

COMMITTENTE:



ALTA SORVEGLIANZA:



GENERAL CONTRACTOR:



INFRASTRUTTURE FERROVIARIE STRATEGICHE DEFINITE DALLA LEGGE OBIETTIVO N. 443/01

**TRATTA A.V. /A.C. TERZO VALICO DEI GIOVI
PROGETTO ESECUTIVO**

Sistemazione idraulica Fosso Rio Pradella

Relazione di calcolo

GENERAL CONTRACTOR	DIRETTORE DEI LAVORI
Consorzio Cociv Ing.P.P.Marcheselli	

COMMESSA	LOTTO	FASE	ENTE	TIPO DOC.	OPERA/DISCIPLINA	PROGR.	REV.
I G 5 1	0 2	E	C V	C L	I N 1 1 0 X	0 0 1	A

Progettazione :								IL PROGETTISTA
Rev	Descrizione	Redatto	Data	Verificato	Data	Progettista Integratore	Data	
A00	Prima Emissione	ALPINA <i>Adriano Fara</i>	27/09/2013	COCIV <i>[Signature]</i>	27/09/2013	A. Palomba <i>[Signature]</i>	30/09/2013	 Consorzio Collegamenti Integrati Veloci Dott. Ing. Aldo Mancarella Ordine Ingegneri Prov. TO n. 6271 R

n. Elab.:	File: IG51-02-E-CV-CL-IN11-0X-001-A00.DOCX
-----------	--

GENERAL CONTRACTOR  Consorzio Collegamenti Integrati Veloci	ALTA SORVEGLIANZA  GRUPPO FERROVIE DELLO STATO ITALIANE
	IG51-02-E-CV-CL-IN11-0X-001_A00 Relazione di calcolo
	Foglio 3 di 84

INDICE

INDICE.....	3
1. PREMESSA.....	6
2. CARATTERISTICHE DEI MATERIALI.....	7
2.1. Calcestruzzo.....	7
2.2. Acciaio per cemento armato.....	7
2.3. Durabilità e prescrizioni sui materiali.....	8
3. NORMATIVA DI RIFERIMENTO.....	9
4. GEOMETRIA.....	10
5. DEFINIZIONE DEL COEFFICIENTE DI SOTTOFONDO KS.....	11
6. ANALISI DEI CARICHI.....	15
6.1. Peso proprio strutture.....	15
6.2. Carichi permanenti portati.....	15
6.3. Spinta del terreno.....	16
6.4. Spinte e sottospinte idrauliche.....	17
6.5. Carichi variabili stradali.....	18
6.6. Carichi sismici.....	19
7. CALCOLO DELLE SOLLECITAZIONI.....	20
7.1. Modello di calcolo.....	20
7.2. Geometria delle aste.....	21
7.3. Condizioni di carico.....	21
7.4. Analisi dei carichi sulle aste e ai nodi del modello.....	21
7.4.1. Caso A.....	21
7.4.2. Caso B.....	23
7.4.3. Caso C.....	23
7.4.4. Caso D.....	24
7.5. Combinazioni di carico.....	25
7.6. Diagrammi di involuppo.....	26
7.6.1. Caso A.....	26
7.6.2. Caso B.....	31
7.6.3. Caso C.....	36
7.6.4. Caso D.....	37
8. VERIFICHE.....	42
8.1. CASO A.....	42

8.1.1.	Verifiche alle tensioni ammissibili	43
8.1.2.	Verifiche a fessurazione	43
8.2.	CASO B	44
8.2.1.	Verifiche alle tensioni ammissibili	44
8.2.2.	Verifiche a fessurazione	45
8.3.	CASO C	46
8.4.	CASO D	46
8.4.1.	Verifiche alle tensioni ammissibili	47
8.4.2.	Verifiche a fessurazione	47
9.	VERIFICA EFFETTI LONGITUDINALI DA RITIRO	49
9.1.	Coazioni interne dovute ai fenomeni di ritiro	49
9.2.	Calcolo delle sollecitazioni longitudinali dovute ai fenomeni di ritiro	50
10.	VERIFICA MURI DI IMBOCCO.....	51
10.1.	Stratigrafia e parametri geotecnici	52
10.2.	Geometria	54
10.3.	Analisi dei carichi e condizioni di carico	56
10.4.	Risultati delle analisi e verifiche di stabilità.....	57
10.5.	Verifiche strutturali	61
11.	TABULATI DI CALCOLO	67
11.1.	Dati di input scatolare – caso A	Errore. Il segnalibro non è definito.
11.2.	Dati di output scatolare – Caso A	Errore. Il segnalibro non è definito.
11.1.	Dati di input scatolare – caso B e C	Errore. Il segnalibro non è definito.
11.2.	Dati di output scatolare – Caso B e C	Errore. Il segnalibro non è definito.
11.3.	Dati di input scatolare – caso D.....	Errore. Il segnalibro non è definito.
11.4.	Dati di output scatolare – Caso D.....	Errore. Il segnalibro non è definito.
11.5.	Muro h =5.70 m.....	67
11.6.	Muro h=4.00 m.....	77

GENERAL CONTRACTOR



ALTA SORVEGLIANZA



IG51-02-E-CV-CL-IN11-0X-001_A00
Relazione di calcolo

Foglio
5 di 84

GENERAL CONTRACTOR 	ALTA SORVEGLIANZA 
	IG51-02-E-CV-CL-IN11-0X-001_A00 Relazione di calcolo
	Foglio 6 di 84

1. PREMESSA

Con la presente relazione si intende fornire i calcoli statici e le verifiche di sicurezza del tombino idraulico IN11 che sottopassa la linea ferroviaria in corrispondenza della progressiva 28+335.45 (al di sotto della galleria artificiale GA1J).

Il tombino idraulico di dimensioni 4.0x3.0 m ricalca l'andamento planimetrico del Rio Pradella, affluente di sinistra del torrente Scrivia (Comune di Arquata Scrivia (AL)), che nel tratto interessato ha direzione Nord-Sud.

La struttura scatolare a sezione rettangolare è realizzata in calcestruzzo armato gettato in opera e ha dimensioni nette interne pari a 4.00x3.00 m, il tombino si sviluppa per circa 200 m e sottopassa:

- la galleria artificiale ferroviaria GA1J alla progressiva 25+335.45, in corrispondenza della GA è previsto un ritombamento della stessa che realizza un ricoprimento del tombino idraulico di circa 14 m;
- la rampa stradale IR1C che realizza un ricoprimento sul tombino scatolare di circa 14.00 m;
- la rampa di accesso al piazzale (TR12) che realizza un ricoprimento sul tombino scatolare di circa 6.90 m.

L'opera ricade in zona sismica di III categoria (S=6).

Le verifiche di sicurezza vengono effettuate con il metodo delle Tensioni Ammissibili.

2. CARATTERISTICHE DEI MATERIALI

2.1. Calcestruzzo

Per il magrone di sottofondazione si prevede l'utilizzo di calcestruzzo di classe Rck 15.

Per la realizzazione dello scatolare di linea si prevede l'utilizzo di calcestruzzo avente classe di resistenza C32/40 ($R_{ck} \geq 40 \text{ N/mm}^2$) che presenta le seguenti caratteristiche:

Resistenza caratteristica a compressione (cilindrica)	$f_{ck} = 0.83 \times R_{ck} = 33.20 \text{ N/mm}^2$
Resistenza media a compressione	$f_{cm} = f_{ck} + 8 = 41.20 \text{ N/mm}^2$
Modulo elastico	$E_{cm} = 22000 \cdot (f_{cm}/10)^{0.3} = 33643 \text{ N/mm}^2$
Resistenza di calcolo a compressione	$f_{cd} = \alpha_{cc} \cdot f_{ck} / \gamma_c = 0.85 \cdot f_{ck} / 1.5 = 18.81 \text{ N/mm}^2$
Resistenza a trazione media	$f_{ctm} = 0.30 \cdot f_{ck}^{2/3} = 3.10 \text{ N/mm}^2$
Resistenza a trazione	$f_{ctk} = 0.7 \cdot f_{ctm} = 2.17 \text{ N/mm}^2$
Resistenza a trazione di calcolo	$f_{ctd} = f_{ctk} / \gamma_c = 1.45 \text{ N/mm}^2$
Tensioni ammissibili	$\sigma_c = 12.20 \text{ N/mm}^2$
	$\tau_{c0} = 7.00 \text{ N/mm}^2$
	$\tau_{c1} = 21.10 \text{ N/mm}^2$

2.2. Acciaio per cemento armato

Per le armature metalliche si adottano tondini in acciaio del tipo B450C saldabile, controllato in stabilimento e che presentano le seguenti caratteristiche:

Proprietà	Requisito
Limite di snervamento f_y	$\geq 450 \text{ MPa}$
Limite di rottura f_t	$\geq 540 \text{ MPa}$
Allungamento totale al carico massimo A_{gt}	$\geq 7.5\%$
Rapporto f_t/f_y	$1,15 \leq R_m/R_e \leq 1,35$
Rapporto $f_y \text{ misurato} / f_{ynom}$	$\leq 1,25$

Tensione di snervamento caratteristica	$f_{yk} \geq 450 \text{ N/mm}^2$
Tensione caratteristica a rottura	$f_{tk} \geq 540 \text{ N/mm}^2$
Tensione ammissibile	$\sigma_s = 260.00 \text{ N/mm}^2$

GENERAL CONTRACTOR 	ALTA SORVEGLIANZA 
	IG51-02-E-CV-CL-IN11-0X-001_A00 Relazione di calcolo
	Foglio 8 di 84

2.3. Durabilità e prescrizioni sui materiali

Per garantire la durabilità delle strutture in calcestruzzo armato ordinario, esposte all'azione dell'ambiente, si devono adottare i provvedimenti atti a limitare gli effetti di degrado indotti dall'attacco chimico, fisico e derivante dalla corrosione delle armature e dai cicli di gelo e disgelo.

Al fine di ottenere la prestazione richiesta in funzione delle condizioni ambientali, nonché per la definizione della relativa classe, si fa riferimento alle indicazioni contenute nelle Linee Guida sul calcestruzzo strutturale edite dal Servizio Tecnico Centrale del Consiglio Superiore dei Lavori Pubblici ovvero alle norme UNI EN 206-1:2006 ed UNI 11104:2004.

Per le opere della presente relazione si adotta quanto segue:

Fondazione CLASSE DI ESPOSIZIONE XC2

Elevazione CLASSE DI ESPOSIZIONE XC2

Nel caso in esame la struttura si trova a permanente contatto con il terreno pertanto deve essere condotta la verifica a fessurazione per la combinazione TA5. Per questa verifica si considerano, in accordo con l'Istruzione n. I/SC/PS-OM/2298 "Sovraccarichi per il calcolo dei ponti ferroviari. Istruzioni per la progettazione, l'esecuzione ed il collaudo", i seguenti limiti di apertura delle fessure:

- superfici in contatto permanente con il terreno (superfici esterne) wk = 0.10 mm;
- superfici non in contatto permanente con il terreno (superfici interne) wk = 0.20 mm.

Il copriferro minimo assunto è pari a 4 cm.

L'apertura a fessure minima di 0.10 mm per le superfici esterne è portata a 0.15 mm essendo il copriferro dell'armatura trasversale (interna a quella longitudinale) pari a circa 6 cm ($c/c_{min} \leq 1.5$, con $c_{min} = 4 \text{ cm}$).

GENERAL CONTRACTOR 	ALTA SORVEGLIANZA 
	IG51-02-E-CV-CL-IN11-0X-001_A00 Relazione di calcolo Foglio 9 di 84

3. NORMATIVA DI RIFERIMENTO

Il dimensionamento e la verifica degli elementi strutturali sono stati condotti nel rispetto delle vigenti normative di seguito riportate:

- D.M. 09/01/1996: "Norme tecniche per l'esecuzione delle opere in cemento armato normale e precompresso e per le strutture metalliche";
- D.M. 16/01/1996: "Norme tecniche relative ai criteri generali per la verifica di sicurezza delle costruzioni e dei carichi e dei sovraccarichi";
- Circ. Min. 04/07/1996 n. 156 STC: "Istruzioni per l'applicazione delle Norme tecniche relative ai criteri generali per la verifica di sicurezza delle costruzioni e dei carichi e dei sovraccarichi";
- L. 05/11/1971 n. 1086: "Norme per la disciplina delle opere in conglomerato cementizio armato normale e precompresso ed a struttura metallica";
- D.M. 14/02/1992: "Norme tecniche per l'esecuzione delle opere in cemento armato normale e precompresso e per le strutture metalliche" (valido per il metodo alle tensioni ammissibili);
- Circ. Min. 24/06/1993 n. 37406: "Istruzioni relative alle Norme tecniche per l'esecuzione delle opere in cemento armato normale e precompresso e per le strutture metalliche" (valido per il metodo alle tensioni ammissibili);
- Circ. Min. 15/10/1996 n. 252: "Istruzioni relative alle Norme tecniche per l'esecuzione delle opere in cemento armato normale e precompresso e per le strutture metalliche";
- L. 02/02/1974 n. 64: "Provvedimenti per le costruzioni con particolari prescrizioni per le zone sismiche";
- D.M. 16/01/1996: "Norme tecniche per le costruzioni in zona sismica";
- Ordinanza n. 3274: "Primi elementi in materia di criteri generali per la classificazione sismica del territorio nazionale e di normative tecniche per le costruzioni in zona sismica";
- Circ. Min. 10/04/1997 n. 65: "Istruzioni per l'applicazione delle Norme tecniche per le costruzioni in zona sismica di cui al D.M. 16/01/1996";
- Asa Servizi di Ingegneria (Ferrovie dello Stato), Istruzione n. I/SC/PS-OM/2298 del 02/06/1995, Testo completo delle relative integrazioni: 13/01/1997: "Sovraccarichi per il calcolo dei ponti ferroviari. Istruzioni per la progettazione, l'esecuzione ed il collaudo";
- Ferrovie dello Stato - Istruzione F.S. 44/b (Testo aggiornato secondo il D.M. 16/01/1999): "Istruzioni tecniche per i manufatti sotto binario da costruire in zona sismica".

4. GEOMETRIA

Il tombino è realizzato in cemento armato gettato in opera, ha sezione scatolare cava di dimensioni interne nette $b \times h = 4.00 \times 3.00$ m. Le pareti laterali hanno spessore 100 cm, la soletta superiore ha spessore 100 cm e quella inferiore 100 cm.

Si riporta nel seguito una sezione trasversale dell'opera.



Figura 1 – Sezione trasversale dell'opera

B	= 6.00 m	larghezza scatolare
H	= 5.00 m	altezza totale
s_f	= 1.00 m	spessore soletta di fondazione
s_p	= 1.00 m	spessore pareti
s_s	= 1.00 m	spessore soletta superiore
s_{ric}	= var m	spessore del ricoprimento

L'opera non è interessata dalla presenza della falda, posta in corrispondenza dell'intradosso della fondazione.

GENERAL CONTRACTOR  Consorzio Collegamenti Integrati Veloci	ALTA SORVEGLIANZA  GRUPPO FERROVIE DELLO STATO ITALIANE
	IG51-02-E-CV-CL-IN11-0X-001_A00 Relazione di calcolo
	Foglio 11 di 84

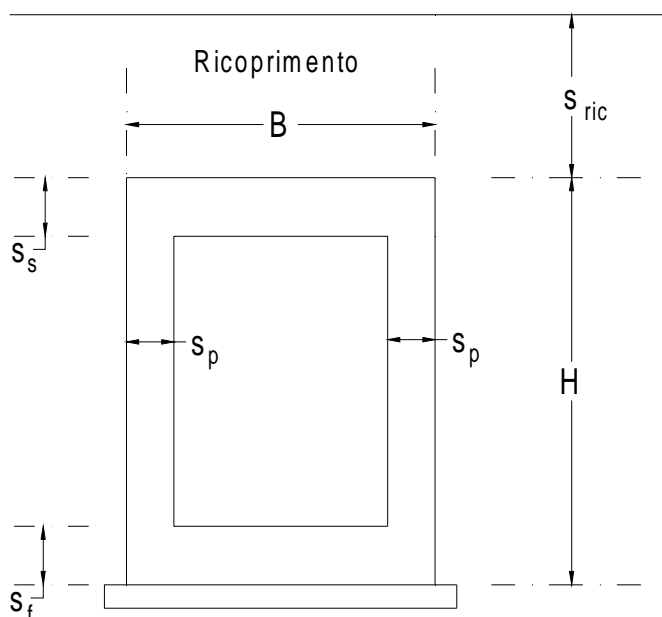
5. DEFINIZIONE DEL COEFFICIENTE DI SOTTOFONDO K_S

Ai fini del calcolo strutturale dei tombini che attraversano la linea ferroviaria, la costante di sottofondo K_S è stata definita come rapporto tra la pressione p esercitata dalla fondazione ed il corrispondente cedimento s :

$$K_S = p / s \quad [\text{kN/m}^3]$$

K_S dipende in maniera significativa da:

- Profilo di rigidità del sottosuolo nell'area di influenza della fondazione;
- Dimensioni della fondazione;
- Quota d'imposta della fondazione da p.c.;
- Pressione esercitata dalla fondazione sul terreno.

Alla luce del numero significativo di tombini per i quali è necessario definire il coefficiente K_S , si è deciso di sviluppare degli abachi attraverso i quali, una volta noti i valori di B (lato minore fondazione), z (quota d'imposta fondazione) e p (pressione esercitata dalla fondazione sul terreno) sia possibile definire il valore di K_S da utilizzare per l'opera in oggetto, avendo assunto un profilo di rigidità del terreno cautelativo per rappresentare in modo adeguato le caratteristiche di deformabilità dell'intera tratta.

I calcoli parametrici del cedimento sono stati eseguiti secondo il metodo del cedimento monodimensionale in cui sono stati fatti variare i valori di B , z e p e quindi calcolati i corrispondenti valori di K_S sulla base della definizione $K_S = p / s$.

Il calcolo è stato basato sulle seguenti ipotesi:

- comportamento rigido della fondazione;
- estensione dell'area di influenza lungo la quale è calcolato il cedimento fino alla quota in cui il carico trasmesso dalla fondazione comporta un incremento del 10% dello stato di sforzo iniziale presente nel terreno.

Sono stati considerati i seguenti valori dei parametri di progetto:

- Lato minore della fondazione $B = 4.0, 5.0, 6.0$ e 7.0 m;
- Quota d'imposta $z = 2.0, 4.0$ e 6.0 m;
- Pressione trasmessa dalla fondazione al terreno $p = 100, 150, 200, 250, 300$ e 350 kPa.

Nell'abaco, per ogni quota d'imposta z considerata è definito il valore di K_S in funzione della larghezza della fondazione B e del carico totale p agente su di essa.

La costante di sottofondo adottata per la modellazione, funzione del tipo di terreno presente in situ, è pari a $K_S = 26000 \text{ kN/m}^3$, ipotizzando un piano di imposta medio a 4.0 m da p.c. e una larghezza dell'opera $B = 6.0$ m.

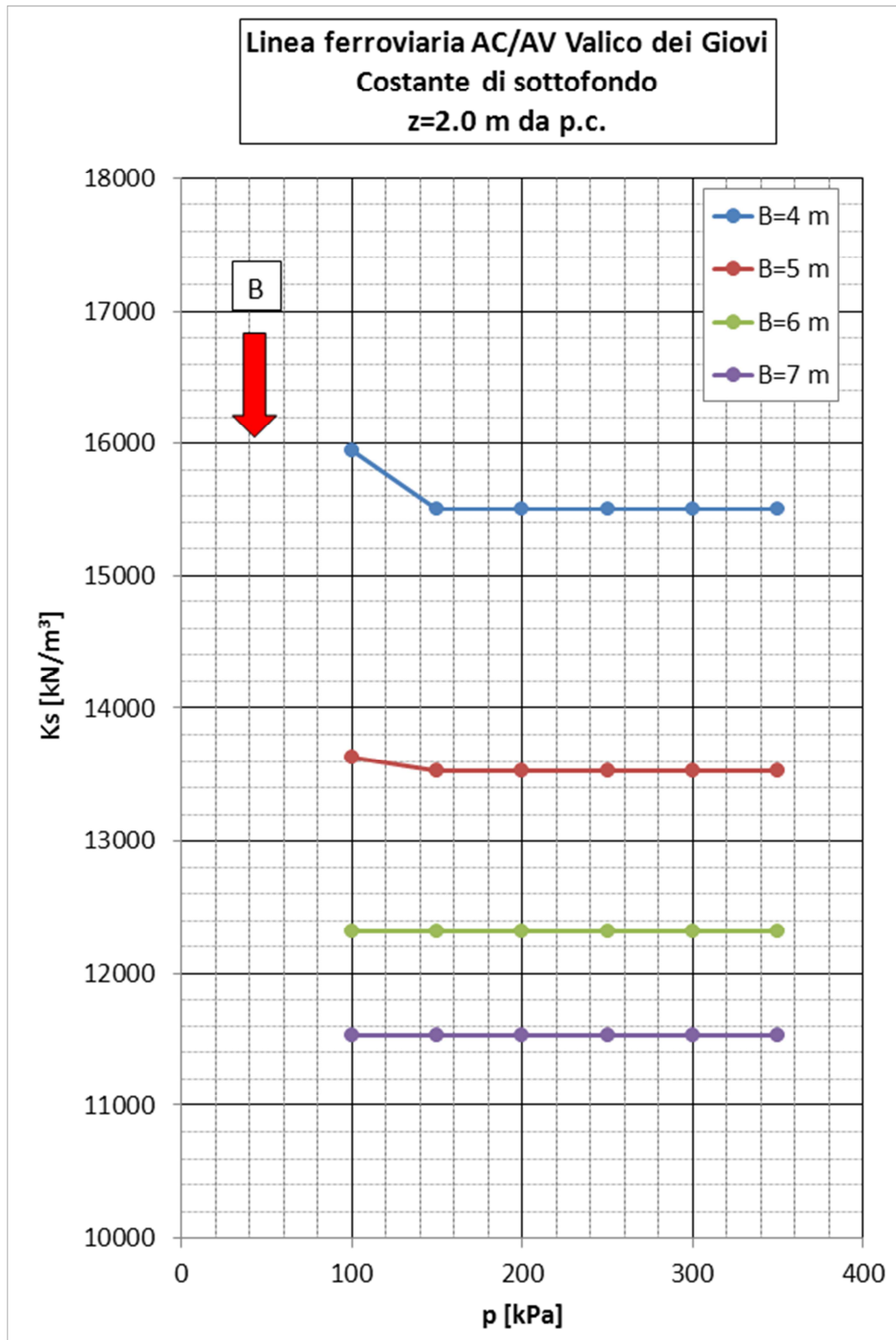

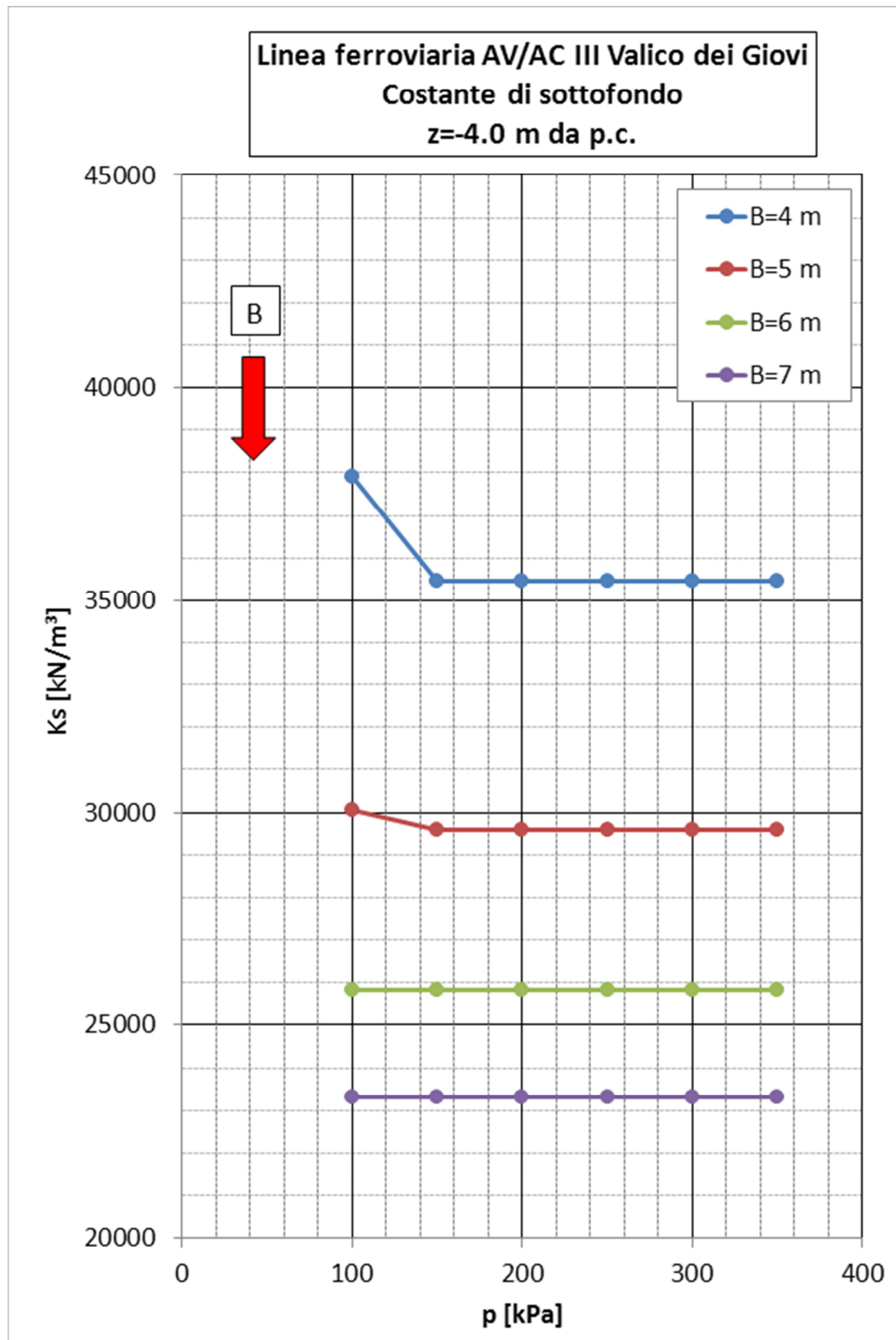

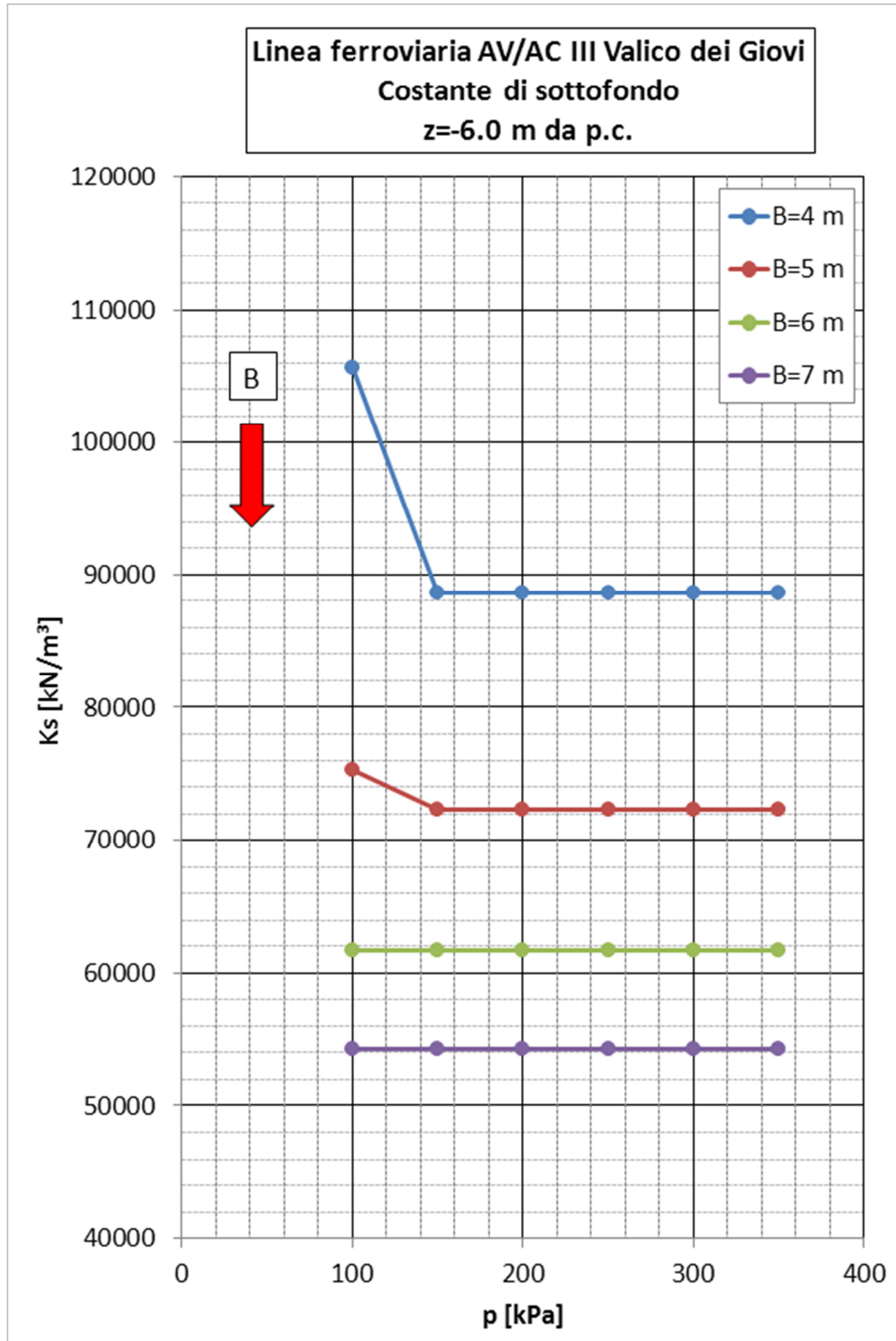

GENERAL CONTRACTOR  Consorzio Collegamenti Integrati Veloci	ALTA SORVEGLIANZA  GRUPPO FERROVIE DELLO STATO ITALIANE
	IG51-02-E-CV-CL-IN11-0X-001_A00 Relazione di calcolo
	Foglio 15 di 84

6. ANALISI DEI CARICHI

Nel seguente paragrafo si descrivono i carichi elementari che agiscono sulla struttura in oggetto. Tali azioni sono definite secondo le vigenti normative e sono utilizzate per la generazione delle combinazioni di carico nell'ambito delle verifiche alle tensioni ammissibili eseguite. Tutti i carichi elementari si riferiscono a un concio longitudinale di larghezza unitaria, pertanto sono tutti definiti rispetto all'unità di lunghezza.

Per i materiali si assumono i seguenti pesi specifici:

calcestruzzo armato: $\gamma_{c.a.} = 25 \text{ kN/m}^3$

rilevato: $\gamma_{ril} = 20 \text{ kN/m}^3$

Le analisi sono eseguiti per le seguenti situazioni:

- CASO A: sottopassaggio della galleria artificiale GA1J;
- CASO B: ricoprimento di circa 14 m (tratto in prossimità della GA1J);
- CASO C: sottopasso della rampa IR1C (ricoprimento di circa 14.00 m);
- CASO D: sottopasso della rampa di accesso al piazzale (ricoprimento di 6.90 m).

6.1. Peso proprio strutture

Il peso proprio delle strutture è assegnato automaticamente dal programma di calcolo.

6.2. Carichi permanenti portati

Si assumono i seguenti carichi permanenti:

Ricoprimento soletta superiore $S_{ric} \cdot \gamma_{ril}$

I permanenti portati hanno l'andamento riportato in figura seguente:

GENERAL CONTRACTOR  Consorzio Collegamenti Integrati Veloci	ALTA SORVEGLIANZA  GRUPPO FERROVIE DELLO STATO ITALIANE
	IG51-02-E-CV-CL-IN11-0X-001_A00 Relazione di calcolo
	Foglio 16 di 84



Figura 2 – Schema carichi permanenti

Nel tratto in cui lo scatolare sottopassa la galleria artificiale il carico permanente portato è costituito dal carico che la stessa scarica in fondazione e dal ricoprimento realizzato con massi cementati ($\gamma = 25 \text{ kN/m}^3$) di spessore medio sul tombino pari a circa 1.6 m.

6.3. Spinta del terreno

Le azioni del terreno (spinta sulle pareti, peso del ricoprimento) vengono valutate per i seguenti parametri:

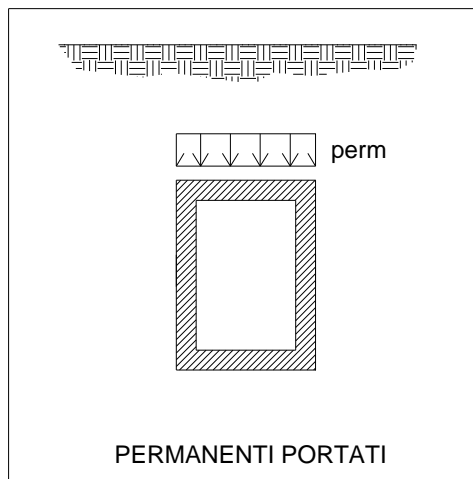
$$\gamma = 20 \text{ kN/m}^3$$

$$\phi = 35^\circ$$

$$c = 0$$

La pressione orizzontale efficace del terreno, σ'_h , sul manufatto viene posta pari ad una frazione della tensione verticale efficace litostatica:

$$\sigma'_h = K \sigma'_v$$

con: σ'_v = tensione efficace verticale

K = coefficiente di spinta

La tensione verticale litostatica ha la seguente espressione:

$$\sigma_v(z) = (s_{ric} + z) \cdot \gamma_t$$

dove: s_{ric} = ricoprimento del manufatto

z = distanza dall'estradosso del manufatto

γ_t = peso specifico del terreno

La pressione orizzontale ha l'andamento riportato in figura seguente:



Figura 3 – Schema carichi spinta terreno

La spinta permanente del terreno viene analizzata per la condizione di $K = K_0 = 1 - \sin\phi$.

6.4. Spinte e sottospinte idrauliche

La presenza della falda comporta azioni idrostatiche sui piedritti e sulla soletta di fondazione. Esse risultano pari a:

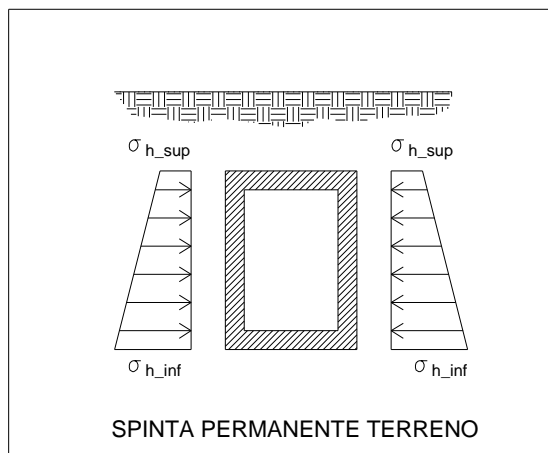
- Spinta orizzontale sui piedritti: $\sigma_h(z) = (z - z_f) \cdot \gamma_w$
 - Sottospinta sulla soletta inferiore: $\sigma_v(z) = (z_s - z_f) \cdot \gamma_w$
- dove z_s = quota della soletta inferiore.

Per la posizione della falda rispetto all'opera in oggetto non si hanno azioni idrostatiche.

6.5. Carichi variabili stradali

Per i carichi variabili stradali si considera il mezzo convenzionale a tre assi da 200 kN ciascuno.



Figura 4 – Impronta di carico

In direzione trasversale i carichi vengono ripartiti fino al piano della soletta di copertura dello scatolare, utilizzando una diffusione nel ricoprimento pari all'angolo ϕ .

Il carico, che viene incrementato per tenere conto degli effetti dinamici attraverso il coefficiente dinamico $\Phi=1.4$, viene ripartito sulla propria superficie di influenza, tenendo conto della ripartizione sopra esposta:

$$Q'_{vk} \Rightarrow q'_{vk} = (100 \cdot 6) / ((2.3 + 2 \cdot s_{ric} \cdot \tan\phi) \cdot (3.3 + 2 \cdot s_{ric} \cdot \tan\phi))$$

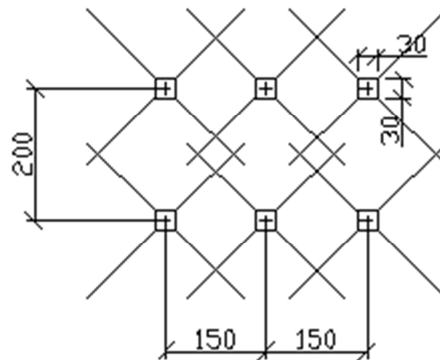
Il carico è moltiplicato per il coefficiente dinamico: $\Phi \cdot q'_{vk}$

La spinta statica uniforme del sovraccarico stradale sulle pareti dello scatolare è pari a:

$$\sigma_{sf} = k_0 \cdot \Phi \cdot q'_{vk}$$



Figura 5 – Schema di carico spinta del terreno per sovraccarico stradale

GENERAL CONTRACTOR  Consorzio Collegamenti Integrati Veloci	ALTA SORVEGLIANZA  GRUPPO FERROVIE DELLO STATO ITALIANE
	IG51-02-E-CV-CL-IN11-0X-001_A00 Relazione di calcolo
	Foglio 19 di 84

6.6. Carichi sismici

La verifica in condizione sismica è condotta solo nei casi in cui il ricoprimento è inferiore alla metà dell'altezza totale dello scatolare, $s_{ric} < H/2$. Essendo lo spessore di ricoprimento sempre superiore a 2.5 m (altezza dello scatolare $H = 5.00$ m) la verifica in condizione sismica è omessa.

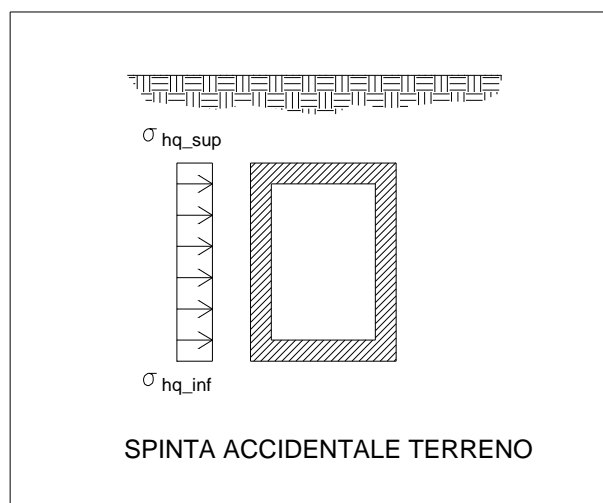
7. CALCOLO DELLE SOLLECITAZIONI

La verifica dello scatolare viene condotto con programma di calcolo automatico che determina, tenendo conto delle azioni descritte, le sollecitazioni massime nei singoli elementi strutturali; nei nodi significativi sono poi effettuate le verifiche di sicurezza con il metodo delle tensioni ammissibili.

7.1. Modello di calcolo

Il modello di calcolo è costituito da un telaio piano che rappresenta una striscia di scatolare di larghezza unitaria. Le solette, di copertura e fondazione, ed i montanti sono modellati da elementi trave, posti in corrispondenza della rispettiva linea media. L'elemento trave che rappresenta la soletta di fondazione è considerato poggiante su di un letto di molle con assegnata costante di Winkler.

Il modello di calcolo, insieme alla numerazione dei nodi, è riportato in figura successiva.

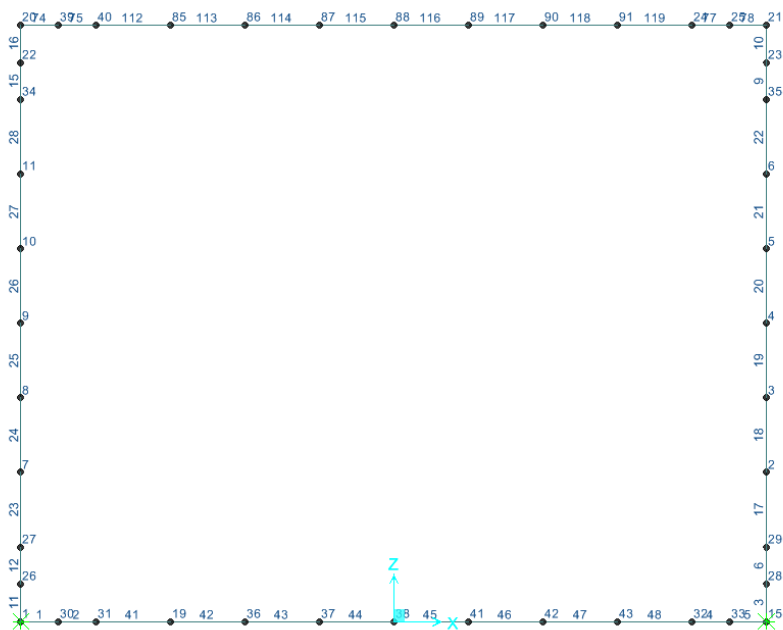

Le verifiche strutturali sono eseguite in corrispondenza delle sezioni più sollecitate. Con riferimento alle sezioni di incastro, i valori di sollecitazione flettente e tagliante – utilizzati per le verifiche – sono stati valutati come illustrato nel seguente schema:

GENERAL CONTRACTOR  Consorzio Collegamenti Integrati Veloci	ALTA SORVEGLIANZA  GRUPPO FERROVIE DELLO STATO ITALIANE
	IG51-02-E-CV-CL-IN11-0X-001_A00 Relazione di calcolo
	Foglio 21 di 84

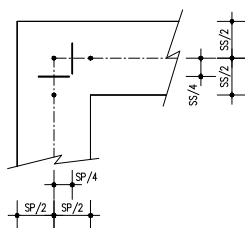

VERIFICHE A FLESSIONE

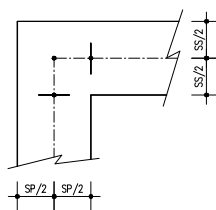

VERIFICHE A FESSURAZIONE E TAGLIO

Nello specifico le azioni per le verifiche flessionali sono ricavate dal modello numerico in corrispondenza della sezione posta a un quarto dello spessore dall'asse dell'elemento finito, l'azione tagliante e le azioni per le verifiche a fessurazione vengono invece valutate in corrispondenza della sezione posta a un mezzo dello spessore dall'asse dell'elemento finito.

7.2. Geometria delle aste

Gli spessori delle aste nel modello rispettano la geometria dello scatolare. In particolare:

- Soletta inferiore: Sezione 100x100 cm
- Soletta superiore: Sezione 100x100 cm
- Pareti laterali: Sezione 100x100 cm

7.3. Condizioni di carico

Si analizzano le seguenti condizioni di carico elementari per le diverse situazioni analizzate.

- I. Pesi propri
- II. Permanenti portati
- III. Spinta statica delle terre
- IV. Carichi variabili verticali (sovraccarico stradale)
- V. Spinta dei carichi variabili sul ritto destro
- VI. Spinta dei carichi variabili sul ritto sinistro

7.4. Analisi dei carichi sulle aste e ai nodi del modello

In relazione alle dimensioni dello scatolare in oggetto ed alle situazioni di carico, si riportano le azioni sulle aste del modello di calcolo, per le diverse condizioni di carico elementari riportate in precedenza.

7.4.1. Caso A

CONDIZIONE DI CARICO I: Peso proprio

Applicato automaticamente dal programma di calcolo ad ogni asta.

CONDIZIONE DI CARICO II: Permanenti portati

Di seguito si riporta l'andamento della pressione di contatto tra la fondazione della galleria artificiale e il terreno per la condizione rara.

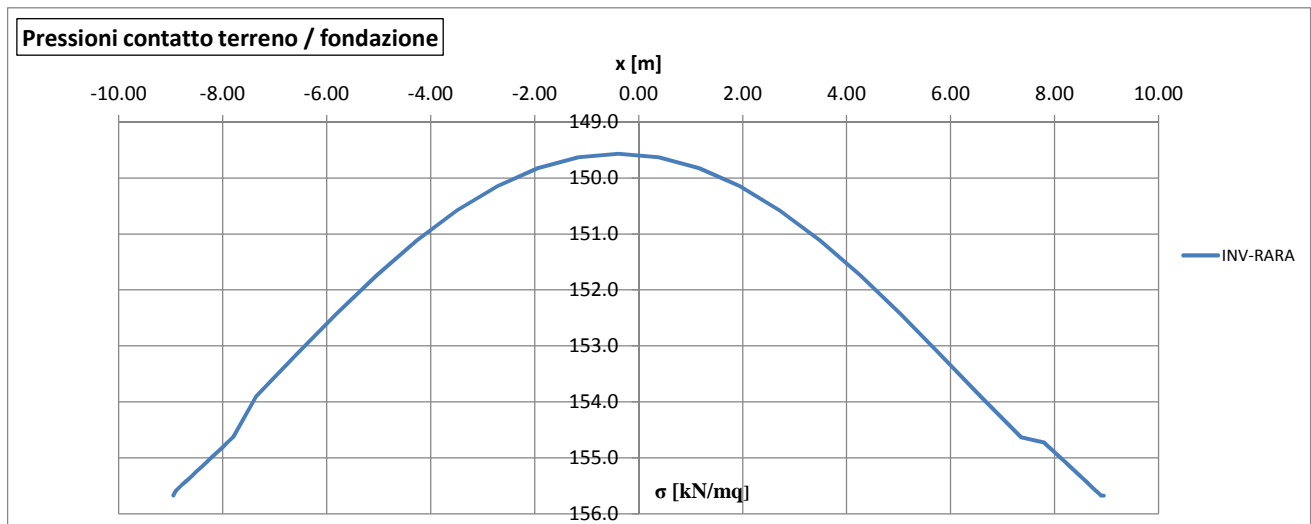

Per i calcoli si assume un carico uniformemente distribuito pari a 156 kN/m.

Soletta superiore:

Elemento	Spess.	γ	Peso
Scarico GA			156.00 kN/m
Ricoprimento massi cementati	1.62 m	25 kN/m ³	40.50 kN/m
Totale			196.50 kN/m

CONDIZIONE DI CARICO III: Spinta delle terre

$$K = K_0 = 1 - \sin\phi = 0.426$$

$$\sigma_{h1} = 0.426 \cdot [20 \cdot (1.62 + 1.00/2)] = \mathbf{18.08 \text{ kN/m}}$$

$$\sigma_{h2} = 0.426 \cdot [20 \cdot (1.62 + 1.00 + 3.00 + 1.00/2)] = \mathbf{52.19 \text{ kN/m}}$$

$$F1 = 0.426 \cdot [20 \cdot (1.62 + 1.00/4) \cdot 1.00/2] = \mathbf{7.97 \text{ kN}}$$

$$F2 = 0.426 \cdot [20 \cdot (1.62 + 1.00 + 3.00 + 1.00 \cdot 3/4) \cdot 1.00/2] = \mathbf{27.16 \text{ kN}}$$

CONDIZIONE DI CARICO IV, V e VI: Carichi variabili

In questa situazione non si considerano carichi variabili che insistono sul ricoprimento della galleria.

GENERAL CONTRACTOR  Consorzio Collegamenti Integrati Veloci	ALTA SORVEGLIANZA  GRUPPO FERROVIE DELLO STATO ITALIANE
	IG51-02-E-CV-CL-IN11-0X-001_A00 Relazione di calcolo
	Foglio 23 di 84

7.4.2. Caso B

CONDIZIONE DI CARICO I: Peso proprio

Applicato automaticamente dal programma di calcolo ad ogni asta.

CONDIZIONE DI CARICO II: Permanenti portati

Soletta superiore:

Elemento	Spess.	γ	Peso
Ricoprimento massi cementati	14.0 m	20 kN/m ³	280.00 kN/m
Totale			280.00 kN/m

CONDIZIONE DI CARICO III: Spinta delle terre

$$K = K_0 = 1 - \sin\phi = 0.426$$

$$\sigma_{h1} = 0.426 \cdot [20 \cdot (14.0 + 1.00/2)] = \mathbf{123.66 \text{ kN/m}}$$

$$\sigma_{h2} = 0.426 \cdot [20 \cdot (14.0 + 1.00 + 3.00 + 1.00/2)] = \mathbf{157.78 \text{ kN/m}}$$

$$F1 = 0.426 \cdot [20 \cdot (14.0 + 1.00/4) \cdot 1.00/2] = \mathbf{60.77 \text{ kN}}$$

$$F2 = 0.426 \cdot [20 \cdot (14.0 + 1.00 + 3.00 + 1.00 \cdot 3/4) \cdot 1.00/2] = \mathbf{79.95 \text{ kN}}$$

CONDIZIONE DI CARICO IV, V e VI: Carichi variabili

In questa situazione non si considerano carichi variabili che insistono sul ricoprimento della galleria.

7.4.3. Caso C

CONDIZIONE DI CARICO I: Peso proprio

Applicato automaticamente dal programma di calcolo ad ogni asta.

CONDIZIONE DI CARICO II: Permanenti portati

Soletta superiore:

Elemento	Spess.	γ	Peso
Ricoprimento massi cementati	14.0 m	20 kN/m ³	280.00 kN/m
Totale			280.00 kN/m

CONDIZIONE DI CARICO III: Spinta delle terre

$$K = K_0 = 1 - \sin\phi = 0.426$$

$$\sigma_{h1} = 0.426 \cdot [20 \cdot (14.00 + 1.00/2)] = \mathbf{123.66 \text{ kN/m}}$$

$$\sigma_{h2} = 0.426 \cdot [20 \cdot (14.00 + 1.00 + 3.00 + 1.00/2)] = \mathbf{157.78 \text{ kN/m}}$$

$$F1 = 0.426 \cdot [20 \cdot (14.00 + 1.00/4) \cdot 1.00/2] = \mathbf{60.77 \text{ kN}}$$

$$F2 = 0.426 \cdot [20 \cdot (14.00 + 1.00 + 3.00 + 1.00 \cdot 3/4) \cdot 1.00/2] = \mathbf{79.95 \text{ kN}}$$

CONDIZIONE DI CARICO IV, V e VI: Carichi variabili

$$Q'_{vk} \Rightarrow q'_{vk} = (100 \cdot 6) / ((2.3 + 2 \cdot 14.0 \cdot \tan 35^\circ) \cdot (3.3 + 2 \cdot 14.0 \cdot \tan 35^\circ)) = 1.20 \text{ kN/m}$$

Il carico è moltiplicato per il coefficiente dinamico: $\Phi \cdot q'_{vk} = 1.4 \cdot 1.20 = 1.67 \text{ kN/m}$

La spinta statica uniforme del sovraccarico stradale sulle pareti dello scatolare è pari a:

$$\sigma_{sf} = k_0 \cdot \Phi \cdot q'_{vk} = 0.426 \cdot 1.67 = 0.71 \text{ kN/m}$$

I carichi stradali sono modestissimi rispetto al ricoprimento di 14.0 m, il caso C si può quindi riportare al caso B sopra indicato.

7.4.4. Caso D

CONDIZIONE DI CARICO I: Peso proprio

Applicato automaticamente dal programma di calcolo ad ogni asta.

CONDIZIONE DI CARICO II: Permanenti portati

Soletta superiore:

Elemento	Spess.	γ	Peso
Ricoprimento massi cementati	6.90 m	20 kN/m ³	138.00 kN/m
Totale			138.00 kN/m

CONDIZIONE DI CARICO III: Spinta delle terre

$$K = K_0 = 1 - \sin\phi = 0.426$$

$$\sigma_{h1} = 0.426 \cdot [20 \cdot (6.90 + 1.00/2)] = \mathbf{63.11 \text{ kN/m}}$$

$$\sigma_{h2} = 0.426 \cdot [20 \cdot (6.90 + 1.00 + 3.00 + 1.00/2)] = \mathbf{97.22 \text{ kN/m}}$$

$$F1 = 0.426 \cdot [20 \cdot (6.90 + 1.00/4) \cdot 1.00/2] = \mathbf{30.49 \text{ kN}}$$

$$F2 = 0.426 \cdot [20 \cdot (6.90 + 1.00 + 3.00 + 1.00 \cdot 3/4) \cdot 1.00/2] = \mathbf{49.68 \text{ kN}}$$

CONDIZIONE DI CARICO IV, V e VI: Carichi variabili

GENERAL CONTRACTOR 	ALTA SORVEGLIANZA 	
	IG51-02-E-CV-CL-IN11-0X-001_A00 Relazione di calcolo <table border="1" data-bbox="1420 235 1546 295"> <tr> <td>Foglio 25 di 84</td> </tr> </table>	Foglio 25 di 84
Foglio 25 di 84		

$$Q'_{vk} \Rightarrow q'_{vk} = (100 \cdot 6) / ((2.3 + 2 \cdot 6.90 \cdot \tan 35^\circ) \cdot (3.3 + 2 \cdot 6.90 \cdot \tan 35^\circ)) = 3.87 \text{ kN/m}$$

Il carico è moltiplicato per il coefficiente dinamico: $\Phi \cdot q'_{vk} = 1.4 \cdot 3.87 = 5.42 \text{ kN/m}$

La spinta statica uniforme del sovraccarico stradale sulle pareti dello scatolare è pari a:

$$\sigma_{sf} = k_0 \cdot \Phi \cdot q'_{vk} = 0.426 \cdot 5.42 = 2.31 \text{ kN/m}$$

7.5. Combinazioni di carico

In relazione alle condizioni elementari di carico riportate ai paragrafi precedenti, le verifiche di sicurezza vengono condotte per le combinazioni di carico di seguito riportate.

Fase di esercizio:

- Combinazione 1: I + II + III
- Combinazione 2: I + II + 0.7 · III
- Combinazione 3: I + II + III + IV + V + VI
- Combinazione 4: I + II + 0.7 · III + IV + V + VI
- Combinazione 5: I + II + III + V
- Combinazione 6: I + II + 0.7 · III + V

Verifica a fessurazione:

- Combinazione 7: I + II + III + 0.7 · (IV + V + VI)

7.6. Diagrammi di involuppo

7.6.1. Caso A

Di seguito si riportano i diagrammi delle sollecitazioni flettenti, taglianti e flessionali agenti sulla struttura nella condizione di involuppo delle combinazioni TA:

Momento flettente:

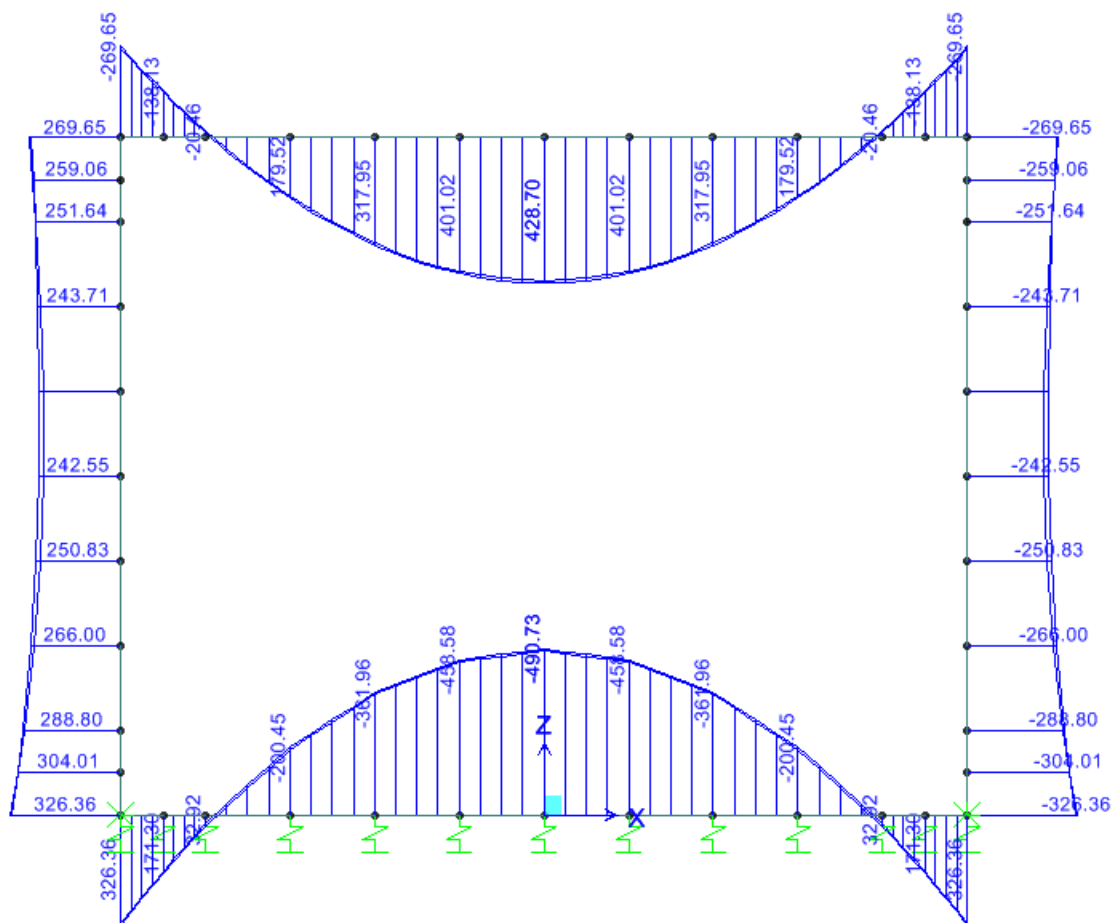

Azione assiale:

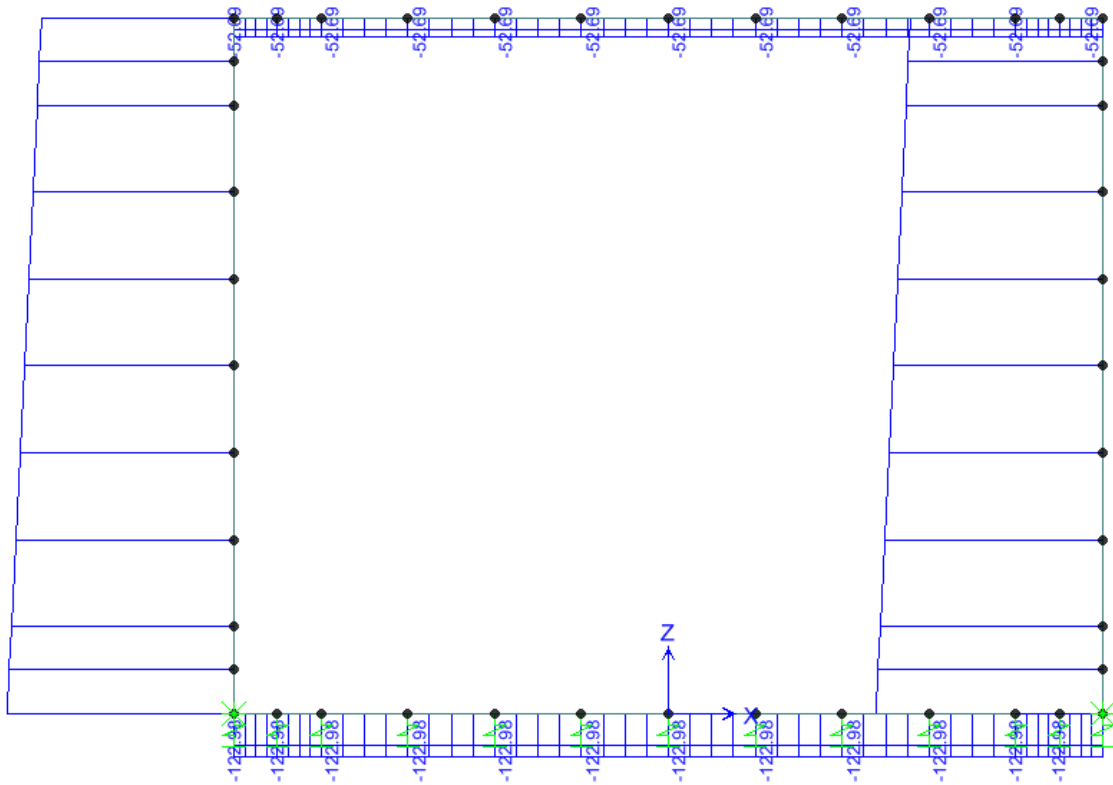

Azione tagliante:

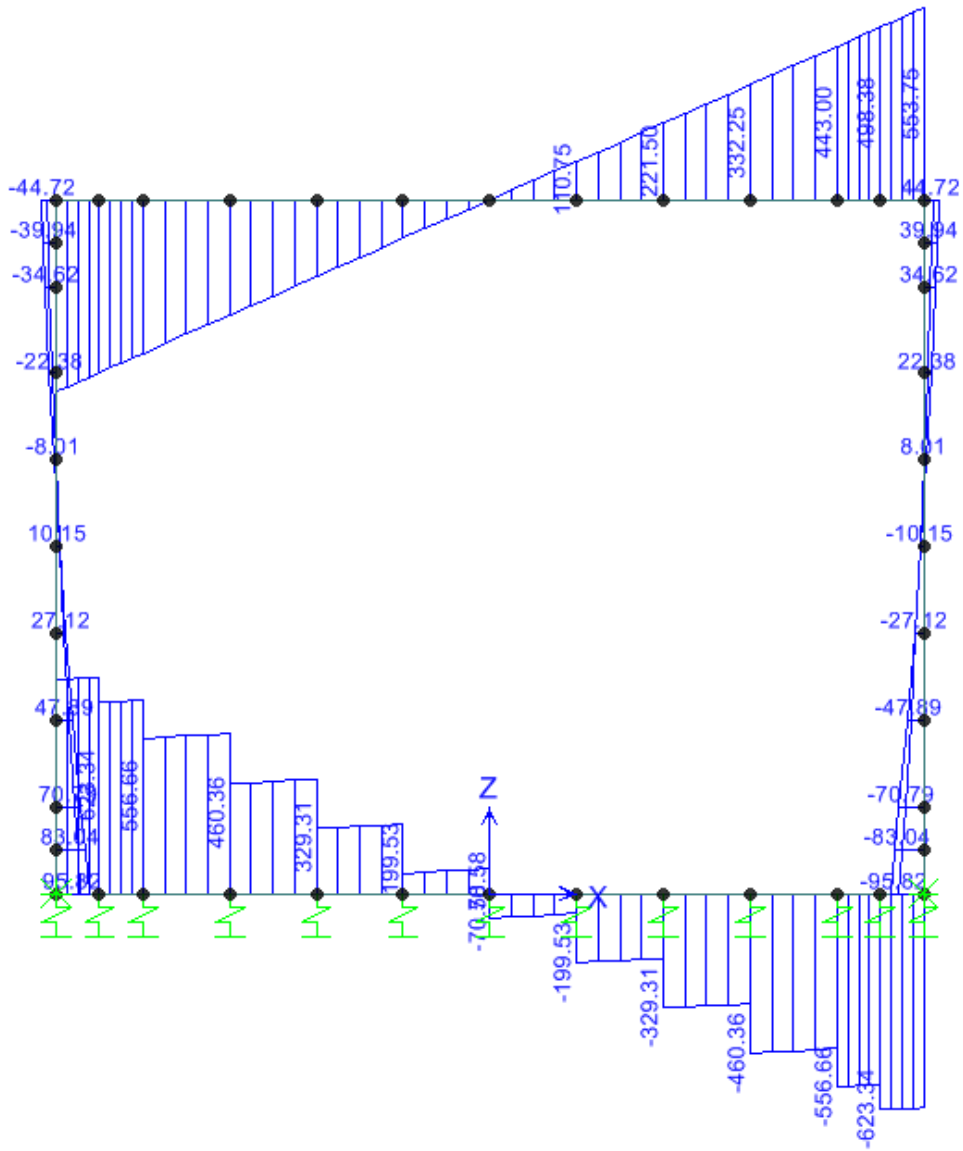

Di seguito si riportano i diagrammi delle sollecitazioni flettenti e flessionali agenti sulla struttura per la combinazione 7, verifica a fessurazione.

Momento flettente:

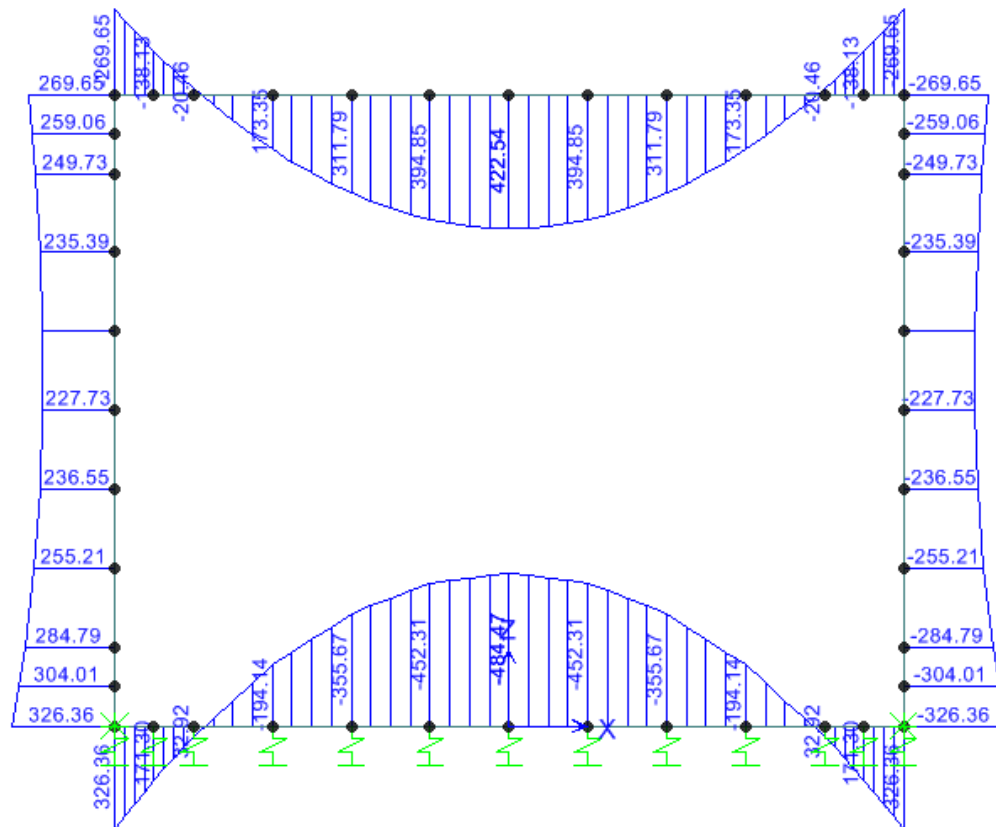

Azione assiale:

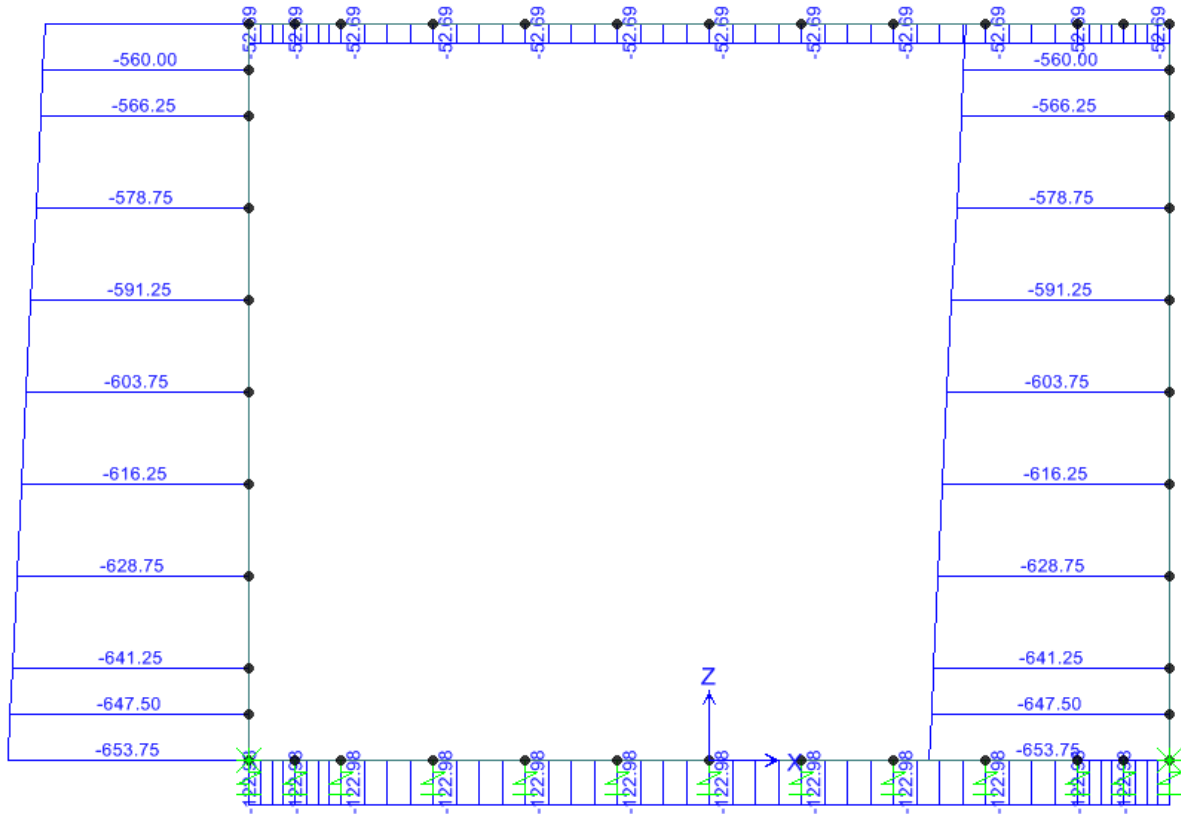

7.6.2. Caso B

Di seguito si riportano i diagrammi delle sollecitazioni flettenti, taglianti e flessionali agenti sulla struttura nella condizione di involucro delle combinazioni TA:

Momento flettente:

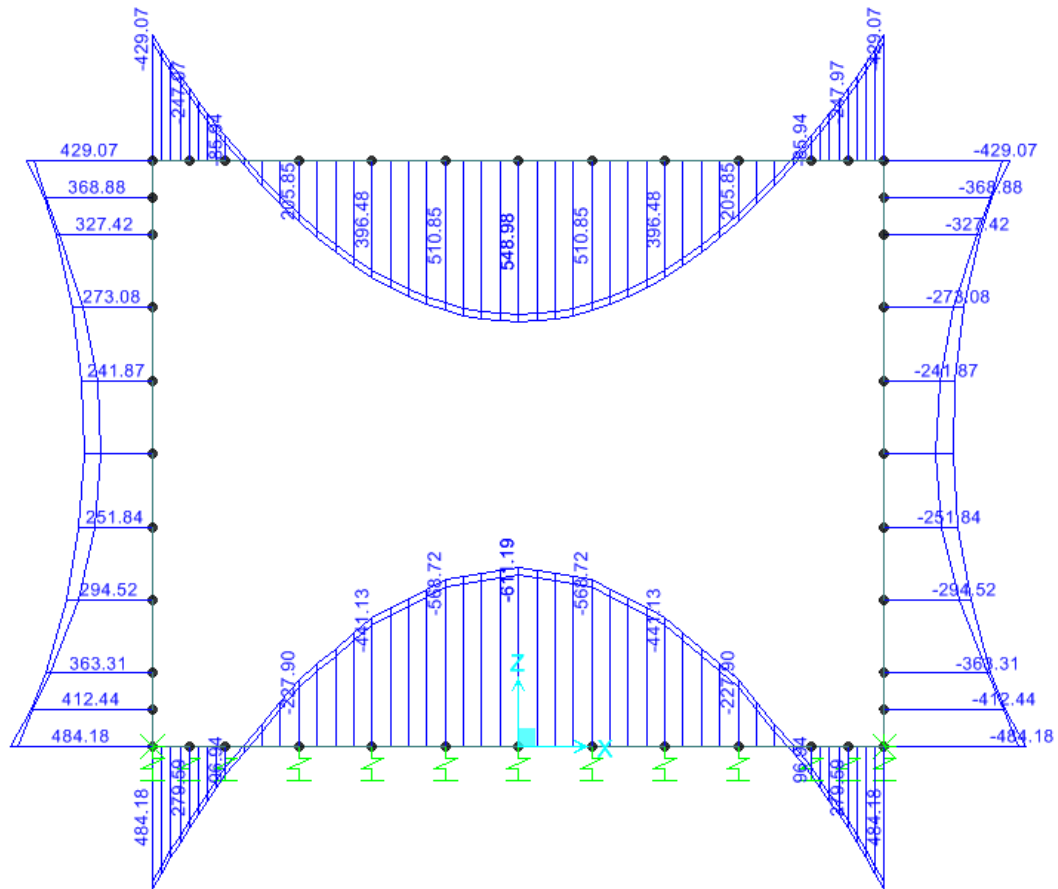

Azione assiale:

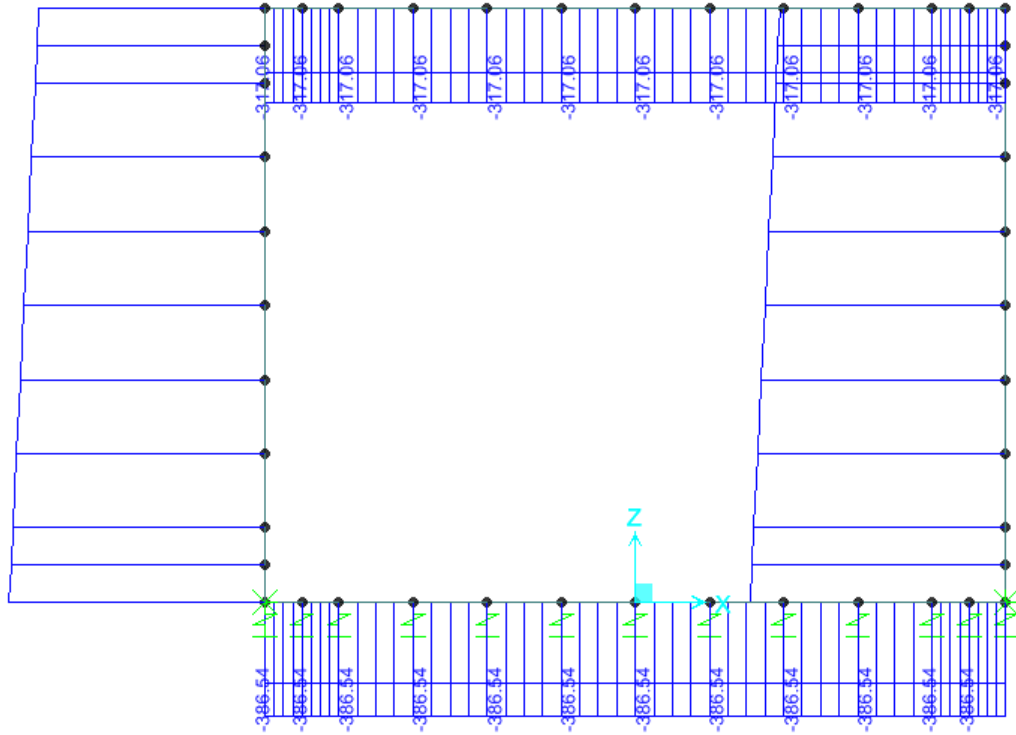

Azione tagliante:

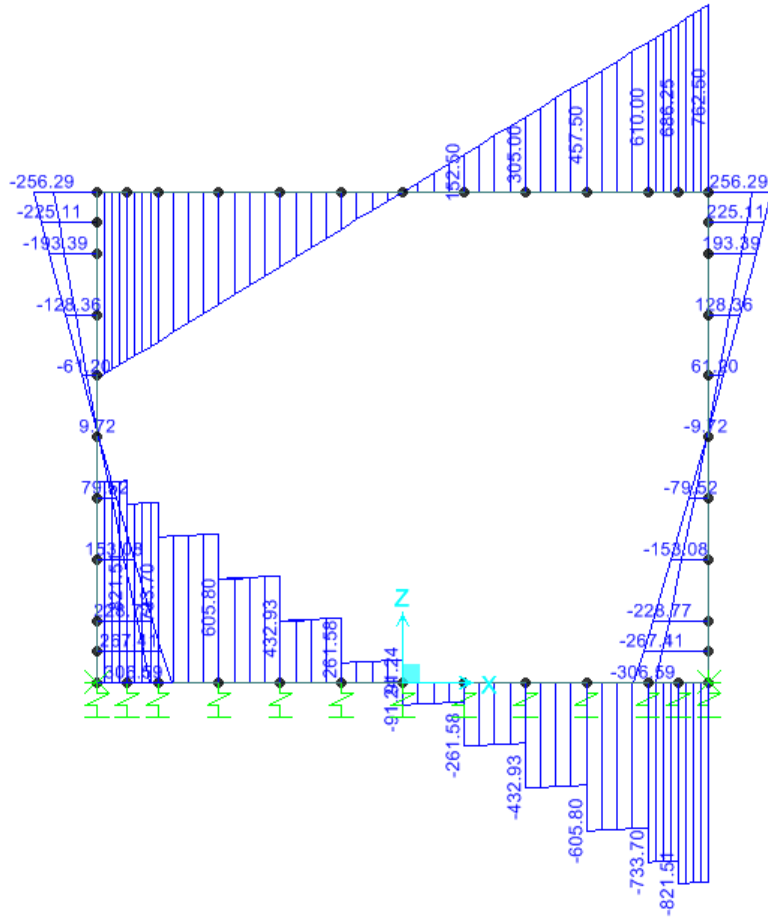

Di seguito si riportano i diagrammi delle sollecitazioni flettenti e flessionali agenti sulla struttura per la combinazione 7, verifica a fessurazione.

Momento flettente:

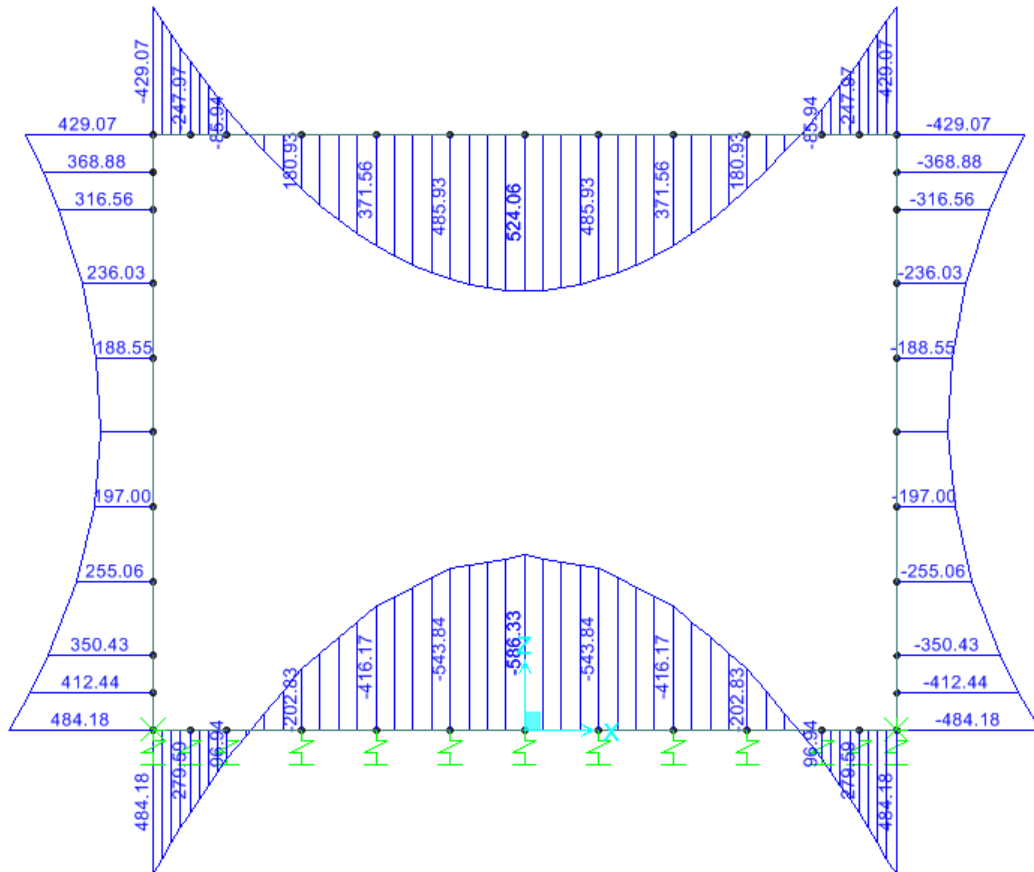



Azione assiale:

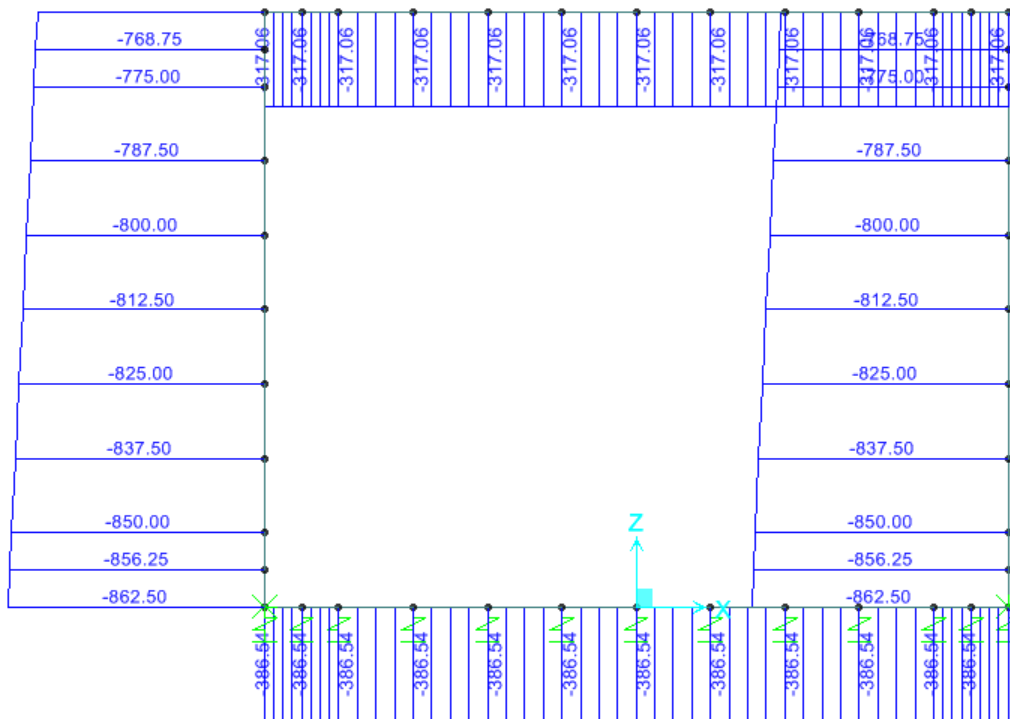

<p>GENERAL CONTRACTOR</p> 	<p>ALTA SORVEGLIANZA</p> 
	<p>IG51-02-E-CV-CL-IN11-0X-001_A00 Relazione di calcolo</p> <p>Foglio 36 di 84</p>

7.6.3. Caso C

Si rimanda a quanto riportato per il Caso B.

7.6.4. Caso D

Di seguito si riportano i diagrammi delle sollecitazioni flettenti, taglianti e flessionali agenti sulla struttura nella condizione di involucro delle combinazioni TA:

Momento flettente:

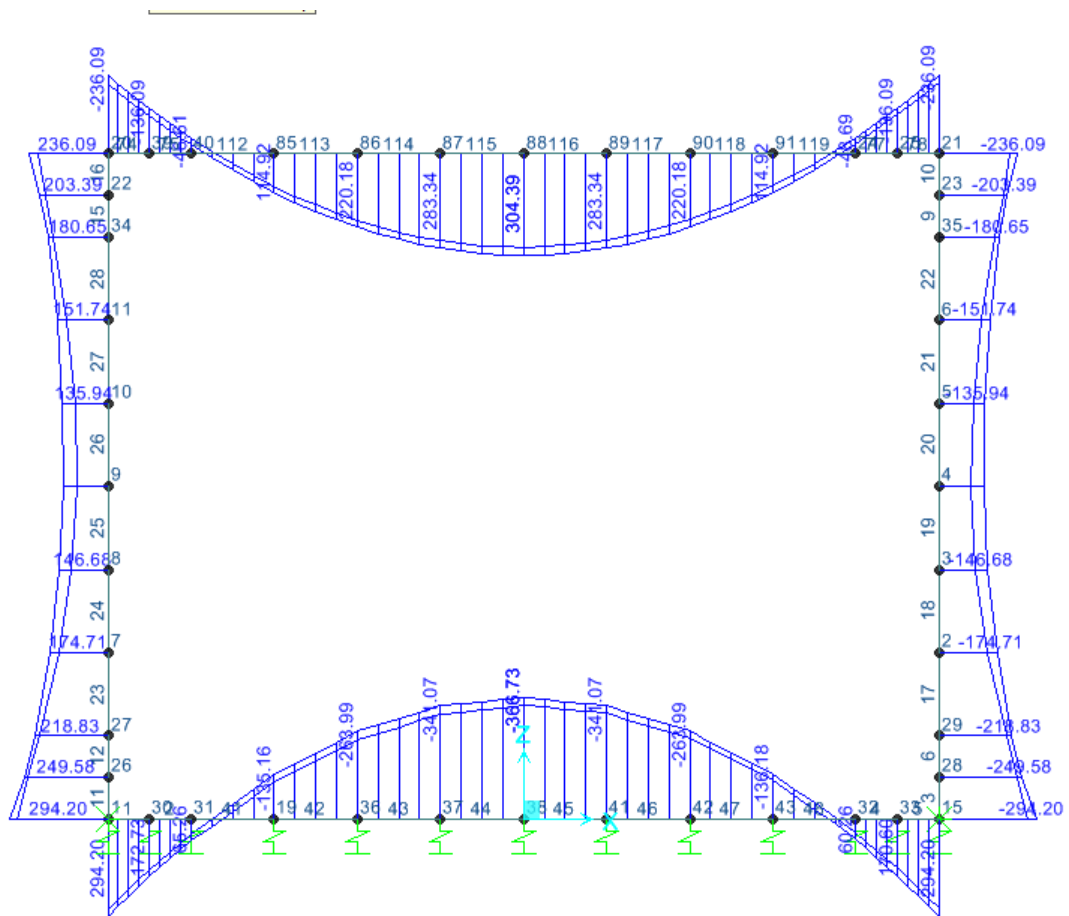



Azione assiale:

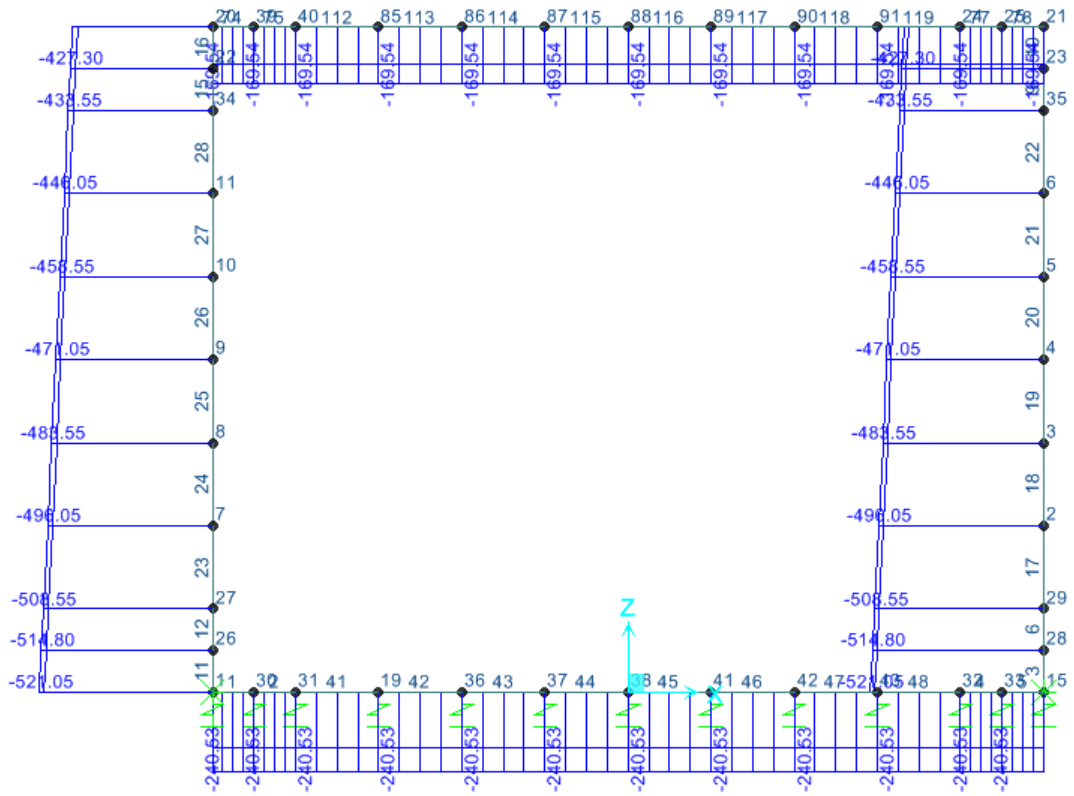

Azione tagliante:

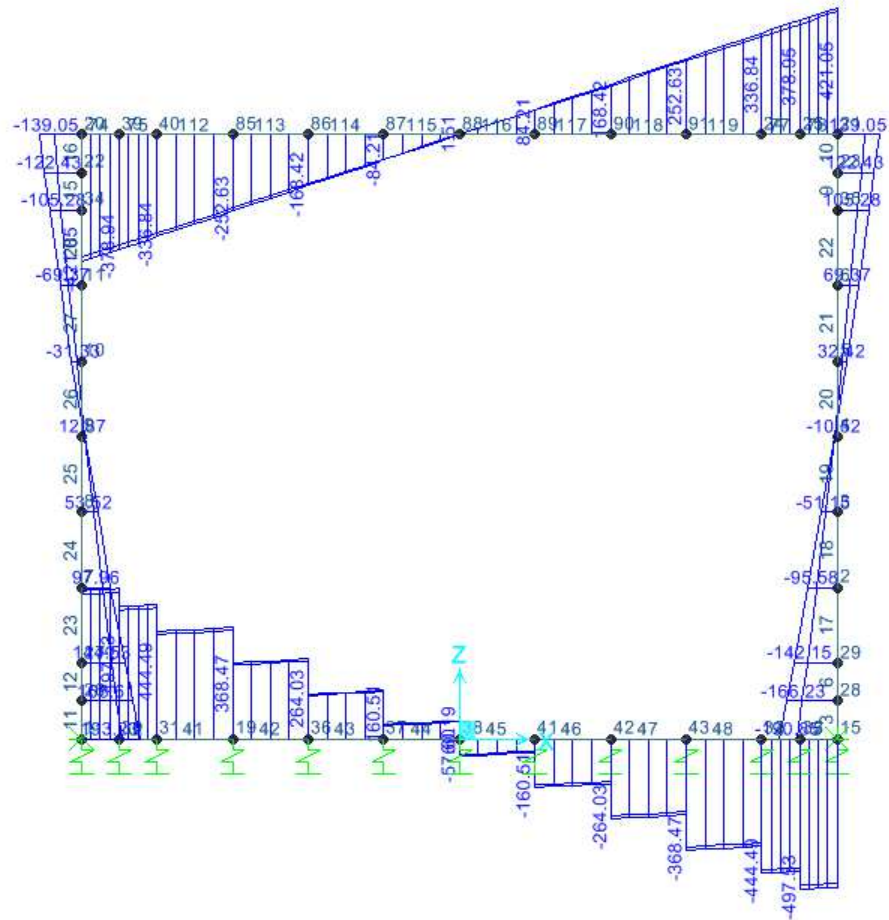

Di seguito si riportano i diagrammi delle sollecitazioni flettenti e flessionali agenti sulla struttura per la combinazione 7, verifica a fessurazione.

Momento flettente:

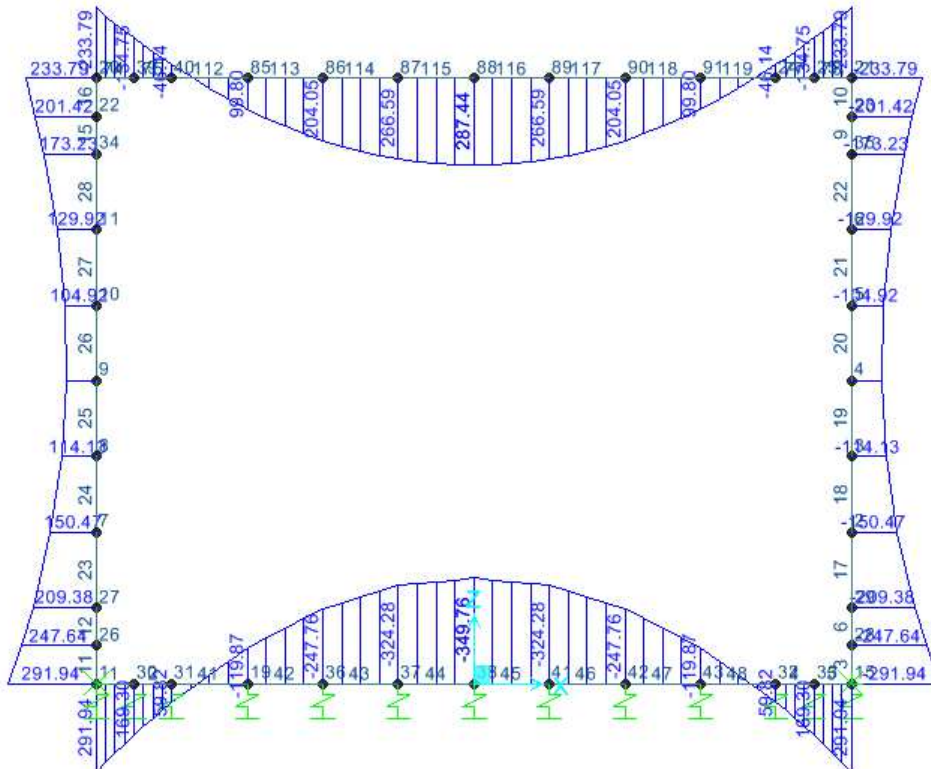



Azione assiale:

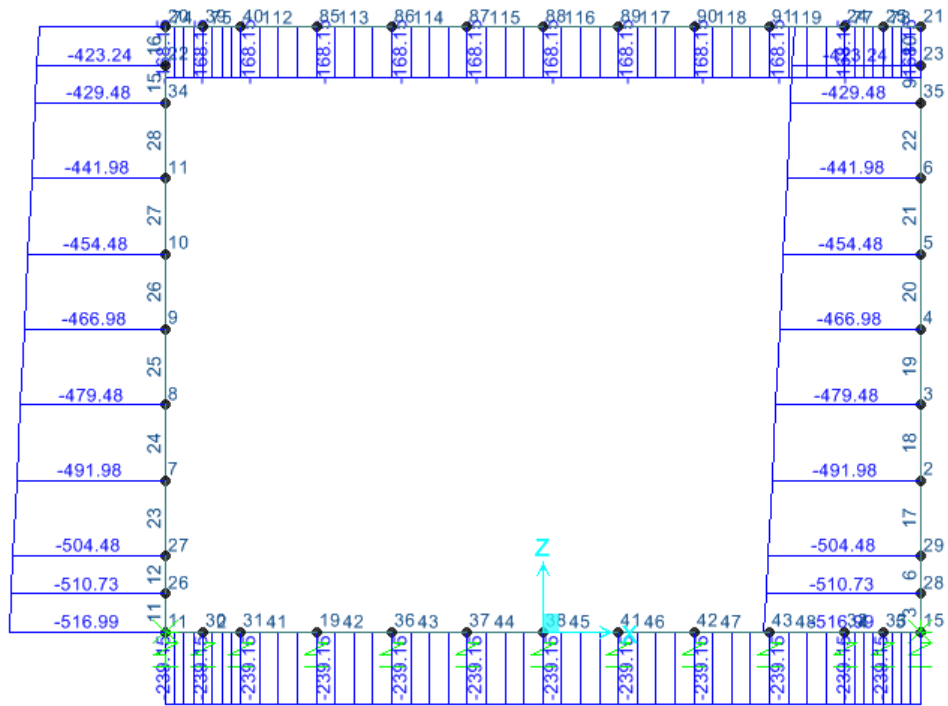

GENERAL CONTRACTOR  Consorzio Collegamenti Integrati Veloci	ALTA SORVEGLIANZA  GRUPPO FERROVIE DELLO STATO ITALIANE
	IG51-02-E-CV-CL-IN11-0X-001_A00 Relazione di calcolo
	Foglio 42 di 84

8. VERIFICHE

Si forniscono nel seguito le verifiche alle tensioni ammissibili ed alla fessurazione nelle sezioni principali di ciascun elemento strutturale (platea, montanti e soletta).

Il momento flettente si verifica, oltre che nelle sezioni di mezzeria, anche nelle sezioni a metà tra asse piedritto e sezione d'attacco piedritto – soletta, nel caso delle verifiche della soletta, e in quelle a metà tra asse soletta e sezione d'attacco soletta – piedritto, per le verifiche del piedritto. Il taglio si verifica nelle sezioni d'attacco degli elementi.

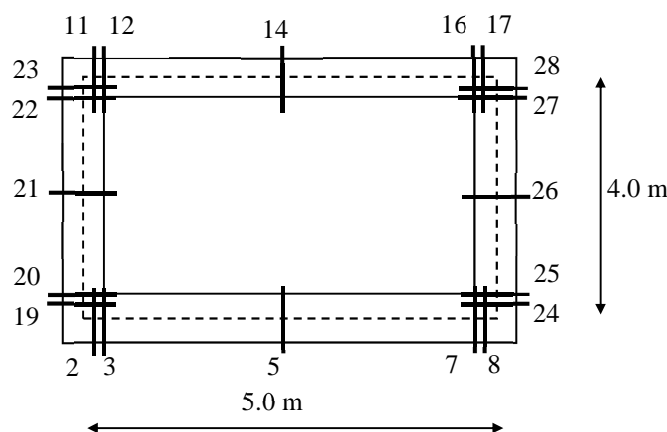

Nelle solette superiore e inferiore, il copriferro netto delle armature trasversali è di 60 mm (allo spessore minimo del copriferro di 40 mm si è sommato il diametro dell'armatura longitudinale costituita da $\phi 20$), nei piedritti, il copriferro netto delle armature verticali è di 74 mm (allo spessore minimo del copriferro di 40 mm si è sommato il diametro dell'armatura longitudinale costituita da $\phi 20$ e il diametro degli spilli costituita da $\phi 14$).

Per la disposizione delle armature si rimanda agli elaborati specifici, nelle tabelle di verifica sono riportate le armature compresse e tese per ciascun nodo in cui è stata condotta la verifica.

8.1. CASO A

Tale situazione si riferisce al tratto in cui lo scatolare sottopassa la galleria artificiale GA1J.

La soletta di copertura è così armata:

- all'incastro con il piedritto con un'armatura al lembo superiore (lembo teso) costituita da $\phi 20/20$ e al lembo inferiore (lembo compresso) costituita da $\phi 24/20$;
- in mezzeria con un'armatura al lembo inferiore (lembo teso) costituita da $\phi 24/20$ e al lembo superiore (lembo compresso) costituita da $\phi 20/20$.

La soletta di fondazione è così armata:

- all'incastro con il piedritto con un'armatura al lembo inferiore (lembo teso) costituita da $\phi 20/20$ e al lembo superiore (lembo compresso) costituita da $\phi 24/20$;

GENERAL CONTRACTOR  Consorzio Collegamenti Integrati Veloci	ALTA SORVEGLIANZA  GRUPPO FERROVIE DELLO STATO ITALIANE	
IG51-02-E-CV-CL-IN11-0X-001_A00 Relazione di calcolo		Foglio 43 di 84

- in mezzeria con un'armatura al lembo superiore (lembo teso) costituita da $\phi 24/20$ e al lembo inferiore (lembo compresso) costituita da $\phi 20/20$.

I piedritti sono armati per tutto il loro sviluppo con un'armatura al lembo esterno (lembo teso) costituita da $\phi 20/20$ e al lembo interno (lembo compresso) costituita da $\phi 20/20$.

8.1.1. Verifiche alle tensioni ammissibili

	Sez.	M (kNm)	N (kN)	A_s (mm ²)	A'_s (mm ²)	X (mm)	σ_c (N/mm ²)	σ_s (N/mm ²)
Soletta inferiore sp. 100 cm	2	171.30	-	$\phi 20/20$	$\phi 24/20$	170.6	-1.88	125.3
	5	-490.73	-	$\phi 24/20$	$\phi 20/20$	206.3	-4.81	252.5
Soletta superiore sp. 100 cm	14	428.70	-	$\phi 24/20$	$\phi 20/20$	206.3	-4.20	220.6
	17	-138.13	-	$\phi 20/20$	$\phi 24/20$	170.6	-1.51	101.0
Piedritto sinistro sp. 100 cm	19	304.01	-647.50	$\phi 20/20$	$\phi 20/20$	422.7	-3.19	55.9
	21	242.55	-603.75	$\phi 20/20$	$\phi 20/20$	495.8	-2.44	31.0
	23	259.06	-560.00	$\phi 20/20$	$\phi 20/20$	428.8	-2.71	46.2

A_s : armatura tesa

A'_s : armatura compressa

X : posizione asse neutro da lembo compresso

Nelle verifiche delle solette si è trascurata l'azione assiale di compressione.

	Sezione	T (kN)	b (mm)	d (mm)	τ (N/mm ²)	
Soletta inferiore	3	556.66	1000	940	0.66	$< \tau_{co} = 0.73 \text{ N/mm}^2$
	7	556.66	1000	940	0.66	$< \tau_{co} = 0.73 \text{ N/mm}^2$
Soletta superiore	12	443.00	1000	940	0.52	$< \tau_{co} = 0.73 \text{ N/mm}^2$
	16	443.00	1000	940	0.52	$< \tau_{co} = 0.73 \text{ N/mm}^2$
Piedritti	20	70.79	1000	926	0.08	$< \tau_{co} = 0.73 \text{ N/mm}^2$
	22	166.46	1000	926	0.20	$< \tau_{co} = 0.73 \text{ N/mm}^2$

La tensione tangenziale è sempre inferiore alla τ_{co} , non è necessario disporre un'apposita armatura a taglio, si dispongono spilli $\phi 14$ disposti a maglia 40x40 cm.

8.1.2. Verifiche a fessurazione

Le verifiche a fessurazione vengono condotte per la condizione di carico TA5. Dovrà risultare:

- a contatto con il terreno $w_k \leq 0.15 \text{ mm}$;
- non a contatto con il terreno $w_k \leq 0.2 \text{ mm}$.

Il prospetto seguente riassume i risultati delle verifiche.

	Sez.	M (kNm)	N (kN)	A_s (mm ²)	A'_s (mm ²)	w (mm)	w_k (mm)
Soletta inferiore	3	171.30	-	φ20/20	φ24/20	-	0.15
	5	-484.47	-	φ24/20	φ20/20	-	0.20
Soletta superiore	14	422.54	-	φ24/20	φ20/20	-	0.20
	16	-138.13	-	φ20/20	φ24/20	-	0.15
Piedritti	20	304.01	-647.50	φ20/20	φ20/20	-	0.15
	22	259.06	-560.00	φ20/20	φ20/20	-	0.15

Nelle verifiche delle solette si è trascurata l'azione assiale di compressione.

8.2. CASO B

Tale situazione si riferisce al tratto in cui lo scatolare presenta un ricoprimento di circa 14 m in prossimità della GA1J.

La soletta di copertura è così armata:

- all'incastro con il piedritto con un'armatura al lembo superiore (lembo teso) costituita da φ20/20 e al lembo inferiore (lembo compresso) costituita da φ24/20;
- in mezzeria con un'armatura al lembo inferiore (lembo teso) costituita da φ24/20+φ24/40 e al lembo superiore (lembo compresso) costituita da φ20/20.

La soletta di fondazione è così armata:

- all'incastro con il piedritto con un'armatura al lembo inferiore (lembo teso) costituita da φ20/20 e al lembo superiore (lembo compresso) costituita da φ24/20;
- in mezzeria con un'armatura al lembo superiore (lembo teso) costituita da φ24/20+φ24/40 e al lembo inferiore (lembo compresso) costituita da φ20/20.

I piedritti sono armati per tutto il loro sviluppo con un'armatura al lembo esterno (lembo teso) costituita da φ20/20 e al lembo interno (lembo compresso) costituita da φ20/20.

8.2.1. Verifiche alle tensioni ammissibili

	Sez.	M (kNm)	N (kN)	A_s (mm ²)	A'_s (mm ²)	X (mm)	σ_c (N/mm ²)	σ_s (N/mm ²)
Soletta inferiore	2	279.59	-	φ20/20	φ24/20	170.6	-3.06	204.5

sp. 100 cm	5	-611.19	-	$\phi 24/20 + \phi 24/40$	$\phi 20/20$	246.9	-5.14	212.6
Soletta superiore sp. 100 cm	14	548.98	-	$\phi 24/20 + \phi 24/20$	$\phi 20/20$	246.9	-4.62	191.0
	17	-247.97	-	$\phi 20/40$	$\phi 24/20$	170.6	-2.72	181.4
Piedritto sinistro sp. 100 cm	19	412.44	-856.25	$\phi 20/20$	$\phi 20/20$	412.5	-4.36	79.9
	21	234.55	-812.50	$\phi 20/20$	$\phi 20/20$	700.4	-2.23	10.3
	23	368.88	-768.75	$\phi 20/20$	$\phi 20/20$	414.0	-3.90	70.9

A_s : armatura tesa

A'_s : armatura compressa

X : posizione asse neutro da lembo compresso

Nelle verifiche delle solette si è trascurata l'azione assiale di compressione.

	Sezione	T (kN)	b (mm)	d (mm)	τ (N/mm ²)	
Soletta inferiore	3	733.70	1000	940	0.87	$> \tau_{co} = 0.73 \text{ N/mm}^2$
	7	733.70	1000	940	0.87	$> \tau_{co} = 0.73 \text{ N/mm}^2$
Soletta superiore	12	610.00	1000	940	0.72	$< \tau_{co} = 0.73 \text{ N/mm}^2$
	16	610.00	1000	940	0.72	$< \tau_{co} = 0.73 \text{ N/mm}^2$
Piedritti	20	228.77	1000	926	0.27	$< \tau_{co} = 0.73 \text{ N/mm}^2$
	22	193.39	1000	926	0.23	$< \tau_{co} = 0.73 \text{ N/mm}^2$

Nella soletta inferiore la tensione tangenziale supera la τ_{co} (rimanendo inferiore alla τ_{c1}), per cui è necessario disporre un'armatura a taglio costituita da $\phi 14$ disposti a maglia 20x20 cm ($A_{st} = 3850 \text{ mm}^2$) in corrispondenza del tratto di circa 0.6 m in corrispondenza dell'attacco della soletta con i piedritti.

$$A_{st} = T_{max} \cdot 100 / (0.9 \cdot h \cdot \sigma_f) = 3613 \text{ mm}^2$$

Nei piedritti e nella soletta superiore la tensione tangenziale è sempre inferiore alla τ_{co} , non è necessario disporre un'apposita armatura a taglio, si dispongono spilli $\phi 14$ disposti a maglia 40x40 cm.

8.2.2. Verifiche a fessurazione

Le verifiche a fessurazione vengono condotte per la condizione di carico TA5. Dovrà risultare:

- a contatto con il terreno $w_k \leq 0.15 \text{ mm}$;

- non a contatto con il terreno $w_k \leq 0.2$ mm.

Il prospetto seguente riassume i risultati delle verifiche.

	Sez.	M (kNm)	N (kN)	A _s (mm ²)	A' _s (mm ²)	w (mm)	w _k (mm)
Soletta inferiore	3	279.59	-	φ20/20	φ24/20	-	0.15
	5	-586.33	-	φ24/20 + φ24/40	φ20/20	0.20	0.20
Soletta superiore	14	524.06	-	φ24/20 + φ24/20	φ20/20	-	0.20
	16	-247.97	-	φ20/20	φ24/20	-	0.15
Piedritti	20	412.44	-856.25	φ20/20	φ20/20	-	0.15
	22	368.88	-768.75	φ20/20	φ20/20	-	0.15

Nelle verifiche delle solette si è trascurata l'azione assiale di compressione.

8.3. CASO C

Si rimanda a quanto riportato per il Caso B.

8.4. CASO D

Tale situazione si riferisce al tratto in cui lo scatolare sottopassa la rampa di accesso al piazzale (ricoprimento di 6.90 m).

La soletta di copertura è così armata:

- all'incastro con il piedritto con un'armatura al lembo superiore (lembo teso) costituita da φ20/20 e al lembo inferiore (lembo compresso) costituita da φ20/20;
- in mezzeria con un'armatura al lembo inferiore (lembo teso) costituita da φ20/20 e al lembo superiore (lembo compresso) costituita da φ20/20.

La soletta di fondazione è così armata:

- all'incastro con il piedritto con un'armatura al lembo inferiore (lembo teso) costituita da φ20/20 e al lembo superiore (lembo compresso) costituita da φ20/20;
- in mezzeria con un'armatura al lembo superiore (lembo teso) costituita da φ20/20+φ16/40 e al lembo inferiore (lembo compresso) costituita da φ20/20.

I piedritti sono armati per tutto il loro sviluppo con un'armatura al lembo esterno (lembo teso) costituita da φ20/20 e al lembo interno (lembo compresso) costituita da φ20/20.

8.4.1. Verifiche alle tensioni ammissibili

	Sez.	M (kNm)	N (kN)	A _s (mm ²)	A' _s (mm ²)	X (mm)	σ _c (N/mm ²)	σ _s (N/mm ²)
Soletta inferiore sp. 100 cm	2	172.73	-	φ20/20	φ240/20	175.0	-1.95	126.4
	5	-366.73	-	φ20/20 + φ16/40	φ20/20	198.6	-3.71	204.6
Soletta superiore sp. 100 cm	14	304.39	-	φ20/20	φ20/20	175.0	-3.44	222.7
	17	-136.09	-	φ20/20	φ20/20	175.0	-1.54	99.6
Piedritto sinistro sp. 100 cm	19	249.58	-499.74	φ20/20	φ20/20	398.9	-2.67	51.8
	21	134.10	-455.99	φ20/20	φ20/20	688.1	-1.28	6.3
	23	203.39	-412.24	φ20/20	φ20/20	403.4	-2.17	41.3

A_s : armatura tesa

A'_s : armatura compressa

X : posizione asse neutro da lembo compresso

Nelle verifiche delle solette si è trascurata l'azione assiale di compressione.

	Sezione	T (kN)	b (mm)	d (mm)	τ (N/mm ²)	
Soletta inferiore	3	444.49	1000	940	0.53	< τ _{co} = 0.73 N/mm ²
	7	444.49	1000	940	0.53	< τ _{co} = 0.73 N/mm ²
Soletta superiore	12	336.84	1000	940	0.40	< τ _{co} = 0.73 N/mm ²
	16	336.84	1000	940	0.40	< τ _{co} = 0.73 N/mm ²
Piedritti	20	144.53	1000	926	0.17	< τ _{co} = 0.73 N/mm ²
	22	105.28	1000	926	0.13	< τ _{co} = 0.73 N/mm ²

La tensione tangenziale è sempre inferiore alla τ_{co}, non è necessario disporre un'apposita armatura a taglio, si dispongono spilli φ14 disposti a maglia 40x40 cm.

8.4.2. Verifiche a fessurazione

Le verifiche a fessurazione vengono condotte per la condizione di carico TA5. Dovrà risultare:

- a contatto con il terreno $w_k \leq 0.15$ mm;
- non a contatto con il terreno $w_k \leq 0.2$ mm.

Il prospetto seguente riassume i risultati delle verifiche.

	Sez.	M (kNm)	N (kN)	A _s (mm ²)	A' _s (mm ²)	w (mm)	w _k (mm)
Soletta inferiore	3	169.30	-	φ20/20	φ240/20	-	0.15
	5	-349.76	-	φ20/20 + φ16/40	φ20/20	-	0.20
Soletta superiore	14	287.44	-	φ20/20	φ20/20	-	0.20
	16	-134.75	-	φ20/20	φ20/20	-	0.15
Piedritti	20	247.64	-510.74	φ20/20	φ20/20	-	0.15
	22	201.42	-423.24	φ20/20	φ20/20	-	0.15

Nelle verifiche delle solette si è trascurata l'azione assiale di compressione.

GENERAL CONTRACTOR  Consorzio Collegamenti Integrati Veloci	ALTA SORVEGLIANZA  GRUPPO FERROVIE DELLO STATO ITALIANE
	IG51-02-E-CV-CL-IN11-0X-001_A00 Relazione di calcolo
	Foglio 49 di 84

9. VERIFICA EFFETTI LONGITUDINALI DA RITIRO

Vengono discussi brevemente gli effetti dovuti al ritiro nel calcestruzzo che provocano stati interni di coazione con l'armatura. Scopo della trattazione è quello di verificare l'armatura minima longitudinale dello scatolare.

9.1. Coazioni interne dovute ai fenomeni di ritiro

Per il calcolo delle coazioni interne dovute ai fenomeni di ritiro si consideri una sezione di area unitaria A_c con un'unica barra di armatura di area A_s come rappresentato nell'immagine sottostante:

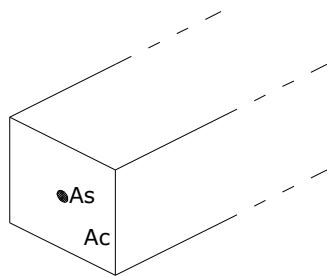

Si assumono le seguenti ipotesi:

perfetta aderenza tra calcestruzzo ed acciaio;

deformata piana della sezione in calcestruzzo;

comportamento del calcestruzzo e dell'acciaio elastico e lineare,

Le equazioni di equilibrio, congruenza e legame dell'insieme calcestruzzo + acciaio che governano il fenomeno sono:

$$N_c + N_s = 0 \quad (\text{equazione di equilibrio})$$

$$\varepsilon_r = \varepsilon_s - \varepsilon_c \quad (\text{equazione di congruenza})$$

$$N_c = A_c \sigma_c = A_c E_c \varepsilon_c \quad (\text{equazione legame costitutivo del calcestruzzo})$$

$$N_s = A_s \sigma_s = A_s E_s \varepsilon_s \quad (\text{equazione legame costitutivo dell'acciaio})$$

Sostituendo le equazioni di legame in quella di equilibrio ed esprimendo la deformazione del calcestruzzo in funzione di quella dell'acciaio si ha:

$$N_s = -N_c = A_s E_s A_c E_c \varepsilon_r / (A_s E_s + A_c E_c)$$

Il comportamento viscoso del calcestruzzo viene considerato attraverso l'abbattimento del modulo elastico, pertanto è necessario sostituire il valore di E_c con E_c^* . La tensione sull'acciaio e sul calcestruzzo risultano quindi pari a:

GENERAL CONTRACTOR  Consorzio Collegamenti Integrati Veloci	ALTA SORVEGLIANZA  GRUPPO FERROVIE DELLO STATO ITALIANE
	IG51-02-E-CV-CL-IN11-0X-001_A00 Relazione di calcolo
	Foglio 50 di 84

$$\sigma_s = A_c E_c^* E_s \varepsilon_r / (A_s E_s + A_c E_c^*)$$

$$\sigma_c = -A_s E_c^* E_s \varepsilon_r / (A_s E_s + A_c E_c^*)$$

9.2. Calcolo delle sollecitazioni longitudinali dovute ai fenomeni di ritiro

L'analisi delle sollecitazioni viene svolta per una striscia di larghezza unitaria, assumendo la dimensione convenzionale h_0 pari a $2 \times A/u = 2 \times H$, ed un calcestruzzo C32/40.

Caratteristiche della sezione:

$$B = 100 \text{ cm}$$

$$H = 100 \text{ cm}$$

$$A_{s, \text{long}} = 1 + 1 \varnothing 20/20 = 3140 \text{ mm}^2$$

$$E_s = 210000 \text{ N/mm}^2$$

$$E_c = 33643 \text{ N/mm}^2$$

Deformazione da ritiro:

$$U.R. = 75\%$$

$$\varepsilon_r = \varepsilon_{ca} + \varepsilon_{cd} = 0.35 \text{ ‰}$$

A favore di sicurezza, si assume una deformazione $\varepsilon_r = 0.35 \text{ ‰}$.

Effetto viscosità:

Il modulo viscoso a tempo infinito, in considerazione del valore di h_0 , della resistenza del calcestruzzo e della U.R., può cautelativamente essere assunto pari a $\phi (t = \infty) = 1.6$. Il modulo elastico ridotto del calcestruzzo risulta quindi pari a:

$$E_c^* = E_c / (1 + \phi) = 12940 \text{ N/mm}^2$$

Tensioni nei materiali:

$$\sigma_s = -(1000 \times 1000) \times 12940 \times 210000 \times 0.00035 / (3140 \times 210000 + 1000 \times 1000 \times 12940) = -66.76 \text{ N/mm}^2$$

$$\sigma_c = 3140 \times 12940 \times 210000 \times 0.00035 / (3140 \times 210000 + 1000 \times 1000 \times 12940) = 0.21 \text{ N/mm}^2$$

La sollecitazione sul calcestruzzo risulta molto inferiore rispetto alla resistenza a trazione e quindi non porta a fessurazione il calcestruzzo; la sollecitazione sull'acciaio risulta modesta ed accettabile per le normali condizioni di esercizio della struttura.

GENERAL CONTRACTOR 	ALTA SORVEGLIANZA 
	IG51-02-E-CV-CL-IN11-0X-001_A00 Relazione di calcolo
	Foglio 51 di 84

10. VERIFICA MURI DI IMBOCCO

L'opera prevede agli imbocchi dei muri di sostegno del rilevato, si tratta di muri a mensola in c.a. avente all'imbocco altezza di 5.20 m e allo sbocco altezza di 4.00 m e 5.70 m.

Il muro all'imbocco e allo sbocco di altezza 5.20 m e 5.70 m hanno una fondazione di altezza 1.00 m e larghezza 4.80 m e paramento verticale inclinato a monte con pendenza 1/10 e larghezza minima in testa di 0.40 m.

Il muro allo sbocco di altezza 4.00 m ha una fondazione di altezza 0.80 m e larghezza 3.70 m e paramento verticale inclinato a monte con pendenza 1/10 e larghezza minima in testa di 0.40 m.

Di seguito si eseguono il calcolo e le verifiche di stabilità e strutturali dei muri in oggetto, mediante il programma MAX 10.0 della Aztec Informatica.

10.1. Stratigrafia e parametri geotecnici

Muro h=5.70 m:

Il piano di imposta è di circa 1.0 sotto il fondo scorrevole del canale esistente.

Rinterro:	H = 5.7 m;	$\gamma = 20 \text{ kN/m}^3$;	$c = 0 \text{ kPa}$;	$\phi = 35^\circ$;	$\delta = 23^\circ$.
Unità fl3:	H = 2 m;	$\gamma = 19 \text{ kN/m}^3$;	$c = 0 \text{ kPa}$;	$\phi = 28^\circ$;	$\delta = 19^\circ$.
Unità fc_alterata:	H = 2 m;	$\gamma = 21 \text{ kN/m}^3$;	$c = 0.15 \text{ kPa}$;	$\phi = 21^\circ$;	$\delta = 14^\circ$.
Unità fc	H = var m;	$\gamma = 21 \text{ kN/m}^3$;	$c = 0.30 \text{ kPa}$;	$\phi = 23^\circ$;	$\delta = 15^\circ$.

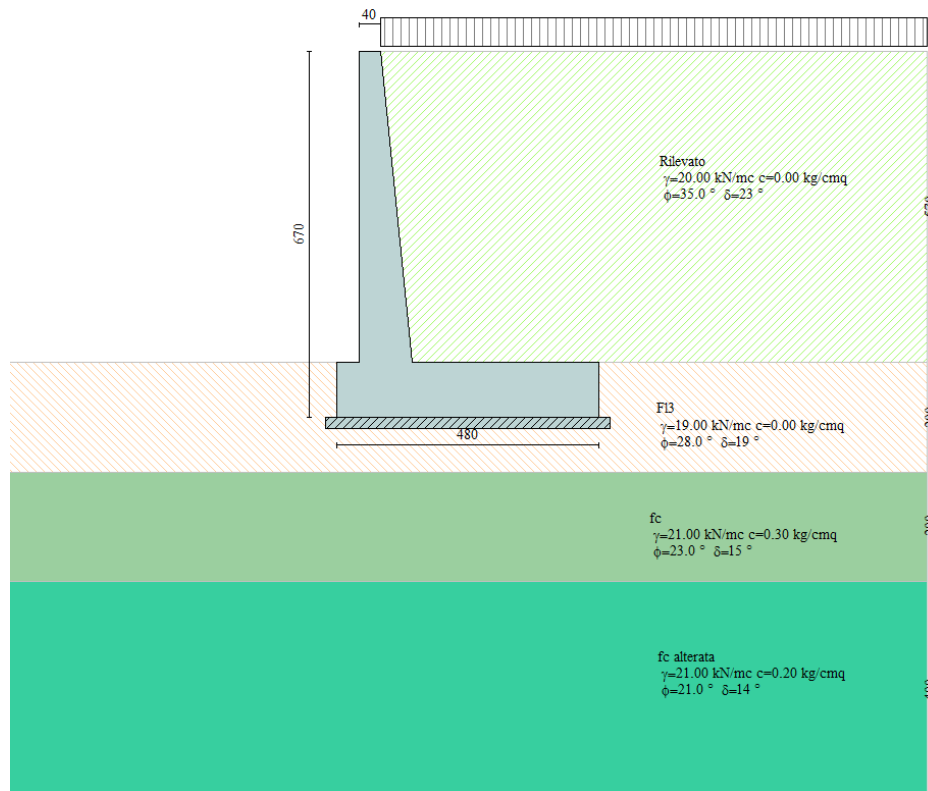

Muro h=4.00 m:

Il piano di imposta del muro è posto a circa 2.0 m sopra il fondo scorrevole del canale esistente.

Rinterro:	H = 4.0 m;	$\gamma = 20 \text{ kN/m}^3$;	c = 0 kPa;	$\phi = 35^\circ$;	$\delta = 23^\circ$.
Unità fl3:	H = 3.0 m ;	$\gamma = 19 \text{ kN/m}^3$;	c = 0 kPa;	$\phi = 28^\circ$;	$\delta = 19^\circ$.
Unità fc_alterata:	H = 2 m;	$\gamma = 21 \text{ kN/m}^3$;	c = 0.15 kPa;	$\phi = 21^\circ$;	$\delta = 14^\circ$.
Unità fc	H = var m;	$\gamma = 21 \text{ kN/m}^3$;	c = 0.30 kPa;	$\phi = 23^\circ$;	$\delta = 15^\circ$.

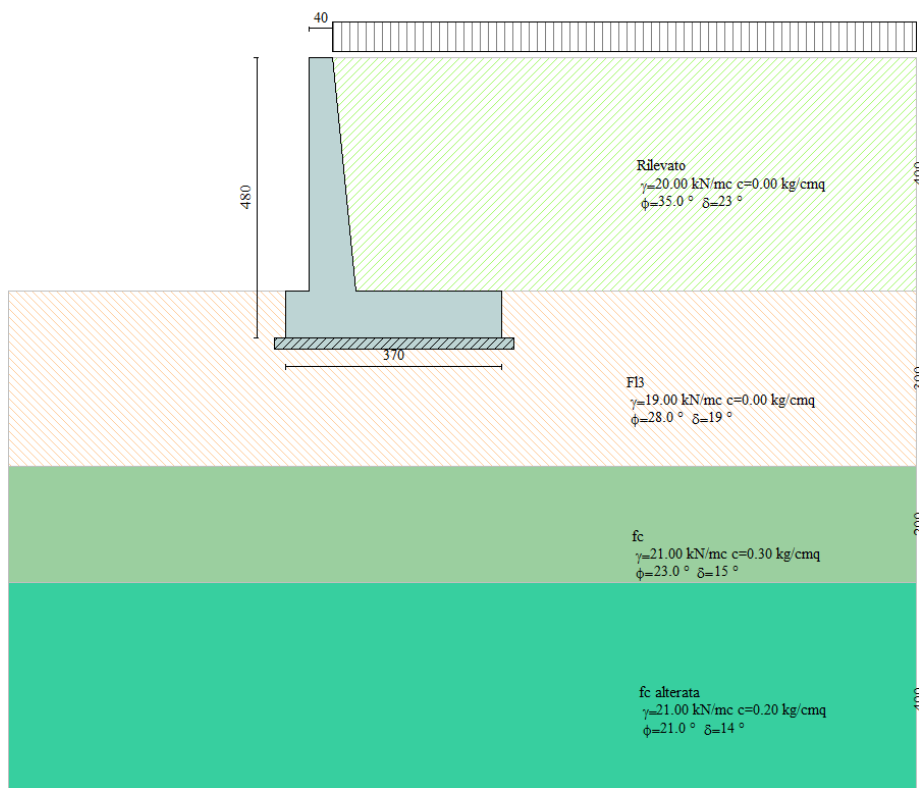

10.2. Geometria

Muro h=5.70 m:

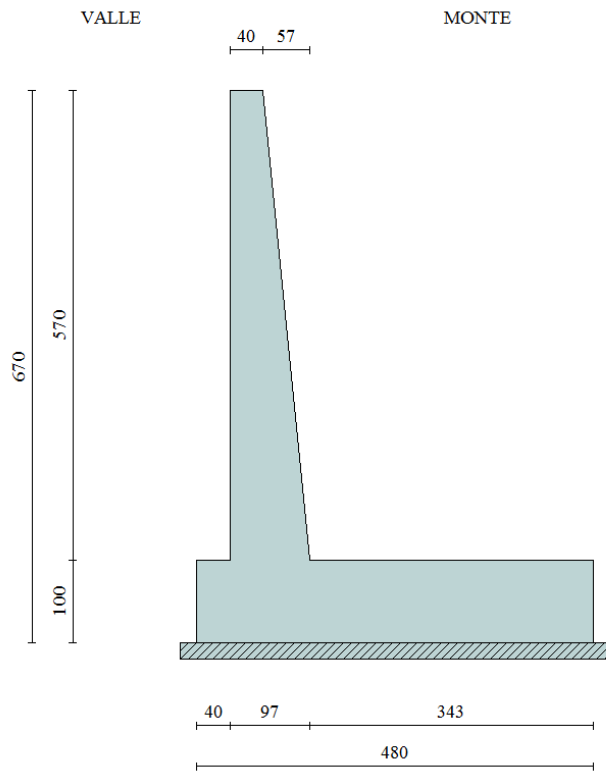

Muro h=4.00 m:

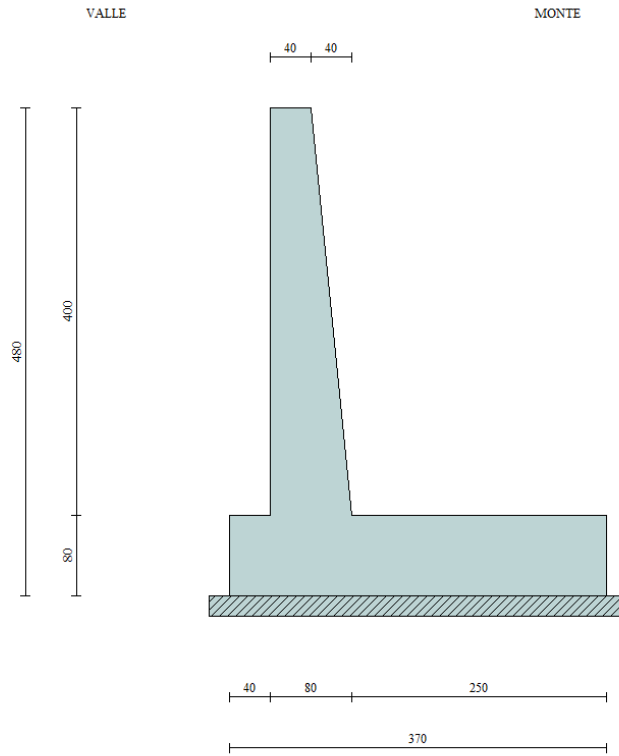

GENERAL CONTRACTOR  Consorzio Collegamenti Integrati Veloci	ALTA SORVEGLIANZA  GRUPPO FERROVIE DELLO STATO ITALIANE
	IG51-02-E-CV-CL-IN11-0X-001_A00 Relazione di calcolo
	Foglio 56 di 84

10.3. Analisi dei carichi e condizioni di carico

Peso proprio: $\gamma_{cls} = 25 \text{ kN/m}^3$

Sisma

Si considera un'azione sismica di terza categoria, con $K_n = 0.04$.

Carichi variabili sul rilevato

sovraccarico in esercizio..... $q_{statico} = 10.00 \text{ kN/m}^2$

sovraccarico ferroviario sismico..... $q_{sismico} = 0.00 \text{ kN/m}^2$

Per il calcolo si utilizza il programma MAX 10.0 "Analisi e calcolo dei muri di sostegno" della Aztec Informatica.

Il programma calcola le sollecitazioni nel muro e nella fondazione, gli sforzi sul terreno, verifica lo scorrimento e il ribaltamento nonché la stabilità globale dell'opera.

Il programma Max 10.0, una volta inserita la geometria del muro, i parametri del terreno, i carichi esterni e il coefficiente di intensità sismica svolge autonomamente il calcolo del muro per le varie verifiche di resistenza e stabilità.



Si prendono in esame due condizioni di carico

1. **condizione di esercizio** : permanenti + variabili
2. **condizione sismica** : permanenti + sisma

10.4. Risultati delle analisi e verifiche di stabilità





Muro h=5.70 m:

Risultati combinazione n° 1

Tensioni ammissibili			
Coefficienti sicurezza	Spinta	Forze	Risultanti
	CALCOLATI		RICHIESTI
Coefficiente di sicurezza a ribaltamento	7.02		1.50
Coefficiente di sicurezza a scorrimento	1.96		1.30
Coefficiente di sicurezza a carico limite	2.86		2.00
Coefficiente di sicurezza stabilità globale	1.48		1.30

Help

Risultati combinazione n° 2

Tensioni ammissibili - Sismica			
Coefficienti sicurezza	Spinta	Forze	Risultanti
	CALCOLATI		RICHIESTI
Coefficiente di sicurezza a ribaltamento	5.16		1.50
Coefficiente di sicurezza a scorrimento	1.60		1.30
Coefficiente di sicurezza a carico limite	2.44		2.00
Coefficiente di sicurezza stabilità globale	1.46		1.30

Help

Combinazione 1 – statica

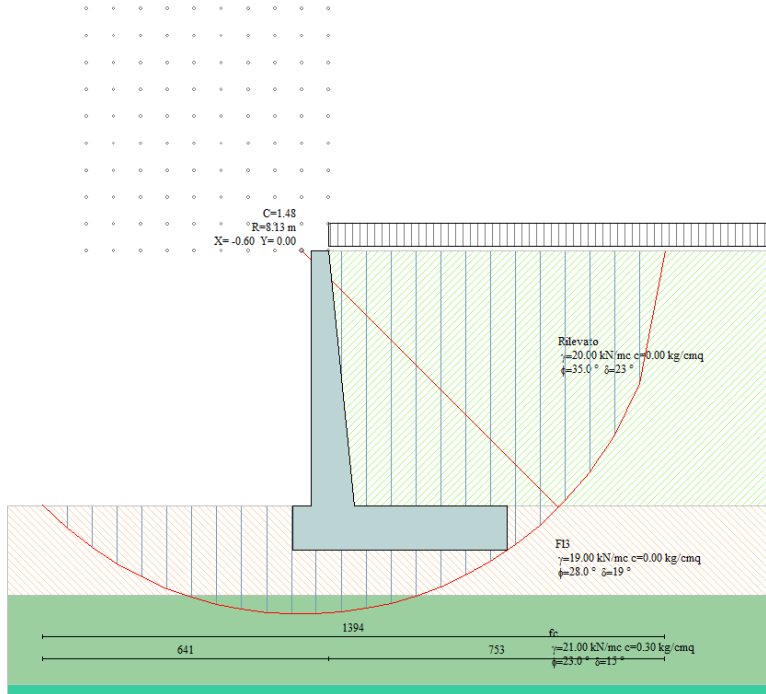

Combinazione 2 – sismica

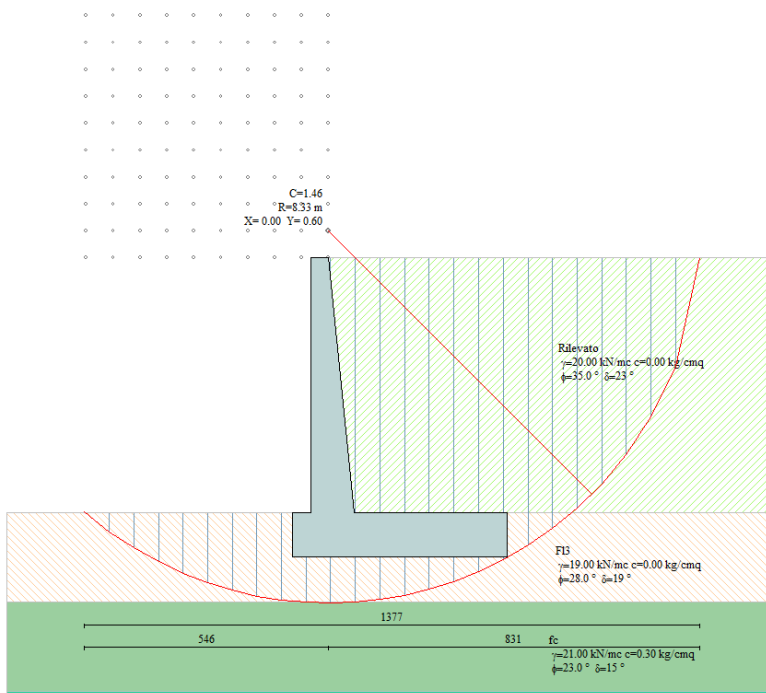





Muro h=4.00 m:

Risultati combinazione n° 1

Tensioni ammissibili			
Coefficienti sicurezza	Spinta	Forze	Risultanti
	CALCOLATI		RICHIESTI
Coefficiente di sicurezza a ribaltamento	7.72		1.50
Coefficiente di sicurezza a scorrimento	2.01		1.30
Coefficiente di sicurezza a carico limite	3.26		2.00
Coefficiente di sicurezza stabilità globale	1.43		1.30

Help

Risultati combinazione n° 2

Tensioni ammissibili - Sismica			
Coefficienti sicurezza	Spinta	Forze	Risultanti
	CALCOLATI		RICHIESTI
Coefficiente di sicurezza a ribaltamento	5.84		1.50
Coefficiente di sicurezza a scorrimento	1.66		1.30
Coefficiente di sicurezza a carico limite	2.92		2.00
Coefficiente di sicurezza stabilità globale	1.44		1.30

Help

Combinazione 1 – statica

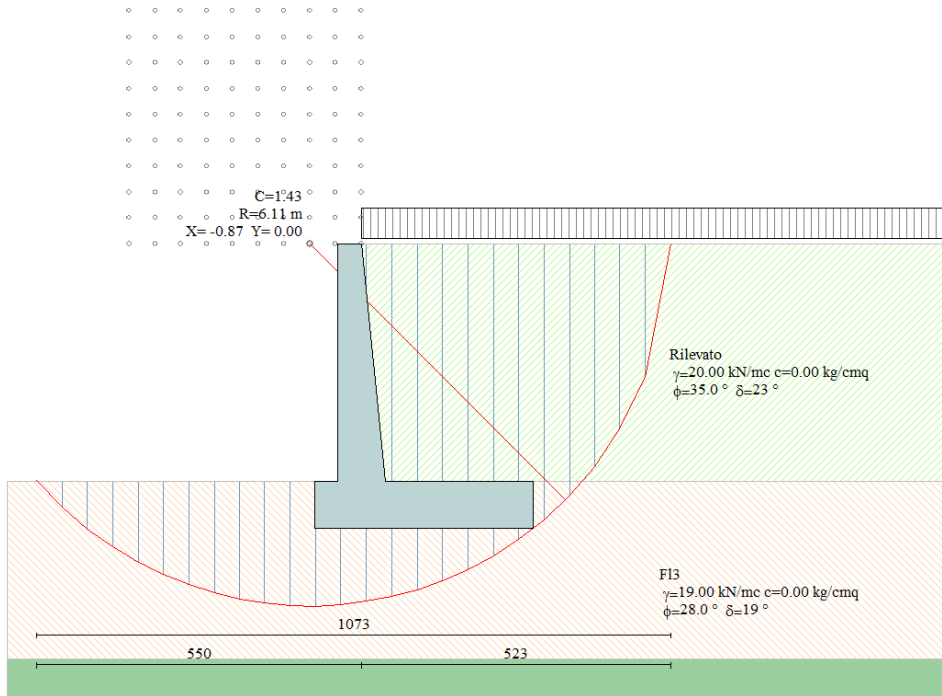

Combinazione 2 – sismica

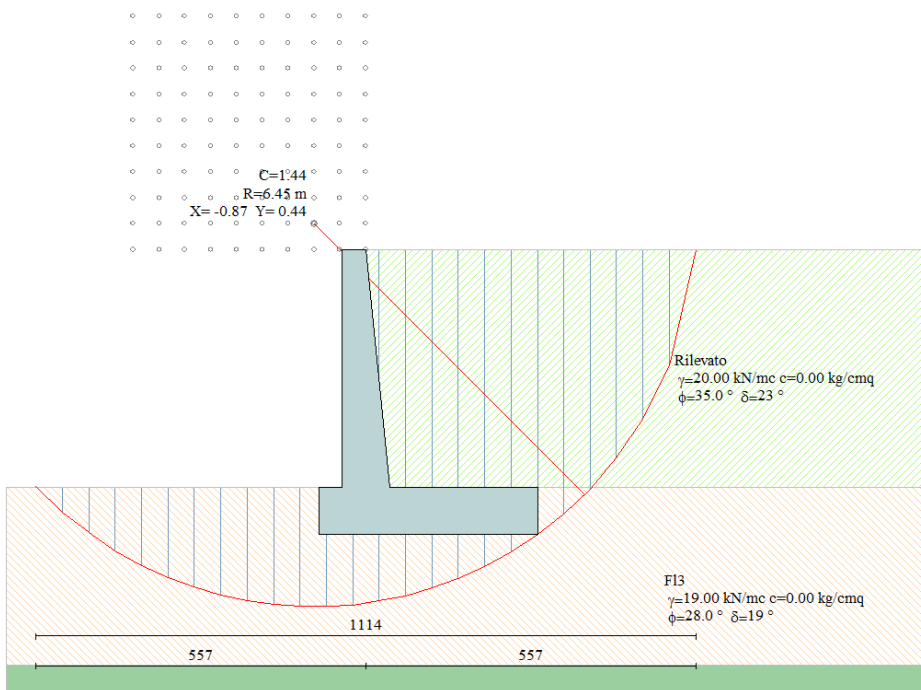

10.5. Verifiche strutturali

Muro imbocco elevazione

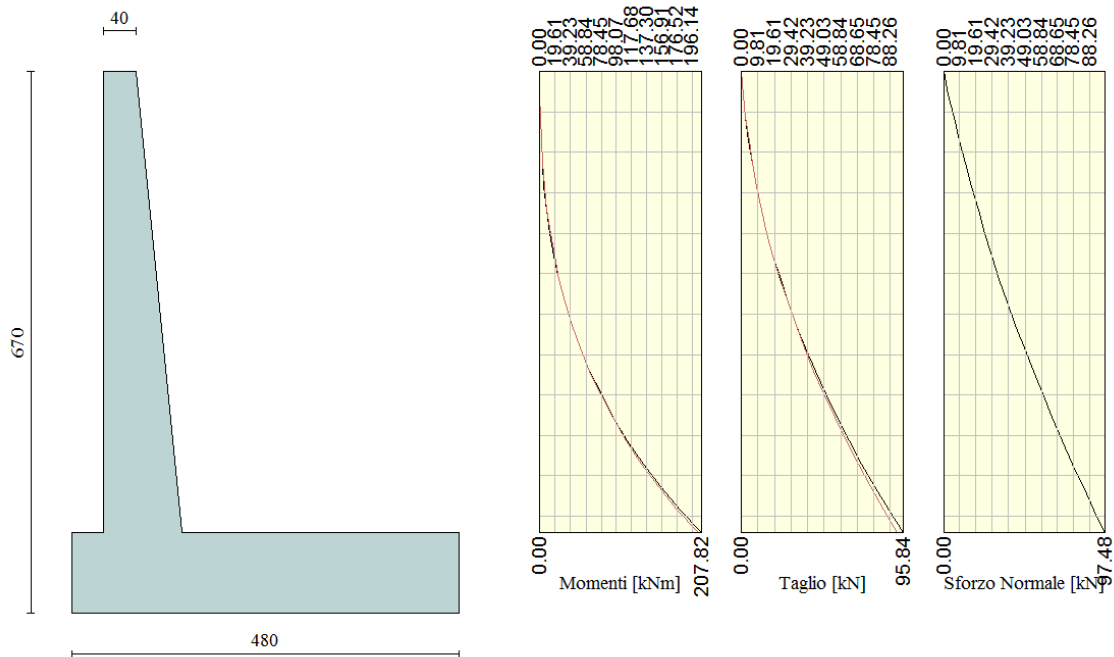

$$M = 207.82 \text{ kNm/m}$$

$$N = 97.48 \text{ kN/m}$$

$$T = 95.84 \text{ kN/m}$$

L'elevazione è costituita da un calcestruzzo di classe C32/40, ha uno spessore di verifica di 97 cm. L'armatura verticale è costituita da $\phi 20/20$ e quella longitudinale da $\phi 14/20$, non è necessario disporre armatura a taglio, si dispongono comunque spilli $\phi 10/40 \times 40$. La distanza tra la barra di armatura e il lembo esterno della sezione è stata calcolata come segue: al copriferro minimo (4.0 cm) è stato sommato il diametro della barra di armatura esterna che si sviluppa in senso longitudinale (14 mm), il diametro dello spillo (10 mm), per cui il copriferro di verifica è 6.4 cm.

Momento massimo	M =	207.82	kNm
Azione assiale	N =	-97.48	kN

Verifiche di resistenza			
Asse neutro (da lembo compresso)	x =	20.51	cm
Momento di inerzia sezione parzializzata	J =	1452809	cm ⁴
eccentricità	e =	213.19	cm
tensione cls	$\sigma_c =$	2.55	MPa

tensione acciaio layer 1	$\sigma_{s1} =$	-128.8	MPa
tensione acciaio layer 2	$\sigma_{s2} =$		MPa

Verifica a fessurazione			
Asse neutro (da lembo compresso)	$x =$	20.51	cm
eccentricità	$e =$	213.19	cm
tensione cls per fessurazione	$\sigma_c =$	2.55	MPa
tensione acciaio per fessurazione	$\sigma_{s1} =$	128.8	MPa
momento di fessurazione	$M_{cr} =$	597.60	kNm
azione assiale per apertura fessure	$N_{cr} =$	280.31	kN
tensione cls prima fessurazione	$\sigma_{cr} =$	7.33	MPa
tensione acciaio prima fessurazione	$\sigma_{sr} =$	370.3	MPa
		$M_{cr} > M$	

Verifica a taglio			
massimo sforzo di taglio	$\tau_{max} =$	0.12	MPa

La sezione non si fessura nemmeno sotto i massimi carichi di esercizio, pertanto anche la verifica a fessurazione è automaticamente soddisfatta. Il massimo sforzo tagliante è inferiore a τ_{c0} , per cui non si rende necessaria un'apposita armatura a taglio.

Muro imbocco fondazione

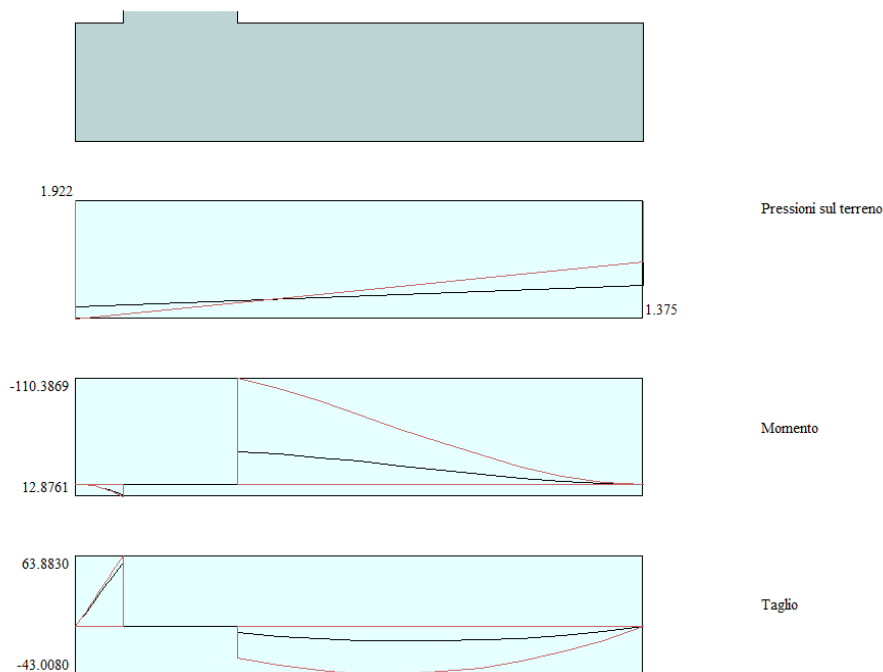

$M = 110.38 \text{ kNm/m}$

GENERAL CONTRACTOR  Consorzio Collegamenti Integrati Veloci	ALTA SORVEGLIANZA  GRUPPO FERROVIE DELLO STATO ITALIANE
	IG51-02-E-CV-CL-IN11-0X-001_A00 Relazione di calcolo
	Foglio 63 di 84

$$T = 63.88 \text{ kN/m}$$

La fondazione è costituita da un calcestruzzo di classe C32/40, ha uno spessore di verifica di 100 cm. L'armatura trasversale è costituita da $\phi 20/20$ e quella longitudinale da $\phi 16/20$, non è necessario disporre armatura a taglio. La distanza tra la barra di armatura e il lembo esterno della sezione è stata calcolata come segue: al copriferro minimo (4.0 cm) è stato sommato il diametro della barra di armatura esterna che si sviluppa in senso longitudinale (16 mm), per cui il copriferro di verifica è 5.6 cm.

Momento massimo	M =	110.38	kNm
Taglio massimo	T =	63.88	kN
Verifiche di resistenza			
Asse neutro (da lembo compresso)	x =	17.50	cm
Momento di inerzia sezione parzializzata	J =	1563999	cm ⁴
tensione cls	$\sigma_c =$	1.24	MPa
tensione acciaio layer 1	$\sigma_{s1} =$	-80.3	MPa
tensione acciaio layer 2	$\sigma_{s2} =$		MPa
Verifica a fessurazione			
tensione cls per fessurazione	$\sigma_c =$	1.24	MPa
tensione acciaio per fessurazione	$\sigma_{s1} =$	80.3	MPa
momento di prima fessurazione	$M_{fctk} =$	491.42	kNm
momento di apertura fessure	$M_{fctm} =$	585.03	kNm
tensione acciaio per M_{fctm}	$\sigma_{sr} =$	425.9	MPa
		$M_{cr} > M$	mm
Verifica a taglio			
massimo sforzo di taglio	$\tau_{max} =$	0.08	MPa

La sezione non si fessura nemmeno sotto i massimi carichi di esercizio, pertanto anche la verifica a fessurazione è automaticamente soddisfatta. Il massimo sforzo tagliante è inferiore a τ_{c0} , per cui non si rende necessaria un'apposita armatura a taglio.

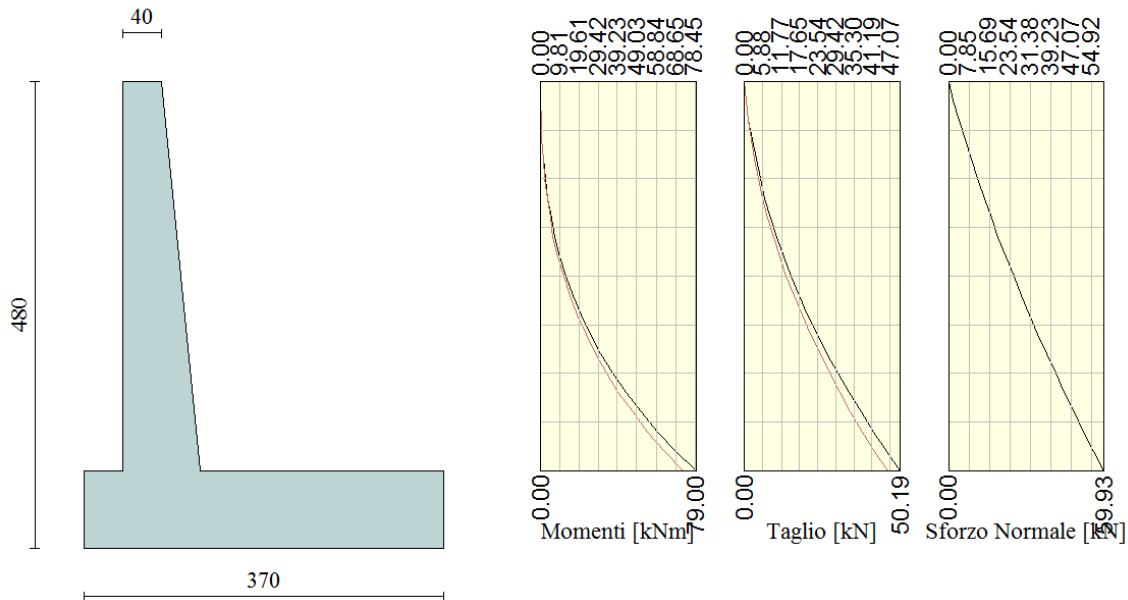
Muro h=4.00 m

$$M = 79.00 \text{ kNm/m}$$

$$N = 59.33 \text{ kN/m}$$

$$T = 50.19 \text{ kN/m}$$

L'elevazione è costituita da un calcestruzzo di classe C32/40, ha uno spessore di verifica di 80 cm. L'armatura verticale è costituita da $\phi 20/20$ al lembo interno e $\phi 16/20$ a quello esterno e quella longitudinale da $\phi 14/20$, non è necessario disporre armatura a taglio, si dispongono comunque spilli $\phi 10/40 \times 40$. La distanza tra la barra di armatura e il lembo esterno della sezione è stata calcolata come segue: al copriferro minimo (4.0 cm) è stato sommato il diametro della barra di armatura esterna che si sviluppa in senso longitudinale (14 mm), il diametro dello spillo (10 mm), per cui il copriferro di verifica è 6.4 cm.

Momento massimo	M =	79.00	kNm
Azione assiale	N =	-59.33	kN

Verifiche di resistenza			
Asse neutro (da lembo compresso)	x =	19.47	cm
Momento di inerzia sezione parzializzata	J =	933875	cm ⁴
eccentricità	e =	133.15	cm
tensione cls	$\sigma_c =$	1.39	MPa
tensione acciaio layer 1	$\sigma_{s1} =$	-57.0	MPa

tensione acciaio layer 2	$\sigma_{s2} =$	MPa
--------------------------	-----------------	-----

Verifica a fessurazione			
Asse neutro (da lembo compresso)	$x =$	19.47	cm
eccentricità	$e =$	133.15	cm
tensione cls per fessurazione	$\sigma_c =$	1.39	MPa
tensione acciaio per fessurazione	$\sigma_{s1} =$	57.0	MPa
momento di fessurazione	$M_{cr} =$	417.99	kNm
azione assiale per apertura fessure	$N_{cr} =$	313.91	kN
tensione cls prima fessurazione	$\sigma_{cr} =$	7.37	MPa
tensione acciaio prima fessurazione	$\sigma_{sr} =$	301.7	MPa
		$M_{cr} > M$	

Verifica a taglio			
massimo sforzo di taglio	$\tau_{max} =$	0.08	MPa

La sezione non si fessura nemmeno sotto i massimi carichi di esercizio, pertanto anche la verifica a fessurazione è automaticamente soddisfatta. Il massimo sforzo tagliante è inferiore a τ_{c0} , per cui non si rende necessaria un'apposita armatura a taglio.

Muro sbocco fondazione

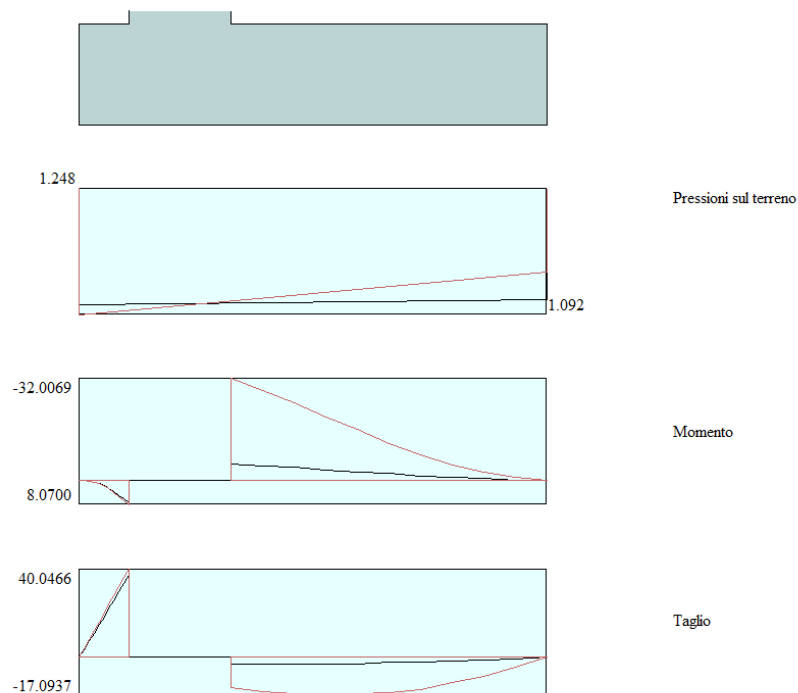

$$M = 32.01 \text{ kNm/m}$$

GENERAL CONTRACTOR  Consorzio Collegamenti Integrati Veloci	ALTA SORVEGLIANZA  GRUPPO FERROVIE DELLO STATO ITALIANE
	IG51-02-E-CV-CL-IN11-0X-001_A00 Relazione di calcolo
	Foglio 66 di 84

$$T = 40.05 \text{ kN/m}$$

La fondazione è costituita da un calcestruzzo di classe C32/40, ha uno spessore di verifica di 80 cm. L'armatura trasversale è costituita da $\phi 20/20$ e quella longitudinale da $\phi 16/20$, non è necessario disporre armatura a taglio. La distanza tra la barra di armatura e il lembo esterno della sezione è stata calcolata come segue: al copriferro minimo (4.0 cm) è stato sommato il diametro della barra di armatura esterna che si sviluppa in senso longitudinale (16 mm), per cui il copriferro di verifica è 5.6 cm.

Momento massimo	M =	32.01	kNm
Taglio massimo	T =	40.05	kN
Verifiche di resistenza			
Asse neutro (da lembo compresso)	x =	15.27	cm
Momento di inerzia sezione parzializzata	J =	932577	cm ⁴
tensione cls	$\sigma_c =$	0.52	MPa
tensione acciaio layer 1	$\sigma_{s1} =$	-29.9	MPa
tensione acciaio layer 2	$\sigma_{s2} =$		MPa
Verifica a fessurazione			
tensione cls per fessurazione	$\sigma_c =$	0.52	MPa
tensione acciaio per fessurazione	$\sigma_{s1} =$	29.9	MPa
momento di prima fessurazione	$M_{fctk} =$	319.96	kNm
momento di apertura fessure	$M_{fctm} =$	380.91	kNm
tensione acciaio per M_{fctm}	$\sigma_{sr} =$	356.2	MPa
		$M_{cr} > M$	mm
Verifica a taglio			
massimo sforzo di taglio	$\tau_{max} =$	0.06	MPa

La sezione non si fessura nemmeno sotto i massimi carichi di esercizio, pertanto anche la verifica a fessurazione è automaticamente soddisfatta. Il massimo sforzo tagliante è inferiore a τ_{c0} , per cui non si rende necessaria un'apposita armatura a taglio.

GENERAL CONTRACTOR  Consorzio Collegamenti Integrati Veloci	ALTA SORVEGLIANZA  GRUPPO FERROVIE DELLO STATO ITALIANE
	IG51-02-E-CV-CL-IN11-0X-001_A00 Relazione di calcolo
	Foglio 67 di 84

11. TABULATI DI CALCOLO

Per i tabulati di input e output dello scatolare si rimanda al file allegato.

11.1. Muro h =5.70 m

Il calcolo dei muri di sostegno viene eseguito secondo le seguenti fasi:

- Calcolo della spinta del terreno
- Verifica a ribaltamento
- Verifica a scorrimento del muro sul piano di posa
- Verifica della stabilità complesso fondazione terreno (carico limite)
- Verifica della stabilità globale

Calcolo delle sollecitazioni sia del muro che della fondazione, progetto delle armature e relative verifiche dei materiali.

Calcolo della spinta sul muro

Metodo di Culmann

Il metodo di Culmann adotta le stesse ipotesi di base del metodo di Coulomb. La differenza sostanziale è che mentre Coulomb considera un terrapieno con superficie a pendenza costante e carico uniformemente distribuito (il che permette di ottenere una espressione in forma chiusa per il coefficiente di spinta) il metodo di Culmann consente di analizzare situazioni con profilo di forma generica e carichi sia concentrati che distribuiti comunque disposti. Inoltre, rispetto al metodo di Coulomb, risulta più immediato e lineare tener conto della coesione del masso spingente. Il metodo di Culmann, nato come metodo essenzialmente grafico, si è evoluto per essere trattato mediante analisi numerica (noto in questa forma come metodo del cuneo di tentativo). Come il metodo di Coulomb anche questo metodo considera una superficie di rottura rettilinea.

I passi del procedimento risolutivo sono i seguenti:

- si impone una superficie di rottura (angolo di inclinazione p rispetto all'orizzontale) e si considera il cuneo di spinta delimitato dalla superficie di rottura stessa, dalla parete su cui si calcola la spinta e dal profilo del terreno;
- si valutano tutte le forze agenti sul cuneo di spinta e cioè peso proprio (W), carichi sul terrapieno, resistenza per attrito e per coesione lungo la superficie di rottura (R e C) e resistenza per coesione lungo la parete (A);
- dalle equazioni di equilibrio si ricava il valore della spinta S sulla parete.

Questo processo viene iterato fino a trovare l'angolo di rottura per cui la spinta risulta massima.

La convergenza non si raggiunge se il terrapieno risulta inclinato di un angolo maggiore dell'angolo d'attrito del terreno.

Nei casi in cui è applicabile il metodo di Coulomb (profilo a monte rettilineo e carico uniformemente distribuito) i risultati ottenuti col metodo di Culmann coincidono con quelli del metodo di Coulomb.

Le pressioni sulla parete di spinta si ricavano derivando l'espressione della spinta S rispetto all'ordinata z . Noto il diagramma delle pressioni è possibile ricavare il punto di applicazione della spinta.

Spinta in presenza di sisma

Per tener conto dell'incremento di spinta dovuta al sisma si fa riferimento al metodo di Mononobe-Okabe (cui fa riferimento la Normativa Italiana).

La Normativa Italiana suggerisce di tener conto di un incremento di spinta dovuto al sisma nel modo seguente.

Detta ϵ l'inclinazione del terrapieno rispetto all'orizzontale e β l'inclinazione della parete rispetto alla verticale, si calcola la spinta S' considerando un'inclinazione del terrapieno e della parte pari a

$$\epsilon' = \epsilon + \theta$$

$$\beta' = \beta + \theta$$

dove $\theta = \arctg(C)$ essendo C il coefficiente di intensità sismica.

Detta S la spinta calcolata in condizioni statiche l'incremento di spinta da applicare è espresso da

$$\Delta S = AS' - S$$

dove il coefficiente A vale

$$A = \frac{\cos^2(\beta + \theta)}{\cos^2\beta \cos\theta}$$

Adottando il metodo di Mononobe-Okabe per il calcolo della spinta, il coefficiente A viene posto pari a 1.

Tale incremento di spinta deve essere applicato ad una distanza dalla base pari a 2/3 dell'altezza del muro stesso.

Oltre a questo incremento bisogna tener conto delle forze d'inerzia orizzontali che si destano per effetto del sisma. Tale forza viene valutata come

$$F_i = CW$$

dove W è il peso del muro, del terreno soprastante la mensola di monte ed i relativi sovraccarichi e va applicata nel baricentro dei pesi.

Il metodo di Culmann tiene conto automaticamente dell'incremento di spinta. Basta inserire nell'equazione risolutiva la forza d'inerzia del cuneo di spinta. La superficie di rottura nel caso di sisma risulta meno inclinata della corrispondente superficie in assenza di sisma.

Verifica a ribaltamento

GENERAL CONTRACTOR  Consorzio Collegamenti Integrati Veloci	ALTA SORVEGLIANZA  GRUPPO FERROVIE DELLO STATO ITALIANE
	IG51-02-E-CV-CL-IN11-0X-001_A00 Relazione di calcolo
	Foglio 68 di 84

La verifica a ribaltamento consiste nel determinare il momento risultante di tutte le forze che tendono a fare ribaltare il muro (momento ribaltante M_r) ed il momento risultante di tutte le forze che tendono a stabilizzare il muro (momento stabilizzante M_s) rispetto allo spigolo a valle della fondazione e verificare che il rapporto M_s/M_r sia maggiore di un determinato coefficiente di sicurezza η_r .
La Normativa Italiana (D.M. 1988) impone che sia $\eta_r \geq 1.5$.

Deve quindi essere verificata la seguente disequaglianza

$$\frac{M_s}{M_r} \geq \eta_r$$

Il momento ribaltante M_r è dato dalla componente orizzontale della spinta S , dalle forze di inerzia del muro e del terreno gravante sulla fondazione di monte (caso di presenza di sisma) per i rispettivi bracci. Nel momento stabilizzante interviene il peso del muro (applicato nel baricentro) ed il peso del terreno gravante sulla fondazione di monte. Per quanto riguarda invece la componente verticale della spinta essa sarà stabilizzante se l'angolo d'attrito terra-muro δ è positivo, ribaltante se δ è negativo. δ è positivo quando è il terrapieno che scorre rispetto al muro, negativo quando è il muro che tende a scorrere rispetto al terrapieno (questo può essere il caso di una spalla da ponte gravata da carichi notevoli). Se sono presenti dei tiranti essi contribuiscono al momento stabilizzante.
Questa verifica ha significato solo per fondazione superficiale e non per fondazione su pali.

Verifica a scorrimento

Per la verifica a scorrimento del muro lungo il piano di fondazione deve risultare che la somma di tutte le forze parallele al piano di posa che tendono a fare scorrere il muro deve essere minore di tutte le forze, parallele al piano di scorrimento, che si oppongono allo scivolamento, secondo un certo coefficiente di sicurezza. La verifica a scorrimento risulta soddisfatta se il rapporto fra la risultante delle forze resistenti allo scivolamento F_r e la risultante delle forze che tendono a fare scorrere il muro F_s risulta maggiore di un determinato coefficiente di sicurezza η_s .
La Normativa Italiana (D.M. 1988) impone che $\eta_s \geq 1.3$

$$\frac{F_r}{F_s} \geq \eta_s$$

Le forze che intervengono nella F_s sono: la componente della spinta parallela al piano di fondazione e la componente delle forze d'inerzia parallela al piano di fondazione. La forza resistente è data dalla resistenza d'attrito e dalla resistenza per adesione lungo la base della fondazione. Detta N la componente normale al piano di fondazione del carico totale gravante in fondazione e indicando con δ_r l'angolo d'attrito terreno-fondazione, con c_a l'adesione terreno-fondazione e con B_f la larghezza della fondazione reagenti, la forza resistente può esprimersi come

$$F_r = N \operatorname{tg} \delta_r + c_a B_f$$

La Normativa consente di computare, nelle forze resistenti, una aliquota dell'eventuale spinta dovuta al terreno posto a valle del muro. In tal caso, però, il coefficiente di sicurezza deve essere aumentato opportunamente. L'aliquota di spinta passiva che si può considerare ai fini della verifica a scorrimento non può comunque superare il 50 per cento.

Per quanto riguarda l'angolo d'attrito terra-fondazione, δ_r , diversi autori suggeriscono di assumere un valore di δ_r pari all'angolo d'attrito del terreno di fondazione.

Verifica al carico limite

Il rapporto fra il carico limite in fondazione e la componente normale della risultante dei carichi trasmessi dal muro sul terreno di fondazione deve essere superiore a η_q . Cioè, detto Q_u , il carico limite ed R la risultante verticale dei carichi in fondazione, deve essere:

$$\frac{Q_u}{R} \geq \eta_q$$

La Normativa Italiana (D.M. 1988) impone che $\eta_q \geq 2.0$

Si adotta per il calcolo del carico limite in fondazione il metodo di MEYERHOF.

L'espressione del carico ultimo è data dalla relazione:

$$Q_u = c N_c d_{ic} + q N_q d_{iq} + 0.5 \gamma B N_\gamma d_{i\gamma}$$

In questa espressione

c	coesione del terreno in fondazione;
ϕ	angolo di attrito del terreno in fondazione;
γ	peso di volume del terreno in fondazione;
B	larghezza della fondazione;
D	profondità del piano di posa;
q	pressione geostatica alla quota del piano di posa.

I vari fattori che compaiono nella formula sono dati da:

$$A = e^{\pi \operatorname{tg} \phi}$$

$$N_q = A \operatorname{tg}^2(45^\circ + \phi/2)$$

$$N_c = (N_q - 1) \operatorname{ctg} \phi$$

GENERAL CONTRACTOR  Consorzio Collegamenti Integrati Veloci	ALTA SORVEGLIANZA  GRUPPO FERROVIE DELLO STATO ITALIANE
	IG51-02-E-CV-CL-IN11-0X-001_A00 Relazione di calcolo
	Foglio 69 di 84

$$N_y = (N_q - 1) \operatorname{tg}(1.4\phi)$$

Indichiamo con K_p il coefficiente di spinta passiva espresso da:

$$K_p = \operatorname{tg}^2(45^\circ + \phi/2)$$

I fattori d e i che compaiono nella formula sono rispettivamente i fattori di profondità ed i fattori di inclinazione del carico espressi dalle seguenti relazioni:

Fattori di profondità

$$d_q = 1 + 0.2 \frac{D}{B} \sqrt{K_p}$$

$$d_q = d_\gamma = 1 \quad \text{per } \phi = 0$$

$$d_q = d_\gamma = 1 + 0.1 \frac{D}{B} \sqrt{K_p} \quad \text{per } \phi > 0$$

Fattori di inclinazione

Indicando con θ l'angolo che la risultante dei carichi forma con la verticale (espresso in gradi) e con ϕ l'angolo d'attrito del terreno di posa abbiamo:

$$i_c = i_q = (1 - \theta^\circ/90)^\alpha$$

$$i_\gamma = \left(1 - \frac{\theta^\circ}{\phi^\circ}\right)^\alpha \quad \text{per } \phi > 0$$

$$i_\gamma = 0 \quad \text{per } \phi = 0$$

Verifica alla stabilità globale

La verifica alla stabilità globale del complesso muro+terreno deve fornire un coefficiente di sicurezza non inferiore a η_g

La Normativa Italiana (D.M. 1988) impone che $\eta_g \geq 1.3$

Viene usata la tecnica della suddivisione a strisce della superficie di scorrimento da analizzare. La superficie di scorrimento viene supposta circolare e determinata in modo tale da non avere intersezione con il profilo del muro o con i pali di fondazione. Si determina il minimo coefficiente di sicurezza su una maglia di centri di dimensioni 10x10 posta in prossimità della sommità del muro. Il numero di strisce è pari a 50.

Il coefficiente di sicurezza fornito da Fellenius si esprime secondo la seguente formula:

$$\eta = \frac{\sum_i \left(\frac{c_i b_i}{\cos \alpha_i} + [W_i \cos \alpha_i - u_i] \operatorname{tg} \phi_i \right)}{\sum_i W_i \sin \alpha_i}$$

dove n è il numero delle strisce considerate, b_i e α_i sono la larghezza e l'inclinazione della base della striscia i_{esima} rispetto all'orizzontale, W_i è il peso della striscia i_{esima} e c_i e ϕ_i sono le caratteristiche del terreno (coesione ed angolo di attrito) lungo la base della striscia.

Inoltre u_i ed l_i rappresentano la pressione neutra lungo la base della striscia e la lunghezza della base della striscia ($l_i = b_i / \cos \alpha_i$).

Quindi, assunto un cerchio di tentativo lo si suddivide in n strisce e dalla formula precedente si ricava η . Questo procedimento viene eseguito per il numero di centri prefissato e viene assunto come coefficiente di sicurezza della scarpata il minimo dei coefficienti così determinati.

Normativa

Spinte e verifiche secondo :

- D.M. 11/03/1988
- D.M. 16/01/1996

Geometria muro e fondazione

Descrizione

Muro a mensola in c.a.

Altezza del paramento	5.70 [m]
Spessore in sommità	0.40 [m]
Spessore all'attacco con la fondazione	0.97 [m]
Inclinazione paramento esterno	0.00 [%]

GENERAL CONTRACTOR  Consorzio Collegamenti Integrati Veloci	ALTA SORVEGLIANZA  GRUPPO FERROVIE DELLO STATO ITALIANE	
IG51-02-E-CV-CL-IN11-0X-001_A00 Relazione di calcolo		Foglio 70 di 84

Inclinazione paramento interno 10.00 [%]
Lunghezza del muro 10.00 [m]

Fondazione

Lunghezza mensola fondazione di valle 0.40 [m]
Lunghezza mensola fondazione di monte 3.43 [m]
Lunghezza totale fondazione 4.80 [m]
Inclinazione piano di posa della fondazione 0.00 [%]
Spessore fondazione 1.00 [m]
Spessore magrone 0.20 [m]

Geometria profilo terreno a monte del muro

Simbologia adottata e sistema di riferimento

(Sistema di riferimento con origine in testa al muro, ascissa X positiva verso monte, ordinata Y positiva verso l'alto)

N numero ordine del punto
X ascissa del punto espressa in [m]
Y ordinata del punto espressa in [m]
A inclinazione del tratto espressa in [°]

N	X	Y	A
1	10.00	0.00	0.00

Terreno a valle del muro

Inclinazione terreno a valle del muro rispetto all'orizzontale 0.00 [%]
Altezza del rinterro rispetto all'attacco fondaz.valle-paramento 0.00 [m]

Descrizione terreni

Simbologia adottata

Nr. Indice del terreno
Descrizione Descrizione terreno
 γ Peso di volume del terreno espresso in [kN/mc]
 γ_s Peso di volume saturo del terreno espresso in [kN/mc]
 ϕ Angolo d'attrito interno espresso in [°]
 δ Angolo d'attrito terra-muro espresso in [°]
c Coesione espressa in [kg/cm²]
 c_a Adesione terra-muro espressa in [kg/cm²]

Descrizione	γ	γ_s	ϕ	δ	c	c_a
Rilevato	20.00	20.00	35.00	23.33	0.000	0.000
F13	19.00	19.00	28.00	18.67	0.000	0.000
fc alterata	21.00	21.00	21.00	14.00	0.200	0.000
fc	21.00	21.00	23.00	15.33	0.300	0.000

Stratigrafia

Simbologia adottata

N Indice dello strato
H Spessore dello strato espresso in [m]
a Inclinazione espressa in [%]
 K_w Costante di Winkler orizzontale espressa in Kg/cm²/cm
 K_s Coefficiente di spinta
Terreno Terreno dello strato

Nr.	H	a	K_w	K_s	Terreno
1	5.70	0.00	12.51	0.00	Rilevato
2	2.00	0.00	3.17	0.00	F13
3	2.00	0.00	0.00	0.00	fc alterata
4	4.00	0.00	0.00	0.00	fc

Condizioni di carico

Simbologia e convenzioni di segno adottate

Carichi verticali positivi verso il basso.
Carichi orizzontali positivi verso sinistra.

GENERAL CONTRACTOR  Consorzio Collegamenti Integrati Veloci	ALTA SORVEGLIANZA  GRUPPO FERROVIE DELLO STATO ITALIANE
	IG51-02-E-CV-CL-IN11-0X-001_A00 Relazione di calcolo
	Foglio 71 di 84

Momento positivo senso antiorario.

X Ascissa del punto di applicazione del carico concentrato espressa in [m]
F_x Componente orizzontale del carico concentrato espressa in [kN]
F_y Componente verticale del carico concentrato espressa in [kN]
M Momento espresso in [kNm]
X_i Ascissa del punto iniziale del carico ripartito espressa in [m]
X_f Ascissa del punto finale del carico ripartito espressa in [m]
Q_i Intensità del carico per $x=X_i$ espressa in [kN/m]
Q_f Intensità del carico per $x=X_f$ espressa in [kN/m]
D/C Tipo carico : D=distribuito C=concentrato

Condizione n° 1 (Sovraccarico stradale)

D Profilo $X_i=0.00$ $X_f=10.00$ $Q_i=10.0000$ $Q_f=10.0000$

Descrizione combinazioni di carico

Simbologia adottata

C Coefficiente totale di partecipazione della condizione

Combinazione n° 1 Tensioni ammissibili

	C
Peso proprio	1.00
Spinta terreno	1.00
Sovraccarico stradale	1.00

Combinazione n° 2 Tensioni ammissibili - Sismica

	C
Peso proprio	1.00
Spinta terreno	1.00

Impostazioni di analisi

Metodo verifica sezioni

Tensioni ammissibili

Impostazioni avanzate

Diagramma correttivo per eccentricità negativa con aliquota di parzializzazione pari a 0.00

Quadro riassuntivo coeff. di sicurezza calcolati

Simbologia adottata

C Identificativo della combinazione
Tipo Tipo combinazione
Sisma Combinazione sismica
CS_{SCO} Coeff. di sicurezza allo scorrimento
CS_{RIB} Coeff. di sicurezza al ribaltamento
CS_{QLIM} Coeff. di sicurezza a carico limite
CS_{STAB} Coeff. di sicurezza a stabilità globale

C	Tipo	Sisma	CS _{sco}	CS _{rib}	CS _{qlim}	CS _{stab}
1	TAMM - [2]	--	1.96	7.02	2.86	1.48
2	TAMM - [3]	Orizzontale	1.60	5.16	2.44	1.46

Analisi della spinta e verifiche

Sistema di riferimento adottato per le coordinate :

Origine in testa al muro (spigolo di monte)

Ascisse X (espresse in [m]) positive verso monte

Ordinate Y (espresse in [m]) positive verso l'alto

Le forze orizzontali sono considerate positive se agenti da monte verso valle

Le forze verticali sono considerate positive se agenti dall'alto verso il basso

Calcolo riferito ad 1 metro di muro

Tipo di analisi

Calcolo della spinta

Calcolo del carico limite

metodo di Culmann

metodo di Meyerhof

GENERAL CONTRACTOR  Consorzio Collegamenti Integrati Veloci	ALTA SORVEGLIANZA  GRUPPO FERROVIE DELLO STATO ITALIANE	
IG51-02-E-CV-CL-IN11-0X-001_A00 Relazione di calcolo		Foglio 72 di 84

Calcolo della stabilità globale
Calcolo della spinta in condizioni di

metodo di Fellenius
Spinta attiva

Sisma

Coefficiente di intensità sismica (percento)
Forma diagramma incremento sismico

4.00
Triangolare con vertice in basso

Partecipazione spinta passiva (percento)
Lunghezza del muro

0.0
10.00 [m]

Peso muro
Baricentro del muro

217.6125 [kN]
X=0.87 Y=-4.87

Superficie di spinta

Punto inferiore superficie di spinta
Punto superiore superficie di spinta
Altezza della superficie di spinta
Inclinazione superficie di spinta (rispetto alla verticale)

X = 4.00 Y = -6.70
X = 4.00 Y = 0.00
6.70 [m]
0.00 [%]

COMBINAZIONE n° 1

Valore della spinta statica
Componente orizzontale della spinta statica
Componente verticale della spinta statica
Punto d'applicazione della spinta
Inclinaz. della spinta rispetto alla normale alla superficie
Inclinazione linea di rottura in condizioni statiche

136.1081 [kN]
126.1655 [kN]
51.0655 [kN]
X = 4.00 [m] Y = -4.48 [m]
40.47 [%]
141.73 [%]

Peso terrapieno gravante sulla fondazione a monte
Baricentro terrapieno gravante sulla fondazione a monte

463.5100 [kN]
X = 2.14 [m] Y = -2.78 [m]

Risultanti

Risultante dei carichi applicati in dir. orizzontale
Risultante dei carichi applicati in dir. verticale
Momento ribaltante rispetto allo spigolo a valle
Momento stabilizzante rispetto allo spigolo a valle
Sforzo normale sul piano di posa della fondazione
Sforzo tangenziale sul piano di posa della fondazione
Eccentricità rispetto al baricentro della fondazione
Risultante in fondazione
Inclinazione della risultante (rispetto alla normale)
Momento rispetto al baricentro della fondazione
Carico ultimo della fondazione

126.1655 [kN]
732.1880 [kN]
280.5463 [kNm]
1969.7099 [kNm]
732.1880 [kN]
126.1655 [kN]
0.09 [m]
742.9785 [kN]
17.23 [%]
68.0876 [kNm]
2092.6556 [kN]

Tensioni sul terreno

Lunghezza fondazione reagente
Tensione terreno allo spigolo di valle
Tensione terreno allo spigolo di monte

4.80 [m]
1.7362 [kg/cm²]
1.3746 [kg/cm²]

Fattori per il calcolo della capacità portante

$N_c = 25.80$
 $N_q = 14.72$
 $N_\gamma = 11.19$

$N'_c = 21.92$
 $N'_q = 12.10$
 $N'_\gamma = 4.90$

COEFFICIENTI DI SICUREZZA

Coefficiente di sicurezza a ribaltamento
Coefficiente di sicurezza a scorrimento
Coefficiente di sicurezza a carico ultimo
Coefficiente di sicurezza a stabilità globale

7.02
1.96
2.86
1.48

Stabilità globale muro + terreno

Combinazione n° 1

Le ascisse X sono considerate positive verso monte
Le ordinate Y sono considerate positive verso l'alto
Origine in testa al muro (spigolo contro terra)

W peso della striscia espresso in [kN]
 α angolo fra la base della striscia e l'orizzontale espresso in [°] (positivo antiorario)
 ϕ angolo d'attrito del terreno lungo la base della striscia
c coesione del terreno lungo la base della striscia espressa in [kg/cm²]
b larghezza della striscia espressa in [m]
u pressione neutra lungo la base della striscia espressa in [kg/cm²]

Metodo di Fellenius

GENERAL CONTRACTOR  Consorzio Collegamenti Integrati Veloci	ALTA SORVEGLIANZA  GRUPPO FERROVIE DELLO STATO ITALIANE	
IG51-02-E-CV-CL-IN11-0X-001_A00 Relazione di calcolo		Foglio 73 di 84

Numero di cerchi analizzati 36
Numero di strisce 25

Cerchio critico
Coordinate del centro X[m]= -0.60 Y[m]= 0.00
Raggio del cerchio R[m]= 8.13
Ascissa a valle del cerchio Xi[m]= -6.41
Ascissa a monte del cerchio Xs[m]= 7.53
Larghezza della striscia dx[m]= 0.56
Coefficiente di sicurezza C= 1.48
Le strisce sono numerate da monte verso valle

Caratteristiche delle strisce

Striscia	W	$\alpha(^{\circ})$	$W\sin\alpha$	$b/\cos\alpha$	ϕ	c	u
1	2249.81	79.33	2210.90	3.01	35.00	0.000	0.000
2	4585.08	64.15	4126.17	1.28	35.00	0.000	0.000
3	5710.64	56.11	4740.49	1.00	35.00	0.000	0.000
4	6554.03	49.55	4987.78	0.86	35.00	0.000	0.000
5	7219.89	43.80	4997.32	0.77	29.41	0.000	0.000
6	7749.15	38.56	4830.79	0.71	28.00	0.000	0.000
7	8387.14	33.69	4652.23	0.67	28.00	0.000	0.000
8	8853.22	29.08	4302.72	0.64	28.00	0.000	0.000
9	9160.59	24.67	3823.15	0.61	28.00	0.000	0.000
10	9412.22	20.41	3282.05	0.59	27.45	0.016	0.000
11	9622.63	16.26	2694.95	0.58	21.00	0.200	0.000
12	9790.39	12.21	2070.01	0.57	21.00	0.200	0.000
13	10132.56	8.21	1446.99	0.56	21.00	0.200	0.000
14	11174.95	4.25	828.98	0.56	21.00	0.200	0.000
15	4767.49	0.32	26.50	0.56	21.00	0.200	0.000
16	2645.52	-3.62	-166.84	0.56	21.00	0.200	0.000
17	2580.30	-7.57	-339.79	0.56	21.00	0.200	0.000
18	2468.09	-11.56	-494.39	0.57	21.00	0.200	0.000
19	2307.17	-15.60	-620.50	0.58	21.00	0.200	0.000
20	2101.74	-19.73	-709.51	0.59	26.41	0.046	0.000
21	1859.39	-23.97	-755.33	0.61	28.00	0.000	0.000
22	1563.16	-28.35	-742.32	0.63	28.00	0.000	0.000
23	1205.82	-32.93	-655.43	0.66	28.00	0.000	0.000
24	777.82	-37.75	-476.23	0.71	28.00	0.000	0.000
25	264.79	-42.92	-180.33	0.76	28.00	0.000	0.000

$\Sigma W_i = 1305.7133$ [kN]
 $\Sigma W_i \sin\alpha_i = 430.3264$ [kN]
 $\Sigma W_i \cos\alpha_i \tan\phi_i = 533.7851$ [kN]
 $\Sigma c_i b_i / \cos\alpha_i = 103.5699$ [kN]

Sollecitazioni paramento

Combinazione n° 1

L'ordinata Y (espressa in m) è considerata positiva verso il basso con origine in testa al muro
Momento positivo se tende le fibre contro terra (a monte), espresso in kNm
Sforzo normale positivo di compressione, espresso in kN
Taglio positivo se diretto da monte verso valle, espresso in kN

Nr.	Y	N	M	T
1	0.00	0.0000	0.0000	0.0000
2	0.29	2.9512	0.1419	0.9175
3	0.57	6.1048	0.6473	2.2448
4	0.86	9.4608	1.6357	3.9803
5	1.14	13.0191	3.2264	6.1239
6	1.43	16.7799	5.5385	8.6753
7	1.71	20.7430	8.6911	11.6347
8	2.00	24.9085	12.8035	15.0021
9	2.28	29.2765	17.9948	18.7774
10	2.57	33.8468	24.3841	22.9607
11	2.85	38.6195	32.0907	27.5519
12	3.14	43.5946	41.2337	32.5510
13	3.42	48.7721	51.9322	37.9581
14	3.71	54.1519	64.3055	43.7732
15	3.99	59.7342	78.4727	49.9962
16	4.28	65.5188	94.5530	56.6271
17	4.56	71.5059	112.6655	63.6660
18	4.85	77.6953	132.9295	71.1129
19	5.13	84.0871	155.4640	78.9677
20	5.42	90.6813	180.3883	87.2304
21	5.70	97.4779	207.8165	95.8358

GENERAL CONTRACTOR  Consorzio Collegamenti Integrati Veloci	ALTA SORVEGLIANZA  GRUPPO FERROVIE DELLO STATO ITALIANE	
IG51-02-E-CV-CL-IN11-0X-001_A00 Relazione di calcolo		Foglio 74 di 84

Sollecitazioni fondazione di valle

Combinazione n° 1

L'ascissa X (espressa in m) è considerata positiva verso monte con origine in corrispondenza dell'estremo libero della fondazione di valle

Momento positivo se tende le fibre inferiori, espresso in kNm

Taglio positivo se diretto verso l'alto, espresso in kN

Nr.	X	M	T
1	0.00	0.0000	0.0000
2	0.04	0.1161	5.8049
3	0.08	0.4642	11.5980
4	0.12	1.0438	17.3792
5	0.16	1.8544	23.1487
6	0.20	2.8956	28.9063
7	0.24	4.1668	34.6521
8	0.28	5.6676	40.3861
9	0.32	7.3975	46.1082
10	0.36	9.3561	51.8186
11	0.40	11.5428	57.5171

Sollecitazioni fondazione di monte

Combinazione n° 1

L'ascissa X (espressa in m) è considerata positiva verso valle con origine in corrispondenza dell'estremo libero della fondazione di monte

Momento positivo se tende le fibre inferiori, espresso in kNm

Taglio positivo se diretto verso l'alto, espresso in kN

Nr.	X	M	T
1	0.00	0.0000	0.0000
2	0.34	-0.7851	-4.4333
3	0.69	-2.9418	-7.9973
4	1.03	-6.1719	-10.6922
5	1.37	-10.1773	-12.5179
6	1.71	-14.6598	-13.4744
7	2.06	-19.3214	-13.5617
8	2.40	-23.8638	-12.7798
9	2.74	-27.9890	-11.1288
10	3.09	-31.3988	-8.6085
11	3.43	-33.7951	-5.2191

COMBINAZIONE n° 2

Valore della spinta statica	118.9708	[kN]		
Componente orizzontale della spinta statica	110.3395	[kN]		
Componente verticale della spinta statica	44.4888	[kN]		
Punto d'applicazione della spinta	X = 4.00	[m]	Y = -4.62	[m]
Inclinaz. della spinta rispetto alla normale alla superficie	40.32	[%]		
Inclinazione linea di rottura in condizioni statiche	141.73	[%]		

Incremento sismico della spinta	10.7558	[kN]		
Punto d'applicazione dell'incremento sismico di spinta	X = 4.00	[m]	Y = -2.24	[m]
Inclinazione linea di rottura in condizioni sismiche	131.72	[%]		

Peso terrapieno gravante sulla fondazione a monte	423.5100	[kN]		
Baricentro terrapieno gravante sulla fondazione a monte	X = 2.14	[m]	Y = -2.78	[m]
Inerzia del muro	8.7045	[kN]		
Inerzia del terrapieno fondazione di monte	16.9404	[kN]		

Risultanti

Risultante dei carichi applicati in dir. orizzontale	145.9599	[kN]
Risultante dei carichi applicati in dir. verticale	689.6334	[kN]
Momento ribaltante rispetto allo spigolo a valle	356.6684	[kNm]
Momento stabilizzante rispetto allo spigolo a valle	1839.8937	[kNm]
Sforzo normale sul piano di posa della fondazione	689.6334	[kN]
Sforzo tangenziale sul piano di posa della fondazione	145.9599	[kN]
Eccentricità rispetto al baricentro della fondazione	0.25	[m]
Risultante in fondazione	704.9103	[kN]
Inclinazione della risultante (rispetto alla normale)	21.16	[%]
Momento rispetto al baricentro della fondazione	171.8950	[kNm]
Carico ultimo della fondazione	1682.2838	[kN]

Tensioni sul terreno

Lunghezza fondazione reagente	4.80	[m]
Tensione terreno allo spigolo di valle	1.9215	[kg/cm ²]

Tensione terreno allo spigolo di monte

1.0086 [kg/cmq]

Fattori per il calcolo della capacità portante $N_c = 25.80$ $N_q = 14.72$ $N_\gamma = 11.19$ $N'_c = 20.75$ $N'_q = 11.45$ $N'_\gamma = 3.80$ COEFFICIENTI DI SICUREZZA

Coefficiente di sicurezza a ribaltamento

5.16

Coefficiente di sicurezza a scorrimento

1.60

Coefficiente di sicurezza a carico ultimo

2.44

Coefficiente di sicurezza a stabilità globale

1.46

Stabilità globale muro + terreno

Combinazione n° 2

Le ascisse X sono considerate positive verso monte

Le ordinate Y sono considerate positive verso l'alto

Origine in testa al muro (spigolo contro terra)

W peso della striscia espresso in [kN]

 α angolo fra la base della striscia e l'orizzontale espresso in [°] (positivo antiorario) ϕ angolo d'attrito del terreno lungo la base della striscia

c coesione del terreno lungo la base della striscia espressa in [kg/cmq]

b larghezza della striscia espressa in [m]

u pressione neutra lungo la base della striscia espressa in [kg/cmq]

Metodo di Fellenius

Numero di cerchi analizzati 36

Numero di strisce 25

Cerchio critico

Coordinate del centro X[m]= 0.00 Y[m]= 0.60

Raggio del cerchio R[m]= 8.33

Ascissa a valle del cerchio Xi[m]= -5.46

Ascissa a monte del cerchio Xs[m]= 8.31

Larghezza della striscia dx[m]= 0.55

Coefficiente di sicurezza C= 1.46

Le strisce sono numerate da monte verso valle

Caratteristiche delle strisce

Striscia	W	α (°)	$W\sin\alpha$	$b/\cos\alpha$	ϕ	c	u
1	1355.94	77.16	1322.01	2.48	35.00	0.000	0.000
2	3356.32	64.37	3026.16	1.27	35.00	0.000	0.000
3	4468.70	56.55	3728.48	1.00	35.00	0.000	0.000
4	5307.02	50.15	4074.40	0.86	35.00	0.000	0.000
5	5981.57	44.53	4195.06	0.77	35.00	0.000	0.000
6	6532.24	39.42	4148.10	0.71	29.58	0.000	0.000
7	6977.39	34.66	3968.45	0.67	28.00	0.000	0.000
8	7400.80	30.17	3719.11	0.64	28.00	0.000	0.000
9	7954.67	25.87	3470.76	0.61	28.00	0.000	0.000
10	8215.68	21.72	3040.78	0.59	28.00	0.000	0.000
11	8427.59	17.69	2561.39	0.58	28.00	0.000	0.000
12	8594.07	13.75	2043.20	0.57	28.00	0.000	0.000
13	8717.74	9.88	1495.67	0.56	28.00	0.000	0.000
14	8800.44	6.05	927.48	0.55	27.74	0.007	0.000
15	9566.67	2.25	375.15	0.55	21.00	0.200	0.000
16	9074.04	-1.54	-244.64	0.55	21.00	0.200	0.000
17	2299.40	-5.34	-214.15	0.55	26.79	0.035	0.000
18	2040.70	-9.17	-325.11	0.56	28.00	0.000	0.000
19	1925.33	-13.03	-434.14	0.57	28.00	0.000	0.000
20	1767.80	-16.96	-515.62	0.58	28.00	0.000	0.000
21	1565.70	-20.97	-560.30	0.59	28.00	0.000	0.000
22	1315.63	-25.09	-557.90	0.61	28.00	0.000	0.000
23	1012.92	-29.36	-496.60	0.63	28.00	0.000	0.000
24	651.01	-33.81	-362.28	0.66	28.00	0.000	0.000
25	220.55	-38.52	-137.35	0.70	28.00	0.000	0.000

 $\Sigma W_i = 1211.4339$ [kN] $\Sigma W_i \sin\alpha_i = 375.0920$ [kN] $\Sigma W_i \cos\alpha_i \tan\phi_i = 558.1286$ [kN] $\Sigma c_i b_i / \cos\alpha_i = 23.8884$ [kN]

Sollecitazioni paramento

GENERAL CONTRACTOR  Consorzio Collegamenti Integrati Veloci	ALTA SORVEGLIANZA  GRUPPO FERROVIE DELLO STATO ITALIANE	
IG51-02-E-CV-CL-IN11-0X-001_A00 Relazione di calcolo		Foglio 76 di 84

Combinazione n° 2

L'ordinata Y (espressa in m) è considerata positiva verso il basso con origine in testa al muro

Momento positivo se tende le fibre contro terra (a monte), espresso in kNm

Sforzo normale positivo di compressione, espresso in kN

Taglio positivo se diretto da monte verso valle, espresso in kN

Nr.	Y	N	M	T
1	0.00	0.0000	0.0000	0.0000
2	0.29	2.9512	0.1549	1.0041
3	0.57	6.1048	0.6939	2.3893
4	0.86	9.4608	1.7286	4.1556
5	1.14	13.0191	3.3704	6.3029
6	1.43	16.7799	5.7308	8.8313
7	1.71	20.7430	8.9214	11.7407
8	2.00	24.9085	13.0537	15.0313
9	2.28	29.2765	18.2391	18.7028
10	2.57	33.8468	24.5892	22.7555
11	2.85	38.6195	32.2155	27.1892
12	3.14	43.5946	41.2295	32.0040
13	3.42	48.7721	51.7427	37.1998
14	3.71	54.1519	63.8665	42.7767
15	3.99	59.7342	77.7126	48.7346
16	4.28	65.5188	93.3924	55.0737
17	4.56	71.5059	111.0174	61.7938
18	4.85	77.6953	130.6991	68.8949
19	5.13	84.0871	152.5491	76.3771
20	5.42	90.6813	176.6788	84.2404
21	5.70	97.4779	203.1947	92.4195

Sollecitazioni fondazione di valle

Combinazione n° 2

L'ascissa X (espressa in m) è considerata positiva verso monte con origine in corrispondenza dell'estremo libero della fondazione di valle

Momento positivo se tende le fibre inferiori, espresso in kNm

Taglio positivo se diretto verso l'alto, espresso in kN

Nr.	X	M	T
1	0.00	0.0000	0.0000
2	0.04	0.1306	6.5226
3	0.08	0.5214	13.0153
4	0.12	1.1714	19.4783
5	0.16	2.0793	25.9113
6	0.20	3.2439	32.3146
7	0.24	4.6640	38.6879
8	0.28	6.3385	45.0315
9	0.32	8.2662	51.3452
10	0.36	10.4457	57.6290
11	0.40	12.8761	63.8830

Sollecitazioni fondazione di monte

Combinazione n° 2

L'ascissa X (espressa in m) è considerata positiva verso valle con origine in corrispondenza dell'estremo libero della fondazione di monte

Momento positivo se tende le fibre inferiori, espresso in kNm

Taglio positivo se diretto verso l'alto, espresso in kN

Nr.	X	M	T
1	0.00	0.0000	0.0000
2	0.34	-2.2329	-12.6539
3	0.69	-8.4297	-23.1135
4	1.03	-17.8378	-31.3787
5	1.37	-29.7046	-37.4495
6	1.71	-43.2773	-41.3260
7	2.06	-57.8033	-43.0080
8	2.40	-72.5299	-42.4958
9	2.74	-86.7045	-39.7891
10	3.09	-99.5744	-34.8881
11	3.43	-110.3869	-27.7928

GENERAL CONTRACTOR  Consorzio Collegamenti Integrati Veloci	ALTA SORVEGLIANZA  GRUPPO FERROVIE DELLO STATO ITALIANE
	IG51-02-E-CV-CL-IN11-0X-001_A00 Relazione di calcolo
	Foglio 77 di 84

11.2. Muro h=4.00 m

Geometria muro e fondazione

Descrizione

Altezza del paramento	4.00 [m]
Spessore in sommità	0.40 [m]
Spessore all'attacco con la fondazione	0.80 [m]
Inclinazione paramento esterno	0.00 [%]
Inclinazione paramento interno	10.00 [%]
Lunghezza del muro	10.00 [m]

Muro a mensola in c.a.

Fondazione

Lunghezza mensola fondazione di valle	0.40 [m]
Lunghezza mensola fondazione di monte	2.50 [m]
Lunghezza totale fondazione	3.70 [m]
Inclinazione piano di posa della fondazione	0.00 [%]
Spessore fondazione	0.80 [m]
Spessore magrone	0.20 [m]

Materiali utilizzati per la struttura

Calcestruzzo

Peso specifico	25.000 [kN/mc]
Resistenza caratteristica a compressione R_{bk}	250.0 [kg/cm ²]
Tensione ammissibile a compressione σ_c	85.0 [kg/cm ²]
Tensione tangenziale ammissibile τ_{c0}	5.3 [kg/cm ²]
Tensione tangenziale ammissibile τ_{c1}	16.9 [kg/cm ²]

Acciaio

Tipo	FeB44K
Tensione ammissibile σ_{ba}	2600.0 [kg/cm ²]

Geometria profilo terreno a monte del muro

Simbologia adottata e sistema di riferimento

(Sistema di riferimento con origine in testa al muro, ascissa X positiva verso monte, ordinata Y positiva verso l'alto)

N numero ordine del punto
X ascissa del punto espressa in [m]
Y ordinata del punto espressa in [m]
A inclinazione del tratto espressa in [°]

N	X	Y	A
1	10.00	0.00	0.00

Terreno a valle del muro

Inclinazione terreno a valle del muro rispetto all'orizzontale	0.00	[%]
Altezza del rinterro rispetto all'attacco fondaz.valle-paramento	0.00	[m]

Descrizione terreni

Simbologia adottata

Nr.	Indice del terreno
Descrizione	Descrizione terreno
γ	Peso di volume del terreno espresso in [kN/mc]
γ_s	Peso di volume saturo del terreno espresso in [kN/mc]
ϕ	Angolo d'attrito interno espresso in [°]
δ	Angolo d'attrito terra-muro espresso in [°]
c	Coesione espressa in [kg/cm ²]
c_a	Adesione terra-muro espressa in [kg/cm ²]

Descrizione	γ	γ_s	ϕ	δ	c	c_a
Rilevato	20.00	20.00	35.00	23.33	0.000	0.000
F13	19.00	19.00	28.00	18.67	0.000	0.000
fc alterata	21.00	21.00	21.00	14.00	0.200	0.000
fc	21.00	21.00	23.00	15.33	0.300	0.000

Stratigrafia

Simbologia adottata

N	Indice dello strato
H	Spessore dello strato espresso in [m]
a	Inclinazione espressa in [%]
K _w	Costante di Winkler orizzontale espressa in Kg/cm ² /cm
K _s	Coefficiente di spinta
Terreno	Terreno dello strato

Nr.	H	a	K _w	K _s	Terreno
1	4.00	0.00	12.51	0.00	Rilevato
2	3.00	0.00	2.50	0.00	F13
3	2.00	0.00	0.00	0.00	fc alterata
4	4.00	0.00	0.00	0.00	fc

Condizioni di carico

Simbologia e convenzioni di segno adottate

Carichi verticali positivi verso il basso.

Carichi orizzontali positivi verso sinistra.

Momento positivo senso antiorario.

X	Ascissa del punto di applicazione del carico concentrato espressa in [m]
F _x	Componente orizzontale del carico concentrato espressa in [kN]
F _y	Componente verticale del carico concentrato espressa in [kN]
M	Momento espresso in [kNm]
X _i	Ascissa del punto iniziale del carico ripartito espressa in [m]
X _f	Ascissa del punto finale del carico ripartito espressa in [m]
Q _i	Intensità del carico per x=X _i espressa in [kN/m]
Q _f	Intensità del carico per x=X _f espressa in [kN/m]
D / C	Tipo carico : D=distribuito C=concentrato

Condizione n° 1 (Sovraccarico stradale)

D	Profilo	X _i =0.00	X _f =10.00	Q _i =10.0000	Q _f =10.0000
---	---------	----------------------	-----------------------	-------------------------	-------------------------

Descrizione combinazioni di carico

Simbologia adottata

C Coefficiente totale di partecipazione della condizione

Combinazione n° 1 Tensioni ammissibili

	C
Peso proprio	1.00
Spinta terreno	1.00
Sovraccarico stradale	1.00

Combinazione n° 2 Tensioni ammissibili - Sismica

	C
Peso proprio	1.00
Spinta terreno	1.00

Impostazioni di analisi

Metodo verifica sezioni

Tensioni ammissibili

Impostazioni avanzate

Diagramma correttivo per eccentricità negativa con aliquota di parzializzazione pari a 0.00

Quadro riassuntivo coeff. di sicurezza calcolati

Simbologia adottata

C	Identificativo della combinazione
Tipo	Tipo combinazione
Sisma	Combinazione sismica
CS _{SCO}	Coeff. di sicurezza allo scorrimento
CS _{RIB}	Coeff. di sicurezza al ribaltamento
CS _{QLM}	Coeff. di sicurezza a carico limite

GENERAL CONTRACTOR  Consorzio Collegamenti Integrati Veloci	ALTA SORVEGLIANZA  GRUPPO FERROVIE DELLO STATO ITALIANE	
IG51-02-E-CV-CL-IN11-0X-001_A00 Relazione di calcolo		Foglio 79 di 84

CS_{STAB} Coeff. di sicurezza a stabilità globale

C	Tipo	Sisma	CS_{SCO}	CS_{rib}	CS_{qim}	CS_{stab}
1	TAMM - [2]	--	2.01	7.72	3.26	1.43
2	TAMM - [3]	Orizzontale	1.66	5.84	2.92	1.44

Analisi della spinta e verifiche

Sistema di riferimento adottato per le coordinate :

Origine in testa al muro (spigolo di monte)

Ascisse X (esprese in [m]) positive verso monte

Ordinate Y (esprese in [m]) positive verso l'alto

Le forze orizzontali sono considerate positive se agenti da monte verso valle

Le forze verticali sono considerate positive se agenti dall'alto verso il basso

Calcolo riferito ad 1 metro di muro

Tipo di analisi

Calcolo della spinta

metodo di Culmann

Calcolo del carico limite

metodo di Meyerhof

Calcolo della stabilità globale

metodo di Fellenius

Calcolo della spinta in condizioni di

Spinta attiva

Sisma

Coefficiente di intensità sismica (percento)

4.00

Forma diagramma incremento sismico

Triangolare con vertice in basso

Partecipazione spinta passiva (percento)

0.0

Lunghezza del muro

10.00 [m]

Peso muro

134.0000 [kN]

Baricentro del muro

X=0.54 Y=-3.42

Superficie di spinta

Punto inferiore superficie di spinta

X = 2.90 Y = -4.80

Punto superiore superficie di spinta

X = 2.90 Y = 0.00

Altezza della superficie di spinta

4.80 [m]

Inclinazione superficie di spinta(rispetto alla verticale)

0.00 [%]

COMBINAZIONE n° 1

Valore della spinta statica

73.8512 [kN]

Componente orizzontale della spinta statica

68.5055 [kN]

Componente verticale della spinta statica

27.5860 [kN]

Punto d'applicazione della spinta

X = 2.90 [m]

Y = -3.18 [m]

Inclinaz. della spinta rispetto alla normale alla superficie

40.27 [%]

Inclinazione linea di rottura in condizioni statiche

141.73 [%]

Peso terrapieno gravante sulla fondazione a monte

245.0000 [kN]

Baricentro terrapieno gravante sulla fondazione a monte

X = 1.55 [m]

Y = -1.95 [m]

Risultanti

Risultante dei carichi applicati in dir. orizzontale

68.5055 [kN]

Risultante dei carichi applicati in dir. verticale

406.5860 [kN]

Momento ribaltante rispetto allo spigolo a valle

110.9624 [kNm]

Momento stabilizzante rispetto allo spigolo a valle

856.7798 [kNm]

Sforzo normale sul piano di posa della fondazione

406.5860 [kN]

Sforzo tangenziale sul piano di posa della fondazione

68.5055 [kN]

Eccentricità rispetto al baricentro della fondazione

0.02 [m]

Risultante in fondazione

412.3168 [kN]

Inclinazione della risultante (rispetto alla normale)

16.85 [%]

Momento rispetto al baricentro della fondazione

6.3667 [kNm]

Carico ultimo della fondazione

1327.3247 [kN]

Tensioni sul terreno

Lunghezza fondazione reagente

3.70 [m]

Tensione terreno allo spigolo di valle

1.1490 [kg/cm²]

Tensione terreno allo spigolo di monte

1.0921 [kg/cm²]

Fattori per il calcolo della capacità portante

$N_c = 25.80$

$N_c^* = 22.09$

$N_q = 14.72$

$N_q^* = 12.18$

$N_\gamma = 11.19$

$N_\gamma^* = 5.03$

COEFFICIENTI DI SICUREZZA

Coefficiente di sicurezza a ribaltamento	7.72
Coefficiente di sicurezza a scorrimento	2.01
Coefficiente di sicurezza a carico ultimo	3.26
Coefficiente di sicurezza a stabilità globale	1.43

Stabilità globale muro + terreno

Combinazione n° 1

Le ascisse X sono considerate positive verso monte

Le ordinate Y sono considerate positive verso l'alto

Origine in testa al muro (spigolo contro terra)

W	peso della striscia espresso in [kN]
α	angolo fra la base della striscia e l'orizzontale espresso in [°] (positivo antiorario)
ϕ	angolo d'attrito del terreno lungo la base della striscia
c	coesione del terreno lungo la base della striscia espressa in [kg/cmq]
b	larghezza della striscia espressa in [m]
u	pressione neutra lungo la base della striscia espressa in [kg/cmq]

Metodo di Fellenius

Numero di cerchi analizzati 36

Numero di strisce 25

Cerchio critico

Coordinate del centro X[m]= -0.87 Y[m]= 0.00

Raggio del cerchio R[m]= 6.11

Ascissa a valle del cerchio Xi[m]= -5.50

Ascissa a monte del cerchio Xs[m]= 5.23

Larghezza della striscia dx[m]= 0.43

Coefficiente di sicurezza C= 1.43

Le strisce sono numerate da monte verso valle

Caratteristiche delle strisce

Striscia	W	$\alpha(^{\circ})$	$W\sin\alpha$	$b/\cos\alpha$	ϕ	c	u
1	1422.14	79.19	1396.92	2.29	35.00	0.000	0.000
2	2788.72	63.82	2502.59	0.97	35.00	0.000	0.000
3	3446.07	55.67	2845.92	0.76	35.00	0.000	0.000
4	3934.96	49.03	2970.97	0.65	31.53	0.000	0.000
5	4310.82	43.19	2950.44	0.59	28.00	0.000	0.000
6	4719.91	37.87	2897.72	0.54	28.00	0.000	0.000
7	5054.40	32.92	2747.06	0.51	28.00	0.000	0.000
8	5267.12	28.24	2491.84	0.49	28.00	0.000	0.000
9	5442.49	23.75	2191.75	0.47	28.00	0.000	0.000
10	5584.67	19.41	1856.01	0.46	28.00	0.000	0.000
11	5696.58	15.19	1492.38	0.44	28.00	0.000	0.000
12	6057.11	11.05	1160.68	0.44	28.00	0.000	0.000
13	6399.06	6.97	776.03	0.43	28.00	0.000	0.000
14	2488.74	2.92	126.73	0.43	28.00	0.000	0.000
15	1758.21	-1.11	-34.15	0.43	28.00	0.000	0.000
16	1727.71	-5.15	-155.10	0.43	28.00	0.000	0.000
17	1682.66	-9.21	-269.43	0.43	28.00	0.000	0.000
18	1611.42	-13.33	-371.40	0.44	28.00	0.000	0.000
19	1512.83	-17.51	-455.11	0.45	28.00	0.000	0.000
20	1385.17	-21.79	-514.17	0.46	28.00	0.000	0.000
21	1225.95	-26.20	-541.35	0.48	28.00	0.000	0.000
22	1031.71	-30.80	-528.21	0.50	28.00	0.000	0.000
23	797.43	-35.62	-464.42	0.53	28.00	0.000	0.000
24	515.70	-40.76	-336.68	0.57	28.00	0.000	0.000
25	174.81	-46.34	-126.46	0.62	28.00	0.000	0.000

$\Sigma W_i = 745.6741$ [kN]

$\Sigma W_i \sin\alpha_i = 241.3508$ [kN]

$\Sigma W_i \cos\alpha_i \tan\phi_i = 346.0807$ [kN]

$\Sigma c_i b_i / \cos\alpha_i = 0.0000$ [kN]

Sollecitazioni paramento

Combinazione n° 1

L'ordinata Y (espressa in m) è considerata positiva verso il basso con origine in testa al muro

Momento positivo se tende le fibre contro terra (a monte), espresso in kNm

Sforzo normale positivo di compressione, espresso in kN

Taglio positivo se diretto da monte verso valle, espresso in kN

Nr.	Y	N	M	T
1	0.00	0.0000	0.0000	0.0000
2	0.20	2.0498	0.0669	0.6005
3	0.40	4.1993	0.2952	1.4038
4	0.60	6.4485	0.7264	2.4083
5	0.80	8.7973	1.4017	3.6136
6	1.00	11.2459	2.3622	5.0199
7	1.20	13.7940	3.6491	6.6271
8	1.40	16.4419	5.3037	8.4352
9	1.60	19.1894	7.3670	10.4442
10	1.80	22.0366	9.8803	12.6541
11	2.00	24.9834	12.8848	15.0648
12	2.20	28.0300	16.4216	17.6765
13	2.40	31.1761	20.5320	20.4891
14	2.60	34.4220	25.2571	23.5025
15	2.80	37.7675	30.6380	26.7169
16	3.00	41.2127	36.7160	30.1322
17	3.20	44.7576	43.5323	33.7483
18	3.40	48.4021	51.1281	37.5654
19	3.60	52.1463	59.5444	41.5833
20	3.80	55.9902	68.8226	45.8022
21	4.00	59.9337	79.0020	50.1898

Sollecitazioni fondazione di valle

Combinazione n° 1

L'ascissa X (espressa in m) è considerata positiva verso monte con origine in corrispondenza dell'estremo libero della fondazione di valle

Momento positivo se tende le fibre inferiori, espresso in kNm

Taglio positivo se diretto verso l'alto, espresso in kN

Nr.	X	M	T
1	0.00	0.0000	0.0000
2	0.04	0.0741	3.7059
3	0.08	0.2964	7.4094
4	0.12	0.6669	11.1106
5	0.16	1.1853	14.8092
6	0.20	1.8516	18.5055
7	0.24	2.6657	22.1994
8	0.28	3.6275	25.8908
9	0.32	4.7369	29.5799
10	0.36	5.9938	33.2665
11	0.40	7.3982	36.9507

Sollecitazioni fondazione di monte

Combinazione n° 1

L'ascissa X (espressa in m) è considerata positiva verso valle con origine in corrispondenza dell'estremo libero della fondazione di monte

Momento positivo se tende le fibre inferiori, espresso in kNm

Taglio positivo se diretto verso l'alto, espresso in kN

Nr.	X	M	T
1	0.00	0.0000	0.0000
2	0.25	-0.0868	-0.6784
3	0.50	-0.3314	-1.2626
4	0.75	-0.7102	-1.7525
5	1.00	-1.1997	-2.1481
6	1.25	-1.7764	-2.4495
7	1.50	-2.4166	-2.6566
8	1.75	-3.0968	-2.7694
9	2.00	-3.7935	-2.7879
10	2.25	-4.4829	-2.7122
11	2.50	-5.1417	-2.5422

COMBINAZIONE n° 2

Valore della spinta statica	61.5155	[kN]		
Componente orizzontale della spinta statica	57.1066	[kN]		
Componente verticale della spinta statica	22.8689	[kN]		
Punto d'applicazione della spinta	X = 2.90	[m]	Y = -3.31	[m]
Inclinaz. della spinta rispetto alla normale alla superficie	40.05	[%]		
Inclinazione linea di rottura in condizioni statiche	141.73	[%]		
Incremento sismico della spinta	5.5408	[kN]		
Punto d'applicazione dell'incremento sismico di spinta	X = 2.90	[m]	Y = -1.60	[m]

GENERAL CONTRACTOR  Consorzio Collegamenti Integrati Veloci	ALTA SORVEGLIANZA  GRUPPO FERROVIE DELLO STATO ITALIANE	
IG51-02-E-CV-CL-IN11-0X-001_A00 Relazione di calcolo		Foglio 82 di 84

Inclinazione linea di rottura in condizioni sismiche	131.72	[%]		
Peso terrapieno gravante sulla fondazione a monte	216.0000	[kN]		
Baricentro terrapieno gravante sulla fondazione a monte	X = 1.55	[m]	Y = -1.95	[m]
Inerzia del muro	5.3600	[kN]		
Inerzia del terrapieno fondazione di monte	8.6400	[kN]		

Risultanti

Risultante dei carichi applicati in dir. orizzontale	76.2503	[kN]
Risultante dei carichi applicati in dir. verticale	374.9287	[kN]
Momento ribaltante rispetto allo spigolo a valle	133.3066	[kNm]
Momento stabilizzante rispetto allo spigolo a valle	778.8695	[kNm]
Sforzo normale sul piano di posa della fondazione	374.9287	[kN]
Sforzo tangenziale sul piano di posa della fondazione	76.2503	[kN]
Eccentricità rispetto al baricentro della fondazione	0.13	[m]
Risultante in fondazione	382.6038	[kN]
Inclinazione della risultante (rispetto alla normale)	20.34	[%]
Momento rispetto al baricentro della fondazione	48.0551	[kNm]
Carico ultimo della fondazione	1094.8542	[kN]

Tensioni sul terreno

Lunghezza fondazione reagente	3.70	[m]
Tensione terreno allo spigolo di valle	1.2480	[kg/cm ²]
Tensione terreno allo spigolo di monte	0.8185	[kg/cm ²]

Fattori per il calcolo della capacità portante

$N_c = 25.80$	$N'_c = 21.05$
$N_q = 14.72$	$N'_q = 11.60$
$N_\gamma = 11.19$	$N'_\gamma = 4.03$

COEFFICIENTI DI SICUREZZA

Coefficiente di sicurezza a ribaltamento	5.84
Coefficiente di sicurezza a scorrimento	1.66
Coefficiente di sicurezza a carico ultimo	2.92
Coefficiente di sicurezza a stabilità globale	1.44

Stabilità globale muro + terreno

Combinazione n° 2

Le ascisse X sono considerate positive verso monte
Le ordinate Y sono considerate positive verso l'alto
Origine in testa al muro (spigolo contro terra)

W peso della striscia espresso in [kN]
 α angolo fra la base della striscia e l'orizzontale espresso in [°] (positivo antiorario)
 ϕ angolo d'attrito del terreno lungo la base della striscia
c coesione del terreno lungo la base della striscia espressa in [kg/cm²]
b larghezza della striscia espressa in [m]
u pressione neutra lungo la base della striscia espressa in [kg/cm²]

Metodo di Fellenius

Numero di cerchi analizzati 36
Numero di strisce 25

Cerchio critico

Coordinate del centro X[m]= -0.87 Y[m]= 0.44
Raggio del cerchio R[m]= 6.45
Ascissa a valle del cerchio Xi[m]= -5.57
Ascissa a monte del cerchio Xs[m]= 5.57
Larghezza della striscia dx[m]= 0.45
Coefficiente di sicurezza C= 1.44
Le strisce sono numerate da monte verso valle

Caratteristiche delle strisce

Striscia	W	$\alpha(^{\circ})$	$W\sin\alpha$	$b/\cos\alpha$	ϕ	c	u
1	884.45	77.10	862.11	2.00	35.00	0.000	0.000
2	2181.58	63.85	1958.22	1.01	35.00	0.000	0.000
3	2892.76	55.83	2393.35	0.79	35.00	0.000	0.000
4	3426.58	49.27	2596.64	0.68	34.62	0.000	0.000
5	3843.43	43.51	2646.01	0.61	28.00	0.000	0.000
6	4179.48	38.26	2587.96	0.57	28.00	0.000	0.000
7	4645.38	33.37	2555.02	0.53	28.00	0.000	0.000
8	4879.26	28.74	2346.21	0.51	28.00	0.000	0.000
9	5072.95	24.31	2088.61	0.49	28.00	0.000	0.000
10	5230.99	20.03	1792.07	0.47	28.00	0.000	0.000
11	5356.58	15.87	1464.86	0.46	28.00	0.000	0.000
12	5538.24	11.79	1131.78	0.46	28.00	0.000	0.000
13	6354.13	7.77	859.40	0.45	28.00	0.000	0.000

GENERAL CONTRACTOR  Consorzio Collegamenti Integrati Veloci	ALTA SORVEGLIANZA  GRUPPO FERROVIE DELLO STATO ITALIANE	
IG51-02-E-CV-CL-IN11-0X-001_A00 Relazione di calcolo		Foglio 83 di 84

14	3762.94	3.79	248.90	0.45	28.00	0.000	0.000
15	1803.29	-0.17	-5.34	0.45	28.00	0.000	0.000
16	1725.14	-4.13	-124.32	0.45	28.00	0.000	0.000
17	1683.78	-8.12	-237.70	0.45	28.00	0.000	0.000
18	1614.92	-12.14	-339.58	0.46	28.00	0.000	0.000
19	1517.50	-16.22	-423.97	0.46	28.00	0.000	0.000
20	1389.90	-20.40	-484.39	0.48	28.00	0.000	0.000
21	1229.84	-24.69	-513.62	0.49	28.00	0.000	0.000
22	1034.07	-29.13	-503.36	0.51	28.00	0.000	0.000
23	798.03	-33.78	-443.66	0.54	28.00	0.000	0.000
24	515.09	-38.69	-322.00	0.57	28.00	0.000	0.000
25	175.13	-43.98	-121.60	0.62	28.00	0.000	0.000

$\Sigma W_i = 703.4956$ [kN]
 $\Sigma W_i \sin \alpha_i = 215.8636$ [kN]
 $\Sigma W_i \cos \alpha_i \tan \phi_i = 332.1551$ [kN]
 $\Sigma c_i b_i / \cos \alpha_i = 0.0000$ [kN]

Sollecitazioni paramento

Combinazione n° 2

L'ordinata Y (espressa in m) è considerata positiva verso il basso con origine in testa al muro
Momento positivo se tende le fibre contro terra (a monte), espresso in kNm
Sforzo normale positivo di compressione, espresso in kN
Taglio positivo se diretto da monte verso valle, espresso in kN

Nr.	Y	N	M	T
1	0.00	0.0000	0.0000	0.0000
2	0.20	2.0498	0.0589	0.5184
3	0.40	4.1993	0.2613	1.2244
4	0.60	6.4485	0.6458	2.1180
5	0.80	8.7973	1.2508	3.1994
6	1.00	11.2459	2.1149	4.4683
7	1.20	13.7940	3.2767	5.9250
8	1.40	16.4419	4.7747	7.5693
9	1.60	19.1894	6.6474	9.4013
10	1.80	22.0366	8.9333	11.4209
11	2.00	24.9834	11.6710	13.6282
12	2.20	28.0300	14.8991	16.0231
13	2.40	31.1761	18.6560	18.6057
14	2.60	34.4220	22.9803	21.3759
15	2.80	37.7675	27.9105	24.3339
16	3.00	41.2127	33.4852	27.4794
17	3.20	44.7576	39.7428	30.8127
18	3.40	48.4021	46.7220	34.3335
19	3.60	52.1463	54.4613	38.0421
20	3.80	55.9902	62.9992	41.9383
21	4.00	59.9337	72.3725	45.9900

Sollecitazioni fondazione di valle

Combinazione n° 2

L'ascissa X (espressa in m) è considerata positiva verso monte con origine in corrispondenza dell'estremo libero della fondazione di valle
Momento positivo se tende le fibre inferiori, espresso in kNm
Taglio positivo se diretto verso l'alto, espresso in kN

Nr.	X	M	T
1	0.00	0.0000	0.0000
2	0.04	0.0818	4.0866
3	0.08	0.3267	8.1550
4	0.12	0.7340	12.2053
5	0.16	1.3029	16.2372
6	0.20	2.0327	20.2510
7	0.24	2.9227	24.2466
8	0.28	3.9722	28.2239
9	0.32	5.1804	32.1830
10	0.36	6.5466	36.1239
11	0.40	8.0700	40.0466

Sollecitazioni fondazione di monte

Combinazione n° 2

L'ascissa X (espressa in m) è considerata positiva verso valle con origine in corrispondenza dell'estremo libero della fondazione di monte



Momento positivo se tende le fibre inferiori, espresso in kNm
Taglio positivo se diretto verso l'alto, espresso in kN

Nr.	X	M	T
1	0.00	0.0000	0.0000
2	0.25	-0.5869	-4.5766
3	0.50	-2.2290	-8.4416
4	0.75	-4.7484	-11.5951
5	1.00	-7.9672	-14.0371
6	1.25	-11.7076	-15.7675
7	1.50	-15.7917	-16.7864
8	1.75	-20.0415	-17.0937
9	2.00	-24.2793	-16.6896
10	2.25	-28.3270	-15.5739
11	2.50	-32.0069	-13.7466

COMMITTENTE:



ALTA SORVEGLIANZA:



GENERAL CONTRACTOR:



INFRASTRUTTURE FERROVIARIE STRATEGICHE DEFINITE DALLA LEGGE OBIETTIVO N. 443/01

**TRATTA A.V. /A.C. TERZO VALICO DEI GIOVI
PROGETTO ESECUTIVO**

Sistemazione idraulica Fosso Rio Pradella

Relazione di calcolo ALLEGATI

GENERAL CONTRACTOR	DIRETTORE DEI LAVORI
Consorzio Cociv Ing.P.P.Marcheselli	

COMMESSA	LOTTO	FASE	ENTE	TIPO DOC.	OPERA/DISCIPLINA	PROGR.	REV.
I G 5 1	0 2	E	C V	C L	I N 1 1 0 X	0 0 1	A

Progettazione :

Rev	Descrizione	Redatto	Data	Verificato	Data	Progettista Integratore	Data	IL PROGETTISTA
A00	Prima Emissione	ALPINA <i>Adriano Fava</i>	27/09/2013	COCIV <i>[Signature]</i>	27/09/2013	A. Palomba <i>[Signature]</i>	30/09/2013	 Consorzio Collegamenti Integrati Veloci Dott. Ing. Aldo Mancarella Ordine Ingegneri Prov. TO n. 6271 R

n. Elab.:	File: IG51-02-E-CV-CL-IN11-0X-001-A00-ALLEGATI
-----------	--

GENERAL CONTRACTOR 	ALTA SORVEGLIANZA 
	IG51-02-E-CV-CL-IN11-0X-001_A00 Relazione di calcolo
	Foglio 3 di 929

INDICE

INDICE.....		3
1. TABULATI DI CALCOLO		5
1.1. Dati di input scatolare – caso A		5
1.2. Dati di output scatolare – Caso A		16
1.1. Dati di input scatolare – caso B e C		312
1.2. Dati di output scatolare – Caso B e C		323
1.3. Dati di input scatolare – caso D		647
1.4. Dati di output scatolare – Caso D		659

GENERAL CONTRACTOR



ALTA SORVEGLIANZA



IG51-02-E-CV-CL-IN11-0X-001_A00
Relazione di calcolo

Foglio
4 di 929

<p>GENERAL CONTRACTOR</p>  <p>Consorzio Collegamenti Integrati Veloci</p>	<p>ALTA SORVEGLIANZA</p>  <p>GRUPPO FERROVIE DELLO STATO ITALIANE</p>
<p>IG51-02-E-CV-CL-IN11-0X-001_A00 Relazione di calcolo</p>	
<p>Foglio 5 di 929</p>	

1. TABULATI DI CALCOLO

1.1. Dati di input scatolare – caso A

File D:\13_15_COCIV\01_Calcoli\IN11\giorgio\IN11_situazione1-input.txt was saved on 9/17/13 at 11.02.40

TABLE: "PROGRAM CONTROL"

ProgramName=SAP2000 Version=15.0.0 ProgLevel=Ultimate LicenseNum=266BC LicenseOS=Yes LicenseSC=Yes
LicenseBR=No LicenseHT=No CurrUnits="KN, m, C" SteelCode=AISC-ASD89 ConcCode="ACI 318-99" AlumCode="AA-ASD
2000" _
ColdCode=AISI-ASD96 BridgeCode="AASHTO LRFD 2007" RegenHinge=No

TABLE: "ACTIVE DEGREES OF FREEDOM"

UX=Yes UY=Yes UZ=Yes RX=Yes RY=Yes RZ=Yes

TABLE: "ANALYSIS OPTIONS"

Solver=Advanced SolverProc=Auto Force32Bit=No StiffCase=None GeomMod=No

TABLE: "COORDINATE SYSTEMS"

Name=GLOBAL Type=Cartesian X=0 Y=0 Z=0 AboutZ=0 AboutY=0 AboutX=0

TABLE: "GRID LINES"

CoordSys=GLOBAL AxisDir=X XXYZCoord=-2.5 LineType=Primary LineColor=Gray4 Visible=Yes BubbleLoc=End
AllVisible=Yes BubbleSize=1
CoordSys=GLOBAL AxisDir=X XXYZCoord=-2.25 LineType=Primary LineColor=Gray4 Visible=Yes BubbleLoc=End
CoordSys=GLOBAL AxisDir=X XXYZCoord=-2 LineType=Primary LineColor=Gray4 Visible=Yes BubbleLoc=End
CoordSys=GLOBAL AxisDir=X XXYZCoord=0 LineType=Primary LineColor=Gray4 Visible=Yes BubbleLoc=End
CoordSys=GLOBAL AxisDir=X XXYZCoord=2 LineType=Primary LineColor=Gray4 Visible=Yes BubbleLoc=End
CoordSys=GLOBAL AxisDir=X XXYZCoord=2.25 LineType=Primary LineColor=Gray4 Visible=Yes BubbleLoc=End
CoordSys=GLOBAL AxisDir=X XXYZCoord=2.5 LineType=Primary LineColor=Gray4 Visible=Yes BubbleLoc=End
CoordSys=GLOBAL AxisDir=Y XXYZCoord=0 LineType=Primary LineColor=Gray4 Visible=Yes BubbleLoc=End
CoordSys=GLOBAL AxisDir=Z XXYZCoord=0 LineType=Primary LineColor=Gray8Dark Visible=Yes BubbleLoc=End
CoordSys=GLOBAL AxisDir=Z XXYZCoord=0.25 LineType=Primary LineColor=Gray8Dark Visible=Yes
BubbleLoc=End
CoordSys=GLOBAL AxisDir=Z XXYZCoord=0.5 LineType=Primary LineColor=Gray8Dark Visible=Yes
BubbleLoc=End
CoordSys=GLOBAL AxisDir=Z XXYZCoord=3.5 LineType=Primary LineColor=Gray8Dark Visible=Yes
BubbleLoc=End
CoordSys=GLOBAL AxisDir=Z XXYZCoord=3.75 LineType=Primary LineColor=Gray8Dark Visible=Yes
BubbleLoc=End
CoordSys=GLOBAL AxisDir=Z XXYZCoord=4 LineType=Primary LineColor=Gray8Dark Visible=Yes BubbleLoc=End

TABLE: "MATERIAL PROPERTIES 01 - GENERAL"

Material=A416Gr270 Type=Tendon SymType=Uniaxial TempDepend=No Color=Blue Notes="ASTM A416 Grade 270
added 30/07/2013 14.54.57"
Material=A615Gr60 Type=Rebar SymType=Uniaxial TempDepend=No Color=Red Notes="ASTM A615 Grade 60 added
04/07/2013 15.33.53"
Material=CONC Type=Concrete SymType=Isotropic TempDepend=No Color=Black Notes="Normalweight f'c = 4 ksi
added 04/07/2013 15.33.53"
Material=OTHER Type=Other SymType=Isotropic TempDepend=No Color=Black Notes="Material added 04/07/2013
15.33.53"
Material=REBAR Type=Rebar SymType=Uniaxial TempDepend=No Color=Red Notes="ASTM A615 Grade 60 added
04/07/2013 15.33.53"
Material=STEEL Type=Steel SymType=Isotropic TempDepend=No Color=Black Notes="ASTM A36 added 04/07/2013
15.33.53"

TABLE: "MATERIAL PROPERTIES 02 - BASIC MECHANICAL PROPERTIES"

Material=A416Gr270 UnitWeight=76.9728639422648 UnitMass=7.84904737995992 E1=196500599.8512 A1=0.0000117
Material=A615Gr60 UnitWeight=76.9728639422648 UnitMass=7.84904737995992 E1=199947978.795958 A1=0.0000117
Material=CONC UnitWeight=25 UnitMass=2.5 E1=36049965 G12=15673897.826087 U12=0.15
A1=9.89999989542412E-06
Material=OTHER UnitWeight=23.5616130828857 UnitMass=2.40067982673645 E1=24821126 G12=10342135.8076484
U12=0.20000002980232 A1=9.89999989542412E-06
Material=REBAR UnitWeight=76.9728639422648 UnitMass=7.84904737995992 E1=199947978.795958 A1=0.0000117
Material=STEEL UnitWeight=76.8195419311523 UnitMass=7.82709980010986 E1=199947968 G12=76903063.9101877
U12=0.300000011920929 A1=1.1699999049597E-05

TABLE: "MATERIAL PROPERTIES 03A - STEEL DATA"

Material=STEEL Fy=248211.265625 Fu=310264.08203125 EffFy=372316.8984375 EffFu=341290.490234375
SSCurveOpt="User Defined" SSHysType=Kinematic

TABLE: "MATERIAL PROPERTIES 03B - CONCRETE DATA"

Material=CONC Fc=27579 LtWtConc=No SSCurveOpt="User Defined" SSHysType=Kinematic FAngle=0 DAngle=0

TABLE: "MATERIAL PROPERTIES 03E - REBAR DATA"

<p>GENERAL CONTRACTOR</p>  <p>Consorzio Collegamenti Integrati Veloci</p>	<p>ALTA SORVEGLIANZA</p>  <p>GRUPPO FERROVIE DELLO STATO ITALIANE</p>	
<p>IG51-02-E-CV-CL-IN11-0X-001_A00 Relazione di calcolo</p>		<p>Foglio 6 di 929</p>

Material=A615Gr60 Fy=413685.473370947 Fu=620528.21005642 EffFy=455054.020708041 EffFu=682581.031062062
SSCurveOpt=Simple SSHysType=Kinematic SHard=0.01 SCap=0.09 FinalSlope=-0.1 UseCTDef=No
Material=REBAR Fy=275790 Fu=413685 EffFy=303369 EffFu=455053.5 SSCurveOpt=Simple SSHysType=Kinematic
SHard=0.01 SCap=0.09 FinalSlope=-0.1 UseCTDef=No

TABLE: "MATERIAL PROPERTIES 03F - TENDON DATA"
Material=A416Gr270 Fy=1689905.15872032 Fu=1861584.63016926 SSCurveOpt="270 ksi" SSHysType=Kinematic
FinalSlope=-0.1

TABLE: "MATERIAL PROPERTIES 03G - OTHER DATA"
Material=OTHER SSHysType=Elastic FAngle=0 DAngle=0

TABLE: "MATERIAL PROPERTIES 04 - USER STRESS-STRAIN CURVES"

Material=CONC	Point=1	Strain=-4.32412541870706E-02	Stress=0	PointID=-E
Material=CONC	Point=2	Strain=-3.02688779309494E-02	Stress=-206842.736685473	PointID=-D
Material=CONC	Point=3	Strain=-1.72965016748283E-02	Stress=-413685.473370947	PointID=-C
Material=CONC	Point=4	Strain=-1.78929327670637E-03	Stress=-413685.473370947	PointID=-B
Material=CONC	Point=5	Strain=0	Stress=0	PointID=A
Material=CONC	Point=6	Strain=1.78929327670637E-03	Stress=413685.473370947	PointID=B
Material=CONC	Point=7	Strain=1.72965016748283E-02	Stress=413685.473370947	
Material=CONC	Point=8	Strain=4.32412541870706E-02	Stress=517106.841713683	PointID=C
Material=CONC	Point=9	Strain=0.069186006699313	Stress=517106.841713683	PointID=D
Material=CONC	Point=10	Strain=8.64825083741413E-02	Stress=413685.473370947	PointID=E
Material=OTHER	Point=1	Strain=-4.02882608951745E-08	Stress=-1	
Material=OTHER	Point=2	Strain=0	Stress=0	PointID=A
Material=OTHER	Point=3	Strain=4.02882608951745E-08	Stress=1	
Material=STEEL	Point=1	Strain=-0.05	Stress=0	PointID=-E
Material=STEEL	Point=2	Strain=-0.035	Stress=-124105.642011284	PointID=-D
Material=STEEL	Point=3	Strain=-0.02	Stress=-248211.284022568	PointID=-C
Material=STEEL	Point=4	Strain=-1.24137931034483E-03	Stress=-248211.284022568	PointID=-B
Material=STEEL	Point=5	Strain=0	Stress=0	PointID=A
Material=STEEL	Point=6	Strain=1.24137931034483E-03	Stress=248211.284022568	PointID=B
Material=STEEL	Point=7	Strain=0.02	Stress=248211.284022568	
Material=STEEL	Point=8	Strain=0.05	Stress=399895.957591915	PointID=C
Material=STEEL	Point=9	Strain=0.08	Stress=399895.957591915	PointID=D
Material=STEEL	Point=10	Strain=0.1	Stress=248211.284022568	PointID=E

TABLE: "MATERIAL PROPERTIES 06 - DAMPING PARAMETERS"

Material=A416Gr270	ModalRatio=0	VisMass=0	VisStiff=0	HysMass=0	HysStiff=0
Material=A615Gr60	ModalRatio=0	VisMass=0	VisStiff=0	HysMass=0	HysStiff=0
Material=CONC	ModalRatio=0	VisMass=0	VisStiff=0	HysMass=0	HysStiff=0
Material=OTHER	ModalRatio=0	VisMass=0	VisStiff=0	HysMass=0	HysStiff=0
Material=REBAR	ModalRatio=0	VisMass=0	VisStiff=0	HysMass=0	HysStiff=0
Material=STEEL	ModalRatio=0	VisMass=0	VisStiff=0	HysMass=0	HysStiff=0

TABLE: "FRAME SECTION PROPERTIES 01 - GENERAL"

SectionName=1000x1000 Material=CONC Shape=Rectangular t3=1 t2=1 Area=1 TorsConst=0.1408333333333333
I33=8.33333333333333E-02 I22=8.33333333333333E-02 AS2=0.833333333333333 AS3=0.833333333333333
S33=0.166666666666667
S22=0.166666666666667 Z33=0.25 Z22=0.25 R33=0.288675134594813 R22=0.288675134594813 ConcCol=No
ConcBeam=Yes Color=8421440 TotalWt=449.999997019768 TotalMass=44.9999997019768 FromFile=No AMod=1
A2Mod=1
A3Mod=1 JMod=1 I2Mod=1 I3Mod=1 MMod=1 WMod=1

TABLE: "FRAME SECTION PROPERTIES 03 - CONCRETE BEAM"

SectionName=1000x1000 RebarMatL=A615Gr60 RebarMatC=REBAR TopCover=0 BotCover=0 TopLeftArea=0
TopRghtArea=0 BotLeftArea=0 BotRghtArea=0

TABLE: "LOAD PATTERN DEFINITIONS"

LoadPat=PESOPR	DesignType=DEAD	SelfWtMult=1
LoadPat=TERRVERT	DesignType=OTHER	SelfWtMult=0
LoadPat=TERRLAT	DesignType=OTHER	SelfWtMult=0
LoadPat=ACCVERT	DesignType=OTHER	SelfWtMult=0
LoadPat=ACCLATDX	DesignType=OTHER	SelfWtMult=0
LoadPat=ACCLATSX	DesignType=OTHER	SelfWtMult=0

TABLE: "CONSTRAINT DEFINITIONS - BEAM"

Name=BEAM1 CoordSys=GLOBAL Axis=Auto

TABLE: "CONSTRAINT DEFINITIONS - BODY"

Name=BODY1 CoordSys=GLOBAL UX=Yes UY=Yes UZ=Yes RX=Yes RY=Yes RZ=Yes

TABLE: "CONSTRAINT DEFINITIONS - DIAPHRAGM"

Name=DIAPH1 CoordSys=GLOBAL Axis=Z MultiLevel=No

TABLE: "CONSTRAINT DEFINITIONS - EQUAL"

Name=EQUAL1 CoordSys=GLOBAL UX=Yes UY=Yes UZ=Yes RX=Yes RY=Yes RZ=Yes

TABLE: "CONSTRAINT DEFINITIONS - LOCAL"

Name=LOCAL1 U1=Yes U2=Yes U3=Yes R1=Yes R2=Yes R3=Yes

TABLE: "CONSTRAINT DEFINITIONS - PLATE"



Name=PLATE1 CoordSys=GLOBAL Axis=Auto

TABLE: "CONSTRAINT DEFINITIONS - ROD"

Name=ROD1 CoordSys=GLOBAL Axis=Auto

TABLE: "CONSTRAINT DEFINITIONS - WELD"

Name=WELD1 CoordSys=GLOBAL UX=Yes UY=Yes UZ=Yes RX=Yes RY=Yes RZ=Yes Tolerance=2.53999996930361E-02

TABLE: "LOAD CASE DEFINITIONS"

Case	Type	InitialCond	DesTypeOpt	DesignType	DesActOpt
Case=PESOPR	Type=LinStatic	InitialCond=Zero	DesTypeOpt="Prog Det"	DesignType=DEAD	DesActOpt="Prog Det"
DesignAct=Non-Composite	AutoType=None	RunCase=Yes	CaseStatus=Finished		
Case=TERRVERT	Type=LinStatic	InitialCond=Zero	DesTypeOpt="Prog Det"	DesignType=OTHER	DesActOpt="Prog Det"
Det	DesignAct=Other	AutoType=None	RunCase=Yes	CaseStatus=Finished	
Case=TERRLAT	Type=LinStatic	InitialCond=Zero	DesTypeOpt="Prog Det"	DesignType=OTHER	DesActOpt="Prog Det"
Det	DesignAct=Other	AutoType=None	RunCase=Yes	CaseStatus=Finished	
Case=ACCVERT	Type=LinStatic	InitialCond=Zero	DesTypeOpt="Prog Det"	DesignType=OTHER	DesActOpt="Prog Det"
Det	DesignAct=Other	AutoType=None	RunCase=Yes	CaseStatus=Finished	
Case=ACCLATDX	Type=LinStatic	InitialCond=Zero	DesTypeOpt="Prog Det"	DesignType=OTHER	DesActOpt="Prog Det"
Det	DesignAct=Other	AutoType=None	RunCase=Yes	CaseStatus=Finished	
Case=ACCLATXSX	Type=LinStatic	InitialCond=Zero	DesTypeOpt="Prog Det"	DesignType=OTHER	DesActOpt="Prog Det"
Det	DesignAct=Other	AutoType=None	RunCase=Yes	CaseStatus=Finished	
Case=TERRCOST	Type=LinStatic	InitialCond=Zero	DesTypeOpt="Prog Det"	DesignType=OTHER	DesActOpt="Prog Det"
Det	DesignAct=Other	AutoType=None	RunCase=Yes	CaseStatus=Finished	
Case=SOVRCOST	Type=LinStatic	InitialCond=Zero	DesTypeOpt="Prog Det"	DesignType=OTHER	DesActOpt="Prog Det"
Det	DesignAct=Other	AutoType=None	RunCase=Yes	CaseStatus=Finished	

TABLE: "CASE - STATIC 1 - LOAD ASSIGNMENTS"

Case	LoadType	LoadName	LoadSF
Case=PESOPR	LoadType="Load pattern"	LoadName=PESOPR	LoadSF=1
Case=TERRVERT	LoadType="Load pattern"	LoadName=TERRVERT	LoadSF=1
Case=TERRLAT	LoadType="Load pattern"	LoadName=TERRLAT	LoadSF=1
Case=ACCVERT	LoadType="Load pattern"	LoadName=ACCVERT	LoadSF=1
Case=ACCLATDX	LoadType="Load pattern"	LoadName=ACCLATDX	LoadSF=1
Case=ACCLATXSX	LoadType="Load pattern"	LoadName=ACCLATXSX	LoadSF=1

TABLE: "JOINT COORDINATES"

Joint	CoordSys	CoordType	XorR	Y	Z	SpecialJt	GlobalX	GlobalY	GlobalZ
Joint=1	CoordSys=GLOBAL	CoordType=Cartesian	XorR=-2.49999997615814	Y=0	Z=0	SpecialJt=No	GlobalX=-2.49999997615814	GlobalY=0	GlobalZ=0
Joint=15	CoordSys=GLOBAL	CoordType=Cartesian	XorR=2.49999997615814	Y=0	Z=0	SpecialJt=No	GlobalX=2.49999997615814	GlobalY=0	GlobalZ=0
Joint=19	CoordSys=GLOBAL	CoordType=Cartesian	XorR=-1.5	Y=0	Z=0	SpecialJt=No	GlobalX=-1.5	GlobalY=0	GlobalZ=0
Joint=20	CoordSys=GLOBAL	CoordType=Cartesian	XorR=-2.49999997615814	Y=0	Z=4	SpecialJt=No	GlobalX=-2.49999997615814	GlobalY=0	GlobalZ=4
Joint=21	CoordSys=GLOBAL	CoordType=Cartesian	XorR=2.49999997615814	Y=0	Z=3.99999997615814	SpecialJt=No	GlobalX=2.49999997615814	GlobalY=0	GlobalZ=3.99999997615814
Joint=22	CoordSys=GLOBAL	CoordType=Cartesian	XorR=-2.5	Y=0	Z=3.75	SpecialJt=Yes	GlobalX=-2.5	GlobalY=0	GlobalZ=3.75
Joint=23	CoordSys=GLOBAL	CoordType=Cartesian	XorR=2.5	Y=0	Z=3.75	SpecialJt=Yes	GlobalX=2.5	GlobalY=0	GlobalZ=3.75
Joint=24	CoordSys=GLOBAL	CoordType=Cartesian	XorR=2	Y=0	Z=4	SpecialJt=Yes	GlobalX=2	GlobalY=0	GlobalZ=4
Joint=25	CoordSys=GLOBAL	CoordType=Cartesian	XorR=2.25	Y=0	Z=4	SpecialJt=Yes	GlobalX=2.25	GlobalY=0	GlobalZ=4
Joint=26	CoordSys=GLOBAL	CoordType=Cartesian	XorR=-2.5	Y=0	Z=0.25	SpecialJt=Yes	GlobalX=-2.5	GlobalY=0	GlobalZ=0.25
Joint=27	CoordSys=GLOBAL	CoordType=Cartesian	XorR=-2.5	Y=0	Z=0.5	SpecialJt=Yes	GlobalX=-2.5	GlobalY=0	GlobalZ=0.5
Joint=28	CoordSys=GLOBAL	CoordType=Cartesian	XorR=2.5	Y=0	Z=0.25	SpecialJt=Yes	GlobalX=2.5	GlobalY=0	GlobalZ=0.25
Joint=29	CoordSys=GLOBAL	CoordType=Cartesian	XorR=2.5	Y=0	Z=0.5	SpecialJt=Yes	GlobalX=2.5	GlobalY=0	GlobalZ=0.5
Joint=30	CoordSys=GLOBAL	CoordType=Cartesian	XorR=-2.25	Y=0	Z=0	SpecialJt=Yes	GlobalX=-2.25	GlobalY=0	GlobalZ=0
Joint=31	CoordSys=GLOBAL	CoordType=Cartesian	XorR=-2	Y=0	Z=0	SpecialJt=Yes	GlobalX=-2	GlobalY=0	GlobalZ=0
Joint=32	CoordSys=GLOBAL	CoordType=Cartesian	XorR=2	Y=0	Z=0	SpecialJt=Yes	GlobalX=2	GlobalY=0	GlobalZ=0
Joint=33	CoordSys=GLOBAL	CoordType=Cartesian	XorR=2.25	Y=0	Z=0	SpecialJt=Yes	GlobalX=2.25	GlobalY=0	GlobalZ=0
Joint=34	CoordSys=GLOBAL	CoordType=Cartesian	XorR=-2.49999997615814	Y=0	Z=3.5	SpecialJt=Yes	GlobalX=-2.49999997615814	GlobalY=0	GlobalZ=3.5
Joint=35	CoordSys=GLOBAL	CoordType=Cartesian	XorR=2.49999997615814	Y=0	Z=3.5	SpecialJt=Yes	GlobalX=2.49999997615814	GlobalY=0	GlobalZ=3.5
Joint=36	CoordSys=GLOBAL	CoordType=Cartesian	XorR=-1	Y=0	Z=0	SpecialJt=No	GlobalX=-1	GlobalY=0	GlobalZ=0
Joint=37	CoordSys=GLOBAL	CoordType=Cartesian	XorR=-0.5	Y=0	Z=0	SpecialJt=No	GlobalX=-0.5	GlobalY=0	GlobalZ=0
Joint=38	CoordSys=GLOBAL	CoordType=Cartesian	XorR=0	Y=0	Z=0	SpecialJt=No	GlobalX=0	GlobalY=0	GlobalZ=0
Joint=39	CoordSys=GLOBAL	CoordType=Cartesian	XorR=-2.25	Y=0	Z=4	SpecialJt=Yes	GlobalX=-2.25	GlobalY=0	GlobalZ=4



Joint=40	CoordSys=GLOBAL	CoordType=Cartesian	XorR=-2	Y=0	Z=4	SpecialJt=Yes	GlobalX=-2	GlobalY=0	GlobalZ=4
Joint=41	CoordSys=GLOBAL	CoordType=Cartesian	XorR=0.5	Y=0	Z=0	SpecialJt=No	GlobalX=0.5	GlobalY=0	GlobalZ=0
Joint=42	CoordSys=GLOBAL	CoordType=Cartesian	XorR=1	Y=0	Z=0	SpecialJt=No	GlobalX=1	GlobalY=0	GlobalZ=0
Joint=43	CoordSys=GLOBAL	CoordType=Cartesian	XorR=1.5	Y=0	Z=0	SpecialJt=No	GlobalX=1.5	GlobalY=0	GlobalZ=0
Joint=44	CoordSys=GLOBAL	CoordType=Cartesian	XorR=-1.5	Y=0	Z=4	SpecialJt=No	GlobalX=-1.5	GlobalY=0	GlobalZ=4
Joint=45	CoordSys=GLOBAL	CoordType=Cartesian	XorR=-1	Y=0	Z=4	SpecialJt=No	GlobalX=-1	GlobalY=0	GlobalZ=4
Joint=46	CoordSys=GLOBAL	CoordType=Cartesian	XorR=-0.5	Y=0	Z=4	SpecialJt=No	GlobalX=-0.5	GlobalY=0	GlobalZ=4
Joint=47	CoordSys=GLOBAL	CoordType=Cartesian	XorR=0	Y=0	Z=4	SpecialJt=No	GlobalX=0	GlobalY=0	GlobalZ=4
Joint=48	CoordSys=GLOBAL	CoordType=Cartesian	XorR=0.5	Y=0	Z=4	SpecialJt=No	GlobalX=0.5	GlobalY=0	GlobalZ=4
Joint=49	CoordSys=GLOBAL	CoordType=Cartesian	XorR=1	Y=0	Z=4	SpecialJt=No	GlobalX=1	GlobalY=0	GlobalZ=4
Joint=50	CoordSys=GLOBAL	CoordType=Cartesian	XorR=1.5	Y=0	Z=4	SpecialJt=No	GlobalX=1.5	GlobalY=0	GlobalZ=4
Joint=51	CoordSys=GLOBAL	CoordType=Cartesian	XorR=-2.4999999602636	Y=0	Z=1	SpecialJt=No	GlobalX=-	GlobalY=0	GlobalZ=1
Joint=52	CoordSys=GLOBAL	CoordType=Cartesian	XorR=-2.4999999205271	Y=0	Z=1.5	SpecialJt=No	GlobalX=-2.4999999205271	GlobalY=0	GlobalZ=1.5
Joint=53	CoordSys=GLOBAL	CoordType=Cartesian	XorR=-2.4999998807907	Y=0	Z=2	SpecialJt=No	GlobalX=-2.4999998807907	GlobalY=0	GlobalZ=2
Joint=54	CoordSys=GLOBAL	CoordType=Cartesian	XorR=-2.4999998410543	Y=0	Z=2.5	SpecialJt=No	GlobalX=-2.4999998410543	GlobalY=0	GlobalZ=2.5
Joint=55	CoordSys=GLOBAL	CoordType=Cartesian	XorR=-2.4999998013179	Y=0	Z=3	SpecialJt=No	GlobalX=-2.4999998013179	GlobalY=0	GlobalZ=3
Joint=56	CoordSys=GLOBAL	CoordType=Cartesian	XorR=2.4999999602636	Y=0	Z=1	SpecialJt=No	GlobalX=2.4999999602636	GlobalY=0	GlobalZ=1
Joint=57	CoordSys=GLOBAL	CoordType=Cartesian	XorR=2.4999999205271	Y=0	Z=1.5	SpecialJt=No	GlobalX=2.4999999205271	GlobalY=0	GlobalZ=1.5
Joint=58	CoordSys=GLOBAL	CoordType=Cartesian	XorR=2.4999998807907	Y=0	Z=2	SpecialJt=No	GlobalX=2.4999998807907	GlobalY=0	GlobalZ=2
Joint=59	CoordSys=GLOBAL	CoordType=Cartesian	XorR=2.4999998410543	Y=0	Z=2.5	SpecialJt=No	GlobalX=2.4999998410543	GlobalY=0	GlobalZ=2.5
Joint=60	CoordSys=GLOBAL	CoordType=Cartesian	XorR=2.4999998013179	Y=0	Z=3	SpecialJt=No	GlobalX=2.4999998013179	GlobalY=0	GlobalZ=3

TABLE: "CONNECTIVITY - FRAME"

Frame=1	JointI=1	JointJ=30	IsCurved=No	Length=0.249999976158142	CentroidX=-2.37499998807907	CentroidY=0	CentroidZ=0
Frame=2	JointI=30	JointJ=31	IsCurved=No	Length=0.25	CentroidX=-2.125	CentroidY=0	CentroidZ=0
Frame=4	JointI=32	JointJ=33	IsCurved=No	Length=0.25	CentroidX=2.125	CentroidY=0	CentroidZ=0
Frame=5	JointI=33	JointJ=15	IsCurved=No	Length=0.249999976158142	CentroidX=2.37499998807907	CentroidY=0	CentroidZ=0
Frame=6	JointI=15	JointJ=28	IsCurved=No	Length=0.250000000000001	CentroidX=2.49999998807907	CentroidY=0	CentroidZ=0.125
Frame=7	JointI=28	JointJ=29	IsCurved=No	Length=0.25	CentroidX=2.5	CentroidY=0	CentroidZ=0.375
Frame=9	JointI=35	JointJ=23	IsCurved=No	Length=0.250000000000002	CentroidX=2.49999998807907	CentroidY=0	CentroidZ=3.625
Frame=10	JointI=23	JointJ=21	IsCurved=No	Length=0.249999976158143	CentroidX=2.49999998807907	CentroidY=0	CentroidZ=3.87499998807907
Frame=11	JointI=20	JointJ=39	IsCurved=No	Length=0.249999976158142	CentroidX=-2.37499998807907	CentroidY=0	CentroidZ=4
Frame=12	JointI=39	JointJ=40	IsCurved=No	Length=0.25	CentroidX=-2.125	CentroidY=0	CentroidZ=4
Frame=14	JointI=24	JointJ=25	IsCurved=No	Length=0.25	CentroidX=2.125	CentroidY=0	CentroidZ=4
Frame=15	JointI=25	JointJ=21	IsCurved=No	Length=0.249999976158143	CentroidX=2.37499998807907	CentroidY=0	CentroidZ=3.99999998807907
Frame=16	JointI=1	JointJ=26	IsCurved=No	Length=0.250000000000001	CentroidX=-2.49999998807907	CentroidY=0	CentroidZ=0.125
Frame=17	JointI=26	JointJ=27	IsCurved=No	Length=0.25	CentroidX=-2.5	CentroidY=0	CentroidZ=0.375
Frame=19	JointI=34	JointJ=22	IsCurved=No	Length=0.250000000000002	CentroidX=-2.49999998807907	CentroidY=0	CentroidZ=3.625
Frame=20	JointI=22	JointJ=20	IsCurved=No	Length=0.250000000000001	CentroidX=-2.49999998807907	CentroidY=0	CentroidZ=3.875
Frame=41	JointI=31	JointJ=19	IsCurved=No	Length=0.5	CentroidX=-1.75	CentroidY=0	CentroidZ=0
Frame=42	JointI=19	JointJ=36	IsCurved=No	Length=0.5	CentroidX=-1.25	CentroidY=0	CentroidZ=0
Frame=43	JointI=36	JointJ=37	IsCurved=No	Length=0.5	CentroidX=-0.75	CentroidY=0	CentroidZ=0
Frame=44	JointI=37	JointJ=38	IsCurved=No	Length=0.5	CentroidX=-0.25	CentroidY=0	CentroidZ=0
Frame=45	JointI=38	JointJ=41	IsCurved=No	Length=0.5	CentroidX=0.25	CentroidY=0	CentroidZ=0
Frame=46	JointI=41	JointJ=42	IsCurved=No	Length=0.5	CentroidX=0.75	CentroidY=0	CentroidZ=0
Frame=47	JointI=42	JointJ=43	IsCurved=No	Length=0.5	CentroidX=1.25	CentroidY=0	CentroidZ=0
Frame=48	JointI=43	JointJ=32	IsCurved=No	Length=0.5	CentroidX=1.75	CentroidY=0	CentroidZ=0
Frame=49	JointI=40	JointJ=44	IsCurved=No	Length=0.5	CentroidX=-1.75	CentroidY=0	CentroidZ=4
Frame=50	JointI=44	JointJ=45	IsCurved=No	Length=0.5	CentroidX=-1.25	CentroidY=0	CentroidZ=4
Frame=51	JointI=45	JointJ=46	IsCurved=No	Length=0.5	CentroidX=-0.75	CentroidY=0	CentroidZ=4
Frame=52	JointI=46	JointJ=47	IsCurved=No	Length=0.5	CentroidX=-0.25	CentroidY=0	CentroidZ=4



Frame=53	JointI=47	JointJ=48	IsCurved=No	Length=0.5	CentroidX=0.25	CentroidY=0	CentroidZ=4
Frame=54	JointI=48	JointJ=49	IsCurved=No	Length=0.5	CentroidX=0.75	CentroidY=0	CentroidZ=4
Frame=55	JointI=49	JointJ=50	IsCurved=No	Length=0.5	CentroidX=1.25	CentroidY=0	CentroidZ=4
Frame=56	JointI=50	JointJ=24	IsCurved=No	Length=0.5	CentroidX=1.75	CentroidY=0	CentroidZ=4
Frame=57	JointI=27	JointJ=51	IsCurved=No	Length=0.5	CentroidX=-2.4999999801318	CentroidY=0	CentroidZ=0.75
Frame=58	JointI=51	JointJ=52	IsCurved=No	Length=0.5	CentroidX=-2.49999999403954	CentroidY=0	CentroidZ=1.25
Frame=59	JointI=52	JointJ=53	IsCurved=No	Length=0.5	CentroidX=-2.49999999006589	CentroidY=0	CentroidZ=1.75
Frame=60	JointI=53	JointJ=54	IsCurved=No	Length=0.5	CentroidX=-2.49999998609225	CentroidY=0	CentroidZ=2.25
Frame=61	JointI=54	JointJ=55	IsCurved=No	Length=0.5	CentroidX=-2.49999998211861	CentroidY=0	CentroidZ=2.75
Frame=62	JointI=55	JointJ=34	IsCurved=No	Length=0.5	CentroidX=-2.49999997814496	CentroidY=0	CentroidZ=3.25
Frame=63	JointI=29	JointJ=56	IsCurved=No	Length=0.5	CentroidX=2.4999999801318	CentroidY=0	CentroidZ=0.75
Frame=64	JointI=56	JointJ=57	IsCurved=No	Length=0.5	CentroidX=2.49999999403954	CentroidY=0	CentroidZ=1.25
Frame=65	JointI=57	JointJ=58	IsCurved=No	Length=0.5	CentroidX=2.49999999006589	CentroidY=0	CentroidZ=1.75
Frame=66	JointI=58	JointJ=59	IsCurved=No	Length=0.5	CentroidX=2.49999998609225	CentroidY=0	CentroidZ=2.25
Frame=67	JointI=59	JointJ=60	IsCurved=No	Length=0.5	CentroidX=2.49999998211861	CentroidY=0	CentroidZ=2.75
Frame=68	JointI=60	JointJ=35	IsCurved=No	Length=0.5	CentroidX=2.49999997814496	CentroidY=0	CentroidZ=3.25

TABLE: "JOINT RESTRAINT ASSIGNMENTS"

Joint=1	U1=Yes	U2=Yes	U3=No	R1=Yes	R2=No	R3=Yes
Joint=15	U1=No	U2=Yes	U3=No	R1=Yes	R2=No	R3=Yes

TABLE: "JOINT SPRING ASSIGNMENTS 1 - UNCOUPLED"

Joint=1	CoordSys=Local	U1=0	U2=0	U3=0	R1=0	R2=0	R3=0
Joint=15	CoordSys=Local	U1=0	U2=0	U3=0	R1=0	R2=0	R3=0

TABLE: "JOINT LOADS - FORCE"

Joint=1	LoadPat=TERRLAT	CoordSys=GLOBAL	F1=27.16	F2=0	F3=0	M1=0	M2=0	M3=0
Joint=15	LoadPat=TERRLAT	CoordSys=GLOBAL	F1=-27.16	F2=0	F3=0	M1=0	M2=0	M3=0
Joint=20	LoadPat=TERRLAT	CoordSys=GLOBAL	F1=7.97	F2=0	F3=0	M1=0	M2=0	M3=0
Joint=21	LoadPat=TERRLAT	CoordSys=GLOBAL	F1=-7.97	F2=0	F3=0	M1=0	M2=0	M3=0

TABLE: "FRAME SECTION ASSIGNMENTS"

Frame=1	SectionType=Rectangular	AutoSelect=N.A.	AnalSect=1000x1000	DesignSect=1000x1000	MatProp=Default
Frame=2	SectionType=Rectangular	AutoSelect=N.A.	AnalSect=1000x1000	DesignSect=1000x1000	MatProp=Default
Frame=4	SectionType=Rectangular	AutoSelect=N.A.	AnalSect=1000x1000	DesignSect=1000x1000	MatProp=Default
Frame=5	SectionType=Rectangular	AutoSelect=N.A.	AnalSect=1000x1000	DesignSect=1000x1000	MatProp=Default
Frame=6	SectionType=Rectangular	AutoSelect=N.A.	AnalSect=1000x1000	DesignSect=1000x1000	MatProp=Default
Frame=7	SectionType=Rectangular	AutoSelect=N.A.	AnalSect=1000x1000	DesignSect=1000x1000	MatProp=Default
Frame=9	SectionType=Rectangular	AutoSelect=N.A.	AnalSect=1000x1000	DesignSect=1000x1000	MatProp=Default
Frame=10	SectionType=Rectangular	AutoSelect=N.A.	AnalSect=1000x1000	DesignSect=1000x1000	MatProp=Default
Frame=11	SectionType=Rectangular	AutoSelect=N.A.	AnalSect=1000x1000	DesignSect=1000x1000	MatProp=Default
Frame=12	SectionType=Rectangular	AutoSelect=N.A.	AnalSect=1000x1000	DesignSect=1000x1000	MatProp=Default
Frame=14	SectionType=Rectangular	AutoSelect=N.A.	AnalSect=1000x1000	DesignSect=1000x1000	MatProp=Default
Frame=15	SectionType=Rectangular	AutoSelect=N.A.	AnalSect=1000x1000	DesignSect=1000x1000	MatProp=Default
Frame=16	SectionType=Rectangular	AutoSelect=N.A.	AnalSect=1000x1000	DesignSect=1000x1000	MatProp=Default
Frame=17	SectionType=Rectangular	AutoSelect=N.A.	AnalSect=1000x1000	DesignSect=1000x1000	MatProp=Default
Frame=19	SectionType=Rectangular	AutoSelect=N.A.	AnalSect=1000x1000	DesignSect=1000x1000	MatProp=Default
Frame=20	SectionType=Rectangular	AutoSelect=N.A.	AnalSect=1000x1000	DesignSect=1000x1000	MatProp=Default
Frame=41	SectionType=Rectangular	AutoSelect=N.A.	AnalSect=1000x1000	DesignSect=1000x1000	MatProp=Default
Frame=42	SectionType=Rectangular	AutoSelect=N.A.	AnalSect=1000x1000	DesignSect=1000x1000	MatProp=Default
Frame=43	SectionType=Rectangular	AutoSelect=N.A.	AnalSect=1000x1000	DesignSect=1000x1000	MatProp=Default
Frame=44	SectionType=Rectangular	AutoSelect=N.A.	AnalSect=1000x1000	DesignSect=1000x1000	MatProp=Default
Frame=45	SectionType=Rectangular	AutoSelect=N.A.	AnalSect=1000x1000	DesignSect=1000x1000	MatProp=Default
Frame=46	SectionType=Rectangular	AutoSelect=N.A.	AnalSect=1000x1000	DesignSect=1000x1000	MatProp=Default



Frame=61	CardinalPt="10 (centroid)"	Mirror2=No	Transform=No
Frame=62	CardinalPt="10 (centroid)"	Mirror2=No	Transform=No
Frame=63	CardinalPt="10 (centroid)"	Mirror2=No	Transform=No
Frame=64	CardinalPt="10 (centroid)"	Mirror2=No	Transform=No
Frame=65	CardinalPt="10 (centroid)"	Mirror2=No	Transform=No
Frame=66	CardinalPt="10 (centroid)"	Mirror2=No	Transform=No
Frame=67	CardinalPt="10 (centroid)"	Mirror2=No	Transform=No
Frame=68	CardinalPt="10 (centroid)"	Mirror2=No	Transform=No

TABLE: "FRAME OFFSET ALONG LENGTH ASSIGNMENTS"

Frame=1	Type=User	LengthI=0	LengthJ=0	RigidFactor=1
Frame=2	Type=User	LengthI=0	LengthJ=0	RigidFactor=1
Frame=4	Type=User	LengthI=0	LengthJ=0	RigidFactor=1
Frame=5	Type=User	LengthI=0	LengthJ=0	RigidFactor=1
Frame=6	Type=User	LengthI=0	LengthJ=0	RigidFactor=1
Frame=7	Type=User	LengthI=0	LengthJ=0	RigidFactor=1
Frame=9	Type=User	LengthI=0	LengthJ=0	RigidFactor=1
Frame=10	Type=User	LengthI=0	LengthJ=0	RigidFactor=1
Frame=11	Type=User	LengthI=0	LengthJ=0	RigidFactor=1
Frame=12	Type=User	LengthI=0	LengthJ=0	RigidFactor=1
Frame=14	Type=User	LengthI=0	LengthJ=0	RigidFactor=1
Frame=15	Type=User	LengthI=0	LengthJ=0	RigidFactor=1
Frame=16	Type=User	LengthI=0	LengthJ=0	RigidFactor=1
Frame=17	Type=User	LengthI=0	LengthJ=0	RigidFactor=1
Frame=19	Type=User	LengthI=0	LengthJ=0	RigidFactor=1
Frame=20	Type=User	LengthI=0	LengthJ=0	RigidFactor=1
Frame=41	Type=User	LengthI=0	LengthJ=0	RigidFactor=1
Frame=42	Type=User	LengthI=0	LengthJ=0	RigidFactor=1
Frame=43	Type=User	LengthI=0	LengthJ=0	RigidFactor=1
Frame=44	Type=User	LengthI=0	LengthJ=0	RigidFactor=1
Frame=45	Type=User	LengthI=0	LengthJ=0	RigidFactor=1
Frame=46	Type=User	LengthI=0	LengthJ=0	RigidFactor=1
Frame=47	Type=User	LengthI=0	LengthJ=0	RigidFactor=1
Frame=48	Type=User	LengthI=0	LengthJ=0	RigidFactor=1
Frame=49	Type=User	LengthI=0	LengthJ=0	RigidFactor=1
Frame=50	Type=User	LengthI=0	LengthJ=0	RigidFactor=1
Frame=51	Type=User	LengthI=0	LengthJ=0	RigidFactor=1
Frame=52	Type=User	LengthI=0	LengthJ=0	RigidFactor=1
Frame=53	Type=User	LengthI=0	LengthJ=0	RigidFactor=1
Frame=54	Type=User	LengthI=0	LengthJ=0	RigidFactor=1
Frame=55	Type=User	LengthI=0	LengthJ=0	RigidFactor=1
Frame=56	Type=User	LengthI=0	LengthJ=0	RigidFactor=1
Frame=57	Type=User	LengthI=0	LengthJ=0	RigidFactor=1
Frame=58	Type=User	LengthI=0	LengthJ=0	RigidFactor=1
Frame=59	Type=User	LengthI=0	LengthJ=0	RigidFactor=1
Frame=60	Type=User	LengthI=0	LengthJ=0	RigidFactor=1
Frame=61	Type=User	LengthI=0	LengthJ=0	RigidFactor=1
Frame=62	Type=User	LengthI=0	LengthJ=0	RigidFactor=1
Frame=63	Type=User	LengthI=0	LengthJ=0	RigidFactor=1
Frame=64	Type=User	LengthI=0	LengthJ=0	RigidFactor=1
Frame=65	Type=User	LengthI=0	LengthJ=0	RigidFactor=1
Frame=66	Type=User	LengthI=0	LengthJ=0	RigidFactor=1
Frame=67	Type=User	LengthI=0	LengthJ=0	RigidFactor=1
Frame=68	Type=User	LengthI=0	LengthJ=0	RigidFactor=1

TABLE: "FRAME OUTPUT STATION ASSIGNMENTS"

Frame=1	StationType=MinNumSta	MinNumSta=5	AddAtElmInt=Yes	AddAtPtLoad=Yes
Frame=2	StationType=MinNumSta	MinNumSta=5	AddAtElmInt=Yes	AddAtPtLoad=Yes
Frame=4	StationType=MinNumSta	MinNumSta=5	AddAtElmInt=Yes	AddAtPtLoad=Yes
Frame=5	StationType=MinNumSta	MinNumSta=5	AddAtElmInt=Yes	AddAtPtLoad=Yes
Frame=6	StationType=MinNumSta	MinNumSta=2	AddAtElmInt=Yes	AddAtPtLoad=Yes
Frame=7	StationType=MinNumSta	MinNumSta=2	AddAtElmInt=Yes	AddAtPtLoad=Yes
Frame=9	StationType=MinNumSta	MinNumSta=2	AddAtElmInt=Yes	AddAtPtLoad=Yes
Frame=10	StationType=MinNumSta	MinNumSta=2	AddAtElmInt=Yes	AddAtPtLoad=Yes
Frame=11	StationType=MinNumSta	MinNumSta=5	AddAtElmInt=Yes	AddAtPtLoad=Yes
Frame=12	StationType=MinNumSta	MinNumSta=5	AddAtElmInt=Yes	AddAtPtLoad=Yes
Frame=14	StationType=MinNumSta	MinNumSta=5	AddAtElmInt=Yes	AddAtPtLoad=Yes
Frame=15	StationType=MinNumSta	MinNumSta=5	AddAtElmInt=Yes	AddAtPtLoad=Yes
Frame=16	StationType=MinNumSta	MinNumSta=2	AddAtElmInt=Yes	AddAtPtLoad=Yes
Frame=17	StationType=MinNumSta	MinNumSta=2	AddAtElmInt=Yes	AddAtPtLoad=Yes
Frame=19	StationType=MinNumSta	MinNumSta=2	AddAtElmInt=Yes	AddAtPtLoad=Yes
Frame=20	StationType=MinNumSta	MinNumSta=2	AddAtElmInt=Yes	AddAtPtLoad=Yes
Frame=41	StationType=MinNumSta	MinNumSta=5	AddAtElmInt=Yes	AddAtPtLoad=Yes
Frame=42	StationType=MinNumSta	MinNumSta=5	AddAtElmInt=Yes	AddAtPtLoad=Yes
Frame=43	StationType=MinNumSta	MinNumSta=5	AddAtElmInt=Yes	AddAtPtLoad=Yes
Frame=44	StationType=MinNumSta	MinNumSta=5	AddAtElmInt=Yes	AddAtPtLoad=Yes
Frame=45	StationType=MinNumSta	MinNumSta=5	AddAtElmInt=Yes	AddAtPtLoad=Yes
Frame=46	StationType=MinNumSta	MinNumSta=5	AddAtElmInt=Yes	AddAtPtLoad=Yes
Frame=47	StationType=MinNumSta	MinNumSta=5	AddAtElmInt=Yes	AddAtPtLoad=Yes
Frame=48	StationType=MinNumSta	MinNumSta=5	AddAtElmInt=Yes	AddAtPtLoad=Yes
Frame=49	StationType=MinNumSta	MinNumSta=5	AddAtElmInt=Yes	AddAtPtLoad=Yes
Frame=50	StationType=MinNumSta	MinNumSta=5	AddAtElmInt=Yes	AddAtPtLoad=Yes



Frame=61	AutoMesh=No	AtJoints=No	AtFrames=No	NumSegments=0	MaxLength=0	MaxDegrees=0
Frame=62	AutoMesh=No	AtJoints=No	AtFrames=No	NumSegments=0	MaxLength=0	MaxDegrees=0
Frame=63	AutoMesh=No	AtJoints=No	AtFrames=No	NumSegments=0	MaxLength=0	MaxDegrees=0
Frame=64	AutoMesh=No	AtJoints=No	AtFrames=No	NumSegments=0	MaxLength=0	MaxDegrees=0
Frame=65	AutoMesh=No	AtJoints=No	AtFrames=No	NumSegments=0	MaxLength=0	MaxDegrees=0
Frame=66	AutoMesh=No	AtJoints=No	AtFrames=No	NumSegments=0	MaxLength=0	MaxDegrees=0
Frame=67	AutoMesh=No	AtJoints=No	AtFrames=No	NumSegments=0	MaxLength=0	MaxDegrees=0
Frame=68	AutoMesh=No	AtJoints=No	AtFrames=No	NumSegments=0	MaxLength=0	MaxDegrees=0

TABLE: "FRAME LOADS - DISTRIBUTED"

Frame=6	LoadPat=TERRLAT	CoordSys=GLOBAL	Type=Force	Dir=X	DistType=RelDist	RelDistA=0	RelDistB=1
AbsDistA=0	AbsDistB=0.250000000000001	FOverLA=-52.19	FOverLB=-50.058124987293				
Frame=7	LoadPat=TERRLAT	CoordSys=GLOBAL	Type=Force	Dir=X	DistType=RelDist	RelDistA=0	RelDistB=1
AbsDistA=0	AbsDistB=0.25	FOverLA=-50.058124987293	FOverLB=-47.9262499745861				
Frame=9	LoadPat=TERRLAT	CoordSys=GLOBAL	Type=Force	Dir=X	DistType=RelDist	RelDistA=0	RelDistB=1
AbsDistA=0	AbsDistB=0.250000000000002	FOverLA=-22.3437498221025	FOverLB=-20.2118748093955				
Frame=10	LoadPat=TERRLAT	CoordSys=GLOBAL	Type=Force	Dir=X	DistType=RelDist	RelDistA=0	RelDistB=1
AbsDistA=0	AbsDistB=0.249999976158143	FOverLA=-20.2118748093955	FOverLB=-18.08				
Frame=11	LoadPat=TERRVERT	CoordSys=GLOBAL	Type=Force	Dir=Gravity	DistType=RelDist	RelDistA=0	RelDistB=1
RelDistB=1	AbsDistA=0	AbsDistB=0.249999976158142	FOverLA=156	FOverLB=156			
Frame=11	LoadPat=TERRVERT	CoordSys=GLOBAL	Type=Force	Dir=Gravity	DistType=RelDist	RelDistA=0	RelDistB=1
RelDistB=1	AbsDistA=0	AbsDistB=0.249999976158142	FOverLA=40.5	FOverLB=40.5			
Frame=12	LoadPat=TERRVERT	CoordSys=GLOBAL	Type=Force	Dir=Gravity	DistType=RelDist	RelDistA=0	RelDistB=1
RelDistB=1	AbsDistA=0	AbsDistB=0.25	FOverLA=156	FOverLB=156			
Frame=12	LoadPat=TERRVERT	CoordSys=GLOBAL	Type=Force	Dir=Gravity	DistType=RelDist	RelDistA=0	RelDistB=1
RelDistB=1	AbsDistA=0	AbsDistB=0.25	FOverLA=40.5	FOverLB=40.5			
Frame=14	LoadPat=TERRVERT	CoordSys=GLOBAL	Type=Force	Dir=Gravity	DistType=RelDist	RelDistA=0	RelDistB=1
RelDistB=1	AbsDistA=0	AbsDistB=0.25	FOverLA=156	FOverLB=156			
Frame=14	LoadPat=TERRVERT	CoordSys=GLOBAL	Type=Force	Dir=Gravity	DistType=RelDist	RelDistA=0	RelDistB=1
RelDistB=1	AbsDistA=0	AbsDistB=0.25	FOverLA=40.5	FOverLB=40.5			
Frame=15	LoadPat=TERRVERT	CoordSys=GLOBAL	Type=Force	Dir=Gravity	DistType=RelDist	RelDistA=0	RelDistB=1
RelDistB=1	AbsDistA=0	AbsDistB=0.249999976158143	FOverLA=156	FOverLB=156			
Frame=15	LoadPat=TERRVERT	CoordSys=GLOBAL	Type=Force	Dir=Gravity	DistType=RelDist	RelDistA=0	RelDistB=1
RelDistB=1	AbsDistA=0	AbsDistB=0.249999976158143	FOverLA=40.5	FOverLB=40.5			
Frame=16	LoadPat=TERRLAT	CoordSys=GLOBAL	Type=Force	Dir=X	DistType=RelDist	RelDistA=0	RelDistB=1
AbsDistA=0	AbsDistB=0.250000000000001	FOverLA=52.19	FOverLB=50.058125				
Frame=17	LoadPat=TERRLAT	CoordSys=GLOBAL	Type=Force	Dir=X	DistType=RelDist	RelDistA=0	RelDistB=1
AbsDistA=0	AbsDistB=0.25	FOverLA=50.058125	FOverLB=47.92625				
Frame=19	LoadPat=TERRLAT	CoordSys=GLOBAL	Type=Force	Dir=X	DistType=RelDist	RelDistA=0	RelDistB=1
AbsDistA=0	AbsDistB=0.250000000000002	FOverLA=22.34375	FOverLB=20.211875				
Frame=20	LoadPat=TERRLAT	CoordSys=GLOBAL	Type=Force	Dir=X	DistType=RelDist	RelDistA=0	RelDistB=1
AbsDistA=0	AbsDistB=0.250000000000001	FOverLA=20.211875	FOverLB=18.08				
Frame=49	LoadPat=TERRVERT	CoordSys=GLOBAL	Type=Force	Dir=Gravity	DistType=RelDist	RelDistA=0	RelDistB=1
RelDistB=1	AbsDistA=0	AbsDistB=0.5	FOverLA=156	FOverLB=156			
Frame=49	LoadPat=TERRVERT	CoordSys=GLOBAL	Type=Force	Dir=Gravity	DistType=RelDist	RelDistA=0	RelDistB=1
RelDistB=1	AbsDistA=0	AbsDistB=0.5	FOverLA=40.5	FOverLB=40.5			
Frame=50	LoadPat=TERRVERT	CoordSys=GLOBAL	Type=Force	Dir=Gravity	DistType=RelDist	RelDistA=0	RelDistB=1
RelDistB=1	AbsDistA=0	AbsDistB=0.5	FOverLA=156	FOverLB=156			
Frame=50	LoadPat=TERRVERT	CoordSys=GLOBAL	Type=Force	Dir=Gravity	DistType=RelDist	RelDistA=0	RelDistB=1
RelDistB=1	AbsDistA=0	AbsDistB=0.5	FOverLA=40.5	FOverLB=40.5			
Frame=51	LoadPat=TERRVERT	CoordSys=GLOBAL	Type=Force	Dir=Gravity	DistType=RelDist	RelDistA=0	RelDistB=1
RelDistB=1	AbsDistA=0	AbsDistB=0.5	FOverLA=156	FOverLB=156			
Frame=51	LoadPat=TERRVERT	CoordSys=GLOBAL	Type=Force	Dir=Gravity	DistType=RelDist	RelDistA=0	RelDistB=1
RelDistB=1	AbsDistA=0	AbsDistB=0.5	FOverLA=40.5	FOverLB=40.5			
Frame=52	LoadPat=TERRVERT	CoordSys=GLOBAL	Type=Force	Dir=Gravity	DistType=RelDist	RelDistA=0	RelDistB=1
RelDistB=1	AbsDistA=0	AbsDistB=0.5	FOverLA=156	FOverLB=156			
Frame=52	LoadPat=TERRVERT	CoordSys=GLOBAL	Type=Force	Dir=Gravity	DistType=RelDist	RelDistA=0	RelDistB=1
RelDistB=1	AbsDistA=0	AbsDistB=0.5	FOverLA=40.5	FOverLB=40.5			
Frame=53	LoadPat=TERRVERT	CoordSys=GLOBAL	Type=Force	Dir=Gravity	DistType=RelDist	RelDistA=0	RelDistB=1
RelDistB=1	AbsDistA=0	AbsDistB=0.5	FOverLA=156	FOverLB=156			
Frame=53	LoadPat=TERRVERT	CoordSys=GLOBAL	Type=Force	Dir=Gravity	DistType=RelDist	RelDistA=0	RelDistB=1
RelDistB=1	AbsDistA=0	AbsDistB=0.5	FOverLA=40.5	FOverLB=40.5			
Frame=54	LoadPat=TERRVERT	CoordSys=GLOBAL	Type=Force	Dir=Gravity	DistType=RelDist	RelDistA=0	RelDistB=1
RelDistB=1	AbsDistA=0	AbsDistB=0.5	FOverLA=156	FOverLB=156			
Frame=54	LoadPat=TERRVERT	CoordSys=GLOBAL	Type=Force	Dir=Gravity	DistType=RelDist	RelDistA=0	RelDistB=1
RelDistB=1	AbsDistA=0	AbsDistB=0.5	FOverLA=40.5	FOverLB=40.5			
Frame=55	LoadPat=TERRVERT	CoordSys=GLOBAL	Type=Force	Dir=Gravity	DistType=RelDist	RelDistA=0	RelDistB=1
RelDistB=1	AbsDistA=0	AbsDistB=0.5	FOverLA=156	FOverLB=156			
Frame=55	LoadPat=TERRVERT	CoordSys=GLOBAL	Type=Force	Dir=Gravity	DistType=RelDist	RelDistA=0	RelDistB=1
RelDistB=1	AbsDistA=0	AbsDistB=0.5	FOverLA=40.5	FOverLB=40.5			
Frame=56	LoadPat=TERRVERT	CoordSys=GLOBAL	Type=Force	Dir=Gravity	DistType=RelDist	RelDistA=0	RelDistB=1
RelDistB=1	AbsDistA=0	AbsDistB=0.5	FOverLA=156	FOverLB=156			
Frame=56	LoadPat=TERRVERT	CoordSys=GLOBAL	Type=Force	Dir=Gravity	DistType=RelDist	RelDistA=0	RelDistB=1
RelDistB=1	AbsDistA=0	AbsDistB=0.5	FOverLA=40.5	FOverLB=40.5			
Frame=57	LoadPat=TERRLAT	CoordSys=GLOBAL	Type=Force	Dir=X	DistType=RelDist	RelDistA=0	RelDistB=1
AbsDistA=0	AbsDistB=0.5	FOverLA=47.92625	FOverLB=43.6625				
Frame=58	LoadPat=TERRLAT	CoordSys=GLOBAL	Type=Force	Dir=X	DistType=RelDist	RelDistA=0	RelDistB=0.5
AbsDistA=0	AbsDistB=0.25	FOverLA=43.6625	FOverLB=41.530625				
Frame=58	LoadPat=TERRLAT	CoordSys=GLOBAL	Type=Force	Dir=X	DistType=RelDist	RelDistA=0.5	RelDistB=1
AbsDistA=0.25	AbsDistB=0.5	FOverLA=41.530625	FOverLB=39.39875				
Frame=59	LoadPat=TERRLAT	CoordSys=GLOBAL	Type=Force	Dir=X	DistType=RelDist	RelDistA=0	RelDistB=1
AbsDistA=0	AbsDistB=0.5	FOverLA=39.39875	FOverLB=35.135				



Frame=60	LoadPat=TERRLAT	CoordSys=GLOBAL	Type=Force	Dir=X	DistType=RelDist	RelDistA=0	RelDistB=1
AbsDistA=0	AbsDistB=0.5	FOverLA=35.135	FOverLB=30.87125				
Frame=61	LoadPat=TERRLAT	CoordSys=GLOBAL	Type=Force	Dir=X	DistType=RelDist	RelDistA=0	RelDistB=0.5
AbsDistA=0	AbsDistB=0.25	FOverLA=30.87125	FOverLB=28.739375				
Frame=61	LoadPat=TERRLAT	CoordSys=GLOBAL	Type=Force	Dir=X	DistType=RelDist	RelDistA=0.5	RelDistB=1
AbsDistA=0.25	AbsDistB=0.5	FOverLA=28.739375	FOverLB=26.6075				
Frame=62	LoadPat=TERRLAT	CoordSys=GLOBAL	Type=Force	Dir=X	DistType=RelDist	RelDistA=0	RelDistB=1
AbsDistA=0	AbsDistB=0.5	FOverLA=26.6075	FOverLB=22.34375				
Frame=63	LoadPat=TERRLAT	CoordSys=GLOBAL	Type=Force	Dir=X	DistType=RelDist	RelDistA=0	RelDistB=1
AbsDistA=0	AbsDistB=0.5	FOverLA=-47.9262499745861	FOverLB=-43.6624999491721				
Frame=64	LoadPat=TERRLAT	CoordSys=GLOBAL	Type=Force	Dir=X	DistType=RelDist	RelDistA=0	RelDistB=0.5
AbsDistA=0	AbsDistB=0.25	FOverLA=-43.6624999491721	FOverLB=-41.5306249364652				
Frame=64	LoadPat=TERRLAT	CoordSys=GLOBAL	Type=Force	Dir=X	DistType=RelDist	RelDistA=0.5	RelDistB=1
AbsDistA=0.25	AbsDistB=0.5	FOverLA=-41.5306249364652	FOverLB=-39.3987499237582				
Frame=65	LoadPat=TERRLAT	CoordSys=GLOBAL	Type=Force	Dir=X	DistType=RelDist	RelDistA=0	RelDistB=1
AbsDistA=0	AbsDistB=0.5	FOverLA=-39.3987499237582	FOverLB=-35.1349998983443				
Frame=66	LoadPat=TERRLAT	CoordSys=GLOBAL	Type=Force	Dir=X	DistType=RelDist	RelDistA=0	RelDistB=1
AbsDistA=0	AbsDistB=0.5	FOverLA=-35.1349998983443	FOverLB=-30.8712498729303				
Frame=67	LoadPat=TERRLAT	CoordSys=GLOBAL	Type=Force	Dir=X	DistType=RelDist	RelDistA=0	RelDistB=0.5
AbsDistA=0	AbsDistB=0.25	FOverLA=-30.8712498729303	FOverLB=-28.7393748602234				
Frame=67	LoadPat=TERRLAT	CoordSys=GLOBAL	Type=Force	Dir=X	DistType=RelDist	RelDistA=0.5	RelDistB=1
AbsDistA=0.25	AbsDistB=0.5	FOverLA=-28.7393748602234	FOverLB=-26.6074998475164				
Frame=68	LoadPat=TERRLAT	CoordSys=GLOBAL	Type=Force	Dir=X	DistType=RelDist	RelDistA=0	RelDistB=1
AbsDistA=0	AbsDistB=0.5	FOverLA=-26.6074998475164	FOverLB=-22.3437498221025				

TABLE: "FRAME DESIGN PROCEDURES"

Frame=1	DesignProc="From Material"
Frame=2	DesignProc="From Material"
Frame=4	DesignProc="From Material"
Frame=5	DesignProc="From Material"
Frame=6	DesignProc="From Material"
Frame=7	DesignProc="From Material"
Frame=9	DesignProc="From Material"
Frame=10	DesignProc="From Material"
Frame=11	DesignProc="From Material"
Frame=12	DesignProc="From Material"
Frame=14	DesignProc="From Material"
Frame=15	DesignProc="From Material"
Frame=16	DesignProc="From Material"
Frame=17	DesignProc="From Material"
Frame=19	DesignProc="From Material"
Frame=20	DesignProc="From Material"
Frame=41	DesignProc="From Material"
Frame=42	DesignProc="From Material"
Frame=43	DesignProc="From Material"
Frame=44	DesignProc="From Material"
Frame=45	DesignProc="From Material"
Frame=46	DesignProc="From Material"
Frame=47	DesignProc="From Material"
Frame=48	DesignProc="From Material"
Frame=49	DesignProc="From Material"
Frame=50	DesignProc="From Material"
Frame=51	DesignProc="From Material"
Frame=52	DesignProc="From Material"
Frame=53	DesignProc="From Material"
Frame=54	DesignProc="From Material"
Frame=55	DesignProc="From Material"
Frame=56	DesignProc="From Material"
Frame=57	DesignProc="From Material"
Frame=58	DesignProc="From Material"
Frame=59	DesignProc="From Material"
Frame=60	DesignProc="From Material"
Frame=61	DesignProc="From Material"
Frame=62	DesignProc="From Material"
Frame=63	DesignProc="From Material"
Frame=64	DesignProc="From Material"
Frame=65	DesignProc="From Material"
Frame=66	DesignProc="From Material"
Frame=67	DesignProc="From Material"
Frame=68	DesignProc="From Material"

TABLE: "OVERWRITES - CONCRETE DESIGN - ACI 318-99"

Frame=1	DesignSect="Program Determined"	FrameType="Program Determined"	RLLF=0	XLMajor=0	XLMinor=0
Frame=2	DesignSect="Program Determined"	FrameType="Program Determined"	RLLF=0	XLMajor=0	XLMinor=0
Frame=4	DesignSect="Program Determined"	FrameType="Program Determined"	RLLF=0	XLMajor=0	XLMinor=0
Frame=5	DesignSect="Program Determined"	FrameType="Program Determined"	RLLF=0	XLMajor=0	XLMinor=0
Frame=6	DesignSect="Program Determined"	FrameType="Program Determined"	RLLF=0	XLMajor=0	XLMinor=0
Frame=7	DesignSect="Program Determined"	FrameType="Program Determined"	RLLF=0	XLMajor=0	XLMinor=0
Frame=9	DesignSect="Program Determined"	FrameType="Program Determined"	RLLF=0	XLMajor=0	XLMinor=0
Frame=10	DesignSect="Program Determined"	FrameType="Program Determined"	RLLF=0	XLMajor=0	XLMinor=0
Frame=11	DesignSect="Program Determined"	FrameType="Program Determined"	RLLF=0	XLMajor=0	XLMinor=0
Frame=12	DesignSect="Program Determined"	FrameType="Program Determined"	RLLF=0	XLMajor=0	XLMinor=0

<p>GENERAL CONTRACTOR</p>  <p>Consorzio Collegamenti Integrati Veloci</p>	<p>ALTA SORVEGLIANZA</p>  <p>GRUPPO FERROVIE DELLO STATO ITALIANE</p>	
<p>IG51-02-E-CV-CL-IN11-0X-001_A00</p> <p>Relazione di calcolo</p>		
		<p>Foglio 16 di 929</p>

1.2. Dati di output scatolare – Caso A

File D:\13_15_CO CIV\01_Calcoli\IN11\giorgio\IN11_situazione1-output.txt was saved on 9/17/13 at 11.03.48

TABLE: "PROGRAM CONTROL"

ProgramName=SAP2000 Version=15.0.0 ProgLevel=Ultimate LicenseNum=266BC LicenseOS=Yes LicenseSC=Yes
LicenseBR=No LicenseHT=No CurrUnits="KN, m, C" SteelCode=AISC-ASD89 ConcCode="ACI 318-99" AlumCode="AA-ASD
2000" - ColdCode=AISI-ASD96 BridgeCode="AASHTO LRFD 2007" RegenHinge=No

TABLE: "JOINT DISPLACEMENTS"

Joint=1	OutputCase=PESOPR	CaseType=LinStatic	U1=0	U2=0	U3=-3.52537204993402E-03	R1=0	R2=-
4.26489779227633E-05	R3=0						
Joint=1	OutputCase=TERRVERT	CaseType=LinStatic	U1=0	U2=0	U3=-7.76783474156145E-03	R1=0	R2=-
1.49633173836085E-04	R3=0						
Joint=1	OutputCase=TERRLAT	CaseType=LinStatic	U1=0	U2=0	U3=1.44068724647938E-05	R1=0	
R2=1.74905180086046E-05	R3=0						
Joint=1	OutputCase=ACCLATDX	CaseType=LinStatic	U1=0	U2=0	U3=0	R1=0	R2=0
						R3=0	
Joint=1	OutputCase=ACCLATSX	CaseType=LinStatic	U1=0	U2=0	U3=0	R1=0	R2=0
						R3=0	
Joint=1	OutputCase=TERRCOST	CaseType=LinStatic	U1=0	U2=0	U3=0	R1=0	R2=0
						R3=0	
Joint=1	OutputCase=SOVRCOST	CaseType=LinStatic	U1=0	U2=0	U3=0	R1=0	R2=0
						R3=0	
Joint=1	OutputCase=ENVE	CaseType=Combination	StepType=Max	U1=0	U2=0	U3=-1.12787999190307E-02	R1=0
R2=-1.74791633750244E-04	R3=0						
Joint=1	OutputCase=ENVE	CaseType=Combination	StepType=Min	U1=0	U2=0	U3=-1.12831219807701E-02	R1=0
R2=-1.80038789152825E-04	R3=0						
Joint=1	OutputCase=FESSUR	CaseType=Combination	U1=0	U2=0	U3=-1.12787999190307E-02	R1=0	R2=-
1.74791633750244E-04	R3=0						
Joint=15	OutputCase=PESOPR	CaseType=LinStatic	U1=-2.10415552297417E-06	U2=0	U3=-3.52537202276943E-03		
R1=0	R2=4.26489669602817E-05	R3=0					
Joint=15	OutputCase=TERRVERT	CaseType=LinStatic	U1=1.59893159716015E-07	U2=0	U3=-7.76783474136212E-03		
R1=0	R2=1.49633173452118E-04	R3=0					
Joint=15	OutputCase=TERRLAT	CaseType=LinStatic	U1=-1.51121089770876E-05	U2=0	U3=1.44068177002497E-05		
R1=0	R2=-1.74904955341235E-05	R3=0					
Joint=15	OutputCase=ACCLATDX	CaseType=LinStatic	U1=0	U2=0	U3=0	R1=0	R2=0
						R3=0	
Joint=15	OutputCase=ACCLATSX	CaseType=LinStatic	U1=0	U2=0	U3=0	R1=0	R2=0
						R3=0	
Joint=15	OutputCase=TERRCOST	CaseType=LinStatic	U1=0	U2=0	U3=0	R1=0	R2=0
						R3=0	
Joint=15	OutputCase=SOVRCOST	CaseType=LinStatic	U1=0	U2=0	U3=0	R1=0	R2=0
						R3=0	
Joint=15	OutputCase=ENVE	CaseType=Combination	StepType=Max	U1=-1.25227386472194E-05	U2=0	U3=-	
1.12787999464313E-02	R1=0	R2=1.80038793538513E-04	R3=0				
Joint=15	OutputCase=ENVE	CaseType=Combination	StepType=Min	U1=-1.70563713403457E-05	U2=0	U3=-	
1.12831219917414E-02	R1=0	R2=1.74791644878276E-04	R3=0				
Joint=15	OutputCase=FESSUR	CaseType=Combination	U1=-1.70563713403457E-05	U2=0	U3=-1.12787999464313E-02		
R1=0	R2=1.74791644878276E-04	R3=0					
Joint=19	OutputCase=PESOPR	CaseType=LinStatic	U1=-4.20831098574797E-07	U2=0	U3=-3.46716630606235E-03		
R1=0	R2=-4.6892066653918E-05	R3=0					
Joint=19	OutputCase=TERRVERT	CaseType=LinStatic	U1=3.19786314857488E-08	U2=0	U3=-7.57524370397889E-03		
R1=0	R2=-1.54251677924824E-04	R3=0					
Joint=19	OutputCase=TERRLAT	CaseType=LinStatic	U1=-3.02242175218142E-06	U2=0	U3=4.47228061680634E-07		
R1=0	R2=1.0455970672573E-05	R3=0					
Joint=19	OutputCase=ACCLATDX	CaseType=LinStatic	U1=0	U2=0	U3=0	R1=0	R2=0
						R3=0	
Joint=19	OutputCase=ACCLATSX	CaseType=LinStatic	U1=0	U2=0	U3=0	R1=0	R2=0
						R3=0	
Joint=19	OutputCase=TERRCOST	CaseType=LinStatic	U1=0	U2=0	U3=0	R1=0	R2=0
						R3=0	
Joint=19	OutputCase=SOVRCOST	CaseType=LinStatic	U1=0	U2=0	U3=0	R1=0	R2=0
						R3=0	
Joint=19	OutputCase=ENVE	CaseType=Combination	StepType=Max	U1=-2.50454769361604E-06	U2=0	U3=-	
1.10419627819796E-02	R1=0	R2=-1.90687773906169E-04	R3=0				
Joint=19	OutputCase=ENVE	CaseType=Combination	StepType=Min	U1=-3.41127421927047E-06	U2=0	U3=-	
1.10420969503981E-02	R1=0	R2=-1.93824565107941E-04	R3=0				
Joint=19	OutputCase=FESSUR	CaseType=Combination	U1=-3.41127421927047E-06	U2=0	U3=-1.10419627819796E-02		
R1=0	R2=-1.90687773906169E-04	R3=0					
Joint=20	OutputCase=PESOPR	CaseType=LinStatic	U1=-2.10417755046862E-06	U2=0	U3=-3.53785472593507E-03		
R1=0	R2=2.58073055391805E-05	R3=0					
Joint=20	OutputCase=TERRVERT	CaseType=LinStatic	U1=1.59890710541164E-07	U2=0	U3=-7.82234242603192E-03		
R1=0	R2=1.50912955625481E-04	R3=0					
Joint=20	OutputCase=TERRLAT	CaseType=LinStatic	U1=-2.92966640269711E-06	U2=0	U3=1.44068730410795E-05		
R1=0	R2=-1.71014723550763E-05	R3=0					
Joint=20	OutputCase=ACCLATDX	CaseType=LinStatic	U1=0	U2=0	U3=0	R1=0	R2=0
						R3=0	
Joint=20	OutputCase=ACCLATSX	CaseType=LinStatic	U1=0	U2=0	U3=0	R1=0	R2=0
						R3=0	
Joint=20	OutputCase=TERRCOST	CaseType=LinStatic	U1=0	U2=0	U3=0	R1=0	R2=0
						R3=0	
Joint=20	OutputCase=SOVRCOST	CaseType=LinStatic	U1=0	U2=0	U3=0	R1=0	R2=0
						R3=0	
Joint=20	OutputCase=ENVE	CaseType=Combination	StepType=Max	U1=-3.99505332181544E-06	U2=0	U3=-	
1.13457902789259E-02	R1=0	R2=1.64749230516108E-04	R3=0				
Joint=20	OutputCase=ENVE	CaseType=Combination	StepType=Min	U1=-4.87395324262457E-06	U2=0	U3=-	
1.13501123408382E-02	R1=0	R2=1.59618788809585E-04	R3=0				
Joint=20	OutputCase=FESSUR	CaseType=Combination	U1=-4.87395324262457E-06	U2=0	U3=-1.13457902789259E-02		
R1=0	R2=1.59618788809585E-04	R3=0					
Joint=21	OutputCase=PESOPR	CaseType=LinStatic	U1=-2.13272219625735E-11	U2=0	U3=-3.53785469866542E-03		
R1=0	R2=-2.5807316408325E-05	R3=0					
Joint=21	OutputCase=TERRVERT	CaseType=LinStatic	U1=1.87870460141394E-12	U2=0	U3=-7.8223424255514E-03		
R1=0	R2=-1.50912955515037E-04	R3=0					
Joint=21	OutputCase=TERRLAT	CaseType=LinStatic	U1=-1.21823522707293E-05	U2=0	U3=1.44068182023757E-05		
R1=0	R2=1.71014947101897E-05	R3=0					



Joint=21	OutputCase=ACCLATDX	CaseType=LinStatic	U1=0	U2=0	U3=0	R1=0	R2=0	R3=0
Joint=21	OutputCase=ACCLATSX	CaseType=LinStatic	U1=0	U2=0	U3=0	R1=0	R2=0	R3=0
Joint=21	OutputCase=TERRCOST	CaseType=LinStatic	U1=0	U2=0	U3=0	R1=0	R2=0	R3=0
Joint=21	OutputCase=SOVRCOST	CaseType=LinStatic	U1=0	U2=0	U3=0	R1=0	R2=0	R3=0
Joint=21	OutputCase=ENVE	CaseType=Combination	StepType=Max	U1=-8.52766603802784E-06	U2=0	U3=-		
1.13457903060144E-02	R1=0	R2=-1.59618777213172E-04	R3=0					
Joint=21	OutputCase=ENVE	CaseType=Combination	StepType=Min	U1=-1.21823717192466E-05	U2=0	U3=-		
1.13501123514752E-02	R1=0	R2=-1.64749225626229E-04	R3=0					
Joint=21	OutputCase=FESSUR	CaseType=Combination	U1=-1.21823717192466E-05	U2=0	U3=-1.13457903060144E-02			
R1=0	R2=-1.59618777213172E-04	R3=0						
Joint=22	OutputCase=PESOPR	CaseType=LinStatic	U1=-8.61403512723312E-06	U2=0	U3=-3.53739962779927E-03			
R1=0	R2=2.38959628340483E-05	R3=0						
Joint=22	OutputCase=TERRVERT	CaseType=LinStatic	U1=-3.51752822571525E-05	U2=0	U3=-7.81893569261931E-03			
R1=0	R2=1.31948942758197E-04	R3=0						
Joint=22	OutputCase=TERRLAT	CaseType=LinStatic	U1=2.58891958436088E-06	U2=0	U3=1.44068725497645E-05			
R1=0	R2=-1.82167097051148E-05	R3=0						
Joint=22	OutputCase=ACCLATDX	CaseType=LinStatic	U1=0	U2=0	U3=0	R1=0	R2=0	R3=0
Joint=22	OutputCase=ACCLATSX	CaseType=LinStatic	U1=0	U2=0	U3=0	R1=0	R2=0	R3=0
Joint=22	OutputCase=TERRCOST	CaseType=LinStatic	U1=0	U2=0	U3=0	R1=0	R2=0	R3=0
Joint=22	OutputCase=SOVRCOST	CaseType=LinStatic	U1=0	U2=0	U3=0	R1=0	R2=0	R3=0
Joint=22	OutputCase=ENVE	CaseType=Combination	StepType=Max	U1=-4.12003978000248E-05	U2=0	U3=-		
1.13419284478688E-02	R1=0	R2=1.43093208798665E-04	R3=0					
Joint=22	OutputCase=ENVE	CaseType=Combination	StepType=Min	U1=-4.19770736753331E-05	U2=0	U3=-		
1.13462505096337E-02	R1=0	R2=1.37628195887131E-04	R3=0					
Joint=22	OutputCase=FESSUR	CaseType=Combination	U1=-4.12003978000248E-05	U2=0	U3=-1.13419284478688E-02			
R1=0	R2=1.37628195887131E-04	R3=0						
Joint=23	OutputCase=PESOPR	CaseType=LinStatic	U1=6.50983836507213E-06	U2=0	U3=-3.53739960057493E-03			
R1=0	R2=-2.38959738658036E-05	R3=0						
Joint=23	OutputCase=TERRVERT	CaseType=LinStatic	U1=3.53351716649935E-05	U2=0	U3=-7.81893569246094E-03			
R1=0	R2=-1.31948944375239E-04	R3=0						
Joint=23	OutputCase=TERRLAT	CaseType=LinStatic	U1=-1.7700943314584E-05	U2=0	U3=1.44068177156951E-05			
R1=0	R2=1.82167320157143E-05	R3=0						
Joint=23	OutputCase=ACCLATDX	CaseType=LinStatic	U1=0	U2=0	U3=0	R1=0	R2=0	R3=0
Joint=23	OutputCase=ACCLATSX	CaseType=LinStatic	U1=0	U2=0	U3=0	R1=0	R2=0	R3=0
Joint=23	OutputCase=TERRCOST	CaseType=LinStatic	U1=0	U2=0	U3=0	R1=0	R2=0	R3=0
Joint=23	OutputCase=SOVRCOST	CaseType=LinStatic	U1=0	U2=0	U3=0	R1=0	R2=0	R3=0
Joint=23	OutputCase=ENVE	CaseType=Combination	StepType=Max	U1=2.94543497098569E-05	U2=0	U3=-		
1.13419284753202E-02	R1=0	R2=-1.37628186225328E-04	R3=0					
Joint=23	OutputCase=ENVE	CaseType=Combination	StepType=Min	U1=2.41440667154817E-05	U2=0	U3=-		
1.13462505206349E-02	R1=0	R2=-1.43093205830043E-04	R3=0					
Joint=23	OutputCase=FESSUR	CaseType=Combination	U1=2.41440667154817E-05	U2=0	U3=-1.13419284753202E-02			
R1=0	R2=-1.37628186225328E-04	R3=0						
Joint=24	OutputCase=PESOPR	CaseType=LinStatic	U1=-2.10437571764814E-07	U2=0	U3=-0.003553376628178			
R1=0	R2=-2.68871916410928E-05	R3=0						
Joint=24	OutputCase=TERRVERT	CaseType=LinStatic	U1=1.59868661875071E-08	U2=0	U3=-7.92097514207055E-03			
R1=0	R2=-1.69787276118889E-04	R3=0						
Joint=24	OutputCase=TERRLAT	CaseType=LinStatic	U1=-1.12570833706119E-05	U2=0	U3=2.21024911048341E-05			
R1=0	R2=1.36811980685553E-05	R3=0						
Joint=24	OutputCase=ACCLATDX	CaseType=LinStatic	U1=0	U2=0	U3=0	R1=0	R2=0	R3=0
Joint=24	OutputCase=ACCLATSX	CaseType=LinStatic	U1=0	U2=0	U3=0	R1=0	R2=0	R3=0
Joint=24	OutputCase=TERRCOST	CaseType=LinStatic	U1=0	U2=0	U3=0	R1=0	R2=0	R3=0
Joint=24	OutputCase=SOVRCOST	CaseType=LinStatic	U1=0	U2=0	U3=0	R1=0	R2=0	R3=0
Joint=24	OutputCase=ENVE	CaseType=Combination	StepType=Max	U1=-8.07440906500561E-06	U2=0	U3=-		
1.14522492791437E-02	R1=0	R2=-1.82993269691426E-04	R3=0					
Joint=24	OutputCase=ENVE	CaseType=Combination	StepType=Min	U1=-1.14515340761892E-05	U2=0	U3=-		
1.14588800264752E-02	R1=0	R2=-1.87097629111993E-04	R3=0					
Joint=24	OutputCase=FESSUR	CaseType=Combination	U1=-1.14515340761892E-05	U2=0	U3=-1.14522492791437E-02			
R1=0	R2=-1.82993269691426E-04	R3=0						
Joint=25	OutputCase=PESOPR	CaseType=LinStatic	U1=-1.05229794612748E-07	U2=0	U3=-3.54560933812872E-03			
R1=0	R2=-2.69323793434461E-05	R3=0						
Joint=25	OutputCase=TERRVERT	CaseType=LinStatic	U1=7.99220812549754E-09	U2=0	U3=-7.87095991119402E-03			
R1=0	R2=-1.64949200516038E-04	R3=0						
Joint=25	OutputCase=TERRLAT	CaseType=LinStatic	U1=-1.17197176490582E-05	U2=0	U3=1.84684230402392E-05			
R1=0	R2=1.53913465005327E-05	R3=0						
Joint=25	OutputCase=ACCLATDX	CaseType=LinStatic	U1=0	U2=0	U3=0	R1=0	R2=0	R3=0
Joint=25	OutputCase=ACCLATSX	CaseType=LinStatic	U1=0	U2=0	U3=0	R1=0	R2=0	R3=0
Joint=25	OutputCase=TERRCOST	CaseType=LinStatic	U1=0	U2=0	U3=0	R1=0	R2=0	R3=0
Joint=25	OutputCase=SOVRCOST	CaseType=LinStatic	U1=0	U2=0	U3=0	R1=0	R2=0	R3=0
Joint=25	OutputCase=ENVE	CaseType=Combination	StepType=Max	U1=-8.30103994082802E-06	U2=0	U3=-		
1.13981008262825E-02	R1=0	R2=-1.76490233358951E-04	R3=0					
Joint=25	OutputCase=ENVE	CaseType=Combination	StepType=Min	U1=-1.18169552355455E-05	U2=0	U3=-		
1.14036413531946E-02	R1=0	R2=-1.81107637309111E-04	R3=0					
Joint=25	OutputCase=FESSUR	CaseType=Combination	U1=-1.18169552355455E-05	U2=0	U3=-1.13981008262825E-02			
R1=0	R2=-1.76490233358951E-04	R3=0						
Joint=26	OutputCase=PESOPR	CaseType=LinStatic	U1=-9.5345841384469E-06	U2=0	U3=-3.52647728770581E-03			
R1=0	R2=-3.60032852561211E-05	R3=0						
Joint=26	OutputCase=TERRVERT	CaseType=LinStatic	U1=-3.51053273167033E-05	U2=0	U3=-7.77124147495062E-03			
R1=0	R2=-1.3102892058159E-04	R3=0						
Joint=26	OutputCase=TERRLAT	CaseType=LinStatic	U1=5.96733898989997E-06	U2=0	U3=1.44068729863591E-05			
R1=0	R2=1.84472225387765E-05	R3=0						
Joint=26	OutputCase=ACCLATDX	CaseType=LinStatic	U1=0	U2=0	U3=0	R1=0	R2=0	R3=0
Joint=26	OutputCase=ACCLATSX	CaseType=LinStatic	U1=0	U2=0	U3=0	R1=0	R2=0	R3=0



Joint=26	OutputCase=TERRCOST	CaseType=LinStatic	U1=0	U2=0	U3=0	R1=0	R2=0	R3=0
Joint=26	OutputCase=SOVRCOST	CaseType=LinStatic	U1=0	U2=0	U3=0	R1=0	R2=0	R3=0
Joint=26	OutputCase=ENVE	CaseType=Combination	StepType=Max	U1=-3.86725724652502E-05	U2=0	U3=-		
1.12833118896701E-02	R1=0	R2=-1.48584983298934E-04	R3=0					
Joint=26	OutputCase=ENVE	CaseType=Combination	StepType=Min	U1=-4.04627741622202E-05	U2=0	U3=-		
0.011287633951566	R1=0	R2=-1.54119150060567E-04	R3=0					
Joint=26	OutputCase=FESSUR	CaseType=Combination	U1=-3.86725724652502E-05	U2=0	U3=-1.12833118896701E-02			
R1=0	R2=-1.48584983298934E-04	R3=0						
Joint=27	OutputCase=PESOPR	CaseType=LinStatic	U1=-1.74471978149332E-05	U2=0	U3=-3.52753918193645E-03			
R1=0	R2=-2.96732157638634E-05	R3=0						
Joint=27	OutputCase=TERRVERT	CaseType=LinStatic	U1=-6.55565926699786E-05	U2=0	U3=-7.77464820499265E-03			
R1=0	R2=-1.12400682865573E-04	R3=0						
Joint=27	OutputCase=TERRLAT	CaseType=LinStatic	U1=1.17493019349102E-05	U2=0	U3=1.44068729886766E-05			
R1=0	R2=1.79671378739867E-05	R3=0						
Joint=27	OutputCase=ACCLATDX	CaseType=LinStatic	U1=0	U2=0	U3=0	R1=0	R2=0	R3=0
Joint=27	OutputCase=ACCLATSX	CaseType=LinStatic	U1=0	U2=0	U3=0	R1=0	R2=0	R3=0
Joint=27	OutputCase=TERRCOST	CaseType=LinStatic	U1=0	U2=0	U3=0	R1=0	R2=0	R3=0
Joint=27	OutputCase=SOVRCOST	CaseType=LinStatic	U1=0	U2=0	U3=0	R1=0	R2=0	R3=0
Joint=27	OutputCase=ENVE	CaseType=Combination	StepType=Max	U1=-7.12544885500016E-05	U2=0	U3=-		
1.12877805139404E-02	R1=0	R2=-1.24106760755449E-04	R3=0					
Joint=27	OutputCase=ENVE	CaseType=Combination	StepType=Min	U1=-7.47792791304747E-05	U2=0	U3=-		
0.011292102575837	R1=0	R2=-1.29496902117645E-04	R3=0					
Joint=27	OutputCase=FESSUR	CaseType=Combination	U1=-7.12544885500016E-05	U2=0	U3=-1.12877805139404E-02			
R1=0	R2=-1.24106760755449E-04	R3=0						
Joint=28	OutputCase=PESOPR	CaseType=LinStatic	U1=7.43042587427526E-06	U2=0	U3=-3.52647726053724E-03			
R1=0	R2=3.60032742890224E-05	R3=0						
Joint=28	OutputCase=TERRVERT	CaseType=LinStatic	U1=3.52652203701523E-05	U2=0	U3=-7.77124147475402E-03			
R1=0	R2=1.3102892011542E-04	R3=0						
Joint=28	OutputCase=TERRLAT	CaseType=LinStatic	U1=-2.10794423192591E-05	U2=0	U3=1.44068182171795E-05			
R1=0	R2=-1.84471999625191E-05	R3=0						
Joint=28	OutputCase=ACCLATDX	CaseType=LinStatic	U1=0	U2=0	U3=0	R1=0	R2=0	R3=0
Joint=28	OutputCase=ACCLATSX	CaseType=LinStatic	U1=0	U2=0	U3=0	R1=0	R2=0	R3=0
Joint=28	OutputCase=TERRCOST	CaseType=LinStatic	U1=0	U2=0	U3=0	R1=0	R2=0	R3=0
Joint=28	OutputCase=SOVRCOST	CaseType=LinStatic	U1=0	U2=0	U3=0	R1=0	R2=0	R3=0
Joint=28	OutputCase=ENVE	CaseType=Combination	StepType=Max	U1=2.79400366209461E-05	U2=0	U3=-		
1.12833119170741E-02	R1=0	R2=1.54119154430679E-04	R3=0					
Joint=28	OutputCase=ENVE	CaseType=Combination	StepType=Min	U1=2.16162039251684E-05	U2=0	U3=-		
1.12876339625392E-02	R1=0	R2=1.48584994441923E-04	R3=0					
Joint=28	OutputCase=FESSUR	CaseType=Combination	U1=2.16162039251684E-05	U2=0	U3=-1.12833119170741E-02			
R1=0	R2=1.48584994441923E-04	R3=0						
Joint=29	OutputCase=PESOPR	CaseType=LinStatic	U1=1.53430368084098E-05	U2=0	U3=-3.5275391547639E-03			
R1=0	R2=2.96732047921469E-05	R3=0						
Joint=29	OutputCase=TERRVERT	CaseType=LinStatic	U1=6.57164855966097E-05	U2=0	U3=-7.77464820479878E-03			
R1=0	R2=1.12400682317199E-04	R3=0						
Joint=29	OutputCase=TERRLAT	CaseType=LinStatic	U1=-2.68613995933326E-05	U2=0	U3=1.4406818214862E-05			
R1=0	R2=-1.79671152133421E-05	R3=0						
Joint=29	OutputCase=ACCLATDX	CaseType=LinStatic	U1=0	U2=0	U3=0	R1=0	R2=0	R3=0
Joint=29	OutputCase=ACCLATSX	CaseType=LinStatic	U1=0	U2=0	U3=0	R1=0	R2=0	R3=0
Joint=29	OutputCase=TERRCOST	CaseType=LinStatic	U1=0	U2=0	U3=0	R1=0	R2=0	R3=0
Joint=29	OutputCase=SOVRCOST	CaseType=LinStatic	U1=0	U2=0	U3=0	R1=0	R2=0	R3=0
Joint=29	OutputCase=ENVE	CaseType=Combination	StepType=Max	U1=6.22565426896867E-05	U2=0	U3=-		
1.12877805413478E-02	R1=0	R2=1.29496906460006E-04	R3=0					
Joint=29	OutputCase=ENVE	CaseType=Combination	StepType=Min	U1=5.41981228116869E-05	U2=0	U3=-		
1.12921025868123E-02	R1=0	R2=1.24106771896004E-04	R3=0					
Joint=29	OutputCase=FESSUR	CaseType=Combination	U1=5.41981228116869E-05	U2=0	U3=-1.12877805413478E-02			
R1=0	R2=1.24106771896004E-04	R3=0						
Joint=30	OutputCase=PESOPR	CaseType=LinStatic	U1=-1.05207767118653E-07	U2=0	U3=-3.51104087247651E-03			
R1=0	R2=-4.78596313023848E-05	R3=0						
Joint=30	OutputCase=TERRVERT	CaseType=LinStatic	U1=7.99465729961469E-09	U2=0	U3=-7.71958700318508E-03			
R1=0	R2=-1.63377947771993E-04	R3=0						
Joint=30	OutputCase=TERRLAT	CaseType=LinStatic	U1=-7.55605384000241E-07	U2=0	U3=1.02554500717496E-05			
R1=0	R2=1.57281960763423E-05	R3=0						
Joint=30	OutputCase=ACCLATDX	CaseType=LinStatic	U1=0	U2=0	U3=0	R1=0	R2=0	R3=0
Joint=30	OutputCase=ACCLATSX	CaseType=LinStatic	U1=0	U2=0	U3=0	R1=0	R2=0	R3=0
Joint=30	OutputCase=TERRCOST	CaseType=LinStatic	U1=0	U2=0	U3=0	R1=0	R2=0	R3=0
Joint=30	OutputCase=SOVRCOST	CaseType=LinStatic	U1=0	U2=0	U3=0	R1=0	R2=0	R3=0
Joint=30	OutputCase=ENVE	CaseType=Combination	StepType=Max	U1=-6.26136878619207E-07	U2=0	U3=-		
1.12203724255898E-02	R1=0	R2=-1.95509382998036E-04	R3=0					
Joint=30	OutputCase=ENVE	CaseType=Combination	StepType=Min	U1=-8.52818493819279E-07	U2=0	U3=-		
1.12234490606114E-02	R1=0	R2=-2.00227841820939E-04	R3=0					
Joint=30	OutputCase=FESSUR	CaseType=Combination	U1=-8.52818493819279E-07	U2=0	U3=-1.12203724255898E-02			
R1=0	R2=-1.95509382998036E-04	R3=0						
Joint=31	OutputCase=PESOPR	CaseType=LinStatic	U1=-2.10415544270701E-07	U2=0	U3=-3.49611077173095E-03			
R1=0	R2=-5.00352964251022E-05	R3=0						
Joint=31	OutputCase=TERRVERT	CaseType=LinStatic	U1=1.59893153616594E-08	U2=0	U3=-7.67003184051742E-03			
R1=0	R2=-1.67949707403476E-04	R3=0						
Joint=31	OutputCase=TERRLAT	CaseType=LinStatic	U1=-1.51121084006063E-06	U2=0	U3=6.54570412611154E-06			
R1=0	R2=1.39675414992489E-05	R3=0						
Joint=31	OutputCase=ACCLATDX	CaseType=LinStatic	U1=0	U2=0	U3=0	R1=0	R2=0	R3=0
Joint=31	OutputCase=ACCLATSX	CaseType=LinStatic	U1=0	U2=0	U3=0	R1=0	R2=0	R3=0
Joint=31	OutputCase=TERRCOST	CaseType=LinStatic	U1=0	U2=0	U3=0	R1=0	R2=0	R3=0
Joint=31	OutputCase=SOVRCOST	CaseType=LinStatic	U1=0	U2=0	U3=0	R1=0	R2=0	R3=0



Joint=31	OutputCase=ENVE	CaseType=Combination	StepType=Max	U1=-1.25227381695148E-06	U2=0	U3=-
1.11595969081223E-02	R1=0	R2=-2.0401746232933E-04	R3=0			
Joint=31	OutputCase=ENVE	CaseType=Combination	StepType=Min	U1=-1.70563706896967E-06	U2=0	U3=-
1.11615606193601E-02	R1=0	R2=-2.08207724779104E-04	R3=0			
Joint=31	OutputCase=FESSUR	CaseType=Combination		U1=-1.70563706896967E-06	U2=0	U3=-1.11595969081223E-02
R1=0	R2=-2.0401746232933E-04	R3=0				
Joint=32	OutputCase=PESOPR	CaseType=LinStatic		U1=-1.89373997870347E-06	U2=0	U3=-3.49611075005764E-03
R1=0	R2=5.00352854904304E-05	R3=0				
Joint=32	OutputCase=TERRVERT	CaseType=LinStatic		U1=1.43903844354375E-07	U2=0	U3=-7.67003184045659E-03
R1=0	R2=1.67949707167486E-04	R3=0				
Joint=32	OutputCase=TERRLAT	CaseType=LinStatic		U1=-1.36008981370269E-05	U2=0	U3=6.54566055309705E-06
R1=0	R2=-1.39675192628231E-05	R3=0				
Joint=32	OutputCase=ACCLATDX	CaseType=LinStatic		U1=0	U2=0	U3=0
Joint=32	OutputCase=ACCLATSX	CaseType=LinStatic		U1=0	U2=0	U3=0
Joint=32	OutputCase=TERRCOST	CaseType=LinStatic		U1=0	U2=0	U3=0
Joint=32	OutputCase=SOVRCOST	CaseType=LinStatic		U1=0	U2=0	U3=0
Joint=32	OutputCase=ENVE	CaseType=Combination	StepType=Max	U1=-1.12704648302679E-05	U2=0	U3=-
1.11595969299611E-02	R1=0	R2=2.0820772917394E-04	R3=0			
Joint=32	OutputCase=ENVE	CaseType=Combination	StepType=Min	U1=-1.5350734271376E-05	U2=0	U3=-
1.11615606281271E-02	R1=0	R2=2.04017473395094E-04	R3=0			
Joint=32	OutputCase=FESSUR	CaseType=Combination		U1=-1.5350734271376E-05	U2=0	U3=-1.11595969299611E-02
R1=0	R2=2.04017473395094E-04	R3=0				
Joint=33	OutputCase=PESOPR	CaseType=LinStatic		U1=-1.99894775585552E-06	U2=0	U3=-3.51104084806085E-03
R1=0	R2=4.78596203495768E-05	R3=0				
Joint=33	OutputCase=TERRVERT	CaseType=LinStatic		U1=1.51898502416419E-07	U2=0	U3=-7.71958700306426E-03
R1=0	R2=1.63377947466123E-04	R3=0				
Joint=33	OutputCase=TERRLAT	CaseType=LinStatic		U1=-1.43565035930873E-05	U2=0	U3=1.02554009209752E-05
R1=0	R2=-1.57281737174495E-05	R3=0				
Joint=33	OutputCase=ACCLATDX	CaseType=LinStatic		U1=0	U2=0	U3=0
Joint=33	OutputCase=ACCLATSX	CaseType=LinStatic		U1=0	U2=0	U3=0
Joint=33	OutputCase=TERRCOST	CaseType=LinStatic		U1=0	U2=0	U3=0
Joint=33	OutputCase=SOVRCOST	CaseType=LinStatic		U1=0	U2=0	U3=0
Joint=33	OutputCase=ENVE	CaseType=Combination	StepType=Max	U1=-1.18966017686002E-05	U2=0	U3=-
1.12203724502041E-02	R1=0	R2=2.00227846213485E-04	R3=0			
Joint=33	OutputCase=ENVE	CaseType=Combination	StepType=Min	U1=-1.62035528465264E-05	U2=0	U3=-
1.12234490704804E-02	R1=0	R2=1.9550939409825E-04	R3=0			
Joint=33	OutputCase=FESSUR	CaseType=Combination		U1=-1.62035528465264E-05	U2=0	U3=-1.12203724502041E-02
R1=0	R2=1.9550939409825E-04	R3=0				
Joint=34	OutputCase=PESOPR	CaseType=LinStatic		U1=-1.46066039460676E-05	U2=0	U3=-3.53690118821389E-03
R1=0	R2=2.16689968015931E-05	R3=0				
Joint=34	OutputCase=TERRVERT	CaseType=LinStatic		U1=-6.57724488205705E-05	U2=0	U3=-7.81552896549602E-03
R1=0	R2=1.13008913865099E-04	R3=0				
Joint=34	OutputCase=TERRLAT	CaseType=LinStatic		U1=8.14721209910953E-06	U2=0	U3=1.44068730435731E-05
R1=0	R2=-1.82103599798468E-05	R3=0				
Joint=34	OutputCase=ACCLATDX	CaseType=LinStatic		U1=0	U2=0	U3=0
Joint=34	OutputCase=ACCLATSX	CaseType=LinStatic		U1=0	U2=0	U3=0
Joint=34	OutputCase=TERRCOST	CaseType=LinStatic		U1=0	U2=0	U3=0
Joint=34	OutputCase=SOVRCOST	CaseType=LinStatic		U1=0	U2=0	U3=0
Joint=34	OutputCase=ENVE	CaseType=Combination	StepType=Max	U1=-7.22318406675285E-05	U2=0	U3=-
1.13380232806663E-02	R1=0	R2=1.21930658680799E-04	R3=0			
Joint=34	OutputCase=ENVE	CaseType=Combination	StepType=Min	U1=-7.46760042972614E-05	U2=0	U3=-
1.13423453425794E-02	R1=0	R2=1.16467550686845E-04	R3=0			
Joint=34	OutputCase=FESSUR	CaseType=Combination		U1=-7.22318406675285E-05	U2=0	U3=-1.13380232806663E-02
R1=0	R2=1.16467550686845E-04	R3=0				
Joint=35	OutputCase=PESOPR	CaseType=LinStatic		U1=1.2502409941268E-05	U2=0	U3=-3.53690116099354E-03
R1=0	R2=-2.16690078287296E-05	R3=0				
Joint=35	OutputCase=TERRVERT	CaseType=LinStatic		U1=6.59323386223961E-05	U2=0	U3=-7.81552896533492E-03
R1=0	R2=-1.13008915399934E-04	R3=0				
Joint=35	OutputCase=TERRLAT	CaseType=LinStatic		U1=-2.32592414304137E-05	U2=0	U3=1.44068182141392E-05
R1=0	R2=1.82103823990378E-05	R3=0				
Joint=35	OutputCase=ACCLATDX	CaseType=LinStatic		U1=0	U2=0	U3=0
Joint=35	OutputCase=ACCLATSX	CaseType=LinStatic		U1=0	U2=0	U3=0
Joint=35	OutputCase=TERRCOST	CaseType=LinStatic		U1=0	U2=0	U3=0
Joint=35	OutputCase=SOVRCOST	CaseType=LinStatic		U1=0	U2=0	U3=0
Joint=35	OutputCase=ENVE	CaseType=Combination	StepType=Max	U1=6.21532795623745E-05	U2=0	U3=-
1.13380233081143E-02	R1=0	R2=-1.16467540829626E-04	R3=0			
Joint=35	OutputCase=ENVE	CaseType=Combination	StepType=Min	U1=5.51755071332504E-05	U2=0	U3=-
1.13423453535786E-02	R1=0	R2=-1.21930655549337E-04	R3=0			
Joint=35	OutputCase=FESSUR	CaseType=Combination		U1=5.51755071332504E-05	U2=0	U3=-1.13380233081143E-02
R1=0	R2=-1.16467540829626E-04	R3=0				
Joint=36	OutputCase=PESOPR	CaseType=LinStatic		U1=-6.31246652878893E-07	U2=0	U3=-3.44316295772203E-03
R1=0	R2=-3.57102341991112E-05	R3=0				
Joint=36	OutputCase=TERRVERT	CaseType=LinStatic		U1=4.79679476098381E-08	U2=0	U3=-7.49748666247557E-03
R1=0	R2=-1.16270241211176E-04	R3=0				
Joint=36	OutputCase=TERRLAT	CaseType=LinStatic		U1=-4.5336326643022E-06	U2=0	U3=-3.89896904206935E-06
R1=0	R2=6.9593965331434E-06	R3=0				
Joint=36	OutputCase=ACCLATDX	CaseType=LinStatic		U1=0	U2=0	U3=0
Joint=36	OutputCase=ACCLATSX	CaseType=LinStatic		U1=0	U2=0	U3=0
Joint=36	OutputCase=TERRCOST	CaseType=LinStatic		U1=0	U2=0	U3=0
Joint=36	OutputCase=SOVRCOST	CaseType=LinStatic		U1=0	U2=0	U3=0
Joint=36	OutputCase=ENVE	CaseType=Combination	StepType=Max	U1=-3.7568215702806E-06	U2=0	U3=-
0.010943378898527	R1=0	R2=-1.45021078877144E-04	R3=0			



Joint=36 OutputCase=ENVE CaseType=Combination StepType=Min U1=-5.11691136957126E-06 U2=0 U3=-
 1.09445485892397E-02 R1=0 R2=-1.47108897837087E-04 R3=0
 Joint=36 OutputCase=FESSUR CaseType=Combination U1=-5.11691136957126E-06 U2=0 U3=-1.09445485892397E-02
 R1=0 R2=-1.45021078877144E-04 R3=0
 Joint=37 OutputCase=PESOPR CaseType=LinStatic U1=-8.41662207182989E-07 U2=0 U3=-3.42743257993165E-03
 R1=0 R2=-1.9187483251049E-05 R3=0
 Joint=37 OutputCase=TERRVERT CaseType=LinStatic U1=6.39572637339275E-08 U2=0 U3=-7.44682194944826E-03
 R1=0 R2=-6.21584770823287E-05 R3=0
 Joint=37 OutputCase=TERRLAT CaseType=LinStatic U1=-6.04484357642299E-06 U2=0 U3=-6.50227751697996E-06
 R1=0 R2=3.47595197931042E-06 R3=0
 Joint=37 OutputCase=ACCLATDX CaseType=LinStatic U1=0 U2=0 U3=0 R1=0 R2=0 R3=0
 Joint=37 OutputCase=ACCLATSX CaseType=LinStatic U1=0 U2=0 U3=0 R1=0 R2=0 R3=0
 Joint=37 OutputCase=TERRCOST CaseType=LinStatic U1=0 U2=0 U3=0 R1=0 R2=0 R3=0
 Joint=37 OutputCase=SOVRCOST CaseType=LinStatic U1=0 U2=0 U3=0 R1=0 R2=0 R3=0
 Joint=37 OutputCase=ENVE CaseType=Combination StepType=Max U1=-5.00909544694515E-06 U2=0 U3=-
 1.08788061236418E-02 R1=0 R2=-7.78700083540673E-05 R3=0
 Joint=37 OutputCase=ENVE CaseType=Combination StepType=Min U1=-6.82254851987205E-06 U2=0 U3=-
 1.08807568068969E-02 R1=0 R2=-7.89127939478604E-05 R3=0
 Joint=37 OutputCase=FESSUR CaseType=Combination U1=-6.82254851987205E-06 U2=0 U3=-1.08807568068969E-02
 R1=0 R2=-7.78700083540673E-05 R3=0
 Joint=38 OutputCase=PESOPR CaseType=LinStatic U1=-1.05207776148709E-06 U2=0 U3=-3.42196804686701E-03
 R1=0 R2=-5.3950557035482E-12 R3=0
 Joint=38 OutputCase=TERRVERT CaseType=LinStatic U1=7.99465798580169E-08 U2=0 U3=-7.42926632829146E-03
 R1=0 R2=1.34784727595563E-14 R3=0
 Joint=38 OutputCase=TERRLAT CaseType=LinStatic U1=-7.55605448854377E-06 U2=0 U3=-7.36926847078869E-06
 R1=0 R2=1.08112178301282E-11 R3=0
 Joint=38 OutputCase=ACCLATDX CaseType=LinStatic U1=0 U2=0 U3=0 R1=0 R2=0 R3=0
 Joint=38 OutputCase=ACCLATSX CaseType=LinStatic U1=0 U2=0 U3=0 R1=0 R2=0 R3=0
 Joint=38 OutputCase=TERRCOST CaseType=LinStatic U1=0 U2=0 U3=0 R1=0 R2=0 R3=0
 Joint=38 OutputCase=SOVRCOST CaseType=LinStatic U1=0 U2=0 U3=0 R1=0 R2=0 R3=0
 Joint=38 OutputCase=ENVE CaseType=Combination StepType=Max U1=-6.26136932360971E-06 U2=0 U3=-
 0.010856392863088 R1=0 R2=5.42964059933954E-12 R3=0
 Joint=38 OutputCase=ENVE CaseType=Combination StepType=Min U1=-8.52818567017284E-06 U2=0 U3=-
 1.08586036436293E-02 R1=0 R2=2.18627525030108E-12 R3=0
 Joint=38 OutputCase=FESSUR CaseType=Combination U1=-8.52818567017284E-06 U2=0 U3=-1.08586036436293E-02
 R1=0 R2=5.42964059933954E-12 R3=0
 Joint=39 OutputCase=PESOPR CaseType=LinStatic U1=-1.99896978334995E-06 U2=0 U3=-3.54560936265994E-03
 R1=0 R2=2.69323684548627E-05 R3=0
 Joint=39 OutputCase=TERRVERT CaseType=LinStatic U1=1.51896053241599E-07 U2=0 U3=-7.87095991168619E-03
 R1=0 R2=1.64949200549528E-04 R3=0
 Joint=39 OutputCase=TERRLAT CaseType=LinStatic U1=-3.39230063702326E-06 U2=0 U3=1.84684722310778E-05
 R1=0 R2=-1.53913242113354E-05 R3=0
 Joint=39 OutputCase=ACCLATDX CaseType=LinStatic U1=0 U2=0 U3=0 R1=0 R2=0 R3=0
 Joint=39 OutputCase=ACCLATSX CaseType=LinStatic U1=0 U2=0 U3=0 R1=0 R2=0 R3=0
 Joint=39 OutputCase=TERRCOST CaseType=LinStatic U1=0 U2=0 U3=0 R1=0 R2=0 R3=0
 Joint=39 OutputCase=SOVRCOST CaseType=LinStatic U1=0 U2=0 U3=0 R1=0 R2=0 R3=0
 Joint=39 OutputCase=ENVE CaseType=Combination StepType=Max U1=-4.22168417602463E-06 U2=0 U3=-
 0.011398100802115 R1=0 R2=1.81107642056456E-04 R3=0
 Joint=39 OutputCase=ENVE CaseType=Combination StepType=Min U1=-5.23937436713161E-06 U2=0 U3=-
 1.14036413437844E-02 R1=0 R2=1.76490244793055E-04 R3=0
 Joint=39 OutputCase=FESSUR CaseType=Combination U1=-5.23937436713161E-06 U2=0 U3=-0.011398100802115
 R1=0 R2=1.76490244793055E-04 R3=0
 Joint=40 OutputCase=PESOPR CaseType=LinStatic U1=-1.89376200619788E-06 U2=0 U3=-3.55337664998615E-03
 R1=0 R2=2.68871807485811E-05 R3=0
 Joint=40 OutputCase=TERRVERT CaseType=LinStatic U1=1.43901395179604E-07 U2=0 U3=-7.92097514255462E-03
 R1=0 R2=1.69787276082497E-04 R3=0
 Joint=40 OutputCase=TERRLAT CaseType=LinStatic U1=-3.85493491546964E-06 U2=0 U3=2.21025347512295E-05
 R1=0 R2=-1.36811758975497E-05 R3=0
 Joint=40 OutputCase=ACCLATDX CaseType=LinStatic U1=0 U2=0 U3=0 R1=0 R2=0 R3=0
 Joint=40 OutputCase=ACCLATSX CaseType=LinStatic U1=0 U2=0 U3=0 R1=0 R2=0 R3=0
 Joint=40 OutputCase=TERRCOST CaseType=LinStatic U1=0 U2=0 U3=0 R1=0 R2=0 R3=0
 Joint=40 OutputCase=SOVRCOST CaseType=LinStatic U1=0 U2=0 U3=0 R1=0 R2=0 R3=0
 Joint=40 OutputCase=ENVE CaseType=Combination StepType=Max U1=-4.44831505184703E-06 U2=0 U3=-
 1.14522492577895E-02 R1=0 R2=1.87097633702794E-04 R3=0
 Joint=40 OutputCase=ENVE CaseType=Combination StepType=Min U1=-5.60479552648792E-06 U2=0 U3=-
 1.14588800182149E-02 R1=0 R2=1.82993280933529E-04 R3=0
 Joint=40 OutputCase=FESSUR CaseType=Combination U1=-5.60479552648792E-06 U2=0 U3=-1.14522492577895E-02
 R1=0 R2=1.82993280933529E-04 R3=0
 Joint=41 OutputCase=PESOPR CaseType=LinStatic U1=-1.26249331579118E-06 U2=0 U3=-3.42743257454615E-03
 R1=0 R2=1.91874724482562E-05 R3=0
 Joint=41 OutputCase=TERRVERT CaseType=LinStatic U1=9.59358959821063E-08 U2=0 U3=-7.44682194947411E-03
 R1=0 R2=6.2158477092864E-05 R3=0
 Joint=41 OutputCase=TERRLAT CaseType=LinStatic U1=-9.06726540066456E-06 U2=0 U3=-6.50228829378973E-06
 R1=0 R2=-3.47593031120035E-06 R3=0
 Joint=41 OutputCase=ACCLATDX CaseType=LinStatic U1=0 U2=0 U3=0 R1=0 R2=0 R3=0
 Joint=41 OutputCase=ACCLATSX CaseType=LinStatic U1=0 U2=0 U3=0 R1=0 R2=0 R3=0
 Joint=41 OutputCase=TERRCOST CaseType=LinStatic U1=0 U2=0 U3=0 R1=0 R2=0 R3=0
 Joint=41 OutputCase=SOVRCOST CaseType=LinStatic U1=0 U2=0 U3=0 R1=0 R2=0 R3=0
 Joint=41 OutputCase=ENVE CaseType=Combination StepType=Max U1=-7.51364320027427E-06 U2=0 U3=-
 1.08788061258259E-02 R1=0 R2=7.891279832328E-05 R3=0
 Joint=41 OutputCase=ENVE CaseType=Combination StepType=Min U1=-1.02338228204736E-05 U2=0 U3=-
 0.010880756812314 R1=0 R2=7.78700192299199E-05 R3=0



Joint=41 OutputCase=FESSUR CaseType=Combination U1=-1.02338228204736E-05 U2=0 U3=-0.010880756812314
 R1=0 R2=7.78700192299199E-05 R3=0
 Joint=42 OutputCase=PESOPR CaseType=LinStatic U1=-1.47290887009528E-06 U2=0 U3=-3.44316294693615E-03
 R1=0 R2=3.571022336119E-05 R3=0
 Joint=42 OutputCase=TERRVERT CaseType=LinStatic U1=1.11925212106196E-07 U2=0 U3=-7.49748666251085E-03
 R1=0 R2=1.16270241172433E-04 R3=0
 Joint=42 OutputCase=TERRLAT CaseType=LinStatic U1=-1.05784763127853E-05 U2=0 U3=-3.89899064575475E-06
 R1=0 R2=-6.95937473383945E-06 R3=0
 Joint=42 OutputCase=ACCLATDX CaseType=LinStatic U1=0 U2=0 U3=0 R1=0 R2=0 R3=0
 Joint=42 OutputCase=ACCLATSX CaseType=LinStatic U1=0 U2=0 U3=0 R1=0 R2=0 R3=0
 Joint=42 OutputCase=TERRCOST CaseType=LinStatic U1=0 U2=0 U3=0 R1=0 R2=0 R3=0
 Joint=42 OutputCase=SOVRCOST CaseType=LinStatic U1=0 U2=0 U3=0 R1=0 R2=0 R3=0
 Joint=42 OutputCase=ENVE CaseType=Combination StepType=Max U1=-8.76591707693883E-06 U2=0 U3=-
 0.010943378902899 R1=0 R2=1.47108902219935E-04 R3=0
 Joint=42 OutputCase=ENVE CaseType=Combination StepType=Min U1=-1.19394599707744E-05 U2=0 U3=-
 1.09445486000928E-02 R1=0 R2=1.45021089799783E-04 R3=0
 Joint=42 OutputCase=FESSUR CaseType=Combination U1=-1.19394599707744E-05 U2=0 U3=-1.09445486000928E-02
 R1=0 R2=1.45021089799783E-04 R3=0
 Joint=43 OutputCase=PESOPR CaseType=LinStatic U1=-1.68332442439937E-06 U2=0 U3=-3.46716628984925E-03
 R1=0 R2=4.68920557671692E-05 R3=0
 Joint=43 OutputCase=TERRVERT CaseType=LinStatic U1=1.27914528230285E-07 U2=0 U3=-7.57524370399077E-03
 R1=0 R2=1.54251677803914E-04 R3=0
 Joint=43 OutputCase=TERRLAT CaseType=LinStatic U1=-1.20896872249061E-05 U2=0 U3=4.47195536796848E-07
 R1=0 R2=-1.04559486740708E-05 R3=0
 Joint=43 OutputCase=ACCLATDX CaseType=LinStatic U1=0 U2=0 U3=0 R1=0 R2=0 R3=0
 Joint=43 OutputCase=ACCLATSX CaseType=LinStatic U1=0 U2=0 U3=0 R1=0 R2=0 R3=0
 Joint=43 OutputCase=TERRCOST CaseType=LinStatic U1=0 U2=0 U3=0 R1=0 R2=0 R3=0
 Joint=43 OutputCase=SOVRCOST CaseType=LinStatic U1=0 U2=0 U3=0 R1=0 R2=0 R3=0
 Joint=43 OutputCase=ENVE CaseType=Combination StepType=Max U1=-1.00181909536034E-05 U2=0 U3=-
 1.10419627983032E-02 R1=0 R2=1.93824569499234E-04 R3=0
 Joint=43 OutputCase=ENVE CaseType=Combination StepType=Min U1=-1.36450971210752E-05 U2=0 U3=-
 1.10420969569643E-02 R1=0 R2=1.90687784897013E-04 R3=0
 Joint=43 OutputCase=FESSUR CaseType=Combination U1=-1.36450971210752E-05 U2=0 U3=-1.10419627983032E-02
 R1=0 R2=1.90687784897013E-04 R3=0
 Joint=44 OutputCase=PESOPR CaseType=LinStatic U1=-1.68334645189374E-06 U2=0 U3=-3.56787644436437E-03
 R1=0 R2=2.38061644304028E-05 R3=0
 Joint=44 OutputCase=TERRVERT CaseType=LinStatic U1=1.27912079055615E-07 U2=0 U3=-8.01676716951606E-03
 R1=0 R2=1.55956989637183E-04 R3=0
 Joint=44 OutputCase=TERRLAT CaseType=LinStatic U1=-4.78020347236242E-06 U2=0 U3=2.80880485518484E-05
 R1=0 R2=-1.02608792491209E-05 R3=0
 Joint=44 OutputCase=ACCLATDX CaseType=LinStatic U1=0 U2=0 U3=0 R1=0 R2=0 R3=0
 Joint=44 OutputCase=ACCLATSX CaseType=LinStatic U1=0 U2=0 U3=0 R1=0 R2=0 R3=0
 Joint=44 OutputCase=TERRCOST CaseType=LinStatic U1=0 U2=0 U3=0 R1=0 R2=0 R3=0
 Joint=44 OutputCase=SOVRCOST CaseType=LinStatic U1=0 U2=0 U3=0 R1=0 R2=0 R3=0
 Joint=44 OutputCase=ENVE CaseType=Combination StepType=Max U1=-4.90157680349182E-06 U2=0 U3=-
 1.15565555653286E-02 R1=0 R2=1.72580538593202E-04 R3=0
 Joint=44 OutputCase=ENVE CaseType=Combination StepType=Min U1=-6.33563784520054E-06 U2=0 U3=-
 1.15649819798941E-02 R1=0 R2=1.69502274818465E-04 R3=0
 Joint=44 OutputCase=FESSUR CaseType=Combination U1=-6.33563784520054E-06 U2=0 U3=-1.15565555653286E-02
 R1=0 R2=1.69502274818465E-04 R3=0
 Joint=45 OutputCase=PESOPR CaseType=LinStatic U1=-1.4729308975896E-06 U2=0 U3=-3.57953371822394E-03
 R1=0 R2=1.76044793413488E-05 R3=0
 Joint=45 OutputCase=TERRVERT CaseType=LinStatic U1=1.11922762931626E-07 U2=0 U3=-0.008095410236111
 R1=0 R2=1.17598246661961E-04 R3=0
 Joint=45 OutputCase=TERRLAT CaseType=LinStatic U1=-5.7054720292552E-06 U2=0 U3=3.23634140213004E-05
 R1=0 R2=-6.84058257288223E-06 R3=0
 Joint=45 OutputCase=ACCLATDX CaseType=LinStatic U1=0 U2=0 U3=0 R1=0 R2=0 R3=0
 Joint=45 OutputCase=ACCLATSX CaseType=LinStatic U1=0 U2=0 U3=0 R1=0 R2=0 R3=0
 Joint=45 OutputCase=TERRCOST CaseType=LinStatic U1=0 U2=0 U3=0 R1=0 R2=0 R3=0
 Joint=45 OutputCase=SOVRCOST CaseType=LinStatic U1=0 U2=0 U3=0 R1=0 R2=0 R3=0
 Joint=45 OutputCase=ENVE CaseType=Combination StepType=Max U1=-5.35483855513661E-06 U2=0 U3=-
 1.16425805403136E-02 R1=0 R2=1.30414318202293E-04 R3=0
 Joint=45 OutputCase=ENVE CaseType=Combination StepType=Min U1=-7.06648016391317E-06 U2=0 U3=-
 0.01165228956452 R1=0 R2=1.28362143430428E-04 R3=0
 Joint=45 OutputCase=FESSUR CaseType=Combination U1=-7.06648016391317E-06 U2=0 U3=-1.16425805403136E-02
 R1=0 R2=1.28362143430428E-04 R3=0
 Joint=46 OutputCase=PESOPR CaseType=LinStatic U1=-1.26251534328546E-06 U2=0 U3=-3.58704819291041E-03
 R1=0 R2=9.32234840535353E-06 R3=0
 Joint=46 OutputCase=TERRVERT CaseType=LinStatic U1=9.59334468076372E-08 U2=0 U3=-8.14668415212002E-03
 R1=0 R2=6.288719933895E-05 R3=0
 Joint=46 OutputCase=TERRLAT CaseType=LinStatic U1=-6.63074058614797E-06 U2=0 U3=3.49286311456806E-05
 R1=0 R2=-3.42028586883382E-06 R3=0
 Joint=46 OutputCase=ACCLATDX CaseType=LinStatic U1=0 U2=0 U3=0 R1=0 R2=0 R3=0
 Joint=46 OutputCase=ACCLATSX CaseType=LinStatic U1=0 U2=0 U3=0 R1=0 R2=0 R3=0
 Joint=46 OutputCase=TERRCOST CaseType=LinStatic U1=0 U2=0 U3=0 R1=0 R2=0 R3=0
 Joint=46 OutputCase=SOVRCOST CaseType=LinStatic U1=0 U2=0 U3=0 R1=0 R2=0 R3=0
 Joint=46 OutputCase=ENVE CaseType=Combination StepType=Max U1=-5.8081003067814E-06 U2=0 U3=-
 1.16988037138848E-02 R1=0 R2=6.98153476361199E-05 R3=0
 Joint=46 OutputCase=ENVE CaseType=Combination StepType=Min U1=-7.7973224826258E-06 U2=0 U3=-
 1.17092823032285E-02 R1=0 R2=6.87892618754698E-05 R3=0
 Joint=46 OutputCase=FESSUR CaseType=Combination U1=-7.7973224826258E-06 U2=0 U3=-1.16988037138848E-02
 R1=0 R2=6.87892618754698E-05 R3=0



Joint=47 OutputCase=PESOPR CaseType=LinStatic U1=-1.05209978898133E-06 U2=0 U3=-3.58963970123129E-03
 R1=0 R2=-5.45365092799843E-12 R3=0
 Joint=47 OutputCase=TERRVERT CaseType=LinStatic U1=7.99441306836094E-08 U2=0 U3=-8.16445680341476E-03
 R1=0 R2=-1.49736793560345E-13 R3=0
 Joint=47 OutputCase=TERRLAT CaseType=LinStatic U1=-7.55600914304075E-06 U2=0 U3=3.57836999110842E-05
 R1=0 R2=1.08630244031435E-11 R3=0
 Joint=47 OutputCase=ACCLATDX CaseType=LinStatic U1=0 U2=0 U3=0 R1=0 R2=0 R3=0
 Joint=47 OutputCase=ACCLATSX CaseType=LinStatic U1=0 U2=0 U3=0 R1=0 R2=0 R3=0
 Joint=47 OutputCase=TERRCOST CaseType=LinStatic U1=0 U2=0 U3=0 R1=0 R2=0 R3=0
 Joint=47 OutputCase=SOVRCOST CaseType=LinStatic U1=0 U2=0 U3=0 R1=0 R2=0 R3=0
 Joint=47 OutputCase=ENVE CaseType=Combination StepType=Max U1=-6.26136205842625E-06 U2=0 U3=-
 0.011718312804735 R1=0 R2=5.25963668158475E-12 R3=0
 Joint=47 OutputCase=ENVE CaseType=Combination StepType=Min U1=-8.52816480133847E-06 U2=0 U3=-
 1.17290479147083E-02 R1=0 R2=2.00072936064169E-12 R3=0
 Joint=47 OutputCase=FESSUR CaseType=Combination U1=-8.52816480133847E-06 U2=0 U3=-0.011718312804735
 R1=0 R2=5.25963668158475E-12 R3=0
 Joint=48 OutputCase=PESOPR CaseType=LinStatic U1=-8.41684234677204E-07 U2=0 U3=-3.58704818745606E-03
 R1=0 R2=-9.32235931173139E-06 R3=0
 Joint=48 OutputCase=TERRVERT CaseType=LinStatic U1=6.39548145595817E-08 U2=0 U3=-8.1466841519579E-03
 R1=0 R2=-6.2887199621981E-05 R3=0
 Joint=48 OutputCase=TERRLAT CaseType=LinStatic U1=-8.48127769993352E-06 U2=0 U3=3.49286203036063E-05
 R1=0 R2=3.42030762269242E-06 R3=0
 Joint=48 OutputCase=ACCLATDX CaseType=LinStatic U1=0 U2=0 U3=0 R1=0 R2=0 R3=0
 Joint=48 OutputCase=ACCLATSX CaseType=LinStatic U1=0 U2=0 U3=0 R1=0 R2=0 R3=0
 Joint=48 OutputCase=TERRCOST CaseType=LinStatic U1=0 U2=0 U3=0 R1=0 R2=0 R3=0
 Joint=48 OutputCase=SOVRCOST CaseType=LinStatic U1=0 U2=0 U3=0 R1=0 R2=0 R3=0
 Joint=48 OutputCase=ENVE CaseType=Combination StepType=Max U1=-6.71462381007109E-06 U2=0 U3=-
 1.16988037191104E-02 R1=0 R2=-6.878925131102E-05 R3=0
 Joint=48 OutputCase=ENVE CaseType=Combination StepType=Min U1=-9.25900712005115E-06 U2=0 U3=-
 1.17092823052014E-02 R1=0 R2=-6.98153435978277E-05 R3=0
 Joint=48 OutputCase=FESSUR CaseType=Combination U1=-9.25900712005115E-06 U2=0 U3=-1.16988037191104E-02
 R1=0 R2=-6.878925131102E-05 R3=0
 Joint=49 OutputCase=PESOPR CaseType=LinStatic U1=-6.31268680373076E-07 U2=0 U3=-3.57953370731617E-03
 R1=0 R2=-1.76044902449543E-05 R3=0
 Joint=49 OutputCase=TERRVERT CaseType=LinStatic U1=4.79654984355539E-08 U2=0 U3=-8.09541023580319E-03
 R1=0 R2=-1.17598246895666E-04 R3=0
 Joint=49 OutputCase=TERRLAT CaseType=LinStatic U1=-9.4065462568263E-06 U2=0 U3=3.23633923093419E-05
 R1=0 R2=6.84060441017025E-06 R3=0
 Joint=49 OutputCase=ACCLATDX CaseType=LinStatic U1=0 U2=0 U3=0 R1=0 R2=0 R3=0
 Joint=49 OutputCase=ACCLATSX CaseType=LinStatic U1=0 U2=0 U3=0 R1=0 R2=0 R3=0
 Joint=49 OutputCase=TERRCOST CaseType=LinStatic U1=0 U2=0 U3=0 R1=0 R2=0 R3=0
 Joint=49 OutputCase=SOVRCOST CaseType=LinStatic U1=0 U2=0 U3=0 R1=0 R2=0 R3=0
 Joint=49 OutputCase=ENVE CaseType=Combination StepType=Max U1=-7.16788556171593E-06 U2=0 U3=-
 0.01164258055081 R1=0 R2=-1.2836213273045E-04 R3=0
 Joint=49 OutputCase=ENVE CaseType=Combination StepType=Min U1=-9.98984943876382E-06 U2=0 U3=-
 1.16522895685028E-02 R1=0 R2=-1.30414314053501E-04 R3=0
 Joint=49 OutputCase=FESSUR CaseType=Combination U1=-9.98984943876382E-06 U2=0 U3=-0.01164258055081
 R1=0 R2=-1.2836213273045E-04 R3=0
 Joint=50 OutputCase=PESOPR CaseType=LinStatic U1=-4.20853126068948E-07 U2=0 U3=-3.56787642800502E-03
 R1=0 R2=-2.38061753293856E-05 R3=0
 Joint=50 OutputCase=TERRVERT CaseType=LinStatic U1=3.19761823115261E-08 U2=0 U3=-8.01676716909546E-03
 R1=0 R2=-1.55956989788674E-04 R3=0
 Joint=50 OutputCase=TERRLAT CaseType=LinStatic U1=-1.03318148137191E-05 U2=0 U3=2.80880159143861E-05
 R1=0 R2=1.02609012254579E-05 R3=0
 Joint=50 OutputCase=ACCLATDX CaseType=LinStatic U1=0 U2=0 U3=0 R1=0 R2=0 R3=0
 Joint=50 OutputCase=ACCLATSX CaseType=LinStatic U1=0 U2=0 U3=0 R1=0 R2=0 R3=0
 Joint=50 OutputCase=TERRCOST CaseType=LinStatic U1=0 U2=0 U3=0 R1=0 R2=0 R3=0
 Joint=50 OutputCase=SOVRCOST CaseType=LinStatic U1=0 U2=0 U3=0 R1=0 R2=0 R3=0
 Joint=50 OutputCase=ENVE CaseType=Combination StepType=Max U1=-7.62114731336077E-06 U2=0 U3=-
 1.1556555811861E-02 R1=0 R2=-1.69502263892601E-04 R3=0
 Joint=50 OutputCase=ENVE CaseType=Combination StepType=Min U1=-1.07206917574765E-05 U2=0 U3=-
 1.15649819859604E-02 R1=0 R2=-1.72580534260239E-04 R3=0
 Joint=50 OutputCase=FESSUR CaseType=Combination U1=-1.07206917574765E-05 U2=0 U3=-1.1556555811861E-02
 R1=0 R2=-1.69502263892601E-04 R3=0
 Joint=51 OutputCase=PESOPR CaseType=LinStatic U1=-2.87221376110804E-05 U2=0 U3=-3.52953294244097E-03
 R1=0 R2=-1.79599468219406E-05 R3=0
 Joint=51 OutputCase=TERRVERT CaseType=LinStatic U1=-1.12472955037423E-04 U2=0 U3=-7.78146166470398E-03
 R1=0 R2=-7.50722556734261E-05 R3=0
 Joint=51 OutputCase=TERRLAT CaseType=LinStatic U1=2.15517632815574E-05 U2=0 U3=1.44068729203846E-05
 R1=0 R2=1.37047687639153E-05 R3=0
 Joint=51 OutputCase=ACCLATDX CaseType=LinStatic U1=0 U2=0 U3=0 R1=0 R2=0 R3=0
 Joint=51 OutputCase=ACCLATSX CaseType=LinStatic U1=0 U2=0 U3=0 R1=0 R2=0 R3=0
 Joint=51 OutputCase=TERRCOST CaseType=LinStatic U1=0 U2=0 U3=0 R1=0 R2=0 R3=0
 Joint=51 OutputCase=SOVRCOST CaseType=LinStatic U1=0 U2=0 U3=0 R1=0 R2=0 R3=0
 Joint=51 OutputCase=ENVE CaseType=Combination StepType=Max U1=-1.19643329366946E-04 U2=0 U3=-
 1.12965877342246E-02 R1=0 R2=-7.93274337314514E-05 R3=0
 Joint=51 OutputCase=ENVE CaseType=Combination StepType=Min U1=-1.26108858351413E-04 U2=0 U3=-
 1.13009097961007E-02 R1=0 R2=-8.3438864360626E-05 R3=0
 Joint=51 OutputCase=FESSUR CaseType=Combination U1=-1.19643329366946E-04 U2=0 U3=-1.12965877342246E-02
 R1=0 R2=-7.93274337314514E-05 R3=0
 Joint=52 OutputCase=PESOPR CaseType=LinStatic U1=-3.44560662932259E-05 U2=0 U3=-3.53135333250219E-03
 R1=0 R2=-7.50917129677916E-06 R3=0

Joint=52	OutputCase=TERRVERT	CaseType=LinStatic	U1=-1.40701119915831E-04	U2=0	U3=-7.78827512456382E-03				
R1=0	R2=-3.76478929094269E-05	R3=0							
Joint=52	OutputCase=TERRLAT	CaseType=LinStatic	U1=2.76032538320416E-05	U2=0	U3=1.44068728794962E-05				
R1=0	R2=6.60886502487851E-06	R3=0							
Joint=52	OutputCase=ACCLATDX	CaseType=LinStatic	U1=0	U2=0	U3=0	R1=0	R2=0	R3=0	
Joint=52	OutputCase=ACCLATSX	CaseType=LinStatic	U1=0	U2=0	U3=0	R1=0	R2=0	R3=0	
Joint=52	OutputCase=TERRCOST	CaseType=LinStatic	U1=0	U2=0	U3=0	R1=0	R2=0	R3=0	
Joint=52	OutputCase=SOVRCOST	CaseType=LinStatic	U1=0	U2=0	U3=0	R1=0	R2=0	R3=0	
Joint=52	OutputCase=ENVE	CaseType=Combination	StepType=Max	U1=-1.47553932377015E-04	U2=0	U3=-			
1.13052215841865E-02	R1=0	R2=-3.85481991813275E-05	R3=0						
Joint=52	OutputCase=ENVE	CaseType=Combination	StepType=Min	U1=-1.55834908526627E-04	U2=0	U3=-			
1.13095436460504E-02	R1=0	R2=-4.05308586887911E-05	R3=0						
Joint=52	OutputCase=FESSUR	CaseType=Combination	U1=-1.47553932377015E-04	U2=0	U3=-1.13052215841865E-02				
R1=0	R2=-3.85481991813275E-05	R3=0							
Joint=53	OutputCase=PESOPR	CaseType=LinStatic	U1=-3.52802305676837E-05	U2=0	U3=-3.53300035211511E-03				
R1=0	R2=1.67911081988795E-06	R3=0							
Joint=53	OutputCase=TERRVERT	CaseType=LinStatic	U1=-1.50193119519276E-04	U2=0	U3=-7.79508858457257E-03				
R1=0	R2=-1.27594573574991E-07	R3=0							
Joint=53	OutputCase=TERRLAT	CaseType=LinStatic	U1=2.90080180467876E-05	U2=0	U3=1.44068728733653E-05				
R1=0	R2=-1.5925290163122E-06	R3=0							
Joint=53	OutputCase=ACCLATDX	CaseType=LinStatic	U1=0	U2=0	U3=0	R1=0	R2=0	R3=0	
Joint=53	OutputCase=ACCLATSX	CaseType=LinStatic	U1=0	U2=0	U3=0	R1=0	R2=0	R3=0	
Joint=53	OutputCase=TERRCOST	CaseType=LinStatic	U1=0	U2=0	U3=0	R1=0	R2=0	R3=0	
Joint=53	OutputCase=SOVRCOST	CaseType=LinStatic	U1=0	U2=0	U3=0	R1=0	R2=0	R3=0	
Joint=53	OutputCase=ENVE	CaseType=Combination	StepType=Max	U1=-1.56465332040172E-04	U2=0	U3=-			
1.13136820638143E-02	R1=0	R2=4.3674593489442E-07	R3=0						
Joint=53	OutputCase=ENVE	CaseType=Combination	StepType=Min	U1=-1.65167737454208E-04	U2=0	U3=-			
1.13180041256763E-02	R1=0	R2=-4.1012769999239E-08	R3=0						
Joint=53	OutputCase=FESSUR	CaseType=Combination	U1=-1.56465332040172E-04	U2=0	U3=-1.13136820638143E-02				
R1=0	R2=-4.1012769999239E-08	R3=0							
Joint=54	OutputCase=PESOPR	CaseType=LinStatic	U1=-3.18258771366342E-05	U2=0	U3=-3.53447400127472E-03				
R1=0	R2=9.60489953632772E-06	R3=0							
Joint=54	OutputCase=TERRVERT	CaseType=LinStatic	U1=-1.40900986061832E-04	U2=0	U3=-7.80190204473059E-03				
R1=0	R2=3.74886393341298E-05	R3=0							
Joint=54	OutputCase=TERRLAT	CaseType=LinStatic	U1=2.56899700447064E-05	U2=0	U3=1.44068729028315E-05				
R1=0	R2=-9.34877905252229E-06	R3=0							
Joint=54	OutputCase=ACCLATDX	CaseType=LinStatic	U1=0	U2=0	U3=0	R1=0	R2=0	R3=0	
Joint=54	OutputCase=ACCLATSX	CaseType=LinStatic	U1=0	U2=0	U3=0	R1=0	R2=0	R3=0	
Joint=54	OutputCase=TERRCOST	CaseType=LinStatic	U1=0	U2=0	U3=0	R1=0	R2=0	R3=0	
Joint=54	OutputCase=SOVRCOST	CaseType=LinStatic	U1=0	U2=0	U3=0	R1=0	R2=0	R3=0	
Joint=54	OutputCase=ENVE	CaseType=Combination	StepType=Max	U1=-1.4703689315376E-04	U2=0	U3=-			
1.13219691731025E-02	R1=0	R2=4.05493935336919E-05	R3=0						
Joint=54	OutputCase=ENVE	CaseType=Combination	StepType=Min	U1=-1.54743884167172E-04	U2=0	U3=-			
1.13262912349733E-02	R1=0	R2=3.77447598179353E-05	R3=0						
Joint=54	OutputCase=FESSUR	CaseType=Combination	U1=-1.4703689315376E-04	U2=0	U3=-1.13219691731025E-02				
R1=0	R2=3.77447598179353E-05	R3=0							
Joint=55	OutputCase=PESOPR	CaseType=LinStatic	U1=-2.47242526981243E-05	U2=0	U3=-3.53577427997598E-03				
R1=0	R2=1.62681948608071E-05	R3=0							
Joint=55	OutputCase=TERRVERT	CaseType=LinStatic	U1=-1.12776751757572E-04	U2=0	U3=-7.80871550503828E-03				
R1=0	R2=7.52008088136877E-05	R3=0							
Joint=55	OutputCase=TERRLAT	CaseType=LinStatic	U1=1.83039885933574E-05	U2=0	U3=1.44068729629253E-05				
R1=0	R2=-1.52866607962941E-05	R3=0							
Joint=55	OutputCase=ACCLATDX	CaseType=LinStatic	U1=0	U2=0	U3=0	R1=0	R2=0	R3=0	
Joint=55	OutputCase=ACCLATSX	CaseType=LinStatic	U1=0	U2=0	U3=0	R1=0	R2=0	R3=0	
Joint=55	OutputCase=TERRCOST	CaseType=LinStatic	U1=0	U2=0	U3=0	R1=0	R2=0	R3=0	
Joint=55	OutputCase=SOVRCOST	CaseType=LinStatic	U1=0	U2=0	U3=0	R1=0	R2=0	R3=0	
Joint=55	OutputCase=ENVE	CaseType=Combination	StepType=Max	U1=-1.19197015862339E-04	U2=0	U3=-			
1.13300829120513E-02	R1=0	R2=8.0768341117089E-05	R3=0						
Joint=55	OutputCase=ENVE	CaseType=Combination	StepType=Min	U1=-1.24688212440346E-04	U2=0	U3=-			
1.13344049739402E-02	R1=0	R2=7.61823428782007E-05	R3=0						
Joint=55	OutputCase=FESSUR	CaseType=Combination	U1=-1.19197015862339E-04	U2=0	U3=-1.13300829120513E-02				
R1=0	R2=7.61823428782007E-05	R3=0							
Joint=56	OutputCase=PESOPR	CaseType=LinStatic	U1=2.66179711163898E-05	U2=0	U3=-3.52953291526045E-03				
R1=0	R2=1.79599358409882E-05	R3=0							
Joint=56	OutputCase=TERRVERT	CaseType=LinStatic	U1=1.12632847648765E-04	U2=0	U3=-7.78146166451557E-03				
R1=0	R2=7.5072254960644E-05	R3=0							
Joint=56	OutputCase=TERRLAT	CaseType=LinStatic	U1=-3.66638495460369E-05	U2=0	U3=1.44068181373001E-05				
R1=0	R2=-1.37047459862005E-05	R3=0							
Joint=56	OutputCase=ACCLATDX	CaseType=LinStatic	U1=0	U2=0	U3=0	R1=0	R2=0	R3=0	
Joint=56	OutputCase=ACCLATSX	CaseType=LinStatic	U1=0	U2=0	U3=0	R1=0	R2=0	R3=0	
Joint=56	OutputCase=TERRCOST	CaseType=LinStatic	U1=0	U2=0	U3=0	R1=0	R2=0	R3=0	
Joint=56	OutputCase=SOVRCOST	CaseType=LinStatic	U1=0	U2=0	U3=0	R1=0	R2=0	R3=0	
Joint=56	OutputCase=ENVE	CaseType=Combination	StepType=Max	U1=1.13586124082929E-04	U2=0	U3=-			
1.12965877616387E-02	R1=0	R2=8.34388686112918E-05	R3=0						
Joint=56	OutputCase=ENVE	CaseType=Combination	StepType=Min	U1=1.02586969219118E-04	U2=0	U3=-			
1.13009098070799E-02	R1=0	R2=7.93274448154317E-05	R3=0						
Joint=56	OutputCase=FESSUR	CaseType=Combination	U1=1.02586969219118E-04	U2=0	U3=-1.12965877616387E-02				
R1=0	R2=7.93274448154317E-05	R3=0							
Joint=57	OutputCase=PESOPR	CaseType=LinStatic	U1=3.23518943057502E-05	U2=0	U3=-3.53135330531371E-03				
R1=0	R2=7.50916030659051E-06	R3=0							
Joint=57	OutputCase=TERRVERT	CaseType=LinStatic	U1=1.4086101212968E-04	U2=0	U3=-7.78827512438088E-03				
R1=0	R2=3.76478920322355E-05	R3=0							



Joint=57	OutputCase=TERRLAT	CaseType=LinStatic	U1=-4.27153286619809E-05	U2=0	U3=1.44068180871418E-05			
R1=0	R2=-6.60884219760083E-06	R3=0						
Joint=57	OutputCase=ACCLATDX	CaseType=LinStatic	U1=0	U2=0	U3=0	R1=0	R2=0	R3=0
Joint=57	OutputCase=ACCLATSX	CaseType=LinStatic	U1=0	U2=0	U3=0	R1=0	R2=0	R3=0
Joint=57	OutputCase=TERRCOST	CaseType=LinStatic	U1=0	U2=0	U3=0	R1=0	R2=0	R3=0
Joint=57	OutputCase=SOVRCOST	CaseType=LinStatic	U1=0	U2=0	U3=0	R1=0	R2=0	R3=0
Joint=57	OutputCase=ENVE	CaseType=Combination	StepType=Max	U1=1.43312176372044E-04	U2=0	U3=-		
1.13052216116074E-02	R1=0	R2=4.05308628005055E-05	R3=0					
Joint=57	OutputCase=ENVE	CaseType=Combination	StepType=Min	U1=1.3049757777345E-04	U2=0	U3=-		
1.13095436570336E-02	R1=0	R2=3.85482101412252E-05	R3=0					
Joint=57	OutputCase=FESSUR	CaseType=Combination	U1=1.3049757777345E-04	U2=0	U3=-1.13052216116074E-02			
R1=0	R2=3.85482101412252E-05	R3=0						
Joint=58	OutputCase=PESOPR	CaseType=LinStatic	U1=3.31760530828047E-05	U2=0	U3=-3.53300032491866E-03			
R1=0	R2=-1.67912181931316E-06	R3=0						
Joint=58	OutputCase=TERRVERT	CaseType=LinStatic	U1=1.50353011253428E-04	U2=0	U3=-7.79508858439508E-03			
R1=0	R2=1.27593531973499E-07	R3=0						
Joint=58	OutputCase=TERRLAT	CaseType=LinStatic	U1=-4.41200814352124E-05	U2=0	U3=1.4406818071741E-05			
R1=0	R2=1.59255182828921E-06	R3=0						
Joint=58	OutputCase=ACCLATDX	CaseType=LinStatic	U1=0	U2=0	U3=0	R1=0	R2=0	R3=0
Joint=58	OutputCase=ACCLATSX	CaseType=LinStatic	U1=0	U2=0	U3=0	R1=0	R2=0	R3=0
Joint=58	OutputCase=TERRCOST	CaseType=LinStatic	U1=0	U2=0	U3=0	R1=0	R2=0	R3=0
Joint=58	OutputCase=SOVRCOST	CaseType=LinStatic	U1=0	U2=0	U3=0	R1=0	R2=0	R3=0
Joint=58	OutputCase=ENVE	CaseType=Combination	StepType=Max	U1=1.52645007331584E-04	U2=0	U3=-		
0.011313682091242	R1=0	R2=4.10235409495434E-08	R3=0					
Joint=58	OutputCase=ENVE	CaseType=Combination	StepType=Min	U1=1.3940898290102E-04	U2=0	U3=-		
1.13180041366635E-02	R1=0	R2=-4.36742007537219E-07	R3=0					
Joint=58	OutputCase=FESSUR	CaseType=Combination	U1=1.3940898290102E-04	U2=0	U3=-0.011313682091242			
R1=0	R2=4.10235409495434E-08	R3=0						
Joint=59	OutputCase=PESOPR	CaseType=LinStatic	U1=2.97216941497335E-05	U2=0	U3=-3.53447397407029E-03			
R1=0	R2=-9.60491054498975E-06	R3=0						
Joint=59	OutputCase=TERRVERT	CaseType=LinStatic	U1=1.41060877234081E-04	U2=0	U3=-7.80190204455857E-03			
R1=0	R2=-3.7488640540142E-05	R3=0						
Joint=59	OutputCase=TERRLAT	CaseType=LinStatic	U1=-4.08020220166797E-05	U2=0	U3=1.44068180919374E-05			
R1=0	R2=9.34880178803606E-06	R3=0						
Joint=59	OutputCase=ACCLATDX	CaseType=LinStatic	U1=0	U2=0	U3=0	R1=0	R2=0	R3=0
Joint=59	OutputCase=ACCLATSX	CaseType=LinStatic	U1=0	U2=0	U3=0	R1=0	R2=0	R3=0
Joint=59	OutputCase=TERRCOST	CaseType=LinStatic	U1=0	U2=0	U3=0	R1=0	R2=0	R3=0
Joint=59	OutputCase=SOVRCOST	CaseType=LinStatic	U1=0	U2=0	U3=0	R1=0	R2=0	R3=0
Joint=59	OutputCase=ENVE	CaseType=Combination	StepType=Max	U1=1.42221155972138E-04	U2=0	U3=-		
1.13219692005369E-02	R1=0	R2=-3.77447492970957E-05	R3=0					
Joint=59	OutputCase=ENVE	CaseType=Combination	StepType=Min	U1=1.29980549367134E-04	U2=0	U3=-		
1.13262912459645E-02	R1=0	R2=-4.05493898335065E-05	R3=0					
Joint=59	OutputCase=FESSUR	CaseType=Combination	U1=1.29980549367134E-04	U2=0	U3=-1.13219692005369E-02			
R1=0	R2=-3.77447492970957E-05	R3=0						
Joint=60	OutputCase=PESOPR	CaseType=LinStatic	U1=2.26200642045835E-05	U2=0	U3=-3.53577425276359E-03			
R1=0	R2=-1.62682058787062E-05	R3=0						
Joint=60	OutputCase=TERRVERT	CaseType=LinStatic	U1=1.12936642285712E-04	U2=0	U3=-7.80871550487172E-03			
R1=0	R2=-7.52008101841112E-05	R3=0						
Joint=60	OutputCase=TERRLAT	CaseType=LinStatic	U1=-3.34160292038644E-05	U2=0	U3=1.44068181427613E-05			
R1=0	R2=1.52866833989406E-05	R3=0						
Joint=60	OutputCase=ACCLATDX	CaseType=LinStatic	U1=0	U2=0	U3=0	R1=0	R2=0	R3=0
Joint=60	OutputCase=ACCLATSX	CaseType=LinStatic	U1=0	U2=0	U3=0	R1=0	R2=0	R3=0
Joint=60	OutputCase=TERRCOST	CaseType=LinStatic	U1=0	U2=0	U3=0	R1=0	R2=0	R3=0
Joint=60	OutputCase=SOVRCOST	CaseType=LinStatic	U1=0	U2=0	U3=0	R1=0	R2=0	R3=0
Joint=60	OutputCase=ENVE	CaseType=Combination	StepType=Max	U1=1.12165486047591E-04	U2=0	U3=-		
1.13300829394926E-02	R1=0	R2=-7.61823326638768E-05	R3=0					
Joint=60	OutputCase=ENVE	CaseType=Combination	StepType=Min	U1=1.02140677286431E-04	U2=0	U3=-		
1.13344049849354E-02	R1=0	R2=-8.0768337683559E-05	R3=0					
Joint=60	OutputCase=FESSUR	CaseType=Combination	U1=1.02140677286431E-04	U2=0	U3=-1.13300829394926E-02			
R1=0	R2=-7.61823326638768E-05	R3=0						

TABLE: "JOINT REACTIONS"

Joint=1	OutputCase=PESOPR	CaseType=LinStatic	F1=-2.82263101791288E-12	F2=0	F3=11.4574580696171	M1=0		
M2=0	M3=0							
Joint=1	OutputCase=TERRVERT	CaseType=LinStatic	F1=-9.62407931126563E-12	F2=0	F3=25.2454605024798	M1=0		
M2=0	M3=0							
Joint=1	OutputCase=TERRLAT	CaseType=LinStatic	F1=-8.37684829946284E-07	F2=0	F3=-0.046822331045254			
M1=0	M2=0	M3=0						
Joint=1	OutputCase=ACCLATDX	CaseType=LinStatic	F1=0	F2=0	F3=0	M1=0	M2=0	M3=0
Joint=1	OutputCase=ACCLATSX	CaseType=LinStatic	F1=0	F2=0	F3=0	M1=0	M2=0	M3=0
Joint=1	OutputCase=TERRCOST	CaseType=LinStatic	F1=0	F2=0	F3=0	M1=0	M2=0	M3=0
Joint=1	OutputCase=SOVRCOST	CaseType=LinStatic	F1=0	F2=0	F3=0	M1=0	M2=0	M3=0
Joint=1	OutputCase=ENVE	CaseType=Combination	StepType=Max	F1=-5.86391827672728E-07	F2=0			
F3=36.6701429403652	M1=0	M2=0	M3=0					
Joint=1	OutputCase=ENVE	CaseType=Combination	StepType=Min	F1=-8.37697276656613E-07	F2=0			
F3=36.6560962410516	M1=0	M2=0	M3=0					
Joint=1	OutputCase=FESSUR	CaseType=Combination	F1=-8.37697276656613E-07	F2=0	F3=36.6560962410516	M1=0		
M2=0	M3=0							
Joint=15	OutputCase=PESOPR	CaseType=LinStatic	F1=0	F2=0	F3=11.4574579813322	M1=0	M2=0	M3=0
Joint=15	OutputCase=TERRVERT	CaseType=LinStatic	F1=0	F2=0	F3=25.2454605018319	M1=0	M2=0	M3=0
Joint=15	OutputCase=TERRLAT	CaseType=LinStatic	F1=0	F2=0	F3=-4.68221530605027E-02	M1=0	M2=0	M3=0
Joint=15	OutputCase=ACCLATDX	CaseType=LinStatic	F1=0	F2=0	F3=0	M1=0	M2=0	M3=0



Joint=15	OutputCase=ACCLATSX	CaseType=LinStatic	F1=0	F2=0	F3=0	M1=0	M2=0	M3=0
Joint=15	OutputCase=TERRCOST	CaseType=LinStatic	F1=0	F2=0	F3=0	M1=0	M2=0	M3=0
Joint=15	OutputCase=SOVRCOST	CaseType=LinStatic	F1=0	F2=0	F3=0	M1=0	M2=0	M3=0
Joint=15	OutputCase=ENVE	CaseType=Combination	StepType=Max	F1=0	F2=0	F3=36.6701429760218		M1=0
M2=0	M3=0							
Joint=15	OutputCase=ENVE	CaseType=Combination	StepType=Min	F1=0	F2=0	F3=36.6560963301036		M1=0
M2=0	M3=0							
Joint=15	OutputCase=FESSUR	CaseType=Combination	F1=0	F2=0	F3=36.6560963301036	M1=0	M2=0	M3=0
Joint=19	OutputCase=PESOPR	CaseType=LinStatic	F1=0	F2=0	F3=45.0731619788105	M1=0	M2=0	M3=0
Joint=19	OutputCase=TERRVERT	CaseType=LinStatic	F1=0	F2=0	F3=98.4781681517255	M1=0	M2=0	M3=0
Joint=19	OutputCase=TERRLAT	CaseType=LinStatic	F1=0	F2=0	F3=-5.81396480184824E-03	M1=0	M2=0	M3=0
Joint=19	OutputCase=ACCLATDX	CaseType=LinStatic	F1=0	F2=0	F3=0	M1=0	M2=0	M3=0
Joint=19	OutputCase=ACCLATSX	CaseType=LinStatic	F1=0	F2=0	F3=0	M1=0	M2=0	M3=0
Joint=19	OutputCase=TERRCOST	CaseType=LinStatic	F1=0	F2=0	F3=0	M1=0	M2=0	M3=0
Joint=19	OutputCase=SOVRCOST	CaseType=LinStatic	F1=0	F2=0	F3=0	M1=0	M2=0	M3=0
Joint=19	OutputCase=ENVE	CaseType=Combination	StepType=Max	F1=0	F2=0	F3=143.547260355175		M1=0
M2=0	M3=0							
Joint=19	OutputCase=ENVE	CaseType=Combination	StepType=Min	F1=0	F2=0	F3=143.545516165734		M1=0
M2=0	M3=0							
Joint=19	OutputCase=FESSUR	CaseType=Combination	F1=0	F2=0	F3=143.545516165734	M1=0	M2=0	M3=0
Joint=30	OutputCase=PESOPR	CaseType=LinStatic	F1=0	F2=0	F3=22.8217645828707	M1=0	M2=0	M3=0
Joint=30	OutputCase=TERRVERT	CaseType=LinStatic	F1=0	F2=0	F3=50.1773131280622	M1=0	M2=0	M3=0
Joint=30	OutputCase=TERRLAT	CaseType=LinStatic	F1=0	F2=0	F3=-6.66604222877555E-02	M1=0	M2=0	M3=0
Joint=30	OutputCase=ACCLATDX	CaseType=LinStatic	F1=0	F2=0	F3=0	M1=0	M2=0	M3=0
Joint=30	OutputCase=ACCLATSX	CaseType=LinStatic	F1=0	F2=0	F3=0	M1=0	M2=0	M3=0
Joint=30	OutputCase=TERRCOST	CaseType=LinStatic	F1=0	F2=0	F3=0	M1=0	M2=0	M3=0
Joint=30	OutputCase=SOVRCOST	CaseType=LinStatic	F1=0	F2=0	F3=0	M1=0	M2=0	M3=0
Joint=30	OutputCase=ENVE	CaseType=Combination	StepType=Max	F1=0	F2=0	F3=72.9524154153315		M1=0
M2=0	M3=0							
Joint=30	OutputCase=ENVE	CaseType=Combination	StepType=Min	F1=0	F2=0	F3=72.9324172886452		M1=0
M2=0	M3=0							
Joint=30	OutputCase=FESSUR	CaseType=Combination	F1=0	F2=0	F3=72.9324172886452	M1=0	M2=0	M3=0
Joint=31	OutputCase=PESOPR	CaseType=LinStatic	F1=0	F2=0	F3=34.0870800243767	M1=0	M2=0	M3=0
Joint=31	OutputCase=TERRVERT	CaseType=LinStatic	F1=0	F2=0	F3=74.7828104450448	M1=0	M2=0	M3=0
Joint=31	OutputCase=TERRLAT	CaseType=LinStatic	F1=0	F2=0	F3=-6.38206152295876E-02	M1=0	M2=0	M3=0
Joint=31	OutputCase=ACCLATDX	CaseType=LinStatic	F1=0	F2=0	F3=0	M1=0	M2=0	M3=0
Joint=31	OutputCase=ACCLATSX	CaseType=LinStatic	F1=0	F2=0	F3=0	M1=0	M2=0	M3=0
Joint=31	OutputCase=TERRCOST	CaseType=LinStatic	F1=0	F2=0	F3=0	M1=0	M2=0	M3=0
Joint=31	OutputCase=SOVRCOST	CaseType=LinStatic	F1=0	F2=0	F3=0	M1=0	M2=0	M3=0
Joint=31	OutputCase=ENVE	CaseType=Combination	StepType=Max	F1=0	F2=0	F3=108.825216038761		M1=0
M2=0	M3=0							
Joint=31	OutputCase=ENVE	CaseType=Combination	StepType=Min	F1=0	F2=0	F3=108.806069854192		M1=0
M2=0	M3=0							
Joint=31	OutputCase=FESSUR	CaseType=Combination	F1=0	F2=0	F3=108.806069854192	M1=0	M2=0	M3=0
Joint=32	OutputCase=PESOPR	CaseType=LinStatic	F1=0	F2=0	F3=34.087079813062	M1=0	M2=0	M3=0
Joint=32	OutputCase=TERRVERT	CaseType=LinStatic	F1=0	F2=0	F3=74.7828104444518	M1=0	M2=0	M3=0
Joint=32	OutputCase=TERRLAT	CaseType=LinStatic	F1=0	F2=0	F3=-6.38201903926962E-02	M1=0	M2=0	M3=0
Joint=32	OutputCase=ACCLATDX	CaseType=LinStatic	F1=0	F2=0	F3=0	M1=0	M2=0	M3=0
Joint=32	OutputCase=ACCLATSX	CaseType=LinStatic	F1=0	F2=0	F3=0	M1=0	M2=0	M3=0
Joint=32	OutputCase=TERRCOST	CaseType=LinStatic	F1=0	F2=0	F3=0	M1=0	M2=0	M3=0
Joint=32	OutputCase=SOVRCOST	CaseType=LinStatic	F1=0	F2=0	F3=0	M1=0	M2=0	M3=0
Joint=32	OutputCase=ENVE	CaseType=Combination	StepType=Max	F1=0	F2=0	F3=108.825216124239		M1=0
M2=0	M3=0							
Joint=32	OutputCase=ENVE	CaseType=Combination	StepType=Min	F1=0	F2=0	F3=108.806070067121		M1=0
M2=0	M3=0							
Joint=32	OutputCase=FESSUR	CaseType=Combination	F1=0	F2=0	F3=108.806070067121	M1=0	M2=0	M3=0
Joint=33	OutputCase=PESOPR	CaseType=LinStatic	F1=0	F2=0	F3=22.821764424169	M1=0	M2=0	M3=0
Joint=33	OutputCase=TERRVERT	CaseType=LinStatic	F1=0	F2=0	F3=50.1773131272768	M1=0	M2=0	M3=0
Joint=33	OutputCase=TERRLAT	CaseType=LinStatic	F1=0	F2=0	F3=-0.066660102807737	M1=0	M2=0	M3=0
Joint=33	OutputCase=ACCLATDX	CaseType=LinStatic	F1=0	F2=0	F3=0	M1=0	M2=0	M3=0
Joint=33	OutputCase=ACCLATSX	CaseType=LinStatic	F1=0	F2=0	F3=0	M1=0	M2=0	M3=0
Joint=33	OutputCase=TERRCOST	CaseType=LinStatic	F1=0	F2=0	F3=0	M1=0	M2=0	M3=0
Joint=33	OutputCase=SOVRCOST	CaseType=LinStatic	F1=0	F2=0	F3=0	M1=0	M2=0	M3=0
Joint=33	OutputCase=ENVE	CaseType=Combination	StepType=Max	F1=0	F2=0	F3=72.9524154794804		M1=0
M2=0	M3=0							
Joint=33	OutputCase=ENVE	CaseType=Combination	StepType=Min	F1=0	F2=0	F3=72.9324174486381		M1=0
M2=0	M3=0							
Joint=33	OutputCase=FESSUR	CaseType=Combination	F1=0	F2=0	F3=72.9324174486381	M1=0	M2=0	M3=0
Joint=36	OutputCase=PESOPR	CaseType=LinStatic	F1=0	F2=0	F3=44.7611184503864	M1=0	M2=0	M3=0
Joint=36	OutputCase=TERRVERT	CaseType=LinStatic	F1=0	F2=0	F3=97.4673266121824	M1=0	M2=0	M3=0
Joint=36	OutputCase=TERRLAT	CaseType=LinStatic	F1=0	F2=0	F3=5.06865975469016E-02	M1=0	M2=0	M3=0
Joint=36	OutputCase=ACCLATDX	CaseType=LinStatic	F1=0	F2=0	F3=0	M1=0	M2=0	M3=0
Joint=36	OutputCase=ACCLATSX	CaseType=LinStatic	F1=0	F2=0	F3=0	M1=0	M2=0	M3=0
Joint=36	OutputCase=TERRCOST	CaseType=LinStatic	F1=0	F2=0	F3=0	M1=0	M2=0	M3=0
Joint=36	OutputCase=SOVRCOST	CaseType=LinStatic	F1=0	F2=0	F3=0	M1=0	M2=0	M3=0
Joint=36	OutputCase=ENVE	CaseType=Combination	StepType=Max	F1=0	F2=0	F3=142.279131660116		M1=0
M2=0	M3=0							
Joint=36	OutputCase=ENVE	CaseType=Combination	StepType=Min	F1=0	F2=0	F3=142.263925680852		M1=0
M2=0	M3=0							
Joint=36	OutputCase=FESSUR	CaseType=Combination	F1=0	F2=0	F3=142.279131660116	M1=0	M2=0	M3=0
Joint=37	OutputCase=PESOPR	CaseType=LinStatic	F1=0	F2=0	F3=44.5566235391115	M1=0	M2=0	M3=0
Joint=37	OutputCase=TERRVERT	CaseType=LinStatic	F1=0	F2=0	F3=96.8086853428274	M1=0	M2=0	M3=0



Joint=37	OutputCase=TERRLAT	CaseType=LinStatic	F1=0	F2=0	F3=8.45296077207394E-02	M1=0	M2=0	M3=0
Joint=37	OutputCase=ACCLATDX	CaseType=LinStatic	F1=0	F2=0	F3=0	M1=0	M2=0	M3=0
Joint=37	OutputCase=ACCLATSX	CaseType=LinStatic	F1=0	F2=0	F3=0	M1=0	M2=0	M3=0
Joint=37	OutputCase=TERRCOST	CaseType=LinStatic	F1=0	F2=0	F3=0	M1=0	M2=0	M3=0
Joint=37	OutputCase=SOVRCOST	CaseType=LinStatic	F1=0	F2=0	F3=0	M1=0	M2=0	M3=0
Joint=37	OutputCase=ENVE	CaseType=Combination	StepType=Max	F1=0	F2=0	F3=141.44983848966	M1=0	M2=0
M3=0								
Joint=37	OutputCase=ENVE	CaseType=Combination	StepType=Min	F1=0	F2=0	F3=141.424479607343	M1=0	
M2=0								
M3=0								
Joint=37	OutputCase=FESSUR	CaseType=Combination	F1=0	F2=0	F3=141.44983848966	M1=0	M2=0	M3=0
Joint=38	OutputCase=PESOPR	CaseType=LinStatic	F1=0	F2=0	F3=44.4855846092711	M1=0	M2=0	M3=0
Joint=38	OutputCase=TERRVERT	CaseType=LinStatic	F1=0	F2=0	F3=96.580462267789	M1=0	M2=0	M3=0
Joint=38	OutputCase=TERRLAT	CaseType=LinStatic	F1=0	F2=0	F3=9.58004901202529E-02	M1=0	M2=0	M3=0
Joint=38	OutputCase=ACCLATDX	CaseType=LinStatic	F1=0	F2=0	F3=0	M1=0	M2=0	M3=0
Joint=38	OutputCase=ACCLATSX	CaseType=LinStatic	F1=0	F2=0	F3=0	M1=0	M2=0	M3=0
Joint=38	OutputCase=TERRCOST	CaseType=LinStatic	F1=0	F2=0	F3=0	M1=0	M2=0	M3=0
Joint=38	OutputCase=SOVRCOST	CaseType=LinStatic	F1=0	F2=0	F3=0	M1=0	M2=0	M3=0
Joint=38	OutputCase=ENVE	CaseType=Combination	StepType=Max	F1=0	F2=0	F3=141.16184736718	M1=0	M2=0
M3=0								
Joint=38	OutputCase=ENVE	CaseType=Combination	StepType=Min	F1=0	F2=0	F3=141.133107220144	M1=0	
M2=0								
M3=0								
Joint=38	OutputCase=FESSUR	CaseType=Combination	F1=0	F2=0	F3=141.16184736718	M1=0	M2=0	M3=0
Joint=41	OutputCase=PESOPR	CaseType=LinStatic	F1=0	F2=0	F3=44.5566234690999	M1=0	M2=0	M3=0
Joint=41	OutputCase=TERRVERT	CaseType=LinStatic	F1=0	F2=0	F3=96.8086853431634	M1=0	M2=0	M3=0
Joint=41	OutputCase=TERRLAT	CaseType=LinStatic	F1=0	F2=0	F3=8.45297478192665E-02	M1=0	M2=0	M3=0
Joint=41	OutputCase=ACCLATDX	CaseType=LinStatic	F1=0	F2=0	F3=0	M1=0	M2=0	M3=0
Joint=41	OutputCase=ACCLATSX	CaseType=LinStatic	F1=0	F2=0	F3=0	M1=0	M2=0	M3=0
Joint=41	OutputCase=TERRCOST	CaseType=LinStatic	F1=0	F2=0	F3=0	M1=0	M2=0	M3=0
Joint=41	OutputCase=SOVRCOST	CaseType=LinStatic	F1=0	F2=0	F3=0	M1=0	M2=0	M3=0
Joint=41	OutputCase=ENVE	CaseType=Combination	StepType=Max	F1=0	F2=0	F3=141.449838560083	M1=0	
M2=0								
M3=0								
Joint=41	OutputCase=ENVE	CaseType=Combination	StepType=Min	F1=0	F2=0	F3=141.424479635737	M1=0	
M2=0								
M3=0								
Joint=41	OutputCase=FESSUR	CaseType=Combination	F1=0	F2=0	F3=141.449838560083	M1=0	M2=0	M3=0
Joint=42	OutputCase=PESOPR	CaseType=LinStatic	F1=0	F2=0	F3=44.76111831017	M1=0	M2=0	M3=0
Joint=42	OutputCase=TERRVERT	CaseType=LinStatic	F1=0	F2=0	F3=97.4673266126411	M1=0	M2=0	M3=0
Joint=42	OutputCase=TERRLAT	CaseType=LinStatic	F1=0	F2=0	F3=5.06868783948118E-02	M1=0	M2=0	M3=0
Joint=42	OutputCase=ACCLATDX	CaseType=LinStatic	F1=0	F2=0	F3=0	M1=0	M2=0	M3=0
Joint=42	OutputCase=ACCLATSX	CaseType=LinStatic	F1=0	F2=0	F3=0	M1=0	M2=0	M3=0
Joint=42	OutputCase=TERRCOST	CaseType=LinStatic	F1=0	F2=0	F3=0	M1=0	M2=0	M3=0
Joint=42	OutputCase=SOVRCOST	CaseType=LinStatic	F1=0	F2=0	F3=0	M1=0	M2=0	M3=0
Joint=42	OutputCase=ENVE	CaseType=Combination	StepType=Max	F1=0	F2=0	F3=142.279131801206	M1=0	
M2=0								
M3=0								
Joint=42	OutputCase=ENVE	CaseType=Combination	StepType=Min	F1=0	F2=0	F3=142.263925737687	M1=0	
M2=0								
M3=0								
Joint=42	OutputCase=FESSUR	CaseType=Combination	F1=0	F2=0	F3=142.279131801206	M1=0	M2=0	M3=0
Joint=43	OutputCase=PESOPR	CaseType=LinStatic	F1=0	F2=0	F3=45.0731617680402	M1=0	M2=0	M3=0
Joint=43	OutputCase=TERRVERT	CaseType=LinStatic	F1=0	F2=0	F3=98.47816815188	M1=0	M2=0	M3=0
Joint=43	OutputCase=TERRLAT	CaseType=LinStatic	F1=0	F2=0	F3=-5.81354197835902E-03	M1=0	M2=0	M3=0
Joint=43	OutputCase=ACCLATDX	CaseType=LinStatic	F1=0	F2=0	F3=0	M1=0	M2=0	M3=0
Joint=43	OutputCase=ACCLATSX	CaseType=LinStatic	F1=0	F2=0	F3=0	M1=0	M2=0	M3=0
Joint=43	OutputCase=TERRCOST	CaseType=LinStatic	F1=0	F2=0	F3=0	M1=0	M2=0	M3=0
Joint=43	OutputCase=SOVRCOST	CaseType=LinStatic	F1=0	F2=0	F3=0	M1=0	M2=0	M3=0
Joint=43	OutputCase=ENVE	CaseType=Combination	StepType=Max	F1=0	F2=0	F3=143.547260440535	M1=0	
M2=0								
M3=0								
Joint=43	OutputCase=ENVE	CaseType=Combination	StepType=Min	F1=0	F2=0	F3=143.545516377942	M1=0	
M2=0								
M3=0								
Joint=43	OutputCase=FESSUR	CaseType=Combination	F1=0	F2=0	F3=143.545516377942	M1=0	M2=0	M3=0

TABLE: "ASSEMBLED JOINT MASSES"

Joint=1	U1=0.624999970197679	U2=0.624999970197679	U3=0.624999970197679	R1=0	R2=0	R3=0
Joint=15	U1=0.624999970197679	U2=0.624999970197679	U3=0.624999970197679	R1=0	R2=0	R3=0
Joint=19	U1=1.25	U2=1.25	U3=1.25	R1=0	R2=0	R3=0
Joint=20	U1=0.624999970197679	U2=0.624999970197679	U3=0.624999970197679	R1=0	R2=0	R3=0
Joint=21	U1=0.624999940395358	U2=0.624999940395358	U3=0.624999940395358	R1=0	R2=0	R3=0
Joint=22	U1=0.625000000000003	U2=0.625000000000003	U3=0.625000000000003	R1=0	R2=0	R3=0
Joint=23	U1=0.624999970197681	U2=0.624999970197681	U3=0.624999970197681	R1=0	R2=0	R3=0
Joint=24	U1=0.9375	U2=0.9375	U3=0.9375	R1=0	R2=0	R3=0
Joint=25	U1=0.624999970197679	U2=0.624999970197679	U3=0.624999970197679	R1=0	R2=0	R3=0
Joint=26	U1=0.625000000000001	U2=0.625000000000001	U3=0.625000000000001	R1=0	R2=0	R3=0
Joint=27	U1=0.9375	U2=0.9375	U3=0.9375	R1=0	R2=0	R3=0
Joint=28	U1=0.625000000000001	U2=0.625000000000001	U3=0.625000000000001	R1=0	R2=0	R3=0
Joint=29	U1=0.9375	U2=0.9375	U3=0.9375	R1=0	R2=0	R3=0
Joint=30	U1=0.624999970197678	U2=0.624999970197678	U3=0.624999970197678	R1=0	R2=0	R3=0
Joint=31	U1=0.9375	U2=0.9375	U3=0.9375	R1=0	R2=0	R3=0
Joint=32	U1=0.9375	U2=0.9375	U3=0.9375	R1=0	R2=0	R3=0
Joint=33	U1=0.624999970197678	U2=0.624999970197678	U3=0.624999970197678	R1=0	R2=0	R3=0
Joint=34	U1=0.937500000000002	U2=0.937500000000002	U3=0.937500000000002	R1=0	R2=0	R3=0
Joint=35	U1=0.937500000000002	U2=0.937500000000002	U3=0.937500000000002	R1=0	R2=0	R3=0
Joint=36	U1=1.25	U2=1.25	U3=1.25	R1=0	R2=0	R3=0
Joint=37	U1=1.25	U2=1.25	U3=1.25	R1=0	R2=0	R3=0
Joint=38	U1=1.25	U2=1.25	U3=1.25	R1=0	R2=0	R3=0



Joint=39 U1=0.624999970197678 U2=0.624999970197678 U3=0.624999970197678 R1=0 R2=0 R3=0
 Joint=40 U1=0.9375 U2=0.9375 U3=0.9375 R1=0 R2=0 R3=0
 Joint=41 U1=1.25 U2=1.25 U3=1.25 R1=0 R2=0 R3=0
 Joint=42 U1=1.25 U2=1.25 U3=1.25 R1=0 R2=0 R3=0
 Joint=43 U1=1.25 U2=1.25 U3=1.25 R1=0 R2=0 R3=0
 Joint=44 U1=1.25 U2=1.25 U3=1.25 R1=0 R2=0 R3=0
 Joint=45 U1=1.25 U2=1.25 U3=1.25 R1=0 R2=0 R3=0
 Joint=46 U1=1.25 U2=1.25 U3=1.25 R1=0 R2=0 R3=0
 Joint=47 U1=1.25 U2=1.25 U3=1.25 R1=0 R2=0 R3=0
 Joint=48 U1=1.25 U2=1.25 U3=1.25 R1=0 R2=0 R3=0
 Joint=49 U1=1.25 U2=1.25 U3=1.25 R1=0 R2=0 R3=0
 Joint=50 U1=1.25 U2=1.25 U3=1.25 R1=0 R2=0 R3=0
 Joint=51 U1=1.25 U2=1.25 U3=1.25 R1=0 R2=0 R3=0
 Joint=52 U1=1.25 U2=1.25 U3=1.25 R1=0 R2=0 R3=0
 Joint=53 U1=1.25 U2=1.25 U3=1.25 R1=0 R2=0 R3=0
 Joint=54 U1=1.25 U2=1.25 U3=1.25 R1=0 R2=0 R3=0
 Joint=55 U1=1.25 U2=1.25 U3=1.25 R1=0 R2=0 R3=0
 Joint=56 U1=1.25 U2=1.25 U3=1.25 R1=0 R2=0 R3=0
 Joint=57 U1=1.25 U2=1.25 U3=1.25 R1=0 R2=0 R3=0
 Joint=58 U1=1.25 U2=1.25 U3=1.25 R1=0 R2=0 R3=0
 Joint=59 U1=1.25 U2=1.25 U3=1.25 R1=0 R2=0 R3=0
 Joint=60 U1=1.25 U2=1.25 U3=1.25 R1=0 R2=0 R3=0

TABLE: "ELEMENT FORCES - FRAMES"

Frame=1 Station=0 OutputCase=PESOPR CaseType=LinStatic P=-15.1709467362365 V2=151.042541323724 V3=0
 T=0 M2=0 M3=81.755362440781 S11Max=475.36122790845 PtS11Max=1 x2S11Max=-0.5 x3S11Max=-0.5
 S11Min=-505.703121380923 PtS11Min=3 x2S11Min=0.5 x3S11Min=-0.5 FrameElem=1 ElemStation=0
 Frame=1 Station=6.24999940395355E-02 OutputCase=PESOPR CaseType=LinStatic P=-15.1709467362365
 V2=152.605041174713 V3=0 T=0 M2=0 M3=72.2663763926452 S11Max=418.427311619635 PtS11Max=1 x2S11Max=-0.5
 x3S11Max=-0.5
 S11Min=-448.769205092108 PtS11Min=3 x2S11Min=0.5 x3S11Min=-0.5 FrameElem=1
 ElemStation=6.24999940395355E-02
 Frame=1 Station=0.124999988079071 OutputCase=PESOPR CaseType=LinStatic P=-15.1709467362365
 V2=154.167541025701 V3=0 T=0 M2=0 M3=62.6797341131358 S11Max=360.907457942578 PtS11Max=1 x2S11Max=-0.5
 x3S11Max=-0.5
 S11Min=-391.249351415051 PtS11Min=3 x2S11Min=0.5 x3S11Min=-0.5 FrameElem=1
 ElemStation=0.124999988079071
 Frame=1 Station=0.187499982118607 OutputCase=PESOPR CaseType=LinStatic P=-15.1709467362365
 V2=155.73004087669 V3=0 T=0 M2=0 M3=52.9954356022528 S11Max=302.80166687728 PtS11Max=1 x2S11Max=-0.5
 x3S11Max=-0.5
 S11Min=-333.143560349753 PtS11Min=3 x2S11Min=0.5 x3S11Min=-0.5 FrameElem=1
 ElemStation=0.187499982118607
 Frame=1 Station=0.249999976158142 OutputCase=PESOPR CaseType=LinStatic P=-15.1709467362365
 V2=157.292540727678 V3=0 T=0 M2=0 M3=43.2134808599963 S11Max=244.109938423741 PtS11Max=1 x2S11Max=-0.5
 x3S11Max=-0.5
 S11Min=-274.451831896214 PtS11Min=3 x2S11Min=0.5 x3S11Min=-0.5 FrameElem=1
 ElemStation=0.249999976158142
 Frame=1 Station=0 OutputCase=TERRVERT CaseType=LinStatic P=1.15282857329472 V2=466.004534616135 V3=0
 T=0 M2=0 M3=223.41678346409 S11Max=1341.65352935784 PtS11Max=1 x2S11Max=-0.5 x3S11Max=-0.5
 S11Min=-1339.34787221125 PtS11Min=3 x2S11Min=0.5 x3S11Min=-0.5 FrameElem=1 ElemStation=0
 Frame=1 Station=6.24999940395355E-02 OutputCase=TERRVERT CaseType=LinStatic P=1.15282857329472
 V2=466.004534616135 V3=0 T=0 M2=0 M3=194.291502828185 S11Max=1166.90184554241 PtS11Max=1 x2S11Max=-0.5
 x3S11Max=-0.5
 S11Min=-1164.59618839582 PtS11Min=3 x2S11Min=0.5 x3S11Min=-0.5 FrameElem=1
 ElemStation=6.24999940395355E-02
 Frame=1 Station=0.124999988079071 OutputCase=TERRVERT CaseType=LinStatic P=1.15282857329472
 V2=466.004534616135 V3=0 T=0 M2=0 M3=165.16622219228 S11Max=992.150161726977 PtS11Max=1 x2S11Max=-0.5
 x3S11Max=-0.5
 S11Min=-989.844504580387 PtS11Min=3 x2S11Min=0.5 x3S11Min=-0.5 FrameElem=1
 ElemStation=0.124999988079071
 Frame=1 Station=0.187499982118607 OutputCase=TERRVERT CaseType=LinStatic P=1.15282857329472
 V2=466.004534616135 V3=0 T=0 M2=0 M3=136.040941556375 S11Max=817.398477911547 PtS11Max=1 x2S11Max=-0.5
 x3S11Max=-0.5
 S11Min=-815.092820764957 PtS11Min=3 x2S11Min=0.5 x3S11Min=-0.5 FrameElem=1
 ElemStation=0.187499982118607
 Frame=1 Station=0.249999976158142 OutputCase=TERRVERT CaseType=LinStatic P=1.15282857329472
 V2=466.004534616135 V3=0 T=0 M2=0 M3=106.91566092047 S11Max=642.646794096117 PtS11Max=1 x2S11Max=-0.5
 x3S11Max=-0.5
 S11Min=-640.341136949527 PtS11Min=3 x2S11Min=0.5 x3S11Min=-0.5 FrameElem=1
 ElemStation=0.249999976158142
 Frame=1 Station=0 OutputCase=TERRLAT CaseType=LinStatic P=-108.958200979145 V2=4.68219968626045E-02
 V3=0 T=0 M2=0 M3=21.1830694275959 S11Max=18.1402155864307 PtS11Max=1 x2S11Max=-0.5 x3S11Max=-0.5
 S11Min=-236.05661754472 PtS11Min=3 x2S11Min=0.5 x3S11Min=-0.5 FrameElem=1 ElemStation=0
 Frame=1 Station=6.24999940395355E-02 OutputCase=TERRLAT CaseType=LinStatic P=-108.958200979145
 V2=4.68219968626045E-02 V3=0 T=0 M2=0 M3=21.1801430530711 S11Max=18.1226573392817 PtS11Max=1
 x2S11Max=-0.5
 x3S11Max=-0.5 S11Min=-236.039059297571 PtS11Min=3 x2S11Min=0.5 x3S11Min=-0.5 FrameElem=1
 ElemStation=6.24999940395355E-02
 Frame=1 Station=0.124999988079071 OutputCase=TERRLAT CaseType=LinStatic P=-108.958200979145
 V2=4.68219968626045E-02 V3=0 T=0 M2=0 M3=21.1772166785462 S11Max=18.1050990921327 PtS11Max=1
 x2S11Max=-0.5



x3S11Max=-0.5 S11Min=-236.021501050422 PtS11Min=3 x2S11Min=0.5 x3S11Min=-0.5 FrameElem=1
 ElemStation=0.124999988079071
 Frame=1 Station=0.187499982118607 OutputCase=TERRLAT CaseType=LinStatic P=-108.958200979145
 V2=4.68219968626045E-02 V3=0 T=0 M2=0 M3=21.1742903040214 S11Max=18.0875408449837 PtS11Max=1
 x2S11Max=-0.5 _
 x3S11Max=-0.5 S11Min=-236.003942803273 PtS11Min=3 x2S11Min=0.5 x3S11Min=-0.5 FrameElem=1
 ElemStation=0.187499982118607
 Frame=1 Station=0.249999976158142 OutputCase=TERRLAT CaseType=LinStatic P=-108.958200979145
 V2=4.68219968626045E-02 V3=0 T=0 M2=0 M3=21.1713639294966 S11Max=18.0699825978347 PtS11Max=1
 x2S11Max=-0.5 _
 x3S11Max=-0.5 S11Min=-235.986384556124 PtS11Min=3 x2S11Min=0.5 x3S11Min=-0.5 FrameElem=1
 ElemStation=0.249999976158142
 Frame=1 Station=0 OutputCase=ACCLATDX CaseType=LinStatic P=0 V2=0 V3=0 T=0 M2=0 M3=0 S11Max=0
 PtS11Max=0 x2S11Max=0 x3S11Max=0 S11Min=0 PtS11Min=0 x2S11Min=0 x3S11Min=0 FrameElem=1 ElemStation=0
 Frame=1 Station=6.24999940395355E-02 OutputCase=ACCLATDX CaseType=LinStatic P=0 V2=0 V3=0 T=0
 M2=0 M3=0 S11Max=0 PtS11Max=0 x2S11Max=0 x3S11Max=0 S11Min=0 PtS11Min=0 x2S11Min=0 x3S11Min=0
 FrameElem=1 ElemStation=6.24999940395355E-02
 Frame=1 Station=0.124999988079071 OutputCase=ACCLATDX CaseType=LinStatic P=0 V2=0 V3=0 T=0 M2=0
 M3=0 S11Max=0 PtS11Max=0 x2S11Max=0 x3S11Max=0 S11Min=0 PtS11Min=0 x2S11Min=0 x3S11Min=0
 FrameElem=1 ElemStation=0.124999988079071
 Frame=1 Station=0.187499982118607 OutputCase=ACCLATDX CaseType=LinStatic P=0 V2=0 V3=0 T=0 M2=0
 M3=0 S11Max=0 PtS11Max=0 x2S11Max=0 x3S11Max=0 S11Min=0 PtS11Min=0 x2S11Min=0 x3S11Min=0
 FrameElem=1 ElemStation=0.187499982118607
 Frame=1 Station=0.249999976158142 OutputCase=ACCLATDX CaseType=LinStatic P=0 V2=0 V3=0 T=0 M2=0
 M3=0 S11Max=0 PtS11Max=0 x2S11Max=0 x3S11Max=0 S11Min=0 PtS11Min=0 x2S11Min=0 x3S11Min=0
 FrameElem=1 ElemStation=0.249999976158142
 Frame=1 Station=0 OutputCase=ACCLATSX CaseType=LinStatic P=0 V2=0 V3=0 T=0 M2=0 M3=0 S11Max=0
 PtS11Max=0 x2S11Max=0 x3S11Max=0 S11Min=0 PtS11Min=0 x2S11Min=0 x3S11Min=0 FrameElem=1 ElemStation=0
 Frame=1 Station=6.24999940395355E-02 OutputCase=ACCLATSX CaseType=LinStatic P=0 V2=0 V3=0 T=0
 M2=0 M3=0 S11Max=0 PtS11Max=0 x2S11Max=0 x3S11Max=0 S11Min=0 PtS11Min=0 x2S11Min=0 x3S11Min=0
 FrameElem=1 ElemStation=6.24999940395355E-02
 Frame=1 Station=0.124999988079071 OutputCase=ACCLATSX CaseType=LinStatic P=0 V2=0 V3=0 T=0 M2=0
 M3=0 S11Max=0 PtS11Max=0 x2S11Max=0 x3S11Max=0 S11Min=0 PtS11Min=0 x2S11Min=0 x3S11Min=0
 FrameElem=1 ElemStation=0.124999988079071
 Frame=1 Station=0.187499982118607 OutputCase=ACCLATSX CaseType=LinStatic P=0 V2=0 V3=0 T=0 M2=0
 M3=0 S11Max=0 PtS11Max=0 x2S11Max=0 x3S11Max=0 S11Min=0 PtS11Min=0 x2S11Min=0 x3S11Min=0
 FrameElem=1 ElemStation=0.187499982118607
 Frame=1 Station=0.249999976158142 OutputCase=ACCLATSX CaseType=LinStatic P=0 V2=0 V3=0 T=0 M2=0
 M3=0 S11Max=0 PtS11Max=0 x2S11Max=0 x3S11Max=0 S11Min=0 PtS11Min=0 x2S11Min=0 x3S11Min=0
 FrameElem=1 ElemStation=0.249999976158142
 Frame=1 Station=0 OutputCase=TERRCOST CaseType=LinStatic P=0 V2=0 V3=0 T=0 M2=0 M3=0 S11Max=0
 PtS11Max=0 x2S11Max=0 x3S11Max=0 S11Min=0 PtS11Min=0 x2S11Min=0 x3S11Min=0 FrameElem=1 ElemStation=0
 Frame=1 Station=6.24999940395355E-02 OutputCase=TERRCOST CaseType=LinStatic P=0 V2=0 V3=0 T=0
 M2=0 M3=0 S11Max=0 PtS11Max=0 x2S11Max=0 x3S11Max=0 S11Min=0 PtS11Min=0 x2S11Min=0 x3S11Min=0
 FrameElem=1 ElemStation=6.24999940395355E-02
 Frame=1 Station=0.124999988079071 OutputCase=TERRCOST CaseType=LinStatic P=0 V2=0 V3=0 T=0 M2=0
 M3=0 S11Max=0 PtS11Max=0 x2S11Max=0 x3S11Max=0 S11Min=0 PtS11Min=0 x2S11Min=0 x3S11Min=0
 FrameElem=1 ElemStation=0.124999988079071
 Frame=1 Station=0.187499982118607 OutputCase=TERRCOST CaseType=LinStatic P=0 V2=0 V3=0 T=0 M2=0
 M3=0 S11Max=0 PtS11Max=0 x2S11Max=0 x3S11Max=0 S11Min=0 PtS11Min=0 x2S11Min=0 x3S11Min=0
 FrameElem=1 ElemStation=0.187499982118607
 Frame=1 Station=0.249999976158142 OutputCase=TERRCOST CaseType=LinStatic P=0 V2=0 V3=0 T=0 M2=0
 M3=0 S11Max=0 PtS11Max=0 x2S11Max=0 x3S11Max=0 S11Min=0 PtS11Min=0 x2S11Min=0 x3S11Min=0
 FrameElem=1 ElemStation=0.249999976158142
 Frame=1 Station=0 OutputCase=SOVRCOST CaseType=LinStatic P=0 V2=0 V3=0 T=0 M2=0 M3=0 S11Max=0
 PtS11Max=0 x2S11Max=0 x3S11Max=0 S11Min=0 PtS11Min=0 x2S11Min=0 x3S11Min=0 FrameElem=1 ElemStation=0
 Frame=1 Station=6.24999940395355E-02 OutputCase=SOVRCOST CaseType=LinStatic P=0 V2=0 V3=0 T=0
 M2=0 M3=0 S11Max=0 PtS11Max=0 x2S11Max=0 x3S11Max=0 S11Min=0 PtS11Min=0 x2S11Min=0 x3S11Min=0
 FrameElem=1 ElemStation=6.24999940395355E-02
 Frame=1 Station=0.124999988079071 OutputCase=SOVRCOST CaseType=LinStatic P=0 V2=0 V3=0 T=0 M2=0
 M3=0 S11Max=0 PtS11Max=0 x2S11Max=0 x3S11Max=0 S11Min=0 PtS11Min=0 x2S11Min=0 x3S11Min=0
 FrameElem=1 ElemStation=0.124999988079071
 Frame=1 Station=0.187499982118607 OutputCase=SOVRCOST CaseType=LinStatic P=0 V2=0 V3=0 T=0 M2=0
 M3=0 S11Max=0 PtS11Max=0 x2S11Max=0 x3S11Max=0 S11Min=0 PtS11Min=0 x2S11Min=0 x3S11Min=0
 FrameElem=1 ElemStation=0.187499982118607
 Frame=1 Station=0.249999976158142 OutputCase=SOVRCOST CaseType=LinStatic P=0 V2=0 V3=0 T=0 M2=0
 M3=0 S11Max=0 PtS11Max=0 x2S11Max=0 x3S11Max=0 S11Min=0 PtS11Min=0 x2S11Min=0 x3S11Min=0
 FrameElem=1 ElemStation=0.249999976158142
 Frame=1 Station=0 OutputCase=ENVE CaseType=Combination StepType=Max P=-90.2888588483431
 V2=617.093897936722 V3=0 T=0 M2=0 M3=326.355215332467 S11Max=1835.15497285272 PtS11Max=1 x2S11Max=-0.5
 x3S11Max=-0.5 _
 S11Min=-2010.29062587347 PtS11Min=3 x2S11Min=0.5 x3S11Min=-0.5 FrameElem=1 ElemStation=0
 Frame=1 Station=6.24999940395355E-02 OutputCase=ENVE CaseType=Combination StepType=Max P=-
 90.2888588483431 V2=618.65639778771 V3=0 T=0 M2=0 M3=287.738022273901 S11Max=1603.45181450132
 PtS11Max=1 x2S11Max=-0.5 _
 x3S11Max=-0.5 S11Min=-1778.59273499622 PtS11Min=3 x2S11Min=0.5 x3S11Min=-0.5 FrameElem=1
 ElemStation=6.24999940395355E-02
 Frame=1 Station=0.124999988079071 OutputCase=ENVE CaseType=Combination StepType=Max P=-90.2888588483431
 V2=620.218897638699 V3=0 T=0 M2=0 M3=249.023172983962 S11Max=1371.16271876169 PtS11Max=1 x2S11Max=-0.5
 _
 x3S11Max=-0.5 S11Min=-1546.30890673073 PtS11Min=3 x2S11Min=0.5 x3S11Min=-0.5 FrameElem=1
 ElemStation=0.124999988079071



Frame=1 Station=0.187499982118607 OutputCase=ENVE CaseType=Combination StepType=Max P=-90.2888588483431
 V2=621.781397489687 V3=0 T=0 M2=0 M3=210.21066746265 S11Max=1138.28768563381 PtS11Max=1 x2S11Max=-0.5
 -
 x3S11Max=-0.5 S11Min=-1313.439141077 PtS11Min=3 x2S11Min=0.5 x3S11Min=-0.5 FrameElem=1
 ElemStation=0.187499982118607
 Frame=1 Station=0.249999976158142 OutputCase=ENVE CaseType=Combination StepType=Max P=-90.2888588483431
 V2=623.343897340676 V3=0 T=0 M2=0 M3=171.300505709963 S11Max=904.826715117693 PtS11Max=1 x2S11Max=-0.5
 -
 x3S11Max=-0.5 S11Min=-1079.98343803503 PtS11Min=3 x2S11Min=0.5 x3S11Min=-0.5 FrameElem=1
 ElemStation=0.249999976158142
 Frame=1 Station=0 OutputCase=ENVE CaseType=Combination StepType=Min P=-122.976319142087
 V2=617.079851337663 V3=0 T=0 M2=0 M3=320.000294504188 S11Max=1829.71290817679 PtS11Max=1 x2S11Max=-0.5
 x3S11Max=-0.5
 S11Min=-2081.10761113689 PtS11Min=3 x2S11Min=0.5 x3S11Min=-0.5 FrameElem=1 ElemStation=0
 Frame=1 Station=6.24999940395355E-02 OutputCase=ENVE CaseType=Combination StepType=Min P=-
 122.976319142087 V2=618.642351188652 V3=0 T=0 M2=0 M3=281.38397935798 S11Max=1598.01501729954
 PtS11Max=1 x2S11Max=-0.5
 x3S11Max=-0.5 S11Min=-1849.4044527855 PtS11Min=3 x2S11Min=0.5 x3S11Min=-0.5 FrameElem=1
 ElemStation=6.24999940395355E-02
 Frame=1 Station=0.124999988079071 OutputCase=ENVE CaseType=Combination StepType=Min P=-122.976319142087
 V2=620.20485103964 V3=0 T=0 M2=0 M3=242.670007980398 S11Max=1365.73118903405 PtS11Max=1 x2S11Max=-0.5
 -
 x3S11Max=-0.5 S11Min=-1617.11535704586 PtS11Min=3 x2S11Min=0.5 x3S11Min=-0.5 FrameElem=1
 ElemStation=0.124999988079071
 Frame=1 Station=0.187499982118607 OutputCase=ENVE CaseType=Combination StepType=Min P=-122.976319142087
 V2=621.767350890628 V3=0 T=0 M2=0 M3=203.858380371443 S11Max=1132.86142338032 PtS11Max=1 x2S11Max=-0.5
 -
 x3S11Max=-0.5 S11Min=-1384.24032391798 PtS11Min=3 x2S11Min=0.5 x3S11Min=-0.5 FrameElem=1
 ElemStation=0.187499982118607
 Frame=1 Station=0.249999976158142 OutputCase=ENVE CaseType=Combination StepType=Min P=-122.976319142087
 V2=623.329850741617 V3=0 T=0 M2=0 M3=164.949096531114 S11Max=899.405720338343 PtS11Max=1 x2S11Max=-0.5
 -
 x3S11Max=-0.5 S11Min=-1150.77935340187 PtS11Min=3 x2S11Min=0.5 x3S11Min=-0.5 FrameElem=1
 ElemStation=0.249999976158142
 Frame=1 Station=0 OutputCase=FESSUR CaseType=Combination P=-122.976319142087 V2=617.093897936722 V3=0
 T=0 M2=0 M3=326.355215332467 S11Max=1835.15497285272 PtS11Max=1 x2S11Max=-0.5 x3S11Max=-0.5
 S11Min=-2081.10761113689 PtS11Min=3 x2S11Min=0.5 x3S11Min=-0.5 FrameElem=1 ElemStation=0
 Frame=1 Station=6.24999940395355E-02 OutputCase=FESSUR CaseType=Combination P=-122.976319142087
 V2=618.65639778771 V3=0 T=0 M2=0 M3=287.738022273901 S11Max=1603.45181450132 PtS11Max=1 x2S11Max=-0.5
 x3S11Max=-0.5
 S11Min=-1849.4044527855 PtS11Min=3 x2S11Min=0.5 x3S11Min=-0.5 FrameElem=1
 ElemStation=6.24999940395355E-02
 Frame=1 Station=0.124999988079071 OutputCase=FESSUR CaseType=Combination P=-122.976319142087
 V2=620.218897638699 V3=0 T=0 M2=0 M3=249.023172983962 S11Max=1371.16271876169 PtS11Max=1 x2S11Max=-0.5
 x3S11Max=-0.5
 S11Min=-1617.11535704586 PtS11Min=3 x2S11Min=0.5 x3S11Min=-0.5 FrameElem=1
 ElemStation=0.124999988079071
 Frame=1 Station=0.187499982118607 OutputCase=FESSUR CaseType=Combination P=-122.976319142087
 V2=621.781397489687 V3=0 T=0 M2=0 M3=210.21066746265 S11Max=1138.28768563381 PtS11Max=1 x2S11Max=-0.5
 x3S11Max=-0.5
 S11Min=-1384.24032391798 PtS11Min=3 x2S11Min=0.5 x3S11Min=-0.5 FrameElem=1
 ElemStation=0.187499982118607
 Frame=1 Station=0.249999976158142 OutputCase=FESSUR CaseType=Combination P=-122.976319142087
 V2=623.343897340676 V3=0 T=0 M2=0 M3=171.300505709963 S11Max=904.826715117693 PtS11Max=1 x2S11Max=-0.5
 x3S11Max=-0.5
 S11Min=-1150.77935340187 PtS11Min=3 x2S11Min=0.5 x3S11Min=-0.5 FrameElem=1
 ElemStation=0.249999976158142
 Frame=2 Station=0 OutputCase=PESOPR CaseType=LinStatic P=-15.1709467362365 V2=134.470776144881 V3=0
 T=0 M2=0 M3=43.2134808600058 S11Max=244.109938423798 PtS11Max=1 x2S11Max=-0.5 x3S11Max=-0.5
 S11Min=-274.451831896271 PtS11Min=3 x2S11Min=0.5 x3S11Min=-0.5 FrameElem=2 ElemStation=0
 Frame=2 Station=0.0625 OutputCase=PESOPR CaseType=LinStatic P=-15.1709467362365 V2=136.033276144881
 V3=0 T=0 M2=0 M3=34.7602292259508 S11Max=193.390428619468 PtS11Max=1 x2S11Max=-0.5 x3S11Max=-0.5
 S11Min=-223.732322091941 PtS11Min=3 x2S11Min=0.5 x3S11Min=-0.5 FrameElem=2 ElemStation=0.0625
 Frame=2 Station=0.125 OutputCase=PESOPR CaseType=LinStatic P=-15.1709467362365 V2=137.595776144881
 V3=0 T=0 M2=0 M3=26.2093213418957 S11Max=142.084981315138 PtS11Max=1 x2S11Max=-0.5 x3S11Max=-0.5
 S11Min=-172.426874787611 PtS11Min=3 x2S11Min=0.5 x3S11Min=-0.5 FrameElem=2 ElemStation=0.125
 Frame=2 Station=0.1875 OutputCase=PESOPR CaseType=LinStatic P=-15.1709467362365 V2=139.158276144881
 V3=0 T=0 M2=0 M3=17.5607572078407 S11Max=90.1935965108074 PtS11Max=1 x2S11Max=-0.5 x3S11Max=-0.5
 S11Min=-120.53548998328 PtS11Min=3 x2S11Min=0.5 x3S11Min=-0.5 FrameElem=2 ElemStation=0.1875
 Frame=2 Station=0.25 OutputCase=PESOPR CaseType=LinStatic P=-15.1709467362365 V2=140.720776144881
 V3=0 T=0 M2=0 M3=8.8145368237856 S11Max=37.7162742064771 PtS11Max=1 x2S11Max=-0.5 x3S11Max=-0.5
 S11Min=-68.0581676789501 PtS11Min=3 x2S11Min=0.5 x3S11Min=-0.5 FrameElem=2 ElemStation=0.25
 Frame=2 Station=0 OutputCase=TERRVERT CaseType=LinStatic P=1.15282857329472 V2=415.827221488347 V3=0
 T=0 M2=0 M3=106.915660920502 S11Max=642.646794096307 PtS11Max=1 x2S11Max=-0.5 x3S11Max=-0.5
 S11Min=-640.341136949717 PtS11Min=3 x2S11Min=0.5 x3S11Min=-0.5 FrameElem=2 ElemStation=0
 Frame=2 Station=0.0625 OutputCase=TERRVERT CaseType=LinStatic P=1.15282857329472 V2=415.827221488347
 V3=0 T=0 M2=0 M3=80.9264595774803 S11Max=486.711586038176 PtS11Max=1 x2S11Max=-0.5 x3S11Max=-0.5
 S11Min=-484.405928891587 PtS11Min=3 x2S11Min=0.5 x3S11Min=-0.5 FrameElem=2 ElemStation=0.0625
 Frame=2 Station=0.125 OutputCase=TERRVERT CaseType=LinStatic P=1.15282857329472 V2=415.827221488347
 V3=0 T=0 M2=0 M3=54.9372582344586 S11Max=330.776377980046 PtS11Max=1 x2S11Max=-0.5 x3S11Max=-0.5
 S11Min=-328.470720833457 PtS11Min=3 x2S11Min=0.5 x3S11Min=-0.5 FrameElem=2 ElemStation=0.125

```

Frame=2 Station=0.1875 OutputCase=TERRVERT CaseType=LinStatic P=1.15282857329472 V2=415.827221488347
V3=0 T=0 M2=0 M3=28.9480568914369 S11Max=174.841169921916 PtS11Max=1 x2S11Max=-0.5 x3S11Max=-0.5 _
S11Min=-172.535512775326 PtS11Min=3 x2S11Min=0.5 x3S11Min=-0.5 FrameElem=2 ElemStation=0.1875
Frame=2 Station=0.25 OutputCase=TERRVERT CaseType=LinStatic P=1.15282857329472 V2=415.827221488347
V3=0 T=0 M2=0 M3=2.95885554841516 S11Max=18.9059618637857 PtS11Max=1 x2S11Max=-0.5 x3S11Max=-0.5 _
S11Min=-16.6003047171962 PtS11Min=3 x2S11Min=0.5 x3S11Min=-0.5 FrameElem=2 ElemStation=0.25
Frame=2 Station=0 OutputCase=TERRLAT CaseType=LinStatic P=-108.958200979145 V2=0.113482419150046 V3=0
T=0 M2=0 M3=21.1713639294965 S11Max=18.0699825978344 PtS11Max=1 x2S11Max=-0.5 x3S11Max=-0.5 _
S11Min=-235.986384556124 PtS11Min=3 x2S11Min=0.5 x3S11Min=-0.5 FrameElem=2 ElemStation=0
Frame=2 Station=0.0625 OutputCase=TERRLAT CaseType=LinStatic P=-108.958200979145 V2=0.113482419150046
V3=0 T=0 M2=0 M3=21.1642712782996 S11Max=18.0274266906531 PtS11Max=1 x2S11Max=-0.5 x3S11Max=-0.5 _
S11Min=-235.943828648943 PtS11Min=3 x2S11Min=0.5 x3S11Min=-0.5 FrameElem=2 ElemStation=0.0625
Frame=2 Station=0.125 OutputCase=TERRLAT CaseType=LinStatic P=-108.958200979145 V2=0.113482419150046
V3=0 T=0 M2=0 M3=21.1571786271028 S11Max=17.9848707834719 PtS11Max=1 x2S11Max=-0.5 x3S11Max=-0.5 _
S11Min=-235.901272741761 PtS11Min=3 x2S11Min=0.5 x3S11Min=-0.5 FrameElem=2 ElemStation=0.125
Frame=2 Station=0.1875 OutputCase=TERRLAT CaseType=LinStatic P=-108.958200979145 V2=0.113482419150046
V3=0 T=0 M2=0 M3=21.1500859759059 S11Max=17.9423148762906 PtS11Max=1 x2S11Max=-0.5 x3S11Max=-0.5 _
S11Min=-235.85871683458 PtS11Min=3 x2S11Min=0.5 x3S11Min=-0.5 FrameElem=2 ElemStation=0.1875
Frame=2 Station=0.25 OutputCase=TERRLAT CaseType=LinStatic P=-108.958200979145 V2=0.113482419150046
V3=0 T=0 M2=0 M3=21.142993324709 S11Max=17.8997589691093 PtS11Max=1 x2S11Max=-0.5 x3S11Max=-0.5 _
S11Min=-235.816160927399 PtS11Min=3 x2S11Min=0.5 x3S11Min=-0.5 FrameElem=2 ElemStation=0.25
Frame=2 Station=0 OutputCase=ACCLATDX CaseType=LinStatic P=0 V2=0 V3=0 T=0 M2=0 M3=0 S11Max=0
PtS11Max=0 x2S11Max=0 x3S11Max=0 S11Min=0 PtS11Min=0 x2S11Min=0 x3S11Min=0 FrameElem=2 ElemStation=0
Frame=2 Station=0.0625 OutputCase=ACCLATDX CaseType=LinStatic P=0 V2=0 V3=0 T=0 M2=0 M3=0
S11Max=0 PtS11Max=0 x2S11Max=0 x3S11Max=0 S11Min=0 PtS11Min=0 x2S11Min=0 x3S11Min=0 FrameElem=2
ElemStation=0.0625
Frame=2 Station=0.125 OutputCase=ACCLATDX CaseType=LinStatic P=0 V2=0 V3=0 T=0 M2=0 M3=0
S11Max=0 PtS11Max=0 x2S11Max=0 x3S11Max=0 S11Min=0 PtS11Min=0 x2S11Min=0 x3S11Min=0 FrameElem=2
ElemStation=0.125
Frame=2 Station=0.1875 OutputCase=ACCLATDX CaseType=LinStatic P=0 V2=0 V3=0 T=0 M2=0 M3=0
S11Max=0 PtS11Max=0 x2S11Max=0 x3S11Max=0 S11Min=0 PtS11Min=0 x2S11Min=0 x3S11Min=0 FrameElem=2
ElemStation=0.1875
Frame=2 Station=0.25 OutputCase=ACCLATDX CaseType=LinStatic P=0 V2=0 V3=0 T=0 M2=0 M3=0
S11Max=0 PtS11Max=0 x2S11Max=0 x3S11Max=0 S11Min=0 PtS11Min=0 x2S11Min=0 x3S11Min=0 FrameElem=2
ElemStation=0.25
Frame=2 Station=0 OutputCase=ACCLATSX CaseType=LinStatic P=0 V2=0 V3=0 T=0 M2=0 M3=0 S11Max=0
PtS11Max=0 x2S11Max=0 x3S11Max=0 S11Min=0 PtS11Min=0 x2S11Min=0 x3S11Min=0 FrameElem=2 ElemStation=0
Frame=2 Station=0.0625 OutputCase=ACCLATSX CaseType=LinStatic P=0 V2=0 V3=0 T=0 M2=0 M3=0
S11Max=0 PtS11Max=0 x2S11Max=0 x3S11Max=0 S11Min=0 PtS11Min=0 x2S11Min=0 x3S11Min=0 FrameElem=2
ElemStation=0.0625
Frame=2 Station=0.125 OutputCase=ACCLATSX CaseType=LinStatic P=0 V2=0 V3=0 T=0 M2=0 M3=0
S11Max=0 PtS11Max=0 x2S11Max=0 x3S11Max=0 S11Min=0 PtS11Min=0 x2S11Min=0 x3S11Min=0 FrameElem=2
ElemStation=0.125
Frame=2 Station=0.1875 OutputCase=ACCLATSX CaseType=LinStatic P=0 V2=0 V3=0 T=0 M2=0 M3=0
S11Max=0 PtS11Max=0 x2S11Max=0 x3S11Max=0 S11Min=0 PtS11Min=0 x2S11Min=0 x3S11Min=0 FrameElem=2
ElemStation=0.1875
Frame=2 Station=0.25 OutputCase=ACCLATSX CaseType=LinStatic P=0 V2=0 V3=0 T=0 M2=0 M3=0
S11Max=0 PtS11Max=0 x2S11Max=0 x3S11Max=0 S11Min=0 PtS11Min=0 x2S11Min=0 x3S11Min=0 FrameElem=2
ElemStation=0.25
Frame=2 Station=0 OutputCase=TERRCOST CaseType=LinStatic P=0 V2=0 V3=0 T=0 M2=0 M3=0 S11Max=0
PtS11Max=0 x2S11Max=0 x3S11Max=0 S11Min=0 PtS11Min=0 x2S11Min=0 x3S11Min=0 FrameElem=2 ElemStation=0
Frame=2 Station=0.0625 OutputCase=TERRCOST CaseType=LinStatic P=0 V2=0 V3=0 T=0 M2=0 M3=0
S11Max=0 PtS11Max=0 x2S11Max=0 x3S11Max=0 S11Min=0 PtS11Min=0 x2S11Min=0 x3S11Min=0 FrameElem=2
ElemStation=0.0625
Frame=2 Station=0.125 OutputCase=TERRCOST CaseType=LinStatic P=0 V2=0 V3=0 T=0 M2=0 M3=0
S11Max=0 PtS11Max=0 x2S11Max=0 x3S11Max=0 S11Min=0 PtS11Min=0 x2S11Min=0 x3S11Min=0 FrameElem=2
ElemStation=0.125
Frame=2 Station=0.1875 OutputCase=TERRCOST CaseType=LinStatic P=0 V2=0 V3=0 T=0 M2=0 M3=0
S11Max=0 PtS11Max=0 x2S11Max=0 x3S11Max=0 S11Min=0 PtS11Min=0 x2S11Min=0 x3S11Min=0 FrameElem=2
ElemStation=0.1875
Frame=2 Station=0.25 OutputCase=TERRCOST CaseType=LinStatic P=0 V2=0 V3=0 T=0 M2=0 M3=0
S11Max=0 PtS11Max=0 x2S11Max=0 x3S11Max=0 S11Min=0 PtS11Min=0 x2S11Min=0 x3S11Min=0 FrameElem=2
ElemStation=0.25
Frame=2 Station=0 OutputCase=SOVRCOST CaseType=LinStatic P=0 V2=0 V3=0 T=0 M2=0 M3=0 S11Max=0
PtS11Max=0 x2S11Max=0 x3S11Max=0 S11Min=0 PtS11Min=0 x2S11Min=0 x3S11Min=0 FrameElem=2 ElemStation=0
Frame=2 Station=0.0625 OutputCase=SOVRCOST CaseType=LinStatic P=0 V2=0 V3=0 T=0 M2=0 M3=0
S11Max=0 PtS11Max=0 x2S11Max=0 x3S11Max=0 S11Min=0 PtS11Min=0 x2S11Min=0 x3S11Min=0 FrameElem=2
ElemStation=0.0625
Frame=2 Station=0.125 OutputCase=SOVRCOST CaseType=LinStatic P=0 V2=0 V3=0 T=0 M2=0 M3=0
S11Max=0 PtS11Max=0 x2S11Max=0 x3S11Max=0 S11Min=0 PtS11Min=0 x2S11Min=0 x3S11Min=0 FrameElem=2
ElemStation=0.125
Frame=2 Station=0.1875 OutputCase=SOVRCOST CaseType=LinStatic P=0 V2=0 V3=0 T=0 M2=0 M3=0
S11Max=0 PtS11Max=0 x2S11Max=0 x3S11Max=0 S11Min=0 PtS11Min=0 x2S11Min=0 x3S11Min=0 FrameElem=2
ElemStation=0.1875
Frame=2 Station=0.25 OutputCase=SOVRCOST CaseType=LinStatic P=0 V2=0 V3=0 T=0 M2=0 M3=0
S11Max=0 PtS11Max=0 x2S11Max=0 x3S11Max=0 S11Min=0 PtS11Min=0 x2S11Min=0 x3S11Min=0 FrameElem=2
ElemStation=0.25
Frame=2 Station=0 OutputCase=ENVE CaseType=Combination StepType=Max P=-90.2888588483431
V2=550.411480052378 V3=0 T=0 M2=0 M3=171.300505710004 S11Max=904.826715117939 PtS11Max=1 x2S11Max=-0.5
x3S11Max=-0.5 _
S11Min=-1079.98343803528 PtS11Min=3 x2S11Min=0.5 x3S11Min=-0.5 FrameElem=2 ElemStation=0

```



Frame=2 Station=0.0625 OutputCase=ENVE CaseType=Combination StepType=Max P=-90.2888588483431
 V2=551.973980052378 V3=0 T=0 M2=0 M3=136.850960081731 S11Max=698.129441348297 PtS11Max=1 x2S11Max=-0.5
 x3S11Max=-0.5
 S11Min=-873.298931037788 PtS11Min=3 x2S11Min=0.5 x3S11Min=-0.5 FrameElem=2 ElemStation=0.0625
 Frame=2 Station=0.125 OutputCase=ENVE CaseType=Combination StepType=Max P=-90.2888588483431
 V2=553.536480052378 V3=0 T=0 M2=0 M3=102.303758203457 S11Max=490.846230078656 PtS11Max=1 x2S11Max=-0.5
 x3S11Max=-0.5
 S11Min=-666.0284865403 PtS11Min=3 x2S11Min=0.5 x3S11Min=-0.5 FrameElem=2 ElemStation=0.125
 Frame=2 Station=0.1875 OutputCase=ENVE CaseType=Combination StepType=Max P=-90.2888588483431
 V2=555.098980052378 V3=0 T=0 M2=0 M3=67.6589000751834 S11Max=282.977081309014 PtS11Max=1 x2S11Max=-0.5
 x3S11Max=-0.5
 S11Min=-458.172104542813 PtS11Min=3 x2S11Min=0.5 x3S11Min=-0.5 FrameElem=2 ElemStation=0.1875
 Frame=2 Station=0.25 OutputCase=ENVE CaseType=Combination StepType=Max P=-90.2888588483431
 V2=556.661480052378 V3=0 T=0 M2=0 M3=32.9163856969098 S11Max=74.5219950393721 PtS11Max=1 x2S11Max=-0.5
 x3S11Max=-0.5
 S11Min=-249.729785045326 PtS11Min=3 x2S11Min=0.5 x3S11Min=-0.5 FrameElem=2 ElemStation=0.25
 Frame=2 Station=0 OutputCase=ENVE CaseType=Combination StepType=Min P=-122.976319142087
 V2=550.377435326633 V3=0 T=0 M2=0 M3=164.949096531155 S11Max=899.405720338589 PtS11Max=1 x2S11Max=-0.5
 x3S11Max=-0.5
 S11Min=-1150.77935340211 PtS11Min=3 x2S11Min=0.5 x3S11Min=-0.5 FrameElem=2 ElemStation=0
 Frame=2 Station=0.0625 OutputCase=ENVE CaseType=Combination StepType=Min P=-122.976319142087
 V2=551.939935326633 V3=0 T=0 M2=0 M3=130.501678698241 S11Max=692.721213341101 PtS11Max=1 x2S11Max=-0.5
 x3S11Max=-0.5
 S11Min=-944.082079632471 PtS11Min=3 x2S11Min=0.5 x3S11Min=-0.5 FrameElem=2 ElemStation=0.0625
 Frame=2 Station=0.125 OutputCase=ENVE CaseType=Combination StepType=Min P=-122.976319142087
 V2=553.502435326633 V3=0 T=0 M2=0 M3=95.9566046153262 S11Max=485.450768843614 PtS11Max=1 x2S11Max=-0.5
 x3S11Max=-0.5
 S11Min=-736.798868362829 PtS11Min=3 x2S11Min=0.5 x3S11Min=-0.5 FrameElem=2 ElemStation=0.125
 Frame=2 Station=0.1875 OutputCase=ENVE CaseType=Combination StepType=Min P=-122.976319142087
 V2=555.064935326633 V3=0 T=0 M2=0 M3=61.3138742824116 S11Max=277.594386846127 PtS11Max=1 x2S11Max=-0.5
 x3S11Max=-0.5
 S11Min=-528.929719593187 PtS11Min=3 x2S11Min=0.5 x3S11Min=-0.5 FrameElem=2 ElemStation=0.1875
 Frame=2 Station=0.25 OutputCase=ENVE CaseType=Combination StepType=Min P=-122.976319142087
 V2=556.627435326633 V3=0 T=0 M2=0 M3=26.5734876994971 S11Max=69.1520673486393 PtS11Max=1 x2S11Max=-0.5
 x3S11Max=-0.5
 S11Min=-320.474633323545 PtS11Min=3 x2S11Min=0.5 x3S11Min=-0.5 FrameElem=2 ElemStation=0.25
 Frame=2 Station=0 OutputCase=FESSUR CaseType=Combination P=-122.976319142087 V2=550.411480052378 V3=0
 T=0 M2=0 M3=171.300505710004 S11Max=904.826715117939 PtS11Max=1 x2S11Max=-0.5 x3S11Max=-0.5
 S11Min=-1150.77935340211 PtS11Min=3 x2S11Min=0.5 x3S11Min=-0.5 FrameElem=2 ElemStation=0
 Frame=2 Station=0.0625 OutputCase=FESSUR CaseType=Combination P=-122.976319142087 V2=551.973980052378
 V3=0 T=0 M2=0 M3=136.850960081731 S11Max=698.129441348297 PtS11Max=1 x2S11Max=-0.5 x3S11Max=-0.5
 S11Min=-944.082079632471 PtS11Min=3 x2S11Min=0.5 x3S11Min=-0.5 FrameElem=2 ElemStation=0.0625
 Frame=2 Station=0.125 OutputCase=FESSUR CaseType=Combination P=-122.976319142087 V2=553.536480052378
 V3=0 T=0 M2=0 M3=102.303758203457 S11Max=490.846230078656 PtS11Max=1 x2S11Max=-0.5 x3S11Max=-0.5
 S11Min=-736.798868362829 PtS11Min=3 x2S11Min=0.5 x3S11Min=-0.5 FrameElem=2 ElemStation=0.125
 Frame=2 Station=0.1875 OutputCase=FESSUR CaseType=Combination P=-122.976319142087 V2=555.098980052378
 V3=0 T=0 M2=0 M3=67.6589000751834 S11Max=282.977081309014 PtS11Max=1 x2S11Max=-0.5 x3S11Max=-0.5
 S11Min=-528.929719593187 PtS11Min=3 x2S11Min=0.5 x3S11Min=-0.5 FrameElem=2 ElemStation=0.1875
 Frame=2 Station=0.25 OutputCase=FESSUR CaseType=Combination P=-122.976319142087 V2=556.661480052378
 V3=0 T=0 M2=0 M3=32.9163856969098 S11Max=74.5219950393721 PtS11Max=1 x2S11Max=-0.5 x3S11Max=-0.5
 S11Min=-320.474633323545 PtS11Min=3 x2S11Min=0.5 x3S11Min=-0.5 FrameElem=2 ElemStation=0.25
 Frame=4 Station=0 OutputCase=PESOPR CaseType=LinStatic P=-15.1709467362366 V2=-140.720775817346 V3=0
 T=0 M2=0 M3=8.81453708266417 S11Max=37.7162757597484 PtS11Max=1 x2S11Max=-0.5 x3S11Max=-0.5
 S11Min=-68.0581692322216 PtS11Min=3 x2S11Min=0.5 x3S11Min=-0.5 FrameElem=4 ElemStation=0
 Frame=4 Station=0.0625 OutputCase=PESOPR CaseType=LinStatic P=-15.1709467362366 V2=-139.158275817346
 V3=0 T=0 M2=0 M3=17.5607574462483 S11Max=90.1935979412533 PtS11Max=1 x2S11Max=-0.5 x3S11Max=-0.5
 S11Min=-120.535491413727 PtS11Min=3 x2S11Min=0.5 x3S11Min=-0.5 FrameElem=4 ElemStation=0.0625
 Frame=4 Station=0.125 OutputCase=PESOPR CaseType=LinStatic P=-15.1709467362366 V2=-137.595775817346
 V3=0 T=0 M2=0 M3=26.2093215598325 S11Max=142.084982622758 PtS11Max=1 x2S11Max=-0.5 x3S11Max=-0.5
 S11Min=-172.426876095231 PtS11Min=3 x2S11Min=0.5 x3S11Min=-0.5 FrameElem=4 ElemStation=0.125
 Frame=4 Station=0.1875 OutputCase=PESOPR CaseType=LinStatic P=-15.1709467362366 V2=-136.033275817346
 V3=0 T=0 M2=0 M3=34.7602294234166 S11Max=193.390429804263 PtS11Max=1 x2S11Max=-0.5 x3S11Max=-0.5
 S11Min=-223.732323276736 PtS11Min=3 x2S11Min=0.5 x3S11Min=-0.5 FrameElem=4 ElemStation=0.1875
 Frame=4 Station=0.25 OutputCase=PESOPR CaseType=LinStatic P=-15.1709467362366 V2=-134.470775817346
 V3=0 T=0 M2=0 M3=43.2134810370007 S11Max=244.109939485768 PtS11Max=1 x2S11Max=-0.5 x3S11Max=-0.5
 S11Min=-274.451832958241 PtS11Min=3 x2S11Min=0.5 x3S11Min=-0.5 FrameElem=4 ElemStation=0.25
 Frame=4 Station=0 OutputCase=TERRVERT CaseType=LinStatic P=1.15282857329472 V2=-415.827221883403 V3=0
 T=0 M2=0 M3=2.95885633877333 S11Max=18.9059666059347 PtS11Max=1 x2S11Max=-0.5 x3S11Max=-0.5
 S11Min=-16.6003094593453 PtS11Min=3 x2S11Min=0.5 x3S11Min=-0.5 FrameElem=4 ElemStation=0
 Frame=4 Station=0.0625 OutputCase=TERRVERT CaseType=LinStatic P=1.15282857329472 V2=-415.827221883403
 V3=0 T=0 M2=0 M3=28.948057706486 S11Max=174.841174812211 PtS11Max=1 x2S11Max=-0.5 x3S11Max=-0.5
 S11Min=-172.535517665621 PtS11Min=3 x2S11Min=0.5 x3S11Min=-0.5 FrameElem=4 ElemStation=0.0625
 Frame=4 Station=0.125 OutputCase=TERRVERT CaseType=LinStatic P=1.15282857329472 V2=-415.827221883403
 V3=0 T=0 M2=0 M3=54.9372590741987 S11Max=330.776383018487 PtS11Max=1 x2S11Max=-0.5 x3S11Max=-0.5
 S11Min=-328.470725871897 PtS11Min=3 x2S11Min=0.5 x3S11Min=-0.5 FrameElem=4 ElemStation=0.125
 Frame=4 Station=0.1875 OutputCase=TERRVERT CaseType=LinStatic P=1.15282857329472 V2=-415.827221883403
 V3=0 T=0 M2=0 M3=80.9264604419113 S11Max=486.711591224763 PtS11Max=1 x2S11Max=-0.5 x3S11Max=-0.5
 S11Min=-484.405934078173 PtS11Min=3 x2S11Min=0.5 x3S11Min=-0.5 FrameElem=4 ElemStation=0.1875
 Frame=4 Station=0.25 OutputCase=TERRVERT CaseType=LinStatic P=1.15282857329472 V2=-415.827221883403
 V3=0 T=0 M2=0 M3=106.915661809624 S11Max=642.646799431039 PtS11Max=1 x2S11Max=-0.5 x3S11Max=-0.5
 S11Min=-640.341142284449 PtS11Min=3 x2S11Min=0.5 x3S11Min=-0.5 FrameElem=4 ElemStation=0.25

```

Frame=4 Station=0 OutputCase=TERRLAT CaseType=LinStatic P=-108.958200979145 V2=-0.1134825900495 V3=0
T=0 M2=0 M3=21.1429918317019 S11Max=17.8997500110664 PtS11Max=1 x2S11Max=-0.5 x3S11Max=-0.5 _
S11Min=-235.816151969356 PtS11Min=3 x2S11Min=0.5 x3S11Min=-0.5 FrameElem=4 ElemStation=0
Frame=4 Station=0.0625 OutputCase=TERRLAT CaseType=LinStatic P=-108.958200979145 V2=-0.1134825900495
V3=0 T=0 M2=0 M3=21.15008449358 S11Max=17.9423059823349 PtS11Max=1 x2S11Max=-0.5 x3S11Max=-0.5 _
S11Min=-235.858707940625 PtS11Min=3 x2S11Min=0.5 x3S11Min=-0.5 FrameElem=4 ElemStation=0.0625
Frame=4 Station=0.125 OutputCase=TERRLAT CaseType=LinStatic P=-108.958200979145 V2=-0.1134825900495
V3=0 T=0 M2=0 M3=21.1571771554581 S11Max=17.9848619536035 PtS11Max=1 x2S11Max=-0.5 x3S11Max=-0.5 _
S11Min=-235.901263911893 PtS11Min=3 x2S11Min=0.5 x3S11Min=-0.5 FrameElem=4 ElemStation=0.125
Frame=4 Station=0.1875 OutputCase=TERRLAT CaseType=LinStatic P=-108.958200979145 V2=-0.1134825900495
V3=0 T=0 M2=0 M3=21.1642698173362 S11Max=18.0274179248721 PtS11Max=1 x2S11Max=-0.5 x3S11Max=-0.5 _
S11Min=-235.943819883162 PtS11Min=3 x2S11Min=0.5 x3S11Min=-0.5 FrameElem=4 ElemStation=0.1875
Frame=4 Station=0.25 OutputCase=TERRLAT CaseType=LinStatic P=-108.958200979145 V2=-0.1134825900495
V3=0 T=0 M2=0 M3=21.1713624792143 S11Max=18.0699738961406 PtS11Max=1 x2S11Max=-0.5 x3S11Max=-0.5 _
S11Min=-235.986375854431 PtS11Min=3 x2S11Min=0.5 x3S11Min=-0.5 FrameElem=4 ElemStation=0.25
Frame=4 Station=0 OutputCase=ACCLATDX CaseType=LinStatic P=0 V2=0 V3=0 T=0 M2=0 M3=0 S11Max=0
PtS11Max=0 x2S11Max=0 x3S11Max=0 S11Min=0 PtS11Min=0 x2S11Min=0 x3S11Min=0 FrameElem=4 ElemStation=0
Frame=4 Station=0.0625 OutputCase=ACCLATDX CaseType=LinStatic P=0 V2=0 V3=0 T=0 M2=0 M3=0
S11Max=0 PtS11Max=0 x2S11Max=0 x3S11Max=0 S11Min=0 PtS11Min=0 x2S11Min=0 x3S11Min=0 FrameElem=4
ElemStation=0.0625
Frame=4 Station=0.125 OutputCase=ACCLATDX CaseType=LinStatic P=0 V2=0 V3=0 T=0 M2=0 M3=0
S11Max=0 PtS11Max=0 x2S11Max=0 x3S11Max=0 S11Min=0 PtS11Min=0 x2S11Min=0 x3S11Min=0 FrameElem=4
ElemStation=0.125
Frame=4 Station=0.1875 OutputCase=ACCLATDX CaseType=LinStatic P=0 V2=0 V3=0 T=0 M2=0 M3=0
S11Max=0 PtS11Max=0 x2S11Max=0 x3S11Max=0 S11Min=0 PtS11Min=0 x2S11Min=0 x3S11Min=0 FrameElem=4
ElemStation=0.1875
Frame=4 Station=0.25 OutputCase=ACCLATDX CaseType=LinStatic P=0 V2=0 V3=0 T=0 M2=0 M3=0
S11Max=0 PtS11Max=0 x2S11Max=0 x3S11Max=0 S11Min=0 PtS11Min=0 x2S11Min=0 x3S11Min=0 FrameElem=4
ElemStation=0.25
Frame=4 Station=0 OutputCase=ACCLATSX CaseType=LinStatic P=0 V2=0 V3=0 T=0 M2=0 M3=0 S11Max=0
PtS11Max=0 x2S11Max=0 x3S11Max=0 S11Min=0 PtS11Min=0 x2S11Min=0 x3S11Min=0 FrameElem=4 ElemStation=0
Frame=4 Station=0.0625 OutputCase=ACCLATSX CaseType=LinStatic P=0 V2=0 V3=0 T=0 M2=0 M3=0
S11Max=0 PtS11Max=0 x2S11Max=0 x3S11Max=0 S11Min=0 PtS11Min=0 x2S11Min=0 x3S11Min=0 FrameElem=4
ElemStation=0.0625
Frame=4 Station=0.125 OutputCase=ACCLATSX CaseType=LinStatic P=0 V2=0 V3=0 T=0 M2=0 M3=0
S11Max=0 PtS11Max=0 x2S11Max=0 x3S11Max=0 S11Min=0 PtS11Min=0 x2S11Min=0 x3S11Min=0 FrameElem=4
ElemStation=0.125
Frame=4 Station=0.1875 OutputCase=ACCLATSX CaseType=LinStatic P=0 V2=0 V3=0 T=0 M2=0 M3=0
S11Max=0 PtS11Max=0 x2S11Max=0 x3S11Max=0 S11Min=0 PtS11Min=0 x2S11Min=0 x3S11Min=0 FrameElem=4
ElemStation=0.1875
Frame=4 Station=0.25 OutputCase=ACCLATSX CaseType=LinStatic P=0 V2=0 V3=0 T=0 M2=0 M3=0
S11Max=0 PtS11Max=0 x2S11Max=0 x3S11Max=0 S11Min=0 PtS11Min=0 x2S11Min=0 x3S11Min=0 FrameElem=4
ElemStation=0.25
Frame=4 Station=0 OutputCase=TERRCOST CaseType=LinStatic P=0 V2=0 V3=0 T=0 M2=0 M3=0 S11Max=0
PtS11Max=0 x2S11Max=0 x3S11Max=0 S11Min=0 PtS11Min=0 x2S11Min=0 x3S11Min=0 FrameElem=4 ElemStation=0
Frame=4 Station=0.0625 OutputCase=TERRCOST CaseType=LinStatic P=0 V2=0 V3=0 T=0 M2=0 M3=0
S11Max=0 PtS11Max=0 x2S11Max=0 x3S11Max=0 S11Min=0 PtS11Min=0 x2S11Min=0 x3S11Min=0 FrameElem=4
ElemStation=0.0625
Frame=4 Station=0.125 OutputCase=TERRCOST CaseType=LinStatic P=0 V2=0 V3=0 T=0 M2=0 M3=0
S11Max=0 PtS11Max=0 x2S11Max=0 x3S11Max=0 S11Min=0 PtS11Min=0 x2S11Min=0 x3S11Min=0 FrameElem=4
ElemStation=0.125
Frame=4 Station=0.1875 OutputCase=TERRCOST CaseType=LinStatic P=0 V2=0 V3=0 T=0 M2=0 M3=0
S11Max=0 PtS11Max=0 x2S11Max=0 x3S11Max=0 S11Min=0 PtS11Min=0 x2S11Min=0 x3S11Min=0 FrameElem=4
ElemStation=0.1875
Frame=4 Station=0.25 OutputCase=TERRCOST CaseType=LinStatic P=0 V2=0 V3=0 T=0 M2=0 M3=0
S11Max=0 PtS11Max=0 x2S11Max=0 x3S11Max=0 S11Min=0 PtS11Min=0 x2S11Min=0 x3S11Min=0 FrameElem=4
ElemStation=0.25
Frame=4 Station=0 OutputCase=SOVRCOST CaseType=LinStatic P=0 V2=0 V3=0 T=0 M2=0 M3=0 S11Max=0
PtS11Max=0 x2S11Max=0 x3S11Max=0 S11Min=0 PtS11Min=0 x2S11Min=0 x3S11Min=0 FrameElem=4 ElemStation=0
Frame=4 Station=0.0625 OutputCase=SOVRCOST CaseType=LinStatic P=0 V2=0 V3=0 T=0 M2=0 M3=0
S11Max=0 PtS11Max=0 x2S11Max=0 x3S11Max=0 S11Min=0 PtS11Min=0 x2S11Min=0 x3S11Min=0 FrameElem=4
ElemStation=0.0625
Frame=4 Station=0.125 OutputCase=SOVRCOST CaseType=LinStatic P=0 V2=0 V3=0 T=0 M2=0 M3=0
S11Max=0 PtS11Max=0 x2S11Max=0 x3S11Max=0 S11Min=0 PtS11Min=0 x2S11Min=0 x3S11Min=0 FrameElem=4
ElemStation=0.125
Frame=4 Station=0.1875 OutputCase=SOVRCOST CaseType=LinStatic P=0 V2=0 V3=0 T=0 M2=0 M3=0
S11Max=0 PtS11Max=0 x2S11Max=0 x3S11Max=0 S11Min=0 PtS11Min=0 x2S11Min=0 x3S11Min=0 FrameElem=4
ElemStation=0.1875
Frame=4 Station=0.25 OutputCase=SOVRCOST CaseType=LinStatic P=0 V2=0 V3=0 T=0 M2=0 M3=0
S11Max=0 PtS11Max=0 x2S11Max=0 x3S11Max=0 S11Min=0 PtS11Min=0 x2S11Min=0 x3S11Min=0 FrameElem=4
ElemStation=0.25
Frame=4 Station=0 OutputCase=ENVE CaseType=Combination StepType=Max P=-90.2888588483434 V2=-
556.627435513784 V3=0 T=0 M2=0 M3=32.9163852531394 S11Max=74.5219923767495 PtS11Max=1 x2S11Max=-0.5
x3S11Max=-0.5 _
S11Min=-249.729785070116 PtS11Min=3 x2S11Min=0.5 x3S11Min=-0.5 FrameElem=4 ElemStation=0
Frame=4 Station=0.0625 OutputCase=ENVE CaseType=Combination StepType=Max P=-90.2888588483434 V2=-
555.064935513784 V3=0 T=0 M2=0 M3=67.6588996463143 S11Max=282.977078735799 PtS11Max=1 x2S11Max=-0.5 _
x3S11Max=-0.5 S11Min=-458.172104637785 PtS11Min=3 x2S11Min=0.5 x3S11Min=-0.5 FrameElem=4
ElemStation=0.0625
Frame=4 Station=0.125 OutputCase=ENVE CaseType=Combination StepType=Max P=-90.2888588483434 V2=-
553.502435513784 V3=0 T=0 M2=0 M3=102.303757789489 S11Max=490.846227594848 PtS11Max=1 x2S11Max=-0.5
x3S11Max=-0.5 _

```



S11Min=-666.028486705454 PtS11Min=3 x2S11Min=0.5 x3S11Min=-0.5 FrameElem=4 ElemStation=0.125
 Frame=4 Station=0.1875 OutputCase=ENVE CaseType=Combination StepType=Max P=-90.2888588483434 V2=-
 551.939935513784 V3=0 T=0 M2=0 M3=136.850959682664 S11Max=698.129438953898 PtS11Max=1 x2S11Max=-0.5 _
 x3S11Max=-0.5 S11Min=-873.298931273123 PtS11Min=3 x2S11Min=0.5 x3S11Min=-0.5 FrameElem=4
 ElemStation=0.1875
 Frame=4 Station=0.25 OutputCase=ENVE CaseType=Combination StepType=Max P=-90.2888588483434 V2=-
 550.377435513784 V3=0 T=0 M2=0 M3=171.300505325839 S11Max=904.826712812947 PtS11Max=1 x2S11Max=-0.5
 x3S11Max=-0.5 _
 S11Min=-1079.98343834079 PtS11Min=3 x2S11Min=0.5 x3S11Min=-0.5 FrameElem=4 ElemStation=0.25
 Frame=4 Station=0 OutputCase=ENVE CaseType=Combination StepType=Min P=-122.976319142087 V2=-
 556.661480290798 V3=0 T=0 M2=0 M3=26.5734877036288 S11Max=69.1520673734296 PtS11Max=1 x2S11Max=-0.5
 x3S11Max=-0.5 _
 S11Min=-320.474630660923 PtS11Min=3 x2S11Min=0.5 x3S11Min=-0.5 FrameElem=4 ElemStation=0
 Frame=4 Station=0.0625 OutputCase=ENVE CaseType=Combination StepType=Min P=-122.976319142087 V2=-
 555.098980290798 V3=0 T=0 M2=0 M3=61.3138742982403 S11Max=277.594386941098 PtS11Max=1 x2S11Max=-0.5 _
 x3S11Max=-0.5 S11Min=-528.929717019973 PtS11Min=3 x2S11Min=0.5 x3S11Min=-0.5 FrameElem=4
 ElemStation=0.0625
 Frame=4 Station=0.125 OutputCase=ENVE CaseType=Combination StepType=Min P=-122.976319142087 V2=-
 553.536480290798 V3=0 T=0 M2=0 M3=95.9566046428518 S11Max=485.450769008767 PtS11Max=1 x2S11Max=-0.5
 x3S11Max=-0.5 _
 S11Min=-736.798865879022 PtS11Min=3 x2S11Min=0.5 x3S11Min=-0.5 FrameElem=4 ElemStation=0.125
 Frame=4 Station=0.1875 OutputCase=ENVE CaseType=Combination StepType=Min P=-122.976319142087 V2=-
 551.973980290798 V3=0 T=0 M2=0 M3=130.501678737463 S11Max=692.721213576436 PtS11Max=1 x2S11Max=-0.5 _
 x3S11Max=-0.5 S11Min=-944.082077238071 PtS11Min=3 x2S11Min=0.5 x3S11Min=-0.5 FrameElem=4
 ElemStation=0.1875
 Frame=4 Station=0.25 OutputCase=ENVE CaseType=Combination StepType=Min P=-122.976319142087 V2=-
 550.411480290798 V3=0 T=0 M2=0 M3=164.949096582075 S11Max=899.405720644105 PtS11Max=1 x2S11Max=-0.5
 x3S11Max=-0.5 _
 S11Min=-1150.77935109712 PtS11Min=3 x2S11Min=0.5 x3S11Min=-0.5 FrameElem=4 ElemStation=0.25
 Frame=4 Station=0 OutputCase=FESSUR CaseType=Combination P=-122.976319142087 V2=-556.661480290798
 V3=0 T=0 M2=0 M3=32.9163852531394 S11Max=74.5219923767495 PtS11Max=1 x2S11Max=-0.5 x3S11Max=-0.5 _
 S11Min=-320.474630660923 PtS11Min=3 x2S11Min=0.5 x3S11Min=-0.5 FrameElem=4 ElemStation=0
 Frame=4 Station=0.0625 OutputCase=FESSUR CaseType=Combination P=-122.976319142087 V2=-555.098980290798
 V3=0 T=0 M2=0 M3=67.6588996463143 S11Max=282.977078735799 PtS11Max=1 x2S11Max=-0.5 x3S11Max=-0.5 _
 S11Min=-528.929717019973 PtS11Min=3 x2S11Min=0.5 x3S11Min=-0.5 FrameElem=4 ElemStation=0.0625
 Frame=4 Station=0.125 OutputCase=FESSUR CaseType=Combination P=-122.976319142087 V2=-553.536480290798
 V3=0 T=0 M2=0 M3=102.303757789489 S11Max=490.846227594848 PtS11Max=1 x2S11Max=-0.5 x3S11Max=-0.5 _
 S11Min=-736.798865879022 PtS11Min=3 x2S11Min=0.5 x3S11Min=-0.5 FrameElem=4 ElemStation=0.125
 Frame=4 Station=0.1875 OutputCase=FESSUR CaseType=Combination P=-122.976319142087 V2=-551.973980290798
 V3=0 T=0 M2=0 M3=136.850959682664 S11Max=698.129438953898 PtS11Max=1 x2S11Max=-0.5 x3S11Max=-0.5 _
 S11Min=-944.082077238071 PtS11Min=3 x2S11Min=0.5 x3S11Min=-0.5 FrameElem=4 ElemStation=0.1875
 Frame=4 Station=0.25 OutputCase=FESSUR CaseType=Combination P=-122.976319142087 V2=-550.411480290798
 V3=0 T=0 M2=0 M3=171.300505325839 S11Max=904.826712812947 PtS11Max=1 x2S11Max=-0.5 x3S11Max=-0.5 _
 S11Min=-1150.77935109712 PtS11Min=3 x2S11Min=0.5 x3S11Min=-0.5 FrameElem=4 ElemStation=0.25
 Frame=5 Station=0 OutputCase=PESOPR CaseType=LinStatic P=-15.1709467362359 V2=-157.292540241557 V3=0
 T=0 M2=0 M3=43.2134810370117 S11Max=244.109939485834 PtS11Max=1 x2S11Max=-0.5 x3S11Max=-0.5 _
 S11Min=-274.451832958306 PtS11Min=3 x2S11Min=0.5 x3S11Min=-0.5 FrameElem=5 ElemStation=0
 Frame=5 Station=6.24999940395355E-02 OutputCase=PESOPR CaseType=LinStatic P=-15.1709467362359 V2=-
 155.730040390568 V3=0 T=0 M2=0 M3=52.9954357488856 S11Max=302.801667757078 PtS11Max=1 x2S11Max=-0.5
 x3S11Max=-0.5 _
 S11Min=-333.143561229549 PtS11Min=3 x2S11Min=0.5 x3S11Min=-0.5 FrameElem=5
 ElemStation=6.24999940395355E-02
 Frame=5 Station=0.124999988079071 OutputCase=PESOPR CaseType=LinStatic P=-15.1709467362359 V2=-
 154.16754053958 V3=0 T=0 M2=0 M3=62.679734229386 S11Max=360.90745864008 PtS11Max=1 x2S11Max=-0.5
 x3S11Max=-0.5 _
 S11Min=-391.249352112552 PtS11Min=3 x2S11Min=0.5 x3S11Min=-0.5 FrameElem=5
 ElemStation=0.124999988079071
 Frame=5 Station=0.187499982118607 OutputCase=PESOPR CaseType=LinStatic P=-15.1709467362359 V2=-
 152.605040688592 V3=0 T=0 M2=0 M3=72.2663764785128 S11Max=418.427312134841 PtS11Max=1 x2S11Max=-0.5
 x3S11Max=-0.5 _
 S11Min=-448.769205607313 PtS11Min=3 x2S11Min=0.5 x3S11Min=-0.5 FrameElem=5
 ElemStation=0.187499982118607
 Frame=5 Station=0.249999976158142 OutputCase=PESOPR CaseType=LinStatic P=-15.1709467362359 V2=-
 151.042540837603 V3=0 T=0 M2=0 M3=81.7553624962661 S11Max=475.36122824136 PtS11Max=1 x2S11Max=-0.5
 x3S11Max=-0.5 _
 S11Min=-505.703121713832 PtS11Min=3 x2S11Min=0.5 x3S11Min=-0.5 FrameElem=5
 ElemStation=0.249999976158142
 Frame=5 Station=0 OutputCase=TERRVERT CaseType=LinStatic P=1.15282857329198 V2=-466.004535010667 V3=0
 T=0 M2=0 M3=106.915661809617 S11Max=642.646799430992 PtS11Max=1 x2S11Max=-0.5 x3S11Max=-0.5 _
 S11Min=-640.341142284408 PtS11Min=3 x2S11Min=0.5 x3S11Min=-0.5 FrameElem=5 ElemStation=0
 Frame=5 Station=6.24999940395355E-02 OutputCase=TERRVERT CaseType=LinStatic P=1.15282857329198 V2=-
 466.004535010667 V3=0 T=0 M2=0 M3=136.04094247018 S11Max=817.398483394372 PtS11Max=1 x2S11Max=-0.5
 x3S11Max=-0.5 _
 S11Min=-815.092826247787 PtS11Min=3 x2S11Min=0.5 x3S11Min=-0.5 FrameElem=5
 ElemStation=6.24999940395355E-02
 Frame=5 Station=0.124999988079071 OutputCase=TERRVERT CaseType=LinStatic P=1.15282857329198 V2=-
 466.004535010667 V3=0 T=0 M2=0 M3=165.166223130743 S11Max=992.150167357751 PtS11Max=1 x2S11Max=-0.5
 x3S11Max=-0.5 _
 S11Min=-989.844510211167 PtS11Min=3 x2S11Min=0.5 x3S11Min=-0.5 FrameElem=5
 ElemStation=0.124999988079071



Frame=5 Station=0.187499982118607 OutputCase=TERRVERT CaseType=LinStatic P=1.15282857329198 V2=-
 466.004535010667 V3=0 T=0 M2=0 M3=194.291503791306 S11Max=1166.90185132113 PtS11Max=1 x2S11Max=-0.5
 x3S11Max=-0.5 _
 S11Min=-1164.59619417455 PtS11Min=3 x2S11Min=0.5 x3S11Min=-0.5 FrameElem=5
 ElemStation=0.187499982118607
 Frame=5 Station=0.249999976158142 OutputCase=TERRVERT CaseType=LinStatic P=1.15282857329198 V2=-
 466.004535010667 V3=0 T=0 M2=0 M3=223.416784451869 S11Max=1341.65353528451 PtS11Max=1 x2S11Max=-0.5
 x3S11Max=-0.5 _
 S11Min=-1339.34787813792 PtS11Min=3 x2S11Min=0.5 x3S11Min=-0.5 FrameElem=5
 ElemStation=0.249999976158142
 Frame=5 Station=0 OutputCase=TERRLAT CaseType=LinStatic P=-108.958200979145 V2=-4.68224872419114E-02
 V3=0 T=0 M2=0 M3=21.1713624792142 S11Max=18.0699738961398 PtS11Max=1 x2S11Max=-0.5 x3S11Max=-0.5 _
 S11Min=-235.98637585443 PtS11Min=3 x2S11Min=0.5 x3S11Min=-0.5 FrameElem=5 ElemStation=0
 Frame=5 Station=6.24999940395355E-02 OutputCase=TERRLAT CaseType=LinStatic P=-108.958200979145 V2=-
 4.68224872419114E-02 V3=0 T=0 M2=0 M3=21.1742888843877 S11Max=18.087532327181 PtS11Max=1 x2S11Max=-0.5
 _
 x3S11Max=-0.5 S11Min=-236.003934285471 PtS11Min=3 x2S11Min=0.5 x3S11Min=-0.5 FrameElem=5
 ElemStation=6.24999940395355E-02
 Frame=5 Station=0.124999988079071 OutputCase=TERRLAT CaseType=LinStatic P=-108.958200979145 V2=-
 4.68224872419114E-02 V3=0 T=0 M2=0 M3=21.1772152895612 S11Max=18.1050907582222 PtS11Max=1 x2S11Max=-
 0.5 _
 x3S11Max=-0.5 S11Min=-236.021492716513 PtS11Min=3 x2S11Min=0.5 x3S11Min=-0.5 FrameElem=5
 ElemStation=0.124999988079071
 Frame=5 Station=0.187499982118607 OutputCase=TERRLAT CaseType=LinStatic P=-108.958200979145 V2=-
 4.68224872419114E-02 V3=0 T=0 M2=0 M3=21.1801416947348 S11Max=18.1226491892635 PtS11Max=1 x2S11Max=-
 0.5 _
 x3S11Max=-0.5 S11Min=-236.039051147554 PtS11Min=3 x2S11Min=0.5 x3S11Min=-0.5 FrameElem=5
 ElemStation=0.187499982118607
 Frame=5 Station=0.249999976158142 OutputCase=TERRLAT CaseType=LinStatic P=-108.958200979145 V2=-
 4.68224872419114E-02 V3=0 T=0 M2=0 M3=21.1830680999083 S11Max=18.1402076203047 PtS11Max=1 x2S11Max=-
 0.5 _
 x3S11Max=-0.5 S11Min=-236.056609578595 PtS11Min=3 x2S11Min=0.5 x3S11Min=-0.5 FrameElem=5
 ElemStation=0.249999976158142
 Frame=5 Station=0 OutputCase=ACCLATDX CaseType=LinStatic P=0 V2=0 V3=0 T=0 M2=0 M3=0 S11Max=0
 PtS11Max=0 x2S11Max=0 x3S11Max=0 S11Min=0 PtS11Min=0 x2S11Min=0 x3S11Min=0 FrameElem=5 ElemStation=0
 Frame=5 Station=6.24999940395355E-02 OutputCase=ACCLATDX CaseType=LinStatic P=0 V2=0 V3=0 T=0
 M2=0 M3=0 S11Max=0 PtS11Max=0 x2S11Max=0 x3S11Max=0 S11Min=0 PtS11Min=0 x2S11Min=0 x3S11Min=0
 FrameElem=5 ElemStation=6.24999940395355E-02
 Frame=5 Station=0.124999988079071 OutputCase=ACCLATDX CaseType=LinStatic P=0 V2=0 V3=0 T=0 M2=0
 M3=0 S11Max=0 PtS11Max=0 x2S11Max=0 x3S11Max=0 S11Min=0 PtS11Min=0 x2S11Min=0 x3S11Min=0
 FrameElem=5 ElemStation=0.124999988079071
 Frame=5 Station=0.187499982118607 OutputCase=ACCLATDX CaseType=LinStatic P=0 V2=0 V3=0 T=0 M2=0
 M3=0 S11Max=0 PtS11Max=0 x2S11Max=0 x3S11Max=0 S11Min=0 PtS11Min=0 x2S11Min=0 x3S11Min=0
 FrameElem=5 ElemStation=0.187499982118607
 Frame=5 Station=0.249999976158142 OutputCase=ACCLATDX CaseType=LinStatic P=0 V2=0 V3=0 T=0 M2=0
 M3=0 S11Max=0 PtS11Max=0 x2S11Max=0 x3S11Max=0 S11Min=0 PtS11Min=0 x2S11Min=0 x3S11Min=0
 FrameElem=5 ElemStation=0.249999976158142
 Frame=5 Station=0 OutputCase=ACCLATSX CaseType=LinStatic P=0 V2=0 V3=0 T=0 M2=0 M3=0 S11Max=0
 PtS11Max=0 x2S11Max=0 x3S11Max=0 S11Min=0 PtS11Min=0 x2S11Min=0 x3S11Min=0 FrameElem=5 ElemStation=0
 Frame=5 Station=6.24999940395355E-02 OutputCase=ACCLATSX CaseType=LinStatic P=0 V2=0 V3=0 T=0
 M2=0 M3=0 S11Max=0 PtS11Max=0 x2S11Max=0 x3S11Max=0 S11Min=0 PtS11Min=0 x2S11Min=0 x3S11Min=0
 FrameElem=5 ElemStation=6.24999940395355E-02
 Frame=5 Station=0.124999988079071 OutputCase=ACCLATSX CaseType=LinStatic P=0 V2=0 V3=0 T=0 M2=0
 M3=0 S11Max=0 PtS11Max=0 x2S11Max=0 x3S11Max=0 S11Min=0 PtS11Min=0 x2S11Min=0 x3S11Min=0
 FrameElem=5 ElemStation=0.124999988079071
 Frame=5 Station=0.187499982118607 OutputCase=ACCLATSX CaseType=LinStatic P=0 V2=0 V3=0 T=0 M2=0
 M3=0 S11Max=0 PtS11Max=0 x2S11Max=0 x3S11Max=0 S11Min=0 PtS11Min=0 x2S11Min=0 x3S11Min=0
 FrameElem=5 ElemStation=0.187499982118607
 Frame=5 Station=0.249999976158142 OutputCase=ACCLATSX CaseType=LinStatic P=0 V2=0 V3=0 T=0 M2=0
 M3=0 S11Max=0 PtS11Max=0 x2S11Max=0 x3S11Max=0 S11Min=0 PtS11Min=0 x2S11Min=0 x3S11Min=0
 FrameElem=5 ElemStation=0.249999976158142
 Frame=5 Station=0 OutputCase=TERRCOST CaseType=LinStatic P=0 V2=0 V3=0 T=0 M2=0 M3=0 S11Max=0
 PtS11Max=0 x2S11Max=0 x3S11Max=0 S11Min=0 PtS11Min=0 x2S11Min=0 x3S11Min=0 FrameElem=5 ElemStation=0
 Frame=5 Station=6.24999940395355E-02 OutputCase=TERRCOST CaseType=LinStatic P=0 V2=0 V3=0 T=0
 M2=0 M3=0 S11Max=0 PtS11Max=0 x2S11Max=0 x3S11Max=0 S11Min=0 PtS11Min=0 x2S11Min=0 x3S11Min=0
 FrameElem=5 ElemStation=6.24999940395355E-02
 Frame=5 Station=0.124999988079071 OutputCase=TERRCOST CaseType=LinStatic P=0 V2=0 V3=0 T=0 M2=0
 M3=0 S11Max=0 PtS11Max=0 x2S11Max=0 x3S11Max=0 S11Min=0 PtS11Min=0 x2S11Min=0 x3S11Min=0
 FrameElem=5 ElemStation=0.124999988079071
 Frame=5 Station=0.187499982118607 OutputCase=TERRCOST CaseType=LinStatic P=0 V2=0 V3=0 T=0 M2=0
 M3=0 S11Max=0 PtS11Max=0 x2S11Max=0 x3S11Max=0 S11Min=0 PtS11Min=0 x2S11Min=0 x3S11Min=0
 FrameElem=5 ElemStation=0.187499982118607
 Frame=5 Station=0.249999976158142 OutputCase=TERRCOST CaseType=LinStatic P=0 V2=0 V3=0 T=0 M2=0
 M3=0 S11Max=0 PtS11Max=0 x2S11Max=0 x3S11Max=0 S11Min=0 PtS11Min=0 x2S11Min=0 x3S11Min=0
 FrameElem=5 ElemStation=0.249999976158142
 Frame=5 Station=0 OutputCase=SOVRCOST CaseType=LinStatic P=0 V2=0 V3=0 T=0 M2=0 M3=0 S11Max=0
 PtS11Max=0 x2S11Max=0 x3S11Max=0 S11Min=0 PtS11Min=0 x2S11Min=0 x3S11Min=0 FrameElem=5 ElemStation=0
 Frame=5 Station=6.24999940395355E-02 OutputCase=SOVRCOST CaseType=LinStatic P=0 V2=0 V3=0 T=0
 M2=0 M3=0 S11Max=0 PtS11Max=0 x2S11Max=0 x3S11Max=0 S11Min=0 PtS11Min=0 x2S11Min=0 x3S11Min=0
 FrameElem=5 ElemStation=6.24999940395355E-02



```

Frame=5 Station=0.124999988079071 OutputCase=SOVRCOST CaseType=LinStatic P=0 V2=0 V3=0 T=0 M2=0
M3=0 S11Max=0 PtS11Max=0 x2S11Max=0 x3S11Max=0 S11Min=0 PtS11Min=0 x2S11Min=0 x3S11Min=0
FrameElem=5 ElemStation=0.124999988079071
Frame=5 Station=0.187499982118607 OutputCase=SOVRCOST CaseType=LinStatic P=0 V2=0 V3=0 T=0 M2=0
M3=0 S11Max=0 PtS11Max=0 x2S11Max=0 x3S11Max=0 S11Min=0 PtS11Min=0 x2S11Min=0 x3S11Min=0
FrameElem=5 ElemStation=0.187499982118607
Frame=5 Station=0.249999976158142 OutputCase=SOVRCOST CaseType=LinStatic P=0 V2=0 V3=0 T=0 M2=0
M3=0 S11Max=0 PtS11Max=0 x2S11Max=0 x3S11Max=0 S11Min=0 PtS11Min=0 x2S11Min=0 x3S11Min=0
FrameElem=5 ElemStation=0.249999976158142
Frame=5 Station=0 OutputCase=ENVE CaseType=Combination StepType=Max P=-90.2888588483455 V2=-
623.329850993293 V3=0 T=0 M2=0 M3=171.300505325843 S11Max=904.826712812966 PtS11Max=1 x2S11Max=-0.5
x3S11Max=-0.5
S11Min=-1079.98343834082 PtS11Min=3 x2S11Min=0.5 x3S11Min=-0.5 FrameElem=5 ElemStation=0
Frame=5 Station=6.24999940395355E-02 OutputCase=ENVE CaseType=Combination StepType=Max P=-
90.2888588483455 V2=-621.767351142304 V3=0 T=0 M2=0 M3=210.210667103453 S11Max=1138.28768347863
PtS11Max=1 x2S11Max=-0.5
x3S11Max=-0.5 S11Min=-1313.43914147717 PtS11Min=3 x2S11Min=0.5 x3S11Min=-0.5 FrameElem=5
ElemStation=6.24999940395355E-02
Frame=5 Station=0.124999988079071 OutputCase=ENVE CaseType=Combination StepType=Max P=-90.2888588483455
V2=-620.204851291316 V3=0 T=0 M2=0 M3=249.02317264969 S11Max=1371.16271675605 PtS11Max=1 x2S11Max=-0.5
-
x3S11Max=-0.5 S11Min=-1546.30890722528 PtS11Min=3 x2S11Min=0.5 x3S11Min=-0.5 FrameElem=5
ElemStation=0.124999988079071
Frame=5 Station=0.187499982118607 OutputCase=ENVE CaseType=Combination StepType=Max P=-90.2888588483455
V2=-618.642351440328 V3=0 T=0 M2=0 M3=287.738021964554 S11Max=1603.45181264523 PtS11Max=1 x2S11Max=-
0.5
x3S11Max=-0.5 S11Min=-1778.59273558515 PtS11Min=3 x2S11Min=0.5 x3S11Min=-0.5 FrameElem=5
ElemStation=0.187499982118607
Frame=5 Station=0.249999976158142 OutputCase=ENVE CaseType=Combination StepType=Max P=-90.2888588483455
V2=-617.079851589339 V3=0 T=0 M2=0 M3=326.355215048044 S11Max=1835.15497114617 PtS11Max=1 x2S11Max=-
0.5
x3S11Max=-0.5 S11Min=-2010.29062655677 PtS11Min=3 x2S11Min=0.5 x3S11Min=-0.5 FrameElem=5
ElemStation=0.249999976158142
Frame=5 Station=0 OutputCase=ENVE CaseType=Combination StepType=Min P=-122.976319142089 V2=-
623.343897739465 V3=0 T=0 M2=0 M3=164.949096582078 S11Max=899.405720644124 PtS11Max=1 x2S11Max=-0.5
x3S11Max=-0.5
S11Min=-1150.77935109714 PtS11Min=3 x2S11Min=0.5 x3S11Min=-0.5 FrameElem=5 ElemStation=0
Frame=5 Station=6.24999940395355E-02 OutputCase=ENVE CaseType=Combination StepType=Min P=-
122.976319142089 V2=-621.781397888477 V3=0 T=0 M2=0 M3=203.858380438137 S11Max=1132.86142378048
PtS11Max=1 x2S11Max=-0.5
x3S11Max=-0.5 S11Min=-1384.24032176281 PtS11Min=3 x2S11Min=0.5 x3S11Min=-0.5 FrameElem=5
ElemStation=6.24999940395355E-02
Frame=5 Station=0.124999988079071 OutputCase=ENVE CaseType=Combination StepType=Min P=-122.976319142089
V2=-620.218898037488 V3=0 T=0 M2=0 M3=242.670008062822 S11Max=1365.73118952859 PtS11Max=1 x2S11Max=-
0.5
x3S11Max=-0.5 S11Min=-1617.11535504023 PtS11Min=3 x2S11Min=0.5 x3S11Min=-0.5 FrameElem=5
ElemStation=0.124999988079071
Frame=5 Station=0.187499982118607 OutputCase=ENVE CaseType=Combination StepType=Min P=-122.976319142089
V2=-618.6563981865 V3=0 T=0 M2=0 M3=281.383979456133 S11Max=1598.01501788846 PtS11Max=1 x2S11Max=-0.5
-
x3S11Max=-0.5 S11Min=-1849.40445092941 PtS11Min=3 x2S11Min=0.5 x3S11Min=-0.5 FrameElem=5
ElemStation=0.187499982118607
Frame=5 Station=0.249999976158142 OutputCase=ENVE CaseType=Combination StepType=Min P=-122.976319142089
V2=-617.093898335512 V3=0 T=0 M2=0 M3=320.000294618071 S11Max=1829.71290886008 PtS11Max=1 x2S11Max=-
0.5
x3S11Max=-0.5 S11Min=-2081.10760943035 PtS11Min=3 x2S11Min=0.5 x3S11Min=-0.5 FrameElem=5
ElemStation=0.249999976158142
Frame=5 Station=0 OutputCase=FESSUR CaseType=Combination P=-122.976319142089 V2=-623.343897739465
V3=0 T=0 M2=0 M3=171.300505325843 S11Max=904.826712812966 PtS11Max=1 x2S11Max=-0.5 x3S11Max=-0.5
S11Min=-1150.77935109714 PtS11Min=3 x2S11Min=0.5 x3S11Min=-0.5 FrameElem=5 ElemStation=0
Frame=5 Station=6.24999940395355E-02 OutputCase=FESSUR CaseType=Combination P=-122.976319142089 V2=-
621.781397888477 V3=0 T=0 M2=0 M3=210.210667103453 S11Max=1138.28768347863 PtS11Max=1 x2S11Max=-0.5
x3S11Max=-0.5 S11Min=-1384.24032176281 PtS11Min=3 x2S11Min=0.5 x3S11Min=-0.5 FrameElem=5
ElemStation=6.24999940395355E-02
Frame=5 Station=0.124999988079071 OutputCase=FESSUR CaseType=Combination P=-122.976319142089 V2=-
620.218898037488 V3=0 T=0 M2=0 M3=249.02317264969 S11Max=1371.16271675605 PtS11Max=1 x2S11Max=-0.5
x3S11Max=-0.5
S11Min=-1617.11535504023 PtS11Min=3 x2S11Min=0.5 x3S11Min=-0.5 FrameElem=5
ElemStation=0.124999988079071
Frame=5 Station=0.187499982118607 OutputCase=FESSUR CaseType=Combination P=-122.976319142089 V2=-
618.6563981865 V3=0 T=0 M2=0 M3=287.738021964554 S11Max=1603.45181264523 PtS11Max=1 x2S11Max=-0.5
x3S11Max=-0.5
S11Min=-1849.40445092941 PtS11Min=3 x2S11Min=0.5 x3S11Min=-0.5 FrameElem=5
ElemStation=0.187499982118607
Frame=5 Station=0.249999976158142 OutputCase=FESSUR CaseType=Combination P=-122.976319142089 V2=-
617.093898335512 V3=0 T=0 M2=0 M3=326.355215048044 S11Max=1835.15497114617 PtS11Max=1 x2S11Max=-0.5
x3S11Max=-0.5
S11Min=-2081.10760943035 PtS11Min=3 x2S11Min=0.5 x3S11Min=-0.5 FrameElem=5
ElemStation=0.249999976158142
Frame=6 Station=0 OutputCase=PESOPR CaseType=LinStatic P=-162.50000265602 V2=-15.1709312390282 V3=0
T=0 M2=0 M3=-81.7553624962645 S11Max=328.032174711986 PtS11Max=3 x2S11Max=0.5 x3S11Max=-0.5
S11Min=-653.032175243189 PtS11Min=1 x2S11Min=-0.5 x3S11Min=-0.5 FrameElem=6 ElemStation=0

```



Frame=6 Station=0.250000000000001 OutputCase=PESOPR CaseType=LinStatic P=-156.250000265602 V2=-15.1709318350747 V3=0 T=0 M2=0 M3=-77.9626296120016 S11Max=311.525777406408 PtS11Max=3 x2S11Max=0.5 x3S11Max=-0.5 _
 S11Min=-624.025777937611 PtS11Min=1 x2S11Min=-0.5 x3S11Min=-0.5 FrameElem=6
 ElemStation=0.250000000000001
 Frame=6 Station=0 OutputCase=TERRVERT CaseType=LinStatic P=-491.249995402293 V2=1.15287542254248 V3=0 T=0 M2=0 M3=-223.416784451878 S11Max=849.250711308974 PtS11Max=3 x2S11Max=0.5 x3S11Max=-0.5 _
 S11Min=-1831.75070211356 PtS11Min=1 x2S11Min=-0.5 x3S11Min=-0.5 FrameElem=6 ElemStation=0
 Frame=6 Station=0.250000000000001 OutputCase=TERRVERT CaseType=LinStatic P=-491.249995402293 V2=1.15287542254248 V3=0 T=0 M2=0 M3=-223.705003307514 S11Max=850.980024442788 PtS11Max=3 x2S11Max=0.5 x3S11Max=-0.5 _
 S11Min=-1833.48001524737 PtS11Min=1 x2S11Min=-0.5 x3S11Min=-0.5 FrameElem=6
 ElemStation=0.250000000000001
 Frame=6 Station=0 OutputCase=TERRLAT CaseType=LinStatic P=-8.13506585473078E-06 V2=-81.7982009791453 V3=0 T=0 M2=0 M3=-21.1830680999084 S11Max=127.098400464384 PtS11Max=3 x2S11Max=0.5 x3S11Max=-0.5 _
 S11Min=-127.098416734516 PtS11Min=1 x2S11Min=-0.5 x3S11Min=-0.5 FrameElem=6 ElemStation=0
 Frame=6 Station=0.250000000000001 OutputCase=TERRLAT CaseType=LinStatic P=-6.91617322550804E-06 V2=-69.0171853557337 V3=0 T=0 M2=0 M3=-2.3422483237396 S11Max=14.0534830262643 PtS11Max=3 x2S11Max=0.5 _
 x3S11Max=-0.5 S11Min=-14.0534968586108 PtS11Min=1 x2S11Min=-0.5 x3S11Min=-0.5 FrameElem=6
 ElemStation=0.250000000000001
 Frame=6 Station=0 OutputCase=ACCLATDX CaseType=LinStatic P=0 V2=0 V3=0 T=0 M2=0 M3=0 S11Max=0 PtS11Max=0 x2S11Max=0 x3S11Max=0 S11Min=0 PtS11Min=0 x2S11Min=0 x3S11Min=0
 Frame=6 Station=0.250000000000001 OutputCase=ACCLATDX CaseType=LinStatic P=0 V2=0 V3=0 T=0 M2=0 M3=0 S11Max=0 PtS11Max=0 x2S11Max=0 x3S11Max=0 S11Min=0 PtS11Min=0 x2S11Min=0 x3S11Min=0
 FrameElem=6 ElemStation=0.250000000000001
 Frame=6 Station=0 OutputCase=ACCLATSX CaseType=LinStatic P=0 V2=0 V3=0 T=0 M2=0 M3=0 S11Max=0 PtS11Max=0 x2S11Max=0 x3S11Max=0 S11Min=0 PtS11Min=0 x2S11Min=0 x3S11Min=0
 Frame=6 Station=0.250000000000001 OutputCase=ACCLATSX CaseType=LinStatic P=0 V2=0 V3=0 T=0 M2=0 M3=0 S11Max=0 PtS11Max=0 x2S11Max=0 x3S11Max=0 S11Min=0 PtS11Min=0 x2S11Min=0 x3S11Min=0
 FrameElem=6 ElemStation=0.250000000000001
 Frame=6 Station=0 OutputCase=TERRCOST CaseType=LinStatic P=0 V2=0 V3=0 T=0 M2=0 M3=0 S11Max=0 PtS11Max=0 x2S11Max=0 x3S11Max=0 S11Min=0 PtS11Min=0 x2S11Min=0 x3S11Min=0
 Frame=6 Station=0.250000000000001 OutputCase=TERRCOST CaseType=LinStatic P=0 V2=0 V3=0 T=0 M2=0 M3=0 S11Max=0 PtS11Max=0 x2S11Max=0 x3S11Max=0 S11Min=0 PtS11Min=0 x2S11Min=0 x3S11Min=0
 FrameElem=6 ElemStation=0.250000000000001
 Frame=6 Station=0 OutputCase=SOVRCOST CaseType=LinStatic P=0 V2=0 V3=0 T=0 M2=0 M3=0 S11Max=0 PtS11Max=0 x2S11Max=0 x3S11Max=0 S11Min=0 PtS11Min=0 x2S11Min=0 x3S11Min=0
 Frame=6 Station=0.250000000000001 OutputCase=SOVRCOST CaseType=LinStatic P=0 V2=0 V3=0 T=0 M2=0 M3=0 S11Max=0 PtS11Max=0 x2S11Max=0 x3S11Max=0 S11Min=0 PtS11Min=0 x2S11Min=0 x3S11Min=0
 FrameElem=6 ElemStation=0.250000000000001
 Frame=6 Station=0 OutputCase=ENVE CaseType=Combination StepType=Max P=-653.750001362441 V2=-71.2767965018875 V3=0 T=0 M2=0 M3=-320.000294618078 S11Max=1304.38128648534 PtS11Max=3 x2S11Max=0.5 x3S11Max=-0.5 _
 S11Min=-2573.75176907091 PtS11Min=1 x2S11Min=-0.5 x3S11Min=-0.5 FrameElem=6 ElemStation=0
 Frame=6 Station=0.250000000000001 OutputCase=ENVE CaseType=Combination StepType=Max P=-647.500000509216 V2=-62.3300861615458 V3=0 T=0 M2=0 M3=-303.307206746133 S11Max=1176.55928487546 PtS11Max=3 x2S11Max=0.5 x3S11Max=-0.5 _
 S11Min=-2467.34324098601 PtS11Min=1 x2S11Min=-0.5 x3S11Min=-0.5 FrameElem=6
 ElemStation=0.250000000000001
 Frame=6 Station=0 OutputCase=ENVE CaseType=Combination StepType=Min P=-653.750003802961 V2=-95.8162567956311 V3=0 T=0 M2=0 M3=-326.355215048051 S11Max=1266.25176634603 PtS11Max=3 x2S11Max=0.5 x3S11Max=-0.5 _
 S11Min=-2611.88129409127 PtS11Min=1 x2S11Min=-0.5 x3S11Min=-0.5 FrameElem=6 ElemStation=0
 Frame=6 Station=0.250000000000001 OutputCase=ENVE CaseType=Combination StepType=Min P=-647.500002584068 V2=-83.0352417682659 V3=0 T=0 M2=0 M3=-304.009881243255 S11Max=1172.34323996758 PtS11Max=3 x2S11Max=0.5 x3S11Max=-0.5 _
 S11Min=-2471.5592900436 PtS11Min=1 x2S11Min=-0.5 x3S11Min=-0.5 FrameElem=6
 ElemStation=0.250000000000001
 Frame=6 Station=0 OutputCase=FESSUR CaseType=Combination P=-653.750003802961 V2=-95.8162567956311 V3=0 T=0 M2=0 M3=-326.355215048051 S11Max=1304.38128648534 PtS11Max=3 x2S11Max=0.5 x3S11Max=-0.5 _
 S11Min=-2611.88129409127 PtS11Min=1 x2S11Min=-0.5 x3S11Min=-0.5 FrameElem=6 ElemStation=0
 Frame=6 Station=0.250000000000001 OutputCase=FESSUR CaseType=Combination P=-647.500002584068 V2=-83.0352417682659 V3=0 T=0 M2=0 M3=-304.009881243255 S11Max=1176.55928487546 PtS11Max=3 x2S11Max=0.5 x3S11Max=-0.5 _
 S11Min=-2471.5592900436 PtS11Min=1 x2S11Min=-0.5 x3S11Min=-0.5 FrameElem=6
 ElemStation=0.250000000000001
 Frame=7 Station=0 OutputCase=PESOPR CaseType=LinStatic P=-156.249998818792 V2=-15.170946736235 V3=0 T=0 M2=0 M3=-77.9626296120061 S11Max=311.525778853245 PtS11Max=3 x2S11Max=0.5 x3S11Max=-0.5 _
 S11Min=-624.025776490829 PtS11Min=1 x2S11Min=-0.5 x3S11Min=-0.5 FrameElem=7 ElemStation=0
 Frame=7 Station=0.25 OutputCase=PESOPR CaseType=LinStatic P=-149.999998818792 V2=-15.170946736235 V3=0 T=0 M2=0 M3=-74.1698929279474 S11Max=295.019358748892 PtS11Max=3 x2S11Max=0.5 x3S11Max=-0.5 _
 S11Min=-595.019356386476 PtS11Min=1 x2S11Min=-0.5 x3S11Min=-0.5 FrameElem=7 ElemStation=0.25
 Frame=7 Station=0 OutputCase=TERRVERT CaseType=LinStatic P=-491.249995512189 V2=1.15282857329566 V3=0 T=0 M2=0 M3=-223.705003307517 S11Max=850.98002432914 PtS11Max=3 x2S11Max=0.5 x3S11Max=-0.5 _
 S11Min=-1833.48001535729 PtS11Min=1 x2S11Min=-0.5 x3S11Min=-0.5 FrameElem=7 ElemStation=0
 Frame=7 Station=0.25 OutputCase=TERRVERT CaseType=LinStatic P=-491.249995512189 V2=1.15282857329566 V3=0 T=0 M2=0 M3=-223.993210450841 S11Max=852.709267192858 PtS11Max=3 x2S11Max=0.5 x3S11Max=-0.5 _
 S11Min=-1835.20925821724 PtS11Min=1 x2S11Min=-0.5 x3S11Min=-0.5 FrameElem=7 ElemStation=0.25
 Frame=7 Station=0 OutputCase=TERRLAT CaseType=LinStatic P=-3.34182004735339E-07 V2=-69.0171853557338 V3=0 T=0 M2=0 M3=-2.34224832373957 S11Max=14.0534896082554 PtS11Max=3 x2S11Max=0.5 x3S11Max=-0.5 _
 S11Min=-14.0534902766194 PtS11Min=1 x2S11Min=-0.5 x3S11Min=-0.5 FrameElem=7 ElemStation=0



Frame=7 Station=0.25 OutputCase=TERRLAT CaseType=LinStatic P=-3.34182004735339E-07 V2=-56.7691384854989
 V3=0 T=0 M2=0 M3=13.3699386407233 S11Max=80.219631510158 PtS11Max=1 x2S11Max=-0.5 x3S11Max=-0.5 _
 S11Min=-80.219632178522 PtS11Min=3 x2S11Min=0.5 x3S11Min=-0.5 FrameElem=7 ElemStation=0.25
 Frame=7 Station=0 OutputCase=ACCLATDX CaseType=LinStatic P=0 V2=0 V3=0 T=0 M2=0 M3=0 S11Max=0
 PtS11Max=0 x2S11Max=0 x3S11Max=0 S11Min=0 PtS11Min=0 x2S11Min=0 x3S11Min=0 FrameElem=7 ElemStation=0
 Frame=7 Station=0.25 OutputCase=ACCLATDX CaseType=LinStatic P=0 V2=0 V3=0 T=0 M2=0 M3=0
 S11Max=0 PtS11Max=0 x2S11Max=0 x3S11Max=0 S11Min=0 PtS11Min=0 x2S11Min=0 x3S11Min=0 FrameElem=7
 ElemStation=0.25
 Frame=7 Station=0 OutputCase=ACCLATSX CaseType=LinStatic P=0 V2=0 V3=0 T=0 M2=0 M3=0 S11Max=0
 PtS11Max=0 x2S11Max=0 x3S11Max=0 S11Min=0 PtS11Min=0 x2S11Min=0 x3S11Min=0 FrameElem=7 ElemStation=0
 Frame=7 Station=0.25 OutputCase=ACCLATSX CaseType=LinStatic P=0 V2=0 V3=0 T=0 M2=0 M3=0
 S11Max=0 PtS11Max=0 x2S11Max=0 x3S11Max=0 S11Min=0 PtS11Min=0 x2S11Min=0 x3S11Min=0 FrameElem=7
 ElemStation=0.25
 Frame=7 Station=0 OutputCase=TERRCOST CaseType=LinStatic P=0 V2=0 V3=0 T=0 M2=0 M3=0 S11Max=0
 PtS11Max=0 x2S11Max=0 x3S11Max=0 S11Min=0 PtS11Min=0 x2S11Min=0 x3S11Min=0 FrameElem=7 ElemStation=0
 Frame=7 Station=0.25 OutputCase=TERRCOST CaseType=LinStatic P=0 V2=0 V3=0 T=0 M2=0 M3=0
 S11Max=0 PtS11Max=0 x2S11Max=0 x3S11Max=0 S11Min=0 PtS11Min=0 x2S11Min=0 x3S11Min=0 FrameElem=7
 ElemStation=0.25
 Frame=7 Station=0 OutputCase=SOVRCOST CaseType=LinStatic P=0 V2=0 V3=0 T=0 M2=0 M3=0 S11Max=0
 PtS11Max=0 x2S11Max=0 x3S11Max=0 S11Min=0 PtS11Min=0 x2S11Min=0 x3S11Min=0 FrameElem=7 ElemStation=0
 Frame=7 Station=0.25 OutputCase=SOVRCOST CaseType=LinStatic P=0 V2=0 V3=0 T=0 M2=0 M3=0
 S11Max=0 PtS11Max=0 x2S11Max=0 x3S11Max=0 S11Min=0 PtS11Min=0 x2S11Min=0 x3S11Min=0 FrameElem=7
 ElemStation=0.25
 Frame=7 Station=0 OutputCase=ENVE CaseType=Combination StepType=Max P=-647.499994564909 V2=-
 62.330147911953 V3=0 T=0 M2=0 M3=-303.307206746141 S11Max=1176.55929279441 PtS11Max=3 x2S11Max=0.5
 x3S11Max=-0.5 _
 S11Min=-2467.34323504176 PtS11Min=1 x2S11Min=-0.5 x3S11Min=-0.5 FrameElem=7 ElemStation=0
 Frame=7 Station=0.25 OutputCase=ENVE CaseType=Combination StepType=Max P=-641.249994564909 V2=-
 53.7565151027886 V3=0 T=0 M2=0 M3=-284.793164738065 S11Max=1091.57488341678 PtS11Max=3 x2S11Max=0.5
 x3S11Max=-0.5 _
 S11Min=-2350.00898309355 PtS11Min=1 x2S11Min=-0.5 x3S11Min=-0.5 FrameElem=7 ElemStation=0.25
 Frame=7 Station=0 OutputCase=ENVE CaseType=Combination StepType=Min P=-647.499994665163 V2=-
 83.0353035186731 V3=0 T=0 M2=0 M3=-304.009881243263 S11Max=1172.34324591194 PtS11Max=3 x2S11Max=0.5
 x3S11Max=-0.5 _
 S11Min=-2471.55928212474 PtS11Min=1 x2S11Min=-0.5 x3S11Min=-0.5 FrameElem=7 ElemStation=0
 Frame=7 Station=0.25 OutputCase=ENVE CaseType=Combination StepType=Min P=-641.249994665163 V2=-
 70.7872566484382 V3=0 T=0 M2=0 M3=-288.804146330282 S11Max=1067.50899376323 PtS11Max=3 x2S11Max=0.5
 x3S11Max=-0.5 _
 S11Min=-2374.0748725466 PtS11Min=1 x2S11Min=-0.5 x3S11Min=-0.5 FrameElem=7 ElemStation=0.25
 Frame=7 Station=0 OutputCase=FESSUR CaseType=Combination P=-647.499994665163 V2=-83.0353035186731
 V3=0 T=0 M2=0 M3=-304.009881243263 S11Max=1176.55929279441 PtS11Max=3 x2S11Max=0.5 x3S11Max=-0.5 _
 S11Min=-2471.55928212474 PtS11Min=1 x2S11Min=-0.5 x3S11Min=-0.5 FrameElem=7 ElemStation=0
 Frame=7 Station=0.25 OutputCase=FESSUR CaseType=Combination P=-641.249994665163 V2=-70.7872566484382
 V3=0 T=0 M2=0 M3=-284.793164738065 S11Max=1067.50899376323 PtS11Max=3 x2S11Max=0.5 x3S11Max=-0.5 _
 S11Min=-2350.00898309355 PtS11Min=1 x2S11Min=-0.5 x3S11Min=-0.5 FrameElem=7 ElemStation=0.25
 Frame=9 Station=0 OutputCase=PESOPR CaseType=LinStatic P=-75.000002653105 V2=-15.1709395836784 V3=0
 T=0 M2=0 M3=-28.65705003703 S11Max=96.9422999568694 PtS11Max=3 x2S11Max=0.5 x3S11Max=-0.5 _
 S11Min=-246.94230048749 PtS11Min=1 x2S11Min=-0.5 x3S11Min=-0.5 FrameElem=9 ElemStation=0
 Frame=9 Station=0.250000000000002 OutputCase=PESOPR CaseType=LinStatic P=-68.7500002653105 V2=-
 15.1709401797248 V3=0 T=0 M2=0 M3=-24.8643150666046 S11Max=80.4358901343169 PtS11Max=3 x2S11Max=0.5
 x3S11Max=-0.5 _
 S11Min=-217.935890664938 PtS11Min=1 x2S11Min=-0.5 x3S11Min=-0.5 FrameElem=9
 ElemStation=0.250000000000002
 Frame=9 Station=0 OutputCase=TERRVERT CaseType=LinStatic P=-491.249995401595 V2=1.15287542254691 V3=0
 T=0 M2=0 M3=-227.451684458421 S11Max=873.460111348933 PtS11Max=3 x2S11Max=0.5 x3S11Max=-0.5 _
 S11Min=-1855.96010215212 PtS11Min=1 x2S11Min=-0.5 x3S11Min=-0.5 FrameElem=9 ElemStation=0
 Frame=9 Station=0.250000000000002 OutputCase=TERRVERT CaseType=LinStatic P=-491.249995401595
 V2=1.15287542254691 V3=0 T=0 M2=0 M3=-227.739903314058 S11Max=875.189424482754 PtS11Max=3 x2S11Max=0.5
 x3S11Max=-0.5 _
 S11Min=-1857.68941528594 PtS11Min=1 x2S11Min=-0.5 x3S11Min=-0.5 FrameElem=9
 ElemStation=0.250000000000002
 Frame=9 Station=0 OutputCase=TERRLAT CaseType=LinStatic P=4.30409454565961E-06 V2=48.6358612095335
 V3=0 T=0 M2=0 M3=6.38297944030923 S11Max=38.2978809459499 PtS11Max=1 x2S11Max=-0.5 x3S11Max=-0.5 _
 S11Min=-38.2978723377608 PtS11Min=3 x2S11Min=0.5 x3S11Min=-0.5 FrameElem=9 ElemStation=0
 Frame=9 Station=0.250000000000002 OutputCase=TERRLAT CaseType=LinStatic P=4.81139712164082E-06
 V2=53.9553142884707 V3=0 T=0 M2=0 M3=-6.45202101263256 S11Max=38.7121308871925 PtS11Max=3 x2S11Max=0.5
 x3S11Max=-0.5 _
 S11Min=-38.7121212643982 PtS11Min=1 x2S11Min=-0.5 x3S11Min=-0.5 FrameElem=9
 ElemStation=0.250000000000002
 Frame=9 Station=0 OutputCase=ACCLATDX CaseType=LinStatic P=0 V2=0 V3=0 T=0 M2=0 M3=0 S11Max=0
 PtS11Max=0 x2S11Max=0 x3S11Max=0 S11Min=0 PtS11Min=0 x2S11Min=0 x3S11Min=0 FrameElem=9 ElemStation=0
 Frame=9 Station=0.250000000000002 OutputCase=ACCLATDX CaseType=LinStatic P=0 V2=0 V3=0 T=0 M2=0
 M3=0 S11Max=0 PtS11Max=0 x2S11Max=0 x3S11Max=0 S11Min=0 PtS11Min=0 x2S11Min=0 x3S11Min=0
 FrameElem=9 ElemStation=0.250000000000002
 Frame=9 Station=0 OutputCase=ACCLATSX CaseType=LinStatic P=0 V2=0 V3=0 T=0 M2=0 M3=0 S11Max=0
 PtS11Max=0 x2S11Max=0 x3S11Max=0 S11Min=0 PtS11Min=0 x2S11Min=0 x3S11Min=0 FrameElem=9 ElemStation=0
 Frame=9 Station=0.250000000000002 OutputCase=ACCLATSX CaseType=LinStatic P=0 V2=0 V3=0 T=0 M2=0
 M3=0 S11Max=0 PtS11Max=0 x2S11Max=0 x3S11Max=0 S11Min=0 PtS11Min=0 x2S11Min=0 x3S11Min=0
 FrameElem=9 ElemStation=0.250000000000002
 Frame=9 Station=0 OutputCase=TERRCOST CaseType=LinStatic P=0 V2=0 V3=0 T=0 M2=0 M3=0 S11Max=0
 PtS11Max=0 x2S11Max=0 x3S11Max=0 S11Min=0 PtS11Min=0 x2S11Min=0 x3S11Min=0 FrameElem=9 ElemStation=0



Frame=9 Station=0.250000000000002 OutputCase=TERRCOST CaseType=LinStatic P=0 V2=0 V3=0 T=0 M2=0
 M3=0 S11Max=0 PtS11Max=0 x2S11Max=0 x3S11Max=0 S11Min=0 PtS11Min=0 x2S11Min=0 x3S11Min=0
 FrameElem=9 ElemStation=0.250000000000002
 Frame=9 Station=0 OutputCase=SOVRCOST CaseType=LinStatic P=0 V2=0 V3=0 T=0 M2=0 M3=0 S11Max=0
 PtS11Max=0 x2S11Max=0 x3S11Max=0 S11Min=0 PtS11Min=0 x2S11Min=0 x3S11Min=0 FrameElem=9 ElemStation=0
 Frame=9 Station=0.250000000000002 OutputCase=SOVRCOST CaseType=LinStatic P=0 V2=0 V3=0 T=0 M2=0
 M3=0 S11Max=0 PtS11Max=0 x2S11Max=0 x3S11Max=0 S11Min=0 PtS11Min=0 x2S11Min=0 x3S11Min=0
 FrameElem=9 ElemStation=0.250000000000002
 Frame=9 Station=0 OutputCase=ENVE CaseType=Combination StepType=Max P=-566.249991362811
 V2=34.617797048402 V3=0 T=0 M2=0 M3=-249.725755055142 S11Max=943.59390066937 PtS11Max=3 x2S11Max=0.5
 x3S11Max=-0.5
 S11Min=-2064.60452169366 PtS11Min=1 x2S11Min=-0.5 x3S11Min=-0.5 FrameElem=9 ElemStation=0
 Frame=9 Station=0.250000000000002 OutputCase=ENVE CaseType=Combination StepType=Max P=-559.999990855508
 V2=39.9372495312928 V3=0 T=0 M2=0 M3=-257.120633089505 S11Max=994.337445504263 PtS11Max=3 x2S11Max=0.5
 x3S11Max=-0.5
 S11Min=-2102.72379083596 PtS11Min=1 x2S11Min=-0.5 x3S11Min=-0.5 FrameElem=9
 ElemStation=0.250000000000002
 Frame=9 Station=0 OutputCase=ENVE CaseType=Combination StepType=Min P=-566.249992654039
 V2=20.027038685542 V3=0 T=0 M2=0 M3=-251.640648887235 S11Max=932.104538968042 PtS11Max=3 x2S11Max=0.5
 x3S11Max=-0.5
 S11Min=-2076.09388597745 PtS11Min=1 x2S11Min=-0.5 x3S11Min=-0.5 FrameElem=9 ElemStation=0
 Frame=9 Station=0.250000000000002 OutputCase=ENVE CaseType=Combination StepType=Min P=-559.999992298927
 V2=23.7506552447516 V3=0 T=0 M2=0 M3=-259.056239393295 S11Max=982.723806238105 PtS11Max=3 x2S11Max=0.5
 x3S11Max=-0.5
 S11Min=-2114.33742721528 PtS11Min=1 x2S11Min=-0.5 x3S11Min=-0.5 FrameElem=9
 ElemStation=0.250000000000002
 Frame=9 Station=0 OutputCase=FESSUR CaseType=Combination P=-566.249991362811 V2=34.617797048402 V3=0
 T=0 M2=0 M3=-249.725755055142 S11Max=932.104538968042 PtS11Max=3 x2S11Max=0.5 x3S11Max=-0.5
 S11Min=-2064.60452169366 PtS11Min=1 x2S11Min=-0.5 x3S11Min=-0.5 FrameElem=9 ElemStation=0
 Frame=9 Station=0.250000000000002 OutputCase=FESSUR CaseType=Combination P=-559.999990855508
 V2=39.9372495312928 V3=0 T=0 M2=0 M3=-259.056239393295 S11Max=994.337445504263 PtS11Max=3 x2S11Max=0.5
 x3S11Max=-0.5
 S11Min=-2114.33742721528 PtS11Min=1 x2S11Min=-0.5 x3S11Min=-0.5 FrameElem=9
 ElemStation=0.250000000000002
 Frame=10 Station=0 OutputCase=PESOPR CaseType=LinStatic P=-68.7499973719241 V2=-15.170953292748 V3=0
 T=0 M2=0 M3=-24.8643150666031 S11Max=80.4358930276943 PtS11Max=3 x2S11Max=0.5 x3S11Max=-0.5
 S11Min=-217.935887771543 PtS11Min=1 x2S11Min=-0.5 x3S11Min=-0.5 FrameElem=10 ElemStation=0
 Frame=10 Station=0.249999976158143 OutputCase=PESOPR CaseType=LinStatic P=-62.4999979679706 V2=-15.1709526967015
 V3=0 T=0 M2=0 M3=-21.0715771796256 S11Max=63.9294651097829 PtS11Max=3 x2S11Max=0.5
 x3S11Max=-0.5
 S11Min=-188.929461045724 PtS11Min=1 x2S11Min=-0.5 x3S11Min=-0.5 FrameElem=10
 ElemStation=0.249999976158143
 Frame=10 Station=0 OutputCase=TERRVERT CaseType=LinStatic P=-491.249995622085 V2=1.15278172404203
 V3=0 T=0 M2=0 M3=-227.739903314056 S11Max=875.189424262249 PtS11Max=3 x2S11Max=0.5 x3S11Max=-0.5
 S11Min=-1857.68941550642 PtS11Min=1 x2S11Min=-0.5 x3S11Min=-0.5 FrameElem=10 ElemStation=0
 Frame=10 Station=0.249999976158143 OutputCase=TERRVERT CaseType=LinStatic P=-491.249995622085
 V2=1.15278172404203 V3=0 T=0 M2=0 M3=-228.028098717582 S11Max=876.918596683405 PtS11Max=3 x2S11Max=0.5
 x3S11Max=-0.5
 S11Min=-1859.41858792758 PtS11Min=1 x2S11Min=-0.5 x3S11Min=-0.5 FrameElem=10
 ElemStation=0.249999976158143
 Frame=10 Station=0 OutputCase=TERRLAT CaseType=LinStatic P=-5.4797619668534E-06 V2=53.9553142884712
 V3=0 T=0 M2=0 M3=-6.45202101263257 S11Max=38.7121205960335 PtS11Max=3 x2S11Max=0.5 x3S11Max=-0.5
 S11Min=-38.7121315555574 PtS11Min=1 x2S11Min=-0.5 x3S11Min=-0.5 FrameElem=10 ElemStation=0
 Frame=10 Station=0.249999976158143 OutputCase=TERRLAT CaseType=LinStatic P=-5.93623668431245E-06
 V2=58.7417981831709 V3=0 T=0 M2=0 M3=-20.550262240648 S11Max=123.301567507652 PtS11Max=3 x2S11Max=0.5
 x3S11Max=-0.5
 S11Min=-123.301579380125 PtS11Min=1 x2S11Min=-0.5 x3S11Min=-0.5 FrameElem=10
 ElemStation=0.249999976158143
 Frame=10 Station=0 OutputCase=ACCLATDX CaseType=LinStatic P=0 V2=0 V3=0 T=0 M2=0 M3=0
 S11Max=0 PtS11Max=0 x2S11Max=0 x3S11Max=0 S11Min=0 PtS11Min=0 x2S11Min=0 x3S11Min=0 FrameElem=10
 ElemStation=0
 Frame=10 Station=0.249999976158143 OutputCase=ACCLATDX CaseType=LinStatic P=0 V2=0 V3=0 T=0 M2=0
 M3=0 S11Max=0 PtS11Max=0 x2S11Max=0 x3S11Max=0 S11Min=0 PtS11Min=0 x2S11Min=0 x3S11Min=0
 FrameElem=10 ElemStation=0.249999976158143
 Frame=10 Station=0 OutputCase=ACCLATSX CaseType=LinStatic P=0 V2=0 V3=0 T=0 M2=0 M3=0
 S11Max=0 PtS11Max=0 x2S11Max=0 x3S11Max=0 S11Min=0 PtS11Min=0 x2S11Min=0 x3S11Min=0 FrameElem=10
 ElemStation=0
 Frame=10 Station=0.249999976158143 OutputCase=ACCLATSX CaseType=LinStatic P=0 V2=0 V3=0 T=0 M2=0
 M3=0 S11Max=0 PtS11Max=0 x2S11Max=0 x3S11Max=0 S11Min=0 PtS11Min=0 x2S11Min=0 x3S11Min=0
 FrameElem=10 ElemStation=0.249999976158143
 Frame=10 Station=0 OutputCase=TERRCOST CaseType=LinStatic P=0 V2=0 V3=0 T=0 M2=0 M3=0
 S11Max=0 PtS11Max=0 x2S11Max=0 x3S11Max=0 S11Min=0 PtS11Min=0 x2S11Min=0 x3S11Min=0 FrameElem=10
 ElemStation=0
 Frame=10 Station=0.249999976158143 OutputCase=TERRCOST CaseType=LinStatic P=0 V2=0 V3=0 T=0 M2=0
 M3=0 S11Max=0 PtS11Max=0 x2S11Max=0 x3S11Max=0 S11Min=0 PtS11Min=0 x2S11Min=0 x3S11Min=0
 FrameElem=10 ElemStation=0.249999976158143
 Frame=10 Station=0 OutputCase=SOVRCOST CaseType=LinStatic P=0 V2=0 V3=0 T=0 M2=0 M3=0
 S11Max=0 PtS11Max=0 x2S11Max=0 x3S11Max=0 S11Min=0 PtS11Min=0 x2S11Min=0 x3S11Min=0 FrameElem=10
 ElemStation=0
 Frame=10 Station=0.249999976158143 OutputCase=SOVRCOST CaseType=LinStatic P=0 V2=0 V3=0 T=0 M2=0
 M3=0 S11Max=0 PtS11Max=0 x2S11Max=0 x3S11Max=0 S11Min=0 PtS11Min=0 x2S11Min=0 x3S11Min=0
 FrameElem=10 ElemStation=0.249999976158143



Frame=10 Station=0 OutputCase=ENVE CaseType=Combination StepType=Max P=-559.999996829843
 V2=39.9371427197652 V3=0 T=0 M2=0 M3=-257.120633089502 S11Max=994.337437885977 PtS11Max=3 x2S11Max=0.5
 x3S11Max=-0.5 _
 S11Min=-2102.72379536685 PtS11Min=1 x2S11Min=-0.5 x3S11Min=-0.5 FrameElem=10 ElemStation=0
 Frame=10 Station=0.249999976158143 OutputCase=ENVE CaseType=Combination StepType=Max P=-
 553.749997745422 V2=44.7236272105114 V3=0 T=0 M2=0 M3=-263.484859465661 S11Max=1064.14962930084
 PtS11Max=3 x2S11Max=0.5 _
 x3S11Max=-0.5 S11Min=-2134.65915453939 PtS11Min=1 x2S11Min=-0.5 x3S11Min=-0.5 FrameElem=10
 ElemStation=0.249999976158143
 Frame=10 Station=0 OutputCase=ENVE CaseType=Combination StepType=Min P=-559.999998473771
 V2=23.7505484332239 V3=0 T=0 M2=0 M3=-259.056239393291 S11Max=982.723801707167 PtS11Max=3 x2S11Max=0.5
 x3S11Max=-0.5 _
 S11Min=-2114.33743483352 PtS11Min=1 x2S11Min=-0.5 x3S11Min=-0.5 FrameElem=10 ElemStation=0
 Frame=10 Station=0.249999976158143 OutputCase=ENVE CaseType=Combination StepType=Min P=-
 553.749999526293 V2=27.1010877555601 V3=0 T=0 M2=0 M3=-269.649938137855 S11Max=1027.15915904854
 PtS11Max=3 x2S11Max=0.5 _
 x3S11Max=-0.5 S11Min=-2171.64962835343 PtS11Min=1 x2S11Min=-0.5 x3S11Min=-0.5 FrameElem=10
 ElemStation=0.249999976158143
 Frame=10 Station=0 OutputCase=FESSUR CaseType=Combination P=-559.999998473771 V2=39.9371427197652
 V3=0 T=0 M2=0 M3=-259.056239393291 S11Max=994.337437885977 PtS11Max=3 x2S11Max=0.5 x3S11Max=-0.5 _
 S11Min=-2114.33743483352 PtS11Min=1 x2S11Min=-0.5 x3S11Min=-0.5 FrameElem=10 ElemStation=0
 Frame=10 Station=0.249999976158143 OutputCase=FESSUR CaseType=Combination P=-553.749999526293
 V2=44.7236272105114 V3=0 T=0 M2=0 M3=-269.649938137855 S11Max=1064.14962930084 PtS11Max=3 x2S11Max=0.5
 x3S11Max=-0.5 _
 S11Min=-2171.64962835343 PtS11Min=1 x2S11Min=-0.5 x3S11Min=-0.5 FrameElem=10
 ElemStation=0.249999976158143
 Frame=11 Station=0 OutputCase=PESOPR CaseType=LinStatic P=15.1709467362393 V2=-62.4999993928068 V3=0
 T=0 M2=0 M3=-21.0715767624133 S11Max=141.600407310719 PtS11Max=3 x2S11Max=0.5 x3S11Max=-0.5 _
 S11Min=-111.258513838241 PtS11Min=1 x2S11Min=-0.5 x3S11Min=-0.5 FrameElem=11 ElemStation=0
 Frame=11 Station=6.24999940395355E-02 OutputCase=PESOPR CaseType=LinStatic P=15.1709467362393 V2=-
 60.9374995418184 V3=0 T=0 M2=0 M3=-17.2141552885787 S11Max=118.455878467711 PtS11Max=3 x2S11Max=0.5
 x3S11Max=-0.5 _
 S11Min=-88.1139849952328 PtS11Min=1 x2S11Min=-0.5 x3S11Min=-0.5 FrameElem=11
 ElemStation=6.24999940395355E-02
 Frame=11 Station=0.124999988079071 OutputCase=PESOPR CaseType=LinStatic P=15.1709467362393 V2=-
 59.37499969083 V3=0 T=0 M2=0 M3=-13.4543900461176 S11Max=95.897287012945 PtS11Max=3 x2S11Max=0.5
 x3S11Max=-0.5 _
 S11Min=-65.5553935404664 PtS11Min=1 x2S11Min=-0.5 x3S11Min=-0.5 FrameElem=11
 ElemStation=0.124999988079071
 Frame=11 Station=0.187499982118607 OutputCase=PESOPR CaseType=LinStatic P=15.1709467362393 V2=-
 57.8124998398416 V3=0 T=0 M2=0 M3=-9.79228103503009 S11Max=73.9246329464199 PtS11Max=3 x2S11Max=0.5
 x3S11Max=-0.5 _
 S11Min=-43.5827394739412 PtS11Min=1 x2S11Min=-0.5 x3S11Min=-0.5 FrameElem=11
 ElemStation=0.187499982118607
 Frame=11 Station=0.249999976158142 OutputCase=PESOPR CaseType=LinStatic P=15.1709467362393 V2=-
 56.2499999888532 V3=0 T=0 M2=0 M3=-6.22782825531611 S11Max=52.537916268136 PtS11Max=3 x2S11Max=0.5
 x3S11Max=-0.5 _
 S11Min=-22.1960227956574 PtS11Min=1 x2S11Min=-0.5 x3S11Min=-0.5 FrameElem=11
 ElemStation=0.249999976158142
 Frame=11 Station=0 OutputCase=TERRVERT CaseType=LinStatic P=-1.15282857328763 V2=-491.249995117367
 V3=0 T=0 M2=0 M3=-228.028097757211 S11Max=1367.01575796998 PtS11Max=3 x2S11Max=0.5 x3S11Max=-0.5 _
 S11Min=-1369.32141511655 PtS11Min=1 x2S11Min=-0.5 x3S11Min=-0.5 FrameElem=11 ElemStation=0
 Frame=11 Station=6.24999940395355E-02 OutputCase=TERRVERT CaseType=LinStatic P=-1.15282857328763 V2=-
 478.968746288598 V3=0 T=0 M2=0 M3=-197.708764979752 S11Max=1185.09976130522 PtS11Max=3 x2S11Max=0.5 _
 x3S11Max=-0.5 S11Min=-1187.4054184518 PtS11Min=1 x2S11Min=-0.5 x3S11Min=-0.5 FrameElem=11
 ElemStation=6.24999940395355E-02
 Frame=11 Station=0.124999988079071 OutputCase=TERRVERT CaseType=LinStatic P=-1.15282857328763 V2=-
 466.687497459829 V3=0 T=0 M2=0 M3=-168.157010180889 S11Max=1007.78923251204 PtS11Max=3 x2S11Max=0.5
 x3S11Max=-0.5 _
 S11Min=-1010.09488965862 PtS11Min=1 x2S11Min=-0.5 x3S11Min=-0.5 FrameElem=11
 ElemStation=0.124999988079071
 Frame=11 Station=0.187499982118607 OutputCase=TERRVERT CaseType=LinStatic P=-1.15282857328763 V2=-
 454.406248631061 V3=0 T=0 M2=0 M3=-139.372833360622 S11Max=835.084171590442 PtS11Max=3 x2S11Max=0.5
 x3S11Max=-0.5 _
 S11Min=-837.389828737017 PtS11Min=1 x2S11Min=-0.5 x3S11Min=-0.5 FrameElem=11
 ElemStation=0.187499982118607
 Frame=11 Station=0.249999976158142 OutputCase=TERRVERT CaseType=LinStatic P=-1.15282857328763 V2=-
 442.124999802292 V3=0 T=0 M2=0 M3=-111.356234518951 S11Max=666.984578540416 PtS11Max=3 x2S11Max=0.5
 x3S11Max=-0.5 _
 S11Min=-669.290235686992 PtS11Min=1 x2S11Min=-0.5 x3S11Min=-0.5 FrameElem=11
 ElemStation=0.249999976158142
 Frame=11 Station=0 OutputCase=TERRLAT CaseType=LinStatic P=-66.7117981831701 V2=3.34180413119611E-07
 V3=0 T=0 M2=0 M3=-20.5502621602774 S11Max=56.5897747784942 PtS11Max=3 x2S11Max=0.5 x3S11Max=-0.5 _
 S11Min=-190.013371144834 PtS11Min=1 x2S11Min=-0.5 x3S11Min=-0.5 FrameElem=11 ElemStation=0
 Frame=11 Station=6.24999940395355E-02 OutputCase=TERRLAT CaseType=LinStatic P=-66.7117981831701
 V2=3.34180413119611E-07 V3=0 T=0 M2=0 M3=-20.5502621811637 S11Max=56.5897749038118 PtS11Max=3
 x2S11Max=0.5 _
 x3S11Max=-0.5 S11Min=-190.013371270152 PtS11Min=1 x2S11Min=-0.5 x3S11Min=-0.5 FrameElem=11
 ElemStation=6.24999940395355E-02
 Frame=11 Station=0.124999988079071 OutputCase=TERRLAT CaseType=LinStatic P=-66.7117981831701
 V2=3.34180413119611E-07 V3=0 T=0 M2=0 M3=-20.5502622020499 S11Max=56.5897750291295 PtS11Max=3
 x2S11Max=0.5 _



x3S11Max=-0.5 S11Min=-190.01337139547 PtS11Min=1 x2S11Min=-0.5 x3S11Min=-0.5 FrameElem=11
 ElemStation=0.124999988079071
 Frame=11 Station=0.187499982118607 OutputCase=TERRLAT CaseType=LinStatic P=-66.7117981831701
 V2=3.34180413119611E-07 V3=0 T=0 M2=0 M3=-20.5502622229362 S11Max=56.5897751544471 PtS11Max=3
 x2S11Max=0.5 _
 x3S11Max=-0.5 S11Min=-190.013371520787 PtS11Min=1 x2S11Min=-0.5 x3S11Min=-0.5 FrameElem=11
 ElemStation=0.187499982118607
 Frame=11 Station=0.249999976158142 OutputCase=TERRLAT CaseType=LinStatic P=-66.7117981831701
 V2=3.34180413119611E-07 V3=0 T=0 M2=0 M3=-20.5502622438225 S11Max=56.5897752797647 PtS11Max=3
 x2S11Max=0.5 _
 x3S11Max=-0.5 S11Min=-190.013371646105 PtS11Min=1 x2S11Min=-0.5 x3S11Min=-0.5 FrameElem=11
 ElemStation=0.249999976158142
 Frame=11 Station=0 OutputCase=ACCLATDX CaseType=LinStatic P=0 V2=0 V3=0 T=0 M2=0 M3=0
 S11Max=0 PtS11Max=0 x2S11Max=0 x3S11Max=0 S11Min=0 PtS11Min=0 x2S11Min=0 x3S11Min=0 FrameElem=11
 ElemStation=0
 Frame=11 Station=6.24999940395355E-02 OutputCase=ACCLATDX CaseType=LinStatic P=0 V2=0 V3=0 T=0
 M2=0 M3=0 S11Max=0 PtS11Max=0 x2S11Max=0 x3S11Max=0 S11Min=0 PtS11Min=0 x2S11Min=0 x3S11Min=0
 FrameElem=11 ElemStation=6.24999940395355E-02
 Frame=11 Station=0.124999988079071 OutputCase=ACCLATDX CaseType=LinStatic P=0 V2=0 V3=0 T=0 M2=0
 M3=0 S11Max=0 PtS11Max=0 x2S11Max=0 x3S11Max=0 S11Min=0 PtS11Min=0 x2S11Min=0 x3S11Min=0
 FrameElem=11 ElemStation=0.124999988079071
 Frame=11 Station=0.187499982118607 OutputCase=ACCLATDX CaseType=LinStatic P=0 V2=0 V3=0 T=0 M2=0
 M3=0 S11Max=0 PtS11Max=0 x2S11Max=0 x3S11Max=0 S11Min=0 PtS11Min=0 x2S11Min=0 x3S11Min=0
 FrameElem=11 ElemStation=0.187499982118607
 Frame=11 Station=0.249999976158142 OutputCase=ACCLATDX CaseType=LinStatic P=0 V2=0 V3=0 T=0 M2=0
 M3=0 S11Max=0 PtS11Max=0 x2S11Max=0 x3S11Max=0 S11Min=0 PtS11Min=0 x2S11Min=0 x3S11Min=0
 FrameElem=11 ElemStation=0.249999976158142
 Frame=11 Station=0 OutputCase=ACCLATSX CaseType=LinStatic P=0 V2=0 V3=0 T=0 M2=0 M3=0
 S11Max=0 PtS11Max=0 x2S11Max=0 x3S11Max=0 S11Min=0 PtS11Min=0 x2S11Min=0 x3S11Min=0 FrameElem=11
 ElemStation=0
 Frame=11 Station=6.24999940395355E-02 OutputCase=ACCLATSX CaseType=LinStatic P=0 V2=0 V3=0 T=0
 M2=0 M3=0 S11Max=0 PtS11Max=0 x2S11Max=0 x3S11Max=0 S11Min=0 PtS11Min=0 x2S11Min=0 x3S11Min=0
 FrameElem=11 ElemStation=6.24999940395355E-02
 Frame=11 Station=0.124999988079071 OutputCase=ACCLATSX CaseType=LinStatic P=0 V2=0 V3=0 T=0 M2=0
 M3=0 S11Max=0 PtS11Max=0 x2S11Max=0 x3S11Max=0 S11Min=0 PtS11Min=0 x2S11Min=0 x3S11Min=0
 FrameElem=11 ElemStation=0.124999988079071
 Frame=11 Station=0.187499982118607 OutputCase=ACCLATSX CaseType=LinStatic P=0 V2=0 V3=0 T=0 M2=0
 M3=0 S11Max=0 PtS11Max=0 x2S11Max=0 x3S11Max=0 S11Min=0 PtS11Min=0 x2S11Min=0 x3S11Min=0
 FrameElem=11 ElemStation=0.187499982118607
 Frame=11 Station=0.249999976158142 OutputCase=ACCLATSX CaseType=LinStatic P=0 V2=0 V3=0 T=0 M2=0
 M3=0 S11Max=0 PtS11Max=0 x2S11Max=0 x3S11Max=0 S11Min=0 PtS11Min=0 x2S11Min=0 x3S11Min=0
 FrameElem=11 ElemStation=0.249999976158142
 Frame=11 Station=0 OutputCase=TERRCOST CaseType=LinStatic P=0 V2=0 V3=0 T=0 M2=0 M3=0
 S11Max=0 PtS11Max=0 x2S11Max=0 x3S11Max=0 S11Min=0 PtS11Min=0 x2S11Min=0 x3S11Min=0 FrameElem=11
 ElemStation=0
 Frame=11 Station=6.24999940395355E-02 OutputCase=TERRCOST CaseType=LinStatic P=0 V2=0 V3=0 T=0
 M2=0 M3=0 S11Max=0 PtS11Max=0 x2S11Max=0 x3S11Max=0 S11Min=0 PtS11Min=0 x2S11Min=0 x3S11Min=0
 FrameElem=11 ElemStation=6.24999940395355E-02
 Frame=11 Station=0.124999988079071 OutputCase=TERRCOST CaseType=LinStatic P=0 V2=0 V3=0 T=0 M2=0
 M3=0 S11Max=0 PtS11Max=0 x2S11Max=0 x3S11Max=0 S11Min=0 PtS11Min=0 x2S11Min=0 x3S11Min=0
 FrameElem=11 ElemStation=0.124999988079071
 Frame=11 Station=0.187499982118607 OutputCase=TERRCOST CaseType=LinStatic P=0 V2=0 V3=0 T=0 M2=0
 M3=0 S11Max=0 PtS11Max=0 x2S11Max=0 x3S11Max=0 S11Min=0 PtS11Min=0 x2S11Min=0 x3S11Min=0
 FrameElem=11 ElemStation=0.187499982118607
 Frame=11 Station=0.249999976158142 OutputCase=TERRCOST CaseType=LinStatic P=0 V2=0 V3=0 T=0 M2=0
 M3=0 S11Max=0 PtS11Max=0 x2S11Max=0 x3S11Max=0 S11Min=0 PtS11Min=0 x2S11Min=0 x3S11Min=0
 FrameElem=11 ElemStation=0.249999976158142
 Frame=11 Station=0 OutputCase=SOVRCOST CaseType=LinStatic P=0 V2=0 V3=0 T=0 M2=0 M3=0
 S11Max=0 PtS11Max=0 x2S11Max=0 x3S11Max=0 S11Min=0 PtS11Min=0 x2S11Min=0 x3S11Min=0 FrameElem=11
 ElemStation=0
 Frame=11 Station=6.24999940395355E-02 OutputCase=SOVRCOST CaseType=LinStatic P=0 V2=0 V3=0 T=0
 M2=0 M3=0 S11Max=0 PtS11Max=0 x2S11Max=0 x3S11Max=0 S11Min=0 PtS11Min=0 x2S11Min=0 x3S11Min=0
 FrameElem=11 ElemStation=6.24999940395355E-02
 Frame=11 Station=0.124999988079071 OutputCase=SOVRCOST CaseType=LinStatic P=0 V2=0 V3=0 T=0 M2=0
 M3=0 S11Max=0 PtS11Max=0 x2S11Max=0 x3S11Max=0 S11Min=0 PtS11Min=0 x2S11Min=0 x3S11Min=0
 FrameElem=11 ElemStation=0.124999988079071
 Frame=11 Station=0.187499982118607 OutputCase=SOVRCOST CaseType=LinStatic P=0 V2=0 V3=0 T=0 M2=0
 M3=0 S11Max=0 PtS11Max=0 x2S11Max=0 x3S11Max=0 S11Min=0 PtS11Min=0 x2S11Min=0 x3S11Min=0
 FrameElem=11 ElemStation=0.187499982118607
 Frame=11 Station=0.249999976158142 OutputCase=SOVRCOST CaseType=LinStatic P=0 V2=0 V3=0 T=0 M2=0
 M3=0 S11Max=0 PtS11Max=0 x2S11Max=0 x3S11Max=0 S11Min=0 PtS11Min=0 x2S11Min=0 x3S11Min=0
 FrameElem=11 ElemStation=0.249999976158142
 Frame=11 Station=0 OutputCase=ENVE CaseType=Combination StepType=Max P=-32.6801405652674 V2=-
 553.749994175993 V3=0 T=0 M2=0 M3=-263.484858031819 S11Max=1565.20594005919 PtS11Max=3 x2S11Max=0.5
 x3S11Max=-0.5 _
 S11Min=-1613.58928875618 PtS11Min=1 x2S11Min=-0.5 x3S11Min=-0.5 FrameElem=11 ElemStation=0
 Frame=11 Station=6.24999940395355E-02 OutputCase=ENVE CaseType=Combination StepType=Max P=-
 32.6801405652674 V2=-539.906245496236 V3=0 T=0 M2=0 M3=-229.308103795145 S11Max=1360.14541467675
 PtS11Max=3 x2S11Max=0.5 _
 x3S11Max=-0.5 S11Min=-1408.52876333614 PtS11Min=1 x2S11Min=-0.5 x3S11Min=-0.5 FrameElem=11
 ElemStation=6.24999940395355E-02



Frame=11 Station=0.124999988079071 OutputCase=ENVE CaseType=Combination StepType=Max P=-
 32.6801405652674 V2=-526.062496816479 V3=0 T=0 M2=0 M3=-195.996583768441 S11Max=1160.27629455412
 PtS11Max=3 x2S11Max=0.5 _
 x3S11Max=-0.5 S11Min=-1208.65964317591 PtS11Min=1 x2S11Min=-0.5 x3S11Min=-0.5 FrameElem=11
 ElemStation=0.124999988079071
 Frame=11 Station=0.187499982118607 OutputCase=ENVE CaseType=Combination StepType=Max P=-
 32.6801405652674 V2=-512.218748136722 V3=0 T=0 M2=0 M3=-163.550297951707 S11Max=965.598579691309
 PtS11Max=3 x2S11Max=0.5 _
 x3S11Max=-0.5 S11Min=-1013.98192827551 PtS11Min=1 x2S11Min=-0.5 x3S11Min=-0.5 FrameElem=11
 ElemStation=0.187499982118607
 Frame=11 Station=0.249999976158142 OutputCase=ENVE CaseType=Combination StepType=Max P=-
 32.6801405652674 V2=-498.374999456965 V3=0 T=0 M2=0 M3=-131.969246344943 S11Max=776.112270088317
 PtS11Max=3 x2S11Max=0.5 _
 x3S11Max=-0.5 S11Min=-824.495618634922 PtS11Min=1 x2S11Min=-0.5 x3S11Min=-0.5 FrameElem=11
 ElemStation=0.249999976158142
 Frame=11 Station=0 OutputCase=ENVE CaseType=Combination StepType=Min P=-52.6936800202184 V2=-
 553.749994276247 V3=0 T=0 M2=0 M3=-269.649936679902 S11Max=1548.22900762564 PtS11Max=3 x2S11Max=0.5
 x3S11Max=-0.5 _
 S11Min=-1670.59330009963 PtS11Min=1 x2S11Min=-0.5 x3S11Min=-0.5 FrameElem=11 ElemStation=0
 Frame=11 Station=6.24999940395355E-02 OutputCase=ENVE CaseType=Combination StepType=Min P=-
 52.6936800202184 V2=-539.90624559649 V3=0 T=0 M2=0 M3=-235.473182449494 S11Max=1343.1684822056
 PtS11Max=3 x2S11Max=0.5 _
 x3S11Max=-0.5 S11Min=-1465.53277471718 PtS11Min=1 x2S11Min=-0.5 x3S11Min=-0.5 FrameElem=11
 ElemStation=6.24999940395355E-02
 Frame=11 Station=0.124999988079071 OutputCase=ENVE CaseType=Combination StepType=Min P=-
 52.6936800202184 V2=-526.062496916733 V3=0 T=0 M2=0 M3=-202.161662429056 S11Max=1143.29936204538
 PtS11Max=3 x2S11Max=0.5 _
 x3S11Max=-0.5 S11Min=-1265.66365459456 PtS11Min=1 x2S11Min=-0.5 x3S11Min=-0.5 FrameElem=11
 ElemStation=0.124999988079071
 Frame=11 Station=0.187499982118607 OutputCase=ENVE CaseType=Combination StepType=Min P=-
 52.6936800202184 V2=-512.218748236976 V3=0 T=0 M2=0 M3=-169.715376618588 S11Max=948.621647144975
 PtS11Max=3 x2S11Max=0.5 _
 x3S11Max=-0.5 S11Min=-1070.98593973175 PtS11Min=1 x2S11Min=-0.5 x3S11Min=-0.5 FrameElem=11
 ElemStation=0.187499982118607
 Frame=11 Station=0.249999976158142 OutputCase=ENVE CaseType=Combination StepType=Min P=-
 52.6936800202184 V2=-498.374999557219 V3=0 T=0 M2=0 M3=-138.134325018089 S11Max=759.135337504388
 PtS11Max=3 x2S11Max=0.5 _
 x3S11Max=-0.5 S11Min=-881.499630128754 PtS11Min=1 x2S11Min=-0.5 x3S11Min=-0.5 FrameElem=11
 ElemStation=0.249999976158142
 Frame=11 Station=0 OutputCase=FESSUR CaseType=Combination P=-52.6936800202184 V2=-553.749994175993
 V3=0 T=0 M2=0 M3=-269.649936679902 S11Max=1565.20594005919 PtS11Max=3 x2S11Max=0.5 x3S11Max=-0.5 _
 S11Min=-1670.59330009963 PtS11Min=1 x2S11Min=-0.5 x3S11Min=-0.5 FrameElem=11 ElemStation=0
 Frame=11 Station=6.24999940395355E-02 OutputCase=FESSUR CaseType=Combination P=-52.6936800202184 V2=-
 539.906245496236 V3=0 T=0 M2=0 M3=-235.473182449494 S11Max=1360.14541467675 PtS11Max=3 x2S11Max=0.5 _
 x3S11Max=-0.5 S11Min=-1465.53277471718 PtS11Min=1 x2S11Min=-0.5 x3S11Min=-0.5 FrameElem=11
 ElemStation=6.24999940395355E-02
 Frame=11 Station=0.124999988079071 OutputCase=FESSUR CaseType=Combination P=-52.6936800202184 V2=-
 526.062496816479 V3=0 T=0 M2=0 M3=-202.161662429056 S11Max=1160.27629455412 PtS11Max=3 x2S11Max=0.5
 x3S11Max=-0.5 _
 S11Min=-1265.66365459456 PtS11Min=1 x2S11Min=-0.5 x3S11Min=-0.5 FrameElem=11
 ElemStation=0.124999988079071
 Frame=11 Station=0.187499982118607 OutputCase=FESSUR CaseType=Combination P=-52.6936800202184 V2=-
 512.218748136722 V3=0 T=0 M2=0 M3=-169.715376618588 S11Max=965.598579691309 PtS11Max=3 x2S11Max=0.5
 x3S11Max=-0.5 _
 S11Min=-1070.98593973175 PtS11Min=1 x2S11Min=-0.5 x3S11Min=-0.5 FrameElem=11
 ElemStation=0.187499982118607
 Frame=11 Station=0.249999976158142 OutputCase=FESSUR CaseType=Combination P=-52.6936800202184 V2=-
 498.374999456965 V3=0 T=0 M2=0 M3=-138.134325018089 S11Max=776.112270088317 PtS11Max=3 x2S11Max=0.5
 x3S11Max=-0.5 _
 S11Min=-881.499630128754 PtS11Min=1 x2S11Min=-0.5 x3S11Min=-0.5 FrameElem=11
 ElemStation=0.249999976158142
 Frame=12 Station=0 OutputCase=PESOPR CaseType=LinStatic P=15.1709467362397 V2=-56.249999988823 V3=0
 T=0 M2=0 M3=-6.22782825531613 S11Max=52.5379162681365 PtS11Max=3 x2S11Max=0.5 x3S11Max=-0.5 _
 S11Min=-22.196022795657 PtS11Min=1 x2S11Min=-0.5 x3S11Min=-0.5 FrameElem=12 ElemStation=0
 Frame=12 Station=0.0625 OutputCase=PESOPR CaseType=LinStatic P=15.1709467362397 V2=-54.687499988823
 V3=0 T=0 M2=0 M3=-2.76103138101098 S11Max=31.7371350223056 PtS11Max=3 x2S11Max=0.5 x3S11Max=-0.5 _
 S11Min=-1.39524154982615 PtS11Min=1 x2S11Min=-0.5 x3S11Min=-0.5 FrameElem=12 ElemStation=0.0625
 Frame=12 Station=0.125 OutputCase=PESOPR CaseType=LinStatic P=15.1709467362397 V2=-53.124999988823
 V3=0 T=0 M2=0 M3=0.608109243294166 S11Max=18.8196021960047 PtS11Max=1 x2S11Max=-0.5 x3S11Max=-0.5 _
 S11Min=11.5222912764747 PtS11Min=3 x2S11Min=0.5 x3S11Min=-0.5 FrameElem=12 ElemStation=0.125
 Frame=12 Station=0.1875 OutputCase=PESOPR CaseType=LinStatic P=15.1709467362397 V2=-51.562499988823
 V3=0 T=0 M2=0 M3=3.87959361759931 S11Max=38.4485084418356 PtS11Max=1 x2S11Max=-0.5 x3S11Max=-0.5 _
 S11Min=-8.10661496935614 PtS11Min=3 x2S11Min=0.5 x3S11Min=-0.5 FrameElem=12 ElemStation=0.1875
 Frame=12 Station=0.25 OutputCase=PESOPR CaseType=LinStatic P=15.1709467362397 V2=-49.999999988823
 V3=0 T=0 M2=0 M3=7.05342174190446 S11Max=57.4914771876665 PtS11Max=1 x2S11Max=-0.5 x3S11Max=-0.5 _
 S11Min=-27.149583715187 PtS11Min=3 x2S11Min=0.5 x3S11Min=-0.5 FrameElem=12 ElemStation=0.25
 Frame=12 Station=0 OutputCase=TERRVERT CaseType=LinStatic P=-1.15282857328748 V2=-442.124999802385
 V3=0 T=0 M2=0 M3=-111.356234518942 S11Max=666.984578540365 PtS11Max=3 x2S11Max=0.5 x3S11Max=-0.5 _
 S11Min=-669.29023568694 PtS11Min=1 x2S11Min=-0.5 x3S11Min=-0.5 FrameElem=12 ElemStation=0.25
 Frame=12 Station=0.0625 OutputCase=TERRVERT CaseType=LinStatic P=-1.15282857328748 V2=-429.843749802385
 V3=0 T=0 M2=0 M3=-84.107211093793 S11Max=503.490437989471 PtS11Max=3 x2S11Max=0.5 x3S11Max=-0.5 _
 S11Min=-505.796095136046 PtS11Min=1 x2S11Min=-0.5 x3S11Min=-0.5 FrameElem=12 ElemStation=0.0625

```

Frame=12 Station=0.125 OutputCase=TERRVERT CaseType=LinStatic P=-1.15282857328748 V2=-417.562499802385
V3=0 T=0 M2=0 M3=-57.625765793644 S11Max=344.601766188576 PtS11Max=3 x2S11Max=0.5 x3S11Max=-0.5 _
S11Min=-346.907423335151 PtS11Min=1 x2S11Min=-0.5 x3S11Min=-0.5 FrameElem=12 ElemStation=0.125
Frame=12 Station=0.1875 OutputCase=TERRVERT CaseType=LinStatic P=-1.15282857328748 V2=-405.281249802385
V3=0 T=0 M2=0 M3=-31.9118986184949 S11Max=190.318563137682 PtS11Max=3 x2S11Max=0.5 x3S11Max=-0.5 _
S11Min=-192.624220284257 PtS11Min=1 x2S11Min=-0.5 x3S11Min=-0.5 FrameElem=12 ElemStation=0.1875
Frame=12 Station=0.25 OutputCase=TERRVERT CaseType=LinStatic P=-1.15282857328748 V2=-392.999999802385
V3=0 T=0 M2=0 M3=-6.96560956834583 S11Max=40.6408288367875 PtS11Max=3 x2S11Max=0.5 x3S11Max=-0.5 _
S11Min=-42.9464859833624 PtS11Min=1 x2S11Min=-0.5 x3S11Min=-0.5 FrameElem=12 ElemStation=0.25
Frame=12 Station=0.25 OutputCase=TERRLAT CaseType=LinStatic P=-66.7117981831701 V2=3.34180867866962E-07
V3=0 T=0 M2=0 M3=-20.5502622438224 S11Max=56.5897752797641 PtS11Max=3 x2S11Max=0.5 x3S11Max=-0.5 _
S11Min=-190.013371646104 PtS11Min=1 x2S11Min=-0.5 x3S11Min=-0.5 FrameElem=12 ElemStation=0
Frame=12 Station=0.0625 OutputCase=TERRLAT CaseType=LinStatic P=-66.7117981831701 V2=3.34180867866962E-
07 V3=0 T=0 M2=0 M3=-20.5502622647087 S11Max=56.589775405082 PtS11Max=3 x2S11Max=0.5 x3S11Max=-0.5 _
S11Min=-190.013371771422 PtS11Min=1 x2S11Min=-0.5 x3S11Min=-0.5 FrameElem=12 ElemStation=0.0625
Frame=12 Station=0.125 OutputCase=TERRLAT CaseType=LinStatic P=-66.7117981831701 V2=3.34180867866962E-
07 V3=0 T=0 M2=0 M3=-20.550262285595 S11Max=56.5897755303998 PtS11Max=3 x2S11Max=0.5 x3S11Max=-0.5 _
S11Min=-190.01337189674 PtS11Min=1 x2S11Min=-0.5 x3S11Min=-0.5 FrameElem=12 ElemStation=0.125
Frame=12 Station=0.1875 OutputCase=TERRLAT CaseType=LinStatic P=-66.7117981831701 V2=3.34180867866962E-
07 V3=0 T=0 M2=0 M3=-20.5502623064813 S11Max=56.5897756557176 PtS11Max=3 x2S11Max=0.5 x3S11Max=-0.5
-
S11Min=-190.013372022058 PtS11Min=1 x2S11Min=-0.5 x3S11Min=-0.5 FrameElem=12 ElemStation=0.1875
Frame=12 Station=0.25 OutputCase=TERRLAT CaseType=LinStatic P=-66.7117981831701 V2=3.34180867866962E-07
V3=0 T=0 M2=0 M3=-20.5502623273676 S11Max=56.5897757810354 PtS11Max=3 x2S11Max=0.5 x3S11Max=-0.5 _
S11Min=-190.013372147376 PtS11Min=1 x2S11Min=-0.5 x3S11Min=-0.5 FrameElem=12 ElemStation=0.25
Frame=12 Station=0 OutputCase=ACCLATDX CaseType=LinStatic P=0 V2=0 V3=0 T=0 M2=0 M3=0
S11Max=0 PtS11Max=0 x2S11Max=0 x3S11Max=0 S11Min=0 PtS11Min=0 x2S11Min=0 x3S11Min=0 FrameElem=12
ElemStation=0
Frame=12 Station=0.0625 OutputCase=ACCLATDX CaseType=LinStatic P=0 V2=0 V3=0 T=0 M2=0 M3=0
S11Max=0 PtS11Max=0 x2S11Max=0 x3S11Max=0 S11Min=0 PtS11Min=0 x2S11Min=0 x3S11Min=0 FrameElem=12
ElemStation=0.0625
Frame=12 Station=0.125 OutputCase=ACCLATDX CaseType=LinStatic P=0 V2=0 V3=0 T=0 M2=0 M3=0
S11Max=0 PtS11Max=0 x2S11Max=0 x3S11Max=0 S11Min=0 PtS11Min=0 x2S11Min=0 x3S11Min=0 FrameElem=12
ElemStation=0.125
Frame=12 Station=0.1875 OutputCase=ACCLATDX CaseType=LinStatic P=0 V2=0 V3=0 T=0 M2=0 M3=0
S11Max=0 PtS11Max=0 x2S11Max=0 x3S11Max=0 S11Min=0 PtS11Min=0 x2S11Min=0 x3S11Min=0 FrameElem=12
ElemStation=0.1875
Frame=12 Station=0.25 OutputCase=ACCLATDX CaseType=LinStatic P=0 V2=0 V3=0 T=0 M2=0 M3=0
S11Max=0 PtS11Max=0 x2S11Max=0 x3S11Max=0 S11Min=0 PtS11Min=0 x2S11Min=0 x3S11Min=0 FrameElem=12
ElemStation=0.25
Frame=12 Station=0 OutputCase=ACCLATSX CaseType=LinStatic P=0 V2=0 V3=0 T=0 M2=0 M3=0
S11Max=0 PtS11Max=0 x2S11Max=0 x3S11Max=0 S11Min=0 PtS11Min=0 x2S11Min=0 x3S11Min=0 FrameElem=12
ElemStation=0
Frame=12 Station=0.0625 OutputCase=ACCLATSX CaseType=LinStatic P=0 V2=0 V3=0 T=0 M2=0 M3=0
S11Max=0 PtS11Max=0 x2S11Max=0 x3S11Max=0 S11Min=0 PtS11Min=0 x2S11Min=0 x3S11Min=0 FrameElem=12
ElemStation=0.0625
Frame=12 Station=0.125 OutputCase=ACCLATSX CaseType=LinStatic P=0 V2=0 V3=0 T=0 M2=0 M3=0
S11Max=0 PtS11Max=0 x2S11Max=0 x3S11Max=0 S11Min=0 PtS11Min=0 x2S11Min=0 x3S11Min=0 FrameElem=12
ElemStation=0.125
Frame=12 Station=0.1875 OutputCase=ACCLATSX CaseType=LinStatic P=0 V2=0 V3=0 T=0 M2=0 M3=0
S11Max=0 PtS11Max=0 x2S11Max=0 x3S11Max=0 S11Min=0 PtS11Min=0 x2S11Min=0 x3S11Min=0 FrameElem=12
ElemStation=0.1875
Frame=12 Station=0.25 OutputCase=ACCLATSX CaseType=LinStatic P=0 V2=0 V3=0 T=0 M2=0 M3=0
S11Max=0 PtS11Max=0 x2S11Max=0 x3S11Max=0 S11Min=0 PtS11Min=0 x2S11Min=0 x3S11Min=0 FrameElem=12
ElemStation=0.25
Frame=12 Station=0 OutputCase=TERRCOST CaseType=LinStatic P=0 V2=0 V3=0 T=0 M2=0 M3=0
S11Max=0 PtS11Max=0 x2S11Max=0 x3S11Max=0 S11Min=0 PtS11Min=0 x2S11Min=0 x3S11Min=0 FrameElem=12
ElemStation=0
Frame=12 Station=0.0625 OutputCase=TERRCOST CaseType=LinStatic P=0 V2=0 V3=0 T=0 M2=0 M3=0
S11Max=0 PtS11Max=0 x2S11Max=0 x3S11Max=0 S11Min=0 PtS11Min=0 x2S11Min=0 x3S11Min=0 FrameElem=12
ElemStation=0.0625
Frame=12 Station=0.125 OutputCase=TERRCOST CaseType=LinStatic P=0 V2=0 V3=0 T=0 M2=0 M3=0
S11Max=0 PtS11Max=0 x2S11Max=0 x3S11Max=0 S11Min=0 PtS11Min=0 x2S11Min=0 x3S11Min=0 FrameElem=12
ElemStation=0.125
Frame=12 Station=0.1875 OutputCase=TERRCOST CaseType=LinStatic P=0 V2=0 V3=0 T=0 M2=0 M3=0
S11Max=0 PtS11Max=0 x2S11Max=0 x3S11Max=0 S11Min=0 PtS11Min=0 x2S11Min=0 x3S11Min=0 FrameElem=12
ElemStation=0.1875
Frame=12 Station=0.25 OutputCase=TERRCOST CaseType=LinStatic P=0 V2=0 V3=0 T=0 M2=0 M3=0
S11Max=0 PtS11Max=0 x2S11Max=0 x3S11Max=0 S11Min=0 PtS11Min=0 x2S11Min=0 x3S11Min=0 FrameElem=12
ElemStation=0.25
Frame=12 Station=0 OutputCase=SOVRCOST CaseType=LinStatic P=0 V2=0 V3=0 T=0 M2=0 M3=0
S11Max=0 PtS11Max=0 x2S11Max=0 x3S11Max=0 S11Min=0 PtS11Min=0 x2S11Min=0 x3S11Min=0 FrameElem=12
ElemStation=0
Frame=12 Station=0.0625 OutputCase=SOVRCOST CaseType=LinStatic P=0 V2=0 V3=0 T=0 M2=0 M3=0
S11Max=0 PtS11Max=0 x2S11Max=0 x3S11Max=0 S11Min=0 PtS11Min=0 x2S11Min=0 x3S11Min=0 FrameElem=12
ElemStation=0.0625
Frame=12 Station=0.125 OutputCase=SOVRCOST CaseType=LinStatic P=0 V2=0 V3=0 T=0 M2=0 M3=0
S11Max=0 PtS11Max=0 x2S11Max=0 x3S11Max=0 S11Min=0 PtS11Min=0 x2S11Min=0 x3S11Min=0 FrameElem=12
ElemStation=0.125
Frame=12 Station=0.1875 OutputCase=SOVRCOST CaseType=LinStatic P=0 V2=0 V3=0 T=0 M2=0 M3=0
S11Max=0 PtS11Max=0 x2S11Max=0 x3S11Max=0 S11Min=0 PtS11Min=0 x2S11Min=0 x3S11Min=0 FrameElem=12
ElemStation=0.1875

```



Frame=12 Station=0.25 OutputCase=SOVRCOST CaseType=LinStatic P=0 V2=0 V3=0 T=0 M2=0 M3=0
 S11Max=0 PtS11Max=0 x2S11Max=0 x3S11Max=0 S11Min=0 PtS11Min=0 x2S11Min=0 x3S11Min=0 FrameElem=12
 ElemStation=0.25
 Frame=12 Station=0 OutputCase=ENVE CaseType=Combination StepType=Max P=-32.6801405652668 V2=-
 498.374999457086 V3=0 T=0 M2=0 M3=-131.969246344934 S11Max=776.112270088266 PtS11Max=3 x2S11Max=0.5
 x3S11Max=-0.5
 S11Min=-824.49561863487 PtS11Min=1 x2S11Min=-0.5 x3S11Min=-0.5 FrameElem=12 ElemStation=0
 Frame=12 Station=0.0625 OutputCase=ENVE CaseType=Combination StepType=Max P=-32.6801405652668 V2=-
 484.531249457086 V3=0 T=0 M2=0 M3=-101.2534260601 S11Max=591.817348416858 PtS11Max=3 x2S11Max=0.5
 x3S11Max=-0.5
 S11Min=-640.200696925867 PtS11Min=1 x2S11Min=-0.5 x3S11Min=-0.5 FrameElem=12 ElemStation=0.0625
 Frame=12 Station=0.125 OutputCase=ENVE CaseType=Combination StepType=Max P=-32.6801405652668 V2=-
 470.687499457086 V3=0 T=0 M2=0 M3=-71.4028401502663 S11Max=412.713832995451 PtS11Max=3 x2S11Max=0.5
 x3S11Max=-0.5 S11Min=-461.097181466864 PtS11Min=1 x2S11Min=-0.5 x3S11Min=-0.5 FrameElem=12
 ElemStation=0.125
 Frame=12 Station=0.1875 OutputCase=ENVE CaseType=Combination StepType=Max P=-32.6801405652668 V2=-
 456.843749457086 V3=0 T=0 M2=0 M3=-42.4174886154325 S11Max=238.801723824043 PtS11Max=3 x2S11Max=0.5
 x3S11Max=-0.5 S11Min=-287.185072257862 PtS11Min=1 x2S11Min=-0.5 x3S11Min=-0.5 FrameElem=12
 ElemStation=0.1875
 Frame=12 Station=0.25 OutputCase=ENVE CaseType=Combination StepType=Max P=-32.6801405652668 V2=-
 442.99999457086 V3=0 T=0 M2=0 M3=-14.2973714555987 S11Max=70.0810209026359 PtS11Max=3 x2S11Max=0.5
 x3S11Max=-0.5
 S11Min=-118.464369298859 PtS11Min=1 x2S11Min=-0.5 x3S11Min=-0.5 FrameElem=12 ElemStation=0.25
 Frame=12 Station=0 OutputCase=ENVE CaseType=Combination StepType=Min P=-52.6936800202179 V2=-
 498.374999557341 V3=0 T=0 M2=0 M3=-138.134325018081 S11Max=759.135337504336 PtS11Max=3 x2S11Max=0.5
 x3S11Max=-0.5
 S11Min=-881.499630128701 PtS11Min=1 x2S11Min=-0.5 x3S11Min=-0.5 FrameElem=12 ElemStation=0
 Frame=12 Station=0.0625 OutputCase=ENVE CaseType=Combination StepType=Min P=-52.6936800202179 V2=-
 484.531249557341 V3=0 T=0 M2=0 M3=-107.418504739513 S11Max=574.840415795334 PtS11Max=3 x2S11Max=0.5
 x3S11Max=-0.5 S11Min=-697.204708457294 PtS11Min=1 x2S11Min=-0.5 x3S11Min=-0.5 FrameElem=12
 ElemStation=0.0625
 Frame=12 Station=0.125 OutputCase=ENVE CaseType=Combination StepType=Min P=-52.6936800202179 V2=-
 470.687499557341 V3=0 T=0 M2=0 M3=-77.5679188359448 S11Max=395.736900336331 PtS11Max=3 x2S11Max=0.5
 x3S11Max=-0.5 S11Min=-518.101193035886 PtS11Min=1 x2S11Min=-0.5 x3S11Min=-0.5 FrameElem=12
 ElemStation=0.125
 Frame=12 Station=0.1875 OutputCase=ENVE CaseType=Combination StepType=Min P=-52.6936800202179 V2=-
 456.843749557341 V3=0 T=0 M2=0 M3=-48.5825673073769 S11Max=221.824791127328 PtS11Max=3 x2S11Max=0.5
 x3S11Max=-0.5 S11Min=-344.189083864479 PtS11Min=1 x2S11Min=-0.5 x3S11Min=-0.5 FrameElem=12
 ElemStation=0.1875
 Frame=12 Station=0.25 OutputCase=ENVE CaseType=Combination StepType=Min P=-52.6936800202179 V2=-
 442.999999557341 V3=0 T=0 M2=0 M3=-20.462450153809 S11Max=53.1040881683253 PtS11Max=3 x2S11Max=0.5
 x3S11Max=-0.5
 S11Min=-175.468380943072 PtS11Min=1 x2S11Min=-0.5 x3S11Min=-0.5 FrameElem=12 ElemStation=0.25
 V3=0 T=0 M2=0 M3=-138.134325018081 S11Max=776.112270088266 PtS11Max=3 x2S11Max=0.5 x3S11Max=-0.5
 S11Min=-881.499630128701 PtS11Min=1 x2S11Min=-0.5 x3S11Min=-0.5 FrameElem=12 ElemStation=0
 V3=0 T=0 M2=0 M3=-107.418504739513 S11Max=591.817348416858 PtS11Max=3 x2S11Max=0.5 x3S11Max=-0.5
 S11Min=-697.204708457294 PtS11Min=1 x2S11Min=-0.5 x3S11Min=-0.5 FrameElem=12 ElemStation=0.0625
 V3=0 T=0 M2=0 M3=-77.5679188359448 S11Max=412.713832995451 PtS11Max=3 x2S11Max=0.5 x3S11Max=-0.5
 S11Min=-518.101193035886 PtS11Min=1 x2S11Min=-0.5 x3S11Min=-0.5 FrameElem=12 ElemStation=0.125
 V3=0 T=0 M2=0 M3=-48.5825673073769 S11Max=238.801723824043 PtS11Max=3 x2S11Max=0.5 x3S11Max=-0.5
 S11Min=-344.189083864479 PtS11Min=1 x2S11Min=-0.5 x3S11Min=-0.5 FrameElem=12 ElemStation=0.1875
 V3=0 T=0 M2=0 M3=-20.462450153809 S11Max=70.0810209026359 PtS11Max=3 x2S11Max=0.5 x3S11Max=-0.5
 S11Min=-175.468380943072 PtS11Min=1 x2S11Min=-0.5 x3S11Min=-0.5 FrameElem=12 ElemStation=0.25
 T=0 M2=0 M3=7.05342169747018 S11Max=57.4914769210603 PtS11Max=1 x2S11Max=-0.5 x3S11Max=-0.5
 S11Min=-27.1495834485819 PtS11Min=3 x2S11Min=0.5 x3S11Min=-0.5 FrameElem=14 ElemStation=0
 V3=0 T=0 M2=0 M3=3.87959357177897 S11Max=38.448508166913 PtS11Max=1 x2S11Max=-0.5 x3S11Max=-0.5
 S11Min=-8.1066146944346 PtS11Min=3 x2S11Min=0.5 x3S11Min=-0.5 FrameElem=14 ElemStation=0.0625
 V3=0 T=0 M2=0 M3=0.608109196087753 S11Max=18.8196019127657 PtS11Max=1 x2S11Max=-0.5 x3S11Max=-0.5
 S11Min=11.5222915597127 PtS11Min=3 x2S11Min=0.5 x3S11Min=-0.5 FrameElem=14 ElemStation=0.125
 V3=0 T=0 M2=0 M3=0.1875 OutputCase=PESOPR CaseType=LinStatic P=15.1709467362392 V2=54.6875000110595
 S11Max=31.73713531386 PtS11Max=3 x2S11Max=0.5 x3S11Max=-0.5
 S11Min=-1.39524184138156 PtS11Min=1 x2S11Min=-0.5 x3S11Min=-0.5 FrameElem=14 ElemStation=0.1875
 V3=0 T=0 M2=0 M3=-6.22782830529468 S11Max=52.5379165680073 PtS11Max=3 x2S11Max=0.5 x3S11Max=-0.5
 S11Min=-22.1960230955289 PtS11Min=1 x2S11Min=-0.5 x3S11Min=-0.5 FrameElem=14 ElemStation=0.25
 V3=0 T=0 M2=0 M3=-6.96561035869672 S11Max=40.6408335788907 PtS11Max=3 x2S11Max=0.5 x3S11Max=-0.5
 S11Min=-42.94649072547 PtS11Min=1 x2S11Min=-0.5 x3S11Min=-0.5 FrameElem=14 ElemStation=0
 V3=0 T=0 M2=0 M3=-31.9118994335367 S11Max=190.318568027931 PtS11Max=3 x2S11Max=0.5 x3S11Max=-0.5
 S11Min=-192.62422517451 PtS11Min=1 x2S11Min=-0.5 x3S11Min=-0.5 FrameElem=14 ElemStation=0.0625
 V3=0 T=0 M2=0 M3=-57.6257666333768 S11Max=344.601771226971 PtS11Max=3 x2S11Max=0.5 x3S11Max=-0.5
 S11Min=-346.90742837355 PtS11Min=1 x2S11Min=-0.5 x3S11Min=-0.5 FrameElem=14 ElemStation=0.125

```

Frame=14 Station=0.1875 OutputCase=TERRVERT CaseType=LinStatic P=-1.15282857328964 V2=429.84375019744
V3=0 T=0 M2=0 M3=-84.1072119582168 S11Max=503.490443176011 PtS11Max=3 x2S11Max=0.5 x3S11Max=-0.5 _
S11Min=-505.79610032259 PtS11Min=1 x2S11Min=-0.5 x3S11Min=-0.5 FrameElem=14 ElemStation=0.1875
Frame=14 Station=0.25 OutputCase=TERRVERT CaseType=LinStatic P=-1.15282857328964 V2=442.12500019744
V3=0 T=0 M2=0 M3=-111.356235408057 S11Max=666.984583875051 PtS11Max=3 x2S11Max=0.5 x3S11Max=-0.5 _
S11Min=-669.290241021631 PtS11Min=1 x2S11Min=-0.5 x3S11Min=-0.5 FrameElem=14 ElemStation=0.25
Frame=14 Station=0 OutputCase=TERRLAT CaseType=LinStatic P=-66.7117981831705 V2=3.34180867866962E-07
V3=0 T=0 M2=0 M3=-20.5502636640907 S11Max=56.5897838013734 PtS11Max=3 x2S11Max=0.5 x3S11Max=-0.5 _
S11Min=-190.013380167714 PtS11Min=1 x2S11Min=-0.5 x3S11Min=-0.5 FrameElem=14 ElemStation=0
Frame=14 Station=0.0625 OutputCase=TERRLAT CaseType=LinStatic P=-66.7117981831705 V2=3.34180867866962E-07
V3=0 T=0 M2=0 M3=-20.550263684977 S11Max=56.5897839266913 PtS11Max=3 x2S11Max=0.5 x3S11Max=-0.5 _
S11Min=-190.013380293032 PtS11Min=1 x2S11Min=-0.5 x3S11Min=-0.5 FrameElem=14 ElemStation=0.0625
Frame=14 Station=0.125 OutputCase=TERRLAT CaseType=LinStatic P=-66.7117981831705 V2=3.34180867866962E-07
V3=0 T=0 M2=0 M3=-20.5502637058633 S11Max=56.5897840520091 PtS11Max=3 x2S11Max=0.5 x3S11Max=-0.5
-
S11Min=-190.01338041835 PtS11Min=1 x2S11Min=-0.5 x3S11Min=-0.5 FrameElem=14 ElemStation=0.125
Frame=14 Station=0.1875 OutputCase=TERRLAT CaseType=LinStatic P=-66.7117981831705 V2=3.34180867866962E-07
V3=0 T=0 M2=0 M3=-20.5502637267496 S11Max=56.5897841773269 PtS11Max=3 x2S11Max=0.5 x3S11Max=-0.5
-
S11Min=-190.013380543668 PtS11Min=1 x2S11Min=-0.5 x3S11Min=-0.5 FrameElem=14 ElemStation=0.1875
Frame=14 Station=0.25 OutputCase=TERRLAT CaseType=LinStatic P=-66.7117981831705 V2=3.34180867866962E-07
V3=0 T=0 M2=0 M3=-20.5502637476359 S11Max=56.5897843026447 PtS11Max=3 x2S11Max=0.5 x3S11Max=-0.5 _
S11Min=-190.013380668986 PtS11Min=1 x2S11Min=-0.5 x3S11Min=-0.5 FrameElem=14 ElemStation=0.25
Frame=14 Station=0 OutputCase=ACCLATDX CaseType=LinStatic P=0 V2=0 V3=0 T=0 M2=0 M3=0
S11Max=0 PtS11Max=0 x2S11Max=0 x3S11Max=0 S11Min=0 PtS11Min=0 x2S11Min=0 x3S11Min=0 FrameElem=14
ElemStation=0
Frame=14 Station=0.0625 OutputCase=ACCLATDX CaseType=LinStatic P=0 V2=0 V3=0 T=0 M2=0 M3=0
S11Max=0 PtS11Max=0 x2S11Max=0 x3S11Max=0 S11Min=0 PtS11Min=0 x2S11Min=0 x3S11Min=0 FrameElem=14
ElemStation=0.0625
Frame=14 Station=0.125 OutputCase=ACCLATDX CaseType=LinStatic P=0 V2=0 V3=0 T=0 M2=0 M3=0
S11Max=0 PtS11Max=0 x2S11Max=0 x3S11Max=0 S11Min=0 PtS11Min=0 x2S11Min=0 x3S11Min=0 FrameElem=14
ElemStation=0.125
Frame=14 Station=0.1875 OutputCase=ACCLATDX CaseType=LinStatic P=0 V2=0 V3=0 T=0 M2=0 M3=0
S11Max=0 PtS11Max=0 x2S11Max=0 x3S11Max=0 S11Min=0 PtS11Min=0 x2S11Min=0 x3S11Min=0 FrameElem=14
ElemStation=0.1875
Frame=14 Station=0.25 OutputCase=ACCLATDX CaseType=LinStatic P=0 V2=0 V3=0 T=0 M2=0 M3=0
S11Max=0 PtS11Max=0 x2S11Max=0 x3S11Max=0 S11Min=0 PtS11Min=0 x2S11Min=0 x3S11Min=0 FrameElem=14
ElemStation=0.25
Frame=14 Station=0 OutputCase=ACCLATSX CaseType=LinStatic P=0 V2=0 V3=0 T=0 M2=0 M3=0
S11Max=0 PtS11Max=0 x2S11Max=0 x3S11Max=0 S11Min=0 PtS11Min=0 x2S11Min=0 x3S11Min=0 FrameElem=14
ElemStation=0
Frame=14 Station=0.0625 OutputCase=ACCLATSX CaseType=LinStatic P=0 V2=0 V3=0 T=0 M2=0 M3=0
S11Max=0 PtS11Max=0 x2S11Max=0 x3S11Max=0 S11Min=0 PtS11Min=0 x2S11Min=0 x3S11Min=0 FrameElem=14
ElemStation=0.0625
Frame=14 Station=0.125 OutputCase=ACCLATSX CaseType=LinStatic P=0 V2=0 V3=0 T=0 M2=0 M3=0
S11Max=0 PtS11Max=0 x2S11Max=0 x3S11Max=0 S11Min=0 PtS11Min=0 x2S11Min=0 x3S11Min=0 FrameElem=14
ElemStation=0.125
Frame=14 Station=0.1875 OutputCase=ACCLATSX CaseType=LinStatic P=0 V2=0 V3=0 T=0 M2=0 M3=0
S11Max=0 PtS11Max=0 x2S11Max=0 x3S11Max=0 S11Min=0 PtS11Min=0 x2S11Min=0 x3S11Min=0 FrameElem=14
ElemStation=0.1875
Frame=14 Station=0.25 OutputCase=ACCLATSX CaseType=LinStatic P=0 V2=0 V3=0 T=0 M2=0 M3=0
S11Max=0 PtS11Max=0 x2S11Max=0 x3S11Max=0 S11Min=0 PtS11Min=0 x2S11Min=0 x3S11Min=0 FrameElem=14
ElemStation=0.25
Frame=14 Station=0 OutputCase=TERRCOST CaseType=LinStatic P=0 V2=0 V3=0 T=0 M2=0 M3=0
S11Max=0 PtS11Max=0 x2S11Max=0 x3S11Max=0 S11Min=0 PtS11Min=0 x2S11Min=0 x3S11Min=0 FrameElem=14
ElemStation=0
Frame=14 Station=0.0625 OutputCase=TERRCOST CaseType=LinStatic P=0 V2=0 V3=0 T=0 M2=0 M3=0
S11Max=0 PtS11Max=0 x2S11Max=0 x3S11Max=0 S11Min=0 PtS11Min=0 x2S11Min=0 x3S11Min=0 FrameElem=14
ElemStation=0.0625
Frame=14 Station=0.125 OutputCase=TERRCOST CaseType=LinStatic P=0 V2=0 V3=0 T=0 M2=0 M3=0
S11Max=0 PtS11Max=0 x2S11Max=0 x3S11Max=0 S11Min=0 PtS11Min=0 x2S11Min=0 x3S11Min=0 FrameElem=14
ElemStation=0.125
Frame=14 Station=0.1875 OutputCase=TERRCOST CaseType=LinStatic P=0 V2=0 V3=0 T=0 M2=0 M3=0
S11Max=0 PtS11Max=0 x2S11Max=0 x3S11Max=0 S11Min=0 PtS11Min=0 x2S11Min=0 x3S11Min=0 FrameElem=14
ElemStation=0.1875
Frame=14 Station=0.25 OutputCase=TERRCOST CaseType=LinStatic P=0 V2=0 V3=0 T=0 M2=0 M3=0
S11Max=0 PtS11Max=0 x2S11Max=0 x3S11Max=0 S11Min=0 PtS11Min=0 x2S11Min=0 x3S11Min=0 FrameElem=14
ElemStation=0.25
Frame=14 Station=0 OutputCase=SOVRCOST CaseType=LinStatic P=0 V2=0 V3=0 T=0 M2=0 M3=0
S11Max=0 PtS11Max=0 x2S11Max=0 x3S11Max=0 S11Min=0 PtS11Min=0 x2S11Min=0 x3S11Min=0 FrameElem=14
ElemStation=0
Frame=14 Station=0.0625 OutputCase=SOVRCOST CaseType=LinStatic P=0 V2=0 V3=0 T=0 M2=0 M3=0
S11Max=0 PtS11Max=0 x2S11Max=0 x3S11Max=0 S11Min=0 PtS11Min=0 x2S11Min=0 x3S11Min=0 FrameElem=14
ElemStation=0.0625
Frame=14 Station=0.125 OutputCase=SOVRCOST CaseType=LinStatic P=0 V2=0 V3=0 T=0 M2=0 M3=0
S11Max=0 PtS11Max=0 x2S11Max=0 x3S11Max=0 S11Min=0 PtS11Min=0 x2S11Min=0 x3S11Min=0 FrameElem=14
ElemStation=0.125
Frame=14 Station=0.1875 OutputCase=SOVRCOST CaseType=LinStatic P=0 V2=0 V3=0 T=0 M2=0 M3=0
S11Max=0 PtS11Max=0 x2S11Max=0 x3S11Max=0 S11Min=0 PtS11Min=0 x2S11Min=0 x3S11Min=0 FrameElem=14
ElemStation=0.1875

```



Frame=14 Station=0.25 OutputCase=SOVRCOST CaseType=LinStatic P=0 V2=0 V3=0 T=0 M2=0 M3=0
 S11Max=0 PtS11Max=0 x2S11Max=0 x3S11Max=0 S11Min=0 PtS11Min=0 x2S11Min=0 x3S11Min=0 FrameElem=14
 ElemStation=0.25
 Frame=14 Station=0 OutputCase=ENVE CaseType=Combination StepType=Max P=-32.6801405652697
 V2=443.000000542681 V3=0 T=0 M2=0 M3=-14.29737322609 S11Max=70.0810339316822 PtS11Max=3 x2S11Max=0.5
 x3S11Max=-0.5
 S11Min=-118.46437992181 PtS11Min=1 x2S11Min=-0.5 x3S11Min=-0.5 FrameElem=14 ElemStation=0
 Frame=14 Station=0.0625 OutputCase=ENVE CaseType=Combination StepType=Max P=-32.6801405652697
 V2=456.843750542681 V3=0 T=0 M2=0 M3=-42.4174904412416 S11Max=238.801737260188 PtS11Max=3 x2S11Max=0.5
 x3S11Max=-0.5 S11Min=-287.18508321272 PtS11Min=1 x2S11Min=-0.5 x3S11Min=-0.5 FrameElem=14
 ElemStation=0.0625
 Frame=14 Station=0.125 OutputCase=ENVE CaseType=Combination StepType=Max P=-32.6801405652697
 V2=470.687500542681 V3=0 T=0 M2=0 M3=-71.4028420313933 S11Max=412.713846838693 PtS11Max=3 x2S11Max=0.5
 x3S11Max=-0.5
 S11Min=-461.09719275363 PtS11Min=1 x2S11Min=-0.5 x3S11Min=-0.5 FrameElem=14 ElemStation=0.125
 Frame=14 Station=0.1875 OutputCase=ENVE CaseType=Combination StepType=Max P=-32.6801405652697
 V2=484.531250542681 V3=0 T=0 M2=0 M3=-101.253427996545 S11Max=591.817362667198 PtS11Max=3 x2S11Max=0.5
 x3S11Max=-0.5 S11Min=-640.200708544539 PtS11Min=1 x2S11Min=-0.5 x3S11Min=-0.5 FrameElem=14
 ElemStation=0.1875
 Frame=14 Station=0.25 OutputCase=ENVE CaseType=Combination StepType=Max P=-32.6801405652697
 V2=498.375000542681 V3=0 T=0 M2=0 M3=-131.969248336697 S11Max=776.112284745703 PtS11Max=3 x2S11Max=0.5
 x3S11Max=-0.5
 S11Min=-824.495630585449 PtS11Min=1 x2S11Min=-0.5 x3S11Min=-0.5 FrameElem=14 ElemStation=0.25
 Frame=14 Station=0 OutputCase=ENVE CaseType=Combination StepType=Min P=-52.6936800202209
 V2=443.000000442426 V3=0 T=0 M2=0 M3=-20.4624523253172 S11Max=53.1040987912702 PtS11Max=3 x2S11Max=0.5
 x3S11Max=-0.5
 S11Min=-175.468393972124 PtS11Min=1 x2S11Min=-0.5 x3S11Min=-0.5 FrameElem=14 ElemStation=0
 Frame=14 Station=0.0625 OutputCase=ENVE CaseType=Combination StepType=Min P=-52.6936800202209
 V2=456.843750442426 V3=0 T=0 M2=0 M3=-48.5825695467347 S11Max=221.82480208218 PtS11Max=3 x2S11Max=0.5
 x3S11Max=-0.5
 S11Min=-344.189097300629 PtS11Min=1 x2S11Min=-0.5 x3S11Min=-0.5 FrameElem=14 ElemStation=0.0625
 Frame=14 Station=0.125 OutputCase=ENVE CaseType=Combination StepType=Min P=-52.6936800202209
 V2=470.687500442426 V3=0 T=0 M2=0 M3=-77.5679211431523 S11Max=395.73691162309 PtS11Max=3 x2S11Max=0.5
 x3S11Max=-0.5
 S11Min=-518.101206879135 PtS11Min=1 x2S11Min=-0.5 x3S11Min=-0.5 FrameElem=14 ElemStation=0.125
 Frame=14 Station=0.1875 OutputCase=ENVE CaseType=Combination StepType=Min P=-52.6936800202209
 V2=484.531250442426 V3=0 T=0 M2=0 M3=-107.41850711457 S11Max=574.840427414 PtS11Max=3 x2S11Max=0.5
 x3S11Max=-0.5
 S11Min=-697.20472270764 PtS11Min=1 x2S11Min=-0.5 x3S11Min=-0.5 FrameElem=14 ElemStation=0.1875
 Frame=14 Station=0.25 OutputCase=ENVE CaseType=Combination StepType=Min P=-52.6936800202209
 V2=498.375000442426 V3=0 T=0 M2=0 M3=-138.134327460987 S11Max=759.13534945491 PtS11Max=3 x2S11Max=0.5
 x3S11Max=-0.5
 S11Min=-881.499644786145 PtS11Min=1 x2S11Min=-0.5 x3S11Min=-0.5 FrameElem=14 ElemStation=0.25
 Frame=14 Station=0 OutputCase=FESSUR CaseType=Combination P=-52.6936800202209 V2=443.000000542681
 V3=0 T=0 M2=0 M3=-20.4624523253172 S11Max=70.0810339316822 PtS11Max=3 x2S11Max=0.5 x3S11Max=-0.5
 S11Min=-175.468393972124 PtS11Min=1 x2S11Min=-0.5 x3S11Min=-0.5 FrameElem=14 ElemStation=0
 Frame=14 Station=0.0625 OutputCase=FESSUR CaseType=Combination P=-52.6936800202209 V2=456.843750542681
 V3=0 T=0 M2=0 M3=-48.5825695467347 S11Max=238.801737260188 PtS11Max=3 x2S11Max=0.5 x3S11Max=-0.5
 S11Min=-344.189097300629 PtS11Min=1 x2S11Min=-0.5 x3S11Min=-0.5 FrameElem=14 ElemStation=0.0625
 Frame=14 Station=0.125 OutputCase=FESSUR CaseType=Combination P=-52.6936800202209 V2=470.687500542681
 V3=0 T=0 M2=0 M3=-77.5679211431523 S11Max=412.713846838693 PtS11Max=3 x2S11Max=0.5 x3S11Max=-0.5
 S11Min=-518.101206879135 PtS11Min=1 x2S11Min=-0.5 x3S11Min=-0.5 FrameElem=14 ElemStation=0.125
 Frame=14 Station=0.1875 OutputCase=FESSUR CaseType=Combination P=-52.6936800202209 V2=484.531250542681
 V3=0 T=0 M2=0 M3=-107.41850711457 S11Max=591.817362667198 PtS11Max=3 x2S11Max=0.5 x3S11Max=-0.5
 S11Min=-697.20472270764 PtS11Min=1 x2S11Min=-0.5 x3S11Min=-0.5 FrameElem=14 ElemStation=0.1875
 Frame=14 Station=0.25 OutputCase=FESSUR CaseType=Combination P=-52.6936800202209 V2=498.375000542681
 V3=0 T=0 M2=0 M3=-138.134327460987 S11Max=776.112284745703 PtS11Max=3 x2S11Max=0.5 x3S11Max=-0.5
 S11Min=-881.499644786145 PtS11Min=1 x2S11Min=-0.5 x3S11Min=-0.5 FrameElem=14 ElemStation=0.25
 Frame=15 Station=0 OutputCase=PESOPR CaseType=LinStatic P=15.1709413718193 V2=56.2500014578109 V3=0
 T=0 M2=0 M3=-6.2278283052874 S11Max=52.5379112035437 PtS11Max=3 x2S11Max=0.5 x3S11Max=-0.5
 S11Min=-22.1960284599052 PtS11Min=1 x2S11Min=-0.5 x3S11Min=-0.5 FrameElem=15 ElemStation=0
 Frame=15 Station=6.24999940395358E-02 OutputCase=PESOPR CaseType=LinStatic P=15.1709412228076
 V2=57.8125013087993 V3=0 T=0 M2=0 M3=-9.79228117681124 S11Max=73.9246282836751 PtS11Max=3 x2S11Max=0.5
 x3S11Max=-0.5
 S11Min=-43.5827458380598 PtS11Min=1 x2S11Min=-0.5 x3S11Min=-0.5 FrameElem=15
 ElemStation=6.24999940395358E-02
 Frame=15 Station=0.124999988079072 OutputCase=PESOPR CaseType=LinStatic P=15.170941073796
 V2=59.3750011597876 V3=0 T=0 M2=0 M3=-13.4543902797086 S11Max=95.8972827520478 PtS11Max=3 x2S11Max=0.5
 x3S11Max=-0.5
 S11Min=-65.5554006044557 PtS11Min=1 x2S11Min=-0.5 x3S11Min=-0.5 FrameElem=15
 ElemStation=0.124999988079072
 Frame=15 Station=0.187499982118607 OutputCase=PESOPR CaseType=LinStatic P=15.1709409247844
 V2=60.937501010776 V3=0 T=0 M2=0 M3=-17.2141556139796 S11Max=118.455874608662 PtS11Max=3 x2S11Max=0.5
 x3S11Max=-0.5
 S11Min=-88.1139927590929 PtS11Min=1 x2S11Min=-0.5 x3S11Min=-0.5 FrameElem=15
 ElemStation=0.187499982118607
 Frame=15 Station=0.249999976158143 OutputCase=PESOPR CaseType=LinStatic P=15.1709407757728
 V2=62.5000008617644 V3=0 T=0 M2=0 M3=-21.071577179624 S11Max=141.600403853517 PtS11Max=3 x2S11Max=0.5
 x3S11Max=-0.5



S11Min=-111.258522301971 PtS11Min=1 x2S11Min=-0.5 x3S11Min=-0.5 FrameElem=15
 ElemStation=0.24999976158143
 Frame=15 Station=0 OutputCase=TERRVERT CaseType=LinStatic P=-1.15287073762297 V2=442.125000087428
 V3=0 T=0 M2=0 M3=-111.356235408006 S11Max=666.984541710412 PtS11Max=3 x2S11Max=0.5 x3S11Max=-0.5 _
 S11Min=-669.290283185658 PtS11Min=1 x2S11Min=-0.5 x3S11Min=-0.5 FrameElem=15 ElemStation=0
 Frame=15 Station=6.24999940395358E-02 OutputCase=TERRVERT CaseType=LinStatic P=-1.15287190885426
 V2=454.406248916197 V3=0 T=0 M2=0 M3=-139.372834267498 S11Max=835.084133696133 PtS11Max=3 x2S11Max=0.5
 _
 x3S11Max=-0.5 S11Min=-837.389877513842 PtS11Min=1 x2S11Min=-0.5 x3S11Min=-0.5 FrameElem=15
 ElemStation=6.24999940395358E-02
 Frame=15 Station=0.124999988079072 OutputCase=TERRVERT CaseType=LinStatic P=-1.15287308008555
 V2=466.687497744965 V3=0 T=0 M2=0 M3=-168.157011105586 S11Max=1007.78919355343 PtS11Max=3 x2S11Max=0.5
 x3S11Max=-0.5 _
 S11Min=-1010.0949397136 PtS11Min=1 x2S11Min=-0.5 x3S11Min=-0.5 FrameElem=15
 ElemStation=0.124999988079072
 Frame=15 Station=0.187499982118607 OutputCase=TERRVERT CaseType=LinStatic P=-1.15287425131683
 V2=478.968746573734 V3=0 T=0 M2=0 M3=-197.70876592227 S11Max=1185.09972128231 PtS11Max=3 x2S11Max=0.5
 x3S11Max=-0.5 _
 S11Min=-1187.40546978494 PtS11Min=1 x2S11Min=-0.5 x3S11Min=-0.5 FrameElem=15
 ElemStation=0.187499982118607
 Frame=15 Station=0.24999976158143 OutputCase=TERRVERT CaseType=LinStatic P=-1.15287542254812
 V2=491.249995402503 V3=0 T=0 M2=0 M3=-228.028098717551 S11Max=1367.01571688276 PtS11Max=3 x2S11Max=0.5
 x3S11Max=-0.5 _
 S11Min=-1369.32146772785 PtS11Min=1 x2S11Min=-0.5 x3S11Min=-0.5 FrameElem=15
 ElemStation=0.24999976158143
 Frame=15 Station=0 OutputCase=TERRLAT CaseType=LinStatic P=-66.71179818317 V2=-6.02795194026839E-06
 V3=0 T=0 M2=0 M3=-20.5502637476359 S11Max=56.5897843026455 PtS11Max=3 x2S11Max=0.5 x3S11Max=-0.5 _
 S11Min=-190.013380668985 PtS11Min=1 x2S11Min=-0.5 x3S11Min=-0.5 FrameElem=15 ElemStation=0
 Frame=15 Station=6.24999940395358E-02 OutputCase=TERRLAT CaseType=LinStatic P=-66.71179818317 V2=-
 6.02795194026839E-06 V3=0 T=0 M2=0 M3=-20.5502633708889 S11Max=56.5897820421637 PtS11Max=3
 x2S11Max=0.5 _
 x3S11Max=-0.5 S11Min=-190.013378408504 PtS11Min=1 x2S11Min=-0.5 x3S11Min=-0.5 FrameElem=15
 ElemStation=6.24999940395358E-02
 Frame=15 Station=0.124999988079072 OutputCase=TERRLAT CaseType=LinStatic P=-66.71179818317 V2=-
 6.02795194026839E-06 V3=0 T=0 M2=0 M3=-20.550262994142 S11Max=56.5897797816819 PtS11Max=3 x2S11Max=0.5
 x3S11Max=-0.5 _
 S11Min=-190.013376148022 PtS11Min=1 x2S11Min=-0.5 x3S11Min=-0.5 FrameElem=15
 ElemStation=0.124999988079072
 Frame=15 Station=0.187499982118607 OutputCase=TERRLAT CaseType=LinStatic P=-66.71179818317 V2=-
 6.02795194026839E-06 V3=0 T=0 M2=0 M3=-20.550262617395 S11Max=56.5897775212002 PtS11Max=3 x2S11Max=0.5
 x3S11Max=-0.5 _
 S11Min=-190.01337388754 PtS11Min=1 x2S11Min=-0.5 x3S11Min=-0.5 FrameElem=15
 ElemStation=0.187499982118607
 Frame=15 Station=0.24999976158143 OutputCase=TERRLAT CaseType=LinStatic P=-66.71179818317 V2=-
 6.02795194026839E-06 V3=0 T=0 M2=0 M3=-20.5502622406481 S11Max=56.5897752607184 PtS11Max=3
 x2S11Max=0.5 _
 x3S11Max=-0.5 S11Min=-190.013371627058 PtS11Min=1 x2S11Min=-0.5 x3S11Min=-0.5 FrameElem=15
 ElemStation=0.24999976158143
 Frame=15 Station=0 OutputCase=ACCLATDX CaseType=LinStatic P=0 V2=0 V3=0 T=0 M2=0 M3=0
 S11Max=0 PtS11Max=0 x2S11Max=0 x3S11Max=0 S11Min=0 PtS11Min=0 x2S11Min=0 x3S11Min=0 FrameElem=15
 ElemStation=0
 Frame=15 Station=6.24999940395358E-02 OutputCase=ACCLATDX CaseType=LinStatic P=0 V2=0 V3=0 T=0
 M2=0 M3=0 S11Max=0 PtS11Max=0 x2S11Max=0 x3S11Max=0 S11Min=0 PtS11Min=0 x2S11Min=0 x3S11Min=0
 FrameElem=15 ElemStation=6.24999940395358E-02
 Frame=15 Station=0.124999988079072 OutputCase=ACCLATDX CaseType=LinStatic P=0 V2=0 V3=0 T=0 M2=0
 M3=0 S11Max=0 PtS11Max=0 x2S11Max=0 x3S11Max=0 S11Min=0 PtS11Min=0 x2S11Min=0 x3S11Min=0
 FrameElem=15 ElemStation=0.124999988079072
 Frame=15 Station=0.187499982118607 OutputCase=ACCLATDX CaseType=LinStatic P=0 V2=0 V3=0 T=0 M2=0
 M3=0 S11Max=0 PtS11Max=0 x2S11Max=0 x3S11Max=0 S11Min=0 PtS11Min=0 x2S11Min=0 x3S11Min=0
 FrameElem=15 ElemStation=0.187499982118607
 Frame=15 Station=0.24999976158143 OutputCase=ACCLATDX CaseType=LinStatic P=0 V2=0 V3=0 T=0 M2=0
 M3=0 S11Max=0 PtS11Max=0 x2S11Max=0 x3S11Max=0 S11Min=0 PtS11Min=0 x2S11Min=0 x3S11Min=0
 FrameElem=15 ElemStation=0.24999976158143
 Frame=15 Station=0 OutputCase=ACCLATSX CaseType=LinStatic P=0 V2=0 V3=0 T=0 M2=0 M3=0
 S11Max=0 PtS11Max=0 x2S11Max=0 x3S11Max=0 S11Min=0 PtS11Min=0 x2S11Min=0 x3S11Min=0 FrameElem=15
 ElemStation=0
 Frame=15 Station=6.24999940395358E-02 OutputCase=ACCLATSX CaseType=LinStatic P=0 V2=0 V3=0 T=0
 M2=0 M3=0 S11Max=0 PtS11Max=0 x2S11Max=0 x3S11Max=0 S11Min=0 PtS11Min=0 x2S11Min=0 x3S11Min=0
 FrameElem=15 ElemStation=6.24999940395358E-02
 Frame=15 Station=0.124999988079072 OutputCase=ACCLATSX CaseType=LinStatic P=0 V2=0 V3=0 T=0 M2=0
 M3=0 S11Max=0 PtS11Max=0 x2S11Max=0 x3S11Max=0 S11Min=0 PtS11Min=0 x2S11Min=0 x3S11Min=0
 FrameElem=15 ElemStation=0.124999988079072
 Frame=15 Station=0.187499982118607 OutputCase=ACCLATSX CaseType=LinStatic P=0 V2=0 V3=0 T=0 M2=0
 M3=0 S11Max=0 PtS11Max=0 x2S11Max=0 x3S11Max=0 S11Min=0 PtS11Min=0 x2S11Min=0 x3S11Min=0
 FrameElem=15 ElemStation=0.187499982118607
 Frame=15 Station=0.24999976158143 OutputCase=ACCLATSX CaseType=LinStatic P=0 V2=0 V3=0 T=0 M2=0
 M3=0 S11Max=0 PtS11Max=0 x2S11Max=0 x3S11Max=0 S11Min=0 PtS11Min=0 x2S11Min=0 x3S11Min=0
 FrameElem=15 ElemStation=0.24999976158143
 Frame=15 Station=0 OutputCase=TERRCOST CaseType=LinStatic P=0 V2=0 V3=0 T=0 M2=0 M3=0
 S11Max=0 PtS11Max=0 x2S11Max=0 x3S11Max=0 S11Min=0 PtS11Min=0 x2S11Min=0 x3S11Min=0 FrameElem=15
 ElemStation=0



Frame=15 Station=6.24999940395358E-02 OutputCase=TERRCOST CaseType=LinStatic P=0 V2=0 V3=0 T=0
 M2=0 M3=0 S11Max=0 PtS11Max=0 x2S11Max=0 x3S11Max=0 S11Min=0 PtS11Min=0 x2S11Min=0 x3S11Min=0
 FrameElem=15 ElemStation=6.24999940395358E-02
 Frame=15 Station=0.124999988079072 OutputCase=TERRCOST CaseType=LinStatic P=0 V2=0 V3=0 T=0 M2=0
 M3=0 S11Max=0 PtS11Max=0 x2S11Max=0 x3S11Max=0 S11Min=0 PtS11Min=0 x2S11Min=0 x3S11Min=0
 FrameElem=15 ElemStation=0.124999988079072
 Frame=15 Station=0.187499982118607 OutputCase=TERRCOST CaseType=LinStatic P=0 V2=0 V3=0 T=0 M2=0
 M3=0 S11Max=0 PtS11Max=0 x2S11Max=0 x3S11Max=0 S11Min=0 PtS11Min=0 x2S11Min=0 x3S11Min=0
 FrameElem=15 ElemStation=0.187499982118607
 Frame=15 Station=0.249999976158143 OutputCase=TERRCOST CaseType=LinStatic P=0 V2=0 V3=0 T=0 M2=0
 M3=0 S11Max=0 PtS11Max=0 x2S11Max=0 x3S11Max=0 S11Min=0 PtS11Min=0 x2S11Min=0 x3S11Min=0
 FrameElem=15 ElemStation=0.249999976158143
 Frame=15 Station=0 OutputCase=SOVRCOST CaseType=LinStatic P=0 V2=0 V3=0 T=0 M2=0 M3=0
 S11Max=0 PtS11Max=0 x2S11Max=0 x3S11Max=0 S11Min=0 PtS11Min=0 x2S11Min=0 x3S11Min=0 FrameElem=15
 ElemStation=0
 Frame=15 Station=6.24999940395358E-02 OutputCase=SOVRCOST CaseType=LinStatic P=0 V2=0 V3=0 T=0
 M2=0 M3=0 S11Max=0 PtS11Max=0 x2S11Max=0 x3S11Max=0 S11Min=0 PtS11Min=0 x2S11Min=0 x3S11Min=0
 FrameElem=15 ElemStation=6.24999940395358E-02
 Frame=15 Station=0.124999988079072 OutputCase=SOVRCOST CaseType=LinStatic P=0 V2=0 V3=0 T=0 M2=0
 M3=0 S11Max=0 PtS11Max=0 x2S11Max=0 x3S11Max=0 S11Min=0 PtS11Min=0 x2S11Min=0 x3S11Min=0
 FrameElem=15 ElemStation=0.124999988079072
 Frame=15 Station=0.187499982118607 OutputCase=SOVRCOST CaseType=LinStatic P=0 V2=0 V3=0 T=0 M2=0
 M3=0 S11Max=0 PtS11Max=0 x2S11Max=0 x3S11Max=0 S11Min=0 PtS11Min=0 x2S11Min=0 x3S11Min=0
 FrameElem=15 ElemStation=0.187499982118607
 Frame=15 Station=0.249999976158143 OutputCase=SOVRCOST CaseType=LinStatic P=0 V2=0 V3=0 T=0 M2=0
 M3=0 S11Max=0 PtS11Max=0 x2S11Max=0 x3S11Max=0 S11Min=0 PtS11Min=0 x2S11Min=0 x3S11Min=0
 FrameElem=15 ElemStation=0.249999976158143
 Frame=15 Station=0 OutputCase=ENVE CaseType=Combination StepType=Max P=-32.6801880940227
 V2=498.374997325672 V3=0 T=0 M2=0 M3=-131.969248336638 S11Max=776.112237216601 PtS11Max=3 x2S11Max=0.5
 x3S11Max=-0.5
 S11Min=-824.495678113853 PtS11Min=1 x2S11Min=-0.5 x3S11Min=-0.5 FrameElem=15 ElemStation=0
 Frame=15 Station=6.24999940395358E-02 OutputCase=ENVE CaseType=Combination StepType=Max P=-
 32.6801894142656 V2=512.218746005429 V3=0 T=0 M2=0 M3=-163.550299803931 S11Max=965.598544021972
 PtS11Max=3 x2S11Max=0.5
 x3S11Max=-0.5 S11Min=-1013.98198823785 PtS11Min=1 x2S11Min=-0.5 x3S11Min=-0.5 FrameElem=15
 ElemStation=6.24999940395358E-02
 Frame=15 Station=0.124999988079072 OutputCase=ENVE CaseType=Combination StepType=Max P=-
 32.6801907345085 V2=526.062494685187 V3=0 T=0 M2=0 M3=-195.996585481194 S11Max=1160.27625608716
 PtS11Max=3 x2S11Max=0.5
 x3S11Max=-0.5 S11Min=-1208.65970362167 PtS11Min=1 x2S11Min=-0.5 x3S11Min=-0.5 FrameElem=15
 ElemStation=0.124999988079072
 Frame=15 Station=0.187499982118607 OutputCase=ENVE CaseType=Combination StepType=Max P=-
 32.6801920547514 V2=539.906243364944 V3=0 T=0 M2=0 M3=-229.308105368426 S11Max=1360.14537341217
 PtS11Max=3 x2S11Max=0.5
 x3S11Max=-0.5 S11Min=-1408.52882426531 PtS11Min=1 x2S11Min=-0.5 x3S11Min=-0.5 FrameElem=15
 ElemStation=0.187499982118607
 Frame=15 Station=0.249999976158143 OutputCase=ENVE CaseType=Combination StepType=Max P=-
 32.6801933749943 V2=553.749992044701 V3=0 T=0 M2=0 M3=-263.484859465628 S11Max=1565.20589599699
 PtS11Max=3 x2S11Max=0.5
 x3S11Max=-0.5 S11Min=-1613.58935016876 PtS11Min=1 x2S11Min=-0.5 x3S11Min=-0.5 FrameElem=15
 ElemStation=0.249999976158143
 Frame=15 Station=0 OutputCase=ENVE CaseType=Combination StepType=Min P=-52.6937275489737
 V2=498.374995517287 V3=0 T=0 M2=0 M3=-138.134327460929 S11Max=759.135301925808 PtS11Max=3 x2S11Max=0.5
 x3S11Max=-0.5
 S11Min=-881.499692314549 PtS11Min=1 x2S11Min=-0.5 x3S11Min=-0.5 FrameElem=15 ElemStation=0
 Frame=15 Station=6.24999940395358E-02 OutputCase=ENVE CaseType=Combination StepType=Min P=-
 52.6937288692166 V2=512.218744197044 V3=0 T=0 M2=0 M3=-169.715378815198 S11Max=948.621609409323
 PtS11Max=3 x2S11Max=0.5
 x3S11Max=-0.5 S11Min=-1070.98600176041 PtS11Min=1 x2S11Min=-0.5 x3S11Min=-0.5 FrameElem=15
 ElemStation=6.24999940395358E-02
 Frame=15 Station=0.124999988079072 OutputCase=ENVE CaseType=Combination StepType=Min P=-
 52.6937301894595 V2=526.062492876801 V3=0 T=0 M2=0 M3=-202.161664379437 S11Max=1143.29932215266
 PtS11Max=3 x2S11Max=0.5
 x3S11Max=-0.5 S11Min=-1265.66371646608 PtS11Min=1 x2S11Min=-0.5 x3S11Min=-0.5 FrameElem=15
 ElemStation=0.124999988079072
 Frame=15 Station=0.187499982118607 OutputCase=ENVE CaseType=Combination StepType=Min P=-
 52.6937315097024 V2=539.906241556558 V3=0 T=0 M2=0 M3=-235.473184153645 S11Max=1343.16844015581
 PtS11Max=3 x2S11Max=0.5
 x3S11Max=-0.5 S11Min=-1465.53283643157 PtS11Min=1 x2S11Min=-0.5 x3S11Min=-0.5 FrameElem=15
 ElemStation=0.187499982118607
 Frame=15 Station=0.249999976158143 OutputCase=ENVE CaseType=Combination StepType=Min P=-
 52.6937328299453 V2=553.749990236315 V3=0 T=0 M2=0 M3=-269.649938137823 S11Max=1548.22896341878
 PtS11Max=3 x2S11Max=0.5
 x3S11Max=-0.5 S11Min=-1670.59336165688 PtS11Min=1 x2S11Min=-0.5 x3S11Min=-0.5 FrameElem=15
 ElemStation=0.249999976158143
 Frame=15 Station=0 OutputCase=FESSUR CaseType=Combination P=-52.6937275489737 V2=498.374995517287
 V3=0 T=0 M2=0 M3=-138.134327460929 S11Max=776.112237216601 PtS11Max=3 x2S11Max=0.5 x3S11Max=-0.5
 S11Min=-881.499692314549 PtS11Min=1 x2S11Min=-0.5 x3S11Min=-0.5 FrameElem=15 ElemStation=0
 Frame=15 Station=6.24999940395358E-02 OutputCase=FESSUR CaseType=Combination P=-52.6937288692166
 V2=512.218744197044 V3=0 T=0 M2=0 M3=-169.715378815198 S11Max=965.598544021972 PtS11Max=3 x2S11Max=0.5



x3S11Max=-0.5 S11Min=-1070.98600176041 PtS11Min=1 x2S11Min=-0.5 x3S11Min=-0.5 FrameElem=15
 ElemStation=6.24999940395358E-02
 Frame=15 Station=0.124999988079072 OutputCase=FESSUR CaseType=Combination P=-52.6937301894595
 V2=526.062492876801 V3=0 T=0 M2=0 M3=-202.161664379437 S11Max=1160.27625608716 PtS11Max=3 x2S11Max=0.5
 x3S11Max=-0.5 _
 S11Min=-1265.66371646608 PtS11Min=1 x2S11Min=-0.5 x3S11Min=-0.5 FrameElem=15
 ElemStation=0.124999988079072
 Frame=15 Station=0.187499982118607 OutputCase=FESSUR CaseType=Combination P=-52.6937315097024
 V2=539.906241556558 V3=0 T=0 M2=0 M3=-235.473184153645 S11Max=1360.14537341217 PtS11Max=3 x2S11Max=0.5
 x3S11Max=-0.5 _
 S11Min=-1465.53283643157 PtS11Min=1 x2S11Min=-0.5 x3S11Min=-0.5 FrameElem=15
 ElemStation=0.187499982118607
 Frame=15 Station=0.249999976158143 OutputCase=FESSUR CaseType=Combination P=-52.6937328299453
 V2=553.749990236315 V3=0 T=0 M2=0 M3=-269.649938137823 S11Max=1565.20589599699 PtS11Max=3 x2S11Max=0.5
 x3S11Max=-0.5 _
 S11Min=-1670.59336165688 PtS11Min=1 x2S11Min=-0.5 x3S11Min=-0.5 FrameElem=15
 ElemStation=0.249999976158143
 Frame=16 Station=0 OutputCase=PESOPR CaseType=LinStatic P=-162.500000840286 V2=15.1709312390318 V3=0
 T=0 M2=0 M3=81.7553624407837 S11Max=328.032173804416 PtS11Max=1 x2S11Max=-0.5 x3S11Max=-0.5 _
 S11Min=-653.032175484988 PtS11Min=3 x2S11Min=0.5 x3S11Min=-0.5 FrameElem=16 ElemStation=0
 Frame=16 Station=0.250000000000001 OutputCase=PESOPR CaseType=LinStatic P=-156.250000840286
 V2=15.1709318350782 V3=0 T=0 M2=0 M3=77.9626295565199 S11Max=311.525776498834 PtS11Max=1 x2S11Max=-0.5
 x3S11Max=-0.5 _
 S11Min=-624.025778179405 PtS11Min=3 x2S11Min=0.5 x3S11Min=-0.5 FrameElem=16
 ElemStation=0.250000000000001
 Frame=16 Station=0 OutputCase=TERRVERT CaseType=LinStatic P=-491.249995008809 V2=-1.15287542253486
 V3=0 T=0 M2=0 M3=223.41678346408 S11Max=849.250705775671 PtS11Max=1 x2S11Max=-0.5 x3S11Max=-0.5 _
 S11Min=-1831.75069579329 PtS11Min=3 x2S11Min=0.5 x3S11Min=-0.5 FrameElem=16 ElemStation=0
 Frame=16 Station=0.250000000000001 OutputCase=TERRVERT CaseType=LinStatic P=-491.249995008809 V2=-
 1.15287542253486 V3=0 T=0 M2=0 M3=223.705002319714 S11Max=850.980018909473 PtS11Max=1 x2S11Max=-0.5
 x3S11Max=-0.5 _
 S11Min=-1833.48000892709 PtS11Min=3 x2S11Min=0.5 x3S11Min=-0.5 FrameElem=16
 ElemStation=0.250000000000001
 Frame=16 Station=0 OutputCase=TERRLAT CaseType=LinStatic P=-7.46670139051275E-06 V2=81.7982018168292
 V3=0 T=0 M2=0 M3=21.1830694275959 S11Max=127.098409098874 PtS11Max=1 x2S11Max=-0.5 x3S11Max=-0.5 _
 S11Min=-127.098424032277 PtS11Min=3 x2S11Min=0.5 x3S11Min=-0.5 FrameElem=16 ElemStation=0
 Frame=16 Station=0.250000000000001 OutputCase=TERRLAT CaseType=LinStatic P=-6.24780876113853E-06
 V2=69.0171861918292 V3=0 T=0 M2=0 M3=2.34224944213851 S11Max=14.0534904050223 PtS11Max=1 x2S11Max=-0.5
 -
 x3S11Max=-0.5 S11Min=-14.0535029006398 PtS11Min=3 x2S11Min=0.5 x3S11Min=-0.5 FrameElem=16
 ElemStation=0.250000000000001
 Frame=16 Station=0 OutputCase=ACCLATDX CaseType=LinStatic P=0 V2=0 V3=0 T=0 M2=0 M3=0
 S11Max=0 PtS11Max=0 x2S11Max=0 x3S11Max=0 S11Min=0 PtS11Min=0 x2S11Min=0 x3S11Min=0 FrameElem=16
 ElemStation=0
 Frame=16 Station=0.250000000000001 OutputCase=ACCLATDX CaseType=LinStatic P=0 V2=0 V3=0 T=0 M2=0
 M3=0 S11Max=0 PtS11Max=0 x2S11Max=0 x3S11Max=0 S11Min=0 PtS11Min=0 x2S11Min=0 x3S11Min=0
 FrameElem=16 ElemStation=0.250000000000001
 Frame=16 Station=0 OutputCase=ACCLATSX CaseType=LinStatic P=0 V2=0 V3=0 T=0 M2=0 M3=0
 S11Max=0 PtS11Max=0 x2S11Max=0 x3S11Max=0 S11Min=0 PtS11Min=0 x2S11Min=0 x3S11Min=0 FrameElem=16
 ElemStation=0
 Frame=16 Station=0.250000000000001 OutputCase=ACCLATSX CaseType=LinStatic P=0 V2=0 V3=0 T=0 M2=0
 M3=0 S11Max=0 PtS11Max=0 x2S11Max=0 x3S11Max=0 S11Min=0 PtS11Min=0 x2S11Min=0 x3S11Min=0
 FrameElem=16 ElemStation=0.250000000000001
 Frame=16 Station=0 OutputCase=TERRCOST CaseType=LinStatic P=0 V2=0 V3=0 T=0 M2=0 M3=0
 S11Max=0 PtS11Max=0 x2S11Max=0 x3S11Max=0 S11Min=0 PtS11Min=0 x2S11Min=0 x3S11Min=0 FrameElem=16
 ElemStation=0
 Frame=16 Station=0.250000000000001 OutputCase=TERRCOST CaseType=LinStatic P=0 V2=0 V3=0 T=0 M2=0
 M3=0 S11Max=0 PtS11Max=0 x2S11Max=0 x3S11Max=0 S11Min=0 PtS11Min=0 x2S11Min=0 x3S11Min=0
 FrameElem=16 ElemStation=0.250000000000001
 Frame=16 Station=0 OutputCase=SOVRCOST CaseType=LinStatic P=0 V2=0 V3=0 T=0 M2=0 M3=0
 S11Max=0 PtS11Max=0 x2S11Max=0 x3S11Max=0 S11Min=0 PtS11Min=0 x2S11Min=0 x3S11Min=0 FrameElem=16
 ElemStation=0
 Frame=16 Station=0.250000000000001 OutputCase=SOVRCOST CaseType=LinStatic P=0 V2=0 V3=0 T=0 M2=0
 M3=0 S11Max=0 PtS11Max=0 x2S11Max=0 x3S11Max=0 S11Min=0 PtS11Min=0 x2S11Min=0 x3S11Min=0
 FrameElem=16 ElemStation=0.250000000000001
 Frame=16 Station=0 OutputCase=ENVE CaseType=Combination StepType=Max P=-653.750001075786
 V2=95.8162576333261 V3=0 T=0 M2=0 M3=326.35251533246 S11Max=1304.38128867896 PtS11Max=1 x2S11Max=-0.5
 x3S11Max=-0.5 _
 S11Min=-2573.75176810087 PtS11Min=3 x2S11Min=0.5 x3S11Min=-0.5 FrameElem=16 ElemStation=0
 Frame=16 Station=0.250000000000001 OutputCase=ENVE CaseType=Combination StepType=Max P=-
 647.50000222561 V2=83.0352426043726 V3=0 T=0 M2=0 M3=304.009881318372 S11Max=1176.55928581333
 PtS11Max=1 x2S11Max=-0.5 _
 x3S11Max=-0.5 S11Min=-2467.34323913695 PtS11Min=3 x2S11Min=0.5 x3S11Min=-0.5 FrameElem=16
 ElemStation=0.250000000000001
 Frame=16 Station=0 OutputCase=ENVE CaseType=Combination StepType=Min P=-653.750003315797
 V2=71.2767970882773 V3=0 T=0 M2=0 M3=320.000294504181 S11Max=1266.2517659493 PtS11Max=1 x2S11Max=-0.5
 x3S11Max=-0.5 _
 S11Min=-2611.88129531055 PtS11Min=3 x2S11Min=0.5 x3S11Min=-0.5 FrameElem=16 ElemStation=0
 Frame=16 Station=0.250000000000001 OutputCase=ENVE CaseType=Combination StepType=Min P=-
 647.500002096904 V2=62.3300867468238 V3=0 T=0 M2=0 M3=303.307206485731 S11Max=1172.34323869182
 PtS11Max=1 x2S11Max=-0.5 _

x3S11Max=-0.5 S11Min=-2471.55929000714 PtS11Min=3 x2S11Min=0.5 x3S11Min=-0.5 FrameElem=16
ElemStation=0.250000000000001
Frame=16 Station=0 OutputCase=FESSUR CaseType=Combination P=-653.750003315797 V2=95.816257633261
V3=0 T=0 M2=0 M3=326.35521533246 S11Max=1304.38128867896 PtS11Max=1 x2S11Max=-0.5 x3S11Max=-0.5
S11Min=-2611.88129531055 PtS11Min=3 x2S11Min=0.5 x3S11Min=-0.5 FrameElem=16 ElemStation=0
Frame=16 Station=0.250000000000001 OutputCase=FESSUR CaseType=Combination P=-647.500002096904
V2=83.0352426043726 V3=0 T=0 M2=0 M3=304.009881318372 S11Max=1176.55928581333 PtS11Max=1 x2S11Max=-0.5
x3S11Max=-0.5
S11Min=-2471.55929000714 PtS11Min=3 x2S11Min=0.5 x3S11Min=-0.5 FrameElem=16
ElemStation=0.250000000000001
Frame=17 Station=0 OutputCase=PESOPR CaseType=LinStatic P=-156.249999393243 V2=15.1709467362397 V3=0
T=0 M2=0 M3=77.9626295565153 S11Max=311.525777945848 PtS11Max=1 x2S11Max=-0.5 x3S11Max=-0.5
S11Min=-624.025776732335 PtS11Min=3 x2S11Min=0.5 x3S11Min=-0.5 FrameElem=17 ElemStation=0
Frame=17 Station=0.25 OutputCase=PESOPR CaseType=LinStatic P=-149.999999393243 V2=15.1709467362397
V3=0 T=0 M2=0 M3=74.1698928724553 S11Max=295.019357841489 PtS11Max=1 x2S11Max=-0.5 x3S11Max=-0.5
S11Min=-595.019356627975 PtS11Min=3 x2S11Min=0.5 x3S11Min=-0.5 FrameElem=17 ElemStation=0.25
Frame=17 Station=0 OutputCase=TERRVERT CaseType=LinStatic P=-491.24999511824 V2=-1.15282857328475
V3=0 T=0 M2=0 M3=223.705002319706 S11Max=850.980018799993 PtS11Max=1 x2S11Max=-0.5 x3S11Max=-0.5
S11Min=-1833.48000903647 PtS11Min=3 x2S11Min=0.5 x3S11Min=-0.5 FrameElem=17 ElemStation=0
Frame=17 Station=0.25 OutputCase=TERRVERT CaseType=LinStatic P=-491.24999511824 V2=-1.15282857328475
V3=0 T=0 M2=0 M3=223.993209463027 S11Max=852.70926165992 PtS11Max=1 x2S11Max=-0.5 x3S11Max=-0.5
S11Min=-1835.2092518964 PtS11Min=3 x2S11Min=0.5 x3S11Min=-0.5 FrameElem=17 ElemStation=0.25
Frame=17 Station=0 OutputCase=TERRLAT CaseType=LinStatic P=3.3418245948269E-07 V2=69.0171861918294
V3=0 T=0 M2=0 M3=2.34224944213844 S11Max=14.0534969870131 PtS11Max=1 x2S11Max=-0.5 x3S11Max=-0.5
S11Min=-14.0534963186482 PtS11Min=3 x2S11Min=0.5 x3S11Min=-0.5 FrameElem=17 ElemStation=0
Frame=17 Station=0.25 OutputCase=TERRLAT CaseType=LinStatic P=3.3418245948269E-07 V2=56.7691393168294
V3=0 T=0 M2=0 M3=-13.3699377308189 S11Max=80.2196267190959 PtS11Max=3 x2S11Max=0.5 x3S11Max=-0.5
S11Min=-80.2196260507309 PtS11Min=1 x2S11Min=-0.5 x3S11Min=-0.5 FrameElem=17 ElemStation=0.25
Frame=17 Station=0 OutputCase=ACCLATDX CaseType=LinStatic P=0 V2=0 V3=0 T=0 M2=0 M3=0
S11Max=0 PtS11Max=0 x2S11Max=0 x3S11Max=0 S11Min=0 PtS11Min=0 x2S11Min=0 x3S11Min=0 FrameElem=17
ElemStation=0
Frame=17 Station=0.25 OutputCase=ACCLATDX CaseType=LinStatic P=0 V2=0 V3=0 T=0 M2=0 M3=0
S11Max=0 PtS11Max=0 x2S11Max=0 x3S11Max=0 S11Min=0 PtS11Min=0 x2S11Min=0 x3S11Min=0 FrameElem=17
ElemStation=0.25
Frame=17 Station=0 OutputCase=ACCLATSX CaseType=LinStatic P=0 V2=0 V3=0 T=0 M2=0 M3=0
S11Max=0 PtS11Max=0 x2S11Max=0 x3S11Max=0 S11Min=0 PtS11Min=0 x2S11Min=0 x3S11Min=0 FrameElem=17
ElemStation=0
Frame=17 Station=0.25 OutputCase=ACCLATSX CaseType=LinStatic P=0 V2=0 V3=0 T=0 M2=0 M3=0
S11Max=0 PtS11Max=0 x2S11Max=0 x3S11Max=0 S11Min=0 PtS11Min=0 x2S11Min=0 x3S11Min=0 FrameElem=17
ElemStation=0.25
Frame=17 Station=0 OutputCase=TERRCOST CaseType=LinStatic P=0 V2=0 V3=0 T=0 M2=0 M3=0
S11Max=0 PtS11Max=0 x2S11Max=0 x3S11Max=0 S11Min=0 PtS11Min=0 x2S11Min=0 x3S11Min=0 FrameElem=17
ElemStation=0
Frame=17 Station=0.25 OutputCase=TERRCOST CaseType=LinStatic P=0 V2=0 V3=0 T=0 M2=0 M3=0
S11Max=0 PtS11Max=0 x2S11Max=0 x3S11Max=0 S11Min=0 PtS11Min=0 x2S11Min=0 x3S11Min=0 FrameElem=17
ElemStation=0.25
Frame=17 Station=0 OutputCase=SOVRCOST CaseType=LinStatic P=0 V2=0 V3=0 T=0 M2=0 M3=0
S11Max=0 PtS11Max=0 x2S11Max=0 x3S11Max=0 S11Min=0 PtS11Min=0 x2S11Min=0 x3S11Min=0 FrameElem=17
ElemStation=0
Frame=17 Station=0.25 OutputCase=SOVRCOST CaseType=LinStatic P=0 V2=0 V3=0 T=0 M2=0 M3=0
S11Max=0 PtS11Max=0 x2S11Max=0 x3S11Max=0 S11Min=0 PtS11Min=0 x2S11Min=0 x3S11Min=0 FrameElem=17
ElemStation=0.25
Frame=17 Station=0 OutputCase=ENVE CaseType=Combination StepType=Max P=-647.499994177301
V2=83.0353043547843 V3=0 T=0 M2=0 M3=304.009881318359 S11Max=1176.55929373285 PtS11Max=1 x2S11Max=-0.5
x3S11Max=-0.5
S11Min=-2467.34323319186 PtS11Min=3 x2S11Min=0.5 x3S11Min=-0.5 FrameElem=17 ElemStation=0
Frame=17 Station=0.25 OutputCase=ENVE CaseType=Combination StepType=Max P=-641.249994177301
V2=70.7872574797843 V3=0 T=0 M2=0 M3=288.804145923909 S11Max=1091.5748812659 PtS11Max=1 x2S11Max=-0.5
x3S11Max=-0.5
S11Min=-2350.00898180528 PtS11Min=3 x2S11Min=0.5 x3S11Min=-0.5 FrameElem=17 ElemStation=0.25
Frame=17 Station=0 OutputCase=ENVE CaseType=Combination StepType=Min P=-647.499994277556
V2=62.3301484972355 V3=0 T=0 M2=0 M3=303.307206485718 S11Max=1172.34324463675 PtS11Max=1 x2S11Max=-0.5
x3S11Max=-0.5
S11Min=-2471.55928208746 PtS11Min=3 x2S11Min=0.5 x3S11Min=-0.5 FrameElem=17 ElemStation=0
Frame=17 Station=0.25 OutputCase=ENVE CaseType=Combination StepType=Min P=-641.249994277556
V2=53.7565156847355 V3=0 T=0 M2=0 M3=284.793164604663 S11Max=1067.50899345068 PtS11Max=1 x2S11Max=-0.5
x3S11Max=-0.5
S11Min=-2374.07486982101 PtS11Min=3 x2S11Min=0.5 x3S11Min=-0.5 FrameElem=17 ElemStation=0.25
Frame=17 Station=0 OutputCase=FESSUR CaseType=Combination P=-647.499994177301 V2=83.0353043547843
V3=0 T=0 M2=0 M3=304.009881318359 S11Max=1176.55929373285 PtS11Max=1 x2S11Max=-0.5 x3S11Max=-0.5
S11Min=-2471.55928208746 PtS11Min=3 x2S11Min=0.5 x3S11Min=-0.5 FrameElem=17 ElemStation=0
Frame=17 Station=0.25 OutputCase=FESSUR CaseType=Combination P=-641.249994177301 V2=70.7872574797843
V3=0 T=0 M2=0 M3=284.793164604663 S11Max=1067.50899345068 PtS11Max=1 x2S11Max=-0.5 x3S11Max=-0.5
S11Min=-2350.00898180528 PtS11Min=3 x2S11Min=0.5 x3S11Min=-0.5 FrameElem=17 ElemStation=0.25
Frame=19 Station=0 OutputCase=PESOPR CaseType=LinStatic P=-75.0000008397619 V2=15.1709395836816 V3=0
T=0 M2=0 M3=28.6570499815281 S11Max=96.9422990494065 PtS11Max=1 x2S11Max=-0.5 x3S11Max=-0.5
S11Min=-246.94230072893 PtS11Min=3 x2S11Min=0.5 x3S11Min=-0.5 FrameElem=19 ElemStation=0
Frame=19 Station=0.250000000000002 OutputCase=PESOPR CaseType=LinStatic P=-68.7500008397619
V2=15.1709401797281 V3=0 T=0 M2=0 M3=24.8643150111018 S11Max=80.4358892268491 PtS11Max=1 x2S11Max=-0.5
x3S11Max=-0.5
S11Min=-217.935890906373 PtS11Min=3 x2S11Min=0.5 x3S11Min=-0.5 FrameElem=19
ElemStation=0.250000000000002



Frame=19 Station=0 OutputCase=TERRVERT CaseType=LinStatic P=-491.249995007413 V2=-1.15287542254055
 V3=0 T=0 M2=0 M3=227.451683470577 S11Max=873.460105816052 PtS11Max=1 x2S11Max=-0.5 x3S11Max=-0.5 _
 S11Min=-1855.96009583088 PtS11Min=3 x2S11Min=0.5 x3S11Min=-0.5 FrameElem=19 ElemStation=0
 Frame=19 Station=0.250000000000002 OutputCase=TERRVERT CaseType=LinStatic P=-491.249995007413 V2=-
 1.15287542254055 V3=0 T=0 M2=0 M3=227.739902326212 S11Max=875.189418949862 PtS11Max=1 x2S11Max=-0.5
 x3S11Max=-0.5 _
 S11Min=-1857.68940896469 PtS11Min=3 x2S11Min=0.5 x3S11Min=-0.5 FrameElem=19
 ElemStation=0.250000000000002
 Frame=19 Station=0 OutputCase=TERRLAT CaseType=LinStatic P=4.97245855513029E-06 V2=-48.6358606831697
 V3=0 T=0 M2=0 M3=-6.38298068130786 S11Max=38.2978890603057 PtS11Max=3 x2S11Max=0.5 x3S11Max=-0.5 _
 S11Min=-38.2978791153886 PtS11Min=1 x2S11Min=-0.5 x3S11Min=-0.5 FrameElem=19 ElemStation=0
 Frame=19 Station=0.250000000000002 OutputCase=TERRLAT CaseType=LinStatic P=5.47976113550439E-06 V2=-
 53.9553138081697 V3=0 T=0 M2=0 M3=6.45201964573464 S11Max=38.712123354169 PtS11Max=1 x2S11Max=-0.5 _
 x3S11Max=-0.5 S11Min=-38.7121123946467 PtS11Min=3 x2S11Min=0.5 x3S11Min=-0.5 FrameElem=19
 ElemStation=0.250000000000002
 Frame=19 Station=0 OutputCase=ACCLATDX CaseType=LinStatic P=0 V2=0 V3=0 T=0 M2=0 M3=0
 S11Max=0 PtS11Max=0 x2S11Max=0 x3S11Max=0 S11Min=0 PtS11Min=0 x2S11Min=0 x3S11Min=0 FrameElem=19
 ElemStation=0
 Frame=19 Station=0.250000000000002 OutputCase=ACCLATDX CaseType=LinStatic P=0 V2=0 V3=0 T=0 M2=0
 M3=0 S11Max=0 PtS11Max=0 x2S11Max=0 x3S11Max=0 S11Min=0 PtS11Min=0 x2S11Min=0 x3S11Min=0
 FrameElem=19 ElemStation=0.250000000000002
 Frame=19 Station=0 OutputCase=ACCLATSX CaseType=LinStatic P=0 V2=0 V3=0 T=0 M2=0 M3=0
 S11Max=0 PtS11Max=0 x2S11Max=0 x3S11Max=0 S11Min=0 PtS11Min=0 x2S11Min=0 x3S11Min=0 FrameElem=19
 ElemStation=0
 Frame=19 Station=0.250000000000002 OutputCase=ACCLATSX CaseType=LinStatic P=0 V2=0 V3=0 T=0 M2=0
 M3=0 S11Max=0 PtS11Max=0 x2S11Max=0 x3S11Max=0 S11Min=0 PtS11Min=0 x2S11Min=0 x3S11Min=0
 FrameElem=19 ElemStation=0.250000000000002
 Frame=19 Station=0 OutputCase=TERRCOST CaseType=LinStatic P=0 V2=0 V3=0 T=0 M2=0 M3=0
 S11Max=0 PtS11Max=0 x2S11Max=0 x3S11Max=0 S11Min=0 PtS11Min=0 x2S11Min=0 x3S11Min=0 FrameElem=19
 ElemStation=0
 Frame=19 Station=0.250000000000002 OutputCase=TERRCOST CaseType=LinStatic P=0 V2=0 V3=0 T=0 M2=0
 M3=0 S11Max=0 PtS11Max=0 x2S11Max=0 x3S11Max=0 S11Min=0 PtS11Min=0 x2S11Min=0 x3S11Min=0
 FrameElem=19 ElemStation=0.250000000000002
 Frame=19 Station=0 OutputCase=SOVRCOST CaseType=LinStatic P=0 V2=0 V3=0 T=0 M2=0 M3=0
 S11Max=0 PtS11Max=0 x2S11Max=0 x3S11Max=0 S11Min=0 PtS11Min=0 x2S11Min=0 x3S11Min=0 FrameElem=19
 ElemStation=0
 Frame=19 Station=0.250000000000002 OutputCase=SOVRCOST CaseType=LinStatic P=0 V2=0 V3=0 T=0 M2=0
 M3=0 S11Max=0 PtS11Max=0 x2S11Max=0 x3S11Max=0 S11Min=0 PtS11Min=0 x2S11Min=0 x3S11Min=0
 FrameElem=19 ElemStation=0.250000000000002
 Frame=19 Station=0 OutputCase=ENVE CaseType=Combination StepType=Max P=-566.249990874716 V2=-
 20.0270383170777 V3=0 T=0 M2=0 M3=251.64064697519 S11Max=943.593889484686 PtS11Max=1 x2S11Max=-0.5
 x3S11Max=-0.5 _
 S11Min=-2064.6045074995 PtS11Min=3 x2S11Min=0.5 x3S11Min=-0.5 FrameElem=19 ElemStation=0
 Frame=19 Station=0.250000000000002 OutputCase=ENVE CaseType=Combination StepType=Max P=-
 559.999990367413 V2=-23.7506549085312 V3=0 T=0 M2=0 M3=259.056236983049 S11Max=994.33743153088
 PtS11Max=1 x2S11Max=-0.5 _
 x3S11Max=-0.5 S11Min=-2102.72377854731 PtS11Min=3 x2S11Min=0.5 x3S11Min=-0.5 FrameElem=19
 ElemStation=0.250000000000002
 Frame=19 Station=0 OutputCase=ENVE CaseType=Combination StepType=Min P=-566.249992366453 V2=-
 34.6177965220286 V3=0 T=0 M2=0 M3=249.725752770798 S11Max=932.104525750069 PtS11Max=1 x2S11Max=-0.5
 x3S11Max=-0.5 _
 S11Min=-2076.09387421759 PtS11Min=3 x2S11Min=0.5 x3S11Min=-0.5 FrameElem=19 ElemStation=0
 Frame=19 Station=0.250000000000002 OutputCase=ENVE CaseType=Combination StepType=Min P=-
 559.999992011342 V2=-39.9372490509821 V3=0 T=0 M2=0 M3=257.120631089329 S11Max=982.72379452463
 PtS11Max=1 x2S11Max=-0.5 _
 x3S11Max=-0.5 S11Min=-2114.33741226571 PtS11Min=3 x2S11Min=0.5 x3S11Min=-0.5 FrameElem=19
 ElemStation=0.250000000000002
 Frame=19 Station=0 OutputCase=FESSUR CaseType=Combination P=-566.249990874716 V2=-34.6177965220286
 V3=0 T=0 M2=0 M3=249.725752770798 S11Max=932.104525750069 PtS11Max=1 x2S11Max=-0.5 x3S11Max=-0.5 _
 S11Min=-2064.6045074995 PtS11Min=3 x2S11Min=0.5 x3S11Min=-0.5 FrameElem=19 ElemStation=0
 Frame=19 Station=0.250000000000002 OutputCase=FESSUR CaseType=Combination P=-559.999990367413 V2=-
 39.9372490509821 V3=0 T=0 M2=0 M3=259.056236983049 S11Max=994.33743153088 PtS11Max=1 x2S11Max=-0.5
 x3S11Max=-0.5 _
 S11Min=-2114.33741226571 PtS11Min=3 x2S11Min=0.5 x3S11Min=-0.5 FrameElem=19
 ElemStation=0.250000000000002
 Frame=20 Station=0 OutputCase=PESOPR CaseType=LinStatic P=-68.7499979460263 V2=15.1709532927494 V3=0
 T=0 M2=0 M3=24.8643150110989 S11Max=80.435892120567 PtS11Max=1 x2S11Max=-0.5 x3S11Max=-0.5 _
 S11Min=-217.93588801262 PtS11Min=3 x2S11Min=0.5 x3S11Min=-0.5 FrameElem=20 ElemStation=0
 Frame=20 Station=0.250000000000001 OutputCase=PESOPR CaseType=LinStatic P=-62.4999979460263
 V2=15.170952696703 V3=0 T=0 M2=0 M3=21.0715767624173 S11Max=63.9294626284776 PtS11Max=1 x2S11Max=-0.5
 x3S11Max=-0.5 _
 S11Min=-188.92945852053 PtS11Min=3 x2S11Min=0.5 x3S11Min=-0.5 FrameElem=20
 ElemStation=0.250000000000001
 Frame=20 Station=0 OutputCase=TERRVERT CaseType=LinStatic P=-491.249995227205 V2=-1.15278172404055
 V3=0 T=0 M2=0 M3=227.739902326204 S11Max=875.189418730019 PtS11Max=1 x2S11Max=-0.5 x3S11Max=-0.5 _
 S11Min=-1857.68940918443 PtS11Min=3 x2S11Min=0.5 x3S11Min=-0.5 FrameElem=20 ElemStation=0
 Frame=20 Station=0.250000000000001 OutputCase=TERRVERT CaseType=LinStatic P=-491.249995227205 V2=-
 1.15278172404055 V3=0 T=0 M2=0 M3=228.028097757214 S11Max=876.91859131608 PtS11Max=1 x2S11Max=-0.5
 x3S11Max=-0.5 _
 S11Min=-1859.41858177049 PtS11Min=3 x2S11Min=0.5 x3S11Min=-0.5 FrameElem=20
 ElemStation=0.250000000000001



Frame=20 Station=0 OutputCase=TERRLAT CaseType=LinStatic P=-4.81139886687743E-06 V2=-53.9553138081698
 V3=0 T=0 M2=0 M3=6.45201964573479 S11Max=38.7121130630099 PtS11Max=1 x2S11Max=-0.5 x3S11Max=-0.5 _
 S11Min=-38.7121226858076 PtS11Min=3 x2S11Min=0.5 x3S11Min=-0.5 FrameElem=20 ElemStation=0
 Frame=20 Station=0.250000000000001 OutputCase=TERRLAT CaseType=LinStatic P=-5.26787358660866E-06 V2=-
 58.7417981831698 V3=0 T=0 M2=0 M3=20.5502621602773 S11Max=123.30156769379 PtS11Max=1 x2S11Max=-0.5 _
 x3S11Max=-0.5 S11Min=-123.301578229537 PtS11Min=3 x2S11Min=0.5 x3S11Min=-0.5 FrameElem=20
 ElemStation=0.250000000000001
 Frame=20 Station=0 OutputCase=ACCLATDX CaseType=LinStatic P=0 V2=0 V3=0 T=0 M2=0 M3=0
 S11Max=0 PtS11Max=0 x2S11Max=0 x3S11Max=0 S11Min=0 PtS11Min=0 x2S11Min=0 x3S11Min=0 FrameElem=20
 ElemStation=0
 Frame=20 Station=0.250000000000001 OutputCase=ACCLATDX CaseType=LinStatic P=0 V2=0 V3=0 T=0 M2=0
 M3=0 S11Max=0 PtS11Max=0 x2S11Max=0 x3S11Max=0 S11Min=0 PtS11Min=0 x2S11Min=0 x3S11Min=0
 FrameElem=20 ElemStation=0.250000000000001
 Frame=20 Station=0 OutputCase=ACCLATSX CaseType=LinStatic P=0 V2=0 V3=0 T=0 M2=0 M3=0
 S11Max=0 PtS11Max=0 x2S11Max=0 x3S11Max=0 S11Min=0 PtS11Min=0 x2S11Min=0 x3S11Min=0 FrameElem=20
 ElemStation=0
 Frame=20 Station=0.250000000000001 OutputCase=ACCLATSX CaseType=LinStatic P=0 V2=0 V3=0 T=0 M2=0
 M3=0 S11Max=0 PtS11Max=0 x2S11Max=0 x3S11Max=0 S11Min=0 PtS11Min=0 x2S11Min=0 x3S11Min=0
 FrameElem=20 ElemStation=0.250000000000001
 Frame=20 Station=0 OutputCase=TERRCOST CaseType=LinStatic P=0 V2=0 V3=0 T=0 M2=0 M3=0
 S11Max=0 PtS11Max=0 x2S11Max=0 x3S11Max=0 S11Min=0 PtS11Min=0 x2S11Min=0 x3S11Min=0 FrameElem=20
 ElemStation=0
 Frame=20 Station=0.250000000000001 OutputCase=TERRCOST CaseType=LinStatic P=0 V2=0 V3=0 T=0 M2=0
 M3=0 S11Max=0 PtS11Max=0 x2S11Max=0 x3S11Max=0 S11Min=0 PtS11Min=0 x2S11Min=0 x3S11Min=0
 FrameElem=20 ElemStation=0.250000000000001
 Frame=20 Station=0 OutputCase=SOVRCOST CaseType=LinStatic P=0 V2=0 V3=0 T=0 M2=0 M3=0
 S11Max=0 PtS11Max=0 x2S11Max=0 x3S11Max=0 S11Min=0 PtS11Min=0 x2S11Min=0 x3S11Min=0 FrameElem=20
 ElemStation=0
 Frame=20 Station=0.250000000000001 OutputCase=SOVRCOST CaseType=LinStatic P=0 V2=0 V3=0 T=0 M2=0
 M3=0 S11Max=0 PtS11Max=0 x2S11Max=0 x3S11Max=0 S11Min=0 PtS11Min=0 x2S11Min=0 x3S11Min=0
 FrameElem=20 ElemStation=0.250000000000001
 Frame=20 Station=0 OutputCase=ENVE CaseType=Combination StepType=Max P=-559.99999654121 V2=-
 23.75054809701 V3=0 T=0 M2=0 M3=259.056236983038 S11Max=994.337423913596 PtS11Max=1 x2S11Max=-0.5
 x3S11Max=-0.5 _
 S11Min=-2102.72378307711 PtS11Min=3 x2S11Min=0.5 x3S11Min=-0.5 FrameElem=20 ElemStation=0
 Frame=20 Station=0.250000000000001 OutputCase=ENVE CaseType=Combination StepType=Max P=-
 553.749996860742 V2=-27.1010877555564 V3=0 T=0 M2=0 M3=269.649936679909 S11Max=1064.14962163835
 PtS11Max=1 x2S11Max=-0.5 _
 x3S11Max=-0.5 S11Min=-2134.6591450517 PtS11Min=3 x2S11Min=0.5 x3S11Min=-0.5 FrameElem=20
 ElemStation=0.250000000000001
 Frame=20 Station=0 OutputCase=ENVE CaseType=Combination StepType=Min P=-559.99999798463 V2=-
 39.9371422394609 V3=0 T=0 M2=0 M3=257.120631089317 S11Max=982.723789994693 PtS11Max=1 x2S11Max=-0.5
 x3S11Max=-0.5 _
 S11Min=-2114.33741988286 PtS11Min=3 x2S11Min=0.5 x3S11Min=-0.5 FrameElem=20 ElemStation=0
 Frame=20 Station=0.250000000000001 OutputCase=ENVE CaseType=Combination StepType=Min P=-
 553.749998441104 V2=-44.7236272105074 V3=0 T=0 M2=0 M3=263.484858031826 S11Max=1027.15915133021
 PtS11Max=1 x2S11Max=-0.5 _
 x3S11Max=-0.5 S11Min=-2171.64961852056 PtS11Min=3 x2S11Min=0.5 x3S11Min=-0.5 FrameElem=20
 ElemStation=0.250000000000001
 Frame=20 Station=0 OutputCase=FESSUR CaseType=Combination P=-559.99999798463 V2=-39.9371422394609
 V3=0 T=0 M2=0 M3=259.056236983038 S11Max=994.337423913596 PtS11Max=1 x2S11Max=-0.5 x3S11Max=-0.5 _
 S11Min=-2114.33741988286 PtS11Min=3 x2S11Min=0.5 x3S11Min=-0.5 FrameElem=20 ElemStation=0
 Frame=20 Station=0.250000000000001 OutputCase=FESSUR CaseType=Combination P=-553.749998441104 V2=-
 44.7236272105074 V3=0 T=0 M2=0 M3=269.649936679909 S11Max=1064.14962163835 PtS11Max=1 x2S11Max=-0.5
 x3S11Max=-0.5 _
 S11Min=-2171.64961852056 PtS11Min=3 x2S11Min=0.5 x3S11Min=-0.5 FrameElem=20
 ElemStation=0.250000000000001
 Frame=41 Station=0 OutputCase=PESOPR CaseType=LinStatic P=-15.1709467362365 V2=106.633696120567 V3=0
 T=0 M2=0 M3=8.81453682378924 S11Max=37.7162742064989 PtS11Max=1 x2S11Max=-0.5 x3S11Max=-0.5 _
 S11Min=-68.058167678972 PtS11Min=3 x2S11Min=0.5 x3S11Min=-0.5 FrameElem=41 ElemStation=0
 Frame=41 Station=0.125 OutputCase=PESOPR CaseType=LinStatic P=-15.1709467362365 V2=109.758696120567
 V3=0 T=0 M2=0 M3=-4.70998769128164 S11Max=13.0889794114533 PtS11Max=3 x2S11Max=0.5 x3S11Max=-0.5 _
 S11Min=-43.4308728839264 PtS11Min=1 x2S11Min=-0.5 x3S11Min=-0.5 FrameElem=41 ElemStation=0.125
 Frame=41 Station=0.25 OutputCase=PESOPR CaseType=LinStatic P=-15.1709467362365 V2=112.883696120567
 V3=0 T=0 M2=0 M3=-18.6251372063525 S11Max=96.5798765018786 PtS11Max=3 x2S11Max=0.5 x3S11Max=-0.5 _
 S11Min=-126.921769974352 PtS11Min=1 x2S11Min=-0.5 x3S11Min=-0.5 FrameElem=41 ElemStation=0.25
 Frame=41 Station=0.375 OutputCase=PESOPR CaseType=LinStatic P=-15.1709467362365 V2=116.008696120567
 V3=0 T=0 M2=0 M3=-32.9309117214234 S11Max=182.414523592304 PtS11Max=3 x2S11Max=0.5 x3S11Max=-0.5 _
 S11Min=-212.756417064777 PtS11Min=1 x2S11Min=-0.5 x3S11Min=-0.5 FrameElem=41 ElemStation=0.375
 Frame=41 Station=0.5 OutputCase=PESOPR CaseType=LinStatic P=-15.1709467362365 V2=119.133696120567
 V3=0 T=0 M2=0 M3=-47.6273112364943 S11Max=270.592920682729 PtS11Max=3 x2S11Max=0.5 x3S11Max=-0.5 _
 S11Min=-300.934814155202 PtS11Min=1 x2S11Min=-0.5 x3S11Min=-0.5 FrameElem=41 ElemStation=0.5
 Frame=41 Station=0 OutputCase=TERRVERT CaseType=LinStatic P=1.15282857329472 V2=341.044411043287 V3=0
 T=0 M2=0 M3=2.9588554841516 S11Max=18.9059618637857 PtS11Max=1 x2S11Max=-0.5 x3S11Max=-0.5 _
 S11Min=-16.6003047171962 PtS11Min=3 x2S11Min=0.5 x3S11Min=-0.5 FrameElem=41 ElemStation=0
 Frame=41 Station=0.125 OutputCase=TERRVERT CaseType=LinStatic P=1.15282857329472 V2=341.044411043287
 V3=0 T=0 M2=0 M3=-39.6716958319957 S11Max=239.183003565269 PtS11Max=3 x2S11Max=0.5 x3S11Max=-0.5 _
 S11Min=-236.87734641868 PtS11Min=1 x2S11Min=-0.5 x3S11Min=-0.5 FrameElem=41 ElemStation=0.125
 Frame=41 Station=0.25 OutputCase=TERRVERT CaseType=LinStatic P=1.15282857329472 V2=341.044411043287
 V3=0 T=0 M2=0 M3=-82.3022472124067 S11Max=494.966311847735 PtS11Max=3 x2S11Max=0.5 x3S11Max=-0.5 _
 S11Min=-492.660654701145 PtS11Min=1 x2S11Min=-0.5 x3S11Min=-0.5 FrameElem=41 ElemStation=0.25

```

Frame=41 Station=0.375 OutputCase=TERRVERT CaseType=LinStatic P=1.15282857329472 V2=341.044411043287
V3=0 T=0 M2=0 M3=-124.932798592818 S11Max=750.7496201302 PtS11Max=3 x2S11Max=0.5 x3S11Max=-0.5 _
S11Min=-748.443962983611 PtS11Min=1 x2S11Min=-0.5 x3S11Min=-0.5 FrameElem=41 ElemStation=0.375
Frame=41 Station=0.5 OutputCase=TERRVERT CaseType=LinStatic P=1.15282857329472 V2=341.044411043287
V3=0 T=0 M2=0 M3=-167.563349973228 S11Max=1006.53292841267 PtS11Max=3 x2S11Max=0.5 x3S11Max=-0.5 _
S11Min=-1004.22727126608 PtS11Min=1 x2S11Min=-0.5 x3S11Min=-0.5 FrameElem=41 ElemStation=0.5
Frame=41 Station=0 OutputCase=TERRLAT CaseType=LinStatic P=-108.958200979145 V2=0.177303034379563
V3=0 T=0 M2=0 M3=21.142993324709 S11Max=17.8997589691093 PtS11Max=1 x2S11Max=-0.5 x3S11Max=-0.5 _
S11Min=-235.816160927399 PtS11Min=3 x2S11Min=0.5 x3S11Min=-0.5 FrameElem=41 ElemStation=0
Frame=41 Station=0.125 OutputCase=TERRLAT CaseType=LinStatic P=-108.958200979145 V2=0.177303034379563
V3=0 T=0 M2=0 M3=21.1208304454116 S11Max=17.7667816933246 PtS11Max=1 x2S11Max=-0.5 x3S11Max=-0.5 _
S11Min=-235.683183651614 PtS11Min=3 x2S11Min=0.5 x3S11Min=-0.5 FrameElem=41 ElemStation=0.125
Frame=41 Station=0.25 OutputCase=TERRLAT CaseType=LinStatic P=-108.958200979145 V2=0.177303034379563
V3=0 T=0 M2=0 M3=21.0986675661141 S11Max=17.63380441754 PtS11Max=1 x2S11Max=-0.5 x3S11Max=-0.5 _
S11Min=-235.550206375829 PtS11Min=3 x2S11Min=0.5 x3S11Min=-0.5 FrameElem=41 ElemStation=0.25
Frame=41 Station=0.375 OutputCase=TERRLAT CaseType=LinStatic P=-108.958200979145 V2=0.177303034379563
V3=0 T=0 M2=0 M3=21.0765046868167 S11Max=17.5008271417553 PtS11Max=1 x2S11Max=-0.5 x3S11Max=-0.5 _
S11Min=-235.417229100045 PtS11Min=3 x2S11Min=0.5 x3S11Min=-0.5 FrameElem=41 ElemStation=0.375
Frame=41 Station=0.5 OutputCase=TERRLAT CaseType=LinStatic P=-108.958200979145 V2=0.177303034379563
V3=0 T=0 M2=0 M3=21.0543418075192 S11Max=17.3678498659706 PtS11Max=1 x2S11Max=-0.5 x3S11Max=-0.5 _
S11Min=-235.28425182426 PtS11Min=3 x2S11Min=0.5 x3S11Min=-0.5 FrameElem=41 ElemStation=0.5
Frame=41 Station=0 OutputCase=ACCLATDX CaseType=LinStatic P=0 V2=0 V3=0 T=0 M2=0 M3=0
S11Max=0 PtS11Max=0 x2S11Max=0 x3S11Max=0 S11Min=0 PtS11Min=0 x2S11Min=0 x3S11Min=0 FrameElem=41
ElemStation=0
Frame=41 Station=0.125 OutputCase=ACCLATDX CaseType=LinStatic P=0 V2=0 V3=0 T=0 M2=0 M3=0
S11Max=0 PtS11Max=0 x2S11Max=0 x3S11Max=0 S11Min=0 PtS11Min=0 x2S11Min=0 x3S11Min=0 FrameElem=41
ElemStation=0.125
Frame=41 Station=0.25 OutputCase=ACCLATDX CaseType=LinStatic P=0 V2=0 V3=0 T=0 M2=0 M3=0
S11Max=0 PtS11Max=0 x2S11Max=0 x3S11Max=0 S11Min=0 PtS11Min=0 x2S11Min=0 x3S11Min=0 FrameElem=41
ElemStation=0.25
Frame=41 Station=0.375 OutputCase=ACCLATDX CaseType=LinStatic P=0 V2=0 V3=0 T=0 M2=0 M3=0
S11Max=0 PtS11Max=0 x2S11Max=0 x3S11Max=0 S11Min=0 PtS11Min=0 x2S11Min=0 x3S11Min=0 FrameElem=41
ElemStation=0.375
Frame=41 Station=0.5 OutputCase=ACCLATDX CaseType=LinStatic P=0 V2=0 V3=0 T=0 M2=0 M3=0
S11Max=0 PtS11Max=0 x2S11Max=0 x3S11Max=0 S11Min=0 PtS11Min=0 x2S11Min=0 x3S11Min=0 FrameElem=41
ElemStation=0.5
Frame=41 Station=0 OutputCase=ACCLATSX CaseType=LinStatic P=0 V2=0 V3=0 T=0 M2=0 M3=0
S11Max=0 PtS11Max=0 x2S11Max=0 x3S11Max=0 S11Min=0 PtS11Min=0 x2S11Min=0 x3S11Min=0 FrameElem=41
ElemStation=0
Frame=41 Station=0.125 OutputCase=ACCLATSX CaseType=LinStatic P=0 V2=0 V3=0 T=0 M2=0 M3=0
S11Max=0 PtS11Max=0 x2S11Max=0 x3S11Max=0 S11Min=0 PtS11Min=0 x2S11Min=0 x3S11Min=0 FrameElem=41
ElemStation=0.125
Frame=41 Station=0.25 OutputCase=ACCLATSX CaseType=LinStatic P=0 V2=0 V3=0 T=0 M2=0 M3=0
S11Max=0 PtS11Max=0 x2S11Max=0 x3S11Max=0 S11Min=0 PtS11Min=0 x2S11Min=0 x3S11Min=0 FrameElem=41
ElemStation=0.25
Frame=41 Station=0.375 OutputCase=ACCLATSX CaseType=LinStatic P=0 V2=0 V3=0 T=0 M2=0 M3=0
S11Max=0 PtS11Max=0 x2S11Max=0 x3S11Max=0 S11Min=0 PtS11Min=0 x2S11Min=0 x3S11Min=0 FrameElem=41
ElemStation=0.375
Frame=41 Station=0.5 OutputCase=ACCLATSX CaseType=LinStatic P=0 V2=0 V3=0 T=0 M2=0 M3=0
S11Max=0 PtS11Max=0 x2S11Max=0 x3S11Max=0 S11Min=0 PtS11Min=0 x2S11Min=0 x3S11Min=0 FrameElem=41
ElemStation=0.5
Frame=41 Station=0 OutputCase=TERRCOST CaseType=LinStatic P=0 V2=0 V3=0 T=0 M2=0 M3=0
S11Max=0 PtS11Max=0 x2S11Max=0 x3S11Max=0 S11Min=0 PtS11Min=0 x2S11Min=0 x3S11Min=0 FrameElem=41
ElemStation=0
Frame=41 Station=0.125 OutputCase=TERRCOST CaseType=LinStatic P=0 V2=0 V3=0 T=0 M2=0 M3=0
S11Max=0 PtS11Max=0 x2S11Max=0 x3S11Max=0 S11Min=0 PtS11Min=0 x2S11Min=0 x3S11Min=0 FrameElem=41
ElemStation=0.125
Frame=41 Station=0.25 OutputCase=TERRCOST CaseType=LinStatic P=0 V2=0 V3=0 T=0 M2=0 M3=0
S11Max=0 PtS11Max=0 x2S11Max=0 x3S11Max=0 S11Min=0 PtS11Min=0 x2S11Min=0 x3S11Min=0 FrameElem=41
ElemStation=0.25
Frame=41 Station=0.375 OutputCase=TERRCOST CaseType=LinStatic P=0 V2=0 V3=0 T=0 M2=0 M3=0
S11Max=0 PtS11Max=0 x2S11Max=0 x3S11Max=0 S11Min=0 PtS11Min=0 x2S11Min=0 x3S11Min=0 FrameElem=41
ElemStation=0.375
Frame=41 Station=0.5 OutputCase=TERRCOST CaseType=LinStatic P=0 V2=0 V3=0 T=0 M2=0 M3=0
S11Max=0 PtS11Max=0 x2S11Max=0 x3S11Max=0 S11Min=0 PtS11Min=0 x2S11Min=0 x3S11Min=0 FrameElem=41
ElemStation=0.5
Frame=41 Station=0 OutputCase=SOVRCOST CaseType=LinStatic P=0 V2=0 V3=0 T=0 M2=0 M3=0
S11Max=0 PtS11Max=0 x2S11Max=0 x3S11Max=0 S11Min=0 PtS11Min=0 x2S11Min=0 x3S11Min=0 FrameElem=41
ElemStation=0
Frame=41 Station=0.125 OutputCase=SOVRCOST CaseType=LinStatic P=0 V2=0 V3=0 T=0 M2=0 M3=0
S11Max=0 PtS11Max=0 x2S11Max=0 x3S11Max=0 S11Min=0 PtS11Min=0 x2S11Min=0 x3S11Min=0 FrameElem=41
ElemStation=0.125
Frame=41 Station=0.25 OutputCase=SOVRCOST CaseType=LinStatic P=0 V2=0 V3=0 T=0 M2=0 M3=0
S11Max=0 PtS11Max=0 x2S11Max=0 x3S11Max=0 S11Min=0 PtS11Min=0 x2S11Min=0 x3S11Min=0 FrameElem=41
ElemStation=0.25
Frame=41 Station=0.375 OutputCase=SOVRCOST CaseType=LinStatic P=0 V2=0 V3=0 T=0 M2=0 M3=0
S11Max=0 PtS11Max=0 x2S11Max=0 x3S11Max=0 S11Min=0 PtS11Min=0 x2S11Min=0 x3S11Min=0 FrameElem=41
ElemStation=0.375
Frame=41 Station=0.5 OutputCase=SOVRCOST CaseType=LinStatic P=0 V2=0 V3=0 T=0 M2=0 M3=0
S11Max=0 PtS11Max=0 x2S11Max=0 x3S11Max=0 S11Min=0 PtS11Min=0 x2S11Min=0 x3S11Min=0 FrameElem=41
ElemStation=0.5

```



Frame=41 Station=0 OutputCase=ENVE CaseType=Combination StepType=Max P=-90.2888588483431
 V2=447.855410198234 V3=0 T=0 M2=0 M3=32.9163856969134 S11Max=74.5219950393939 PtS11Max=1 x2S11Max=-0.5
 x3S11Max=-0.5
 S11Min=-249.729785045347 PtS11Min=3 x2S11Min=0.5 x3S11Min=-0.5 FrameElem=41 ElemStation=0
 Frame=41 Station=0.125 OutputCase=ENVE CaseType=Combination StepType=Max P=-90.2888588483431
 V2=450.980410198234 V3=0 T=0 M2=0 M3=-23.2608530778658 S11Max=87.2937544205926 PtS11Max=3 x2S11Max=0.5
 x3S11Max=-0.5
 S11Min=-262.541437609282 PtS11Min=1 x2S11Min=-0.5 x3S11Min=-0.5 FrameElem=41 ElemStation=0.125
 Frame=41 Station=0.25 OutputCase=ENVE CaseType=Combination StepType=Max P=-90.2888588483431
 V2=454.105410198234 V3=0 T=0 M2=0 M3=-79.8287168526451 S11Max=426.661043886533 PtS11Max=3 x2S11Max=0.5
 x3S11Max=-0.5
 S11Min=-601.948620257957 PtS11Min=1 x2S11Min=-0.5 x3S11Min=-0.5 FrameElem=41 ElemStation=0.25
 Frame=41 Station=0.375 OutputCase=ENVE CaseType=Combination StepType=Max P=-90.2888588483431
 V2=457.230410198234 V3=0 T=0 M2=0 M3=-136.787205627424 S11Max=768.372083352473 PtS11Max=3 x2S11Max=0.5
 x3S11Max=-0.5
 S11Min=-943.699552906632 PtS11Min=1 x2S11Min=-0.5 x3S11Min=-0.5 FrameElem=41 ElemStation=0.375
 Frame=41 Station=0.5 OutputCase=ENVE CaseType=Combination StepType=Max P=-90.2888588483431
 V2=460.355410198234 V3=0 T=0 M2=0 M3=-194.136319402204 S11Max=1112.42687281841 PtS11Max=3 x2S11Max=0.5
 x3S11Max=-0.5
 S11Min=-1287.79423555531 PtS11Min=1 x2S11Min=-0.5 x3S11Min=-0.5 FrameElem=41 ElemStation=0.5
 Frame=41 Station=0 OutputCase=ENVE CaseType=Combination StepType=Min P=-122.976319142087
 V2=447.80221928792 V3=0 T=0 M2=0 M3=26.5734876995007 S11Max=69.1520673486611 PtS11Max=1 x2S11Max=-0.5
 x3S11Max=-0.5
 S11Min=-320.474633323567 PtS11Min=3 x2S11Min=0.5 x3S11Min=-0.5 FrameElem=41 ElemStation=0
 Frame=41 Station=0.125 OutputCase=ENVE CaseType=Combination StepType=Min P=-122.976319142087
 V2=450.92721928792 V3=0 T=0 M2=0 M3=-29.5971022114893 S11Max=16.5887993251084 PtS11Max=3 x2S11Max=0.5
 x3S11Max=-0.5
 S11Min=-267.871472117279 PtS11Min=1 x2S11Min=-0.5 x3S11Min=-0.5 FrameElem=41 ElemStation=0.125
 Frame=41 Station=0.25 OutputCase=ENVE CaseType=Combination StepType=Min P=-122.976319142087
 V2=454.05221928792 V3=0 T=0 M2=0 M3=-86.1583171224793 S11Max=355.995981973784 PtS11Max=3 x2S11Max=0.5
 x3S11Max=-0.5
 S11Min=-607.238761583219 PtS11Min=1 x2S11Min=-0.5 x3S11Min=-0.5 FrameElem=41 ElemStation=0.25
 Frame=41 Station=0.375 OutputCase=ENVE CaseType=Combination StepType=Min P=-122.976319142087
 V2=457.17721928792 V3=0 T=0 M2=0 M3=-143.110157033469 S11Max=697.746914622459 PtS11Max=3 x2S11Max=0.5
 x3S11Max=-0.5
 S11Min=-948.949801049159 PtS11Min=1 x2S11Min=-0.5 x3S11Min=-0.5 FrameElem=41 ElemStation=0.375
 Frame=41 Station=0.5 OutputCase=ENVE CaseType=Combination StepType=Min P=-122.976319142087
 V2=460.30221928792 V3=0 T=0 M2=0 M3=-200.452621944459 S11Max=1041.84159727113 PtS11Max=3 x2S11Max=0.5
 x3S11Max=-0.5
 S11Min=-1293.0045905151 PtS11Min=1 x2S11Min=-0.5 x3S11Min=-0.5 FrameElem=41 ElemStation=0.5
 Frame=41 Station=0 OutputCase=FESSUR CaseType=Combination StepType=Min P=-122.976319142087 V2=447.855410198234
 V3=0 T=0 M2=0 M3=32.9163856969134 S11Max=74.5219950393939 PtS11Max=1 x2S11Max=-0.5 x3S11Max=-0.5
 S11Min=-320.474633323567 PtS11Min=3 x2S11Min=0.5 x3S11Min=-0.5 FrameElem=41 ElemStation=0
 Frame=41 Station=0.125 OutputCase=FESSUR CaseType=Combination StepType=Min P=-122.976319142087 V2=450.980410198234
 V3=0 T=0 M2=0 M3=-23.2608530778658 S11Max=16.5887993251084 PtS11Max=3 x2S11Max=0.5 x3S11Max=-0.5
 S11Min=-262.541437609282 PtS11Min=1 x2S11Min=-0.5 x3S11Min=-0.5 FrameElem=41 ElemStation=0.125
 Frame=41 Station=0.25 OutputCase=FESSUR CaseType=Combination StepType=Min P=-122.976319142087 V2=454.105410198234
 V3=0 T=0 M2=0 M3=-79.8287168526451 S11Max=355.995981973784 PtS11Max=3 x2S11Max=0.5 x3S11Max=-0.5
 S11Min=-601.948620257957 PtS11Min=1 x2S11Min=-0.5 x3S11Min=-0.5 FrameElem=41 ElemStation=0.25
 Frame=41 Station=0.375 OutputCase=FESSUR CaseType=Combination StepType=Min P=-122.976319142087 V2=457.230410198234
 V3=0 T=0 M2=0 M3=-136.787205627424 S11Max=697.746914622459 PtS11Max=3 x2S11Max=0.5 x3S11Max=-0.5
 S11Min=-943.699552906632 PtS11Min=1 x2S11Min=-0.5 x3S11Min=-0.5 FrameElem=41 ElemStation=0.375
 Frame=41 Station=0.5 OutputCase=FESSUR CaseType=Combination StepType=Min P=-122.976319142087 V2=460.355410198234
 V3=0 T=0 M2=0 M3=-194.136319402204 S11Max=1041.84159727113 PtS11Max=3 x2S11Max=0.5 x3S11Max=-0.5
 S11Min=-1287.79423555531 PtS11Min=1 x2S11Min=-0.5 x3S11Min=-0.5 FrameElem=41 ElemStation=0.5
 Frame=42 Station=0 OutputCase=PESOPR CaseType=LinStatic P=-15.1709467362365 V2=74.060534141754 V3=0
 T=0 M2=0 M3=-47.6273112365016 S11Max=270.592920682773 PtS11Max=3 x2S11Max=0.5 x3S11Max=-0.5
 S11Min=-300.934814155246 PtS11Min=1 x2S11Min=-0.5 x3S11Min=-0.5 FrameElem=42 ElemStation=0
 Frame=42 Station=0.125 OutputCase=PESOPR CaseType=LinStatic P=-15.1709467362365 V2=77.185534141754
 V3=0 T=0 M2=0 M3=-57.0801905042208 S11Max=327.310196289088 PtS11Max=3 x2S11Max=0.5 x3S11Max=-0.5
 S11Min=-357.652089761561 PtS11Min=1 x2S11Min=-0.5 x3S11Min=-0.5 FrameElem=42 ElemStation=0.125
 Frame=42 Station=0.25 OutputCase=PESOPR CaseType=LinStatic P=-15.1709467362365 V2=80.310534141754
 V3=0 T=0 M2=0 M3=-66.9236947719401 S11Max=386.371221895404 PtS11Max=3 x2S11Max=0.5 x3S11Max=-0.5
 S11Min=-416.713115367877 PtS11Min=1 x2S11Min=-0.5 x3S11Min=-0.5 FrameElem=42 ElemStation=0.25
 Frame=42 Station=0.375 OutputCase=PESOPR CaseType=LinStatic P=-15.1709467362365 V2=83.435534141754
 V3=0 T=0 M2=0 M3=-77.1578240396593 S11Max=447.775997501719 PtS11Max=3 x2S11Max=0.5 x3S11Max=-0.5
 S11Min=-478.117890974192 PtS11Min=1 x2S11Min=-0.5 x3S11Min=-0.5 FrameElem=42 ElemStation=0.375
 Frame=42 Station=0.5 OutputCase=PESOPR CaseType=LinStatic P=-15.1709467362365 V2=86.560534141754 V3=0
 T=0 M2=0 M3=-87.7825783073786 S11Max=511.524523108035 PtS11Max=3 x2S11Max=0.5 x3S11Max=-0.5
 S11Min=-541.866416580508 PtS11Min=1 x2S11Min=-0.5 x3S11Min=-0.5 FrameElem=42 ElemStation=0.5
 Frame=42 Station=0 OutputCase=TERRVERT CaseType=LinStatic P=1.15282857329472 V2=242.566242891568 V3=0
 T=0 M2=0 M3=-167.563349973236 S11Max=1006.53292841271 PtS11Max=3 x2S11Max=0.5 x3S11Max=-0.5
 S11Min=-1004.22727126612 PtS11Min=1 x2S11Min=-0.5 x3S11Min=-0.5 FrameElem=42 ElemStation=0
 Frame=42 Station=0.125 OutputCase=TERRVERT CaseType=LinStatic P=1.15282857329472 V2=242.566242891568
 V3=0 T=0 M2=0 M3=-197.884130334682 S11Max=1188.45761058138 PtS11Max=3 x2S11Max=0.5 x3S11Max=-0.5
 S11Min=-1186.1519534348 PtS11Min=1 x2S11Min=-0.5 x3S11Min=-0.5 FrameElem=42 ElemStation=0.125
 Frame=42 Station=0.25 OutputCase=TERRVERT CaseType=LinStatic P=1.15282857329472 V2=242.566242891568
 V3=0 T=0 M2=0 M3=-228.204910696128 S11Max=1370.38229275006 PtS11Max=3 x2S11Max=0.5 x3S11Max=-0.5
 S11Min=-1368.07663560347 PtS11Min=1 x2S11Min=-0.5 x3S11Min=-0.5 FrameElem=42 ElemStation=0.25
 Frame=42 Station=0.375 OutputCase=TERRVERT CaseType=LinStatic P=1.15282857329472 V2=242.566242891568
 V3=0 T=0 M2=0 M3=-258.525691057574 S11Max=1552.30697491874 PtS11Max=3 x2S11Max=0.5 x3S11Max=-0.5
 S11Min=-1550.00131777215 PtS11Min=1 x2S11Min=-0.5 x3S11Min=-0.5 FrameElem=42 ElemStation=0.375

```

Frame=42 Station=0.5 OutputCase=TERRVERT CaseType=LinStatic P=1.15282857329472 V2=242.566242891568
V3=0 T=0 M2=0 M3=-288.84647141902 S11Max=1734.23165708741 PtS11Max=3 x2S11Max=0.5 x3S11Max=-0.5 _
S11Min=-1731.92599994082 PtS11Min=1 x2S11Min=-0.5 x3S11Min=-0.5 FrameElem=42 ElemStation=0.5
Frame=42 Station=0 OutputCase=TERRLAT CaseType=LinStatic P=-108.958200979145 V2=0.183116999181372
V3=0 T=0 M2=0 M3=21.0543418075192 S11Max=17.3678498659707 PtS11Max=1 x2S11Max=-0.5 x3S11Max=-0.5 _
S11Min=-235.28425182426 PtS11Min=3 x2S11Min=0.5 x3S11Min=-0.5 FrameElem=42 ElemStation=0
Frame=42 Station=0.125 OutputCase=TERRLAT CaseType=LinStatic P=-108.958200979145 V2=0.183116999181372
V3=0 T=0 M2=0 M3=21.0314521826216 S11Max=17.2305121165846 PtS11Max=1 x2S11Max=-0.5 x3S11Max=-0.5 _
S11Min=-235.146914074874 PtS11Min=3 x2S11Min=0.5 x3S11Min=-0.5 FrameElem=42 ElemStation=0.125
Frame=42 Station=0.25 OutputCase=TERRLAT CaseType=LinStatic P=-108.958200979145 V2=0.183116999181372
V3=0 T=0 M2=0 M3=21.0085625577239 S11Max=17.0931743671986 PtS11Max=1 x2S11Max=-0.5 x3S11Max=-0.5 _
S11Min=-235.009576325488 PtS11Min=3 x2S11Min=0.5 x3S11Min=-0.5 FrameElem=42 ElemStation=0.25
Frame=42 Station=0.375 OutputCase=TERRLAT CaseType=LinStatic P=-108.958200979145 V2=0.183116999181372
V3=0 T=0 M2=0 M3=20.9856729328262 S11Max=16.9558366178126 PtS11Max=1 x2S11Max=-0.5 x3S11Max=-0.5 _
S11Min=-234.872238576102 PtS11Min=3 x2S11Min=0.5 x3S11Min=-0.5 FrameElem=42 ElemStation=0.375
Frame=42 Station=0.5 OutputCase=TERRLAT CaseType=LinStatic P=-108.958200979145 V2=0.183116999181372
V3=0 T=0 M2=0 M3=20.9627833079285 S11Max=16.8184988684265 PtS11Max=1 x2S11Max=-0.5 x3S11Max=-0.5 _
S11Min=-234.734900826716 PtS11Min=3 x2S11Min=0.5 x3S11Min=-0.5 FrameElem=42 ElemStation=0.5
Frame=42 Station=0 OutputCase=ACCLATDX CaseType=LinStatic P=0 V2=0 V3=0 T=0 M2=0 M3=0
S11Max=0 PtS11Max=0 x2S11Max=0 x3S11Max=0 S11Min=0 PtS11Min=0 x2S11Min=0 x3S11Min=0 FrameElem=42
ElemStation=0
Frame=42 Station=0.125 OutputCase=ACCLATDX CaseType=LinStatic P=0 V2=0 V3=0 T=0 M2=0 M3=0
S11Max=0 PtS11Max=0 x2S11Max=0 x3S11Max=0 S11Min=0 PtS11Min=0 x2S11Min=0 x3S11Min=0 FrameElem=42
ElemStation=0.125
Frame=42 Station=0.25 OutputCase=ACCLATDX CaseType=LinStatic P=0 V2=0 V3=0 T=0 M2=0 M3=0
S11Max=0 PtS11Max=0 x2S11Max=0 x3S11Max=0 S11Min=0 PtS11Min=0 x2S11Min=0 x3S11Min=0 FrameElem=42
ElemStation=0.25
Frame=42 Station=0.375 OutputCase=ACCLATDX CaseType=LinStatic P=0 V2=0 V3=0 T=0 M2=0 M3=0
S11Max=0 PtS11Max=0 x2S11Max=0 x3S11Max=0 S11Min=0 PtS11Min=0 x2S11Min=0 x3S11Min=0 FrameElem=42
ElemStation=0.375
Frame=42 Station=0.5 OutputCase=ACCLATDX CaseType=LinStatic P=0 V2=0 V3=0 T=0 M2=0 M3=0
S11Max=0 PtS11Max=0 x2S11Max=0 x3S11Max=0 S11Min=0 PtS11Min=0 x2S11Min=0 x3S11Min=0 FrameElem=42
ElemStation=0.5
Frame=42 Station=0 OutputCase=ACCLATSX CaseType=LinStatic P=0 V2=0 V3=0 T=0 M2=0 M3=0
S11Max=0 PtS11Max=0 x2S11Max=0 x3S11Max=0 S11Min=0 PtS11Min=0 x2S11Min=0 x3S11Min=0 FrameElem=42
ElemStation=0
Frame=42 Station=0.125 OutputCase=ACCLATSX CaseType=LinStatic P=0 V2=0 V3=0 T=0 M2=0 M3=0
S11Max=0 PtS11Max=0 x2S11Max=0 x3S11Max=0 S11Min=0 PtS11Min=0 x2S11Min=0 x3S11Min=0 FrameElem=42
ElemStation=0.125
Frame=42 Station=0.25 OutputCase=ACCLATSX CaseType=LinStatic P=0 V2=0 V3=0 T=0 M2=0 M3=0
S11Max=0 PtS11Max=0 x2S11Max=0 x3S11Max=0 S11Min=0 PtS11Min=0 x2S11Min=0 x3S11Min=0 FrameElem=42
ElemStation=0.25
Frame=42 Station=0.375 OutputCase=ACCLATSX CaseType=LinStatic P=0 V2=0 V3=0 T=0 M2=0 M3=0
S11Max=0 PtS11Max=0 x2S11Max=0 x3S11Max=0 S11Min=0 PtS11Min=0 x2S11Min=0 x3S11Min=0 FrameElem=42
ElemStation=0.375
Frame=42 Station=0.5 OutputCase=ACCLATSX CaseType=LinStatic P=0 V2=0 V3=0 T=0 M2=0 M3=0
S11Max=0 PtS11Max=0 x2S11Max=0 x3S11Max=0 S11Min=0 PtS11Min=0 x2S11Min=0 x3S11Min=0 FrameElem=42
ElemStation=0.5
Frame=42 Station=0 OutputCase=TERRCOST CaseType=LinStatic P=0 V2=0 V3=0 T=0 M2=0 M3=0
S11Max=0 PtS11Max=0 x2S11Max=0 x3S11Max=0 S11Min=0 PtS11Min=0 x2S11Min=0 x3S11Min=0 FrameElem=42
ElemStation=0
Frame=42 Station=0.125 OutputCase=TERRCOST CaseType=LinStatic P=0 V2=0 V3=0 T=0 M2=0 M3=0
S11Max=0 PtS11Max=0 x2S11Max=0 x3S11Max=0 S11Min=0 PtS11Min=0 x2S11Min=0 x3S11Min=0 FrameElem=42
ElemStation=0.125
Frame=42 Station=0.25 OutputCase=TERRCOST CaseType=LinStatic P=0 V2=0 V3=0 T=0 M2=0 M3=0
S11Max=0 PtS11Max=0 x2S11Max=0 x3S11Max=0 S11Min=0 PtS11Min=0 x2S11Min=0 x3S11Min=0 FrameElem=42
ElemStation=0.25
Frame=42 Station=0.375 OutputCase=TERRCOST CaseType=LinStatic P=0 V2=0 V3=0 T=0 M2=0 M3=0
S11Max=0 PtS11Max=0 x2S11Max=0 x3S11Max=0 S11Min=0 PtS11Min=0 x2S11Min=0 x3S11Min=0 FrameElem=42
ElemStation=0.375
Frame=42 Station=0.5 OutputCase=TERRCOST CaseType=LinStatic P=0 V2=0 V3=0 T=0 M2=0 M3=0
S11Max=0 PtS11Max=0 x2S11Max=0 x3S11Max=0 S11Min=0 PtS11Min=0 x2S11Min=0 x3S11Min=0 FrameElem=42
ElemStation=0.5
Frame=42 Station=0 OutputCase=SOVRCOST CaseType=LinStatic P=0 V2=0 V3=0 T=0 M2=0 M3=0
S11Max=0 PtS11Max=0 x2S11Max=0 x3S11Max=0 S11Min=0 PtS11Min=0 x2S11Min=0 x3S11Min=0 FrameElem=42
ElemStation=0
Frame=42 Station=0.125 OutputCase=SOVRCOST CaseType=LinStatic P=0 V2=0 V3=0 T=0 M2=0 M3=0
S11Max=0 PtS11Max=0 x2S11Max=0 x3S11Max=0 S11Min=0 PtS11Min=0 x2S11Min=0 x3S11Min=0 FrameElem=42
ElemStation=0.125
Frame=42 Station=0.25 OutputCase=SOVRCOST CaseType=LinStatic P=0 V2=0 V3=0 T=0 M2=0 M3=0
S11Max=0 PtS11Max=0 x2S11Max=0 x3S11Max=0 S11Min=0 PtS11Min=0 x2S11Min=0 x3S11Min=0 FrameElem=42
ElemStation=0.25
Frame=42 Station=0.375 OutputCase=SOVRCOST CaseType=LinStatic P=0 V2=0 V3=0 T=0 M2=0 M3=0
S11Max=0 PtS11Max=0 x2S11Max=0 x3S11Max=0 S11Min=0 PtS11Min=0 x2S11Min=0 x3S11Min=0 FrameElem=42
ElemStation=0.375
Frame=42 Station=0.5 OutputCase=SOVRCOST CaseType=LinStatic P=0 V2=0 V3=0 T=0 M2=0 M3=0
S11Max=0 PtS11Max=0 x2S11Max=0 x3S11Max=0 S11Min=0 PtS11Min=0 x2S11Min=0 x3S11Min=0 FrameElem=42
ElemStation=0.5
Frame=42 Station=0 OutputCase=ENVE CaseType=Combination StepType=Max P=-90.2888588483431
V2=316.809894032503 V3=0 T=0 M2=0 M3=-194.136319402218 S11Max=1112.4268728185 PtS11Max=3 x2S11Max=0.5
x3S11Max=-0.5 _
S11Min=-1287.7942355554 PtS11Min=1 x2S11Min=-0.5 x3S11Min=-0.5 FrameElem=42 ElemStation=0

```



Frame=42 Station=0.125 OutputCase=ENVE CaseType=Combination StepType=Max P=-90.2888588483431
 V2=319.934894032503 V3=0 T=0 M2=0 M3=-233.932868656281 S11Max=1351.16496701806 PtS11Max=3 x2S11Max=0.5
 x3S11Max=-0.5
 S11Min=-1526.57353107977 PtS11Min=1 x2S11Min=-0.5 x3S11Min=-0.5 FrameElem=42 ElemStation=0.125
 Frame=42 Station=0.25 OutputCase=ENVE CaseType=Combination StepType=Max P=-90.2888588483431
 V2=323.059894032503 V3=0 T=0 M2=0 M3=-274.120042910344 S11Max=1592.24681121762 PtS11Max=3 x2S11Max=0.5
 x3S11Max=-0.5
 S11Min=-1767.69657660415 PtS11Min=1 x2S11Min=-0.5 x3S11Min=-0.5 FrameElem=42 ElemStation=0.25
 Frame=42 Station=0.375 OutputCase=ENVE CaseType=Combination StepType=Max P=-90.2888588483431
 V2=326.184894032503 V3=0 T=0 M2=0 M3=-314.697842164407 S11Max=1835.67240541718 PtS11Max=3 x2S11Max=0.5
 x3S11Max=-0.5
 S11Min=-2011.16337212853 PtS11Min=1 x2S11Min=-0.5 x3S11Min=-0.5 FrameElem=42 ElemStation=0.375
 Frame=42 Station=0.5 OutputCase=ENVE CaseType=Combination StepType=Max P=-90.2888588483431
 V2=329.309894032503 V3=0 T=0 M2=0 M3=-355.66626641847 S11Max=2081.44174961675 PtS11Max=3 x2S11Max=0.5
 x3S11Max=-0.5
 S11Min=-2256.9739176529 PtS11Min=1 x2S11Min=-0.5 x3S11Min=-0.5 FrameElem=42 ElemStation=0.5
 Frame=42 Station=0 OutputCase=ENVE CaseType=Combination StepType=Min P=-122.976319142087
 V2=316.754958932749 V3=0 T=0 M2=0 M3=-200.452621944474 S11Max=1041.84159727122 PtS11Max=3 x2S11Max=0.5
 x3S11Max=-0.5
 S11Min=-1293.00459051519 PtS11Min=1 x2S11Min=-0.5 x3S11Min=-0.5 FrameElem=42 ElemStation=0
 Frame=42 Station=0.125 OutputCase=ENVE CaseType=Combination StepType=Min P=-122.976319142087
 V2=319.879958932749 V3=0 T=0 M2=0 M3=-240.242304311067 S11Max=1280.6208927956 PtS11Max=3 x2S11Max=0.5
 x3S11Max=-0.5
 S11Min=-1531.74268471475 PtS11Min=1 x2S11Min=-0.5 x3S11Min=-0.5 FrameElem=42 ElemStation=0.125
 Frame=42 Station=0.25 OutputCase=ENVE CaseType=Combination StepType=Min P=-122.976319142087
 V2=323.004958932749 V3=0 T=0 M2=0 M3=-280.422611677661 S11Max=1521.74393831998 PtS11Max=3 x2S11Max=0.5
 x3S11Max=-0.5
 S11Min=-1772.82452891431 PtS11Min=1 x2S11Min=-0.5 x3S11Min=-0.5 FrameElem=42 ElemStation=0.25
 Frame=42 Station=0.375 OutputCase=ENVE CaseType=Combination StepType=Min P=-122.976319142087
 V2=326.129958932749 V3=0 T=0 M2=0 M3=-320.993544044255 S11Max=1765.21073384435 PtS11Max=3 x2S11Max=0.5
 x3S11Max=-0.5
 S11Min=-2016.25012311387 PtS11Min=1 x2S11Min=-0.5 x3S11Min=-0.5 FrameElem=42 ElemStation=0.375
 Frame=42 Station=0.5 OutputCase=ENVE CaseType=Combination StepType=Min P=-122.976319142087
 V2=329.254958932749 V3=0 T=0 M2=0 M3=-361.955101410848 S11Max=2011.02127936873 PtS11Max=3 x2S11Max=0.5
 x3S11Max=-0.5
 S11Min=-2262.01946731343 PtS11Min=1 x2S11Min=-0.5 x3S11Min=-0.5 FrameElem=42 ElemStation=0.5
 Frame=42 Station=0 OutputCase=FESSUR CaseType=Combination P=-122.976319142087 V2=316.809894032503
 V3=0 T=0 M2=0 M3=-194.136319402218 S11Max=1041.84159727122 PtS11Max=3 x2S11Max=0.5 x3S11Max=-0.5
 S11Min=-1287.7942355554 PtS11Min=1 x2S11Min=-0.5 x3S11Min=-0.5 FrameElem=42 ElemStation=0
 Frame=42 Station=0.125 OutputCase=FESSUR CaseType=Combination P=-122.976319142087 V2=319.934894032503
 V3=0 T=0 M2=0 M3=-233.932868656281 S11Max=1280.6208927956 PtS11Max=3 x2S11Max=0.5 x3S11Max=-0.5
 S11Min=-1526.57353107977 PtS11Min=1 x2S11Min=-0.5 x3S11Min=-0.5 FrameElem=42 ElemStation=0.125
 Frame=42 Station=0.25 OutputCase=FESSUR CaseType=Combination P=-122.976319142087 V2=323.059894032503
 V3=0 T=0 M2=0 M3=-274.120042910344 S11Max=1521.74393831998 PtS11Max=3 x2S11Max=0.5 x3S11Max=-0.5
 S11Min=-1767.69657660415 PtS11Min=1 x2S11Min=-0.5 x3S11Min=-0.5 FrameElem=42 ElemStation=0.25
 Frame=42 Station=0.375 OutputCase=FESSUR CaseType=Combination P=-122.976319142087 V2=326.184894032503
 V3=0 T=0 M2=0 M3=-314.697842164407 S11Max=1765.21073384435 PtS11Max=3 x2S11Max=0.5 x3S11Max=-0.5
 S11Min=-2011.16337212853 PtS11Min=1 x2S11Min=-0.5 x3S11Min=-0.5 FrameElem=42 ElemStation=0.375
 Frame=42 Station=0.5 OutputCase=FESSUR CaseType=Combination P=-122.976319142087 V2=329.309894032503
 V3=0 T=0 M2=0 M3=-355.66626641847 S11Max=2011.02127936873 PtS11Max=3 x2S11Max=0.5 x3S11Max=-0.5
 S11Min=-2256.9739176529 PtS11Min=1 x2S11Min=-0.5 x3S11Min=-0.5 FrameElem=42 ElemStation=0.5
 Frame=43 Station=0 OutputCase=PESOPR CaseType=LinStatic P=-15.1709467362365 V2=41.7994156913774 V3=0
 T=0 M2=0 M3=-87.7825783073786 S11Max=511.524523108035 PtS11Max=3 x2S11Max=0.5 x3S11Max=-0.5
 S11Min=-541.866416580508 PtS11Min=1 x2S11Min=-0.5 x3S11Min=-0.5 FrameElem=43 ElemStation=0
 Frame=43 Station=0.125 OutputCase=PESOPR CaseType=LinStatic P=-15.1709467362365 V2=44.9244156913774
 V3=0 T=0 M2=0 M3=-93.2028177688007 S11Max=544.045959876568 PtS11Max=3 x2S11Max=0.5 x3S11Max=-0.5
 S11Min=-574.387853349041 PtS11Min=1 x2S11Min=-0.5 x3S11Min=-0.5 FrameElem=43 ElemStation=0.125
 Frame=43 Station=0.25 OutputCase=PESOPR CaseType=LinStatic P=-15.1709467362365 V2=48.0494156913774
 V3=0 T=0 M2=0 M3=-99.0136822302229 S11Max=578.911146645101 PtS11Max=3 x2S11Max=0.5 x3S11Max=-0.5
 S11Min=-609.253040117574 PtS11Min=1 x2S11Min=-0.5 x3S11Min=-0.5 FrameElem=43 ElemStation=0.25
 Frame=43 Station=0.375 OutputCase=PESOPR CaseType=LinStatic P=-15.1709467362365 V2=51.1744156913774
 V3=0 T=0 M2=0 M3=-105.215171691645 S11Max=616.120083413634 PtS11Max=3 x2S11Max=0.5 x3S11Max=-0.5
 S11Min=-646.461976886107 PtS11Min=1 x2S11Min=-0.5 x3S11Min=-0.5 FrameElem=43 ElemStation=0.375
 Frame=43 Station=0.5 OutputCase=PESOPR CaseType=LinStatic P=-15.1709467362365 V2=54.2994156913774
 V3=0 T=0 M2=0 M3=-111.807286153067 S11Max=655.672770182167 PtS11Max=3 x2S11Max=0.5 x3S11Max=-0.5
 S11Min=-686.01466365464 PtS11Min=1 x2S11Min=-0.5 x3S11Min=-0.5 FrameElem=43 ElemStation=0.5
 Frame=43 Station=0 OutputCase=TERRVERT CaseType=LinStatic P=1.15282857329472 V2=145.098916279443 V3=0
 T=0 M2=0 M3=-288.846471419005 S11Max=1734.23165708732 PtS11Max=3 x2S11Max=0.5 x3S11Max=-0.5
 S11Min=-1731.92599994073 PtS11Min=1 x2S11Min=-0.5 x3S11Min=-0.5 FrameElem=43 ElemStation=0
 Frame=43 Station=0.125 OutputCase=TERRVERT CaseType=LinStatic P=1.15282857329472 V2=145.098916279443
 V3=0 T=0 M2=0 M3=-306.983835953935 S11Max=1843.05584429691 PtS11Max=3 x2S11Max=0.5 x3S11Max=-0.5
 S11Min=-1840.75018715032 PtS11Min=1 x2S11Min=-0.5 x3S11Min=-0.5 FrameElem=43 ElemStation=0.125
 Frame=43 Station=0.25 OutputCase=TERRVERT CaseType=LinStatic P=1.15282857329472 V2=145.098916279443
 V3=0 T=0 M2=0 M3=-325.121200488866 S11Max=1951.88003150649 PtS11Max=3 x2S11Max=0.5 x3S11Max=-0.5
 S11Min=-1949.5743743599 PtS11Min=1 x2S11Min=-0.5 x3S11Min=-0.5 FrameElem=43 ElemStation=0.25
 Frame=43 Station=0.375 OutputCase=TERRVERT CaseType=LinStatic P=1.15282857329472 V2=145.098916279443
 V3=0 T=0 M2=0 M3=-343.258565023796 S11Max=2060.70421871607 PtS11Max=3 x2S11Max=0.5 x3S11Max=-0.5
 S11Min=-2058.39856156948 PtS11Min=1 x2S11Min=-0.5 x3S11Min=-0.5 FrameElem=43 ElemStation=0.375
 Frame=43 Station=0.5 OutputCase=TERRVERT CaseType=LinStatic P=1.15282857329472 V2=145.098916279443
 V3=0 T=0 M2=0 M3=-361.395929558726 S11Max=2169.52840592565 PtS11Max=3 x2S11Max=0.5 x3S11Max=-0.5
 S11Min=-2167.22274877906 PtS11Min=1 x2S11Min=-0.5 x3S11Min=-0.5 FrameElem=43 ElemStation=0.5



```

Frame=43 Station=0 OutputCase=TERRLAT CaseType=LinStatic P=-108.958200979145 V2=0.13243040163448 V3=0
T=0 M2=0 M3=20.9627833079285 S11Max=16.8184988684264 PtS11Max=1 x2S11Max=-0.5 x3S11Max=-0.5 _
S11Min=-234.734900826716 PtS11Min=3 x2S11Min=0.5 x3S11Min=-0.5 FrameElem=43 ElemStation=0
Frame=43 Station=0.125 OutputCase=TERRLAT CaseType=LinStatic P=-108.958200979145 V2=0.13243040163448
V3=0 T=0 M2=0 M3=20.9462295077242 S11Max=16.7191760672006 PtS11Max=1 x2S11Max=-0.5 x3S11Max=-0.5 _
S11Min=-234.63557802549 PtS11Min=3 x2S11Min=0.5 x3S11Min=-0.5 FrameElem=43 ElemStation=0.125
Frame=43 Station=0.25 OutputCase=TERRLAT CaseType=LinStatic P=-108.958200979145 V2=0.13243040163448
V3=0 T=0 M2=0 M3=20.9296757075199 S11Max=16.6198532659747 PtS11Max=1 x2S11Max=-0.5 x3S11Max=-0.5 _
S11Min=-234.536255224264 PtS11Min=3 x2S11Min=0.5 x3S11Min=-0.5 FrameElem=43 ElemStation=0.25
Frame=43 Station=0.375 OutputCase=TERRLAT CaseType=LinStatic P=-108.958200979145 V2=0.13243040163448
V3=0 T=0 M2=0 M3=20.9131219073156 S11Max=16.5205304647488 PtS11Max=1 x2S11Max=-0.5 x3S11Max=-0.5 _
S11Min=-234.436932423038 PtS11Min=3 x2S11Min=0.5 x3S11Min=-0.5 FrameElem=43 ElemStation=0.375
Frame=43 Station=0.5 OutputCase=TERRLAT CaseType=LinStatic P=-108.958200979145 V2=0.13243040163448
V3=0 T=0 M2=0 M3=20.8965681071113 S11Max=16.421207663523 PtS11Max=1 x2S11Max=-0.5 x3S11Max=-0.5 _
S11Min=-234.337609621812 PtS11Min=3 x2S11Min=0.5 x3S11Min=-0.5 FrameElem=43 ElemStation=0.5
Frame=43 Station=0 OutputCase=ACCLATDX CaseType=LinStatic P=0 V2=0 V3=0 T=0 M2=0 M3=0
S11Max=0 PtS11Max=0 x2S11Max=0 x3S11Max=0 S11Min=0 PtS11Min=0 x2S11Min=0 x3S11Min=0 FrameElem=43
ElemStation=0
Frame=43 Station=0.125 OutputCase=ACCLATDX CaseType=LinStatic P=0 V2=0 V3=0 T=0 M2=0 M3=0
S11Max=0 PtS11Max=0 x2S11Max=0 x3S11Max=0 S11Min=0 PtS11Min=0 x2S11Min=0 x3S11Min=0 FrameElem=43
ElemStation=0.125
Frame=43 Station=0.25 OutputCase=ACCLATDX CaseType=LinStatic P=0 V2=0 V3=0 T=0 M2=0 M3=0
S11Max=0 PtS11Max=0 x2S11Max=0 x3S11Max=0 S11Min=0 PtS11Min=0 x2S11Min=0 x3S11Min=0 FrameElem=43
ElemStation=0.25
Frame=43 Station=0.375 OutputCase=ACCLATDX CaseType=LinStatic P=0 V2=0 V3=0 T=0 M2=0 M3=0
S11Max=0 PtS11Max=0 x2S11Max=0 x3S11Max=0 S11Min=0 PtS11Min=0 x2S11Min=0 x3S11Min=0 FrameElem=43
ElemStation=0.375
Frame=43 Station=0.5 OutputCase=ACCLATDX CaseType=LinStatic P=0 V2=0 V3=0 T=0 M2=0 M3=0
S11Max=0 PtS11Max=0 x2S11Max=0 x3S11Max=0 S11Min=0 PtS11Min=0 x2S11Min=0 x3S11Min=0 FrameElem=43
ElemStation=0.5
Frame=43 Station=0 OutputCase=ACCLATSX CaseType=LinStatic P=0 V2=0 V3=0 T=0 M2=0 M3=0
S11Max=0 PtS11Max=0 x2S11Max=0 x3S11Max=0 S11Min=0 PtS11Min=0 x2S11Min=0 x3S11Min=0 FrameElem=43
ElemStation=0
Frame=43 Station=0.125 OutputCase=ACCLATSX CaseType=LinStatic P=0 V2=0 V3=0 T=0 M2=0 M3=0
S11Max=0 PtS11Max=0 x2S11Max=0 x3S11Max=0 S11Min=0 PtS11Min=0 x2S11Min=0 x3S11Min=0 FrameElem=43
ElemStation=0.125
Frame=43 Station=0.25 OutputCase=ACCLATSX CaseType=LinStatic P=0 V2=0 V3=0 T=0 M2=0 M3=0
S11Max=0 PtS11Max=0 x2S11Max=0 x3S11Max=0 S11Min=0 PtS11Min=0 x2S11Min=0 x3S11Min=0 FrameElem=43
ElemStation=0.25
Frame=43 Station=0.375 OutputCase=ACCLATSX CaseType=LinStatic P=0 V2=0 V3=0 T=0 M2=0 M3=0
S11Max=0 PtS11Max=0 x2S11Max=0 x3S11Max=0 S11Min=0 PtS11Min=0 x2S11Min=0 x3S11Min=0 FrameElem=43
ElemStation=0.375
Frame=43 Station=0.5 OutputCase=ACCLATSX CaseType=LinStatic P=0 V2=0 V3=0 T=0 M2=0 M3=0
S11Max=0 PtS11Max=0 x2S11Max=0 x3S11Max=0 S11Min=0 PtS11Min=0 x2S11Min=0 x3S11Min=0 FrameElem=43
ElemStation=0.5
Frame=43 Station=0 OutputCase=TERRCOST CaseType=LinStatic P=0 V2=0 V3=0 T=0 M2=0 M3=0
S11Max=0 PtS11Max=0 x2S11Max=0 x3S11Max=0 S11Min=0 PtS11Min=0 x2S11Min=0 x3S11Min=0 FrameElem=43
ElemStation=0
Frame=43 Station=0.125 OutputCase=TERRCOST CaseType=LinStatic P=0 V2=0 V3=0 T=0 M2=0 M3=0
S11Max=0 PtS11Max=0 x2S11Max=0 x3S11Max=0 S11Min=0 PtS11Min=0 x2S11Min=0 x3S11Min=0 FrameElem=43
ElemStation=0.125
Frame=43 Station=0.25 OutputCase=TERRCOST CaseType=LinStatic P=0 V2=0 V3=0 T=0 M2=0 M3=0
S11Max=0 PtS11Max=0 x2S11Max=0 x3S11Max=0 S11Min=0 PtS11Min=0 x2S11Min=0 x3S11Min=0 FrameElem=43
ElemStation=0.25
Frame=43 Station=0.375 OutputCase=TERRCOST CaseType=LinStatic P=0 V2=0 V3=0 T=0 M2=0 M3=0
S11Max=0 PtS11Max=0 x2S11Max=0 x3S11Max=0 S11Min=0 PtS11Min=0 x2S11Min=0 x3S11Min=0 FrameElem=43
ElemStation=0.375
Frame=43 Station=0.5 OutputCase=TERRCOST CaseType=LinStatic P=0 V2=0 V3=0 T=0 M2=0 M3=0
S11Max=0 PtS11Max=0 x2S11Max=0 x3S11Max=0 S11Min=0 PtS11Min=0 x2S11Min=0 x3S11Min=0 FrameElem=43
ElemStation=0.5
Frame=43 Station=0 OutputCase=SOVRCOST CaseType=LinStatic P=0 V2=0 V3=0 T=0 M2=0 M3=0
S11Max=0 PtS11Max=0 x2S11Max=0 x3S11Max=0 S11Min=0 PtS11Min=0 x2S11Min=0 x3S11Min=0 FrameElem=43
ElemStation=0
Frame=43 Station=0.125 OutputCase=SOVRCOST CaseType=LinStatic P=0 V2=0 V3=0 T=0 M2=0 M3=0
S11Max=0 PtS11Max=0 x2S11Max=0 x3S11Max=0 S11Min=0 PtS11Min=0 x2S11Min=0 x3S11Min=0 FrameElem=43
ElemStation=0.125
Frame=43 Station=0.25 OutputCase=SOVRCOST CaseType=LinStatic P=0 V2=0 V3=0 T=0 M2=0 M3=0
S11Max=0 PtS11Max=0 x2S11Max=0 x3S11Max=0 S11Min=0 PtS11Min=0 x2S11Min=0 x3S11Min=0 FrameElem=43
ElemStation=0.25
Frame=43 Station=0.375 OutputCase=SOVRCOST CaseType=LinStatic P=0 V2=0 V3=0 T=0 M2=0 M3=0
S11Max=0 PtS11Max=0 x2S11Max=0 x3S11Max=0 S11Min=0 PtS11Min=0 x2S11Min=0 x3S11Min=0 FrameElem=43
ElemStation=0.375
Frame=43 Station=0.5 OutputCase=SOVRCOST CaseType=LinStatic P=0 V2=0 V3=0 T=0 M2=0 M3=0
S11Max=0 PtS11Max=0 x2S11Max=0 x3S11Max=0 S11Min=0 PtS11Min=0 x2S11Min=0 x3S11Min=0 FrameElem=43
ElemStation=0.5
Frame=43 Station=0 OutputCase=ENVE CaseType=Combination StepType=Max P=-90.2888588483431
V2=187.030762372455 V3=0 T=0 M2=0 M3=-355.666266418455 S11Max=2081.44174961666 PtS11Max=3 x2S11Max=0.5
x3S11Max=-0.5 _
S11Min=-2256.97391765282 PtS11Min=1 x2S11Min=-0.5 x3S11Min=-0.5 FrameElem=43 ElemStation=0
Frame=43 Station=0.125 OutputCase=ENVE CaseType=Combination StepType=Max P=-90.2888588483431
V2=190.155762372455 V3=0 T=0 M2=0 M3=-379.240424215012 S11Max=2222.85689955563 PtS11Max=3 x2S11Max=0.5
x3S11Max=-0.5 _

```



S11Min=-2398.41886443216 PtS11Min=1 x2S11Min=-0.5 x3S11Min=-0.5 FrameElem=43 ElemStation=0.125
 Frame=43 Station=0.25 OutputCase=ENVE CaseType=Combination StepType=Max P=-90.2888588483431
 V2=193.280762372455 V3=0 T=0 M2=0 M3=-403.205207011569 S11Max=2366.61579949461 PtS11Max=3 x2S11Max=0.5
 x3S11Max=-0.5 _
 S11Min=-2542.2075612115 PtS11Min=1 x2S11Min=-0.5 x3S11Min=-0.5 FrameElem=43 ElemStation=0.25
 Frame=43 Station=0.375 OutputCase=ENVE CaseType=Combination StepType=Max P=-90.2888588483431
 V2=196.405762372455 V3=0 T=0 M2=0 M3=-427.560614808126 S11Max=2512.71844943358 PtS11Max=3 x2S11Max=0.5
 x3S11Max=-0.5 _
 S11Min=-2688.34000799084 PtS11Min=1 x2S11Min=-0.5 x3S11Min=-0.5 FrameElem=43 ElemStation=0.375
 Frame=43 Station=0.5 OutputCase=ENVE CaseType=Combination StepType=Max P=-90.2888588483431
 V2=199.530762372455 V3=0 T=0 M2=0 M3=-452.306647604682 S11Max=2661.16484937255 PtS11Max=3 x2S11Max=0.5
 x3S11Max=-0.5 _
 S11Min=-2836.81620477018 PtS11Min=1 x2S11Min=-0.5 x3S11Min=-0.5 FrameElem=43 ElemStation=0.5
 Frame=43 Station=0 OutputCase=ENVE CaseType=Combination StepType=Min P=-122.976319142087
 V2=186.991033251965 V3=0 T=0 M2=0 M3=-361.955101410834 S11Max=2011.02127936864 PtS11Max=3 x2S11Max=0.5
 x3S11Max=-0.5 _
 S11Min=-2262.01946731334 PtS11Min=1 x2S11Min=-0.5 x3S11Min=-0.5 FrameElem=43 ElemStation=0
 Frame=43 Station=0.125 OutputCase=ENVE CaseType=Combination StepType=Min P=-122.976319142087
 V2=190.116033251965 V3=0 T=0 M2=0 M3=-385.524293067329 S11Max=2152.46622614798 PtS11Max=3 x2S11Max=0.5
 x3S11Max=-0.5 _
 S11Min=-2403.43461725232 PtS11Min=1 x2S11Min=-0.5 x3S11Min=-0.5 FrameElem=43 ElemStation=0.125
 Frame=43 Station=0.25 OutputCase=ENVE CaseType=Combination StepType=Min P=-122.976319142087
 V2=193.241033251965 V3=0 T=0 M2=0 M3=-409.484109723825 S11Max=2296.25492292733 PtS11Max=3 x2S11Max=0.5
 x3S11Max=-0.5 _
 S11Min=-2547.19351719129 PtS11Min=1 x2S11Min=-0.5 x3S11Min=-0.5 FrameElem=43 ElemStation=0.25
 Frame=43 Station=0.375 OutputCase=ENVE CaseType=Combination StepType=Min P=-122.976319142087
 V2=196.366033251965 V3=0 T=0 M2=0 M3=-433.83455138032 S11Max=2442.38736970667 PtS11Max=3 x2S11Max=0.5
 x3S11Max=-0.5 _
 S11Min=-2693.29616713026 PtS11Min=1 x2S11Min=-0.5 x3S11Min=-0.5 FrameElem=43 ElemStation=0.375
 Frame=43 Station=0.5 OutputCase=ENVE CaseType=Combination StepType=Min P=-122.976319142087
 V2=199.491033251965 V3=0 T=0 M2=0 M3=-458.575618036816 S11Max=2590.86356648601 PtS11Max=3 x2S11Max=0.5
 x3S11Max=-0.5 _
 S11Min=-2841.74256706924 PtS11Min=1 x2S11Min=-0.5 x3S11Min=-0.5 FrameElem=43 ElemStation=0.5
 Frame=43 Station=0 OutputCase=FESSUR CaseType=Combination P=-122.976319142087 V2=187.030762372455
 V3=0 T=0 M2=0 M3=-355.666266418455 S11Max=2011.02127936864 PtS11Max=3 x2S11Max=0.5 x3S11Max=-0.5 _
 S11Min=-2256.97391765282 PtS11Min=1 x2S11Min=-0.5 x3S11Min=-0.5 FrameElem=43 ElemStation=0
 Frame=43 Station=0.125 OutputCase=FESSUR CaseType=Combination P=-122.976319142087 V2=190.155762372455
 V3=0 T=0 M2=0 M3=-379.240424215012 S11Max=2152.46622614798 PtS11Max=3 x2S11Max=0.5 x3S11Max=-0.5 _
 S11Min=-2398.41886443216 PtS11Min=1 x2S11Min=-0.5 x3S11Min=-0.5 FrameElem=43 ElemStation=0.125
 Frame=43 Station=0.25 OutputCase=FESSUR CaseType=Combination P=-122.976319142087 V2=193.280762372455
 V3=0 T=0 M2=0 M3=-403.205207011569 S11Max=2296.25492292733 PtS11Max=3 x2S11Max=0.5 x3S11Max=-0.5 _
 S11Min=-2542.2075612115 PtS11Min=1 x2S11Min=-0.5 x3S11Min=-0.5 FrameElem=43 ElemStation=0.25
 Frame=43 Station=0.375 OutputCase=FESSUR CaseType=Combination P=-122.976319142087 V2=196.405762372455
 V3=0 T=0 M2=0 M3=-427.560614808126 S11Max=2442.38736970667 PtS11Max=3 x2S11Max=0.5 x3S11Max=-0.5 _
 S11Min=-2688.34000799084 PtS11Min=1 x2S11Min=-0.5 x3S11Min=-0.5 FrameElem=43 ElemStation=0.375
 Frame=43 Station=0.5 OutputCase=FESSUR CaseType=Combination P=-122.976319142087 V2=199.530762372455
 V3=0 T=0 M2=0 M3=-452.306647604682 S11Max=2590.86356648601 PtS11Max=3 x2S11Max=0.5 x3S11Max=-0.5 _
 S11Min=-2836.81620477018 PtS11Min=1 x2S11Min=-0.5 x3S11Min=-0.5 FrameElem=43 ElemStation=0.5
 Frame=44 Station=0 OutputCase=PESOPR CaseType=LinStatic P=-15.1709467362365 V2=9.74279215224669 V3=0
 T=0 M2=0 M3=-111.807286153078 S11Max=655.672770182232 PtS11Max=3 x2S11Max=0.5 x3S11Max=-0.5 _
 S11Min=-686.014663654706 PtS11Min=1 x2S11Min=-0.5 x3S11Min=-0.5 FrameElem=44 ElemStation=0
 Frame=44 Station=0.125 OutputCase=PESOPR CaseType=LinStatic P=-15.1709467362365 V2=12.8677921522467
 V3=0 T=0 M2=0 M3=-113.220447672109 S11Max=664.151739296417 PtS11Max=3 x2S11Max=0.5 x3S11Max=-0.5 _
 S11Min=-694.493632768891 PtS11Min=1 x2S11Min=-0.5 x3S11Min=-0.5 FrameElem=44 ElemStation=0.125
 Frame=44 Station=0.25 OutputCase=PESOPR CaseType=LinStatic P=-15.1709467362365 V2=15.9927921522467
 V3=0 T=0 M2=0 M3=-115.02423419114 S11Max=674.974458410602 PtS11Max=3 x2S11Max=0.5 x3S11Max=-0.5 _
 S11Min=-705.316351883076 PtS11Min=1 x2S11Min=-0.5 x3S11Min=-0.5 FrameElem=44 ElemStation=0.25
 Frame=44 Station=0.375 OutputCase=PESOPR CaseType=LinStatic P=-15.1709467362365 V2=19.1177921522467
 V3=0 T=0 M2=0 M3=-117.218645710171 S11Max=688.140927524787 PtS11Max=3 x2S11Max=0.5 x3S11Max=-0.5 _
 S11Min=-718.482820997261 PtS11Min=1 x2S11Min=-0.5 x3S11Min=-0.5 FrameElem=44 ElemStation=0.375
 Frame=44 Station=0.5 OutputCase=PESOPR CaseType=LinStatic P=-15.1709467362365 V2=22.2427921522467
 V3=0 T=0 M2=0 M3=-119.803682229202 S11Max=703.651146638972 PtS11Max=3 x2S11Max=0.5 x3S11Max=-0.5 _
 S11Min=-733.993040111446 PtS11Min=1 x2S11Min=-0.5 x3S11Min=-0.5 FrameElem=44 ElemStation=0.5
 Frame=44 Station=0 OutputCase=TERRVERT CaseType=LinStatic P=1.15282857329472 V2=48.2902309365163 V3=0
 T=0 M2=0 M3=-361.395929558726 S11Max=2169.52840592565 PtS11Max=3 x2S11Max=0.5 x3S11Max=-0.5 _
 S11Min=-2167.22274877906 PtS11Min=1 x2S11Min=-0.5 x3S11Min=-0.5 FrameElem=44 ElemStation=0
 Frame=44 Station=0.125 OutputCase=TERRVERT CaseType=LinStatic P=1.15282857329472 V2=48.2902309365163
 V3=0 T=0 M2=0 M3=-367.432208425791 S11Max=2205.74607912804 PtS11Max=3 x2S11Max=0.5 x3S11Max=-0.5 _
 S11Min=-2203.44042198145 PtS11Min=1 x2S11Min=-0.5 x3S11Min=-0.5 FrameElem=44 ElemStation=0.125
 Frame=44 Station=0.25 OutputCase=TERRVERT CaseType=LinStatic P=1.15282857329472 V2=48.2902309365163
 V3=0 T=0 M2=0 M3=-373.468487292856 S11Max=2241.96375233043 PtS11Max=3 x2S11Max=0.5 x3S11Max=-0.5 _
 S11Min=-2239.65809518384 PtS11Min=1 x2S11Min=-0.5 x3S11Min=-0.5 FrameElem=44 ElemStation=0.25
 Frame=44 Station=0.375 OutputCase=TERRVERT CaseType=LinStatic P=1.15282857329472 V2=48.2902309365163
 V3=0 T=0 M2=0 M3=-379.50476615992 S11Max=2278.18142553282 PtS11Max=3 x2S11Max=0.5 x3S11Max=-0.5 _
 S11Min=-2275.87576838623 PtS11Min=1 x2S11Min=-0.5 x3S11Min=-0.5 FrameElem=44 ElemStation=0.375
 Frame=44 Station=0.5 OutputCase=TERRVERT CaseType=LinStatic P=1.15282857329472 V2=48.2902309365163
 V3=0 T=0 M2=0 M3=-385.541045026985 S11Max=2314.3990987352 PtS11Max=3 x2S11Max=0.5 x3S11Max=-0.5 _
 S11Min=-2312.09344158861 PtS11Min=1 x2S11Min=-0.5 x3S11Min=-0.5 FrameElem=44 ElemStation=0.5
 Frame=44 Station=0 OutputCase=TERRLAT CaseType=LinStatic P=-108.958200979145 V2=4.79007939137261E-02
 V3=0 T=0 M2=0 M3=20.8965681071113 S11Max=16.4212076635229 PtS11Max=1 x2S11Max=-0.5 x3S11Max=-0.5 _
 S11Min=-234.337609621812 PtS11Min=3 x2S11Min=0.5 x3S11Min=-0.5 FrameElem=44 ElemStation=0



Frame=44 Station=0.125 OutputCase=TERRLAT CaseType=LinStatic P=-108.958200979145 V2=4.79007939137261E-02 V3=0 T=0 M2=0 M3=20.8905805078721 S11Max=16.3852820680876 PtS11Max=1 x2S11Max=-0.5 x3S11Max=-0.5
 S11Min=-234.301684026377 PtS11Min=3 x2S11Min=0.5 x3S11Min=-0.5 FrameElem=44 ElemStation=0.125
 Frame=44 Station=0.25 OutputCase=TERRLAT CaseType=LinStatic P=-108.958200979145 V2=4.79007939137261E-02 V3=0 T=0 M2=0 M3=20.8845929086328 S11Max=16.3493564726523 PtS11Max=1 x2S11Max=-0.5 x3S11Max=-0.5 S11Min=-234.265758430942 PtS11Min=3 x2S11Min=0.5 x3S11Min=-0.5 FrameElem=44 ElemStation=0.25
 Frame=44 Station=0.375 OutputCase=TERRLAT CaseType=LinStatic P=-108.958200979145 V2=4.79007939137261E-02 V3=0 T=0 M2=0 M3=20.8786053093936 S11Max=16.313430877217 PtS11Max=1 x2S11Max=-0.5 x3S11Max=-0.5 S11Min=-234.229832835507 PtS11Min=3 x2S11Min=0.5 x3S11Min=-0.5 FrameElem=44 ElemStation=0.375
 Frame=44 Station=0.5 OutputCase=TERRLAT CaseType=LinStatic P=-108.958200979145 V2=4.79007939137261E-02 V3=0 T=0 M2=0 M3=20.8726177101544 S11Max=16.2775052817817 PtS11Max=1 x2S11Max=-0.5 x3S11Max=-0.5 S11Min=-234.193907240071 PtS11Min=3 x2S11Min=0.5 x3S11Min=-0.5 FrameElem=44 ElemStation=0.5
 Frame=44 Station=0 OutputCase=ACCLATDX CaseType=LinStatic P=0 V2=0 V3=0 T=0 M2=0 M3=0 S11Max=0 PtS11Max=0 x2S11Max=0 x3S11Max=0 S11Min=0 PtS11Min=0 x2S11Min=0 x3S11Min=0 FrameElem=44 ElemStation=0
 Frame=44 Station=0.125 OutputCase=ACCLATDX CaseType=LinStatic P=0 V2=0 V3=0 T=0 M2=0 M3=0 S11Max=0 PtS11Max=0 x2S11Max=0 x3S11Max=0 S11Min=0 PtS11Min=0 x2S11Min=0 x3S11Min=0 FrameElem=44 ElemStation=0.125
 Frame=44 Station=0.25 OutputCase=ACCLATDX CaseType=LinStatic P=0 V2=0 V3=0 T=0 M2=0 M3=0 S11Max=0 PtS11Max=0 x2S11Max=0 x3S11Max=0 S11Min=0 PtS11Min=0 x2S11Min=0 x3S11Min=0 FrameElem=44 ElemStation=0.25
 Frame=44 Station=0.375 OutputCase=ACCLATDX CaseType=LinStatic P=0 V2=0 V3=0 T=0 M2=0 M3=0 S11Max=0 PtS11Max=0 x2S11Max=0 x3S11Max=0 S11Min=0 PtS11Min=0 x2S11Min=0 x3S11Min=0 FrameElem=44 ElemStation=0.375
 Frame=44 Station=0.5 OutputCase=ACCLATDX CaseType=LinStatic P=0 V2=0 V3=0 T=0 M2=0 M3=0 S11Max=0 PtS11Max=0 x2S11Max=0 x3S11Max=0 S11Min=0 PtS11Min=0 x2S11Min=0 x3S11Min=0 FrameElem=44 ElemStation=0.5
 Frame=44 Station=0 OutputCase=ACCLATSX CaseType=LinStatic P=0 V2=0 V3=0 T=0 M2=0 M3=0 S11Max=0 PtS11Max=0 x2S11Max=0 x3S11Max=0 S11Min=0 PtS11Min=0 x2S11Min=0 x3S11Min=0 FrameElem=44 ElemStation=0
 Frame=44 Station=0.125 OutputCase=ACCLATSX CaseType=LinStatic P=0 V2=0 V3=0 T=0 M2=0 M3=0 S11Max=0 PtS11Max=0 x2S11Max=0 x3S11Max=0 S11Min=0 PtS11Min=0 x2S11Min=0 x3S11Min=0 FrameElem=44 ElemStation=0.125
 Frame=44 Station=0.25 OutputCase=ACCLATSX CaseType=LinStatic P=0 V2=0 V3=0 T=0 M2=0 M3=0 S11Max=0 PtS11Max=0 x2S11Max=0 x3S11Max=0 S11Min=0 PtS11Min=0 x2S11Min=0 x3S11Min=0 FrameElem=44 ElemStation=0.25
 Frame=44 Station=0.375 OutputCase=ACCLATSX CaseType=LinStatic P=0 V2=0 V3=0 T=0 M2=0 M3=0 S11Max=0 PtS11Max=0 x2S11Max=0 x3S11Max=0 S11Min=0 PtS11Min=0 x2S11Min=0 x3S11Min=0 FrameElem=44 ElemStation=0.375
 Frame=44 Station=0.5 OutputCase=ACCLATSX CaseType=LinStatic P=0 V2=0 V3=0 T=0 M2=0 M3=0 S11Max=0 PtS11Max=0 x2S11Max=0 x3S11Max=0 S11Min=0 PtS11Min=0 x2S11Min=0 x3S11Min=0 FrameElem=44 ElemStation=0.5
 Frame=44 Station=0 OutputCase=TERRCOST CaseType=LinStatic P=0 V2=0 V3=0 T=0 M2=0 M3=0 S11Max=0 PtS11Max=0 x2S11Max=0 x3S11Max=0 S11Min=0 PtS11Min=0 x2S11Min=0 x3S11Min=0 FrameElem=44 ElemStation=0
 Frame=44 Station=0.125 OutputCase=TERRCOST CaseType=LinStatic P=0 V2=0 V3=0 T=0 M2=0 M3=0 S11Max=0 PtS11Max=0 x2S11Max=0 x3S11Max=0 S11Min=0 PtS11Min=0 x2S11Min=0 x3S11Min=0 FrameElem=44 ElemStation=0.125
 Frame=44 Station=0.25 OutputCase=TERRCOST CaseType=LinStatic P=0 V2=0 V3=0 T=0 M2=0 M3=0 S11Max=0 PtS11Max=0 x2S11Max=0 x3S11Max=0 S11Min=0 PtS11Min=0 x2S11Min=0 x3S11Min=0 FrameElem=44 ElemStation=0.25
 Frame=44 Station=0.375 OutputCase=TERRCOST CaseType=LinStatic P=0 V2=0 V3=0 T=0 M2=0 M3=0 S11Max=0 PtS11Max=0 x2S11Max=0 x3S11Max=0 S11Min=0 PtS11Min=0 x2S11Min=0 x3S11Min=0 FrameElem=44 ElemStation=0.375
 Frame=44 Station=0.5 OutputCase=TERRCOST CaseType=LinStatic P=0 V2=0 V3=0 T=0 M2=0 M3=0 S11Max=0 PtS11Max=0 x2S11Max=0 x3S11Max=0 S11Min=0 PtS11Min=0 x2S11Min=0 x3S11Min=0 FrameElem=44 ElemStation=0.5
 Frame=44 Station=0 OutputCase=SOVRCOST CaseType=LinStatic P=0 V2=0 V3=0 T=0 M2=0 M3=0 S11Max=0 PtS11Max=0 x2S11Max=0 x3S11Max=0 S11Min=0 PtS11Min=0 x2S11Min=0 x3S11Min=0 FrameElem=44 ElemStation=0
 Frame=44 Station=0.125 OutputCase=SOVRCOST CaseType=LinStatic P=0 V2=0 V3=0 T=0 M2=0 M3=0 S11Max=0 PtS11Max=0 x2S11Max=0 x3S11Max=0 S11Min=0 PtS11Min=0 x2S11Min=0 x3S11Min=0 FrameElem=44 ElemStation=0.125
 Frame=44 Station=0.25 OutputCase=SOVRCOST CaseType=LinStatic P=0 V2=0 V3=0 T=0 M2=0 M3=0 S11Max=0 PtS11Max=0 x2S11Max=0 x3S11Max=0 S11Min=0 PtS11Min=0 x2S11Min=0 x3S11Min=0 FrameElem=44 ElemStation=0.25
 Frame=44 Station=0.375 OutputCase=SOVRCOST CaseType=LinStatic P=0 V2=0 V3=0 T=0 M2=0 M3=0 S11Max=0 PtS11Max=0 x2S11Max=0 x3S11Max=0 S11Min=0 PtS11Min=0 x2S11Min=0 x3S11Min=0 FrameElem=44 ElemStation=0.375
 Frame=44 Station=0.5 OutputCase=SOVRCOST CaseType=LinStatic P=0 V2=0 V3=0 T=0 M2=0 M3=0 S11Max=0 PtS11Max=0 x2S11Max=0 x3S11Max=0 S11Min=0 PtS11Min=0 x2S11Min=0 x3S11Min=0 FrameElem=44 ElemStation=0.5
 Frame=44 Station=0 OutputCase=ENVE CaseType=Combination StepType=Max P=-90.2888588483432 V2=58.0809238826767 V3=0 T=0 M2=0 M3=-452.306647604693 S11Max=2661.16484937262 PtS11Max=3 x2S11Max=0.5 x3S11Max=-0.5 S11Min=-2836.81620477025 PtS11Min=1 x2S11Min=-0.5 x3S11Min=-0.5 FrameElem=44 ElemStation=0
 Frame=44 Station=0.125 OutputCase=ENVE CaseType=Combination StepType=Max P=-90.2888588483432 V2=61.2059238826767 V3=0 T=0 M2=0 M3=-459.762075590028 S11Max=2705.88663960599 PtS11Max=3 x2S11Max=0.5 x3S11Max=-0.5 S11Min=-2881.54877268225 PtS11Min=1 x2S11Min=-0.5 x3S11Min=-0.5 FrameElem=44 ElemStation=0.125



Frame=44 Station=0.25 OutputCase=ENVE CaseType=Combination StepType=Max P=-90.2888588483432
 V2=64.3309238826767 V3=0 T=0 M2=0 M3=-467.608128575363 S11Max=2752.95217983937 PtS11Max=3 x2S11Max=0.5
 x3S11Max=-0.5 _
 S11Min=-2928.62509059426 PtS11Min=1 x2S11Min=-0.5 x3S11Min=-0.5 FrameElem=44 ElemStation=0.25
 Frame=44 Station=0.375 OutputCase=ENVE CaseType=Combination StepType=Max P=-90.2888588483432
 V2=67.4559238826767 V3=0 T=0 M2=0 M3=-475.844806560697 S11Max=2802.36147007275 PtS11Max=3 x2S11Max=0.5
 x3S11Max=-0.5 _
 S11Min=-2978.04515850627 PtS11Min=1 x2S11Min=-0.5 x3S11Min=-0.5 FrameElem=44 ElemStation=0.375
 Frame=44 Station=0.5 OutputCase=ENVE CaseType=Combination StepType=Max P=-90.2888588483432
 V2=70.5809238826767 V3=0 T=0 M2=0 M3=-484.472109546032 S11Max=2854.11451030613 PtS11Max=3 x2S11Max=0.5
 x3S11Max=-0.5 _
 S11Min=-3029.80897641828 PtS11Min=1 x2S11Min=-0.5 x3S11Min=-0.5 FrameElem=44 ElemStation=0.5
 Frame=44 Station=0 OutputCase=ENVE CaseType=Combination StepType=Min P=-122.976319142087
 V2=58.0665536445026 V3=0 T=0 M2=0 M3=-458.575618036827 S11Max=2590.86356648607 PtS11Max=3 x2S11Max=0.5
 x3S11Max=-0.5 _
 S11Min=-2841.7425670693 PtS11Min=1 x2S11Min=-0.5 x3S11Min=-0.5 FrameElem=44 ElemStation=0
 Frame=44 Station=0.125 OutputCase=ENVE CaseType=Combination StepType=Min P=-122.976319142087
 V2=61.1915536445026 V3=0 T=0 M2=0 M3=-466.02924974239 S11Max=2635.59613439808 PtS11Max=3 x2S11Max=0.5
 x3S11Max=-0.5 _
 S11Min=-2886.46435730268 PtS11Min=1 x2S11Min=-0.5 x3S11Min=-0.5 FrameElem=44 ElemStation=0.125
 Frame=44 Station=0.25 OutputCase=ENVE CaseType=Combination StepType=Min P=-122.976319142087
 V2=64.3165536445026 V3=0 T=0 M2=0 M3=-473.873506447952 S11Max=2682.67245231009 PtS11Max=3 x2S11Max=0.5
 x3S11Max=-0.5 _
 S11Min=-2933.52989753606 PtS11Min=1 x2S11Min=-0.5 x3S11Min=-0.5 FrameElem=44 ElemStation=0.25
 Frame=44 Station=0.375 OutputCase=ENVE CaseType=Combination StepType=Min P=-122.976319142087
 V2=67.4415536445026 V3=0 T=0 M2=0 M3=-482.108388153515 S11Max=2732.0925202221 PtS11Max=3 x2S11Max=0.5
 x3S11Max=-0.5 _
 S11Min=-2982.93918776943 PtS11Min=1 x2S11Min=-0.5 x3S11Min=-0.5 FrameElem=44 ElemStation=0.375
 Frame=44 Station=0.5 OutputCase=ENVE CaseType=Combination StepType=Min P=-122.976319142087
 V2=70.5665536445026 V3=0 T=0 M2=0 M3=-490.733894859078 S11Max=2783.8563381341 PtS11Max=3 x2S11Max=0.5
 x3S11Max=-0.5 _
 S11Min=-3034.69222800281 PtS11Min=1 x2S11Min=-0.5 x3S11Min=-0.5 FrameElem=44 ElemStation=0.5
 Frame=44 Station=0 OutputCase=FESSUR CaseType=Combination P=-122.976319142087 V2=58.0809238826767
 V3=0 T=0 M2=0 M3=-452.306647604693 S11Max=2590.86356648607 PtS11Max=3 x2S11Max=0.5 x3S11Max=-0.5 _
 S11Min=-2836.81620477025 PtS11Min=1 x2S11Min=-0.5 x3S11Min=-0.5 FrameElem=44 ElemStation=0
 Frame=44 Station=0.125 OutputCase=FESSUR CaseType=Combination P=-122.976319142087 V2=61.2059238826767
 V3=0 T=0 M2=0 M3=-459.762075590028 S11Max=2635.59613439808 PtS11Max=3 x2S11Max=0.5 x3S11Max=-0.5 _
 S11Min=-2881.54877268225 PtS11Min=1 x2S11Min=-0.5 x3S11Min=-0.5 FrameElem=44 ElemStation=0.125
 Frame=44 Station=0.25 OutputCase=FESSUR CaseType=Combination P=-122.976319142087 V2=64.3309238826767
 V3=0 T=0 M2=0 M3=-467.608128575363 S11Max=2682.67245231009 PtS11Max=3 x2S11Max=0.5 x3S11Max=-0.5 _
 S11Min=-2928.62509059426 PtS11Min=1 x2S11Min=-0.5 x3S11Min=-0.5 FrameElem=44 ElemStation=0.25
 Frame=44 Station=0.375 OutputCase=FESSUR CaseType=Combination P=-122.976319142087 V2=67.4559238826767
 V3=0 T=0 M2=0 M3=-475.844806560697 S11Max=2732.0925202221 PtS11Max=3 x2S11Max=0.5 x3S11Max=-0.5 _
 S11Min=-2978.04515850627 PtS11Min=1 x2S11Min=-0.5 x3S11Min=-0.5 FrameElem=44 ElemStation=0.375
 Frame=44 Station=0.5 OutputCase=FESSUR CaseType=Combination P=-122.976319142087 V2=70.5809238826767
 V3=0 T=0 M2=0 M3=-484.472109546032 S11Max=2783.8563381341 PtS11Max=3 x2S11Max=0.5 x3S11Max=-0.5 _
 S11Min=-3029.80897641828 PtS11Min=1 x2S11Min=-0.5 x3S11Min=-0.5 FrameElem=44 ElemStation=0.5
 Frame=45 Station=0.25 OutputCase=PESOPR CaseType=LinStatic P=-15.1709467362365 V2=-22.2427924570075 V3=0
 T=0 M2=0 M3=-119.803682229198 S11Max=703.651146638951 PtS11Max=3 x2S11Max=0.5 x3S11Max=-0.5 _
 S11Min=-733.993040111424 PtS11Min=1 x2S11Min=-0.5 x3S11Min=-0.5 FrameElem=45 ElemStation=0
 Frame=45 Station=0.125 OutputCase=PESOPR CaseType=LinStatic P=-15.1709467362365 V2=-19.1177924570075
 V3=0 T=0 M2=0 M3=-117.218645672072 S11Max=688.140927296195 PtS11Max=3 x2S11Max=0.5 x3S11Max=-0.5 _
 S11Min=-718.48282076868 PtS11Min=1 x2S11Min=-0.5 x3S11Min=-0.5 FrameElem=45 ElemStation=0.125
 Frame=45 Station=0.25 OutputCase=PESOPR CaseType=LinStatic P=-15.1709467362365 V2=-15.9927924570075
 V3=0 T=0 M2=0 M3=-115.024234114946 S11Max=674.974457953439 PtS11Max=3 x2S11Max=0.5 x3S11Max=-0.5 _
 S11Min=-705.316351425913 PtS11Min=1 x2S11Min=-0.5 x3S11Min=-0.5 FrameElem=45 ElemStation=0.25
 Frame=45 Station=0.375 OutputCase=PESOPR CaseType=LinStatic P=-15.1709467362365 V2=-12.8677924570075
 V3=0 T=0 M2=0 M3=-113.22044755782 S11Max=664.151738610684 PtS11Max=3 x2S11Max=0.5 x3S11Max=-0.5 _
 S11Min=-694.493632083157 PtS11Min=1 x2S11Min=-0.5 x3S11Min=-0.5 FrameElem=45 ElemStation=0.375
 Frame=45 Station=0.5 OutputCase=PESOPR CaseType=LinStatic P=-15.1709467362365 V2=-9.74279245700745
 V3=0 T=0 M2=0 M3=-111.807286000694 S11Max=655.672769267928 PtS11Max=3 x2S11Max=0.5 x3S11Max=-0.5 _
 S11Min=-686.014662740401 PtS11Min=1 x2S11Min=-0.5 x3S11Min=-0.5 FrameElem=45 ElemStation=0.5
 Frame=45 Station=0 OutputCase=TERRVERT CaseType=LinStatic P=1.15282857329472 V2=-48.2902313312516
 V3=0 T=0 M2=0 M3=-385.541045026999 S11Max=2314.39909873529 PtS11Max=3 x2S11Max=0.5 x3S11Max=-0.5 _
 S11Min=-2312.0934415887 PtS11Min=1 x2S11Min=-0.5 x3S11Min=-0.5 FrameElem=45 ElemStation=0
 Frame=45 Station=0.125 OutputCase=TERRVERT CaseType=LinStatic P=1.15282857329472 V2=-48.2902313312516
 V3=0 T=0 M2=0 M3=-379.504766110593 S11Max=2278.18142523685 PtS11Max=3 x2S11Max=0.5 x3S11Max=-0.5 _
 S11Min=-2275.87576809026 PtS11Min=1 x2S11Min=-0.5 x3S11Min=-0.5 FrameElem=45 ElemStation=0.125
 Frame=45 Station=0.25 OutputCase=TERRVERT CaseType=LinStatic P=1.15282857329472 V2=-48.2902313312516
 V3=0 T=0 M2=0 M3=-373.468487194186 S11Max=2241.96375173841 PtS11Max=3 x2S11Max=0.5 x3S11Max=-0.5 _
 S11Min=-2239.65809459182 PtS11Min=1 x2S11Min=-0.5 x3S11Min=-0.5 FrameElem=45 ElemStation=0.25
 Frame=45 Station=0.375 OutputCase=TERRVERT CaseType=LinStatic P=1.15282857329472 V2=-48.2902313312516
 V3=0 T=0 M2=0 M3=-367.43220827778 S11Max=2205.74607823997 PtS11Max=3 x2S11Max=0.5 x3S11Max=-0.5 _
 S11Min=-2203.44042109338 PtS11Min=1 x2S11Min=-0.5 x3S11Min=-0.5 FrameElem=45 ElemStation=0.375
 Frame=45 Station=0.5 OutputCase=TERRVERT CaseType=LinStatic P=1.15282857329472 V2=-48.2902313312516
 V3=0 T=0 M2=0 M3=-361.395929361373 S11Max=2169.52840474154 PtS11Max=3 x2S11Max=0.5 x3S11Max=-0.5 _
 S11Min=-2167.22274759495 PtS11Min=1 x2S11Min=-0.5 x3S11Min=-0.5 FrameElem=45 ElemStation=0.5
 Frame=45 Station=0 OutputCase=TERRLAT CaseType=LinStatic P=-108.958200979145 V2=-4.78996962064855E-02
 V3=0 T=0 M2=0 M3=20.8726177101544 S11Max=16.2775052817816 PtS11Max=1 x2S11Max=-0.5 x3S11Max=-0.5 _
 S11Min=-234.193907240071 PtS11Min=3 x2S11Min=0.5 x3S11Min=-0.5 FrameElem=45 ElemStation=0

Frame=45 Station=0.125 OutputCase=TERRLAT CaseType=LinStatic P=-108.958200979145 V2=-4.78996962064855E-02 V3=0 T=0 M2=0 M3=20.8786051721802 S11Max=16.3134300539365 PtS11Max=1 x2S11Max=-0.5 x3S11Max=-0.5

S11Min=-234.229832012226 PtS11Min=3 x2S11Min=0.5 x3S11Min=-0.5 FrameElem=45 ElemStation=0.125

Frame=45 Station=0.25 OutputCase=TERRLAT CaseType=LinStatic P=-108.958200979145 V2=-4.78996962064855E-02 V3=0 T=0 M2=0 M3=20.884592634206 S11Max=16.3493548260914 PtS11Max=1 x2S11Max=-0.5 x3S11Max=-0.5 S11Min=-234.265756784381 PtS11Min=3 x2S11Min=0.5 x3S11Min=-0.5 FrameElem=45 ElemStation=0.25

Frame=45 Station=0.375 OutputCase=TERRLAT CaseType=LinStatic P=-108.958200979145 V2=-4.78996962064855E-02 V3=0 T=0 M2=0 M3=20.8905800962318 S11Max=16.3852795982462 PtS11Max=1 x2S11Max=-0.5 x3S11Max=-0.5

S11Min=-234.301681556536 PtS11Min=3 x2S11Min=0.5 x3S11Min=-0.5 FrameElem=45 ElemStation=0.375

Frame=45 Station=0.5 OutputCase=TERRLAT CaseType=LinStatic P=-108.958200979145 V2=-4.78996962064855E-02 V3=0 T=0 M2=0 M3=20.8965675582577 S11Max=16.4212043704011 PtS11Max=1 x2S11Max=-0.5 x3S11Max=-0.5 S11Min=-234.337606328691 PtS11Min=3 x2S11Min=0.5 x3S11Min=-0.5 FrameElem=45 ElemStation=0.5

Frame=45 Station=0 OutputCase=ACCLATDX CaseType=LinStatic P=0 V2=0 V3=0 T=0 M2=0 M3=0 S11Max=0 PtS11Max=0 x2S11Max=0 x3S11Max=0 S11Min=0 PtS11Min=0 x2S11Min=0 x3S11Min=0 FrameElem=45 ElemStation=0

Frame=45 Station=0.125 OutputCase=ACCLATDX CaseType=LinStatic P=0 V2=0 V3=0 T=0 M2=0 M3=0 S11Max=0 PtS11Max=0 x2S11Max=0 x3S11Max=0 S11Min=0 PtS11Min=0 x2S11Min=0 x3S11Min=0 FrameElem=45 ElemStation=0.125

Frame=45 Station=0.25 OutputCase=ACCLATDX CaseType=LinStatic P=0 V2=0 V3=0 T=0 M2=0 M3=0 S11Max=0 PtS11Max=0 x2S11Max=0 x3S11Max=0 S11Min=0 PtS11Min=0 x2S11Min=0 x3S11Min=0 FrameElem=45 ElemStation=0.25

Frame=45 Station=0.375 OutputCase=ACCLATDX CaseType=LinStatic P=0 V2=0 V3=0 T=0 M2=0 M3=0 S11Max=0 PtS11Max=0 x2S11Max=0 x3S11Max=0 S11Min=0 PtS11Min=0 x2S11Min=0 x3S11Min=0 FrameElem=45 ElemStation=0.375

Frame=45 Station=0.5 OutputCase=ACCLATDX CaseType=LinStatic P=0 V2=0 V3=0 T=0 M2=0 M3=0 S11Max=0 PtS11Max=0 x2S11Max=0 x3S11Max=0 S11Min=0 PtS11Min=0 x2S11Min=0 x3S11Min=0 FrameElem=45 ElemStation=0.5

Frame=45 Station=0 OutputCase=ACCLATSX CaseType=LinStatic P=0 V2=0 V3=0 T=0 M2=0 M3=0 S11Max=0 PtS11Max=0 x2S11Max=0 x3S11Max=0 S11Min=0 PtS11Min=0 x2S11Min=0 x3S11Min=0 FrameElem=45 ElemStation=0

Frame=45 Station=0.125 OutputCase=ACCLATSX CaseType=LinStatic P=0 V2=0 V3=0 T=0 M2=0 M3=0 S11Max=0 PtS11Max=0 x2S11Max=0 x3S11Max=0 S11Min=0 PtS11Min=0 x2S11Min=0 x3S11Min=0 FrameElem=45 ElemStation=0.125

Frame=45 Station=0.25 OutputCase=ACCLATSX CaseType=LinStatic P=0 V2=0 V3=0 T=0 M2=0 M3=0 S11Max=0 PtS11Max=0 x2S11Max=0 x3S11Max=0 S11Min=0 PtS11Min=0 x2S11Min=0 x3S11Min=0 FrameElem=45 ElemStation=0.25

Frame=45 Station=0.375 OutputCase=ACCLATSX CaseType=LinStatic P=0 V2=0 V3=0 T=0 M2=0 M3=0 S11Max=0 PtS11Max=0 x2S11Max=0 x3S11Max=0 S11Min=0 PtS11Min=0 x2S11Min=0 x3S11Min=0 FrameElem=45 ElemStation=0.375

Frame=45 Station=0.5 OutputCase=ACCLATSX CaseType=LinStatic P=0 V2=0 V3=0 T=0 M2=0 M3=0 S11Max=0 PtS11Max=0 x2S11Max=0 x3S11Max=0 S11Min=0 PtS11Min=0 x2S11Min=0 x3S11Min=0 FrameElem=45 ElemStation=0.5

Frame=45 Station=0 OutputCase=TERRCOST CaseType=LinStatic P=0 V2=0 V3=0 T=0 M2=0 M3=0 S11Max=0 PtS11Max=0 x2S11Max=0 x3S11Max=0 S11Min=0 PtS11Min=0 x2S11Min=0 x3S11Min=0 FrameElem=45 ElemStation=0

Frame=45 Station=0.125 OutputCase=TERRCOST CaseType=LinStatic P=0 V2=0 V3=0 T=0 M2=0 M3=0 S11Max=0 PtS11Max=0 x2S11Max=0 x3S11Max=0 S11Min=0 PtS11Min=0 x2S11Min=0 x3S11Min=0 FrameElem=45 ElemStation=0.125

Frame=45 Station=0.25 OutputCase=TERRCOST CaseType=LinStatic P=0 V2=0 V3=0 T=0 M2=0 M3=0 S11Max=0 PtS11Max=0 x2S11Max=0 x3S11Max=0 S11Min=0 PtS11Min=0 x2S11Min=0 x3S11Min=0 FrameElem=45 ElemStation=0.25

Frame=45 Station=0.375 OutputCase=TERRCOST CaseType=LinStatic P=0 V2=0 V3=0 T=0 M2=0 M3=0 S11Max=0 PtS11Max=0 x2S11Max=0 x3S11Max=0 S11Min=0 PtS11Min=0 x2S11Min=0 x3S11Min=0 FrameElem=45 ElemStation=0.375

Frame=45 Station=0.5 OutputCase=TERRCOST CaseType=LinStatic P=0 V2=0 V3=0 T=0 M2=0 M3=0 S11Max=0 PtS11Max=0 x2S11Max=0 x3S11Max=0 S11Min=0 PtS11Min=0 x2S11Min=0 x3S11Min=0 FrameElem=45 ElemStation=0.5

Frame=45 Station=0 OutputCase=SOVRCOST CaseType=LinStatic P=0 V2=0 V3=0 T=0 M2=0 M3=0 S11Max=0 PtS11Max=0 x2S11Max=0 x3S11Max=0 S11Min=0 PtS11Min=0 x2S11Min=0 x3S11Min=0 FrameElem=45 ElemStation=0

Frame=45 Station=0.125 OutputCase=SOVRCOST CaseType=LinStatic P=0 V2=0 V3=0 T=0 M2=0 M3=0 S11Max=0 PtS11Max=0 x2S11Max=0 x3S11Max=0 S11Min=0 PtS11Min=0 x2S11Min=0 x3S11Min=0 FrameElem=45 ElemStation=0.125

Frame=45 Station=0.25 OutputCase=SOVRCOST CaseType=LinStatic P=0 V2=0 V3=0 T=0 M2=0 M3=0 S11Max=0 PtS11Max=0 x2S11Max=0 x3S11Max=0 S11Min=0 PtS11Min=0 x2S11Min=0 x3S11Min=0 FrameElem=45 ElemStation=0.25

Frame=45 Station=0.375 OutputCase=SOVRCOST CaseType=LinStatic P=0 V2=0 V3=0 T=0 M2=0 M3=0 S11Max=0 PtS11Max=0 x2S11Max=0 x3S11Max=0 S11Min=0 PtS11Min=0 x2S11Min=0 x3S11Min=0 FrameElem=45 ElemStation=0.375

Frame=45 Station=0.5 OutputCase=SOVRCOST CaseType=LinStatic P=0 V2=0 V3=0 T=0 M2=0 M3=0 S11Max=0 PtS11Max=0 x2S11Max=0 x3S11Max=0 S11Min=0 PtS11Min=0 x2S11Min=0 x3S11Min=0 FrameElem=45 ElemStation=0.5

Frame=45 Station=0 OutputCase=ENVE CaseType=Combination StepType=Max P=-90.2888588483432 V2=-70.5665535756036 V3=0 T=0 M2=0 M3=-484.472109546043 S11Max=2854.11451030619 PtS11Max=3 x2S11Max=0.5 x3S11Max=-0.5

S11Min=-3029.80897641834 PtS11Min=1 x2S11Min=-0.5 x3S11Min=-0.5 FrameElem=45 ElemStation=0

Frame=45 Station=0.125 OutputCase=ENVE CaseType=Combination StepType=Max P=-90.2888588483432 V2=-67.4415535756036 V3=0 T=0 M2=0 M3=-475.844806610484 S11Max=2802.36147012449 PtS11Max=3 x2S11Max=0.5 x3S11Max=-0.5 S11Min=-2978.04515880499 PtS11Min=1 x2S11Min=-0.5 x3S11Min=-0.5 FrameElem=45 ElemStation=0.125



Frame=45 Station=0.25 OutputCase=ENVE CaseType=Combination StepType=Max P=-90.2888588483432 V2=-
 64.3165535756036 V3=0 T=0 M2=0 M3=-467.608128674926 S11Max=2752.95217994279 PtS11Max=3 x2S11Max=0.5
 x3S11Max=-0.5 _
 S11Min=-2928.62509119164 PtS11Min=1 x2S11Min=-0.5 x3S11Min=-0.5 FrameElem=45 ElemStation=0.25
 Frame=45 Station=0.375 OutputCase=ENVE CaseType=Combination StepType=Max P=-90.2888588483432 V2=-
 61.1915535756036 V3=0 T=0 M2=0 M3=-459.762075739368 S11Max=2705.88663976108 PtS11Max=3 x2S11Max=0.5 _
 x3S11Max=-0.5 S11Min=-2881.5487735783 PtS11Min=1 x2S11Min=-0.5 x3S11Min=-0.5 FrameElem=45
 ElemStation=0.375
 Frame=45 Station=0.5 OutputCase=ENVE CaseType=Combination StepType=Max P=-90.2888588483432 V2=-
 58.0665535756036 V3=0 T=0 M2=0 M3=-452.30664780381 S11Max=2661.16484957938 PtS11Max=3 x2S11Max=0.5
 x3S11Max=-0.5 _
 S11Min=-2836.81620596495 PtS11Min=1 x2S11Min=-0.5 x3S11Min=-0.5 FrameElem=45 ElemStation=0.5
 Frame=45 Station=0 OutputCase=ENVE CaseType=Combination StepType=Min P=-122.976319142087 V2=-
 70.5809234844655 V3=0 T=0 M2=0 M3=-490.733894859089 S11Max=2783.85633813417 PtS11Max=3 x2S11Max=0.5
 x3S11Max=-0.5 _
 S11Min=-3034.69222800288 PtS11Min=1 x2S11Min=-0.5 x3S11Min=-0.5 FrameElem=45 ElemStation=0
 Frame=45 Station=0.125 OutputCase=ENVE CaseType=Combination StepType=Min P=-122.976319142087 V2=-
 67.4559234844655 V3=0 T=0 M2=0 M3=-482.108388162139 S11Max=2732.09252052082 PtS11Max=3 x2S11Max=0.5 _
 x3S11Max=-0.5 S11Min=-2982.93918782117 PtS11Min=1 x2S11Min=-0.5 x3S11Min=-0.5 FrameElem=45
 ElemStation=0.125
 Frame=45 Station=0.25 OutputCase=ENVE CaseType=Combination StepType=Min P=-122.976319142087 V2=-
 64.3309234844655 V3=0 T=0 M2=0 M3=-473.873506465188 S11Max=2682.67245290747 PtS11Max=3 x2S11Max=0.5
 x3S11Max=-0.5 _
 S11Min=-2933.52989763947 PtS11Min=1 x2S11Min=-0.5 x3S11Min=-0.5 FrameElem=45 ElemStation=0.25
 Frame=45 Station=0.375 OutputCase=ENVE CaseType=Combination StepType=Min P=-122.976319142087 V2=-
 61.2059234844655 V3=0 T=0 M2=0 M3=-466.029249768238 S11Max=2635.59613529412 PtS11Max=3 x2S11Max=0.5 _
 x3S11Max=-0.5 S11Min=-2886.46435745777 PtS11Min=1 x2S11Min=-0.5 x3S11Min=-0.5 FrameElem=45
 ElemStation=0.375
 Frame=45 Station=0.5 OutputCase=ENVE CaseType=Combination StepType=Min P=-122.976319142087 V2=-
 58.0809234844655 V3=0 T=0 M2=0 M3=-458.575618071287 S11Max=2590.86356768077 PtS11Max=3 x2S11Max=0.5
 x3S11Max=-0.5 _
 S11Min=-2841.74256727607 PtS11Min=1 x2S11Min=-0.5 x3S11Min=-0.5 FrameElem=45 ElemStation=0.5
 Frame=45 Station=0 OutputCase=FESSUR CaseType=Combination StepType=Min P=-122.976319142087 V2=-70.5809234844655
 V3=0 T=0 M2=0 M3=-484.472109546043 S11Max=2783.85633813417 PtS11Max=3 x2S11Max=0.5 x3S11Max=-0.5 _
 S11Min=-3029.80897641834 PtS11Min=1 x2S11Min=-0.5 x3S11Min=-0.5 FrameElem=45 ElemStation=0
 Frame=45 Station=0.125 OutputCase=FESSUR CaseType=Combination StepType=Min P=-122.976319142087 V2=-67.4559234844655
 V3=0 T=0 M2=0 M3=-475.844806610484 S11Max=2732.09252052082 PtS11Max=3 x2S11Max=0.5 x3S11Max=-0.5 _
 S11Min=-2978.04515880499 PtS11Min=1 x2S11Min=-0.5 x3S11Min=-0.5 FrameElem=45 ElemStation=0.125
 Frame=45 Station=0.25 OutputCase=FESSUR CaseType=Combination StepType=Min P=-122.976319142087 V2=-64.3309234844655
 V3=0 T=0 M2=0 M3=-467.608128674926 S11Max=2682.67245290747 PtS11Max=3 x2S11Max=0.5 x3S11Max=-0.5 _
 S11Min=-2928.62509119164 PtS11Min=1 x2S11Min=-0.5 x3S11Min=-0.5 FrameElem=45 ElemStation=0.25
 Frame=45 Station=0.375 OutputCase=FESSUR CaseType=Combination StepType=Min P=-122.976319142087 V2=-61.2059234844655
 V3=0 T=0 M2=0 M3=-459.762075739368 S11Max=2635.59613529412 PtS11Max=3 x2S11Max=0.5 x3S11Max=-0.5 _
 S11Min=-2881.5487735783 PtS11Min=1 x2S11Min=-0.5 x3S11Min=-0.5 FrameElem=45 ElemStation=0.375
 Frame=45 Station=0.5 OutputCase=FESSUR CaseType=Combination StepType=Min P=-122.976319142087 V2=-58.0809234844655
 V3=0 T=0 M2=0 M3=-452.30664780381 S11Max=2590.86356768077 PtS11Max=3 x2S11Max=0.5 x3S11Max=-0.5 _
 S11Min=-2836.81620596495 PtS11Min=1 x2S11Min=-0.5 x3S11Min=-0.5 FrameElem=45 ElemStation=0.5
 Frame=46 Station=0 OutputCase=PESOPR CaseType=LinStatic P=-15.1709467362365 V2=-54.2994159261143 V3=0
 T=0 M2=0 M3=-111.807286000691 S11Max=655.672769267906 PtS11Max=3 x2S11Max=0.5 x3S11Max=-0.5 _
 S11Min=-686.01466274038 PtS11Min=1 x2S11Min=-0.5 x3S11Min=-0.5 FrameElem=46 ElemStation=0
 Frame=46 Station=0.125 OutputCase=PESOPR CaseType=LinStatic P=-15.1709467362365 V2=-51.1744159261143
 V3=0 T=0 M2=0 M3=-105.215171509926 S11Max=616.120082323321 PtS11Max=3 x2S11Max=0.5 x3S11Max=-0.5 _
 S11Min=-646.461975795974 PtS11Min=1 x2S11Min=-0.5 x3S11Min=-0.5 FrameElem=46 ElemStation=0.125
 Frame=46 Station=0.25 OutputCase=PESOPR CaseType=LinStatic P=-15.1709467362365 V2=-48.0494159261143
 V3=0 T=0 M2=0 M3=-99.0136820191619 S11Max=578.911145378735 PtS11Max=3 x2S11Max=0.5 x3S11Max=-0.5 _
 S11Min=-609.253038851208 PtS11Min=1 x2S11Min=-0.5 x3S11Min=-0.5 FrameElem=46 ElemStation=0.25
 Frame=46 Station=0.375 OutputCase=PESOPR CaseType=LinStatic P=-15.1709467362365 V2=-44.9244159261143
 V3=0 T=0 M2=0 M3=-93.2028175283976 S11Max=544.045958434149 PtS11Max=3 x2S11Max=0.5 x3S11Max=-0.5 _
 S11Min=-574.387851906622 PtS11Min=1 x2S11Min=-0.5 x3S11Min=-0.5 FrameElem=46 ElemStation=0.375
 Frame=46 Station=0.5 OutputCase=PESOPR CaseType=LinStatic P=-15.1709467362365 V2=-41.7994159261143
 V3=0 T=0 M2=0 M3=-87.7825780376334 S11Max=511.524521489564 PtS11Max=3 x2S11Max=0.5 x3S11Max=-0.5 _
 S11Min=-541.866414962037 PtS11Min=1 x2S11Min=-0.5 x3S11Min=-0.5 FrameElem=46 ElemStation=0.5
 Frame=46 Station=0 OutputCase=TERRVERT CaseType=LinStatic P=1.15282857329472 V2=-145.098916674382
 V3=0 T=0 M2=0 M3=-361.395929361381 S11Max=2169.52840474158 PtS11Max=3 x2S11Max=0.5 x3S11Max=-0.5 _
 S11Min=-2167.22274759499 PtS11Min=1 x2S11Min=-0.5 x3S11Min=-0.5 FrameElem=46 ElemStation=0
 Frame=46 Station=0.125 OutputCase=TERRVERT CaseType=LinStatic P=1.15282857329472 V2=-145.098916674382
 V3=0 T=0 M2=0 M3=-343.258564777083 S11Max=2060.70421723579 PtS11Max=3 x2S11Max=0.5 x3S11Max=-0.5 _
 S11Min=-2058.3985600892 PtS11Min=1 x2S11Min=-0.5 x3S11Min=-0.5 FrameElem=46 ElemStation=0.125
 Frame=46 Station=0.25 OutputCase=TERRVERT CaseType=LinStatic P=1.15282857329472 V2=-145.098916674382
 V3=0 T=0 M2=0 M3=-325.121200192785 S11Max=1951.88002973001 PtS11Max=3 x2S11Max=0.5 x3S11Max=-0.5 _
 S11Min=-1949.57437258342 PtS11Min=1 x2S11Min=-0.5 x3S11Min=-0.5 FrameElem=46 ElemStation=0.25
 Frame=46 Station=0.375 OutputCase=TERRVERT CaseType=LinStatic P=1.15282857329472 V2=-145.098916674382
 V3=0 T=0 M2=0 M3=-306.983835608487 S11Max=1843.05584222422 PtS11Max=3 x2S11Max=0.5 x3S11Max=-0.5 _
 S11Min=-1840.75018507763 PtS11Min=1 x2S11Min=-0.5 x3S11Min=-0.5 FrameElem=46 ElemStation=0.375
 Frame=46 Station=0.5 OutputCase=TERRVERT CaseType=LinStatic P=1.15282857329472 V2=-145.098916674382
 V3=0 T=0 M2=0 M3=-288.84647102419 S11Max=1734.23165471843 PtS11Max=3 x2S11Max=0.5 x3S11Max=-0.5 _
 S11Min=-1731.92599757184 PtS11Min=1 x2S11Min=-0.5 x3S11Min=-0.5 FrameElem=46 ElemStation=0.5
 Frame=46 Station=0 OutputCase=TERRLAT CaseType=LinStatic P=-108.958200979145 V2=-0.132429444025746
 V3=0 T=0 M2=0 M3=20.8965675582577 S11Max=16.4212043704013 PtS11Max=1 x2S11Max=-0.5 x3S11Max=-0.5 _
 S11Min=-234.337606328691 PtS11Min=3 x2S11Min=0.5 x3S11Min=-0.5 FrameElem=46 ElemStation=0
 Frame=46 Station=0.125 OutputCase=TERRLAT CaseType=LinStatic P=-108.958200979145 V2=-0.132429444025746
 V3=0 T=0 M2=0 M3=20.9131212387609 S11Max=16.5205264534206 PtS11Max=1 x2S11Max=-0.5 x3S11Max=-0.5 _

S11Min=-234.43692841171 PtS11Min=3 x2S11Min=0.5 x3S11Min=-0.5 FrameElem=46 ElemStation=0.125
 Frame=46 Station=0.25 OutputCase=TERRLAT CaseType=LinStatic P=-108.958200979145 V2=-0.132429444025746
 V3=0 T=0 M2=0 M3=20.9296749192641 S11Max=16.6198485364399 PtS11Max=1 x2S11Max=-0.5 x3S11Max=-0.5 _
 S11Min=-234.536250494729 PtS11Min=3 x2S11Min=0.5 x3S11Min=-0.5 FrameElem=46 ElemStation=0.25
 Frame=46 Station=0.375 OutputCase=TERRLAT CaseType=LinStatic P=-108.958200979145 V2=-0.132429444025746
 V3=0 T=0 M2=0 M3=20.9462285997673 S11Max=16.7191706194592 PtS11Max=1 x2S11Max=-0.5 x3S11Max=-0.5 _
 S11Min=-234.635572577749 PtS11Min=3 x2S11Min=0.5 x3S11Min=-0.5 FrameElem=46 ElemStation=0.375
 Frame=46 Station=0.5 OutputCase=TERRLAT CaseType=LinStatic P=-108.958200979145 V2=-0.132429444025746
 V3=0 T=0 M2=0 M3=20.9627822802705 S11Max=16.8184927024785 PtS11Max=1 x2S11Max=-0.5 x3S11Max=-0.5 _
 S11Min=-234.734894660768 PtS11Min=3 x2S11Min=0.5 x3S11Min=-0.5 FrameElem=46 ElemStation=0.5
 Frame=46 Station=0 OutputCase=ACCLATDX CaseType=LinStatic P=0 V2=0 V3=0 T=0 M2=0 M3=0
 S11Max=0 PtS11Max=0 x2S11Max=0 x3S11Max=0 S11Min=0 PtS11Min=0 x2S11Min=0 x3S11Min=0 FrameElem=46
 ElemStation=0
 Frame=46 Station=0.125 OutputCase=ACCLATDX CaseType=LinStatic P=0 V2=0 V3=0 T=0 M2=0 M3=0
 S11Max=0 PtS11Max=0 x2S11Max=0 x3S11Max=0 S11Min=0 PtS11Min=0 x2S11Min=0 x3S11Min=0 FrameElem=46
 ElemStation=0.125
 Frame=46 Station=0.25 OutputCase=ACCLATDX CaseType=LinStatic P=0 V2=0 V3=0 T=0 M2=0 M3=0
 S11Max=0 PtS11Max=0 x2S11Max=0 x3S11Max=0 S11Min=0 PtS11Min=0 x2S11Min=0 x3S11Min=0 FrameElem=46
 ElemStation=0.25
 Frame=46 Station=0.375 OutputCase=ACCLATDX CaseType=LinStatic P=0 V2=0 V3=0 T=0 M2=0 M3=0
 S11Max=0 PtS11Max=0 x2S11Max=0 x3S11Max=0 S11Min=0 PtS11Min=0 x2S11Min=0 x3S11Min=0 FrameElem=46
 ElemStation=0.375
 Frame=46 Station=0.5 OutputCase=ACCLATDX CaseType=LinStatic P=0 V2=0 V3=0 T=0 M2=0 M3=0
 S11Max=0 PtS11Max=0 x2S11Max=0 x3S11Max=0 S11Min=0 PtS11Min=0 x2S11Min=0 x3S11Min=0 FrameElem=46
 ElemStation=0.5
 Frame=46 Station=0 OutputCase=ACCLATSX CaseType=LinStatic P=0 V2=0 V3=0 T=0 M2=0 M3=0
 S11Max=0 PtS11Max=0 x2S11Max=0 x3S11Max=0 S11Min=0 PtS11Min=0 x2S11Min=0 x3S11Min=0 FrameElem=46
 ElemStation=0
 Frame=46 Station=0.125 OutputCase=ACCLATSX CaseType=LinStatic P=0 V2=0 V3=0 T=0 M2=0 M3=0
 S11Max=0 PtS11Max=0 x2S11Max=0 x3S11Max=0 S11Min=0 PtS11Min=0 x2S11Min=0 x3S11Min=0 FrameElem=46
 ElemStation=0.125
 Frame=46 Station=0.25 OutputCase=ACCLATSX CaseType=LinStatic P=0 V2=0 V3=0 T=0 M2=0 M3=0
 S11Max=0 PtS11Max=0 x2S11Max=0 x3S11Max=0 S11Min=0 PtS11Min=0 x2S11Min=0 x3S11Min=0 FrameElem=46
 ElemStation=0.25
 Frame=46 Station=0.375 OutputCase=ACCLATSX CaseType=LinStatic P=0 V2=0 V3=0 T=0 M2=0 M3=0
 S11Max=0 PtS11Max=0 x2S11Max=0 x3S11Max=0 S11Min=0 PtS11Min=0 x2S11Min=0 x3S11Min=0 FrameElem=46
 ElemStation=0.375
 Frame=46 Station=0.5 OutputCase=ACCLATSX CaseType=LinStatic P=0 V2=0 V3=0 T=0 M2=0 M3=0
 S11Max=0 PtS11Max=0 x2S11Max=0 x3S11Max=0 S11Min=0 PtS11Min=0 x2S11Min=0 x3S11Min=0 FrameElem=46
 ElemStation=0.5
 Frame=46 Station=0 OutputCase=TERRCOST CaseType=LinStatic P=0 V2=0 V3=0 T=0 M2=0 M3=0
 S11Max=0 PtS11Max=0 x2S11Max=0 x3S11Max=0 S11Min=0 PtS11Min=0 x2S11Min=0 x3S11Min=0 FrameElem=46
 ElemStation=0
 Frame=46 Station=0.125 OutputCase=TERRCOST CaseType=LinStatic P=0 V2=0 V3=0 T=0 M2=0 M3=0
 S11Max=0 PtS11Max=0 x2S11Max=0 x3S11Max=0 S11Min=0 PtS11Min=0 x2S11Min=0 x3S11Min=0 FrameElem=46
 ElemStation=0.125
 Frame=46 Station=0.25 OutputCase=TERRCOST CaseType=LinStatic P=0 V2=0 V3=0 T=0 M2=0 M3=0
 S11Max=0 PtS11Max=0 x2S11Max=0 x3S11Max=0 S11Min=0 PtS11Min=0 x2S11Min=0 x3S11Min=0 FrameElem=46
 ElemStation=0.25
 Frame=46 Station=0.375 OutputCase=TERRCOST CaseType=LinStatic P=0 V2=0 V3=0 T=0 M2=0 M3=0
 S11Max=0 PtS11Max=0 x2S11Max=0 x3S11Max=0 S11Min=0 PtS11Min=0 x2S11Min=0 x3S11Min=0 FrameElem=46
 ElemStation=0.375
 Frame=46 Station=0.5 OutputCase=TERRCOST CaseType=LinStatic P=0 V2=0 V3=0 T=0 M2=0 M3=0
 S11Max=0 PtS11Max=0 x2S11Max=0 x3S11Max=0 S11Min=0 PtS11Min=0 x2S11Min=0 x3S11Min=0 FrameElem=46
 ElemStation=0.5
 Frame=46 Station=0 OutputCase=SOVRCOST CaseType=LinStatic P=0 V2=0 V3=0 T=0 M2=0 M3=0
 S11Max=0 PtS11Max=0 x2S11Max=0 x3S11Max=0 S11Min=0 PtS11Min=0 x2S11Min=0 x3S11Min=0 FrameElem=46
 ElemStation=0
 Frame=46 Station=0.125 OutputCase=SOVRCOST CaseType=LinStatic P=0 V2=0 V3=0 T=0 M2=0 M3=0
 S11Max=0 PtS11Max=0 x2S11Max=0 x3S11Max=0 S11Min=0 PtS11Min=0 x2S11Min=0 x3S11Min=0 FrameElem=46
 ElemStation=0.125
 Frame=46 Station=0.25 OutputCase=SOVRCOST CaseType=LinStatic P=0 V2=0 V3=0 T=0 M2=0 M3=0
 S11Max=0 PtS11Max=0 x2S11Max=0 x3S11Max=0 S11Min=0 PtS11Min=0 x2S11Min=0 x3S11Min=0 FrameElem=46
 ElemStation=0.25
 Frame=46 Station=0.375 OutputCase=SOVRCOST CaseType=LinStatic P=0 V2=0 V3=0 T=0 M2=0 M3=0
 S11Max=0 PtS11Max=0 x2S11Max=0 x3S11Max=0 S11Min=0 PtS11Min=0 x2S11Min=0 x3S11Min=0 FrameElem=46
 ElemStation=0.375
 Frame=46 Station=0.5 OutputCase=SOVRCOST CaseType=LinStatic P=0 V2=0 V3=0 T=0 M2=0 M3=0
 S11Max=0 PtS11Max=0 x2S11Max=0 x3S11Max=0 S11Min=0 PtS11Min=0 x2S11Min=0 x3S11Min=0 FrameElem=46
 ElemStation=0.5
 Frame=46 Station=0 OutputCase=ENVE CaseType=Combination StepType=Max P=-90.2888588483432 V2=-
 199.491033211314 V3=0 T=0 M2=0 M3=-452.306647803814 S11Max=2661.1648495794 PtS11Max=3 x2S11Max=0.5
 x3S11Max=-0.5 _
 S11Min=-2836.81620596497 PtS11Min=1 x2S11Min=-0.5 x3S11Min=-0.5 FrameElem=46 ElemStation=0
 Frame=46 Station=0.125 OutputCase=ENVE CaseType=Combination StepType=Max P=-90.2888588483432 V2=-
 196.366033211314 V3=0 T=0 M2=0 M3=-427.560615048248 S11Max=2512.71844967092 PtS11Max=3 x2S11Max=0.5 _
 x3S11Max=-0.5 S11Min=-2688.34000943158 PtS11Min=1 x2S11Min=-0.5 x3S11Min=-0.5 FrameElem=46
 ElemStation=0.125
 Frame=46 Station=0.25 OutputCase=ENVE CaseType=Combination StepType=Max P=-90.2888588483432 V2=-
 193.241033211314 V3=0 T=0 M2=0 M3=-403.205207292683 S11Max=2366.61579976243 PtS11Max=3 x2S11Max=0.5
 x3S11Max=-0.5 _
 S11Min=-2542.20756289818 PtS11Min=1 x2S11Min=-0.5 x3S11Min=-0.5 FrameElem=46 ElemStation=0.25



Frame=46 Station=0.375 OutputCase=ENVE CaseType=Combination StepType=Max P=-90.2888588483432 V2=-190.116033211314 V3=0 T=0 M2=0 M3=-379.240424537118 S11Max=2222.85689985394 PtS11Max=3 x2S11Max=0.5 x3S11Max=-0.5 S11Min=-2398.41886636479 PtS11Min=1 x2S11Min=-0.5 x3S11Min=-0.5 FrameElem=46 ElemStation=0.375
 Frame=46 Station=0.5 OutputCase=ENVE CaseType=Combination StepType=Max P=-90.2888588483432 V2=-186.991033211314 V3=0 T=0 M2=0 M3=-355.666266781553 S11Max=2081.44174994546 PtS11Max=3 x2S11Max=0.5 x3S11Max=-0.5 S11Min=-2256.9739198314 PtS11Min=1 x2S11Min=-0.5 x3S11Min=-0.5 FrameElem=46 ElemStation=0.5
 Frame=46 Station=0 OutputCase=ENVE CaseType=Combination StepType=Min P=-122.976319142087 V2=-199.530762044522 V3=0 T=0 M2=0 M3=-458.575618071291 S11Max=2590.86356768079 PtS11Max=3 x2S11Max=0.5 x3S11Max=-0.5 S11Min=-2841.74256727609 PtS11Min=1 x2S11Min=-0.5 x3S11Min=-0.5 FrameElem=46 ElemStation=0
 Frame=46 Station=0.125 OutputCase=ENVE CaseType=Combination StepType=Min P=-122.976319142087 V2=-196.405762044522 V3=0 T=0 M2=0 M3=-433.834551419877 S11Max=2442.3873711474 PtS11Max=3 x2S11Max=0.5 x3S11Max=-0.5 S11Min=-2693.2961673676 PtS11Min=1 x2S11Min=-0.5 x3S11Min=-0.5 FrameElem=46 ElemStation=0.125
 Frame=46 Station=0.25 OutputCase=ENVE CaseType=Combination StepType=Min P=-122.976319142087 V2=-193.280762044522 V3=0 T=0 M2=0 M3=-409.484109768462 S11Max=2296.25492461401 PtS11Max=3 x2S11Max=0.5 x3S11Max=-0.5 S11Min=-2547.19351745912 PtS11Min=1 x2S11Min=-0.5 x3S11Min=-0.5 FrameElem=46 ElemStation=0.25
 Frame=46 Station=0.375 OutputCase=ENVE CaseType=Combination StepType=Min P=-122.976319142087 V2=-190.155762044522 V3=0 T=0 M2=0 M3=-385.524293117048 S11Max=2152.46622808062 PtS11Max=3 x2S11Max=0.5 x3S11Max=-0.5 S11Min=-2403.43461755063 PtS11Min=1 x2S11Min=-0.5 x3S11Min=-0.5 FrameElem=46 ElemStation=0.375
 Frame=46 Station=0.5 OutputCase=ENVE CaseType=Combination StepType=Min P=-122.976319142087 V2=-187.030762044522 V3=0 T=0 M2=0 M3=-361.955101465634 S11Max=2011.02128154723 PtS11Max=3 x2S11Max=0.5 x3S11Max=-0.5 S11Min=-2262.01946764215 PtS11Min=1 x2S11Min=-0.5 x3S11Min=-0.5 FrameElem=46 ElemStation=0.5
 Frame=46 Station=0 OutputCase=FESSUR CaseType=Combination P=-122.976319142087 V2=-199.530762044522 V3=0 T=0 M2=0 M3=-452.306647803814 S11Max=2590.86356768079 PtS11Max=3 x2S11Max=0.5 x3S11Max=-0.5 S11Min=-2836.81620596497 PtS11Min=1 x2S11Min=-0.5 x3S11Min=-0.5 FrameElem=46 ElemStation=0
 Frame=46 Station=0.125 OutputCase=FESSUR CaseType=Combination P=-122.976319142087 V2=-196.405762044522 V3=0 T=0 M2=0 M3=-427.560615048248 S11Max=2442.3873711474 PtS11Max=3 x2S11Max=0.5 x3S11Max=-0.5 S11Min=-2688.34000943158 PtS11Min=1 x2S11Min=-0.5 x3S11Min=-0.5 FrameElem=46 ElemStation=0.125
 Frame=46 Station=0.25 OutputCase=FESSUR CaseType=Combination P=-122.976319142087 V2=-193.280762044522 V3=0 T=0 M2=0 M3=-403.205207292683 S11Max=2296.25492461401 PtS11Max=3 x2S11Max=0.5 x3S11Max=-0.5 S11Min=-2542.20756289818 PtS11Min=1 x2S11Min=-0.5 x3S11Min=-0.5 FrameElem=46 ElemStation=0.25
 Frame=46 Station=0.375 OutputCase=FESSUR CaseType=Combination P=-122.976319142087 V2=-190.155762044522 V3=0 T=0 M2=0 M3=-379.240424537118 S11Max=2152.46622808062 PtS11Max=3 x2S11Max=0.5 x3S11Max=-0.5 S11Min=-2398.41886636479 PtS11Min=1 x2S11Min=-0.5 x3S11Min=-0.5 FrameElem=46 ElemStation=0.375
 Frame=46 Station=0.5 OutputCase=FESSUR CaseType=Combination P=-122.976319142087 V2=-187.030762044522 V3=0 T=0 M2=0 M3=-355.666266781553 S11Max=2011.02128154723 PtS11Max=3 x2S11Max=0.5 x3S11Max=-0.5 S11Min=-2256.9739198314 PtS11Min=1 x2S11Min=-0.5 x3S11Min=-0.5 FrameElem=46 ElemStation=0.5
 Frame=47 Station=0 OutputCase=PESOPR CaseType=LinStatic P=-15.1709467362365 V2=-86.5605342362687 V3=0 T=0 M2=0 M3=-87.782578037637 S11Max=511.524521489585 PtS11Max=3 x2S11Max=0.5 x3S11Max=-0.5 S11Min=-541.866414962058 PtS11Min=1 x2S11Min=-0.5 x3S11Min=-0.5 FrameElem=47 ElemStation=0
 Frame=47 Station=0.125 OutputCase=PESOPR CaseType=LinStatic P=-15.1709467362365 V2=-83.4355342362687 V3=0 T=0 M2=0 M3=-77.1578237581034 S11Max=447.775995812384 PtS11Max=3 x2S11Max=0.5 x3S11Max=-0.5 S11Min=-478.117889284857 PtS11Min=1 x2S11Min=-0.5 x3S11Min=-0.5 FrameElem=47 ElemStation=0.125
 Frame=47 Station=0.25 OutputCase=PESOPR CaseType=LinStatic P=-15.1709467362365 V2=-80.3105342362687 V3=0 T=0 M2=0 M3=-66.9236944785698 S11Max=386.371220135182 PtS11Max=3 x2S11Max=0.5 x3S11Max=-0.5 S11Min=-416.713113607655 PtS11Min=1 x2S11Min=-0.5 x3S11Min=-0.5 FrameElem=47 ElemStation=0.25
 Frame=47 Station=0.375 OutputCase=PESOPR CaseType=LinStatic P=-15.1709467362365 V2=-77.1855342362687 V3=0 T=0 M2=0 M3=-57.0801901990362 S11Max=327.310194457981 PtS11Max=3 x2S11Max=0.5 x3S11Max=-0.5 S11Min=-357.652087930454 PtS11Min=1 x2S11Min=-0.5 x3S11Min=-0.5 FrameElem=47 ElemStation=0.375
 Frame=47 Station=0.5 OutputCase=PESOPR CaseType=LinStatic P=-15.1709467362365 V2=-74.0605342362687 V3=0 T=0 M2=0 M3=-47.6273109195026 S11Max=270.592918780779 PtS11Max=3 x2S11Max=0.5 x3S11Max=-0.5 S11Min=-300.934812253252 PtS11Min=1 x2S11Min=-0.5 x3S11Min=-0.5 FrameElem=47 ElemStation=0.5
 Frame=47 Station=0 OutputCase=TERRVERT CaseType=LinStatic P=1.15282857329472 V2=-242.566243287001 V3=0 T=0 M2=0 M3=-288.846471024197 S11Max=1734.23165471848 PtS11Max=3 x2S11Max=0.5 x3S11Max=-0.5 S11Min=-1731.92599757189 PtS11Min=1 x2S11Min=-0.5 x3S11Min=-0.5 FrameElem=47 ElemStation=0
 Frame=47 Station=0.125 OutputCase=TERRVERT CaseType=LinStatic P=1.15282857329472 V2=-242.566243287001 V3=0 T=0 M2=0 M3=-258.525690613322 S11Max=1552.30697225323 PtS11Max=3 x2S11Max=0.5 x3S11Max=-0.5 S11Min=-1550.00131510664 PtS11Min=1 x2S11Min=-0.5 x3S11Min=-0.5 FrameElem=47 ElemStation=0.125
 Frame=47 Station=0.25 OutputCase=TERRVERT CaseType=LinStatic P=1.15282857329472 V2=-242.566243287001 V3=0 T=0 M2=0 M3=-228.204910202447 S11Max=1370.38228978797 PtS11Max=3 x2S11Max=0.5 x3S11Max=-0.5 S11Min=-1368.07663264139 PtS11Min=1 x2S11Min=-0.5 x3S11Min=-0.5 FrameElem=47 ElemStation=0.25
 Frame=47 Station=0.375 OutputCase=TERRVERT CaseType=LinStatic P=1.15282857329472 V2=-242.566243287001 V3=0 T=0 M2=0 M3=-197.884129791571 S11Max=1188.45760732272 PtS11Max=3 x2S11Max=0.5 x3S11Max=-0.5 S11Min=-1186.15195017613 PtS11Min=1 x2S11Min=-0.5 x3S11Min=-0.5 FrameElem=47 ElemStation=0.375
 Frame=47 Station=0.5 OutputCase=TERRVERT CaseType=LinStatic P=1.15282857329472 V2=-242.566243287001 V3=0 T=0 M2=0 M3=-167.563349380696 S11Max=1006.53292485747 PtS11Max=3 x2S11Max=0.5 x3S11Max=-0.5 S11Min=-1004.22726771088 PtS11Min=1 x2S11Min=-0.5 x3S11Min=-0.5 FrameElem=47 ElemStation=0.5
 Frame=47 Station=0 OutputCase=TERRLAT CaseType=LinStatic P=-108.958200979145 V2=-0.183116322420581 V3=0 T=0 M2=0 M3=20.9627822802705 S11Max=16.8184927024784 PtS11Max=1 x2S11Max=-0.5 x3S11Max=-0.5 S11Min=-234.734894660768 PtS11Min=3 x2S11Min=0.5 x3S11Min=-0.5 FrameElem=47 ElemStation=0
 Frame=47 Station=0.125 OutputCase=TERRLAT CaseType=LinStatic P=-108.958200979145 V2=-0.183116322420581 V3=0 T=0 M2=0 M3=20.9856718205731 S11Max=16.9558299442938 PtS11Max=1 x2S11Max=-0.5 x3S11Max=-0.5 S11Min=-234.872231902584 PtS11Min=3 x2S11Min=0.5 x3S11Min=-0.5 FrameElem=47 ElemStation=0.125
 Frame=47 Station=0.25 OutputCase=TERRLAT CaseType=LinStatic P=-108.958200979145 V2=-0.183116322420581 V3=0 T=0 M2=0 M3=21.0085613608757 S11Max=17.0931671861093 PtS11Max=1 x2S11Max=-0.5 x3S11Max=-0.5 S11Min=-235.009569144399 PtS11Min=3 x2S11Min=0.5 x3S11Min=-0.5 FrameElem=47 ElemStation=0.25

Frame=47 Station=0.375 OutputCase=TERRLAT CaseType=LinStatic P=-108.958200979145 V2=-0.183116322420581
V3=0 T=0 M2=0 M3=21.0314509011783 S11Max=17.2305044279247 PtS11Max=1 x2S11Max=-0.5 x3S11Max=-0.5 _
S11Min=-235.146906386214 PtS11Min=3 x2S11Min=0.5 x3S11Min=-0.5 FrameElem=47 ElemStation=0.375

Frame=47 Station=0.5 OutputCase=TERRLAT CaseType=LinStatic P=-108.958200979145 V2=-0.183116322420581
V3=0 T=0 M2=0 M3=21.0543404414808 S11Max=17.3678416697401 PtS11Max=1 x2S11Max=-0.5 x3S11Max=-0.5 _
S11Min=-235.28424362803 PtS11Min=3 x2S11Min=0.5 x3S11Min=-0.5 FrameElem=47 ElemStation=0.5

Frame=47 Station=0 OutputCase=ACCLATDX CaseType=LinStatic P=0 V2=0 V3=0 T=0 M2=0 M3=0
S11Max=0 PtS11Max=0 x2S11Max=0 x3S11Max=0 S11Min=0 PtS11Min=0 x2S11Min=0 x3S11Min=0 FrameElem=47
ElemStation=0

Frame=47 Station=0.125 OutputCase=ACCLATDX CaseType=LinStatic P=0 V2=0 V3=0 T=0 M2=0 M3=0
S11Max=0 PtS11Max=0 x2S11Max=0 x3S11Max=0 S11Min=0 PtS11Min=0 x2S11Min=0 x3S11Min=0 FrameElem=47
ElemStation=0.125

Frame=47 Station=0.25 OutputCase=ACCLATDX CaseType=LinStatic P=0 V2=0 V3=0 T=0 M2=0 M3=0
S11Max=0 PtS11Max=0 x2S11Max=0 x3S11Max=0 S11Min=0 PtS11Min=0 x2S11Min=0 x3S11Min=0 FrameElem=47
ElemStation=0.25

Frame=47 Station=0.375 OutputCase=ACCLATDX CaseType=LinStatic P=0 V2=0 V3=0 T=0 M2=0 M3=0
S11Max=0 PtS11Max=0 x2S11Max=0 x3S11Max=0 S11Min=0 PtS11Min=0 x2S11Min=0 x3S11Min=0 FrameElem=47
ElemStation=0.375

Frame=47 Station=0.5 OutputCase=ACCLATDX CaseType=LinStatic P=0 V2=0 V3=0 T=0 M2=0 M3=0
S11Max=0 PtS11Max=0 x2S11Max=0 x3S11Max=0 S11Min=0 PtS11Min=0 x2S11Min=0 x3S11Min=0 FrameElem=47
ElemStation=0.5

Frame=47 Station=0 OutputCase=ACCLATSX CaseType=LinStatic P=0 V2=0 V3=0 T=0 M2=0 M3=0
S11Max=0 PtS11Max=0 x2S11Max=0 x3S11Max=0 S11Min=0 PtS11Min=0 x2S11Min=0 x3S11Min=0 FrameElem=47
ElemStation=0

Frame=47 Station=0.125 OutputCase=ACCLATSX CaseType=LinStatic P=0 V2=0 V3=0 T=0 M2=0 M3=0
S11Max=0 PtS11Max=0 x2S11Max=0 x3S11Max=0 S11Min=0 PtS11Min=0 x2S11Min=0 x3S11Min=0 FrameElem=47
ElemStation=0.125

Frame=47 Station=0.25 OutputCase=ACCLATSX CaseType=LinStatic P=0 V2=0 V3=0 T=0 M2=0 M3=0
S11Max=0 PtS11Max=0 x2S11Max=0 x3S11Max=0 S11Min=0 PtS11Min=0 x2S11Min=0 x3S11Min=0 FrameElem=47
ElemStation=0.25

Frame=47 Station=0.375 OutputCase=ACCLATSX CaseType=LinStatic P=0 V2=0 V3=0 T=0 M2=0 M3=0
S11Max=0 PtS11Max=0 x2S11Max=0 x3S11Max=0 S11Min=0 PtS11Min=0 x2S11Min=0 x3S11Min=0 FrameElem=47
ElemStation=0.375

Frame=47 Station=0.5 OutputCase=ACCLATSX CaseType=LinStatic P=0 V2=0 V3=0 T=0 M2=0 M3=0
S11Max=0 PtS11Max=0 x2S11Max=0 x3S11Max=0 S11Min=0 PtS11Min=0 x2S11Min=0 x3S11Min=0 FrameElem=47
ElemStation=0.5

Frame=47 Station=0 OutputCase=TERRCOST CaseType=LinStatic P=0 V2=0 V3=0 T=0 M2=0 M3=0
S11Max=0 PtS11Max=0 x2S11Max=0 x3S11Max=0 S11Min=0 PtS11Min=0 x2S11Min=0 x3S11Min=0 FrameElem=47
ElemStation=0

Frame=47 Station=0.125 OutputCase=TERRCOST CaseType=LinStatic P=0 V2=0 V3=0 T=0 M2=0 M3=0
S11Max=0 PtS11Max=0 x2S11Max=0 x3S11Max=0 S11Min=0 PtS11Min=0 x2S11Min=0 x3S11Min=0 FrameElem=47
ElemStation=0.125

Frame=47 Station=0.25 OutputCase=TERRCOST CaseType=LinStatic P=0 V2=0 V3=0 T=0 M2=0 M3=0
S11Max=0 PtS11Max=0 x2S11Max=0 x3S11Max=0 S11Min=0 PtS11Min=0 x2S11Min=0 x3S11Min=0 FrameElem=47
ElemStation=0.25

Frame=47 Station=0.375 OutputCase=TERRCOST CaseType=LinStatic P=0 V2=0 V3=0 T=0 M2=0 M3=0
S11Max=0 PtS11Max=0 x2S11Max=0 x3S11Max=0 S11Min=0 PtS11Min=0 x2S11Min=0 x3S11Min=0 FrameElem=47
ElemStation=0.375

Frame=47 Station=0.5 OutputCase=TERRCOST CaseType=LinStatic P=0 V2=0 V3=0 T=0 M2=0 M3=0
S11Max=0 PtS11Max=0 x2S11Max=0 x3S11Max=0 S11Min=0 PtS11Min=0 x2S11Min=0 x3S11Min=0 FrameElem=47
ElemStation=0.5

Frame=47 Station=0 OutputCase=SOVRCOST CaseType=LinStatic P=0 V2=0 V3=0 T=0 M2=0 M3=0
S11Max=0 PtS11Max=0 x2S11Max=0 x3S11Max=0 S11Min=0 PtS11Min=0 x2S11Min=0 x3S11Min=0 FrameElem=47
ElemStation=0

Frame=47 Station=0.125 OutputCase=SOVRCOST CaseType=LinStatic P=0 V2=0 V3=0 T=0 M2=0 M3=0
S11Max=0 PtS11Max=0 x2S11Max=0 x3S11Max=0 S11Min=0 PtS11Min=0 x2S11Min=0 x3S11Min=0 FrameElem=47
ElemStation=0.125

Frame=47 Station=0.25 OutputCase=SOVRCOST CaseType=LinStatic P=0 V2=0 V3=0 T=0 M2=0 M3=0
S11Max=0 PtS11Max=0 x2S11Max=0 x3S11Max=0 S11Min=0 PtS11Min=0 x2S11Min=0 x3S11Min=0 FrameElem=47
ElemStation=0.25

Frame=47 Station=0.375 OutputCase=SOVRCOST CaseType=LinStatic P=0 V2=0 V3=0 T=0 M2=0 M3=0
S11Max=0 PtS11Max=0 x2S11Max=0 x3S11Max=0 S11Min=0 PtS11Min=0 x2S11Min=0 x3S11Min=0 FrameElem=47
ElemStation=0.375

Frame=47 Station=0.5 OutputCase=SOVRCOST CaseType=LinStatic P=0 V2=0 V3=0 T=0 M2=0 M3=0
S11Max=0 PtS11Max=0 x2S11Max=0 x3S11Max=0 S11Min=0 PtS11Min=0 x2S11Min=0 x3S11Min=0 FrameElem=47
ElemStation=0.5

Frame=47 Station=0 OutputCase=ENVE CaseType=Combination StepType=Max P=-90.2888588483432 V2=-
329.254958948964 V3=0 T=0 M2=0 M3=-355.666266781563 S11Max=2081.44174994552 PtS11Max=3 x2S11Max=0.5
x3S11Max=-0.5 _
S11Min=-2256.97391983147 PtS11Min=1 x2S11Min=-0.5 x3S11Min=-0.5 FrameElem=47 ElemStation=0

Frame=47 Station=0.125 OutputCase=ENVE CaseType=Combination StepType=Max P=-90.2888588483432 V2=-
326.129958948964 V3=0 T=0 M2=0 M3=-314.697842550852 S11Max=1835.6724057338 PtS11Max=3 x2S11Max=0.5
x3S11Max=-0.5 _
S11Min=-2011.1633744472 PtS11Min=1 x2S11Min=-0.5 x3S11Min=-0.5 FrameElem=47 ElemStation=0.125

Frame=47 Station=0.25 OutputCase=ENVE CaseType=Combination StepType=Max P=-90.2888588483432 V2=-
323.004958948964 V3=0 T=0 M2=0 M3=-274.120043320141 S11Max=1592.24681152208 PtS11Max=3 x2S11Max=0.5
x3S11Max=-0.5 _
S11Min=-1767.69657906293 PtS11Min=1 x2S11Min=-0.5 x3S11Min=-0.5 FrameElem=47 ElemStation=0.25

Frame=47 Station=0.375 OutputCase=ENVE CaseType=Combination StepType=Max P=-90.2888588483432 V2=-
319.879958948964 V3=0 T=0 M2=0 M3=-233.932869089429 S11Max=1351.16496731035 PtS11Max=3 x2S11Max=0.5
x3S11Max=-0.5 S11Min=-1526.57353367866 PtS11Min=1 x2S11Min=-0.5 x3S11Min=-0.5 FrameElem=47
ElemStation=0.375



Frame=47 Station=0.5 OutputCase=ENVE CaseType=Combination StepType=Max P=-90.288858483432 V2=-316.754958948964 V3=0 T=0 M2=0 M3=-194.136319858718 S11Max=1112.42687309863 PtS11Max=3 x2S11Max=0.5 x3S11Max=-0.5
 S11Min=-1287.7942382944 PtS11Min=1 x2S11Min=-0.5 x3S11Min=-0.5 FrameElem=47 ElemStation=0.5
 Frame=47 Station=0 OutputCase=ENVE CaseType=Combination StepType=Min P=-122.976319142087 V2=-329.309893845691 V3=0 T=0 M2=0 M3=-361.955101465645 S11Max=2011.02128154729 PtS11Max=3 x2S11Max=0.5 x3S11Max=-0.5
 S11Min=-2262.01946764221 PtS11Min=1 x2S11Min=-0.5 x3S11Min=-0.5 FrameElem=47 ElemStation=0
 Frame=47 Station=0.125 OutputCase=ENVE CaseType=Combination StepType=Min P=-122.976319142087 V2=-326.184893845691 V3=0 T=0 M2=0 M3=-320.993544097024 S11Max=1765.21073616303 PtS11Max=3 x2S11Max=0.5 x3S11Max=-0.5
 S11Min=-2016.25012343049 PtS11Min=1 x2S11Min=-0.5 x3S11Min=-0.5 FrameElem=47 ElemStation=0.125
 Frame=47 Station=0.25 OutputCase=ENVE CaseType=Combination StepType=Min P=-122.976319142087 V2=-323.059893845691 V3=0 T=0 M2=0 M3=-280.422611728403 S11Max=1521.74394077876 PtS11Max=3 x2S11Max=0.5 x3S11Max=-0.5
 S11Min=-1772.82452921876 PtS11Min=1 x2S11Min=-0.5 x3S11Min=-0.5 FrameElem=47 ElemStation=0.25
 Frame=47 Station=0.375 OutputCase=ENVE CaseType=Combination StepType=Min P=-122.976319142087 V2=-319.934893845691 V3=0 T=0 M2=0 M3=-240.242304359783 S11Max=1280.62089539449 PtS11Max=3 x2S11Max=0.5 x3S11Max=-0.5
 S11Min=-1531.74268500704 PtS11Min=1 x2S11Min=-0.5 x3S11Min=-0.5 FrameElem=47 ElemStation=0.375
 Frame=47 Station=0.5 OutputCase=ENVE CaseType=Combination StepType=Min P=-122.976319142087 V2=-316.809893845691 V3=0 T=0 M2=0 M3=-200.452621991162 S11Max=1041.84160001022 PtS11Max=3 x2S11Max=0.5 x3S11Max=-0.5
 S11Min=-1293.00459079532 PtS11Min=1 x2S11Min=-0.5 x3S11Min=-0.5 FrameElem=47 ElemStation=0.5
 Frame=47 Station=0 OutputCase=FESSUR CaseType=Combination P=-122.976319142087 V2=-329.309893845691 V3=0 T=0 M2=0 M3=-355.666266781563 S11Max=2011.02128154729 PtS11Max=3 x2S11Max=0.5 x3S11Max=-0.5
 S11Min=-2256.97391983147 PtS11Min=1 x2S11Min=-0.5 x3S11Min=-0.5 FrameElem=47 ElemStation=0
 Frame=47 Station=0.125 OutputCase=FESSUR CaseType=Combination P=-122.976319142087 V2=-326.184893845691 V3=0 T=0 M2=0 M3=-314.697842550852 S11Max=1765.21073616303 PtS11Max=3 x2S11Max=0.5 x3S11Max=-0.5
 S11Min=-2011.1633744472 PtS11Min=1 x2S11Min=-0.5 x3S11Min=-0.5 FrameElem=47 ElemStation=0.125
 Frame=47 Station=0.25 OutputCase=FESSUR CaseType=Combination P=-122.976319142087 V2=-323.059893845691 V3=0 T=0 M2=0 M3=-274.120043320141 S11Max=1521.74394077876 PtS11Max=3 x2S11Max=0.5 x3S11Max=-0.5
 S11Min=-1767.69657906293 PtS11Min=1 x2S11Min=-0.5 x3S11Min=-0.5 FrameElem=47 ElemStation=0.25
 Frame=47 Station=0.375 OutputCase=FESSUR CaseType=Combination P=-122.976319142087 V2=-319.934893845691 V3=0 T=0 M2=0 M3=-233.932869089429 S11Max=1280.62089539449 PtS11Max=3 x2S11Max=0.5 x3S11Max=-0.5
 S11Min=-1526.57353367866 PtS11Min=1 x2S11Min=-0.5 x3S11Min=-0.5 FrameElem=47 ElemStation=0.375
 Frame=47 Station=0.5 OutputCase=FESSUR CaseType=Combination P=-122.976319142087 V2=-316.809893845691 V3=0 T=0 M2=0 M3=-194.136319858718 S11Max=1041.84160001022 PtS11Max=3 x2S11Max=0.5 x3S11Max=-0.5
 S11Min=-1287.7942382944 PtS11Min=1 x2S11Min=-0.5 x3S11Min=-0.5 FrameElem=47 ElemStation=0.5
 Frame=48 Station=0 OutputCase=PESOPR CaseType=LinStatic P=-15.1709467362366 V2=-119.133696004326 V3=0 T=0 M2=0 M3=-47.627310919499 S11Max=270.592918780757 PtS11Max=3 x2S11Max=0.5 x3S11Max=-0.5
 S11Min=-300.934812253231 PtS11Min=1 x2S11Min=-0.5 x3S11Min=-0.5 FrameElem=48 ElemStation=0
 Frame=48 Station=0.125 OutputCase=PESOPR CaseType=LinStatic P=-15.1709467362366 V2=-116.008696004326 V3=0 T=0 M2=0 M3=-32.9309114189582 S11Max=182.414521777513 PtS11Max=3 x2S11Max=0.5 x3S11Max=-0.5
 S11Min=-212.756415249986 PtS11Min=1 x2S11Min=-0.5 x3S11Min=-0.5 FrameElem=48 ElemStation=0.125
 Frame=48 Station=0.25 OutputCase=PESOPR CaseType=LinStatic P=-15.1709467362366 V2=-112.883696004326 V3=0 T=0 M2=0 M3=-18.6251369184174 S11Max=96.5798747742679 PtS11Max=3 x2S11Max=0.5 x3S11Max=-0.5
 S11Min=-126.921768246741 PtS11Min=1 x2S11Min=-0.5 x3S11Min=-0.5 FrameElem=48 ElemStation=0.25
 Frame=48 Station=0.375 OutputCase=PESOPR CaseType=LinStatic P=-15.1709467362366 V2=-109.758696004326 V3=0 T=0 M2=0 M3=-4.70998741787662 S11Max=13.088977710232 PtS11Max=3 x2S11Max=0.5 x3S11Max=-0.5
 S11Min=-43.4308712434963 PtS11Min=1 x2S11Min=-0.5 x3S11Min=-0.5 FrameElem=48 ElemStation=0.375
 Frame=48 Station=0.5 OutputCase=PESOPR CaseType=LinStatic P=-15.1709467362366 V2=-106.633696004326 V3=0 T=0 M2=0 M3=8.81453708266417 S11Max=37.7162757597485 PtS11Max=1 x2S11Max=-0.5 x3S11Max=-0.5
 S11Min=-68.0581692322216 PtS11Min=3 x2S11Min=-0.5 x3S11Min=-0.5 FrameElem=48 ElemStation=0.5
 Frame=48 Station=0 OutputCase=TERRVERT CaseType=LinStatic P=1.15282857329472 V2=-341.044411438954 V3=0 T=0 M2=0 M3=-167.563349380689 S11Max=1006.53292485743 PtS11Max=3 x2S11Max=0.5 x3S11Max=-0.5
 S11Min=-1004.22726771084 PtS11Min=1 x2S11Min=-0.5 x3S11Min=-0.5 FrameElem=48 ElemStation=0
 Frame=48 Station=0.125 OutputCase=TERRVERT CaseType=LinStatic P=1.15282857329472 V2=-341.044411438954 V3=0 T=0 M2=0 M3=-124.93279795082 S11Max=750.749616278214 PtS11Max=3 x2S11Max=0.5 x3S11Max=-0.5
 S11Min=-748.443959131624 PtS11Min=1 x2S11Min=-0.5 x3S11Min=-0.5 FrameElem=48 ElemStation=0.125
 Frame=48 Station=0.25 OutputCase=TERRVERT CaseType=LinStatic P=1.15282857329472 V2=-341.044411438954 V3=0 T=0 M2=0 M3=-82.3022465209506 S11Max=494.966307698998 PtS11Max=3 x2S11Max=0.5 x3S11Max=-0.5
 S11Min=-492.660650552409 PtS11Min=1 x2S11Min=-0.5 x3S11Min=-0.5 FrameElem=48 ElemStation=0.25
 Frame=48 Station=0.375 OutputCase=TERRVERT CaseType=LinStatic P=1.15282857329472 V2=-341.044411438954 V3=0 T=0 M2=0 M3=-39.6716950910813 S11Max=239.182999119783 PtS11Max=3 x2S11Max=0.5 x3S11Max=-0.5
 S11Min=-236.877341973193 PtS11Min=1 x2S11Min=-0.5 x3S11Min=-0.5 FrameElem=48 ElemStation=0.375
 Frame=48 Station=0.5 OutputCase=TERRVERT CaseType=LinStatic P=1.15282857329472 V2=-341.044411438954 V3=0 T=0 M2=0 M3=2.95885633878788 S11Max=18.905966606022 PtS11Max=1 x2S11Max=-0.5 x3S11Max=-0.5
 S11Min=-16.6003094594326 PtS11Min=3 x2S11Min=-0.5 x3S11Min=-0.5 FrameElem=48 ElemStation=0.5
 Frame=48 Station=0 OutputCase=TERRLAT CaseType=LinStatic P=-108.958200979145 V2=-0.17730278044219 V3=0 T=0 M2=0 M3=21.0543404414808 S11Max=17.3678416697399 PtS11Max=1 x2S11Max=-0.5 x3S11Max=-0.5
 S11Min=-235.28424362803 PtS11Min=3 x2S11Min=0.5 x3S11Min=-0.5 FrameElem=48 ElemStation=0
 Frame=48 Station=0.125 OutputCase=TERRLAT CaseType=LinStatic P=-108.958200979145 V2=-0.17730278044219 V3=0 T=0 M2=0 M3=21.0765032890361 S11Max=17.5008187550715 PtS11Max=1 x2S11Max=-0.5 x3S11Max=-0.5
 S11Min=-235.417220713361 PtS11Min=3 x2S11Min=0.5 x3S11Min=-0.5 FrameElem=48 ElemStation=0.125
 Frame=48 Station=0.25 OutputCase=TERRLAT CaseType=LinStatic P=-108.958200979145 V2=-0.17730278044219 V3=0 T=0 M2=0 M3=21.0986661365913 S11Max=17.6337958404031 PtS11Max=1 x2S11Max=-0.5 x3S11Max=-0.5
 S11Min=-235.550197798693 PtS11Min=3 x2S11Min=0.5 x3S11Min=-0.5 FrameElem=48 ElemStation=0.25
 Frame=48 Station=0.375 OutputCase=TERRLAT CaseType=LinStatic P=-108.958200979145 V2=-0.17730278044219 V3=0 T=0 M2=0 M3=21.1208289841466 S11Max=17.7667729257348 PtS11Max=1 x2S11Max=-0.5 x3S11Max=-0.5
 S11Min=-235.683174884024 PtS11Min=3 x2S11Min=0.5 x3S11Min=-0.5 FrameElem=48 ElemStation=0.375

Frame=48 Station=0.5 OutputCase=TERRLAT CaseType=LinStatic P=-108.958200979145 V2=-0.17730278044219
V3=0 T=0 M2=0 M3=21.1429918317019 S11Max=17.8997500110664 PtS11Max=1 x2S11Max=-0.5 x3S11Max=-0.5 _
S11Min=-235.816151969356 PtS11Min=3 x2S11Min=0.5 x3S11Min=-0.5 FrameElem=48 ElemStation=0.5

Frame=48 Station=0 OutputCase=ACCLATDX CaseType=LinStatic P=0 V2=0 V3=0 T=0 M2=0 M3=0
S11Max=0 PtS11Max=0 x2S11Max=0 x3S11Max=0 S11Min=0 PtS11Min=0 x2S11Min=0 x3S11Min=0 FrameElem=48
ElemStation=0

Frame=48 Station=0.125 OutputCase=ACCLATDX CaseType=LinStatic P=0 V2=0 V3=0 T=0 M2=0 M3=0
S11Max=0 PtS11Max=0 x2S11Max=0 x3S11Max=0 S11Min=0 PtS11Min=0 x2S11Min=0 x3S11Min=0 FrameElem=48
ElemStation=0.125

Frame=48 Station=0.25 OutputCase=ACCLATDX CaseType=LinStatic P=0 V2=0 V3=0 T=0 M2=0 M3=0
S11Max=0 PtS11Max=0 x2S11Max=0 x3S11Max=0 S11Min=0 PtS11Min=0 x2S11Min=0 x3S11Min=0 FrameElem=48
ElemStation=0.25

Frame=48 Station=0.375 OutputCase=ACCLATDX CaseType=LinStatic P=0 V2=0 V3=0 T=0 M2=0 M3=0
S11Max=0 PtS11Max=0 x2S11Max=0 x3S11Max=0 S11Min=0 PtS11Min=0 x2S11Min=0 x3S11Min=0 FrameElem=48
ElemStation=0.375

Frame=48 Station=0.5 OutputCase=ACCLATDX CaseType=LinStatic P=0 V2=0 V3=0 T=0 M2=0 M3=0
S11Max=0 PtS11Max=0 x2S11Max=0 x3S11Max=0 S11Min=0 PtS11Min=0 x2S11Min=0 x3S11Min=0 FrameElem=48
ElemStation=0.5

Frame=48 Station=0 OutputCase=ACCLATSX CaseType=LinStatic P=0 V2=0 V3=0 T=0 M2=0 M3=0
S11Max=0 PtS11Max=0 x2S11Max=0 x3S11Max=0 S11Min=0 PtS11Min=0 x2S11Min=0 x3S11Min=0 FrameElem=48
ElemStation=0

Frame=48 Station=0.125 OutputCase=ACCLATSX CaseType=LinStatic P=0 V2=0 V3=0 T=0 M2=0 M3=0
S11Max=0 PtS11Max=0 x2S11Max=0 x3S11Max=0 S11Min=0 PtS11Min=0 x2S11Min=0 x3S11Min=0 FrameElem=48
ElemStation=0.125

Frame=48 Station=0.25 OutputCase=ACCLATSX CaseType=LinStatic P=0 V2=0 V3=0 T=0 M2=0 M3=0
S11Max=0 PtS11Max=0 x2S11Max=0 x3S11Max=0 S11Min=0 PtS11Min=0 x2S11Min=0 x3S11Min=0 FrameElem=48
ElemStation=0.25

Frame=48 Station=0.375 OutputCase=ACCLATSX CaseType=LinStatic P=0 V2=0 V3=0 T=0 M2=0 M3=0
S11Max=0 PtS11Max=0 x2S11Max=0 x3S11Max=0 S11Min=0 PtS11Min=0 x2S11Min=0 x3S11Min=0 FrameElem=48
ElemStation=0.375

Frame=48 Station=0.5 OutputCase=ACCLATSX CaseType=LinStatic P=0 V2=0 V3=0 T=0 M2=0 M3=0
S11Max=0 PtS11Max=0 x2S11Max=0 x3S11Max=0 S11Min=0 PtS11Min=0 x2S11Min=0 x3S11Min=0 FrameElem=48
ElemStation=0.5

Frame=48 Station=0 OutputCase=TERRCOST CaseType=LinStatic P=0 V2=0 V3=0 T=0 M2=0 M3=0
S11Max=0 PtS11Max=0 x2S11Max=0 x3S11Max=0 S11Min=0 PtS11Min=0 x2S11Min=0 x3S11Min=0 FrameElem=48
ElemStation=0

Frame=48 Station=0.125 OutputCase=TERRCOST CaseType=LinStatic P=0 V2=0 V3=0 T=0 M2=0 M3=0
S11Max=0 PtS11Max=0 x2S11Max=0 x3S11Max=0 S11Min=0 PtS11Min=0 x2S11Min=0 x3S11Min=0 FrameElem=48
ElemStation=0.125

Frame=48 Station=0.25 OutputCase=TERRCOST CaseType=LinStatic P=0 V2=0 V3=0 T=0 M2=0 M3=0
S11Max=0 PtS11Max=0 x2S11Max=0 x3S11Max=0 S11Min=0 PtS11Min=0 x2S11Min=0 x3S11Min=0 FrameElem=48
ElemStation=0.25

Frame=48 Station=0.375 OutputCase=TERRCOST CaseType=LinStatic P=0 V2=0 V3=0 T=0 M2=0 M3=0
S11Max=0 PtS11Max=0 x2S11Max=0 x3S11Max=0 S11Min=0 PtS11Min=0 x2S11Min=0 x3S11Min=0 FrameElem=48
ElemStation=0.375

Frame=48 Station=0.5 OutputCase=TERRCOST CaseType=LinStatic P=0 V2=0 V3=0 T=0 M2=0 M3=0
S11Max=0 PtS11Max=0 x2S11Max=0 x3S11Max=0 S11Min=0 PtS11Min=0 x2S11Min=0 x3S11Min=0 FrameElem=48
ElemStation=0.5

Frame=48 Station=0 OutputCase=SOVRCOST CaseType=LinStatic P=0 V2=0 V3=0 T=0 M2=0 M3=0
S11Max=0 PtS11Max=0 x2S11Max=0 x3S11Max=0 S11Min=0 PtS11Min=0 x2S11Min=0 x3S11Min=0 FrameElem=48
ElemStation=0

Frame=48 Station=0.125 OutputCase=SOVRCOST CaseType=LinStatic P=0 V2=0 V3=0 T=0 M2=0 M3=0
S11Max=0 PtS11Max=0 x2S11Max=0 x3S11Max=0 S11Min=0 PtS11Min=0 x2S11Min=0 x3S11Min=0 FrameElem=48
ElemStation=0.125

Frame=48 Station=0.25 OutputCase=SOVRCOST CaseType=LinStatic P=0 V2=0 V3=0 T=0 M2=0 M3=0
S11Max=0 PtS11Max=0 x2S11Max=0 x3S11Max=0 S11Min=0 PtS11Min=0 x2S11Min=0 x3S11Min=0 FrameElem=48
ElemStation=0.25

Frame=48 Station=0.375 OutputCase=SOVRCOST CaseType=LinStatic P=0 V2=0 V3=0 T=0 M2=0 M3=0
S11Max=0 PtS11Max=0 x2S11Max=0 x3S11Max=0 S11Min=0 PtS11Min=0 x2S11Min=0 x3S11Min=0 FrameElem=48
ElemStation=0.375

Frame=48 Station=0.5 OutputCase=SOVRCOST CaseType=LinStatic P=0 V2=0 V3=0 T=0 M2=0 M3=0
S11Max=0 PtS11Max=0 x2S11Max=0 x3S11Max=0 S11Min=0 PtS11Min=0 x2S11Min=0 x3S11Min=0 FrameElem=48
ElemStation=0.5

Frame=48 Station=0 OutputCase=ENVE CaseType=Combination StepType=Max P=-90.2888588483432 V2=-
460.30221938959 V3=0 T=0 M2=0 M3=-194.136319858707 S11Max=1112.42687309857 PtS11Max=3 x2S11Max=0.5
x3S11Max=-0.5 _
S11Min=-1287.79423829433 PtS11Min=1 x2S11Min=-0.5 x3S11Min=-0.5 FrameElem=48 ElemStation=0

Frame=48 Station=0.125 OutputCase=ENVE CaseType=Combination StepType=Max P=-90.2888588483432 V2=-
457.17721938959 V3=0 T=0 M2=0 M3=-136.787206080742 S11Max=768.372083556373 PtS11Max=3 x2S11Max=0.5
x3S11Max=-0.5 _
S11Min=-943.699555626538 PtS11Min=1 x2S11Min=-0.5 x3S11Min=-0.5 FrameElem=48 ElemStation=0.125

Frame=48 Station=0.25 OutputCase=ENVE CaseType=Combination StepType=Max P=-90.2888588483432 V2=-
454.05221938959 V3=0 T=0 M2=0 M3=-79.8287173027767 S11Max=426.661044014181 PtS11Max=3 x2S11Max=0.5
x3S11Max=-0.5 _
S11Min=-601.948622958747 PtS11Min=1 x2S11Min=-0.5 x3S11Min=-0.5 FrameElem=48 ElemStation=0.25

Frame=48 Station=0.375 OutputCase=ENVE CaseType=Combination StepType=Max P=-90.2888588483432 V2=-
450.92721938959 V3=0 T=0 M2=0 M3=-23.2608535248114 S11Max=87.2937544719888 PtS11Max=3 x2S11Max=0.5
x3S11Max=-0.5 _
S11Min=-262.541440290955 PtS11Min=1 x2S11Min=-0.5 x3S11Min=-0.5 FrameElem=48 ElemStation=0.375

Frame=48 Station=0.5 OutputCase=ENVE CaseType=Combination StepType=Max P=-90.2888588483432 V2=-
447.80221938959 V3=0 T=0 M2=0 M3=32.9163852531539 S11Max=74.5219923768369 PtS11Max=1 x2S11Max=-0.5
x3S11Max=-0.5 _



S11Min=-249.729785070203 PtS11Min=3 x2S11Min=0.5 x3S11Min=-0.5 FrameElem=48 ElemStation=0.5
 Frame=48 Station=0 OutputCase=ENVE CaseType=Combination StepType=Min P=-122.976319142087 V2=-
 460.355410223722 V3=0 T=0 M2=0 M3=-200.452621991151 S11Max=1041.84160001016 PtS11Max=3 x2S11Max=0.5
 x3S11Max=-0.5 _
 S11Min=-1293.00459079525 PtS11Min=1 x2S11Min=-0.5 x3S11Min=-0.5 FrameElem=48 ElemStation=0
 Frame=48 Station=0.125 OutputCase=ENVE CaseType=Combination StepType=Min P=-122.976319142087 V2=-
 457.230410223722 V3=0 T=0 M2=0 M3=-143.110157067453 S11Max=697.746917342365 PtS11Max=3 x2S11Max=0.5 _
 x3S11Max=-0.5 S11Min=-948.94980125306 PtS11Min=1 x2S11Min=-0.5 x3S11Min=-0.5 FrameElem=48
 ElemStation=0.125
 Frame=48 Station=0.25 OutputCase=ENVE CaseType=Combination StepType=Min P=-122.976319142087 V2=-
 454.105410223722 V3=0 T=0 M2=0 M3=-86.1583171437541 S11Max=355.995984674573 PtS11Max=3 x2S11Max=0.5
 x3S11Max=-0.5 _
 S11Min=-607.238761710868 PtS11Min=1 x2S11Min=-0.5 x3S11Min=-0.5 FrameElem=48 ElemStation=0.25
 Frame=48 Station=0.375 OutputCase=ENVE CaseType=Combination StepType=Min P=-122.976319142087 V2=-
 450.980410223722 V3=0 T=0 M2=0 M3=-29.5971022200553 S11Max=16.5888020067815 PtS11Max=3 x2S11Max=0.5 _
 x3S11Max=-0.5 S11Min=-267.871472168675 PtS11Min=1 x2S11Min=-0.5 x3S11Min=-0.5 FrameElem=48
 ElemStation=0.375
 Frame=48 Station=0.5 OutputCase=ENVE CaseType=Combination StepType=Min P=-122.976319142087 V2=-
 447.855410223722 V3=0 T=0 M2=0 M3=26.5734877036434 S11Max=69.152067373517 PtS11Max=1 x2S11Max=-0.5
 x3S11Max=-0.5 _
 S11Min=-320.47463066101 PtS11Min=3 x2S11Min=0.5 x3S11Min=-0.5 FrameElem=48 ElemStation=0.5
 Frame=48 Station=0 OutputCase=FESSUR CaseType=Combination P=-122.976319142087 V2=-460.355410223722
 V3=0 T=0 M2=0 M3=-194.136319858707 S11Max=1041.84160001016 PtS11Max=3 x2S11Max=0.5 x3S11Max=-0.5 _
 S11Min=-1287.79423829433 PtS11Min=1 x2S11Min=-0.5 x3S11Min=-0.5 FrameElem=48 ElemStation=0
 Frame=48 Station=0.125 OutputCase=FESSUR CaseType=Combination P=-122.976319142087 V2=-457.230410223722
 V3=0 T=0 M2=0 M3=-136.787206080742 S11Max=697.746917342365 PtS11Max=3 x2S11Max=0.5 x3S11Max=-0.5 _
 S11Min=-943.699555626538 PtS11Min=1 x2S11Min=-0.5 x3S11Min=-0.5 FrameElem=48 ElemStation=0.125
 Frame=48 Station=0.25 OutputCase=FESSUR CaseType=Combination P=-122.976319142087 V2=-454.105410223722
 V3=0 T=0 M2=0 M3=-79.8287173027767 S11Max=355.995984674573 PtS11Max=3 x2S11Max=0.5 x3S11Max=-0.5 _
 S11Min=-601.948622958747 PtS11Min=1 x2S11Min=-0.5 x3S11Min=-0.5 FrameElem=48 ElemStation=0.25
 Frame=48 Station=0.375 OutputCase=FESSUR CaseType=Combination P=-122.976319142087 V2=-450.980410223722
 V3=0 T=0 M2=0 M3=-23.2608535248114 S11Max=16.5888020067815 PtS11Max=3 x2S11Max=0.5 x3S11Max=-0.5 _
 S11Min=-262.541440290955 PtS11Min=1 x2S11Min=-0.5 x3S11Min=-0.5 FrameElem=48 ElemStation=0.375
 Frame=48 Station=0.5 OutputCase=FESSUR CaseType=Combination P=-122.976319142087 V2=-447.855410223722
 V3=0 T=0 M2=0 M3=32.9163852531539 S11Max=74.5219923768369 PtS11Max=1 x2S11Max=-0.5 x3S11Max=-0.5 _
 S11Min=-320.47463066101 PtS11Min=3 x2S11Min=0.5 x3S11Min=-0.5 FrameElem=48 ElemStation=0.5
 Frame=49 Station=0 OutputCase=PESOPR CaseType=LinStatic P=15.1709467362397 V2=-49.999999888678 V3=0
 T=0 M2=0 M3=7.05342174191173 S11Max=57.4914771877101 PtS11Max=1 x2S11Max=-0.5 x3S11Max=-0.5 _
 S11Min=-27.1495837152307 PtS11Min=3 x2S11Min=0.5 x3S11Min=-0.5 FrameElem=49 ElemStation=0
 Frame=49 Station=0.125 OutputCase=PESOPR CaseType=LinStatic P=15.1709467362397 V2=-46.874999988678
 V3=0 T=0 M2=0 M3=13.1081092405202 S11Max=93.8196021793609 PtS11Max=1 x2S11Max=-0.5 x3S11Max=-0.5 _
 S11Min=-63.4777087068816 PtS11Min=3 x2S11Min=0.5 x3S11Min=-0.5 FrameElem=49 ElemStation=0.125
 Frame=49 Station=0.25 OutputCase=PESOPR CaseType=LinStatic P=15.1709467362397 V2=-43.749999988678
 V3=0 T=0 M2=0 M3=18.7721717391287 S11Max=127.803977171012 PtS11Max=1 x2S11Max=-0.5 x3S11Max=-0.5 _
 S11Min=-97.4620836985324 PtS11Min=3 x2S11Min=0.5 x3S11Min=-0.5 FrameElem=49 ElemStation=0.25
 Frame=49 Station=0.375 OutputCase=PESOPR CaseType=LinStatic P=15.1709467362397 V2=-40.624999988678
 V3=0 T=0 M2=0 M3=24.0456092377372 S11Max=159.444602162663 PtS11Max=1 x2S11Max=-0.5 x3S11Max=-0.5 _
 S11Min=-129.102708690183 PtS11Min=3 x2S11Min=0.5 x3S11Min=-0.5 FrameElem=49 ElemStation=0.375
 Frame=49 Station=0.5 OutputCase=PESOPR CaseType=LinStatic P=15.1709467362397 V2=-37.499999988678
 V3=0 T=0 M2=0 M3=28.9284217363456 S11Max=188.741477154313 PtS11Max=1 x2S11Max=-0.5 x3S11Max=-0.5 _
 S11Min=-158.399583681834 PtS11Min=3 x2S11Min=0.5 x3S11Min=-0.5 FrameElem=49 ElemStation=0.5
 Frame=49 Station=0 OutputCase=TERRVERT CaseType=LinStatic P=-1.15282857328748 V2=-392.99999802356
 V3=0 T=0 M2=0 M3=-6.96560956833127 S11Max=40.6408288367002 PtS11Max=3 x2S11Max=0.5 x3S11Max=-0.5 _
 S11Min=-42.9464859832751 PtS11Min=1 x2S11Min=-0.5 x3S11Min=-0.5 FrameElem=49 ElemStation=0
 Frame=49 Station=0.125 OutputCase=TERRVERT CaseType=LinStatic P=-1.15282857328748 V2=-368.437499802356
 V3=0 T=0 M2=0 M3=40.6242341569632 S11Max=242.592576368492 PtS11Max=1 x2S11Max=-0.5 x3S11Max=-0.5 _
 S11Min=-244.898233515067 PtS11Min=3 x2S11Min=0.5 x3S11Min=-0.5 FrameElem=49 ElemStation=0.125
 Frame=49 Station=0.25 OutputCase=TERRVERT CaseType=LinStatic P=-1.15282857328748 V2=-343.874999802356
 V3=0 T=0 M2=0 M3=85.1437653822577 S11Max=509.709763720259 PtS11Max=1 x2S11Max=-0.5 x3S11Max=-0.5 _
 S11Min=-512.015420866834 PtS11Min=3 x2S11Min=0.5 x3S11Min=-0.5 FrameElem=49 ElemStation=0.25
 Frame=49 Station=0.375 OutputCase=TERRVERT CaseType=LinStatic P=-1.15282857328748 V2=-319.312499802356
 V3=0 T=0 M2=0 M3=126.592984107552 S11Max=758.405076072026 PtS11Max=1 x2S11Max=-0.5 x3S11Max=-0.5 _
 S11Min=-760.710733218601 PtS11Min=3 x2S11Min=0.5 x3S11Min=-0.5 FrameElem=49 ElemStation=0.375
 Frame=49 Station=0.5 OutputCase=TERRVERT CaseType=LinStatic P=-1.15282857328748 V2=-294.749999802356
 V3=0 T=0 M2=0 M3=164.971890332847 S11Max=988.678513423793 PtS11Max=1 x2S11Max=-0.5 x3S11Max=-0.5 _
 S11Min=-990.984170570368 PtS11Min=3 x2S11Min=0.5 x3S11Min=-0.5 FrameElem=49 ElemStation=0.5
 Frame=49 Station=0 OutputCase=TERRLAT CaseType=LinStatic P=-66.7117981831702 V2=3.34180413119611E-07
 V3=0 T=0 M2=0 M3=-20.5502623273677 S11Max=56.5897757810359 PtS11Max=3 x2S11Max=0.5 x3S11Max=-0.5 _
 S11Min=-190.013372147376 PtS11Min=1 x2S11Min=-0.5 x3S11Min=-0.5 FrameElem=49 ElemStation=0
 Frame=49 Station=0.125 OutputCase=TERRLAT CaseType=LinStatic P=-66.7117981831702 V2=3.34180413119611E-07
 V3=0 T=0 M2=0 M3=-20.5502623691402 S11Max=56.5897760316712 PtS11Max=3 x2S11Max=0.5 x3S11Max=-0.5
 _
 S11Min=-190.013372398012 PtS11Min=1 x2S11Min=-0.5 x3S11Min=-0.5 FrameElem=49 ElemStation=0.125
 Frame=49 Station=0.25 OutputCase=TERRLAT CaseType=LinStatic P=-66.7117981831702 V2=3.34180413119611E-07
 V3=0 T=0 M2=0 M3=-20.5502624109128 S11Max=56.5897762823065 PtS11Max=3 x2S11Max=0.5 x3S11Max=-0.5 _
 S11Min=-190.013372648647 PtS11Min=1 x2S11Min=-0.5 x3S11Min=-0.5 FrameElem=49 ElemStation=0.25
 Frame=49 Station=0.375 OutputCase=TERRLAT CaseType=LinStatic P=-66.7117981831702 V2=3.34180413119611E-07
 V3=0 T=0 M2=0 M3=-20.5502624526853 S11Max=56.5897765329418 PtS11Max=3 x2S11Max=0.5 x3S11Max=-0.5
 _
 S11Min=-190.013372899282 PtS11Min=1 x2S11Min=-0.5 x3S11Min=-0.5 FrameElem=49 ElemStation=0.375
 Frame=49 Station=0.5 OutputCase=TERRLAT CaseType=LinStatic P=-66.7117981831702 V2=3.34180413119611E-07
 V3=0 T=0 M2=0 M3=-20.5502624944579 S11Max=56.5897767835771 PtS11Max=3 x2S11Max=0.5 x3S11Max=-0.5 _



S11Min=-190.013373149917 PtS11Min=1 x2S11Min=-0.5 x3S11Min=-0.5 FrameElem=49 ElemStation=0.5
 Frame=49 Station=0 OutputCase=ACCLATDX CaseType=LinStatic P=0 V2=0 V3=0 T=0 M2=0 M3=0
 S11Max=0 PtS11Max=0 x2S11Max=0 x3S11Max=0 S11Min=0 PtS11Min=0 x2S11Min=0 x3S11Min=0 FrameElem=49
 ElemStation=0
 Frame=49 Station=0.125 OutputCase=ACCLATDX CaseType=LinStatic P=0 V2=0 V3=0 T=0 M2=0 M3=0
 S11Max=0 PtS11Max=0 x2S11Max=0 x3S11Max=0 S11Min=0 PtS11Min=0 x2S11Min=0 x3S11Min=0 FrameElem=49
 ElemStation=0.125
 Frame=49 Station=0.25 OutputCase=ACCLATDX CaseType=LinStatic P=0 V2=0 V3=0 T=0 M2=0 M3=0
 S11Max=0 PtS11Max=0 x2S11Max=0 x3S11Max=0 S11Min=0 PtS11Min=0 x2S11Min=0 x3S11Min=0 FrameElem=49
 ElemStation=0.25
 Frame=49 Station=0.375 OutputCase=ACCLATDX CaseType=LinStatic P=0 V2=0 V3=0 T=0 M2=0 M3=0
 S11Max=0 PtS11Max=0 x2S11Max=0 x3S11Max=0 S11Min=0 PtS11Min=0 x2S11Min=0 x3S11Min=0 FrameElem=49
 ElemStation=0.375
 Frame=49 Station=0.5 OutputCase=ACCLATDX CaseType=LinStatic P=0 V2=0 V3=0 T=0 M2=0 M3=0
 S11Max=0 PtS11Max=0 x2S11Max=0 x3S11Max=0 S11Min=0 PtS11Min=0 x2S11Min=0 x3S11Min=0 FrameElem=49
 ElemStation=0.5
 Frame=49 Station=0 OutputCase=ACCLATSX CaseType=LinStatic P=0 V2=0 V3=0 T=0 M2=0 M3=0
 S11Max=0 PtS11Max=0 x2S11Max=0 x3S11Max=0 S11Min=0 PtS11Min=0 x2S11Min=0 x3S11Min=0 FrameElem=49
 ElemStation=0
 Frame=49 Station=0.125 OutputCase=ACCLATSX CaseType=LinStatic P=0 V2=0 V3=0 T=0 M2=0 M3=0
 S11Max=0 PtS11Max=0 x2S11Max=0 x3S11Max=0 S11Min=0 PtS11Min=0 x2S11Min=0 x3S11Min=0 FrameElem=49
 ElemStation=0.125
 Frame=49 Station=0.25 OutputCase=ACCLATSX CaseType=LinStatic P=0 V2=0 V3=0 T=0 M2=0 M3=0
 S11Max=0 PtS11Max=0 x2S11Max=0 x3S11Max=0 S11Min=0 PtS11Min=0 x2S11Min=0 x3S11Min=0 FrameElem=49
 ElemStation=0.25
 Frame=49 Station=0.375 OutputCase=ACCLATSX CaseType=LinStatic P=0 V2=0 V3=0 T=0 M2=0 M3=0
 S11Max=0 PtS11Max=0 x2S11Max=0 x3S11Max=0 S11Min=0 PtS11Min=0 x2S11Min=0 x3S11Min=0 FrameElem=49
 ElemStation=0.375
 Frame=49 Station=0.5 OutputCase=ACCLATSX CaseType=LinStatic P=0 V2=0 V3=0 T=0 M2=0 M3=0
 S11Max=0 PtS11Max=0 x2S11Max=0 x3S11Max=0 S11Min=0 PtS11Min=0 x2S11Min=0 x3S11Min=0 FrameElem=49
 ElemStation=0.5
 Frame=49 Station=0 OutputCase=TERRCOST CaseType=LinStatic P=0 V2=0 V3=0 T=0 M2=0 M3=0
 S11Max=0 PtS11Max=0 x2S11Max=0 x3S11Max=0 S11Min=0 PtS11Min=0 x2S11Min=0 x3S11Min=0 FrameElem=49
 ElemStation=0
 Frame=49 Station=0.125 OutputCase=TERRCOST CaseType=LinStatic P=0 V2=0 V3=0 T=0 M2=0 M3=0
 S11Max=0 PtS11Max=0 x2S11Max=0 x3S11Max=0 S11Min=0 PtS11Min=0 x2S11Min=0 x3S11Min=0 FrameElem=49
 ElemStation=0.125
 Frame=49 Station=0.25 OutputCase=TERRCOST CaseType=LinStatic P=0 V2=0 V3=0 T=0 M2=0 M3=0
 S11Max=0 PtS11Max=0 x2S11Max=0 x3S11Max=0 S11Min=0 PtS11Min=0 x2S11Min=0 x3S11Min=0 FrameElem=49
 ElemStation=0.25
 Frame=49 Station=0.375 OutputCase=TERRCOST CaseType=LinStatic P=0 V2=0 V3=0 T=0 M2=0 M3=0
 S11Max=0 PtS11Max=0 x2S11Max=0 x3S11Max=0 S11Min=0 PtS11Min=0 x2S11Min=0 x3S11Min=0 FrameElem=49
 ElemStation=0.375
 Frame=49 Station=0.5 OutputCase=TERRCOST CaseType=LinStatic P=0 V2=0 V3=0 T=0 M2=0 M3=0
 S11Max=0 PtS11Max=0 x2S11Max=0 x3S11Max=0 S11Min=0 PtS11Min=0 x2S11Min=0 x3S11Min=0 FrameElem=49
 ElemStation=0.5
 Frame=49 Station=0 OutputCase=SOVRCOST CaseType=LinStatic P=0 V2=0 V3=0 T=0 M2=0 M3=0
 S11Max=0 PtS11Max=0 x2S11Max=0 x3S11Max=0 S11Min=0 PtS11Min=0 x2S11Min=0 x3S11Min=0 FrameElem=49
 ElemStation=0
 Frame=49 Station=0.125 OutputCase=SOVRCOST CaseType=LinStatic P=0 V2=0 V3=0 T=0 M2=0 M3=0
 S11Max=0 PtS11Max=0 x2S11Max=0 x3S11Max=0 S11Min=0 PtS11Min=0 x2S11Min=0 x3S11Min=0 FrameElem=49
 ElemStation=0.125
 Frame=49 Station=0.25 OutputCase=SOVRCOST CaseType=LinStatic P=0 V2=0 V3=0 T=0 M2=0 M3=0
 S11Max=0 PtS11Max=0 x2S11Max=0 x3S11Max=0 S11Min=0 PtS11Min=0 x2S11Min=0 x3S11Min=0 FrameElem=49
 ElemStation=0.25
 Frame=49 Station=0.375 OutputCase=SOVRCOST CaseType=LinStatic P=0 V2=0 V3=0 T=0 M2=0 M3=0
 S11Max=0 PtS11Max=0 x2S11Max=0 x3S11Max=0 S11Min=0 PtS11Min=0 x2S11Min=0 x3S11Min=0 FrameElem=49
 ElemStation=0.375
 Frame=49 Station=0.5 OutputCase=SOVRCOST CaseType=LinStatic P=0 V2=0 V3=0 T=0 M2=0 M3=0
 S11Max=0 PtS11Max=0 x2S11Max=0 x3S11Max=0 S11Min=0 PtS11Min=0 x2S11Min=0 x3S11Min=0 FrameElem=49
 ElemStation=0.5
 Frame=49 Station=0 OutputCase=ENVE CaseType=Combination StepType=Max P=-32.6801405652669 V2=-
 442.99999457043 V3=0 T=0 M2=0 M3=-14.2973714555769 S11Max=70.0810209025053 PtS11Max=3 x2S11Max=0.5
 x3S11Max=-0.5
 S11Min=-118.464369298728 PtS11Min=1 x2S11Min=-0.5 x3S11Min=-0.5 FrameElem=49 ElemStation=0
 Frame=49 Station=0.125 OutputCase=ENVE CaseType=Combination StepType=Max P=-32.6801405652669 V2=-
 415.312499457043 V3=0 T=0 M2=0 M3=39.3471597390853 S11Max=203.402817869245 PtS11Max=1 x2S11Max=-0.5
 x3S11Max=-0.5 S11Min=-251.786166190277 PtS11Min=3 x2S11Min=0.5 x3S11Min=-0.5 FrameElem=49
 ElemStation=0.125
 Frame=49 Station=0.25 OutputCase=ENVE CaseType=Combination StepType=Max P=-32.6801405652669 V2=-
 387.62499457043 V3=0 T=0 M2=0 M3=89.5307534337474 S11Max=504.504380037218 PtS11Max=1 x2S11Max=-0.5
 x3S11Max=-0.5
 S11Min=-552.88772828306 PtS11Min=3 x2S11Min=0.5 x3S11Min=-0.5 FrameElem=49 ElemStation=0.25
 Frame=49 Station=0.375 OutputCase=ENVE CaseType=Combination StepType=Max P=-32.6801405652669 V2=-
 359.937499457043 V3=0 T=0 M2=0 M3=136.25340962841 S11Max=784.840317205191 PtS11Max=1 x2S11Max=-0.5
 x3S11Max=-0.5
 S11Min=-833.223665375842 PtS11Min=3 x2S11Min=0.5 x3S11Min=-0.5 FrameElem=49 ElemStation=0.375
 Frame=49 Station=0.5 OutputCase=ENVE CaseType=Combination StepType=Max P=-32.6801405652669 V2=-
 332.249999457043 V3=0 T=0 M2=0 M3=179.515128323072 S11Max=1044.41062937316 PtS11Max=1 x2S11Max=-0.5
 x3S11Max=-0.5
 S11Min=-1092.79397746862 PtS11Min=3 x2S11Min=0.5 x3S11Min=-0.5 FrameElem=49 ElemStation=0.5



Frame=49 Station=0 OutputCase=ENVE CaseType=Combination StepType=Min P=-52.693680020218 V2=-442.99999557297 V3=0 T=0 M2=0 M3=-20.4624501537872 S11Max=53.1040881681945 PtS11Max=3 x2S11Max=0.5 x3S11Max=-0.5
 S11Min=-175.468380942941 PtS11Min=1 x2S11Min=-0.5 x3S11Min=-0.5 FrameElem=49 ElemStation=0
 Frame=49 Station=0.125 OutputCase=ENVE CaseType=Combination StepType=Min P=-52.693680020218 V2=-415.312499557297 V3=0 T=0 M2=0 M3=33.1820810283432 S11Max=146.398806149841 PtS11Max=1 x2S11Max=-0.5 x3S11Max=-0.5
 S11Min=-268.763098999778 PtS11Min=3 x2S11Min=0.5 x3S11Min=-0.5 FrameElem=49 ElemStation=0.125
 Frame=49 Station=0.25 OutputCase=ENVE CaseType=Combination StepType=Min P=-52.693680020218 V2=-387.624999557297 V3=0 T=0 M2=0 M3=83.3656747104736 S11Max=447.500368242624 PtS11Max=1 x2S11Max=-0.5 x3S11Max=-0.5
 S11Min=-569.864661167751 PtS11Min=3 x2S11Min=0.5 x3S11Min=-0.5 FrameElem=49 ElemStation=0.25
 Frame=49 Station=0.375 OutputCase=ENVE CaseType=Combination StepType=Min P=-52.693680020218 V2=-359.937499557297 V3=0 T=0 M2=0 M3=130.088330892604 S11Max=727.836305335406 PtS11Max=1 x2S11Max=-0.5 x3S11Max=-0.5
 S11Min=-850.200598335725 PtS11Min=3 x2S11Min=0.5 x3S11Min=-0.5 FrameElem=49 ElemStation=0.375
 Frame=49 Station=0.5 OutputCase=ENVE CaseType=Combination StepType=Min P=-52.693680020218 V2=-332.249999557297 V3=0 T=0 M2=0 M3=173.350049574734 S11Max=987.406617428189 PtS11Max=1 x2S11Max=-0.5 x3S11Max=-0.5
 S11Min=-1109.7709105037 PtS11Min=3 x2S11Min=0.5 x3S11Min=-0.5 FrameElem=49 ElemStation=0.5
 Frame=49 Station=0 OutputCase=FESSUR CaseType=Combination StepType=Min P=-52.693680020218 V2=-442.99999457043 V3=0 T=0 M2=0 M3=-20.4624501537872 S11Max=70.0810209025053 PtS11Max=3 x2S11Max=0.5 x3S11Max=-0.5
 S11Min=-175.468380942941 PtS11Min=1 x2S11Min=-0.5 x3S11Min=-0.5 FrameElem=49 ElemStation=0
 Frame=49 Station=0.125 OutputCase=FESSUR CaseType=Combination StepType=Min P=-52.693680020218 V2=-415.312499457043 V3=0 T=0 M2=0 M3=33.1820810283432 S11Max=146.398806149841 PtS11Max=1 x2S11Max=-0.5 x3S11Max=-0.5
 S11Min=-251.786166190277 PtS11Min=3 x2S11Min=0.5 x3S11Min=-0.5 FrameElem=49 ElemStation=0.125
 Frame=49 Station=0.25 OutputCase=FESSUR CaseType=Combination StepType=Min P=-52.693680020218 V2=-387.624999457043 V3=0 T=0 M2=0 M3=83.3656747104736 S11Max=447.500368242624 PtS11Max=1 x2S11Max=-0.5 x3S11Max=-0.5
 S11Min=-552.88772828306 PtS11Min=3 x2S11Min=0.5 x3S11Min=-0.5 FrameElem=49 ElemStation=0.25
 Frame=49 Station=0.375 OutputCase=FESSUR CaseType=Combination StepType=Min P=-52.693680020218 V2=-359.937499457043 V3=0 T=0 M2=0 M3=130.088330892604 S11Max=727.836305335406 PtS11Max=1 x2S11Max=-0.5 x3S11Max=-0.5
 S11Min=-833.223665375842 PtS11Min=3 x2S11Min=0.5 x3S11Min=-0.5 FrameElem=49 ElemStation=0.375
 Frame=49 Station=0.5 OutputCase=FESSUR CaseType=Combination StepType=Min P=-52.693680020218 V2=-332.249999457043 V3=0 T=0 M2=0 M3=173.350049574734 S11Max=987.406617428189 PtS11Max=1 x2S11Max=-0.5 x3S11Max=-0.5
 S11Min=-1092.79397746862 PtS11Min=3 x2S11Min=0.5 x3S11Min=-0.5 FrameElem=49 ElemStation=0.5
 Frame=50 Station=0 OutputCase=PESOPR CaseType=LinStatic P=15.1709467362397 V2=-37.499999888678 V3=0 T=0 M2=0 M3=28.9284217363529 S11Max=188.741477154357 PtS11Max=1 x2S11Max=-0.5 x3S11Max=-0.5
 S11Min=-158.399583681878 PtS11Min=3 x2S11Min=0.5 x3S11Min=-0.5 FrameElem=50 ElemStation=0
 Frame=50 Station=0.125 OutputCase=PESOPR CaseType=LinStatic P=15.1709467362397 V2=-34.3749999888678 V3=0 T=0 M2=0 M3=33.4206092349614 S11Max=215.694602146008 PtS11Max=1 x2S11Max=-0.5 x3S11Max=-0.5
 S11Min=-185.352708673529 PtS11Min=3 x2S11Min=0.5 x3S11Min=-0.5 FrameElem=50 ElemStation=0.125
 Frame=50 Station=0.25 OutputCase=PESOPR CaseType=LinStatic P=15.1709467362397 V2=-31.2499999888678 V3=0 T=0 M2=0 M3=37.5221717335698 S11Max=240.303977137659 PtS11Max=1 x2S11Max=-0.5 x3S11Max=-0.5
 S11Min=-209.962083665179 PtS11Min=3 x2S11Min=0.5 x3S11Min=-0.5 FrameElem=50 ElemStation=0.25
 Frame=50 Station=0.375 OutputCase=PESOPR CaseType=LinStatic P=15.1709467362397 V2=-28.1249999888678 V3=0 T=0 M2=0 M3=41.2331092321783 S11Max=262.56960212931 PtS11Max=1 x2S11Max=-0.5 x3S11Max=-0.5
 S11Min=-232.22770865683 PtS11Min=3 x2S11Min=0.5 x3S11Min=-0.5 FrameElem=50 ElemStation=0.375
 Frame=50 Station=0.5 OutputCase=PESOPR CaseType=LinStatic P=15.1709467362397 V2=-24.999999888678 V3=0 T=0 M2=0 M3=44.5534217307868 S11Max=282.49147712096 PtS11Max=1 x2S11Max=-0.5 x3S11Max=-0.5
 S11Min=-252.149583648481 PtS11Min=3 x2S11Min=0.5 x3S11Min=-0.5 FrameElem=50 ElemStation=0.5
 Frame=50 Station=0 OutputCase=TERRVERT CaseType=LinStatic P=-1.15282857328748 V2=-294.749999802385 V3=0 T=0 M2=0 M3=164.971890332861 S11Max=988.67851342388 PtS11Max=1 x2S11Max=-0.5 x3S11Max=-0.5
 S11Min=-990.984170570455 PtS11Min=3 x2S11Min=0.5 x3S11Min=-0.5 FrameElem=50 ElemStation=0
 Frame=50 Station=0.125 OutputCase=TERRVERT CaseType=LinStatic P=-1.15282857328748 V2=-270.187499802385 V3=0 T=0 M2=0 M3=200.280484058159 S11Max=1200.53007577567 PtS11Max=1 x2S11Max=-0.5 x3S11Max=-0.5
 S11Min=-1202.83573292224 PtS11Min=3 x2S11Min=0.5 x3S11Min=-0.5 FrameElem=50 ElemStation=0.125
 Frame=50 Station=0.25 OutputCase=TERRVERT CaseType=LinStatic P=-1.15282857328748 V2=-245.624999802385 V3=0 T=0 M2=0 M3=232.518765283457 S11Max=1393.95976312746 PtS11Max=1 x2S11Max=-0.5 x3S11Max=-0.5
 S11Min=-1396.26542027403 PtS11Min=3 x2S11Min=0.5 x3S11Min=-0.5 FrameElem=50 ElemStation=0.25
 Frame=50 Station=0.375 OutputCase=TERRVERT CaseType=LinStatic P=-1.15282857328748 V2=-221.062499802385 V3=0 T=0 M2=0 M3=261.686734008756 S11Max=1568.96757547925 PtS11Max=1 x2S11Max=-0.5 x3S11Max=-0.5
 S11Min=-1571.27323262582 PtS11Min=3 x2S11Min=0.5 x3S11Min=-0.5 FrameElem=50 ElemStation=0.375
 Frame=50 Station=0.5 OutputCase=TERRVERT CaseType=LinStatic P=-1.15282857328748 V2=-196.499999802385 V3=0 T=0 M2=0 M3=287.784390234054 S11Max=1725.55351283103 PtS11Max=1 x2S11Max=-0.5 x3S11Max=-0.5
 S11Min=-1727.85916997761 PtS11Min=3 x2S11Min=0.5 x3S11Min=-0.5 FrameElem=50 ElemStation=0.5
 Frame=50 Station=0 OutputCase=TERRLAT CaseType=LinStatic P=-66.7117981831703 V2=3.34180754180125E-07 V3=0 T=0 M2=0 M3=-20.5502624944579 S11Max=56.5897767835773 PtS11Max=3 x2S11Max=0.5 x3S11Max=-0.5
 S11Min=-190.013373149918 PtS11Min=1 x2S11Min=-0.5 x3S11Min=-0.5 FrameElem=50 ElemStation=0
 Frame=50 Station=0.125 OutputCase=TERRLAT CaseType=LinStatic P=-66.7117981831703 V2=3.34180754180125E-07 V3=0 T=0 M2=0 M3=-20.5502625362305 S11Max=56.5897770342129 PtS11Max=3 x2S11Max=0.5 x3S11Max=-0.5
 S11Min=-190.013373400553 PtS11Min=1 x2S11Min=-0.5 x3S11Min=-0.5 FrameElem=50 ElemStation=0.125
 Frame=50 Station=0.25 OutputCase=TERRLAT CaseType=LinStatic P=-66.7117981831703 V2=3.34180754180125E-07 V3=0 T=0 M2=0 M3=-20.5502625780031 S11Max=56.5897772848485 PtS11Max=3 x2S11Max=0.5 x3S11Max=-0.5
 S11Min=-190.013373651189 PtS11Min=1 x2S11Min=-0.5 x3S11Min=-0.5 FrameElem=50 ElemStation=0.25
 Frame=50 Station=0.375 OutputCase=TERRLAT CaseType=LinStatic P=-66.7117981831703 V2=3.34180754180125E-07 V3=0 T=0 M2=0 M3=-20.5502626197757 S11Max=56.589777535484 PtS11Max=3 x2S11Max=0.5 x3S11Max=-0.5
 S11Min=-190.013373901825 PtS11Min=1 x2S11Min=-0.5 x3S11Min=-0.5 FrameElem=50 ElemStation=0.375
 Frame=50 Station=0.5 OutputCase=TERRLAT CaseType=LinStatic P=-66.7117981831703 V2=3.34180754180125E-07 V3=0 T=0 M2=0 M3=-20.5502626615483 S11Max=56.5897777861196 PtS11Max=3 x2S11Max=0.5 x3S11Max=-0.5
 S11Min=-190.01337415246 PtS11Min=1 x2S11Min=-0.5 x3S11Min=-0.5 FrameElem=50 ElemStation=0.5



```

Frame=50 Station=0 OutputCase=ACCLATDX CaseType=LinStatic P=0 V2=0 V3=0 T=0 M2=0 M3=0
S11Max=0 PtS11Max=0 x2S11Max=0 x3S11Max=0 S11Min=0 PtS11Min=0 x2S11Min=0 x3S11Min=0 FrameElem=50
ElemStation=0
Frame=50 Station=0.125 OutputCase=ACCLATDX CaseType=LinStatic P=0 V2=0 V3=0 T=0 M2=0 M3=0
S11Max=0 PtS11Max=0 x2S11Max=0 x3S11Max=0 S11Min=0 PtS11Min=0 x2S11Min=0 x3S11Min=0 FrameElem=50
ElemStation=0.125
Frame=50 Station=0.25 OutputCase=ACCLATDX CaseType=LinStatic P=0 V2=0 V3=0 T=0 M2=0 M3=0
S11Max=0 PtS11Max=0 x2S11Max=0 x3S11Max=0 S11Min=0 PtS11Min=0 x2S11Min=0 x3S11Min=0 FrameElem=50
ElemStation=0.25
Frame=50 Station=0.375 OutputCase=ACCLATDX CaseType=LinStatic P=0 V2=0 V3=0 T=0 M2=0 M3=0
S11Max=0 PtS11Max=0 x2S11Max=0 x3S11Max=0 S11Min=0 PtS11Min=0 x2S11Min=0 x3S11Min=0 FrameElem=50
ElemStation=0.375
Frame=50 Station=0.5 OutputCase=ACCLATDX CaseType=LinStatic P=0 V2=0 V3=0 T=0 M2=0 M3=0
S11Max=0 PtS11Max=0 x2S11Max=0 x3S11Max=0 S11Min=0 PtS11Min=0 x2S11Min=0 x3S11Min=0 FrameElem=50
ElemStation=0.5
Frame=50 Station=0 OutputCase=ACCLATSX CaseType=LinStatic P=0 V2=0 V3=0 T=0 M2=0 M3=0
S11Max=0 PtS11Max=0 x2S11Max=0 x3S11Max=0 S11Min=0 PtS11Min=0 x2S11Min=0 x3S11Min=0 FrameElem=50
ElemStation=0
Frame=50 Station=0.125 OutputCase=ACCLATSX CaseType=LinStatic P=0 V2=0 V3=0 T=0 M2=0 M3=0
S11Max=0 PtS11Max=0 x2S11Max=0 x3S11Max=0 S11Min=0 PtS11Min=0 x2S11Min=0 x3S11Min=0 FrameElem=50
ElemStation=0.125
Frame=50 Station=0.25 OutputCase=ACCLATSX CaseType=LinStatic P=0 V2=0 V3=0 T=0 M2=0 M3=0
S11Max=0 PtS11Max=0 x2S11Max=0 x3S11Max=0 S11Min=0 PtS11Min=0 x2S11Min=0 x3S11Min=0 FrameElem=50
ElemStation=0.25
Frame=50 Station=0.375 OutputCase=ACCLATSX CaseType=LinStatic P=0 V2=0 V3=0 T=0 M2=0 M3=0
S11Max=0 PtS11Max=0 x2S11Max=0 x3S11Max=0 S11Min=0 PtS11Min=0 x2S11Min=0 x3S11Min=0 FrameElem=50
ElemStation=0.375
Frame=50 Station=0.5 OutputCase=ACCLATSX CaseType=LinStatic P=0 V2=0 V3=0 T=0 M2=0 M3=0
S11Max=0 PtS11Max=0 x2S11Max=0 x3S11Max=0 S11Min=0 PtS11Min=0 x2S11Min=0 x3S11Min=0 FrameElem=50
ElemStation=0.5
Frame=50 Station=0 OutputCase=TERRCOST CaseType=LinStatic P=0 V2=0 V3=0 T=0 M2=0 M3=0
S11Max=0 PtS11Max=0 x2S11Max=0 x3S11Max=0 S11Min=0 PtS11Min=0 x2S11Min=0 x3S11Min=0 FrameElem=50
ElemStation=0
Frame=50 Station=0.125 OutputCase=TERRCOST CaseType=LinStatic P=0 V2=0 V3=0 T=0 M2=0 M3=0
S11Max=0 PtS11Max=0 x2S11Max=0 x3S11Max=0 S11Min=0 PtS11Min=0 x2S11Min=0 x3S11Min=0 FrameElem=50
ElemStation=0.125
Frame=50 Station=0.25 OutputCase=TERRCOST CaseType=LinStatic P=0 V2=0 V3=0 T=0 M2=0 M3=0
S11Max=0 PtS11Max=0 x2S11Max=0 x3S11Max=0 S11Min=0 PtS11Min=0 x2S11Min=0 x3S11Min=0 FrameElem=50
ElemStation=0.25
Frame=50 Station=0.375 OutputCase=TERRCOST CaseType=LinStatic P=0 V2=0 V3=0 T=0 M2=0 M3=0
S11Max=0 PtS11Max=0 x2S11Max=0 x3S11Max=0 S11Min=0 PtS11Min=0 x2S11Min=0 x3S11Min=0 FrameElem=50
ElemStation=0.375
Frame=50 Station=0.5 OutputCase=TERRCOST CaseType=LinStatic P=0 V2=0 V3=0 T=0 M2=0 M3=0
S11Max=0 PtS11Max=0 x2S11Max=0 x3S11Max=0 S11Min=0 PtS11Min=0 x2S11Min=0 x3S11Min=0 FrameElem=50
ElemStation=0.5
Frame=50 Station=0 OutputCase=SOVRCOST CaseType=LinStatic P=0 V2=0 V3=0 T=0 M2=0 M3=0
S11Max=0 PtS11Max=0 x2S11Max=0 x3S11Max=0 S11Min=0 PtS11Min=0 x2S11Min=0 x3S11Min=0 FrameElem=50
ElemStation=0
Frame=50 Station=0.125 OutputCase=SOVRCOST CaseType=LinStatic P=0 V2=0 V3=0 T=0 M2=0 M3=0
S11Max=0 PtS11Max=0 x2S11Max=0 x3S11Max=0 S11Min=0 PtS11Min=0 x2S11Min=0 x3S11Min=0 FrameElem=50
ElemStation=0.125
Frame=50 Station=0.25 OutputCase=SOVRCOST CaseType=LinStatic P=0 V2=0 V3=0 T=0 M2=0 M3=0
S11Max=0 PtS11Max=0 x2S11Max=0 x3S11Max=0 S11Min=0 PtS11Min=0 x2S11Min=0 x3S11Min=0 FrameElem=50
ElemStation=0.25
Frame=50 Station=0.375 OutputCase=SOVRCOST CaseType=LinStatic P=0 V2=0 V3=0 T=0 M2=0 M3=0
S11Max=0 PtS11Max=0 x2S11Max=0 x3S11Max=0 S11Min=0 PtS11Min=0 x2S11Min=0 x3S11Min=0 FrameElem=50
ElemStation=0.375
Frame=50 Station=0.5 OutputCase=SOVRCOST CaseType=LinStatic P=0 V2=0 V3=0 T=0 M2=0 M3=0
S11Max=0 PtS11Max=0 x2S11Max=0 x3S11Max=0 S11Min=0 PtS11Min=0 x2S11Min=0 x3S11Min=0 FrameElem=50
ElemStation=0.5
Frame=50 Station=0 OutputCase=ENVE CaseType=Combination StepType=Max P=-32.680140565267 V2=-
332.249999457072 V3=0 T=0 M2=0 M3=179.515128323094 S11Max=1044.41062937329 PtS11Max=1 x2S11Max=-0.5
x3S11Max=-0.5
S11Min=-1092.79397746876 PtS11Min=3 x2S11Min=0.5 x3S11Min=-0.5 FrameElem=50 ElemStation=0
Frame=50 Station=0.125 OutputCase=ENVE CaseType=Combination StepType=Max P=-32.680140565267 V2=-
304.562499457072 V3=0 T=0 M2=0 M3=219.315909517759 S11Max=1283.21531654129 PtS11Max=1 x2S11Max=-0.5
x3S11Max=-0.5
S11Min=-1331.59866456156 PtS11Min=3 x2S11Min=0.5 x3S11Min=-0.5 FrameElem=50 ElemStation=0.125
Frame=50 Station=0.25 OutputCase=ENVE CaseType=Combination StepType=Max P=-32.680140565267 V2=-
276.874999457072 V3=0 T=0 M2=0 M3=255.65753212425 S11Max=1501.25437870928 PtS11Max=1 x2S11Max=-0.5
x3S11Max=-0.5
S11Min=-1549.63772665436 PtS11Min=3 x2S11Min=0.5 x3S11Min=-0.5 FrameElem=50 ElemStation=0.25
Frame=50 Station=0.375 OutputCase=ENVE CaseType=Combination StepType=Max P=-32.680140565267 V2=-
249.187499457072 V3=0 T=0 M2=0 M3=288.534659407091 S11Max=1698.52781587728 PtS11Max=1 x2S11Max=-0.5
x3S11Max=-0.5
S11Min=-1746.91116374717 PtS11Min=3 x2S11Min=0.5 x3S11Min=-0.5 FrameElem=50 ElemStation=0.375
Frame=50 Station=0.5 OutputCase=ENVE CaseType=Combination StepType=Max P=-32.680140565267 V2=-
221.499999457072 V3=0 T=0 M2=0 M3=317.952628101757 S11Max=1875.03562804527 PtS11Max=1 x2S11Max=-0.5
x3S11Max=-0.5
S11Min=-1923.41897583997 PtS11Min=3 x2S11Min=0.5 x3S11Min=-0.5 FrameElem=50 ElemStation=0.5

```



Frame=50 Station=0 OutputCase=ENVE CaseType=Combination StepType=Min P=-52.6936800202181 V2=-
 332.249999557326 V3=0 T=0 M2=0 M3=173.350049574756 S11Max=987.406617428319 PtS11Max=1 x2S11Max=-0.5
 x3S11Max=-0.5 _
 S11Min=-1109.77091050383 PtS11Min=3 x2S11Min=0.5 x3S11Min=-0.5 FrameElem=50 ElemStation=0
 Frame=50 Station=0.125 OutputCase=ENVE CaseType=Combination StepType=Min P=-52.6936800202181 V2=-
 304.562499557326 V3=0 T=0 M2=0 M3=213.15083075689 S11Max=1226.21130452112 PtS11Max=1 x2S11Max=-0.5
 x3S11Max=-0.5 _
 S11Min=-1348.57559767182 PtS11Min=3 x2S11Min=0.5 x3S11Min=-0.5 FrameElem=50 ElemStation=0.125
 Frame=50 Station=0.25 OutputCase=ENVE CaseType=Combination StepType=Min P=-52.6936800202181 V2=-
 276.874999557326 V3=0 T=0 M2=0 M3=249.490674439024 S11Max=1444.25036661393 PtS11Max=1 x2S11Max=-0.5
 x3S11Max=-0.5 _
 S11Min=-1566.61465983982 PtS11Min=3 x2S11Min=0.5 x3S11Min=-0.5 FrameElem=50 ElemStation=0.25
 Frame=50 Station=0.375 OutputCase=ENVE CaseType=Combination StepType=Min P=-52.6936800202181 V2=-
 249.187499557326 V3=0 T=0 M2=0 M3=282.369580621158 S11Max=1641.52380370673 PtS11Max=1 x2S11Max=-0.5
 x3S11Max=-0.5 _
 S11Min=-1763.88809700781 PtS11Min=3 x2S11Min=0.5 x3S11Min=-0.5 FrameElem=50
 ElemStation=0.375
 Frame=50 Station=0.5 OutputCase=ENVE CaseType=Combination StepType=Min P=-52.6936800202181 V2=-
 221.499999557326 V3=0 T=0 M2=0 M3=311.787549303292 S11Max=1818.03161579954 PtS11Max=1 x2S11Max=-0.5
 x3S11Max=-0.5 _
 S11Min=-1940.39590917581 PtS11Min=3 x2S11Min=0.5 x3S11Min=-0.5 FrameElem=50 ElemStation=0.5
 Frame=50 Station=0 OutputCase=FESSUR CaseType=Combination StepType=Min P=-52.6936800202181 V2=-332.24999957072
 V3=0 T=0 M2=0 M3=173.350049574756 S11Max=987.406617428319 PtS11Max=1 x2S11Max=-0.5 x3S11Max=-0.5 _
 S11Min=-1092.79397746876 PtS11Min=3 x2S11Min=0.5 x3S11Min=-0.5 FrameElem=50 ElemStation=0
 Frame=50 Station=0.125 OutputCase=FESSUR CaseType=Combination StepType=Min P=-52.6936800202181 V2=-304.56249957072
 V3=0 T=0 M2=0 M3=213.15083075689 S11Max=1226.21130452112 PtS11Max=1 x2S11Max=-0.5 x3S11Max=-0.5 _
 S11Min=-1331.59866456156 PtS11Min=3 x2S11Min=0.5 x3S11Min=-0.5 FrameElem=50 ElemStation=0.125
 Frame=50 Station=0.25 OutputCase=FESSUR CaseType=Combination StepType=Min P=-52.6936800202181 V2=-276.87499957072
 V3=0 T=0 M2=0 M3=249.490674439024 S11Max=1444.25036661393 PtS11Max=1 x2S11Max=-0.5 x3S11Max=-0.5 _
 S11Min=-1549.63772665436 PtS11Min=3 x2S11Min=0.5 x3S11Min=-0.5 FrameElem=50 ElemStation=0.25
 Frame=50 Station=0.375 OutputCase=FESSUR CaseType=Combination StepType=Min P=-52.6936800202181 V2=-249.18749957072
 V3=0 T=0 M2=0 M3=282.369580621158 S11Max=1641.52380370673 PtS11Max=1 x2S11Max=-0.5 x3S11Max=-0.5 _
 S11Min=-1746.91116374717 PtS11Min=3 x2S11Min=0.5 x3S11Min=-0.5 FrameElem=50 ElemStation=0.375
 Frame=50 Station=0.5 OutputCase=FESSUR CaseType=Combination StepType=Min P=-52.6936800202181 V2=-221.49999957072
 V3=0 T=0 M2=0 M3=311.787549303292 S11Max=1818.03161579954 PtS11Max=1 x2S11Max=-0.5 x3S11Max=-0.5 _
 S11Min=-1923.41897583997 PtS11Min=3 x2S11Min=0.5 x3S11Min=-0.5 FrameElem=50 ElemStation=0.5
 Frame=51 Station=0 OutputCase=PESOPR CaseType=LinStatic P=15.1709467362397 V2=-24.999999888678 V3=0
 T=0 M2=0 M3=44.5534217307904 S11Max=282.491477120982 PtS11Max=1 x2S11Max=-0.5 x3S11Max=-0.5 _
 S11Min=-252.149583648503 PtS11Min=3 x2S11Min=0.5 x3S11Min=-0.5 FrameElem=51 ElemStation=0
 Frame=51 Station=0.125 OutputCase=PESOPR CaseType=LinStatic P=15.1709467362397 V2=-21.8749999888678
 V3=0 T=0 M2=0 M3=47.4831092293989 S11Max=300.069602112633 PtS11Max=1 x2S11Max=-0.5 x3S11Max=-0.5 _
 S11Min=-269.727708640154 PtS11Min=3 x2S11Min=0.5 x3S11Min=-0.5 FrameElem=51 ElemStation=0.125
 Frame=51 Station=0.25 OutputCase=PESOPR CaseType=LinStatic P=15.1709467362397 V2=-18.7499999888678
 V3=0 T=0 M2=0 M3=50.0221717280074 S11Max=315.303977104284 PtS11Max=1 x2S11Max=-0.5 x3S11Max=-0.5 _
 S11Min=-284.962083631805 PtS11Min=3 x2S11Min=0.5 x3S11Min=-0.5 FrameElem=51 ElemStation=0.25
 Frame=51 Station=0.375 OutputCase=PESOPR CaseType=LinStatic P=15.1709467362397 V2=-15.6249999888678
 V3=0 T=0 M2=0 M3=52.1706092266159 S11Max=328.194602095935 PtS11Max=1 x2S11Max=-0.5 x3S11Max=-0.5 _
 S11Min=-297.852708623455 PtS11Min=3 x2S11Min=0.5 x3S11Min=-0.5 FrameElem=51 ElemStation=0.375
 Frame=51 Station=0.5 OutputCase=PESOPR CaseType=LinStatic P=15.1709467362397 V2=-12.4999999888678
 V3=0 T=0 M2=0 M3=53.9284217252243 S11Max=338.741477087586 PtS11Max=1 x2S11Max=-0.5 x3S11Max=-0.5 _
 S11Min=-308.399583615106 PtS11Min=3 x2S11Min=0.5 x3S11Min=-0.5 FrameElem=51 ElemStation=0.5
 Frame=51 Station=0 OutputCase=TERRVERT CaseType=LinStatic P=-1.15282857328748 V2=-196.499999802414
 V3=0 T=0 M2=0 M3=287.784390234054 S11Max=1725.55351283103 PtS11Max=1 x2S11Max=-0.5 x3S11Max=-0.5 _
 S11Min=-1727.85916997761 PtS11Min=3 x2S11Min=0.5 x3S11Min=-0.5 FrameElem=51 ElemStation=0
 Frame=51 Station=0.125 OutputCase=TERRVERT CaseType=LinStatic P=-1.15282857328748 V2=-171.937499802414
 V3=0 T=0 M2=0 M3=310.811733959355 S11Max=1863.71757518285 PtS11Max=1 x2S11Max=-0.5 x3S11Max=-0.5 _
 S11Min=-1866.02323232942 PtS11Min=3 x2S11Min=0.5 x3S11Min=-0.5 FrameElem=51 ElemStation=0.125
 Frame=51 Station=0.25 OutputCase=TERRVERT CaseType=LinStatic P=-1.15282857328748 V2=-147.374999802414
 V3=0 T=0 M2=0 M3=330.768765184657 S11Max=1983.45976253466 PtS11Max=1 x2S11Max=-0.5 x3S11Max=-0.5 _
 S11Min=-1985.76541968123 PtS11Min=3 x2S11Min=0.5 x3S11Min=-0.5 FrameElem=51 ElemStation=0.25
 Frame=51 Station=0.375 OutputCase=TERRVERT CaseType=LinStatic P=-1.15282857328748 V2=-122.812499802414
 V3=0 T=0 M2=0 M3=347.655483909959 S11Max=2084.78007488647 PtS11Max=1 x2S11Max=-0.5 x3S11Max=-0.5 _
 S11Min=-2087.08573203304 PtS11Min=3 x2S11Min=0.5 x3S11Min=-0.5 FrameElem=51 ElemStation=0.375
 Frame=51 Station=0.5 OutputCase=TERRVERT CaseType=LinStatic P=-1.15282857328748 V2=-98.249999802414
 V3=0 T=0 M2=0 M3=361.471890135261 S11Max=2167.67851223828 PtS11Max=1 x2S11Max=-0.5 x3S11Max=-0.5 _
 S11Min=-2169.98416938485 PtS11Min=3 x2S11Min=0.5 x3S11Min=-0.5 FrameElem=51 ElemStation=0.5
 Frame=51 Station=0 OutputCase=TERRLAT CaseType=LinStatic P=-66.7117981831702 V2=3.34180640493287E-07
 V3=0 T=0 M2=0 M3=-20.5502626615483 S11Max=56.5897777861197 PtS11Max=3 x2S11Max=0.5 x3S11Max=-0.5 _
 S11Min=-190.01337415246 PtS11Min=1 x2S11Min=-0.5 x3S11Min=-0.5 FrameElem=51 ElemStation=0
 Frame=51 Station=0.125 OutputCase=TERRLAT CaseType=LinStatic P=-66.7117981831702 V2=3.34180640493287E-
 07 V3=0 T=0 M2=0 M3=-20.5502627033209 S11Max=56.5897780367552 PtS11Max=3 x2S11Max=0.5 x3S11Max=-0.5
 _
 S11Min=-190.013374403096 PtS11Min=1 x2S11Min=-0.5 x3S11Min=-0.5 FrameElem=51 ElemStation=0.125
 Frame=51 Station=0.25 OutputCase=TERRLAT CaseType=LinStatic P=-66.7117981831702 V2=3.34180640493287E-07
 V3=0 T=0 M2=0 M3=-20.5502627450935 S11Max=56.5897782873907 PtS11Max=3 x2S11Max=0.5 x3S11Max=-0.5 _
 S11Min=-190.013374653731 PtS11Min=1 x2S11Min=-0.5 x3S11Min=-0.5 FrameElem=51 ElemStation=0.25
 Frame=51 Station=0.375 OutputCase=TERRLAT CaseType=LinStatic P=-66.7117981831702 V2=3.34180640493287E-
 07 V3=0 T=0 M2=0 M3=-20.5502627868661 S11Max=56.5897785380262 PtS11Max=3 x2S11Max=0.5 x3S11Max=-0.5
 _
 S11Min=-190.013374904367 PtS11Min=1 x2S11Min=-0.5 x3S11Min=-0.5 FrameElem=51 ElemStation=0.375
 Frame=51 Station=0.5 OutputCase=TERRLAT CaseType=LinStatic P=-66.7117981831702 V2=3.34180640493287E-07
 V3=0 T=0 M2=0 M3=-20.5502628286386 S11Max=56.5897787886616 PtS11Max=3 x2S11Max=0.5 x3S11Max=-0.5 _
 S11Min=-190.013375155002 PtS11Min=1 x2S11Min=-0.5 x3S11Min=-0.5 FrameElem=51 ElemStation=0.5



```

Frame=51 Station=0 OutputCase=ACCLATDX CaseType=LinStatic P=0 V2=0 V3=0 T=0 M2=0 M3=0
S11Max=0 PtS11Max=0 x2S11Max=0 x3S11Max=0 S11Min=0 PtS11Min=0 x2S11Min=0 x3S11Min=0 FrameElem=51
ElemStation=0
Frame=51 Station=0.125 OutputCase=ACCLATDX CaseType=LinStatic P=0 V2=0 V3=0 T=0 M2=0 M3=0
S11Max=0 PtS11Max=0 x2S11Max=0 x3S11Max=0 S11Min=0 PtS11Min=0 x2S11Min=0 x3S11Min=0 FrameElem=51
ElemStation=0.125
Frame=51 Station=0.25 OutputCase=ACCLATDX CaseType=LinStatic P=0 V2=0 V3=0 T=0 M2=0 M3=0
S11Max=0 PtS11Max=0 x2S11Max=0 x3S11Max=0 S11Min=0 PtS11Min=0 x2S11Min=0 x3S11Min=0 FrameElem=51
ElemStation=0.25
Frame=51 Station=0.375 OutputCase=ACCLATDX CaseType=LinStatic P=0 V2=0 V3=0 T=0 M2=0 M3=0
S11Max=0 PtS11Max=0 x2S11Max=0 x3S11Max=0 S11Min=0 PtS11Min=0 x2S11Min=0 x3S11Min=0 FrameElem=51
ElemStation=0.375
Frame=51 Station=0.5 OutputCase=ACCLATDX CaseType=LinStatic P=0 V2=0 V3=0 T=0 M2=0 M3=0
S11Max=0 PtS11Max=0 x2S11Max=0 x3S11Max=0 S11Min=0 PtS11Min=0 x2S11Min=0 x3S11Min=0 FrameElem=51
ElemStation=0.5
Frame=51 Station=0 OutputCase=ACCLATSX CaseType=LinStatic P=0 V2=0 V3=0 T=0 M2=0 M3=0
S11Max=0 PtS11Max=0 x2S11Max=0 x3S11Max=0 S11Min=0 PtS11Min=0 x2S11Min=0 x3S11Min=0 FrameElem=51
ElemStation=0
Frame=51 Station=0.125 OutputCase=ACCLATSX CaseType=LinStatic P=0 V2=0 V3=0 T=0 M2=0 M3=0
S11Max=0 PtS11Max=0 x2S11Max=0 x3S11Max=0 S11Min=0 PtS11Min=0 x2S11Min=0 x3S11Min=0 FrameElem=51
ElemStation=0.125
Frame=51 Station=0.25 OutputCase=ACCLATSX CaseType=LinStatic P=0 V2=0 V3=0 T=0 M2=0 M3=0
S11Max=0 PtS11Max=0 x2S11Max=0 x3S11Max=0 S11Min=0 PtS11Min=0 x2S11Min=0 x3S11Min=0 FrameElem=51
ElemStation=0.25
Frame=51 Station=0.375 OutputCase=ACCLATSX CaseType=LinStatic P=0 V2=0 V3=0 T=0 M2=0 M3=0
S11Max=0 PtS11Max=0 x2S11Max=0 x3S11Max=0 S11Min=0 PtS11Min=0 x2S11Min=0 x3S11Min=0 FrameElem=51
ElemStation=0.375
Frame=51 Station=0.5 OutputCase=ACCLATSX CaseType=LinStatic P=0 V2=0 V3=0 T=0 M2=0 M3=0
S11Max=0 PtS11Max=0 x2S11Max=0 x3S11Max=0 S11Min=0 PtS11Min=0 x2S11Min=0 x3S11Min=0 FrameElem=51
ElemStation=0.5
Frame=51 Station=0 OutputCase=TERRCOST CaseType=LinStatic P=0 V2=0 V3=0 T=0 M2=0 M3=0
S11Max=0 PtS11Max=0 x2S11Max=0 x3S11Max=0 S11Min=0 PtS11Min=0 x2S11Min=0 x3S11Min=0 FrameElem=51
ElemStation=0
Frame=51 Station=0.125 OutputCase=TERRCOST CaseType=LinStatic P=0 V2=0 V3=0 T=0 M2=0 M3=0
S11Max=0 PtS11Max=0 x2S11Max=0 x3S11Max=0 S11Min=0 PtS11Min=0 x2S11Min=0 x3S11Min=0 FrameElem=51
ElemStation=0.125
Frame=51 Station=0.25 OutputCase=TERRCOST CaseType=LinStatic P=0 V2=0 V3=0 T=0 M2=0 M3=0
S11Max=0 PtS11Max=0 x2S11Max=0 x3S11Max=0 S11Min=0 PtS11Min=0 x2S11Min=0 x3S11Min=0 FrameElem=51
ElemStation=0.25
Frame=51 Station=0.375 OutputCase=TERRCOST CaseType=LinStatic P=0 V2=0 V3=0 T=0 M2=0 M3=0
S11Max=0 PtS11Max=0 x2S11Max=0 x3S11Max=0 S11Min=0 PtS11Min=0 x2S11Min=0 x3S11Min=0 FrameElem=51
ElemStation=0.375
Frame=51 Station=0.5 OutputCase=TERRCOST CaseType=LinStatic P=0 V2=0 V3=0 T=0 M2=0 M3=0
S11Max=0 PtS11Max=0 x2S11Max=0 x3S11Max=0 S11Min=0 PtS11Min=0 x2S11Min=0 x3S11Min=0 FrameElem=51
ElemStation=0.5
Frame=51 Station=0 OutputCase=SOVRCOST CaseType=LinStatic P=0 V2=0 V3=0 T=0 M2=0 M3=0
S11Max=0 PtS11Max=0 x2S11Max=0 x3S11Max=0 S11Min=0 PtS11Min=0 x2S11Min=0 x3S11Min=0 FrameElem=51
ElemStation=0
Frame=51 Station=0.125 OutputCase=SOVRCOST CaseType=LinStatic P=0 V2=0 V3=0 T=0 M2=0 M3=0
S11Max=0 PtS11Max=0 x2S11Max=0 x3S11Max=0 S11Min=0 PtS11Min=0 x2S11Min=0 x3S11Min=0 FrameElem=51
ElemStation=0.125
Frame=51 Station=0.25 OutputCase=SOVRCOST CaseType=LinStatic P=0 V2=0 V3=0 T=0 M2=0 M3=0
S11Max=0 PtS11Max=0 x2S11Max=0 x3S11Max=0 S11Min=0 PtS11Min=0 x2S11Min=0 x3S11Min=0 FrameElem=51
ElemStation=0.25
Frame=51 Station=0.375 OutputCase=SOVRCOST CaseType=LinStatic P=0 V2=0 V3=0 T=0 M2=0 M3=0
S11Max=0 PtS11Max=0 x2S11Max=0 x3S11Max=0 S11Min=0 PtS11Min=0 x2S11Min=0 x3S11Min=0 FrameElem=51
ElemStation=0.375
Frame=51 Station=0.5 OutputCase=SOVRCOST CaseType=LinStatic P=0 V2=0 V3=0 T=0 M2=0 M3=0
S11Max=0 PtS11Max=0 x2S11Max=0 x3S11Max=0 S11Min=0 PtS11Min=0 x2S11Min=0 x3S11Min=0 FrameElem=51
ElemStation=0.5
Frame=51 Station=0 OutputCase=ENVE CaseType=Combination StepType=Max P=-32.6801405652669 V2=-
221.499999457101 V3=0 T=0 M2=0 M3=317.95262810176 S11Max=1875.0356280453 PtS11Max=1 x2S11Max=-0.5
x3S11Max=-0.5
S11Min=-1923.41897583999 PtS11Min=3 x2S11Min=0.5 x3S11Min=-0.5 FrameElem=51 ElemStation=0
Frame=51 Station=0.125 OutputCase=ENVE CaseType=Combination StepType=Max P=-32.6801405652669 V2=-
193.812499457101 V3=0 T=0 M2=0 M3=343.90965929643 S11Max=2030.77781521331 PtS11Max=1 x2S11Max=-0.5
x3S11Max=-0.5
S11Min=-2079.16116293282 PtS11Min=3 x2S11Min=0.5 x3S11Min=-0.5 FrameElem=51 ElemStation=0.125
Frame=51 Station=0.25 OutputCase=ENVE CaseType=Combination StepType=Max P=-32.6801405652669 V2=-
166.124999457101 V3=0 T=0 M2=0 M3=366.405752991099 S11Max=2165.75437738133 PtS11Max=1 x2S11Max=-0.5
x3S11Max=-0.5
S11Min=-2214.13772502564 PtS11Min=3 x2S11Min=0.5 x3S11Min=-0.5 FrameElem=51 ElemStation=0.25
Frame=51 Station=0.375 OutputCase=ENVE CaseType=Combination StepType=Max P=-32.6801405652669 V2=-
138.437499457101 V3=0 T=0 M2=0 M3=385.440909185769 S11Max=2279.96531454934 PtS11Max=1 x2S11Max=-0.5
x3S11Max=-0.5 S11Min=-2328.34866211847 PtS11Min=3 x2S11Min=0.5 x3S11Min=-0.5 FrameElem=51
ElemStation=0.375
Frame=51 Station=0.5 OutputCase=ENVE CaseType=Combination StepType=Max P=-32.6801405652669 V2=-
110.749999457101 V3=0 T=0 M2=0 M3=401.015127880438 S11Max=2373.41062671736 PtS11Max=1 x2S11Max=-0.5
x3S11Max=-0.5
S11Min=-2421.7939742113 PtS11Min=3 x2S11Min=0.5 x3S11Min=-0.5 FrameElem=51 ElemStation=0.5

```



Frame=51 Station=0 OutputCase=ENVE CaseType=Combination StepType=Min P=-52.693680020218 V2=-221.49999557355 V3=0 T=0 M2=0 M3=311.787549303296 S11Max=1818.03161579956 PtS11Max=1 x2S11Max=-0.5 x3S11Max=-0.5
 S11Min=-1940.39590917583 PtS11Min=3 x2S11Min=0.5 x3S11Min=-0.5 FrameElem=51 ElemStation=0
 Frame=51 Station=0.125 OutputCase=ENVE CaseType=Combination StepType=Min P=-52.693680020218 V2=-193.812499557355 V3=0 T=0 M2=0 M3=337.744580485434 S11Max=1973.77380289238 PtS11Max=1 x2S11Max=-0.5 x3S11Max=-0.5
 S11Min=-2096.13809634385 PtS11Min=3 x2S11Min=0.5 x3S11Min=-0.5 FrameElem=51 ElemStation=0.125
 Frame=51 Station=0.25 OutputCase=ENVE CaseType=Combination StepType=Min P=-52.693680020218 V2=-166.124999557355 V3=0 T=0 M2=0 M3=360.240674167571 S11Max=2108.75036498521 PtS11Max=1 x2S11Max=-0.5 x3S11Max=-0.5
 S11Min=-2231.11465851186 PtS11Min=3 x2S11Min=0.5 x3S11Min=-0.5 FrameElem=51 ElemStation=0.25
 Frame=51 Station=0.375 OutputCase=ENVE CaseType=Combination StepType=Min P=-52.693680020218 V2=-138.437499557355 V3=0 T=0 M2=0 M3=379.275830349709 S11Max=2222.96130207803 PtS11Max=1 x2S11Max=-0.5 x3S11Max=-0.5
 S11Min=-2345.32559567988 PtS11Min=3 x2S11Min=0.5 x3S11Min=-0.5 FrameElem=51 ElemStation=0.375
 Frame=51 Station=0.5 OutputCase=ENVE CaseType=Combination StepType=Min P=-52.693680020218 V2=-110.749999557355 V3=0 T=0 M2=0 M3=394.850049031846 S11Max=2316.40661417086 PtS11Max=1 x2S11Max=-0.5 x3S11Max=-0.5
 S11Min=-2438.7709078479 PtS11Min=3 x2S11Min=0.5 x3S11Min=-0.5 FrameElem=51 ElemStation=0.5
 Frame=51 Station=0 OutputCase=FESSUR CaseType=Combination StepType=Min P=-52.693680020218 V2=-221.49999457101 V3=0 T=0 M2=0 M3=311.787549303296 S11Max=1818.03161579956 PtS11Max=1 x2S11Max=-0.5 x3S11Max=-0.5
 S11Min=-1923.41897583999 PtS11Min=3 x2S11Min=0.5 x3S11Min=-0.5 FrameElem=51 ElemStation=0
 Frame=51 Station=0.125 OutputCase=FESSUR CaseType=Combination StepType=Min P=-52.693680020218 V2=-193.812499457101 V3=0 T=0 M2=0 M3=337.744580485434 S11Max=1973.77380289238 PtS11Max=1 x2S11Max=-0.5 x3S11Max=-0.5
 S11Min=-2079.16116293282 PtS11Min=3 x2S11Min=0.5 x3S11Min=-0.5 FrameElem=51 ElemStation=0.125
 Frame=51 Station=0.25 OutputCase=FESSUR CaseType=Combination StepType=Min P=-52.693680020218 V2=-166.124999457101 V3=0 T=0 M2=0 M3=360.240674167571 S11Max=2108.75036498521 PtS11Max=1 x2S11Max=-0.5 x3S11Max=-0.5
 S11Min=-2214.13772502564 PtS11Min=3 x2S11Min=0.5 x3S11Min=-0.5 FrameElem=51 ElemStation=0.25
 Frame=51 Station=0.375 OutputCase=FESSUR CaseType=Combination StepType=Min P=-52.693680020218 V2=-138.437499457101 V3=0 T=0 M2=0 M3=379.275830349709 S11Max=2222.96130207803 PtS11Max=1 x2S11Max=-0.5 x3S11Max=-0.5
 S11Min=-2328.34866211847 PtS11Min=3 x2S11Min=0.5 x3S11Min=-0.5 FrameElem=51 ElemStation=0.375
 Frame=51 Station=0.5 OutputCase=FESSUR CaseType=Combination StepType=Min P=-52.693680020218 V2=-110.749999457101 V3=0 T=0 M2=0 M3=394.850049031846 S11Max=2316.40661417086 PtS11Max=1 x2S11Max=-0.5 x3S11Max=-0.5
 S11Min=-2421.7939742113 PtS11Min=3 x2S11Min=0.5 x3S11Min=-0.5 FrameElem=51 ElemStation=0.5
 Frame=52 Station=0 OutputCase=PESOPR CaseType=LinStatic P=15.1709467362389 V2=-12.499999888823 V3=0 T=0 M2=0 M3=53.9284217252316 S11Max=338.741477087628 PtS11Max=1 x2S11Max=-0.5 x3S11Max=-0.5
 S11Min=-308.399583615151 PtS11Min=3 x2S11Min=0.5 x3S11Min=-0.5 FrameElem=52 ElemStation=0
 Frame=52 Station=0.125 OutputCase=PESOPR CaseType=LinStatic P=15.1709467362389 V2=-9.37499998888234 V3=0 T=0 M2=0 M3=55.2956092238419 S11Max=346.94460207929 PtS11Max=1 x2S11Max=-0.5 x3S11Max=-0.5
 S11Min=-316.602708606812 PtS11Min=3 x2S11Min=0.5 x3S11Min=-0.5 FrameElem=52 ElemStation=0.125
 Frame=52 Station=0.25 OutputCase=PESOPR CaseType=LinStatic P=15.1709467362389 V2=-6.24999998888234 V3=0 T=0 M2=0 M3=56.2721717224522 S11Max=352.803977070952 PtS11Max=1 x2S11Max=-0.5 x3S11Max=-0.5
 S11Min=-322.462083598474 PtS11Min=3 x2S11Min=0.5 x3S11Min=-0.5 FrameElem=52 ElemStation=0.25
 Frame=52 Station=0.375 OutputCase=PESOPR CaseType=LinStatic P=15.1709467362389 V2=-3.12499998888234 V3=0 T=0 M2=0 M3=56.8581092210625 S11Max=356.319602062614 PtS11Max=1 x2S11Max=-0.5 x3S11Max=-0.5
 S11Min=-325.977708590136 PtS11Min=3 x2S11Min=0.5 x3S11Min=-0.5 FrameElem=52 ElemStation=0.375
 Frame=52 Station=0.5 OutputCase=PESOPR CaseType=LinStatic P=15.1709467362389 V2=1.11176632344723E-08 V3=0 T=0 M2=0 M3=57.0534217196728 S11Max=357.491477054275 PtS11Max=1 x2S11Max=-0.5 x3S11Max=-0.5
 S11Min=-327.149583581798 PtS11Min=3 x2S11Min=0.5 x3S11Min=-0.5 FrameElem=52 ElemStation=0.5
 Frame=52 Station=0 OutputCase=TERRVERT CaseType=LinStatic P=-1.15282857329027 V2=-98.2499998024432 V3=0 T=0 M2=0 M3=361.471890135261 S11Max=2167.67851223827 PtS11Max=1 x2S11Max=-0.5 x3S11Max=-0.5
 S11Min=-2169.98416938485 PtS11Min=3 x2S11Min=0.5 x3S11Min=-0.5 FrameElem=52 ElemStation=0
 Frame=52 Station=0.125 OutputCase=TERRVERT CaseType=LinStatic P=-1.15282857329027 V2=-73.6874998024432 V3=0 T=0 M2=0 M3=372.217983860566 S11Max=2232.15507459011 PtS11Max=1 x2S11Max=-0.5 x3S11Max=-0.5
 S11Min=-2234.46073173669 PtS11Min=3 x2S11Min=0.5 x3S11Min=-0.5 FrameElem=52 ElemStation=0.125
 Frame=52 Station=0.25 OutputCase=TERRVERT CaseType=LinStatic P=-1.15282857329027 V2=-49.1249998024432 V3=0 T=0 M2=0 M3=379.893765085872 S11Max=2278.20976194194 PtS11Max=1 x2S11Max=-0.5 x3S11Max=-0.5
 S11Min=-2280.51541908852 PtS11Min=3 x2S11Min=0.5 x3S11Min=-0.5 FrameElem=52 ElemStation=0.25
 Frame=52 Station=0.375 OutputCase=TERRVERT CaseType=LinStatic P=-1.15282857329027 V2=-24.5624998024432 V3=0 T=0 M2=0 M3=384.499233811177 S11Max=2305.84257429377 PtS11Max=1 x2S11Max=-0.5 x3S11Max=-0.5
 S11Min=-2308.14823144035 PtS11Min=3 x2S11Min=0.5 x3S11Min=-0.5 FrameElem=52 ElemStation=0.375
 Frame=52 Station=0.5 OutputCase=TERRVERT CaseType=LinStatic P=-1.15282857329027 V2=1.97556801140308E-07 V3=0 T=0 M2=0 M3=386.034390036482 S11Max=2315.0535116456 PtS11Max=1 x2S11Max=-0.5 x3S11Max=-0.5
 S11Min=-2317.35916879218 PtS11Min=3 x2S11Min=0.5 x3S11Min=-0.5 FrameElem=52 ElemStation=0.5
 Frame=52 Station=0 OutputCase=TERRLAT CaseType=LinStatic P=-66.7117981831702 V2=3.34180640493287E-07 V3=0 T=0 M2=0 M3=-20.5502628286387 S11Max=56.5897787886622 PtS11Max=3 x2S11Max=0.5 x3S11Max=-0.5
 S11Min=-190.013375155003 PtS11Min=1 x2S11Min=-0.5 x3S11Min=-0.5 FrameElem=52 ElemStation=0
 Frame=52 Station=0.125 OutputCase=TERRLAT CaseType=LinStatic P=-66.7117981831702 V2=3.34180640493287E-07 V3=0 T=0 M2=0 M3=-20.5502628704113 S11Max=56.5897790392976 PtS11Max=3 x2S11Max=0.5 x3S11Max=-0.5
 S11Min=-190.013375405638 PtS11Min=1 x2S11Min=-0.5 x3S11Min=-0.5 FrameElem=52 ElemStation=0.125
 Frame=52 Station=0.25 OutputCase=TERRLAT CaseType=LinStatic P=-66.7117981831702 V2=3.34180640493287E-07 V3=0 T=0 M2=0 M3=-20.5502629121839 S11Max=56.5897792899331 PtS11Max=3 x2S11Max=0.5 x3S11Max=-0.5
 S11Min=-190.013375656273 PtS11Min=1 x2S11Min=-0.5 x3S11Min=-0.5 FrameElem=52 ElemStation=0.25
 Frame=52 Station=0.375 OutputCase=TERRLAT CaseType=LinStatic P=-66.7117981831702 V2=3.34180640493287E-07 V3=0 T=0 M2=0 M3=-20.5502629539565 S11Max=56.5897795405686 PtS11Max=3 x2S11Max=0.5 x3S11Max=-0.5
 S11Min=-190.013375906909 PtS11Min=1 x2S11Min=-0.5 x3S11Min=-0.5 FrameElem=52 ElemStation=0.375
 Frame=52 Station=0.5 OutputCase=TERRLAT CaseType=LinStatic P=-66.7117981831702 V2=3.34180640493287E-07 V3=0 T=0 M2=0 M3=-20.550262995729 S11Max=56.5897797912041 PtS11Max=3 x2S11Max=0.5 x3S11Max=-0.5
 S11Min=-190.013376157544 PtS11Min=1 x2S11Min=-0.5 x3S11Min=-0.5 FrameElem=52 ElemStation=0.5



Frame=52 Station=0 OutputCase=ACCLATDX CaseType=LinStatic P=0 V2=0 V3=0 T=0 M2=0 M3=0
 S11Max=0 PtS11Max=0 x2S11Max=0 x3S11Max=0 S11Min=0 PtS11Min=0 x2S11Min=0 x3S11Min=0 FrameElem=52
 ElemStation=0
 Frame=52 Station=0.125 OutputCase=ACCLATDX CaseType=LinStatic P=0 V2=0 V3=0 T=0 M2=0 M3=0
 S11Max=0 PtS11Max=0 x2S11Max=0 x3S11Max=0 S11Min=0 PtS11Min=0 x2S11Min=0 x3S11Min=0 FrameElem=52
 ElemStation=0.125
 Frame=52 Station=0.25 OutputCase=ACCLATDX CaseType=LinStatic P=0 V2=0 V3=0 T=0 M2=0 M3=0
 S11Max=0 PtS11Max=0 x2S11Max=0 x3S11Max=0 S11Min=0 PtS11Min=0 x2S11Min=0 x3S11Min=0 FrameElem=52
 ElemStation=0.25
 Frame=52 Station=0.375 OutputCase=ACCLATDX CaseType=LinStatic P=0 V2=0 V3=0 T=0 M2=0 M3=0
 S11Max=0 PtS11Max=0 x2S11Max=0 x3S11Max=0 S11Min=0 PtS11Min=0 x2S11Min=0 x3S11Min=0 FrameElem=52
 ElemStation=0.375
 Frame=52 Station=0.5 OutputCase=ACCLATDX CaseType=LinStatic P=0 V2=0 V3=0 T=0 M2=0 M3=0
 S11Max=0 PtS11Max=0 x2S11Max=0 x3S11Max=0 S11Min=0 PtS11Min=0 x2S11Min=0 x3S11Min=0 FrameElem=52
 ElemStation=0.5
 Frame=52 Station=0 OutputCase=ACCLATSX CaseType=LinStatic P=0 V2=0 V3=0 T=0 M2=0 M3=0
 S11Max=0 PtS11Max=0 x2S11Max=0 x3S11Max=0 S11Min=0 PtS11Min=0 x2S11Min=0 x3S11Min=0 FrameElem=52
 ElemStation=0
 Frame=52 Station=0.125 OutputCase=ACCLATSX CaseType=LinStatic P=0 V2=0 V3=0 T=0 M2=0 M3=0
 S11Max=0 PtS11Max=0 x2S11Max=0 x3S11Max=0 S11Min=0 PtS11Min=0 x2S11Min=0 x3S11Min=0 FrameElem=52
 ElemStation=0.125
 Frame=52 Station=0.25 OutputCase=ACCLATSX CaseType=LinStatic P=0 V2=0 V3=0 T=0 M2=0 M3=0
 S11Max=0 PtS11Max=0 x2S11Max=0 x3S11Max=0 S11Min=0 PtS11Min=0 x2S11Min=0 x3S11Min=0 FrameElem=52
 ElemStation=0.25
 Frame=52 Station=0.375 OutputCase=ACCLATSX CaseType=LinStatic P=0 V2=0 V3=0 T=0 M2=0 M3=0
 S11Max=0 PtS11Max=0 x2S11Max=0 x3S11Max=0 S11Min=0 PtS11Min=0 x2S11Min=0 x3S11Min=0 FrameElem=52
 ElemStation=0.375
 Frame=52 Station=0.5 OutputCase=ACCLATSX CaseType=LinStatic P=0 V2=0 V3=0 T=0 M2=0 M3=0
 S11Max=0 PtS11Max=0 x2S11Max=0 x3S11Max=0 S11Min=0 PtS11Min=0 x2S11Min=0 x3S11Min=0 FrameElem=52
 ElemStation=0.5
 Frame=52 Station=0 OutputCase=TERRCOST CaseType=LinStatic P=0 V2=0 V3=0 T=0 M2=0 M3=0
 S11Max=0 PtS11Max=0 x2S11Max=0 x3S11Max=0 S11Min=0 PtS11Min=0 x2S11Min=0 x3S11Min=0 FrameElem=52
 ElemStation=0
 Frame=52 Station=0.125 OutputCase=TERRCOST CaseType=LinStatic P=0 V2=0 V3=0 T=0 M2=0 M3=0
 S11Max=0 PtS11Max=0 x2S11Max=0 x3S11Max=0 S11Min=0 PtS11Min=0 x2S11Min=0 x3S11Min=0 FrameElem=52
 ElemStation=0.125
 Frame=52 Station=0.25 OutputCase=TERRCOST CaseType=LinStatic P=0 V2=0 V3=0 T=0 M2=0 M3=0
 S11Max=0 PtS11Max=0 x2S11Max=0 x3S11Max=0 S11Min=0 PtS11Min=0 x2S11Min=0 x3S11Min=0 FrameElem=52
 ElemStation=0.25
 Frame=52 Station=0.375 OutputCase=TERRCOST CaseType=LinStatic P=0 V2=0 V3=0 T=0 M2=0 M3=0
 S11Max=0 PtS11Max=0 x2S11Max=0 x3S11Max=0 S11Min=0 PtS11Min=0 x2S11Min=0 x3S11Min=0 FrameElem=52
 ElemStation=0.375
 Frame=52 Station=0.5 OutputCase=TERRCOST CaseType=LinStatic P=0 V2=0 V3=0 T=0 M2=0 M3=0
 S11Max=0 PtS11Max=0 x2S11Max=0 x3S11Max=0 S11Min=0 PtS11Min=0 x2S11Min=0 x3S11Min=0 FrameElem=52
 ElemStation=0.5
 Frame=52 Station=0 OutputCase=SOVRCOST CaseType=LinStatic P=0 V2=0 V3=0 T=0 M2=0 M3=0
 S11Max=0 PtS11Max=0 x2S11Max=0 x3S11Max=0 S11Min=0 PtS11Min=0 x2S11Min=0 x3S11Min=0 FrameElem=52
 ElemStation=0
 Frame=52 Station=0.125 OutputCase=SOVRCOST CaseType=LinStatic P=0 V2=0 V3=0 T=0 M2=0 M3=0
 S11Max=0 PtS11Max=0 x2S11Max=0 x3S11Max=0 S11Min=0 PtS11Min=0 x2S11Min=0 x3S11Min=0 FrameElem=52
 ElemStation=0.125
 Frame=52 Station=0.25 OutputCase=SOVRCOST CaseType=LinStatic P=0 V2=0 V3=0 T=0 M2=0 M3=0
 S11Max=0 PtS11Max=0 x2S11Max=0 x3S11Max=0 S11Min=0 PtS11Min=0 x2S11Min=0 x3S11Min=0 FrameElem=52
 ElemStation=0.25
 Frame=52 Station=0.375 OutputCase=SOVRCOST CaseType=LinStatic P=0 V2=0 V3=0 T=0 M2=0 M3=0
 S11Max=0 PtS11Max=0 x2S11Max=0 x3S11Max=0 S11Min=0 PtS11Min=0 x2S11Min=0 x3S11Min=0 FrameElem=52
 ElemStation=0.375
 Frame=52 Station=0.5 OutputCase=SOVRCOST CaseType=LinStatic P=0 V2=0 V3=0 T=0 M2=0 M3=0
 S11Max=0 PtS11Max=0 x2S11Max=0 x3S11Max=0 S11Min=0 PtS11Min=0 x2S11Min=0 x3S11Min=0 FrameElem=52
 ElemStation=0.5
 Frame=52 Station=0 OutputCase=ENVE CaseType=Combination StepType=Max P=-32.6801405652705 V2=-
 110.749999457145 V3=0 T=0 M2=0 M3=401.015127880445 S11Max=2373.4106267174 PtS11Max=1 x2S11Max=-0.5
 x3S11Max=-0.5 _
 S11Min=-2421.79397421134 PtS11Min=3 x2S11Min=0.5 x3S11Min=-0.5 FrameElem=52 ElemStation=0
 Frame=52 Station=0.125 OutputCase=ENVE CaseType=Combination StepType=Max P=-32.6801405652705 V2=-
 83.0624994571449 V3=0 T=0 M2=0 M3=413.12840907512 S11Max=2446.09031388545 PtS11Max=1 x2S11Max=-0.5
 x3S11Max=-0.5 _
 S11Min=-2494.4736613042 PtS11Min=3 x2S11Min=0.5 x3S11Min=-0.5 FrameElem=52 ElemStation=0.125
 Frame=52 Station=0.25 OutputCase=ENVE CaseType=Combination StepType=Max P=-32.6801405652705 V2=-
 55.3749994571449 V3=0 T=0 M2=0 M3=421.780752769795 S11Max=2498.0043760535 PtS11Max=1 x2S11Max=-0.5
 x3S11Max=-0.5 _
 S11Min=-2546.38772339706 PtS11Min=3 x2S11Min=0.5 x3S11Min=-0.5 FrameElem=52 ElemStation=0.25
 Frame=52 Station=0.375 OutputCase=ENVE CaseType=Combination StepType=Max P=-32.6801405652705 V2=-
 27.6874994571449 V3=0 T=0 M2=0 M3=426.97215896447 S11Max=2529.15281322155 PtS11Max=1 x2S11Max=-0.5
 x3S11Max=-0.5 _
 S11Min=-2577.53616048992 PtS11Min=3 x2S11Min=0.5 x3S11Min=-0.5 FrameElem=52 ElemStation=0.375
 Frame=52 Station=0.5 OutputCase=ENVE CaseType=Combination StepType=Max P=-32.6801405652705
 V2=5.42855104868067E-07 V3=0 T=0 M2=0 M3=428.702627659145 S11Max=2539.5356253896 PtS11Max=1 x2S11Max=-
 0.5 _
 x3S11Max=-0.5 S11Min=-2587.91897258278 PtS11Min=3 x2S11Min=0.5 x3S11Min=-0.5 FrameElem=52
 ElemStation=0.5



Frame=52 Station=0 OutputCase=ENVE CaseType=Combination StepType=Min P=-52.6936800202216 V2=-110.749999557399 V3=0 T=0 M2=0 M3=394.850049031854 S11Max=2316.4066141709 PtS11Max=1 x2S11Max=-0.5 x3S11Max=-0.5
 S11Min=-2438.77090784794 PtS11Min=3 x2S11Min=0.5 x3S11Min=-0.5 FrameElem=52 ElemStation=0
 Frame=52 Station=0.125 OutputCase=ENVE CaseType=Combination StepType=Min P=-52.6936800202216 V2=-83.0624995573991 V3=0 T=0 M2=0 M3=406.963330213997 S11Max=2389.08630126376 PtS11Max=1 x2S11Max=-0.5 x3S11Max=-0.5
 x3S11Max=-0.5 S11Min=-2511.45059501599 PtS11Min=3 x2S11Min=0.5 x3S11Min=-0.5 FrameElem=52 ElemStation=0.125
 Frame=52 Station=0.25 OutputCase=ENVE CaseType=Combination StepType=Min P=-52.6936800202216 V2=-55.3749995573991 V3=0 T=0 M2=0 M3=415.61567389614 S11Max=2441.00036335662 PtS11Max=1 x2S11Max=-0.5 x3S11Max=-0.5
 S11Min=-2563.36465718404 PtS11Min=3 x2S11Min=0.5 x3S11Min=-0.5 FrameElem=52 ElemStation=0.25
 Frame=52 Station=0.375 OutputCase=ENVE CaseType=Combination StepType=Min P=-52.6936800202216 V2=-27.6874995573991 V3=0 T=0 M2=0 M3=420.807080078283 S11Max=2472.14880044948 PtS11Max=1 x2S11Max=-0.5 x3S11Max=-0.5
 x3S11Max=-0.5 S11Min=-2594.51309435209 PtS11Min=3 x2S11Min=0.5 x3S11Min=-0.5 FrameElem=52 ElemStation=0.375
 Frame=52 Station=0.5 OutputCase=ENVE CaseType=Combination StepType=Min P=-52.6936800202216 V2=4.42600912720081E-07 V3=0 T=0 M2=0 M3=422.537548760426 S11Max=2482.53161254234 PtS11Max=1 x2S11Max=-0.5 x3S11Max=-0.5
 x3S11Max=-0.5 S11Min=-2604.89590652014 PtS11Min=3 x2S11Min=0.5 x3S11Min=-0.5 FrameElem=52 ElemStation=0.5
 Frame=52 Station=0 OutputCase=FESSUR CaseType=Combination P=-52.6936800202216 V2=-110.749999457145 V3=0 T=0 M2=0 M3=394.850049031854 S11Max=2316.4066141709 PtS11Max=1 x2S11Max=-0.5 x3S11Max=-0.5
 S11Min=-2421.79397421134 PtS11Min=3 x2S11Min=0.5 x3S11Min=-0.5 FrameElem=52 ElemStation=0
 Frame=52 Station=0.125 OutputCase=FESSUR CaseType=Combination P=-52.6936800202216 V2=-83.0624994571449 V3=0 T=0 M2=0 M3=406.963330213997 S11Max=2389.08630126376 PtS11Max=1 x2S11Max=-0.5 x3S11Max=-0.5
 S11Min=-2494.4736613042 PtS11Min=3 x2S11Min=0.5 x3S11Min=-0.5 FrameElem=52 ElemStation=0.125
 Frame=52 Station=0.25 OutputCase=FESSUR CaseType=Combination P=-52.6936800202216 V2=-55.3749994571449 V3=0 T=0 M2=0 M3=415.61567389614 S11Max=2441.00036335662 PtS11Max=1 x2S11Max=-0.5 x3S11Max=-0.5
 S11Min=-2546.38772339706 PtS11Min=3 x2S11Min=0.5 x3S11Min=-0.5 FrameElem=52 ElemStation=0.25
 Frame=52 Station=0.375 OutputCase=FESSUR CaseType=Combination P=-52.6936800202216 V2=-27.6874994571449 V3=0 T=0 M2=0 M3=420.807080078283 S11Max=2472.14880044948 PtS11Max=1 x2S11Max=-0.5 x3S11Max=-0.5
 S11Min=-2577.53616048992 PtS11Min=3 x2S11Min=0.5 x3S11Min=-0.5 FrameElem=52 ElemStation=0.375
 Frame=52 Station=0.5 OutputCase=FESSUR CaseType=Combination P=-52.6936800202216 V2=5.42855104868067E-07 V3=0 T=0 M2=0 M3=422.537548760426 S11Max=2482.53161254234 PtS11Max=1 x2S11Max=-0.5 x3S11Max=-0.5
 S11Min=-2587.91897258278 PtS11Min=3 x2S11Min=0.5 x3S11Min=-0.5 FrameElem=52 ElemStation=0.5
 Frame=53 Station=0 OutputCase=PESOPR CaseType=LinStatic P=15.1709467362388 V2=1.11031113192439E-08 V3=0 T=0 M2=0 M3=57.05342171968 S11Max=357.491477054319 PtS11Max=1 x2S11Max=-0.5 x3S11Max=-0.5
 S11Min=-327.149583581841 PtS11Min=3 x2S11Min=0.5 x3S11Min=-0.5 FrameElem=53 ElemStation=0
 Frame=53 Station=0.125 OutputCase=PESOPR CaseType=LinStatic P=15.1709467362388 V2=3.12500001110311 V3=0 T=0 M2=0 M3=56.8581092182922 S11Max=356.319602045992 PtS11Max=1 x2S11Max=-0.5 x3S11Max=-0.5
 S11Min=-325.977708573514 PtS11Min=3 x2S11Min=0.5 x3S11Min=-0.5 FrameElem=53 ElemStation=0.125
 Frame=53 Station=0.25 OutputCase=PESOPR CaseType=LinStatic P=15.1709467362388 V2=6.25000001110311 V3=0 T=0 M2=0 M3=56.2721717169043 S11Max=352.803977037664 PtS11Max=1 x2S11Max=-0.5 x3S11Max=-0.5
 S11Min=-322.462083565187 PtS11Min=3 x2S11Min=0.5 x3S11Min=-0.5 FrameElem=53 ElemStation=0.25
 Frame=53 Station=0.375 OutputCase=PESOPR CaseType=LinStatic P=15.1709467362388 V2=9.37500001110311 V3=0 T=0 M2=0 M3=55.2956092155164 S11Max=346.944602029337 PtS11Max=1 x2S11Max=-0.5 x3S11Max=-0.5
 S11Min=-316.602708556859 PtS11Min=3 x2S11Min=0.5 x3S11Min=-0.5 FrameElem=53 ElemStation=0.375
 Frame=53 Station=0.5 OutputCase=PESOPR CaseType=LinStatic P=15.1709467362388 V2=12.5000000111031 V3=0 T=0 M2=0 M3=53.9284217141285 S11Max=338.74147702101 PtS11Max=1 x2S11Max=-0.5 x3S11Max=-0.5
 S11Min=-308.399583548532 PtS11Min=3 x2S11Min=0.5 x3S11Min=-0.5 FrameElem=53 ElemStation=0.5
 Frame=53 Station=0 OutputCase=TERRVERT CaseType=LinStatic P=-1.15282857329028 V2=1.97615008801222E-07 V3=0 T=0 M2=0 M3=386.034390036475 S11Max=2315.05351164556 PtS11Max=1 x2S11Max=-0.5 x3S11Max=-0.5
 S11Min=-2317.35916879214 PtS11Min=3 x2S11Min=0.5 x3S11Min=-0.5 FrameElem=53 ElemStation=0
 Frame=53 Station=0.125 OutputCase=TERRVERT CaseType=LinStatic P=-1.15282857329028 V2=24.562500197615 V3=0 T=0 M2=0 M3=384.499233761773 S11Max=2305.84257399735 PtS11Max=1 x2S11Max=-0.5 x3S11Max=-0.5
 S11Min=-2308.14823114393 PtS11Min=3 x2S11Min=0.5 x3S11Min=-0.5 FrameElem=53 ElemStation=0.125
 Frame=53 Station=0.25 OutputCase=TERRVERT CaseType=LinStatic P=-1.15282857329028 V2=49.125000197615 V3=0 T=0 M2=0 M3=379.893764987071 S11Max=2278.20976134914 PtS11Max=1 x2S11Max=-0.5 x3S11Max=-0.5
 S11Min=-2280.51541849572 PtS11Min=3 x2S11Min=0.5 x3S11Min=-0.5 FrameElem=53 ElemStation=0.25
 Frame=53 Station=0.375 OutputCase=TERRVERT CaseType=LinStatic P=-1.15282857329028 V2=73.687500197615 V3=0 T=0 M2=0 M3=372.217983712369 S11Max=2232.15507370093 PtS11Max=1 x2S11Max=-0.5 x3S11Max=-0.5
 S11Min=-2234.46073084751 PtS11Min=3 x2S11Min=0.5 x3S11Min=-0.5 FrameElem=53 ElemStation=0.375
 Frame=53 Station=0.5 OutputCase=TERRVERT CaseType=LinStatic P=-1.15282857329028 V2=98.250000197615 V3=0 T=0 M2=0 M3=361.471889937668 S11Max=2167.67851105272 PtS11Max=1 x2S11Max=-0.5 x3S11Max=-0.5
 S11Min=-2169.9841681993 PtS11Min=3 x2S11Min=0.5 x3S11Min=-0.5 FrameElem=53 ElemStation=0.5
 Frame=53 Station=0 OutputCase=TERRLAT CaseType=LinStatic P=-66.7117981831701 V2=3.34180867866962E-07 V3=0 T=0 M2=0 M3=-20.5502629957291 S11Max=56.5897797912043 PtS11Max=3 x2S11Max=0.5 x3S11Max=-0.5
 S11Min=-190.013376157545 PtS11Min=1 x2S11Min=-0.5 x3S11Min=-0.5 FrameElem=53 ElemStation=0
 Frame=53 Station=0.125 OutputCase=TERRLAT CaseType=LinStatic P=-66.7117981831701 V2=3.34180867866962E-07 V3=0 T=0 M2=0 M3=-20.5502630375017 S11Max=56.58978004184 PtS11Max=3 x2S11Max=0.5 x3S11Max=-0.5
 S11Min=-190.01337640818 PtS11Min=1 x2S11Min=-0.5 x3S11Min=-0.5 FrameElem=53 ElemStation=0.125
 Frame=53 Station=0.25 OutputCase=TERRLAT CaseType=LinStatic P=-66.7117981831701 V2=3.34180867866962E-07 V3=0 T=0 M2=0 M3=-20.5502630792743 S11Max=56.5897802924756 PtS11Max=3 x2S11Max=0.5 x3S11Max=-0.5
 S11Min=-190.013376658816 PtS11Min=1 x2S11Min=-0.5 x3S11Min=-0.5 FrameElem=53 ElemStation=0.25
 Frame=53 Station=0.375 OutputCase=TERRLAT CaseType=LinStatic P=-66.7117981831701 V2=3.34180867866962E-07 V3=0 T=0 M2=0 M3=-20.5502631210469 S11Max=56.5897805431113 PtS11Max=3 x2S11Max=0.5 x3S11Max=-0.5
 S11Min=-190.013376909451 PtS11Min=1 x2S11Min=-0.5 x3S11Min=-0.5 FrameElem=53 ElemStation=0.375
 Frame=53 Station=0.5 OutputCase=TERRLAT CaseType=LinStatic P=-66.7117981831701 V2=3.34180867866962E-07 V3=0 T=0 M2=0 M3=-20.5502631628195 S11Max=56.5897807937469 PtS11Max=3 x2S11Max=0.5 x3S11Max=-0.5
 S11Min=-190.013377160087 PtS11Min=1 x2S11Min=-0.5 x3S11Min=-0.5 FrameElem=53 ElemStation=0.5

```

Frame=53 Station=0 OutputCase=ACCLATDX CaseType=LinStatic P=0 V2=0 V3=0 T=0 M2=0 M3=0
S11Max=0 PtS11Max=0 x2S11Max=0 x3S11Max=0 S11Min=0 PtS11Min=0 x2S11Min=0 x3S11Min=0 FrameElem=53
ElemStation=0
Frame=53 Station=0.125 OutputCase=ACCLATDX CaseType=LinStatic P=0 V2=0 V3=0 T=0 M2=0 M3=0
S11Max=0 PtS11Max=0 x2S11Max=0 x3S11Max=0 S11Min=0 PtS11Min=0 x2S11Min=0 x3S11Min=0 FrameElem=53
ElemStation=0.125
Frame=53 Station=0.25 OutputCase=ACCLATDX CaseType=LinStatic P=0 V2=0 V3=0 T=0 M2=0 M3=0
S11Max=0 PtS11Max=0 x2S11Max=0 x3S11Max=0 S11Min=0 PtS11Min=0 x2S11Min=0 x3S11Min=0 FrameElem=53
ElemStation=0.25
Frame=53 Station=0.375 OutputCase=ACCLATDX CaseType=LinStatic P=0 V2=0 V3=0 T=0 M2=0 M3=0
S11Max=0 PtS11Max=0 x2S11Max=0 x3S11Max=0 S11Min=0 PtS11Min=0 x2S11Min=0 x3S11Min=0 FrameElem=53
ElemStation=0.375
Frame=53 Station=0.5 OutputCase=ACCLATDX CaseType=LinStatic P=0 V2=0 V3=0 T=0 M2=0 M3=0
S11Max=0 PtS11Max=0 x2S11Max=0 x3S11Max=0 S11Min=0 PtS11Min=0 x2S11Min=0 x3S11Min=0 FrameElem=53
ElemStation=0.5
Frame=53 Station=0 OutputCase=ACCLATSX CaseType=LinStatic P=0 V2=0 V3=0 T=0 M2=0 M3=0
S11Max=0 PtS11Max=0 x2S11Max=0 x3S11Max=0 S11Min=0 PtS11Min=0 x2S11Min=0 x3S11Min=0 FrameElem=53
ElemStation=0
Frame=53 Station=0.125 OutputCase=ACCLATSX CaseType=LinStatic P=0 V2=0 V3=0 T=0 M2=0 M3=0
S11Max=0 PtS11Max=0 x2S11Max=0 x3S11Max=0 S11Min=0 PtS11Min=0 x2S11Min=0 x3S11Min=0 FrameElem=53
ElemStation=0.125
Frame=53 Station=0.25 OutputCase=ACCLATSX CaseType=LinStatic P=0 V2=0 V3=0 T=0 M2=0 M3=0
S11Max=0 PtS11Max=0 x2S11Max=0 x3S11Max=0 S11Min=0 PtS11Min=0 x2S11Min=0 x3S11Min=0 FrameElem=53
ElemStation=0.25
Frame=53 Station=0.375 OutputCase=ACCLATSX CaseType=LinStatic P=0 V2=0 V3=0 T=0 M2=0 M3=0
S11Max=0 PtS11Max=0 x2S11Max=0 x3S11Max=0 S11Min=0 PtS11Min=0 x2S11Min=0 x3S11Min=0 FrameElem=53
ElemStation=0.375
Frame=53 Station=0.5 OutputCase=ACCLATSX CaseType=LinStatic P=0 V2=0 V3=0 T=0 M2=0 M3=0
S11Max=0 PtS11Max=0 x2S11Max=0 x3S11Max=0 S11Min=0 PtS11Min=0 x2S11Min=0 x3S11Min=0 FrameElem=53
ElemStation=0.5
Frame=53 Station=0 OutputCase=TERRCOST CaseType=LinStatic P=0 V2=0 V3=0 T=0 M2=0 M3=0
S11Max=0 PtS11Max=0 x2S11Max=0 x3S11Max=0 S11Min=0 PtS11Min=0 x2S11Min=0 x3S11Min=0 FrameElem=53
ElemStation=0
Frame=53 Station=0.125 OutputCase=TERRCOST CaseType=LinStatic P=0 V2=0 V3=0 T=0 M2=0 M3=0
S11Max=0 PtS11Max=0 x2S11Max=0 x3S11Max=0 S11Min=0 PtS11Min=0 x2S11Min=0 x3S11Min=0 FrameElem=53
ElemStation=0.125
Frame=53 Station=0.25 OutputCase=TERRCOST CaseType=LinStatic P=0 V2=0 V3=0 T=0 M2=0 M3=0
S11Max=0 PtS11Max=0 x2S11Max=0 x3S11Max=0 S11Min=0 PtS11Min=0 x2S11Min=0 x3S11Min=0 FrameElem=53
ElemStation=0.25
Frame=53 Station=0.375 OutputCase=TERRCOST CaseType=LinStatic P=0 V2=0 V3=0 T=0 M2=0 M3=0
S11Max=0 PtS11Max=0 x2S11Max=0 x3S11Max=0 S11Min=0 PtS11Min=0 x2S11Min=0 x3S11Min=0 FrameElem=53
ElemStation=0.375
Frame=53 Station=0.5 OutputCase=TERRCOST CaseType=LinStatic P=0 V2=0 V3=0 T=0 M2=0 M3=0
S11Max=0 PtS11Max=0 x2S11Max=0 x3S11Max=0 S11Min=0 PtS11Min=0 x2S11Min=0 x3S11Min=0 FrameElem=53
ElemStation=0.5
Frame=53 Station=0 OutputCase=SOVRCOST CaseType=LinStatic P=0 V2=0 V3=0 T=0 M2=0 M3=0
S11Max=0 PtS11Max=0 x2S11Max=0 x3S11Max=0 S11Min=0 PtS11Min=0 x2S11Min=0 x3S11Min=0 FrameElem=53
ElemStation=0
Frame=53 Station=0.125 OutputCase=SOVRCOST CaseType=LinStatic P=0 V2=0 V3=0 T=0 M2=0 M3=0
S11Max=0 PtS11Max=0 x2S11Max=0 x3S11Max=0 S11Min=0 PtS11Min=0 x2S11Min=0 x3S11Min=0 FrameElem=53
ElemStation=0.125
Frame=53 Station=0.25 OutputCase=SOVRCOST CaseType=LinStatic P=0 V2=0 V3=0 T=0 M2=0 M3=0
S11Max=0 PtS11Max=0 x2S11Max=0 x3S11Max=0 S11Min=0 PtS11Min=0 x2S11Min=0 x3S11Min=0 FrameElem=53
ElemStation=0.25
Frame=53 Station=0.375 OutputCase=SOVRCOST CaseType=LinStatic P=0 V2=0 V3=0 T=0 M2=0 M3=0
S11Max=0 PtS11Max=0 x2S11Max=0 x3S11Max=0 S11Min=0 PtS11Min=0 x2S11Min=0 x3S11Min=0 FrameElem=53
ElemStation=0.375
Frame=53 Station=0.5 OutputCase=SOVRCOST CaseType=LinStatic P=0 V2=0 V3=0 T=0 M2=0 M3=0
S11Max=0 PtS11Max=0 x2S11Max=0 x3S11Max=0 S11Min=0 PtS11Min=0 x2S11Min=0 x3S11Min=0 FrameElem=53
ElemStation=0.5
Frame=53 Station=0 OutputCase=ENVE CaseType=Combination StepType=Max P=-32.6801405652705
V2=5.42898987987428E-07 V3=0 T=0 M2=0 M3=428.702627659145 S11Max=2539.5356253896 PtS11Max=1 x2S11Max=-
0.5 x3S11Max=-0.5
S11Min=-2587.91897258278 PtS11Min=3 x2S11Min=0.5 x3S11Min=-0.5 FrameElem=53 ElemStation=0
Frame=53 Station=0.125 OutputCase=ENVE CaseType=Combination StepType=Max P=-32.6801405652705
V2=27.687500542899 V3=0 T=0 M2=0 M3=426.972158853814 S11Max=2529.15281255761 PtS11Max=1 x2S11Max=-0.5
x3S11Max=-0.5
S11Min=-2577.5361596756 PtS11Min=3 x2S11Min=0.5 x3S11Min=-0.5 FrameElem=53 ElemStation=0.125
Frame=53 Station=0.25 OutputCase=ENVE CaseType=Combination StepType=Max P=-32.6801405652705
V2=55.375000542899 V3=0 T=0 M2=0 M3=421.780752548484 S11Max=2498.00437472563 PtS11Max=1 x2S11Max=-0.5
x3S11Max=-0.5
S11Min=-2546.38772176843 PtS11Min=3 x2S11Min=0.5 x3S11Min=-0.5 FrameElem=53 ElemStation=0.25
Frame=53 Station=0.375 OutputCase=ENVE CaseType=Combination StepType=Max P=-32.6801405652705
V2=83.062500542899 V3=0 T=0 M2=0 M3=413.128408743153 S11Max=2446.09031189365 PtS11Max=1 x2S11Max=-0.5
x3S11Max=-0.5
S11Min=-2494.47365886126 PtS11Min=3 x2S11Min=0.5 x3S11Min=-0.5 FrameElem=53 ElemStation=0.375
Frame=53 Station=0.5 OutputCase=ENVE CaseType=Combination StepType=Max P=-32.6801405652705
V2=110.750000542899 V3=0 T=0 M2=0 M3=401.015127437822 S11Max=2373.41062406166 PtS11Max=1 x2S11Max=-0.5
x3S11Max=-0.5
S11Min=-2421.79397095408 PtS11Min=3 x2S11Min=0.5 x3S11Min=-0.5 FrameElem=53 ElemStation=0.5

```



Frame=53 Station=0 OutputCase=ENVE CaseType=Combination StepType=Min P=-52.6936800202215
 V2=4.42644727627339E-07 V3=0 T=0 M2=0 M3=422.537548760426 S11Max=2482.53161254234 PtS11Max=1
 x2S11Max=-0.5 x3S11Max=-0.5
 S11Min=-2604.89590652014 PtS11Min=3 x2S11Min=0.5 x3S11Min=-0.5 FrameElem=53 ElemStation=0
 Frame=53 Station=0.125 OutputCase=ENVE CaseType=Combination StepType=Min P=-52.6936800202215
 V2=27.6875004426447 V3=0 T=0 M2=0 M3=420.807079942564 S11Max=2472.14879963516 PtS11Max=1 x2S11Max=-0.5
 x3S11Max=-0.5
 S11Min=-2594.51309368816 PtS11Min=3 x2S11Min=0.5 x3S11Min=-0.5 FrameElem=53 ElemStation=0.125
 Frame=53 Station=0.25 OutputCase=ENVE CaseType=Combination StepType=Min P=-52.6936800202215
 V2=55.3750004426447 V3=0 T=0 M2=0 M3=415.615673624701 S11Max=2441.00036172799 PtS11Max=1 x2S11Max=-0.5
 x3S11Max=-0.5
 S11Min=-2563.36465585617 PtS11Min=3 x2S11Min=0.5 x3S11Min=-0.5 FrameElem=53 ElemStation=0.25
 Frame=53 Station=0.375 OutputCase=ENVE CaseType=Combination StepType=Min P=-52.6936800202215
 V2=83.0625004426447 V3=0 T=0 M2=0 M3=406.963329806839 S11Max=2389.08629882081 PtS11Max=1 x2S11Max=-0.5
 x3S11Max=-0.5
 S11Min=-2511.45059302419 PtS11Min=3 x2S11Min=0.5 x3S11Min=-0.5 FrameElem=53 ElemStation=0.375
 Frame=53 Station=0.5 OutputCase=ENVE CaseType=Combination StepType=Min P=-52.6936800202215
 V2=110.750000442645 V3=0 T=0 M2=0 M3=394.850048488977 S11Max=2316.40661091364 PtS11Max=1 x2S11Max=-0.5
 x3S11Max=-0.5
 S11Min=-2438.7709051922 PtS11Min=3 x2S11Min=0.5 x3S11Min=-0.5 FrameElem=53 ElemStation=0.5
 Frame=53 Station=0 OutputCase=FESSUR CaseType=Combination P=-52.6936800202215 V2=5.4289897987428E-07
 V3=0 T=0 M2=0 M3=422.537548760426 S11Max=2482.53161254234 PtS11Max=1 x2S11Max=-0.5 x3S11Max=-0.5
 S11Min=-2587.91897258278 PtS11Min=3 x2S11Min=0.5 x3S11Min=-0.5 FrameElem=53 ElemStation=0
 Frame=53 Station=0.125 OutputCase=FESSUR CaseType=Combination P=-52.6936800202215 V2=27.687500542899
 V3=0 T=0 M2=0 M3=420.807079942564 S11Max=2472.14879963516 PtS11Max=1 x2S11Max=-0.5 x3S11Max=-0.5
 S11Min=-2577.5361596756 PtS11Min=3 x2S11Min=0.5 x3S11Min=-0.5 FrameElem=53 ElemStation=0.125
 Frame=53 Station=0.25 OutputCase=FESSUR CaseType=Combination P=-52.6936800202215 V2=55.375000542899
 V3=0 T=0 M2=0 M3=415.615673624701 S11Max=2441.00036172799 PtS11Max=1 x2S11Max=-0.5 x3S11Max=-0.5
 S11Min=-2546.38772176843 PtS11Min=3 x2S11Min=0.5 x3S11Min=-0.5 FrameElem=53 ElemStation=0.25
 Frame=53 Station=0.375 OutputCase=FESSUR CaseType=Combination P=-52.6936800202215 V2=83.062500542899
 V3=0 T=0 M2=0 M3=406.963329806839 S11Max=2389.08629882081 PtS11Max=1 x2S11Max=-0.5 x3S11Max=-0.5
 S11Min=-2494.47365886126 PtS11Min=3 x2S11Min=0.5 x3S11Min=-0.5 FrameElem=53 ElemStation=0.375
 Frame=53 Station=0.5 OutputCase=FESSUR CaseType=Combination P=-52.6936800202215 V2=110.750000542899
 V3=0 T=0 M2=0 M3=394.850048488977 S11Max=2316.40661091364 PtS11Max=1 x2S11Max=-0.5 x3S11Max=-0.5
 S11Min=-2421.79397095408 PtS11Min=3 x2S11Min=0.5 x3S11Min=-0.5 FrameElem=53 ElemStation=0.5
 Frame=54 Station=0 OutputCase=PESOPR CaseType=LinStatic P=15.1709467362389 V2=12.500000111177 V3=0
 T=0 M2=0 M3=53.9284217141321 S11Max=338.741477021032 PtS11Max=1 x2S11Max=-0.5 x3S11Max=-0.5
 S11Min=-308.399583548554 PtS11Min=3 x2S11Min=0.5 x3S11Min=-0.5 FrameElem=54 ElemStation=0
 Frame=54 Station=0.125 OutputCase=PESOPR CaseType=LinStatic P=15.1709467362389 V2=15.6250000111177
 V3=0 T=0 M2=0 M3=52.1706092127424 S11Max=328.194602012693 PtS11Max=1 x2S11Max=-0.5 x3S11Max=-0.5
 S11Min=-297.852708540216 PtS11Min=3 x2S11Min=0.5 x3S11Min=-0.5 FrameElem=54 ElemStation=0.125
 Frame=54 Station=0.25 OutputCase=PESOPR CaseType=LinStatic P=15.1709467362389 V2=18.7500000111177
 V3=0 T=0 M2=0 M3=50.0221717113527 S11Max=315.303977004355 PtS11Max=1 x2S11Max=-0.5 x3S11Max=-0.5
 S11Min=-284.962083531877 PtS11Min=3 x2S11Min=0.5 x3S11Min=-0.5 FrameElem=54 ElemStation=0.25
 Frame=54 Station=0.375 OutputCase=PESOPR CaseType=LinStatic P=15.1709467362389 V2=21.8750000111177
 V3=0 T=0 M2=0 M3=47.483109209963 S11Max=300.069601996017 PtS11Max=1 x2S11Max=-0.5 x3S11Max=-0.5
 S11Min=-269.727708523539 PtS11Min=3 x2S11Min=0.5 x3S11Min=-0.5 FrameElem=54 ElemStation=0.375
 Frame=54 Station=0.5 OutputCase=PESOPR CaseType=LinStatic P=15.1709467362389 V2=25.000000111177 V3=0
 T=0 M2=0 M3=44.5534217085733 S11Max=282.491476987679 PtS11Max=1 x2S11Max=-0.5 x3S11Max=-0.5
 S11Min=-252.149583515201 PtS11Min=3 x2S11Min=0.5 x3S11Min=-0.5 FrameElem=54 ElemStation=0.5
 Frame=54 Station=0 OutputCase=TERRVERT CaseType=LinStatic P=-1.15282857329027 V2=98.2500001975859
 V3=0 T=0 M2=0 M3=361.471889937668 S11Max=2167.67851105272 PtS11Max=1 x2S11Max=-0.5 x3S11Max=-0.5
 S11Min=-2169.9841681993 PtS11Min=3 x2S11Min=0.5 x3S11Min=-0.5 FrameElem=54 ElemStation=0
 Frame=54 Station=0.125 OutputCase=TERRVERT CaseType=LinStatic P=-1.15282857329027 V2=122.812500197586
 V3=0 T=0 M2=0 M3=347.655483662969 S11Max=2084.78007340453 PtS11Max=1 x2S11Max=-0.5 x3S11Max=-0.5
 S11Min=-2087.08573055111 PtS11Min=3 x2S11Min=0.5 x3S11Min=-0.5 FrameElem=54 ElemStation=0.125
 Frame=54 Station=0.25 OutputCase=TERRVERT CaseType=LinStatic P=-1.15282857329027 V2=147.375000197586
 V3=0 T=0 M2=0 M3=330.768764888271 S11Max=1983.45976075634 PtS11Max=1 x2S11Max=-0.5 x3S11Max=-0.5
 S11Min=-1985.76541790292 PtS11Min=3 x2S11Min=0.5 x3S11Min=-0.5 FrameElem=54 ElemStation=0.25
 Frame=54 Station=0.375 OutputCase=TERRVERT CaseType=LinStatic P=-1.15282857329027 V2=171.937500197586
 V3=0 T=0 M2=0 M3=310.811733613573 S11Max=1863.71757310815 PtS11Max=1 x2S11Max=-0.5 x3S11Max=-0.5
 S11Min=-1866.02323025473 PtS11Min=3 x2S11Min=0.5 x3S11Min=-0.5 FrameElem=54 ElemStation=0.375
 Frame=54 Station=0.5 OutputCase=TERRVERT CaseType=LinStatic P=-1.15282857329027 V2=196.500000197586
 V3=0 T=0 M2=0 M3=287.784389838875 S11Max=1725.55351045996 PtS11Max=1 x2S11Max=-0.5 x3S11Max=-0.5
 S11Min=-1727.85916760654 PtS11Min=3 x2S11Min=0.5 x3S11Min=-0.5 FrameElem=54 ElemStation=0.5
 Frame=54 Station=0 OutputCase=TERRLAT CaseType=LinStatic P=-66.7117981831701 V2=3.34180867866962E-07
 V3=0 T=0 M2=0 M3=-20.5502631628194 S11Max=56.5897807937466 PtS11Max=3 x2S11Max=0.5 x3S11Max=-0.5
 S11Min=-190.013377160087 PtS11Min=1 x2S11Min=-0.5 x3S11Min=-0.5 FrameElem=54 ElemStation=0
 Frame=54 Station=0.125 OutputCase=TERRLAT CaseType=LinStatic P=-66.7117981831701 V2=3.34180867866962E-07
 V3=0 T=0 M2=0 M3=-20.5502632045921 S11Max=56.5897810443822 PtS11Max=3 x2S11Max=0.5 x3S11Max=-0.5
 S11Min=-190.013377410722 PtS11Min=1 x2S11Min=-0.5 x3S11Min=-0.5 FrameElem=54 ElemStation=0.125
 Frame=54 Station=0.25 OutputCase=TERRLAT CaseType=LinStatic P=-66.7117981831701 V2=3.34180867866962E-07
 V3=0 T=0 M2=0 M3=-20.5502632463647 S11Max=56.5897812950179 PtS11Max=3 x2S11Max=0.5 x3S11Max=-0.5
 S11Min=-190.013377661358 PtS11Min=1 x2S11Min=-0.5 x3S11Min=-0.5 FrameElem=54 ElemStation=0.25
 Frame=54 Station=0.375 OutputCase=TERRLAT CaseType=LinStatic P=-66.7117981831701 V2=3.34180867866962E-07
 V3=0 T=0 M2=0 M3=-20.5502632881373 S11Max=56.5897815456535 PtS11Max=3 x2S11Max=0.5 x3S11Max=-0.5
 S11Min=-190.013377911994 PtS11Min=1 x2S11Min=-0.5 x3S11Min=-0.5 FrameElem=54 ElemStation=0.375
 Frame=54 Station=0.5 OutputCase=TERRLAT CaseType=LinStatic P=-66.7117981831701 V2=3.34180867866962E-07
 V3=0 T=0 M2=0 M3=-20.5502633299099 S11Max=56.5897817962892 PtS11Max=3 x2S11Max=0.5 x3S11Max=-0.5
 S11Min=-190.013378162629 PtS11Min=1 x2S11Min=-0.5 x3S11Min=-0.5 FrameElem=54 ElemStation=0.5

```

Frame=54 Station=0 OutputCase=ACCLATDX CaseType=LinStatic P=0 V2=0 V3=0 T=0 M2=0 M3=0
S11Max=0 PtS11Max=0 x2S11Max=0 x3S11Max=0 S11Min=0 PtS11Min=0 x2S11Min=0 x3S11Min=0 FrameElem=54
ElemStation=0
Frame=54 Station=0.125 OutputCase=ACCLATDX CaseType=LinStatic P=0 V2=0 V3=0 T=0 M2=0 M3=0
S11Max=0 PtS11Max=0 x2S11Max=0 x3S11Max=0 S11Min=0 PtS11Min=0 x2S11Min=0 x3S11Min=0 FrameElem=54
ElemStation=0.125
Frame=54 Station=0.25 OutputCase=ACCLATDX CaseType=LinStatic P=0 V2=0 V3=0 T=0 M2=0 M3=0
S11Max=0 PtS11Max=0 x2S11Max=0 x3S11Max=0 S11Min=0 PtS11Min=0 x2S11Min=0 x3S11Min=0 FrameElem=54
ElemStation=0.25
Frame=54 Station=0.375 OutputCase=ACCLATDX CaseType=LinStatic P=0 V2=0 V3=0 T=0 M2=0 M3=0
S11Max=0 PtS11Max=0 x2S11Max=0 x3S11Max=0 S11Min=0 PtS11Min=0 x2S11Min=0 x3S11Min=0 FrameElem=54
ElemStation=0.375
Frame=54 Station=0.5 OutputCase=ACCLATDX CaseType=LinStatic P=0 V2=0 V3=0 T=0 M2=0 M3=0
S11Max=0 PtS11Max=0 x2S11Max=0 x3S11Max=0 S11Min=0 PtS11Min=0 x2S11Min=0 x3S11Min=0 FrameElem=54
ElemStation=0.5
Frame=54 Station=0 OutputCase=ACCLATSX CaseType=LinStatic P=0 V2=0 V3=0 T=0 M2=0 M3=0
S11Max=0 PtS11Max=0 x2S11Max=0 x3S11Max=0 S11Min=0 PtS11Min=0 x2S11Min=0 x3S11Min=0 FrameElem=54
ElemStation=0
Frame=54 Station=0.125 OutputCase=ACCLATSX CaseType=LinStatic P=0 V2=0 V3=0 T=0 M2=0 M3=0
S11Max=0 PtS11Max=0 x2S11Max=0 x3S11Max=0 S11Min=0 PtS11Min=0 x2S11Min=0 x3S11Min=0 FrameElem=54
ElemStation=0.125
Frame=54 Station=0.25 OutputCase=ACCLATSX CaseType=LinStatic P=0 V2=0 V3=0 T=0 M2=0 M3=0
S11Max=0 PtS11Max=0 x2S11Max=0 x3S11Max=0 S11Min=0 PtS11Min=0 x2S11Min=0 x3S11Min=0 FrameElem=54
ElemStation=0.25
Frame=54 Station=0.375 OutputCase=ACCLATSX CaseType=LinStatic P=0 V2=0 V3=0 T=0 M2=0 M3=0
S11Max=0 PtS11Max=0 x2S11Max=0 x3S11Max=0 S11Min=0 PtS11Min=0 x2S11Min=0 x3S11Min=0 FrameElem=54
ElemStation=0.375
Frame=54 Station=0.5 OutputCase=ACCLATSX CaseType=LinStatic P=0 V2=0 V3=0 T=0 M2=0 M3=0
S11Max=0 PtS11Max=0 x2S11Max=0 x3S11Max=0 S11Min=0 PtS11Min=0 x2S11Min=0 x3S11Min=0 FrameElem=54
ElemStation=0.5
Frame=54 Station=0 OutputCase=TERRCOST CaseType=LinStatic P=0 V2=0 V3=0 T=0 M2=0 M3=0
S11Max=0 PtS11Max=0 x2S11Max=0 x3S11Max=0 S11Min=0 PtS11Min=0 x2S11Min=0 x3S11Min=0 FrameElem=54
ElemStation=0
Frame=54 Station=0.125 OutputCase=TERRCOST CaseType=LinStatic P=0 V2=0 V3=0 T=0 M2=0 M3=0
S11Max=0 PtS11Max=0 x2S11Max=0 x3S11Max=0 S11Min=0 PtS11Min=0 x2S11Min=0 x3S11Min=0 FrameElem=54
ElemStation=0.125
Frame=54 Station=0.25 OutputCase=TERRCOST CaseType=LinStatic P=0 V2=0 V3=0 T=0 M2=0 M3=0
S11Max=0 PtS11Max=0 x2S11Max=0 x3S11Max=0 S11Min=0 PtS11Min=0 x2S11Min=0 x3S11Min=0 FrameElem=54
ElemStation=0.25
Frame=54 Station=0.375 OutputCase=TERRCOST CaseType=LinStatic P=0 V2=0 V3=0 T=0 M2=0 M3=0
S11Max=0 PtS11Max=0 x2S11Max=0 x3S11Max=0 S11Min=0 PtS11Min=0 x2S11Min=0 x3S11Min=0 FrameElem=54
ElemStation=0.375
Frame=54 Station=0.5 OutputCase=TERRCOST CaseType=LinStatic P=0 V2=0 V3=0 T=0 M2=0 M3=0
S11Max=0 PtS11Max=0 x2S11Max=0 x3S11Max=0 S11Min=0 PtS11Min=0 x2S11Min=0 x3S11Min=0 FrameElem=54
ElemStation=0.5
Frame=54 Station=0 OutputCase=SOVRCOST CaseType=LinStatic P=0 V2=0 V3=0 T=0 M2=0 M3=0
S11Max=0 PtS11Max=0 x2S11Max=0 x3S11Max=0 S11Min=0 PtS11Min=0 x2S11Min=0 x3S11Min=0 FrameElem=54
ElemStation=0
Frame=54 Station=0.125 OutputCase=SOVRCOST CaseType=LinStatic P=0 V2=0 V3=0 T=0 M2=0 M3=0
S11Max=0 PtS11Max=0 x2S11Max=0 x3S11Max=0 S11Min=0 PtS11Min=0 x2S11Min=0 x3S11Min=0 FrameElem=54
ElemStation=0.125
Frame=54 Station=0.25 OutputCase=SOVRCOST CaseType=LinStatic P=0 V2=0 V3=0 T=0 M2=0 M3=0
S11Max=0 PtS11Max=0 x2S11Max=0 x3S11Max=0 S11Min=0 PtS11Min=0 x2S11Min=0 x3S11Min=0 FrameElem=54
ElemStation=0.25
Frame=54 Station=0.375 OutputCase=SOVRCOST CaseType=LinStatic P=0 V2=0 V3=0 T=0 M2=0 M3=0
S11Max=0 PtS11Max=0 x2S11Max=0 x3S11Max=0 S11Min=0 PtS11Min=0 x2S11Min=0 x3S11Min=0 FrameElem=54
ElemStation=0.375
Frame=54 Station=0.5 OutputCase=SOVRCOST CaseType=LinStatic P=0 V2=0 V3=0 T=0 M2=0 M3=0
S11Max=0 PtS11Max=0 x2S11Max=0 x3S11Max=0 S11Min=0 PtS11Min=0 x2S11Min=0 x3S11Min=0 FrameElem=54
ElemStation=0.5
Frame=54 Station=0 OutputCase=ENVE CaseType=Combination StepType=Max P=-32.6801405652705
V2=110.750000542884 V3=0 T=0 M2=0 M3=401.015127437826 S11Max=2373.41062406169 PtS11Max=1 x2S11Max=-0.5
x3S11Max=-0.5
S11Min=-2421.7939709541 PtS11Min=3 x2S11Min=0.5 x3S11Min=-0.5 FrameElem=54 ElemStation=0
Frame=54 Station=0.125 OutputCase=ENVE CaseType=Combination StepType=Max P=-32.6801405652705
V2=138.437500542884 V3=0 T=0 M2=0 M3=385.440908632497 S11Max=2279.96531122971 PtS11Max=1 x2S11Max=-0.5
x3S11Max=-0.5
S11Min=-2328.34865804694 PtS11Min=3 x2S11Min=0.5 x3S11Min=-0.5 FrameElem=54 ElemStation=0.125
Frame=54 Station=0.25 OutputCase=ENVE CaseType=Combination StepType=Max P=-32.6801405652705
V2=166.125000542884 V3=0 T=0 M2=0 M3=366.405752327169 S11Max=2165.75437339774 PtS11Max=1 x2S11Max=-0.5
x3S11Max=-0.5
S11Min=-2214.13772013978 PtS11Min=3 x2S11Min=0.5 x3S11Min=-0.5 FrameElem=54 ElemStation=0.25
Frame=54 Station=0.375 OutputCase=ENVE CaseType=Combination StepType=Max P=-32.6801405652705
V2=193.812500542884 V3=0 T=0 M2=0 M3=343.90965852184 S11Max=2030.77781056577 PtS11Max=1 x2S11Max=-0.5
x3S11Max=-0.5
S11Min=-2079.16115723261 PtS11Min=3 x2S11Min=0.5 x3S11Min=-0.5 FrameElem=54 ElemStation=0.375
Frame=54 Station=0.5 OutputCase=ENVE CaseType=Combination StepType=Max P=-32.6801405652705
V2=221.500000542884 V3=0 T=0 M2=0 M3=317.952627216511 S11Max=1875.0356227338 PtS11Max=1 x2S11Max=-0.5
x3S11Max=-0.5
S11Min=-1923.41896932545 PtS11Min=3 x2S11Min=0.5 x3S11Min=-0.5 FrameElem=54 ElemStation=0.5

```



Frame=54 Station=0 OutputCase=ENVE CaseType=Combination StepType=Min P=-52.6936800202215
 V2=110.75000044263 V3=0 T=0 M2=0 M3=394.85004848898 S11Max=2316.40661091366 PtS11Max=1 x2S11Max=-0.5
 x3S11Max=-0.5 _
 S11Min=-2438.77090519223 PtS11Min=3 x2S11Min=0.5 x3S11Min=-0.5 FrameElem=54 ElemStation=0
 Frame=54 Station=0.125 OutputCase=ENVE CaseType=Combination StepType=Min P=-52.6936800202215
 V2=138.43750044263 V3=0 T=0 M2=0 M3=379.27582967112 S11Max=2222.9612980065 PtS11Max=1 x2S11Max=-0.5
 x3S11Max=-0.5 _
 S11Min=-2345.32559236025 PtS11Min=3 x2S11Min=0.5 x3S11Min=-0.5 FrameElem=54 ElemStation=0.125
 Frame=54 Station=0.25 OutputCase=ENVE CaseType=Combination StepType=Min P=-52.6936800202215
 V2=166.12500044263 V3=0 T=0 M2=0 M3=360.240673353259 S11Max=2108.75036009933 PtS11Max=1 x2S11Max=-0.5
 x3S11Max=-0.5 _
 S11Min=-2231.11465452828 PtS11Min=3 x2S11Min=0.5 x3S11Min=-0.5 FrameElem=54 ElemStation=0.25
 Frame=54 Station=0.375 OutputCase=ENVE CaseType=Combination StepType=Min P=-52.6936800202215
 V2=193.81250044263 V3=0 T=0 M2=0 M3=337.744579535399 S11Max=1973.77379719217 PtS11Max=1 x2S11Max=-0.5
 x3S11Max=-0.5 _
 S11Min=-2096.13809169631 PtS11Min=3 x2S11Min=0.5 x3S11Min=-0.5 FrameElem=54 ElemStation=0.375
 Frame=54 Station=0.5 OutputCase=ENVE CaseType=Combination StepType=Min P=-52.6936800202215
 V2=221.50000044263 V3=0 T=0 M2=0 M3=311.787548217538 S11Max=1818.03160928501 PtS11Max=1 x2S11Max=-0.5
 x3S11Max=-0.5 _
 S11Min=-1940.39590386434 PtS11Min=3 x2S11Min=0.5 x3S11Min=-0.5 FrameElem=54 ElemStation=0.5
 Frame=54 Station=0 OutputCase=FESSUR CaseType=Combination StepType=Min P=-52.6936800202215 V2=110.750000542884
 V3=0 T=0 M2=0 M3=394.85004848898 S11Max=2316.40661091366 PtS11Max=1 x2S11Max=-0.5 x3S11Max=-0.5 _
 S11Min=-2421.7939709541 PtS11Min=3 x2S11Min=0.5 x3S11Min=-0.5 FrameElem=54 ElemStation=0
 Frame=54 Station=0.125 OutputCase=FESSUR CaseType=Combination StepType=Min P=-52.6936800202215 V2=138.437500542884
 V3=0 T=0 M2=0 M3=379.27582967112 S11Max=2222.9612980065 PtS11Max=1 x2S11Max=-0.5 x3S11Max=-0.5 _
 S11Min=-2328.34865804694 PtS11Min=3 x2S11Min=0.5 x3S11Min=-0.5 FrameElem=54 ElemStation=0.125
 Frame=54 Station=0.25 OutputCase=FESSUR CaseType=Combination StepType=Min P=-52.6936800202215 V2=166.125000542884
 V3=0 T=0 M2=0 M3=360.240673353259 S11Max=2108.75036009933 PtS11Max=1 x2S11Max=-0.5 x3S11Max=-0.5 _
 S11Min=-2214.13772013978 PtS11Min=3 x2S11Min=0.5 x3S11Min=-0.5 FrameElem=54 ElemStation=0.25
 Frame=54 Station=0.375 OutputCase=FESSUR CaseType=Combination StepType=Min P=-52.6936800202215 V2=193.812500542884
 V3=0 T=0 M2=0 M3=337.744579535399 S11Max=1973.77379719217 PtS11Max=1 x2S11Max=-0.5 x3S11Max=-0.5 _
 S11Min=-2079.16115723261 PtS11Min=3 x2S11Min=0.5 x3S11Min=-0.5 FrameElem=54 ElemStation=0.375
 Frame=54 Station=0.5 OutputCase=FESSUR CaseType=Combination StepType=Min P=-52.6936800202215 V2=221.500000542884
 V3=0 T=0 M2=0 M3=311.787548217538 S11Max=1818.03160928501 PtS11Max=1 x2S11Max=-0.5 x3S11Max=-0.5 _
 S11Min=-1923.41896932545 PtS11Min=3 x2S11Min=0.5 x3S11Min=-0.5 FrameElem=54 ElemStation=0.5
 Frame=55 Station=0 OutputCase=PESOPR CaseType=LinStatic P=15.1709467362389 V2=25.000000111031 V3=0
 T=0 M2=0 M3=44.5534217085733 S11Max=282.491476987679 PtS11Max=1 x2S11Max=-0.5 x3S11Max=-0.5 _
 S11Min=-252.149583515201 PtS11Min=3 x2S11Min=0.5 x3S11Min=-0.5 FrameElem=55 ElemStation=0
 Frame=55 Station=0.125 OutputCase=PESOPR CaseType=LinStatic P=15.1709467362389 V2=28.1250000111031
 V3=0 T=0 M2=0 M3=41.2331092071854 S11Max=262.569601979351 PtS11Max=1 x2S11Max=-0.5 x3S11Max=-0.5 _
 S11Min=-232.227708506874 PtS11Min=3 x2S11Min=0.5 x3S11Min=-0.5 FrameElem=55 ElemStation=0.125
 Frame=55 Station=0.25 OutputCase=PESOPR CaseType=LinStatic P=15.1709467362389 V2=31.2500000111031
 V3=0 T=0 M2=0 M3=37.5221717057975 S11Max=240.303976971024 PtS11Max=1 x2S11Max=-0.5 x3S11Max=-0.5 _
 S11Min=-209.962083498546 PtS11Min=3 x2S11Min=0.5 x3S11Min=-0.5 FrameElem=55 ElemStation=0.25
 Frame=55 Station=0.375 OutputCase=PESOPR CaseType=LinStatic P=15.1709467362389 V2=34.3750000111031
 V3=0 T=0 M2=0 M3=33.4206092044096 S11Max=215.694601962697 PtS11Max=1 x2S11Max=-0.5 x3S11Max=-0.5 _
 S11Min=-185.352708490219 PtS11Min=3 x2S11Min=0.5 x3S11Min=-0.5 FrameElem=55 ElemStation=0.375
 Frame=55 Station=0.5 OutputCase=PESOPR CaseType=LinStatic P=15.1709467362389 V2=37.5000000111031 V3=0
 T=0 M2=0 M3=28.9284217030217 S11Max=188.741476954369 PtS11Max=1 x2S11Max=-0.5 x3S11Max=-0.5 _
 S11Min=-158.399583481892 PtS11Min=3 x2S11Min=0.5 x3S11Min=-0.5 FrameElem=55 ElemStation=0.5
 Frame=55 Station=0 OutputCase=TERRVERT CaseType=LinStatic P=-1.15282857329027 V2=196.500000197586
 V3=0 T=0 M2=0 M3=287.784389838882 S11Max=1725.55351046 PtS11Max=1 x2S11Max=-0.5 x3S11Max=-0.5 _
 S11Min=-1727.85916760658 PtS11Min=3 x2S11Min=0.5 x3S11Min=-0.5 FrameElem=55 ElemStation=0
 Frame=55 Station=0.125 OutputCase=TERRVERT CaseType=LinStatic P=-1.15282857329027 V2=221.062500197586
 V3=0 T=0 M2=0 M3=261.686733564184 S11Max=1568.96757281181 PtS11Max=1 x2S11Max=-0.5 x3S11Max=-0.5 _
 S11Min=-1571.27322995839 PtS11Min=3 x2S11Min=0.5 x3S11Min=-0.5 FrameElem=55 ElemStation=0.125
 Frame=55 Station=0.25 OutputCase=TERRVERT CaseType=LinStatic P=-1.15282857329027 V2=245.625000197586
 V3=0 T=0 M2=0 M3=232.518764789485 S11Max=1393.95976016362 PtS11Max=1 x2S11Max=-0.5 x3S11Max=-0.5 _
 S11Min=-1396.2654173102 PtS11Min=3 x2S11Min=0.5 x3S11Min=-0.5 FrameElem=55 ElemStation=0.25
 Frame=55 Station=0.375 OutputCase=TERRVERT CaseType=LinStatic P=-1.15282857329027 V2=270.187500197586
 V3=0 T=0 M2=0 M3=200.280483514787 S11Max=1200.53007251543 PtS11Max=1 x2S11Max=-0.5 x3S11Max=-0.5 _
 S11Min=-1202.83572966201 PtS11Min=3 x2S11Min=0.5 x3S11Min=-0.5 FrameElem=55 ElemStation=0.375
 Frame=55 Station=0.5 OutputCase=TERRVERT CaseType=LinStatic P=-1.15282857329027 V2=294.750000197586
 V3=0 T=0 M2=0 M3=164.971889740089 S11Max=988.678509867243 PtS11Max=1 x2S11Max=-0.5 x3S11Max=-0.5 _
 S11Min=-990.984167013824 PtS11Min=3 x2S11Min=0.5 x3S11Min=-0.5 FrameElem=55 ElemStation=0.5
 Frame=55 Station=0 OutputCase=TERRLAT CaseType=LinStatic P=-66.7117981831701 V2=3.34180867866962E-07
 V3=0 T=0 M2=0 M3=-20.5502633299098 S11Max=56.5897817962889 PtS11Max=3 x2S11Max=0.5 x3S11Max=-0.5 _
 S11Min=-190.013378162629 PtS11Min=1 x2S11Min=-0.5 x3S11Min=-0.5 FrameElem=55 ElemStation=0
 Frame=55 Station=0.125 OutputCase=TERRLAT CaseType=LinStatic P=-66.7117981831701 V2=3.34180867866962E-07
 07 V3=0 T=0 M2=0 M3=-20.5502633716824 S11Max=56.5897820469246 PtS11Max=3 x2S11Max=0.5 x3S11Max=-0.5
 _
 S11Min=-190.013378413265 PtS11Min=1 x2S11Min=-0.5 x3S11Min=-0.5 FrameElem=55 ElemStation=0.125
 Frame=55 Station=0.25 OutputCase=TERRLAT CaseType=LinStatic P=-66.7117981831701 V2=3.34180867866962E-07
 V3=0 T=0 M2=0 M3=-20.5502634134551 S11Max=56.5897822975602 PtS11Max=3 x2S11Max=0.5 x3S11Max=-0.5 _
 S11Min=-190.0133786639 PtS11Min=1 x2S11Min=-0.5 x3S11Min=-0.5 FrameElem=55 ElemStation=0.25
 Frame=55 Station=0.375 OutputCase=TERRLAT CaseType=LinStatic P=-66.7117981831701 V2=3.34180867866962E-07
 07 V3=0 T=0 M2=0 M3=-20.5502634552277 S11Max=56.5897825481959 PtS11Max=3 x2S11Max=0.5 x3S11Max=-0.5
 _
 S11Min=-190.013378914536 PtS11Min=1 x2S11Min=-0.5 x3S11Min=-0.5 FrameElem=55 ElemStation=0.375
 Frame=55 Station=0.5 OutputCase=TERRLAT CaseType=LinStatic P=-66.7117981831701 V2=3.34180867866962E-07
 V3=0 T=0 M2=0 M3=-20.5502634970003 S11Max=56.5897827988315 PtS11Max=3 x2S11Max=0.5 x3S11Max=-0.5 _
 S11Min=-190.013379165172 PtS11Min=1 x2S11Min=-0.5 x3S11Min=-0.5 FrameElem=55 ElemStation=0.5



```

Frame=55 Station=0 OutputCase=ACCLATDX CaseType=LinStatic P=0 V2=0 V3=0 T=0 M2=0 M3=0
S11Max=0 PtS11Max=0 x2S11Max=0 x3S11Max=0 S11Min=0 PtS11Min=0 x2S11Min=0 x3S11Min=0 FrameElem=55
ElemStation=0
Frame=55 Station=0.125 OutputCase=ACCLATDX CaseType=LinStatic P=0 V2=0 V3=0 T=0 M2=0 M3=0
S11Max=0 PtS11Max=0 x2S11Max=0 x3S11Max=0 S11Min=0 PtS11Min=0 x2S11Min=0 x3S11Min=0 FrameElem=55
ElemStation=0.125
Frame=55 Station=0.25 OutputCase=ACCLATDX CaseType=LinStatic P=0 V2=0 V3=0 T=0 M2=0 M3=0
S11Max=0 PtS11Max=0 x2S11Max=0 x3S11Max=0 S11Min=0 PtS11Min=0 x2S11Min=0 x3S11Min=0 FrameElem=55
ElemStation=0.25
Frame=55 Station=0.375 OutputCase=ACCLATDX CaseType=LinStatic P=0 V2=0 V3=0 T=0 M2=0 M3=0
S11Max=0 PtS11Max=0 x2S11Max=0 x3S11Max=0 S11Min=0 PtS11Min=0 x2S11Min=0 x3S11Min=0 FrameElem=55
ElemStation=0.375
Frame=55 Station=0.5 OutputCase=ACCLATDX CaseType=LinStatic P=0 V2=0 V3=0 T=0 M2=0 M3=0
S11Max=0 PtS11Max=0 x2S11Max=0 x3S11Max=0 S11Min=0 PtS11Min=0 x2S11Min=0 x3S11Min=0 FrameElem=55
ElemStation=0.5
Frame=55 Station=0 OutputCase=ACCLATSX CaseType=LinStatic P=0 V2=0 V3=0 T=0 M2=0 M3=0
S11Max=0 PtS11Max=0 x2S11Max=0 x3S11Max=0 S11Min=0 PtS11Min=0 x2S11Min=0 x3S11Min=0 FrameElem=55
ElemStation=0
Frame=55 Station=0.125 OutputCase=ACCLATSX CaseType=LinStatic P=0 V2=0 V3=0 T=0 M2=0 M3=0
S11Max=0 PtS11Max=0 x2S11Max=0 x3S11Max=0 S11Min=0 PtS11Min=0 x2S11Min=0 x3S11Min=0 FrameElem=55
ElemStation=0.125
Frame=55 Station=0.25 OutputCase=ACCLATSX CaseType=LinStatic P=0 V2=0 V3=0 T=0 M2=0 M3=0
S11Max=0 PtS11Max=0 x2S11Max=0 x3S11Max=0 S11Min=0 PtS11Min=0 x2S11Min=0 x3S11Min=0 FrameElem=55
ElemStation=0.25
Frame=55 Station=0.375 OutputCase=ACCLATSX CaseType=LinStatic P=0 V2=0 V3=0 T=0 M2=0 M3=0
S11Max=0 PtS11Max=0 x2S11Max=0 x3S11Max=0 S11Min=0 PtS11Min=0 x2S11Min=0 x3S11Min=0 FrameElem=55
ElemStation=0.375
Frame=55 Station=0.5 OutputCase=ACCLATSX CaseType=LinStatic P=0 V2=0 V3=0 T=0 M2=0 M3=0
S11Max=0 PtS11Max=0 x2S11Max=0 x3S11Max=0 S11Min=0 PtS11Min=0 x2S11Min=0 x3S11Min=0 FrameElem=55
ElemStation=0.5
Frame=55 Station=0 OutputCase=TERRCOST CaseType=LinStatic P=0 V2=0 V3=0 T=0 M2=0 M3=0
S11Max=0 PtS11Max=0 x2S11Max=0 x3S11Max=0 S11Min=0 PtS11Min=0 x2S11Min=0 x3S11Min=0 FrameElem=55
ElemStation=0
Frame=55 Station=0.125 OutputCase=TERRCOST CaseType=LinStatic P=0 V2=0 V3=0 T=0 M2=0 M3=0
S11Max=0 PtS11Max=0 x2S11Max=0 x3S11Max=0 S11Min=0 PtS11Min=0 x2S11Min=0 x3S11Min=0 FrameElem=55
ElemStation=0.125
Frame=55 Station=0.25 OutputCase=TERRCOST CaseType=LinStatic P=0 V2=0 V3=0 T=0 M2=0 M3=0
S11Max=0 PtS11Max=0 x2S11Max=0 x3S11Max=0 S11Min=0 PtS11Min=0 x2S11Min=0 x3S11Min=0 FrameElem=55
ElemStation=0.25
Frame=55 Station=0.375 OutputCase=TERRCOST CaseType=LinStatic P=0 V2=0 V3=0 T=0 M2=0 M3=0
S11Max=0 PtS11Max=0 x2S11Max=0 x3S11Max=0 S11Min=0 PtS11Min=0 x2S11Min=0 x3S11Min=0 FrameElem=55
ElemStation=0.375
Frame=55 Station=0.5 OutputCase=TERRCOST CaseType=LinStatic P=0 V2=0 V3=0 T=0 M2=0 M3=0
S11Max=0 PtS11Max=0 x2S11Max=0 x3S11Max=0 S11Min=0 PtS11Min=0 x2S11Min=0 x3S11Min=0 FrameElem=55
ElemStation=0.5
Frame=55 Station=0 OutputCase=SOVRCOST CaseType=LinStatic P=0 V2=0 V3=0 T=0 M2=0 M3=0
S11Max=0 PtS11Max=0 x2S11Max=0 x3S11Max=0 S11Min=0 PtS11Min=0 x2S11Min=0 x3S11Min=0 FrameElem=55
ElemStation=0
Frame=55 Station=0.125 OutputCase=SOVRCOST CaseType=LinStatic P=0 V2=0 V3=0 T=0 M2=0 M3=0
S11Max=0 PtS11Max=0 x2S11Max=0 x3S11Max=0 S11Min=0 PtS11Min=0 x2S11Min=0 x3S11Min=0 FrameElem=55
ElemStation=0.125
Frame=55 Station=0.25 OutputCase=SOVRCOST CaseType=LinStatic P=0 V2=0 V3=0 T=0 M2=0 M3=0
S11Max=0 PtS11Max=0 x2S11Max=0 x3S11Max=0 S11Min=0 PtS11Min=0 x2S11Min=0 x3S11Min=0 FrameElem=55
ElemStation=0.25
Frame=55 Station=0.375 OutputCase=SOVRCOST CaseType=LinStatic P=0 V2=0 V3=0 T=0 M2=0 M3=0
S11Max=0 PtS11Max=0 x2S11Max=0 x3S11Max=0 S11Min=0 PtS11Min=0 x2S11Min=0 x3S11Min=0 FrameElem=55
ElemStation=0.375
Frame=55 Station=0.5 OutputCase=SOVRCOST CaseType=LinStatic P=0 V2=0 V3=0 T=0 M2=0 M3=0
S11Max=0 PtS11Max=0 x2S11Max=0 x3S11Max=0 S11Min=0 PtS11Min=0 x2S11Min=0 x3S11Min=0 FrameElem=55
ElemStation=0.5
Frame=55 Station=0 OutputCase=ENVE CaseType=Combination StepType=Max P=-32.6801405652705
V2=221.5000054287 V3=0 T=0 M2=0 M3=317.952627216518 S11Max=1875.03562273384 PtS11Max=1 x2S11Max=-0.5
x3S11Max=-0.5
S11Min=-1923.41896932549 PtS11Min=3 x2S11Min=0.5 x3S11Min=-0.5 FrameElem=55 ElemStation=0
Frame=55 Station=0.125 OutputCase=ENVE CaseType=Combination StepType=Max P=-32.6801405652705
V2=249.18750054287 V3=0 T=0 M2=0 M3=288.534658411191 S11Max=1698.52780990188 PtS11Max=1 x2S11Max=-0.5
x3S11Max=-0.5
S11Min=-1746.91115641834 PtS11Min=3 x2S11Min=0.5 x3S11Min=-0.5 FrameElem=55 ElemStation=0.125
Frame=55 Station=0.25 OutputCase=ENVE CaseType=Combination StepType=Max P=-32.6801405652705
V2=276.87500054287 V3=0 T=0 M2=0 M3=255.655752105864 S11Max=1501.25437206992 PtS11Max=1 x2S11Max=-0.5
x3S11Max=-0.5
S11Min=-1549.63771851119 PtS11Min=3 x2S11Min=0.5 x3S11Min=-0.5 FrameElem=55 ElemStation=0.25
Frame=55 Station=0.375 OutputCase=ENVE CaseType=Combination StepType=Max P=-32.6801405652705
V2=304.56250054287 V3=0 T=0 M2=0 M3=219.315908300537 S11Max=1283.21530923795 PtS11Max=1 x2S11Max=-0.5
x3S11Max=-0.5
S11Min=-1331.59865560404 PtS11Min=3 x2S11Min=0.5 x3S11Min=-0.5 FrameElem=55 ElemStation=0.375
Frame=55 Station=0.5 OutputCase=ENVE CaseType=Combination StepType=Max P=-32.6801405652705
V2=332.25000054287 V3=0 T=0 M2=0 M3=179.51512699521 S11Max=1044.41062140599 PtS11Max=1 x2S11Max=-0.5
x3S11Max=-0.5
S11Min=-1092.79396769688 PtS11Min=3 x2S11Min=0.5 x3S11Min=-0.5 FrameElem=55 ElemStation=0.5

```



Frame=55 Station=0 OutputCase=ENVE CaseType=Combination StepType=Min P=-52.6936800202215
 V2=221.500000442616 V3=0 T=0 M2=0 M3=311.787548217545 S11Max=1818.03160928505 PtS11Max=1 x2S11Max=-0.5
 x3S11Max=-0.5 _
 S11Min=-1940.39590386438 PtS11Min=3 x2S11Min=0.5 x3S11Min=-0.5 FrameElem=55 ElemStation=0
 Frame=55 Station=0.125 OutputCase=ENVE CaseType=Combination StepType=Min P=-52.6936800202215
 V2=249.187500442616 V3=0 T=0 M2=0 M3=282.369579399687 S11Max=1641.5237963779 PtS11Max=1 x2S11Max=-0.5
 x3S11Max=-0.5 _
 S11Min=-1763.88809103242 PtS11Min=3 x2S11Min=0.5 x3S11Min=-0.5 FrameElem=55 ElemStation=0.125
 Frame=55 Station=0.25 OutputCase=ENVE CaseType=Combination StepType=Min P=-52.6936800202215
 V2=276.875000442616 V3=0 T=0 M2=0 M3=249.490673081828 S11Max=1444.25035847075 PtS11Max=1 x2S11Max=-0.5
 x3S11Max=-0.5 _
 S11Min=-1566.61465320046 PtS11Min=3 x2S11Min=0.5 x3S11Min=-0.5 FrameElem=55 ElemStation=0.25
 Frame=55 Station=0.375 OutputCase=ENVE CaseType=Combination StepType=Min P=-52.6936800202215
 V2=304.562500442616 V3=0 T=0 M2=0 M3=213.150829263969 S11Max=1226.21129556359 PtS11Max=1 x2S11Max=-0.5
 x3S11Max=-0.5 _
 S11Min=-1348.5755903685 PtS11Min=3 x2S11Min=0.5 x3S11Min=-0.5 FrameElem=55 ElemStation=0.375
 Frame=55 Station=0.5 OutputCase=ENVE CaseType=Combination StepType=Min P=-52.6936800202215
 V2=332.250000442616 V3=0 T=0 M2=0 M3=173.35004794611 S11Max=987.406607656441 PtS11Max=1 x2S11Max=-0.5
 x3S11Max=-0.5 _
 S11Min=-1109.77090253653 PtS11Min=3 x2S11Min=0.5 x3S11Min=-0.5 FrameElem=55 ElemStation=0.5
 Frame=55 Station=0 OutputCase=FESSUR CaseType=Combination P=-52.6936800202215 V2=221.5000054287 V3=0
 T=0 M2=0 M3=311.787548217545 S11Max=1818.03160928505 PtS11Max=1 x2S11Max=-0.5 x3S11Max=-0.5 _
 S11Min=-1923.41896932549 PtS11Min=3 x2S11Min=0.5 x3S11Min=-0.5 FrameElem=55 ElemStation=0
 Frame=55 Station=0.125 OutputCase=FESSUR CaseType=Combination P=-52.6936800202215 V2=249.18750054287
 V3=0 T=0 M2=0 M3=282.369579399687 S11Max=1641.5237963779 PtS11Max=1 x2S11Max=-0.5 x3S11Max=-0.5 _
 S11Min=-1746.91115641834 PtS11Min=3 x2S11Min=0.5 x3S11Min=-0.5 FrameElem=55 ElemStation=0.125
 Frame=55 Station=0.25 OutputCase=FESSUR CaseType=Combination P=-52.6936800202215 V2=276.87500054287
 V3=0 T=0 M2=0 M3=249.490673081828 S11Max=1444.25035847075 PtS11Max=1 x2S11Max=-0.5 x3S11Max=-0.5 _
 S11Min=-1549.63771851119 PtS11Min=3 x2S11Min=0.5 x3S11Min=-0.5 FrameElem=55 ElemStation=0.25
 Frame=55 Station=0.375 OutputCase=FESSUR CaseType=Combination P=-52.6936800202215 V2=304.56250054287
 V3=0 T=0 M2=0 M3=213.150829263969 S11Max=1226.21129556359 PtS11Max=1 x2S11Max=-0.5 x3S11Max=-0.5 _
 S11Min=-1331.59865560404 PtS11Min=3 x2S11Min=0.5 x3S11Min=-0.5 FrameElem=55 ElemStation=0.375
 Frame=55 Station=0.5 OutputCase=FESSUR CaseType=Combination P=-52.6936800202215 V2=332.25000054287
 V3=0 T=0 M2=0 M3=173.35004794611 S11Max=987.406607656441 PtS11Max=1 x2S11Max=-0.5 x3S11Max=-0.5 _
 S11Min=-1092.79396769688 PtS11Min=3 x2S11Min=0.5 x3S11Min=-0.5 FrameElem=55 ElemStation=0.5
 Frame=56 Station=0.25 OutputCase=PESOPR CaseType=LinStatic P=15.1709467362392 V2=37.500000110886 V3=0
 T=0 M2=0 M3=28.9284217030217 S11Max=188.74147695437 PtS11Max=1 x2S11Max=-0.5 x3S11Max=-0.5 _
 S11Min=-158.399583481891 PtS11Min=3 x2S11Min=0.5 x3S11Min=-0.5 FrameElem=56 ElemStation=0
 Frame=56 Station=0.125 OutputCase=PESOPR CaseType=LinStatic P=15.1709467362392 V2=40.6250000110886
 V3=0 T=0 M2=0 M3=24.0456092016357 S11Max=159.444601946053 PtS11Max=1 x2S11Max=-0.5 x3S11Max=-0.5 _
 S11Min=-129.102708473575 PtS11Min=3 x2S11Min=0.5 x3S11Min=-0.5 FrameElem=56 ElemStation=0.125
 Frame=56 Station=0.25 OutputCase=PESOPR CaseType=LinStatic P=15.1709467362392 V2=43.7500000110886
 V3=0 T=0 M2=0 M3=18.7721717002496 S11Max=127.803976937737 PtS11Max=1 x2S11Max=-0.5 x3S11Max=-0.5 _
 S11Min=-97.4620834652584 PtS11Min=3 x2S11Min=0.5 x3S11Min=-0.5 FrameElem=56 ElemStation=0.25
 Frame=56 Station=0.375 OutputCase=PESOPR CaseType=LinStatic P=15.1709467362392 V2=46.8750000110886
 V3=0 T=0 M2=0 M3=13.1081091988635 S11Max=93.8196019294204 PtS11Max=1 x2S11Max=-0.5 x3S11Max=-0.5 _
 S11Min=-63.477708456942 PtS11Min=3 x2S11Min=0.5 x3S11Min=-0.5 FrameElem=56 ElemStation=0.375
 Frame=56 Station=0.5 OutputCase=PESOPR CaseType=LinStatic P=15.1709467362392 V2=50.0000000110886 V3=0
 T=0 M2=0 M3=7.05342169747746 S11Max=57.491476921104 PtS11Max=1 x2S11Max=-0.5 x3S11Max=-0.5 _
 S11Min=-27.1495834486255 PtS11Min=3 x2S11Min=0.5 x3S11Min=-0.5 FrameElem=56 ElemStation=0.5
 Frame=56 Station=0 OutputCase=TERRVERT CaseType=LinStatic P=-1.15282857328964 V2=294.750000197557
 V3=0 T=0 M2=0 M3=164.971889740096 S11Max=988.678509867288 PtS11Max=1 x2S11Max=-0.5 x3S11Max=-0.5 _
 S11Min=-990.984167013867 PtS11Min=3 x2S11Min=0.5 x3S11Min=-0.5 FrameElem=56 ElemStation=0
 Frame=56 Station=0.125 OutputCase=TERRVERT CaseType=LinStatic P=-1.15282857328964 V2=319.312500197557
 V3=0 T=0 M2=0 M3=126.592983465402 S11Max=758.40507221912 PtS11Max=1 x2S11Max=-0.5 x3S11Max=-0.5 _
 S11Min=-760.710729365699 PtS11Min=3 x2S11Min=0.5 x3S11Min=-0.5 FrameElem=56 ElemStation=0.125
 Frame=56 Station=0.25 OutputCase=TERRVERT CaseType=LinStatic P=-1.15282857328964 V2=343.875000197557
 V3=0 T=0 M2=0 M3=85.143764690707 S11Max=509.709759570953 PtS11Max=1 x2S11Max=-0.5 x3S11Max=-0.5 _
 S11Min=-512.015416717532 PtS11Min=3 x2S11Min=0.5 x3S11Min=-0.5 FrameElem=56 ElemStation=0.25
 Frame=56 Station=0.375 OutputCase=TERRVERT CaseType=LinStatic P=-1.15282857328964 V2=368.437500197557
 V3=0 T=0 M2=0 M3=40.6242334160124 S11Max=242.592571922785 PtS11Max=1 x2S11Max=-0.5 x3S11Max=-0.5 _
 S11Min=-244.898229069364 PtS11Min=3 x2S11Min=0.5 x3S11Min=-0.5 FrameElem=56 ElemStation=0.375
 Frame=56 Station=0.5 OutputCase=TERRVERT CaseType=LinStatic P=-1.15282857328964 V2=393.000000197557
 V3=0 T=0 M2=0 M3=-6.96561035868217 S11Max=40.6408335788034 PtS11Max=3 x2S11Max=0.5 x3S11Max=-0.5 _
 S11Min=-42.9464907253827 PtS11Min=1 x2S11Min=-0.5 x3S11Min=-0.5 FrameElem=56 ElemStation=0.5
 Frame=56 Station=0 OutputCase=TERRLAT CaseType=LinStatic P=-66.7117981831703 V2=3.34180867866962E-07
 V3=0 T=0 M2=0 M3=-20.5502634970002 S11Max=56.589782798831 PtS11Max=3 x2S11Max=0.5 x3S11Max=-0.5 _
 S11Min=-190.013379165172 PtS11Min=1 x2S11Min=-0.5 x3S11Min=-0.5 FrameElem=56 ElemStation=0
 Frame=56 Station=0.125 OutputCase=TERRLAT CaseType=LinStatic P=-66.7117981831703 V2=3.34180867866962E-07
 V3=0 T=0 M2=0 M3=-20.5502635387728 S11Max=56.5897830494667 PtS11Max=3 x2S11Max=0.5 x3S11Max=-0.5
 _
 S11Min=-190.013379415807 PtS11Min=1 x2S11Min=-0.5 x3S11Min=-0.5 FrameElem=56 ElemStation=0.125
 Frame=56 Station=0.25 OutputCase=TERRLAT CaseType=LinStatic P=-66.7117981831703 V2=3.34180867866962E-07
 V3=0 T=0 M2=0 M3=-20.5502635805454 S11Max=56.589783001023 PtS11Max=3 x2S11Max=0.5 x3S11Max=-0.5 _
 S11Min=-190.013379666443 PtS11Min=1 x2S11Min=-0.5 x3S11Min=-0.5 FrameElem=56 ElemStation=0.25
 Frame=56 Station=0.375 OutputCase=TERRLAT CaseType=LinStatic P=-66.7117981831703 V2=3.34180867866962E-07
 V3=0 T=0 M2=0 M3=-20.5502636223181 S11Max=56.589783550738 PtS11Max=3 x2S11Max=0.5 x3S11Max=-0.5 _
 S11Min=-190.013379917079 PtS11Min=1 x2S11Min=-0.5 x3S11Min=-0.5 FrameElem=56 ElemStation=0.375
 Frame=56 Station=0.5 OutputCase=TERRLAT CaseType=LinStatic P=-66.7117981831703 V2=3.34180867866962E-07
 V3=0 T=0 M2=0 M3=-20.5502636640907 S11Max=56.5897838013736 PtS11Max=3 x2S11Max=0.5 x3S11Max=-0.5 _
 S11Min=-190.013380167714 PtS11Min=1 x2S11Min=-0.5 x3S11Min=-0.5 FrameElem=56 ElemStation=0.5



Frame=56 Station=0 OutputCase=ACCLATDX CaseType=LinStatic P=0 V2=0 V3=0 T=0 M2=0 M3=0
 S11Max=0 PtS11Max=0 x2S11Max=0 x3S11Max=0 S11Min=0 PtS11Min=0 x2S11Min=0 x3S11Min=0 FrameElem=56
 ElemStation=0
 Frame=56 Station=0.125 OutputCase=ACCLATDX CaseType=LinStatic P=0 V2=0 V3=0 T=0 M2=0 M3=0
 S11Max=0 PtS11Max=0 x2S11Max=0 x3S11Max=0 S11Min=0 PtS11Min=0 x2S11Min=0 x3S11Min=0 FrameElem=56
 ElemStation=0.125
 Frame=56 Station=0.25 OutputCase=ACCLATDX CaseType=LinStatic P=0 V2=0 V3=0 T=0 M2=0 M3=0
 S11Max=0 PtS11Max=0 x2S11Max=0 x3S11Max=0 S11Min=0 PtS11Min=0 x2S11Min=0 x3S11Min=0 FrameElem=56
 ElemStation=0.25
 Frame=56 Station=0.375 OutputCase=ACCLATDX CaseType=LinStatic P=0 V2=0 V3=0 T=0 M2=0 M3=0
 S11Max=0 PtS11Max=0 x2S11Max=0 x3S11Max=0 S11Min=0 PtS11Min=0 x2S11Min=0 x3S11Min=0 FrameElem=56
 ElemStation=0.375
 Frame=56 Station=0.5 OutputCase=ACCLATDX CaseType=LinStatic P=0 V2=0 V3=0 T=0 M2=0 M3=0
 S11Max=0 PtS11Max=0 x2S11Max=0 x3S11Max=0 S11Min=0 PtS11Min=0 x2S11Min=0 x3S11Min=0 FrameElem=56
 ElemStation=0.5
 Frame=56 Station=0 OutputCase=ACCLATSX CaseType=LinStatic P=0 V2=0 V3=0 T=0 M2=0 M3=0
 S11Max=0 PtS11Max=0 x2S11Max=0 x3S11Max=0 S11Min=0 PtS11Min=0 x2S11Min=0 x3S11Min=0 FrameElem=56
 ElemStation=0
 Frame=56 Station=0.125 OutputCase=ACCLATSX CaseType=LinStatic P=0 V2=0 V3=0 T=0 M2=0 M3=0
 S11Max=0 PtS11Max=0 x2S11Max=0 x3S11Max=0 S11Min=0 PtS11Min=0 x2S11Min=0 x3S11Min=0 FrameElem=56
 ElemStation=0.125
 Frame=56 Station=0.25 OutputCase=ACCLATSX CaseType=LinStatic P=0 V2=0 V3=0 T=0 M2=0 M3=0
 S11Max=0 PtS11Max=0 x2S11Max=0 x3S11Max=0 S11Min=0 PtS11Min=0 x2S11Min=0 x3S11Min=0 FrameElem=56
 ElemStation=0.25
 Frame=56 Station=0.375 OutputCase=ACCLATSX CaseType=LinStatic P=0 V2=0 V3=0 T=0 M2=0 M3=0
 S11Max=0 PtS11Max=0 x2S11Max=0 x3S11Max=0 S11Min=0 PtS11Min=0 x2S11Min=0 x3S11Min=0 FrameElem=56
 ElemStation=0.375
 Frame=56 Station=0.5 OutputCase=ACCLATSX CaseType=LinStatic P=0 V2=0 V3=0 T=0 M2=0 M3=0
 S11Max=0 PtS11Max=0 x2S11Max=0 x3S11Max=0 S11Min=0 PtS11Min=0 x2S11Min=0 x3S11Min=0 FrameElem=56
 ElemStation=0.5
 Frame=56 Station=0 OutputCase=TERRCOST CaseType=LinStatic P=0 V2=0 V3=0 T=0 M2=0 M3=0
 S11Max=0 PtS11Max=0 x2S11Max=0 x3S11Max=0 S11Min=0 PtS11Min=0 x2S11Min=0 x3S11Min=0 FrameElem=56
 ElemStation=0
 Frame=56 Station=0.125 OutputCase=TERRCOST CaseType=LinStatic P=0 V2=0 V3=0 T=0 M2=0 M3=0
 S11Max=0 PtS11Max=0 x2S11Max=0 x3S11Max=0 S11Min=0 PtS11Min=0 x2S11Min=0 x3S11Min=0 FrameElem=56
 ElemStation=0.125
 Frame=56 Station=0.25 OutputCase=TERRCOST CaseType=LinStatic P=0 V2=0 V3=0 T=0 M2=0 M3=0
 S11Max=0 PtS11Max=0 x2S11Max=0 x3S11Max=0 S11Min=0 PtS11Min=0 x2S11Min=0 x3S11Min=0 FrameElem=56
 ElemStation=0.25
 Frame=56 Station=0.375 OutputCase=TERRCOST CaseType=LinStatic P=0 V2=0 V3=0 T=0 M2=0 M3=0
 S11Max=0 PtS11Max=0 x2S11Max=0 x3S11Max=0 S11Min=0 PtS11Min=0 x2S11Min=0 x3S11Min=0 FrameElem=56
 ElemStation=0.375
 Frame=56 Station=0.5 OutputCase=TERRCOST CaseType=LinStatic P=0 V2=0 V3=0 T=0 M2=0 M3=0
 S11Max=0 PtS11Max=0 x2S11Max=0 x3S11Max=0 S11Min=0 PtS11Min=0 x2S11Min=0 x3S11Min=0 FrameElem=56
 ElemStation=0.5
 Frame=56 Station=0 OutputCase=SOVRCOST CaseType=LinStatic P=0 V2=0 V3=0 T=0 M2=0 M3=0
 S11Max=0 PtS11Max=0 x2S11Max=0 x3S11Max=0 S11Min=0 PtS11Min=0 x2S11Min=0 x3S11Min=0 FrameElem=56
 ElemStation=0
 Frame=56 Station=0.125 OutputCase=SOVRCOST CaseType=LinStatic P=0 V2=0 V3=0 T=0 M2=0 M3=0
 S11Max=0 PtS11Max=0 x2S11Max=0 x3S11Max=0 S11Min=0 PtS11Min=0 x2S11Min=0 x3S11Min=0 FrameElem=56
 ElemStation=0.125
 Frame=56 Station=0.25 OutputCase=SOVRCOST CaseType=LinStatic P=0 V2=0 V3=0 T=0 M2=0 M3=0
 S11Max=0 PtS11Max=0 x2S11Max=0 x3S11Max=0 S11Min=0 PtS11Min=0 x2S11Min=0 x3S11Min=0 FrameElem=56
 ElemStation=0.25
 Frame=56 Station=0.375 OutputCase=SOVRCOST CaseType=LinStatic P=0 V2=0 V3=0 T=0 M2=0 M3=0
 S11Max=0 PtS11Max=0 x2S11Max=0 x3S11Max=0 S11Min=0 PtS11Min=0 x2S11Min=0 x3S11Min=0 FrameElem=56
 ElemStation=0.375
 Frame=56 Station=0.5 OutputCase=SOVRCOST CaseType=LinStatic P=0 V2=0 V3=0 T=0 M2=0 M3=0
 S11Max=0 PtS11Max=0 x2S11Max=0 x3S11Max=0 S11Min=0 PtS11Min=0 x2S11Min=0 x3S11Min=0 FrameElem=56
 ElemStation=0.5
 Frame=56 Station=0 OutputCase=ENVE CaseType=Combination StepType=Max P=-32.6801405652697
 V2=332.250000542826 V3=0 T=0 M2=0 M3=179.515126995218 S11Max=1044.41062140604 PtS11Max=1 x2S11Max=-0.5
 x3S11Max=-0.5
 S11Min=-1092.79396769693 PtS11Min=3 x2S11Min=0.5 x3S11Min=-0.5 FrameElem=56 ElemStation=0
 Frame=56 Station=0.125 OutputCase=ENVE CaseType=Combination StepType=Max P=-32.6801405652697
 V2=359.937500542826 V3=0 T=0 M2=0 M3=136.253408189896 S11Max=784.840308574108 PtS11Max=1 x2S11Max=-0.5
 x3S11Max=-0.5
 S11Min=-833.223654789808 PtS11Min=3 x2S11Min=0.5 x3S11Min=-0.5 FrameElem=56 ElemStation=0.125
 Frame=56 Station=0.25 OutputCase=ENVE CaseType=Combination StepType=Max P=-32.6801405652697
 V2=387.625000542826 V3=0 T=0 M2=0 M3=89.5307518845748 S11Max=504.504370742179 PtS11Max=1 x2S11Max=-0.5
 x3S11Max=-0.5
 S11Min=-552.887716882688 PtS11Min=3 x2S11Min=0.5 x3S11Min=-0.5 FrameElem=56 ElemStation=0.25
 Frame=56 Station=0.375 OutputCase=ENVE CaseType=Combination StepType=Max P=-32.6801405652697
 V2=415.312500542826 V3=0 T=0 M2=0 M3=39.3471580792533 S11Max=203.40280791025 PtS11Max=1 x2S11Max=-0.5
 x3S11Max=-0.5
 S11Min=-251.786153975568 PtS11Min=3 x2S11Min=0.5 x3S11Min=-0.5 FrameElem=56 ElemStation=0.375
 Frame=56 Station=0.5 OutputCase=ENVE CaseType=Combination StepType=Max P=-32.6801405652697
 V2=443.000000542826 V3=0 T=0 M2=0 M3=-14.2973732260682 S11Max=70.0810339315515 PtS11Max=3 x2S11Max=0.5
 x3S11Max=-0.5
 S11Min=-118.464379921679 PtS11Min=1 x2S11Min=-0.5 x3S11Min=-0.5 FrameElem=56 ElemStation=0.5



Frame=56 Station=0 OutputCase=ENVE CaseType=Combination StepType=Min P=-52.6936800202208
 V2=332.250000442572 V3=0 T=0 M2=0 M3=173.350047946118 S11Max=987.406607656486 PtS11Max=1 x2S11Max=-0.5
 x3S11Max=-0.5
 S11Min=-1109.77090253658 PtS11Min=3 x2S11Min=0.5 x3S11Min=-0.5 FrameElem=56 ElemStation=0
 Frame=56 Station=0.125 OutputCase=ENVE CaseType=Combination StepType=Min P=-52.6936800202208
 V2=359.937500442572 V3=0 T=0 M2=0 M3=130.088329128264 S11Max=727.836294749366 PtS11Max=1 x2S11Max=-0.5
 x3S11Max=-0.5
 S11Min=-850.200589704648 PtS11Min=3 x2S11Min=0.5 x3S11Min=-0.5 FrameElem=56 ElemStation=0.125
 Frame=56 Station=0.25 OutputCase=ENVE CaseType=Combination StepType=Min P=-52.6936800202208
 V2=387.625000442572 V3=0 T=0 M2=0 M3=83.3656728104112 S11Max=447.500356842246 PtS11Max=1 x2S11Max=-0.5
 x3S11Max=-0.5
 S11Min=-569.864651872719 PtS11Min=3 x2S11Min=0.5 x3S11Min=-0.5 FrameElem=56 ElemStation=0.25
 Frame=56 Station=0.375 OutputCase=ENVE CaseType=Combination StepType=Min P=-52.6936800202208
 V2=415.312500442572 V3=0 T=0 M2=0 M3=33.1820789925579 S11Max=146.398793935127 PtS11Max=1 x2S11Max=-0.5
 x3S11Max=-0.5
 S11Min=-268.76308904079 PtS11Min=3 x2S11Min=0.5 x3S11Min=-0.5 FrameElem=56 ElemStation=0.375
 Frame=56 Station=0.5 OutputCase=ENVE CaseType=Combination StepType=Min P=-52.6936800202208
 V2=443.000000442572 V3=0 T=0 M2=0 M3=-20.4624523252954 S11Max=53.1040987911394 PtS11Max=3 x2S11Max=0.5
 x3S11Max=-0.5
 S11Min=-175.468393971993 PtS11Min=1 x2S11Min=-0.5 x3S11Min=-0.5 FrameElem=56 ElemStation=0.5
 Frame=56 Station=0 OutputCase=FESSUR CaseType=Combination StepType=Min P=-52.6936800202208 V2=332.250000542826
 V3=0 T=0 M2=0 M3=173.350047946118 S11Max=987.406607656486 PtS11Max=1 x2S11Max=-0.5 x3S11Max=-0.5
 S11Min=-1092.79396769693 PtS11Min=3 x2S11Min=0.5 x3S11Min=-0.5 FrameElem=56 ElemStation=0
 Frame=56 Station=0.125 OutputCase=FESSUR CaseType=Combination StepType=Min P=-52.6936800202208 V2=359.937500542826
 V3=0 T=0 M2=0 M3=130.088329128264 S11Max=727.836294749366 PtS11Max=1 x2S11Max=-0.5 x3S11Max=-0.5
 S11Min=-833.223654789808 PtS11Min=3 x2S11Min=0.5 x3S11Min=-0.5 FrameElem=56 ElemStation=0.125
 Frame=56 Station=0.25 OutputCase=FESSUR CaseType=Combination StepType=Min P=-52.6936800202208 V2=387.625000542826
 V3=0 T=0 M2=0 M3=83.3656728104112 S11Max=447.500356842246 PtS11Max=1 x2S11Max=-0.5 x3S11Max=-0.5
 S11Min=-552.887716882688 PtS11Min=3 x2S11Min=0.5 x3S11Min=-0.5 FrameElem=56 ElemStation=0.25
 Frame=56 Station=0.375 OutputCase=FESSUR CaseType=Combination StepType=Min P=-52.6936800202208 V2=415.312500542826
 V3=0 T=0 M2=0 M3=33.1820789925579 S11Max=146.398793935127 PtS11Max=1 x2S11Max=-0.5 x3S11Max=-0.5
 S11Min=-251.786153975568 PtS11Min=3 x2S11Min=0.5 x3S11Min=-0.5 FrameElem=56 ElemStation=0.375
 Frame=56 Station=0.5 OutputCase=FESSUR CaseType=Combination StepType=Min P=-52.6936800202208 V2=443.000000542826
 V3=0 T=0 M2=0 M3=-20.4624523252954 S11Max=70.0810339315515 PtS11Max=3 x2S11Max=0.5 x3S11Max=-0.5
 S11Min=-175.468393971993 PtS11Min=1 x2S11Min=-0.5 x3S11Min=-0.5 FrameElem=56 ElemStation=0.5
 Frame=57 Station=0 OutputCase=PESOPR CaseType=LinStatic P=-149.99999272637 V2=15.1709478289918 V3=0
 T=0 M2=0 M3=74.1698928724554 S11Max=295.019357962095 PtS11Max=1 x2S11Max=-0.5 x3S11Max=-0.5
 S11Min=-595.019356507369 PtS11Min=3 x2S11Min=0.5 x3S11Min=-0.5 FrameElem=57 ElemStation=0
 Frame=57 Station=0.5 OutputCase=PESOPR CaseType=LinStatic P=-137.49999272637 V2=15.1709478289918
 V3=0 T=0 M2=0 M3=66.5844189331242 S11Max=262.006514326108 PtS11Max=1 x2S11Max=-0.5 x3S11Max=-0.5
 S11Min=-537.006512871382 PtS11Min=3 x2S11Min=0.5 x3S11Min=-0.5 FrameElem=57 ElemStation=0.5
 Frame=57 Station=0 OutputCase=TERRVERT CaseType=LinStatic P=-491.24999512732 V2=-1.15282466918006
 V3=0 T=0 M2=0 M3=223.993209463027 S11Max=852.709261650843 PtS11Max=1 x2S11Max=-0.5 x3S11Max=-0.5
 S11Min=-1835.20925190548 PtS11Min=3 x2S11Min=0.5 x3S11Min=-0.5 FrameElem=57 ElemStation=0
 Frame=57 Station=0.5 OutputCase=TERRVERT CaseType=LinStatic P=-491.24999512732 V2=-1.15282466918006
 V3=0 T=0 M2=0 M3=224.569621797617 S11Max=856.167735658383 PtS11Max=1 x2S11Max=-0.5 x3S11Max=-0.5
 S11Min=-1838.66772591302 PtS11Min=3 x2S11Min=0.5 x3S11Min=-0.5 FrameElem=57 ElemStation=0.5
 Frame=57 Station=0 OutputCase=TERRLAT CaseType=LinStatic P=7.85342763265362E-07 V2=56.7691393168294
 V3=0 T=0 M2=0 M3=-13.3699377308188 S11Max=80.2196271702558 PtS11Max=3 x2S11Max=0.5 x3S11Max=-0.5
 S11Min=-80.2196255995702 PtS11Min=1 x2S11Min=-0.5 x3S11Min=-0.5 FrameElem=57 ElemStation=0
 Frame=57 Station=0.5 OutputCase=TERRLAT CaseType=LinStatic P=6.03372277139247E-07 V2=33.8719518168294
 V3=0 T=0 M2=0 M3=-35.9413823892335 S11Max=215.648294938773 PtS11Max=3 x2S11Max=0.5 x3S11Max=-0.5
 S11Min=-215.648293732029 PtS11Min=1 x2S11Min=-0.5 x3S11Min=-0.5 FrameElem=57 ElemStation=0.5
 Frame=57 Station=0 OutputCase=ACCLATDX CaseType=LinStatic P=0 V2=0 V3=0 T=0 M2=0 M3=0
 S11Max=0 PtS11Max=0 x2S11Max=0 x3S11Max=0 S11Min=0 PtS11Min=0 x2S11Min=0 x3S11Min=0 FrameElem=57
 ElemStation=0
 Frame=57 Station=0.5 OutputCase=ACCLATDX CaseType=LinStatic P=0 V2=0 V3=0 T=0 M2=0 M3=0
 S11Max=0 PtS11Max=0 x2S11Max=0 x3S11Max=0 S11Min=0 PtS11Min=0 x2S11Min=0 x3S11Min=0 FrameElem=57
 ElemStation=0.5
 Frame=57 Station=0 OutputCase=ACCLATSX CaseType=LinStatic P=0 V2=0 V3=0 T=0 M2=0 M3=0
 S11Max=0 PtS11Max=0 x2S11Max=0 x3S11Max=0 S11Min=0 PtS11Min=0 x2S11Min=0 x3S11Min=0 FrameElem=57
 ElemStation=0
 Frame=57 Station=0.5 OutputCase=ACCLATSX CaseType=LinStatic P=0 V2=0 V3=0 T=0 M2=0 M3=0
 S11Max=0 PtS11Max=0 x2S11Max=0 x3S11Max=0 S11Min=0 PtS11Min=0 x2S11Min=0 x3S11Min=0 FrameElem=57
 ElemStation=0.5
 Frame=57 Station=0 OutputCase=TERRCOST CaseType=LinStatic P=0 V2=0 V3=0 T=0 M2=0 M3=0
 S11Max=0 PtS11Max=0 x2S11Max=0 x3S11Max=0 S11Min=0 PtS11Min=0 x2S11Min=0 x3S11Min=0 FrameElem=57
 ElemStation=0
 Frame=57 Station=0.5 OutputCase=TERRCOST CaseType=LinStatic P=0 V2=0 V3=0 T=0 M2=0 M3=0
 S11Max=0 PtS11Max=0 x2S11Max=0 x3S11Max=0 S11Min=0 PtS11Min=0 x2S11Min=0 x3S11Min=0 FrameElem=57
 ElemStation=0.5
 Frame=57 Station=0 OutputCase=SOVRCOST CaseType=LinStatic P=0 V2=0 V3=0 T=0 M2=0 M3=0
 S11Max=0 PtS11Max=0 x2S11Max=0 x3S11Max=0 S11Min=0 PtS11Min=0 x2S11Min=0 x3S11Min=0 FrameElem=57
 ElemStation=0
 Frame=57 Station=0.5 OutputCase=SOVRCOST CaseType=LinStatic P=0 V2=0 V3=0 T=0 M2=0 M3=0
 S11Max=0 PtS11Max=0 x2S11Max=0 x3S11Max=0 S11Min=0 PtS11Min=0 x2S11Min=0 x3S11Min=0 FrameElem=57
 ElemStation=0.5
 Frame=57 Station=0 OutputCase=ENVE CaseType=Combination StepType=Max P=-641.249993614615
 V2=70.7872625759822 V3=0 T=0 M2=0 M3=288.804145923909 S11Max=1091.57488169324 PtS11Max=1 x2S11Max=-0.5
 x3S11Max=-0.5
 S11Min=-2350.0089812426 PtS11Min=3 x2S11Min=0.5 x3S11Min=-0.5 FrameElem=57 ElemStation=0



Frame=57 Station=0.5 OutputCase=ENVE CaseType=Combination StepType=Max P=-628.749993796585
 V2=47.8900749766411 V3=0 T=0 M2=0 M3=265.995073058278 S11Max=967.220444372071 PtS11Max=1 x2S11Max=-0.5
 x3S11Max=-0.5 _
 S11Min=-2160.02594384563 PtS11Min=3 x2S11Min=0.5 x3S11Min=-0.5 FrameElem=57 ElemStation=0.5
 Frame=57 Station=0 OutputCase=ENVE CaseType=Combination StepType=Min P=-641.249993850217
 V2=53.7565207809334 V3=0 T=0 M2=0 M3=284.793164604664 S11Max=1067.50899401337 PtS11Max=1 x2S11Max=-0.5
 x3S11Max=-0.5 _
 S11Min=-2374.07486939367 PtS11Min=3 x2S11Min=0.5 x3S11Min=-0.5 FrameElem=57 ElemStation=0
 Frame=57 Station=0.5 OutputCase=ENVE CaseType=Combination StepType=Min P=-628.749993977597
 V2=37.7284894315923 V3=0 T=0 M2=0 M3=255.212658341508 S11Max=902.525956252462 PtS11Max=1 x2S11Max=-0.5
 x3S11Max=-0.5 _
 S11Min=-2224.72043232726 PtS11Min=3 x2S11Min=0.5 x3S11Min=-0.5 FrameElem=57 ElemStation=0.5
 Frame=57 Station=0 OutputCase=FESSUR CaseType=Combination P=-641.249993614615 V2=70.7872625759822
 V3=0 T=0 M2=0 M3=284.793164604664 S11Max=1067.50899401337 PtS11Max=1 x2S11Max=-0.5 x3S11Max=-0.5 _
 S11Min=-2350.0089812426 PtS11Min=3 x2S11Min=0.5 x3S11Min=-0.5 FrameElem=57 ElemStation=0
 Frame=57 Station=0.5 OutputCase=FESSUR CaseType=Combination P=-628.749993796585 V2=47.8900749766411
 V3=0 T=0 M2=0 M3=255.212658341508 S11Max=902.525956252462 PtS11Max=1 x2S11Max=-0.5 x3S11Max=-0.5 _
 S11Min=-2160.02594384563 PtS11Min=3 x2S11Min=0.5 x3S11Min=-0.5 FrameElem=57 ElemStation=0.5
 Frame=58 Station=0 OutputCase=PESOPR CaseType=LinStatic P=-137.499999272608 V2=15.1709478289919 V3=0
 T=0 M2=0 M3=66.5844189331242 S11Max=262.006514326137 PtS11Max=1 x2S11Max=-0.5 x3S11Max=-0.5 _
 S11Min=-537.006512871353 PtS11Min=3 x2S11Min=0.5 x3S11Min=-0.5 FrameElem=58 ElemStation=0
 Frame=58 Station=0.5 OutputCase=PESOPR CaseType=LinStatic P=-124.999999272608 V2=15.1709477296508
 V3=0 T=0 M2=0 M3=58.9989450434636 S11Max=228.993670988173 PtS11Max=1 x2S11Max=-0.5 x3S11Max=-0.5 _
 S11Min=-478.993669533389 PtS11Min=3 x2S11Min=0.5 x3S11Min=-0.5 FrameElem=58 ElemStation=0.5
 Frame=58 Station=0 OutputCase=TERRVERT CaseType=LinStatic P=-491.249995127437 V2=-1.15282466918052
 V3=0 T=0 M2=0 M3=224.569621797617 S11Max=856.167735658266 PtS11Max=1 x2S11Max=-0.5 x3S11Max=-0.5 _
 S11Min=-1838.66772591314 PtS11Min=3 x2S11Min=0.5 x3S11Min=-0.5 FrameElem=58 ElemStation=0
 Frame=58 Station=0.5 OutputCase=TERRVERT CaseType=LinStatic P=-491.249995127437 V2=-1.15282466918052
 V3=0 T=0 M2=0 M3=225.146034132207 S11Max=859.626209665808 PtS11Max=1 x2S11Max=-0.5 x3S11Max=-0.5 _
 S11Min=-1842.12619992068 PtS11Min=3 x2S11Min=0.5 x3S11Min=-0.5 FrameElem=58 ElemStation=0.5
 Frame=58 Station=0 OutputCase=TERRLAT CaseType=LinStatic P=6.03372427576687E-07 V2=33.8719518168292
 V3=0 T=0 M2=0 M3=-35.9413823892336 S11Max=215.648294938774 PtS11Max=3 x2S11Max=0.5 x3S11Max=-0.5 _
 S11Min=-215.648293732029 PtS11Min=1 x2S11Min=-0.5 x3S11Min=-0.5 FrameElem=58 ElemStation=0
 Frame=58 Station=0.5 OutputCase=TERRLAT CaseType=LinStatic P=4.38344542274816E-07 V2=13.1066393168292
 V3=0 T=0 M2=0 M3=-47.5972020476482 S11Max=285.583212724234 PtS11Max=3 x2S11Max=0.5 x3S11Max=-0.5 _
 S11Min=-285.583211847545 PtS11Min=1 x2S11Min=-0.5 x3S11Min=-0.5 FrameElem=58 ElemStation=0.5
 Frame=58 Station=0 OutputCase=ACCLATDX CaseType=LinStatic P=0 V2=0 V3=0 T=0 M2=0 M3=0
 S11Max=0 PtS11Max=0 x2S11Max=0 x3S11Max=0 S11Min=0 PtS11Min=0 x2S11Min=0 x3S11Min=0 FrameElem=58
 ElemStation=0
 Frame=58 Station=0.5 OutputCase=ACCLATDX CaseType=LinStatic P=0 V2=0 V3=0 T=0 M2=0 M3=0
 S11Max=0 PtS11Max=0 x2S11Max=0 x3S11Max=0 S11Min=0 PtS11Min=0 x2S11Min=0 x3S11Min=0 FrameElem=58
 ElemStation=0.5
 Frame=58 Station=0 OutputCase=ACCLATSX CaseType=LinStatic P=0 V2=0 V3=0 T=0 M2=0 M3=0
 S11Max=0 PtS11Max=0 x2S11Max=0 x3S11Max=0 S11Min=0 PtS11Min=0 x2S11Min=0 x3S11Min=0 FrameElem=58
 ElemStation=0
 Frame=58 Station=0.5 OutputCase=ACCLATSX CaseType=LinStatic P=0 V2=0 V3=0 T=0 M2=0 M3=0
 S11Max=0 PtS11Max=0 x2S11Max=0 x3S11Max=0 S11Min=0 PtS11Min=0 x2S11Min=0 x3S11Min=0 FrameElem=58
 ElemStation=0.5
 Frame=58 Station=0 OutputCase=TERRCOST CaseType=LinStatic P=0 V2=0 V3=0 T=0 M2=0 M3=0
 S11Max=0 PtS11Max=0 x2S11Max=0 x3S11Max=0 S11Min=0 PtS11Min=0 x2S11Min=0 x3S11Min=0 FrameElem=58
 ElemStation=0
 Frame=58 Station=0.5 OutputCase=TERRCOST CaseType=LinStatic P=0 V2=0 V3=0 T=0 M2=0 M3=0
 S11Max=0 PtS11Max=0 x2S11Max=0 x3S11Max=0 S11Min=0 PtS11Min=0 x2S11Min=0 x3S11Min=0 FrameElem=58
 ElemStation=0.5
 Frame=58 Station=0 OutputCase=SOVRCOST CaseType=LinStatic P=0 V2=0 V3=0 T=0 M2=0 M3=0
 S11Max=0 PtS11Max=0 x2S11Max=0 x3S11Max=0 S11Min=0 PtS11Min=0 x2S11Min=0 x3S11Min=0 FrameElem=58
 ElemStation=0
 Frame=58 Station=0.5 OutputCase=SOVRCOST CaseType=LinStatic P=0 V2=0 V3=0 T=0 M2=0 M3=0
 S11Max=0 PtS11Max=0 x2S11Max=0 x3S11Max=0 S11Min=0 PtS11Min=0 x2S11Min=0 x3S11Min=0 FrameElem=58
 ElemStation=0.5
 Frame=58 Station=0 OutputCase=ENVE CaseType=Combination StepType=Max P=-628.749993796672
 V2=47.8900749766406 V3=0 T=0 M2=0 M3=265.995073058278 S11Max=967.220444371983 PtS11Max=1 x2S11Max=-0.5
 x3S11Max=-0.5 _
 S11Min=-2160.02594384572 PtS11Min=3 x2S11Min=0.5 x3S11Min=-0.5 FrameElem=58 ElemStation=0
 Frame=58 Station=0.5 OutputCase=ENVE CaseType=Combination StepType=Max P=-616.2499939617
 V2=27.1247623772995 V3=0 T=0 M2=0 M3=250.826937742317 S11Max=888.7116323607 PtS11Max=1 x2S11Max=-0.5
 x3S11Max=-0.5 _
 S11Min=-2035.53665672984 PtS11Min=3 x2S11Min=0.5 x3S11Min=-0.5 FrameElem=58 ElemStation=0.5
 Frame=58 Station=0 OutputCase=ENVE CaseType=Combination StepType=Min P=-628.749993977684
 V2=37.7284894315918 V3=0 T=0 M2=0 M3=255.212658341508 S11Max=902.525956252375 PtS11Max=1 x2S11Max=-0.5
 x3S11Max=-0.5 _
 S11Min=-2224.72043232735 PtS11Min=3 x2S11Min=0.5 x3S11Min=-0.5 FrameElem=58 ElemStation=0
 Frame=58 Station=0.5 OutputCase=ENVE CaseType=Combination StepType=Min P=-616.249994093203
 V2=23.1927705822507 V3=0 T=0 M2=0 M3=236.547777128023 S11Max=803.036668806437 PtS11Max=1 x2S11Max=-0.5
 x3S11Max=-0.5 _
 S11Min=-2121.21162054711 PtS11Min=3 x2S11Min=0.5 x3S11Min=-0.5 FrameElem=58 ElemStation=0.5
 Frame=58 Station=0 OutputCase=FESSUR CaseType=Combination P=-628.749993796672 V2=47.8900749766406
 V3=0 T=0 M2=0 M3=255.212658341508 S11Max=902.525956252375 PtS11Max=1 x2S11Max=-0.5 x3S11Max=-0.5 _
 S11Min=-2160.02594384572 PtS11Min=3 x2S11Min=0.5 x3S11Min=-0.5 FrameElem=58 ElemStation=0
 Frame=58 Station=0.5 OutputCase=FESSUR CaseType=Combination P=-616.2499939617 V2=27.1247623772995
 V3=0 T=0 M2=0 M3=236.547777128023 S11Max=803.036668806437 PtS11Max=1 x2S11Max=-0.5 x3S11Max=-0.5 _
 S11Min=-2035.53665672984 PtS11Min=3 x2S11Min=0.5 x3S11Min=-0.5 FrameElem=58 ElemStation=0.5

Frame=59 Station=0 OutputCase=PESOPR CaseType=LinStatic P=-124.99999927255 V2=15.1709477296499 V3=0
T=0 M2=0 M3=58.9989450434633 S11Max=228.99367098823 PtS11Max=1 x2S11Max=-0.5 x3S11Max=-0.5 _
S11Min=-478.993669533329 PtS11Min=3 x2S11Min=0.5 x3S11Min=-0.5 FrameElem=59 ElemStation=0

Frame=59 Station=0.5 OutputCase=PESOPR CaseType=LinStatic P=-112.49999927255 V2=15.1709476303088 V3=0
T=0 M2=0 M3=51.4134712034736 S11Max=195.980827948292 PtS11Max=1 x2S11Max=-0.5 x3S11Max=-0.5 _
S11Min=-420.980826493391 PtS11Min=3 x2S11Min=0.5 x3S11Min=-0.5 FrameElem=59 ElemStation=0.5

Frame=59 Station=0.5 OutputCase=TERRVERT CaseType=LinStatic P=-491.2499995127204 V2=-1.15282466918461
V3=0 T=0 M2=0 M3=225.146034132207 S11Max=859.626209666037 PtS11Max=1 x2S11Max=-0.5 x3S11Max=-0.5 _
S11Min=-1842.12619992045 PtS11Min=3 x2S11Min=0.5 x3S11Min=-0.5 FrameElem=59 ElemStation=0

Frame=59 Station=0.5 OutputCase=TERRVERT CaseType=LinStatic P=-491.2499995127204 V2=-1.15282466918461
V3=0 T=0 M2=0 M3=225.722446466799 S11Max=863.084683673591 PtS11Max=1 x2S11Max=-0.5 x3S11Max=-0.5 _
S11Min=-1845.584673928 PtS11Min=3 x2S11Min=0.5 x3S11Min=-0.5 FrameElem=59 ElemStation=0.5

Frame=59 Station=0.5 OutputCase=TERRLAT CaseType=LinStatic P=4.38343931818963E-07 V2=13.1066393168297
V3=0 T=0 M2=0 M3=-47.5972020476482 S11Max=285.583212724233 PtS11Max=3 x2S11Max=0.5 x3S11Max=-0.5 _
S11Min=-285.583211847545 PtS11Min=1 x2S11Min=-0.5 x3S11Min=-0.5 FrameElem=59 ElemStation=0

Frame=59 Station=0.5 OutputCase=TERRLAT CaseType=LinStatic P=2.90258667678123E-07 V2=-5.52679818317027
V3=0 T=0 M2=0 M3=-49.403334206063 S11Max=296.420005526637 PtS11Max=3 x2S11Max=0.5 x3S11Max=-0.5 _
S11Min=-296.420004946119 PtS11Min=1 x2S11Min=-0.5 x3S11Min=-0.5 FrameElem=59 ElemStation=0.5

Frame=59 Station=0 OutputCase=ACCLATDX CaseType=LinStatic P=0 V2=0 V3=0 T=0 M2=0 M3=0
S11Max=0 PtS11Max=0 x2S11Max=0 x3S11Max=0 S11Min=0 PtS11Min=0 x2S11Min=0 x3S11Min=0 FrameElem=59
ElemStation=0

Frame=59 Station=0.5 OutputCase=ACCLATDX CaseType=LinStatic P=0 V2=0 V3=0 T=0 M2=0 M3=0
S11Max=0 PtS11Max=0 x2S11Max=0 x3S11Max=0 S11Min=0 PtS11Min=0 x2S11Min=0 x3S11Min=0 FrameElem=59
ElemStation=0.5

Frame=59 Station=0 OutputCase=ACCLATSX CaseType=LinStatic P=0 V2=0 V3=0 T=0 M2=0 M3=0
S11Max=0 PtS11Max=0 x2S11Max=0 x3S11Max=0 S11Min=0 PtS11Min=0 x2S11Min=0 x3S11Min=0 FrameElem=59
ElemStation=0

Frame=59 Station=0.5 OutputCase=ACCLATSX CaseType=LinStatic P=0 V2=0 V3=0 T=0 M2=0 M3=0
S11Max=0 PtS11Max=0 x2S11Max=0 x3S11Max=0 S11Min=0 PtS11Min=0 x2S11Min=0 x3S11Min=0 FrameElem=59
ElemStation=0.5

Frame=59 Station=0 OutputCase=TERRCOST CaseType=LinStatic P=0 V2=0 V3=0 T=0 M2=0 M3=0
S11Max=0 PtS11Max=0 x2S11Max=0 x3S11Max=0 S11Min=0 PtS11Min=0 x2S11Min=0 x3S11Min=0 FrameElem=59
ElemStation=0

Frame=59 Station=0.5 OutputCase=TERRCOST CaseType=LinStatic P=0 V2=0 V3=0 T=0 M2=0 M3=0
S11Max=0 PtS11Max=0 x2S11Max=0 x3S11Max=0 S11Min=0 PtS11Min=0 x2S11Min=0 x3S11Min=0 FrameElem=59
ElemStation=0.5

Frame=59 Station=0 OutputCase=SOVRCOST CaseType=LinStatic P=0 V2=0 V3=0 T=0 M2=0 M3=0
S11Max=0 PtS11Max=0 x2S11Max=0 x3S11Max=0 S11Min=0 PtS11Min=0 x2S11Min=0 x3S11Min=0 FrameElem=59
ElemStation=0

Frame=59 Station=0.5 OutputCase=SOVRCOST CaseType=LinStatic P=0 V2=0 V3=0 T=0 M2=0 M3=0
S11Max=0 PtS11Max=0 x2S11Max=0 x3S11Max=0 S11Min=0 PtS11Min=0 x2S11Min=0 x3S11Min=0 FrameElem=59
ElemStation=0.5

Frame=59 Station=0 OutputCase=ENVE CaseType=Combination StepType=Max P=-616.24999396141
V2=27.124762377295 V3=0 T=0 M2=0 M3=250.826937742316 S11Max=888.711632360986 PtS11Max=1 x2S11Max=-0.5
x3S11Max=-0.5 _
S11Min=-2035.53665672954 PtS11Min=3 x2S11Min=0.5 x3S11Min=-0.5 FrameElem=59 ElemStation=0

Frame=59 Station=0.5 OutputCase=ENVE CaseType=Combination StepType=Max P=-603.749994109495
V2=10.149364232905 V3=0 T=0 M2=0 M3=242.553583726029 S11Max=851.571508159599 PtS11Max=1 x2S11Max=-0.5
x3S11Max=-0.5 _
S11Min=-1970.14549489475 PtS11Min=3 x2S11Min=0.5 x3S11Min=-0.5 FrameElem=59 ElemStation=0.5

Frame=59 Station=0 OutputCase=ENVE CaseType=Combination StepType=Min P=-616.249994092913
V2=23.1927705822461 V3=0 T=0 M2=0 M3=236.547777128022 S11Max=803.036668806722 PtS11Max=1 x2S11Max=-0.5
x3S11Max=-0.5 _
S11Min=-2121.21162054681 PtS11Min=3 x2S11Min=0.5 x3S11Min=-0.5 FrameElem=59 ElemStation=0

Frame=59 Station=0.5 OutputCase=ENVE CaseType=Combination StepType=Min P=-603.749994196573
V2=8.49132477795396 V3=0 T=0 M2=0 M3=227.73258346421 S11Max=762.645506675763 PtS11Max=1 x2S11Max=-0.5
x3S11Max=-0.5 _
S11Min=-2059.07149655274 PtS11Min=3 x2S11Min=0.5 x3S11Min=-0.5 FrameElem=59 ElemStation=0.5

Frame=59 Station=0 OutputCase=FESSUR CaseType=Combination P=-616.24999396141 V2=27.124762377295 V3=0
T=0 M2=0 M3=236.547777128022 S11Max=803.036668806722 PtS11Max=1 x2S11Max=-0.5 x3S11Max=-0.5 _
S11Min=-2035.53665672954 PtS11Min=3 x2S11Min=0.5 x3S11Min=-0.5 FrameElem=59 ElemStation=0

Frame=59 Station=0.5 OutputCase=FESSUR CaseType=Combination P=-603.749994109495 V2=8.49132477795396
V3=0 T=0 M2=0 M3=227.73258346421 S11Max=762.645506675763 PtS11Max=1 x2S11Max=-0.5 x3S11Max=-0.5 _
S11Min=-1970.14549489475 PtS11Min=3 x2S11Min=0.5 x3S11Min=-0.5 FrameElem=59 ElemStation=0.5

Frame=60 Station=0 OutputCase=PESOPR CaseType=LinStatic P=-112.499999272521 V2=15.1709476303088 V3=0
T=0 M2=0 M3=51.4134712034736 S11Max=195.980827948321 PtS11Max=1 x2S11Max=-0.5 x3S11Max=-0.5 _
S11Min=-420.980826493362 PtS11Min=3 x2S11Min=0.5 x3S11Min=-0.5 FrameElem=60 ElemStation=0

Frame=60 Station=0.5 OutputCase=PESOPR CaseType=LinStatic P=-99.9999992725207 V2=15.1709475309677
V3=0 T=0 M2=0 M3=43.8279974131545 S11Max=162.967985206406 PtS11Max=1 x2S11Max=-0.5 x3S11Max=-0.5 _
S11Min=-362.967983751447 PtS11Min=3 x2S11Min=0.5 x3S11Min=-0.5 FrameElem=60 ElemStation=0.5

Frame=60 Station=0 OutputCase=TERRVERT CaseType=LinStatic P=-491.2499995127204 V2=-1.15282466918507
V3=0 T=0 M2=0 M3=225.722446466799 S11Max=863.084683673592 PtS11Max=1 x2S11Max=-0.5 x3S11Max=-0.5 _
S11Min=-1845.584673928 PtS11Min=3 x2S11Min=0.5 x3S11Min=-0.5 FrameElem=60 ElemStation=0

Frame=60 Station=0.5 OutputCase=TERRVERT CaseType=LinStatic P=-491.2499995127204 V2=-1.15282466918507
V3=0 T=0 M2=0 M3=226.298858801392 S11Max=866.543157681147 PtS11Max=1 x2S11Max=-0.5 x3S11Max=-0.5 _
S11Min=-1849.04314793555 PtS11Min=3 x2S11Min=0.5 x3S11Min=-0.5 FrameElem=60 ElemStation=0.5

Frame=60 Station=0 OutputCase=TERRLAT CaseType=LinStatic P=2.90258867607918E-07 V2=-5.52679818317029
V3=0 T=0 M2=0 M3=-49.403334206063 S11Max=296.420005526637 PtS11Max=3 x2S11Max=0.5 x3S11Max=-0.5 _
S11Min=-296.420004946119 PtS11Min=1 x2S11Min=-0.5 x3S11Min=-0.5 FrameElem=60 ElemStation=0

Frame=60 Station=0.5 OutputCase=TERRLAT CaseType=LinStatic P=1.5911623928444E-07 V2=-22.0283606831703
V3=0 T=0 M2=0 M3=-42.4257163644779 S11Max=254.554298345984 PtS11Max=3 x2S11Max=0.5 x3S11Max=-0.5 _
S11Min=-254.554298027751 PtS11Min=1 x2S11Min=-0.5 x3S11Min=-0.5 FrameElem=60 ElemStation=0.5



Frame=60 Station=0 OutputCase=ACCLATDX CaseType=LinStatic P=0 V2=0 V3=0 T=0 M2=0 M3=0
 S11Max=0 PtS11Max=0 x2S11Max=0 x3S11Max=0 S11Min=0 PtS11Min=0 x2S11Min=0 x3S11Min=0 FrameElem=60
 ElemStation=0
 Frame=60 Station=0.5 OutputCase=ACCLATDX CaseType=LinStatic P=0 V2=0 V3=0 T=0 M2=0 M3=0
 S11Max=0 PtS11Max=0 x2S11Max=0 x3S11Max=0 S11Min=0 PtS11Min=0 x2S11Min=0 x3S11Min=0 FrameElem=60
 ElemStation=0.5
 Frame=60 Station=0 OutputCase=ACCLATSX CaseType=LinStatic P=0 V2=0 V3=0 T=0 M2=0 M3=0
 S11Max=0 PtS11Max=0 x2S11Max=0 x3S11Max=0 S11Min=0 PtS11Min=0 x2S11Min=0 x3S11Min=0 FrameElem=60
 ElemStation=0
 Frame=60 Station=0.5 OutputCase=ACCLATSX CaseType=LinStatic P=0 V2=0 V3=0 T=0 M2=0 M3=0
 S11Max=0 PtS11Max=0 x2S11Max=0 x3S11Max=0 S11Min=0 PtS11Min=0 x2S11Min=0 x3S11Min=0 FrameElem=60
 ElemStation=0.5
 Frame=60 Station=0 OutputCase=TERRCOST CaseType=LinStatic P=0 V2=0 V3=0 T=0 M2=0 M3=0
 S11Max=0 PtS11Max=0 x2S11Max=0 x3S11Max=0 S11Min=0 PtS11Min=0 x2S11Min=0 x3S11Min=0 FrameElem=60
 ElemStation=0
 Frame=60 Station=0.5 OutputCase=TERRCOST CaseType=LinStatic P=0 V2=0 V3=0 T=0 M2=0 M3=0
 S11Max=0 PtS11Max=0 x2S11Max=0 x3S11Max=0 S11Min=0 PtS11Min=0 x2S11Min=0 x3S11Min=0 FrameElem=60
 ElemStation=0.5
 Frame=60 Station=0 OutputCase=SOVRCOST CaseType=LinStatic P=0 V2=0 V3=0 T=0 M2=0 M3=0
 S11Max=0 PtS11Max=0 x2S11Max=0 x3S11Max=0 S11Min=0 PtS11Min=0 x2S11Min=0 x3S11Min=0 FrameElem=60
 ElemStation=0
 Frame=60 Station=0.5 OutputCase=SOVRCOST CaseType=LinStatic P=0 V2=0 V3=0 T=0 M2=0 M3=0
 S11Max=0 PtS11Max=0 x2S11Max=0 x3S11Max=0 S11Min=0 PtS11Min=0 x2S11Min=0 x3S11Min=0 FrameElem=60
 ElemStation=0.5
 Frame=60 Station=0 OutputCase=ENVE CaseType=Combination StepType=Max P=-603.749994109466
 V2=10.1493642329045 V3=0 T=0 M2=0 M3=242.553583726029 S11Max=851.571508159629 PtS11Max=1 x2S11Max=-0.5
 x3S11Max=-0.5
 S11Min=-1970.14549489472 PtS11Min=3 x2S11Min=0.5 x3S11Min=-0.5 FrameElem=60 ElemStation=0
 Frame=60 Station=0.5 OutputCase=ENVE CaseType=Combination StepType=Max P=-591.249994240608 V2=-
 1.40172961643655 V3=0 T=0 M2=0 M3=240.428854759412 S11Max=851.323134268127 PtS11Max=1 x2S11Max=-0.5
 x3S11Max=-0.5
 S11Min=-1957.45683334102 PtS11Min=3 x2S11Min=0.5 x3S11Min=-0.5 FrameElem=60 ElemStation=0.5
 Frame=60 Station=0 OutputCase=ENVE CaseType=Combination StepType=Min P=-603.749994196543
 V2=8.49132477795342 V3=0 T=0 M2=0 M3=227.73258346421 S11Max=762.645506675794 PtS11Max=1 x2S11Max=-0.5
 x3S11Max=-0.5
 S11Min=-2059.07149655272 PtS11Min=3 x2S11Min=0.5 x3S11Min=-0.5 FrameElem=60 ElemStation=0
 Frame=60 Station=0.5 OutputCase=ENVE CaseType=Combination StepType=Min P=-591.249994288343 V2=-
 8.01023782138764 V3=0 T=0 M2=0 M3=227.701139850068 S11Max=774.956844859802 PtS11Max=1 x2S11Max=-0.5
 x3S11Max=-0.5
 S11Min=-2033.82312284481 PtS11Min=3 x2S11Min=0.5 x3S11Min=-0.5 FrameElem=60 ElemStation=0.5
 Frame=60 Station=0 OutputCase=FESSUR CaseType=Combination P=-603.749994109466 V2=8.49132477795342
 V3=0 T=0 M2=0 M3=227.73258346421 S11Max=762.645506675794 PtS11Max=1 x2S11Max=-0.5 x3S11Max=-0.5
 S11Min=-1970.14549489472 PtS11Min=3 x2S11Min=0.5 x3S11Min=-0.5 FrameElem=60 ElemStation=0
 Frame=60 Station=0.5 OutputCase=FESSUR CaseType=Combination P=-591.249994240608 V2=-8.01023782138764
 V3=0 T=0 M2=0 M3=227.701139850068 S11Max=774.956844859802 PtS11Max=1 x2S11Max=-0.5 x3S11Max=-0.5
 S11Min=-1957.45683334102 PtS11Min=3 x2S11Min=0.5 x3S11Min=-0.5 FrameElem=60 ElemStation=0.5
 Frame=61 Station=0 OutputCase=PESOPR CaseType=LinStatic P=-99.999992724333 V2=15.1709475309674 V3=0
 T=0 M2=0 M3=43.8279974131545 S11Max=162.967985206493 PtS11Max=1 x2S11Max=-0.5 x3S11Max=-0.5
 S11Min=-362.96798375136 PtS11Min=3 x2S11Min=0.5 x3S11Min=-0.5 FrameElem=61 ElemStation=0
 Frame=61 Station=0.5 OutputCase=PESOPR CaseType=LinStatic P=-87.499992724333 V2=15.1709474316263
 V3=0 T=0 M2=0 M3=36.242523672506 S11Max=129.955142762603 PtS11Max=1 x2S11Max=-0.5 x3S11Max=-0.5
 S11Min=-304.95514130747 PtS11Min=3 x2S11Min=0.5 x3S11Min=-0.5 FrameElem=61 ElemStation=0.5
 Frame=61 Station=0 OutputCase=TERRVERT CaseType=LinStatic P=-491.249995127087 V2=-1.15282466918597
 V3=0 T=0 M2=0 M3=226.298858801392 S11Max=866.543157681262 PtS11Max=1 x2S11Max=-0.5 x3S11Max=-0.5
 S11Min=-1849.04314793544 PtS11Min=3 x2S11Min=0.5 x3S11Min=-0.5 FrameElem=61 ElemStation=0
 Frame=61 Station=0.5 OutputCase=TERRVERT CaseType=LinStatic P=-491.249995127087 V2=-1.15282466918597
 V3=0 T=0 M2=0 M3=226.875271135985 S11Max=870.00163168882 PtS11Max=1 x2S11Max=-0.5 x3S11Max=-0.5
 S11Min=-1852.50162194299 PtS11Min=3 x2S11Min=0.5 x3S11Min=-0.5 FrameElem=61 ElemStation=0.5
 Frame=61 Station=0 OutputCase=TERRLAT CaseType=LinStatic P=1.59115870701498E-07 V2=-22.02836068317
 V3=0 T=0 M2=0 M3=-42.4257163644779 S11Max=254.554298345983 PtS11Max=3 x2S11Max=0.5 x3S11Max=-0.5
 S11Min=-254.554298027751 PtS11Min=1 x2S11Min=-0.5 x3S11Min=-0.5 FrameElem=61 ElemStation=0
 Frame=61 Station=0.5 OutputCase=TERRLAT CaseType=LinStatic P=4.49158616455669E-08 V2=-36.39804818317
 V3=0 T=0 M2=0 M3=-27.7302860228929 S11Max=166.381716182273 PtS11Max=3 x2S11Max=0.5 x3S11Max=-0.5
 S11Min=-166.381716092441 PtS11Min=1 x2S11Min=-0.5 x3S11Min=-0.5 FrameElem=61 ElemStation=0.5
 Frame=61 Station=0 OutputCase=ACCLATDX CaseType=LinStatic P=0 V2=0 V3=0 T=0 M2=0 M3=0
 S11Max=0 PtS11Max=0 x2S11Max=0 x3S11Max=0 S11Min=0 PtS11Min=0 x2S11Min=0 x3S11Min=0 FrameElem=61
 ElemStation=0
 Frame=61 Station=0.5 OutputCase=ACCLATDX CaseType=LinStatic P=0 V2=0 V3=0 T=0 M2=0 M3=0
 S11Max=0 PtS11Max=0 x2S11Max=0 x3S11Max=0 S11Min=0 PtS11Min=0 x2S11Min=0 x3S11Min=0 FrameElem=61
 ElemStation=0.5
 Frame=61 Station=0 OutputCase=ACCLATSX CaseType=LinStatic P=0 V2=0 V3=0 T=0 M2=0 M3=0
 S11Max=0 PtS11Max=0 x2S11Max=0 x3S11Max=0 S11Min=0 PtS11Min=0 x2S11Min=0 x3S11Min=0 FrameElem=61
 ElemStation=0
 Frame=61 Station=0.5 OutputCase=ACCLATSX CaseType=LinStatic P=0 V2=0 V3=0 T=0 M2=0 M3=0
 S11Max=0 PtS11Max=0 x2S11Max=0 x3S11Max=0 S11Min=0 PtS11Min=0 x2S11Min=0 x3S11Min=0 FrameElem=61
 ElemStation=0.5
 Frame=61 Station=0 OutputCase=TERRCOST CaseType=LinStatic P=0 V2=0 V3=0 T=0 M2=0 M3=0
 S11Max=0 PtS11Max=0 x2S11Max=0 x3S11Max=0 S11Min=0 PtS11Min=0 x2S11Min=0 x3S11Min=0 FrameElem=61
 ElemStation=0
 Frame=61 Station=0.5 OutputCase=TERRCOST CaseType=LinStatic P=0 V2=0 V3=0 T=0 M2=0 M3=0
 S11Max=0 PtS11Max=0 x2S11Max=0 x3S11Max=0 S11Min=0 PtS11Min=0 x2S11Min=0 x3S11Min=0 FrameElem=61
 ElemStation=0.5



Frame=61 Station=0 OutputCase=SOVRCOST CaseType=LinStatic P=0 V2=0 V3=0 T=0 M2=0 M3=0
 S11Max=0 PtS11Max=0 x2S11Max=0 x3S11Max=0 S11Min=0 PtS11Min=0 x2S11Min=0 x3S11Min=0 FrameElem=61
 ElemStation=0
 Frame=61 Station=0.5 OutputCase=SOVRCOST CaseType=LinStatic P=0 V2=0 V3=0 T=0 M2=0 M3=0
 S11Max=0 PtS11Max=0 x2S11Max=0 x3S11Max=0 S11Min=0 PtS11Min=0 x2S11Min=0 x3S11Min=0 FrameElem=61
 ElemStation=0.5
 Frame=61 Station=0 OutputCase=ENVE CaseType=Combination StepType=Max P=-591.249994240405 V2=-
 1.4017296164376 V3=0 T=0 M2=0 M3=240.428854759412 S11Max=851.32313426833 PtS11Max=1 x2S11Max=-0.5
 x3S11Max=-0.5 _
 S11Min=-1957.45683334081 PtS11Min=3 x2S11Min=0.5 x3S11Min=-0.5 FrameElem=61 ElemStation=0
 Frame=61 Station=0.5 OutputCase=ENVE CaseType=Combination StepType=Max P=-578.749994354605 V2=-
 11.4605109657787 V3=0 T=0 M2=0 M3=243.706594592466 S11Max=883.489573186714 PtS11Max=1 x2S11Max=-0.5
 x3S11Max=-0.5 _
 S11Min=-1991.07504706819 PtS11Min=3 x2S11Min=0.5 x3S11Min=-0.5 FrameElem=61 ElemStation=0.5
 Frame=61 Station=0 OutputCase=ENVE CaseType=Combination StepType=Min P=-591.24999428814 V2=-
 8.01023782138861 V3=0 T=0 M2=0 M3=227.701139850068 S11Max=774.956844860004 PtS11Max=1 x2S11Max=-0.5
 x3S11Max=-0.5 _
 S11Min=-2033.82312284461 PtS11Min=3 x2S11Min=0.5 x3S11Min=-0.5 FrameElem=61 ElemStation=0
 Frame=61 Station=0.5 OutputCase=ENVE CaseType=Combination StepType=Min P=-578.74999436808 V2=-
 22.3799254207297 V3=0 T=0 M2=0 M3=235.387508785598 S11Max=833.575058358982 PtS11Max=1 x2S11Max=-0.5
 x3S11Max=-0.5 _
 S11Min=-2040.98956192287 PtS11Min=3 x2S11Min=0.5 x3S11Min=-0.5 FrameElem=61 ElemStation=0.5
 Frame=61 Station=0 OutputCase=FESSUR CaseType=Combination P=-591.249994240405 V2=-8.01023782138861
 V3=0 T=0 M2=0 M3=227.701139850068 S11Max=774.956844860004 PtS11Max=1 x2S11Max=-0.5 x3S11Max=-0.5 _
 S11Min=-1957.45683334081 PtS11Min=3 x2S11Min=0.5 x3S11Min=-0.5 FrameElem=61 ElemStation=0
 Frame=61 Station=0.5 OutputCase=FESSUR CaseType=Combination P=-578.749994354605 V2=-22.3799254207297
 V3=0 T=0 M2=0 M3=235.387508785598 S11Max=833.575058358982 PtS11Max=1 x2S11Max=-0.5 x3S11Max=-0.5 _
 S11Min=-1991.07504706819 PtS11Min=3 x2S11Min=0.5 x3S11Min=-0.5 FrameElem=61 ElemStation=0.5
 Frame=62 Station=0 OutputCase=PESOPR CaseType=LinStatic P=-87.4999992724042 V2=15.1709474316264 V3=0
 T=0 M2=0 M3=36.242523672506 S11Max=129.955142762632 PtS11Max=1 x2S11Max=-0.5 x3S11Max=-0.5 _
 S11Min=-304.955141307441 PtS11Min=3 x2S11Min=0.5 x3S11Min=-0.5 FrameElem=62 ElemStation=0
 Frame=62 Station=0.5 OutputCase=PESOPR CaseType=LinStatic P=-74.9999992724042 V2=15.1709473322853
 V3=0 T=0 M2=0 M3=28.6570499815281 S11Max=96.9423006167645 PtS11Max=1 x2S11Max=-0.5 x3S11Max=-0.5 _
 S11Min=-246.942299161573 PtS11Min=3 x2S11Min=0.5 x3S11Min=-0.5 FrameElem=62 ElemStation=0.5
 Frame=62 Station=0 OutputCase=TERRVERT CaseType=LinStatic P=-491.249995127087 V2=-1.15282466918597
 V3=0 T=0 M2=0 M3=226.875271135985 S11Max=870.001631688821 PtS11Max=1 x2S11Max=-0.5 x3S11Max=-0.5 _
 S11Min=-1852.501621943 PtS11Min=3 x2S11Min=0.5 x3S11Min=-0.5 FrameElem=62 ElemStation=0
 Frame=62 Station=0.5 OutputCase=TERRVERT CaseType=LinStatic P=-491.249995127087 V2=-1.15282466918597
 V3=0 T=0 M2=0 M3=227.451683470578 S11Max=873.460105696379 PtS11Max=1 x2S11Max=-0.5 x3S11Max=-0.5 _
 S11Min=-1855.96009595055 PtS11Min=3 x2S11Min=0.5 x3S11Min=-0.5 FrameElem=62 ElemStation=0.5
 Frame=62 Station=0 OutputCase=TERRLAT CaseType=LinStatic P=4.49156232207315E-08 V2=-36.39804818317
 V3=0 T=0 M2=0 M3=-27.7302860228929 S11Max=166.381716182273 PtS11Max=3 x2S11Max=0.5 x3S11Max=-0.5 _
 S11Min=-166.381716092442 PtS11Min=1 x2S11Min=-0.5 x3S11Min=-0.5 FrameElem=62 ElemStation=0
 Frame=62 Station=0.5 OutputCase=TERRLAT CaseType=LinStatic P=-5.2341777437015E-08 V2=-48.63586068317
 V3=0 T=0 M2=0 M3=-6.38298068130792 S11Max=38.2978840355057 PtS11Max=3 x2S11Max=0.5 x3S11Max=-0.5 _
 S11Min=-38.2978841401893 PtS11Min=1 x2S11Min=-0.5 x3S11Min=-0.5 FrameElem=62 ElemStation=0.5
 Frame=62 Station=0 OutputCase=ACCLATDX CaseType=LinStatic P=0 V2=0 V3=0 T=0 M2=0 M3=0
 S11Max=0 PtS11Max=0 x2S11Max=0 x3S11Max=0 S11Min=0 PtS11Min=0 x2S11Min=0 x3S11Min=0 FrameElem=62
 ElemStation=0
 Frame=62 Station=0.5 OutputCase=ACCLATDX CaseType=LinStatic P=0 V2=0 V3=0 T=0 M2=0 M3=0
 S11Max=0 PtS11Max=0 x2S11Max=0 x3S11Max=0 S11Min=0 PtS11Min=0 x2S11Min=0 x3S11Min=0 FrameElem=62
 ElemStation=0.5
 Frame=62 Station=0 OutputCase=ACCLATSX CaseType=LinStatic P=0 V2=0 V3=0 T=0 M2=0 M3=0
 S11Max=0 PtS11Max=0 x2S11Max=0 x3S11Max=0 S11Min=0 PtS11Min=0 x2S11Min=0 x3S11Min=0 FrameElem=62
 ElemStation=0
 Frame=62 Station=0.5 OutputCase=ACCLATSX CaseType=LinStatic P=0 V2=0 V3=0 T=0 M2=0 M3=0
 S11Max=0 PtS11Max=0 x2S11Max=0 x3S11Max=0 S11Min=0 PtS11Min=0 x2S11Min=0 x3S11Min=0 FrameElem=62
 ElemStation=0.5
 Frame=62 Station=0 OutputCase=TERRCOST CaseType=LinStatic P=0 V2=0 V3=0 T=0 M2=0 M3=0
 S11Max=0 PtS11Max=0 x2S11Max=0 x3S11Max=0 S11Min=0 PtS11Min=0 x2S11Min=0 x3S11Min=0 FrameElem=62
 ElemStation=0
 Frame=62 Station=0.5 OutputCase=TERRCOST CaseType=LinStatic P=0 V2=0 V3=0 T=0 M2=0 M3=0
 S11Max=0 PtS11Max=0 x2S11Max=0 x3S11Max=0 S11Min=0 PtS11Min=0 x2S11Min=0 x3S11Min=0 FrameElem=62
 ElemStation=0.5
 Frame=62 Station=0 OutputCase=SOVRCOST CaseType=LinStatic P=0 V2=0 V3=0 T=0 M2=0 M3=0
 S11Max=0 PtS11Max=0 x2S11Max=0 x3S11Max=0 S11Min=0 PtS11Min=0 x2S11Min=0 x3S11Min=0 FrameElem=62
 ElemStation=0
 Frame=62 Station=0.5 OutputCase=SOVRCOST CaseType=LinStatic P=0 V2=0 V3=0 T=0 M2=0 M3=0
 S11Max=0 PtS11Max=0 x2S11Max=0 x3S11Max=0 S11Min=0 PtS11Min=0 x2S11Min=0 x3S11Min=0 FrameElem=62
 ElemStation=0.5
 Frame=62 Station=0 OutputCase=ENVE CaseType=Combination StepType=Max P=-578.749994354576 V2=-
 11.4605109657786 V3=0 T=0 M2=0 M3=243.706594592466 S11Max=883.489573186744 PtS11Max=1 x2S11Max=-0.5
 x3S11Max=-0.5 _
 S11Min=-1991.07504706816 PtS11Min=3 x2S11Min=0.5 x3S11Min=-0.5 FrameElem=62 ElemStation=0
 Frame=62 Station=0.5 OutputCase=ENVE CaseType=Combination StepType=Max P=-566.249994436131 V2=-
 20.0269798151197 V3=0 T=0 M2=0 M3=251.64064697519 S11Max=943.593887415011 PtS11Max=1 x2S11Max=-0.5
 x3S11Max=-0.5 _
 S11Min=-2064.60451107662 PtS11Min=3 x2S11Min=0.5 x3S11Min=-0.5 FrameElem=62 ElemStation=0.5
 Frame=62 Station=0 OutputCase=ENVE CaseType=Combination StepType=Min P=-578.749994368051 V2=-
 22.3799254207296 V3=0 T=0 M2=0 M3=235.387508785598 S11Max=833.575058359012 PtS11Max=1 x2S11Max=-0.5
 x3S11Max=-0.5 _
 S11Min=-2040.98956192285 PtS11Min=3 x2S11Min=0.5 x3S11Min=-0.5 FrameElem=62 ElemStation=0



Frame=62 Station=0.5 OutputCase=ENVE CaseType=Combination StepType=Min P=-566.249994451833 V2=-
 34.6177380200707 V3=0 T=0 M2=0 M3=249.725752770798 S11Max=932.104522172955 PtS11Max=1 x2S11Max=-0.5
 x3S11Max=-0.5 _
 S11Min=-2076.09387628727 PtS11Min=3 x2S11Min=0.5 x3S11Min=-0.5 FrameElem=62 ElemStation=0.5
 Frame=62 Station=0 OutputCase=FESSUR CaseType=Combination P=-578.749994354576 V2=-22.3799254207296
 V3=0 T=0 M2=0 M3=235.387508785598 S11Max=833.575058359012 PtS11Max=1 x2S11Max=-0.5 x3S11Max=-0.5 _
 S11Min=-1991.07504706816 PtS11Min=3 x2S11Min=0.5 x3S11Min=-0.5 FrameElem=62 ElemStation=0
 Frame=62 Station=0.5 OutputCase=FESSUR CaseType=Combination P=-566.249994451833 V2=-34.6177380200707
 V3=0 T=0 M2=0 M3=249.725752770798 S11Max=932.104522172955 PtS11Max=1 x2S11Max=-0.5 x3S11Max=-0.5 _
 S11Min=-2064.60451107662 PtS11Min=3 x2S11Min=0.5 x3S11Min=-0.5 FrameElem=62 ElemStation=0
 Frame=63 Station=0 OutputCase=PESOPR CaseType=LinStatic P=-149.999998698244 V2=-15.170947928329 V3=0
 T=0 M2=0 M3=-74.1698929279467 S11Max=295.019358869437 PtS11Max=3 x2S11Max=0.5 x3S11Max=-0.5 _
 S11Min=-595.019356265924 PtS11Min=1 x2S11Min=-0.5 x3S11Min=-0.5 FrameElem=63 ElemStation=0
 Frame=63 Station=0.5 OutputCase=PESOPR CaseType=LinStatic P=-137.499998698244 V2=-15.170947828988
 V3=0 T=0 M2=0 M3=-66.5844189886175 S11Max=262.006515233461 PtS11Max=3 x2S11Max=0.5 x3S11Max=-0.5 _
 S11Min=-537.006512629949 PtS11Min=1 x2S11Min=-0.5 x3S11Min=-0.5 FrameElem=63 ElemStation=0.5
 Frame=63 Station=0 OutputCase=TERRVERT CaseType=LinStatic P=-491.24999552127 V2=1.15282466919143 V3=0
 T=0 M2=0 M3=-223.993210450844 S11Max=852.709267183792 PtS11Max=3 x2S11Max=0.5 x3S11Max=-0.5 _
 S11Min=-1835.20925822633 PtS11Min=1 x2S11Min=-0.5 x3S11Min=-0.5 FrameElem=63 ElemStation=0
 Frame=63 Station=0.5 OutputCase=TERRVERT CaseType=LinStatic P=-491.24999552127 V2=1.15282466919143
 V3=0 T=0 M2=0 M3=-224.569622785439 S11Max=856.167741191367 PtS11Max=3 x2S11Max=0.5 x3S11Max=-0.5 _
 S11Min=-1838.66773223391 PtS11Min=1 x2S11Min=-0.5 x3S11Min=-0.5 FrameElem=63 ElemStation=0
 Frame=63 Station=0 OutputCase=TERRLAT CaseType=LinStatic P=1.16978526421008E-07 V2=-56.7691384854991
 V3=0 T=0 M2=0 M3=13.3699386407234 S11Max=80.2196319613188 PtS11Max=1 x2S11Max=-0.5 x3S11Max=-0.5 _
 S11Min=-80.2196317273617 PtS11Min=3 x2S11Min=0.5 x3S11Min=-0.5 FrameElem=63 ElemStation=0
 Frame=63 Station=0.5 OutputCase=TERRLAT CaseType=LinStatic P=-6.49919595536285E-08 V2=-33.8719510045595
 V3=0 T=0 M2=0 M3=35.9413828877086 S11Max=215.648297261259 PtS11Max=1 x2S11Max=-0.5 x3S11Max=-0.5 _
 S11Min=-215.648297391243 PtS11Min=3 x2S11Min=0.5 x3S11Min=-0.5 FrameElem=63 ElemStation=0.5
 Frame=63 Station=0 OutputCase=ACCLATDX CaseType=LinStatic P=0 V2=0 V3=0 T=0 M2=0 M3=0
 S11Max=0 PtS11Max=0 x2S11Max=0 x3S11Max=0 S11Min=0 PtS11Min=0 x2S11Min=0 x3S11Min=0 FrameElem=63
 ElemStation=0
 Frame=63 Station=0.5 OutputCase=ACCLATDX CaseType=LinStatic P=0 V2=0 V3=0 T=0 M2=0 M3=0
 S11Max=0 PtS11Max=0 x2S11Max=0 x3S11Max=0 S11Min=0 PtS11Min=0 x2S11Min=0 x3S11Min=0 FrameElem=63
 ElemStation=0.5
 Frame=63 Station=0 OutputCase=ACCLATSX CaseType=LinStatic P=0 V2=0 V3=0 T=0 M2=0 M3=0
 S11Max=0 PtS11Max=0 x2S11Max=0 x3S11Max=0 S11Min=0 PtS11Min=0 x2S11Min=0 x3S11Min=0 FrameElem=63
 ElemStation=0
 Frame=63 Station=0.5 OutputCase=ACCLATSX CaseType=LinStatic P=0 V2=0 V3=0 T=0 M2=0 M3=0
 S11Max=0 PtS11Max=0 x2S11Max=0 x3S11Max=0 S11Min=0 PtS11Min=0 x2S11Min=0 x3S11Min=0 FrameElem=63
 ElemStation=0.5
 Frame=63 Station=0 OutputCase=TERRCOST CaseType=LinStatic P=0 V2=0 V3=0 T=0 M2=0 M3=0
 S11Max=0 PtS11Max=0 x2S11Max=0 x3S11Max=0 S11Min=0 PtS11Min=0 x2S11Min=0 x3S11Min=0 FrameElem=63
 ElemStation=0
 Frame=63 Station=0.5 OutputCase=TERRCOST CaseType=LinStatic P=0 V2=0 V3=0 T=0 M2=0 M3=0
 S11Max=0 PtS11Max=0 x2S11Max=0 x3S11Max=0 S11Min=0 PtS11Min=0 x2S11Min=0 x3S11Min=0 FrameElem=63
 ElemStation=0.5
 Frame=63 Station=0 OutputCase=SOVRCOST CaseType=LinStatic P=0 V2=0 V3=0 T=0 M2=0 M3=0
 S11Max=0 PtS11Max=0 x2S11Max=0 x3S11Max=0 S11Min=0 PtS11Min=0 x2S11Min=0 x3S11Min=0 FrameElem=63
 ElemStation=0
 Frame=63 Station=0.5 OutputCase=SOVRCOST CaseType=LinStatic P=0 V2=0 V3=0 T=0 M2=0 M3=0
 S11Max=0 PtS11Max=0 x2S11Max=0 x3S11Max=0 S11Min=0 PtS11Min=0 x2S11Min=0 x3S11Min=0 FrameElem=63
 ElemStation=0.5
 Frame=63 Station=0 OutputCase=ENVE CaseType=Combination StepType=Max P=-641.249994102535 V2=-
 53.756520198987 V3=0 T=0 M2=0 M3=-284.793164738067 S11Max=1091.57488384408 PtS11Max=3 x2S11Max=0.5
 x3S11Max=-0.5 _
 S11Min=-2350.00898253094 PtS11Min=1 x2S11Min=-0.5 x3S11Min=-0.5 FrameElem=63 ElemStation=0
 Frame=63 Station=0.5 OutputCase=ENVE CaseType=Combination StepType=Max P=-628.749994265008 V2=-
 37.7284888629882 V3=0 T=0 M2=0 M3=-255.212658886348 S11Max=967.220448250957 PtS11Max=3 x2S11Max=0.5
 x3S11Max=-0.5 _
 S11Min=-2160.0259476026 PtS11Min=1 x2S11Min=-0.5 x3S11Min=-0.5 FrameElem=63 ElemStation=0.5
 Frame=63 Station=0 OutputCase=ENVE CaseType=Combination StepType=Min P=-641.249994137629 V2=-
 70.7872617446367 V3=0 T=0 M2=0 M3=-288.804146330284 S11Max=1067.50899432587 PtS11Max=3 x2S11Max=0.5
 x3S11Max=-0.5 _
 S11Min=-2374.07487211933 PtS11Min=1 x2S11Min=-0.5 x3S11Min=-0.5 FrameElem=63 ElemStation=0
 Frame=63 Station=0.5 OutputCase=ENVE CaseType=Combination StepType=Min P=-628.749994284506 V2=-
 47.8900741643561 V3=0 T=0 M2=0 M3=-265.995073752661 S11Max=902.525959033584 PtS11Max=3 x2S11Max=0.5
 x3S11Max=-0.5 _
 S11Min=-2224.72043678097 PtS11Min=1 x2S11Min=-0.5 x3S11Min=-0.5 FrameElem=63 ElemStation=0.5
 Frame=63 Station=0 OutputCase=FESSUR CaseType=Combination P=-641.249994102535 V2=-70.7872617446367
 V3=0 T=0 M2=0 M3=-284.793164738067 S11Max=1067.50899432587 PtS11Max=3 x2S11Max=0.5 x3S11Max=-0.5 _
 S11Min=-2350.00898253094 PtS11Min=1 x2S11Min=-0.5 x3S11Min=-0.5 FrameElem=63 ElemStation=0
 Frame=63 Station=0.5 OutputCase=FESSUR CaseType=Combination P=-628.749994284506 V2=-47.8900741643561
 V3=0 T=0 M2=0 M3=-255.212658886348 S11Max=902.525959033584 PtS11Max=3 x2S11Max=0.5 x3S11Max=-0.5 _
 S11Min=-2160.0259476026 PtS11Min=1 x2S11Min=-0.5 x3S11Min=-0.5 FrameElem=63 ElemStation=0.5
 Frame=64 Station=0 OutputCase=PESOPR CaseType=LinStatic P=-137.499998698215 V2=-15.1709478289881 V3=0
 T=0 M2=0 M3=-66.5844189886175 S11Max=262.00651523349 PtS11Max=3 x2S11Max=0.5 x3S11Max=-0.5 _
 S11Min=-537.00651262992 PtS11Min=1 x2S11Min=-0.5 x3S11Min=-0.5 FrameElem=64 ElemStation=0
 Frame=64 Station=0.5 OutputCase=PESOPR CaseType=LinStatic P=-124.999998698215 V2=-15.170947729647
 V3=0 T=0 M2=0 M3=-58.9989450989587 S11Max=228.993671895538 PtS11Max=3 x2S11Max=0.5 x3S11Max=-0.5 _
 S11Min=-478.993669291967 PtS11Min=1 x2S11Min=-0.5 x3S11Min=-0.5 FrameElem=64 ElemStation=0.5
 Frame=64 Station=0 OutputCase=TERRVERT CaseType=LinStatic P=-491.24999552127 V2=1.15282466919143 V3=0
 T=0 M2=0 M3=-224.569622785439 S11Max=856.167741191366 PtS11Max=3 x2S11Max=0.5 x3S11Max=-0.5 _



S11Min=-1838.66773223391 PtS11Min=1 x2S11Min=-0.5 x3S11Min=-0.5 FrameElem=64 ElemStation=0
 Frame=64 Station=0.5 OutputCase=TERRVERT CaseType=LinStatic P=-491.24999552127 V2=1.15282466919143
 V3=0 T=0 M2=0 M3=-225.146035120035 S11Max=859.62621519894 PtS11Max=3 x2S11Max=0.5 x3S11Max=-0.5 _
 S11Min=-1842.12620624148 PtS11Min=1 x2S11Min=-0.5 x3S11Min=-0.5 FrameElem=64 ElemStation=0.5
 Frame=64 Station=0 OutputCase=TERRLAT CaseType=LinStatic P=-6.49920366413426E-08 V2=-33.8719510045596
 V3=0 T=0 M2=0 M3=35.9413828877086 S11Max=215.648297261259 PtS11Max=1 x2S11Max=-0.5 x3S11Max=-0.5 _
 S11Min=-215.648297391244 PtS11Min=3 x2S11Min=0.5 x3S11Min=-0.5 FrameElem=64 ElemStation=0
 Frame=64 Station=0.5 OutputCase=TERRLAT CaseType=LinStatic P=-2.30019921690749E-07 V2=-13.106638536327
 V3=0 T=0 M2=0 M3=47.5972021474008 S11Max=285.583212654385 PtS11Max=1 x2S11Max=-0.5 x3S11Max=-0.5 _
 S11Min=-285.583213114425 PtS11Min=3 x2S11Min=0.5 x3S11Min=-0.5 FrameElem=64 ElemStation=0.5
 Frame=64 Station=0 OutputCase=ACCLATDX CaseType=LinStatic P=0 V2=0 V3=0 T=0 M2=0 M3=0
 S11Max=0 PtS11Max=0 x2S11Max=0 x3S11Max=0 S11Min=0 PtS11Min=0 x2S11Min=0 x3S11Min=0 FrameElem=64
 ElemStation=0
 Frame=64 Station=0.5 OutputCase=ACCLATDX CaseType=LinStatic P=0 V2=0 V3=0 T=0 M2=0 M3=0
 S11Max=0 PtS11Max=0 x2S11Max=0 x3S11Max=0 S11Min=0 PtS11Min=0 x2S11Min=0 x3S11Min=0 FrameElem=64
 ElemStation=0.5
 Frame=64 Station=0 OutputCase=ACCLATSX CaseType=LinStatic P=0 V2=0 V3=0 T=0 M2=0 M3=0
 S11Max=0 PtS11Max=0 x2S11Max=0 x3S11Max=0 S11Min=0 PtS11Min=0 x2S11Min=0 x3S11Min=0 FrameElem=64
 ElemStation=0
 Frame=64 Station=0.5 OutputCase=ACCLATSX CaseType=LinStatic P=0 V2=0 V3=0 T=0 M2=0 M3=0
 S11Max=0 PtS11Max=0 x2S11Max=0 x3S11Max=0 S11Min=0 PtS11Min=0 x2S11Min=0 x3S11Min=0 FrameElem=64
 ElemStation=0.5
 Frame=64 Station=0 OutputCase=TERRCOST CaseType=LinStatic P=0 V2=0 V3=0 T=0 M2=0 M3=0
 S11Max=0 PtS11Max=0 x2S11Max=0 x3S11Max=0 S11Min=0 PtS11Min=0 x2S11Min=0 x3S11Min=0 FrameElem=64
 ElemStation=0
 Frame=64 Station=0.5 OutputCase=TERRCOST CaseType=LinStatic P=0 V2=0 V3=0 T=0 M2=0 M3=0
 S11Max=0 PtS11Max=0 x2S11Max=0 x3S11Max=0 S11Min=0 PtS11Min=0 x2S11Min=0 x3S11Min=0 FrameElem=64
 ElemStation=0.5
 Frame=64 Station=0 OutputCase=SOVRCOST CaseType=LinStatic P=0 V2=0 V3=0 T=0 M2=0 M3=0
 S11Max=0 PtS11Max=0 x2S11Max=0 x3S11Max=0 S11Min=0 PtS11Min=0 x2S11Min=0 x3S11Min=0 FrameElem=64
 ElemStation=0
 Frame=64 Station=0.5 OutputCase=SOVRCOST CaseType=LinStatic P=0 V2=0 V3=0 T=0 M2=0 M3=0
 S11Max=0 PtS11Max=0 x2S11Max=0 x3S11Max=0 S11Min=0 PtS11Min=0 x2S11Min=0 x3S11Min=0 FrameElem=64
 ElemStation=0.5
 Frame=64 Station=0 OutputCase=ENVE CaseType=Combination StepType=Max P=-628.749994264979 V2=-
 37.7284888629884 V3=0 T=0 M2=0 M3=-255.212658886348 S11Max=967.220448250986 PtS11Max=3 x2S11Max=0.5
 x3S11Max=-0.5 _
 S11Min=-2160.02594760257 PtS11Min=1 x2S11Min=-0.5 x3S11Min=-0.5 FrameElem=64 ElemStation=0
 Frame=64 Station=0.5 OutputCase=ENVE CaseType=Combination StepType=Max P=-616.249994380498 V2=-
 23.1927700358845 V3=0 T=0 M2=0 M3=-236.547778071593 S11Max=888.711637914381 PtS11Max=3 x2S11Max=0.5
 x3S11Max=-0.5 _
 S11Min=-2035.53666287906 PtS11Min=1 x2S11Min=-0.5 x3S11Min=-0.5 FrameElem=64 ElemStation=0.5
 Frame=64 Station=0 OutputCase=ENVE CaseType=Combination StepType=Min P=-628.749994284477 V2=-
 47.8900741643563 V3=0 T=0 M2=0 M3=-265.995073752661 S11Max=902.525959033613 PtS11Max=3 x2S11Max=0.5
 x3S11Max=-0.5 _
 S11Min=-2224.72043678094 PtS11Min=1 x2S11Min=-0.5 x3S11Min=-0.5 FrameElem=64 ElemStation=0
 Frame=64 Station=0.5 OutputCase=ENVE CaseType=Combination StepType=Min P=-616.249994449504 V2=-
 27.1247615967826 V3=0 T=0 M2=0 M3=-250.826938715813 S11Max=803.036673980053 PtS11Max=3 x2S11Max=0.5
 x3S11Max=-0.5 _
 S11Min=-2121.21162667538 PtS11Min=1 x2S11Min=-0.5 x3S11Min=-0.5 FrameElem=64 ElemStation=0.5
 Frame=64 Station=0 OutputCase=FESSUR CaseType=Combination P=-628.749994284477 V2=-47.8900741643563
 V3=0 T=0 M2=0 M3=-255.212658886348 S11Max=902.525959033613 PtS11Max=3 x2S11Max=0.5 x3S11Max=-0.5 _
 S11Min=-2160.02594760257 PtS11Min=1 x2S11Min=-0.5 x3S11Min=-0.5 FrameElem=64 ElemStation=0
 Frame=64 Station=0.5 OutputCase=FESSUR CaseType=Combination P=-616.249994449504 V2=-27.1247615967826
 V3=0 T=0 M2=0 M3=-236.547778071593 S11Max=803.036673980053 PtS11Max=3 x2S11Max=0.5 x3S11Max=-0.5 _
 S11Min=-2035.53666287906 PtS11Min=1 x2S11Min=-0.5 x3S11Min=-0.5 FrameElem=64 ElemStation=0.5
 Frame=65 Station=0 OutputCase=PESOPR CaseType=LinStatic P=-124.999998698098 V2=-15.170947229647 V3=0
 T=0 M2=0 M3=-58.9989450989588 S11Max=228.993671895655 PtS11Max=3 x2S11Max=0.5 x3S11Max=-0.5 _
 S11Min=-478.993669291851 PtS11Min=1 x2S11Min=-0.5 x3S11Min=-0.5 FrameElem=65 ElemStation=0
 Frame=65 Station=0.5 OutputCase=PESOPR CaseType=LinStatic P=-112.499998698098 V2=-15.1709476303059
 V3=0 T=0 M2=0 M3=-51.4134712589706 S11Max=195.980828855725 PtS11Max=3 x2S11Max=0.5 x3S11Max=-0.5 _
 S11Min=-420.980826251922 PtS11Min=1 x2S11Min=-0.5 x3S11Min=-0.5 FrameElem=65 ElemStation=0.5
 Frame=65 Station=0 OutputCase=TERRVERT CaseType=LinStatic P=-491.24999552092 V2=1.15282466919098 V3=0
 T=0 M2=0 M3=-225.146035120035 S11Max=859.626215199292 PtS11Max=3 x2S11Max=0.5 x3S11Max=-0.5 _
 S11Min=-1842.12620624113 PtS11Min=1 x2S11Min=-0.5 x3S11Min=-0.5 FrameElem=65 ElemStation=0
 Frame=65 Station=0.5 OutputCase=TERRVERT CaseType=LinStatic P=-491.24999552092 V2=1.15282466919098
 V3=0 T=0 M2=0 M3=-225.146035120035 S11Max=859.626215199292 PtS11Max=3 x2S11Max=0.5 x3S11Max=-0.5 _
 S11Min=-1845.58468024871 PtS11Min=1 x2S11Min=-0.5 x3S11Min=-0.5 FrameElem=65 ElemStation=0.5
 Frame=65 Station=0 OutputCase=TERRLAT CaseType=LinStatic P=-2.30020077651716E-07 V2=-13.1066385363272
 V3=0 T=0 M2=0 M3=47.5972021474009 S11Max=285.583212654386 PtS11Max=1 x2S11Max=-0.5 x3S11Max=-0.5 _
 S11Min=-285.583213114426 PtS11Min=3 x2S11Min=0.5 x3S11Min=-0.5 FrameElem=65 ElemStation=0
 Frame=65 Station=0.5 OutputCase=TERRLAT CaseType=LinStatic P=-3.78105341439106E-07 V2=5.52679891919844
 V3=0 T=0 M2=0 M3=49.403339261537 S11Max=296.420003178817 PtS11Max=1 x2S11Max=-0.5 x3S11Max=-0.5 _
 S11Min=-296.420003935027 PtS11Min=3 x2S11Min=0.5 x3S11Min=-0.5 FrameElem=65 ElemStation=0.5
 Frame=65 Station=0 OutputCase=ACCLATDX CaseType=LinStatic P=0 V2=0 V3=0 T=0 M2=0 M3=0
 S11Max=0 PtS11Max=0 x2S11Max=0 x3S11Max=0 S11Min=0 PtS11Min=0 x2S11Min=0 x3S11Min=0 FrameElem=65
 ElemStation=0
 Frame=65 Station=0.5 OutputCase=ACCLATDX CaseType=LinStatic P=0 V2=0 V3=0 T=0 M2=0 M3=0
 S11Max=0 PtS11Max=0 x2S11Max=0 x3S11Max=0 S11Min=0 PtS11Min=0 x2S11Min=0 x3S11Min=0 FrameElem=65
 ElemStation=0.5



Frame=65 Station=0 OutputCase=ACCLATSX CaseType=LinStatic P=0 V2=0 V3=0 T=0 M2=0 M3=0
 S11Max=0 PtS11Max=0 x2S11Max=0 x3S11Max=0 S11Min=0 PtS11Min=0 x2S11Min=0 x3S11Min=0 FrameElem=65
 ElemStation=0
 Frame=65 Station=0.5 OutputCase=ACCLATSX CaseType=LinStatic P=0 V2=0 V3=0 T=0 M2=0 M3=0
 S11Max=0 PtS11Max=0 x2S11Max=0 x3S11Max=0 S11Min=0 PtS11Min=0 x2S11Min=0 x3S11Min=0 FrameElem=65
 ElemStation=0.5
 Frame=65 Station=0 OutputCase=TERRCOST CaseType=LinStatic P=0 V2=0 V3=0 T=0 M2=0 M3=0
 S11Max=0 PtS11Max=0 x2S11Max=0 x3S11Max=0 S11Min=0 PtS11Min=0 x2S11Min=0 x3S11Min=0 FrameElem=65
 ElemStation=0
 Frame=65 Station=0.5 OutputCase=TERRCOST CaseType=LinStatic P=0 V2=0 V3=0 T=0 M2=0 M3=0
 S11Max=0 PtS11Max=0 x2S11Max=0 x3S11Max=0 S11Min=0 PtS11Min=0 x2S11Min=0 x3S11Min=0 FrameElem=65
 ElemStation=0.5
 Frame=65 Station=0 OutputCase=SOVRCOST CaseType=LinStatic P=0 V2=0 V3=0 T=0 M2=0 M3=0
 S11Max=0 PtS11Max=0 x2S11Max=0 x3S11Max=0 S11Min=0 PtS11Min=0 x2S11Min=0 x3S11Min=0 FrameElem=65
 ElemStation=0
 Frame=65 Station=0.5 OutputCase=SOVRCOST CaseType=LinStatic P=0 V2=0 V3=0 T=0 M2=0 M3=0
 S11Max=0 PtS11Max=0 x2S11Max=0 x3S11Max=0 S11Min=0 PtS11Min=0 x2S11Min=0 x3S11Min=0 FrameElem=65
 ElemStation=0.5
 Frame=65 Station=0 OutputCase=ENVE CaseType=Combination StepType=Max P=-616.249994380033 V2=-
 23.192770035885 V3=0 T=0 M2=0 M3=-236.547778071593 S11Max=888.711637914849 PtS11Max=3 x2S11Max=0.5
 x3S11Max=-0.5 _
 S11Min=-2035.5366628786 PtS11Min=1 x2S11Min=-0.5 x3S11Min=-0.5 FrameElem=65 ElemStation=0
 Frame=65 Station=0.5 OutputCase=ENVE CaseType=Combination StepType=Max P=-603.749994483693 V2=-
 8.49132404191647 V3=0 T=0 M2=0 M3=-227.732584787448 S11Max=851.571515308071 PtS11Max=3 x2S11Max=0.5
 x3S11Max=-0.5 _
 S11Min=-1970.14550332181 PtS11Min=1 x2S11Min=-0.5 x3S11Min=-0.5 FrameElem=65 ElemStation=0.5
 Frame=65 Station=0 OutputCase=ENVE CaseType=Combination StepType=Min P=-616.24999449039 V2=-
 27.1247615967832 V3=0 T=0 M2=0 M3=-250.826938715814 S11Max=803.036673980521 PtS11Max=3 x2S11Max=0.5
 x3S11Max=-0.5 _
 S11Min=-2121.21162667491 PtS11Min=1 x2S11Min=-0.5 x3S11Min=-0.5 FrameElem=65 ElemStation=0
 Frame=65 Station=0.5 OutputCase=ENVE CaseType=Combination StepType=Min P=-603.749994597124 V2=-
 10.149363717676 V3=0 T=0 M2=0 M3=-242.553584965294 S11Max=762.645514127563 PtS11Max=3 x2S11Max=0.5
 x3S11Max=-0.5 _
 S11Min=-2059.07150427546 PtS11Min=1 x2S11Min=-0.5 x3S11Min=-0.5 FrameElem=65 ElemStation=0.5
 Frame=65 Station=0 OutputCase=FESSUR CaseType=Combination P=-616.249994449039 V2=-27.1247615967832
 V3=0 T=0 M2=0 M3=-236.547778071593 S11Max=803.036673980521 PtS11Max=3 x2S11Max=0.5 x3S11Max=-0.5 _
 S11Min=-2035.5366628786 PtS11Min=1 x2S11Min=-0.5 x3S11Min=-0.5 FrameElem=65 ElemStation=0
 Frame=65 Station=0.5 OutputCase=FESSUR CaseType=Combination P=-603.749994597124 V2=-8.49132404191647
 V3=0 T=0 M2=0 M3=-227.732584787448 S11Max=762.645514127563 PtS11Max=3 x2S11Max=0.5 x3S11Max=-0.5 _
 S11Min=-1970.14550332181 PtS11Min=1 x2S11Min=-0.5 x3S11Min=-0.5 FrameElem=65 ElemStation=0.5
 Frame=66 Station=0 OutputCase=PESOPR CaseType=LinStatic P=-112.499998698011 V2=-15.1709476303055 V3=0
 T=0 M2=0 M3=-51.4134712589706 S11Max=195.980828855812 PtS11Max=3 x2S11Max=0.5 x3S11Max=-0.5 _
 S11Min=-420.980826251835 PtS11Min=1 x2S11Min=-0.5 x3S11Min=-0.5 FrameElem=66 ElemStation=0
 Frame=66 Station=0.5 OutputCase=PESOPR CaseType=LinStatic P=-99.999998698011 V2=-15.1709475309644
 V3=0 T=0 M2=0 M3=-43.8279974686531 S11Max=162.967986113908 PtS11Max=3 x2S11Max=0.5 x3S11Max=-0.5 _
 S11Min=-362.96798350993 PtS11Min=1 x2S11Min=-0.5 x3S11Min=-0.5 FrameElem=66 ElemStation=0.5
 Frame=66 Station=0 OutputCase=TERRVERT CaseType=LinStatic P=-491.24999552092 V2=1.15282466919234 V3=0
 T=0 M2=0 M3=-225.722447454631 S11Max=863.084689206866 PtS11Max=3 x2S11Max=0.5 x3S11Max=-0.5 _
 S11Min=-1845.58468024871 PtS11Min=1 x2S11Min=-0.5 x3S11Min=-0.5 FrameElem=66 ElemStation=0
 Frame=66 Station=0.5 OutputCase=TERRVERT CaseType=LinStatic P=-491.24999552092 V2=1.15282466919234
 V3=0 T=0 M2=0 M3=-226.298859789227 S11Max=866.543163214443 PtS11Max=3 x2S11Max=0.5 x3S11Max=-0.5 _
 S11Min=-1849.04315425628 PtS11Min=1 x2S11Min=-0.5 x3S11Min=-0.5 FrameElem=66 ElemStation=0.5
 Frame=66 Station=0 OutputCase=TERRLAT CaseType=LinStatic P=-3.78105596610112E-07 V2=5.52679891919843
 V3=0 T=0 M2=0 M3=49.4033339261536 S11Max=296.420003178816 PtS11Max=1 x2S11Max=-0.5 x3S11Max=-0.5 _
 S11Min=-296.420003935027 PtS11Min=3 x2S11Min=0.5 x3S11Min=-0.5 FrameElem=66 ElemStation=0
 Frame=66 Station=0.5 OutputCase=TERRLAT CaseType=LinStatic P=-5.09248224479153E-07 V2=22.0283613620171
 V3=0 T=0 M2=0 M3=42.4257157303202 S11Max=254.554293872673 PtS11Max=1 x2S11Max=-0.5 x3S11Max=-0.5 _
 S11Min=-254.55429489117 PtS11Min=3 x2S11Min=0.5 x3S11Min=-0.5 FrameElem=66 ElemStation=0.5
 Frame=66 Station=0 OutputCase=ACCLATDX CaseType=LinStatic P=0 V2=0 V3=0 T=0 M2=0 M3=0
 S11Max=0 PtS11Max=0 x2S11Max=0 x3S11Max=0 S11Min=0 PtS11Min=0 x2S11Min=0 x3S11Min=0 FrameElem=66
 ElemStation=0
 Frame=66 Station=0.5 OutputCase=ACCLATDX CaseType=LinStatic P=0 V2=0 V3=0 T=0 M2=0 M3=0
 S11Max=0 PtS11Max=0 x2S11Max=0 x3S11Max=0 S11Min=0 PtS11Min=0 x2S11Min=0 x3S11Min=0 FrameElem=66
 ElemStation=0.5
 Frame=66 Station=0 OutputCase=ACCLATSX CaseType=LinStatic P=0 V2=0 V3=0 T=0 M2=0 M3=0
 S11Max=0 PtS11Max=0 x2S11Max=0 x3S11Max=0 S11Min=0 PtS11Min=0 x2S11Min=0 x3S11Min=0 FrameElem=66
 ElemStation=0
 Frame=66 Station=0.5 OutputCase=ACCLATSX CaseType=LinStatic P=0 V2=0 V3=0 T=0 M2=0 M3=0
 S11Max=0 PtS11Max=0 x2S11Max=0 x3S11Max=0 S11Min=0 PtS11Min=0 x2S11Min=0 x3S11Min=0 FrameElem=66
 ElemStation=0.5
 Frame=66 Station=0 OutputCase=TERRCOST CaseType=LinStatic P=0 V2=0 V3=0 T=0 M2=0 M3=0
 S11Max=0 PtS11Max=0 x2S11Max=0 x3S11Max=0 S11Min=0 PtS11Min=0 x2S11Min=0 x3S11Min=0 FrameElem=66
 ElemStation=0
 Frame=66 Station=0.5 OutputCase=TERRCOST CaseType=LinStatic P=0 V2=0 V3=0 T=0 M2=0 M3=0
 S11Max=0 PtS11Max=0 x2S11Max=0 x3S11Max=0 S11Min=0 PtS11Min=0 x2S11Min=0 x3S11Min=0 FrameElem=66
 ElemStation=0.5
 Frame=66 Station=0 OutputCase=SOVRCOST CaseType=LinStatic P=0 V2=0 V3=0 T=0 M2=0 M3=0
 S11Max=0 PtS11Max=0 x2S11Max=0 x3S11Max=0 S11Min=0 PtS11Min=0 x2S11Min=0 x3S11Min=0 FrameElem=66
 ElemStation=0
 Frame=66 Station=0.5 OutputCase=SOVRCOST CaseType=LinStatic P=0 V2=0 V3=0 T=0 M2=0 M3=0
 S11Max=0 PtS11Max=0 x2S11Max=0 x3S11Max=0 S11Min=0 PtS11Min=0 x2S11Min=0 x3S11Min=0 FrameElem=66
 ElemStation=0.5

Frame=66 Station=0 OutputCase=ENVE CaseType=Combination StepType=Max P=-603.749994483605 V2=-8.49132404191471 V3=0 T=0 M2=0 M3=-227.732584787448 S11Max=851.571515308159 PtS11Max=3 x2S11Max=0.5 x3S11Max=-0.5
 S11Min=-1970.14550332173 PtS11Min=1 x2S11Min=-0.5 x3S11Min=-0.5 FrameElem=66 ElemStation=0
 Frame=66 Station=0.5 OutputCase=ENVE CaseType=Combination StepType=Max P=-591.249994575405 V2=8.01023850024501 V3=0 T=0 M2=0 M3=-227.70114152756 S11Max=851.323142904532 PtS11Max=3 x2S11Max=0.5 x3S11Max=-0.5
 S11Min=-1957.45684389354 PtS11Min=1 x2S11Min=-0.5 x3S11Min=-0.5 FrameElem=66 ElemStation=0.5
 Frame=66 Station=0 OutputCase=ENVE CaseType=Combination StepType=Min P=-603.749994597037 V2=-10.1493637176742 V3=0 T=0 M2=0 M3=-242.553584965294 S11Max=762.645514127651 PtS11Max=3 x2S11Max=0.5 x3S11Max=-0.5
 S11Min=-2059.07150427537 PtS11Min=1 x2S11Min=-0.5 x3S11Min=-0.5 FrameElem=66 ElemStation=0
 Frame=66 Station=0.5 OutputCase=ENVE CaseType=Combination StepType=Min P=-591.24999472818 V2=1.40173009163989 V3=0 T=0 M2=0 M3=-240.428856246656 S11Max=774.956854437181 PtS11Max=3 x2S11Max=0.5 x3S11Max=-0.5
 S11Min=-2033.82313205534 PtS11Min=1 x2S11Min=-0.5 x3S11Min=-0.5 FrameElem=66 ElemStation=0.5
 Frame=66 Station=0 OutputCase=FESSUR CaseType=Combination P=-603.749994597037 V2=-8.49132404191471 V3=0 T=0 M2=0 M3=-227.732584787448 S11Max=762.645514127651 PtS11Max=3 x2S11Max=0.5 x3S11Max=-0.5
 S11Min=-1970.14550332173 PtS11Min=1 x2S11Min=-0.5 x3S11Min=-0.5 FrameElem=66 ElemStation=0
 Frame=66 Station=0.5 OutputCase=FESSUR CaseType=Combination P=-591.24999472818 V2=8.01023850024501 V3=0 T=0 M2=0 M3=-227.70114152756 S11Max=774.956854437181 PtS11Max=3 x2S11Max=0.5 x3S11Max=-0.5
 S11Min=-1957.45684389354 PtS11Min=1 x2S11Min=-0.5 x3S11Min=-0.5 FrameElem=66 ElemStation=0.5
 Frame=67 Station=0 OutputCase=PESOPR CaseType=LinStatic P=-99.9999986979819 V2=-15.1709475309647 V3=0 T=0 M2=0 M3=-43.827997468653 S11Max=162.967986113936 PtS11Max=3 x2S11Max=0.5 x3S11Max=-0.5
 S11Min=-362.9679835099 PtS11Min=1 x2S11Min=-0.5 x3S11Min=-0.5 FrameElem=67 ElemStation=0
 Frame=67 Station=0.5 OutputCase=PESOPR CaseType=LinStatic P=-87.4999986979819 V2=-15.1709474316236 V3=0 T=0 M2=0 M3=-36.242523728006 S11Max=129.955143670054 PtS11Max=3 x2S11Max=0.5 x3S11Max=-0.5
 S11Min=-304.955141066018 PtS11Min=1 x2S11Min=-0.5 x3S11Min=-0.5 FrameElem=67 ElemStation=0.5
 Frame=67 Station=0 OutputCase=TERRVERT CaseType=LinStatic P=-491.2499952092 V2=1.1528246691928 V3=0 T=0 M2=0 M3=-226.298859789227 S11Max=866.543163214439 PtS11Max=3 x2S11Max=0.5 x3S11Max=-0.5
 S11Min=-1849.04315425628 PtS11Min=1 x2S11Min=-0.5 x3S11Min=-0.5 FrameElem=67 ElemStation=0
 Frame=67 Station=0.5 OutputCase=TERRVERT CaseType=LinStatic P=-491.2499952092 V2=1.1528246691928 V3=0 T=0 M2=0 M3=-226.875272123823 S11Max=870.001637222018 PtS11Max=3 x2S11Max=0.5 x3S11Max=-0.5
 S11Min=-1852.50162826386 PtS11Min=1 x2S11Min=-0.5 x3S11Min=-0.5 FrameElem=67 ElemStation=0.5
 Frame=67 Station=0 OutputCase=TERRLAT CaseType=LinStatic P=-5.09248593516531E-07 V2=22.0283613620169 V3=0 T=0 M2=0 M3=42.4257157303202 S11Max=254.554293872672 PtS11Max=1 x2S11Max=-0.5 x3S11Max=-0.5
 S11Min=-254.554294891169 PtS11Min=3 x2S11Min=0.5 x3S11Min=-0.5 FrameElem=67 ElemStation=0
 Frame=67 Station=0.5 OutputCase=TERRLAT CaseType=LinStatic P=-6.2344860201704E-07 V2=36.3980487921286 V3=0 T=0 M2=0 M3=27.7302850662543 S11Max=166.381709774077 PtS11Max=1 x2S11Max=-0.5 x3S11Max=-0.5
 S11Min=-166.381711020975 PtS11Min=3 x2S11Min=0.5 x3S11Min=-0.5 FrameElem=67 ElemStation=0.5
 Frame=67 Station=0 OutputCase=ACCLATDX CaseType=LinStatic P=0 V2=0 V3=0 T=0 M2=0 M3=0 S11Max=0 PtS11Max=0 x2S11Max=0 x3S11Max=0 S11Min=0 PtS11Min=0 x2S11Min=0 x3S11Min=0 FrameElem=67 ElemStation=0
 Frame=67 Station=0.5 OutputCase=ACCLATDX CaseType=LinStatic P=0 V2=0 V3=0 T=0 M2=0 M3=0 S11Max=0 PtS11Max=0 x2S11Max=0 x3S11Max=0 S11Min=0 PtS11Min=0 x2S11Min=0 x3S11Min=0 FrameElem=67 ElemStation=0.5
 Frame=67 Station=0 OutputCase=ACCLATSX CaseType=LinStatic P=0 V2=0 V3=0 T=0 M2=0 M3=0 S11Max=0 PtS11Max=0 x2S11Max=0 x3S11Max=0 S11Min=0 PtS11Min=0 x2S11Min=0 x3S11Min=0 FrameElem=67 ElemStation=0
 Frame=67 Station=0.5 OutputCase=ACCLATSX CaseType=LinStatic P=0 V2=0 V3=0 T=0 M2=0 M3=0 S11Max=0 PtS11Max=0 x2S11Max=0 x3S11Max=0 S11Min=0 PtS11Min=0 x2S11Min=0 x3S11Min=0 FrameElem=67 ElemStation=0.5
 Frame=67 Station=0 OutputCase=TERRCOST CaseType=LinStatic P=0 V2=0 V3=0 T=0 M2=0 M3=0 S11Max=0 PtS11Max=0 x2S11Max=0 x3S11Max=0 S11Min=0 PtS11Min=0 x2S11Min=0 x3S11Min=0 FrameElem=67 ElemStation=0
 Frame=67 Station=0.5 OutputCase=TERRCOST CaseType=LinStatic P=0 V2=0 V3=0 T=0 M2=0 M3=0 S11Max=0 PtS11Max=0 x2S11Max=0 x3S11Max=0 S11Min=0 PtS11Min=0 x2S11Min=0 x3S11Min=0 FrameElem=67 ElemStation=0.5
 Frame=67 Station=0 OutputCase=SOVRCOST CaseType=LinStatic P=0 V2=0 V3=0 T=0 M2=0 M3=0 S11Max=0 PtS11Max=0 x2S11Max=0 x3S11Max=0 S11Min=0 PtS11Min=0 x2S11Min=0 x3S11Min=0 FrameElem=67 ElemStation=0
 Frame=67 Station=0.5 OutputCase=SOVRCOST CaseType=LinStatic P=0 V2=0 V3=0 T=0 M2=0 M3=0 S11Max=0 PtS11Max=0 x2S11Max=0 x3S11Max=0 S11Min=0 PtS11Min=0 x2S11Min=0 x3S11Min=0 FrameElem=67 ElemStation=0.5
 Frame=67 Station=0 OutputCase=ENVE CaseType=Combination StepType=Max P=-591.249994575376 V2=8.01023850024501 V3=0 T=0 M2=0 M3=-227.70114152756 S11Max=851.323142904557 PtS11Max=3 x2S11Max=0.5 x3S11Max=-0.5
 S11Min=-1957.45684389351 PtS11Min=1 x2S11Min=-0.5 x3S11Min=-0.5 FrameElem=67 ElemStation=0
 Frame=67 Station=0.5 OutputCase=ENVE CaseType=Combination StepType=Max P=-578.749994655316 V2=22.3799260296978 V3=0 T=0 M2=0 M3=-235.387510785575 S11Max=883.489583177389 PtS11Max=3 x2S11Max=0.5 x3S11Max=-0.5
 S11Min=-1991.0750595558 PtS11Min=1 x2S11Min=-0.5 x3S11Min=-0.5 FrameElem=67 ElemStation=0.5
 Frame=67 Station=0 OutputCase=ENVE CaseType=Combination StepType=Min P=-591.249994728151 V2=1.40173009163994 V3=0 T=0 M2=0 M3=-240.428856246656 S11Max=774.956854437206 PtS11Max=3 x2S11Max=0.5 x3S11Max=-0.5
 S11Min=-2033.82313205531 PtS11Min=1 x2S11Min=-0.5 x3S11Min=-0.5 FrameElem=67 ElemStation=0
 Frame=67 Station=0.5 OutputCase=ENVE CaseType=Combination StepType=Min P=-578.749994842351 V2=11.4605113920592 V3=0 T=0 M2=0 M3=-243.706596305451 S11Max=833.575069871097 PtS11Max=3 x2S11Max=0.5 x3S11Max=-0.5
 S11Min=-2040.98957248802 PtS11Min=1 x2S11Min=-0.5 x3S11Min=-0.5 FrameElem=67 ElemStation=0.5
 Frame=67 Station=0 OutputCase=FESSUR CaseType=Combination P=-591.249994728151 V2=8.01023850024501 V3=0 T=0 M2=0 M3=-227.70114152756 S11Max=774.956854437206 PtS11Max=3 x2S11Max=0.5 x3S11Max=-0.5



S11Min=-1957.45684389351 PtS11Min=1 x2S11Min=-0.5 x3S11Min=-0.5 FrameElem=67 ElemStation=0
 Frame=67 Station=0.5 OutputCase=FESSUR CaseType=Combination P=-578.749994842351 V2=22.3799260296978
 V3=0 T=0 M2=0 M3=-235.387510785575 S11Max=833.575069871097 PtS11Max=3 x2S11Max=0.5 x3S11Max=-0.5
 S11Min=-1991.0750595558 PtS11Min=1 x2S11Min=-0.5 x3S11Min=-0.5 FrameElem=67 ElemStation=0.5
 Frame=68 Station=0 OutputCase=PESOPR CaseType=LinStatic P=-87.4999986980984 V2=-15.170947316233 V3=0
 T=0 M2=0 M3=-36.2425237280065 S11Max=129.955143669941 PtS11Max=3 x2S11Max=0.5 x3S11Max=-0.5
 S11Min=-304.955141066138 PtS11Min=1 x2S11Min=-0.5 x3S11Min=-0.5 FrameElem=68 ElemStation=0
 Frame=68 Station=0.5 OutputCase=PESOPR CaseType=LinStatic P=-74.9999986980984 V2=-15.170947322823
 V3=0 T=0 M2=0 M3=-28.6570500370301 S11Max=96.9423015240825 PtS11Max=3 x2S11Max=0.5 x3S11Max=-0.5
 S11Min=-246.942298920279 PtS11Min=1 x2S11Min=-0.5 x3S11Min=-0.5 FrameElem=68 ElemStation=0.5
 Frame=68 Station=0 OutputCase=TERRVERT CaseType=LinStatic P=-491.24999552092 V2=1.15282466919189 V3=0
 T=0 M2=0 M3=-226.875272123825 S11Max=870.001637222033 PtS11Max=3 x2S11Max=0.5 x3S11Max=-0.5
 S11Min=-1852.50162826387 PtS11Min=1 x2S11Min=-0.5 x3S11Min=-0.5 FrameElem=68 ElemStation=0
 Frame=68 Station=0.5 OutputCase=TERRVERT CaseType=LinStatic P=-491.24999552092 V2=1.15282466919189
 V3=0 T=0 M2=0 M3=-227.451684458421 S11Max=873.460111229608 PtS11Max=3 x2S11Max=0.5 x3S11Max=-0.5
 S11Min=-1855.96010227145 PtS11Min=1 x2S11Min=-0.5 x3S11Min=-0.5 FrameElem=68 ElemStation=0.5
 Frame=68 Station=0 OutputCase=TERRLAT CaseType=LinStatic P=-6.23448386249947E-07 V2=36.3980487921285
 V3=0 T=0 M2=0 M3=27.7302850662542 S11Max=166.381709774077 PtS11Max=1 x2S11Max=-0.5 x3S11Max=-0.5
 S11Min=-166.381711020973 PtS11Min=3 x2S11Min=-0.5 x3S11Min=-0.5 FrameElem=68 ElemStation=0
 Frame=68 Station=0.5 OutputCase=TERRLAT CaseType=LinStatic P=-7.20705786251286E-07 V2=48.6358612095332
 V3=0 T=0 M2=0 M3=6.38297944030927 S11Max=38.2978759211498 PtS11Max=1 x2S11Max=-0.5 x3S11Max=-0.5
 S11Min=-38.2978773625614 PtS11Min=3 x2S11Min=-0.5 x3S11Min=-0.5 FrameElem=68 ElemStation=0.5
 Frame=68 Station=0 OutputCase=ACCLATDX CaseType=LinStatic P=0 V2=0 V3=0 T=0 M2=0 M3=0
 S11Max=0 PtS11Max=0 x2S11Max=0 x3S11Max=0 S11Min=0 PtS11Min=0 x2S11Min=0 x3S11Min=0 FrameElem=68
 ElemStation=0
 Frame=68 Station=0.5 OutputCase=ACCLATDX CaseType=LinStatic P=0 V2=0 V3=0 T=0 M2=0 M3=0
 S11Max=0 PtS11Max=0 x2S11Max=0 x3S11Max=0 S11Min=0 PtS11Min=0 x2S11Min=0 x3S11Min=0 FrameElem=68
 ElemStation=0.5
 Frame=68 Station=0 OutputCase=ACCLATSX CaseType=LinStatic P=0 V2=0 V3=0 T=0 M2=0 M3=0
 S11Max=0 PtS11Max=0 x2S11Max=0 x3S11Max=0 S11Min=0 PtS11Min=0 x2S11Min=0 x3S11Min=0 FrameElem=68
 ElemStation=0
 Frame=68 Station=0.5 OutputCase=ACCLATSX CaseType=LinStatic P=0 V2=0 V3=0 T=0 M2=0 M3=0
 S11Max=0 PtS11Max=0 x2S11Max=0 x3S11Max=0 S11Min=0 PtS11Min=0 x2S11Min=0 x3S11Min=0 FrameElem=68
 ElemStation=0.5
 Frame=68 Station=0 OutputCase=TERRCOST CaseType=LinStatic P=0 V2=0 V3=0 T=0 M2=0 M3=0
 S11Max=0 PtS11Max=0 x2S11Max=0 x3S11Max=0 S11Min=0 PtS11Min=0 x2S11Min=0 x3S11Min=0 FrameElem=68
 ElemStation=0
 Frame=68 Station=0.5 OutputCase=TERRCOST CaseType=LinStatic P=0 V2=0 V3=0 T=0 M2=0 M3=0
 S11Max=0 PtS11Max=0 x2S11Max=0 x3S11Max=0 S11Min=0 PtS11Min=0 x2S11Min=0 x3S11Min=0 FrameElem=68
 ElemStation=0.5
 Frame=68 Station=0 OutputCase=SOVRCOST CaseType=LinStatic P=0 V2=0 V3=0 T=0 M2=0 M3=0
 S11Max=0 PtS11Max=0 x2S11Max=0 x3S11Max=0 S11Min=0 PtS11Min=0 x2S11Min=0 x3S11Min=0 FrameElem=68
 ElemStation=0
 Frame=68 Station=0.5 OutputCase=SOVRCOST CaseType=LinStatic P=0 V2=0 V3=0 T=0 M2=0 M3=0
 S11Max=0 PtS11Max=0 x2S11Max=0 x3S11Max=0 S11Min=0 PtS11Min=0 x2S11Min=0 x3S11Min=0 FrameElem=68
 ElemStation=0.5
 Frame=68 Station=0 OutputCase=ENVE CaseType=Combination StepType=Max P=-578.749994655433
 V2=22.3799260296971 V3=0 T=0 M2=0 M3=-235.387510785578 S11Max=883.489583177292 PtS11Max=3 x2S11Max=0.5
 x3S11Max=-0.5
 S11Min=-1991.07505955593 PtS11Min=1 x2S11Min=-0.5 x3S11Min=-0.5 FrameElem=68 ElemStation=0
 Frame=68 Station=0.5 OutputCase=ENVE CaseType=Combination StepType=Max P=-566.249994723513
 V2=34.6177385464429 V3=0 T=0 M2=0 M3=-249.725755055142 S11Max=943.593898599898 PtS11Max=3 x2S11Max=0.5
 x3S11Max=-0.5
 S11Min=-2064.60452527058 PtS11Min=1 x2S11Min=-0.5 x3S11Min=-0.5 FrameElem=68 ElemStation=0.5
 Frame=68 Station=0 OutputCase=ENVE CaseType=Combination StepType=Min P=-578.749994842467
 V2=11.4605113920585 V3=0 T=0 M2=0 M3=-243.706596305454 S11Max=833.575069871 PtS11Max=3 x2S11Max=0.5
 x3S11Max=-0.5
 S11Min=-2040.98957248816 PtS11Min=1 x2S11Min=-0.5 x3S11Min=-0.5 FrameElem=68 ElemStation=0
 Frame=68 Station=0.5 OutputCase=ENVE CaseType=Combination StepType=Min P=-566.249994939725
 V2=20.0269801835829 V3=0 T=0 M2=0 M3=-251.640648887235 S11Max=932.104535391129 PtS11Max=3 x2S11Max=0.5
 x3S11Max=-0.5
 S11Min=-2076.09388804692 PtS11Min=1 x2S11Min=-0.5 x3S11Min=-0.5 FrameElem=68 ElemStation=0.5
 Frame=68 Station=0 OutputCase=FESSUR CaseType=Combination P=-578.749994842467 V2=22.3799260296971
 V3=0 T=0 M2=0 M3=-235.387510785578 S11Max=833.575069871 PtS11Max=3 x2S11Max=0.5 x3S11Max=-0.5
 S11Min=-1991.07505955593 PtS11Min=1 x2S11Min=-0.5 x3S11Min=-0.5 FrameElem=68 ElemStation=0
 Frame=68 Station=0.5 OutputCase=FESSUR CaseType=Combination P=-566.249994939725 V2=34.6177385464429
 V3=0 T=0 M2=0 M3=-249.725755055142 S11Max=932.104535391129 PtS11Max=3 x2S11Max=0.5 x3S11Max=-0.5
 S11Min=-2064.60452527058 PtS11Min=1 x2S11Min=-0.5 x3S11Min=-0.5 FrameElem=68 ElemStation=0.5

TABLE: "ELEMENT STRESSES - FRAMES"

Frame=1	Station=0	OutputCase=PESOPR	CaseType=LinStatic	Point=0	X2=0	X3=0	S11=-15.1709467362365
IsS11Max=No	IsS11Min=No	FrameElem=1	ElemStation=0				
Frame=1	Station=0	OutputCase=PESOPR	CaseType=LinStatic	Point=1	X2=-0.5	X3=-0.5	S11=475.36122790845
IsS11Max=Yes	IsS11Min=No	FrameElem=1	ElemStation=0				
Frame=1	Station=0	OutputCase=PESOPR	CaseType=LinStatic	Point=2	X2=-0.5	X3=0.5	S11=475.36122790845
IsS11Max=No	IsS11Min=No	FrameElem=1	ElemStation=0				
Frame=1	Station=0	OutputCase=PESOPR	CaseType=LinStatic	Point=3	X2=0.5	X3=-0.5	S11=-505.703121380923
IsS11Max=No	IsS11Min=Yes	FrameElem=1	ElemStation=0				
Frame=1	Station=0	OutputCase=PESOPR	CaseType=LinStatic	Point=4	X2=0.5	X3=0.5	S11=-505.703121380923
IsS11Max=No	IsS11Min=No	FrameElem=1	ElemStation=0				
Frame=1	Station=6.24999940395355E-02	OutputCase=PESOPR	CaseType=LinStatic	Point=0	X2=0	X3=0	S11=-15.1709467362365
IsS11Max=No	IsS11Min=No	FrameElem=1	ElemStation=6.24999940395355E-02				



Frame=1 Station=6.24999940395355E-02 OutputCase=PESOPR CaseType=LinStatic Point=1 X2=-0.5 X3=-0.5
 S11=418.427311619635 IsS11Max=Yes IsS11Min=No FrameElem=1 ElemStation=6.24999940395355E-02
 Frame=1 Station=6.24999940395355E-02 OutputCase=PESOPR CaseType=LinStatic Point=2 X2=-0.5 X3=0.5
 S11=418.427311619635 IsS11Max=No IsS11Min=No FrameElem=1 ElemStation=6.24999940395355E-02
 Frame=1 Station=6.24999940395355E-02 OutputCase=PESOPR CaseType=LinStatic Point=3 X2=0.5 X3=-0.5
 S11=-448.769205092108 IsS11Max=No IsS11Min=Yes FrameElem=1 ElemStation=6.24999940395355E-02
 Frame=1 Station=6.24999940395355E-02 OutputCase=PESOPR CaseType=LinStatic Point=4 X2=0.5 X3=0.5
 S11=-448.769205092108 IsS11Max=No IsS11Min=No FrameElem=1 ElemStation=6.24999940395355E-02
 Frame=1 Station=0.124999988079071 OutputCase=PESOPR CaseType=LinStatic Point=0 X2=0 X3=0 S11=-
 15.1709467362365 IsS11Max=No IsS11Min=No FrameElem=1 ElemStation=0.124999988079071
 Frame=1 Station=0.124999988079071 OutputCase=PESOPR CaseType=LinStatic Point=1 X2=-0.5 X3=-0.5
 S11=360.907457942578 IsS11Max=Yes IsS11Min=No FrameElem=1 ElemStation=0.124999988079071
 Frame=1 Station=0.124999988079071 OutputCase=PESOPR CaseType=LinStatic Point=2 X2=-0.5 X3=0.5
 S11=360.907457942578 IsS11Max=No IsS11Min=No FrameElem=1 ElemStation=0.124999988079071
 Frame=1 Station=0.124999988079071 OutputCase=PESOPR CaseType=LinStatic Point=3 X2=0.5 X3=-0.5 S11=-
 391.249351415051 IsS11Max=No IsS11Min=Yes FrameElem=1 ElemStation=0.124999988079071
 Frame=1 Station=0.124999988079071 OutputCase=PESOPR CaseType=LinStatic Point=4 X2=0.5 X3=0.5 S11=-
 391.249351415051 IsS11Max=No IsS11Min=No FrameElem=1 ElemStation=0.124999988079071
 Frame=1 Station=0.187499982118607 OutputCase=PESOPR CaseType=LinStatic Point=0 X2=0 X3=0 S11=-
 15.1709467362365 IsS11Max=No IsS11Min=No FrameElem=1 ElemStation=0.187499982118607
 Frame=1 Station=0.187499982118607 OutputCase=PESOPR CaseType=LinStatic Point=1 X2=-0.5 X3=-0.5
 S11=302.80166687728 IsS11Max=Yes IsS11Min=No FrameElem=1 ElemStation=0.187499982118607
 Frame=1 Station=0.187499982118607 OutputCase=PESOPR CaseType=LinStatic Point=2 X2=-0.5 X3=0.5
 S11=302.80166687728 IsS11Max=No IsS11Min=No FrameElem=1 ElemStation=0.187499982118607
 Frame=1 Station=0.187499982118607 OutputCase=PESOPR CaseType=LinStatic Point=3 X2=0.5 X3=-0.5 S11=-
 333.143560349753 IsS11Max=No IsS11Min=Yes FrameElem=1 ElemStation=0.187499982118607
 Frame=1 Station=0.187499982118607 OutputCase=PESOPR CaseType=LinStatic Point=4 X2=0.5 X3=0.5 S11=-
 333.143560349753 IsS11Max=No IsS11Min=No FrameElem=1 ElemStation=0.187499982118607
 Frame=1 Station=0.249999976158142 OutputCase=PESOPR CaseType=LinStatic Point=0 X2=0 X3=0 S11=-
 15.1709467362365 IsS11Max=No IsS11Min=No FrameElem=1 ElemStation=0.249999976158142
 Frame=1 Station=0.249999976158142 OutputCase=PESOPR CaseType=LinStatic Point=1 X2=-0.5 X3=-0.5
 S11=244.109938423741 IsS11Max=Yes IsS11Min=No FrameElem=1 ElemStation=0.249999976158142
 Frame=1 Station=0.249999976158142 OutputCase=PESOPR CaseType=LinStatic Point=2 X2=-0.5 X3=0.5
 S11=244.109938423741 IsS11Max=No IsS11Min=No FrameElem=1 ElemStation=0.249999976158142
 Frame=1 Station=0.249999976158142 OutputCase=PESOPR CaseType=LinStatic Point=3 X2=0.5 X3=-0.5 S11=-
 274.451831896214 IsS11Max=No IsS11Min=Yes FrameElem=1 ElemStation=0.249999976158142
 Frame=1 Station=0.249999976158142 OutputCase=PESOPR CaseType=LinStatic Point=4 X2=0.5 X3=0.5 S11=-
 274.451831896214 IsS11Max=No IsS11Min=No FrameElem=1 ElemStation=0.249999976158142
 Frame=1 Station=0 OutputCase=TERRVERT CaseType=LinStatic Point=0 X2=0 X3=0 S11=1.15282857329472
 IsS11Max=No IsS11Min=No FrameElem=1 ElemStation=0
 Frame=1 Station=0 OutputCase=TERRVERT CaseType=LinStatic Point=1 X2=-0.5 X3=-0.5
 S11=1341.65352935784 IsS11Max=Yes IsS11Min=No FrameElem=1 ElemStation=0
 Frame=1 Station=0 OutputCase=TERRVERT CaseType=LinStatic Point=2 X2=-0.5 X3=0.5
 S11=1341.65352935784 IsS11Max=No IsS11Min=No FrameElem=1 ElemStation=0
 Frame=1 Station=0 OutputCase=TERRVERT CaseType=LinStatic Point=3 X2=0.5 X3=-0.5 S11=-
 1339.34787221125 IsS11Max=No IsS11Min=Yes FrameElem=1 ElemStation=0
 Frame=1 Station=0 OutputCase=TERRVERT CaseType=LinStatic Point=4 X2=0.5 X3=0.5 S11=-
 1339.34787221125 IsS11Max=No IsS11Min=No FrameElem=1 ElemStation=0
 Frame=1 Station=6.24999940395355E-02 OutputCase=TERRVERT CaseType=LinStatic Point=0 X2=0 X3=0
 S11=1.15282857329472 IsS11Max=No IsS11Min=No FrameElem=1 ElemStation=6.24999940395355E-02
 Frame=1 Station=6.24999940395355E-02 OutputCase=TERRVERT CaseType=LinStatic Point=1 X2=-0.5 X3=-0.5
 S11=1166.90184554241 IsS11Max=Yes IsS11Min=No FrameElem=1 ElemStation=6.24999940395355E-02
 Frame=1 Station=6.24999940395355E-02 OutputCase=TERRVERT CaseType=LinStatic Point=2 X2=-0.5 X3=0.5
 S11=1166.90184554241 IsS11Max=No IsS11Min=No FrameElem=1 ElemStation=6.24999940395355E-02
 Frame=1 Station=6.24999940395355E-02 OutputCase=TERRVERT CaseType=LinStatic Point=3 X2=0.5 X3=-0.5
 S11=-1164.59618839582 IsS11Max=No IsS11Min=Yes FrameElem=1 ElemStation=6.24999940395355E-02
 Frame=1 Station=6.24999940395355E-02 OutputCase=TERRVERT CaseType=LinStatic Point=4 X2=0.5 X3=0.5
 S11=-1164.59618839582 IsS11Max=No IsS11Min=No FrameElem=1 ElemStation=6.24999940395355E-02
 Frame=1 Station=0.124999988079071 OutputCase=TERRVERT CaseType=LinStatic Point=0 X2=0 X3=0
 S11=1.15282857329472 IsS11Max=No IsS11Min=No FrameElem=1 ElemStation=0.124999988079071
 Frame=1 Station=0.124999988079071 OutputCase=TERRVERT CaseType=LinStatic Point=1 X2=-0.5 X3=-0.5
 S11=992.150161726977 IsS11Max=Yes IsS11Min=No FrameElem=1 ElemStation=0.124999988079071
 Frame=1 Station=0.124999988079071 OutputCase=TERRVERT CaseType=LinStatic Point=2 X2=-0.5 X3=0.5
 S11=992.150161726977 IsS11Max=No IsS11Min=No FrameElem=1 ElemStation=0.124999988079071
 Frame=1 Station=0.124999988079071 OutputCase=TERRVERT CaseType=LinStatic Point=3 X2=0.5 X3=-0.5
 S11=-989.844504580387 IsS11Max=No IsS11Min=Yes FrameElem=1 ElemStation=0.124999988079071
 Frame=1 Station=0.124999988079071 OutputCase=TERRVERT CaseType=LinStatic Point=4 X2=0.5 X3=0.5
 S11=-989.844504580387 IsS11Max=No IsS11Min=No FrameElem=1 ElemStation=0.124999988079071
 Frame=1 Station=0.187499982118607 OutputCase=TERRVERT CaseType=LinStatic Point=0 X2=0 X3=0
 S11=1.15282857329472 IsS11Max=No IsS11Min=No FrameElem=1 ElemStation=0.187499982118607
 Frame=1 Station=0.187499982118607 OutputCase=TERRVERT CaseType=LinStatic Point=1 X2=-0.5 X3=-0.5
 S11=817.398477911547 IsS11Max=Yes IsS11Min=No FrameElem=1 ElemStation=0.187499982118607
 Frame=1 Station=0.187499982118607 OutputCase=TERRVERT CaseType=LinStatic Point=2 X2=-0.5 X3=0.5
 S11=817.398477911547 IsS11Max=No IsS11Min=No FrameElem=1 ElemStation=0.187499982118607
 Frame=1 Station=0.187499982118607 OutputCase=TERRVERT CaseType=LinStatic Point=3 X2=0.5 X3=-0.5
 S11=-815.092820764957 IsS11Max=No IsS11Min=Yes FrameElem=1 ElemStation=0.187499982118607
 Frame=1 Station=0.187499982118607 OutputCase=TERRVERT CaseType=LinStatic Point=4 X2=0.5 X3=0.5
 S11=-815.092820764957 IsS11Max=No IsS11Min=No FrameElem=1 ElemStation=0.187499982118607
 Frame=1 Station=0.249999976158142 OutputCase=TERRVERT CaseType=LinStatic Point=0 X2=0 X3=0
 S11=1.15282857329472 IsS11Max=No IsS11Min=No FrameElem=1 ElemStation=0.249999976158142
 Frame=1 Station=0.249999976158142 OutputCase=TERRVERT CaseType=LinStatic Point=1 X2=-0.5 X3=-0.5
 S11=642.646794096117 IsS11Max=Yes IsS11Min=No FrameElem=1 ElemStation=0.249999976158142

```

Frame=1 Station=0.249999976158142 OutputCase=SOVRCOST CaseType=LinStatic Point=0 X2=0 X3=0 S11=0
IsS11Max=Yes IsS11Min=Yes FrameElem=1 ElemStation=0.249999976158142
Frame=1 Station=0.249999976158142 OutputCase=SOVRCOST CaseType=LinStatic Point=1 X2=-0.5 X3=-0.5
S11=0 IsS11Max=No IsS11Min=No FrameElem=1 ElemStation=0.249999976158142
Frame=1 Station=0.249999976158142 OutputCase=SOVRCOST CaseType=LinStatic Point=2 X2=-0.5 X3=0.5
S11=0 IsS11Max=No IsS11Min=No FrameElem=1 ElemStation=0.249999976158142
Frame=1 Station=0.249999976158142 OutputCase=SOVRCOST CaseType=LinStatic Point=3 X2=0.5 X3=-0.5
S11=0 IsS11Max=No IsS11Min=No FrameElem=1 ElemStation=0.249999976158142
Frame=1 Station=0.249999976158142 OutputCase=SOVRCOST CaseType=LinStatic Point=4 X2=0.5 X3=0.5
S11=0 IsS11Max=No IsS11Min=No FrameElem=1 ElemStation=0.249999976158142
Frame=1 Station=0 OutputCase=ENVE CaseType=Combination StepType=Max Point=0 X2=0 X3=0 S11=-
90.2888588483431 IsS11Max=No IsS11Min=No FrameElem=1 ElemStation=0
Frame=1 Station=0 OutputCase=ENVE CaseType=Combination StepType=Max Point=1 X2=-0.5 X3=-0.5
S11=1835.15497285272 IsS11Max=Yes IsS11Min=No FrameElem=1 ElemStation=0
Frame=1 Station=0 OutputCase=ENVE CaseType=Combination StepType=Max Point=2 X2=-0.5 X3=0.5
S11=1835.15497285272 IsS11Max=No IsS11Min=No FrameElem=1 ElemStation=0
Frame=1 Station=0 OutputCase=ENVE CaseType=Combination StepType=Max Point=3 X2=0.5 X3=-0.5 S11=-
2010.29062587347 IsS11Max=No IsS11Min=Yes FrameElem=1 ElemStation=0
Frame=1 Station=0 OutputCase=ENVE CaseType=Combination StepType=Max Point=4 X2=0.5 X3=0.5 S11=-
2010.29062587347 IsS11Max=No IsS11Min=No FrameElem=1 ElemStation=0
Frame=1 Station=6.24999940395355E-02 OutputCase=ENVE CaseType=Combination StepType=Max Point=0 X2=0
X3=0 S11=-90.2888588483431 IsS11Max=No IsS11Min=No FrameElem=1 ElemStation=6.24999940395355E-02
Frame=1 Station=6.24999940395355E-02 OutputCase=ENVE CaseType=Combination StepType=Max Point=1 X2=-
0.5 X3=-0.5 S11=1603.45181450132 IsS11Max=Yes IsS11Min=No FrameElem=1 ElemStation=6.24999940395355E-02
Frame=1 Station=6.24999940395355E-02 OutputCase=ENVE CaseType=Combination StepType=Max Point=2 X2=-
0.5 X3=0.5 S11=1603.45181450132 IsS11Max=No IsS11Min=No FrameElem=1 ElemStation=6.24999940395355E-02
Frame=1 Station=6.24999940395355E-02 OutputCase=ENVE CaseType=Combination StepType=Max Point=3 X2=0.5
X3=-0.5 S11=-1778.59273499622 IsS11Max=No IsS11Min=Yes FrameElem=1 ElemStation=6.24999940395355E-02
Frame=1 Station=6.24999940395355E-02 OutputCase=ENVE CaseType=Combination StepType=Max Point=4 X2=0.5
X3=0.5 S11=-1778.59273499622 IsS11Max=No IsS11Min=No FrameElem=1 ElemStation=6.24999940395355E-02
Frame=1 Station=0.124999988079071 OutputCase=ENVE CaseType=Combination StepType=Max Point=0 X2=0
X3=0 S11=-90.2888588483431 IsS11Max=No IsS11Min=No FrameElem=1 ElemStation=0.124999988079071
Frame=1 Station=0.124999988079071 OutputCase=ENVE CaseType=Combination StepType=Max Point=1 X2=-0.5
X3=-0.5 S11=1371.16271876169 IsS11Max=Yes IsS11Min=No FrameElem=1 ElemStation=0.124999988079071
Frame=1 Station=0.124999988079071 OutputCase=ENVE CaseType=Combination StepType=Max Point=2 X2=-0.5
X3=0.5 S11=1371.16271876169 IsS11Max=No IsS11Min=No FrameElem=1 ElemStation=0.124999988079071
Frame=1 Station=0.124999988079071 OutputCase=ENVE CaseType=Combination StepType=Max Point=3 X2=0.5
X3=-0.5 S11=-1546.30890673073 IsS11Max=No IsS11Min=Yes FrameElem=1 ElemStation=0.124999988079071
Frame=1 Station=0.124999988079071 OutputCase=ENVE CaseType=Combination StepType=Max Point=4 X2=0.5
X3=0.5 S11=-1546.30890673073 IsS11Max=No IsS11Min=No FrameElem=1 ElemStation=0.124999988079071
Frame=1 Station=0.187499982118607 OutputCase=ENVE CaseType=Combination StepType=Max Point=0 X2=0
X3=0 S11=-90.2888588483431 IsS11Max=No IsS11Min=No FrameElem=1 ElemStation=0.187499982118607
Frame=1 Station=0.187499982118607 OutputCase=ENVE CaseType=Combination StepType=Max Point=1 X2=-0.5
X3=-0.5 S11=1138.28768563381 IsS11Max=Yes IsS11Min=No FrameElem=1 ElemStation=0.187499982118607
Frame=1 Station=0.187499982118607 OutputCase=ENVE CaseType=Combination StepType=Max Point=2 X2=-0.5
X3=0.5 S11=1138.28768563381 IsS11Max=No IsS11Min=No FrameElem=1 ElemStation=0.187499982118607
Frame=1 Station=0.187499982118607 OutputCase=ENVE CaseType=Combination StepType=Max Point=3 X2=0.5
X3=-0.5 S11=-1313.439141077 IsS11Max=No IsS11Min=Yes FrameElem=1 ElemStation=0.187499982118607
Frame=1 Station=0.187499982118607 OutputCase=ENVE CaseType=Combination StepType=Max Point=4 X2=0.5
X3=0.5 S11=-1313.439141077 IsS11Max=No IsS11Min=No FrameElem=1 ElemStation=0.187499982118607
Frame=1 Station=0.249999976158142 OutputCase=ENVE CaseType=Combination StepType=Max Point=0 X2=0
X3=0 S11=-90.2888588483431 IsS11Max=No IsS11Min=No FrameElem=1 ElemStation=0.249999976158142
Frame=1 Station=0.249999976158142 OutputCase=ENVE CaseType=Combination StepType=Max Point=1 X2=-0.5
X3=-0.5 S11=904.826715117693 IsS11Max=Yes IsS11Min=No FrameElem=1 ElemStation=0.249999976158142
Frame=1 Station=0.249999976158142 OutputCase=ENVE CaseType=Combination StepType=Max Point=2 X2=-0.5
X3=0.5 S11=904.826715117693 IsS11Max=No IsS11Min=No FrameElem=1 ElemStation=0.249999976158142
Frame=1 Station=0.249999976158142 OutputCase=ENVE CaseType=Combination StepType=Max Point=3 X2=0.5
X3=-0.5 S11=-1079.98343803503 IsS11Max=No IsS11Min=Yes FrameElem=1 ElemStation=0.249999976158142
Frame=1 Station=0.249999976158142 OutputCase=ENVE CaseType=Combination StepType=Max Point=4 X2=0.5
X3=0.5 S11=-1079.98343803503 IsS11Max=No IsS11Min=No FrameElem=1 ElemStation=0.249999976158142
Frame=1 Station=0 OutputCase=ENVE CaseType=Combination StepType=Min Point=0 X2=0 X3=0 S11=-
122.976319142087 IsS11Max=No IsS11Min=No FrameElem=1 ElemStation=0
Frame=1 Station=0 OutputCase=ENVE CaseType=Combination StepType=Min Point=1 X2=-0.5 X3=-0.5
S11=1829.71290817679 IsS11Max=Yes IsS11Min=No FrameElem=1 ElemStation=0
Frame=1 Station=0 OutputCase=ENVE CaseType=Combination StepType=Min Point=2 X2=-0.5 X3=0.5
S11=1829.71290817679 IsS11Max=No IsS11Min=No FrameElem=1 ElemStation=0
Frame=1 Station=0 OutputCase=ENVE CaseType=Combination StepType=Min Point=3 X2=0.5 X3=-0.5 S11=-
2081.10761113689 IsS11Max=No IsS11Min=Yes FrameElem=1 ElemStation=0
Frame=1 Station=0 OutputCase=ENVE CaseType=Combination StepType=Min Point=4 X2=0.5 X3=0.5 S11=-
2081.10761113689 IsS11Max=No IsS11Min=No FrameElem=1 ElemStation=0
Frame=1 Station=6.24999940395355E-02 OutputCase=ENVE CaseType=Combination StepType=Min Point=0 X2=0
X3=0 S11=-122.976319142087 IsS11Max=No IsS11Min=No FrameElem=1 ElemStation=6.24999940395355E-02
Frame=1 Station=6.24999940395355E-02 OutputCase=ENVE CaseType=Combination StepType=Min Point=1 X2=-
0.5 X3=-0.5 S11=1598.01501729954 IsS11Max=Yes IsS11Min=No FrameElem=1 ElemStation=6.24999940395355E-02
Frame=1 Station=6.24999940395355E-02 OutputCase=ENVE CaseType=Combination StepType=Min Point=2 X2=-
0.5 X3=0.5 S11=1598.01501729954 IsS11Max=No IsS11Min=No FrameElem=1 ElemStation=6.24999940395355E-02
Frame=1 Station=6.24999940395355E-02 OutputCase=ENVE CaseType=Combination StepType=Min Point=3 X2=0.5
X3=-0.5 S11=-1849.4044527855 IsS11Max=No IsS11Min=Yes FrameElem=1 ElemStation=6.24999940395355E-02
Frame=1 Station=6.24999940395355E-02 OutputCase=ENVE CaseType=Combination StepType=Min Point=4 X2=0.5
X3=0.5 S11=-1849.4044527855 IsS11Max=No IsS11Min=No FrameElem=1 ElemStation=6.24999940395355E-02
Frame=1 Station=0.124999988079071 OutputCase=ENVE CaseType=Combination StepType=Min Point=0 X2=0
X3=0 S11=-122.976319142087 IsS11Max=No IsS11Min=No FrameElem=1 ElemStation=0.124999988079071

```

Frame=2	Station=0	OutputCase=PESOPR	CaseType=LinStatic	Point=2	X2=-0.5	X3=0.5	S11=244.109938423798
IsS11Max=No	IsS11Min=No	FrameElem=2	ElemStation=0				
Frame=2	Station=0	OutputCase=PESOPR	CaseType=LinStatic	Point=3	X2=0.5	X3=-0.5	S11=-274.451831896271
IsS11Max=No	IsS11Min=Yes	FrameElem=2	ElemStation=0				
Frame=2	Station=0	OutputCase=PESOPR	CaseType=LinStatic	Point=4	X2=0.5	X3=0.5	S11=-274.451831896271
IsS11Max=No	IsS11Min=No	FrameElem=2	ElemStation=0				
Frame=2	Station=0.0625	OutputCase=PESOPR	CaseType=LinStatic	Point=0	X2=0	X3=0	S11=-15.1709467362365
IsS11Max=No	IsS11Min=No	FrameElem=2	ElemStation=0.0625				
Frame=2	Station=0.0625	OutputCase=PESOPR	CaseType=LinStatic	Point=1	X2=-0.5	X3=-0.5	S11=193.390428619468
IsS11Max=Yes	IsS11Min=No	FrameElem=2	ElemStation=0.0625				
Frame=2	Station=0.0625	OutputCase=PESOPR	CaseType=LinStatic	Point=2	X2=-0.5	X3=0.5	S11=193.390428619468
IsS11Max=No	IsS11Min=No	FrameElem=2	ElemStation=0.0625				
Frame=2	Station=0.0625	OutputCase=PESOPR	CaseType=LinStatic	Point=3	X2=0.5	X3=-0.5	S11=-223.732322091941
IsS11Max=No	IsS11Min=Yes	FrameElem=2	ElemStation=0.0625				
Frame=2	Station=0.0625	OutputCase=PESOPR	CaseType=LinStatic	Point=4	X2=0.5	X3=0.5	S11=-223.732322091941
IsS11Max=No	IsS11Min=No	FrameElem=2	ElemStation=0.0625				
Frame=2	Station=0.125	OutputCase=PESOPR	CaseType=LinStatic	Point=0	X2=0	X3=0	S11=-15.1709467362365
IsS11Max=No	IsS11Min=No	FrameElem=2	ElemStation=0.125				
Frame=2	Station=0.125	OutputCase=PESOPR	CaseType=LinStatic	Point=1	X2=-0.5	X3=-0.5	S11=142.084981315138
IsS11Max=Yes	IsS11Min=No	FrameElem=2	ElemStation=0.125				
Frame=2	Station=0.125	OutputCase=PESOPR	CaseType=LinStatic	Point=2	X2=-0.5	X3=0.5	S11=142.084981315138
IsS11Max=No	IsS11Min=No	FrameElem=2	ElemStation=0.125				
Frame=2	Station=0.125	OutputCase=PESOPR	CaseType=LinStatic	Point=3	X2=0.5	X3=-0.5	S11=-172.426874787611
IsS11Max=No	IsS11Min=Yes	FrameElem=2	ElemStation=0.125				
Frame=2	Station=0.125	OutputCase=PESOPR	CaseType=LinStatic	Point=4	X2=0.5	X3=0.5	S11=-172.426874787611
IsS11Max=No	IsS11Min=No	FrameElem=2	ElemStation=0.125				
Frame=2	Station=0.1875	OutputCase=PESOPR	CaseType=LinStatic	Point=0	X2=0	X3=0	S11=-15.1709467362365
IsS11Max=No	IsS11Min=No	FrameElem=2	ElemStation=0.1875				
Frame=2	Station=0.1875	OutputCase=PESOPR	CaseType=LinStatic	Point=1	X2=-0.5	X3=-0.5	S11=90.1935965108074
IsS11Max=Yes	IsS11Min=No	FrameElem=2	ElemStation=0.1875				
Frame=2	Station=0.1875	OutputCase=PESOPR	CaseType=LinStatic	Point=2	X2=-0.5	X3=0.5	S11=90.1935965108074
IsS11Max=No	IsS11Min=No	FrameElem=2	ElemStation=0.1875				
Frame=2	Station=0.1875	OutputCase=PESOPR	CaseType=LinStatic	Point=3	X2=0.5	X3=-0.5	S11=-120.53548998328
IsS11Max=No	IsS11Min=Yes	FrameElem=2	ElemStation=0.1875				
Frame=2	Station=0.1875	OutputCase=PESOPR	CaseType=LinStatic	Point=4	X2=0.5	X3=0.5	S11=-120.53548998328
IsS11Max=No	IsS11Min=No	FrameElem=2	ElemStation=0.1875				
Frame=2	Station=0.25	OutputCase=PESOPR	CaseType=LinStatic	Point=0	X2=0	X3=0	S11=-15.1709467362365
IsS11Max=No	IsS11Min=No	FrameElem=2	ElemStation=0.25				
Frame=2	Station=0.25	OutputCase=PESOPR	CaseType=LinStatic	Point=1	X2=-0.5	X3=-0.5	S11=37.7162742064771
IsS11Max=Yes	IsS11Min=No	FrameElem=2	ElemStation=0.25				
Frame=2	Station=0.25	OutputCase=PESOPR	CaseType=LinStatic	Point=2	X2=-0.5	X3=0.5	S11=37.7162742064771
IsS11Max=No	IsS11Min=No	FrameElem=2	ElemStation=0.25				
Frame=2	Station=0.25	OutputCase=PESOPR	CaseType=LinStatic	Point=3	X2=0.5	X3=-0.5	S11=-68.0581676789501
IsS11Max=No	IsS11Min=Yes	FrameElem=2	ElemStation=0.25				
Frame=2	Station=0.25	OutputCase=PESOPR	CaseType=LinStatic	Point=4	X2=0.5	X3=0.5	S11=-68.0581676789501
IsS11Max=No	IsS11Min=No	FrameElem=2	ElemStation=0.25				
Frame=2	Station=0	OutputCase=TERRVERT	CaseType=LinStatic	Point=0	X2=0	X3=0	S11=1.15282857329472
IsS11Max=No	IsS11Min=No	FrameElem=2	ElemStation=0				
Frame=2	Station=0	OutputCase=TERRVERT	CaseType=LinStatic	Point=1	X2=-0.5	X3=-0.5	S11=642.646794096307
IsS11Max=Yes	IsS11Min=No	FrameElem=2	ElemStation=0				
Frame=2	Station=0	OutputCase=TERRVERT	CaseType=LinStatic	Point=2	X2=-0.5	X3=0.5	S11=642.646794096307
IsS11Max=No	IsS11Min=No	FrameElem=2	ElemStation=0				
Frame=2	Station=0	OutputCase=TERRVERT	CaseType=LinStatic	Point=3	X2=0.5	X3=-0.5	S11=-640.341136949717
IsS11Max=No	IsS11Min=Yes	FrameElem=2	ElemStation=0				
Frame=2	Station=0	OutputCase=TERRVERT	CaseType=LinStatic	Point=4	X2=0.5	X3=0.5	S11=-640.341136949717
IsS11Max=No	IsS11Min=No	FrameElem=2	ElemStation=0				
Frame=2	Station=0.0625	OutputCase=TERRVERT	CaseType=LinStatic	Point=0	X2=0	X3=0	S11=1.15282857329472
IsS11Max=No	IsS11Min=No	FrameElem=2	ElemStation=0.0625				
Frame=2	Station=0.0625	OutputCase=TERRVERT	CaseType=LinStatic	Point=1	X2=-0.5	X3=-0.5	S11=486.711586038176
IsS11Max=Yes	IsS11Min=No	FrameElem=2	ElemStation=0.0625				
Frame=2	Station=0.0625	OutputCase=TERRVERT	CaseType=LinStatic	Point=2	X2=-0.5	X3=0.5	S11=486.711586038176
IsS11Max=No	IsS11Min=No	FrameElem=2	ElemStation=0.0625				
Frame=2	Station=0.0625	OutputCase=TERRVERT	CaseType=LinStatic	Point=3	X2=0.5	X3=-0.5	S11=-484.405928891587
IsS11Max=No	IsS11Min=Yes	FrameElem=2	ElemStation=0.0625				
Frame=2	Station=0.0625	OutputCase=TERRVERT	CaseType=LinStatic	Point=4	X2=0.5	X3=0.5	S11=-484.405928891587
IsS11Max=No	IsS11Min=No	FrameElem=2	ElemStation=0.0625				
Frame=2	Station=0.125	OutputCase=TERRVERT	CaseType=LinStatic	Point=0	X2=0	X3=0	S11=1.15282857329472
IsS11Max=No	IsS11Min=No	FrameElem=2	ElemStation=0.125				
Frame=2	Station=0.125	OutputCase=TERRVERT	CaseType=LinStatic	Point=1	X2=-0.5	X3=-0.5	S11=330.776377980046
IsS11Max=Yes	IsS11Min=No	FrameElem=2	ElemStation=0.125				
Frame=2	Station=0.125	OutputCase=TERRVERT	CaseType=LinStatic	Point=2	X2=-0.5	X3=0.5	S11=330.776377980046
IsS11Max=No	IsS11Min=No	FrameElem=2	ElemStation=0.125				
Frame=2	Station=0.125	OutputCase=TERRVERT	CaseType=LinStatic	Point=3	X2=0.5	X3=-0.5	S11=-328.470720833457
IsS11Max=No	IsS11Min=Yes	FrameElem=2	ElemStation=0.125				
Frame=2	Station=0.125	OutputCase=TERRVERT	CaseType=LinStatic	Point=4	X2=0.5	X3=0.5	S11=-328.470720833457
IsS11Max=No	IsS11Min=No	FrameElem=2	ElemStation=0.125				
Frame=2	Station=0.1875	OutputCase=TERRVERT	CaseType=LinStatic	Point=0	X2=0	X3=0	S11=1.15282857329472
IsS11Max=No	IsS11Min=No	FrameElem=2	ElemStation=0.1875				
Frame=2	Station=0.1875	OutputCase=TERRVERT	CaseType=LinStatic	Point=1	X2=-0.5	X3=-0.5	S11=174.841169921916
IsS11Max=Yes	IsS11Min=No	FrameElem=2	ElemStation=0.1875				
Frame=2	Station=0.1875	OutputCase=TERRVERT	CaseType=LinStatic	Point=2	X2=-0.5	X3=0.5	S11=174.841169921916
IsS11Max=No	IsS11Min=No	FrameElem=2	ElemStation=0.1875				

Frame=2	Station=0.1875	OutputCase=TERRVERT	CaseType=LinStatic	Point=3	X2=0.5	X3=-0.5	S11=-
172.535512775326	IsS11Max=No	IsS11Min=Yes	FrameElem=2	ElemStation=0.1875			
Frame=2	Station=0.1875	OutputCase=TERRVERT	CaseType=LinStatic	Point=4	X2=0.5	X3=0.5	S11=-
172.535512775326	IsS11Max=No	IsS11Min=No	FrameElem=2	ElemStation=0.1875			
Frame=2	Station=0.25	OutputCase=TERRVERT	CaseType=LinStatic	Point=0	X2=0	X3=0	S11=1.15282857329472
IsS11Max=No	IsS11Min=No	FrameElem=2	ElemStation=0.25				
Frame=2	Station=0.25	OutputCase=TERRVERT	CaseType=LinStatic	Point=1	X2=-0.5	X3=-0.5	
S11=18.9059618637857	IsS11Max=Yes	IsS11Min=No	FrameElem=2	ElemStation=0.25			
Frame=2	Station=0.25	OutputCase=TERRVERT	CaseType=LinStatic	Point=2	X2=-0.5	X3=0.5	
S11=18.9059618637857	IsS11Max=No	IsS11Min=No	FrameElem=2	ElemStation=0.25			
Frame=2	Station=0.25	OutputCase=TERRVERT	CaseType=LinStatic	Point=3	X2=0.5	X3=-0.5	S11=-
16.6003047171962	IsS11Max=No	IsS11Min=Yes	FrameElem=2	ElemStation=0.25			
Frame=2	Station=0.25	OutputCase=TERRVERT	CaseType=LinStatic	Point=4	X2=0.5	X3=0.5	S11=-
16.6003047171962	IsS11Max=No	IsS11Min=No	FrameElem=2	ElemStation=0.25			
Frame=2	Station=0	OutputCase=TERRLAT	CaseType=LinStatic	Point=0	X2=0	X3=0	S11=-108.958200979145
IsS11Max=No	IsS11Min=No	FrameElem=2	ElemStation=0				
Frame=2	Station=0	OutputCase=TERRLAT	CaseType=LinStatic	Point=1	X2=-0.5	X3=-0.5	
S11=18.0699825978344	IsS11Max=Yes	IsS11Min=No	FrameElem=2	ElemStation=0			
Frame=2	Station=0	OutputCase=TERRLAT	CaseType=LinStatic	Point=2	X2=-0.5	X3=0.5	S11=18.0699825978344
IsS11Max=No	IsS11Min=No	FrameElem=2	ElemStation=0				
Frame=2	Station=0	OutputCase=TERRLAT	CaseType=LinStatic	Point=3	X2=0.5	X3=-0.5	S11=-
235.986384556124	IsS11Max=No	IsS11Min=Yes	FrameElem=2	ElemStation=0			
Frame=2	Station=0	OutputCase=TERRLAT	CaseType=LinStatic	Point=4	X2=0.5	X3=0.5	S11=-235.986384556124
IsS11Max=No	IsS11Min=No	FrameElem=2	ElemStation=0				
Frame=2	Station=0.0625	OutputCase=TERRLAT	CaseType=LinStatic	Point=0	X2=0	X3=0	S11=-
108.958200979145	IsS11Max=No	IsS11Min=No	FrameElem=2	ElemStation=0.0625			
Frame=2	Station=0.0625	OutputCase=TERRLAT	CaseType=LinStatic	Point=1	X2=-0.5	X3=-0.5	
S11=18.0274266906531	IsS11Max=Yes	IsS11Min=No	FrameElem=2	ElemStation=0.0625			
Frame=2	Station=0.0625	OutputCase=TERRLAT	CaseType=LinStatic	Point=2	X2=-0.5	X3=0.5	
S11=18.0274266906531	IsS11Max=No	IsS11Min=No	FrameElem=2	ElemStation=0.0625			
Frame=2	Station=0.0625	OutputCase=TERRLAT	CaseType=LinStatic	Point=3	X2=0.5	X3=-0.5	S11=-
235.943828648943	IsS11Max=No	IsS11Min=Yes	FrameElem=2	ElemStation=0.0625			
Frame=2	Station=0.0625	OutputCase=TERRLAT	CaseType=LinStatic	Point=4	X2=0.5	X3=0.5	S11=-
235.943828648943	IsS11Max=No	IsS11Min=No	FrameElem=2	ElemStation=0.0625			
Frame=2	Station=0.125	OutputCase=TERRLAT	CaseType=LinStatic	Point=0	X2=0	X3=0	S11=-108.958200979145
IsS11Max=No	IsS11Min=No	FrameElem=2	ElemStation=0.125				
Frame=2	Station=0.125	OutputCase=TERRLAT	CaseType=LinStatic	Point=1	X2=-0.5	X3=-0.5	
S11=17.9848707834719	IsS11Max=Yes	IsS11Min=No	FrameElem=2	ElemStation=0.125			
Frame=2	Station=0.125	OutputCase=TERRLAT	CaseType=LinStatic	Point=2	X2=-0.5	X3=0.5	
S11=17.9848707834719	IsS11Max=No	IsS11Min=No	FrameElem=2	ElemStation=0.125			
Frame=2	Station=0.125	OutputCase=TERRLAT	CaseType=LinStatic	Point=3	X2=0.5	X3=-0.5	S11=-
235.901272741761	IsS11Max=No	IsS11Min=Yes	FrameElem=2	ElemStation=0.125			
Frame=2	Station=0.125	OutputCase=TERRLAT	CaseType=LinStatic	Point=4	X2=0.5	X3=0.5	S11=-
235.901272741761	IsS11Max=No	IsS11Min=No	FrameElem=2	ElemStation=0.125			
Frame=2	Station=0.1875	OutputCase=TERRLAT	CaseType=LinStatic	Point=0	X2=0	X3=0	S11=-
108.958200979145	IsS11Max=No	IsS11Min=No	FrameElem=2	ElemStation=0.1875			
Frame=2	Station=0.1875	OutputCase=TERRLAT	CaseType=LinStatic	Point=1	X2=-0.5	X3=-0.5	
S11=17.9423148762906	IsS11Max=Yes	IsS11Min=No	FrameElem=2	ElemStation=0.1875			
Frame=2	Station=0.1875	OutputCase=TERRLAT	CaseType=LinStatic	Point=2	X2=-0.5	X3=0.5	
S11=17.9423148762906	IsS11Max=No	IsS11Min=No	FrameElem=2	ElemStation=0.1875			
Frame=2	Station=0.1875	OutputCase=TERRLAT	CaseType=LinStatic	Point=3	X2=0.5	X3=-0.5	S11=-
235.85871683458	IsS11Max=No	IsS11Min=Yes	FrameElem=2	ElemStation=0.1875			
Frame=2	Station=0.1875	OutputCase=TERRLAT	CaseType=LinStatic	Point=4	X2=0.5	X3=0.5	S11=-
235.85871683458	IsS11Max=No	IsS11Min=No	FrameElem=2	ElemStation=0.1875			
Frame=2	Station=0.25	OutputCase=TERRLAT	CaseType=LinStatic	Point=0	X2=0	X3=0	S11=-108.958200979145
IsS11Max=No	IsS11Min=No	FrameElem=2	ElemStation=0.25				
Frame=2	Station=0.25	OutputCase=TERRLAT	CaseType=LinStatic	Point=1	X2=-0.5	X3=-0.5	
S11=17.8997589691093	IsS11Max=Yes	IsS11Min=No	FrameElem=2	ElemStation=0.25			
Frame=2	Station=0.25	OutputCase=TERRLAT	CaseType=LinStatic	Point=2	X2=-0.5	X3=0.5	
S11=17.8997589691093	IsS11Max=No	IsS11Min=No	FrameElem=2	ElemStation=0.25			
Frame=2	Station=0.25	OutputCase=TERRLAT	CaseType=LinStatic	Point=3	X2=0.5	X3=-0.5	S11=-
235.816160927399	IsS11Max=No	IsS11Min=Yes	FrameElem=2	ElemStation=0.25			
Frame=2	Station=0.25	OutputCase=TERRLAT	CaseType=LinStatic	Point=4	X2=0.5	X3=0.5	S11=-
235.816160927399	IsS11Max=No	IsS11Min=No	FrameElem=2	ElemStation=0.25			
Frame=2	Station=0	OutputCase=ACCLATDX	CaseType=LinStatic	Point=0	X2=0	X3=0	S11=0
IsS11Min=Yes	FrameElem=2	ElemStation=0					IsS11Max=Yes
Frame=2	Station=0	OutputCase=ACCLATDX	CaseType=LinStatic	Point=1	X2=-0.5	X3=-0.5	S11=0
IsS11Max=No	IsS11Min=No	FrameElem=2	ElemStation=0				
Frame=2	Station=0	OutputCase=ACCLATDX	CaseType=LinStatic	Point=2	X2=-0.5	X3=0.5	S11=0
IsS11Min=No	FrameElem=2	ElemStation=0					IsS11Max=No
Frame=2	Station=0	OutputCase=ACCLATDX	CaseType=LinStatic	Point=3	X2=0.5	X3=-0.5	S11=0
IsS11Min=No	FrameElem=2	ElemStation=0					IsS11Max=No
Frame=2	Station=0	OutputCase=ACCLATDX	CaseType=LinStatic	Point=4	X2=0.5	X3=0.5	S11=0
IsS11Min=No	FrameElem=2	ElemStation=0					IsS11Max=No
Frame=2	Station=0.0625	OutputCase=ACCLATDX	CaseType=LinStatic	Point=0	X2=0	X3=0	S11=0
IsS11Max=Yes	IsS11Min=Yes	FrameElem=2	ElemStation=0.0625				
Frame=2	Station=0.0625	OutputCase=ACCLATDX	CaseType=LinStatic	Point=1	X2=-0.5	X3=-0.5	S11=0
IsS11Max=No	IsS11Min=No	FrameElem=2	ElemStation=0.0625				
Frame=2	Station=0.0625	OutputCase=ACCLATDX	CaseType=LinStatic	Point=2	X2=-0.5	X3=0.5	S11=0
IsS11Max=No	IsS11Min=No	FrameElem=2	ElemStation=0.0625				
Frame=2	Station=0.0625	OutputCase=ACCLATDX	CaseType=LinStatic	Point=3	X2=0.5	X3=-0.5	S11=0
IsS11Max=No	IsS11Min=No	FrameElem=2	ElemStation=0.0625				

Frame=2	Station=0.1875	OutputCase=SOVRCOST	CaseType=LinStatic	Point=1	X2=-0.5	X3=-0.5	S11=0
IsS11Max=No	IsS11Min=No	FrameElem=2	ElemStation=0.1875				
Frame=2	Station=0.1875	OutputCase=SOVRCOST	CaseType=LinStatic	Point=2	X2=-0.5	X3=0.5	S11=0
IsS11Max=No	IsS11Min=No	FrameElem=2	ElemStation=0.1875				
Frame=2	Station=0.1875	OutputCase=SOVRCOST	CaseType=LinStatic	Point=3	X2=0.5	X3=-0.5	S11=0
IsS11Max=No	IsS11Min=No	FrameElem=2	ElemStation=0.1875				
Frame=2	Station=0.1875	OutputCase=SOVRCOST	CaseType=LinStatic	Point=4	X2=0.5	X3=0.5	S11=0
IsS11Max=No	IsS11Min=No	FrameElem=2	ElemStation=0.1875				
Frame=2	Station=0.25	OutputCase=SOVRCOST	CaseType=LinStatic	Point=0	X2=0	X3=0	S11=0
IsS11Min=Yes	FrameElem=2	ElemStation=0.25					IsS11Max=Yes
Frame=2	Station=0.25	OutputCase=SOVRCOST	CaseType=LinStatic	Point=1	X2=-0.5	X3=-0.5	S11=0
IsS11Max=No	IsS11Min=No	FrameElem=2	ElemStation=0.25				
Frame=2	Station=0.25	OutputCase=SOVRCOST	CaseType=LinStatic	Point=2	X2=-0.5	X3=0.5	S11=0
IsS11Max=No	IsS11Min=No	FrameElem=2	ElemStation=0.25				
Frame=2	Station=0.25	OutputCase=SOVRCOST	CaseType=LinStatic	Point=3	X2=0.5	X3=-0.5	S11=0
IsS11Max=No	IsS11Min=No	FrameElem=2	ElemStation=0.25				
Frame=2	Station=0.25	OutputCase=SOVRCOST	CaseType=LinStatic	Point=4	X2=0.5	X3=0.5	S11=0
IsS11Max=No	IsS11Min=No	FrameElem=2	ElemStation=0.25				
Frame=2	Station=0	OutputCase=ENVE	CaseType=Combination	StepType=Max	Point=0	X2=0	X3=0
90.2888588483431	IsS11Max=No	IsS11Min=No	FrameElem=2	ElemStation=0			S11=-
Frame=2	Station=0	OutputCase=ENVE	CaseType=Combination	StepType=Max	Point=1	X2=-0.5	X3=-0.5
S11=904.826715117939	IsS11Max=Yes	IsS11Min=No	FrameElem=2	ElemStation=0			
Frame=2	Station=0	OutputCase=ENVE	CaseType=Combination	StepType=Max	Point=2	X2=-0.5	X3=0.5
S11=904.826715117939	IsS11Max=No	IsS11Min=No	FrameElem=2	ElemStation=0			
Frame=2	Station=0	OutputCase=ENVE	CaseType=Combination	StepType=Max	Point=3	X2=0.5	X3=-0.5
1079.98343803528	IsS11Max=No	IsS11Min=Yes	FrameElem=2	ElemStation=0			S11=-
Frame=2	Station=0	OutputCase=ENVE	CaseType=Combination	StepType=Max	Point=4	X2=0.5	X3=0.5
1079.98343803528	IsS11Max=No	IsS11Min=No	FrameElem=2	ElemStation=0			
Frame=2	Station=0.0625	OutputCase=ENVE	CaseType=Combination	StepType=Max	Point=0	X2=0	X3=0
90.2888588483431	IsS11Max=No	IsS11Min=No	FrameElem=2	ElemStation=0.0625			S11=-
Frame=2	Station=0.0625	OutputCase=ENVE	CaseType=Combination	StepType=Max	Point=1	X2=-0.5	X3=-0.5
S11=698.129441348297	IsS11Max=Yes	IsS11Min=No	FrameElem=2	ElemStation=0.0625			
Frame=2	Station=0.0625	OutputCase=ENVE	CaseType=Combination	StepType=Max	Point=2	X2=-0.5	X3=0.5
S11=698.129441348297	IsS11Max=No	IsS11Min=No	FrameElem=2	ElemStation=0.0625			
Frame=2	Station=0.0625	OutputCase=ENVE	CaseType=Combination	StepType=Max	Point=3	X2=0.5	X3=-0.5
S11=-873.298931037788	IsS11Max=No	IsS11Min=Yes	FrameElem=2	ElemStation=0.0625			
Frame=2	Station=0.0625	OutputCase=ENVE	CaseType=Combination	StepType=Max	Point=4	X2=0.5	X3=0.5
S11=-873.298931037788	IsS11Max=No	IsS11Min=No	FrameElem=2	ElemStation=0.0625			
Frame=2	Station=0.125	OutputCase=ENVE	CaseType=Combination	StepType=Max	Point=0	X2=0	X3=0
90.2888588483431	IsS11Max=No	IsS11Min=No	FrameElem=2	ElemStation=0.125			S11=-
Frame=2	Station=0.125	OutputCase=ENVE	CaseType=Combination	StepType=Max	Point=1	X2=-0.5	X3=-0.5
S11=490.846230078656	IsS11Max=Yes	IsS11Min=No	FrameElem=2	ElemStation=0.125			
Frame=2	Station=0.125	OutputCase=ENVE	CaseType=Combination	StepType=Max	Point=2	X2=-0.5	X3=0.5
S11=490.846230078656	IsS11Max=No	IsS11Min=No	FrameElem=2	ElemStation=0.125			
Frame=2	Station=0.125	OutputCase=ENVE	CaseType=Combination	StepType=Max	Point=3	X2=0.5	X3=-0.5
S11=-666.0284865403	IsS11Max=No	IsS11Min=Yes	FrameElem=2	ElemStation=0.125			
Frame=2	Station=0.125	OutputCase=ENVE	CaseType=Combination	StepType=Max	Point=4	X2=0.5	X3=0.5
S11=-666.0284865403	IsS11Max=No	IsS11Min=No	FrameElem=2	ElemStation=0.125			
Frame=2	Station=0.1875	OutputCase=ENVE	CaseType=Combination	StepType=Max	Point=0	X2=0	X3=0
90.2888588483431	IsS11Max=No	IsS11Min=No	FrameElem=2	ElemStation=0.1875			S11=-
Frame=2	Station=0.1875	OutputCase=ENVE	CaseType=Combination	StepType=Max	Point=1	X2=-0.5	X3=-0.5
S11=282.977081309014	IsS11Max=Yes	IsS11Min=No	FrameElem=2	ElemStation=0.1875			
Frame=2	Station=0.1875	OutputCase=ENVE	CaseType=Combination	StepType=Max	Point=2	X2=-0.5	X3=0.5
S11=282.977081309014	IsS11Max=No	IsS11Min=No	FrameElem=2	ElemStation=0.1875			
Frame=2	Station=0.1875	OutputCase=ENVE	CaseType=Combination	StepType=Max	Point=3	X2=0.5	X3=-0.5
S11=-458.172104542813	IsS11Max=No	IsS11Min=Yes	FrameElem=2	ElemStation=0.1875			
Frame=2	Station=0.1875	OutputCase=ENVE	CaseType=Combination	StepType=Max	Point=4	X2=0.5	X3=0.5
S11=-458.172104542813	IsS11Max=No	IsS11Min=No	FrameElem=2	ElemStation=0.1875			
Frame=2	Station=0.25	OutputCase=ENVE	CaseType=Combination	StepType=Max	Point=0	X2=0	X3=0
90.2888588483431	IsS11Max=No	IsS11Min=No	FrameElem=2	ElemStation=0.25			S11=-
Frame=2	Station=0.25	OutputCase=ENVE	CaseType=Combination	StepType=Max	Point=1	X2=-0.5	X3=-0.5
S11=74.5219950393721	IsS11Max=Yes	IsS11Min=No	FrameElem=2	ElemStation=0.25			
Frame=2	Station=0.25	OutputCase=ENVE	CaseType=Combination	StepType=Max	Point=2	X2=-0.5	X3=0.5
S11=74.5219950393721	IsS11Max=No	IsS11Min=No	FrameElem=2	ElemStation=0.25			
Frame=2	Station=0.25	OutputCase=ENVE	CaseType=Combination	StepType=Max	Point=3	X2=0.5	X3=-0.5
S11=-249.729785045326	IsS11Max=No	IsS11Min=Yes	FrameElem=2	ElemStation=0.25			
Frame=2	Station=0.25	OutputCase=ENVE	CaseType=Combination	StepType=Max	Point=4	X2=0.5	X3=0.5
S11=-249.729785045326	IsS11Max=No	IsS11Min=No	FrameElem=2	ElemStation=0.25			
Frame=2	Station=0	OutputCase=ENVE	CaseType=Combination	StepType=Min	Point=0	X2=0	X3=0
122.976319142087	IsS11Max=No	IsS11Min=No	FrameElem=2	ElemStation=0			S11=-
Frame=2	Station=0	OutputCase=ENVE	CaseType=Combination	StepType=Min	Point=1	X2=-0.5	X3=-0.5
S11=899.405720338589	IsS11Max=Yes	IsS11Min=No	FrameElem=2	ElemStation=0			
Frame=2	Station=0	OutputCase=ENVE	CaseType=Combination	StepType=Min	Point=2	X2=-0.5	X3=0.5
S11=899.405720338589	IsS11Max=No	IsS11Min=No	FrameElem=2	ElemStation=0			
Frame=2	Station=0	OutputCase=ENVE	CaseType=Combination	StepType=Min	Point=3	X2=0.5	X3=-0.5
1150.77935340211	IsS11Max=No	IsS11Min=Yes	FrameElem=2	ElemStation=0			S11=-
Frame=2	Station=0	OutputCase=ENVE	CaseType=Combination	StepType=Min	Point=4	X2=0.5	X3=0.5
1150.77935340211	IsS11Max=No	IsS11Min=No	FrameElem=2	ElemStation=0			
Frame=2	Station=0.0625	OutputCase=ENVE	CaseType=Combination	StepType=Min	Point=0	X2=0	X3=0
122.976319142087	IsS11Max=No	IsS11Min=No	FrameElem=2	ElemStation=0.0625			S11=-
Frame=2	Station=0.0625	OutputCase=ENVE	CaseType=Combination	StepType=Min	Point=1	X2=-0.5	X3=-0.5
S11=692.721213341101	IsS11Max=Yes	IsS11Min=No	FrameElem=2	ElemStation=0.0625			

Frame=2	Station=0.0625	OutputCase=ENVE	CaseType=Combination	StepType=Min	Point=2	X2=-0.5	X3=0.5	
S11=692.721213341101	IsS11Max=No	IsS11Min=No	FrameElem=2	ElemStation=0.0625				
Frame=2	Station=0.0625	OutputCase=ENVE	CaseType=Combination	StepType=Min	Point=3	X2=0.5	X3=-0.5	
S11=-944.082079632471	IsS11Max=No	IsS11Min=Yes	FrameElem=2	ElemStation=0.0625				
Frame=2	Station=0.0625	OutputCase=ENVE	CaseType=Combination	StepType=Min	Point=4	X2=0.5	X3=0.5	
S11=-944.082079632471	IsS11Max=No	IsS11Min=No	FrameElem=2	ElemStation=0.0625				
Frame=2	Station=0.125	OutputCase=ENVE	CaseType=Combination	StepType=Min	Point=0	X2=0	X3=0	S11=-
122.976319142087	IsS11Max=No	IsS11Min=No	FrameElem=2	ElemStation=0.125				
Frame=2	Station=0.125	OutputCase=ENVE	CaseType=Combination	StepType=Min	Point=1	X2=-0.5	X3=-0.5	
S11=485.450768843614	IsS11Max=Yes	IsS11Min=No	FrameElem=2	ElemStation=0.125				
Frame=2	Station=0.125	OutputCase=ENVE	CaseType=Combination	StepType=Min	Point=2	X2=-0.5	X3=0.5	
S11=485.450768843614	IsS11Max=No	IsS11Min=No	FrameElem=2	ElemStation=0.125				
Frame=2	Station=0.125	OutputCase=ENVE	CaseType=Combination	StepType=Min	Point=3	X2=0.5	X3=-0.5	
S11=-736.798868362829	IsS11Max=No	IsS11Min=Yes	FrameElem=2	ElemStation=0.125				
Frame=2	Station=0.125	OutputCase=ENVE	CaseType=Combination	StepType=Min	Point=4	X2=0.5	X3=0.5	
S11=-736.798868362829	IsS11Max=No	IsS11Min=No	FrameElem=2	ElemStation=0.125				
Frame=2	Station=0.1875	OutputCase=ENVE	CaseType=Combination	StepType=Min	Point=0	X2=0	X3=0	S11=-
122.976319142087	IsS11Max=No	IsS11Min=No	FrameElem=2	ElemStation=0.1875				
Frame=2	Station=0.1875	OutputCase=ENVE	CaseType=Combination	StepType=Min	Point=1	X2=-0.5	X3=-0.5	
S11=277.594386846127	IsS11Max=Yes	IsS11Min=No	FrameElem=2	ElemStation=0.1875				
Frame=2	Station=0.1875	OutputCase=ENVE	CaseType=Combination	StepType=Min	Point=2	X2=-0.5	X3=0.5	
S11=277.594386846127	IsS11Max=No	IsS11Min=No	FrameElem=2	ElemStation=0.1875				
Frame=2	Station=0.1875	OutputCase=ENVE	CaseType=Combination	StepType=Min	Point=3	X2=0.5	X3=-0.5	
S11=-528.929719593187	IsS11Max=No	IsS11Min=Yes	FrameElem=2	ElemStation=0.1875				
Frame=2	Station=0.1875	OutputCase=ENVE	CaseType=Combination	StepType=Min	Point=4	X2=0.5	X3=0.5	
S11=-528.929719593187	IsS11Max=No	IsS11Min=No	FrameElem=2	ElemStation=0.1875				
Frame=2	Station=0.25	OutputCase=ENVE	CaseType=Combination	StepType=Min	Point=0	X2=0	X3=0	S11=-
122.976319142087	IsS11Max=No	IsS11Min=No	FrameElem=2	ElemStation=0.25				
Frame=2	Station=0.25	OutputCase=ENVE	CaseType=Combination	StepType=Min	Point=1	X2=-0.5	X3=-0.5	
S11=69.1520673486393	IsS11Max=Yes	IsS11Min=No	FrameElem=2	ElemStation=0.25				
Frame=2	Station=0.25	OutputCase=ENVE	CaseType=Combination	StepType=Min	Point=2	X2=-0.5	X3=0.5	
S11=69.1520673486393	IsS11Max=No	IsS11Min=No	FrameElem=2	ElemStation=0.25				
Frame=2	Station=0.25	OutputCase=ENVE	CaseType=Combination	StepType=Min	Point=3	X2=0.5	X3=-0.5	
S11=-320.474633323545	IsS11Max=No	IsS11Min=Yes	FrameElem=2	ElemStation=0.25				
Frame=2	Station=0.25	OutputCase=ENVE	CaseType=Combination	StepType=Min	Point=4	X2=0.5	X3=0.5	
S11=-320.474633323545	IsS11Max=No	IsS11Min=No	FrameElem=2	ElemStation=0.25				
Frame=2	Station=0	OutputCase=FESSUR	CaseType=Combination	Point=0	X2=0	X3=0	S11=-122.976319142087	
IsS11Max=No	IsS11Min=No	FrameElem=2	ElemStation=0					
Frame=2	Station=0	OutputCase=FESSUR	CaseType=Combination	Point=1	X2=-0.5	X3=-0.5		
S11=904.826715117939	IsS11Max=Yes	IsS11Min=No	FrameElem=2	ElemStation=0				
Frame=2	Station=0	OutputCase=FESSUR	CaseType=Combination	Point=2	X2=-0.5	X3=0.5		
S11=904.826715117939	IsS11Max=No	IsS11Min=No	FrameElem=2	ElemStation=0				
Frame=2	Station=0	OutputCase=FESSUR	CaseType=Combination	Point=3	X2=0.5	X3=-0.5	S11=-	
1150.77935340211	IsS11Max=No	IsS11Min=Yes	FrameElem=2	ElemStation=0				
Frame=2	Station=0	OutputCase=FESSUR	CaseType=Combination	Point=4	X2=0.5	X3=0.5	S11=-	
1150.77935340211	IsS11Max=No	IsS11Min=No	FrameElem=2	ElemStation=0				
Frame=2	Station=0.0625	OutputCase=FESSUR	CaseType=Combination	Point=0	X2=0	X3=0	S11=-	
122.976319142087	IsS11Max=No	IsS11Min=No	FrameElem=2	ElemStation=0.0625				
Frame=2	Station=0.0625	OutputCase=FESSUR	CaseType=Combination	Point=1	X2=-0.5	X3=-0.5		
S11=698.129441348297	IsS11Max=Yes	IsS11Min=No	FrameElem=2	ElemStation=0.0625				
Frame=2	Station=0.0625	OutputCase=FESSUR	CaseType=Combination	Point=2	X2=-0.5	X3=0.5		
S11=698.129441348297	IsS11Max=No	IsS11Min=No	FrameElem=2	ElemStation=0.0625				
Frame=2	Station=0.0625	OutputCase=FESSUR	CaseType=Combination	Point=3	X2=0.5	X3=-0.5	S11=-	
944.082079632471	IsS11Max=No	IsS11Min=Yes	FrameElem=2	ElemStation=0.0625				
Frame=2	Station=0.0625	OutputCase=FESSUR	CaseType=Combination	Point=4	X2=0.5	X3=0.5	S11=-	
944.082079632471	IsS11Max=No	IsS11Min=No	FrameElem=2	ElemStation=0.0625				
Frame=2	Station=0.125	OutputCase=FESSUR	CaseType=Combination	Point=0	X2=0	X3=0	S11=-	
122.976319142087	IsS11Max=No	IsS11Min=No	FrameElem=2	ElemStation=0.125				
Frame=2	Station=0.125	OutputCase=FESSUR	CaseType=Combination	Point=1	X2=-0.5	X3=-0.5		
S11=490.846230078656	IsS11Max=Yes	IsS11Min=No	FrameElem=2	ElemStation=0.125				
Frame=2	Station=0.125	OutputCase=FESSUR	CaseType=Combination	Point=2	X2=-0.5	X3=0.5		
S11=490.846230078656	IsS11Max=No	IsS11Min=No	FrameElem=2	ElemStation=0.125				
Frame=2	Station=0.125	OutputCase=FESSUR	CaseType=Combination	Point=3	X2=0.5	X3=-0.5	S11=-	
736.798868362829	IsS11Max=No	IsS11Min=Yes	FrameElem=2	ElemStation=0.125				
Frame=2	Station=0.125	OutputCase=FESSUR	CaseType=Combination	Point=4	X2=0.5	X3=0.5	S11=-	
736.798868362829	IsS11Max=No	IsS11Min=No	FrameElem=2	ElemStation=0.125				
Frame=2	Station=0.1875	OutputCase=FESSUR	CaseType=Combination	Point=0	X2=0	X3=0	S11=-	
122.976319142087	IsS11Max=No	IsS11Min=No	FrameElem=2	ElemStation=0.1875				
Frame=2	Station=0.1875	OutputCase=FESSUR	CaseType=Combination	Point=1	X2=-0.5	X3=-0.5		
S11=282.977081309014	IsS11Max=Yes	IsS11Min=No	FrameElem=2	ElemStation=0.1875				
Frame=2	Station=0.1875	OutputCase=FESSUR	CaseType=Combination	Point=2	X2=-0.5	X3=0.5		
S11=282.977081309014	IsS11Max=No	IsS11Min=No	FrameElem=2	ElemStation=0.1875				
Frame=2	Station=0.1875	OutputCase=FESSUR	CaseType=Combination	Point=3	X2=0.5	X3=-0.5	S11=-	
528.929719593187	IsS11Max=No	IsS11Min=Yes	FrameElem=2	ElemStation=0.1875				
Frame=2	Station=0.1875	OutputCase=FESSUR	CaseType=Combination	Point=4	X2=0.5	X3=0.5	S11=-	
528.929719593187	IsS11Max=No	IsS11Min=No	FrameElem=2	ElemStation=0.1875				
Frame=2	Station=0.25	OutputCase=FESSUR	CaseType=Combination	Point=0	X2=0	X3=0	S11=-122.976319142087	
IsS11Max=No	IsS11Min=No	FrameElem=2	ElemStation=0.25					
Frame=2	Station=0.25	OutputCase=FESSUR	CaseType=Combination	Point=1	X2=-0.5	X3=-0.5		
S11=74.5219950393721	IsS11Max=Yes	IsS11Min=No	FrameElem=2	ElemStation=0.25				
Frame=2	Station=0.25	OutputCase=FESSUR	CaseType=Combination	Point=2	X2=-0.5	X3=0.5		
S11=74.5219950393721	IsS11Max=No	IsS11Min=No	FrameElem=2	ElemStation=0.25				

Frame=2	Station=0.25	OutputCase=FESSUR	CaseType=Combination	Point=3	X2=0.5	X3=-0.5	S11=-
320.474633323545	IsS11Max=No	IsS11Min=Yes	FrameElem=2	ElemStation=0.25			
Frame=2	Station=0.25	OutputCase=FESSUR	CaseType=Combination	Point=4	X2=0.5	X3=0.5	S11=-
320.474633323545	IsS11Max=No	IsS11Min=No	FrameElem=2	ElemStation=0.25			
Frame=4	Station=0	OutputCase=PESOPR	CaseType=LinStatic	Point=0	X2=0	X3=0	S11=-15.1709467362366
IsS11Max=No	IsS11Min=No	FrameElem=4	ElemStation=0				
Frame=4	Station=0	OutputCase=PESOPR	CaseType=LinStatic	Point=1	X2=-0.5	X3=-0.5	S11=37.7162757597484
IsS11Max=Yes	IsS11Min=No	FrameElem=4	ElemStation=0				
Frame=4	Station=0	OutputCase=PESOPR	CaseType=LinStatic	Point=2	X2=-0.5	X3=0.5	S11=37.7162757597484
IsS11Max=No	IsS11Min=No	FrameElem=4	ElemStation=0				
Frame=4	Station=0	OutputCase=PESOPR	CaseType=LinStatic	Point=3	X2=0.5	X3=-0.5	S11=-68.0581692322216
IsS11Max=No	IsS11Min=Yes	FrameElem=4	ElemStation=0				
Frame=4	Station=0	OutputCase=PESOPR	CaseType=LinStatic	Point=4	X2=0.5	X3=0.5	S11=-68.0581692322216
IsS11Max=No	IsS11Min=No	FrameElem=4	ElemStation=0				
Frame=4	Station=0.0625	OutputCase=PESOPR	CaseType=LinStatic	Point=0	X2=0	X3=0	S11=-15.1709467362366
IsS11Max=No	IsS11Min=No	FrameElem=4	ElemStation=0.0625				
Frame=4	Station=0.0625	OutputCase=PESOPR	CaseType=LinStatic	Point=1	X2=-0.5	X3=-0.5	
S11=90.1935979412533	IsS11Max=Yes	IsS11Min=No	FrameElem=4	ElemStation=0.0625			
Frame=4	Station=0.0625	OutputCase=PESOPR	CaseType=LinStatic	Point=2	X2=-0.5	X3=0.5	
S11=90.1935979412533	IsS11Max=No	IsS11Min=No	FrameElem=4	ElemStation=0.0625			
Frame=4	Station=0.0625	OutputCase=PESOPR	CaseType=LinStatic	Point=3	X2=0.5	X3=-0.5	S11=-
120.535491413727	IsS11Max=No	IsS11Min=Yes	FrameElem=4	ElemStation=0.0625			
Frame=4	Station=0.0625	OutputCase=PESOPR	CaseType=LinStatic	Point=4	X2=0.5	X3=0.5	S11=-
120.535491413727	IsS11Max=No	IsS11Min=No	FrameElem=4	ElemStation=0.0625			
Frame=4	Station=0.125	OutputCase=PESOPR	CaseType=LinStatic	Point=0	X2=0	X3=0	S11=-15.1709467362366
IsS11Max=No	IsS11Min=No	FrameElem=4	ElemStation=0.125				
Frame=4	Station=0.125	OutputCase=PESOPR	CaseType=LinStatic	Point=1	X2=-0.5	X3=-0.5	
S11=142.084982622758	IsS11Max=Yes	IsS11Min=No	FrameElem=4	ElemStation=0.125			
Frame=4	Station=0.125	OutputCase=PESOPR	CaseType=LinStatic	Point=2	X2=-0.5	X3=0.5	
S11=142.084982622758	IsS11Max=No	IsS11Min=No	FrameElem=4	ElemStation=0.125			
Frame=4	Station=0.125	OutputCase=PESOPR	CaseType=LinStatic	Point=3	X2=0.5	X3=-0.5	S11=-
172.426876095231	IsS11Max=No	IsS11Min=Yes	FrameElem=4	ElemStation=0.125			
Frame=4	Station=0.125	OutputCase=PESOPR	CaseType=LinStatic	Point=4	X2=0.5	X3=0.5	S11=-
172.426876095231	IsS11Max=No	IsS11Min=No	FrameElem=4	ElemStation=0.125			
Frame=4	Station=0.1875	OutputCase=PESOPR	CaseType=LinStatic	Point=0	X2=0	X3=0	S11=-15.1709467362366
IsS11Max=No	IsS11Min=No	FrameElem=4	ElemStation=0.1875				
Frame=4	Station=0.1875	OutputCase=PESOPR	CaseType=LinStatic	Point=1	X2=-0.5	X3=-0.5	
S11=193.390429804263	IsS11Max=Yes	IsS11Min=No	FrameElem=4	ElemStation=0.1875			
Frame=4	Station=0.1875	OutputCase=PESOPR	CaseType=LinStatic	Point=2	X2=-0.5	X3=0.5	
S11=193.390429804263	IsS11Max=No	IsS11Min=No	FrameElem=4	ElemStation=0.1875			
Frame=4	Station=0.1875	OutputCase=PESOPR	CaseType=LinStatic	Point=3	X2=0.5	X3=-0.5	S11=-
223.732323276736	IsS11Max=No	IsS11Min=Yes	FrameElem=4	ElemStation=0.1875			
Frame=4	Station=0.1875	OutputCase=PESOPR	CaseType=LinStatic	Point=4	X2=0.5	X3=0.5	S11=-
223.732323276736	IsS11Max=No	IsS11Min=No	FrameElem=4	ElemStation=0.1875			
Frame=4	Station=0.25	OutputCase=PESOPR	CaseType=LinStatic	Point=0	X2=0	X3=0	S11=-15.1709467362366
IsS11Max=No	IsS11Min=No	FrameElem=4	ElemStation=0.25				
Frame=4	Station=0.25	OutputCase=PESOPR	CaseType=LinStatic	Point=1	X2=-0.5	X3=-0.5	
S11=244.109939485768	IsS11Max=Yes	IsS11Min=No	FrameElem=4	ElemStation=0.25			
Frame=4	Station=0.25	OutputCase=PESOPR	CaseType=LinStatic	Point=2	X2=-0.5	X3=0.5	
S11=244.109939485768	IsS11Max=No	IsS11Min=No	FrameElem=4	ElemStation=0.25			
Frame=4	Station=0.25	OutputCase=PESOPR	CaseType=LinStatic	Point=3	X2=0.5	X3=-0.5	S11=-
274.451832958241	IsS11Max=No	IsS11Min=Yes	FrameElem=4	ElemStation=0.25			
Frame=4	Station=0.25	OutputCase=PESOPR	CaseType=LinStatic	Point=4	X2=0.5	X3=0.5	S11=-
274.451832958241	IsS11Max=No	IsS11Min=No	FrameElem=4	ElemStation=0.25			
Frame=4	Station=0	OutputCase=TERRVERT	CaseType=LinStatic	Point=0	X2=0	X3=0	S11=1.15282857329472
IsS11Max=No	IsS11Min=No	FrameElem=4	ElemStation=0				
Frame=4	Station=0	OutputCase=TERRVERT	CaseType=LinStatic	Point=1	X2=-0.5	X3=-0.5	
S11=18.9059666059347	IsS11Max=Yes	IsS11Min=No	FrameElem=4	ElemStation=0			
Frame=4	Station=0	OutputCase=TERRVERT	CaseType=LinStatic	Point=2	X2=-0.5	X3=0.5	
S11=18.9059666059347	IsS11Max=No	IsS11Min=No	FrameElem=4	ElemStation=0			
Frame=4	Station=0	OutputCase=TERRVERT	CaseType=LinStatic	Point=3	X2=0.5	X3=-0.5	S11=-
16.6003094593453	IsS11Max=No	IsS11Min=Yes	FrameElem=4	ElemStation=0			
Frame=4	Station=0	OutputCase=TERRVERT	CaseType=LinStatic	Point=4	X2=0.5	X3=0.5	S11=-
16.6003094593453	IsS11Max=No	IsS11Min=No	FrameElem=4	ElemStation=0			
Frame=4	Station=0.0625	OutputCase=TERRVERT	CaseType=LinStatic	Point=0	X2=0	X3=0	
S11=1.15282857329472	IsS11Max=No	IsS11Min=No	FrameElem=4	ElemStation=0.0625			
Frame=4	Station=0.0625	OutputCase=TERRVERT	CaseType=LinStatic	Point=1	X2=-0.5	X3=-0.5	
S11=174.841174812211	IsS11Max=Yes	IsS11Min=No	FrameElem=4	ElemStation=0.0625			
Frame=4	Station=0.0625	OutputCase=TERRVERT	CaseType=LinStatic	Point=2	X2=-0.5	X3=0.5	
S11=174.841174812211	IsS11Max=No	IsS11Min=No	FrameElem=4	ElemStation=0.0625			
Frame=4	Station=0.0625	OutputCase=TERRVERT	CaseType=LinStatic	Point=3	X2=0.5	X3=-0.5	S11=-
172.535517665621	IsS11Max=No	IsS11Min=Yes	FrameElem=4	ElemStation=0.0625			
Frame=4	Station=0.0625	OutputCase=TERRVERT	CaseType=LinStatic	Point=4	X2=0.5	X3=0.5	S11=-
172.535517665621	IsS11Max=No	IsS11Min=No	FrameElem=4	ElemStation=0.0625			
Frame=4	Station=0.125	OutputCase=TERRVERT	CaseType=LinStatic	Point=0	X2=0	X3=0	S11=1.15282857329472
IsS11Max=No	IsS11Min=No	FrameElem=4	ElemStation=0.125				
Frame=4	Station=0.125	OutputCase=TERRVERT	CaseType=LinStatic	Point=1	X2=-0.5	X3=-0.5	
S11=330.776383018487	IsS11Max=Yes	IsS11Min=No	FrameElem=4	ElemStation=0.125			
Frame=4	Station=0.125	OutputCase=TERRVERT	CaseType=LinStatic	Point=2	X2=-0.5	X3=0.5	
S11=330.776383018487	IsS11Max=No	IsS11Min=No	FrameElem=4	ElemStation=0.125			
Frame=4	Station=0.125	OutputCase=TERRVERT	CaseType=LinStatic	Point=3	X2=0.5	X3=-0.5	S11=-
328.470725871897	IsS11Max=No	IsS11Min=Yes	FrameElem=4	ElemStation=0.125			

```

Frame=4 Station=0.125 OutputCase=TERRVERT CaseType=LinStatic Point=4 X2=0.5 X3=0.5 S11=-
328.470725871897 IsS11Max=No IsS11Min=No FrameElem=4 ElemStation=0.125
Frame=4 Station=0.1875 OutputCase=TERRVERT CaseType=LinStatic Point=0 X2=0 X3=0
S11=1.15282857329472 IsS11Max=No IsS11Min=No FrameElem=4 ElemStation=0.1875
Frame=4 Station=0.1875 OutputCase=TERRVERT CaseType=LinStatic Point=1 X2=-0.5 X3=-0.5
S11=486.711591224763 IsS11Max=Yes IsS11Min=No FrameElem=4 ElemStation=0.1875
Frame=4 Station=0.1875 OutputCase=TERRVERT CaseType=LinStatic Point=2 X2=-0.5 X3=0.5
S11=486.711591224763 IsS11Max=No IsS11Min=No FrameElem=4 ElemStation=0.1875
Frame=4 Station=0.1875 OutputCase=TERRVERT CaseType=LinStatic Point=3 X2=0.5 X3=-0.5 S11=-
484.405934078173 IsS11Max=No IsS11Min=Yes FrameElem=4 ElemStation=0.1875
Frame=4 Station=0.1875 OutputCase=TERRVERT CaseType=LinStatic Point=4 X2=0.5 X3=0.5 S11=-
484.405934078173 IsS11Max=No IsS11Min=No FrameElem=4 ElemStation=0.1875
Frame=4 Station=0.25 OutputCase=TERRVERT CaseType=LinStatic Point=0 X2=0 X3=0 S11=1.15282857329472
IsS11Max=No IsS11Min=No FrameElem=4 ElemStation=0.25
Frame=4 Station=0.25 OutputCase=TERRVERT CaseType=LinStatic Point=1 X2=-0.5 X3=-0.5
S11=642.646799431039 IsS11Max=Yes IsS11Min=No FrameElem=4 ElemStation=0.25
Frame=4 Station=0.25 OutputCase=TERRVERT CaseType=LinStatic Point=2 X2=-0.5 X3=0.5
S11=642.646799431039 IsS11Max=No IsS11Min=No FrameElem=4 ElemStation=0.25
Frame=4 Station=0.25 OutputCase=TERRVERT CaseType=LinStatic Point=3 X2=0.5 X3=-0.5 S11=-
640.341142284449 IsS11Max=No IsS11Min=Yes FrameElem=4 ElemStation=0.25
Frame=4 Station=0.25 OutputCase=TERRVERT CaseType=LinStatic Point=4 X2=0.5 X3=0.5 S11=-
640.341142284449 IsS11Max=No IsS11Min=No FrameElem=4 ElemStation=0.25
Frame=4 Station=0 OutputCase=TERRLAT CaseType=LinStatic Point=0 X2=0 X3=0 S11=-108.958200979145
IsS11Max=No IsS11Min=No FrameElem=4 ElemStation=0
Frame=4 Station=0 OutputCase=TERRLAT CaseType=LinStatic Point=1 X2=-0.5 X3=-0.5
S11=17.8997500110664 IsS11Max=Yes IsS11Min=No FrameElem=4 ElemStation=0
Frame=4 Station=0 OutputCase=TERRLAT CaseType=LinStatic Point=2 X2=-0.5 X3=0.5 S11=17.8997500110664
IsS11Max=No IsS11Min=No FrameElem=4 ElemStation=0
Frame=4 Station=0 OutputCase=TERRLAT CaseType=LinStatic Point=3 X2=0.5 X3=-0.5 S11=-
235.816151969356 IsS11Max=No IsS11Min=Yes FrameElem=4 ElemStation=0
Frame=4 Station=0 OutputCase=TERRLAT CaseType=LinStatic Point=4 X2=0.5 X3=0.5 S11=-235.816151969356
IsS11Max=No IsS11Min=No FrameElem=4 ElemStation=0
Frame=4 Station=0.0625 OutputCase=TERRLAT CaseType=LinStatic Point=0 X2=0 X3=0 S11=-
108.958200979145 IsS11Max=No IsS11Min=No FrameElem=4 ElemStation=0.0625
Frame=4 Station=0.0625 OutputCase=TERRLAT CaseType=LinStatic Point=1 X2=-0.5 X3=-0.5
S11=17.9423059823349 IsS11Max=Yes IsS11Min=No FrameElem=4 ElemStation=0.0625
Frame=4 Station=0.0625 OutputCase=TERRLAT CaseType=LinStatic Point=2 X2=-0.5 X3=0.5
S11=17.9423059823349 IsS11Max=No IsS11Min=No FrameElem=4 ElemStation=0.0625
Frame=4 Station=0.0625 OutputCase=TERRLAT CaseType=LinStatic Point=3 X2=0.5 X3=-0.5 S11=-
235.858707940625 IsS11Max=No IsS11Min=Yes FrameElem=4 ElemStation=0.0625
Frame=4 Station=0.0625 OutputCase=TERRLAT CaseType=LinStatic Point=4 X2=0.5 X3=0.5 S11=-
235.858707940625 IsS11Max=No IsS11Min=No FrameElem=4 ElemStation=0.0625
Frame=4 Station=0.125 OutputCase=TERRLAT CaseType=LinStatic Point=0 X2=0 X3=0 S11=-108.958200979145
IsS11Max=No IsS11Min=No FrameElem=4 ElemStation=0.125
Frame=4 Station=0.125 OutputCase=TERRLAT CaseType=LinStatic Point=1 X2=-0.5 X3=-0.5
S11=17.9848619536035 IsS11Max=Yes IsS11Min=No FrameElem=4 ElemStation=0.125
Frame=4 Station=0.125 OutputCase=TERRLAT CaseType=LinStatic Point=2 X2=-0.5 X3=0.5
S11=17.9848619536035 IsS11Max=No IsS11Min=No FrameElem=4 ElemStation=0.125
Frame=4 Station=0.125 OutputCase=TERRLAT CaseType=LinStatic Point=3 X2=0.5 X3=-0.5 S11=-
235.901263911893 IsS11Max=No IsS11Min=Yes FrameElem=4 ElemStation=0.125
Frame=4 Station=0.125 OutputCase=TERRLAT CaseType=LinStatic Point=4 X2=0.5 X3=0.5 S11=-
235.901263911893 IsS11Max=No IsS11Min=No FrameElem=4 ElemStation=0.125
Frame=4 Station=0.1875 OutputCase=TERRLAT CaseType=LinStatic Point=0 X2=0 X3=0 S11=-
108.958200979145 IsS11Max=No IsS11Min=No FrameElem=4 ElemStation=0.1875
Frame=4 Station=0.1875 OutputCase=TERRLAT CaseType=LinStatic Point=1 X2=-0.5 X3=-0.5
S11=18.0274179248721 IsS11Max=Yes IsS11Min=No FrameElem=4 ElemStation=0.1875
Frame=4 Station=0.1875 OutputCase=TERRLAT CaseType=LinStatic Point=2 X2=-0.5 X3=0.5
S11=18.0274179248721 IsS11Max=No IsS11Min=No FrameElem=4 ElemStation=0.1875
Frame=4 Station=0.1875 OutputCase=TERRLAT CaseType=LinStatic Point=3 X2=0.5 X3=-0.5 S11=-
235.943819883162 IsS11Max=No IsS11Min=Yes FrameElem=4 ElemStation=0.1875
Frame=4 Station=0.1875 OutputCase=TERRLAT CaseType=LinStatic Point=4 X2=0.5 X3=0.5 S11=-
235.943819883162 IsS11Max=No IsS11Min=No FrameElem=4 ElemStation=0.1875
Frame=4 Station=0.25 OutputCase=TERRLAT CaseType=LinStatic Point=0 X2=0 X3=0 S11=-108.958200979145
IsS11Max=No IsS11Min=No FrameElem=4 ElemStation=0.25
Frame=4 Station=0.25 OutputCase=TERRLAT CaseType=LinStatic Point=1 X2=-0.5 X3=-0.5
S11=18.0699738961406 IsS11Max=Yes IsS11Min=No FrameElem=4 ElemStation=0.25
Frame=4 Station=0.25 OutputCase=TERRLAT CaseType=LinStatic Point=2 X2=-0.5 X3=0.5
S11=18.0699738961406 IsS11Max=No IsS11Min=No FrameElem=4 ElemStation=0.25
Frame=4 Station=0.25 OutputCase=TERRLAT CaseType=LinStatic Point=3 X2=0.5 X3=-0.5 S11=-
235.986375854431 IsS11Max=No IsS11Min=Yes FrameElem=4 ElemStation=0.25
Frame=4 Station=0.25 OutputCase=TERRLAT CaseType=LinStatic Point=4 X2=0.5 X3=0.5 S11=-
235.986375854431 IsS11Max=No IsS11Min=No FrameElem=4 ElemStation=0.25
Frame=4 Station=0 OutputCase=ACCLATDX CaseType=LinStatic Point=0 X2=0 X3=0 S11=0 IsS11Max=Yes
IsS11Min=Yes FrameElem=4 ElemStation=0
Frame=4 Station=0 OutputCase=ACCLATDX CaseType=LinStatic Point=1 X2=-0.5 X3=-0.5 S11=0
IsS11Max=No IsS11Min=No FrameElem=4 ElemStation=0
Frame=4 Station=0 OutputCase=ACCLATDX CaseType=LinStatic Point=2 X2=-0.5 X3=0.5 S11=0 IsS11Max=No
IsS11Min=No FrameElem=4 ElemStation=0
Frame=4 Station=0 OutputCase=ACCLATDX CaseType=LinStatic Point=3 X2=0.5 X3=-0.5 S11=0 IsS11Max=No
IsS11Min=No FrameElem=4 ElemStation=0
Frame=4 Station=0 OutputCase=ACCLATDX CaseType=LinStatic Point=4 X2=0.5 X3=0.5 S11=0 IsS11Max=No
IsS11Min=No FrameElem=4 ElemStation=0

```



Frame=4	Station=0.125	OutputCase=SOVRCOST	CaseType=LinStatic	Point=2	X2=-0.5	X3=0.5	S11=0	
IsS11Max=No	IsS11Min=No	FrameElem=4	ElemStation=0.125					
Frame=4	Station=0.125	OutputCase=SOVRCOST	CaseType=LinStatic	Point=3	X2=0.5	X3=-0.5	S11=0	
IsS11Max=No	IsS11Min=No	FrameElem=4	ElemStation=0.125					
Frame=4	Station=0.125	OutputCase=SOVRCOST	CaseType=LinStatic	Point=4	X2=0.5	X3=0.5	S11=0	
IsS11Max=No	IsS11Min=No	FrameElem=4	ElemStation=0.125					
Frame=4	Station=0.1875	OutputCase=SOVRCOST	CaseType=LinStatic	Point=0	X2=0	X3=0	S11=0	
IsS11Max=Yes	IsS11Min=Yes	FrameElem=4	ElemStation=0.1875					
Frame=4	Station=0.1875	OutputCase=SOVRCOST	CaseType=LinStatic	Point=1	X2=-0.5	X3=-0.5	S11=0	
IsS11Max=No	IsS11Min=No	FrameElem=4	ElemStation=0.1875					
Frame=4	Station=0.1875	OutputCase=SOVRCOST	CaseType=LinStatic	Point=2	X2=-0.5	X3=0.5	S11=0	
IsS11Max=No	IsS11Min=No	FrameElem=4	ElemStation=0.1875					
Frame=4	Station=0.1875	OutputCase=SOVRCOST	CaseType=LinStatic	Point=3	X2=0.5	X3=-0.5	S11=0	
IsS11Max=No	IsS11Min=No	FrameElem=4	ElemStation=0.1875					
Frame=4	Station=0.1875	OutputCase=SOVRCOST	CaseType=LinStatic	Point=4	X2=0.5	X3=0.5	S11=0	
IsS11Max=No	IsS11Min=No	FrameElem=4	ElemStation=0.1875					
Frame=4	Station=0.25	OutputCase=SOVRCOST	CaseType=LinStatic	Point=0	X2=0	X3=0	S11=0	
IsS11Min=Yes	FrameElem=4	ElemStation=0.25					IsS11Max=Yes	
Frame=4	Station=0.25	OutputCase=SOVRCOST	CaseType=LinStatic	Point=1	X2=-0.5	X3=-0.5	S11=0	
IsS11Max=No	IsS11Min=No	FrameElem=4	ElemStation=0.25					
Frame=4	Station=0.25	OutputCase=SOVRCOST	CaseType=LinStatic	Point=2	X2=-0.5	X3=0.5	S11=0	
IsS11Max=No	IsS11Min=No	FrameElem=4	ElemStation=0.25					
Frame=4	Station=0.25	OutputCase=SOVRCOST	CaseType=LinStatic	Point=3	X2=0.5	X3=-0.5	S11=0	
IsS11Max=No	IsS11Min=No	FrameElem=4	ElemStation=0.25					
Frame=4	Station=0.25	OutputCase=SOVRCOST	CaseType=LinStatic	Point=4	X2=0.5	X3=0.5	S11=0	
IsS11Max=No	IsS11Min=No	FrameElem=4	ElemStation=0.25					
Frame=4	Station=0	OutputCase=ENVE	CaseType=Combination	StepType=Max	Point=0	X2=0	X3=0	S11=-
90.2888588483434	IsS11Max=No	IsS11Min=No	FrameElem=4	ElemStation=0				
Frame=4	Station=0	OutputCase=ENVE	CaseType=Combination	StepType=Max	Point=1	X2=-0.5	X3=-0.5	
S11=74.5219923767495	IsS11Max=Yes	IsS11Min=No	FrameElem=4	ElemStation=0				
Frame=4	Station=0	OutputCase=ENVE	CaseType=Combination	StepType=Max	Point=2	X2=-0.5	X3=0.5	
S11=74.5219923767495	IsS11Max=No	IsS11Min=No	FrameElem=4	ElemStation=0				
Frame=4	Station=0	OutputCase=ENVE	CaseType=Combination	StepType=Max	Point=3	X2=0.5	X3=-0.5	S11=-
249.729785070116	IsS11Max=No	IsS11Min=Yes	FrameElem=4	ElemStation=0				
Frame=4	Station=0	OutputCase=ENVE	CaseType=Combination	StepType=Max	Point=4	X2=0.5	X3=0.5	S11=-
249.729785070116	IsS11Max=No	IsS11Min=No	FrameElem=4	ElemStation=0				
Frame=4	Station=0.0625	OutputCase=ENVE	CaseType=Combination	StepType=Max	Point=0	X2=0	X3=0	S11=-
90.2888588483434	IsS11Max=No	IsS11Min=No	FrameElem=4	ElemStation=0.0625				
Frame=4	Station=0.0625	OutputCase=ENVE	CaseType=Combination	StepType=Max	Point=1	X2=-0.5	X3=-0.5	
S11=282.977078735799	IsS11Max=Yes	IsS11Min=No	FrameElem=4	ElemStation=0.0625				
Frame=4	Station=0.0625	OutputCase=ENVE	CaseType=Combination	StepType=Max	Point=2	X2=-0.5	X3=0.5	
S11=282.977078735799	IsS11Max=No	IsS11Min=No	FrameElem=4	ElemStation=0.0625				
Frame=4	Station=0.0625	OutputCase=ENVE	CaseType=Combination	StepType=Max	Point=3	X2=0.5	X3=-0.5	
S11=-458.172104637785	IsS11Max=No	IsS11Min=Yes	FrameElem=4	ElemStation=0.0625				
Frame=4	Station=0.0625	OutputCase=ENVE	CaseType=Combination	StepType=Max	Point=4	X2=0.5	X3=0.5	
S11=-458.172104637785	IsS11Max=No	IsS11Min=No	FrameElem=4	ElemStation=0.0625				
Frame=4	Station=0.125	OutputCase=ENVE	CaseType=Combination	StepType=Max	Point=0	X2=0	X3=0	S11=-
90.2888588483434	IsS11Max=No	IsS11Min=No	FrameElem=4	ElemStation=0.125				
Frame=4	Station=0.125	OutputCase=ENVE	CaseType=Combination	StepType=Max	Point=1	X2=-0.5	X3=-0.5	
S11=490.846227594848	IsS11Max=Yes	IsS11Min=No	FrameElem=4	ElemStation=0.125				
Frame=4	Station=0.125	OutputCase=ENVE	CaseType=Combination	StepType=Max	Point=2	X2=-0.5	X3=0.5	
S11=490.846227594848	IsS11Max=No	IsS11Min=No	FrameElem=4	ElemStation=0.125				
Frame=4	Station=0.125	OutputCase=ENVE	CaseType=Combination	StepType=Max	Point=3	X2=0.5	X3=-0.5	
S11=-666.028486705454	IsS11Max=No	IsS11Min=Yes	FrameElem=4	ElemStation=0.125				
Frame=4	Station=0.125	OutputCase=ENVE	CaseType=Combination	StepType=Max	Point=4	X2=0.5	X3=0.5	
S11=-666.028486705454	IsS11Max=No	IsS11Min=No	FrameElem=4	ElemStation=0.125				
Frame=4	Station=0.1875	OutputCase=ENVE	CaseType=Combination	StepType=Max	Point=0	X2=0	X3=0	S11=-
90.2888588483434	IsS11Max=No	IsS11Min=No	FrameElem=4	ElemStation=0.1875				
Frame=4	Station=0.1875	OutputCase=ENVE	CaseType=Combination	StepType=Max	Point=1	X2=-0.5	X3=-0.5	
S11=698.129438953898	IsS11Max=Yes	IsS11Min=No	FrameElem=4	ElemStation=0.1875				
Frame=4	Station=0.1875	OutputCase=ENVE	CaseType=Combination	StepType=Max	Point=2	X2=-0.5	X3=0.5	
S11=698.129438953898	IsS11Max=No	IsS11Min=No	FrameElem=4	ElemStation=0.1875				
Frame=4	Station=0.1875	OutputCase=ENVE	CaseType=Combination	StepType=Max	Point=3	X2=0.5	X3=-0.5	
S11=-873.298931273123	IsS11Max=No	IsS11Min=Yes	FrameElem=4	ElemStation=0.1875				
Frame=4	Station=0.1875	OutputCase=ENVE	CaseType=Combination	StepType=Max	Point=4	X2=0.5	X3=0.5	
S11=-873.298931273123	IsS11Max=No	IsS11Min=No	FrameElem=4	ElemStation=0.1875				
Frame=4	Station=0.25	OutputCase=ENVE	CaseType=Combination	StepType=Max	Point=0	X2=0	X3=0	S11=-
90.2888588483434	IsS11Max=No	IsS11Min=No	FrameElem=4	ElemStation=0.25				
Frame=4	Station=0.25	OutputCase=ENVE	CaseType=Combination	StepType=Max	Point=1	X2=-0.5	X3=-0.5	
S11=904.826712812947	IsS11Max=Yes	IsS11Min=No	FrameElem=4	ElemStation=0.25				
Frame=4	Station=0.25	OutputCase=ENVE	CaseType=Combination	StepType=Max	Point=2	X2=-0.5	X3=0.5	
S11=904.826712812947	IsS11Max=No	IsS11Min=No	FrameElem=4	ElemStation=0.25				
Frame=4	Station=0.25	OutputCase=ENVE	CaseType=Combination	StepType=Max	Point=3	X2=0.5	X3=-0.5	
S11=-1079.98343834079	IsS11Max=No	IsS11Min=Yes	FrameElem=4	ElemStation=0.25				
Frame=4	Station=0.25	OutputCase=ENVE	CaseType=Combination	StepType=Max	Point=4	X2=0.5	X3=0.5	
S11=-1079.98343834079	IsS11Max=No	IsS11Min=No	FrameElem=4	ElemStation=0.25				
Frame=4	Station=0	OutputCase=ENVE	CaseType=Combination	StepType=Min	Point=0	X2=0	X3=0	S11=-
122.976319142087	IsS11Max=No	IsS11Min=No	FrameElem=4	ElemStation=0				
Frame=4	Station=0	OutputCase=ENVE	CaseType=Combination	StepType=Min	Point=1	X2=-0.5	X3=-0.5	
S11=69.1520673734296	IsS11Max=Yes	IsS11Min=No	FrameElem=4	ElemStation=0				
Frame=4	Station=0	OutputCase=ENVE	CaseType=Combination	StepType=Min	Point=2	X2=-0.5	X3=0.5	
S11=69.1520673734296	IsS11Max=No	IsS11Min=No	FrameElem=4	ElemStation=0				

Frame=4	Station=0	OutputCase=ENVE	CaseType=Combination	StepType=Min	Point=3	X2=0.5	X3=-0.5	S11=-
320.474630660923		IsS11Max=No	IsS11Min=Yes	FrameElem=4	ElemStation=0			
Frame=4	Station=0	OutputCase=ENVE	CaseType=Combination	StepType=Min	Point=4	X2=0.5	X3=0.5	S11=-
320.474630660923		IsS11Max=No	IsS11Min=No	FrameElem=4	ElemStation=0			
Frame=4	Station=0.0625	OutputCase=ENVE	CaseType=Combination	StepType=Min	Point=0	X2=0	X3=0	S11=-
122.976319142087		IsS11Max=No	IsS11Min=No	FrameElem=4	ElemStation=0.0625			
Frame=4	Station=0.0625	OutputCase=ENVE	CaseType=Combination	StepType=Min	Point=1	X2=-0.5	X3=-0.5	
S11=277.594386941098		IsS11Max=Yes	IsS11Min=No	FrameElem=4	ElemStation=0.0625			
Frame=4	Station=0.0625	OutputCase=ENVE	CaseType=Combination	StepType=Min	Point=2	X2=-0.5	X3=0.5	
S11=277.594386941098		IsS11Max=No	IsS11Min=No	FrameElem=4	ElemStation=0.0625			
Frame=4	Station=0.0625	OutputCase=ENVE	CaseType=Combination	StepType=Min	Point=3	X2=0.5	X3=-0.5	
S11=-528.929717019973		IsS11Max=No	IsS11Min=Yes	FrameElem=4	ElemStation=0.0625			
Frame=4	Station=0.0625	OutputCase=ENVE	CaseType=Combination	StepType=Min	Point=4	X2=0.5	X3=0.5	
S11=-528.929717019973		IsS11Max=No	IsS11Min=No	FrameElem=4	ElemStation=0.0625			
Frame=4	Station=0.125	OutputCase=ENVE	CaseType=Combination	StepType=Min	Point=0	X2=0	X3=0	S11=-
122.976319142087		IsS11Max=No	IsS11Min=No	FrameElem=4	ElemStation=0.125			
Frame=4	Station=0.125	OutputCase=ENVE	CaseType=Combination	StepType=Min	Point=1	X2=-0.5	X3=-0.5	
S11=485.450769008767		IsS11Max=Yes	IsS11Min=No	FrameElem=4	ElemStation=0.125			
Frame=4	Station=0.125	OutputCase=ENVE	CaseType=Combination	StepType=Min	Point=2	X2=-0.5	X3=0.5	
S11=485.450769008767		IsS11Max=No	IsS11Min=No	FrameElem=4	ElemStation=0.125			
Frame=4	Station=0.125	OutputCase=ENVE	CaseType=Combination	StepType=Min	Point=3	X2=0.5	X3=-0.5	
S11=-736.798865879022		IsS11Max=No	IsS11Min=Yes	FrameElem=4	ElemStation=0.125			
Frame=4	Station=0.125	OutputCase=ENVE	CaseType=Combination	StepType=Min	Point=4	X2=0.5	X3=0.5	
S11=-736.798865879022		IsS11Max=No	IsS11Min=No	FrameElem=4	ElemStation=0.125			
Frame=4	Station=0.1875	OutputCase=ENVE	CaseType=Combination	StepType=Min	Point=0	X2=0	X3=0	S11=-
122.976319142087		IsS11Max=No	IsS11Min=No	FrameElem=4	ElemStation=0.1875			
Frame=4	Station=0.1875	OutputCase=ENVE	CaseType=Combination	StepType=Min	Point=1	X2=-0.5	X3=-0.5	
S11=692.721213576436		IsS11Max=Yes	IsS11Min=No	FrameElem=4	ElemStation=0.1875			
Frame=4	Station=0.1875	OutputCase=ENVE	CaseType=Combination	StepType=Min	Point=2	X2=-0.5	X3=0.5	
S11=692.721213576436		IsS11Max=No	IsS11Min=No	FrameElem=4	ElemStation=0.1875			
Frame=4	Station=0.1875	OutputCase=ENVE	CaseType=Combination	StepType=Min	Point=3	X2=0.5	X3=-0.5	
S11=-944.082077238071		IsS11Max=No	IsS11Min=Yes	FrameElem=4	ElemStation=0.1875			
Frame=4	Station=0.1875	OutputCase=ENVE	CaseType=Combination	StepType=Min	Point=4	X2=0.5	X3=0.5	
S11=-944.082077238071		IsS11Max=No	IsS11Min=No	FrameElem=4	ElemStation=0.1875			
Frame=4	Station=0.25	OutputCase=ENVE	CaseType=Combination	StepType=Min	Point=0	X2=0	X3=0	S11=-
122.976319142087		IsS11Max=No	IsS11Min=No	FrameElem=4	ElemStation=0.25			
Frame=4	Station=0.25	OutputCase=ENVE	CaseType=Combination	StepType=Min	Point=1	X2=-0.5	X3=-0.5	
S11=899.405720644105		IsS11Max=Yes	IsS11Min=No	FrameElem=4	ElemStation=0.25			
Frame=4	Station=0.25	OutputCase=ENVE	CaseType=Combination	StepType=Min	Point=2	X2=-0.5	X3=0.5	
S11=899.405720644105		IsS11Max=No	IsS11Min=No	FrameElem=4	ElemStation=0.25			
Frame=4	Station=0.25	OutputCase=ENVE	CaseType=Combination	StepType=Min	Point=3	X2=0.5	X3=-0.5	
S11=-1150.77935109712		IsS11Max=No	IsS11Min=Yes	FrameElem=4	ElemStation=0.25			
Frame=4	Station=0.25	OutputCase=ENVE	CaseType=Combination	StepType=Min	Point=4	X2=0.5	X3=0.5	
S11=-1150.77935109712		IsS11Max=No	IsS11Min=No	FrameElem=4	ElemStation=0.25			
Frame=4	Station=0	OutputCase=FESSUR	CaseType=Combination	Point=0	X2=0	X3=0	S11=-122.976319142087	
IsS11Max=No	IsS11Min=No	FrameElem=4	ElemStation=0					
Frame=4	Station=0	OutputCase=FESSUR	CaseType=Combination	Point=1	X2=-0.5	X3=-0.5		
S11=74.5219923767495		IsS11Max=Yes	IsS11Min=No	FrameElem=4	ElemStation=0			
Frame=4	Station=0	OutputCase=FESSUR	CaseType=Combination	Point=2	X2=-0.5	X3=0.5		
S11=74.5219923767495		IsS11Max=No	IsS11Min=No	FrameElem=4	ElemStation=0			
Frame=4	Station=0	OutputCase=FESSUR	CaseType=Combination	Point=3	X2=0.5	X3=-0.5	S11=-	
320.474630660923		IsS11Max=No	IsS11Min=Yes	FrameElem=4	ElemStation=0			
Frame=4	Station=0	OutputCase=FESSUR	CaseType=Combination	Point=4	X2=0.5	X3=0.5	S11=-	
320.474630660923		IsS11Max=No	IsS11Min=No	FrameElem=4	ElemStation=0			
Frame=4	Station=0.0625	OutputCase=FESSUR	CaseType=Combination	Point=0	X2=0	X3=0	S11=-	
122.976319142087		IsS11Max=No	IsS11Min=No	FrameElem=4	ElemStation=0.0625			
Frame=4	Station=0.0625	OutputCase=FESSUR	CaseType=Combination	Point=1	X2=-0.5	X3=-0.5		
S11=282.977078735799		IsS11Max=Yes	IsS11Min=No	FrameElem=4	ElemStation=0.0625			
Frame=4	Station=0.0625	OutputCase=FESSUR	CaseType=Combination	Point=2	X2=-0.5	X3=0.5		
S11=282.977078735799		IsS11Max=No	IsS11Min=No	FrameElem=4	ElemStation=0.0625			
Frame=4	Station=0.0625	OutputCase=FESSUR	CaseType=Combination	Point=3	X2=0.5	X3=-0.5	S11=-	
528.929717019973		IsS11Max=No	IsS11Min=Yes	FrameElem=4	ElemStation=0.0625			
Frame=4	Station=0.0625	OutputCase=FESSUR	CaseType=Combination	Point=4	X2=0.5	X3=0.5	S11=-	
528.929717019973		IsS11Max=No	IsS11Min=No	FrameElem=4	ElemStation=0.0625			
Frame=4	Station=0.125	OutputCase=FESSUR	CaseType=Combination	Point=0	X2=0	X3=0	S11=-	
122.976319142087		IsS11Max=No	IsS11Min=No	FrameElem=4	ElemStation=0.125			
Frame=4	Station=0.125	OutputCase=FESSUR	CaseType=Combination	Point=1	X2=-0.5	X3=-0.5		
S11=490.846227594848		IsS11Max=Yes	IsS11Min=No	FrameElem=4	ElemStation=0.125			
Frame=4	Station=0.125	OutputCase=FESSUR	CaseType=Combination	Point=2	X2=-0.5	X3=0.5		
S11=490.846227594848		IsS11Max=No	IsS11Min=No	FrameElem=4	ElemStation=0.125			
Frame=4	Station=0.125	OutputCase=FESSUR	CaseType=Combination	Point=3	X2=0.5	X3=-0.5	S11=-	
736.798865879022		IsS11Max=No	IsS11Min=Yes	FrameElem=4	ElemStation=0.125			
Frame=4	Station=0.125	OutputCase=FESSUR	CaseType=Combination	Point=4	X2=0.5	X3=0.5	S11=-	
736.798865879022		IsS11Max=No	IsS11Min=No	FrameElem=4	ElemStation=0.125			
Frame=4	Station=0.1875	OutputCase=FESSUR	CaseType=Combination	Point=0	X2=0	X3=0	S11=-	
122.976319142087		IsS11Max=No	IsS11Min=No	FrameElem=4	ElemStation=0.1875			
Frame=4	Station=0.1875	OutputCase=FESSUR	CaseType=Combination	Point=1	X2=-0.5	X3=-0.5		
S11=698.129438953898		IsS11Max=Yes	IsS11Min=No	FrameElem=4	ElemStation=0.1875			
Frame=4	Station=0.1875	OutputCase=FESSUR	CaseType=Combination	Point=2	X2=-0.5	X3=0.5		
S11=698.129438953898		IsS11Max=No	IsS11Min=No	FrameElem=4	ElemStation=0.1875			
Frame=4	Station=0.1875	OutputCase=FESSUR	CaseType=Combination	Point=3	X2=0.5	X3=-0.5	S11=-	
944.082077238071		IsS11Max=No	IsS11Min=Yes	FrameElem=4	ElemStation=0.1875			



Frame=4 Station=0.1875 OutputCase=FESSUR CaseType=Combination Point=4 X2=0.5 X3=0.5 S11=-
 944.082077238071 IsS11Max=No IsS11Min=No FrameElem=4 ElemStation=0.1875
 Frame=4 Station=0.25 OutputCase=FESSUR CaseType=Combination Point=0 X2=0 X3=0 S11=-122.976319142087
 IsS11Max=No IsS11Min=No FrameElem=4 ElemStation=0.25
 Frame=4 Station=0.25 OutputCase=FESSUR CaseType=Combination Point=1 X2=-0.5 X3=-0.5
 S11=904.826712812947 IsS11Max=Yes IsS11Min=No FrameElem=4 ElemStation=0.25
 Frame=4 Station=0.25 OutputCase=FESSUR CaseType=Combination Point=2 X2=-0.5 X3=0.5
 S11=904.826712812947 IsS11Max=No IsS11Min=No FrameElem=4 ElemStation=0.25
 Frame=4 Station=0.25 OutputCase=FESSUR CaseType=Combination Point=3 X2=0.5 X3=-0.5 S11=-
 1150.77935109712 IsS11Max=No IsS11Min=Yes FrameElem=4 ElemStation=0.25
 Frame=4 Station=0.25 OutputCase=FESSUR CaseType=Combination Point=4 X2=0.5 X3=0.5 S11=-
 1150.77935109712 IsS11Max=No IsS11Min=No FrameElem=4 ElemStation=0.25
 Frame=5 Station=0 OutputCase=PESOPR CaseType=LinStatic Point=0 X2=0 X3=0 S11=-15.1709467362359
 IsS11Max=No IsS11Min=No FrameElem=5 ElemStation=0
 Frame=5 Station=0 OutputCase=PESOPR CaseType=LinStatic Point=1 X2=-0.5 X3=-0.5 S11=244.109939485834
 IsS11Max=Yes IsS11Min=No FrameElem=5 ElemStation=0
 Frame=5 Station=0 OutputCase=PESOPR CaseType=LinStatic Point=2 X2=-0.5 X3=0.5 S11=244.109939485834
 IsS11Max=No IsS11Min=No FrameElem=5 ElemStation=0
 Frame=5 Station=0 OutputCase=PESOPR CaseType=LinStatic Point=3 X2=0.5 X3=-0.5 S11=-274.451832958306
 IsS11Max=No IsS11Min=Yes FrameElem=5 ElemStation=0
 Frame=5 Station=0 OutputCase=PESOPR CaseType=LinStatic Point=4 X2=0.5 X3=0.5 S11=-274.451832958306
 IsS11Max=No IsS11Min=No FrameElem=5 ElemStation=0
 Frame=5 Station=6.24999940395355E-02 OutputCase=PESOPR CaseType=LinStatic Point=0 X2=0 X3=0 S11=-
 15.1709467362359 IsS11Max=No IsS11Min=No FrameElem=5 ElemStation=6.24999940395355E-02
 Frame=5 Station=6.24999940395355E-02 OutputCase=PESOPR CaseType=LinStatic Point=1 X2=-0.5 X3=-0.5
 S11=302.801667757078 IsS11Max=Yes IsS11Min=No FrameElem=5 ElemStation=6.24999940395355E-02
 Frame=5 Station=6.24999940395355E-02 OutputCase=PESOPR CaseType=LinStatic Point=2 X2=-0.5 X3=0.5
 S11=302.801667757078 IsS11Max=No IsS11Min=No FrameElem=5 ElemStation=6.24999940395355E-02
 Frame=5 Station=6.24999940395355E-02 OutputCase=PESOPR CaseType=LinStatic Point=3 X2=0.5 X3=-0.5
 S11=-333.143561229549 IsS11Max=No IsS11Min=Yes FrameElem=5 ElemStation=6.24999940395355E-02
 Frame=5 Station=6.24999940395355E-02 OutputCase=PESOPR CaseType=LinStatic Point=4 X2=0.5 X3=0.5
 S11=-333.143561229549 IsS11Max=No IsS11Min=No FrameElem=5 ElemStation=6.24999940395355E-02
 Frame=5 Station=0.124999988079071 OutputCase=PESOPR CaseType=LinStatic Point=0 X2=0 X3=0 S11=-
 15.1709467362359 IsS11Max=No IsS11Min=No FrameElem=5 ElemStation=0.124999988079071
 Frame=5 Station=0.124999988079071 OutputCase=PESOPR CaseType=LinStatic Point=1 X2=-0.5 X3=-0.5
 S11=360.90745864008 IsS11Max=Yes IsS11Min=No FrameElem=5 ElemStation=0.124999988079071
 Frame=5 Station=0.124999988079071 OutputCase=PESOPR CaseType=LinStatic Point=2 X2=-0.5 X3=0.5
 S11=360.90745864008 IsS11Max=No IsS11Min=No FrameElem=5 ElemStation=0.124999988079071
 Frame=5 Station=0.124999988079071 OutputCase=PESOPR CaseType=LinStatic Point=3 X2=0.5 X3=-0.5 S11=-
 391.249352112552 IsS11Max=No IsS11Min=Yes FrameElem=5 ElemStation=0.124999988079071
 Frame=5 Station=0.124999988079071 OutputCase=PESOPR CaseType=LinStatic Point=4 X2=0.5 X3=0.5 S11=-
 391.249352112552 IsS11Max=No IsS11Min=No FrameElem=5 ElemStation=0.124999988079071
 Frame=5 Station=0.187499982118607 OutputCase=PESOPR CaseType=LinStatic Point=0 X2=0 X3=0 S11=-
 15.1709467362359 IsS11Max=No IsS11Min=No FrameElem=5 ElemStation=0.187499982118607
 Frame=5 Station=0.187499982118607 OutputCase=PESOPR CaseType=LinStatic Point=1 X2=-0.5 X3=-0.5
 S11=418.427312134841 IsS11Max=Yes IsS11Min=No FrameElem=5 ElemStation=0.187499982118607
 Frame=5 Station=0.187499982118607 OutputCase=PESOPR CaseType=LinStatic Point=2 X2=-0.5 X3=0.5
 S11=418.427312134841 IsS11Max=No IsS11Min=No FrameElem=5 ElemStation=0.187499982118607
 Frame=5 Station=0.187499982118607 OutputCase=PESOPR CaseType=LinStatic Point=3 X2=0.5 X3=-0.5 S11=-
 448.769205607313 IsS11Max=No IsS11Min=Yes FrameElem=5 ElemStation=0.187499982118607
 Frame=5 Station=0.187499982118607 OutputCase=PESOPR CaseType=LinStatic Point=4 X2=0.5 X3=0.5 S11=-
 448.769205607313 IsS11Max=No IsS11Min=No FrameElem=5 ElemStation=0.187499982118607
 Frame=5 Station=0.249999976158142 OutputCase=PESOPR CaseType=LinStatic Point=0 X2=0 X3=0 S11=-
 15.1709467362359 IsS11Max=No IsS11Min=No FrameElem=5 ElemStation=0.249999976158142
 Frame=5 Station=0.249999976158142 OutputCase=PESOPR CaseType=LinStatic Point=1 X2=-0.5 X3=-0.5
 S11=475.36122824136 IsS11Max=Yes IsS11Min=No FrameElem=5 ElemStation=0.249999976158142
 Frame=5 Station=0.249999976158142 OutputCase=PESOPR CaseType=LinStatic Point=2 X2=-0.5 X3=0.5
 S11=475.36122824136 IsS11Max=No IsS11Min=No FrameElem=5 ElemStation=0.249999976158142
 Frame=5 Station=0.249999976158142 OutputCase=PESOPR CaseType=LinStatic Point=3 X2=0.5 X3=-0.5 S11=-
 505.703121713832 IsS11Max=No IsS11Min=Yes FrameElem=5 ElemStation=0.249999976158142
 Frame=5 Station=0.249999976158142 OutputCase=PESOPR CaseType=LinStatic Point=4 X2=0.5 X3=0.5 S11=-
 505.703121713832 IsS11Max=No IsS11Min=No FrameElem=5 ElemStation=0.249999976158142
 Frame=5 Station=0 OutputCase=TERRVERT CaseType=LinStatic Point=0 X2=0 X3=0 S11=1.15282857329198
 IsS11Max=No IsS11Min=No FrameElem=5 ElemStation=0
 Frame=5 Station=0 OutputCase=TERRVERT CaseType=LinStatic Point=1 X2=-0.5 X3=-0.5
 S11=642.646799430992 IsS11Max=Yes IsS11Min=No FrameElem=5 ElemStation=0
 Frame=5 Station=0 OutputCase=TERRVERT CaseType=LinStatic Point=2 X2=-0.5 X3=0.5
 S11=642.646799430992 IsS11Max=No IsS11Min=No FrameElem=5 ElemStation=0
 Frame=5 Station=0 OutputCase=TERRVERT CaseType=LinStatic Point=3 X2=0.5 X3=-0.5 S11=-
 640.341142284408 IsS11Max=No IsS11Min=Yes FrameElem=5 ElemStation=0
 Frame=5 Station=0 OutputCase=TERRVERT CaseType=LinStatic Point=4 X2=0.5 X3=0.5 S11=-
 640.341142284408 IsS11Max=No IsS11Min=No FrameElem=5 ElemStation=0
 Frame=5 Station=6.24999940395355E-02 OutputCase=TERRVERT CaseType=LinStatic Point=0 X2=0 X3=0
 S11=1.15282857329198 IsS11Max=No IsS11Min=No FrameElem=5 ElemStation=6.24999940395355E-02
 Frame=5 Station=6.24999940395355E-02 OutputCase=TERRVERT CaseType=LinStatic Point=1 X2=-0.5 X3=-0.5
 S11=817.398483394372 IsS11Max=Yes IsS11Min=No FrameElem=5 ElemStation=6.24999940395355E-02
 Frame=5 Station=6.24999940395355E-02 OutputCase=TERRVERT CaseType=LinStatic Point=2 X2=-0.5 X3=0.5
 S11=817.398483394372 IsS11Max=No IsS11Min=No FrameElem=5 ElemStation=6.24999940395355E-02
 Frame=5 Station=6.24999940395355E-02 OutputCase=TERRVERT CaseType=LinStatic Point=3 X2=0.5 X3=-0.5
 S11=-815.092826247787 IsS11Max=No IsS11Min=Yes FrameElem=5 ElemStation=6.24999940395355E-02
 Frame=5 Station=6.24999940395355E-02 OutputCase=TERRVERT CaseType=LinStatic Point=4 X2=0.5 X3=0.5
 S11=-815.092826247787 IsS11Max=No IsS11Min=No FrameElem=5 ElemStation=6.24999940395355E-02

Frame=5 Station=6.24999940395355E-02 OutputCase=SOVRCOST CaseType=LinStatic Point=3 X2=0.5 X3=-0.5
S11=0 IsS11Max=No IsS11Min=No FrameElem=5 ElemStation=6.24999940395355E-02
Frame=5 Station=6.24999940395355E-02 OutputCase=SOVRCOST CaseType=LinStatic Point=4 X2=0.5 X3=0.5
S11=0 IsS11Max=No IsS11Min=No FrameElem=5 ElemStation=6.24999940395355E-02
Frame=5 Station=0.124999988079071 OutputCase=SOVRCOST CaseType=LinStatic Point=0 X2=0 X3=0 S11=0
IsS11Max=Yes IsS11Min=Yes FrameElem=5 ElemStation=0.124999988079071
Frame=5 Station=0.124999988079071 OutputCase=SOVRCOST CaseType=LinStatic Point=1 X2=-0.5 X3=-0.5
S11=0 IsS11Max=No IsS11Min=No FrameElem=5 ElemStation=0.124999988079071
Frame=5 Station=0.124999988079071 OutputCase=SOVRCOST CaseType=LinStatic Point=2 X2=-0.5 X3=0.5
S11=0 IsS11Max=No IsS11Min=No FrameElem=5 ElemStation=0.124999988079071
Frame=5 Station=0.124999988079071 OutputCase=SOVRCOST CaseType=LinStatic Point=3 X2=0.5 X3=-0.5
S11=0 IsS11Max=No IsS11Min=No FrameElem=5 ElemStation=0.124999988079071
Frame=5 Station=0.124999988079071 OutputCase=SOVRCOST CaseType=LinStatic Point=4 X2=0.5 X3=0.5
S11=0 IsS11Max=No IsS11Min=No FrameElem=5 ElemStation=0.124999988079071
Frame=5 Station=0.187499982118607 OutputCase=SOVRCOST CaseType=LinStatic Point=0 X2=0 X3=0 S11=0
IsS11Max=Yes IsS11Min=Yes FrameElem=5 ElemStation=0.187499982118607
Frame=5 Station=0.187499982118607 OutputCase=SOVRCOST CaseType=LinStatic Point=1 X2=-0.5 X3=-0.5
S11=0 IsS11Max=No IsS11Min=No FrameElem=5 ElemStation=0.187499982118607
Frame=5 Station=0.187499982118607 OutputCase=SOVRCOST CaseType=LinStatic Point=2 X2=-0.5 X3=0.5
S11=0 IsS11Max=No IsS11Min=No FrameElem=5 ElemStation=0.187499982118607
Frame=5 Station=0.187499982118607 OutputCase=SOVRCOST CaseType=LinStatic Point=3 X2=0.5 X3=-0.5
S11=0 IsS11Max=No IsS11Min=No FrameElem=5 ElemStation=0.187499982118607
Frame=5 Station=0.187499982118607 OutputCase=SOVRCOST CaseType=LinStatic Point=4 X2=0.5 X3=0.5
S11=0 IsS11Max=No IsS11Min=No FrameElem=5 ElemStation=0.187499982118607
Frame=5 Station=0.249999976158142 OutputCase=SOVRCOST CaseType=LinStatic Point=0 X2=0 X3=0 S11=0
IsS11Max=Yes IsS11Min=Yes FrameElem=5 ElemStation=0.249999976158142
Frame=5 Station=0.249999976158142 OutputCase=SOVRCOST CaseType=LinStatic Point=1 X2=-0.5 X3=-0.5
S11=0 IsS11Max=No IsS11Min=No FrameElem=5 ElemStation=0.249999976158142
Frame=5 Station=0.249999976158142 OutputCase=SOVRCOST CaseType=LinStatic Point=2 X2=-0.5 X3=0.5
S11=0 IsS11Max=No IsS11Min=No FrameElem=5 ElemStation=0.249999976158142
Frame=5 Station=0.249999976158142 OutputCase=SOVRCOST CaseType=LinStatic Point=3 X2=0.5 X3=-0.5
S11=0 IsS11Max=No IsS11Min=No FrameElem=5 ElemStation=0.249999976158142
Frame=5 Station=0.249999976158142 OutputCase=SOVRCOST CaseType=LinStatic Point=4 X2=0.5 X3=0.5
S11=0 IsS11Max=No IsS11Min=No FrameElem=5 ElemStation=0.249999976158142
Frame=5 Station=0 OutputCase=ENVE CaseType=Combination StepType=Max Point=0 X2=0 X3=0 S11=-
90.2888588483455 IsS11Max=No IsS11Min=No FrameElem=5 ElemStation=0
Frame=5 Station=0 OutputCase=ENVE CaseType=Combination StepType=Max Point=1 X2=-0.5 X3=-0.5
S11=904.826712812966 IsS11Max=Yes IsS11Min=No FrameElem=5 ElemStation=0
Frame=5 Station=0 OutputCase=ENVE CaseType=Combination StepType=Max Point=2 X2=-0.5 X3=0.5
S11=904.826712812966 IsS11Max=No IsS11Min=No FrameElem=5 ElemStation=0
Frame=5 Station=0 OutputCase=ENVE CaseType=Combination StepType=Max Point=3 X2=0.5 X3=-0.5 S11=-
1079.98343834082 IsS11Max=No IsS11Min=Yes FrameElem=5 ElemStation=0
Frame=5 Station=0 OutputCase=ENVE CaseType=Combination StepType=Max Point=4 X2=0.5 X3=0.5 S11=-
1079.98343834082 IsS11Max=No IsS11Min=No FrameElem=5 ElemStation=0
Frame=5 Station=6.24999940395355E-02 OutputCase=ENVE CaseType=Combination StepType=Max Point=0 X2=0
X3=0 S11=-90.2888588483455 IsS11Max=No IsS11Min=No FrameElem=5 ElemStation=6.24999940395355E-02
Frame=5 Station=6.24999940395355E-02 OutputCase=ENVE CaseType=Combination StepType=Max Point=1 X2=-
0.5 X3=-0.5 S11=1138.28768347863 IsS11Max=Yes IsS11Min=No FrameElem=5 ElemStation=6.24999940395355E-02
Frame=5 Station=6.24999940395355E-02 OutputCase=ENVE CaseType=Combination StepType=Max Point=2 X2=-
0.5 X3=0.5 S11=1138.28768347863 IsS11Max=No IsS11Min=No FrameElem=5 ElemStation=6.24999940395355E-02
Frame=5 Station=6.24999940395355E-02 OutputCase=ENVE CaseType=Combination StepType=Max Point=3 X2=0.5
X3=-0.5 S11=-1313.43914147717 IsS11Max=No IsS11Min=Yes FrameElem=5 ElemStation=6.24999940395355E-02
Frame=5 Station=6.24999940395355E-02 OutputCase=ENVE CaseType=Combination StepType=Max Point=4 X2=0.5
X3=0.5 S11=-1313.43914147717 IsS11Max=No IsS11Min=No FrameElem=5 ElemStation=6.24999940395355E-02
Frame=5 Station=0.124999988079071 OutputCase=ENVE CaseType=Combination StepType=Max Point=0 X2=0
X3=0 S11=-90.2888588483455 IsS11Max=No IsS11Min=No FrameElem=5 ElemStation=0.124999988079071
Frame=5 Station=0.124999988079071 OutputCase=ENVE CaseType=Combination StepType=Max Point=1 X2=-0.5
X3=-0.5 S11=1371.16271675605 IsS11Max=Yes IsS11Min=No FrameElem=5 ElemStation=0.124999988079071
Frame=5 Station=0.124999988079071 OutputCase=ENVE CaseType=Combination StepType=Max Point=2 X2=-0.5
X3=0.5 S11=1371.16271675605 IsS11Max=No IsS11Min=No FrameElem=5 ElemStation=0.124999988079071
Frame=5 Station=0.124999988079071 OutputCase=ENVE CaseType=Combination StepType=Max Point=3 X2=0.5
X3=-0.5 S11=-1546.30890722528 IsS11Max=No IsS11Min=Yes FrameElem=5 ElemStation=0.124999988079071
Frame=5 Station=0.124999988079071 OutputCase=ENVE CaseType=Combination StepType=Max Point=4 X2=0.5
X3=0.5 S11=-1546.30890722528 IsS11Max=No IsS11Min=No FrameElem=5 ElemStation=0.124999988079071
Frame=5 Station=0.187499982118607 OutputCase=ENVE CaseType=Combination StepType=Max Point=0 X2=0
X3=0 S11=-90.2888588483455 IsS11Max=No IsS11Min=No FrameElem=5 ElemStation=0.187499982118607
Frame=5 Station=0.187499982118607 OutputCase=ENVE CaseType=Combination StepType=Max Point=1 X2=-0.5
X3=-0.5 S11=1603.45181264523 IsS11Max=Yes IsS11Min=No FrameElem=5 ElemStation=0.187499982118607
Frame=5 Station=0.187499982118607 OutputCase=ENVE CaseType=Combination StepType=Max Point=2 X2=-0.5
X3=0.5 S11=1603.45181264523 IsS11Max=No IsS11Min=No FrameElem=5 ElemStation=0.187499982118607
Frame=5 Station=0.187499982118607 OutputCase=ENVE CaseType=Combination StepType=Max Point=3 X2=0.5
X3=-0.5 S11=-1778.59273558515 IsS11Max=No IsS11Min=Yes FrameElem=5 ElemStation=0.187499982118607
Frame=5 Station=0.187499982118607 OutputCase=ENVE CaseType=Combination StepType=Max Point=4 X2=0.5
X3=0.5 S11=-1778.59273558515 IsS11Max=No IsS11Min=No FrameElem=5 ElemStation=0.187499982118607
Frame=5 Station=0.249999976158142 OutputCase=ENVE CaseType=Combination StepType=Max Point=0 X2=0
X3=0 S11=-90.2888588483455 IsS11Max=No IsS11Min=No FrameElem=5 ElemStation=0.249999976158142
Frame=5 Station=0.249999976158142 OutputCase=ENVE CaseType=Combination StepType=Max Point=1 X2=-0.5
X3=-0.5 S11=1835.15497114617 IsS11Max=Yes IsS11Min=No FrameElem=5 ElemStation=0.249999976158142
Frame=5 Station=0.249999976158142 OutputCase=ENVE CaseType=Combination StepType=Max Point=2 X2=-0.5
X3=0.5 S11=1835.15497114617 IsS11Max=No IsS11Min=No FrameElem=5 ElemStation=0.249999976158142
Frame=5 Station=0.249999976158142 OutputCase=ENVE CaseType=Combination StepType=Max Point=3 X2=0.5
X3=-0.5 S11=-2010.29062655677 IsS11Max=No IsS11Min=Yes FrameElem=5 ElemStation=0.249999976158142

Frame=5 Station=0.187499982118607 OutputCase=FESSUR CaseType=Combination Point=0 X2=0 X3=0 S11=-122.976319142089 IsS11Max=No IsS11Min=No FrameElem=5 ElemStation=0.187499982118607

Frame=5 Station=0.187499982118607 OutputCase=FESSUR CaseType=Combination Point=1 X2=-0.5 X3=-0.5 S11=1603.45181264523 IsS11Max=Yes IsS11Min=No FrameElem=5 ElemStation=0.187499982118607

Frame=5 Station=0.187499982118607 OutputCase=FESSUR CaseType=Combination Point=2 X2=-0.5 X3=0.5 S11=1603.45181264523 IsS11Max=No IsS11Min=No FrameElem=5 ElemStation=0.187499982118607

Frame=5 Station=0.187499982118607 OutputCase=FESSUR CaseType=Combination Point=3 X2=0.5 X3=-0.5 S11=-1849.40445092941 IsS11Max=No IsS11Min=Yes FrameElem=5 ElemStation=0.187499982118607

Frame=5 Station=0.187499982118607 OutputCase=FESSUR CaseType=Combination Point=4 X2=0.5 X3=0.5 S11=-1849.40445092941 IsS11Max=No IsS11Min=No FrameElem=5 ElemStation=0.187499982118607

Frame=5 Station=0.249999976158142 OutputCase=FESSUR CaseType=Combination Point=0 X2=0 X3=0 S11=-122.976319142089 IsS11Max=No IsS11Min=No FrameElem=5 ElemStation=0.249999976158142

Frame=5 Station=0.249999976158142 OutputCase=FESSUR CaseType=Combination Point=1 X2=-0.5 X3=-0.5 S11=1835.15497114617 IsS11Max=Yes IsS11Min=No FrameElem=5 ElemStation=0.249999976158142

Frame=5 Station=0.249999976158142 OutputCase=FESSUR CaseType=Combination Point=2 X2=-0.5 X3=0.5 S11=1835.15497114617 IsS11Max=No IsS11Min=No FrameElem=5 ElemStation=0.249999976158142

Frame=5 Station=0.249999976158142 OutputCase=FESSUR CaseType=Combination Point=3 X2=0.5 X3=-0.5 S11=-2081.10760943035 IsS11Max=No IsS11Min=Yes FrameElem=5 ElemStation=0.249999976158142

Frame=5 Station=0.249999976158142 OutputCase=FESSUR CaseType=Combination Point=4 X2=0.5 X3=0.5 S11=-2081.10760943035 IsS11Max=No IsS11Min=No FrameElem=5 ElemStation=0.249999976158142

Frame=6 Station=0 OutputCase=PESOPR CaseType=LinStatic Point=0 X2=0 X3=0 S11=-162.500000265602 IsS11Max=No IsS11Min=No FrameElem=6 ElemStation=0

Frame=6 Station=0 OutputCase=PESOPR CaseType=LinStatic Point=1 X2=-0.5 X3=-0.5 S11=-653.032175243189 IsS11Max=No IsS11Min=Yes FrameElem=6 ElemStation=0

Frame=6 Station=0 OutputCase=PESOPR CaseType=LinStatic Point=2 X2=-0.5 X3=0.5 S11=-653.032175243189 IsS11Max=No IsS11Min=No FrameElem=6 ElemStation=0

Frame=6 Station=0 OutputCase=PESOPR CaseType=LinStatic Point=3 X2=0.5 X3=-0.5 S11=328.032174711986 IsS11Max=Yes IsS11Min=No FrameElem=6 ElemStation=0

Frame=6 Station=0 OutputCase=PESOPR CaseType=LinStatic Point=4 X2=0.5 X3=0.5 S11=328.032174711986 IsS11Max=No IsS11Min=No FrameElem=6 ElemStation=0

Frame=6 Station=0.250000000000001 OutputCase=PESOPR CaseType=LinStatic Point=0 X2=0 X3=0 S11=-156.250000265602 IsS11Max=No IsS11Min=No FrameElem=6 ElemStation=0.250000000000001

Frame=6 Station=0.250000000000001 OutputCase=PESOPR CaseType=LinStatic Point=1 X2=-0.5 X3=-0.5 S11=-624.025777937611 IsS11Max=No IsS11Min=Yes FrameElem=6 ElemStation=0.250000000000001

Frame=6 Station=0.250000000000001 OutputCase=PESOPR CaseType=LinStatic Point=2 X2=-0.5 X3=0.5 S11=-624.025777937611 IsS11Max=No IsS11Min=No FrameElem=6 ElemStation=0.250000000000001

Frame=6 Station=0.250000000000001 OutputCase=PESOPR CaseType=LinStatic Point=3 X2=0.5 X3=-0.5 S11=311.525777406408 IsS11Max=Yes IsS11Min=No FrameElem=6 ElemStation=0.250000000000001

Frame=6 Station=0.250000000000001 OutputCase=PESOPR CaseType=LinStatic Point=4 X2=0.5 X3=0.5 S11=311.525777406408 IsS11Max=No IsS11Min=No FrameElem=6 ElemStation=0.250000000000001

Frame=6 Station=0 OutputCase=TERRVERT CaseType=LinStatic Point=0 X2=0 X3=0 S11=-491.249995402293 IsS11Max=No IsS11Min=No FrameElem=6 ElemStation=0

Frame=6 Station=0 OutputCase=TERRVERT CaseType=LinStatic Point=1 X2=-0.5 X3=-0.5 S11=-1831.75070211356 IsS11Max=No IsS11Min=Yes FrameElem=6 ElemStation=0

Frame=6 Station=0 OutputCase=TERRVERT CaseType=LinStatic Point=2 X2=-0.5 X3=0.5 S11=-1831.75070211356 IsS11Max=No IsS11Min=No FrameElem=6 ElemStation=0

Frame=6 Station=0 OutputCase=TERRVERT CaseType=LinStatic Point=3 X2=0.5 X3=-0.5 S11=849.250711308974 IsS11Max=Yes IsS11Min=No FrameElem=6 ElemStation=0

Frame=6 Station=0 OutputCase=TERRVERT CaseType=LinStatic Point=4 X2=0.5 X3=0.5 S11=849.250711308974 IsS11Max=No IsS11Min=No FrameElem=6 ElemStation=0

Frame=6 Station=0.250000000000001 OutputCase=TERRVERT CaseType=LinStatic Point=0 X2=0 X3=0 S11=-491.249995402293 IsS11Max=No IsS11Min=No FrameElem=6 ElemStation=0.250000000000001

Frame=6 Station=0.250000000000001 OutputCase=TERRVERT CaseType=LinStatic Point=1 X2=-0.5 X3=-0.5 S11=-1833.48001524737 IsS11Max=No IsS11Min=Yes FrameElem=6 ElemStation=0.250000000000001

Frame=6 Station=0.250000000000001 OutputCase=TERRVERT CaseType=LinStatic Point=2 X2=-0.5 X3=0.5 S11=-1833.48001524737 IsS11Max=No IsS11Min=No FrameElem=6 ElemStation=0.250000000000001

Frame=6 Station=0.250000000000001 OutputCase=TERRVERT CaseType=LinStatic Point=3 X2=0.5 X3=-0.5 S11=850.980024442788 IsS11Max=Yes IsS11Min=No FrameElem=6 ElemStation=0.250000000000001

Frame=6 Station=0.250000000000001 OutputCase=TERRVERT CaseType=LinStatic Point=4 X2=0.5 X3=0.5 S11=850.980024442788 IsS11Max=No IsS11Min=No FrameElem=6 ElemStation=0.250000000000001

Frame=6 Station=0 OutputCase=TERRLAT CaseType=LinStatic Point=0 X2=0 X3=0 S11=-8.13506585473078E-06 IsS11Max=No IsS11Min=No FrameElem=6 ElemStation=0

Frame=6 Station=0 OutputCase=TERRLAT CaseType=LinStatic Point=1 X2=-0.5 X3=-0.5 S11=-127.098416734516 IsS11Max=No IsS11Min=Yes FrameElem=6 ElemStation=0

Frame=6 Station=0 OutputCase=TERRLAT CaseType=LinStatic Point=2 X2=-0.5 X3=0.5 S11=-127.098416734516 IsS11Max=No IsS11Min=No FrameElem=6 ElemStation=0

Frame=6 Station=0 OutputCase=TERRLAT CaseType=LinStatic Point=3 X2=0.5 X3=-0.5 S11=127.098400464384 IsS11Max=Yes IsS11Min=No FrameElem=6 ElemStation=0

Frame=6 Station=0 OutputCase=TERRLAT CaseType=LinStatic Point=4 X2=0.5 X3=0.5 S11=127.098400464384 IsS11Max=No IsS11Min=No FrameElem=6 ElemStation=0

Frame=6 Station=0.250000000000001 OutputCase=TERRLAT CaseType=LinStatic Point=0 X2=0 X3=0 S11=-6.91617322550804E-06 IsS11Max=No IsS11Min=No FrameElem=6 ElemStation=0.250000000000001

Frame=6 Station=0.250000000000001 OutputCase=TERRLAT CaseType=LinStatic Point=1 X2=-0.5 X3=-0.5 S11=-14.0534968586108 IsS11Max=No IsS11Min=Yes FrameElem=6 ElemStation=0.250000000000001

Frame=6 Station=0.250000000000001 OutputCase=TERRLAT CaseType=LinStatic Point=2 X2=-0.5 X3=0.5 S11=-14.0534968586108 IsS11Max=No IsS11Min=No FrameElem=6 ElemStation=0.250000000000001

Frame=6 Station=0.250000000000001 OutputCase=TERRLAT CaseType=LinStatic Point=3 X2=0.5 X3=-0.5 S11=14.0534830262643 IsS11Max=Yes IsS11Min=No FrameElem=6 ElemStation=0.250000000000001

Frame=6 Station=0.250000000000001 OutputCase=TERRLAT CaseType=LinStatic Point=4 X2=0.5 X3=0.5 S11=14.0534830262643 IsS11Max=No IsS11Min=No FrameElem=6 ElemStation=0.250000000000001

Frame=6 Station=0 OutputCase=ACCLATDX CaseType=LinStatic Point=0 X2=0 X3=0 S11=0 IsS11Max=Yes IsS11Min=Yes FrameElem=6 ElemStation=0

```

Frame=6 Station=0 OutputCase=ENVE CaseType=Combination StepType=Max Point=2 X2=-0.5 X3=0.5 S11=-
2573.75176907091 IsS11Max=No IsS11Min=No FrameElem=6 ElemStation=0
Frame=6 Station=0 OutputCase=ENVE CaseType=Combination StepType=Max Point=3 X2=0.5 X3=-0.5
S11=1304.38128648534 IsS11Max=Yes IsS11Min=No FrameElem=6 ElemStation=0
Frame=6 Station=0 OutputCase=ENVE CaseType=Combination StepType=Max Point=4 X2=0.5 X3=0.5
S11=1304.38128648534 IsS11Max=No IsS11Min=No FrameElem=6 ElemStation=0
Frame=6 Station=0 OutputCase=ENVE CaseType=Combination StepType=Max Point=0 X2=0
X3=0 S11=-647.500000509216 IsS11Max=No IsS11Min=No FrameElem=6 ElemStation=0.250000000000001
Frame=6 Station=0 OutputCase=ENVE CaseType=Combination StepType=Max Point=1 X2=-0.5
X3=-0.5 S11=-2467.34324098601 IsS11Max=Yes IsS11Min=Yes FrameElem=6 ElemStation=0.250000000000001
Frame=6 Station=0 OutputCase=ENVE CaseType=Combination StepType=Max Point=2 X2=-0.5
X3=0.5 S11=-2467.34324098601 IsS11Max=No IsS11Min=No FrameElem=6 ElemStation=0.250000000000001
Frame=6 Station=0 OutputCase=ENVE CaseType=Combination StepType=Max Point=3 X2=0.5
X3=-0.5 S11=1176.55928487546 IsS11Max=Yes IsS11Min=No FrameElem=6 ElemStation=0.250000000000001
Frame=6 Station=0 OutputCase=ENVE CaseType=Combination StepType=Max Point=4 X2=0.5
X3=0.5 S11=1176.55928487546 IsS11Max=No IsS11Min=No FrameElem=6 ElemStation=0.250000000000001
Frame=6 Station=0 OutputCase=ENVE CaseType=Combination StepType=Min Point=0 X2=0 X3=0 S11=-
653.750003802961 IsS11Max=No IsS11Min=No FrameElem=6 ElemStation=0
Frame=6 Station=0 OutputCase=ENVE CaseType=Combination StepType=Min Point=1 X2=-0.5 X3=-0.5 S11=-
2611.88129409127 IsS11Max=No IsS11Min=Yes FrameElem=6 ElemStation=0
Frame=6 Station=0 OutputCase=ENVE CaseType=Combination StepType=Min Point=2 X2=-0.5 X3=0.5 S11=-
2611.88129409127 IsS11Max=No IsS11Min=No FrameElem=6 ElemStation=0
Frame=6 Station=0 OutputCase=ENVE CaseType=Combination StepType=Min Point=3 X2=0.5 X3=-0.5
S11=1266.25176634603 IsS11Max=Yes IsS11Min=No FrameElem=6 ElemStation=0
Frame=6 Station=0 OutputCase=ENVE CaseType=Combination StepType=Min Point=4 X2=0.5 X3=0.5
S11=1266.25176634603 IsS11Max=No IsS11Min=No FrameElem=6 ElemStation=0
Frame=6 Station=0 OutputCase=ENVE CaseType=Combination StepType=Min Point=0 X2=0
X3=0 S11=-647.500002584068 IsS11Max=No IsS11Min=No FrameElem=6 ElemStation=0.250000000000001
Frame=6 Station=0 OutputCase=ENVE CaseType=Combination StepType=Min Point=1 X2=-0.5
X3=-0.5 S11=-2471.5592900436 IsS11Max=No IsS11Min=Yes FrameElem=6 ElemStation=0.250000000000001
Frame=6 Station=0 OutputCase=ENVE CaseType=Combination StepType=Min Point=2 X2=-0.5
X3=0.5 S11=-2471.5592900436 IsS11Max=No IsS11Min=No FrameElem=6 ElemStation=0.250000000000001
Frame=6 Station=0 OutputCase=ENVE CaseType=Combination StepType=Min Point=3 X2=0.5
X3=-0.5 S11=1172.34323996758 IsS11Max=Yes IsS11Min=No FrameElem=6 ElemStation=0.250000000000001
Frame=6 Station=0 OutputCase=ENVE CaseType=Combination StepType=Min Point=4 X2=0.5
X3=0.5 S11=1172.34323996758 IsS11Max=No IsS11Min=No FrameElem=6 ElemStation=0.250000000000001
Frame=6 Station=0 OutputCase=FESSUR CaseType=Combination Point=0 X2=0 X3=0 S11=-653.750003802961
IsS11Max=No IsS11Min=No FrameElem=6 ElemStation=0
Frame=6 Station=0 OutputCase=FESSUR CaseType=Combination Point=1 X2=-0.5 X3=-0.5 S11=-
2611.88129409127 IsS11Max=No IsS11Min=Yes FrameElem=6 ElemStation=0
Frame=6 Station=0 OutputCase=FESSUR CaseType=Combination Point=2 X2=-0.5 X3=0.5 S11=-
2611.88129409127 IsS11Max=No IsS11Min=No FrameElem=6 ElemStation=0
Frame=6 Station=0 OutputCase=FESSUR CaseType=Combination Point=3 X2=0.5 X3=-0.5
S11=1304.38128648534 IsS11Max=Yes IsS11Min=No FrameElem=6 ElemStation=0
Frame=6 Station=0 OutputCase=FESSUR CaseType=Combination Point=4 X2=0.5 X3=0.5 S11=1304.38128648534
IsS11Max=No IsS11Min=No FrameElem=6 ElemStation=0
Frame=6 Station=0 OutputCase=FESSUR CaseType=Combination Point=0 X2=0 X3=0 S11=-
647.500002584068 IsS11Max=No IsS11Min=No FrameElem=6 ElemStation=0.250000000000001
Frame=6 Station=0 OutputCase=FESSUR CaseType=Combination Point=1 X2=-0.5 X3=-0.5
S11=-2471.5592900436 IsS11Max=No IsS11Min=Yes FrameElem=6 ElemStation=0.250000000000001
Frame=6 Station=0 OutputCase=FESSUR CaseType=Combination Point=2 X2=-0.5 X3=0.5
S11=-2471.5592900436 IsS11Max=No IsS11Min=No FrameElem=6 ElemStation=0.250000000000001
Frame=6 Station=0 OutputCase=FESSUR CaseType=Combination Point=3 X2=0.5 X3=-0.5
S11=1176.55928487546 IsS11Max=Yes IsS11Min=No FrameElem=6 ElemStation=0.250000000000001
Frame=6 Station=0 OutputCase=FESSUR CaseType=Combination Point=4 X2=0.5 X3=0.5
S11=1176.55928487546 IsS11Max=No IsS11Min=No FrameElem=6 ElemStation=0.250000000000001
Frame=7 Station=0 OutputCase=PESOPR CaseType=LinStatic Point=0 X2=0 X3=0 S11=-156.249998818792
IsS11Max=No IsS11Min=No FrameElem=7 ElemStation=0
Frame=7 Station=0 OutputCase=PESOPR CaseType=LinStatic Point=1 X2=-0.5 X3=-0.5 S11=-
624.025776490829 IsS11Max=No IsS11Min=Yes FrameElem=7 ElemStation=0
Frame=7 Station=0 OutputCase=PESOPR CaseType=LinStatic Point=2 X2=-0.5 X3=0.5 S11=-624.025776490829
IsS11Max=No IsS11Min=No FrameElem=7 ElemStation=0
Frame=7 Station=0 OutputCase=PESOPR CaseType=LinStatic Point=3 X2=0.5 X3=-0.5 S11=311.525778853245
IsS11Max=Yes IsS11Min=No FrameElem=7 ElemStation=0
Frame=7 Station=0 OutputCase=PESOPR CaseType=LinStatic Point=4 X2=0.5 X3=0.5 S11=311.525778853245
IsS11Max=No IsS11Min=No FrameElem=7 ElemStation=0
Frame=7 Station=0.25 OutputCase=PESOPR CaseType=LinStatic Point=0 X2=0 X3=0 S11=-149.999998818792
IsS11Max=No IsS11Min=No FrameElem=7 ElemStation=0.25
Frame=7 Station=0.25 OutputCase=PESOPR CaseType=LinStatic Point=1 X2=-0.5 X3=-0.5 S11=-
595.019356386476 IsS11Max=No IsS11Min=Yes FrameElem=7 ElemStation=0.25
Frame=7 Station=0.25 OutputCase=PESOPR CaseType=LinStatic Point=2 X2=-0.5 X3=0.5 S11=-
595.019356386476 IsS11Max=No IsS11Min=No FrameElem=7 ElemStation=0.25
Frame=7 Station=0.25 OutputCase=PESOPR CaseType=LinStatic Point=3 X2=0.5 X3=-0.5
S11=295.019358748892 IsS11Max=Yes IsS11Min=No FrameElem=7 ElemStation=0.25
Frame=7 Station=0.25 OutputCase=PESOPR CaseType=LinStatic Point=4 X2=0.5 X3=0.5
S11=295.019358748892 IsS11Max=No IsS11Min=No FrameElem=7 ElemStation=0.25
Frame=7 Station=0 OutputCase=TERRVERT CaseType=LinStatic Point=0 X2=0 X3=0 S11=-491.24999512189
IsS11Max=No IsS11Min=No FrameElem=7 ElemStation=0
Frame=7 Station=0 OutputCase=TERRVERT CaseType=LinStatic Point=1 X2=-0.5 X3=-0.5 S11=-
1833.48001535729 IsS11Max=No IsS11Min=Yes FrameElem=7 ElemStation=0
Frame=7 Station=0 OutputCase=TERRVERT CaseType=LinStatic Point=2 X2=-0.5 X3=0.5 S11=-
1833.48001535729 IsS11Max=No IsS11Min=No FrameElem=7 ElemStation=0

```



Frame=7	Station=0	OutputCase=TERRVERT	CaseType=LinStatic	Point=3	X2=0.5	X3=-0.5			
S11=850.980024332914	IsS11Max=Yes	IsS11Min=No	FrameElem=7	ElemStation=0					
Frame=7	Station=0	OutputCase=TERRVERT	CaseType=LinStatic	Point=4	X2=0.5	X3=0.5	S11=850.980024332914		
IsS11Max=No	IsS11Min=No	FrameElem=7	ElemStation=0						
Frame=7	Station=0.25	OutputCase=TERRVERT	CaseType=LinStatic	Point=0	X2=0	X3=0	S11=-491.249995512189		
IsS11Max=No	IsS11Min=No	FrameElem=7	ElemStation=0.25						
Frame=7	Station=0.25	OutputCase=TERRVERT	CaseType=LinStatic	Point=1	X2=-0.5	X3=-0.5	S11=-		
1835.20925821724	IsS11Max=No	IsS11Min=Yes	FrameElem=7	ElemStation=0.25					
Frame=7	Station=0.25	OutputCase=TERRVERT	CaseType=LinStatic	Point=2	X2=-0.5	X3=0.5	S11=-		
1835.20925821724	IsS11Max=No	IsS11Min=No	FrameElem=7	ElemStation=0.25					
Frame=7	Station=0.25	OutputCase=TERRVERT	CaseType=LinStatic	Point=3	X2=0.5	X3=-0.5			
S11=852.709267192858	IsS11Max=Yes	IsS11Min=No	FrameElem=7	ElemStation=0.25					
Frame=7	Station=0.25	OutputCase=TERRVERT	CaseType=LinStatic	Point=4	X2=0.5	X3=0.5			
S11=852.709267192858	IsS11Max=No	IsS11Min=No	FrameElem=7	ElemStation=0.25					
Frame=7	Station=0	OutputCase=TERRLAT	CaseType=LinStatic	Point=0	X2=0	X3=0	S11=-3.34182004735339E-07		
IsS11Max=No	IsS11Min=No	FrameElem=7	ElemStation=0						
Frame=7	Station=0	OutputCase=TERRLAT	CaseType=LinStatic	Point=1	X2=-0.5	X3=-0.5	S11=-		
14.0534902766194	IsS11Max=No	IsS11Min=Yes	FrameElem=7	ElemStation=0					
Frame=7	Station=0	OutputCase=TERRLAT	CaseType=LinStatic	Point=2	X2=-0.5	X3=0.5	S11=-		
14.0534902766194	IsS11Max=No	IsS11Min=No	FrameElem=7	ElemStation=0					
Frame=7	Station=0	OutputCase=TERRLAT	CaseType=LinStatic	Point=3	X2=0.5	X3=-0.5	S11=14.0534896082554		
IsS11Max=Yes	IsS11Min=No	FrameElem=7	ElemStation=0						
Frame=7	Station=0	OutputCase=TERRLAT	CaseType=LinStatic	Point=4	X2=0.5	X3=0.5	S11=14.0534896082554		
IsS11Max=No	IsS11Min=No	FrameElem=7	ElemStation=0						
Frame=7	Station=0.25	OutputCase=TERRLAT	CaseType=LinStatic	Point=0	X2=0	X3=0	S11=-		
3.34182004735339E-07	IsS11Max=No	IsS11Min=No	FrameElem=7	ElemStation=0.25					
Frame=7	Station=0.25	OutputCase=TERRLAT	CaseType=LinStatic	Point=1	X2=-0.5	X3=-0.5			
S11=80.219631510158	IsS11Max=Yes	IsS11Min=No	FrameElem=7	ElemStation=0.25					
Frame=7	Station=0.25	OutputCase=TERRLAT	CaseType=LinStatic	Point=2	X2=-0.5	X3=0.5			
S11=80.219631510158	IsS11Max=No	IsS11Min=No	FrameElem=7	ElemStation=0.25					
Frame=7	Station=0.25	OutputCase=TERRLAT	CaseType=LinStatic	Point=3	X2=0.5	X3=-0.5	S11=-		
80.219632178522	IsS11Max=No	IsS11Min=Yes	FrameElem=7	ElemStation=0.25					
Frame=7	Station=0.25	OutputCase=TERRLAT	CaseType=LinStatic	Point=4	X2=0.5	X3=0.5	S11=-		
80.219632178522	IsS11Max=No	IsS11Min=No	FrameElem=7	ElemStation=0.25					
Frame=7	Station=0	OutputCase=ACCLATDX	CaseType=LinStatic	Point=0	X2=0	X3=0	S11=0	IsS11Max=Yes	
IsS11Min=Yes	FrameElem=7	ElemStation=0							
Frame=7	Station=0	OutputCase=ACCLATDX	CaseType=LinStatic	Point=1	X2=-0.5	X3=-0.5	S11=0		
IsS11Max=No	IsS11Min=No	FrameElem=7	ElemStation=0						
Frame=7	Station=0	OutputCase=ACCLATDX	CaseType=LinStatic	Point=2	X2=-0.5	X3=0.5	S11=0	IsS11Max=No	
IsS11Min=No	FrameElem=7	ElemStation=0							
Frame=7	Station=0	OutputCase=ACCLATDX	CaseType=LinStatic	Point=3	X2=0.5	X3=-0.5	S11=0	IsS11Max=No	
IsS11Min=No	FrameElem=7	ElemStation=0							
Frame=7	Station=0	OutputCase=ACCLATDX	CaseType=LinStatic	Point=4	X2=0.5	X3=0.5	S11=0	IsS11Max=No	
IsS11Min=No	FrameElem=7	ElemStation=0							
Frame=7	Station=0.25	OutputCase=ACCLATDX	CaseType=LinStatic	Point=0	X2=0	X3=0	S11=0	IsS11Max=Yes	
IsS11Min=Yes	FrameElem=7	ElemStation=0.25							
Frame=7	Station=0.25	OutputCase=ACCLATDX	CaseType=LinStatic	Point=1	X2=-0.5	X3=-0.5	S11=0		
IsS11Max=No	IsS11Min=No	FrameElem=7	ElemStation=0.25						
Frame=7	Station=0.25	OutputCase=ACCLATDX	CaseType=LinStatic	Point=2	X2=-0.5	X3=0.5	S11=0		
IsS11Max=No	IsS11Min=No	FrameElem=7	ElemStation=0.25						
Frame=7	Station=0.25	OutputCase=ACCLATDX	CaseType=LinStatic	Point=3	X2=0.5	X3=-0.5	S11=0		
IsS11Max=No	IsS11Min=No	FrameElem=7	ElemStation=0.25						
Frame=7	Station=0.25	OutputCase=ACCLATDX	CaseType=LinStatic	Point=4	X2=0.5	X3=0.5	S11=0		
IsS11Max=No	IsS11Min=No	FrameElem=7	ElemStation=0.25						
Frame=7	Station=0	OutputCase=ACCLATSX	CaseType=LinStatic	Point=0	X2=0	X3=0	S11=0	IsS11Max=Yes	
IsS11Min=Yes	FrameElem=7	ElemStation=0							
Frame=7	Station=0	OutputCase=ACCLATSX	CaseType=LinStatic	Point=1	X2=-0.5	X3=-0.5	S11=0		
IsS11Max=No	IsS11Min=No	FrameElem=7	ElemStation=0						
Frame=7	Station=0	OutputCase=ACCLATSX	CaseType=LinStatic	Point=2	X2=-0.5	X3=0.5	S11=0	IsS11Max=No	
IsS11Min=No	FrameElem=7	ElemStation=0							
Frame=7	Station=0	OutputCase=ACCLATSX	CaseType=LinStatic	Point=3	X2=0.5	X3=-0.5	S11=0	IsS11Max=No	
IsS11Min=No	FrameElem=7	ElemStation=0							
Frame=7	Station=0	OutputCase=ACCLATSX	CaseType=LinStatic	Point=4	X2=0.5	X3=0.5	S11=0	IsS11Max=No	
IsS11Min=No	FrameElem=7	ElemStation=0							
Frame=7	Station=0.25	OutputCase=ACCLATSX	CaseType=LinStatic	Point=0	X2=0	X3=0	S11=0	IsS11Max=Yes	
IsS11Min=Yes	FrameElem=7	ElemStation=0.25							
Frame=7	Station=0.25	OutputCase=ACCLATSX	CaseType=LinStatic	Point=1	X2=-0.5	X3=-0.5	S11=0		
IsS11Max=No	IsS11Min=No	FrameElem=7	ElemStation=0.25						
Frame=7	Station=0.25	OutputCase=ACCLATSX	CaseType=LinStatic	Point=2	X2=-0.5	X3=0.5	S11=0		
IsS11Max=No	IsS11Min=No	FrameElem=7	ElemStation=0.25						
Frame=7	Station=0.25	OutputCase=ACCLATSX	CaseType=LinStatic	Point=3	X2=0.5	X3=-0.5	S11=0		
IsS11Max=No	IsS11Min=No	FrameElem=7	ElemStation=0.25						
Frame=7	Station=0.25	OutputCase=ACCLATSX	CaseType=LinStatic	Point=4	X2=0.5	X3=0.5	S11=0		
IsS11Max=No	IsS11Min=No	FrameElem=7	ElemStation=0.25						
Frame=7	Station=0	OutputCase=TERRCOST	CaseType=LinStatic	Point=0	X2=0	X3=0	S11=0	IsS11Max=Yes	
IsS11Min=Yes	FrameElem=7	ElemStation=0							
Frame=7	Station=0	OutputCase=TERRCOST	CaseType=LinStatic	Point=1	X2=-0.5	X3=-0.5	S11=0		
IsS11Max=No	IsS11Min=No	FrameElem=7	ElemStation=0						
Frame=7	Station=0	OutputCase=TERRCOST	CaseType=LinStatic	Point=2	X2=-0.5	X3=0.5	S11=0	IsS11Max=No	
IsS11Min=No	FrameElem=7	ElemStation=0							
Frame=7	Station=0	OutputCase=TERRCOST	CaseType=LinStatic	Point=3	X2=0.5	X3=-0.5	S11=0	IsS11Max=No	
IsS11Min=No	FrameElem=7	ElemStation=0							

Frame=7	Station=0	OutputCase=TERRCOST	CaseType=LinStatic	Point=4	X2=0.5	X3=0.5	S11=0	IsS11Max=No
IsS11Min=No	FrameElem=7	ElemStation=0						
Frame=7	Station=0.25	OutputCase=TERRCOST	CaseType=LinStatic	Point=0	X2=0	X3=0	S11=0	IsS11Max=Yes
IsS11Min=Yes	FrameElem=7	ElemStation=0.25						
Frame=7	Station=0.25	OutputCase=TERRCOST	CaseType=LinStatic	Point=1	X2=-0.5	X3=-0.5	S11=0	
IsS11Max=No	IsS11Min=No	FrameElem=7	ElemStation=0.25					
Frame=7	Station=0.25	OutputCase=TERRCOST	CaseType=LinStatic	Point=2	X2=-0.5	X3=0.5	S11=0	
IsS11Max=No	IsS11Min=No	FrameElem=7	ElemStation=0.25					
Frame=7	Station=0.25	OutputCase=TERRCOST	CaseType=LinStatic	Point=3	X2=0.5	X3=-0.5	S11=0	
IsS11Max=No	IsS11Min=No	FrameElem=7	ElemStation=0.25					
Frame=7	Station=0.25	OutputCase=TERRCOST	CaseType=LinStatic	Point=4	X2=0.5	X3=0.5	S11=0	
IsS11Max=No	IsS11Min=No	FrameElem=7	ElemStation=0.25					
Frame=7	Station=0	OutputCase=SOVRCOST	CaseType=LinStatic	Point=0	X2=0	X3=0	S11=0	IsS11Max=Yes
IsS11Min=Yes	FrameElem=7	ElemStation=0						
Frame=7	Station=0	OutputCase=SOVRCOST	CaseType=LinStatic	Point=1	X2=-0.5	X3=-0.5	S11=0	
IsS11Max=No	IsS11Min=No	FrameElem=7	ElemStation=0					
Frame=7	Station=0	OutputCase=SOVRCOST	CaseType=LinStatic	Point=2	X2=-0.5	X3=0.5	S11=0	IsS11Max=No
IsS11Min=No	FrameElem=7	ElemStation=0						
Frame=7	Station=0	OutputCase=SOVRCOST	CaseType=LinStatic	Point=3	X2=0.5	X3=-0.5	S11=0	IsS11Max=No
IsS11Min=No	FrameElem=7	ElemStation=0						
Frame=7	Station=0	OutputCase=SOVRCOST	CaseType=LinStatic	Point=4	X2=0.5	X3=0.5	S11=0	IsS11Max=No
IsS11Min=No	FrameElem=7	ElemStation=0						
Frame=7	Station=0.25	OutputCase=SOVRCOST	CaseType=LinStatic	Point=0	X2=0	X3=0	S11=0	IsS11Max=Yes
IsS11Min=Yes	FrameElem=7	ElemStation=0.25						
Frame=7	Station=0.25	OutputCase=SOVRCOST	CaseType=LinStatic	Point=1	X2=-0.5	X3=-0.5	S11=0	
IsS11Max=No	IsS11Min=No	FrameElem=7	ElemStation=0.25					
Frame=7	Station=0.25	OutputCase=SOVRCOST	CaseType=LinStatic	Point=2	X2=-0.5	X3=0.5	S11=0	
IsS11Max=No	IsS11Min=No	FrameElem=7	ElemStation=0.25					
Frame=7	Station=0.25	OutputCase=SOVRCOST	CaseType=LinStatic	Point=3	X2=0.5	X3=-0.5	S11=0	
IsS11Max=No	IsS11Min=No	FrameElem=7	ElemStation=0.25					
Frame=7	Station=0.25	OutputCase=SOVRCOST	CaseType=LinStatic	Point=4	X2=0.5	X3=0.5	S11=0	
IsS11Max=No	IsS11Min=No	FrameElem=7	ElemStation=0.25					
Frame=7	Station=0	OutputCase=ENVE	CaseType=Combination	StepType=Max	Point=0	X2=0	X3=0	S11=-
647.499994564909	IsS11Max=No	IsS11Min=No	FrameElem=7	ElemStation=0				
Frame=7	Station=0	OutputCase=ENVE	CaseType=Combination	StepType=Max	Point=1	X2=-0.5	X3=-0.5	S11=-
2467.34323504176	IsS11Max=No	IsS11Min=Yes	FrameElem=7	ElemStation=0				
Frame=7	Station=0	OutputCase=ENVE	CaseType=Combination	StepType=Max	Point=2	X2=-0.5	X3=0.5	S11=-
2467.34323504176	IsS11Max=No	IsS11Min=No	FrameElem=7	ElemStation=0				
Frame=7	Station=0	OutputCase=ENVE	CaseType=Combination	StepType=Max	Point=3	X2=0.5	X3=-0.5	
S11=1176.55929279441	IsS11Max=Yes	IsS11Min=No	FrameElem=7	ElemStation=0				
Frame=7	Station=0	OutputCase=ENVE	CaseType=Combination	StepType=Max	Point=4	X2=0.5	X3=0.5	
S11=1176.55929279441	IsS11Max=No	IsS11Min=No	FrameElem=7	ElemStation=0				
Frame=7	Station=0.25	OutputCase=ENVE	CaseType=Combination	StepType=Max	Point=0	X2=0	X3=0	S11=-
641.249994564909	IsS11Max=No	IsS11Min=No	FrameElem=7	ElemStation=0.25				
Frame=7	Station=0.25	OutputCase=ENVE	CaseType=Combination	StepType=Max	Point=1	X2=-0.5	X3=-0.5	
S11=-2350.00898309355	IsS11Max=No	IsS11Min=Yes	FrameElem=7	ElemStation=0.25				
Frame=7	Station=0.25	OutputCase=ENVE	CaseType=Combination	StepType=Max	Point=2	X2=-0.5	X3=0.5	
S11=-2350.00898309355	IsS11Max=No	IsS11Min=No	FrameElem=7	ElemStation=0.25				
Frame=7	Station=0.25	OutputCase=ENVE	CaseType=Combination	StepType=Max	Point=3	X2=0.5	X3=-0.5	
S11=1091.57488341678	IsS11Max=Yes	IsS11Min=No	FrameElem=7	ElemStation=0.25				
Frame=7	Station=0.25	OutputCase=ENVE	CaseType=Combination	StepType=Max	Point=4	X2=0.5	X3=0.5	
S11=1091.57488341678	IsS11Max=No	IsS11Min=No	FrameElem=7	ElemStation=0.25				
Frame=7	Station=0	OutputCase=ENVE	CaseType=Combination	StepType=Min	Point=0	X2=0	X3=0	S11=-
647.499994665163	IsS11Max=No	IsS11Min=No	FrameElem=7	ElemStation=0				
Frame=7	Station=0	OutputCase=ENVE	CaseType=Combination	StepType=Min	Point=1	X2=-0.5	X3=-0.5	S11=-
2471.55928212474	IsS11Max=No	IsS11Min=Yes	FrameElem=7	ElemStation=0				
Frame=7	Station=0	OutputCase=ENVE	CaseType=Combination	StepType=Min	Point=2	X2=-0.5	X3=0.5	S11=-
2471.55928212474	IsS11Max=No	IsS11Min=No	FrameElem=7	ElemStation=0				
Frame=7	Station=0	OutputCase=ENVE	CaseType=Combination	StepType=Min	Point=3	X2=0.5	X3=-0.5	
S11=1172.34324591194	IsS11Max=Yes	IsS11Min=No	FrameElem=7	ElemStation=0				
Frame=7	Station=0	OutputCase=ENVE	CaseType=Combination	StepType=Min	Point=4	X2=0.5	X3=0.5	
S11=1172.34324591194	IsS11Max=No	IsS11Min=No	FrameElem=7	ElemStation=0				
Frame=7	Station=0.25	OutputCase=ENVE	CaseType=Combination	StepType=Min	Point=0	X2=0	X3=0	S11=-
641.249994665163	IsS11Max=No	IsS11Min=No	FrameElem=7	ElemStation=0.25				
Frame=7	Station=0.25	OutputCase=ENVE	CaseType=Combination	StepType=Min	Point=1	X2=-0.5	X3=-0.5	
S11=-2374.0748725466	IsS11Max=No	IsS11Min=Yes	FrameElem=7	ElemStation=0.25				
Frame=7	Station=0.25	OutputCase=ENVE	CaseType=Combination	StepType=Min	Point=2	X2=-0.5	X3=0.5	
S11=-2374.0748725466	IsS11Max=No	IsS11Min=No	FrameElem=7	ElemStation=0.25				
Frame=7	Station=0.25	OutputCase=ENVE	CaseType=Combination	StepType=Min	Point=3	X2=0.5	X3=-0.5	
S11=1067.50899376323	IsS11Max=Yes	IsS11Min=No	FrameElem=7	ElemStation=0.25				
Frame=7	Station=0.25	OutputCase=ENVE	CaseType=Combination	StepType=Min	Point=4	X2=0.5	X3=0.5	
S11=1067.50899376323	IsS11Max=No	IsS11Min=No	FrameElem=7	ElemStation=0.25				
Frame=7	Station=0	OutputCase=FESSUR	CaseType=Combination	Point=0	X2=0	X3=0	S11=-647.499994665163	
IsS11Max=No	IsS11Min=No	FrameElem=7	ElemStation=0					
Frame=7	Station=0	OutputCase=FESSUR	CaseType=Combination	Point=1	X2=-0.5	X3=-0.5	S11=-	
2471.55928212474	IsS11Max=No	IsS11Min=Yes	FrameElem=7	ElemStation=0				
Frame=7	Station=0	OutputCase=FESSUR	CaseType=Combination	Point=2	X2=-0.5	X3=0.5	S11=-	
2471.55928212474	IsS11Max=No	IsS11Min=No	FrameElem=7	ElemStation=0				
Frame=7	Station=0	OutputCase=FESSUR	CaseType=Combination	Point=3	X2=0.5	X3=-0.5		
S11=1176.55929279441	IsS11Max=Yes	IsS11Min=No	FrameElem=7	ElemStation=0				
Frame=7	Station=0	OutputCase=FESSUR	CaseType=Combination	Point=4	X2=0.5	X3=0.5	S11=1176.55929279441	
IsS11Max=No	IsS11Min=No	FrameElem=7	ElemStation=0					



Frame=7	Station=0.25	OutputCase=FESSUR	CaseType=Combination	Point=0	X2=0	X3=0	S11=-641.249994665163
IsS11Max=No	IsS11Min=No	FrameElem=7	ElemStation=0.25				
Frame=7	Station=0.25	OutputCase=FESSUR	CaseType=Combination	Point=1	X2=-0.5	X3=-0.5	S11=-
2350.00898309355	IsS11Max=No	IsS11Min=Yes	FrameElem=7	ElemStation=0.25			
Frame=7	Station=0.25	OutputCase=FESSUR	CaseType=Combination	Point=2	X2=-0.5	X3=0.5	S11=-
2350.00898309355	IsS11Max=No	IsS11Min=No	FrameElem=7	ElemStation=0.25			
Frame=7	Station=0.25	OutputCase=FESSUR	CaseType=Combination	Point=3	X2=0.5	X3=-0.5	
S11=1067.50899376323	IsS11Max=Yes	IsS11Min=No	FrameElem=7	ElemStation=0.25			
Frame=7	Station=0.25	OutputCase=FESSUR	CaseType=Combination	Point=4	X2=0.5	X3=0.5	
S11=1067.50899376323	IsS11Max=No	IsS11Min=No	FrameElem=7	ElemStation=0.25			
Frame=9	Station=0	OutputCase=PESOPR	CaseType=LinStatic	Point=0	X2=0	X3=0	S11=-75.0000002653105
IsS11Max=No	IsS11Min=No	FrameElem=9	ElemStation=0				
Frame=9	Station=0	OutputCase=PESOPR	CaseType=LinStatic	Point=1	X2=-0.5	X3=-0.5	S11=-246.94230048749
IsS11Max=No	IsS11Min=Yes	FrameElem=9	ElemStation=0				
Frame=9	Station=0	OutputCase=PESOPR	CaseType=LinStatic	Point=2	X2=-0.5	X3=0.5	S11=-246.94230048749
IsS11Max=No	IsS11Min=No	FrameElem=9	ElemStation=0				
Frame=9	Station=0	OutputCase=PESOPR	CaseType=LinStatic	Point=3	X2=0.5	X3=-0.5	S11=96.9422999568694
IsS11Max=Yes	IsS11Min=No	FrameElem=9	ElemStation=0				
Frame=9	Station=0	OutputCase=PESOPR	CaseType=LinStatic	Point=4	X2=0.5	X3=0.5	S11=96.9422999568694
IsS11Max=No	IsS11Min=No	FrameElem=9	ElemStation=0				
Frame=9	Station=0.25000000000002	OutputCase=PESOPR	CaseType=LinStatic	Point=0	X2=0	X3=0	S11=-
68.7500002653105	IsS11Max=No	IsS11Min=No	FrameElem=9	ElemStation=0.25000000000002			
Frame=9	Station=0.25000000000002	OutputCase=PESOPR	CaseType=LinStatic	Point=1	X2=-0.5	X3=-0.5	
S11=-217.935890664938	IsS11Max=No	IsS11Min=Yes	FrameElem=9	ElemStation=0.25000000000002			
Frame=9	Station=0.25000000000002	OutputCase=PESOPR	CaseType=LinStatic	Point=2	X2=-0.5	X3=0.5	S11=-
217.935890664938	IsS11Max=No	IsS11Min=No	FrameElem=9	ElemStation=0.25000000000002			
Frame=9	Station=0.25000000000002	OutputCase=PESOPR	CaseType=LinStatic	Point=3	X2=0.5	X3=-0.5	
S11=80.4358901343169	IsS11Max=Yes	IsS11Min=No	FrameElem=9	ElemStation=0.25000000000002			
Frame=9	Station=0.25000000000002	OutputCase=PESOPR	CaseType=LinStatic	Point=4	X2=0.5	X3=0.5	
S11=80.4358901343169	IsS11Max=No	IsS11Min=No	FrameElem=9	ElemStation=0.25000000000002			
Frame=9	Station=0	OutputCase=TERRVERT	CaseType=LinStatic	Point=0	X2=0	X3=0	S11=-491.249995401595
IsS11Max=No	IsS11Min=No	FrameElem=9	ElemStation=0				
Frame=9	Station=0	OutputCase=TERRVERT	CaseType=LinStatic	Point=1	X2=-0.5	X3=-0.5	S11=-
1855.96010215212	IsS11Max=No	IsS11Min=Yes	FrameElem=9	ElemStation=0			
Frame=9	Station=0	OutputCase=TERRVERT	CaseType=LinStatic	Point=2	X2=-0.5	X3=0.5	S11=-
1855.96010215212	IsS11Max=No	IsS11Min=No	FrameElem=9	ElemStation=0			
Frame=9	Station=0	OutputCase=TERRVERT	CaseType=LinStatic	Point=3	X2=0.5	X3=-0.5	
S11=873.460111348933	IsS11Max=Yes	IsS11Min=No	FrameElem=9	ElemStation=0			
Frame=9	Station=0	OutputCase=TERRVERT	CaseType=LinStatic	Point=4	X2=0.5	X3=0.5	S11=873.460111348933
IsS11Max=No	IsS11Min=No	FrameElem=9	ElemStation=0				
Frame=9	Station=0.25000000000002	OutputCase=TERRVERT	CaseType=LinStatic	Point=0	X2=0	X3=0	S11=-
491.249995401595	IsS11Max=No	IsS11Min=No	FrameElem=9	ElemStation=0.25000000000002			
Frame=9	Station=0.25000000000002	OutputCase=TERRVERT	CaseType=LinStatic	Point=1	X2=-0.5	X3=-0.5	
S11=-1857.68941528594	IsS11Max=No	IsS11Min=Yes	FrameElem=9	ElemStation=0.25000000000002			
Frame=9	Station=0.25000000000002	OutputCase=TERRVERT	CaseType=LinStatic	Point=2	X2=-0.5	X3=0.5	
S11=-1857.68941528594	IsS11Max=No	IsS11Min=No	FrameElem=9	ElemStation=0.25000000000002			
Frame=9	Station=0.25000000000002	OutputCase=TERRVERT	CaseType=LinStatic	Point=3	X2=0.5	X3=-0.5	
S11=875.189424482754	IsS11Max=Yes	IsS11Min=No	FrameElem=9	ElemStation=0.25000000000002			
Frame=9	Station=0.25000000000002	OutputCase=TERRVERT	CaseType=LinStatic	Point=4	X2=0.5	X3=0.5	
S11=875.189424482754	IsS11Max=No	IsS11Min=No	FrameElem=9	ElemStation=0.25000000000002			
Frame=9	Station=0	OutputCase=TERRLAT	CaseType=LinStatic	Point=0	X2=0	X3=0	S11=4.30409454565961E-06
IsS11Max=No	IsS11Min=No	FrameElem=9	ElemStation=0				
Frame=9	Station=0	OutputCase=TERRLAT	CaseType=LinStatic	Point=1	X2=-0.5	X3=-0.5	
S11=38.2978809459499	IsS11Max=Yes	IsS11Min=No	FrameElem=9	ElemStation=0			
Frame=9	Station=0	OutputCase=TERRLAT	CaseType=LinStatic	Point=2	X2=-0.5	X3=0.5	S11=38.2978809459499
IsS11Max=No	IsS11Min=No	FrameElem=9	ElemStation=0				
Frame=9	Station=0	OutputCase=TERRLAT	CaseType=LinStatic	Point=3	X2=0.5	X3=-0.5	S11=-
38.2978723377608	IsS11Max=No	IsS11Min=Yes	FrameElem=9	ElemStation=0			
Frame=9	Station=0	OutputCase=TERRLAT	CaseType=LinStatic	Point=4	X2=0.5	X3=0.5	S11=-38.2978723377608
IsS11Max=No	IsS11Min=No	FrameElem=9	ElemStation=0				
Frame=9	Station=0.25000000000002	OutputCase=TERRLAT	CaseType=LinStatic	Point=0	X2=0	X3=0	
S11=4.81139712164082E-06	IsS11Max=No	IsS11Min=No	FrameElem=9	ElemStation=0.25000000000002			
Frame=9	Station=0.25000000000002	OutputCase=TERRLAT	CaseType=LinStatic	Point=1	X2=-0.5	X3=-0.5	
S11=-38.7121212643982	IsS11Max=No	IsS11Min=Yes	FrameElem=9	ElemStation=0.25000000000002			
Frame=9	Station=0.25000000000002	OutputCase=TERRLAT	CaseType=LinStatic	Point=2	X2=-0.5	X3=0.5	
S11=-38.7121212643982	IsS11Max=No	IsS11Min=No	FrameElem=9	ElemStation=0.25000000000002			
Frame=9	Station=0.25000000000002	OutputCase=TERRLAT	CaseType=LinStatic	Point=3	X2=0.5	X3=-0.5	
S11=38.7121308871925	IsS11Max=Yes	IsS11Min=No	FrameElem=9	ElemStation=0.25000000000002			
Frame=9	Station=0.25000000000002	OutputCase=TERRLAT	CaseType=LinStatic	Point=4	X2=0.5	X3=0.5	
S11=38.7121308871925	IsS11Max=No	IsS11Min=No	FrameElem=9	ElemStation=0.25000000000002			
Frame=9	Station=0	OutputCase=ACCLATDX	CaseType=LinStatic	Point=0	X2=0	X3=0	S11=0 IsS11Max=Yes
IsS11Min=Yes	FrameElem=9	ElemStation=0					
Frame=9	Station=0	OutputCase=ACCLATDX	CaseType=LinStatic	Point=1	X2=-0.5	X3=-0.5	S11=0
IsS11Max=No	IsS11Min=No	FrameElem=9	ElemStation=0				
Frame=9	Station=0	OutputCase=ACCLATDX	CaseType=LinStatic	Point=2	X2=-0.5	X3=0.5	S11=0 IsS11Max=No
IsS11Min=No	FrameElem=9	ElemStation=0					
Frame=9	Station=0	OutputCase=ACCLATDX	CaseType=LinStatic	Point=3	X2=0.5	X3=-0.5	S11=0 IsS11Max=No
IsS11Min=No	FrameElem=9	ElemStation=0					
Frame=9	Station=0	OutputCase=ACCLATDX	CaseType=LinStatic	Point=4	X2=0.5	X3=0.5	S11=0 IsS11Max=No
IsS11Min=No	FrameElem=9	ElemStation=0					
Frame=9	Station=0.25000000000002	OutputCase=ACCLATDX	CaseType=LinStatic	Point=0	X2=0	X3=0	S11=0
IsS11Max=Yes	IsS11Min=Yes	FrameElem=9	ElemStation=0.25000000000002				

Frame=9 Station=0.250000000000002 OutputCase=ENVE CaseType=Combination StepType=Max Point=2 X2=-0.5
X3=0.5 S11=-2102.72379083596 IsS11Max=No IsS11Min=No FrameElem=9 ElemStation=0.250000000000002
Frame=9 Station=0.250000000000002 OutputCase=ENVE CaseType=Combination StepType=Max Point=3 X2=0.5
X3=-0.5 S11=994.337445504263 IsS11Max=Yes IsS11Min=No FrameElem=9 ElemStation=0.250000000000002
Frame=9 Station=0.250000000000002 OutputCase=ENVE CaseType=Combination StepType=Max Point=4 X2=0.5
X3=0.5 S11=994.337445504263 IsS11Max=No IsS11Min=No FrameElem=9 ElemStation=0.250000000000002
Frame=9 Station=0 OutputCase=ENVE CaseType=Combination StepType=Min Point=0 X2=0 X3=0 S11=-
566.249992654039 IsS11Max=No IsS11Min=No FrameElem=9 ElemStation=0
Frame=9 Station=0 OutputCase=ENVE CaseType=Combination StepType=Min Point=1 X2=-0.5 X3=-0.5 S11=-
2076.09388597745 IsS11Max=No IsS11Min=Yes FrameElem=9 ElemStation=0
Frame=9 Station=0 OutputCase=ENVE CaseType=Combination StepType=Min Point=2 X2=-0.5 X3=0.5 S11=-
2076.09388597745 IsS11Max=No IsS11Min=No FrameElem=9 ElemStation=0
Frame=9 Station=0 OutputCase=ENVE CaseType=Combination StepType=Min Point=3 X2=0.5 X3=-0.5
S11=932.104538968042 IsS11Max=Yes IsS11Min=No FrameElem=9 ElemStation=0
Frame=9 Station=0 OutputCase=ENVE CaseType=Combination StepType=Min Point=4 X2=0.5 X3=0.5
S11=932.104538968042 IsS11Max=No IsS11Min=No FrameElem=9 ElemStation=0
Frame=9 Station=0.250000000000002 OutputCase=ENVE CaseType=Combination StepType=Min Point=0 X2=0
X3=0 S11=-559.999992298927 IsS11Max=No IsS11Min=No FrameElem=9 ElemStation=0.250000000000002
Frame=9 Station=0.250000000000002 OutputCase=ENVE CaseType=Combination StepType=Min Point=1 X2=-0.5
X3=-0.5 S11=-2114.33742721528 IsS11Max=No IsS11Min=Yes FrameElem=9 ElemStation=0.250000000000002
Frame=9 Station=0.250000000000002 OutputCase=ENVE CaseType=Combination StepType=Min Point=2 X2=-0.5
X3=0.5 S11=-2114.33742721528 IsS11Max=No IsS11Min=No FrameElem=9 ElemStation=0.250000000000002
Frame=9 Station=0.250000000000002 OutputCase=ENVE CaseType=Combination StepType=Min Point=3 X2=0.5
X3=-0.5 S11=982.723806238105 IsS11Max=Yes IsS11Min=No FrameElem=9 ElemStation=0.250000000000002
Frame=9 Station=0.250000000000002 OutputCase=ENVE CaseType=Combination StepType=Min Point=4 X2=0.5
X3=0.5 S11=982.723806238105 IsS11Max=No IsS11Min=No FrameElem=9 ElemStation=0.250000000000002
Frame=9 Station=0 OutputCase=FESSUR CaseType=Combination Point=0 X2=0 X3=0 S11=-566.249991362811
IsS11Max=No IsS11Min=No FrameElem=9 ElemStation=0
Frame=9 Station=0 OutputCase=FESSUR CaseType=Combination Point=1 X2=-0.5 X3=-0.5 S11=-
2064.60452169366 IsS11Max=No IsS11Min=Yes FrameElem=9 ElemStation=0
Frame=9 Station=0 OutputCase=FESSUR CaseType=Combination Point=2 X2=-0.5 X3=0.5 S11=-
2064.60452169366 IsS11Max=No IsS11Min=No FrameElem=9 ElemStation=0
Frame=9 Station=0 OutputCase=FESSUR CaseType=Combination Point=3 X2=0.5 X3=-0.5
S11=932.104538968042 IsS11Max=Yes IsS11Min=No FrameElem=9 ElemStation=0
Frame=9 Station=0 OutputCase=FESSUR CaseType=Combination Point=4 X2=0.5 X3=0.5 S11=932.104538968042
IsS11Max=No IsS11Min=No FrameElem=9 ElemStation=0
Frame=9 Station=0.250000000000002 OutputCase=FESSUR CaseType=Combination Point=0 X2=0 X3=0 S11=-
559.999990855508 IsS11Max=No IsS11Min=No FrameElem=9 ElemStation=0.250000000000002
Frame=9 Station=0.250000000000002 OutputCase=FESSUR CaseType=Combination Point=1 X2=-0.5 X3=-0.5
S11=-2114.33742721528 IsS11Max=No IsS11Min=Yes FrameElem=9 ElemStation=0.250000000000002
Frame=9 Station=0.250000000000002 OutputCase=FESSUR CaseType=Combination Point=2 X2=-0.5 X3=0.5
S11=-2114.33742721528 IsS11Max=No IsS11Min=No FrameElem=9 ElemStation=0.250000000000002
Frame=9 Station=0.250000000000002 OutputCase=FESSUR CaseType=Combination Point=3 X2=0.5 X3=-0.5
S11=994.337445504263 IsS11Max=Yes IsS11Min=No FrameElem=9 ElemStation=0.250000000000002
Frame=9 Station=0.250000000000002 OutputCase=FESSUR CaseType=Combination Point=4 X2=0.5 X3=0.5
S11=994.337445504263 IsS11Max=No IsS11Min=No FrameElem=9 ElemStation=0.250000000000002
Frame=10 Station=0 OutputCase=PESOPR CaseType=LinStatic Point=0 X2=0 X3=0 S11=-68.7499973719241
IsS11Max=No IsS11Min=No FrameElem=10 ElemStation=0
Frame=10 Station=0 OutputCase=PESOPR CaseType=LinStatic Point=1 X2=-0.5 X3=-0.5 S11=-
217.935887771543 IsS11Max=No IsS11Min=Yes FrameElem=10 ElemStation=0
Frame=10 Station=0 OutputCase=PESOPR CaseType=LinStatic Point=2 X2=-0.5 X3=0.5 S11=-
217.935887771543 IsS11Max=No IsS11Min=No FrameElem=10 ElemStation=0
Frame=10 Station=0 OutputCase=PESOPR CaseType=LinStatic Point=3 X2=0.5 X3=-0.5 S11=80.4358930276943
IsS11Max=Yes IsS11Min=No FrameElem=10 ElemStation=0
Frame=10 Station=0 OutputCase=PESOPR CaseType=LinStatic Point=4 X2=0.5 X3=0.5 S11=80.4358930276943
IsS11Max=No IsS11Min=No FrameElem=10 ElemStation=0
Frame=10 Station=0.249999976158143 OutputCase=PESOPR CaseType=LinStatic Point=0 X2=0 X3=0 S11=-
62.4999979679706 IsS11Max=No IsS11Min=No FrameElem=10 ElemStation=0.249999976158143
Frame=10 Station=0.249999976158143 OutputCase=PESOPR CaseType=LinStatic Point=1 X2=-0.5 X3=-0.5
S11=-188.929461045724 IsS11Max=No IsS11Min=Yes FrameElem=10 ElemStation=0.249999976158143
Frame=10 Station=0.249999976158143 OutputCase=PESOPR CaseType=LinStatic Point=2 X2=-0.5 X3=0.5
S11=-188.929461045724 IsS11Max=No IsS11Min=No FrameElem=10 ElemStation=0.249999976158143
Frame=10 Station=0.249999976158143 OutputCase=PESOPR CaseType=LinStatic Point=3 X2=0.5 X3=-0.5
S11=63.9294651097829 IsS11Max=Yes IsS11Min=No FrameElem=10 ElemStation=0.249999976158143
Frame=10 Station=0.249999976158143 OutputCase=PESOPR CaseType=LinStatic Point=4 X2=0.5 X3=0.5
S11=63.9294651097829 IsS11Max=No IsS11Min=No FrameElem=10 ElemStation=0.249999976158143
Frame=10 Station=0 OutputCase=TERRVERT CaseType=LinStatic Point=0 X2=0 X3=0 S11=-491.249995622085
IsS11Max=No IsS11Min=No FrameElem=10 ElemStation=0
Frame=10 Station=0 OutputCase=TERRVERT CaseType=LinStatic Point=1 X2=-0.5 X3=-0.5 S11=-
1857.68941550642 IsS11Max=No IsS11Min=Yes FrameElem=10 ElemStation=0
Frame=10 Station=0 OutputCase=TERRVERT CaseType=LinStatic Point=2 X2=-0.5 X3=0.5 S11=-
1857.68941550642 IsS11Max=No IsS11Min=No FrameElem=10 ElemStation=0
Frame=10 Station=0 OutputCase=TERRVERT CaseType=LinStatic Point=3 X2=0.5 X3=-0.5
S11=875.189424262249 IsS11Max=Yes IsS11Min=No FrameElem=10 ElemStation=0
Frame=10 Station=0 OutputCase=TERRVERT CaseType=LinStatic Point=4 X2=0.5 X3=0.5
S11=875.189424262249 IsS11Max=No IsS11Min=No FrameElem=10 ElemStation=0
Frame=10 Station=0.249999976158143 OutputCase=TERRVERT CaseType=LinStatic Point=0 X2=0 X3=0 S11=-
491.249995622085 IsS11Max=No IsS11Min=No FrameElem=10 ElemStation=0.249999976158143
Frame=10 Station=0.249999976158143 OutputCase=TERRVERT CaseType=LinStatic Point=1 X2=-0.5 X3=-0.5
S11=-1859.41858792758 IsS11Max=No IsS11Min=Yes FrameElem=10 ElemStation=0.249999976158143
Frame=10 Station=0.249999976158143 OutputCase=TERRVERT CaseType=LinStatic Point=2 X2=-0.5 X3=0.5
S11=-1859.41858792758 IsS11Max=No IsS11Min=No FrameElem=10 ElemStation=0.249999976158143

Frame=10 Station=0.249999976158143 OutputCase=TERRVERT CaseType=LinStatic Point=3 X2=0.5 X3=-0.5
S11=876.918596683405 IsS11Max=Yes IsS11Min=No FrameElem=10 ElemStation=0.249999976158143
Frame=10 Station=0.249999976158143 OutputCase=TERRVERT CaseType=LinStatic Point=4 X2=0.5 X3=0.5
S11=876.918596683405 IsS11Max=No IsS11Min=No FrameElem=10 ElemStation=0.249999976158143
Frame=10 Station=0 OutputCase=TERRLAT CaseType=LinStatic Point=0 X2=0 X3=0 S11=-5.4797619668534E-06
IsS11Max=No IsS11Min=No FrameElem=10 ElemStation=0
Frame=10 Station=0 OutputCase=TERRLAT CaseType=LinStatic Point=1 X2=-0.5 X3=-0.5 S11=-
38.7121315555574 IsS11Max=No IsS11Min=Yes FrameElem=10 ElemStation=0
Frame=10 Station=0 OutputCase=TERRLAT CaseType=LinStatic Point=2 X2=-0.5 X3=0.5 S11=-
38.7121315555574 IsS11Max=No IsS11Min=No FrameElem=10 ElemStation=0
Frame=10 Station=0 OutputCase=TERRLAT CaseType=LinStatic Point=3 X2=0.5 X3=-0.5
S11=38.7121205960335 IsS11Max=Yes IsS11Min=No FrameElem=10 ElemStation=0
Frame=10 Station=0 OutputCase=TERRLAT CaseType=LinStatic Point=4 X2=0.5 X3=0.5 S11=38.7121205960335
IsS11Max=No IsS11Min=No FrameElem=10 ElemStation=0
Frame=10 Station=0.249999976158143 OutputCase=TERRLAT CaseType=LinStatic Point=0 X2=0 X3=0 S11=-
5.93623668431245E-06 IsS11Max=No IsS11Min=No FrameElem=10 ElemStation=0.249999976158143
Frame=10 Station=0.249999976158143 OutputCase=TERRLAT CaseType=LinStatic Point=1 X2=-0.5 X3=-0.5
S11=-123.301579380125 IsS11Max=No IsS11Min=Yes FrameElem=10 ElemStation=0.249999976158143
Frame=10 Station=0.249999976158143 OutputCase=TERRLAT CaseType=LinStatic Point=2 X2=-0.5 X3=0.5
S11=-123.301579380125 IsS11Max=No IsS11Min=No FrameElem=10 ElemStation=0.249999976158143
Frame=10 Station=0.249999976158143 OutputCase=TERRLAT CaseType=LinStatic Point=3 X2=0.5 X3=-0.5
S11=123.301567507652 IsS11Max=Yes IsS11Min=No FrameElem=10 ElemStation=0.249999976158143
Frame=10 Station=0.249999976158143 OutputCase=TERRLAT CaseType=LinStatic Point=4 X2=0.5 X3=0.5
S11=123.301567507652 IsS11Max=No IsS11Min=No FrameElem=10 ElemStation=0.249999976158143
Frame=10 Station=0 OutputCase=ACCLATDX CaseType=LinStatic Point=0 X2=0 X3=0 S11=0 IsS11Max=Yes
IsS11Min=Yes FrameElem=10 ElemStation=0
Frame=10 Station=0 OutputCase=ACCLATDX CaseType=LinStatic Point=1 X2=-0.5 X3=-0.5 S11=0
IsS11Max=No IsS11Min=No FrameElem=10 ElemStation=0
Frame=10 Station=0 OutputCase=ACCLATDX CaseType=LinStatic Point=2 X2=-0.5 X3=0.5 S11=0
IsS11Max=No IsS11Min=No FrameElem=10 ElemStation=0
Frame=10 Station=0 OutputCase=ACCLATDX CaseType=LinStatic Point=3 X2=0.5 X3=-0.5 S11=0
IsS11Max=No IsS11Min=No FrameElem=10 ElemStation=0
Frame=10 Station=0 OutputCase=ACCLATDX CaseType=LinStatic Point=4 X2=0.5 X3=0.5 S11=0 IsS11Max=No
IsS11Min=No FrameElem=10 ElemStation=0
Frame=10 Station=0.249999976158143 OutputCase=ACCLATDX CaseType=LinStatic Point=0 X2=0 X3=0 S11=0
IsS11Max=Yes IsS11Min=Yes FrameElem=10 ElemStation=0.249999976158143
Frame=10 Station=0.249999976158143 OutputCase=ACCLATDX CaseType=LinStatic Point=1 X2=-0.5 X3=-0.5
S11=0 IsS11Max=No IsS11Min=No FrameElem=10 ElemStation=0.249999976158143
Frame=10 Station=0.249999976158143 OutputCase=ACCLATDX CaseType=LinStatic Point=2 X2=-0.5 X3=0.5
S11=0 IsS11Max=No IsS11Min=No FrameElem=10 ElemStation=0.249999976158143
Frame=10 Station=0.249999976158143 OutputCase=ACCLATDX CaseType=LinStatic Point=3 X2=0.5 X3=-0.5
S11=0 IsS11Max=No IsS11Min=No FrameElem=10 ElemStation=0.249999976158143
Frame=10 Station=0.249999976158143 OutputCase=ACCLATDX CaseType=LinStatic Point=4 X2=0.5 X3=0.5
S11=0 IsS11Max=No IsS11Min=No FrameElem=10 ElemStation=0.249999976158143
Frame=10 Station=0 OutputCase=ACCLATSX CaseType=LinStatic Point=0 X2=0 X3=0 S11=0 IsS11Max=Yes
IsS11Min=Yes FrameElem=10 ElemStation=0
Frame=10 Station=0 OutputCase=ACCLATSX CaseType=LinStatic Point=1 X2=-0.5 X3=-0.5 S11=0
IsS11Max=No IsS11Min=No FrameElem=10 ElemStation=0
Frame=10 Station=0 OutputCase=ACCLATSX CaseType=LinStatic Point=2 X2=-0.5 X3=0.5 S11=0
IsS11Max=No IsS11Min=No FrameElem=10 ElemStation=0
Frame=10 Station=0 OutputCase=ACCLATSX CaseType=LinStatic Point=3 X2=0.5 X3=-0.5 S11=0
IsS11Max=No IsS11Min=No FrameElem=10 ElemStation=0
Frame=10 Station=0 OutputCase=ACCLATSX CaseType=LinStatic Point=4 X2=0.5 X3=0.5 S11=0 IsS11Max=No
IsS11Min=No FrameElem=10 ElemStation=0
Frame=10 Station=0.249999976158143 OutputCase=ACCLATSX CaseType=LinStatic Point=0 X2=0 X3=0 S11=0
IsS11Max=Yes IsS11Min=Yes FrameElem=10 ElemStation=0.249999976158143
Frame=10 Station=0.249999976158143 OutputCase=ACCLATSX CaseType=LinStatic Point=1 X2=-0.5 X3=-0.5
S11=0 IsS11Max=No IsS11Min=No FrameElem=10 ElemStation=0.249999976158143
Frame=10 Station=0.249999976158143 OutputCase=ACCLATSX CaseType=LinStatic Point=2 X2=-0.5 X3=0.5
S11=0 IsS11Max=No IsS11Min=No FrameElem=10 ElemStation=0.249999976158143
Frame=10 Station=0.249999976158143 OutputCase=ACCLATSX CaseType=LinStatic Point=3 X2=0.5 X3=-0.5
S11=0 IsS11Max=No IsS11Min=No FrameElem=10 ElemStation=0.249999976158143
Frame=10 Station=0.249999976158143 OutputCase=ACCLATSX CaseType=LinStatic Point=4 X2=0.5 X3=0.5
S11=0 IsS11Max=No IsS11Min=No FrameElem=10 ElemStation=0.249999976158143
Frame=10 Station=0 OutputCase=TERRCOST CaseType=LinStatic Point=0 X2=0 X3=0 S11=0 IsS11Max=Yes
IsS11Min=Yes FrameElem=10 ElemStation=0
Frame=10 Station=0 OutputCase=TERRCOST CaseType=LinStatic Point=1 X2=-0.5 X3=-0.5 S11=0
IsS11Max=No IsS11Min=No FrameElem=10 ElemStation=0
Frame=10 Station=0 OutputCase=TERRCOST CaseType=LinStatic Point=2 X2=-0.5 X3=0.5 S11=0
IsS11Max=No IsS11Min=No FrameElem=10 ElemStation=0
Frame=10 Station=0 OutputCase=TERRCOST CaseType=LinStatic Point=3 X2=0.5 X3=-0.5 S11=0
IsS11Max=No IsS11Min=No FrameElem=10 ElemStation=0
Frame=10 Station=0 OutputCase=TERRCOST CaseType=LinStatic Point=4 X2=0.5 X3=0.5 S11=0 IsS11Max=No
IsS11Min=No FrameElem=10 ElemStation=0
Frame=10 Station=0.249999976158143 OutputCase=TERRCOST CaseType=LinStatic Point=0 X2=0 X3=0 S11=0
IsS11Max=Yes IsS11Min=Yes FrameElem=10 ElemStation=0.249999976158143
Frame=10 Station=0.249999976158143 OutputCase=TERRCOST CaseType=LinStatic Point=1 X2=-0.5 X3=-0.5
S11=0 IsS11Max=No IsS11Min=No FrameElem=10 ElemStation=0.249999976158143
Frame=10 Station=0.249999976158143 OutputCase=TERRCOST CaseType=LinStatic Point=2 X2=-0.5 X3=0.5
S11=0 IsS11Max=No IsS11Min=No FrameElem=10 ElemStation=0.249999976158143
Frame=10 Station=0.249999976158143 OutputCase=TERRCOST CaseType=LinStatic Point=3 X2=0.5 X3=-0.5
S11=0 IsS11Max=No IsS11Min=No FrameElem=10 ElemStation=0.249999976158143



Frame=11	Station=0	OutputCase=PESOPR	CaseType=LinStatic	Point=0	X2=0	X3=0	S11=15.1709467362393
IsS11Max=No	IsS11Min=No	FrameElem=11	ElemStation=0				
Frame=11	Station=0	OutputCase=PESOPR	CaseType=LinStatic	Point=1	X2=-0.5	X3=-0.5	S11=-
111.258513838241	IsS11Max=No	IsS11Min=Yes	FrameElem=11	ElemStation=0			
Frame=11	Station=0	OutputCase=PESOPR	CaseType=LinStatic	Point=2	X2=-0.5	X3=0.5	S11=-
111.258513838241	IsS11Max=No	IsS11Min=No	FrameElem=11	ElemStation=0			
Frame=11	Station=0	OutputCase=PESOPR	CaseType=LinStatic	Point=3	X2=0.5	X3=-0.5	S11=141.600407310719
IsS11Max=Yes	IsS11Min=No	FrameElem=11	ElemStation=0				
Frame=11	Station=0	OutputCase=PESOPR	CaseType=LinStatic	Point=4	X2=0.5	X3=0.5	S11=141.600407310719
IsS11Max=No	IsS11Min=No	FrameElem=11	ElemStation=0				
Frame=11	Station=6.24999940395355E-02	OutputCase=PESOPR	CaseType=LinStatic	Point=0	X2=0	X3=0	
S11=15.1709467362393	IsS11Max=No	IsS11Min=No	FrameElem=11	ElemStation=6.24999940395355E-02			
Frame=11	Station=6.24999940395355E-02	OutputCase=PESOPR	CaseType=LinStatic	Point=1	X2=-0.5	X3=-0.5	
S11=-88.1139849952328	IsS11Max=No	IsS11Min=Yes	FrameElem=11	ElemStation=6.24999940395355E-02			
Frame=11	Station=6.24999940395355E-02	OutputCase=PESOPR	CaseType=LinStatic	Point=2	X2=-0.5	X3=0.5	
S11=-88.1139849952328	IsS11Max=No	IsS11Min=No	FrameElem=11	ElemStation=6.24999940395355E-02			
Frame=11	Station=6.24999940395355E-02	OutputCase=PESOPR	CaseType=LinStatic	Point=3	X2=0.5	X3=-0.5	
S11=118.455878467711	IsS11Max=Yes	IsS11Min=No	FrameElem=11	ElemStation=6.24999940395355E-02			
Frame=11	Station=6.24999940395355E-02	OutputCase=PESOPR	CaseType=LinStatic	Point=4	X2=0.5	X3=0.5	
S11=118.455878467711	IsS11Max=No	IsS11Min=No	FrameElem=11	ElemStation=6.24999940395355E-02			
Frame=11	Station=0.124999988079071	OutputCase=PESOPR	CaseType=LinStatic	Point=0	X2=0	X3=0	
S11=15.1709467362393	IsS11Max=No	IsS11Min=No	FrameElem=11	ElemStation=0.124999988079071			
Frame=11	Station=0.124999988079071	OutputCase=PESOPR	CaseType=LinStatic	Point=1	X2=-0.5	X3=-0.5	
S11=-65.5553935404664	IsS11Max=No	IsS11Min=Yes	FrameElem=11	ElemStation=0.124999988079071			
Frame=11	Station=0.124999988079071	OutputCase=PESOPR	CaseType=LinStatic	Point=2	X2=-0.5	X3=0.5	
S11=-65.5553935404664	IsS11Max=No	IsS11Min=No	FrameElem=11	ElemStation=0.124999988079071			
Frame=11	Station=0.124999988079071	OutputCase=PESOPR	CaseType=LinStatic	Point=3	X2=0.5	X3=-0.5	
S11=95.897287012945	IsS11Max=Yes	IsS11Min=No	FrameElem=11	ElemStation=0.124999988079071			
Frame=11	Station=0.124999988079071	OutputCase=PESOPR	CaseType=LinStatic	Point=4	X2=0.5	X3=0.5	
S11=95.897287012945	IsS11Max=No	IsS11Min=No	FrameElem=11	ElemStation=0.124999988079071			
Frame=11	Station=0.187499982118607	OutputCase=PESOPR	CaseType=LinStatic	Point=0	X2=0	X3=0	
S11=15.1709467362393	IsS11Max=No	IsS11Min=No	FrameElem=11	ElemStation=0.187499982118607			
Frame=11	Station=0.187499982118607	OutputCase=PESOPR	CaseType=LinStatic	Point=1	X2=-0.5	X3=-0.5	
S11=-43.5827394739412	IsS11Max=No	IsS11Min=Yes	FrameElem=11	ElemStation=0.187499982118607			
Frame=11	Station=0.187499982118607	OutputCase=PESOPR	CaseType=LinStatic	Point=2	X2=-0.5	X3=0.5	
S11=-43.5827394739412	IsS11Max=No	IsS11Min=No	FrameElem=11	ElemStation=0.187499982118607			
Frame=11	Station=0.187499982118607	OutputCase=PESOPR	CaseType=LinStatic	Point=3	X2=0.5	X3=-0.5	
S11=73.9246329464199	IsS11Max=Yes	IsS11Min=No	FrameElem=11	ElemStation=0.187499982118607			
Frame=11	Station=0.187499982118607	OutputCase=PESOPR	CaseType=LinStatic	Point=4	X2=0.5	X3=0.5	
S11=73.9246329464199	IsS11Max=No	IsS11Min=No	FrameElem=11	ElemStation=0.187499982118607			
Frame=11	Station=0.249999976158142	OutputCase=PESOPR	CaseType=LinStatic	Point=0	X2=0	X3=0	
S11=15.1709467362393	IsS11Max=No	IsS11Min=No	FrameElem=11	ElemStation=0.249999976158142			
Frame=11	Station=0.249999976158142	OutputCase=PESOPR	CaseType=LinStatic	Point=1	X2=-0.5	X3=-0.5	
S11=-22.1960227956574	IsS11Max=No	IsS11Min=Yes	FrameElem=11	ElemStation=0.249999976158142			
Frame=11	Station=0.249999976158142	OutputCase=PESOPR	CaseType=LinStatic	Point=2	X2=-0.5	X3=0.5	
S11=-22.1960227956574	IsS11Max=No	IsS11Min=No	FrameElem=11	ElemStation=0.249999976158142			
Frame=11	Station=0.249999976158142	OutputCase=PESOPR	CaseType=LinStatic	Point=3	X2=0.5	X3=-0.5	
S11=52.537916268136	IsS11Max=Yes	IsS11Min=No	FrameElem=11	ElemStation=0.249999976158142			
Frame=11	Station=0.249999976158142	OutputCase=PESOPR	CaseType=LinStatic	Point=4	X2=0.5	X3=0.5	
S11=52.537916268136	IsS11Max=No	IsS11Min=No	FrameElem=11	ElemStation=0.249999976158142			
Frame=11	Station=0	OutputCase=TERRVERT	CaseType=LinStatic	Point=0	X2=0	X3=0	S11=-1.15282857328763
IsS11Max=No	IsS11Min=No	FrameElem=11	ElemStation=0				
Frame=11	Station=0	OutputCase=TERRVERT	CaseType=LinStatic	Point=1	X2=-0.5	X3=-0.5	S11=-
1369.32141511655	IsS11Max=No	IsS11Min=Yes	FrameElem=11	ElemStation=0			
Frame=11	Station=0	OutputCase=TERRVERT	CaseType=LinStatic	Point=2	X2=-0.5	X3=0.5	S11=-
1369.32141511655	IsS11Max=No	IsS11Min=No	FrameElem=11	ElemStation=0			
Frame=11	Station=0	OutputCase=TERRVERT	CaseType=LinStatic	Point=3	X2=0.5	X3=-0.5	
S11=1367.01575796998	IsS11Max=Yes	IsS11Min=No	FrameElem=11	ElemStation=0			
Frame=11	Station=0	OutputCase=TERRVERT	CaseType=LinStatic	Point=4	X2=0.5	X3=0.5	
S11=1367.01575796998	IsS11Max=No	IsS11Min=No	FrameElem=11	ElemStation=0			
Frame=11	Station=6.24999940395355E-02	OutputCase=TERRVERT	CaseType=LinStatic	Point=0	X2=0	X3=0	
S11=-1.15282857328763	IsS11Max=No	IsS11Min=No	FrameElem=11	ElemStation=6.24999940395355E-02			
Frame=11	Station=6.24999940395355E-02	OutputCase=TERRVERT	CaseType=LinStatic	Point=1	X2=-0.5	X3=-0.5	
S11=-1187.4054184518	IsS11Max=No	IsS11Min=Yes	FrameElem=11	ElemStation=6.24999940395355E-02			
Frame=11	Station=6.24999940395355E-02	OutputCase=TERRVERT	CaseType=LinStatic	Point=2	X2=-0.5	X3=0.5	
S11=-1187.4054184518	IsS11Max=No	IsS11Min=No	FrameElem=11	ElemStation=6.24999940395355E-02			
Frame=11	Station=6.24999940395355E-02	OutputCase=TERRVERT	CaseType=LinStatic	Point=3	X2=0.5	X3=-0.5	
S11=1185.09976130522	IsS11Max=Yes	IsS11Min=No	FrameElem=11	ElemStation=6.24999940395355E-02			
Frame=11	Station=6.24999940395355E-02	OutputCase=TERRVERT	CaseType=LinStatic	Point=4	X2=0.5	X3=0.5	
S11=1185.09976130522	IsS11Max=No	IsS11Min=No	FrameElem=11	ElemStation=6.24999940395355E-02			
Frame=11	Station=0.124999988079071	OutputCase=TERRVERT	CaseType=LinStatic	Point=0	X2=0	X3=0	S11=-
1.15282857328763	IsS11Max=No	IsS11Min=No	FrameElem=11	ElemStation=0.124999988079071			
Frame=11	Station=0.124999988079071	OutputCase=TERRVERT	CaseType=LinStatic	Point=1	X2=-0.5	X3=-0.5	
S11=-1010.09488965862	IsS11Max=No	IsS11Min=Yes	FrameElem=11	ElemStation=0.124999988079071			
Frame=11	Station=0.124999988079071	OutputCase=TERRVERT	CaseType=LinStatic	Point=2	X2=-0.5	X3=0.5	
S11=-1010.09488965862	IsS11Max=No	IsS11Min=No	FrameElem=11	ElemStation=0.124999988079071			
Frame=11	Station=0.124999988079071	OutputCase=TERRVERT	CaseType=LinStatic	Point=3	X2=0.5	X3=-0.5	
S11=1007.78923251204	IsS11Max=Yes	IsS11Min=No	FrameElem=11	ElemStation=0.124999988079071			
Frame=11	Station=0.124999988079071	OutputCase=TERRVERT	CaseType=LinStatic	Point=4	X2=0.5	X3=0.5	
S11=1007.78923251204	IsS11Max=No	IsS11Min=No	FrameElem=11	ElemStation=0.124999988079071			
Frame=11	Station=0.187499982118607	OutputCase=TERRVERT	CaseType=LinStatic	Point=0	X2=0	X3=0	S11=-
1.15282857328763	IsS11Max=No	IsS11Min=No	FrameElem=11	ElemStation=0.187499982118607			



Frame=11 Station=0.187499982118607 OutputCase=TERRVERT CaseType=LinStatic Point=1 X2=-0.5 X3=-0.5
 S11=-837.389828737017 IsS11Max=No IsS11Min=Yes FrameElem=11 ElemStation=0.187499982118607
 Frame=11 Station=0.187499982118607 OutputCase=TERRVERT CaseType=LinStatic Point=2 X2=-0.5 X3=0.5
 S11=-837.389828737017 IsS11Max=No IsS11Min=No FrameElem=11 ElemStation=0.187499982118607
 Frame=11 Station=0.187499982118607 OutputCase=TERRVERT CaseType=LinStatic Point=3 X2=0.5 X3=-0.5
 S11=835.084171590442 IsS11Max=Yes IsS11Min=No FrameElem=11 ElemStation=0.187499982118607
 Frame=11 Station=0.187499982118607 OutputCase=TERRVERT CaseType=LinStatic Point=4 X2=0.5 X3=0.5
 S11=835.084171590442 IsS11Max=No IsS11Min=No FrameElem=11 ElemStation=0.187499982118607
 Frame=11 Station=0.249999976158142 OutputCase=TERRVERT CaseType=LinStatic Point=0 X2=0 X3=0 S11=-
 1.15282857328763 IsS11Max=No IsS11Min=No FrameElem=11 ElemStation=0.249999976158142
 Frame=11 Station=0.249999976158142 OutputCase=TERRVERT CaseType=LinStatic Point=1 X2=-0.5 X3=-0.5
 S11=-669.290235686992 IsS11Max=No IsS11Min=Yes FrameElem=11 ElemStation=0.249999976158142
 Frame=11 Station=0.249999976158142 OutputCase=TERRVERT CaseType=LinStatic Point=2 X2=-0.5 X3=0.5
 S11=-669.290235686992 IsS11Max=No IsS11Min=No FrameElem=11 ElemStation=0.249999976158142
 Frame=11 Station=0.249999976158142 OutputCase=TERRVERT CaseType=LinStatic Point=3 X2=0.5 X3=-0.5
 S11=666.984578540416 IsS11Max=Yes IsS11Min=No FrameElem=11 ElemStation=0.249999976158142
 Frame=11 Station=0.249999976158142 OutputCase=TERRVERT CaseType=LinStatic Point=4 X2=0.5 X3=0.5
 S11=666.984578540416 IsS11Max=No IsS11Min=No FrameElem=11 ElemStation=0.249999976158142
 Frame=11 Station=0 OutputCase=TERRLAT CaseType=LinStatic Point=0 X2=0 X3=0 S11=-66.7117981831701
 IsS11Max=No IsS11Min=No FrameElem=11 ElemStation=0
 Frame=11 Station=0 OutputCase=TERRLAT CaseType=LinStatic Point=1 X2=-0.5 X3=-0.5 S11=-
 190.013371144834 IsS11Max=No IsS11Min=Yes FrameElem=11 ElemStation=0
 Frame=11 Station=0 OutputCase=TERRLAT CaseType=LinStatic Point=2 X2=-0.5 X3=0.5 S11=-
 190.013371144834 IsS11Max=No IsS11Min=No FrameElem=11 ElemStation=0
 Frame=11 Station=0 OutputCase=TERRLAT CaseType=LinStatic Point=3 X2=0.5 X3=-0.5
 S11=56.5897747784942 IsS11Max=Yes IsS11Min=No FrameElem=11 ElemStation=0
 Frame=11 Station=0 OutputCase=TERRLAT CaseType=LinStatic Point=4 X2=0.5 X3=0.5 S11=56.5897747784942
 IsS11Max=No IsS11Min=No FrameElem=11 ElemStation=0
 Frame=11 Station=6.24999940395355E-02 OutputCase=TERRLAT CaseType=LinStatic Point=0 X2=0 X3=0 S11=-
 66.7117981831701 IsS11Max=No IsS11Min=No FrameElem=11 ElemStation=6.24999940395355E-02
 Frame=11 Station=6.24999940395355E-02 OutputCase=TERRLAT CaseType=LinStatic Point=1 X2=-0.5 X3=-0.5
 S11=-190.013371270152 IsS11Max=No IsS11Min=Yes FrameElem=11 ElemStation=6.24999940395355E-02
 Frame=11 Station=6.24999940395355E-02 OutputCase=TERRLAT CaseType=LinStatic Point=2 X2=-0.5 X3=0.5
 S11=-190.013371270152 IsS11Max=No IsS11Min=No FrameElem=11 ElemStation=6.24999940395355E-02
 Frame=11 Station=6.24999940395355E-02 OutputCase=TERRLAT CaseType=LinStatic Point=3 X2=0.5 X3=-0.5
 S11=56.5897749038118 IsS11Max=Yes IsS11Min=No FrameElem=11 ElemStation=6.24999940395355E-02
 Frame=11 Station=6.24999940395355E-02 OutputCase=TERRLAT CaseType=LinStatic Point=4 X2=0.5 X3=0.5
 S11=56.5897749038118 IsS11Max=No IsS11Min=No FrameElem=11 ElemStation=6.24999940395355E-02
 Frame=11 Station=0.124999988079071 OutputCase=TERRLAT CaseType=LinStatic Point=0 X2=0 X3=0 S11=-
 66.7117981831701 IsS11Max=No IsS11Min=No FrameElem=11 ElemStation=0.124999988079071
 Frame=11 Station=0.124999988079071 OutputCase=TERRLAT CaseType=LinStatic Point=1 X2=-0.5 X3=-0.5
 S11=-190.01337139547 IsS11Max=No IsS11Min=Yes FrameElem=11 ElemStation=0.124999988079071
 Frame=11 Station=0.124999988079071 OutputCase=TERRLAT CaseType=LinStatic Point=2 X2=-0.5 X3=0.5
 S11=-190.01337139547 IsS11Max=No IsS11Min=No FrameElem=11 ElemStation=0.124999988079071
 Frame=11 Station=0.124999988079071 OutputCase=TERRLAT CaseType=LinStatic Point=3 X2=0.5 X3=-0.5
 S11=56.5897750291295 IsS11Max=Yes IsS11Min=No FrameElem=11 ElemStation=0.124999988079071
 Frame=11 Station=0.124999988079071 OutputCase=TERRLAT CaseType=LinStatic Point=4 X2=0.5 X3=0.5
 S11=56.5897750291295 IsS11Max=No IsS11Min=No FrameElem=11 ElemStation=0.124999988079071
 Frame=11 Station=0.187499982118607 OutputCase=TERRLAT CaseType=LinStatic Point=0 X2=0 X3=0 S11=-
 66.7117981831701 IsS11Max=No IsS11Min=No FrameElem=11 ElemStation=0.187499982118607
 Frame=11 Station=0.187499982118607 OutputCase=TERRLAT CaseType=LinStatic Point=1 X2=-0.5 X3=-0.5
 S11=-190.013371520787 IsS11Max=No IsS11Min=Yes FrameElem=11 ElemStation=0.187499982118607
 Frame=11 Station=0.187499982118607 OutputCase=TERRLAT CaseType=LinStatic Point=2 X2=-0.5 X3=0.5
 S11=-190.013371520787 IsS11Max=No IsS11Min=No FrameElem=11 ElemStation=0.187499982118607
 Frame=11 Station=0.187499982118607 OutputCase=TERRLAT CaseType=LinStatic Point=3 X2=0.5 X3=-0.5
 S11=56.5897751544471 IsS11Max=Yes IsS11Min=No FrameElem=11 ElemStation=0.187499982118607
 Frame=11 Station=0.187499982118607 OutputCase=TERRLAT CaseType=LinStatic Point=4 X2=0.5 X3=0.5
 S11=56.5897751544471 IsS11Max=No IsS11Min=No FrameElem=11 ElemStation=0.187499982118607
 Frame=11 Station=0.249999976158142 OutputCase=TERRLAT CaseType=LinStatic Point=0 X2=0 X3=0 S11=-
 66.7117981831701 IsS11Max=No IsS11Min=No FrameElem=11 ElemStation=0.249999976158142
 Frame=11 Station=0.249999976158142 OutputCase=TERRLAT CaseType=LinStatic Point=1 X2=-0.5 X3=-0.5
 S11=-190.013371646105 IsS11Max=No IsS11Min=Yes FrameElem=11 ElemStation=0.249999976158142
 Frame=11 Station=0.249999976158142 OutputCase=TERRLAT CaseType=LinStatic Point=2 X2=-0.5 X3=0.5
 S11=-190.013371646105 IsS11Max=No IsS11Min=No FrameElem=11 ElemStation=0.249999976158142
 Frame=11 Station=0.249999976158142 OutputCase=TERRLAT CaseType=LinStatic Point=3 X2=0.5 X3=-0.5
 S11=56.5897752797647 IsS11Max=Yes IsS11Min=No FrameElem=11 ElemStation=0.249999976158142
 Frame=11 Station=0.249999976158142 OutputCase=TERRLAT CaseType=LinStatic Point=4 X2=0.5 X3=0.5
 S11=56.5897752797647 IsS11Max=No IsS11Min=No FrameElem=11 ElemStation=0.249999976158142
 Frame=11 Station=0 OutputCase=ACCLATDX CaseType=LinStatic Point=0 X2=0 X3=0 S11=0 IsS11Max=Yes
 IsS11Min=Yes FrameElem=11 ElemStation=0
 Frame=11 Station=0 OutputCase=ACCLATDX CaseType=LinStatic Point=1 X2=-0.5 X3=-0.5 S11=0
 IsS11Max=No IsS11Min=No FrameElem=11 ElemStation=0
 Frame=11 Station=0 OutputCase=ACCLATDX CaseType=LinStatic Point=2 X2=-0.5 X3=0.5 S11=0
 IsS11Max=No IsS11Min=No FrameElem=11 ElemStation=0
 Frame=11 Station=0 OutputCase=ACCLATDX CaseType=LinStatic Point=3 X2=0.5 X3=-0.5 S11=0
 IsS11Max=No IsS11Min=No FrameElem=11 ElemStation=0
 Frame=11 Station=0 OutputCase=ACCLATDX CaseType=LinStatic Point=4 X2=0.5 X3=0.5 S11=0 IsS11Max=No
 IsS11Min=No FrameElem=11 ElemStation=0
 Frame=11 Station=6.24999940395355E-02 OutputCase=ACCLATDX CaseType=LinStatic Point=0 X2=0 X3=0
 S11=0 IsS11Max=Yes IsS11Min=Yes FrameElem=11 ElemStation=6.24999940395355E-02
 Frame=11 Station=6.24999940395355E-02 OutputCase=ACCLATDX CaseType=LinStatic Point=1 X2=-0.5 X3=-0.5
 S11=0 IsS11Max=No IsS11Min=No FrameElem=11 ElemStation=6.24999940395355E-02



Frame=11 Station=0.124999988079071 OutputCase=SOVRCOST CaseType=LinStatic Point=4 X2=0.5 X3=0.5
 S11=0 IsS11Max=No IsS11Min=No FrameElem=11 ElemStation=0.124999988079071
 Frame=11 Station=0.187499982118607 OutputCase=SOVRCOST CaseType=LinStatic Point=0 X2=0 X3=0 S11=0
 IsS11Max=Yes IsS11Min=Yes FrameElem=11 ElemStation=0.187499982118607
 Frame=11 Station=0.187499982118607 OutputCase=SOVRCOST CaseType=LinStatic Point=1 X2=-0.5 X3=-0.5
 S11=0 IsS11Max=No IsS11Min=No FrameElem=11 ElemStation=0.187499982118607
 Frame=11 Station=0.187499982118607 OutputCase=SOVRCOST CaseType=LinStatic Point=2 X2=-0.5 X3=0.5
 S11=0 IsS11Max=No IsS11Min=No FrameElem=11 ElemStation=0.187499982118607
 Frame=11 Station=0.187499982118607 OutputCase=SOVRCOST CaseType=LinStatic Point=3 X2=0.5 X3=-0.5
 S11=0 IsS11Max=No IsS11Min=No FrameElem=11 ElemStation=0.187499982118607
 Frame=11 Station=0.187499982118607 OutputCase=SOVRCOST CaseType=LinStatic Point=4 X2=0.5 X3=0.5
 S11=0 IsS11Max=No IsS11Min=No FrameElem=11 ElemStation=0.187499982118607
 Frame=11 Station=0.249999976158142 OutputCase=SOVRCOST CaseType=LinStatic Point=0 X2=0 X3=0 S11=0
 IsS11Max=Yes IsS11Min=Yes FrameElem=11 ElemStation=0.249999976158142
 Frame=11 Station=0.249999976158142 OutputCase=SOVRCOST CaseType=LinStatic Point=1 X2=-0.5 X3=-0.5
 S11=0 IsS11Max=No IsS11Min=No FrameElem=11 ElemStation=0.249999976158142
 Frame=11 Station=0.249999976158142 OutputCase=SOVRCOST CaseType=LinStatic Point=2 X2=-0.5 X3=0.5
 S11=0 IsS11Max=No IsS11Min=No FrameElem=11 ElemStation=0.249999976158142
 Frame=11 Station=0.249999976158142 OutputCase=SOVRCOST CaseType=LinStatic Point=3 X2=0.5 X3=-0.5
 S11=0 IsS11Max=No IsS11Min=No FrameElem=11 ElemStation=0.249999976158142
 Frame=11 Station=0.249999976158142 OutputCase=SOVRCOST CaseType=LinStatic Point=4 X2=0.5 X3=0.5
 S11=0 IsS11Max=No IsS11Min=No FrameElem=11 ElemStation=0.249999976158142
 Frame=11 Station=0 OutputCase=ENVE CaseType=Combination StepType=Max Point=0 X2=0 X3=0 S11=-
 32.6801405652674 IsS11Max=No IsS11Min=No FrameElem=11 ElemStation=0
 Frame=11 Station=0 OutputCase=ENVE CaseType=Combination StepType=Max Point=1 X2=-0.5 X3=-0.5
 S11=-1613.58928875618 IsS11Max=No IsS11Min=Yes FrameElem=11 ElemStation=0
 Frame=11 Station=0 OutputCase=ENVE CaseType=Combination StepType=Max Point=2 X2=-0.5 X3=0.5 S11=-
 1613.58928875618 IsS11Max=No IsS11Min=No FrameElem=11 ElemStation=0
 Frame=11 Station=0 OutputCase=ENVE CaseType=Combination StepType=Max Point=3 X2=0.5 X3=-0.5
 S11=1565.20594005919 IsS11Max=Yes IsS11Min=No FrameElem=11 ElemStation=0
 Frame=11 Station=0 OutputCase=ENVE CaseType=Combination StepType=Max Point=4 X2=0.5 X3=0.5
 S11=1565.20594005919 IsS11Max=No IsS11Min=No FrameElem=11 ElemStation=0
 Frame=11 Station=6.24999940395355E-02 OutputCase=ENVE CaseType=Combination StepType=Max Point=0 X2=0
 X3=0 S11=-32.6801405652674 IsS11Max=No IsS11Min=No FrameElem=11 ElemStation=6.24999940395355E-02
 Frame=11 Station=6.24999940395355E-02 OutputCase=ENVE CaseType=Combination StepType=Max Point=1 X2=-
 0.5 X3=-0.5 S11=-1408.52876333614 IsS11Max=No IsS11Min=Yes FrameElem=11 ElemStation=6.24999940395355E-02
 Frame=11 Station=6.24999940395355E-02 OutputCase=ENVE CaseType=Combination StepType=Max Point=2 X2=-
 0.5 X3=0.5 S11=-1408.52876333614 IsS11Max=No IsS11Min=No FrameElem=11 ElemStation=6.24999940395355E-02
 Frame=11 Station=6.24999940395355E-02 OutputCase=ENVE CaseType=Combination StepType=Max Point=3
 X2=0.5 X3=-0.5 S11=1360.14541467675 IsS11Max=Yes IsS11Min=No FrameElem=11 ElemStation=6.24999940395355E-
 02
 Frame=11 Station=6.24999940395355E-02 OutputCase=ENVE CaseType=Combination StepType=Max Point=4
 X2=0.5 X3=0.5 S11=1360.14541467675 IsS11Max=No IsS11Min=No FrameElem=11 ElemStation=6.24999940395355E-02
 Frame=11 Station=0.124999988079071 OutputCase=ENVE CaseType=Combination StepType=Max Point=0 X2=0
 X3=0 S11=-32.6801405652674 IsS11Max=No IsS11Min=No FrameElem=11 ElemStation=0.124999988079071
 Frame=11 Station=0.124999988079071 OutputCase=ENVE CaseType=Combination StepType=Max Point=1 X2=-0.5
 X3=-0.5 S11=-1208.65964317591 IsS11Max=No IsS11Min=Yes FrameElem=11 ElemStation=0.124999988079071
 Frame=11 Station=0.124999988079071 OutputCase=ENVE CaseType=Combination StepType=Max Point=2 X2=-0.5
 X3=0.5 S11=-1208.65964317591 IsS11Max=No IsS11Min=No FrameElem=11 ElemStation=0.124999988079071
 Frame=11 Station=0.124999988079071 OutputCase=ENVE CaseType=Combination StepType=Max Point=3 X2=0.5
 X3=-0.5 S11=1160.27629455412 IsS11Max=Yes IsS11Min=No FrameElem=11 ElemStation=0.124999988079071
 Frame=11 Station=0.124999988079071 OutputCase=ENVE CaseType=Combination StepType=Max Point=4 X2=0.5
 X3=0.5 S11=1160.27629455412 IsS11Max=No IsS11Min=No FrameElem=11 ElemStation=0.124999988079071
 Frame=11 Station=0.187499982118607 OutputCase=ENVE CaseType=Combination StepType=Max Point=0 X2=0
 X3=0 S11=-32.6801405652674 IsS11Max=No IsS11Min=No FrameElem=11 ElemStation=0.187499982118607
 Frame=11 Station=0.187499982118607 OutputCase=ENVE CaseType=Combination StepType=Max Point=1 X2=-0.5
 X3=-0.5 S11=-1013.98192827551 IsS11Max=No IsS11Min=Yes FrameElem=11 ElemStation=0.187499982118607
 Frame=11 Station=0.187499982118607 OutputCase=ENVE CaseType=Combination StepType=Max Point=2 X2=-0.5
 X3=0.5 S11=-1013.98192827551 IsS11Max=No IsS11Min=No FrameElem=11 ElemStation=0.187499982118607
 Frame=11 Station=0.187499982118607 OutputCase=ENVE CaseType=Combination StepType=Max Point=3 X2=0.5
 X3=-0.5 S11=965.598579691309 IsS11Max=Yes IsS11Min=No FrameElem=11 ElemStation=0.187499982118607
 Frame=11 Station=0.187499982118607 OutputCase=ENVE CaseType=Combination StepType=Max Point=4 X2=0.5
 X3=0.5 S11=965.598579691309 IsS11Max=No IsS11Min=No FrameElem=11 ElemStation=0.187499982118607
 Frame=11 Station=0.249999976158142 OutputCase=ENVE CaseType=Combination StepType=Max Point=0 X2=0
 X3=0 S11=-32.6801405652674 IsS11Max=No IsS11Min=No FrameElem=11 ElemStation=0.249999976158142
 Frame=11 Station=0.249999976158142 OutputCase=ENVE CaseType=Combination StepType=Max Point=1 X2=-0.5
 X3=-0.5 S11=-824.495618634922 IsS11Max=No IsS11Min=Yes FrameElem=11 ElemStation=0.249999976158142
 Frame=11 Station=0.249999976158142 OutputCase=ENVE CaseType=Combination StepType=Max Point=2 X2=-0.5
 X3=0.5 S11=-824.495618634922 IsS11Max=No IsS11Min=No FrameElem=11 ElemStation=0.249999976158142
 Frame=11 Station=0.249999976158142 OutputCase=ENVE CaseType=Combination StepType=Max Point=3 X2=0.5
 X3=-0.5 S11=776.112270088317 IsS11Max=Yes IsS11Min=No FrameElem=11 ElemStation=0.249999976158142
 Frame=11 Station=0.249999976158142 OutputCase=ENVE CaseType=Combination StepType=Max Point=4 X2=0.5
 X3=0.5 S11=776.112270088317 IsS11Max=No IsS11Min=No FrameElem=11 ElemStation=0.249999976158142
 Frame=11 Station=0 OutputCase=ENVE CaseType=Combination StepType=Min Point=0 X2=0 X3=0 S11=-
 52.6936800202184 IsS11Max=No IsS11Min=No FrameElem=11 ElemStation=0
 Frame=11 Station=0 OutputCase=ENVE CaseType=Combination StepType=Min Point=1 X2=-0.5 X3=-0.5
 S11=-1670.59330009963 IsS11Max=No IsS11Min=Yes FrameElem=11 ElemStation=0
 Frame=11 Station=0 OutputCase=ENVE CaseType=Combination StepType=Min Point=2 X2=-0.5 X3=0.5 S11=-
 1670.59330009963 IsS11Max=No IsS11Min=No FrameElem=11 ElemStation=0
 Frame=11 Station=0 OutputCase=ENVE CaseType=Combination StepType=Min Point=3 X2=0.5 X3=-0.5
 S11=1548.22900762564 IsS11Max=Yes IsS11Min=No FrameElem=11 ElemStation=0



Frame=11 Station=0.187499982118607 OutputCase=FESSUR CaseType=Combination Point=4 X2=0.5 X3=0.5
 S11=965.598579691309 IsS11Max=No IsS11Min=No FrameElem=11 ElemStation=0.187499982118607
 Frame=11 Station=0.249999976158142 OutputCase=FESSUR CaseType=Combination Point=0 X2=0 X3=0 S11=-
 52.6936800202184 IsS11Max=No IsS11Min=No FrameElem=11 ElemStation=0.249999976158142
 Frame=11 Station=0.249999976158142 OutputCase=FESSUR CaseType=Combination Point=1 X2=-0.5 X3=-0.5
 S11=-881.499630128754 IsS11Max=No IsS11Min=Yes FrameElem=11 ElemStation=0.249999976158142
 Frame=11 Station=0.249999976158142 OutputCase=FESSUR CaseType=Combination Point=2 X2=-0.5 X3=0.5
 S11=-881.499630128754 IsS11Max=No IsS11Min=No FrameElem=11 ElemStation=0.249999976158142
 Frame=11 Station=0.249999976158142 OutputCase=FESSUR CaseType=Combination Point=3 X2=0.5 X3=-0.5
 S11=776.112270088317 IsS11Max=Yes IsS11Min=No FrameElem=11 ElemStation=0.249999976158142
 Frame=11 Station=0.249999976158142 OutputCase=FESSUR CaseType=Combination Point=4 X2=0.5 X3=0.5
 S11=776.112270088317 IsS11Max=No IsS11Min=No FrameElem=11 ElemStation=0.249999976158142
 Frame=12 Station=0 OutputCase=PESOPR CaseType=LinStatic Point=0 X2=0 X3=0 S11=15.1709467362397
 IsS11Max=No IsS11Min=No FrameElem=12 ElemStation=0
 Frame=12 Station=0 OutputCase=PESOPR CaseType=LinStatic Point=1 X2=-0.5 X3=-0.5 S11=-
 22.196022795657 IsS11Max=No IsS11Min=Yes FrameElem=12 ElemStation=0
 Frame=12 Station=0 OutputCase=PESOPR CaseType=LinStatic Point=2 X2=-0.5 X3=0.5 S11=-22.196022795657
 IsS11Max=No IsS11Min=No FrameElem=12 ElemStation=0
 Frame=12 Station=0 OutputCase=PESOPR CaseType=LinStatic Point=3 X2=0.5 X3=-0.5 S11=52.5379162681365
 IsS11Max=Yes IsS11Min=No FrameElem=12 ElemStation=0
 Frame=12 Station=0 OutputCase=PESOPR CaseType=LinStatic Point=4 X2=0.5 X3=0.5 S11=52.5379162681365
 IsS11Max=No IsS11Min=No FrameElem=12 ElemStation=0
 Frame=12 Station=0.0625 OutputCase=PESOPR CaseType=LinStatic Point=0 X2=0 X3=0 S11=15.1709467362397
 IsS11Max=No IsS11Min=No FrameElem=12 ElemStation=0.0625
 Frame=12 Station=0.0625 OutputCase=PESOPR CaseType=LinStatic Point=1 X2=-0.5 X3=-0.5 S11=-
 1.39524154982615 IsS11Max=No IsS11Min=Yes FrameElem=12 ElemStation=0.0625
 Frame=12 Station=0.0625 OutputCase=PESOPR CaseType=LinStatic Point=2 X2=-0.5 X3=0.5 S11=-
 1.39524154982615 IsS11Max=No IsS11Min=No FrameElem=12 ElemStation=0.0625
 Frame=12 Station=0.0625 OutputCase=PESOPR CaseType=LinStatic Point=3 X2=0.5 X3=-0.5
 S11=31.7371350223056 IsS11Max=Yes IsS11Min=No FrameElem=12 ElemStation=0.0625
 Frame=12 Station=0.0625 OutputCase=PESOPR CaseType=LinStatic Point=4 X2=0.5 X3=0.5
 S11=31.7371350223056 IsS11Max=No IsS11Min=No FrameElem=12 ElemStation=0.0625
 Frame=12 Station=0.125 OutputCase=PESOPR CaseType=LinStatic Point=0 X2=0 X3=0 S11=15.1709467362397
 IsS11Max=No IsS11Min=No FrameElem=12 ElemStation=0.125
 Frame=12 Station=0.125 OutputCase=PESOPR CaseType=LinStatic Point=1 X2=-0.5 X3=-0.5
 S11=18.8196021960047 IsS11Max=Yes IsS11Min=No FrameElem=12 ElemStation=0.125
 Frame=12 Station=0.125 OutputCase=PESOPR CaseType=LinStatic Point=2 X2=-0.5 X3=0.5
 S11=18.8196021960047 IsS11Max=No IsS11Min=No FrameElem=12 ElemStation=0.125
 Frame=12 Station=0.125 OutputCase=PESOPR CaseType=LinStatic Point=3 X2=0.5 X3=-0.5
 S11=11.5222912764747 IsS11Max=No IsS11Min=Yes FrameElem=12 ElemStation=0.125
 Frame=12 Station=0.125 OutputCase=PESOPR CaseType=LinStatic Point=4 X2=0.5 X3=0.5
 S11=11.5222912764747 IsS11Max=No IsS11Min=No FrameElem=12 ElemStation=0.125
 Frame=12 Station=0.1875 OutputCase=PESOPR CaseType=LinStatic Point=0 X2=0 X3=0 S11=15.1709467362397
 IsS11Max=No IsS11Min=No FrameElem=12 ElemStation=0.1875
 Frame=12 Station=0.1875 OutputCase=PESOPR CaseType=LinStatic Point=1 X2=-0.5 X3=-0.5
 S11=38.4485084418356 IsS11Max=Yes IsS11Min=No FrameElem=12 ElemStation=0.1875
 Frame=12 Station=0.1875 OutputCase=PESOPR CaseType=LinStatic Point=2 X2=-0.5 X3=0.5
 S11=38.4485084418356 IsS11Max=No IsS11Min=No FrameElem=12 ElemStation=0.1875
 Frame=12 Station=0.1875 OutputCase=PESOPR CaseType=LinStatic Point=3 X2=0.5 X3=-0.5 S11=-
 8.10661496935614 IsS11Max=No IsS11Min=Yes FrameElem=12 ElemStation=0.1875
 Frame=12 Station=0.1875 OutputCase=PESOPR CaseType=LinStatic Point=4 X2=0.5 X3=0.5 S11=-
 8.10661496935614 IsS11Max=No IsS11Min=No FrameElem=12 ElemStation=0.1875
 Frame=12 Station=0.25 OutputCase=PESOPR CaseType=LinStatic Point=0 X2=0 X3=0 S11=15.1709467362397
 IsS11Max=No IsS11Min=No FrameElem=12 ElemStation=0.25
 Frame=12 Station=0.25 OutputCase=PESOPR CaseType=LinStatic Point=1 X2=-0.5 X3=-0.5
 S11=57.4914771876665 IsS11Max=Yes IsS11Min=No FrameElem=12 ElemStation=0.25
 Frame=12 Station=0.25 OutputCase=PESOPR CaseType=LinStatic Point=2 X2=-0.5 X3=0.5
 S11=57.4914771876665 IsS11Max=No IsS11Min=No FrameElem=12 ElemStation=0.25
 Frame=12 Station=0.25 OutputCase=PESOPR CaseType=LinStatic Point=3 X2=0.5 X3=-0.5 S11=-
 27.149583715187 IsS11Max=No IsS11Min=Yes FrameElem=12 ElemStation=0.25
 Frame=12 Station=0.25 OutputCase=PESOPR CaseType=LinStatic Point=4 X2=0.5 X3=0.5 S11=-
 27.149583715187 IsS11Max=No IsS11Min=No FrameElem=12 ElemStation=0.25
 Frame=12 Station=0 OutputCase=TERRVERT CaseType=LinStatic Point=0 X2=0 X3=0 S11=-1.15282857328748
 IsS11Max=No IsS11Min=No FrameElem=12 ElemStation=0
 Frame=12 Station=0 OutputCase=TERRVERT CaseType=LinStatic Point=1 X2=-0.5 X3=-0.5 S11=-
 669.29023568694 IsS11Max=No IsS11Min=Yes FrameElem=12 ElemStation=0
 Frame=12 Station=0 OutputCase=TERRVERT CaseType=LinStatic Point=2 X2=-0.5 X3=0.5 S11=-
 669.29023568694 IsS11Max=No IsS11Min=No FrameElem=12 ElemStation=0
 Frame=12 Station=0 OutputCase=TERRVERT CaseType=LinStatic Point=3 X2=0.5 X3=-0.5
 S11=666.984578540365 IsS11Max=Yes IsS11Min=No FrameElem=12 ElemStation=0
 Frame=12 Station=0 OutputCase=TERRVERT CaseType=LinStatic Point=4 X2=0.5 X3=0.5
 S11=666.984578540365 IsS11Max=No IsS11Min=No FrameElem=12 ElemStation=0
 Frame=12 Station=0.0625 OutputCase=TERRVERT CaseType=LinStatic Point=0 X2=0 X3=0 S11=-
 1.15282857328748 IsS11Max=No IsS11Min=No FrameElem=12 ElemStation=0.0625
 Frame=12 Station=0.0625 OutputCase=TERRVERT CaseType=LinStatic Point=1 X2=-0.5 X3=-0.5 S11=-
 505.796095136046 IsS11Max=No IsS11Min=Yes FrameElem=12 ElemStation=0.0625
 Frame=12 Station=0.0625 OutputCase=TERRVERT CaseType=LinStatic Point=2 X2=-0.5 X3=0.5 S11=-
 505.796095136046 IsS11Max=No IsS11Min=No FrameElem=12 ElemStation=0.0625
 Frame=12 Station=0.0625 OutputCase=TERRVERT CaseType=LinStatic Point=3 X2=0.5 X3=-0.5
 S11=503.490437989471 IsS11Max=Yes IsS11Min=No FrameElem=12 ElemStation=0.0625
 Frame=12 Station=0.0625 OutputCase=TERRVERT CaseType=LinStatic Point=4 X2=0.5 X3=0.5
 S11=503.490437989471 IsS11Max=No IsS11Min=No FrameElem=12 ElemStation=0.0625

Frame=12	Station=0.125	OutputCase=TERRVERT	CaseType=LinStatic	Point=0	X2=0	X3=0	S11=-
1.15282857328748	IsS11Max=No	IsS11Min=No	FrameElem=12	ElemStation=0.125			
Frame=12	Station=0.125	OutputCase=TERRVERT	CaseType=LinStatic	Point=1	X2=-0.5	X3=-0.5	S11=-
346.907423335151	IsS11Max=No	IsS11Min=Yes	FrameElem=12	ElemStation=0.125			
Frame=12	Station=0.125	OutputCase=TERRVERT	CaseType=LinStatic	Point=2	X2=-0.5	X3=0.5	S11=-
346.907423335151	IsS11Max=No	IsS11Min=No	FrameElem=12	ElemStation=0.125			
Frame=12	Station=0.125	OutputCase=TERRVERT	CaseType=LinStatic	Point=3	X2=0.5	X3=-0.5	
S11=344.601766188576	IsS11Max=Yes	IsS11Min=No	FrameElem=12	ElemStation=0.125			
Frame=12	Station=0.125	OutputCase=TERRVERT	CaseType=LinStatic	Point=4	X2=0.5	X3=0.5	
S11=344.601766188576	IsS11Max=No	IsS11Min=No	FrameElem=12	ElemStation=0.125			
Frame=12	Station=0.1875	OutputCase=TERRVERT	CaseType=LinStatic	Point=0	X2=0	X3=0	S11=-
1.15282857328748	IsS11Max=No	IsS11Min=No	FrameElem=12	ElemStation=0.1875			
Frame=12	Station=0.1875	OutputCase=TERRVERT	CaseType=LinStatic	Point=1	X2=-0.5	X3=-0.5	S11=-
192.624220284257	IsS11Max=No	IsS11Min=Yes	FrameElem=12	ElemStation=0.1875			
Frame=12	Station=0.1875	OutputCase=TERRVERT	CaseType=LinStatic	Point=2	X2=-0.5	X3=0.5	S11=-
192.624220284257	IsS11Max=No	IsS11Min=No	FrameElem=12	ElemStation=0.1875			
Frame=12	Station=0.1875	OutputCase=TERRVERT	CaseType=LinStatic	Point=3	X2=0.5	X3=-0.5	
S11=190.318563137682	IsS11Max=Yes	IsS11Min=No	FrameElem=12	ElemStation=0.1875			
Frame=12	Station=0.1875	OutputCase=TERRVERT	CaseType=LinStatic	Point=4	X2=0.5	X3=0.5	
S11=190.318563137682	IsS11Max=No	IsS11Min=No	FrameElem=12	ElemStation=0.1875			
Frame=12	Station=0.25	OutputCase=TERRVERT	CaseType=LinStatic	Point=0	X2=0	X3=0	S11=-
1.15282857328748	IsS11Max=No	IsS11Min=No	FrameElem=12	ElemStation=0.25			
Frame=12	Station=0.25	OutputCase=TERRVERT	CaseType=LinStatic	Point=1	X2=-0.5	X3=-0.5	S11=-
42.9464859833624	IsS11Max=No	IsS11Min=Yes	FrameElem=12	ElemStation=0.25			
Frame=12	Station=0.25	OutputCase=TERRVERT	CaseType=LinStatic	Point=2	X2=-0.5	X3=0.5	S11=-
42.9464859833624	IsS11Max=No	IsS11Min=No	FrameElem=12	ElemStation=0.25			
Frame=12	Station=0.25	OutputCase=TERRVERT	CaseType=LinStatic	Point=3	X2=0.5	X3=-0.5	
S11=40.6408288367875	IsS11Max=Yes	IsS11Min=No	FrameElem=12	ElemStation=0.25			
Frame=12	Station=0.25	OutputCase=TERRVERT	CaseType=LinStatic	Point=4	X2=0.5	X3=0.5	
S11=40.6408288367875	IsS11Max=No	IsS11Min=No	FrameElem=12	ElemStation=0.25			
Frame=12	Station=0	OutputCase=TERRLAT	CaseType=LinStatic	Point=0	X2=0	X3=0	S11=-66.7117981831701
IsS11Max=No	IsS11Min=No	FrameElem=12	ElemStation=0				
Frame=12	Station=0	OutputCase=TERRLAT	CaseType=LinStatic	Point=1	X2=-0.5	X3=-0.5	S11=-
190.013371646104	IsS11Max=No	IsS11Min=Yes	FrameElem=12	ElemStation=0			
Frame=12	Station=0	OutputCase=TERRLAT	CaseType=LinStatic	Point=2	X2=-0.5	X3=0.5	S11=-
190.013371646104	IsS11Max=No	IsS11Min=No	FrameElem=12	ElemStation=0			
Frame=12	Station=0	OutputCase=TERRLAT	CaseType=LinStatic	Point=3	X2=0.5	X3=-0.5	
S11=56.5897752797641	IsS11Max=Yes	IsS11Min=No	FrameElem=12	ElemStation=0			
Frame=12	Station=0	OutputCase=TERRLAT	CaseType=LinStatic	Point=4	X2=0.5	X3=0.5	S11=56.5897752797641
IsS11Max=No	IsS11Min=No	FrameElem=12	ElemStation=0				
Frame=12	Station=0.0625	OutputCase=TERRLAT	CaseType=LinStatic	Point=0	X2=0	X3=0	S11=-
66.7117981831701	IsS11Max=No	IsS11Min=No	FrameElem=12	ElemStation=0.0625			
Frame=12	Station=0.0625	OutputCase=TERRLAT	CaseType=LinStatic	Point=1	X2=-0.5	X3=-0.5	S11=-
190.013371771422	IsS11Max=No	IsS11Min=Yes	FrameElem=12	ElemStation=0.0625			
Frame=12	Station=0.0625	OutputCase=TERRLAT	CaseType=LinStatic	Point=2	X2=-0.5	X3=0.5	S11=-
190.013371771422	IsS11Max=No	IsS11Min=No	FrameElem=12	ElemStation=0.0625			
Frame=12	Station=0.0625	OutputCase=TERRLAT	CaseType=LinStatic	Point=3	X2=0.5	X3=-0.5	
S11=56.589775405082	IsS11Max=Yes	IsS11Min=No	FrameElem=12	ElemStation=0.0625			
Frame=12	Station=0.0625	OutputCase=TERRLAT	CaseType=LinStatic	Point=4	X2=0.5	X3=0.5	
S11=56.589775405082	IsS11Max=No	IsS11Min=No	FrameElem=12	ElemStation=0.0625			
Frame=12	Station=0.125	OutputCase=TERRLAT	CaseType=LinStatic	Point=0	X2=0	X3=0	S11=-
66.7117981831701	IsS11Max=No	IsS11Min=No	FrameElem=12	ElemStation=0.125			
Frame=12	Station=0.125	OutputCase=TERRLAT	CaseType=LinStatic	Point=1	X2=-0.5	X3=-0.5	S11=-
190.01337189674	IsS11Max=No	IsS11Min=Yes	FrameElem=12	ElemStation=0.125			
Frame=12	Station=0.125	OutputCase=TERRLAT	CaseType=LinStatic	Point=2	X2=-0.5	X3=0.5	S11=-
190.01337189674	IsS11Max=No	IsS11Min=No	FrameElem=12	ElemStation=0.125			
Frame=12	Station=0.125	OutputCase=TERRLAT	CaseType=LinStatic	Point=3	X2=0.5	X3=-0.5	
S11=56.5897755303998	IsS11Max=Yes	IsS11Min=No	FrameElem=12	ElemStation=0.125			
Frame=12	Station=0.125	OutputCase=TERRLAT	CaseType=LinStatic	Point=4	X2=0.5	X3=0.5	
S11=56.5897755303998	IsS11Max=No	IsS11Min=No	FrameElem=12	ElemStation=0.125			
Frame=12	Station=0.1875	OutputCase=TERRLAT	CaseType=LinStatic	Point=0	X2=0	X3=0	S11=-
66.7117981831701	IsS11Max=No	IsS11Min=No	FrameElem=12	ElemStation=0.1875			
Frame=12	Station=0.1875	OutputCase=TERRLAT	CaseType=LinStatic	Point=1	X2=-0.5	X3=-0.5	S11=-
190.013372022058	IsS11Max=No	IsS11Min=Yes	FrameElem=12	ElemStation=0.1875			
Frame=12	Station=0.1875	OutputCase=TERRLAT	CaseType=LinStatic	Point=2	X2=-0.5	X3=0.5	S11=-
190.013372022058	IsS11Max=No	IsS11Min=No	FrameElem=12	ElemStation=0.1875			
Frame=12	Station=0.1875	OutputCase=TERRLAT	CaseType=LinStatic	Point=3	X2=0.5	X3=-0.5	
S11=56.5897756557176	IsS11Max=Yes	IsS11Min=No	FrameElem=12	ElemStation=0.1875			
Frame=12	Station=0.1875	OutputCase=TERRLAT	CaseType=LinStatic	Point=4	X2=0.5	X3=0.5	
S11=56.5897756557176	IsS11Max=No	IsS11Min=No	FrameElem=12	ElemStation=0.1875			
Frame=12	Station=0.25	OutputCase=TERRLAT	CaseType=LinStatic	Point=0	X2=0	X3=0	S11=-66.7117981831701
IsS11Max=No	IsS11Min=No	FrameElem=12	ElemStation=0.25				
Frame=12	Station=0.25	OutputCase=TERRLAT	CaseType=LinStatic	Point=1	X2=-0.5	X3=-0.5	S11=-
190.013372147376	IsS11Max=No	IsS11Min=Yes	FrameElem=12	ElemStation=0.25			
Frame=12	Station=0.25	OutputCase=TERRLAT	CaseType=LinStatic	Point=2	X2=-0.5	X3=0.5	S11=-
190.013372147376	IsS11Max=No	IsS11Min=No	FrameElem=12	ElemStation=0.25			
Frame=12	Station=0.25	OutputCase=TERRLAT	CaseType=LinStatic	Point=3	X2=0.5	X3=-0.5	
S11=56.5897757810354	IsS11Max=Yes	IsS11Min=No	FrameElem=12	ElemStation=0.25			
Frame=12	Station=0.25	OutputCase=TERRLAT	CaseType=LinStatic	Point=4	X2=0.5	X3=0.5	
S11=56.5897757810354	IsS11Max=No	IsS11Min=No	FrameElem=12	ElemStation=0.25			
Frame=12	Station=0	OutputCase=ACCLATDX	CaseType=LinStatic	Point=0	X2=0	X3=0	S11=0
IsS11Max=Yes	IsS11Min=Yes	FrameElem=12	ElemStation=0				



Frame=12 Station=0.25 OutputCase=ENVE CaseType=Combination StepType=Max Point=4 X2=0.5 X3=0.5
 S11=70.0810209026359 IsS11Max=No IsS11Min=No FrameElem=12 ElemStation=0.25
 Frame=12 Station=0 OutputCase=ENVE CaseType=Combination StepType=Min Point=0 X2=0 X3=0 S11=-
 52.6936800202179 IsS11Max=No IsS11Min=No FrameElem=12 ElemStation=0
 Frame=12 Station=0 OutputCase=ENVE CaseType=Combination StepType=Min Point=1 X2=-0.5 X3=-0.5
 S11=-881.499630128701 IsS11Max=No IsS11Min=Yes FrameElem=12 ElemStation=0
 Frame=12 Station=0 OutputCase=ENVE CaseType=Combination StepType=Min Point=2 X2=-0.5 X3=0.5 S11=-
 881.499630128701 IsS11Max=No IsS11Min=No FrameElem=12 ElemStation=0
 Frame=12 Station=0 OutputCase=ENVE CaseType=Combination StepType=Min Point=3 X2=0.5 X3=-0.5
 S11=759.135337504336 IsS11Max=Yes IsS11Min=No FrameElem=12 ElemStation=0
 Frame=12 Station=0 OutputCase=ENVE CaseType=Combination StepType=Min Point=4 X2=0.5 X3=0.5
 S11=759.135337504336 IsS11Max=No IsS11Min=No FrameElem=12 ElemStation=0
 Frame=12 Station=0 OutputCase=ENVE CaseType=Combination StepType=Min Point=0 X2=0 X3=0 S11=-
 52.6936800202179 IsS11Max=No IsS11Min=No FrameElem=12 ElemStation=0.0625
 Frame=12 Station=0.0625 OutputCase=ENVE CaseType=Combination StepType=Min Point=1 X2=-0.5 X3=-0.5
 S11=-697.204708457294 IsS11Max=No IsS11Min=Yes FrameElem=12 ElemStation=0.0625
 Frame=12 Station=0.0625 OutputCase=ENVE CaseType=Combination StepType=Min Point=2 X2=-0.5 X3=0.5
 S11=-697.204708457294 IsS11Max=No IsS11Min=No FrameElem=12 ElemStation=0.0625
 Frame=12 Station=0.0625 OutputCase=ENVE CaseType=Combination StepType=Min Point=3 X2=0.5 X3=-0.5
 S11=574.840415795334 IsS11Max=Yes IsS11Min=No FrameElem=12 ElemStation=0.0625
 Frame=12 Station=0.0625 OutputCase=ENVE CaseType=Combination StepType=Min Point=4 X2=0.5 X3=0.5
 S11=574.840415795334 IsS11Max=No IsS11Min=No FrameElem=12 ElemStation=0.0625
 Frame=12 Station=0.125 OutputCase=ENVE CaseType=Combination StepType=Min Point=0 X2=0 X3=0 S11=-
 52.6936800202179 IsS11Max=No IsS11Min=No FrameElem=12 ElemStation=0.125
 Frame=12 Station=0.125 OutputCase=ENVE CaseType=Combination StepType=Min Point=1 X2=-0.5 X3=-0.5
 S11=-518.101193035886 IsS11Max=No IsS11Min=Yes FrameElem=12 ElemStation=0.125
 Frame=12 Station=0.125 OutputCase=ENVE CaseType=Combination StepType=Min Point=2 X2=-0.5 X3=0.5
 S11=-518.101193035886 IsS11Max=No IsS11Min=No FrameElem=12 ElemStation=0.125
 Frame=12 Station=0.125 OutputCase=ENVE CaseType=Combination StepType=Min Point=3 X2=0.5 X3=-0.5
 S11=395.736900336331 IsS11Max=Yes IsS11Min=No FrameElem=12 ElemStation=0.125
 Frame=12 Station=0.125 OutputCase=ENVE CaseType=Combination StepType=Min Point=4 X2=0.5 X3=0.5
 S11=395.736900336331 IsS11Max=No IsS11Min=No FrameElem=12 ElemStation=0.125
 Frame=12 Station=0.1875 OutputCase=ENVE CaseType=Combination StepType=Min Point=0 X2=0 X3=0 S11=-
 52.6936800202179 IsS11Max=No IsS11Min=No FrameElem=12 ElemStation=0.1875
 Frame=12 Station=0.1875 OutputCase=ENVE CaseType=Combination StepType=Min Point=1 X2=-0.5 X3=-0.5
 S11=-344.189083864479 IsS11Max=No IsS11Min=Yes FrameElem=12 ElemStation=0.1875
 Frame=12 Station=0.1875 OutputCase=ENVE CaseType=Combination StepType=Min Point=2 X2=-0.5 X3=0.5
 S11=-344.189083864479 IsS11Max=No IsS11Min=No FrameElem=12 ElemStation=0.1875
 Frame=12 Station=0.1875 OutputCase=ENVE CaseType=Combination StepType=Min Point=3 X2=0.5 X3=-0.5
 S11=221.824791127328 IsS11Max=Yes IsS11Min=No FrameElem=12 ElemStation=0.1875
 Frame=12 Station=0.1875 OutputCase=ENVE CaseType=Combination StepType=Min Point=4 X2=0.5 X3=0.5
 S11=221.824791127328 IsS11Max=No IsS11Min=No FrameElem=12 ElemStation=0.1875
 Frame=12 Station=0.25 OutputCase=ENVE CaseType=Combination StepType=Min Point=0 X2=0 X3=0 S11=-
 52.6936800202179 IsS11Max=No IsS11Min=No FrameElem=12 ElemStation=0.25
 Frame=12 Station=0.25 OutputCase=ENVE CaseType=Combination StepType=Min Point=1 X2=-0.5 X3=-0.5
 S11=-175.468380943072 IsS11Max=No IsS11Min=Yes FrameElem=12 ElemStation=0.25
 Frame=12 Station=0.25 OutputCase=ENVE CaseType=Combination StepType=Min Point=2 X2=-0.5 X3=0.5
 S11=-175.468380943072 IsS11Max=No IsS11Min=No FrameElem=12 ElemStation=0.25
 Frame=12 Station=0.25 OutputCase=ENVE CaseType=Combination StepType=Min Point=3 X2=0.5 X3=-0.5
 S11=53.1040881683253 IsS11Max=Yes IsS11Min=No FrameElem=12 ElemStation=0.25
 Frame=12 Station=0.25 OutputCase=ENVE CaseType=Combination StepType=Min Point=4 X2=0.5 X3=0.5
 S11=53.1040881683253 IsS11Max=No IsS11Min=No FrameElem=12 ElemStation=0.25
 Frame=12 Station=0 OutputCase=FESSUR CaseType=Combination Point=0 X2=0 X3=0 S11=-52.6936800202179
 IsS11Max=No IsS11Min=No FrameElem=12 ElemStation=0
 Frame=12 Station=0 OutputCase=FESSUR CaseType=Combination Point=1 X2=-0.5 X3=-0.5 S11=-
 881.499630128701 IsS11Max=No IsS11Min=Yes FrameElem=12 ElemStation=0
 Frame=12 Station=0 OutputCase=FESSUR CaseType=Combination Point=2 X2=-0.5 X3=0.5 S11=-
 881.499630128701 IsS11Max=No IsS11Min=No FrameElem=12 ElemStation=0
 Frame=12 Station=0 OutputCase=FESSUR CaseType=Combination Point=3 X2=0.5 X3=-0.5
 S11=776.112270088266 IsS11Max=Yes IsS11Min=No FrameElem=12 ElemStation=0
 Frame=12 Station=0 OutputCase=FESSUR CaseType=Combination Point=4 X2=0.5 X3=0.5
 S11=776.112270088266 IsS11Max=No IsS11Min=No FrameElem=12 ElemStation=0
 Frame=12 Station=0.0625 OutputCase=FESSUR CaseType=Combination Point=0 X2=0 X3=0 S11=-
 52.6936800202179 IsS11Max=No IsS11Min=No FrameElem=12 ElemStation=0.0625
 Frame=12 Station=0.0625 OutputCase=FESSUR CaseType=Combination Point=1 X2=-0.5 X3=-0.5 S11=-
 697.204708457294 IsS11Max=No IsS11Min=Yes FrameElem=12 ElemStation=0.0625
 Frame=12 Station=0.0625 OutputCase=FESSUR CaseType=Combination Point=2 X2=-0.5 X3=0.5 S11=-
 697.204708457294 IsS11Max=No IsS11Min=No FrameElem=12 ElemStation=0.0625
 Frame=12 Station=0.0625 OutputCase=FESSUR CaseType=Combination Point=3 X2=0.5 X3=-0.5
 S11=591.817348416858 IsS11Max=Yes IsS11Min=No FrameElem=12 ElemStation=0.0625
 Frame=12 Station=0.125 OutputCase=FESSUR CaseType=Combination Point=4 X2=0.5 X3=0.5
 S11=591.817348416858 IsS11Max=No IsS11Min=No FrameElem=12 ElemStation=0.0625
 Frame=12 Station=0.125 OutputCase=FESSUR CaseType=Combination Point=0 X2=0 X3=0 S11=-
 52.6936800202179 IsS11Max=No IsS11Min=No FrameElem=12 ElemStation=0.125
 Frame=12 Station=0.125 OutputCase=FESSUR CaseType=Combination Point=1 X2=-0.5 X3=-0.5 S11=-
 518.101193035886 IsS11Max=No IsS11Min=Yes FrameElem=12 ElemStation=0.125
 Frame=12 Station=0.125 OutputCase=FESSUR CaseType=Combination Point=2 X2=-0.5 X3=0.5 S11=-
 518.101193035886 IsS11Max=No IsS11Min=No FrameElem=12 ElemStation=0.125
 Frame=12 Station=0.125 OutputCase=FESSUR CaseType=Combination Point=3 X2=0.5 X3=-0.5
 S11=412.713832995451 IsS11Max=Yes IsS11Min=No FrameElem=12 ElemStation=0.125
 Frame=12 Station=0.125 OutputCase=FESSUR CaseType=Combination Point=4 X2=0.5 X3=0.5
 S11=412.713832995451 IsS11Max=No IsS11Min=No FrameElem=12 ElemStation=0.125



Frame=12	Station=0.1875	OutputCase=FESSUR	CaseType=Combination	Point=0	X2=0	X3=0	S11=-
52.6936800202179	Iss11Max=No	Iss11Min=No	FrameElem=12	ElemStation=0.1875			
Frame=12	Station=0.1875	OutputCase=FESSUR	CaseType=Combination	Point=1	X2=-0.5	X3=-0.5	S11=-
344.189083864479	Iss11Max=No	Iss11Min=Yes	FrameElem=12	ElemStation=0.1875			
Frame=12	Station=0.1875	OutputCase=FESSUR	CaseType=Combination	Point=2	X2=-0.5	X3=0.5	S11=-
344.189083864479	Iss11Max=No	Iss11Min=No	FrameElem=12	ElemStation=0.1875			
Frame=12	Station=0.1875	OutputCase=FESSUR	CaseType=Combination	Point=3	X2=0.5	X3=-0.5	
S11=238.801723824043	Iss11Max=Yes	Iss11Min=No	FrameElem=12	ElemStation=0.1875			
Frame=12	Station=0.1875	OutputCase=FESSUR	CaseType=Combination	Point=4	X2=0.5	X3=0.5	
S11=238.801723824043	Iss11Max=No	Iss11Min=No	FrameElem=12	ElemStation=0.1875			
Frame=12	Station=0.25	OutputCase=FESSUR	CaseType=Combination	Point=0	X2=0	X3=0	S11=-
52.6936800202179	Iss11Max=No	Iss11Min=No	FrameElem=12	ElemStation=0.25			
Frame=12	Station=0.25	OutputCase=FESSUR	CaseType=Combination	Point=1	X2=-0.5	X3=-0.5	S11=-
175.468380943072	Iss11Max=No	Iss11Min=Yes	FrameElem=12	ElemStation=0.25			
Frame=12	Station=0.25	OutputCase=FESSUR	CaseType=Combination	Point=2	X2=-0.5	X3=0.5	S11=-
175.468380943072	Iss11Max=No	Iss11Min=No	FrameElem=12	ElemStation=0.25			
Frame=12	Station=0.25	OutputCase=FESSUR	CaseType=Combination	Point=3	X2=0.5	X3=-0.5	
S11=70.0810209026359	Iss11Max=Yes	Iss11Min=No	FrameElem=12	ElemStation=0.25			
Frame=12	Station=0.25	OutputCase=FESSUR	CaseType=Combination	Point=4	X2=0.5	X3=0.5	
S11=70.0810209026359	Iss11Max=No	Iss11Min=No	FrameElem=12	ElemStation=0.25			
Frame=14	Station=0	OutputCase=PESOPR	CaseType=LinStatic	Point=0	X2=0	X3=0	S11=15.1709467362392
Iss11Max=No	Iss11Min=No	FrameElem=14	ElemStation=0				
Frame=14	Station=0	OutputCase=PESOPR	CaseType=LinStatic	Point=1	X2=-0.5	X3=-0.5	
S11=57.4914769210603	Iss11Max=Yes	Iss11Min=No	FrameElem=14	ElemStation=0			
Frame=14	Station=0	OutputCase=PESOPR	CaseType=LinStatic	Point=2	X2=-0.5	X3=0.5	S11=57.4914769210603
Iss11Max=No	Iss11Min=No	FrameElem=14	ElemStation=0				
Frame=14	Station=0	OutputCase=PESOPR	CaseType=LinStatic	Point=3	X2=0.5	X3=-0.5	S11=-
27.1495834485819	Iss11Max=No	Iss11Min=Yes	FrameElem=14	ElemStation=0			
Frame=14	Station=0	OutputCase=PESOPR	CaseType=LinStatic	Point=4	X2=0.5	X3=0.5	S11=-27.1495834485819
Iss11Max=No	Iss11Min=No	FrameElem=14	ElemStation=0				
Frame=14	Station=0.0625	OutputCase=PESOPR	CaseType=LinStatic	Point=0	X2=0	X3=0	S11=15.1709467362392
Iss11Max=No	Iss11Min=No	FrameElem=14	ElemStation=0.0625				
Frame=14	Station=0.0625	OutputCase=PESOPR	CaseType=LinStatic	Point=1	X2=-0.5	X3=-0.5	
S11=38.448508166913	Iss11Max=Yes	Iss11Min=No	FrameElem=14	ElemStation=0.0625			
Frame=14	Station=0.0625	OutputCase=PESOPR	CaseType=LinStatic	Point=2	X2=-0.5	X3=0.5	
S11=38.448508166913	Iss11Max=No	Iss11Min=No	FrameElem=14	ElemStation=0.0625			
Frame=14	Station=0.0625	OutputCase=PESOPR	CaseType=LinStatic	Point=3	X2=0.5	X3=-0.5	S11=-
8.1066146944346	Iss11Max=No	Iss11Min=Yes	FrameElem=14	ElemStation=0.0625			
Frame=14	Station=0.0625	OutputCase=PESOPR	CaseType=LinStatic	Point=4	X2=0.5	X3=0.5	S11=-
8.1066146944346	Iss11Max=No	Iss11Min=No	FrameElem=14	ElemStation=0.0625			
Frame=14	Station=0.125	OutputCase=PESOPR	CaseType=LinStatic	Point=0	X2=0	X3=0	S11=15.1709467362392
Iss11Max=No	Iss11Min=No	FrameElem=14	ElemStation=0.125				
Frame=14	Station=0.125	OutputCase=PESOPR	CaseType=LinStatic	Point=1	X2=-0.5	X3=-0.5	
S11=18.8196019127657	Iss11Max=Yes	Iss11Min=No	FrameElem=14	ElemStation=0.125			
Frame=14	Station=0.125	OutputCase=PESOPR	CaseType=LinStatic	Point=2	X2=-0.5	X3=0.5	
S11=18.8196019127657	Iss11Max=No	Iss11Min=No	FrameElem=14	ElemStation=0.125			
Frame=14	Station=0.125	OutputCase=PESOPR	CaseType=LinStatic	Point=3	X2=0.5	X3=-0.5	
S11=11.5222915597127	Iss11Max=No	Iss11Min=Yes	FrameElem=14	ElemStation=0.125			
Frame=14	Station=0.125	OutputCase=PESOPR	CaseType=LinStatic	Point=4	X2=0.5	X3=0.5	
S11=11.5222915597127	Iss11Max=No	Iss11Min=No	FrameElem=14	ElemStation=0.125			
Frame=14	Station=0.1875	OutputCase=PESOPR	CaseType=LinStatic	Point=0	X2=0	X3=0	S11=15.1709467362392
Iss11Max=No	Iss11Min=No	FrameElem=14	ElemStation=0.1875				
Frame=14	Station=0.1875	OutputCase=PESOPR	CaseType=LinStatic	Point=1	X2=-0.5	X3=-0.5	S11=-
1.39524184138156	Iss11Max=No	Iss11Min=Yes	FrameElem=14	ElemStation=0.1875			
Frame=14	Station=0.1875	OutputCase=PESOPR	CaseType=LinStatic	Point=2	X2=-0.5	X3=0.5	S11=-
1.39524184138156	Iss11Max=No	Iss11Min=No	FrameElem=14	ElemStation=0.1875			
Frame=14	Station=0.1875	OutputCase=PESOPR	CaseType=LinStatic	Point=3	X2=0.5	X3=-0.5	
S11=31.73713531386	Iss11Max=Yes	Iss11Min=No	FrameElem=14	ElemStation=0.1875			
Frame=14	Station=0.1875	OutputCase=PESOPR	CaseType=LinStatic	Point=4	X2=0.5	X3=0.5	
S11=31.73713531386	Iss11Max=No	Iss11Min=No	FrameElem=14	ElemStation=0.1875			
Frame=14	Station=0.25	OutputCase=PESOPR	CaseType=LinStatic	Point=0	X2=0	X3=0	S11=15.1709467362392
Iss11Max=No	Iss11Min=No	FrameElem=14	ElemStation=0.25				
Frame=14	Station=0.25	OutputCase=PESOPR	CaseType=LinStatic	Point=1	X2=-0.5	X3=-0.5	S11=-
22.1960230955289	Iss11Max=No	Iss11Min=Yes	FrameElem=14	ElemStation=0.25			
Frame=14	Station=0.25	OutputCase=PESOPR	CaseType=LinStatic	Point=2	X2=-0.5	X3=0.5	S11=-
22.1960230955289	Iss11Max=No	Iss11Min=No	FrameElem=14	ElemStation=0.25			
Frame=14	Station=0.25	OutputCase=PESOPR	CaseType=LinStatic	Point=3	X2=0.5	X3=-0.5	
S11=52.5379165680073	Iss11Max=Yes	Iss11Min=No	FrameElem=14	ElemStation=0.25			
Frame=14	Station=0.25	OutputCase=PESOPR	CaseType=LinStatic	Point=4	X2=0.5	X3=0.5	
S11=52.5379165680073	Iss11Max=No	Iss11Min=No	FrameElem=14	ElemStation=0.25			
Frame=14	Station=0	OutputCase=TERRVERT	CaseType=LinStatic	Point=0	X2=0	X3=0	S11=-1.15282857328964
Iss11Max=No	Iss11Min=No	FrameElem=14	ElemStation=0				
Frame=14	Station=0	OutputCase=TERRVERT	CaseType=LinStatic	Point=1	X2=-0.5	X3=-0.5	S11=-
42.94649072547	Iss11Max=No	Iss11Min=Yes	FrameElem=14	ElemStation=0			
Frame=14	Station=0	OutputCase=TERRVERT	CaseType=LinStatic	Point=2	X2=-0.5	X3=0.5	S11=-
42.94649072547	Iss11Max=No	Iss11Min=No	FrameElem=14	ElemStation=0			
Frame=14	Station=0	OutputCase=TERRVERT	CaseType=LinStatic	Point=3	X2=0.5	X3=-0.5	
S11=40.6408335788907	Iss11Max=Yes	Iss11Min=No	FrameElem=14	ElemStation=0			
Frame=14	Station=0	OutputCase=TERRVERT	CaseType=LinStatic	Point=4	X2=0.5	X3=0.5	
S11=40.6408335788907	Iss11Max=No	Iss11Min=No	FrameElem=14	ElemStation=0			
Frame=14	Station=0.0625	OutputCase=TERRVERT	CaseType=LinStatic	Point=0	X2=0	X3=0	S11=-
1.15282857328964	Iss11Max=No	Iss11Min=No	FrameElem=14	ElemStation=0.0625			

Frame=14	Station=0.0625	OutputCase=TERRVERT	CaseType=LinStatic	Point=1	X2=-0.5	X3=-0.5	S11=-
192.62422517451	IsS11Max=No	IsS11Min=Yes	FrameElem=14	ElemStation=0.0625			
Frame=14	Station=0.0625	OutputCase=TERRVERT	CaseType=LinStatic	Point=2	X2=-0.5	X3=0.5	S11=-
192.62422517451	IsS11Max=No	IsS11Min=No	FrameElem=14	ElemStation=0.0625			
Frame=14	Station=0.0625	OutputCase=TERRVERT	CaseType=LinStatic	Point=3	X2=0.5	X3=-0.5	
S11=190.318568027931	IsS11Max=Yes	IsS11Min=No	FrameElem=14	ElemStation=0.0625			
Frame=14	Station=0.0625	OutputCase=TERRVERT	CaseType=LinStatic	Point=4	X2=0.5	X3=0.5	
S11=190.318568027931	IsS11Max=No	IsS11Min=No	FrameElem=14	ElemStation=0.0625			
Frame=14	Station=0.125	OutputCase=TERRVERT	CaseType=LinStatic	Point=0	X2=0	X3=0	S11=-
1.15282857328964	IsS11Max=No	IsS11Min=No	FrameElem=14	ElemStation=0.125			
Frame=14	Station=0.125	OutputCase=TERRVERT	CaseType=LinStatic	Point=1	X2=-0.5	X3=-0.5	S11=-
346.90742837355	IsS11Max=No	IsS11Min=Yes	FrameElem=14	ElemStation=0.125			
Frame=14	Station=0.125	OutputCase=TERRVERT	CaseType=LinStatic	Point=2	X2=-0.5	X3=0.5	S11=-
346.90742837355	IsS11Max=No	IsS11Min=No	FrameElem=14	ElemStation=0.125			
Frame=14	Station=0.125	OutputCase=TERRVERT	CaseType=LinStatic	Point=3	X2=0.5	X3=-0.5	
S11=344.601771226971	IsS11Max=Yes	IsS11Min=No	FrameElem=14	ElemStation=0.125			
Frame=14	Station=0.125	OutputCase=TERRVERT	CaseType=LinStatic	Point=4	X2=0.5	X3=0.5	
S11=344.601771226971	IsS11Max=No	IsS11Min=No	FrameElem=14	ElemStation=0.125			
Frame=14	Station=0.1875	OutputCase=TERRVERT	CaseType=LinStatic	Point=0	X2=0	X3=0	S11=-
1.15282857328964	IsS11Max=No	IsS11Min=No	FrameElem=14	ElemStation=0.1875			
Frame=14	Station=0.1875	OutputCase=TERRVERT	CaseType=LinStatic	Point=1	X2=-0.5	X3=-0.5	S11=-
505.79610032259	IsS11Max=No	IsS11Min=Yes	FrameElem=14	ElemStation=0.1875			
Frame=14	Station=0.1875	OutputCase=TERRVERT	CaseType=LinStatic	Point=2	X2=-0.5	X3=0.5	S11=-
505.79610032259	IsS11Max=No	IsS11Min=No	FrameElem=14	ElemStation=0.1875			
Frame=14	Station=0.1875	OutputCase=TERRVERT	CaseType=LinStatic	Point=3	X2=0.5	X3=-0.5	
S11=503.490443176011	IsS11Max=Yes	IsS11Min=No	FrameElem=14	ElemStation=0.1875			
Frame=14	Station=0.1875	OutputCase=TERRVERT	CaseType=LinStatic	Point=4	X2=0.5	X3=0.5	
S11=503.490443176011	IsS11Max=No	IsS11Min=No	FrameElem=14	ElemStation=0.1875			
Frame=14	Station=0.25	OutputCase=TERRVERT	CaseType=LinStatic	Point=0	X2=0	X3=0	S11=-
1.15282857328964	IsS11Max=No	IsS11Min=No	FrameElem=14	ElemStation=0.25			
Frame=14	Station=0.25	OutputCase=TERRVERT	CaseType=LinStatic	Point=1	X2=-0.5	X3=-0.5	S11=-
669.290241021631	IsS11Max=No	IsS11Min=Yes	FrameElem=14	ElemStation=0.25			
Frame=14	Station=0.25	OutputCase=TERRVERT	CaseType=LinStatic	Point=2	X2=-0.5	X3=0.5	S11=-
669.290241021631	IsS11Max=No	IsS11Min=No	FrameElem=14	ElemStation=0.25			
Frame=14	Station=0.25	OutputCase=TERRVERT	CaseType=LinStatic	Point=3	X2=0.5	X3=-0.5	
S11=666.984583875051	IsS11Max=Yes	IsS11Min=No	FrameElem=14	ElemStation=0.25			
Frame=14	Station=0.25	OutputCase=TERRVERT	CaseType=LinStatic	Point=4	X2=0.5	X3=0.5	
S11=666.984583875051	IsS11Max=No	IsS11Min=No	FrameElem=14	ElemStation=0.25			
Frame=14	Station=0	OutputCase=TERRLAT	CaseType=LinStatic	Point=0	X2=0	X3=0	S11=-66.7117981831705
IsS11Max=No	IsS11Min=No	FrameElem=14	ElemStation=0				
Frame=14	Station=0	OutputCase=TERRLAT	CaseType=LinStatic	Point=1	X2=-0.5	X3=-0.5	S11=-
190.013380167714	IsS11Max=No	IsS11Min=Yes	FrameElem=14	ElemStation=0			
Frame=14	Station=0	OutputCase=TERRLAT	CaseType=LinStatic	Point=2	X2=-0.5	X3=0.5	S11=-
190.013380167714	IsS11Max=No	IsS11Min=No	FrameElem=14	ElemStation=0			
Frame=14	Station=0	OutputCase=TERRLAT	CaseType=LinStatic	Point=3	X2=0.5	X3=-0.5	
S11=56.5897838013734	IsS11Max=Yes	IsS11Min=No	FrameElem=14	ElemStation=0			
Frame=14	Station=0	OutputCase=TERRLAT	CaseType=LinStatic	Point=4	X2=0.5	X3=0.5	S11=56.5897838013734
IsS11Max=No	IsS11Min=No	FrameElem=14	ElemStation=0				
Frame=14	Station=0.0625	OutputCase=TERRLAT	CaseType=LinStatic	Point=0	X2=0	X3=0	S11=-
66.7117981831705	IsS11Max=No	IsS11Min=No	FrameElem=14	ElemStation=0.0625			
Frame=14	Station=0.0625	OutputCase=TERRLAT	CaseType=LinStatic	Point=1	X2=-0.5	X3=-0.5	S11=-
190.013380293032	IsS11Max=No	IsS11Min=Yes	FrameElem=14	ElemStation=0.0625			
Frame=14	Station=0.0625	OutputCase=TERRLAT	CaseType=LinStatic	Point=2	X2=-0.5	X3=0.5	S11=-
190.013380293032	IsS11Max=No	IsS11Min=No	FrameElem=14	ElemStation=0.0625			
Frame=14	Station=0.0625	OutputCase=TERRLAT	CaseType=LinStatic	Point=3	X2=0.5	X3=-0.5	
S11=56.5897839266913	IsS11Max=Yes	IsS11Min=No	FrameElem=14	ElemStation=0.0625			
Frame=14	Station=0.0625	OutputCase=TERRLAT	CaseType=LinStatic	Point=4	X2=0.5	X3=0.5	
S11=56.5897839266913	IsS11Max=No	IsS11Min=No	FrameElem=14	ElemStation=0.0625			
Frame=14	Station=0.125	OutputCase=TERRLAT	CaseType=LinStatic	Point=0	X2=0	X3=0	S11=-
66.7117981831705	IsS11Max=No	IsS11Min=No	FrameElem=14	ElemStation=0.125			
Frame=14	Station=0.125	OutputCase=TERRLAT	CaseType=LinStatic	Point=1	X2=-0.5	X3=-0.5	S11=-
190.01338041835	IsS11Max=No	IsS11Min=Yes	FrameElem=14	ElemStation=0.125			
Frame=14	Station=0.125	OutputCase=TERRLAT	CaseType=LinStatic	Point=2	X2=-0.5	X3=0.5	S11=-
190.01338041835	IsS11Max=No	IsS11Min=No	FrameElem=14	ElemStation=0.125			
Frame=14	Station=0.125	OutputCase=TERRLAT	CaseType=LinStatic	Point=3	X2=0.5	X3=-0.5	
S11=56.5897840520091	IsS11Max=Yes	IsS11Min=No	FrameElem=14	ElemStation=0.125			
Frame=14	Station=0.125	OutputCase=TERRLAT	CaseType=LinStatic	Point=4	X2=0.5	X3=0.5	
S11=56.5897840520091	IsS11Max=No	IsS11Min=No	FrameElem=14	ElemStation=0.125			
Frame=14	Station=0.1875	OutputCase=TERRLAT	CaseType=LinStatic	Point=0	X2=0	X3=0	S11=-
66.7117981831705	IsS11Max=No	IsS11Min=No	FrameElem=14	ElemStation=0.1875			
Frame=14	Station=0.1875	OutputCase=TERRLAT	CaseType=LinStatic	Point=1	X2=-0.5	X3=-0.5	S11=-
190.013380543668	IsS11Max=No	IsS11Min=Yes	FrameElem=14	ElemStation=0.1875			
Frame=14	Station=0.1875	OutputCase=TERRLAT	CaseType=LinStatic	Point=2	X2=-0.5	X3=0.5	S11=-
190.013380543668	IsS11Max=No	IsS11Min=No	FrameElem=14	ElemStation=0.1875			
Frame=14	Station=0.1875	OutputCase=TERRLAT	CaseType=LinStatic	Point=3	X2=0.5	X3=-0.5	
S11=56.5897841773269	IsS11Max=Yes	IsS11Min=No	FrameElem=14	ElemStation=0.1875			
Frame=14	Station=0.1875	OutputCase=TERRLAT	CaseType=LinStatic	Point=4	X2=0.5	X3=0.5	
S11=56.5897841773269	IsS11Max=No	IsS11Min=No	FrameElem=14	ElemStation=0.1875			
Frame=14	Station=0.25	OutputCase=TERRLAT	CaseType=LinStatic	Point=0	X2=0	X3=0	S11=-66.7117981831705
IsS11Max=No	IsS11Min=No	FrameElem=14	ElemStation=0.25				
Frame=14	Station=0.25	OutputCase=TERRLAT	CaseType=LinStatic	Point=1	X2=-0.5	X3=-0.5	S11=-
190.013380668986	IsS11Max=No	IsS11Min=Yes	FrameElem=14	ElemStation=0.25			

Frame=14	Station=0	OutputCase=SOVRCOST	CaseType=LinStatic	Point=4	X2=0.5	X3=0.5	S11=0	IsS11Max=No
IsS11Min=No	FrameElem=14	ElemStation=0						
Frame=14	Station=0.0625	OutputCase=SOVRCOST	CaseType=LinStatic	Point=0	X2=0	X3=0	S11=0	
IsS11Max=Yes	IsS11Min=Yes	FrameElem=14	ElemStation=0.0625					
Frame=14	Station=0.0625	OutputCase=SOVRCOST	CaseType=LinStatic	Point=1	X2=-0.5	X3=-0.5	S11=0	
IsS11Max=No	IsS11Min=No	FrameElem=14	ElemStation=0.0625					
Frame=14	Station=0.0625	OutputCase=SOVRCOST	CaseType=LinStatic	Point=2	X2=-0.5	X3=0.5	S11=0	
IsS11Max=No	IsS11Min=No	FrameElem=14	ElemStation=0.0625					
Frame=14	Station=0.0625	OutputCase=SOVRCOST	CaseType=LinStatic	Point=3	X2=0.5	X3=-0.5	S11=0	
IsS11Max=No	IsS11Min=No	FrameElem=14	ElemStation=0.0625					
Frame=14	Station=0.0625	OutputCase=SOVRCOST	CaseType=LinStatic	Point=4	X2=0.5	X3=0.5	S11=0	
IsS11Max=No	IsS11Min=No	FrameElem=14	ElemStation=0.0625					
Frame=14	Station=0.125	OutputCase=SOVRCOST	CaseType=LinStatic	Point=0	X2=0	X3=0	S11=0	
IsS11Max=Yes	IsS11Min=Yes	FrameElem=14	ElemStation=0.125					
Frame=14	Station=0.125	OutputCase=SOVRCOST	CaseType=LinStatic	Point=1	X2=-0.5	X3=-0.5	S11=0	
IsS11Max=No	IsS11Min=No	FrameElem=14	ElemStation=0.125					
Frame=14	Station=0.125	OutputCase=SOVRCOST	CaseType=LinStatic	Point=2	X2=-0.5	X3=0.5	S11=0	
IsS11Max=No	IsS11Min=No	FrameElem=14	ElemStation=0.125					
Frame=14	Station=0.125	OutputCase=SOVRCOST	CaseType=LinStatic	Point=3	X2=0.5	X3=-0.5	S11=0	
IsS11Max=No	IsS11Min=No	FrameElem=14	ElemStation=0.125					
Frame=14	Station=0.125	OutputCase=SOVRCOST	CaseType=LinStatic	Point=4	X2=0.5	X3=0.5	S11=0	
IsS11Max=No	IsS11Min=No	FrameElem=14	ElemStation=0.125					
Frame=14	Station=0.1875	OutputCase=SOVRCOST	CaseType=LinStatic	Point=0	X2=0	X3=0	S11=0	
IsS11Max=Yes	IsS11Min=Yes	FrameElem=14	ElemStation=0.1875					
Frame=14	Station=0.1875	OutputCase=SOVRCOST	CaseType=LinStatic	Point=1	X2=-0.5	X3=-0.5	S11=0	
IsS11Max=No	IsS11Min=No	FrameElem=14	ElemStation=0.1875					
Frame=14	Station=0.1875	OutputCase=SOVRCOST	CaseType=LinStatic	Point=2	X2=-0.5	X3=0.5	S11=0	
IsS11Max=No	IsS11Min=No	FrameElem=14	ElemStation=0.1875					
Frame=14	Station=0.1875	OutputCase=SOVRCOST	CaseType=LinStatic	Point=3	X2=0.5	X3=-0.5	S11=0	
IsS11Max=No	IsS11Min=No	FrameElem=14	ElemStation=0.1875					
Frame=14	Station=0.1875	OutputCase=SOVRCOST	CaseType=LinStatic	Point=4	X2=0.5	X3=0.5	S11=0	
IsS11Max=No	IsS11Min=No	FrameElem=14	ElemStation=0.1875					
Frame=14	Station=0.25	OutputCase=SOVRCOST	CaseType=LinStatic	Point=0	X2=0	X3=0	S11=0	IsS11Max=Yes
IsS11Min=Yes	FrameElem=14	ElemStation=0.25						
Frame=14	Station=0.25	OutputCase=SOVRCOST	CaseType=LinStatic	Point=1	X2=-0.5	X3=-0.5	S11=0	
IsS11Max=No	IsS11Min=No	FrameElem=14	ElemStation=0.25					
Frame=14	Station=0.25	OutputCase=SOVRCOST	CaseType=LinStatic	Point=2	X2=-0.5	X3=0.5	S11=0	
IsS11Max=No	IsS11Min=No	FrameElem=14	ElemStation=0.25					
Frame=14	Station=0.25	OutputCase=SOVRCOST	CaseType=LinStatic	Point=3	X2=0.5	X3=-0.5	S11=0	
IsS11Max=No	IsS11Min=No	FrameElem=14	ElemStation=0.25					
Frame=14	Station=0.25	OutputCase=SOVRCOST	CaseType=LinStatic	Point=4	X2=0.5	X3=0.5	S11=0	
IsS11Max=No	IsS11Min=No	FrameElem=14	ElemStation=0.25					
Frame=14	Station=0	OutputCase=ENVE	CaseType=Combination	StepType=Max	Point=0	X2=0	X3=0	S11=-
32.6801405652697	IsS11Max=No	IsS11Min=No	FrameElem=14	ElemStation=0				
Frame=14	Station=0	OutputCase=ENVE	CaseType=Combination	StepType=Max	Point=1	X2=-0.5	X3=-0.5	
S11=-118.46437992181	IsS11Max=No	IsS11Min=Yes	FrameElem=14	ElemStation=0				
Frame=14	Station=0	OutputCase=ENVE	CaseType=Combination	StepType=Max	Point=2	X2=-0.5	X3=0.5	S11=-
118.46437992181	IsS11Max=No	IsS11Min=No	FrameElem=14	ElemStation=0				
Frame=14	Station=0	OutputCase=ENVE	CaseType=Combination	StepType=Max	Point=3	X2=0.5	X3=-0.5	
S11=70.0810339316822	IsS11Max=Yes	IsS11Min=No	FrameElem=14	ElemStation=0				
Frame=14	Station=0	OutputCase=ENVE	CaseType=Combination	StepType=Max	Point=4	X2=0.5	X3=0.5	
S11=70.0810339316822	IsS11Max=No	IsS11Min=No	FrameElem=14	ElemStation=0				
Frame=14	Station=0.0625	OutputCase=ENVE	CaseType=Combination	StepType=Max	Point=0	X2=0	X3=0	S11=-
32.6801405652697	IsS11Max=No	IsS11Min=No	FrameElem=14	ElemStation=0.0625				
Frame=14	Station=0.0625	OutputCase=ENVE	CaseType=Combination	StepType=Max	Point=1	X2=-0.5	X3=-0.5	
S11=-287.18508321272	IsS11Max=No	IsS11Min=Yes	FrameElem=14	ElemStation=0.0625				
Frame=14	Station=0.0625	OutputCase=ENVE	CaseType=Combination	StepType=Max	Point=2	X2=-0.5	X3=0.5	
S11=-287.18508321272	IsS11Max=No	IsS11Min=No	FrameElem=14	ElemStation=0.0625				
Frame=14	Station=0.0625	OutputCase=ENVE	CaseType=Combination	StepType=Max	Point=3	X2=0.5	X3=-0.5	
S11=238.801737260188	IsS11Max=Yes	IsS11Min=No	FrameElem=14	ElemStation=0.0625				
Frame=14	Station=0.0625	OutputCase=ENVE	CaseType=Combination	StepType=Max	Point=4	X2=0.5	X3=0.5	
S11=238.801737260188	IsS11Max=No	IsS11Min=No	FrameElem=14	ElemStation=0.0625				
Frame=14	Station=0.125	OutputCase=ENVE	CaseType=Combination	StepType=Max	Point=0	X2=0	X3=0	S11=-
32.6801405652697	IsS11Max=No	IsS11Min=No	FrameElem=14	ElemStation=0.125				
Frame=14	Station=0.125	OutputCase=ENVE	CaseType=Combination	StepType=Max	Point=1	X2=-0.5	X3=-0.5	
S11=-461.09719275363	IsS11Max=No	IsS11Min=Yes	FrameElem=14	ElemStation=0.125				
Frame=14	Station=0.125	OutputCase=ENVE	CaseType=Combination	StepType=Max	Point=2	X2=-0.5	X3=0.5	
S11=-461.09719275363	IsS11Max=No	IsS11Min=No	FrameElem=14	ElemStation=0.125				
Frame=14	Station=0.125	OutputCase=ENVE	CaseType=Combination	StepType=Max	Point=3	X2=0.5	X3=-0.5	
S11=412.713846838693	IsS11Max=Yes	IsS11Min=No	FrameElem=14	ElemStation=0.125				
Frame=14	Station=0.125	OutputCase=ENVE	CaseType=Combination	StepType=Max	Point=4	X2=0.5	X3=0.5	
S11=412.713846838693	IsS11Max=No	IsS11Min=No	FrameElem=14	ElemStation=0.125				
Frame=14	Station=0.1875	OutputCase=ENVE	CaseType=Combination	StepType=Max	Point=0	X2=0	X3=0	S11=-
32.6801405652697	IsS11Max=No	IsS11Min=No	FrameElem=14	ElemStation=0.1875				
Frame=14	Station=0.1875	OutputCase=ENVE	CaseType=Combination	StepType=Max	Point=1	X2=-0.5	X3=-0.5	
S11=-640.200708544539	IsS11Max=No	IsS11Min=Yes	FrameElem=14	ElemStation=0.1875				
Frame=14	Station=0.1875	OutputCase=ENVE	CaseType=Combination	StepType=Max	Point=2	X2=-0.5	X3=0.5	
S11=-640.200708544539	IsS11Max=No	IsS11Min=No	FrameElem=14	ElemStation=0.1875				
Frame=14	Station=0.1875	OutputCase=ENVE	CaseType=Combination	StepType=Max	Point=3	X2=0.5	X3=-0.5	
S11=591.817362667198	IsS11Max=Yes	IsS11Min=No	FrameElem=14	ElemStation=0.1875				
Frame=14	Station=0.1875	OutputCase=ENVE	CaseType=Combination	StepType=Max	Point=4	X2=0.5	X3=0.5	
S11=591.817362667198	IsS11Max=No	IsS11Min=No	FrameElem=14	ElemStation=0.1875				

Frame=14	Station=0.25	OutputCase=ENVE	CaseType=Combination	StepType=Max	Point=0	X2=0	X3=0	S11=-
32.6801405652697	IsS11Max=No	IsS11Min=No	FrameElem=14	ElemStation=0.25				
Frame=14	Station=0.25	OutputCase=ENVE	CaseType=Combination	StepType=Max	Point=1	X2=-0.5	X3=-0.5	
S11=-824.495630585449	IsS11Max=No	IsS11Min=Yes	FrameElem=14	ElemStation=0.25				
Frame=14	Station=0.25	OutputCase=ENVE	CaseType=Combination	StepType=Max	Point=2	X2=-0.5	X3=0.5	
S11=-824.495630585449	IsS11Max=No	IsS11Min=No	FrameElem=14	ElemStation=0.25				
Frame=14	Station=0.25	OutputCase=ENVE	CaseType=Combination	StepType=Max	Point=3	X2=0.5	X3=-0.5	
S11=776.112284745703	IsS11Max=Yes	IsS11Min=No	FrameElem=14	ElemStation=0.25				
Frame=14	Station=0.25	OutputCase=ENVE	CaseType=Combination	StepType=Max	Point=4	X2=0.5	X3=0.5	
S11=776.112284745703	IsS11Max=No	IsS11Min=No	FrameElem=14	ElemStation=0.25				
Frame=14	Station=0	OutputCase=ENVE	CaseType=Combination	StepType=Min	Point=0	X2=0	X3=0	S11=-
52.6936800202209	IsS11Max=No	IsS11Min=No	FrameElem=14	ElemStation=0				
Frame=14	Station=0	OutputCase=ENVE	CaseType=Combination	StepType=Min	Point=1	X2=-0.5	X3=-0.5	
S11=-175.468393972124	IsS11Max=No	IsS11Min=Yes	FrameElem=14	ElemStation=0				
Frame=14	Station=0	OutputCase=ENVE	CaseType=Combination	StepType=Min	Point=2	X2=-0.5	X3=0.5	S11=-
175.468393972124	IsS11Max=No	IsS11Min=No	FrameElem=14	ElemStation=0				
Frame=14	Station=0	OutputCase=ENVE	CaseType=Combination	StepType=Min	Point=3	X2=0.5	X3=-0.5	
S11=53.1040987912702	IsS11Max=Yes	IsS11Min=No	FrameElem=14	ElemStation=0				
Frame=14	Station=0	OutputCase=ENVE	CaseType=Combination	StepType=Min	Point=4	X2=0.5	X3=0.5	
S11=53.1040987912702	IsS11Max=No	IsS11Min=No	FrameElem=14	ElemStation=0				
Frame=14	Station=0.0625	OutputCase=ENVE	CaseType=Combination	StepType=Min	Point=0	X2=0	X3=0	S11=-
52.6936800202209	IsS11Max=No	IsS11Min=No	FrameElem=14	ElemStation=0.0625				
Frame=14	Station=0.0625	OutputCase=ENVE	CaseType=Combination	StepType=Min	Point=1	X2=-0.5	X3=-0.5	
S11=-344.189097300629	IsS11Max=No	IsS11Min=Yes	FrameElem=14	ElemStation=0.0625				
Frame=14	Station=0.0625	OutputCase=ENVE	CaseType=Combination	StepType=Min	Point=2	X2=-0.5	X3=0.5	
S11=-344.189097300629	IsS11Max=No	IsS11Min=No	FrameElem=14	ElemStation=0.0625				
Frame=14	Station=0.0625	OutputCase=ENVE	CaseType=Combination	StepType=Min	Point=3	X2=0.5	X3=-0.5	
S11=221.82480208218	IsS11Max=Yes	IsS11Min=No	FrameElem=14	ElemStation=0.0625				
Frame=14	Station=0.0625	OutputCase=ENVE	CaseType=Combination	StepType=Min	Point=4	X2=0.5	X3=0.5	
S11=221.82480208218	IsS11Max=No	IsS11Min=No	FrameElem=14	ElemStation=0.0625				
Frame=14	Station=0.125	OutputCase=ENVE	CaseType=Combination	StepType=Min	Point=0	X2=0	X3=0	S11=-
52.6936800202209	IsS11Max=No	IsS11Min=No	FrameElem=14	ElemStation=0.125				
Frame=14	Station=0.125	OutputCase=ENVE	CaseType=Combination	StepType=Min	Point=1	X2=-0.5	X3=-0.5	
S11=-518.101206879135	IsS11Max=No	IsS11Min=Yes	FrameElem=14	ElemStation=0.125				
Frame=14	Station=0.125	OutputCase=ENVE	CaseType=Combination	StepType=Min	Point=2	X2=-0.5	X3=0.5	
S11=-518.101206879135	IsS11Max=No	IsS11Min=No	FrameElem=14	ElemStation=0.125				
Frame=14	Station=0.125	OutputCase=ENVE	CaseType=Combination	StepType=Min	Point=3	X2=0.5	X3=-0.5	
S11=395.73691162309	IsS11Max=Yes	IsS11Min=No	FrameElem=14	ElemStation=0.125				
Frame=14	Station=0.125	OutputCase=ENVE	CaseType=Combination	StepType=Min	Point=4	X2=0.5	X3=0.5	
S11=395.73691162309	IsS11Max=No	IsS11Min=No	FrameElem=14	ElemStation=0.125				
Frame=14	Station=0.1875	OutputCase=ENVE	CaseType=Combination	StepType=Min	Point=0	X2=0	X3=0	S11=-
52.6936800202209	IsS11Max=No	IsS11Min=No	FrameElem=14	ElemStation=0.1875				
Frame=14	Station=0.1875	OutputCase=ENVE	CaseType=Combination	StepType=Min	Point=1	X2=-0.5	X3=-0.5	
S11=-697.20472270764	IsS11Max=No	IsS11Min=Yes	FrameElem=14	ElemStation=0.1875				
Frame=14	Station=0.1875	OutputCase=ENVE	CaseType=Combination	StepType=Min	Point=2	X2=-0.5	X3=0.5	
S11=-697.20472270764	IsS11Max=No	IsS11Min=No	FrameElem=14	ElemStation=0.1875				
Frame=14	Station=0.1875	OutputCase=ENVE	CaseType=Combination	StepType=Min	Point=3	X2=0.5	X3=-0.5	
S11=574.840427414	IsS11Max=Yes	IsS11Min=No	FrameElem=14	ElemStation=0.1875				
Frame=14	Station=0.1875	OutputCase=ENVE	CaseType=Combination	StepType=Min	Point=4	X2=0.5	X3=0.5	
S11=574.840427414	IsS11Max=No	IsS11Min=No	FrameElem=14	ElemStation=0.1875				
Frame=14	Station=0.25	OutputCase=ENVE	CaseType=Combination	StepType=Min	Point=0	X2=0	X3=0	S11=-
52.6936800202209	IsS11Max=No	IsS11Min=No	FrameElem=14	ElemStation=0.25				
Frame=14	Station=0.25	OutputCase=ENVE	CaseType=Combination	StepType=Min	Point=1	X2=-0.5	X3=-0.5	
S11=-881.499644786145	IsS11Max=No	IsS11Min=Yes	FrameElem=14	ElemStation=0.25				
Frame=14	Station=0.25	OutputCase=ENVE	CaseType=Combination	StepType=Min	Point=2	X2=-0.5	X3=0.5	
S11=-881.499644786145	IsS11Max=No	IsS11Min=No	FrameElem=14	ElemStation=0.25				
Frame=14	Station=0.25	OutputCase=ENVE	CaseType=Combination	StepType=Min	Point=3	X2=0.5	X3=-0.5	
S11=759.13534945491	IsS11Max=Yes	IsS11Min=No	FrameElem=14	ElemStation=0.25				
Frame=14	Station=0.25	OutputCase=ENVE	CaseType=Combination	StepType=Min	Point=4	X2=0.5	X3=0.5	
S11=759.13534945491	IsS11Max=No	IsS11Min=No	FrameElem=14	ElemStation=0.25				
Frame=14	Station=0	OutputCase=FESSUR	CaseType=Combination	Point=0	X2=0	X3=0	S11=-52.6936800202209	
IsS11Max=No	IsS11Min=No	FrameElem=14	ElemStation=0					
Frame=14	Station=0	OutputCase=FESSUR	CaseType=Combination	Point=1	X2=-0.5	X3=-0.5	S11=-	
175.468393972124	IsS11Max=No	IsS11Min=Yes	FrameElem=14	ElemStation=0				
Frame=14	Station=0	OutputCase=FESSUR	CaseType=Combination	Point=2	X2=-0.5	X3=0.5	S11=-	
175.468393972124	IsS11Max=No	IsS11Min=No	FrameElem=14	ElemStation=0				
Frame=14	Station=0	OutputCase=FESSUR	CaseType=Combination	Point=3	X2=0.5	X3=-0.5		
S11=70.0810339316822	IsS11Max=Yes	IsS11Min=No	FrameElem=14	ElemStation=0				
Frame=14	Station=0	OutputCase=FESSUR	CaseType=Combination	Point=4	X2=0.5	X3=0.5		
S11=70.0810339316822	IsS11Max=No	IsS11Min=No	FrameElem=14	ElemStation=0				
Frame=14	Station=0.0625	OutputCase=FESSUR	CaseType=Combination	Point=0	X2=0	X3=0	S11=-	
52.6936800202209	IsS11Max=No	IsS11Min=No	FrameElem=14	ElemStation=0.0625				
Frame=14	Station=0.0625	OutputCase=FESSUR	CaseType=Combination	Point=1	X2=-0.5	X3=-0.5	S11=-	
344.189097300629	IsS11Max=No	IsS11Min=Yes	FrameElem=14	ElemStation=0.0625				
Frame=14	Station=0.0625	OutputCase=FESSUR	CaseType=Combination	Point=2	X2=-0.5	X3=0.5	S11=-	
344.189097300629	IsS11Max=No	IsS11Min=No	FrameElem=14	ElemStation=0.0625				
Frame=14	Station=0.0625	OutputCase=FESSUR	CaseType=Combination	Point=3	X2=0.5	X3=-0.5		
S11=238.801737260188	IsS11Max=Yes	IsS11Min=No	FrameElem=14	ElemStation=0.0625				
Frame=14	Station=0.0625	OutputCase=FESSUR	CaseType=Combination	Point=4	X2=0.5	X3=0.5		
S11=238.801737260188	IsS11Max=No	IsS11Min=No	FrameElem=14	ElemStation=0.0625				
Frame=14	Station=0.125	OutputCase=FESSUR	CaseType=Combination	Point=0	X2=0	X3=0	S11=-	
52.6936800202209	IsS11Max=No	IsS11Min=No	FrameElem=14	ElemStation=0.125				

Frame=14	Station=0.125	OutputCase=FESSUR	CaseType=Combination	Point=1	X2=-0.5	X3=-0.5	S11=-
518.101206879135	Iss11Max=No	Iss11Min=Yes	FrameElem=14	ElemStation=0.125			
Frame=14	Station=0.125	OutputCase=FESSUR	CaseType=Combination	Point=2	X2=-0.5	X3=0.5	S11=-
518.101206879135	Iss11Max=No	Iss11Min=No	FrameElem=14	ElemStation=0.125			
Frame=14	Station=0.125	OutputCase=FESSUR	CaseType=Combination	Point=3	X2=0.5	X3=-0.5	
S11=412.713846838693	Iss11Max=Yes	Iss11Min=No	FrameElem=14	ElemStation=0.125			
Frame=14	Station=0.125	OutputCase=FESSUR	CaseType=Combination	Point=4	X2=0.5	X3=0.5	
S11=412.713846838693	Iss11Max=No	Iss11Min=No	FrameElem=14	ElemStation=0.125			
Frame=14	Station=0.1875	OutputCase=FESSUR	CaseType=Combination	Point=0	X2=0	X3=0	S11=-
52.6936800202209	Iss11Max=No	Iss11Min=No	FrameElem=14	ElemStation=0.1875			
Frame=14	Station=0.1875	OutputCase=FESSUR	CaseType=Combination	Point=1	X2=-0.5	X3=-0.5	S11=-
697.20472270764	Iss11Max=No	Iss11Min=Yes	FrameElem=14	ElemStation=0.1875			
Frame=14	Station=0.1875	OutputCase=FESSUR	CaseType=Combination	Point=2	X2=-0.5	X3=0.5	S11=-
697.20472270764	Iss11Max=No	Iss11Min=No	FrameElem=14	ElemStation=0.1875			
Frame=14	Station=0.1875	OutputCase=FESSUR	CaseType=Combination	Point=3	X2=0.5	X3=-0.5	
S11=591.817362667198	Iss11Max=Yes	Iss11Min=No	FrameElem=14	ElemStation=0.1875			
Frame=14	Station=0.1875	OutputCase=FESSUR	CaseType=Combination	Point=4	X2=0.5	X3=0.5	
S11=591.817362667198	Iss11Max=No	Iss11Min=No	FrameElem=14	ElemStation=0.1875			
Frame=14	Station=0.25	OutputCase=FESSUR	CaseType=Combination	Point=0	X2=0	X3=0	S11=-
52.6936800202209	Iss11Max=No	Iss11Min=No	FrameElem=14	ElemStation=0.25			
Frame=14	Station=0.25	OutputCase=FESSUR	CaseType=Combination	Point=1	X2=-0.5	X3=-0.5	S11=-
881.499644786145	Iss11Max=No	Iss11Min=Yes	FrameElem=14	ElemStation=0.25			
Frame=14	Station=0.25	OutputCase=FESSUR	CaseType=Combination	Point=2	X2=-0.5	X3=0.5	S11=-
881.499644786145	Iss11Max=No	Iss11Min=No	FrameElem=14	ElemStation=0.25			
Frame=14	Station=0.25	OutputCase=FESSUR	CaseType=Combination	Point=3	X2=0.5	X3=-0.5	
S11=776.112284745703	Iss11Max=Yes	Iss11Min=No	FrameElem=14	ElemStation=0.25			
Frame=14	Station=0.25	OutputCase=FESSUR	CaseType=Combination	Point=4	X2=0.5	X3=0.5	
S11=776.112284745703	Iss11Max=No	Iss11Min=No	FrameElem=14	ElemStation=0.25			
Frame=15	Station=0	OutputCase=PESOPR	CaseType=LinStatic	Point=0	X2=0	X3=0	S11=15.1709413718193
Iss11Max=No	Iss11Min=No	FrameElem=15	ElemStation=0				
Frame=15	Station=0	OutputCase=PESOPR	CaseType=LinStatic	Point=1	X2=-0.5	X3=-0.5	S11=-
22.1960284599052	Iss11Max=No	Iss11Min=Yes	FrameElem=15	ElemStation=0			
Frame=15	Station=0	OutputCase=PESOPR	CaseType=LinStatic	Point=2	X2=-0.5	X3=0.5	S11=-
22.1960284599052	Iss11Max=No	Iss11Min=No	FrameElem=15	ElemStation=0			
Frame=15	Station=0	OutputCase=PESOPR	CaseType=LinStatic	Point=3	X2=0.5	X3=-0.5	S11=52.5379112035437
Iss11Max=Yes	Iss11Min=No	FrameElem=15	ElemStation=0				
Frame=15	Station=0	OutputCase=PESOPR	CaseType=LinStatic	Point=4	X2=0.5	X3=0.5	S11=52.5379112035437
Iss11Max=No	Iss11Min=No	FrameElem=15	ElemStation=0				
Frame=15	Station=6.24999940395358E-02	OutputCase=PESOPR	CaseType=LinStatic	Point=0	X2=0	X3=0	
S11=15.1709412228076	Iss11Max=No	Iss11Min=No	FrameElem=15	ElemStation=6.24999940395358E-02			
Frame=15	Station=6.24999940395358E-02	OutputCase=PESOPR	CaseType=LinStatic	Point=1	X2=-0.5	X3=-0.5	
S11=-43.5827458380598	Iss11Max=No	Iss11Min=Yes	FrameElem=15	ElemStation=6.24999940395358E-02			
Frame=15	Station=6.24999940395358E-02	OutputCase=PESOPR	CaseType=LinStatic	Point=2	X2=-0.5	X3=0.5	
S11=-43.5827458380598	Iss11Max=No	Iss11Min=No	FrameElem=15	ElemStation=6.24999940395358E-02			
Frame=15	Station=6.24999940395358E-02	OutputCase=PESOPR	CaseType=LinStatic	Point=3	X2=0.5	X3=-0.5	
S11=73.9246282836751	Iss11Max=Yes	Iss11Min=No	FrameElem=15	ElemStation=6.24999940395358E-02			
Frame=15	Station=6.24999940395358E-02	OutputCase=PESOPR	CaseType=LinStatic	Point=4	X2=0.5	X3=0.5	
S11=73.9246282836751	Iss11Max=No	Iss11Min=No	FrameElem=15	ElemStation=6.24999940395358E-02			
Frame=15	Station=0.124999988079072	OutputCase=PESOPR	CaseType=LinStatic	Point=0	X2=0	X3=0	
S11=15.170941073796	Iss11Max=No	Iss11Min=No	FrameElem=15	ElemStation=0.124999988079072			
Frame=15	Station=0.124999988079072	OutputCase=PESOPR	CaseType=LinStatic	Point=1	X2=-0.5	X3=-0.5	
S11=-65.5554006044557	Iss11Max=No	Iss11Min=Yes	FrameElem=15	ElemStation=0.124999988079072			
Frame=15	Station=0.124999988079072	OutputCase=PESOPR	CaseType=LinStatic	Point=2	X2=-0.5	X3=0.5	
S11=-65.5554006044557	Iss11Max=No	Iss11Min=No	FrameElem=15	ElemStation=0.124999988079072			
Frame=15	Station=0.124999988079072	OutputCase=PESOPR	CaseType=LinStatic	Point=3	X2=0.5	X3=-0.5	
S11=95.8972827520478	Iss11Max=Yes	Iss11Min=No	FrameElem=15	ElemStation=0.124999988079072			
Frame=15	Station=0.124999988079072	OutputCase=PESOPR	CaseType=LinStatic	Point=4	X2=0.5	X3=0.5	
S11=95.8972827520478	Iss11Max=No	Iss11Min=No	FrameElem=15	ElemStation=0.124999988079072			
Frame=15	Station=0.187499982118607	OutputCase=PESOPR	CaseType=LinStatic	Point=0	X2=0	X3=0	
S11=15.1709409247844	Iss11Max=No	Iss11Min=No	FrameElem=15	ElemStation=0.187499982118607			
Frame=15	Station=0.187499982118607	OutputCase=PESOPR	CaseType=LinStatic	Point=1	X2=-0.5	X3=-0.5	
S11=-88.1139927590929	Iss11Max=No	Iss11Min=Yes	FrameElem=15	ElemStation=0.187499982118607			
Frame=15	Station=0.187499982118607	OutputCase=PESOPR	CaseType=LinStatic	Point=2	X2=-0.5	X3=0.5	
S11=-88.1139927590929	Iss11Max=No	Iss11Min=No	FrameElem=15	ElemStation=0.187499982118607			
Frame=15	Station=0.187499982118607	OutputCase=PESOPR	CaseType=LinStatic	Point=3	X2=0.5	X3=-0.5	
S11=118.455874608662	Iss11Max=Yes	Iss11Min=No	FrameElem=15	ElemStation=0.187499982118607			
Frame=15	Station=0.187499982118607	OutputCase=PESOPR	CaseType=LinStatic	Point=4	X2=0.5	X3=0.5	
S11=118.455874608662	Iss11Max=No	Iss11Min=No	FrameElem=15	ElemStation=0.187499982118607			
Frame=15	Station=0.249999976158143	OutputCase=PESOPR	CaseType=LinStatic	Point=0	X2=0	X3=0	
S11=15.1709407757728	Iss11Max=No	Iss11Min=No	FrameElem=15	ElemStation=0.249999976158143			
Frame=15	Station=0.249999976158143	OutputCase=PESOPR	CaseType=LinStatic	Point=1	X2=-0.5	X3=-0.5	
S11=-111.258522301971	Iss11Max=No	Iss11Min=Yes	FrameElem=15	ElemStation=0.249999976158143			
Frame=15	Station=0.249999976158143	OutputCase=PESOPR	CaseType=LinStatic	Point=2	X2=-0.5	X3=0.5	
S11=-111.258522301971	Iss11Max=No	Iss11Min=No	FrameElem=15	ElemStation=0.249999976158143			
Frame=15	Station=0.249999976158143	OutputCase=PESOPR	CaseType=LinStatic	Point=3	X2=0.5	X3=-0.5	
S11=141.600403853517	Iss11Max=Yes	Iss11Min=No	FrameElem=15	ElemStation=0.249999976158143			
Frame=15	Station=0.249999976158143	OutputCase=PESOPR	CaseType=LinStatic	Point=4	X2=0.5	X3=0.5	
S11=141.600403853517	Iss11Max=No	Iss11Min=No	FrameElem=15	ElemStation=0.249999976158143			
Frame=15	Station=0	OutputCase=TERRVERT	CaseType=LinStatic	Point=0	X2=0	X3=0	S11=-1.15287073762297
Iss11Max=No	Iss11Min=No	FrameElem=15	ElemStation=0				
Frame=15	Station=0	OutputCase=TERRVERT	CaseType=LinStatic	Point=1	X2=-0.5	X3=-0.5	S11=-
669.290283185658	Iss11Max=No	Iss11Min=Yes	FrameElem=15	ElemStation=0			

Frame=15 Station=0 OutputCase=TERRVERT CaseType=LinStatic Point=2 X2=-0.5 X3=0.5 S11=-669.290283185658 IsS11Max=No IsS11Min=No FrameElem=15 ElemStation=0

Frame=15 Station=0 OutputCase=TERRVERT CaseType=LinStatic Point=3 X2=0.5 X3=-0.5 S11=666.984541710412 IsS11Max=Yes IsS11Min=No FrameElem=15 ElemStation=0

Frame=15 Station=0 OutputCase=TERRVERT CaseType=LinStatic Point=4 X2=0.5 X3=0.5 S11=666.984541710412 IsS11Max=No IsS11Min=No FrameElem=15 ElemStation=0

Frame=15 Station=6.24999940395358E-02 OutputCase=TERRVERT CaseType=LinStatic Point=0 X2=0 X3=0 S11=-1.15287190885426 IsS11Max=No IsS11Min=No FrameElem=15 ElemStation=6.24999940395358E-02

Frame=15 Station=6.24999940395358E-02 OutputCase=TERRVERT CaseType=LinStatic Point=1 X2=-0.5 X3=-0.5 S11=-837.389877513842 IsS11Max=No IsS11Min=Yes FrameElem=15 ElemStation=6.24999940395358E-02

Frame=15 Station=6.24999940395358E-02 OutputCase=TERRVERT CaseType=LinStatic Point=2 X2=-0.5 X3=0.5 S11=-837.389877513842 IsS11Max=No IsS11Min=No FrameElem=15 ElemStation=6.24999940395358E-02

Frame=15 Station=6.24999940395358E-02 OutputCase=TERRVERT CaseType=LinStatic Point=3 X2=0.5 X3=-0.5 S11=835.084133696133 IsS11Max=Yes IsS11Min=No FrameElem=15 ElemStation=6.24999940395358E-02

Frame=15 Station=6.24999940395358E-02 OutputCase=TERRVERT CaseType=LinStatic Point=4 X2=0.5 X3=0.5 S11=835.084133696133 IsS11Max=No IsS11Min=No FrameElem=15 ElemStation=6.24999940395358E-02

Frame=15 Station=0.124999988079072 OutputCase=TERRVERT CaseType=LinStatic Point=0 X2=0 X3=0 S11=-1.15287308008555 IsS11Max=No IsS11Min=No FrameElem=15 ElemStation=0.124999988079072

Frame=15 Station=0.124999988079072 OutputCase=TERRVERT CaseType=LinStatic Point=1 X2=-0.5 X3=-0.5 S11=-1010.0949397136 IsS11Max=No IsS11Min=Yes FrameElem=15 ElemStation=0.124999988079072

Frame=15 Station=0.124999988079072 OutputCase=TERRVERT CaseType=LinStatic Point=2 X2=-0.5 X3=0.5 S11=-1010.0949397136 IsS11Max=No IsS11Min=No FrameElem=15 ElemStation=0.124999988079072

Frame=15 Station=0.124999988079072 OutputCase=TERRVERT CaseType=LinStatic Point=3 X2=0.5 X3=-0.5 S11=1007.78919355343 IsS11Max=Yes IsS11Min=No FrameElem=15 ElemStation=0.124999988079072

Frame=15 Station=0.124999988079072 OutputCase=TERRVERT CaseType=LinStatic Point=4 X2=0.5 X3=0.5 S11=1007.78919355343 IsS11Max=No IsS11Min=No FrameElem=15 ElemStation=0.124999988079072

Frame=15 Station=0.187499982118607 OutputCase=TERRVERT CaseType=LinStatic Point=0 X2=0 X3=0 S11=-1.15287425131683 IsS11Max=No IsS11Min=No FrameElem=15 ElemStation=0.187499982118607

Frame=15 Station=0.187499982118607 OutputCase=TERRVERT CaseType=LinStatic Point=1 X2=-0.5 X3=-0.5 S11=-1187.40546978494 IsS11Max=No IsS11Min=Yes FrameElem=15 ElemStation=0.187499982118607

Frame=15 Station=0.187499982118607 OutputCase=TERRVERT CaseType=LinStatic Point=2 X2=-0.5 X3=0.5 S11=-1187.40546978494 IsS11Max=No IsS11Min=No FrameElem=15 ElemStation=0.187499982118607

Frame=15 Station=0.187499982118607 OutputCase=TERRVERT CaseType=LinStatic Point=3 X2=0.5 X3=-0.5 S11=1185.09972128231 IsS11Max=Yes IsS11Min=No FrameElem=15 ElemStation=0.187499982118607

Frame=15 Station=0.187499982118607 OutputCase=TERRVERT CaseType=LinStatic Point=4 X2=0.5 X3=0.5 S11=1185.09972128231 IsS11Max=No IsS11Min=No FrameElem=15 ElemStation=0.187499982118607

Frame=15 Station=0.249999976158143 OutputCase=TERRVERT CaseType=LinStatic Point=0 X2=0 X3=0 S11=-1.15287542254812 IsS11Max=No IsS11Min=No FrameElem=15 ElemStation=0.249999976158143

Frame=15 Station=0.249999976158143 OutputCase=TERRVERT CaseType=LinStatic Point=1 X2=-0.5 X3=-0.5 S11=-1369.32146772785 IsS11Max=No IsS11Min=Yes FrameElem=15 ElemStation=0.249999976158143

Frame=15 Station=0.249999976158143 OutputCase=TERRVERT CaseType=LinStatic Point=2 X2=-0.5 X3=0.5 S11=-1369.32146772785 IsS11Max=No IsS11Min=No FrameElem=15 ElemStation=0.249999976158143

Frame=15 Station=0.249999976158143 OutputCase=TERRVERT CaseType=LinStatic Point=3 X2=0.5 X3=-0.5 S11=1367.01571688276 IsS11Max=Yes IsS11Min=No FrameElem=15 ElemStation=0.249999976158143

Frame=15 Station=0.249999976158143 OutputCase=TERRVERT CaseType=LinStatic Point=4 X2=0.5 X3=0.5 S11=1367.01571688276 IsS11Max=No IsS11Min=No FrameElem=15 ElemStation=0.249999976158143

Frame=15 Station=0 OutputCase=TERRLAT CaseType=LinStatic Point=0 X2=0 X3=0 S11=-66.71179818317 IsS11Max=No IsS11Min=No FrameElem=15 ElemStation=0

Frame=15 Station=0 OutputCase=TERRLAT CaseType=LinStatic Point=1 X2=-0.5 X3=-0.5 S11=-190.013380668985 IsS11Max=No IsS11Min=Yes FrameElem=15 ElemStation=0

Frame=15 Station=0 OutputCase=TERRLAT CaseType=LinStatic Point=2 X2=-0.5 X3=0.5 S11=-190.013380668985 IsS11Max=No IsS11Min=No FrameElem=15 ElemStation=0

Frame=15 Station=0 OutputCase=TERRLAT CaseType=LinStatic Point=3 X2=0.5 X3=-0.5 S11=56.5897843026455 IsS11Max=Yes IsS11Min=No FrameElem=15 ElemStation=0

Frame=15 Station=0 OutputCase=TERRLAT CaseType=LinStatic Point=4 X2=0.5 X3=0.5 S11=56.5897843026455 IsS11Max=No IsS11Min=No FrameElem=15 ElemStation=0

Frame=15 Station=6.24999940395358E-02 OutputCase=TERRLAT CaseType=LinStatic Point=0 X2=0 X3=0 S11=-66.71179818317 IsS11Max=No IsS11Min=No FrameElem=15 ElemStation=6.24999940395358E-02

Frame=15 Station=6.24999940395358E-02 OutputCase=TERRLAT CaseType=LinStatic Point=1 X2=-0.5 X3=-0.5 S11=-190.013378408504 IsS11Max=No IsS11Min=Yes FrameElem=15 ElemStation=6.24999940395358E-02

Frame=15 Station=6.24999940395358E-02 OutputCase=TERRLAT CaseType=LinStatic Point=2 X2=-0.5 X3=0.5 S11=-190.013378408504 IsS11Max=No IsS11Min=No FrameElem=15 ElemStation=6.24999940395358E-02

Frame=15 Station=6.24999940395358E-02 OutputCase=TERRLAT CaseType=LinStatic Point=3 X2=0.5 X3=-0.5 S11=56.5897820421637 IsS11Max=Yes IsS11Min=No FrameElem=15 ElemStation=6.24999940395358E-02

Frame=15 Station=6.24999940395358E-02 OutputCase=TERRLAT CaseType=LinStatic Point=4 X2=0.5 X3=0.5 S11=56.5897820421637 IsS11Max=No IsS11Min=No FrameElem=15 ElemStation=6.24999940395358E-02

Frame=15 Station=0.124999988079072 OutputCase=TERRLAT CaseType=LinStatic Point=0 X2=0 X3=0 S11=-66.71179818317 IsS11Max=No IsS11Min=No FrameElem=15 ElemStation=0.124999988079072

Frame=15 Station=0.124999988079072 OutputCase=TERRLAT CaseType=LinStatic Point=1 X2=-0.5 X3=-0.5 S11=-190.013376148022 IsS11Max=No IsS11Min=Yes FrameElem=15 ElemStation=0.124999988079072

Frame=15 Station=0.124999988079072 OutputCase=TERRLAT CaseType=LinStatic Point=2 X2=-0.5 X3=0.5 S11=-190.013376148022 IsS11Max=No IsS11Min=No FrameElem=15 ElemStation=0.124999988079072

Frame=15 Station=0.124999988079072 OutputCase=TERRLAT CaseType=LinStatic Point=3 X2=0.5 X3=-0.5 S11=56.5897797816819 IsS11Max=Yes IsS11Min=No FrameElem=15 ElemStation=0.124999988079072

Frame=15 Station=0.124999988079072 OutputCase=TERRLAT CaseType=LinStatic Point=4 X2=0.5 X3=0.5 S11=56.5897797816819 IsS11Max=No IsS11Min=No FrameElem=15 ElemStation=0.124999988079072

Frame=15 Station=0.187499982118607 OutputCase=TERRLAT CaseType=LinStatic Point=0 X2=0 X3=0 S11=-66.71179818317 IsS11Max=No IsS11Min=No FrameElem=15 ElemStation=0.187499982118607

Frame=15 Station=0.187499982118607 OutputCase=TERRLAT CaseType=LinStatic Point=1 X2=-0.5 X3=-0.5 S11=-190.01337388754 IsS11Max=No IsS11Min=Yes FrameElem=15 ElemStation=0.187499982118607

Frame=15 Station=0.187499982118607 OutputCase=TERRLAT CaseType=LinStatic Point=2 X2=-0.5 X3=0.5 S11=-190.01337388754 IsS11Max=No IsS11Min=No FrameElem=15 ElemStation=0.187499982118607



Frame=15 Station=0.187499982118607 OutputCase=ENVE CaseType=Combination StepType=Max Point=0 X2=0
 X3=0 S11=-32.6801920547514 IsS11Max=No IsS11Min=No FrameElem=15 ElemStation=0.187499982118607
 Frame=15 Station=0.187499982118607 OutputCase=ENVE CaseType=Combination StepType=Max Point=1 X2=-0.5
 X3=-0.5 S11=-1408.52882426531 IsS11Max=No IsS11Min=Yes FrameElem=15 ElemStation=0.187499982118607
 Frame=15 Station=0.187499982118607 OutputCase=ENVE CaseType=Combination StepType=Max Point=2 X2=-0.5
 X3=0.5 S11=-1408.52882426531 IsS11Max=No IsS11Min=No FrameElem=15 ElemStation=0.187499982118607
 Frame=15 Station=0.187499982118607 OutputCase=ENVE CaseType=Combination StepType=Max Point=3 X2=0.5
 X3=-0.5 S11=1360.14537341217 IsS11Max=Yes IsS11Min=No FrameElem=15 ElemStation=0.187499982118607
 Frame=15 Station=0.187499982118607 OutputCase=ENVE CaseType=Combination StepType=Max Point=4 X2=0.5
 X3=0.5 S11=1360.14537341217 IsS11Max=No IsS11Min=No FrameElem=15 ElemStation=0.187499982118607
 Frame=15 Station=0.249999976158143 OutputCase=ENVE CaseType=Combination StepType=Max Point=0 X2=0
 X3=0 S11=-32.6801933749943 IsS11Max=No IsS11Min=No FrameElem=15 ElemStation=0.249999976158143
 Frame=15 Station=0.249999976158143 OutputCase=ENVE CaseType=Combination StepType=Max Point=1 X2=-0.5
 X3=-0.5 S11=-1613.58935016876 IsS11Max=No IsS11Min=Yes FrameElem=15 ElemStation=0.249999976158143
 Frame=15 Station=0.249999976158143 OutputCase=ENVE CaseType=Combination StepType=Max Point=2 X2=-0.5
 X3=0.5 S11=-1613.58935016876 IsS11Max=No IsS11Min=No FrameElem=15 ElemStation=0.249999976158143
 Frame=15 Station=0.249999976158143 OutputCase=ENVE CaseType=Combination StepType=Max Point=3 X2=0.5
 X3=-0.5 S11=1565.20589599699 IsS11Max=Yes IsS11Min=No FrameElem=15 ElemStation=0.249999976158143
 Frame=15 Station=0.249999976158143 OutputCase=ENVE CaseType=Combination StepType=Max Point=4 X2=0.5
 X3=0.5 S11=1565.20589599699 IsS11Max=No IsS11Min=No FrameElem=15 ElemStation=0.249999976158143
 Frame=15 Station=0 OutputCase=ENVE CaseType=Combination StepType=Min Point=0 X2=0 X3=0 S11=-
 52.6937275489737 IsS11Max=No IsS11Min=No FrameElem=15 ElemStation=0
 Frame=15 Station=0 OutputCase=ENVE CaseType=Combination StepType=Min Point=1 X2=-0.5 X3=-0.5
 S11=-881.499692314549 IsS11Max=No IsS11Min=Yes FrameElem=15 ElemStation=0
 Frame=15 Station=0 OutputCase=ENVE CaseType=Combination StepType=Min Point=2 X2=-0.5 X3=0.5 S11=-
 881.499692314549 IsS11Max=No IsS11Min=No FrameElem=15 ElemStation=0
 Frame=15 Station=0 OutputCase=ENVE CaseType=Combination StepType=Min Point=3 X2=0.5 X3=-0.5
 S11=759.135301925808 IsS11Max=Yes IsS11Min=No FrameElem=15 ElemStation=0
 Frame=15 Station=0 OutputCase=ENVE CaseType=Combination StepType=Min Point=4 X2=0.5 X3=0.5
 S11=759.135301925808 IsS11Max=No IsS11Min=No FrameElem=15 ElemStation=0
 Frame=15 Station=6.24999940395358E-02 OutputCase=ENVE CaseType=Combination StepType=Min Point=0 X2=0
 X3=0 S11=-52.6937288692166 IsS11Max=No IsS11Min=No FrameElem=15 ElemStation=6.24999940395358E-02
 Frame=15 Station=6.24999940395358E-02 OutputCase=ENVE CaseType=Combination StepType=Min Point=1 X2=-
 0.5 X3=-0.5 S11=-1070.98600176041 IsS11Max=No IsS11Min=Yes FrameElem=15 ElemStation=6.24999940395358E-02
 Frame=15 Station=6.24999940395358E-02 OutputCase=ENVE CaseType=Combination StepType=Min Point=2 X2=-
 0.5 X3=0.5 S11=-1070.98600176041 IsS11Max=No IsS11Min=No FrameElem=15 ElemStation=6.24999940395358E-02
 Frame=15 Station=6.24999940395358E-02 OutputCase=ENVE CaseType=Combination StepType=Min Point=3
 X2=0.5 X3=-0.5 S11=948.621609409323 IsS11Max=Yes IsS11Min=No FrameElem=15 ElemStation=6.24999940395358E-
 02
 Frame=15 Station=6.24999940395358E-02 OutputCase=ENVE CaseType=Combination StepType=Min Point=4
 X2=0.5 X3=0.5 S11=948.621609409323 IsS11Max=No IsS11Min=No FrameElem=15 ElemStation=6.24999940395358E-02
 Frame=15 Station=0.124999988079072 OutputCase=ENVE CaseType=Combination StepType=Min Point=0 X2=0
 X3=0 S11=-52.6937301894595 IsS11Max=No IsS11Min=No FrameElem=15 ElemStation=0.124999988079072
 Frame=15 Station=0.124999988079072 OutputCase=ENVE CaseType=Combination StepType=Min Point=1 X2=-0.5
 X3=-0.5 S11=-1265.66371646608 IsS11Max=No IsS11Min=Yes FrameElem=15 ElemStation=0.124999988079072
 Frame=15 Station=0.124999988079072 OutputCase=ENVE CaseType=Combination StepType=Min Point=2 X2=-0.5
 X3=0.5 S11=-1265.66371646608 IsS11Max=No IsS11Min=No FrameElem=15 ElemStation=0.124999988079072
 Frame=15 Station=0.124999988079072 OutputCase=ENVE CaseType=Combination StepType=Min Point=3 X2=0.5
 X3=-0.5 S11=1143.29932215266 IsS11Max=Yes IsS11Min=No FrameElem=15 ElemStation=0.124999988079072
 Frame=15 Station=0.124999988079072 OutputCase=ENVE CaseType=Combination StepType=Min Point=4 X2=0.5
 X3=0.5 S11=1143.29932215266 IsS11Max=No IsS11Min=No FrameElem=15 ElemStation=0.124999988079072
 Frame=15 Station=0.187499982118607 OutputCase=ENVE CaseType=Combination StepType=Min Point=0 X2=0
 X3=0 S11=-52.6937315097024 IsS11Max=No IsS11Min=No FrameElem=15 ElemStation=0.187499982118607
 Frame=15 Station=0.187499982118607 OutputCase=ENVE CaseType=Combination StepType=Min Point=1 X2=-0.5
 X3=-0.5 S11=-1465.53283643157 IsS11Max=No IsS11Min=Yes FrameElem=15 ElemStation=0.187499982118607
 Frame=15 Station=0.187499982118607 OutputCase=ENVE CaseType=Combination StepType=Min Point=2 X2=-0.5
 X3=0.5 S11=-1465.53283643157 IsS11Max=No IsS11Min=No FrameElem=15 ElemStation=0.187499982118607
 Frame=15 Station=0.187499982118607 OutputCase=ENVE CaseType=Combination StepType=Min Point=3 X2=0.5
 X3=-0.5 S11=1343.16844015581 IsS11Max=Yes IsS11Min=No FrameElem=15 ElemStation=0.187499982118607
 Frame=15 Station=0.187499982118607 OutputCase=ENVE CaseType=Combination StepType=Min Point=4 X2=0.5
 X3=0.5 S11=1343.16844015581 IsS11Max=No IsS11Min=No FrameElem=15 ElemStation=0.187499982118607
 Frame=15 Station=0.249999976158143 OutputCase=ENVE CaseType=Combination StepType=Min Point=0 X2=0
 X3=0 S11=-52.6937328299453 IsS11Max=No IsS11Min=No FrameElem=15 ElemStation=0.249999976158143
 Frame=15 Station=0.249999976158143 OutputCase=ENVE CaseType=Combination StepType=Min Point=1 X2=-0.5
 X3=-0.5 S11=-1670.59336165688 IsS11Max=No IsS11Min=Yes FrameElem=15 ElemStation=0.249999976158143
 Frame=15 Station=0.249999976158143 OutputCase=ENVE CaseType=Combination StepType=Min Point=2 X2=-0.5
 X3=0.5 S11=-1670.59336165688 IsS11Max=No IsS11Min=No FrameElem=15 ElemStation=0.249999976158143
 Frame=15 Station=0.249999976158143 OutputCase=ENVE CaseType=Combination StepType=Min Point=3 X2=0.5
 X3=-0.5 S11=1548.22896341878 IsS11Max=Yes IsS11Min=No FrameElem=15 ElemStation=0.249999976158143
 Frame=15 Station=0.249999976158143 OutputCase=ENVE CaseType=Combination StepType=Min Point=4 X2=0.5
 X3=0.5 S11=1548.22896341878 IsS11Max=No IsS11Min=No FrameElem=15 ElemStation=0.249999976158143
 Frame=15 Station=0 OutputCase=FESSUR CaseType=Combination Point=0 X2=0 X3=0 S11=-52.6937275489737
 IsS11Max=No IsS11Min=No FrameElem=15 ElemStation=0
 Frame=15 Station=0 OutputCase=FESSUR CaseType=Combination Point=1 X2=-0.5 X3=-0.5 S11=-
 881.499692314549 IsS11Max=No IsS11Min=Yes FrameElem=15 ElemStation=0
 Frame=15 Station=0 OutputCase=FESSUR CaseType=Combination Point=2 X2=-0.5 X3=0.5 S11=-
 881.499692314549 IsS11Max=No IsS11Min=No FrameElem=15 ElemStation=0
 Frame=15 Station=0 OutputCase=FESSUR CaseType=Combination Point=3 X2=0.5 X3=-0.5
 S11=776.112237216601 IsS11Max=Yes IsS11Min=No FrameElem=15 ElemStation=0
 Frame=15 Station=0 OutputCase=FESSUR CaseType=Combination Point=4 X2=0.5 X3=0.5
 S11=776.112237216601 IsS11Max=No IsS11Min=No FrameElem=15 ElemStation=0



Frame=15 Station=6.24999940395358E-02 OutputCase=FESSUR CaseType=Combination Point=0 X2=0 X3=0
 S11=-52.6937288692166 IsS11Max=No IsS11Min=No FrameElem=15 ElemStation=6.24999940395358E-02
 Frame=15 Station=6.24999940395358E-02 OutputCase=FESSUR CaseType=Combination Point=1 X2=-0.5 X3=-0.5
 S11=-1070.98600176041 IsS11Max=No IsS11Min=Yes FrameElem=15 ElemStation=6.24999940395358E-02
 Frame=15 Station=6.24999940395358E-02 OutputCase=FESSUR CaseType=Combination Point=2 X2=-0.5 X3=0.5
 S11=-1070.98600176041 IsS11Max=No IsS11Min=No FrameElem=15 ElemStation=6.24999940395358E-02
 Frame=15 Station=6.24999940395358E-02 OutputCase=FESSUR CaseType=Combination Point=3 X2=0.5 X3=-0.5
 S11=965.598544021972 IsS11Max=Yes IsS11Min=No FrameElem=15 ElemStation=6.24999940395358E-02
 Frame=15 Station=6.24999940395358E-02 OutputCase=FESSUR CaseType=Combination Point=4 X2=0.5 X3=0.5
 S11=965.598544021972 IsS11Max=No IsS11Min=No FrameElem=15 ElemStation=6.24999940395358E-02
 Frame=15 Station=0.124999988079072 OutputCase=FESSUR CaseType=Combination Point=0 X2=0 X3=0 S11=-
 52.6937301894595 IsS11Max=No IsS11Min=No FrameElem=15 ElemStation=0.124999988079072
 Frame=15 Station=0.124999988079072 OutputCase=FESSUR CaseType=Combination Point=1 X2=-0.5 X3=-0.5
 S11=-1265.66371646608 IsS11Max=No IsS11Min=Yes FrameElem=15 ElemStation=0.124999988079072
 Frame=15 Station=0.124999988079072 OutputCase=FESSUR CaseType=Combination Point=2 X2=-0.5 X3=0.5
 S11=-1265.66371646608 IsS11Max=No IsS11Min=No FrameElem=15 ElemStation=0.124999988079072
 Frame=15 Station=0.124999988079072 OutputCase=FESSUR CaseType=Combination Point=3 X2=0.5 X3=-0.5
 S11=1160.27625608716 IsS11Max=Yes IsS11Min=No FrameElem=15 ElemStation=0.124999988079072
 Frame=15 Station=0.124999988079072 OutputCase=FESSUR CaseType=Combination Point=4 X2=0.5 X3=0.5
 S11=1160.27625608716 IsS11Max=No IsS11Min=No FrameElem=15 ElemStation=0.124999988079072
 Frame=15 Station=0.187499982118607 OutputCase=FESSUR CaseType=Combination Point=0 X2=0 X3=0 S11=-
 52.6937315097024 IsS11Max=No IsS11Min=No FrameElem=15 ElemStation=0.187499982118607
 Frame=15 Station=0.187499982118607 OutputCase=FESSUR CaseType=Combination Point=1 X2=-0.5 X3=-0.5
 S11=-1465.53283643157 IsS11Max=No IsS11Min=Yes FrameElem=15 ElemStation=0.187499982118607
 Frame=15 Station=0.187499982118607 OutputCase=FESSUR CaseType=Combination Point=2 X2=-0.5 X3=0.5
 S11=-1465.53283643157 IsS11Max=No IsS11Min=No FrameElem=15 ElemStation=0.187499982118607
 Frame=15 Station=0.187499982118607 OutputCase=FESSUR CaseType=Combination Point=3 X2=0.5 X3=-0.5
 S11=1360.14537341217 IsS11Max=Yes IsS11Min=No FrameElem=15 ElemStation=0.187499982118607
 Frame=15 Station=0.187499982118607 OutputCase=FESSUR CaseType=Combination Point=4 X2=0.5 X3=0.5
 S11=1360.14537341217 IsS11Max=No IsS11Min=No FrameElem=15 ElemStation=0.187499982118607
 Frame=15 Station=0.249999976158143 OutputCase=FESSUR CaseType=Combination Point=0 X2=0 X3=0 S11=-
 52.6937328299453 IsS11Max=No IsS11Min=No FrameElem=15 ElemStation=0.249999976158143
 Frame=15 Station=0.249999976158143 OutputCase=FESSUR CaseType=Combination Point=1 X2=-0.5 X3=-0.5
 S11=-1670.59336165688 IsS11Max=No IsS11Min=Yes FrameElem=15 ElemStation=0.249999976158143
 Frame=15 Station=0.249999976158143 OutputCase=FESSUR CaseType=Combination Point=2 X2=-0.5 X3=0.5
 S11=-1670.59336165688 IsS11Max=No IsS11Min=No FrameElem=15 ElemStation=0.249999976158143
 Frame=15 Station=0.249999976158143 OutputCase=FESSUR CaseType=Combination Point=3 X2=0.5 X3=-0.5
 S11=1565.20589599699 IsS11Max=Yes IsS11Min=No FrameElem=15 ElemStation=0.249999976158143
 Frame=15 Station=0.249999976158143 OutputCase=FESSUR CaseType=Combination Point=4 X2=0.5 X3=0.5
 S11=1565.20589599699 IsS11Max=No IsS11Min=No FrameElem=15 ElemStation=0.249999976158143
 Frame=16 Station=0 OutputCase=PESOPR CaseType=LinStatic Point=0 X2=0 X3=0 S11=-162.500000840286
 IsS11Max=No IsS11Min=No FrameElem=16 ElemStation=0
 Frame=16 Station=0 OutputCase=PESOPR CaseType=LinStatic Point=1 X2=-0.5 X3=-0.5
 S11=328.032173804416 IsS11Max=Yes IsS11Min=No FrameElem=16 ElemStation=0
 Frame=16 Station=0 OutputCase=PESOPR CaseType=LinStatic Point=2 X2=-0.5 X3=0.5 S11=328.032173804416
 IsS11Max=No IsS11Min=No FrameElem=16 ElemStation=0
 Frame=16 Station=0 OutputCase=PESOPR CaseType=LinStatic Point=3 X2=0.5 X3=-0.5 S11=-
 653.032175484988 IsS11Max=No IsS11Min=Yes FrameElem=16 ElemStation=0
 Frame=16 Station=0 OutputCase=PESOPR CaseType=LinStatic Point=4 X2=0.5 X3=0.5 S11=-653.032175484988
 IsS11Max=No IsS11Min=No FrameElem=16 ElemStation=0
 Frame=16 Station=0.250000000000001 OutputCase=PESOPR CaseType=LinStatic Point=0 X2=0 X3=0 S11=-
 156.2500000840286 IsS11Max=No IsS11Min=No FrameElem=16 ElemStation=0.250000000000001
 Frame=16 Station=0.250000000000001 OutputCase=PESOPR CaseType=LinStatic Point=1 X2=-0.5 X3=-0.5
 S11=311.525776498834 IsS11Max=Yes IsS11Min=No FrameElem=16 ElemStation=0.250000000000001
 Frame=16 Station=0.250000000000001 OutputCase=PESOPR CaseType=LinStatic Point=2 X2=-0.5 X3=0.5
 S11=311.525776498834 IsS11Max=No IsS11Min=No FrameElem=16 ElemStation=0.250000000000001
 Frame=16 Station=0.250000000000001 OutputCase=PESOPR CaseType=LinStatic Point=3 X2=0.5 X3=-0.5
 S11=-624.025778179405 IsS11Max=No IsS11Min=Yes FrameElem=16 ElemStation=0.250000000000001
 Frame=16 Station=0.250000000000001 OutputCase=PESOPR CaseType=LinStatic Point=4 X2=0.5 X3=0.5 S11=-
 624.025778179405 IsS11Max=No IsS11Min=No FrameElem=16 ElemStation=0.250000000000001
 Frame=16 Station=0 OutputCase=TERRVERT CaseType=LinStatic Point=0 X2=0 X3=0 S11=-491.249995008809
 IsS11Max=No IsS11Min=No FrameElem=16 ElemStation=0
 Frame=16 Station=0 OutputCase=TERRVERT CaseType=LinStatic Point=1 X2=-0.5 X3=-0.5
 S11=849.250705775671 IsS11Max=Yes IsS11Min=No FrameElem=16 ElemStation=0
 Frame=16 Station=0 OutputCase=TERRVERT CaseType=LinStatic Point=2 X2=-0.5 X3=0.5
 S11=849.250705775671 IsS11Max=No IsS11Min=No FrameElem=16 ElemStation=0
 Frame=16 Station=0 OutputCase=TERRVERT CaseType=LinStatic Point=3 X2=0.5 X3=-0.5 S11=-
 1831.75069579329 IsS11Max=No IsS11Min=Yes FrameElem=16 ElemStation=0
 Frame=16 Station=0 OutputCase=TERRVERT CaseType=LinStatic Point=4 X2=0.5 X3=0.5 S11=-
 1831.75069579329 IsS11Max=No IsS11Min=No FrameElem=16 ElemStation=0
 Frame=16 Station=0.250000000000001 OutputCase=TERRVERT CaseType=LinStatic Point=0 X2=0 X3=0 S11=-
 491.249995008809 IsS11Max=No IsS11Min=No FrameElem=16 ElemStation=0.250000000000001
 Frame=16 Station=0.250000000000001 OutputCase=TERRVERT CaseType=LinStatic Point=1 X2=-0.5 X3=-0.5
 S11=850.980018909473 IsS11Max=Yes IsS11Min=No FrameElem=16 ElemStation=0.250000000000001
 Frame=16 Station=0.250000000000001 OutputCase=TERRVERT CaseType=LinStatic Point=2 X2=-0.5 X3=0.5
 S11=850.980018909473 IsS11Max=No IsS11Min=No FrameElem=16 ElemStation=0.250000000000001
 Frame=16 Station=0.250000000000001 OutputCase=TERRVERT CaseType=LinStatic Point=3 X2=0.5 X3=-0.5
 S11=-1833.48000892709 IsS11Max=No IsS11Min=Yes FrameElem=16 ElemStation=0.250000000000001
 Frame=16 Station=0.250000000000001 OutputCase=TERRVERT CaseType=LinStatic Point=4 X2=0.5 X3=0.5
 S11=-1833.48000892709 IsS11Max=No IsS11Min=No FrameElem=16 ElemStation=0.250000000000001
 Frame=16 Station=0 OutputCase=TERRLAT CaseType=LinStatic Point=0 X2=0 X3=0 S11=-7.46670139051275E-
 06 IsS11Max=No IsS11Min=No FrameElem=16 ElemStation=0



Frame=16	Station=0	OutputCase=SOVRCOST	CaseType=LinStatic	Point=2	X2=-0.5	X3=0.5	S11=0
IsS11Max=No	IsS11Min=No	FrameElem=16	ElemStation=0				
Frame=16	Station=0	OutputCase=SOVRCOST	CaseType=LinStatic	Point=3	X2=0.5	X3=-0.5	S11=0
IsS11Max=No	IsS11Min=No	FrameElem=16	ElemStation=0				
Frame=16	Station=0	OutputCase=SOVRCOST	CaseType=LinStatic	Point=4	X2=0.5	X3=0.5	S11=0
IsS11Min=No	FrameElem=16	ElemStation=0					IsS11Max=No
Frame=16	Station=0.2500000000000001	OutputCase=SOVRCOST	CaseType=LinStatic	Point=0	X2=0	X3=0	S11=0
IsS11Max=Yes	IsS11Min=Yes	FrameElem=16	ElemStation=0.2500000000000001				
Frame=16	Station=0.2500000000000001	OutputCase=SOVRCOST	CaseType=LinStatic	Point=1	X2=-0.5	X3=-0.5	
S11=0	IsS11Max=No	IsS11Min=No	FrameElem=16	ElemStation=0.2500000000000001			
Frame=16	Station=0.2500000000000001	OutputCase=SOVRCOST	CaseType=LinStatic	Point=2	X2=-0.5	X3=0.5	
S11=0	IsS11Max=No	IsS11Min=No	FrameElem=16	ElemStation=0.2500000000000001			
Frame=16	Station=0.2500000000000001	OutputCase=SOVRCOST	CaseType=LinStatic	Point=3	X2=0.5	X3=-0.5	
S11=0	IsS11Max=No	IsS11Min=No	FrameElem=16	ElemStation=0.2500000000000001			
Frame=16	Station=0.2500000000000001	OutputCase=SOVRCOST	CaseType=LinStatic	Point=4	X2=0.5	X3=0.5	
S11=0	IsS11Max=No	IsS11Min=No	FrameElem=16	ElemStation=0.2500000000000001			
Frame=16	Station=0	OutputCase=ENVE	CaseType=Combination	StepType=Max	Point=0	X2=0	X3=0
S11=-653.750001075786	IsS11Max=No	IsS11Min=No	FrameElem=16	ElemStation=0			
Frame=16	Station=0	OutputCase=ENVE	CaseType=Combination	StepType=Max	Point=1	X2=-0.5	X3=-0.5
S11=1304.38128867896	IsS11Max=Yes	IsS11Min=No	FrameElem=16	ElemStation=0			
Frame=16	Station=0	OutputCase=ENVE	CaseType=Combination	StepType=Max	Point=2	X2=-0.5	X3=0.5
S11=1304.38128867896	IsS11Max=No	IsS11Min=No	FrameElem=16	ElemStation=0			
Frame=16	Station=0	OutputCase=ENVE	CaseType=Combination	StepType=Max	Point=3	X2=0.5	X3=-0.5
S11=-2573.75176810087	IsS11Max=No	IsS11Min=Yes	FrameElem=16	ElemStation=0			
Frame=16	Station=0	OutputCase=ENVE	CaseType=Combination	StepType=Max	Point=4	X2=0.5	X3=0.5
S11=-2573.75176810087	IsS11Max=No	IsS11Min=No	FrameElem=16	ElemStation=0			
Frame=16	Station=0.2500000000000001	OutputCase=ENVE	CaseType=Combination	StepType=Max	Point=0	X2=0	
X3=0	S11=-647.500000222561	IsS11Max=No	IsS11Min=No	FrameElem=16	ElemStation=0.2500000000000001		
Frame=16	Station=0.2500000000000001	OutputCase=ENVE	CaseType=Combination	StepType=Max	Point=1	X2=-0.5	
X3=-0.5	S11=1176.55928581333	IsS11Max=Yes	IsS11Min=No	FrameElem=16	ElemStation=0.2500000000000001		
Frame=16	Station=0.2500000000000001	OutputCase=ENVE	CaseType=Combination	StepType=Max	Point=2	X2=-0.5	
X3=0.5	S11=1176.55928581333	IsS11Max=No	IsS11Min=No	FrameElem=16	ElemStation=0.2500000000000001		
Frame=16	Station=0.2500000000000001	OutputCase=ENVE	CaseType=Combination	StepType=Max	Point=3	X2=0.5	
X3=-0.5	S11=-2467.34323913695	IsS11Max=No	IsS11Min=Yes	FrameElem=16	ElemStation=0.2500000000000001		
Frame=16	Station=0.2500000000000001	OutputCase=ENVE	CaseType=Combination	StepType=Max	Point=4	X2=0.5	
X3=0.5	S11=-2467.34323913695	IsS11Max=No	IsS11Min=No	FrameElem=16	ElemStation=0.2500000000000001		
Frame=16	Station=0	OutputCase=ENVE	CaseType=Combination	StepType=Min	Point=0	X2=0	X3=0
S11=-653.750003315797	IsS11Max=No	IsS11Min=No	FrameElem=16	ElemStation=0			
Frame=16	Station=0	OutputCase=ENVE	CaseType=Combination	StepType=Min	Point=1	X2=-0.5	X3=-0.5
S11=1266.2517659493	IsS11Max=Yes	IsS11Min=No	FrameElem=16	ElemStation=0			
Frame=16	Station=0	OutputCase=ENVE	CaseType=Combination	StepType=Min	Point=2	X2=-0.5	X3=0.5
S11=1266.2517659493	IsS11Max=No	IsS11Min=No	FrameElem=16	ElemStation=0			
Frame=16	Station=0	OutputCase=ENVE	CaseType=Combination	StepType=Min	Point=3	X2=0.5	X3=-0.5
S11=-2611.88129531055	IsS11Max=No	IsS11Min=Yes	FrameElem=16	ElemStation=0			
Frame=16	Station=0	OutputCase=ENVE	CaseType=Combination	StepType=Min	Point=4	X2=0.5	X3=0.5
S11=-2611.88129531055	IsS11Max=No	IsS11Min=No	FrameElem=16	ElemStation=0			
Frame=16	Station=0.2500000000000001	OutputCase=ENVE	CaseType=Combination	StepType=Min	Point=0	X2=0	
X3=0	S11=-647.500002096904	IsS11Max=No	IsS11Min=No	FrameElem=16	ElemStation=0.2500000000000001		
Frame=16	Station=0.2500000000000001	OutputCase=ENVE	CaseType=Combination	StepType=Min	Point=1	X2=-0.5	
X3=-0.5	S11=1172.34323869182	IsS11Max=Yes	IsS11Min=No	FrameElem=16	ElemStation=0.2500000000000001		
Frame=16	Station=0.2500000000000001	OutputCase=ENVE	CaseType=Combination	StepType=Min	Point=2	X2=-0.5	
X3=0.5	S11=1172.34323869182	IsS11Max=No	IsS11Min=No	FrameElem=16	ElemStation=0.2500000000000001		
Frame=16	Station=0.2500000000000001	OutputCase=ENVE	CaseType=Combination	StepType=Min	Point=3	X2=0.5	
X3=-0.5	S11=-2471.55929000714	IsS11Max=No	IsS11Min=Yes	FrameElem=16	ElemStation=0.2500000000000001		
Frame=16	Station=0.2500000000000001	OutputCase=ENVE	CaseType=Combination	StepType=Min	Point=4	X2=0.5	
X3=0.5	S11=-2471.55929000714	IsS11Max=No	IsS11Min=No	FrameElem=16	ElemStation=0.2500000000000001		
Frame=16	Station=0	OutputCase=FESSUR	CaseType=Combination	Point=0	X2=0	X3=0	S11=-653.750003315797
IsS11Max=No	IsS11Min=No	FrameElem=16	ElemStation=0				
Frame=16	Station=0	OutputCase=FESSUR	CaseType=Combination	Point=1	X2=-0.5	X3=-0.5	
S11=1304.38128867896	IsS11Max=Yes	IsS11Min=No	FrameElem=16	ElemStation=0			
Frame=16	Station=0	OutputCase=FESSUR	CaseType=Combination	Point=2	X2=-0.5	X3=0.5	
S11=1304.38128867896	IsS11Max=No	IsS11Min=No	FrameElem=16	ElemStation=0			
Frame=16	Station=0	OutputCase=FESSUR	CaseType=Combination	Point=3	X2=0.5	X3=-0.5	S11=-
S11=2611.88129531055	IsS11Max=No	IsS11Min=Yes	FrameElem=16	ElemStation=0			
Frame=16	Station=0	OutputCase=FESSUR	CaseType=Combination	Point=4	X2=0.5	X3=0.5	S11=-
S11=2611.88129531055	IsS11Max=No	IsS11Min=No	FrameElem=16	ElemStation=0			
Frame=16	Station=0.2500000000000001	OutputCase=FESSUR	CaseType=Combination	Point=0	X2=0	X3=0	S11=-
S11=-647.500002096904	IsS11Max=No	IsS11Min=No	FrameElem=16	ElemStation=0.2500000000000001			
Frame=16	Station=0.2500000000000001	OutputCase=FESSUR	CaseType=Combination	Point=1	X2=-0.5	X3=-0.5	
S11=1176.55928581333	IsS11Max=Yes	IsS11Min=No	FrameElem=16	ElemStation=0.2500000000000001			
Frame=16	Station=0.2500000000000001	OutputCase=FESSUR	CaseType=Combination	Point=2	X2=-0.5	X3=0.5	
S11=1176.55928581333	IsS11Max=No	IsS11Min=No	FrameElem=16	ElemStation=0.2500000000000001			
Frame=16	Station=0.2500000000000001	OutputCase=FESSUR	CaseType=Combination	Point=3	X2=0.5	X3=-0.5	
S11=-2471.55929000714	IsS11Max=No	IsS11Min=Yes	FrameElem=16	ElemStation=0.2500000000000001			
Frame=16	Station=0.2500000000000001	OutputCase=FESSUR	CaseType=Combination	Point=4	X2=0.5	X3=0.5	
S11=-2471.55929000714	IsS11Max=No	IsS11Min=No	FrameElem=16	ElemStation=0.2500000000000001			
Frame=17	Station=0	OutputCase=PESOPR	CaseType=LinStatic	Point=0	X2=0	X3=0	S11=-156.249999393243
IsS11Max=No	IsS11Min=No	FrameElem=17	ElemStation=0				
Frame=17	Station=0	OutputCase=PESOPR	CaseType=LinStatic	Point=1	X2=-0.5	X3=-0.5	
S11=311.525777945848	IsS11Max=Yes	IsS11Min=No	FrameElem=17	ElemStation=0			
Frame=17	Station=0	OutputCase=PESOPR	CaseType=LinStatic	Point=2	X2=-0.5	X3=0.5	S11=311.525777945848
IsS11Max=No	IsS11Min=No	FrameElem=17	ElemStation=0				

Frame=17	Station=0	OutputCase=PESOPR	CaseType=LinStatic	Point=3	X2=0.5	X3=-0.5	S11=-
624.025776732335	IsS11Max=No	IsS11Min=Yes	FrameElem=17	ElemStation=0			
Frame=17	Station=0	OutputCase=PESOPR	CaseType=LinStatic	Point=4	X2=0.5	X3=0.5	S11=-624.025776732335
IsS11Max=No	IsS11Min=No	FrameElem=17	ElemStation=0				
Frame=17	Station=0.25	OutputCase=PESOPR	CaseType=LinStatic	Point=0	X2=0	X3=0	S11=-149.999999393243
IsS11Max=No	IsS11Min=No	FrameElem=17	ElemStation=0.25				
Frame=17	Station=0.25	OutputCase=PESOPR	CaseType=LinStatic	Point=1	X2=-0.5	X3=-0.5	
S11=295.019357841489	IsS11Max=Yes	IsS11Min=No	FrameElem=17	ElemStation=0.25			
Frame=17	Station=0.25	OutputCase=PESOPR	CaseType=LinStatic	Point=2	X2=-0.5	X3=0.5	
S11=295.019357841489	IsS11Max=No	IsS11Min=No	FrameElem=17	ElemStation=0.25			
Frame=17	Station=0.25	OutputCase=PESOPR	CaseType=LinStatic	Point=3	X2=0.5	X3=-0.5	S11=-
595.019356627975	IsS11Max=No	IsS11Min=Yes	FrameElem=17	ElemStation=0.25			
Frame=17	Station=0.25	OutputCase=PESOPR	CaseType=LinStatic	Point=4	X2=0.5	X3=0.5	S11=-
595.019356627975	IsS11Max=No	IsS11Min=No	FrameElem=17	ElemStation=0.25			
Frame=17	Station=0	OutputCase=TERRVERT	CaseType=LinStatic	Point=0	X2=0	X3=0	S11=-491.24999511824
IsS11Max=No	IsS11Min=No	FrameElem=17	ElemStation=0				
Frame=17	Station=0	OutputCase=TERRVERT	CaseType=LinStatic	Point=1	X2=-0.5	X3=-0.5	
S11=850.980018799993	IsS11Max=Yes	IsS11Min=No	FrameElem=17	ElemStation=0			
Frame=17	Station=0	OutputCase=TERRVERT	CaseType=LinStatic	Point=2	X2=-0.5	X3=0.5	
S11=850.980018799993	IsS11Max=No	IsS11Min=No	FrameElem=17	ElemStation=0			
Frame=17	Station=0	OutputCase=TERRVERT	CaseType=LinStatic	Point=3	X2=0.5	X3=-0.5	S11=-
1833.48000903647	IsS11Max=No	IsS11Min=Yes	FrameElem=17	ElemStation=0			
Frame=17	Station=0	OutputCase=TERRVERT	CaseType=LinStatic	Point=4	X2=0.5	X3=0.5	S11=-
1833.48000903647	IsS11Max=No	IsS11Min=No	FrameElem=17	ElemStation=0			
Frame=17	Station=0.25	OutputCase=TERRVERT	CaseType=LinStatic	Point=0	X2=0	X3=0	S11=-491.24999511824
IsS11Max=No	IsS11Min=No	FrameElem=17	ElemStation=0.25				
Frame=17	Station=0.25	OutputCase=TERRVERT	CaseType=LinStatic	Point=1	X2=-0.5	X3=-0.5	
S11=852.70926165992	IsS11Max=Yes	IsS11Min=No	FrameElem=17	ElemStation=0.25			
Frame=17	Station=0.25	OutputCase=TERRVERT	CaseType=LinStatic	Point=2	X2=-0.5	X3=0.5	
S11=852.70926165992	IsS11Max=No	IsS11Min=No	FrameElem=17	ElemStation=0.25			
Frame=17	Station=0.25	OutputCase=TERRVERT	CaseType=LinStatic	Point=3	X2=0.5	X3=-0.5	S11=-
1835.2092518964	IsS11Max=No	IsS11Min=Yes	FrameElem=17	ElemStation=0.25			
Frame=17	Station=0.25	OutputCase=TERRVERT	CaseType=LinStatic	Point=4	X2=0.5	X3=0.5	S11=-
1835.2092518964	IsS11Max=No	IsS11Min=No	FrameElem=17	ElemStation=0.25			
Frame=17	Station=0	OutputCase=TERRLAT	CaseType=LinStatic	Point=0	X2=0	X3=0	S11=3.3418245948269E-07
IsS11Max=No	IsS11Min=No	FrameElem=17	ElemStation=0				
Frame=17	Station=0	OutputCase=TERRLAT	CaseType=LinStatic	Point=1	X2=-0.5	X3=-0.5	
S11=14.0534969870131	IsS11Max=Yes	IsS11Min=No	FrameElem=17	ElemStation=0			
Frame=17	Station=0	OutputCase=TERRLAT	CaseType=LinStatic	Point=2	X2=-0.5	X3=0.5	
S11=14.0534969870131	IsS11Max=No	IsS11Min=No	FrameElem=17	ElemStation=0			
Frame=17	Station=0	OutputCase=TERRLAT	CaseType=LinStatic	Point=3	X2=0.5	X3=-0.5	S11=-
14.0534963186482	IsS11Max=No	IsS11Min=Yes	FrameElem=17	ElemStation=0			
Frame=17	Station=0	OutputCase=TERRLAT	CaseType=LinStatic	Point=4	X2=0.5	X3=0.5	S11=-
14.0534963186482	IsS11Max=No	IsS11Min=No	FrameElem=17	ElemStation=0			
Frame=17	Station=0.25	OutputCase=TERRLAT	CaseType=LinStatic	Point=0	X2=0	X3=0	S11=3.3418245948269E-07
IsS11Max=No	IsS11Min=No	FrameElem=17	ElemStation=0.25				
Frame=17	Station=0.25	OutputCase=TERRLAT	CaseType=LinStatic	Point=1	X2=-0.5	X3=-0.5	S11=-
80.2196260507309	IsS11Max=No	IsS11Min=Yes	FrameElem=17	ElemStation=0.25			
Frame=17	Station=0.25	OutputCase=TERRLAT	CaseType=LinStatic	Point=2	X2=-0.5	X3=0.5	S11=-
80.2196260507309	IsS11Max=No	IsS11Min=No	FrameElem=17	ElemStation=0.25			
Frame=17	Station=0.25	OutputCase=TERRLAT	CaseType=LinStatic	Point=3	X2=0.5	X3=-0.5	
S11=80.2196267190959	IsS11Max=Yes	IsS11Min=No	FrameElem=17	ElemStation=0.25			
Frame=17	Station=0.25	OutputCase=TERRLAT	CaseType=LinStatic	Point=4	X2=0.5	X3=0.5	
S11=80.2196267190959	IsS11Max=No	IsS11Min=No	FrameElem=17	ElemStation=0.25			
Frame=17	Station=0	OutputCase=ACCLATDX	CaseType=LinStatic	Point=0	X2=0	X3=0	S11=0
IsS11Min=Yes	FrameElem=17	ElemStation=0					IsS11Max=Yes
Frame=17	Station=0	OutputCase=ACCLATDX	CaseType=LinStatic	Point=1	X2=-0.5	X3=-0.5	S11=0
IsS11Max=No	IsS11Min=No	FrameElem=17	ElemStation=0				
Frame=17	Station=0	OutputCase=ACCLATDX	CaseType=LinStatic	Point=2	X2=-0.5	X3=0.5	S11=0
IsS11Max=No	IsS11Min=No	FrameElem=17	ElemStation=0				
Frame=17	Station=0	OutputCase=ACCLATDX	CaseType=LinStatic	Point=3	X2=0.5	X3=-0.5	S11=0
IsS11Max=No	IsS11Min=No	FrameElem=17	ElemStation=0				
Frame=17	Station=0.25	OutputCase=ACCLATDX	CaseType=LinStatic	Point=4	X2=0.5	X3=0.5	S11=0
IsS11Max=No	IsS11Min=No	FrameElem=17	ElemStation=0.25				
Frame=17	Station=0	OutputCase=ACCLATDX	CaseType=LinStatic	Point=0	X2=0	X3=0	S11=0
IsS11Min=Yes	FrameElem=17	ElemStation=0					IsS11Max=Yes
Frame=17	Station=0.25	OutputCase=ACCLATDX	CaseType=LinStatic	Point=1	X2=-0.5	X3=-0.5	S11=0
IsS11Max=No	IsS11Min=No	FrameElem=17	ElemStation=0.25				
Frame=17	Station=0.25	OutputCase=ACCLATDX	CaseType=LinStatic	Point=2	X2=-0.5	X3=0.5	S11=0
IsS11Max=No	IsS11Min=No	FrameElem=17	ElemStation=0.25				
Frame=17	Station=0.25	OutputCase=ACCLATDX	CaseType=LinStatic	Point=3	X2=0.5	X3=-0.5	S11=0
IsS11Max=No	IsS11Min=No	FrameElem=17	ElemStation=0.25				
Frame=17	Station=0.25	OutputCase=ACCLATDX	CaseType=LinStatic	Point=4	X2=0.5	X3=0.5	S11=0
IsS11Max=No	IsS11Min=No	FrameElem=17	ElemStation=0.25				
Frame=17	Station=0	OutputCase=ACCLATSX	CaseType=LinStatic	Point=0	X2=0	X3=0	S11=0
IsS11Min=Yes	FrameElem=17	ElemStation=0					IsS11Max=Yes
Frame=17	Station=0	OutputCase=ACCLATSX	CaseType=LinStatic	Point=1	X2=-0.5	X3=-0.5	S11=0
IsS11Max=No	IsS11Min=No	FrameElem=17	ElemStation=0				
Frame=17	Station=0	OutputCase=ACCLATSX	CaseType=LinStatic	Point=2	X2=-0.5	X3=0.5	S11=0
IsS11Max=No	IsS11Min=No	FrameElem=17	ElemStation=0				
Frame=17	Station=0	OutputCase=ACCLATSX	CaseType=LinStatic	Point=3	X2=0.5	X3=-0.5	S11=0
IsS11Max=No	IsS11Min=No	FrameElem=17	ElemStation=0				



Frame=17	Station=0	OutputCase=ACCLATSX	CaseType=LinStatic	Point=4	X2=0.5	X3=0.5	S11=0	IsS11Max=No
IsS11Min=No	FrameElem=17	ElemStation=0						
Frame=17	Station=0.25	OutputCase=ACCLATSX	CaseType=LinStatic	Point=0	X2=0	X3=0	S11=0	IsS11Max=Yes
IsS11Min=Yes	FrameElem=17	ElemStation=0.25						
Frame=17	Station=0.25	OutputCase=ACCLATSX	CaseType=LinStatic	Point=1	X2=-0.5	X3=-0.5	S11=0	
IsS11Max=No	IsS11Min=No	FrameElem=17	ElemStation=0.25					
Frame=17	Station=0.25	OutputCase=ACCLATSX	CaseType=LinStatic	Point=2	X2=-0.5	X3=0.5	S11=0	
IsS11Max=No	IsS11Min=No	FrameElem=17	ElemStation=0.25					
Frame=17	Station=0.25	OutputCase=ACCLATSX	CaseType=LinStatic	Point=3	X2=0.5	X3=-0.5	S11=0	
IsS11Max=No	IsS11Min=No	FrameElem=17	ElemStation=0.25					
Frame=17	Station=0.25	OutputCase=ACCLATSX	CaseType=LinStatic	Point=4	X2=0.5	X3=0.5	S11=0	
IsS11Max=No	IsS11Min=No	FrameElem=17	ElemStation=0.25					
Frame=17	Station=0	OutputCase=TERRCOST	CaseType=LinStatic	Point=0	X2=0	X3=0	S11=0	IsS11Max=Yes
IsS11Min=Yes	FrameElem=17	ElemStation=0						
Frame=17	Station=0	OutputCase=TERRCOST	CaseType=LinStatic	Point=1	X2=-0.5	X3=-0.5	S11=0	
IsS11Max=No	IsS11Min=No	FrameElem=17	ElemStation=0					
Frame=17	Station=0	OutputCase=TERRCOST	CaseType=LinStatic	Point=2	X2=-0.5	X3=0.5	S11=0	
IsS11Max=No	IsS11Min=No	FrameElem=17	ElemStation=0					
Frame=17	Station=0	OutputCase=TERRCOST	CaseType=LinStatic	Point=3	X2=0.5	X3=-0.5	S11=0	
IsS11Max=No	IsS11Min=No	FrameElem=17	ElemStation=0					
Frame=17	Station=0	OutputCase=TERRCOST	CaseType=LinStatic	Point=4	X2=0.5	X3=0.5	S11=0	IsS11Max=No
IsS11Min=No	FrameElem=17	ElemStation=0						
Frame=17	Station=0.25	OutputCase=TERRCOST	CaseType=LinStatic	Point=0	X2=0	X3=0	S11=0	IsS11Max=Yes
IsS11Min=Yes	FrameElem=17	ElemStation=0.25						
Frame=17	Station=0.25	OutputCase=TERRCOST	CaseType=LinStatic	Point=1	X2=-0.5	X3=-0.5	S11=0	
IsS11Max=No	IsS11Min=No	FrameElem=17	ElemStation=0.25					
Frame=17	Station=0.25	OutputCase=TERRCOST	CaseType=LinStatic	Point=2	X2=-0.5	X3=0.5	S11=0	
IsS11Max=No	IsS11Min=No	FrameElem=17	ElemStation=0.25					
Frame=17	Station=0.25	OutputCase=TERRCOST	CaseType=LinStatic	Point=3	X2=0.5	X3=-0.5	S11=0	
IsS11Max=No	IsS11Min=No	FrameElem=17	ElemStation=0.25					
Frame=17	Station=0.25	OutputCase=TERRCOST	CaseType=LinStatic	Point=4	X2=0.5	X3=0.5	S11=0	
IsS11Max=No	IsS11Min=No	FrameElem=17	ElemStation=0.25					
Frame=17	Station=0	OutputCase=SOVRCOST	CaseType=LinStatic	Point=0	X2=0	X3=0	S11=0	IsS11Max=Yes
IsS11Min=Yes	FrameElem=17	ElemStation=0						
Frame=17	Station=0	OutputCase=SOVRCOST	CaseType=LinStatic	Point=1	X2=-0.5	X3=-0.5	S11=0	
IsS11Max=No	IsS11Min=No	FrameElem=17	ElemStation=0					
Frame=17	Station=0	OutputCase=SOVRCOST	CaseType=LinStatic	Point=2	X2=-0.5	X3=0.5	S11=0	
IsS11Max=No	IsS11Min=No	FrameElem=17	ElemStation=0					
Frame=17	Station=0	OutputCase=SOVRCOST	CaseType=LinStatic	Point=3	X2=0.5	X3=-0.5	S11=0	
IsS11Max=No	IsS11Min=No	FrameElem=17	ElemStation=0					
Frame=17	Station=0	OutputCase=SOVRCOST	CaseType=LinStatic	Point=4	X2=0.5	X3=0.5	S11=0	IsS11Max=No
IsS11Min=No	FrameElem=17	ElemStation=0						
Frame=17	Station=0.25	OutputCase=SOVRCOST	CaseType=LinStatic	Point=0	X2=0	X3=0	S11=0	IsS11Max=Yes
IsS11Min=Yes	FrameElem=17	ElemStation=0.25						
Frame=17	Station=0.25	OutputCase=SOVRCOST	CaseType=LinStatic	Point=1	X2=-0.5	X3=-0.5	S11=0	
IsS11Max=No	IsS11Min=No	FrameElem=17	ElemStation=0.25					
Frame=17	Station=0.25	OutputCase=SOVRCOST	CaseType=LinStatic	Point=2	X2=-0.5	X3=0.5	S11=0	
IsS11Max=No	IsS11Min=No	FrameElem=17	ElemStation=0.25					
Frame=17	Station=0.25	OutputCase=SOVRCOST	CaseType=LinStatic	Point=3	X2=0.5	X3=-0.5	S11=0	
IsS11Max=No	IsS11Min=No	FrameElem=17	ElemStation=0.25					
Frame=17	Station=0.25	OutputCase=SOVRCOST	CaseType=LinStatic	Point=4	X2=0.5	X3=0.5	S11=0	
IsS11Max=No	IsS11Min=No	FrameElem=17	ElemStation=0.25					
Frame=17	Station=0	OutputCase=ENVE	CaseType=Combination	StepType=Max	Point=0	X2=0	X3=0	S11=-
647.499994177301	IsS11Max=No	IsS11Min=No	FrameElem=17	ElemStation=0				
Frame=17	Station=0	OutputCase=ENVE	CaseType=Combination	StepType=Max	Point=1	X2=-0.5	X3=-0.5	
S11=1176.55929373285	IsS11Max=Yes	IsS11Min=No	FrameElem=17	ElemStation=0				
Frame=17	Station=0	OutputCase=ENVE	CaseType=Combination	StepType=Max	Point=2	X2=-0.5	X3=0.5	
S11=1176.55929373285	IsS11Max=No	IsS11Min=No	FrameElem=17	ElemStation=0				
Frame=17	Station=0	OutputCase=ENVE	CaseType=Combination	StepType=Max	Point=3	X2=0.5	X3=-0.5	S11=-
2467.34323319186	IsS11Max=No	IsS11Min=Yes	FrameElem=17	ElemStation=0				
Frame=17	Station=0	OutputCase=ENVE	CaseType=Combination	StepType=Max	Point=4	X2=0.5	X3=0.5	S11=-
2467.34323319186	IsS11Max=No	IsS11Min=No	FrameElem=17	ElemStation=0				
Frame=17	Station=0.25	OutputCase=ENVE	CaseType=Combination	StepType=Max	Point=0	X2=0	X3=0	S11=-
641.249994177301	IsS11Max=No	IsS11Min=No	FrameElem=17	ElemStation=0.25				
Frame=17	Station=0.25	OutputCase=ENVE	CaseType=Combination	StepType=Max	Point=1	X2=-0.5	X3=-0.5	
S11=1091.5748812659	IsS11Max=Yes	IsS11Min=No	FrameElem=17	ElemStation=0.25				
Frame=17	Station=0.25	OutputCase=ENVE	CaseType=Combination	StepType=Max	Point=2	X2=-0.5	X3=0.5	
S11=1091.5748812659	IsS11Max=No	IsS11Min=No	FrameElem=17	ElemStation=0.25				
Frame=17	Station=0.25	OutputCase=ENVE	CaseType=Combination	StepType=Max	Point=3	X2=0.5	X3=-0.5	
S11=-2350.00898180528	IsS11Max=No	IsS11Min=Yes	FrameElem=17	ElemStation=0.25				
Frame=17	Station=0.25	OutputCase=ENVE	CaseType=Combination	StepType=Max	Point=4	X2=0.5	X3=0.5	
S11=-2350.00898180528	IsS11Max=No	IsS11Min=No	FrameElem=17	ElemStation=0.25				
Frame=17	Station=0	OutputCase=ENVE	CaseType=Combination	StepType=Min	Point=0	X2=0	X3=0	S11=-
647.499994277556	IsS11Max=No	IsS11Min=No	FrameElem=17	ElemStation=0				
Frame=17	Station=0	OutputCase=ENVE	CaseType=Combination	StepType=Min	Point=1	X2=-0.5	X3=-0.5	
S11=1172.34324463675	IsS11Max=Yes	IsS11Min=No	FrameElem=17	ElemStation=0				
Frame=17	Station=0	OutputCase=ENVE	CaseType=Combination	StepType=Min	Point=2	X2=-0.5	X3=0.5	
S11=1172.34324463675	IsS11Max=No	IsS11Min=No	FrameElem=17	ElemStation=0				
Frame=17	Station=0	OutputCase=ENVE	CaseType=Combination	StepType=Min	Point=3	X2=0.5	X3=-0.5	S11=-
2471.55928208746	IsS11Max=No	IsS11Min=Yes	FrameElem=17	ElemStation=0				
Frame=17	Station=0	OutputCase=ENVE	CaseType=Combination	StepType=Min	Point=4	X2=0.5	X3=0.5	S11=-
2471.55928208746	IsS11Max=No	IsS11Min=No	FrameElem=17	ElemStation=0				

Frame=17	Station=0.25	OutputCase=ENVE	CaseType=Combination	StepType=Min	Point=0	X2=0	X3=0	S11=-
641.249994277556		IsS11Max=No	IsS11Min=No	FrameElem=17	ElemStation=0.25			
Frame=17	Station=0.25	OutputCase=ENVE	CaseType=Combination	StepType=Min	Point=1	X2=-0.5	X3=-0.5	
S11=1067.50899345068		IsS11Max=Yes	IsS11Min=No	FrameElem=17	ElemStation=0.25			
Frame=17	Station=0.25	OutputCase=ENVE	CaseType=Combination	StepType=Min	Point=2	X2=-0.5	X3=0.5	
S11=1067.50899345068		IsS11Max=No	IsS11Min=No	FrameElem=17	ElemStation=0.25			
Frame=17	Station=0.25	OutputCase=ENVE	CaseType=Combination	StepType=Min	Point=3	X2=0.5	X3=-0.5	
S11=-2374.07486982101		IsS11Max=No	IsS11Min=Yes	FrameElem=17	ElemStation=0.25			
Frame=17	Station=0.25	OutputCase=ENVE	CaseType=Combination	StepType=Min	Point=4	X2=0.5	X3=0.5	
S11=-2374.07486982101		IsS11Max=No	IsS11Min=No	FrameElem=17	ElemStation=0.25			
Frame=17	Station=0	OutputCase=FESSUR	CaseType=Combination	Point=0	X2=0	X3=0	S11=-647.499994177301	
IsS11Max=No	IsS11Min=No	FrameElem=17	ElemStation=0					
Frame=17	Station=0	OutputCase=FESSUR	CaseType=Combination	Point=1	X2=-0.5	X3=-0.5		
S11=1176.55929373285		IsS11Max=Yes	IsS11Min=No	FrameElem=17	ElemStation=0			
Frame=17	Station=0	OutputCase=FESSUR	CaseType=Combination	Point=2	X2=-0.5	X3=0.5		
S11=1176.55929373285		IsS11Max=No	IsS11Min=No	FrameElem=17	ElemStation=0			
Frame=17	Station=0	OutputCase=FESSUR	CaseType=Combination	Point=3	X2=0.5	X3=-0.5	S11=-	
2471.55928208746		IsS11Max=No	IsS11Min=Yes	FrameElem=17	ElemStation=0			
Frame=17	Station=0	OutputCase=FESSUR	CaseType=Combination	Point=4	X2=0.5	X3=0.5	S11=-	
2471.55928208746		IsS11Max=No	IsS11Min=No	FrameElem=17	ElemStation=0			
Frame=17	Station=0.25	OutputCase=FESSUR	CaseType=Combination	Point=0	X2=0	X3=0	S11=-	
641.249994177301		IsS11Max=No	IsS11Min=No	FrameElem=17	ElemStation=0.25			
Frame=17	Station=0.25	OutputCase=FESSUR	CaseType=Combination	Point=1	X2=-0.5	X3=-0.5		
S11=1067.50899345068		IsS11Max=Yes	IsS11Min=No	FrameElem=17	ElemStation=0.25			
Frame=17	Station=0.25	OutputCase=FESSUR	CaseType=Combination	Point=2	X2=-0.5	X3=0.5		
S11=1067.50899345068		IsS11Max=No	IsS11Min=No	FrameElem=17	ElemStation=0.25			
Frame=17	Station=0.25	OutputCase=FESSUR	CaseType=Combination	Point=3	X2=0.5	X3=-0.5	S11=-	
2350.00898180528		IsS11Max=No	IsS11Min=Yes	FrameElem=17	ElemStation=0.25			
Frame=17	Station=0.25	OutputCase=FESSUR	CaseType=Combination	Point=4	X2=0.5	X3=0.5	S11=-	
2350.00898180528		IsS11Max=No	IsS11Min=No	FrameElem=17	ElemStation=0.25			
Frame=19	Station=0	OutputCase=PESOPR	CaseType=LinStatic	Point=0	X2=0	X3=0	S11=-75.0000008397619	
IsS11Max=No	IsS11Min=No	FrameElem=19	ElemStation=0					
Frame=19	Station=0	OutputCase=PESOPR	CaseType=LinStatic	Point=1	X2=-0.5	X3=-0.5		
S11=96.9422990494065		IsS11Max=Yes	IsS11Min=No	FrameElem=19	ElemStation=0			
Frame=19	Station=0	OutputCase=PESOPR	CaseType=LinStatic	Point=2	X2=-0.5	X3=0.5	S11=96.9422990494065	
IsS11Max=No	IsS11Min=No	FrameElem=19	ElemStation=0					
Frame=19	Station=0	OutputCase=PESOPR	CaseType=LinStatic	Point=3	X2=0.5	X3=-0.5	S11=-246.94230072893	
IsS11Max=No	IsS11Min=Yes	FrameElem=19	ElemStation=0					
Frame=19	Station=0	OutputCase=PESOPR	CaseType=LinStatic	Point=4	X2=0.5	X3=0.5	S11=-246.94230072893	
IsS11Max=No	IsS11Min=No	FrameElem=19	ElemStation=0					
Frame=19	Station=0.250000000000002	OutputCase=PESOPR	CaseType=LinStatic	Point=0	X2=0	X3=0	S11=-	
68.7500008397619		IsS11Max=No	IsS11Min=No	FrameElem=19	ElemStation=0.250000000000002			
Frame=19	Station=0.250000000000002	OutputCase=PESOPR	CaseType=LinStatic	Point=1	X2=-0.5	X3=-0.5		
S11=80.4358892268491		IsS11Max=Yes	IsS11Min=No	FrameElem=19	ElemStation=0.250000000000002			
Frame=19	Station=0.250000000000002	OutputCase=PESOPR	CaseType=LinStatic	Point=2	X2=-0.5	X3=0.5		
S11=80.4358892268491		IsS11Max=No	IsS11Min=No	FrameElem=19	ElemStation=0.250000000000002			
Frame=19	Station=0.250000000000002	OutputCase=PESOPR	CaseType=LinStatic	Point=3	X2=0.5	X3=-0.5		
S11=-217.935890906373		IsS11Max=No	IsS11Min=Yes	FrameElem=19	ElemStation=0.250000000000002			
Frame=19	Station=0.250000000000002	OutputCase=PESOPR	CaseType=LinStatic	Point=4	X2=0.5	X3=0.5	S11=-	
217.935890906373		IsS11Max=No	IsS11Min=No	FrameElem=19	ElemStation=0.250000000000002			
Frame=19	Station=0	OutputCase=TERRVERT	CaseType=LinStatic	Point=0	X2=0	X3=0	S11=-491.249995007413	
IsS11Max=No	IsS11Min=No	FrameElem=19	ElemStation=0					
Frame=19	Station=0	OutputCase=TERRVERT	CaseType=LinStatic	Point=1	X2=-0.5	X3=-0.5		
S11=873.460105816052		IsS11Max=Yes	IsS11Min=No	FrameElem=19	ElemStation=0			
Frame=19	Station=0	OutputCase=TERRVERT	CaseType=LinStatic	Point=2	X2=-0.5	X3=0.5		
S11=873.460105816052		IsS11Max=No	IsS11Min=No	FrameElem=19	ElemStation=0			
Frame=19	Station=0	OutputCase=TERRVERT	CaseType=LinStatic	Point=3	X2=0.5	X3=-0.5	S11=-	
1855.96009583088		IsS11Max=No	IsS11Min=Yes	FrameElem=19	ElemStation=0			
Frame=19	Station=0	OutputCase=TERRVERT	CaseType=LinStatic	Point=4	X2=0.5	X3=0.5	S11=-	
1855.96009583088		IsS11Max=No	IsS11Min=No	FrameElem=19	ElemStation=0			
Frame=19	Station=0.250000000000002	OutputCase=TERRVERT	CaseType=LinStatic	Point=0	X2=0	X3=0	S11=-	
491.249995007413		IsS11Max=No	IsS11Min=No	FrameElem=19	ElemStation=0.250000000000002			
Frame=19	Station=0.250000000000002	OutputCase=TERRVERT	CaseType=LinStatic	Point=1	X2=-0.5	X3=-0.5		
S11=875.189418949862		IsS11Max=Yes	IsS11Min=No	FrameElem=19	ElemStation=0.250000000000002			
Frame=19	Station=0.250000000000002	OutputCase=TERRVERT	CaseType=LinStatic	Point=2	X2=-0.5	X3=0.5		
S11=875.189418949862		IsS11Max=No	IsS11Min=No	FrameElem=19	ElemStation=0.250000000000002			
Frame=19	Station=0.250000000000002	OutputCase=TERRVERT	CaseType=LinStatic	Point=3	X2=0.5	X3=-0.5		
S11=-1857.68940896469		IsS11Max=No	IsS11Min=Yes	FrameElem=19	ElemStation=0.250000000000002			
Frame=19	Station=0.250000000000002	OutputCase=TERRVERT	CaseType=LinStatic	Point=4	X2=0.5	X3=0.5		
S11=-1857.68940896469		IsS11Max=No	IsS11Min=No	FrameElem=19	ElemStation=0.250000000000002			
Frame=19	Station=0	OutputCase=TERRLAT	CaseType=LinStatic	Point=0	X2=0	X3=0	S11=4.97245855513029E-06	
IsS11Max=No	IsS11Min=No	FrameElem=19	ElemStation=0					
Frame=19	Station=0	OutputCase=TERRLAT	CaseType=LinStatic	Point=1	X2=-0.5	X3=-0.5	S11=-	
38.2978791153886		IsS11Max=No	IsS11Min=Yes	FrameElem=19	ElemStation=0			
Frame=19	Station=0	OutputCase=TERRLAT	CaseType=LinStatic	Point=2	X2=-0.5	X3=0.5	S11=-	
38.2978791153886		IsS11Max=No	IsS11Min=No	FrameElem=19	ElemStation=0			
Frame=19	Station=0	OutputCase=TERRLAT	CaseType=LinStatic	Point=3	X2=0.5	X3=-0.5		
S11=38.2978890603057		IsS11Max=Yes	IsS11Min=No	FrameElem=19	ElemStation=0			
Frame=19	Station=0	OutputCase=TERRLAT	CaseType=LinStatic	Point=4	X2=0.5	X3=0.5	S11=38.2978890603057	
IsS11Max=No	IsS11Min=No	FrameElem=19	ElemStation=0					
Frame=19	Station=0.250000000000002	OutputCase=TERRLAT	CaseType=LinStatic	Point=0	X2=0	X3=0		
S11=5.47976113550439E-06		IsS11Max=No	IsS11Min=No	FrameElem=19	ElemStation=0.250000000000002			



Frame=19 Station=0.250000000000002 OutputCase=SOVRCOST CaseType=LinStatic Point=2 X2=-0.5 X3=0.5
 S11=0 IsS11Max=No IsS11Min=No FrameElem=19 ElemStation=0.250000000000002
 Frame=19 Station=0.250000000000002 OutputCase=SOVRCOST CaseType=LinStatic Point=3 X2=0.5 X3=-0.5
 S11=0 IsS11Max=No IsS11Min=No FrameElem=19 ElemStation=0.250000000000002
 Frame=19 Station=0.250000000000002 OutputCase=SOVRCOST CaseType=LinStatic Point=4 X2=0.5 X3=0.5
 S11=0 IsS11Max=No IsS11Min=No FrameElem=19 ElemStation=0.250000000000002
 Frame=19 Station=0 OutputCase=ENVE CaseType=Combination StepType=Max Point=0 X2=0 X3=0 S11=-
 566.249990874716 IsS11Max=No IsS11Min=No FrameElem=19 ElemStation=0
 Frame=19 Station=0 OutputCase=ENVE CaseType=Combination StepType=Max Point=1 X2=-0.5 X3=-0.5
 S11=943.593889484686 IsS11Max=Yes IsS11Min=No FrameElem=19 ElemStation=0
 Frame=19 Station=0 OutputCase=ENVE CaseType=Combination StepType=Max Point=2 X2=-0.5 X3=0.5
 S11=943.593889484686 IsS11Max=No IsS11Min=No FrameElem=19 ElemStation=0
 Frame=19 Station=0 OutputCase=ENVE CaseType=Combination StepType=Max Point=3 X2=0.5 X3=-0.5 S11=-
 2064.6045074995 IsS11Max=No IsS11Min=Yes FrameElem=19 ElemStation=0
 Frame=19 Station=0 OutputCase=ENVE CaseType=Combination StepType=Max Point=4 X2=0.5 X3=0.5 S11=-
 2064.6045074995 IsS11Max=No IsS11Min=No FrameElem=19 ElemStation=0
 Frame=19 Station=0.250000000000002 OutputCase=ENVE CaseType=Combination StepType=Max Point=0 X2=0
 X3=0 S11=-559.99990367413 IsS11Max=No IsS11Min=No FrameElem=19 ElemStation=0.250000000000002
 Frame=19 Station=0.250000000000002 OutputCase=ENVE CaseType=Combination StepType=Max Point=1 X2=-0.5
 X3=-0.5 S11=994.33743153088 IsS11Max=Yes IsS11Min=No FrameElem=19 ElemStation=0.250000000000002
 Frame=19 Station=0.250000000000002 OutputCase=ENVE CaseType=Combination StepType=Max Point=2 X2=-0.5
 X3=0.5 S11=994.33743153088 IsS11Max=No IsS11Min=No FrameElem=19 ElemStation=0.250000000000002
 Frame=19 Station=0.250000000000002 OutputCase=ENVE CaseType=Combination StepType=Max Point=3 X2=0.5
 X3=-0.5 S11=-2102.72377854731 IsS11Max=No IsS11Min=Yes FrameElem=19 ElemStation=0.250000000000002
 Frame=19 Station=0.250000000000002 OutputCase=ENVE CaseType=Combination StepType=Max Point=4 X2=0.5
 X3=0.5 S11=-2102.72377854731 IsS11Max=No IsS11Min=No FrameElem=19 ElemStation=0.250000000000002
 Frame=19 Station=0 OutputCase=ENVE CaseType=Combination StepType=Min Point=0 X2=0 X3=0 S11=-
 566.249992366453 IsS11Max=No IsS11Min=No FrameElem=19 ElemStation=0
 Frame=19 Station=0 OutputCase=ENVE CaseType=Combination StepType=Min Point=1 X2=-0.5 X3=-0.5
 S11=932.104525750069 IsS11Max=Yes IsS11Min=No FrameElem=19 ElemStation=0
 Frame=19 Station=0 OutputCase=ENVE CaseType=Combination StepType=Min Point=2 X2=-0.5 X3=0.5
 S11=932.104525750069 IsS11Max=No IsS11Min=No FrameElem=19 ElemStation=0
 Frame=19 Station=0 OutputCase=ENVE CaseType=Combination StepType=Min Point=3 X2=0.5 X3=-0.5 S11=-
 2076.09387421759 IsS11Max=No IsS11Min=Yes FrameElem=19 ElemStation=0
 Frame=19 Station=0 OutputCase=ENVE CaseType=Combination StepType=Min Point=4 X2=0.5 X3=0.5 S11=-
 2076.09387421759 IsS11Max=No IsS11Min=No FrameElem=19 ElemStation=0
 Frame=19 Station=0.250000000000002 OutputCase=ENVE CaseType=Combination StepType=Min Point=0 X2=0
 X3=0 S11=-559.99992011342 IsS11Max=No IsS11Min=No FrameElem=19 ElemStation=0.250000000000002
 Frame=19 Station=0.250000000000002 OutputCase=ENVE CaseType=Combination StepType=Min Point=1 X2=-0.5
 X3=-0.5 S11=982.72379452463 IsS11Max=Yes IsS11Min=No FrameElem=19 ElemStation=0.250000000000002
 Frame=19 Station=0.250000000000002 OutputCase=ENVE CaseType=Combination StepType=Min Point=2 X2=-0.5
 X3=0.5 S11=982.72379452463 IsS11Max=No IsS11Min=No FrameElem=19 ElemStation=0.250000000000002
 Frame=19 Station=0.250000000000002 OutputCase=ENVE CaseType=Combination StepType=Min Point=3 X2=0.5
 X3=-0.5 S11=-2114.33741226571 IsS11Max=No IsS11Min=Yes FrameElem=19 ElemStation=0.250000000000002
 Frame=19 Station=0.250000000000002 OutputCase=ENVE CaseType=Combination StepType=Min Point=4 X2=0.5
 X3=0.5 S11=-2114.33741226571 IsS11Max=No IsS11Min=No FrameElem=19 ElemStation=0.250000000000002
 Frame=19 Station=0 OutputCase=FESSUR CaseType=Combination Point=0 X2=0 X3=0 S11=-566.249990874716
 IsS11Max=No IsS11Min=No FrameElem=19 ElemStation=0
 Frame=19 Station=0 OutputCase=FESSUR CaseType=Combination Point=1 X2=-0.5 X3=-0.5
 S11=932.104525750069 IsS11Max=Yes IsS11Min=No FrameElem=19 ElemStation=0
 Frame=19 Station=0 OutputCase=FESSUR CaseType=Combination Point=2 X2=-0.5 X3=0.5
 S11=932.104525750069 IsS11Max=No IsS11Min=No FrameElem=19 ElemStation=0
 Frame=19 Station=0 OutputCase=FESSUR CaseType=Combination Point=3 X2=0.5 X3=-0.5 S11=-
 2064.6045074995 IsS11Max=No IsS11Min=Yes FrameElem=19 ElemStation=0
 Frame=19 Station=0 OutputCase=FESSUR CaseType=Combination Point=4 X2=0.5 X3=0.5 S11=-
 2064.6045074995 IsS11Max=No IsS11Min=No FrameElem=19 ElemStation=0
 Frame=19 Station=0.250000000000002 OutputCase=FESSUR CaseType=Combination Point=0 X2=0 X3=0 S11=-
 559.99990367413 IsS11Max=No IsS11Min=No FrameElem=19 ElemStation=0.250000000000002
 Frame=19 Station=0.250000000000002 OutputCase=FESSUR CaseType=Combination Point=1 X2=-0.5 X3=-0.5
 S11=994.33743153088 IsS11Max=Yes IsS11Min=No FrameElem=19 ElemStation=0.250000000000002
 Frame=19 Station=0.250000000000002 OutputCase=FESSUR CaseType=Combination Point=2 X2=-0.5 X3=0.5
 S11=994.33743153088 IsS11Max=No IsS11Min=No FrameElem=19 ElemStation=0.250000000000002
 Frame=19 Station=0.250000000000002 OutputCase=FESSUR CaseType=Combination Point=3 X2=0.5 X3=-0.5
 S11=-2114.33741226571 IsS11Max=No IsS11Min=Yes FrameElem=19 ElemStation=0.250000000000002
 Frame=19 Station=0.250000000000002 OutputCase=FESSUR CaseType=Combination Point=4 X2=0.5 X3=0.5
 S11=-2114.33741226571 IsS11Max=No IsS11Min=No FrameElem=19 ElemStation=0.250000000000002
 Frame=20 Station=0 OutputCase=PESOPR CaseType=LinStatic Point=0 X2=0 X3=0 S11=-68.7499979460263
 IsS11Max=No IsS11Min=No FrameElem=20 ElemStation=0
 Frame=20 Station=0 OutputCase=PESOPR CaseType=LinStatic Point=1 X2=-0.5 X3=-0.5 S11=80.435892120567
 IsS11Max=Yes IsS11Min=No FrameElem=20 ElemStation=0
 Frame=20 Station=0 OutputCase=PESOPR CaseType=LinStatic Point=2 X2=-0.5 X3=0.5 S11=80.435892120567
 IsS11Max=No IsS11Min=No FrameElem=20 ElemStation=0
 Frame=20 Station=0 OutputCase=PESOPR CaseType=LinStatic Point=3 X2=0.5 X3=-0.5 S11=-217.93588801262
 IsS11Max=No IsS11Min=Yes FrameElem=20 ElemStation=0
 Frame=20 Station=0 OutputCase=PESOPR CaseType=LinStatic Point=4 X2=0.5 X3=0.5 S11=-217.93588801262
 IsS11Max=No IsS11Min=No FrameElem=20 ElemStation=0
 Frame=20 Station=0.250000000000001 OutputCase=PESOPR CaseType=LinStatic Point=0 X2=0 X3=0 S11=-
 62.4999979460263 IsS11Max=No IsS11Min=No FrameElem=20 ElemStation=0.250000000000001
 Frame=20 Station=0.250000000000001 OutputCase=PESOPR CaseType=LinStatic Point=1 X2=-0.5 X3=-0.5
 S11=63.9294626284776 IsS11Max=Yes IsS11Min=No FrameElem=20 ElemStation=0.250000000000001
 Frame=20 Station=0.250000000000001 OutputCase=PESOPR CaseType=LinStatic Point=2 X2=-0.5 X3=0.5
 S11=63.9294626284776 IsS11Max=No IsS11Min=No FrameElem=20 ElemStation=0.250000000000001

```

Frame=20 Station=0.250000000000001 OutputCase=ACCLATSX CaseType=LinStatic Point=4 X2=0.5 X3=0.5
S11=0 IsS11Max=No IsS11Min=No FrameElem=20 ElemStation=0.250000000000001
Frame=20 Station=0 OutputCase=TERRCOST CaseType=LinStatic Point=0 X2=0 X3=0 S11=0 IsS11Max=Yes
IsS11Min=Yes FrameElem=20 ElemStation=0
Frame=20 Station=0 OutputCase=TERRCOST CaseType=LinStatic Point=1 X2=-0.5 X3=-0.5 S11=0
IsS11Max=No IsS11Min=No FrameElem=20 ElemStation=0
Frame=20 Station=0 OutputCase=TERRCOST CaseType=LinStatic Point=2 X2=-0.5 X3=0.5 S11=0
IsS11Max=No IsS11Min=No FrameElem=20 ElemStation=0
Frame=20 Station=0 OutputCase=TERRCOST CaseType=LinStatic Point=3 X2=0.5 X3=-0.5 S11=0
IsS11Max=No IsS11Min=No FrameElem=20 ElemStation=0
Frame=20 Station=0 OutputCase=TERRCOST CaseType=LinStatic Point=4 X2=0.5 X3=0.5 S11=0 IsS11Max=No
IsS11Min=No FrameElem=20 ElemStation=0
Frame=20 Station=0.250000000000001 OutputCase=TERRCOST CaseType=LinStatic Point=0 X2=0 X3=0 S11=0
IsS11Max=Yes IsS11Min=Yes FrameElem=20 ElemStation=0.250000000000001
Frame=20 Station=0.250000000000001 OutputCase=TERRCOST CaseType=LinStatic Point=1 X2=-0.5 X3=-0.5
S11=0 IsS11Max=No IsS11Min=No FrameElem=20 ElemStation=0.250000000000001
Frame=20 Station=0.250000000000001 OutputCase=TERRCOST CaseType=LinStatic Point=2 X2=-0.5 X3=0.5
S11=0 IsS11Max=No IsS11Min=No FrameElem=20 ElemStation=0.250000000000001
Frame=20 Station=0.250000000000001 OutputCase=TERRCOST CaseType=LinStatic Point=3 X2=0.5 X3=-0.5
S11=0 IsS11Max=No IsS11Min=No FrameElem=20 ElemStation=0.250000000000001
Frame=20 Station=0.250000000000001 OutputCase=TERRCOST CaseType=LinStatic Point=4 X2=0.5 X3=0.5
S11=0 IsS11Max=No IsS11Min=No FrameElem=20 ElemStation=0.250000000000001
Frame=20 Station=0 OutputCase=SOVRCOST CaseType=LinStatic Point=0 X2=0 X3=0 S11=0 IsS11Max=Yes
IsS11Min=Yes FrameElem=20 ElemStation=0
Frame=20 Station=0 OutputCase=SOVRCOST CaseType=LinStatic Point=1 X2=-0.5 X3=-0.5 S11=0
IsS11Max=No IsS11Min=No FrameElem=20 ElemStation=0
Frame=20 Station=0 OutputCase=SOVRCOST CaseType=LinStatic Point=2 X2=-0.5 X3=0.5 S11=0
IsS11Max=No IsS11Min=No FrameElem=20 ElemStation=0
Frame=20 Station=0 OutputCase=SOVRCOST CaseType=LinStatic Point=3 X2=0.5 X3=-0.5 S11=0
IsS11Max=No IsS11Min=No FrameElem=20 ElemStation=0
Frame=20 Station=0 OutputCase=SOVRCOST CaseType=LinStatic Point=4 X2=0.5 X3=0.5 S11=0 IsS11Max=No
IsS11Min=No FrameElem=20 ElemStation=0
Frame=20 Station=0.250000000000001 OutputCase=SOVRCOST CaseType=LinStatic Point=0 X2=0 X3=0 S11=0
IsS11Max=Yes IsS11Min=Yes FrameElem=20 ElemStation=0.250000000000001
Frame=20 Station=0.250000000000001 OutputCase=SOVRCOST CaseType=LinStatic Point=1 X2=-0.5 X3=-0.5
S11=0 IsS11Max=No IsS11Min=No FrameElem=20 ElemStation=0.250000000000001
Frame=20 Station=0.250000000000001 OutputCase=SOVRCOST CaseType=LinStatic Point=2 X2=-0.5 X3=0.5
S11=0 IsS11Max=No IsS11Min=No FrameElem=20 ElemStation=0.250000000000001
Frame=20 Station=0.250000000000001 OutputCase=SOVRCOST CaseType=LinStatic Point=3 X2=0.5 X3=-0.5
S11=0 IsS11Max=No IsS11Min=No FrameElem=20 ElemStation=0.250000000000001
Frame=20 Station=0.250000000000001 OutputCase=SOVRCOST CaseType=LinStatic Point=4 X2=0.5 X3=0.5
S11=0 IsS11Max=No IsS11Min=No FrameElem=20 ElemStation=0.250000000000001
Frame=20 Station=0 OutputCase=ENVE CaseType=Combination StepType=Max Point=0 X2=0 X3=0 S11=-
559.99999654121 IsS11Max=No IsS11Min=No FrameElem=20 ElemStation=0
Frame=20 Station=0 OutputCase=ENVE CaseType=Combination StepType=Max Point=1 X2=-0.5 X3=-0.5
S11=994.337423913596 IsS11Max=Yes IsS11Min=No FrameElem=20 ElemStation=0
Frame=20 Station=0 OutputCase=ENVE CaseType=Combination StepType=Max Point=2 X2=-0.5 X3=0.5
S11=994.337423913596 IsS11Max=No IsS11Min=No FrameElem=20 ElemStation=0
Frame=20 Station=0 OutputCase=ENVE CaseType=Combination StepType=Max Point=3 X2=0.5 X3=-0.5 S11=-
2102.72378307711 IsS11Max=No IsS11Min=Yes FrameElem=20 ElemStation=0
Frame=20 Station=0 OutputCase=ENVE CaseType=Combination StepType=Max Point=4 X2=0.5 X3=0.5 S11=-
2102.72378307711 IsS11Max=No IsS11Min=No FrameElem=20 ElemStation=0
Frame=20 Station=0.250000000000001 OutputCase=ENVE CaseType=Combination StepType=Max Point=0 X2=0
X3=0 S11=-553.749996860742 IsS11Max=No IsS11Min=No FrameElem=20 ElemStation=0.250000000000001
Frame=20 Station=0.250000000000001 OutputCase=ENVE CaseType=Combination StepType=Max Point=1 X2=-0.5
X3=-0.5 S11=1064.14962163835 IsS11Max=Yes IsS11Min=No FrameElem=20 ElemStation=0.250000000000001
Frame=20 Station=0.250000000000001 OutputCase=ENVE CaseType=Combination StepType=Max Point=2 X2=-0.5
X3=0.5 S11=1064.14962163835 IsS11Max=No IsS11Min=No FrameElem=20 ElemStation=0.250000000000001
Frame=20 Station=0.250000000000001 OutputCase=ENVE CaseType=Combination StepType=Max Point=3 X2=0.5
X3=-0.5 S11=-2134.6591450517 IsS11Max=No IsS11Min=Yes FrameElem=20 ElemStation=0.250000000000001
Frame=20 Station=0.250000000000001 OutputCase=ENVE CaseType=Combination StepType=Max Point=4 X2=0.5
X3=0.5 S11=-2134.6591450517 IsS11Max=No IsS11Min=No FrameElem=20 ElemStation=0.250000000000001
Frame=20 Station=0 OutputCase=ENVE CaseType=Combination StepType=Min Point=0 X2=0 X3=0 S11=-
559.99999798463 IsS11Max=No IsS11Min=No FrameElem=20 ElemStation=0
Frame=20 Station=0 OutputCase=ENVE CaseType=Combination StepType=Min Point=1 X2=-0.5 X3=-0.5
S11=982.723789994693 IsS11Max=Yes IsS11Min=No FrameElem=20 ElemStation=0
Frame=20 Station=0 OutputCase=ENVE CaseType=Combination StepType=Min Point=2 X2=-0.5 X3=0.5
S11=982.723789994693 IsS11Max=No IsS11Min=No FrameElem=20 ElemStation=0
Frame=20 Station=0 OutputCase=ENVE CaseType=Combination StepType=Min Point=3 X2=0.5 X3=-0.5 S11=-
2114.33741988286 IsS11Max=No IsS11Min=Yes FrameElem=20 ElemStation=0
Frame=20 Station=0 OutputCase=ENVE CaseType=Combination StepType=Min Point=4 X2=0.5 X3=0.5 S11=-
2114.33741988286 IsS11Max=No IsS11Min=No FrameElem=20 ElemStation=0
Frame=20 Station=0.250000000000001 OutputCase=ENVE CaseType=Combination StepType=Min Point=0 X2=0
X3=0 S11=-553.749998441104 IsS11Max=No IsS11Min=No FrameElem=20 ElemStation=0.250000000000001
Frame=20 Station=0.250000000000001 OutputCase=ENVE CaseType=Combination StepType=Min Point=1 X2=-0.5
X3=-0.5 S11=1027.15915133021 IsS11Max=Yes IsS11Min=No FrameElem=20 ElemStation=0.250000000000001
Frame=20 Station=0.250000000000001 OutputCase=ENVE CaseType=Combination StepType=Min Point=2 X2=-0.5
X3=0.5 S11=1027.15915133021 IsS11Max=No IsS11Min=No FrameElem=20 ElemStation=0.250000000000001
Frame=20 Station=0.250000000000001 OutputCase=ENVE CaseType=Combination StepType=Min Point=3 X2=0.5
X3=-0.5 S11=-2171.64961852056 IsS11Max=No IsS11Min=Yes FrameElem=20 ElemStation=0.250000000000001
Frame=20 Station=0.250000000000001 OutputCase=ENVE CaseType=Combination StepType=Min Point=4 X2=0.5
X3=0.5 S11=-2171.64961852056 IsS11Max=No IsS11Min=No FrameElem=20 ElemStation=0.250000000000001

```

```

Frame=20 Station=0 OutputCase=FESSUR CaseType=Combination Point=0 X2=0 X3=0 S11=-559.99999798463
IsS11Max=No IsS11Min=No FrameElem=20 ElemStation=0
Frame=20 Station=0 OutputCase=FESSUR CaseType=Combination Point=1 X2=-0.5 X3=-0.5
S11=994.337423913596 IsS11Max=No IsS11Min=No FrameElem=20 ElemStation=0
Frame=20 Station=0 OutputCase=FESSUR CaseType=Combination Point=2 X2=-0.5 X3=0.5
S11=994.337423913596 IsS11Max=No IsS11Min=No FrameElem=20 ElemStation=0
Frame=20 Station=0 OutputCase=FESSUR CaseType=Combination Point=3 X2=0.5 X3=-0.5 S11=-
2114.33741988286 IsS11Max=No IsS11Min=Yes FrameElem=20 ElemStation=0
Frame=20 Station=0 OutputCase=FESSUR CaseType=Combination Point=4 X2=0.5 X3=0.5 S11=-
2114.33741988286 IsS11Max=No IsS11Min=No FrameElem=20 ElemStation=0
Frame=20 Station=0.2500000000000001 OutputCase=FESSUR CaseType=Combination Point=0 X2=0 X3=0 S11=-
553.749998441104 IsS11Max=No IsS11Min=No FrameElem=20 ElemStation=0.2500000000000001
Frame=20 Station=0.2500000000000001 OutputCase=FESSUR CaseType=Combination Point=1 X2=-0.5 X3=-0.5
S11=1064.14962163835 IsS11Max=Yes IsS11Min=No FrameElem=20 ElemStation=0.2500000000000001
Frame=20 Station=0.2500000000000001 OutputCase=FESSUR CaseType=Combination Point=2 X2=-0.5 X3=0.5
S11=1064.14962163835 IsS11Max=No IsS11Min=No FrameElem=20 ElemStation=0.2500000000000001
Frame=20 Station=0.2500000000000001 OutputCase=FESSUR CaseType=Combination Point=3 X2=0.5 X3=-0.5
S11=-2171.64961852056 IsS11Max=No IsS11Min=Yes FrameElem=20 ElemStation=0.2500000000000001
Frame=20 Station=0.2500000000000001 OutputCase=FESSUR CaseType=Combination Point=4 X2=0.5 X3=0.5
S11=-2171.64961852056 IsS11Max=No IsS11Min=No FrameElem=20 ElemStation=0.2500000000000001
Frame=41 Station=0 OutputCase=PESOPR CaseType=LinStatic Point=0 X2=0 X3=0 S11=-15.1709467362365
IsS11Max=No IsS11Min=No FrameElem=41 ElemStation=0
Frame=41 Station=0 OutputCase=PESOPR CaseType=LinStatic Point=1 X2=-0.5 X3=-0.5
S11=37.7162742064989 IsS11Max=Yes IsS11Min=No FrameElem=41 ElemStation=0
Frame=41 Station=0 OutputCase=PESOPR CaseType=LinStatic Point=2 X2=-0.5 X3=0.5 S11=37.7162742064989
IsS11Max=No IsS11Min=No FrameElem=41 ElemStation=0
Frame=41 Station=0 OutputCase=PESOPR CaseType=LinStatic Point=3 X2=0.5 X3=-0.5 S11=-68.058167678972
IsS11Max=No IsS11Min=Yes FrameElem=41 ElemStation=0
Frame=41 Station=0 OutputCase=PESOPR CaseType=LinStatic Point=4 X2=0.5 X3=0.5 S11=-68.058167678972
IsS11Max=No IsS11Min=No FrameElem=41 ElemStation=0
Frame=41 Station=0.125 OutputCase=PESOPR CaseType=LinStatic Point=0 X2=0 X3=0 S11=-15.1709467362365
IsS11Max=No IsS11Min=No FrameElem=41 ElemStation=0.125
Frame=41 Station=0.125 OutputCase=PESOPR CaseType=LinStatic Point=1 X2=-0.5 X3=-0.5 S11=-
43.4308728839264 IsS11Max=No IsS11Min=Yes FrameElem=41 ElemStation=0.125
Frame=41 Station=0.125 OutputCase=PESOPR CaseType=LinStatic Point=2 X2=-0.5 X3=0.5 S11=-
43.4308728839264 IsS11Max=No IsS11Min=No FrameElem=41 ElemStation=0.125
Frame=41 Station=0.125 OutputCase=PESOPR CaseType=LinStatic Point=3 X2=0.5 X3=-0.5
S11=13.0889794114533 IsS11Max=Yes IsS11Min=No FrameElem=41 ElemStation=0.125
Frame=41 Station=0.125 OutputCase=PESOPR CaseType=LinStatic Point=4 X2=0.5 X3=0.5
S11=13.0889794114533 IsS11Max=No IsS11Min=No FrameElem=41 ElemStation=0.125
Frame=41 Station=0.25 OutputCase=PESOPR CaseType=LinStatic Point=0 X2=0 X3=0 S11=-15.1709467362365
IsS11Max=No IsS11Min=No FrameElem=41 ElemStation=0.25
Frame=41 Station=0.25 OutputCase=PESOPR CaseType=LinStatic Point=1 X2=-0.5 X3=-0.5 S11=-
126.921769974352 IsS11Max=No IsS11Min=Yes FrameElem=41 ElemStation=0.25
Frame=41 Station=0.25 OutputCase=PESOPR CaseType=LinStatic Point=2 X2=-0.5 X3=0.5 S11=-
126.921769974352 IsS11Max=No IsS11Min=No FrameElem=41 ElemStation=0.25
Frame=41 Station=0.25 OutputCase=PESOPR CaseType=LinStatic Point=3 X2=0.5 X3=-0.5
S11=96.5798765018786 IsS11Max=Yes IsS11Min=No FrameElem=41 ElemStation=0.25
Frame=41 Station=0.25 OutputCase=PESOPR CaseType=LinStatic Point=4 X2=0.5 X3=0.5
S11=96.5798765018786 IsS11Max=No IsS11Min=No FrameElem=41 ElemStation=0.25
Frame=41 Station=0.375 OutputCase=PESOPR CaseType=LinStatic Point=0 X2=0 X3=0 S11=-15.1709467362365
IsS11Max=No IsS11Min=No FrameElem=41 ElemStation=0.375
Frame=41 Station=0.375 OutputCase=PESOPR CaseType=LinStatic Point=1 X2=-0.5 X3=-0.5 S11=-
212.756417064777 IsS11Max=No IsS11Min=Yes FrameElem=41 ElemStation=0.375
Frame=41 Station=0.375 OutputCase=PESOPR CaseType=LinStatic Point=2 X2=-0.5 X3=0.5 S11=-
212.756417064777 IsS11Max=No IsS11Min=No FrameElem=41 ElemStation=0.375
Frame=41 Station=0.375 OutputCase=PESOPR CaseType=LinStatic Point=3 X2=0.5 X3=-0.5
S11=182.414523592304 IsS11Max=Yes IsS11Min=No FrameElem=41 ElemStation=0.375
Frame=41 Station=0.375 OutputCase=PESOPR CaseType=LinStatic Point=4 X2=0.5 X3=0.5
S11=182.414523592304 IsS11Max=No IsS11Min=No FrameElem=41 ElemStation=0.375
Frame=41 Station=0.5 OutputCase=PESOPR CaseType=LinStatic Point=0 X2=0 X3=0 S11=-15.1709467362365
IsS11Max=No IsS11Min=No FrameElem=41 ElemStation=0.5
Frame=41 Station=0.5 OutputCase=PESOPR CaseType=LinStatic Point=1 X2=-0.5 X3=-0.5 S11=-
300.934814155202 IsS11Max=No IsS11Min=Yes FrameElem=41 ElemStation=0.5
Frame=41 Station=0.5 OutputCase=PESOPR CaseType=LinStatic Point=2 X2=-0.5 X3=0.5 S11=-
300.934814155202 IsS11Max=No IsS11Min=No FrameElem=41 ElemStation=0.5
Frame=41 Station=0.5 OutputCase=PESOPR CaseType=LinStatic Point=3 X2=0.5 X3=-0.5
S11=270.592920682729 IsS11Max=Yes IsS11Min=No FrameElem=41 ElemStation=0.5
Frame=41 Station=0.5 OutputCase=PESOPR CaseType=LinStatic Point=4 X2=0.5 X3=0.5
S11=270.592920682729 IsS11Max=No IsS11Min=No FrameElem=41 ElemStation=0.5
Frame=41 Station=0 OutputCase=TERRVERT CaseType=LinStatic Point=0 X2=0 X3=0 S11=1.15282857329472
IsS11Max=No IsS11Min=No FrameElem=41 ElemStation=0
Frame=41 Station=0 OutputCase=TERRVERT CaseType=LinStatic Point=1 X2=-0.5 X3=-0.5
S11=18.9059618637857 IsS11Max=Yes IsS11Min=No FrameElem=41 ElemStation=0
Frame=41 Station=0 OutputCase=TERRVERT CaseType=LinStatic Point=2 X2=-0.5 X3=0.5
S11=18.9059618637857 IsS11Max=No IsS11Min=No FrameElem=41 ElemStation=0
Frame=41 Station=0 OutputCase=TERRVERT CaseType=LinStatic Point=3 X2=0.5 X3=-0.5 S11=-
16.6003047171962 IsS11Max=No IsS11Min=Yes FrameElem=41 ElemStation=0
Frame=41 Station=0 OutputCase=TERRVERT CaseType=LinStatic Point=4 X2=0.5 X3=0.5 S11=-
16.6003047171962 IsS11Max=No IsS11Min=No FrameElem=41 ElemStation=0
Frame=41 Station=0.125 OutputCase=TERRVERT CaseType=LinStatic Point=0 X2=0 X3=0
S11=1.15282857329472 IsS11Max=No IsS11Min=No FrameElem=41 ElemStation=0.125

```

Frame=41	Station=0.125	OutputCase=TERRVERT	CaseType=LinStatic	Point=1	X2=-0.5	X3=-0.5	S11=-
236.87734641868	IsS11Max=No	IsS11Min=Yes	FrameElem=41	ElemStation=0.125			
Frame=41	Station=0.125	OutputCase=TERRVERT	CaseType=LinStatic	Point=2	X2=-0.5	X3=0.5	S11=-
236.87734641868	IsS11Max=No	IsS11Min=No	FrameElem=41	ElemStation=0.125			
Frame=41	Station=0.125	OutputCase=TERRVERT	CaseType=LinStatic	Point=3	X2=0.5	X3=-0.5	
S11=239.183003565269	IsS11Max=Yes	IsS11Min=No	FrameElem=41	ElemStation=0.125			
Frame=41	Station=0.125	OutputCase=TERRVERT	CaseType=LinStatic	Point=4	X2=0.5	X3=0.5	
S11=239.183003565269	IsS11Max=No	IsS11Min=No	FrameElem=41	ElemStation=0.125			
Frame=41	Station=0.25	OutputCase=TERRVERT	CaseType=LinStatic	Point=0	X2=0	X3=0	S11=1.15282857329472
IsS11Max=No	IsS11Min=No	FrameElem=41	ElemStation=0.25				
Frame=41	Station=0.25	OutputCase=TERRVERT	CaseType=LinStatic	Point=1	X2=-0.5	X3=-0.5	S11=-
492.660654701145	IsS11Max=No	IsS11Min=Yes	FrameElem=41	ElemStation=0.25			
Frame=41	Station=0.25	OutputCase=TERRVERT	CaseType=LinStatic	Point=2	X2=-0.5	X3=0.5	S11=-
492.660654701145	IsS11Max=No	IsS11Min=No	FrameElem=41	ElemStation=0.25			
Frame=41	Station=0.25	OutputCase=TERRVERT	CaseType=LinStatic	Point=3	X2=0.5	X3=-0.5	
S11=494.966311847735	IsS11Max=Yes	IsS11Min=No	FrameElem=41	ElemStation=0.25			
Frame=41	Station=0.25	OutputCase=TERRVERT	CaseType=LinStatic	Point=4	X2=0.5	X3=0.5	
S11=494.966311847735	IsS11Max=No	IsS11Min=No	FrameElem=41	ElemStation=0.25			
Frame=41	Station=0.375	OutputCase=TERRVERT	CaseType=LinStatic	Point=0	X2=0	X3=0	
S11=1.15282857329472	IsS11Max=No	IsS11Min=No	FrameElem=41	ElemStation=0.375			
Frame=41	Station=0.375	OutputCase=TERRVERT	CaseType=LinStatic	Point=1	X2=-0.5	X3=-0.5	S11=-
748.443962983611	IsS11Max=No	IsS11Min=Yes	FrameElem=41	ElemStation=0.375			
Frame=41	Station=0.375	OutputCase=TERRVERT	CaseType=LinStatic	Point=2	X2=-0.5	X3=0.5	S11=-
748.443962983611	IsS11Max=No	IsS11Min=No	FrameElem=41	ElemStation=0.375			
Frame=41	Station=0.375	OutputCase=TERRVERT	CaseType=LinStatic	Point=3	X2=0.5	X3=-0.5	
S11=750.7496201302	IsS11Max=Yes	IsS11Min=No	FrameElem=41	ElemStation=0.375			
Frame=41	Station=0.375	OutputCase=TERRVERT	CaseType=LinStatic	Point=4	X2=0.5	X3=0.5	
S11=750.7496201302	IsS11Max=No	IsS11Min=No	FrameElem=41	ElemStation=0.375			
Frame=41	Station=0.5	OutputCase=TERRVERT	CaseType=LinStatic	Point=0	X2=0	X3=0	S11=1.15282857329472
IsS11Max=No	IsS11Min=No	FrameElem=41	ElemStation=0.5				
Frame=41	Station=0.5	OutputCase=TERRVERT	CaseType=LinStatic	Point=1	X2=-0.5	X3=-0.5	S11=-
1004.22727126608	IsS11Max=No	IsS11Min=Yes	FrameElem=41	ElemStation=0.5			
Frame=41	Station=0.5	OutputCase=TERRVERT	CaseType=LinStatic	Point=2	X2=-0.5	X3=0.5	S11=-
1004.22727126608	IsS11Max=No	IsS11Min=No	FrameElem=41	ElemStation=0.5			
Frame=41	Station=0.5	OutputCase=TERRVERT	CaseType=LinStatic	Point=3	X2=0.5	X3=-0.5	
S11=1006.53292841267	IsS11Max=Yes	IsS11Min=No	FrameElem=41	ElemStation=0.5			
Frame=41	Station=0.5	OutputCase=TERRVERT	CaseType=LinStatic	Point=4	X2=0.5	X3=0.5	
S11=1006.53292841267	IsS11Max=No	IsS11Min=No	FrameElem=41	ElemStation=0.5			
Frame=41	Station=0	OutputCase=TERRLAT	CaseType=LinStatic	Point=0	X2=0	X3=0	S11=-108.958200979145
IsS11Max=No	IsS11Min=No	FrameElem=41	ElemStation=0				
Frame=41	Station=0	OutputCase=TERRLAT	CaseType=LinStatic	Point=1	X2=-0.5	X3=-0.5	
S11=17.8997589691093	IsS11Max=Yes	IsS11Min=No	FrameElem=41	ElemStation=0			
Frame=41	Station=0	OutputCase=TERRLAT	CaseType=LinStatic	Point=2	X2=-0.5	X3=0.5	
S11=17.8997589691093	IsS11Max=No	IsS11Min=No	FrameElem=41	ElemStation=0			
Frame=41	Station=0	OutputCase=TERRLAT	CaseType=LinStatic	Point=3	X2=0.5	X3=-0.5	S11=-
235.816160927399	IsS11Max=No	IsS11Min=Yes	FrameElem=41	ElemStation=0			
Frame=41	Station=0	OutputCase=TERRLAT	CaseType=LinStatic	Point=4	X2=0.5	X3=0.5	S11=-
235.816160927399	IsS11Max=No	IsS11Min=No	FrameElem=41	ElemStation=0			
Frame=41	Station=0.125	OutputCase=TERRLAT	CaseType=LinStatic	Point=0	X2=0	X3=0	S11=-
108.958200979145	IsS11Max=No	IsS11Min=No	FrameElem=41	ElemStation=0.125			
Frame=41	Station=0.125	OutputCase=TERRLAT	CaseType=LinStatic	Point=1	X2=-0.5	X3=-0.5	
S11=17.7667816933246	IsS11Max=Yes	IsS11Min=No	FrameElem=41	ElemStation=0.125			
Frame=41	Station=0.125	OutputCase=TERRLAT	CaseType=LinStatic	Point=2	X2=-0.5	X3=0.5	
S11=17.7667816933246	IsS11Max=No	IsS11Min=No	FrameElem=41	ElemStation=0.125			
Frame=41	Station=0.125	OutputCase=TERRLAT	CaseType=LinStatic	Point=3	X2=0.5	X3=-0.5	S11=-
235.683183651614	IsS11Max=No	IsS11Min=Yes	FrameElem=41	ElemStation=0.125			
Frame=41	Station=0.125	OutputCase=TERRLAT	CaseType=LinStatic	Point=4	X2=0.5	X3=0.5	S11=-
235.683183651614	IsS11Max=No	IsS11Min=No	FrameElem=41	ElemStation=0.125			
Frame=41	Station=0.25	OutputCase=TERRLAT	CaseType=LinStatic	Point=0	X2=0	X3=0	S11=-108.958200979145
IsS11Max=No	IsS11Min=No	FrameElem=41	ElemStation=0.25				
Frame=41	Station=0.25	OutputCase=TERRLAT	CaseType=LinStatic	Point=1	X2=-0.5	X3=-0.5	
S11=17.63380441754	IsS11Max=Yes	IsS11Min=No	FrameElem=41	ElemStation=0.25			
Frame=41	Station=0.25	OutputCase=TERRLAT	CaseType=LinStatic	Point=2	X2=-0.5	X3=0.5	
S11=17.63380441754	IsS11Max=No	IsS11Min=No	FrameElem=41	ElemStation=0.25			
Frame=41	Station=0.25	OutputCase=TERRLAT	CaseType=LinStatic	Point=3	X2=0.5	X3=-0.5	S11=-
235.550206375829	IsS11Max=No	IsS11Min=Yes	FrameElem=41	ElemStation=0.25			
Frame=41	Station=0.25	OutputCase=TERRLAT	CaseType=LinStatic	Point=4	X2=0.5	X3=0.5	S11=-
235.550206375829	IsS11Max=No	IsS11Min=No	FrameElem=41	ElemStation=0.25			
Frame=41	Station=0.375	OutputCase=TERRLAT	CaseType=LinStatic	Point=0	X2=0	X3=0	S11=-
108.958200979145	IsS11Max=No	IsS11Min=No	FrameElem=41	ElemStation=0.375			
Frame=41	Station=0.375	OutputCase=TERRLAT	CaseType=LinStatic	Point=1	X2=-0.5	X3=-0.5	
S11=17.5008271417553	IsS11Max=Yes	IsS11Min=No	FrameElem=41	ElemStation=0.375			
Frame=41	Station=0.375	OutputCase=TERRLAT	CaseType=LinStatic	Point=2	X2=-0.5	X3=0.5	
S11=17.5008271417553	IsS11Max=No	IsS11Min=No	FrameElem=41	ElemStation=0.375			
Frame=41	Station=0.375	OutputCase=TERRLAT	CaseType=LinStatic	Point=3	X2=0.5	X3=-0.5	S11=-
235.417229100045	IsS11Max=No	IsS11Min=Yes	FrameElem=41	ElemStation=0.375			
Frame=41	Station=0.375	OutputCase=TERRLAT	CaseType=LinStatic	Point=4	X2=0.5	X3=0.5	S11=-
235.417229100045	IsS11Max=No	IsS11Min=No	FrameElem=41	ElemStation=0.375			
Frame=41	Station=0.5	OutputCase=TERRLAT	CaseType=LinStatic	Point=0	X2=0	X3=0	S11=-108.958200979145
IsS11Max=No	IsS11Min=No	FrameElem=41	ElemStation=0.5				
Frame=41	Station=0.5	OutputCase=TERRLAT	CaseType=LinStatic	Point=1	X2=-0.5	X3=-0.5	
S11=17.3678498659706	IsS11Max=Yes	IsS11Min=No	FrameElem=41	ElemStation=0.5			

Frame=41	Station=0	OutputCase=SOVRCOST	CaseType=LinStatic	Point=4	X2=0.5	X3=0.5	S11=0	IsS11Max=No
IsS11Min=No	FrameElem=41	ElemStation=0						
Frame=41	Station=0.125	OutputCase=SOVRCOST	CaseType=LinStatic	Point=0	X2=0	X3=0	S11=0	
IsS11Max=Yes	IsS11Min=Yes	FrameElem=41	ElemStation=0.125					
Frame=41	Station=0.125	OutputCase=SOVRCOST	CaseType=LinStatic	Point=1	X2=-0.5	X3=-0.5	S11=0	
IsS11Max=No	IsS11Min=No	FrameElem=41	ElemStation=0.125					
Frame=41	Station=0.125	OutputCase=SOVRCOST	CaseType=LinStatic	Point=2	X2=-0.5	X3=0.5	S11=0	
IsS11Max=No	IsS11Min=No	FrameElem=41	ElemStation=0.125					
Frame=41	Station=0.125	OutputCase=SOVRCOST	CaseType=LinStatic	Point=3	X2=0.5	X3=-0.5	S11=0	
IsS11Max=No	IsS11Min=No	FrameElem=41	ElemStation=0.125					
Frame=41	Station=0.125	OutputCase=SOVRCOST	CaseType=LinStatic	Point=4	X2=0.5	X3=0.5	S11=0	
IsS11Max=No	IsS11Min=No	FrameElem=41	ElemStation=0.125					
Frame=41	Station=0.25	OutputCase=SOVRCOST	CaseType=LinStatic	Point=0	X2=0	X3=0	S11=0	IsS11Max=Yes
IsS11Min=Yes	FrameElem=41	ElemStation=0.25						
Frame=41	Station=0.25	OutputCase=SOVRCOST	CaseType=LinStatic	Point=1	X2=-0.5	X3=-0.5	S11=0	
IsS11Max=No	IsS11Min=No	FrameElem=41	ElemStation=0.25					
Frame=41	Station=0.25	OutputCase=SOVRCOST	CaseType=LinStatic	Point=2	X2=-0.5	X3=0.5	S11=0	
IsS11Max=No	IsS11Min=No	FrameElem=41	ElemStation=0.25					
Frame=41	Station=0.25	OutputCase=SOVRCOST	CaseType=LinStatic	Point=3	X2=0.5	X3=-0.5	S11=0	
IsS11Max=No	IsS11Min=No	FrameElem=41	ElemStation=0.25					
Frame=41	Station=0.25	OutputCase=SOVRCOST	CaseType=LinStatic	Point=4	X2=0.5	X3=0.5	S11=0	
IsS11Max=No	IsS11Min=No	FrameElem=41	ElemStation=0.25					
Frame=41	Station=0.375	OutputCase=SOVRCOST	CaseType=LinStatic	Point=0	X2=0	X3=0	S11=0	
IsS11Max=Yes	IsS11Min=Yes	FrameElem=41	ElemStation=0.375					
Frame=41	Station=0.375	OutputCase=SOVRCOST	CaseType=LinStatic	Point=1	X2=-0.5	X3=-0.5	S11=0	
IsS11Max=No	IsS11Min=No	FrameElem=41	ElemStation=0.375					
Frame=41	Station=0.375	OutputCase=SOVRCOST	CaseType=LinStatic	Point=2	X2=-0.5	X3=0.5	S11=0	
IsS11Max=No	IsS11Min=No	FrameElem=41	ElemStation=0.375					
Frame=41	Station=0.375	OutputCase=SOVRCOST	CaseType=LinStatic	Point=3	X2=0.5	X3=-0.5	S11=0	
IsS11Max=No	IsS11Min=No	FrameElem=41	ElemStation=0.375					
Frame=41	Station=0.375	OutputCase=SOVRCOST	CaseType=LinStatic	Point=4	X2=0.5	X3=0.5	S11=0	
IsS11Max=No	IsS11Min=No	FrameElem=41	ElemStation=0.375					
Frame=41	Station=0.5	OutputCase=SOVRCOST	CaseType=LinStatic	Point=0	X2=0	X3=0	S11=0	IsS11Max=Yes
IsS11Min=Yes	FrameElem=41	ElemStation=0.5						
Frame=41	Station=0.5	OutputCase=SOVRCOST	CaseType=LinStatic	Point=1	X2=-0.5	X3=-0.5	S11=0	
IsS11Max=No	IsS11Min=No	FrameElem=41	ElemStation=0.5					
Frame=41	Station=0.5	OutputCase=SOVRCOST	CaseType=LinStatic	Point=2	X2=-0.5	X3=0.5	S11=0	
IsS11Max=No	IsS11Min=No	FrameElem=41	ElemStation=0.5					
Frame=41	Station=0.5	OutputCase=SOVRCOST	CaseType=LinStatic	Point=3	X2=0.5	X3=-0.5	S11=0	
IsS11Max=No	IsS11Min=No	FrameElem=41	ElemStation=0.5					
Frame=41	Station=0.5	OutputCase=SOVRCOST	CaseType=LinStatic	Point=4	X2=0.5	X3=0.5	S11=0	
IsS11Max=No	IsS11Min=No	FrameElem=41	ElemStation=0.5					
Frame=41	Station=0	OutputCase=ENVE	CaseType=Combination	StepType=Max	Point=0	X2=0	X3=0	S11=-
90.2888588483431	IsS11Max=No	IsS11Min=No	FrameElem=41	ElemStation=0				
Frame=41	Station=0	OutputCase=ENVE	CaseType=Combination	StepType=Max	Point=1	X2=-0.5	X3=-0.5	
S11=74.5219950393939	IsS11Max=Yes	IsS11Min=No	FrameElem=41	ElemStation=0				
Frame=41	Station=0	OutputCase=ENVE	CaseType=Combination	StepType=Max	Point=2	X2=-0.5	X3=0.5	
S11=74.5219950393939	IsS11Max=No	IsS11Min=No	FrameElem=41	ElemStation=0				
Frame=41	Station=0	OutputCase=ENVE	CaseType=Combination	StepType=Max	Point=3	X2=0.5	X3=-0.5	S11=-
249.729785045347	IsS11Max=No	IsS11Min=Yes	FrameElem=41	ElemStation=0				
Frame=41	Station=0	OutputCase=ENVE	CaseType=Combination	StepType=Max	Point=4	X2=0.5	X3=0.5	S11=-
249.729785045347	IsS11Max=No	IsS11Min=No	FrameElem=41	ElemStation=0				
Frame=41	Station=0.125	OutputCase=ENVE	CaseType=Combination	StepType=Max	Point=0	X2=0	X3=0	S11=-
90.2888588483431	IsS11Max=No	IsS11Min=No	FrameElem=41	ElemStation=0.125				
Frame=41	Station=0.125	OutputCase=ENVE	CaseType=Combination	StepType=Max	Point=1	X2=-0.5	X3=-0.5	
S11=-262.541437609282	IsS11Max=No	IsS11Min=Yes	FrameElem=41	ElemStation=0.125				
Frame=41	Station=0.125	OutputCase=ENVE	CaseType=Combination	StepType=Max	Point=2	X2=-0.5	X3=0.5	
S11=-262.541437609282	IsS11Max=No	IsS11Min=No	FrameElem=41	ElemStation=0.125				
Frame=41	Station=0.125	OutputCase=ENVE	CaseType=Combination	StepType=Max	Point=3	X2=0.5	X3=-0.5	
S11=87.2937544205926	IsS11Max=Yes	IsS11Min=No	FrameElem=41	ElemStation=0.125				
Frame=41	Station=0.125	OutputCase=ENVE	CaseType=Combination	StepType=Max	Point=4	X2=0.5	X3=0.5	
S11=87.2937544205926	IsS11Max=No	IsS11Min=No	FrameElem=41	ElemStation=0.125				
Frame=41	Station=0.25	OutputCase=ENVE	CaseType=Combination	StepType=Max	Point=0	X2=0	X3=0	S11=-
90.2888588483431	IsS11Max=No	IsS11Min=No	FrameElem=41	ElemStation=0.25				
Frame=41	Station=0.25	OutputCase=ENVE	CaseType=Combination	StepType=Max	Point=1	X2=-0.5	X3=-0.5	
S11=-601.948620257957	IsS11Max=No	IsS11Min=Yes	FrameElem=41	ElemStation=0.25				
Frame=41	Station=0.25	OutputCase=ENVE	CaseType=Combination	StepType=Max	Point=2	X2=-0.5	X3=0.5	
S11=-601.948620257957	IsS11Max=No	IsS11Min=No	FrameElem=41	ElemStation=0.25				
Frame=41	Station=0.25	OutputCase=ENVE	CaseType=Combination	StepType=Max	Point=3	X2=0.5	X3=-0.5	
S11=426.661043886533	IsS11Max=Yes	IsS11Min=No	FrameElem=41	ElemStation=0.25				
Frame=41	Station=0.25	OutputCase=ENVE	CaseType=Combination	StepType=Max	Point=4	X2=0.5	X3=0.5	
S11=426.661043886533	IsS11Max=No	IsS11Min=No	FrameElem=41	ElemStation=0.25				
Frame=41	Station=0.375	OutputCase=ENVE	CaseType=Combination	StepType=Max	Point=0	X2=0	X3=0	S11=-
90.2888588483431	IsS11Max=No	IsS11Min=No	FrameElem=41	ElemStation=0.375				
Frame=41	Station=0.375	OutputCase=ENVE	CaseType=Combination	StepType=Max	Point=1	X2=-0.5	X3=-0.5	
S11=-943.699552906632	IsS11Max=No	IsS11Min=Yes	FrameElem=41	ElemStation=0.375				
Frame=41	Station=0.375	OutputCase=ENVE	CaseType=Combination	StepType=Max	Point=2	X2=-0.5	X3=0.5	
S11=-943.699552906632	IsS11Max=No	IsS11Min=No	FrameElem=41	ElemStation=0.375				
Frame=41	Station=0.375	OutputCase=ENVE	CaseType=Combination	StepType=Max	Point=3	X2=0.5	X3=-0.5	
S11=768.372083352473	IsS11Max=Yes	IsS11Min=No	FrameElem=41	ElemStation=0.375				
Frame=41	Station=0.375	OutputCase=ENVE	CaseType=Combination	StepType=Max	Point=4	X2=0.5	X3=0.5	
S11=768.372083352473	IsS11Max=No	IsS11Min=No	FrameElem=41	ElemStation=0.375				

Frame=41	Station=0.5	OutputCase=ENVE	CaseType=Combination	StepType=Max	Point=0	X2=0	X3=0	S11=-
90.2888588483431	IsS11Max=No	IsS11Min=No	FrameElem=41	ElemStation=0.5				
Frame=41	Station=0.5	OutputCase=ENVE	CaseType=Combination	StepType=Max	Point=1	X2=-0.5	X3=-0.5	
S11=-1287.79423555531	IsS11Max=No	IsS11Min=Yes	FrameElem=41	ElemStation=0.5				
Frame=41	Station=0.5	OutputCase=ENVE	CaseType=Combination	StepType=Max	Point=2	X2=-0.5	X3=0.5	
S11=-1287.79423555531	IsS11Max=No	IsS11Min=No	FrameElem=41	ElemStation=0.5				
Frame=41	Station=0.5	OutputCase=ENVE	CaseType=Combination	StepType=Max	Point=3	X2=0.5	X3=-0.5	
S11=1112.42687281841	IsS11Max=Yes	IsS11Min=No	FrameElem=41	ElemStation=0.5				
Frame=41	Station=0.5	OutputCase=ENVE	CaseType=Combination	StepType=Max	Point=4	X2=0.5	X3=0.5	
S11=1112.42687281841	IsS11Max=No	IsS11Min=No	FrameElem=41	ElemStation=0.5				
Frame=41	Station=0	OutputCase=ENVE	CaseType=Combination	StepType=Min	Point=0	X2=0	X3=0	S11=-
122.976319142087	IsS11Max=No	IsS11Min=No	FrameElem=41	ElemStation=0				
Frame=41	Station=0	OutputCase=ENVE	CaseType=Combination	StepType=Min	Point=1	X2=-0.5	X3=-0.5	
S11=69.1520673486611	IsS11Max=Yes	IsS11Min=No	FrameElem=41	ElemStation=0				
Frame=41	Station=0	OutputCase=ENVE	CaseType=Combination	StepType=Min	Point=2	X2=-0.5	X3=0.5	
S11=69.1520673486611	IsS11Max=No	IsS11Min=No	FrameElem=41	ElemStation=0				
Frame=41	Station=0	OutputCase=ENVE	CaseType=Combination	StepType=Min	Point=3	X2=0.5	X3=-0.5	S11=-
320.47463323567	IsS11Max=No	IsS11Min=Yes	FrameElem=41	ElemStation=0				
Frame=41	Station=0	OutputCase=ENVE	CaseType=Combination	StepType=Min	Point=4	X2=0.5	X3=0.5	S11=-
320.47463323567	IsS11Max=No	IsS11Min=No	FrameElem=41	ElemStation=0				
Frame=41	Station=0.125	OutputCase=ENVE	CaseType=Combination	StepType=Min	Point=0	X2=0	X3=0	S11=-
122.976319142087	IsS11Max=No	IsS11Min=No	FrameElem=41	ElemStation=0.125				
Frame=41	Station=0.125	OutputCase=ENVE	CaseType=Combination	StepType=Min	Point=1	X2=-0.5	X3=-0.5	
S11=-267.871472117279	IsS11Max=No	IsS11Min=Yes	FrameElem=41	ElemStation=0.125				
Frame=41	Station=0.125	OutputCase=ENVE	CaseType=Combination	StepType=Min	Point=2	X2=-0.5	X3=0.5	
S11=-267.871472117279	IsS11Max=No	IsS11Min=No	FrameElem=41	ElemStation=0.125				
Frame=41	Station=0.125	OutputCase=ENVE	CaseType=Combination	StepType=Min	Point=3	X2=0.5	X3=-0.5	
S11=16.5887993251084	IsS11Max=Yes	IsS11Min=No	FrameElem=41	ElemStation=0.125				
Frame=41	Station=0.125	OutputCase=ENVE	CaseType=Combination	StepType=Min	Point=4	X2=0.5	X3=0.5	
S11=16.5887993251084	IsS11Max=No	IsS11Min=No	FrameElem=41	ElemStation=0.125				
Frame=41	Station=0.25	OutputCase=ENVE	CaseType=Combination	StepType=Min	Point=0	X2=0	X3=0	S11=-
122.976319142087	IsS11Max=No	IsS11Min=No	FrameElem=41	ElemStation=0.25				
Frame=41	Station=0.25	OutputCase=ENVE	CaseType=Combination	StepType=Min	Point=1	X2=-0.5	X3=-0.5	
S11=-607.238761583219	IsS11Max=No	IsS11Min=Yes	FrameElem=41	ElemStation=0.25				
Frame=41	Station=0.25	OutputCase=ENVE	CaseType=Combination	StepType=Min	Point=2	X2=-0.5	X3=0.5	
S11=-607.238761583219	IsS11Max=No	IsS11Min=No	FrameElem=41	ElemStation=0.25				
Frame=41	Station=0.25	OutputCase=ENVE	CaseType=Combination	StepType=Min	Point=3	X2=0.5	X3=-0.5	
S11=355.995981973784	IsS11Max=Yes	IsS11Min=No	FrameElem=41	ElemStation=0.25				
Frame=41	Station=0.25	OutputCase=ENVE	CaseType=Combination	StepType=Min	Point=4	X2=0.5	X3=0.5	
S11=355.995981973784	IsS11Max=No	IsS11Min=No	FrameElem=41	ElemStation=0.25				
Frame=41	Station=0.375	OutputCase=ENVE	CaseType=Combination	StepType=Min	Point=0	X2=0	X3=0	S11=-
122.976319142087	IsS11Max=No	IsS11Min=No	FrameElem=41	ElemStation=0.375				
Frame=41	Station=0.375	OutputCase=ENVE	CaseType=Combination	StepType=Min	Point=1	X2=-0.5	X3=-0.5	
S11=-948.949801049159	IsS11Max=No	IsS11Min=Yes	FrameElem=41	ElemStation=0.375				
Frame=41	Station=0.375	OutputCase=ENVE	CaseType=Combination	StepType=Min	Point=2	X2=-0.5	X3=0.5	
S11=-948.949801049159	IsS11Max=No	IsS11Min=No	FrameElem=41	ElemStation=0.375				
Frame=41	Station=0.375	OutputCase=ENVE	CaseType=Combination	StepType=Min	Point=3	X2=0.5	X3=-0.5	
S11=697.746914622459	IsS11Max=Yes	IsS11Min=No	FrameElem=41	ElemStation=0.375				
Frame=41	Station=0.375	OutputCase=ENVE	CaseType=Combination	StepType=Min	Point=4	X2=0.5	X3=0.5	
S11=697.746914622459	IsS11Max=No	IsS11Min=No	FrameElem=41	ElemStation=0.375				
Frame=41	Station=0.5	OutputCase=ENVE	CaseType=Combination	StepType=Min	Point=0	X2=0	X3=0	S11=-
122.976319142087	IsS11Max=No	IsS11Min=No	FrameElem=41	ElemStation=0.5				
Frame=41	Station=0.5	OutputCase=ENVE	CaseType=Combination	StepType=Min	Point=1	X2=-0.5	X3=-0.5	
S11=-1293.0045905151	IsS11Max=No	IsS11Min=Yes	FrameElem=41	ElemStation=0.5				
Frame=41	Station=0.5	OutputCase=ENVE	CaseType=Combination	StepType=Min	Point=2	X2=-0.5	X3=0.5	
S11=-1293.0045905151	IsS11Max=No	IsS11Min=No	FrameElem=41	ElemStation=0.5				
Frame=41	Station=0.5	OutputCase=ENVE	CaseType=Combination	StepType=Min	Point=3	X2=0.5	X3=-0.5	
S11=1041.84159727113	IsS11Max=Yes	IsS11Min=No	FrameElem=41	ElemStation=0.5				
Frame=41	Station=0.5	OutputCase=ENVE	CaseType=Combination	StepType=Min	Point=4	X2=0.5	X3=0.5	
S11=1041.84159727113	IsS11Max=No	IsS11Min=No	FrameElem=41	ElemStation=0.5				
Frame=41	Station=0	OutputCase=FESSUR	CaseType=Combination	Point=0	X2=0	X3=0	S11=-122.976319142087	
IsS11Max=No	IsS11Min=No	FrameElem=41	ElemStation=0					
Frame=41	Station=0	OutputCase=FESSUR	CaseType=Combination	Point=1	X2=-0.5	X3=-0.5		
S11=74.5219950393939	IsS11Max=Yes	IsS11Min=No	FrameElem=41	ElemStation=0				
Frame=41	Station=0	OutputCase=FESSUR	CaseType=Combination	Point=2	X2=-0.5	X3=0.5		
S11=74.5219950393939	IsS11Max=No	IsS11Min=No	FrameElem=41	ElemStation=0				
Frame=41	Station=0	OutputCase=FESSUR	CaseType=Combination	Point=3	X2=0.5	X3=-0.5	S11=-	
320.47463323567	IsS11Max=No	IsS11Min=Yes	FrameElem=41	ElemStation=0				
Frame=41	Station=0	OutputCase=FESSUR	CaseType=Combination	Point=4	X2=0.5	X3=0.5	S11=-	
320.47463323567	IsS11Max=No	IsS11Min=No	FrameElem=41	ElemStation=0				
Frame=41	Station=0.125	OutputCase=FESSUR	CaseType=Combination	Point=0	X2=0	X3=0	S11=-	
122.976319142087	IsS11Max=No	IsS11Min=No	FrameElem=41	ElemStation=0.125				
Frame=41	Station=0.125	OutputCase=FESSUR	CaseType=Combination	Point=1	X2=-0.5	X3=-0.5	S11=-	
262.541437609282	IsS11Max=No	IsS11Min=Yes	FrameElem=41	ElemStation=0.125				
Frame=41	Station=0.125	OutputCase=FESSUR	CaseType=Combination	Point=2	X2=-0.5	X3=0.5	S11=-	
262.541437609282	IsS11Max=No	IsS11Min=No	FrameElem=41	ElemStation=0.125				
Frame=41	Station=0.125	OutputCase=FESSUR	CaseType=Combination	Point=3	X2=0.5	X3=-0.5		
S11=16.5887993251084	IsS11Max=Yes	IsS11Min=No	FrameElem=41	ElemStation=0.125				
Frame=41	Station=0.125	OutputCase=FESSUR	CaseType=Combination	Point=4	X2=0.5	X3=0.5		
S11=16.5887993251084	IsS11Max=No	IsS11Min=No	FrameElem=41	ElemStation=0.125				
Frame=41	Station=0.25	OutputCase=FESSUR	CaseType=Combination	Point=0	X2=0	X3=0	S11=-	
122.976319142087	IsS11Max=No	IsS11Min=No	FrameElem=41	ElemStation=0.25				

Frame=41	Station=0.25	OutputCase=FESSUR	CaseType=Combination	Point=1	X2=-0.5	X3=-0.5	S11=-
601.948620257957	IsS11Max=No	IsS11Min=Yes	FrameElem=41	ElemStation=0.25			
Frame=41	Station=0.25	OutputCase=FESSUR	CaseType=Combination	Point=2	X2=-0.5	X3=0.5	S11=-
601.948620257957	IsS11Max=No	IsS11Min=No	FrameElem=41	ElemStation=0.25			
Frame=41	Station=0.25	OutputCase=FESSUR	CaseType=Combination	Point=3	X2=0.5	X3=-0.5	
S11=355.995981973784	IsS11Max=Yes	IsS11Min=No	FrameElem=41	ElemStation=0.25			
Frame=41	Station=0.25	OutputCase=FESSUR	CaseType=Combination	Point=4	X2=0.5	X3=0.5	
S11=355.995981973784	IsS11Max=No	IsS11Min=No	FrameElem=41	ElemStation=0.25			
Frame=41	Station=0.375	OutputCase=FESSUR	CaseType=Combination	Point=0	X2=0	X3=0	S11=-
122.976319142087	IsS11Max=No	IsS11Min=No	FrameElem=41	ElemStation=0.375			
Frame=41	Station=0.375	OutputCase=FESSUR	CaseType=Combination	Point=1	X2=-0.5	X3=-0.5	S11=-
943.699552906632	IsS11Max=No	IsS11Min=Yes	FrameElem=41	ElemStation=0.375			
Frame=41	Station=0.375	OutputCase=FESSUR	CaseType=Combination	Point=2	X2=-0.5	X3=0.5	S11=-
943.699552906632	IsS11Max=No	IsS11Min=No	FrameElem=41	ElemStation=0.375			
Frame=41	Station=0.375	OutputCase=FESSUR	CaseType=Combination	Point=3	X2=0.5	X3=-0.5	
S11=697.746914622459	IsS11Max=Yes	IsS11Min=No	FrameElem=41	ElemStation=0.375			
Frame=41	Station=0.375	OutputCase=FESSUR	CaseType=Combination	Point=4	X2=0.5	X3=0.5	
S11=697.746914622459	IsS11Max=No	IsS11Min=No	FrameElem=41	ElemStation=0.375			
Frame=41	Station=0.5	OutputCase=FESSUR	CaseType=Combination	Point=0	X2=0	X3=0	S11=-122.976319142087
IsS11Max=No	IsS11Min=No	FrameElem=41	ElemStation=0.5				
Frame=41	Station=0.5	OutputCase=FESSUR	CaseType=Combination	Point=1	X2=-0.5	X3=-0.5	S11=-
1287.7942355531	IsS11Max=No	IsS11Min=Yes	FrameElem=41	ElemStation=0.5			
Frame=41	Station=0.5	OutputCase=FESSUR	CaseType=Combination	Point=2	X2=-0.5	X3=0.5	S11=-
1287.7942355531	IsS11Max=No	IsS11Min=No	FrameElem=41	ElemStation=0.5			
Frame=41	Station=0.5	OutputCase=FESSUR	CaseType=Combination	Point=3	X2=0.5	X3=-0.5	
S11=1041.84159727113	IsS11Max=Yes	IsS11Min=No	FrameElem=41	ElemStation=0.5			
Frame=41	Station=0.5	OutputCase=FESSUR	CaseType=Combination	Point=4	X2=0.5	X3=0.5	
S11=1041.84159727113	IsS11Max=No	IsS11Min=No	FrameElem=41	ElemStation=0.5			
Frame=42	Station=0	OutputCase=PESOPR	CaseType=LinStatic	Point=0	X2=0	X3=0	S11=-15.1709467362365
IsS11Max=No	IsS11Min=No	FrameElem=42	ElemStation=0				
Frame=42	Station=0	OutputCase=PESOPR	CaseType=LinStatic	Point=1	X2=-0.5	X3=-0.5	S11=-
300.934814155246	IsS11Max=No	IsS11Min=Yes	FrameElem=42	ElemStation=0			
Frame=42	Station=0	OutputCase=PESOPR	CaseType=LinStatic	Point=2	X2=-0.5	X3=0.5	S11=-
300.934814155246	IsS11Max=No	IsS11Min=No	FrameElem=42	ElemStation=0			
Frame=42	Station=0	OutputCase=PESOPR	CaseType=LinStatic	Point=3	X2=0.5	X3=-0.5	S11=270.592920682773
IsS11Max=Yes	IsS11Min=No	FrameElem=42	ElemStation=0				
Frame=42	Station=0	OutputCase=PESOPR	CaseType=LinStatic	Point=4	X2=0.5	X3=0.5	S11=270.592920682773
IsS11Max=No	IsS11Min=No	FrameElem=42	ElemStation=0				
Frame=42	Station=0.125	OutputCase=PESOPR	CaseType=LinStatic	Point=0	X2=0	X3=0	S11=-15.1709467362365
IsS11Max=No	IsS11Min=No	FrameElem=42	ElemStation=0.125				
Frame=42	Station=0.125	OutputCase=PESOPR	CaseType=LinStatic	Point=1	X2=-0.5	X3=-0.5	S11=-
357.652089761561	IsS11Max=No	IsS11Min=Yes	FrameElem=42	ElemStation=0.125			
Frame=42	Station=0.125	OutputCase=PESOPR	CaseType=LinStatic	Point=2	X2=-0.5	X3=0.5	S11=-
357.652089761561	IsS11Max=No	IsS11Min=No	FrameElem=42	ElemStation=0.125			
Frame=42	Station=0.125	OutputCase=PESOPR	CaseType=LinStatic	Point=3	X2=0.5	X3=-0.5	
S11=327.310196289088	IsS11Max=Yes	IsS11Min=No	FrameElem=42	ElemStation=0.125			
Frame=42	Station=0.125	OutputCase=PESOPR	CaseType=LinStatic	Point=4	X2=0.5	X3=0.5	
S11=327.310196289088	IsS11Max=No	IsS11Min=No	FrameElem=42	ElemStation=0.125			
Frame=42	Station=0.25	OutputCase=PESOPR	CaseType=LinStatic	Point=0	X2=0	X3=0	S11=-15.1709467362365
IsS11Max=No	IsS11Min=No	FrameElem=42	ElemStation=0.25				
Frame=42	Station=0.25	OutputCase=PESOPR	CaseType=LinStatic	Point=1	X2=-0.5	X3=-0.5	S11=-
416.713115367877	IsS11Max=No	IsS11Min=Yes	FrameElem=42	ElemStation=0.25			
Frame=42	Station=0.25	OutputCase=PESOPR	CaseType=LinStatic	Point=2	X2=-0.5	X3=0.5	S11=-
416.713115367877	IsS11Max=No	IsS11Min=No	FrameElem=42	ElemStation=0.25			
Frame=42	Station=0.25	OutputCase=PESOPR	CaseType=LinStatic	Point=3	X2=0.5	X3=-0.5	
S11=386.371221895404	IsS11Max=Yes	IsS11Min=No	FrameElem=42	ElemStation=0.25			
Frame=42	Station=0.25	OutputCase=PESOPR	CaseType=LinStatic	Point=4	X2=0.5	X3=0.5	
S11=386.371221895404	IsS11Max=No	IsS11Min=No	FrameElem=42	ElemStation=0.25			
Frame=42	Station=0.375	OutputCase=PESOPR	CaseType=LinStatic	Point=0	X2=0	X3=0	S11=-15.1709467362365
IsS11Max=No	IsS11Min=No	FrameElem=42	ElemStation=0.375				
Frame=42	Station=0.375	OutputCase=PESOPR	CaseType=LinStatic	Point=1	X2=-0.5	X3=-0.5	S11=-
478.117890974192	IsS11Max=No	IsS11Min=Yes	FrameElem=42	ElemStation=0.375			
Frame=42	Station=0.375	OutputCase=PESOPR	CaseType=LinStatic	Point=2	X2=-0.5	X3=0.5	S11=-
478.117890974192	IsS11Max=No	IsS11Min=No	FrameElem=42	ElemStation=0.375			
Frame=42	Station=0.375	OutputCase=PESOPR	CaseType=LinStatic	Point=3	X2=0.5	X3=-0.5	
S11=447.775997501719	IsS11Max=Yes	IsS11Min=No	FrameElem=42	ElemStation=0.375			
Frame=42	Station=0.375	OutputCase=PESOPR	CaseType=LinStatic	Point=4	X2=0.5	X3=0.5	
S11=447.775997501719	IsS11Max=No	IsS11Min=No	FrameElem=42	ElemStation=0.375			
Frame=42	Station=0.5	OutputCase=PESOPR	CaseType=LinStatic	Point=0	X2=0	X3=0	S11=-15.1709467362365
IsS11Max=No	IsS11Min=No	FrameElem=42	ElemStation=0.5				
Frame=42	Station=0.5	OutputCase=PESOPR	CaseType=LinStatic	Point=1	X2=-0.5	X3=-0.5	S11=-
541.866416580508	IsS11Max=No	IsS11Min=Yes	FrameElem=42	ElemStation=0.5			
Frame=42	Station=0.5	OutputCase=PESOPR	CaseType=LinStatic	Point=2	X2=-0.5	X3=0.5	S11=-
541.866416580508	IsS11Max=No	IsS11Min=No	FrameElem=42	ElemStation=0.5			
Frame=42	Station=0.5	OutputCase=PESOPR	CaseType=LinStatic	Point=3	X2=0.5	X3=-0.5	
S11=511.524523108035	IsS11Max=Yes	IsS11Min=No	FrameElem=42	ElemStation=0.5			
Frame=42	Station=0.5	OutputCase=PESOPR	CaseType=LinStatic	Point=4	X2=0.5	X3=0.5	
S11=511.524523108035	IsS11Max=No	IsS11Min=No	FrameElem=42	ElemStation=0.5			
Frame=42	Station=0	OutputCase=TERRVERT	CaseType=LinStatic	Point=0	X2=0	X3=0	S11=1.15282857329472
IsS11Max=No	IsS11Min=No	FrameElem=42	ElemStation=0				
Frame=42	Station=0	OutputCase=TERRVERT	CaseType=LinStatic	Point=1	X2=-0.5	X3=-0.5	S11=-
1004.22727126612	IsS11Max=No	IsS11Min=Yes	FrameElem=42	ElemStation=0			

Frame=42	Station=0	OutputCase=TERRVERT	CaseType=LinStatic	Point=2	X2=-0.5	X3=0.5	S11=-
1004.22727126612	IsS11Max=No	IsS11Min=No	FrameElem=42	ElemStation=0			
Frame=42	Station=0	OutputCase=TERRVERT	CaseType=LinStatic	Point=3	X2=0.5	X3=-0.5	
S11=1006.53292841271	IsS11Max=Yes	IsS11Min=No	FrameElem=42	ElemStation=0			
Frame=42	Station=0	OutputCase=TERRVERT	CaseType=LinStatic	Point=4	X2=0.5	X3=0.5	
S11=1006.53292841271	IsS11Max=No	IsS11Min=No	FrameElem=42	ElemStation=0			
Frame=42	Station=0.125	OutputCase=TERRVERT	CaseType=LinStatic	Point=0	X2=0	X3=0	
S11=1.15282857329472	IsS11Max=No	IsS11Min=No	FrameElem=42	ElemStation=0.125			
Frame=42	Station=0.125	OutputCase=TERRVERT	CaseType=LinStatic	Point=1	X2=-0.5	X3=-0.5	S11=-
1186.1519534348	IsS11Max=No	IsS11Min=Yes	FrameElem=42	ElemStation=0.125			
Frame=42	Station=0.125	OutputCase=TERRVERT	CaseType=LinStatic	Point=2	X2=-0.5	X3=0.5	S11=-
1186.1519534348	IsS11Max=No	IsS11Min=No	FrameElem=42	ElemStation=0.125			
Frame=42	Station=0.125	OutputCase=TERRVERT	CaseType=LinStatic	Point=3	X2=0.5	X3=-0.5	
S11=1188.45761058138	IsS11Max=Yes	IsS11Min=No	FrameElem=42	ElemStation=0.125			
Frame=42	Station=0.125	OutputCase=TERRVERT	CaseType=LinStatic	Point=4	X2=0.5	X3=0.5	
S11=1188.45761058138	IsS11Max=No	IsS11Min=No	FrameElem=42	ElemStation=0.125			
Frame=42	Station=0.25	OutputCase=TERRVERT	CaseType=LinStatic	Point=0	X2=0	X3=0	S11=1.15282857329472
IsS11Max=No	IsS11Min=No	FrameElem=42	ElemStation=0.25				
Frame=42	Station=0.25	OutputCase=TERRVERT	CaseType=LinStatic	Point=1	X2=-0.5	X3=-0.5	S11=-
1368.07663560347	IsS11Max=No	IsS11Min=Yes	FrameElem=42	ElemStation=0.25			
Frame=42	Station=0.25	OutputCase=TERRVERT	CaseType=LinStatic	Point=2	X2=-0.5	X3=0.5	S11=-
1368.07663560347	IsS11Max=No	IsS11Min=No	FrameElem=42	ElemStation=0.25			
Frame=42	Station=0.25	OutputCase=TERRVERT	CaseType=LinStatic	Point=3	X2=0.5	X3=-0.5	
S11=1370.38229275006	IsS11Max=Yes	IsS11Min=No	FrameElem=42	ElemStation=0.25			
Frame=42	Station=0.25	OutputCase=TERRVERT	CaseType=LinStatic	Point=4	X2=0.5	X3=0.5	
S11=1370.38229275006	IsS11Max=No	IsS11Min=No	FrameElem=42	ElemStation=0.25			
Frame=42	Station=0.375	OutputCase=TERRVERT	CaseType=LinStatic	Point=0	X2=0	X3=0	
S11=1.15282857329472	IsS11Max=No	IsS11Min=No	FrameElem=42	ElemStation=0.375			
Frame=42	Station=0.375	OutputCase=TERRVERT	CaseType=LinStatic	Point=1	X2=-0.5	X3=-0.5	S11=-
1550.00131777215	IsS11Max=No	IsS11Min=Yes	FrameElem=42	ElemStation=0.375			
Frame=42	Station=0.375	OutputCase=TERRVERT	CaseType=LinStatic	Point=2	X2=-0.5	X3=0.5	S11=-
1550.00131777215	IsS11Max=No	IsS11Min=No	FrameElem=42	ElemStation=0.375			
Frame=42	Station=0.375	OutputCase=TERRVERT	CaseType=LinStatic	Point=3	X2=0.5	X3=-0.5	
S11=1552.30697491874	IsS11Max=Yes	IsS11Min=No	FrameElem=42	ElemStation=0.375			
Frame=42	Station=0.375	OutputCase=TERRVERT	CaseType=LinStatic	Point=4	X2=0.5	X3=0.5	
S11=1552.30697491874	IsS11Max=No	IsS11Min=No	FrameElem=42	ElemStation=0.375			
Frame=42	Station=0.5	OutputCase=TERRVERT	CaseType=LinStatic	Point=0	X2=0	X3=0	S11=1.15282857329472
IsS11Max=No	IsS11Min=No	FrameElem=42	ElemStation=0.5				
Frame=42	Station=0.5	OutputCase=TERRVERT	CaseType=LinStatic	Point=1	X2=-0.5	X3=-0.5	S11=-
1731.92599994082	IsS11Max=No	IsS11Min=Yes	FrameElem=42	ElemStation=0.5			
Frame=42	Station=0.5	OutputCase=TERRVERT	CaseType=LinStatic	Point=2	X2=-0.5	X3=0.5	S11=-
1731.92599994082	IsS11Max=No	IsS11Min=No	FrameElem=42	ElemStation=0.5			
Frame=42	Station=0.5	OutputCase=TERRVERT	CaseType=LinStatic	Point=3	X2=0.5	X3=-0.5	
S11=1734.23165708741	IsS11Max=Yes	IsS11Min=No	FrameElem=42	ElemStation=0.5			
Frame=42	Station=0.5	OutputCase=TERRVERT	CaseType=LinStatic	Point=4	X2=0.5	X3=0.5	
S11=1734.23165708741	IsS11Max=No	IsS11Min=No	FrameElem=42	ElemStation=0.5			
Frame=42	Station=0	OutputCase=TERRLAT	CaseType=LinStatic	Point=0	X2=0	X3=0	S11=-108.958200979145
IsS11Max=No	IsS11Min=No	FrameElem=42	ElemStation=0				
Frame=42	Station=0	OutputCase=TERRLAT	CaseType=LinStatic	Point=1	X2=-0.5	X3=-0.5	
S11=17.3678498659707	IsS11Max=Yes	IsS11Min=No	FrameElem=42	ElemStation=0			
Frame=42	Station=0	OutputCase=TERRLAT	CaseType=LinStatic	Point=2	X2=-0.5	X3=0.5	
S11=17.3678498659707	IsS11Max=No	IsS11Min=No	FrameElem=42	ElemStation=0			
Frame=42	Station=0	OutputCase=TERRLAT	CaseType=LinStatic	Point=3	X2=0.5	X3=-0.5	S11=-
235.28425182426	IsS11Max=No	IsS11Min=Yes	FrameElem=42	ElemStation=0			
Frame=42	Station=0	OutputCase=TERRLAT	CaseType=LinStatic	Point=4	X2=0.5	X3=0.5	S11=-235.28425182426
IsS11Max=No	IsS11Min=No	FrameElem=42	ElemStation=0				
Frame=42	Station=0.125	OutputCase=TERRLAT	CaseType=LinStatic	Point=0	X2=0	X3=0	S11=-
108.958200979145	IsS11Max=No	IsS11Min=No	FrameElem=42	ElemStation=0.125			
Frame=42	Station=0.125	OutputCase=TERRLAT	CaseType=LinStatic	Point=1	X2=-0.5	X3=-0.5	
S11=17.2305121165846	IsS11Max=Yes	IsS11Min=No	FrameElem=42	ElemStation=0.125			
Frame=42	Station=0.125	OutputCase=TERRLAT	CaseType=LinStatic	Point=2	X2=-0.5	X3=0.5	
S11=17.2305121165846	IsS11Max=No	IsS11Min=No	FrameElem=42	ElemStation=0.125			
Frame=42	Station=0.125	OutputCase=TERRLAT	CaseType=LinStatic	Point=3	X2=0.5	X3=-0.5	S11=-
235.146914074874	IsS11Max=No	IsS11Min=Yes	FrameElem=42	ElemStation=0.125			
Frame=42	Station=0.125	OutputCase=TERRLAT	CaseType=LinStatic	Point=4	X2=0.5	X3=0.5	S11=-
235.146914074874	IsS11Max=No	IsS11Min=No	FrameElem=42	ElemStation=0.125			
Frame=42	Station=0.25	OutputCase=TERRLAT	CaseType=LinStatic	Point=0	X2=0	X3=0	S11=-108.958200979145
IsS11Max=No	IsS11Min=No	FrameElem=42	ElemStation=0.25				
Frame=42	Station=0.25	OutputCase=TERRLAT	CaseType=LinStatic	Point=1	X2=-0.5	X3=-0.5	
S11=17.0931743671986	IsS11Max=Yes	IsS11Min=No	FrameElem=42	ElemStation=0.25			
Frame=42	Station=0.25	OutputCase=TERRLAT	CaseType=LinStatic	Point=2	X2=-0.5	X3=0.5	
S11=17.0931743671986	IsS11Max=No	IsS11Min=No	FrameElem=42	ElemStation=0.25			
Frame=42	Station=0.25	OutputCase=TERRLAT	CaseType=LinStatic	Point=3	X2=0.5	X3=-0.5	S11=-
235.009576325488	IsS11Max=No	IsS11Min=Yes	FrameElem=42	ElemStation=0.25			
Frame=42	Station=0.25	OutputCase=TERRLAT	CaseType=LinStatic	Point=4	X2=0.5	X3=0.5	S11=-
235.009576325488	IsS11Max=No	IsS11Min=No	FrameElem=42	ElemStation=0.25			
Frame=42	Station=0.375	OutputCase=TERRLAT	CaseType=LinStatic	Point=0	X2=0	X3=0	S11=-
108.958200979145	IsS11Max=No	IsS11Min=No	FrameElem=42	ElemStation=0.375			
Frame=42	Station=0.375	OutputCase=TERRLAT	CaseType=LinStatic	Point=1	X2=-0.5	X3=-0.5	
S11=16.9558366178126	IsS11Max=Yes	IsS11Min=No	FrameElem=42	ElemStation=0.375			
Frame=42	Station=0.375	OutputCase=TERRLAT	CaseType=LinStatic	Point=2	X2=-0.5	X3=0.5	
S11=16.9558366178126	IsS11Max=No	IsS11Min=No	FrameElem=42	ElemStation=0.375			

Frame=42	Station=0	OutputCase=SOVRCOST	CaseType=LinStatic	Point=0	X2=0	X3=0	S11=0	IsS11Max=Yes
IsS11Min=Yes	FrameElem=42	ElemStation=0						
Frame=42	Station=0	OutputCase=SOVRCOST	CaseType=LinStatic	Point=1	X2=-0.5	X3=-0.5	S11=0	
IsS11Max=No	IsS11Min=No	FrameElem=42	ElemStation=0					
Frame=42	Station=0	OutputCase=SOVRCOST	CaseType=LinStatic	Point=2	X2=-0.5	X3=0.5	S11=0	
IsS11Max=No	IsS11Min=No	FrameElem=42	ElemStation=0					
Frame=42	Station=0	OutputCase=SOVRCOST	CaseType=LinStatic	Point=3	X2=0.5	X3=-0.5	S11=0	
IsS11Max=No	IsS11Min=No	FrameElem=42	ElemStation=0					
Frame=42	Station=0	OutputCase=SOVRCOST	CaseType=LinStatic	Point=4	X2=0.5	X3=0.5	S11=0	IsS11Max=No
IsS11Min=No	FrameElem=42	ElemStation=0						
Frame=42	Station=0.125	OutputCase=SOVRCOST	CaseType=LinStatic	Point=0	X2=0	X3=0	S11=0	
IsS11Max=Yes	IsS11Min=Yes	FrameElem=42	ElemStation=0.125					
Frame=42	Station=0.125	OutputCase=SOVRCOST	CaseType=LinStatic	Point=1	X2=-0.5	X3=-0.5	S11=0	
IsS11Max=No	IsS11Min=No	FrameElem=42	ElemStation=0.125					
Frame=42	Station=0.125	OutputCase=SOVRCOST	CaseType=LinStatic	Point=2	X2=-0.5	X3=0.5	S11=0	
IsS11Max=No	IsS11Min=No	FrameElem=42	ElemStation=0.125					
Frame=42	Station=0.125	OutputCase=SOVRCOST	CaseType=LinStatic	Point=3	X2=0.5	X3=-0.5	S11=0	
IsS11Max=No	IsS11Min=No	FrameElem=42	ElemStation=0.125					
Frame=42	Station=0.125	OutputCase=SOVRCOST	CaseType=LinStatic	Point=4	X2=0.5	X3=0.5	S11=0	
IsS11Max=No	IsS11Min=No	FrameElem=42	ElemStation=0.125					
Frame=42	Station=0.25	OutputCase=SOVRCOST	CaseType=LinStatic	Point=0	X2=0	X3=0	S11=0	IsS11Max=Yes
IsS11Min=Yes	FrameElem=42	ElemStation=0.25						
Frame=42	Station=0.25	OutputCase=SOVRCOST	CaseType=LinStatic	Point=1	X2=-0.5	X3=-0.5	S11=0	
IsS11Max=No	IsS11Min=No	FrameElem=42	ElemStation=0.25					
Frame=42	Station=0.25	OutputCase=SOVRCOST	CaseType=LinStatic	Point=2	X2=-0.5	X3=0.5	S11=0	
IsS11Max=No	IsS11Min=No	FrameElem=42	ElemStation=0.25					
Frame=42	Station=0.25	OutputCase=SOVRCOST	CaseType=LinStatic	Point=3	X2=0.5	X3=-0.5	S11=0	
IsS11Max=No	IsS11Min=No	FrameElem=42	ElemStation=0.25					
Frame=42	Station=0.25	OutputCase=SOVRCOST	CaseType=LinStatic	Point=4	X2=0.5	X3=0.5	S11=0	
IsS11Max=No	IsS11Min=No	FrameElem=42	ElemStation=0.25					
Frame=42	Station=0.375	OutputCase=SOVRCOST	CaseType=LinStatic	Point=0	X2=0	X3=0	S11=0	
IsS11Max=Yes	IsS11Min=Yes	FrameElem=42	ElemStation=0.375					
Frame=42	Station=0.375	OutputCase=SOVRCOST	CaseType=LinStatic	Point=1	X2=-0.5	X3=-0.5	S11=0	
IsS11Max=No	IsS11Min=No	FrameElem=42	ElemStation=0.375					
Frame=42	Station=0.375	OutputCase=SOVRCOST	CaseType=LinStatic	Point=2	X2=-0.5	X3=0.5	S11=0	
IsS11Max=No	IsS11Min=No	FrameElem=42	ElemStation=0.375					
Frame=42	Station=0.375	OutputCase=SOVRCOST	CaseType=LinStatic	Point=3	X2=0.5	X3=-0.5	S11=0	
IsS11Max=No	IsS11Min=No	FrameElem=42	ElemStation=0.375					
Frame=42	Station=0.375	OutputCase=SOVRCOST	CaseType=LinStatic	Point=4	X2=0.5	X3=0.5	S11=0	
IsS11Max=No	IsS11Min=No	FrameElem=42	ElemStation=0.375					
Frame=42	Station=0.5	OutputCase=SOVRCOST	CaseType=LinStatic	Point=0	X2=0	X3=0	S11=0	IsS11Max=Yes
IsS11Min=Yes	FrameElem=42	ElemStation=0.5						
Frame=42	Station=0.5	OutputCase=SOVRCOST	CaseType=LinStatic	Point=1	X2=-0.5	X3=-0.5	S11=0	
IsS11Max=No	IsS11Min=No	FrameElem=42	ElemStation=0.5					
Frame=42	Station=0.5	OutputCase=SOVRCOST	CaseType=LinStatic	Point=2	X2=-0.5	X3=0.5	S11=0	
IsS11Max=No	IsS11Min=No	FrameElem=42	ElemStation=0.5					
Frame=42	Station=0.5	OutputCase=SOVRCOST	CaseType=LinStatic	Point=3	X2=0.5	X3=-0.5	S11=0	
IsS11Max=No	IsS11Min=No	FrameElem=42	ElemStation=0.5					
Frame=42	Station=0.5	OutputCase=SOVRCOST	CaseType=LinStatic	Point=4	X2=0.5	X3=0.5	S11=0	
IsS11Max=No	IsS11Min=No	FrameElem=42	ElemStation=0.5					
Frame=42	Station=0	OutputCase=ENVE	CaseType=Combination	StepType=Max	Point=0	X2=0	X3=0	S11=-
IsS11Max=No	IsS11Min=No	FrameElem=42	ElemStation=0					
90.2888588483431	Station=0	OutputCase=ENVE	CaseType=Combination	StepType=Max	Point=1	X2=-0.5	X3=-0.5	
S11=-1287.794235554	IsS11Max=No	IsS11Min=Yes	FrameElem=42	ElemStation=0				
Frame=42	Station=0	OutputCase=ENVE	CaseType=Combination	StepType=Max	Point=2	X2=-0.5	X3=0.5	S11=-
1287.794235554	IsS11Max=No	IsS11Min=No	FrameElem=42	ElemStation=0				
Frame=42	Station=0	OutputCase=ENVE	CaseType=Combination	StepType=Max	Point=3	X2=0.5	X3=-0.5	
S11=1112.4268728185	IsS11Max=Yes	IsS11Min=No	FrameElem=42	ElemStation=0				
Frame=42	Station=0	OutputCase=ENVE	CaseType=Combination	StepType=Max	Point=4	X2=0.5	X3=0.5	
S11=1112.4268728185	IsS11Max=No	IsS11Min=No	FrameElem=42	ElemStation=0				
Frame=42	Station=0.125	OutputCase=ENVE	CaseType=Combination	StepType=Max	Point=0	X2=0	X3=0	S11=-
90.2888588483431	IsS11Max=No	IsS11Min=No	FrameElem=42	ElemStation=0.125				
Frame=42	Station=0.125	OutputCase=ENVE	CaseType=Combination	StepType=Max	Point=1	X2=-0.5	X3=-0.5	
S11=-1526.57353107977	IsS11Max=No	IsS11Min=Yes	FrameElem=42	ElemStation=0.125				
Frame=42	Station=0.125	OutputCase=ENVE	CaseType=Combination	StepType=Max	Point=2	X2=-0.5	X3=0.5	
S11=-1526.57353107977	IsS11Max=No	IsS11Min=No	FrameElem=42	ElemStation=0.125				
Frame=42	Station=0.125	OutputCase=ENVE	CaseType=Combination	StepType=Max	Point=3	X2=0.5	X3=-0.5	
S11=1351.16496701806	IsS11Max=Yes	IsS11Min=No	FrameElem=42	ElemStation=0.125				
Frame=42	Station=0.125	OutputCase=ENVE	CaseType=Combination	StepType=Max	Point=4	X2=0.5	X3=0.5	
S11=1351.16496701806	IsS11Max=No	IsS11Min=No	FrameElem=42	ElemStation=0.125				
Frame=42	Station=0.25	OutputCase=ENVE	CaseType=Combination	StepType=Max	Point=0	X2=0	X3=0	S11=-
90.2888588483431	IsS11Max=No	IsS11Min=No	FrameElem=42	ElemStation=0.25				
Frame=42	Station=0.25	OutputCase=ENVE	CaseType=Combination	StepType=Max	Point=1	X2=-0.5	X3=-0.5	
S11=-1767.69657660415	IsS11Max=No	IsS11Min=Yes	FrameElem=42	ElemStation=0.25				
Frame=42	Station=0.25	OutputCase=ENVE	CaseType=Combination	StepType=Max	Point=2	X2=-0.5	X3=0.5	
S11=-1767.69657660415	IsS11Max=No	IsS11Min=No	FrameElem=42	ElemStation=0.25				
Frame=42	Station=0.25	OutputCase=ENVE	CaseType=Combination	StepType=Max	Point=3	X2=0.5	X3=-0.5	
S11=1592.24681121762	IsS11Max=Yes	IsS11Min=No	FrameElem=42	ElemStation=0.25				
Frame=42	Station=0.25	OutputCase=ENVE	CaseType=Combination	StepType=Max	Point=4	X2=0.5	X3=0.5	
S11=1592.24681121762	IsS11Max=No	IsS11Min=No	FrameElem=42	ElemStation=0.25				
Frame=42	Station=0.375	OutputCase=ENVE	CaseType=Combination	StepType=Max	Point=0	X2=0	X3=0	S11=-
90.2888588483431	IsS11Max=No	IsS11Min=No	FrameElem=42	ElemStation=0.375				

Frame=42	Station=0.375	OutputCase=ENVE	CaseType=Combination	StepType=Max	Point=1	X2=-0.5	X3=-0.5	
S11=-2011.16337212853	IsS11Max=No	IsS11Min=Yes	FrameElem=42	ElemStation=0.375				
Frame=42	Station=0.375	OutputCase=ENVE	CaseType=Combination	StepType=Max	Point=2	X2=-0.5	X3=0.5	
S11=-2011.16337212853	IsS11Max=No	IsS11Min=No	FrameElem=42	ElemStation=0.375				
Frame=42	Station=0.375	OutputCase=ENVE	CaseType=Combination	StepType=Max	Point=3	X2=0.5	X3=-0.5	
S11=1835.67240541718	IsS11Max=Yes	IsS11Min=No	FrameElem=42	ElemStation=0.375				
Frame=42	Station=0.375	OutputCase=ENVE	CaseType=Combination	StepType=Max	Point=4	X2=0.5	X3=0.5	
S11=1835.67240541718	IsS11Max=No	IsS11Min=No	FrameElem=42	ElemStation=0.375				
Frame=42	Station=0.5	OutputCase=ENVE	CaseType=Combination	StepType=Max	Point=0	X2=0	X3=0	S11=-
90.2888588483431	IsS11Max=No	IsS11Min=No	FrameElem=42	ElemStation=0.5				
Frame=42	Station=0.5	OutputCase=ENVE	CaseType=Combination	StepType=Max	Point=1	X2=-0.5	X3=-0.5	
S11=-2256.9739176529	IsS11Max=No	IsS11Min=Yes	FrameElem=42	ElemStation=0.5				
Frame=42	Station=0.5	OutputCase=ENVE	CaseType=Combination	StepType=Max	Point=2	X2=-0.5	X3=0.5	
S11=-2256.9739176529	IsS11Max=No	IsS11Min=No	FrameElem=42	ElemStation=0.5				
Frame=42	Station=0.5	OutputCase=ENVE	CaseType=Combination	StepType=Max	Point=3	X2=0.5	X3=-0.5	
S11=2081.44174961675	IsS11Max=Yes	IsS11Min=No	FrameElem=42	ElemStation=0.5				
Frame=42	Station=0.5	OutputCase=ENVE	CaseType=Combination	StepType=Max	Point=4	X2=0.5	X3=0.5	
S11=2081.44174961675	IsS11Max=No	IsS11Min=No	FrameElem=42	ElemStation=0.5				
Frame=42	Station=0	OutputCase=ENVE	CaseType=Combination	StepType=Min	Point=0	X2=0	X3=0	S11=-
122.976319142087	IsS11Max=No	IsS11Min=No	FrameElem=42	ElemStation=0				
Frame=42	Station=0	OutputCase=ENVE	CaseType=Combination	StepType=Min	Point=1	X2=-0.5	X3=-0.5	
S11=-1293.00459051519	IsS11Max=No	IsS11Min=Yes	FrameElem=42	ElemStation=0				
Frame=42	Station=0	OutputCase=ENVE	CaseType=Combination	StepType=Min	Point=2	X2=-0.5	X3=0.5	S11=-
1293.00459051519	IsS11Max=No	IsS11Min=No	FrameElem=42	ElemStation=0				
Frame=42	Station=0	OutputCase=ENVE	CaseType=Combination	StepType=Min	Point=3	X2=0.5	X3=-0.5	
S11=1041.84159727122	IsS11Max=Yes	IsS11Min=No	FrameElem=42	ElemStation=0				
Frame=42	Station=0	OutputCase=ENVE	CaseType=Combination	StepType=Min	Point=4	X2=0.5	X3=0.5	
S11=1041.84159727122	IsS11Max=No	IsS11Min=No	FrameElem=42	ElemStation=0				
Frame=42	Station=0.125	OutputCase=ENVE	CaseType=Combination	StepType=Min	Point=0	X2=0	X3=0	S11=-
122.976319142087	IsS11Max=No	IsS11Min=No	FrameElem=42	ElemStation=0.125				
Frame=42	Station=0.125	OutputCase=ENVE	CaseType=Combination	StepType=Min	Point=1	X2=-0.5	X3=-0.5	
S11=-1531.74268471475	IsS11Max=No	IsS11Min=Yes	FrameElem=42	ElemStation=0.125				
Frame=42	Station=0.125	OutputCase=ENVE	CaseType=Combination	StepType=Min	Point=2	X2=-0.5	X3=0.5	
S11=-1531.74268471475	IsS11Max=No	IsS11Min=No	FrameElem=42	ElemStation=0.125				
Frame=42	Station=0.125	OutputCase=ENVE	CaseType=Combination	StepType=Min	Point=3	X2=0.5	X3=-0.5	
S11=1280.6208927956	IsS11Max=Yes	IsS11Min=No	FrameElem=42	ElemStation=0.125				
Frame=42	Station=0.125	OutputCase=ENVE	CaseType=Combination	StepType=Min	Point=4	X2=0.5	X3=0.5	
S11=1280.6208927956	IsS11Max=No	IsS11Min=No	FrameElem=42	ElemStation=0.125				
Frame=42	Station=0.25	OutputCase=ENVE	CaseType=Combination	StepType=Min	Point=0	X2=0	X3=0	S11=-
122.976319142087	IsS11Max=No	IsS11Min=No	FrameElem=42	ElemStation=0.25				
Frame=42	Station=0.25	OutputCase=ENVE	CaseType=Combination	StepType=Min	Point=1	X2=-0.5	X3=-0.5	
S11=-1772.82452891431	IsS11Max=No	IsS11Min=Yes	FrameElem=42	ElemStation=0.25				
Frame=42	Station=0.25	OutputCase=ENVE	CaseType=Combination	StepType=Min	Point=2	X2=-0.5	X3=0.5	
S11=-1772.82452891431	IsS11Max=No	IsS11Min=No	FrameElem=42	ElemStation=0.25				
Frame=42	Station=0.25	OutputCase=ENVE	CaseType=Combination	StepType=Min	Point=3	X2=0.5	X3=-0.5	
S11=1521.74393831998	IsS11Max=Yes	IsS11Min=No	FrameElem=42	ElemStation=0.25				
Frame=42	Station=0.25	OutputCase=ENVE	CaseType=Combination	StepType=Min	Point=4	X2=0.5	X3=0.5	
S11=1521.74393831998	IsS11Max=No	IsS11Min=No	FrameElem=42	ElemStation=0.25				
Frame=42	Station=0.375	OutputCase=ENVE	CaseType=Combination	StepType=Min	Point=0	X2=0	X3=0	S11=-
122.976319142087	IsS11Max=No	IsS11Min=No	FrameElem=42	ElemStation=0.375				
Frame=42	Station=0.375	OutputCase=ENVE	CaseType=Combination	StepType=Min	Point=1	X2=-0.5	X3=-0.5	
S11=-2016.25012311387	IsS11Max=No	IsS11Min=Yes	FrameElem=42	ElemStation=0.375				
Frame=42	Station=0.375	OutputCase=ENVE	CaseType=Combination	StepType=Min	Point=2	X2=-0.5	X3=0.5	
S11=-2016.25012311387	IsS11Max=No	IsS11Min=No	FrameElem=42	ElemStation=0.375				
Frame=42	Station=0.375	OutputCase=ENVE	CaseType=Combination	StepType=Min	Point=3	X2=0.5	X3=-0.5	
S11=1765.21073384435	IsS11Max=Yes	IsS11Min=No	FrameElem=42	ElemStation=0.375				
Frame=42	Station=0.375	OutputCase=ENVE	CaseType=Combination	StepType=Min	Point=4	X2=0.5	X3=0.5	
S11=1765.21073384435	IsS11Max=No	IsS11Min=No	FrameElem=42	ElemStation=0.375				
Frame=42	Station=0.5	OutputCase=ENVE	CaseType=Combination	StepType=Min	Point=0	X2=0	X3=0	S11=-
122.976319142087	IsS11Max=No	IsS11Min=No	FrameElem=42	ElemStation=0.5				
Frame=42	Station=0.5	OutputCase=ENVE	CaseType=Combination	StepType=Min	Point=1	X2=-0.5	X3=-0.5	
S11=-2262.01946731343	IsS11Max=No	IsS11Min=Yes	FrameElem=42	ElemStation=0.5				
Frame=42	Station=0.5	OutputCase=ENVE	CaseType=Combination	StepType=Min	Point=2	X2=-0.5	X3=0.5	
S11=-2262.01946731343	IsS11Max=No	IsS11Min=No	FrameElem=42	ElemStation=0.5				
Frame=42	Station=0.5	OutputCase=ENVE	CaseType=Combination	StepType=Min	Point=3	X2=0.5	X3=-0.5	
S11=2011.02127936873	IsS11Max=Yes	IsS11Min=No	FrameElem=42	ElemStation=0.5				
Frame=42	Station=0.5	OutputCase=ENVE	CaseType=Combination	StepType=Min	Point=4	X2=0.5	X3=0.5	
S11=2011.02127936873	IsS11Max=No	IsS11Min=No	FrameElem=42	ElemStation=0.5				
Frame=42	Station=0	OutputCase=FESSUR	CaseType=Combination	Point=0	X2=0	X3=0	S11=-122.976319142087	
IsS11Max=No	IsS11Min=No	FrameElem=42	ElemStation=0					
Frame=42	Station=0	OutputCase=FESSUR	CaseType=Combination	Point=1	X2=-0.5	X3=-0.5	S11=-	
1287.7942355554	IsS11Max=No	IsS11Min=Yes	FrameElem=42	ElemStation=0				
Frame=42	Station=0	OutputCase=FESSUR	CaseType=Combination	Point=2	X2=-0.5	X3=0.5	S11=-	
1287.7942355554	IsS11Max=No	IsS11Min=No	FrameElem=42	ElemStation=0				
Frame=42	Station=0	OutputCase=FESSUR	CaseType=Combination	Point=3	X2=0.5	X3=-0.5		
S11=1041.84159727122	IsS11Max=Yes	IsS11Min=No	FrameElem=42	ElemStation=0				
Frame=42	Station=0	OutputCase=FESSUR	CaseType=Combination	Point=4	X2=0.5	X3=0.5		
S11=1041.84159727122	IsS11Max=No	IsS11Min=No	FrameElem=42	ElemStation=0				
Frame=42	Station=0.125	OutputCase=FESSUR	CaseType=Combination	Point=0	X2=0	X3=0	S11=-	
122.976319142087	IsS11Max=No	IsS11Min=No	FrameElem=42	ElemStation=0.125				
Frame=42	Station=0.125	OutputCase=FESSUR	CaseType=Combination	Point=1	X2=-0.5	X3=-0.5	S11=-	
1526.57353107977	IsS11Max=No	IsS11Min=Yes	FrameElem=42	ElemStation=0.125				

Frame=42	Station=0.125	OutputCase=FESSUR	CaseType=Combination	Point=2	X2=-0.5	X3=0.5	S11=-
1526.57353107977	IsS11Max=No	IsS11Min=No	FrameElem=42	ElemStation=0.125			
Frame=42	Station=0.125	OutputCase=FESSUR	CaseType=Combination	Point=3	X2=0.5	X3=-0.5	
S11=1280.6208927956	IsS11Max=Yes	IsS11Min=No	FrameElem=42	ElemStation=0.125			
Frame=42	Station=0.125	OutputCase=FESSUR	CaseType=Combination	Point=4	X2=0.5	X3=0.5	
S11=1280.6208927956	IsS11Max=No	IsS11Min=No	FrameElem=42	ElemStation=0.125			
Frame=42	Station=0.25	OutputCase=FESSUR	CaseType=Combination	Point=0	X2=0	X3=0	S11=-
122.976319142087	IsS11Max=No	IsS11Min=No	FrameElem=42	ElemStation=0.25			
Frame=42	Station=0.25	OutputCase=FESSUR	CaseType=Combination	Point=1	X2=-0.5	X3=-0.5	S11=-
1767.69657660415	IsS11Max=No	IsS11Min=Yes	FrameElem=42	ElemStation=0.25			
Frame=42	Station=0.25	OutputCase=FESSUR	CaseType=Combination	Point=2	X2=-0.5	X3=0.5	S11=-
1767.69657660415	IsS11Max=No	IsS11Min=No	FrameElem=42	ElemStation=0.25			
Frame=42	Station=0.25	OutputCase=FESSUR	CaseType=Combination	Point=3	X2=0.5	X3=-0.5	
S11=1521.74393831998	IsS11Max=Yes	IsS11Min=No	FrameElem=42	ElemStation=0.25			
Frame=42	Station=0.25	OutputCase=FESSUR	CaseType=Combination	Point=4	X2=0.5	X3=0.5	
S11=1521.74393831998	IsS11Max=No	IsS11Min=No	FrameElem=42	ElemStation=0.25			
Frame=42	Station=0.375	OutputCase=FESSUR	CaseType=Combination	Point=0	X2=0	X3=0	S11=-
122.976319142087	IsS11Max=No	IsS11Min=No	FrameElem=42	ElemStation=0.375			
Frame=42	Station=0.375	OutputCase=FESSUR	CaseType=Combination	Point=1	X2=-0.5	X3=-0.5	S11=-
2011.16337212853	IsS11Max=No	IsS11Min=Yes	FrameElem=42	ElemStation=0.375			
Frame=42	Station=0.375	OutputCase=FESSUR	CaseType=Combination	Point=2	X2=-0.5	X3=0.5	S11=-
2011.16337212853	IsS11Max=No	IsS11Min=No	FrameElem=42	ElemStation=0.375			
Frame=42	Station=0.375	OutputCase=FESSUR	CaseType=Combination	Point=3	X2=0.5	X3=-0.5	
S11=1765.21073384435	IsS11Max=Yes	IsS11Min=No	FrameElem=42	ElemStation=0.375			
Frame=42	Station=0.375	OutputCase=FESSUR	CaseType=Combination	Point=4	X2=0.5	X3=0.5	
S11=1765.21073384435	IsS11Max=No	IsS11Min=No	FrameElem=42	ElemStation=0.375			
Frame=42	Station=0.5	OutputCase=FESSUR	CaseType=Combination	Point=0	X2=0	X3=0	S11=-122.976319142087
IsS11Max=No	IsS11Min=No	FrameElem=42	ElemStation=0.5				
Frame=42	Station=0.5	OutputCase=FESSUR	CaseType=Combination	Point=1	X2=-0.5	X3=-0.5	S11=-
2256.9739176529	IsS11Max=No	IsS11Min=Yes	FrameElem=42	ElemStation=0.5			
Frame=42	Station=0.5	OutputCase=FESSUR	CaseType=Combination	Point=2	X2=-0.5	X3=0.5	S11=-
2256.9739176529	IsS11Max=No	IsS11Min=No	FrameElem=42	ElemStation=0.5			
Frame=42	Station=0.5	OutputCase=FESSUR	CaseType=Combination	Point=3	X2=0.5	X3=-0.5	
S11=2011.02127936873	IsS11Max=Yes	IsS11Min=No	FrameElem=42	ElemStation=0.5			
Frame=42	Station=0.5	OutputCase=FESSUR	CaseType=Combination	Point=4	X2=0.5	X3=0.5	
S11=2011.02127936873	IsS11Max=No	IsS11Min=No	FrameElem=42	ElemStation=0.5			
Frame=43	Station=0	OutputCase=PESOPR	CaseType=LinStatic	Point=0	X2=0	X3=0	S11=-15.1709467362365
IsS11Max=No	IsS11Min=No	FrameElem=43	ElemStation=0				
Frame=43	Station=0	OutputCase=PESOPR	CaseType=LinStatic	Point=1	X2=-0.5	X3=-0.5	S11=-
541.866416580508	IsS11Max=No	IsS11Min=Yes	FrameElem=43	ElemStation=0			
Frame=43	Station=0	OutputCase=PESOPR	CaseType=LinStatic	Point=2	X2=-0.5	X3=0.5	S11=-
541.866416580508	IsS11Max=No	IsS11Min=No	FrameElem=43	ElemStation=0			
Frame=43	Station=0	OutputCase=PESOPR	CaseType=LinStatic	Point=3	X2=0.5	X3=-0.5	S11=511.524523108035
IsS11Max=Yes	IsS11Min=No	FrameElem=43	ElemStation=0				
Frame=43	Station=0	OutputCase=PESOPR	CaseType=LinStatic	Point=4	X2=0.5	X3=0.5	S11=511.524523108035
IsS11Max=No	IsS11Min=No	FrameElem=43	ElemStation=0				
Frame=43	Station=0.125	OutputCase=PESOPR	CaseType=LinStatic	Point=0	X2=0	X3=0	S11=-15.1709467362365
IsS11Max=No	IsS11Min=No	FrameElem=43	ElemStation=0.125				
Frame=43	Station=0.125	OutputCase=PESOPR	CaseType=LinStatic	Point=1	X2=-0.5	X3=-0.5	S11=-
574.387853349041	IsS11Max=No	IsS11Min=Yes	FrameElem=43	ElemStation=0.125			
Frame=43	Station=0.125	OutputCase=PESOPR	CaseType=LinStatic	Point=2	X2=-0.5	X3=0.5	S11=-
574.387853349041	IsS11Max=No	IsS11Min=No	FrameElem=43	ElemStation=0.125			
Frame=43	Station=0.125	OutputCase=PESOPR	CaseType=LinStatic	Point=3	X2=0.5	X3=-0.5	
S11=544.045959876568	IsS11Max=Yes	IsS11Min=No	FrameElem=43	ElemStation=0.125			
Frame=43	Station=0.125	OutputCase=PESOPR	CaseType=LinStatic	Point=4	X2=0.5	X3=0.5	
S11=544.045959876568	IsS11Max=No	IsS11Min=No	FrameElem=43	ElemStation=0.125			
Frame=43	Station=0.25	OutputCase=PESOPR	CaseType=LinStatic	Point=0	X2=0	X3=0	S11=-15.1709467362365
IsS11Max=No	IsS11Min=No	FrameElem=43	ElemStation=0.25				
Frame=43	Station=0.25	OutputCase=PESOPR	CaseType=LinStatic	Point=1	X2=-0.5	X3=-0.5	S11=-
609.253040117574	IsS11Max=No	IsS11Min=Yes	FrameElem=43	ElemStation=0.25			
Frame=43	Station=0.25	OutputCase=PESOPR	CaseType=LinStatic	Point=2	X2=-0.5	X3=0.5	S11=-
609.253040117574	IsS11Max=No	IsS11Min=No	FrameElem=43	ElemStation=0.25			
Frame=43	Station=0.25	OutputCase=PESOPR	CaseType=LinStatic	Point=3	X2=0.5	X3=-0.5	
S11=578.911146645101	IsS11Max=Yes	IsS11Min=No	FrameElem=43	ElemStation=0.25			
Frame=43	Station=0.25	OutputCase=PESOPR	CaseType=LinStatic	Point=4	X2=0.5	X3=0.5	
S11=578.911146645101	IsS11Max=No	IsS11Min=No	FrameElem=43	ElemStation=0.25			
Frame=43	Station=0.375	OutputCase=PESOPR	CaseType=LinStatic	Point=0	X2=0	X3=0	S11=-15.1709467362365
IsS11Max=No	IsS11Min=No	FrameElem=43	ElemStation=0.375				
Frame=43	Station=0.375	OutputCase=PESOPR	CaseType=LinStatic	Point=1	X2=-0.5	X3=-0.5	S11=-
646.461976886107	IsS11Max=No	IsS11Min=Yes	FrameElem=43	ElemStation=0.375			
Frame=43	Station=0.375	OutputCase=PESOPR	CaseType=LinStatic	Point=2	X2=-0.5	X3=0.5	S11=-
646.461976886107	IsS11Max=No	IsS11Min=No	FrameElem=43	ElemStation=0.375			
Frame=43	Station=0.375	OutputCase=PESOPR	CaseType=LinStatic	Point=3	X2=0.5	X3=-0.5	
S11=616.120083413634	IsS11Max=Yes	IsS11Min=No	FrameElem=43	ElemStation=0.375			
Frame=43	Station=0.375	OutputCase=PESOPR	CaseType=LinStatic	Point=4	X2=0.5	X3=0.5	
S11=616.120083413634	IsS11Max=No	IsS11Min=No	FrameElem=43	ElemStation=0.375			
Frame=43	Station=0.5	OutputCase=PESOPR	CaseType=LinStatic	Point=0	X2=0	X3=0	S11=-15.1709467362365
IsS11Max=No	IsS11Min=No	FrameElem=43	ElemStation=0.5				
Frame=43	Station=0.5	OutputCase=PESOPR	CaseType=LinStatic	Point=1	X2=-0.5	X3=-0.5	S11=-
686.01466365464	IsS11Max=No	IsS11Min=Yes	FrameElem=43	ElemStation=0.5			
Frame=43	Station=0.5	OutputCase=PESOPR	CaseType=LinStatic	Point=2	X2=-0.5	X3=0.5	S11=-
686.01466365464	IsS11Max=No	IsS11Min=No	FrameElem=43	ElemStation=0.5			

Frame=43	Station=0.5	OutputCase=PESOPR	CaseType=LinStatic	Point=3	X2=0.5	X3=-0.5	
S11=655.672770182167	IsS11Max=Yes	IsS11Min=No	FrameElem=43	ElemStation=0.5			
Frame=43	Station=0.5	OutputCase=PESOPR	CaseType=LinStatic	Point=4	X2=0.5	X3=0.5	
S11=655.672770182167	IsS11Max=No	IsS11Min=No	FrameElem=43	ElemStation=0.5			
Frame=43	Station=0	OutputCase=TERRVERT	CaseType=LinStatic	Point=0	X2=0	X3=0	S11=1.15282857329472
IsS11Max=No	IsS11Min=No	FrameElem=43	ElemStation=0				
Frame=43	Station=0	OutputCase=TERRVERT	CaseType=LinStatic	Point=1	X2=-0.5	X3=-0.5	S11=-
1731.92599994073	IsS11Max=No	IsS11Min=Yes	FrameElem=43	ElemStation=0			
Frame=43	Station=0	OutputCase=TERRVERT	CaseType=LinStatic	Point=2	X2=-0.5	X3=0.5	S11=-
1731.92599994073	IsS11Max=No	IsS11Min=No	FrameElem=43	ElemStation=0			
Frame=43	Station=0	OutputCase=TERRVERT	CaseType=LinStatic	Point=3	X2=0.5	X3=-0.5	
S11=1734.23165708732	IsS11Max=Yes	IsS11Min=No	FrameElem=43	ElemStation=0			
Frame=43	Station=0	OutputCase=TERRVERT	CaseType=LinStatic	Point=4	X2=0.5	X3=0.5	
S11=1734.23165708732	IsS11Max=No	IsS11Min=No	FrameElem=43	ElemStation=0			
Frame=43	Station=0.125	OutputCase=TERRVERT	CaseType=LinStatic	Point=0	X2=0	X3=0	
S11=1.15282857329472	IsS11Max=No	IsS11Min=No	FrameElem=43	ElemStation=0.125			
Frame=43	Station=0.125	OutputCase=TERRVERT	CaseType=LinStatic	Point=1	X2=-0.5	X3=-0.5	S11=-
1840.75018715032	IsS11Max=No	IsS11Min=Yes	FrameElem=43	ElemStation=0.125			
Frame=43	Station=0.125	OutputCase=TERRVERT	CaseType=LinStatic	Point=2	X2=-0.5	X3=0.5	S11=-
1840.75018715032	IsS11Max=No	IsS11Min=No	FrameElem=43	ElemStation=0.125			
Frame=43	Station=0.125	OutputCase=TERRVERT	CaseType=LinStatic	Point=3	X2=0.5	X3=-0.5	
S11=1843.05584429691	IsS11Max=Yes	IsS11Min=No	FrameElem=43	ElemStation=0.125			
Frame=43	Station=0.125	OutputCase=TERRVERT	CaseType=LinStatic	Point=4	X2=0.5	X3=0.5	
S11=1843.05584429691	IsS11Max=No	IsS11Min=No	FrameElem=43	ElemStation=0.125			
Frame=43	Station=0.25	OutputCase=TERRVERT	CaseType=LinStatic	Point=0	X2=0	X3=0	S11=1.15282857329472
IsS11Max=No	IsS11Min=No	FrameElem=43	ElemStation=0.25				
Frame=43	Station=0.25	OutputCase=TERRVERT	CaseType=LinStatic	Point=1	X2=-0.5	X3=-0.5	S11=-
1949.5743743599	IsS11Max=No	IsS11Min=Yes	FrameElem=43	ElemStation=0.25			
Frame=43	Station=0.25	OutputCase=TERRVERT	CaseType=LinStatic	Point=2	X2=-0.5	X3=0.5	S11=-
1949.5743743599	IsS11Max=No	IsS11Min=No	FrameElem=43	ElemStation=0.25			
Frame=43	Station=0.25	OutputCase=TERRVERT	CaseType=LinStatic	Point=3	X2=0.5	X3=-0.5	
S11=1951.88003150649	IsS11Max=Yes	IsS11Min=No	FrameElem=43	ElemStation=0.25			
Frame=43	Station=0.25	OutputCase=TERRVERT	CaseType=LinStatic	Point=4	X2=0.5	X3=0.5	
S11=1951.88003150649	IsS11Max=No	IsS11Min=No	FrameElem=43	ElemStation=0.25			
Frame=43	Station=0.375	OutputCase=TERRVERT	CaseType=LinStatic	Point=0	X2=0	X3=0	
S11=1.15282857329472	IsS11Max=No	IsS11Min=No	FrameElem=43	ElemStation=0.375			
Frame=43	Station=0.375	OutputCase=TERRVERT	CaseType=LinStatic	Point=1	X2=-0.5	X3=-0.5	S11=-
2058.39856156948	IsS11Max=No	IsS11Min=Yes	FrameElem=43	ElemStation=0.375			
Frame=43	Station=0.375	OutputCase=TERRVERT	CaseType=LinStatic	Point=2	X2=-0.5	X3=0.5	S11=-
2058.39856156948	IsS11Max=No	IsS11Min=No	FrameElem=43	ElemStation=0.375			
Frame=43	Station=0.375	OutputCase=TERRVERT	CaseType=LinStatic	Point=3	X2=0.5	X3=-0.5	
S11=2060.70421871607	IsS11Max=Yes	IsS11Min=No	FrameElem=43	ElemStation=0.375			
Frame=43	Station=0.375	OutputCase=TERRVERT	CaseType=LinStatic	Point=4	X2=0.5	X3=0.5	
S11=2060.70421871607	IsS11Max=No	IsS11Min=No	FrameElem=43	ElemStation=0.375			
Frame=43	Station=0.5	OutputCase=TERRVERT	CaseType=LinStatic	Point=0	X2=0	X3=0	S11=1.15282857329472
IsS11Max=No	IsS11Min=No	FrameElem=43	ElemStation=0.5				
Frame=43	Station=0.5	OutputCase=TERRVERT	CaseType=LinStatic	Point=1	X2=-0.5	X3=-0.5	S11=-
2167.22274877906	IsS11Max=No	IsS11Min=Yes	FrameElem=43	ElemStation=0.5			
Frame=43	Station=0.5	OutputCase=TERRVERT	CaseType=LinStatic	Point=2	X2=-0.5	X3=0.5	S11=-
2167.22274877906	IsS11Max=No	IsS11Min=No	FrameElem=43	ElemStation=0.5			
Frame=43	Station=0.5	OutputCase=TERRVERT	CaseType=LinStatic	Point=3	X2=0.5	X3=-0.5	
S11=2169.52840592565	IsS11Max=Yes	IsS11Min=No	FrameElem=43	ElemStation=0.5			
Frame=43	Station=0.5	OutputCase=TERRVERT	CaseType=LinStatic	Point=4	X2=0.5	X3=0.5	
S11=2169.52840592565	IsS11Max=No	IsS11Min=No	FrameElem=43	ElemStation=0.5			
Frame=43	Station=0	OutputCase=TERRLAT	CaseType=LinStatic	Point=0	X2=0	X3=0	S11=-108.958200979145
IsS11Max=No	IsS11Min=No	FrameElem=43	ElemStation=0				
Frame=43	Station=0	OutputCase=TERRLAT	CaseType=LinStatic	Point=1	X2=-0.5	X3=-0.5	
S11=16.8184988684264	IsS11Max=Yes	IsS11Min=No	FrameElem=43	ElemStation=0			
Frame=43	Station=0	OutputCase=TERRLAT	CaseType=LinStatic	Point=2	X2=-0.5	X3=0.5	
S11=16.8184988684264	IsS11Max=No	IsS11Min=No	FrameElem=43	ElemStation=0			
Frame=43	Station=0	OutputCase=TERRLAT	CaseType=LinStatic	Point=3	X2=0.5	X3=-0.5	S11=-
234.734900826716	IsS11Max=No	IsS11Min=Yes	FrameElem=43	ElemStation=0			
Frame=43	Station=0	OutputCase=TERRLAT	CaseType=LinStatic	Point=4	X2=0.5	X3=0.5	S11=-
234.734900826716	IsS11Max=No	IsS11Min=No	FrameElem=43	ElemStation=0			
Frame=43	Station=0.125	OutputCase=TERRLAT	CaseType=LinStatic	Point=0	X2=0	X3=0	S11=-
108.958200979145	IsS11Max=No	IsS11Min=No	FrameElem=43	ElemStation=0.125			
Frame=43	Station=0.125	OutputCase=TERRLAT	CaseType=LinStatic	Point=1	X2=-0.5	X3=-0.5	
S11=16.7191760672006	IsS11Max=Yes	IsS11Min=No	FrameElem=43	ElemStation=0.125			
Frame=43	Station=0.125	OutputCase=TERRLAT	CaseType=LinStatic	Point=2	X2=-0.5	X3=0.5	
S11=16.7191760672006	IsS11Max=No	IsS11Min=No	FrameElem=43	ElemStation=0.125			
Frame=43	Station=0.125	OutputCase=TERRLAT	CaseType=LinStatic	Point=3	X2=0.5	X3=-0.5	S11=-
234.63557802549	IsS11Max=No	IsS11Min=Yes	FrameElem=43	ElemStation=0.125			
Frame=43	Station=0.125	OutputCase=TERRLAT	CaseType=LinStatic	Point=4	X2=0.5	X3=0.5	S11=-
234.63557802549	IsS11Max=No	IsS11Min=No	FrameElem=43	ElemStation=0.125			
Frame=43	Station=0.25	OutputCase=TERRLAT	CaseType=LinStatic	Point=0	X2=0	X3=0	S11=-108.958200979145
IsS11Max=No	IsS11Min=No	FrameElem=43	ElemStation=0.25				
Frame=43	Station=0.25	OutputCase=TERRLAT	CaseType=LinStatic	Point=1	X2=-0.5	X3=-0.5	
S11=16.6198532659747	IsS11Max=Yes	IsS11Min=No	FrameElem=43	ElemStation=0.25			
Frame=43	Station=0.25	OutputCase=TERRLAT	CaseType=LinStatic	Point=2	X2=-0.5	X3=0.5	
S11=16.6198532659747	IsS11Max=No	IsS11Min=No	FrameElem=43	ElemStation=0.25			
Frame=43	Station=0.25	OutputCase=TERRLAT	CaseType=LinStatic	Point=3	X2=0.5	X3=-0.5	S11=-
234.536255224264	IsS11Max=No	IsS11Min=Yes	FrameElem=43	ElemStation=0.25			

Frame=43	Station=0.5	OutputCase=TERRCOST	CaseType=LinStatic	Point=1	X2=-0.5	X3=-0.5	S11=0	
IsS11Max=No	IsS11Min=No	FrameElem=43	ElemStation=0.5					
Frame=43	Station=0.5	OutputCase=TERRCOST	CaseType=LinStatic	Point=2	X2=-0.5	X3=0.5	S11=0	
IsS11Max=No	IsS11Min=No	FrameElem=43	ElemStation=0.5					
Frame=43	Station=0.5	OutputCase=TERRCOST	CaseType=LinStatic	Point=3	X2=0.5	X3=-0.5	S11=0	
IsS11Max=No	IsS11Min=No	FrameElem=43	ElemStation=0.5					
Frame=43	Station=0.5	OutputCase=TERRCOST	CaseType=LinStatic	Point=4	X2=0.5	X3=0.5	S11=0	
IsS11Max=No	IsS11Min=No	FrameElem=43	ElemStation=0.5					
Frame=43	Station=0	OutputCase=SOVRCOST	CaseType=LinStatic	Point=0	X2=0	X3=0	S11=0	
IsS11Min=Yes	FrameElem=43	ElemStation=0					IsS11Max=Yes	
Frame=43	Station=0	OutputCase=SOVRCOST	CaseType=LinStatic	Point=1	X2=-0.5	X3=-0.5	S11=0	
IsS11Max=No	IsS11Min=No	FrameElem=43	ElemStation=0					
Frame=43	Station=0	OutputCase=SOVRCOST	CaseType=LinStatic	Point=2	X2=-0.5	X3=0.5	S11=0	
IsS11Max=No	IsS11Min=No	FrameElem=43	ElemStation=0					
Frame=43	Station=0	OutputCase=SOVRCOST	CaseType=LinStatic	Point=3	X2=0.5	X3=-0.5	S11=0	
IsS11Max=No	IsS11Min=No	FrameElem=43	ElemStation=0					
Frame=43	Station=0	OutputCase=SOVRCOST	CaseType=LinStatic	Point=4	X2=0.5	X3=0.5	S11=0	
IsS11Max=No	IsS11Min=No	FrameElem=43	ElemStation=0				IsS11Max=No	
Frame=43	Station=0.125	OutputCase=SOVRCOST	CaseType=LinStatic	Point=0	X2=0	X3=0	S11=0	
IsS11Max=Yes	IsS11Min=Yes	FrameElem=43	ElemStation=0.125					
Frame=43	Station=0.125	OutputCase=SOVRCOST	CaseType=LinStatic	Point=1	X2=-0.5	X3=-0.5	S11=0	
IsS11Max=No	IsS11Min=No	FrameElem=43	ElemStation=0.125					
Frame=43	Station=0.125	OutputCase=SOVRCOST	CaseType=LinStatic	Point=2	X2=-0.5	X3=0.5	S11=0	
IsS11Max=No	IsS11Min=No	FrameElem=43	ElemStation=0.125					
Frame=43	Station=0.125	OutputCase=SOVRCOST	CaseType=LinStatic	Point=3	X2=0.5	X3=-0.5	S11=0	
IsS11Max=No	IsS11Min=No	FrameElem=43	ElemStation=0.125					
Frame=43	Station=0.125	OutputCase=SOVRCOST	CaseType=LinStatic	Point=4	X2=0.5	X3=0.5	S11=0	
IsS11Max=No	IsS11Min=No	FrameElem=43	ElemStation=0.125					
Frame=43	Station=0.25	OutputCase=SOVRCOST	CaseType=LinStatic	Point=0	X2=0	X3=0	S11=0	
IsS11Min=Yes	FrameElem=43	ElemStation=0.25					IsS11Max=Yes	
Frame=43	Station=0.25	OutputCase=SOVRCOST	CaseType=LinStatic	Point=1	X2=-0.5	X3=-0.5	S11=0	
IsS11Max=No	IsS11Min=No	FrameElem=43	ElemStation=0.25					
Frame=43	Station=0.25	OutputCase=SOVRCOST	CaseType=LinStatic	Point=2	X2=-0.5	X3=0.5	S11=0	
IsS11Max=No	IsS11Min=No	FrameElem=43	ElemStation=0.25					
Frame=43	Station=0.25	OutputCase=SOVRCOST	CaseType=LinStatic	Point=3	X2=0.5	X3=-0.5	S11=0	
IsS11Max=No	IsS11Min=No	FrameElem=43	ElemStation=0.25					
Frame=43	Station=0.25	OutputCase=SOVRCOST	CaseType=LinStatic	Point=4	X2=0.5	X3=0.5	S11=0	
IsS11Max=No	IsS11Min=No	FrameElem=43	ElemStation=0.25					
Frame=43	Station=0.375	OutputCase=SOVRCOST	CaseType=LinStatic	Point=0	X2=0	X3=0	S11=0	
IsS11Max=Yes	IsS11Min=Yes	FrameElem=43	ElemStation=0.375					
Frame=43	Station=0.375	OutputCase=SOVRCOST	CaseType=LinStatic	Point=1	X2=-0.5	X3=-0.5	S11=0	
IsS11Max=No	IsS11Min=No	FrameElem=43	ElemStation=0.375					
Frame=43	Station=0.375	OutputCase=SOVRCOST	CaseType=LinStatic	Point=2	X2=-0.5	X3=0.5	S11=0	
IsS11Max=No	IsS11Min=No	FrameElem=43	ElemStation=0.375					
Frame=43	Station=0.375	OutputCase=SOVRCOST	CaseType=LinStatic	Point=3	X2=0.5	X3=-0.5	S11=0	
IsS11Max=No	IsS11Min=No	FrameElem=43	ElemStation=0.375					
Frame=43	Station=0.375	OutputCase=SOVRCOST	CaseType=LinStatic	Point=4	X2=0.5	X3=0.5	S11=0	
IsS11Max=No	IsS11Min=No	FrameElem=43	ElemStation=0.375					
Frame=43	Station=0.5	OutputCase=SOVRCOST	CaseType=LinStatic	Point=0	X2=0	X3=0	S11=0	
IsS11Min=Yes	FrameElem=43	ElemStation=0.5					IsS11Max=Yes	
Frame=43	Station=0.5	OutputCase=SOVRCOST	CaseType=LinStatic	Point=1	X2=-0.5	X3=-0.5	S11=0	
IsS11Max=No	IsS11Min=No	FrameElem=43	ElemStation=0.5					
Frame=43	Station=0.5	OutputCase=SOVRCOST	CaseType=LinStatic	Point=2	X2=-0.5	X3=0.5	S11=0	
IsS11Max=No	IsS11Min=No	FrameElem=43	ElemStation=0.5					
Frame=43	Station=0.5	OutputCase=SOVRCOST	CaseType=LinStatic	Point=3	X2=0.5	X3=-0.5	S11=0	
IsS11Max=No	IsS11Min=No	FrameElem=43	ElemStation=0.5					
Frame=43	Station=0.5	OutputCase=SOVRCOST	CaseType=LinStatic	Point=4	X2=0.5	X3=0.5	S11=0	
IsS11Max=No	IsS11Min=No	FrameElem=43	ElemStation=0.5					
Frame=43	Station=0	OutputCase=ENVE	CaseType=Combination	StepType=Max	Point=0	X2=0	X3=0	S11=-
90.2888588483431	IsS11Max=No	IsS11Min=No	FrameElem=43	ElemStation=0				
Frame=43	Station=0	OutputCase=ENVE	CaseType=Combination	StepType=Max	Point=1	X2=-0.5	X3=-0.5	
S11=-2256.97391765282	IsS11Max=No	IsS11Min=Yes	FrameElem=43	ElemStation=0				
Frame=43	Station=0	OutputCase=ENVE	CaseType=Combination	StepType=Max	Point=2	X2=-0.5	X3=0.5	S11=-
2256.97391765282	IsS11Max=No	IsS11Min=No	FrameElem=43	ElemStation=0				
Frame=43	Station=0	OutputCase=ENVE	CaseType=Combination	StepType=Max	Point=3	X2=0.5	X3=-0.5	
S11=2081.44174961666	IsS11Max=Yes	IsS11Min=No	FrameElem=43	ElemStation=0				
Frame=43	Station=0	OutputCase=ENVE	CaseType=Combination	StepType=Max	Point=4	X2=0.5	X3=0.5	
S11=2081.44174961666	IsS11Max=No	IsS11Min=No	FrameElem=43	ElemStation=0				
Frame=43	Station=0.125	OutputCase=ENVE	CaseType=Combination	StepType=Max	Point=0	X2=0	X3=0	S11=-
90.2888588483431	IsS11Max=No	IsS11Min=No	FrameElem=43	ElemStation=0.125				
Frame=43	Station=0.125	OutputCase=ENVE	CaseType=Combination	StepType=Max	Point=1	X2=-0.5	X3=-0.5	
S11=-2398.41886443216	IsS11Max=No	IsS11Min=Yes	FrameElem=43	ElemStation=0.125				
Frame=43	Station=0.125	OutputCase=ENVE	CaseType=Combination	StepType=Max	Point=2	X2=-0.5	X3=0.5	
S11=-2398.41886443216	IsS11Max=No	IsS11Min=No	FrameElem=43	ElemStation=0.125				
Frame=43	Station=0.125	OutputCase=ENVE	CaseType=Combination	StepType=Max	Point=3	X2=0.5	X3=-0.5	
S11=2222.85689955563	IsS11Max=Yes	IsS11Min=No	FrameElem=43	ElemStation=0.125				
Frame=43	Station=0.125	OutputCase=ENVE	CaseType=Combination	StepType=Max	Point=4	X2=0.5	X3=0.5	
S11=2222.85689955563	IsS11Max=No	IsS11Min=No	FrameElem=43	ElemStation=0.125				
Frame=43	Station=0.25	OutputCase=ENVE	CaseType=Combination	StepType=Max	Point=0	X2=0	X3=0	S11=-
90.2888588483431	IsS11Max=No	IsS11Min=No	FrameElem=43	ElemStation=0.25				
Frame=43	Station=0.25	OutputCase=ENVE	CaseType=Combination	StepType=Max	Point=1	X2=-0.5	X3=-0.5	
S11=-2542.2075612115	IsS11Max=No	IsS11Min=Yes	FrameElem=43	ElemStation=0.25				

Frame=43	Station=0.25	OutputCase=ENVE	CaseType=Combination	StepType=Max	Point=2	X2=-0.5	X3=0.5	
S11=-2542.2075612115	IsS11Max=No	IsS11Min=No	FrameElem=43	ElemStation=0.25				
Frame=43	Station=0.25	OutputCase=ENVE	CaseType=Combination	StepType=Max	Point=3	X2=0.5	X3=-0.5	
S11=2366.61579949461	IsS11Max=Yes	IsS11Min=No	FrameElem=43	ElemStation=0.25				
Frame=43	Station=0.25	OutputCase=ENVE	CaseType=Combination	StepType=Max	Point=4	X2=0.5	X3=0.5	
S11=2366.61579949461	IsS11Max=No	IsS11Min=No	FrameElem=43	ElemStation=0.25				
Frame=43	Station=0.375	OutputCase=ENVE	CaseType=Combination	StepType=Max	Point=0	X2=0	X3=0	S11=-
90.2888588483431	IsS11Max=No	IsS11Min=No	FrameElem=43	ElemStation=0.375				
Frame=43	Station=0.375	OutputCase=ENVE	CaseType=Combination	StepType=Max	Point=1	X2=-0.5	X3=-0.5	
S11=-2688.34000799084	IsS11Max=No	IsS11Min=Yes	FrameElem=43	ElemStation=0.375				
Frame=43	Station=0.375	OutputCase=ENVE	CaseType=Combination	StepType=Max	Point=2	X2=-0.5	X3=0.5	
S11=-2688.34000799084	IsS11Max=No	IsS11Min=No	FrameElem=43	ElemStation=0.375				
Frame=43	Station=0.375	OutputCase=ENVE	CaseType=Combination	StepType=Max	Point=3	X2=0.5	X3=-0.5	
S11=2512.71844943358	IsS11Max=Yes	IsS11Min=No	FrameElem=43	ElemStation=0.375				
Frame=43	Station=0.375	OutputCase=ENVE	CaseType=Combination	StepType=Max	Point=4	X2=0.5	X3=0.5	
S11=2512.71844943358	IsS11Max=No	IsS11Min=No	FrameElem=43	ElemStation=0.375				
Frame=43	Station=0.5	OutputCase=ENVE	CaseType=Combination	StepType=Max	Point=0	X2=0	X3=0	S11=-
90.2888588483431	IsS11Max=No	IsS11Min=No	FrameElem=43	ElemStation=0.5				
Frame=43	Station=0.5	OutputCase=ENVE	CaseType=Combination	StepType=Max	Point=1	X2=-0.5	X3=-0.5	
S11=-2836.81620477018	IsS11Max=No	IsS11Min=Yes	FrameElem=43	ElemStation=0.5				
Frame=43	Station=0.5	OutputCase=ENVE	CaseType=Combination	StepType=Max	Point=2	X2=-0.5	X3=0.5	
S11=-2836.81620477018	IsS11Max=No	IsS11Min=No	FrameElem=43	ElemStation=0.5				
Frame=43	Station=0.5	OutputCase=ENVE	CaseType=Combination	StepType=Max	Point=3	X2=0.5	X3=-0.5	
S11=2661.16484937255	IsS11Max=Yes	IsS11Min=No	FrameElem=43	ElemStation=0.5				
Frame=43	Station=0.5	OutputCase=ENVE	CaseType=Combination	StepType=Max	Point=4	X2=0.5	X3=0.5	
S11=2661.16484937255	IsS11Max=No	IsS11Min=No	FrameElem=43	ElemStation=0.5				
Frame=43	Station=0	OutputCase=ENVE	CaseType=Combination	StepType=Min	Point=0	X2=0	X3=0	S11=-
122.976319142087	IsS11Max=No	IsS11Min=No	FrameElem=43	ElemStation=0				
Frame=43	Station=0	OutputCase=ENVE	CaseType=Combination	StepType=Min	Point=1	X2=-0.5	X3=0.5	
S11=-2262.01946731334	IsS11Max=No	IsS11Min=Yes	FrameElem=43	ElemStation=0				
Frame=43	Station=0	OutputCase=ENVE	CaseType=Combination	StepType=Min	Point=2	X2=-0.5	X3=0.5	S11=-
2262.01946731334	IsS11Max=No	IsS11Min=No	FrameElem=43	ElemStation=0				
Frame=43	Station=0	OutputCase=ENVE	CaseType=Combination	StepType=Min	Point=3	X2=0.5	X3=-0.5	
S11=2011.02127936864	IsS11Max=Yes	IsS11Min=No	FrameElem=43	ElemStation=0				
Frame=43	Station=0	OutputCase=ENVE	CaseType=Combination	StepType=Min	Point=4	X2=0.5	X3=0.5	
S11=2011.02127936864	IsS11Max=No	IsS11Min=No	FrameElem=43	ElemStation=0				
Frame=43	Station=0.125	OutputCase=ENVE	CaseType=Combination	StepType=Min	Point=0	X2=0	X3=0	S11=-
122.976319142087	IsS11Max=No	IsS11Min=No	FrameElem=43	ElemStation=0.125				
Frame=43	Station=0.125	OutputCase=ENVE	CaseType=Combination	StepType=Min	Point=1	X2=-0.5	X3=-0.5	
S11=-2403.43461725232	IsS11Max=No	IsS11Min=Yes	FrameElem=43	ElemStation=0.125				
Frame=43	Station=0.125	OutputCase=ENVE	CaseType=Combination	StepType=Min	Point=2	X2=-0.5	X3=0.5	
S11=-2403.43461725232	IsS11Max=No	IsS11Min=No	FrameElem=43	ElemStation=0.125				
Frame=43	Station=0.125	OutputCase=ENVE	CaseType=Combination	StepType=Min	Point=3	X2=0.5	X3=-0.5	
S11=2152.46622614798	IsS11Max=Yes	IsS11Min=No	FrameElem=43	ElemStation=0.125				
Frame=43	Station=0.125	OutputCase=ENVE	CaseType=Combination	StepType=Min	Point=4	X2=0.5	X3=0.5	
S11=2152.46622614798	IsS11Max=No	IsS11Min=No	FrameElem=43	ElemStation=0.125				
Frame=43	Station=0.25	OutputCase=ENVE	CaseType=Combination	StepType=Min	Point=0	X2=0	X3=0	S11=-
122.976319142087	IsS11Max=No	IsS11Min=No	FrameElem=43	ElemStation=0.25				
Frame=43	Station=0.25	OutputCase=ENVE	CaseType=Combination	StepType=Min	Point=1	X2=-0.5	X3=-0.5	
S11=-2547.19351719129	IsS11Max=No	IsS11Min=Yes	FrameElem=43	ElemStation=0.25				
Frame=43	Station=0.25	OutputCase=ENVE	CaseType=Combination	StepType=Min	Point=2	X2=-0.5	X3=0.5	
S11=-2547.19351719129	IsS11Max=No	IsS11Min=No	FrameElem=43	ElemStation=0.25				
Frame=43	Station=0.25	OutputCase=ENVE	CaseType=Combination	StepType=Min	Point=3	X2=0.5	X3=-0.5	
S11=2296.25492292733	IsS11Max=Yes	IsS11Min=No	FrameElem=43	ElemStation=0.25				
Frame=43	Station=0.25	OutputCase=ENVE	CaseType=Combination	StepType=Min	Point=4	X2=0.5	X3=0.5	
S11=2296.25492292733	IsS11Max=No	IsS11Min=No	FrameElem=43	ElemStation=0.25				
Frame=43	Station=0.375	OutputCase=ENVE	CaseType=Combination	StepType=Min	Point=0	X2=0	X3=0	S11=-
122.976319142087	IsS11Max=No	IsS11Min=No	FrameElem=43	ElemStation=0.375				
Frame=43	Station=0.375	OutputCase=ENVE	CaseType=Combination	StepType=Min	Point=1	X2=-0.5	X3=-0.5	
S11=-2693.29616713026	IsS11Max=No	IsS11Min=Yes	FrameElem=43	ElemStation=0.375				
Frame=43	Station=0.375	OutputCase=ENVE	CaseType=Combination	StepType=Min	Point=2	X2=-0.5	X3=0.5	
S11=-2693.29616713026	IsS11Max=No	IsS11Min=No	FrameElem=43	ElemStation=0.375				
Frame=43	Station=0.375	OutputCase=ENVE	CaseType=Combination	StepType=Min	Point=3	X2=0.5	X3=-0.5	
S11=2442.38736970667	IsS11Max=Yes	IsS11Min=No	FrameElem=43	ElemStation=0.375				
Frame=43	Station=0.375	OutputCase=ENVE	CaseType=Combination	StepType=Min	Point=4	X2=0.5	X3=0.5	
S11=2442.38736970667	IsS11Max=No	IsS11Min=No	FrameElem=43	ElemStation=0.375				
Frame=43	Station=0.5	OutputCase=ENVE	CaseType=Combination	StepType=Min	Point=0	X2=0	X3=0	S11=-
122.976319142087	IsS11Max=No	IsS11Min=No	FrameElem=43	ElemStation=0.5				
Frame=43	Station=0.5	OutputCase=ENVE	CaseType=Combination	StepType=Min	Point=1	X2=-0.5	X3=-0.5	
S11=-2841.74256706924	IsS11Max=No	IsS11Min=Yes	FrameElem=43	ElemStation=0.5				
Frame=43	Station=0.5	OutputCase=ENVE	CaseType=Combination	StepType=Min	Point=2	X2=-0.5	X3=0.5	
S11=-2841.74256706924	IsS11Max=No	IsS11Min=No	FrameElem=43	ElemStation=0.5				
Frame=43	Station=0.5	OutputCase=ENVE	CaseType=Combination	StepType=Min	Point=3	X2=0.5	X3=-0.5	
S11=2590.86356648601	IsS11Max=Yes	IsS11Min=No	FrameElem=43	ElemStation=0.5				
Frame=43	Station=0.5	OutputCase=ENVE	CaseType=Combination	StepType=Min	Point=4	X2=0.5	X3=0.5	
S11=2590.86356648601	IsS11Max=No	IsS11Min=No	FrameElem=43	ElemStation=0.5				
Frame=43	Station=0	OutputCase=FESSUR	CaseType=Combination	Point=0	X2=0	X3=0	S11=-122.976319142087	
IsS11Max=No	IsS11Min=No	FrameElem=43	ElemStation=0					
Frame=43	Station=0	OutputCase=FESSUR	CaseType=Combination	Point=1	X2=-0.5	X3=-0.5	S11=-	
2256.97391765282	IsS11Max=No	IsS11Min=Yes	FrameElem=43	ElemStation=0				
Frame=43	Station=0	OutputCase=FESSUR	CaseType=Combination	Point=2	X2=-0.5	X3=0.5	S11=-	
2256.97391765282	IsS11Max=No	IsS11Min=No	FrameElem=43	ElemStation=0				

Frame=43 Station=0 OutputCase=FESSUR CaseType=Combination Point=3 X2=0.5 X3=-0.5
S11=2011.02127936864 IsS11Max=Yes IsS11Min=No FrameElem=43 ElemStation=0
Frame=43 Station=0 OutputCase=FESSUR CaseType=Combination Point=4 X2=0.5 X3=0.5
S11=2011.02127936864 IsS11Max=No IsS11Min=No FrameElem=43 ElemStation=0
Frame=43 Station=0.125 OutputCase=FESSUR CaseType=Combination Point=0 X2=0 X3=0 S11=-
122.976319142087 IsS11Max=No IsS11Min=No FrameElem=43 ElemStation=0.125
Frame=43 Station=0.125 OutputCase=FESSUR CaseType=Combination Point=1 X2=-0.5 X3=-0.5 S11=-
2398.41886443216 IsS11Max=No IsS11Min=Yes FrameElem=43 ElemStation=0.125
Frame=43 Station=0.125 OutputCase=FESSUR CaseType=Combination Point=2 X2=-0.5 X3=0.5 S11=-
2398.41886443216 IsS11Max=No IsS11Min=No FrameElem=43 ElemStation=0.125
Frame=43 Station=0.125 OutputCase=FESSUR CaseType=Combination Point=3 X2=0.5 X3=-0.5
S11=2152.46622614798 IsS11Max=Yes IsS11Min=No FrameElem=43 ElemStation=0.125
Frame=43 Station=0.125 OutputCase=FESSUR CaseType=Combination Point=4 X2=0.5 X3=0.5
S11=2152.46622614798 IsS11Max=No IsS11Min=No FrameElem=43 ElemStation=0.125
Frame=43 Station=0.25 OutputCase=FESSUR CaseType=Combination Point=0 X2=0 X3=0 S11=-
122.976319142087 IsS11Max=No IsS11Min=No FrameElem=43 ElemStation=0.25
Frame=43 Station=0.25 OutputCase=FESSUR CaseType=Combination Point=1 X2=-0.5 X3=-0.5 S11=-
2542.2075612115 IsS11Max=No IsS11Min=Yes FrameElem=43 ElemStation=0.25
Frame=43 Station=0.25 OutputCase=FESSUR CaseType=Combination Point=2 X2=-0.5 X3=0.5 S11=-
2542.2075612115 IsS11Max=No IsS11Min=No FrameElem=43 ElemStation=0.25
Frame=43 Station=0.25 OutputCase=FESSUR CaseType=Combination Point=3 X2=0.5 X3=-0.5
S11=2296.25492292733 IsS11Max=Yes IsS11Min=No FrameElem=43 ElemStation=0.25
Frame=43 Station=0.25 OutputCase=FESSUR CaseType=Combination Point=4 X2=0.5 X3=0.5
S11=2296.25492292733 IsS11Max=No IsS11Min=No FrameElem=43 ElemStation=0.25
Frame=43 Station=0.375 OutputCase=FESSUR CaseType=Combination Point=0 X2=0 X3=0 S11=-
122.976319142087 IsS11Max=No IsS11Min=No FrameElem=43 ElemStation=0.375
Frame=43 Station=0.375 OutputCase=FESSUR CaseType=Combination Point=1 X2=-0.5 X3=-0.5 S11=-
2688.34000799084 IsS11Max=No IsS11Min=Yes FrameElem=43 ElemStation=0.375
Frame=43 Station=0.375 OutputCase=FESSUR CaseType=Combination Point=2 X2=-0.5 X3=0.5 S11=-
2688.34000799084 IsS11Max=No IsS11Min=No FrameElem=43 ElemStation=0.375
Frame=43 Station=0.375 OutputCase=FESSUR CaseType=Combination Point=3 X2=0.5 X3=-0.5
S11=2442.38736970667 IsS11Max=Yes IsS11Min=No FrameElem=43 ElemStation=0.375
Frame=43 Station=0.375 OutputCase=FESSUR CaseType=Combination Point=4 X2=0.5 X3=0.5
S11=2442.38736970667 IsS11Max=No IsS11Min=No FrameElem=43 ElemStation=0.375
Frame=43 Station=0.5 OutputCase=FESSUR CaseType=Combination Point=0 X2=0 X3=0 S11=-122.976319142087
IsS11Max=No IsS11Min=No FrameElem=43 ElemStation=0.5
Frame=43 Station=0.5 OutputCase=FESSUR CaseType=Combination Point=1 X2=-0.5 X3=-0.5 S11=-
2836.81620477018 IsS11Max=No IsS11Min=Yes FrameElem=43 ElemStation=0.5
Frame=43 Station=0.5 OutputCase=FESSUR CaseType=Combination Point=2 X2=-0.5 X3=0.5 S11=-
2836.81620477018 IsS11Max=No IsS11Min=No FrameElem=43 ElemStation=0.5
Frame=43 Station=0.5 OutputCase=FESSUR CaseType=Combination Point=3 X2=0.5 X3=-0.5
S11=2590.86356648601 IsS11Max=Yes IsS11Min=No FrameElem=43 ElemStation=0.5
Frame=43 Station=0.5 OutputCase=FESSUR CaseType=Combination Point=4 X2=0.5 X3=0.5
S11=2590.86356648601 IsS11Max=No IsS11Min=No FrameElem=43 ElemStation=0.5
Frame=44 Station=0 OutputCase=PESOPR CaseType=LinStatic Point=0 X2=0 X3=0 S11=-15.1709467362365
IsS11Max=No IsS11Min=No FrameElem=44 ElemStation=0
Frame=44 Station=0 OutputCase=PESOPR CaseType=LinStatic Point=1 X2=-0.5 X3=-0.5 S11=-
686.014663654706 IsS11Max=No IsS11Min=Yes FrameElem=44 ElemStation=0
Frame=44 Station=0 OutputCase=PESOPR CaseType=LinStatic Point=2 X2=-0.5 X3=0.5 S11=-
686.014663654706 IsS11Max=No IsS11Min=No FrameElem=44 ElemStation=0
Frame=44 Station=0 OutputCase=PESOPR CaseType=LinStatic Point=3 X2=0.5 X3=-0.5 S11=655.672770182232
IsS11Max=Yes IsS11Min=No FrameElem=44 ElemStation=0
Frame=44 Station=0 OutputCase=PESOPR CaseType=LinStatic Point=4 X2=0.5 X3=0.5 S11=655.672770182232
IsS11Max=No IsS11Min=No FrameElem=44 ElemStation=0
Frame=44 Station=0.125 OutputCase=PESOPR CaseType=LinStatic Point=0 X2=0 X3=0 S11=-15.1709467362365
IsS11Max=No IsS11Min=No FrameElem=44 ElemStation=0.125
Frame=44 Station=0.125 OutputCase=PESOPR CaseType=LinStatic Point=1 X2=-0.5 X3=-0.5 S11=-
694.493632768891 IsS11Max=No IsS11Min=Yes FrameElem=44 ElemStation=0.125
Frame=44 Station=0.125 OutputCase=PESOPR CaseType=LinStatic Point=2 X2=-0.5 X3=0.5 S11=-
694.493632768891 IsS11Max=No IsS11Min=No FrameElem=44 ElemStation=0.125
Frame=44 Station=0.125 OutputCase=PESOPR CaseType=LinStatic Point=3 X2=0.5 X3=-0.5
S11=664.151739296417 IsS11Max=Yes IsS11Min=No FrameElem=44 ElemStation=0.125
Frame=44 Station=0.125 OutputCase=PESOPR CaseType=LinStatic Point=4 X2=0.5 X3=0.5
S11=664.151739296417 IsS11Max=No IsS11Min=No FrameElem=44 ElemStation=0.125
Frame=44 Station=0.25 OutputCase=PESOPR CaseType=LinStatic Point=0 X2=0 X3=0 S11=-15.1709467362365
IsS11Max=No IsS11Min=No FrameElem=44 ElemStation=0.25
Frame=44 Station=0.25 OutputCase=PESOPR CaseType=LinStatic Point=1 X2=-0.5 X3=-0.5 S11=-
705.316351883076 IsS11Max=No IsS11Min=Yes FrameElem=44 ElemStation=0.25
Frame=44 Station=0.25 OutputCase=PESOPR CaseType=LinStatic Point=2 X2=-0.5 X3=0.5 S11=-
705.316351883076 IsS11Max=No IsS11Min=No FrameElem=44 ElemStation=0.25
Frame=44 Station=0.25 OutputCase=PESOPR CaseType=LinStatic Point=3 X2=0.5 X3=-0.5
S11=674.974458410602 IsS11Max=Yes IsS11Min=No FrameElem=44 ElemStation=0.25
Frame=44 Station=0.25 OutputCase=PESOPR CaseType=LinStatic Point=4 X2=0.5 X3=0.5
S11=674.974458410602 IsS11Max=No IsS11Min=No FrameElem=44 ElemStation=0.25
Frame=44 Station=0.375 OutputCase=PESOPR CaseType=LinStatic Point=0 X2=0 X3=0 S11=-15.1709467362365
IsS11Max=No IsS11Min=No FrameElem=44 ElemStation=0.375
Frame=44 Station=0.375 OutputCase=PESOPR CaseType=LinStatic Point=1 X2=-0.5 X3=-0.5 S11=-
718.482820997261 IsS11Max=No IsS11Min=Yes FrameElem=44 ElemStation=0.375
Frame=44 Station=0.375 OutputCase=PESOPR CaseType=LinStatic Point=2 X2=-0.5 X3=0.5 S11=-
718.482820997261 IsS11Max=No IsS11Min=No FrameElem=44 ElemStation=0.375
Frame=44 Station=0.375 OutputCase=PESOPR CaseType=LinStatic Point=3 X2=0.5 X3=-0.5
S11=688.140927524787 IsS11Max=Yes IsS11Min=No FrameElem=44 ElemStation=0.375

Frame=44 Station=0.375 OutputCase=PESOPR CaseType=LinStatic Point=4 X2=0.5 X3=0.5
 S11=688.140927524787 IsS11Max=No IsS11Min=No FrameElem=44 ElemStation=0.375
 Frame=44 Station=0.5 OutputCase=PESOPR CaseType=LinStatic Point=0 X2=0 X3=0 S11=-15.1709467362365
 IsS11Max=No IsS11Min=No FrameElem=44 ElemStation=0.5
 Frame=44 Station=0.5 OutputCase=PESOPR CaseType=LinStatic Point=1 X2=-0.5 X3=-0.5 S11=-
 733.993040111446 IsS11Max=No IsS11Min=Yes FrameElem=44 ElemStation=0.5
 Frame=44 Station=0.5 OutputCase=PESOPR CaseType=LinStatic Point=2 X2=-0.5 X3=0.5 S11=-
 733.993040111446 IsS11Max=No IsS11Min=No FrameElem=44 ElemStation=0.5
 Frame=44 Station=0.5 OutputCase=PESOPR CaseType=LinStatic Point=3 X2=0.5 X3=-0.5
 S11=703.651146638972 IsS11Max=Yes IsS11Min=No FrameElem=44 ElemStation=0.5
 Frame=44 Station=0.5 OutputCase=PESOPR CaseType=LinStatic Point=4 X2=0.5 X3=0.5
 S11=703.651146638972 IsS11Max=No IsS11Min=No FrameElem=44 ElemStation=0.5
 Frame=44 Station=0 OutputCase=TERRVERT CaseType=LinStatic Point=0 X2=0 X3=0 S11=1.15282857329472
 IsS11Max=No IsS11Min=No FrameElem=44 ElemStation=0
 Frame=44 Station=0 OutputCase=TERRVERT CaseType=LinStatic Point=1 X2=-0.5 X3=-0.5 S11=-
 2167.22274877906 IsS11Max=No IsS11Min=Yes FrameElem=44 ElemStation=0
 Frame=44 Station=0 OutputCase=TERRVERT CaseType=LinStatic Point=2 X2=-0.5 X3=0.5 S11=-
 2167.22274877906 IsS11Max=No IsS11Min=No FrameElem=44 ElemStation=0
 Frame=44 Station=0 OutputCase=TERRVERT CaseType=LinStatic Point=3 X2=0.5 X3=-0.5
 S11=2169.52840592565 IsS11Max=Yes IsS11Min=No FrameElem=44 ElemStation=0
 Frame=44 Station=0 OutputCase=TERRVERT CaseType=LinStatic Point=4 X2=0.5 X3=0.5
 S11=2169.52840592565 IsS11Max=No IsS11Min=No FrameElem=44 ElemStation=0
 Frame=44 Station=0.125 OutputCase=TERRVERT CaseType=LinStatic Point=0 X2=0 X3=0
 S11=1.15282857329472 IsS11Max=No IsS11Min=No FrameElem=44 ElemStation=0.125
 Frame=44 Station=0.125 OutputCase=TERRVERT CaseType=LinStatic Point=1 X2=-0.5 X3=-0.5 S11=-
 2203.44042198145 IsS11Max=No IsS11Min=Yes FrameElem=44 ElemStation=0.125
 Frame=44 Station=0.125 OutputCase=TERRVERT CaseType=LinStatic Point=2 X2=-0.5 X3=0.5 S11=-
 2203.44042198145 IsS11Max=No IsS11Min=No FrameElem=44 ElemStation=0.125
 Frame=44 Station=0.125 OutputCase=TERRVERT CaseType=LinStatic Point=3 X2=0.5 X3=-0.5
 S11=2205.74607912804 IsS11Max=Yes IsS11Min=No FrameElem=44 ElemStation=0.125
 Frame=44 Station=0.125 OutputCase=TERRVERT CaseType=LinStatic Point=4 X2=0.5 X3=0.5
 S11=2205.74607912804 IsS11Max=No IsS11Min=No FrameElem=44 ElemStation=0.125
 Frame=44 Station=0.25 OutputCase=TERRVERT CaseType=LinStatic Point=0 X2=0 X3=0 S11=1.15282857329472
 IsS11Max=No IsS11Min=No FrameElem=44 ElemStation=0.25
 Frame=44 Station=0.25 OutputCase=TERRVERT CaseType=LinStatic Point=1 X2=-0.5 X3=-0.5 S11=-
 2239.65809518384 IsS11Max=No IsS11Min=Yes FrameElem=44 ElemStation=0.25
 Frame=44 Station=0.25 OutputCase=TERRVERT CaseType=LinStatic Point=2 X2=-0.5 X3=0.5 S11=-
 2239.65809518384 IsS11Max=No IsS11Min=No FrameElem=44 ElemStation=0.25
 Frame=44 Station=0.25 OutputCase=TERRVERT CaseType=LinStatic Point=3 X2=0.5 X3=-0.5
 S11=2241.96375233043 IsS11Max=Yes IsS11Min=No FrameElem=44 ElemStation=0.25
 Frame=44 Station=0.25 OutputCase=TERRVERT CaseType=LinStatic Point=4 X2=0.5 X3=0.5
 S11=2241.96375233043 IsS11Max=No IsS11Min=No FrameElem=44 ElemStation=0.25
 Frame=44 Station=0.375 OutputCase=TERRVERT CaseType=LinStatic Point=0 X2=0 X3=0
 S11=1.15282857329472 IsS11Max=No IsS11Min=No FrameElem=44 ElemStation=0.375
 Frame=44 Station=0.375 OutputCase=TERRVERT CaseType=LinStatic Point=1 X2=-0.5 X3=-0.5 S11=-
 2275.87576838623 IsS11Max=No IsS11Min=Yes FrameElem=44 ElemStation=0.375
 Frame=44 Station=0.375 OutputCase=TERRVERT CaseType=LinStatic Point=2 X2=-0.5 X3=0.5 S11=-
 2275.87576838623 IsS11Max=No IsS11Min=No FrameElem=44 ElemStation=0.375
 Frame=44 Station=0.375 OutputCase=TERRVERT CaseType=LinStatic Point=3 X2=0.5 X3=-0.5
 S11=2278.18142553282 IsS11Max=Yes IsS11Min=No FrameElem=44 ElemStation=0.375
 Frame=44 Station=0.375 OutputCase=TERRVERT CaseType=LinStatic Point=4 X2=0.5 X3=0.5
 S11=2278.18142553282 IsS11Max=No IsS11Min=No FrameElem=44 ElemStation=0.375
 Frame=44 Station=0.5 OutputCase=TERRVERT CaseType=LinStatic Point=0 X2=0 X3=0 S11=1.15282857329472
 IsS11Max=No IsS11Min=No FrameElem=44 ElemStation=0.5
 Frame=44 Station=0.5 OutputCase=TERRVERT CaseType=LinStatic Point=1 X2=-0.5 X3=-0.5 S11=-
 2312.09344158861 IsS11Max=No IsS11Min=Yes FrameElem=44 ElemStation=0.5
 Frame=44 Station=0.5 OutputCase=TERRVERT CaseType=LinStatic Point=2 X2=-0.5 X3=0.5 S11=-
 2312.09344158861 IsS11Max=No IsS11Min=No FrameElem=44 ElemStation=0.5
 Frame=44 Station=0.5 OutputCase=TERRVERT CaseType=LinStatic Point=3 X2=0.5 X3=-0.5
 S11=2314.3990987352 IsS11Max=Yes IsS11Min=No FrameElem=44 ElemStation=0.5
 Frame=44 Station=0.5 OutputCase=TERRVERT CaseType=LinStatic Point=4 X2=0.5 X3=0.5
 S11=2314.3990987352 IsS11Max=No IsS11Min=No FrameElem=44 ElemStation=0.5
 Frame=44 Station=0 OutputCase=TERRLAT CaseType=LinStatic Point=0 X2=0 X3=0 S11=-108.958200979145
 IsS11Max=No IsS11Min=No FrameElem=44 ElemStation=0
 Frame=44 Station=0 OutputCase=TERRLAT CaseType=LinStatic Point=1 X2=-0.5 X3=-0.5
 S11=16.4212076635229 IsS11Max=Yes IsS11Min=No FrameElem=44 ElemStation=0
 Frame=44 Station=0 OutputCase=TERRLAT CaseType=LinStatic Point=2 X2=-0.5 X3=0.5
 S11=16.4212076635229 IsS11Max=No IsS11Min=No FrameElem=44 ElemStation=0
 Frame=44 Station=0 OutputCase=TERRLAT CaseType=LinStatic Point=3 X2=0.5 X3=-0.5 S11=-
 234.337609621812 IsS11Max=No IsS11Min=Yes FrameElem=44 ElemStation=0
 Frame=44 Station=0 OutputCase=TERRLAT CaseType=LinStatic Point=4 X2=0.5 X3=0.5 S11=-
 234.337609621812 IsS11Max=No IsS11Min=No FrameElem=44 ElemStation=0
 Frame=44 Station=0.125 OutputCase=TERRLAT CaseType=LinStatic Point=0 X2=0 X3=0 S11=-
 108.958200979145 IsS11Max=No IsS11Min=No FrameElem=44 ElemStation=0.125
 Frame=44 Station=0.125 OutputCase=TERRLAT CaseType=LinStatic Point=1 X2=-0.5 X3=-0.5
 S11=16.3852820680876 IsS11Max=Yes IsS11Min=No FrameElem=44 ElemStation=0.125
 Frame=44 Station=0.125 OutputCase=TERRLAT CaseType=LinStatic Point=2 X2=-0.5 X3=0.5
 S11=16.3852820680876 IsS11Max=No IsS11Min=No FrameElem=44 ElemStation=0.125
 Frame=44 Station=0.125 OutputCase=TERRLAT CaseType=LinStatic Point=3 X2=0.5 X3=-0.5 S11=-
 234.301684026377 IsS11Max=No IsS11Min=Yes FrameElem=44 ElemStation=0.125
 Frame=44 Station=0.125 OutputCase=TERRLAT CaseType=LinStatic Point=4 X2=0.5 X3=0.5 S11=-
 234.301684026377 IsS11Max=No IsS11Min=No FrameElem=44 ElemStation=0.125

Frame=44	Station=0.25	OutputCase=TERRLAT	CaseType=LinStatic	Point=0	X2=0	X3=0	S11=-108.958200979145
IsS11Max=No	IsS11Min=No	FrameElem=44	ElemStation=0.25				
Frame=44	Station=0.25	OutputCase=TERRLAT	CaseType=LinStatic	Point=1	X2=-0.5	X3=-0.5	
S11=16.3493564726523	IsS11Max=Yes	IsS11Min=No	FrameElem=44	ElemStation=0.25			
Frame=44	Station=0.25	OutputCase=TERRLAT	CaseType=LinStatic	Point=2	X2=-0.5	X3=0.5	
S11=16.3493564726523	IsS11Max=No	IsS11Min=No	FrameElem=44	ElemStation=0.25			
Frame=44	Station=0.25	OutputCase=TERRLAT	CaseType=LinStatic	Point=3	X2=0.5	X3=-0.5	S11=-
234.265758430942	IsS11Max=No	IsS11Min=Yes	FrameElem=44	ElemStation=0.25			
Frame=44	Station=0.25	OutputCase=TERRLAT	CaseType=LinStatic	Point=4	X2=0.5	X3=0.5	S11=-
234.265758430942	IsS11Max=No	IsS11Min=No	FrameElem=44	ElemStation=0.25			
Frame=44	Station=0.375	OutputCase=TERRLAT	CaseType=LinStatic	Point=0	X2=0	X3=0	S11=-
108.958200979145	IsS11Max=No	IsS11Min=No	FrameElem=44	ElemStation=0.375			
Frame=44	Station=0.375	OutputCase=TERRLAT	CaseType=LinStatic	Point=1	X2=-0.5	X3=-0.5	
S11=16.313430877217	IsS11Max=Yes	IsS11Min=No	FrameElem=44	ElemStation=0.375			
Frame=44	Station=0.375	OutputCase=TERRLAT	CaseType=LinStatic	Point=2	X2=-0.5	X3=0.5	
S11=16.313430877217	IsS11Max=No	IsS11Min=No	FrameElem=44	ElemStation=0.375			
Frame=44	Station=0.375	OutputCase=TERRLAT	CaseType=LinStatic	Point=3	X2=0.5	X3=-0.5	S11=-
234.229832835507	IsS11Max=No	IsS11Min=Yes	FrameElem=44	ElemStation=0.375			
Frame=44	Station=0.375	OutputCase=TERRLAT	CaseType=LinStatic	Point=4	X2=0.5	X3=0.5	S11=-
234.229832835507	IsS11Max=No	IsS11Min=No	FrameElem=44	ElemStation=0.375			
Frame=44	Station=0.5	OutputCase=TERRLAT	CaseType=LinStatic	Point=0	X2=0	X3=0	S11=-108.958200979145
IsS11Max=No	IsS11Min=No	FrameElem=44	ElemStation=0.5				
Frame=44	Station=0.5	OutputCase=TERRLAT	CaseType=LinStatic	Point=1	X2=-0.5	X3=-0.5	
S11=16.2775052817817	IsS11Max=Yes	IsS11Min=No	FrameElem=44	ElemStation=0.5			
Frame=44	Station=0.5	OutputCase=TERRLAT	CaseType=LinStatic	Point=2	X2=-0.5	X3=0.5	
S11=16.2775052817817	IsS11Max=No	IsS11Min=No	FrameElem=44	ElemStation=0.5			
Frame=44	Station=0.5	OutputCase=TERRLAT	CaseType=LinStatic	Point=3	X2=0.5	X3=-0.5	S11=-
234.193907240071	IsS11Max=No	IsS11Min=Yes	FrameElem=44	ElemStation=0.5			
Frame=44	Station=0.5	OutputCase=TERRLAT	CaseType=LinStatic	Point=4	X2=0.5	X3=0.5	S11=-
234.193907240071	IsS11Max=No	IsS11Min=No	FrameElem=44	ElemStation=0.5			
Frame=44	Station=0	OutputCase=ACCLATDX	CaseType=LinStatic	Point=0	X2=0	X3=0	S11=0 IsS11Max=Yes
IsS11Min=Yes	FrameElem=44	ElemStation=0					
Frame=44	Station=0	OutputCase=ACCLATDX	CaseType=LinStatic	Point=1	X2=-0.5	X3=-0.5	S11=0
IsS11Max=No	IsS11Min=No	FrameElem=44	ElemStation=0				
Frame=44	Station=0	OutputCase=ACCLATDX	CaseType=LinStatic	Point=2	X2=-0.5	X3=0.5	S11=0
IsS11Max=No	IsS11Min=No	FrameElem=44	ElemStation=0				
Frame=44	Station=0	OutputCase=ACCLATDX	CaseType=LinStatic	Point=3	X2=0.5	X3=-0.5	S11=0
IsS11Max=No	IsS11Min=No	FrameElem=44	ElemStation=0				
Frame=44	Station=0	OutputCase=ACCLATDX	CaseType=LinStatic	Point=4	X2=0.5	X3=0.5	S11=0 IsS11Max=No
IsS11Min=No	FrameElem=44	ElemStation=0					
Frame=44	Station=0.125	OutputCase=ACCLATDX	CaseType=LinStatic	Point=0	X2=0	X3=0	S11=0
IsS11Max=Yes	IsS11Min=Yes	FrameElem=44	ElemStation=0.125				
Frame=44	Station=0.125	OutputCase=ACCLATDX	CaseType=LinStatic	Point=1	X2=-0.5	X3=-0.5	S11=0
IsS11Max=No	IsS11Min=No	FrameElem=44	ElemStation=0.125				
Frame=44	Station=0.125	OutputCase=ACCLATDX	CaseType=LinStatic	Point=2	X2=-0.5	X3=0.5	S11=0
IsS11Max=No	IsS11Min=No	FrameElem=44	ElemStation=0.125				
Frame=44	Station=0.125	OutputCase=ACCLATDX	CaseType=LinStatic	Point=3	X2=0.5	X3=-0.5	S11=0
IsS11Max=No	IsS11Min=No	FrameElem=44	ElemStation=0.125				
Frame=44	Station=0.125	OutputCase=ACCLATDX	CaseType=LinStatic	Point=4	X2=0.5	X3=0.5	S11=0
IsS11Max=No	IsS11Min=No	FrameElem=44	ElemStation=0.125				
Frame=44	Station=0.25	OutputCase=ACCLATDX	CaseType=LinStatic	Point=0	X2=0	X3=0	S11=0 IsS11Max=Yes
IsS11Min=Yes	FrameElem=44	ElemStation=0.25					
Frame=44	Station=0.25	OutputCase=ACCLATDX	CaseType=LinStatic	Point=1	X2=-0.5	X3=-0.5	S11=0
IsS11Max=No	IsS11Min=No	FrameElem=44	ElemStation=0.25				
Frame=44	Station=0.25	OutputCase=ACCLATDX	CaseType=LinStatic	Point=2	X2=-0.5	X3=0.5	S11=0
IsS11Max=No	IsS11Min=No	FrameElem=44	ElemStation=0.25				
Frame=44	Station=0.25	OutputCase=ACCLATDX	CaseType=LinStatic	Point=3	X2=0.5	X3=-0.5	S11=0
IsS11Max=No	IsS11Min=No	FrameElem=44	ElemStation=0.25				
Frame=44	Station=0.25	OutputCase=ACCLATDX	CaseType=LinStatic	Point=4	X2=0.5	X3=0.5	S11=0
IsS11Max=No	IsS11Min=No	FrameElem=44	ElemStation=0.25				
Frame=44	Station=0.375	OutputCase=ACCLATDX	CaseType=LinStatic	Point=0	X2=0	X3=0	S11=0
IsS11Max=Yes	IsS11Min=Yes	FrameElem=44	ElemStation=0.375				
Frame=44	Station=0.375	OutputCase=ACCLATDX	CaseType=LinStatic	Point=1	X2=-0.5	X3=-0.5	S11=0
IsS11Max=No	IsS11Min=No	FrameElem=44	ElemStation=0.375				
Frame=44	Station=0.375	OutputCase=ACCLATDX	CaseType=LinStatic	Point=2	X2=-0.5	X3=0.5	S11=0
IsS11Max=No	IsS11Min=No	FrameElem=44	ElemStation=0.375				
Frame=44	Station=0.375	OutputCase=ACCLATDX	CaseType=LinStatic	Point=3	X2=0.5	X3=-0.5	S11=0
IsS11Max=No	IsS11Min=No	FrameElem=44	ElemStation=0.375				
Frame=44	Station=0.375	OutputCase=ACCLATDX	CaseType=LinStatic	Point=4	X2=0.5	X3=0.5	S11=0
IsS11Max=No	IsS11Min=No	FrameElem=44	ElemStation=0.375				
Frame=44	Station=0.5	OutputCase=ACCLATDX	CaseType=LinStatic	Point=0	X2=0	X3=0	S11=0 IsS11Max=Yes
IsS11Min=Yes	FrameElem=44	ElemStation=0.5					
Frame=44	Station=0.5	OutputCase=ACCLATDX	CaseType=LinStatic	Point=1	X2=-0.5	X3=-0.5	S11=0
IsS11Max=No	IsS11Min=No	FrameElem=44	ElemStation=0.5				
Frame=44	Station=0.5	OutputCase=ACCLATDX	CaseType=LinStatic	Point=2	X2=-0.5	X3=0.5	S11=0
IsS11Max=No	IsS11Min=No	FrameElem=44	ElemStation=0.5				
Frame=44	Station=0.5	OutputCase=ACCLATDX	CaseType=LinStatic	Point=3	X2=0.5	X3=-0.5	S11=0
IsS11Max=No	IsS11Min=No	FrameElem=44	ElemStation=0.5				
Frame=44	Station=0.5	OutputCase=ACCLATDX	CaseType=LinStatic	Point=4	X2=0.5	X3=0.5	S11=0
IsS11Max=No	IsS11Min=No	FrameElem=44	ElemStation=0.5				
Frame=44	Station=0	OutputCase=ACCLATDX	CaseType=LinStatic	Point=0	X2=0	X3=0	S11=0 IsS11Max=Yes
IsS11Min=Yes	FrameElem=44	ElemStation=0					

Frame=44	Station=0.375	OutputCase=TERRCOST	CaseType=LinStatic	Point=2	X2=-0.5	X3=0.5	S11=0
IsS11Max=No	IsS11Min=No	FrameElem=44	ElemStation=0.375				
Frame=44	Station=0.375	OutputCase=TERRCOST	CaseType=LinStatic	Point=3	X2=0.5	X3=-0.5	S11=0
IsS11Max=No	IsS11Min=No	FrameElem=44	ElemStation=0.375				
Frame=44	Station=0.375	OutputCase=TERRCOST	CaseType=LinStatic	Point=4	X2=0.5	X3=0.5	S11=0
IsS11Max=No	IsS11Min=No	FrameElem=44	ElemStation=0.375				
Frame=44	Station=0.5	OutputCase=TERRCOST	CaseType=LinStatic	Point=0	X2=0	X3=0	S11=0
IsS11Min=Yes	FrameElem=44	ElemStation=0.5					IsS11Max=Yes
Frame=44	Station=0.5	OutputCase=TERRCOST	CaseType=LinStatic	Point=1	X2=-0.5	X3=-0.5	S11=0
IsS11Max=No	IsS11Min=No	FrameElem=44	ElemStation=0.5				
Frame=44	Station=0.5	OutputCase=TERRCOST	CaseType=LinStatic	Point=2	X2=-0.5	X3=0.5	S11=0
IsS11Max=No	IsS11Min=No	FrameElem=44	ElemStation=0.5				
Frame=44	Station=0.5	OutputCase=TERRCOST	CaseType=LinStatic	Point=3	X2=0.5	X3=-0.5	S11=0
IsS11Max=No	IsS11Min=No	FrameElem=44	ElemStation=0.5				
Frame=44	Station=0.5	OutputCase=TERRCOST	CaseType=LinStatic	Point=4	X2=0.5	X3=0.5	S11=0
IsS11Max=No	IsS11Min=No	FrameElem=44	ElemStation=0.5				
Frame=44	Station=0	OutputCase=SOVRCOST	CaseType=LinStatic	Point=0	X2=0	X3=0	S11=0
IsS11Min=Yes	FrameElem=44	ElemStation=0					IsS11Max=Yes
Frame=44	Station=0	OutputCase=SOVRCOST	CaseType=LinStatic	Point=1	X2=-0.5	X3=-0.5	S11=0
IsS11Max=No	IsS11Min=No	FrameElem=44	ElemStation=0				
Frame=44	Station=0	OutputCase=SOVRCOST	CaseType=LinStatic	Point=2	X2=-0.5	X3=0.5	S11=0
IsS11Max=No	IsS11Min=No	FrameElem=44	ElemStation=0				
Frame=44	Station=0	OutputCase=SOVRCOST	CaseType=LinStatic	Point=3	X2=0.5	X3=-0.5	S11=0
IsS11Max=No	IsS11Min=No	FrameElem=44	ElemStation=0				
Frame=44	Station=0	OutputCase=SOVRCOST	CaseType=LinStatic	Point=4	X2=0.5	X3=0.5	S11=0
IsS11Min=No	FrameElem=44	ElemStation=0					IsS11Max=No
Frame=44	Station=0.125	OutputCase=SOVRCOST	CaseType=LinStatic	Point=0	X2=0	X3=0	S11=0
IsS11Max=Yes	IsS11Min=Yes	FrameElem=44	ElemStation=0.125				
Frame=44	Station=0.125	OutputCase=SOVRCOST	CaseType=LinStatic	Point=1	X2=-0.5	X3=-0.5	S11=0
IsS11Max=No	IsS11Min=No	FrameElem=44	ElemStation=0.125				
Frame=44	Station=0.125	OutputCase=SOVRCOST	CaseType=LinStatic	Point=2	X2=-0.5	X3=0.5	S11=0
IsS11Max=No	IsS11Min=No	FrameElem=44	ElemStation=0.125				
Frame=44	Station=0.125	OutputCase=SOVRCOST	CaseType=LinStatic	Point=3	X2=0.5	X3=-0.5	S11=0
IsS11Max=No	IsS11Min=No	FrameElem=44	ElemStation=0.125				
Frame=44	Station=0.125	OutputCase=SOVRCOST	CaseType=LinStatic	Point=4	X2=0.5	X3=0.5	S11=0
IsS11Max=No	IsS11Min=No	FrameElem=44	ElemStation=0.125				
Frame=44	Station=0.25	OutputCase=SOVRCOST	CaseType=LinStatic	Point=0	X2=0	X3=0	S11=0
IsS11Min=Yes	FrameElem=44	ElemStation=0.25					IsS11Max=Yes
Frame=44	Station=0.25	OutputCase=SOVRCOST	CaseType=LinStatic	Point=1	X2=-0.5	X3=-0.5	S11=0
IsS11Max=No	IsS11Min=No	FrameElem=44	ElemStation=0.25				
Frame=44	Station=0.25	OutputCase=SOVRCOST	CaseType=LinStatic	Point=2	X2=-0.5	X3=0.5	S11=0
IsS11Max=No	IsS11Min=No	FrameElem=44	ElemStation=0.25				
Frame=44	Station=0.25	OutputCase=SOVRCOST	CaseType=LinStatic	Point=3	X2=0.5	X3=-0.5	S11=0
IsS11Max=No	IsS11Min=No	FrameElem=44	ElemStation=0.25				
Frame=44	Station=0.25	OutputCase=SOVRCOST	CaseType=LinStatic	Point=4	X2=0.5	X3=0.5	S11=0
IsS11Max=No	IsS11Min=No	FrameElem=44	ElemStation=0.25				
Frame=44	Station=0.375	OutputCase=SOVRCOST	CaseType=LinStatic	Point=0	X2=0	X3=0	S11=0
IsS11Max=Yes	IsS11Min=Yes	FrameElem=44	ElemStation=0.375				
Frame=44	Station=0.375	OutputCase=SOVRCOST	CaseType=LinStatic	Point=1	X2=-0.5	X3=-0.5	S11=0
IsS11Max=No	IsS11Min=No	FrameElem=44	ElemStation=0.375				
Frame=44	Station=0.375	OutputCase=SOVRCOST	CaseType=LinStatic	Point=2	X2=-0.5	X3=0.5	S11=0
IsS11Max=No	IsS11Min=No	FrameElem=44	ElemStation=0.375				
Frame=44	Station=0.375	OutputCase=SOVRCOST	CaseType=LinStatic	Point=3	X2=0.5	X3=-0.5	S11=0
IsS11Max=No	IsS11Min=No	FrameElem=44	ElemStation=0.375				
Frame=44	Station=0.375	OutputCase=SOVRCOST	CaseType=LinStatic	Point=4	X2=0.5	X3=0.5	S11=0
IsS11Max=No	IsS11Min=No	FrameElem=44	ElemStation=0.375				
Frame=44	Station=0.5	OutputCase=SOVRCOST	CaseType=LinStatic	Point=0	X2=0	X3=0	S11=0
IsS11Min=Yes	FrameElem=44	ElemStation=0.5					IsS11Max=Yes
Frame=44	Station=0.5	OutputCase=SOVRCOST	CaseType=LinStatic	Point=1	X2=-0.5	X3=-0.5	S11=0
IsS11Max=No	IsS11Min=No	FrameElem=44	ElemStation=0.5				
Frame=44	Station=0.5	OutputCase=SOVRCOST	CaseType=LinStatic	Point=2	X2=-0.5	X3=0.5	S11=0
IsS11Max=No	IsS11Min=No	FrameElem=44	ElemStation=0.5				
Frame=44	Station=0.5	OutputCase=SOVRCOST	CaseType=LinStatic	Point=3	X2=0.5	X3=-0.5	S11=0
IsS11Max=No	IsS11Min=No	FrameElem=44	ElemStation=0.5				
Frame=44	Station=0.5	OutputCase=SOVRCOST	CaseType=LinStatic	Point=4	X2=0.5	X3=0.5	S11=0
IsS11Max=No	IsS11Min=No	FrameElem=44	ElemStation=0.5				
Frame=44	Station=0	OutputCase=ENVE	CaseType=Combination	StepType=Max	Point=0	X2=0	X3=0
S11=-2836.81620477025	IsS11Max=No	IsS11Min=No	FrameElem=44	ElemStation=0			
Frame=44	Station=0	OutputCase=ENVE	CaseType=Combination	StepType=Max	Point=1	X2=-0.5	X3=-0.5
IsS11Max=No	IsS11Min=Yes	FrameElem=44	ElemStation=0				
Frame=44	Station=0	OutputCase=ENVE	CaseType=Combination	StepType=Max	Point=2	X2=-0.5	X3=0.5
S11=-2836.81620477025	IsS11Max=No	IsS11Min=No	FrameElem=44	ElemStation=0			
Frame=44	Station=0	OutputCase=ENVE	CaseType=Combination	StepType=Max	Point=3	X2=0.5	X3=-0.5
S11=2661.16484937262	IsS11Max=Yes	IsS11Min=No	FrameElem=44	ElemStation=0			
Frame=44	Station=0	OutputCase=ENVE	CaseType=Combination	StepType=Max	Point=4	X2=0.5	X3=0.5
S11=2661.16484937262	IsS11Max=No	IsS11Min=No	FrameElem=44	ElemStation=0			
Frame=44	Station=0.125	OutputCase=ENVE	CaseType=Combination	StepType=Max	Point=0	X2=0	X3=0
S11=-2888.588483432	IsS11Max=No	IsS11Min=No	FrameElem=44	ElemStation=0.125			
Frame=44	Station=0.125	OutputCase=ENVE	CaseType=Combination	StepType=Max	Point=1	X2=-0.5	X3=-0.5
S11=-2881.54877268225	IsS11Max=No	IsS11Min=Yes	FrameElem=44	ElemStation=0.125			
Frame=44	Station=0.125	OutputCase=ENVE	CaseType=Combination	StepType=Max	Point=2	X2=-0.5	X3=0.5
S11=-2881.54877268225	IsS11Max=No	IsS11Min=No	FrameElem=44	ElemStation=0.125			

Frame=44	Station=0.125	OutputCase=ENVE	CaseType=Combination	StepType=Max	Point=3	X2=0.5	X3=-0.5	
S11=2705.88663960599	IsS11Max=Yes	IsS11Min=No	FrameElem=44	ElemStation=0.125				
Frame=44	Station=0.125	OutputCase=ENVE	CaseType=Combination	StepType=Max	Point=4	X2=0.5	X3=0.5	
S11=2705.88663960599	IsS11Max=No	IsS11Min=No	FrameElem=44	ElemStation=0.125				
Frame=44	Station=0.25	OutputCase=ENVE	CaseType=Combination	StepType=Max	Point=0	X2=0	X3=0	S11=-
90.2888588483432	IsS11Max=No	IsS11Min=No	FrameElem=44	ElemStation=0.25				
Frame=44	Station=0.25	OutputCase=ENVE	CaseType=Combination	StepType=Max	Point=1	X2=-0.5	X3=-0.5	
S11=-2928.62509059426	IsS11Max=No	IsS11Min=Yes	FrameElem=44	ElemStation=0.25				
Frame=44	Station=0.25	OutputCase=ENVE	CaseType=Combination	StepType=Max	Point=2	X2=-0.5	X3=0.5	
S11=-2928.62509059426	IsS11Max=No	IsS11Min=No	FrameElem=44	ElemStation=0.25				
Frame=44	Station=0.25	OutputCase=ENVE	CaseType=Combination	StepType=Max	Point=3	X2=0.5	X3=-0.5	
S11=2752.95217983937	IsS11Max=Yes	IsS11Min=No	FrameElem=44	ElemStation=0.25				
Frame=44	Station=0.25	OutputCase=ENVE	CaseType=Combination	StepType=Max	Point=4	X2=0.5	X3=0.5	
S11=2752.95217983937	IsS11Max=No	IsS11Min=No	FrameElem=44	ElemStation=0.25				
Frame=44	Station=0.375	OutputCase=ENVE	CaseType=Combination	StepType=Max	Point=0	X2=0	X3=0	S11=-
90.2888588483432	IsS11Max=No	IsS11Min=No	FrameElem=44	ElemStation=0.375				
Frame=44	Station=0.375	OutputCase=ENVE	CaseType=Combination	StepType=Max	Point=1	X2=-0.5	X3=-0.5	
S11=-2978.04515850627	IsS11Max=No	IsS11Min=Yes	FrameElem=44	ElemStation=0.375				
Frame=44	Station=0.375	OutputCase=ENVE	CaseType=Combination	StepType=Max	Point=2	X2=-0.5	X3=0.5	
S11=-2978.04515850627	IsS11Max=No	IsS11Min=No	FrameElem=44	ElemStation=0.375				
Frame=44	Station=0.375	OutputCase=ENVE	CaseType=Combination	StepType=Max	Point=3	X2=0.5	X3=-0.5	
S11=2802.36147007275	IsS11Max=Yes	IsS11Min=No	FrameElem=44	ElemStation=0.375				
Frame=44	Station=0.375	OutputCase=ENVE	CaseType=Combination	StepType=Max	Point=4	X2=0.5	X3=0.5	
S11=2802.36147007275	IsS11Max=No	IsS11Min=No	FrameElem=44	ElemStation=0.375				
Frame=44	Station=0.5	OutputCase=ENVE	CaseType=Combination	StepType=Max	Point=0	X2=0	X3=0	S11=-
90.2888588483432	IsS11Max=No	IsS11Min=No	FrameElem=44	ElemStation=0.5				
Frame=44	Station=0.5	OutputCase=ENVE	CaseType=Combination	StepType=Max	Point=1	X2=-0.5	X3=-0.5	
S11=-3029.80897641828	IsS11Max=No	IsS11Min=Yes	FrameElem=44	ElemStation=0.5				
Frame=44	Station=0.5	OutputCase=ENVE	CaseType=Combination	StepType=Max	Point=2	X2=-0.5	X3=0.5	
S11=-3029.80897641828	IsS11Max=No	IsS11Min=No	FrameElem=44	ElemStation=0.5				
Frame=44	Station=0.5	OutputCase=ENVE	CaseType=Combination	StepType=Max	Point=3	X2=0.5	X3=-0.5	
S11=2854.11451030613	IsS11Max=Yes	IsS11Min=No	FrameElem=44	ElemStation=0.5				
Frame=44	Station=0.5	OutputCase=ENVE	CaseType=Combination	StepType=Max	Point=4	X2=0.5	X3=0.5	
S11=2854.11451030613	IsS11Max=No	IsS11Min=No	FrameElem=44	ElemStation=0.5				
Frame=44	Station=0	OutputCase=ENVE	CaseType=Combination	StepType=Min	Point=0	X2=0	X3=0	S11=-
122.976319142087	IsS11Max=No	IsS11Min=No	FrameElem=44	ElemStation=0				
Frame=44	Station=0	OutputCase=ENVE	CaseType=Combination	StepType=Min	Point=1	X2=-0.5	X3=-0.5	
S11=-2841.7425670693	IsS11Max=No	IsS11Min=Yes	FrameElem=44	ElemStation=0				
Frame=44	Station=0	OutputCase=ENVE	CaseType=Combination	StepType=Min	Point=2	X2=-0.5	X3=0.5	S11=-
2841.7425670693	IsS11Max=No	IsS11Min=No	FrameElem=44	ElemStation=0				
Frame=44	Station=0	OutputCase=ENVE	CaseType=Combination	StepType=Min	Point=3	X2=0.5	X3=-0.5	
S11=2590.86356648607	IsS11Max=Yes	IsS11Min=No	FrameElem=44	ElemStation=0				
Frame=44	Station=0	OutputCase=ENVE	CaseType=Combination	StepType=Min	Point=4	X2=0.5	X3=0.5	
S11=2590.86356648607	IsS11Max=No	IsS11Min=No	FrameElem=44	ElemStation=0				
Frame=44	Station=0.125	OutputCase=ENVE	CaseType=Combination	StepType=Min	Point=0	X2=0	X3=0	S11=-
122.976319142087	IsS11Max=No	IsS11Min=No	FrameElem=44	ElemStation=0.125				
Frame=44	Station=0.125	OutputCase=ENVE	CaseType=Combination	StepType=Min	Point=1	X2=-0.5	X3=-0.5	
S11=-2886.46435730268	IsS11Max=No	IsS11Min=Yes	FrameElem=44	ElemStation=0.125				
Frame=44	Station=0.125	OutputCase=ENVE	CaseType=Combination	StepType=Min	Point=2	X2=-0.5	X3=0.5	
S11=-2886.46435730268	IsS11Max=No	IsS11Min=No	FrameElem=44	ElemStation=0.125				
Frame=44	Station=0.125	OutputCase=ENVE	CaseType=Combination	StepType=Min	Point=3	X2=0.5	X3=-0.5	
S11=2635.59613439808	IsS11Max=Yes	IsS11Min=No	FrameElem=44	ElemStation=0.125				
Frame=44	Station=0.125	OutputCase=ENVE	CaseType=Combination	StepType=Min	Point=4	X2=0.5	X3=0.5	
S11=2635.59613439808	IsS11Max=No	IsS11Min=No	FrameElem=44	ElemStation=0.125				
Frame=44	Station=0.25	OutputCase=ENVE	CaseType=Combination	StepType=Min	Point=0	X2=0	X3=0	S11=-
122.976319142087	IsS11Max=No	IsS11Min=No	FrameElem=44	ElemStation=0.25				
Frame=44	Station=0.25	OutputCase=ENVE	CaseType=Combination	StepType=Min	Point=1	X2=-0.5	X3=-0.5	
S11=-2933.52989753606	IsS11Max=No	IsS11Min=Yes	FrameElem=44	ElemStation=0.25				
Frame=44	Station=0.25	OutputCase=ENVE	CaseType=Combination	StepType=Min	Point=2	X2=-0.5	X3=0.5	
S11=-2933.52989753606	IsS11Max=No	IsS11Min=No	FrameElem=44	ElemStation=0.25				
Frame=44	Station=0.25	OutputCase=ENVE	CaseType=Combination	StepType=Min	Point=3	X2=0.5	X3=-0.5	
S11=2682.67245231009	IsS11Max=Yes	IsS11Min=No	FrameElem=44	ElemStation=0.25				
Frame=44	Station=0.25	OutputCase=ENVE	CaseType=Combination	StepType=Min	Point=4	X2=0.5	X3=0.5	
S11=2682.67245231009	IsS11Max=No	IsS11Min=No	FrameElem=44	ElemStation=0.25				
Frame=44	Station=0.375	OutputCase=ENVE	CaseType=Combination	StepType=Min	Point=0	X2=0	X3=0	S11=-
122.976319142087	IsS11Max=No	IsS11Min=No	FrameElem=44	ElemStation=0.375				
Frame=44	Station=0.375	OutputCase=ENVE	CaseType=Combination	StepType=Min	Point=1	X2=-0.5	X3=-0.5	
S11=-2982.93918776943	IsS11Max=No	IsS11Min=Yes	FrameElem=44	ElemStation=0.375				
Frame=44	Station=0.375	OutputCase=ENVE	CaseType=Combination	StepType=Min	Point=2	X2=-0.5	X3=0.5	
S11=-2982.93918776943	IsS11Max=No	IsS11Min=No	FrameElem=44	ElemStation=0.375				
Frame=44	Station=0.375	OutputCase=ENVE	CaseType=Combination	StepType=Min	Point=3	X2=0.5	X3=-0.5	
S11=2732.0925202221	IsS11Max=Yes	IsS11Min=No	FrameElem=44	ElemStation=0.375				
Frame=44	Station=0.375	OutputCase=ENVE	CaseType=Combination	StepType=Min	Point=4	X2=0.5	X3=0.5	
S11=2732.0925202221	IsS11Max=No	IsS11Min=No	FrameElem=44	ElemStation=0.375				
Frame=44	Station=0.5	OutputCase=ENVE	CaseType=Combination	StepType=Min	Point=0	X2=0	X3=0	S11=-
122.976319142087	IsS11Max=No	IsS11Min=No	FrameElem=44	ElemStation=0.5				
Frame=44	Station=0.5	OutputCase=ENVE	CaseType=Combination	StepType=Min	Point=1	X2=-0.5	X3=-0.5	
S11=-3034.69222800281	IsS11Max=No	IsS11Min=Yes	FrameElem=44	ElemStation=0.5				
Frame=44	Station=0.5	OutputCase=ENVE	CaseType=Combination	StepType=Min	Point=2	X2=-0.5	X3=0.5	
S11=-3034.69222800281	IsS11Max=No	IsS11Min=No	FrameElem=44	ElemStation=0.5				
Frame=44	Station=0.5	OutputCase=ENVE	CaseType=Combination	StepType=Min	Point=3	X2=0.5	X3=-0.5	
S11=2783.8563381341	IsS11Max=Yes	IsS11Min=No	FrameElem=44	ElemStation=0.5				



Frame=44	Station=0.5	OutputCase=ENVE	CaseType=Combination	StepType=Min	Point=4	X2=0.5	X3=0.5		
S11=2783.8563381341	IsS11Max=No	IsS11Min=No	FrameElem=44	ElemStation=0.5					
Frame=44	Station=0	OutputCase=FESSUR	CaseType=Combination	Point=0	X2=0	X3=0	S11=-122.976319142087		
IsS11Max=No	IsS11Min=No	FrameElem=44	ElemStation=0						
Frame=44	Station=0	OutputCase=FESSUR	CaseType=Combination	Point=1	X2=-0.5	X3=-0.5	S11=-		
2836.81620477025	IsS11Max=No	IsS11Min=Yes	FrameElem=44	ElemStation=0					
Frame=44	Station=0	OutputCase=FESSUR	CaseType=Combination	Point=2	X2=-0.5	X3=0.5	S11=-		
2836.81620477025	IsS11Max=No	IsS11Min=No	FrameElem=44	ElemStation=0					
Frame=44	Station=0	OutputCase=FESSUR	CaseType=Combination	Point=3	X2=0.5	X3=-0.5			
S11=2590.86356648607	IsS11Max=Yes	IsS11Min=No	FrameElem=44	ElemStation=0					
Frame=44	Station=0	OutputCase=FESSUR	CaseType=Combination	Point=4	X2=0.5	X3=0.5			
S11=2590.86356648607	IsS11Max=No	IsS11Min=No	FrameElem=44	ElemStation=0					
Frame=44	Station=0.125	OutputCase=FESSUR	CaseType=Combination	Point=0	X2=0	X3=0	S11=-		
122.976319142087	IsS11Max=No	IsS11Min=No	FrameElem=44	ElemStation=0.125					
Frame=44	Station=0.125	OutputCase=FESSUR	CaseType=Combination	Point=1	X2=-0.5	X3=-0.5	S11=-		
2881.54877268225	IsS11Max=No	IsS11Min=Yes	FrameElem=44	ElemStation=0.125					
Frame=44	Station=0.125	OutputCase=FESSUR	CaseType=Combination	Point=2	X2=-0.5	X3=0.5	S11=-		
2881.54877268225	IsS11Max=No	IsS11Min=No	FrameElem=44	ElemStation=0.125					
Frame=44	Station=0.125	OutputCase=FESSUR	CaseType=Combination	Point=3	X2=0.5	X3=-0.5			
S11=2635.59613439808	IsS11Max=Yes	IsS11Min=No	FrameElem=44	ElemStation=0.125					
Frame=44	Station=0.125	OutputCase=FESSUR	CaseType=Combination	Point=4	X2=0.5	X3=0.5			
S11=2635.59613439808	IsS11Max=No	IsS11Min=No	FrameElem=44	ElemStation=0.125					
Frame=44	Station=0.25	OutputCase=FESSUR	CaseType=Combination	Point=0	X2=0	X3=0	S11=-		
122.976319142087	IsS11Max=No	IsS11Min=No	FrameElem=44	ElemStation=0.25					
Frame=44	Station=0.25	OutputCase=FESSUR	CaseType=Combination	Point=1	X2=-0.5	X3=-0.5	S11=-		
2928.62509059426	IsS11Max=No	IsS11Min=Yes	FrameElem=44	ElemStation=0.25					
Frame=44	Station=0.25	OutputCase=FESSUR	CaseType=Combination	Point=2	X2=-0.5	X3=0.5	S11=-		
2928.62509059426	IsS11Max=No	IsS11Min=No	FrameElem=44	ElemStation=0.25					
Frame=44	Station=0.25	OutputCase=FESSUR	CaseType=Combination	Point=3	X2=0.5	X3=-0.5			
S11=2682.67245231009	IsS11Max=Yes	IsS11Min=No	FrameElem=44	ElemStation=0.25					
Frame=44	Station=0.25	OutputCase=FESSUR	CaseType=Combination	Point=4	X2=0.5	X3=0.5			
S11=2682.67245231009	IsS11Max=No	IsS11Min=No	FrameElem=44	ElemStation=0.25					
Frame=44	Station=0.375	OutputCase=FESSUR	CaseType=Combination	Point=0	X2=0	X3=0	S11=-		
122.976319142087	IsS11Max=No	IsS11Min=No	FrameElem=44	ElemStation=0.375					
Frame=44	Station=0.375	OutputCase=FESSUR	CaseType=Combination	Point=1	X2=-0.5	X3=-0.5	S11=-		
2978.04515850627	IsS11Max=No	IsS11Min=Yes	FrameElem=44	ElemStation=0.375					
Frame=44	Station=0.375	OutputCase=FESSUR	CaseType=Combination	Point=2	X2=-0.5	X3=0.5	S11=-		
2978.04515850627	IsS11Max=No	IsS11Min=No	FrameElem=44	ElemStation=0.375					
Frame=44	Station=0.375	OutputCase=FESSUR	CaseType=Combination	Point=3	X2=0.5	X3=-0.5			
S11=2732.0925202221	IsS11Max=Yes	IsS11Min=No	FrameElem=44	ElemStation=0.375					
Frame=44	Station=0.375	OutputCase=FESSUR	CaseType=Combination	Point=4	X2=0.5	X3=0.5			
S11=2732.0925202221	IsS11Max=No	IsS11Min=No	FrameElem=44	ElemStation=0.375					
Frame=44	Station=0.5	OutputCase=FESSUR	CaseType=Combination	Point=0	X2=0	X3=0	S11=-122.976319142087		
IsS11Max=No	IsS11Min=No	FrameElem=44	ElemStation=0.5						
Frame=44	Station=0.5	OutputCase=FESSUR	CaseType=Combination	Point=1	X2=-0.5	X3=-0.5	S11=-		
3029.80897641828	IsS11Max=No	IsS11Min=Yes	FrameElem=44	ElemStation=0.5					
Frame=44	Station=0.5	OutputCase=FESSUR	CaseType=Combination	Point=2	X2=-0.5	X3=0.5	S11=-		
3029.80897641828	IsS11Max=No	IsS11Min=No	FrameElem=44	ElemStation=0.5					
Frame=44	Station=0.5	OutputCase=FESSUR	CaseType=Combination	Point=3	X2=0.5	X3=-0.5			
S11=2783.8563381341	IsS11Max=Yes	IsS11Min=No	FrameElem=44	ElemStation=0.5					
Frame=44	Station=0.5	OutputCase=FESSUR	CaseType=Combination	Point=4	X2=0.5	X3=0.5			
S11=2783.8563381341	IsS11Max=No	IsS11Min=No	FrameElem=44	ElemStation=0.5					
Frame=45	Station=0	OutputCase=PESOPR	CaseType=LinStatic	Point=0	X2=0	X3=0	S11=-15.1709467362365		
IsS11Max=No	IsS11Min=No	FrameElem=45	ElemStation=0						
Frame=45	Station=0	OutputCase=PESOPR	CaseType=LinStatic	Point=1	X2=-0.5	X3=-0.5	S11=-		
733.993040111424	IsS11Max=No	IsS11Min=Yes	FrameElem=45	ElemStation=0					
Frame=45	Station=0	OutputCase=PESOPR	CaseType=LinStatic	Point=2	X2=-0.5	X3=0.5	S11=-		
733.993040111424	IsS11Max=No	IsS11Min=No	FrameElem=45	ElemStation=0					
Frame=45	Station=0	OutputCase=PESOPR	CaseType=LinStatic	Point=3	X2=0.5	X3=-0.5	S11=703.651146638951		
IsS11Max=Yes	IsS11Min=No	FrameElem=45	ElemStation=0						
Frame=45	Station=0	OutputCase=PESOPR	CaseType=LinStatic	Point=4	X2=0.5	X3=0.5	S11=703.651146638951		
IsS11Max=No	IsS11Min=No	FrameElem=45	ElemStation=0						
Frame=45	Station=0.125	OutputCase=PESOPR	CaseType=LinStatic	Point=0	X2=0	X3=0	S11=-15.1709467362365		
IsS11Max=No	IsS11Min=No	FrameElem=45	ElemStation=0.125						
Frame=45	Station=0.125	OutputCase=PESOPR	CaseType=LinStatic	Point=1	X2=-0.5	X3=-0.5	S11=-		
718.482820768668	IsS11Max=No	IsS11Min=Yes	FrameElem=45	ElemStation=0.125					
Frame=45	Station=0.125	OutputCase=PESOPR	CaseType=LinStatic	Point=2	X2=-0.5	X3=0.5	S11=-		
718.482820768668	IsS11Max=No	IsS11Min=No	FrameElem=45	ElemStation=0.125					
Frame=45	Station=0.125	OutputCase=PESOPR	CaseType=LinStatic	Point=3	X2=0.5	X3=-0.5			
S11=688.140927296195	IsS11Max=Yes	IsS11Min=No	FrameElem=45	ElemStation=0.125					
Frame=45	Station=0.125	OutputCase=PESOPR	CaseType=LinStatic	Point=4	X2=0.5	X3=0.5			
S11=688.140927296195	IsS11Max=No	IsS11Min=No	FrameElem=45	ElemStation=0.125					
Frame=45	Station=0.25	OutputCase=PESOPR	CaseType=LinStatic	Point=0	X2=0	X3=0	S11=-15.1709467362365		
IsS11Max=No	IsS11Min=No	FrameElem=45	ElemStation=0.25						
Frame=45	Station=0.25	OutputCase=PESOPR	CaseType=LinStatic	Point=1	X2=-0.5	X3=-0.5	S11=-		
705.316351425913	IsS11Max=No	IsS11Min=Yes	FrameElem=45	ElemStation=0.25					
Frame=45	Station=0.25	OutputCase=PESOPR	CaseType=LinStatic	Point=2	X2=-0.5	X3=0.5	S11=-		
705.316351425913	IsS11Max=No	IsS11Min=No	FrameElem=45	ElemStation=0.25					
Frame=45	Station=0.25	OutputCase=PESOPR	CaseType=LinStatic	Point=3	X2=0.5	X3=-0.5			
S11=674.974457953439	IsS11Max=Yes	IsS11Min=No	FrameElem=45	ElemStation=0.25					
Frame=45	Station=0.25	OutputCase=PESOPR	CaseType=LinStatic	Point=4	X2=0.5	X3=0.5			
S11=674.974457953439	IsS11Max=No	IsS11Min=No	FrameElem=45	ElemStation=0.25					

Frame=45	Station=0.375	OutputCase=PESOPR	CaseType=LinStatic	Point=0	X2=0	X3=0	S11=-15.1709467362365
IsS11Max=No	IsS11Min=No	FrameElem=45	ElemStation=0.375				
Frame=45	Station=0.375	OutputCase=PESOPR	CaseType=LinStatic	Point=1	X2=-0.5	X3=-0.5	S11=-
694.493632083157	IsS11Max=No	IsS11Min=Yes	FrameElem=45	ElemStation=0.375			
Frame=45	Station=0.375	OutputCase=PESOPR	CaseType=LinStatic	Point=2	X2=-0.5	X3=0.5	S11=-
694.493632083157	IsS11Max=No	IsS11Min=No	FrameElem=45	ElemStation=0.375			
Frame=45	Station=0.375	OutputCase=PESOPR	CaseType=LinStatic	Point=3	X2=0.5	X3=-0.5	
S11=664.151738610684	IsS11Max=Yes	IsS11Min=No	FrameElem=45	ElemStation=0.375			
Frame=45	Station=0.375	OutputCase=PESOPR	CaseType=LinStatic	Point=4	X2=0.5	X3=0.5	
S11=664.151738610684	IsS11Max=No	IsS11Min=No	FrameElem=45	ElemStation=0.375			
Frame=45	Station=0.5	OutputCase=PESOPR	CaseType=LinStatic	Point=0	X2=0	X3=0	S11=-15.1709467362365
IsS11Max=No	IsS11Min=No	FrameElem=45	ElemStation=0.5				
Frame=45	Station=0.5	OutputCase=PESOPR	CaseType=LinStatic	Point=1	X2=-0.5	X3=-0.5	S11=-
686.014662740401	IsS11Max=No	IsS11Min=Yes	FrameElem=45	ElemStation=0.5			
Frame=45	Station=0.5	OutputCase=PESOPR	CaseType=LinStatic	Point=2	X2=-0.5	X3=0.5	S11=-
686.014662740401	IsS11Max=No	IsS11Min=No	FrameElem=45	ElemStation=0.5			
Frame=45	Station=0.5	OutputCase=PESOPR	CaseType=LinStatic	Point=3	X2=0.5	X3=-0.5	
S11=655.672769267928	IsS11Max=Yes	IsS11Min=No	FrameElem=45	ElemStation=0.5			
Frame=45	Station=0.5	OutputCase=PESOPR	CaseType=LinStatic	Point=4	X2=0.5	X3=0.5	
S11=655.672769267928	IsS11Max=No	IsS11Min=No	FrameElem=45	ElemStation=0.5			
Frame=45	Station=0	OutputCase=TERRVERT	CaseType=LinStatic	Point=0	X2=0	X3=0	S11=1.15282857329472
IsS11Max=No	IsS11Min=No	FrameElem=45	ElemStation=0				
Frame=45	Station=0	OutputCase=TERRVERT	CaseType=LinStatic	Point=1	X2=-0.5	X3=-0.5	S11=-
2312.0934415887	IsS11Max=No	IsS11Min=Yes	FrameElem=45	ElemStation=0			
Frame=45	Station=0	OutputCase=TERRVERT	CaseType=LinStatic	Point=2	X2=-0.5	X3=0.5	S11=-
2312.0934415887	IsS11Max=No	IsS11Min=No	FrameElem=45	ElemStation=0			
Frame=45	Station=0	OutputCase=TERRVERT	CaseType=LinStatic	Point=3	X2=0.5	X3=-0.5	
S11=2314.39909873529	IsS11Max=Yes	IsS11Min=No	FrameElem=45	ElemStation=0			
Frame=45	Station=0	OutputCase=TERRVERT	CaseType=LinStatic	Point=4	X2=0.5	X3=0.5	
S11=2314.39909873529	IsS11Max=No	IsS11Min=No	FrameElem=45	ElemStation=0			
Frame=45	Station=0.125	OutputCase=TERRVERT	CaseType=LinStatic	Point=0	X2=0	X3=0	
S11=1.15282857329472	IsS11Max=No	IsS11Min=No	FrameElem=45	ElemStation=0.125			
Frame=45	Station=0.125	OutputCase=TERRVERT	CaseType=LinStatic	Point=1	X2=-0.5	X3=-0.5	S11=-
2275.87576809026	IsS11Max=No	IsS11Min=Yes	FrameElem=45	ElemStation=0.125			
Frame=45	Station=0.125	OutputCase=TERRVERT	CaseType=LinStatic	Point=2	X2=-0.5	X3=0.5	S11=-
2275.87576809026	IsS11Max=No	IsS11Min=No	FrameElem=45	ElemStation=0.125			
Frame=45	Station=0.125	OutputCase=TERRVERT	CaseType=LinStatic	Point=3	X2=0.5	X3=-0.5	
S11=2278.18142523685	IsS11Max=Yes	IsS11Min=No	FrameElem=45	ElemStation=0.125			
Frame=45	Station=0.125	OutputCase=TERRVERT	CaseType=LinStatic	Point=4	X2=0.5	X3=0.5	
S11=2278.18142523685	IsS11Max=No	IsS11Min=No	FrameElem=45	ElemStation=0.125			
Frame=45	Station=0.25	OutputCase=TERRVERT	CaseType=LinStatic	Point=0	X2=0	X3=0	S11=1.15282857329472
IsS11Max=No	IsS11Min=No	FrameElem=45	ElemStation=0.25				
Frame=45	Station=0.25	OutputCase=TERRVERT	CaseType=LinStatic	Point=1	X2=-0.5	X3=-0.5	S11=-
2239.65809459182	IsS11Max=No	IsS11Min=Yes	FrameElem=45	ElemStation=0.25			
Frame=45	Station=0.25	OutputCase=TERRVERT	CaseType=LinStatic	Point=2	X2=-0.5	X3=0.5	S11=-
2239.65809459182	IsS11Max=No	IsS11Min=No	FrameElem=45	ElemStation=0.25			
Frame=45	Station=0.25	OutputCase=TERRVERT	CaseType=LinStatic	Point=3	X2=0.5	X3=-0.5	
S11=2241.96375173841	IsS11Max=Yes	IsS11Min=No	FrameElem=45	ElemStation=0.25			
Frame=45	Station=0.25	OutputCase=TERRVERT	CaseType=LinStatic	Point=4	X2=0.5	X3=0.5	
S11=2241.96375173841	IsS11Max=No	IsS11Min=No	FrameElem=45	ElemStation=0.25			
Frame=45	Station=0.375	OutputCase=TERRVERT	CaseType=LinStatic	Point=0	X2=0	X3=0	
S11=1.15282857329472	IsS11Max=No	IsS11Min=No	FrameElem=45	ElemStation=0.375			
Frame=45	Station=0.375	OutputCase=TERRVERT	CaseType=LinStatic	Point=1	X2=-0.5	X3=-0.5	S11=-
2203.44042109338	IsS11Max=No	IsS11Min=Yes	FrameElem=45	ElemStation=0.375			
Frame=45	Station=0.375	OutputCase=TERRVERT	CaseType=LinStatic	Point=2	X2=-0.5	X3=0.5	S11=-
2203.44042109338	IsS11Max=No	IsS11Min=No	FrameElem=45	ElemStation=0.375			
Frame=45	Station=0.375	OutputCase=TERRVERT	CaseType=LinStatic	Point=3	X2=0.5	X3=-0.5	
S11=2205.74607823997	IsS11Max=Yes	IsS11Min=No	FrameElem=45	ElemStation=0.375			
Frame=45	Station=0.375	OutputCase=TERRVERT	CaseType=LinStatic	Point=4	X2=0.5	X3=0.5	
S11=2205.74607823997	IsS11Max=No	IsS11Min=No	FrameElem=45	ElemStation=0.375			
Frame=45	Station=0.5	OutputCase=TERRVERT	CaseType=LinStatic	Point=0	X2=0	X3=0	S11=1.15282857329472
IsS11Max=No	IsS11Min=No	FrameElem=45	ElemStation=0.5				
Frame=45	Station=0.5	OutputCase=TERRVERT	CaseType=LinStatic	Point=1	X2=-0.5	X3=-0.5	S11=-
2167.22274759495	IsS11Max=No	IsS11Min=Yes	FrameElem=45	ElemStation=0.5			
Frame=45	Station=0.5	OutputCase=TERRVERT	CaseType=LinStatic	Point=2	X2=-0.5	X3=0.5	S11=-
2167.22274759495	IsS11Max=No	IsS11Min=No	FrameElem=45	ElemStation=0.5			
Frame=45	Station=0.5	OutputCase=TERRVERT	CaseType=LinStatic	Point=3	X2=0.5	X3=-0.5	
S11=2169.52840474154	IsS11Max=Yes	IsS11Min=No	FrameElem=45	ElemStation=0.5			
Frame=45	Station=0.5	OutputCase=TERRVERT	CaseType=LinStatic	Point=4	X2=0.5	X3=0.5	
S11=2169.52840474154	IsS11Max=No	IsS11Min=No	FrameElem=45	ElemStation=0.5			
Frame=45	Station=0	OutputCase=TERRLAT	CaseType=LinStatic	Point=0	X2=0	X3=0	S11=-108.958200979145
IsS11Max=No	IsS11Min=No	FrameElem=45	ElemStation=0				
Frame=45	Station=0	OutputCase=TERRLAT	CaseType=LinStatic	Point=1	X2=-0.5	X3=-0.5	
S11=16.2775052817816	IsS11Max=Yes	IsS11Min=No	FrameElem=45	ElemStation=0			
Frame=45	Station=0	OutputCase=TERRLAT	CaseType=LinStatic	Point=2	X2=-0.5	X3=0.5	
S11=16.2775052817816	IsS11Max=No	IsS11Min=No	FrameElem=45	ElemStation=0			
Frame=45	Station=0	OutputCase=TERRLAT	CaseType=LinStatic	Point=3	X2=0.5	X3=-0.5	S11=-
234.193907240071	IsS11Max=No	IsS11Min=Yes	FrameElem=45	ElemStation=0			
Frame=45	Station=0	OutputCase=TERRLAT	CaseType=LinStatic	Point=4	X2=0.5	X3=0.5	S11=-
234.193907240071	IsS11Max=No	IsS11Min=No	FrameElem=45	ElemStation=0			
Frame=45	Station=0.125	OutputCase=TERRLAT	CaseType=LinStatic	Point=0	X2=0	X3=0	S11=-
108.958200979145	IsS11Max=No	IsS11Min=No	FrameElem=45	ElemStation=0.125			

Frame=45	Station=0.125	OutputCase=TERRLAT	CaseType=LinStatic	Point=1	X2=-0.5	X3=-0.5			
S11=16.3134300539365	IsS11Max=Yes	IsS11Min=No	FrameElem=45	ElemStation=0.125					
Frame=45	Station=0.125	OutputCase=TERRLAT	CaseType=LinStatic	Point=2	X2=-0.5	X3=0.5			
S11=16.3134300539365	IsS11Max=No	IsS11Min=No	FrameElem=45	ElemStation=0.125					
Frame=45	Station=0.125	OutputCase=TERRLAT	CaseType=LinStatic	Point=3	X2=0.5	X3=-0.5	S11=-		
234.229832012226	IsS11Max=No	IsS11Min=Yes	FrameElem=45	ElemStation=0.125					
Frame=45	Station=0.125	OutputCase=TERRLAT	CaseType=LinStatic	Point=4	X2=0.5	X3=0.5	S11=-		
234.229832012226	IsS11Max=No	IsS11Min=No	FrameElem=45	ElemStation=0.125					
Frame=45	Station=0.25	OutputCase=TERRLAT	CaseType=LinStatic	Point=0	X2=0	X3=0	S11=-108.958200979145		
IsS11Max=No	IsS11Min=No	FrameElem=45	ElemStation=0.25						
Frame=45	Station=0.25	OutputCase=TERRLAT	CaseType=LinStatic	Point=1	X2=-0.5	X3=-0.5			
S11=16.3493548260914	IsS11Max=Yes	IsS11Min=No	FrameElem=45	ElemStation=0.25					
Frame=45	Station=0.25	OutputCase=TERRLAT	CaseType=LinStatic	Point=2	X2=-0.5	X3=0.5			
S11=16.3493548260914	IsS11Max=No	IsS11Min=No	FrameElem=45	ElemStation=0.25					
Frame=45	Station=0.25	OutputCase=TERRLAT	CaseType=LinStatic	Point=3	X2=0.5	X3=-0.5	S11=-		
234.265756784381	IsS11Max=No	IsS11Min=Yes	FrameElem=45	ElemStation=0.25					
Frame=45	Station=0.25	OutputCase=TERRLAT	CaseType=LinStatic	Point=4	X2=0.5	X3=0.5	S11=-		
234.265756784381	IsS11Max=No	IsS11Min=No	FrameElem=45	ElemStation=0.25					
Frame=45	Station=0.375	OutputCase=TERRLAT	CaseType=LinStatic	Point=0	X2=0	X3=0	S11=-		
108.958200979145	IsS11Max=No	IsS11Min=No	FrameElem=45	ElemStation=0.375					
Frame=45	Station=0.375	OutputCase=TERRLAT	CaseType=LinStatic	Point=1	X2=-0.5	X3=-0.5			
S11=16.3852795982462	IsS11Max=Yes	IsS11Min=No	FrameElem=45	ElemStation=0.375					
Frame=45	Station=0.375	OutputCase=TERRLAT	CaseType=LinStatic	Point=2	X2=-0.5	X3=0.5			
S11=16.3852795982462	IsS11Max=No	IsS11Min=No	FrameElem=45	ElemStation=0.375					
Frame=45	Station=0.375	OutputCase=TERRLAT	CaseType=LinStatic	Point=3	X2=0.5	X3=-0.5	S11=-		
234.301681556536	IsS11Max=No	IsS11Min=Yes	FrameElem=45	ElemStation=0.375					
Frame=45	Station=0.375	OutputCase=TERRLAT	CaseType=LinStatic	Point=4	X2=0.5	X3=0.5	S11=-		
234.301681556536	IsS11Max=No	IsS11Min=No	FrameElem=45	ElemStation=0.375					
Frame=45	Station=0.5	OutputCase=TERRLAT	CaseType=LinStatic	Point=0	X2=0	X3=0	S11=-108.958200979145		
IsS11Max=No	IsS11Min=No	FrameElem=45	ElemStation=0.5						
Frame=45	Station=0.5	OutputCase=TERRLAT	CaseType=LinStatic	Point=1	X2=-0.5	X3=-0.5			
S11=16.4212043704011	IsS11Max=Yes	IsS11Min=No	FrameElem=45	ElemStation=0.5					
Frame=45	Station=0.5	OutputCase=TERRLAT	CaseType=LinStatic	Point=2	X2=-0.5	X3=0.5			
S11=16.4212043704011	IsS11Max=No	IsS11Min=No	FrameElem=45	ElemStation=0.5					
Frame=45	Station=0.5	OutputCase=TERRLAT	CaseType=LinStatic	Point=3	X2=0.5	X3=-0.5	S11=-		
234.337606328691	IsS11Max=No	IsS11Min=Yes	FrameElem=45	ElemStation=0.5					
Frame=45	Station=0.5	OutputCase=TERRLAT	CaseType=LinStatic	Point=4	X2=0.5	X3=0.5	S11=-		
234.337606328691	IsS11Max=No	IsS11Min=No	FrameElem=45	ElemStation=0.5					
Frame=45	Station=0	OutputCase=ACCLATDX	CaseType=LinStatic	Point=0	X2=0	X3=0	S11=0	IsS11Max=Yes	
IsS11Min=Yes	FrameElem=45	ElemStation=0							
Frame=45	Station=0	OutputCase=ACCLATDX	CaseType=LinStatic	Point=1	X2=-0.5	X3=-0.5	S11=0		
IsS11Max=No	IsS11Min=No	FrameElem=45	ElemStation=0						
Frame=45	Station=0	OutputCase=ACCLATDX	CaseType=LinStatic	Point=2	X2=-0.5	X3=0.5	S11=0		
IsS11Max=No	IsS11Min=No	FrameElem=45	ElemStation=0						
Frame=45	Station=0	OutputCase=ACCLATDX	CaseType=LinStatic	Point=3	X2=0.5	X3=-0.5	S11=0		
IsS11Max=No	IsS11Min=No	FrameElem=45	ElemStation=0						
Frame=45	Station=0	OutputCase=ACCLATDX	CaseType=LinStatic	Point=4	X2=0.5	X3=0.5	S11=0	IsS11Max=No	
IsS11Min=No	FrameElem=45	ElemStation=0							
Frame=45	Station=0.125	OutputCase=ACCLATDX	CaseType=LinStatic	Point=0	X2=0	X3=0	S11=0		
IsS11Max=Yes	IsS11Min=Yes	FrameElem=45	ElemStation=0.125						
Frame=45	Station=0.125	OutputCase=ACCLATDX	CaseType=LinStatic	Point=1	X2=-0.5	X3=-0.5	S11=0		
IsS11Max=No	IsS11Min=No	FrameElem=45	ElemStation=0.125						
Frame=45	Station=0.125	OutputCase=ACCLATDX	CaseType=LinStatic	Point=2	X2=-0.5	X3=0.5	S11=0		
IsS11Max=No	IsS11Min=No	FrameElem=45	ElemStation=0.125						
Frame=45	Station=0.125	OutputCase=ACCLATDX	CaseType=LinStatic	Point=3	X2=0.5	X3=-0.5	S11=0		
IsS11Max=No	IsS11Min=No	FrameElem=45	ElemStation=0.125						
Frame=45	Station=0.125	OutputCase=ACCLATDX	CaseType=LinStatic	Point=4	X2=0.5	X3=0.5	S11=0		
IsS11Max=No	IsS11Min=No	FrameElem=45	ElemStation=0.125						
Frame=45	Station=0.25	OutputCase=ACCLATDX	CaseType=LinStatic	Point=0	X2=0	X3=0	S11=0	IsS11Max=Yes	
IsS11Min=Yes	FrameElem=45	ElemStation=0.25							
Frame=45	Station=0.25	OutputCase=ACCLATDX	CaseType=LinStatic	Point=1	X2=-0.5	X3=-0.5	S11=0		
IsS11Max=No	IsS11Min=No	FrameElem=45	ElemStation=0.25						
Frame=45	Station=0.25	OutputCase=ACCLATDX	CaseType=LinStatic	Point=2	X2=-0.5	X3=0.5	S11=0		
IsS11Max=No	IsS11Min=No	FrameElem=45	ElemStation=0.25						
Frame=45	Station=0.25	OutputCase=ACCLATDX	CaseType=LinStatic	Point=3	X2=0.5	X3=-0.5	S11=0		
IsS11Max=No	IsS11Min=No	FrameElem=45	ElemStation=0.25						
Frame=45	Station=0.25	OutputCase=ACCLATDX	CaseType=LinStatic	Point=4	X2=0.5	X3=0.5	S11=0		
IsS11Max=No	IsS11Min=No	FrameElem=45	ElemStation=0.25						
Frame=45	Station=0.375	OutputCase=ACCLATDX	CaseType=LinStatic	Point=0	X2=0	X3=0	S11=0		
IsS11Max=Yes	IsS11Min=Yes	FrameElem=45	ElemStation=0.375						
Frame=45	Station=0.375	OutputCase=ACCLATDX	CaseType=LinStatic	Point=1	X2=-0.5	X3=-0.5	S11=0		
IsS11Max=No	IsS11Min=No	FrameElem=45	ElemStation=0.375						
Frame=45	Station=0.375	OutputCase=ACCLATDX	CaseType=LinStatic	Point=2	X2=-0.5	X3=0.5	S11=0		
IsS11Max=No	IsS11Min=No	FrameElem=45	ElemStation=0.375						
Frame=45	Station=0.375	OutputCase=ACCLATDX	CaseType=LinStatic	Point=3	X2=0.5	X3=-0.5	S11=0		
IsS11Max=No	IsS11Min=No	FrameElem=45	ElemStation=0.375						
Frame=45	Station=0.375	OutputCase=ACCLATDX	CaseType=LinStatic	Point=4	X2=0.5	X3=0.5	S11=0		
IsS11Max=No	IsS11Min=No	FrameElem=45	ElemStation=0.375						
Frame=45	Station=0.5	OutputCase=ACCLATDX	CaseType=LinStatic	Point=0	X2=0	X3=0	S11=0	IsS11Max=Yes	
IsS11Min=Yes	FrameElem=45	ElemStation=0.5							
Frame=45	Station=0.5	OutputCase=ACCLATDX	CaseType=LinStatic	Point=1	X2=-0.5	X3=-0.5	S11=0		
IsS11Max=No	IsS11Min=No	FrameElem=45	ElemStation=0.5						

Frame=45	Station=0	OutputCase=ENVE	CaseType=Combination	StepType=Max	Point=4	X2=0.5	X3=0.5	
S11=2854.11451030619	IsS11Max=No	IsS11Min=No	FrameElem=45	ElemStation=0				
Frame=45	Station=0.125	OutputCase=ENVE	CaseType=Combination	StepType=Max	Point=0	X2=0	X3=0	S11=-
90.2888588483432	IsS11Max=No	IsS11Min=No	FrameElem=45	ElemStation=0.125				
Frame=45	Station=0.125	OutputCase=ENVE	CaseType=Combination	StepType=Max	Point=1	X2=-0.5	X3=-0.5	
S11=-2978.04515880499	IsS11Max=No	IsS11Min=Yes	FrameElem=45	ElemStation=0.125				
Frame=45	Station=0.125	OutputCase=ENVE	CaseType=Combination	StepType=Max	Point=2	X2=-0.5	X3=0.5	
S11=-2978.04515880499	IsS11Max=No	IsS11Min=No	FrameElem=45	ElemStation=0.125				
Frame=45	Station=0.125	OutputCase=ENVE	CaseType=Combination	StepType=Max	Point=3	X2=0.5	X3=-0.5	
S11=2802.36147012449	IsS11Max=Yes	IsS11Min=No	FrameElem=45	ElemStation=0.125				
Frame=45	Station=0.125	OutputCase=ENVE	CaseType=Combination	StepType=Max	Point=4	X2=0.5	X3=0.5	
S11=2802.36147012449	IsS11Max=No	IsS11Min=No	FrameElem=45	ElemStation=0.125				
Frame=45	Station=0.25	OutputCase=ENVE	CaseType=Combination	StepType=Max	Point=0	X2=0	X3=0	S11=-
90.2888588483432	IsS11Max=No	IsS11Min=No	FrameElem=45	ElemStation=0.25				
Frame=45	Station=0.25	OutputCase=ENVE	CaseType=Combination	StepType=Max	Point=1	X2=-0.5	X3=-0.5	
S11=-2928.62509119164	IsS11Max=No	IsS11Min=Yes	FrameElem=45	ElemStation=0.25				
Frame=45	Station=0.25	OutputCase=ENVE	CaseType=Combination	StepType=Max	Point=2	X2=-0.5	X3=0.5	
S11=-2928.62509119164	IsS11Max=No	IsS11Min=No	FrameElem=45	ElemStation=0.25				
Frame=45	Station=0.25	OutputCase=ENVE	CaseType=Combination	StepType=Max	Point=3	X2=0.5	X3=-0.5	
S11=2752.95217994279	IsS11Max=Yes	IsS11Min=No	FrameElem=45	ElemStation=0.25				
Frame=45	Station=0.25	OutputCase=ENVE	CaseType=Combination	StepType=Max	Point=4	X2=0.5	X3=0.5	
S11=2752.95217994279	IsS11Max=No	IsS11Min=No	FrameElem=45	ElemStation=0.25				
Frame=45	Station=0.375	OutputCase=ENVE	CaseType=Combination	StepType=Max	Point=0	X2=0	X3=0	S11=-
90.2888588483432	IsS11Max=No	IsS11Min=No	FrameElem=45	ElemStation=0.375				
Frame=45	Station=0.375	OutputCase=ENVE	CaseType=Combination	StepType=Max	Point=1	X2=-0.5	X3=-0.5	
S11=-2881.5487735783	IsS11Max=No	IsS11Min=Yes	FrameElem=45	ElemStation=0.375				
Frame=45	Station=0.375	OutputCase=ENVE	CaseType=Combination	StepType=Max	Point=2	X2=-0.5	X3=0.5	
S11=-2881.5487735783	IsS11Max=No	IsS11Min=No	FrameElem=45	ElemStation=0.375				
Frame=45	Station=0.375	OutputCase=ENVE	CaseType=Combination	StepType=Max	Point=3	X2=0.5	X3=-0.5	
S11=2705.88663976108	IsS11Max=Yes	IsS11Min=No	FrameElem=45	ElemStation=0.375				
Frame=45	Station=0.375	OutputCase=ENVE	CaseType=Combination	StepType=Max	Point=4	X2=0.5	X3=0.5	
S11=2705.88663976108	IsS11Max=No	IsS11Min=No	FrameElem=45	ElemStation=0.375				
Frame=45	Station=0.5	OutputCase=ENVE	CaseType=Combination	StepType=Max	Point=0	X2=0	X3=0	S11=-
90.2888588483432	IsS11Max=No	IsS11Min=No	FrameElem=45	ElemStation=0.5				
Frame=45	Station=0.5	OutputCase=ENVE	CaseType=Combination	StepType=Max	Point=1	X2=-0.5	X3=-0.5	
S11=-2836.81620596495	IsS11Max=No	IsS11Min=Yes	FrameElem=45	ElemStation=0.5				
Frame=45	Station=0.5	OutputCase=ENVE	CaseType=Combination	StepType=Max	Point=2	X2=-0.5	X3=0.5	
S11=-2836.81620596495	IsS11Max=No	IsS11Min=No	FrameElem=45	ElemStation=0.5				
Frame=45	Station=0.5	OutputCase=ENVE	CaseType=Combination	StepType=Max	Point=3	X2=0.5	X3=-0.5	
S11=2661.16484957938	IsS11Max=Yes	IsS11Min=No	FrameElem=45	ElemStation=0.5				
Frame=45	Station=0.5	OutputCase=ENVE	CaseType=Combination	StepType=Max	Point=4	X2=0.5	X3=0.5	
S11=2661.16484957938	IsS11Max=No	IsS11Min=No	FrameElem=45	ElemStation=0.5				
Frame=45	Station=0	OutputCase=ENVE	CaseType=Combination	StepType=Min	Point=0	X2=0	X3=0	S11=-
122.976319142087	IsS11Max=No	IsS11Min=No	FrameElem=45	ElemStation=0				
Frame=45	Station=0	OutputCase=ENVE	CaseType=Combination	StepType=Min	Point=1	X2=-0.5	X3=-0.5	
S11=-3034.69222800288	IsS11Max=No	IsS11Min=Yes	FrameElem=45	ElemStation=0				
Frame=45	Station=0	OutputCase=ENVE	CaseType=Combination	StepType=Min	Point=2	X2=-0.5	X3=0.5	S11=-
3034.69222800288	IsS11Max=No	IsS11Min=No	FrameElem=45	ElemStation=0				
Frame=45	Station=0	OutputCase=ENVE	CaseType=Combination	StepType=Min	Point=3	X2=0.5	X3=-0.5	
S11=2783.85633813417	IsS11Max=Yes	IsS11Min=No	FrameElem=45	ElemStation=0				
Frame=45	Station=0	OutputCase=ENVE	CaseType=Combination	StepType=Min	Point=4	X2=0.5	X3=0.5	
S11=2783.85633813417	IsS11Max=No	IsS11Min=No	FrameElem=45	ElemStation=0				
Frame=45	Station=0.125	OutputCase=ENVE	CaseType=Combination	StepType=Min	Point=0	X2=0	X3=0	S11=-
122.976319142087	IsS11Max=No	IsS11Min=No	FrameElem=45	ElemStation=0.125				
Frame=45	Station=0.125	OutputCase=ENVE	CaseType=Combination	StepType=Min	Point=1	X2=-0.5	X3=-0.5	
S11=-2982.93918782117	IsS11Max=No	IsS11Min=Yes	FrameElem=45	ElemStation=0.125				
Frame=45	Station=0.125	OutputCase=ENVE	CaseType=Combination	StepType=Min	Point=2	X2=-0.5	X3=0.5	
S11=-2982.93918782117	IsS11Max=No	IsS11Min=No	FrameElem=45	ElemStation=0.125				
Frame=45	Station=0.125	OutputCase=ENVE	CaseType=Combination	StepType=Min	Point=3	X2=0.5	X3=-0.5	
S11=2732.09252052082	IsS11Max=Yes	IsS11Min=No	FrameElem=45	ElemStation=0.125				
Frame=45	Station=0.125	OutputCase=ENVE	CaseType=Combination	StepType=Min	Point=4	X2=0.5	X3=0.5	
S11=2732.09252052082	IsS11Max=No	IsS11Min=No	FrameElem=45	ElemStation=0.125				
Frame=45	Station=0.25	OutputCase=ENVE	CaseType=Combination	StepType=Min	Point=0	X2=0	X3=0	S11=-
122.976319142087	IsS11Max=No	IsS11Min=No	FrameElem=45	ElemStation=0.25				
Frame=45	Station=0.25	OutputCase=ENVE	CaseType=Combination	StepType=Min	Point=1	X2=-0.5	X3=-0.5	
S11=-2933.52989763947	IsS11Max=No	IsS11Min=Yes	FrameElem=45	ElemStation=0.25				
Frame=45	Station=0.25	OutputCase=ENVE	CaseType=Combination	StepType=Min	Point=2	X2=-0.5	X3=0.5	
S11=-2933.52989763947	IsS11Max=No	IsS11Min=No	FrameElem=45	ElemStation=0.25				
Frame=45	Station=0.25	OutputCase=ENVE	CaseType=Combination	StepType=Min	Point=3	X2=0.5	X3=-0.5	
S11=2682.67245290747	IsS11Max=Yes	IsS11Min=No	FrameElem=45	ElemStation=0.25				
Frame=45	Station=0.25	OutputCase=ENVE	CaseType=Combination	StepType=Min	Point=4	X2=0.5	X3=0.5	
S11=2682.67245290747	IsS11Max=No	IsS11Min=No	FrameElem=45	ElemStation=0.25				
Frame=45	Station=0.375	OutputCase=ENVE	CaseType=Combination	StepType=Min	Point=0	X2=0	X3=0	S11=-
122.976319142087	IsS11Max=No	IsS11Min=No	FrameElem=45	ElemStation=0.375				
Frame=45	Station=0.375	OutputCase=ENVE	CaseType=Combination	StepType=Min	Point=1	X2=-0.5	X3=-0.5	
S11=-2886.46435745777	IsS11Max=No	IsS11Min=Yes	FrameElem=45	ElemStation=0.375				
Frame=45	Station=0.375	OutputCase=ENVE	CaseType=Combination	StepType=Min	Point=2	X2=-0.5	X3=0.5	
S11=-2886.46435745777	IsS11Max=No	IsS11Min=No	FrameElem=45	ElemStation=0.375				
Frame=45	Station=0.375	OutputCase=ENVE	CaseType=Combination	StepType=Min	Point=3	X2=0.5	X3=-0.5	
S11=2635.59613529412	IsS11Max=Yes	IsS11Min=No	FrameElem=45	ElemStation=0.375				
Frame=45	Station=0.375	OutputCase=ENVE	CaseType=Combination	StepType=Min	Point=4	X2=0.5	X3=0.5	
S11=2635.59613529412	IsS11Max=No	IsS11Min=No	FrameElem=45	ElemStation=0.375				

Frame=45	Station=0.5	OutputCase=ENVE	CaseType=Combination	StepType=Min	Point=0	X2=0	X3=0	S11=-
122.976319142087	IsS11Max=No	IsS11Min=No	FrameElem=45	ElemStation=0.5				
Frame=45	Station=0.5	OutputCase=ENVE	CaseType=Combination	StepType=Min	Point=1	X2=-0.5	X3=-0.5	
S11=-2841.74256727607	IsS11Max=No	IsS11Min=Yes	FrameElem=45	ElemStation=0.5				
Frame=45	Station=0.5	OutputCase=ENVE	CaseType=Combination	StepType=Min	Point=2	X2=-0.5	X3=0.5	
S11=-2841.74256727607	IsS11Max=No	IsS11Min=No	FrameElem=45	ElemStation=0.5				
Frame=45	Station=0.5	OutputCase=ENVE	CaseType=Combination	StepType=Min	Point=3	X2=0.5	X3=-0.5	
S11=2590.86356768077	IsS11Max=Yes	IsS11Min=No	FrameElem=45	ElemStation=0.5				
Frame=45	Station=0.5	OutputCase=ENVE	CaseType=Combination	StepType=Min	Point=4	X2=0.5	X3=0.5	
S11=2590.86356768077	IsS11Max=No	IsS11Min=No	FrameElem=45	ElemStation=0.5				
Frame=45	Station=0	OutputCase=FESSUR	CaseType=Combination	Point=0	X2=0	X3=0	S11=-122.976319142087	
IsS11Max=No	IsS11Min=No	FrameElem=45	ElemStation=0					
Frame=45	Station=0	OutputCase=FESSUR	CaseType=Combination	Point=1	X2=-0.5	X3=-0.5	S11=-	
3029.80897641834	IsS11Max=No	IsS11Min=Yes	FrameElem=45	ElemStation=0				
Frame=45	Station=0	OutputCase=FESSUR	CaseType=Combination	Point=2	X2=-0.5	X3=0.5	S11=-	
3029.80897641834	IsS11Max=No	IsS11Min=No	FrameElem=45	ElemStation=0				
Frame=45	Station=0	OutputCase=FESSUR	CaseType=Combination	Point=3	X2=0.5	X3=-0.5		
S11=2783.85633813417	IsS11Max=Yes	IsS11Min=No	FrameElem=45	ElemStation=0				
Frame=45	Station=0	OutputCase=FESSUR	CaseType=Combination	Point=4	X2=0.5	X3=0.5		
S11=2783.85633813417	IsS11Max=No	IsS11Min=No	FrameElem=45	ElemStation=0				
Frame=45	Station=0.125	OutputCase=FESSUR	CaseType=Combination	Point=0	X2=0	X3=0	S11=-	
122.976319142087	IsS11Max=No	IsS11Min=No	FrameElem=45	ElemStation=0.125				
Frame=45	Station=0.125	OutputCase=FESSUR	CaseType=Combination	Point=1	X2=-0.5	X3=-0.5	S11=-	
2978.04515880499	IsS11Max=No	IsS11Min=Yes	FrameElem=45	ElemStation=0.125				
Frame=45	Station=0.125	OutputCase=FESSUR	CaseType=Combination	Point=2	X2=-0.5	X3=0.5	S11=-	
2978.04515880499	IsS11Max=No	IsS11Min=No	FrameElem=45	ElemStation=0.125				
Frame=45	Station=0.125	OutputCase=FESSUR	CaseType=Combination	Point=3	X2=0.5	X3=-0.5		
S11=2732.09252052082	IsS11Max=Yes	IsS11Min=No	FrameElem=45	ElemStation=0.125				
Frame=45	Station=0.125	OutputCase=FESSUR	CaseType=Combination	Point=4	X2=0.5	X3=0.5		
S11=2732.09252052082	IsS11Max=No	IsS11Min=No	FrameElem=45	ElemStation=0.125				
Frame=45	Station=0.25	OutputCase=FESSUR	CaseType=Combination	Point=0	X2=0	X3=0	S11=-	
122.976319142087	IsS11Max=No	IsS11Min=No	FrameElem=45	ElemStation=0.25				
Frame=45	Station=0.25	OutputCase=FESSUR	CaseType=Combination	Point=1	X2=-0.5	X3=-0.5	S11=-	
2928.62509119164	IsS11Max=No	IsS11Min=Yes	FrameElem=45	ElemStation=0.25				
Frame=45	Station=0.25	OutputCase=FESSUR	CaseType=Combination	Point=2	X2=-0.5	X3=0.5	S11=-	
2928.62509119164	IsS11Max=No	IsS11Min=No	FrameElem=45	ElemStation=0.25				
Frame=45	Station=0.25	OutputCase=FESSUR	CaseType=Combination	Point=3	X2=0.5	X3=-0.5		
S11=2682.67245290747	IsS11Max=Yes	IsS11Min=No	FrameElem=45	ElemStation=0.25				
Frame=45	Station=0.25	OutputCase=FESSUR	CaseType=Combination	Point=4	X2=0.5	X3=0.5		
S11=2682.67245290747	IsS11Max=No	IsS11Min=No	FrameElem=45	ElemStation=0.25				
Frame=45	Station=0.375	OutputCase=FESSUR	CaseType=Combination	Point=0	X2=0	X3=0	S11=-	
122.976319142087	IsS11Max=No	IsS11Min=No	FrameElem=45	ElemStation=0.375				
Frame=45	Station=0.375	OutputCase=FESSUR	CaseType=Combination	Point=1	X2=-0.5	X3=-0.5	S11=-	
2881.5487735783	IsS11Max=No	IsS11Min=Yes	FrameElem=45	ElemStation=0.375				
Frame=45	Station=0.375	OutputCase=FESSUR	CaseType=Combination	Point=2	X2=-0.5	X3=0.5	S11=-	
2881.5487735783	IsS11Max=No	IsS11Min=No	FrameElem=45	ElemStation=0.375				
Frame=45	Station=0.375	OutputCase=FESSUR	CaseType=Combination	Point=3	X2=0.5	X3=-0.5		
S11=2635.59613529412	IsS11Max=Yes	IsS11Min=No	FrameElem=45	ElemStation=0.375				
Frame=45	Station=0.375	OutputCase=FESSUR	CaseType=Combination	Point=4	X2=0.5	X3=0.5		
S11=2635.59613529412	IsS11Max=No	IsS11Min=No	FrameElem=45	ElemStation=0.375				
Frame=45	Station=0.5	OutputCase=FESSUR	CaseType=Combination	Point=0	X2=0	X3=0	S11=-122.976319142087	
IsS11Max=No	IsS11Min=No	FrameElem=45	ElemStation=0.5					
Frame=45	Station=0.5	OutputCase=FESSUR	CaseType=Combination	Point=1	X2=-0.5	X3=-0.5	S11=-	
2836.81620596495	IsS11Max=No	IsS11Min=Yes	FrameElem=45	ElemStation=0.5				
Frame=45	Station=0.5	OutputCase=FESSUR	CaseType=Combination	Point=2	X2=-0.5	X3=0.5	S11=-	
2836.81620596495	IsS11Max=No	IsS11Min=No	FrameElem=45	ElemStation=0.5				
Frame=45	Station=0.5	OutputCase=FESSUR	CaseType=Combination	Point=3	X2=0.5	X3=-0.5		
S11=2590.86356768077	IsS11Max=Yes	IsS11Min=No	FrameElem=45	ElemStation=0.5				
Frame=45	Station=0.5	OutputCase=FESSUR	CaseType=Combination	Point=4	X2=0.5	X3=0.5		
S11=2590.86356768077	IsS11Max=No	IsS11Min=No	FrameElem=45	ElemStation=0.5				
Frame=46	Station=0	OutputCase=PESOPR	CaseType=LinStatic	Point=0	X2=0	X3=0	S11=-15.1709467362365	
IsS11Max=No	IsS11Min=No	FrameElem=46	ElemStation=0					
Frame=46	Station=0	OutputCase=PESOPR	CaseType=LinStatic	Point=1	X2=-0.5	X3=-0.5	S11=-	
686.01466274038	IsS11Max=No	IsS11Min=Yes	FrameElem=46	ElemStation=0				
Frame=46	Station=0	OutputCase=PESOPR	CaseType=LinStatic	Point=2	X2=-0.5	X3=0.5	S11=-686.01466274038	
IsS11Max=No	IsS11Min=No	FrameElem=46	ElemStation=0					
Frame=46	Station=0	OutputCase=PESOPR	CaseType=LinStatic	Point=3	X2=0.5	X3=-0.5	S11=655.672769267906	
IsS11Max=Yes	IsS11Min=No	FrameElem=46	ElemStation=0					
Frame=46	Station=0	OutputCase=PESOPR	CaseType=LinStatic	Point=4	X2=0.5	X3=0.5	S11=655.672769267906	
IsS11Max=No	IsS11Min=No	FrameElem=46	ElemStation=0					
Frame=46	Station=0.125	OutputCase=PESOPR	CaseType=LinStatic	Point=0	X2=0	X3=0	S11=-15.1709467362365	
IsS11Max=No	IsS11Min=No	FrameElem=46	ElemStation=0.125					
Frame=46	Station=0.125	OutputCase=PESOPR	CaseType=LinStatic	Point=1	X2=-0.5	X3=-0.5	S11=-	
646.461975795794	IsS11Max=No	IsS11Min=Yes	FrameElem=46	ElemStation=0.125				
Frame=46	Station=0.125	OutputCase=PESOPR	CaseType=LinStatic	Point=2	X2=-0.5	X3=0.5	S11=-	
646.461975795794	IsS11Max=No	IsS11Min=No	FrameElem=46	ElemStation=0.125				
Frame=46	Station=0.125	OutputCase=PESOPR	CaseType=LinStatic	Point=3	X2=0.5	X3=-0.5		
S11=616.120082323321	IsS11Max=Yes	IsS11Min=No	FrameElem=46	ElemStation=0.125				
Frame=46	Station=0.125	OutputCase=PESOPR	CaseType=LinStatic	Point=4	X2=0.5	X3=0.5		
S11=616.120082323321	IsS11Max=No	IsS11Min=No	FrameElem=46	ElemStation=0.125				
Frame=46	Station=0.25	OutputCase=PESOPR	CaseType=LinStatic	Point=0	X2=0	X3=0	S11=-15.1709467362365	
IsS11Max=No	IsS11Min=No	FrameElem=46	ElemStation=0.25					

Frame=46	Station=0.25	OutputCase=PESOPR	CaseType=LinStatic	Point=1	X2=-0.5	X3=-0.5	S11=-
609.253038851208	IsS11Max=No	IsS11Min=Yes	FrameElem=46	ElemStation=0.25			
Frame=46	Station=0.25	OutputCase=PESOPR	CaseType=LinStatic	Point=2	X2=-0.5	X3=0.5	S11=-
609.253038851208	IsS11Max=No	IsS11Min=No	FrameElem=46	ElemStation=0.25			
Frame=46	Station=0.25	OutputCase=PESOPR	CaseType=LinStatic	Point=3	X2=0.5	X3=-0.5	
S11=578.911145378735	IsS11Max=Yes	IsS11Min=No	FrameElem=46	ElemStation=0.25			
Frame=46	Station=0.25	OutputCase=PESOPR	CaseType=LinStatic	Point=4	X2=0.5	X3=0.5	
S11=578.911145378735	IsS11Max=No	IsS11Min=No	FrameElem=46	ElemStation=0.25			
Frame=46	Station=0.375	OutputCase=PESOPR	CaseType=LinStatic	Point=0	X2=0	X3=0	S11=-15.1709467362365
IsS11Max=No	IsS11Min=No	FrameElem=46	ElemStation=0.375				
Frame=46	Station=0.375	OutputCase=PESOPR	CaseType=LinStatic	Point=1	X2=-0.5	X3=-0.5	S11=-
574.387851906622	IsS11Max=No	IsS11Min=Yes	FrameElem=46	ElemStation=0.375			
Frame=46	Station=0.375	OutputCase=PESOPR	CaseType=LinStatic	Point=2	X2=-0.5	X3=0.5	S11=-
574.387851906622	IsS11Max=No	IsS11Min=No	FrameElem=46	ElemStation=0.375			
Frame=46	Station=0.375	OutputCase=PESOPR	CaseType=LinStatic	Point=3	X2=0.5	X3=-0.5	
S11=544.045958434149	IsS11Max=Yes	IsS11Min=No	FrameElem=46	ElemStation=0.375			
Frame=46	Station=0.375	OutputCase=PESOPR	CaseType=LinStatic	Point=4	X2=0.5	X3=0.5	
S11=544.045958434149	IsS11Max=No	IsS11Min=No	FrameElem=46	ElemStation=0.375			
Frame=46	Station=0.5	OutputCase=PESOPR	CaseType=LinStatic	Point=0	X2=0	X3=0	S11=-15.1709467362365
IsS11Max=No	IsS11Min=No	FrameElem=46	ElemStation=0.5				
Frame=46	Station=0.5	OutputCase=PESOPR	CaseType=LinStatic	Point=1	X2=-0.5	X3=-0.5	S11=-
541.866414962037	IsS11Max=No	IsS11Min=Yes	FrameElem=46	ElemStation=0.5			
Frame=46	Station=0.5	OutputCase=PESOPR	CaseType=LinStatic	Point=2	X2=-0.5	X3=0.5	S11=-
541.866414962037	IsS11Max=No	IsS11Min=No	FrameElem=46	ElemStation=0.5			
Frame=46	Station=0.5	OutputCase=PESOPR	CaseType=LinStatic	Point=3	X2=0.5	X3=-0.5	
S11=511.524521489564	IsS11Max=Yes	IsS11Min=No	FrameElem=46	ElemStation=0.5			
Frame=46	Station=0.5	OutputCase=PESOPR	CaseType=LinStatic	Point=4	X2=0.5	X3=0.5	
S11=511.524521489564	IsS11Max=No	IsS11Min=No	FrameElem=46	ElemStation=0.5			
Frame=46	Station=0	OutputCase=TERRVERT	CaseType=LinStatic	Point=0	X2=0	X3=0	S11=1.15282857329472
IsS11Max=No	IsS11Min=No	FrameElem=46	ElemStation=0				
Frame=46	Station=0	OutputCase=TERRVERT	CaseType=LinStatic	Point=1	X2=-0.5	X3=-0.5	S11=-
2167.22274759499	IsS11Max=No	IsS11Min=Yes	FrameElem=46	ElemStation=0			
Frame=46	Station=0	OutputCase=TERRVERT	CaseType=LinStatic	Point=2	X2=-0.5	X3=0.5	S11=-
2167.22274759499	IsS11Max=No	IsS11Min=No	FrameElem=46	ElemStation=0			
Frame=46	Station=0	OutputCase=TERRVERT	CaseType=LinStatic	Point=3	X2=0.5	X3=-0.5	
S11=2169.52840474158	IsS11Max=Yes	IsS11Min=No	FrameElem=46	ElemStation=0			
Frame=46	Station=0	OutputCase=TERRVERT	CaseType=LinStatic	Point=4	X2=0.5	X3=0.5	
S11=2169.52840474158	IsS11Max=No	IsS11Min=No	FrameElem=46	ElemStation=0			
Frame=46	Station=0.125	OutputCase=TERRVERT	CaseType=LinStatic	Point=0	X2=0	X3=0	
S11=1.15282857329472	IsS11Max=No	IsS11Min=No	FrameElem=46	ElemStation=0.125			
Frame=46	Station=0.125	OutputCase=TERRVERT	CaseType=LinStatic	Point=1	X2=-0.5	X3=-0.5	S11=-
2058.3985600892	IsS11Max=No	IsS11Min=Yes	FrameElem=46	ElemStation=0.125			
Frame=46	Station=0.125	OutputCase=TERRVERT	CaseType=LinStatic	Point=2	X2=-0.5	X3=0.5	S11=-
2058.3985600892	IsS11Max=No	IsS11Min=No	FrameElem=46	ElemStation=0.125			
Frame=46	Station=0.125	OutputCase=TERRVERT	CaseType=LinStatic	Point=3	X2=0.5	X3=-0.5	
S11=2060.70421723579	IsS11Max=Yes	IsS11Min=No	FrameElem=46	ElemStation=0.125			
Frame=46	Station=0.125	OutputCase=TERRVERT	CaseType=LinStatic	Point=4	X2=0.5	X3=0.5	
S11=2060.70421723579	IsS11Max=No	IsS11Min=No	FrameElem=46	ElemStation=0.125			
Frame=46	Station=0.25	OutputCase=TERRVERT	CaseType=LinStatic	Point=0	X2=0	X3=0	S11=1.15282857329472
IsS11Max=No	IsS11Min=No	FrameElem=46	ElemStation=0.25				
Frame=46	Station=0.25	OutputCase=TERRVERT	CaseType=LinStatic	Point=1	X2=-0.5	X3=-0.5	S11=-
1949.57437258342	IsS11Max=No	IsS11Min=Yes	FrameElem=46	ElemStation=0.25			
Frame=46	Station=0.25	OutputCase=TERRVERT	CaseType=LinStatic	Point=2	X2=-0.5	X3=0.5	S11=-
1949.57437258342	IsS11Max=No	IsS11Min=No	FrameElem=46	ElemStation=0.25			
Frame=46	Station=0.25	OutputCase=TERRVERT	CaseType=LinStatic	Point=3	X2=0.5	X3=-0.5	
S11=1951.88002973001	IsS11Max=Yes	IsS11Min=No	FrameElem=46	ElemStation=0.25			
Frame=46	Station=0.25	OutputCase=TERRVERT	CaseType=LinStatic	Point=4	X2=0.5	X3=0.5	
S11=1951.88002973001	IsS11Max=No	IsS11Min=No	FrameElem=46	ElemStation=0.25			
Frame=46	Station=0.375	OutputCase=TERRVERT	CaseType=LinStatic	Point=0	X2=0	X3=0	
S11=1.15282857329472	IsS11Max=No	IsS11Min=No	FrameElem=46	ElemStation=0.375			
Frame=46	Station=0.375	OutputCase=TERRVERT	CaseType=LinStatic	Point=1	X2=-0.5	X3=-0.5	S11=-
1840.75018507763	IsS11Max=No	IsS11Min=Yes	FrameElem=46	ElemStation=0.375			
Frame=46	Station=0.375	OutputCase=TERRVERT	CaseType=LinStatic	Point=2	X2=-0.5	X3=0.5	S11=-
1840.75018507763	IsS11Max=No	IsS11Min=No	FrameElem=46	ElemStation=0.375			
Frame=46	Station=0.375	OutputCase=TERRVERT	CaseType=LinStatic	Point=3	X2=0.5	X3=-0.5	
S11=1843.05584222422	IsS11Max=Yes	IsS11Min=No	FrameElem=46	ElemStation=0.375			
Frame=46	Station=0.375	OutputCase=TERRVERT	CaseType=LinStatic	Point=4	X2=0.5	X3=0.5	
S11=1843.05584222422	IsS11Max=No	IsS11Min=No	FrameElem=46	ElemStation=0.375			
Frame=46	Station=0.5	OutputCase=TERRVERT	CaseType=LinStatic	Point=0	X2=0	X3=0	S11=1.15282857329472
IsS11Max=No	IsS11Min=No	FrameElem=46	ElemStation=0.5				
Frame=46	Station=0.5	OutputCase=TERRVERT	CaseType=LinStatic	Point=1	X2=-0.5	X3=-0.5	S11=-
1731.92599757184	IsS11Max=No	IsS11Min=Yes	FrameElem=46	ElemStation=0.5			
Frame=46	Station=0.5	OutputCase=TERRVERT	CaseType=LinStatic	Point=2	X2=-0.5	X3=0.5	S11=-
1731.92599757184	IsS11Max=No	IsS11Min=No	FrameElem=46	ElemStation=0.5			
Frame=46	Station=0.5	OutputCase=TERRVERT	CaseType=LinStatic	Point=3	X2=0.5	X3=-0.5	
S11=1734.23165471843	IsS11Max=Yes	IsS11Min=No	FrameElem=46	ElemStation=0.5			
Frame=46	Station=0.5	OutputCase=TERRVERT	CaseType=LinStatic	Point=4	X2=0.5	X3=0.5	
S11=1734.23165471843	IsS11Max=No	IsS11Min=No	FrameElem=46	ElemStation=0.5			
Frame=46	Station=0	OutputCase=TERRLAT	CaseType=LinStatic	Point=0	X2=0	X3=0	S11=-108.958200979145
IsS11Max=No	IsS11Min=No	FrameElem=46	ElemStation=0				
Frame=46	Station=0	OutputCase=TERRLAT	CaseType=LinStatic	Point=1	X2=-0.5	X3=-0.5	
S11=16.4212043704013	IsS11Max=Yes	IsS11Min=No	FrameElem=46	ElemStation=0			



Frame=46	Station=0	OutputCase=TERRLAT	CaseType=LinStatic	Point=2	X2=-0.5	X3=0.5			
S11=16.4212043704013	IsS11Max=No	IsS11Min=No	FrameElem=46	ElemStation=0					
Frame=46	Station=0	OutputCase=TERRLAT	CaseType=LinStatic	Point=3	X2=0.5	X3=-0.5	S11=-		
234.337606328691	IsS11Max=No	IsS11Min=Yes	FrameElem=46	ElemStation=0					
Frame=46	Station=0	OutputCase=TERRLAT	CaseType=LinStatic	Point=4	X2=0.5	X3=0.5	S11=-		
234.337606328691	IsS11Max=No	IsS11Min=No	FrameElem=46	ElemStation=0					
Frame=46	Station=0.125	OutputCase=TERRLAT	CaseType=LinStatic	Point=0	X2=0	X3=0	S11=-		
108.958200979145	IsS11Max=No	IsS11Min=No	FrameElem=46	ElemStation=0.125					
Frame=46	Station=0.125	OutputCase=TERRLAT	CaseType=LinStatic	Point=1	X2=-0.5	X3=-0.5			
S11=16.5205264534206	IsS11Max=Yes	IsS11Min=No	FrameElem=46	ElemStation=0.125					
Frame=46	Station=0.125	OutputCase=TERRLAT	CaseType=LinStatic	Point=2	X2=-0.5	X3=0.5			
S11=16.5205264534206	IsS11Max=No	IsS11Min=No	FrameElem=46	ElemStation=0.125					
Frame=46	Station=0.125	OutputCase=TERRLAT	CaseType=LinStatic	Point=3	X2=0.5	X3=-0.5	S11=-		
234.43692841171	IsS11Max=No	IsS11Min=Yes	FrameElem=46	ElemStation=0.125					
Frame=46	Station=0.125	OutputCase=TERRLAT	CaseType=LinStatic	Point=4	X2=0.5	X3=0.5	S11=-		
234.43692841171	IsS11Max=No	IsS11Min=No	FrameElem=46	ElemStation=0.125					
Frame=46	Station=0.25	OutputCase=TERRLAT	CaseType=LinStatic	Point=0	X2=0	X3=0	S11=-108.958200979145		
IsS11Max=No	IsS11Min=No	FrameElem=46	ElemStation=0.25						
Frame=46	Station=0.25	OutputCase=TERRLAT	CaseType=LinStatic	Point=1	X2=-0.5	X3=-0.5			
S11=16.6198485364399	IsS11Max=Yes	IsS11Min=No	FrameElem=46	ElemStation=0.25					
Frame=46	Station=0.25	OutputCase=TERRLAT	CaseType=LinStatic	Point=2	X2=-0.5	X3=0.5			
S11=16.6198485364399	IsS11Max=No	IsS11Min=No	FrameElem=46	ElemStation=0.25					
Frame=46	Station=0.25	OutputCase=TERRLAT	CaseType=LinStatic	Point=3	X2=0.5	X3=-0.5	S11=-		
234.536250494729	IsS11Max=No	IsS11Min=Yes	FrameElem=46	ElemStation=0.25					
Frame=46	Station=0.25	OutputCase=TERRLAT	CaseType=LinStatic	Point=4	X2=0.5	X3=0.5	S11=-		
234.536250494729	IsS11Max=No	IsS11Min=No	FrameElem=46	ElemStation=0.25					
Frame=46	Station=0.375	OutputCase=TERRLAT	CaseType=LinStatic	Point=0	X2=0	X3=0	S11=-		
108.958200979145	IsS11Max=No	IsS11Min=No	FrameElem=46	ElemStation=0.375					
Frame=46	Station=0.375	OutputCase=TERRLAT	CaseType=LinStatic	Point=1	X2=-0.5	X3=-0.5			
S11=16.7191706194592	IsS11Max=Yes	IsS11Min=No	FrameElem=46	ElemStation=0.375					
Frame=46	Station=0.375	OutputCase=TERRLAT	CaseType=LinStatic	Point=2	X2=-0.5	X3=0.5			
S11=16.7191706194592	IsS11Max=No	IsS11Min=No	FrameElem=46	ElemStation=0.375					
Frame=46	Station=0.375	OutputCase=TERRLAT	CaseType=LinStatic	Point=3	X2=0.5	X3=-0.5	S11=-		
234.635572577749	IsS11Max=No	IsS11Min=Yes	FrameElem=46	ElemStation=0.375					
Frame=46	Station=0.375	OutputCase=TERRLAT	CaseType=LinStatic	Point=4	X2=0.5	X3=0.5	S11=-		
234.635572577749	IsS11Max=No	IsS11Min=No	FrameElem=46	ElemStation=0.375					
Frame=46	Station=0.5	OutputCase=TERRLAT	CaseType=LinStatic	Point=0	X2=0	X3=0	S11=-108.958200979145		
IsS11Max=No	IsS11Min=No	FrameElem=46	ElemStation=0.5						
Frame=46	Station=0.5	OutputCase=TERRLAT	CaseType=LinStatic	Point=1	X2=-0.5	X3=-0.5			
S11=16.8184927024785	IsS11Max=Yes	IsS11Min=No	FrameElem=46	ElemStation=0.5					
Frame=46	Station=0.5	OutputCase=TERRLAT	CaseType=LinStatic	Point=2	X2=-0.5	X3=0.5			
S11=16.8184927024785	IsS11Max=No	IsS11Min=No	FrameElem=46	ElemStation=0.5					
Frame=46	Station=0.5	OutputCase=TERRLAT	CaseType=LinStatic	Point=3	X2=0.5	X3=-0.5	S11=-		
234.734894660768	IsS11Max=No	IsS11Min=Yes	FrameElem=46	ElemStation=0.5					
Frame=46	Station=0.5	OutputCase=TERRLAT	CaseType=LinStatic	Point=4	X2=0.5	X3=0.5	S11=-		
234.734894660768	IsS11Max=No	IsS11Min=No	FrameElem=46	ElemStation=0.5					
Frame=46	Station=0	OutputCase=ACCLATDX	CaseType=LinStatic	Point=0	X2=0	X3=0	S11=0	IsS11Max=Yes	
IsS11Min=Yes	FrameElem=46	ElemStation=0							
Frame=46	Station=0	OutputCase=ACCLATDX	CaseType=LinStatic	Point=1	X2=-0.5	X3=-0.5	S11=0		
IsS11Max=No	IsS11Min=No	FrameElem=46	ElemStation=0						
Frame=46	Station=0	OutputCase=ACCLATDX	CaseType=LinStatic	Point=2	X2=-0.5	X3=0.5	S11=0		
IsS11Max=No	IsS11Min=No	FrameElem=46	ElemStation=0						
Frame=46	Station=0	OutputCase=ACCLATDX	CaseType=LinStatic	Point=3	X2=0.5	X3=-0.5	S11=0		
IsS11Max=No	IsS11Min=No	FrameElem=46	ElemStation=0						
Frame=46	Station=0	OutputCase=ACCLATDX	CaseType=LinStatic	Point=4	X2=0.5	X3=0.5	S11=0	IsS11Max=No	
IsS11Min=No	FrameElem=46	ElemStation=0							
Frame=46	Station=0.125	OutputCase=ACCLATDX	CaseType=LinStatic	Point=0	X2=0	X3=0	S11=0		
IsS11Max=Yes	IsS11Min=Yes	FrameElem=46	ElemStation=0.125						
Frame=46	Station=0.125	OutputCase=ACCLATDX	CaseType=LinStatic	Point=1	X2=-0.5	X3=-0.5	S11=0		
IsS11Max=No	IsS11Min=No	FrameElem=46	ElemStation=0.125						
Frame=46	Station=0.125	OutputCase=ACCLATDX	CaseType=LinStatic	Point=2	X2=-0.5	X3=0.5	S11=0		
IsS11Max=No	IsS11Min=No	FrameElem=46	ElemStation=0.125						
Frame=46	Station=0.125	OutputCase=ACCLATDX	CaseType=LinStatic	Point=3	X2=0.5	X3=-0.5	S11=0		
IsS11Max=No	IsS11Min=No	FrameElem=46	ElemStation=0.125						
Frame=46	Station=0.125	OutputCase=ACCLATDX	CaseType=LinStatic	Point=4	X2=0.5	X3=0.5	S11=0		
IsS11Max=No	IsS11Min=No	FrameElem=46	ElemStation=0.125						
Frame=46	Station=0.25	OutputCase=ACCLATDX	CaseType=LinStatic	Point=0	X2=0	X3=0	S11=0	IsS11Max=Yes	
IsS11Min=Yes	FrameElem=46	ElemStation=0.25							
Frame=46	Station=0.25	OutputCase=ACCLATDX	CaseType=LinStatic	Point=1	X2=-0.5	X3=-0.5	S11=0		
IsS11Max=No	IsS11Min=No	FrameElem=46	ElemStation=0.25						
Frame=46	Station=0.25	OutputCase=ACCLATDX	CaseType=LinStatic	Point=2	X2=-0.5	X3=0.5	S11=0		
IsS11Max=No	IsS11Min=No	FrameElem=46	ElemStation=0.25						
Frame=46	Station=0.25	OutputCase=ACCLATDX	CaseType=LinStatic	Point=3	X2=0.5	X3=-0.5	S11=0		
IsS11Max=No	IsS11Min=No	FrameElem=46	ElemStation=0.25						
Frame=46	Station=0.25	OutputCase=ACCLATDX	CaseType=LinStatic	Point=4	X2=0.5	X3=0.5	S11=0		
IsS11Max=No	IsS11Min=No	FrameElem=46	ElemStation=0.25						
Frame=46	Station=0.375	OutputCase=ACCLATDX	CaseType=LinStatic	Point=0	X2=0	X3=0	S11=0		
IsS11Max=Yes	IsS11Min=Yes	FrameElem=46	ElemStation=0.375						
Frame=46	Station=0.375	OutputCase=ACCLATDX	CaseType=LinStatic	Point=1	X2=-0.5	X3=-0.5	S11=0		
IsS11Max=No	IsS11Min=No	FrameElem=46	ElemStation=0.375						
Frame=46	Station=0.375	OutputCase=ACCLATDX	CaseType=LinStatic	Point=2	X2=-0.5	X3=0.5	S11=0		
IsS11Max=No	IsS11Min=No	FrameElem=46	ElemStation=0.375						

Frame=46	Station=0	OutputCase=ENVE	CaseType=Combination	StepType=Max	Point=0	X2=0	X3=0	S11=-
90.2888588483432	IsS11Max=No	IsS11Min=No	FrameElem=46	ElemStation=0				
Frame=46	Station=0	OutputCase=ENVE	CaseType=Combination	StepType=Max	Point=1	X2=-0.5	X3=-0.5	
S11=-2836.81620596497	IsS11Max=No	IsS11Min=Yes	FrameElem=46	ElemStation=0				
Frame=46	Station=0	OutputCase=ENVE	CaseType=Combination	StepType=Max	Point=2	X2=-0.5	X3=0.5	S11=-
2836.81620596497	IsS11Max=No	IsS11Min=No	FrameElem=46	ElemStation=0				
Frame=46	Station=0	OutputCase=ENVE	CaseType=Combination	StepType=Max	Point=3	X2=0.5	X3=-0.5	
S11=2661.1648495794	IsS11Max=Yes	IsS11Min=No	FrameElem=46	ElemStation=0				
Frame=46	Station=0	OutputCase=ENVE	CaseType=Combination	StepType=Max	Point=4	X2=0.5	X3=0.5	
S11=2661.1648495794	IsS11Max=No	IsS11Min=No	FrameElem=46	ElemStation=0				
Frame=46	Station=0.125	OutputCase=ENVE	CaseType=Combination	StepType=Max	Point=0	X2=0	X3=0	S11=-
90.2888588483432	IsS11Max=No	IsS11Min=No	FrameElem=46	ElemStation=0.125				
Frame=46	Station=0.125	OutputCase=ENVE	CaseType=Combination	StepType=Max	Point=1	X2=-0.5	X3=-0.5	
S11=-2688.34000943158	IsS11Max=No	IsS11Min=Yes	FrameElem=46	ElemStation=0.125				
Frame=46	Station=0.125	OutputCase=ENVE	CaseType=Combination	StepType=Max	Point=2	X2=-0.5	X3=0.5	
S11=-2688.34000943158	IsS11Max=No	IsS11Min=No	FrameElem=46	ElemStation=0.125				
Frame=46	Station=0.125	OutputCase=ENVE	CaseType=Combination	StepType=Max	Point=3	X2=0.5	X3=-0.5	
S11=2512.71844967092	IsS11Max=Yes	IsS11Min=No	FrameElem=46	ElemStation=0.125				
Frame=46	Station=0.125	OutputCase=ENVE	CaseType=Combination	StepType=Max	Point=4	X2=0.5	X3=0.5	
S11=2512.71844967092	IsS11Max=No	IsS11Min=No	FrameElem=46	ElemStation=0.125				
Frame=46	Station=0.25	OutputCase=ENVE	CaseType=Combination	StepType=Max	Point=0	X2=0	X3=0	S11=-
90.2888588483432	IsS11Max=No	IsS11Min=No	FrameElem=46	ElemStation=0.25				
Frame=46	Station=0.25	OutputCase=ENVE	CaseType=Combination	StepType=Max	Point=1	X2=-0.5	X3=-0.5	
S11=-2542.20756289818	IsS11Max=No	IsS11Min=Yes	FrameElem=46	ElemStation=0.25				
Frame=46	Station=0.25	OutputCase=ENVE	CaseType=Combination	StepType=Max	Point=2	X2=-0.5	X3=0.5	
S11=-2542.20756289818	IsS11Max=No	IsS11Min=No	FrameElem=46	ElemStation=0.25				
Frame=46	Station=0.25	OutputCase=ENVE	CaseType=Combination	StepType=Max	Point=3	X2=0.5	X3=-0.5	
S11=2366.61579976243	IsS11Max=Yes	IsS11Min=No	FrameElem=46	ElemStation=0.25				
Frame=46	Station=0.25	OutputCase=ENVE	CaseType=Combination	StepType=Max	Point=4	X2=0.5	X3=0.5	
S11=2366.61579976243	IsS11Max=No	IsS11Min=No	FrameElem=46	ElemStation=0.25				
Frame=46	Station=0.375	OutputCase=ENVE	CaseType=Combination	StepType=Max	Point=0	X2=0	X3=0	S11=-
90.2888588483432	IsS11Max=No	IsS11Min=No	FrameElem=46	ElemStation=0.375				
Frame=46	Station=0.375	OutputCase=ENVE	CaseType=Combination	StepType=Max	Point=1	X2=-0.5	X3=-0.5	
S11=-2398.41886636479	IsS11Max=No	IsS11Min=Yes	FrameElem=46	ElemStation=0.375				
Frame=46	Station=0.375	OutputCase=ENVE	CaseType=Combination	StepType=Max	Point=2	X2=-0.5	X3=0.5	
S11=-2398.41886636479	IsS11Max=No	IsS11Min=No	FrameElem=46	ElemStation=0.375				
Frame=46	Station=0.375	OutputCase=ENVE	CaseType=Combination	StepType=Max	Point=3	X2=0.5	X3=-0.5	
S11=2222.85689985394	IsS11Max=Yes	IsS11Min=No	FrameElem=46	ElemStation=0.375				
Frame=46	Station=0.375	OutputCase=ENVE	CaseType=Combination	StepType=Max	Point=4	X2=0.5	X3=0.5	
S11=2222.85689985394	IsS11Max=No	IsS11Min=No	FrameElem=46	ElemStation=0.375				
Frame=46	Station=0.5	OutputCase=ENVE	CaseType=Combination	StepType=Max	Point=0	X2=0	X3=0	S11=-
90.2888588483432	IsS11Max=No	IsS11Min=No	FrameElem=46	ElemStation=0.5				
Frame=46	Station=0.5	OutputCase=ENVE	CaseType=Combination	StepType=Max	Point=1	X2=-0.5	X3=-0.5	
S11=-2256.9739198314	IsS11Max=No	IsS11Min=Yes	FrameElem=46	ElemStation=0.5				
Frame=46	Station=0.5	OutputCase=ENVE	CaseType=Combination	StepType=Max	Point=2	X2=-0.5	X3=0.5	
S11=-2256.9739198314	IsS11Max=No	IsS11Min=No	FrameElem=46	ElemStation=0.5				
Frame=46	Station=0.5	OutputCase=ENVE	CaseType=Combination	StepType=Max	Point=3	X2=0.5	X3=-0.5	
S11=2081.44174994546	IsS11Max=Yes	IsS11Min=No	FrameElem=46	ElemStation=0.5				
Frame=46	Station=0.5	OutputCase=ENVE	CaseType=Combination	StepType=Max	Point=4	X2=0.5	X3=0.5	
S11=2081.44174994546	IsS11Max=No	IsS11Min=No	FrameElem=46	ElemStation=0.5				
Frame=46	Station=0	OutputCase=ENVE	CaseType=Combination	StepType=Min	Point=0	X2=0	X3=0	S11=-
122.976319142087	IsS11Max=No	IsS11Min=No	FrameElem=46	ElemStation=0				
Frame=46	Station=0	OutputCase=ENVE	CaseType=Combination	StepType=Min	Point=1	X2=-0.5	X3=-0.5	
S11=-2841.74256727609	IsS11Max=No	IsS11Min=Yes	FrameElem=46	ElemStation=0				
Frame=46	Station=0	OutputCase=ENVE	CaseType=Combination	StepType=Min	Point=2	X2=-0.5	X3=0.5	S11=-
2841.74256727609	IsS11Max=No	IsS11Min=No	FrameElem=46	ElemStation=0				
Frame=46	Station=0	OutputCase=ENVE	CaseType=Combination	StepType=Min	Point=3	X2=0.5	X3=-0.5	
S11=2590.86356768079	IsS11Max=Yes	IsS11Min=No	FrameElem=46	ElemStation=0				
Frame=46	Station=0	OutputCase=ENVE	CaseType=Combination	StepType=Min	Point=4	X2=0.5	X3=0.5	
S11=2590.86356768079	IsS11Max=No	IsS11Min=No	FrameElem=46	ElemStation=0				
Frame=46	Station=0.125	OutputCase=ENVE	CaseType=Combination	StepType=Min	Point=0	X2=0	X3=0	S11=-
122.976319142087	IsS11Max=No	IsS11Min=No	FrameElem=46	ElemStation=0.125				
Frame=46	Station=0.125	OutputCase=ENVE	CaseType=Combination	StepType=Min	Point=1	X2=-0.5	X3=-0.5	
S11=-2693.2961673676	IsS11Max=No	IsS11Min=Yes	FrameElem=46	ElemStation=0.125				
Frame=46	Station=0.125	OutputCase=ENVE	CaseType=Combination	StepType=Min	Point=2	X2=-0.5	X3=0.5	
S11=-2693.2961673676	IsS11Max=No	IsS11Min=No	FrameElem=46	ElemStation=0.125				
Frame=46	Station=0.125	OutputCase=ENVE	CaseType=Combination	StepType=Min	Point=3	X2=0.5	X3=-0.5	
S11=2442.3873711474	IsS11Max=Yes	IsS11Min=No	FrameElem=46	ElemStation=0.125				
Frame=46	Station=0.125	OutputCase=ENVE	CaseType=Combination	StepType=Min	Point=4	X2=0.5	X3=0.5	
S11=2442.3873711474	IsS11Max=No	IsS11Min=No	FrameElem=46	ElemStation=0.125				
Frame=46	Station=0.25	OutputCase=ENVE	CaseType=Combination	StepType=Min	Point=0	X2=0	X3=0	S11=-
122.976319142087	IsS11Max=No	IsS11Min=No	FrameElem=46	ElemStation=0.25				
Frame=46	Station=0.25	OutputCase=ENVE	CaseType=Combination	StepType=Min	Point=1	X2=-0.5	X3=-0.5	
S11=-2547.19351745912	IsS11Max=No	IsS11Min=Yes	FrameElem=46	ElemStation=0.25				
Frame=46	Station=0.25	OutputCase=ENVE	CaseType=Combination	StepType=Min	Point=2	X2=-0.5	X3=0.5	
S11=-2547.19351745912	IsS11Max=No	IsS11Min=No	FrameElem=46	ElemStation=0.25				
Frame=46	Station=0.25	OutputCase=ENVE	CaseType=Combination	StepType=Min	Point=3	X2=0.5	X3=-0.5	
S11=2296.25492461401	IsS11Max=Yes	IsS11Min=No	FrameElem=46	ElemStation=0.25				
Frame=46	Station=0.25	OutputCase=ENVE	CaseType=Combination	StepType=Min	Point=4	X2=0.5	X3=0.5	
S11=2296.25492461401	IsS11Max=No	IsS11Min=No	FrameElem=46	ElemStation=0.25				
Frame=46	Station=0.375	OutputCase=ENVE	CaseType=Combination	StepType=Min	Point=0	X2=0	X3=0	S11=-
122.976319142087	IsS11Max=No	IsS11Min=No	FrameElem=46	ElemStation=0.375				

Frame=46	Station=0.375	OutputCase=ENVE	CaseType=Combination	StepType=Min	Point=1	X2=-0.5	X3=-0.5	
S11=-2403.43461755063	IsS11Max=No	IsS11Min=Yes	FrameElem=46	ElemStation=0.375				
Frame=46	Station=0.375	OutputCase=ENVE	CaseType=Combination	StepType=Min	Point=2	X2=-0.5	X3=0.5	
S11=-2403.43461755063	IsS11Max=No	IsS11Min=No	FrameElem=46	ElemStation=0.375				
Frame=46	Station=0.375	OutputCase=ENVE	CaseType=Combination	StepType=Min	Point=3	X2=0.5	X3=-0.5	
S11=2152.46622808062	IsS11Max=Yes	IsS11Min=No	FrameElem=46	ElemStation=0.375				
Frame=46	Station=0.375	OutputCase=ENVE	CaseType=Combination	StepType=Min	Point=4	X2=0.5	X3=0.5	
S11=2152.46622808062	IsS11Max=No	IsS11Min=No	FrameElem=46	ElemStation=0.375				
Frame=46	Station=0.5	OutputCase=ENVE	CaseType=Combination	StepType=Min	Point=0	X2=0	X3=0	S11=-
122.976319142087	IsS11Max=No	IsS11Min=No	FrameElem=46	ElemStation=0.5				
Frame=46	Station=0.5	OutputCase=ENVE	CaseType=Combination	StepType=Min	Point=1	X2=-0.5	X3=-0.5	
S11=-2262.01946764215	IsS11Max=No	IsS11Min=Yes	FrameElem=46	ElemStation=0.5				
Frame=46	Station=0.5	OutputCase=ENVE	CaseType=Combination	StepType=Min	Point=2	X2=-0.5	X3=0.5	
S11=-2262.01946764215	IsS11Max=No	IsS11Min=No	FrameElem=46	ElemStation=0.5				
Frame=46	Station=0.5	OutputCase=ENVE	CaseType=Combination	StepType=Min	Point=3	X2=0.5	X3=-0.5	
S11=2011.02128154723	IsS11Max=Yes	IsS11Min=No	FrameElem=46	ElemStation=0.5				
Frame=46	Station=0.5	OutputCase=ENVE	CaseType=Combination	StepType=Min	Point=4	X2=0.5	X3=0.5	
S11=2011.02128154723	IsS11Max=No	IsS11Min=No	FrameElem=46	ElemStation=0.5				
Frame=46	Station=0	OutputCase=FESSUR	CaseType=Combination	Point=0	X2=0	X3=0	S11=-122.976319142087	
IsS11Max=No	IsS11Min=No	FrameElem=46	ElemStation=0					
Frame=46	Station=0	OutputCase=FESSUR	CaseType=Combination	Point=1	X2=-0.5	X3=-0.5	S11=-	
2836.81620596497	IsS11Max=No	IsS11Min=Yes	FrameElem=46	ElemStation=0				
Frame=46	Station=0	OutputCase=FESSUR	CaseType=Combination	Point=2	X2=-0.5	X3=0.5	S11=-	
2836.81620596497	IsS11Max=No	IsS11Min=No	FrameElem=46	ElemStation=0				
Frame=46	Station=0	OutputCase=FESSUR	CaseType=Combination	Point=3	X2=0.5	X3=-0.5		
S11=2590.86356768079	IsS11Max=Yes	IsS11Min=No	FrameElem=46	ElemStation=0				
Frame=46	Station=0	OutputCase=FESSUR	CaseType=Combination	Point=4	X2=0.5	X3=0.5		
S11=2590.86356768079	IsS11Max=No	IsS11Min=No	FrameElem=46	ElemStation=0				
Frame=46	Station=0.125	OutputCase=FESSUR	CaseType=Combination	Point=0	X2=0	X3=0	S11=-	
122.976319142087	IsS11Max=No	IsS11Min=No	FrameElem=46	ElemStation=0.125				
Frame=46	Station=0.125	OutputCase=FESSUR	CaseType=Combination	Point=1	X2=-0.5	X3=-0.5	S11=-	
2688.34000943158	IsS11Max=No	IsS11Min=Yes	FrameElem=46	ElemStation=0.125				
Frame=46	Station=0.125	OutputCase=FESSUR	CaseType=Combination	Point=2	X2=-0.5	X3=0.5	S11=-	
2688.34000943158	IsS11Max=No	IsS11Min=No	FrameElem=46	ElemStation=0.125				
Frame=46	Station=0.125	OutputCase=FESSUR	CaseType=Combination	Point=3	X2=0.5	X3=-0.5		
S11=2442.3873711474	IsS11Max=Yes	IsS11Min=No	FrameElem=46	ElemStation=0.125				
Frame=46	Station=0.125	OutputCase=FESSUR	CaseType=Combination	Point=4	X2=0.5	X3=0.5		
S11=2442.3873711474	IsS11Max=No	IsS11Min=No	FrameElem=46	ElemStation=0.125				
Frame=46	Station=0.25	OutputCase=FESSUR	CaseType=Combination	Point=0	X2=0	X3=0	S11=-	
122.976319142087	IsS11Max=No	IsS11Min=No	FrameElem=46	ElemStation=0.25				
Frame=46	Station=0.25	OutputCase=FESSUR	CaseType=Combination	Point=1	X2=-0.5	X3=-0.5	S11=-	
2542.20756289818	IsS11Max=No	IsS11Min=Yes	FrameElem=46	ElemStation=0.25				
Frame=46	Station=0.25	OutputCase=FESSUR	CaseType=Combination	Point=2	X2=-0.5	X3=0.5	S11=-	
2542.20756289818	IsS11Max=No	IsS11Min=No	FrameElem=46	ElemStation=0.25				
Frame=46	Station=0.25	OutputCase=FESSUR	CaseType=Combination	Point=3	X2=0.5	X3=-0.5		
S11=2296.25492461401	IsS11Max=Yes	IsS11Min=No	FrameElem=46	ElemStation=0.25				
Frame=46	Station=0.25	OutputCase=FESSUR	CaseType=Combination	Point=4	X2=0.5	X3=0.5		
S11=2296.25492461401	IsS11Max=No	IsS11Min=No	FrameElem=46	ElemStation=0.25				
Frame=46	Station=0.375	OutputCase=FESSUR	CaseType=Combination	Point=0	X2=0	X3=0	S11=-	
122.976319142087	IsS11Max=No	IsS11Min=No	FrameElem=46	ElemStation=0.375				
Frame=46	Station=0.375	OutputCase=FESSUR	CaseType=Combination	Point=1	X2=-0.5	X3=-0.5	S11=-	
2398.41886636479	IsS11Max=No	IsS11Min=Yes	FrameElem=46	ElemStation=0.375				
Frame=46	Station=0.375	OutputCase=FESSUR	CaseType=Combination	Point=2	X2=-0.5	X3=0.5	S11=-	
2398.41886636479	IsS11Max=No	IsS11Min=No	FrameElem=46	ElemStation=0.375				
Frame=46	Station=0.375	OutputCase=FESSUR	CaseType=Combination	Point=3	X2=0.5	X3=-0.5		
S11=2152.46622808062	IsS11Max=Yes	IsS11Min=No	FrameElem=46	ElemStation=0.375				
Frame=46	Station=0.375	OutputCase=FESSUR	CaseType=Combination	Point=4	X2=0.5	X3=0.5		
S11=2152.46622808062	IsS11Max=No	IsS11Min=No	FrameElem=46	ElemStation=0.375				
Frame=46	Station=0.5	OutputCase=FESSUR	CaseType=Combination	Point=0	X2=0	X3=0	S11=-122.976319142087	
IsS11Max=No	IsS11Min=No	FrameElem=46	ElemStation=0.5					
Frame=46	Station=0.5	OutputCase=FESSUR	CaseType=Combination	Point=1	X2=-0.5	X3=-0.5	S11=-	
2256.9739198314	IsS11Max=No	IsS11Min=Yes	FrameElem=46	ElemStation=0.5				
Frame=46	Station=0.5	OutputCase=FESSUR	CaseType=Combination	Point=2	X2=-0.5	X3=0.5	S11=-	
2256.9739198314	IsS11Max=No	IsS11Min=No	FrameElem=46	ElemStation=0.5				
Frame=46	Station=0.5	OutputCase=FESSUR	CaseType=Combination	Point=3	X2=0.5	X3=-0.5		
S11=2011.02128154723	IsS11Max=Yes	IsS11Min=No	FrameElem=46	ElemStation=0.5				
Frame=46	Station=0.5	OutputCase=FESSUR	CaseType=Combination	Point=4	X2=0.5	X3=0.5		
S11=2011.02128154723	IsS11Max=No	IsS11Min=No	FrameElem=46	ElemStation=0.5				
Frame=47	Station=0	OutputCase=PESOPR	CaseType=LinStatic	Point=0	X2=0	X3=0	S11=-15.1709467362365	
IsS11Max=No	IsS11Min=No	FrameElem=47	ElemStation=0					
Frame=47	Station=0	OutputCase=PESOPR	CaseType=LinStatic	Point=1	X2=-0.5	X3=-0.5	S11=-	
541.866414962058	IsS11Max=No	IsS11Min=Yes	FrameElem=47	ElemStation=0				
Frame=47	Station=0	OutputCase=PESOPR	CaseType=LinStatic	Point=2	X2=-0.5	X3=0.5	S11=-	
541.866414962058	IsS11Max=No	IsS11Min=No	FrameElem=47	ElemStation=0				
Frame=47	Station=0	OutputCase=PESOPR	CaseType=LinStatic	Point=3	X2=0.5	X3=-0.5	S11=511.524521489585	
IsS11Max=Yes	IsS11Min=No	FrameElem=47	ElemStation=0					
Frame=47	Station=0	OutputCase=PESOPR	CaseType=LinStatic	Point=4	X2=0.5	X3=0.5	S11=511.524521489585	
IsS11Max=No	IsS11Min=No	FrameElem=47	ElemStation=0					
Frame=47	Station=0.125	OutputCase=PESOPR	CaseType=LinStatic	Point=0	X2=0	X3=0	S11=-15.1709467362365	
IsS11Max=No	IsS11Min=No	FrameElem=47	ElemStation=0.125					
Frame=47	Station=0.125	OutputCase=PESOPR	CaseType=LinStatic	Point=1	X2=-0.5	X3=-0.5	S11=-	
478.117889284857	IsS11Max=No	IsS11Min=Yes	FrameElem=47	ElemStation=0.125				

Frame=47 Station=0.125 OutputCase=PESOPR CaseType=LinStatic Point=2 X2=-0.5 X3=0.5 S11=-
 478.117889284857 IsS11Max=No IsS11Min=No FrameElem=47 ElemStation=0.125
 Frame=47 Station=0.125 OutputCase=PESOPR CaseType=LinStatic Point=3 X2=0.5 X3=-0.5
 S11=447.775995812384 IsS11Max=Yes IsS11Min=No FrameElem=47 ElemStation=0.125
 Frame=47 Station=0.125 OutputCase=PESOPR CaseType=LinStatic Point=4 X2=0.5 X3=0.5
 S11=447.775995812384 IsS11Max=No IsS11Min=No FrameElem=47 ElemStation=0.125
 Frame=47 Station=0.25 OutputCase=PESOPR CaseType=LinStatic Point=0 X2=0 X3=0 S11=-15.1709467362365
 IsS11Max=No IsS11Min=No FrameElem=47 ElemStation=0.25
 Frame=47 Station=0.25 OutputCase=PESOPR CaseType=LinStatic Point=1 X2=-0.5 X3=-0.5 S11=-
 416.713113607655 IsS11Max=No IsS11Min=Yes FrameElem=47 ElemStation=0.25
 Frame=47 Station=0.25 OutputCase=PESOPR CaseType=LinStatic Point=2 X2=-0.5 X3=0.5 S11=-
 416.713113607655 IsS11Max=No IsS11Min=No FrameElem=47 ElemStation=0.25
 Frame=47 Station=0.25 OutputCase=PESOPR CaseType=LinStatic Point=3 X2=0.5 X3=-0.5
 S11=386.371220135182 IsS11Max=Yes IsS11Min=No FrameElem=47 ElemStation=0.25
 Frame=47 Station=0.25 OutputCase=PESOPR CaseType=LinStatic Point=4 X2=0.5 X3=0.5
 S11=386.371220135182 IsS11Max=No IsS11Min=No FrameElem=47 ElemStation=0.25
 Frame=47 Station=0.375 OutputCase=PESOPR CaseType=LinStatic Point=0 X2=0 X3=0 S11=-15.1709467362365
 IsS11Max=No IsS11Min=No FrameElem=47 ElemStation=0.375
 Frame=47 Station=0.375 OutputCase=PESOPR CaseType=LinStatic Point=1 X2=-0.5 X3=-0.5 S11=-
 357.652087930454 IsS11Max=No IsS11Min=Yes FrameElem=47 ElemStation=0.375
 Frame=47 Station=0.375 OutputCase=PESOPR CaseType=LinStatic Point=2 X2=-0.5 X3=0.5 S11=-
 357.652087930454 IsS11Max=No IsS11Min=No FrameElem=47 ElemStation=0.375
 Frame=47 Station=0.375 OutputCase=PESOPR CaseType=LinStatic Point=3 X2=0.5 X3=-0.5
 S11=327.310194457981 IsS11Max=Yes IsS11Min=No FrameElem=47 ElemStation=0.375
 Frame=47 Station=0.375 OutputCase=PESOPR CaseType=LinStatic Point=4 X2=0.5 X3=0.5
 S11=327.310194457981 IsS11Max=No IsS11Min=No FrameElem=47 ElemStation=0.375
 Frame=47 Station=0.5 OutputCase=PESOPR CaseType=LinStatic Point=0 X2=0 X3=0 S11=-15.1709467362365
 IsS11Max=No IsS11Min=No FrameElem=47 ElemStation=0.5
 Frame=47 Station=0.5 OutputCase=PESOPR CaseType=LinStatic Point=1 X2=-0.5 X3=-0.5 S11=-
 300.934812253252 IsS11Max=No IsS11Min=Yes FrameElem=47 ElemStation=0.5
 Frame=47 Station=0.5 OutputCase=PESOPR CaseType=LinStatic Point=2 X2=-0.5 X3=0.5 S11=-
 300.934812253252 IsS11Max=No IsS11Min=No FrameElem=47 ElemStation=0.5
 Frame=47 Station=0.5 OutputCase=PESOPR CaseType=LinStatic Point=3 X2=0.5 X3=-0.5
 S11=270.592918780779 IsS11Max=Yes IsS11Min=No FrameElem=47 ElemStation=0.5
 Frame=47 Station=0.5 OutputCase=PESOPR CaseType=LinStatic Point=4 X2=0.5 X3=0.5
 S11=270.592918780779 IsS11Max=No IsS11Min=No FrameElem=47 ElemStation=0.5
 Frame=47 Station=0 OutputCase=TERRVERT CaseType=LinStatic Point=0 X2=0 X3=0 S11=1.15282857329472
 IsS11Max=No IsS11Min=No FrameElem=47 ElemStation=0
 Frame=47 Station=0 OutputCase=TERRVERT CaseType=LinStatic Point=1 X2=-0.5 X3=-0.5 S11=-
 1731.92599757189 IsS11Max=No IsS11Min=Yes FrameElem=47 ElemStation=0
 Frame=47 Station=0 OutputCase=TERRVERT CaseType=LinStatic Point=2 X2=-0.5 X3=0.5 S11=-
 1731.92599757189 IsS11Max=No IsS11Min=No FrameElem=47 ElemStation=0
 Frame=47 Station=0 OutputCase=TERRVERT CaseType=LinStatic Point=3 X2=0.5 X3=-0.5
 S11=1734.23165471848 IsS11Max=Yes IsS11Min=No FrameElem=47 ElemStation=0
 Frame=47 Station=0 OutputCase=TERRVERT CaseType=LinStatic Point=4 X2=0.5 X3=0.5
 S11=1734.23165471848 IsS11Max=No IsS11Min=No FrameElem=47 ElemStation=0
 Frame=47 Station=0.125 OutputCase=TERRVERT CaseType=LinStatic Point=0 X2=0 X3=0
 S11=1.15282857329472 IsS11Max=No IsS11Min=No FrameElem=47 ElemStation=0.125
 Frame=47 Station=0.125 OutputCase=TERRVERT CaseType=LinStatic Point=1 X2=-0.5 X3=-0.5 S11=-
 1550.00131510664 IsS11Max=No IsS11Min=Yes FrameElem=47 ElemStation=0.125
 Frame=47 Station=0.125 OutputCase=TERRVERT CaseType=LinStatic Point=2 X2=-0.5 X3=0.5 S11=-
 1550.00131510664 IsS11Max=No IsS11Min=No FrameElem=47 ElemStation=0.125
 Frame=47 Station=0.125 OutputCase=TERRVERT CaseType=LinStatic Point=3 X2=0.5 X3=-0.5
 S11=1552.30697225323 IsS11Max=Yes IsS11Min=No FrameElem=47 ElemStation=0.125
 Frame=47 Station=0.125 OutputCase=TERRVERT CaseType=LinStatic Point=4 X2=0.5 X3=0.5
 S11=1552.30697225323 IsS11Max=No IsS11Min=No FrameElem=47 ElemStation=0.125
 Frame=47 Station=0.25 OutputCase=TERRVERT CaseType=LinStatic Point=0 X2=0 X3=0 S11=1.15282857329472
 IsS11Max=No IsS11Min=No FrameElem=47 ElemStation=0.25
 Frame=47 Station=0.25 OutputCase=TERRVERT CaseType=LinStatic Point=1 X2=-0.5 X3=-0.5 S11=-
 1368.07663264139 IsS11Max=No IsS11Min=Yes FrameElem=47 ElemStation=0.25
 Frame=47 Station=0.25 OutputCase=TERRVERT CaseType=LinStatic Point=2 X2=-0.5 X3=0.5 S11=-
 1368.07663264139 IsS11Max=No IsS11Min=No FrameElem=47 ElemStation=0.25
 Frame=47 Station=0.25 OutputCase=TERRVERT CaseType=LinStatic Point=3 X2=0.5 X3=-0.5
 S11=1370.38228978797 IsS11Max=Yes IsS11Min=No FrameElem=47 ElemStation=0.25
 Frame=47 Station=0.25 OutputCase=TERRVERT CaseType=LinStatic Point=4 X2=0.5 X3=0.5
 S11=1370.38228978797 IsS11Max=No IsS11Min=No FrameElem=47 ElemStation=0.25
 Frame=47 Station=0.375 OutputCase=TERRVERT CaseType=LinStatic Point=0 X2=0 X3=0
 S11=1.15282857329472 IsS11Max=No IsS11Min=No FrameElem=47 ElemStation=0.375
 Frame=47 Station=0.375 OutputCase=TERRVERT CaseType=LinStatic Point=1 X2=-0.5 X3=-0.5 S11=-
 1186.15195017613 IsS11Max=No IsS11Min=Yes FrameElem=47 ElemStation=0.375
 Frame=47 Station=0.375 OutputCase=TERRVERT CaseType=LinStatic Point=2 X2=-0.5 X3=0.5 S11=-
 1186.15195017613 IsS11Max=No IsS11Min=No FrameElem=47 ElemStation=0.375
 Frame=47 Station=0.375 OutputCase=TERRVERT CaseType=LinStatic Point=3 X2=0.5 X3=-0.5
 S11=1188.45760732272 IsS11Max=Yes IsS11Min=No FrameElem=47 ElemStation=0.375
 Frame=47 Station=0.375 OutputCase=TERRVERT CaseType=LinStatic Point=4 X2=0.5 X3=0.5
 S11=1188.45760732272 IsS11Max=No IsS11Min=No FrameElem=47 ElemStation=0.375
 Frame=47 Station=0.5 OutputCase=TERRVERT CaseType=LinStatic Point=0 X2=0 X3=0 S11=1.15282857329472
 IsS11Max=No IsS11Min=No FrameElem=47 ElemStation=0.5
 Frame=47 Station=0.5 OutputCase=TERRVERT CaseType=LinStatic Point=1 X2=-0.5 X3=-0.5 S11=-
 1004.22726771088 IsS11Max=No IsS11Min=Yes FrameElem=47 ElemStation=0.5
 Frame=47 Station=0.5 OutputCase=TERRVERT CaseType=LinStatic Point=2 X2=-0.5 X3=0.5 S11=-
 1004.22726771088 IsS11Max=No IsS11Min=No FrameElem=47 ElemStation=0.5



Frame=47	Station=0.5	OutputCase=TERRVERT	CaseType=LinStatic	Point=3	X2=0.5	X3=-0.5		
S11=1006.53292485747	IsS11Max=Yes	IsS11Min=No	FrameElem=47	ElemStation=0.5				
Frame=47	Station=0.5	OutputCase=TERRVERT	CaseType=LinStatic	Point=4	X2=0.5	X3=0.5		
S11=1006.53292485747	IsS11Max=No	IsS11Min=No	FrameElem=47	ElemStation=0.5				
Frame=47	Station=0	OutputCase=TERRLAT	CaseType=LinStatic	Point=0	X2=0	X3=0	S11=-108.958200979145	
IsS11Max=No	IsS11Min=No	FrameElem=47	ElemStation=0					
Frame=47	Station=0	OutputCase=TERRLAT	CaseType=LinStatic	Point=1	X2=-0.5	X3=-0.5		
S11=16.8184927024784	IsS11Max=Yes	IsS11Min=No	FrameElem=47	ElemStation=0				
Frame=47	Station=0	OutputCase=TERRLAT	CaseType=LinStatic	Point=2	X2=-0.5	X3=0.5		
S11=16.8184927024784	IsS11Max=No	IsS11Min=No	FrameElem=47	ElemStation=0				
Frame=47	Station=0	OutputCase=TERRLAT	CaseType=LinStatic	Point=3	X2=0.5	X3=-0.5	S11=-	
234.734894660768	IsS11Max=No	IsS11Min=Yes	FrameElem=47	ElemStation=0				
Frame=47	Station=0	OutputCase=TERRLAT	CaseType=LinStatic	Point=4	X2=0.5	X3=0.5	S11=-	
234.734894660768	IsS11Max=No	IsS11Min=No	FrameElem=47	ElemStation=0				
Frame=47	Station=0.125	OutputCase=TERRLAT	CaseType=LinStatic	Point=0	X2=0	X3=0	S11=-	
108.958200979145	IsS11Max=No	IsS11Min=No	FrameElem=47	ElemStation=0.125				
Frame=47	Station=0.125	OutputCase=TERRLAT	CaseType=LinStatic	Point=1	X2=-0.5	X3=-0.5		
S11=16.9558299442938	IsS11Max=Yes	IsS11Min=No	FrameElem=47	ElemStation=0.125				
Frame=47	Station=0.125	OutputCase=TERRLAT	CaseType=LinStatic	Point=2	X2=-0.5	X3=0.5		
S11=16.9558299442938	IsS11Max=No	IsS11Min=No	FrameElem=47	ElemStation=0.125				
Frame=47	Station=0.125	OutputCase=TERRLAT	CaseType=LinStatic	Point=3	X2=0.5	X3=-0.5	S11=-	
234.872231902584	IsS11Max=No	IsS11Min=Yes	FrameElem=47	ElemStation=0.125				
Frame=47	Station=0.125	OutputCase=TERRLAT	CaseType=LinStatic	Point=4	X2=0.5	X3=0.5	S11=-	
234.872231902584	IsS11Max=No	IsS11Min=No	FrameElem=47	ElemStation=0.125				
Frame=47	Station=0.25	OutputCase=TERRLAT	CaseType=LinStatic	Point=0	X2=0	X3=0	S11=-108.958200979145	
IsS11Max=No	IsS11Min=No	FrameElem=47	ElemStation=0.25					
Frame=47	Station=0.25	OutputCase=TERRLAT	CaseType=LinStatic	Point=1	X2=-0.5	X3=-0.5		
S11=17.0931671861093	IsS11Max=Yes	IsS11Min=No	FrameElem=47	ElemStation=0.25				
Frame=47	Station=0.25	OutputCase=TERRLAT	CaseType=LinStatic	Point=2	X2=-0.5	X3=0.5		
S11=17.0931671861093	IsS11Max=No	IsS11Min=No	FrameElem=47	ElemStation=0.25				
Frame=47	Station=0.25	OutputCase=TERRLAT	CaseType=LinStatic	Point=3	X2=0.5	X3=-0.5	S11=-	
235.009569144399	IsS11Max=No	IsS11Min=Yes	FrameElem=47	ElemStation=0.25				
Frame=47	Station=0.25	OutputCase=TERRLAT	CaseType=LinStatic	Point=4	X2=0.5	X3=0.5	S11=-	
235.009569144399	IsS11Max=No	IsS11Min=No	FrameElem=47	ElemStation=0.25				
Frame=47	Station=0.375	OutputCase=TERRLAT	CaseType=LinStatic	Point=0	X2=0	X3=0	S11=-	
108.958200979145	IsS11Max=No	IsS11Min=No	FrameElem=47	ElemStation=0.375				
Frame=47	Station=0.375	OutputCase=TERRLAT	CaseType=LinStatic	Point=1	X2=-0.5	X3=-0.5		
S11=17.2305044279247	IsS11Max=Yes	IsS11Min=No	FrameElem=47	ElemStation=0.375				
Frame=47	Station=0.375	OutputCase=TERRLAT	CaseType=LinStatic	Point=2	X2=-0.5	X3=0.5		
S11=17.2305044279247	IsS11Max=No	IsS11Min=No	FrameElem=47	ElemStation=0.375				
Frame=47	Station=0.375	OutputCase=TERRLAT	CaseType=LinStatic	Point=3	X2=0.5	X3=-0.5	S11=-	
235.146906386214	IsS11Max=No	IsS11Min=Yes	FrameElem=47	ElemStation=0.375				
Frame=47	Station=0.375	OutputCase=TERRLAT	CaseType=LinStatic	Point=4	X2=0.5	X3=0.5	S11=-	
235.146906386214	IsS11Max=No	IsS11Min=No	FrameElem=47	ElemStation=0.375				
Frame=47	Station=0.5	OutputCase=TERRLAT	CaseType=LinStatic	Point=0	X2=0	X3=0	S11=-108.958200979145	
IsS11Max=No	IsS11Min=No	FrameElem=47	ElemStation=0.5					
Frame=47	Station=0.5	OutputCase=TERRLAT	CaseType=LinStatic	Point=1	X2=-0.5	X3=-0.5		
S11=17.3678416697401	IsS11Max=Yes	IsS11Min=No	FrameElem=47	ElemStation=0.5				
Frame=47	Station=0.5	OutputCase=TERRLAT	CaseType=LinStatic	Point=2	X2=-0.5	X3=0.5		
S11=17.3678416697401	IsS11Max=No	IsS11Min=No	FrameElem=47	ElemStation=0.5				
Frame=47	Station=0.5	OutputCase=TERRLAT	CaseType=LinStatic	Point=3	X2=0.5	X3=-0.5	S11=-	
235.28424362803	IsS11Max=No	IsS11Min=Yes	FrameElem=47	ElemStation=0.5				
Frame=47	Station=0.5	OutputCase=TERRLAT	CaseType=LinStatic	Point=4	X2=0.5	X3=0.5	S11=-	
235.28424362803	IsS11Max=No	IsS11Min=No	FrameElem=47	ElemStation=0.5				
Frame=47	Station=0	OutputCase=ACCLATDX	CaseType=LinStatic	Point=0	X2=0	X3=0	S11=0	IsS11Max=Yes
IsS11Min=Yes	FrameElem=47	ElemStation=0						
Frame=47	Station=0	OutputCase=ACCLATDX	CaseType=LinStatic	Point=1	X2=-0.5	X3=-0.5	S11=0	
IsS11Max=No	IsS11Min=No	FrameElem=47	ElemStation=0					
Frame=47	Station=0	OutputCase=ACCLATDX	CaseType=LinStatic	Point=2	X2=-0.5	X3=0.5	S11=0	
IsS11Max=No	IsS11Min=No	FrameElem=47	ElemStation=0					
Frame=47	Station=0	OutputCase=ACCLATDX	CaseType=LinStatic	Point=3	X2=0.5	X3=-0.5	S11=0	
IsS11Max=No	IsS11Min=No	FrameElem=47	ElemStation=0					
Frame=47	Station=0	OutputCase=ACCLATDX	CaseType=LinStatic	Point=4	X2=0.5	X3=0.5	S11=0	IsS11Max=No
IsS11Min=No	FrameElem=47	ElemStation=0						
Frame=47	Station=0.125	OutputCase=ACCLATDX	CaseType=LinStatic	Point=0	X2=0	X3=0	S11=0	
IsS11Max=Yes	IsS11Min=Yes	FrameElem=47	ElemStation=0.125					
Frame=47	Station=0.125	OutputCase=ACCLATDX	CaseType=LinStatic	Point=1	X2=-0.5	X3=-0.5	S11=0	
IsS11Max=No	IsS11Min=No	FrameElem=47	ElemStation=0.125					
Frame=47	Station=0.125	OutputCase=ACCLATDX	CaseType=LinStatic	Point=2	X2=-0.5	X3=0.5	S11=0	
IsS11Max=No	IsS11Min=No	FrameElem=47	ElemStation=0.125					
Frame=47	Station=0.125	OutputCase=ACCLATDX	CaseType=LinStatic	Point=3	X2=0.5	X3=-0.5	S11=0	
IsS11Max=No	IsS11Min=No	FrameElem=47	ElemStation=0.125					
Frame=47	Station=0.125	OutputCase=ACCLATDX	CaseType=LinStatic	Point=4	X2=0.5	X3=0.5	S11=0	
IsS11Max=No	IsS11Min=No	FrameElem=47	ElemStation=0.125					
Frame=47	Station=0.25	OutputCase=ACCLATDX	CaseType=LinStatic	Point=0	X2=0	X3=0	S11=0	IsS11Max=Yes
IsS11Min=Yes	FrameElem=47	ElemStation=0.25						
Frame=47	Station=0.25	OutputCase=ACCLATDX	CaseType=LinStatic	Point=1	X2=-0.5	X3=-0.5	S11=0	
IsS11Max=No	IsS11Min=No	FrameElem=47	ElemStation=0.25					
Frame=47	Station=0.25	OutputCase=ACCLATDX	CaseType=LinStatic	Point=2	X2=-0.5	X3=0.5	S11=0	
IsS11Max=No	IsS11Min=No	FrameElem=47	ElemStation=0.25					
Frame=47	Station=0.25	OutputCase=ACCLATDX	CaseType=LinStatic	Point=3	X2=0.5	X3=-0.5	S11=0	
IsS11Max=No	IsS11Min=No	FrameElem=47	ElemStation=0.25					

Frame=47	Station=0.5	OutputCase=SOVRCOST	CaseType=LinStatic	Point=1	X2=-0.5	X3=-0.5	S11=0	
IsS11Max=No	IsS11Min=No	FrameElem=47	ElemStation=0.5					
Frame=47	Station=0.5	OutputCase=SOVRCOST	CaseType=LinStatic	Point=2	X2=-0.5	X3=0.5	S11=0	
IsS11Max=No	IsS11Min=No	FrameElem=47	ElemStation=0.5					
Frame=47	Station=0.5	OutputCase=SOVRCOST	CaseType=LinStatic	Point=3	X2=0.5	X3=-0.5	S11=0	
IsS11Max=No	IsS11Min=No	FrameElem=47	ElemStation=0.5					
Frame=47	Station=0.5	OutputCase=SOVRCOST	CaseType=LinStatic	Point=4	X2=0.5	X3=0.5	S11=0	
IsS11Max=No	IsS11Min=No	FrameElem=47	ElemStation=0.5					
Frame=47	Station=0	OutputCase=ENVE	CaseType=Combination	StepType=Max	Point=0	X2=0	X3=0	S11=-
90.2888588483432	IsS11Max=No	IsS11Min=No	FrameElem=47	ElemStation=0				
Frame=47	Station=0	OutputCase=ENVE	CaseType=Combination	StepType=Max	Point=1	X2=-0.5	X3=-0.5	
S11=-2256.97391983147	IsS11Max=No	IsS11Min=Yes	FrameElem=47	ElemStation=0				
Frame=47	Station=0	OutputCase=ENVE	CaseType=Combination	StepType=Max	Point=2	X2=-0.5	X3=0.5	S11=-
2256.97391983147	IsS11Max=No	IsS11Min=No	FrameElem=47	ElemStation=0				
Frame=47	Station=0	OutputCase=ENVE	CaseType=Combination	StepType=Max	Point=3	X2=0.5	X3=-0.5	
S11=2081.44174994552	IsS11Max=Yes	IsS11Min=No	FrameElem=47	ElemStation=0				
Frame=47	Station=0	OutputCase=ENVE	CaseType=Combination	StepType=Max	Point=4	X2=0.5	X3=0.5	
S11=2081.44174994552	IsS11Max=No	IsS11Min=No	FrameElem=47	ElemStation=0				
Frame=47	Station=0.125	OutputCase=ENVE	CaseType=Combination	StepType=Max	Point=0	X2=0	X3=0	S11=-
90.2888588483432	IsS11Max=No	IsS11Min=No	FrameElem=47	ElemStation=0.125				
Frame=47	Station=0.125	OutputCase=ENVE	CaseType=Combination	StepType=Max	Point=1	X2=-0.5	X3=-0.5	
S11=-2011.1633744472	IsS11Max=No	IsS11Min=Yes	FrameElem=47	ElemStation=0.125				
Frame=47	Station=0.125	OutputCase=ENVE	CaseType=Combination	StepType=Max	Point=2	X2=-0.5	X3=0.5	
S11=-2011.1633744472	IsS11Max=No	IsS11Min=No	FrameElem=47	ElemStation=0.125				
Frame=47	Station=0.125	OutputCase=ENVE	CaseType=Combination	StepType=Max	Point=3	X2=0.5	X3=-0.5	
S11=1835.6724057338	IsS11Max=Yes	IsS11Min=No	FrameElem=47	ElemStation=0.125				
Frame=47	Station=0.125	OutputCase=ENVE	CaseType=Combination	StepType=Max	Point=4	X2=0.5	X3=0.5	
S11=1835.6724057338	IsS11Max=No	IsS11Min=No	FrameElem=47	ElemStation=0.125				
Frame=47	Station=0.25	OutputCase=ENVE	CaseType=Combination	StepType=Max	Point=0	X2=0	X3=0	S11=-
90.2888588483432	IsS11Max=No	IsS11Min=No	FrameElem=47	ElemStation=0.25				
Frame=47	Station=0.25	OutputCase=ENVE	CaseType=Combination	StepType=Max	Point=1	X2=-0.5	X3=-0.5	
S11=-1767.69657906293	IsS11Max=No	IsS11Min=Yes	FrameElem=47	ElemStation=0.25				
Frame=47	Station=0.25	OutputCase=ENVE	CaseType=Combination	StepType=Max	Point=2	X2=-0.5	X3=0.5	
S11=-1767.69657906293	IsS11Max=No	IsS11Min=No	FrameElem=47	ElemStation=0.25				
Frame=47	Station=0.25	OutputCase=ENVE	CaseType=Combination	StepType=Max	Point=3	X2=0.5	X3=-0.5	
S11=1592.24681152208	IsS11Max=Yes	IsS11Min=No	FrameElem=47	ElemStation=0.25				
Frame=47	Station=0.25	OutputCase=ENVE	CaseType=Combination	StepType=Max	Point=4	X2=0.5	X3=0.5	
S11=1592.24681152208	IsS11Max=No	IsS11Min=No	FrameElem=47	ElemStation=0.25				
Frame=47	Station=0.375	OutputCase=ENVE	CaseType=Combination	StepType=Max	Point=0	X2=0	X3=0	S11=-
90.2888588483432	IsS11Max=No	IsS11Min=No	FrameElem=47	ElemStation=0.375				
Frame=47	Station=0.375	OutputCase=ENVE	CaseType=Combination	StepType=Max	Point=1	X2=-0.5	X3=-0.5	
S11=-1526.57353367866	IsS11Max=No	IsS11Min=Yes	FrameElem=47	ElemStation=0.375				
Frame=47	Station=0.375	OutputCase=ENVE	CaseType=Combination	StepType=Max	Point=2	X2=-0.5	X3=0.5	
S11=-1526.57353367866	IsS11Max=No	IsS11Min=No	FrameElem=47	ElemStation=0.375				
Frame=47	Station=0.375	OutputCase=ENVE	CaseType=Combination	StepType=Max	Point=3	X2=0.5	X3=-0.5	
S11=1351.16496731035	IsS11Max=Yes	IsS11Min=No	FrameElem=47	ElemStation=0.375				
Frame=47	Station=0.375	OutputCase=ENVE	CaseType=Combination	StepType=Max	Point=4	X2=0.5	X3=0.5	
S11=1351.16496731035	IsS11Max=No	IsS11Min=No	FrameElem=47	ElemStation=0.375				
Frame=47	Station=0.5	OutputCase=ENVE	CaseType=Combination	StepType=Max	Point=0	X2=0	X3=0	S11=-
90.2888588483432	IsS11Max=No	IsS11Min=No	FrameElem=47	ElemStation=0.5				
Frame=47	Station=0.5	OutputCase=ENVE	CaseType=Combination	StepType=Max	Point=1	X2=-0.5	X3=-0.5	
S11=-1287.7942382944	IsS11Max=No	IsS11Min=Yes	FrameElem=47	ElemStation=0.5				
Frame=47	Station=0.5	OutputCase=ENVE	CaseType=Combination	StepType=Max	Point=2	X2=-0.5	X3=0.5	
S11=-1287.7942382944	IsS11Max=No	IsS11Min=No	FrameElem=47	ElemStation=0.5				
Frame=47	Station=0.5	OutputCase=ENVE	CaseType=Combination	StepType=Max	Point=3	X2=0.5	X3=-0.5	
S11=1112.42687309863	IsS11Max=Yes	IsS11Min=No	FrameElem=47	ElemStation=0.5				
Frame=47	Station=0.5	OutputCase=ENVE	CaseType=Combination	StepType=Max	Point=4	X2=0.5	X3=0.5	
S11=1112.42687309863	IsS11Max=No	IsS11Min=No	FrameElem=47	ElemStation=0.5				
Frame=47	Station=0	OutputCase=ENVE	CaseType=Combination	StepType=Min	Point=0	X2=0	X3=0	S11=-
122.976319142087	IsS11Max=No	IsS11Min=No	FrameElem=47	ElemStation=0				
Frame=47	Station=0	OutputCase=ENVE	CaseType=Combination	StepType=Min	Point=1	X2=-0.5	X3=-0.5	
S11=-2262.01946764221	IsS11Max=No	IsS11Min=Yes	FrameElem=47	ElemStation=0				
Frame=47	Station=0	OutputCase=ENVE	CaseType=Combination	StepType=Min	Point=2	X2=-0.5	X3=0.5	S11=-
2262.01946764221	IsS11Max=No	IsS11Min=No	FrameElem=47	ElemStation=0				
Frame=47	Station=0	OutputCase=ENVE	CaseType=Combination	StepType=Min	Point=3	X2=0.5	X3=-0.5	
S11=2011.02128154729	IsS11Max=Yes	IsS11Min=No	FrameElem=47	ElemStation=0				
Frame=47	Station=0	OutputCase=ENVE	CaseType=Combination	StepType=Min	Point=4	X2=0.5	X3=0.5	
S11=2011.02128154729	IsS11Max=No	IsS11Min=No	FrameElem=47	ElemStation=0				
Frame=47	Station=0.125	OutputCase=ENVE	CaseType=Combination	StepType=Min	Point=0	X2=0	X3=0	S11=-
122.976319142087	IsS11Max=No	IsS11Min=No	FrameElem=47	ElemStation=0.125				
Frame=47	Station=0.125	OutputCase=ENVE	CaseType=Combination	StepType=Min	Point=1	X2=-0.5	X3=-0.5	
S11=-2016.25012343049	IsS11Max=No	IsS11Min=Yes	FrameElem=47	ElemStation=0.125				
Frame=47	Station=0.125	OutputCase=ENVE	CaseType=Combination	StepType=Min	Point=2	X2=-0.5	X3=0.5	
S11=-2016.25012343049	IsS11Max=No	IsS11Min=No	FrameElem=47	ElemStation=0.125				
Frame=47	Station=0.125	OutputCase=ENVE	CaseType=Combination	StepType=Min	Point=3	X2=0.5	X3=-0.5	
S11=1765.21073616303	IsS11Max=Yes	IsS11Min=No	FrameElem=47	ElemStation=0.125				
Frame=47	Station=0.125	OutputCase=ENVE	CaseType=Combination	StepType=Min	Point=4	X2=0.5	X3=0.5	
S11=1765.21073616303	IsS11Max=No	IsS11Min=No	FrameElem=47	ElemStation=0.125				
Frame=47	Station=0.25	OutputCase=ENVE	CaseType=Combination	StepType=Min	Point=0	X2=0	X3=0	S11=-
122.976319142087	IsS11Max=No	IsS11Min=No	FrameElem=47	ElemStation=0.25				
Frame=47	Station=0.25	OutputCase=ENVE	CaseType=Combination	StepType=Min	Point=1	X2=-0.5	X3=-0.5	
S11=-1772.82452921876	IsS11Max=No	IsS11Min=Yes	FrameElem=47	ElemStation=0.25				

Frame=47	Station=0.25	OutputCase=ENVE	CaseType=Combination	StepType=Min	Point=2	X2=-0.5	X3=0.5	
S11=-1772.82452921876	IsS11Max=No	IsS11Min=No	FrameElem=47	ElemStation=0.25				
Frame=47	Station=0.25	OutputCase=ENVE	CaseType=Combination	StepType=Min	Point=3	X2=0.5	X3=-0.5	
S11=1521.74394077876	IsS11Max=Yes	IsS11Min=No	FrameElem=47	ElemStation=0.25				
Frame=47	Station=0.25	OutputCase=ENVE	CaseType=Combination	StepType=Min	Point=4	X2=0.5	X3=0.5	
S11=1521.74394077876	IsS11Max=No	IsS11Min=No	FrameElem=47	ElemStation=0.25				
Frame=47	Station=0.375	OutputCase=ENVE	CaseType=Combination	StepType=Min	Point=0	X2=0	X3=0	S11=-
122.976319142087	IsS11Max=No	IsS11Min=No	FrameElem=47	ElemStation=0.375				
Frame=47	Station=0.375	OutputCase=ENVE	CaseType=Combination	StepType=Min	Point=1	X2=-0.5	X3=-0.5	
S11=-1531.74268500704	IsS11Max=No	IsS11Min=Yes	FrameElem=47	ElemStation=0.375				
Frame=47	Station=0.375	OutputCase=ENVE	CaseType=Combination	StepType=Min	Point=2	X2=-0.5	X3=0.5	
S11=-1531.74268500704	IsS11Max=No	IsS11Min=No	FrameElem=47	ElemStation=0.375				
Frame=47	Station=0.375	OutputCase=ENVE	CaseType=Combination	StepType=Min	Point=3	X2=0.5	X3=-0.5	
S11=1280.62089539449	IsS11Max=Yes	IsS11Min=No	FrameElem=47	ElemStation=0.375				
Frame=47	Station=0.375	OutputCase=ENVE	CaseType=Combination	StepType=Min	Point=4	X2=0.5	X3=0.5	
S11=1280.62089539449	IsS11Max=No	IsS11Min=No	FrameElem=47	ElemStation=0.375				
Frame=47	Station=0.5	OutputCase=ENVE	CaseType=Combination	StepType=Min	Point=0	X2=0	X3=0	S11=-
122.976319142087	IsS11Max=No	IsS11Min=No	FrameElem=47	ElemStation=0.5				
Frame=47	Station=0.5	OutputCase=ENVE	CaseType=Combination	StepType=Min	Point=1	X2=-0.5	X3=-0.5	
S11=-1293.00459079532	IsS11Max=No	IsS11Min=Yes	FrameElem=47	ElemStation=0.5				
Frame=47	Station=0.5	OutputCase=ENVE	CaseType=Combination	StepType=Min	Point=2	X2=-0.5	X3=0.5	
S11=-1293.00459079532	IsS11Max=No	IsS11Min=No	FrameElem=47	ElemStation=0.5				
Frame=47	Station=0.5	OutputCase=ENVE	CaseType=Combination	StepType=Min	Point=3	X2=0.5	X3=-0.5	
S11=1041.84160001022	IsS11Max=Yes	IsS11Min=No	FrameElem=47	ElemStation=0.5				
Frame=47	Station=0.5	OutputCase=ENVE	CaseType=Combination	StepType=Min	Point=4	X2=0.5	X3=0.5	
S11=1041.84160001022	IsS11Max=No	IsS11Min=No	FrameElem=47	ElemStation=0.5				
Frame=47	Station=0	OutputCase=FESSUR	CaseType=Combination	Point=0	X2=0	X3=0	S11=-122.976319142087	
IsS11Max=No	IsS11Min=No	FrameElem=47	ElemStation=0					
Frame=47	Station=0	OutputCase=FESSUR	CaseType=Combination	Point=1	X2=-0.5	X3=-0.5	S11=-	
2256.97391983147	IsS11Max=No	IsS11Min=Yes	FrameElem=47	ElemStation=0				
Frame=47	Station=0	OutputCase=FESSUR	CaseType=Combination	Point=2	X2=-0.5	X3=0.5	S11=-	
2256.97391983147	IsS11Max=No	IsS11Min=No	FrameElem=47	ElemStation=0				
Frame=47	Station=0	OutputCase=FESSUR	CaseType=Combination	Point=3	X2=0.5	X3=-0.5		
S11=2011.02128154729	IsS11Max=Yes	IsS11Min=No	FrameElem=47	ElemStation=0				
Frame=47	Station=0	OutputCase=FESSUR	CaseType=Combination	Point=4	X2=0.5	X3=0.5		
S11=2011.02128154729	IsS11Max=No	IsS11Min=No	FrameElem=47	ElemStation=0				
Frame=47	Station=0.125	OutputCase=FESSUR	CaseType=Combination	Point=0	X2=0	X3=0	S11=-	
122.976319142087	IsS11Max=No	IsS11Min=No	FrameElem=47	ElemStation=0.125				
Frame=47	Station=0.125	OutputCase=FESSUR	CaseType=Combination	Point=1	X2=-0.5	X3=-0.5	S11=-	
2011.1633744472	IsS11Max=No	IsS11Min=Yes	FrameElem=47	ElemStation=0.125				
Frame=47	Station=0.125	OutputCase=FESSUR	CaseType=Combination	Point=2	X2=-0.5	X3=0.5	S11=-	
2011.1633744472	IsS11Max=No	IsS11Min=No	FrameElem=47	ElemStation=0.125				
Frame=47	Station=0.125	OutputCase=FESSUR	CaseType=Combination	Point=3	X2=0.5	X3=-0.5		
S11=1765.21073616303	IsS11Max=Yes	IsS11Min=No	FrameElem=47	ElemStation=0.125				
Frame=47	Station=0.125	OutputCase=FESSUR	CaseType=Combination	Point=4	X2=0.5	X3=0.5		
S11=1765.21073616303	IsS11Max=No	IsS11Min=No	FrameElem=47	ElemStation=0.125				
Frame=47	Station=0.25	OutputCase=FESSUR	CaseType=Combination	Point=0	X2=0	X3=0	S11=-	
122.976319142087	IsS11Max=No	IsS11Min=No	FrameElem=47	ElemStation=0.25				
Frame=47	Station=0.25	OutputCase=FESSUR	CaseType=Combination	Point=1	X2=-0.5	X3=-0.5	S11=-	
1767.69657906293	IsS11Max=No	IsS11Min=Yes	FrameElem=47	ElemStation=0.25				
Frame=47	Station=0.25	OutputCase=FESSUR	CaseType=Combination	Point=2	X2=-0.5	X3=0.5	S11=-	
1767.69657906293	IsS11Max=No	IsS11Min=No	FrameElem=47	ElemStation=0.25				
Frame=47	Station=0.25	OutputCase=FESSUR	CaseType=Combination	Point=3	X2=0.5	X3=-0.5		
S11=1521.74394077876	IsS11Max=Yes	IsS11Min=No	FrameElem=47	ElemStation=0.25				
Frame=47	Station=0.25	OutputCase=FESSUR	CaseType=Combination	Point=4	X2=0.5	X3=0.5		
S11=1521.74394077876	IsS11Max=No	IsS11Min=No	FrameElem=47	ElemStation=0.25				
Frame=47	Station=0.375	OutputCase=FESSUR	CaseType=Combination	Point=0	X2=0	X3=0	S11=-	
122.976319142087	IsS11Max=No	IsS11Min=No	FrameElem=47	ElemStation=0.375				
Frame=47	Station=0.375	OutputCase=FESSUR	CaseType=Combination	Point=1	X2=-0.5	X3=-0.5	S11=-	
1526.57353367866	IsS11Max=No	IsS11Min=Yes	FrameElem=47	ElemStation=0.375				
Frame=47	Station=0.375	OutputCase=FESSUR	CaseType=Combination	Point=2	X2=-0.5	X3=0.5	S11=-	
1526.57353367866	IsS11Max=No	IsS11Min=No	FrameElem=47	ElemStation=0.375				
Frame=47	Station=0.375	OutputCase=FESSUR	CaseType=Combination	Point=3	X2=0.5	X3=-0.5		
S11=1280.62089539449	IsS11Max=Yes	IsS11Min=No	FrameElem=47	ElemStation=0.375				
Frame=47	Station=0.375	OutputCase=FESSUR	CaseType=Combination	Point=4	X2=0.5	X3=0.5		
S11=1280.62089539449	IsS11Max=No	IsS11Min=No	FrameElem=47	ElemStation=0.375				
Frame=47	Station=0.5	OutputCase=FESSUR	CaseType=Combination	Point=0	X2=0	X3=0	S11=-122.976319142087	
IsS11Max=No	IsS11Min=No	FrameElem=47	ElemStation=0.5					
Frame=47	Station=0.5	OutputCase=FESSUR	CaseType=Combination	Point=1	X2=-0.5	X3=-0.5	S11=-	
1287.7942382944	IsS11Max=No	IsS11Min=Yes	FrameElem=47	ElemStation=0.5				
Frame=47	Station=0.5	OutputCase=FESSUR	CaseType=Combination	Point=2	X2=-0.5	X3=0.5	S11=-	
1287.7942382944	IsS11Max=No	IsS11Min=No	FrameElem=47	ElemStation=0.5				
Frame=47	Station=0.5	OutputCase=FESSUR	CaseType=Combination	Point=3	X2=0.5	X3=-0.5		
S11=1041.84160001022	IsS11Max=Yes	IsS11Min=No	FrameElem=47	ElemStation=0.5				
Frame=47	Station=0.5	OutputCase=FESSUR	CaseType=Combination	Point=4	X2=0.5	X3=0.5		
S11=1041.84160001022	IsS11Max=No	IsS11Min=No	FrameElem=47	ElemStation=0.5				
Frame=48	Station=0	OutputCase=PESOPR	CaseType=LinStatic	Point=0	X2=0	X3=0	S11=-15.1709467362366	
IsS11Max=No	IsS11Min=No	FrameElem=48	ElemStation=0					
Frame=48	Station=0	OutputCase=PESOPR	CaseType=LinStatic	Point=1	X2=-0.5	X3=-0.5	S11=-	
300.934812253231	IsS11Max=No	IsS11Min=Yes	FrameElem=48	ElemStation=0				
Frame=48	Station=0	OutputCase=PESOPR	CaseType=LinStatic	Point=2	X2=-0.5	X3=0.5	S11=-	
300.934812253231	IsS11Max=No	IsS11Min=No	FrameElem=48	ElemStation=0				

Frame=48	Station=0	OutputCase=PESOPR	CaseType=LinStatic	Point=3	X2=0.5	X3=-0.5	S11=270.592918780757
IsS11Max=Yes	IsS11Min=No	FrameElem=48	ElemStation=0				
Frame=48	Station=0	OutputCase=PESOPR	CaseType=LinStatic	Point=4	X2=0.5	X3=0.5	S11=270.592918780757
IsS11Max=No	IsS11Min=No	FrameElem=48	ElemStation=0				
Frame=48	Station=0.125	OutputCase=PESOPR	CaseType=LinStatic	Point=0	X2=0	X3=0	S11=-15.1709467362366
IsS11Max=No	IsS11Min=No	FrameElem=48	ElemStation=0.125				
Frame=48	Station=0.125	OutputCase=PESOPR	CaseType=LinStatic	Point=1	X2=-0.5	X3=-0.5	S11=-
212.756415249986	IsS11Max=No	IsS11Min=Yes	FrameElem=48	ElemStation=0.125			
Frame=48	Station=0.125	OutputCase=PESOPR	CaseType=LinStatic	Point=2	X2=-0.5	X3=0.5	S11=-
212.756415249986	IsS11Max=No	IsS11Min=No	FrameElem=48	ElemStation=0.125			
Frame=48	Station=0.125	OutputCase=PESOPR	CaseType=LinStatic	Point=3	X2=0.5	X3=-0.5	
S11=182.414521777513	IsS11Max=Yes	IsS11Min=No	FrameElem=48	ElemStation=0.125			
Frame=48	Station=0.125	OutputCase=PESOPR	CaseType=LinStatic	Point=4	X2=0.5	X3=0.5	
S11=182.414521777513	IsS11Max=No	IsS11Min=No	FrameElem=48	ElemStation=0.125			
Frame=48	Station=0.25	OutputCase=PESOPR	CaseType=LinStatic	Point=0	X2=0	X3=0	S11=-15.1709467362366
IsS11Max=No	IsS11Min=No	FrameElem=48	ElemStation=0.25				
Frame=48	Station=0.25	OutputCase=PESOPR	CaseType=LinStatic	Point=1	X2=-0.5	X3=-0.5	S11=-
126.921768246741	IsS11Max=No	IsS11Min=Yes	FrameElem=48	ElemStation=0.25			
Frame=48	Station=0.25	OutputCase=PESOPR	CaseType=LinStatic	Point=2	X2=-0.5	X3=0.5	S11=-
126.921768246741	IsS11Max=No	IsS11Min=No	FrameElem=48	ElemStation=0.25			
Frame=48	Station=0.25	OutputCase=PESOPR	CaseType=LinStatic	Point=3	X2=0.5	X3=-0.5	
S11=96.5798747742679	IsS11Max=Yes	IsS11Min=No	FrameElem=48	ElemStation=0.25			
Frame=48	Station=0.25	OutputCase=PESOPR	CaseType=LinStatic	Point=4	X2=0.5	X3=0.5	
S11=96.5798747742679	IsS11Max=No	IsS11Min=No	FrameElem=48	ElemStation=0.25			
Frame=48	Station=0.375	OutputCase=PESOPR	CaseType=LinStatic	Point=0	X2=0	X3=0	S11=-15.1709467362366
IsS11Max=No	IsS11Min=No	FrameElem=48	ElemStation=0.375				
Frame=48	Station=0.375	OutputCase=PESOPR	CaseType=LinStatic	Point=1	X2=-0.5	X3=-0.5	S11=-
43.4308712434963	IsS11Max=No	IsS11Min=Yes	FrameElem=48	ElemStation=0.375			
Frame=48	Station=0.375	OutputCase=PESOPR	CaseType=LinStatic	Point=2	X2=-0.5	X3=0.5	S11=-
43.4308712434963	IsS11Max=No	IsS11Min=No	FrameElem=48	ElemStation=0.375			
Frame=48	Station=0.375	OutputCase=PESOPR	CaseType=LinStatic	Point=3	X2=0.5	X3=-0.5	
S11=13.0889777710232	IsS11Max=Yes	IsS11Min=No	FrameElem=48	ElemStation=0.375			
Frame=48	Station=0.375	OutputCase=PESOPR	CaseType=LinStatic	Point=4	X2=0.5	X3=0.5	
S11=13.0889777710232	IsS11Max=No	IsS11Min=No	FrameElem=48	ElemStation=0.375			
Frame=48	Station=0.5	OutputCase=PESOPR	CaseType=LinStatic	Point=0	X2=0	X3=0	S11=-15.1709467362366
IsS11Max=No	IsS11Min=No	FrameElem=48	ElemStation=0.5				
Frame=48	Station=0.5	OutputCase=PESOPR	CaseType=LinStatic	Point=1	X2=-0.5	X3=-0.5	
S11=37.7162757597485	IsS11Max=Yes	IsS11Min=No	FrameElem=48	ElemStation=0.5			
Frame=48	Station=0.5	OutputCase=PESOPR	CaseType=LinStatic	Point=2	X2=-0.5	X3=0.5	
S11=37.7162757597485	IsS11Max=No	IsS11Min=No	FrameElem=48	ElemStation=0.5			
Frame=48	Station=0.5	OutputCase=PESOPR	CaseType=LinStatic	Point=3	X2=0.5	X3=-0.5	S11=-
68.0581692322216	IsS11Max=No	IsS11Min=Yes	FrameElem=48	ElemStation=0.5			
Frame=48	Station=0.5	OutputCase=PESOPR	CaseType=LinStatic	Point=4	X2=0.5	X3=0.5	S11=-
68.0581692322216	IsS11Max=No	IsS11Min=No	FrameElem=48	ElemStation=0.5			
Frame=48	Station=0	OutputCase=TERRVERT	CaseType=LinStatic	Point=0	X2=0	X3=0	S11=1.15282857329472
IsS11Max=No	IsS11Min=No	FrameElem=48	ElemStation=0				
Frame=48	Station=0	OutputCase=TERRVERT	CaseType=LinStatic	Point=1	X2=-0.5	X3=-0.5	S11=-
1004.22726771084	IsS11Max=No	IsS11Min=Yes	FrameElem=48	ElemStation=0			
Frame=48	Station=0	OutputCase=TERRVERT	CaseType=LinStatic	Point=2	X2=-0.5	X3=0.5	S11=-
1004.22726771084	IsS11Max=No	IsS11Min=No	FrameElem=48	ElemStation=0			
Frame=48	Station=0	OutputCase=TERRVERT	CaseType=LinStatic	Point=3	X2=0.5	X3=-0.5	
S11=1006.53292485743	IsS11Max=Yes	IsS11Min=No	FrameElem=48	ElemStation=0			
Frame=48	Station=0	OutputCase=TERRVERT	CaseType=LinStatic	Point=4	X2=0.5	X3=0.5	
S11=1006.53292485743	IsS11Max=No	IsS11Min=No	FrameElem=48	ElemStation=0			
Frame=48	Station=0.125	OutputCase=TERRVERT	CaseType=LinStatic	Point=0	X2=0	X3=0	
S11=1.15282857329472	IsS11Max=No	IsS11Min=No	FrameElem=48	ElemStation=0.125			
Frame=48	Station=0.125	OutputCase=TERRVERT	CaseType=LinStatic	Point=1	X2=-0.5	X3=-0.5	S11=-
748.443959131624	IsS11Max=No	IsS11Min=Yes	FrameElem=48	ElemStation=0.125			
Frame=48	Station=0.125	OutputCase=TERRVERT	CaseType=LinStatic	Point=2	X2=-0.5	X3=0.5	S11=-
748.443959131624	IsS11Max=No	IsS11Min=No	FrameElem=48	ElemStation=0.125			
Frame=48	Station=0.125	OutputCase=TERRVERT	CaseType=LinStatic	Point=3	X2=0.5	X3=-0.5	
S11=750.749616278214	IsS11Max=Yes	IsS11Min=No	FrameElem=48	ElemStation=0.125			
Frame=48	Station=0.125	OutputCase=TERRVERT	CaseType=LinStatic	Point=4	X2=0.5	X3=0.5	
S11=750.749616278214	IsS11Max=No	IsS11Min=No	FrameElem=48	ElemStation=0.125			
Frame=48	Station=0.25	OutputCase=TERRVERT	CaseType=LinStatic	Point=0	X2=0	X3=0	S11=1.15282857329472
IsS11Max=No	IsS11Min=No	FrameElem=48	ElemStation=0.25				
Frame=48	Station=0.25	OutputCase=TERRVERT	CaseType=LinStatic	Point=1	X2=-0.5	X3=-0.5	S11=-
492.660650552409	IsS11Max=No	IsS11Min=Yes	FrameElem=48	ElemStation=0.25			
Frame=48	Station=0.25	OutputCase=TERRVERT	CaseType=LinStatic	Point=2	X2=-0.5	X3=0.5	S11=-
492.660650552409	IsS11Max=No	IsS11Min=No	FrameElem=48	ElemStation=0.25			
Frame=48	Station=0.25	OutputCase=TERRVERT	CaseType=LinStatic	Point=3	X2=0.5	X3=-0.5	
S11=494.966307698998	IsS11Max=Yes	IsS11Min=No	FrameElem=48	ElemStation=0.25			
Frame=48	Station=0.25	OutputCase=TERRVERT	CaseType=LinStatic	Point=4	X2=0.5	X3=0.5	
S11=494.966307698998	IsS11Max=No	IsS11Min=No	FrameElem=48	ElemStation=0.25			
Frame=48	Station=0.375	OutputCase=TERRVERT	CaseType=LinStatic	Point=0	X2=0	X3=0	
S11=1.15282857329472	IsS11Max=No	IsS11Min=No	FrameElem=48	ElemStation=0.375			
Frame=48	Station=0.375	OutputCase=TERRVERT	CaseType=LinStatic	Point=1	X2=-0.5	X3=-0.5	S11=-
236.877341973193	IsS11Max=No	IsS11Min=Yes	FrameElem=48	ElemStation=0.375			
Frame=48	Station=0.375	OutputCase=TERRVERT	CaseType=LinStatic	Point=2	X2=-0.5	X3=0.5	S11=-
236.877341973193	IsS11Max=No	IsS11Min=No	FrameElem=48	ElemStation=0.375			
Frame=48	Station=0.375	OutputCase=TERRVERT	CaseType=LinStatic	Point=3	X2=0.5	X3=-0.5	
S11=239.182999119783	IsS11Max=Yes	IsS11Min=No	FrameElem=48	ElemStation=0.375			

Frame=48	Station=0.375	OutputCase=TERRVERT	CaseType=LinStatic	Point=4	X2=0.5	X3=0.5			
S11=239.182999119783	IsS11Max=No	IsS11Min=No	FrameElem=48	ElemStation=0.375					
Frame=48	Station=0.5	OutputCase=TERRVERT	CaseType=LinStatic	Point=0	X2=0	X3=0	S11=1.15282857329472		
IsS11Max=No	IsS11Min=No	FrameElem=48	ElemStation=0.5						
Frame=48	Station=0.5	OutputCase=TERRVERT	CaseType=LinStatic	Point=1	X2=-0.5	X3=-0.5			
S11=18.905966606022	IsS11Max=Yes	IsS11Min=No	FrameElem=48	ElemStation=0.5					
Frame=48	Station=0.5	OutputCase=TERRVERT	CaseType=LinStatic	Point=2	X2=-0.5	X3=0.5			
S11=18.905966606022	IsS11Max=No	IsS11Min=No	FrameElem=48	ElemStation=0.5					
Frame=48	Station=0.5	OutputCase=TERRVERT	CaseType=LinStatic	Point=3	X2=0.5	X3=-0.5	S11=-		
16.6003094594326	IsS11Max=No	IsS11Min=Yes	FrameElem=48	ElemStation=0.5					
Frame=48	Station=0.5	OutputCase=TERRVERT	CaseType=LinStatic	Point=4	X2=0.5	X3=0.5	S11=-		
16.6003094594326	IsS11Max=No	IsS11Min=No	FrameElem=48	ElemStation=0.5					
Frame=48	Station=0	OutputCase=TERRLAT	CaseType=LinStatic	Point=0	X2=0	X3=0	S11=-108.958200979145		
IsS11Max=No	IsS11Min=No	FrameElem=48	ElemStation=0						
Frame=48	Station=0	OutputCase=TERRLAT	CaseType=LinStatic	Point=1	X2=-0.5	X3=-0.5			
S11=17.3678416697399	IsS11Max=Yes	IsS11Min=No	FrameElem=48	ElemStation=0					
Frame=48	Station=0	OutputCase=TERRLAT	CaseType=LinStatic	Point=2	X2=-0.5	X3=0.5			
S11=17.3678416697399	IsS11Max=No	IsS11Min=No	FrameElem=48	ElemStation=0					
Frame=48	Station=0	OutputCase=TERRLAT	CaseType=LinStatic	Point=3	X2=0.5	X3=-0.5	S11=-		
235.28424362803	IsS11Max=No	IsS11Min=Yes	FrameElem=48	ElemStation=0					
Frame=48	Station=0	OutputCase=TERRLAT	CaseType=LinStatic	Point=4	X2=0.5	X3=0.5	S11=-235.28424362803		
IsS11Max=No	IsS11Min=No	FrameElem=48	ElemStation=0						
Frame=48	Station=0.125	OutputCase=TERRLAT	CaseType=LinStatic	Point=0	X2=0	X3=0	S11=-		
108.958200979145	IsS11Max=No	IsS11Min=No	FrameElem=48	ElemStation=0.125					
Frame=48	Station=0.125	OutputCase=TERRLAT	CaseType=LinStatic	Point=1	X2=-0.5	X3=-0.5			
S11=17.5008187550715	IsS11Max=Yes	IsS11Min=No	FrameElem=48	ElemStation=0.125					
Frame=48	Station=0.125	OutputCase=TERRLAT	CaseType=LinStatic	Point=2	X2=-0.5	X3=0.5			
S11=17.5008187550715	IsS11Max=No	IsS11Min=No	FrameElem=48	ElemStation=0.125					
Frame=48	Station=0.125	OutputCase=TERRLAT	CaseType=LinStatic	Point=3	X2=0.5	X3=-0.5	S11=-		
235.417220713361	IsS11Max=No	IsS11Min=Yes	FrameElem=48	ElemStation=0.125					
Frame=48	Station=0.125	OutputCase=TERRLAT	CaseType=LinStatic	Point=4	X2=0.5	X3=0.5	S11=-		
235.417220713361	IsS11Max=No	IsS11Min=No	FrameElem=48	ElemStation=0.125					
Frame=48	Station=0.25	OutputCase=TERRLAT	CaseType=LinStatic	Point=0	X2=0	X3=0	S11=-108.958200979145		
IsS11Max=No	IsS11Min=No	FrameElem=48	ElemStation=0.25						
Frame=48	Station=0.25	OutputCase=TERRLAT	CaseType=LinStatic	Point=1	X2=-0.5	X3=-0.5			
S11=17.6337958404031	IsS11Max=Yes	IsS11Min=No	FrameElem=48	ElemStation=0.25					
Frame=48	Station=0.25	OutputCase=TERRLAT	CaseType=LinStatic	Point=2	X2=-0.5	X3=0.5			
S11=17.6337958404031	IsS11Max=No	IsS11Min=No	FrameElem=48	ElemStation=0.25					
Frame=48	Station=0.25	OutputCase=TERRLAT	CaseType=LinStatic	Point=3	X2=0.5	X3=-0.5	S11=-		
235.550197798693	IsS11Max=No	IsS11Min=Yes	FrameElem=48	ElemStation=0.25					
Frame=48	Station=0.25	OutputCase=TERRLAT	CaseType=LinStatic	Point=4	X2=0.5	X3=0.5	S11=-		
235.550197798693	IsS11Max=No	IsS11Min=No	FrameElem=48	ElemStation=0.25					
Frame=48	Station=0.375	OutputCase=TERRLAT	CaseType=LinStatic	Point=0	X2=0	X3=0	S11=-		
108.958200979145	IsS11Max=No	IsS11Min=No	FrameElem=48	ElemStation=0.375					
Frame=48	Station=0.375	OutputCase=TERRLAT	CaseType=LinStatic	Point=1	X2=-0.5	X3=-0.5			
S11=17.7667729257348	IsS11Max=Yes	IsS11Min=No	FrameElem=48	ElemStation=0.375					
Frame=48	Station=0.375	OutputCase=TERRLAT	CaseType=LinStatic	Point=2	X2=-0.5	X3=0.5			
S11=17.7667729257348	IsS11Max=No	IsS11Min=No	FrameElem=48	ElemStation=0.375					
Frame=48	Station=0.375	OutputCase=TERRLAT	CaseType=LinStatic	Point=3	X2=0.5	X3=-0.5	S11=-		
235.683174884024	IsS11Max=No	IsS11Min=Yes	FrameElem=48	ElemStation=0.375					
Frame=48	Station=0.375	OutputCase=TERRLAT	CaseType=LinStatic	Point=4	X2=0.5	X3=0.5	S11=-		
235.683174884024	IsS11Max=No	IsS11Min=No	FrameElem=48	ElemStation=0.375					
Frame=48	Station=0.5	OutputCase=TERRLAT	CaseType=LinStatic	Point=0	X2=0	X3=0	S11=-108.958200979145		
IsS11Max=No	IsS11Min=No	FrameElem=48	ElemStation=0.5						
Frame=48	Station=0.5	OutputCase=TERRLAT	CaseType=LinStatic	Point=1	X2=-0.5	X3=-0.5			
S11=17.8997500110664	IsS11Max=Yes	IsS11Min=No	FrameElem=48	ElemStation=0.5					
Frame=48	Station=0.5	OutputCase=TERRLAT	CaseType=LinStatic	Point=2	X2=-0.5	X3=0.5			
S11=17.8997500110664	IsS11Max=No	IsS11Min=No	FrameElem=48	ElemStation=0.5					
Frame=48	Station=0.5	OutputCase=TERRLAT	CaseType=LinStatic	Point=3	X2=0.5	X3=-0.5	S11=-		
235.816151969356	IsS11Max=No	IsS11Min=Yes	FrameElem=48	ElemStation=0.5					
Frame=48	Station=0.5	OutputCase=TERRLAT	CaseType=LinStatic	Point=4	X2=0.5	X3=0.5	S11=-		
235.816151969356	IsS11Max=No	IsS11Min=No	FrameElem=48	ElemStation=0.5					
Frame=48	Station=0	OutputCase=ACCLATDX	CaseType=LinStatic	Point=0	X2=0	X3=0	S11=0	IsS11Max=Yes	
IsS11Min=Yes	FrameElem=48	ElemStation=0							
Frame=48	Station=0	OutputCase=ACCLATDX	CaseType=LinStatic	Point=1	X2=-0.5	X3=-0.5	S11=0		
IsS11Max=No	IsS11Min=No	FrameElem=48	ElemStation=0						
Frame=48	Station=0	OutputCase=ACCLATDX	CaseType=LinStatic	Point=2	X2=-0.5	X3=0.5	S11=0		
IsS11Max=No	IsS11Min=No	FrameElem=48	ElemStation=0						
Frame=48	Station=0	OutputCase=ACCLATDX	CaseType=LinStatic	Point=3	X2=0.5	X3=-0.5	S11=0		
IsS11Max=No	IsS11Min=No	FrameElem=48	ElemStation=0						
Frame=48	Station=0	OutputCase=ACCLATDX	CaseType=LinStatic	Point=4	X2=0.5	X3=0.5	S11=0	IsS11Max=No	
IsS11Min=No	FrameElem=48	ElemStation=0							
Frame=48	Station=0.125	OutputCase=ACCLATDX	CaseType=LinStatic	Point=0	X2=0	X3=0	S11=0		
IsS11Max=Yes	IsS11Min=Yes	FrameElem=48	ElemStation=0.125						
Frame=48	Station=0.125	OutputCase=ACCLATDX	CaseType=LinStatic	Point=1	X2=-0.5	X3=-0.5	S11=0		
IsS11Max=No	IsS11Min=No	FrameElem=48	ElemStation=0.125						
Frame=48	Station=0.125	OutputCase=ACCLATDX	CaseType=LinStatic	Point=2	X2=-0.5	X3=0.5	S11=0		
IsS11Max=No	IsS11Min=No	FrameElem=48	ElemStation=0.125						
Frame=48	Station=0.125	OutputCase=ACCLATDX	CaseType=LinStatic	Point=3	X2=0.5	X3=-0.5	S11=0		
IsS11Max=No	IsS11Min=No	FrameElem=48	ElemStation=0.125						
Frame=48	Station=0.125	OutputCase=ACCLATDX	CaseType=LinStatic	Point=4	X2=0.5	X3=0.5	S11=0		
IsS11Max=No	IsS11Min=No	FrameElem=48	ElemStation=0.125						

Frame=48	Station=0.375	OutputCase=SOVRCOST	CaseType=LinStatic	Point=2	X2=-0.5	X3=0.5	S11=0
IsS11Max=No	IsS11Min=No	FrameElem=48	ElemStation=0.375				
Frame=48	Station=0.375	OutputCase=SOVRCOST	CaseType=LinStatic	Point=3	X2=0.5	X3=-0.5	S11=0
IsS11Max=No	IsS11Min=No	FrameElem=48	ElemStation=0.375				
Frame=48	Station=0.375	OutputCase=SOVRCOST	CaseType=LinStatic	Point=4	X2=0.5	X3=0.5	S11=0
IsS11Max=No	IsS11Min=No	FrameElem=48	ElemStation=0.375				
Frame=48	Station=0.5	OutputCase=SOVRCOST	CaseType=LinStatic	Point=0	X2=0	X3=0	S11=0
IsS11Min=Yes	FrameElem=48	ElemStation=0.5					IsS11Max=Yes
Frame=48	Station=0.5	OutputCase=SOVRCOST	CaseType=LinStatic	Point=1	X2=-0.5	X3=-0.5	S11=0
IsS11Max=No	IsS11Min=No	FrameElem=48	ElemStation=0.5				
Frame=48	Station=0.5	OutputCase=SOVRCOST	CaseType=LinStatic	Point=2	X2=-0.5	X3=0.5	S11=0
IsS11Max=No	IsS11Min=No	FrameElem=48	ElemStation=0.5				
Frame=48	Station=0.5	OutputCase=SOVRCOST	CaseType=LinStatic	Point=3	X2=0.5	X3=-0.5	S11=0
IsS11Max=No	IsS11Min=No	FrameElem=48	ElemStation=0.5				
Frame=48	Station=0.5	OutputCase=SOVRCOST	CaseType=LinStatic	Point=4	X2=0.5	X3=0.5	S11=0
IsS11Max=No	IsS11Min=No	FrameElem=48	ElemStation=0.5				
Frame=48	Station=0	OutputCase=ENVE	CaseType=Combination	StepType=Max	Point=0	X2=0	X3=0
S11=-1287.79423829433	IsS11Max=No	IsS11Min=No	FrameElem=48	ElemStation=0			
Frame=48	Station=0	OutputCase=ENVE	CaseType=Combination	StepType=Max	Point=1	X2=-0.5	X3=-0.5
S11=-1287.79423829433	IsS11Max=No	IsS11Min=Yes	FrameElem=48	ElemStation=0			
Frame=48	Station=0	OutputCase=ENVE	CaseType=Combination	StepType=Max	Point=2	X2=-0.5	X3=0.5
S11=-1287.79423829433	IsS11Max=No	IsS11Min=No	FrameElem=48	ElemStation=0			
Frame=48	Station=0	OutputCase=ENVE	CaseType=Combination	StepType=Max	Point=3	X2=0.5	X3=-0.5
S11=1112.42687309857	IsS11Max=Yes	IsS11Min=No	FrameElem=48	ElemStation=0			
Frame=48	Station=0	OutputCase=ENVE	CaseType=Combination	StepType=Max	Point=4	X2=0.5	X3=0.5
S11=1112.42687309857	IsS11Max=No	IsS11Min=No	FrameElem=48	ElemStation=0			
Frame=48	Station=0.125	OutputCase=ENVE	CaseType=Combination	StepType=Max	Point=0	X2=0	X3=0
S11=-943.69955626538	IsS11Max=No	IsS11Min=No	FrameElem=48	ElemStation=0.125			
Frame=48	Station=0.125	OutputCase=ENVE	CaseType=Combination	StepType=Max	Point=1	X2=-0.5	X3=-0.5
S11=-943.69955626538	IsS11Max=No	IsS11Min=No	FrameElem=48	ElemStation=0.125			
Frame=48	Station=0.125	OutputCase=ENVE	CaseType=Combination	StepType=Max	Point=2	X2=-0.5	X3=0.5
S11=-943.69955626538	IsS11Max=No	IsS11Min=No	FrameElem=48	ElemStation=0.125			
Frame=48	Station=0.125	OutputCase=ENVE	CaseType=Combination	StepType=Max	Point=3	X2=0.5	X3=-0.5
S11=768.372083556373	IsS11Max=Yes	IsS11Min=No	FrameElem=48	ElemStation=0.125			
Frame=48	Station=0.125	OutputCase=ENVE	CaseType=Combination	StepType=Max	Point=4	X2=0.5	X3=0.5
S11=768.372083556373	IsS11Max=No	IsS11Min=No	FrameElem=48	ElemStation=0.125			
Frame=48	Station=0.25	OutputCase=ENVE	CaseType=Combination	StepType=Max	Point=0	X2=0	X3=0
S11=-90.2888588483432	IsS11Max=No	IsS11Min=No	FrameElem=48	ElemStation=0.25			
Frame=48	Station=0.25	OutputCase=ENVE	CaseType=Combination	StepType=Max	Point=1	X2=-0.5	X3=-0.5
S11=-601.948622958747	IsS11Max=No	IsS11Min=Yes	FrameElem=48	ElemStation=0.25			
Frame=48	Station=0.25	OutputCase=ENVE	CaseType=Combination	StepType=Max	Point=2	X2=-0.5	X3=0.5
S11=-601.948622958747	IsS11Max=No	IsS11Min=No	FrameElem=48	ElemStation=0.25			
Frame=48	Station=0.25	OutputCase=ENVE	CaseType=Combination	StepType=Max	Point=3	X2=0.5	X3=-0.5
S11=426.661044014181	IsS11Max=Yes	IsS11Min=No	FrameElem=48	ElemStation=0.25			
Frame=48	Station=0.25	OutputCase=ENVE	CaseType=Combination	StepType=Max	Point=4	X2=0.5	X3=0.5
S11=426.661044014181	IsS11Max=No	IsS11Min=No	FrameElem=48	ElemStation=0.25			
Frame=48	Station=0.375	OutputCase=ENVE	CaseType=Combination	StepType=Max	Point=0	X2=0	X3=0
S11=-90.2888588483432	IsS11Max=No	IsS11Min=No	FrameElem=48	ElemStation=0.375			
Frame=48	Station=0.375	OutputCase=ENVE	CaseType=Combination	StepType=Max	Point=1	X2=-0.5	X3=-0.5
S11=-262.541440290955	IsS11Max=No	IsS11Min=Yes	FrameElem=48	ElemStation=0.375			
Frame=48	Station=0.375	OutputCase=ENVE	CaseType=Combination	StepType=Max	Point=2	X2=-0.5	X3=0.5
S11=-262.541440290955	IsS11Max=No	IsS11Min=No	FrameElem=48	ElemStation=0.375			
Frame=48	Station=0.375	OutputCase=ENVE	CaseType=Combination	StepType=Max	Point=3	X2=0.5	X3=-0.5
S11=87.2937544719888	IsS11Max=Yes	IsS11Min=No	FrameElem=48	ElemStation=0.375			
Frame=48	Station=0.375	OutputCase=ENVE	CaseType=Combination	StepType=Max	Point=4	X2=0.5	X3=0.5
S11=87.2937544719888	IsS11Max=No	IsS11Min=No	FrameElem=48	ElemStation=0.375			
Frame=48	Station=0.5	OutputCase=ENVE	CaseType=Combination	StepType=Max	Point=0	X2=0	X3=0
S11=-90.2888588483432	IsS11Max=No	IsS11Min=No	FrameElem=48	ElemStation=0.5			
Frame=48	Station=0.5	OutputCase=ENVE	CaseType=Combination	StepType=Max	Point=1	X2=-0.5	X3=-0.5
S11=74.5219923768369	IsS11Max=Yes	IsS11Min=No	FrameElem=48	ElemStation=0.5			
Frame=48	Station=0.5	OutputCase=ENVE	CaseType=Combination	StepType=Max	Point=2	X2=-0.5	X3=0.5
S11=74.5219923768369	IsS11Max=No	IsS11Min=No	FrameElem=48	ElemStation=0.5			
Frame=48	Station=0.5	OutputCase=ENVE	CaseType=Combination	StepType=Max	Point=3	X2=0.5	X3=-0.5
S11=-249.729785070203	IsS11Max=No	IsS11Min=Yes	FrameElem=48	ElemStation=0.5			
Frame=48	Station=0.5	OutputCase=ENVE	CaseType=Combination	StepType=Max	Point=4	X2=0.5	X3=0.5
S11=-249.729785070203	IsS11Max=No	IsS11Min=No	FrameElem=48	ElemStation=0.5			
Frame=48	Station=0	OutputCase=ENVE	CaseType=Combination	StepType=Min	Point=0	X2=0	X3=0
S11=-122.976319142087	IsS11Max=No	IsS11Min=No	FrameElem=48	ElemStation=0			
Frame=48	Station=0	OutputCase=ENVE	CaseType=Combination	StepType=Min	Point=1	X2=-0.5	X3=-0.5
S11=-1293.00459079525	IsS11Max=No	IsS11Min=Yes	FrameElem=48	ElemStation=0			
Frame=48	Station=0	OutputCase=ENVE	CaseType=Combination	StepType=Min	Point=2	X2=-0.5	X3=0.5
S11=-1293.00459079525	IsS11Max=No	IsS11Min=No	FrameElem=48	ElemStation=0			
Frame=48	Station=0	OutputCase=ENVE	CaseType=Combination	StepType=Min	Point=3	X2=0.5	X3=-0.5
S11=1041.84160001016	IsS11Max=Yes	IsS11Min=No	FrameElem=48	ElemStation=0			
Frame=48	Station=0	OutputCase=ENVE	CaseType=Combination	StepType=Min	Point=4	X2=0.5	X3=0.5
S11=1041.84160001016	IsS11Max=No	IsS11Min=No	FrameElem=48	ElemStation=0			
Frame=48	Station=0.125	OutputCase=ENVE	CaseType=Combination	StepType=Min	Point=0	X2=0	X3=0
S11=-122.976319142087	IsS11Max=No	IsS11Min=No	FrameElem=48	ElemStation=0.125			
Frame=48	Station=0.125	OutputCase=ENVE	CaseType=Combination	StepType=Min	Point=1	X2=-0.5	X3=-0.5
S11=-948.94980125306	IsS11Max=No	IsS11Min=Yes	FrameElem=48	ElemStation=0.125			
Frame=48	Station=0.125	OutputCase=ENVE	CaseType=Combination	StepType=Min	Point=2	X2=-0.5	X3=0.5
S11=-948.94980125306	IsS11Max=No	IsS11Min=No	FrameElem=48	ElemStation=0.125			

Frame=48	Station=0.125	OutputCase=ENVE	CaseType=Combination	StepType=Min	Point=3	X2=0.5	X3=-0.5	
S11=697.746917342365	IsS11Max=Yes	IsS11Min=No	FrameElem=48	ElemStation=0.125				
Frame=48	Station=0.125	OutputCase=ENVE	CaseType=Combination	StepType=Min	Point=4	X2=0.5	X3=0.5	
S11=697.746917342365	IsS11Max=No	IsS11Min=No	FrameElem=48	ElemStation=0.125				
Frame=48	Station=0.25	OutputCase=ENVE	CaseType=Combination	StepType=Min	Point=0	X2=0	X3=0	S11=-
S11=122.976319142087	IsS11Max=No	IsS11Min=No	FrameElem=48	ElemStation=0.25				
Frame=48	Station=0.25	OutputCase=ENVE	CaseType=Combination	StepType=Min	Point=1	X2=-0.5	X3=-0.5	
S11=-607.238761710868	IsS11Max=No	IsS11Min=Yes	FrameElem=48	ElemStation=0.25				
Frame=48	Station=0.25	OutputCase=ENVE	CaseType=Combination	StepType=Min	Point=2	X2=-0.5	X3=0.5	
S11=-607.238761710868	IsS11Max=No	IsS11Min=No	FrameElem=48	ElemStation=0.25				
Frame=48	Station=0.25	OutputCase=ENVE	CaseType=Combination	StepType=Min	Point=3	X2=0.5	X3=-0.5	
S11=355.995984674573	IsS11Max=Yes	IsS11Min=No	FrameElem=48	ElemStation=0.25				
Frame=48	Station=0.25	OutputCase=ENVE	CaseType=Combination	StepType=Min	Point=4	X2=0.5	X3=0.5	
S11=355.995984674573	IsS11Max=No	IsS11Min=No	FrameElem=48	ElemStation=0.25				
Frame=48	Station=0.375	OutputCase=ENVE	CaseType=Combination	StepType=Min	Point=0	X2=0	X3=0	S11=-
S11=122.976319142087	IsS11Max=No	IsS11Min=No	FrameElem=48	ElemStation=0.375				
Frame=48	Station=0.375	OutputCase=ENVE	CaseType=Combination	StepType=Min	Point=1	X2=-0.5	X3=-0.5	
S11=-267.871472168675	IsS11Max=No	IsS11Min=Yes	FrameElem=48	ElemStation=0.375				
Frame=48	Station=0.375	OutputCase=ENVE	CaseType=Combination	StepType=Min	Point=2	X2=-0.5	X3=0.5	
S11=-267.871472168675	IsS11Max=No	IsS11Min=No	FrameElem=48	ElemStation=0.375				
Frame=48	Station=0.375	OutputCase=ENVE	CaseType=Combination	StepType=Min	Point=3	X2=0.5	X3=-0.5	
S11=16.5888020067815	IsS11Max=Yes	IsS11Min=No	FrameElem=48	ElemStation=0.375				
Frame=48	Station=0.375	OutputCase=ENVE	CaseType=Combination	StepType=Min	Point=4	X2=0.5	X3=0.5	
S11=16.5888020067815	IsS11Max=No	IsS11Min=No	FrameElem=48	ElemStation=0.375				
Frame=48	Station=0.5	OutputCase=ENVE	CaseType=Combination	StepType=Min	Point=0	X2=0	X3=0	S11=-
S11=122.976319142087	IsS11Max=No	IsS11Min=No	FrameElem=48	ElemStation=0.5				
Frame=48	Station=0.5	OutputCase=ENVE	CaseType=Combination	StepType=Min	Point=1	X2=-0.5	X3=-0.5	
S11=69.152067373517	IsS11Max=Yes	IsS11Min=No	FrameElem=48	ElemStation=0.5				
Frame=48	Station=0.5	OutputCase=ENVE	CaseType=Combination	StepType=Min	Point=2	X2=-0.5	X3=0.5	
S11=69.152067373517	IsS11Max=No	IsS11Min=No	FrameElem=48	ElemStation=0.5				
Frame=48	Station=0.5	OutputCase=ENVE	CaseType=Combination	StepType=Min	Point=3	X2=0.5	X3=-0.5	
S11=-320.47463066101	IsS11Max=No	IsS11Min=Yes	FrameElem=48	ElemStation=0.5				
Frame=48	Station=0.5	OutputCase=ENVE	CaseType=Combination	StepType=Min	Point=4	X2=0.5	X3=0.5	
S11=-320.47463066101	IsS11Max=No	IsS11Min=No	FrameElem=48	ElemStation=0.5				
Frame=48	Station=0	OutputCase=FESSUR	CaseType=Combination	Point=0	X2=0	X3=0	S11=-122.976319142087	
IsS11Max=No	IsS11Min=No	FrameElem=48	ElemStation=0					
Frame=48	Station=0	OutputCase=FESSUR	CaseType=Combination	Point=1	X2=-0.5	X3=-0.5	S11=-	
S11=1287.79423829433	IsS11Max=No	IsS11Min=Yes	FrameElem=48	ElemStation=0				
Frame=48	Station=0	OutputCase=FESSUR	CaseType=Combination	Point=2	X2=-0.5	X3=0.5	S11=-	
S11=1287.79423829433	IsS11Max=No	IsS11Min=No	FrameElem=48	ElemStation=0				
Frame=48	Station=0	OutputCase=FESSUR	CaseType=Combination	Point=3	X2=0.5	X3=-0.5		
S11=1041.84160001016	IsS11Max=Yes	IsS11Min=No	FrameElem=48	ElemStation=0				
Frame=48	Station=0	OutputCase=FESSUR	CaseType=Combination	Point=4	X2=0.5	X3=0.5		
S11=1041.84160001016	IsS11Max=No	IsS11Min=No	FrameElem=48	ElemStation=0				
Frame=48	Station=0.125	OutputCase=FESSUR	CaseType=Combination	Point=0	X2=0	X3=0	S11=-	
S11=122.976319142087	IsS11Max=No	IsS11Min=No	FrameElem=48	ElemStation=0.125				
Frame=48	Station=0.125	OutputCase=FESSUR	CaseType=Combination	Point=1	X2=-0.5	X3=-0.5	S11=-	
S11=943.699555626538	IsS11Max=No	IsS11Min=Yes	FrameElem=48	ElemStation=0.125				
Frame=48	Station=0.125	OutputCase=FESSUR	CaseType=Combination	Point=2	X2=-0.5	X3=0.5	S11=-	
S11=943.699555626538	IsS11Max=No	IsS11Min=No	FrameElem=48	ElemStation=0.125				
Frame=48	Station=0.125	OutputCase=FESSUR	CaseType=Combination	Point=3	X2=0.5	X3=-0.5		
S11=697.746917342365	IsS11Max=Yes	IsS11Min=No	FrameElem=48	ElemStation=0.125				
Frame=48	Station=0.125	OutputCase=FESSUR	CaseType=Combination	Point=4	X2=0.5	X3=0.5		
S11=697.746917342365	IsS11Max=No	IsS11Min=No	FrameElem=48	ElemStation=0.125				
Frame=48	Station=0.25	OutputCase=FESSUR	CaseType=Combination	Point=0	X2=0	X3=0	S11=-	
S11=122.976319142087	IsS11Max=No	IsS11Min=No	FrameElem=48	ElemStation=0.25				
Frame=48	Station=0.25	OutputCase=FESSUR	CaseType=Combination	Point=1	X2=-0.5	X3=-0.5	S11=-	
S11=601.948622958747	IsS11Max=No	IsS11Min=Yes	FrameElem=48	ElemStation=0.25				
Frame=48	Station=0.25	OutputCase=FESSUR	CaseType=Combination	Point=2	X2=-0.5	X3=0.5	S11=-	
S11=601.948622958747	IsS11Max=No	IsS11Min=No	FrameElem=48	ElemStation=0.25				
Frame=48	Station=0.25	OutputCase=FESSUR	CaseType=Combination	Point=3	X2=0.5	X3=-0.5		
S11=355.995984674573	IsS11Max=Yes	IsS11Min=No	FrameElem=48	ElemStation=0.25				
Frame=48	Station=0.25	OutputCase=FESSUR	CaseType=Combination	Point=4	X2=0.5	X3=0.5		
S11=355.995984674573	IsS11Max=No	IsS11Min=No	FrameElem=48	ElemStation=0.25				
Frame=48	Station=0.375	OutputCase=FESSUR	CaseType=Combination	Point=0	X2=0	X3=0	S11=-	
S11=122.976319142087	IsS11Max=No	IsS11Min=No	FrameElem=48	ElemStation=0.375				
Frame=48	Station=0.375	OutputCase=FESSUR	CaseType=Combination	Point=1	X2=-0.5	X3=-0.5	S11=-	
S11=262.541440290955	IsS11Max=No	IsS11Min=Yes	FrameElem=48	ElemStation=0.375				
Frame=48	Station=0.375	OutputCase=FESSUR	CaseType=Combination	Point=2	X2=-0.5	X3=0.5	S11=-	
S11=262.541440290955	IsS11Max=No	IsS11Min=No	FrameElem=48	ElemStation=0.375				
Frame=48	Station=0.375	OutputCase=FESSUR	CaseType=Combination	Point=3	X2=0.5	X3=-0.5		
S11=16.5888020067815	IsS11Max=Yes	IsS11Min=No	FrameElem=48	ElemStation=0.375				
Frame=48	Station=0.375	OutputCase=FESSUR	CaseType=Combination	Point=4	X2=0.5	X3=0.5		
S11=16.5888020067815	IsS11Max=No	IsS11Min=No	FrameElem=48	ElemStation=0.375				
Frame=48	Station=0.5	OutputCase=FESSUR	CaseType=Combination	Point=0	X2=0	X3=0	S11=-122.976319142087	
IsS11Max=No	IsS11Min=No	FrameElem=48	ElemStation=0.5					
Frame=48	Station=0.5	OutputCase=FESSUR	CaseType=Combination	Point=1	X2=-0.5	X3=-0.5		
S11=74.5219923768369	IsS11Max=Yes	IsS11Min=No	FrameElem=48	ElemStation=0.5				
Frame=48	Station=0.5	OutputCase=FESSUR	CaseType=Combination	Point=2	X2=-0.5	X3=0.5		
S11=74.5219923768369	IsS11Max=No	IsS11Min=No	FrameElem=48	ElemStation=0.5				
Frame=48	Station=0.5	OutputCase=FESSUR	CaseType=Combination	Point=3	X2=0.5	X3=-0.5	S11=-	
S11=320.47463066101	IsS11Max=No	IsS11Min=Yes	FrameElem=48	ElemStation=0.5				

Frame=48 Station=0.5 OutputCase=FESSUR CaseType=Combination Point=4 X2=0.5 X3=0.5 S11=-
320.47463066101 IsS11Max=No IsS11Min=No FrameElem=48 ElemStation=0.5
Frame=49 Station=0 OutputCase=PESOPR CaseType=LinStatic Point=0 X2=0 X3=0 S11=15.1709467362397
IsS11Max=No IsS11Min=No FrameElem=49 ElemStation=0
Frame=49 Station=0 OutputCase=PESOPR CaseType=LinStatic Point=1 X2=-0.5 X3=-0.5
S11=57.4914771877101 IsS11Max=Yes IsS11Min=No FrameElem=49 ElemStation=0
Frame=49 Station=0 OutputCase=PESOPR CaseType=LinStatic Point=2 X2=-0.5 X3=0.5 S11=57.4914771877101
IsS11Max=No IsS11Min=No FrameElem=49 ElemStation=0
Frame=49 Station=0 OutputCase=PESOPR CaseType=LinStatic Point=3 X2=0.5 X3=-0.5 S11=-
27.1495837152307 IsS11Max=No IsS11Min=Yes FrameElem=49 ElemStation=0
Frame=49 Station=0 OutputCase=PESOPR CaseType=LinStatic Point=4 X2=0.5 X3=0.5 S11=-27.1495837152307
IsS11Max=No IsS11Min=No FrameElem=49 ElemStation=0
Frame=49 Station=0.125 OutputCase=PESOPR CaseType=LinStatic Point=0 X2=0 X3=0 S11=15.1709467362397
IsS11Max=No IsS11Min=No FrameElem=49 ElemStation=0.125
Frame=49 Station=0.125 OutputCase=PESOPR CaseType=LinStatic Point=1 X2=-0.5 X3=-0.5
S11=93.8196021793609 IsS11Max=Yes IsS11Min=No FrameElem=49 ElemStation=0.125
Frame=49 Station=0.125 OutputCase=PESOPR CaseType=LinStatic Point=2 X2=-0.5 X3=0.5
S11=93.8196021793609 IsS11Max=No IsS11Min=No FrameElem=49 ElemStation=0.125
Frame=49 Station=0.125 OutputCase=PESOPR CaseType=LinStatic Point=3 X2=0.5 X3=-0.5 S11=-
63.4777087068816 IsS11Max=No IsS11Min=Yes FrameElem=49 ElemStation=0.125
Frame=49 Station=0.125 OutputCase=PESOPR CaseType=LinStatic Point=4 X2=0.5 X3=0.5 S11=-
63.4777087068816 IsS11Max=No IsS11Min=No FrameElem=49 ElemStation=0.125
Frame=49 Station=0.25 OutputCase=PESOPR CaseType=LinStatic Point=0 X2=0 X3=0 S11=15.1709467362397
IsS11Max=No IsS11Min=No FrameElem=49 ElemStation=0.25
Frame=49 Station=0.25 OutputCase=PESOPR CaseType=LinStatic Point=1 X2=-0.5 X3=-0.5
S11=127.803977171012 IsS11Max=Yes IsS11Min=No FrameElem=49 ElemStation=0.25
Frame=49 Station=0.25 OutputCase=PESOPR CaseType=LinStatic Point=2 X2=-0.5 X3=0.5
S11=127.803977171012 IsS11Max=No IsS11Min=No FrameElem=49 ElemStation=0.25
Frame=49 Station=0.25 OutputCase=PESOPR CaseType=LinStatic Point=3 X2=0.5 X3=-0.5 S11=-
97.4620836985324 IsS11Max=No IsS11Min=Yes FrameElem=49 ElemStation=0.25
Frame=49 Station=0.25 OutputCase=PESOPR CaseType=LinStatic Point=4 X2=0.5 X3=0.5 S11=-
97.4620836985324 IsS11Max=No IsS11Min=No FrameElem=49 ElemStation=0.25
Frame=49 Station=0.375 OutputCase=PESOPR CaseType=LinStatic Point=0 X2=0 X3=0 S11=15.1709467362397
IsS11Max=No IsS11Min=No FrameElem=49 ElemStation=0.375
Frame=49 Station=0.375 OutputCase=PESOPR CaseType=LinStatic Point=1 X2=-0.5 X3=-0.5
S11=159.444602162663 IsS11Max=Yes IsS11Min=No FrameElem=49 ElemStation=0.375
Frame=49 Station=0.375 OutputCase=PESOPR CaseType=LinStatic Point=2 X2=-0.5 X3=0.5
S11=159.444602162663 IsS11Max=No IsS11Min=No FrameElem=49 ElemStation=0.375
Frame=49 Station=0.375 OutputCase=PESOPR CaseType=LinStatic Point=3 X2=0.5 X3=-0.5 S11=-
129.102708690183 IsS11Max=No IsS11Min=Yes FrameElem=49 ElemStation=0.375
Frame=49 Station=0.375 OutputCase=PESOPR CaseType=LinStatic Point=4 X2=0.5 X3=0.5 S11=-
129.102708690183 IsS11Max=No IsS11Min=No FrameElem=49 ElemStation=0.375
Frame=49 Station=0.5 OutputCase=PESOPR CaseType=LinStatic Point=0 X2=0 X3=0 S11=15.1709467362397
IsS11Max=No IsS11Min=No FrameElem=49 ElemStation=0.5
Frame=49 Station=0.5 OutputCase=PESOPR CaseType=LinStatic Point=1 X2=-0.5 X3=-0.5
S11=188.741477154313 IsS11Max=Yes IsS11Min=No FrameElem=49 ElemStation=0.5
Frame=49 Station=0.5 OutputCase=PESOPR CaseType=LinStatic Point=2 X2=-0.5 X3=0.5
S11=188.741477154313 IsS11Max=No IsS11Min=No FrameElem=49 ElemStation=0.5
Frame=49 Station=0.5 OutputCase=PESOPR CaseType=LinStatic Point=3 X2=0.5 X3=-0.5 S11=-
158.399583681834 IsS11Max=No IsS11Min=Yes FrameElem=49 ElemStation=0.5
Frame=49 Station=0.5 OutputCase=PESOPR CaseType=LinStatic Point=4 X2=0.5 X3=0.5 S11=-
158.399583681834 IsS11Max=No IsS11Min=No FrameElem=49 ElemStation=0.5
Frame=49 Station=0 OutputCase=TERRVERT CaseType=LinStatic Point=0 X2=0 X3=0 S11=-1.15282857328748
IsS11Max=No IsS11Min=No FrameElem=49 ElemStation=0
Frame=49 Station=0 OutputCase=TERRVERT CaseType=LinStatic Point=1 X2=-0.5 X3=-0.5 S11=-
42.9464859832751 IsS11Max=No IsS11Min=Yes FrameElem=49 ElemStation=0
Frame=49 Station=0 OutputCase=TERRVERT CaseType=LinStatic Point=2 X2=-0.5 X3=0.5 S11=-
42.9464859832751 IsS11Max=No IsS11Min=No FrameElem=49 ElemStation=0
Frame=49 Station=0 OutputCase=TERRVERT CaseType=LinStatic Point=3 X2=0.5 X3=-0.5
S11=40.6408288367002 IsS11Max=Yes IsS11Min=No FrameElem=49 ElemStation=0
Frame=49 Station=0 OutputCase=TERRVERT CaseType=LinStatic Point=4 X2=0.5 X3=0.5
S11=40.6408288367002 IsS11Max=No IsS11Min=No FrameElem=49 ElemStation=0
Frame=49 Station=0.125 OutputCase=TERRVERT CaseType=LinStatic Point=0 X2=0 X3=0 S11=-
1.15282857328748 IsS11Max=No IsS11Min=No FrameElem=49 ElemStation=0.125
Frame=49 Station=0.125 OutputCase=TERRVERT CaseType=LinStatic Point=1 X2=-0.5 X3=-0.5
S11=242.592576368492 IsS11Max=Yes IsS11Min=No FrameElem=49 ElemStation=0.125
Frame=49 Station=0.125 OutputCase=TERRVERT CaseType=LinStatic Point=2 X2=-0.5 X3=0.5
S11=242.592576368492 IsS11Max=No IsS11Min=No FrameElem=49 ElemStation=0.125
Frame=49 Station=0.125 OutputCase=TERRVERT CaseType=LinStatic Point=3 X2=0.5 X3=-0.5 S11=-
244.898233515067 IsS11Max=No IsS11Min=Yes FrameElem=49 ElemStation=0.125
Frame=49 Station=0.125 OutputCase=TERRVERT CaseType=LinStatic Point=4 X2=0.5 X3=0.5 S11=-
244.898233515067 IsS11Max=No IsS11Min=No FrameElem=49 ElemStation=0.125
Frame=49 Station=0.25 OutputCase=TERRVERT CaseType=LinStatic Point=0 X2=0 X3=0 S11=-
1.15282857328748 IsS11Max=No IsS11Min=No FrameElem=49 ElemStation=0.25
Frame=49 Station=0.25 OutputCase=TERRVERT CaseType=LinStatic Point=1 X2=-0.5 X3=-0.5
S11=509.709763720259 IsS11Max=Yes IsS11Min=No FrameElem=49 ElemStation=0.25
Frame=49 Station=0.25 OutputCase=TERRVERT CaseType=LinStatic Point=2 X2=-0.5 X3=0.5
S11=509.709763720259 IsS11Max=No IsS11Min=No FrameElem=49 ElemStation=0.25
Frame=49 Station=0.25 OutputCase=TERRVERT CaseType=LinStatic Point=3 X2=0.5 X3=-0.5 S11=-
512.015420866834 IsS11Max=No IsS11Min=Yes FrameElem=49 ElemStation=0.25
Frame=49 Station=0.25 OutputCase=TERRVERT CaseType=LinStatic Point=4 X2=0.5 X3=0.5 S11=-
512.015420866834 IsS11Max=No IsS11Min=No FrameElem=49 ElemStation=0.25



Frame=49	Station=0.375	OutputCase=TERRVERT	CaseType=LinStatic	Point=0	X2=0	X3=0	S11=-
1.15282857328748	IsS11Max=No	IsS11Min=No	FrameElem=49	ElemStation=0.375			
Frame=49	Station=0.375	OutputCase=TERRVERT	CaseType=LinStatic	Point=1	X2=-0.5	X3=-0.5	
S11=758.405076072026	IsS11Max=Yes	IsS11Min=No	FrameElem=49	ElemStation=0.375			
Frame=49	Station=0.375	OutputCase=TERRVERT	CaseType=LinStatic	Point=2	X2=-0.5	X3=0.5	
S11=758.405076072026	IsS11Max=No	IsS11Min=No	FrameElem=49	ElemStation=0.375			
Frame=49	Station=0.375	OutputCase=TERRVERT	CaseType=LinStatic	Point=3	X2=0.5	X3=-0.5	S11=-
760.710733218601	IsS11Max=No	IsS11Min=Yes	FrameElem=49	ElemStation=0.375			
Frame=49	Station=0.375	OutputCase=TERRVERT	CaseType=LinStatic	Point=4	X2=0.5	X3=0.5	S11=-
760.710733218601	IsS11Max=No	IsS11Min=No	FrameElem=49	ElemStation=0.375			
Frame=49	Station=0.5	OutputCase=TERRVERT	CaseType=LinStatic	Point=0	X2=0	X3=0	S11=-1.15282857328748
IsS11Max=No	IsS11Min=No	FrameElem=49	ElemStation=0.5				
Frame=49	Station=0.5	OutputCase=TERRVERT	CaseType=LinStatic	Point=1	X2=-0.5	X3=-0.5	
S11=988.678513423793	IsS11Max=Yes	IsS11Min=No	FrameElem=49	ElemStation=0.5			
Frame=49	Station=0.5	OutputCase=TERRVERT	CaseType=LinStatic	Point=2	X2=-0.5	X3=0.5	
S11=988.678513423793	IsS11Max=No	IsS11Min=No	FrameElem=49	ElemStation=0.5			
Frame=49	Station=0.5	OutputCase=TERRVERT	CaseType=LinStatic	Point=3	X2=0.5	X3=-0.5	S11=-
990.984170570368	IsS11Max=No	IsS11Min=Yes	FrameElem=49	ElemStation=0.5			
Frame=49	Station=0.5	OutputCase=TERRVERT	CaseType=LinStatic	Point=4	X2=0.5	X3=0.5	S11=-
990.984170570368	IsS11Max=No	IsS11Min=No	FrameElem=49	ElemStation=0.5			
Frame=49	Station=0	OutputCase=TERRLAT	CaseType=LinStatic	Point=0	X2=0	X3=0	S11=-66.7117981831702
IsS11Max=No	IsS11Min=No	FrameElem=49	ElemStation=0				
Frame=49	Station=0	OutputCase=TERRLAT	CaseType=LinStatic	Point=1	X2=-0.5	X3=-0.5	S11=-
190.013372147376	IsS11Max=No	IsS11Min=Yes	FrameElem=49	ElemStation=0			
Frame=49	Station=0	OutputCase=TERRLAT	CaseType=LinStatic	Point=2	X2=-0.5	X3=0.5	S11=-
190.013372147376	IsS11Max=No	IsS11Min=No	FrameElem=49	ElemStation=0			
Frame=49	Station=0	OutputCase=TERRLAT	CaseType=LinStatic	Point=3	X2=0.5	X3=-0.5	
S11=56.5897757810359	IsS11Max=Yes	IsS11Min=No	FrameElem=49	ElemStation=0			
Frame=49	Station=0	OutputCase=TERRLAT	CaseType=LinStatic	Point=4	X2=0.5	X3=0.5	S11=56.5897757810359
IsS11Max=No	IsS11Min=No	FrameElem=49	ElemStation=0				
Frame=49	Station=0.125	OutputCase=TERRLAT	CaseType=LinStatic	Point=0	X2=0	X3=0	S11=-
66.7117981831702	IsS11Max=No	IsS11Min=No	FrameElem=49	ElemStation=0.125			
Frame=49	Station=0.125	OutputCase=TERRLAT	CaseType=LinStatic	Point=1	X2=-0.5	X3=-0.5	S11=-
190.013372398012	IsS11Max=No	IsS11Min=Yes	FrameElem=49	ElemStation=0.125			
Frame=49	Station=0.125	OutputCase=TERRLAT	CaseType=LinStatic	Point=2	X2=-0.5	X3=0.5	S11=-
190.013372398012	IsS11Max=No	IsS11Min=No	FrameElem=49	ElemStation=0.125			
Frame=49	Station=0.125	OutputCase=TERRLAT	CaseType=LinStatic	Point=3	X2=0.5	X3=-0.5	
S11=56.5897760316712	IsS11Max=Yes	IsS11Min=No	FrameElem=49	ElemStation=0.125			
Frame=49	Station=0.125	OutputCase=TERRLAT	CaseType=LinStatic	Point=4	X2=0.5	X3=0.5	
S11=56.5897760316712	IsS11Max=No	IsS11Min=No	FrameElem=49	ElemStation=0.125			
Frame=49	Station=0.25	OutputCase=TERRLAT	CaseType=LinStatic	Point=0	X2=0	X3=0	S11=-66.7117981831702
IsS11Max=No	IsS11Min=No	FrameElem=49	ElemStation=0.25				
Frame=49	Station=0.25	OutputCase=TERRLAT	CaseType=LinStatic	Point=1	X2=-0.5	X3=-0.5	S11=-
190.013372648647	IsS11Max=No	IsS11Min=Yes	FrameElem=49	ElemStation=0.25			
Frame=49	Station=0.25	OutputCase=TERRLAT	CaseType=LinStatic	Point=2	X2=-0.5	X3=0.5	S11=-
190.013372648647	IsS11Max=No	IsS11Min=No	FrameElem=49	ElemStation=0.25			
Frame=49	Station=0.25	OutputCase=TERRLAT	CaseType=LinStatic	Point=3	X2=0.5	X3=-0.5	
S11=56.5897762823065	IsS11Max=Yes	IsS11Min=No	FrameElem=49	ElemStation=0.25			
Frame=49	Station=0.25	OutputCase=TERRLAT	CaseType=LinStatic	Point=4	X2=0.5	X3=0.5	
S11=56.5897762823065	IsS11Max=No	IsS11Min=No	FrameElem=49	ElemStation=0.25			
Frame=49	Station=0.375	OutputCase=TERRLAT	CaseType=LinStatic	Point=0	X2=0	X3=0	S11=-
66.7117981831702	IsS11Max=No	IsS11Min=No	FrameElem=49	ElemStation=0.375			
Frame=49	Station=0.375	OutputCase=TERRLAT	CaseType=LinStatic	Point=1	X2=-0.5	X3=-0.5	S11=-
190.013372899282	IsS11Max=No	IsS11Min=Yes	FrameElem=49	ElemStation=0.375			
Frame=49	Station=0.375	OutputCase=TERRLAT	CaseType=LinStatic	Point=2	X2=-0.5	X3=0.5	S11=-
190.013372899282	IsS11Max=No	IsS11Min=No	FrameElem=49	ElemStation=0.375			
Frame=49	Station=0.375	OutputCase=TERRLAT	CaseType=LinStatic	Point=3	X2=0.5	X3=-0.5	
S11=56.5897765329418	IsS11Max=Yes	IsS11Min=No	FrameElem=49	ElemStation=0.375			
Frame=49	Station=0.375	OutputCase=TERRLAT	CaseType=LinStatic	Point=4	X2=0.5	X3=0.5	
S11=56.5897765329418	IsS11Max=No	IsS11Min=No	FrameElem=49	ElemStation=0.375			
Frame=49	Station=0.5	OutputCase=TERRLAT	CaseType=LinStatic	Point=0	X2=0	X3=0	S11=-66.7117981831702
IsS11Max=No	IsS11Min=No	FrameElem=49	ElemStation=0.5				
Frame=49	Station=0.5	OutputCase=TERRLAT	CaseType=LinStatic	Point=1	X2=-0.5	X3=-0.5	S11=-
190.013373149917	IsS11Max=No	IsS11Min=Yes	FrameElem=49	ElemStation=0.5			
Frame=49	Station=0.5	OutputCase=TERRLAT	CaseType=LinStatic	Point=2	X2=-0.5	X3=0.5	S11=-
190.013373149917	IsS11Max=No	IsS11Min=No	FrameElem=49	ElemStation=0.5			
Frame=49	Station=0.5	OutputCase=TERRLAT	CaseType=LinStatic	Point=3	X2=0.5	X3=-0.5	
S11=56.5897767835771	IsS11Max=Yes	IsS11Min=No	FrameElem=49	ElemStation=0.5			
Frame=49	Station=0.5	OutputCase=TERRLAT	CaseType=LinStatic	Point=4	X2=0.5	X3=0.5	
S11=56.5897767835771	IsS11Max=No	IsS11Min=No	FrameElem=49	ElemStation=0.5			
Frame=49	Station=0	OutputCase=ACCLATDX	CaseType=LinStatic	Point=0	X2=0	X3=0	S11=0 IsS11Max=Yes
IsS11Min=Yes	FrameElem=49	ElemStation=0					
Frame=49	Station=0	OutputCase=ACCLATDX	CaseType=LinStatic	Point=1	X2=-0.5	X3=-0.5	S11=0
IsS11Max=No	IsS11Min=No	FrameElem=49	ElemStation=0				
Frame=49	Station=0	OutputCase=ACCLATDX	CaseType=LinStatic	Point=2	X2=-0.5	X3=0.5	S11=0
IsS11Max=No	IsS11Min=No	FrameElem=49	ElemStation=0				
Frame=49	Station=0	OutputCase=ACCLATDX	CaseType=LinStatic	Point=3	X2=0.5	X3=-0.5	S11=0
IsS11Max=No	IsS11Min=No	FrameElem=49	ElemStation=0				
Frame=49	Station=0	OutputCase=ACCLATDX	CaseType=LinStatic	Point=4	X2=0.5	X3=0.5	S11=0 IsS11Max=No
IsS11Min=No	FrameElem=49	ElemStation=0					
Frame=49	Station=0.125	OutputCase=ACCLATDX	CaseType=LinStatic	Point=0	X2=0	X3=0	S11=0
IsS11Max=Yes	IsS11Min=Yes	FrameElem=49	ElemStation=0.125				

Frame=49	Station=0.25	OutputCase=SOVRCOST	CaseType=LinStatic	Point=3	X2=0.5	X3=-0.5	S11=0	
IsS11Max=No	IsS11Min=No	FrameElem=49	ElemStation=0.25					
Frame=49	Station=0.25	OutputCase=SOVRCOST	CaseType=LinStatic	Point=4	X2=0.5	X3=0.5	S11=0	
IsS11Max=No	IsS11Min=No	FrameElem=49	ElemStation=0.25					
Frame=49	Station=0.375	OutputCase=SOVRCOST	CaseType=LinStatic	Point=0	X2=0	X3=0	S11=0	
IsS11Max=Yes	IsS11Min=Yes	FrameElem=49	ElemStation=0.375					
Frame=49	Station=0.375	OutputCase=SOVRCOST	CaseType=LinStatic	Point=1	X2=-0.5	X3=-0.5	S11=0	
IsS11Max=No	IsS11Min=No	FrameElem=49	ElemStation=0.375					
Frame=49	Station=0.375	OutputCase=SOVRCOST	CaseType=LinStatic	Point=2	X2=-0.5	X3=0.5	S11=0	
IsS11Max=No	IsS11Min=No	FrameElem=49	ElemStation=0.375					
Frame=49	Station=0.375	OutputCase=SOVRCOST	CaseType=LinStatic	Point=3	X2=0.5	X3=-0.5	S11=0	
IsS11Max=No	IsS11Min=No	FrameElem=49	ElemStation=0.375					
Frame=49	Station=0.375	OutputCase=SOVRCOST	CaseType=LinStatic	Point=4	X2=0.5	X3=0.5	S11=0	
IsS11Max=No	IsS11Min=No	FrameElem=49	ElemStation=0.375					
Frame=49	Station=0.5	OutputCase=SOVRCOST	CaseType=LinStatic	Point=0	X2=0	X3=0	S11=0	
IsS11Min=Yes	FrameElem=49	ElemStation=0.5					IsS11Max=Yes	
Frame=49	Station=0.5	OutputCase=SOVRCOST	CaseType=LinStatic	Point=1	X2=-0.5	X3=-0.5	S11=0	
IsS11Max=No	IsS11Min=No	FrameElem=49	ElemStation=0.5					
Frame=49	Station=0.5	OutputCase=SOVRCOST	CaseType=LinStatic	Point=2	X2=-0.5	X3=0.5	S11=0	
IsS11Max=No	IsS11Min=No	FrameElem=49	ElemStation=0.5					
Frame=49	Station=0.5	OutputCase=SOVRCOST	CaseType=LinStatic	Point=3	X2=0.5	X3=-0.5	S11=0	
IsS11Max=No	IsS11Min=No	FrameElem=49	ElemStation=0.5					
Frame=49	Station=0.5	OutputCase=SOVRCOST	CaseType=LinStatic	Point=4	X2=0.5	X3=0.5	S11=0	
IsS11Max=No	IsS11Min=No	FrameElem=49	ElemStation=0.5					
Frame=49	Station=0	OutputCase=ENVE	CaseType=Combination	StepType=Max	Point=0	X2=0	X3=0	S11=-
32.6801405652669	IsS11Max=No	IsS11Min=No	FrameElem=49	ElemStation=0				
Frame=49	Station=0	OutputCase=ENVE	CaseType=Combination	StepType=Max	Point=1	X2=-0.5	X3=-0.5	
S11=-118.464369298728	IsS11Max=No	IsS11Min=Yes	FrameElem=49	ElemStation=0				
Frame=49	Station=0	OutputCase=ENVE	CaseType=Combination	StepType=Max	Point=2	X2=-0.5	X3=0.5	S11=-
118.464369298728	IsS11Max=No	IsS11Min=No	FrameElem=49	ElemStation=0				
Frame=49	Station=0	OutputCase=ENVE	CaseType=Combination	StepType=Max	Point=3	X2=0.5	X3=-0.5	
S11=70.0810209025053	IsS11Max=Yes	IsS11Min=No	FrameElem=49	ElemStation=0				
Frame=49	Station=0	OutputCase=ENVE	CaseType=Combination	StepType=Max	Point=4	X2=0.5	X3=0.5	
S11=70.0810209025053	IsS11Max=No	IsS11Min=No	FrameElem=49	ElemStation=0				
Frame=49	Station=0.125	OutputCase=ENVE	CaseType=Combination	StepType=Max	Point=0	X2=0	X3=0	S11=-
32.6801405652669	IsS11Max=No	IsS11Min=No	FrameElem=49	ElemStation=0.125				
Frame=49	Station=0.125	OutputCase=ENVE	CaseType=Combination	StepType=Max	Point=1	X2=-0.5	X3=-0.5	
S11=203.402817869245	IsS11Max=Yes	IsS11Min=No	FrameElem=49	ElemStation=0.125				
Frame=49	Station=0.125	OutputCase=ENVE	CaseType=Combination	StepType=Max	Point=2	X2=-0.5	X3=0.5	
S11=203.402817869245	IsS11Max=No	IsS11Min=No	FrameElem=49	ElemStation=0.125				
Frame=49	Station=0.125	OutputCase=ENVE	CaseType=Combination	StepType=Max	Point=3	X2=0.5	X3=-0.5	
S11=-251.786166190277	IsS11Max=No	IsS11Min=Yes	FrameElem=49	ElemStation=0.125				
Frame=49	Station=0.125	OutputCase=ENVE	CaseType=Combination	StepType=Max	Point=4	X2=0.5	X3=0.5	
S11=-251.786166190277	IsS11Max=No	IsS11Min=No	FrameElem=49	ElemStation=0.125				
Frame=49	Station=0.25	OutputCase=ENVE	CaseType=Combination	StepType=Max	Point=0	X2=0	X3=0	S11=-
32.6801405652669	IsS11Max=No	IsS11Min=No	FrameElem=49	ElemStation=0.25				
Frame=49	Station=0.25	OutputCase=ENVE	CaseType=Combination	StepType=Max	Point=1	X2=-0.5	X3=-0.5	
S11=504.504380037218	IsS11Max=Yes	IsS11Min=No	FrameElem=49	ElemStation=0.25				
Frame=49	Station=0.25	OutputCase=ENVE	CaseType=Combination	StepType=Max	Point=2	X2=-0.5	X3=0.5	
S11=504.504380037218	IsS11Max=No	IsS11Min=No	FrameElem=49	ElemStation=0.25				
Frame=49	Station=0.25	OutputCase=ENVE	CaseType=Combination	StepType=Max	Point=3	X2=0.5	X3=-0.5	
S11=-552.88772828306	IsS11Max=No	IsS11Min=Yes	FrameElem=49	ElemStation=0.25				
Frame=49	Station=0.25	OutputCase=ENVE	CaseType=Combination	StepType=Max	Point=4	X2=0.5	X3=0.5	
S11=-552.88772828306	IsS11Max=No	IsS11Min=No	FrameElem=49	ElemStation=0.25				
Frame=49	Station=0.375	OutputCase=ENVE	CaseType=Combination	StepType=Max	Point=0	X2=0	X3=0	S11=-
32.6801405652669	IsS11Max=No	IsS11Min=No	FrameElem=49	ElemStation=0.375				
Frame=49	Station=0.375	OutputCase=ENVE	CaseType=Combination	StepType=Max	Point=1	X2=-0.5	X3=-0.5	
S11=784.840317205191	IsS11Max=Yes	IsS11Min=No	FrameElem=49	ElemStation=0.375				
Frame=49	Station=0.375	OutputCase=ENVE	CaseType=Combination	StepType=Max	Point=2	X2=-0.5	X3=0.5	
S11=784.840317205191	IsS11Max=No	IsS11Min=No	FrameElem=49	ElemStation=0.375				
Frame=49	Station=0.375	OutputCase=ENVE	CaseType=Combination	StepType=Max	Point=3	X2=0.5	X3=-0.5	
S11=-833.223665375842	IsS11Max=No	IsS11Min=Yes	FrameElem=49	ElemStation=0.375				
Frame=49	Station=0.375	OutputCase=ENVE	CaseType=Combination	StepType=Max	Point=4	X2=0.5	X3=0.5	
S11=-833.223665375842	IsS11Max=No	IsS11Min=No	FrameElem=49	ElemStation=0.375				
Frame=49	Station=0.5	OutputCase=ENVE	CaseType=Combination	StepType=Max	Point=0	X2=0	X3=0	S11=-
32.6801405652669	IsS11Max=No	IsS11Min=No	FrameElem=49	ElemStation=0.5				
Frame=49	Station=0.5	OutputCase=ENVE	CaseType=Combination	StepType=Max	Point=1	X2=-0.5	X3=-0.5	
S11=1044.41062937316	IsS11Max=Yes	IsS11Min=No	FrameElem=49	ElemStation=0.5				
Frame=49	Station=0.5	OutputCase=ENVE	CaseType=Combination	StepType=Max	Point=2	X2=-0.5	X3=0.5	
S11=1044.41062937316	IsS11Max=No	IsS11Min=No	FrameElem=49	ElemStation=0.5				
Frame=49	Station=0.5	OutputCase=ENVE	CaseType=Combination	StepType=Max	Point=3	X2=0.5	X3=-0.5	
S11=-1092.79397746862	IsS11Max=No	IsS11Min=Yes	FrameElem=49	ElemStation=0.5				
Frame=49	Station=0.5	OutputCase=ENVE	CaseType=Combination	StepType=Max	Point=4	X2=0.5	X3=0.5	
S11=-1092.79397746862	IsS11Max=No	IsS11Min=No	FrameElem=49	ElemStation=0.5				
Frame=49	Station=0	OutputCase=ENVE	CaseType=Combination	StepType=Min	Point=0	X2=0	X3=0	S11=-
52.693680020218	IsS11Max=No	IsS11Min=No	FrameElem=49	ElemStation=0				
Frame=49	Station=0	OutputCase=ENVE	CaseType=Combination	StepType=Min	Point=1	X2=-0.5	X3=-0.5	
S11=-175.468380942941	IsS11Max=No	IsS11Min=Yes	FrameElem=49	ElemStation=0				
Frame=49	Station=0	OutputCase=ENVE	CaseType=Combination	StepType=Min	Point=2	X2=-0.5	X3=0.5	S11=-
175.468380942941	IsS11Max=No	IsS11Min=No	FrameElem=49	ElemStation=0				
Frame=49	Station=0	OutputCase=ENVE	CaseType=Combination	StepType=Min	Point=3	X2=0.5	X3=-0.5	
S11=53.1040881681945	IsS11Max=Yes	IsS11Min=No	FrameElem=49	ElemStation=0				

```

Frame=49 Station=0 OutputCase=ENVE CaseType=Combination StepType=Min Point=4 X2=0.5 X3=0.5
S11=53.1040881681945 IsS11Max=No IsS11Min=No FrameElem=49 ElemStation=0
Frame=49 Station=0.125 OutputCase=ENVE CaseType=Combination StepType=Min Point=0 X2=0 X3=0 S11=-
52.693680020218 IsS11Max=No IsS11Min=No FrameElem=49 ElemStation=0.125
Frame=49 Station=0.125 OutputCase=ENVE CaseType=Combination StepType=Min Point=1 X2=-0.5 X3=-0.5
S11=146.398806149841 IsS11Max=Yes IsS11Min=No FrameElem=49 ElemStation=0.125
Frame=49 Station=0.125 OutputCase=ENVE CaseType=Combination StepType=Min Point=2 X2=-0.5 X3=0.5
S11=146.398806149841 IsS11Max=No IsS11Min=No FrameElem=49 ElemStation=0.125
Frame=49 Station=0.125 OutputCase=ENVE CaseType=Combination StepType=Min Point=3 X2=0.5 X3=-0.5
S11=-268.763098999778 IsS11Max=No IsS11Min=Yes FrameElem=49 ElemStation=0.125
Frame=49 Station=0.125 OutputCase=ENVE CaseType=Combination StepType=Min Point=4 X2=0.5 X3=0.5
S11=-268.763098999778 IsS11Max=No IsS11Min=No FrameElem=49 ElemStation=0.125
Frame=49 Station=0.25 OutputCase=ENVE CaseType=Combination StepType=Min Point=0 X2=0 X3=0 S11=-
52.693680020218 IsS11Max=No IsS11Min=No FrameElem=49 ElemStation=0.25
Frame=49 Station=0.25 OutputCase=ENVE CaseType=Combination StepType=Min Point=1 X2=-0.5 X3=-0.5
S11=447.500368242624 IsS11Max=Yes IsS11Min=No FrameElem=49 ElemStation=0.25
Frame=49 Station=0.25 OutputCase=ENVE CaseType=Combination StepType=Min Point=2 X2=-0.5 X3=0.5
S11=447.500368242624 IsS11Max=No IsS11Min=No FrameElem=49 ElemStation=0.25
Frame=49 Station=0.25 OutputCase=ENVE CaseType=Combination StepType=Min Point=3 X2=0.5 X3=-0.5
S11=-569.864661167751 IsS11Max=No IsS11Min=Yes FrameElem=49 ElemStation=0.25
Frame=49 Station=0.25 OutputCase=ENVE CaseType=Combination StepType=Min Point=4 X2=0.5 X3=0.5
S11=-569.864661167751 IsS11Max=No IsS11Min=No FrameElem=49 ElemStation=0.25
Frame=49 Station=0.375 OutputCase=ENVE CaseType=Combination StepType=Min Point=0 X2=0 X3=0 S11=-
52.693680020218 IsS11Max=No IsS11Min=No FrameElem=49 ElemStation=0.375
Frame=49 Station=0.375 OutputCase=ENVE CaseType=Combination StepType=Min Point=1 X2=-0.5 X3=-0.5
S11=727.836305335406 IsS11Max=Yes IsS11Min=No FrameElem=49 ElemStation=0.375
Frame=49 Station=0.375 OutputCase=ENVE CaseType=Combination StepType=Min Point=2 X2=-0.5 X3=0.5
S11=727.836305335406 IsS11Max=No IsS11Min=No FrameElem=49 ElemStation=0.375
Frame=49 Station=0.375 OutputCase=ENVE CaseType=Combination StepType=Min Point=3 X2=0.5 X3=-0.5
S11=-850.200598335725 IsS11Max=No IsS11Min=Yes FrameElem=49 ElemStation=0.375
Frame=49 Station=0.375 OutputCase=ENVE CaseType=Combination StepType=Min Point=4 X2=0.5 X3=0.5
S11=-850.200598335725 IsS11Max=No IsS11Min=No FrameElem=49 ElemStation=0.375
Frame=49 Station=0.5 OutputCase=ENVE CaseType=Combination StepType=Min Point=0 X2=0 X3=0 S11=-
52.693680020218 IsS11Max=No IsS11Min=No FrameElem=49 ElemStation=0.5
Frame=49 Station=0.5 OutputCase=ENVE CaseType=Combination StepType=Min Point=1 X2=-0.5 X3=-0.5
S11=987.406617428189 IsS11Max=Yes IsS11Min=No FrameElem=49 ElemStation=0.5
Frame=49 Station=0.5 OutputCase=ENVE CaseType=Combination StepType=Min Point=2 X2=-0.5 X3=0.5
S11=987.406617428189 IsS11Max=No IsS11Min=No FrameElem=49 ElemStation=0.5
Frame=49 Station=0.5 OutputCase=ENVE CaseType=Combination StepType=Min Point=3 X2=0.5 X3=-0.5
S11=-1109.7709105037 IsS11Max=No IsS11Min=Yes FrameElem=49 ElemStation=0.5
Frame=49 Station=0.5 OutputCase=ENVE CaseType=Combination StepType=Min Point=4 X2=0.5 X3=0.5
S11=-1109.7709105037 IsS11Max=No IsS11Min=No FrameElem=49 ElemStation=0.5
Frame=49 Station=0 OutputCase=FESSUR CaseType=Combination Point=0 X2=0 X3=0 S11=-52.693680020218
IsS11Max=No IsS11Min=No FrameElem=49 ElemStation=0
Frame=49 Station=0 OutputCase=FESSUR CaseType=Combination Point=1 X2=-0.5 X3=-0.5 S11=-
175.468380942941 IsS11Max=No IsS11Min=Yes FrameElem=49 ElemStation=0
Frame=49 Station=0 OutputCase=FESSUR CaseType=Combination Point=2 X2=-0.5 X3=0.5 S11=-
175.468380942941 IsS11Max=No IsS11Min=No FrameElem=49 ElemStation=0
Frame=49 Station=0 OutputCase=FESSUR CaseType=Combination Point=3 X2=0.5 X3=-0.5
S11=70.0810209025053 IsS11Max=Yes IsS11Min=No FrameElem=49 ElemStation=0
Frame=49 Station=0 OutputCase=FESSUR CaseType=Combination Point=4 X2=0.5 X3=0.5
S11=70.0810209025053 IsS11Max=No IsS11Min=No FrameElem=49 ElemStation=0
Frame=49 Station=0.125 OutputCase=FESSUR CaseType=Combination Point=0 X2=0 X3=0 S11=-
52.693680020218 IsS11Max=No IsS11Min=No FrameElem=49 ElemStation=0.125
Frame=49 Station=0.125 OutputCase=FESSUR CaseType=Combination Point=1 X2=-0.5 X3=-0.5
S11=146.398806149841 IsS11Max=Yes IsS11Min=No FrameElem=49 ElemStation=0.125
Frame=49 Station=0.125 OutputCase=FESSUR CaseType=Combination Point=2 X2=-0.5 X3=0.5
S11=146.398806149841 IsS11Max=No IsS11Min=No FrameElem=49 ElemStation=0.125
Frame=49 Station=0.125 OutputCase=FESSUR CaseType=Combination Point=3 X2=0.5 X3=-0.5 S11=-
251.786166190277 IsS11Max=No IsS11Min=Yes FrameElem=49 ElemStation=0.125
Frame=49 Station=0.125 OutputCase=FESSUR CaseType=Combination Point=4 X2=0.5 X3=0.5 S11=-
251.786166190277 IsS11Max=No IsS11Min=No FrameElem=49 ElemStation=0.125
Frame=49 Station=0.25 OutputCase=FESSUR CaseType=Combination Point=0 X2=0 X3=0 S11=-52.693680020218
IsS11Max=No IsS11Min=No FrameElem=49 ElemStation=0.25
Frame=49 Station=0.25 OutputCase=FESSUR CaseType=Combination Point=1 X2=-0.5 X3=-0.5
S11=447.500368242624 IsS11Max=Yes IsS11Min=No FrameElem=49 ElemStation=0.25
Frame=49 Station=0.25 OutputCase=FESSUR CaseType=Combination Point=2 X2=-0.5 X3=0.5
S11=447.500368242624 IsS11Max=No IsS11Min=No FrameElem=49 ElemStation=0.25
Frame=49 Station=0.25 OutputCase=FESSUR CaseType=Combination Point=3 X2=0.5 X3=-0.5 S11=-
552.88772828306 IsS11Max=No IsS11Min=Yes FrameElem=49 ElemStation=0.25
Frame=49 Station=0.25 OutputCase=FESSUR CaseType=Combination Point=4 X2=0.5 X3=0.5 S11=-
552.88772828306 IsS11Max=No IsS11Min=No FrameElem=49 ElemStation=0.25
Frame=49 Station=0.375 OutputCase=FESSUR CaseType=Combination Point=0 X2=0 X3=0 S11=-
52.693680020218 IsS11Max=No IsS11Min=No FrameElem=49 ElemStation=0.375
Frame=49 Station=0.375 OutputCase=FESSUR CaseType=Combination Point=1 X2=-0.5 X3=-0.5
S11=727.836305335406 IsS11Max=Yes IsS11Min=No FrameElem=49 ElemStation=0.375
Frame=49 Station=0.375 OutputCase=FESSUR CaseType=Combination Point=2 X2=-0.5 X3=0.5
S11=727.836305335406 IsS11Max=No IsS11Min=No FrameElem=49 ElemStation=0.375
Frame=49 Station=0.375 OutputCase=FESSUR CaseType=Combination Point=3 X2=0.5 X3=-0.5 S11=-
833.223665375842 IsS11Max=No IsS11Min=Yes FrameElem=49 ElemStation=0.375
Frame=49 Station=0.375 OutputCase=FESSUR CaseType=Combination Point=4 X2=0.5 X3=0.5 S11=-
833.223665375842 IsS11Max=No IsS11Min=No FrameElem=49 ElemStation=0.375

```

Frame=49	Station=0.5	OutputCase=FESSUR	CaseType=Combination	Point=0	X2=0	X3=0	S11=-52.693680020218
IsS11Max=No	IsS11Min=No	FrameElem=49	ElemStation=0.5				
Frame=49	Station=0.5	OutputCase=FESSUR	CaseType=Combination	Point=1	X2=-0.5	X3=-0.5	
S11=987.406617428189	IsS11Max=Yes	IsS11Min=No	FrameElem=49	ElemStation=0.5			
Frame=49	Station=0.5	OutputCase=FESSUR	CaseType=Combination	Point=2	X2=-0.5	X3=0.5	
S11=987.406617428189	IsS11Max=No	IsS11Min=No	FrameElem=49	ElemStation=0.5			
Frame=49	Station=0.5	OutputCase=FESSUR	CaseType=Combination	Point=3	X2=0.5	X3=-0.5	S11=-
1092.79397746862	IsS11Max=No	IsS11Min=Yes	FrameElem=49	ElemStation=0.5			
Frame=49	Station=0.5	OutputCase=FESSUR	CaseType=Combination	Point=4	X2=0.5	X3=0.5	S11=-
1092.79397746862	IsS11Max=No	IsS11Min=No	FrameElem=49	ElemStation=0.5			
Frame=50	Station=0	OutputCase=PESOPR	CaseType=LinStatic	Point=0	X2=0	X3=0	S11=15.1709467362397
IsS11Max=No	IsS11Min=No	FrameElem=50	ElemStation=0				
Frame=50	Station=0	OutputCase=PESOPR	CaseType=LinStatic	Point=1	X2=-0.5	X3=-0.5	
S11=188.741477154357	IsS11Max=Yes	IsS11Min=No	FrameElem=50	ElemStation=0			
Frame=50	Station=0	OutputCase=PESOPR	CaseType=LinStatic	Point=2	X2=-0.5	X3=0.5	S11=188.741477154357
IsS11Max=No	IsS11Min=No	FrameElem=50	ElemStation=0				
Frame=50	Station=0	OutputCase=PESOPR	CaseType=LinStatic	Point=3	X2=0.5	X3=-0.5	S11=-
158.399583681878	IsS11Max=No	IsS11Min=Yes	FrameElem=50	ElemStation=0			
Frame=50	Station=0	OutputCase=PESOPR	CaseType=LinStatic	Point=4	X2=0.5	X3=0.5	S11=-158.399583681878
IsS11Max=No	IsS11Min=No	FrameElem=50	ElemStation=0				
Frame=50	Station=0.125	OutputCase=PESOPR	CaseType=LinStatic	Point=0	X2=0	X3=0	S11=15.1709467362397
IsS11Max=No	IsS11Min=No	FrameElem=50	ElemStation=0.125				
Frame=50	Station=0.125	OutputCase=PESOPR	CaseType=LinStatic	Point=1	X2=-0.5	X3=-0.5	
S11=215.694602146008	IsS11Max=Yes	IsS11Min=No	FrameElem=50	ElemStation=0.125			
Frame=50	Station=0.125	OutputCase=PESOPR	CaseType=LinStatic	Point=2	X2=-0.5	X3=0.5	
S11=215.694602146008	IsS11Max=No	IsS11Min=No	FrameElem=50	ElemStation=0.125			
Frame=50	Station=0.125	OutputCase=PESOPR	CaseType=LinStatic	Point=3	X2=0.5	X3=-0.5	S11=-
185.352708673529	IsS11Max=No	IsS11Min=Yes	FrameElem=50	ElemStation=0.125			
Frame=50	Station=0.125	OutputCase=PESOPR	CaseType=LinStatic	Point=4	X2=0.5	X3=0.5	S11=-
185.352708673529	IsS11Max=No	IsS11Min=No	FrameElem=50	ElemStation=0.125			
Frame=50	Station=0.25	OutputCase=PESOPR	CaseType=LinStatic	Point=0	X2=0	X3=0	S11=15.1709467362397
IsS11Max=No	IsS11Min=No	FrameElem=50	ElemStation=0.25				
Frame=50	Station=0.25	OutputCase=PESOPR	CaseType=LinStatic	Point=1	X2=-0.5	X3=-0.5	
S11=240.303977137659	IsS11Max=Yes	IsS11Min=No	FrameElem=50	ElemStation=0.25			
Frame=50	Station=0.25	OutputCase=PESOPR	CaseType=LinStatic	Point=2	X2=-0.5	X3=0.5	
S11=240.303977137659	IsS11Max=No	IsS11Min=No	FrameElem=50	ElemStation=0.25			
Frame=50	Station=0.25	OutputCase=PESOPR	CaseType=LinStatic	Point=3	X2=0.5	X3=-0.5	S11=-
209.962083665179	IsS11Max=No	IsS11Min=Yes	FrameElem=50	ElemStation=0.25			
Frame=50	Station=0.25	OutputCase=PESOPR	CaseType=LinStatic	Point=4	X2=0.5	X3=0.5	S11=-
209.962083665179	IsS11Max=No	IsS11Min=No	FrameElem=50	ElemStation=0.25			
Frame=50	Station=0.375	OutputCase=PESOPR	CaseType=LinStatic	Point=0	X2=0	X3=0	S11=15.1709467362397
IsS11Max=No	IsS11Min=No	FrameElem=50	ElemStation=0.375				
Frame=50	Station=0.375	OutputCase=PESOPR	CaseType=LinStatic	Point=1	X2=-0.5	X3=-0.5	
S11=262.56960212931	IsS11Max=Yes	IsS11Min=No	FrameElem=50	ElemStation=0.375			
Frame=50	Station=0.375	OutputCase=PESOPR	CaseType=LinStatic	Point=2	X2=-0.5	X3=0.5	
S11=262.56960212931	IsS11Max=No	IsS11Min=No	FrameElem=50	ElemStation=0.375			
Frame=50	Station=0.375	OutputCase=PESOPR	CaseType=LinStatic	Point=3	X2=0.5	X3=-0.5	S11=-
232.22770865683	IsS11Max=No	IsS11Min=Yes	FrameElem=50	ElemStation=0.375			
Frame=50	Station=0.375	OutputCase=PESOPR	CaseType=LinStatic	Point=4	X2=0.5	X3=0.5	S11=-
232.22770865683	IsS11Max=No	IsS11Min=No	FrameElem=50	ElemStation=0.375			
Frame=50	Station=0.5	OutputCase=PESOPR	CaseType=LinStatic	Point=0	X2=0	X3=0	S11=15.1709467362397
IsS11Max=No	IsS11Min=No	FrameElem=50	ElemStation=0.5				
Frame=50	Station=0.5	OutputCase=PESOPR	CaseType=LinStatic	Point=1	X2=-0.5	X3=-0.5	
S11=282.49147712096	IsS11Max=Yes	IsS11Min=No	FrameElem=50	ElemStation=0.5			
Frame=50	Station=0.5	OutputCase=PESOPR	CaseType=LinStatic	Point=2	X2=-0.5	X3=0.5	
S11=282.49147712096	IsS11Max=No	IsS11Min=No	FrameElem=50	ElemStation=0.5			
Frame=50	Station=0.5	OutputCase=PESOPR	CaseType=LinStatic	Point=3	X2=0.5	X3=-0.5	S11=-
252.149583648481	IsS11Max=No	IsS11Min=Yes	FrameElem=50	ElemStation=0.5			
Frame=50	Station=0.5	OutputCase=PESOPR	CaseType=LinStatic	Point=4	X2=0.5	X3=0.5	S11=-
252.149583648481	IsS11Max=No	IsS11Min=No	FrameElem=50	ElemStation=0.5			
Frame=50	Station=0	OutputCase=TERRVERT	CaseType=LinStatic	Point=0	X2=0	X3=0	S11=-1.15282857328748
IsS11Max=No	IsS11Min=No	FrameElem=50	ElemStation=0				
Frame=50	Station=0	OutputCase=TERRVERT	CaseType=LinStatic	Point=1	X2=-0.5	X3=-0.5	
S11=988.67851342388	IsS11Max=Yes	IsS11Min=No	FrameElem=50	ElemStation=0			
Frame=50	Station=0	OutputCase=TERRVERT	CaseType=LinStatic	Point=2	X2=-0.5	X3=0.5	
S11=988.67851342388	IsS11Max=No	IsS11Min=No	FrameElem=50	ElemStation=0			
Frame=50	Station=0	OutputCase=TERRVERT	CaseType=LinStatic	Point=3	X2=0.5	X3=-0.5	S11=-
990.984170570455	IsS11Max=No	IsS11Min=Yes	FrameElem=50	ElemStation=0			
Frame=50	Station=0	OutputCase=TERRVERT	CaseType=LinStatic	Point=4	X2=0.5	X3=0.5	S11=-
990.984170570455	IsS11Max=No	IsS11Min=No	FrameElem=50	ElemStation=0			
Frame=50	Station=0.125	OutputCase=TERRVERT	CaseType=LinStatic	Point=0	X2=0	X3=0	S11=-
1.15282857328748	IsS11Max=No	IsS11Min=No	FrameElem=50	ElemStation=0.125			
Frame=50	Station=0.125	OutputCase=TERRVERT	CaseType=LinStatic	Point=1	X2=-0.5	X3=-0.5	
S11=1200.53007577567	IsS11Max=Yes	IsS11Min=No	FrameElem=50	ElemStation=0.125			
Frame=50	Station=0.125	OutputCase=TERRVERT	CaseType=LinStatic	Point=2	X2=-0.5	X3=0.5	
S11=1200.53007577567	IsS11Max=No	IsS11Min=No	FrameElem=50	ElemStation=0.125			
Frame=50	Station=0.125	OutputCase=TERRVERT	CaseType=LinStatic	Point=3	X2=0.5	X3=-0.5	S11=-
1202.83573292224	IsS11Max=No	IsS11Min=Yes	FrameElem=50	ElemStation=0.125			
Frame=50	Station=0.125	OutputCase=TERRVERT	CaseType=LinStatic	Point=4	X2=0.5	X3=0.5	S11=-
1202.83573292224	IsS11Max=No	IsS11Min=No	FrameElem=50	ElemStation=0.125			
Frame=50	Station=0.25	OutputCase=TERRVERT	CaseType=LinStatic	Point=0	X2=0	X3=0	S11=-
1.15282857328748	IsS11Max=No	IsS11Min=No	FrameElem=50	ElemStation=0.25			

Frame=50	Station=0.25	OutputCase=TERRVERT	CaseType=LinStatic	Point=1	X2=-0.5	X3=-0.5		
S11=1393.95976312746	IsS11Max=Yes	IsS11Min=No	FrameElem=50	ElemStation=0.25				
Frame=50	Station=0.25	OutputCase=TERRVERT	CaseType=LinStatic	Point=2	X2=-0.5	X3=0.5		
S11=1393.95976312746	IsS11Max=No	IsS11Min=No	FrameElem=50	ElemStation=0.25				
Frame=50	Station=0.25	OutputCase=TERRVERT	CaseType=LinStatic	Point=3	X2=0.5	X3=-0.5	S11=-	
1396.26542027403	IsS11Max=No	IsS11Min=Yes	FrameElem=50	ElemStation=0.25				
Frame=50	Station=0.25	OutputCase=TERRVERT	CaseType=LinStatic	Point=4	X2=0.5	X3=0.5	S11=-	
1396.26542027403	IsS11Max=No	IsS11Min=No	FrameElem=50	ElemStation=0.25				
Frame=50	Station=0.375	OutputCase=TERRVERT	CaseType=LinStatic	Point=0	X2=0	X3=0	S11=-	
1.15282857328748	IsS11Max=No	IsS11Min=Yes	FrameElem=50	ElemStation=0.375				
Frame=50	Station=0.375	OutputCase=TERRVERT	CaseType=LinStatic	Point=1	X2=-0.5	X3=-0.5		
S11=1568.96757547925	IsS11Max=Yes	IsS11Min=No	FrameElem=50	ElemStation=0.375				
Frame=50	Station=0.375	OutputCase=TERRVERT	CaseType=LinStatic	Point=2	X2=-0.5	X3=0.5		
S11=1568.96757547925	IsS11Max=No	IsS11Min=No	FrameElem=50	ElemStation=0.375				
Frame=50	Station=0.375	OutputCase=TERRVERT	CaseType=LinStatic	Point=3	X2=0.5	X3=-0.5	S11=-	
1571.27323262582	IsS11Max=No	IsS11Min=Yes	FrameElem=50	ElemStation=0.375				
Frame=50	Station=0.375	OutputCase=TERRVERT	CaseType=LinStatic	Point=4	X2=0.5	X3=0.5	S11=-	
1571.27323262582	IsS11Max=No	IsS11Min=No	FrameElem=50	ElemStation=0.375				
Frame=50	Station=0.5	OutputCase=TERRVERT	CaseType=LinStatic	Point=0	X2=0	X3=0	S11=-1.15282857328748	
IsS11Max=No	IsS11Min=No	FrameElem=50	ElemStation=0.5					
Frame=50	Station=0.5	OutputCase=TERRVERT	CaseType=LinStatic	Point=1	X2=-0.5	X3=-0.5		
S11=1725.55351283103	IsS11Max=Yes	IsS11Min=No	FrameElem=50	ElemStation=0.5				
Frame=50	Station=0.5	OutputCase=TERRVERT	CaseType=LinStatic	Point=2	X2=-0.5	X3=0.5		
S11=1725.55351283103	IsS11Max=No	IsS11Min=No	FrameElem=50	ElemStation=0.5				
Frame=50	Station=0.5	OutputCase=TERRVERT	CaseType=LinStatic	Point=3	X2=0.5	X3=-0.5	S11=-	
1727.85916997761	IsS11Max=No	IsS11Min=Yes	FrameElem=50	ElemStation=0.5				
Frame=50	Station=0.5	OutputCase=TERRVERT	CaseType=LinStatic	Point=4	X2=0.5	X3=0.5	S11=-	
1727.85916997761	IsS11Max=No	IsS11Min=No	FrameElem=50	ElemStation=0.5				
Frame=50	Station=0	OutputCase=TERRLAT	CaseType=LinStatic	Point=0	X2=0	X3=0	S11=-66.7117981831703	
IsS11Max=No	IsS11Min=No	FrameElem=50	ElemStation=0					
Frame=50	Station=0	OutputCase=TERRLAT	CaseType=LinStatic	Point=1	X2=-0.5	X3=-0.5	S11=-	
190.013373149918	IsS11Max=No	IsS11Min=Yes	FrameElem=50	ElemStation=0				
Frame=50	Station=0	OutputCase=TERRLAT	CaseType=LinStatic	Point=2	X2=-0.5	X3=0.5	S11=-	
190.013373149918	IsS11Max=No	IsS11Min=No	FrameElem=50	ElemStation=0				
Frame=50	Station=0	OutputCase=TERRLAT	CaseType=LinStatic	Point=3	X2=0.5	X3=-0.5		
S11=56.5897767835773	IsS11Max=Yes	IsS11Min=No	FrameElem=50	ElemStation=0				
Frame=50	Station=0	OutputCase=TERRLAT	CaseType=LinStatic	Point=4	X2=0.5	X3=0.5	S11=56.5897767835773	
IsS11Max=No	IsS11Min=No	FrameElem=50	ElemStation=0					
Frame=50	Station=0.125	OutputCase=TERRLAT	CaseType=LinStatic	Point=0	X2=0	X3=0	S11=-	
66.7117981831703	IsS11Max=No	IsS11Min=No	FrameElem=50	ElemStation=0.125				
Frame=50	Station=0.125	OutputCase=TERRLAT	CaseType=LinStatic	Point=1	X2=-0.5	X3=-0.5	S11=-	
190.013373400553	IsS11Max=No	IsS11Min=Yes	FrameElem=50	ElemStation=0.125				
Frame=50	Station=0.125	OutputCase=TERRLAT	CaseType=LinStatic	Point=2	X2=-0.5	X3=0.5	S11=-	
190.013373400553	IsS11Max=No	IsS11Min=No	FrameElem=50	ElemStation=0.125				
Frame=50	Station=0.125	OutputCase=TERRLAT	CaseType=LinStatic	Point=3	X2=0.5	X3=-0.5		
S11=56.5897770342129	IsS11Max=Yes	IsS11Min=No	FrameElem=50	ElemStation=0.125				
Frame=50	Station=0.125	OutputCase=TERRLAT	CaseType=LinStatic	Point=4	X2=0.5	X3=0.5		
S11=56.5897770342129	IsS11Max=No	IsS11Min=No	FrameElem=50	ElemStation=0.125				
Frame=50	Station=0.25	OutputCase=TERRLAT	CaseType=LinStatic	Point=0	X2=0	X3=0	S11=-66.7117981831703	
IsS11Max=No	IsS11Min=No	FrameElem=50	ElemStation=0.25					
Frame=50	Station=0.25	OutputCase=TERRLAT	CaseType=LinStatic	Point=1	X2=-0.5	X3=-0.5	S11=-	
190.013373651189	IsS11Max=No	IsS11Min=Yes	FrameElem=50	ElemStation=0.25				
Frame=50	Station=0.25	OutputCase=TERRLAT	CaseType=LinStatic	Point=2	X2=-0.5	X3=0.5	S11=-	
190.013373651189	IsS11Max=No	IsS11Min=No	FrameElem=50	ElemStation=0.25				
Frame=50	Station=0.25	OutputCase=TERRLAT	CaseType=LinStatic	Point=3	X2=0.5	X3=-0.5		
S11=56.5897772848485	IsS11Max=Yes	IsS11Min=No	FrameElem=50	ElemStation=0.25				
Frame=50	Station=0.25	OutputCase=TERRLAT	CaseType=LinStatic	Point=4	X2=0.5	X3=0.5		
S11=56.5897772848485	IsS11Max=No	IsS11Min=No	FrameElem=50	ElemStation=0.25				
Frame=50	Station=0.375	OutputCase=TERRLAT	CaseType=LinStatic	Point=0	X2=0	X3=0	S11=-	
66.7117981831703	IsS11Max=No	IsS11Min=No	FrameElem=50	ElemStation=0.375				
Frame=50	Station=0.375	OutputCase=TERRLAT	CaseType=LinStatic	Point=1	X2=-0.5	X3=-0.5	S11=-	
190.013373901825	IsS11Max=No	IsS11Min=Yes	FrameElem=50	ElemStation=0.375				
Frame=50	Station=0.375	OutputCase=TERRLAT	CaseType=LinStatic	Point=2	X2=-0.5	X3=0.5	S11=-	
190.013373901825	IsS11Max=No	IsS11Min=No	FrameElem=50	ElemStation=0.375				
Frame=50	Station=0.375	OutputCase=TERRLAT	CaseType=LinStatic	Point=3	X2=0.5	X3=-0.5		
S11=56.589777535484	IsS11Max=Yes	IsS11Min=No	FrameElem=50	ElemStation=0.375				
Frame=50	Station=0.375	OutputCase=TERRLAT	CaseType=LinStatic	Point=4	X2=0.5	X3=0.5		
S11=56.589777535484	IsS11Max=No	IsS11Min=No	FrameElem=50	ElemStation=0.375				
Frame=50	Station=0.5	OutputCase=TERRLAT	CaseType=LinStatic	Point=0	X2=0	X3=0	S11=-66.7117981831703	
IsS11Max=No	IsS11Min=No	FrameElem=50	ElemStation=0.5					
Frame=50	Station=0.5	OutputCase=TERRLAT	CaseType=LinStatic	Point=1	X2=-0.5	X3=-0.5	S11=-	
190.01337415246	IsS11Max=No	IsS11Min=Yes	FrameElem=50	ElemStation=0.5				
Frame=50	Station=0.5	OutputCase=TERRLAT	CaseType=LinStatic	Point=2	X2=-0.5	X3=0.5	S11=-	
190.01337415246	IsS11Max=No	IsS11Min=No	FrameElem=50	ElemStation=0.5				
Frame=50	Station=0.5	OutputCase=TERRLAT	CaseType=LinStatic	Point=3	X2=0.5	X3=-0.5		
S11=56.5897777861196	IsS11Max=Yes	IsS11Min=No	FrameElem=50	ElemStation=0.5				
Frame=50	Station=0.5	OutputCase=TERRLAT	CaseType=LinStatic	Point=4	X2=0.5	X3=0.5		
S11=56.5897777861196	IsS11Max=No	IsS11Min=No	FrameElem=50	ElemStation=0.5				
Frame=50	Station=0	OutputCase=ACCLATDX	CaseType=LinStatic	Point=0	X2=0	X3=0	S11=0	IsS11Max=Yes
IsS11Min=Yes	FrameElem=50	ElemStation=0						
Frame=50	Station=0	OutputCase=ACCLATDX	CaseType=LinStatic	Point=1	X2=-0.5	X3=-0.5	S11=0	
IsS11Max=No	IsS11Min=No	FrameElem=50	ElemStation=0					

Frame=50	Station=0.125	OutputCase=SOVRCOST	CaseType=LinStatic	Point=4	X2=0.5	X3=0.5	S11=0	
IsS11Max=No	IsS11Min=No	FrameElem=50	ElemStation=0.125					
Frame=50	Station=0.25	OutputCase=SOVRCOST	CaseType=LinStatic	Point=0	X2=0	X3=0	S11=0	IsS11Max=Yes
IsS11Min=Yes	FrameElem=50	ElemStation=0.25						
Frame=50	Station=0.25	OutputCase=SOVRCOST	CaseType=LinStatic	Point=1	X2=-0.5	X3=-0.5	S11=0	
IsS11Max=No	IsS11Min=No	FrameElem=50	ElemStation=0.25					
Frame=50	Station=0.25	OutputCase=SOVRCOST	CaseType=LinStatic	Point=2	X2=-0.5	X3=0.5	S11=0	
IsS11Max=No	IsS11Min=No	FrameElem=50	ElemStation=0.25					
Frame=50	Station=0.25	OutputCase=SOVRCOST	CaseType=LinStatic	Point=3	X2=0.5	X3=-0.5	S11=0	
IsS11Max=No	IsS11Min=No	FrameElem=50	ElemStation=0.25					
Frame=50	Station=0.25	OutputCase=SOVRCOST	CaseType=LinStatic	Point=4	X2=0.5	X3=0.5	S11=0	
IsS11Max=No	IsS11Min=No	FrameElem=50	ElemStation=0.25					
Frame=50	Station=0.375	OutputCase=SOVRCOST	CaseType=LinStatic	Point=0	X2=0	X3=0	S11=0	
IsS11Max=Yes	IsS11Min=Yes	FrameElem=50	ElemStation=0.375					
Frame=50	Station=0.375	OutputCase=SOVRCOST	CaseType=LinStatic	Point=1	X2=-0.5	X3=-0.5	S11=0	
IsS11Max=No	IsS11Min=No	FrameElem=50	ElemStation=0.375					
Frame=50	Station=0.375	OutputCase=SOVRCOST	CaseType=LinStatic	Point=2	X2=-0.5	X3=0.5	S11=0	
IsS11Max=No	IsS11Min=No	FrameElem=50	ElemStation=0.375					
Frame=50	Station=0.375	OutputCase=SOVRCOST	CaseType=LinStatic	Point=3	X2=0.5	X3=-0.5	S11=0	
IsS11Max=No	IsS11Min=No	FrameElem=50	ElemStation=0.375					
Frame=50	Station=0.375	OutputCase=SOVRCOST	CaseType=LinStatic	Point=4	X2=0.5	X3=0.5	S11=0	
IsS11Max=No	IsS11Min=No	FrameElem=50	ElemStation=0.375					
Frame=50	Station=0.5	OutputCase=SOVRCOST	CaseType=LinStatic	Point=0	X2=0	X3=0	S11=0	IsS11Max=Yes
IsS11Min=Yes	FrameElem=50	ElemStation=0.5						
Frame=50	Station=0.5	OutputCase=SOVRCOST	CaseType=LinStatic	Point=1	X2=-0.5	X3=-0.5	S11=0	
IsS11Max=No	IsS11Min=No	FrameElem=50	ElemStation=0.5					
Frame=50	Station=0.5	OutputCase=SOVRCOST	CaseType=LinStatic	Point=2	X2=-0.5	X3=0.5	S11=0	
IsS11Max=No	IsS11Min=No	FrameElem=50	ElemStation=0.5					
Frame=50	Station=0.5	OutputCase=SOVRCOST	CaseType=LinStatic	Point=3	X2=0.5	X3=-0.5	S11=0	
IsS11Max=No	IsS11Min=No	FrameElem=50	ElemStation=0.5					
Frame=50	Station=0.5	OutputCase=SOVRCOST	CaseType=LinStatic	Point=4	X2=0.5	X3=0.5	S11=0	
IsS11Max=No	IsS11Min=No	FrameElem=50	ElemStation=0.5					
Frame=50	Station=0	OutputCase=ENVE	CaseType=Combination	StepType=Max	Point=0	X2=0	X3=0	S11=-
32.680140565267	IsS11Max=No	IsS11Min=No	FrameElem=50	ElemStation=0				
Frame=50	Station=0	OutputCase=ENVE	CaseType=Combination	StepType=Max	Point=1	X2=-0.5	X3=-0.5	
S11=1044.41062937329	IsS11Max=Yes	IsS11Min=No	FrameElem=50	ElemStation=0				
Frame=50	Station=0	OutputCase=ENVE	CaseType=Combination	StepType=Max	Point=2	X2=-0.5	X3=0.5	
S11=1044.41062937329	IsS11Max=No	IsS11Min=No	FrameElem=50	ElemStation=0				
Frame=50	Station=0	OutputCase=ENVE	CaseType=Combination	StepType=Max	Point=3	X2=0.5	X3=-0.5	S11=-
1092.79397746876	IsS11Max=No	IsS11Min=Yes	FrameElem=50	ElemStation=0				
Frame=50	Station=0	OutputCase=ENVE	CaseType=Combination	StepType=Max	Point=4	X2=0.5	X3=0.5	S11=-
1092.79397746876	IsS11Max=No	IsS11Min=No	FrameElem=50	ElemStation=0				
Frame=50	Station=0.125	OutputCase=ENVE	CaseType=Combination	StepType=Max	Point=0	X2=0	X3=0	S11=-
32.680140565267	IsS11Max=No	IsS11Min=No	FrameElem=50	ElemStation=0.125				
Frame=50	Station=0.125	OutputCase=ENVE	CaseType=Combination	StepType=Max	Point=1	X2=-0.5	X3=-0.5	
S11=1283.21531654129	IsS11Max=Yes	IsS11Min=No	FrameElem=50	ElemStation=0.125				
Frame=50	Station=0.125	OutputCase=ENVE	CaseType=Combination	StepType=Max	Point=2	X2=-0.5	X3=0.5	
S11=1283.21531654129	IsS11Max=No	IsS11Min=No	FrameElem=50	ElemStation=0.125				
Frame=50	Station=0.125	OutputCase=ENVE	CaseType=Combination	StepType=Max	Point=3	X2=0.5	X3=-0.5	
S11=-1331.59866456156	IsS11Max=No	IsS11Min=Yes	FrameElem=50	ElemStation=0.125				
Frame=50	Station=0.125	OutputCase=ENVE	CaseType=Combination	StepType=Max	Point=4	X2=0.5	X3=0.5	
S11=-1331.59866456156	IsS11Max=No	IsS11Min=No	FrameElem=50	ElemStation=0.125				
Frame=50	Station=0.25	OutputCase=ENVE	CaseType=Combination	StepType=Max	Point=0	X2=0	X3=0	S11=-
32.680140565267	IsS11Max=No	IsS11Min=No	FrameElem=50	ElemStation=0.25				
Frame=50	Station=0.25	OutputCase=ENVE	CaseType=Combination	StepType=Max	Point=1	X2=-0.5	X3=-0.5	
S11=1501.25437870928	IsS11Max=Yes	IsS11Min=No	FrameElem=50	ElemStation=0.25				
Frame=50	Station=0.25	OutputCase=ENVE	CaseType=Combination	StepType=Max	Point=2	X2=-0.5	X3=0.5	
S11=1501.25437870928	IsS11Max=No	IsS11Min=No	FrameElem=50	ElemStation=0.25				
Frame=50	Station=0.25	OutputCase=ENVE	CaseType=Combination	StepType=Max	Point=3	X2=0.5	X3=-0.5	
S11=-1549.63772665436	IsS11Max=No	IsS11Min=Yes	FrameElem=50	ElemStation=0.25				
Frame=50	Station=0.25	OutputCase=ENVE	CaseType=Combination	StepType=Max	Point=4	X2=0.5	X3=0.5	
S11=-1549.63772665436	IsS11Max=No	IsS11Min=No	FrameElem=50	ElemStation=0.25				
Frame=50	Station=0.375	OutputCase=ENVE	CaseType=Combination	StepType=Max	Point=0	X2=0	X3=0	S11=-
32.680140565267	IsS11Max=No	IsS11Min=No	FrameElem=50	ElemStation=0.375				
Frame=50	Station=0.375	OutputCase=ENVE	CaseType=Combination	StepType=Max	Point=1	X2=-0.5	X3=-0.5	
S11=1698.52781587728	IsS11Max=Yes	IsS11Min=No	FrameElem=50	ElemStation=0.375				
Frame=50	Station=0.375	OutputCase=ENVE	CaseType=Combination	StepType=Max	Point=2	X2=-0.5	X3=0.5	
S11=1698.52781587728	IsS11Max=No	IsS11Min=No	FrameElem=50	ElemStation=0.375				
Frame=50	Station=0.375	OutputCase=ENVE	CaseType=Combination	StepType=Max	Point=3	X2=0.5	X3=-0.5	
S11=-1746.91116374717	IsS11Max=No	IsS11Min=Yes	FrameElem=50	ElemStation=0.375				
Frame=50	Station=0.375	OutputCase=ENVE	CaseType=Combination	StepType=Max	Point=4	X2=0.5	X3=0.5	
S11=-1746.91116374717	IsS11Max=No	IsS11Min=No	FrameElem=50	ElemStation=0.375				
Frame=50	Station=0.5	OutputCase=ENVE	CaseType=Combination	StepType=Max	Point=0	X2=0	X3=0	S11=-
32.680140565267	IsS11Max=No	IsS11Min=No	FrameElem=50	ElemStation=0.5				
Frame=50	Station=0.5	OutputCase=ENVE	CaseType=Combination	StepType=Max	Point=1	X2=-0.5	X3=-0.5	
S11=1875.03562804527	IsS11Max=Yes	IsS11Min=No	FrameElem=50	ElemStation=0.5				
Frame=50	Station=0.5	OutputCase=ENVE	CaseType=Combination	StepType=Max	Point=2	X2=-0.5	X3=0.5	
S11=1875.03562804527	IsS11Max=No	IsS11Min=No	FrameElem=50	ElemStation=0.5				
Frame=50	Station=0.5	OutputCase=ENVE	CaseType=Combination	StepType=Max	Point=3	X2=0.5	X3=-0.5	
S11=-1923.41897583997	IsS11Max=No	IsS11Min=Yes	FrameElem=50	ElemStation=0.5				
Frame=50	Station=0.5	OutputCase=ENVE	CaseType=Combination	StepType=Max	Point=4	X2=0.5	X3=0.5	
S11=-1923.41897583997	IsS11Max=No	IsS11Min=No	FrameElem=50	ElemStation=0.5				

Frame=50	Station=0	OutputCase=ENVE	CaseType=Combination	StepType=Min	Point=0	X2=0	X3=0	S11=-
52.6936800202181	IsS11Max=No	IsS11Min=No	FrameElem=50	ElemStation=0				
Frame=50	Station=0	OutputCase=ENVE	CaseType=Combination	StepType=Min	Point=1	X2=-0.5	X3=-0.5	
S11=987.406617428319	IsS11Max=Yes	IsS11Min=No	FrameElem=50	ElemStation=0				
Frame=50	Station=0	OutputCase=ENVE	CaseType=Combination	StepType=Min	Point=2	X2=-0.5	X3=0.5	
S11=987.406617428319	IsS11Max=No	IsS11Min=No	FrameElem=50	ElemStation=0				
Frame=50	Station=0	OutputCase=ENVE	CaseType=Combination	StepType=Min	Point=3	X2=0.5	X3=-0.5	S11=-
1109.77091050383	IsS11Max=No	IsS11Min=Yes	FrameElem=50	ElemStation=0				
Frame=50	Station=0	OutputCase=ENVE	CaseType=Combination	StepType=Min	Point=4	X2=0.5	X3=0.5	S11=-
1109.77091050383	IsS11Max=No	IsS11Min=No	FrameElem=50	ElemStation=0				
Frame=50	Station=0.125	OutputCase=ENVE	CaseType=Combination	StepType=Min	Point=0	X2=0	X3=0	S11=-
52.6936800202181	IsS11Max=No	IsS11Min=No	FrameElem=50	ElemStation=0.125				
Frame=50	Station=0.125	OutputCase=ENVE	CaseType=Combination	StepType=Min	Point=1	X2=-0.5	X3=-0.5	
S11=1226.21130452112	IsS11Max=Yes	IsS11Min=No	FrameElem=50	ElemStation=0.125				
Frame=50	Station=0.125	OutputCase=ENVE	CaseType=Combination	StepType=Min	Point=2	X2=-0.5	X3=0.5	
S11=1226.21130452112	IsS11Max=No	IsS11Min=No	FrameElem=50	ElemStation=0.125				
Frame=50	Station=0.125	OutputCase=ENVE	CaseType=Combination	StepType=Min	Point=3	X2=0.5	X3=-0.5	
S11=-1348.57559767182	IsS11Max=No	IsS11Min=Yes	FrameElem=50	ElemStation=0.125				
Frame=50	Station=0.125	OutputCase=ENVE	CaseType=Combination	StepType=Min	Point=4	X2=0.5	X3=0.5	
S11=-1348.57559767182	IsS11Max=No	IsS11Min=No	FrameElem=50	ElemStation=0.125				
Frame=50	Station=0.25	OutputCase=ENVE	CaseType=Combination	StepType=Min	Point=0	X2=0	X3=0	S11=-
52.6936800202181	IsS11Max=No	IsS11Min=No	FrameElem=50	ElemStation=0.25				
Frame=50	Station=0.25	OutputCase=ENVE	CaseType=Combination	StepType=Min	Point=1	X2=-0.5	X3=-0.5	
S11=1444.25036661393	IsS11Max=Yes	IsS11Min=No	FrameElem=50	ElemStation=0.25				
Frame=50	Station=0.25	OutputCase=ENVE	CaseType=Combination	StepType=Min	Point=2	X2=-0.5	X3=0.5	
S11=1444.25036661393	IsS11Max=No	IsS11Min=No	FrameElem=50	ElemStation=0.25				
Frame=50	Station=0.25	OutputCase=ENVE	CaseType=Combination	StepType=Min	Point=3	X2=0.5	X3=-0.5	
S11=-1566.61465983982	IsS11Max=No	IsS11Min=Yes	FrameElem=50	ElemStation=0.25				
Frame=50	Station=0.25	OutputCase=ENVE	CaseType=Combination	StepType=Min	Point=4	X2=0.5	X3=0.5	
S11=-1566.61465983982	IsS11Max=No	IsS11Min=No	FrameElem=50	ElemStation=0.25				
Frame=50	Station=0.375	OutputCase=ENVE	CaseType=Combination	StepType=Min	Point=0	X2=0	X3=0	S11=-
52.6936800202181	IsS11Max=No	IsS11Min=No	FrameElem=50	ElemStation=0.375				
Frame=50	Station=0.375	OutputCase=ENVE	CaseType=Combination	StepType=Min	Point=1	X2=-0.5	X3=-0.5	
S11=1641.52380370673	IsS11Max=Yes	IsS11Min=No	FrameElem=50	ElemStation=0.375				
Frame=50	Station=0.375	OutputCase=ENVE	CaseType=Combination	StepType=Min	Point=2	X2=-0.5	X3=0.5	
S11=1641.52380370673	IsS11Max=No	IsS11Min=No	FrameElem=50	ElemStation=0.375				
Frame=50	Station=0.375	OutputCase=ENVE	CaseType=Combination	StepType=Min	Point=3	X2=0.5	X3=-0.5	
S11=-1763.88809700781	IsS11Max=No	IsS11Min=Yes	FrameElem=50	ElemStation=0.375				
Frame=50	Station=0.375	OutputCase=ENVE	CaseType=Combination	StepType=Min	Point=4	X2=0.5	X3=0.5	
S11=-1763.88809700781	IsS11Max=No	IsS11Min=No	FrameElem=50	ElemStation=0.375				
Frame=50	Station=0.5	OutputCase=ENVE	CaseType=Combination	StepType=Min	Point=0	X2=0	X3=0	S11=-
52.6936800202181	IsS11Max=No	IsS11Min=No	FrameElem=50	ElemStation=0.5				
Frame=50	Station=0.5	OutputCase=ENVE	CaseType=Combination	StepType=Min	Point=1	X2=-0.5	X3=-0.5	
S11=1818.03161579954	IsS11Max=Yes	IsS11Min=No	FrameElem=50	ElemStation=0.5				
Frame=50	Station=0.5	OutputCase=ENVE	CaseType=Combination	StepType=Min	Point=2	X2=-0.5	X3=0.5	
S11=1818.03161579954	IsS11Max=No	IsS11Min=No	FrameElem=50	ElemStation=0.5				
Frame=50	Station=0.5	OutputCase=ENVE	CaseType=Combination	StepType=Min	Point=3	X2=0.5	X3=-0.5	
S11=-1940.39590917581	IsS11Max=No	IsS11Min=Yes	FrameElem=50	ElemStation=0.5				
Frame=50	Station=0.5	OutputCase=ENVE	CaseType=Combination	StepType=Min	Point=4	X2=0.5	X3=0.5	
S11=-1940.39590917581	IsS11Max=No	IsS11Min=No	FrameElem=50	ElemStation=0.5				
Frame=50	Station=0	OutputCase=FESSUR	CaseType=Combination	Point=0	X2=0	X3=0	S11=-52.6936800202181	
IsS11Max=No	IsS11Min=No	FrameElem=50	ElemStation=0					
Frame=50	Station=0	OutputCase=FESSUR	CaseType=Combination	Point=1	X2=-0.5	X3=-0.5		
S11=987.406617428319	IsS11Max=Yes	IsS11Min=No	FrameElem=50	ElemStation=0				
Frame=50	Station=0	OutputCase=FESSUR	CaseType=Combination	Point=2	X2=-0.5	X3=0.5		
S11=987.406617428319	IsS11Max=No	IsS11Min=No	FrameElem=50	ElemStation=0				
Frame=50	Station=0	OutputCase=FESSUR	CaseType=Combination	Point=3	X2=0.5	X3=-0.5	S11=-	
1092.79397746876	IsS11Max=No	IsS11Min=Yes	FrameElem=50	ElemStation=0				
Frame=50	Station=0	OutputCase=FESSUR	CaseType=Combination	Point=4	X2=0.5	X3=0.5	S11=-	
1092.79397746876	IsS11Max=No	IsS11Min=No	FrameElem=50	ElemStation=0				
Frame=50	Station=0.125	OutputCase=FESSUR	CaseType=Combination	Point=0	X2=0	X3=0	S11=-	
52.6936800202181	IsS11Max=No	IsS11Min=No	FrameElem=50	ElemStation=0.125				
Frame=50	Station=0.125	OutputCase=FESSUR	CaseType=Combination	Point=1	X2=-0.5	X3=-0.5		
S11=1226.21130452112	IsS11Max=Yes	IsS11Min=No	FrameElem=50	ElemStation=0.125				
Frame=50	Station=0.125	OutputCase=FESSUR	CaseType=Combination	Point=2	X2=-0.5	X3=0.5		
S11=1226.21130452112	IsS11Max=No	IsS11Min=No	FrameElem=50	ElemStation=0.125				
Frame=50	Station=0.125	OutputCase=FESSUR	CaseType=Combination	Point=3	X2=0.5	X3=-0.5	S11=-	
1331.59866456156	IsS11Max=No	IsS11Min=Yes	FrameElem=50	ElemStation=0.125				
Frame=50	Station=0.125	OutputCase=FESSUR	CaseType=Combination	Point=4	X2=0.5	X3=0.5	S11=-	
1331.59866456156	IsS11Max=No	IsS11Min=No	FrameElem=50	ElemStation=0.125				
Frame=50	Station=0.25	OutputCase=FESSUR	CaseType=Combination	Point=0	X2=0	X3=0	S11=-	
52.6936800202181	IsS11Max=No	IsS11Min=No	FrameElem=50	ElemStation=0.25				
Frame=50	Station=0.25	OutputCase=FESSUR	CaseType=Combination	Point=1	X2=-0.5	X3=-0.5		
S11=1444.25036661393	IsS11Max=Yes	IsS11Min=No	FrameElem=50	ElemStation=0.25				
Frame=50	Station=0.25	OutputCase=FESSUR	CaseType=Combination	Point=2	X2=-0.5	X3=0.5		
S11=1444.25036661393	IsS11Max=No	IsS11Min=No	FrameElem=50	ElemStation=0.25				
Frame=50	Station=0.25	OutputCase=FESSUR	CaseType=Combination	Point=3	X2=0.5	X3=-0.5	S11=-	
1549.63772665436	IsS11Max=No	IsS11Min=Yes	FrameElem=50	ElemStation=0.25				
Frame=50	Station=0.25	OutputCase=FESSUR	CaseType=Combination	Point=4	X2=0.5	X3=0.5	S11=-	
1549.63772665436	IsS11Max=No	IsS11Min=No	FrameElem=50	ElemStation=0.25				
Frame=50	Station=0.375	OutputCase=FESSUR	CaseType=Combination	Point=0	X2=0	X3=0	S11=-	
52.6936800202181	IsS11Max=No	IsS11Min=No	FrameElem=50	ElemStation=0.375				

Frame=50 Station=0.375 OutputCase=FESSUR CaseType=Combination Point=1 X2=-0.5 X3=-0.5
 S11=1641.52380370673 IsS11Max=Yes IsS11Min=No FrameElem=50 ElemStation=0.375
 Frame=50 Station=0.375 OutputCase=FESSUR CaseType=Combination Point=2 X2=-0.5 X3=0.5
 S11=1641.52380370673 IsS11Max=No IsS11Min=No FrameElem=50 ElemStation=0.375
 Frame=50 Station=0.375 OutputCase=FESSUR CaseType=Combination Point=3 X2=0.5 X3=-0.5 S11=-
 1746.9116374717 IsS11Max=No IsS11Min=Yes FrameElem=50 ElemStation=0.375
 Frame=50 Station=0.375 OutputCase=FESSUR CaseType=Combination Point=4 X2=0.5 X3=0.5 S11=-
 1746.9116374717 IsS11Max=No IsS11Min=No FrameElem=50 ElemStation=0.375
 Frame=50 Station=0.5 OutputCase=FESSUR CaseType=Combination Point=0 X2=0 X3=0 S11=-52.6936800202181
 IsS11Max=No IsS11Min=No FrameElem=50 ElemStation=0.5
 Frame=50 Station=0.5 OutputCase=FESSUR CaseType=Combination Point=1 X2=-0.5 X3=-0.5
 S11=1818.03161579954 IsS11Max=Yes IsS11Min=No FrameElem=50 ElemStation=0.5
 Frame=50 Station=0.5 OutputCase=FESSUR CaseType=Combination Point=2 X2=-0.5 X3=0.5
 S11=1818.03161579954 IsS11Max=No IsS11Min=No FrameElem=50 ElemStation=0.5
 Frame=50 Station=0.5 OutputCase=FESSUR CaseType=Combination Point=3 X2=0.5 X3=-0.5 S11=-
 1923.41897583997 IsS11Max=No IsS11Min=Yes FrameElem=50 ElemStation=0.5
 Frame=50 Station=0.5 OutputCase=FESSUR CaseType=Combination Point=4 X2=0.5 X3=0.5 S11=-
 1923.41897583997 IsS11Max=No IsS11Min=No FrameElem=50 ElemStation=0.5
 Frame=51 Station=0 OutputCase=PESOPR CaseType=LinStatic Point=0 X2=0 X3=0 S11=15.1709467362397
 IsS11Max=No IsS11Min=No FrameElem=51 ElemStation=0
 Frame=51 Station=0 OutputCase=PESOPR CaseType=LinStatic Point=1 X2=-0.5 X3=-0.5
 S11=282.491477120982 IsS11Max=Yes IsS11Min=No FrameElem=51 ElemStation=0
 Frame=51 Station=0 OutputCase=PESOPR CaseType=LinStatic Point=2 X2=-0.5 X3=0.5 S11=282.491477120982
 IsS11Max=No IsS11Min=No FrameElem=51 ElemStation=0
 Frame=51 Station=0 OutputCase=PESOPR CaseType=LinStatic Point=3 X2=0.5 X3=-0.5 S11=-
 252.149583648503 IsS11Max=No IsS11Min=Yes FrameElem=51 ElemStation=0
 Frame=51 Station=0 OutputCase=PESOPR CaseType=LinStatic Point=4 X2=0.5 X3=0.5 S11=-252.149583648503
 IsS11Max=No IsS11Min=No FrameElem=51 ElemStation=0
 Frame=51 Station=0.125 OutputCase=PESOPR CaseType=LinStatic Point=0 X2=0 X3=0 S11=15.1709467362397
 IsS11Max=No IsS11Min=No FrameElem=51 ElemStation=0.125
 Frame=51 Station=0.125 OutputCase=PESOPR CaseType=LinStatic Point=1 X2=-0.5 X3=-0.5
 S11=300.069602112633 IsS11Max=Yes IsS11Min=No FrameElem=51 ElemStation=0.125
 Frame=51 Station=0.125 OutputCase=PESOPR CaseType=LinStatic Point=2 X2=-0.5 X3=0.5
 S11=300.069602112633 IsS11Max=No IsS11Min=No FrameElem=51 ElemStation=0.125
 Frame=51 Station=0.125 OutputCase=PESOPR CaseType=LinStatic Point=3 X2=0.5 X3=-0.5 S11=-
 269.727708640154 IsS11Max=No IsS11Min=No FrameElem=51 ElemStation=0.125
 Frame=51 Station=0.125 OutputCase=PESOPR CaseType=LinStatic Point=4 X2=0.5 X3=0.5 S11=-
 269.727708640154 IsS11Max=No IsS11Min=No FrameElem=51 ElemStation=0.125
 Frame=51 Station=0.25 OutputCase=PESOPR CaseType=LinStatic Point=0 X2=0 X3=0 S11=15.1709467362397
 IsS11Max=No IsS11Min=No FrameElem=51 ElemStation=0.25
 Frame=51 Station=0.25 OutputCase=PESOPR CaseType=LinStatic Point=1 X2=-0.5 X3=-0.5
 S11=315.303977104284 IsS11Max=Yes IsS11Min=No FrameElem=51 ElemStation=0.25
 Frame=51 Station=0.25 OutputCase=PESOPR CaseType=LinStatic Point=2 X2=-0.5 X3=0.5
 S11=315.303977104284 IsS11Max=No IsS11Min=No FrameElem=51 ElemStation=0.25
 Frame=51 Station=0.25 OutputCase=PESOPR CaseType=LinStatic Point=3 X2=0.5 X3=-0.5 S11=-
 284.962083631805 IsS11Max=No IsS11Min=Yes FrameElem=51 ElemStation=0.25
 Frame=51 Station=0.25 OutputCase=PESOPR CaseType=LinStatic Point=4 X2=0.5 X3=0.5 S11=-
 284.962083631805 IsS11Max=No IsS11Min=No FrameElem=51 ElemStation=0.25
 Frame=51 Station=0.375 OutputCase=PESOPR CaseType=LinStatic Point=0 X2=0 X3=0 S11=15.1709467362397
 IsS11Max=No IsS11Min=No FrameElem=51 ElemStation=0.375
 Frame=51 Station=0.375 OutputCase=PESOPR CaseType=LinStatic Point=1 X2=-0.5 X3=-0.5
 S11=328.194602095935 IsS11Max=Yes IsS11Min=No FrameElem=51 ElemStation=0.375
 Frame=51 Station=0.375 OutputCase=PESOPR CaseType=LinStatic Point=2 X2=-0.5 X3=0.5
 S11=328.194602095935 IsS11Max=No IsS11Min=No FrameElem=51 ElemStation=0.375
 Frame=51 Station=0.375 OutputCase=PESOPR CaseType=LinStatic Point=3 X2=0.5 X3=-0.5 S11=-
 297.852708623455 IsS11Max=No IsS11Min=Yes FrameElem=51 ElemStation=0.375
 Frame=51 Station=0.375 OutputCase=PESOPR CaseType=LinStatic Point=4 X2=0.5 X3=0.5 S11=-
 297.852708623455 IsS11Max=No IsS11Min=No FrameElem=51 ElemStation=0.375
 Frame=51 Station=0.5 OutputCase=PESOPR CaseType=LinStatic Point=0 X2=0 X3=0 S11=15.1709467362397
 IsS11Max=No IsS11Min=No FrameElem=51 ElemStation=0.5
 Frame=51 Station=0.5 OutputCase=PESOPR CaseType=LinStatic Point=1 X2=-0.5 X3=-0.5
 S11=338.741477087586 IsS11Max=Yes IsS11Min=No FrameElem=51 ElemStation=0.5
 Frame=51 Station=0.5 OutputCase=PESOPR CaseType=LinStatic Point=2 X2=-0.5 X3=0.5
 S11=338.741477087586 IsS11Max=No IsS11Min=No FrameElem=51 ElemStation=0.5
 Frame=51 Station=0.5 OutputCase=PESOPR CaseType=LinStatic Point=3 X2=0.5 X3=-0.5 S11=-
 308.399583615106 IsS11Max=No IsS11Min=Yes FrameElem=51 ElemStation=0.5
 Frame=51 Station=0.5 OutputCase=PESOPR CaseType=LinStatic Point=4 X2=0.5 X3=0.5 S11=-
 308.399583615106 IsS11Max=No IsS11Min=No FrameElem=51 ElemStation=0.5
 Frame=51 Station=0 OutputCase=TERRVERT CaseType=LinStatic Point=0 X2=0 X3=0 S11=-1.15282857328748
 IsS11Max=No IsS11Min=No FrameElem=51 ElemStation=0
 Frame=51 Station=0 OutputCase=TERRVERT CaseType=LinStatic Point=1 X2=-0.5 X3=-0.5
 S11=1725.55351283103 IsS11Max=Yes IsS11Min=No FrameElem=51 ElemStation=0
 Frame=51 Station=0 OutputCase=TERRVERT CaseType=LinStatic Point=2 X2=-0.5 X3=0.5
 S11=1725.55351283103 IsS11Max=No IsS11Min=No FrameElem=51 ElemStation=0
 Frame=51 Station=0 OutputCase=TERRVERT CaseType=LinStatic Point=3 X2=0.5 X3=-0.5 S11=-
 1727.85916997761 IsS11Max=No IsS11Min=Yes FrameElem=51 ElemStation=0
 Frame=51 Station=0 OutputCase=TERRVERT CaseType=LinStatic Point=4 X2=0.5 X3=0.5 S11=-
 1727.85916997761 IsS11Max=No IsS11Min=No FrameElem=51 ElemStation=0
 Frame=51 Station=0.125 OutputCase=TERRVERT CaseType=LinStatic Point=0 X2=0 X3=0 S11=-
 1.15282857328748 IsS11Max=No IsS11Min=No FrameElem=51 ElemStation=0.125
 Frame=51 Station=0.125 OutputCase=TERRVERT CaseType=LinStatic Point=1 X2=-0.5 X3=-0.5
 S11=1863.71757518285 IsS11Max=Yes IsS11Min=No FrameElem=51 ElemStation=0.125

```

Frame=51 Station=0.125 OutputCase=TERRVERT CaseType=LinStatic Point=2 X2=-0.5 X3=0.5
S11=1863.71757518285 IsS11Max=No IsS11Min=No FrameElem=51 ElemStation=0.125
Frame=51 Station=0.125 OutputCase=TERRVERT CaseType=LinStatic Point=3 X2=0.5 X3=-0.5 S11=-
1866.02323232942 IsS11Max=No IsS11Min=Yes FrameElem=51 ElemStation=0.125
Frame=51 Station=0.125 OutputCase=TERRVERT CaseType=LinStatic Point=4 X2=0.5 X3=0.5 S11=-
1866.02323232942 IsS11Max=No IsS11Min=No FrameElem=51 ElemStation=0.125
Frame=51 Station=0.25 OutputCase=TERRVERT CaseType=LinStatic Point=0 X2=0 X3=0 S11=-
1.15282857328748 IsS11Max=No IsS11Min=No FrameElem=51 ElemStation=0.25
Frame=51 Station=0.25 OutputCase=TERRVERT CaseType=LinStatic Point=1 X2=-0.5 X3=-0.5
S11=1983.45976253466 IsS11Max=Yes IsS11Min=No FrameElem=51 ElemStation=0.25
Frame=51 Station=0.25 OutputCase=TERRVERT CaseType=LinStatic Point=2 X2=-0.5 X3=0.5
S11=1983.45976253466 IsS11Max=No IsS11Min=No FrameElem=51 ElemStation=0.25
Frame=51 Station=0.25 OutputCase=TERRVERT CaseType=LinStatic Point=3 X2=0.5 X3=-0.5 S11=-
1985.76541968123 IsS11Max=No IsS11Min=Yes FrameElem=51 ElemStation=0.25
Frame=51 Station=0.25 OutputCase=TERRVERT CaseType=LinStatic Point=4 X2=0.5 X3=0.5 S11=-
1985.76541968123 IsS11Max=No IsS11Min=No FrameElem=51 ElemStation=0.25
Frame=51 Station=0.375 OutputCase=TERRVERT CaseType=LinStatic Point=0 X2=0 X3=0 S11=-
1.15282857328748 IsS11Max=No IsS11Min=No FrameElem=51 ElemStation=0.375
Frame=51 Station=0.375 OutputCase=TERRVERT CaseType=LinStatic Point=1 X2=-0.5 X3=-0.5
S11=2084.78007488647 IsS11Max=Yes IsS11Min=No FrameElem=51 ElemStation=0.375
Frame=51 Station=0.375 OutputCase=TERRVERT CaseType=LinStatic Point=2 X2=-0.5 X3=0.5
S11=2084.78007488647 IsS11Max=No IsS11Min=No FrameElem=51 ElemStation=0.375
Frame=51 Station=0.375 OutputCase=TERRVERT CaseType=LinStatic Point=3 X2=0.5 X3=-0.5 S11=-
2087.08573203304 IsS11Max=No IsS11Min=Yes FrameElem=51 ElemStation=0.375
Frame=51 Station=0.375 OutputCase=TERRVERT CaseType=LinStatic Point=4 X2=0.5 X3=0.5 S11=-
2087.08573203304 IsS11Max=No IsS11Min=No FrameElem=51 ElemStation=0.375
Frame=51 Station=0.5 OutputCase=TERRVERT CaseType=LinStatic Point=0 X2=0 X3=0 S11=-1.15282857328748
IsS11Max=No IsS11Min=No FrameElem=51 ElemStation=0.5
Frame=51 Station=0.5 OutputCase=TERRVERT CaseType=LinStatic Point=1 X2=-0.5 X3=-0.5
S11=2167.67851223828 IsS11Max=Yes IsS11Min=No FrameElem=51 ElemStation=0.5
Frame=51 Station=0.5 OutputCase=TERRVERT CaseType=LinStatic Point=2 X2=-0.5 X3=0.5
S11=2167.67851223828 IsS11Max=No IsS11Min=No FrameElem=51 ElemStation=0.5
Frame=51 Station=0.5 OutputCase=TERRVERT CaseType=LinStatic Point=3 X2=0.5 X3=-0.5 S11=-
2169.98416938485 IsS11Max=No IsS11Min=Yes FrameElem=51 ElemStation=0.5
Frame=51 Station=0.5 OutputCase=TERRVERT CaseType=LinStatic Point=4 X2=0.5 X3=0.5 S11=-
2169.98416938485 IsS11Max=No IsS11Min=No FrameElem=51 ElemStation=0.5
Frame=51 Station=0 OutputCase=TERRLAT CaseType=LinStatic Point=0 X2=0 X3=0 S11=-66.7117981831702
IsS11Max=No IsS11Min=No FrameElem=51 ElemStation=0
Frame=51 Station=0 OutputCase=TERRLAT CaseType=LinStatic Point=1 X2=-0.5 X3=-0.5 S11=-
190.01337415246 IsS11Max=No IsS11Min=Yes FrameElem=51 ElemStation=0
Frame=51 Station=0 OutputCase=TERRLAT CaseType=LinStatic Point=2 X2=-0.5 X3=0.5 S11=-
190.01337415246 IsS11Max=No IsS11Min=No FrameElem=51 ElemStation=0
Frame=51 Station=0 OutputCase=TERRLAT CaseType=LinStatic Point=3 X2=0.5 X3=-0.5
S11=56.5897777861197 IsS11Max=Yes IsS11Min=No FrameElem=51 ElemStation=0
Frame=51 Station=0 OutputCase=TERRLAT CaseType=LinStatic Point=4 X2=0.5 X3=0.5 S11=56.5897777861197
IsS11Max=No IsS11Min=No FrameElem=51 ElemStation=0
Frame=51 Station=0.125 OutputCase=TERRLAT CaseType=LinStatic Point=0 X2=0 X3=0 S11=-
66.7117981831702 IsS11Max=No IsS11Min=No FrameElem=51 ElemStation=0.125
Frame=51 Station=0.125 OutputCase=TERRLAT CaseType=LinStatic Point=1 X2=-0.5 X3=-0.5 S11=-
190.013374403096 IsS11Max=No IsS11Min=Yes FrameElem=51 ElemStation=0.125
Frame=51 Station=0.125 OutputCase=TERRLAT CaseType=LinStatic Point=2 X2=-0.5 X3=0.5 S11=-
190.013374403096 IsS11Max=No IsS11Min=No FrameElem=51 ElemStation=0.125
Frame=51 Station=0.125 OutputCase=TERRLAT CaseType=LinStatic Point=3 X2=0.5 X3=-0.5
S11=56.5897780367552 IsS11Max=Yes IsS11Min=No FrameElem=51 ElemStation=0.125
Frame=51 Station=0.125 OutputCase=TERRLAT CaseType=LinStatic Point=4 X2=0.5 X3=0.5
S11=56.5897780367552 IsS11Max=No IsS11Min=No FrameElem=51 ElemStation=0.125
Frame=51 Station=0.25 OutputCase=TERRLAT CaseType=LinStatic Point=0 X2=0 X3=0 S11=-66.7117981831702
IsS11Max=No IsS11Min=No FrameElem=51 ElemStation=0.25
Frame=51 Station=0.25 OutputCase=TERRLAT CaseType=LinStatic Point=1 X2=-0.5 X3=-0.5 S11=-
190.013374653731 IsS11Max=No IsS11Min=Yes FrameElem=51 ElemStation=0.25
Frame=51 Station=0.25 OutputCase=TERRLAT CaseType=LinStatic Point=2 X2=-0.5 X3=0.5 S11=-
190.013374653731 IsS11Max=No IsS11Min=No FrameElem=51 ElemStation=0.25
Frame=51 Station=0.25 OutputCase=TERRLAT CaseType=LinStatic Point=3 X2=0.5 X3=-0.5
S11=56.5897782873907 IsS11Max=Yes IsS11Min=No FrameElem=51 ElemStation=0.25
Frame=51 Station=0.25 OutputCase=TERRLAT CaseType=LinStatic Point=4 X2=0.5 X3=0.5
S11=56.5897782873907 IsS11Max=No IsS11Min=No FrameElem=51 ElemStation=0.25
Frame=51 Station=0.375 OutputCase=TERRLAT CaseType=LinStatic Point=0 X2=0 X3=0 S11=-
66.7117981831702 IsS11Max=No IsS11Min=No FrameElem=51 ElemStation=0.375
Frame=51 Station=0.375 OutputCase=TERRLAT CaseType=LinStatic Point=1 X2=-0.5 X3=-0.5 S11=-
190.013374904367 IsS11Max=No IsS11Min=Yes FrameElem=51 ElemStation=0.375
Frame=51 Station=0.375 OutputCase=TERRLAT CaseType=LinStatic Point=2 X2=-0.5 X3=0.5 S11=-
190.013374904367 IsS11Max=No IsS11Min=No FrameElem=51 ElemStation=0.375
Frame=51 Station=0.375 OutputCase=TERRLAT CaseType=LinStatic Point=3 X2=0.5 X3=-0.5
S11=56.5897785380262 IsS11Max=Yes IsS11Min=No FrameElem=51 ElemStation=0.375
Frame=51 Station=0.375 OutputCase=TERRLAT CaseType=LinStatic Point=4 X2=0.5 X3=0.5
S11=56.5897785380262 IsS11Max=No IsS11Min=No FrameElem=51 ElemStation=0.375
Frame=51 Station=0.5 OutputCase=TERRLAT CaseType=LinStatic Point=0 X2=0 X3=0 S11=-66.7117981831702
IsS11Max=No IsS11Min=No FrameElem=51 ElemStation=0.5
Frame=51 Station=0.5 OutputCase=TERRLAT CaseType=LinStatic Point=1 X2=-0.5 X3=-0.5 S11=-
190.013375155002 IsS11Max=No IsS11Min=Yes FrameElem=51 ElemStation=0.5
Frame=51 Station=0.5 OutputCase=TERRLAT CaseType=LinStatic Point=2 X2=-0.5 X3=0.5 S11=-
190.013375155002 IsS11Max=No IsS11Min=No FrameElem=51 ElemStation=0.5

```

Frame=51	Station=0.125	OutputCase=SOVRCOST	CaseType=LinStatic	Point=0	X2=0	X3=0	S11=0	
IsS11Max=Yes	IsS11Min=Yes	FrameElem=51	ElemStation=0.125					
Frame=51	Station=0.125	OutputCase=SOVRCOST	CaseType=LinStatic	Point=1	X2=-0.5	X3=-0.5	S11=0	
IsS11Max=No	IsS11Min=No	FrameElem=51	ElemStation=0.125					
Frame=51	Station=0.125	OutputCase=SOVRCOST	CaseType=LinStatic	Point=2	X2=-0.5	X3=0.5	S11=0	
IsS11Max=No	IsS11Min=No	FrameElem=51	ElemStation=0.125					
Frame=51	Station=0.125	OutputCase=SOVRCOST	CaseType=LinStatic	Point=3	X2=0.5	X3=-0.5	S11=0	
IsS11Max=No	IsS11Min=No	FrameElem=51	ElemStation=0.125					
Frame=51	Station=0.125	OutputCase=SOVRCOST	CaseType=LinStatic	Point=4	X2=0.5	X3=0.5	S11=0	
IsS11Max=No	IsS11Min=No	FrameElem=51	ElemStation=0.125					
Frame=51	Station=0.25	OutputCase=SOVRCOST	CaseType=LinStatic	Point=0	X2=0	X3=0	S11=0	IsS11Max=Yes
IsS11Min=Yes	FrameElem=51	ElemStation=0.25						
Frame=51	Station=0.25	OutputCase=SOVRCOST	CaseType=LinStatic	Point=1	X2=-0.5	X3=-0.5	S11=0	
IsS11Max=No	IsS11Min=No	FrameElem=51	ElemStation=0.25					
Frame=51	Station=0.25	OutputCase=SOVRCOST	CaseType=LinStatic	Point=2	X2=-0.5	X3=0.5	S11=0	
IsS11Max=No	IsS11Min=No	FrameElem=51	ElemStation=0.25					
Frame=51	Station=0.25	OutputCase=SOVRCOST	CaseType=LinStatic	Point=3	X2=0.5	X3=-0.5	S11=0	
IsS11Max=No	IsS11Min=No	FrameElem=51	ElemStation=0.25					
Frame=51	Station=0.25	OutputCase=SOVRCOST	CaseType=LinStatic	Point=4	X2=0.5	X3=0.5	S11=0	
IsS11Max=No	IsS11Min=No	FrameElem=51	ElemStation=0.25					
Frame=51	Station=0.375	OutputCase=SOVRCOST	CaseType=LinStatic	Point=0	X2=0	X3=0	S11=0	
IsS11Max=Yes	IsS11Min=Yes	FrameElem=51	ElemStation=0.375					
Frame=51	Station=0.375	OutputCase=SOVRCOST	CaseType=LinStatic	Point=1	X2=-0.5	X3=-0.5	S11=0	
IsS11Max=No	IsS11Min=No	FrameElem=51	ElemStation=0.375					
Frame=51	Station=0.375	OutputCase=SOVRCOST	CaseType=LinStatic	Point=2	X2=-0.5	X3=0.5	S11=0	
IsS11Max=No	IsS11Min=No	FrameElem=51	ElemStation=0.375					
Frame=51	Station=0.375	OutputCase=SOVRCOST	CaseType=LinStatic	Point=3	X2=0.5	X3=-0.5	S11=0	
IsS11Max=No	IsS11Min=No	FrameElem=51	ElemStation=0.375					
Frame=51	Station=0.375	OutputCase=SOVRCOST	CaseType=LinStatic	Point=4	X2=0.5	X3=0.5	S11=0	
IsS11Max=No	IsS11Min=No	FrameElem=51	ElemStation=0.375					
Frame=51	Station=0.5	OutputCase=SOVRCOST	CaseType=LinStatic	Point=0	X2=0	X3=0	S11=0	IsS11Max=Yes
IsS11Min=Yes	FrameElem=51	ElemStation=0.5						
Frame=51	Station=0.5	OutputCase=SOVRCOST	CaseType=LinStatic	Point=1	X2=-0.5	X3=-0.5	S11=0	
IsS11Max=No	IsS11Min=No	FrameElem=51	ElemStation=0.5					
Frame=51	Station=0.5	OutputCase=SOVRCOST	CaseType=LinStatic	Point=2	X2=-0.5	X3=0.5	S11=0	
IsS11Max=No	IsS11Min=No	FrameElem=51	ElemStation=0.5					
Frame=51	Station=0.5	OutputCase=SOVRCOST	CaseType=LinStatic	Point=3	X2=0.5	X3=-0.5	S11=0	
IsS11Max=No	IsS11Min=No	FrameElem=51	ElemStation=0.5					
Frame=51	Station=0.5	OutputCase=SOVRCOST	CaseType=LinStatic	Point=4	X2=0.5	X3=0.5	S11=0	
IsS11Max=No	IsS11Min=No	FrameElem=51	ElemStation=0.5					
Frame=51	Station=0	OutputCase=ENVE	CaseType=Combination	StepType=Max	Point=0	X2=0	X3=0	S11=-
32.6801405652669	IsS11Max=No	IsS11Min=No	FrameElem=51	ElemStation=0				
Frame=51	Station=0	OutputCase=ENVE	CaseType=Combination	StepType=Max	Point=1	X2=-0.5	X3=-0.5	
S11=1875.0356280453	IsS11Max=Yes	IsS11Min=No	FrameElem=51	ElemStation=0				
Frame=51	Station=0	OutputCase=ENVE	CaseType=Combination	StepType=Max	Point=2	X2=-0.5	X3=0.5	
S11=1875.0356280453	IsS11Max=No	IsS11Min=No	FrameElem=51	ElemStation=0				
Frame=51	Station=0	OutputCase=ENVE	CaseType=Combination	StepType=Max	Point=3	X2=0.5	X3=-0.5	S11=-
1923.41897583999	IsS11Max=No	IsS11Min=Yes	FrameElem=51	ElemStation=0				
Frame=51	Station=0	OutputCase=ENVE	CaseType=Combination	StepType=Max	Point=4	X2=0.5	X3=0.5	S11=-
1923.41897583999	IsS11Max=No	IsS11Min=No	FrameElem=51	ElemStation=0				
Frame=51	Station=0.125	OutputCase=ENVE	CaseType=Combination	StepType=Max	Point=0	X2=0	X3=0	S11=-
32.6801405652669	IsS11Max=No	IsS11Min=No	FrameElem=51	ElemStation=0.125				
Frame=51	Station=0.125	OutputCase=ENVE	CaseType=Combination	StepType=Max	Point=1	X2=-0.5	X3=-0.5	
S11=2030.77781521331	IsS11Max=Yes	IsS11Min=No	FrameElem=51	ElemStation=0.125				
Frame=51	Station=0.125	OutputCase=ENVE	CaseType=Combination	StepType=Max	Point=2	X2=-0.5	X3=0.5	
S11=2030.77781521331	IsS11Max=No	IsS11Min=No	FrameElem=51	ElemStation=0.125				
Frame=51	Station=0.125	OutputCase=ENVE	CaseType=Combination	StepType=Max	Point=3	X2=0.5	X3=-0.5	
S11=-2079.16116293282	IsS11Max=No	IsS11Min=Yes	FrameElem=51	ElemStation=0.125				
Frame=51	Station=0.125	OutputCase=ENVE	CaseType=Combination	StepType=Max	Point=4	X2=0.5	X3=0.5	
S11=-2079.16116293282	IsS11Max=No	IsS11Min=No	FrameElem=51	ElemStation=0.125				
Frame=51	Station=0.25	OutputCase=ENVE	CaseType=Combination	StepType=Max	Point=0	X2=0	X3=0	S11=-
32.6801405652669	IsS11Max=No	IsS11Min=No	FrameElem=51	ElemStation=0.25				
Frame=51	Station=0.25	OutputCase=ENVE	CaseType=Combination	StepType=Max	Point=1	X2=-0.5	X3=-0.5	
S11=2165.75437738133	IsS11Max=Yes	IsS11Min=No	FrameElem=51	ElemStation=0.25				
Frame=51	Station=0.25	OutputCase=ENVE	CaseType=Combination	StepType=Max	Point=2	X2=-0.5	X3=0.5	
S11=2165.75437738133	IsS11Max=No	IsS11Min=No	FrameElem=51	ElemStation=0.25				
Frame=51	Station=0.25	OutputCase=ENVE	CaseType=Combination	StepType=Max	Point=3	X2=0.5	X3=-0.5	
S11=-2214.13772502564	IsS11Max=No	IsS11Min=Yes	FrameElem=51	ElemStation=0.25				
Frame=51	Station=0.25	OutputCase=ENVE	CaseType=Combination	StepType=Max	Point=4	X2=0.5	X3=0.5	
S11=-2214.13772502564	IsS11Max=No	IsS11Min=No	FrameElem=51	ElemStation=0.25				
Frame=51	Station=0.375	OutputCase=ENVE	CaseType=Combination	StepType=Max	Point=0	X2=0	X3=0	S11=-
32.6801405652669	IsS11Max=No	IsS11Min=No	FrameElem=51	ElemStation=0.375				
Frame=51	Station=0.375	OutputCase=ENVE	CaseType=Combination	StepType=Max	Point=1	X2=-0.5	X3=-0.5	
S11=2279.96531454934	IsS11Max=Yes	IsS11Min=No	FrameElem=51	ElemStation=0.375				
Frame=51	Station=0.375	OutputCase=ENVE	CaseType=Combination	StepType=Max	Point=2	X2=-0.5	X3=0.5	
S11=2279.96531454934	IsS11Max=No	IsS11Min=No	FrameElem=51	ElemStation=0.375				
Frame=51	Station=0.375	OutputCase=ENVE	CaseType=Combination	StepType=Max	Point=3	X2=0.5	X3=-0.5	
S11=-2328.34866211847	IsS11Max=No	IsS11Min=Yes	FrameElem=51	ElemStation=0.375				
Frame=51	Station=0.375	OutputCase=ENVE	CaseType=Combination	StepType=Max	Point=4	X2=0.5	X3=0.5	
S11=-2328.34866211847	IsS11Max=No	IsS11Min=No	FrameElem=51	ElemStation=0.375				
Frame=51	Station=0.5	OutputCase=ENVE	CaseType=Combination	StepType=Max	Point=0	X2=0	X3=0	S11=-
32.6801405652669	IsS11Max=No	IsS11Min=No	FrameElem=51	ElemStation=0.5				

Frame=51	Station=0.5	OutputCase=ENVE	CaseType=Combination	StepType=Max	Point=1	X2=-0.5	X3=-0.5	
S11=2373.41062671736	IsS11Max=Yes	IsS11Min=No	FrameElem=51	ElemStation=0.5				
Frame=51	Station=0.5	OutputCase=ENVE	CaseType=Combination	StepType=Max	Point=2	X2=-0.5	X3=0.5	
S11=2373.41062671736	IsS11Max=No	IsS11Min=No	FrameElem=51	ElemStation=0.5				
Frame=51	Station=0.5	OutputCase=ENVE	CaseType=Combination	StepType=Max	Point=3	X2=0.5	X3=-0.5	
S11=-2421.7939742113	IsS11Max=No	IsS11Min=Yes	FrameElem=51	ElemStation=0.5				
Frame=51	Station=0.5	OutputCase=ENVE	CaseType=Combination	StepType=Max	Point=4	X2=0.5	X3=0.5	
S11=-2421.7939742113	IsS11Max=No	IsS11Min=No	FrameElem=51	ElemStation=0.5				
Frame=51	Station=0	OutputCase=ENVE	CaseType=Combination	StepType=Min	Point=0	X2=0	X3=0	S11=-
52.693680020218	IsS11Max=No	IsS11Min=No	FrameElem=51	ElemStation=0				
Frame=51	Station=0	OutputCase=ENVE	CaseType=Combination	StepType=Min	Point=1	X2=-0.5	X3=-0.5	
S11=1818.03161579956	IsS11Max=Yes	IsS11Min=No	FrameElem=51	ElemStation=0				
Frame=51	Station=0	OutputCase=ENVE	CaseType=Combination	StepType=Min	Point=2	X2=-0.5	X3=0.5	
S11=1818.03161579956	IsS11Max=No	IsS11Min=No	FrameElem=51	ElemStation=0				
Frame=51	Station=0	OutputCase=ENVE	CaseType=Combination	StepType=Min	Point=3	X2=0.5	X3=-0.5	S11=-
1940.39590917583	IsS11Max=No	IsS11Min=Yes	FrameElem=51	ElemStation=0				
Frame=51	Station=0	OutputCase=ENVE	CaseType=Combination	StepType=Min	Point=4	X2=0.5	X3=0.5	S11=-
1940.39590917583	IsS11Max=No	IsS11Min=No	FrameElem=51	ElemStation=0				
Frame=51	Station=0.125	OutputCase=ENVE	CaseType=Combination	StepType=Min	Point=0	X2=0	X3=0	S11=-
52.693680020218	IsS11Max=No	IsS11Min=No	FrameElem=51	ElemStation=0.125				
Frame=51	Station=0.125	OutputCase=ENVE	CaseType=Combination	StepType=Min	Point=1	X2=-0.5	X3=-0.5	
S11=1973.77380289238	IsS11Max=Yes	IsS11Min=No	FrameElem=51	ElemStation=0.125				
Frame=51	Station=0.125	OutputCase=ENVE	CaseType=Combination	StepType=Min	Point=2	X2=-0.5	X3=0.5	
S11=1973.77380289238	IsS11Max=No	IsS11Min=No	FrameElem=51	ElemStation=0.125				
Frame=51	Station=0.125	OutputCase=ENVE	CaseType=Combination	StepType=Min	Point=3	X2=0.5	X3=-0.5	
S11=-2096.13809634385	IsS11Max=No	IsS11Min=Yes	FrameElem=51	ElemStation=0.125				
Frame=51	Station=0.125	OutputCase=ENVE	CaseType=Combination	StepType=Min	Point=4	X2=0.5	X3=0.5	
S11=-2096.13809634385	IsS11Max=No	IsS11Min=No	FrameElem=51	ElemStation=0.125				
Frame=51	Station=0.25	OutputCase=ENVE	CaseType=Combination	StepType=Min	Point=0	X2=0	X3=0	S11=-
52.693680020218	IsS11Max=No	IsS11Min=No	FrameElem=51	ElemStation=0.25				
Frame=51	Station=0.25	OutputCase=ENVE	CaseType=Combination	StepType=Min	Point=1	X2=-0.5	X3=-0.5	
S11=2108.75036498521	IsS11Max=Yes	IsS11Min=No	FrameElem=51	ElemStation=0.25				
Frame=51	Station=0.25	OutputCase=ENVE	CaseType=Combination	StepType=Min	Point=2	X2=-0.5	X3=0.5	
S11=2108.75036498521	IsS11Max=No	IsS11Min=No	FrameElem=51	ElemStation=0.25				
Frame=51	Station=0.25	OutputCase=ENVE	CaseType=Combination	StepType=Min	Point=3	X2=0.5	X3=-0.5	
S11=-2231.11465851186	IsS11Max=No	IsS11Min=Yes	FrameElem=51	ElemStation=0.25				
Frame=51	Station=0.25	OutputCase=ENVE	CaseType=Combination	StepType=Min	Point=4	X2=0.5	X3=0.5	
S11=-2231.11465851186	IsS11Max=No	IsS11Min=No	FrameElem=51	ElemStation=0.25				
Frame=51	Station=0.375	OutputCase=ENVE	CaseType=Combination	StepType=Min	Point=0	X2=0	X3=0	S11=-
52.693680020218	IsS11Max=No	IsS11Min=No	FrameElem=51	ElemStation=0.375				
Frame=51	Station=0.375	OutputCase=ENVE	CaseType=Combination	StepType=Min	Point=1	X2=-0.5	X3=-0.5	
S11=2222.96130207803	IsS11Max=Yes	IsS11Min=No	FrameElem=51	ElemStation=0.375				
Frame=51	Station=0.375	OutputCase=ENVE	CaseType=Combination	StepType=Min	Point=2	X2=-0.5	X3=0.5	
S11=2222.96130207803	IsS11Max=No	IsS11Min=No	FrameElem=51	ElemStation=0.375				
Frame=51	Station=0.375	OutputCase=ENVE	CaseType=Combination	StepType=Min	Point=3	X2=0.5	X3=-0.5	
S11=-2345.32559567988	IsS11Max=No	IsS11Min=Yes	FrameElem=51	ElemStation=0.375				
Frame=51	Station=0.375	OutputCase=ENVE	CaseType=Combination	StepType=Min	Point=4	X2=0.5	X3=0.5	
S11=-2345.32559567988	IsS11Max=No	IsS11Min=No	FrameElem=51	ElemStation=0.375				
Frame=51	Station=0.5	OutputCase=ENVE	CaseType=Combination	StepType=Min	Point=0	X2=0	X3=0	S11=-
52.693680020218	IsS11Max=No	IsS11Min=No	FrameElem=51	ElemStation=0.5				
Frame=51	Station=0.5	OutputCase=ENVE	CaseType=Combination	StepType=Min	Point=1	X2=-0.5	X3=-0.5	
S11=2316.40661417086	IsS11Max=Yes	IsS11Min=No	FrameElem=51	ElemStation=0.5				
Frame=51	Station=0.5	OutputCase=ENVE	CaseType=Combination	StepType=Min	Point=2	X2=-0.5	X3=0.5	
S11=2316.40661417086	IsS11Max=No	IsS11Min=No	FrameElem=51	ElemStation=0.5				
Frame=51	Station=0.5	OutputCase=ENVE	CaseType=Combination	StepType=Min	Point=3	X2=0.5	X3=-0.5	
S11=-2438.7709078479	IsS11Max=No	IsS11Min=Yes	FrameElem=51	ElemStation=0.5				
Frame=51	Station=0.5	OutputCase=ENVE	CaseType=Combination	StepType=Min	Point=4	X2=0.5	X3=0.5	
S11=-2438.7709078479	IsS11Max=No	IsS11Min=No	FrameElem=51	ElemStation=0.5				
Frame=51	Station=0	OutputCase=FESSUR	CaseType=Combination	Point=0	X2=0	X3=0	S11=-52.693680020218	
IsS11Max=No	IsS11Min=No	FrameElem=51	ElemStation=0					
Frame=51	Station=0	OutputCase=FESSUR	CaseType=Combination	Point=1	X2=-0.5	X3=-0.5		
S11=1818.03161579956	IsS11Max=Yes	IsS11Min=No	FrameElem=51	ElemStation=0				
Frame=51	Station=0	OutputCase=FESSUR	CaseType=Combination	Point=2	X2=-0.5	X3=0.5		
S11=1818.03161579956	IsS11Max=No	IsS11Min=No	FrameElem=51	ElemStation=0				
Frame=51	Station=0	OutputCase=FESSUR	CaseType=Combination	Point=3	X2=0.5	X3=-0.5	S11=-	
1923.41897583999	IsS11Max=No	IsS11Min=Yes	FrameElem=51	ElemStation=0				
Frame=51	Station=0	OutputCase=FESSUR	CaseType=Combination	Point=4	X2=0.5	X3=0.5	S11=-	
1923.41897583999	IsS11Max=No	IsS11Min=No	FrameElem=51	ElemStation=0				
Frame=51	Station=0.125	OutputCase=FESSUR	CaseType=Combination	Point=0	X2=0	X3=0	S11=-	
52.693680020218	IsS11Max=No	IsS11Min=No	FrameElem=51	ElemStation=0.125				
Frame=51	Station=0.125	OutputCase=FESSUR	CaseType=Combination	Point=1	X2=-0.5	X3=-0.5		
S11=1973.77380289238	IsS11Max=Yes	IsS11Min=No	FrameElem=51	ElemStation=0.125				
Frame=51	Station=0.125	OutputCase=FESSUR	CaseType=Combination	Point=2	X2=-0.5	X3=0.5		
S11=1973.77380289238	IsS11Max=No	IsS11Min=No	FrameElem=51	ElemStation=0.125				
Frame=51	Station=0.125	OutputCase=FESSUR	CaseType=Combination	Point=3	X2=0.5	X3=-0.5	S11=-	
2079.16116293282	IsS11Max=No	IsS11Min=Yes	FrameElem=51	ElemStation=0.125				
Frame=51	Station=0.125	OutputCase=FESSUR	CaseType=Combination	Point=4	X2=0.5	X3=0.5	S11=-	
2079.16116293282	IsS11Max=No	IsS11Min=No	FrameElem=51	ElemStation=0.125				
Frame=51	Station=0.25	OutputCase=FESSUR	CaseType=Combination	Point=0	X2=0	X3=0	S11=-52.693680020218	
IsS11Max=No	IsS11Min=No	FrameElem=51	ElemStation=0.25					
Frame=51	Station=0.25	OutputCase=FESSUR	CaseType=Combination	Point=1	X2=-0.5	X3=-0.5		
S11=2108.75036498521	IsS11Max=Yes	IsS11Min=No	FrameElem=51	ElemStation=0.25				

```

Frame=51 Station=0.25 OutputCase=FESSUR CaseType=Combination Point=2 X2=-0.5 X3=0.5
S11=2108.75036498521 IsS11Max=No IsS11Min=No FrameElem=51 ElemStation=0.25
Frame=51 Station=0.25 OutputCase=FESSUR CaseType=Combination Point=3 X2=0.5 X3=-0.5 S11=-
2214.13772502564 IsS11Max=No IsS11Min=Yes FrameElem=51 ElemStation=0.25
Frame=51 Station=0.25 OutputCase=FESSUR CaseType=Combination Point=4 X2=0.5 X3=0.5 S11=-
2214.13772502564 IsS11Max=No IsS11Min=No FrameElem=51 ElemStation=0.25
Frame=51 Station=0.375 OutputCase=FESSUR CaseType=Combination Point=0 X2=0 X3=0 S11=-
52.693680020218 IsS11Max=No IsS11Min=No FrameElem=51 ElemStation=0.375
Frame=51 Station=0.375 OutputCase=FESSUR CaseType=Combination Point=1 X2=-0.5 X3=-0.5
S11=2222.96130207803 IsS11Max=Yes IsS11Min=No FrameElem=51 ElemStation=0.375
Frame=51 Station=0.375 OutputCase=FESSUR CaseType=Combination Point=2 X2=-0.5 X3=0.5
S11=2222.96130207803 IsS11Max=No IsS11Min=No FrameElem=51 ElemStation=0.375
Frame=51 Station=0.375 OutputCase=FESSUR CaseType=Combination Point=3 X2=0.5 X3=-0.5 S11=-
2328.34866211847 IsS11Max=No IsS11Min=Yes FrameElem=51 ElemStation=0.375
Frame=51 Station=0.375 OutputCase=FESSUR CaseType=Combination Point=4 X2=0.5 X3=0.5 S11=-
2328.34866211847 IsS11Max=No IsS11Min=No FrameElem=51 ElemStation=0.375
Frame=51 Station=0.5 OutputCase=FESSUR CaseType=Combination Point=0 X2=0 X3=0 S11=-52.693680020218
IsS11Max=No IsS11Min=No FrameElem=51 ElemStation=0.5
Frame=51 Station=0.5 OutputCase=FESSUR CaseType=Combination Point=1 X2=-0.5 X3=-0.5
S11=2316.40661417086 IsS11Max=Yes IsS11Min=No FrameElem=51 ElemStation=0.5
Frame=51 Station=0.5 OutputCase=FESSUR CaseType=Combination Point=2 X2=-0.5 X3=0.5
S11=2316.40661417086 IsS11Max=No IsS11Min=No FrameElem=51 ElemStation=0.5
Frame=51 Station=0.5 OutputCase=FESSUR CaseType=Combination Point=3 X2=0.5 X3=-0.5 S11=-
2421.7939742113 IsS11Max=No IsS11Min=Yes FrameElem=51 ElemStation=0.5
Frame=51 Station=0.5 OutputCase=FESSUR CaseType=Combination Point=4 X2=0.5 X3=0.5 S11=-
2421.7939742113 IsS11Max=No IsS11Min=No FrameElem=51 ElemStation=0.5
Frame=52 Station=0 OutputCase=PESOPR CaseType=LinStatic Point=0 X2=0 X3=0 S11=15.1709467362389
IsS11Max=No IsS11Min=No FrameElem=52 ElemStation=0
Frame=52 Station=0 OutputCase=PESOPR CaseType=LinStatic Point=1 X2=-0.5 X3=-0.5
S11=338.741477087628 IsS11Max=Yes IsS11Min=No FrameElem=52 ElemStation=0
Frame=52 Station=0 OutputCase=PESOPR CaseType=LinStatic Point=2 X2=-0.5 X3=0.5 S11=338.741477087628
IsS11Max=No IsS11Min=No FrameElem=52 ElemStation=0
Frame=52 Station=0 OutputCase=PESOPR CaseType=LinStatic Point=3 X2=0.5 X3=-0.5 S11=-
308.399583615151 IsS11Max=No IsS11Min=Yes FrameElem=52 ElemStation=0
Frame=52 Station=0 OutputCase=PESOPR CaseType=LinStatic Point=4 X2=0.5 X3=0.5 S11=-308.399583615151
IsS11Max=No IsS11Min=No FrameElem=52 ElemStation=0
Frame=52 Station=0.125 OutputCase=PESOPR CaseType=LinStatic Point=0 X2=0 X3=0 S11=15.1709467362389
IsS11Max=No IsS11Min=No FrameElem=52 ElemStation=0.125
Frame=52 Station=0.125 OutputCase=PESOPR CaseType=LinStatic Point=1 X2=-0.5 X3=-0.5
S11=346.94460207929 IsS11Max=Yes IsS11Min=No FrameElem=52 ElemStation=0.125
Frame=52 Station=0.125 OutputCase=PESOPR CaseType=LinStatic Point=2 X2=-0.5 X3=0.5
S11=346.94460207929 IsS11Max=No IsS11Min=No FrameElem=52 ElemStation=0.125
Frame=52 Station=0.125 OutputCase=PESOPR CaseType=LinStatic Point=3 X2=0.5 X3=-0.5 S11=-
316.602708606812 IsS11Max=No IsS11Min=Yes FrameElem=52 ElemStation=0.125
Frame=52 Station=0.125 OutputCase=PESOPR CaseType=LinStatic Point=4 X2=0.5 X3=0.5 S11=-
316.602708606812 IsS11Max=No IsS11Min=No FrameElem=52 ElemStation=0.125
Frame=52 Station=0.25 OutputCase=PESOPR CaseType=LinStatic Point=0 X2=0 X3=0 S11=15.1709467362389
IsS11Max=No IsS11Min=No FrameElem=52 ElemStation=0.25
Frame=52 Station=0.25 OutputCase=PESOPR CaseType=LinStatic Point=1 X2=-0.5 X3=-0.5
S11=352.803977070952 IsS11Max=Yes IsS11Min=No FrameElem=52 ElemStation=0.25
Frame=52 Station=0.25 OutputCase=PESOPR CaseType=LinStatic Point=2 X2=-0.5 X3=0.5
S11=352.803977070952 IsS11Max=No IsS11Min=No FrameElem=52 ElemStation=0.25
Frame=52 Station=0.25 OutputCase=PESOPR CaseType=LinStatic Point=3 X2=0.5 X3=-0.5 S11=-
322.462083598474 IsS11Max=No IsS11Min=Yes FrameElem=52 ElemStation=0.25
Frame=52 Station=0.25 OutputCase=PESOPR CaseType=LinStatic Point=4 X2=0.5 X3=0.5 S11=-
322.462083598474 IsS11Max=No IsS11Min=No FrameElem=52 ElemStation=0.25
Frame=52 Station=0.375 OutputCase=PESOPR CaseType=LinStatic Point=0 X2=0 X3=0 S11=15.1709467362389
IsS11Max=No IsS11Min=No FrameElem=52 ElemStation=0.375
Frame=52 Station=0.375 OutputCase=PESOPR CaseType=LinStatic Point=1 X2=-0.5 X3=-0.5
S11=356.319602062614 IsS11Max=Yes IsS11Min=No FrameElem=52 ElemStation=0.375
Frame=52 Station=0.375 OutputCase=PESOPR CaseType=LinStatic Point=2 X2=-0.5 X3=0.5
S11=356.319602062614 IsS11Max=No IsS11Min=No FrameElem=52 ElemStation=0.375
Frame=52 Station=0.375 OutputCase=PESOPR CaseType=LinStatic Point=3 X2=0.5 X3=-0.5 S11=-
325.977708590136 IsS11Max=No IsS11Min=Yes FrameElem=52 ElemStation=0.375
Frame=52 Station=0.375 OutputCase=PESOPR CaseType=LinStatic Point=4 X2=0.5 X3=0.5 S11=-
325.977708590136 IsS11Max=No IsS11Min=No FrameElem=52 ElemStation=0.375
Frame=52 Station=0.5 OutputCase=PESOPR CaseType=LinStatic Point=0 X2=0 X3=0 S11=15.1709467362389
IsS11Max=No IsS11Min=No FrameElem=52 ElemStation=0.5
Frame=52 Station=0.5 OutputCase=PESOPR CaseType=LinStatic Point=1 X2=-0.5 X3=-0.5
S11=357.491477054275 IsS11Max=Yes IsS11Min=No FrameElem=52 ElemStation=0.5
Frame=52 Station=0.5 OutputCase=PESOPR CaseType=LinStatic Point=2 X2=-0.5 X3=0.5
S11=357.491477054275 IsS11Max=No IsS11Min=No FrameElem=52 ElemStation=0.5
Frame=52 Station=0.5 OutputCase=PESOPR CaseType=LinStatic Point=3 X2=0.5 X3=-0.5 S11=-
327.149583581798 IsS11Max=No IsS11Min=Yes FrameElem=52 ElemStation=0.5
Frame=52 Station=0.5 OutputCase=PESOPR CaseType=LinStatic Point=4 X2=0.5 X3=0.5 S11=-
327.149583581798 IsS11Max=No IsS11Min=No FrameElem=52 ElemStation=0.5
Frame=52 Station=0 OutputCase=TERRVERT CaseType=LinStatic Point=0 X2=0 X3=0 S11=-1.15282857329027
IsS11Max=No IsS11Min=No FrameElem=52 ElemStation=0
Frame=52 Station=0 OutputCase=TERRVERT CaseType=LinStatic Point=1 X2=-0.5 X3=-0.5
S11=2167.67851223827 IsS11Max=Yes IsS11Min=No FrameElem=52 ElemStation=0
Frame=52 Station=0 OutputCase=TERRVERT CaseType=LinStatic Point=2 X2=-0.5 X3=0.5
S11=2167.67851223827 IsS11Max=No IsS11Min=No FrameElem=52 ElemStation=0

```

Frame=52	Station=0	OutputCase=TERRVERT	CaseType=LinStatic	Point=3	X2=0.5	X3=-0.5	S11=-
2169.98416938485	IsS11Max=No	IsS11Min=Yes	FrameElem=52	ElemStation=0			
Frame=52	Station=0	OutputCase=TERRVERT	CaseType=LinStatic	Point=4	X2=0.5	X3=0.5	S11=-
2169.98416938485	IsS11Max=No	IsS11Min=No	FrameElem=52	ElemStation=0			
Frame=52	Station=0.125	OutputCase=TERRVERT	CaseType=LinStatic	Point=0	X2=0	X3=0	S11=-
1.15282857329027	IsS11Max=No	IsS11Min=No	FrameElem=52	ElemStation=0.125			
Frame=52	Station=0.125	OutputCase=TERRVERT	CaseType=LinStatic	Point=1	X2=-0.5	X3=-0.5	
S11=2232.15507459011	IsS11Max=Yes	IsS11Min=No	FrameElem=52	ElemStation=0.125			
Frame=52	Station=0.125	OutputCase=TERRVERT	CaseType=LinStatic	Point=2	X2=-0.5	X3=0.5	
S11=2232.15507459011	IsS11Max=No	IsS11Min=No	FrameElem=52	ElemStation=0.125			
Frame=52	Station=0.125	OutputCase=TERRVERT	CaseType=LinStatic	Point=3	X2=0.5	X3=-0.5	S11=-
2234.46073173669	IsS11Max=No	IsS11Min=Yes	FrameElem=52	ElemStation=0.125			
Frame=52	Station=0.125	OutputCase=TERRVERT	CaseType=LinStatic	Point=4	X2=0.5	X3=0.5	S11=-
2234.46073173669	IsS11Max=No	IsS11Min=No	FrameElem=52	ElemStation=0.125			
Frame=52	Station=0.25	OutputCase=TERRVERT	CaseType=LinStatic	Point=0	X2=0	X3=0	S11=-
1.15282857329027	IsS11Max=No	IsS11Min=No	FrameElem=52	ElemStation=0.25			
Frame=52	Station=0.25	OutputCase=TERRVERT	CaseType=LinStatic	Point=1	X2=-0.5	X3=-0.5	
S11=2278.20976194194	IsS11Max=Yes	IsS11Min=No	FrameElem=52	ElemStation=0.25			
Frame=52	Station=0.25	OutputCase=TERRVERT	CaseType=LinStatic	Point=2	X2=-0.5	X3=0.5	
S11=2278.20976194194	IsS11Max=No	IsS11Min=No	FrameElem=52	ElemStation=0.25			
Frame=52	Station=0.25	OutputCase=TERRVERT	CaseType=LinStatic	Point=3	X2=0.5	X3=-0.5	S11=-
2280.51541908852	IsS11Max=No	IsS11Min=Yes	FrameElem=52	ElemStation=0.25			
Frame=52	Station=0.25	OutputCase=TERRVERT	CaseType=LinStatic	Point=4	X2=0.5	X3=0.5	S11=-
2280.51541908852	IsS11Max=No	IsS11Min=No	FrameElem=52	ElemStation=0.25			
Frame=52	Station=0.375	OutputCase=TERRVERT	CaseType=LinStatic	Point=0	X2=0	X3=0	S11=-
1.15282857329027	IsS11Max=No	IsS11Min=No	FrameElem=52	ElemStation=0.375			
Frame=52	Station=0.375	OutputCase=TERRVERT	CaseType=LinStatic	Point=1	X2=-0.5	X3=-0.5	
S11=2305.84257429377	IsS11Max=Yes	IsS11Min=No	FrameElem=52	ElemStation=0.375			
Frame=52	Station=0.375	OutputCase=TERRVERT	CaseType=LinStatic	Point=2	X2=-0.5	X3=0.5	
S11=2305.84257429377	IsS11Max=No	IsS11Min=No	FrameElem=52	ElemStation=0.375			
Frame=52	Station=0.375	OutputCase=TERRVERT	CaseType=LinStatic	Point=3	X2=0.5	X3=-0.5	S11=-
2308.14823144035	IsS11Max=No	IsS11Min=Yes	FrameElem=52	ElemStation=0.375			
Frame=52	Station=0.375	OutputCase=TERRVERT	CaseType=LinStatic	Point=4	X2=0.5	X3=0.5	S11=-
2308.14823144035	IsS11Max=No	IsS11Min=No	FrameElem=52	ElemStation=0.375			
Frame=52	Station=0.5	OutputCase=TERRVERT	CaseType=LinStatic	Point=0	X2=0	X3=0	S11=-1.15282857329027
IsS11Max=No	IsS11Min=No	FrameElem=52	ElemStation=0.5				
Frame=52	Station=0.5	OutputCase=TERRVERT	CaseType=LinStatic	Point=1	X2=-0.5	X3=-0.5	
S11=2315.0535116456	IsS11Max=Yes	IsS11Min=No	FrameElem=52	ElemStation=0.5			
Frame=52	Station=0.5	OutputCase=TERRVERT	CaseType=LinStatic	Point=2	X2=-0.5	X3=0.5	
S11=2315.0535116456	IsS11Max=No	IsS11Min=No	FrameElem=52	ElemStation=0.5			
Frame=52	Station=0.5	OutputCase=TERRVERT	CaseType=LinStatic	Point=3	X2=0.5	X3=-0.5	S11=-
2317.35916879218	IsS11Max=No	IsS11Min=Yes	FrameElem=52	ElemStation=0.5			
Frame=52	Station=0.5	OutputCase=TERRVERT	CaseType=LinStatic	Point=4	X2=0.5	X3=0.5	S11=-
2317.35916879218	IsS11Max=No	IsS11Min=No	FrameElem=52	ElemStation=0.5			
Frame=52	Station=0	OutputCase=TERRLAT	CaseType=LinStatic	Point=0	X2=0	X3=0	S11=-66.7117981831702
IsS11Max=No	IsS11Min=No	FrameElem=52	ElemStation=0				
Frame=52	Station=0	OutputCase=TERRLAT	CaseType=LinStatic	Point=1	X2=-0.5	X3=-0.5	S11=-
190.013375155003	IsS11Max=No	IsS11Min=Yes	FrameElem=52	ElemStation=0			
Frame=52	Station=0	OutputCase=TERRLAT	CaseType=LinStatic	Point=2	X2=-0.5	X3=0.5	S11=-
190.013375155003	IsS11Max=No	IsS11Min=No	FrameElem=52	ElemStation=0			
Frame=52	Station=0	OutputCase=TERRLAT	CaseType=LinStatic	Point=3	X2=0.5	X3=-0.5	
S11=56.5897787886622	IsS11Max=Yes	IsS11Min=No	FrameElem=52	ElemStation=0			
Frame=52	Station=0	OutputCase=TERRLAT	CaseType=LinStatic	Point=4	X2=0.5	X3=0.5	S11=56.5897787886622
IsS11Max=No	IsS11Min=No	FrameElem=52	ElemStation=0				
Frame=52	Station=0.125	OutputCase=TERRLAT	CaseType=LinStatic	Point=0	X2=0	X3=0	S11=-
66.7117981831702	IsS11Max=No	IsS11Min=No	FrameElem=52	ElemStation=0.125			
Frame=52	Station=0.125	OutputCase=TERRLAT	CaseType=LinStatic	Point=1	X2=-0.5	X3=-0.5	S11=-
190.013375405638	IsS11Max=No	IsS11Min=Yes	FrameElem=52	ElemStation=0.125			
Frame=52	Station=0.125	OutputCase=TERRLAT	CaseType=LinStatic	Point=2	X2=-0.5	X3=0.5	S11=-
190.013375405638	IsS11Max=No	IsS11Min=No	FrameElem=52	ElemStation=0.125			
Frame=52	Station=0.125	OutputCase=TERRLAT	CaseType=LinStatic	Point=3	X2=0.5	X3=-0.5	
S11=56.5897790392976	IsS11Max=Yes	IsS11Min=No	FrameElem=52	ElemStation=0.125			
Frame=52	Station=0.125	OutputCase=TERRLAT	CaseType=LinStatic	Point=4	X2=0.5	X3=0.5	
S11=56.5897790392976	IsS11Max=No	IsS11Min=No	FrameElem=52	ElemStation=0.125			
Frame=52	Station=0.25	OutputCase=TERRLAT	CaseType=LinStatic	Point=0	X2=0	X3=0	S11=-66.7117981831702
IsS11Max=No	IsS11Min=No	FrameElem=52	ElemStation=0.25				
Frame=52	Station=0.25	OutputCase=TERRLAT	CaseType=LinStatic	Point=1	X2=-0.5	X3=-0.5	S11=-
190.013375656273	IsS11Max=No	IsS11Min=Yes	FrameElem=52	ElemStation=0.25			
Frame=52	Station=0.25	OutputCase=TERRLAT	CaseType=LinStatic	Point=2	X2=-0.5	X3=0.5	S11=-
190.013375656273	IsS11Max=No	IsS11Min=No	FrameElem=52	ElemStation=0.25			
Frame=52	Station=0.25	OutputCase=TERRLAT	CaseType=LinStatic	Point=3	X2=0.5	X3=-0.5	
S11=56.5897792899331	IsS11Max=Yes	IsS11Min=No	FrameElem=52	ElemStation=0.25			
Frame=52	Station=0.25	OutputCase=TERRLAT	CaseType=LinStatic	Point=4	X2=0.5	X3=0.5	
S11=56.5897792899331	IsS11Max=No	IsS11Min=No	FrameElem=52	ElemStation=0.25			
Frame=52	Station=0.375	OutputCase=TERRLAT	CaseType=LinStatic	Point=0	X2=0	X3=0	S11=-
66.7117981831702	IsS11Max=No	IsS11Min=No	FrameElem=52	ElemStation=0.375			
Frame=52	Station=0.375	OutputCase=TERRLAT	CaseType=LinStatic	Point=1	X2=-0.5	X3=-0.5	S11=-
190.013375906909	IsS11Max=No	IsS11Min=Yes	FrameElem=52	ElemStation=0.375			
Frame=52	Station=0.375	OutputCase=TERRLAT	CaseType=LinStatic	Point=2	X2=-0.5	X3=0.5	S11=-
190.013375906909	IsS11Max=No	IsS11Min=No	FrameElem=52	ElemStation=0.375			
Frame=52	Station=0.375	OutputCase=TERRLAT	CaseType=LinStatic	Point=3	X2=0.5	X3=-0.5	
S11=56.5897795405686	IsS11Max=Yes	IsS11Min=No	FrameElem=52	ElemStation=0.375			

Frame=52	Station=0	OutputCase=SOVRCOST	CaseType=LinStatic	Point=1	X2=-0.5	X3=-0.5	S11=0	
IsS11Max=No	IsS11Min=No	FrameElem=52	ElemStation=0					
Frame=52	Station=0	OutputCase=SOVRCOST	CaseType=LinStatic	Point=2	X2=-0.5	X3=0.5	S11=0	
IsS11Max=No	IsS11Min=No	FrameElem=52	ElemStation=0					
Frame=52	Station=0	OutputCase=SOVRCOST	CaseType=LinStatic	Point=3	X2=0.5	X3=-0.5	S11=0	
IsS11Max=No	IsS11Min=No	FrameElem=52	ElemStation=0					
Frame=52	Station=0	OutputCase=SOVRCOST	CaseType=LinStatic	Point=4	X2=0.5	X3=0.5	S11=0	IsS11Max=No
IsS11Min=No	FrameElem=52	ElemStation=0						
Frame=52	Station=0.125	OutputCase=SOVRCOST	CaseType=LinStatic	Point=0	X2=0	X3=0	S11=0	
IsS11Max=Yes	IsS11Min=Yes	FrameElem=52	ElemStation=0.125					
Frame=52	Station=0.125	OutputCase=SOVRCOST	CaseType=LinStatic	Point=1	X2=-0.5	X3=-0.5	S11=0	
IsS11Max=No	IsS11Min=No	FrameElem=52	ElemStation=0.125					
Frame=52	Station=0.125	OutputCase=SOVRCOST	CaseType=LinStatic	Point=2	X2=-0.5	X3=0.5	S11=0	
IsS11Max=No	IsS11Min=No	FrameElem=52	ElemStation=0.125					
Frame=52	Station=0.125	OutputCase=SOVRCOST	CaseType=LinStatic	Point=3	X2=0.5	X3=-0.5	S11=0	
IsS11Max=No	IsS11Min=No	FrameElem=52	ElemStation=0.125					
Frame=52	Station=0.125	OutputCase=SOVRCOST	CaseType=LinStatic	Point=4	X2=0.5	X3=0.5	S11=0	
IsS11Max=No	IsS11Min=No	FrameElem=52	ElemStation=0.125					
Frame=52	Station=0.25	OutputCase=SOVRCOST	CaseType=LinStatic	Point=0	X2=0	X3=0	S11=0	IsS11Max=Yes
IsS11Min=Yes	FrameElem=52	ElemStation=0.25						
Frame=52	Station=0.25	OutputCase=SOVRCOST	CaseType=LinStatic	Point=1	X2=-0.5	X3=-0.5	S11=0	
IsS11Max=No	IsS11Min=No	FrameElem=52	ElemStation=0.25					
Frame=52	Station=0.25	OutputCase=SOVRCOST	CaseType=LinStatic	Point=2	X2=-0.5	X3=0.5	S11=0	
IsS11Max=No	IsS11Min=No	FrameElem=52	ElemStation=0.25					
Frame=52	Station=0.25	OutputCase=SOVRCOST	CaseType=LinStatic	Point=3	X2=0.5	X3=-0.5	S11=0	
IsS11Max=No	IsS11Min=No	FrameElem=52	ElemStation=0.25					
Frame=52	Station=0.25	OutputCase=SOVRCOST	CaseType=LinStatic	Point=4	X2=0.5	X3=0.5	S11=0	
IsS11Max=No	IsS11Min=No	FrameElem=52	ElemStation=0.25					
Frame=52	Station=0.375	OutputCase=SOVRCOST	CaseType=LinStatic	Point=0	X2=0	X3=0	S11=0	
IsS11Max=Yes	IsS11Min=Yes	FrameElem=52	ElemStation=0.375					
Frame=52	Station=0.375	OutputCase=SOVRCOST	CaseType=LinStatic	Point=1	X2=-0.5	X3=-0.5	S11=0	
IsS11Max=No	IsS11Min=No	FrameElem=52	ElemStation=0.375					
Frame=52	Station=0.375	OutputCase=SOVRCOST	CaseType=LinStatic	Point=2	X2=-0.5	X3=0.5	S11=0	
IsS11Max=No	IsS11Min=No	FrameElem=52	ElemStation=0.375					
Frame=52	Station=0.375	OutputCase=SOVRCOST	CaseType=LinStatic	Point=3	X2=0.5	X3=-0.5	S11=0	
IsS11Max=No	IsS11Min=No	FrameElem=52	ElemStation=0.375					
Frame=52	Station=0.375	OutputCase=SOVRCOST	CaseType=LinStatic	Point=4	X2=0.5	X3=0.5	S11=0	
IsS11Max=No	IsS11Min=No	FrameElem=52	ElemStation=0.375					
Frame=52	Station=0.5	OutputCase=SOVRCOST	CaseType=LinStatic	Point=0	X2=0	X3=0	S11=0	IsS11Max=Yes
IsS11Min=Yes	FrameElem=52	ElemStation=0.5						
Frame=52	Station=0.5	OutputCase=SOVRCOST	CaseType=LinStatic	Point=1	X2=-0.5	X3=-0.5	S11=0	
IsS11Max=No	IsS11Min=No	FrameElem=52	ElemStation=0.5					
Frame=52	Station=0.5	OutputCase=SOVRCOST	CaseType=LinStatic	Point=2	X2=-0.5	X3=0.5	S11=0	
IsS11Max=No	IsS11Min=No	FrameElem=52	ElemStation=0.5					
Frame=52	Station=0.5	OutputCase=SOVRCOST	CaseType=LinStatic	Point=3	X2=0.5	X3=-0.5	S11=0	
IsS11Max=No	IsS11Min=No	FrameElem=52	ElemStation=0.5					
Frame=52	Station=0.5	OutputCase=SOVRCOST	CaseType=LinStatic	Point=4	X2=0.5	X3=0.5	S11=0	
IsS11Max=No	IsS11Min=No	FrameElem=52	ElemStation=0.5					
Frame=52	Station=0	OutputCase=ENVE	CaseType=Combination	StepType=Max	Point=0	X2=0	X3=0	S11=-
32.6801405652705	IsS11Max=No	IsS11Min=No	FrameElem=52	ElemStation=0				
Frame=52	Station=0	OutputCase=ENVE	CaseType=Combination	StepType=Max	Point=1	X2=-0.5	X3=-0.5	
S11=2373.4106267174	IsS11Max=Yes	IsS11Min=No	FrameElem=52	ElemStation=0				
Frame=52	Station=0	OutputCase=ENVE	CaseType=Combination	StepType=Max	Point=2	X2=-0.5	X3=0.5	
S11=2373.4106267174	IsS11Max=No	IsS11Min=No	FrameElem=52	ElemStation=0				
Frame=52	Station=0	OutputCase=ENVE	CaseType=Combination	StepType=Max	Point=3	X2=0.5	X3=-0.5	S11=-
2421.79397421134	IsS11Max=No	IsS11Min=Yes	FrameElem=52	ElemStation=0				
Frame=52	Station=0	OutputCase=ENVE	CaseType=Combination	StepType=Max	Point=4	X2=0.5	X3=0.5	S11=-
2421.79397421134	IsS11Max=No	IsS11Min=No	FrameElem=52	ElemStation=0				
Frame=52	Station=0.125	OutputCase=ENVE	CaseType=Combination	StepType=Max	Point=0	X2=0	X3=0	S11=-
32.6801405652705	IsS11Max=No	IsS11Min=No	FrameElem=52	ElemStation=0.125				
Frame=52	Station=0.125	OutputCase=ENVE	CaseType=Combination	StepType=Max	Point=1	X2=-0.5	X3=-0.5	
S11=2446.09031388545	IsS11Max=Yes	IsS11Min=No	FrameElem=52	ElemStation=0.125				
Frame=52	Station=0.125	OutputCase=ENVE	CaseType=Combination	StepType=Max	Point=2	X2=-0.5	X3=0.5	
S11=2446.09031388545	IsS11Max=No	IsS11Min=No	FrameElem=52	ElemStation=0.125				
Frame=52	Station=0.125	OutputCase=ENVE	CaseType=Combination	StepType=Max	Point=3	X2=0.5	X3=-0.5	
S11=-2494.4736613042	IsS11Max=No	IsS11Min=Yes	FrameElem=52	ElemStation=0.125				
Frame=52	Station=0.125	OutputCase=ENVE	CaseType=Combination	StepType=Max	Point=4	X2=0.5	X3=0.5	
S11=-2494.4736613042	IsS11Max=No	IsS11Min=No	FrameElem=52	ElemStation=0.125				
Frame=52	Station=0.25	OutputCase=ENVE	CaseType=Combination	StepType=Max	Point=0	X2=0	X3=0	S11=-
32.6801405652705	IsS11Max=No	IsS11Min=No	FrameElem=52	ElemStation=0.25				
Frame=52	Station=0.25	OutputCase=ENVE	CaseType=Combination	StepType=Max	Point=1	X2=-0.5	X3=-0.5	
S11=2498.0043760535	IsS11Max=Yes	IsS11Min=No	FrameElem=52	ElemStation=0.25				
Frame=52	Station=0.25	OutputCase=ENVE	CaseType=Combination	StepType=Max	Point=2	X2=-0.5	X3=0.5	
S11=2498.0043760535	IsS11Max=No	IsS11Min=No	FrameElem=52	ElemStation=0.25				
Frame=52	Station=0.25	OutputCase=ENVE	CaseType=Combination	StepType=Max	Point=3	X2=0.5	X3=-0.5	
S11=-2546.38772339706	IsS11Max=No	IsS11Min=Yes	FrameElem=52	ElemStation=0.25				
Frame=52	Station=0.25	OutputCase=ENVE	CaseType=Combination	StepType=Max	Point=4	X2=0.5	X3=0.5	
S11=-2546.38772339706	IsS11Max=No	IsS11Min=No	FrameElem=52	ElemStation=0.25				
Frame=52	Station=0.375	OutputCase=ENVE	CaseType=Combination	StepType=Max	Point=0	X2=0	X3=0	S11=-
32.6801405652705	IsS11Max=No	IsS11Min=No	FrameElem=52	ElemStation=0.375				
Frame=52	Station=0.375	OutputCase=ENVE	CaseType=Combination	StepType=Max	Point=1	X2=-0.5	X3=-0.5	
S11=2529.15281322155	IsS11Max=Yes	IsS11Min=No	FrameElem=52	ElemStation=0.375				



Frame=52	Station=0.375	OutputCase=ENVE	CaseType=Combination	StepType=Max	Point=2	X2=-0.5	X3=0.5	
S11=2529.15281322155	IsS11Max=No	IsS11Min=No	FrameElem=52	ElemStation=0.375				
Frame=52	Station=0.375	OutputCase=ENVE	CaseType=Combination	StepType=Max	Point=3	X2=0.5	X3=-0.5	
S11=-2577.53616048992	IsS11Max=No	IsS11Min=Yes	FrameElem=52	ElemStation=0.375				
Frame=52	Station=0.375	OutputCase=ENVE	CaseType=Combination	StepType=Max	Point=4	X2=0.5	X3=0.5	
S11=-2577.53616048992	IsS11Max=No	IsS11Min=No	FrameElem=52	ElemStation=0.375				
Frame=52	Station=0.5	OutputCase=ENVE	CaseType=Combination	StepType=Max	Point=0	X2=0	X3=0	S11=-
32.6801405652705	IsS11Max=No	IsS11Min=No	FrameElem=52	ElemStation=0.5				
Frame=52	Station=0.5	OutputCase=ENVE	CaseType=Combination	StepType=Max	Point=1	X2=-0.5	X3=-0.5	
S11=2539.5356253896	IsS11Max=Yes	IsS11Min=No	FrameElem=52	ElemStation=0.5				
Frame=52	Station=0.5	OutputCase=ENVE	CaseType=Combination	StepType=Max	Point=2	X2=-0.5	X3=0.5	
S11=2539.5356253896	IsS11Max=No	IsS11Min=No	FrameElem=52	ElemStation=0.5				
Frame=52	Station=0.5	OutputCase=ENVE	CaseType=Combination	StepType=Max	Point=3	X2=0.5	X3=-0.5	
S11=-2587.91897258278	IsS11Max=No	IsS11Min=Yes	FrameElem=52	ElemStation=0.5				
Frame=52	Station=0.5	OutputCase=ENVE	CaseType=Combination	StepType=Max	Point=4	X2=0.5	X3=0.5	
S11=-2587.91897258278	IsS11Max=No	IsS11Min=No	FrameElem=52	ElemStation=0.5				
Frame=52	Station=0	OutputCase=ENVE	CaseType=Combination	StepType=Min	Point=0	X2=0	X3=0	S11=-
52.6936800202216	IsS11Max=No	IsS11Min=No	FrameElem=52	ElemStation=0				
Frame=52	Station=0	OutputCase=ENVE	CaseType=Combination	StepType=Min	Point=1	X2=-0.5	X3=-0.5	
S11=2316.4066141709	IsS11Max=Yes	IsS11Min=No	FrameElem=52	ElemStation=0				
Frame=52	Station=0	OutputCase=ENVE	CaseType=Combination	StepType=Min	Point=2	X2=-0.5	X3=0.5	
S11=2316.4066141709	IsS11Max=No	IsS11Min=No	FrameElem=52	ElemStation=0				
Frame=52	Station=0	OutputCase=ENVE	CaseType=Combination	StepType=Min	Point=3	X2=0.5	X3=-0.5	S11=-
2438.77090784794	IsS11Max=No	IsS11Min=Yes	FrameElem=52	ElemStation=0				
Frame=52	Station=0	OutputCase=ENVE	CaseType=Combination	StepType=Min	Point=4	X2=0.5	X3=0.5	S11=-
2438.77090784794	IsS11Max=No	IsS11Min=No	FrameElem=52	ElemStation=0				
Frame=52	Station=0.125	OutputCase=ENVE	CaseType=Combination	StepType=Min	Point=0	X2=0	X3=0	S11=-
52.6936800202216	IsS11Max=No	IsS11Min=No	FrameElem=52	ElemStation=0.125				
Frame=52	Station=0.125	OutputCase=ENVE	CaseType=Combination	StepType=Min	Point=1	X2=-0.5	X3=-0.5	
S11=2389.08630126376	IsS11Max=Yes	IsS11Min=No	FrameElem=52	ElemStation=0.125				
Frame=52	Station=0.125	OutputCase=ENVE	CaseType=Combination	StepType=Min	Point=2	X2=-0.5	X3=0.5	
S11=2389.08630126376	IsS11Max=No	IsS11Min=No	FrameElem=52	ElemStation=0.125				
Frame=52	Station=0.125	OutputCase=ENVE	CaseType=Combination	StepType=Min	Point=3	X2=0.5	X3=-0.5	
S11=-2511.45059501599	IsS11Max=No	IsS11Min=Yes	FrameElem=52	ElemStation=0.125				
Frame=52	Station=0.125	OutputCase=ENVE	CaseType=Combination	StepType=Min	Point=4	X2=0.5	X3=0.5	
S11=-2511.45059501599	IsS11Max=No	IsS11Min=No	FrameElem=52	ElemStation=0.125				
Frame=52	Station=0.25	OutputCase=ENVE	CaseType=Combination	StepType=Min	Point=0	X2=0	X3=0	S11=-
52.6936800202216	IsS11Max=No	IsS11Min=No	FrameElem=52	ElemStation=0.25				
Frame=52	Station=0.25	OutputCase=ENVE	CaseType=Combination	StepType=Min	Point=1	X2=-0.5	X3=-0.5	
S11=2441.00036335662	IsS11Max=Yes	IsS11Min=No	FrameElem=52	ElemStation=0.25				
Frame=52	Station=0.25	OutputCase=ENVE	CaseType=Combination	StepType=Min	Point=2	X2=-0.5	X3=0.5	
S11=2441.00036335662	IsS11Max=No	IsS11Min=No	FrameElem=52	ElemStation=0.25				
Frame=52	Station=0.25	OutputCase=ENVE	CaseType=Combination	StepType=Min	Point=3	X2=0.5	X3=-0.5	
S11=-2563.36465718404	IsS11Max=No	IsS11Min=Yes	FrameElem=52	ElemStation=0.25				
Frame=52	Station=0.25	OutputCase=ENVE	CaseType=Combination	StepType=Min	Point=4	X2=0.5	X3=0.5	
S11=-2563.36465718404	IsS11Max=No	IsS11Min=No	FrameElem=52	ElemStation=0.25				
Frame=52	Station=0.375	OutputCase=ENVE	CaseType=Combination	StepType=Min	Point=0	X2=0	X3=0	S11=-
52.6936800202216	IsS11Max=No	IsS11Min=No	FrameElem=52	ElemStation=0.375				
Frame=52	Station=0.375	OutputCase=ENVE	CaseType=Combination	StepType=Min	Point=1	X2=-0.5	X3=-0.5	
S11=2472.14880044948	IsS11Max=Yes	IsS11Min=No	FrameElem=52	ElemStation=0.375				
Frame=52	Station=0.375	OutputCase=ENVE	CaseType=Combination	StepType=Min	Point=2	X2=-0.5	X3=0.5	
S11=2472.14880044948	IsS11Max=No	IsS11Min=No	FrameElem=52	ElemStation=0.375				
Frame=52	Station=0.375	OutputCase=ENVE	CaseType=Combination	StepType=Min	Point=3	X2=0.5	X3=-0.5	
S11=-2594.51309435209	IsS11Max=No	IsS11Min=Yes	FrameElem=52	ElemStation=0.375				
Frame=52	Station=0.375	OutputCase=ENVE	CaseType=Combination	StepType=Min	Point=4	X2=0.5	X3=0.5	
S11=-2594.51309435209	IsS11Max=No	IsS11Min=No	FrameElem=52	ElemStation=0.375				
Frame=52	Station=0.5	OutputCase=ENVE	CaseType=Combination	StepType=Min	Point=0	X2=0	X3=0	S11=-
52.6936800202216	IsS11Max=No	IsS11Min=No	FrameElem=52	ElemStation=0.5				
Frame=52	Station=0.5	OutputCase=ENVE	CaseType=Combination	StepType=Min	Point=1	X2=-0.5	X3=-0.5	
S11=2482.53161254234	IsS11Max=Yes	IsS11Min=No	FrameElem=52	ElemStation=0.5				
Frame=52	Station=0.5	OutputCase=ENVE	CaseType=Combination	StepType=Min	Point=2	X2=-0.5	X3=0.5	
S11=2482.53161254234	IsS11Max=No	IsS11Min=No	FrameElem=52	ElemStation=0.5				
Frame=52	Station=0.5	OutputCase=ENVE	CaseType=Combination	StepType=Min	Point=3	X2=0.5	X3=-0.5	
S11=-2604.89590652014	IsS11Max=No	IsS11Min=Yes	FrameElem=52	ElemStation=0.5				
Frame=52	Station=0.5	OutputCase=ENVE	CaseType=Combination	StepType=Min	Point=4	X2=0.5	X3=0.5	
S11=-2604.89590652014	IsS11Max=No	IsS11Min=No	FrameElem=52	ElemStation=0.5				
Frame=52	Station=0	OutputCase=FESSUR	CaseType=Combination	Point=0	X2=0	X3=0	S11=-52.6936800202216	
IsS11Max=No	IsS11Min=No	FrameElem=52	ElemStation=0					
Frame=52	Station=0	OutputCase=FESSUR	CaseType=Combination	Point=1	X2=-0.5	X3=-0.5		
S11=2316.4066141709	IsS11Max=Yes	IsS11Min=No	FrameElem=52	ElemStation=0				
Frame=52	Station=0	OutputCase=FESSUR	CaseType=Combination	Point=2	X2=-0.5	X3=0.5		
S11=2316.4066141709	IsS11Max=No	IsS11Min=No	FrameElem=52	ElemStation=0				
Frame=52	Station=0	OutputCase=FESSUR	CaseType=Combination	Point=3	X2=0.5	X3=-0.5	S11=-	
2421.79397421134	IsS11Max=No	IsS11Min=Yes	FrameElem=52	ElemStation=0				
Frame=52	Station=0	OutputCase=FESSUR	CaseType=Combination	Point=4	X2=0.5	X3=0.5	S11=-	
2421.79397421134	IsS11Max=No	IsS11Min=No	FrameElem=52	ElemStation=0				
Frame=52	Station=0.125	OutputCase=FESSUR	CaseType=Combination	Point=0	X2=0	X3=0	S11=-	
52.6936800202216	IsS11Max=No	IsS11Min=No	FrameElem=52	ElemStation=0.125				
Frame=52	Station=0.125	OutputCase=FESSUR	CaseType=Combination	Point=1	X2=-0.5	X3=-0.5		
S11=2389.08630126376	IsS11Max=Yes	IsS11Min=No	FrameElem=52	ElemStation=0.125				
Frame=52	Station=0.125	OutputCase=FESSUR	CaseType=Combination	Point=2	X2=-0.5	X3=0.5		
S11=2389.08630126376	IsS11Max=No	IsS11Min=No	FrameElem=52	ElemStation=0.125				



Frame=52	Station=0.125	OutputCase=FESSUR	CaseType=Combination	Point=3	X2=0.5	X3=-0.5	S11=-
2494.4736613042	IsS11Max=No	IsS11Min=Yes	FrameElem=52	ElemStation=0.125			
Frame=52	Station=0.125	OutputCase=FESSUR	CaseType=Combination	Point=4	X2=0.5	X3=0.5	S11=-
2494.4736613042	IsS11Max=No	IsS11Min=No	FrameElem=52	ElemStation=0.125			
Frame=52	Station=0.25	OutputCase=FESSUR	CaseType=Combination	Point=0	X2=0	X3=0	S11=-
52.6936800202216	IsS11Max=No	IsS11Min=No	FrameElem=52	ElemStation=0.25			
Frame=52	Station=0.25	OutputCase=FESSUR	CaseType=Combination	Point=1	X2=-0.5	X3=-0.5	
S11=2441.00036335662	IsS11Max=Yes	IsS11Min=No	FrameElem=52	ElemStation=0.25			
Frame=52	Station=0.25	OutputCase=FESSUR	CaseType=Combination	Point=2	X2=-0.5	X3=0.5	
S11=2441.00036335662	IsS11Max=No	IsS11Min=No	FrameElem=52	ElemStation=0.25			
Frame=52	Station=0.25	OutputCase=FESSUR	CaseType=Combination	Point=3	X2=0.5	X3=-0.5	S11=-
2546.38772339706	IsS11Max=No	IsS11Min=Yes	FrameElem=52	ElemStation=0.25			
Frame=52	Station=0.25	OutputCase=FESSUR	CaseType=Combination	Point=4	X2=0.5	X3=0.5	S11=-
2546.38772339706	IsS11Max=No	IsS11Min=No	FrameElem=52	ElemStation=0.25			
Frame=52	Station=0.375	OutputCase=FESSUR	CaseType=Combination	Point=0	X2=0	X3=0	S11=-
52.6936800202216	IsS11Max=No	IsS11Min=No	FrameElem=52	ElemStation=0.375			
Frame=52	Station=0.375	OutputCase=FESSUR	CaseType=Combination	Point=1	X2=-0.5	X3=-0.5	
S11=2472.14880044948	IsS11Max=Yes	IsS11Min=No	FrameElem=52	ElemStation=0.375			
Frame=52	Station=0.375	OutputCase=FESSUR	CaseType=Combination	Point=2	X2=-0.5	X3=0.5	
S11=2472.14880044948	IsS11Max=No	IsS11Min=No	FrameElem=52	ElemStation=0.375			
Frame=52	Station=0.375	OutputCase=FESSUR	CaseType=Combination	Point=3	X2=0.5	X3=-0.5	S11=-
2577.53616048992	IsS11Max=No	IsS11Min=Yes	FrameElem=52	ElemStation=0.375			
Frame=52	Station=0.375	OutputCase=FESSUR	CaseType=Combination	Point=4	X2=0.5	X3=0.5	S11=-
2577.53616048992	IsS11Max=No	IsS11Min=No	FrameElem=52	ElemStation=0.375			
Frame=52	Station=0.5	OutputCase=FESSUR	CaseType=Combination	Point=0	X2=0	X3=0	S11=-52.6936800202216
IsS11Max=No	IsS11Min=No	FrameElem=52	ElemStation=0.5				
Frame=52	Station=0.5	OutputCase=FESSUR	CaseType=Combination	Point=1	X2=-0.5	X3=-0.5	
S11=2482.53161254234	IsS11Max=Yes	IsS11Min=No	FrameElem=52	ElemStation=0.5			
Frame=52	Station=0.5	OutputCase=FESSUR	CaseType=Combination	Point=2	X2=-0.5	X3=0.5	
S11=2482.53161254234	IsS11Max=No	IsS11Min=No	FrameElem=52	ElemStation=0.5			
Frame=52	Station=0.5	OutputCase=FESSUR	CaseType=Combination	Point=3	X2=0.5	X3=-0.5	S11=-
2587.91897258278	IsS11Max=No	IsS11Min=Yes	FrameElem=52	ElemStation=0.5			
Frame=52	Station=0.5	OutputCase=FESSUR	CaseType=Combination	Point=4	X2=0.5	X3=0.5	S11=-
2587.91897258278	IsS11Max=No	IsS11Min=No	FrameElem=52	ElemStation=0.5			
Frame=53	Station=0	OutputCase=PESOPR	CaseType=LinStatic	Point=0	X2=0	X3=0	S11=15.1709467362388
IsS11Max=No	IsS11Min=No	FrameElem=53	ElemStation=0				
Frame=53	Station=0	OutputCase=PESOPR	CaseType=LinStatic	Point=1	X2=-0.5	X3=-0.5	
S11=357.491477054319	IsS11Max=Yes	IsS11Min=No	FrameElem=53	ElemStation=0			
Frame=53	Station=0	OutputCase=PESOPR	CaseType=LinStatic	Point=2	X2=-0.5	X3=0.5	S11=357.491477054319
IsS11Max=No	IsS11Min=No	FrameElem=53	ElemStation=0				
Frame=53	Station=0	OutputCase=PESOPR	CaseType=LinStatic	Point=3	X2=0.5	X3=-0.5	S11=-
327.149583581841	IsS11Max=No	IsS11Min=Yes	FrameElem=53	ElemStation=0			
Frame=53	Station=0	OutputCase=PESOPR	CaseType=LinStatic	Point=4	X2=0.5	X3=0.5	S11=-327.149583581841
IsS11Max=No	IsS11Min=No	FrameElem=53	ElemStation=0				
Frame=53	Station=0.125	OutputCase=PESOPR	CaseType=LinStatic	Point=0	X2=0	X3=0	S11=15.1709467362388
IsS11Max=No	IsS11Min=No	FrameElem=53	ElemStation=0.125				
Frame=53	Station=0.125	OutputCase=PESOPR	CaseType=LinStatic	Point=1	X2=-0.5	X3=-0.5	
S11=356.319602045992	IsS11Max=Yes	IsS11Min=No	FrameElem=53	ElemStation=0.125			
Frame=53	Station=0.125	OutputCase=PESOPR	CaseType=LinStatic	Point=2	X2=-0.5	X3=0.5	
S11=356.319602045992	IsS11Max=No	IsS11Min=No	FrameElem=53	ElemStation=0.125			
Frame=53	Station=0.125	OutputCase=PESOPR	CaseType=LinStatic	Point=3	X2=0.5	X3=-0.5	S11=-
325.977708573514	IsS11Max=No	IsS11Min=Yes	FrameElem=53	ElemStation=0.125			
Frame=53	Station=0.125	OutputCase=PESOPR	CaseType=LinStatic	Point=4	X2=0.5	X3=0.5	S11=-
325.977708573514	IsS11Max=No	IsS11Min=No	FrameElem=53	ElemStation=0.125			
Frame=53	Station=0.25	OutputCase=PESOPR	CaseType=LinStatic	Point=0	X2=0	X3=0	S11=15.1709467362388
IsS11Max=No	IsS11Min=No	FrameElem=53	ElemStation=0.25				
Frame=53	Station=0.25	OutputCase=PESOPR	CaseType=LinStatic	Point=1	X2=-0.5	X3=-0.5	
S11=352.803977037664	IsS11Max=Yes	IsS11Min=No	FrameElem=53	ElemStation=0.25			
Frame=53	Station=0.25	OutputCase=PESOPR	CaseType=LinStatic	Point=2	X2=-0.5	X3=0.5	
S11=352.803977037664	IsS11Max=No	IsS11Min=No	FrameElem=53	ElemStation=0.25			
Frame=53	Station=0.25	OutputCase=PESOPR	CaseType=LinStatic	Point=3	X2=0.5	X3=-0.5	S11=-
322.462083565187	IsS11Max=No	IsS11Min=Yes	FrameElem=53	ElemStation=0.25			
Frame=53	Station=0.25	OutputCase=PESOPR	CaseType=LinStatic	Point=4	X2=0.5	X3=0.5	S11=-
322.462083565187	IsS11Max=No	IsS11Min=No	FrameElem=53	ElemStation=0.25			
Frame=53	Station=0.375	OutputCase=PESOPR	CaseType=LinStatic	Point=0	X2=0	X3=0	S11=15.1709467362388
IsS11Max=No	IsS11Min=No	FrameElem=53	ElemStation=0.375				
Frame=53	Station=0.375	OutputCase=PESOPR	CaseType=LinStatic	Point=1	X2=-0.5	X3=-0.5	
S11=346.944602029337	IsS11Max=Yes	IsS11Min=No	FrameElem=53	ElemStation=0.375			
Frame=53	Station=0.375	OutputCase=PESOPR	CaseType=LinStatic	Point=2	X2=-0.5	X3=0.5	
S11=346.944602029337	IsS11Max=No	IsS11Min=No	FrameElem=53	ElemStation=0.375			
Frame=53	Station=0.375	OutputCase=PESOPR	CaseType=LinStatic	Point=3	X2=0.5	X3=-0.5	S11=-
316.602708556859	IsS11Max=No	IsS11Min=Yes	FrameElem=53	ElemStation=0.375			
Frame=53	Station=0.375	OutputCase=PESOPR	CaseType=LinStatic	Point=4	X2=0.5	X3=0.5	S11=-
316.602708556859	IsS11Max=No	IsS11Min=No	FrameElem=53	ElemStation=0.375			
Frame=53	Station=0.5	OutputCase=PESOPR	CaseType=LinStatic	Point=0	X2=0	X3=0	S11=15.1709467362388
IsS11Max=No	IsS11Min=No	FrameElem=53	ElemStation=0.5				
Frame=53	Station=0.5	OutputCase=PESOPR	CaseType=LinStatic	Point=1	X2=-0.5	X3=-0.5	
S11=338.74147702101	IsS11Max=Yes	IsS11Min=No	FrameElem=53	ElemStation=0.5			
Frame=53	Station=0.5	OutputCase=PESOPR	CaseType=LinStatic	Point=2	X2=-0.5	X3=0.5	
S11=338.74147702101	IsS11Max=No	IsS11Min=No	FrameElem=53	ElemStation=0.5			
Frame=53	Station=0.5	OutputCase=PESOPR	CaseType=LinStatic	Point=3	X2=0.5	X3=-0.5	S11=-
308.399583548532	IsS11Max=No	IsS11Min=Yes	FrameElem=53	ElemStation=0.5			

Frame=53	Station=0.5	OutputCase=PESOPR	CaseType=LinStatic	Point=4	X2=0.5	X3=0.5	S11=-
308.399583548532	IsS11Max=No	IsS11Min=No	FrameElem=53	ElemStation=0.5			
Frame=53	Station=0	OutputCase=TERRVERT	CaseType=LinStatic	Point=0	X2=0	X3=0	S11=-1.15282857329028
IsS11Max=No	IsS11Min=No	FrameElem=53	ElemStation=0				
Frame=53	Station=0	OutputCase=TERRVERT	CaseType=LinStatic	Point=1	X2=-0.5	X3=-0.5	
S11=2315.05351164556	IsS11Max=Yes	IsS11Min=No	FrameElem=53	ElemStation=0			
Frame=53	Station=0	OutputCase=TERRVERT	CaseType=LinStatic	Point=2	X2=-0.5	X3=0.5	
S11=2315.05351164556	IsS11Max=No	IsS11Min=No	FrameElem=53	ElemStation=0			
Frame=53	Station=0	OutputCase=TERRVERT	CaseType=LinStatic	Point=3	X2=0.5	X3=-0.5	S11=-
2317.35916879214	IsS11Max=Yes	IsS11Min=Yes	FrameElem=53	ElemStation=0			
Frame=53	Station=0	OutputCase=TERRVERT	CaseType=LinStatic	Point=4	X2=0.5	X3=0.5	S11=-
2317.35916879214	IsS11Max=No	IsS11Min=No	FrameElem=53	ElemStation=0			
Frame=53	Station=0.125	OutputCase=TERRVERT	CaseType=LinStatic	Point=0	X2=0	X3=0	S11=-
1.15282857329028	IsS11Max=No	IsS11Min=No	FrameElem=53	ElemStation=0.125			
Frame=53	Station=0.125	OutputCase=TERRVERT	CaseType=LinStatic	Point=1	X2=-0.5	X3=-0.5	
S11=2305.84257399735	IsS11Max=Yes	IsS11Min=No	FrameElem=53	ElemStation=0.125			
Frame=53	Station=0.125	OutputCase=TERRVERT	CaseType=LinStatic	Point=2	X2=-0.5	X3=0.5	
S11=2305.84257399735	IsS11Max=No	IsS11Min=No	FrameElem=53	ElemStation=0.125			
Frame=53	Station=0.125	OutputCase=TERRVERT	CaseType=LinStatic	Point=3	X2=0.5	X3=-0.5	S11=-
2308.14823114393	IsS11Max=No	IsS11Min=Yes	FrameElem=53	ElemStation=0.125			
Frame=53	Station=0.125	OutputCase=TERRVERT	CaseType=LinStatic	Point=4	X2=0.5	X3=0.5	S11=-
2308.14823114393	IsS11Max=No	IsS11Min=No	FrameElem=53	ElemStation=0.125			
Frame=53	Station=0.25	OutputCase=TERRVERT	CaseType=LinStatic	Point=0	X2=0	X3=0	S11=-
1.15282857329028	IsS11Max=No	IsS11Min=No	FrameElem=53	ElemStation=0.25			
Frame=53	Station=0.25	OutputCase=TERRVERT	CaseType=LinStatic	Point=1	X2=-0.5	X3=-0.5	
S11=2278.20976134914	IsS11Max=Yes	IsS11Min=No	FrameElem=53	ElemStation=0.25			
Frame=53	Station=0.25	OutputCase=TERRVERT	CaseType=LinStatic	Point=2	X2=-0.5	X3=0.5	
S11=2278.20976134914	IsS11Max=No	IsS11Min=No	FrameElem=53	ElemStation=0.25			
Frame=53	Station=0.25	OutputCase=TERRVERT	CaseType=LinStatic	Point=3	X2=0.5	X3=-0.5	S11=-
2280.51541849572	IsS11Max=No	IsS11Min=Yes	FrameElem=53	ElemStation=0.25			
Frame=53	Station=0.25	OutputCase=TERRVERT	CaseType=LinStatic	Point=4	X2=0.5	X3=0.5	S11=-
2280.51541849572	IsS11Max=No	IsS11Min=No	FrameElem=53	ElemStation=0.25			
Frame=53	Station=0.375	OutputCase=TERRVERT	CaseType=LinStatic	Point=0	X2=0	X3=0	S11=-
1.15282857329028	IsS11Max=No	IsS11Min=No	FrameElem=53	ElemStation=0.375			
Frame=53	Station=0.375	OutputCase=TERRVERT	CaseType=LinStatic	Point=1	X2=-0.5	X3=-0.5	
S11=2232.15507370093	IsS11Max=Yes	IsS11Min=No	FrameElem=53	ElemStation=0.375			
Frame=53	Station=0.375	OutputCase=TERRVERT	CaseType=LinStatic	Point=2	X2=-0.5	X3=0.5	
S11=2232.15507370093	IsS11Max=No	IsS11Min=No	FrameElem=53	ElemStation=0.375			
Frame=53	Station=0.375	OutputCase=TERRVERT	CaseType=LinStatic	Point=3	X2=0.5	X3=-0.5	S11=-
2234.46073084751	IsS11Max=No	IsS11Min=Yes	FrameElem=53	ElemStation=0.375			
Frame=53	Station=0.375	OutputCase=TERRVERT	CaseType=LinStatic	Point=4	X2=0.5	X3=0.5	S11=-
2234.46073084751	IsS11Max=No	IsS11Min=No	FrameElem=53	ElemStation=0.375			
Frame=53	Station=0.5	OutputCase=TERRVERT	CaseType=LinStatic	Point=0	X2=0	X3=0	S11=-1.15282857329028
IsS11Max=No	IsS11Min=No	FrameElem=53	ElemStation=0.5				
Frame=53	Station=0.5	OutputCase=TERRVERT	CaseType=LinStatic	Point=1	X2=-0.5	X3=-0.5	
S11=2167.67851105272	IsS11Max=Yes	IsS11Min=No	FrameElem=53	ElemStation=0.5			
Frame=53	Station=0.5	OutputCase=TERRVERT	CaseType=LinStatic	Point=2	X2=-0.5	X3=0.5	
S11=2167.67851105272	IsS11Max=No	IsS11Min=No	FrameElem=53	ElemStation=0.5			
Frame=53	Station=0.5	OutputCase=TERRVERT	CaseType=LinStatic	Point=3	X2=0.5	X3=-0.5	S11=-
2169.9841681993	IsS11Max=No	IsS11Min=Yes	FrameElem=53	ElemStation=0.5			
Frame=53	Station=0.5	OutputCase=TERRVERT	CaseType=LinStatic	Point=4	X2=0.5	X3=0.5	S11=-
2169.9841681993	IsS11Max=No	IsS11Min=No	FrameElem=53	ElemStation=0.5			
Frame=53	Station=0	OutputCase=TERRLAT	CaseType=LinStatic	Point=0	X2=0	X3=0	S11=-66.7117981831701
IsS11Max=No	IsS11Min=No	FrameElem=53	ElemStation=0				
Frame=53	Station=0	OutputCase=TERRLAT	CaseType=LinStatic	Point=1	X2=-0.5	X3=-0.5	S11=-
190.013376157545	IsS11Max=No	IsS11Min=Yes	FrameElem=53	ElemStation=0			
Frame=53	Station=0	OutputCase=TERRLAT	CaseType=LinStatic	Point=2	X2=-0.5	X3=0.5	S11=-
190.013376157545	IsS11Max=No	IsS11Min=No	FrameElem=53	ElemStation=0			
Frame=53	Station=0	OutputCase=TERRLAT	CaseType=LinStatic	Point=3	X2=0.5	X3=-0.5	
S11=56.5897797912043	IsS11Max=Yes	IsS11Min=No	FrameElem=53	ElemStation=0			
Frame=53	Station=0	OutputCase=TERRLAT	CaseType=LinStatic	Point=4	X2=0.5	X3=0.5	S11=56.5897797912043
IsS11Max=No	IsS11Min=No	FrameElem=53	ElemStation=0				
Frame=53	Station=0.125	OutputCase=TERRLAT	CaseType=LinStatic	Point=0	X2=0	X3=0	S11=-
66.7117981831701	IsS11Max=No	IsS11Min=No	FrameElem=53	ElemStation=0.125			
Frame=53	Station=0.125	OutputCase=TERRLAT	CaseType=LinStatic	Point=1	X2=-0.5	X3=-0.5	S11=-
190.01337640818	IsS11Max=No	IsS11Min=Yes	FrameElem=53	ElemStation=0.125			
Frame=53	Station=0.125	OutputCase=TERRLAT	CaseType=LinStatic	Point=2	X2=-0.5	X3=0.5	S11=-
190.01337640818	IsS11Max=No	IsS11Min=No	FrameElem=53	ElemStation=0.125			
Frame=53	Station=0.125	OutputCase=TERRLAT	CaseType=LinStatic	Point=3	X2=0.5	X3=-0.5	
S11=56.58978004184	IsS11Max=Yes	IsS11Min=No	FrameElem=53	ElemStation=0.125			
Frame=53	Station=0.125	OutputCase=TERRLAT	CaseType=LinStatic	Point=4	X2=0.5	X3=0.5	
S11=56.58978004184	IsS11Max=No	IsS11Min=No	FrameElem=53	ElemStation=0.125			
Frame=53	Station=0.25	OutputCase=TERRLAT	CaseType=LinStatic	Point=0	X2=0	X3=0	S11=-66.7117981831701
IsS11Max=No	IsS11Min=No	FrameElem=53	ElemStation=0.25				
Frame=53	Station=0.25	OutputCase=TERRLAT	CaseType=LinStatic	Point=1	X2=-0.5	X3=-0.5	S11=-
190.013376658816	IsS11Max=No	IsS11Min=Yes	FrameElem=53	ElemStation=0.25			
Frame=53	Station=0.25	OutputCase=TERRLAT	CaseType=LinStatic	Point=2	X2=-0.5	X3=0.5	S11=-
190.013376658816	IsS11Max=No	IsS11Min=No	FrameElem=53	ElemStation=0.25			
Frame=53	Station=0.25	OutputCase=TERRLAT	CaseType=LinStatic	Point=3	X2=0.5	X3=-0.5	
S11=56.5897802924756	IsS11Max=Yes	IsS11Min=No	FrameElem=53	ElemStation=0.25			
Frame=53	Station=0.25	OutputCase=TERRLAT	CaseType=LinStatic	Point=4	X2=0.5	X3=0.5	
S11=56.5897802924756	IsS11Max=No	IsS11Min=No	FrameElem=53	ElemStation=0.25			

Frame=53	Station=0.375	OutputCase=TERRLAT	CaseType=LinStatic	Point=0	X2=0	X3=0	S11=-		
66.7117981831701	IsS11Max=No	IsS11Min=No	FrameElem=53	ElemStation=0.375					
Frame=53	Station=0.375	OutputCase=TERRLAT	CaseType=LinStatic	Point=1	X2=-0.5	X3=-0.5	S11=-		
190.013376909451	IsS11Max=No	IsS11Min=Yes	FrameElem=53	ElemStation=0.375					
Frame=53	Station=0.375	OutputCase=TERRLAT	CaseType=LinStatic	Point=2	X2=-0.5	X3=0.5	S11=-		
190.013376909451	IsS11Max=No	IsS11Min=No	FrameElem=53	ElemStation=0.375					
Frame=53	Station=0.375	OutputCase=TERRLAT	CaseType=LinStatic	Point=3	X2=0.5	X3=-0.5			
S11=56.5897805431113	IsS11Max=Yes	IsS11Min=No	FrameElem=53	ElemStation=0.375					
Frame=53	Station=0.375	OutputCase=TERRLAT	CaseType=LinStatic	Point=4	X2=0.5	X3=0.5			
S11=56.5897805431113	IsS11Max=No	IsS11Min=No	FrameElem=53	ElemStation=0.375					
Frame=53	Station=0.5	OutputCase=TERRLAT	CaseType=LinStatic	Point=0	X2=0	X3=0	S11=-66.7117981831701		
IsS11Max=No	IsS11Min=No	FrameElem=53	ElemStation=0.5						
Frame=53	Station=0.5	OutputCase=TERRLAT	CaseType=LinStatic	Point=1	X2=-0.5	X3=-0.5	S11=-		
190.013377160087	IsS11Max=No	IsS11Min=Yes	FrameElem=53	ElemStation=0.5					
Frame=53	Station=0.5	OutputCase=TERRLAT	CaseType=LinStatic	Point=2	X2=-0.5	X3=0.5	S11=-		
190.013377160087	IsS11Max=No	IsS11Min=No	FrameElem=53	ElemStation=0.5					
Frame=53	Station=0.5	OutputCase=TERRLAT	CaseType=LinStatic	Point=3	X2=0.5	X3=-0.5			
S11=56.5897807937469	IsS11Max=Yes	IsS11Min=No	FrameElem=53	ElemStation=0.5					
Frame=53	Station=0.5	OutputCase=TERRLAT	CaseType=LinStatic	Point=4	X2=0.5	X3=0.5			
S11=56.5897807937469	IsS11Max=No	IsS11Min=No	FrameElem=53	ElemStation=0.5					
Frame=53	Station=0	OutputCase=ACCLATDX	CaseType=LinStatic	Point=0	X2=0	X3=0	S11=0	IsS11Max=Yes	
IsS11Min=Yes	FrameElem=53	ElemStation=0							
Frame=53	Station=0	OutputCase=ACCLATDX	CaseType=LinStatic	Point=1	X2=-0.5	X3=-0.5	S11=0		
IsS11Max=No	IsS11Min=No	FrameElem=53	ElemStation=0						
Frame=53	Station=0	OutputCase=ACCLATDX	CaseType=LinStatic	Point=2	X2=-0.5	X3=0.5	S11=0		
IsS11Max=No	IsS11Min=No	FrameElem=53	ElemStation=0						
Frame=53	Station=0	OutputCase=ACCLATDX	CaseType=LinStatic	Point=3	X2=0.5	X3=-0.5	S11=0		
IsS11Max=No	IsS11Min=No	FrameElem=53	ElemStation=0						
Frame=53	Station=0	OutputCase=ACCLATDX	CaseType=LinStatic	Point=4	X2=0.5	X3=0.5	S11=0	IsS11Max=No	
IsS11Min=No	FrameElem=53	ElemStation=0							
Frame=53	Station=0.125	OutputCase=ACCLATDX	CaseType=LinStatic	Point=0	X2=0	X3=0	S11=0		
IsS11Max=Yes	IsS11Min=Yes	FrameElem=53	ElemStation=0.125						
Frame=53	Station=0.125	OutputCase=ACCLATDX	CaseType=LinStatic	Point=1	X2=-0.5	X3=-0.5	S11=0		
IsS11Max=No	IsS11Min=No	FrameElem=53	ElemStation=0.125						
Frame=53	Station=0.125	OutputCase=ACCLATDX	CaseType=LinStatic	Point=2	X2=-0.5	X3=0.5	S11=0		
IsS11Max=No	IsS11Min=No	FrameElem=53	ElemStation=0.125						
Frame=53	Station=0.125	OutputCase=ACCLATDX	CaseType=LinStatic	Point=3	X2=0.5	X3=-0.5	S11=0		
IsS11Max=No	IsS11Min=No	FrameElem=53	ElemStation=0.125						
Frame=53	Station=0.125	OutputCase=ACCLATDX	CaseType=LinStatic	Point=4	X2=0.5	X3=0.5	S11=0		
IsS11Max=No	IsS11Min=No	FrameElem=53	ElemStation=0.125						
Frame=53	Station=0.25	OutputCase=ACCLATDX	CaseType=LinStatic	Point=0	X2=0	X3=0	S11=0	IsS11Max=Yes	
IsS11Min=Yes	FrameElem=53	ElemStation=0.25							
Frame=53	Station=0.25	OutputCase=ACCLATDX	CaseType=LinStatic	Point=1	X2=-0.5	X3=-0.5	S11=0		
IsS11Max=No	IsS11Min=No	FrameElem=53	ElemStation=0.25						
Frame=53	Station=0.25	OutputCase=ACCLATDX	CaseType=LinStatic	Point=2	X2=-0.5	X3=0.5	S11=0		
IsS11Max=No	IsS11Min=No	FrameElem=53	ElemStation=0.25						
Frame=53	Station=0.25	OutputCase=ACCLATDX	CaseType=LinStatic	Point=3	X2=0.5	X3=-0.5	S11=0		
IsS11Max=No	IsS11Min=No	FrameElem=53	ElemStation=0.25						
Frame=53	Station=0.25	OutputCase=ACCLATDX	CaseType=LinStatic	Point=4	X2=0.5	X3=0.5	S11=0		
IsS11Max=No	IsS11Min=No	FrameElem=53	ElemStation=0.25						
Frame=53	Station=0.375	OutputCase=ACCLATDX	CaseType=LinStatic	Point=0	X2=0	X3=0	S11=0		
IsS11Max=Yes	IsS11Min=Yes	FrameElem=53	ElemStation=0.375						
Frame=53	Station=0.375	OutputCase=ACCLATDX	CaseType=LinStatic	Point=1	X2=-0.5	X3=-0.5	S11=0		
IsS11Max=No	IsS11Min=No	FrameElem=53	ElemStation=0.375						
Frame=53	Station=0.375	OutputCase=ACCLATDX	CaseType=LinStatic	Point=2	X2=-0.5	X3=0.5	S11=0		
IsS11Max=No	IsS11Min=No	FrameElem=53	ElemStation=0.375						
Frame=53	Station=0.375	OutputCase=ACCLATDX	CaseType=LinStatic	Point=3	X2=0.5	X3=-0.5	S11=0		
IsS11Max=No	IsS11Min=No	FrameElem=53	ElemStation=0.375						
Frame=53	Station=0.375	OutputCase=ACCLATDX	CaseType=LinStatic	Point=4	X2=0.5	X3=0.5	S11=0		
IsS11Max=No	IsS11Min=No	FrameElem=53	ElemStation=0.375						
Frame=53	Station=0.5	OutputCase=ACCLATDX	CaseType=LinStatic	Point=0	X2=0	X3=0	S11=0	IsS11Max=Yes	
IsS11Min=Yes	FrameElem=53	ElemStation=0.5							
Frame=53	Station=0.5	OutputCase=ACCLATDX	CaseType=LinStatic	Point=1	X2=-0.5	X3=-0.5	S11=0		
IsS11Max=No	IsS11Min=No	FrameElem=53	ElemStation=0.5						
Frame=53	Station=0.5	OutputCase=ACCLATDX	CaseType=LinStatic	Point=2	X2=-0.5	X3=0.5	S11=0		
IsS11Max=No	IsS11Min=No	FrameElem=53	ElemStation=0.5						
Frame=53	Station=0.5	OutputCase=ACCLATDX	CaseType=LinStatic	Point=3	X2=0.5	X3=-0.5	S11=0		
IsS11Max=No	IsS11Min=No	FrameElem=53	ElemStation=0.5						
Frame=53	Station=0.5	OutputCase=ACCLATDX	CaseType=LinStatic	Point=4	X2=0.5	X3=0.5	S11=0		
IsS11Max=No	IsS11Min=No	FrameElem=53	ElemStation=0.5						
Frame=53	Station=0	OutputCase=ACCLATSX	CaseType=LinStatic	Point=0	X2=0	X3=0	S11=0	IsS11Max=Yes	
IsS11Min=Yes	FrameElem=53	ElemStation=0							
Frame=53	Station=0	OutputCase=ACCLATSX	CaseType=LinStatic	Point=1	X2=-0.5	X3=-0.5	S11=0		
IsS11Max=No	IsS11Min=No	FrameElem=53	ElemStation=0						
Frame=53	Station=0	OutputCase=ACCLATSX	CaseType=LinStatic	Point=2	X2=-0.5	X3=0.5	S11=0		
IsS11Max=No	IsS11Min=No	FrameElem=53	ElemStation=0						
Frame=53	Station=0	OutputCase=ACCLATSX	CaseType=LinStatic	Point=3	X2=0.5	X3=-0.5	S11=0		
IsS11Max=No	IsS11Min=No	FrameElem=53	ElemStation=0						
Frame=53	Station=0	OutputCase=ACCLATSX	CaseType=LinStatic	Point=4	X2=0.5	X3=0.5	S11=0	IsS11Max=No	
IsS11Min=No	FrameElem=53	ElemStation=0							
Frame=53	Station=0.125	OutputCase=ACCLATSX	CaseType=LinStatic	Point=0	X2=0	X3=0	S11=0		
IsS11Max=Yes	IsS11Min=Yes	FrameElem=53	ElemStation=0.125						

Frame=53	Station=0.25	OutputCase=ENVE	CaseType=Combination	StepType=Max	Point=3	X2=0.5	X3=-0.5	
S11=-2546.38772176843	IsS11Max=No	IsS11Min=Yes	FrameElem=53	ElemStation=0.25				
Frame=53	Station=0.25	OutputCase=ENVE	CaseType=Combination	StepType=Max	Point=4	X2=0.5	X3=0.5	
S11=-2546.38772176843	IsS11Max=No	IsS11Min=No	FrameElem=53	ElemStation=0.25				
Frame=53	Station=0.375	OutputCase=ENVE	CaseType=Combination	StepType=Max	Point=0	X2=0	X3=0	S11=-
32.6801405652705	IsS11Max=No	IsS11Min=No	FrameElem=53	ElemStation=0.375				
Frame=53	Station=0.375	OutputCase=ENVE	CaseType=Combination	StepType=Max	Point=1	X2=-0.5	X3=-0.5	
S11=2446.09031189365	IsS11Max=Yes	IsS11Min=No	FrameElem=53	ElemStation=0.375				
Frame=53	Station=0.375	OutputCase=ENVE	CaseType=Combination	StepType=Max	Point=2	X2=-0.5	X3=0.5	
S11=2446.09031189365	IsS11Max=No	IsS11Min=No	FrameElem=53	ElemStation=0.375				
Frame=53	Station=0.375	OutputCase=ENVE	CaseType=Combination	StepType=Max	Point=3	X2=0.5	X3=-0.5	
S11=-2494.47365886126	IsS11Max=No	IsS11Min=Yes	FrameElem=53	ElemStation=0.375				
Frame=53	Station=0.375	OutputCase=ENVE	CaseType=Combination	StepType=Max	Point=4	X2=0.5	X3=0.5	
S11=-2494.47365886126	IsS11Max=No	IsS11Min=No	FrameElem=53	ElemStation=0.375				
Frame=53	Station=0.5	OutputCase=ENVE	CaseType=Combination	StepType=Max	Point=0	X2=0	X3=0	S11=-
32.6801405652705	IsS11Max=No	IsS11Min=No	FrameElem=53	ElemStation=0.5				
Frame=53	Station=0.5	OutputCase=ENVE	CaseType=Combination	StepType=Max	Point=1	X2=-0.5	X3=-0.5	
S11=2373.41062406166	IsS11Max=Yes	IsS11Min=No	FrameElem=53	ElemStation=0.5				
Frame=53	Station=0.5	OutputCase=ENVE	CaseType=Combination	StepType=Max	Point=2	X2=-0.5	X3=0.5	
S11=2373.41062406166	IsS11Max=No	IsS11Min=No	FrameElem=53	ElemStation=0.5				
Frame=53	Station=0.5	OutputCase=ENVE	CaseType=Combination	StepType=Max	Point=3	X2=0.5	X3=-0.5	
S11=-2421.79397095408	IsS11Max=No	IsS11Min=Yes	FrameElem=53	ElemStation=0.5				
Frame=53	Station=0.5	OutputCase=ENVE	CaseType=Combination	StepType=Max	Point=4	X2=0.5	X3=0.5	
S11=-2421.79397095408	IsS11Max=No	IsS11Min=No	FrameElem=53	ElemStation=0.5				
Frame=53	Station=0	OutputCase=ENVE	CaseType=Combination	StepType=Min	Point=0	X2=0	X3=0	S11=-
52.6936800202215	IsS11Max=No	IsS11Min=No	FrameElem=53	ElemStation=0				
Frame=53	Station=0	OutputCase=ENVE	CaseType=Combination	StepType=Min	Point=1	X2=-0.5	X3=-0.5	
S11=2482.53161254234	IsS11Max=Yes	IsS11Min=No	FrameElem=53	ElemStation=0				
Frame=53	Station=0	OutputCase=ENVE	CaseType=Combination	StepType=Min	Point=2	X2=-0.5	X3=0.5	
S11=2482.53161254234	IsS11Max=No	IsS11Min=No	FrameElem=53	ElemStation=0				
Frame=53	Station=0	OutputCase=ENVE	CaseType=Combination	StepType=Min	Point=3	X2=0.5	X3=-0.5	S11=-
2604.89590652014	IsS11Max=No	IsS11Min=Yes	FrameElem=53	ElemStation=0				
Frame=53	Station=0	OutputCase=ENVE	CaseType=Combination	StepType=Min	Point=4	X2=0.5	X3=0.5	S11=-
2604.89590652014	IsS11Max=No	IsS11Min=No	FrameElem=53	ElemStation=0				
Frame=53	Station=0.125	OutputCase=ENVE	CaseType=Combination	StepType=Min	Point=0	X2=0	X3=0	S11=-
52.6936800202215	IsS11Max=No	IsS11Min=No	FrameElem=53	ElemStation=0.125				
Frame=53	Station=0.125	OutputCase=ENVE	CaseType=Combination	StepType=Min	Point=1	X2=-0.5	X3=-0.5	
S11=2472.14879963516	IsS11Max=Yes	IsS11Min=No	FrameElem=53	ElemStation=0.125				
Frame=53	Station=0.125	OutputCase=ENVE	CaseType=Combination	StepType=Min	Point=2	X2=-0.5	X3=0.5	
S11=2472.14879963516	IsS11Max=No	IsS11Min=No	FrameElem=53	ElemStation=0.125				
Frame=53	Station=0.125	OutputCase=ENVE	CaseType=Combination	StepType=Min	Point=3	X2=0.5	X3=-0.5	
S11=-2594.51309368816	IsS11Max=No	IsS11Min=Yes	FrameElem=53	ElemStation=0.125				
Frame=53	Station=0.125	OutputCase=ENVE	CaseType=Combination	StepType=Min	Point=4	X2=0.5	X3=0.5	
S11=-2594.51309368816	IsS11Max=No	IsS11Min=No	FrameElem=53	ElemStation=0.125				
Frame=53	Station=0.25	OutputCase=ENVE	CaseType=Combination	StepType=Min	Point=0	X2=0	X3=0	S11=-
52.6936800202215	IsS11Max=No	IsS11Min=No	FrameElem=53	ElemStation=0.25				
Frame=53	Station=0.25	OutputCase=ENVE	CaseType=Combination	StepType=Min	Point=1	X2=-0.5	X3=-0.5	
S11=2441.00036172799	IsS11Max=Yes	IsS11Min=No	FrameElem=53	ElemStation=0.25				
Frame=53	Station=0.25	OutputCase=ENVE	CaseType=Combination	StepType=Min	Point=2	X2=-0.5	X3=0.5	
S11=2441.00036172799	IsS11Max=No	IsS11Min=No	FrameElem=53	ElemStation=0.25				
Frame=53	Station=0.25	OutputCase=ENVE	CaseType=Combination	StepType=Min	Point=3	X2=0.5	X3=-0.5	
S11=-2563.36465585617	IsS11Max=No	IsS11Min=Yes	FrameElem=53	ElemStation=0.25				
Frame=53	Station=0.25	OutputCase=ENVE	CaseType=Combination	StepType=Min	Point=4	X2=0.5	X3=0.5	
S11=-2563.36465585617	IsS11Max=No	IsS11Min=No	FrameElem=53	ElemStation=0.25				
Frame=53	Station=0.375	OutputCase=ENVE	CaseType=Combination	StepType=Min	Point=0	X2=0	X3=0	S11=-
52.6936800202215	IsS11Max=No	IsS11Min=No	FrameElem=53	ElemStation=0.375				
Frame=53	Station=0.375	OutputCase=ENVE	CaseType=Combination	StepType=Min	Point=1	X2=-0.5	X3=-0.5	
S11=2389.08629882081	IsS11Max=Yes	IsS11Min=No	FrameElem=53	ElemStation=0.375				
Frame=53	Station=0.375	OutputCase=ENVE	CaseType=Combination	StepType=Min	Point=2	X2=-0.5	X3=0.5	
S11=2389.08629882081	IsS11Max=No	IsS11Min=No	FrameElem=53	ElemStation=0.375				
Frame=53	Station=0.375	OutputCase=ENVE	CaseType=Combination	StepType=Min	Point=3	X2=0.5	X3=-0.5	
S11=-2511.45059302419	IsS11Max=No	IsS11Min=Yes	FrameElem=53	ElemStation=0.375				
Frame=53	Station=0.375	OutputCase=ENVE	CaseType=Combination	StepType=Min	Point=4	X2=0.5	X3=0.5	
S11=-2511.45059302419	IsS11Max=No	IsS11Min=No	FrameElem=53	ElemStation=0.375				
Frame=53	Station=0.5	OutputCase=ENVE	CaseType=Combination	StepType=Min	Point=0	X2=0	X3=0	S11=-
52.6936800202215	IsS11Max=No	IsS11Min=No	FrameElem=53	ElemStation=0.5				
Frame=53	Station=0.5	OutputCase=ENVE	CaseType=Combination	StepType=Min	Point=1	X2=-0.5	X3=-0.5	
S11=2316.40661091364	IsS11Max=Yes	IsS11Min=No	FrameElem=53	ElemStation=0.5				
Frame=53	Station=0.5	OutputCase=ENVE	CaseType=Combination	StepType=Min	Point=2	X2=-0.5	X3=0.5	
S11=2316.40661091364	IsS11Max=No	IsS11Min=No	FrameElem=53	ElemStation=0.5				
Frame=53	Station=0.5	OutputCase=ENVE	CaseType=Combination	StepType=Min	Point=3	X2=0.5	X3=-0.5	
S11=-2438.7709051922	IsS11Max=No	IsS11Min=Yes	FrameElem=53	ElemStation=0.5				
Frame=53	Station=0.5	OutputCase=ENVE	CaseType=Combination	StepType=Min	Point=4	X2=0.5	X3=0.5	
S11=-2438.7709051922	IsS11Max=No	IsS11Min=No	FrameElem=53	ElemStation=0.5				
Frame=53	Station=0	OutputCase=FESSUR	CaseType=Combination	Point=0	X2=0	X3=0	S11=-52.6936800202215	
IsS11Max=No	IsS11Min=No	FrameElem=53	ElemStation=0					
Frame=53	Station=0	OutputCase=FESSUR	CaseType=Combination	Point=1	X2=-0.5	X3=-0.5		
S11=2482.53161254234	IsS11Max=Yes	IsS11Min=No	FrameElem=53	ElemStation=0				
Frame=53	Station=0	OutputCase=FESSUR	CaseType=Combination	Point=2	X2=-0.5	X3=0.5		
S11=2482.53161254234	IsS11Max=No	IsS11Min=No	FrameElem=53	ElemStation=0				
Frame=53	Station=0	OutputCase=FESSUR	CaseType=Combination	Point=3	X2=0.5	X3=-0.5	S11=-	
2587.91897258278	IsS11Max=No	IsS11Min=Yes	FrameElem=53	ElemStation=0				

Frame=53	Station=0	OutputCase=FESSUR	CaseType=Combination	Point=4	X2=0.5	X3=0.5	S11=-
2587.91897258278	IsS11Max=No	IsS11Min=No	FrameElem=53	ElemStation=0			
Frame=53	Station=0.125	OutputCase=FESSUR	CaseType=Combination	Point=0	X2=0	X3=0	S11=-
52.6936800202215	IsS11Max=No	IsS11Min=No	FrameElem=53	ElemStation=0.125			
Frame=53	Station=0.125	OutputCase=FESSUR	CaseType=Combination	Point=1	X2=-0.5	X3=-0.5	
S11=2472.14879963516	IsS11Max=Yes	IsS11Min=No	FrameElem=53	ElemStation=0.125			
Frame=53	Station=0.125	OutputCase=FESSUR	CaseType=Combination	Point=2	X2=-0.5	X3=0.5	
S11=2472.14879963516	IsS11Max=No	IsS11Min=No	FrameElem=53	ElemStation=0.125			
Frame=53	Station=0.125	OutputCase=FESSUR	CaseType=Combination	Point=3	X2=0.5	X3=-0.5	S11=-
2577.5361596756	IsS11Max=No	IsS11Min=Yes	FrameElem=53	ElemStation=0.125			
Frame=53	Station=0.125	OutputCase=FESSUR	CaseType=Combination	Point=4	X2=0.5	X3=0.5	S11=-
2577.5361596756	IsS11Max=No	IsS11Min=No	FrameElem=53	ElemStation=0.125			
Frame=53	Station=0.25	OutputCase=FESSUR	CaseType=Combination	Point=0	X2=0	X3=0	S11=-
52.6936800202215	IsS11Max=No	IsS11Min=No	FrameElem=53	ElemStation=0.25			
Frame=53	Station=0.25	OutputCase=FESSUR	CaseType=Combination	Point=1	X2=-0.5	X3=-0.5	
S11=2441.00036172799	IsS11Max=Yes	IsS11Min=No	FrameElem=53	ElemStation=0.25			
Frame=53	Station=0.25	OutputCase=FESSUR	CaseType=Combination	Point=2	X2=-0.5	X3=0.5	
S11=2441.00036172799	IsS11Max=No	IsS11Min=No	FrameElem=53	ElemStation=0.25			
Frame=53	Station=0.25	OutputCase=FESSUR	CaseType=Combination	Point=3	X2=0.5	X3=-0.5	S11=-
2546.38772176843	IsS11Max=No	IsS11Min=Yes	FrameElem=53	ElemStation=0.25			
Frame=53	Station=0.25	OutputCase=FESSUR	CaseType=Combination	Point=4	X2=0.5	X3=0.5	S11=-
2546.38772176843	IsS11Max=No	IsS11Min=No	FrameElem=53	ElemStation=0.25			
Frame=53	Station=0.375	OutputCase=FESSUR	CaseType=Combination	Point=0	X2=0	X3=0	S11=-
52.6936800202215	IsS11Max=No	IsS11Min=No	FrameElem=53	ElemStation=0.375			
Frame=53	Station=0.375	OutputCase=FESSUR	CaseType=Combination	Point=1	X2=-0.5	X3=-0.5	
S11=2389.08629882081	IsS11Max=Yes	IsS11Min=No	FrameElem=53	ElemStation=0.375			
Frame=53	Station=0.375	OutputCase=FESSUR	CaseType=Combination	Point=2	X2=-0.5	X3=0.5	
S11=2389.08629882081	IsS11Max=No	IsS11Min=No	FrameElem=53	ElemStation=0.375			
Frame=53	Station=0.375	OutputCase=FESSUR	CaseType=Combination	Point=3	X2=0.5	X3=-0.5	S11=-
2494.47365886126	IsS11Max=No	IsS11Min=Yes	FrameElem=53	ElemStation=0.375			
Frame=53	Station=0.375	OutputCase=FESSUR	CaseType=Combination	Point=4	X2=0.5	X3=0.5	S11=-
2494.47365886126	IsS11Max=No	IsS11Min=No	FrameElem=53	ElemStation=0.375			
Frame=53	Station=0.5	OutputCase=FESSUR	CaseType=Combination	Point=0	X2=0	X3=0	S11=-52.6936800202215
IsS11Max=No	IsS11Min=No	FrameElem=53	ElemStation=0.5				
Frame=53	Station=0.5	OutputCase=FESSUR	CaseType=Combination	Point=1	X2=-0.5	X3=-0.5	
S11=2316.40661091364	IsS11Max=Yes	IsS11Min=No	FrameElem=53	ElemStation=0.5			
Frame=53	Station=0.5	OutputCase=FESSUR	CaseType=Combination	Point=2	X2=-0.5	X3=0.5	
S11=2316.40661091364	IsS11Max=No	IsS11Min=No	FrameElem=53	ElemStation=0.5			
Frame=53	Station=0.5	OutputCase=FESSUR	CaseType=Combination	Point=3	X2=0.5	X3=-0.5	S11=-
2421.79397095408	IsS11Max=No	IsS11Min=Yes	FrameElem=53	ElemStation=0.5			
Frame=53	Station=0.5	OutputCase=FESSUR	CaseType=Combination	Point=4	X2=0.5	X3=0.5	S11=-
2421.79397095408	IsS11Max=No	IsS11Min=No	FrameElem=53	ElemStation=0.5			
Frame=54	Station=0	OutputCase=PESOPR	CaseType=LinStatic	Point=0	X2=0	X3=0	S11=15.1709467362389
IsS11Max=No	IsS11Min=No	FrameElem=54	ElemStation=0				
Frame=54	Station=0	OutputCase=PESOPR	CaseType=LinStatic	Point=1	X2=-0.5	X3=-0.5	
S11=338.741477021032	IsS11Max=Yes	IsS11Min=No	FrameElem=54	ElemStation=0			
Frame=54	Station=0	OutputCase=PESOPR	CaseType=LinStatic	Point=2	X2=-0.5	X3=0.5	S11=338.741477021032
IsS11Max=No	IsS11Min=No	FrameElem=54	ElemStation=0				
Frame=54	Station=0	OutputCase=PESOPR	CaseType=LinStatic	Point=3	X2=0.5	X3=-0.5	S11=-
308.399583548554	IsS11Max=No	IsS11Min=Yes	FrameElem=54	ElemStation=0			
Frame=54	Station=0	OutputCase=PESOPR	CaseType=LinStatic	Point=4	X2=0.5	X3=0.5	S11=-308.399583548554
IsS11Max=No	IsS11Min=No	FrameElem=54	ElemStation=0				
Frame=54	Station=0.125	OutputCase=PESOPR	CaseType=LinStatic	Point=0	X2=0	X3=0	S11=15.1709467362389
IsS11Max=No	IsS11Min=No	FrameElem=54	ElemStation=0.125				
Frame=54	Station=0.125	OutputCase=PESOPR	CaseType=LinStatic	Point=1	X2=-0.5	X3=-0.5	
S11=328.194602012693	IsS11Max=Yes	IsS11Min=No	FrameElem=54	ElemStation=0.125			
Frame=54	Station=0.125	OutputCase=PESOPR	CaseType=LinStatic	Point=2	X2=-0.5	X3=0.5	
S11=328.194602012693	IsS11Max=No	IsS11Min=No	FrameElem=54	ElemStation=0.125			
Frame=54	Station=0.125	OutputCase=PESOPR	CaseType=LinStatic	Point=3	X2=0.5	X3=-0.5	S11=-
297.852708540216	IsS11Max=No	IsS11Min=Yes	FrameElem=54	ElemStation=0.125			
Frame=54	Station=0.125	OutputCase=PESOPR	CaseType=LinStatic	Point=4	X2=0.5	X3=0.5	S11=-
297.852708540216	IsS11Max=No	IsS11Min=No	FrameElem=54	ElemStation=0.125			
Frame=54	Station=0.25	OutputCase=PESOPR	CaseType=LinStatic	Point=0	X2=0	X3=0	S11=15.1709467362389
IsS11Max=No	IsS11Min=No	FrameElem=54	ElemStation=0.25				
Frame=54	Station=0.25	OutputCase=PESOPR	CaseType=LinStatic	Point=1	X2=-0.5	X3=-0.5	
S11=315.303977004355	IsS11Max=Yes	IsS11Min=No	FrameElem=54	ElemStation=0.25			
Frame=54	Station=0.25	OutputCase=PESOPR	CaseType=LinStatic	Point=2	X2=-0.5	X3=0.5	
S11=315.303977004355	IsS11Max=No	IsS11Min=No	FrameElem=54	ElemStation=0.25			
Frame=54	Station=0.25	OutputCase=PESOPR	CaseType=LinStatic	Point=3	X2=0.5	X3=-0.5	S11=-
284.962083531877	IsS11Max=No	IsS11Min=Yes	FrameElem=54	ElemStation=0.25			
Frame=54	Station=0.25	OutputCase=PESOPR	CaseType=LinStatic	Point=4	X2=0.5	X3=0.5	S11=-
284.962083531877	IsS11Max=No	IsS11Min=No	FrameElem=54	ElemStation=0.25			
Frame=54	Station=0.375	OutputCase=PESOPR	CaseType=LinStatic	Point=0	X2=0	X3=0	S11=15.1709467362389
IsS11Max=No	IsS11Min=No	FrameElem=54	ElemStation=0.375				
Frame=54	Station=0.375	OutputCase=PESOPR	CaseType=LinStatic	Point=1	X2=-0.5	X3=-0.5	
S11=300.069601996017	IsS11Max=Yes	IsS11Min=No	FrameElem=54	ElemStation=0.375			
Frame=54	Station=0.375	OutputCase=PESOPR	CaseType=LinStatic	Point=2	X2=-0.5	X3=0.5	
S11=300.069601996017	IsS11Max=No	IsS11Min=No	FrameElem=54	ElemStation=0.375			
Frame=54	Station=0.375	OutputCase=PESOPR	CaseType=LinStatic	Point=3	X2=0.5	X3=-0.5	S11=-
269.727708523539	IsS11Max=No	IsS11Min=Yes	FrameElem=54	ElemStation=0.375			
Frame=54	Station=0.375	OutputCase=PESOPR	CaseType=LinStatic	Point=4	X2=0.5	X3=0.5	S11=-
269.727708523539	IsS11Max=No	IsS11Min=No	FrameElem=54	ElemStation=0.375			

Frame=54	Station=0.5	OutputCase=PESOPR	CaseType=LinStatic	Point=0	X2=0	X3=0	S11=15.1709467362389
IsS11Max=No	IsS11Min=No	FrameElem=54	ElemStation=0.5				
Frame=54	Station=0.5	OutputCase=PESOPR	CaseType=LinStatic	Point=1	X2=-0.5	X3=-0.5	
S11=282.491476987679	IsS11Max=Yes	IsS11Min=No	FrameElem=54	ElemStation=0.5			
Frame=54	Station=0.5	OutputCase=PESOPR	CaseType=LinStatic	Point=2	X2=-0.5	X3=0.5	
S11=282.491476987679	IsS11Max=No	IsS11Min=No	FrameElem=54	ElemStation=0.5			
Frame=54	Station=0.5	OutputCase=PESOPR	CaseType=LinStatic	Point=3	X2=0.5	X3=-0.5	S11=-
252.149583515201	IsS11Max=No	IsS11Min=Yes	FrameElem=54	ElemStation=0.5			
Frame=54	Station=0.5	OutputCase=PESOPR	CaseType=LinStatic	Point=4	X2=0.5	X3=0.5	S11=-
252.149583515201	IsS11Max=No	IsS11Min=No	FrameElem=54	ElemStation=0.5			
Frame=54	Station=0	OutputCase=TERRVERT	CaseType=LinStatic	Point=0	X2=0	X3=0	S11=-1.15282857329027
IsS11Max=No	IsS11Min=No	FrameElem=54	ElemStation=0				
Frame=54	Station=0	OutputCase=TERRVERT	CaseType=LinStatic	Point=1	X2=-0.5	X3=-0.5	
S11=2167.67851105272	IsS11Max=Yes	IsS11Min=No	FrameElem=54	ElemStation=0			
Frame=54	Station=0	OutputCase=TERRVERT	CaseType=LinStatic	Point=2	X2=-0.5	X3=0.5	
S11=2167.67851105272	IsS11Max=No	IsS11Min=No	FrameElem=54	ElemStation=0			
Frame=54	Station=0	OutputCase=TERRVERT	CaseType=LinStatic	Point=3	X2=0.5	X3=-0.5	S11=-
2169.9841681993	IsS11Max=No	IsS11Min=Yes	FrameElem=54	ElemStation=0			
Frame=54	Station=0	OutputCase=TERRVERT	CaseType=LinStatic	Point=4	X2=0.5	X3=0.5	S11=-
2169.9841681993	IsS11Max=No	IsS11Min=No	FrameElem=54	ElemStation=0			
Frame=54	Station=0.125	OutputCase=TERRVERT	CaseType=LinStatic	Point=0	X2=0	X3=0	S11=-
1.15282857329027	IsS11Max=No	IsS11Min=No	FrameElem=54	ElemStation=0.125			
Frame=54	Station=0.125	OutputCase=TERRVERT	CaseType=LinStatic	Point=1	X2=-0.5	X3=-0.5	
S11=2084.78007340453	IsS11Max=Yes	IsS11Min=No	FrameElem=54	ElemStation=0.125			
Frame=54	Station=0.125	OutputCase=TERRVERT	CaseType=LinStatic	Point=2	X2=-0.5	X3=0.5	
S11=2084.78007340453	IsS11Max=No	IsS11Min=No	FrameElem=54	ElemStation=0.125			
Frame=54	Station=0.125	OutputCase=TERRVERT	CaseType=LinStatic	Point=3	X2=0.5	X3=-0.5	S11=-
2087.08573055111	IsS11Max=No	IsS11Min=Yes	FrameElem=54	ElemStation=0.125			
Frame=54	Station=0.125	OutputCase=TERRVERT	CaseType=LinStatic	Point=4	X2=0.5	X3=0.5	S11=-
2087.08573055111	IsS11Max=No	IsS11Min=No	FrameElem=54	ElemStation=0.125			
Frame=54	Station=0.25	OutputCase=TERRVERT	CaseType=LinStatic	Point=0	X2=0	X3=0	S11=-
1.15282857329027	IsS11Max=No	IsS11Min=No	FrameElem=54	ElemStation=0.25			
Frame=54	Station=0.25	OutputCase=TERRVERT	CaseType=LinStatic	Point=1	X2=-0.5	X3=-0.5	
S11=1983.45976075634	IsS11Max=Yes	IsS11Min=No	FrameElem=54	ElemStation=0.25			
Frame=54	Station=0.25	OutputCase=TERRVERT	CaseType=LinStatic	Point=2	X2=-0.5	X3=0.5	
S11=1983.45976075634	IsS11Max=No	IsS11Min=No	FrameElem=54	ElemStation=0.25			
Frame=54	Station=0.25	OutputCase=TERRVERT	CaseType=LinStatic	Point=3	X2=0.5	X3=-0.5	S11=-
1985.76541790292	IsS11Max=No	IsS11Min=Yes	FrameElem=54	ElemStation=0.25			
Frame=54	Station=0.25	OutputCase=TERRVERT	CaseType=LinStatic	Point=4	X2=0.5	X3=0.5	S11=-
1985.76541790292	IsS11Max=No	IsS11Min=No	FrameElem=54	ElemStation=0.25			
Frame=54	Station=0.375	OutputCase=TERRVERT	CaseType=LinStatic	Point=0	X2=0	X3=0	S11=-
1.15282857329027	IsS11Max=No	IsS11Min=No	FrameElem=54	ElemStation=0.375			
Frame=54	Station=0.375	OutputCase=TERRVERT	CaseType=LinStatic	Point=1	X2=-0.5	X3=-0.5	
S11=1863.71757310815	IsS11Max=Yes	IsS11Min=No	FrameElem=54	ElemStation=0.375			
Frame=54	Station=0.375	OutputCase=TERRVERT	CaseType=LinStatic	Point=2	X2=-0.5	X3=0.5	
S11=1863.71757310815	IsS11Max=No	IsS11Min=No	FrameElem=54	ElemStation=0.375			
Frame=54	Station=0.375	OutputCase=TERRVERT	CaseType=LinStatic	Point=3	X2=0.5	X3=-0.5	S11=-
1866.02323025473	IsS11Max=No	IsS11Min=Yes	FrameElem=54	ElemStation=0.375			
Frame=54	Station=0.375	OutputCase=TERRVERT	CaseType=LinStatic	Point=4	X2=0.5	X3=0.5	S11=-
1866.02323025473	IsS11Max=No	IsS11Min=No	FrameElem=54	ElemStation=0.375			
Frame=54	Station=0.5	OutputCase=TERRVERT	CaseType=LinStatic	Point=0	X2=0	X3=0	S11=-1.15282857329027
IsS11Max=No	IsS11Min=No	FrameElem=54	ElemStation=0.5				
Frame=54	Station=0.5	OutputCase=TERRVERT	CaseType=LinStatic	Point=1	X2=-0.5	X3=-0.5	
S11=1725.55351045996	IsS11Max=Yes	IsS11Min=No	FrameElem=54	ElemStation=0.5			
Frame=54	Station=0.5	OutputCase=TERRVERT	CaseType=LinStatic	Point=2	X2=-0.5	X3=0.5	
S11=1725.55351045996	IsS11Max=No	IsS11Min=No	FrameElem=54	ElemStation=0.5			
Frame=54	Station=0.5	OutputCase=TERRVERT	CaseType=LinStatic	Point=3	X2=0.5	X3=-0.5	S11=-
1727.85916760654	IsS11Max=No	IsS11Min=Yes	FrameElem=54	ElemStation=0.5			
Frame=54	Station=0.5	OutputCase=TERRVERT	CaseType=LinStatic	Point=4	X2=0.5	X3=0.5	S11=-
1727.85916760654	IsS11Max=No	IsS11Min=No	FrameElem=54	ElemStation=0.5			
Frame=54	Station=0	OutputCase=TERRLAT	CaseType=LinStatic	Point=0	X2=0	X3=0	S11=-66.7117981831701
IsS11Max=No	IsS11Min=No	FrameElem=54	ElemStation=0				
Frame=54	Station=0	OutputCase=TERRLAT	CaseType=LinStatic	Point=1	X2=-0.5	X3=-0.5	S11=-
190.013377160087	IsS11Max=No	IsS11Min=Yes	FrameElem=54	ElemStation=0			
Frame=54	Station=0	OutputCase=TERRLAT	CaseType=LinStatic	Point=2	X2=-0.5	X3=0.5	S11=-
190.013377160087	IsS11Max=No	IsS11Min=No	FrameElem=54	ElemStation=0			
Frame=54	Station=0	OutputCase=TERRLAT	CaseType=LinStatic	Point=3	X2=0.5	X3=-0.5	
S11=56.5897807937466	IsS11Max=Yes	IsS11Min=No	FrameElem=54	ElemStation=0			
Frame=54	Station=0	OutputCase=TERRLAT	CaseType=LinStatic	Point=4	X2=0.5	X3=0.5	S11=56.5897807937466
IsS11Max=No	IsS11Min=No	FrameElem=54	ElemStation=0				
Frame=54	Station=0.125	OutputCase=TERRLAT	CaseType=LinStatic	Point=0	X2=0	X3=0	S11=-
66.7117981831701	IsS11Max=No	IsS11Min=No	FrameElem=54	ElemStation=0.125			
Frame=54	Station=0.125	OutputCase=TERRLAT	CaseType=LinStatic	Point=1	X2=-0.5	X3=-0.5	S11=-
190.013377410722	IsS11Max=No	IsS11Min=Yes	FrameElem=54	ElemStation=0.125			
Frame=54	Station=0.125	OutputCase=TERRLAT	CaseType=LinStatic	Point=2	X2=-0.5	X3=0.5	S11=-
190.013377410722	IsS11Max=No	IsS11Min=No	FrameElem=54	ElemStation=0.125			
Frame=54	Station=0.125	OutputCase=TERRLAT	CaseType=LinStatic	Point=3	X2=0.5	X3=-0.5	
S11=56.5897810443822	IsS11Max=Yes	IsS11Min=No	FrameElem=54	ElemStation=0.125			
Frame=54	Station=0.125	OutputCase=TERRLAT	CaseType=LinStatic	Point=4	X2=0.5	X3=0.5	
S11=56.5897810443822	IsS11Max=No	IsS11Min=No	FrameElem=54	ElemStation=0.125			
Frame=54	Station=0.25	OutputCase=TERRLAT	CaseType=LinStatic	Point=0	X2=0	X3=0	S11=-66.7117981831701
IsS11Max=No	IsS11Min=No	FrameElem=54	ElemStation=0.25				



Frame=54	Station=0.125	OutputCase=ENVE	CaseType=Combination	StepType=Max	Point=4	X2=0.5	X3=0.5	
S11=-2328.34865804694		IsS11Max=No	IsS11Min=No	FrameElem=54	ElemStation=0.125			
Frame=54	Station=0.25	OutputCase=ENVE	CaseType=Combination	StepType=Max	Point=0	X2=0	X3=0	S11=-
32.6801405652705		IsS11Max=No	IsS11Min=No	FrameElem=54	ElemStation=0.25			
Frame=54	Station=0.25	OutputCase=ENVE	CaseType=Combination	StepType=Max	Point=1	X2=-0.5	X3=-0.5	
S11=2165.75437339774		IsS11Max=Yes	IsS11Min=No	FrameElem=54	ElemStation=0.25			
Frame=54	Station=0.25	OutputCase=ENVE	CaseType=Combination	StepType=Max	Point=2	X2=-0.5	X3=0.5	
S11=2165.75437339774		IsS11Max=No	IsS11Min=No	FrameElem=54	ElemStation=0.25			
Frame=54	Station=0.25	OutputCase=ENVE	CaseType=Combination	StepType=Max	Point=3	X2=0.5	X3=-0.5	
S11=-2214.13772013978		IsS11Max=No	IsS11Min=Yes	FrameElem=54	ElemStation=0.25			
Frame=54	Station=0.25	OutputCase=ENVE	CaseType=Combination	StepType=Max	Point=4	X2=0.5	X3=0.5	
S11=-2214.13772013978		IsS11Max=No	IsS11Min=No	FrameElem=54	ElemStation=0.25			
Frame=54	Station=0.375	OutputCase=ENVE	CaseType=Combination	StepType=Max	Point=0	X2=0	X3=0	S11=-
32.6801405652705		IsS11Max=No	IsS11Min=No	FrameElem=54	ElemStation=0.375			
Frame=54	Station=0.375	OutputCase=ENVE	CaseType=Combination	StepType=Max	Point=1	X2=-0.5	X3=-0.5	
S11=2030.77781056577		IsS11Max=Yes	IsS11Min=No	FrameElem=54	ElemStation=0.375			
Frame=54	Station=0.375	OutputCase=ENVE	CaseType=Combination	StepType=Max	Point=2	X2=-0.5	X3=0.5	
S11=2030.77781056577		IsS11Max=No	IsS11Min=No	FrameElem=54	ElemStation=0.375			
Frame=54	Station=0.375	OutputCase=ENVE	CaseType=Combination	StepType=Max	Point=3	X2=0.5	X3=-0.5	
S11=-2079.16115723261		IsS11Max=No	IsS11Min=Yes	FrameElem=54	ElemStation=0.375			
Frame=54	Station=0.375	OutputCase=ENVE	CaseType=Combination	StepType=Max	Point=4	X2=0.5	X3=0.5	
S11=-2079.16115723261		IsS11Max=No	IsS11Min=No	FrameElem=54	ElemStation=0.375			
Frame=54	Station=0.5	OutputCase=ENVE	CaseType=Combination	StepType=Max	Point=0	X2=0	X3=0	S11=-
32.6801405652705		IsS11Max=No	IsS11Min=No	FrameElem=54	ElemStation=0.5			
Frame=54	Station=0.5	OutputCase=ENVE	CaseType=Combination	StepType=Max	Point=1	X2=-0.5	X3=-0.5	
S11=1875.0356227338		IsS11Max=Yes	IsS11Min=No	FrameElem=54	ElemStation=0.5			
Frame=54	Station=0.5	OutputCase=ENVE	CaseType=Combination	StepType=Max	Point=2	X2=-0.5	X3=0.5	
S11=1875.0356227338		IsS11Max=No	IsS11Min=No	FrameElem=54	ElemStation=0.5			
Frame=54	Station=0.5	OutputCase=ENVE	CaseType=Combination	StepType=Max	Point=3	X2=0.5	X3=-0.5	
S11=-1923.41896932545		IsS11Max=No	IsS11Min=Yes	FrameElem=54	ElemStation=0.5			
Frame=54	Station=0.5	OutputCase=ENVE	CaseType=Combination	StepType=Max	Point=4	X2=0.5	X3=0.5	
S11=-1923.41896932545		IsS11Max=No	IsS11Min=No	FrameElem=54	ElemStation=0.5			
Frame=54	Station=0	OutputCase=ENVE	CaseType=Combination	StepType=Min	Point=0	X2=0	X3=0	S11=-
52.6936800202215		IsS11Max=No	IsS11Min=No	FrameElem=54	ElemStation=0			
Frame=54	Station=0	OutputCase=ENVE	CaseType=Combination	StepType=Min	Point=1	X2=-0.5	X3=-0.5	
S11=2316.40661091366		IsS11Max=Yes	IsS11Min=No	FrameElem=54	ElemStation=0			
Frame=54	Station=0	OutputCase=ENVE	CaseType=Combination	StepType=Min	Point=2	X2=-0.5	X3=0.5	
S11=2316.40661091366		IsS11Max=No	IsS11Min=No	FrameElem=54	ElemStation=0			
Frame=54	Station=0	OutputCase=ENVE	CaseType=Combination	StepType=Min	Point=3	X2=0.5	X3=-0.5	S11=-
2438.77090519223		IsS11Max=No	IsS11Min=Yes	FrameElem=54	ElemStation=0			
Frame=54	Station=0	OutputCase=ENVE	CaseType=Combination	StepType=Min	Point=4	X2=0.5	X3=0.5	S11=-
2438.77090519223		IsS11Max=No	IsS11Min=No	FrameElem=54	ElemStation=0			
Frame=54	Station=0.125	OutputCase=ENVE	CaseType=Combination	StepType=Min	Point=0	X2=0	X3=0	S11=-
52.6936800202215		IsS11Max=No	IsS11Min=No	FrameElem=54	ElemStation=0.125			
Frame=54	Station=0.125	OutputCase=ENVE	CaseType=Combination	StepType=Min	Point=1	X2=-0.5	X3=-0.5	
S11=2222.9612980065		IsS11Max=Yes	IsS11Min=No	FrameElem=54	ElemStation=0.125			
Frame=54	Station=0.125	OutputCase=ENVE	CaseType=Combination	StepType=Min	Point=2	X2=-0.5	X3=0.5	
S11=2222.9612980065		IsS11Max=No	IsS11Min=No	FrameElem=54	ElemStation=0.125			
Frame=54	Station=0.125	OutputCase=ENVE	CaseType=Combination	StepType=Min	Point=3	X2=0.5	X3=-0.5	
S11=-2345.32559236025		IsS11Max=No	IsS11Min=Yes	FrameElem=54	ElemStation=0.125			
Frame=54	Station=0.125	OutputCase=ENVE	CaseType=Combination	StepType=Min	Point=4	X2=0.5	X3=0.5	
S11=-2345.32559236025		IsS11Max=No	IsS11Min=No	FrameElem=54	ElemStation=0.125			
Frame=54	Station=0.25	OutputCase=ENVE	CaseType=Combination	StepType=Min	Point=0	X2=0	X3=0	S11=-
52.6936800202215		IsS11Max=No	IsS11Min=No	FrameElem=54	ElemStation=0.25			
Frame=54	Station=0.25	OutputCase=ENVE	CaseType=Combination	StepType=Min	Point=1	X2=-0.5	X3=-0.5	
S11=2108.75036009933		IsS11Max=Yes	IsS11Min=No	FrameElem=54	ElemStation=0.25			
Frame=54	Station=0.25	OutputCase=ENVE	CaseType=Combination	StepType=Min	Point=2	X2=-0.5	X3=0.5	
S11=2108.75036009933		IsS11Max=No	IsS11Min=No	FrameElem=54	ElemStation=0.25			
Frame=54	Station=0.25	OutputCase=ENVE	CaseType=Combination	StepType=Min	Point=3	X2=0.5	X3=-0.5	
S11=-2231.11465452828		IsS11Max=No	IsS11Min=Yes	FrameElem=54	ElemStation=0.25			
Frame=54	Station=0.25	OutputCase=ENVE	CaseType=Combination	StepType=Min	Point=4	X2=0.5	X3=0.5	
S11=-2231.11465452828		IsS11Max=No	IsS11Min=No	FrameElem=54	ElemStation=0.25			
Frame=54	Station=0.375	OutputCase=ENVE	CaseType=Combination	StepType=Min	Point=0	X2=0	X3=0	S11=-
52.6936800202215		IsS11Max=No	IsS11Min=No	FrameElem=54	ElemStation=0.375			
Frame=54	Station=0.375	OutputCase=ENVE	CaseType=Combination	StepType=Min	Point=1	X2=-0.5	X3=-0.5	
S11=1973.77379719217		IsS11Max=Yes	IsS11Min=No	FrameElem=54	ElemStation=0.375			
Frame=54	Station=0.375	OutputCase=ENVE	CaseType=Combination	StepType=Min	Point=2	X2=-0.5	X3=0.5	
S11=1973.77379719217		IsS11Max=No	IsS11Min=No	FrameElem=54	ElemStation=0.375			
Frame=54	Station=0.375	OutputCase=ENVE	CaseType=Combination	StepType=Min	Point=3	X2=0.5	X3=-0.5	
S11=-2096.13809169631		IsS11Max=No	IsS11Min=Yes	FrameElem=54	ElemStation=0.375			
Frame=54	Station=0.375	OutputCase=ENVE	CaseType=Combination	StepType=Min	Point=4	X2=0.5	X3=0.5	
S11=-2096.13809169631		IsS11Max=No	IsS11Min=No	FrameElem=54	ElemStation=0.375			
Frame=54	Station=0.5	OutputCase=ENVE	CaseType=Combination	StepType=Min	Point=0	X2=0	X3=0	S11=-
52.6936800202215		IsS11Max=No	IsS11Min=No	FrameElem=54	ElemStation=0.5			
Frame=54	Station=0.5	OutputCase=ENVE	CaseType=Combination	StepType=Min	Point=1	X2=-0.5	X3=-0.5	
S11=1818.03160928501		IsS11Max=Yes	IsS11Min=No	FrameElem=54	ElemStation=0.5			
Frame=54	Station=0.5	OutputCase=ENVE	CaseType=Combination	StepType=Min	Point=2	X2=-0.5	X3=0.5	
S11=1818.03160928501		IsS11Max=No	IsS11Min=No	FrameElem=54	ElemStation=0.5			
Frame=54	Station=0.5	OutputCase=ENVE	CaseType=Combination	StepType=Min	Point=3	X2=0.5	X3=-0.5	
S11=-1940.39590386434		IsS11Max=No	IsS11Min=Yes	FrameElem=54	ElemStation=0.5			
Frame=54	Station=0.5	OutputCase=ENVE	CaseType=Combination	StepType=Min	Point=4	X2=0.5	X3=0.5	
S11=-1940.39590386434		IsS11Max=No	IsS11Min=No	FrameElem=54	ElemStation=0.5			

Frame=54	Station=0	OutputCase=FESSUR	CaseType=Combination	Point=0	X2=0	X3=0	S11=-52.6936800202215
IsS11Max=No	IsS11Min=No	FrameElem=54	ElemStation=0				
Frame=54	Station=0	OutputCase=FESSUR	CaseType=Combination	Point=1	X2=-0.5	X3=-0.5	
S11=2316.40661091366	IsS11Max=Yes	IsS11Min=No	FrameElem=54	ElemStation=0			
Frame=54	Station=0	OutputCase=FESSUR	CaseType=Combination	Point=2	X2=-0.5	X3=0.5	
S11=2316.40661091366	IsS11Max=No	IsS11Min=No	FrameElem=54	ElemStation=0			
Frame=54	Station=0	OutputCase=FESSUR	CaseType=Combination	Point=3	X2=0.5	X3=-0.5	S11=-
2421.7939709541	IsS11Max=No	IsS11Min=Yes	FrameElem=54	ElemStation=0			
Frame=54	Station=0	OutputCase=FESSUR	CaseType=Combination	Point=4	X2=0.5	X3=0.5	S11=-
2421.7939709541	IsS11Max=No	IsS11Min=No	FrameElem=54	ElemStation=0			
Frame=54	Station=0.125	OutputCase=FESSUR	CaseType=Combination	Point=0	X2=0	X3=0	S11=-
52.6936800202215	IsS11Max=No	IsS11Min=No	FrameElem=54	ElemStation=0.125			
Frame=54	Station=0.125	OutputCase=FESSUR	CaseType=Combination	Point=1	X2=-0.5	X3=-0.5	
S11=2222.9612980065	IsS11Max=Yes	IsS11Min=No	FrameElem=54	ElemStation=0.125			
Frame=54	Station=0.125	OutputCase=FESSUR	CaseType=Combination	Point=2	X2=-0.5	X3=0.5	
S11=2222.9612980065	IsS11Max=No	IsS11Min=No	FrameElem=54	ElemStation=0.125			
Frame=54	Station=0.125	OutputCase=FESSUR	CaseType=Combination	Point=3	X2=0.5	X3=-0.5	S11=-
2328.34865804694	IsS11Max=No	IsS11Min=Yes	FrameElem=54	ElemStation=0.125			
Frame=54	Station=0.125	OutputCase=FESSUR	CaseType=Combination	Point=4	X2=0.5	X3=0.5	S11=-
2328.34865804694	IsS11Max=No	IsS11Min=No	FrameElem=54	ElemStation=0.125			
Frame=54	Station=0.25	OutputCase=FESSUR	CaseType=Combination	Point=0	X2=0	X3=0	S11=-
52.6936800202215	IsS11Max=No	IsS11Min=No	FrameElem=54	ElemStation=0.25			
Frame=54	Station=0.25	OutputCase=FESSUR	CaseType=Combination	Point=1	X2=-0.5	X3=-0.5	
S11=2108.75036009933	IsS11Max=Yes	IsS11Min=No	FrameElem=54	ElemStation=0.25			
Frame=54	Station=0.25	OutputCase=FESSUR	CaseType=Combination	Point=2	X2=-0.5	X3=0.5	
S11=2108.75036009933	IsS11Max=No	IsS11Min=No	FrameElem=54	ElemStation=0.25			
Frame=54	Station=0.25	OutputCase=FESSUR	CaseType=Combination	Point=3	X2=0.5	X3=-0.5	S11=-
2214.13772013978	IsS11Max=No	IsS11Min=Yes	FrameElem=54	ElemStation=0.25			
Frame=54	Station=0.25	OutputCase=FESSUR	CaseType=Combination	Point=4	X2=0.5	X3=0.5	S11=-
2214.13772013978	IsS11Max=No	IsS11Min=No	FrameElem=54	ElemStation=0.25			
Frame=54	Station=0.375	OutputCase=FESSUR	CaseType=Combination	Point=0	X2=0	X3=0	S11=-
52.6936800202215	IsS11Max=No	IsS11Min=No	FrameElem=54	ElemStation=0.375			
Frame=54	Station=0.375	OutputCase=FESSUR	CaseType=Combination	Point=1	X2=-0.5	X3=-0.5	
S11=1973.77379719217	IsS11Max=Yes	IsS11Min=No	FrameElem=54	ElemStation=0.375			
Frame=54	Station=0.375	OutputCase=FESSUR	CaseType=Combination	Point=2	X2=-0.5	X3=0.5	
S11=1973.77379719217	IsS11Max=No	IsS11Min=No	FrameElem=54	ElemStation=0.375			
Frame=54	Station=0.375	OutputCase=FESSUR	CaseType=Combination	Point=3	X2=0.5	X3=-0.5	S11=-
2079.16115723261	IsS11Max=No	IsS11Min=Yes	FrameElem=54	ElemStation=0.375			
Frame=54	Station=0.375	OutputCase=FESSUR	CaseType=Combination	Point=4	X2=0.5	X3=0.5	S11=-
2079.16115723261	IsS11Max=No	IsS11Min=No	FrameElem=54	ElemStation=0.375			
Frame=54	Station=0.5	OutputCase=FESSUR	CaseType=Combination	Point=0	X2=0	X3=0	S11=-52.6936800202215
IsS11Max=No	IsS11Min=No	FrameElem=54	ElemStation=0.5				
Frame=54	Station=0.5	OutputCase=FESSUR	CaseType=Combination	Point=1	X2=-0.5	X3=-0.5	
S11=1818.03160928501	IsS11Max=Yes	IsS11Min=No	FrameElem=54	ElemStation=0.5			
Frame=54	Station=0.5	OutputCase=FESSUR	CaseType=Combination	Point=2	X2=-0.5	X3=0.5	
S11=1818.03160928501	IsS11Max=No	IsS11Min=No	FrameElem=54	ElemStation=0.5			
Frame=54	Station=0.5	OutputCase=FESSUR	CaseType=Combination	Point=3	X2=0.5	X3=-0.5	S11=-
1923.41896932545	IsS11Max=No	IsS11Min=Yes	FrameElem=54	ElemStation=0.5			
Frame=54	Station=0.5	OutputCase=FESSUR	CaseType=Combination	Point=4	X2=0.5	X3=0.5	S11=-
1923.41896932545	IsS11Max=No	IsS11Min=No	FrameElem=54	ElemStation=0.5			
Frame=55	Station=0	OutputCase=PESOPR	CaseType=LinStatic	Point=0	X2=0	X3=0	S11=15.1709467362389
IsS11Max=No	IsS11Min=No	FrameElem=55	ElemStation=0				
Frame=55	Station=0	OutputCase=PESOPR	CaseType=LinStatic	Point=1	X2=-0.5	X3=-0.5	
S11=282.491476987679	IsS11Max=Yes	IsS11Min=No	FrameElem=55	ElemStation=0			
Frame=55	Station=0	OutputCase=PESOPR	CaseType=LinStatic	Point=2	X2=-0.5	X3=0.5	S11=282.491476987679
IsS11Max=No	IsS11Min=No	FrameElem=55	ElemStation=0				
Frame=55	Station=0	OutputCase=PESOPR	CaseType=LinStatic	Point=3	X2=0.5	X3=-0.5	S11=-
252.149583515201	IsS11Max=No	IsS11Min=Yes	FrameElem=55	ElemStation=0			
Frame=55	Station=0	OutputCase=PESOPR	CaseType=LinStatic	Point=4	X2=0.5	X3=0.5	S11=-252.149583515201
IsS11Max=No	IsS11Min=No	FrameElem=55	ElemStation=0				
Frame=55	Station=0.125	OutputCase=PESOPR	CaseType=LinStatic	Point=0	X2=0	X3=0	S11=15.1709467362389
IsS11Max=No	IsS11Min=No	FrameElem=55	ElemStation=0.125				
Frame=55	Station=0.125	OutputCase=PESOPR	CaseType=LinStatic	Point=1	X2=-0.5	X3=-0.5	
S11=262.569601979351	IsS11Max=Yes	IsS11Min=No	FrameElem=55	ElemStation=0.125			
Frame=55	Station=0.125	OutputCase=PESOPR	CaseType=LinStatic	Point=2	X2=-0.5	X3=0.5	
S11=262.569601979351	IsS11Max=No	IsS11Min=No	FrameElem=55	ElemStation=0.125			
Frame=55	Station=0.125	OutputCase=PESOPR	CaseType=LinStatic	Point=3	X2=0.5	X3=-0.5	S11=-
232.227708506874	IsS11Max=No	IsS11Min=Yes	FrameElem=55	ElemStation=0.125			
Frame=55	Station=0.125	OutputCase=PESOPR	CaseType=LinStatic	Point=4	X2=0.5	X3=0.5	S11=-
232.227708506874	IsS11Max=No	IsS11Min=No	FrameElem=55	ElemStation=0.125			
Frame=55	Station=0.25	OutputCase=PESOPR	CaseType=LinStatic	Point=0	X2=0	X3=0	S11=15.1709467362389
IsS11Max=No	IsS11Min=No	FrameElem=55	ElemStation=0.25				
Frame=55	Station=0.25	OutputCase=PESOPR	CaseType=LinStatic	Point=1	X2=-0.5	X3=-0.5	
S11=240.303976971024	IsS11Max=Yes	IsS11Min=No	FrameElem=55	ElemStation=0.25			
Frame=55	Station=0.25	OutputCase=PESOPR	CaseType=LinStatic	Point=2	X2=-0.5	X3=0.5	
S11=240.303976971024	IsS11Max=No	IsS11Min=No	FrameElem=55	ElemStation=0.25			
Frame=55	Station=0.25	OutputCase=PESOPR	CaseType=LinStatic	Point=3	X2=0.5	X3=-0.5	S11=-
209.962083498546	IsS11Max=No	IsS11Min=Yes	FrameElem=55	ElemStation=0.25			
Frame=55	Station=0.25	OutputCase=PESOPR	CaseType=LinStatic	Point=4	X2=0.5	X3=0.5	S11=-
209.962083498546	IsS11Max=No	IsS11Min=No	FrameElem=55	ElemStation=0.25			
Frame=55	Station=0.375	OutputCase=PESOPR	CaseType=LinStatic	Point=0	X2=0	X3=0	S11=15.1709467362389
IsS11Max=No	IsS11Min=No	FrameElem=55	ElemStation=0.375				

Frame=55 Station=0.375 OutputCase=PESOPR CaseType=LinStatic Point=1 X2=-0.5 X3=-0.5
 S11=215.694601962697 IsS11Max=Yes IsS11Min=No FrameElem=55 ElemStation=0.375
 Frame=55 Station=0.375 OutputCase=PESOPR CaseType=LinStatic Point=2 X2=-0.5 X3=0.5
 S11=215.694601962697 IsS11Max=No IsS11Min=No FrameElem=55 ElemStation=0.375
 Frame=55 Station=0.375 OutputCase=PESOPR CaseType=LinStatic Point=3 X2=0.5 X3=-0.5 S11=-
 185.352708490219 IsS11Max=No IsS11Min=Yes FrameElem=55 ElemStation=0.375
 Frame=55 Station=0.375 OutputCase=PESOPR CaseType=LinStatic Point=4 X2=0.5 X3=0.5 S11=-
 185.352708490219 IsS11Max=No IsS11Min=No FrameElem=55 ElemStation=0.375
 Frame=55 Station=0.5 OutputCase=PESOPR CaseType=LinStatic Point=0 X2=0 X3=0 S11=15.1709467362389
 IsS11Max=No IsS11Min=No FrameElem=55 ElemStation=0.5
 Frame=55 Station=0.5 OutputCase=PESOPR CaseType=LinStatic Point=1 X2=-0.5 X3=-0.5
 S11=188.741476954369 IsS11Max=Yes IsS11Min=No FrameElem=55 ElemStation=0.5
 Frame=55 Station=0.5 OutputCase=PESOPR CaseType=LinStatic Point=2 X2=-0.5 X3=0.5
 S11=188.741476954369 IsS11Max=No IsS11Min=No FrameElem=55 ElemStation=0.5
 Frame=55 Station=0.5 OutputCase=PESOPR CaseType=LinStatic Point=3 X2=0.5 X3=-0.5 S11=-
 158.399583481892 IsS11Max=No IsS11Min=Yes FrameElem=55 ElemStation=0.5
 Frame=55 Station=0.5 OutputCase=PESOPR CaseType=LinStatic Point=4 X2=0.5 X3=0.5 S11=-
 158.399583481892 IsS11Max=No IsS11Min=No FrameElem=55 ElemStation=0.5
 Frame=55 Station=0 OutputCase=TERRVERT CaseType=LinStatic Point=0 X2=0 X3=0 S11=-1.15282857329027
 IsS11Max=No IsS11Min=No FrameElem=55 ElemStation=0
 Frame=55 Station=0 OutputCase=TERRVERT CaseType=LinStatic Point=1 X2=-0.5 X3=-0.5 S11=1725.55351046
 IsS11Max=Yes IsS11Min=No FrameElem=55 ElemStation=0
 Frame=55 Station=0 OutputCase=TERRVERT CaseType=LinStatic Point=2 X2=-0.5 X3=0.5 S11=1725.55351046
 IsS11Max=No IsS11Min=No FrameElem=55 ElemStation=0
 Frame=55 Station=0 OutputCase=TERRVERT CaseType=LinStatic Point=3 X2=0.5 X3=-0.5 S11=-
 1727.85916760658 IsS11Max=No IsS11Min=Yes FrameElem=55 ElemStation=0
 Frame=55 Station=0 OutputCase=TERRVERT CaseType=LinStatic Point=4 X2=0.5 X3=0.5 S11=-
 1727.85916760658 IsS11Max=No IsS11Min=No FrameElem=55 ElemStation=0
 Frame=55 Station=0.125 OutputCase=TERRVERT CaseType=LinStatic Point=0 X2=0 X3=0 S11=-
 1.15282857329027 IsS11Max=No IsS11Min=No FrameElem=55 ElemStation=0.125
 Frame=55 Station=0.125 OutputCase=TERRVERT CaseType=LinStatic Point=1 X2=-0.5 X3=-0.5
 S11=1568.96757281181 IsS11Max=Yes IsS11Min=No FrameElem=55 ElemStation=0.125
 Frame=55 Station=0.125 OutputCase=TERRVERT CaseType=LinStatic Point=2 X2=-0.5 X3=0.5
 S11=1568.96757281181 IsS11Max=No IsS11Min=No FrameElem=55 ElemStation=0.125
 Frame=55 Station=0.125 OutputCase=TERRVERT CaseType=LinStatic Point=3 X2=0.5 X3=-0.5 S11=-
 1571.27322995839 IsS11Max=No IsS11Min=Yes FrameElem=55 ElemStation=0.125
 Frame=55 Station=0.125 OutputCase=TERRVERT CaseType=LinStatic Point=4 X2=0.5 X3=0.5 S11=-
 1571.27322995839 IsS11Max=No IsS11Min=No FrameElem=55 ElemStation=0.125
 Frame=55 Station=0.25 OutputCase=TERRVERT CaseType=LinStatic Point=0 X2=0 X3=0 S11=-
 1.15282857329027 IsS11Max=No IsS11Min=No FrameElem=55 ElemStation=0.25
 Frame=55 Station=0.25 OutputCase=TERRVERT CaseType=LinStatic Point=1 X2=-0.5 X3=-0.5
 S11=1393.95976016362 IsS11Max=Yes IsS11Min=No FrameElem=55 ElemStation=0.25
 Frame=55 Station=0.25 OutputCase=TERRVERT CaseType=LinStatic Point=2 X2=-0.5 X3=0.5
 S11=1393.95976016362 IsS11Max=No IsS11Min=No FrameElem=55 ElemStation=0.25
 Frame=55 Station=0.25 OutputCase=TERRVERT CaseType=LinStatic Point=3 X2=0.5 X3=-0.5 S11=-
 1396.2654173102 IsS11Max=No IsS11Min=Yes FrameElem=55 ElemStation=0.25
 Frame=55 Station=0.25 OutputCase=TERRVERT CaseType=LinStatic Point=4 X2=0.5 X3=0.5 S11=-
 1396.2654173102 IsS11Max=No IsS11Min=No FrameElem=55 ElemStation=0.25
 Frame=55 Station=0.375 OutputCase=TERRVERT CaseType=LinStatic Point=0 X2=0 X3=0 S11=-
 1.15282857329027 IsS11Max=No IsS11Min=No FrameElem=55 ElemStation=0.375
 Frame=55 Station=0.375 OutputCase=TERRVERT CaseType=LinStatic Point=1 X2=-0.5 X3=-0.5
 S11=1200.53007251543 IsS11Max=Yes IsS11Min=No FrameElem=55 ElemStation=0.375
 Frame=55 Station=0.375 OutputCase=TERRVERT CaseType=LinStatic Point=2 X2=-0.5 X3=0.5
 S11=1200.53007251543 IsS11Max=No IsS11Min=No FrameElem=55 ElemStation=0.375
 Frame=55 Station=0.375 OutputCase=TERRVERT CaseType=LinStatic Point=3 X2=0.5 X3=-0.5 S11=-
 1202.83572966201 IsS11Max=No IsS11Min=Yes FrameElem=55 ElemStation=0.375
 Frame=55 Station=0.375 OutputCase=TERRVERT CaseType=LinStatic Point=4 X2=0.5 X3=0.5 S11=-
 1202.83572966201 IsS11Max=No IsS11Min=No FrameElem=55 ElemStation=0.375
 Frame=55 Station=0.5 OutputCase=TERRVERT CaseType=LinStatic Point=0 X2=0 X3=0 S11=-1.15282857329027
 IsS11Max=No IsS11Min=No FrameElem=55 ElemStation=0.5
 Frame=55 Station=0.5 OutputCase=TERRVERT CaseType=LinStatic Point=1 X2=-0.5 X3=-0.5
 S11=988.678509867243 IsS11Max=Yes IsS11Min=No FrameElem=55 ElemStation=0.5
 Frame=55 Station=0.5 OutputCase=TERRVERT CaseType=LinStatic Point=2 X2=-0.5 X3=0.5
 S11=988.678509867243 IsS11Max=No IsS11Min=No FrameElem=55 ElemStation=0.5
 Frame=55 Station=0.5 OutputCase=TERRVERT CaseType=LinStatic Point=3 X2=0.5 X3=-0.5 S11=-
 990.984167013824 IsS11Max=No IsS11Min=Yes FrameElem=55 ElemStation=0.5
 Frame=55 Station=0.5 OutputCase=TERRVERT CaseType=LinStatic Point=4 X2=0.5 X3=0.5 S11=-
 990.984167013824 IsS11Max=No IsS11Min=No FrameElem=55 ElemStation=0.5
 Frame=55 Station=0 OutputCase=TERRLAT CaseType=LinStatic Point=0 X2=0 X3=0 S11=-66.7117981831701
 IsS11Max=No IsS11Min=No FrameElem=55 ElemStation=0
 Frame=55 Station=0 OutputCase=TERRLAT CaseType=LinStatic Point=1 X2=-0.5 X3=-0.5 S11=-
 190.013378162629 IsS11Max=No IsS11Min=Yes FrameElem=55 ElemStation=0
 Frame=55 Station=0 OutputCase=TERRLAT CaseType=LinStatic Point=2 X2=-0.5 X3=0.5 S11=-
 190.013378162629 IsS11Max=No IsS11Min=No FrameElem=55 ElemStation=0
 Frame=55 Station=0 OutputCase=TERRLAT CaseType=LinStatic Point=3 X2=0.5 X3=-0.5
 S11=56.5897817962889 IsS11Max=Yes IsS11Min=No FrameElem=55 ElemStation=0
 Frame=55 Station=0 OutputCase=TERRLAT CaseType=LinStatic Point=4 X2=0.5 X3=0.5 S11=56.5897817962889
 IsS11Max=No IsS11Min=No FrameElem=55 ElemStation=0
 Frame=55 Station=0.125 OutputCase=TERRLAT CaseType=LinStatic Point=0 X2=0 X3=0 S11=-
 66.7117981831701 IsS11Max=No IsS11Min=No FrameElem=55 ElemStation=0.125
 Frame=55 Station=0.125 OutputCase=TERRLAT CaseType=LinStatic Point=1 X2=-0.5 X3=-0.5 S11=-
 190.013378413265 IsS11Max=No IsS11Min=Yes FrameElem=55 ElemStation=0.125

Frame=55	Station=0.25	OutputCase=TERRCOST	CaseType=LinStatic	Point=4	X2=0.5	X3=0.5	S11=0	
IsS11Max=No	IsS11Min=No	FrameElem=55	ElemStation=0.25					
Frame=55	Station=0.375	OutputCase=TERRCOST	CaseType=LinStatic	Point=0	X2=0	X3=0	S11=0	
IsS11Max=Yes	IsS11Min=Yes	FrameElem=55	ElemStation=0.375					
Frame=55	Station=0.375	OutputCase=TERRCOST	CaseType=LinStatic	Point=1	X2=-0.5	X3=-0.5	S11=0	
IsS11Max=No	IsS11Min=No	FrameElem=55	ElemStation=0.375					
Frame=55	Station=0.375	OutputCase=TERRCOST	CaseType=LinStatic	Point=2	X2=-0.5	X3=0.5	S11=0	
IsS11Max=No	IsS11Min=No	FrameElem=55	ElemStation=0.375					
Frame=55	Station=0.375	OutputCase=TERRCOST	CaseType=LinStatic	Point=3	X2=0.5	X3=-0.5	S11=0	
IsS11Max=No	IsS11Min=No	FrameElem=55	ElemStation=0.375					
Frame=55	Station=0.375	OutputCase=TERRCOST	CaseType=LinStatic	Point=4	X2=0.5	X3=0.5	S11=0	
IsS11Max=No	IsS11Min=No	FrameElem=55	ElemStation=0.375					
Frame=55	Station=0.5	OutputCase=TERRCOST	CaseType=LinStatic	Point=0	X2=0	X3=0	S11=0	IsS11Max=Yes
IsS11Min=Yes	FrameElem=55	ElemStation=0.5						
Frame=55	Station=0.5	OutputCase=TERRCOST	CaseType=LinStatic	Point=1	X2=-0.5	X3=-0.5	S11=0	
IsS11Max=No	IsS11Min=No	FrameElem=55	ElemStation=0.5					
Frame=55	Station=0.5	OutputCase=TERRCOST	CaseType=LinStatic	Point=2	X2=-0.5	X3=0.5	S11=0	
IsS11Max=No	IsS11Min=No	FrameElem=55	ElemStation=0.5					
Frame=55	Station=0.5	OutputCase=TERRCOST	CaseType=LinStatic	Point=3	X2=0.5	X3=-0.5	S11=0	
IsS11Max=No	IsS11Min=No	FrameElem=55	ElemStation=0.5					
Frame=55	Station=0.5	OutputCase=TERRCOST	CaseType=LinStatic	Point=4	X2=0.5	X3=0.5	S11=0	
IsS11Max=No	IsS11Min=No	FrameElem=55	ElemStation=0.5					
Frame=55	Station=0	OutputCase=SOVRCOST	CaseType=LinStatic	Point=0	X2=0	X3=0	S11=0	IsS11Max=Yes
IsS11Min=Yes	FrameElem=55	ElemStation=0						
Frame=55	Station=0	OutputCase=SOVRCOST	CaseType=LinStatic	Point=1	X2=-0.5	X3=-0.5	S11=0	
IsS11Max=No	IsS11Min=No	FrameElem=55	ElemStation=0					
Frame=55	Station=0	OutputCase=SOVRCOST	CaseType=LinStatic	Point=2	X2=-0.5	X3=0.5	S11=0	
IsS11Max=No	IsS11Min=No	FrameElem=55	ElemStation=0					
Frame=55	Station=0	OutputCase=SOVRCOST	CaseType=LinStatic	Point=3	X2=0.5	X3=-0.5	S11=0	
IsS11Max=No	IsS11Min=No	FrameElem=55	ElemStation=0					
Frame=55	Station=0	OutputCase=SOVRCOST	CaseType=LinStatic	Point=4	X2=0.5	X3=0.5	S11=0	IsS11Max=No
IsS11Min=No	FrameElem=55	ElemStation=0						
Frame=55	Station=0.125	OutputCase=SOVRCOST	CaseType=LinStatic	Point=0	X2=0	X3=0	S11=0	
IsS11Max=Yes	IsS11Min=Yes	FrameElem=55	ElemStation=0.125					
Frame=55	Station=0.125	OutputCase=SOVRCOST	CaseType=LinStatic	Point=1	X2=-0.5	X3=-0.5	S11=0	
IsS11Max=No	IsS11Min=No	FrameElem=55	ElemStation=0.125					
Frame=55	Station=0.125	OutputCase=SOVRCOST	CaseType=LinStatic	Point=2	X2=-0.5	X3=0.5	S11=0	
IsS11Max=No	IsS11Min=No	FrameElem=55	ElemStation=0.125					
Frame=55	Station=0.125	OutputCase=SOVRCOST	CaseType=LinStatic	Point=3	X2=0.5	X3=-0.5	S11=0	
IsS11Max=No	IsS11Min=No	FrameElem=55	ElemStation=0.125					
Frame=55	Station=0.125	OutputCase=SOVRCOST	CaseType=LinStatic	Point=4	X2=0.5	X3=0.5	S11=0	
IsS11Max=No	IsS11Min=No	FrameElem=55	ElemStation=0.125					
Frame=55	Station=0.25	OutputCase=SOVRCOST	CaseType=LinStatic	Point=0	X2=0	X3=0	S11=0	IsS11Max=Yes
IsS11Min=Yes	FrameElem=55	ElemStation=0.25						
Frame=55	Station=0.25	OutputCase=SOVRCOST	CaseType=LinStatic	Point=1	X2=-0.5	X3=-0.5	S11=0	
IsS11Max=No	IsS11Min=No	FrameElem=55	ElemStation=0.25					
Frame=55	Station=0.25	OutputCase=SOVRCOST	CaseType=LinStatic	Point=2	X2=-0.5	X3=0.5	S11=0	
IsS11Max=No	IsS11Min=No	FrameElem=55	ElemStation=0.25					
Frame=55	Station=0.25	OutputCase=SOVRCOST	CaseType=LinStatic	Point=3	X2=0.5	X3=-0.5	S11=0	
IsS11Max=No	IsS11Min=No	FrameElem=55	ElemStation=0.25					
Frame=55	Station=0.25	OutputCase=SOVRCOST	CaseType=LinStatic	Point=4	X2=0.5	X3=0.5	S11=0	
IsS11Max=No	IsS11Min=No	FrameElem=55	ElemStation=0.25					
Frame=55	Station=0.375	OutputCase=SOVRCOST	CaseType=LinStatic	Point=0	X2=0	X3=0	S11=0	
IsS11Max=Yes	IsS11Min=Yes	FrameElem=55	ElemStation=0.375					
Frame=55	Station=0.375	OutputCase=SOVRCOST	CaseType=LinStatic	Point=1	X2=-0.5	X3=-0.5	S11=0	
IsS11Max=No	IsS11Min=No	FrameElem=55	ElemStation=0.375					
Frame=55	Station=0.375	OutputCase=SOVRCOST	CaseType=LinStatic	Point=2	X2=-0.5	X3=0.5	S11=0	
IsS11Max=No	IsS11Min=No	FrameElem=55	ElemStation=0.375					
Frame=55	Station=0.375	OutputCase=SOVRCOST	CaseType=LinStatic	Point=3	X2=0.5	X3=-0.5	S11=0	
IsS11Max=No	IsS11Min=No	FrameElem=55	ElemStation=0.375					
Frame=55	Station=0.375	OutputCase=SOVRCOST	CaseType=LinStatic	Point=4	X2=0.5	X3=0.5	S11=0	
IsS11Max=No	IsS11Min=No	FrameElem=55	ElemStation=0.375					
Frame=55	Station=0.5	OutputCase=SOVRCOST	CaseType=LinStatic	Point=0	X2=0	X3=0	S11=0	IsS11Max=Yes
IsS11Min=Yes	FrameElem=55	ElemStation=0.5						
Frame=55	Station=0.5	OutputCase=SOVRCOST	CaseType=LinStatic	Point=1	X2=-0.5	X3=-0.5	S11=0	
IsS11Max=No	IsS11Min=No	FrameElem=55	ElemStation=0.5					
Frame=55	Station=0.5	OutputCase=SOVRCOST	CaseType=LinStatic	Point=2	X2=-0.5	X3=0.5	S11=0	
IsS11Max=No	IsS11Min=No	FrameElem=55	ElemStation=0.5					
Frame=55	Station=0.5	OutputCase=SOVRCOST	CaseType=LinStatic	Point=3	X2=0.5	X3=-0.5	S11=0	
IsS11Max=No	IsS11Min=No	FrameElem=55	ElemStation=0.5					
Frame=55	Station=0.5	OutputCase=SOVRCOST	CaseType=LinStatic	Point=4	X2=0.5	X3=0.5	S11=0	
IsS11Max=No	IsS11Min=No	FrameElem=55	ElemStation=0.5					
Frame=55	Station=0	OutputCase=ENVE	CaseType=Combination	StepType=Max	Point=0	X2=0	X3=0	S11=-
32.6801405652705	IsS11Max=No	IsS11Min=No	FrameElem=55	ElemStation=0				
Frame=55	Station=0	OutputCase=ENVE	CaseType=Combination	StepType=Max	Point=1	X2=-0.5	X3=-0.5	
S11=1875.03562273384	IsS11Max=Yes	IsS11Min=No	FrameElem=55	ElemStation=0				
Frame=55	Station=0	OutputCase=ENVE	CaseType=Combination	StepType=Max	Point=2	X2=-0.5	X3=0.5	
S11=1875.03562273384	IsS11Max=No	IsS11Min=No	FrameElem=55	ElemStation=0				
Frame=55	Station=0	OutputCase=ENVE	CaseType=Combination	StepType=Max	Point=3	X2=0.5	X3=-0.5	S11=-
1923.41896932549	IsS11Max=No	IsS11Min=Yes	FrameElem=55	ElemStation=0				
Frame=55	Station=0	OutputCase=ENVE	CaseType=Combination	StepType=Max	Point=4	X2=0.5	X3=0.5	S11=-
1923.41896932549	IsS11Max=No	IsS11Min=No	FrameElem=55	ElemStation=0				

Frame=55	Station=0.125	OutputCase=ENVE	CaseType=Combination	StepType=Max	Point=0	X2=0	X3=0	S11=-
32.6801405652705	IsS11Max=No	IsS11Min=No	FrameElem=55	ElemStation=0.125				
Frame=55	Station=0.125	OutputCase=ENVE	CaseType=Combination	StepType=Max	Point=1	X2=-0.5	X3=-0.5	
S11=1698.52780990188	IsS11Max=Yes	IsS11Min=No	FrameElem=55	ElemStation=0.125				
Frame=55	Station=0.125	OutputCase=ENVE	CaseType=Combination	StepType=Max	Point=2	X2=-0.5	X3=0.5	
S11=1698.52780990188	IsS11Max=No	IsS11Min=No	FrameElem=55	ElemStation=0.125				
Frame=55	Station=0.125	OutputCase=ENVE	CaseType=Combination	StepType=Max	Point=3	X2=0.5	X3=-0.5	
S11=-1746.91115641834	IsS11Max=No	IsS11Min=Yes	FrameElem=55	ElemStation=0.125				
Frame=55	Station=0.125	OutputCase=ENVE	CaseType=Combination	StepType=Max	Point=4	X2=0.5	X3=0.5	
S11=-1746.91115641834	IsS11Max=No	IsS11Min=No	FrameElem=55	ElemStation=0.125				
Frame=55	Station=0.25	OutputCase=ENVE	CaseType=Combination	StepType=Max	Point=0	X2=0	X3=0	S11=-
32.6801405652705	IsS11Max=No	IsS11Min=No	FrameElem=55	ElemStation=0.25				
Frame=55	Station=0.25	OutputCase=ENVE	CaseType=Combination	StepType=Max	Point=1	X2=-0.5	X3=-0.5	
S11=1501.25437206992	IsS11Max=Yes	IsS11Min=No	FrameElem=55	ElemStation=0.25				
Frame=55	Station=0.25	OutputCase=ENVE	CaseType=Combination	StepType=Max	Point=2	X2=-0.5	X3=0.5	
S11=1501.25437206992	IsS11Max=No	IsS11Min=No	FrameElem=55	ElemStation=0.25				
Frame=55	Station=0.25	OutputCase=ENVE	CaseType=Combination	StepType=Max	Point=3	X2=0.5	X3=-0.5	
S11=-1549.63771851119	IsS11Max=No	IsS11Min=Yes	FrameElem=55	ElemStation=0.25				
Frame=55	Station=0.25	OutputCase=ENVE	CaseType=Combination	StepType=Max	Point=4	X2=0.5	X3=0.5	
S11=-1549.63771851119	IsS11Max=No	IsS11Min=No	FrameElem=55	ElemStation=0.25				
Frame=55	Station=0.375	OutputCase=ENVE	CaseType=Combination	StepType=Max	Point=0	X2=0	X3=0	S11=-
32.6801405652705	IsS11Max=No	IsS11Min=No	FrameElem=55	ElemStation=0.375				
Frame=55	Station=0.375	OutputCase=ENVE	CaseType=Combination	StepType=Max	Point=1	X2=-0.5	X3=-0.5	
S11=1283.21530923795	IsS11Max=Yes	IsS11Min=No	FrameElem=55	ElemStation=0.375				
Frame=55	Station=0.375	OutputCase=ENVE	CaseType=Combination	StepType=Max	Point=2	X2=-0.5	X3=0.5	
S11=1283.21530923795	IsS11Max=No	IsS11Min=No	FrameElem=55	ElemStation=0.375				
Frame=55	Station=0.375	OutputCase=ENVE	CaseType=Combination	StepType=Max	Point=3	X2=0.5	X3=-0.5	
S11=-1331.59865560404	IsS11Max=No	IsS11Min=Yes	FrameElem=55	ElemStation=0.375				
Frame=55	Station=0.375	OutputCase=ENVE	CaseType=Combination	StepType=Max	Point=4	X2=0.5	X3=0.5	
S11=-1331.59865560404	IsS11Max=No	IsS11Min=No	FrameElem=55	ElemStation=0.375				
Frame=55	Station=0.5	OutputCase=ENVE	CaseType=Combination	StepType=Max	Point=0	X2=0	X3=0	S11=-
32.6801405652705	IsS11Max=No	IsS11Min=No	FrameElem=55	ElemStation=0.5				
Frame=55	Station=0.5	OutputCase=ENVE	CaseType=Combination	StepType=Max	Point=1	X2=-0.5	X3=-0.5	
S11=1044.41062140599	IsS11Max=Yes	IsS11Min=No	FrameElem=55	ElemStation=0.5				
Frame=55	Station=0.5	OutputCase=ENVE	CaseType=Combination	StepType=Max	Point=2	X2=-0.5	X3=0.5	
S11=1044.41062140599	IsS11Max=No	IsS11Min=No	FrameElem=55	ElemStation=0.5				
Frame=55	Station=0.5	OutputCase=ENVE	CaseType=Combination	StepType=Max	Point=3	X2=0.5	X3=-0.5	
S11=-1092.79396769688	IsS11Max=No	IsS11Min=Yes	FrameElem=55	ElemStation=0.5				
Frame=55	Station=0.5	OutputCase=ENVE	CaseType=Combination	StepType=Max	Point=4	X2=0.5	X3=0.5	
S11=-1092.79396769688	IsS11Max=No	IsS11Min=No	FrameElem=55	ElemStation=0.5				
Frame=55	Station=0	OutputCase=ENVE	CaseType=Combination	StepType=Min	Point=0	X2=0	X3=0	S11=-
52.6936800202215	IsS11Max=No	IsS11Min=No	FrameElem=55	ElemStation=0				
Frame=55	Station=0	OutputCase=ENVE	CaseType=Combination	StepType=Min	Point=1	X2=-0.5	X3=-0.5	
S11=1818.03160928505	IsS11Max=Yes	IsS11Min=No	FrameElem=55	ElemStation=0				
Frame=55	Station=0	OutputCase=ENVE	CaseType=Combination	StepType=Min	Point=2	X2=-0.5	X3=0.5	
S11=1818.03160928505	IsS11Max=No	IsS11Min=No	FrameElem=55	ElemStation=0				
Frame=55	Station=0	OutputCase=ENVE	CaseType=Combination	StepType=Min	Point=3	X2=0.5	X3=-0.5	S11=-
1940.39590386438	IsS11Max=No	IsS11Min=Yes	FrameElem=55	ElemStation=0				
Frame=55	Station=0	OutputCase=ENVE	CaseType=Combination	StepType=Min	Point=4	X2=0.5	X3=0.5	S11=-
1940.39590386438	IsS11Max=No	IsS11Min=No	FrameElem=55	ElemStation=0				
Frame=55	Station=0.125	OutputCase=ENVE	CaseType=Combination	StepType=Min	Point=0	X2=0	X3=0	S11=-
52.6936800202215	IsS11Max=No	IsS11Min=No	FrameElem=55	ElemStation=0.125				
Frame=55	Station=0.125	OutputCase=ENVE	CaseType=Combination	StepType=Min	Point=1	X2=-0.5	X3=-0.5	
S11=1641.5237963779	IsS11Max=Yes	IsS11Min=No	FrameElem=55	ElemStation=0.125				
Frame=55	Station=0.125	OutputCase=ENVE	CaseType=Combination	StepType=Min	Point=2	X2=-0.5	X3=0.5	
S11=1641.5237963779	IsS11Max=No	IsS11Min=No	FrameElem=55	ElemStation=0.125				
Frame=55	Station=0.125	OutputCase=ENVE	CaseType=Combination	StepType=Min	Point=3	X2=0.5	X3=-0.5	
S11=-1763.88809103242	IsS11Max=No	IsS11Min=Yes	FrameElem=55	ElemStation=0.125				
Frame=55	Station=0.125	OutputCase=ENVE	CaseType=Combination	StepType=Min	Point=4	X2=0.5	X3=0.5	
S11=-1763.88809103242	IsS11Max=No	IsS11Min=No	FrameElem=55	ElemStation=0.125				
Frame=55	Station=0.25	OutputCase=ENVE	CaseType=Combination	StepType=Min	Point=0	X2=0	X3=0	S11=-
52.6936800202215	IsS11Max=No	IsS11Min=No	FrameElem=55	ElemStation=0.25				
Frame=55	Station=0.25	OutputCase=ENVE	CaseType=Combination	StepType=Min	Point=1	X2=-0.5	X3=-0.5	
S11=1444.25035847075	IsS11Max=Yes	IsS11Min=No	FrameElem=55	ElemStation=0.25				
Frame=55	Station=0.25	OutputCase=ENVE	CaseType=Combination	StepType=Min	Point=2	X2=-0.5	X3=0.5	
S11=1444.25035847075	IsS11Max=No	IsS11Min=No	FrameElem=55	ElemStation=0.25				
Frame=55	Station=0.25	OutputCase=ENVE	CaseType=Combination	StepType=Min	Point=3	X2=0.5	X3=-0.5	
S11=-1566.61465320046	IsS11Max=No	IsS11Min=Yes	FrameElem=55	ElemStation=0.25				
Frame=55	Station=0.25	OutputCase=ENVE	CaseType=Combination	StepType=Min	Point=4	X2=0.5	X3=0.5	
S11=-1566.61465320046	IsS11Max=No	IsS11Min=No	FrameElem=55	ElemStation=0.25				
Frame=55	Station=0.375	OutputCase=ENVE	CaseType=Combination	StepType=Min	Point=0	X2=0	X3=0	S11=-
52.6936800202215	IsS11Max=No	IsS11Min=No	FrameElem=55	ElemStation=0.375				
Frame=55	Station=0.375	OutputCase=ENVE	CaseType=Combination	StepType=Min	Point=1	X2=-0.5	X3=-0.5	
S11=1226.21129556359	IsS11Max=Yes	IsS11Min=No	FrameElem=55	ElemStation=0.375				
Frame=55	Station=0.375	OutputCase=ENVE	CaseType=Combination	StepType=Min	Point=2	X2=-0.5	X3=0.5	
S11=1226.21129556359	IsS11Max=No	IsS11Min=No	FrameElem=55	ElemStation=0.375				
Frame=55	Station=0.375	OutputCase=ENVE	CaseType=Combination	StepType=Min	Point=3	X2=0.5	X3=-0.5	
S11=-1348.5755903685	IsS11Max=No	IsS11Min=Yes	FrameElem=55	ElemStation=0.375				
Frame=55	Station=0.375	OutputCase=ENVE	CaseType=Combination	StepType=Min	Point=4	X2=0.5	X3=0.5	
S11=-1348.5755903685	IsS11Max=No	IsS11Min=No	FrameElem=55	ElemStation=0.375				
Frame=55	Station=0.5	OutputCase=ENVE	CaseType=Combination	StepType=Min	Point=0	X2=0	X3=0	S11=-
52.6936800202215	IsS11Max=No	IsS11Min=No	FrameElem=55	ElemStation=0.5				

Frame=55	Station=0.5	OutputCase=ENVE	CaseType=Combination	StepType=Min	Point=1	X2=-0.5	X3=-0.5	
S11=987.406607656441	IsS11Max=Yes	IsS11Min=No	FrameElem=55	ElemStation=0.5				
Frame=55	Station=0.5	OutputCase=ENVE	CaseType=Combination	StepType=Min	Point=2	X2=-0.5	X3=0.5	
S11=987.406607656441	IsS11Max=No	IsS11Min=No	FrameElem=55	ElemStation=0.5				
Frame=55	Station=0.5	OutputCase=ENVE	CaseType=Combination	StepType=Min	Point=3	X2=0.5	X3=-0.5	
S11=-1109.77090253653	IsS11Max=No	IsS11Min=Yes	FrameElem=55	ElemStation=0.5				
Frame=55	Station=0.5	OutputCase=ENVE	CaseType=Combination	StepType=Min	Point=4	X2=0.5	X3=0.5	
S11=-1109.77090253653	IsS11Max=No	IsS11Min=No	FrameElem=55	ElemStation=0.5				
Frame=55	Station=0	OutputCase=FESSUR	CaseType=Combination	Point=0	X2=0	X3=0	S11=-52.6936800202215	
IsS11Max=No	IsS11Min=No	FrameElem=55	ElemStation=0					
Frame=55	Station=0	OutputCase=FESSUR	CaseType=Combination	Point=1	X2=-0.5	X3=-0.5		
S11=1818.03160928505	IsS11Max=Yes	IsS11Min=No	FrameElem=55	ElemStation=0				
Frame=55	Station=0	OutputCase=FESSUR	CaseType=Combination	Point=2	X2=-0.5	X3=0.5		
S11=1818.03160928505	IsS11Max=No	IsS11Min=No	FrameElem=55	ElemStation=0				
Frame=55	Station=0	OutputCase=FESSUR	CaseType=Combination	Point=3	X2=0.5	X3=-0.5	S11=-	
1923.41896932549	IsS11Max=No	IsS11Min=Yes	FrameElem=55	ElemStation=0				
Frame=55	Station=0	OutputCase=FESSUR	CaseType=Combination	Point=4	X2=0.5	X3=0.5	S11=-	
1923.41896932549	IsS11Max=No	IsS11Min=No	FrameElem=55	ElemStation=0				
Frame=55	Station=0.125	OutputCase=FESSUR	CaseType=Combination	Point=0	X2=0	X3=0	S11=-	
52.6936800202215	IsS11Max=No	IsS11Min=No	FrameElem=55	ElemStation=0.125				
Frame=55	Station=0.125	OutputCase=FESSUR	CaseType=Combination	Point=1	X2=-0.5	X3=-0.5		
S11=1641.5237963779	IsS11Max=Yes	IsS11Min=No	FrameElem=55	ElemStation=0.125				
Frame=55	Station=0.125	OutputCase=FESSUR	CaseType=Combination	Point=2	X2=-0.5	X3=0.5		
S11=1641.5237963779	IsS11Max=No	IsS11Min=No	FrameElem=55	ElemStation=0.125				
Frame=55	Station=0.125	OutputCase=FESSUR	CaseType=Combination	Point=3	X2=0.5	X3=-0.5	S11=-	
1746.91115641834	IsS11Max=No	IsS11Min=Yes	FrameElem=55	ElemStation=0.125				
Frame=55	Station=0.125	OutputCase=FESSUR	CaseType=Combination	Point=4	X2=0.5	X3=0.5	S11=-	
1746.91115641834	IsS11Max=No	IsS11Min=No	FrameElem=55	ElemStation=0.125				
Frame=55	Station=0.25	OutputCase=FESSUR	CaseType=Combination	Point=0	X2=0	X3=0	S11=-	
52.6936800202215	IsS11Max=No	IsS11Min=No	FrameElem=55	ElemStation=0.25				
Frame=55	Station=0.25	OutputCase=FESSUR	CaseType=Combination	Point=1	X2=-0.5	X3=-0.5		
S11=1444.25035847075	IsS11Max=Yes	IsS11Min=No	FrameElem=55	ElemStation=0.25				
Frame=55	Station=0.25	OutputCase=FESSUR	CaseType=Combination	Point=2	X2=-0.5	X3=0.5		
S11=1444.25035847075	IsS11Max=No	IsS11Min=No	FrameElem=55	ElemStation=0.25				
Frame=55	Station=0.25	OutputCase=FESSUR	CaseType=Combination	Point=3	X2=0.5	X3=-0.5	S11=-	
1549.63771851119	IsS11Max=No	IsS11Min=Yes	FrameElem=55	ElemStation=0.25				
Frame=55	Station=0.25	OutputCase=FESSUR	CaseType=Combination	Point=4	X2=0.5	X3=0.5	S11=-	
1549.63771851119	IsS11Max=No	IsS11Min=No	FrameElem=55	ElemStation=0.25				
Frame=55	Station=0.375	OutputCase=FESSUR	CaseType=Combination	Point=0	X2=0	X3=0	S11=-	
52.6936800202215	IsS11Max=No	IsS11Min=No	FrameElem=55	ElemStation=0.375				
Frame=55	Station=0.375	OutputCase=FESSUR	CaseType=Combination	Point=1	X2=-0.5	X3=-0.5		
S11=1226.21129556359	IsS11Max=Yes	IsS11Min=No	FrameElem=55	ElemStation=0.375				
Frame=55	Station=0.375	OutputCase=FESSUR	CaseType=Combination	Point=2	X2=-0.5	X3=0.5		
S11=1226.21129556359	IsS11Max=No	IsS11Min=No	FrameElem=55	ElemStation=0.375				
Frame=55	Station=0.375	OutputCase=FESSUR	CaseType=Combination	Point=3	X2=0.5	X3=-0.5	S11=-	
1331.59865560404	IsS11Max=No	IsS11Min=Yes	FrameElem=55	ElemStation=0.375				
Frame=55	Station=0.375	OutputCase=FESSUR	CaseType=Combination	Point=4	X2=0.5	X3=0.5	S11=-	
1331.59865560404	IsS11Max=No	IsS11Min=No	FrameElem=55	ElemStation=0.375				
Frame=55	Station=0.5	OutputCase=FESSUR	CaseType=Combination	Point=0	X2=0	X3=0	S11=-52.6936800202215	
IsS11Max=No	IsS11Min=No	FrameElem=55	ElemStation=0.5					
Frame=55	Station=0.5	OutputCase=FESSUR	CaseType=Combination	Point=1	X2=-0.5	X3=-0.5		
S11=987.406607656441	IsS11Max=Yes	IsS11Min=No	FrameElem=55	ElemStation=0.5				
Frame=55	Station=0.5	OutputCase=FESSUR	CaseType=Combination	Point=2	X2=-0.5	X3=0.5		
S11=987.406607656441	IsS11Max=No	IsS11Min=No	FrameElem=55	ElemStation=0.5				
Frame=55	Station=0.5	OutputCase=FESSUR	CaseType=Combination	Point=3	X2=0.5	X3=-0.5	S11=-	
1092.79396769688	IsS11Max=No	IsS11Min=Yes	FrameElem=55	ElemStation=0.5				
Frame=55	Station=0.5	OutputCase=FESSUR	CaseType=Combination	Point=4	X2=0.5	X3=0.5	S11=-	
1092.79396769688	IsS11Max=No	IsS11Min=No	FrameElem=55	ElemStation=0.5				
Frame=56	Station=0	OutputCase=PESOPR	CaseType=LinStatic	Point=0	X2=0	X3=0	S11=15.1709467362392	
IsS11Max=No	IsS11Min=No	FrameElem=56	ElemStation=0					
Frame=56	Station=0	OutputCase=PESOPR	CaseType=LinStatic	Point=1	X2=-0.5	X3=-0.5	S11=188.74147695437	
IsS11Max=Yes	IsS11Min=No	FrameElem=56	ElemStation=0					
Frame=56	Station=0	OutputCase=PESOPR	CaseType=LinStatic	Point=2	X2=-0.5	X3=0.5	S11=188.74147695437	
IsS11Max=No	IsS11Min=No	FrameElem=56	ElemStation=0					
Frame=56	Station=0	OutputCase=PESOPR	CaseType=LinStatic	Point=3	X2=0.5	X3=-0.5	S11=-	
158.399583481891	IsS11Max=No	IsS11Min=Yes	FrameElem=56	ElemStation=0				
Frame=56	Station=0	OutputCase=PESOPR	CaseType=LinStatic	Point=4	X2=0.5	X3=0.5	S11=-158.399583481891	
IsS11Max=No	IsS11Min=No	FrameElem=56	ElemStation=0					
Frame=56	Station=0.125	OutputCase=PESOPR	CaseType=LinStatic	Point=0	X2=0	X3=0	S11=15.1709467362392	
IsS11Max=No	IsS11Min=No	FrameElem=56	ElemStation=0.125					
Frame=56	Station=0.125	OutputCase=PESOPR	CaseType=LinStatic	Point=1	X2=-0.5	X3=-0.5		
S11=159.444601946053	IsS11Max=Yes	IsS11Min=No	FrameElem=56	ElemStation=0.125				
Frame=56	Station=0.125	OutputCase=PESOPR	CaseType=LinStatic	Point=2	X2=-0.5	X3=0.5		
S11=159.444601946053	IsS11Max=No	IsS11Min=No	FrameElem=56	ElemStation=0.125				
Frame=56	Station=0.125	OutputCase=PESOPR	CaseType=LinStatic	Point=3	X2=0.5	X3=-0.5	S11=-	
129.102708473575	IsS11Max=No	IsS11Min=Yes	FrameElem=56	ElemStation=0.125				
Frame=56	Station=0.125	OutputCase=PESOPR	CaseType=LinStatic	Point=4	X2=0.5	X3=0.5	S11=-	
129.102708473575	IsS11Max=No	IsS11Min=No	FrameElem=56	ElemStation=0.125				
Frame=56	Station=0.25	OutputCase=PESOPR	CaseType=LinStatic	Point=0	X2=0	X3=0	S11=15.1709467362392	
IsS11Max=No	IsS11Min=No	FrameElem=56	ElemStation=0.25					
Frame=56	Station=0.25	OutputCase=PESOPR	CaseType=LinStatic	Point=1	X2=-0.5	X3=-0.5		
S11=127.803976937737	IsS11Max=Yes	IsS11Min=No	FrameElem=56	ElemStation=0.25				

```

Frame=56 Station=0.25 OutputCase=PESOPR CaseType=LinStatic Point=2 X2=-0.5 X3=0.5
S11=127.803976937737 IsS11Max=No IsS11Min=No FrameElem=56 ElemStation=0.25
Frame=56 Station=0.25 OutputCase=PESOPR CaseType=LinStatic Point=3 X2=0.5 X3=-0.5 S11=-
97.4620834652584 IsS11Max=No IsS11Min=Yes FrameElem=56 ElemStation=0.25
Frame=56 Station=0.25 OutputCase=PESOPR CaseType=LinStatic Point=4 X2=0.5 X3=0.5 S11=-
97.4620834652584 IsS11Max=No IsS11Min=No FrameElem=56 ElemStation=0.25
Frame=56 Station=0.375 OutputCase=PESOPR CaseType=LinStatic Point=0 X2=0 X3=0 S11=15.1709467362392
IsS11Max=No IsS11Min=No FrameElem=56 ElemStation=0.375
Frame=56 Station=0.375 OutputCase=PESOPR CaseType=LinStatic Point=1 X2=-0.5 X3=-0.5
S11=93.8196019294204 IsS11Max=Yes IsS11Min=No FrameElem=56 ElemStation=0.375
Frame=56 Station=0.375 OutputCase=PESOPR CaseType=LinStatic Point=2 X2=-0.5 X3=0.5
S11=93.8196019294204 IsS11Max=No IsS11Min=No FrameElem=56 ElemStation=0.375
Frame=56 Station=0.375 OutputCase=PESOPR CaseType=LinStatic Point=3 X2=0.5 X3=-0.5 S11=-
63.477708456942 IsS11Max=No IsS11Min=Yes FrameElem=56 ElemStation=0.375
Frame=56 Station=0.375 OutputCase=PESOPR CaseType=LinStatic Point=4 X2=0.5 X3=0.5 S11=-
63.477708456942 IsS11Max=No IsS11Min=No FrameElem=56 ElemStation=0.375
Frame=56 Station=0.5 OutputCase=PESOPR CaseType=LinStatic Point=0 X2=0 X3=0 S11=15.1709467362392
IsS11Max=No IsS11Min=No FrameElem=56 ElemStation=0.5
Frame=56 Station=0.5 OutputCase=PESOPR CaseType=LinStatic Point=1 X2=-0.5 X3=-0.5
S11=57.491476921104 IsS11Max=Yes IsS11Min=No FrameElem=56 ElemStation=0.5
Frame=56 Station=0.5 OutputCase=PESOPR CaseType=LinStatic Point=2 X2=-0.5 X3=0.5
S11=57.491476921104 IsS11Max=No IsS11Min=No FrameElem=56 ElemStation=0.5
Frame=56 Station=0.5 OutputCase=PESOPR CaseType=LinStatic Point=3 X2=0.5 X3=-0.5 S11=-
27.1495834486255 IsS11Max=No IsS11Min=Yes FrameElem=56 ElemStation=0.5
Frame=56 Station=0.5 OutputCase=PESOPR CaseType=LinStatic Point=4 X2=0.5 X3=0.5 S11=-
27.1495834486255 IsS11Max=No IsS11Min=No FrameElem=56 ElemStation=0.5
Frame=56 Station=0 OutputCase=TERRVERT CaseType=LinStatic Point=0 X2=0 X3=0 S11=-1.15282857328964
IsS11Max=No IsS11Min=No FrameElem=56 ElemStation=0
Frame=56 Station=0 OutputCase=TERRVERT CaseType=LinStatic Point=1 X2=-0.5 X3=-0.5
S11=988.678509867288 IsS11Max=Yes IsS11Min=No FrameElem=56 ElemStation=0
Frame=56 Station=0 OutputCase=TERRVERT CaseType=LinStatic Point=2 X2=-0.5 X3=0.5
S11=988.678509867288 IsS11Max=No IsS11Min=No FrameElem=56 ElemStation=0
Frame=56 Station=0 OutputCase=TERRVERT CaseType=LinStatic Point=3 X2=0.5 X3=-0.5 S11=-
990.984167013867 IsS11Max=No IsS11Min=Yes FrameElem=56 ElemStation=0
Frame=56 Station=0 OutputCase=TERRVERT CaseType=LinStatic Point=4 X2=0.5 X3=0.5 S11=-
990.984167013867 IsS11Max=No IsS11Min=No FrameElem=56 ElemStation=0
Frame=56 Station=0.125 OutputCase=TERRVERT CaseType=LinStatic Point=0 X2=0 X3=0 S11=-
1.15282857328964 IsS11Max=No IsS11Min=No FrameElem=56 ElemStation=0.125
Frame=56 Station=0.125 OutputCase=TERRVERT CaseType=LinStatic Point=1 X2=-0.5 X3=-0.5
S11=758.40507221912 IsS11Max=Yes IsS11Min=No FrameElem=56 ElemStation=0.125
Frame=56 Station=0.125 OutputCase=TERRVERT CaseType=LinStatic Point=2 X2=-0.5 X3=0.5
S11=758.40507221912 IsS11Max=No IsS11Min=No FrameElem=56 ElemStation=0.125
Frame=56 Station=0.125 OutputCase=TERRVERT CaseType=LinStatic Point=3 X2=0.5 X3=-0.5 S11=-
760.710729365699 IsS11Max=No IsS11Min=Yes FrameElem=56 ElemStation=0.125
Frame=56 Station=0.125 OutputCase=TERRVERT CaseType=LinStatic Point=4 X2=0.5 X3=0.5 S11=-
760.710729365699 IsS11Max=No IsS11Min=No FrameElem=56 ElemStation=0.125
Frame=56 Station=0.25 OutputCase=TERRVERT CaseType=LinStatic Point=0 X2=0 X3=0 S11=-
1.15282857328964 IsS11Max=No IsS11Min=No FrameElem=56 ElemStation=0.25
Frame=56 Station=0.25 OutputCase=TERRVERT CaseType=LinStatic Point=1 X2=-0.5 X3=-0.5
S11=509.709759570953 IsS11Max=Yes IsS11Min=No FrameElem=56 ElemStation=0.25
Frame=56 Station=0.25 OutputCase=TERRVERT CaseType=LinStatic Point=2 X2=-0.5 X3=0.5
S11=509.709759570953 IsS11Max=No IsS11Min=No FrameElem=56 ElemStation=0.25
Frame=56 Station=0.25 OutputCase=TERRVERT CaseType=LinStatic Point=3 X2=0.5 X3=-0.5 S11=-
512.015416717532 IsS11Max=No IsS11Min=Yes FrameElem=56 ElemStation=0.25
Frame=56 Station=0.25 OutputCase=TERRVERT CaseType=LinStatic Point=4 X2=0.5 X3=0.5 S11=-
512.015416717532 IsS11Max=No IsS11Min=No FrameElem=56 ElemStation=0.25
Frame=56 Station=0.375 OutputCase=TERRVERT CaseType=LinStatic Point=0 X2=0 X3=0 S11=-
1.15282857328964 IsS11Max=No IsS11Min=No FrameElem=56 ElemStation=0.375
Frame=56 Station=0.375 OutputCase=TERRVERT CaseType=LinStatic Point=1 X2=-0.5 X3=-0.5
S11=242.592571922785 IsS11Max=Yes IsS11Min=No FrameElem=56 ElemStation=0.375
Frame=56 Station=0.375 OutputCase=TERRVERT CaseType=LinStatic Point=2 X2=-0.5 X3=0.5
S11=242.592571922785 IsS11Max=No IsS11Min=No FrameElem=56 ElemStation=0.375
Frame=56 Station=0.375 OutputCase=TERRVERT CaseType=LinStatic Point=3 X2=0.5 X3=-0.5 S11=-
244.898229069364 IsS11Max=No IsS11Min=Yes FrameElem=56 ElemStation=0.375
Frame=56 Station=0.375 OutputCase=TERRVERT CaseType=LinStatic Point=4 X2=0.5 X3=0.5 S11=-
244.898229069364 IsS11Max=No IsS11Min=No FrameElem=56 ElemStation=0.375
Frame=56 Station=0.5 OutputCase=TERRVERT CaseType=LinStatic Point=0 X2=0 X3=0 S11=-1.15282857328964
IsS11Max=No IsS11Min=No FrameElem=56 ElemStation=0.5
Frame=56 Station=0.5 OutputCase=TERRVERT CaseType=LinStatic Point=1 X2=-0.5 X3=-0.5 S11=-
42.9464907253827 IsS11Max=No IsS11Min=Yes FrameElem=56 ElemStation=0.5
Frame=56 Station=0.5 OutputCase=TERRVERT CaseType=LinStatic Point=2 X2=-0.5 X3=0.5 S11=-
42.9464907253827 IsS11Max=No IsS11Min=No FrameElem=56 ElemStation=0.5
Frame=56 Station=0.5 OutputCase=TERRVERT CaseType=LinStatic Point=3 X2=0.5 X3=-0.5
S11=40.6408335788034 IsS11Max=Yes IsS11Min=No FrameElem=56 ElemStation=0.5
Frame=56 Station=0.5 OutputCase=TERRVERT CaseType=LinStatic Point=4 X2=0.5 X3=0.5
S11=40.6408335788034 IsS11Max=No IsS11Min=No FrameElem=56 ElemStation=0.5
Frame=56 Station=0 OutputCase=TERRLAT CaseType=LinStatic Point=0 X2=0 X3=0 S11=-66.7117981831703
IsS11Max=No IsS11Min=No FrameElem=56 ElemStation=0
Frame=56 Station=0 OutputCase=TERRLAT CaseType=LinStatic Point=1 X2=-0.5 X3=-0.5 S11=-
190.013379165172 IsS11Max=No IsS11Min=Yes FrameElem=56 ElemStation=0
Frame=56 Station=0 OutputCase=TERRLAT CaseType=LinStatic Point=2 X2=-0.5 X3=0.5 S11=-
190.013379165172 IsS11Max=No IsS11Min=No FrameElem=56 ElemStation=0

```



Frame=56	Station=0	OutputCase=ENVE	CaseType=Combination	StepType=Max	Point=1	X2=-0.5	X3=-0.5		
S11=1044.41062140604	IsS11Max=Yes	IsS11Min=No	FrameElem=56	ElemStation=0					
Frame=56	Station=0	OutputCase=ENVE	CaseType=Combination	StepType=Max	Point=2	X2=-0.5	X3=0.5		
S11=1044.41062140604	IsS11Max=No	IsS11Min=No	FrameElem=56	ElemStation=0					
Frame=56	Station=0	OutputCase=ENVE	CaseType=Combination	StepType=Max	Point=3	X2=0.5	X3=-0.5	S11=-	
1092.79396769693	IsS11Max=No	IsS11Min=Yes	FrameElem=56	ElemStation=0					
Frame=56	Station=0	OutputCase=ENVE	CaseType=Combination	StepType=Max	Point=4	X2=0.5	X3=0.5	S11=-	
1092.79396769693	IsS11Max=No	IsS11Min=No	FrameElem=56	ElemStation=0					
Frame=56	Station=0.125	OutputCase=ENVE	CaseType=Combination	StepType=Max	Point=0	X2=0	X3=0	S11=-	
32.6801405652697	IsS11Max=No	IsS11Min=No	FrameElem=56	ElemStation=0.125					
Frame=56	Station=0.125	OutputCase=ENVE	CaseType=Combination	StepType=Max	Point=1	X2=-0.5	X3=-0.5		
S11=784.840308574108	IsS11Max=Yes	IsS11Min=No	FrameElem=56	ElemStation=0.125					
Frame=56	Station=0.125	OutputCase=ENVE	CaseType=Combination	StepType=Max	Point=2	X2=-0.5	X3=0.5		
S11=784.840308574108	IsS11Max=No	IsS11Min=No	FrameElem=56	ElemStation=0.125					
Frame=56	Station=0.125	OutputCase=ENVE	CaseType=Combination	StepType=Max	Point=3	X2=0.5	X3=-0.5		
S11=-833.223654789808	IsS11Max=No	IsS11Min=Yes	FrameElem=56	ElemStation=0.125					
Frame=56	Station=0.125	OutputCase=ENVE	CaseType=Combination	StepType=Max	Point=4	X2=0.5	X3=0.5		
S11=-833.223654789808	IsS11Max=No	IsS11Min=No	FrameElem=56	ElemStation=0.125					
Frame=56	Station=0.25	OutputCase=ENVE	CaseType=Combination	StepType=Max	Point=0	X2=0	X3=0	S11=-	
32.6801405652697	IsS11Max=No	IsS11Min=No	FrameElem=56	ElemStation=0.25					
Frame=56	Station=0.25	OutputCase=ENVE	CaseType=Combination	StepType=Max	Point=1	X2=-0.5	X3=-0.5		
S11=504.504370742179	IsS11Max=Yes	IsS11Min=No	FrameElem=56	ElemStation=0.25					
Frame=56	Station=0.25	OutputCase=ENVE	CaseType=Combination	StepType=Max	Point=2	X2=-0.5	X3=0.5		
S11=504.504370742179	IsS11Max=No	IsS11Min=No	FrameElem=56	ElemStation=0.25					
Frame=56	Station=0.25	OutputCase=ENVE	CaseType=Combination	StepType=Max	Point=3	X2=0.5	X3=-0.5		
S11=-552.887716882688	IsS11Max=No	IsS11Min=Yes	FrameElem=56	ElemStation=0.25					
Frame=56	Station=0.25	OutputCase=ENVE	CaseType=Combination	StepType=Max	Point=4	X2=0.5	X3=0.5		
S11=-552.887716882688	IsS11Max=No	IsS11Min=No	FrameElem=56	ElemStation=0.25					
Frame=56	Station=0.375	OutputCase=ENVE	CaseType=Combination	StepType=Max	Point=0	X2=0	X3=0	S11=-	
32.6801405652697	IsS11Max=No	IsS11Min=No	FrameElem=56	ElemStation=0.375					
Frame=56	Station=0.375	OutputCase=ENVE	CaseType=Combination	StepType=Max	Point=1	X2=-0.5	X3=-0.5		
S11=203.40280791025	IsS11Max=Yes	IsS11Min=No	FrameElem=56	ElemStation=0.375					
Frame=56	Station=0.375	OutputCase=ENVE	CaseType=Combination	StepType=Max	Point=2	X2=-0.5	X3=0.5		
S11=203.40280791025	IsS11Max=No	IsS11Min=No	FrameElem=56	ElemStation=0.375					
Frame=56	Station=0.375	OutputCase=ENVE	CaseType=Combination	StepType=Max	Point=3	X2=0.5	X3=-0.5		
S11=-251.786153975568	IsS11Max=No	IsS11Min=Yes	FrameElem=56	ElemStation=0.375					
Frame=56	Station=0.375	OutputCase=ENVE	CaseType=Combination	StepType=Max	Point=4	X2=0.5	X3=0.5		
S11=-251.786153975568	IsS11Max=No	IsS11Min=No	FrameElem=56	ElemStation=0.375					
Frame=56	Station=0.5	OutputCase=ENVE	CaseType=Combination	StepType=Max	Point=0	X2=0	X3=0	S11=-	
32.6801405652697	IsS11Max=No	IsS11Min=No	FrameElem=56	ElemStation=0.5					
Frame=56	Station=0.5	OutputCase=ENVE	CaseType=Combination	StepType=Max	Point=1	X2=-0.5	X3=-0.5		
S11=-118.464379921679	IsS11Max=No	IsS11Min=Yes	FrameElem=56	ElemStation=0.5					
Frame=56	Station=0.5	OutputCase=ENVE	CaseType=Combination	StepType=Max	Point=2	X2=-0.5	X3=0.5		
S11=-118.464379921679	IsS11Max=No	IsS11Min=No	FrameElem=56	ElemStation=0.5					
Frame=56	Station=0.5	OutputCase=ENVE	CaseType=Combination	StepType=Max	Point=3	X2=0.5	X3=-0.5		
S11=70.0810339315515	IsS11Max=Yes	IsS11Min=No	FrameElem=56	ElemStation=0.5					
Frame=56	Station=0.5	OutputCase=ENVE	CaseType=Combination	StepType=Max	Point=4	X2=0.5	X3=0.5		
S11=70.0810339315515	IsS11Max=No	IsS11Min=No	FrameElem=56	ElemStation=0.5					
Frame=56	Station=0	OutputCase=ENVE	CaseType=Combination	StepType=Min	Point=0	X2=0	X3=0	S11=-	
52.6936800202208	IsS11Max=No	IsS11Min=No	FrameElem=56	ElemStation=0					
Frame=56	Station=0	OutputCase=ENVE	CaseType=Combination	StepType=Min	Point=1	X2=-0.5	X3=-0.5		
S11=987.406607656486	IsS11Max=Yes	IsS11Min=No	FrameElem=56	ElemStation=0					
Frame=56	Station=0	OutputCase=ENVE	CaseType=Combination	StepType=Min	Point=2	X2=-0.5	X3=0.5		
S11=987.406607656486	IsS11Max=No	IsS11Min=No	FrameElem=56	ElemStation=0					
Frame=56	Station=0	OutputCase=ENVE	CaseType=Combination	StepType=Min	Point=3	X2=0.5	X3=-0.5	S11=-	
1109.77090253658	IsS11Max=No	IsS11Min=Yes	FrameElem=56	ElemStation=0					
Frame=56	Station=0	OutputCase=ENVE	CaseType=Combination	StepType=Min	Point=4	X2=0.5	X3=0.5	S11=-	
1109.77090253658	IsS11Max=No	IsS11Min=No	FrameElem=56	ElemStation=0					
Frame=56	Station=0.125	OutputCase=ENVE	CaseType=Combination	StepType=Min	Point=0	X2=0	X3=0	S11=-	
52.6936800202208	IsS11Max=No	IsS11Min=No	FrameElem=56	ElemStation=0.125					
Frame=56	Station=0.125	OutputCase=ENVE	CaseType=Combination	StepType=Min	Point=1	X2=-0.5	X3=-0.5		
S11=727.836294749366	IsS11Max=Yes	IsS11Min=No	FrameElem=56	ElemStation=0.125					
Frame=56	Station=0.125	OutputCase=ENVE	CaseType=Combination	StepType=Min	Point=2	X2=-0.5	X3=0.5		
S11=727.836294749366	IsS11Max=No	IsS11Min=No	FrameElem=56	ElemStation=0.125					
Frame=56	Station=0.125	OutputCase=ENVE	CaseType=Combination	StepType=Min	Point=3	X2=0.5	X3=-0.5		
S11=-850.200589704648	IsS11Max=No	IsS11Min=Yes	FrameElem=56	ElemStation=0.125					
Frame=56	Station=0.125	OutputCase=ENVE	CaseType=Combination	StepType=Min	Point=4	X2=0.5	X3=0.5		
S11=-850.200589704648	IsS11Max=No	IsS11Min=No	FrameElem=56	ElemStation=0.125					
Frame=56	Station=0.25	OutputCase=ENVE	CaseType=Combination	StepType=Min	Point=0	X2=0	X3=0	S11=-	
52.6936800202208	IsS11Max=No	IsS11Min=No	FrameElem=56	ElemStation=0.25					
Frame=56	Station=0.25	OutputCase=ENVE	CaseType=Combination	StepType=Min	Point=1	X2=-0.5	X3=-0.5		
S11=447.500356842246	IsS11Max=Yes	IsS11Min=No	FrameElem=56	ElemStation=0.25					
Frame=56	Station=0.25	OutputCase=ENVE	CaseType=Combination	StepType=Min	Point=2	X2=-0.5	X3=0.5		
S11=447.500356842246	IsS11Max=No	IsS11Min=No	FrameElem=56	ElemStation=0.25					
Frame=56	Station=0.25	OutputCase=ENVE	CaseType=Combination	StepType=Min	Point=3	X2=0.5	X3=-0.5		
S11=-569.864651872719	IsS11Max=No	IsS11Min=Yes	FrameElem=56	ElemStation=0.25					
Frame=56	Station=0.25	OutputCase=ENVE	CaseType=Combination	StepType=Min	Point=4	X2=0.5	X3=0.5		
S11=-569.864651872719	IsS11Max=No	IsS11Min=No	FrameElem=56	ElemStation=0.25					
Frame=56	Station=0.375	OutputCase=ENVE	CaseType=Combination	StepType=Min	Point=0	X2=0	X3=0	S11=-	
52.6936800202208	IsS11Max=No	IsS11Min=No	FrameElem=56	ElemStation=0.375					
Frame=56	Station=0.375	OutputCase=ENVE	CaseType=Combination	StepType=Min	Point=1	X2=-0.5	X3=-0.5		
S11=146.398793935127	IsS11Max=Yes	IsS11Min=No	FrameElem=56	ElemStation=0.375					



Frame=56	Station=0.375	OutputCase=ENVE	CaseType=Combination	StepType=Min	Point=2	X2=-0.5	X3=0.5	
S11=146.398793935127	IsS11Max=No	IsS11Min=No	FrameElem=56	ElemStation=0.375				
Frame=56	Station=0.375	OutputCase=ENVE	CaseType=Combination	StepType=Min	Point=3	X2=0.5	X3=-0.5	
S11=-268.76308904079	IsS11Max=No	IsS11Min=Yes	FrameElem=56	ElemStation=0.375				
Frame=56	Station=0.375	OutputCase=ENVE	CaseType=Combination	StepType=Min	Point=4	X2=0.5	X3=0.5	
S11=-268.76308904079	IsS11Max=No	IsS11Min=No	FrameElem=56	ElemStation=0.375				
Frame=56	Station=0.5	OutputCase=ENVE	CaseType=Combination	StepType=Min	Point=0	X2=0	X3=0	S11=-
52.6936800202208	IsS11Max=No	IsS11Min=No	FrameElem=56	ElemStation=0.5				
Frame=56	Station=0.5	OutputCase=ENVE	CaseType=Combination	StepType=Min	Point=1	X2=-0.5	X3=-0.5	
S11=-175.468393971993	IsS11Max=No	IsS11Min=Yes	FrameElem=56	ElemStation=0.5				
Frame=56	Station=0.5	OutputCase=ENVE	CaseType=Combination	StepType=Min	Point=2	X2=-0.5	X3=0.5	
S11=-175.468393971993	IsS11Max=No	IsS11Min=No	FrameElem=56	ElemStation=0.5				
Frame=56	Station=0.5	OutputCase=ENVE	CaseType=Combination	StepType=Min	Point=3	X2=0.5	X3=-0.5	
S11=53.1040987911394	IsS11Max=Yes	IsS11Min=No	FrameElem=56	ElemStation=0.5				
Frame=56	Station=0.5	OutputCase=ENVE	CaseType=Combination	StepType=Min	Point=4	X2=0.5	X3=0.5	
S11=53.1040987911394	IsS11Max=No	IsS11Min=No	FrameElem=56	ElemStation=0.5				
Frame=56	Station=0	OutputCase=FESSUR	CaseType=Combination	Point=0	X2=0	X3=0	S11=-52.6936800202208	
IsS11Max=No	IsS11Min=No	FrameElem=56	ElemStation=0					
Frame=56	Station=0	OutputCase=FESSUR	CaseType=Combination	Point=1	X2=-0.5	X3=-0.5		
S11=987.406607656486	IsS11Max=Yes	IsS11Min=No	FrameElem=56	ElemStation=0				
Frame=56	Station=0	OutputCase=FESSUR	CaseType=Combination	Point=2	X2=-0.5	X3=0.5		
S11=987.406607656486	IsS11Max=No	IsS11Min=No	FrameElem=56	ElemStation=0				
Frame=56	Station=0	OutputCase=FESSUR	CaseType=Combination	Point=3	X2=0.5	X3=-0.5	S11=-	
1092.79396769693	IsS11Max=No	IsS11Min=Yes	FrameElem=56	ElemStation=0				
Frame=56	Station=0	OutputCase=FESSUR	CaseType=Combination	Point=4	X2=0.5	X3=0.5	S11=-	
1092.79396769693	IsS11Max=No	IsS11Min=No	FrameElem=56	ElemStation=0				
Frame=56	Station=0.125	OutputCase=FESSUR	CaseType=Combination	Point=0	X2=0	X3=0	S11=-	
52.6936800202208	IsS11Max=No	IsS11Min=No	FrameElem=56	ElemStation=0.125				
Frame=56	Station=0.125	OutputCase=FESSUR	CaseType=Combination	Point=1	X2=-0.5	X3=-0.5		
S11=727.836294749366	IsS11Max=Yes	IsS11Min=No	FrameElem=56	ElemStation=0.125				
Frame=56	Station=0.125	OutputCase=FESSUR	CaseType=Combination	Point=2	X2=-0.5	X3=0.5		
S11=727.836294749366	IsS11Max=No	IsS11Min=No	FrameElem=56	ElemStation=0.125				
Frame=56	Station=0.125	OutputCase=FESSUR	CaseType=Combination	Point=3	X2=0.5	X3=-0.5	S11=-	
833.223654789808	IsS11Max=No	IsS11Min=Yes	FrameElem=56	ElemStation=0.125				
Frame=56	Station=0.125	OutputCase=FESSUR	CaseType=Combination	Point=4	X2=0.5	X3=0.5	S11=-	
833.223654789808	IsS11Max=No	IsS11Min=No	FrameElem=56	ElemStation=0.125				
Frame=56	Station=0.25	OutputCase=FESSUR	CaseType=Combination	Point=0	X2=0	X3=0	S11=-	
52.6936800202208	IsS11Max=No	IsS11Min=No	FrameElem=56	ElemStation=0.25				
Frame=56	Station=0.25	OutputCase=FESSUR	CaseType=Combination	Point=1	X2=-0.5	X3=-0.5		
S11=447.500356842246	IsS11Max=Yes	IsS11Min=No	FrameElem=56	ElemStation=0.25				
Frame=56	Station=0.25	OutputCase=FESSUR	CaseType=Combination	Point=2	X2=-0.5	X3=0.5		
S11=447.500356842246	IsS11Max=No	IsS11Min=No	FrameElem=56	ElemStation=0.25				
Frame=56	Station=0.25	OutputCase=FESSUR	CaseType=Combination	Point=3	X2=0.5	X3=-0.5	S11=-	
552.887716882688	IsS11Max=No	IsS11Min=Yes	FrameElem=56	ElemStation=0.25				
Frame=56	Station=0.25	OutputCase=FESSUR	CaseType=Combination	Point=4	X2=0.5	X3=0.5	S11=-	
552.887716882688	IsS11Max=No	IsS11Min=No	FrameElem=56	ElemStation=0.25				
Frame=56	Station=0.375	OutputCase=FESSUR	CaseType=Combination	Point=0	X2=0	X3=0	S11=-	
52.6936800202208	IsS11Max=No	IsS11Min=No	FrameElem=56	ElemStation=0.375				
Frame=56	Station=0.375	OutputCase=FESSUR	CaseType=Combination	Point=1	X2=-0.5	X3=-0.5		
S11=146.398793935127	IsS11Max=Yes	IsS11Min=No	FrameElem=56	ElemStation=0.375				
Frame=56	Station=0.375	OutputCase=FESSUR	CaseType=Combination	Point=2	X2=-0.5	X3=0.5		
S11=146.398793935127	IsS11Max=No	IsS11Min=No	FrameElem=56	ElemStation=0.375				
Frame=56	Station=0.375	OutputCase=FESSUR	CaseType=Combination	Point=3	X2=0.5	X3=-0.5	S11=-	
251.786153975568	IsS11Max=No	IsS11Min=Yes	FrameElem=56	ElemStation=0.375				
Frame=56	Station=0.375	OutputCase=FESSUR	CaseType=Combination	Point=4	X2=0.5	X3=0.5	S11=-	
251.786153975568	IsS11Max=No	IsS11Min=No	FrameElem=56	ElemStation=0.375				
Frame=56	Station=0.5	OutputCase=FESSUR	CaseType=Combination	Point=0	X2=0	X3=0	S11=-52.6936800202208	
IsS11Max=No	IsS11Min=No	FrameElem=56	ElemStation=0.5					
Frame=56	Station=0.5	OutputCase=FESSUR	CaseType=Combination	Point=1	X2=-0.5	X3=-0.5	S11=-	
175.468393971993	IsS11Max=No	IsS11Min=Yes	FrameElem=56	ElemStation=0.5				
Frame=56	Station=0.5	OutputCase=FESSUR	CaseType=Combination	Point=2	X2=-0.5	X3=0.5	S11=-	
175.468393971993	IsS11Max=No	IsS11Min=No	FrameElem=56	ElemStation=0.5				
Frame=56	Station=0.5	OutputCase=FESSUR	CaseType=Combination	Point=3	X2=0.5	X3=-0.5		
S11=70.0810339315515	IsS11Max=Yes	IsS11Min=No	FrameElem=56	ElemStation=0.5				
Frame=56	Station=0.5	OutputCase=FESSUR	CaseType=Combination	Point=4	X2=0.5	X3=0.5		
S11=70.0810339315515	IsS11Max=No	IsS11Min=No	FrameElem=56	ElemStation=0.5				
Frame=57	Station=0	OutputCase=PESOPR	CaseType=LinStatic	Point=0	X2=0	X3=0	S11=-149.99999272637	
IsS11Max=No	IsS11Min=No	FrameElem=57	ElemStation=0					
Frame=57	Station=0	OutputCase=PESOPR	CaseType=LinStatic	Point=1	X2=-0.5	X3=-0.5		
S11=295.019357962095	IsS11Max=Yes	IsS11Min=No	FrameElem=57	ElemStation=0				
Frame=57	Station=0	OutputCase=PESOPR	CaseType=LinStatic	Point=2	X2=-0.5	X3=0.5	S11=295.019357962095	
IsS11Max=No	IsS11Min=No	FrameElem=57	ElemStation=0					
Frame=57	Station=0	OutputCase=PESOPR	CaseType=LinStatic	Point=3	X2=0.5	X3=-0.5	S11=-	
595.019356507369	IsS11Max=No	IsS11Min=Yes	FrameElem=57	ElemStation=0				
Frame=57	Station=0	OutputCase=PESOPR	CaseType=LinStatic	Point=4	X2=0.5	X3=0.5	S11=-595.019356507369	
IsS11Max=No	IsS11Min=No	FrameElem=57	ElemStation=0					
Frame=57	Station=0.5	OutputCase=PESOPR	CaseType=LinStatic	Point=0	X2=0	X3=0	S11=-137.49999272637	
IsS11Max=No	IsS11Min=No	FrameElem=57	ElemStation=0.5					
Frame=57	Station=0.5	OutputCase=PESOPR	CaseType=LinStatic	Point=1	X2=-0.5	X3=-0.5		
S11=262.006514326108	IsS11Max=Yes	IsS11Min=No	FrameElem=57	ElemStation=0.5				
Frame=57	Station=0.5	OutputCase=PESOPR	CaseType=LinStatic	Point=2	X2=-0.5	X3=0.5		
S11=262.006514326108	IsS11Max=No	IsS11Min=No	FrameElem=57	ElemStation=0.5				

Frame=57	Station=0.5	OutputCase=PESOPR	CaseType=LinStatic	Point=3	X2=0.5	X3=-0.5	S11=-
537.006512871382	IsS11Max=No	IsS11Min=Yes	FrameElem=57	ElemStation=0.5			
Frame=57	Station=0.5	OutputCase=PESOPR	CaseType=LinStatic	Point=4	X2=0.5	X3=0.5	S11=-
537.006512871382	IsS11Max=No	IsS11Min=No	FrameElem=57	ElemStation=0.5			
Frame=57	Station=0	OutputCase=TERRVERT	CaseType=LinStatic	Point=0	X2=0	X3=0	S11=-491.24999512732
IsS11Max=No	IsS11Min=No	FrameElem=57	ElemStation=0				
Frame=57	Station=0	OutputCase=TERRVERT	CaseType=LinStatic	Point=1	X2=-0.5	X3=-0.5	
S11=852.709261650843	IsS11Max=Yes	IsS11Min=No	FrameElem=57	ElemStation=0			
Frame=57	Station=0	OutputCase=TERRVERT	CaseType=LinStatic	Point=2	X2=-0.5	X3=0.5	
S11=852.709261650843	IsS11Max=No	IsS11Min=No	FrameElem=57	ElemStation=0			
Frame=57	Station=0	OutputCase=TERRVERT	CaseType=LinStatic	Point=3	X2=0.5	X3=-0.5	S11=-
1835.20925190548	IsS11Max=No	IsS11Min=Yes	FrameElem=57	ElemStation=0			
Frame=57	Station=0	OutputCase=TERRVERT	CaseType=LinStatic	Point=4	X2=0.5	X3=0.5	S11=-
1835.20925190548	IsS11Max=No	IsS11Min=No	FrameElem=57	ElemStation=0			
Frame=57	Station=0.5	OutputCase=TERRVERT	CaseType=LinStatic	Point=0	X2=0	X3=0	S11=-491.24999512732
IsS11Max=No	IsS11Min=No	FrameElem=57	ElemStation=0.5				
Frame=57	Station=0.5	OutputCase=TERRVERT	CaseType=LinStatic	Point=1	X2=-0.5	X3=-0.5	
S11=856.167735658383	IsS11Max=Yes	IsS11Min=No	FrameElem=57	ElemStation=0.5			
Frame=57	Station=0.5	OutputCase=TERRVERT	CaseType=LinStatic	Point=2	X2=-0.5	X3=0.5	
S11=856.167735658383	IsS11Max=No	IsS11Min=No	FrameElem=57	ElemStation=0.5			
Frame=57	Station=0.5	OutputCase=TERRVERT	CaseType=LinStatic	Point=3	X2=0.5	X3=-0.5	S11=-
1838.66772591302	IsS11Max=No	IsS11Min=Yes	FrameElem=57	ElemStation=0.5			
Frame=57	Station=0.5	OutputCase=TERRVERT	CaseType=LinStatic	Point=4	X2=0.5	X3=0.5	S11=-
1838.66772591302	IsS11Max=No	IsS11Min=No	FrameElem=57	ElemStation=0.5			
Frame=57	Station=0	OutputCase=TERRLAT	CaseType=LinStatic	Point=0	X2=0	X3=0	S11=7.85342763265362E-07
IsS11Max=No	IsS11Min=No	FrameElem=57	ElemStation=0				
Frame=57	Station=0	OutputCase=TERRLAT	CaseType=LinStatic	Point=1	X2=-0.5	X3=-0.5	S11=-
80.2196255995702	IsS11Max=No	IsS11Min=Yes	FrameElem=57	ElemStation=0			
Frame=57	Station=0	OutputCase=TERRLAT	CaseType=LinStatic	Point=2	X2=-0.5	X3=0.5	S11=-
80.2196255995702	IsS11Max=No	IsS11Min=No	FrameElem=57	ElemStation=0			
Frame=57	Station=0	OutputCase=TERRLAT	CaseType=LinStatic	Point=3	X2=0.5	X3=-0.5	
S11=80.2196271702558	IsS11Max=Yes	IsS11Min=No	FrameElem=57	ElemStation=0			
Frame=57	Station=0.5	OutputCase=TERRLAT	CaseType=LinStatic	Point=4	X2=0.5	X3=0.5	S11=80.2196271702558
IsS11Max=No	IsS11Min=No	FrameElem=57	ElemStation=0				
Frame=57	Station=0.5	OutputCase=TERRLAT	CaseType=LinStatic	Point=0	X2=0	X3=0	S11=6.03372277139247E-07
IsS11Max=No	IsS11Min=No	FrameElem=57	ElemStation=0.5				
Frame=57	Station=0.5	OutputCase=TERRLAT	CaseType=LinStatic	Point=1	X2=-0.5	X3=-0.5	S11=-
215.648293732029	IsS11Max=No	IsS11Min=Yes	FrameElem=57	ElemStation=0.5			
Frame=57	Station=0.5	OutputCase=TERRLAT	CaseType=LinStatic	Point=2	X2=-0.5	X3=0.5	S11=-
215.648293732029	IsS11Max=No	IsS11Min=No	FrameElem=57	ElemStation=0.5			
Frame=57	Station=0.5	OutputCase=TERRLAT	CaseType=LinStatic	Point=3	X2=0.5	X3=-0.5	
S11=215.648294938773	IsS11Max=Yes	IsS11Min=No	FrameElem=57	ElemStation=0.5			
Frame=57	Station=0.5	OutputCase=TERRLAT	CaseType=LinStatic	Point=4	X2=0.5	X3=0.5	
S11=215.648294938773	IsS11Max=No	IsS11Min=No	FrameElem=57	ElemStation=0.5			
Frame=57	Station=0	OutputCase=ACCLATDX	CaseType=LinStatic	Point=0	X2=0	X3=0	S11=0
IsS11Max=Yes	FrameElem=57	ElemStation=0					IsS11Max=Yes
Frame=57	Station=0	OutputCase=ACCLATDX	CaseType=LinStatic	Point=1	X2=-0.5	X3=-0.5	S11=0
IsS11Max=No	IsS11Min=No	FrameElem=57	ElemStation=0				
Frame=57	Station=0	OutputCase=ACCLATDX	CaseType=LinStatic	Point=2	X2=-0.5	X3=0.5	S11=0
IsS11Max=No	IsS11Min=No	FrameElem=57	ElemStation=0				
Frame=57	Station=0	OutputCase=ACCLATDX	CaseType=LinStatic	Point=3	X2=0.5	X3=-0.5	S11=0
IsS11Max=No	IsS11Min=No	FrameElem=57	ElemStation=0				
Frame=57	Station=0	OutputCase=ACCLATDX	CaseType=LinStatic	Point=4	X2=0.5	X3=0.5	S11=0
IsS11Max=No	IsS11Min=No	FrameElem=57	ElemStation=0				IsS11Max=No
Frame=57	Station=0.5	OutputCase=ACCLATDX	CaseType=LinStatic	Point=0	X2=0	X3=0	S11=0
IsS11Min=No	FrameElem=57	ElemStation=0					
Frame=57	Station=0.5	OutputCase=ACCLATDX	CaseType=LinStatic	Point=0	X2=0	X3=0	S11=0
IsS11Min=Yes	FrameElem=57	ElemStation=0.5					IsS11Max=Yes
Frame=57	Station=0.5	OutputCase=ACCLATDX	CaseType=LinStatic	Point=1	X2=-0.5	X3=-0.5	S11=0
IsS11Max=No	IsS11Min=No	FrameElem=57	ElemStation=0.5				
Frame=57	Station=0.5	OutputCase=ACCLATDX	CaseType=LinStatic	Point=2	X2=-0.5	X3=0.5	S11=0
IsS11Max=No	IsS11Min=No	FrameElem=57	ElemStation=0.5				
Frame=57	Station=0.5	OutputCase=ACCLATDX	CaseType=LinStatic	Point=3	X2=0.5	X3=-0.5	S11=0
IsS11Max=No	IsS11Min=No	FrameElem=57	ElemStation=0.5				
Frame=57	Station=0.5	OutputCase=ACCLATDX	CaseType=LinStatic	Point=4	X2=0.5	X3=0.5	S11=0
IsS11Max=No	IsS11Min=No	FrameElem=57	ElemStation=0.5				
Frame=57	Station=0	OutputCase=ACCLATSX	CaseType=LinStatic	Point=0	X2=0	X3=0	S11=0
IsS11Min=Yes	FrameElem=57	ElemStation=0					IsS11Max=Yes
Frame=57	Station=0	OutputCase=ACCLATSX	CaseType=LinStatic	Point=1	X2=-0.5	X3=-0.5	S11=0
IsS11Max=No	IsS11Min=No	FrameElem=57	ElemStation=0				
Frame=57	Station=0	OutputCase=ACCLATSX	CaseType=LinStatic	Point=2	X2=-0.5	X3=0.5	S11=0
IsS11Max=No	IsS11Min=No	FrameElem=57	ElemStation=0				
Frame=57	Station=0	OutputCase=ACCLATSX	CaseType=LinStatic	Point=3	X2=0.5	X3=-0.5	S11=0
IsS11Max=No	IsS11Min=No	FrameElem=57	ElemStation=0				
Frame=57	Station=0	OutputCase=ACCLATSX	CaseType=LinStatic	Point=4	X2=0.5	X3=0.5	S11=0
IsS11Max=No	IsS11Min=No	FrameElem=57	ElemStation=0				IsS11Max=No
Frame=57	Station=0.5	OutputCase=ACCLATSX	CaseType=LinStatic	Point=0	X2=0	X3=0	S11=0
IsS11Min=Yes	FrameElem=57	ElemStation=0.5					IsS11Max=Yes
Frame=57	Station=0.5	OutputCase=ACCLATSX	CaseType=LinStatic	Point=1	X2=-0.5	X3=-0.5	S11=0
IsS11Max=No	IsS11Min=No	FrameElem=57	ElemStation=0.5				
Frame=57	Station=0.5	OutputCase=ACCLATSX	CaseType=LinStatic	Point=2	X2=-0.5	X3=0.5	S11=0
IsS11Max=No	IsS11Min=No	FrameElem=57	ElemStation=0.5				
Frame=57	Station=0.5	OutputCase=ACCLATSX	CaseType=LinStatic	Point=3	X2=0.5	X3=-0.5	S11=0
IsS11Max=No	IsS11Min=No	FrameElem=57	ElemStation=0.5				
Frame=57	Station=0.5	OutputCase=ACCLATSX	CaseType=LinStatic	Point=3	X2=0.5	X3=-0.5	S11=0
IsS11Max=No	IsS11Min=No	FrameElem=57	ElemStation=0.5				

Frame=57	Station=0.5	OutputCase=ACCLATSX	CaseType=LinStatic	Point=4	X2=0.5	X3=0.5	S11=0	
IsS11Max=No	IsS11Min=No	FrameElem=57	ElemStation=0.5					
Frame=57	Station=0	OutputCase=TERRCOST	CaseType=LinStatic	Point=0	X2=0	X3=0	S11=0	IsS11Max=Yes
IsS11Min=Yes	FrameElem=57	ElemStation=0						
Frame=57	Station=0	OutputCase=TERRCOST	CaseType=LinStatic	Point=1	X2=-0.5	X3=-0.5	S11=0	
IsS11Max=No	IsS11Min=No	FrameElem=57	ElemStation=0					
Frame=57	Station=0	OutputCase=TERRCOST	CaseType=LinStatic	Point=2	X2=-0.5	X3=0.5	S11=0	
IsS11Max=No	IsS11Min=No	FrameElem=57	ElemStation=0					
Frame=57	Station=0	OutputCase=TERRCOST	CaseType=LinStatic	Point=3	X2=0.5	X3=-0.5	S11=0	
IsS11Max=No	IsS11Min=No	FrameElem=57	ElemStation=0					
Frame=57	Station=0	OutputCase=TERRCOST	CaseType=LinStatic	Point=4	X2=0.5	X3=0.5	S11=0	IsS11Max=No
IsS11Min=No	FrameElem=57	ElemStation=0						
Frame=57	Station=0.5	OutputCase=TERRCOST	CaseType=LinStatic	Point=0	X2=0	X3=0	S11=0	IsS11Max=Yes
IsS11Min=Yes	FrameElem=57	ElemStation=0.5						
Frame=57	Station=0.5	OutputCase=TERRCOST	CaseType=LinStatic	Point=1	X2=-0.5	X3=-0.5	S11=0	
IsS11Max=No	IsS11Min=No	FrameElem=57	ElemStation=0.5					
Frame=57	Station=0.5	OutputCase=TERRCOST	CaseType=LinStatic	Point=2	X2=-0.5	X3=0.5	S11=0	
IsS11Max=No	IsS11Min=No	FrameElem=57	ElemStation=0.5					
Frame=57	Station=0.5	OutputCase=TERRCOST	CaseType=LinStatic	Point=3	X2=0.5	X3=-0.5	S11=0	
IsS11Max=No	IsS11Min=No	FrameElem=57	ElemStation=0.5					
Frame=57	Station=0.5	OutputCase=TERRCOST	CaseType=LinStatic	Point=4	X2=0.5	X3=0.5	S11=0	
IsS11Max=No	IsS11Min=No	FrameElem=57	ElemStation=0.5					
Frame=57	Station=0	OutputCase=SOVRCOST	CaseType=LinStatic	Point=0	X2=0	X3=0	S11=0	IsS11Max=Yes
IsS11Min=Yes	FrameElem=57	ElemStation=0						
Frame=57	Station=0	OutputCase=SOVRCOST	CaseType=LinStatic	Point=1	X2=-0.5	X3=-0.5	S11=0	
IsS11Max=No	IsS11Min=No	FrameElem=57	ElemStation=0					
Frame=57	Station=0	OutputCase=SOVRCOST	CaseType=LinStatic	Point=2	X2=-0.5	X3=0.5	S11=0	
IsS11Max=No	IsS11Min=No	FrameElem=57	ElemStation=0					
Frame=57	Station=0	OutputCase=SOVRCOST	CaseType=LinStatic	Point=3	X2=0.5	X3=-0.5	S11=0	
IsS11Max=No	IsS11Min=No	FrameElem=57	ElemStation=0					
Frame=57	Station=0	OutputCase=SOVRCOST	CaseType=LinStatic	Point=4	X2=0.5	X3=0.5	S11=0	IsS11Max=No
IsS11Min=No	FrameElem=57	ElemStation=0						
Frame=57	Station=0.5	OutputCase=SOVRCOST	CaseType=LinStatic	Point=0	X2=0	X3=0	S11=0	IsS11Max=Yes
IsS11Min=Yes	FrameElem=57	ElemStation=0.5						
Frame=57	Station=0.5	OutputCase=SOVRCOST	CaseType=LinStatic	Point=1	X2=-0.5	X3=-0.5	S11=0	
IsS11Max=No	IsS11Min=No	FrameElem=57	ElemStation=0.5					
Frame=57	Station=0.5	OutputCase=SOVRCOST	CaseType=LinStatic	Point=2	X2=-0.5	X3=0.5	S11=0	
IsS11Max=No	IsS11Min=No	FrameElem=57	ElemStation=0.5					
Frame=57	Station=0.5	OutputCase=SOVRCOST	CaseType=LinStatic	Point=3	X2=0.5	X3=-0.5	S11=0	
IsS11Max=No	IsS11Min=No	FrameElem=57	ElemStation=0.5					
Frame=57	Station=0.5	OutputCase=SOVRCOST	CaseType=LinStatic	Point=4	X2=0.5	X3=0.5	S11=0	
IsS11Max=No	IsS11Min=No	FrameElem=57	ElemStation=0.5					
Frame=57	Station=0	OutputCase=ENVE	CaseType=Combination	StepType=Max	Point=0	X2=0	X3=0	S11=-
IsS11Max=No	IsS11Min=No	FrameElem=57	ElemStation=0					
641.249993614615	IsS11Max=No	IsS11Min=No	FrameElem=57	ElemStation=0				
Frame=57	Station=0	OutputCase=ENVE	CaseType=Combination	StepType=Max	Point=1	X2=-0.5	X3=-0.5	
S11=1091.57488169324	IsS11Max=Yes	IsS11Min=No	FrameElem=57	ElemStation=0				
Frame=57	Station=0	OutputCase=ENVE	CaseType=Combination	StepType=Max	Point=2	X2=-0.5	X3=0.5	
S11=1091.57488169324	IsS11Max=No	IsS11Min=No	FrameElem=57	ElemStation=0				
Frame=57	Station=0	OutputCase=ENVE	CaseType=Combination	StepType=Max	Point=3	X2=0.5	X3=-0.5	S11=-
2350.0089812426	IsS11Max=No	IsS11Min=Yes	FrameElem=57	ElemStation=0				
Frame=57	Station=0	OutputCase=ENVE	CaseType=Combination	StepType=Max	Point=4	X2=0.5	X3=0.5	S11=-
2350.0089812426	IsS11Max=No	IsS11Min=No	FrameElem=57	ElemStation=0				
Frame=57	Station=0.5	OutputCase=ENVE	CaseType=Combination	StepType=Max	Point=0	X2=0	X3=0	S11=-
628.749993796585	IsS11Max=No	IsS11Min=No	FrameElem=57	ElemStation=0.5				
Frame=57	Station=0.5	OutputCase=ENVE	CaseType=Combination	StepType=Max	Point=1	X2=-0.5	X3=-0.5	
S11=967.220444372071	IsS11Max=Yes	IsS11Min=No	FrameElem=57	ElemStation=0.5				
Frame=57	Station=0.5	OutputCase=ENVE	CaseType=Combination	StepType=Max	Point=2	X2=-0.5	X3=0.5	
S11=967.220444372071	IsS11Max=No	IsS11Min=No	FrameElem=57	ElemStation=0.5				
Frame=57	Station=0.5	OutputCase=ENVE	CaseType=Combination	StepType=Max	Point=3	X2=0.5	X3=-0.5	
S11=-2160.02594384563	IsS11Max=No	IsS11Min=Yes	FrameElem=57	ElemStation=0.5				
Frame=57	Station=0.5	OutputCase=ENVE	CaseType=Combination	StepType=Max	Point=4	X2=0.5	X3=0.5	
S11=-2160.02594384563	IsS11Max=No	IsS11Min=No	FrameElem=57	ElemStation=0.5				
Frame=57	Station=0	OutputCase=ENVE	CaseType=Combination	StepType=Min	Point=0	X2=0	X3=0	S11=-
641.249993850217	IsS11Max=No	IsS11Min=No	FrameElem=57	ElemStation=0				
Frame=57	Station=0	OutputCase=ENVE	CaseType=Combination	StepType=Min	Point=1	X2=-0.5	X3=-0.5	
S11=1067.50899401337	IsS11Max=Yes	IsS11Min=No	FrameElem=57	ElemStation=0				
Frame=57	Station=0	OutputCase=ENVE	CaseType=Combination	StepType=Min	Point=2	X2=-0.5	X3=0.5	
S11=1067.50899401337	IsS11Max=No	IsS11Min=No	FrameElem=57	ElemStation=0				
Frame=57	Station=0	OutputCase=ENVE	CaseType=Combination	StepType=Min	Point=3	X2=0.5	X3=-0.5	S11=-
2374.07486939367	IsS11Max=No	IsS11Min=Yes	FrameElem=57	ElemStation=0				
Frame=57	Station=0	OutputCase=ENVE	CaseType=Combination	StepType=Min	Point=4	X2=0.5	X3=0.5	S11=-
2374.07486939367	IsS11Max=No	IsS11Min=No	FrameElem=57	ElemStation=0				
Frame=57	Station=0.5	OutputCase=ENVE	CaseType=Combination	StepType=Min	Point=0	X2=0	X3=0	S11=-
628.749993977597	IsS11Max=No	IsS11Min=No	FrameElem=57	ElemStation=0.5				
Frame=57	Station=0.5	OutputCase=ENVE	CaseType=Combination	StepType=Min	Point=1	X2=-0.5	X3=-0.5	
S11=902.525956252462	IsS11Max=Yes	IsS11Min=No	FrameElem=57	ElemStation=0.5				
Frame=57	Station=0.5	OutputCase=ENVE	CaseType=Combination	StepType=Min	Point=2	X2=-0.5	X3=0.5	
S11=902.525956252462	IsS11Max=No	IsS11Min=No	FrameElem=57	ElemStation=0.5				
Frame=57	Station=0.5	OutputCase=ENVE	CaseType=Combination	StepType=Min	Point=3	X2=0.5	X3=-0.5	
S11=-2224.72043232726	IsS11Max=No	IsS11Min=Yes	FrameElem=57	ElemStation=0.5				
Frame=57	Station=0.5	OutputCase=ENVE	CaseType=Combination	StepType=Min	Point=4	X2=0.5	X3=0.5	
S11=-2224.72043232726	IsS11Max=No	IsS11Min=No	FrameElem=57	ElemStation=0.5				

Frame=57	Station=0	OutputCase=FESSUR	CaseType=Combination	Point=0	X2=0	X3=0	S11=-641.249993614615
IsS11Max=No	IsS11Min=No	FrameElem=57	ElemStation=0				
Frame=57	Station=0	OutputCase=FESSUR	CaseType=Combination	Point=1	X2=-0.5	X3=-0.5	
S11=1067.50899401337	IsS11Max=Yes	IsS11Min=No	FrameElem=57	ElemStation=0			
Frame=57	Station=0	OutputCase=FESSUR	CaseType=Combination	Point=2	X2=-0.5	X3=0.5	
S11=1067.50899401337	IsS11Max=No	IsS11Min=No	FrameElem=57	ElemStation=0			
Frame=57	Station=0	OutputCase=FESSUR	CaseType=Combination	Point=3	X2=0.5	X3=-0.5	S11=-
2350.0089812426	IsS11Max=No	IsS11Min=Yes	FrameElem=57	ElemStation=0			
Frame=57	Station=0	OutputCase=FESSUR	CaseType=Combination	Point=4	X2=0.5	X3=0.5	S11=-
2350.0089812426	IsS11Max=No	IsS11Min=No	FrameElem=57	ElemStation=0			
Frame=57	Station=0.5	OutputCase=FESSUR	CaseType=Combination	Point=0	X2=0	X3=0	S11=-628.749993796585
IsS11Max=No	IsS11Min=No	FrameElem=57	ElemStation=0.5				
Frame=57	Station=0.5	OutputCase=FESSUR	CaseType=Combination	Point=1	X2=-0.5	X3=-0.5	
S11=902.525956252462	IsS11Max=Yes	IsS11Min=No	FrameElem=57	ElemStation=0.5			
Frame=57	Station=0.5	OutputCase=FESSUR	CaseType=Combination	Point=2	X2=-0.5	X3=0.5	
S11=902.525956252462	IsS11Max=No	IsS11Min=No	FrameElem=57	ElemStation=0.5			
Frame=57	Station=0.5	OutputCase=FESSUR	CaseType=Combination	Point=3	X2=0.5	X3=-0.5	S11=-
2160.02594384563	IsS11Max=No	IsS11Min=Yes	FrameElem=57	ElemStation=0.5			
Frame=57	Station=0.5	OutputCase=FESSUR	CaseType=Combination	Point=4	X2=0.5	X3=0.5	S11=-
2160.02594384563	IsS11Max=No	IsS11Min=No	FrameElem=57	ElemStation=0.5			
Frame=58	Station=0	OutputCase=PESOPR	CaseType=LinStatic	Point=0	X2=0	X3=0	S11=-137.499999272608
IsS11Max=No	IsS11Min=No	FrameElem=58	ElemStation=0				
Frame=58	Station=0	OutputCase=PESOPR	CaseType=LinStatic	Point=1	X2=-0.5	X3=-0.5	
S11=262.006514326137	IsS11Max=Yes	IsS11Min=No	FrameElem=58	ElemStation=0			
Frame=58	Station=0	OutputCase=PESOPR	CaseType=LinStatic	Point=2	X2=-0.5	X3=0.5	S11=262.006514326137
IsS11Max=No	IsS11Min=No	FrameElem=58	ElemStation=0				
Frame=58	Station=0	OutputCase=PESOPR	CaseType=LinStatic	Point=3	X2=0.5	X3=-0.5	S11=-
537.006512871353	IsS11Max=No	IsS11Min=Yes	FrameElem=58	ElemStation=0			
Frame=58	Station=0	OutputCase=PESOPR	CaseType=LinStatic	Point=4	X2=0.5	X3=0.5	S11=-537.006512871353
IsS11Max=No	IsS11Min=No	FrameElem=58	ElemStation=0				
Frame=58	Station=0.5	OutputCase=PESOPR	CaseType=LinStatic	Point=0	X2=0	X3=0	S11=-124.999999272608
IsS11Max=No	IsS11Min=No	FrameElem=58	ElemStation=0.5				
Frame=58	Station=0.5	OutputCase=PESOPR	CaseType=LinStatic	Point=1	X2=-0.5	X3=-0.5	
S11=228.993670988173	IsS11Max=Yes	IsS11Min=No	FrameElem=58	ElemStation=0.5			
Frame=58	Station=0.5	OutputCase=PESOPR	CaseType=LinStatic	Point=2	X2=-0.5	X3=0.5	
S11=228.993670988173	IsS11Max=No	IsS11Min=No	FrameElem=58	ElemStation=0.5			
Frame=58	Station=0.5	OutputCase=PESOPR	CaseType=LinStatic	Point=3	X2=0.5	X3=-0.5	S11=-
478.993669533389	IsS11Max=No	IsS11Min=Yes	FrameElem=58	ElemStation=0.5			
Frame=58	Station=0.5	OutputCase=PESOPR	CaseType=LinStatic	Point=4	X2=0.5	X3=0.5	S11=-
478.993669533389	IsS11Max=No	IsS11Min=No	FrameElem=58	ElemStation=0.5			
Frame=58	Station=0	OutputCase=TERRVERT	CaseType=LinStatic	Point=0	X2=0	X3=0	S11=-491.249995127437
IsS11Max=No	IsS11Min=No	FrameElem=58	ElemStation=0				
Frame=58	Station=0	OutputCase=TERRVERT	CaseType=LinStatic	Point=1	X2=-0.5	X3=-0.5	
S11=856.167735658266	IsS11Max=Yes	IsS11Min=No	FrameElem=58	ElemStation=0			
Frame=58	Station=0	OutputCase=TERRVERT	CaseType=LinStatic	Point=2	X2=-0.5	X3=0.5	
S11=856.167735658266	IsS11Max=No	IsS11Min=No	FrameElem=58	ElemStation=0			
Frame=58	Station=0	OutputCase=TERRVERT	CaseType=LinStatic	Point=3	X2=0.5	X3=-0.5	S11=-
1838.66772591314	IsS11Max=No	IsS11Min=Yes	FrameElem=58	ElemStation=0			
Frame=58	Station=0	OutputCase=TERRVERT	CaseType=LinStatic	Point=4	X2=0.5	X3=0.5	S11=-
1838.66772591314	IsS11Max=No	IsS11Min=No	FrameElem=58	ElemStation=0			
Frame=58	Station=0.5	OutputCase=TERRVERT	CaseType=LinStatic	Point=0	X2=0	X3=0	S11=-491.249995127437
IsS11Max=No	IsS11Min=No	FrameElem=58	ElemStation=0.5				
Frame=58	Station=0.5	OutputCase=TERRVERT	CaseType=LinStatic	Point=1	X2=-0.5	X3=-0.5	
S11=859.626209665808	IsS11Max=Yes	IsS11Min=No	FrameElem=58	ElemStation=0.5			
Frame=58	Station=0.5	OutputCase=TERRVERT	CaseType=LinStatic	Point=2	X2=-0.5	X3=0.5	
S11=859.626209665808	IsS11Max=No	IsS11Min=No	FrameElem=58	ElemStation=0.5			
Frame=58	Station=0.5	OutputCase=TERRVERT	CaseType=LinStatic	Point=3	X2=0.5	X3=-0.5	S11=-
1842.12619992068	IsS11Max=No	IsS11Min=Yes	FrameElem=58	ElemStation=0.5			
Frame=58	Station=0.5	OutputCase=TERRVERT	CaseType=LinStatic	Point=4	X2=0.5	X3=0.5	S11=-
1842.12619992068	IsS11Max=No	IsS11Min=No	FrameElem=58	ElemStation=0.5			
Frame=58	Station=0	OutputCase=TERRLAT	CaseType=LinStatic	Point=0	X2=0	X3=0	S11=6.03372427576687E-07
IsS11Max=No	IsS11Min=No	FrameElem=58	ElemStation=0				
Frame=58	Station=0	OutputCase=TERRLAT	CaseType=LinStatic	Point=1	X2=-0.5	X3=-0.5	S11=-
215.648293732029	IsS11Max=No	IsS11Min=Yes	FrameElem=58	ElemStation=0			
Frame=58	Station=0	OutputCase=TERRLAT	CaseType=LinStatic	Point=2	X2=-0.5	X3=0.5	S11=-
215.648293732029	IsS11Max=No	IsS11Min=No	FrameElem=58	ElemStation=0			
Frame=58	Station=0	OutputCase=TERRLAT	CaseType=LinStatic	Point=3	X2=0.5	X3=-0.5	
S11=215.648294938774	IsS11Max=Yes	IsS11Min=No	FrameElem=58	ElemStation=0			
Frame=58	Station=0	OutputCase=TERRLAT	CaseType=LinStatic	Point=4	X2=0.5	X3=0.5	S11=215.648294938774
IsS11Max=No	IsS11Min=No	FrameElem=58	ElemStation=0				
Frame=58	Station=0.5	OutputCase=TERRLAT	CaseType=LinStatic	Point=0	X2=0	X3=0	S11=4.38344542274816E-07
IsS11Max=No	IsS11Min=No	FrameElem=58	ElemStation=0.5				
Frame=58	Station=0.5	OutputCase=TERRLAT	CaseType=LinStatic	Point=1	X2=-0.5	X3=-0.5	S11=-
285.583211847545	IsS11Max=No	IsS11Min=Yes	FrameElem=58	ElemStation=0.5			
Frame=58	Station=0.5	OutputCase=TERRLAT	CaseType=LinStatic	Point=2	X2=-0.5	X3=0.5	S11=-
285.583211847545	IsS11Max=No	IsS11Min=No	FrameElem=58	ElemStation=0.5			
Frame=58	Station=0.5	OutputCase=TERRLAT	CaseType=LinStatic	Point=3	X2=0.5	X3=-0.5	
S11=285.583212724234	IsS11Max=Yes	IsS11Min=No	FrameElem=58	ElemStation=0.5			
Frame=58	Station=0.5	OutputCase=TERRLAT	CaseType=LinStatic	Point=4	X2=0.5	X3=0.5	
S11=285.583212724234	IsS11Max=No	IsS11Min=No	FrameElem=58	ElemStation=0.5			
Frame=58	Station=0	OutputCase=ACCLATDX	CaseType=LinStatic	Point=0	X2=0	X3=0	S11=0
IsS11Max=Yes	IsS11Min=Yes	FrameElem=58	ElemStation=0				

Frame=58	Station=0	OutputCase=ENVE	CaseType=Combination	StepType=Max	Point=2	X2=-0.5	X3=0.5		
S11=967.220444371983	IsS11Max=No	IsS11Min=No	FrameElem=58	ElemStation=0					
Frame=58	Station=0	OutputCase=ENVE	CaseType=Combination	StepType=Max	Point=3	X2=0.5	X3=-0.5	S11=-	
2160.02594384572	IsS11Max=No	IsS11Min=Yes	FrameElem=58	ElemStation=0					
Frame=58	Station=0	OutputCase=ENVE	CaseType=Combination	StepType=Max	Point=4	X2=0.5	X3=0.5	S11=-	
2160.02594384572	IsS11Max=No	IsS11Min=No	FrameElem=58	ElemStation=0					
Frame=58	Station=0.5	OutputCase=ENVE	CaseType=Combination	StepType=Max	Point=0	X2=0	X3=0	S11=-	
616.2499939617	IsS11Max=No	IsS11Min=No	FrameElem=58	ElemStation=0.5					
Frame=58	Station=0.5	OutputCase=ENVE	CaseType=Combination	StepType=Max	Point=1	X2=-0.5	X3=-0.5		
S11=888.7116323607	IsS11Max=Yes	IsS11Min=No	FrameElem=58	ElemStation=0.5					
Frame=58	Station=0.5	OutputCase=ENVE	CaseType=Combination	StepType=Max	Point=2	X2=-0.5	X3=0.5		
S11=888.7116323607	IsS11Max=No	IsS11Min=No	FrameElem=58	ElemStation=0.5					
Frame=58	Station=0.5	OutputCase=ENVE	CaseType=Combination	StepType=Max	Point=3	X2=0.5	X3=-0.5		
S11=-2035.53665672984	IsS11Max=No	IsS11Min=Yes	FrameElem=58	ElemStation=0.5					
Frame=58	Station=0.5	OutputCase=ENVE	CaseType=Combination	StepType=Max	Point=4	X2=0.5	X3=0.5		
S11=-2035.53665672984	IsS11Max=No	IsS11Min=No	FrameElem=58	ElemStation=0.5					
Frame=58	Station=0	OutputCase=ENVE	CaseType=Combination	StepType=Min	Point=0	X2=0	X3=0	S11=-	
628.749993977684	IsS11Max=No	IsS11Min=No	FrameElem=58	ElemStation=0					
Frame=58	Station=0	OutputCase=ENVE	CaseType=Combination	StepType=Min	Point=1	X2=-0.5	X3=-0.5		
S11=902.525956252375	IsS11Max=Yes	IsS11Min=No	FrameElem=58	ElemStation=0					
Frame=58	Station=0.5	OutputCase=ENVE	CaseType=Combination	StepType=Min	Point=2	X2=-0.5	X3=0.5		
S11=902.525956252375	IsS11Max=No	IsS11Min=No	FrameElem=58	ElemStation=0					
Frame=58	Station=0	OutputCase=ENVE	CaseType=Combination	StepType=Min	Point=3	X2=0.5	X3=-0.5	S11=-	
2224.72043232735	IsS11Max=No	IsS11Min=Yes	FrameElem=58	ElemStation=0					
Frame=58	Station=0	OutputCase=ENVE	CaseType=Combination	StepType=Min	Point=4	X2=0.5	X3=0.5	S11=-	
2224.72043232735	IsS11Max=No	IsS11Min=No	FrameElem=58	ElemStation=0					
Frame=58	Station=0.5	OutputCase=ENVE	CaseType=Combination	StepType=Min	Point=0	X2=0	X3=0	S11=-	
616.249994093203	IsS11Max=No	IsS11Min=No	FrameElem=58	ElemStation=0.5					
Frame=58	Station=0.5	OutputCase=ENVE	CaseType=Combination	StepType=Min	Point=1	X2=-0.5	X3=-0.5		
S11=803.036668806437	IsS11Max=Yes	IsS11Min=No	FrameElem=58	ElemStation=0.5					
Frame=58	Station=0.5	OutputCase=ENVE	CaseType=Combination	StepType=Min	Point=2	X2=-0.5	X3=0.5		
S11=803.036668806437	IsS11Max=No	IsS11Min=No	FrameElem=58	ElemStation=0.5					
Frame=58	Station=0.5	OutputCase=ENVE	CaseType=Combination	StepType=Min	Point=3	X2=0.5	X3=-0.5		
S11=-2121.21162054711	IsS11Max=No	IsS11Min=Yes	FrameElem=58	ElemStation=0.5					
Frame=58	Station=0.5	OutputCase=ENVE	CaseType=Combination	StepType=Min	Point=4	X2=0.5	X3=0.5		
S11=-2121.21162054711	IsS11Max=No	IsS11Min=No	FrameElem=58	ElemStation=0.5					
Frame=58	Station=0	OutputCase=FESSUR	CaseType=Combination	Point=0	X2=0	X3=0	S11=-628.749993796672		
IsS11Max=No	IsS11Min=No	FrameElem=58	ElemStation=0						
Frame=58	Station=0	OutputCase=FESSUR	CaseType=Combination	Point=1	X2=-0.5	X3=-0.5			
S11=902.525956252375	IsS11Max=Yes	IsS11Min=No	FrameElem=58	ElemStation=0					
Frame=58	Station=0	OutputCase=FESSUR	CaseType=Combination	Point=2	X2=-0.5	X3=0.5			
S11=902.525956252375	IsS11Max=No	IsS11Min=No	FrameElem=58	ElemStation=0					
Frame=58	Station=0	OutputCase=FESSUR	CaseType=Combination	Point=3	X2=0.5	X3=-0.5	S11=-		
2160.02594384572	IsS11Max=No	IsS11Min=Yes	FrameElem=58	ElemStation=0					
Frame=58	Station=0	OutputCase=FESSUR	CaseType=Combination	Point=4	X2=0.5	X3=0.5	S11=-		
2160.02594384572	IsS11Max=No	IsS11Min=No	FrameElem=58	ElemStation=0					
Frame=58	Station=0.5	OutputCase=FESSUR	CaseType=Combination	Point=0	X2=0	X3=0	S11=-616.2499939617		
IsS11Max=No	IsS11Min=No	FrameElem=58	ElemStation=0.5						
Frame=58	Station=0.5	OutputCase=FESSUR	CaseType=Combination	Point=1	X2=-0.5	X3=-0.5			
S11=803.036668806437	IsS11Max=Yes	IsS11Min=No	FrameElem=58	ElemStation=0.5					
Frame=58	Station=0.5	OutputCase=FESSUR	CaseType=Combination	Point=2	X2=-0.5	X3=0.5			
S11=803.036668806437	IsS11Max=No	IsS11Min=No	FrameElem=58	ElemStation=0.5					
Frame=58	Station=0.5	OutputCase=FESSUR	CaseType=Combination	Point=3	X2=0.5	X3=-0.5	S11=-		
2035.53665672984	IsS11Max=No	IsS11Min=Yes	FrameElem=58	ElemStation=0.5					
Frame=58	Station=0.5	OutputCase=FESSUR	CaseType=Combination	Point=4	X2=0.5	X3=0.5	S11=-		
2035.53665672984	IsS11Max=No	IsS11Min=No	FrameElem=58	ElemStation=0.5					
Frame=59	Station=0	OutputCase=PESOPR	CaseType=LinStatic	Point=0	X2=0	X3=0	S11=-124.99999927255		
IsS11Max=No	IsS11Min=No	FrameElem=59	ElemStation=0						
Frame=59	Station=0	OutputCase=PESOPR	CaseType=LinStatic	Point=1	X2=-0.5	X3=-0.5	S11=228.99367098823		
IsS11Max=Yes	IsS11Min=No	FrameElem=59	ElemStation=0						
Frame=59	Station=0	OutputCase=PESOPR	CaseType=LinStatic	Point=2	X2=-0.5	X3=0.5	S11=228.99367098823		
IsS11Max=No	IsS11Min=No	FrameElem=59	ElemStation=0						
Frame=59	Station=0	OutputCase=PESOPR	CaseType=LinStatic	Point=3	X2=0.5	X3=-0.5	S11=-		
478.993669533329	IsS11Max=No	IsS11Min=Yes	FrameElem=59	ElemStation=0					
Frame=59	Station=0	OutputCase=PESOPR	CaseType=LinStatic	Point=4	X2=0.5	X3=0.5	S11=-478.993669533329		
IsS11Max=No	IsS11Min=No	FrameElem=59	ElemStation=0						
Frame=59	Station=0.5	OutputCase=PESOPR	CaseType=LinStatic	Point=0	X2=0	X3=0	S11=-112.49999927255		
IsS11Max=No	IsS11Min=No	FrameElem=59	ElemStation=0.5						
Frame=59	Station=0.5	OutputCase=PESOPR	CaseType=LinStatic	Point=1	X2=-0.5	X3=-0.5			
S11=195.980827948292	IsS11Max=Yes	IsS11Min=No	FrameElem=59	ElemStation=0.5					
Frame=59	Station=0.5	OutputCase=PESOPR	CaseType=LinStatic	Point=2	X2=-0.5	X3=0.5			
S11=195.980827948292	IsS11Max=No	IsS11Min=No	FrameElem=59	ElemStation=0.5					
Frame=59	Station=0.5	OutputCase=PESOPR	CaseType=LinStatic	Point=3	X2=0.5	X3=-0.5	S11=-		
420.980826493391	IsS11Max=No	IsS11Min=Yes	FrameElem=59	ElemStation=0.5					
Frame=59	Station=0.5	OutputCase=PESOPR	CaseType=LinStatic	Point=4	X2=0.5	X3=0.5	S11=-		
420.980826493391	IsS11Max=No	IsS11Min=No	FrameElem=59	ElemStation=0.5					
Frame=59	Station=0	OutputCase=TERRVERT	CaseType=LinStatic	Point=0	X2=0	X3=0	S11=-491.249995127204		
IsS11Max=No	IsS11Min=No	FrameElem=59	ElemStation=0						
Frame=59	Station=0	OutputCase=TERRVERT	CaseType=LinStatic	Point=1	X2=-0.5	X3=-0.5			
S11=859.626209666037	IsS11Max=Yes	IsS11Min=No	FrameElem=59	ElemStation=0					
Frame=59	Station=0	OutputCase=TERRVERT	CaseType=LinStatic	Point=2	X2=-0.5	X3=0.5			
S11=859.626209666037	IsS11Max=No	IsS11Min=No	FrameElem=59	ElemStation=0					



Frame=59	Station=0	OutputCase=TERRVERT	CaseType=LinStatic	Point=3	X2=0.5	X3=-0.5	S11=-
1842.12619992045	IsS11Max=No	IsS11Min=Yes	FrameElem=59	ElemStation=0			
Frame=59	Station=0	OutputCase=TERRVERT	CaseType=LinStatic	Point=4	X2=0.5	X3=0.5	S11=-
1842.12619992045	IsS11Max=No	IsS11Min=No	FrameElem=59	ElemStation=0			
Frame=59	Station=0.5	OutputCase=TERRVERT	CaseType=LinStatic	Point=0	X2=0	X3=0	S11=-491.249995127204
IsS11Max=No	IsS11Min=No	FrameElem=59	ElemStation=0.5				
Frame=59	Station=0.5	OutputCase=TERRVERT	CaseType=LinStatic	Point=1	X2=-0.5	X3=-0.5	
S11=863.084683673591	IsS11Max=Yes	IsS11Min=No	FrameElem=59	ElemStation=0.5			
Frame=59	Station=0.5	OutputCase=TERRVERT	CaseType=LinStatic	Point=2	X2=-0.5	X3=0.5	
S11=863.084683673591	IsS11Max=No	IsS11Min=No	FrameElem=59	ElemStation=0.5			
Frame=59	Station=0.5	OutputCase=TERRVERT	CaseType=LinStatic	Point=3	X2=0.5	X3=-0.5	S11=-
1845.584673928	IsS11Max=No	IsS11Min=Yes	FrameElem=59	ElemStation=0.5			
Frame=59	Station=0.5	OutputCase=TERRVERT	CaseType=LinStatic	Point=4	X2=0.5	X3=0.5	S11=-
1845.584673928	IsS11Max=No	IsS11Min=No	FrameElem=59	ElemStation=0.5			
Frame=59	Station=0	OutputCase=TERRLAT	CaseType=LinStatic	Point=0	X2=0	X3=0	S11=4.38343931818963E-07
IsS11Max=No	IsS11Min=No	FrameElem=59	ElemStation=0				
Frame=59	Station=0	OutputCase=TERRLAT	CaseType=LinStatic	Point=1	X2=-0.5	X3=-0.5	S11=-
285.583211847545	IsS11Max=No	IsS11Min=Yes	FrameElem=59	ElemStation=0			
Frame=59	Station=0	OutputCase=TERRLAT	CaseType=LinStatic	Point=2	X2=-0.5	X3=0.5	S11=-
285.583211847545	IsS11Max=No	IsS11Min=No	FrameElem=59	ElemStation=0			
Frame=59	Station=0	OutputCase=TERRLAT	CaseType=LinStatic	Point=3	X2=0.5	X3=-0.5	
S11=285.583212724233	IsS11Max=Yes	IsS11Min=No	FrameElem=59	ElemStation=0			
Frame=59	Station=0	OutputCase=TERRLAT	CaseType=LinStatic	Point=4	X2=0.5	X3=0.5	S11=285.583212724233
IsS11Max=No	IsS11Min=No	FrameElem=59	ElemStation=0				
Frame=59	Station=0.5	OutputCase=TERRLAT	CaseType=LinStatic	Point=0	X2=0	X3=0	S11=2.90258667678123E-07
IsS11Max=No	IsS11Min=No	FrameElem=59	ElemStation=0.5				
Frame=59	Station=0.5	OutputCase=TERRLAT	CaseType=LinStatic	Point=1	X2=-0.5	X3=-0.5	S11=-
296.420004946119	IsS11Max=No	IsS11Min=Yes	FrameElem=59	ElemStation=0.5			
Frame=59	Station=0.5	OutputCase=TERRLAT	CaseType=LinStatic	Point=2	X2=-0.5	X3=0.5	S11=-
296.420004946119	IsS11Max=No	IsS11Min=No	FrameElem=59	ElemStation=0.5			
Frame=59	Station=0.5	OutputCase=TERRLAT	CaseType=LinStatic	Point=3	X2=0.5	X3=-0.5	
S11=296.420005526637	IsS11Max=Yes	IsS11Min=No	FrameElem=59	ElemStation=0.5			
Frame=59	Station=0.5	OutputCase=TERRLAT	CaseType=LinStatic	Point=4	X2=0.5	X3=0.5	
S11=296.420005526637	IsS11Max=No	IsS11Min=No	FrameElem=59	ElemStation=0.5			
Frame=59	Station=0	OutputCase=ACCLATDX	CaseType=LinStatic	Point=0	X2=0	X3=0	S11=0
IsS11Min=Yes	FrameElem=59	ElemStation=0					IsS11Max=Yes
Frame=59	Station=0	OutputCase=ACCLATDX	CaseType=LinStatic	Point=1	X2=-0.5	X3=-0.5	S11=0
IsS11Max=No	IsS11Min=No	FrameElem=59	ElemStation=0				
Frame=59	Station=0	OutputCase=ACCLATDX	CaseType=LinStatic	Point=2	X2=-0.5	X3=0.5	S11=0
IsS11Max=No	IsS11Min=No	FrameElem=59	ElemStation=0				
Frame=59	Station=0	OutputCase=ACCLATDX	CaseType=LinStatic	Point=3	X2=0.5	X3=-0.5	S11=0
IsS11Max=No	IsS11Min=No	FrameElem=59	ElemStation=0				
Frame=59	Station=0	OutputCase=ACCLATDX	CaseType=LinStatic	Point=4	X2=0.5	X3=0.5	S11=0
IsS11Max=No	IsS11Min=No	FrameElem=59	ElemStation=0				IsS11Max=No
IsS11Min=No	FrameElem=59	ElemStation=0					
Frame=59	Station=0.5	OutputCase=ACCLATDX	CaseType=LinStatic	Point=0	X2=0	X3=0	S11=0
IsS11Min=Yes	FrameElem=59	ElemStation=0.5					IsS11Max=Yes
Frame=59	Station=0.5	OutputCase=ACCLATDX	CaseType=LinStatic	Point=1	X2=-0.5	X3=-0.5	S11=0
IsS11Max=No	IsS11Min=No	FrameElem=59	ElemStation=0.5				
Frame=59	Station=0.5	OutputCase=ACCLATDX	CaseType=LinStatic	Point=2	X2=-0.5	X3=0.5	S11=0
IsS11Max=No	IsS11Min=No	FrameElem=59	ElemStation=0.5				
Frame=59	Station=0.5	OutputCase=ACCLATDX	CaseType=LinStatic	Point=3	X2=0.5	X3=-0.5	S11=0
IsS11Max=No	IsS11Min=No	FrameElem=59	ElemStation=0.5				
Frame=59	Station=0.5	OutputCase=ACCLATDX	CaseType=LinStatic	Point=4	X2=0.5	X3=0.5	S11=0
IsS11Max=No	IsS11Min=No	FrameElem=59	ElemStation=0.5				
Frame=59	Station=0	OutputCase=ACCLATSX	CaseType=LinStatic	Point=0	X2=0	X3=0	S11=0
IsS11Min=Yes	FrameElem=59	ElemStation=0					IsS11Max=Yes
Frame=59	Station=0	OutputCase=ACCLATSX	CaseType=LinStatic	Point=1	X2=-0.5	X3=-0.5	S11=0
IsS11Max=No	IsS11Min=No	FrameElem=59	ElemStation=0				
Frame=59	Station=0	OutputCase=ACCLATSX	CaseType=LinStatic	Point=2	X2=-0.5	X3=0.5	S11=0
IsS11Max=No	IsS11Min=No	FrameElem=59	ElemStation=0				
Frame=59	Station=0	OutputCase=ACCLATSX	CaseType=LinStatic	Point=3	X2=0.5	X3=-0.5	S11=0
IsS11Max=No	IsS11Min=No	FrameElem=59	ElemStation=0				
Frame=59	Station=0	OutputCase=ACCLATSX	CaseType=LinStatic	Point=4	X2=0.5	X3=0.5	S11=0
IsS11Max=No	IsS11Min=No	FrameElem=59	ElemStation=0				IsS11Max=No
IsS11Min=No	FrameElem=59	ElemStation=0					
Frame=59	Station=0.5	OutputCase=ACCLATSX	CaseType=LinStatic	Point=0	X2=0	X3=0	S11=0
IsS11Min=Yes	FrameElem=59	ElemStation=0.5					IsS11Max=Yes
Frame=59	Station=0.5	OutputCase=ACCLATSX	CaseType=LinStatic	Point=1	X2=-0.5	X3=-0.5	S11=0
IsS11Max=No	IsS11Min=No	FrameElem=59	ElemStation=0.5				
Frame=59	Station=0.5	OutputCase=ACCLATSX	CaseType=LinStatic	Point=2	X2=-0.5	X3=0.5	S11=0
IsS11Max=No	IsS11Min=No	FrameElem=59	ElemStation=0.5				
Frame=59	Station=0.5	OutputCase=ACCLATSX	CaseType=LinStatic	Point=3	X2=0.5	X3=-0.5	S11=0
IsS11Max=No	IsS11Min=No	FrameElem=59	ElemStation=0.5				
Frame=59	Station=0.5	OutputCase=ACCLATSX	CaseType=LinStatic	Point=4	X2=0.5	X3=0.5	S11=0
IsS11Max=No	IsS11Min=No	FrameElem=59	ElemStation=0.5				
Frame=59	Station=0	OutputCase=TERRCOST	CaseType=LinStatic	Point=0	X2=0	X3=0	S11=0
IsS11Min=Yes	FrameElem=59	ElemStation=0					IsS11Max=Yes
Frame=59	Station=0	OutputCase=TERRCOST	CaseType=LinStatic	Point=1	X2=-0.5	X3=-0.5	S11=0
IsS11Max=No	IsS11Min=No	FrameElem=59	ElemStation=0				
Frame=59	Station=0	OutputCase=TERRCOST	CaseType=LinStatic	Point=2	X2=-0.5	X3=0.5	S11=0
IsS11Max=No	IsS11Min=No	FrameElem=59	ElemStation=0				
Frame=59	Station=0	OutputCase=TERRCOST	CaseType=LinStatic	Point=3	X2=0.5	X3=-0.5	S11=0
IsS11Max=No	IsS11Min=No	FrameElem=59	ElemStation=0				

Frame=59	Station=0	OutputCase=TERRCOST	CaseType=LinStatic	Point=4	X2=0.5	X3=0.5	S11=0	IsS11Max=No
IsS11Min=No	FrameElem=59	ElemStation=0						
Frame=59	Station=0.5	OutputCase=TERRCOST	CaseType=LinStatic	Point=0	X2=0	X3=0	S11=0	IsS11Max=Yes
IsS11Min=Yes	FrameElem=59	ElemStation=0.5						
Frame=59	Station=0.5	OutputCase=TERRCOST	CaseType=LinStatic	Point=1	X2=-0.5	X3=-0.5	S11=0	
IsS11Max=No	IsS11Min=No	FrameElem=59	ElemStation=0.5					
Frame=59	Station=0.5	OutputCase=TERRCOST	CaseType=LinStatic	Point=2	X2=-0.5	X3=0.5	S11=0	
IsS11Max=No	IsS11Min=No	FrameElem=59	ElemStation=0.5					
Frame=59	Station=0.5	OutputCase=TERRCOST	CaseType=LinStatic	Point=3	X2=0.5	X3=-0.5	S11=0	
IsS11Max=No	IsS11Min=No	FrameElem=59	ElemStation=0.5					
Frame=59	Station=0.5	OutputCase=TERRCOST	CaseType=LinStatic	Point=4	X2=0.5	X3=0.5	S11=0	
IsS11Max=No	IsS11Min=No	FrameElem=59	ElemStation=0.5					
Frame=59	Station=0	OutputCase=SOVRCOST	CaseType=LinStatic	Point=0	X2=0	X3=0	S11=0	IsS11Max=Yes
IsS11Min=Yes	FrameElem=59	ElemStation=0						
Frame=59	Station=0	OutputCase=SOVRCOST	CaseType=LinStatic	Point=1	X2=-0.5	X3=-0.5	S11=0	
IsS11Max=No	IsS11Min=No	FrameElem=59	ElemStation=0					
Frame=59	Station=0	OutputCase=SOVRCOST	CaseType=LinStatic	Point=2	X2=-0.5	X3=0.5	S11=0	
IsS11Max=No	IsS11Min=No	FrameElem=59	ElemStation=0					
Frame=59	Station=0	OutputCase=SOVRCOST	CaseType=LinStatic	Point=3	X2=0.5	X3=-0.5	S11=0	
IsS11Max=No	IsS11Min=No	FrameElem=59	ElemStation=0					
Frame=59	Station=0	OutputCase=SOVRCOST	CaseType=LinStatic	Point=4	X2=0.5	X3=0.5	S11=0	IsS11Max=No
IsS11Min=No	FrameElem=59	ElemStation=0						
Frame=59	Station=0.5	OutputCase=SOVRCOST	CaseType=LinStatic	Point=0	X2=0	X3=0	S11=0	IsS11Max=Yes
IsS11Min=Yes	FrameElem=59	ElemStation=0.5						
Frame=59	Station=0.5	OutputCase=SOVRCOST	CaseType=LinStatic	Point=1	X2=-0.5	X3=-0.5	S11=0	
IsS11Max=No	IsS11Min=No	FrameElem=59	ElemStation=0.5					
Frame=59	Station=0.5	OutputCase=SOVRCOST	CaseType=LinStatic	Point=2	X2=-0.5	X3=0.5	S11=0	
IsS11Max=No	IsS11Min=No	FrameElem=59	ElemStation=0.5					
Frame=59	Station=0.5	OutputCase=SOVRCOST	CaseType=LinStatic	Point=3	X2=0.5	X3=-0.5	S11=0	
IsS11Max=No	IsS11Min=No	FrameElem=59	ElemStation=0.5					
Frame=59	Station=0.5	OutputCase=SOVRCOST	CaseType=LinStatic	Point=4	X2=0.5	X3=0.5	S11=0	
IsS11Max=No	IsS11Min=No	FrameElem=59	ElemStation=0.5					
Frame=59	Station=0	OutputCase=ENVE	CaseType=Combination	StepType=Max	Point=0	X2=0	X3=0	S11=-
616.24999396141	IsS11Max=No	IsS11Min=No	FrameElem=59	ElemStation=0				
Frame=59	Station=0	OutputCase=ENVE	CaseType=Combination	StepType=Max	Point=1	X2=-0.5	X3=-0.5	
S11=888.711632360986	IsS11Max=Yes	IsS11Min=No	FrameElem=59	ElemStation=0				
Frame=59	Station=0	OutputCase=ENVE	CaseType=Combination	StepType=Max	Point=2	X2=-0.5	X3=0.5	
S11=888.711632360986	IsS11Max=No	IsS11Min=No	FrameElem=59	ElemStation=0				
Frame=59	Station=0	OutputCase=ENVE	CaseType=Combination	StepType=Max	Point=3	X2=0.5	X3=-0.5	S11=-
2035.53665672954	IsS11Max=No	IsS11Min=Yes	FrameElem=59	ElemStation=0				
Frame=59	Station=0	OutputCase=ENVE	CaseType=Combination	StepType=Max	Point=4	X2=0.5	X3=0.5	S11=-
2035.53665672954	IsS11Max=No	IsS11Min=No	FrameElem=59	ElemStation=0				
Frame=59	Station=0.5	OutputCase=ENVE	CaseType=Combination	StepType=Max	Point=0	X2=0	X3=0	S11=-
603.749994109495	IsS11Max=No	IsS11Min=No	FrameElem=59	ElemStation=0.5				
Frame=59	Station=0.5	OutputCase=ENVE	CaseType=Combination	StepType=Max	Point=1	X2=-0.5	X3=-0.5	
S11=851.571508159599	IsS11Max=Yes	IsS11Min=No	FrameElem=59	ElemStation=0.5				
Frame=59	Station=0.5	OutputCase=ENVE	CaseType=Combination	StepType=Max	Point=2	X2=-0.5	X3=0.5	
S11=851.571508159599	IsS11Max=No	IsS11Min=No	FrameElem=59	ElemStation=0.5				
Frame=59	Station=0.5	OutputCase=ENVE	CaseType=Combination	StepType=Max	Point=3	X2=0.5	X3=-0.5	
S11=-1970.14549489475	IsS11Max=No	IsS11Min=Yes	FrameElem=59	ElemStation=0.5				
Frame=59	Station=0.5	OutputCase=ENVE	CaseType=Combination	StepType=Max	Point=4	X2=0.5	X3=0.5	
S11=-1970.14549489475	IsS11Max=No	IsS11Min=No	FrameElem=59	ElemStation=0.5				
Frame=59	Station=0	OutputCase=ENVE	CaseType=Combination	StepType=Min	Point=0	X2=0	X3=0	S11=-
616.249994092913	IsS11Max=No	IsS11Min=No	FrameElem=59	ElemStation=0				
Frame=59	Station=0	OutputCase=ENVE	CaseType=Combination	StepType=Min	Point=1	X2=-0.5	X3=-0.5	
S11=803.036668806722	IsS11Max=Yes	IsS11Min=No	FrameElem=59	ElemStation=0				
Frame=59	Station=0	OutputCase=ENVE	CaseType=Combination	StepType=Min	Point=2	X2=-0.5	X3=0.5	
S11=803.036668806722	IsS11Max=No	IsS11Min=No	FrameElem=59	ElemStation=0				
Frame=59	Station=0	OutputCase=ENVE	CaseType=Combination	StepType=Min	Point=3	X2=0.5	X3=-0.5	S11=-
2121.21162054681	IsS11Max=No	IsS11Min=Yes	FrameElem=59	ElemStation=0				
Frame=59	Station=0	OutputCase=ENVE	CaseType=Combination	StepType=Min	Point=4	X2=0.5	X3=0.5	S11=-
2121.21162054681	IsS11Max=No	IsS11Min=No	FrameElem=59	ElemStation=0				
Frame=59	Station=0.5	OutputCase=ENVE	CaseType=Combination	StepType=Min	Point=0	X2=0	X3=0	S11=-
603.749994196573	IsS11Max=No	IsS11Min=No	FrameElem=59	ElemStation=0.5				
Frame=59	Station=0.5	OutputCase=ENVE	CaseType=Combination	StepType=Min	Point=1	X2=-0.5	X3=-0.5	
S11=762.645506675763	IsS11Max=Yes	IsS11Min=No	FrameElem=59	ElemStation=0.5				
Frame=59	Station=0.5	OutputCase=ENVE	CaseType=Combination	StepType=Min	Point=2	X2=-0.5	X3=0.5	
S11=762.645506675763	IsS11Max=No	IsS11Min=No	FrameElem=59	ElemStation=0.5				
Frame=59	Station=0.5	OutputCase=ENVE	CaseType=Combination	StepType=Min	Point=3	X2=0.5	X3=-0.5	
S11=-2059.07149655274	IsS11Max=No	IsS11Min=Yes	FrameElem=59	ElemStation=0.5				
Frame=59	Station=0.5	OutputCase=ENVE	CaseType=Combination	StepType=Min	Point=4	X2=0.5	X3=0.5	
S11=-2059.07149655274	IsS11Max=No	IsS11Min=No	FrameElem=59	ElemStation=0.5				
Frame=59	Station=0	OutputCase=FESSUR	CaseType=Combination	Point=0	X2=0	X3=0	S11=-616.24999396141	
IsS11Max=No	IsS11Min=No	FrameElem=59	ElemStation=0					
Frame=59	Station=0	OutputCase=FESSUR	CaseType=Combination	Point=1	X2=-0.5	X3=-0.5		
S11=803.036668806722	IsS11Max=Yes	IsS11Min=No	FrameElem=59	ElemStation=0				
Frame=59	Station=0	OutputCase=FESSUR	CaseType=Combination	Point=2	X2=-0.5	X3=0.5		
S11=803.036668806722	IsS11Max=No	IsS11Min=No	FrameElem=59	ElemStation=0				
Frame=59	Station=0	OutputCase=FESSUR	CaseType=Combination	Point=3	X2=0.5	X3=-0.5	S11=-	
2035.53665672954	IsS11Max=No	IsS11Min=Yes	FrameElem=59	ElemStation=0				
Frame=59	Station=0	OutputCase=FESSUR	CaseType=Combination	Point=4	X2=0.5	X3=0.5	S11=-	
2035.53665672954	IsS11Max=No	IsS11Min=No	FrameElem=59	ElemStation=0				

Frame=59	Station=0.5	OutputCase=FESSUR	CaseType=Combination	Point=0	X2=0	X3=0	S11=-603.749994109495
IsS11Max=No	IsS11Min=No	FrameElem=59	ElemStation=0.5				
Frame=59	Station=0.5	OutputCase=FESSUR	CaseType=Combination	Point=1	X2=-0.5	X3=-0.5	
S11=762.645506675763	IsS11Max=Yes	IsS11Min=No	FrameElem=59	ElemStation=0.5			
Frame=59	Station=0.5	OutputCase=FESSUR	CaseType=Combination	Point=2	X2=-0.5	X3=0.5	
S11=762.645506675763	IsS11Max=No	IsS11Min=No	FrameElem=59	ElemStation=0.5			
Frame=59	Station=0.5	OutputCase=FESSUR	CaseType=Combination	Point=3	X2=0.5	X3=-0.5	S11=-
1970.14549489475	IsS11Max=No	IsS11Min=Yes	FrameElem=59	ElemStation=0.5			
Frame=59	Station=0.5	OutputCase=FESSUR	CaseType=Combination	Point=4	X2=0.5	X3=0.5	S11=-
1970.14549489475	IsS11Max=No	IsS11Min=No	FrameElem=59	ElemStation=0.5			
Frame=60	Station=0	OutputCase=PESOPR	CaseType=LinStatic	Point=0	X2=0	X3=0	S11=-112.499999272521
IsS11Max=No	IsS11Min=No	FrameElem=60	ElemStation=0				
Frame=60	Station=0	OutputCase=PESOPR	CaseType=LinStatic	Point=1	X2=-0.5	X3=-0.5	
S11=195.980827948321	IsS11Max=Yes	IsS11Min=No	FrameElem=60	ElemStation=0			
Frame=60	Station=0	OutputCase=PESOPR	CaseType=LinStatic	Point=2	X2=-0.5	X3=0.5	S11=195.980827948321
IsS11Max=No	IsS11Min=No	FrameElem=60	ElemStation=0				
Frame=60	Station=0	OutputCase=PESOPR	CaseType=LinStatic	Point=3	X2=0.5	X3=-0.5	S11=-
420.980826493362	IsS11Max=No	IsS11Min=Yes	FrameElem=60	ElemStation=0			
Frame=60	Station=0	OutputCase=PESOPR	CaseType=LinStatic	Point=4	X2=0.5	X3=0.5	S11=-420.980826493362
IsS11Max=No	IsS11Min=No	FrameElem=60	ElemStation=0				
Frame=60	Station=0.5	OutputCase=PESOPR	CaseType=LinStatic	Point=0	X2=0	X3=0	S11=-99.9999992725207
IsS11Max=No	IsS11Min=No	FrameElem=60	ElemStation=0.5				
Frame=60	Station=0.5	OutputCase=PESOPR	CaseType=LinStatic	Point=1	X2=-0.5	X3=-0.5	
S11=162.967985206406	IsS11Max=Yes	IsS11Min=No	FrameElem=60	ElemStation=0.5			
Frame=60	Station=0.5	OutputCase=PESOPR	CaseType=LinStatic	Point=2	X2=-0.5	X3=0.5	
S11=162.967985206406	IsS11Max=No	IsS11Min=No	FrameElem=60	ElemStation=0.5			
Frame=60	Station=0.5	OutputCase=PESOPR	CaseType=LinStatic	Point=3	X2=0.5	X3=-0.5	S11=-
362.967983751447	IsS11Max=No	IsS11Min=Yes	FrameElem=60	ElemStation=0.5			
Frame=60	Station=0.5	OutputCase=PESOPR	CaseType=LinStatic	Point=4	X2=0.5	X3=0.5	S11=-
362.967983751447	IsS11Max=No	IsS11Min=No	FrameElem=60	ElemStation=0.5			
Frame=60	Station=0	OutputCase=TERRVERT	CaseType=LinStatic	Point=0	X2=0	X3=0	S11=-491.249995127204
IsS11Max=No	IsS11Min=No	FrameElem=60	ElemStation=0				
Frame=60	Station=0	OutputCase=TERRVERT	CaseType=LinStatic	Point=1	X2=-0.5	X3=-0.5	
S11=863.084683673592	IsS11Max=Yes	IsS11Min=No	FrameElem=60	ElemStation=0			
Frame=60	Station=0	OutputCase=TERRVERT	CaseType=LinStatic	Point=2	X2=-0.5	X3=0.5	
S11=863.084683673592	IsS11Max=No	IsS11Min=No	FrameElem=60	ElemStation=0			
Frame=60	Station=0	OutputCase=TERRVERT	CaseType=LinStatic	Point=3	X2=0.5	X3=-0.5	S11=-
1845.584673928	IsS11Max=No	IsS11Min=Yes	FrameElem=60	ElemStation=0			
Frame=60	Station=0	OutputCase=TERRVERT	CaseType=LinStatic	Point=4	X2=0.5	X3=0.5	S11=-1845.584673928
IsS11Max=No	IsS11Min=No	FrameElem=60	ElemStation=0				
Frame=60	Station=0.5	OutputCase=TERRVERT	CaseType=LinStatic	Point=0	X2=0	X3=0	S11=-491.249995127204
IsS11Max=No	IsS11Min=No	FrameElem=60	ElemStation=0.5				
Frame=60	Station=0.5	OutputCase=TERRVERT	CaseType=LinStatic	Point=1	X2=-0.5	X3=-0.5	
S11=866.543157681147	IsS11Max=Yes	IsS11Min=No	FrameElem=60	ElemStation=0.5			
Frame=60	Station=0.5	OutputCase=TERRVERT	CaseType=LinStatic	Point=2	X2=-0.5	X3=0.5	
S11=866.543157681147	IsS11Max=No	IsS11Min=No	FrameElem=60	ElemStation=0.5			
Frame=60	Station=0.5	OutputCase=TERRVERT	CaseType=LinStatic	Point=3	X2=0.5	X3=-0.5	S11=-
1849.04314793555	IsS11Max=No	IsS11Min=Yes	FrameElem=60	ElemStation=0.5			
Frame=60	Station=0.5	OutputCase=TERRVERT	CaseType=LinStatic	Point=4	X2=0.5	X3=0.5	S11=-
1849.04314793555	IsS11Max=No	IsS11Min=No	FrameElem=60	ElemStation=0.5			
Frame=60	Station=0	OutputCase=TERRLAT	CaseType=LinStatic	Point=0	X2=0	X3=0	S11=2.90258867607918E-07
IsS11Max=No	IsS11Min=No	FrameElem=60	ElemStation=0				
Frame=60	Station=0	OutputCase=TERRLAT	CaseType=LinStatic	Point=1	X2=-0.5	X3=-0.5	S11=-
296.420004946119	IsS11Max=No	IsS11Min=Yes	FrameElem=60	ElemStation=0			
Frame=60	Station=0	OutputCase=TERRLAT	CaseType=LinStatic	Point=2	X2=-0.5	X3=0.5	S11=-
296.420004946119	IsS11Max=No	IsS11Min=No	FrameElem=60	ElemStation=0			
Frame=60	Station=0	OutputCase=TERRLAT	CaseType=LinStatic	Point=3	X2=0.5	X3=-0.5	
S11=296.420005526637	IsS11Max=Yes	IsS11Min=No	FrameElem=60	ElemStation=0			
Frame=60	Station=0	OutputCase=TERRLAT	CaseType=LinStatic	Point=4	X2=0.5	X3=0.5	S11=296.420005526637
IsS11Max=No	IsS11Min=No	FrameElem=60	ElemStation=0				
Frame=60	Station=0.5	OutputCase=TERRLAT	CaseType=LinStatic	Point=0	X2=0	X3=0	S11=1.5911623928444E-07
IsS11Max=No	IsS11Min=No	FrameElem=60	ElemStation=0.5				
Frame=60	Station=0.5	OutputCase=TERRLAT	CaseType=LinStatic	Point=1	X2=-0.5	X3=-0.5	S11=-
254.554298027751	IsS11Max=No	IsS11Min=Yes	FrameElem=60	ElemStation=0.5			
Frame=60	Station=0.5	OutputCase=TERRLAT	CaseType=LinStatic	Point=2	X2=-0.5	X3=0.5	S11=-
254.554298027751	IsS11Max=No	IsS11Min=No	FrameElem=60	ElemStation=0.5			
Frame=60	Station=0.5	OutputCase=TERRLAT	CaseType=LinStatic	Point=3	X2=0.5	X3=-0.5	
S11=254.554298345984	IsS11Max=Yes	IsS11Min=No	FrameElem=60	ElemStation=0.5			
Frame=60	Station=0.5	OutputCase=TERRLAT	CaseType=LinStatic	Point=4	X2=0.5	X3=0.5	
S11=254.554298345984	IsS11Max=No	IsS11Min=No	FrameElem=60	ElemStation=0.5			
Frame=60	Station=0	OutputCase=ACCLATDX	CaseType=LinStatic	Point=0	X2=0	X3=0	S11=0 IsS11Max=Yes
IsS11Min=Yes	FrameElem=60	ElemStation=0					
Frame=60	Station=0	OutputCase=ACCLATDX	CaseType=LinStatic	Point=1	X2=-0.5	X3=-0.5	S11=0
IsS11Max=No	IsS11Min=No	FrameElem=60	ElemStation=0				
Frame=60	Station=0	OutputCase=ACCLATDX	CaseType=LinStatic	Point=2	X2=-0.5	X3=0.5	S11=0
IsS11Max=No	IsS11Min=No	FrameElem=60	ElemStation=0				
Frame=60	Station=0	OutputCase=ACCLATDX	CaseType=LinStatic	Point=3	X2=0.5	X3=-0.5	S11=0
IsS11Max=No	IsS11Min=No	FrameElem=60	ElemStation=0				
Frame=60	Station=0	OutputCase=ACCLATDX	CaseType=LinStatic	Point=4	X2=0.5	X3=0.5	S11=0 IsS11Max=No
IsS11Min=No	FrameElem=60	ElemStation=0					
Frame=60	Station=0.5	OutputCase=ACCLATDX	CaseType=LinStatic	Point=0	X2=0	X3=0	S11=0 IsS11Max=Yes
IsS11Min=Yes	FrameElem=60	ElemStation=0.5					

Frame=60	Station=0.5	OutputCase=ENVE	CaseType=Combination	StepType=Max	Point=2	X2=-0.5	X3=0.5	
S11=851.323134268127	IsS11Max=No	IsS11Min=No	FrameElem=60	ElemStation=0.5				
Frame=60	Station=0.5	OutputCase=ENVE	CaseType=Combination	StepType=Max	Point=3	X2=0.5	X3=-0.5	
S11=-1957.45683334102	IsS11Max=No	IsS11Min=Yes	FrameElem=60	ElemStation=0.5				
Frame=60	Station=0.5	OutputCase=ENVE	CaseType=Combination	StepType=Max	Point=4	X2=0.5	X3=0.5	
S11=-1957.45683334102	IsS11Max=No	IsS11Min=No	FrameElem=60	ElemStation=0.5				
Frame=60	Station=0	OutputCase=ENVE	CaseType=Combination	StepType=Min	Point=0	X2=0	X3=0	S11=-
603.749994196543	IsS11Max=No	IsS11Min=No	FrameElem=60	ElemStation=0				
Frame=60	Station=0	OutputCase=ENVE	CaseType=Combination	StepType=Min	Point=1	X2=-0.5	X3=-0.5	
S11=762.645506675794	IsS11Max=Yes	IsS11Min=No	FrameElem=60	ElemStation=0				
Frame=60	Station=0	OutputCase=ENVE	CaseType=Combination	StepType=Min	Point=2	X2=-0.5	X3=0.5	
S11=762.645506675794	IsS11Max=No	IsS11Min=No	FrameElem=60	ElemStation=0				
Frame=60	Station=0	OutputCase=ENVE	CaseType=Combination	StepType=Min	Point=3	X2=0.5	X3=-0.5	S11=-
2059.07149655272	IsS11Max=No	IsS11Min=Yes	FrameElem=60	ElemStation=0				
Frame=60	Station=0	OutputCase=ENVE	CaseType=Combination	StepType=Min	Point=4	X2=0.5	X3=0.5	S11=-
2059.07149655272	IsS11Max=No	IsS11Min=No	FrameElem=60	ElemStation=0				
Frame=60	Station=0.5	OutputCase=ENVE	CaseType=Combination	StepType=Min	Point=0	X2=0	X3=0	S11=-
591.249994288343	IsS11Max=No	IsS11Min=No	FrameElem=60	ElemStation=0.5				
Frame=60	Station=0.5	OutputCase=ENVE	CaseType=Combination	StepType=Min	Point=1	X2=-0.5	X3=-0.5	
S11=774.956844859802	IsS11Max=Yes	IsS11Min=No	FrameElem=60	ElemStation=0.5				
Frame=60	Station=0.5	OutputCase=ENVE	CaseType=Combination	StepType=Min	Point=2	X2=-0.5	X3=0.5	
S11=774.956844859802	IsS11Max=No	IsS11Min=No	FrameElem=60	ElemStation=0.5				
Frame=60	Station=0.5	OutputCase=ENVE	CaseType=Combination	StepType=Min	Point=3	X2=0.5	X3=-0.5	
S11=-2033.82312284481	IsS11Max=No	IsS11Min=Yes	FrameElem=60	ElemStation=0.5				
Frame=60	Station=0.5	OutputCase=ENVE	CaseType=Combination	StepType=Min	Point=4	X2=0.5	X3=0.5	
S11=-2033.82312284481	IsS11Max=No	IsS11Min=No	FrameElem=60	ElemStation=0.5				
Frame=60	Station=0	OutputCase=FESSUR	CaseType=Combination	Point=0	X2=0	X3=0	S11=-603.749994109466	
IsS11Max=No	IsS11Min=No	FrameElem=60	ElemStation=0					
Frame=60	Station=0	OutputCase=FESSUR	CaseType=Combination	Point=1	X2=-0.5	X3=-0.5		
S11=762.645506675794	IsS11Max=Yes	IsS11Min=No	FrameElem=60	ElemStation=0				
Frame=60	Station=0	OutputCase=FESSUR	CaseType=Combination	Point=2	X2=-0.5	X3=0.5		
S11=762.645506675794	IsS11Max=No	IsS11Min=No	FrameElem=60	ElemStation=0				
Frame=60	Station=0	OutputCase=FESSUR	CaseType=Combination	Point=3	X2=0.5	X3=-0.5	S11=-	
1970.14549489472	IsS11Max=No	IsS11Min=Yes	FrameElem=60	ElemStation=0				
Frame=60	Station=0	OutputCase=FESSUR	CaseType=Combination	Point=4	X2=0.5	X3=0.5	S11=-	
1970.14549489472	IsS11Max=No	IsS11Min=No	FrameElem=60	ElemStation=0				
Frame=60	Station=0.5	OutputCase=FESSUR	CaseType=Combination	Point=0	X2=0	X3=0	S11=-591.249994240608	
IsS11Max=No	IsS11Min=No	FrameElem=60	ElemStation=0.5					
Frame=60	Station=0.5	OutputCase=FESSUR	CaseType=Combination	Point=1	X2=-0.5	X3=-0.5		
S11=774.956844859802	IsS11Max=Yes	IsS11Min=No	FrameElem=60	ElemStation=0.5				
Frame=60	Station=0.5	OutputCase=FESSUR	CaseType=Combination	Point=2	X2=-0.5	X3=0.5		
S11=774.956844859802	IsS11Max=No	IsS11Min=No	FrameElem=60	ElemStation=0.5				
Frame=60	Station=0.5	OutputCase=FESSUR	CaseType=Combination	Point=3	X2=0.5	X3=-0.5	S11=-	
1957.45683334102	IsS11Max=No	IsS11Min=Yes	FrameElem=60	ElemStation=0.5				
Frame=60	Station=0.5	OutputCase=FESSUR	CaseType=Combination	Point=4	X2=0.5	X3=0.5	S11=-	
1957.45683334102	IsS11Max=No	IsS11Min=No	FrameElem=60	ElemStation=0.5				
Frame=61	Station=0	OutputCase=PESOPR	CaseType=LinStatic	Point=0	X2=0	X3=0	S11=-99.9999992724333	
IsS11Max=No	IsS11Min=No	FrameElem=61	ElemStation=0					
Frame=61	Station=0	OutputCase=PESOPR	CaseType=LinStatic	Point=1	X2=-0.5	X3=-0.5		
S11=162.967985206493	IsS11Max=Yes	IsS11Min=No	FrameElem=61	ElemStation=0				
Frame=61	Station=0	OutputCase=PESOPR	CaseType=LinStatic	Point=2	X2=-0.5	X3=0.5	S11=162.967985206493	
IsS11Max=No	IsS11Min=No	FrameElem=61	ElemStation=0					
Frame=61	Station=0	OutputCase=PESOPR	CaseType=LinStatic	Point=3	X2=0.5	X3=-0.5	S11=-362.96798375136	
IsS11Max=No	IsS11Min=Yes	FrameElem=61	ElemStation=0					
Frame=61	Station=0	OutputCase=PESOPR	CaseType=LinStatic	Point=4	X2=0.5	X3=0.5	S11=-362.96798375136	
IsS11Max=No	IsS11Min=No	FrameElem=61	ElemStation=0					
Frame=61	Station=0.5	OutputCase=PESOPR	CaseType=LinStatic	Point=0	X2=0	X3=0	S11=-87.4999992724333	
IsS11Max=No	IsS11Min=No	FrameElem=61	ElemStation=0.5					
Frame=61	Station=0.5	OutputCase=PESOPR	CaseType=LinStatic	Point=1	X2=-0.5	X3=-0.5		
S11=129.955142762603	IsS11Max=Yes	IsS11Min=No	FrameElem=61	ElemStation=0.5				
Frame=61	Station=0.5	OutputCase=PESOPR	CaseType=LinStatic	Point=2	X2=-0.5	X3=0.5		
S11=129.955142762603	IsS11Max=No	IsS11Min=No	FrameElem=61	ElemStation=0.5				
Frame=61	Station=0.5	OutputCase=PESOPR	CaseType=LinStatic	Point=3	X2=0.5	X3=-0.5	S11=-	
304.95514130747	IsS11Max=No	IsS11Min=Yes	FrameElem=61	ElemStation=0.5				
Frame=61	Station=0.5	OutputCase=PESOPR	CaseType=LinStatic	Point=4	X2=0.5	X3=0.5	S11=-	
304.95514130747	IsS11Max=No	IsS11Min=No	FrameElem=61	ElemStation=0.5				
Frame=61	Station=0	OutputCase=TERRVERT	CaseType=LinStatic	Point=0	X2=0	X3=0	S11=-491.249995127087	
IsS11Max=No	IsS11Min=No	FrameElem=61	ElemStation=0					
Frame=61	Station=0	OutputCase=TERRVERT	CaseType=LinStatic	Point=1	X2=-0.5	X3=-0.5		
S11=866.543157681262	IsS11Max=Yes	IsS11Min=No	FrameElem=61	ElemStation=0				
Frame=61	Station=0	OutputCase=TERRVERT	CaseType=LinStatic	Point=2	X2=-0.5	X3=0.5		
S11=866.543157681262	IsS11Max=No	IsS11Min=No	FrameElem=61	ElemStation=0				
Frame=61	Station=0	OutputCase=TERRVERT	CaseType=LinStatic	Point=3	X2=0.5	X3=-0.5	S11=-	
1849.04314793544	IsS11Max=No	IsS11Min=Yes	FrameElem=61	ElemStation=0				
Frame=61	Station=0	OutputCase=TERRVERT	CaseType=LinStatic	Point=4	X2=0.5	X3=0.5	S11=-	
1849.04314793544	IsS11Max=No	IsS11Min=No	FrameElem=61	ElemStation=0				
Frame=61	Station=0.5	OutputCase=TERRVERT	CaseType=LinStatic	Point=0	X2=0	X3=0	S11=-491.249995127087	
IsS11Max=No	IsS11Min=No	FrameElem=61	ElemStation=0.5					
Frame=61	Station=0.5	OutputCase=TERRVERT	CaseType=LinStatic	Point=1	X2=-0.5	X3=-0.5		
S11=870.00163168882	IsS11Max=Yes	IsS11Min=No	FrameElem=61	ElemStation=0.5				
Frame=61	Station=0.5	OutputCase=TERRVERT	CaseType=LinStatic	Point=2	X2=-0.5	X3=0.5		
S11=870.00163168882	IsS11Max=No	IsS11Min=No	FrameElem=61	ElemStation=0.5				

Frame=61	Station=0.5	OutputCase=TERRVERT	CaseType=LinStatic	Point=3	X2=0.5	X3=-0.5	S11=-	
1852.50162194299	IsS11Max=No	IsS11Min=Yes	FrameElem=61	ElemStation=0.5				
Frame=61	Station=0.5	OutputCase=TERRVERT	CaseType=LinStatic	Point=4	X2=0.5	X3=0.5	S11=-	
1852.50162194299	IsS11Max=No	IsS11Min=No	FrameElem=61	ElemStation=0.5				
Frame=61	Station=0	OutputCase=TERRLAT	CaseType=LinStatic	Point=0	X2=0	X3=0	S11=1.59115870701498E-07	
IsS11Max=No	IsS11Min=No	FrameElem=61	ElemStation=0					
Frame=61	Station=0	OutputCase=TERRLAT	CaseType=LinStatic	Point=1	X2=-0.5	X3=-0.5	S11=-	
254.554298027751	IsS11Max=No	IsS11Min=Yes	FrameElem=61	ElemStation=0				
Frame=61	Station=0	OutputCase=TERRLAT	CaseType=LinStatic	Point=2	X2=-0.5	X3=0.5	S11=-	
254.554298027751	IsS11Max=No	IsS11Min=No	FrameElem=61	ElemStation=0				
Frame=61	Station=0	OutputCase=TERRLAT	CaseType=LinStatic	Point=3	X2=0.5	X3=-0.5		
S11=254.554298345983	IsS11Max=Yes	IsS11Min=No	FrameElem=61	ElemStation=0				
Frame=61	Station=0	OutputCase=TERRLAT	CaseType=LinStatic	Point=4	X2=0.5	X3=0.5	S11=254.554298345983	
IsS11Max=No	IsS11Min=No	FrameElem=61	ElemStation=0					
Frame=61	Station=0.5	OutputCase=TERRLAT	CaseType=LinStatic	Point=0	X2=0	X3=0	S11=4.49158616455669E-08	
IsS11Max=No	IsS11Min=No	FrameElem=61	ElemStation=0.5					
Frame=61	Station=0.5	OutputCase=TERRLAT	CaseType=LinStatic	Point=1	X2=-0.5	X3=-0.5	S11=-	
166.381716092441	IsS11Max=No	IsS11Min=Yes	FrameElem=61	ElemStation=0.5				
Frame=61	Station=0.5	OutputCase=TERRLAT	CaseType=LinStatic	Point=2	X2=-0.5	X3=0.5	S11=-	
166.381716092441	IsS11Max=No	IsS11Min=No	FrameElem=61	ElemStation=0.5				
Frame=61	Station=0.5	OutputCase=TERRLAT	CaseType=LinStatic	Point=3	X2=0.5	X3=-0.5		
S11=166.381716182273	IsS11Max=Yes	IsS11Min=No	FrameElem=61	ElemStation=0.5				
Frame=61	Station=0.5	OutputCase=TERRLAT	CaseType=LinStatic	Point=4	X2=0.5	X3=0.5		
S11=166.381716182273	IsS11Max=No	IsS11Min=No	FrameElem=61	ElemStation=0.5				
Frame=61	Station=0	OutputCase=ACCLATDX	CaseType=LinStatic	Point=0	X2=0	X3=0	S11=0	IsS11Max=Yes
IsS11Min=Yes	FrameElem=61	ElemStation=0						
Frame=61	Station=0	OutputCase=ACCLATDX	CaseType=LinStatic	Point=1	X2=-0.5	X3=-0.5	S11=0	
IsS11Max=No	IsS11Min=No	FrameElem=61	ElemStation=0					
Frame=61	Station=0	OutputCase=ACCLATDX	CaseType=LinStatic	Point=2	X2=-0.5	X3=0.5	S11=0	
IsS11Max=No	IsS11Min=No	FrameElem=61	ElemStation=0					
Frame=61	Station=0	OutputCase=ACCLATDX	CaseType=LinStatic	Point=3	X2=0.5	X3=-0.5	S11=0	
IsS11Max=No	IsS11Min=No	FrameElem=61	ElemStation=0					
Frame=61	Station=0	OutputCase=ACCLATDX	CaseType=LinStatic	Point=4	X2=0.5	X3=0.5	S11=0	IsS11Max=No
IsS11Min=No	FrameElem=61	ElemStation=0						
Frame=61	Station=0.5	OutputCase=ACCLATDX	CaseType=LinStatic	Point=0	X2=0	X3=0	S11=0	IsS11Max=Yes
IsS11Min=Yes	FrameElem=61	ElemStation=0.5						
Frame=61	Station=0.5	OutputCase=ACCLATDX	CaseType=LinStatic	Point=1	X2=-0.5	X3=-0.5	S11=0	
IsS11Max=No	IsS11Min=No	FrameElem=61	ElemStation=0.5					
Frame=61	Station=0.5	OutputCase=ACCLATDX	CaseType=LinStatic	Point=2	X2=-0.5	X3=0.5	S11=0	
IsS11Max=No	IsS11Min=No	FrameElem=61	ElemStation=0.5					
Frame=61	Station=0.5	OutputCase=ACCLATDX	CaseType=LinStatic	Point=3	X2=0.5	X3=-0.5	S11=0	
IsS11Max=No	IsS11Min=No	FrameElem=61	ElemStation=0.5					
Frame=61	Station=0.5	OutputCase=ACCLATDX	CaseType=LinStatic	Point=4	X2=0.5	X3=0.5	S11=0	
IsS11Max=No	IsS11Min=No	FrameElem=61	ElemStation=0.5					
Frame=61	Station=0	OutputCase=ACCLATSX	CaseType=LinStatic	Point=0	X2=0	X3=0	S11=0	IsS11Max=Yes
IsS11Min=Yes	FrameElem=61	ElemStation=0						
Frame=61	Station=0	OutputCase=ACCLATSX	CaseType=LinStatic	Point=1	X2=-0.5	X3=-0.5	S11=0	
IsS11Max=No	IsS11Min=No	FrameElem=61	ElemStation=0					
Frame=61	Station=0	OutputCase=ACCLATSX	CaseType=LinStatic	Point=2	X2=-0.5	X3=0.5	S11=0	
IsS11Max=No	IsS11Min=No	FrameElem=61	ElemStation=0					
Frame=61	Station=0	OutputCase=ACCLATSX	CaseType=LinStatic	Point=3	X2=0.5	X3=-0.5	S11=0	
IsS11Max=No	IsS11Min=No	FrameElem=61	ElemStation=0					
Frame=61	Station=0	OutputCase=ACCLATSX	CaseType=LinStatic	Point=4	X2=0.5	X3=0.5	S11=0	IsS11Max=No
IsS11Min=No	FrameElem=61	ElemStation=0						
Frame=61	Station=0.5	OutputCase=ACCLATSX	CaseType=LinStatic	Point=0	X2=0	X3=0	S11=0	IsS11Max=Yes
IsS11Min=Yes	FrameElem=61	ElemStation=0.5						
Frame=61	Station=0.5	OutputCase=ACCLATSX	CaseType=LinStatic	Point=1	X2=-0.5	X3=-0.5	S11=0	
IsS11Max=No	IsS11Min=No	FrameElem=61	ElemStation=0.5					
Frame=61	Station=0.5	OutputCase=ACCLATSX	CaseType=LinStatic	Point=2	X2=-0.5	X3=0.5	S11=0	
IsS11Max=No	IsS11Min=No	FrameElem=61	ElemStation=0.5					
Frame=61	Station=0.5	OutputCase=ACCLATSX	CaseType=LinStatic	Point=3	X2=0.5	X3=-0.5	S11=0	
IsS11Max=No	IsS11Min=No	FrameElem=61	ElemStation=0.5					
Frame=61	Station=0.5	OutputCase=ACCLATSX	CaseType=LinStatic	Point=4	X2=0.5	X3=0.5	S11=0	
IsS11Max=No	IsS11Min=No	FrameElem=61	ElemStation=0.5					
Frame=61	Station=0	OutputCase=TERRCOST	CaseType=LinStatic	Point=0	X2=0	X3=0	S11=0	IsS11Max=Yes
IsS11Min=Yes	FrameElem=61	ElemStation=0						
Frame=61	Station=0	OutputCase=TERRCOST	CaseType=LinStatic	Point=1	X2=-0.5	X3=-0.5	S11=0	
IsS11Max=No	IsS11Min=No	FrameElem=61	ElemStation=0					
Frame=61	Station=0	OutputCase=TERRCOST	CaseType=LinStatic	Point=2	X2=-0.5	X3=0.5	S11=0	
IsS11Max=No	IsS11Min=No	FrameElem=61	ElemStation=0					
Frame=61	Station=0	OutputCase=TERRCOST	CaseType=LinStatic	Point=3	X2=0.5	X3=-0.5	S11=0	
IsS11Max=No	IsS11Min=No	FrameElem=61	ElemStation=0					
Frame=61	Station=0	OutputCase=TERRCOST	CaseType=LinStatic	Point=4	X2=0.5	X3=0.5	S11=0	IsS11Max=No
IsS11Min=No	FrameElem=61	ElemStation=0						
Frame=61	Station=0.5	OutputCase=TERRCOST	CaseType=LinStatic	Point=0	X2=0	X3=0	S11=0	IsS11Max=Yes
IsS11Min=Yes	FrameElem=61	ElemStation=0.5						
Frame=61	Station=0.5	OutputCase=TERRCOST	CaseType=LinStatic	Point=1	X2=-0.5	X3=-0.5	S11=0	
IsS11Max=No	IsS11Min=No	FrameElem=61	ElemStation=0.5					
Frame=61	Station=0.5	OutputCase=TERRCOST	CaseType=LinStatic	Point=2	X2=-0.5	X3=0.5	S11=0	
IsS11Max=No	IsS11Min=No	FrameElem=61	ElemStation=0.5					
Frame=61	Station=0.5	OutputCase=TERRCOST	CaseType=LinStatic	Point=3	X2=0.5	X3=-0.5	S11=0	
IsS11Max=No	IsS11Min=No	FrameElem=61	ElemStation=0.5					
Frame=61	Station=0.5	OutputCase=TERRCOST	CaseType=LinStatic	Point=4	X2=0.5	X3=0.5	S11=0	
IsS11Max=No	IsS11Min=No	FrameElem=61	ElemStation=0.5					

Frame=61	Station=0.5	OutputCase=TERRCOST	CaseType=LinStatic	Point=4	X2=0.5	X3=0.5	S11=0	
IsS11Max=No	IsS11Min=No	FrameElem=61	ElemStation=0.5					
Frame=61	Station=0	OutputCase=SOVRCOST	CaseType=LinStatic	Point=0	X2=0	X3=0	S11=0	IsS11Max=Yes
IsS11Min=Yes	FrameElem=61	ElemStation=0						
Frame=61	Station=0	OutputCase=SOVRCOST	CaseType=LinStatic	Point=1	X2=-0.5	X3=-0.5	S11=0	
IsS11Max=No	IsS11Min=No	FrameElem=61	ElemStation=0					
Frame=61	Station=0	OutputCase=SOVRCOST	CaseType=LinStatic	Point=2	X2=-0.5	X3=0.5	S11=0	
IsS11Max=No	IsS11Min=No	FrameElem=61	ElemStation=0					
Frame=61	Station=0	OutputCase=SOVRCOST	CaseType=LinStatic	Point=3	X2=0.5	X3=-0.5	S11=0	
IsS11Max=No	IsS11Min=No	FrameElem=61	ElemStation=0					
Frame=61	Station=0	OutputCase=SOVRCOST	CaseType=LinStatic	Point=4	X2=0.5	X3=0.5	S11=0	IsS11Max=No
IsS11Min=No	FrameElem=61	ElemStation=0						
Frame=61	Station=0	OutputCase=SOVRCOST	CaseType=LinStatic	Point=0	X2=0	X3=0	S11=0	IsS11Max=Yes
IsS11Min=Yes	FrameElem=61	ElemStation=0.5						
Frame=61	Station=0.5	OutputCase=SOVRCOST	CaseType=LinStatic	Point=1	X2=-0.5	X3=-0.5	S11=0	
IsS11Max=No	IsS11Min=No	FrameElem=61	ElemStation=0.5					
Frame=61	Station=0.5	OutputCase=SOVRCOST	CaseType=LinStatic	Point=2	X2=-0.5	X3=0.5	S11=0	
IsS11Max=No	IsS11Min=No	FrameElem=61	ElemStation=0.5					
Frame=61	Station=0.5	OutputCase=SOVRCOST	CaseType=LinStatic	Point=3	X2=0.5	X3=-0.5	S11=0	
IsS11Max=No	IsS11Min=No	FrameElem=61	ElemStation=0.5					
Frame=61	Station=0.5	OutputCase=SOVRCOST	CaseType=LinStatic	Point=4	X2=0.5	X3=0.5	S11=0	
IsS11Max=No	IsS11Min=No	FrameElem=61	ElemStation=0.5					
Frame=61	Station=0	OutputCase=ENVE	CaseType=Combination	StepType=Max	Point=0	X2=0	X3=0	S11=-
591.249994240405	IsS11Max=No	IsS11Min=No	FrameElem=61	ElemStation=0				
Frame=61	Station=0	OutputCase=ENVE	CaseType=Combination	StepType=Max	Point=1	X2=-0.5	X3=-0.5	
S11=851.32313426833	IsS11Max=Yes	IsS11Min=No	FrameElem=61	ElemStation=0				
Frame=61	Station=0	OutputCase=ENVE	CaseType=Combination	StepType=Max	Point=2	X2=-0.5	X3=0.5	
S11=851.32313426833	IsS11Max=No	IsS11Min=No	FrameElem=61	ElemStation=0				
Frame=61	Station=0	OutputCase=ENVE	CaseType=Combination	StepType=Max	Point=3	X2=0.5	X3=-0.5	S11=-
1957.45683334081	IsS11Max=No	IsS11Min=Yes	FrameElem=61	ElemStation=0				
Frame=61	Station=0	OutputCase=ENVE	CaseType=Combination	StepType=Max	Point=4	X2=0.5	X3=0.5	S11=-
1957.45683334081	IsS11Max=No	IsS11Min=No	FrameElem=61	ElemStation=0				
Frame=61	Station=0.5	OutputCase=ENVE	CaseType=Combination	StepType=Max	Point=0	X2=0	X3=0	S11=-
578.749994354605	IsS11Max=No	IsS11Min=No	FrameElem=61	ElemStation=0.5				
Frame=61	Station=0.5	OutputCase=ENVE	CaseType=Combination	StepType=Max	Point=1	X2=-0.5	X3=-0.5	
S11=883.489573186714	IsS11Max=Yes	IsS11Min=No	FrameElem=61	ElemStation=0.5				
Frame=61	Station=0.5	OutputCase=ENVE	CaseType=Combination	StepType=Max	Point=2	X2=-0.5	X3=0.5	
S11=883.489573186714	IsS11Max=No	IsS11Min=No	FrameElem=61	ElemStation=0.5				
Frame=61	Station=0.5	OutputCase=ENVE	CaseType=Combination	StepType=Max	Point=3	X2=0.5	X3=-0.5	
S11=-1991.07504706819	IsS11Max=No	IsS11Min=Yes	FrameElem=61	ElemStation=0.5				
Frame=61	Station=0.5	OutputCase=ENVE	CaseType=Combination	StepType=Max	Point=4	X2=0.5	X3=0.5	
S11=-1991.07504706819	IsS11Max=No	IsS11Min=No	FrameElem=61	ElemStation=0.5				
Frame=61	Station=0	OutputCase=ENVE	CaseType=Combination	StepType=Min	Point=0	X2=0	X3=0	S11=-
591.24999428814	IsS11Max=No	IsS11Min=No	FrameElem=61	ElemStation=0				
Frame=61	Station=0	OutputCase=ENVE	CaseType=Combination	StepType=Min	Point=1	X2=-0.5	X3=-0.5	
S11=774.956844860004	IsS11Max=Yes	IsS11Min=No	FrameElem=61	ElemStation=0				
Frame=61	Station=0	OutputCase=ENVE	CaseType=Combination	StepType=Min	Point=2	X2=-0.5	X3=0.5	
S11=774.956844860004	IsS11Max=No	IsS11Min=No	FrameElem=61	ElemStation=0				
Frame=61	Station=0	OutputCase=ENVE	CaseType=Combination	StepType=Min	Point=3	X2=0.5	X3=-0.5	S11=-
2033.82312284461	IsS11Max=No	IsS11Min=Yes	FrameElem=61	ElemStation=0				
Frame=61	Station=0	OutputCase=ENVE	CaseType=Combination	StepType=Min	Point=4	X2=0.5	X3=0.5	S11=-
2033.82312284461	IsS11Max=No	IsS11Min=No	FrameElem=61	ElemStation=0				
Frame=61	Station=0.5	OutputCase=ENVE	CaseType=Combination	StepType=Min	Point=0	X2=0	X3=0	S11=-
578.74999436808	IsS11Max=No	IsS11Min=No	FrameElem=61	ElemStation=0.5				
Frame=61	Station=0.5	OutputCase=ENVE	CaseType=Combination	StepType=Min	Point=1	X2=-0.5	X3=-0.5	
S11=833.575058358982	IsS11Max=Yes	IsS11Min=No	FrameElem=61	ElemStation=0.5				
Frame=61	Station=0.5	OutputCase=ENVE	CaseType=Combination	StepType=Min	Point=2	X2=-0.5	X3=0.5	
S11=833.575058358982	IsS11Max=No	IsS11Min=No	FrameElem=61	ElemStation=0.5				
Frame=61	Station=0.5	OutputCase=ENVE	CaseType=Combination	StepType=Min	Point=3	X2=0.5	X3=-0.5	
S11=-2040.98956192287	IsS11Max=No	IsS11Min=Yes	FrameElem=61	ElemStation=0.5				
Frame=61	Station=0.5	OutputCase=ENVE	CaseType=Combination	StepType=Min	Point=4	X2=0.5	X3=0.5	
S11=-2040.98956192287	IsS11Max=No	IsS11Min=No	FrameElem=61	ElemStation=0.5				
Frame=61	Station=0	OutputCase=FESSUR	CaseType=Combination	Point=0	X2=0	X3=0	S11=-591.249994240405	
IsS11Max=No	IsS11Min=No	FrameElem=61	ElemStation=0					
Frame=61	Station=0	OutputCase=FESSUR	CaseType=Combination	Point=1	X2=-0.5	X3=-0.5		
S11=774.956844860004	IsS11Max=Yes	IsS11Min=No	FrameElem=61	ElemStation=0				
Frame=61	Station=0	OutputCase=FESSUR	CaseType=Combination	Point=2	X2=-0.5	X3=0.5		
S11=774.956844860004	IsS11Max=No	IsS11Min=No	FrameElem=61	ElemStation=0				
Frame=61	Station=0	OutputCase=FESSUR	CaseType=Combination	Point=3	X2=0.5	X3=-0.5	S11=-	
1957.45683334081	IsS11Max=No	IsS11Min=Yes	FrameElem=61	ElemStation=0				
Frame=61	Station=0	OutputCase=FESSUR	CaseType=Combination	Point=4	X2=0.5	X3=0.5	S11=-	
1957.45683334081	IsS11Max=No	IsS11Min=No	FrameElem=61	ElemStation=0				
Frame=61	Station=0.5	OutputCase=FESSUR	CaseType=Combination	Point=0	X2=0	X3=0	S11=-578.749994354605	
IsS11Max=No	IsS11Min=No	FrameElem=61	ElemStation=0.5					
Frame=61	Station=0.5	OutputCase=FESSUR	CaseType=Combination	Point=1	X2=-0.5	X3=-0.5		
S11=833.575058358982	IsS11Max=Yes	IsS11Min=No	FrameElem=61	ElemStation=0.5				
Frame=61	Station=0.5	OutputCase=FESSUR	CaseType=Combination	Point=2	X2=-0.5	X3=0.5		
S11=833.575058358982	IsS11Max=No	IsS11Min=No	FrameElem=61	ElemStation=0.5				
Frame=61	Station=0.5	OutputCase=FESSUR	CaseType=Combination	Point=3	X2=0.5	X3=-0.5	S11=-	
1991.07504706819	IsS11Max=No	IsS11Min=Yes	FrameElem=61	ElemStation=0.5				
Frame=61	Station=0.5	OutputCase=FESSUR	CaseType=Combination	Point=4	X2=0.5	X3=0.5	S11=-	
1991.07504706819	IsS11Max=No	IsS11Min=No	FrameElem=61	ElemStation=0.5				



Frame=62	Station=0	OutputCase=PESOPR	CaseType=LinStatic	Point=0	X2=0	X3=0	S11=-87.4999992724042
IsS11Max=No	IsS11Min=No	FrameElem=62	ElemStation=0				
Frame=62	Station=0	OutputCase=PESOPR	CaseType=LinStatic	Point=1	X2=-0.5	X3=-0.5	
S11=129.955142762632	IsS11Max=Yes	IsS11Min=No	FrameElem=62	ElemStation=0			
Frame=62	Station=0	OutputCase=PESOPR	CaseType=LinStatic	Point=2	X2=-0.5	X3=0.5	S11=129.955142762632
IsS11Max=No	IsS11Min=No	FrameElem=62	ElemStation=0				
Frame=62	Station=0	OutputCase=PESOPR	CaseType=LinStatic	Point=3	X2=0.5	X3=-0.5	S11=-
304.955141307441	IsS11Max=No	IsS11Min=Yes	FrameElem=62	ElemStation=0			
Frame=62	Station=0	OutputCase=PESOPR	CaseType=LinStatic	Point=4	X2=0.5	X3=0.5	S11=-304.955141307441
IsS11Max=No	IsS11Min=No	FrameElem=62	ElemStation=0				
Frame=62	Station=0.5	OutputCase=PESOPR	CaseType=LinStatic	Point=0	X2=0	X3=0	S11=-74.9999992724042
IsS11Max=No	IsS11Min=No	FrameElem=62	ElemStation=0.5				
Frame=62	Station=0.5	OutputCase=PESOPR	CaseType=LinStatic	Point=1	X2=-0.5	X3=-0.5	
S11=96.9423006167645	IsS11Max=Yes	IsS11Min=No	FrameElem=62	ElemStation=0.5			
Frame=62	Station=0.5	OutputCase=PESOPR	CaseType=LinStatic	Point=2	X2=-0.5	X3=0.5	
S11=96.9423006167645	IsS11Max=No	IsS11Min=No	FrameElem=62	ElemStation=0.5			
Frame=62	Station=0.5	OutputCase=PESOPR	CaseType=LinStatic	Point=3	X2=0.5	X3=-0.5	S11=-
246.942299161573	IsS11Max=No	IsS11Min=Yes	FrameElem=62	ElemStation=0.5			
Frame=62	Station=0.5	OutputCase=PESOPR	CaseType=LinStatic	Point=4	X2=0.5	X3=0.5	S11=-
246.942299161573	IsS11Max=No	IsS11Min=No	FrameElem=62	ElemStation=0.5			
Frame=62	Station=0	OutputCase=TERRVERT	CaseType=LinStatic	Point=0	X2=0	X3=0	S11=-491.249995127087
IsS11Max=No	IsS11Min=No	FrameElem=62	ElemStation=0				
Frame=62	Station=0	OutputCase=TERRVERT	CaseType=LinStatic	Point=1	X2=-0.5	X3=-0.5	
S11=870.001631688821	IsS11Max=Yes	IsS11Min=No	FrameElem=62	ElemStation=0			
Frame=62	Station=0	OutputCase=TERRVERT	CaseType=LinStatic	Point=2	X2=-0.5	X3=0.5	
S11=870.001631688821	IsS11Max=No	IsS11Min=No	FrameElem=62	ElemStation=0			
Frame=62	Station=0	OutputCase=TERRVERT	CaseType=LinStatic	Point=3	X2=0.5	X3=-0.5	S11=-
1852.501621943	IsS11Max=No	IsS11Min=Yes	FrameElem=62	ElemStation=0			
Frame=62	Station=0	OutputCase=TERRVERT	CaseType=LinStatic	Point=4	X2=0.5	X3=0.5	S11=-1852.501621943
IsS11Max=No	IsS11Min=No	FrameElem=62	ElemStation=0				
Frame=62	Station=0.5	OutputCase=TERRVERT	CaseType=LinStatic	Point=0	X2=0	X3=0	S11=-491.249995127087
IsS11Max=No	IsS11Min=No	FrameElem=62	ElemStation=0.5				
Frame=62	Station=0.5	OutputCase=TERRVERT	CaseType=LinStatic	Point=1	X2=-0.5	X3=-0.5	
S11=873.460105696379	IsS11Max=Yes	IsS11Min=No	FrameElem=62	ElemStation=0.5			
Frame=62	Station=0.5	OutputCase=TERRVERT	CaseType=LinStatic	Point=2	X2=-0.5	X3=0.5	
S11=873.460105696379	IsS11Max=No	IsS11Min=No	FrameElem=62	ElemStation=0.5			
Frame=62	Station=0.5	OutputCase=TERRVERT	CaseType=LinStatic	Point=3	X2=0.5	X3=-0.5	S11=-
1855.96009595055	IsS11Max=No	IsS11Min=Yes	FrameElem=62	ElemStation=0.5			
Frame=62	Station=0.5	OutputCase=TERRVERT	CaseType=LinStatic	Point=4	X2=0.5	X3=0.5	S11=-
1855.96009595055	IsS11Max=No	IsS11Min=No	FrameElem=62	ElemStation=0.5			
Frame=62	Station=0	OutputCase=TERRLAT	CaseType=LinStatic	Point=0	X2=0	X3=0	S11=4.49156232207315E-08
IsS11Max=No	IsS11Min=No	FrameElem=62	ElemStation=0				
Frame=62	Station=0	OutputCase=TERRLAT	CaseType=LinStatic	Point=1	X2=-0.5	X3=-0.5	S11=-
166.381716092442	IsS11Max=No	IsS11Min=Yes	FrameElem=62	ElemStation=0			
Frame=62	Station=0	OutputCase=TERRLAT	CaseType=LinStatic	Point=2	X2=-0.5	X3=0.5	S11=-
166.381716092442	IsS11Max=No	IsS11Min=No	FrameElem=62	ElemStation=0			
Frame=62	Station=0	OutputCase=TERRLAT	CaseType=LinStatic	Point=3	X2=0.5	X3=-0.5	
S11=166.381716182273	IsS11Max=Yes	IsS11Min=No	FrameElem=62	ElemStation=0			
Frame=62	Station=0	OutputCase=TERRLAT	CaseType=LinStatic	Point=4	X2=0.5	X3=0.5	S11=166.381716182273
IsS11Max=No	IsS11Min=No	FrameElem=62	ElemStation=0				
Frame=62	Station=0.5	OutputCase=TERRLAT	CaseType=LinStatic	Point=0	X2=0	X3=0	S11=-5.2341777437015E-
08	IsS11Max=No	IsS11Min=No	FrameElem=62	ElemStation=0.5			
Frame=62	Station=0.5	OutputCase=TERRLAT	CaseType=LinStatic	Point=1	X2=-0.5	X3=-0.5	S11=-
38.2978841401893	IsS11Max=No	IsS11Min=Yes	FrameElem=62	ElemStation=0.5			
Frame=62	Station=0.5	OutputCase=TERRLAT	CaseType=LinStatic	Point=2	X2=-0.5	X3=0.5	S11=-
38.2978841401893	IsS11Max=No	IsS11Min=No	FrameElem=62	ElemStation=0.5			
Frame=62	Station=0.5	OutputCase=TERRLAT	CaseType=LinStatic	Point=3	X2=0.5	X3=-0.5	
S11=38.2978840355057	IsS11Max=Yes	IsS11Min=No	FrameElem=62	ElemStation=0.5			
Frame=62	Station=0.5	OutputCase=TERRLAT	CaseType=LinStatic	Point=4	X2=0.5	X3=0.5	
S11=38.2978840355057	IsS11Max=No	IsS11Min=No	FrameElem=62	ElemStation=0.5			
Frame=62	Station=0	OutputCase=ACCLATDX	CaseType=LinStatic	Point=0	X2=0	X3=0	S11=0 IsS11Max=Yes
IsS11Min=Yes	FrameElem=62	ElemStation=0					
Frame=62	Station=0	OutputCase=ACCLATDX	CaseType=LinStatic	Point=1	X2=-0.5	X3=-0.5	S11=0
IsS11Max=No	IsS11Min=No	FrameElem=62	ElemStation=0				
Frame=62	Station=0	OutputCase=ACCLATDX	CaseType=LinStatic	Point=2	X2=-0.5	X3=0.5	S11=0
IsS11Max=No	IsS11Min=No	FrameElem=62	ElemStation=0				
Frame=62	Station=0	OutputCase=ACCLATDX	CaseType=LinStatic	Point=3	X2=0.5	X3=-0.5	S11=0
IsS11Max=No	IsS11Min=No	FrameElem=62	ElemStation=0				
Frame=62	Station=0	OutputCase=ACCLATDX	CaseType=LinStatic	Point=4	X2=0.5	X3=0.5	S11=0 IsS11Max=No
IsS11Min=No	FrameElem=62	ElemStation=0					
Frame=62	Station=0.5	OutputCase=ACCLATDX	CaseType=LinStatic	Point=0	X2=0	X3=0	S11=0 IsS11Max=Yes
IsS11Min=Yes	FrameElem=62	ElemStation=0.5					
Frame=62	Station=0.5	OutputCase=ACCLATDX	CaseType=LinStatic	Point=1	X2=-0.5	X3=-0.5	S11=0
IsS11Max=No	IsS11Min=No	FrameElem=62	ElemStation=0.5				
Frame=62	Station=0.5	OutputCase=ACCLATDX	CaseType=LinStatic	Point=2	X2=-0.5	X3=0.5	S11=0
IsS11Max=No	IsS11Min=No	FrameElem=62	ElemStation=0.5				
Frame=62	Station=0.5	OutputCase=ACCLATDX	CaseType=LinStatic	Point=3	X2=0.5	X3=-0.5	S11=0
IsS11Max=No	IsS11Min=No	FrameElem=62	ElemStation=0.5				
Frame=62	Station=0.5	OutputCase=ACCLATDX	CaseType=LinStatic	Point=4	X2=0.5	X3=0.5	S11=0
IsS11Max=No	IsS11Min=No	FrameElem=62	ElemStation=0.5				
Frame=62	Station=0	OutputCase=ACCLATDX	CaseType=LinStatic	Point=0	X2=0	X3=0	S11=0 IsS11Max=Yes
IsS11Min=Yes	FrameElem=62	ElemStation=0					

Frame=62	Station=0	OutputCase=ACCLATSX	CaseType=LinStatic	Point=1	X2=-0.5	X3=-0.5	S11=0	
IsS11Max=No	IsS11Min=No	FrameElem=62	ElemStation=0					
Frame=62	Station=0	OutputCase=ACCLATSX	CaseType=LinStatic	Point=2	X2=-0.5	X3=0.5	S11=0	
IsS11Max=No	IsS11Min=No	FrameElem=62	ElemStation=0					
Frame=62	Station=0	OutputCase=ACCLATSX	CaseType=LinStatic	Point=3	X2=0.5	X3=-0.5	S11=0	
IsS11Max=No	IsS11Min=No	FrameElem=62	ElemStation=0					
Frame=62	Station=0	OutputCase=ACCLATSX	CaseType=LinStatic	Point=4	X2=0.5	X3=0.5	S11=0	IsS11Max=No
IsS11Min=No	FrameElem=62	ElemStation=0						
Frame=62	Station=0.5	OutputCase=ACCLATSX	CaseType=LinStatic	Point=0	X2=0	X3=0	S11=0	IsS11Max=Yes
IsS11Min=Yes	FrameElem=62	ElemStation=0.5						
Frame=62	Station=0.5	OutputCase=ACCLATSX	CaseType=LinStatic	Point=1	X2=-0.5	X3=-0.5	S11=0	
IsS11Max=No	IsS11Min=No	FrameElem=62	ElemStation=0.5					
Frame=62	Station=0.5	OutputCase=ACCLATSX	CaseType=LinStatic	Point=2	X2=-0.5	X3=0.5	S11=0	
IsS11Max=No	IsS11Min=No	FrameElem=62	ElemStation=0.5					
Frame=62	Station=0.5	OutputCase=ACCLATSX	CaseType=LinStatic	Point=3	X2=0.5	X3=-0.5	S11=0	
IsS11Max=No	IsS11Min=No	FrameElem=62	ElemStation=0.5					
Frame=62	Station=0.5	OutputCase=ACCLATSX	CaseType=LinStatic	Point=4	X2=0.5	X3=0.5	S11=0	
IsS11Max=No	IsS11Min=No	FrameElem=62	ElemStation=0.5					
Frame=62	Station=0	OutputCase=TERRCOST	CaseType=LinStatic	Point=0	X2=0	X3=0	S11=0	IsS11Max=Yes
IsS11Min=Yes	FrameElem=62	ElemStation=0						
Frame=62	Station=0	OutputCase=TERRCOST	CaseType=LinStatic	Point=1	X2=-0.5	X3=-0.5	S11=0	
IsS11Max=No	IsS11Min=No	FrameElem=62	ElemStation=0					
Frame=62	Station=0	OutputCase=TERRCOST	CaseType=LinStatic	Point=2	X2=-0.5	X3=0.5	S11=0	
IsS11Max=No	IsS11Min=No	FrameElem=62	ElemStation=0					
Frame=62	Station=0	OutputCase=TERRCOST	CaseType=LinStatic	Point=3	X2=0.5	X3=-0.5	S11=0	
IsS11Max=No	IsS11Min=No	FrameElem=62	ElemStation=0					
Frame=62	Station=0	OutputCase=TERRCOST	CaseType=LinStatic	Point=4	X2=0.5	X3=0.5	S11=0	IsS11Max=No
IsS11Min=No	FrameElem=62	ElemStation=0						
Frame=62	Station=0.5	OutputCase=TERRCOST	CaseType=LinStatic	Point=0	X2=0	X3=0	S11=0	IsS11Max=Yes
IsS11Min=Yes	FrameElem=62	ElemStation=0.5						
Frame=62	Station=0.5	OutputCase=TERRCOST	CaseType=LinStatic	Point=1	X2=-0.5	X3=-0.5	S11=0	
IsS11Max=No	IsS11Min=No	FrameElem=62	ElemStation=0.5					
Frame=62	Station=0.5	OutputCase=TERRCOST	CaseType=LinStatic	Point=2	X2=-0.5	X3=0.5	S11=0	
IsS11Max=No	IsS11Min=No	FrameElem=62	ElemStation=0.5					
Frame=62	Station=0.5	OutputCase=TERRCOST	CaseType=LinStatic	Point=3	X2=0.5	X3=-0.5	S11=0	
IsS11Max=No	IsS11Min=No	FrameElem=62	ElemStation=0.5					
Frame=62	Station=0.5	OutputCase=TERRCOST	CaseType=LinStatic	Point=4	X2=0.5	X3=0.5	S11=0	
IsS11Max=No	IsS11Min=No	FrameElem=62	ElemStation=0.5					
Frame=62	Station=0	OutputCase=SOVRCOST	CaseType=LinStatic	Point=0	X2=0	X3=0	S11=0	IsS11Max=Yes
IsS11Min=Yes	FrameElem=62	ElemStation=0						
Frame=62	Station=0	OutputCase=SOVRCOST	CaseType=LinStatic	Point=1	X2=-0.5	X3=-0.5	S11=0	
IsS11Max=No	IsS11Min=No	FrameElem=62	ElemStation=0					
Frame=62	Station=0	OutputCase=SOVRCOST	CaseType=LinStatic	Point=2	X2=-0.5	X3=0.5	S11=0	
IsS11Max=No	IsS11Min=No	FrameElem=62	ElemStation=0					
Frame=62	Station=0	OutputCase=SOVRCOST	CaseType=LinStatic	Point=3	X2=0.5	X3=-0.5	S11=0	
IsS11Max=No	IsS11Min=No	FrameElem=62	ElemStation=0					
Frame=62	Station=0	OutputCase=SOVRCOST	CaseType=LinStatic	Point=4	X2=0.5	X3=0.5	S11=0	IsS11Max=No
IsS11Min=No	FrameElem=62	ElemStation=0						
Frame=62	Station=0.5	OutputCase=SOVRCOST	CaseType=LinStatic	Point=0	X2=0	X3=0	S11=0	IsS11Max=Yes
IsS11Min=Yes	FrameElem=62	ElemStation=0.5						
Frame=62	Station=0.5	OutputCase=SOVRCOST	CaseType=LinStatic	Point=1	X2=-0.5	X3=-0.5	S11=0	
IsS11Max=No	IsS11Min=No	FrameElem=62	ElemStation=0.5					
Frame=62	Station=0.5	OutputCase=SOVRCOST	CaseType=LinStatic	Point=2	X2=-0.5	X3=0.5	S11=0	
IsS11Max=No	IsS11Min=No	FrameElem=62	ElemStation=0.5					
Frame=62	Station=0.5	OutputCase=SOVRCOST	CaseType=LinStatic	Point=3	X2=0.5	X3=-0.5	S11=0	
IsS11Max=No	IsS11Min=No	FrameElem=62	ElemStation=0.5					
Frame=62	Station=0.5	OutputCase=SOVRCOST	CaseType=LinStatic	Point=4	X2=0.5	X3=0.5	S11=0	
IsS11Max=No	IsS11Min=No	FrameElem=62	ElemStation=0.5					
Frame=62	Station=0	OutputCase=ENVE	CaseType=Combination	StepType=Max	Point=0	X2=0	X3=0	S11=-
578.749994354576	IsS11Max=No	IsS11Min=No	FrameElem=62	ElemStation=0				
Frame=62	Station=0	OutputCase=ENVE	CaseType=Combination	StepType=Max	Point=1	X2=-0.5	X3=-0.5	
S11=883.489573186744	IsS11Max=Yes	IsS11Min=No	FrameElem=62	ElemStation=0				
Frame=62	Station=0	OutputCase=ENVE	CaseType=Combination	StepType=Max	Point=2	X2=-0.5	X3=0.5	
S11=883.489573186744	IsS11Max=No	IsS11Min=No	FrameElem=62	ElemStation=0				
Frame=62	Station=0	OutputCase=ENVE	CaseType=Combination	StepType=Max	Point=3	X2=0.5	X3=-0.5	S11=-
1991.07504706816	IsS11Max=No	IsS11Min=Yes	FrameElem=62	ElemStation=0				
Frame=62	Station=0	OutputCase=ENVE	CaseType=Combination	StepType=Max	Point=4	X2=0.5	X3=0.5	S11=-
1991.07504706816	IsS11Max=No	IsS11Min=No	FrameElem=62	ElemStation=0				
Frame=62	Station=0.5	OutputCase=ENVE	CaseType=Combination	StepType=Max	Point=0	X2=0	X3=0	S11=-
566.249994436131	IsS11Max=No	IsS11Min=No	FrameElem=62	ElemStation=0.5				
Frame=62	Station=0.5	OutputCase=ENVE	CaseType=Combination	StepType=Max	Point=1	X2=-0.5	X3=-0.5	
S11=943.593887415011	IsS11Max=Yes	IsS11Min=No	FrameElem=62	ElemStation=0.5				
Frame=62	Station=0.5	OutputCase=ENVE	CaseType=Combination	StepType=Max	Point=2	X2=-0.5	X3=0.5	
S11=943.593887415011	IsS11Max=No	IsS11Min=No	FrameElem=62	ElemStation=0.5				
Frame=62	Station=0.5	OutputCase=ENVE	CaseType=Combination	StepType=Max	Point=3	X2=0.5	X3=-0.5	
S11=-2064.60451107662	IsS11Max=No	IsS11Min=Yes	FrameElem=62	ElemStation=0.5				
Frame=62	Station=0.5	OutputCase=ENVE	CaseType=Combination	StepType=Max	Point=4	X2=0.5	X3=0.5	
S11=-2064.60451107662	IsS11Max=No	IsS11Min=No	FrameElem=62	ElemStation=0.5				
Frame=62	Station=0	OutputCase=ENVE	CaseType=Combination	StepType=Min	Point=0	X2=0	X3=0	S11=-
578.749994368051	IsS11Max=No	IsS11Min=No	FrameElem=62	ElemStation=0				
Frame=62	Station=0	OutputCase=ENVE	CaseType=Combination	StepType=Min	Point=1	X2=-0.5	X3=-0.5	
S11=833.575058359012	IsS11Max=Yes	IsS11Min=No	FrameElem=62	ElemStation=0				



Frame=62	Station=0	OutputCase=ENVE	CaseType=Combination	StepType=Min	Point=2	X2=-0.5	X3=0.5		
S11=833.575058359012	IsS11Max=No	IsS11Min=No	FrameElem=62	ElemStation=0					
Frame=62	Station=0	OutputCase=ENVE	CaseType=Combination	StepType=Min	Point=3	X2=0.5	X3=-0.5	S11=-	
2040.98956192285	IsS11Max=No	IsS11Min=Yes	FrameElem=62	ElemStation=0					
Frame=62	Station=0	OutputCase=ENVE	CaseType=Combination	StepType=Min	Point=4	X2=0.5	X3=0.5	S11=-	
2040.98956192285	IsS11Max=No	IsS11Min=No	FrameElem=62	ElemStation=0					
Frame=62	Station=0.5	OutputCase=ENVE	CaseType=Combination	StepType=Min	Point=0	X2=0	X3=0	S11=-	
566.249994451833	IsS11Max=No	IsS11Min=No	FrameElem=62	ElemStation=0.5					
Frame=62	Station=0.5	OutputCase=ENVE	CaseType=Combination	StepType=Min	Point=1	X2=-0.5	X3=-0.5		
S11=932.104522172955	IsS11Max=Yes	IsS11Min=No	FrameElem=62	ElemStation=0.5					
Frame=62	Station=0.5	OutputCase=ENVE	CaseType=Combination	StepType=Min	Point=2	X2=-0.5	X3=0.5		
S11=932.104522172955	IsS11Max=No	IsS11Min=No	FrameElem=62	ElemStation=0.5					
Frame=62	Station=0.5	OutputCase=ENVE	CaseType=Combination	StepType=Min	Point=3	X2=0.5	X3=-0.5		
S11=-2076.09387628727	IsS11Max=No	IsS11Min=Yes	FrameElem=62	ElemStation=0.5					
Frame=62	Station=0.5	OutputCase=ENVE	CaseType=Combination	StepType=Min	Point=4	X2=0.5	X3=0.5		
S11=-2076.09387628727	IsS11Max=No	IsS11Min=No	FrameElem=62	ElemStation=0.5					
Frame=62	Station=0	OutputCase=FESSUR	CaseType=Combination	Point=0	X2=0	X3=0	S11=-578.749994354576		
IsS11Max=No	IsS11Min=No	FrameElem=62	ElemStation=0						
Frame=62	Station=0	OutputCase=FESSUR	CaseType=Combination	Point=1	X2=-0.5	X3=-0.5			
S11=833.575058359012	IsS11Max=Yes	IsS11Min=No	FrameElem=62	ElemStation=0					
Frame=62	Station=0	OutputCase=FESSUR	CaseType=Combination	Point=2	X2=-0.5	X3=0.5			
S11=833.575058359012	IsS11Max=No	IsS11Min=No	FrameElem=62	ElemStation=0					
Frame=62	Station=0	OutputCase=FESSUR	CaseType=Combination	Point=3	X2=0.5	X3=-0.5	S11=-		
1991.07504706816	IsS11Max=No	IsS11Min=Yes	FrameElem=62	ElemStation=0					
Frame=62	Station=0	OutputCase=FESSUR	CaseType=Combination	Point=4	X2=0.5	X3=0.5	S11=-		
1991.07504706816	IsS11Max=No	IsS11Min=No	FrameElem=62	ElemStation=0					
Frame=62	Station=0.5	OutputCase=FESSUR	CaseType=Combination	Point=0	X2=0	X3=0	S11=-566.249994451833		
IsS11Max=No	IsS11Min=No	FrameElem=62	ElemStation=0.5						
Frame=62	Station=0.5	OutputCase=FESSUR	CaseType=Combination	Point=1	X2=-0.5	X3=-0.5			
S11=932.104522172955	IsS11Max=Yes	IsS11Min=No	FrameElem=62	ElemStation=0.5					
Frame=62	Station=0.5	OutputCase=FESSUR	CaseType=Combination	Point=2	X2=-0.5	X3=0.5			
S11=932.104522172955	IsS11Max=No	IsS11Min=No	FrameElem=62	ElemStation=0.5					
Frame=62	Station=0.5	OutputCase=FESSUR	CaseType=Combination	Point=3	X2=0.5	X3=-0.5	S11=-		
2064.60451107662	IsS11Max=No	IsS11Min=Yes	FrameElem=62	ElemStation=0.5					
Frame=62	Station=0.5	OutputCase=FESSUR	CaseType=Combination	Point=4	X2=0.5	X3=0.5	S11=-		
2064.60451107662	IsS11Max=No	IsS11Min=No	FrameElem=62	ElemStation=0.5					
Frame=63	Station=0	OutputCase=PESOPR	CaseType=LinStatic	Point=0	X2=0	X3=0	S11=-149.999998698244		
IsS11Max=No	IsS11Min=No	FrameElem=63	ElemStation=0						
Frame=63	Station=0	OutputCase=PESOPR	CaseType=LinStatic	Point=1	X2=-0.5	X3=-0.5	S11=-		
595.019356265924	IsS11Max=No	IsS11Min=Yes	FrameElem=63	ElemStation=0					
Frame=63	Station=0	OutputCase=PESOPR	CaseType=LinStatic	Point=2	X2=-0.5	X3=0.5	S11=-		
595.019356265924	IsS11Max=No	IsS11Min=No	FrameElem=63	ElemStation=0					
Frame=63	Station=0	OutputCase=PESOPR	CaseType=LinStatic	Point=3	X2=0.5	X3=-0.5	S11=295.019358869437		
IsS11Max=Yes	IsS11Min=No	FrameElem=63	ElemStation=0						
Frame=63	Station=0	OutputCase=PESOPR	CaseType=LinStatic	Point=4	X2=0.5	X3=0.5	S11=295.019358869437		
IsS11Max=No	IsS11Min=No	FrameElem=63	ElemStation=0						
Frame=63	Station=0.5	OutputCase=PESOPR	CaseType=LinStatic	Point=0	X2=0	X3=0	S11=-137.499998698244		
IsS11Max=No	IsS11Min=No	FrameElem=63	ElemStation=0.5						
Frame=63	Station=0.5	OutputCase=PESOPR	CaseType=LinStatic	Point=1	X2=-0.5	X3=-0.5	S11=-		
537.006512629949	IsS11Max=No	IsS11Min=Yes	FrameElem=63	ElemStation=0.5					
Frame=63	Station=0.5	OutputCase=PESOPR	CaseType=LinStatic	Point=2	X2=-0.5	X3=0.5	S11=-		
537.006512629949	IsS11Max=No	IsS11Min=No	FrameElem=63	ElemStation=0.5					
Frame=63	Station=0.5	OutputCase=PESOPR	CaseType=LinStatic	Point=3	X2=0.5	X3=-0.5			
S11=262.006515233461	IsS11Max=Yes	IsS11Min=No	FrameElem=63	ElemStation=0.5					
Frame=63	Station=0.5	OutputCase=PESOPR	CaseType=LinStatic	Point=4	X2=0.5	X3=0.5			
S11=262.006515233461	IsS11Max=No	IsS11Min=No	FrameElem=63	ElemStation=0.5					
Frame=63	Station=0	OutputCase=TERRVERT	CaseType=LinStatic	Point=0	X2=0	X3=0	S11=-491.24999552127		
IsS11Max=No	IsS11Min=No	FrameElem=63	ElemStation=0						
Frame=63	Station=0	OutputCase=TERRVERT	CaseType=LinStatic	Point=1	X2=-0.5	X3=-0.5	S11=-		
1835.20925822633	IsS11Max=No	IsS11Min=Yes	FrameElem=63	ElemStation=0					
Frame=63	Station=0	OutputCase=TERRVERT	CaseType=LinStatic	Point=2	X2=-0.5	X3=0.5	S11=-		
1835.20925822633	IsS11Max=No	IsS11Min=No	FrameElem=63	ElemStation=0					
Frame=63	Station=0	OutputCase=TERRVERT	CaseType=LinStatic	Point=3	X2=0.5	X3=-0.5			
S11=852.709267183792	IsS11Max=Yes	IsS11Min=No	FrameElem=63	ElemStation=0					
Frame=63	Station=0	OutputCase=TERRVERT	CaseType=LinStatic	Point=4	X2=0.5	X3=0.5			
S11=852.709267183792	IsS11Max=No	IsS11Min=No	FrameElem=63	ElemStation=0					
Frame=63	Station=0.5	OutputCase=TERRVERT	CaseType=LinStatic	Point=0	X2=0	X3=0	S11=-491.24999552127		
IsS11Max=No	IsS11Min=No	FrameElem=63	ElemStation=0.5						
Frame=63	Station=0.5	OutputCase=TERRVERT	CaseType=LinStatic	Point=1	X2=-0.5	X3=-0.5	S11=-		
1838.66773223391	IsS11Max=No	IsS11Min=Yes	FrameElem=63	ElemStation=0.5					
Frame=63	Station=0.5	OutputCase=TERRVERT	CaseType=LinStatic	Point=2	X2=-0.5	X3=0.5	S11=-		
1838.66773223391	IsS11Max=No	IsS11Min=No	FrameElem=63	ElemStation=0.5					
Frame=63	Station=0.5	OutputCase=TERRVERT	CaseType=LinStatic	Point=3	X2=0.5	X3=-0.5			
S11=856.167741191367	IsS11Max=Yes	IsS11Min=No	FrameElem=63	ElemStation=0.5					
Frame=63	Station=0.5	OutputCase=TERRVERT	CaseType=LinStatic	Point=4	X2=0.5	X3=0.5			
S11=856.167741191367	IsS11Max=No	IsS11Min=No	FrameElem=63	ElemStation=0.5					
Frame=63	Station=0	OutputCase=TERRLAT	CaseType=LinStatic	Point=0	X2=0	X3=0	S11=1.16978526421008E-07		
IsS11Max=No	IsS11Min=No	FrameElem=63	ElemStation=0						
Frame=63	Station=0	OutputCase=TERRLAT	CaseType=LinStatic	Point=1	X2=-0.5	X3=-0.5			
S11=80.2196319613188	IsS11Max=Yes	IsS11Min=No	FrameElem=63	ElemStation=0					
Frame=63	Station=0	OutputCase=TERRLAT	CaseType=LinStatic	Point=2	X2=-0.5	X3=0.5			
S11=80.2196319613188	IsS11Max=No	IsS11Min=No	FrameElem=63	ElemStation=0					

Frame=63	Station=0	OutputCase=SOVRCOST	CaseType=LinStatic	Point=4	X2=0.5	X3=0.5	S11=0	IsS11Max=No
IsS11Min=No	FrameElem=63	ElemStation=0						
Frame=63	Station=0.5	OutputCase=SOVRCOST	CaseType=LinStatic	Point=0	X2=0	X3=0	S11=0	IsS11Max=Yes
IsS11Min=Yes	FrameElem=63	ElemStation=0.5						
Frame=63	Station=0.5	OutputCase=SOVRCOST	CaseType=LinStatic	Point=1	X2=-0.5	X3=-0.5	S11=0	
IsS11Max=No	IsS11Min=No	FrameElem=63	ElemStation=0.5					
Frame=63	Station=0.5	OutputCase=SOVRCOST	CaseType=LinStatic	Point=2	X2=-0.5	X3=0.5	S11=0	
IsS11Max=No	IsS11Min=No	FrameElem=63	ElemStation=0.5					
Frame=63	Station=0.5	OutputCase=SOVRCOST	CaseType=LinStatic	Point=3	X2=0.5	X3=-0.5	S11=0	
IsS11Max=No	IsS11Min=No	FrameElem=63	ElemStation=0.5					
Frame=63	Station=0.5	OutputCase=SOVRCOST	CaseType=LinStatic	Point=4	X2=0.5	X3=0.5	S11=0	
IsS11Max=No	IsS11Min=No	FrameElem=63	ElemStation=0.5					
Frame=63	Station=0	OutputCase=ENVE	CaseType=Combination	StepType=Max	Point=0	X2=0	X3=0	S11=-
641.249994102535	IsS11Max=No	IsS11Min=No	FrameElem=63	ElemStation=0				
Frame=63	Station=0	OutputCase=ENVE	CaseType=Combination	StepType=Max	Point=1	X2=-0.5	X3=-0.5	
S11=-2350.00898253094	IsS11Max=No	IsS11Min=Yes	FrameElem=63	ElemStation=0				
Frame=63	Station=0	OutputCase=ENVE	CaseType=Combination	StepType=Max	Point=2	X2=-0.5	X3=0.5	S11=-
2350.00898253094	IsS11Max=No	IsS11Min=No	FrameElem=63	ElemStation=0				
Frame=63	Station=0	OutputCase=ENVE	CaseType=Combination	StepType=Max	Point=3	X2=0.5	X3=-0.5	
S11=1091.57488384408	IsS11Max=Yes	IsS11Min=No	FrameElem=63	ElemStation=0				
Frame=63	Station=0	OutputCase=ENVE	CaseType=Combination	StepType=Max	Point=4	X2=0.5	X3=0.5	
S11=1091.57488384408	IsS11Max=No	IsS11Min=No	FrameElem=63	ElemStation=0				
Frame=63	Station=0.5	OutputCase=ENVE	CaseType=Combination	StepType=Max	Point=0	X2=0	X3=0	S11=-
628.749994265008	IsS11Max=No	IsS11Min=No	FrameElem=63	ElemStation=0.5				
Frame=63	Station=0.5	OutputCase=ENVE	CaseType=Combination	StepType=Max	Point=1	X2=-0.5	X3=-0.5	
S11=-2160.0259476026	IsS11Max=No	IsS11Min=Yes	FrameElem=63	ElemStation=0.5				
Frame=63	Station=0.5	OutputCase=ENVE	CaseType=Combination	StepType=Max	Point=2	X2=-0.5	X3=0.5	
S11=-2160.0259476026	IsS11Max=No	IsS11Min=No	FrameElem=63	ElemStation=0.5				
Frame=63	Station=0.5	OutputCase=ENVE	CaseType=Combination	StepType=Max	Point=3	X2=0.5	X3=-0.5	
S11=967.220448250957	IsS11Max=Yes	IsS11Min=No	FrameElem=63	ElemStation=0.5				
Frame=63	Station=0.5	OutputCase=ENVE	CaseType=Combination	StepType=Max	Point=4	X2=0.5	X3=0.5	
S11=967.220448250957	IsS11Max=No	IsS11Min=No	FrameElem=63	ElemStation=0.5				
Frame=63	Station=0	OutputCase=ENVE	CaseType=Combination	StepType=Min	Point=0	X2=0	X3=0	S11=-
641.249994137629	IsS11Max=No	IsS11Min=No	FrameElem=63	ElemStation=0				
Frame=63	Station=0	OutputCase=ENVE	CaseType=Combination	StepType=Min	Point=1	X2=-0.5	X3=-0.5	
S11=-2374.07487211933	IsS11Max=No	IsS11Min=Yes	FrameElem=63	ElemStation=0				
Frame=63	Station=0	OutputCase=ENVE	CaseType=Combination	StepType=Min	Point=2	X2=-0.5	X3=0.5	S11=-
2374.07487211933	IsS11Max=No	IsS11Min=No	FrameElem=63	ElemStation=0				
Frame=63	Station=0	OutputCase=ENVE	CaseType=Combination	StepType=Min	Point=3	X2=0.5	X3=-0.5	
S11=1067.50899432587	IsS11Max=Yes	IsS11Min=No	FrameElem=63	ElemStation=0				
Frame=63	Station=0	OutputCase=ENVE	CaseType=Combination	StepType=Min	Point=4	X2=0.5	X3=0.5	
S11=1067.50899432587	IsS11Max=No	IsS11Min=No	FrameElem=63	ElemStation=0				
Frame=63	Station=0.5	OutputCase=ENVE	CaseType=Combination	StepType=Min	Point=0	X2=0	X3=0	S11=-
628.749994284506	IsS11Max=No	IsS11Min=No	FrameElem=63	ElemStation=0.5				
Frame=63	Station=0.5	OutputCase=ENVE	CaseType=Combination	StepType=Min	Point=1	X2=-0.5	X3=-0.5	
S11=-2224.72043678097	IsS11Max=No	IsS11Min=Yes	FrameElem=63	ElemStation=0.5				
Frame=63	Station=0.5	OutputCase=ENVE	CaseType=Combination	StepType=Min	Point=2	X2=-0.5	X3=0.5	
S11=-2224.72043678097	IsS11Max=No	IsS11Min=No	FrameElem=63	ElemStation=0.5				
Frame=63	Station=0.5	OutputCase=ENVE	CaseType=Combination	StepType=Min	Point=3	X2=0.5	X3=-0.5	
S11=902.525959033584	IsS11Max=Yes	IsS11Min=No	FrameElem=63	ElemStation=0.5				
Frame=63	Station=0.5	OutputCase=ENVE	CaseType=Combination	StepType=Min	Point=4	X2=0.5	X3=0.5	
S11=902.525959033584	IsS11Max=No	IsS11Min=No	FrameElem=63	ElemStation=0.5				
Frame=63	Station=0	OutputCase=FESSUR	CaseType=Combination	Point=0	X2=0	X3=0	S11=-641.249994102535	
IsS11Max=No	IsS11Min=No	FrameElem=63	ElemStation=0					
Frame=63	Station=0	OutputCase=FESSUR	CaseType=Combination	Point=1	X2=-0.5	X3=-0.5	S11=-	
2350.00898253094	IsS11Max=No	IsS11Min=Yes	FrameElem=63	ElemStation=0				
Frame=63	Station=0	OutputCase=FESSUR	CaseType=Combination	Point=2	X2=-0.5	X3=0.5	S11=-	
2350.00898253094	IsS11Max=No	IsS11Min=No	FrameElem=63	ElemStation=0				
Frame=63	Station=0	OutputCase=FESSUR	CaseType=Combination	Point=3	X2=0.5	X3=-0.5		
S11=1067.50899432587	IsS11Max=Yes	IsS11Min=No	FrameElem=63	ElemStation=0				
Frame=63	Station=0	OutputCase=FESSUR	CaseType=Combination	Point=4	X2=0.5	X3=0.5		
S11=1067.50899432587	IsS11Max=No	IsS11Min=No	FrameElem=63	ElemStation=0				
Frame=63	Station=0.5	OutputCase=FESSUR	CaseType=Combination	Point=0	X2=0	X3=0	S11=-628.749994284506	
IsS11Max=No	IsS11Min=No	FrameElem=63	ElemStation=0.5					
Frame=63	Station=0.5	OutputCase=FESSUR	CaseType=Combination	Point=1	X2=-0.5	X3=-0.5	S11=-	
2160.0259476026	IsS11Max=No	IsS11Min=Yes	FrameElem=63	ElemStation=0.5				
Frame=63	Station=0.5	OutputCase=FESSUR	CaseType=Combination	Point=2	X2=-0.5	X3=0.5	S11=-	
2160.0259476026	IsS11Max=No	IsS11Min=No	FrameElem=63	ElemStation=0.5				
Frame=63	Station=0.5	OutputCase=FESSUR	CaseType=Combination	Point=3	X2=0.5	X3=-0.5		
S11=902.525959033584	IsS11Max=Yes	IsS11Min=No	FrameElem=63	ElemStation=0.5				
Frame=63	Station=0.5	OutputCase=FESSUR	CaseType=Combination	Point=4	X2=0.5	X3=0.5		
S11=902.525959033584	IsS11Max=No	IsS11Min=No	FrameElem=63	ElemStation=0.5				
Frame=64	Station=0	OutputCase=PESOPR	CaseType=LinStatic	Point=0	X2=0	X3=0	S11=-137.499998698215	
IsS11Max=No	IsS11Min=No	FrameElem=64	ElemStation=0					
Frame=64	Station=0	OutputCase=PESOPR	CaseType=LinStatic	Point=1	X2=-0.5	X3=-0.5	S11=-	
537.00651262992	IsS11Max=No	IsS11Min=Yes	FrameElem=64	ElemStation=0				
Frame=64	Station=0	OutputCase=PESOPR	CaseType=LinStatic	Point=2	X2=-0.5	X3=0.5	S11=-537.00651262992	
IsS11Max=No	IsS11Min=No	FrameElem=64	ElemStation=0					
Frame=64	Station=0	OutputCase=PESOPR	CaseType=LinStatic	Point=3	X2=0.5	X3=-0.5	S11=262.00651523349	
IsS11Max=Yes	IsS11Min=No	FrameElem=64	ElemStation=0					
Frame=64	Station=0	OutputCase=PESOPR	CaseType=LinStatic	Point=4	X2=0.5	X3=0.5	S11=262.00651523349	
IsS11Max=No	IsS11Min=No	FrameElem=64	ElemStation=0					

Frame=64	Station=0.5	OutputCase=PESOPR	CaseType=LinStatic	Point=0	X2=0	X3=0	S11=-124.999998698215	
IsS11Max=No	IsS11Min=No	FrameElem=64	ElemStation=0.5					
Frame=64	Station=0.5	OutputCase=PESOPR	CaseType=LinStatic	Point=1	X2=-0.5	X3=-0.5	S11=-	
478.993669291967	IsS11Max=No	IsS11Min=Yes	FrameElem=64	ElemStation=0.5				
Frame=64	Station=0.5	OutputCase=PESOPR	CaseType=LinStatic	Point=2	X2=-0.5	X3=0.5	S11=-	
478.993669291967	IsS11Max=No	IsS11Min=No	FrameElem=64	ElemStation=0.5				
Frame=64	Station=0.5	OutputCase=PESOPR	CaseType=LinStatic	Point=3	X2=0.5	X3=-0.5		
S11=228.993671895538	IsS11Max=Yes	IsS11Min=No	FrameElem=64	ElemStation=0.5				
Frame=64	Station=0.5	OutputCase=PESOPR	CaseType=LinStatic	Point=4	X2=0.5	X3=0.5		
S11=228.993671895538	IsS11Max=No	IsS11Min=No	FrameElem=64	ElemStation=0.5				
Frame=64	Station=0	OutputCase=TERRVERT	CaseType=LinStatic	Point=0	X2=0	X3=0	S11=-491.24999552127	
IsS11Max=No	IsS11Min=No	FrameElem=64	ElemStation=0					
Frame=64	Station=0	OutputCase=TERRVERT	CaseType=LinStatic	Point=1	X2=-0.5	X3=-0.5	S11=-	
1838.66773223391	IsS11Max=No	IsS11Min=Yes	FrameElem=64	ElemStation=0				
Frame=64	Station=0	OutputCase=TERRVERT	CaseType=LinStatic	Point=2	X2=-0.5	X3=0.5	S11=-	
1838.66773223391	IsS11Max=No	IsS11Min=No	FrameElem=64	ElemStation=0				
Frame=64	Station=0	OutputCase=TERRVERT	CaseType=LinStatic	Point=3	X2=0.5	X3=-0.5		
S11=856.167741191366	IsS11Max=Yes	IsS11Min=No	FrameElem=64	ElemStation=0				
Frame=64	Station=0	OutputCase=TERRVERT	CaseType=LinStatic	Point=4	X2=0.5	X3=0.5		
S11=856.167741191366	IsS11Max=No	IsS11Min=No	FrameElem=64	ElemStation=0				
Frame=64	Station=0.5	OutputCase=TERRVERT	CaseType=LinStatic	Point=0	X2=0	X3=0	S11=-491.24999552127	
IsS11Max=No	IsS11Min=No	FrameElem=64	ElemStation=0.5					
Frame=64	Station=0.5	OutputCase=TERRVERT	CaseType=LinStatic	Point=1	X2=-0.5	X3=-0.5	S11=-	
1842.12620624148	IsS11Max=No	IsS11Min=Yes	FrameElem=64	ElemStation=0.5				
Frame=64	Station=0.5	OutputCase=TERRVERT	CaseType=LinStatic	Point=2	X2=-0.5	X3=0.5	S11=-	
1842.12620624148	IsS11Max=No	IsS11Min=No	FrameElem=64	ElemStation=0.5				
Frame=64	Station=0.5	OutputCase=TERRVERT	CaseType=LinStatic	Point=3	X2=0.5	X3=-0.5		
S11=859.62621519894	IsS11Max=Yes	IsS11Min=No	FrameElem=64	ElemStation=0.5				
Frame=64	Station=0.5	OutputCase=TERRVERT	CaseType=LinStatic	Point=4	X2=0.5	X3=0.5		
S11=859.62621519894	IsS11Max=No	IsS11Min=No	FrameElem=64	ElemStation=0.5				
Frame=64	Station=0	OutputCase=TERRLAT	CaseType=LinStatic	Point=0	X2=0	X3=0	S11=-6.49920366413426E-	
08	IsS11Max=No	IsS11Min=No	FrameElem=64	ElemStation=0				
Frame=64	Station=0	OutputCase=TERRLAT	CaseType=LinStatic	Point=1	X2=-0.5	X3=-0.5		
S11=215.648297261259	IsS11Max=Yes	IsS11Min=No	FrameElem=64	ElemStation=0				
Frame=64	Station=0	OutputCase=TERRLAT	CaseType=LinStatic	Point=2	X2=-0.5	X3=0.5		
S11=215.648297261259	IsS11Max=No	IsS11Min=No	FrameElem=64	ElemStation=0				
Frame=64	Station=0	OutputCase=TERRLAT	CaseType=LinStatic	Point=3	X2=0.5	X3=-0.5	S11=-	
215.648297391244	IsS11Max=No	IsS11Min=Yes	FrameElem=64	ElemStation=0				
Frame=64	Station=0	OutputCase=TERRLAT	CaseType=LinStatic	Point=4	X2=0.5	X3=0.5	S11=-	
215.648297391244	IsS11Max=No	IsS11Min=No	FrameElem=64	ElemStation=0				
Frame=64	Station=0.5	OutputCase=TERRLAT	CaseType=LinStatic	Point=0	X2=0	X3=0	S11=-	
2.30019921690749B-07	IsS11Max=No	IsS11Min=No	FrameElem=64	ElemStation=0.5				
Frame=64	Station=0.5	OutputCase=TERRLAT	CaseType=LinStatic	Point=1	X2=-0.5	X3=-0.5		
S11=285.583212654385	IsS11Max=Yes	IsS11Min=No	FrameElem=64	ElemStation=0.5				
Frame=64	Station=0.5	OutputCase=TERRLAT	CaseType=LinStatic	Point=2	X2=-0.5	X3=0.5		
S11=285.583212654385	IsS11Max=No	IsS11Min=No	FrameElem=64	ElemStation=0.5				
Frame=64	Station=0.5	OutputCase=TERRLAT	CaseType=LinStatic	Point=3	X2=0.5	X3=-0.5	S11=-	
285.583213114425	IsS11Max=No	IsS11Min=Yes	FrameElem=64	ElemStation=0.5				
Frame=64	Station=0.5	OutputCase=TERRLAT	CaseType=LinStatic	Point=4	X2=0.5	X3=0.5	S11=-	
285.583213114425	IsS11Max=No	IsS11Min=No	FrameElem=64	ElemStation=0.5				
Frame=64	Station=0	OutputCase=ACCLATDX	CaseType=LinStatic	Point=0	X2=0	X3=0	S11=0	IsS11Max=Yes
IsS11Min=Yes	FrameElem=64	ElemStation=0						
Frame=64	Station=0	OutputCase=ACCLATDX	CaseType=LinStatic	Point=1	X2=-0.5	X3=-0.5	S11=0	
IsS11Max=No	IsS11Min=No	FrameElem=64	ElemStation=0					
Frame=64	Station=0	OutputCase=ACCLATDX	CaseType=LinStatic	Point=2	X2=-0.5	X3=0.5	S11=0	
IsS11Max=No	IsS11Min=No	FrameElem=64	ElemStation=0					
Frame=64	Station=0	OutputCase=ACCLATDX	CaseType=LinStatic	Point=3	X2=0.5	X3=-0.5	S11=0	
IsS11Max=No	IsS11Min=No	FrameElem=64	ElemStation=0					
Frame=64	Station=0	OutputCase=ACCLATDX	CaseType=LinStatic	Point=4	X2=0.5	X3=0.5	S11=0	IsS11Max=No
IsS11Min=No	FrameElem=64	ElemStation=0						
Frame=64	Station=0.5	OutputCase=ACCLATDX	CaseType=LinStatic	Point=0	X2=0	X3=0	S11=0	IsS11Max=Yes
IsS11Min=Yes	FrameElem=64	ElemStation=0.5						
Frame=64	Station=0.5	OutputCase=ACCLATDX	CaseType=LinStatic	Point=1	X2=-0.5	X3=-0.5	S11=0	
IsS11Max=No	IsS11Min=No	FrameElem=64	ElemStation=0.5					
Frame=64	Station=0.5	OutputCase=ACCLATDX	CaseType=LinStatic	Point=2	X2=-0.5	X3=0.5	S11=0	
IsS11Max=No	IsS11Min=No	FrameElem=64	ElemStation=0.5					
Frame=64	Station=0.5	OutputCase=ACCLATDX	CaseType=LinStatic	Point=3	X2=0.5	X3=-0.5	S11=0	
IsS11Max=No	IsS11Min=No	FrameElem=64	ElemStation=0.5					
Frame=64	Station=0.5	OutputCase=ACCLATDX	CaseType=LinStatic	Point=4	X2=0.5	X3=0.5	S11=0	
IsS11Max=No	IsS11Min=No	FrameElem=64	ElemStation=0.5					
Frame=64	Station=0	OutputCase=ACCLATDX	CaseType=LinStatic	Point=0	X2=0	X3=0	S11=0	IsS11Max=Yes
IsS11Min=Yes	FrameElem=64	ElemStation=0						
Frame=64	Station=0	OutputCase=ACCLATDX	CaseType=LinStatic	Point=1	X2=-0.5	X3=-0.5	S11=0	
IsS11Max=No	IsS11Min=No	FrameElem=64	ElemStation=0					
Frame=64	Station=0	OutputCase=ACCLATDX	CaseType=LinStatic	Point=2	X2=-0.5	X3=0.5	S11=0	
IsS11Max=No	IsS11Min=No	FrameElem=64	ElemStation=0					
Frame=64	Station=0	OutputCase=ACCLATDX	CaseType=LinStatic	Point=3	X2=0.5	X3=-0.5	S11=0	
IsS11Max=No	IsS11Min=No	FrameElem=64	ElemStation=0					
Frame=64	Station=0	OutputCase=ACCLATDX	CaseType=LinStatic	Point=4	X2=0.5	X3=0.5	S11=0	IsS11Max=No
IsS11Min=No	FrameElem=64	ElemStation=0						
Frame=64	Station=0.5	OutputCase=ACCLATDX	CaseType=LinStatic	Point=0	X2=0	X3=0	S11=0	IsS11Max=Yes
IsS11Min=Yes	FrameElem=64	ElemStation=0.5						

Frame=64	Station=0.5	OutputCase=ACCLATSX	CaseType=LinStatic	Point=1	X2=-0.5	X3=-0.5	S11=0	
IsS11Max=No	IsS11Min=No	FrameElem=64	ElemStation=0.5					
Frame=64	Station=0.5	OutputCase=ACCLATSX	CaseType=LinStatic	Point=2	X2=-0.5	X3=0.5	S11=0	
IsS11Max=No	IsS11Min=No	FrameElem=64	ElemStation=0.5					
Frame=64	Station=0.5	OutputCase=ACCLATSX	CaseType=LinStatic	Point=3	X2=0.5	X3=-0.5	S11=0	
IsS11Max=No	IsS11Min=No	FrameElem=64	ElemStation=0.5					
Frame=64	Station=0.5	OutputCase=ACCLATSX	CaseType=LinStatic	Point=4	X2=0.5	X3=0.5	S11=0	
IsS11Max=No	IsS11Min=No	FrameElem=64	ElemStation=0.5					
Frame=64	Station=0	OutputCase=TERRCOST	CaseType=LinStatic	Point=0	X2=0	X3=0	S11=0	
IsS11Min=Yes	FrameElem=64	ElemStation=0					IsS11Max=Yes	
Frame=64	Station=0	OutputCase=TERRCOST	CaseType=LinStatic	Point=1	X2=-0.5	X3=-0.5	S11=0	
IsS11Max=No	IsS11Min=No	FrameElem=64	ElemStation=0					
Frame=64	Station=0	OutputCase=TERRCOST	CaseType=LinStatic	Point=2	X2=-0.5	X3=0.5	S11=0	
IsS11Max=No	IsS11Min=No	FrameElem=64	ElemStation=0					
Frame=64	Station=0	OutputCase=TERRCOST	CaseType=LinStatic	Point=3	X2=0.5	X3=-0.5	S11=0	
IsS11Max=No	IsS11Min=No	FrameElem=64	ElemStation=0					
Frame=64	Station=0	OutputCase=TERRCOST	CaseType=LinStatic	Point=4	X2=0.5	X3=0.5	S11=0	
IsS11Max=No	IsS11Min=No	FrameElem=64	ElemStation=0				IsS11Max=No	
Frame=64	Station=0	OutputCase=TERRCOST	CaseType=LinStatic	Point=0	X2=0	X3=0	S11=0	
IsS11Min=Yes	FrameElem=64	ElemStation=0.5					IsS11Max=Yes	
Frame=64	Station=0.5	OutputCase=TERRCOST	CaseType=LinStatic	Point=1	X2=-0.5	X3=-0.5	S11=0	
IsS11Max=No	IsS11Min=No	FrameElem=64	ElemStation=0.5					
Frame=64	Station=0.5	OutputCase=TERRCOST	CaseType=LinStatic	Point=2	X2=-0.5	X3=0.5	S11=0	
IsS11Max=No	IsS11Min=No	FrameElem=64	ElemStation=0.5					
Frame=64	Station=0.5	OutputCase=TERRCOST	CaseType=LinStatic	Point=3	X2=0.5	X3=-0.5	S11=0	
IsS11Max=No	IsS11Min=No	FrameElem=64	ElemStation=0.5					
Frame=64	Station=0.5	OutputCase=TERRCOST	CaseType=LinStatic	Point=4	X2=0.5	X3=0.5	S11=0	
IsS11Max=No	IsS11Min=No	FrameElem=64	ElemStation=0.5					
Frame=64	Station=0	OutputCase=SOVRCOST	CaseType=LinStatic	Point=0	X2=0	X3=0	S11=0	
IsS11Min=Yes	FrameElem=64	ElemStation=0					IsS11Max=Yes	
Frame=64	Station=0	OutputCase=SOVRCOST	CaseType=LinStatic	Point=1	X2=-0.5	X3=-0.5	S11=0	
IsS11Max=No	IsS11Min=No	FrameElem=64	ElemStation=0					
Frame=64	Station=0	OutputCase=SOVRCOST	CaseType=LinStatic	Point=2	X2=-0.5	X3=0.5	S11=0	
IsS11Max=No	IsS11Min=No	FrameElem=64	ElemStation=0					
Frame=64	Station=0	OutputCase=SOVRCOST	CaseType=LinStatic	Point=3	X2=0.5	X3=-0.5	S11=0	
IsS11Max=No	IsS11Min=No	FrameElem=64	ElemStation=0					
Frame=64	Station=0	OutputCase=SOVRCOST	CaseType=LinStatic	Point=4	X2=0.5	X3=0.5	S11=0	
IsS11Max=No	IsS11Min=No	FrameElem=64	ElemStation=0				IsS11Max=No	
Frame=64	Station=0	OutputCase=SOVRCOST	CaseType=LinStatic	Point=0	X2=0	X3=0	S11=0	
IsS11Min=Yes	FrameElem=64	ElemStation=0.5					IsS11Max=Yes	
Frame=64	Station=0.5	OutputCase=SOVRCOST	CaseType=LinStatic	Point=1	X2=-0.5	X3=-0.5	S11=0	
IsS11Max=No	IsS11Min=No	FrameElem=64	ElemStation=0.5					
Frame=64	Station=0.5	OutputCase=SOVRCOST	CaseType=LinStatic	Point=2	X2=-0.5	X3=0.5	S11=0	
IsS11Max=No	IsS11Min=No	FrameElem=64	ElemStation=0.5					
Frame=64	Station=0.5	OutputCase=SOVRCOST	CaseType=LinStatic	Point=3	X2=0.5	X3=-0.5	S11=0	
IsS11Max=No	IsS11Min=No	FrameElem=64	ElemStation=0.5					
Frame=64	Station=0.5	OutputCase=SOVRCOST	CaseType=LinStatic	Point=4	X2=0.5	X3=0.5	S11=0	
IsS11Max=No	IsS11Min=No	FrameElem=64	ElemStation=0.5					
Frame=64	Station=0	OutputCase=ENVE	CaseType=Combination	StepType=Max	Point=0	X2=0	X3=0	S11=-
628.749994264979	IsS11Max=No	IsS11Min=No	FrameElem=64	ElemStation=0				
Frame=64	Station=0	OutputCase=ENVE	CaseType=Combination	StepType=Max	Point=1	X2=-0.5	X3=-0.5	
S11=-2160.02594760257	IsS11Max=No	IsS11Min=Yes	FrameElem=64	ElemStation=0				
Frame=64	Station=0	OutputCase=ENVE	CaseType=Combination	StepType=Max	Point=2	X2=-0.5	X3=0.5	S11=-
2160.02594760257	IsS11Max=No	IsS11Min=No	FrameElem=64	ElemStation=0				
Frame=64	Station=0	OutputCase=ENVE	CaseType=Combination	StepType=Max	Point=3	X2=0.5	X3=-0.5	
S11=967.220448250986	IsS11Max=Yes	IsS11Min=No	FrameElem=64	ElemStation=0				
Frame=64	Station=0	OutputCase=ENVE	CaseType=Combination	StepType=Max	Point=4	X2=0.5	X3=0.5	
S11=967.220448250986	IsS11Max=No	IsS11Min=No	FrameElem=64	ElemStation=0				
Frame=64	Station=0.5	OutputCase=ENVE	CaseType=Combination	StepType=Max	Point=0	X2=0	X3=0	S11=-
616.249994380498	IsS11Max=No	IsS11Min=No	FrameElem=64	ElemStation=0.5				
Frame=64	Station=0.5	OutputCase=ENVE	CaseType=Combination	StepType=Max	Point=1	X2=-0.5	X3=-0.5	
S11=-2035.53666287906	IsS11Max=No	IsS11Min=Yes	FrameElem=64	ElemStation=0.5				
Frame=64	Station=0.5	OutputCase=ENVE	CaseType=Combination	StepType=Max	Point=2	X2=-0.5	X3=0.5	
S11=-2035.53666287906	IsS11Max=No	IsS11Min=No	FrameElem=64	ElemStation=0.5				
Frame=64	Station=0.5	OutputCase=ENVE	CaseType=Combination	StepType=Max	Point=3	X2=0.5	X3=-0.5	
S11=888.711637914381	IsS11Max=Yes	IsS11Min=No	FrameElem=64	ElemStation=0.5				
Frame=64	Station=0.5	OutputCase=ENVE	CaseType=Combination	StepType=Max	Point=4	X2=0.5	X3=0.5	
S11=888.711637914381	IsS11Max=No	IsS11Min=No	FrameElem=64	ElemStation=0.5				
Frame=64	Station=0	OutputCase=ENVE	CaseType=Combination	StepType=Min	Point=0	X2=0	X3=0	S11=-
628.749994284477	IsS11Max=No	IsS11Min=No	FrameElem=64	ElemStation=0				
Frame=64	Station=0	OutputCase=ENVE	CaseType=Combination	StepType=Min	Point=1	X2=-0.5	X3=-0.5	
S11=-2224.72043678094	IsS11Max=No	IsS11Min=Yes	FrameElem=64	ElemStation=0				
Frame=64	Station=0	OutputCase=ENVE	CaseType=Combination	StepType=Min	Point=2	X2=-0.5	X3=0.5	S11=-
2224.72043678094	IsS11Max=No	IsS11Min=No	FrameElem=64	ElemStation=0				
Frame=64	Station=0	OutputCase=ENVE	CaseType=Combination	StepType=Min	Point=3	X2=0.5	X3=-0.5	
S11=902.525959033613	IsS11Max=Yes	IsS11Min=No	FrameElem=64	ElemStation=0				
Frame=64	Station=0	OutputCase=ENVE	CaseType=Combination	StepType=Min	Point=4	X2=0.5	X3=0.5	
S11=902.525959033613	IsS11Max=No	IsS11Min=No	FrameElem=64	ElemStation=0				
Frame=64	Station=0.5	OutputCase=ENVE	CaseType=Combination	StepType=Min	Point=0	X2=0	X3=0	S11=-
616.249994449504	IsS11Max=No	IsS11Min=No	FrameElem=64	ElemStation=0.5				
Frame=64	Station=0.5	OutputCase=ENVE	CaseType=Combination	StepType=Min	Point=1	X2=-0.5	X3=-0.5	
S11=-2121.21162667538	IsS11Max=No	IsS11Min=Yes	FrameElem=64	ElemStation=0.5				



Frame=64	Station=0.5	OutputCase=ENVE	CaseType=Combination	StepType=Min	Point=2	X2=-0.5	X3=0.5	
S11=-2121.21162667538	IsS11Max=No	IsS11Min=No	FrameElem=64	ElemStation=0.5				
Frame=64	Station=0.5	OutputCase=ENVE	CaseType=Combination	StepType=Min	Point=3	X2=0.5	X3=-0.5	
S11=803.036673980053	IsS11Max=Yes	IsS11Min=No	FrameElem=64	ElemStation=0.5				
Frame=64	Station=0.5	OutputCase=ENVE	CaseType=Combination	StepType=Min	Point=4	X2=0.5	X3=0.5	
S11=803.036673980053	IsS11Max=No	IsS11Min=No	FrameElem=64	ElemStation=0.5				
Frame=64	Station=0	OutputCase=FESSUR	CaseType=Combination	Point=0	X2=0	X3=0	S11=-628.749994284477	
IsS11Max=No	IsS11Min=No	FrameElem=64	ElemStation=0					
Frame=64	Station=0	OutputCase=FESSUR	CaseType=Combination	Point=1	X2=-0.5	X3=-0.5	S11=-	
2160.02594760257	IsS11Max=No	IsS11Min=Yes	FrameElem=64	ElemStation=0				
Frame=64	Station=0	OutputCase=FESSUR	CaseType=Combination	Point=2	X2=-0.5	X3=0.5	S11=-	
2160.02594760257	IsS11Max=No	IsS11Min=No	FrameElem=64	ElemStation=0				
Frame=64	Station=0	OutputCase=FESSUR	CaseType=Combination	Point=3	X2=0.5	X3=-0.5		
S11=902.525959033613	IsS11Max=Yes	IsS11Min=No	FrameElem=64	ElemStation=0				
Frame=64	Station=0	OutputCase=FESSUR	CaseType=Combination	Point=4	X2=0.5	X3=0.5		
S11=902.525959033613	IsS11Max=No	IsS11Min=No	FrameElem=64	ElemStation=0				
Frame=64	Station=0.5	OutputCase=FESSUR	CaseType=Combination	Point=0	X2=0	X3=0	S11=-616.249994449504	
IsS11Max=No	IsS11Min=No	FrameElem=64	ElemStation=0.5					
Frame=64	Station=0.5	OutputCase=FESSUR	CaseType=Combination	Point=1	X2=-0.5	X3=-0.5	S11=-	
2035.53666287906	IsS11Max=No	IsS11Min=Yes	FrameElem=64	ElemStation=0.5				
Frame=64	Station=0.5	OutputCase=FESSUR	CaseType=Combination	Point=2	X2=-0.5	X3=0.5	S11=-	
2035.53666287906	IsS11Max=No	IsS11Min=No	FrameElem=64	ElemStation=0.5				
Frame=64	Station=0.5	OutputCase=FESSUR	CaseType=Combination	Point=3	X2=0.5	X3=-0.5		
S11=803.036673980053	IsS11Max=Yes	IsS11Min=No	FrameElem=64	ElemStation=0.5				
Frame=64	Station=0.5	OutputCase=FESSUR	CaseType=Combination	Point=4	X2=0.5	X3=0.5		
S11=803.036673980053	IsS11Max=No	IsS11Min=No	FrameElem=64	ElemStation=0.5				
Frame=65	Station=0	OutputCase=PESOPR	CaseType=LinStatic	Point=0	X2=0	X3=0	S11=-124.999998698098	
IsS11Max=No	IsS11Min=No	FrameElem=65	ElemStation=0					
Frame=65	Station=0	OutputCase=PESOPR	CaseType=LinStatic	Point=1	X2=-0.5	X3=-0.5	S11=-	
478.993669291851	IsS11Max=No	IsS11Min=Yes	FrameElem=65	ElemStation=0				
Frame=65	Station=0	OutputCase=PESOPR	CaseType=LinStatic	Point=2	X2=-0.5	X3=0.5	S11=-	
478.993669291851	IsS11Max=No	IsS11Min=No	FrameElem=65	ElemStation=0				
Frame=65	Station=0	OutputCase=PESOPR	CaseType=LinStatic	Point=3	X2=0.5	X3=-0.5	S11=228.993671895655	
IsS11Max=Yes	IsS11Min=No	FrameElem=65	ElemStation=0					
Frame=65	Station=0	OutputCase=PESOPR	CaseType=LinStatic	Point=4	X2=0.5	X3=0.5	S11=228.993671895655	
IsS11Max=No	IsS11Min=No	FrameElem=65	ElemStation=0					
Frame=65	Station=0.5	OutputCase=PESOPR	CaseType=LinStatic	Point=0	X2=0	X3=0	S11=-112.499998698098	
IsS11Max=No	IsS11Min=No	FrameElem=65	ElemStation=0.5					
Frame=65	Station=0.5	OutputCase=PESOPR	CaseType=LinStatic	Point=1	X2=-0.5	X3=-0.5	S11=-	
420.980826251922	IsS11Max=No	IsS11Min=Yes	FrameElem=65	ElemStation=0.5				
Frame=65	Station=0.5	OutputCase=PESOPR	CaseType=LinStatic	Point=2	X2=-0.5	X3=0.5	S11=-	
420.980826251922	IsS11Max=No	IsS11Min=No	FrameElem=65	ElemStation=0.5				
Frame=65	Station=0.5	OutputCase=PESOPR	CaseType=LinStatic	Point=3	X2=0.5	X3=-0.5		
S11=195.980828855725	IsS11Max=Yes	IsS11Min=No	FrameElem=65	ElemStation=0.5				
Frame=65	Station=0.5	OutputCase=PESOPR	CaseType=LinStatic	Point=4	X2=0.5	X3=0.5		
S11=195.980828855725	IsS11Max=No	IsS11Min=No	FrameElem=65	ElemStation=0.5				
Frame=65	Station=0	OutputCase=TERRVERT	CaseType=LinStatic	Point=0	X2=0	X3=0	S11=-491.24999552092	
IsS11Max=No	IsS11Min=No	FrameElem=65	ElemStation=0					
Frame=65	Station=0	OutputCase=TERRVERT	CaseType=LinStatic	Point=1	X2=-0.5	X3=-0.5	S11=-	
1842.12620624113	IsS11Max=No	IsS11Min=Yes	FrameElem=65	ElemStation=0				
Frame=65	Station=0	OutputCase=TERRVERT	CaseType=LinStatic	Point=2	X2=-0.5	X3=0.5	S11=-	
1842.12620624113	IsS11Max=No	IsS11Min=No	FrameElem=65	ElemStation=0				
Frame=65	Station=0	OutputCase=TERRVERT	CaseType=LinStatic	Point=3	X2=0.5	X3=-0.5		
S11=859.626215199292	IsS11Max=Yes	IsS11Min=No	FrameElem=65	ElemStation=0				
Frame=65	Station=0	OutputCase=TERRVERT	CaseType=LinStatic	Point=4	X2=0.5	X3=0.5		
S11=859.626215199292	IsS11Max=No	IsS11Min=No	FrameElem=65	ElemStation=0				
Frame=65	Station=0.5	OutputCase=TERRVERT	CaseType=LinStatic	Point=0	X2=0	X3=0	S11=-491.24999552092	
IsS11Max=No	IsS11Min=No	FrameElem=65	ElemStation=0.5					
Frame=65	Station=0.5	OutputCase=TERRVERT	CaseType=LinStatic	Point=1	X2=-0.5	X3=-0.5	S11=-	
1845.58468024871	IsS11Max=No	IsS11Min=Yes	FrameElem=65	ElemStation=0.5				
Frame=65	Station=0.5	OutputCase=TERRVERT	CaseType=LinStatic	Point=2	X2=-0.5	X3=0.5	S11=-	
1845.58468024871	IsS11Max=No	IsS11Min=No	FrameElem=65	ElemStation=0.5				
Frame=65	Station=0.5	OutputCase=TERRVERT	CaseType=LinStatic	Point=3	X2=0.5	X3=-0.5		
S11=863.084689206865	IsS11Max=Yes	IsS11Min=No	FrameElem=65	ElemStation=0.5				
Frame=65	Station=0.5	OutputCase=TERRVERT	CaseType=LinStatic	Point=4	X2=0.5	X3=0.5		
S11=863.084689206865	IsS11Max=No	IsS11Min=No	FrameElem=65	ElemStation=0.5				
Frame=65	Station=0	OutputCase=TERRLAT	CaseType=LinStatic	Point=0	X2=0	X3=0	S11=-2.30020077651716E-	
07	IsS11Max=No	IsS11Min=No	FrameElem=65	ElemStation=0				
Frame=65	Station=0	OutputCase=TERRLAT	CaseType=LinStatic	Point=1	X2=-0.5	X3=-0.5		
S11=285.583212654386	IsS11Max=Yes	IsS11Min=No	FrameElem=65	ElemStation=0				
Frame=65	Station=0	OutputCase=TERRLAT	CaseType=LinStatic	Point=2	X2=-0.5	X3=0.5		
S11=285.583212654386	IsS11Max=No	IsS11Min=No	FrameElem=65	ElemStation=0				
Frame=65	Station=0	OutputCase=TERRLAT	CaseType=LinStatic	Point=3	X2=0.5	X3=-0.5	S11=-	
285.583213114426	IsS11Max=No	IsS11Min=Yes	FrameElem=65	ElemStation=0				
Frame=65	Station=0	OutputCase=TERRLAT	CaseType=LinStatic	Point=4	X2=0.5	X3=0.5	S11=-	
285.583213114426	IsS11Max=No	IsS11Min=No	FrameElem=65	ElemStation=0				
Frame=65	Station=0.5	OutputCase=TERRLAT	CaseType=LinStatic	Point=0	X2=0	X3=0	S11=-	
3.78105341439106E-07	IsS11Max=No	IsS11Min=No	FrameElem=65	ElemStation=0.5				
Frame=65	Station=0.5	OutputCase=TERRLAT	CaseType=LinStatic	Point=1	X2=-0.5	X3=-0.5		
S11=296.420003178817	IsS11Max=Yes	IsS11Min=No	FrameElem=65	ElemStation=0.5				
Frame=65	Station=0.5	OutputCase=TERRLAT	CaseType=LinStatic	Point=2	X2=-0.5	X3=0.5		
S11=296.420003178817	IsS11Max=No	IsS11Min=No	FrameElem=65	ElemStation=0.5				

Frame=65	Station=0.5	OutputCase=SOVRCOST	CaseType=LinStatic	Point=4	X2=0.5	X3=0.5	S11=0	
IsS11Max=No	IsS11Min=No	FrameElem=65	ElemStation=0.5					
Frame=65	Station=0	OutputCase=ENVE	CaseType=Combination	StepType=Max	Point=0	X2=0	X3=0	S11=-
616.249994380033	IsS11Max=No	IsS11Min=No	FrameElem=65	ElemStation=0				
Frame=65	Station=0	OutputCase=ENVE	CaseType=Combination	StepType=Max	Point=1	X2=-0.5	X3=-0.5	
S11=-2035.5366628786	IsS11Max=No	IsS11Min=Yes	FrameElem=65	ElemStation=0				
Frame=65	Station=0	OutputCase=ENVE	CaseType=Combination	StepType=Max	Point=2	X2=-0.5	X3=0.5	S11=-
2035.5366628786	IsS11Max=No	IsS11Min=No	FrameElem=65	ElemStation=0				
Frame=65	Station=0	OutputCase=ENVE	CaseType=Combination	StepType=Max	Point=3	X2=0.5	X3=-0.5	
S11=888.711637914849	IsS11Max=Yes	IsS11Min=No	FrameElem=65	ElemStation=0				
Frame=65	Station=0	OutputCase=ENVE	CaseType=Combination	StepType=Max	Point=4	X2=0.5	X3=0.5	
S11=888.711637914849	IsS11Max=No	IsS11Min=No	FrameElem=65	ElemStation=0				
Frame=65	Station=0.5	OutputCase=ENVE	CaseType=Combination	StepType=Max	Point=0	X2=0	X3=0	S11=-
603.749994483693	IsS11Max=No	IsS11Min=No	FrameElem=65	ElemStation=0.5				
Frame=65	Station=0.5	OutputCase=ENVE	CaseType=Combination	StepType=Max	Point=1	X2=-0.5	X3=-0.5	
S11=-1970.14550332181	IsS11Max=No	IsS11Min=Yes	FrameElem=65	ElemStation=0.5				
Frame=65	Station=0.5	OutputCase=ENVE	CaseType=Combination	StepType=Max	Point=2	X2=-0.5	X3=0.5	
S11=-1970.14550332181	IsS11Max=No	IsS11Min=No	FrameElem=65	ElemStation=0.5				
Frame=65	Station=0.5	OutputCase=ENVE	CaseType=Combination	StepType=Max	Point=3	X2=0.5	X3=-0.5	
S11=851.571515308071	IsS11Max=Yes	IsS11Min=No	FrameElem=65	ElemStation=0.5				
Frame=65	Station=0.5	OutputCase=ENVE	CaseType=Combination	StepType=Max	Point=4	X2=0.5	X3=0.5	
S11=851.571515308071	IsS11Max=No	IsS11Min=No	FrameElem=65	ElemStation=0.5				
Frame=65	Station=0	OutputCase=ENVE	CaseType=Combination	StepType=Min	Point=0	X2=0	X3=0	S11=-
616.249994449039	IsS11Max=No	IsS11Min=No	FrameElem=65	ElemStation=0				
Frame=65	Station=0	OutputCase=ENVE	CaseType=Combination	StepType=Min	Point=1	X2=-0.5	X3=-0.5	
S11=-2121.21162667491	IsS11Max=No	IsS11Min=Yes	FrameElem=65	ElemStation=0				
Frame=65	Station=0	OutputCase=ENVE	CaseType=Combination	StepType=Min	Point=2	X2=-0.5	X3=0.5	S11=-
2121.21162667491	IsS11Max=No	IsS11Min=No	FrameElem=65	ElemStation=0				
Frame=65	Station=0	OutputCase=ENVE	CaseType=Combination	StepType=Min	Point=3	X2=0.5	X3=-0.5	
S11=803.036673980521	IsS11Max=Yes	IsS11Min=No	FrameElem=65	ElemStation=0				
Frame=65	Station=0	OutputCase=ENVE	CaseType=Combination	StepType=Min	Point=4	X2=0.5	X3=0.5	
S11=803.036673980521	IsS11Max=No	IsS11Min=No	FrameElem=65	ElemStation=0				
Frame=65	Station=0.5	OutputCase=ENVE	CaseType=Combination	StepType=Min	Point=0	X2=0	X3=0	S11=-
603.749994597124	IsS11Max=No	IsS11Min=No	FrameElem=65	ElemStation=0.5				
Frame=65	Station=0.5	OutputCase=ENVE	CaseType=Combination	StepType=Min	Point=1	X2=-0.5	X3=-0.5	
S11=-2059.07150427546	IsS11Max=No	IsS11Min=Yes	FrameElem=65	ElemStation=0.5				
Frame=65	Station=0.5	OutputCase=ENVE	CaseType=Combination	StepType=Min	Point=2	X2=-0.5	X3=0.5	
S11=-2059.07150427546	IsS11Max=No	IsS11Min=No	FrameElem=65	ElemStation=0.5				
Frame=65	Station=0.5	OutputCase=ENVE	CaseType=Combination	StepType=Min	Point=3	X2=0.5	X3=-0.5	
S11=762.645514127563	IsS11Max=Yes	IsS11Min=No	FrameElem=65	ElemStation=0.5				
Frame=65	Station=0.5	OutputCase=ENVE	CaseType=Combination	StepType=Min	Point=4	X2=0.5	X3=0.5	
S11=762.645514127563	IsS11Max=No	IsS11Min=No	FrameElem=65	ElemStation=0.5				
Frame=65	Station=0	OutputCase=FESSUR	CaseType=Combination	Point=0	X2=0	X3=0	S11=-616.249994449039	
IsS11Max=No	IsS11Min=No	FrameElem=65	ElemStation=0					
Frame=65	Station=0	OutputCase=FESSUR	CaseType=Combination	Point=1	X2=-0.5	X3=-0.5	S11=-	
2035.5366628786	IsS11Max=No	IsS11Min=Yes	FrameElem=65	ElemStation=0				
Frame=65	Station=0	OutputCase=FESSUR	CaseType=Combination	Point=2	X2=-0.5	X3=0.5	S11=-	
2035.5366628786	IsS11Max=No	IsS11Min=No	FrameElem=65	ElemStation=0				
Frame=65	Station=0	OutputCase=FESSUR	CaseType=Combination	Point=3	X2=0.5	X3=-0.5		
S11=803.036673980521	IsS11Max=Yes	IsS11Min=No	FrameElem=65	ElemStation=0				
Frame=65	Station=0	OutputCase=FESSUR	CaseType=Combination	Point=4	X2=0.5	X3=0.5		
S11=803.036673980521	IsS11Max=No	IsS11Min=No	FrameElem=65	ElemStation=0				
Frame=65	Station=0.5	OutputCase=FESSUR	CaseType=Combination	Point=0	X2=0	X3=0	S11=-603.749994597124	
IsS11Max=No	IsS11Min=No	FrameElem=65	ElemStation=0.5					
Frame=65	Station=0.5	OutputCase=FESSUR	CaseType=Combination	Point=1	X2=-0.5	X3=-0.5	S11=-	
1970.14550332181	IsS11Max=No	IsS11Min=Yes	FrameElem=65	ElemStation=0.5				
Frame=65	Station=0.5	OutputCase=FESSUR	CaseType=Combination	Point=2	X2=-0.5	X3=0.5	S11=-	
1970.14550332181	IsS11Max=No	IsS11Min=No	FrameElem=65	ElemStation=0.5				
Frame=65	Station=0.5	OutputCase=FESSUR	CaseType=Combination	Point=3	X2=0.5	X3=-0.5		
S11=762.645514127563	IsS11Max=Yes	IsS11Min=No	FrameElem=65	ElemStation=0.5				
Frame=65	Station=0.5	OutputCase=FESSUR	CaseType=Combination	Point=4	X2=0.5	X3=0.5		
S11=762.645514127563	IsS11Max=No	IsS11Min=No	FrameElem=65	ElemStation=0.5				
Frame=66	Station=0	OutputCase=PESOPR	CaseType=LinStatic	Point=0	X2=0	X3=0	S11=-112.499998698011	
IsS11Max=No	IsS11Min=No	FrameElem=66	ElemStation=0					
Frame=66	Station=0	OutputCase=PESOPR	CaseType=LinStatic	Point=1	X2=-0.5	X3=-0.5	S11=-	
420.980826251835	IsS11Max=No	IsS11Min=Yes	FrameElem=66	ElemStation=0				
Frame=66	Station=0	OutputCase=PESOPR	CaseType=LinStatic	Point=2	X2=-0.5	X3=0.5	S11=-	
420.980826251835	IsS11Max=No	IsS11Min=No	FrameElem=66	ElemStation=0				
Frame=66	Station=0	OutputCase=PESOPR	CaseType=LinStatic	Point=3	X2=0.5	X3=-0.5	S11=195.980828855812	
IsS11Max=Yes	IsS11Min=No	FrameElem=66	ElemStation=0					
Frame=66	Station=0	OutputCase=PESOPR	CaseType=LinStatic	Point=4	X2=0.5	X3=0.5	S11=195.980828855812	
IsS11Max=No	IsS11Min=No	FrameElem=66	ElemStation=0					
Frame=66	Station=0.5	OutputCase=PESOPR	CaseType=LinStatic	Point=0	X2=0	X3=0	S11=-99.999998698011	
IsS11Max=No	IsS11Min=No	FrameElem=66	ElemStation=0.5					
Frame=66	Station=0.5	OutputCase=PESOPR	CaseType=LinStatic	Point=1	X2=-0.5	X3=-0.5	S11=-	
362.96798350993	IsS11Max=No	IsS11Min=Yes	FrameElem=66	ElemStation=0.5				
Frame=66	Station=0.5	OutputCase=PESOPR	CaseType=LinStatic	Point=2	X2=-0.5	X3=0.5	S11=-	
362.96798350993	IsS11Max=No	IsS11Min=No	FrameElem=66	ElemStation=0.5				
Frame=66	Station=0.5	OutputCase=PESOPR	CaseType=LinStatic	Point=3	X2=0.5	X3=-0.5		
S11=162.967986113908	IsS11Max=Yes	IsS11Min=No	FrameElem=66	ElemStation=0.5				
Frame=66	Station=0.5	OutputCase=PESOPR	CaseType=LinStatic	Point=4	X2=0.5	X3=0.5		
S11=162.967986113908	IsS11Max=No	IsS11Min=No	FrameElem=66	ElemStation=0.5				

Frame=66	Station=0	OutputCase=TERRVERT	CaseType=LinStatic	Point=0	X2=0	X3=0	S11=-491.24999552092
IsS11Max=No	IsS11Min=No	FrameElem=66	ElemStation=0				
Frame=66	Station=0	OutputCase=TERRVERT	CaseType=LinStatic	Point=1	X2=-0.5	X3=-0.5	S11=-
1845.58468024871	IsS11Max=No	IsS11Min=Yes	FrameElem=66	ElemStation=0			
Frame=66	Station=0	OutputCase=TERRVERT	CaseType=LinStatic	Point=2	X2=-0.5	X3=0.5	S11=-
1845.58468024871	IsS11Max=No	IsS11Min=No	FrameElem=66	ElemStation=0			
Frame=66	Station=0	OutputCase=TERRVERT	CaseType=LinStatic	Point=3	X2=0.5	X3=-0.5	
S11=863.084689206866	IsS11Max=Yes	IsS11Min=No	FrameElem=66	ElemStation=0			
Frame=66	Station=0	OutputCase=TERRVERT	CaseType=LinStatic	Point=4	X2=0.5	X3=0.5	
S11=863.084689206866	IsS11Max=No	IsS11Min=No	FrameElem=66	ElemStation=0			
Frame=66	Station=0.5	OutputCase=TERRVERT	CaseType=LinStatic	Point=0	X2=0	X3=0	S11=-491.24999552092
IsS11Max=No	IsS11Min=No	FrameElem=66	ElemStation=0.5				
Frame=66	Station=0.5	OutputCase=TERRVERT	CaseType=LinStatic	Point=1	X2=-0.5	X3=-0.5	S11=-
1849.04315425628	IsS11Max=No	IsS11Min=Yes	FrameElem=66	ElemStation=0.5			
Frame=66	Station=0.5	OutputCase=TERRVERT	CaseType=LinStatic	Point=2	X2=-0.5	X3=0.5	S11=-
1849.04315425628	IsS11Max=No	IsS11Min=No	FrameElem=66	ElemStation=0.5			
Frame=66	Station=0.5	OutputCase=TERRVERT	CaseType=LinStatic	Point=3	X2=0.5	X3=-0.5	
S11=866.543163214443	IsS11Max=Yes	IsS11Min=No	FrameElem=66	ElemStation=0.5			
Frame=66	Station=0.5	OutputCase=TERRVERT	CaseType=LinStatic	Point=4	X2=0.5	X3=0.5	
S11=866.543163214443	IsS11Max=No	IsS11Min=No	FrameElem=66	ElemStation=0.5			
Frame=66	Station=0	OutputCase=TERRLAT	CaseType=LinStatic	Point=0	X2=0	X3=0	S11=-3.78105596610112E-
07	IsS11Max=No	IsS11Min=No	FrameElem=66	ElemStation=0			
Frame=66	Station=0	OutputCase=TERRLAT	CaseType=LinStatic	Point=1	X2=-0.5	X3=-0.5	
S11=296.420003178816	IsS11Max=Yes	IsS11Min=No	FrameElem=66	ElemStation=0			
Frame=66	Station=0	OutputCase=TERRLAT	CaseType=LinStatic	Point=2	X2=-0.5	X3=0.5	
S11=296.420003178816	IsS11Max=No	IsS11Min=No	FrameElem=66	ElemStation=0			
Frame=66	Station=0	OutputCase=TERRLAT	CaseType=LinStatic	Point=3	X2=0.5	X3=-0.5	S11=-
296.420003935027	IsS11Max=No	IsS11Min=Yes	FrameElem=66	ElemStation=0			
Frame=66	Station=0	OutputCase=TERRLAT	CaseType=LinStatic	Point=4	X2=0.5	X3=0.5	S11=-
296.420003935027	IsS11Max=No	IsS11Min=No	FrameElem=66	ElemStation=0			
Frame=66	Station=0.5	OutputCase=TERRLAT	CaseType=LinStatic	Point=0	X2=0	X3=0	S11=-
5.09248224479153E-07	IsS11Max=No	IsS11Min=No	FrameElem=66	ElemStation=0.5			
Frame=66	Station=0.5	OutputCase=TERRLAT	CaseType=LinStatic	Point=1	X2=-0.5	X3=-0.5	
S11=254.554293872673	IsS11Max=Yes	IsS11Min=No	FrameElem=66	ElemStation=0.5			
Frame=66	Station=0.5	OutputCase=TERRLAT	CaseType=LinStatic	Point=2	X2=-0.5	X3=0.5	
S11=254.554293872673	IsS11Max=No	IsS11Min=No	FrameElem=66	ElemStation=0.5			
Frame=66	Station=0.5	OutputCase=TERRLAT	CaseType=LinStatic	Point=3	X2=0.5	X3=-0.5	S11=-
254.55429489117	IsS11Max=No	IsS11Min=Yes	FrameElem=66	ElemStation=0.5			
Frame=66	Station=0.5	OutputCase=TERRLAT	CaseType=LinStatic	Point=4	X2=0.5	X3=0.5	S11=-
254.55429489117	IsS11Max=No	IsS11Min=No	FrameElem=66	ElemStation=0.5			
Frame=66	Station=0	OutputCase=ACCLATDX	CaseType=LinStatic	Point=0	X2=0	X3=0	S11=0
IsS11Min=Yes	FrameElem=66	ElemStation=0					IsS11Max=Yes
Frame=66	Station=0	OutputCase=ACCLATDX	CaseType=LinStatic	Point=1	X2=-0.5	X3=-0.5	S11=0
IsS11Max=No	IsS11Min=No	FrameElem=66	ElemStation=0				
Frame=66	Station=0	OutputCase=ACCLATDX	CaseType=LinStatic	Point=2	X2=-0.5	X3=0.5	S11=0
IsS11Max=No	IsS11Min=No	FrameElem=66	ElemStation=0				
Frame=66	Station=0	OutputCase=ACCLATDX	CaseType=LinStatic	Point=3	X2=0.5	X3=-0.5	S11=0
IsS11Max=No	IsS11Min=No	FrameElem=66	ElemStation=0				
Frame=66	Station=0	OutputCase=ACCLATDX	CaseType=LinStatic	Point=4	X2=0.5	X3=0.5	S11=0
IsS11Max=No	IsS11Min=No	FrameElem=66	ElemStation=0				IsS11Max=No
IsS11Min=No	FrameElem=66	ElemStation=0					
Frame=66	Station=0.5	OutputCase=ACCLATDX	CaseType=LinStatic	Point=0	X2=0	X3=0	S11=0
IsS11Min=Yes	FrameElem=66	ElemStation=0.5					IsS11Max=Yes
Frame=66	Station=0.5	OutputCase=ACCLATDX	CaseType=LinStatic	Point=1	X2=-0.5	X3=-0.5	S11=0
IsS11Max=No	IsS11Min=No	FrameElem=66	ElemStation=0.5				
Frame=66	Station=0.5	OutputCase=ACCLATDX	CaseType=LinStatic	Point=2	X2=-0.5	X3=0.5	S11=0
IsS11Max=No	IsS11Min=No	FrameElem=66	ElemStation=0.5				
Frame=66	Station=0.5	OutputCase=ACCLATDX	CaseType=LinStatic	Point=3	X2=0.5	X3=-0.5	S11=0
IsS11Max=No	IsS11Min=No	FrameElem=66	ElemStation=0.5				
Frame=66	Station=0.5	OutputCase=ACCLATDX	CaseType=LinStatic	Point=4	X2=0.5	X3=0.5	S11=0
IsS11Max=No	IsS11Min=No	FrameElem=66	ElemStation=0.5				
Frame=66	Station=0	OutputCase=ACCLATSX	CaseType=LinStatic	Point=0	X2=0	X3=0	S11=0
IsS11Min=Yes	FrameElem=66	ElemStation=0					IsS11Max=Yes
Frame=66	Station=0	OutputCase=ACCLATSX	CaseType=LinStatic	Point=1	X2=-0.5	X3=-0.5	S11=0
IsS11Max=No	IsS11Min=No	FrameElem=66	ElemStation=0				
Frame=66	Station=0	OutputCase=ACCLATSX	CaseType=LinStatic	Point=2	X2=-0.5	X3=0.5	S11=0
IsS11Max=No	IsS11Min=No	FrameElem=66	ElemStation=0				
Frame=66	Station=0	OutputCase=ACCLATSX	CaseType=LinStatic	Point=3	X2=0.5	X3=-0.5	S11=0
IsS11Max=No	IsS11Min=No	FrameElem=66	ElemStation=0				
Frame=66	Station=0	OutputCase=ACCLATSX	CaseType=LinStatic	Point=4	X2=0.5	X3=0.5	S11=0
IsS11Max=No	IsS11Min=No	FrameElem=66	ElemStation=0				IsS11Max=No
IsS11Min=No	FrameElem=66	ElemStation=0					
Frame=66	Station=0.5	OutputCase=ACCLATSX	CaseType=LinStatic	Point=0	X2=0	X3=0	S11=0
IsS11Min=Yes	FrameElem=66	ElemStation=0.5					IsS11Max=Yes
Frame=66	Station=0.5	OutputCase=ACCLATSX	CaseType=LinStatic	Point=1	X2=-0.5	X3=-0.5	S11=0
IsS11Max=No	IsS11Min=No	FrameElem=66	ElemStation=0.5				
Frame=66	Station=0.5	OutputCase=ACCLATSX	CaseType=LinStatic	Point=2	X2=-0.5	X3=0.5	S11=0
IsS11Max=No	IsS11Min=No	FrameElem=66	ElemStation=0.5				
Frame=66	Station=0.5	OutputCase=ACCLATSX	CaseType=LinStatic	Point=3	X2=0.5	X3=-0.5	S11=0
IsS11Max=No	IsS11Min=No	FrameElem=66	ElemStation=0.5				
Frame=66	Station=0.5	OutputCase=ACCLATSX	CaseType=LinStatic	Point=4	X2=0.5	X3=0.5	S11=0
IsS11Max=No	IsS11Min=No	FrameElem=66	ElemStation=0.5				
Frame=66	Station=0	OutputCase=TERRCOST	CaseType=LinStatic	Point=0	X2=0	X3=0	S11=0
IsS11Min=Yes	FrameElem=66	ElemStation=0					IsS11Max=Yes

Frame=66	Station=0	OutputCase=TERRCOST	CaseType=LinStatic	Point=1	X2=-0.5	X3=-0.5	S11=0		
IsS11Max=No	IsS11Min=No	FrameElem=66	ElemStation=0						
Frame=66	Station=0	OutputCase=TERRCOST	CaseType=LinStatic	Point=2	X2=-0.5	X3=0.5	S11=0		
IsS11Max=No	IsS11Min=No	FrameElem=66	ElemStation=0						
Frame=66	Station=0	OutputCase=TERRCOST	CaseType=LinStatic	Point=3	X2=0.5	X3=-0.5	S11=0		
IsS11Max=No	IsS11Min=No	FrameElem=66	ElemStation=0						
Frame=66	Station=0	OutputCase=TERRCOST	CaseType=LinStatic	Point=4	X2=0.5	X3=0.5	S11=0	IsS11Max=No	
IsS11Min=No	FrameElem=66	ElemStation=0							
Frame=66	Station=0.5	OutputCase=TERRCOST	CaseType=LinStatic	Point=0	X2=0	X3=0	S11=0	IsS11Max=Yes	
IsS11Min=Yes	FrameElem=66	ElemStation=0.5							
Frame=66	Station=0.5	OutputCase=TERRCOST	CaseType=LinStatic	Point=1	X2=-0.5	X3=-0.5	S11=0		
IsS11Max=No	IsS11Min=No	FrameElem=66	ElemStation=0.5						
Frame=66	Station=0.5	OutputCase=TERRCOST	CaseType=LinStatic	Point=2	X2=-0.5	X3=0.5	S11=0		
IsS11Max=No	IsS11Min=No	FrameElem=66	ElemStation=0.5						
Frame=66	Station=0.5	OutputCase=TERRCOST	CaseType=LinStatic	Point=3	X2=0.5	X3=-0.5	S11=0		
IsS11Max=No	IsS11Min=No	FrameElem=66	ElemStation=0.5						
Frame=66	Station=0.5	OutputCase=TERRCOST	CaseType=LinStatic	Point=4	X2=0.5	X3=0.5	S11=0		
IsS11Max=No	IsS11Min=No	FrameElem=66	ElemStation=0.5						
Frame=66	Station=0	OutputCase=SOVRCOST	CaseType=LinStatic	Point=0	X2=0	X3=0	S11=0	IsS11Max=Yes	
IsS11Min=Yes	FrameElem=66	ElemStation=0							
Frame=66	Station=0	OutputCase=SOVRCOST	CaseType=LinStatic	Point=1	X2=-0.5	X3=-0.5	S11=0		
IsS11Max=No	IsS11Min=No	FrameElem=66	ElemStation=0						
Frame=66	Station=0	OutputCase=SOVRCOST	CaseType=LinStatic	Point=2	X2=-0.5	X3=0.5	S11=0		
IsS11Max=No	IsS11Min=No	FrameElem=66	ElemStation=0						
Frame=66	Station=0	OutputCase=SOVRCOST	CaseType=LinStatic	Point=3	X2=0.5	X3=-0.5	S11=0		
IsS11Max=No	IsS11Min=No	FrameElem=66	ElemStation=0						
Frame=66	Station=0	OutputCase=SOVRCOST	CaseType=LinStatic	Point=4	X2=0.5	X3=0.5	S11=0	IsS11Max=No	
IsS11Min=No	FrameElem=66	ElemStation=0							
Frame=66	Station=0.5	OutputCase=SOVRCOST	CaseType=LinStatic	Point=0	X2=0	X3=0	S11=0	IsS11Max=Yes	
IsS11Min=Yes	FrameElem=66	ElemStation=0.5							
Frame=66	Station=0.5	OutputCase=SOVRCOST	CaseType=LinStatic	Point=1	X2=-0.5	X3=-0.5	S11=0		
IsS11Max=No	IsS11Min=No	FrameElem=66	ElemStation=0.5						
Frame=66	Station=0.5	OutputCase=SOVRCOST	CaseType=LinStatic	Point=2	X2=-0.5	X3=0.5	S11=0		
IsS11Max=No	IsS11Min=No	FrameElem=66	ElemStation=0.5						
Frame=66	Station=0.5	OutputCase=SOVRCOST	CaseType=LinStatic	Point=3	X2=0.5	X3=-0.5	S11=0		
IsS11Max=No	IsS11Min=No	FrameElem=66	ElemStation=0.5						
Frame=66	Station=0.5	OutputCase=SOVRCOST	CaseType=LinStatic	Point=4	X2=0.5	X3=0.5	S11=0		
IsS11Max=No	IsS11Min=No	FrameElem=66	ElemStation=0.5						
Frame=66	Station=0	OutputCase=ENVE	CaseType=Combination	StepType=Max	Point=0	X2=0	X3=0	S11=-	
603.749994483605	IsS11Max=No	IsS11Min=No	FrameElem=66	ElemStation=0					
Frame=66	Station=0	OutputCase=ENVE	CaseType=Combination	StepType=Max	Point=1	X2=-0.5	X3=-0.5		
S11=-1970.14550332173	IsS11Max=No	IsS11Min=Yes	FrameElem=66	ElemStation=0					
Frame=66	Station=0	OutputCase=ENVE	CaseType=Combination	StepType=Max	Point=2	X2=-0.5	X3=0.5	S11=-	
1970.14550332173	IsS11Max=No	IsS11Min=No	FrameElem=66	ElemStation=0					
Frame=66	Station=0	OutputCase=ENVE	CaseType=Combination	StepType=Max	Point=3	X2=0.5	X3=-0.5		
S11=851.571515308159	IsS11Max=Yes	IsS11Min=No	FrameElem=66	ElemStation=0					
Frame=66	Station=0	OutputCase=ENVE	CaseType=Combination	StepType=Max	Point=4	X2=0.5	X3=0.5		
S11=851.571515308159	IsS11Max=No	IsS11Min=No	FrameElem=66	ElemStation=0					
Frame=66	Station=0.5	OutputCase=ENVE	CaseType=Combination	StepType=Max	Point=0	X2=0	X3=0	S11=-	
591.249994575405	IsS11Max=No	IsS11Min=No	FrameElem=66	ElemStation=0.5					
Frame=66	Station=0.5	OutputCase=ENVE	CaseType=Combination	StepType=Max	Point=1	X2=-0.5	X3=-0.5		
S11=-1957.45684389354	IsS11Max=No	IsS11Min=Yes	FrameElem=66	ElemStation=0.5					
Frame=66	Station=0.5	OutputCase=ENVE	CaseType=Combination	StepType=Max	Point=2	X2=-0.5	X3=0.5		
S11=-1957.45684389354	IsS11Max=No	IsS11Min=No	FrameElem=66	ElemStation=0.5					
Frame=66	Station=0.5	OutputCase=ENVE	CaseType=Combination	StepType=Max	Point=3	X2=0.5	X3=-0.5		
S11=851.323142904532	IsS11Max=Yes	IsS11Min=No	FrameElem=66	ElemStation=0.5					
Frame=66	Station=0.5	OutputCase=ENVE	CaseType=Combination	StepType=Max	Point=4	X2=0.5	X3=0.5		
S11=851.323142904532	IsS11Max=No	IsS11Min=No	FrameElem=66	ElemStation=0.5					
Frame=66	Station=0	OutputCase=ENVE	CaseType=Combination	StepType=Min	Point=0	X2=0	X3=0	S11=-	
603.749994597037	IsS11Max=No	IsS11Min=No	FrameElem=66	ElemStation=0					
Frame=66	Station=0	OutputCase=ENVE	CaseType=Combination	StepType=Min	Point=1	X2=-0.5	X3=-0.5		
S11=-2059.07150427537	IsS11Max=No	IsS11Min=Yes	FrameElem=66	ElemStation=0					
Frame=66	Station=0	OutputCase=ENVE	CaseType=Combination	StepType=Min	Point=2	X2=-0.5	X3=0.5	S11=-	
2059.07150427537	IsS11Max=No	IsS11Min=No	FrameElem=66	ElemStation=0					
Frame=66	Station=0	OutputCase=ENVE	CaseType=Combination	StepType=Min	Point=3	X2=0.5	X3=-0.5		
S11=762.645514127651	IsS11Max=Yes	IsS11Min=No	FrameElem=66	ElemStation=0					
Frame=66	Station=0	OutputCase=ENVE	CaseType=Combination	StepType=Min	Point=4	X2=0.5	X3=0.5		
S11=762.645514127651	IsS11Max=No	IsS11Min=No	FrameElem=66	ElemStation=0					
Frame=66	Station=0.5	OutputCase=ENVE	CaseType=Combination	StepType=Min	Point=0	X2=0	X3=0	S11=-	
591.24999472818	IsS11Max=No	IsS11Min=No	FrameElem=66	ElemStation=0.5					
Frame=66	Station=0.5	OutputCase=ENVE	CaseType=Combination	StepType=Min	Point=1	X2=-0.5	X3=-0.5		
S11=-2033.82313205534	IsS11Max=No	IsS11Min=Yes	FrameElem=66	ElemStation=0.5					
Frame=66	Station=0.5	OutputCase=ENVE	CaseType=Combination	StepType=Min	Point=2	X2=-0.5	X3=0.5		
S11=-2033.82313205534	IsS11Max=No	IsS11Min=No	FrameElem=66	ElemStation=0.5					
Frame=66	Station=0.5	OutputCase=ENVE	CaseType=Combination	StepType=Min	Point=3	X2=0.5	X3=-0.5		
S11=774.956854437181	IsS11Max=Yes	IsS11Min=No	FrameElem=66	ElemStation=0.5					
Frame=66	Station=0.5	OutputCase=ENVE	CaseType=Combination	StepType=Min	Point=4	X2=0.5	X3=0.5		
S11=774.956854437181	IsS11Max=No	IsS11Min=No	FrameElem=66	ElemStation=0.5					
Frame=66	Station=0	OutputCase=FESSUR	CaseType=Combination	Point=0	X2=0	X3=0	S11=-603.749994597037		
IsS11Max=No	IsS11Min=No	FrameElem=66	ElemStation=0						
Frame=66	Station=0	OutputCase=FESSUR	CaseType=Combination	Point=1	X2=-0.5	X3=-0.5	S11=-		
1970.14550332173	IsS11Max=No	IsS11Min=Yes	FrameElem=66	ElemStation=0					



Frame=66	Station=0	OutputCase=FESSUR	CaseType=Combination	Point=2	X2=-0.5	X3=0.5	S11=-
1970.14550332173	IsS11Max=No	IsS11Min=No	FrameElem=66	ElemStation=0			
Frame=66	Station=0	OutputCase=FESSUR	CaseType=Combination	Point=3	X2=0.5	X3=-0.5	
S11=762.645514127651	IsS11Max=Yes	IsS11Min=No	FrameElem=66	ElemStation=0			
Frame=66	Station=0	OutputCase=FESSUR	CaseType=Combination	Point=4	X2=0.5	X3=0.5	
S11=762.645514127651	IsS11Max=No	IsS11Min=No	FrameElem=66	ElemStation=0			
Frame=66	Station=0.5	OutputCase=FESSUR	CaseType=Combination	Point=0	X2=0	X3=0	S11=-591.24999472818
IsS11Max=No	IsS11Min=No	FrameElem=66	ElemStation=0.5				
Frame=66	Station=0.5	OutputCase=FESSUR	CaseType=Combination	Point=1	X2=-0.5	X3=-0.5	S11=-
1957.45684389354	IsS11Max=No	IsS11Min=Yes	FrameElem=66	ElemStation=0.5			
Frame=66	Station=0.5	OutputCase=FESSUR	CaseType=Combination	Point=2	X2=-0.5	X3=0.5	S11=-
1957.45684389354	IsS11Max=No	IsS11Min=No	FrameElem=66	ElemStation=0.5			
Frame=66	Station=0.5	OutputCase=FESSUR	CaseType=Combination	Point=3	X2=0.5	X3=-0.5	
S11=774.956854437181	IsS11Max=Yes	IsS11Min=No	FrameElem=66	ElemStation=0.5			
Frame=66	Station=0.5	OutputCase=FESSUR	CaseType=Combination	Point=4	X2=0.5	X3=0.5	
S11=774.956854437181	IsS11Max=No	IsS11Min=No	FrameElem=66	ElemStation=0.5			
Frame=67	Station=0	OutputCase=PESOPR	CaseType=LinStatic	Point=0	X2=0	X3=0	S11=-99.999986979819
IsS11Max=No	IsS11Min=No	FrameElem=67	ElemStation=0				
Frame=67	Station=0	OutputCase=PESOPR	CaseType=LinStatic	Point=1	X2=-0.5	X3=-0.5	S11=-362.9679835099
IsS11Max=No	IsS11Min=Yes	FrameElem=67	ElemStation=0				
Frame=67	Station=0	OutputCase=PESOPR	CaseType=LinStatic	Point=2	X2=-0.5	X3=0.5	S11=-362.9679835099
IsS11Max=No	IsS11Min=No	FrameElem=67	ElemStation=0				
Frame=67	Station=0	OutputCase=PESOPR	CaseType=LinStatic	Point=3	X2=0.5	X3=-0.5	S11=162.967986113936
IsS11Max=Yes	IsS11Min=No	FrameElem=67	ElemStation=0				
Frame=67	Station=0	OutputCase=PESOPR	CaseType=LinStatic	Point=4	X2=0.5	X3=0.5	S11=162.967986113936
IsS11Max=No	IsS11Min=No	FrameElem=67	ElemStation=0				
Frame=67	Station=0.5	OutputCase=PESOPR	CaseType=LinStatic	Point=0	X2=0	X3=0	S11=-87.4999986979819
IsS11Max=No	IsS11Min=No	FrameElem=67	ElemStation=0.5				
Frame=67	Station=0.5	OutputCase=PESOPR	CaseType=LinStatic	Point=1	X2=-0.5	X3=-0.5	S11=-
304.955141066018	IsS11Max=No	IsS11Min=Yes	FrameElem=67	ElemStation=0.5			
Frame=67	Station=0.5	OutputCase=PESOPR	CaseType=LinStatic	Point=2	X2=-0.5	X3=0.5	S11=-
304.955141066018	IsS11Max=No	IsS11Min=No	FrameElem=67	ElemStation=0.5			
Frame=67	Station=0.5	OutputCase=PESOPR	CaseType=LinStatic	Point=3	X2=0.5	X3=-0.5	
S11=129.955143670054	IsS11Max=Yes	IsS11Min=No	FrameElem=67	ElemStation=0.5			
Frame=67	Station=0.5	OutputCase=PESOPR	CaseType=LinStatic	Point=4	X2=0.5	X3=0.5	
S11=129.955143670054	IsS11Max=No	IsS11Min=No	FrameElem=67	ElemStation=0.5			
Frame=67	Station=0	OutputCase=TERRVERT	CaseType=LinStatic	Point=0	X2=0	X3=0	S11=-491.24999552092
IsS11Max=No	IsS11Min=No	FrameElem=67	ElemStation=0				
Frame=67	Station=0	OutputCase=TERRVERT	CaseType=LinStatic	Point=1	X2=-0.5	X3=-0.5	S11=-
1849.04315425628	IsS11Max=No	IsS11Min=Yes	FrameElem=67	ElemStation=0			
Frame=67	Station=0	OutputCase=TERRVERT	CaseType=LinStatic	Point=2	X2=-0.5	X3=0.5	S11=-
1849.04315425628	IsS11Max=No	IsS11Min=No	FrameElem=67	ElemStation=0			
Frame=67	Station=0	OutputCase=TERRVERT	CaseType=LinStatic	Point=3	X2=0.5	X3=-0.5	
S11=866.543163214439	IsS11Max=Yes	IsS11Min=No	FrameElem=67	ElemStation=0			
Frame=67	Station=0.5	OutputCase=TERRVERT	CaseType=LinStatic	Point=4	X2=0.5	X3=0.5	
S11=866.543163214439	IsS11Max=No	IsS11Min=No	FrameElem=67	ElemStation=0			
Frame=67	Station=0.5	OutputCase=TERRVERT	CaseType=LinStatic	Point=0	X2=0	X3=0	S11=-491.24999552092
IsS11Max=No	IsS11Min=No	FrameElem=67	ElemStation=0.5				
Frame=67	Station=0.5	OutputCase=TERRVERT	CaseType=LinStatic	Point=1	X2=-0.5	X3=-0.5	S11=-
1852.50162826386	IsS11Max=No	IsS11Min=Yes	FrameElem=67	ElemStation=0.5			
Frame=67	Station=0.5	OutputCase=TERRVERT	CaseType=LinStatic	Point=2	X2=-0.5	X3=0.5	S11=-
1852.50162826386	IsS11Max=No	IsS11Min=No	FrameElem=67	ElemStation=0.5			
Frame=67	Station=0.5	OutputCase=TERRVERT	CaseType=LinStatic	Point=3	X2=0.5	X3=-0.5	
S11=870.001637222018	IsS11Max=Yes	IsS11Min=No	FrameElem=67	ElemStation=0.5			
Frame=67	Station=0.5	OutputCase=TERRVERT	CaseType=LinStatic	Point=4	X2=0.5	X3=0.5	
S11=870.001637222018	IsS11Max=No	IsS11Min=No	FrameElem=67	ElemStation=0.5			
Frame=67	Station=0	OutputCase=TERRLAT	CaseType=LinStatic	Point=0	X2=0	X3=0	S11=-5.09248593516531E-
07	IsS11Max=No	IsS11Min=No	FrameElem=67	ElemStation=0			
Frame=67	Station=0	OutputCase=TERRLAT	CaseType=LinStatic	Point=1	X2=-0.5	X3=-0.5	
S11=254.554293872672	IsS11Max=Yes	IsS11Min=No	FrameElem=67	ElemStation=0			
Frame=67	Station=0	OutputCase=TERRLAT	CaseType=LinStatic	Point=2	X2=-0.5	X3=0.5	
S11=254.554293872672	IsS11Max=No	IsS11Min=No	FrameElem=67	ElemStation=0			
Frame=67	Station=0	OutputCase=TERRLAT	CaseType=LinStatic	Point=3	X2=0.5	X3=-0.5	S11=-
254.554294891169	IsS11Max=No	IsS11Min=Yes	FrameElem=67	ElemStation=0			
Frame=67	Station=0	OutputCase=TERRLAT	CaseType=LinStatic	Point=4	X2=0.5	X3=0.5	S11=-
254.554294891169	IsS11Max=No	IsS11Min=No	FrameElem=67	ElemStation=0			
Frame=67	Station=0.5	OutputCase=TERRLAT	CaseType=LinStatic	Point=0	X2=0	X3=0	S11=-6.2344860201704E-
07	IsS11Max=No	IsS11Min=No	FrameElem=67	ElemStation=0.5			
Frame=67	Station=0.5	OutputCase=TERRLAT	CaseType=LinStatic	Point=1	X2=-0.5	X3=-0.5	
S11=166.381709774077	IsS11Max=Yes	IsS11Min=No	FrameElem=67	ElemStation=0.5			
Frame=67	Station=0.5	OutputCase=TERRLAT	CaseType=LinStatic	Point=2	X2=-0.5	X3=0.5	
S11=166.381709774077	IsS11Max=No	IsS11Min=No	FrameElem=67	ElemStation=0.5			
Frame=67	Station=0.5	OutputCase=TERRLAT	CaseType=LinStatic	Point=3	X2=0.5	X3=-0.5	S11=-
166.381711020975	IsS11Max=No	IsS11Min=Yes	FrameElem=67	ElemStation=0.5			
Frame=67	Station=0.5	OutputCase=TERRLAT	CaseType=LinStatic	Point=4	X2=0.5	X3=0.5	S11=-
166.381711020975	IsS11Max=No	IsS11Min=No	FrameElem=67	ElemStation=0.5			
Frame=67	Station=0	OutputCase=ACCLATDX	CaseType=LinStatic	Point=0	X2=0	X3=0	S11=0
IsS11Min=Yes	FrameElem=67	ElemStation=0					IsS11Max=Yes
Frame=67	Station=0	OutputCase=ACCLATDX	CaseType=LinStatic	Point=1	X2=-0.5	X3=-0.5	S11=0
IsS11Max=No	IsS11Min=No	FrameElem=67	ElemStation=0				
Frame=67	Station=0	OutputCase=ACCLATDX	CaseType=LinStatic	Point=2	X2=-0.5	X3=0.5	S11=0
IsS11Max=No	IsS11Min=No	FrameElem=67	ElemStation=0				

Frame=67	Station=0	OutputCase=ACCLATDX	CaseType=LinStatic	Point=3	X2=0.5	X3=-0.5	S11=0	
IsS11Max=No	IsS11Min=No	FrameElem=67	ElemStation=0					
Frame=67	Station=0	OutputCase=ACCLATDX	CaseType=LinStatic	Point=4	X2=0.5	X3=0.5	S11=0	IsS11Max=No
IsS11Min=No	FrameElem=67	ElemStation=0						
Frame=67	Station=0.5	OutputCase=ACCLATDX	CaseType=LinStatic	Point=0	X2=0	X3=0	S11=0	IsS11Max=Yes
IsS11Min=Yes	FrameElem=67	ElemStation=0.5						
Frame=67	Station=0.5	OutputCase=ACCLATDX	CaseType=LinStatic	Point=1	X2=-0.5	X3=-0.5	S11=0	
IsS11Max=No	IsS11Min=No	FrameElem=67	ElemStation=0.5					
Frame=67	Station=0.5	OutputCase=ACCLATDX	CaseType=LinStatic	Point=2	X2=-0.5	X3=0.5	S11=0	
IsS11Max=No	IsS11Min=No	FrameElem=67	ElemStation=0.5					
Frame=67	Station=0.5	OutputCase=ACCLATDX	CaseType=LinStatic	Point=3	X2=0.5	X3=-0.5	S11=0	
IsS11Max=No	IsS11Min=No	FrameElem=67	ElemStation=0.5					
Frame=67	Station=0.5	OutputCase=ACCLATDX	CaseType=LinStatic	Point=4	X2=0.5	X3=0.5	S11=0	
IsS11Max=No	IsS11Min=No	FrameElem=67	ElemStation=0.5					
Frame=67	Station=0	OutputCase=ACCLATSX	CaseType=LinStatic	Point=0	X2=0	X3=0	S11=0	IsS11Max=Yes
IsS11Min=Yes	FrameElem=67	ElemStation=0						
Frame=67	Station=0	OutputCase=ACCLATSX	CaseType=LinStatic	Point=1	X2=-0.5	X3=-0.5	S11=0	
IsS11Max=No	IsS11Min=No	FrameElem=67	ElemStation=0					
Frame=67	Station=0	OutputCase=ACCLATSX	CaseType=LinStatic	Point=2	X2=-0.5	X3=0.5	S11=0	
IsS11Max=No	IsS11Min=No	FrameElem=67	ElemStation=0					
Frame=67	Station=0	OutputCase=ACCLATSX	CaseType=LinStatic	Point=3	X2=0.5	X3=-0.5	S11=0	
IsS11Max=No	IsS11Min=No	FrameElem=67	ElemStation=0					
Frame=67	Station=0	OutputCase=ACCLATSX	CaseType=LinStatic	Point=4	X2=0.5	X3=0.5	S11=0	IsS11Max=No
IsS11Min=No	FrameElem=67	ElemStation=0						
Frame=67	Station=0.5	OutputCase=ACCLATSX	CaseType=LinStatic	Point=0	X2=0	X3=0	S11=0	IsS11Max=Yes
IsS11Min=Yes	FrameElem=67	ElemStation=0.5						
Frame=67	Station=0.5	OutputCase=ACCLATSX	CaseType=LinStatic	Point=1	X2=-0.5	X3=-0.5	S11=0	
IsS11Max=No	IsS11Min=No	FrameElem=67	ElemStation=0.5					
Frame=67	Station=0.5	OutputCase=ACCLATSX	CaseType=LinStatic	Point=2	X2=-0.5	X3=0.5	S11=0	
IsS11Max=No	IsS11Min=No	FrameElem=67	ElemStation=0.5					
Frame=67	Station=0.5	OutputCase=ACCLATSX	CaseType=LinStatic	Point=3	X2=0.5	X3=-0.5	S11=0	
IsS11Max=No	IsS11Min=No	FrameElem=67	ElemStation=0.5					
Frame=67	Station=0.5	OutputCase=ACCLATSX	CaseType=LinStatic	Point=4	X2=0.5	X3=0.5	S11=0	
IsS11Max=No	IsS11Min=No	FrameElem=67	ElemStation=0.5					
Frame=67	Station=0	OutputCase=TERRCOST	CaseType=LinStatic	Point=0	X2=0	X3=0	S11=0	IsS11Max=Yes
IsS11Min=Yes	FrameElem=67	ElemStation=0						
Frame=67	Station=0	OutputCase=TERRCOST	CaseType=LinStatic	Point=1	X2=-0.5	X3=-0.5	S11=0	
IsS11Max=No	IsS11Min=No	FrameElem=67	ElemStation=0					
Frame=67	Station=0	OutputCase=TERRCOST	CaseType=LinStatic	Point=2	X2=-0.5	X3=0.5	S11=0	
IsS11Max=No	IsS11Min=No	FrameElem=67	ElemStation=0					
Frame=67	Station=0	OutputCase=TERRCOST	CaseType=LinStatic	Point=3	X2=0.5	X3=-0.5	S11=0	
IsS11Max=No	IsS11Min=No	FrameElem=67	ElemStation=0					
Frame=67	Station=0	OutputCase=TERRCOST	CaseType=LinStatic	Point=4	X2=0.5	X3=0.5	S11=0	IsS11Max=No
IsS11Min=No	FrameElem=67	ElemStation=0						
Frame=67	Station=0.5	OutputCase=TERRCOST	CaseType=LinStatic	Point=0	X2=0	X3=0	S11=0	IsS11Max=Yes
IsS11Min=Yes	FrameElem=67	ElemStation=0.5						
Frame=67	Station=0.5	OutputCase=TERRCOST	CaseType=LinStatic	Point=1	X2=-0.5	X3=-0.5	S11=0	
IsS11Max=No	IsS11Min=No	FrameElem=67	ElemStation=0.5					
Frame=67	Station=0.5	OutputCase=TERRCOST	CaseType=LinStatic	Point=2	X2=-0.5	X3=0.5	S11=0	
IsS11Max=No	IsS11Min=No	FrameElem=67	ElemStation=0.5					
Frame=67	Station=0.5	OutputCase=TERRCOST	CaseType=LinStatic	Point=3	X2=0.5	X3=-0.5	S11=0	
IsS11Max=No	IsS11Min=No	FrameElem=67	ElemStation=0.5					
Frame=67	Station=0.5	OutputCase=TERRCOST	CaseType=LinStatic	Point=4	X2=0.5	X3=0.5	S11=0	
IsS11Max=No	IsS11Min=No	FrameElem=67	ElemStation=0.5					
Frame=67	Station=0	OutputCase=SOVRCOST	CaseType=LinStatic	Point=0	X2=0	X3=0	S11=0	IsS11Max=Yes
IsS11Min=Yes	FrameElem=67	ElemStation=0						
Frame=67	Station=0	OutputCase=SOVRCOST	CaseType=LinStatic	Point=1	X2=-0.5	X3=-0.5	S11=0	
IsS11Max=No	IsS11Min=No	FrameElem=67	ElemStation=0					
Frame=67	Station=0	OutputCase=SOVRCOST	CaseType=LinStatic	Point=2	X2=-0.5	X3=0.5	S11=0	
IsS11Max=No	IsS11Min=No	FrameElem=67	ElemStation=0					
Frame=67	Station=0	OutputCase=SOVRCOST	CaseType=LinStatic	Point=3	X2=0.5	X3=-0.5	S11=0	
IsS11Max=No	IsS11Min=No	FrameElem=67	ElemStation=0					
Frame=67	Station=0	OutputCase=SOVRCOST	CaseType=LinStatic	Point=4	X2=0.5	X3=0.5	S11=0	IsS11Max=No
IsS11Min=No	FrameElem=67	ElemStation=0						
Frame=67	Station=0.5	OutputCase=SOVRCOST	CaseType=LinStatic	Point=0	X2=0	X3=0	S11=0	IsS11Max=Yes
IsS11Min=Yes	FrameElem=67	ElemStation=0.5						
Frame=67	Station=0.5	OutputCase=SOVRCOST	CaseType=LinStatic	Point=1	X2=-0.5	X3=-0.5	S11=0	
IsS11Max=No	IsS11Min=No	FrameElem=67	ElemStation=0.5					
Frame=67	Station=0.5	OutputCase=SOVRCOST	CaseType=LinStatic	Point=2	X2=-0.5	X3=0.5	S11=0	
IsS11Max=No	IsS11Min=No	FrameElem=67	ElemStation=0.5					
Frame=67	Station=0.5	OutputCase=SOVRCOST	CaseType=LinStatic	Point=3	X2=0.5	X3=-0.5	S11=0	
IsS11Max=No	IsS11Min=No	FrameElem=67	ElemStation=0.5					
Frame=67	Station=0.5	OutputCase=SOVRCOST	CaseType=LinStatic	Point=4	X2=0.5	X3=0.5	S11=0	
IsS11Max=No	IsS11Min=No	FrameElem=67	ElemStation=0.5					
Frame=67	Station=0	OutputCase=ENVE	CaseType=Combination	StepType=Max	Point=0	X2=0	X3=0	S11=-
591.249994575376	IsS11Max=No	IsS11Min=No	FrameElem=67	ElemStation=0				
Frame=67	Station=0	OutputCase=ENVE	CaseType=Combination	StepType=Max	Point=1	X2=-0.5	X3=-0.5	
S11=-1957.45684389351	IsS11Max=No	IsS11Min=Yes	FrameElem=67	ElemStation=0				
Frame=67	Station=0	OutputCase=ENVE	CaseType=Combination	StepType=Max	Point=2	X2=-0.5	X3=0.5	S11=-
1957.45684389351	IsS11Max=No	IsS11Min=No	FrameElem=67	ElemStation=0				
Frame=67	Station=0	OutputCase=ENVE	CaseType=Combination	StepType=Max	Point=3	X2=0.5	X3=-0.5	
S11=851.323142904557	IsS11Max=Yes	IsS11Min=No	FrameElem=67	ElemStation=0				

Frame=67	Station=0	OutputCase=ENVE	CaseType=Combination	StepType=Max	Point=4	X2=0.5	X3=0.5		
S11=851.323142904557		IsS11Max=No	IsS11Min=No	FrameElem=67	ElemStation=0				
Frame=67	Station=0.5	OutputCase=ENVE	CaseType=Combination	StepType=Max	Point=0	X2=0	X3=0	S11=-	
578.749994655316		IsS11Max=No	IsS11Min=No	FrameElem=67	ElemStation=0.5				
Frame=67	Station=0.5	OutputCase=ENVE	CaseType=Combination	StepType=Max	Point=1	X2=-0.5	X3=-0.5		
S11=-1991.0750595558		IsS11Max=No	IsS11Min=Yes	FrameElem=67	ElemStation=0.5				
Frame=67	Station=0.5	OutputCase=ENVE	CaseType=Combination	StepType=Max	Point=2	X2=-0.5	X3=0.5		
S11=-1991.0750595558		IsS11Max=No	IsS11Min=No	FrameElem=67	ElemStation=0.5				
Frame=67	Station=0.5	OutputCase=ENVE	CaseType=Combination	StepType=Max	Point=3	X2=0.5	X3=-0.5		
S11=883.489583177389		IsS11Max=Yes	IsS11Min=No	FrameElem=67	ElemStation=0.5				
Frame=67	Station=0.5	OutputCase=ENVE	CaseType=Combination	StepType=Max	Point=4	X2=0.5	X3=0.5		
S11=883.489583177389		IsS11Max=No	IsS11Min=No	FrameElem=67	ElemStation=0.5				
Frame=67	Station=0	OutputCase=ENVE	CaseType=Combination	StepType=Min	Point=0	X2=0	X3=0	S11=-	
591.249994728151		IsS11Max=No	IsS11Min=No	FrameElem=67	ElemStation=0				
Frame=67	Station=0	OutputCase=ENVE	CaseType=Combination	StepType=Min	Point=1	X2=-0.5	X3=-0.5		
S11=-2033.82313205531		IsS11Max=No	IsS11Min=Yes	FrameElem=67	ElemStation=0				
Frame=67	Station=0	OutputCase=ENVE	CaseType=Combination	StepType=Min	Point=2	X2=-0.5	X3=0.5	S11=-	
2033.82313205531		IsS11Max=No	IsS11Min=No	FrameElem=67	ElemStation=0				
Frame=67	Station=0	OutputCase=ENVE	CaseType=Combination	StepType=Min	Point=3	X2=0.5	X3=-0.5		
S11=774.956854437206		IsS11Max=Yes	IsS11Min=No	FrameElem=67	ElemStation=0				
Frame=67	Station=0	OutputCase=ENVE	CaseType=Combination	StepType=Min	Point=4	X2=0.5	X3=0.5		
S11=774.956854437206		IsS11Max=No	IsS11Min=No	FrameElem=67	ElemStation=0				
Frame=67	Station=0.5	OutputCase=ENVE	CaseType=Combination	StepType=Min	Point=0	X2=0	X3=0	S11=-	
578.749994842351		IsS11Max=No	IsS11Min=No	FrameElem=67	ElemStation=0.5				
Frame=67	Station=0.5	OutputCase=ENVE	CaseType=Combination	StepType=Min	Point=1	X2=-0.5	X3=-0.5		
S11=-2040.98957248802		IsS11Max=No	IsS11Min=Yes	FrameElem=67	ElemStation=0.5				
Frame=67	Station=0.5	OutputCase=ENVE	CaseType=Combination	StepType=Min	Point=2	X2=-0.5	X3=0.5		
S11=-2040.98957248802		IsS11Max=No	IsS11Min=No	FrameElem=67	ElemStation=0.5				
Frame=67	Station=0.5	OutputCase=ENVE	CaseType=Combination	StepType=Min	Point=3	X2=0.5	X3=-0.5		
S11=833.575069871097		IsS11Max=Yes	IsS11Min=No	FrameElem=67	ElemStation=0.5				
Frame=67	Station=0.5	OutputCase=ENVE	CaseType=Combination	StepType=Min	Point=4	X2=0.5	X3=0.5		
S11=833.575069871097		IsS11Max=No	IsS11Min=No	FrameElem=67	ElemStation=0.5				
Frame=67	Station=0	OutputCase=FESSUR	CaseType=Combination	Point=0	X2=0	X3=0	S11=-591.249994728151		
IsS11Max=No	IsS11Min=No	FrameElem=67	ElemStation=0						
Frame=67	Station=0	OutputCase=FESSUR	CaseType=Combination	Point=1	X2=-0.5	X3=-0.5	S11=-		
1957.45684389351		IsS11Max=No	IsS11Min=Yes	FrameElem=67	ElemStation=0				
Frame=67	Station=0	OutputCase=FESSUR	CaseType=Combination	Point=2	X2=-0.5	X3=0.5	S11=-		
1957.45684389351		IsS11Max=No	IsS11Min=No	FrameElem=67	ElemStation=0				
Frame=67	Station=0	OutputCase=FESSUR	CaseType=Combination	Point=3	X2=0.5	X3=-0.5			
S11=774.956854437206		IsS11Max=Yes	IsS11Min=No	FrameElem=67	ElemStation=0				
Frame=67	Station=0	OutputCase=FESSUR	CaseType=Combination	Point=4	X2=0.5	X3=0.5			
S11=774.956854437206		IsS11Max=No	IsS11Min=No	FrameElem=67	ElemStation=0				
Frame=67	Station=0.5	OutputCase=FESSUR	CaseType=Combination	Point=0	X2=0	X3=0	S11=-578.749994842351		
IsS11Max=No	IsS11Min=No	FrameElem=67	ElemStation=0.5						
Frame=67	Station=0.5	OutputCase=FESSUR	CaseType=Combination	Point=1	X2=-0.5	X3=-0.5	S11=-		
1991.0750595558		IsS11Max=No	IsS11Min=Yes	FrameElem=67	ElemStation=0.5				
Frame=67	Station=0.5	OutputCase=FESSUR	CaseType=Combination	Point=2	X2=-0.5	X3=0.5	S11=-		
1991.0750595558		IsS11Max=No	IsS11Min=No	FrameElem=67	ElemStation=0.5				
Frame=67	Station=0.5	OutputCase=FESSUR	CaseType=Combination	Point=3	X2=0.5	X3=-0.5			
S11=833.575069871097		IsS11Max=Yes	IsS11Min=No	FrameElem=67	ElemStation=0.5				
Frame=67	Station=0.5	OutputCase=FESSUR	CaseType=Combination	Point=4	X2=0.5	X3=0.5			
S11=833.575069871097		IsS11Max=No	IsS11Min=No	FrameElem=67	ElemStation=0.5				
Frame=68	Station=0	OutputCase=PESOPR	CaseType=LinStatic	Point=0	X2=0	X3=0	S11=-87.4999986980984		
IsS11Max=No	IsS11Min=No	FrameElem=68	ElemStation=0						
Frame=68	Station=0	OutputCase=PESOPR	CaseType=LinStatic	Point=1	X2=-0.5	X3=-0.5	S11=-		
304.955141066138		IsS11Max=No	IsS11Min=Yes	FrameElem=68	ElemStation=0				
Frame=68	Station=0	OutputCase=PESOPR	CaseType=LinStatic	Point=2	X2=-0.5	X3=0.5	S11=-		
304.955141066138		IsS11Max=No	IsS11Min=No	FrameElem=68	ElemStation=0				
Frame=68	Station=0	OutputCase=PESOPR	CaseType=LinStatic	Point=3	X2=0.5	X3=-0.5	S11=129.955143669941		
IsS11Max=Yes	IsS11Min=No	FrameElem=68	ElemStation=0						
Frame=68	Station=0	OutputCase=PESOPR	CaseType=LinStatic	Point=4	X2=0.5	X3=0.5	S11=129.955143669941		
IsS11Max=No	IsS11Min=No	FrameElem=68	ElemStation=0						
Frame=68	Station=0.5	OutputCase=PESOPR	CaseType=LinStatic	Point=0	X2=0	X3=0	S11=-74.9999986980984		
IsS11Max=No	IsS11Min=No	FrameElem=68	ElemStation=0.5						
Frame=68	Station=0.5	OutputCase=PESOPR	CaseType=LinStatic	Point=1	X2=-0.5	X3=-0.5	S11=-		
246.942298920279		IsS11Max=No	IsS11Min=Yes	FrameElem=68	ElemStation=0.5				
Frame=68	Station=0.5	OutputCase=PESOPR	CaseType=LinStatic	Point=2	X2=-0.5	X3=0.5	S11=-		
246.942298920279		IsS11Max=No	IsS11Min=No	FrameElem=68	ElemStation=0.5				
Frame=68	Station=0.5	OutputCase=PESOPR	CaseType=LinStatic	Point=3	X2=0.5	X3=-0.5			
S11=96.9423015240825		IsS11Max=Yes	IsS11Min=No	FrameElem=68	ElemStation=0.5				
Frame=68	Station=0.5	OutputCase=PESOPR	CaseType=LinStatic	Point=4	X2=0.5	X3=0.5			
S11=96.9423015240825		IsS11Max=No	IsS11Min=No	FrameElem=68	ElemStation=0.5				
Frame=68	Station=0	OutputCase=TERRVERT	CaseType=LinStatic	Point=0	X2=0	X3=0	S11=-491.24999552092		
IsS11Max=No	IsS11Min=No	FrameElem=68	ElemStation=0						
Frame=68	Station=0	OutputCase=TERRVERT	CaseType=LinStatic	Point=1	X2=-0.5	X3=-0.5	S11=-		
1852.50162826387		IsS11Max=No	IsS11Min=Yes	FrameElem=68	ElemStation=0				
Frame=68	Station=0	OutputCase=TERRVERT	CaseType=LinStatic	Point=2	X2=-0.5	X3=0.5	S11=-		
1852.50162826387		IsS11Max=No	IsS11Min=No	FrameElem=68	ElemStation=0				
Frame=68	Station=0	OutputCase=TERRVERT	CaseType=LinStatic	Point=3	X2=0.5	X3=-0.5			
S11=870.001637222033		IsS11Max=Yes	IsS11Min=No	FrameElem=68	ElemStation=0				
Frame=68	Station=0	OutputCase=TERRVERT	CaseType=LinStatic	Point=4	X2=0.5	X3=0.5			
S11=870.001637222033		IsS11Max=No	IsS11Min=No	FrameElem=68	ElemStation=0				

Frame=68	Station=0.5	OutputCase=TERRVERT	CaseType=LinStatic	Point=0	X2=0	X3=0	S11=-491.24999552092		
IsS11Max=No	IsS11Min=No	FrameElem=68	ElemStation=0.5						
Frame=68	Station=0.5	OutputCase=TERRVERT	CaseType=LinStatic	Point=1	X2=-0.5	X3=-0.5	S11=-		
1855.96010227145	IsS11Max=No	IsS11Min=Yes	FrameElem=68	ElemStation=0.5					
Frame=68	Station=0.5	OutputCase=TERRVERT	CaseType=LinStatic	Point=2	X2=-0.5	X3=0.5	S11=-		
1855.96010227145	IsS11Max=No	IsS11Min=No	FrameElem=68	ElemStation=0.5					
Frame=68	Station=0.5	OutputCase=TERRVERT	CaseType=LinStatic	Point=3	X2=0.5	X3=-0.5			
S11=873.460111229608	IsS11Max=Yes	IsS11Min=No	FrameElem=68	ElemStation=0.5					
Frame=68	Station=0.5	OutputCase=TERRVERT	CaseType=LinStatic	Point=4	X2=0.5	X3=0.5			
S11=873.460111229608	IsS11Max=No	IsS11Min=No	FrameElem=68	ElemStation=0.5					
Frame=68	Station=0	OutputCase=TERRLAT	CaseType=LinStatic	Point=0	X2=0	X3=0	S11=-6.23448386249947E-		
07	IsS11Max=No	IsS11Min=No	FrameElem=68	ElemStation=0					
Frame=68	Station=0	OutputCase=TERRLAT	CaseType=LinStatic	Point=1	X2=-0.5	X3=-0.5			
S11=166.381709774077	IsS11Max=Yes	IsS11Min=No	FrameElem=68	ElemStation=0					
Frame=68	Station=0	OutputCase=TERRLAT	CaseType=LinStatic	Point=2	X2=-0.5	X3=0.5			
S11=166.381709774077	IsS11Max=No	IsS11Min=No	FrameElem=68	ElemStation=0					
Frame=68	Station=0	OutputCase=TERRLAT	CaseType=LinStatic	Point=3	X2=0.5	X3=-0.5	S11=-		
166.381711020973	IsS11Max=No	IsS11Min=Yes	FrameElem=68	ElemStation=0					
Frame=68	Station=0	OutputCase=TERRLAT	CaseType=LinStatic	Point=4	X2=0.5	X3=0.5	S11=-		
166.381711020973	IsS11Max=No	IsS11Min=No	FrameElem=68	ElemStation=0					
Frame=68	Station=0.5	OutputCase=TERRLAT	CaseType=LinStatic	Point=0	X2=0	X3=0	S11=-		
7.20705786251286E-07	IsS11Max=No	IsS11Min=No	FrameElem=68	ElemStation=0.5					
Frame=68	Station=0.5	OutputCase=TERRLAT	CaseType=LinStatic	Point=1	X2=-0.5	X3=-0.5			
S11=38.2978759211498	IsS11Max=Yes	IsS11Min=No	FrameElem=68	ElemStation=0.5					
Frame=68	Station=0.5	OutputCase=TERRLAT	CaseType=LinStatic	Point=2	X2=-0.5	X3=0.5			
S11=38.2978759211498	IsS11Max=No	IsS11Min=No	FrameElem=68	ElemStation=0.5					
Frame=68	Station=0.5	OutputCase=TERRLAT	CaseType=LinStatic	Point=3	X2=0.5	X3=-0.5	S11=-		
38.2978773625614	IsS11Max=No	IsS11Min=Yes	FrameElem=68	ElemStation=0.5					
Frame=68	Station=0.5	OutputCase=TERRLAT	CaseType=LinStatic	Point=4	X2=0.5	X3=0.5	S11=-		
38.2978773625614	IsS11Max=No	IsS11Min=No	FrameElem=68	ElemStation=0.5					
Frame=68	Station=0	OutputCase=ACCLATDX	CaseType=LinStatic	Point=0	X2=0	X3=0	S11=0	IsS11Max=Yes	
IsS11Min=Yes	FrameElem=68	ElemStation=0							
Frame=68	Station=0	OutputCase=ACCLATDX	CaseType=LinStatic	Point=1	X2=-0.5	X3=-0.5	S11=0		
IsS11Max=No	IsS11Min=No	FrameElem=68	ElemStation=0						
Frame=68	Station=0	OutputCase=ACCLATDX	CaseType=LinStatic	Point=2	X2=-0.5	X3=0.5	S11=0		
IsS11Max=No	IsS11Min=No	FrameElem=68	ElemStation=0						
Frame=68	Station=0	OutputCase=ACCLATDX	CaseType=LinStatic	Point=3	X2=0.5	X3=-0.5	S11=0		
IsS11Max=No	IsS11Min=No	FrameElem=68	ElemStation=0						
Frame=68	Station=0	OutputCase=ACCLATDX	CaseType=LinStatic	Point=4	X2=0.5	X3=0.5	S11=0	IsS11Max=No	
IsS11Min=No	FrameElem=68	ElemStation=0							
Frame=68	Station=0.5	OutputCase=ACCLATDX	CaseType=LinStatic	Point=0	X2=0	X3=0	S11=0	IsS11Max=Yes	
IsS11Min=Yes	FrameElem=68	ElemStation=0.5							
Frame=68	Station=0.5	OutputCase=ACCLATDX	CaseType=LinStatic	Point=1	X2=-0.5	X3=-0.5	S11=0		
IsS11Max=No	IsS11Min=No	FrameElem=68	ElemStation=0.5						
Frame=68	Station=0.5	OutputCase=ACCLATDX	CaseType=LinStatic	Point=2	X2=-0.5	X3=0.5	S11=0		
IsS11Max=No	IsS11Min=No	FrameElem=68	ElemStation=0.5						
Frame=68	Station=0.5	OutputCase=ACCLATDX	CaseType=LinStatic	Point=3	X2=0.5	X3=-0.5	S11=0		
IsS11Max=No	IsS11Min=No	FrameElem=68	ElemStation=0.5						
Frame=68	Station=0.5	OutputCase=ACCLATDX	CaseType=LinStatic	Point=4	X2=0.5	X3=0.5	S11=0		
IsS11Max=No	IsS11Min=No	FrameElem=68	ElemStation=0.5						
Frame=68	Station=0	OutputCase=ACCLATSX	CaseType=LinStatic	Point=0	X2=0	X3=0	S11=0	IsS11Max=Yes	
IsS11Min=Yes	FrameElem=68	ElemStation=0							
Frame=68	Station=0	OutputCase=ACCLATSX	CaseType=LinStatic	Point=1	X2=-0.5	X3=-0.5	S11=0		
IsS11Max=No	IsS11Min=No	FrameElem=68	ElemStation=0						
Frame=68	Station=0	OutputCase=ACCLATSX	CaseType=LinStatic	Point=2	X2=-0.5	X3=0.5	S11=0		
IsS11Max=No	IsS11Min=No	FrameElem=68	ElemStation=0						
Frame=68	Station=0	OutputCase=ACCLATSX	CaseType=LinStatic	Point=3	X2=0.5	X3=-0.5	S11=0		
IsS11Max=No	IsS11Min=No	FrameElem=68	ElemStation=0						
Frame=68	Station=0	OutputCase=ACCLATSX	CaseType=LinStatic	Point=4	X2=0.5	X3=0.5	S11=0	IsS11Max=No	
IsS11Min=No	FrameElem=68	ElemStation=0							
Frame=68	Station=0.5	OutputCase=ACCLATSX	CaseType=LinStatic	Point=0	X2=0	X3=0	S11=0	IsS11Max=Yes	
IsS11Min=Yes	FrameElem=68	ElemStation=0.5							
Frame=68	Station=0.5	OutputCase=ACCLATSX	CaseType=LinStatic	Point=1	X2=-0.5	X3=-0.5	S11=0		
IsS11Max=No	IsS11Min=No	FrameElem=68	ElemStation=0.5						
Frame=68	Station=0.5	OutputCase=ACCLATSX	CaseType=LinStatic	Point=2	X2=-0.5	X3=0.5	S11=0		
IsS11Max=No	IsS11Min=No	FrameElem=68	ElemStation=0.5						
Frame=68	Station=0.5	OutputCase=ACCLATSX	CaseType=LinStatic	Point=3	X2=0.5	X3=-0.5	S11=0		
IsS11Max=No	IsS11Min=No	FrameElem=68	ElemStation=0.5						
Frame=68	Station=0.5	OutputCase=ACCLATSX	CaseType=LinStatic	Point=4	X2=0.5	X3=0.5	S11=0		
IsS11Max=No	IsS11Min=No	FrameElem=68	ElemStation=0.5						
Frame=68	Station=0	OutputCase=TERRCOST	CaseType=LinStatic	Point=0	X2=0	X3=0	S11=0	IsS11Max=Yes	
IsS11Min=Yes	FrameElem=68	ElemStation=0							
Frame=68	Station=0	OutputCase=TERRCOST	CaseType=LinStatic	Point=1	X2=-0.5	X3=-0.5	S11=0		
IsS11Max=No	IsS11Min=No	FrameElem=68	ElemStation=0						
Frame=68	Station=0	OutputCase=TERRCOST	CaseType=LinStatic	Point=2	X2=-0.5	X3=0.5	S11=0		
IsS11Max=No	IsS11Min=No	FrameElem=68	ElemStation=0						
Frame=68	Station=0	OutputCase=TERRCOST	CaseType=LinStatic	Point=3	X2=0.5	X3=-0.5	S11=0		
IsS11Max=No	IsS11Min=No	FrameElem=68	ElemStation=0						
Frame=68	Station=0	OutputCase=TERRCOST	CaseType=LinStatic	Point=4	X2=0.5	X3=0.5	S11=0	IsS11Max=No	
IsS11Min=No	FrameElem=68	ElemStation=0							
Frame=68	Station=0.5	OutputCase=TERRCOST	CaseType=LinStatic	Point=0	X2=0	X3=0	S11=0	IsS11Max=Yes	
IsS11Min=Yes	FrameElem=68	ElemStation=0.5							

Frame=68	Station=0.5	OutputCase=TERRCOST	CaseType=LinStatic	Point=1	X2=-0.5	X3=-0.5	S11=0
IsS11Max=No	IsS11Min=No	FrameElem=68	ElemStation=0.5				
Frame=68	Station=0.5	OutputCase=TERRCOST	CaseType=LinStatic	Point=2	X2=-0.5	X3=0.5	S11=0
IsS11Max=No	IsS11Min=No	FrameElem=68	ElemStation=0.5				
Frame=68	Station=0.5	OutputCase=TERRCOST	CaseType=LinStatic	Point=3	X2=0.5	X3=-0.5	S11=0
IsS11Max=No	IsS11Min=No	FrameElem=68	ElemStation=0.5				
Frame=68	Station=0.5	OutputCase=TERRCOST	CaseType=LinStatic	Point=4	X2=0.5	X3=0.5	S11=0
IsS11Max=No	IsS11Min=No	FrameElem=68	ElemStation=0.5				
Frame=68	Station=0	OutputCase=SOVRCOST	CaseType=LinStatic	Point=0	X2=0	X3=0	S11=0
IsS11Min=Yes	FrameElem=68	ElemStation=0					IsS11Max=Yes
Frame=68	Station=0	OutputCase=SOVRCOST	CaseType=LinStatic	Point=1	X2=-0.5	X3=-0.5	S11=0
IsS11Max=No	IsS11Min=No	FrameElem=68	ElemStation=0				
Frame=68	Station=0	OutputCase=SOVRCOST	CaseType=LinStatic	Point=2	X2=-0.5	X3=0.5	S11=0
IsS11Max=No	IsS11Min=No	FrameElem=68	ElemStation=0				
Frame=68	Station=0	OutputCase=SOVRCOST	CaseType=LinStatic	Point=3	X2=0.5	X3=-0.5	S11=0
IsS11Max=No	IsS11Min=No	FrameElem=68	ElemStation=0				
Frame=68	Station=0	OutputCase=SOVRCOST	CaseType=LinStatic	Point=4	X2=0.5	X3=0.5	S11=0
IsS11Min=No	FrameElem=68	ElemStation=0					IsS11Max=No
Frame=68	Station=0.5	OutputCase=SOVRCOST	CaseType=LinStatic	Point=0	X2=0	X3=0	S11=0
IsS11Min=Yes	FrameElem=68	ElemStation=0.5					IsS11Max=Yes
Frame=68	Station=0.5	OutputCase=SOVRCOST	CaseType=LinStatic	Point=1	X2=-0.5	X3=-0.5	S11=0
IsS11Max=No	IsS11Min=No	FrameElem=68	ElemStation=0.5				
Frame=68	Station=0.5	OutputCase=SOVRCOST	CaseType=LinStatic	Point=2	X2=-0.5	X3=0.5	S11=0
IsS11Max=No	IsS11Min=No	FrameElem=68	ElemStation=0.5				
Frame=68	Station=0.5	OutputCase=SOVRCOST	CaseType=LinStatic	Point=3	X2=0.5	X3=-0.5	S11=0
IsS11Max=No	IsS11Min=No	FrameElem=68	ElemStation=0.5				
Frame=68	Station=0.5	OutputCase=SOVRCOST	CaseType=LinStatic	Point=4	X2=0.5	X3=0.5	S11=0
IsS11Max=No	IsS11Min=No	FrameElem=68	ElemStation=0.5				
Frame=68	Station=0	OutputCase=ENVE	CaseType=Combination	StepType=Max	Point=0	X2=0	X3=0
578.749994655433	IsS11Max=No	IsS11Min=No	FrameElem=68	ElemStation=0			S11=-
Frame=68	Station=0	OutputCase=ENVE	CaseType=Combination	StepType=Max	Point=1	X2=-0.5	X3=-0.5
S11=-1991.07505955593	IsS11Max=No	IsS11Min=Yes	FrameElem=68	ElemStation=0			
Frame=68	Station=0	OutputCase=ENVE	CaseType=Combination	StepType=Max	Point=2	X2=-0.5	X3=0.5
1991.07505955593	IsS11Max=No	IsS11Min=No	FrameElem=68	ElemStation=0			S11=-
Frame=68	Station=0	OutputCase=ENVE	CaseType=Combination	StepType=Max	Point=3	X2=0.5	X3=-0.5
S11=883.489583177292	IsS11Max=Yes	IsS11Min=No	FrameElem=68	ElemStation=0			
Frame=68	Station=0	OutputCase=ENVE	CaseType=Combination	StepType=Max	Point=4	X2=0.5	X3=0.5
S11=883.489583177292	IsS11Max=No	IsS11Min=No	FrameElem=68	ElemStation=0			
Frame=68	Station=0.5	OutputCase=ENVE	CaseType=Combination	StepType=Max	Point=0	X2=0	X3=0
566.249994723513	IsS11Max=No	IsS11Min=No	FrameElem=68	ElemStation=0.5			S11=-
Frame=68	Station=0.5	OutputCase=ENVE	CaseType=Combination	StepType=Max	Point=1	X2=-0.5	X3=-0.5
S11=-2064.60452527058	IsS11Max=No	IsS11Min=Yes	FrameElem=68	ElemStation=0.5			
Frame=68	Station=0.5	OutputCase=ENVE	CaseType=Combination	StepType=Max	Point=2	X2=-0.5	X3=0.5
S11=-2064.60452527058	IsS11Max=No	IsS11Min=No	FrameElem=68	ElemStation=0.5			
Frame=68	Station=0.5	OutputCase=ENVE	CaseType=Combination	StepType=Max	Point=3	X2=0.5	X3=-0.5
S11=943.593898599898	IsS11Max=Yes	IsS11Min=No	FrameElem=68	ElemStation=0.5			
Frame=68	Station=0.5	OutputCase=ENVE	CaseType=Combination	StepType=Max	Point=4	X2=0.5	X3=0.5
S11=943.593898599898	IsS11Max=No	IsS11Min=No	FrameElem=68	ElemStation=0.5			
Frame=68	Station=0	OutputCase=ENVE	CaseType=Combination	StepType=Min	Point=0	X2=0	X3=0
578.749994842467	IsS11Max=No	IsS11Min=No	FrameElem=68	ElemStation=0			S11=-
Frame=68	Station=0	OutputCase=ENVE	CaseType=Combination	StepType=Min	Point=1	X2=-0.5	X3=-0.5
S11=-2040.98957248816	IsS11Max=No	IsS11Min=Yes	FrameElem=68	ElemStation=0			
Frame=68	Station=0	OutputCase=ENVE	CaseType=Combination	StepType=Min	Point=2	X2=-0.5	X3=0.5
2040.98957248816	IsS11Max=No	IsS11Min=No	FrameElem=68	ElemStation=0			S11=-
Frame=68	Station=0	OutputCase=ENVE	CaseType=Combination	StepType=Min	Point=3	X2=0.5	X3=-0.5
S11=833.575069871	IsS11Max=Yes	IsS11Min=No	FrameElem=68	ElemStation=0			
Frame=68	Station=0.5	OutputCase=ENVE	CaseType=Combination	StepType=Min	Point=4	X2=0.5	X3=0.5
S11=833.575069871	IsS11Max=No	IsS11Min=No	FrameElem=68	ElemStation=0			
Frame=68	Station=0.5	OutputCase=ENVE	CaseType=Combination	StepType=Min	Point=0	X2=0	X3=0
566.249994939725	IsS11Max=No	IsS11Min=No	FrameElem=68	ElemStation=0.5			S11=-
Frame=68	Station=0.5	OutputCase=ENVE	CaseType=Combination	StepType=Min	Point=1	X2=-0.5	X3=-0.5
S11=-2076.09388804692	IsS11Max=No	IsS11Min=Yes	FrameElem=68	ElemStation=0.5			
Frame=68	Station=0.5	OutputCase=ENVE	CaseType=Combination	StepType=Min	Point=2	X2=-0.5	X3=0.5
S11=-2076.09388804692	IsS11Max=No	IsS11Min=No	FrameElem=68	ElemStation=0.5			
Frame=68	Station=0.5	OutputCase=ENVE	CaseType=Combination	StepType=Min	Point=3	X2=0.5	X3=-0.5
S11=932.104535391129	IsS11Max=Yes	IsS11Min=No	FrameElem=68	ElemStation=0.5			
Frame=68	Station=0.5	OutputCase=ENVE	CaseType=Combination	StepType=Min	Point=4	X2=0.5	X3=0.5
S11=932.104535391129	IsS11Max=No	IsS11Min=No	FrameElem=68	ElemStation=0.5			
Frame=68	Station=0	OutputCase=FESSUR	CaseType=Combination	Point=0	X2=0	X3=0	S11=-578.749994842467
IsS11Max=No	IsS11Min=No	FrameElem=68	ElemStation=0				
Frame=68	Station=0	OutputCase=FESSUR	CaseType=Combination	Point=1	X2=-0.5	X3=-0.5	S11=-
1991.07505955593	IsS11Max=No	IsS11Min=Yes	FrameElem=68	ElemStation=0			
Frame=68	Station=0	OutputCase=FESSUR	CaseType=Combination	Point=2	X2=-0.5	X3=0.5	S11=-
1991.07505955593	IsS11Max=No	IsS11Min=No	FrameElem=68	ElemStation=0			
Frame=68	Station=0	OutputCase=FESSUR	CaseType=Combination	Point=3	X2=0.5	X3=-0.5	S11=833.575069871
IsS11Max=Yes	IsS11Min=No	FrameElem=68	ElemStation=0				
Frame=68	Station=0	OutputCase=FESSUR	CaseType=Combination	Point=4	X2=0.5	X3=0.5	S11=833.575069871
IsS11Max=No	IsS11Min=No	FrameElem=68	ElemStation=0				
Frame=68	Station=0.5	OutputCase=FESSUR	CaseType=Combination	Point=0	X2=0	X3=0	S11=-566.249994939725
IsS11Max=No	IsS11Min=No	FrameElem=68	ElemStation=0.5				
Frame=68	Station=0.5	OutputCase=FESSUR	CaseType=Combination	Point=1	X2=-0.5	X3=-0.5	S11=-
2064.60452527058	IsS11Max=No	IsS11Min=Yes	FrameElem=68	ElemStation=0.5			



Frame=68 Station=0.5 OutputCase=FESSUR CaseType=Combination Point=2 X2=-0.5 X3=0.5 S11=-
2064.60452527058 Iss11Max=No Iss11Min=No FrameElem=68 ElemStation=0.5
Frame=68 Station=0.5 OutputCase=FESSUR CaseType=Combination Point=3 X2=0.5 X3=-0.5
S11=932.104535391129 Iss11Max=Yes Iss11Min=No FrameElem=68 ElemStation=0.5
Frame=68 Station=0.5 OutputCase=FESSUR CaseType=Combination Point=4 X2=0.5 X3=0.5
S11=932.104535391129 Iss11Max=No Iss11Min=No FrameElem=68 ElemStation=0.5

TABLE: "ELEMENT JOINT FORCES - FRAMES"

Frame=1	Joint=1	OutputCase=PESOPR	CaseType=LinStatic	F1=15.1709467362365	F2=0	F3=-151.042541323728
M1=0	M2=81.7553624407812	M3=0	FrameElem=1			
Frame=1	Joint=30	OutputCase=PESOPR	CaseType=LinStatic	F1=-15.1709467362365	F2=0	F3=157.292540727682
M1=0	M2=-43.2134808599994	M3=0	FrameElem=1			
Frame=1	Joint=1	OutputCase=TERRVERT	CaseType=LinStatic	F1=-1.15282857329472	F2=0	F3=-466.004534616118
M1=0	M2=223.416783464088	M3=0	FrameElem=1			
Frame=1	Joint=30	OutputCase=TERRVERT	CaseType=LinStatic	F1=1.15282857329472	F2=0	F3=466.004534616118
M1=0	M2=-106.915660920466	M3=0	FrameElem=1			
Frame=1	Joint=1	OutputCase=TERRLAT	CaseType=LinStatic	F1=108.958200979145	F2=0	F3=-4.68219968625903E-
02	M1=0	M2=21.1830694275959	M3=0	FrameElem=1		
Frame=1	Joint=30	OutputCase=TERRLAT	CaseType=LinStatic	F1=-108.958200979145	F2=0	
F3=4.68219968625903E-02	M1=0	M2=-21.1713639294965	M3=0	FrameElem=1		
Frame=1	Joint=1	OutputCase=ACCLATDX	CaseType=LinStatic	F1=0	F2=0	F3=0
M1=0	M2=0	M3=0	FrameElem=1			
Frame=1	Joint=30	OutputCase=ACCLATDX	CaseType=LinStatic	F1=0	F2=0	F3=0
M1=0	M2=0	M3=0	FrameElem=1			
Frame=1	Joint=1	OutputCase=ACCLATXSX	CaseType=LinStatic	F1=0	F2=0	F3=0
M1=0	M2=0	M3=0	FrameElem=1			
Frame=1	Joint=30	OutputCase=ACCLATXSX	CaseType=LinStatic	F1=0	F2=0	F3=0
M1=0	M2=0	M3=0	FrameElem=1			
Frame=1	Joint=1	OutputCase=TERRCOST	CaseType=LinStatic	F1=0	F2=0	F3=0
M1=0	M2=0	M3=0	FrameElem=1			
Frame=1	Joint=30	OutputCase=TERRCOST	CaseType=LinStatic	F1=0	F2=0	F3=0
M1=0	M2=0	M3=0	FrameElem=1			
Frame=1	Joint=1	OutputCase=SOVRCOST	CaseType=LinStatic	F1=0	F2=0	F3=0
M1=0	M2=0	M3=0	FrameElem=1			
Frame=1	Joint=30	OutputCase=SOVRCOST	CaseType=LinStatic	F1=0	F2=0	F3=0
M1=0	M2=0	M3=0	FrameElem=1			
Frame=1	Joint=1	OutputCase=ENVE	CaseType=Combination	StepType=Max	F1=122.976319142087	F2=0
F3=-	617.07985133765	M1=0	M2=326.355215332465	M3=0	FrameElem=1	
Frame=1	Joint=30	OutputCase=ENVE	CaseType=Combination	StepType=Max	F1=-90.2888588483431	F2=0
F3=623.343897340662	M1=0	M2=-164.949096531113	M3=0	FrameElem=1		
Frame=1	Joint=1	OutputCase=ENVE	CaseType=Combination	StepType=Min	F1=90.2888588483431	F2=0
F3=-	617.093897936708	M1=0	M2=320.000294504187	M3=0	FrameElem=1	
Frame=1	Joint=30	OutputCase=ENVE	CaseType=Combination	StepType=Min	F1=-122.976319142087	F2=0
F3=623.329850741603	M1=0	M2=-171.300505709962	M3=0	FrameElem=1		
Frame=1	Joint=1	OutputCase=FESSUR	CaseType=Combination	F1=122.976319142087	F2=0	F3=-617.093897936708
M1=0	M2=326.355215332465	M3=0	FrameElem=1			
Frame=1	Joint=30	OutputCase=FESSUR	CaseType=Combination	F1=-122.976319142087	F2=0	F3=623.343897340662
M1=0	M2=-171.300505709962	M3=0	FrameElem=1			
Frame=2	Joint=30	OutputCase=PESOPR	CaseType=LinStatic	F1=15.1709467362365	F2=0	F3=-134.470776144874
M1=0	M2=43.213480860004	M3=0	FrameElem=2			
Frame=2	Joint=31	OutputCase=PESOPR	CaseType=LinStatic	F1=-15.1709467362365	F2=0	F3=140.720776144874
M1=0	M2=-8.81453682378189	M3=0	FrameElem=2			
Frame=2	Joint=30	OutputCase=TERRVERT	CaseType=LinStatic	F1=-1.15282857329472	F2=0	F3=-
415.827221488356	M1=0	M2=106.915660920499	M3=0	FrameElem=2		
Frame=2	Joint=31	OutputCase=TERRVERT	CaseType=LinStatic	F1=1.15282857329472	F2=0	F3=415.827221488356
M1=0	M2=-2.95885554841743	M3=0	FrameElem=2			
Frame=2	Joint=30	OutputCase=TERRLAT	CaseType=LinStatic	F1=108.958200979145	F2=0	F3=-0.113482419150031
M1=0	M2=21.1713639294965	M3=0	FrameElem=2			
Frame=2	Joint=31	OutputCase=TERRLAT	CaseType=LinStatic	F1=-108.958200979145	F2=0	F3=0.113482419150031
M1=0	M2=-21.142993324709	M3=0	FrameElem=2			
Frame=2	Joint=30	OutputCase=ACCLATDX	CaseType=LinStatic	F1=0	F2=0	F3=0
M1=0	M2=0	M3=0	FrameElem=2			
Frame=2	Joint=31	OutputCase=ACCLATDX	CaseType=LinStatic	F1=0	F2=0	F3=0
M1=0	M2=0	M3=0	FrameElem=2			
Frame=2	Joint=30	OutputCase=ACCLATXSX	CaseType=LinStatic	F1=0	F2=0	F3=0
M1=0	M2=0	M3=0	FrameElem=2			
Frame=2	Joint=31	OutputCase=ACCLATXSX	CaseType=LinStatic	F1=0	F2=0	F3=0
M1=0	M2=0	M3=0	FrameElem=2			
Frame=2	Joint=30	OutputCase=TERRCOST	CaseType=LinStatic	F1=0	F2=0	F3=0
M1=0	M2=0	M3=0	FrameElem=2			
Frame=2	Joint=31	OutputCase=TERRCOST	CaseType=LinStatic	F1=0	F2=0	F3=0
M1=0	M2=0	M3=0	FrameElem=2			
Frame=2	Joint=30	OutputCase=SOVRCOST	CaseType=LinStatic	F1=0	F2=0	F3=0
M1=0	M2=0	M3=0	FrameElem=2			
Frame=2	Joint=31	OutputCase=SOVRCOST	CaseType=LinStatic	F1=0	F2=0	F3=0
M1=0	M2=0	M3=0	FrameElem=2			
Frame=2	Joint=30	OutputCase=ENVE	CaseType=Combination	StepType=Max	F1=122.976319142087	F2=0
F3=-	550.377435326636	M1=0	M2=171.30050571	M3=0	FrameElem=2	
Frame=2	Joint=31	OutputCase=ENVE	CaseType=Combination	StepType=Max	F1=-90.2888588483431	F2=0
F3=556.661480052381	M1=0	M2=-26.5734876994956	M3=0	FrameElem=2		
Frame=2	Joint=30	OutputCase=ENVE	CaseType=Combination	StepType=Min	F1=90.2888588483431	F2=0
F3=-	550.411480052381	M1=0	M2=164.949096531151	M3=0	FrameElem=2	



Frame=2 Joint=31 OutputCase=ENVE CaseType=Combination StepType=Min F1=-122.976319142087 F2=0
 F3=556.627435326636 M1=0 M2=-32.9163856969083 M3=0 FrameElem=2
 Frame=2 Joint=30 OutputCase=FESSUR CaseType=Combination F1=122.976319142087 F2=0 F3=-550.411480052381
 M1=0 M2=171.30050571 M3=0 FrameElem=2
 Frame=2 Joint=31 OutputCase=FESSUR CaseType=Combination F1=-122.976319142087 F2=0 F3=556.661480052381
 M1=0 M2=-32.9163856969083 M3=0 FrameElem=2
 Frame=4 Joint=32 OutputCase=PESOPR CaseType=LinStatic F1=15.1709467362366 F2=0 F3=140.720775817348
 M1=0 M2=8.8145370826633 M3=0 FrameElem=4
 Frame=4 Joint=33 OutputCase=PESOPR CaseType=LinStatic F1=-15.1709467362366 F2=0 F3=-134.470775817348
 M1=0 M2=-43.2134810370003 M3=0 FrameElem=4
 Frame=4 Joint=32 OutputCase=TERRVERT CaseType=LinStatic F1=-1.15282857329472 F2=0 F3=415.827221883397
 M1=0 M2=2.95885633877015 M3=0 FrameElem=4
 Frame=4 Joint=33 OutputCase=TERRVERT CaseType=LinStatic F1=1.15282857329472 F2=0 F3=-415.827221883397
 M1=0 M2=-106.915661809612 M3=0 FrameElem=4
 Frame=4 Joint=32 OutputCase=TERRLAT CaseType=LinStatic F1=108.958200979145 F2=0 F3=0.113482590049472
 M1=0 M2=21.1429918317019 M3=0 FrameElem=4
 Frame=4 Joint=33 OutputCase=TERRLAT CaseType=LinStatic F1=-108.958200979145 F2=0 F3=-
 0.113482590049472 M1=0 M2=-21.1713624792143 M3=0 FrameElem=4
 Frame=4 Joint=32 OutputCase=ACCLATDX CaseType=LinStatic F1=0 F2=0 F3=0 M1=0 M2=0 M3=0
 FrameElem=4
 Frame=4 Joint=33 OutputCase=ACCLATDX CaseType=LinStatic F1=0 F2=0 F3=0 M1=0 M2=0 M3=0
 FrameElem=4
 Frame=4 Joint=32 OutputCase=ACCLATSX CaseType=LinStatic F1=0 F2=0 F3=0 M1=0 M2=0 M3=0
 FrameElem=4
 Frame=4 Joint=33 OutputCase=ACCLATSX CaseType=LinStatic F1=0 F2=0 F3=0 M1=0 M2=0 M3=0
 FrameElem=4
 Frame=4 Joint=32 OutputCase=TERRCOST CaseType=LinStatic F1=0 F2=0 F3=0 M1=0 M2=0 M3=0
 FrameElem=4
 Frame=4 Joint=33 OutputCase=TERRCOST CaseType=LinStatic F1=0 F2=0 F3=0 M1=0 M2=0 M3=0
 FrameElem=4
 Frame=4 Joint=32 OutputCase=SOVRCOST CaseType=LinStatic F1=0 F2=0 F3=0 M1=0 M2=0 M3=0
 FrameElem=4
 Frame=4 Joint=33 OutputCase=SOVRCOST CaseType=LinStatic F1=0 F2=0 F3=0 M1=0 M2=0 M3=0
 FrameElem=4
 Frame=4 Joint=32 OutputCase=ENVE CaseType=Combination StepType=Max F1=122.976319142087 F2=0
 F3=556.661480290795 M1=0 M2=32.9163852531353 M3=0 FrameElem=4
 Frame=4 Joint=33 OutputCase=ENVE CaseType=Combination StepType=Max F1=-90.2888588483434 F2=0 F3=-
 550.37743551378 M1=0 M2=-164.949096582062 M3=0 FrameElem=4
 Frame=4 Joint=32 OutputCase=ENVE CaseType=Combination StepType=Min F1=90.2888588483434 F2=0
 F3=556.62743551378 M1=0 M2=26.5734877036248 M3=0 FrameElem=4
 Frame=4 Joint=33 OutputCase=ENVE CaseType=Combination StepType=Min F1=-122.976319142087 F2=0 F3=-
 550.411480290795 M1=0 M2=-171.300505325827 M3=0 FrameElem=4
 Frame=4 Joint=32 OutputCase=FESSUR CaseType=Combination F1=122.976319142087 F2=0 F3=556.661480290795
 M1=0 M2=32.9163852531353 M3=0 FrameElem=4
 Frame=4 Joint=33 OutputCase=FESSUR CaseType=Combination F1=-122.976319142087 F2=0 F3=-
 550.411480290795 M1=0 M2=-171.300505325827 M3=0 FrameElem=4
 Frame=5 Joint=33 OutputCase=PESOPR CaseType=LinStatic F1=15.1709467362359 F2=0 F3=157.292540241552
 M1=0 M2=43.2134810370129 M3=0 FrameElem=5
 Frame=5 Joint=15 OutputCase=PESOPR CaseType=LinStatic F1=-15.1709467362359 F2=0 F3=-151.042540837599
 M1=0 M2=-81.7553624962623 M3=0 FrameElem=5
 Frame=5 Joint=33 OutputCase=TERRVERT CaseType=LinStatic F1=-1.15282857329198 F2=0 F3=466.004535010658
 M1=0 M2=106.915661809617 M3=0 FrameElem=5
 Frame=5 Joint=15 OutputCase=TERRVERT CaseType=LinStatic F1=1.15282857329198 F2=0 F3=-466.004535010658
 M1=0 M2=-223.416784451866 M3=0 FrameElem=5
 Frame=5 Joint=33 OutputCase=TERRLAT CaseType=LinStatic F1=108.958200979145 F2=0 F3=4.68224872419256E-
 02 M1=0 M2=21.1713624792141 M3=0 FrameElem=5
 Frame=5 Joint=15 OutputCase=TERRLAT CaseType=LinStatic F1=-108.958200979145 F2=0 F3=-
 4.68224872419256E-02 M1=0 M2=-21.1830680999084 M3=0 FrameElem=5
 Frame=5 Joint=33 OutputCase=ACCLATDX CaseType=LinStatic F1=0 F2=0 F3=0 M1=0 M2=0 M3=0
 FrameElem=5
 Frame=5 Joint=15 OutputCase=ACCLATDX CaseType=LinStatic F1=0 F2=0 F3=0 M1=0 M2=0 M3=0
 FrameElem=5
 Frame=5 Joint=33 OutputCase=ACCLATSX CaseType=LinStatic F1=0 F2=0 F3=0 M1=0 M2=0 M3=0
 FrameElem=5
 Frame=5 Joint=15 OutputCase=ACCLATSX CaseType=LinStatic F1=0 F2=0 F3=0 M1=0 M2=0 M3=0
 FrameElem=5
 Frame=5 Joint=33 OutputCase=TERRCOST CaseType=LinStatic F1=0 F2=0 F3=0 M1=0 M2=0 M3=0
 FrameElem=5
 Frame=5 Joint=15 OutputCase=TERRCOST CaseType=LinStatic F1=0 F2=0 F3=0 M1=0 M2=0 M3=0
 FrameElem=5
 Frame=5 Joint=33 OutputCase=SOVRCOST CaseType=LinStatic F1=0 F2=0 F3=0 M1=0 M2=0 M3=0
 FrameElem=5
 Frame=5 Joint=15 OutputCase=SOVRCOST CaseType=LinStatic F1=0 F2=0 F3=0 M1=0 M2=0 M3=0
 FrameElem=5
 Frame=5 Joint=33 OutputCase=ENVE CaseType=Combination StepType=Max F1=122.976319142089 F2=0
 F3=623.343897739452 M1=0 M2=171.300505325844 M3=0 FrameElem=5
 Frame=5 Joint=15 OutputCase=ENVE CaseType=Combination StepType=Max F1=-90.2888588483455 F2=0 F3=-
 617.079851589326 M1=0 M2=-320.000294618064 M3=0 FrameElem=5
 Frame=5 Joint=33 OutputCase=ENVE CaseType=Combination StepType=Min F1=90.2888588483455 F2=0
 F3=623.329850993279 M1=0 M2=164.94909658208 M3=0 FrameElem=5
 Frame=5 Joint=15 OutputCase=ENVE CaseType=Combination StepType=Min F1=-122.976319142089 F2=0 F3=-
 617.093898335498 M1=0 M2=-326.355215048036 M3=0 FrameElem=5



Frame=5 Joint=33 OutputCase=FESSUR CaseType=Combination F1=122.976319142089 F2=0 F3=623.343897739452
 M1=0 M2=171.300505325844 M3=0 FrameElem=5
 Frame=5 Joint=15 OutputCase=FESSUR CaseType=Combination F1=-122.976319142089 F2=0 F3=-
 617.093898335498 M1=0 M2=-326.355215048036 M3=0 FrameElem=5
 Frame=6 Joint=15 OutputCase=PESOPR CaseType=LinStatic F1=15.1709467362358 F2=0 F3=162.499998818835
 M1=0 M2=81.7553624962646 M3=0 FrameElem=6
 Frame=6 Joint=28 OutputCase=PESOPR CaseType=LinStatic F1=-15.1709467362358 F2=0 F3=-156.249998818835
 M1=0 M2=-77.9626296120018 M3=0 FrameElem=6
 Frame=6 Joint=15 OutputCase=TERRVERT CaseType=LinStatic F1=-1.15282857329203 F2=0 F3=491.24999551253
 M1=0 M2=223.416784451878 M3=0 FrameElem=6
 Frame=6 Joint=28 OutputCase=TERRVERT CaseType=LinStatic F1=1.15282857329203 F2=0 F3=-491.24999551253
 M1=0 M2=-223.705003307514 M3=0 FrameElem=6
 Frame=6 Joint=15 OutputCase=TERRLAT CaseType=LinStatic F1=81.7982009791457 F2=0 F3=3.34181554512181E-
 07 M1=0 M2=21.1830680999083 M3=0 FrameElem=6
 Frame=6 Joint=28 OutputCase=TERRLAT CaseType=LinStatic F1=-69.017185355734 F2=0 F3=-
 3.34181554512181E-07 M1=0 M2=-2.34224832373959 M3=0 FrameElem=6
 Frame=6 Joint=15 OutputCase=ACCLATDX CaseType=LinStatic F1=0 F2=0 F3=0 M1=0 M2=0 M3=0
 FrameElem=6
 Frame=6 Joint=28 OutputCase=ACCLATDX CaseType=LinStatic F1=0 F2=0 F3=0 M1=0 M2=0 M3=0
 FrameElem=6
 Frame=6 Joint=15 OutputCase=ACCLATSX CaseType=LinStatic F1=0 F2=0 F3=0 M1=0 M2=0 M3=0
 FrameElem=6
 Frame=6 Joint=28 OutputCase=ACCLATSX CaseType=LinStatic F1=0 F2=0 F3=0 M1=0 M2=0 M3=0
 FrameElem=6
 Frame=6 Joint=15 OutputCase=TERRCOST CaseType=LinStatic F1=0 F2=0 F3=0 M1=0 M2=0 M3=0
 FrameElem=6
 Frame=6 Joint=28 OutputCase=TERRCOST CaseType=LinStatic F1=0 F2=0 F3=0 M1=0 M2=0 M3=0
 FrameElem=6
 Frame=6 Joint=15 OutputCase=SOVRCOST CaseType=LinStatic F1=0 F2=0 F3=0 M1=0 M2=0 M3=0
 FrameElem=6
 Frame=6 Joint=28 OutputCase=SOVRCOST CaseType=LinStatic F1=0 F2=0 F3=0 M1=0 M2=0 M3=0
 FrameElem=6
 Frame=6 Joint=15 OutputCase=ENVE CaseType=Combination StepType=Max F1=95.8163191420894 F2=0
 F3=653.749994665546 M1=0 M2=326.355215048051 M3=0 FrameElem=6
 Frame=6 Joint=28 OutputCase=ENVE CaseType=Combination StepType=Max F1=-62.3301479119575 F2=0 F3=-
 647.499994565292 M1=0 M2=-303.307206746133 M3=0 FrameElem=6
 Frame=6 Joint=15 OutputCase=ENVE CaseType=Combination StepType=Min F1=71.2768588483457 F2=0
 F3=653.749994565292 M1=0 M2=320.000294618078 M3=0 FrameElem=6
 Frame=6 Joint=28 OutputCase=ENVE CaseType=Combination StepType=Min F1=-83.0353035186777 F2=0 F3=-
 647.499994665546 M1=0 M2=-304.009881243255 M3=0 FrameElem=6
 Frame=6 Joint=15 OutputCase=FESSUR CaseType=Combination F1=95.8163191420894 F2=0 F3=653.749994665546
 M1=0 M2=326.355215048051 M3=0 FrameElem=6
 Frame=6 Joint=28 OutputCase=FESSUR CaseType=Combination F1=-83.0353035186777 F2=0 F3=-
 647.499994665546 M1=0 M2=-304.009881243255 M3=0 FrameElem=6
 Frame=7 Joint=28 OutputCase=PESOPR CaseType=LinStatic F1=15.170946736235 F2=0 F3=156.249998818792
 M1=0 M2=77.9626296120061 M3=0 FrameElem=7
 Frame=7 Joint=29 OutputCase=PESOPR CaseType=LinStatic F1=-15.170946736235 F2=0 F3=-149.999998818792
 M1=0 M2=-74.1698929279474 M3=0 FrameElem=7
 Frame=7 Joint=28 OutputCase=TERRVERT CaseType=LinStatic F1=-1.15282857329589 F2=0 F3=491.249995512189
 M1=0 M2=223.705003307517 M3=0 FrameElem=7
 Frame=7 Joint=29 OutputCase=TERRVERT CaseType=LinStatic F1=1.15282857329589 F2=0 F3=-491.249995512189
 M1=0 M2=-223.993210450841 M3=0 FrameElem=7
 Frame=7 Joint=28 OutputCase=TERRLAT CaseType=LinStatic F1=69.0171853557339 F2=0 F3=3.34182004735339E-
 07 M1=0 M2=2.34224832373957 M3=0 FrameElem=7
 Frame=7 Joint=29 OutputCase=TERRLAT CaseType=LinStatic F1=-56.769138485499 F2=0 F3=-
 3.34182004735339E-07 M1=0 M2=13.3699386407233 M3=0 FrameElem=7
 Frame=7 Joint=28 OutputCase=ACCLATDX CaseType=LinStatic F1=0 F2=0 F3=0 M1=0 M2=0 M3=0
 FrameElem=7
 Frame=7 Joint=29 OutputCase=ACCLATDX CaseType=LinStatic F1=0 F2=0 F3=0 M1=0 M2=0 M3=0
 FrameElem=7
 Frame=7 Joint=28 OutputCase=ACCLATSX CaseType=LinStatic F1=0 F2=0 F3=0 M1=0 M2=0 M3=0
 FrameElem=7
 Frame=7 Joint=29 OutputCase=ACCLATSX CaseType=LinStatic F1=0 F2=0 F3=0 M1=0 M2=0 M3=0
 FrameElem=7
 Frame=7 Joint=28 OutputCase=TERRCOST CaseType=LinStatic F1=0 F2=0 F3=0 M1=0 M2=0 M3=0
 FrameElem=7
 Frame=7 Joint=29 OutputCase=TERRCOST CaseType=LinStatic F1=0 F2=0 F3=0 M1=0 M2=0 M3=0
 FrameElem=7
 Frame=7 Joint=28 OutputCase=SOVRCOST CaseType=LinStatic F1=0 F2=0 F3=0 M1=0 M2=0 M3=0
 FrameElem=7
 Frame=7 Joint=29 OutputCase=SOVRCOST CaseType=LinStatic F1=0 F2=0 F3=0 M1=0 M2=0 M3=0
 FrameElem=7
 Frame=7 Joint=28 OutputCase=ENVE CaseType=Combination StepType=Max F1=83.0353035186731 F2=0
 F3=647.499994665163 M1=0 M2=304.009881243263 M3=0 FrameElem=7
 Frame=7 Joint=29 OutputCase=ENVE CaseType=Combination StepType=Max F1=-53.7565151027885 F2=0 F3=-
 641.249994564909 M1=0 M2=-284.793164738065 M3=0 FrameElem=7
 Frame=7 Joint=28 OutputCase=ENVE CaseType=Combination StepType=Min F1=62.3301479119529 F2=0
 F3=647.499994564909 M1=0 M2=303.307206746141 M3=0 FrameElem=7
 Frame=7 Joint=29 OutputCase=ENVE CaseType=Combination StepType=Min F1=-70.7872566484382 F2=0 F3=-
 641.249994665163 M1=0 M2=-288.804146330282 M3=0 FrameElem=7
 Frame=7 Joint=28 OutputCase=FESSUR CaseType=Combination F1=83.0353035186731 F2=0 F3=647.499994665163
 M1=0 M2=304.009881243263 M3=0 FrameElem=7



Frame=7 Joint=29 OutputCase=FESSUR CaseType=Combination F1=-70.7872566484382 F2=0 F3=-
 641.249994665163 M1=0 M2=-284.793164738065 M3=0 FrameElem=7
 Frame=9 Joint=35 OutputCase=PESOPR CaseType=LinStatic F1=15.1709467362358 F2=0 F3=74.9999988185143
 M1=0 M2=28.65705003703 M3=0 FrameElem=9
 Frame=9 Joint=23 OutputCase=PESOPR CaseType=LinStatic F1=-15.1709467362358 F2=0 F3=-68.7499988185143
 M1=0 M2=-24.8643150666045 M3=0 FrameElem=9
 Frame=9 Joint=35 OutputCase=TERRVERT CaseType=LinStatic F1=-1.15282857329623 F2=0 F3=491.249995511518
 M1=0 M2=227.451684458421 M3=0 FrameElem=9
 Frame=9 Joint=23 OutputCase=TERRVERT CaseType=LinStatic F1=1.15282857329623 F2=0 F3=-491.249995511518
 M1=0 M2=-227.739903314058 M3=0 FrameElem=9
 Frame=9 Joint=35 OutputCase=TERRLAT CaseType=LinStatic F1=-48.6358612095335 F2=0
 F3=3.34182547142411E-07 M1=0 M2=-6.3829794403092 M3=0 FrameElem=9
 Frame=9 Joint=23 OutputCase=TERRLAT CaseType=LinStatic F1=53.9553142884708 F2=0 F3=-
 3.34182547142411E-07 M1=0 M2=-6.45202101263255 M3=0 FrameElem=9
 Frame=9 Joint=35 OutputCase=ACCLATDX CaseType=LinStatic F1=0 F2=0 F3=0 M1=0 M2=0 M3=0
 FrameElem=9
 Frame=9 Joint=23 OutputCase=ACCLATDX CaseType=LinStatic F1=0 F2=0 F3=0 M1=0 M2=0 M3=0
 FrameElem=9
 Frame=9 Joint=35 OutputCase=ACCLATSX CaseType=LinStatic F1=0 F2=0 F3=0 M1=0 M2=0 M3=0
 FrameElem=9
 Frame=9 Joint=23 OutputCase=ACCLATSX CaseType=LinStatic F1=0 F2=0 F3=0 M1=0 M2=0 M3=0
 FrameElem=9
 Frame=9 Joint=35 OutputCase=TERRCOST CaseType=LinStatic F1=0 F2=0 F3=0 M1=0 M2=0 M3=0
 FrameElem=9
 Frame=9 Joint=23 OutputCase=TERRCOST CaseType=LinStatic F1=0 F2=0 F3=0 M1=0 M2=0 M3=0
 FrameElem=9
 Frame=9 Joint=35 OutputCase=SOVRCOST CaseType=LinStatic F1=0 F2=0 F3=0 M1=0 M2=0 M3=0
 FrameElem=9
 Frame=9 Joint=23 OutputCase=SOVRCOST CaseType=LinStatic F1=0 F2=0 F3=0 M1=0 M2=0 M3=0
 FrameElem=9
 Frame=9 Joint=35 OutputCase=ENVE CaseType=Combination StepType=Max F1=-20.0269846837339 F2=0
 F3=566.249994664215 M1=0 M2=251.640648887235 M3=0 FrameElem=9
 Frame=9 Joint=23 OutputCase=ENVE CaseType=Combination StepType=Max F1=39.9371961255313 F2=0 F3=-
 559.99999456396 M1=0 M2=-257.120633089505 M3=0 FrameElem=9
 Frame=9 Joint=35 OutputCase=ENVE CaseType=Combination StepType=Min F1=-34.617743046594 F2=0
 F3=566.24999456396 M1=0 M2=249.725755055142 M3=0 FrameElem=9
 Frame=9 Joint=23 OutputCase=ENVE CaseType=Combination StepType=Min F1=23.75060183899 F2=0 F3=-
 559.999994664215 M1=0 M2=-259.056239393295 M3=0 FrameElem=9
 Frame=9 Joint=35 OutputCase=FESSUR CaseType=Combination F1=-34.617743046594 F2=0 F3=566.249994664215
 M1=0 M2=249.725755055142 M3=0 FrameElem=9
 Frame=9 Joint=23 OutputCase=FESSUR CaseType=Combination F1=39.9371961255313 F2=0 F3=-559.999994664215
 M1=0 M2=-259.056239393295 M3=0 FrameElem=9
 Frame=10 Joint=23 OutputCase=PESOPR CaseType=LinStatic F1=15.1709467362367 F2=0 F3=68.7499988188591
 M1=0 M2=24.8643150666031 M3=0 FrameElem=10
 Frame=10 Joint=21 OutputCase=PESOPR CaseType=LinStatic F1=-15.1709467362367 F2=0 F3=-62.4999994149055
 M1=0 M2=-21.0715771796256 M3=0 FrameElem=10
 Frame=10 Joint=23 OutputCase=TERRVERT CaseType=LinStatic F1=-1.15282857329646 F2=0
 F3=491.249995512237 M1=0 M2=227.739903314056 M3=0 FrameElem=10
 Frame=10 Joint=21 OutputCase=TERRVERT CaseType=LinStatic F1=1.15282857329646 F2=0 F3=-
 491.249995512237 M1=0 M2=-228.028098717582 M3=0 FrameElem=10
 Frame=10 Joint=23 OutputCase=TERRLAT CaseType=LinStatic F1=-53.9553142884713 F2=0
 F3=3.34182026070495E-07 M1=0 M2=6.45202101263258 M3=0 FrameElem=10
 Frame=10 Joint=21 OutputCase=TERRLAT CaseType=LinStatic F1=58.741798183171 F2=0 F3=-
 3.34182026070495E-07 M1=0 M2=-20.550262240648 M3=0 FrameElem=10
 Frame=10 Joint=23 OutputCase=ACCLATDX CaseType=LinStatic F1=0 F2=0 F3=0 M1=0 M2=0 M3=0
 FrameElem=10
 Frame=10 Joint=21 OutputCase=ACCLATDX CaseType=LinStatic F1=0 F2=0 F3=0 M1=0 M2=0 M3=0
 FrameElem=10
 Frame=10 Joint=23 OutputCase=ACCLATSX CaseType=LinStatic F1=0 F2=0 F3=0 M1=0 M2=0 M3=0
 FrameElem=10
 Frame=10 Joint=21 OutputCase=ACCLATSX CaseType=LinStatic F1=0 F2=0 F3=0 M1=0 M2=0 M3=0
 FrameElem=10
 Frame=10 Joint=23 OutputCase=TERRCOST CaseType=LinStatic F1=0 F2=0 F3=0 M1=0 M2=0 M3=0
 FrameElem=10
 Frame=10 Joint=21 OutputCase=TERRCOST CaseType=LinStatic F1=0 F2=0 F3=0 M1=0 M2=0 M3=0
 FrameElem=10
 Frame=10 Joint=23 OutputCase=SOVRCOST CaseType=LinStatic F1=0 F2=0 F3=0 M1=0 M2=0 M3=0
 FrameElem=10
 Frame=10 Joint=21 OutputCase=SOVRCOST CaseType=LinStatic F1=0 F2=0 F3=0 M1=0 M2=0 M3=0
 FrameElem=10
 Frame=10 Joint=23 OutputCase=ENVE CaseType=Combination StepType=Max F1=-23.7506018389897 F2=0
 F3=559.999994665278 M1=0 M2=259.056239393291 M3=0 FrameElem=10
 Frame=10 Joint=21 OutputCase=ENVE CaseType=Combination StepType=Max F1=44.7236800202308 F2=0 F3=-
 553.74999516107 M1=0 M2=-263.484859465661 M3=0 FrameElem=10
 Frame=10 Joint=23 OutputCase=ENVE CaseType=Combination StepType=Min F1=-39.937196125531 F2=0
 F3=559.999994565023 M1=0 M2=257.120633089502 M3=0 FrameElem=10
 Frame=10 Joint=21 OutputCase=ENVE CaseType=Combination StepType=Min F1=27.1011405652795 F2=0 F3=-
 553.749995261324 M1=0 M2=-269.649938137855 M3=0 FrameElem=10
 Frame=10 Joint=23 OutputCase=FESSUR CaseType=Combination F1=-39.937196125531 F2=0 F3=559.999994665278
 M1=0 M2=259.056239393291 M3=0 FrameElem=10
 Frame=10 Joint=21 OutputCase=FESSUR CaseType=Combination F1=44.7236800202308 F2=0 F3=-
 553.749995261324 M1=0 M2=-269.649938137855 M3=0 FrameElem=10



Frame=11	Joint=20	OutputCase=PESOPR	CaseType=LinStatic	F1=-15.1709467362393	F2=0	F3=62.4999993927967
M1=0	M2=-21.0715767624128	M3=0	FrameElem=11			
Frame=11	Joint=39	OutputCase=PESOPR	CaseType=LinStatic	F1=15.1709467362393	F2=0	F3=-56.2499999888432
M1=0	M2=6.22782825531281	M3=0	FrameElem=11			
Frame=11	Joint=20	OutputCase=TERRVERT	CaseType=LinStatic	F1=1.15282857328763	F2=0	F3=491.249995117351
M1=0	M2=-228.028097757211	M3=0	FrameElem=11			
Frame=11	Joint=39	OutputCase=TERRVERT	CaseType=LinStatic	F1=-1.15282857328763	F2=0	F3=-
442.124999802276	M1=0	M2=111.356234518939	M3=0	FrameElem=11		
Frame=11	Joint=20	OutputCase=TERRLAT	CaseType=LinStatic	F1=66.7117981831701	F2=0	F3=-
3.34180455752175E-07	M1=0	M2=-20.5502621602774	M3=0	FrameElem=11		
Frame=11	Joint=39	OutputCase=TERRLAT	CaseType=LinStatic	F1=-66.7117981831701	F2=0	F3=-
F3=3.34180455752175E-07	M1=0	M2=20.5502622438225	M3=0	FrameElem=11		
Frame=11	Joint=20	OutputCase=ACCLATDX	CaseType=LinStatic	F1=0	F2=0	F3=0
M1=0	M2=0	M3=0	FrameElem=11			
Frame=11	Joint=39	OutputCase=ACCLATDX	CaseType=LinStatic	F1=0	F2=0	F3=0
M1=0	M2=0	M3=0	FrameElem=11			
Frame=11	Joint=20	OutputCase=ACCLATSX	CaseType=LinStatic	F1=0	F2=0	F3=0
M1=0	M2=0	M3=0	FrameElem=11			
Frame=11	Joint=39	OutputCase=ACCLATSX	CaseType=LinStatic	F1=0	F2=0	F3=0
M1=0	M2=0	M3=0	FrameElem=11			
Frame=11	Joint=20	OutputCase=TERRCOST	CaseType=LinStatic	F1=0	F2=0	F3=0
M1=0	M2=0	M3=0	FrameElem=11			
Frame=11	Joint=39	OutputCase=TERRCOST	CaseType=LinStatic	F1=0	F2=0	F3=0
M1=0	M2=0	M3=0	FrameElem=11			
Frame=11	Joint=20	OutputCase=SOVRCOST	CaseType=LinStatic	F1=0	F2=0	F3=0
M1=0	M2=0	M3=0	FrameElem=11			
Frame=11	Joint=39	OutputCase=SOVRCOST	CaseType=LinStatic	F1=0	F2=0	F3=0
M1=0	M2=0	M3=0	FrameElem=11			
Frame=11	Joint=20	OutputCase=ENVE	CaseType=Combination	StepType=Max	F1=52.6936800202184	F2=0
F3=553.749994276221	M1=0	M2=-263.484858031818	M3=0	FrameElem=11		
Frame=11	Joint=39	OutputCase=ENVE	CaseType=Combination	StepType=Max	F1=-32.6801405652674	F2=0
F3=-	M1=0	M2=138.134325018074	M3=0	FrameElem=11		
498.374999456939	Frame=11	Joint=20	OutputCase=ENVE	CaseType=Combination	StepType=Min	F1=32.6801405652674
F2=0	M1=0	M2=-269.649936679901	M3=0	FrameElem=11		
F3=553.749994175967	Frame=11	Joint=39	OutputCase=ENVE	CaseType=Combination	StepType=Min	F1=-52.6936800202184
F2=0	M1=0	M2=131.969246344927	M3=0	FrameElem=11		
498.374999557193	Frame=11	Joint=20	OutputCase=FESSUR	CaseType=Combination	F1=52.6936800202184	F2=0
F3=553.749994175967	M1=0	M2=-269.649936679901	M3=0	FrameElem=11		
Frame=11	Joint=39	OutputCase=FESSUR	CaseType=Combination	F1=-52.6936800202184	F2=0	F3=-
498.374999456939	M1=0	M2=138.134325018074	M3=0	FrameElem=11		
Frame=12	Joint=39	OutputCase=PESOPR	CaseType=LinStatic	F1=-15.1709467362397	F2=0	F3=56.2499999888794
M1=0	M2=-6.22782825531899	M3=0	FrameElem=12			
Frame=12	Joint=40	OutputCase=PESOPR	CaseType=LinStatic	F1=15.1709467362397	F2=0	F3=-49.999999888794
M1=0	M2=-7.0534217419045	M3=0	FrameElem=12			
Frame=12	Joint=39	OutputCase=TERRVERT	CaseType=LinStatic	F1=1.15282857328748	F2=0	F3=442.124999802401
M1=0	M2=-111.356234518939	M3=0	FrameElem=12			
Frame=12	Joint=40	OutputCase=TERRVERT	CaseType=LinStatic	F1=-1.15282857328748	F2=0	F3=-
392.999999802401	M1=0	M2=6.96560956833855	M3=0	FrameElem=12		
Frame=12	Joint=39	OutputCase=TERRLAT	CaseType=LinStatic	F1=66.7117981831701	F2=0	F3=-
3.34180811023543E-07	M1=0	M2=-20.5502622438224	M3=0	FrameElem=12		
Frame=12	Joint=40	OutputCase=TERRLAT	CaseType=LinStatic	F1=-66.7117981831701	F2=0	F3=-
F3=3.34180811023543E-07	M1=0	M2=20.5502623273675	M3=0	FrameElem=12		
Frame=12	Joint=39	OutputCase=ACCLATDX	CaseType=LinStatic	F1=0	F2=0	F3=0
M1=0	M2=0	M3=0	FrameElem=12			
Frame=12	Joint=40	OutputCase=ACCLATDX	CaseType=LinStatic	F1=0	F2=0	F3=0
M1=0	M2=0	M3=0	FrameElem=12			
Frame=12	Joint=39	OutputCase=ACCLATSX	CaseType=LinStatic	F1=0	F2=0	F3=0
M1=0	M2=0	M3=0	FrameElem=12			
Frame=12	Joint=40	OutputCase=ACCLATSX	CaseType=LinStatic	F1=0	F2=0	F3=0
M1=0	M2=0	M3=0	FrameElem=12			
Frame=12	Joint=39	OutputCase=TERRCOST	CaseType=LinStatic	F1=0	F2=0	F3=0
M1=0	M2=0	M3=0	FrameElem=12			
Frame=12	Joint=40	OutputCase=TERRCOST	CaseType=LinStatic	F1=0	F2=0	F3=0
M1=0	M2=0	M3=0	FrameElem=12			
Frame=12	Joint=39	OutputCase=SOVRCOST	CaseType=LinStatic	F1=0	F2=0	F3=0
M1=0	M2=0	M3=0	FrameElem=12			
Frame=12	Joint=40	OutputCase=SOVRCOST	CaseType=LinStatic	F1=0	F2=0	F3=0
M1=0	M2=0	M3=0	FrameElem=12			
Frame=12	Joint=39	OutputCase=ENVE	CaseType=Combination	StepType=Max	F1=52.6936800202179	F2=0
F3=498.374999557354	M1=0	M2=-131.969246344933	M3=0	FrameElem=12		
Frame=12	Joint=40	OutputCase=ENVE	CaseType=Combination	StepType=Max	F1=-32.6801405652668	F2=0
F3=-	M1=0	M2=20.4624501538016	M3=0	FrameElem=12		
442.9999994571	Frame=12	Joint=39	OutputCase=ENVE	CaseType=Combination	StepType=Min	F1=32.6801405652668
F2=0	M1=0	M2=-138.13432501808	M3=0	FrameElem=12		
F3=498.3749994571	Frame=12	Joint=40	OutputCase=ENVE	CaseType=Combination	StepType=Min	F1=-52.6936800202179
F2=0	M1=0	M2=14.2973714555913	M3=0	FrameElem=12		
442.999999557354	Frame=12	Joint=39	OutputCase=FESSUR	CaseType=Combination	F1=52.6936800202179	F2=0
F3=498.3749994571	M1=0	M2=-138.13432501808	M3=0	FrameElem=12		
Frame=12	Joint=40	OutputCase=FESSUR	CaseType=Combination	F1=-52.6936800202179	F2=0	F3=-442.9999994571
M1=0	M2=20.4624501538016	M3=0	FrameElem=12			
Frame=14	Joint=24	OutputCase=PESOPR	CaseType=LinStatic	F1=-15.1709467362392	F2=0	F3=-50.000000110459
M1=0	M2=7.05342169746977	M3=0	FrameElem=14			

Frame=14	Joint=25	OutputCase=PESOPR	CaseType=LinStatic	F1=15.1709467362392	F2=0	F3=56.2500000110459			
M1=0	M2=6.22782830529174	M3=0	FrameElem=14						
Frame=14	Joint=24	OutputCase=TERRVERT	CaseType=LinStatic	F1=1.15282857328964	F2=0	F3=-			
393.000000197462	M1=0	M2=-6.96561035869377	M3=0	FrameElem=14					
Frame=14	Joint=25	OutputCase=TERRVERT	CaseType=LinStatic	F1=-1.15282857328964	F2=0				
F3=442.125000197462	M1=0	M2=111.356235408059	M3=0	FrameElem=14					
Frame=14	Joint=24	OutputCase=TERRLAT	CaseType=LinStatic	F1=66.7117981831705	F2=0	F3=-			
3.34180882077817E-07	M1=0	M2=-20.5502636640906	M3=0	FrameElem=14					
Frame=14	Joint=25	OutputCase=TERRLAT	CaseType=LinStatic	F1=-66.7117981831705	F2=0				
F3=3.34180882077817E-07	M1=0	M2=20.5502637476359	M3=0	FrameElem=14					
Frame=14	Joint=24	OutputCase=ACCLATDX	CaseType=LinStatic	F1=0	F2=0	F3=0	M1=0	M2=0	M3=0
FrameElem=14									
Frame=14	Joint=25	OutputCase=ACCLATDX	CaseType=LinStatic	F1=0	F2=0	F3=0	M1=0	M2=0	M3=0
FrameElem=14									
Frame=14	Joint=24	OutputCase=ACCLATSX	CaseType=LinStatic	F1=0	F2=0	F3=0	M1=0	M2=0	M3=0
FrameElem=14									
Frame=14	Joint=25	OutputCase=ACCLATSX	CaseType=LinStatic	F1=0	F2=0	F3=0	M1=0	M2=0	M3=0
FrameElem=14									
Frame=14	Joint=24	OutputCase=TERRCOST	CaseType=LinStatic	F1=0	F2=0	F3=0	M1=0	M2=0	M3=0
FrameElem=14									
Frame=14	Joint=25	OutputCase=TERRCOST	CaseType=LinStatic	F1=0	F2=0	F3=0	M1=0	M2=0	M3=0
FrameElem=14									
Frame=14	Joint=24	OutputCase=SOVRCOST	CaseType=LinStatic	F1=0	F2=0	F3=0	M1=0	M2=0	M3=0
FrameElem=14									
Frame=14	Joint=25	OutputCase=SOVRCOST	CaseType=LinStatic	F1=0	F2=0	F3=0	M1=0	M2=0	M3=0
FrameElem=14									
Frame=14	Joint=24	OutputCase=ENVE	CaseType=Combination	StepType=Max	F1=52.6936800202209	F2=0	F3=-		
443.000000442434	M1=0	M2=-14.2973732260874	M3=0	FrameElem=14					
Frame=14	Joint=25	OutputCase=ENVE	CaseType=Combination	StepType=Max	F1=-32.6801405652697	F2=0			
F3=498.375000542689	M1=0	M2=138.134327460987	M3=0	FrameElem=14					
Frame=14	Joint=24	OutputCase=ENVE	CaseType=Combination	StepType=Min	F1=32.6801405652697	F2=0	F3=-		
443.000000542689	M1=0	M2=-20.4624523253146	M3=0	FrameElem=14					
Frame=14	Joint=25	OutputCase=ENVE	CaseType=Combination	StepType=Min	F1=-52.6936800202209	F2=0			
F3=498.375000442434	M1=0	M2=131.969248336696	M3=0	FrameElem=14					
Frame=14	Joint=24	OutputCase=PESSUR	CaseType=Combination	F1=52.6936800202209	F2=0	F3=-			
443.000000542689	M1=0	M2=-20.4624523253146	M3=0	FrameElem=14					
Frame=14	Joint=25	OutputCase=PESSUR	CaseType=Combination	F1=-52.6936800202209	F2=0				
F3=498.375000542689	M1=0	M2=138.134327460987	M3=0	FrameElem=14					
Frame=15	Joint=25	OutputCase=PESOPR	CaseType=LinStatic	F1=-15.1709467362379	F2=0	F3=-56.2500000110275			
M1=0	M2=-6.22782830528579	M3=0	FrameElem=15						
Frame=15	Joint=21	OutputCase=PESOPR	CaseType=LinStatic	F1=15.1709467362379	F2=0	F3=62.4999994149811			
M1=0	M2=21.0715771796187	M3=0	FrameElem=15						
Frame=15	Joint=25	OutputCase=TERRVERT	CaseType=LinStatic	F1=1.15282857329259	F2=0	F3=-442.12500019737			
M1=0	M2=-111.356235408031	M3=0	FrameElem=15						
Frame=15	Joint=21	OutputCase=TERRVERT	CaseType=LinStatic	F1=-1.15282857329259	F2=0				
F3=491.249995512445	M1=0	M2=228.028098717568	M3=0	FrameElem=15					
Frame=15	Joint=25	OutputCase=TERRLAT	CaseType=LinStatic	F1=66.7117981831705	F2=0	F3=-			
3.34181379457732E-07	M1=0	M2=-20.5502637476359	M3=0	FrameElem=15					
Frame=15	Joint=21	OutputCase=TERRLAT	CaseType=LinStatic	F1=-66.7117981831705	F2=0				
F3=3.34181379457732E-07	M1=0	M2=20.550262240648	M3=0	FrameElem=15					
Frame=15	Joint=25	OutputCase=ACCLATDX	CaseType=LinStatic	F1=0	F2=0	F3=0	M1=0	M2=0	M3=0
FrameElem=15									
Frame=15	Joint=21	OutputCase=ACCLATDX	CaseType=LinStatic	F1=0	F2=0	F3=0	M1=0	M2=0	M3=0
FrameElem=15									
Frame=15	Joint=25	OutputCase=ACCLATSX	CaseType=LinStatic	F1=0	F2=0	F3=0	M1=0	M2=0	M3=0
FrameElem=15									
Frame=15	Joint=21	OutputCase=ACCLATSX	CaseType=LinStatic	F1=0	F2=0	F3=0	M1=0	M2=0	M3=0
FrameElem=15									
Frame=15	Joint=25	OutputCase=TERRCOST	CaseType=LinStatic	F1=0	F2=0	F3=0	M1=0	M2=0	M3=0
FrameElem=15									
Frame=15	Joint=21	OutputCase=TERRCOST	CaseType=LinStatic	F1=0	F2=0	F3=0	M1=0	M2=0	M3=0
FrameElem=15									
Frame=15	Joint=25	OutputCase=SOVRCOST	CaseType=LinStatic	F1=0	F2=0	F3=0	M1=0	M2=0	M3=0
FrameElem=15									
Frame=15	Joint=21	OutputCase=SOVRCOST	CaseType=LinStatic	F1=0	F2=0	F3=0	M1=0	M2=0	M3=0
FrameElem=15									
Frame=15	Joint=25	OutputCase=ENVE	CaseType=Combination	StepType=Max	F1=52.6936800202252	F2=0	F3=-		
498.375000442324	M1=0	M2=-131.969248336662	M3=0	FrameElem=15					
Frame=15	Joint=21	OutputCase=ENVE	CaseType=Combination	StepType=Max	F1=-32.680140565274	F2=0			
F3=553.749995261608	M1=0	M2=269.649938137835	M3=0	FrameElem=15					
Frame=15	Joint=25	OutputCase=ENVE	CaseType=Combination	StepType=Min	F1=32.680140565274	F2=0	F3=-		
498.375000542579	M1=0	M2=-138.134327460953	M3=0	FrameElem=15					
Frame=15	Joint=21	OutputCase=ENVE	CaseType=Combination	StepType=Min	F1=-52.6936800202252	F2=0			
F3=553.749995161353	M1=0	M2=263.48485946564	M3=0	FrameElem=15					
Frame=15	Joint=25	OutputCase=PESSUR	CaseType=Combination	F1=52.6936800202252	F2=0	F3=-			
498.375000542579	M1=0	M2=-138.134327460953	M3=0	FrameElem=15					
Frame=15	Joint=21	OutputCase=PESSUR	CaseType=Combination	F1=-52.6936800202252	F2=0				
F3=553.749995261608	M1=0	M2=269.649938137835	M3=0	FrameElem=15					
Frame=16	Joint=1	OutputCase=PESOPR	CaseType=LinStatic	F1=-15.1709467362394	F2=0	F3=162.499999393454			
M1=0	M2=-81.7553624407837	M3=0	FrameElem=16						
Frame=16	Joint=26	OutputCase=PESOPR	CaseType=LinStatic	F1=15.1709467362394	F2=0	F3=-156.249999393454			
M1=0	M2=77.9626295565202	M3=0	FrameElem=16						



Frame=16	Joint=1	OutputCase=TERRVERT	CaseType=LinStatic	F1=1.15282857328509	F2=0	F3=491.249995118813
M1=0	M2=-223.41678346408	M3=0	FrameElem=16			
Frame=16	Joint=26	OutputCase=TERRVERT	CaseType=LinStatic	F1=-1.15282857328509	F2=0	F3=-
491.249995118813	M1=0	M2=223.705002319714	M3=0	FrameElem=16		
Frame=16	Joint=1	OutputCase=TERRLAT	CaseType=LinStatic	F1=-81.7982018168295	F2=0	F3=-
3.34183257182739E-07	M1=0	M2=-21.1830694275959	M3=0	FrameElem=16		
Frame=16	Joint=26	OutputCase=TERRLAT	CaseType=LinStatic	F1=69.0171861918295	F2=0	F3=3.3418325718274E-07
M1=0	M2=2.34224944213847	M3=0	FrameElem=16			
Frame=16	Joint=1	OutputCase=ACCLATDX	CaseType=LinStatic	F1=0	F2=0	F3=0
M1=0	M2=0	M3=0	FrameElem=16			
Frame=16	Joint=26	OutputCase=ACCLATDX	CaseType=LinStatic	F1=0	F2=0	F3=0
M1=0	M2=0	M3=0	FrameElem=16			
Frame=16	Joint=1	OutputCase=ACCLATSX	CaseType=LinStatic	F1=0	F2=0	F3=0
M1=0	M2=0	M3=0	FrameElem=16			
Frame=16	Joint=26	OutputCase=ACCLATSX	CaseType=LinStatic	F1=0	F2=0	F3=0
M1=0	M2=0	M3=0	FrameElem=16			
Frame=16	Joint=1	OutputCase=TERRCOST	CaseType=LinStatic	F1=0	F2=0	F3=0
M1=0	M2=0	M3=0	FrameElem=16			
Frame=16	Joint=26	OutputCase=TERRCOST	CaseType=LinStatic	F1=0	F2=0	F3=0
M1=0	M2=0	M3=0	FrameElem=16			
Frame=16	Joint=1	OutputCase=SOVRCOST	CaseType=LinStatic	F1=0	F2=0	F3=0
M1=0	M2=0	M3=0	FrameElem=16			
Frame=16	Joint=26	OutputCase=SOVRCOST	CaseType=LinStatic	F1=0	F2=0	F3=0
M1=0	M2=0	M3=0	FrameElem=16			
Frame=16	Joint=1	OutputCase=ENVE	CaseType=Combination	StepType=Max	F1=-71.2768594347349	F2=0
F3=653.749994278339	M1=0	M2=-320.000294504181	M3=0	FrameElem=16		
Frame=16	Joint=26	OutputCase=ENVE	CaseType=Combination	StepType=Max	F1=83.0353043547838	F2=0
F3=-	647.499994178084	M1=0	M2=304.009881318373	M3=0	FrameElem=16	
Frame=16	Joint=1	OutputCase=ENVE	CaseType=Combination	StepType=Min	F1=-95.8163199797838	F2=0
F3=653.749994178084	M1=0	M2=-326.35521533246	M3=0	FrameElem=16		
Frame=16	Joint=26	OutputCase=ENVE	CaseType=Combination	StepType=Min	F1=62.3301484972349	F2=0
F3=-	647.499994278339	M1=0	M2=303.307206485731	M3=0	FrameElem=16	
Frame=16	Joint=1	OutputCase=PESSUR	CaseType=Combination	F1=-95.8163199797838	F2=0	F3=653.749994178084
M1=0	M2=-326.35521533246	M3=0	FrameElem=16			
Frame=16	Joint=26	OutputCase=PESSUR	CaseType=Combination	F1=83.0353043547838	F2=0	F3=-
647.499994178084	M1=0	M2=304.009881318373	M3=0	FrameElem=16		
Frame=17	Joint=26	OutputCase=PESOPR	CaseType=LinStatic	F1=-15.1709467362397	F2=0	F3=156.249999393243
M1=0	M2=-77.9626295565153	M3=0	FrameElem=17			
Frame=17	Joint=27	OutputCase=PESOPR	CaseType=LinStatic	F1=15.1709467362397	F2=0	F3=-149.99999393243
M1=0	M2=74.1698928724553	M3=0	FrameElem=17			
Frame=17	Joint=26	OutputCase=TERRVERT	CaseType=LinStatic	F1=1.15282857328486	F2=0	F3=491.24999511824
M1=0	M2=-223.705002319706	M3=0	FrameElem=17			
Frame=17	Joint=27	OutputCase=TERRVERT	CaseType=LinStatic	F1=-1.15282857328486	F2=0	F3=-
491.24999511824	M1=0	M2=223.993209463027	M3=0	FrameElem=17		
Frame=17	Joint=26	OutputCase=TERRLAT	CaseType=LinStatic	F1=-69.0171861918293	F2=0	F3=-
3.3418245948269E-07	M1=0	M2=-2.34224944213843	M3=0	FrameElem=17		
Frame=17	Joint=27	OutputCase=TERRLAT	CaseType=LinStatic	F1=56.7691393168293	F2=0	F3=3.3418245948269E-07
M1=0	M2=-13.3699377308189	M3=0	FrameElem=17			
Frame=17	Joint=26	OutputCase=ACCLATDX	CaseType=LinStatic	F1=0	F2=0	F3=0
M1=0	M2=0	M3=0	FrameElem=17			
Frame=17	Joint=27	OutputCase=ACCLATDX	CaseType=LinStatic	F1=0	F2=0	F3=0
M1=0	M2=0	M3=0	FrameElem=17			
Frame=17	Joint=26	OutputCase=ACCLATSX	CaseType=LinStatic	F1=0	F2=0	F3=0
M1=0	M2=0	M3=0	FrameElem=17			
Frame=17	Joint=27	OutputCase=ACCLATSX	CaseType=LinStatic	F1=0	F2=0	F3=0
M1=0	M2=0	M3=0	FrameElem=17			
Frame=17	Joint=26	OutputCase=TERRCOST	CaseType=LinStatic	F1=0	F2=0	F3=0
M1=0	M2=0	M3=0	FrameElem=17			
Frame=17	Joint=27	OutputCase=TERRCOST	CaseType=LinStatic	F1=0	F2=0	F3=0
M1=0	M2=0	M3=0	FrameElem=17			
Frame=17	Joint=26	OutputCase=SOVRCOST	CaseType=LinStatic	F1=0	F2=0	F3=0
M1=0	M2=0	M3=0	FrameElem=17			
Frame=17	Joint=27	OutputCase=SOVRCOST	CaseType=LinStatic	F1=0	F2=0	F3=0
M1=0	M2=0	M3=0	FrameElem=17			
Frame=17	Joint=26	OutputCase=ENVE	CaseType=Combination	StepType=Max	F1=-62.3301484972353	F2=0
F3=647.499994277556	M1=0	M2=-303.307206485718	M3=0	FrameElem=17		
Frame=17	Joint=27	OutputCase=ENVE	CaseType=Combination	StepType=Max	F1=70.7872574797841	F2=0
F3=-	641.249994177301	M1=0	M2=288.804145923909	M3=0	FrameElem=17	
Frame=17	Joint=26	OutputCase=ENVE	CaseType=Combination	StepType=Min	F1=-83.0353043547841	F2=0
F3=647.499994177301	M1=0	M2=-304.009881318359	M3=0	FrameElem=17		
Frame=17	Joint=27	OutputCase=ENVE	CaseType=Combination	StepType=Min	F1=53.7565156847353	F2=0
F3=-	641.249994277556	M1=0	M2=284.793164604664	M3=0	FrameElem=17	
Frame=17	Joint=26	OutputCase=PESSUR	CaseType=Combination	F1=-83.0353043547841	F2=0	F3=-
F3=647.499994177301	M1=0	M2=-304.009881318359	M3=0	FrameElem=17		
Frame=17	Joint=27	OutputCase=PESSUR	CaseType=Combination	F1=70.7872574797841	F2=0	F3=-
641.249994177301	M1=0	M2=284.793164604664	M3=0	FrameElem=17		
Frame=19	Joint=34	OutputCase=PESOPR	CaseType=LinStatic	F1=-15.1709467362389	F2=0	F3=74.999993929008
M1=0	M2=-28.6570499815281	M3=0	FrameElem=19			
Frame=19	Joint=22	OutputCase=PESOPR	CaseType=LinStatic	F1=15.1709467362389	F2=0	F3=-68.7499993929008
M1=0	M2=24.8643150111019	M3=0	FrameElem=19			
Frame=19	Joint=34	OutputCase=TERRVERT	CaseType=LinStatic	F1=1.15282857329032	F2=0	F3=491.249995117335
M1=0	M2=-227.451683470577	M3=0	FrameElem=19			



Frame=19	Joint=22	OutputCase=TERRVERT	CaseType=LinStatic	F1=-1.15282857329032	F2=0	F3=-
491.249995117335	M1=0	M2=227.739902326213	M3=0	FrameElem=19		
Frame=19	Joint=34	OutputCase=TERRLAT	CaseType=LinStatic	F1=48.6358606831699	F2=0	F3=-
3.34181516852312E-07	M1=0	M2=6.38298068130784	M3=0	FrameElem=19		
Frame=19	Joint=22	OutputCase=TERRLAT	CaseType=LinStatic	F1=-53.95531380817	F2=0	F3=3.34181516852312E-07
M1=0	M2=6.45201964573462	M3=0	FrameElem=19			
Frame=19	Joint=34	OutputCase=ACCLATDX	CaseType=LinStatic	F1=0	F2=0	F3=0
M1=0	M2=0	M3=0				
Frame=19	Joint=22	OutputCase=ACCLATDX	CaseType=LinStatic	F1=0	F2=0	F3=0
M1=0	M2=0	M3=0				
Frame=19	Joint=34	OutputCase=ACCLATSX	CaseType=LinStatic	F1=0	F2=0	F3=0
M1=0	M2=0	M3=0				
Frame=19	Joint=22	OutputCase=ACCLATSX	CaseType=LinStatic	F1=0	F2=0	F3=0
M1=0	M2=0	M3=0				
Frame=19	Joint=34	OutputCase=TERRCOST	CaseType=LinStatic	F1=0	F2=0	F3=0
M1=0	M2=0	M3=0				
Frame=19	Joint=22	OutputCase=TERRCOST	CaseType=LinStatic	F1=0	F2=0	F3=0
M1=0	M2=0	M3=0				
Frame=19	Joint=34	OutputCase=SOVRCOST	CaseType=LinStatic	F1=0	F2=0	F3=0
M1=0	M2=0	M3=0				
Frame=19	Joint=22	OutputCase=SOVRCOST	CaseType=LinStatic	F1=0	F2=0	F3=0
M1=0	M2=0	M3=0				
Frame=19	Joint=34	OutputCase=ENVE	CaseType=Combination	StepType=Max	F1=34.6177425202213	F2=0
F3=566.249994276309	M1=0	M2=-249.725752770798	M3=0	FrameElem=19		
Frame=19	Joint=22	OutputCase=ENVE	CaseType=Combination	StepType=Max	F1=-23.7506015027704	F2=0
F3=-559.999994176054	M1=0	M2=259.056236983049	M3=0	FrameElem=19		
Frame=19	Joint=34	OutputCase=ENVE	CaseType=Combination	StepType=Min	F1=20.0269843152703	F2=0
F3=566.249994176054	M1=0	M2=-251.64064697519	M3=0	FrameElem=19		
Frame=19	Joint=22	OutputCase=ENVE	CaseType=Combination	StepType=Min	F1=-39.9371956452214	F2=0
F3=-559.999994276309	M1=0	M2=257.120631089329	M3=0	FrameElem=19		
Frame=19	Joint=34	OutputCase=PESSUR	CaseType=Combination	F1=34.6177425202213	F2=0	F3=566.249994176054
M1=0	M2=-249.725752770798	M3=0	FrameElem=19			
Frame=19	Joint=22	OutputCase=PESSUR	CaseType=Combination	F1=-39.9371956452214	F2=0	F3=-
F3=-559.999994176054	M1=0	M2=259.056236983049	M3=0	FrameElem=19		
Frame=20	Joint=22	OutputCase=PESOPR	CaseType=LinStatic	F1=-15.1709467362387	F2=0	F3=68.7499993927948
M1=0	M2=-24.8643150110989	M3=0	FrameElem=20			
Frame=20	Joint=20	OutputCase=PESOPR	CaseType=LinStatic	F1=15.1709467362387	F2=0	F3=-62.4999993927948
M1=0	M2=21.0715767624173	M3=0	FrameElem=20			
Frame=20	Joint=22	OutputCase=TERRVERT	CaseType=LinStatic	F1=1.15282857329089	F2=0	F3=491.249995117598
M1=0	M2=-227.739902326204	M3=0	FrameElem=20			
Frame=20	Joint=20	OutputCase=TERRVERT	CaseType=LinStatic	F1=-1.15282857329089	F2=0	F3=-
F3=-491.249995117598	M1=0	M2=228.028097757214	M3=0	FrameElem=20		
Frame=20	Joint=22	OutputCase=TERRLAT	CaseType=LinStatic	F1=53.95531380817	F2=0	F3=-3.34180719522311E-07
M1=0	M2=-6.45201964573481	M3=0	FrameElem=20			
Frame=20	Joint=20	OutputCase=TERRLAT	CaseType=LinStatic	F1=-58.74179818317	F2=0	F3=3.34180719522311E-07
M1=0	M2=20.5502621602773	M3=0	FrameElem=20			
Frame=20	Joint=22	OutputCase=ACCLATDX	CaseType=LinStatic	F1=0	F2=0	F3=0
M1=0	M2=0	M3=0				
Frame=20	Joint=20	OutputCase=ACCLATDX	CaseType=LinStatic	F1=0	F2=0	F3=0
M1=0	M2=0	M3=0				
Frame=20	Joint=22	OutputCase=ACCLATSX	CaseType=LinStatic	F1=0	F2=0	F3=0
M1=0	M2=0	M3=0				
Frame=20	Joint=20	OutputCase=ACCLATSX	CaseType=LinStatic	F1=0	F2=0	F3=0
M1=0	M2=0	M3=0				
Frame=20	Joint=22	OutputCase=TERRCOST	CaseType=LinStatic	F1=0	F2=0	F3=0
M1=0	M2=0	M3=0				
Frame=20	Joint=20	OutputCase=TERRCOST	CaseType=LinStatic	F1=0	F2=0	F3=0
M1=0	M2=0	M3=0				
Frame=20	Joint=22	OutputCase=SOVRCOST	CaseType=LinStatic	F1=0	F2=0	F3=0
M1=0	M2=0	M3=0				
Frame=20	Joint=20	OutputCase=SOVRCOST	CaseType=LinStatic	F1=0	F2=0	F3=0
M1=0	M2=0	M3=0				
Frame=20	Joint=22	OutputCase=ENVE	CaseType=Combination	StepType=Max	F1=39.9371956452222	F2=0
F3=559.999994276466	M1=0	M2=-257.120631089317	M3=0	FrameElem=20		
Frame=20	Joint=20	OutputCase=ENVE	CaseType=Combination	StepType=Max	F1=-27.1011405652712	F2=0
F3=-553.749994176212	M1=0	M2=269.649936679908	M3=0	FrameElem=20		
Frame=20	Joint=22	OutputCase=ENVE	CaseType=Combination	StepType=Min	F1=23.7506015027712	F2=0
F3=559.999994176212	M1=0	M2=-259.056236983038	M3=0	FrameElem=20		
Frame=20	Joint=20	OutputCase=ENVE	CaseType=Combination	StepType=Min	F1=-44.7236800202222	F2=0
F3=-553.749994276466	M1=0	M2=263.484858031825	M3=0	FrameElem=20		
Frame=20	Joint=22	OutputCase=PESSUR	CaseType=Combination	F1=39.9371956452222	F2=0	F3=559.999994176212
M1=0	M2=-259.056236983038	M3=0	FrameElem=20			
Frame=20	Joint=20	OutputCase=PESSUR	CaseType=Combination	F1=-44.7236800202222	F2=0	F3=-
F3=-553.749994176212	M1=0	M2=269.649936679908	M3=0	FrameElem=20		
Frame=41	Joint=31	OutputCase=PESOPR	CaseType=LinStatic	F1=15.1709467362365	F2=0	F3=-106.633696120572
M1=0	M2=8.81453682378723	M3=0	FrameElem=41			
Frame=41	Joint=19	OutputCase=PESOPR	CaseType=LinStatic	F1=-15.1709467362365	F2=0	F3=119.133696120572
M1=0	M2=47.6273112365023	M3=0	FrameElem=41			
Frame=41	Joint=31	OutputCase=TERRVERT	CaseType=LinStatic	F1=-1.15282857329472	F2=0	F3=-
F3=-341.044411043279	M1=0	M2=2.95885554841573	M3=0	FrameElem=41		
Frame=41	Joint=19	OutputCase=TERRVERT	CaseType=LinStatic	F1=1.15282857329472	F2=0	F3=341.044411043279
M1=0	M2=167.563349973217	M3=0	FrameElem=41			

Frame=41	Joint=31	OutputCase=TERRLAT	CaseType=LinStatic	F1=108.958200979145	F2=0	F3=-
0.177303034379563	M1=0	M2=21.142993324709	M3=0	FrameElem=41		
Frame=41	Joint=19	OutputCase=TERRLAT	CaseType=LinStatic	F1=-108.958200979145	F2=0	
F3=0.177303034379563	M1=0	M2=-21.0543418075192	M3=0	FrameElem=41		
Frame=41	Joint=31	OutputCase=ACCLATDX	CaseType=LinStatic	F1=0	F2=0	F3=0
FrameElem=41				M1=0	M2=0	M3=0
Frame=41	Joint=19	OutputCase=ACCLATDX	CaseType=LinStatic	F1=0	F2=0	F3=0
FrameElem=41				M1=0	M2=0	M3=0
Frame=41	Joint=31	OutputCase=ACCLATSX	CaseType=LinStatic	F1=0	F2=0	F3=0
FrameElem=41				M1=0	M2=0	M3=0
Frame=41	Joint=19	OutputCase=ACCLATSX	CaseType=LinStatic	F1=0	F2=0	F3=0
FrameElem=41				M1=0	M2=0	M3=0
Frame=41	Joint=31	OutputCase=TERRCOST	CaseType=LinStatic	F1=0	F2=0	F3=0
FrameElem=41				M1=0	M2=0	M3=0
Frame=41	Joint=19	OutputCase=TERRCOST	CaseType=LinStatic	F1=0	F2=0	F3=0
FrameElem=41				M1=0	M2=0	M3=0
Frame=41	Joint=31	OutputCase=SOVRCOST	CaseType=LinStatic	F1=0	F2=0	F3=0
FrameElem=41				M1=0	M2=0	M3=0
Frame=41	Joint=19	OutputCase=SOVRCOST	CaseType=LinStatic	F1=0	F2=0	F3=0
FrameElem=41				M1=0	M2=0	M3=0
Frame=41	Joint=31	OutputCase=ENVE	CaseType=Combination	StepType=Max	F1=122.976319142087	F2=0
447.802219287917	M1=0	M2=32.916385696912	M3=0	FrameElem=41		F3=-
Frame=41	Joint=19	OutputCase=ENVE	CaseType=Combination	StepType=Max	F1=-90.2888588483431	F2=0
F3=460.355410198231	M1=0	M2=200.452621944455	M3=0	FrameElem=41		
Frame=41	Joint=31	OutputCase=ENVE	CaseType=Combination	StepType=Min	F1=90.2888588483431	F2=0
447.855410198231	M1=0	M2=26.5734876994993	M3=0	FrameElem=41		F3=-
Frame=41	Joint=19	OutputCase=ENVE	CaseType=Combination	StepType=Min	F1=-122.976319142087	F2=0
F3=460.302219287917	M1=0	M2=194.1363194022	M3=0	FrameElem=41		
Frame=41	Joint=31	OutputCase=PESSUR	CaseType=Combination	F1=122.976319142087	F2=0	F3=-
447.855410198231	M1=0	M2=32.916385696912	M3=0	FrameElem=41		
Frame=41	Joint=19	OutputCase=PESSUR	CaseType=Combination	F1=-122.976319142087	F2=0	
F3=460.355410198231	M1=0	M2=194.1363194022	M3=0	FrameElem=41		
Frame=42	Joint=19	OutputCase=PESOPR	CaseType=LinStatic	F1=15.1709467362365	F2=0	F3=-74.0605341417562
M1=0	M2=-47.6273112365013	M3=0	FrameElem=42			
Frame=42	Joint=36	OutputCase=PESOPR	CaseType=LinStatic	F1=-15.1709467362365	F2=0	F3=86.5605341417562
M1=0	M2=87.782578307383	M3=0	FrameElem=42			
Frame=42	Joint=19	OutputCase=TERRVERT	CaseType=LinStatic	F1=-1.15282857329472	F2=0	F3=-
242.566242891555	M1=0	M2=-167.563349973235	M3=0	FrameElem=42		
Frame=42	Joint=36	OutputCase=TERRVERT	CaseType=LinStatic	F1=1.15282857329472	F2=0	F3=242.566242891555
M1=0	M2=288.846471419005	M3=0	FrameElem=42			
Frame=42	Joint=19	OutputCase=TERRLAT	CaseType=LinStatic	F1=108.958200979145	F2=0	F3=-
0.183116999181372	M1=0	M2=21.0543418075192	M3=0	FrameElem=42		
Frame=42	Joint=36	OutputCase=TERRLAT	CaseType=LinStatic	F1=-108.958200979145	F2=0	
F3=0.183116999181372	M1=0	M2=-20.9627833079285	M3=0	FrameElem=42		
Frame=42	Joint=19	OutputCase=ACCLATDX	CaseType=LinStatic	F1=0	F2=0	F3=0
FrameElem=42				M1=0	M2=0	M3=0
Frame=42	Joint=36	OutputCase=ACCLATDX	CaseType=LinStatic	F1=0	F2=0	F3=0
FrameElem=42				M1=0	M2=0	M3=0
Frame=42	Joint=19	OutputCase=ACCLATSX	CaseType=LinStatic	F1=0	F2=0	F3=0
FrameElem=42				M1=0	M2=0	M3=0
Frame=42	Joint=36	OutputCase=ACCLATSX	CaseType=LinStatic	F1=0	F2=0	F3=0
FrameElem=42				M1=0	M2=0	M3=0
Frame=42	Joint=19	OutputCase=TERRCOST	CaseType=LinStatic	F1=0	F2=0	F3=0
FrameElem=42				M1=0	M2=0	M3=0
Frame=42	Joint=36	OutputCase=TERRCOST	CaseType=LinStatic	F1=0	F2=0	F3=0
FrameElem=42				M1=0	M2=0	M3=0
Frame=42	Joint=19	OutputCase=SOVRCOST	CaseType=LinStatic	F1=0	F2=0	F3=0
FrameElem=42				M1=0	M2=0	M3=0
Frame=42	Joint=36	OutputCase=SOVRCOST	CaseType=LinStatic	F1=0	F2=0	F3=0
FrameElem=42				M1=0	M2=0	M3=0
Frame=42	Joint=19	OutputCase=ENVE	CaseType=Combination	StepType=Max	F1=122.976319142087	F2=0
316.754958932739	M1=0	M2=-194.136319402217	M3=0	FrameElem=42		F3=-
Frame=42	Joint=36	OutputCase=ENVE	CaseType=Combination	StepType=Max	F1=-90.2888588483431	F2=0
F3=329.309894032493	M1=0	M2=361.955101410838	M3=0	FrameElem=42		
Frame=42	Joint=19	OutputCase=ENVE	CaseType=Combination	StepType=Min	F1=90.2888588483431	F2=0
316.809894032493	M1=0	M2=-200.452621944473	M3=0	FrameElem=42		F3=-
Frame=42	Joint=36	OutputCase=ENVE	CaseType=Combination	StepType=Min	F1=-122.976319142087	F2=0
F3=329.254958932739	M1=0	M2=355.66626641846	M3=0	FrameElem=42		
Frame=42	Joint=19	OutputCase=PESSUR	CaseType=Combination	F1=122.976319142087	F2=0	F3=-
316.809894032493	M1=0	M2=-194.136319402217	M3=0	FrameElem=42		
Frame=42	Joint=36	OutputCase=PESSUR	CaseType=Combination	F1=-122.976319142087	F2=0	
F3=329.309894032493	M1=0	M2=355.66626641846	M3=0	FrameElem=42		
Frame=43	Joint=36	OutputCase=PESOPR	CaseType=LinStatic	F1=15.1709467362365	F2=0	F3=-41.7994156913783
M1=0	M2=-87.7825783073811	M3=0	FrameElem=43			
Frame=43	Joint=37	OutputCase=PESOPR	CaseType=LinStatic	F1=-15.1709467362365	F2=0	F3=54.2994156913783
M1=0	M2=111.80728615307	M3=0	FrameElem=43			
Frame=43	Joint=36	OutputCase=TERRVERT	CaseType=LinStatic	F1=-1.15282857329472	F2=0	F3=-
145.098916279454	M1=0	M2=-288.846471419008	M3=0	FrameElem=43		
Frame=43	Joint=37	OutputCase=TERRVERT	CaseType=LinStatic	F1=1.15282857329472	F2=0	F3=145.098916279454
M1=0	M2=361.395929558728	M3=0	FrameElem=43			
Frame=43	Joint=36	OutputCase=TERRLAT	CaseType=LinStatic	F1=108.958200979145	F2=0	F3=-
0.132430401634483	M1=0	M2=20.9627833079285	M3=0	FrameElem=43		



Frame=43	Joint=37	OutputCase=TERRLAT	CaseType=LinStatic	F1=-108.958200979145	F2=0				
F3=0.132430401634483	M1=0	M2=-20.8965681071113	M3=0	FrameElem=43					
Frame=43	Joint=36	OutputCase=ACCLATDX	CaseType=LinStatic	F1=0	F2=0	F3=0	M1=0	M2=0	M3=0
FrameElem=43									
Frame=43	Joint=37	OutputCase=ACCLATDX	CaseType=LinStatic	F1=0	F2=0	F3=0	M1=0	M2=0	M3=0
FrameElem=43									
Frame=43	Joint=36	OutputCase=ACCLATSX	CaseType=LinStatic	F1=0	F2=0	F3=0	M1=0	M2=0	M3=0
FrameElem=43									
Frame=43	Joint=37	OutputCase=ACCLATSX	CaseType=LinStatic	F1=0	F2=0	F3=0	M1=0	M2=0	M3=0
FrameElem=43									
Frame=43	Joint=36	OutputCase=TERRCOST	CaseType=LinStatic	F1=0	F2=0	F3=0	M1=0	M2=0	M3=0
FrameElem=43									
Frame=43	Joint=37	OutputCase=TERRCOST	CaseType=LinStatic	F1=0	F2=0	F3=0	M1=0	M2=0	M3=0
FrameElem=43									
Frame=43	Joint=36	OutputCase=SOVRCOST	CaseType=LinStatic	F1=0	F2=0	F3=0	M1=0	M2=0	M3=0
FrameElem=43									
Frame=43	Joint=37	OutputCase=SOVRCOST	CaseType=LinStatic	F1=0	F2=0	F3=0	M1=0	M2=0	M3=0
FrameElem=43									
Frame=43	Joint=36	OutputCase=ENVE	CaseType=Combination	StepType=Max	F1=122.976319142087	F2=0	F3=-		
186.991033251977	M1=0	M2=-355.666266418461	M3=0	FrameElem=43					
Frame=43	Joint=37	OutputCase=ENVE	CaseType=Combination	StepType=Max	F1=-90.2888588483431	F2=0			
F3=199.530762372467	M1=0	M2=458.57561803682	M3=0	FrameElem=43					
Frame=43	Joint=36	OutputCase=ENVE	CaseType=Combination	StepType=Min	F1=90.2888588483431	F2=0	F3=-		
187.030762372467	M1=0	M2=-361.955101410839	M3=0	FrameElem=43					
Frame=43	Joint=37	OutputCase=ENVE	CaseType=Combination	StepType=Min	F1=-122.976319142087	F2=0			
F3=199.491033251977	M1=0	M2=452.306647604687	M3=0	FrameElem=43					
Frame=43	Joint=36	OutputCase=FESSUR	CaseType=Combination	F1=122.976319142087	F2=0	F3=-			
187.030762372467	M1=0	M2=-355.666266418461	M3=0	FrameElem=43					
Frame=43	Joint=37	OutputCase=FESSUR	CaseType=Combination	F1=-122.976319142087	F2=0				
F3=199.530762372467	M1=0	M2=452.306647604687	M3=0	FrameElem=43					
Frame=44	Joint=37	OutputCase=PESOPR	CaseType=LinStatic	F1=15.1709467362365	F2=0	F3=-9.7427921522426			
M1=0	M2=-111.80728615308	M3=0	FrameElem=44						
Frame=44	Joint=38	OutputCase=PESOPR	CaseType=LinStatic	F1=-15.1709467362365	F2=0	F3=22.2427921522426			
M1=0	M2=119.803682229201	M3=0	FrameElem=44						
Frame=44	Joint=37	OutputCase=TERRVERT	CaseType=LinStatic	F1=-1.15282857329472	F2=0	F3=-			
48.2902309365254	M1=0	M2=-361.395929558726	M3=0	FrameElem=44					
Frame=44	Joint=38	OutputCase=TERRVERT	CaseType=LinStatic	F1=1.15282857329472	F2=0	F3=48.2902309365254			
M1=0	M2=385.541045026996	M3=0	FrameElem=44						
Frame=44	Joint=37	OutputCase=TERRLAT	CaseType=LinStatic	F1=108.958200979145	F2=0	F3=-			
0.047900793913717	M1=0	M2=20.8965681071113	M3=0	FrameElem=44					
Frame=44	Joint=38	OutputCase=TERRLAT	CaseType=LinStatic	F1=-108.958200979145	F2=0				
F3=0.047900793913717	M1=0	M2=-20.8726177101544	M3=0	FrameElem=44					
Frame=44	Joint=37	OutputCase=ACCLATDX	CaseType=LinStatic	F1=0	F2=0	F3=0	M1=0	M2=0	M3=0
FrameElem=44									
Frame=44	Joint=38	OutputCase=ACCLATDX	CaseType=LinStatic	F1=0	F2=0	F3=0	M1=0	M2=0	M3=0
FrameElem=44									
Frame=44	Joint=37	OutputCase=ACCLATSX	CaseType=LinStatic	F1=0	F2=0	F3=0	M1=0	M2=0	M3=0
FrameElem=44									
Frame=44	Joint=38	OutputCase=ACCLATSX	CaseType=LinStatic	F1=0	F2=0	F3=0	M1=0	M2=0	M3=0
FrameElem=44									
Frame=44	Joint=37	OutputCase=TERRCOST	CaseType=LinStatic	F1=0	F2=0	F3=0	M1=0	M2=0	M3=0
FrameElem=44									
Frame=44	Joint=38	OutputCase=TERRCOST	CaseType=LinStatic	F1=0	F2=0	F3=0	M1=0	M2=0	M3=0
FrameElem=44									
Frame=44	Joint=37	OutputCase=SOVRCOST	CaseType=LinStatic	F1=0	F2=0	F3=0	M1=0	M2=0	M3=0
FrameElem=44									
Frame=44	Joint=38	OutputCase=SOVRCOST	CaseType=LinStatic	F1=0	F2=0	F3=0	M1=0	M2=0	M3=0
FrameElem=44									
Frame=44	Joint=37	OutputCase=ENVE	CaseType=Combination	StepType=Max	F1=122.976319142087	F2=0	F3=-		
58.0665536445076	M1=0	M2=-452.306647604694	M3=0	FrameElem=44					
Frame=44	Joint=38	OutputCase=ENVE	CaseType=Combination	StepType=Max	F1=-90.2888588483432	F2=0			
F3=70.5809238826817	M1=0	M2=490.733894859089	M3=0	FrameElem=44					
Frame=44	Joint=37	OutputCase=ENVE	CaseType=Combination	StepType=Min	F1=90.2888588483432	F2=0	F3=-		
58.0809238826817	M1=0	M2=-458.575618036827	M3=0	FrameElem=44					
Frame=44	Joint=38	OutputCase=ENVE	CaseType=Combination	StepType=Min	F1=-122.976319142087	F2=0			
F3=70.5665536445076	M1=0	M2=484.472109546042	M3=0	FrameElem=44					
Frame=44	Joint=37	OutputCase=FESSUR	CaseType=Combination	F1=122.976319142087	F2=0	F3=-			
58.0809238826817	M1=0	M2=-452.306647604694	M3=0	FrameElem=44					
Frame=44	Joint=38	OutputCase=FESSUR	CaseType=Combination	F1=-122.976319142087	F2=0				
F3=70.5809238826817	M1=0	M2=484.472109546042	M3=0	FrameElem=44					
Frame=45	Joint=38	OutputCase=PESOPR	CaseType=LinStatic	F1=15.1709467362365	F2=0	F3=22.2427924570105			
M1=0	M2=-119.803682229201	M3=0	FrameElem=45						
Frame=45	Joint=41	OutputCase=PESOPR	CaseType=LinStatic	F1=-15.1709467362365	F2=0	F3=-9.74279245701048			
M1=0	M2=111.80728600692	M3=0	FrameElem=45						
Frame=45	Joint=38	OutputCase=TERRVERT	CaseType=LinStatic	F1=-1.15282857329472	F2=0				
F3=48.2902313312417	M1=0	M2=-385.541045026997	M3=0	FrameElem=45					
Frame=45	Joint=41	OutputCase=TERRVERT	CaseType=LinStatic	F1=1.15282857329472	F2=0	F3=-			
48.2902313312417	M1=0	M2=361.395929361383	M3=0	FrameElem=45					
Frame=45	Joint=38	OutputCase=TERRLAT	CaseType=LinStatic	F1=108.958200979145	F2=0				
F3=4.78996962064819E-02	M1=0	M2=20.8726177101544	M3=0	FrameElem=45					
Frame=45	Joint=41	OutputCase=TERRLAT	CaseType=LinStatic	F1=-108.958200979145	F2=0	F3=-			
4.78996962064819E-02	M1=0	M2=-20.8965675582577	M3=0	FrameElem=45					



Frame=61 Joint=54 OutputCase=ENVE CaseType=Combination StepType=Max F1=8.0102425202214 F2=0
 F3=591.24999427688 M1=0 M2=-227.701139850068 M3=0 FrameElem=61
 Frame=61 Joint=55 OutputCase=ENVE CaseType=Combination StepType=Max F1=-11.4605155652704 F2=0 F3=-
 578.749994176625 M1=0 M2=243.706594592466 M3=0 FrameElem=61
 Frame=61 Joint=54 OutputCase=ENVE CaseType=Combination StepType=Min F1=1.40173431527041 F2=0
 F3=591.249994176625 M1=0 M2=-240.428854759412 M3=0 FrameElem=61
 Frame=61 Joint=55 OutputCase=ENVE CaseType=Combination StepType=Min F1=-22.3799300202214 F2=0 F3=-
 578.74999427688 M1=0 M2=235.387508785598 M3=0 FrameElem=61
 Frame=61 Joint=54 OutputCase=FESSUR CaseType=Combination F1=8.0102425202214 F2=0 F3=591.249994176625
 M1=0 M2=-227.701139850068 M3=0 FrameElem=61
 Frame=61 Joint=55 OutputCase=FESSUR CaseType=Combination F1=-22.3799300202214 F2=0 F3=-
 578.749994176625 M1=0 M2=235.387508785598 M3=0 FrameElem=61
 Frame=62 Joint=55 OutputCase=PESOPR CaseType=LinStatic F1=-15.1709467362388 F2=0 F3=87.4999993929916
 M1=0 M2=-36.242523672506 M3=0 FrameElem=62
 Frame=62 Joint=34 OutputCase=PESOPR CaseType=LinStatic F1=15.1709467362388 F2=0 F3=-74.9999993929916
 M1=0 M2=28.6570499815282 M3=0 FrameElem=62
 Frame=62 Joint=55 OutputCase=TERRVERT CaseType=LinStatic F1=1.15282857328998 F2=0 F3=491.249995117925
 M1=0 M2=-226.875271135985 M3=0 FrameElem=62
 Frame=62 Joint=34 OutputCase=TERRVERT CaseType=LinStatic F1=-1.15282857328998 F2=0 F3=-
 491.249995117925 M1=0 M2=227.451683470578 M3=0 FrameElem=62
 Frame=62 Joint=55 OutputCase=TERRLAT CaseType=LinStatic F1=36.39804818317 F2=0 F3=-3.34181143015846E-
 07 M1=0 M2=27.7302860228929 M3=0 FrameElem=62
 Frame=62 Joint=34 OutputCase=TERRLAT CaseType=LinStatic F1=-48.63586068317 F2=0 F3=3.34181143015846E-
 07 M1=0 M2=-6.38298068130792 M3=0 FrameElem=62
 Frame=62 Joint=55 OutputCase=ACCLATDX CaseType=LinStatic F1=0 F2=0 F3=0 M1=0 M2=0 M3=0
 FrameElem=62
 Frame=62 Joint=34 OutputCase=ACCLATDX CaseType=LinStatic F1=0 F2=0 F3=0 M1=0 M2=0 M3=0
 FrameElem=62
 Frame=62 Joint=55 OutputCase=ACCLATSX CaseType=LinStatic F1=0 F2=0 F3=0 M1=0 M2=0 M3=0
 FrameElem=62
 Frame=62 Joint=34 OutputCase=ACCLATSX CaseType=LinStatic F1=0 F2=0 F3=0 M1=0 M2=0 M3=0
 FrameElem=62
 Frame=62 Joint=55 OutputCase=TERRCOST CaseType=LinStatic F1=0 F2=0 F3=0 M1=0 M2=0 M3=0
 FrameElem=62
 Frame=62 Joint=34 OutputCase=TERRCOST CaseType=LinStatic F1=0 F2=0 F3=0 M1=0 M2=0 M3=0
 FrameElem=62
 Frame=62 Joint=55 OutputCase=SOVRCOST CaseType=LinStatic F1=0 F2=0 F3=0 M1=0 M2=0 M3=0
 FrameElem=62
 Frame=62 Joint=34 OutputCase=SOVRCOST CaseType=LinStatic F1=0 F2=0 F3=0 M1=0 M2=0 M3=0
 FrameElem=62
 Frame=62 Joint=55 OutputCase=ENVE CaseType=Combination StepType=Max F1=22.3799300202212 F2=0
 F3=578.74999427699 M1=0 M2=-235.387508785598 M3=0 FrameElem=62
 Frame=62 Joint=34 OutputCase=ENVE CaseType=Combination StepType=Max F1=-20.0269843152702 F2=0 F3=-
 566.249994176736 M1=0 M2=251.64064697519 M3=0 FrameElem=62
 Frame=62 Joint=55 OutputCase=ENVE CaseType=Combination StepType=Min F1=11.4605155652702 F2=0
 F3=578.749994176736 M1=0 M2=-243.706594592466 M3=0 FrameElem=62
 Frame=62 Joint=34 OutputCase=ENVE CaseType=Combination StepType=Min F1=-34.6177425202212 F2=0 F3=-
 566.24999427699 M1=0 M2=249.725752770798 M3=0 FrameElem=62
 Frame=62 Joint=55 OutputCase=FESSUR CaseType=Combination F1=22.3799300202212 F2=0 F3=578.749994176736
 M1=0 M2=-235.387508785598 M3=0 FrameElem=62
 Frame=62 Joint=34 OutputCase=FESSUR CaseType=Combination F1=-34.6177425202212 F2=0 F3=-
 566.249994176736 M1=0 M2=249.725752770798 M3=0 FrameElem=62
 Frame=63 Joint=29 OutputCase=PESOPR CaseType=LinStatic F1=15.1709467362363 F2=0 F3=149.999998818836
 M1=0 M2=74.1698929279467 M3=0 FrameElem=63
 Frame=63 Joint=56 OutputCase=PESOPR CaseType=LinStatic F1=-15.1709467362363 F2=0 F3=-137.499998818836
 M1=0 M2=-66.5844189886175 M3=0 FrameElem=63
 Frame=63 Joint=29 OutputCase=TERRVERT CaseType=LinStatic F1=-1.15282857329504 F2=0
 F3=491.24999511953 M1=0 M2=223.993210450844 M3=0 FrameElem=63
 Frame=63 Joint=56 OutputCase=TERRVERT CaseType=LinStatic F1=1.15282857329504 F2=0 F3=-
 491.24999511953 M1=0 M2=-224.569622785439 M3=0 FrameElem=63
 Frame=63 Joint=29 OutputCase=TERRLAT CaseType=LinStatic F1=56.769138485499 F2=0 F3=3.34181892792634E-
 07 M1=0 M2=-13.3699386407234 M3=0 FrameElem=63
 Frame=63 Joint=56 OutputCase=TERRLAT CaseType=LinStatic F1=-33.8719510045595 F2=0 F3=-
 3.34181892792634E-07 M1=0 M2=35.9413828877086 M3=0 FrameElem=63
 Frame=63 Joint=29 OutputCase=ACCLATDX CaseType=LinStatic F1=0 F2=0 F3=0 M1=0 M2=0 M3=0
 FrameElem=63
 Frame=63 Joint=56 OutputCase=ACCLATDX CaseType=LinStatic F1=0 F2=0 F3=0 M1=0 M2=0 M3=0
 FrameElem=63
 Frame=63 Joint=29 OutputCase=ACCLATSX CaseType=LinStatic F1=0 F2=0 F3=0 M1=0 M2=0 M3=0
 FrameElem=63
 Frame=63 Joint=56 OutputCase=ACCLATSX CaseType=LinStatic F1=0 F2=0 F3=0 M1=0 M2=0 M3=0
 FrameElem=63
 Frame=63 Joint=29 OutputCase=TERRCOST CaseType=LinStatic F1=0 F2=0 F3=0 M1=0 M2=0 M3=0
 FrameElem=63
 Frame=63 Joint=56 OutputCase=TERRCOST CaseType=LinStatic F1=0 F2=0 F3=0 M1=0 M2=0 M3=0
 FrameElem=63
 Frame=63 Joint=29 OutputCase=SOVRCOST CaseType=LinStatic F1=0 F2=0 F3=0 M1=0 M2=0 M3=0
 FrameElem=63
 Frame=63 Joint=56 OutputCase=SOVRCOST CaseType=LinStatic F1=0 F2=0 F3=0 M1=0 M2=0 M3=0
 FrameElem=63
 Frame=63 Joint=29 OutputCase=ENVE CaseType=Combination StepType=Max F1=70.7872566484403 F2=0
 F3=641.249994664971 M1=0 M2=288.804146330284 M3=0 FrameElem=63



Frame=63 Joint=56 OutputCase=ENVE CaseType=Combination StepType=Max F1=-37.7284838661329 F2=0 F3=-
 628.749994564716 M1=0 M2=-255.212658886348 M3=0 FrameElem=63
 Frame=63 Joint=29 OutputCase=ENVE CaseType=Combination StepType=Min F1=53.7565151027906 F2=0
 F3=641.249994564716 M1=0 M2=284.793164738067 M3=0 FrameElem=63
 Frame=63 Joint=56 OutputCase=ENVE CaseType=Combination StepType=Min F1=-47.8900691675008 F2=0 F3=-
 628.749994664971 M1=0 M2=-265.995073752661 M3=0 FrameElem=63
 Frame=63 Joint=29 OutputCase=FESSUR CaseType=Combination F1=70.7872566484403 F2=0 F3=641.249994664971
 M1=0 M2=284.793164738067 M3=0 FrameElem=63
 Frame=63 Joint=56 OutputCase=FESSUR CaseType=Combination F1=-47.8900691675008 F2=0 F3=-
 628.749994664971 M1=0 M2=-255.212658886348 M3=0 FrameElem=63
 Frame=64 Joint=56 OutputCase=PESOPR CaseType=LinStatic F1=15.1709467362361 F2=0 F3=137.499998818796
 M1=0 M2=66.5844189886175 M3=0 FrameElem=64
 Frame=64 Joint=57 OutputCase=PESOPR CaseType=LinStatic F1=-15.1709467362361 F2=0 F3=-124.999998818796
 M1=0 M2=-58.9989450989587 M3=0 FrameElem=64
 Frame=64 Joint=56 OutputCase=TERRVERT CaseType=LinStatic F1=-1.15282857329564 F2=0
 F3=491.249995512152 M1=0 M2=224.569622785439 M3=0 FrameElem=64
 Frame=64 Joint=57 OutputCase=TERRVERT CaseType=LinStatic F1=1.15282857329564 F2=0 F3=-
 491.249995512152 M1=0 M2=-225.146035120035 M3=0 FrameElem=64
 Frame=64 Joint=56 OutputCase=TERRLAT CaseType=LinStatic F1=33.8719510045595 F2=0
 F3=3.34181948680966E-07 M1=0 M2=-35.9413828877086 M3=0 FrameElem=64
 Frame=64 Joint=57 OutputCase=TERRLAT CaseType=LinStatic F1=-13.1066385363269 F2=0 F3=-
 3.34181948680966E-07 M1=0 M2=47.5972021474008 M3=0 FrameElem=64
 Frame=64 Joint=56 OutputCase=ACCLATDX CaseType=LinStatic F1=0 F2=0 F3=0 M1=0 M2=0 M3=0
 FrameElem=64
 Frame=64 Joint=57 OutputCase=ACCLATDX CaseType=LinStatic F1=0 F2=0 F3=0 M1=0 M2=0 M3=0
 FrameElem=64
 Frame=64 Joint=56 OutputCase=ACCLATSX CaseType=LinStatic F1=0 F2=0 F3=0 M1=0 M2=0 M3=0
 FrameElem=64
 Frame=64 Joint=57 OutputCase=ACCLATSX CaseType=LinStatic F1=0 F2=0 F3=0 M1=0 M2=0 M3=0
 FrameElem=64
 Frame=64 Joint=56 OutputCase=TERRCOST CaseType=LinStatic F1=0 F2=0 F3=0 M1=0 M2=0 M3=0
 FrameElem=64
 Frame=64 Joint=57 OutputCase=TERRCOST CaseType=LinStatic F1=0 F2=0 F3=0 M1=0 M2=0 M3=0
 FrameElem=64
 Frame=64 Joint=56 OutputCase=SOVRCOST CaseType=LinStatic F1=0 F2=0 F3=0 M1=0 M2=0 M3=0
 FrameElem=64
 Frame=64 Joint=57 OutputCase=SOVRCOST CaseType=LinStatic F1=0 F2=0 F3=0 M1=0 M2=0 M3=0
 FrameElem=64
 Frame=64 Joint=56 OutputCase=ENVE CaseType=Combination StepType=Max F1=47.8900691675 F2=0
 F3=628.74999466513 M1=0 M2=265.995073752661 M3=0 FrameElem=64
 Frame=64 Joint=57 OutputCase=ENVE CaseType=Combination StepType=Max F1=-23.1927651383693 F2=0 F3=-
 616.249994564876 M1=0 M2=-236.547778071593 M3=0 FrameElem=64
 Frame=64 Joint=56 OutputCase=ENVE CaseType=Combination StepType=Min F1=37.7284838661322 F2=0
 F3=628.749994564876 M1=0 M2=255.212658886348 M3=0 FrameElem=64
 Frame=64 Joint=57 OutputCase=ENVE CaseType=Combination StepType=Min F1=-27.1247566992674 F2=0 F3=-
 616.24999466513 M1=0 M2=-250.826938715813 M3=0 FrameElem=64
 Frame=64 Joint=56 OutputCase=FESSUR CaseType=Combination F1=47.8900691675 F2=0 F3=628.74999466513
 M1=0 M2=255.212658886348 M3=0 FrameElem=64
 Frame=64 Joint=57 OutputCase=FESSUR CaseType=Combination F1=-27.1247566992674 F2=0 F3=-
 616.24999466513 M1=0 M2=-236.547778071593 M3=0 FrameElem=64
 Frame=65 Joint=57 OutputCase=PESOPR CaseType=LinStatic F1=15.1709467362361 F2=0 F3=124.999998818625
 M1=0 M2=58.9989450989588 M3=0 FrameElem=65
 Frame=65 Joint=58 OutputCase=PESOPR CaseType=LinStatic F1=-15.1709467362361 F2=0 F3=-112.499998818625
 M1=0 M2=-51.4134712589706 M3=0 FrameElem=65
 Frame=65 Joint=57 OutputCase=TERRVERT CaseType=LinStatic F1=-1.15282857329497 F2=0
 F3=491.249995511742 M1=0 M2=225.146035120035 M3=0 FrameElem=65
 Frame=65 Joint=58 OutputCase=TERRVERT CaseType=LinStatic F1=1.15282857329497 F2=0 F3=-
 491.249995511742 M1=0 M2=-225.722447454631 M3=0 FrameElem=65
 Frame=65 Joint=57 OutputCase=TERRLAT CaseType=LinStatic F1=13.1066385363267 F2=0
 F3=3.34182667487509E-07 M1=0 M2=-47.5972021474009 M3=0 FrameElem=65
 Frame=65 Joint=58 OutputCase=TERRLAT CaseType=LinStatic F1=5.52679891919892 F2=0 F3=-
 3.34182667487509E-07 M1=0 M2=49.4033339261535 M3=0 FrameElem=65
 Frame=65 Joint=57 OutputCase=ACCLATDX CaseType=LinStatic F1=0 F2=0 F3=0 M1=0 M2=0 M3=0
 FrameElem=65
 Frame=65 Joint=58 OutputCase=ACCLATDX CaseType=LinStatic F1=0 F2=0 F3=0 M1=0 M2=0 M3=0
 FrameElem=65
 Frame=65 Joint=57 OutputCase=ACCLATSX CaseType=LinStatic F1=0 F2=0 F3=0 M1=0 M2=0 M3=0
 FrameElem=65
 Frame=65 Joint=58 OutputCase=ACCLATSX CaseType=LinStatic F1=0 F2=0 F3=0 M1=0 M2=0 M3=0
 FrameElem=65
 Frame=65 Joint=57 OutputCase=TERRCOST CaseType=LinStatic F1=0 F2=0 F3=0 M1=0 M2=0 M3=0
 FrameElem=65
 Frame=65 Joint=58 OutputCase=TERRCOST CaseType=LinStatic F1=0 F2=0 F3=0 M1=0 M2=0 M3=0
 FrameElem=65
 Frame=65 Joint=57 OutputCase=SOVRCOST CaseType=LinStatic F1=0 F2=0 F3=0 M1=0 M2=0 M3=0
 FrameElem=65
 Frame=65 Joint=58 OutputCase=SOVRCOST CaseType=LinStatic F1=0 F2=0 F3=0 M1=0 M2=0 M3=0
 FrameElem=65
 Frame=65 Joint=57 OutputCase=ENVE CaseType=Combination StepType=Max F1=27.1247566992679 F2=0
 F3=616.24999466455 M1=0 M2=250.826938715814 M3=0 FrameElem=65
 Frame=65 Joint=58 OutputCase=ENVE CaseType=Combination StepType=Max F1=-8.49131924374226 F2=0 F3=-
 603.749994564295 M1=0 M2=-227.732584787448 M3=0 FrameElem=65



Frame=65 Joint=57 OutputCase=ENVE CaseType=Combination StepType=Min F1=23.1927651383699 F2=0
 F3=616.249994564295 M1=0 M2=236.547778071593 M3=0 FrameElem=65
 Frame=65 Joint=58 OutputCase=ENVE CaseType=Combination StepType=Min F1=-10.1493589195019 F2=0 F3=-
 603.74999466455 M1=0 M2=-242.553584965294 M3=0 FrameElem=65
 Frame=65 Joint=57 OutputCase=PESSUR CaseType=Combination F1=27.1247566992679 F2=0 F3=616.24999466455
 M1=0 M2=236.547778071593 M3=0 FrameElem=65
 Frame=65 Joint=58 OutputCase=PESSUR CaseType=Combination F1=-8.49131924374226 F2=0 F3=-
 603.74999466455 M1=0 M2=-227.732584787448 M3=0 FrameElem=65
 Frame=66 Joint=58 OutputCase=PESOPR CaseType=LinStatic F1=15.1709467362361 F2=0 F3=112.499998818554
 M1=0 M2=51.4134712589706 M3=0 FrameElem=66
 Frame=66 Joint=59 OutputCase=PESOPR CaseType=LinStatic F1=-15.1709467362361 F2=0 F3=-99.9999988185541
 M1=0 M2=-43.8279974686531 M3=0 FrameElem=66
 Frame=66 Joint=58 OutputCase=TERRVERT CaseType=LinStatic F1=-1.15282857329598 F2=0
 F3=491.249995511773 M1=0 M2=225.722447454631 M3=0 FrameElem=66
 Frame=66 Joint=59 OutputCase=TERRVERT CaseType=LinStatic F1=1.15282857329598 F2=0 F3=-
 491.249995511773 M1=0 M2=-226.298859789227 M3=0 FrameElem=66
 Frame=66 Joint=58 OutputCase=TERRLAT CaseType=LinStatic F1=-5.52679891919857 F2=0
 F3=3.3418254674655E-07 M1=0 M2=-49.4033339261536 M3=0 FrameElem=66
 Frame=66 Joint=59 OutputCase=TERRLAT CaseType=LinStatic F1=22.0283613620172 F2=0 F3=-
 3.3418254674655E-07 M1=0 M2=42.4257157303201 M3=0 FrameElem=66
 Frame=66 Joint=58 OutputCase=ACCLATDX CaseType=LinStatic F1=0 F2=0 F3=0 M1=0 M2=0 M3=0
 FrameElem=66
 Frame=66 Joint=59 OutputCase=ACCLATDX CaseType=LinStatic F1=0 F2=0 F3=0 M1=0 M2=0 M3=0
 FrameElem=66
 Frame=66 Joint=58 OutputCase=ACCLATSX CaseType=LinStatic F1=0 F2=0 F3=0 M1=0 M2=0 M3=0
 FrameElem=66
 Frame=66 Joint=59 OutputCase=ACCLATSX CaseType=LinStatic F1=0 F2=0 F3=0 M1=0 M2=0 M3=0
 FrameElem=66
 Frame=66 Joint=58 OutputCase=TERRCOST CaseType=LinStatic F1=0 F2=0 F3=0 M1=0 M2=0 M3=0
 FrameElem=66
 Frame=66 Joint=59 OutputCase=TERRCOST CaseType=LinStatic F1=0 F2=0 F3=0 M1=0 M2=0 M3=0
 FrameElem=66
 Frame=66 Joint=58 OutputCase=SOVRCOST CaseType=LinStatic F1=0 F2=0 F3=0 M1=0 M2=0 M3=0
 FrameElem=66
 Frame=66 Joint=59 OutputCase=SOVRCOST CaseType=LinStatic F1=0 F2=0 F3=0 M1=0 M2=0 M3=0
 FrameElem=66
 Frame=66 Joint=58 OutputCase=ENVE CaseType=Combination StepType=Max F1=10.1493589195012 F2=0
 F3=603.74999466451 M1=0 M2=242.553584965294 M3=0 FrameElem=66
 Frame=66 Joint=59 OutputCase=ENVE CaseType=Combination StepType=Max F1=8.01024319907707 F2=0 F3=-
 591.249994564255 M1=0 M2=-227.70114152756 M3=0 FrameElem=66
 Frame=66 Joint=58 OutputCase=ENVE CaseType=Combination StepType=Min F1=8.49131924374158 F2=0
 F3=603.749994564255 M1=0 M2=227.732584787448 M3=0 FrameElem=66
 Frame=66 Joint=59 OutputCase=ENVE CaseType=Combination StepType=Min F1=1.4017347904719 F2=0 F3=-
 591.24999466451 M1=0 M2=-240.428856246656 M3=0 FrameElem=66
 Frame=66 Joint=58 OutputCase=PESSUR CaseType=Combination F1=8.49131924374158 F2=0 F3=603.74999466451
 M1=0 M2=227.732584787448 M3=0 FrameElem=66
 Frame=66 Joint=59 OutputCase=PESSUR CaseType=Combination F1=8.01024319907707 F2=0 F3=-591.24999466451
 M1=0 M2=-227.70114152756 M3=0 FrameElem=66
 Frame=67 Joint=59 OutputCase=PESOPR CaseType=LinStatic F1=15.1709467362359 F2=0 F3=99.9999988185548
 M1=0 M2=43.827997468653 M3=0 FrameElem=67
 Frame=67 Joint=60 OutputCase=PESOPR CaseType=LinStatic F1=-15.1709467362359 F2=0 F3=-87.4999988185548
 M1=0 M2=-36.242523728006 M3=0 FrameElem=67
 Frame=67 Joint=59 OutputCase=TERRVERT CaseType=LinStatic F1=-1.15282857329697 F2=0
 F3=491.249995511662 M1=0 M2=226.298859789227 M3=0 FrameElem=67
 Frame=67 Joint=60 OutputCase=TERRVERT CaseType=LinStatic F1=1.15282857329697 F2=0 F3=-
 491.249995511662 M1=0 M2=-226.875272123823 M3=0 FrameElem=67
 Frame=67 Joint=59 OutputCase=TERRLAT CaseType=LinStatic F1=-22.0283613620169 F2=0
 F3=3.34182875641072E-07 M1=0 M2=-42.4257157303202 M3=0 FrameElem=67
 Frame=67 Joint=60 OutputCase=TERRLAT CaseType=LinStatic F1=36.3980487921286 F2=0 F3=-
 3.34182875641072E-07 M1=0 M2=27.7302850662544 M3=0 FrameElem=67
 Frame=67 Joint=59 OutputCase=ACCLATDX CaseType=LinStatic F1=0 F2=0 F3=0 M1=0 M2=0 M3=0
 FrameElem=67
 Frame=67 Joint=60 OutputCase=ACCLATDX CaseType=LinStatic F1=0 F2=0 F3=0 M1=0 M2=0 M3=0
 FrameElem=67
 Frame=67 Joint=59 OutputCase=ACCLATSX CaseType=LinStatic F1=0 F2=0 F3=0 M1=0 M2=0 M3=0
 FrameElem=67
 Frame=67 Joint=60 OutputCase=ACCLATSX CaseType=LinStatic F1=0 F2=0 F3=0 M1=0 M2=0 M3=0
 FrameElem=67
 Frame=67 Joint=59 OutputCase=TERRCOST CaseType=LinStatic F1=0 F2=0 F3=0 M1=0 M2=0 M3=0
 FrameElem=67
 Frame=67 Joint=60 OutputCase=TERRCOST CaseType=LinStatic F1=0 F2=0 F3=0 M1=0 M2=0 M3=0
 FrameElem=67
 Frame=67 Joint=59 OutputCase=SOVRCOST CaseType=LinStatic F1=0 F2=0 F3=0 M1=0 M2=0 M3=0
 FrameElem=67
 Frame=67 Joint=60 OutputCase=SOVRCOST CaseType=LinStatic F1=0 F2=0 F3=0 M1=0 M2=0 M3=0
 FrameElem=67
 Frame=67 Joint=59 OutputCase=ENVE CaseType=Combination StepType=Max F1=-1.40173479047284 F2=0
 F3=591.2499946644 M1=0 M2=240.428856246656 M3=0 FrameElem=67
 Frame=67 Joint=60 OutputCase=ENVE CaseType=Combination StepType=Max F1=22.3799306291896 F2=0 F3=-
 578.749994564145 M1=0 M2=-235.387510785575 M3=0 FrameElem=67
 Frame=67 Joint=59 OutputCase=ENVE CaseType=Combination StepType=Min F1=-8.0102431990779 F2=0
 F3=591.249994564145 M1=0 M2=227.701141527559 M3=0 FrameElem=67



Frame=67 Joint=60 OutputCase=ENVE CaseType=Combination StepType=Min F1=11.460515991551 F2=0 F3=-
 578.7499946644 M1=0 M2=-243.706596305451 M3=0 FrameElem=67
 Frame=67 Joint=59 OutputCase=PESSUR CaseType=Combination F1=-8.0102431990779 F2=0 F3=591.2499946644
 M1=0 M2=227.701141527559 M3=0 FrameElem=67
 Frame=67 Joint=60 OutputCase=PESSUR CaseType=Combination F1=22.3799306291896 F2=0 F3=-578.7499946644
 M1=0 M2=-235.387510785575 M3=0 FrameElem=67
 Frame=68 Joint=60 OutputCase=PESOPR CaseType=LinStatic F1=15.1709467362359 F2=0 F3=87.4999988186561
 M1=0 M2=36.2425237280065 M3=0 FrameElem=68
 Frame=68 Joint=35 OutputCase=PESOPR CaseType=LinStatic F1=-15.1709467362359 F2=0 F3=-74.9999988186561
 M1=0 M2=-28.6570500370301 M3=0 FrameElem=68
 Frame=68 Joint=60 OutputCase=TERRVERT CaseType=LinStatic F1=-1.15282857329635 F2=0
 F3=491.249995511758 M1=0 M2=226.875272123825 M3=0 FrameElem=68
 Frame=68 Joint=35 OutputCase=TERRVERT CaseType=LinStatic F1=1.15282857329635 F2=0 F3=-
 491.249995511758 M1=0 M2=-227.451684458421 M3=0 FrameElem=68
 Frame=68 Joint=60 OutputCase=TERRLAT CaseType=LinStatic F1=-36.3980487921286 F2=0
 F3=3.34182796544188E-07 M1=0 M2=-27.7302850662542 M3=0 FrameElem=68
 Frame=68 Joint=35 OutputCase=TERRLAT CaseType=LinStatic F1=48.6358612095334 F2=0 F3=-
 3.34182796544188E-07 M1=0 M2=6.38297944030927 M3=0 FrameElem=68
 Frame=68 Joint=60 OutputCase=ACCLATDX CaseType=LinStatic F1=0 F2=0 F3=0 M1=0 M2=0 M3=0
 FrameElem=68
 Frame=68 Joint=35 OutputCase=ACCLATDX CaseType=LinStatic F1=0 F2=0 F3=0 M1=0 M2=0 M3=0
 FrameElem=68
 Frame=68 Joint=60 OutputCase=ACCLATSX CaseType=LinStatic F1=0 F2=0 F3=0 M1=0 M2=0 M3=0
 FrameElem=68
 Frame=68 Joint=35 OutputCase=ACCLATSX CaseType=LinStatic F1=0 F2=0 F3=0 M1=0 M2=0 M3=0
 FrameElem=68
 Frame=68 Joint=60 OutputCase=TERRCOST CaseType=LinStatic F1=0 F2=0 F3=0 M1=0 M2=0 M3=0
 FrameElem=68
 Frame=68 Joint=35 OutputCase=TERRCOST CaseType=LinStatic F1=0 F2=0 F3=0 M1=0 M2=0 M3=0
 FrameElem=68
 Frame=68 Joint=60 OutputCase=SOVRCOST CaseType=LinStatic F1=0 F2=0 F3=0 M1=0 M2=0 M3=0
 FrameElem=68
 Frame=68 Joint=35 OutputCase=SOVRCOST CaseType=LinStatic F1=0 F2=0 F3=0 M1=0 M2=0 M3=0
 FrameElem=68
 Frame=68 Joint=60 OutputCase=ENVE CaseType=Combination StepType=Max F1=-11.4605159915505 F2=0
 F3=578.749994664597 M1=0 M2=243.706596305454 M3=0 FrameElem=68
 Frame=68 Joint=35 OutputCase=ENVE CaseType=Combination StepType=Max F1=34.6177430465938 F2=0 F3=-
 566.249994564342 M1=0 M2=-249.725755055142 M3=0 FrameElem=68
 Frame=68 Joint=60 OutputCase=ENVE CaseType=Combination StepType=Min F1=-22.3799306291891 F2=0
 F3=578.749994564342 M1=0 M2=235.387510785578 M3=0 FrameElem=68
 Frame=68 Joint=35 OutputCase=ENVE CaseType=Combination StepType=Min F1=20.0269846837338 F2=0 F3=-
 566.249994664597 M1=0 M2=-251.640648887235 M3=0 FrameElem=68
 Frame=68 Joint=60 OutputCase=PESSUR CaseType=Combination F1=-22.3799306291891 F2=0
 F3=578.749994664597 M1=0 M2=235.387510785578 M3=0 FrameElem=68
 Frame=68 Joint=35 OutputCase=PESSUR CaseType=Combination F1=34.6177430465938 F2=0 F3=-
 566.249994664597 M1=0 M2=-249.725755055142 M3=0 FrameElem=68

TABLE: "OBJECTS AND ELEMENTS - JOINTS"

JointElem	JointObject	GlobalX	GlobalY	GlobalZ
JointElem=1	JointObject=1	GlobalX=-2.49999997615814	GlobalY=0	GlobalZ=0
JointElem=15	JointObject=15	GlobalX=2.49999997615814	GlobalY=0	GlobalZ=0
JointElem=35	JointObject=35	GlobalX=2.49999997615814	GlobalY=0	GlobalZ=3.5
JointElem=40	JointObject=40	GlobalX=-2	GlobalY=0	GlobalZ=4
JointElem=39	JointObject=39	GlobalX=-2.25	GlobalY=0	GlobalZ=4
JointElem=34	JointObject=34	GlobalX=-2.49999997615814	GlobalY=0	GlobalZ=3.5
JointElem=20	JointObject=20	GlobalX=-2.49999997615814	GlobalY=0	GlobalZ=4
JointElem=21	JointObject=21	GlobalX=2.49999997615814	GlobalY=0	GlobalZ=3.99999997615814
JointElem=22	JointObject=22	GlobalX=-2.5	GlobalY=0	GlobalZ=3.75
JointElem=23	JointObject=23	GlobalX=2.5	GlobalY=0	GlobalZ=3.75
JointElem=24	JointObject=24	GlobalX=2	GlobalY=0	GlobalZ=4
JointElem=25	JointObject=25	GlobalX=2.25	GlobalY=0	GlobalZ=4
JointElem=26	JointObject=26	GlobalX=-2.5	GlobalY=0	GlobalZ=0.25
JointElem=27	JointObject=27	GlobalX=-2.5	GlobalY=0	GlobalZ=0.5
JointElem=28	JointObject=28	GlobalX=2.5	GlobalY=0	GlobalZ=0.25
JointElem=29	JointObject=29	GlobalX=2.5	GlobalY=0	GlobalZ=0.5
JointElem=30	JointObject=30	GlobalX=-2.25	GlobalY=0	GlobalZ=0
JointElem=31	JointObject=31	GlobalX=-2	GlobalY=0	GlobalZ=0
JointElem=32	JointObject=32	GlobalX=2	GlobalY=0	GlobalZ=0
JointElem=33	JointObject=33	GlobalX=2.25	GlobalY=0	GlobalZ=0
JointElem=19	JointObject=19	GlobalX=-1.5	GlobalY=0	GlobalZ=0
JointElem=36	JointObject=36	GlobalX=-1	GlobalY=0	GlobalZ=0
JointElem=37	JointObject=37	GlobalX=-0.5	GlobalY=0	GlobalZ=0
JointElem=38	JointObject=38	GlobalX=0	GlobalY=0	GlobalZ=0
JointElem=41	JointObject=41	GlobalX=0.5	GlobalY=0	GlobalZ=0
JointElem=42	JointObject=42	GlobalX=1	GlobalY=0	GlobalZ=0
JointElem=43	JointObject=43	GlobalX=1.5	GlobalY=0	GlobalZ=0
JointElem=44	JointObject=44	GlobalX=-1.5	GlobalY=0	GlobalZ=4
JointElem=45	JointObject=45	GlobalX=-1	GlobalY=0	GlobalZ=4
JointElem=46	JointObject=46	GlobalX=-0.5	GlobalY=0	GlobalZ=4
JointElem=47	JointObject=47	GlobalX=0	GlobalY=0	GlobalZ=4
JointElem=48	JointObject=48	GlobalX=0.5	GlobalY=0	GlobalZ=4
JointElem=49	JointObject=49	GlobalX=1	GlobalY=0	GlobalZ=4
JointElem=50	JointObject=50	GlobalX=1.5	GlobalY=0	GlobalZ=4



JointElem=51	JointObject=51	GlobalX=-2.49999999602636	GlobalY=0	GlobalZ=1
JointElem=52	JointObject=52	GlobalX=-2.49999999205271	GlobalY=0	GlobalZ=1.5
JointElem=53	JointObject=53	GlobalX=-2.49999998807907	GlobalY=0	GlobalZ=2
JointElem=54	JointObject=54	GlobalX=-2.49999998410543	GlobalY=0	GlobalZ=2.5
JointElem=55	JointObject=55	GlobalX=-2.49999998013179	GlobalY=0	GlobalZ=3
JointElem=56	JointObject=56	GlobalX=2.49999999602636	GlobalY=0	GlobalZ=1
JointElem=57	JointObject=57	GlobalX=2.49999999205271	GlobalY=0	GlobalZ=1.5
JointElem=58	JointObject=58	GlobalX=2.49999998807907	GlobalY=0	GlobalZ=2
JointElem=59	JointObject=59	GlobalX=2.49999998410543	GlobalY=0	GlobalZ=2.5
JointElem=60	JointObject=60	GlobalX=2.49999998013179	GlobalY=0	GlobalZ=3

TABLE: "OBJECTS AND ELEMENTS - FRAMES"

FrameElem=1	FrameObject=1	ElemJtI=1	ElemJtJ=30
FrameElem=2	FrameObject=2	ElemJtI=30	ElemJtJ=31
FrameElem=4	FrameObject=4	ElemJtI=32	ElemJtJ=33
FrameElem=5	FrameObject=5	ElemJtI=33	ElemJtJ=15
FrameElem=6	FrameObject=6	ElemJtI=15	ElemJtJ=28
FrameElem=7	FrameObject=7	ElemJtI=28	ElemJtJ=29
FrameElem=9	FrameObject=9	ElemJtI=35	ElemJtJ=23
FrameElem=10	FrameObject=10	ElemJtI=23	ElemJtJ=21
FrameElem=11	FrameObject=11	ElemJtI=20	ElemJtJ=39
FrameElem=12	FrameObject=12	ElemJtI=39	ElemJtJ=40
FrameElem=14	FrameObject=14	ElemJtI=24	ElemJtJ=25
FrameElem=15	FrameObject=15	ElemJtI=25	ElemJtJ=21
FrameElem=16	FrameObject=16	ElemJtI=1	ElemJtJ=26
FrameElem=17	FrameObject=17	ElemJtI=26	ElemJtJ=27
FrameElem=19	FrameObject=19	ElemJtI=34	ElemJtJ=22
FrameElem=20	FrameObject=20	ElemJtI=22	ElemJtJ=20
FrameElem=41	FrameObject=41	ElemJtI=31	ElemJtJ=19
FrameElem=42	FrameObject=42	ElemJtI=19	ElemJtJ=36
FrameElem=43	FrameObject=43	ElemJtI=36	ElemJtJ=37
FrameElem=44	FrameObject=44	ElemJtI=37	ElemJtJ=38
FrameElem=45	FrameObject=45	ElemJtI=38	ElemJtJ=41
FrameElem=46	FrameObject=46	ElemJtI=41	ElemJtJ=42
FrameElem=47	FrameObject=47	ElemJtI=42	ElemJtJ=43
FrameElem=48	FrameObject=48	ElemJtI=43	ElemJtJ=32
FrameElem=49	FrameObject=49	ElemJtI=40	ElemJtJ=44
FrameElem=50	FrameObject=50	ElemJtI=44	ElemJtJ=45
FrameElem=51	FrameObject=51	ElemJtI=45	ElemJtJ=46
FrameElem=52	FrameObject=52	ElemJtI=46	ElemJtJ=47
FrameElem=53	FrameObject=53	ElemJtI=47	ElemJtJ=48
FrameElem=54	FrameObject=54	ElemJtI=48	ElemJtJ=49
FrameElem=55	FrameObject=55	ElemJtI=49	ElemJtJ=50
FrameElem=56	FrameObject=56	ElemJtI=50	ElemJtJ=24
FrameElem=57	FrameObject=57	ElemJtI=27	ElemJtJ=51
FrameElem=58	FrameObject=58	ElemJtI=51	ElemJtJ=52
FrameElem=59	FrameObject=59	ElemJtI=52	ElemJtJ=53
FrameElem=60	FrameObject=60	ElemJtI=53	ElemJtJ=54
FrameElem=61	FrameObject=61	ElemJtI=54	ElemJtJ=55
FrameElem=62	FrameObject=62	ElemJtI=55	ElemJtJ=34
FrameElem=63	FrameObject=63	ElemJtI=29	ElemJtJ=56
FrameElem=64	FrameObject=64	ElemJtI=56	ElemJtJ=57
FrameElem=65	FrameObject=65	ElemJtI=57	ElemJtJ=58
FrameElem=66	FrameObject=66	ElemJtI=58	ElemJtJ=59
FrameElem=67	FrameObject=67	ElemJtI=59	ElemJtJ=60
FrameElem=68	FrameObject=68	ElemJtI=60	ElemJtJ=35

TABLE: "BASE REACTIONS"

OutputCase=PESOPR CaseType=LinStatic GlobalFX=-2.822631017807E-12 GlobalFY=0 GlobalFZ=449.99997020317
 GlobalMX=0 GlobalMY=1.49179850694736E-06 GlobalMZ=0 GlobalX=0 GlobalY=0 GlobalZ=0 XCentroidFX=0
 YCentroidFX=0
 ZCentroidFX=0 XCentroidFY=0 YCentroidFY=0 ZCentroidFY=0 XCentroidFZ=-3.3151078151674E-09
 YCentroidFZ=0 ZCentroidFZ=0
 OutputCase=TERRVERT CaseType=LinStatic GlobalFX=-9.62407931126563E-12 GlobalFY=0
 GlobalFZ=982.499990631356 GlobalMX=0 GlobalMY=3.71433372947649E-09 GlobalMZ=0 GlobalX=0 GlobalY=0
 GlobalZ=0 XCentroidFX=0
 YCentroidFX=0 ZCentroidFX=0 XCentroidFY=0 YCentroidFY=0 ZCentroidFY=0 XCentroidFZ=-
 3.78049238157209E-12 YCentroidFZ=0 ZCentroidFZ=0
 OutputCase=TERRLAT CaseType=LinStatic GlobalFX=-8.37684822840856E-07 GlobalFY=0 GlobalFZ=-
 1.76807873897289E-12 GlobalMX=0 GlobalMY=-2.99859810588832E-06 GlobalMZ=0 GlobalX=0 GlobalY=0 GlobalZ=0
 XCentroidFX=-2.49999999151778 YCentroidFX=0 ZCentroidFX=0 XCentroidFY=0 YCentroidFY=0
 ZCentroidFY=0 XCentroidFZ=-1695964.12184124 YCentroidFZ=0 ZCentroidFZ=0
 OutputCase=ACCLATDX CaseType=LinStatic GlobalFX=0 GlobalFY=0 GlobalFZ=0 GlobalMX=0 GlobalMY=0
 GlobalMZ=0 GlobalX=0 GlobalY=0 GlobalZ=0 XCentroidFX=0 YCentroidFX=0 ZCentroidFX=0 XCentroidFY=0
 YCentroidFY=0
 ZCentroidFY=0 XCentroidFZ=0 YCentroidFZ=0 ZCentroidFZ=0
 OutputCase=ACCLATSX CaseType=LinStatic GlobalFX=0 GlobalFY=0 GlobalFZ=0 GlobalMX=0 GlobalMY=0
 GlobalMZ=0 GlobalX=0 GlobalY=0 GlobalZ=0 XCentroidFX=0 YCentroidFX=0 ZCentroidFX=0 XCentroidFY=0
 YCentroidFY=0
 ZCentroidFY=0 XCentroidFZ=0 YCentroidFZ=0 ZCentroidFZ=0



```

OutputCase=TERRCOST CaseType=LinStatic GlobalFX=0 GlobalFY=0 GlobalFZ=0 GlobalMX=0 GlobalMY=0
GlobalMZ=0 GlobalX=0 GlobalY=0 GlobalZ=0 XCentroidFX=0 YCentroidFX=0 ZCentroidFX=0 XCentroidFY=0
YCentroidFY=0 _
ZCentroidFZ=0 XCentroidFZ=0 YCentroidFZ=0 ZCentroidFZ=0
OutputCase=SOVRCOST CaseType=LinStatic GlobalFX=0 GlobalFY=0 GlobalFZ=0 GlobalMX=0 GlobalMY=0
GlobalMZ=0 GlobalX=0 GlobalY=0 GlobalZ=0 XCentroidFX=0 YCentroidFX=0 ZCentroidFX=0 XCentroidFY=0
YCentroidFY=0 _
ZCentroidFZ=0 XCentroidFZ=0 YCentroidFZ=0 ZCentroidFZ=0
OutputCase=ENVE CaseType=Combination StepType=Max GlobalFX=-5.86391822698928E-07 GlobalFY=0
GlobalFZ=1432.49998765167 GlobalMX=0 GlobalMY=-6.03505833444984E-07 GlobalMZ=0 GlobalX=0 GlobalY=0
GlobalZ=0 _
XCentroidFX=0 YCentroidFX=0 ZCentroidFX=0 XCentroidFY=0 YCentroidFY=0 ZCentroidFY=0
XCentroidFZ=0 YCentroidFZ=0 ZCentroidFZ=0
OutputCase=ENVE CaseType=Combination StepType=Min GlobalFX=-8.37697269551185E-07 GlobalFY=0
GlobalFZ=1432.49998765167 GlobalMX=0 GlobalMY=-1.50308526521148E-06 GlobalMZ=0 GlobalX=0 GlobalY=0
GlobalZ=0 _
XCentroidFX=0 YCentroidFX=0 ZCentroidFX=0 XCentroidFY=0 YCentroidFY=0 ZCentroidFY=0
XCentroidFZ=0 YCentroidFZ=0 ZCentroidFZ=0
OutputCase=FESSUR CaseType=Combination GlobalFX=-8.37697269551185E-07 GlobalFY=0
GlobalFZ=1432.49998765167 GlobalMX=0 GlobalMY=-1.50308526521148E-06 GlobalMZ=0 GlobalX=0 GlobalY=0
GlobalZ=0 _
XCentroidFX=-2.49999999059018 YCentroidFX=0 ZCentroidFX=0 XCentroidFY=0 YCentroidFY=0
ZCentroidFY=0 XCentroidFZ=1.04927419069338E-09 YCentroidFZ=0 ZCentroidFZ=0

```

END TABLE DATA

<p>GENERAL CONTRACTOR</p> 	<p>ALTA SORVEGLIANZA</p> 
<p>IG51-02-E-CV-CL-IN11-0X-001_A00 Relazione di calcolo</p>	
<p>Foglio 312 di 929</p>	

1.1. Dati di input scatolare – caso B e C

File D:\13_15_CO CIV\01_Calcoli\IN11\giorgio\IN11_situazione2-input.txt was saved on 9/17/13 at 11.45.07

TABLE: "PROGRAM CONTROL"

ProgramName=SAP2000 Version=15.0.0 ProgLevel=Ultimate LicenseNum=266BC LicenseOS=Yes LicenseSC=Yes
LicenseBR=No LicenseHT=No CurrUnits="KN, m, C" SteelCode=AISC-ASD89 ConcCode="ACI 318-99" AlumCode="AA-ASD
2000" - ColdCode=AISI-ASD96 BridgeCode="AASHTO LRFD 2007" RegenHinge=No

TABLE: "ACTIVE DEGREES OF FREEDOM"

UX=Yes UY=Yes UZ=Yes RX=Yes RY=Yes RZ=Yes

TABLE: "ANALYSIS OPTIONS"

Solver=Advanced SolverProc=Auto Force32Bit=No StiffCase=None GeomMod=No

TABLE: "COORDINATE SYSTEMS"

Name=GLOBAL Type=Cartesian X=0 Y=0 Z=0 AboutZ=0 AboutY=0 AboutX=0

TABLE: "GRID LINES"

CoordSys=GLOBAL AxisDir=X XXYZCoord=-2.5 LineType=Primary LineColor=Gray4 Visible=Yes BubbleLoc=End
AllVisible=Yes BubbleSize=1
CoordSys=GLOBAL AxisDir=X XXYZCoord=-2.25 LineType=Primary LineColor=Gray4 Visible=Yes BubbleLoc=End
CoordSys=GLOBAL AxisDir=X XXYZCoord=-2 LineType=Primary LineColor=Gray4 Visible=Yes BubbleLoc=End
CoordSys=GLOBAL AxisDir=X XXYZCoord=0 LineType=Primary LineColor=Gray4 Visible=Yes BubbleLoc=End
CoordSys=GLOBAL AxisDir=X XXYZCoord=2 LineType=Primary LineColor=Gray4 Visible=Yes BubbleLoc=End
CoordSys=GLOBAL AxisDir=X XXYZCoord=2.25 LineType=Primary LineColor=Gray4 Visible=Yes BubbleLoc=End
CoordSys=GLOBAL AxisDir=X XXYZCoord=2.5 LineType=Primary LineColor=Gray4 Visible=Yes BubbleLoc=End
CoordSys=GLOBAL AxisDir=Y XXYZCoord=0 LineType=Primary LineColor=Gray4 Visible=Yes BubbleLoc=End
CoordSys=GLOBAL AxisDir=Z XXYZCoord=0 LineType=Primary LineColor=Gray8Dark Visible=Yes BubbleLoc=End
CoordSys=GLOBAL AxisDir=Z XXYZCoord=0.25 LineType=Primary LineColor=Gray8Dark Visible=Yes
BubbleLoc=End
CoordSys=GLOBAL AxisDir=Z XXYZCoord=0.5 LineType=Primary LineColor=Gray8Dark Visible=Yes
BubbleLoc=End
CoordSys=GLOBAL AxisDir=Z XXYZCoord=3.5 LineType=Primary LineColor=Gray8Dark Visible=Yes
BubbleLoc=End
CoordSys=GLOBAL AxisDir=Z XXYZCoord=3.75 LineType=Primary LineColor=Gray8Dark Visible=Yes
BubbleLoc=End
CoordSys=GLOBAL AxisDir=Z XXYZCoord=4 LineType=Primary LineColor=Gray8Dark Visible=Yes BubbleLoc=End

TABLE: "MATERIAL PROPERTIES 01 - GENERAL"

Material=A416Gr270 Type=Tendon SymType=Uniaxial TempDepend=No Color=Blue Notes="ASTM A416 Grade 270
added 30/07/2013 14.54.57"
Material=A615Gr60 Type=Rebar SymType=Uniaxial TempDepend=No Color=Red Notes="ASTM A615 Grade 60 added
04/07/2013 15.33.53"
Material=CONC Type=Concrete SymType=Isotropic TempDepend=No Color=Black Notes="Normalweight f'c = 4 ksi
added 04/07/2013 15.33.53"
Material=OTHER Type=Other SymType=Isotropic TempDepend=No Color=Black Notes="Material added 04/07/2013
15.33.53"
Material=REBAR Type=Rebar SymType=Uniaxial TempDepend=No Color=Red Notes="ASTM A615 Grade 60 added
04/07/2013 15.33.53"
Material=STEEL Type=Steel SymType=Isotropic TempDepend=No Color=Black Notes="ASTM A36 added 04/07/2013
15.33.53"

TABLE: "MATERIAL PROPERTIES 02 - BASIC MECHANICAL PROPERTIES"

Material=A416Gr270 UnitWeight=76.9728639422648 UnitMass=7.84904737995992 E1=196500599.8512 A1=0.0000117
Material=A615Gr60 UnitWeight=76.9728639422648 UnitMass=7.84904737995992 E1=199947978.795958 A1=0.0000117
Material=CONC UnitWeight=25 UnitMass=2.5 E1=36049965 G12=15673897.826087 U12=0.15
A1=9.8999989542412E-06
Material=OTHER UnitWeight=23.5616130828857 UnitMass=2.40067982673645 E1=24821126 G12=10342135.8076484
U12=0.20000002980232 A1=9.8999989542412E-06
Material=REBAR UnitWeight=76.9728639422648 UnitMass=7.84904737995992 E1=199947978.795958 A1=0.0000117
Material=STEEL UnitWeight=76.8195419311523 UnitMass=7.82709980010986 E1=199947968 G12=76903063.9101877
U12=0.30000011920929 A1=1.1699999049597E-05

TABLE: "MATERIAL PROPERTIES 03A - STEEL DATA"

Material=STEEL Fy=248211.265625 Fu=310264.08203125 EffFy=372316.8984375 EffFu=341290.490234375
SSCurveOpt="User Defined" SSHysType=Kinematic

TABLE: "MATERIAL PROPERTIES 03B - CONCRETE DATA"

Material=CONC Fc=27579 LtWtConc=No SSCurveOpt="User Defined" SSHysType=Kinematic FAngle=0 DAngle=0

TABLE: "MATERIAL PROPERTIES 03E - REBAR DATA"

Material=A615Gr60 Fy=413685.473370947 Fu=620528.21005642 EffFy=455054.020708041 EffFu=682581.031062062
SSCurveOpt=Simple SSHysType=Kinematic SHard=0.01 SCap=0.09 FinalSlope=-0.1 UseCTDef=No
Material=REBAR Fy=275790 Fu=413685 EffFy=303369 EffFu=455053.5 SSCurveOpt=Simple SSHysType=Kinematic
SHard=0.01 SCap=0.09 FinalSlope=-0.1 UseCTDef=No

TABLE: "MATERIAL PROPERTIES 03F - TENDON DATA"

Material=A416Gr270 Fy=1689905.15872032 Fu=1861584.63016926 SSCurveOpt="270 ksi" SSHysType=Kinematic
FinalSlope=-0.1

GENERAL CONTRACTOR  Consorzio Collegamenti Integrati Veloci	ALTA SORVEGLIANZA  GRUPPO FERROVIE DELLO STATO ITALIANE
IG51-02-E-CV-CL-IN11-0X-001_A00 Relazione di calcolo	
Foglio 313 di 929	

TABLE: "MATERIAL PROPERTIES 03G - OTHER DATA"

Material=OTHER SSHysType=Elastic FAngle=0 DAngle=0

TABLE: "MATERIAL PROPERTIES 04 - USER STRESS-STRAIN CURVES"

Material=CONC	Point=1	Strain=-4.32412541870706E-02	Stress=0	PointID=-E
Material=CONC	Point=2	Strain=-3.02688779309494E-02	Stress=-206842.736685473	PointID=-D
Material=CONC	Point=3	Strain=-1.72965016748283E-02	Stress=-413685.473370947	PointID=-C
Material=CONC	Point=4	Strain=-1.78929327670637E-03	Stress=-413685.473370947	PointID=-B
Material=CONC	Point=5	Strain=0	Stress=0	PointID=A
Material=CONC	Point=6	Strain=1.78929327670637E-03	Stress=413685.473370947	PointID=B
Material=CONC	Point=7	Strain=1.72965016748283E-02	Stress=413685.473370947	PointID=C
Material=CONC	Point=8	Strain=4.32412541870706E-02	Stress=517106.841713683	PointID=C
Material=CONC	Point=9	Strain=0.069186006699313	Stress=517106.841713683	PointID=D
Material=CONC	Point=10	Strain=8.64825083741413E-02	Stress=413685.473370947	PointID=E
Material=OTHER	Point=1	Strain=-4.02882608951745E-08	Stress=-1	PointID=-E
Material=OTHER	Point=2	Strain=0	Stress=0	PointID=A
Material=OTHER	Point=3	Strain=4.02882608951745E-08	Stress=1	PointID=A
Material=STEEL	Point=1	Strain=-0.05	Stress=0	PointID=-E
Material=STEEL	Point=2	Strain=-0.035	Stress=-124105.642011284	PointID=-D
Material=STEEL	Point=3	Strain=-0.02	Stress=-248211.284022568	PointID=-C
Material=STEEL	Point=4	Strain=-1.24137931034483E-03	Stress=-248211.284022568	PointID=-B
Material=STEEL	Point=5	Strain=0	Stress=0	PointID=A
Material=STEEL	Point=6	Strain=1.24137931034483E-03	Stress=248211.284022568	PointID=B
Material=STEEL	Point=7	Strain=0.02	Stress=248211.284022568	PointID=C
Material=STEEL	Point=8	Strain=0.05	Stress=399895.957591915	PointID=C
Material=STEEL	Point=9	Strain=0.08	Stress=399895.957591915	PointID=D
Material=STEEL	Point=10	Strain=0.1	Stress=248211.284022568	PointID=E

TABLE: "MATERIAL PROPERTIES 06 - DAMPING PARAMETERS"

Material=A416Gr270	ModalRatio=0	VisMass=0	VisStiff=0	HysMass=0	HysStiff=0
Material=A615Gr60	ModalRatio=0	VisMass=0	VisStiff=0	HysMass=0	HysStiff=0
Material=CONC	ModalRatio=0	VisMass=0	VisStiff=0	HysMass=0	HysStiff=0
Material=OTHER	ModalRatio=0	VisMass=0	VisStiff=0	HysMass=0	HysStiff=0
Material=REBAR	ModalRatio=0	VisMass=0	VisStiff=0	HysMass=0	HysStiff=0
Material=STEEL	ModalRatio=0	VisMass=0	VisStiff=0	HysMass=0	HysStiff=0

TABLE: "FRAME SECTION PROPERTIES 01 - GENERAL"

SectionName=1000x1000 Material=CONC Shape=Rectangular t3=1 t2=1 Area=1 TorsConst=0.1408333333333333
 I33=8.33333333333333E-02 I22=8.33333333333333E-02 AS2=0.833333333333333 AS3=0.833333333333333
 S33=0.166666666666667
 S22=0.166666666666667 Z33=0.25 Z22=0.25 R33=0.288675134594813 R22=0.288675134594813 ConcCol=No
 ConcBeam=Yes Color=8421440 TotalWt=449.999997019768 TotalMass=44.9999997019768 FromFile=No AMod=1
 A2Mod=1
 A3Mod=1 JMod=1 I2Mod=1 I3Mod=1 MMod=1 WMod=1

TABLE: "FRAME SECTION PROPERTIES 03 - CONCRETE BEAM"

SectionName=1000x1000 RebarMatL=A615Gr60 RebarMatC=REBAR TopCover=0 BotCover=0 TopLeftArea=0
 TopRightArea=0 BotLeftArea=0 BotRightArea=0

TABLE: "LOAD PATTERN DEFINITIONS"

LoadPat=PESOPR	DesignType=DEAD	SelfWtMult=1
LoadPat=TERRVERT	DesignType=OTHER	SelfWtMult=0
LoadPat=TERRLAT	DesignType=OTHER	SelfWtMult=0
LoadPat=ACCVERT	DesignType=OTHER	SelfWtMult=0
LoadPat=ACCLATDX	DesignType=OTHER	SelfWtMult=0
LoadPat=ACCLATSY	DesignType=OTHER	SelfWtMult=0

TABLE: "AUTO WAVE 3 - WAVE CHARACTERISTICS - GENERAL"

WaveChar=Default WaveType="From Theory" KinFactor=1 SWaterDepth=1800 WaveHeight=720 WavePeriod=12
 WaveTheory=Linear

TABLE: "CONSTRAINT DEFINITIONS - BEAM"

Name=BEAM1 CoordSys=GLOBAL Axis=Auto

TABLE: "CONSTRAINT DEFINITIONS - BODY"

Name=BODY1 CoordSys=GLOBAL UX=Yes UY=Yes UZ=Yes RX=Yes RY=Yes RZ=Yes

TABLE: "CONSTRAINT DEFINITIONS - DIAPHRAGM"

Name=DIAPH1 CoordSys=GLOBAL Axis=Z MultiLevel=No

TABLE: "CONSTRAINT DEFINITIONS - EQUAL"

Name=EQUAL1 CoordSys=GLOBAL UX=Yes UY=Yes UZ=Yes RX=Yes RY=Yes RZ=Yes

TABLE: "CONSTRAINT DEFINITIONS - LOCAL"

Name=LOCAL1 U1=Yes U2=Yes U3=Yes R1=Yes R2=Yes R3=Yes

TABLE: "CONSTRAINT DEFINITIONS - PLATE"

Name=PLATE1 CoordSys=GLOBAL Axis=Auto

TABLE: "CONSTRAINT DEFINITIONS - ROD"

Name=ROD1 CoordSys=GLOBAL Axis=Auto

<p>GENERAL CONTRACTOR</p>  <p>Consorzio Collegamenti Integrati Veloci</p>	<p>ALTA SORVEGLIANZA</p>  <p>GRUPPO FERROVIE DELLO STATO ITALIANE</p>	
<p>IG51-02-E-CV-CL-IN11-0X-001_A00</p> <p>Relazione di calcolo</p>		
		<p>Foglio 314 di 929</p>

TABLE: "CONSTRAINT DEFINITIONS - WELD"
Name=WELD1 CoordSys=GLOBAL UX=Yes UY=Yes UZ=Yes RX=Yes RY=Yes RZ=Yes Tolerance=2.53999996930361E-02

TABLE: "GROUPS 1 - DEFINITIONS"
GroupName=ALL Selection=Yes SectionCut=Yes Steel=Yes Concrete=Yes Aluminum=Yes ColdFormed=Yes
Stage=Yes Bridge=Yes AutoSeismic=No AutoWind=No SelDesSteel=No SelDesAlum=No SelDesCold=No
MassWeight=Yes Color=Yellow

TABLE: "GROUPS 3 - MASSES AND WEIGHTS"
GroupName=ALL SelfMass=44.9999997019768 SelfWeight=449.999997019768 TotalMassX=44.9999997019768
TotalMassY=44.9999997019768 TotalMassZ=44.9999997019768

TABLE: "JOINT PATTERN DEFINITIONS"
Pattern=DEFAULT

TABLE: "MASSES 1 - MASS SOURCE"
MassFrom=Elements

TABLE: "FUNCTION - PLOT FUNCTIONS"
PlotFunc="Input Energy" Type=Energy Component=Input Mode=All

TABLE: "LOAD CASE DEFINITIONS"
Case=PESOPR Type=LinStatic InitialCond=Zero DesTypeOpt="Prog Det" DesignType=DEAD DesActOpt="Prog Det"
DesignAct=Non-Composite AutoType=None RunCase=Yes CaseStatus=Finished
Case=TERRVERT Type=LinStatic InitialCond=Zero DesTypeOpt="Prog Det" DesignType=OTHER DesActOpt="Prog
Det" DesignAct=Other AutoType=None RunCase=Yes CaseStatus=Finished
Case=TERRLAT Type=LinStatic InitialCond=Zero DesTypeOpt="Prog Det" DesignType=OTHER DesActOpt="Prog
Det" DesignAct=Other AutoType=None RunCase=Yes CaseStatus=Finished
Case=ACCVERT Type=LinStatic InitialCond=Zero DesTypeOpt="Prog Det" DesignType=OTHER DesActOpt="Prog
Det" DesignAct=Other AutoType=None RunCase=Yes CaseStatus=Finished
Case=ACCLATDX Type=LinStatic InitialCond=Zero DesTypeOpt="Prog Det" DesignType=OTHER DesActOpt="Prog
Det" DesignAct=Other AutoType=None RunCase=Yes CaseStatus=Finished
Case=ACCLATXS Type=LinStatic InitialCond=Zero DesTypeOpt="Prog Det" DesignType=OTHER DesActOpt="Prog
Det" DesignAct=Other AutoType=None RunCase=Yes CaseStatus=Finished
Case=TERRCOST Type=LinStatic InitialCond=Zero DesTypeOpt="Prog Det" DesignType=OTHER DesActOpt="Prog
Det" DesignAct=Other AutoType=None RunCase=Yes CaseStatus=Finished
Case=SOVRCOST Type=LinStatic InitialCond=Zero DesTypeOpt="Prog Det" DesignType=OTHER DesActOpt="Prog
Det" DesignAct=Other AutoType=None RunCase=Yes CaseStatus=Finished

TABLE: "CASE - STATIC 1 - LOAD ASSIGNMENTS"
Case=PESOPR LoadType="Load pattern" LoadName=PESOPR LoadSF=1
Case=TERRVERT LoadType="Load pattern" LoadName=TERRVERT LoadSF=1
Case=TERRLAT LoadType="Load pattern" LoadName=TERRLAT LoadSF=1
Case=ACCVERT LoadType="Load pattern" LoadName=ACCVERT LoadSF=1
Case=ACCLATDX LoadType="Load pattern" LoadName=ACCLATDX LoadSF=1
Case=ACCLATXS LoadType="Load pattern" LoadName=ACCLATXS LoadSF=1

TABLE: "JOINT COORDINATES"
Joint=1 CoordSys=GLOBAL CoordType=Cartesian XorR=-2.49999997615814 Y=0 Z=0 SpecialJt=No GlobalX=-
2.49999997615814 GlobalY=0 GlobalZ=0
Joint=15 CoordSys=GLOBAL CoordType=Cartesian XorR=2.49999997615814 Y=0 Z=0 SpecialJt=No
GlobalX=2.49999997615814 GlobalY=0 GlobalZ=0
Joint=19 CoordSys=GLOBAL CoordType=Cartesian XorR=-1.5 Y=0 Z=0 SpecialJt=No GlobalX=-1.5
GlobalY=0 GlobalZ=0
Joint=20 CoordSys=GLOBAL CoordType=Cartesian XorR=-2.49999997615814 Y=0 Z=4 SpecialJt=No GlobalX=-
2.49999997615814 GlobalY=0 GlobalZ=4
Joint=21 CoordSys=GLOBAL CoordType=Cartesian XorR=2.49999997615814 Y=0 Z=3.99999997615814
SpecialJt=No GlobalX=2.49999997615814 GlobalY=0 GlobalZ=3.99999997615814
Joint=22 CoordSys=GLOBAL CoordType=Cartesian XorR=-2.5 Y=0 Z=3.75 SpecialJt=Yes GlobalX=-2.5
GlobalY=0 GlobalZ=3.75
Joint=23 CoordSys=GLOBAL CoordType=Cartesian XorR=2.5 Y=0 Z=3.75 SpecialJt=Yes GlobalX=2.5
GlobalY=0 GlobalZ=3.75
Joint=24 CoordSys=GLOBAL CoordType=Cartesian XorR=2 Y=0 Z=4 SpecialJt=Yes GlobalX=2 GlobalY=0
GlobalZ=4
Joint=25 CoordSys=GLOBAL CoordType=Cartesian XorR=2.25 Y=0 Z=4 SpecialJt=Yes GlobalX=2.25
GlobalY=0 GlobalZ=4
Joint=26 CoordSys=GLOBAL CoordType=Cartesian XorR=-2.5 Y=0 Z=0.25 SpecialJt=Yes GlobalX=-2.5
GlobalY=0 GlobalZ=0.25
Joint=27 CoordSys=GLOBAL CoordType=Cartesian XorR=-2.5 Y=0 Z=0.5 SpecialJt=Yes GlobalX=-2.5
GlobalY=0 GlobalZ=0.5
Joint=28 CoordSys=GLOBAL CoordType=Cartesian XorR=2.5 Y=0 Z=0.25 SpecialJt=Yes GlobalX=2.5
GlobalY=0 GlobalZ=0.25
Joint=29 CoordSys=GLOBAL CoordType=Cartesian XorR=2.5 Y=0 Z=0.5 SpecialJt=Yes GlobalX=2.5
GlobalY=0 GlobalZ=0.5
Joint=30 CoordSys=GLOBAL CoordType=Cartesian XorR=-2.25 Y=0 Z=0 SpecialJt=Yes GlobalX=-2.25
GlobalY=0 GlobalZ=0
Joint=31 CoordSys=GLOBAL CoordType=Cartesian XorR=-2 Y=0 Z=0 SpecialJt=Yes GlobalX=-2 GlobalY=0
GlobalZ=0
Joint=32 CoordSys=GLOBAL CoordType=Cartesian XorR=2 Y=0 Z=0 SpecialJt=Yes GlobalX=2 GlobalY=0
GlobalZ=0



Joint=33	CoordSys=GLOBAL	CoordType=Cartesian	XorR=2.25	Y=0	Z=0	SpecialJt=Yes	GlobalX=2.25	GlobalY=0	GlobalZ=0
Joint=34	CoordSys=GLOBAL	CoordType=Cartesian	XorR=-2.49999997615814	Y=0	Z=3.5	SpecialJt=Yes	GlobalX=-2.49999997615814	GlobalY=0	GlobalZ=3.5
Joint=35	CoordSys=GLOBAL	CoordType=Cartesian	XorR=2.49999997615814	Y=0	Z=3.5	SpecialJt=Yes	GlobalX=2.49999997615814	GlobalY=0	GlobalZ=3.5
Joint=36	CoordSys=GLOBAL	CoordType=Cartesian	XorR=-1	Y=0	Z=0	SpecialJt=No	GlobalX=-1	GlobalY=0	GlobalZ=0
Joint=37	CoordSys=GLOBAL	CoordType=Cartesian	XorR=-0.5	Y=0	Z=0	SpecialJt=No	GlobalX=-0.5	GlobalY=0	GlobalZ=0
Joint=38	CoordSys=GLOBAL	CoordType=Cartesian	XorR=0	Y=0	Z=0	SpecialJt=No	GlobalX=0	GlobalY=0	GlobalZ=0
Joint=39	CoordSys=GLOBAL	CoordType=Cartesian	XorR=-2.25	Y=0	Z=4	SpecialJt=Yes	GlobalX=-2.25	GlobalY=0	GlobalZ=4
Joint=40	CoordSys=GLOBAL	CoordType=Cartesian	XorR=-2	Y=0	Z=4	SpecialJt=Yes	GlobalX=-2	GlobalY=0	GlobalZ=4
Joint=41	CoordSys=GLOBAL	CoordType=Cartesian	XorR=0.5	Y=0	Z=0	SpecialJt=No	GlobalX=0.5	GlobalY=0	GlobalZ=0
Joint=42	CoordSys=GLOBAL	CoordType=Cartesian	XorR=1	Y=0	Z=0	SpecialJt=No	GlobalX=1	GlobalY=0	GlobalZ=0
Joint=43	CoordSys=GLOBAL	CoordType=Cartesian	XorR=1.5	Y=0	Z=0	SpecialJt=No	GlobalX=1.5	GlobalY=0	GlobalZ=0
Joint=61	CoordSys=GLOBAL	CoordType=Cartesian	XorR=2.4999999602636	Y=0	Z=1	SpecialJt=No	GlobalX=2.4999999602636	GlobalY=0	GlobalZ=1
Joint=62	CoordSys=GLOBAL	CoordType=Cartesian	XorR=2.4999999205271	Y=0	Z=1.5	SpecialJt=No	GlobalX=2.4999999205271	GlobalY=0	GlobalZ=1.5
Joint=63	CoordSys=GLOBAL	CoordType=Cartesian	XorR=2.4999998807907	Y=0	Z=2	SpecialJt=No	GlobalX=2.4999998807907	GlobalY=0	GlobalZ=2
Joint=64	CoordSys=GLOBAL	CoordType=Cartesian	XorR=2.4999998410543	Y=0	Z=2.5	SpecialJt=No	GlobalX=2.4999998410543	GlobalY=0	GlobalZ=2.5
Joint=65	CoordSys=GLOBAL	CoordType=Cartesian	XorR=2.4999998013179	Y=0	Z=3	SpecialJt=No	GlobalX=2.4999998013179	GlobalY=0	GlobalZ=3
Joint=66	CoordSys=GLOBAL	CoordType=Cartesian	XorR=-2.4999999602636	Y=0	Z=1	SpecialJt=No	GlobalX=-2.4999999602636	GlobalY=0	GlobalZ=1
Joint=67	CoordSys=GLOBAL	CoordType=Cartesian	XorR=-2.4999999205271	Y=0	Z=1.5	SpecialJt=No	GlobalX=-2.4999999205271	GlobalY=0	GlobalZ=1.5
Joint=68	CoordSys=GLOBAL	CoordType=Cartesian	XorR=-2.4999998807907	Y=0	Z=2	SpecialJt=No	GlobalX=-2.4999998807907	GlobalY=0	GlobalZ=2
Joint=69	CoordSys=GLOBAL	CoordType=Cartesian	XorR=-2.4999998410543	Y=0	Z=2.5	SpecialJt=No	GlobalX=-2.4999998410543	GlobalY=0	GlobalZ=2.5
Joint=70	CoordSys=GLOBAL	CoordType=Cartesian	XorR=-2.4999998013179	Y=0	Z=3	SpecialJt=No	GlobalX=-2.4999998013179	GlobalY=0	GlobalZ=3
Joint=85	CoordSys=GLOBAL	CoordType=Cartesian	XorR=-1.5	Y=0	Z=4	SpecialJt=No	GlobalX=-1.5	GlobalY=0	GlobalZ=4
Joint=86	CoordSys=GLOBAL	CoordType=Cartesian	XorR=-1	Y=0	Z=4	SpecialJt=No	GlobalX=-1	GlobalY=0	GlobalZ=4
Joint=87	CoordSys=GLOBAL	CoordType=Cartesian	XorR=-0.5	Y=0	Z=4	SpecialJt=No	GlobalX=-0.5	GlobalY=0	GlobalZ=4
Joint=88	CoordSys=GLOBAL	CoordType=Cartesian	XorR=0	Y=0	Z=4	SpecialJt=No	GlobalX=0	GlobalY=0	GlobalZ=4
Joint=89	CoordSys=GLOBAL	CoordType=Cartesian	XorR=0.5	Y=0	Z=4	SpecialJt=No	GlobalX=0.5	GlobalY=0	GlobalZ=4
Joint=90	CoordSys=GLOBAL	CoordType=Cartesian	XorR=1	Y=0	Z=4	SpecialJt=No	GlobalX=1	GlobalY=0	GlobalZ=4
Joint=91	CoordSys=GLOBAL	CoordType=Cartesian	XorR=1.5	Y=0	Z=4	SpecialJt=No	GlobalX=1.5	GlobalY=0	GlobalZ=4

TABLE: "CONNECTIVITY - FRAME"

Frame=1	JointI=1	JointJ=30	IsCurved=No	Length=0.249999976158142	CentroidX=-2.37499998807907	CentroidY=0	CentroidZ=0
Frame=2	JointI=30	JointJ=31	IsCurved=No	Length=0.25	CentroidX=-2.125	CentroidY=0	CentroidZ=0
Frame=4	JointI=32	JointJ=33	IsCurved=No	Length=0.25	CentroidX=2.125	CentroidY=0	CentroidZ=0
Frame=5	JointI=33	JointJ=15	IsCurved=No	Length=0.249999976158142	CentroidX=2.37499998807907	CentroidY=0	CentroidZ=0
Frame=41	JointI=31	JointJ=19	IsCurved=No	Length=0.5	CentroidX=-1.75	CentroidY=0	CentroidZ=0
Frame=42	JointI=19	JointJ=36	IsCurved=No	Length=0.5	CentroidX=-1.25	CentroidY=0	CentroidZ=0
Frame=43	JointI=36	JointJ=37	IsCurved=No	Length=0.5	CentroidX=-0.75	CentroidY=0	CentroidZ=0
Frame=44	JointI=37	JointJ=38	IsCurved=No	Length=0.5	CentroidX=-0.25	CentroidY=0	CentroidZ=0
Frame=45	JointI=38	JointJ=41	IsCurved=No	Length=0.5	CentroidX=0.25	CentroidY=0	CentroidZ=0
Frame=46	JointI=41	JointJ=42	IsCurved=No	Length=0.5	CentroidX=0.75	CentroidY=0	CentroidZ=0
Frame=47	JointI=42	JointJ=43	IsCurved=No	Length=0.5	CentroidX=1.25	CentroidY=0	CentroidZ=0
Frame=48	JointI=43	JointJ=32	IsCurved=No	Length=0.5	CentroidX=1.75	CentroidY=0	CentroidZ=0
Frame=69	JointI=15	JointJ=28	IsCurved=No	Length=0.250000000000001	CentroidX=2.49999998807907	CentroidY=0	CentroidZ=0.125
Frame=70	JointI=28	JointJ=29	IsCurved=No	Length=0.25	CentroidX=2.5	CentroidY=0	CentroidZ=0.375
Frame=72	JointI=35	JointJ=23	IsCurved=No	Length=0.250000000000002	CentroidX=2.49999998807907	CentroidY=0	CentroidZ=3.625
Frame=73	JointI=23	JointJ=21	IsCurved=No	Length=0.249999976158143	CentroidX=2.49999998807907	CentroidY=0	CentroidZ=3.87499998807907
Frame=74	JointI=20	JointJ=39	IsCurved=No	Length=0.249999976158142	CentroidX=-2.37499998807907	CentroidY=0	CentroidZ=4
Frame=75	JointI=39	JointJ=40	IsCurved=No	Length=0.25	CentroidX=-2.125	CentroidY=0	CentroidZ=4



Frame=77	JointI=24	JointJ=25	IsCurved=No	Length=0.25	CentroidX=2.125	CentroidY=0	CentroidZ=4
Frame=78	JointI=25	JointJ=21	IsCurved=No	Length=0.249999976158143	CentroidX=2.37499998807907		
CentroidY=0	CentroidZ=3.99999998807907						
Frame=79	JointI=1	JointJ=26	IsCurved=No	Length=0.250000000000001	CentroidX=-2.49999998807907		
CentroidY=0	CentroidZ=0.125						
Frame=80	JointI=26	JointJ=27	IsCurved=No	Length=0.25	CentroidX=-2.5	CentroidY=0	CentroidZ=0.375
Frame=82	JointI=34	JointJ=22	IsCurved=No	Length=0.250000000000002	CentroidX=-2.49999998807907		
CentroidY=0	CentroidZ=3.625						
Frame=83	JointI=22	JointJ=20	IsCurved=No	Length=0.250000000000001	CentroidX=-2.49999998807907		
CentroidY=0	CentroidZ=3.875						
Frame=84	JointI=29	JointJ=61	IsCurved=No	Length=0.5	CentroidX=2.4999999801318	CentroidY=0	
CentroidZ=0.75							
Frame=85	JointI=61	JointJ=62	IsCurved=No	Length=0.5	CentroidX=2.49999999403954	CentroidY=0	
CentroidZ=1.25							
Frame=86	JointI=62	JointJ=63	IsCurved=No	Length=0.5	CentroidX=2.4999999906589	CentroidY=0	
CentroidZ=1.75							
Frame=87	JointI=63	JointJ=64	IsCurved=No	Length=0.5	CentroidX=2.49999998609225	CentroidY=0	
CentroidZ=2.25							
Frame=88	JointI=64	JointJ=65	IsCurved=No	Length=0.5	CentroidX=2.49999998211861	CentroidY=0	
CentroidZ=2.75							
Frame=89	JointI=65	JointJ=35	IsCurved=No	Length=0.5	CentroidX=2.49999997814496	CentroidY=0	
CentroidZ=3.25							
Frame=90	JointI=27	JointJ=66	IsCurved=No	Length=0.5	CentroidX=-2.4999999801318	CentroidY=0	
CentroidZ=0.75							
Frame=91	JointI=66	JointJ=67	IsCurved=No	Length=0.5	CentroidX=-2.49999999403954	CentroidY=0	
CentroidZ=1.25							
Frame=92	JointI=67	JointJ=68	IsCurved=No	Length=0.5	CentroidX=-2.4999999906589	CentroidY=0	
CentroidZ=1.75							
Frame=93	JointI=68	JointJ=69	IsCurved=No	Length=0.5	CentroidX=-2.49999998609225	CentroidY=0	
CentroidZ=2.25							
Frame=94	JointI=69	JointJ=70	IsCurved=No	Length=0.5	CentroidX=-2.49999998211861	CentroidY=0	
CentroidZ=2.75							
Frame=95	JointI=70	JointJ=34	IsCurved=No	Length=0.5	CentroidX=-2.49999997814496	CentroidY=0	
CentroidZ=3.25							
Frame=112	JointI=40	JointJ=85	IsCurved=No	Length=0.5	CentroidX=-1.75	CentroidY=0	CentroidZ=4
Frame=113	JointI=85	JointJ=86	IsCurved=No	Length=0.5	CentroidX=-1.25	CentroidY=0	CentroidZ=4
Frame=114	JointI=86	JointJ=87	IsCurved=No	Length=0.5	CentroidX=-0.75	CentroidY=0	CentroidZ=4
Frame=115	JointI=87	JointJ=88	IsCurved=No	Length=0.5	CentroidX=-0.25	CentroidY=0	CentroidZ=4
Frame=116	JointI=88	JointJ=89	IsCurved=No	Length=0.5	CentroidX=0.25	CentroidY=0	CentroidZ=4
Frame=117	JointI=89	JointJ=90	IsCurved=No	Length=0.5	CentroidX=0.75	CentroidY=0	CentroidZ=4
Frame=118	JointI=90	JointJ=91	IsCurved=No	Length=0.5	CentroidX=1.25	CentroidY=0	CentroidZ=4
Frame=119	JointI=91	JointJ=24	IsCurved=No	Length=0.5	CentroidX=1.75	CentroidY=0	CentroidZ=4

TABLE: "JOINT RESTRAINT ASSIGNMENTS"

Joint=1	U1=Yes	U2=Yes	U3=No	R1=Yes	R2=No	R3=Yes
Joint=15	U1=No	U2=Yes	U3=No	R1=Yes	R2=No	R3=Yes

TABLE: "JOINT SPRING ASSIGNMENTS 1 - UNCOUPLED"

Joint=1	CoordSys=Local	U1=0	U2=0	U3=0	R1=0	R2=0	R3=0
Joint=15	CoordSys=Local	U1=0	U2=0	U3=0	R1=0	R2=0	R3=0

TABLE: "JOINT LOADS - FORCE"

Joint=1	LoadPat=TERRLAT	CoordSys=GLOBAL	F1=79.95	F2=0	F3=0	M1=0	M2=0	M3=0
Joint=15	LoadPat=TERRLAT	CoordSys=GLOBAL	F1=-79.95	F2=0	F3=0	M1=0	M2=0	M3=0
Joint=20	LoadPat=TERRLAT	CoordSys=GLOBAL	F1=60.77	F2=0	F3=0	M1=0	M2=0	M3=0
Joint=21	LoadPat=TERRLAT	CoordSys=GLOBAL	F1=-60.77	F2=0	F3=0	M1=0	M2=0	M3=0

TABLE: "FRAME SECTION ASSIGNMENTS"

Frame=1	SectionType=Rectangular	AutoSelect=N.A.	AnalSect=1000x1000	DesignSect=1000x1000	MatProp=Default
Frame=2	SectionType=Rectangular	AutoSelect=N.A.	AnalSect=1000x1000	DesignSect=1000x1000	MatProp=Default
Frame=4	SectionType=Rectangular	AutoSelect=N.A.	AnalSect=1000x1000	DesignSect=1000x1000	MatProp=Default
Frame=5	SectionType=Rectangular	AutoSelect=N.A.	AnalSect=1000x1000	DesignSect=1000x1000	MatProp=Default
Frame=41	SectionType=Rectangular	AutoSelect=N.A.	AnalSect=1000x1000	DesignSect=1000x1000	MatProp=Default
Frame=42	SectionType=Rectangular	AutoSelect=N.A.	AnalSect=1000x1000	DesignSect=1000x1000	MatProp=Default
Frame=43	SectionType=Rectangular	AutoSelect=N.A.	AnalSect=1000x1000	DesignSect=1000x1000	MatProp=Default
Frame=44	SectionType=Rectangular	AutoSelect=N.A.	AnalSect=1000x1000	DesignSect=1000x1000	MatProp=Default
Frame=45	SectionType=Rectangular	AutoSelect=N.A.	AnalSect=1000x1000	DesignSect=1000x1000	MatProp=Default
Frame=46	SectionType=Rectangular	AutoSelect=N.A.	AnalSect=1000x1000	DesignSect=1000x1000	MatProp=Default
Frame=47	SectionType=Rectangular	AutoSelect=N.A.	AnalSect=1000x1000	DesignSect=1000x1000	MatProp=Default
Frame=48	SectionType=Rectangular	AutoSelect=N.A.	AnalSect=1000x1000	DesignSect=1000x1000	MatProp=Default
Frame=69	SectionType=Rectangular	AutoSelect=N.A.	AnalSect=1000x1000	DesignSect=1000x1000	MatProp=Default
Frame=70	SectionType=Rectangular	AutoSelect=N.A.	AnalSect=1000x1000	DesignSect=1000x1000	MatProp=Default



Frame=72	SectionType=Rectangular	AutoSelect=N.A.	AnalSect=1000x1000	DesignSect=1000x1000
MatProp=Default				
Frame=73	SectionType=Rectangular	AutoSelect=N.A.	AnalSect=1000x1000	DesignSect=1000x1000
MatProp=Default				
Frame=74	SectionType=Rectangular	AutoSelect=N.A.	AnalSect=1000x1000	DesignSect=1000x1000
MatProp=Default				
Frame=75	SectionType=Rectangular	AutoSelect=N.A.	AnalSect=1000x1000	DesignSect=1000x1000
MatProp=Default				
Frame=77	SectionType=Rectangular	AutoSelect=N.A.	AnalSect=1000x1000	DesignSect=1000x1000
MatProp=Default				
Frame=78	SectionType=Rectangular	AutoSelect=N.A.	AnalSect=1000x1000	DesignSect=1000x1000
MatProp=Default				
Frame=79	SectionType=Rectangular	AutoSelect=N.A.	AnalSect=1000x1000	DesignSect=1000x1000
MatProp=Default				
Frame=80	SectionType=Rectangular	AutoSelect=N.A.	AnalSect=1000x1000	DesignSect=1000x1000
MatProp=Default				
Frame=82	SectionType=Rectangular	AutoSelect=N.A.	AnalSect=1000x1000	DesignSect=1000x1000
MatProp=Default				
Frame=83	SectionType=Rectangular	AutoSelect=N.A.	AnalSect=1000x1000	DesignSect=1000x1000
MatProp=Default				
Frame=84	SectionType=Rectangular	AutoSelect=N.A.	AnalSect=1000x1000	DesignSect=1000x1000
MatProp=Default				
Frame=85	SectionType=Rectangular	AutoSelect=N.A.	AnalSect=1000x1000	DesignSect=1000x1000
MatProp=Default				
Frame=86	SectionType=Rectangular	AutoSelect=N.A.	AnalSect=1000x1000	DesignSect=1000x1000
MatProp=Default				
Frame=87	SectionType=Rectangular	AutoSelect=N.A.	AnalSect=1000x1000	DesignSect=1000x1000
MatProp=Default				
Frame=88	SectionType=Rectangular	AutoSelect=N.A.	AnalSect=1000x1000	DesignSect=1000x1000
MatProp=Default				
Frame=89	SectionType=Rectangular	AutoSelect=N.A.	AnalSect=1000x1000	DesignSect=1000x1000
MatProp=Default				
Frame=90	SectionType=Rectangular	AutoSelect=N.A.	AnalSect=1000x1000	DesignSect=1000x1000
MatProp=Default				
Frame=91	SectionType=Rectangular	AutoSelect=N.A.	AnalSect=1000x1000	DesignSect=1000x1000
MatProp=Default				
Frame=92	SectionType=Rectangular	AutoSelect=N.A.	AnalSect=1000x1000	DesignSect=1000x1000
MatProp=Default				
Frame=93	SectionType=Rectangular	AutoSelect=N.A.	AnalSect=1000x1000	DesignSect=1000x1000
MatProp=Default				
Frame=94	SectionType=Rectangular	AutoSelect=N.A.	AnalSect=1000x1000	DesignSect=1000x1000
MatProp=Default				
Frame=95	SectionType=Rectangular	AutoSelect=N.A.	AnalSect=1000x1000	DesignSect=1000x1000
MatProp=Default				
Frame=112	SectionType=Rectangular	AutoSelect=N.A.	AnalSect=1000x1000	DesignSect=1000x1000
MatProp=Default				
Frame=113	SectionType=Rectangular	AutoSelect=N.A.	AnalSect=1000x1000	DesignSect=1000x1000
MatProp=Default				
Frame=114	SectionType=Rectangular	AutoSelect=N.A.	AnalSect=1000x1000	DesignSect=1000x1000
MatProp=Default				
Frame=115	SectionType=Rectangular	AutoSelect=N.A.	AnalSect=1000x1000	DesignSect=1000x1000
MatProp=Default				
Frame=116	SectionType=Rectangular	AutoSelect=N.A.	AnalSect=1000x1000	DesignSect=1000x1000
MatProp=Default				
Frame=117	SectionType=Rectangular	AutoSelect=N.A.	AnalSect=1000x1000	DesignSect=1000x1000
MatProp=Default				
Frame=118	SectionType=Rectangular	AutoSelect=N.A.	AnalSect=1000x1000	DesignSect=1000x1000
MatProp=Default				
Frame=119	SectionType=Rectangular	AutoSelect=N.A.	AnalSect=1000x1000	DesignSect=1000x1000
MatProp=Default				

TABLE: "FRAME INSERTION POINT ASSIGNMENTS"

Frame=1	CardinalPt="10 (centroid)"	Mirror2=No	Transform=No
Frame=2	CardinalPt="10 (centroid)"	Mirror2=No	Transform=No
Frame=4	CardinalPt="10 (centroid)"	Mirror2=No	Transform=No
Frame=5	CardinalPt="10 (centroid)"	Mirror2=No	Transform=No
Frame=41	CardinalPt="10 (centroid)"	Mirror2=No	Transform=No
Frame=42	CardinalPt="10 (centroid)"	Mirror2=No	Transform=No
Frame=43	CardinalPt="10 (centroid)"	Mirror2=No	Transform=No
Frame=44	CardinalPt="10 (centroid)"	Mirror2=No	Transform=No
Frame=45	CardinalPt="10 (centroid)"	Mirror2=No	Transform=No
Frame=46	CardinalPt="10 (centroid)"	Mirror2=No	Transform=No
Frame=47	CardinalPt="10 (centroid)"	Mirror2=No	Transform=No
Frame=48	CardinalPt="10 (centroid)"	Mirror2=No	Transform=No
Frame=69	CardinalPt="10 (centroid)"	Mirror2=No	Transform=No
Frame=70	CardinalPt="10 (centroid)"	Mirror2=No	Transform=No
Frame=72	CardinalPt="10 (centroid)"	Mirror2=No	Transform=No
Frame=73	CardinalPt="10 (centroid)"	Mirror2=No	Transform=No
Frame=74	CardinalPt="10 (centroid)"	Mirror2=No	Transform=No
Frame=75	CardinalPt="10 (centroid)"	Mirror2=No	Transform=No
Frame=77	CardinalPt="10 (centroid)"	Mirror2=No	Transform=No
Frame=78	CardinalPt="10 (centroid)"	Mirror2=No	Transform=No

Frame=79	CardinalPt="10 (centroid)"	Mirror2=No	Transform=No
Frame=80	CardinalPt="10 (centroid)"	Mirror2=No	Transform=No
Frame=82	CardinalPt="10 (centroid)"	Mirror2=No	Transform=No
Frame=83	CardinalPt="10 (centroid)"	Mirror2=No	Transform=No
Frame=84	CardinalPt="10 (centroid)"	Mirror2=No	Transform=No
Frame=85	CardinalPt="10 (centroid)"	Mirror2=No	Transform=No
Frame=86	CardinalPt="10 (centroid)"	Mirror2=No	Transform=No
Frame=87	CardinalPt="10 (centroid)"	Mirror2=No	Transform=No
Frame=88	CardinalPt="10 (centroid)"	Mirror2=No	Transform=No
Frame=89	CardinalPt="10 (centroid)"	Mirror2=No	Transform=No
Frame=90	CardinalPt="10 (centroid)"	Mirror2=No	Transform=No
Frame=91	CardinalPt="10 (centroid)"	Mirror2=No	Transform=No
Frame=92	CardinalPt="10 (centroid)"	Mirror2=No	Transform=No
Frame=93	CardinalPt="10 (centroid)"	Mirror2=No	Transform=No
Frame=94	CardinalPt="10 (centroid)"	Mirror2=No	Transform=No
Frame=95	CardinalPt="10 (centroid)"	Mirror2=No	Transform=No
Frame=112	CardinalPt="10 (centroid)"	Mirror2=No	Transform=No
Frame=113	CardinalPt="10 (centroid)"	Mirror2=No	Transform=No
Frame=114	CardinalPt="10 (centroid)"	Mirror2=No	Transform=No
Frame=115	CardinalPt="10 (centroid)"	Mirror2=No	Transform=No
Frame=116	CardinalPt="10 (centroid)"	Mirror2=No	Transform=No
Frame=117	CardinalPt="10 (centroid)"	Mirror2=No	Transform=No
Frame=118	CardinalPt="10 (centroid)"	Mirror2=No	Transform=No
Frame=119	CardinalPt="10 (centroid)"	Mirror2=No	Transform=No

TABLE: "FRAME OFFSET ALONG LENGTH ASSIGNMENTS"

Frame=1	Type=User	LengthI=0	LengthJ=0	RigidFactor=1
Frame=2	Type=User	LengthI=0	LengthJ=0	RigidFactor=1
Frame=4	Type=User	LengthI=0	LengthJ=0	RigidFactor=1
Frame=5	Type=User	LengthI=0	LengthJ=0	RigidFactor=1
Frame=41	Type=User	LengthI=0	LengthJ=0	RigidFactor=1
Frame=42	Type=User	LengthI=0	LengthJ=0	RigidFactor=1
Frame=43	Type=User	LengthI=0	LengthJ=0	RigidFactor=1
Frame=44	Type=User	LengthI=0	LengthJ=0	RigidFactor=1
Frame=45	Type=User	LengthI=0	LengthJ=0	RigidFactor=1
Frame=46	Type=User	LengthI=0	LengthJ=0	RigidFactor=1
Frame=47	Type=User	LengthI=0	LengthJ=0	RigidFactor=1
Frame=48	Type=User	LengthI=0	LengthJ=0	RigidFactor=1
Frame=69	Type=User	LengthI=0	LengthJ=0	RigidFactor=1
Frame=70	Type=User	LengthI=0	LengthJ=0	RigidFactor=1
Frame=72	Type=User	LengthI=0	LengthJ=0	RigidFactor=1
Frame=73	Type=User	LengthI=0	LengthJ=0	RigidFactor=1
Frame=74	Type=User	LengthI=0	LengthJ=0	RigidFactor=1
Frame=75	Type=User	LengthI=0	LengthJ=0	RigidFactor=1
Frame=77	Type=User	LengthI=0	LengthJ=0	RigidFactor=1
Frame=78	Type=User	LengthI=0	LengthJ=0	RigidFactor=1
Frame=79	Type=User	LengthI=0	LengthJ=0	RigidFactor=1
Frame=80	Type=User	LengthI=0	LengthJ=0	RigidFactor=1
Frame=82	Type=User	LengthI=0	LengthJ=0	RigidFactor=1
Frame=83	Type=User	LengthI=0	LengthJ=0	RigidFactor=1
Frame=84	Type=User	LengthI=0	LengthJ=0	RigidFactor=1
Frame=85	Type=User	LengthI=0	LengthJ=0	RigidFactor=1
Frame=86	Type=User	LengthI=0	LengthJ=0	RigidFactor=1
Frame=87	Type=User	LengthI=0	LengthJ=0	RigidFactor=1
Frame=88	Type=User	LengthI=0	LengthJ=0	RigidFactor=1
Frame=89	Type=User	LengthI=0	LengthJ=0	RigidFactor=1
Frame=90	Type=User	LengthI=0	LengthJ=0	RigidFactor=1
Frame=91	Type=User	LengthI=0	LengthJ=0	RigidFactor=1
Frame=92	Type=User	LengthI=0	LengthJ=0	RigidFactor=1
Frame=93	Type=User	LengthI=0	LengthJ=0	RigidFactor=1
Frame=94	Type=User	LengthI=0	LengthJ=0	RigidFactor=1
Frame=95	Type=User	LengthI=0	LengthJ=0	RigidFactor=1
Frame=112	Type=User	LengthI=0	LengthJ=0	RigidFactor=1
Frame=113	Type=User	LengthI=0	LengthJ=0	RigidFactor=1
Frame=114	Type=User	LengthI=0	LengthJ=0	RigidFactor=1
Frame=115	Type=User	LengthI=0	LengthJ=0	RigidFactor=1
Frame=116	Type=User	LengthI=0	LengthJ=0	RigidFactor=1
Frame=117	Type=User	LengthI=0	LengthJ=0	RigidFactor=1
Frame=118	Type=User	LengthI=0	LengthJ=0	RigidFactor=1
Frame=119	Type=User	LengthI=0	LengthJ=0	RigidFactor=1

TABLE: "FRAME OUTPUT STATION ASSIGNMENTS"

Frame=1	StationType=MinNumSta	MinNumSta=5	AddAtElmInt=Yes	AddAtPtLoad=Yes
Frame=2	StationType=MinNumSta	MinNumSta=5	AddAtElmInt=Yes	AddAtPtLoad=Yes
Frame=4	StationType=MinNumSta	MinNumSta=5	AddAtElmInt=Yes	AddAtPtLoad=Yes
Frame=5	StationType=MinNumSta	MinNumSta=5	AddAtElmInt=Yes	AddAtPtLoad=Yes
Frame=41	StationType=MinNumSta	MinNumSta=5	AddAtElmInt=Yes	AddAtPtLoad=Yes
Frame=42	StationType=MinNumSta	MinNumSta=5	AddAtElmInt=Yes	AddAtPtLoad=Yes
Frame=43	StationType=MinNumSta	MinNumSta=5	AddAtElmInt=Yes	AddAtPtLoad=Yes
Frame=44	StationType=MinNumSta	MinNumSta=5	AddAtElmInt=Yes	AddAtPtLoad=Yes
Frame=45	StationType=MinNumSta	MinNumSta=5	AddAtElmInt=Yes	AddAtPtLoad=Yes
Frame=46	StationType=MinNumSta	MinNumSta=5	AddAtElmInt=Yes	AddAtPtLoad=Yes



Frame=79	AutoMesh=No	AtJoints=No	AtFrames=No	NumSegments=0	MaxLength=0	MaxDegrees=0
Frame=80	AutoMesh=No	AtJoints=No	AtFrames=No	NumSegments=0	MaxLength=0	MaxDegrees=0
Frame=82	AutoMesh=No	AtJoints=No	AtFrames=No	NumSegments=0	MaxLength=0	MaxDegrees=0
Frame=83	AutoMesh=No	AtJoints=No	AtFrames=No	NumSegments=0	MaxLength=0	MaxDegrees=0
Frame=84	AutoMesh=No	AtJoints=No	AtFrames=No	NumSegments=0	MaxLength=0	MaxDegrees=0
Frame=85	AutoMesh=No	AtJoints=No	AtFrames=No	NumSegments=0	MaxLength=0	MaxDegrees=0
Frame=86	AutoMesh=No	AtJoints=No	AtFrames=No	NumSegments=0	MaxLength=0	MaxDegrees=0
Frame=87	AutoMesh=No	AtJoints=No	AtFrames=No	NumSegments=0	MaxLength=0	MaxDegrees=0
Frame=88	AutoMesh=No	AtJoints=No	AtFrames=No	NumSegments=0	MaxLength=0	MaxDegrees=0
Frame=89	AutoMesh=No	AtJoints=No	AtFrames=No	NumSegments=0	MaxLength=0	MaxDegrees=0
Frame=90	AutoMesh=No	AtJoints=No	AtFrames=No	NumSegments=0	MaxLength=0	MaxDegrees=0
Frame=91	AutoMesh=No	AtJoints=No	AtFrames=No	NumSegments=0	MaxLength=0	MaxDegrees=0
Frame=92	AutoMesh=No	AtJoints=No	AtFrames=No	NumSegments=0	MaxLength=0	MaxDegrees=0
Frame=93	AutoMesh=No	AtJoints=No	AtFrames=No	NumSegments=0	MaxLength=0	MaxDegrees=0
Frame=94	AutoMesh=No	AtJoints=No	AtFrames=No	NumSegments=0	MaxLength=0	MaxDegrees=0
Frame=95	AutoMesh=No	AtJoints=No	AtFrames=No	NumSegments=0	MaxLength=0	MaxDegrees=0
Frame=112	AutoMesh=No	AtJoints=No	AtFrames=No	NumSegments=0	MaxLength=0	MaxDegrees=0
Frame=113	AutoMesh=No	AtJoints=No	AtFrames=No	NumSegments=0	MaxLength=0	MaxDegrees=0
Frame=114	AutoMesh=No	AtJoints=No	AtFrames=No	NumSegments=0	MaxLength=0	MaxDegrees=0
Frame=115	AutoMesh=No	AtJoints=No	AtFrames=No	NumSegments=0	MaxLength=0	MaxDegrees=0
Frame=116	AutoMesh=No	AtJoints=No	AtFrames=No	NumSegments=0	MaxLength=0	MaxDegrees=0
Frame=117	AutoMesh=No	AtJoints=No	AtFrames=No	NumSegments=0	MaxLength=0	MaxDegrees=0
Frame=118	AutoMesh=No	AtJoints=No	AtFrames=No	NumSegments=0	MaxLength=0	MaxDegrees=0
Frame=119	AutoMesh=No	AtJoints=No	AtFrames=No	NumSegments=0	MaxLength=0	MaxDegrees=0

TABLE: "FRAME LOADS - DISTRIBUTED"

Frame=69	LoadPat=TERRLAT	CoordSys=GLOBAL	Type=Force	Dir=X	DistType=RelDist	RelDistA=0	RelDistB=1
AbsDistA=0	AbsDistB=0.250000000000001	FOverLA=-157.78	FOverLB=-155.647499987289				
Frame=70	LoadPat=TERRLAT	CoordSys=GLOBAL	Type=Force	Dir=X	DistType=RelDist	RelDistA=0	RelDistB=1
AbsDistA=0	AbsDistB=0.25	FOverLA=-155.647499987289	FOverLB=-153.514999974579				
Frame=72	LoadPat=TERRLAT	CoordSys=GLOBAL	Type=Force	Dir=X	DistType=RelDist	RelDistA=0	RelDistB=1
AbsDistA=0	AbsDistB=0.250000000000002	FOverLA=-127.92499982205	FOverLB=-125.79249980934				
Frame=73	LoadPat=TERRLAT	CoordSys=GLOBAL	Type=Force	Dir=X	DistType=RelDist	RelDistA=0	RelDistB=1
AbsDistA=0	AbsDistB=0.249999976158143	FOverLA=-125.79249980934	FOverLB=-123.66				
Frame=74	LoadPat=TERRVERT	CoordSys=GLOBAL	Type=Force	Dir=Gravity	DistType=RelDist	RelDistA=0	RelDistB=1
RelDistB=1	AbsDistA=0	AbsDistB=0.249999976158142	FOverLA=280	FOverLB=280			
Frame=75	LoadPat=TERRVERT	CoordSys=GLOBAL	Type=Force	Dir=Gravity	DistType=RelDist	RelDistA=0	RelDistB=1
RelDistB=1	AbsDistA=0	AbsDistB=0.25	FOverLA=280	FOverLB=280			
Frame=77	LoadPat=TERRVERT	CoordSys=GLOBAL	Type=Force	Dir=Gravity	DistType=RelDist	RelDistA=0	RelDistB=1
RelDistB=1	AbsDistA=0	AbsDistB=0.25	FOverLA=280	FOverLB=280			
Frame=78	LoadPat=TERRVERT	CoordSys=GLOBAL	Type=Force	Dir=Gravity	DistType=RelDist	RelDistA=0	RelDistB=1
RelDistB=1	AbsDistA=0	AbsDistB=0.249999976158143	FOverLA=280	FOverLB=280			
Frame=79	LoadPat=TERRLAT	CoordSys=GLOBAL	Type=Force	Dir=X	DistType=RelDist	RelDistA=0	RelDistB=1
AbsDistA=0	AbsDistB=0.250000000000001	FOverLA=157.78	FOverLB=155.6475				
Frame=80	LoadPat=TERRLAT	CoordSys=GLOBAL	Type=Force	Dir=X	DistType=RelDist	RelDistA=0	RelDistB=1
AbsDistA=0	AbsDistB=0.25	FOverLA=155.6475	FOverLB=153.515				
Frame=82	LoadPat=TERRLAT	CoordSys=GLOBAL	Type=Force	Dir=X	DistType=RelDist	RelDistA=0	RelDistB=1
AbsDistA=0	AbsDistB=0.250000000000002	FOverLA=127.925	FOverLB=125.7925				
Frame=83	LoadPat=TERRLAT	CoordSys=GLOBAL	Type=Force	Dir=X	DistType=RelDist	RelDistA=0	RelDistB=1
AbsDistA=0	AbsDistB=0.250000000000001	FOverLA=125.7925	FOverLB=123.66				
Frame=84	LoadPat=TERRLAT	CoordSys=GLOBAL	Type=Force	Dir=X	DistType=RelDist	RelDistA=0	RelDistB=1
AbsDistA=0	AbsDistB=0.5	FOverLA=-153.514999974579	FOverLB=-149.249999949157				
Frame=85	LoadPat=TERRLAT	CoordSys=GLOBAL	Type=Force	Dir=X	DistType=RelDist	RelDistA=0	RelDistB=1
AbsDistA=0	AbsDistB=0.5	FOverLA=-149.249999949157	FOverLB=-144.984999923736				
Frame=86	LoadPat=TERRLAT	CoordSys=GLOBAL	Type=Force	Dir=X	DistType=RelDist	RelDistA=0	RelDistB=1
AbsDistA=0	AbsDistB=0.5	FOverLA=-144.984999923736	FOverLB=-140.719999898314				
Frame=87	LoadPat=TERRLAT	CoordSys=GLOBAL	Type=Force	Dir=X	DistType=RelDist	RelDistA=0	RelDistB=1
AbsDistA=0	AbsDistB=0.5	FOverLA=-140.719999898314	FOverLB=-136.454999872893				
Frame=88	LoadPat=TERRLAT	CoordSys=GLOBAL	Type=Force	Dir=X	DistType=RelDist	RelDistA=0	RelDistB=1
AbsDistA=0	AbsDistB=0.5	FOverLA=-136.454999872893	FOverLB=-132.189999847472				
Frame=89	LoadPat=TERRLAT	CoordSys=GLOBAL	Type=Force	Dir=X	DistType=RelDist	RelDistA=0	RelDistB=1
AbsDistA=0	AbsDistB=0.5	FOverLA=-132.189999847472	FOverLB=-127.92499982205				
Frame=90	LoadPat=TERRLAT	CoordSys=GLOBAL	Type=Force	Dir=X	DistType=RelDist	RelDistA=0	RelDistB=1
AbsDistA=0	AbsDistB=0.5	FOverLA=153.515	FOverLB=149.25				
Frame=91	LoadPat=TERRLAT	CoordSys=GLOBAL	Type=Force	Dir=X	DistType=RelDist	RelDistA=0	RelDistB=1
AbsDistA=0	AbsDistB=0.5	FOverLA=149.25	FOverLB=144.985				
Frame=92	LoadPat=TERRLAT	CoordSys=GLOBAL	Type=Force	Dir=X	DistType=RelDist	RelDistA=0	RelDistB=1
AbsDistA=0	AbsDistB=0.5	FOverLA=144.985	FOverLB=140.72				
Frame=93	LoadPat=TERRLAT	CoordSys=GLOBAL	Type=Force	Dir=X	DistType=RelDist	RelDistA=0	RelDistB=1
AbsDistA=0	AbsDistB=0.5	FOverLA=140.72	FOverLB=136.455				
Frame=94	LoadPat=TERRLAT	CoordSys=GLOBAL	Type=Force	Dir=X	DistType=RelDist	RelDistA=0	RelDistB=1
AbsDistA=0	AbsDistB=0.5	FOverLA=136.455	FOverLB=132.19				
Frame=95	LoadPat=TERRLAT	CoordSys=GLOBAL	Type=Force	Dir=X	DistType=RelDist	RelDistA=0	RelDistB=1
AbsDistA=0	AbsDistB=0.5	FOverLA=132.19	FOverLB=127.925				
Frame=112	LoadPat=TERRVERT	CoordSys=GLOBAL	Type=Force	Dir=Gravity	DistType=RelDist	RelDistA=0	RelDistB=1
RelDistB=1	AbsDistA=0	AbsDistB=0.5	FOverLA=280	FOverLB=280			
Frame=113	LoadPat=TERRVERT	CoordSys=GLOBAL	Type=Force	Dir=Gravity	DistType=RelDist	RelDistA=0	RelDistB=1
RelDistB=1	AbsDistA=0	AbsDistB=0.5	FOverLA=280	FOverLB=280			
Frame=114	LoadPat=TERRVERT	CoordSys=GLOBAL	Type=Force	Dir=Gravity	DistType=RelDist	RelDistA=0	RelDistB=1
RelDistB=1	AbsDistA=0	AbsDistB=0.5	FOverLA=280	FOverLB=280			
Frame=115	LoadPat=TERRVERT	CoordSys=GLOBAL	Type=Force	Dir=Gravity	DistType=RelDist	RelDistA=0	RelDistB=1
RelDistB=1	AbsDistA=0	AbsDistB=0.5	FOverLA=280	FOverLB=280			



Frame=116	LoadPat=TERRVERT	CoordSys=GLOBAL	Type=Force	Dir=Gravity	DistType=RelDist	RelDistA=0
RelDistB=1	AbsDistA=0	AbsDistB=0.5	FOverLA=280	FOverLB=280		
Frame=117	LoadPat=TERRVERT	CoordSys=GLOBAL	Type=Force	Dir=Gravity	DistType=RelDist	RelDistA=0
RelDistB=1	AbsDistA=0	AbsDistB=0.5	FOverLA=280	FOverLB=280		
Frame=118	LoadPat=TERRVERT	CoordSys=GLOBAL	Type=Force	Dir=Gravity	DistType=RelDist	RelDistA=0
RelDistB=1	AbsDistA=0	AbsDistB=0.5	FOverLA=280	FOverLB=280		
Frame=119	LoadPat=TERRVERT	CoordSys=GLOBAL	Type=Force	Dir=Gravity	DistType=RelDist	RelDistA=0
RelDistB=1	AbsDistA=0	AbsDistB=0.5	FOverLA=280	FOverLB=280		

TABLE: "FRAME DESIGN PROCEDURES"

Frame=1	DesignProc="From Material"
Frame=2	DesignProc="From Material"
Frame=4	DesignProc="From Material"
Frame=5	DesignProc="From Material"
Frame=41	DesignProc="From Material"
Frame=42	DesignProc="From Material"
Frame=43	DesignProc="From Material"
Frame=44	DesignProc="From Material"
Frame=45	DesignProc="From Material"
Frame=46	DesignProc="From Material"
Frame=47	DesignProc="From Material"
Frame=48	DesignProc="From Material"
Frame=69	DesignProc="From Material"
Frame=70	DesignProc="From Material"
Frame=72	DesignProc="From Material"
Frame=73	DesignProc="From Material"
Frame=74	DesignProc="From Material"
Frame=75	DesignProc="From Material"
Frame=77	DesignProc="From Material"
Frame=78	DesignProc="From Material"
Frame=79	DesignProc="From Material"
Frame=80	DesignProc="From Material"
Frame=82	DesignProc="From Material"
Frame=83	DesignProc="From Material"
Frame=84	DesignProc="From Material"
Frame=85	DesignProc="From Material"
Frame=86	DesignProc="From Material"
Frame=87	DesignProc="From Material"
Frame=88	DesignProc="From Material"
Frame=89	DesignProc="From Material"
Frame=90	DesignProc="From Material"
Frame=91	DesignProc="From Material"
Frame=92	DesignProc="From Material"
Frame=93	DesignProc="From Material"
Frame=94	DesignProc="From Material"
Frame=95	DesignProc="From Material"
Frame=112	DesignProc="From Material"
Frame=113	DesignProc="From Material"
Frame=114	DesignProc="From Material"
Frame=115	DesignProc="From Material"
Frame=116	DesignProc="From Material"
Frame=117	DesignProc="From Material"
Frame=118	DesignProc="From Material"
Frame=119	DesignProc="From Material"

TABLE: "OVERWRITES - CONCRETE DESIGN - ACI 318-99"

Frame=1	DesignSect="Program Determined"	FrameType="Program Determined"	RLLF=0	XLMajor=0	XLMinor=0
Frame=2	DesignSect="Program Determined"	FrameType="Program Determined"	RLLF=0	XLMajor=0	XLMinor=0
Frame=4	DesignSect="Program Determined"	FrameType="Program Determined"	RLLF=0	XLMajor=0	XLMinor=0
Frame=5	DesignSect="Program Determined"	FrameType="Program Determined"	RLLF=0	XLMajor=0	XLMinor=0
Frame=41	DesignSect="Program Determined"	FrameType="Program Determined"	RLLF=0	XLMajor=0	XLMinor=0
Frame=42	DesignSect="Program Determined"	FrameType="Program Determined"	RLLF=0	XLMajor=0	XLMinor=0
Frame=43	DesignSect="Program Determined"	FrameType="Program Determined"	RLLF=0	XLMajor=0	XLMinor=0
Frame=44	DesignSect="Program Determined"	FrameType="Program Determined"	RLLF=0	XLMajor=0	XLMinor=0
Frame=45	DesignSect="Program Determined"	FrameType="Program Determined"	RLLF=0	XLMajor=0	XLMinor=0
Frame=46	DesignSect="Program Determined"	FrameType="Program Determined"	RLLF=0	XLMajor=0	XLMinor=0
Frame=47	DesignSect="Program Determined"	FrameType="Program Determined"	RLLF=0	XLMajor=0	XLMinor=0
Frame=48	DesignSect="Program Determined"	FrameType="Program Determined"	RLLF=0	XLMajor=0	XLMinor=0
Frame=69	DesignSect="Program Determined"	FrameType="Program Determined"	RLLF=0	XLMajor=0	XLMinor=0
Frame=70	DesignSect="Program Determined"	FrameType="Program Determined"	RLLF=0	XLMajor=0	XLMinor=0
Frame=72	DesignSect="Program Determined"	FrameType="Program Determined"	RLLF=0	XLMajor=0	XLMinor=0
Frame=73	DesignSect="Program Determined"	FrameType="Program Determined"	RLLF=0	XLMajor=0	XLMinor=0
Frame=74	DesignSect="Program Determined"	FrameType="Program Determined"	RLLF=0	XLMajor=0	XLMinor=0
Frame=75	DesignSect="Program Determined"	FrameType="Program Determined"	RLLF=0	XLMajor=0	XLMinor=0
Frame=77	DesignSect="Program Determined"	FrameType="Program Determined"	RLLF=0	XLMajor=0	XLMinor=0
Frame=78	DesignSect="Program Determined"	FrameType="Program Determined"	RLLF=0	XLMajor=0	XLMinor=0
Frame=79	DesignSect="Program Determined"	FrameType="Program Determined"	RLLF=0	XLMajor=0	XLMinor=0
Frame=80	DesignSect="Program Determined"	FrameType="Program Determined"	RLLF=0	XLMajor=0	XLMinor=0
Frame=82	DesignSect="Program Determined"	FrameType="Program Determined"	RLLF=0	XLMajor=0	XLMinor=0
Frame=83	DesignSect="Program Determined"	FrameType="Program Determined"	RLLF=0	XLMajor=0	XLMinor=0
Frame=84	DesignSect="Program Determined"	FrameType="Program Determined"	RLLF=0	XLMajor=0	XLMinor=0
Frame=85	DesignSect="Program Determined"	FrameType="Program Determined"	RLLF=0	XLMajor=0	XLMinor=0



Frame=86	DesignSect="Program Determined"	FrameType="Program Determined"	RLLF=0	XLMajor=0	XLMinor=0
Frame=87	DesignSect="Program Determined"	FrameType="Program Determined"	RLLF=0	XLMajor=0	XLMinor=0
Frame=88	DesignSect="Program Determined"	FrameType="Program Determined"	RLLF=0	XLMajor=0	XLMinor=0
Frame=89	DesignSect="Program Determined"	FrameType="Program Determined"	RLLF=0	XLMajor=0	XLMinor=0
Frame=90	DesignSect="Program Determined"	FrameType="Program Determined"	RLLF=0	XLMajor=0	XLMinor=0
Frame=91	DesignSect="Program Determined"	FrameType="Program Determined"	RLLF=0	XLMajor=0	XLMinor=0
Frame=92	DesignSect="Program Determined"	FrameType="Program Determined"	RLLF=0	XLMajor=0	XLMinor=0
Frame=93	DesignSect="Program Determined"	FrameType="Program Determined"	RLLF=0	XLMajor=0	XLMinor=0
Frame=94	DesignSect="Program Determined"	FrameType="Program Determined"	RLLF=0	XLMajor=0	XLMinor=0
Frame=95	DesignSect="Program Determined"	FrameType="Program Determined"	RLLF=0	XLMajor=0	XLMinor=0
Frame=112	DesignSect="Program Determined"	FrameType="Program Determined"	RLLF=0	XLMajor=0	XLMinor=0
Frame=113	DesignSect="Program Determined"	FrameType="Program Determined"	RLLF=0	XLMajor=0	XLMinor=0
Frame=114	DesignSect="Program Determined"	FrameType="Program Determined"	RLLF=0	XLMajor=0	XLMinor=0
Frame=115	DesignSect="Program Determined"	FrameType="Program Determined"	RLLF=0	XLMajor=0	XLMinor=0
Frame=116	DesignSect="Program Determined"	FrameType="Program Determined"	RLLF=0	XLMajor=0	XLMinor=0
Frame=117	DesignSect="Program Determined"	FrameType="Program Determined"	RLLF=0	XLMajor=0	XLMinor=0
Frame=118	DesignSect="Program Determined"	FrameType="Program Determined"	RLLF=0	XLMajor=0	XLMinor=0
Frame=119	DesignSect="Program Determined"	FrameType="Program Determined"	RLLF=0	XLMajor=0	XLMinor=0

END TABLE DATA

<p>GENERAL CONTRACTOR</p>  <p>Consorzio Collegamenti Integrati Veloci</p>	<p>ALTA SORVEGLIANZA</p>  <p>GRUPPO FERROVIE DELLO STATO ITALIANE</p>	
<p>IG51-02-E-CV-CL-IN11-0X-001_A00</p> <p>Relazione di calcolo</p>		
		<p>Foglio 323 di 929</p>

1.2. Dati di output scatolare – Caso B e C

File D:\13_15_COClV\01_Calcoli\IN11\giorgio\IN11_situazione2-output.txt was saved on 9/17/13 at 11.45.38

TABLE: "PROGRAM CONTROL"

ProgramName=SAP2000 Version=15.0.0 ProgLevel=Ultimate LicenseNum=266BC LicenseOS=Yes LicenseSC=Yes
LicenseBR=No LicenseHT=No CurrUnits="KN, m, C" SteelCode=AISC-ASD89 ConcCode="ACI 318-99" AlumCode="AA-ASD
2000" - ColdCode=AISI-ASD96 BridgeCode="AASHTO LRFD 2007" RegenHinge=No

TABLE: "JOINT DISPLACEMENTS"

Joint=1	OutputCase=PESOPR	CaseType=LinStatic	U1=0	U2=0	U3=-3.52537204992195E-03	R1=0	R2=-
4.26489779204834E-05	R3=0						
Joint=1	OutputCase=TERRVERT	CaseType=LinStatic	U1=0	U2=0	U3=-1.10686703696171E-02	R1=0	R2=-
2.13217754059561E-04	R3=0						
Joint=1	OutputCase=TERRLAT	CaseType=LinStatic	U1=0	U2=0	U3=5.71789023829823E-05	R1=0	
R2=-6.94174510908476E-05	R3=0						
Joint=1	OutputCase=ACCVERT	CaseType=LinStatic	U1=0	U2=0	U3=0	R1=0	R2=0
Joint=1	OutputCase=ACCLATDX	CaseType=LinStatic	U1=0	U2=0	U3=0	R1=0	R2=0
Joint=1	OutputCase=ACCLATSX	CaseType=LinStatic	U1=0	U2=0	U3=0	R1=0	R2=0
Joint=1	OutputCase=TERRCOST	CaseType=LinStatic	U1=0	U2=0	U3=0	R1=0	R2=0
Joint=1	OutputCase=SOVRCOST	CaseType=LinStatic	U1=0	U2=0	U3=0	R1=0	R2=0
Joint=1	OutputCase=ENVE	CaseType=Combination	StepType=Max	U1=0	U2=0	U3=-1.45368635171561E-02	R1=0
R2=-1.86449280889197E-04	R3=0						
Joint=1	OutputCase=ENVE	CaseType=Combination	StepType=Min	U1=0	U2=0	U3=-0.014554017187871	R1=0
R2=-2.07274516216451E-04	R3=0						
Joint=1	OutputCase=FESSUR	CaseType=Combination	U1=0	U2=0	U3=-1.45368635171561E-02	R1=0	R2=-
1.86449280889197E-04	R3=0						
Joint=15	OutputCase=PESOPR	CaseType=LinStatic	U1=-2.10415552296729E-06	U2=0	U3=-3.52537202276826E-03		
R1=0	R2=4.26489669623703E-05	R3=0					
Joint=15	OutputCase=TERRVERT	CaseType=LinStatic	U1=2.27837581296485E-07	U2=0	U3=-1.10686703693671E-02		
R1=0	R2=2.13217753526073E-04	R3=0					
Joint=15	OutputCase=TERRLAT	CaseType=LinStatic	U1=-5.17356549727195E-05	U2=0	U3=5.71786407930162E-05		
R1=0	R2=-6.94173438849668E-05	R3=0					
Joint=15	OutputCase=ACCVERT	CaseType=LinStatic	U1=0	U2=0	U3=0	R1=0	R2=0
Joint=15	OutputCase=ACCLATDX	CaseType=LinStatic	U1=0	U2=0	U3=0	R1=0	R2=0
Joint=15	OutputCase=ACCLATSX	CaseType=LinStatic	U1=0	U2=0	U3=0	R1=0	R2=0
Joint=15	OutputCase=TERRCOST	CaseType=LinStatic	U1=0	U2=0	U3=0	R1=0	R2=0
Joint=15	OutputCase=SOVRCOST	CaseType=LinStatic	U1=0	U2=0	U3=0	R1=0	R2=0
Joint=15	OutputCase=ENVE	CaseType=Combination	StepType=Max	U1=-3.80912764225744E-05	U2=0	U3=-	
1.45368637513424E-02	R1=0	R2=2.07274579768966E-04	R3=0				
Joint=15	OutputCase=ENVE	CaseType=Combination	StepType=Min	U1=-5.36119729143903E-05	U2=0	U3=-	
1.45540173438803E-02	R1=0	R2=1.86449376603476E-04	R3=0				
Joint=15	OutputCase=FESSUR	CaseType=Combination	U1=-5.36119729143903E-05	U2=0	U3=-1.45368637513424E-02		
R1=0	R2=1.86449376603476E-04	R3=0					
Joint=19	OutputCase=PESOPR	CaseType=LinStatic	U1=-4.20831098573406E-07	U2=0	U3=-3.4671663060526E-03		
R1=0	R2=-4.68920666516232E-05	R3=0					
Joint=19	OutputCase=TERRVERT	CaseType=LinStatic	U1=4.55675156074349E-08	U2=0	U3=-1.07942403924075E-02		
R1=0	R2=-2.19798828587994E-04	R3=0					
Joint=19	OutputCase=TERRLAT	CaseType=LinStatic	U1=-1.0347130846527E-05	U2=0	U3=1.77499936632547E-06		
R1=0	R2=4.14983074541742E-05	R3=0					
Joint=19	OutputCase=ACCVERT	CaseType=LinStatic	U1=0	U2=0	U3=0	R1=0	R2=0
Joint=19	OutputCase=ACCLATDX	CaseType=LinStatic	U1=0	U2=0	U3=0	R1=0	R2=0
Joint=19	OutputCase=ACCLATSX	CaseType=LinStatic	U1=0	U2=0	U3=0	R1=0	R2=0
Joint=19	OutputCase=TERRCOST	CaseType=LinStatic	U1=0	U2=0	U3=0	R1=0	R2=0
Joint=19	OutputCase=SOVRCOST	CaseType=LinStatic	U1=0	U2=0	U3=0	R1=0	R2=0
Joint=19	OutputCase=ENVE	CaseType=Combination	StepType=Max	U1=-7.61825517553487E-06	U2=0	U3=-	
1.42596316990938E-02	R1=0	R2=-2.25192587785443E-04	R3=0				
Joint=19	OutputCase=ENVE	CaseType=Combination	StepType=Min	U1=-1.0722394429493E-05	U2=0	U3=-	
1.42601641989037E-02	R1=0	R2=-2.37642080021696E-04	R3=0				
Joint=19	OutputCase=FESSUR	CaseType=Combination	U1=-1.0722394429493E-05	U2=0	U3=-1.42596316990938E-02		
R1=0	R2=-2.25192587785443E-04	R3=0					
Joint=20	OutputCase=PESOPR	CaseType=LinStatic	U1=-2.10417754173916E-06	U2=0	U3=-3.53785472592297E-03		
R1=0	R2=2.58073055413221E-05	R3=0					
Joint=20	OutputCase=TERRVERT	CaseType=LinStatic	U1=2.27834118616422E-07	U2=0	U3=-1.11463403525775E-02		
R1=0	R2=2.15041361712208E-04	R3=0					
Joint=20	OutputCase=TERRLAT	CaseType=LinStatic	U1=-2.9420491754422E-06	U2=0	U3=5.71789046276616E-05		
R1=0	R2=-6.91299459877835E-05	R3=0					
Joint=20	OutputCase=ACCVERT	CaseType=LinStatic	U1=0	U2=0	U3=0	R1=0	R2=0
Joint=20	OutputCase=ACCLATDX	CaseType=LinStatic	U1=0	U2=0	U3=0	R1=0	R2=0
Joint=20	OutputCase=ACCLATSX	CaseType=LinStatic	U1=0	U2=0	U3=0	R1=0	R2=0
Joint=20	OutputCase=TERRCOST	CaseType=LinStatic	U1=0	U2=0	U3=0	R1=0	R2=0
Joint=20	OutputCase=SOVRCOST	CaseType=LinStatic	U1=0	U2=0	U3=0	R1=0	R2=0
Joint=20	OutputCase=ENVE	CaseType=Combination	StepType=Max	U1=-3.93577784593228E-06	U2=0	U3=-	
1.46270161738728E-02	R1=0	R2=1.92457705062081E-04	R3=0				
Joint=20	OutputCase=ENVE	CaseType=Combination	StepType=Min	U1=-4.81839259856494E-06	U2=0	U3=-	
1.46441698452611E-02	R1=0	R2=1.71718721265746E-04	R3=0				
Joint=20	OutputCase=FESSUR	CaseType=Combination	U1=-4.81839259856494E-06	U2=0	U3=-1.46270161738728E-02		
R1=0	R2=1.71718721265746E-04	R3=0					
Joint=21	OutputCase=PESOPR	CaseType=LinStatic	U1=-2.13185001113332E-11	U2=0	U3=-3.53785469866424E-03		
R1=0	R2=-2.58073164061084E-05	R3=0					



Joint=21	OutputCase=TERRVERT	CaseType=LinStatic	U1=2.70427037192584E-12	U2=0	U3=-1.11463403519269E-02			
R1=0	R2=-2.15041361541221E-04	R3=0						
Joint=21	OutputCase=TERRLAT	CaseType=LinStatic	U1=-4.87931742764586E-05	U2=0	U3=5.71786426621719E-05			
R1=0	R2=6.91300529091697E-05	R3=0						
Joint=21	OutputCase=ACCVERT	CaseType=LinStatic	U1=0	U2=0	U3=0	R1=0	R2=0	R3=0
Joint=21	OutputCase=ACCLATDX	CaseType=LinStatic	U1=0	U2=0	U3=0	R1=0	R2=0	R3=0
Joint=21	OutputCase=ACCLATSX	CaseType=LinStatic	U1=0	U2=0	U3=0	R1=0	R2=0	R3=0
Joint=21	OutputCase=TERRCOST	CaseType=LinStatic	U1=0	U2=0	U3=0	R1=0	R2=0	R3=0
Joint=21	OutputCase=SOVRCOST	CaseType=LinStatic	U1=0	U2=0	U3=0	R1=0	R2=0	R3=0
Joint=21	OutputCase=ENVE	CaseType=Combination	StepType=Max	U1=-3.41552406077507E-05	U2=0	U3=-		
1.46270164079289E-02	R1=0	R2=-1.71718625038159E-04	R3=0					
Joint=21	OutputCase=ENVE	CaseType=Combination	StepType=Min	U1=-4.87931928906883E-05	U2=0	U3=-		
1.46441700007276E-02	R1=0	R2=-1.9245764091091E-04	R3=0					
Joint=21	OutputCase=FESSUR	CaseType=Combination	U1=-4.87931928906883E-05	U2=0	U3=-1.46270164079289E-02			
R1=0	R2=-1.71718625038159E-04	R3=0						
Joint=22	OutputCase=PESOPR	CaseType=LinStatic	U1=-8.61403511903804E-06	U2=0	U3=-3.53739962778717E-03			
R1=0	R2=2.38959628361902E-05	R3=0						
Joint=22	OutputCase=TERRVERT	CaseType=LinStatic	U1=-5.01225395774758E-05	U2=0	U3=-1.11414859741778E-02			
R1=0	R2=1.8801884973847E-04	R3=0						
Joint=22	OutputCase=TERRLAT	CaseType=LinStatic	U1=1.98441464918655E-05	U2=0	U3=5.71789026110285E-05			
R1=0	R2=-7.33439119488566E-05	R3=0						
Joint=22	OutputCase=ACCVERT	CaseType=LinStatic	U1=0	U2=0	U3=0	R1=0	R2=0	R3=0
Joint=22	OutputCase=ACCLATDX	CaseType=LinStatic	U1=0	U2=0	U3=0	R1=0	R2=0	R3=0
Joint=22	OutputCase=ACCLATSX	CaseType=LinStatic	U1=0	U2=0	U3=0	R1=0	R2=0	R3=0
Joint=22	OutputCase=TERRCOST	CaseType=LinStatic	U1=0	U2=0	U3=0	R1=0	R2=0	R3=0
Joint=22	OutputCase=SOVRCOST	CaseType=LinStatic	U1=0	U2=0	U3=0	R1=0	R2=0	R3=0
Joint=22	OutputCase=ENVE	CaseType=Combination	StepType=Max	U1=-3.88924282046483E-05	U2=0	U3=-		
0.014621706699354	R1=0	R2=1.60574074210461E-04	R3=0					
Joint=22	OutputCase=ENVE	CaseType=Combination	StepType=Min	U1=-4.4845672152208E-05	U2=0	U3=-		
1.46388603701373E-02	R1=0	R2=1.38570900625804E-04	R3=0					
Joint=22	OutputCase=FESSUR	CaseType=Combination	U1=-3.88924282046483E-05	U2=0	U3=-0.014621706699354			
R1=0	R2=1.38570900625804E-04	R3=0						
Joint=23	OutputCase=PESOPR	CaseType=LinStatic	U1=6.50983837323885E-06	U2=0	U3=-3.53739960057375E-03			
R1=0	R2=-2.38959738635871E-05	R3=0						
Joint=23	OutputCase=TERRVERT	CaseType=LinStatic	U1=5.03503718636604E-05	U2=0	U3=-1.11414859739863E-02			
R1=0	R2=-1.88018852029041E-04	R3=0						
Joint=23	OutputCase=TERRLAT	CaseType=LinStatic	U1=-7.15793944958801E-05	U2=0	U3=5.71786406690064E-05			
R1=0	R2=7.33440187636593E-05	R3=0						
Joint=23	OutputCase=ACCVERT	CaseType=LinStatic	U1=0	U2=0	U3=0	R1=0	R2=0	R3=0
Joint=23	OutputCase=ACCLATDX	CaseType=LinStatic	U1=0	U2=0	U3=0	R1=0	R2=0	R3=0
Joint=23	OutputCase=ACCLATSX	CaseType=LinStatic	U1=0	U2=0	U3=0	R1=0	R2=0	R3=0
Joint=23	OutputCase=TERRCOST	CaseType=LinStatic	U1=0	U2=0	U3=0	R1=0	R2=0	R3=0
Joint=23	OutputCase=SOVRCOST	CaseType=LinStatic	U1=0	U2=0	U3=0	R1=0	R2=0	R3=0
Joint=23	OutputCase=ENVE	CaseType=Combination	StepType=Max	U1=6.75463408978322E-06	U2=0	U3=-		
0.014621706933891	R1=0	R2=-1.38570807128968E-04	R3=0					
Joint=23	OutputCase=ENVE	CaseType=Combination	StepType=Min	U1=-1.47191842589808E-05	U2=0	U3=-		
1.46388605260917E-02	R1=0	R2=-1.60574012758066E-04	R3=0					
Joint=23	OutputCase=FESSUR	CaseType=Combination	U1=-1.47191842589808E-05	U2=0	U3=-0.014621706933891			
R1=0	R2=-1.38570807128968E-04	R3=0						
Joint=24	OutputCase=PESOPR	CaseType=LinStatic	U1=-2.10437563042198E-07	U2=0	U3=-3.5533766281757E-03			
R1=0	R2=-2.6887191638877E-05	R3=0						
Joint=24	OutputCase=TERRVERT	CaseType=LinStatic	U1=2.27802945792004E-08	U2=0	U3=-1.12868856986174E-02			
R1=0	R2=-2.41936067745183E-04	R3=0						
Joint=24	OutputCase=TERRLAT	CaseType=LinStatic	U1=-4.42080605320635E-05	U2=0	U3=8.82871680769947E-05			
R1=0	R2=5.53040532083566E-05	R3=0						
Joint=24	OutputCase=ACCVERT	CaseType=LinStatic	U1=0	U2=0	U3=0	R1=0	R2=0	R3=0
Joint=24	OutputCase=ACCLATDX	CaseType=LinStatic	U1=0	U2=0	U3=0	R1=0	R2=0	R3=0
Joint=24	OutputCase=ACCLATSX	CaseType=LinStatic	U1=0	U2=0	U3=0	R1=0	R2=0	R3=0
Joint=24	OutputCase=TERRCOST	CaseType=LinStatic	U1=0	U2=0	U3=0	R1=0	R2=0	R3=0
Joint=24	OutputCase=SOVRCOST	CaseType=LinStatic	U1=0	U2=0	U3=0	R1=0	R2=0	R3=0
Joint=24	OutputCase=ENVE	CaseType=Combination	StepType=Max	U1=-3.11332996409074E-05	U2=0	U3=-		
1.47519751587161E-02	R1=0	R2=-2.13519206175703E-04	R3=0					
Joint=24	OutputCase=ENVE	CaseType=Combination	StepType=Min	U1=-4.43957178005265E-05	U2=0	U3=-		
1.47784613091392E-02	R1=0	R2=-2.3011042213821E-04	R3=0					
Joint=24	OutputCase=FESSUR	CaseType=Combination	U1=-4.43957178005265E-05	U2=0	U3=-1.47519751587161E-02			
R1=0	R2=-2.13519206175703E-04	R3=0						
Joint=25	OutputCase=PESOPR	CaseType=LinStatic	U1=-1.05229785890518E-07	U2=0	U3=-3.54560933812698E-03			
R1=0	R2=-2.693237934123E-05	R3=0						
Joint=25	OutputCase=TERRVERT	CaseType=LinStatic	U1=1.13884154056578E-08	U2=0	U3=-1.12156171762505E-02			
R1=0	R2=-2.35042117776745E-04	R3=0						
Joint=25	OutputCase=TERRLAT	CaseType=LinStatic	U1=-4.65006167306888E-05	U2=0	U3=7.35970297672257E-05			
R1=0	R2=6.22170535347745E-05	R3=0						
Joint=25	OutputCase=ACCVERT	CaseType=LinStatic	U1=0	U2=0	U3=0	R1=0	R2=0	R3=0
Joint=25	OutputCase=ACCLATDX	CaseType=LinStatic	U1=0	U2=0	U3=0	R1=0	R2=0	R3=0
Joint=25	OutputCase=ACCLATSX	CaseType=LinStatic	U1=0	U2=0	U3=0	R1=0	R2=0	R3=0
Joint=25	OutputCase=TERRCOST	CaseType=LinStatic	U1=0	U2=0	U3=0	R1=0	R2=0	R3=0
Joint=25	OutputCase=SOVRCOST	CaseType=LinStatic	U1=0	U2=0	U3=0	R1=0	R2=0	R3=0
Joint=25	OutputCase=ENVE	CaseType=Combination	StepType=Max	U1=-3.2644273081967E-05	U2=0	U3=-		
1.46876294846103E-02	R1=0	R2=-1.99757443583201E-04	R3=0					
Joint=25	OutputCase=ENVE	CaseType=Combination	StepType=Min	U1=-4.65944581011737E-05	U2=0	U3=-		
1.47097085935404E-02	R1=0	R2=-2.18422559643633E-04	R3=0					



Joint=25	OutputCase=FESSUR	CaseType=Combination	U1=-4.65944581011737E-05	U2=0	U3=-1.46876294846103E-02
R1=0	R2=-1.99757443583201E-04	R3=0			
Joint=26	OutputCase=PESOPR	CaseType=LinStatic	U1=-9.53458413788014E-06	U2=0	U3=-3.52647728769374E-03
R1=0	R2=-3.60032852538586E-05	R3=0			
Joint=26	OutputCase=TERRVERT	CaseType=LinStatic	U1=-5.00228582612159E-05	U2=0	U3=-1.10735247479834E-02
R1=0	R2=-1.86707876648631E-04	R3=0			
Joint=26	OutputCase=TERRLAT	CaseType=LinStatic	U1=2.32168674740531E-05	U2=0	U3=5.71789044280158E-05
R1=0	R2=7.35015902197317E-05	R3=0			
Joint=26	OutputCase=ACCVERT	CaseType=LinStatic	U1=0	U2=0	U3=0
Joint=26	OutputCase=ACCLATDX	CaseType=LinStatic	U1=0	U2=0	U3=0
Joint=26	OutputCase=ACCLATDX	CaseType=LinStatic	U1=0	U2=0	U3=0
Joint=26	OutputCase=ACCLATSX	CaseType=LinStatic	U1=0	U2=0	U3=0
Joint=26	OutputCase=ACCLATSX	CaseType=LinStatic	U1=0	U2=0	U3=0
Joint=26	OutputCase=TERRCOST	CaseType=LinStatic	U1=0	U2=0	U3=0
Joint=26	OutputCase=TERRCOST	CaseType=LinStatic	U1=0	U2=0	U3=0
Joint=26	OutputCase=SOVRCOST	CaseType=LinStatic	U1=0	U2=0	U3=0
Joint=26	OutputCase=SOVRCOST	CaseType=LinStatic	U1=0	U2=0	U3=0
Joint=26	OutputCase=ENVE	CaseType=Combination	StepType=Max	U1=-3.6340574925043E-05	U2=0
1.45428231312491E-02	R1=0	R2=-1.49209571682758E-04	R3=0		U3=-
Joint=26	OutputCase=ENVE	CaseType=Combination	StepType=Min	U1=-4.33056351672589E-05	U2=0
1.45599768025775E-02	R1=0	R2=-1.71260048748677E-04	R3=0		U3=-
Joint=26	OutputCase=FESSUR	CaseType=Combination	U1=-3.6340574925043E-05	U2=0	U3=-1.45428231312491E-02
R1=0	R2=-1.49209571682758E-04	R3=0			
Joint=27	OutputCase=PESOPR	CaseType=LinStatic	U1=-1.74471978138039E-05	U2=0	U3=-3.52753918192438E-03
R1=0	R2=-2.96732157616169E-05	R3=0			
Joint=27	OutputCase=TERRVERT	CaseType=LinStatic	U1=-9.34139742844816E-05	U2=0	U3=-1.10783791215801E-02
R1=0	R2=-1.60163822905757E-04	R3=0			
Joint=27	OutputCase=TERRLAT	CaseType=LinStatic	U1=4.60327682998141E-05	U2=0	U3=5.71789044397509E-05
R1=0	R2=7.23028593090868E-05	R3=0			
Joint=27	OutputCase=ACCVERT	CaseType=LinStatic	U1=0	U2=0	U3=0
Joint=27	OutputCase=ACCLATDX	CaseType=LinStatic	U1=0	U2=0	U3=0
Joint=27	OutputCase=ACCLATDX	CaseType=LinStatic	U1=0	U2=0	U3=0
Joint=27	OutputCase=ACCLATSX	CaseType=LinStatic	U1=0	U2=0	U3=0
Joint=27	OutputCase=ACCLATSX	CaseType=LinStatic	U1=0	U2=0	U3=0
Joint=27	OutputCase=TERRCOST	CaseType=LinStatic	U1=0	U2=0	U3=0
Joint=27	OutputCase=TERRCOST	CaseType=LinStatic	U1=0	U2=0	U3=0
Joint=27	OutputCase=SOVRCOST	CaseType=LinStatic	U1=0	U2=0	U3=0
Joint=27	OutputCase=SOVRCOST	CaseType=LinStatic	U1=0	U2=0	U3=0
Joint=27	OutputCase=ENVE	CaseType=Combination	StepType=Max	U1=-6.48284037984713E-05	U2=0
1.45487393990648E-02	R1=0	R2=-1.17534179358287E-04	R3=0		U3=-
Joint=27	OutputCase=ENVE	CaseType=Combination	StepType=Min	U1=-7.86382342884156E-05	U2=0
1.45658930703967E-02	R1=0	R2=-1.39225037151013E-04	R3=0		U3=-
Joint=27	OutputCase=FESSUR	CaseType=Combination	U1=-6.48284037984713E-05	U2=0	U3=-1.45487393990648E-02
R1=0	R2=-1.17534179358287E-04	R3=0			
Joint=28	OutputCase=PESOPR	CaseType=LinStatic	U1=7.43042587480719E-06	U2=0	U3=-3.52647726053607E-03
R1=0	R2=3.60032742911265E-05	R3=0			
Joint=28	OutputCase=TERRVERT	CaseType=LinStatic	U1=5.02506956944982E-05	U2=0	U3=-1.10735247477373E-02
R1=0	R2=1.86707875998005E-04	R3=0			
Joint=28	OutputCase=TERRLAT	CaseType=LinStatic	U1=-7.4952495522989E-05	U2=0	U3=5.7178642814577E-05
R1=0	R2=-7.35014825606196E-05	R3=0			
Joint=28	OutputCase=ACCVERT	CaseType=LinStatic	U1=0	U2=0	U3=0
Joint=28	OutputCase=ACCLATDX	CaseType=LinStatic	U1=0	U2=0	U3=0
Joint=28	OutputCase=ACCLATDX	CaseType=LinStatic	U1=0	U2=0	U3=0
Joint=28	OutputCase=ACCLATSX	CaseType=LinStatic	U1=0	U2=0	U3=0
Joint=28	OutputCase=ACCLATSX	CaseType=LinStatic	U1=0	U2=0	U3=0
Joint=28	OutputCase=TERRCOST	CaseType=LinStatic	U1=0	U2=0	U3=0
Joint=28	OutputCase=TERRCOST	CaseType=LinStatic	U1=0	U2=0	U3=0
Joint=28	OutputCase=SOVRCOST	CaseType=LinStatic	U1=0	U2=0	U3=0
Joint=28	OutputCase=SOVRCOST	CaseType=LinStatic	U1=0	U2=0	U3=0
Joint=28	OutputCase=ENVE	CaseType=Combination	StepType=Max	U1=5.21437470321307E-06	U2=0
1.45428233654587E-02	R1=0	R2=1.71260112496697E-04	R3=0		U3=-
Joint=28	OutputCase=ENVE	CaseType=Combination	StepType=Min	U1=-1.72713739536836E-05	U2=0
1.45599769583031E-02	R1=0	R2=1.49209667728512E-04	R3=0		U3=-
Joint=28	OutputCase=FESSUR	CaseType=Combination	U1=-1.72713739536836E-05	U2=0	U3=-1.45428233654587E-02
R1=0	R2=1.49209667728512E-04	R3=0			
Joint=29	OutputCase=PESOPR	CaseType=LinStatic	U1=1.53430368094706E-05	U2=0	U3=-3.52753915476272E-03
R1=0	R2=2.96732047942659E-05	R3=0			
Joint=29	OutputCase=TERRVERT	CaseType=LinStatic	U1=9.36418115404649E-05	U2=0	U3=-1.10783791213379E-02
R1=0	R2=1.60163822137991E-04	R3=0			
Joint=29	OutputCase=TERRLAT	CaseType=LinStatic	U1=-9.7768369320441E-05	U2=0	U3=5.71786428028418E-05
R1=0	R2=-7.23027512665044E-05	R3=0			
Joint=29	OutputCase=ACCVERT	CaseType=LinStatic	U1=0	U2=0	U3=0
Joint=29	OutputCase=ACCLATDX	CaseType=LinStatic	U1=0	U2=0	U3=0
Joint=29	OutputCase=ACCLATDX	CaseType=LinStatic	U1=0	U2=0	U3=0
Joint=29	OutputCase=ACCLATSX	CaseType=LinStatic	U1=0	U2=0	U3=0
Joint=29	OutputCase=ACCLATSX	CaseType=LinStatic	U1=0	U2=0	U3=0
Joint=29	OutputCase=TERRCOST	CaseType=LinStatic	U1=0	U2=0	U3=0
Joint=29	OutputCase=TERRCOST	CaseType=LinStatic	U1=0	U2=0	U3=0
Joint=29	OutputCase=SOVRCOST	CaseType=LinStatic	U1=0	U2=0	U3=0
Joint=29	OutputCase=SOVRCOST	CaseType=LinStatic	U1=0	U2=0	U3=0
Joint=29	OutputCase=ENVE	CaseType=Combination	StepType=Max	U1=4.05469898256267E-05	U2=0
1.45487396332978E-02	R1=0	R2=1.39225101045704E-04	R3=0		U3=-
Joint=29	OutputCase=ENVE	CaseType=Combination	StepType=Min	U1=1.12164790294944E-05	U2=0
1.45658932261387E-02	R1=0	R2=1.17534275665753E-04	R3=0		U3=-
Joint=29	OutputCase=FESSUR	CaseType=Combination	U1=1.12164790294944E-05	U2=0	U3=-1.45487396332978E-02
R1=0	R2=1.17534275665753E-04	R3=0			
Joint=30	OutputCase=PESOPR	CaseType=LinStatic	U1=-1.05207767118305E-07	U2=0	U3=-3.51104087246501E-03
R1=0	R2=-4.78596313000903E-05	R3=0			
Joint=30	OutputCase=TERRVERT	CaseType=LinStatic	U1=1.1391878087048E-08	U2=0	U3=-1.09999204116272E-02
R1=0	R2=-2.32803182568697E-04	R3=0			
Joint=30	OutputCase=TERRLAT	CaseType=LinStatic	U1=-2.58678252661063E-06	U2=0	U3=4.0702479968491E-05
R1=0	R2=6.24230395417646E-05	R3=0			
Joint=30	OutputCase=ACCVERT	CaseType=LinStatic	U1=0	U2=0	U3=0
Joint=30	OutputCase=ACCLATDX	CaseType=LinStatic	U1=0	U2=0	U3=0
Joint=30	OutputCase=ACCLATDX	CaseType=LinStatic	U1=0	U2=0	U3=0
Joint=30	OutputCase=ACCLATSX	CaseType=LinStatic	U1=0	U2=0	U3=0
Joint=30	OutputCase=ACCLATSX	CaseType=LinStatic	U1=0	U2=0	U3=0
Joint=30	OutputCase=TERRCOST	CaseType=LinStatic	U1=0	U2=0	U3=0
Joint=30	OutputCase=TERRCOST	CaseType=LinStatic	U1=0	U2=0	U3=0
Joint=30	OutputCase=SOVRCOST	CaseType=LinStatic	U1=0	U2=0	U3=0
Joint=30	OutputCase=SOVRCOST	CaseType=LinStatic	U1=0	U2=0	U3=0



Joint=30	OutputCase=ENVE	CaseType=Combination	StepType=Max	U1=-1.9045636576587E-06	U2=0	U3=-
1.44702588041237E-02	R1=0	R2=-2.18239774327023E-04	R3=0			
Joint=30	OutputCase=ENVE	CaseType=Combination	StepType=Min	U1=-2.68059841564188E-06	U2=0	U3=-
1.44824695481142E-02	R1=0	R2=-2.36966686189552E-04	R3=0			
Joint=30	OutputCase=FESSUR	CaseType=Combination		U1=-2.68059841564188E-06	U2=0	U3=-1.44702588041237E-02
R1=0	R2=-2.18239774327023E-04	R3=0				
Joint=31	OutputCase=PESOPR	CaseType=LinStatic		U1=-2.10415544270005E-07	U2=0	U3=-3.49611077172004E-03
R1=0	R2=-5.00352964228005E-05	R3=0				
Joint=31	OutputCase=TERRVERT	CaseType=LinStatic		U1=2.27837572605103E-08	U2=0	U3=-1.09293074571916E-02
R1=0	R2=-2.39317649219132E-04	R3=0				
Joint=31	OutputCase=TERRLAT	CaseType=LinStatic		U1=-5.17356529991608E-06	U2=0	U3=2.59790101749802E-05
R1=0	R2=5.54352454895066E-05	R3=0				
Joint=31	OutputCase=ACCVERT	CaseType=LinStatic		U1=0	U2=0	U3=0
Joint=31	OutputCase=ACCLATDX	CaseType=LinStatic		U1=0	U2=0	U3=0
Joint=31	OutputCase=ACCLATSX	CaseType=LinStatic		U1=0	U2=0	U3=0
Joint=31	OutputCase=TERRCOST	CaseType=LinStatic		U1=0	U2=0	U3=0
Joint=31	OutputCase=SOVRCOST	CaseType=LinStatic		U1=0	U2=0	U3=0
Joint=31	OutputCase=ENVE	CaseType=Combination	StepType=Max	U1=-3.80912749695075E-06	U2=0	U3=-
1.43994392187366E-02	R1=0	R2=-2.33917700152426E-04	R3=0			
Joint=31	OutputCase=ENVE	CaseType=Combination	StepType=Min	U1=-5.36119708692558E-06	U2=0	U3=-
1.44072329217891E-02	R1=0	R2=-2.50548273799277E-04	R3=0			
Joint=31	OutputCase=FESSUR	CaseType=Combination		U1=-5.36119708692558E-06	U2=0	U3=-1.43994392187366E-02
R1=0	R2=-2.33917700152426E-04	R3=0				
Joint=32	OutputCase=PESOPR	CaseType=LinStatic		U1=-1.89373997869726E-06	U2=0	U3=-3.49611075005543E-03
R1=0	R2=5.00352854924986E-05	R3=0				
Joint=32	OutputCase=TERRVERT	CaseType=LinStatic		U1=2.0505382403594E-07	U2=0	U3=-1.09293074571321E-02
R1=0	R2=2.3931764889651E-04	R3=0				
Joint=32	OutputCase=TERRLAT	CaseType=LinStatic		U1=-4.65620896728034E-05	U2=0	U3=2.59788019954354E-05
R1=0	R2=-5.54351393494533E-05	R3=0				
Joint=32	OutputCase=ACCVERT	CaseType=LinStatic		U1=0	U2=0	U3=0
Joint=32	OutputCase=ACCLATDX	CaseType=LinStatic		U1=0	U2=0	U3=0
Joint=32	OutputCase=ACCLATSX	CaseType=LinStatic		U1=0	U2=0	U3=0
Joint=32	OutputCase=TERRCOST	CaseType=LinStatic		U1=0	U2=0	U3=0
Joint=32	OutputCase=SOVRCOST	CaseType=LinStatic		U1=0	U2=0	U3=0
Joint=32	OutputCase=ENVE	CaseType=Combination	StepType=Max	U1=-3.42821489256237E-05	U2=0	U3=-
1.43994394051921E-02	R1=0	R2=2.50548336844392E-04	R3=0			
Joint=32	OutputCase=ENVE	CaseType=Combination	StepType=Min	U1=-4.82507758274647E-05	U2=0	U3=-
1.44072330457908E-02	R1=0	R2=2.33917795039556E-04	R3=0			
Joint=32	OutputCase=FESSUR	CaseType=Combination		U1=-4.82507758274647E-05	U2=0	U3=-1.43994394051921E-02
R1=0	R2=2.33917795039556E-04	R3=0				
Joint=33	OutputCase=PESOPR	CaseType=LinStatic		U1=-1.99894775584897E-06	U2=0	U3=-3.51104084805916E-03
R1=0	R2=4.7859620351652E-05	R3=0				
Joint=33	OutputCase=TERRVERT	CaseType=LinStatic		U1=2.16445703209406E-07	U2=0	U3=-1.09999204114856E-02
R1=0	R2=2.32803182146497E-04	R3=0				
Joint=33	OutputCase=TERRLAT	CaseType=LinStatic		U1=-4.91488724461088E-05	U2=0	U3=4.07022451652853E-05
R1=0	R2=-6.24229328503739E-05	R3=0				
Joint=33	OutputCase=ACCVERT	CaseType=LinStatic		U1=0	U2=0	U3=0
Joint=33	OutputCase=ACCLATDX	CaseType=LinStatic		U1=0	U2=0	U3=0
Joint=33	OutputCase=ACCLATSX	CaseType=LinStatic		U1=0	U2=0	U3=0
Joint=33	OutputCase=TERRCOST	CaseType=LinStatic		U1=0	U2=0	U3=0
Joint=33	OutputCase=SOVRCOST	CaseType=LinStatic		U1=0	U2=0	U3=0
Joint=33	OutputCase=ENVE	CaseType=Combination	StepType=Max	U1=-3.61867127649157E-05	U2=0	U3=-
1.44702590143795E-02	R1=0	R2=2.36966749502888E-04	R3=0			
Joint=33	OutputCase=ENVE	CaseType=Combination	StepType=Min	U1=-5.09313744987484E-05	U2=0	U3=-
1.44824696879291E-02	R1=0	R2=2.18239869647776E-04	R3=0			
Joint=33	OutputCase=FESSUR	CaseType=Combination		U1=-5.09313744987484E-05	U2=0	U3=-1.44702590143795E-02
R1=0	R2=2.18239869647776E-04	R3=0				
Joint=34	OutputCase=PESOPR	CaseType=LinStatic		U1=-1.4606603938407E-05	U2=0	U3=-3.53690118820179E-03
R1=0	R2=2.16689968037363E-05	R3=0				
Joint=34	OutputCase=TERRVERT	CaseType=LinStatic		U1=-9.37215555473741E-05	U2=0	U3=-1.11366316047401E-02
R1=0	R2=1.61030513402252E-04	R3=0				
Joint=34	OutputCase=TERRLAT	CaseType=LinStatic		U1=4.24478151623209E-05	U2=0	U3=5.71789046075827E-05
R1=0	R2=-7.25941360595443E-05	R3=0				
Joint=34	OutputCase=ACCVERT	CaseType=LinStatic		U1=0	U2=0	U3=0
Joint=34	OutputCase=ACCLATDX	CaseType=LinStatic		U1=0	U2=0	U3=0
Joint=34	OutputCase=ACCLATSX	CaseType=LinStatic		U1=0	U2=0	U3=0
Joint=34	OutputCase=TERRCOST	CaseType=LinStatic		U1=0	U2=0	U3=0
Joint=34	OutputCase=SOVRCOST	CaseType=LinStatic		U1=0	U2=0	U3=0
Joint=34	OutputCase=ENVE	CaseType=Combination	StepType=Max	U1=-6.58803443234602E-05	U2=0	U3=-
1.46163538883343E-02	R1=0	R2=1.31883614964307E-04	R3=0			
Joint=34	OutputCase=ENVE	CaseType=Combination	StepType=Min	U1=-7.86146888721565E-05	U2=0	U3=-
1.46335075597165E-02	R1=0	R2=1.10105374146444E-04	R3=0			
Joint=34	OutputCase=FESSUR	CaseType=Combination		U1=-6.58803443234602E-05	U2=0	U3=-1.46163538883343E-02
R1=0	R2=1.10105374146444E-04	R3=0				
Joint=35	OutputCase=PESOPR	CaseType=LinStatic		U1=1.25024099488797E-05	U2=0	U3=-3.53690116099235E-03
R1=0	R2=-2.16690078265143E-05	R3=0				
Joint=35	OutputCase=TERRVERT	CaseType=LinStatic		U1=9.3949388391559E-05	U2=0	U3=-1.11366316045446E-02
R1=0	R2=-1.61030515575684E-04	R3=0				
Joint=35	OutputCase=TERRLAT	CaseType=LinStatic		U1=-9.41830899904566E-05	U2=0	U3=5.71786426890334E-05
R1=0	R2=7.25942433646819E-05	R3=0				
Joint=35	OutputCase=ACCVERT	CaseType=LinStatic		U1=0	U2=0	U3=0
Joint=35	OutputCase=ACCLATDX	CaseType=LinStatic		U1=0	U2=0	U3=0



Joint=35	OutputCase=ACCLATSX	CaseType=LinStatic	U1=0	U2=0	U3=0	R1=0	R2=0	R3=0
Joint=35	OutputCase=TERRCOST	CaseType=LinStatic	U1=0	U2=0	U3=0	R1=0	R2=0	R3=0
Joint=35	OutputCase=SOVRCOST	CaseType=LinStatic	U1=0	U2=0	U3=0	R1=0	R2=0	R3=0
Joint=35	OutputCase=ENVE	CaseType=Combination	StepType=Max	U1=4.05236353471191E-05	U2=0	U3=-		
1.46163541228479E-02	R1=0	R2=-1.10105280037516E-04	R3=0					
Joint=35	OutputCase=ENVE	CaseType=Combination	StepType=Min	U1=1.22687083499821E-05	U2=0	U3=-		
1.46335077156547E-02	R1=0	R2=-1.31883553046921E-04	R3=0					
Joint=35	OutputCase=FESSUR	CaseType=Combination	U1=1.22687083499821E-05	U2=0	U3=-1.46163541228479E-02			
R1=0	R2=-1.10105280037516E-04	R3=0						
Joint=36	OutputCase=PESOPR	CaseType=LinStatic	U1=-6.31246652876807E-07	U2=0	U3=-3.44316295771343E-03			
R1=0	R2=-3.5710234196847E-05	R3=0						
Joint=36	OutputCase=TERRVERT	CaseType=LinStatic	U1=6.83512739543594E-08	U2=0	U3=-1.06834415546455E-02			
R1=0	R2=-1.65677697393071E-04	R3=0						
Joint=36	OutputCase=TERRLAT	CaseType=LinStatic	U1=-1.55206963931379E-05	U2=0	U3=-1.54744590441026E-05			
R1=0	R2=2.76208891999364E-05	R3=0						
Joint=36	OutputCase=ACCVERT	CaseType=LinStatic	U1=0	U2=0	U3=0	R1=0	R2=0	R3=0
Joint=36	OutputCase=ACCLATDX	CaseType=LinStatic	U1=0	U2=0	U3=0	R1=0	R2=0	R3=0
Joint=36	OutputCase=ACCLATSX	CaseType=LinStatic	U1=0	U2=0	U3=0	R1=0	R2=0	R3=0
Joint=36	OutputCase=TERRCOST	CaseType=LinStatic	U1=0	U2=0	U3=0	R1=0	R2=0	R3=0
Joint=36	OutputCase=SOVRCOST	CaseType=LinStatic	U1=0	U2=0	U3=0	R1=0	R2=0	R3=0
Joint=36	OutputCase=ENVE	CaseType=Combination	StepType=Max	U1=-1.1427382854119E-05	U2=0	U3=-		
1.41374366336898E-02	R1=0	R2=-1.73767042389981E-04	R3=0					
Joint=36	OutputCase=ENVE	CaseType=Combination	StepType=Min	U1=-1.60835917720604E-05	U2=0	U3=-		
1.41420789714031E-02	R1=0	R2=-1.82053309149962E-04	R3=0					
Joint=36	OutputCase=FESSUR	CaseType=Combination	U1=-1.60835917720604E-05	U2=0	U3=-1.41420789714031E-02			
R1=0	R2=-1.73767042389981E-04	R3=0						
Joint=37	OutputCase=PESOPR	CaseType=LinStatic	U1=-8.41662207180208E-07	U2=0	U3=-3.42743257992418E-03			
R1=0	R2=-1.91874832488283E-05	R3=0						
Joint=37	OutputCase=TERRVERT	CaseType=LinStatic	U1=9.1135032301284E-08	U2=0	U3=-1.06112475615313E-02			
R1=0	R2=-8.85718757337828E-05	R3=0						
Joint=37	OutputCase=TERRLAT	CaseType=LinStatic	U1=-2.06942619397488E-05	U2=0	U3=-2.58066339912533E-05			
R1=0	R2=1.37955804709522E-05	R3=0						
Joint=37	OutputCase=ACCVERT	CaseType=LinStatic	U1=0	U2=0	U3=0	R1=0	R2=0	R3=0
Joint=37	OutputCase=ACCLATDX	CaseType=LinStatic	U1=0	U2=0	U3=0	R1=0	R2=0	R3=0
Joint=37	OutputCase=ACCLATSX	CaseType=LinStatic	U1=0	U2=0	U3=0	R1=0	R2=0	R3=0
Joint=37	OutputCase=TERRCOST	CaseType=LinStatic	U1=0	U2=0	U3=0	R1=0	R2=0	R3=0
Joint=37	OutputCase=SOVRCOST	CaseType=LinStatic	U1=0	U2=0	U3=0	R1=0	R2=0	R3=0
Joint=37	OutputCase=ENVE	CaseType=Combination	StepType=Max	U1=-1.52365105327031E-05	U2=0	U3=-		
1.40567447852493E-02	R1=0	R2=-9.39637785116588E-05	R3=0					
Joint=37	OutputCase=ENVE	CaseType=Combination	StepType=Min	U1=-2.14447891146277E-05	U2=0	U3=-		
1.40644867754467E-02	R1=0	R2=-9.81024526529445E-05	R3=0					
Joint=37	OutputCase=FESSUR	CaseType=Combination	U1=-2.14447891146277E-05	U2=0	U3=-1.40644867754467E-02			
R1=0	R2=-9.39637785116588E-05	R3=0						
Joint=38	OutputCase=PESOPR	CaseType=LinStatic	U1=-1.05207776148362E-06	U2=0	U3=-3.42196804686064E-03			
R1=0	R2=-5.39288405591407E-12	R3=0						
Joint=38	OutputCase=TERRVERT	CaseType=LinStatic	U1=1.13918790648215E-07	U2=0	U3=-1.05862319181561E-02			
R1=0	R2=2.59922292022985E-14	R3=0						
Joint=38	OutputCase=TERRLAT	CaseType=LinStatic	U1=-2.58678274863597E-05	U2=0	U3=-2.92476053050258E-05			
R1=0	R2=5.16667852571524E-11	R3=0						
Joint=38	OutputCase=ACCVERT	CaseType=LinStatic	U1=0	U2=0	U3=0	R1=0	R2=0	R3=0
Joint=38	OutputCase=ACCLATDX	CaseType=LinStatic	U1=0	U2=0	U3=0	R1=0	R2=0	R3=0
Joint=38	OutputCase=ACCLATSX	CaseType=LinStatic	U1=0	U2=0	U3=0	R1=0	R2=0	R3=0
Joint=38	OutputCase=TERRCOST	CaseType=LinStatic	U1=0	U2=0	U3=0	R1=0	R2=0	R3=0
Joint=38	OutputCase=SOVRCOST	CaseType=LinStatic	U1=0	U2=0	U3=0	R1=0	R2=0	R3=0
Joint=38	OutputCase=ENVE	CaseType=Combination	StepType=Max	U1=-1.90456382112872E-05	U2=0	U3=-		
1.40286732887302E-02	R1=0	R2=4.62998934304406E-11	R3=0					
Joint=38	OutputCase=ENVE	CaseType=Combination	StepType=Min	U1=-2.68059864571951E-05	U2=0	U3=-		
1.40374475703217E-02	R1=0	R2=3.07998578532949E-11	R3=0					
Joint=38	OutputCase=FESSUR	CaseType=Combination	U1=-2.68059864571951E-05	U2=0	U3=-1.40374475703217E-02			
R1=0	R2=4.62998934304406E-11	R3=0						
Joint=39	OutputCase=PESOPR	CaseType=LinStatic	U1=-1.99896977462087E-06	U2=0	U3=-3.54560936264837E-03			
R1=0	R2=2.69323684570057E-05	R3=0						
Joint=39	OutputCase=TERRVERT	CaseType=LinStatic	U1=2.16442240529283E-07	U2=0	U3=-1.12156171769211E-02			
R1=0	R2=2.35042117838081E-04	R3=0						
Joint=39	OutputCase=TERRLAT	CaseType=LinStatic	U1=-5.23460515543237E-06	U2=0	U3=7.35972647127717E-05			
R1=0	R2=-6.22169469543357E-05	R3=0						
Joint=39	OutputCase=ACCVERT	CaseType=LinStatic	U1=0	U2=0	U3=0	R1=0	R2=0	R3=0
Joint=39	OutputCase=ACCLATDX	CaseType=LinStatic	U1=0	U2=0	U3=0	R1=0	R2=0	R3=0
Joint=39	OutputCase=ACCLATSX	CaseType=LinStatic	U1=0	U2=0	U3=0	R1=0	R2=0	R3=0
Joint=39	OutputCase=TERRCOST	CaseType=LinStatic	U1=0	U2=0	U3=0	R1=0	R2=0	R3=0
Joint=39	OutputCase=SOVRCOST	CaseType=LinStatic	U1=0	U2=0	U3=0	R1=0	R2=0	R3=0
Joint=39	OutputCase=ENVE	CaseType=Combination	StepType=Max	U1=-5.44675114289424E-06	U2=0	U3=-		
1.46876292748567E-02	R1=0	R2=2.18422623427052E-04	R3=0					
Joint=39	OutputCase=ENVE	CaseType=Combination	StepType=Min	U1=-7.01713268952395E-06	U2=0	U3=-		
1.47097084542705E-02	R1=0	R2=1.99757539340751E-04	R3=0					
Joint=39	OutputCase=FESSUR	CaseType=Combination	U1=-7.01713268952395E-06	U2=0	U3=-1.46876292748567E-02			
R1=0	R2=1.99757539340751E-04	R3=0						
Joint=40	OutputCase=PESOPR	CaseType=LinStatic	U1=-1.89376199746918E-06	U2=0	U3=-3.55337664997511E-03			
R1=0	R2=2.68871807507265E-05	R3=0						
Joint=40	OutputCase=TERRVERT	CaseType=LinStatic	U1=2.0505036135574E-07	U2=0	U3=-1.12868856992798E-02			
R1=0	R2=2.41936067706952E-04	R3=0						

Joint=40	OutputCase=TERRLAT	CaseType=LinStatic	U1=-7.52716135405772E-06	U2=0	U3=8.82873765184869E-05			
R1=0	R2=-5.53039472264077E-05	R3=0						
Joint=40	OutputCase=ACCVERT	CaseType=LinStatic	U1=0	U2=0	U3=0	R1=0	R2=0	R3=0
Joint=40	OutputCase=ACCLATDX	CaseType=LinStatic	U1=0	U2=0	U3=0	R1=0	R2=0	R3=0
Joint=40	OutputCase=ACCLATSX	CaseType=LinStatic	U1=0	U2=0	U3=0	R1=0	R2=0	R3=0
Joint=40	OutputCase=TERRCOST	CaseType=LinStatic	U1=0	U2=0	U3=0	R1=0	R2=0	R3=0
Joint=40	OutputCase=SOVRCOST	CaseType=LinStatic	U1=0	U2=0	U3=0	R1=0	R2=0	R3=0
Joint=40	OutputCase=ENVE	CaseType=Combination	StepType=Max	U1=-6.95772458395385E-06	U2=0	U3=-		
1.47519749727365E-02	R1=0	R2=2.30110485399193E-04	R3=0					
Joint=40	OutputCase=ENVE	CaseType=Combination	StepType=Min	U1=-9.21587299017117E-06	U2=0	U3=-		
0.014778461185692	R1=0	R2=2.13519301231271E-04	R3=0					
Joint=40	OutputCase=FESSUR	CaseType=Combination	U1=-9.21587299017117E-06	U2=0	U3=-1.47519749727365E-02			
R1=0	R2=2.13519301231271E-04	R3=0						
Joint=41	OutputCase=PESOPR	CaseType=LinStatic	U1=-1.26249331578703E-06	U2=0	U3=-3.42743257454084E-03			
R1=0	R2=1.91874724503828E-05	R3=0						
Joint=41	OutputCase=TERRVERT	CaseType=LinStatic	U1=1.36702548995146E-07	U2=0	U3=-1.06112475615749E-02			
R1=0	R2=8.85718757623775E-05	R3=0						
Joint=41	OutputCase=TERRLAT	CaseType=LinStatic	U1=-3.10413930329706E-05	U2=0	U3=-2.58066854996172E-05			
R1=0	R2=-1.37954769270878E-05	R3=0						
Joint=41	OutputCase=ACCVERT	CaseType=LinStatic	U1=0	U2=0	U3=0	R1=0	R2=0	R3=0
Joint=41	OutputCase=ACCLATDX	CaseType=LinStatic	U1=0	U2=0	U3=0	R1=0	R2=0	R3=0
Joint=41	OutputCase=ACCLATSX	CaseType=LinStatic	U1=0	U2=0	U3=0	R1=0	R2=0	R3=0
Joint=41	OutputCase=TERRCOST	CaseType=LinStatic	U1=0	U2=0	U3=0	R1=0	R2=0	R3=0
Joint=41	OutputCase=SOVRCOST	CaseType=LinStatic	U1=0	U2=0	U3=0	R1=0	R2=0	R3=0
Joint=41	OutputCase=ENVE	CaseType=Combination	StepType=Max	U1=-2.28547658898713E-05	U2=0	U3=-		
1.40567448159655E-02	R1=0	R2=9.81025143637988E-05	R3=0					
Joint=41	OutputCase=ENVE	CaseType=Combination	StepType=Min	U1=-3.21671837997625E-05	U2=0	U3=-		
1.40644868216153E-02	R1=0	R2=9.39638712856725E-05	R3=0					
Joint=41	OutputCase=FESSUR	CaseType=Combination	U1=-3.21671837997625E-05	U2=0	U3=-1.40644868216153E-02			
R1=0	R2=9.39638712856725E-05	R3=0						
Joint=42	OutputCase=PESOPR	CaseType=LinStatic	U1=-1.47290887009044E-06	U2=0	U3=-3.4431629469319E-03			
R1=0	R2=3.57102233632812E-05	R3=0						
Joint=42	OutputCase=TERRVERT	CaseType=LinStatic	U1=1.59486307342078E-07	U2=0	U3=-1.06834415547094E-02			
R1=0	R2=1.65677697351473E-04	R3=0						
Joint=42	OutputCase=TERRLAT	CaseType=LinStatic	U1=-3.62149585795815E-05	U2=0	U3=-1.54745622921134E-05			
R1=0	R2=-2.7620785053052E-05	R3=0						
Joint=42	OutputCase=ACCVERT	CaseType=LinStatic	U1=0	U2=0	U3=0	R1=0	R2=0	R3=0
Joint=42	OutputCase=ACCLATDX	CaseType=LinStatic	U1=0	U2=0	U3=0	R1=0	R2=0	R3=0
Joint=42	OutputCase=ACCLATSX	CaseType=LinStatic	U1=0	U2=0	U3=0	R1=0	R2=0	R3=0
Joint=42	OutputCase=TERRCOST	CaseType=LinStatic	U1=0	U2=0	U3=0	R1=0	R2=0	R3=0
Joint=42	OutputCase=SOVRCOST	CaseType=LinStatic	U1=0	U2=0	U3=0	R1=0	R2=0	R3=0
Joint=42	OutputCase=ENVE	CaseType=Combination	StepType=Max	U1=-2.66638935684554E-05	U2=0	U3=-		
1.41374366952458E-02	R1=0	R2=1.82053371177617E-04	R3=0					
Joint=42	OutputCase=ENVE	CaseType=Combination	StepType=Min	U1=-3.75283811423299E-05	U2=0	U3=-		
1.41420790639334E-02	R1=0	R2=1.73767135661702E-04	R3=0					
Joint=42	OutputCase=FESSUR	CaseType=Combination	U1=-3.75283811423299E-05	U2=0	U3=-1.41420790639334E-02			
R1=0	R2=1.73767135661702E-04	R3=0						
Joint=43	OutputCase=PESOPR	CaseType=LinStatic	U1=-1.68332442439385E-06	U2=0	U3=-3.46716628984602E-03			
R1=0	R2=4.68920557692394E-05	R3=0						
Joint=43	OutputCase=TERRVERT	CaseType=LinStatic	U1=1.82270065689009E-07	U2=0	U3=-1.07942403924448E-02			
R1=0	R2=2.19798828429342E-04	R3=0						
Joint=43	OutputCase=TERRLAT	CaseType=LinStatic	U1=-4.13885241261925E-05	U2=0	U3=1.77484394386919E-06			
R1=0	R2=-4.14982023952538E-05	R3=0						
Joint=43	OutputCase=ACCVERT	CaseType=LinStatic	U1=0	U2=0	U3=0	R1=0	R2=0	R3=0
Joint=43	OutputCase=ACCLATDX	CaseType=LinStatic	U1=0	U2=0	U3=0	R1=0	R2=0	R3=0
Joint=43	OutputCase=ACCLATSX	CaseType=LinStatic	U1=0	U2=0	U3=0	R1=0	R2=0	R3=0
Joint=43	OutputCase=TERRCOST	CaseType=LinStatic	U1=0	U2=0	U3=0	R1=0	R2=0	R3=0
Joint=43	OutputCase=SOVRCOST	CaseType=LinStatic	U1=0	U2=0	U3=0	R1=0	R2=0	R3=0
Joint=43	OutputCase=ENVE	CaseType=Combination	StepType=Max	U1=-3.04730212470396E-05	U2=0	U3=-		
0.014259631838347	R1=0	R2=2.37642142521904E-04	R3=0					
Joint=43	OutputCase=ENVE	CaseType=Combination	StepType=Min	U1=-4.28895784848973E-05	U2=0	U3=-		
1.42601642915301E-02	R1=0	R2=2.25192681803327E-04	R3=0					
Joint=43	OutputCase=FESSUR	CaseType=Combination	U1=-4.28895784848973E-05	U2=0	U3=-0.014259631838347			
R1=0	R2=2.25192681803327E-04	R3=0						
Joint=61	OutputCase=PESOPR	CaseType=LinStatic	U1=2.66179711185188E-05	U2=0	U3=-3.52953291525927E-03			
R1=0	R2=1.79599358431337E-05	R3=0						
Joint=61	OutputCase=TERRVERT	CaseType=LinStatic	U1=1.60494642966719E-04	U2=0	U3=-1.10880878680082E-02			
R1=0	R2=1.06973187736878E-04	R3=0						
Joint=61	OutputCase=TERRLAT	CaseType=LinStatic	U1=-1.37557696913151E-04	U2=0	U3=5.71786424826882E-05			
R1=0	R2=-5.72615665887869E-05	R3=0						
Joint=61	OutputCase=ACCVERT	CaseType=LinStatic	U1=0	U2=0	U3=0	R1=0	R2=0	R3=0
Joint=61	OutputCase=ACCLATDX	CaseType=LinStatic	U1=0	U2=0	U3=0	R1=0	R2=0	R3=0
Joint=61	OutputCase=ACCLATSX	CaseType=LinStatic	U1=0	U2=0	U3=0	R1=0	R2=0	R3=0
Joint=61	OutputCase=TERRCOST	CaseType=LinStatic	U1=0	U2=0	U3=0	R1=0	R2=0	R3=0
Joint=61	OutputCase=SOVRCOST	CaseType=LinStatic	U1=0	U2=0	U3=0	R1=0	R2=0	R3=0
Joint=61	OutputCase=ENVE	CaseType=Combination	StepType=Max	U1=9.08222262460319E-05	U2=0	U3=-		
1.45604421407847E-02	R1=0	R2=8.48500269678604E-05	R3=0					
Joint=61	OutputCase=ENVE	CaseType=Combination	StepType=Min	U1=4.95549171720867E-05	U2=0	U3=-		
1.45775957335295E-02	R1=0	R2=6.76715569912244E-05	R3=0					
Joint=61	OutputCase=FESSUR	CaseType=Combination	U1=4.95549171720867E-05	U2=0	U3=-1.45604421407847E-02			
R1=0	R2=6.76715569912244E-05	R3=0						



Joint=62	OutputCase=PESOPR	CaseType=LinStatic	U1=3.23518943089597E-05	U2=0	U3=-3.53135330531252E-03			
R1=0	R2=7.50916030875844E-06	R3=0						
Joint=62	OutputCase=TERRVERT	CaseType=LinStatic	U1=2.00717981670632E-04	U2=0	U3=-0.01109779661489			
R1=0	R2=5.36458512486313E-05	R3=0						
Joint=62	OutputCase=TERRLAT	CaseType=LinStatic	U1=-1.63804083974641E-04	U2=0	U3=5.71786422619386E-05			
R1=0	R2=-3.05926517215222E-05	R3=0						
Joint=62	OutputCase=ACCVERT	CaseType=LinStatic	U1=0	U2=0	U3=0	R1=0	R2=0	R3=0
Joint=62	OutputCase=ACCLATDX	CaseType=LinStatic	U1=0	U2=0	U3=0	R1=0	R2=0	R3=0
Joint=62	OutputCase=ACCLATSX	CaseType=LinStatic	U1=0	U2=0	U3=0	R1=0	R2=0	R3=0
Joint=62	OutputCase=TERRCOST	CaseType=LinStatic	U1=0	U2=0	U3=0	R1=0	R2=0	R3=0
Joint=62	OutputCase=SOVRCOST	CaseType=LinStatic	U1=0	U2=0	U3=0	R1=0	R2=0	R3=0
Joint=62	OutputCase=ENVE	CaseType=Combination	StepType=Max	U1=1.18407017197343E-04	U2=0	U3=-		
1.45719712779406E-02	R1=0	R2=3.97401553523242E-05	R3=0					
Joint=62	OutputCase=ENVE	CaseType=Combination	StepType=Min	U1=6.92657920049504E-05	U2=0	U3=-		
1.45891248706192E-02	R1=0	R2=3.05623598358675E-05	R3=0					
Joint=62	OutputCase=FESSUR	CaseType=Combination	U1=6.92657920049504E-05	U2=0	U3=-1.45719712779406E-02			
R1=0	R2=3.05623598358675E-05	R3=0						
Joint=63	OutputCase=PESOPR	CaseType=LinStatic	U1=3.31760530871048E-05	U2=0	U3=-3.53300032491748E-03			
R1=0	R2=-1.67912181712701E-06	R3=0						
Joint=63	OutputCase=TERRVERT	CaseType=LinStatic	U1=2.1424347660864E-04	U2=0	U3=-0.011107505361984			
R1=0	R2=1.81812673252123E-07	R3=0						
Joint=63	OutputCase=TERRLAT	CaseType=LinStatic	U1=-1.7231304215559E-04	U2=0	U3=5.71786421741629E-05			
R1=0	R2=1.58259349746269E-06	R3=0						
Joint=63	OutputCase=ACCVERT	CaseType=LinStatic	U1=0	U2=0	U3=0	R1=0	R2=0	R3=0
Joint=63	OutputCase=ACCLATDX	CaseType=LinStatic	U1=0	U2=0	U3=0	R1=0	R2=0	R3=0
Joint=63	OutputCase=ACCLATSX	CaseType=LinStatic	U1=0	U2=0	U3=0	R1=0	R2=0	R3=0
Joint=63	OutputCase=TERRCOST	CaseType=LinStatic	U1=0	U2=0	U3=0	R1=0	R2=0	R3=0
Joint=63	OutputCase=SOVRCOST	CaseType=LinStatic	U1=0	U2=0	U3=0	R1=0	R2=0	R3=0
Joint=63	OutputCase=ENVE	CaseType=Combination	StepType=Max	U1=1.26800400186831E-04	U2=0	U3=-		
1.45833270447274E-02	R1=0	R2=8.52843535878046E-08	R3=0					
Joint=63	OutputCase=ENVE	CaseType=Combination	StepType=Min	U1=7.51064875401543E-05	U2=0	U3=-		
1.46004806373796E-02	R1=0	R2=-3.89493695651004E-07	R3=0					
Joint=63	OutputCase=FESSUR	CaseType=Combination	U1=7.51064875401543E-05	U2=0	U3=-1.45833270447274E-02			
R1=0	R2=8.52843535878046E-08	R3=0						
Joint=64	OutputCase=PESOPR	CaseType=LinStatic	U1=2.97216941551323E-05	U2=0	U3=-3.53447397406911E-03			
R1=0	R2=-9.60491054278965E-06	R3=0						
Joint=64	OutputCase=TERRVERT	CaseType=LinStatic	U1=2.01002776737174E-04	U2=0	U3=-1.11172141092908E-02			
R1=0	R2=-5.34189279892601E-05	R3=0						
Joint=64	OutputCase=TERRLAT	CaseType=LinStatic	U1=-1.61906417517617E-04	U2=0	U3=5.71786422289593E-05			
R1=0	R2=3.33202312622218E-05	R3=0						
Joint=64	OutputCase=ACCVERT	CaseType=LinStatic	U1=0	U2=0	U3=0	R1=0	R2=0	R3=0
Joint=64	OutputCase=ACCLATDX	CaseType=LinStatic	U1=0	U2=0	U3=0	R1=0	R2=0	R3=0
Joint=64	OutputCase=ACCLATSX	CaseType=LinStatic	U1=0	U2=0	U3=0	R1=0	R2=0	R3=0
Joint=64	OutputCase=TERRCOST	CaseType=LinStatic	U1=0	U2=0	U3=0	R1=0	R2=0	R3=0
Joint=64	OutputCase=SOVRCOST	CaseType=LinStatic	U1=0	U2=0	U3=0	R1=0	R2=0	R3=0
Joint=64	OutputCase=ENVE	CaseType=Combination	StepType=Max	U1=1.17389978629975E-04	U2=0	U3=-		
1.45945094411309E-02	R1=0	R2=-2.9703607269828E-05	R3=0					
Joint=64	OutputCase=ENVE	CaseType=Combination	StepType=Min	U1=6.881805337469E-05	U2=0	U3=-		
1.46116630337996E-02	R1=0	R2=-3.96996766484945E-05	R3=0					
Joint=64	OutputCase=FESSUR	CaseType=Combination	U1=6.881805337469E-05	U2=0	U3=-1.45945094411309E-02			
R1=0	R2=-2.9703607269828E-05	R3=0						
Joint=65	OutputCase=PESOPR	CaseType=LinStatic	U1=2.26200642110869E-05	U2=0	U3=-3.53577425276241E-03			
R1=0	R2=-1.62682058764964E-05	R3=0						
Joint=65	OutputCase=TERRVERT	CaseType=LinStatic	U1=1.6092753101267E-04	U2=0	U3=-1.11269228568108E-02			
R1=0	R2=-1.07156370738905E-04	R3=0						
Joint=65	OutputCase=TERRLAT	CaseType=LinStatic	U1=-1.34333659517344E-04	U2=0	U3=5.71786424126593E-05			
R1=0	R2=5.88537857986897E-05	R3=0						
Joint=65	OutputCase=ACCVERT	CaseType=LinStatic	U1=0	U2=0	U3=0	R1=0	R2=0	R3=0
Joint=65	OutputCase=ACCLATDX	CaseType=LinStatic	U1=0	U2=0	U3=0	R1=0	R2=0	R3=0
Joint=65	OutputCase=ACCLATSX	CaseType=LinStatic	U1=0	U2=0	U3=0	R1=0	R2=0	R3=0
Joint=65	OutputCase=TERRCOST	CaseType=LinStatic	U1=0	U2=0	U3=0	R1=0	R2=0	R3=0
Joint=65	OutputCase=SOVRCOST	CaseType=LinStatic	U1=0	U2=0	U3=0	R1=0	R2=0	R3=0
Joint=65	OutputCase=ENVE	CaseType=Combination	StepType=Max	U1=8.95140335616159E-05	U2=0	U3=-		
1.46055184671606E-02	R1=0	R2=-6.45707908167122E-05	R3=0					
Joint=65	OutputCase=ENVE	CaseType=Combination	StepType=Min	U1=4.92139357064128E-05	U2=0	U3=-		
1.46226720598844E-02	R1=0	R2=-8.22269265563191E-05	R3=0					
Joint=65	OutputCase=FESSUR	CaseType=Combination	U1=4.92139357064128E-05	U2=0	U3=-1.46055184671606E-02			
R1=0	R2=-6.45707908167122E-05	R3=0						
Joint=66	OutputCase=PESOPR	CaseType=LinStatic	U1=-2.87221376088372E-05	U2=0	U3=-3.52953294242888E-03			
R1=0	R2=-1.79599468197227E-05	R3=0						
Joint=66	OutputCase=TERRVERT	CaseType=LinStatic	U1=-1.60266806153187E-04	U2=0	U3=-1.1088078682426E-02			
R1=0	R2=-1.06973188738921E-04	R3=0						
Joint=66	OutputCase=TERRLAT	CaseType=LinStatic	U1=8.58221501927912E-05	U2=0	U3=5.71789041665374E-05			
R1=0	R2=5.72616751894894E-05	R3=0						
Joint=66	OutputCase=ACCVERT	CaseType=LinStatic	U1=0	U2=0	U3=0	R1=0	R2=0	R3=0
Joint=66	OutputCase=ACCLATDX	CaseType=LinStatic	U1=0	U2=0	U3=0	R1=0	R2=0	R3=0
Joint=66	OutputCase=ACCLATSX	CaseType=LinStatic	U1=0	U2=0	U3=0	R1=0	R2=0	R3=0
Joint=66	OutputCase=TERRCOST	CaseType=LinStatic	U1=0	U2=0	U3=0	R1=0	R2=0	R3=0
Joint=66	OutputCase=SOVRCOST	CaseType=LinStatic	U1=0	U2=0	U3=0	R1=0	R2=0	R3=0
Joint=66	OutputCase=ENVE	CaseType=Combination	StepType=Max	U1=-1.03166793569233E-04	U2=0	U3=-		
1.45604419065049E-02	R1=0	R2=-6.76714603691546E-05	R3=0					



Joint=66	OutputCase=ENVE	CaseType=Combination	StepType=Min	U1=-1.28913438627071E-04	U2=0	U3=-
1.45775955777549E-02	R1=0	R2=-8.48499629260014E-05	R3=0			
Joint=66	OutputCase=FESSUR	CaseType=Combination	U1=-1.03166793569233E-04	U2=0	U3=-1.45604419065049E-02	
R1=0	R2=-6.76714603691546E-05	R3=0				
Joint=67	OutputCase=PESOPR	CaseType=LinStatic	U1=-3.4456066289882E-05	U2=0	U3=-3.5313533324901E-03	
R1=0	R2=-7.50917129458529E-06	R3=0				
Joint=67	OutputCase=TERRVERT	CaseType=LinStatic	U1=-2.00490145416693E-04	U2=0	U3=-1.10977966151166E-02	
R1=0	R2=-5.36458524849531E-05	R3=0				
Joint=67	OutputCase=TERRLAT	CaseType=LinStatic	U1=1.12068591763299E-04	U2=0	U3=5.71789039927278E-05	
R1=0	R2=3.05927606033502E-05	R3=0				
Joint=67	OutputCase=ACCVERT	CaseType=LinStatic	U1=0	U2=0	U3=0	R1=0 R2=0 R3=0
Joint=67	OutputCase=ACCLATDX	CaseType=LinStatic	U1=0	U2=0	U3=0	R1=0 R2=0 R3=0
Joint=67	OutputCase=ACCLATSX	CaseType=LinStatic	U1=0	U2=0	U3=0	R1=0 R2=0 R3=0
Joint=67	OutputCase=TERRCOST	CaseType=LinStatic	U1=0	U2=0	U3=0	R1=0 R2=0 R3=0
Joint=67	OutputCase=SOVRCOST	CaseType=LinStatic	U1=0	U2=0	U3=0	R1=0 R2=0 R3=0
Joint=67	OutputCase=ENVE	CaseType=Combination	StepType=Max	U1=-1.22877619943275E-04	U2=0	U3=-
0.014571971043614	R1=0	R2=-3.05622631761882E-05	R3=0			
Joint=67	OutputCase=ENVE	CaseType=Combination	StepType=Min	U1=-1.56498197472265E-04	U2=0	U3=-
1.45891247148118E-02	R1=0	R2=-3.97400913571933E-05	R3=0			
Joint=67	OutputCase=FESSUR	CaseType=Combination	U1=-1.22877619943275E-04	U2=0	U3=-0.014571971043614	
R1=0	R2=-3.05622631761882E-05	R3=0				
Joint=68	OutputCase=PESOPR	CaseType=LinStatic	U1=-3.528023056325E-05	U2=0	U3=-3.53300035210302E-03	
R1=0	R2=1.67911082206236E-06	R3=0				
Joint=68	OutputCase=TERRVERT	CaseType=LinStatic	U1=-2.14015641031431E-04	U2=0	U3=-1.11075053622029E-02	
R1=0	R2=-1.81814143851826E-07	R3=0				
Joint=68	OutputCase=TERRLAT	CaseType=LinStatic	U1=1.20577604523649E-04	U2=0	U3=5.71789039518921E-05	
R1=0	R2=-1.58248460885954E-06	R3=0				
Joint=68	OutputCase=ACCVERT	CaseType=LinStatic	U1=0	U2=0	U3=0	R1=0 R2=0 R3=0
Joint=68	OutputCase=ACCLATDX	CaseType=LinStatic	U1=0	U2=0	U3=0	R1=0 R2=0 R3=0
Joint=68	OutputCase=ACCLATSX	CaseType=LinStatic	U1=0	U2=0	U3=0	R1=0 R2=0 R3=0
Joint=68	OutputCase=TERRCOST	CaseType=LinStatic	U1=0	U2=0	U3=0	R1=0 R2=0 R3=0
Joint=68	OutputCase=SOVRCOST	CaseType=LinStatic	U1=0	U2=0	U3=0	R1=0 R2=0 R3=0
Joint=68	OutputCase=ENVE	CaseType=Combination	StepType=Max	U1=-1.28718267071032E-04	U2=0	U3=-
0.014583326810354	R1=0	R2=3.89557452008851E-07	R3=0			
Joint=68	OutputCase=ENVE	CaseType=Combination	StepType=Min	U1=-1.64891548428126E-04	U2=0	U3=-
1.46004804815396E-02	R1=0	R2=-8.5187930649013E-08	R3=0			
Joint=68	OutputCase=FESSUR	CaseType=Combination	U1=-1.28718267071032E-04	U2=0	U3=-0.014583326810354	
R1=0	R2=-8.5187930649013E-08	R3=0				
Joint=69	OutputCase=PESOPR	CaseType=LinStatic	U1=-3.18258771311193E-05	U2=0	U3=-3.53447400126262E-03	
R1=0	R2=9.60489953848719E-06	R3=0				
Joint=69	OutputCase=TERRVERT	CaseType=LinStatic	U1=-2.00774941953835E-04	U2=0	U3=-1.11172141095018E-02	
R1=0	R2=5.34189262843828E-05	R3=0				
Joint=69	OutputCase=TERRLAT	CaseType=LinStatic	U1=1.10171034398679E-04	U2=0	U3=5.71789040536285E-05	
R1=0	R2=-3.33201226374916E-05	R3=0				
Joint=69	OutputCase=ACCVERT	CaseType=LinStatic	U1=0	U2=0	U3=0	R1=0 R2=0 R3=0
Joint=69	OutputCase=ACCLATDX	CaseType=LinStatic	U1=0	U2=0	U3=0	R1=0 R2=0 R3=0
Joint=69	OutputCase=ACCLATSX	CaseType=LinStatic	U1=0	U2=0	U3=0	R1=0 R2=0 R3=0
Joint=69	OutputCase=TERRCOST	CaseType=LinStatic	U1=0	U2=0	U3=0	R1=0 R2=0 R3=0
Joint=69	OutputCase=SOVRCOST	CaseType=LinStatic	U1=0	U2=0	U3=0	R1=0 R2=0 R3=0
Joint=69	OutputCase=ENVE	CaseType=Combination	StepType=Max	U1=-1.22429784686275E-04	U2=0	U3=-
1.45945092067108E-02	R1=0	R2=3.96997399766259E-05	R3=0			
Joint=69	OutputCase=ENVE	CaseType=Combination	StepType=Min	U1=-1.55481095005879E-04	U2=0	U3=-
1.46116628779269E-02	R1=0	R2=2.97037031853784E-05	R3=0			
Joint=69	OutputCase=FESSUR	CaseType=Combination	U1=-1.22429784686275E-04	U2=0	U3=-1.45945092067108E-02	
R1=0	R2=2.97037031853784E-05	R3=0				
Joint=70	OutputCase=PESOPR	CaseType=LinStatic	U1=-2.47242526915346E-05	U2=0	U3=-3.53577427996388E-03	
R1=0	R2=1.62681948629562E-05	R3=0				
Joint=70	OutputCase=TERRVERT	CaseType=LinStatic	U1=-1.60699697140338E-04	U2=0	U3=-0.011126922857014	
R1=0	R2=1.07156368799751E-04	R3=0				
Joint=70	OutputCase=TERRLAT	CaseType=LinStatic	U1=8.2598330710348E-05	U2=0	U3=5.71789042842685E-05	
R1=0	R2=-5.88536777037206E-05	R3=0				
Joint=70	OutputCase=ACCVERT	CaseType=LinStatic	U1=0	U2=0	U3=0	R1=0 R2=0 R3=0
Joint=70	OutputCase=ACCLATDX	CaseType=LinStatic	U1=0	U2=0	U3=0	R1=0 R2=0 R3=0
Joint=70	OutputCase=ACCLATSX	CaseType=LinStatic	U1=0	U2=0	U3=0	R1=0 R2=0 R3=0
Joint=70	OutputCase=TERRCOST	CaseType=LinStatic	U1=0	U2=0	U3=0	R1=0 R2=0 R3=0
Joint=70	OutputCase=SOVRCOST	CaseType=LinStatic	U1=0	U2=0	U3=0	R1=0 R2=0 R3=0
Joint=70	OutputCase=ENVE	CaseType=Combination	StepType=Max	U1=-1.02825619121525E-04	U2=0	U3=-
1.46055182326937E-02	R1=0	R2=8.22269892701026E-05	R3=0			
Joint=70	OutputCase=ENVE	CaseType=Combination	StepType=Min	U1=-1.27605118334629E-04	U2=0	U3=-
1.46226719039789E-02	R1=0	R2=6.45708859589864E-05	R3=0			
Joint=70	OutputCase=FESSUR	CaseType=Combination	U1=-1.02825619121525E-04	U2=0	U3=-1.46055182326937E-02	
R1=0	R2=6.45708859589864E-05	R3=0				
Joint=85	OutputCase=PESOPR	CaseType=LinStatic	U1=-1.6833464431658E-06	U2=0	U3=-3.56787644435441E-03	
R1=0	R2=2.38061644325554E-05	R3=0				
Joint=85	OutputCase=TERRVERT	CaseType=LinStatic	U1=1.82266603008683E-07	U2=0	U3=-1.14233832440628E-02	
R1=0	R2=2.2228789311617E-04	R3=0				
Joint=85	OutputCase=TERRLAT	CaseType=LinStatic	U1=-1.21122737513084E-05	U2=0	U3=1.12482850311968E-04	
R1=0	R2=-4.14779476649359E-05	R3=0				
Joint=85	OutputCase=ACCVERT	CaseType=LinStatic	U1=0	U2=0	U3=0	R1=0 R2=0 R3=0
Joint=85	OutputCase=ACCLATDX	CaseType=LinStatic	U1=0	U2=0	U3=0	R1=0 R2=0 R3=0
Joint=85	OutputCase=ACCLATSX	CaseType=LinStatic	U1=0	U2=0	U3=0	R1=0 R2=0 R3=0
Joint=85	OutputCase=TERRCOST	CaseType=LinStatic	U1=0	U2=0	U3=0	R1=0 R2=0 R3=0



Joint=85	OutputCase=SOVRCOST	CaseType=LinStatic	U1=0	U2=0	U3=0	R1=0	R2=0	R3=0
Joint=85	OutputCase=ENVE	CaseType=Combination	StepType=Max	U1=-9.97967146607303E-06	U2=0	U3=-		
1.48787768381053E-02	R1=0	R2=2.17000390378717E-04	R3=0					
Joint=85	OutputCase=ENVE	CaseType=Combination	StepType=Min	U1=-1.36133535914656E-05	U2=0	U3=-		
1.49125216931989E-02	R1=0	R2=2.04557006079236E-04	R3=0					
Joint=85	OutputCase=PESSUR	CaseType=Combination	U1=-1.36133535914656E-05	U2=0	U3=-1.48787768381053E-02			
R1=0	R2=2.04557006079236E-04	R3=0						
Joint=86	OutputCase=PESSUR	CaseType=LinStatic	U1=-1.47293088886242E-06	U2=0	U3=-3.57953371821506E-03			
R1=0	R2=1.76044793435115E-05	R3=0						
Joint=86	OutputCase=TERRVERT	CaseType=LinStatic	U1=1.59482844661627E-07	U2=0	U3=-1.15354446112244E-02			
R1=0	R2=1.67570020695557E-04	R3=0						
Joint=86	OutputCase=TERRLAT	CaseType=LinStatic	U1=-1.66973861485592E-05	U2=0	U3=1.29765324289508E-04			
R1=0	R2=-2.76519479626431E-05	R3=0						
Joint=86	OutputCase=ACCVERT	CaseType=LinStatic	U1=0	U2=0	U3=0	R1=0	R2=0	R3=0
Joint=86	OutputCase=ACCLATDX	CaseType=LinStatic	U1=0	U2=0	U3=0	R1=0	R2=0	R3=0
Joint=86	OutputCase=ACCLATXSX	CaseType=LinStatic	U1=0	U2=0	U3=0	R1=0	R2=0	R3=0
Joint=86	OutputCase=TERRCOST	CaseType=LinStatic	U1=0	U2=0	U3=0	R1=0	R2=0	R3=0
Joint=86	OutputCase=SOVRCOST	CaseType=LinStatic	U1=0	U2=0	U3=0	R1=0	R2=0	R3=0
Joint=86	OutputCase=ENVE	CaseType=Combination	StepType=Max	U1=-1.30016183481922E-05	U2=0	U3=-		
1.49852130051499E-02	R1=0	R2=1.65818136465218E-04	R3=0					
Joint=86	OutputCase=ENVE	CaseType=Combination	StepType=Min	U1=-1.801083419276E-05	U2=0	U3=-		
1.50241426024368E-02	R1=0	R2=1.57522552076425E-04	R3=0					
Joint=86	OutputCase=PESSUR	CaseType=Combination	U1=-1.801083419276E-05	U2=0	U3=-1.49852130051499E-02			
R1=0	R2=1.57522552076425E-04	R3=0						
Joint=87	OutputCase=PESSUR	CaseType=LinStatic	U1=-1.26251533455904E-06	U2=0	U3=-3.58704819290261E-03			
R1=0	R2=9.32234840752839E-06	R3=0						
Joint=87	OutputCase=TERRVERT	CaseType=LinStatic	U1=1.3669908631457E-07	U2=0	U3=-1.16085066798411E-02			
R1=0	R2=8.96102586068254E-05	R3=0						
Joint=87	OutputCase=TERRLAT	CaseType=LinStatic	U1=-2.12824985458099E-05	U2=0	U3=1.40134798380696E-04			
R1=0	R2=-1.38259481195294E-05	R3=0						
Joint=87	OutputCase=ACCVERT	CaseType=LinStatic	U1=0	U2=0	U3=0	R1=0	R2=0	R3=0
Joint=87	OutputCase=ACCLATDX	CaseType=LinStatic	U1=0	U2=0	U3=0	R1=0	R2=0	R3=0
Joint=87	OutputCase=ACCLATXSX	CaseType=LinStatic	U1=0	U2=0	U3=0	R1=0	R2=0	R3=0
Joint=87	OutputCase=TERRCOST	CaseType=LinStatic	U1=0	U2=0	U3=0	R1=0	R2=0	R3=0
Joint=87	OutputCase=SOVRCOST	CaseType=LinStatic	U1=0	U2=0	U3=0	R1=0	R2=0	R3=0
Joint=87	OutputCase=ENVE	CaseType=Combination	StepType=Max	U1=-1.60235652303114E-05	U2=0	U3=-		
1.50554200743631E-02	R1=0	R2=8.92544433306832E-05	R3=0					
Joint=87	OutputCase=ENVE	CaseType=Combination	StepType=Min	U1=-2.24083147940543E-05	U2=0	U3=-		
1.50974605138773E-02	R1=0	R2=8.51066588948244E-05	R3=0					
Joint=87	OutputCase=PESSUR	CaseType=Combination	U1=-2.24083147940543E-05	U2=0	U3=-1.50554200743631E-02			
R1=0	R2=8.51066588948244E-05	R3=0						
Joint=88	OutputCase=PESSUR	CaseType=LinStatic	U1=-1.05209978025566E-06	U2=0	U3=-3.58963970122459E-03			
R1=0	R2=-5.45146458349564E-12	R3=0						
Joint=88	OutputCase=TERRVERT	CaseType=LinStatic	U1=1.13915327967513E-07	U2=0	U3=-1.16338315773638E-02			
R1=0	R2=-2.06534441971308E-13	R3=0						
Joint=88	OutputCase=TERRLAT	CaseType=LinStatic	U1=-2.58676109430606E-05	U2=0	U3=1.43591272515123E-04			
R1=0	R2=5.1864405477308E-11	R3=0						
Joint=88	OutputCase=ACCVERT	CaseType=LinStatic	U1=0	U2=0	U3=0	R1=0	R2=0	R3=0
Joint=88	OutputCase=ACCLATDX	CaseType=LinStatic	U1=0	U2=0	U3=0	R1=0	R2=0	R3=0
Joint=88	OutputCase=ACCLATXSX	CaseType=LinStatic	U1=0	U2=0	U3=0	R1=0	R2=0	R3=0
Joint=88	OutputCase=TERRCOST	CaseType=LinStatic	U1=0	U2=0	U3=0	R1=0	R2=0	R3=0
Joint=88	OutputCase=SOVRCOST	CaseType=LinStatic	U1=0	U2=0	U3=0	R1=0	R2=0	R3=0
Joint=88	OutputCase=ENVE	CaseType=Combination	StepType=Max	U1=-1.90455121124306E-05	U2=0	U3=-		
1.50798800060732E-02	R1=0	R2=4.6206406451841E-11	R3=0					
Joint=88	OutputCase=ENVE	CaseType=Combination	StepType=Min	U1=-2.68057953953487E-05	U2=0	U3=-		
1.51229573878278E-02	R1=0	R2=3.06470848086486E-11	R3=0					
Joint=88	OutputCase=PESSUR	CaseType=Combination	U1=-2.68057953953487E-05	U2=0	U3=-1.50798800060732E-02			
R1=0	R2=4.6206406451841E-11	R3=0						
Joint=89	OutputCase=PESSUR	CaseType=LinStatic	U1=-8.41684225952278E-07	U2=0	U3=-3.58704818745045E-03			
R1=0	R2=-9.32235930953405E-06	R3=0						
Joint=89	OutputCase=TERRVERT	CaseType=LinStatic	U1=9.11315696204562E-08	U2=0	U3=-0.011608506679617			
R1=0	R2=-8.96102589964654E-05	R3=0						
Joint=89	OutputCase=TERRLAT	CaseType=LinStatic	U1=-3.04527233403113E-05	U2=0	U3=1.40134746622376E-04			
R1=0	R2=1.38260519891615E-05	R3=0						
Joint=89	OutputCase=ACCVERT	CaseType=LinStatic	U1=0	U2=0	U3=0	R1=0	R2=0	R3=0
Joint=89	OutputCase=ACCLATDX	CaseType=LinStatic	U1=0	U2=0	U3=0	R1=0	R2=0	R3=0
Joint=89	OutputCase=ACCLATXSX	CaseType=LinStatic	U1=0	U2=0	U3=0	R1=0	R2=0	R3=0
Joint=89	OutputCase=TERRCOST	CaseType=LinStatic	U1=0	U2=0	U3=0	R1=0	R2=0	R3=0
Joint=89	OutputCase=SOVRCOST	CaseType=LinStatic	U1=0	U2=0	U3=0	R1=0	R2=0	R3=0
Joint=89	OutputCase=ENVE	CaseType=Combination	StepType=Max	U1=-2.20674589945497E-05	U2=0	U3=-		
0.015055420120445	R1=0	R2=-8.5106566316838E-05	R3=0					
Joint=89	OutputCase=ENVE	CaseType=Combination	StepType=Min	U1=-3.12032759966431E-05	U2=0	U3=-		
1.50974605444318E-02	R1=0	R2=-8.92543819135864E-05	R3=0					
Joint=89	OutputCase=PESSUR	CaseType=Combination	U1=-3.12032759966431E-05	U2=0	U3=-0.015055420120445			
R1=0	R2=-8.5106566316838E-05	R3=0						
Joint=90	OutputCase=PESSUR	CaseType=LinStatic	U1=-6.31268671648918E-07	U2=0	U3=-3.57953370731166E-03			
R1=0	R2=-1.76044902427477E-05	R3=0						
Joint=90	OutputCase=TERRVERT	CaseType=LinStatic	U1=6.8347811273371E-08	U2=0	U3=-1.15354446107995E-02			
R1=0	R2=-1.67570021014919E-04	R3=0						
Joint=90	OutputCase=TERRLAT	CaseType=LinStatic	U1=-3.5037835737562E-05	U2=0	U3=1.29765220632046E-04			
R1=0	R2=2.76520522547386E-05	R3=0						
Joint=90	OutputCase=ACCVERT	CaseType=LinStatic	U1=0	U2=0	U3=0	R1=0	R2=0	R3=0



Joint=90	OutputCase=ACCLATDX	CaseType=LinStatic	U1=0	U2=0	U3=0	R1=0	R2=0	R3=0
Joint=90	OutputCase=ACCLATSX	CaseType=LinStatic	U1=0	U2=0	U3=0	R1=0	R2=0	R3=0
Joint=90	OutputCase=TERRCOST	CaseType=LinStatic	U1=0	U2=0	U3=0	R1=0	R2=0	R3=0
Joint=90	OutputCase=SOVRCOST	CaseType=LinStatic	U1=0	U2=0	U3=0	R1=0	R2=0	R3=0
Joint=90	OutputCase=ENVE	CaseType=Combination	StepType=Max	U1=-2.5089405876669E-05	U2=0	U3=-		
1.49852130974791E-02	R1=0	R2=-1.57522459002928E-04	R3=0					
Joint=90	OutputCase=ENVE	CaseType=Combination	StepType=Min	U1=-3.56007565979376E-05	U2=0	U3=-		
1.50241426636687E-02	R1=0	R2=-1.65818074679349E-04	R3=0					
Joint=90	OutputCase=FESSUR	CaseType=Combination	U1=-3.56007565979376E-05	U2=0	U3=-1.49852130974791E-02			
R1=0	R2=-1.57522459002928E-04	R3=0						
Joint=91	OutputCase=PESOPR	CaseType=LinStatic	U1=-4.20853117345558E-07	U2=0	U3=-3.56787642800162E-03			
R1=0	R2=-2.38061753271732E-05	R3=0						
Joint=91	OutputCase=TERRVERT	CaseType=LinStatic	U1=4.55640529262857E-08	U2=0	U3=-0.011423383243484			
R1=0	R2=-2.2228789513844E-04	R3=0						
Joint=91	OutputCase=TERRLAT	CaseType=LinStatic	U1=-3.96229481348127E-05	U2=0	U3=1.12482694473723E-04			
R1=0	R2=4.1478052661137E-05	R3=0						
Joint=91	OutputCase=ACCVERT	CaseType=LinStatic	U1=0	U2=0	U3=0	R1=0	R2=0	R3=0
Joint=91	OutputCase=ACCLATDX	CaseType=LinStatic	U1=0	U2=0	U3=0	R1=0	R2=0	R3=0
Joint=91	OutputCase=ACCLATSX	CaseType=LinStatic	U1=0	U2=0	U3=0	R1=0	R2=0	R3=0
Joint=91	OutputCase=TERRCOST	CaseType=LinStatic	U1=0	U2=0	U3=0	R1=0	R2=0	R3=0
Joint=91	OutputCase=SOVRCOST	CaseType=LinStatic	U1=0	U2=0	U3=0	R1=0	R2=0	R3=0
Joint=91	OutputCase=ENVE	CaseType=Combination	StepType=Max	U1=-2.81113527587882E-05	U2=0	U3=-		
1.48787769770119E-02	R1=0	R2=-2.0455691217988E-04	R3=0					
Joint=91	OutputCase=ENVE	CaseType=Combination	StepType=Min	U1=-3.9998237199232E-05	U2=0	U3=-		
0.014912521785354	R1=0	R2=-2.17000327978221E-04	R3=0					
Joint=91	OutputCase=FESSUR	CaseType=Combination	U1=-3.9998237199232E-05	U2=0	U3=-1.48787769770119E-02			
R1=0	R2=-2.0455691217988E-04	R3=0						

TABLE: "JOINT REACTIONS"

Joint=1	OutputCase=PESOPR	CaseType=LinStatic	F1=3.89022147722776E-13	F2=0	F3=11.4574580695779	M1=0	M2=0	M3=0	
Joint=1	OutputCase=TERRVERT	CaseType=LinStatic	F1=4.82969220172436E-12	F2=0	F3=35.973175270586	M1=0	M2=0	M3=0	
Joint=1	OutputCase=TERRLAT	CaseType=LinStatic	F1=-3.35503264636827E-06	F2=0	F3=-0.185831415022426	M1=0	M2=0	M3=0	
Joint=1	OutputCase=ACCVERT	CaseType=LinStatic	F1=0	F2=0	F3=0	M1=0	M2=0	M3=0	
Joint=1	OutputCase=ACCLATDX	CaseType=LinStatic	F1=0	F2=0	F3=0	M1=0	M2=0	M3=0	
Joint=1	OutputCase=ACCLATSX	CaseType=LinStatic	F1=0	F2=0	F3=0	M1=0	M2=0	M3=0	
Joint=1	OutputCase=TERRCOST	CaseType=LinStatic	F1=0	F2=0	F3=0	M1=0	M2=0	M3=0	
Joint=1	OutputCase=SOVRCOST	CaseType=LinStatic	F1=0	F2=0	F3=0	M1=0	M2=0	M3=0	
Joint=1	OutputCase=ENVE	CaseType=Combination	StepType=Max	F1=-2.34851763374344E-06	F2=0	F3=0	M1=0	M2=0	M3=0
F3=47.3005513496481	M1=0	M2=0	M3=0						
Joint=1	OutputCase=ENVE	CaseType=Combination	StepType=Min	F1=-3.35502742765392E-06	F2=0	F3=0	M1=0	M2=0	M3=0
F3=47.2448019251414	M1=0	M2=0	M3=0						
Joint=1	OutputCase=FESSUR	CaseType=Combination	F1=-3.35502742765392E-06	F2=0	F3=47.2448019251414	M1=0	M2=0	M3=0	
Joint=15	OutputCase=PESOPR	CaseType=LinStatic	F1=0	F2=0	F3=11.4574579813284	M1=0	M2=0	M3=0	
Joint=15	OutputCase=TERRVERT	CaseType=LinStatic	F1=0	F2=0	F3=35.9731752697735	M1=0	M2=0	M3=0	
Joint=15	OutputCase=TERRLAT	CaseType=LinStatic	F1=0	F2=0	F3=-0.185830564855117	M1=0	M2=0	M3=0	
Joint=15	OutputCase=ACCVERT	CaseType=LinStatic	F1=0	F2=0	F3=0	M1=0	M2=0	M3=0	
Joint=15	OutputCase=ACCLATDX	CaseType=LinStatic	F1=0	F2=0	F3=0	M1=0	M2=0	M3=0	
Joint=15	OutputCase=ACCLATSX	CaseType=LinStatic	F1=0	F2=0	F3=0	M1=0	M2=0	M3=0	
Joint=15	OutputCase=TERRCOST	CaseType=LinStatic	F1=0	F2=0	F3=0	M1=0	M2=0	M3=0	
Joint=15	OutputCase=SOVRCOST	CaseType=LinStatic	F1=0	F2=0	F3=0	M1=0	M2=0	M3=0	
Joint=15	OutputCase=ENVE	CaseType=Combination	StepType=Max	F1=0	F2=0	F3=47.3005518557033	M1=0	M2=0	M3=0
Joint=15	OutputCase=ENVE	CaseType=Combination	StepType=Min	F1=0	F2=0	F3=47.2448026862468	M1=0	M2=0	M3=0
Joint=15	OutputCase=FESSUR	CaseType=Combination	F1=0	F2=0	F3=47.2448026862468	M1=0	M2=0	M3=0	
Joint=19	OutputCase=PESOPR	CaseType=LinStatic	F1=0	F2=0	F3=45.0731619786838	M1=0	M2=0	M3=0	
Joint=19	OutputCase=TERRVERT	CaseType=LinStatic	F1=0	F2=0	F3=140.325125101297	M1=0	M2=0	M3=0	
Joint=19	OutputCase=TERRLAT	CaseType=LinStatic	F1=0	F2=0	F3=-2.30749917622311E-02	M1=0	M2=0	M3=0	
Joint=19	OutputCase=ACCVERT	CaseType=LinStatic	F1=0	F2=0	F3=0	M1=0	M2=0	M3=0	
Joint=19	OutputCase=ACCLATDX	CaseType=LinStatic	F1=0	F2=0	F3=0	M1=0	M2=0	M3=0	
Joint=19	OutputCase=ACCLATSX	CaseType=LinStatic	F1=0	F2=0	F3=0	M1=0	M2=0	M3=0	
Joint=19	OutputCase=TERRCOST	CaseType=LinStatic	F1=0	F2=0	F3=0	M1=0	M2=0	M3=0	
Joint=19	OutputCase=SOVRCOST	CaseType=LinStatic	F1=0	F2=0	F3=0	M1=0	M2=0	M3=0	
Joint=19	OutputCase=ENVE	CaseType=Combination	StepType=Max	F1=0	F2=0	F3=185.382134585748	M1=0	M2=0	M3=0
Joint=19	OutputCase=ENVE	CaseType=Combination	StepType=Min	F1=0	F2=0	F3=185.375212088219	M1=0	M2=0	M3=0
Joint=19	OutputCase=FESSUR	CaseType=Combination	F1=0	F2=0	F3=185.375212088219	M1=0	M2=0	M3=0	
Joint=30	OutputCase=PESOPR	CaseType=LinStatic	F1=0	F2=0	F3=22.821764582796	M1=0	M2=0	M3=0	
Joint=30	OutputCase=TERRVERT	CaseType=LinStatic	F1=0	F2=0	F3=71.4994792662155	M1=0	M2=0	M3=0	
Joint=30	OutputCase=TERRLAT	CaseType=LinStatic	F1=0	F2=0	F3=-0.264566107179696	M1=0	M2=0	M3=0	
Joint=30	OutputCase=ACCVERT	CaseType=LinStatic	F1=0	F2=0	F3=0	M1=0	M2=0	M3=0	
Joint=30	OutputCase=ACCLATDX	CaseType=LinStatic	F1=0	F2=0	F3=0	M1=0	M2=0	M3=0	
Joint=30	OutputCase=ACCLATSX	CaseType=LinStatic	F1=0	F2=0	F3=0	M1=0	M2=0	M3=0	
Joint=30	OutputCase=TERRCOST	CaseType=LinStatic	F1=0	F2=0	F3=0	M1=0	M2=0	M3=0	
Joint=30	OutputCase=SOVRCOST	CaseType=LinStatic	F1=0	F2=0	F3=0	M1=0	M2=0	M3=0	
Joint=30	OutputCase=ENVE	CaseType=Combination	StepType=Max	F1=0	F2=0	F3=94.1360475739857	M1=0	M2=0	M3=0

Joint=30	OutputCase=ENVE	CaseType=Combination	StepType=Min	F1=0	F2=0	F3=94.0566777418318	M1=0		
M2=0	M3=0								
Joint=30	OutputCase=FESSUR	CaseType=Combination		F1=0	F2=0	F3=94.0566777418318	M1=0	M2=0	M3=0
Joint=31	OutputCase=PESOPR	CaseType=LinStatic		F1=0	F2=0	F3=34.0870800242704	M1=0	M2=0	M3=0
Joint=31	OutputCase=TERRVERT	CaseType=LinStatic		F1=0	F2=0	F3=106.560747707618	M1=0	M2=0	M3=0
Joint=31	OutputCase=TERRLAT	CaseType=LinStatic		F1=0	F2=0	F3=-0.253295349206057	M1=0	M2=0	M3=0
Joint=31	OutputCase=ACCVERT	CaseType=LinStatic		F1=0	F2=0	F3=0	M1=0	M2=0	M3=0
Joint=31	OutputCase=ACCLATDX	CaseType=LinStatic		F1=0	F2=0	F3=0	M1=0	M2=0	M3=0
Joint=31	OutputCase=ACCLATSX	CaseType=LinStatic		F1=0	F2=0	F3=0	M1=0	M2=0	M3=0
Joint=31	OutputCase=TERRCOST	CaseType=LinStatic		F1=0	F2=0	F3=0	M1=0	M2=0	M3=0
Joint=31	OutputCase=SOVRCOST	CaseType=LinStatic		F1=0	F2=0	F3=0	M1=0	M2=0	M3=0
Joint=31	OutputCase=ENVE	CaseType=Combination	StepType=Max	F1=0	F2=0	F3=140.470520987444	M1=0		
M2=0	M3=0								
Joint=31	OutputCase=ENVE	CaseType=Combination	StepType=Min	F1=0	F2=0	F3=140.394532382682	M1=0		
M2=0	M3=0								
Joint=31	OutputCase=FESSUR	CaseType=Combination		F1=0	F2=0	F3=140.394532382682	M1=0	M2=0	M3=0
Joint=32	OutputCase=PESOPR	CaseType=LinStatic		F1=0	F2=0	F3=34.0870798130405	M1=0	M2=0	M3=0
Joint=32	OutputCase=TERRVERT	CaseType=LinStatic		F1=0	F2=0	F3=106.560747707038	M1=0	M2=0	M3=0
Joint=32	OutputCase=TERRLAT	CaseType=LinStatic		F1=0	F2=0	F3=-0.253293319455496	M1=0	M2=0	M3=0
Joint=32	OutputCase=ACCVERT	CaseType=LinStatic		F1=0	F2=0	F3=0	M1=0	M2=0	M3=0
Joint=32	OutputCase=ACCLATDX	CaseType=LinStatic		F1=0	F2=0	F3=0	M1=0	M2=0	M3=0
Joint=32	OutputCase=ACCLATSX	CaseType=LinStatic		F1=0	F2=0	F3=0	M1=0	M2=0	M3=0
Joint=32	OutputCase=TERRCOST	CaseType=LinStatic		F1=0	F2=0	F3=0	M1=0	M2=0	M3=0
Joint=32	OutputCase=SOVRCOST	CaseType=LinStatic		F1=0	F2=0	F3=0	M1=0	M2=0	M3=0
Joint=32	OutputCase=ENVE	CaseType=Combination	StepType=Max	F1=0	F2=0	F3=140.47052219646	M1=0	M2=0	
M3=0									
Joint=32	OutputCase=ENVE	CaseType=Combination	StepType=Min	F1=0	F2=0	F3=140.394534200623	M1=0		
M2=0	M3=0								
Joint=32	OutputCase=FESSUR	CaseType=Combination		F1=0	F2=0	F3=140.394534200623	M1=0	M2=0	M3=0
Joint=33	OutputCase=PESOPR	CaseType=LinStatic		F1=0	F2=0	F3=22.821764424158	M1=0	M2=0	M3=0
Joint=33	OutputCase=TERRVERT	CaseType=LinStatic		F1=0	F2=0	F3=71.4994792652955	M1=0	M2=0	M3=0
Joint=33	OutputCase=TERRLAT	CaseType=LinStatic		F1=0	F2=0	F3=-0.264564580958932	M1=0	M2=0	M3=0
Joint=33	OutputCase=ACCVERT	CaseType=LinStatic		F1=0	F2=0	F3=0	M1=0	M2=0	M3=0
Joint=33	OutputCase=ACCLATDX	CaseType=LinStatic		F1=0	F2=0	F3=0	M1=0	M2=0	M3=0
Joint=33	OutputCase=ACCLATSX	CaseType=LinStatic		F1=0	F2=0	F3=0	M1=0	M2=0	M3=0
Joint=33	OutputCase=TERRCOST	CaseType=LinStatic		F1=0	F2=0	F3=0	M1=0	M2=0	M3=0
Joint=33	OutputCase=SOVRCOST	CaseType=LinStatic		F1=0	F2=0	F3=0	M1=0	M2=0	M3=0
Joint=33	OutputCase=ENVE	CaseType=Combination	StepType=Max	F1=0	F2=0	F3=94.1360484827822	M1=0		
M2=0	M3=0								
Joint=33	OutputCase=ENVE	CaseType=Combination	StepType=Min	F1=0	F2=0	F3=94.0566791084946	M1=0		
M2=0	M3=0								
Joint=33	OutputCase=FESSUR	CaseType=Combination		F1=0	F2=0	F3=94.0566791084946	M1=0	M2=0	M3=0
Joint=36	OutputCase=PESOPR	CaseType=LinStatic		F1=0	F2=0	F3=44.7611184502746	M1=0	M2=0	M3=0
Joint=36	OutputCase=TERRVERT	CaseType=LinStatic		F1=0	F2=0	F3=138.884740210392	M1=0	M2=0	M3=0
Joint=36	OutputCase=TERRLAT	CaseType=LinStatic		F1=0	F2=0	F3=0.201167967573334	M1=0	M2=0	M3=0
Joint=36	OutputCase=ACCVERT	CaseType=LinStatic		F1=0	F2=0	F3=0	M1=0	M2=0	M3=0
Joint=36	OutputCase=ACCLATDX	CaseType=LinStatic		F1=0	F2=0	F3=0	M1=0	M2=0	M3=0
Joint=36	OutputCase=ACCLATSX	CaseType=LinStatic		F1=0	F2=0	F3=0	M1=0	M2=0	M3=0
Joint=36	OutputCase=TERRCOST	CaseType=LinStatic		F1=0	F2=0	F3=0	M1=0	M2=0	M3=0
Joint=36	OutputCase=SOVRCOST	CaseType=LinStatic		F1=0	F2=0	F3=0	M1=0	M2=0	M3=0
Joint=36	OutputCase=ENVE	CaseType=Combination	StepType=Max	F1=0	F2=0	F3=183.84702662824	M1=0	M2=0	
M3=0									
Joint=36	OutputCase=ENVE	CaseType=Combination	StepType=Min	F1=0	F2=0	F3=183.786676237968	M1=0		
M2=0	M3=0								
Joint=36	OutputCase=FESSUR	CaseType=Combination		F1=0	F2=0	F3=183.84702662824	M1=0	M2=0	M3=0
Joint=37	OutputCase=PESOPR	CaseType=LinStatic		F1=0	F2=0	F3=44.5566235390143	M1=0	M2=0	M3=0
Joint=37	OutputCase=TERRVERT	CaseType=LinStatic		F1=0	F2=0	F3=137.946218299906	M1=0	M2=0	M3=0
Joint=37	OutputCase=TERRLAT	CaseType=LinStatic		F1=0	F2=0	F3=0.335486241886293	M1=0	M2=0	M3=0
Joint=37	OutputCase=ACCVERT	CaseType=LinStatic		F1=0	F2=0	F3=0	M1=0	M2=0	M3=0
Joint=37	OutputCase=ACCLATDX	CaseType=LinStatic		F1=0	F2=0	F3=0	M1=0	M2=0	M3=0
Joint=37	OutputCase=ACCLATSX	CaseType=LinStatic		F1=0	F2=0	F3=0	M1=0	M2=0	M3=0
Joint=37	OutputCase=TERRCOST	CaseType=LinStatic		F1=0	F2=0	F3=0	M1=0	M2=0	M3=0
Joint=37	OutputCase=SOVRCOST	CaseType=LinStatic		F1=0	F2=0	F3=0	M1=0	M2=0	M3=0
Joint=37	OutputCase=ENVE	CaseType=Combination	StepType=Max	F1=0	F2=0	F3=182.838328080807	M1=0		
M2=0	M3=0								
Joint=37	OutputCase=ENVE	CaseType=Combination	StepType=Min	F1=0	F2=0	F3=182.737682208241	M1=0		
M2=0	M3=0								
Joint=37	OutputCase=FESSUR	CaseType=Combination		F1=0	F2=0	F3=182.838328080807	M1=0	M2=0	M3=0
Joint=38	OutputCase=PESOPR	CaseType=LinStatic		F1=0	F2=0	F3=44.4855846091883	M1=0	M2=0	M3=0
Joint=38	OutputCase=TERRVERT	CaseType=LinStatic		F1=0	F2=0	F3=137.621014936029	M1=0	M2=0	M3=0
Joint=38	OutputCase=TERRLAT	CaseType=LinStatic		F1=0	F2=0	F3=0.380218868965336	M1=0	M2=0	M3=0
Joint=38	OutputCase=ACCVERT	CaseType=LinStatic		F1=0	F2=0	F3=0	M1=0	M2=0	M3=0
Joint=38	OutputCase=ACCLATDX	CaseType=LinStatic		F1=0	F2=0	F3=0	M1=0	M2=0	M3=0
Joint=38	OutputCase=ACCLATSX	CaseType=LinStatic		F1=0	F2=0	F3=0	M1=0	M2=0	M3=0
Joint=38	OutputCase=TERRCOST	CaseType=LinStatic		F1=0	F2=0	F3=0	M1=0	M2=0	M3=0
Joint=38	OutputCase=SOVRCOST	CaseType=LinStatic		F1=0	F2=0	F3=0	M1=0	M2=0	M3=0
Joint=38	OutputCase=ENVE	CaseType=Combination	StepType=Max	F1=0	F2=0	F3=182.486818414182	M1=0		
M2=0	M3=0								
Joint=38	OutputCase=ENVE	CaseType=Combination	StepType=Min	F1=0	F2=0	F3=182.372752753493	M1=0		
M2=0	M3=0								
Joint=38	OutputCase=FESSUR	CaseType=Combination		F1=0	F2=0	F3=182.486818414182	M1=0	M2=0	M3=0
Joint=41	OutputCase=PESOPR	CaseType=LinStatic		F1=0	F2=0	F3=44.556623469031	M1=0	M2=0	M3=0



Joint=41	OutputCase=TERRVERT	CaseType=LinStatic	F1=0	F2=0	F3=137.946218300473	M1=0	M2=0	M3=0	
Joint=41	OutputCase=TERRLAT	CaseType=LinStatic	F1=0	F2=0	F3=0.335486911495024	M1=0	M2=0	M3=0	
Joint=41	OutputCase=ACCVERT	CaseType=LinStatic	F1=0	F2=0	F3=0	M1=0	M2=0	M3=0	
Joint=41	OutputCase=ACCLATDX	CaseType=LinStatic	F1=0	F2=0	F3=0	M1=0	M2=0	M3=0	
Joint=41	OutputCase=ACCLATSX	CaseType=LinStatic	F1=0	F2=0	F3=0	M1=0	M2=0	M3=0	
Joint=41	OutputCase=TERRCOST	CaseType=LinStatic	F1=0	F2=0	F3=0	M1=0	M2=0	M3=0	
Joint=41	OutputCase=SOVRCOST	CaseType=LinStatic	F1=0	F2=0	F3=0	M1=0	M2=0	M3=0	
Joint=41	OutputCase=ENVE	CaseType=Combination	StepType=Max	F1=0	F2=0	F3=182.838328680999	M1=0	M2=0	M3=0
Joint=41	OutputCase=ENVE	CaseType=Combination	StepType=Min	F1=0	F2=0	F3=182.737682607551	M1=0	M2=0	M3=0
Joint=41	OutputCase=FESSUR	CaseType=Combination	F1=0	F2=0	F3=182.838328680999	M1=0	M2=0	M3=0	
Joint=42	OutputCase=PESOPR	CaseType=LinStatic	F1=0	F2=0	F3=44.7611183101146	M1=0	M2=0	M3=0	
Joint=42	OutputCase=TERRVERT	CaseType=LinStatic	F1=0	F2=0	F3=138.884740211222	M1=0	M2=0	M3=0	
Joint=42	OutputCase=TERRLAT	CaseType=LinStatic	F1=0	F2=0	F3=0.201169309797474	M1=0	M2=0	M3=0	
Joint=42	OutputCase=ACCVERT	CaseType=LinStatic	F1=0	F2=0	F3=0	M1=0	M2=0	M3=0	
Joint=42	OutputCase=ACCLATDX	CaseType=LinStatic	F1=0	F2=0	F3=0	M1=0	M2=0	M3=0	
Joint=42	OutputCase=ACCLATSX	CaseType=LinStatic	F1=0	F2=0	F3=0	M1=0	M2=0	M3=0	
Joint=42	OutputCase=TERRCOST	CaseType=LinStatic	F1=0	F2=0	F3=0	M1=0	M2=0	M3=0	
Joint=42	OutputCase=SOVRCOST	CaseType=LinStatic	F1=0	F2=0	F3=0	M1=0	M2=0	M3=0	
Joint=42	OutputCase=ENVE	CaseType=Combination	StepType=Max	F1=0	F2=0	F3=183.847027831134	M1=0	M2=0	M3=0
Joint=42	OutputCase=ENVE	CaseType=Combination	StepType=Min	F1=0	F2=0	F3=183.786677038195	M1=0	M2=0	M3=0
Joint=42	OutputCase=FESSUR	CaseType=Combination	F1=0	F2=0	F3=183.847027831134	M1=0	M2=0	M3=0	
Joint=43	OutputCase=PESOPR	CaseType=LinStatic	F1=0	F2=0	F3=45.0731617679983	M1=0	M2=0	M3=0	
Joint=43	OutputCase=TERRVERT	CaseType=LinStatic	F1=0	F2=0	F3=140.325125101783	M1=0	M2=0	M3=0	
Joint=43	OutputCase=TERRLAT	CaseType=LinStatic	F1=0	F2=0	F3=-2.30729712702995E-02	M1=0	M2=0	M3=0	
Joint=43	OutputCase=ACCVERT	CaseType=LinStatic	F1=0	F2=0	F3=0	M1=0	M2=0	M3=0	
Joint=43	OutputCase=ACCLATDX	CaseType=LinStatic	F1=0	F2=0	F3=0	M1=0	M2=0	M3=0	
Joint=43	OutputCase=ACCLATSX	CaseType=LinStatic	F1=0	F2=0	F3=0	M1=0	M2=0	M3=0	
Joint=43	OutputCase=TERRCOST	CaseType=LinStatic	F1=0	F2=0	F3=0	M1=0	M2=0	M3=0	
Joint=43	OutputCase=SOVRCOST	CaseType=LinStatic	F1=0	F2=0	F3=0	M1=0	M2=0	M3=0	
Joint=43	OutputCase=ENVE	CaseType=Combination	StepType=Max	F1=0	F2=0	F3=185.382135789892	M1=0	M2=0	M3=0
Joint=43	OutputCase=ENVE	CaseType=Combination	StepType=Min	F1=0	F2=0	F3=185.37521389851	M1=0	M2=0	M3=0
Joint=43	OutputCase=FESSUR	CaseType=Combination	F1=0	F2=0	F3=185.37521389851	M1=0	M2=0	M3=0	

TABLE: "ASSEMBLED JOINT MASSES"

Joint=1	U1=0.624999970197679	U2=0.624999970197679	U3=0.624999970197679	R1=0	R2=0	R3=0
Joint=15	U1=0.624999970197679	U2=0.624999970197679	U3=0.624999970197679	R1=0	R2=0	R3=0
Joint=19	U1=1.25	U2=1.25	U3=1.25	R1=0	R2=0	R3=0
Joint=20	U1=0.624999970197679	U2=0.624999970197679	U3=0.624999970197679	R1=0	R2=0	R3=0
Joint=21	U1=0.624999940395358	U2=0.624999940395358	U3=0.624999940395358	R1=0	R2=0	R3=0
Joint=22	U1=0.625000000000003	U2=0.625000000000003	U3=0.625000000000003	R1=0	R2=0	R3=0
Joint=23	U1=0.624999970197681	U2=0.624999970197681	U3=0.624999970197681	R1=0	R2=0	R3=0
Joint=24	U1=0.9375	U2=0.9375	U3=0.9375	R1=0	R2=0	R3=0
Joint=25	U1=0.624999970197679	U2=0.624999970197679	U3=0.624999970197679	R1=0	R2=0	R3=0
Joint=26	U1=0.625000000000001	U2=0.625000000000001	U3=0.625000000000001	R1=0	R2=0	R3=0
Joint=27	U1=0.9375	U2=0.9375	U3=0.9375	R1=0	R2=0	R3=0
Joint=28	U1=0.625000000000001	U2=0.625000000000001	U3=0.625000000000001	R1=0	R2=0	R3=0
Joint=29	U1=0.9375	U2=0.9375	U3=0.9375	R1=0	R2=0	R3=0
Joint=30	U1=0.624999970197678	U2=0.624999970197678	U3=0.624999970197678	R1=0	R2=0	R3=0
Joint=31	U1=0.9375	U2=0.9375	U3=0.9375	R1=0	R2=0	R3=0
Joint=32	U1=0.9375	U2=0.9375	U3=0.9375	R1=0	R2=0	R3=0
Joint=33	U1=0.624999970197678	U2=0.624999970197678	U3=0.624999970197678	R1=0	R2=0	R3=0
Joint=34	U1=0.937500000000002	U2=0.937500000000002	U3=0.937500000000002	R1=0	R2=0	R3=0
Joint=35	U1=0.937500000000002	U2=0.937500000000002	U3=0.937500000000002	R1=0	R2=0	R3=0
Joint=36	U1=1.25	U2=1.25	U3=1.25	R1=0	R2=0	R3=0
Joint=37	U1=1.25	U2=1.25	U3=1.25	R1=0	R2=0	R3=0
Joint=38	U1=1.25	U2=1.25	U3=1.25	R1=0	R2=0	R3=0
Joint=39	U1=0.624999970197678	U2=0.624999970197678	U3=0.624999970197678	R1=0	R2=0	R3=0
Joint=40	U1=0.9375	U2=0.9375	U3=0.9375	R1=0	R2=0	R3=0
Joint=41	U1=1.25	U2=1.25	U3=1.25	R1=0	R2=0	R3=0
Joint=42	U1=1.25	U2=1.25	U3=1.25	R1=0	R2=0	R3=0
Joint=43	U1=1.25	U2=1.25	U3=1.25	R1=0	R2=0	R3=0
Joint=61	U1=1.25	U2=1.25	U3=1.25	R1=0	R2=0	R3=0
Joint=62	U1=1.25	U2=1.25	U3=1.25	R1=0	R2=0	R3=0
Joint=63	U1=1.25	U2=1.25	U3=1.25	R1=0	R2=0	R3=0
Joint=64	U1=1.25	U2=1.25	U3=1.25	R1=0	R2=0	R3=0
Joint=65	U1=1.25	U2=1.25	U3=1.25	R1=0	R2=0	R3=0
Joint=66	U1=1.25	U2=1.25	U3=1.25	R1=0	R2=0	R3=0
Joint=67	U1=1.25	U2=1.25	U3=1.25	R1=0	R2=0	R3=0
Joint=68	U1=1.25	U2=1.25	U3=1.25	R1=0	R2=0	R3=0
Joint=69	U1=1.25	U2=1.25	U3=1.25	R1=0	R2=0	R3=0
Joint=70	U1=1.25	U2=1.25	U3=1.25	R1=0	R2=0	R3=0
Joint=85	U1=1.25	U2=1.25	U3=1.25	R1=0	R2=0	R3=0
Joint=86	U1=1.25	U2=1.25	U3=1.25	R1=0	R2=0	R3=0
Joint=87	U1=1.25	U2=1.25	U3=1.25	R1=0	R2=0	R3=0
Joint=88	U1=1.25	U2=1.25	U3=1.25	R1=0	R2=0	R3=0
Joint=89	U1=1.25	U2=1.25	U3=1.25	R1=0	R2=0	R3=0



Joint=90 U1=1.25 U2=1.25 U3=1.25 R1=0 R2=0 R3=0
Joint=91 U1=1.25 U2=1.25 U3=1.25 R1=0 R2=0 R3=0

TABLE: "ELEMENT FORCES - FRAMES"

Frame=1 Station=0 OutputCase=PESOPR CaseType=LinStatic P=-15.1709467361864 V2=151.042541323404 V3=0
T=0 M2=0 M3=81.75536244057 S11Max=475.361227907234 PtS11Max=1 x2S11Max=-0.5 x3S11Max=-0.5
S11Min=-505.703121379607 PtS11Min=3 x2S11Min=0.5 x3S11Min=-0.5 FrameElem=1 ElemStation=0

Frame=1 Station=6.24999940395355E-02 OutputCase=PESOPR CaseType=LinStatic P=-15.1709467361864
V2=152.605041174393 V3=0 T=0 M2=0 M3=72.2663763924542 S11Max=418.427311618539 PtS11Max=1 x2S11Max=-0.5
x3S11Max=-0.5
S11Min=-448.769205090912 PtS11Min=3 x2S11Min=0.5 x3S11Min=-0.5 FrameElem=1
ElemStation=6.24999940395355E-02

Frame=1 Station=0.124999988079071 OutputCase=PESOPR CaseType=LinStatic P=-15.1709467361864
V2=154.167541025381 V3=0 T=0 M2=0 M3=62.6797341129648 S11Max=360.907457941602 PtS11Max=1 x2S11Max=-0.5
x3S11Max=-0.5
S11Min=-391.249351413975 PtS11Min=3 x2S11Min=0.5 x3S11Min=-0.5 FrameElem=1
ElemStation=0.124999988079071

Frame=1 Station=0.187499982118607 OutputCase=PESOPR CaseType=LinStatic P=-15.1709467361864
V2=155.730040876369 V3=0 T=0 M2=0 M3=52.9954356021018 S11Max=302.801666876425 PtS11Max=1 x2S11Max=-0.5
x3S11Max=-0.5
S11Min=-333.143560348797 PtS11Min=3 x2S11Min=0.5 x3S11Min=-0.5 FrameElem=1
ElemStation=0.187499982118607

Frame=1 Station=0.249999976158142 OutputCase=PESOPR CaseType=LinStatic P=-15.1709467361864
V2=157.292540727358 V3=0 T=0 M2=0 M3=43.2134808598653 S11Max=244.109938423006 PtS11Max=1 x2S11Max=-0.5
x3S11Max=-0.5
S11Min=-274.451831895378 PtS11Min=3 x2S11Min=0.5 x3S11Min=-0.5 FrameElem=1
ElemStation=0.249999976158142

Frame=1 Station=0 OutputCase=TERRVERT CaseType=LinStatic P=1.64270738195018 V2=664.026817772654 V3=0
T=0 M2=0 M3=318.354704172059 S11Max=1911.77093241431 PtS11Max=1 x2S11Max=-0.5 x3S11Max=-0.5
S11Min=-1908.48551765041 PtS11Min=3 x2S11Min=0.5 x3S11Min=-0.5 FrameElem=1 ElemStation=0

Frame=1 Station=6.24999940395355E-02 OutputCase=TERRVERT CaseType=LinStatic P=1.64270738195018
V2=664.026817772654 V3=0 T=0 M2=0 M3=276.853032019177 S11Max=1662.76089949701 PtS11Max=1 x2S11Max=-0.5
x3S11Max=-0.5
S11Min=-1659.47548473311 PtS11Min=3 x2S11Min=0.5 x3S11Min=-0.5 FrameElem=1
ElemStation=6.24999940395355E-02

Frame=1 Station=0.124999988079071 OutputCase=TERRVERT CaseType=LinStatic P=1.64270738195018
V2=664.026817772654 V3=0 T=0 M2=0 M3=235.351359866294 S11Max=1413.75086657972 PtS11Max=1 x2S11Max=-0.5
x3S11Max=-0.5
S11Min=-1410.46545181581 PtS11Min=3 x2S11Min=0.5 x3S11Min=-0.5 FrameElem=1
ElemStation=0.124999988079071

Frame=1 Station=0.187499982118607 OutputCase=TERRVERT CaseType=LinStatic P=1.64270738195018
V2=664.026817772654 V3=0 T=0 M2=0 M3=193.849687713412 S11Max=1164.74083366242 PtS11Max=1 x2S11Max=-0.5
x3S11Max=-0.5
S11Min=-1161.45541889852 PtS11Min=3 x2S11Min=0.5 x3S11Min=-0.5 FrameElem=1
ElemStation=0.187499982118607

Frame=1 Station=0.249999976158142 OutputCase=TERRVERT CaseType=LinStatic P=1.64270738195018
V2=664.026817772654 V3=0 T=0 M2=0 M3=152.348015560529 S11Max=915.730800745124 PtS11Max=1 x2S11Max=-0.5
x3S11Max=-0.5
S11Min=-912.445385981223 PtS11Min=3 x2S11Min=0.5 x3S11Min=-0.5 FrameElem=1
ElemStation=0.249999976158142

Frame=1 Station=0 OutputCase=TERRLAT CaseType=LinStatic P=-373.013713761058 V2=0.1858297228232 V3=0
T=0 M2=0 M3=84.0726672420623 S11Max=131.422289691315 PtS11Max=1 x2S11Max=-0.5 x3S11Max=-0.5
S11Min=-877.449717213432 PtS11Min=3 x2S11Min=0.5 x3S11Min=-0.5 FrameElem=1 ElemStation=0

Frame=1 Station=6.24999940395355E-02 OutputCase=TERRLAT CaseType=LinStatic P=-373.013713761058
V2=0.1858297228232 V3=0 T=0 M2=0 M3=84.0610528854935 S11Max=131.352603551902 PtS11Max=1 x2S11Max=-0.5
x3S11Max=-0.5
S11Min=-877.380031074019 PtS11Min=3 x2S11Min=0.5 x3S11Min=-0.5 FrameElem=1
ElemStation=6.24999940395355E-02

Frame=1 Station=0.124999988079071 OutputCase=TERRLAT CaseType=LinStatic P=-373.013713761058
V2=0.1858297228232 V3=0 T=0 M2=0 M3=84.0494385289246 S11Max=131.28291741249 PtS11Max=1 x2S11Max=-0.5
x3S11Max=-0.5
S11Min=-877.310344934606 PtS11Min=3 x2S11Min=0.5 x3S11Min=-0.5 FrameElem=1
ElemStation=0.124999988079071

Frame=1 Station=0.187499982118607 OutputCase=TERRLAT CaseType=LinStatic P=-373.013713761058
V2=0.1858297228232 V3=0 T=0 M2=0 M3=84.0378241723558 S11Max=131.213231273077 PtS11Max=1 x2S11Max=-0.5
x3S11Max=-0.5
S11Min=-877.240658795193 PtS11Min=3 x2S11Min=0.5 x3S11Min=-0.5 FrameElem=1
ElemStation=0.187499982118607

Frame=1 Station=0.249999976158142 OutputCase=TERRLAT CaseType=LinStatic P=-373.013713761058
V2=0.1858297228232 V3=0 T=0 M2=0 M3=84.026209815787 S11Max=131.143545133664 PtS11Max=1 x2S11Max=-0.5
x3S11Max=-0.5
S11Min=-877.17097265578 PtS11Min=3 x2S11Min=0.5 x3S11Min=-0.5 FrameElem=1
ElemStation=0.249999976158142

Frame=1 Station=0 OutputCase=ACCVERT CaseType=LinStatic P=0 V2=0 V3=0 T=0 M2=0 M3=0 S11Max=0
PtS11Max=0 x2S11Max=0 x3S11Max=0 S11Min=0 PtS11Min=0 x2S11Min=0 x3S11Min=0 FrameElem=1 ElemStation=0

Frame=1 Station=6.24999940395355E-02 OutputCase=ACCVERT CaseType=LinStatic P=0 V2=0 V3=0 T=0 M2=0
M3=0 S11Max=0 PtS11Max=0 x2S11Max=0 x3S11Max=0 S11Min=0 PtS11Min=0 x2S11Min=0 x3S11Min=0
FrameElem=1 ElemStation=6.24999940395355E-02

Frame=1 Station=0.124999988079071 OutputCase=ACCVERT CaseType=LinStatic P=0 V2=0 V3=0 T=0 M2=0
M3=0 S11Max=0 PtS11Max=0 x2S11Max=0 x3S11Max=0 S11Min=0 PtS11Min=0 x2S11Min=0 x3S11Min=0
FrameElem=1 ElemStation=0.124999988079071



Frame=1 Station=0.187499982118607 OutputCase=ACCVERT CaseType=LinStatic P=0 V2=0 V3=0 T=0 M2=0
 M3=0 S11Max=0 PtS11Max=0 x2S11Max=0 x3S11Max=0 S11Min=0 PtS11Min=0 x2S11Min=0 x3S11Min=0
 FrameElem=1 ElemStation=0.187499982118607
 Frame=1 Station=0.249999976158142 OutputCase=ACCVERT CaseType=LinStatic P=0 V2=0 V3=0 T=0 M2=0
 M3=0 S11Max=0 PtS11Max=0 x2S11Max=0 x3S11Max=0 S11Min=0 PtS11Min=0 x2S11Min=0 x3S11Min=0
 FrameElem=1 ElemStation=0.249999976158142
 Frame=1 Station=0 OutputCase=ACCLATDX CaseType=LinStatic P=0 V2=0 V3=0 T=0 M2=0 M3=0 S11Max=0
 PtS11Max=0 x2S11Max=0 x3S11Max=0 S11Min=0 PtS11Min=0 x2S11Min=0 x3S11Min=0 FrameElem=1 ElemStation=0
 Frame=1 Station=6.24999940395355E-02 OutputCase=ACCLATDX CaseType=LinStatic P=0 V2=0 V3=0 T=0
 M2=0 M3=0 S11Max=0 PtS11Max=0 x2S11Max=0 x3S11Max=0 S11Min=0 PtS11Min=0 x2S11Min=0 x3S11Min=0
 FrameElem=1 ElemStation=6.24999940395355E-02
 Frame=1 Station=0.124999988079071 OutputCase=ACCLATDX CaseType=LinStatic P=0 V2=0 V3=0 T=0 M2=0
 M3=0 S11Max=0 PtS11Max=0 x2S11Max=0 x3S11Max=0 S11Min=0 PtS11Min=0 x2S11Min=0 x3S11Min=0
 FrameElem=1 ElemStation=0.124999988079071
 Frame=1 Station=0.187499982118607 OutputCase=ACCLATDX CaseType=LinStatic P=0 V2=0 V3=0 T=0 M2=0
 M3=0 S11Max=0 PtS11Max=0 x2S11Max=0 x3S11Max=0 S11Min=0 PtS11Min=0 x2S11Min=0 x3S11Min=0
 FrameElem=1 ElemStation=0.187499982118607
 Frame=1 Station=0.249999976158142 OutputCase=ACCLATDX CaseType=LinStatic P=0 V2=0 V3=0 T=0 M2=0
 M3=0 S11Max=0 PtS11Max=0 x2S11Max=0 x3S11Max=0 S11Min=0 PtS11Min=0 x2S11Min=0 x3S11Min=0
 FrameElem=1 ElemStation=0.249999976158142
 Frame=1 Station=0 OutputCase=ACCLATSX CaseType=LinStatic P=0 V2=0 V3=0 T=0 M2=0 M3=0 S11Max=0
 PtS11Max=0 x2S11Max=0 x3S11Max=0 S11Min=0 PtS11Min=0 x2S11Min=0 x3S11Min=0 FrameElem=1 ElemStation=0
 Frame=1 Station=6.24999940395355E-02 OutputCase=ACCLATSX CaseType=LinStatic P=0 V2=0 V3=0 T=0
 M2=0 M3=0 S11Max=0 PtS11Max=0 x2S11Max=0 x3S11Max=0 S11Min=0 PtS11Min=0 x2S11Min=0 x3S11Min=0
 FrameElem=1 ElemStation=6.24999940395355E-02
 Frame=1 Station=0.124999988079071 OutputCase=ACCLATSX CaseType=LinStatic P=0 V2=0 V3=0 T=0 M2=0
 M3=0 S11Max=0 PtS11Max=0 x2S11Max=0 x3S11Max=0 S11Min=0 PtS11Min=0 x2S11Min=0 x3S11Min=0
 FrameElem=1 ElemStation=0.124999988079071
 Frame=1 Station=0.187499982118607 OutputCase=ACCLATSX CaseType=LinStatic P=0 V2=0 V3=0 T=0 M2=0
 M3=0 S11Max=0 PtS11Max=0 x2S11Max=0 x3S11Max=0 S11Min=0 PtS11Min=0 x2S11Min=0 x3S11Min=0
 FrameElem=1 ElemStation=0.187499982118607
 Frame=1 Station=0.249999976158142 OutputCase=ACCLATSX CaseType=LinStatic P=0 V2=0 V3=0 T=0 M2=0
 M3=0 S11Max=0 PtS11Max=0 x2S11Max=0 x3S11Max=0 S11Min=0 PtS11Min=0 x2S11Min=0 x3S11Min=0
 FrameElem=1 ElemStation=0.249999976158142
 Frame=1 Station=0 OutputCase=TERRCOST CaseType=LinStatic P=0 V2=0 V3=0 T=0 M2=0 M3=0 S11Max=0
 PtS11Max=0 x2S11Max=0 x3S11Max=0 S11Min=0 PtS11Min=0 x2S11Min=0 x3S11Min=0 FrameElem=1 ElemStation=0
 Frame=1 Station=6.24999940395355E-02 OutputCase=TERRCOST CaseType=LinStatic P=0 V2=0 V3=0 T=0
 M2=0 M3=0 S11Max=0 PtS11Max=0 x2S11Max=0 x3S11Max=0 S11Min=0 PtS11Min=0 x2S11Min=0 x3S11Min=0
 FrameElem=1 ElemStation=6.24999940395355E-02
 Frame=1 Station=0.124999988079071 OutputCase=TERRCOST CaseType=LinStatic P=0 V2=0 V3=0 T=0 M2=0
 M3=0 S11Max=0 PtS11Max=0 x2S11Max=0 x3S11Max=0 S11Min=0 PtS11Min=0 x2S11Min=0 x3S11Min=0
 FrameElem=1 ElemStation=0.124999988079071
 Frame=1 Station=0.187499982118607 OutputCase=TERRCOST CaseType=LinStatic P=0 V2=0 V3=0 T=0 M2=0
 M3=0 S11Max=0 PtS11Max=0 x2S11Max=0 x3S11Max=0 S11Min=0 PtS11Min=0 x2S11Min=0 x3S11Min=0
 FrameElem=1 ElemStation=0.187499982118607
 Frame=1 Station=0.249999976158142 OutputCase=TERRCOST CaseType=LinStatic P=0 V2=0 V3=0 T=0 M2=0
 M3=0 S11Max=0 PtS11Max=0 x2S11Max=0 x3S11Max=0 S11Min=0 PtS11Min=0 x2S11Min=0 x3S11Min=0
 FrameElem=1 ElemStation=0.249999976158142
 Frame=1 Station=0 OutputCase=SOVRCOST CaseType=LinStatic P=0 V2=0 V3=0 T=0 M2=0 M3=0 S11Max=0
 PtS11Max=0 x2S11Max=0 x3S11Max=0 S11Min=0 PtS11Min=0 x2S11Min=0 x3S11Min=0 FrameElem=1 ElemStation=0
 Frame=1 Station=6.24999940395355E-02 OutputCase=SOVRCOST CaseType=LinStatic P=0 V2=0 V3=0 T=0
 M2=0 M3=0 S11Max=0 PtS11Max=0 x2S11Max=0 x3S11Max=0 S11Min=0 PtS11Min=0 x2S11Min=0 x3S11Min=0
 FrameElem=1 ElemStation=6.24999940395355E-02
 Frame=1 Station=0.124999988079071 OutputCase=SOVRCOST CaseType=LinStatic P=0 V2=0 V3=0 T=0 M2=0
 M3=0 S11Max=0 PtS11Max=0 x2S11Max=0 x3S11Max=0 S11Min=0 PtS11Min=0 x2S11Min=0 x3S11Min=0
 FrameElem=1 ElemStation=0.124999988079071
 Frame=1 Station=0.187499982118607 OutputCase=SOVRCOST CaseType=LinStatic P=0 V2=0 V3=0 T=0 M2=0
 M3=0 S11Max=0 PtS11Max=0 x2S11Max=0 x3S11Max=0 S11Min=0 PtS11Min=0 x2S11Min=0 x3S11Min=0
 FrameElem=1 ElemStation=0.187499982118607
 Frame=1 Station=0.249999976158142 OutputCase=SOVRCOST CaseType=LinStatic P=0 V2=0 V3=0 T=0 M2=0
 M3=0 S11Max=0 PtS11Max=0 x2S11Max=0 x3S11Max=0 S11Min=0 PtS11Min=0 x2S11Min=0 x3S11Min=0
 FrameElem=1 ElemStation=0.249999976158142
 Frame=1 Station=0 OutputCase=ENVE CaseType=Combination StepType=Max P=-274.637838986977
 V2=815.255188818881 V3=0 T=0 M2=0 M3=484.182733854692 S11Max=2518.55445001286 PtS11Max=1 x2S11Max=-0.5
 x3S11Max=-0.5
 S11Min=-3028.40344107942 PtS11Min=3 x2S11Min=0.5 x3S11Min=-0.5 FrameElem=1 ElemStation=0
 Frame=1 Station=6.24999940395355E-02 OutputCase=ENVE CaseType=Combination StepType=Max P=-
 274.637838986977 V2=816.81768866987 V3=0 T=0 M2=0 M3=433.180461297124 S11Max=2212.54081466745
 PtS11Max=1 x2S11Max=-0.5
 x3S11Max=-0.5 S11Min=-2722.41071157584 PtS11Min=3 x2S11Min=0.5 x3S11Min=-0.5 FrameElem=1
 ElemStation=6.24999940395355E-02
 Frame=1 Station=0.124999988079071 OutputCase=ENVE CaseType=Combination StepType=Max P=-274.637838986977
 V2=818.380188520858 V3=0 T=0 M2=0 M3=382.080532508184 S11Max=1905.94124193381 PtS11Max=1 x2S11Max=-0.5
 x3S11Max=-0.5 S11Min=-2415.83204468401 PtS11Min=3 x2S11Min=0.5 x3S11Min=-0.5 FrameElem=1
 ElemStation=0.124999988079071
 Frame=1 Station=0.187499982118607 OutputCase=ENVE CaseType=Combination StepType=Max P=-274.637838986977
 V2=819.942688371847 V3=0 T=0 M2=0 M3=330.882947487869 S11Max=1598.75573181192 PtS11Max=1 x2S11Max=-0.5
 x3S11Max=-0.5 S11Min=-2108.66744040395 PtS11Min=3 x2S11Min=0.5 x3S11Min=-0.5 FrameElem=1
 ElemStation=0.187499982118607



Frame=1 Station=0.249999976158142 OutputCase=ENVE CaseType=Combination StepType=Max P=-274.637838986977
 V2=821.505188222835 V3=0 T=0 M2=0 M3=279.587706236181 S11Max=1290.98428430179 PtS11Max=1 x2S11Max=-0.5
 -
 x3S11Max=-0.5 S11Min=-1800.91689873565 PtS11Min=3 x2S11Min=0.5 x3S11Min=-0.5 FrameElem=1
 ElemStation=0.249999976158142
 Frame=1 Station=0 OutputCase=ENVE CaseType=Combination StepType=Min P=-386.541953115295
 V2=815.199439902034 V3=0 T=0 M2=0 M3=458.960933682073 S11Max=2479.12776310546 PtS11Max=1 x2S11Max=-0.5
 x3S11Max=-0.5
 S11Min=-3291.63835624344 PtS11Min=3 x2S11Min=0.5 x3S11Min=-0.5 FrameElem=1 ElemStation=0
 Frame=1 Station=6.24999940395355E-02 OutputCase=ENVE CaseType=Combination StepType=Min P=-386.541953115295
 386.541953115295 V2=816.761939753023 V3=0 T=0 M2=0 M3=407.962145431476 S11Max=2173.13503360188
 PtS11Max=1 x2S11Max=-0.5
 x3S11Max=-0.5 S11Min=-2371.83963804251 PtS11Min=3 x2S11Min=0.5 x3S11Min=-0.5 FrameElem=1
 ElemStation=6.24999940395355E-02
 Frame=1 Station=0.124999988079071 OutputCase=ENVE CaseType=Combination StepType=Min P=-386.541953115295
 V2=818.324439604011 V3=0 T=0 M2=0 M3=356.865700949506 S11Max=1866.55636671006 PtS11Max=1 x2S11Max=-0.5
 -
 x3S11Max=-0.5 S11Min=-2679.0251481644 PtS11Min=3 x2S11Min=0.5 x3S11Min=-0.5 FrameElem=1
 ElemStation=0.124999988079071
 Frame=1 Station=0.187499982118607 OutputCase=ENVE CaseType=Combination StepType=Min P=-386.541953115295
 V2=819.886939455 V3=0 T=0 M2=0 M3=305.671600236162 S11Max=1559.39176243 PtS11Max=1 x2S11Max=-0.5
 x3S11Max=-0.5 S11Min=-2371.83963804251 PtS11Min=3 x2S11Min=0.5 x3S11Min=-0.5 FrameElem=1
 ElemStation=0.187499982118607
 Frame=1 Station=0.249999976158142 OutputCase=ENVE CaseType=Combination StepType=Min P=-386.541953115295
 V2=821.449439305988 V3=0 T=0 M2=0 M3=254.379843291445 S11Max=1251.64122076169 PtS11Max=1 x2S11Max=-0.5
 -
 x3S11Max=-0.5 S11Min=-2064.06819053238 PtS11Min=3 x2S11Min=0.5 x3S11Min=-0.5 FrameElem=1
 ElemStation=0.249999976158142
 Frame=1 Station=0 OutputCase=FESSUR CaseType=Combination P=-386.541953115295 V2=815.255188818881 V3=0
 T=0 M2=0 M3=484.182733854692 S11Max=2518.55445001286 PtS11Max=1 x2S11Max=-0.5 x3S11Max=-0.5
 S11Min=-3291.63835624344 PtS11Min=3 x2S11Min=0.5 x3S11Min=-0.5 FrameElem=1 ElemStation=0
 Frame=1 Station=6.24999940395355E-02 OutputCase=FESSUR CaseType=Combination P=-386.541953115295
 V2=816.81768866987 V3=0 T=0 M2=0 M3=433.180461297124 S11Max=2212.54081466745 PtS11Max=1 x2S11Max=-0.5
 x3S11Max=-0.5
 S11Min=-2985.62472089804 PtS11Min=3 x2S11Min=0.5 x3S11Min=-0.5 FrameElem=1
 ElemStation=6.24999940395355E-02
 Frame=1 Station=0.124999988079071 OutputCase=FESSUR CaseType=Combination P=-386.541953115295
 V2=818.380188520858 V3=0 T=0 M2=0 M3=382.080532508184 S11Max=1905.94124193381 PtS11Max=1 x2S11Max=-0.5
 x3S11Max=-0.5
 S11Min=-2679.0251481644 PtS11Min=3 x2S11Min=0.5 x3S11Min=-0.5 FrameElem=1
 ElemStation=0.124999988079071
 Frame=1 Station=0.187499982118607 OutputCase=FESSUR CaseType=Combination P=-386.541953115295
 V2=819.942688371847 V3=0 T=0 M2=0 M3=330.882947487869 S11Max=1598.75573181192 PtS11Max=1 x2S11Max=-0.5
 x3S11Max=-0.5
 S11Min=-2371.83963804251 PtS11Min=3 x2S11Min=0.5 x3S11Min=-0.5 FrameElem=1
 ElemStation=0.187499982118607
 Frame=1 Station=0.249999976158142 OutputCase=FESSUR CaseType=Combination P=-386.541953115295
 V2=821.505188222835 V3=0 T=0 M2=0 M3=279.587706236181 S11Max=1290.98428430179 PtS11Max=1 x2S11Max=-0.5
 x3S11Max=-0.5
 S11Min=-2064.06819053238 PtS11Min=3 x2S11Min=0.5 x3S11Min=-0.5 FrameElem=1
 ElemStation=0.249999976158142
 Frame=2 Station=0 OutputCase=PESOPR CaseType=LinStatic P=-15.1709467361864 V2=134.470776144532 V3=0
 T=0 M2=0 M3=43.2134808598748 S11Max=244.109938423063 PtS11Max=1 x2S11Max=-0.5 x3S11Max=-0.5
 S11Min=-274.451831895435 PtS11Min=3 x2S11Min=0.5 x3S11Min=-0.5 FrameElem=2 ElemStation=0
 Frame=2 Station=0.0625 OutputCase=PESOPR CaseType=LinStatic P=-15.1709467361864 V2=136.033276144532
 V3=0 T=0 M2=0 M3=34.7602292258416 S11Max=193.390428618863 PtS11Max=1 x2S11Max=-0.5 x3S11Max=-0.5
 S11Min=-223.732322091236 PtS11Min=3 x2S11Min=0.5 x3S11Min=-0.5 FrameElem=2 ElemStation=0.0625
 Frame=2 Station=0.125 OutputCase=PESOPR CaseType=LinStatic P=-15.1709467361864 V2=137.595776144532
 V3=0 T=0 M2=0 M3=26.2093213418084 S11Max=142.084981314664 PtS11Max=1 x2S11Max=-0.5 x3S11Max=-0.5
 S11Min=-172.426874787037 PtS11Min=3 x2S11Min=0.5 x3S11Min=-0.5 FrameElem=2 ElemStation=0.125
 Frame=2 Station=0.1875 OutputCase=PESOPR CaseType=LinStatic P=-15.1709467361864 V2=139.158276144532
 V3=0 T=0 M2=0 M3=17.5607572077752 S11Max=90.1935965104646 PtS11Max=1 x2S11Max=-0.5 x3S11Max=-0.5
 S11Min=-120.535489982837 PtS11Min=3 x2S11Min=0.5 x3S11Min=-0.5 FrameElem=2 ElemStation=0.1875
 Frame=2 Station=0.25 OutputCase=PESOPR CaseType=LinStatic P=-15.1709467361864 V2=140.720776144532
 V3=0 T=0 M2=0 M3=8.81453682374195 S11Max=37.7162742062653 PtS11Max=1 x2S11Max=-0.5 x3S11Max=-0.5
 S11Min=-68.0581676786381 PtS11Min=3 x2S11Min=0.5 x3S11Min=-0.5 FrameElem=2 ElemStation=0.25
 Frame=2 Station=0 OutputCase=TERRVERT CaseType=LinStatic P=1.64270738195018 V2=592.527338506188 V3=0
 T=0 M2=0 M3=152.348015560565 S11Max=915.730800745339 PtS11Max=1 x2S11Max=-0.5 x3S11Max=-0.5
 S11Min=-912.445385981439 PtS11Min=3 x2S11Min=0.5 x3S11Min=-0.5 FrameElem=2 ElemStation=0
 Frame=2 Station=0.0625 OutputCase=TERRVERT CaseType=LinStatic P=1.64270738195018 V2=592.527338506188
 V3=0 T=0 M2=0 M3=115.315056903928 S11Max=693.533048805519 PtS11Max=1 x2S11Max=-0.5 x3S11Max=-0.5
 S11Min=-690.247634041618 PtS11Min=3 x2S11Min=0.5 x3S11Min=-0.5 FrameElem=2 ElemStation=0.0625
 Frame=2 Station=0.125 OutputCase=TERRVERT CaseType=LinStatic P=1.64270738195018 V2=592.527338506188
 V3=0 T=0 M2=0 M3=78.2820982472913 S11Max=471.335296865698 PtS11Max=1 x2S11Max=-0.5 x3S11Max=-0.5
 S11Min=-468.049882101798 PtS11Min=3 x2S11Min=0.5 x3S11Min=-0.5 FrameElem=2 ElemStation=0.125
 Frame=2 Station=0.1875 OutputCase=TERRVERT CaseType=LinStatic P=1.64270738195018 V2=592.527338506188
 V3=0 T=0 M2=0 M3=41.2491395906545 S11Max=249.137544925877 PtS11Max=1 x2S11Max=-0.5 x3S11Max=-0.5
 S11Min=-245.852130161977 PtS11Min=3 x2S11Min=0.5 x3S11Min=-0.5 FrameElem=2 ElemStation=0.1875
 Frame=2 Station=0.25 OutputCase=TERRVERT CaseType=LinStatic P=1.64270738195018 V2=592.527338506188
 V3=0 T=0 M2=0 M3=4.21618093401776 S11Max=26.9397929860567 PtS11Max=1 x2S11Max=-0.5 x3S11Max=-0.5
 S11Min=-23.6543782221564 PtS11Min=3 x2S11Min=0.5 x3S11Min=-0.5 FrameElem=2 ElemStation=0.25

```

Frame=2 Station=0 OutputCase=TERRLAT CaseType=LinStatic P=-373.013713761058 V2=0.450395830003117 V3=0
T=0 M2=0 M3=84.0262098157868 S11Max=131.143545133663 PtS11Max=1 x2S11Max=-0.5 x3S11Max=-0.5 _
S11Min=-877.170972655779 PtS11Min=3 x2S11Min=0.5 x3S11Min=-0.5 FrameElem=2 ElemStation=0
Frame=2 Station=0.0625 OutputCase=TERRLAT CaseType=LinStatic P=-373.013713761058 V2=0.450395830003117
V3=0 T=0 M2=0 M3=83.9980600764116 S11Max=130.974646697411 PtS11Max=1 x2S11Max=-0.5 x3S11Max=-0.5 _
S11Min=-877.002074219528 PtS11Min=3 x2S11Min=0.5 x3S11Min=-0.5 FrameElem=2 ElemStation=0.0625
Frame=2 Station=0.125 OutputCase=TERRLAT CaseType=LinStatic P=-373.013713761058 V2=0.450395830003117
V3=0 T=0 M2=0 M3=83.9699103370365 S11Max=130.80574826116 PtS11Max=1 x2S11Max=-0.5 x3S11Max=-0.5 _
S11Min=-876.833175783277 PtS11Min=3 x2S11Min=0.5 x3S11Min=-0.5 FrameElem=2 ElemStation=0.125
Frame=2 Station=0.1875 OutputCase=TERRLAT CaseType=LinStatic P=-373.013713761058 V2=0.450395830003117
V3=0 T=0 M2=0 M3=83.9417605976613 S11Max=130.636849824909 PtS11Max=1 x2S11Max=-0.5 x3S11Max=-0.5 _
S11Min=-876.664277347026 PtS11Min=3 x2S11Min=0.5 x3S11Min=-0.5 FrameElem=2 ElemStation=0.1875
Frame=2 Station=0.25 OutputCase=TERRLAT CaseType=LinStatic P=-373.013713761058 V2=0.450395830003117
V3=0 T=0 M2=0 M3=83.9136108582861 S11Max=130.467951388658 PtS11Max=1 x2S11Max=-0.5 x3S11Max=-0.5 _
S11Min=-876.495378910775 PtS11Min=3 x2S11Min=0.5 x3S11Min=-0.5 FrameElem=2 ElemStation=0.25
Frame=2 Station=0 OutputCase=ACCVERT CaseType=LinStatic P=0 V2=0 V3=0 T=0 M2=0 M3=0
PtS11Max=0 x2S11Max=0 x3S11Max=0 S11Min=0 PtS11Min=0 x2S11Min=0 x3S11Min=0 FrameElem=2 ElemStation=0
Frame=2 Station=0.0625 OutputCase=ACCVERT CaseType=LinStatic P=0 V2=0 V3=0 T=0 M2=0 M3=0
S11Max=0 PtS11Max=0 x2S11Max=0 x3S11Max=0 S11Min=0 PtS11Min=0 x2S11Min=0 x3S11Min=0 FrameElem=2
ElemStation=0.0625
Frame=2 Station=0.125 OutputCase=ACCVERT CaseType=LinStatic P=0 V2=0 V3=0 T=0 M2=0 M3=0
S11Max=0 PtS11Max=0 x2S11Max=0 x3S11Max=0 S11Min=0 PtS11Min=0 x2S11Min=0 x3S11Min=0 FrameElem=2
ElemStation=0.125
Frame=2 Station=0.1875 OutputCase=ACCVERT CaseType=LinStatic P=0 V2=0 V3=0 T=0 M2=0 M3=0
S11Max=0 PtS11Max=0 x2S11Max=0 x3S11Max=0 S11Min=0 PtS11Min=0 x2S11Min=0 x3S11Min=0 FrameElem=2
ElemStation=0.1875
Frame=2 Station=0.25 OutputCase=ACCVERT CaseType=LinStatic P=0 V2=0 V3=0 T=0 M2=0 M3=0
S11Max=0 PtS11Max=0 x2S11Max=0 x3S11Max=0 S11Min=0 PtS11Min=0 x2S11Min=0 x3S11Min=0 FrameElem=2
ElemStation=0.25
Frame=2 Station=0 OutputCase=ACCLATDX CaseType=LinStatic P=0 V2=0 V3=0 T=0 M2=0 M3=0 S11Max=0
PtS11Max=0 x2S11Max=0 x3S11Max=0 S11Min=0 PtS11Min=0 x2S11Min=0 x3S11Min=0 FrameElem=2 ElemStation=0
Frame=2 Station=0.0625 OutputCase=ACCLATDX CaseType=LinStatic P=0 V2=0 V3=0 T=0 M2=0 M3=0
S11Max=0 PtS11Max=0 x2S11Max=0 x3S11Max=0 S11Min=0 PtS11Min=0 x2S11Min=0 x3S11Min=0 FrameElem=2
ElemStation=0.0625
Frame=2 Station=0.125 OutputCase=ACCLATDX CaseType=LinStatic P=0 V2=0 V3=0 T=0 M2=0 M3=0
S11Max=0 PtS11Max=0 x2S11Max=0 x3S11Max=0 S11Min=0 PtS11Min=0 x2S11Min=0 x3S11Min=0 FrameElem=2
ElemStation=0.125
Frame=2 Station=0.1875 OutputCase=ACCLATDX CaseType=LinStatic P=0 V2=0 V3=0 T=0 M2=0 M3=0
S11Max=0 PtS11Max=0 x2S11Max=0 x3S11Max=0 S11Min=0 PtS11Min=0 x2S11Min=0 x3S11Min=0 FrameElem=2
ElemStation=0.1875
Frame=2 Station=0.25 OutputCase=ACCLATDX CaseType=LinStatic P=0 V2=0 V3=0 T=0 M2=0 M3=0
S11Max=0 PtS11Max=0 x2S11Max=0 x3S11Max=0 S11Min=0 PtS11Min=0 x2S11Min=0 x3S11Min=0 FrameElem=2
ElemStation=0.25
Frame=2 Station=0 OutputCase=ACCLATSX CaseType=LinStatic P=0 V2=0 V3=0 T=0 M2=0 M3=0 S11Max=0
PtS11Max=0 x2S11Max=0 x3S11Max=0 S11Min=0 PtS11Min=0 x2S11Min=0 x3S11Min=0 FrameElem=2 ElemStation=0
Frame=2 Station=0.0625 OutputCase=ACCLATSX CaseType=LinStatic P=0 V2=0 V3=0 T=0 M2=0 M3=0
S11Max=0 PtS11Max=0 x2S11Max=0 x3S11Max=0 S11Min=0 PtS11Min=0 x2S11Min=0 x3S11Min=0 FrameElem=2
ElemStation=0.0625
Frame=2 Station=0.125 OutputCase=ACCLATSX CaseType=LinStatic P=0 V2=0 V3=0 T=0 M2=0 M3=0
S11Max=0 PtS11Max=0 x2S11Max=0 x3S11Max=0 S11Min=0 PtS11Min=0 x2S11Min=0 x3S11Min=0 FrameElem=2
ElemStation=0.125
Frame=2 Station=0.1875 OutputCase=ACCLATSX CaseType=LinStatic P=0 V2=0 V3=0 T=0 M2=0 M3=0
S11Max=0 PtS11Max=0 x2S11Max=0 x3S11Max=0 S11Min=0 PtS11Min=0 x2S11Min=0 x3S11Min=0 FrameElem=2
ElemStation=0.1875
Frame=2 Station=0.25 OutputCase=ACCLATSX CaseType=LinStatic P=0 V2=0 V3=0 T=0 M2=0 M3=0
S11Max=0 PtS11Max=0 x2S11Max=0 x3S11Max=0 S11Min=0 PtS11Min=0 x2S11Min=0 x3S11Min=0 FrameElem=2
ElemStation=0.25
Frame=2 Station=0 OutputCase=TERRCOST CaseType=LinStatic P=0 V2=0 V3=0 T=0 M2=0 M3=0 S11Max=0
PtS11Max=0 x2S11Max=0 x3S11Max=0 S11Min=0 PtS11Min=0 x2S11Min=0 x3S11Min=0 FrameElem=2 ElemStation=0
Frame=2 Station=0.0625 OutputCase=TERRCOST CaseType=LinStatic P=0 V2=0 V3=0 T=0 M2=0 M3=0
S11Max=0 PtS11Max=0 x2S11Max=0 x3S11Max=0 S11Min=0 PtS11Min=0 x2S11Min=0 x3S11Min=0 FrameElem=2
ElemStation=0.0625
Frame=2 Station=0.125 OutputCase=TERRCOST CaseType=LinStatic P=0 V2=0 V3=0 T=0 M2=0 M3=0
S11Max=0 PtS11Max=0 x2S11Max=0 x3S11Max=0 S11Min=0 PtS11Min=0 x2S11Min=0 x3S11Min=0 FrameElem=2
ElemStation=0.125
Frame=2 Station=0.1875 OutputCase=TERRCOST CaseType=LinStatic P=0 V2=0 V3=0 T=0 M2=0 M3=0
S11Max=0 PtS11Max=0 x2S11Max=0 x3S11Max=0 S11Min=0 PtS11Min=0 x2S11Min=0 x3S11Min=0 FrameElem=2
ElemStation=0.1875
Frame=2 Station=0.25 OutputCase=TERRCOST CaseType=LinStatic P=0 V2=0 V3=0 T=0 M2=0 M3=0
S11Max=0 PtS11Max=0 x2S11Max=0 x3S11Max=0 S11Min=0 PtS11Min=0 x2S11Min=0 x3S11Min=0 FrameElem=2
ElemStation=0.25
Frame=2 Station=0 OutputCase=SOVRCOST CaseType=LinStatic P=0 V2=0 V3=0 T=0 M2=0 M3=0 S11Max=0
PtS11Max=0 x2S11Max=0 x3S11Max=0 S11Min=0 PtS11Min=0 x2S11Min=0 x3S11Min=0 FrameElem=2 ElemStation=0
Frame=2 Station=0.0625 OutputCase=SOVRCOST CaseType=LinStatic P=0 V2=0 V3=0 T=0 M2=0 M3=0
S11Max=0 PtS11Max=0 x2S11Max=0 x3S11Max=0 S11Min=0 PtS11Min=0 x2S11Min=0 x3S11Min=0 FrameElem=2
ElemStation=0.0625
Frame=2 Station=0.125 OutputCase=SOVRCOST CaseType=LinStatic P=0 V2=0 V3=0 T=0 M2=0 M3=0
S11Max=0 PtS11Max=0 x2S11Max=0 x3S11Max=0 S11Min=0 PtS11Min=0 x2S11Min=0 x3S11Min=0 FrameElem=2
ElemStation=0.125
Frame=2 Station=0.1875 OutputCase=SOVRCOST CaseType=LinStatic P=0 V2=0 V3=0 T=0 M2=0 M3=0
S11Max=0 PtS11Max=0 x2S11Max=0 x3S11Max=0 S11Min=0 PtS11Min=0 x2S11Min=0 x3S11Min=0 FrameElem=2
ElemStation=0.1875

```



Frame=2 Station=0.25 OutputCase=SOVRCOST CaseType=LinStatic P=0 V2=0 V3=0 T=0 M2=0 M3=0
 S11Max=0 PtS11Max=0 x2S11Max=0 x3S11Max=0 S11Min=0 PtS11Min=0 x2S11Min=0 x3S11Min=0 FrameElem=2
 ElemStation=0.25
 Frame=2 Station=0 OutputCase=ENVE CaseType=Combination StepType=Max P=-274.637838986977
 V2=727.448510480723 V3=0 T=0 M2=0 M3=279.587706236227 S11Max=1290.98428430206 PtS11Max=1 x2S11Max=-0.5
 x3S11Max=-0.5
 S11Min=-1800.91689873592 PtS11Min=3 x2S11Min=0.5 x3S11Min=-0.5 FrameElem=2 ElemStation=0
 Frame=2 Station=0.0625 OutputCase=ENVE CaseType=Combination StepType=Max P=-274.637838986977
 V2=729.011010480723 V3=0 T=0 M2=0 M3=234.073346206181 S11Max=1017.89812412179 PtS11Max=1 x2S11Max=-0.5
 x3S11Max=-0.5
 S11Min=-1527.88140808652 PtS11Min=3 x2S11Min=0.5 x3S11Min=-0.5 FrameElem=2 ElemStation=0.0625
 Frame=2 Station=0.125 OutputCase=ENVE CaseType=Combination StepType=Max P=-274.637838986977
 V2=730.573510480723 V3=0 T=0 M2=0 M3=188.461329926136 S11Max=744.226026441522 PtS11Max=1 x2S11Max=-0.5
 x3S11Max=-0.5
 S11Min=-1254.25997993713 PtS11Min=3 x2S11Min=0.5 x3S11Min=-0.5 FrameElem=2 ElemStation=0.125
 Frame=2 Station=0.1875 OutputCase=ENVE CaseType=Combination StepType=Max P=-274.637838986977
 V2=732.136010480723 V3=0 T=0 M2=0 M3=142.751657396091 S11Max=469.967991261251 PtS11Max=1 x2S11Max=-0.5
 x3S11Max=-0.5
 S11Min=-980.052614287732 PtS11Min=3 x2S11Min=0.5 x3S11Min=-0.5 FrameElem=2 ElemStation=0.1875
 Frame=2 Station=0.25 OutputCase=ENVE CaseType=Combination StepType=Max P=-274.637838986977
 V2=733.698510480723 V3=0 T=0 M2=0 M3=96.9443286160458 S11Max=195.12401858098 PtS11Max=1 x2S11Max=-0.5
 x3S11Max=-0.5
 S11Min=-705.259311138337 PtS11Min=3 x2S11Min=0.5 x3S11Min=-0.5 FrameElem=2 ElemStation=0.25
 Frame=2 Station=0 OutputCase=ENVE CaseType=Combination StepType=Min P=-386.541953115295
 V2=727.313391731722 V3=0 T=0 M2=0 M3=254.37984329149 S11Max=1251.64122076197 PtS11Max=1 x2S11Max=-0.5
 x3S11Max=-0.5
 S11Min=-2064.06819053265 PtS11Min=3 x2S11Min=0.5 x3S11Min=-0.5 FrameElem=2 ElemStation=0
 Frame=2 Station=0.0625 OutputCase=ENVE CaseType=Combination StepType=Min P=-386.541953115295
 V2=728.875891731722 V3=0 T=0 M2=0 M3=208.873928183258 S11Max=978.60573011257 PtS11Max=1 x2S11Max=-0.5
 x3S11Max=-0.5
 S11Min=-1790.98203035238 PtS11Min=3 x2S11Min=0.5 x3S11Min=-0.5 FrameElem=2 ElemStation=0.0625
 Frame=2 Station=0.125 OutputCase=ENVE CaseType=Combination StepType=Min P=-386.541953115295
 V2=730.438391731722 V3=0 T=0 M2=0 M3=163.270356825025 S11Max=704.984301963174 PtS11Max=1 x2S11Max=-0.5
 x3S11Max=-0.5
 S11Min=-1517.30993267211 PtS11Min=3 x2S11Min=0.5 x3S11Min=-0.5 FrameElem=2 ElemStation=0.125
 Frame=2 Station=0.1875 OutputCase=ENVE CaseType=Combination StepType=Min P=-386.541953115295
 V2=732.000891731722 V3=0 T=0 M2=0 M3=117.569129216793 S11Max=430.776936313778 PtS11Max=1 x2S11Max=-0.5
 x3S11Max=-0.5
 S11Min=-1243.05189749184 PtS11Min=3 x2S11Min=0.5 x3S11Min=-0.5 FrameElem=2 ElemStation=0.1875
 Frame=2 Station=0.25 OutputCase=ENVE CaseType=Combination StepType=Min P=-386.541953115295
 V2=733.563391731722 V3=0 T=0 M2=0 M3=71.7702453585599 S11Max=155.983633164383 PtS11Max=1 x2S11Max=-0.5
 x3S11Max=-0.5
 S11Min=-968.207924811569 PtS11Min=3 x2S11Min=0.5 x3S11Min=-0.5 FrameElem=2 ElemStation=0.25
 Frame=2 Station=0 OutputCase=PESSUR CaseType=Combination P=-386.541953115295 V2=727.448510480723 V3=0
 T=0 M2=0 M3=279.587706236227 S11Max=1290.98428430206 PtS11Max=1 x2S11Max=-0.5 x3S11Max=-0.5
 S11Min=-2064.06819053265 PtS11Min=3 x2S11Min=0.5 x3S11Min=-0.5 FrameElem=2 ElemStation=0
 Frame=2 Station=0.0625 OutputCase=PESSUR CaseType=Combination P=-386.541953115295 V2=729.011010480723
 V3=0 T=0 M2=0 M3=234.073346206181 S11Max=1017.89812412179 PtS11Max=1 x2S11Max=-0.5 x3S11Max=-0.5
 S11Min=-1790.98203035238 PtS11Min=3 x2S11Min=0.5 x3S11Min=-0.5 FrameElem=2 ElemStation=0.0625
 Frame=2 Station=0.125 OutputCase=PESSUR CaseType=Combination P=-386.541953115295 V2=730.573510480723
 V3=0 T=0 M2=0 M3=188.461329926136 S11Max=744.226026441522 PtS11Max=1 x2S11Max=-0.5 x3S11Max=-0.5
 S11Min=-1517.30993267211 PtS11Min=3 x2S11Min=0.5 x3S11Min=-0.5 FrameElem=2 ElemStation=0.125
 Frame=2 Station=0.1875 OutputCase=PESSUR CaseType=Combination P=-386.541953115295 V2=732.136010480723
 V3=0 T=0 M2=0 M3=142.751657396091 S11Max=469.967991261251 PtS11Max=1 x2S11Max=-0.5 x3S11Max=-0.5
 S11Min=-1243.05189749184 PtS11Min=3 x2S11Min=0.5 x3S11Min=-0.5 FrameElem=2 ElemStation=0.1875
 Frame=2 Station=0.25 OutputCase=PESSUR CaseType=Combination P=-386.541953115295 V2=733.698510480723
 V3=0 T=0 M2=0 M3=96.9443286160458 S11Max=195.12401858098 PtS11Max=1 x2S11Max=-0.5 x3S11Max=-0.5
 S11Min=-968.207924811569 PtS11Min=3 x2S11Min=0.5 x3S11Min=-0.5 FrameElem=2 ElemStation=0.25
 Frame=4 Station=0 OutputCase=PESOPR CaseType=LinStatic P=-15.1709467361871 V2=-140.720775817143 V3=0
 T=0 M2=0 M3=8.81453708260597 S11Max=37.7162757594486 PtS11Max=1 x2S11Max=-0.5 x3S11Max=-0.5
 S11Min=-68.0581692318229 PtS11Min=3 x2S11Min=0.5 x3S11Min=-0.5 FrameElem=4 ElemStation=0
 Frame=4 Station=0.0625 OutputCase=PESOPR CaseType=LinStatic P=-15.1709467361871 V2=-139.158275817143
 V3=0 T=0 M2=0 M3=17.5607574461774 S11Max=90.1935979408771 PtS11Max=1 x2S11Max=-0.5 x3S11Max=-0.5
 S11Min=-120.535491413251 PtS11Min=3 x2S11Min=0.5 x3S11Min=-0.5 FrameElem=4 ElemStation=0.0625
 Frame=4 Station=0.125 OutputCase=PESOPR CaseType=LinStatic P=-15.1709467361871 V2=-137.595775817143
 V3=0 T=0 M2=0 M3=26.2093215597488 S11Max=142.084982622306 PtS11Max=1 x2S11Max=-0.5 x3S11Max=-0.5
 S11Min=-172.42687609468 PtS11Min=3 x2S11Min=0.5 x3S11Min=-0.5 FrameElem=4 ElemStation=0.125
 Frame=4 Station=0.1875 OutputCase=PESOPR CaseType=LinStatic P=-15.1709467361871 V2=-136.033275817143
 V3=0 T=0 M2=0 M3=34.7602294233202 S11Max=193.390429803734 PtS11Max=1 x2S11Max=-0.5 x3S11Max=-0.5
 S11Min=-223.732323276108 PtS11Min=3 x2S11Min=0.5 x3S11Min=-0.5 FrameElem=4 ElemStation=0.1875
 Frame=4 Station=0.25 OutputCase=PESOPR CaseType=LinStatic P=-15.1709467361871 V2=-134.470775817143
 V3=0 T=0 M2=0 M3=43.2134810368916 S11Max=244.109939485162 PtS11Max=1 x2S11Max=-0.5 x3S11Max=-0.5
 S11Min=-274.451832957537 PtS11Min=3 x2S11Min=0.5 x3S11Min=-0.5 FrameElem=4 ElemStation=0.25
 Frame=4 Station=0 OutputCase=TERRVERT CaseType=LinStatic P=1.64270738195066 V2=-592.527339069406 V3=0
 T=0 M2=0 M3=4.21618206020503 S11Max=26.9397997431808 PtS11Max=1 x2S11Max=-0.5 x3S11Max=-0.5
 S11Min=-23.6543849792795 PtS11Min=3 x2S11Min=0.5 x3S11Min=-0.5 FrameElem=4 ElemStation=0
 Frame=4 Station=0.0625 OutputCase=TERRVERT CaseType=LinStatic P=1.64270738195066 V2=-592.527339069406
 V3=0 T=0 M2=0 M3=41.2491407520429 S11Max=249.137551894208 PtS11Max=1 x2S11Max=-0.5 x3S11Max=-0.5
 S11Min=-245.852137130307 PtS11Min=3 x2S11Min=0.5 x3S11Min=-0.5 FrameElem=4 ElemStation=0.0625
 Frame=4 Station=0.125 OutputCase=TERRVERT CaseType=LinStatic P=1.64270738195066 V2=-592.527339069406
 V3=0 T=0 M2=0 M3=78.2820994438807 S11Max=471.335304045235 PtS11Max=1 x2S11Max=-0.5 x3S11Max=-0.5
 S11Min=-468.049889281334 PtS11Min=3 x2S11Min=0.5 x3S11Min=-0.5 FrameElem=4 ElemStation=0.125

```

Frame=4 Station=0.1875 OutputCase=TERRVERT CaseType=LinStatic P=1.64270738195066 V2=-592.527339069406
V3=0 T=0 M2=0 M3=115.315058135719 S11Max=693.533056196262 PtS11Max=1 x2S11Max=-0.5 x3S11Max=-0.5 _
S11Min=-690.247641432361 PtS11Min=3 x2S11Min=0.5 x3S11Min=-0.5 FrameElem=4 ElemStation=0.1875
Frame=4 Station=0.25 OutputCase=TERRVERT CaseType=LinStatic P=1.64270738195066 V2=-592.527339069406
V3=0 T=0 M2=0 M3=152.348016827556 S11Max=915.730808347289 PtS11Max=1 x2S11Max=-0.5 x3S11Max=-0.5 _
S11Min=-912.445393583388 PtS11Min=3 x2S11Min=0.5 x3S11Min=-0.5 FrameElem=4 ElemStation=0.25
Frame=4 Station=0 OutputCase=TERRLAT CaseType=LinStatic P=-373.013713761059 V2=-0.450396838020197
V3=0 T=0 M2=0 M3=83.913604107052 S11Max=130.467910881253 PtS11Max=1 x2S11Max=-0.5 x3S11Max=-0.5 _
S11Min=-876.495338403371 PtS11Min=3 x2S11Min=0.5 x3S11Min=-0.5 FrameElem=4 ElemStation=0
Frame=4 Station=0.0625 OutputCase=TERRLAT CaseType=LinStatic P=-373.013713761059 V2=-0.450396838020197
V3=0 T=0 M2=0 M3=83.9417539094283 S11Max=130.636809695511 PtS11Max=1 x2S11Max=-0.5 x3S11Max=-0.5 _
S11Min=-876.664237217629 PtS11Min=3 x2S11Min=0.5 x3S11Min=-0.5 FrameElem=4 ElemStation=0.0625
Frame=4 Station=0.125 OutputCase=TERRLAT CaseType=LinStatic P=-373.013713761059 V2=-0.450396838020197
V3=0 T=0 M2=0 M3=83.9699037118046 S11Max=130.805708509768 PtS11Max=1 x2S11Max=-0.5 x3S11Max=-0.5 _
S11Min=-876.833136031886 PtS11Min=3 x2S11Min=0.5 x3S11Min=-0.5 FrameElem=4 ElemStation=0.125
Frame=4 Station=0.1875 OutputCase=TERRLAT CaseType=LinStatic P=-373.013713761059 V2=-0.450396838020197
V3=0 T=0 M2=0 M3=83.9980535141808 S11Max=130.974607324026 PtS11Max=1 x2S11Max=-0.5 x3S11Max=-0.5 _
S11Min=-877.002034846144 PtS11Min=3 x2S11Min=0.5 x3S11Min=-0.5 FrameElem=4 ElemStation=0.1875
Frame=4 Station=0.25 OutputCase=TERRLAT CaseType=LinStatic P=-373.013713761059 V2=-0.450396838020197
V3=0 T=0 M2=0 M3=84.0262033165571 S11Max=131.143506138283 PtS11Max=1 x2S11Max=-0.5 x3S11Max=-0.5 _
S11Min=-877.170933660402 PtS11Min=3 x2S11Min=0.5 x3S11Min=-0.5 FrameElem=4 ElemStation=0.25
Frame=4 Station=0 OutputCase=ACCVERT CaseType=LinStatic P=0 V2=0 V3=0 T=0 M2=0 M3=0 S11Max=0
PtS11Max=0 x2S11Max=0 x3S11Max=0 S11Min=0 PtS11Min=0 x2S11Min=0 x3S11Min=0 FrameElem=4 ElemStation=0
Frame=4 Station=0.0625 OutputCase=ACCVERT CaseType=LinStatic P=0 V2=0 V3=0 T=0 M2=0 M3=0 S11Max=0
PtS11Max=0 x2S11Max=0 x3S11Max=0 S11Min=0 PtS11Min=0 x2S11Min=0 x3S11Min=0 FrameElem=4
ElemStation=0.0625
Frame=4 Station=0.125 OutputCase=ACCVERT CaseType=LinStatic P=0 V2=0 V3=0 T=0 M2=0 M3=0 S11Max=0
PtS11Max=0 x2S11Max=0 x3S11Max=0 S11Min=0 PtS11Min=0 x2S11Min=0 x3S11Min=0 FrameElem=4
ElemStation=0.125
Frame=4 Station=0.1875 OutputCase=ACCVERT CaseType=LinStatic P=0 V2=0 V3=0 T=0 M2=0 M3=0 S11Max=0
PtS11Max=0 x2S11Max=0 x3S11Max=0 S11Min=0 PtS11Min=0 x2S11Min=0 x3S11Min=0 FrameElem=4
ElemStation=0.1875
Frame=4 Station=0.25 OutputCase=ACCVERT CaseType=LinStatic P=0 V2=0 V3=0 T=0 M2=0 M3=0 S11Max=0
PtS11Max=0 x2S11Max=0 x3S11Max=0 S11Min=0 PtS11Min=0 x2S11Min=0 x3S11Min=0 FrameElem=4
ElemStation=0.25
Frame=4 Station=0 OutputCase=ACCLATDX CaseType=LinStatic P=0 V2=0 V3=0 T=0 M2=0 M3=0 S11Max=0
PtS11Max=0 x2S11Max=0 x3S11Max=0 S11Min=0 PtS11Min=0 x2S11Min=0 x3S11Min=0 FrameElem=4 ElemStation=0
Frame=4 Station=0.0625 OutputCase=ACCLATDX CaseType=LinStatic P=0 V2=0 V3=0 T=0 M2=0 M3=0 S11Max=0
PtS11Max=0 x2S11Max=0 x3S11Max=0 S11Min=0 PtS11Min=0 x2S11Min=0 x3S11Min=0 FrameElem=4
ElemStation=0.0625
Frame=4 Station=0.125 OutputCase=ACCLATDX CaseType=LinStatic P=0 V2=0 V3=0 T=0 M2=0 M3=0 S11Max=0
PtS11Max=0 x2S11Max=0 x3S11Max=0 S11Min=0 PtS11Min=0 x2S11Min=0 x3S11Min=0 FrameElem=4
ElemStation=0.125
Frame=4 Station=0.1875 OutputCase=ACCLATDX CaseType=LinStatic P=0 V2=0 V3=0 T=0 M2=0 M3=0 S11Max=0
PtS11Max=0 x2S11Max=0 x3S11Max=0 S11Min=0 PtS11Min=0 x2S11Min=0 x3S11Min=0 FrameElem=4
ElemStation=0.1875
Frame=4 Station=0.25 OutputCase=ACCLATDX CaseType=LinStatic P=0 V2=0 V3=0 T=0 M2=0 M3=0 S11Max=0
PtS11Max=0 x2S11Max=0 x3S11Max=0 S11Min=0 PtS11Min=0 x2S11Min=0 x3S11Min=0 FrameElem=4
ElemStation=0.25
Frame=4 Station=0 OutputCase=ACCLATSX CaseType=LinStatic P=0 V2=0 V3=0 T=0 M2=0 M3=0 S11Max=0
PtS11Max=0 x2S11Max=0 x3S11Max=0 S11Min=0 PtS11Min=0 x2S11Min=0 x3S11Min=0 FrameElem=4 ElemStation=0
Frame=4 Station=0.0625 OutputCase=ACCLATSX CaseType=LinStatic P=0 V2=0 V3=0 T=0 M2=0 M3=0 S11Max=0
PtS11Max=0 x2S11Max=0 x3S11Max=0 S11Min=0 PtS11Min=0 x2S11Min=0 x3S11Min=0 FrameElem=4
ElemStation=0.0625
Frame=4 Station=0.125 OutputCase=ACCLATSX CaseType=LinStatic P=0 V2=0 V3=0 T=0 M2=0 M3=0 S11Max=0
PtS11Max=0 x2S11Max=0 x3S11Max=0 S11Min=0 PtS11Min=0 x2S11Min=0 x3S11Min=0 FrameElem=4
ElemStation=0.125
Frame=4 Station=0.1875 OutputCase=ACCLATSX CaseType=LinStatic P=0 V2=0 V3=0 T=0 M2=0 M3=0 S11Max=0
PtS11Max=0 x2S11Max=0 x3S11Max=0 S11Min=0 PtS11Min=0 x2S11Min=0 x3S11Min=0 FrameElem=4
ElemStation=0.1875
Frame=4 Station=0.25 OutputCase=ACCLATSX CaseType=LinStatic P=0 V2=0 V3=0 T=0 M2=0 M3=0 S11Max=0
PtS11Max=0 x2S11Max=0 x3S11Max=0 S11Min=0 PtS11Min=0 x2S11Min=0 x3S11Min=0 FrameElem=4
ElemStation=0.25
Frame=4 Station=0 OutputCase=TERRCOST CaseType=LinStatic P=0 V2=0 V3=0 T=0 M2=0 M3=0 S11Max=0
PtS11Max=0 x2S11Max=0 x3S11Max=0 S11Min=0 PtS11Min=0 x2S11Min=0 x3S11Min=0 FrameElem=4 ElemStation=0
Frame=4 Station=0.0625 OutputCase=TERRCOST CaseType=LinStatic P=0 V2=0 V3=0 T=0 M2=0 M3=0 S11Max=0
PtS11Max=0 x2S11Max=0 x3S11Max=0 S11Min=0 PtS11Min=0 x2S11Min=0 x3S11Min=0 FrameElem=4
ElemStation=0.0625
Frame=4 Station=0.125 OutputCase=TERRCOST CaseType=LinStatic P=0 V2=0 V3=0 T=0 M2=0 M3=0 S11Max=0
PtS11Max=0 x2S11Max=0 x3S11Max=0 S11Min=0 PtS11Min=0 x2S11Min=0 x3S11Min=0 FrameElem=4
ElemStation=0.125
Frame=4 Station=0.1875 OutputCase=TERRCOST CaseType=LinStatic P=0 V2=0 V3=0 T=0 M2=0 M3=0 S11Max=0
PtS11Max=0 x2S11Max=0 x3S11Max=0 S11Min=0 PtS11Min=0 x2S11Min=0 x3S11Min=0 FrameElem=4
ElemStation=0.1875
Frame=4 Station=0.25 OutputCase=TERRCOST CaseType=LinStatic P=0 V2=0 V3=0 T=0 M2=0 M3=0 S11Max=0
PtS11Max=0 x2S11Max=0 x3S11Max=0 S11Min=0 PtS11Min=0 x2S11Min=0 x3S11Min=0 FrameElem=4
ElemStation=0.25
Frame=4 Station=0 OutputCase=SOVRCOST CaseType=LinStatic P=0 V2=0 V3=0 T=0 M2=0 M3=0 S11Max=0
PtS11Max=0 x2S11Max=0 x3S11Max=0 S11Min=0 PtS11Min=0 x2S11Min=0 x3S11Min=0 FrameElem=4 ElemStation=0
Frame=4 Station=0.0625 OutputCase=SOVRCOST CaseType=LinStatic P=0 V2=0 V3=0 T=0 M2=0 M3=0 S11Max=0
PtS11Max=0 x2S11Max=0 x3S11Max=0 S11Min=0 PtS11Min=0 x2S11Min=0 x3S11Min=0 FrameElem=4
ElemStation=0.0625

```



Frame=4 Station=0.125 OutputCase=SOVRCOST CaseType=LinStatic P=0 V2=0 V3=0 T=0 M2=0 M3=0
 S11Max=0 PtS11Max=0 x2S11Max=0 x3S11Max=0 S11Min=0 PtS11Min=0 x2S11Min=0 x3S11Min=0 FrameElem=4
 ElemStation=0.125
 Frame=4 Station=0.1875 OutputCase=SOVRCOST CaseType=LinStatic P=0 V2=0 V3=0 T=0 M2=0 M3=0
 S11Max=0 PtS11Max=0 x2S11Max=0 x3S11Max=0 S11Min=0 PtS11Min=0 x2S11Min=0 x3S11Min=0 FrameElem=4
 ElemStation=0.1875
 Frame=4 Station=0.25 OutputCase=SOVRCOST CaseType=LinStatic P=0 V2=0 V3=0 T=0 M2=0 M3=0
 S11Max=0 PtS11Max=0 x2S11Max=0 x3S11Max=0 S11Min=0 PtS11Min=0 x2S11Min=0 x3S11Min=0 FrameElem=4
 ElemStation=0.25
 Frame=4 Station=0 OutputCase=ENVE CaseType=Combination StepType=Max P=-274.637838986978 V2=-
 733.563392673162 V3=0 T=0 M2=0 M3=96.944323249863 S11Max=195.123986383883 PtS11Max=1 x2S11Max=-0.5
 x3S11Max=-0.5
 S11Min=-705.259291093462 PtS11Min=3 x2S11Min=0.5 x3S11Min=-0.5 FrameElem=4 ElemStation=0
 Frame=4 Station=0.0625 OutputCase=ENVE CaseType=Combination StepType=Max P=-274.637838986978 V2=-
 732.000892673162 V3=0 T=0 M2=0 M3=142.751652107649 S11Max=469.967959530596 PtS11Max=1 x2S11Max=-0.5
 x3S11Max=-0.5 S11Min=-980.052594595898 PtS11Min=3 x2S11Min=0.5 x3S11Min=-0.5 FrameElem=4
 ElemStation=0.0625
 Frame=4 Station=0.125 OutputCase=ENVE CaseType=Combination StepType=Max P=-274.637838986978 V2=-
 730.438392673162 V3=0 T=0 M2=0 M3=188.461324715434 S11Max=744.225995177309 PtS11Max=1 x2S11Max=-0.5
 x3S11Max=-0.5
 S11Min=-1254.25996059833 PtS11Min=3 x2S11Min=0.5 x3S11Min=-0.5 FrameElem=4 ElemStation=0.125
 Frame=4 Station=0.1875 OutputCase=ENVE CaseType=Combination StepType=Max P=-274.637838986978 V2=-
 728.875892673162 V3=0 T=0 M2=0 M3=234.07334107322 S11Max=1017.89809332402 PtS11Max=1 x2S11Max=-0.5
 x3S11Max=-0.5
 S11Min=-1527.88138910077 PtS11Min=3 x2S11Min=0.5 x3S11Min=-0.5 FrameElem=4 ElemStation=0.1875
 Frame=4 Station=0.25 OutputCase=ENVE CaseType=Combination StepType=Max P=-274.637838986978 V2=-
 727.313392673162 V3=0 T=0 M2=0 M3=279.587701181005 S11Max=1290.98425397074 PtS11Max=1 x2S11Max=-0.5
 x3S11Max=-0.5
 S11Min=-1800.91688010321 PtS11Min=3 x2S11Min=0.5 x3S11Min=-0.5 FrameElem=4 ElemStation=0.25
 Frame=4 Station=0 OutputCase=ENVE CaseType=Combination StepType=Min P=-386.541953115296 V2=-
 733.698511724568 V3=0 T=0 M2=0 M3=71.7702420177474 S11Max=155.983613119507 PtS11Max=1 x2S11Max=-0.5
 x3S11Max=-0.5
 S11Min=-968.207892614474 PtS11Min=3 x2S11Min=0.5 x3S11Min=-0.5 FrameElem=4 ElemStation=0
 Frame=4 Station=0.0625 OutputCase=ENVE CaseType=Combination StepType=Min P=-386.541953115296 V2=-
 732.136011724568 V3=0 T=0 M2=0 M3=117.56912593482 S11Max=430.776916621943 PtS11Max=1 x2S11Max=-0.5
 x3S11Max=-0.5
 S11Min=-1243.05186576119 PtS11Min=3 x2S11Min=0.5 x3S11Min=-0.5 FrameElem=4 ElemStation=0.0625
 Frame=4 Station=0.125 OutputCase=ENVE CaseType=Combination StepType=Min P=-386.541953115296 V2=-
 730.573511724568 V3=0 T=0 M2=0 M3=163.270353601893 S11Max=704.984282624378 PtS11Max=1 x2S11Max=-0.5
 x3S11Max=-0.5
 S11Min=-1517.3099014079 PtS11Min=3 x2S11Min=0.5 x3S11Min=-0.5 FrameElem=4 ElemStation=0.125
 Frame=4 Station=0.1875 OutputCase=ENVE CaseType=Combination StepType=Min P=-386.541953115296 V2=-
 729.011011724568 V3=0 T=0 M2=0 M3=208.873925018965 S11Max=978.605711126814 PtS11Max=1 x2S11Max=-0.5
 x3S11Max=-0.5 S11Min=-1790.98199955461 PtS11Min=3 x2S11Min=0.5 x3S11Min=-0.5 FrameElem=4
 ElemStation=0.1875
 Frame=4 Station=0.25 OutputCase=ENVE CaseType=Combination StepType=Min P=-386.541953115296 V2=-
 727.448511724568 V3=0 T=0 M2=0 M3=254.379840186038 S11Max=1251.64120212925 PtS11Max=1 x2S11Max=-0.5
 x3S11Max=-0.5
 S11Min=-2064.06816020133 PtS11Min=3 x2S11Min=0.5 x3S11Min=-0.5 FrameElem=4 ElemStation=0.25
 Frame=4 Station=0 OutputCase=FESSUR CaseType=Combination P=-386.541953115296 V2=-733.698511724568
 V3=0 T=0 M2=0 M3=96.944323249863 S11Max=195.123986383883 PtS11Max=1 x2S11Max=-0.5 x3S11Max=-0.5
 S11Min=-968.207892614474 PtS11Min=3 x2S11Min=0.5 x3S11Min=-0.5 FrameElem=4 ElemStation=0
 Frame=4 Station=0.0625 OutputCase=FESSUR CaseType=Combination P=-386.541953115296 V2=-732.136011724568
 V3=0 T=0 M2=0 M3=142.751652107649 S11Max=469.967959530596 PtS11Max=1 x2S11Max=-0.5 x3S11Max=-0.5
 S11Min=-1243.05186576119 PtS11Min=3 x2S11Min=0.5 x3S11Min=-0.5 FrameElem=4 ElemStation=0.0625
 Frame=4 Station=0.125 OutputCase=FESSUR CaseType=Combination P=-386.541953115296 V2=-730.573511724568
 V3=0 T=0 M2=0 M3=188.461324715434 S11Max=744.225995177309 PtS11Max=1 x2S11Max=-0.5 x3S11Max=-0.5
 S11Min=-1517.3099014079 PtS11Min=3 x2S11Min=0.5 x3S11Min=-0.5 FrameElem=4 ElemStation=0.125
 Frame=4 Station=0.1875 OutputCase=FESSUR CaseType=Combination P=-386.541953115296 V2=-729.011011724568
 V3=0 T=0 M2=0 M3=234.07334107322 S11Max=1017.89809332402 PtS11Max=1 x2S11Max=-0.5 x3S11Max=-0.5
 S11Min=-1790.98199955461 PtS11Min=3 x2S11Min=0.5 x3S11Min=-0.5 FrameElem=4 ElemStation=0.1875
 Frame=4 Station=0.25 OutputCase=FESSUR CaseType=Combination P=-386.541953115296 V2=-727.448511724568
 V3=0 T=0 M2=0 M3=279.587701181005 S11Max=1290.98425397074 PtS11Max=1 x2S11Max=-0.5 x3S11Max=-0.5
 S11Min=-2064.06816020133 PtS11Min=3 x2S11Min=0.5 x3S11Min=-0.5 FrameElem=4 ElemStation=0.25
 Frame=5 Station=0 OutputCase=PESOPR CaseType=LinStatic P=-15.1709467361879 V2=-157.292540241295 V3=0
 T=0 M2=0 M3=43.2134810368843 S11Max=244.109939485118 PtS11Max=1 x2S11Max=-0.5 x3S11Max=-0.5
 S11Min=-274.451832957494 PtS11Min=3 x2S11Min=0.5 x3S11Min=-0.5 FrameElem=5 ElemStation=0
 Frame=5 Station=6.24999940395355E-02 OutputCase=PESOPR CaseType=LinStatic P=-15.1709467361879 V2=-
 155.730040390306 V3=0 T=0 M2=0 M3=52.9954357487419 S11Max=302.801667756263 PtS11Max=1 x2S11Max=-0.5
 x3S11Max=-0.5
 S11Min=-333.143561228639 PtS11Min=3 x2S11Min=0.5 x3S11Min=-0.5 FrameElem=5
 ElemStation=6.24999940395355E-02
 Frame=5 Station=0.124999988079071 OutputCase=PESOPR CaseType=LinStatic P=-15.1709467361879 V2=-
 154.167540539318 V3=0 T=0 M2=0 M3=62.6797342292259 S11Max=360.907458639167 PtS11Max=1 x2S11Max=-0.5
 x3S11Max=-0.5
 S11Min=-391.249352111543 PtS11Min=3 x2S11Min=0.5 x3S11Min=-0.5 FrameElem=5
 ElemStation=0.124999988079071
 Frame=5 Station=0.187499982118607 OutputCase=PESOPR CaseType=LinStatic P=-15.1709467361879 V2=-
 152.60504068833 V3=0 T=0 M2=0 M3=72.2663764783363 S11Max=418.42731213383 PtS11Max=1 x2S11Max=-0.5
 x3S11Max=-0.5
 S11Min=-448.769205606206 PtS11Min=3 x2S11Min=0.5 x3S11Min=-0.5 FrameElem=5
 ElemStation=0.187499982118607



Frame=5 Station=0.249999976158142 OutputCase=PESOPR CaseType=LinStatic P=-15.1709467361879 V2=-151.042540837341 V3=0 T=0 M2=0 M3=81.7553624960732 S11Max=475.361228240252 PtS11Max=1 x2S11Max=-0.5 x3S11Max=-0.5
 S11Min=-505.703121712627 PtS11Min=3 x2S11Min=0.5 x3S11Min=-0.5 FrameElem=5
 ElemStation=0.249999976158142
 Frame=5 Station=0 OutputCase=TERRVERT CaseType=LinStatic P=1.64270738195467 V2=-664.026818334707 V3=0 T=0 M2=0 M3=152.3480168276 S11Max=915.730808347555 PtS11Max=1 x2S11Max=-0.5 x3S11Max=-0.5
 S11Min=-912.445393583646 PtS11Min=3 x2S11Min=0.5 x3S11Min=-0.5 FrameElem=5 ElemStation=0
 Frame=5 Station=6.24999940395355E-02 OutputCase=TERRVERT CaseType=LinStatic P=1.64270738195467 V2=-664.026818334707 V3=0 T=0 M2=0 M3=193.849689015611 S11Max=1164.74084147562 PtS11Max=1 x2S11Max=-0.5 x3S11Max=-0.5
 S11Min=-1161.45542671171 PtS11Min=3 x2S11Min=0.5 x3S11Min=-0.5 FrameElem=5
 ElemStation=6.24999940395355E-02
 Frame=5 Station=0.124999988079071 OutputCase=TERRVERT CaseType=LinStatic P=1.64270738195467 V2=-664.026818334707 V3=0 T=0 M2=0 M3=235.351361203622 S11Max=1413.75087460369 PtS11Max=1 x2S11Max=-0.5 x3S11Max=-0.5
 S11Min=-1410.46545983978 PtS11Min=3 x2S11Min=0.5 x3S11Min=-0.5 FrameElem=5
 ElemStation=0.124999988079071
 Frame=5 Station=0.187499982118607 OutputCase=TERRVERT CaseType=LinStatic P=1.64270738195467 V2=-664.026818334707 V3=0 T=0 M2=0 M3=276.853033391633 S11Max=1662.76090773175 PtS11Max=1 x2S11Max=-0.5 x3S11Max=-0.5
 S11Min=-1659.47549296784 PtS11Min=3 x2S11Min=0.5 x3S11Min=-0.5 FrameElem=5
 ElemStation=0.187499982118607
 Frame=5 Station=0.249999976158142 OutputCase=TERRVERT CaseType=LinStatic P=1.64270738195467 V2=-664.026818334707 V3=0 T=0 M2=0 M3=318.354705579644 S11Max=1911.77094085982 PtS11Max=1 x2S11Max=-0.5 x3S11Max=-0.5
 S11Min=-1908.48552609591 PtS11Min=3 x2S11Min=0.5 x3S11Min=-0.5 FrameElem=5
 ElemStation=0.249999976158142
 Frame=5 Station=0 OutputCase=TERRLAT CaseType=LinStatic P=-373.013713761061 V2=-0.18583225706152 V3=0 T=0 M2=0 M3=84.0262033165573 S11Max=131.143506138283 PtS11Max=1 x2S11Max=-0.5 x3S11Max=-0.5
 S11Min=-877.170933660404 PtS11Min=3 x2S11Min=0.5 x3S11Min=-0.5 FrameElem=5 ElemStation=0
 Frame=5 Station=6.24999940395355E-02 OutputCase=TERRLAT CaseType=LinStatic P=-373.013713761061 V2=-0.18583225706152 V3=0 T=0 M2=0 M3=84.037817831516 S11Max=131.213193228035 PtS11Max=1 x2S11Max=-0.5 x3S11Max=-0.5
 S11Min=-877.240620750157 PtS11Min=3 x2S11Min=0.5 x3S11Min=-0.5 FrameElem=5
 ElemStation=6.24999940395355E-02
 Frame=5 Station=0.124999988079071 OutputCase=TERRLAT CaseType=LinStatic P=-373.013713761061 V2=-0.18583225706152 V3=0 T=0 M2=0 M3=84.0494323464746 S11Max=131.282880317787 PtS11Max=1 x2S11Max=-0.5 x3S11Max=-0.5
 S11Min=-877.310307839909 PtS11Min=3 x2S11Min=0.5 x3S11Min=-0.5 FrameElem=5
 ElemStation=0.124999988079071
 Frame=5 Station=0.187499982118607 OutputCase=TERRLAT CaseType=LinStatic P=-373.013713761061 V2=-0.18583225706152 V3=0 T=0 M2=0 M3=84.0610468614333 S11Max=131.352567407539 PtS11Max=1 x2S11Max=-0.5 x3S11Max=-0.5
 S11Min=-877.379994929661 PtS11Min=3 x2S11Min=0.5 x3S11Min=-0.5 FrameElem=5
 ElemStation=0.187499982118607
 Frame=5 Station=0.249999976158142 OutputCase=TERRLAT CaseType=LinStatic P=-373.013713761061 V2=-0.18583225706152 V3=0 T=0 M2=0 M3=84.072661376392 S11Max=131.422254497291 PtS11Max=1 x2S11Max=-0.5 x3S11Max=-0.5
 S11Min=-877.449682019413 PtS11Min=3 x2S11Min=0.5 x3S11Min=-0.5 FrameElem=5
 ElemStation=0.249999976158142
 Frame=5 Station=0 OutputCase=ACCVERT CaseType=LinStatic P=0 V2=0 V3=0 T=0 M2=0 M3=0 S11Max=0 PtS11Max=0 x2S11Max=0 x3S11Max=0 S11Min=0 PtS11Min=0 x2S11Min=0 x3S11Min=0 FrameElem=5 ElemStation=0
 Frame=5 Station=6.24999940395355E-02 OutputCase=ACCVERT CaseType=LinStatic P=0 V2=0 V3=0 T=0 M2=0 M3=0 S11Max=0 PtS11Max=0 x2S11Max=0 x3S11Max=0 S11Min=0 PtS11Min=0 x2S11Min=0 x3S11Min=0
 FrameElem=5 ElemStation=6.24999940395355E-02
 Frame=5 Station=0.124999988079071 OutputCase=ACCVERT CaseType=LinStatic P=0 V2=0 V3=0 T=0 M2=0 M3=0 S11Max=0 PtS11Max=0 x2S11Max=0 x3S11Max=0 S11Min=0 PtS11Min=0 x2S11Min=0 x3S11Min=0
 FrameElem=5 ElemStation=0.124999988079071
 Frame=5 Station=0.187499982118607 OutputCase=ACCVERT CaseType=LinStatic P=0 V2=0 V3=0 T=0 M2=0 M3=0 S11Max=0 PtS11Max=0 x2S11Max=0 x3S11Max=0 S11Min=0 PtS11Min=0 x2S11Min=0 x3S11Min=0
 FrameElem=5 ElemStation=0.187499982118607
 Frame=5 Station=0.249999976158142 OutputCase=ACCVERT CaseType=LinStatic P=0 V2=0 V3=0 T=0 M2=0 M3=0 S11Max=0 PtS11Max=0 x2S11Max=0 x3S11Max=0 S11Min=0 PtS11Min=0 x2S11Min=0 x3S11Min=0
 FrameElem=5 ElemStation=0.249999976158142
 Frame=5 Station=0 OutputCase=ACCLATDX CaseType=LinStatic P=0 V2=0 V3=0 T=0 M2=0 M3=0 S11Max=0 PtS11Max=0 x2S11Max=0 x3S11Max=0 S11Min=0 PtS11Min=0 x2S11Min=0 x3S11Min=0 FrameElem=5 ElemStation=0
 Frame=5 Station=6.24999940395355E-02 OutputCase=ACCLATDX CaseType=LinStatic P=0 V2=0 V3=0 T=0 M2=0 M3=0 S11Max=0 PtS11Max=0 x2S11Max=0 x3S11Max=0 S11Min=0 PtS11Min=0 x2S11Min=0 x3S11Min=0
 FrameElem=5 ElemStation=6.24999940395355E-02
 Frame=5 Station=0.124999988079071 OutputCase=ACCLATDX CaseType=LinStatic P=0 V2=0 V3=0 T=0 M2=0 M3=0 S11Max=0 PtS11Max=0 x2S11Max=0 x3S11Max=0 S11Min=0 PtS11Min=0 x2S11Min=0 x3S11Min=0
 FrameElem=5 ElemStation=0.124999988079071
 Frame=5 Station=0.187499982118607 OutputCase=ACCLATDX CaseType=LinStatic P=0 V2=0 V3=0 T=0 M2=0 M3=0 S11Max=0 PtS11Max=0 x2S11Max=0 x3S11Max=0 S11Min=0 PtS11Min=0 x2S11Min=0 x3S11Min=0
 FrameElem=5 ElemStation=0.187499982118607
 Frame=5 Station=0.249999976158142 OutputCase=ACCLATDX CaseType=LinStatic P=0 V2=0 V3=0 T=0 M2=0 M3=0 S11Max=0 PtS11Max=0 x2S11Max=0 x3S11Max=0 S11Min=0 PtS11Min=0 x2S11Min=0 x3S11Min=0
 FrameElem=5 ElemStation=0.249999976158142
 Frame=5 Station=0 OutputCase=ACCLATSX CaseType=LinStatic P=0 V2=0 V3=0 T=0 M2=0 M3=0 S11Max=0 PtS11Max=0 x2S11Max=0 x3S11Max=0 S11Min=0 PtS11Min=0 x2S11Min=0 x3S11Min=0 FrameElem=5 ElemStation=0



```

Frame=5 Station=6.24999940395355E-02 OutputCase=ACCLATSX CaseType=LinStatic P=0 V2=0 V3=0 T=0
M2=0 M3=0 S11Max=0 PtS11Max=0 x2S11Max=0 x3S11Max=0 S11Min=0 PtS11Min=0 x2S11Min=0 x3S11Min=0
FrameElem=5 ElemStation=6.24999940395355E-02
Frame=5 Station=0.124999988079071 OutputCase=ACCLATSX CaseType=LinStatic P=0 V2=0 V3=0 T=0 M2=0
M3=0 S11Max=0 PtS11Max=0 x2S11Max=0 x3S11Max=0 S11Min=0 PtS11Min=0 x2S11Min=0 x3S11Min=0
FrameElem=5 ElemStation=0.124999988079071
Frame=5 Station=0.187499982118607 OutputCase=ACCLATSX CaseType=LinStatic P=0 V2=0 V3=0 T=0 M2=0
M3=0 S11Max=0 PtS11Max=0 x2S11Max=0 x3S11Max=0 S11Min=0 PtS11Min=0 x2S11Min=0 x3S11Min=0
FrameElem=5 ElemStation=0.187499982118607
Frame=5 Station=0.249999976158142 OutputCase=ACCLATSX CaseType=LinStatic P=0 V2=0 V3=0 T=0 M2=0
M3=0 S11Max=0 PtS11Max=0 x2S11Max=0 x3S11Max=0 S11Min=0 PtS11Min=0 x2S11Min=0 x3S11Min=0
FrameElem=5 ElemStation=0.249999976158142
Frame=5 Station=0 OutputCase=TERRCOST CaseType=LinStatic P=0 V2=0 V3=0 T=0 M2=0 M3=0 S11Max=0
PtS11Max=0 x2S11Max=0 x3S11Max=0 S11Min=0 PtS11Min=0 x2S11Min=0 x3S11Min=0 FrameElem=5 ElemStation=0
Frame=5 Station=6.24999940395355E-02 OutputCase=TERRCOST CaseType=LinStatic P=0 V2=0 V3=0 T=0
M2=0 M3=0 S11Max=0 PtS11Max=0 x2S11Max=0 x3S11Max=0 S11Min=0 PtS11Min=0 x2S11Min=0 x3S11Min=0
FrameElem=5 ElemStation=6.24999940395355E-02
Frame=5 Station=0.124999988079071 OutputCase=TERRCOST CaseType=LinStatic P=0 V2=0 V3=0 T=0 M2=0
M3=0 S11Max=0 PtS11Max=0 x2S11Max=0 x3S11Max=0 S11Min=0 PtS11Min=0 x2S11Min=0 x3S11Min=0
FrameElem=5 ElemStation=0.124999988079071
Frame=5 Station=0.187499982118607 OutputCase=TERRCOST CaseType=LinStatic P=0 V2=0 V3=0 T=0 M2=0
M3=0 S11Max=0 PtS11Max=0 x2S11Max=0 x3S11Max=0 S11Min=0 PtS11Min=0 x2S11Min=0 x3S11Min=0
FrameElem=5 ElemStation=0.187499982118607
Frame=5 Station=0.249999976158142 OutputCase=TERRCOST CaseType=LinStatic P=0 V2=0 V3=0 T=0 M2=0
M3=0 S11Max=0 PtS11Max=0 x2S11Max=0 x3S11Max=0 S11Min=0 PtS11Min=0 x2S11Min=0 x3S11Min=0
FrameElem=5 ElemStation=0.249999976158142
Frame=5 Station=0 OutputCase=SOVRCOST CaseType=LinStatic P=0 V2=0 V3=0 T=0 M2=0 M3=0 S11Max=0
PtS11Max=0 x2S11Max=0 x3S11Max=0 S11Min=0 PtS11Min=0 x2S11Min=0 x3S11Min=0 FrameElem=5 ElemStation=0
Frame=5 Station=6.24999940395355E-02 OutputCase=SOVRCOST CaseType=LinStatic P=0 V2=0 V3=0 T=0
M2=0 M3=0 S11Max=0 PtS11Max=0 x2S11Max=0 x3S11Max=0 S11Min=0 PtS11Min=0 x2S11Min=0 x3S11Min=0
FrameElem=5 ElemStation=6.24999940395355E-02
Frame=5 Station=0.124999988079071 OutputCase=SOVRCOST CaseType=LinStatic P=0 V2=0 V3=0 T=0 M2=0
M3=0 S11Max=0 PtS11Max=0 x2S11Max=0 x3S11Max=0 S11Min=0 PtS11Min=0 x2S11Min=0 x3S11Min=0
FrameElem=5 ElemStation=0.124999988079071
Frame=5 Station=0.187499982118607 OutputCase=SOVRCOST CaseType=LinStatic P=0 V2=0 V3=0 T=0 M2=0
M3=0 S11Max=0 PtS11Max=0 x2S11Max=0 x3S11Max=0 S11Min=0 PtS11Min=0 x2S11Min=0 x3S11Min=0
FrameElem=5 ElemStation=0.187499982118607
Frame=5 Station=0.249999976158142 OutputCase=SOVRCOST CaseType=LinStatic P=0 V2=0 V3=0 T=0 M2=0
M3=0 S11Max=0 PtS11Max=0 x2S11Max=0 x3S11Max=0 S11Min=0 PtS11Min=0 x2S11Min=0 x3S11Min=0
FrameElem=5 ElemStation=0.249999976158142
Frame=5 Station=0 OutputCase=ENVE CaseType=Combination StepType=Max P=-274.637838986976 V2=-
821.449441155945 V3=0 T=0 M2=0 M3=279.587701181042 S11Max=1290.98425397096 PtS11Max=1 x2S11Max=-0.5
x3S11Max=-0.5
S11Min=-1800.91688010342 PtS11Min=3 x2S11Min=0.5 x3S11Min=-0.5 FrameElem=5 ElemStation=0
Frame=5 Station=6.24999940395355E-02 OutputCase=ENVE CaseType=Combination StepType=Max P=-
274.637838986976 V2=-819.886941304957 V3=0 T=0 M2=0 M3=330.882942595869 S11Max=1598.75570245992
PtS11Max=1 x2S11Max=-0.5
x3S11Max=-0.5 S11Min=-2108.66742246546 PtS11Min=3 x2S11Min=0.5 x3S11Min=-0.5 FrameElem=5
ElemStation=6.24999940395355E-02
Frame=5 Station=0.124999988079071 OutputCase=ENVE CaseType=Combination StepType=Max P=-274.637838986976
V2=-818.324441453968 V3=0 T=0 M2=0 M3=382.080527779323 S11Max=1905.94121356064 PtS11Max=1 x2S11Max=-
0.5
x3S11Max=-0.5 S11Min=-2415.83202743926 PtS11Min=3 x2S11Min=0.5 x3S11Min=-0.5 FrameElem=5
ElemStation=0.124999988079071
Frame=5 Station=0.187499982118607 OutputCase=ENVE CaseType=Combination StepType=Max P=-274.637838986976
V2=-816.76194160298 V3=0 T=0 M2=0 M3=433.180456731403 S11Max=2212.54078727312 PtS11Max=1 x2S11Max=-0.5
x3S11Max=-0.5 S11Min=-2722.41069502481 PtS11Min=3 x2S11Min=0.5 x3S11Min=-0.5 FrameElem=5
ElemStation=0.187499982118607
Frame=5 Station=0.249999976158142 OutputCase=ENVE CaseType=Combination StepType=Max P=-274.637838986976
V2=-815.199441751991 V3=0 T=0 M2=0 M3=484.182729452109 S11Max=2518.55442359736 PtS11Max=1 x2S11Max=-
0.5
x3S11Max=-0.5 S11Min=-3028.40342522213 PtS11Min=3 x2S11Min=0.5 x3S11Min=-0.5 FrameElem=5
ElemStation=0.249999976158142
Frame=5 Station=0 OutputCase=ENVE CaseType=Combination StepType=Min P=-386.541953115294 V2=-
821.505190833063 V3=0 T=0 M2=0 M3=254.379840186074 S11Max=1251.64120212947 PtS11Max=1 x2S11Max=-0.5
x3S11Max=-0.5
S11Min=-2064.06816020154 PtS11Min=3 x2S11Min=0.5 x3S11Min=-0.5 FrameElem=5 ElemStation=0
Frame=5 Station=6.24999940395355E-02 OutputCase=ENVE CaseType=Combination StepType=Min P=-
386.541953115294 V2=-819.942690982075 V3=0 T=0 M2=0 M3=305.671597246414 S11Max=1559.39174449151
PtS11Max=1 x2S11Max=-0.5
x3S11Max=-0.5 S11Min=-2371.83960869051 PtS11Min=3 x2S11Min=0.5 x3S11Min=-0.5 FrameElem=5
ElemStation=6.24999940395355E-02
Frame=5 Station=0.124999988079071 OutputCase=ENVE CaseType=Combination StepType=Min P=-386.541953115294
V2=-818.380191131087 V3=0 T=0 M2=0 M3=356.86569807538 S11Max=1866.5563494653 PtS11Max=1 x2S11Max=-0.5
x3S11Max=-0.5 S11Min=-2679.02511979123 PtS11Min=3 x2S11Min=0.5 x3S11Min=-0.5 FrameElem=5
ElemStation=0.124999988079071
Frame=5 Station=0.187499982118607 OutputCase=ENVE CaseType=Combination StepType=Min P=-386.541953115294
V2=-816.817691280098 V3=0 T=0 M2=0 M3=407.962142672973 S11Max=2173.13501705086 PtS11Max=1 x2S11Max=-
0.5
x3S11Max=-0.5

```



x3S11Max=-0.5 S11Min=-2985.62469350371 PtS11Min=3 x2S11Min=0.5 x3S11Min=-0.5 FrameElem=5
 ElemStation=0.187499982118607
 Frame=5 Station=0.249999976158142 OutputCase=ENVE CaseType=Combination StepType=Min P=-386.541953115294
 V2=-815.25519142911 V3=0 T=0 M2=0 M3=458.960931039192 S11Max=2479.12774724817 PtS11Max=1 x2S11Max=-0.5

x3S11Max=-0.5 S11Min=-3291.63832982795 PtS11Min=3 x2S11Min=0.5 x3S11Min=-0.5 FrameElem=5
 ElemStation=0.249999976158142
 Frame=5 Station=0 OutputCase=FESSUR CaseType=Combination P=-386.541953115294 V2=-821.505190833063
 V3=0 T=0 M2=0 M3=279.587701181042 S11Max=1290.98425397096 PtS11Max=1 x2S11Max=-0.5 x3S11Max=-0.5
 S11Min=-2064.06816020154 PtS11Min=3 x2S11Min=0.5 x3S11Min=-0.5 FrameElem=5 ElemStation=0
 Frame=5 Station=6.24999940395355E-02 OutputCase=FESSUR CaseType=Combination P=-386.541953115294 V2=-
 819.942690982075 V3=0 T=0 M2=0 M3=330.882942595869 S11Max=1598.75570245992 PtS11Max=1 x2S11Max=-0.5
 x3S11Max=-0.5 S11Min=-2371.83960869051 PtS11Min=3 x2S11Min=0.5 x3S11Min=-0.5 FrameElem=5
 ElemStation=6.24999940395355E-02
 Frame=5 Station=0.124999988079071 OutputCase=FESSUR CaseType=Combination P=-386.541953115294 V2=-
 818.380191131087 V3=0 T=0 M2=0 M3=382.080527779323 S11Max=1905.94121356064 PtS11Max=1 x2S11Max=-0.5
 x3S11Max=-0.5
 S11Min=-2679.02511979123 PtS11Min=3 x2S11Min=0.5 x3S11Min=-0.5 FrameElem=5
 ElemStation=0.124999988079071
 Frame=5 Station=0.187499982118607 OutputCase=FESSUR CaseType=Combination P=-386.541953115294 V2=-
 816.817691280098 V3=0 T=0 M2=0 M3=433.180456731403 S11Max=2212.54078727312 PtS11Max=1 x2S11Max=-0.5
 x3S11Max=-0.5
 S11Min=-2985.62469350371 PtS11Min=3 x2S11Min=0.5 x3S11Min=-0.5 FrameElem=5
 ElemStation=0.187499982118607
 Frame=5 Station=0.249999976158142 OutputCase=FESSUR CaseType=Combination P=-386.541953115294 V2=-
 815.25519142911 V3=0 T=0 M2=0 M3=484.182729452109 S11Max=2518.55442359736 PtS11Max=1 x2S11Max=-0.5
 x3S11Max=-0.5
 S11Min=-3291.63832982795 PtS11Min=3 x2S11Min=0.5 x3S11Min=-0.5 FrameElem=5
 ElemStation=0.249999976158142
 Frame=41 Station=0 OutputCase=PESOPR CaseType=LinStatic P=-15.1709467361864 V2=106.633696120247 V3=0
 T=0 M2=0 M3=8.81453682374195 S11Max=37.7162742062653 PtS11Max=1 x2S11Max=-0.5 x3S11Max=-0.5
 S11Min=-68.0581676786381 PtS11Min=3 x2S11Min=0.5 x3S11Min=-0.5 FrameElem=41 ElemStation=0
 Frame=41 Station=0.125 OutputCase=PESOPR CaseType=LinStatic P=-15.1709467361864 V2=109.758696120247
 V3=0 T=0 M2=0 M3=-4.70998769128892 S11Max=13.0889794115471 PtS11Max=3 x2S11Max=0.5 x3S11Max=-0.5
 S11Min=-43.4308728839199 PtS11Min=1 x2S11Min=-0.5 x3S11Min=-0.5 FrameElem=41 ElemStation=0.125
 Frame=41 Station=0.25 OutputCase=PESOPR CaseType=LinStatic P=-15.1709467361864 V2=112.883696120247
 V3=0 T=0 M2=0 M3=-18.6251372063198 S11Max=96.5798765017323 PtS11Max=3 x2S11Max=0.5 x3S11Max=-0.5
 S11Min=-126.921769974105 PtS11Min=1 x2S11Min=-0.5 x3S11Min=-0.5 FrameElem=41 ElemStation=0.25
 Frame=41 Station=0.375 OutputCase=PESOPR CaseType=LinStatic P=-15.1709467361864 V2=116.008696120247
 V3=0 T=0 M2=0 M3=-32.9309117213506 S11Max=182.414523591917 PtS11Max=3 x2S11Max=0.5 x3S11Max=-0.5
 S11Min=-212.75641706429 PtS11Min=1 x2S11Min=-0.5 x3S11Min=-0.5 FrameElem=41 ElemStation=0.375
 Frame=41 Station=0.5 OutputCase=PESOPR CaseType=LinStatic P=-15.1709467361864 V2=119.133696120247
 V3=0 T=0 M2=0 M3=-47.6273112363815 S11Max=270.592920682103 PtS11Max=3 x2S11Max=0.5 x3S11Max=-0.5
 S11Min=-300.934814154475 PtS11Min=1 x2S11Min=-0.5 x3S11Min=-0.5 FrameElem=41 ElemStation=0.5
 Frame=41 Station=0.25 OutputCase=TERRVERT CaseType=LinStatic P=1.64270738195018 V2=485.966590798547 V3=0
 T=0 M2=0 M3=4.21618093400321 S11Max=26.9397929859694 PtS11Max=1 x2S11Max=-0.5 x3S11Max=-0.5
 S11Min=-23.6543782220691 PtS11Min=3 x2S11Min=0.5 x3S11Min=-0.5 FrameElem=41 ElemStation=0
 Frame=41 Station=0.125 OutputCase=TERRVERT CaseType=LinStatic P=1.64270738195018 V2=485.966590798547
 V3=0 T=0 M2=0 M3=-56.5296429158152 S11Max=340.820564876841 PtS11Max=3 x2S11Max=0.5 x3S11Max=-0.5
 S11Min=-337.535150112941 PtS11Min=1 x2S11Min=-0.5 x3S11Min=-0.5 FrameElem=41 ElemStation=0.125
 Frame=41 Station=0.25 OutputCase=TERRVERT CaseType=LinStatic P=1.64270738195018 V2=485.966590798547
 V3=0 T=0 M2=0 M3=-117.275466765634 S11Max=705.295507975752 PtS11Max=3 x2S11Max=0.5 x3S11Max=-0.5
 S11Min=-702.010093211851 PtS11Min=1 x2S11Min=-0.5 x3S11Min=-0.5 FrameElem=41 ElemStation=0.25
 Frame=41 Station=0.375 OutputCase=TERRVERT CaseType=LinStatic P=1.64270738195018 V2=485.966590798547
 V3=0 T=0 M2=0 M3=-178.021290615452 S11Max=1069.77045107466 PtS11Max=3 x2S11Max=0.5 x3S11Max=-0.5
 S11Min=-1066.48503631076 PtS11Min=1 x2S11Min=-0.5 x3S11Min=-0.5 FrameElem=41 ElemStation=0.375
 Frame=41 Station=0.5 OutputCase=TERRVERT CaseType=LinStatic P=1.64270738195018 V2=485.966590798547
 V3=0 T=0 M2=0 M3=-238.76711446527 S11Max=1434.24539417357 PtS11Max=3 x2S11Max=0.5 x3S11Max=-0.5
 S11Min=-1430.95997940967 PtS11Min=1 x2S11Min=-0.5 x3S11Min=-0.5 FrameElem=41 ElemStation=0.5
 Frame=41 Station=0 OutputCase=TERRLAT CaseType=LinStatic P=-373.013713761058 V2=0.703691179209386
 V3=0 T=0 M2=0 M3=83.9136108582861 S11Max=130.467951388658 PtS11Max=1 x2S11Max=-0.5 x3S11Max=-0.5
 S11Min=-876.495378910775 PtS11Min=3 x2S11Min=0.5 x3S11Min=-0.5 FrameElem=41 ElemStation=0
 Frame=41 Station=0.125 OutputCase=TERRLAT CaseType=LinStatic P=-373.013713761058 V2=0.703691179209386
 V3=0 T=0 M2=0 M3=83.8256494608849 S11Max=129.940183004251 PtS11Max=1 x2S11Max=-0.5 x3S11Max=-0.5
 S11Min=-875.967610526368 PtS11Min=3 x2S11Min=0.5 x3S11Min=-0.5 FrameElem=41 ElemStation=0.125
 Frame=41 Station=0.25 OutputCase=TERRLAT CaseType=LinStatic P=-373.013713761058 V2=0.703691179209386
 V3=0 T=0 M2=0 M3=83.7376880634837 S11Max=129.412414619844 PtS11Max=1 x2S11Max=-0.5 x3S11Max=-0.5
 S11Min=-875.439842141961 PtS11Min=3 x2S11Min=0.5 x3S11Min=-0.5 FrameElem=41 ElemStation=0.25
 Frame=41 Station=0.375 OutputCase=TERRLAT CaseType=LinStatic P=-373.013713761058 V2=0.703691179209386
 V3=0 T=0 M2=0 M3=83.6497266660826 S11Max=128.884646235437 PtS11Max=1 x2S11Max=-0.5 x3S11Max=-0.5
 S11Min=-874.912073757554 PtS11Min=3 x2S11Min=0.5 x3S11Min=-0.5 FrameElem=41 ElemStation=0.375
 Frame=41 Station=0.5 OutputCase=TERRLAT CaseType=LinStatic P=-373.013713761058 V2=0.703691179209386
 V3=0 T=0 M2=0 M3=83.56176526686814 S11Max=128.35687785103 PtS11Max=1 x2S11Max=-0.5 x3S11Max=-0.5
 S11Min=-874.384305373147 PtS11Min=3 x2S11Min=0.5 x3S11Min=-0.5 FrameElem=41 ElemStation=0.5
 Frame=41 Station=0 OutputCase=ACCVERT CaseType=LinStatic P=0 V2=0 V3=0 T=0 M2=0 M3=0 S11Max=0
 PtS11Max=0 x2S11Max=0 x3S11Max=0 S11Min=0 PtS11Min=0 x2S11Min=0 x3S11Min=0 FrameElem=41
 ElemStation=0
 Frame=41 Station=0.125 OutputCase=ACCVERT CaseType=LinStatic P=0 V2=0 V3=0 T=0 M2=0 M3=0 S11Max=0
 S11Min=0 PtS11Max=0 x2S11Max=0 x3S11Max=0 S11Min=0 PtS11Min=0 x2S11Min=0 x3S11Min=0 FrameElem=41
 ElemStation=0.125



Frame=41 Station=0.25 OutputCase=ACCVERT CaseType=LinStatic P=0 V2=0 V3=0 T=0 M2=0 M3=0
 S11Max=0 PtS11Max=0 x2S11Max=0 x3S11Max=0 S11Min=0 PtS11Min=0 x2S11Min=0 x3S11Min=0 FrameElem=41
 ElemStation=0.25
 Frame=41 Station=0.375 OutputCase=ACCVERT CaseType=LinStatic P=0 V2=0 V3=0 T=0 M2=0 M3=0
 S11Max=0 PtS11Max=0 x2S11Max=0 x3S11Max=0 S11Min=0 PtS11Min=0 x2S11Min=0 x3S11Min=0 FrameElem=41
 ElemStation=0.375
 Frame=41 Station=0.5 OutputCase=ACCVERT CaseType=LinStatic P=0 V2=0 V3=0 T=0 M2=0 M3=0
 S11Max=0 PtS11Max=0 x2S11Max=0 x3S11Max=0 S11Min=0 PtS11Min=0 x2S11Min=0 x3S11Min=0 FrameElem=41
 ElemStation=0.5
 Frame=41 Station=0 OutputCase=ACCLATDX CaseType=LinStatic P=0 V2=0 V3=0 T=0 M2=0 M3=0
 S11Max=0 PtS11Max=0 x2S11Max=0 x3S11Max=0 S11Min=0 PtS11Min=0 x2S11Min=0 x3S11Min=0 FrameElem=41
 ElemStation=0
 Frame=41 Station=0.125 OutputCase=ACCLATDX CaseType=LinStatic P=0 V2=0 V3=0 T=0 M2=0 M3=0
 S11Max=0 PtS11Max=0 x2S11Max=0 x3S11Max=0 S11Min=0 PtS11Min=0 x2S11Min=0 x3S11Min=0 FrameElem=41
 ElemStation=0.125
 Frame=41 Station=0.25 OutputCase=ACCLATDX CaseType=LinStatic P=0 V2=0 V3=0 T=0 M2=0 M3=0
 S11Max=0 PtS11Max=0 x2S11Max=0 x3S11Max=0 S11Min=0 PtS11Min=0 x2S11Min=0 x3S11Min=0 FrameElem=41
 ElemStation=0.25
 Frame=41 Station=0.375 OutputCase=ACCLATDX CaseType=LinStatic P=0 V2=0 V3=0 T=0 M2=0 M3=0
 S11Max=0 PtS11Max=0 x2S11Max=0 x3S11Max=0 S11Min=0 PtS11Min=0 x2S11Min=0 x3S11Min=0 FrameElem=41
 ElemStation=0.375
 Frame=41 Station=0.5 OutputCase=ACCLATDX CaseType=LinStatic P=0 V2=0 V3=0 T=0 M2=0 M3=0
 S11Max=0 PtS11Max=0 x2S11Max=0 x3S11Max=0 S11Min=0 PtS11Min=0 x2S11Min=0 x3S11Min=0 FrameElem=41
 ElemStation=0.5
 Frame=41 Station=0 OutputCase=ACCLATSX CaseType=LinStatic P=0 V2=0 V3=0 T=0 M2=0 M3=0
 S11Max=0 PtS11Max=0 x2S11Max=0 x3S11Max=0 S11Min=0 PtS11Min=0 x2S11Min=0 x3S11Min=0 FrameElem=41
 ElemStation=0
 Frame=41 Station=0.125 OutputCase=ACCLATSX CaseType=LinStatic P=0 V2=0 V3=0 T=0 M2=0 M3=0
 S11Max=0 PtS11Max=0 x2S11Max=0 x3S11Max=0 S11Min=0 PtS11Min=0 x2S11Min=0 x3S11Min=0 FrameElem=41
 ElemStation=0.125
 Frame=41 Station=0.25 OutputCase=ACCLATSX CaseType=LinStatic P=0 V2=0 V3=0 T=0 M2=0 M3=0
 S11Max=0 PtS11Max=0 x2S11Max=0 x3S11Max=0 S11Min=0 PtS11Min=0 x2S11Min=0 x3S11Min=0 FrameElem=41
 ElemStation=0.25
 Frame=41 Station=0.375 OutputCase=ACCLATSX CaseType=LinStatic P=0 V2=0 V3=0 T=0 M2=0 M3=0
 S11Max=0 PtS11Max=0 x2S11Max=0 x3S11Max=0 S11Min=0 PtS11Min=0 x2S11Min=0 x3S11Min=0 FrameElem=41
 ElemStation=0.375
 Frame=41 Station=0.5 OutputCase=ACCLATSX CaseType=LinStatic P=0 V2=0 V3=0 T=0 M2=0 M3=0
 S11Max=0 PtS11Max=0 x2S11Max=0 x3S11Max=0 S11Min=0 PtS11Min=0 x2S11Min=0 x3S11Min=0 FrameElem=41
 ElemStation=0.5
 Frame=41 Station=0 OutputCase=TERRCOST CaseType=LinStatic P=0 V2=0 V3=0 T=0 M2=0 M3=0
 S11Max=0 PtS11Max=0 x2S11Max=0 x3S11Max=0 S11Min=0 PtS11Min=0 x2S11Min=0 x3S11Min=0 FrameElem=41
 ElemStation=0
 Frame=41 Station=0.125 OutputCase=TERRCOST CaseType=LinStatic P=0 V2=0 V3=0 T=0 M2=0 M3=0
 S11Max=0 PtS11Max=0 x2S11Max=0 x3S11Max=0 S11Min=0 PtS11Min=0 x2S11Min=0 x3S11Min=0 FrameElem=41
 ElemStation=0.125
 Frame=41 Station=0.25 OutputCase=TERRCOST CaseType=LinStatic P=0 V2=0 V3=0 T=0 M2=0 M3=0
 S11Max=0 PtS11Max=0 x2S11Max=0 x3S11Max=0 S11Min=0 PtS11Min=0 x2S11Min=0 x3S11Min=0 FrameElem=41
 ElemStation=0.25
 Frame=41 Station=0.375 OutputCase=TERRCOST CaseType=LinStatic P=0 V2=0 V3=0 T=0 M2=0 M3=0
 S11Max=0 PtS11Max=0 x2S11Max=0 x3S11Max=0 S11Min=0 PtS11Min=0 x2S11Min=0 x3S11Min=0 FrameElem=41
 ElemStation=0.375
 Frame=41 Station=0.5 OutputCase=TERRCOST CaseType=LinStatic P=0 V2=0 V3=0 T=0 M2=0 M3=0
 S11Max=0 PtS11Max=0 x2S11Max=0 x3S11Max=0 S11Min=0 PtS11Min=0 x2S11Min=0 x3S11Min=0 FrameElem=41
 ElemStation=0.5
 Frame=41 Station=0 OutputCase=SOVRCOST CaseType=LinStatic P=0 V2=0 V3=0 T=0 M2=0 M3=0
 S11Max=0 PtS11Max=0 x2S11Max=0 x3S11Max=0 S11Min=0 PtS11Min=0 x2S11Min=0 x3S11Min=0 FrameElem=41
 ElemStation=0
 Frame=41 Station=0.125 OutputCase=SOVRCOST CaseType=LinStatic P=0 V2=0 V3=0 T=0 M2=0 M3=0
 S11Max=0 PtS11Max=0 x2S11Max=0 x3S11Max=0 S11Min=0 PtS11Min=0 x2S11Min=0 x3S11Min=0 FrameElem=41
 ElemStation=0.125
 Frame=41 Station=0.25 OutputCase=SOVRCOST CaseType=LinStatic P=0 V2=0 V3=0 T=0 M2=0 M3=0
 S11Max=0 PtS11Max=0 x2S11Max=0 x3S11Max=0 S11Min=0 PtS11Min=0 x2S11Min=0 x3S11Min=0 FrameElem=41
 ElemStation=0.25
 Frame=41 Station=0.375 OutputCase=SOVRCOST CaseType=LinStatic P=0 V2=0 V3=0 T=0 M2=0 M3=0
 S11Max=0 PtS11Max=0 x2S11Max=0 x3S11Max=0 S11Min=0 PtS11Min=0 x2S11Min=0 x3S11Min=0 FrameElem=41
 ElemStation=0.375
 Frame=41 Station=0.5 OutputCase=SOVRCOST CaseType=LinStatic P=0 V2=0 V3=0 T=0 M2=0 M3=0
 S11Max=0 PtS11Max=0 x2S11Max=0 x3S11Max=0 S11Min=0 PtS11Min=0 x2S11Min=0 x3S11Min=0 FrameElem=41
 ElemStation=0.5
 Frame=41 Station=0 OutputCase=ENVE CaseType=Combination StepType=Max P=-274.637838986977
 V2=593.303978098004 V3=0 T=0 M2=0 M3=96.9443286160312 S11Max=195.124018580893 PtS11Max=1 x2S11Max=-0.5
 x3S11Max=-0.5
 S11Min=-705.259311138249 PtS11Min=3 x2S11Min=0.5 x3S11Min=-0.5 FrameElem=41 ElemStation=0
 Frame=41 Station=0.125 OutputCase=ENVE CaseType=Combination StepType=Max P=-274.637838986977
 V2=596.428978098004 V3=0 T=0 M2=0 M3=22.5860188537808 S11Max=-251.02583999261 PtS11Max=1 x2S11Max=-0.5
 x3S11Max=-0.5
 S11Min=-274.637838986977 PtS11Min=0 x2S11Min=0 x3S11Min=0 FrameElem=41 ElemStation=0.125
 Frame=41 Station=0.25 OutputCase=ENVE CaseType=Combination StepType=Max P=-274.637838986977
 V2=599.553978098004 V3=0 T=0 M2=0 M3=-52.1629159084696 S11Max=189.067494978112 PtS11Max=3 x2S11Max=0.5
 x3S11Max=-0.5
 S11Min=-699.519448566112 PtS11Min=1 x2S11Min=-0.5 x3S11Min=-0.5 FrameElem=41 ElemStation=0.25

Frame=41 Station=0.375 OutputCase=ENVE CaseType=Combination StepType=Max P=-274.637838986977
V2=602.678978098004 V3=0 T=0 M2=0 M3=-127.30247567072 S11Max=639.746523036292 PtS11Max=3 x2S11Max=0.5
x3S11Max=-0.5 _
S11Min=-1150.35680713962 PtS11Min=1 x2S11Min=-0.5 x3S11Min=-0.5 FrameElem=41 ElemStation=0.375
Frame=41 Station=0.5 OutputCase=ENVE CaseType=Combination StepType=Max P=-274.637838986977
V2=605.803978098004 V3=0 T=0 M2=0 M3=-202.832660432971 S11Max=1092.76930109447 PtS11Max=3 x2S11Max=0.5
x3S11Max=-0.5 _
S11Min=-1603.53791571312 PtS11Min=1 x2S11Min=-0.5 x3S11Min=-0.5 FrameElem=41 ElemStation=0.5
Frame=41 Station=0 OutputCase=ENVE CaseType=Combination StepType=Min P=-386.541953115295
V2=593.092870744241 V3=0 T=0 M2=0 M3=71.7702453585454 S11Max=155.983633164295 PtS11Max=1 x2S11Max=-0.5
x3S11Max=-0.5 _
S11Min=-968.207924811482 PtS11Min=3 x2S11Min=0.5 x3S11Min=-0.5 FrameElem=41 ElemStation=0
Frame=41 Station=0.125 OutputCase=ENVE CaseType=Combination StepType=Min P=-386.541953115295
V2=596.217870744241 V3=0 T=0 M2=0 M3=-2.56167598448468 S11Max=-290.007894893885 PtS11Max=1 x2S11Max=-
0.5 _
x3S11Max=-0.5 S11Min=-522.058066237979 PtS11Min=3 x2S11Min=0.5 x3S11Min=-0.5 FrameElem=41
ElemStation=0.125
Frame=41 Station=0.25 OutputCase=ENVE CaseType=Combination StepType=Min P=-386.541953115295
V2=599.342870744241 V3=0 T=0 M2=0 M3=-77.2842223275148 S11Max=-73.5644576644767 PtS11Max=3
x2S11Max=0.5 x3S11Max=-0.5 _
S11Min=-738.343172952066 PtS11Min=1 x2S11Min=-0.5 x3S11Min=-0.5 FrameElem=41 ElemStation=0.25
Frame=41 Station=0.375 OutputCase=ENVE CaseType=Combination StepType=Min P=-386.541953115295
V2=602.467870744241 V3=0 T=0 M2=0 M3=-152.397393670545 S11Max=377.272900909026 PtS11Max=3 x2S11Max=0.5
x3S11Max=-0.5 _
S11Min=-1189.02220101025 PtS11Min=1 x2S11Min=-0.5 x3S11Min=-0.5 FrameElem=41 ElemStation=0.375
Frame=41 Station=0.5 OutputCase=ENVE CaseType=Combination StepType=Min P=-386.541953115295
V2=605.592870744241 V3=0 T=0 M2=0 M3=-227.901190013575 S11Max=830.454009482529 PtS11Max=3 x2S11Max=0.5
x3S11Max=-0.5 _
S11Min=-1642.04497906843 PtS11Min=1 x2S11Min=-0.5 x3S11Min=-0.5 FrameElem=41 ElemStation=0.5
Frame=41 Station=0 OutputCase=FESSUR CaseType=Combination P=-386.541953115295 V2=593.303978098004
V3=0 T=0 M2=0 M3=96.9443286160312 S11Max=195.124018580893 PtS11Max=1 x2S11Max=-0.5 x3S11Max=-0.5 _
S11Min=-968.207924811482 PtS11Min=3 x2S11Min=0.5 x3S11Min=-0.5 FrameElem=41 ElemStation=0
Frame=41 Station=0.125 OutputCase=FESSUR CaseType=Combination P=-386.541953115295 V2=596.428978098004
V3=0 T=0 M2=0 M3=22.5860188537808 S11Max=-251.02583999261 PtS11Max=1 x2S11Max=-0.5 x3S11Max=-0.5 _
S11Min=-522.058066237979 PtS11Min=3 x2S11Min=0.5 x3S11Min=-0.5 FrameElem=41 ElemStation=0.125
Frame=41 Station=0.25 OutputCase=FESSUR CaseType=Combination P=-386.541953115295 V2=599.553978098004
V3=0 T=0 M2=0 M3=-52.1629159084696 S11Max=-73.5644576644767 PtS11Max=3 x2S11Max=0.5 x3S11Max=-0.5 _
S11Min=-699.519448566112 PtS11Min=1 x2S11Min=-0.5 x3S11Min=-0.5 FrameElem=41 ElemStation=0.25
Frame=41 Station=0.375 OutputCase=FESSUR CaseType=Combination P=-386.541953115295 V2=602.678978098004
V3=0 T=0 M2=0 M3=-127.30247567072 S11Max=377.272900909026 PtS11Max=3 x2S11Max=0.5 x3S11Max=-0.5 _
S11Min=-1150.35680713962 PtS11Min=1 x2S11Min=-0.5 x3S11Min=-0.5 FrameElem=41 ElemStation=0.375
Frame=41 Station=0.5 OutputCase=FESSUR CaseType=Combination P=-386.541953115295 V2=605.803978098004
V3=0 T=0 M2=0 M3=-202.832660432971 S11Max=830.454009482529 PtS11Max=3 x2S11Max=0.5 x3S11Max=-0.5 _
S11Min=-1603.53791571312 PtS11Min=1 x2S11Min=-0.5 x3S11Min=-0.5 FrameElem=41 ElemStation=0.5
Frame=42 Station=0 OutputCase=PESOPR CaseType=LinStatic P=-15.1709467361864 V2=74.0605341415794 V3=0
T=0 M2=0 M3=-47.6273112363633 S11Max=270.592920681993 PtS11Max=3 x2S11Max=0.5 x3S11Max=-0.5 _
S11Min=-300.934814154366 PtS11Min=1 x2S11Min=-0.5 x3S11Min=-0.5 FrameElem=42 ElemStation=0
Frame=42 Station=0.125 OutputCase=PESOPR CaseType=LinStatic P=-15.1709467361864 V2=77.1855341415794
V3=0 T=0 M2=0 M3=-57.0801905040607 S11Max=327.310196288178 PtS11Max=3 x2S11Max=0.5 x3S11Max=-0.5 _
S11Min=-357.652089760551 PtS11Min=1 x2S11Min=-0.5 x3S11Min=-0.5 FrameElem=42 ElemStation=0.125
Frame=42 Station=0.25 OutputCase=PESOPR CaseType=LinStatic P=-15.1709467361864 V2=80.3105341415794
V3=0 T=0 M2=0 M3=-66.9236947717582 S11Max=386.371221894363 PtS11Max=3 x2S11Max=0.5 x3S11Max=-0.5 _
S11Min=-416.713115366735 PtS11Min=1 x2S11Min=-0.5 x3S11Min=-0.5 FrameElem=42 ElemStation=0.25
Frame=42 Station=0.375 OutputCase=PESOPR CaseType=LinStatic P=-15.1709467361864 V2=83.4355341415794
V3=0 T=0 M2=0 M3=-77.1578240394556 S11Max=447.775997500547 PtS11Max=3 x2S11Max=0.5 x3S11Max=-0.5 _
S11Min=-478.11789097292 PtS11Min=1 x2S11Min=-0.5 x3S11Min=-0.5 FrameElem=42 ElemStation=0.375
Frame=42 Station=0.5 OutputCase=PESOPR CaseType=LinStatic P=-15.1709467361864 V2=86.5605341415794
V3=0 T=0 M2=0 M3=-87.782578307153 S11Max=511.524523106732 PtS11Max=3 x2S11Max=0.5 x3S11Max=-0.5 _
S11Min=-541.866416579104 PtS11Min=1 x2S11Min=-0.5 x3S11Min=-0.5 FrameElem=42 ElemStation=0.5
Frame=42 Station=0 OutputCase=TERRVERT CaseType=LinStatic P=1.64270738195018 V2=345.641465697234 V3=0
T=0 M2=0 M3=-238.767114465256 S11Max=1434.24539417349 PtS11Max=3 x2S11Max=0.5 x3S11Max=-0.5 _
S11Min=-1430.95997940959 PtS11Min=1 x2S11Min=-0.5 x3S11Min=-0.5 FrameElem=42 ElemStation=0
Frame=42 Station=0.125 OutputCase=TERRVERT CaseType=LinStatic P=1.64270738195018 V2=345.641465697234
V3=0 T=0 M2=0 M3=-281.97229767741 S11Max=1693.47649344641 PtS11Max=3 x2S11Max=0.5 x3S11Max=-0.5 _
S11Min=-1690.19107868251 PtS11Min=1 x2S11Min=-0.5 x3S11Min=-0.5 FrameElem=42 ElemStation=0.125
Frame=42 Station=0.25 OutputCase=TERRVERT CaseType=LinStatic P=1.64270738195018 V2=345.641465697234
V3=0 T=0 M2=0 M3=-325.177480889564 S11Max=1952.70759271934 PtS11Max=3 x2S11Max=0.5 x3S11Max=-0.5 _
S11Min=-1949.42217795544 PtS11Min=1 x2S11Min=-0.5 x3S11Min=-0.5 FrameElem=42 ElemStation=0.25
Frame=42 Station=0.375 OutputCase=TERRVERT CaseType=LinStatic P=1.64270738195018 V2=345.641465697234
V3=0 T=0 M2=0 M3=-368.382664101719 S11Max=2211.93869199226 PtS11Max=3 x2S11Max=0.5 x3S11Max=-0.5 _
S11Min=-2208.65327722836 PtS11Min=1 x2S11Min=-0.5 x3S11Min=-0.5 FrameElem=42 ElemStation=0.375
Frame=42 Station=0.5 OutputCase=TERRVERT CaseType=LinStatic P=1.64270738195018 V2=345.641465697234
V3=0 T=0 M2=0 M3=-411.587847313873 S11Max=2471.16979126519 PtS11Max=3 x2S11Max=0.5 x3S11Max=-0.5 _
S11Min=-2467.88437650129 PtS11Min=1 x2S11Min=-0.5 x3S11Min=-0.5 FrameElem=42 ElemStation=0.5
Frame=42 Station=0 OutputCase=TERRLAT CaseType=LinStatic P=-373.013713761058 V2=0.7267661709717 V3=0
T=0 M2=0 M3=83.5617652686815 S11Max=128.356877851031 PtS11Max=1 x2S11Max=-0.5 x3S11Max=-0.5 _
S11Min=-874.384305373147 PtS11Min=3 x2S11Min=0.5 x3S11Min=-0.5 FrameElem=42 ElemStation=0
Frame=42 Station=0.125 OutputCase=TERRLAT CaseType=LinStatic P=-373.013713761058 V2=0.7267661709717
V3=0 T=0 M2=0 M3=83.47091949731 S11Max=127.811803222802 PtS11Max=1 x2S11Max=-0.5 x3S11Max=-0.5 _
S11Min=-873.839230744918 PtS11Min=3 x2S11Min=0.5 x3S11Min=-0.5 FrameElem=42 ElemStation=0.125
Frame=42 Station=0.25 OutputCase=TERRLAT CaseType=LinStatic P=-373.013713761058 V2=0.7267661709717
V3=0 T=0 M2=0 M3=83.3800737259386 S11Max=127.266728594573 PtS11Max=1 x2S11Max=-0.5 x3S11Max=-0.5 _

Frame=42 Station=0 OutputCase=ENVE CaseType=Combination StepType=Max P=-274.637838986977
V2=420.428766009785 V3=0 T=0 M2=0 M3=-202.832660432938 S11Max=1092.76930109428 PtS11Max=3 x2S11Max=0.5
x3S11Max=-0.5 _
S11Min=-1603.53791571292 PtS11Min=1 x2S11Min=-0.5 x3S11Min=-0.5 FrameElem=42 ElemStation=0
Frame=42 Station=0.125 OutputCase=ENVE CaseType=Combination StepType=Max P=-274.637838986977
V2=423.553766009785 V3=0 T=0 M2=0 M3=-255.581568684161 S11Max=1409.09922821315 PtS11Max=3 x2S11Max=0.5
x3S11Max=-0.5 _
S11Min=-1920.03136522026 PtS11Min=1 x2S11Min=-0.5 x3S11Min=-0.5 FrameElem=42 ElemStation=0.125
Frame=42 Station=0.25 OutputCase=ENVE CaseType=Combination StepType=Max P=-274.637838986977
V2=426.678766009785 V3=0 T=0 M2=0 M3=-308.721101935384 S11Max=1727.77290533202 PtS11Max=3 x2S11Max=0.5
x3S11Max=-0.5 _
S11Min=-2238.8685647276 PtS11Min=1 x2S11Min=-0.5 x3S11Min=-0.5 FrameElem=42 ElemStation=0.25
Frame=42 Station=0.375 OutputCase=ENVE CaseType=Combination StepType=Max P=-274.637838986977
V2=429.803766009785 V3=0 T=0 M2=0 M3=-362.251260186607 S11Max=2048.79033245089 PtS11Max=3 x2S11Max=0.5
x3S11Max=-0.5 _
S11Min=-2560.04951423494 PtS11Min=1 x2S11Min=-0.5 x3S11Min=-0.5 FrameElem=42 ElemStation=0.375
Frame=42 Station=0.5 OutputCase=ENVE CaseType=Combination StepType=Max P=-274.637838986977
V2=432.928766009785 V3=0 T=0 M2=0 M3=-416.17204343783 S11Max=2372.15150956976 PtS11Max=3 x2S11Max=0.5
x3S11Max=-0.5 _
S11Min=-2883.57421374228 PtS11Min=1 x2S11Min=-0.5 x3S11Min=-0.5 FrameElem=42 ElemStation=0.5
Frame=42 Station=0 OutputCase=ENVE CaseType=Combination StepType=Min P=-386.541953115295
V2=420.210736158493 V3=0 T=0 M2=0 M3=-227.901190013542 S11Max=830.454009482322 PtS11Max=3 x2S11Max=0.5
x3S11Max=-0.5 _
S11Min=-1642.04497906823 PtS11Min=1 x2S11Min=-0.5 x3S11Min=-0.5 FrameElem=42 ElemStation=0
Frame=42 Station=0.125 OutputCase=ENVE CaseType=Combination StepType=Min P=-386.541953115295
V2=423.335736158493 V3=0 T=0 M2=0 M3=-280.622844533354 S11Max=1146.94745898967 PtS11Max=3 x2S11Max=0.5
x3S11Max=-0.5 _
S11Min=-1958.3749061871 PtS11Min=1 x2S11Min=-0.5 x3S11Min=-0.5 FrameElem=42 ElemStation=0.125
Frame=42 Station=0.25 OutputCase=ENVE CaseType=Combination StepType=Min P=-386.541953115295
V2=426.460736158493 V3=0 T=0 M2=0 M3=-333.735124053166 S11Max=1465.78465849701 PtS11Max=3 x2S11Max=0.5
x3S11Max=-0.5 _
S11Min=-2277.04858330597 PtS11Min=1 x2S11Min=-0.5 x3S11Min=-0.5 FrameElem=42 ElemStation=0.25
Frame=42 Station=0.375 OutputCase=ENVE CaseType=Combination StepType=Min P=-386.541953115295
V2=429.585736158493 V3=0 T=0 M2=0 M3=-387.238028572977 S11Max=1786.96560800435 PtS11Max=3 x2S11Max=0.5
x3S11Max=-0.5 _
S11Min=-2598.06601042484 PtS11Min=1 x2S11Min=-0.5 x3S11Min=-0.5 FrameElem=42 ElemStation=0.375
Frame=42 Station=0.5 OutputCase=ENVE CaseType=Combination StepType=Min P=-386.541953115295
V2=432.710736158493 V3=0 T=0 M2=0 M3=-441.131558092789 S11Max=2110.49030751169 PtS11Max=3 x2S11Max=0.5
x3S11Max=-0.5 _
S11Min=-2921.42718754371 PtS11Min=1 x2S11Min=-0.5 x3S11Min=-0.5 FrameElem=42 ElemStation=0.5
Frame=42 Station=0 OutputCase=FESSUR CaseType=Combination P=-386.541953115295 V2=420.428766009785
V3=0 T=0 M2=0 M3=-202.832660432938 S11Max=830.454009482322 PtS11Max=3 x2S11Max=0.5 x3S11Max=-0.5 _
S11Min=-1603.53791571292 PtS11Min=1 x2S11Min=-0.5 x3S11Min=-0.5 FrameElem=42 ElemStation=0
Frame=42 Station=0.125 OutputCase=FESSUR CaseType=Combination P=-386.541953115295 V2=423.553766009785
V3=0 T=0 M2=0 M3=-255.581568684161 S11Max=1146.94745898967 PtS11Max=3 x2S11Max=0.5 x3S11Max=-0.5 _
S11Min=-1920.03136522026 PtS11Min=1 x2S11Min=-0.5 x3S11Min=-0.5 FrameElem=42 ElemStation=0.125
Frame=42 Station=0.25 OutputCase=FESSUR CaseType=Combination P=-386.541953115295 V2=426.678766009785
V3=0 T=0 M2=0 M3=-308.721101935384 S11Max=1465.78465849701 PtS11Max=3 x2S11Max=0.5 x3S11Max=-0.5 _
S11Min=-2238.8685647276 PtS11Min=1 x2S11Min=-0.5 x3S11Min=-0.5 FrameElem=42 ElemStation=0.25
Frame=42 Station=0.375 OutputCase=FESSUR CaseType=Combination P=-386.541953115295 V2=429.803766009785
V3=0 T=0 M2=0 M3=-362.251260186607 S11Max=1786.96560800435 PtS11Max=3 x2S11Max=0.5 x3S11Max=-0.5 _
S11Min=-2560.04951423494 PtS11Min=1 x2S11Min=-0.5 x3S11Min=-0.5 FrameElem=42 ElemStation=0.375
Frame=42 Station=0.5 OutputCase=FESSUR CaseType=Combination P=-386.541953115295 V2=432.928766009785
V3=0 T=0 M2=0 M3=-416.17204343783 S11Max=2110.49030751169 PtS11Max=3 x2S11Max=0.5 x3S11Max=-0.5 _
S11Min=-2883.57421374228 PtS11Min=1 x2S11Min=-0.5 x3S11Min=-0.5 FrameElem=42 ElemStation=0.5
Frame=43 Station=0 OutputCase=PESOPR CaseType=LinStatic P=-15.1709467361864 V2=41.7994156912609 V3=0
T=0 M2=0 M3=-87.7825783071494 S11Max=511.52452310671 PtS11Max=3 x2S11Max=0.5 x3S11Max=-0.5 _
S11Min=-541.866416579083 PtS11Min=1 x2S11Min=-0.5 x3S11Min=-0.5 FrameElem=43 ElemStation=0
Frame=43 Station=0.125 OutputCase=PESOPR CaseType=LinStatic P=-15.1709467361864 V2=44.9244156912609
V3=0 T=0 M2=0 M3=-93.202817768557 S11Max=544.045959875156 PtS11Max=3 x2S11Max=0.5 x3S11Max=-0.5 _
S11Min=-574.387853347528 PtS11Min=1 x2S11Min=-0.5 x3S11Min=-0.5 FrameElem=43 ElemStation=0.125
Frame=43 Station=0.25 OutputCase=PESOPR CaseType=LinStatic P=-15.1709467361864 V2=48.0494156912609
V3=0 T=0 M2=0 M3=-99.0136822299646 S11Max=578.911146643601 PtS11Max=3 x2S11Max=0.5 x3S11Max=-0.5 _
S11Min=-609.253040115974 PtS11Min=1 x2S11Min=-0.5 x3S11Min=-0.5 FrameElem=43 ElemStation=0.25
Frame=43 Station=0.375 OutputCase=PESOPR CaseType=LinStatic P=-15.1709467361864 V2=51.1744156912609
V3=0 T=0 M2=0 M3=-105.215171691372 S11Max=616.120083412047 PtS11Max=3 x2S11Max=0.5 x3S11Max=-0.5 _
S11Min=-646.46197688442 PtS11Min=1 x2S11Min=-0.5 x3S11Min=-0.5 FrameElem=43 ElemStation=0.375
Frame=43 Station=0.5 OutputCase=PESOPR CaseType=LinStatic P=-15.1709467361864 V2=54.2994156912609
V3=0 T=0 M2=0 M3=-111.80728615278 S11Max=655.672770180493 PtS11Max=3 x2S11Max=0.5 x3S11Max=-0.5 _
S11Min=-686.014663652865 PtS11Min=1 x2S11Min=-0.5 x3S11Min=-0.5 FrameElem=43 ElemStation=0.5
Frame=43 Station=0 OutputCase=TERRVERT CaseType=LinStatic P=1.64270738195018 V2=206.756725486921 V3=0
T=0 M2=0 M3=-411.587847313873 S11Max=2471.16979126519 PtS11Max=3 x2S11Max=0.5 x3S11Max=-0.5 _
S11Min=-2467.88437650129 PtS11Min=1 x2S11Min=-0.5 x3S11Min=-0.5 FrameElem=43 ElemStation=0
Frame=43 Station=0.125 OutputCase=TERRVERT CaseType=LinStatic P=1.64270738195018 V2=206.756725486921
V3=0 T=0 M2=0 M3=-437.432437999738 S11Max=2626.23733538038 PtS11Max=3 x2S11Max=0.5 x3S11Max=-0.5 _
S11Min=-2622.95192061648 PtS11Min=1 x2S11Min=-0.5 x3S11Min=-0.5 FrameElem=43 ElemStation=0.125
Frame=43 Station=0.25 OutputCase=TERRVERT CaseType=LinStatic P=1.64270738195018 V2=206.756725486921
V3=0 T=0 M2=0 M3=-463.277028685603 S11Max=2781.30487949557 PtS11Max=3 x2S11Max=0.5 x3S11Max=-0.5 _
S11Min=-2778.01946473167 PtS11Min=1 x2S11Min=-0.5 x3S11Min=-0.5 FrameElem=43 ElemStation=0.25
Frame=43 Station=0.375 OutputCase=TERRVERT CaseType=LinStatic P=1.64270738195018 V2=206.756725486921
V3=0 T=0 M2=0 M3=-489.121619371468 S11Max=2936.37242361076 PtS11Max=3 x2S11Max=0.5 x3S11Max=-0.5 _
S11Min=-2933.08700884686 PtS11Min=1 x2S11Min=-0.5 x3S11Min=-0.5 FrameElem=43 ElemStation=0.375



Frame=43 Station=0.5 OutputCase=TERRVERT CaseType=LinStatic P=1.64270738195018 V2=206.756725486921
 V3=0 T=0 M2=0 M3=-514.966210057333 S11Max=3091.43996772595 PtS11Max=3 x2S11Max=0.5 x3S11Max=-0.5 _
 S11Min=-3088.15455296205 PtS11Min=1 x2S11Min=-0.5 x3S11Min=-0.5 FrameElem=43 ElemStation=0.5
 Frame=43 Station=0 OutputCase=TERRLAT CaseType=LinStatic P=-373.013713761059 V2=0.525598203398204
 V3=0 T=0 M2=0 M3=83.1983821831956 S11Max=126.176579338115 PtS11Max=1 x2S11Max=-0.5 x3S11Max=-0.5 _
 S11Min=-872.204006860232 PtS11Min=3 x2S11Min=0.5 x3S11Min=-0.5 FrameElem=43 ElemStation=0
 Frame=43 Station=0.125 OutputCase=TERRLAT CaseType=LinStatic P=-373.013713761059 V2=0.525598203398204
 V3=0 T=0 M2=0 M3=83.1326824077708 S11Max=125.782380685566 PtS11Max=1 x2S11Max=-0.5 x3S11Max=-0.5 _
 S11Min=-871.809808207683 PtS11Min=3 x2S11Min=0.5 x3S11Min=-0.5 FrameElem=43 ElemStation=0.125
 Frame=43 Station=0.25 OutputCase=TERRLAT CaseType=LinStatic P=-373.013713761059 V2=0.525598203398204
 V3=0 T=0 M2=0 M3=83.066982632346 S11Max=125.388182033018 PtS11Max=1 x2S11Max=-0.5 x3S11Max=-0.5 _
 S11Min=-871.415609555135 PtS11Min=3 x2S11Min=0.5 x3S11Min=-0.5 FrameElem=43 ElemStation=0.25
 Frame=43 Station=0.375 OutputCase=TERRLAT CaseType=LinStatic P=-373.013713761059 V2=0.525598203398204
 V3=0 T=0 M2=0 M3=83.0012828569213 S11Max=124.993983380469 PtS11Max=1 x2S11Max=-0.5 x3S11Max=-0.5 _
 S11Min=-871.021410902586 PtS11Min=3 x2S11Min=0.5 x3S11Min=-0.5 FrameElem=43 ElemStation=0.375
 Frame=43 Station=0.5 OutputCase=TERRLAT CaseType=LinStatic P=-373.013713761059 V2=0.525598203398204
 V3=0 T=0 M2=0 M3=82.9355830814965 S11Max=124.59978472792 PtS11Max=1 x2S11Max=-0.5 x3S11Max=-0.5 _
 S11Min=-870.627212250037 PtS11Min=3 x2S11Min=0.5 x3S11Min=-0.5 FrameElem=43 ElemStation=0.5
 Frame=43 Station=0 OutputCase=ACCVERT CaseType=LinStatic P=0 V2=0 V3=0 T=0 M2=0 M3=0
 PtS11Max=0 x2S11Max=0 x3S11Max=0 S11Min=0 PtS11Min=0 x2S11Min=0 x3S11Min=0 FrameElem=43
 ElemStation=0
 Frame=43 Station=0.125 OutputCase=ACCVERT CaseType=LinStatic P=0 V2=0 V3=0 T=0 M2=0 M3=0
 S11Max=0 PtS11Max=0 x2S11Max=0 x3S11Max=0 S11Min=0 PtS11Min=0 x2S11Min=0 x3S11Min=0 FrameElem=43
 ElemStation=0.125
 Frame=43 Station=0.25 OutputCase=ACCVERT CaseType=LinStatic P=0 V2=0 V3=0 T=0 M2=0 M3=0
 S11Max=0 PtS11Max=0 x2S11Max=0 x3S11Max=0 S11Min=0 PtS11Min=0 x2S11Min=0 x3S11Min=0 FrameElem=43
 ElemStation=0.25
 Frame=43 Station=0.375 OutputCase=ACCVERT CaseType=LinStatic P=0 V2=0 V3=0 T=0 M2=0 M3=0
 S11Max=0 PtS11Max=0 x2S11Max=0 x3S11Max=0 S11Min=0 PtS11Min=0 x2S11Min=0 x3S11Min=0 FrameElem=43
 ElemStation=0.375
 Frame=43 Station=0.5 OutputCase=ACCVERT CaseType=LinStatic P=0 V2=0 V3=0 T=0 M2=0 M3=0
 S11Max=0 PtS11Max=0 x2S11Max=0 x3S11Max=0 S11Min=0 PtS11Min=0 x2S11Min=0 x3S11Min=0 FrameElem=43
 ElemStation=0.5
 Frame=43 Station=0 OutputCase=ACCLATDX CaseType=LinStatic P=0 V2=0 V3=0 T=0 M2=0 M3=0
 S11Max=0 PtS11Max=0 x2S11Max=0 x3S11Max=0 S11Min=0 PtS11Min=0 x2S11Min=0 x3S11Min=0 FrameElem=43
 ElemStation=0
 Frame=43 Station=0.125 OutputCase=ACCLATDX CaseType=LinStatic P=0 V2=0 V3=0 T=0 M2=0 M3=0
 S11Max=0 PtS11Max=0 x2S11Max=0 x3S11Max=0 S11Min=0 PtS11Min=0 x2S11Min=0 x3S11Min=0 FrameElem=43
 ElemStation=0.125
 Frame=43 Station=0.25 OutputCase=ACCLATDX CaseType=LinStatic P=0 V2=0 V3=0 T=0 M2=0 M3=0
 S11Max=0 PtS11Max=0 x2S11Max=0 x3S11Max=0 S11Min=0 PtS11Min=0 x2S11Min=0 x3S11Min=0 FrameElem=43
 ElemStation=0.25
 Frame=43 Station=0.375 OutputCase=ACCLATDX CaseType=LinStatic P=0 V2=0 V3=0 T=0 M2=0 M3=0
 S11Max=0 PtS11Max=0 x2S11Max=0 x3S11Max=0 S11Min=0 PtS11Min=0 x2S11Min=0 x3S11Min=0 FrameElem=43
 ElemStation=0.375
 Frame=43 Station=0.5 OutputCase=ACCLATDX CaseType=LinStatic P=0 V2=0 V3=0 T=0 M2=0 M3=0
 S11Max=0 PtS11Max=0 x2S11Max=0 x3S11Max=0 S11Min=0 PtS11Min=0 x2S11Min=0 x3S11Min=0 FrameElem=43
 ElemStation=0.5
 Frame=43 Station=0 OutputCase=ACCLATSX CaseType=LinStatic P=0 V2=0 V3=0 T=0 M2=0 M3=0
 S11Max=0 PtS11Max=0 x2S11Max=0 x3S11Max=0 S11Min=0 PtS11Min=0 x2S11Min=0 x3S11Min=0 FrameElem=43
 ElemStation=0
 Frame=43 Station=0.125 OutputCase=ACCLATSX CaseType=LinStatic P=0 V2=0 V3=0 T=0 M2=0 M3=0
 S11Max=0 PtS11Max=0 x2S11Max=0 x3S11Max=0 S11Min=0 PtS11Min=0 x2S11Min=0 x3S11Min=0 FrameElem=43
 ElemStation=0.125
 Frame=43 Station=0.25 OutputCase=ACCLATSX CaseType=LinStatic P=0 V2=0 V3=0 T=0 M2=0 M3=0
 S11Max=0 PtS11Max=0 x2S11Max=0 x3S11Max=0 S11Min=0 PtS11Min=0 x2S11Min=0 x3S11Min=0 FrameElem=43
 ElemStation=0.25
 Frame=43 Station=0.375 OutputCase=ACCLATSX CaseType=LinStatic P=0 V2=0 V3=0 T=0 M2=0 M3=0
 S11Max=0 PtS11Max=0 x2S11Max=0 x3S11Max=0 S11Min=0 PtS11Min=0 x2S11Min=0 x3S11Min=0 FrameElem=43
 ElemStation=0.375
 Frame=43 Station=0.5 OutputCase=ACCLATSX CaseType=LinStatic P=0 V2=0 V3=0 T=0 M2=0 M3=0
 S11Max=0 PtS11Max=0 x2S11Max=0 x3S11Max=0 S11Min=0 PtS11Min=0 x2S11Min=0 x3S11Min=0 FrameElem=43
 ElemStation=0.5
 Frame=43 Station=0 OutputCase=TERRCOST CaseType=LinStatic P=0 V2=0 V3=0 T=0 M2=0 M3=0
 S11Max=0 PtS11Max=0 x2S11Max=0 x3S11Max=0 S11Min=0 PtS11Min=0 x2S11Min=0 x3S11Min=0 FrameElem=43
 ElemStation=0
 Frame=43 Station=0.125 OutputCase=TERRCOST CaseType=LinStatic P=0 V2=0 V3=0 T=0 M2=0 M3=0
 S11Max=0 PtS11Max=0 x2S11Max=0 x3S11Max=0 S11Min=0 PtS11Min=0 x2S11Min=0 x3S11Min=0 FrameElem=43
 ElemStation=0.125
 Frame=43 Station=0.25 OutputCase=TERRCOST CaseType=LinStatic P=0 V2=0 V3=0 T=0 M2=0 M3=0
 S11Max=0 PtS11Max=0 x2S11Max=0 x3S11Max=0 S11Min=0 PtS11Min=0 x2S11Min=0 x3S11Min=0 FrameElem=43
 ElemStation=0.25
 Frame=43 Station=0.375 OutputCase=TERRCOST CaseType=LinStatic P=0 V2=0 V3=0 T=0 M2=0 M3=0
 S11Max=0 PtS11Max=0 x2S11Max=0 x3S11Max=0 S11Min=0 PtS11Min=0 x2S11Min=0 x3S11Min=0 FrameElem=43
 ElemStation=0.375
 Frame=43 Station=0.5 OutputCase=TERRCOST CaseType=LinStatic P=0 V2=0 V3=0 T=0 M2=0 M3=0
 S11Max=0 PtS11Max=0 x2S11Max=0 x3S11Max=0 S11Min=0 PtS11Min=0 x2S11Min=0 x3S11Min=0 FrameElem=43
 ElemStation=0.5
 Frame=43 Station=0 OutputCase=SOVRCOST CaseType=LinStatic P=0 V2=0 V3=0 T=0 M2=0 M3=0
 S11Max=0 PtS11Max=0 x2S11Max=0 x3S11Max=0 S11Min=0 PtS11Min=0 x2S11Min=0 x3S11Min=0 FrameElem=43
 ElemStation=0



Frame=43 Station=0.125 OutputCase=SOVRCOST CaseType=LinStatic P=0 V2=0 V3=0 T=0 M2=0 M3=0
 S11Max=0 PtS11Max=0 x2S11Max=0 x3S11Max=0 S11Min=0 PtS11Min=0 x2S11Min=0 x3S11Min=0 FrameElem=43
 ElemStation=0.125
 Frame=43 Station=0.25 OutputCase=SOVRCOST CaseType=LinStatic P=0 V2=0 V3=0 T=0 M2=0 M3=0
 S11Max=0 PtS11Max=0 x2S11Max=0 x3S11Max=0 S11Min=0 PtS11Min=0 x2S11Min=0 x3S11Min=0 FrameElem=43
 ElemStation=0.25
 Frame=43 Station=0.375 OutputCase=SOVRCOST CaseType=LinStatic P=0 V2=0 V3=0 T=0 M2=0 M3=0
 S11Max=0 PtS11Max=0 x2S11Max=0 x3S11Max=0 S11Min=0 PtS11Min=0 x2S11Min=0 x3S11Min=0 FrameElem=43
 ElemStation=0.375
 Frame=43 Station=0.5 OutputCase=SOVRCOST CaseType=LinStatic P=0 V2=0 V3=0 T=0 M2=0 M3=0
 S11Max=0 PtS11Max=0 x2S11Max=0 x3S11Max=0 S11Min=0 PtS11Min=0 x2S11Min=0 x3S11Min=0 FrameElem=43
 ElemStation=0.5
 Frame=43 Station=0 OutputCase=ENVE CaseType=Combination StepType=Max P=-274.637838986977
 V2=249.08173938158 V3=0 T=0 M2=0 M3=-416.172043437827 S11Max=2372.15150956973 PtS11Max=3 x2S11Max=0.5
 x3S11Max=-0.5 _
 S11Min=-2883.57421374225 PtS11Min=1 x2S11Min=-0.5 x3S11Min=-0.5 FrameElem=43 ElemStation=0
 Frame=43 Station=0.125 OutputCase=ENVE CaseType=Combination StepType=Max P=-274.637838986977
 V2=252.20673938158 V3=0 T=0 M2=0 M3=-447.502573360524 S11Max=2560.01642951015 PtS11Max=3 x2S11Max=0.5
 x3S11Max=-0.5 _
 S11Min=-3071.55739327844 PtS11Min=1 x2S11Min=-0.5 x3S11Min=-0.5 FrameElem=43 ElemStation=0.125
 Frame=43 Station=0.25 OutputCase=ENVE CaseType=Combination StepType=Max P=-274.637838986977
 V2=255.33173938158 V3=0 T=0 M2=0 M3=-479.223728283222 S11Max=2750.22509945057 PtS11Max=3 x2S11Max=0.5
 x3S11Max=-0.5 _
 S11Min=-3261.88432281462 PtS11Min=1 x2S11Min=-0.5 x3S11Min=-0.5 FrameElem=43 ElemStation=0.25
 Frame=43 Station=0.375 OutputCase=ENVE CaseType=Combination StepType=Max P=-274.637838986977
 V2=258.45673938158 V3=0 T=0 M2=0 M3=-511.335508205919 S11Max=2942.777519391 PtS11Max=3 x2S11Max=0.5
 x3S11Max=-0.5 _
 S11Min=-3454.55500235081 PtS11Min=1 x2S11Min=-0.5 x3S11Min=-0.5 FrameElem=43 ElemStation=0.375
 Frame=43 Station=0.5 OutputCase=ENVE CaseType=Combination StepType=Max P=-274.637838986977
 V2=261.58173938158 V3=0 T=0 M2=0 M3=-543.837913128617 S11Max=3137.67368933142 PtS11Max=3 x2S11Max=0.5
 x3S11Max=-0.5 _
 S11Min=-3649.56943188699 PtS11Min=1 x2S11Min=-0.5 x3S11Min=-0.5 FrameElem=43 ElemStation=0.5
 Frame=43 Station=0 OutputCase=ENVE CaseType=Combination StepType=Min P=-386.541953115295
 V2=248.924059920561 V3=0 T=0 M2=0 M3=-441.131558092785 S11Max=2110.49030751166 PtS11Max=3 x2S11Max=0.5
 x3S11Max=-0.5 _
 S11Min=-2921.42718754369 PtS11Min=1 x2S11Min=-0.5 x3S11Min=-0.5 FrameElem=43 ElemStation=0
 Frame=43 Station=0.125 OutputCase=ENVE CaseType=Combination StepType=Min P=-386.541953115295
 V2=252.049059920561 V3=0 T=0 M2=0 M3=-472.442378082855 S11Max=2298.47348704785 PtS11Max=3 x2S11Max=0.5
 x3S11Max=-0.5 _
 S11Min=-3109.29210748411 PtS11Min=1 x2S11Min=-0.5 x3S11Min=-0.5 FrameElem=43 ElemStation=0.125
 Frame=43 Station=0.25 OutputCase=ENVE CaseType=Combination StepType=Min P=-386.541953115295
 V2=255.174059920561 V3=0 T=0 M2=0 M3=-504.143823072925 S11Max=2488.80041658403 PtS11Max=3 x2S11Max=0.5
 x3S11Max=-0.5 _
 S11Min=-3299.50077742453 PtS11Min=1 x2S11Min=-0.5 x3S11Min=-0.5 FrameElem=43 ElemStation=0.25
 Frame=43 Station=0.375 OutputCase=ENVE CaseType=Combination StepType=Min P=-386.541953115295
 V2=258.299059920561 V3=0 T=0 M2=0 M3=-536.235893062996 S11Max=2681.47109612022 PtS11Max=3 x2S11Max=0.5
 x3S11Max=-0.5 _
 S11Min=-3492.05319736495 PtS11Min=1 x2S11Min=-0.5 x3S11Min=-0.5 FrameElem=43 ElemStation=0.375
 Frame=43 Station=0.5 OutputCase=ENVE CaseType=Combination StepType=Min P=-386.541953115295
 V2=261.424059920561 V3=0 T=0 M2=0 M3=-568.718588053066 S11Max=2876.4855256564 PtS11Max=3 x2S11Max=0.5
 x3S11Max=-0.5 _
 S11Min=-3686.94936730537 PtS11Min=1 x2S11Min=-0.5 x3S11Min=-0.5 FrameElem=43 ElemStation=0.5
 Frame=43 Station=0 OutputCase=FESSUR CaseType=Combination P=-386.541953115295 V2=249.08173938158 V3=0
 T=0 M2=0 M3=-416.172043437827 S11Max=2110.49030751166 PtS11Max=3 x2S11Max=0.5 x3S11Max=-0.5 _
 S11Min=-2883.57421374225 PtS11Min=1 x2S11Min=-0.5 x3S11Min=-0.5 FrameElem=43 ElemStation=0
 Frame=43 Station=0.125 OutputCase=FESSUR CaseType=Combination P=-386.541953115295 V2=252.20673938158
 V3=0 T=0 M2=0 M3=-447.502573360524 S11Max=2298.47348704785 PtS11Max=3 x2S11Max=0.5 x3S11Max=-0.5 _
 S11Min=-3071.55739327844 PtS11Min=1 x2S11Min=-0.5 x3S11Min=-0.5 FrameElem=43 ElemStation=0.125
 Frame=43 Station=0.25 OutputCase=FESSUR CaseType=Combination P=-386.541953115295 V2=255.33173938158
 V3=0 T=0 M2=0 M3=-479.223728283222 S11Max=2488.80041658403 PtS11Max=3 x2S11Max=0.5 x3S11Max=-0.5 _
 S11Min=-3261.88432281462 PtS11Min=1 x2S11Min=-0.5 x3S11Min=-0.5 FrameElem=43 ElemStation=0.25
 Frame=43 Station=0.375 OutputCase=FESSUR CaseType=Combination P=-386.541953115295 V2=258.45673938158
 V3=0 T=0 M2=0 M3=-511.335508205919 S11Max=2681.47109612022 PtS11Max=3 x2S11Max=0.5 x3S11Max=-0.5 _
 S11Min=-3454.55500235081 PtS11Min=1 x2S11Min=-0.5 x3S11Min=-0.5 FrameElem=43 ElemStation=0.375
 Frame=43 Station=0.5 OutputCase=FESSUR CaseType=Combination P=-386.541953115295 V2=261.58173938158
 V3=0 T=0 M2=0 M3=-543.837913128617 S11Max=2876.4855256564 PtS11Max=3 x2S11Max=0.5 x3S11Max=-0.5 _
 S11Min=-3649.56943188699 PtS11Min=1 x2S11Min=-0.5 x3S11Min=-0.5 FrameElem=43 ElemStation=0.5
 Frame=44 Station=0 OutputCase=PESOPR CaseType=LinStatic P=-15.1709467361872 V2=9.74279215224669 V3=0
 T=0 M2=0 M3=-111.80728615278 S11Max=655.672770180492 PtS11Max=3 x2S11Max=0.5 x3S11Max=-0.5 _
 S11Min=-686.014663652866 PtS11Min=1 x2S11Min=-0.5 x3S11Min=-0.5 FrameElem=44 ElemStation=0
 Frame=44 Station=0.125 OutputCase=PESOPR CaseType=LinStatic P=-15.1709467361872 V2=12.8677921522467
 V3=0 T=0 M2=0 M3=-113.220447671811 S11Max=664.151739294677 PtS11Max=3 x2S11Max=0.5 x3S11Max=-0.5 _
 S11Min=-694.493632767051 PtS11Min=1 x2S11Min=-0.5 x3S11Min=-0.5 FrameElem=44 ElemStation=0.125
 Frame=44 Station=0.25 OutputCase=PESOPR CaseType=LinStatic P=-15.1709467361872 V2=15.9927921522467
 V3=0 T=0 M2=0 M3=-115.024234190842 S11Max=674.974458408862 PtS11Max=3 x2S11Max=0.5 x3S11Max=-0.5 _
 S11Min=-705.316351881236 PtS11Min=1 x2S11Min=-0.5 x3S11Min=-0.5 FrameElem=44 ElemStation=0.25
 Frame=44 Station=0.375 OutputCase=PESOPR CaseType=LinStatic P=-15.1709467361872 V2=19.1177921522467
 V3=0 T=0 M2=0 M3=-117.218645709872 S11Max=688.140927523047 PtS11Max=3 x2S11Max=0.5 x3S11Max=-0.5 _
 S11Min=-718.482820995421 PtS11Min=1 x2S11Min=-0.5 x3S11Min=-0.5 FrameElem=44 ElemStation=0.375
 Frame=44 Station=0.5 OutputCase=PESOPR CaseType=LinStatic P=-15.1709467361872 V2=22.2427921522467
 V3=0 T=0 M2=0 M3=-119.803682228903 S11Max=703.651146637232 PtS11Max=3 x2S11Max=0.5 x3S11Max=-0.5 _
 S11Min=-733.993040109606 PtS11Min=1 x2S11Min=-0.5 x3S11Min=-0.5 FrameElem=44 ElemStation=0.5



```

Frame=44 Station=0 OutputCase=TERRVERT CaseType=LinStatic P=1.64270738195066 V2=68.8105071869213 V3=0
T=0 M2=0 M3=-514.966210057311 S11Max=3091.43996772582 PtS11Max=3 x2S11Max=0.5 x3S11Max=-0.5 _
S11Min=-3088.15455296192 PtS11Min=1 x2S11Min=-0.5 x3S11Min=-0.5 FrameElem=44 ElemStation=0
Frame=44 Station=0.125 OutputCase=TERRVERT CaseType=LinStatic P=1.64270738195066 V2=68.8105071869213
V3=0 T=0 M2=0 M3=-523.567523455677 S11Max=3143.04784811601 PtS11Max=3 x2S11Max=0.5 x3S11Max=-0.5 _
S11Min=-3139.76243335211 PtS11Min=1 x2S11Min=-0.5 x3S11Min=-0.5 FrameElem=44 ElemStation=0.125
Frame=44 Station=0.25 OutputCase=TERRVERT CaseType=LinStatic P=1.64270738195066 V2=68.8105071869213
V3=0 T=0 M2=0 M3=-532.168836854042 S11Max=3194.6557285062 PtS11Max=3 x2S11Max=0.5 x3S11Max=-0.5 _
S11Min=-3191.3703137423 PtS11Min=1 x2S11Min=-0.5 x3S11Min=-0.5 FrameElem=44 ElemStation=0.25
Frame=44 Station=0.375 OutputCase=TERRVERT CaseType=LinStatic P=1.64270738195066 V2=68.8105071869213
V3=0 T=0 M2=0 M3=-540.770150252407 S11Max=3246.26360889639 PtS11Max=3 x2S11Max=0.5 x3S11Max=-0.5 _
S11Min=-3242.97819413249 PtS11Min=1 x2S11Min=-0.5 x3S11Min=-0.5 FrameElem=44 ElemStation=0.375
Frame=44 Station=0.5 OutputCase=TERRVERT CaseType=LinStatic P=1.64270738195066 V2=68.8105071869213
V3=0 T=0 M2=0 M3=-549.371463650772 S11Max=3297.87148928658 PtS11Max=3 x2S11Max=0.5 x3S11Max=-0.5 _
S11Min=-3294.58607452268 PtS11Min=1 x2S11Min=-0.5 x3S11Min=-0.5 FrameElem=44 ElemStation=0.5
Frame=44 Station=0.75 OutputCase=TERRLAT CaseType=LinStatic P=-373.013713761058 V2=0.190111961511889
V3=0 T=0 M2=0 M3=82.9355830814964 S11Max=124.59978472792 PtS11Max=1 x2S11Max=-0.5 x3S11Max=-0.5 _
S11Min=-870.627212250037 PtS11Min=3 x2S11Min=0.5 x3S11Min=-0.5 FrameElem=44 ElemStation=0
Frame=44 Station=0.125 OutputCase=TERRLAT CaseType=LinStatic P=-373.013713761058 V2=0.190111961511889
V3=0 T=0 M2=0 M3=82.9118190863074 S11Max=124.457200756786 PtS11Max=1 x2S11Max=-0.5 x3S11Max=-0.5 _
S11Min=-870.484628278903 PtS11Min=3 x2S11Min=0.5 x3S11Min=-0.5 FrameElem=44 ElemStation=0.125
Frame=44 Station=0.25 OutputCase=TERRLAT CaseType=LinStatic P=-373.013713761058 V2=0.190111961511889
V3=0 T=0 M2=0 M3=82.8880550911184 S11Max=124.314616785652 PtS11Max=1 x2S11Max=-0.5 x3S11Max=-0.5 _
S11Min=-870.342044307769 PtS11Min=3 x2S11Min=0.5 x3S11Min=-0.5 FrameElem=44 ElemStation=0.25
Frame=44 Station=0.375 OutputCase=TERRLAT CaseType=LinStatic P=-373.013713761058 V2=0.190111961511889
V3=0 T=0 M2=0 M3=82.8642910959294 S11Max=124.172032814518 PtS11Max=1 x2S11Max=-0.5 x3S11Max=-0.5 _
S11Min=-870.199460336635 PtS11Min=3 x2S11Min=0.5 x3S11Min=-0.5 FrameElem=44 ElemStation=0.375
Frame=44 Station=0.5 OutputCase=TERRLAT CaseType=LinStatic P=-373.013713761058 V2=0.190111961511889
V3=0 T=0 M2=0 M3=82.8405271007404 S11Max=124.029448843385 PtS11Max=1 x2S11Max=-0.5 x3S11Max=-0.5 _
S11Min=-870.056876365501 PtS11Min=3 x2S11Min=0.5 x3S11Min=-0.5 FrameElem=44 ElemStation=0.5
Frame=44 Station=0 OutputCase=ACCVERT CaseType=LinStatic P=0 V2=0 V3=0 T=0 M2=0 M3=0
PtS11Max=0 x2S11Max=0 x3S11Max=0 S11Min=0 PtS11Min=0 x2S11Min=0 x3S11Min=0 FrameElem=44
ElemStation=0
Frame=44 Station=0.125 OutputCase=ACCVERT CaseType=LinStatic P=0 V2=0 V3=0 T=0 M2=0 M3=0
S11Max=0 PtS11Max=0 x2S11Max=0 x3S11Max=0 S11Min=0 PtS11Min=0 x2S11Min=0 x3S11Min=0 FrameElem=44
ElemStation=0.125
Frame=44 Station=0.25 OutputCase=ACCVERT CaseType=LinStatic P=0 V2=0 V3=0 T=0 M2=0 M3=0
S11Max=0 PtS11Max=0 x2S11Max=0 x3S11Max=0 S11Min=0 PtS11Min=0 x2S11Min=0 x3S11Min=0 FrameElem=44
ElemStation=0.25
Frame=44 Station=0.375 OutputCase=ACCVERT CaseType=LinStatic P=0 V2=0 V3=0 T=0 M2=0 M3=0
S11Max=0 PtS11Max=0 x2S11Max=0 x3S11Max=0 S11Min=0 PtS11Min=0 x2S11Min=0 x3S11Min=0 FrameElem=44
ElemStation=0.375
Frame=44 Station=0.5 OutputCase=ACCVERT CaseType=LinStatic P=0 V2=0 V3=0 T=0 M2=0 M3=0
S11Max=0 PtS11Max=0 x2S11Max=0 x3S11Max=0 S11Min=0 PtS11Min=0 x2S11Min=0 x3S11Min=0 FrameElem=44
ElemStation=0.5
Frame=44 Station=0 OutputCase=ACCLATDX CaseType=LinStatic P=0 V2=0 V3=0 T=0 M2=0 M3=0
S11Max=0 PtS11Max=0 x2S11Max=0 x3S11Max=0 S11Min=0 PtS11Min=0 x2S11Min=0 x3S11Min=0 FrameElem=44
ElemStation=0
Frame=44 Station=0.125 OutputCase=ACCLATDX CaseType=LinStatic P=0 V2=0 V3=0 T=0 M2=0 M3=0
S11Max=0 PtS11Max=0 x2S11Max=0 x3S11Max=0 S11Min=0 PtS11Min=0 x2S11Min=0 x3S11Min=0 FrameElem=44
ElemStation=0.125
Frame=44 Station=0.25 OutputCase=ACCLATDX CaseType=LinStatic P=0 V2=0 V3=0 T=0 M2=0 M3=0
S11Max=0 PtS11Max=0 x2S11Max=0 x3S11Max=0 S11Min=0 PtS11Min=0 x2S11Min=0 x3S11Min=0 FrameElem=44
ElemStation=0.25
Frame=44 Station=0.375 OutputCase=ACCLATDX CaseType=LinStatic P=0 V2=0 V3=0 T=0 M2=0 M3=0
S11Max=0 PtS11Max=0 x2S11Max=0 x3S11Max=0 S11Min=0 PtS11Min=0 x2S11Min=0 x3S11Min=0 FrameElem=44
ElemStation=0.375
Frame=44 Station=0.5 OutputCase=ACCLATDX CaseType=LinStatic P=0 V2=0 V3=0 T=0 M2=0 M3=0
S11Max=0 PtS11Max=0 x2S11Max=0 x3S11Max=0 S11Min=0 PtS11Min=0 x2S11Min=0 x3S11Min=0 FrameElem=44
ElemStation=0.5
Frame=44 Station=0 OutputCase=ACCLATSX CaseType=LinStatic P=0 V2=0 V3=0 T=0 M2=0 M3=0
S11Max=0 PtS11Max=0 x2S11Max=0 x3S11Max=0 S11Min=0 PtS11Min=0 x2S11Min=0 x3S11Min=0 FrameElem=44
ElemStation=0
Frame=44 Station=0.125 OutputCase=ACCLATSX CaseType=LinStatic P=0 V2=0 V3=0 T=0 M2=0 M3=0
S11Max=0 PtS11Max=0 x2S11Max=0 x3S11Max=0 S11Min=0 PtS11Min=0 x2S11Min=0 x3S11Min=0 FrameElem=44
ElemStation=0.125
Frame=44 Station=0.25 OutputCase=ACCLATSX CaseType=LinStatic P=0 V2=0 V3=0 T=0 M2=0 M3=0
S11Max=0 PtS11Max=0 x2S11Max=0 x3S11Max=0 S11Min=0 PtS11Min=0 x2S11Min=0 x3S11Min=0 FrameElem=44
ElemStation=0.25
Frame=44 Station=0.375 OutputCase=ACCLATSX CaseType=LinStatic P=0 V2=0 V3=0 T=0 M2=0 M3=0
S11Max=0 PtS11Max=0 x2S11Max=0 x3S11Max=0 S11Min=0 PtS11Min=0 x2S11Min=0 x3S11Min=0 FrameElem=44
ElemStation=0.375
Frame=44 Station=0.5 OutputCase=ACCLATSX CaseType=LinStatic P=0 V2=0 V3=0 T=0 M2=0 M3=0
S11Max=0 PtS11Max=0 x2S11Max=0 x3S11Max=0 S11Min=0 PtS11Min=0 x2S11Min=0 x3S11Min=0 FrameElem=44
ElemStation=0.5
Frame=44 Station=0 OutputCase=TERRCOST CaseType=LinStatic P=0 V2=0 V3=0 T=0 M2=0 M3=0
S11Max=0 PtS11Max=0 x2S11Max=0 x3S11Max=0 S11Min=0 PtS11Min=0 x2S11Min=0 x3S11Min=0 FrameElem=44
ElemStation=0
Frame=44 Station=0.125 OutputCase=TERRCOST CaseType=LinStatic P=0 V2=0 V3=0 T=0 M2=0 M3=0
S11Max=0 PtS11Max=0 x2S11Max=0 x3S11Max=0 S11Min=0 PtS11Min=0 x2S11Min=0 x3S11Min=0 FrameElem=44
ElemStation=0.125

```



Frame=44 Station=0.25 OutputCase=TERRCOST CaseType=LinStatic P=0 V2=0 V3=0 T=0 M2=0 M3=0
 S11Max=0 PtS11Max=0 x2S11Max=0 x3S11Max=0 S11Min=0 PtS11Min=0 x2S11Min=0 x3S11Min=0 FrameElem=44
 ElemStation=0.25
 Frame=44 Station=0.375 OutputCase=TERRCOST CaseType=LinStatic P=0 V2=0 V3=0 T=0 M2=0 M3=0
 S11Max=0 PtS11Max=0 x2S11Max=0 x3S11Max=0 S11Min=0 PtS11Min=0 x2S11Min=0 x3S11Min=0 FrameElem=44
 ElemStation=0.375
 Frame=44 Station=0.5 OutputCase=TERRCOST CaseType=LinStatic P=0 V2=0 V3=0 T=0 M2=0 M3=0
 S11Max=0 PtS11Max=0 x2S11Max=0 x3S11Max=0 S11Min=0 PtS11Min=0 x2S11Min=0 x3S11Min=0 FrameElem=44
 ElemStation=0.5
 Frame=44 Station=0 OutputCase=SOVRCOST CaseType=LinStatic P=0 V2=0 V3=0 T=0 M2=0 M3=0
 S11Max=0 PtS11Max=0 x2S11Max=0 x3S11Max=0 S11Min=0 PtS11Min=0 x2S11Min=0 x3S11Min=0 FrameElem=44
 ElemStation=0
 Frame=44 Station=0.125 OutputCase=SOVRCOST CaseType=LinStatic P=0 V2=0 V3=0 T=0 M2=0 M3=0
 S11Max=0 PtS11Max=0 x2S11Max=0 x3S11Max=0 S11Min=0 PtS11Min=0 x2S11Min=0 x3S11Min=0 FrameElem=44
 ElemStation=0.125
 Frame=44 Station=0.25 OutputCase=SOVRCOST CaseType=LinStatic P=0 V2=0 V3=0 T=0 M2=0 M3=0
 S11Max=0 PtS11Max=0 x2S11Max=0 x3S11Max=0 S11Min=0 PtS11Min=0 x2S11Min=0 x3S11Min=0 FrameElem=44
 ElemStation=0.25
 Frame=44 Station=0.375 OutputCase=SOVRCOST CaseType=LinStatic P=0 V2=0 V3=0 T=0 M2=0 M3=0
 S11Max=0 PtS11Max=0 x2S11Max=0 x3S11Max=0 S11Min=0 PtS11Min=0 x2S11Min=0 x3S11Min=0 FrameElem=44
 ElemStation=0.375
 Frame=44 Station=0.5 OutputCase=SOVRCOST CaseType=LinStatic P=0 V2=0 V3=0 T=0 M2=0 M3=0
 S11Max=0 PtS11Max=0 x2S11Max=0 x3S11Max=0 S11Min=0 PtS11Min=0 x2S11Min=0 x3S11Min=0 FrameElem=44
 ElemStation=0.5
 Frame=44 Station=0 OutputCase=ENVE CaseType=Combination StepType=Max P=-274.637838986977
 V2=78.7434113006799 V3=0 T=0 M2=0 M3=-543.837913128595 S11Max=3137.67368933129 PtS11Max=3 x2S11Max=0.5
 x3S11Max=-0.5
 S11Min=-3649.56943188686 PtS11Min=1 x2S11Min=-0.5 x3S11Min=-0.5 FrameElem=44 ElemStation=0
 Frame=44 Station=0.125 OutputCase=ENVE CaseType=Combination StepType=Max P=-274.637838986977
 V2=81.8684113006799 V3=0 T=0 M2=0 M3=-553.87615204118 S11Max=3197.86034761545 PtS11Max=3 x2S11Max=0.5
 x3S11Max=-0.5
 S11Min=-3709.79886536237 PtS11Min=1 x2S11Min=-0.5 x3S11Min=-0.5 FrameElem=44 ElemStation=0.125
 Frame=44 Station=0.25 OutputCase=ENVE CaseType=Combination StepType=Max P=-274.637838986977
 V2=84.9934113006799 V3=0 T=0 M2=0 M3=-564.305015953765 S11Max=3260.39075589962 PtS11Max=3 x2S11Max=0.5
 x3S11Max=-0.5
 S11Min=-3772.37204883788 PtS11Min=1 x2S11Min=-0.5 x3S11Min=-0.5 FrameElem=44 ElemStation=0.25
 Frame=44 Station=0.375 OutputCase=ENVE CaseType=Combination StepType=Max P=-274.637838986977
 V2=88.1184113006799 V3=0 T=0 M2=0 M3=-575.12450486635 S11Max=3325.26491418379 PtS11Max=3 x2S11Max=0.5
 x3S11Max=-0.5
 S11Min=-3837.28898231339 PtS11Min=1 x2S11Min=-0.5 x3S11Min=-0.5 FrameElem=44 ElemStation=0.375
 Frame=44 Station=0.5 OutputCase=ENVE CaseType=Combination StepType=Max P=-274.637838986977
 V2=91.2434113006799 V3=0 T=0 M2=0 M3=-586.334618778935 S11Max=3392.48282246796 PtS11Max=3 x2S11Max=0.5
 x3S11Max=-0.5
 S11Min=-3904.5496657889 PtS11Min=1 x2S11Min=-0.5 x3S11Min=-0.5 FrameElem=44 ElemStation=0.5
 Frame=44 Station=0 OutputCase=ENVE CaseType=Combination StepType=Min P=-386.541953115295
 V2=78.6863777122263 V3=0 T=0 M2=0 M3=-568.718588053044 S11Max=2876.48552565627 PtS11Max=3 x2S11Max=0.5
 x3S11Max=-0.5
 S11Min=-3686.94936730524 PtS11Min=1 x2S11Min=-0.5 x3S11Min=-0.5 FrameElem=44 ElemStation=0
 Frame=44 Station=0.125 OutputCase=ENVE CaseType=Combination StepType=Min P=-386.541953115295
 V2=81.8113777122263 V3=0 T=0 M2=0 M3=-578.749697767072 S11Max=2936.71495913178 PtS11Max=3 x2S11Max=0.5
 x3S11Max=-0.5
 S11Min=-3747.13602558941 PtS11Min=1 x2S11Min=-0.5 x3S11Min=-0.5 FrameElem=44 ElemStation=0.125
 Frame=44 Station=0.25 OutputCase=ENVE CaseType=Combination StepType=Min P=-386.541953115295
 V2=84.9363777122263 V3=0 T=0 M2=0 M3=-589.1714324811 S11Max=2999.28814260729 PtS11Max=3 x2S11Max=0.5
 x3S11Max=-0.5
 S11Min=-3809.66643387358 PtS11Min=1 x2S11Min=-0.5 x3S11Min=-0.5 FrameElem=44 ElemStation=0.25
 Frame=44 Station=0.375 OutputCase=ENVE CaseType=Combination StepType=Min P=-386.541953115295
 V2=88.0613777122263 V3=0 T=0 M2=0 M3=-599.983792195129 S11Max=3064.2050760828 PtS11Max=3 x2S11Max=0.5
 x3S11Max=-0.5
 S11Min=-3874.54059215775 PtS11Min=1 x2S11Min=-0.5 x3S11Min=-0.5 FrameElem=44 ElemStation=0.375
 Frame=44 Station=0.5 OutputCase=ENVE CaseType=Combination StepType=Min P=-386.541953115295
 V2=91.1863777122263 V3=0 T=0 M2=0 M3=-611.186776909157 S11Max=3131.46575955831 PtS11Max=3 x2S11Max=0.5
 x3S11Max=-0.5
 S11Min=-3941.75850044192 PtS11Min=1 x2S11Min=-0.5 x3S11Min=-0.5 FrameElem=44 ElemStation=0.5
 Frame=44 Station=0 OutputCase=FESSUR CaseType=Combination P=-386.541953115295 V2=78.7434113006799
 V3=0 T=0 M2=0 M3=-543.837913128595 S11Max=2876.48552565627 PtS11Max=3 x2S11Max=0.5 x3S11Max=-0.5
 S11Min=-3649.56943188686 PtS11Min=1 x2S11Min=-0.5 x3S11Min=-0.5 FrameElem=44 ElemStation=0
 Frame=44 Station=0.125 OutputCase=FESSUR CaseType=Combination P=-386.541953115295 V2=81.8684113006799
 V3=0 T=0 M2=0 M3=-553.87615204118 S11Max=2936.71495913178 PtS11Max=3 x2S11Max=0.5 x3S11Max=-0.5
 S11Min=-3709.79886536237 PtS11Min=1 x2S11Min=-0.5 x3S11Min=-0.5 FrameElem=44 ElemStation=0.125
 Frame=44 Station=0.25 OutputCase=FESSUR CaseType=Combination P=-386.541953115295 V2=84.9934113006799
 V3=0 T=0 M2=0 M3=-564.305015953765 S11Max=2999.28814260729 PtS11Max=3 x2S11Max=0.5 x3S11Max=-0.5
 S11Min=-3772.37204883788 PtS11Min=1 x2S11Min=-0.5 x3S11Min=-0.5 FrameElem=44 ElemStation=0.25
 Frame=44 Station=0.375 OutputCase=FESSUR CaseType=Combination P=-386.541953115295 V2=88.1184113006799
 V3=0 T=0 M2=0 M3=-575.12450486635 S11Max=3064.2050760828 PtS11Max=3 x2S11Max=0.5 x3S11Max=-0.5
 S11Min=-3837.28898231339 PtS11Min=1 x2S11Min=-0.5 x3S11Min=-0.5 FrameElem=44 ElemStation=0.375
 Frame=44 Station=0.5 OutputCase=FESSUR CaseType=Combination P=-386.541953115295 V2=91.2434113006799
 V3=0 T=0 M2=0 M3=-586.334618778935 S11Max=3131.46575955831 PtS11Max=3 x2S11Max=0.5 x3S11Max=-0.5
 S11Min=-3904.5496657889 PtS11Min=1 x2S11Min=-0.5 x3S11Min=-0.5 FrameElem=44 ElemStation=0.5
 Frame=45 Station=0 OutputCase=PESOPR CaseType=LinStatic P=-15.1709467361871 V2=-22.2427924569347 V3=0
 T=0 M2=0 M3=-119.803682228903 S11Max=703.651146637232 PtS11Max=3 x2S11Max=0.5 x3S11Max=-0.5
 S11Min=-733.993040109606 PtS11Min=1 x2S11Min=-0.5 x3S11Min=-0.5 FrameElem=45 ElemStation=0

```

Frame=45 Station=0.125 OutputCase=PESOPR CaseType=LinStatic P=-15.1709467361871 V2=-19.1177924569347
V3=0 T=0 M2=0 M3=-117.218645671786 S11Max=688.140927294531 PtS11Max=3 x2S11Max=0.5 x3S11Max=-0.5 _
S11Min=-718.482820766905 PtS11Min=1 x2S11Min=-0.5 x3S11Min=-0.5 FrameElem=45 ElemStation=0.125
Frame=45 Station=0.25 OutputCase=PESOPR CaseType=LinStatic P=-15.1709467361871 V2=-15.9927924569347
V3=0 T=0 M2=0 M3=-115.02423411467 S11Max=674.97445795183 PtS11Max=3 x2S11Max=0.5 x3S11Max=-0.5 _
S11Min=-705.316351424204 PtS11Min=1 x2S11Min=-0.5 x3S11Min=-0.5 FrameElem=45 ElemStation=0.25
Frame=45 Station=0.375 OutputCase=PESOPR CaseType=LinStatic P=-15.1709467361871 V2=-12.8677924569347
V3=0 T=0 M2=0 M3=-113.220447557553 S11Max=664.151738609129 PtS11Max=3 x2S11Max=0.5 x3S11Max=-0.5 _
S11Min=-694.493632081503 PtS11Min=1 x2S11Min=-0.5 x3S11Min=-0.5 FrameElem=45 ElemStation=0.375
Frame=45 Station=0.5 OutputCase=PESOPR CaseType=LinStatic P=-15.1709467361871 V2=-9.74279245693469
V3=0 T=0 M2=0 M3=-111.807286000436 S11Max=655.672769266428 PtS11Max=3 x2S11Max=0.5 x3S11Max=-0.5 _
S11Min=-686.014662738802 PtS11Min=1 x2S11Min=-0.5 x3S11Min=-0.5 FrameElem=45 ElemStation=0.5
Frame=45 Station=0 OutputCase=TERRVERT CaseType=LinStatic P=1.64270738195066 V2=-68.8105077490618
V3=0 T=0 M2=0 M3=-549.371463650772 S11Max=3297.87148928658 PtS11Max=3 x2S11Max=0.5 x3S11Max=-0.5 _
S11Min=-3294.58607452268 PtS11Min=1 x2S11Min=-0.5 x3S11Min=-0.5 FrameElem=45 ElemStation=0
Frame=45 Station=0.125 OutputCase=TERRVERT CaseType=LinStatic P=1.64270738195066 V2=-68.8105077490618
V3=0 T=0 M2=0 M3=-540.770150182139 S11Max=3246.26360847479 PtS11Max=3 x2S11Max=0.5 x3S11Max=-0.5 _
S11Min=-3242.97819371089 PtS11Min=1 x2S11Min=-0.5 x3S11Min=-0.5 FrameElem=45 ElemStation=0.125
Frame=45 Station=0.25 OutputCase=TERRVERT CaseType=LinStatic P=1.64270738195066 V2=-68.8105077490618
V3=0 T=0 M2=0 M3=-532.168836713507 S11Max=3194.65572766299 PtS11Max=3 x2S11Max=0.5 x3S11Max=-0.5 _
S11Min=-3191.37031289909 PtS11Min=1 x2S11Min=-0.5 x3S11Min=-0.5 FrameElem=45 ElemStation=0.25
Frame=45 Station=0.375 OutputCase=TERRVERT CaseType=LinStatic P=1.64270738195066 V2=-68.8105077490618
V3=0 T=0 M2=0 M3=-523.567523244874 S11Max=3143.04784685119 PtS11Max=3 x2S11Max=0.5 x3S11Max=-0.5 _
S11Min=-3139.76243208729 PtS11Min=1 x2S11Min=-0.5 x3S11Min=-0.5 FrameElem=45 ElemStation=0.375
Frame=45 Station=0.5 OutputCase=TERRVERT CaseType=LinStatic P=1.64270738195066 V2=-68.8105077490618
V3=0 T=0 M2=0 M3=-514.966209776241 S11Max=3091.4399660394 PtS11Max=3 x2S11Max=0.5 x3S11Max=-0.5 _
S11Min=-3088.1545512755 PtS11Min=1 x2S11Min=-0.5 x3S11Min=-0.5 FrameElem=45 ElemStation=0.5
Frame=45 Station=0 OutputCase=TERRLAT CaseType=LinStatic P=-373.013713761058 V2=-0.190106907453469
V3=0 T=0 M2=0 M3=82.8405271007405 S11Max=124.029448843384 PtS11Max=1 x2S11Max=-0.5 x3S11Max=-0.5 _
S11Min=-870.056876365501 PtS11Min=3 x2S11Min=0.5 x3S11Min=-0.5 FrameElem=45 ElemStation=0
Frame=45 Station=0.125 OutputCase=TERRLAT CaseType=LinStatic P=-373.013713761058 V2=-0.190106907453469
V3=0 T=0 M2=0 M3=82.8642904641722 S11Max=124.172029023975 PtS11Max=1 x2S11Max=-0.5 x3S11Max=-0.5 _
S11Min=-870.199456546091 PtS11Min=3 x2S11Min=0.5 x3S11Min=-0.5 FrameElem=45 ElemStation=0.125
Frame=45 Station=0.25 OutputCase=TERRLAT CaseType=LinStatic P=-373.013713761058 V2=-0.190106907453469
V3=0 T=0 M2=0 M3=82.8880538276038 S11Max=124.314609204565 PtS11Max=1 x2S11Max=-0.5 x3S11Max=-0.5 _
S11Min=-870.342036726682 PtS11Min=3 x2S11Min=0.5 x3S11Min=-0.5 FrameElem=45 ElemStation=0.25
Frame=45 Station=0.375 OutputCase=TERRLAT CaseType=LinStatic P=-373.013713761058 V2=-0.190106907453469
V3=0 T=0 M2=0 M3=82.9118171910355 S11Max=124.457189385155 PtS11Max=1 x2S11Max=-0.5 x3S11Max=-0.5 _
S11Min=-870.484616907272 PtS11Min=3 x2S11Min=0.5 x3S11Min=-0.5 FrameElem=45 ElemStation=0.375
Frame=45 Station=0.5 OutputCase=TERRLAT CaseType=LinStatic P=-373.013713761058 V2=-0.190106907453469
V3=0 T=0 M2=0 M3=82.9355805544672 S11Max=124.599769565745 PtS11Max=1 x2S11Max=-0.5 x3S11Max=-0.5 _
S11Min=-870.627197087862 PtS11Min=3 x2S11Min=0.5 x3S11Min=-0.5 FrameElem=45 ElemStation=0.5
Frame=45 Station=0 OutputCase=ACCVERT CaseType=LinStatic P=0 V2=0 V3=0 T=0 M2=0 M3=0 S11Max=0
PtS11Max=0 x2S11Max=0 x3S11Max=0 S11Min=0 PtS11Min=0 x2S11Min=0 x3S11Min=0 FrameElem=45
ElemStation=0
Frame=45 Station=0.125 OutputCase=ACCVERT CaseType=LinStatic P=0 V2=0 V3=0 T=0 M2=0 M3=0
S11Max=0 PtS11Max=0 x2S11Max=0 x3S11Max=0 S11Min=0 PtS11Min=0 x2S11Min=0 x3S11Min=0 FrameElem=45
ElemStation=0.125
Frame=45 Station=0.25 OutputCase=ACCVERT CaseType=LinStatic P=0 V2=0 V3=0 T=0 M2=0 M3=0
S11Max=0 PtS11Max=0 x2S11Max=0 x3S11Max=0 S11Min=0 PtS11Min=0 x2S11Min=0 x3S11Min=0 FrameElem=45
ElemStation=0.25
Frame=45 Station=0.375 OutputCase=ACCVERT CaseType=LinStatic P=0 V2=0 V3=0 T=0 M2=0 M3=0
S11Max=0 PtS11Max=0 x2S11Max=0 x3S11Max=0 S11Min=0 PtS11Min=0 x2S11Min=0 x3S11Min=0 FrameElem=45
ElemStation=0.375
Frame=45 Station=0.5 OutputCase=ACCVERT CaseType=LinStatic P=0 V2=0 V3=0 T=0 M2=0 M3=0
S11Max=0 PtS11Max=0 x2S11Max=0 x3S11Max=0 S11Min=0 PtS11Min=0 x2S11Min=0 x3S11Min=0 FrameElem=45
ElemStation=0.5
Frame=45 Station=0 OutputCase=ACCLATDX CaseType=LinStatic P=0 V2=0 V3=0 T=0 M2=0 M3=0
S11Max=0 PtS11Max=0 x2S11Max=0 x3S11Max=0 S11Min=0 PtS11Min=0 x2S11Min=0 x3S11Min=0 FrameElem=45
ElemStation=0
Frame=45 Station=0.125 OutputCase=ACCLATDX CaseType=LinStatic P=0 V2=0 V3=0 T=0 M2=0 M3=0
S11Max=0 PtS11Max=0 x2S11Max=0 x3S11Max=0 S11Min=0 PtS11Min=0 x2S11Min=0 x3S11Min=0 FrameElem=45
ElemStation=0.125
Frame=45 Station=0.25 OutputCase=ACCLATDX CaseType=LinStatic P=0 V2=0 V3=0 T=0 M2=0 M3=0
S11Max=0 PtS11Max=0 x2S11Max=0 x3S11Max=0 S11Min=0 PtS11Min=0 x2S11Min=0 x3S11Min=0 FrameElem=45
ElemStation=0.25
Frame=45 Station=0.375 OutputCase=ACCLATDX CaseType=LinStatic P=0 V2=0 V3=0 T=0 M2=0 M3=0
S11Max=0 PtS11Max=0 x2S11Max=0 x3S11Max=0 S11Min=0 PtS11Min=0 x2S11Min=0 x3S11Min=0 FrameElem=45
ElemStation=0.375
Frame=45 Station=0.5 OutputCase=ACCLATDX CaseType=LinStatic P=0 V2=0 V3=0 T=0 M2=0 M3=0
S11Max=0 PtS11Max=0 x2S11Max=0 x3S11Max=0 S11Min=0 PtS11Min=0 x2S11Min=0 x3S11Min=0 FrameElem=45
ElemStation=0.5
Frame=45 Station=0 OutputCase=ACCLATSX CaseType=LinStatic P=0 V2=0 V3=0 T=0 M2=0 M3=0
S11Max=0 PtS11Max=0 x2S11Max=0 x3S11Max=0 S11Min=0 PtS11Min=0 x2S11Min=0 x3S11Min=0 FrameElem=45
ElemStation=0
Frame=45 Station=0.125 OutputCase=ACCLATSX CaseType=LinStatic P=0 V2=0 V3=0 T=0 M2=0 M3=0
S11Max=0 PtS11Max=0 x2S11Max=0 x3S11Max=0 S11Min=0 PtS11Min=0 x2S11Min=0 x3S11Min=0 FrameElem=45
ElemStation=0.125
Frame=45 Station=0.25 OutputCase=ACCLATSX CaseType=LinStatic P=0 V2=0 V3=0 T=0 M2=0 M3=0
S11Max=0 PtS11Max=0 x2S11Max=0 x3S11Max=0 S11Min=0 PtS11Min=0 x2S11Min=0 x3S11Min=0 FrameElem=45
ElemStation=0.25

```



Frame=45 Station=0.375 OutputCase=ACCLATSX CaseType=LinStatic P=0 V2=0 V3=0 T=0 M2=0 M3=0
 S11Max=0 PtS11Max=0 x2S11Max=0 x3S11Max=0 S11Min=0 PtS11Min=0 x2S11Min=0 x3S11Min=0 FrameElem=45
 ElemStation=0.375
 Frame=45 Station=0.5 OutputCase=ACCLATSX CaseType=LinStatic P=0 V2=0 V3=0 T=0 M2=0 M3=0
 S11Max=0 PtS11Max=0 x2S11Max=0 x3S11Max=0 S11Min=0 PtS11Min=0 x2S11Min=0 x3S11Min=0 FrameElem=45
 ElemStation=0.5
 Frame=45 Station=0 OutputCase=TERRCOST CaseType=LinStatic P=0 V2=0 V3=0 T=0 M2=0 M3=0
 S11Max=0 PtS11Max=0 x2S11Max=0 x3S11Max=0 S11Min=0 PtS11Min=0 x2S11Min=0 x3S11Min=0 FrameElem=45
 ElemStation=0
 Frame=45 Station=0.125 OutputCase=TERRCOST CaseType=LinStatic P=0 V2=0 V3=0 T=0 M2=0 M3=0
 S11Max=0 PtS11Max=0 x2S11Max=0 x3S11Max=0 S11Min=0 PtS11Min=0 x2S11Min=0 x3S11Min=0 FrameElem=45
 ElemStation=0.125
 Frame=45 Station=0.25 OutputCase=TERRCOST CaseType=LinStatic P=0 V2=0 V3=0 T=0 M2=0 M3=0
 S11Max=0 PtS11Max=0 x2S11Max=0 x3S11Max=0 S11Min=0 PtS11Min=0 x2S11Min=0 x3S11Min=0 FrameElem=45
 ElemStation=0.25
 Frame=45 Station=0.375 OutputCase=TERRCOST CaseType=LinStatic P=0 V2=0 V3=0 T=0 M2=0 M3=0
 S11Max=0 PtS11Max=0 x2S11Max=0 x3S11Max=0 S11Min=0 PtS11Min=0 x2S11Min=0 x3S11Min=0 FrameElem=45
 ElemStation=0.375
 Frame=45 Station=0.5 OutputCase=TERRCOST CaseType=LinStatic P=0 V2=0 V3=0 T=0 M2=0 M3=0
 S11Max=0 PtS11Max=0 x2S11Max=0 x3S11Max=0 S11Min=0 PtS11Min=0 x2S11Min=0 x3S11Min=0 FrameElem=45
 ElemStation=0.5
 Frame=45 Station=0 OutputCase=SOVRCOST CaseType=LinStatic P=0 V2=0 V3=0 T=0 M2=0 M3=0
 S11Max=0 PtS11Max=0 x2S11Max=0 x3S11Max=0 S11Min=0 PtS11Min=0 x2S11Min=0 x3S11Min=0 FrameElem=45
 ElemStation=0
 Frame=45 Station=0.125 OutputCase=SOVRCOST CaseType=LinStatic P=0 V2=0 V3=0 T=0 M2=0 M3=0
 S11Max=0 PtS11Max=0 x2S11Max=0 x3S11Max=0 S11Min=0 PtS11Min=0 x2S11Min=0 x3S11Min=0 FrameElem=45
 ElemStation=0.125
 Frame=45 Station=0.25 OutputCase=SOVRCOST CaseType=LinStatic P=0 V2=0 V3=0 T=0 M2=0 M3=0
 S11Max=0 PtS11Max=0 x2S11Max=0 x3S11Max=0 S11Min=0 PtS11Min=0 x2S11Min=0 x3S11Min=0 FrameElem=45
 ElemStation=0.25
 Frame=45 Station=0.375 OutputCase=SOVRCOST CaseType=LinStatic P=0 V2=0 V3=0 T=0 M2=0 M3=0
 S11Max=0 PtS11Max=0 x2S11Max=0 x3S11Max=0 S11Min=0 PtS11Min=0 x2S11Min=0 x3S11Min=0 FrameElem=45
 ElemStation=0.375
 Frame=45 Station=0.5 OutputCase=SOVRCOST CaseType=LinStatic P=0 V2=0 V3=0 T=0 M2=0 M3=0
 S11Max=0 PtS11Max=0 x2S11Max=0 x3S11Max=0 S11Min=0 PtS11Min=0 x2S11Min=0 x3S11Min=0 FrameElem=45
 ElemStation=0.5
 Frame=45 Station=0 OutputCase=ENVE CaseType=Combination StepType=Max P=-274.637838986977 V2=-
 91.1863750412139 V3=0 T=0 M2=0 M3=-586.334618778935 S11Max=3392.48282246796 PtS11Max=3 x2S11Max=0.5
 x3S11Max=-0.5
 S11Min=-3904.5496657889 PtS11Min=1 x2S11Min=-0.5 x3S11Min=-0.5 FrameElem=45 ElemStation=0
 Frame=45 Station=0.125 OutputCase=ENVE CaseType=Combination StepType=Max P=-274.637838986977 V2=-
 88.0613750412139 V3=0 T=0 M2=0 M3=-575.124505389753 S11Max=3325.26491618705 PtS11Max=3 x2S11Max=0.5
 x3S11Max=-0.5 S11Min=-3837.28898545382 PtS11Min=1 x2S11Min=-0.5 x3S11Min=-0.5 FrameElem=45
 ElemStation=0.125
 Frame=45 Station=0.25 OutputCase=ENVE CaseType=Combination StepType=Max P=-274.637838986977 V2=-
 84.9363750412139 V3=0 T=0 M2=0 M3=-564.305017000572 S11Max=3260.39075990614 PtS11Max=3 x2S11Max=0.5
 x3S11Max=-0.5
 S11Min=-3772.37205511873 PtS11Min=1 x2S11Min=-0.5 x3S11Min=-0.5 FrameElem=45 ElemStation=0.25
 Frame=45 Station=0.375 OutputCase=ENVE CaseType=Combination StepType=Max P=-274.637838986977 V2=-
 81.8113750412139 V3=0 T=0 M2=0 M3=-553.876153611391 S11Max=3197.86035362523 PtS11Max=3 x2S11Max=0.5
 x3S11Max=-0.5 S11Min=-3709.79887478364 PtS11Min=1 x2S11Min=-0.5 x3S11Min=-0.5 FrameElem=45
 ElemStation=0.375
 Frame=45 Station=0.5 OutputCase=ENVE CaseType=Combination StepType=Max P=-274.637838986977 V2=-
 78.6863750412139 V3=0 T=0 M2=0 M3=-543.83791522221 S11Max=3137.67369734432 PtS11Max=3 x2S11Max=0.5
 x3S11Max=-0.5
 S11Min=-3649.56944444855 PtS11Min=1 x2S11Min=-0.5 x3S11Min=-0.5 FrameElem=45 ElemStation=0.5
 Frame=45 Station=0 OutputCase=ENVE CaseType=Combination StepType=Min P=-386.541953115295 V2=-
 91.24340711345 V3=0 T=0 M2=0 M3=-611.186776909157 S11Max=3131.46575955831 PtS11Max=3 x2S11Max=0.5
 x3S11Max=-0.5
 S11Min=-3941.75850044192 PtS11Min=1 x2S11Min=-0.5 x3S11Min=-0.5 FrameElem=45 ElemStation=0
 Frame=45 Station=0.125 OutputCase=ENVE CaseType=Combination StepType=Min P=-386.541953115295 V2=-
 88.11840711345 V3=0 T=0 M2=0 M3=-599.983792529005 S11Max=3064.20507922323 PtS11Max=3 x2S11Max=0.5
 x3S11Max=-0.5
 S11Min=-3874.54059416101 PtS11Min=1 x2S11Min=-0.5 x3S11Min=-0.5 FrameElem=45 ElemStation=0.125
 Frame=45 Station=0.25 OutputCase=ENVE CaseType=Combination StepType=Min P=-386.541953115295 V2=-
 84.99340711345 V3=0 T=0 M2=0 M3=-589.171433148853 S11Max=2999.28814888814 PtS11Max=3 x2S11Max=0.5
 x3S11Max=-0.5
 S11Min=-3809.6664378801 PtS11Min=1 x2S11Min=-0.5 x3S11Min=-0.5 FrameElem=45 ElemStation=0.25
 Frame=45 Station=0.375 OutputCase=ENVE CaseType=Combination StepType=Min P=-386.541953115295 V2=-
 81.86840711345 V3=0 T=0 M2=0 M3=-578.749698768702 S11Max=2936.71496855305 PtS11Max=3 x2S11Max=0.5
 x3S11Max=-0.5
 S11Min=-3747.13603159919 PtS11Min=1 x2S11Min=-0.5 x3S11Min=-0.5 FrameElem=45 ElemStation=0.375
 Frame=45 Station=0.5 OutputCase=ENVE CaseType=Combination StepType=Min P=-386.541953115295 V2=-
 78.74340711345 V3=0 T=0 M2=0 M3=-568.71858938855 S11Max=2876.48553821796 PtS11Max=3 x2S11Max=0.5
 x3S11Max=-0.5
 S11Min=-3686.94937531828 PtS11Min=1 x2S11Min=-0.5 x3S11Min=-0.5 FrameElem=45 ElemStation=0.5
 Frame=45 Station=0 OutputCase=FESSUR CaseType=Combination P=-386.541953115295 V2=-91.24340711345 V3=0
 T=0 M2=0 M3=-586.334618778935 S11Max=3131.46575955831 PtS11Max=3 x2S11Max=0.5 x3S11Max=-0.5
 S11Min=-3904.5496657889 PtS11Min=1 x2S11Min=-0.5 x3S11Min=-0.5 FrameElem=45 ElemStation=0
 Frame=45 Station=0.125 OutputCase=FESSUR CaseType=Combination P=-386.541953115295 V2=-88.11840711345
 V3=0 T=0 M2=0 M3=-575.124505389753 S11Max=3064.20507922323 PtS11Max=3 x2S11Max=0.5 x3S11Max=-0.5
 S11Min=-3837.28898545382 PtS11Min=1 x2S11Min=-0.5 x3S11Min=-0.5 FrameElem=45 ElemStation=0.125



Frame=45 Station=0.25 OutputCase=FESSUR CaseType=Combination P=-386.541953115295 V2=-84.99340711345
 V3=0 T=0 M2=0 M3=-564.305017000572 S11Max=2999.28814888814 PtS11Max=3 x2S11Max=0.5 x3S11Max=-0.5 _
 S11Min=-3772.37205511873 PtS11Min=1 x2S11Min=-0.5 x3S11Min=-0.5 FrameElem=45 ElemStation=0.25
 Frame=45 Station=0.375 OutputCase=FESSUR CaseType=Combination P=-386.541953115295 V2=-81.86840711345
 V3=0 T=0 M2=0 M3=-553.876153611391 S11Max=2936.71496855305 PtS11Max=3 x2S11Max=0.5 x3S11Max=-0.5 _
 S11Min=-3709.79887478364 PtS11Min=1 x2S11Min=-0.5 x3S11Min=-0.5 FrameElem=45 ElemStation=0.375
 Frame=45 Station=0.5 OutputCase=FESSUR CaseType=Combination P=-386.541953115295 V2=-78.74340711345
 V3=0 T=0 M2=0 M3=-543.83791522221 S11Max=2876.48553821796 PtS11Max=3 x2S11Max=0.5 x3S11Max=-0.5 _
 S11Min=-3649.56944444855 PtS11Min=1 x2S11Min=-0.5 x3S11Min=-0.5 FrameElem=45 ElemStation=0.5
 Frame=46 Station=0 OutputCase=PESOPR CaseType=LinStatic P=-15.1709467361871 V2=-54.2994159259542 V3=0
 T=0 M2=0 M3=-111.807286000439 S11Max=655.67276926645 PtS11Max=3 x2S11Max=0.5 x3S11Max=-0.5 _
 S11Min=-686.014662738824 PtS11Min=1 x2S11Min=-0.5 x3S11Min=-0.5 FrameElem=46 ElemStation=0
 Frame=46 Station=0.125 OutputCase=PESOPR CaseType=LinStatic P=-15.1709467361871 V2=-51.1744159259542
 V3=0 T=0 M2=0 M3=-105.215171509695 S11Max=616.120082321984 PtS11Max=3 x2S11Max=0.5 x3S11Max=-0.5 _
 S11Min=-646.461975794358 PtS11Min=1 x2S11Min=-0.5 x3S11Min=-0.5 FrameElem=46 ElemStation=0.125
 Frame=46 Station=0.25 OutputCase=PESOPR CaseType=LinStatic P=-15.1709467361871 V2=-48.0494159259542
 V3=0 T=0 M2=0 M3=-99.0136820189509 S11Max=578.911145377518 PtS11Max=3 x2S11Max=0.5 x3S11Max=-0.5 _
 S11Min=-609.253038849893 PtS11Min=1 x2S11Min=-0.5 x3S11Min=-0.5 FrameElem=46 ElemStation=0.25
 Frame=46 Station=0.375 OutputCase=PESOPR CaseType=LinStatic P=-15.1709467361871 V2=-44.9244159259542
 V3=0 T=0 M2=0 M3=-93.2028175282067 S11Max=544.045958433053 PtS11Max=3 x2S11Max=0.5 x3S11Max=-0.5 _
 S11Min=-574.387851905427 PtS11Min=1 x2S11Min=-0.5 x3S11Min=-0.5 FrameElem=46 ElemStation=0.375
 Frame=46 Station=0.5 OutputCase=PESOPR CaseType=LinStatic P=-15.1709467361871 V2=-41.7994159259542
 V3=0 T=0 M2=0 M3=-87.7825780374624 S11Max=511.524521488587 PtS11Max=3 x2S11Max=0.5 x3S11Max=-0.5 _
 S11Min=-541.866414960961 PtS11Min=1 x2S11Min=-0.5 x3S11Min=-0.5 FrameElem=46 ElemStation=0.5
 Frame=46 Station=0 OutputCase=TERRVERT CaseType=LinStatic P=1.64270738195065 V2=-206.756726049556
 V3=0 T=0 M2=0 M3=-514.966209776248 S11Max=3091.43996603944 PtS11Max=3 x2S11Max=0.5 x3S11Max=-0.5 _
 S11Min=-3088.15455127554 PtS11Min=1 x2S11Min=-0.5 x3S11Min=-0.5 FrameElem=46 ElemStation=0
 Frame=46 Station=0.125 OutputCase=TERRVERT CaseType=LinStatic P=1.64270738195065 V2=-206.756726049556
 V3=0 T=0 M2=0 M3=-489.121619020054 S11Max=2936.37242150227 PtS11Max=3 x2S11Max=0.5 x3S11Max=-0.5 _
 S11Min=-2933.08700673837 PtS11Min=1 x2S11Min=-0.5 x3S11Min=-0.5 FrameElem=46 ElemStation=0.125
 Frame=46 Station=0.25 OutputCase=TERRVERT CaseType=LinStatic P=1.64270738195065 V2=-206.756726049556
 V3=0 T=0 M2=0 M3=-463.277028263859 S11Max=2781.30487696511 PtS11Max=3 x2S11Max=0.5 x3S11Max=-0.5 _
 S11Min=-2778.01946220121 PtS11Min=1 x2S11Min=-0.5 x3S11Min=-0.5 FrameElem=46 ElemStation=0.25
 Frame=46 Station=0.375 OutputCase=TERRVERT CaseType=LinStatic P=1.64270738195065 V2=-206.756726049556
 V3=0 T=0 M2=0 M3=-437.432437507665 S11Max=2626.23733242794 PtS11Max=3 x2S11Max=0.5 x3S11Max=-0.5 _
 S11Min=-2622.95191766404 PtS11Min=1 x2S11Min=-0.5 x3S11Min=-0.5 FrameElem=46 ElemStation=0.375
 Frame=46 Station=0.5 OutputCase=TERRVERT CaseType=LinStatic P=1.64270738195065 V2=-206.756726049556
 V3=0 T=0 M2=0 M3=-411.58784675147 S11Max=2471.16978789077 PtS11Max=3 x2S11Max=0.5 x3S11Max=-0.5 _
 S11Min=-2467.88437312687 PtS11Min=1 x2S11Min=-0.5 x3S11Min=-0.5 FrameElem=46 ElemStation=0.5
 Frame=46 Station=0 OutputCase=TERRLAT CaseType=LinStatic P=-373.013713761059 V2=-0.525593818948437
 V3=0 T=0 M2=0 M3=82.9355805544672 S11Max=124.599769565744 PtS11Max=1 x2S11Max=-0.5 x3S11Max=-0.5 _
 S11Min=-870.627197087862 PtS11Min=3 x2S11Min=0.5 x3S11Min=-0.5 FrameElem=46 ElemStation=0
 Frame=46 Station=0.125 OutputCase=TERRLAT CaseType=LinStatic P=-373.013713761059 V2=-0.525593818948437
 V3=0 T=0 M2=0 M3=83.0012797818357 S11Max=124.993964929956 PtS11Max=1 x2S11Max=-0.5 x3S11Max=-0.5 _
 S11Min=-871.021392452073 PtS11Min=3 x2S11Min=0.5 x3S11Min=-0.5 FrameElem=46 ElemStation=0.125
 Frame=46 Station=0.25 OutputCase=TERRLAT CaseType=LinStatic P=-373.013713761059 V2=-0.525593818948437
 V3=0 T=0 M2=0 M3=83.0669790092043 S11Max=125.388160294167 PtS11Max=1 x2S11Max=-0.5 x3S11Max=-0.5 _
 S11Min=-871.415587816284 PtS11Min=3 x2S11Min=0.5 x3S11Min=-0.5 FrameElem=46 ElemStation=0.25
 Frame=46 Station=0.375 OutputCase=TERRLAT CaseType=LinStatic P=-373.013713761059 V2=-0.525593818948437
 V3=0 T=0 M2=0 M3=83.1326782365728 S11Max=125.782355658378 PtS11Max=1 x2S11Max=-0.5 x3S11Max=-0.5 _
 S11Min=-871.809783180496 PtS11Min=3 x2S11Min=0.5 x3S11Min=-0.5 FrameElem=46 ElemStation=0.375
 Frame=46 Station=0.5 OutputCase=TERRLAT CaseType=LinStatic P=-373.013713761059 V2=-0.525593818948437
 V3=0 T=0 M2=0 M3=83.1983774639414 S11Max=126.17655102259 PtS11Max=1 x2S11Max=-0.5 x3S11Max=-0.5 _
 S11Min=-872.203978544707 PtS11Min=3 x2S11Min=0.5 x3S11Min=-0.5 FrameElem=46 ElemStation=0.5
 Frame=46 Station=0 OutputCase=ACCVERT CaseType=LinStatic P=0 V2=0 V3=0 T=0 M2=0 M3=0 S11Max=0
 PtS11Max=0 x2S11Max=0 x3S11Max=0 S11Min=0 PtS11Min=0 x2S11Min=0 x3S11Min=0 FrameElem=46
 ElemStation=0
 Frame=46 Station=0.125 OutputCase=ACCVERT CaseType=LinStatic P=0 V2=0 V3=0 T=0 M2=0 M3=0
 S11Max=0 PtS11Max=0 x2S11Max=0 x3S11Max=0 S11Min=0 PtS11Min=0 x2S11Min=0 x3S11Min=0 FrameElem=46
 ElemStation=0.125
 Frame=46 Station=0.25 OutputCase=ACCVERT CaseType=LinStatic P=0 V2=0 V3=0 T=0 M2=0 M3=0
 S11Max=0 PtS11Max=0 x2S11Max=0 x3S11Max=0 S11Min=0 PtS11Min=0 x2S11Min=0 x3S11Min=0 FrameElem=46
 ElemStation=0.25
 Frame=46 Station=0.375 OutputCase=ACCVERT CaseType=LinStatic P=0 V2=0 V3=0 T=0 M2=0 M3=0
 S11Max=0 PtS11Max=0 x2S11Max=0 x3S11Max=0 S11Min=0 PtS11Min=0 x2S11Min=0 x3S11Min=0 FrameElem=46
 ElemStation=0.375
 Frame=46 Station=0.5 OutputCase=ACCVERT CaseType=LinStatic P=0 V2=0 V3=0 T=0 M2=0 M3=0
 S11Max=0 PtS11Max=0 x2S11Max=0 x3S11Max=0 S11Min=0 PtS11Min=0 x2S11Min=0 x3S11Min=0 FrameElem=46
 ElemStation=0.5
 Frame=46 Station=0 OutputCase=ACCLATDX CaseType=LinStatic P=0 V2=0 V3=0 T=0 M2=0 M3=0
 S11Max=0 PtS11Max=0 x2S11Max=0 x3S11Max=0 S11Min=0 PtS11Min=0 x2S11Min=0 x3S11Min=0 FrameElem=46
 ElemStation=0
 Frame=46 Station=0.125 OutputCase=ACCLATDX CaseType=LinStatic P=0 V2=0 V3=0 T=0 M2=0 M3=0
 S11Max=0 PtS11Max=0 x2S11Max=0 x3S11Max=0 S11Min=0 PtS11Min=0 x2S11Min=0 x3S11Min=0 FrameElem=46
 ElemStation=0.125
 Frame=46 Station=0.25 OutputCase=ACCLATDX CaseType=LinStatic P=0 V2=0 V3=0 T=0 M2=0 M3=0
 S11Max=0 PtS11Max=0 x2S11Max=0 x3S11Max=0 S11Min=0 PtS11Min=0 x2S11Min=0 x3S11Min=0 FrameElem=46
 ElemStation=0.25
 Frame=46 Station=0.375 OutputCase=ACCLATDX CaseType=LinStatic P=0 V2=0 V3=0 T=0 M2=0 M3=0
 S11Max=0 PtS11Max=0 x2S11Max=0 x3S11Max=0 S11Min=0 PtS11Min=0 x2S11Min=0 x3S11Min=0 FrameElem=46
 ElemStation=0.375



Frame=46 Station=0.5 OutputCase=ACCLATDX CaseType=LinStatic P=0 V2=0 V3=0 T=0 M2=0 M3=0
 S11Max=0 PtS11Max=0 x2S11Max=0 x3S11Max=0 S11Min=0 PtS11Min=0 x2S11Min=0 x3S11Min=0 FrameElem=46
 ElemStation=0.5
 Frame=46 Station=0 OutputCase=ACCLATSX CaseType=LinStatic P=0 V2=0 V3=0 T=0 M2=0 M3=0
 S11Max=0 PtS11Max=0 x2S11Max=0 x3S11Max=0 S11Min=0 PtS11Min=0 x2S11Min=0 x3S11Min=0 FrameElem=46
 ElemStation=0
 Frame=46 Station=0.125 OutputCase=ACCLATSX CaseType=LinStatic P=0 V2=0 V3=0 T=0 M2=0 M3=0
 S11Max=0 PtS11Max=0 x2S11Max=0 x3S11Max=0 S11Min=0 PtS11Min=0 x2S11Min=0 x3S11Min=0 FrameElem=46
 ElemStation=0.125
 Frame=46 Station=0.25 OutputCase=ACCLATSX CaseType=LinStatic P=0 V2=0 V3=0 T=0 M2=0 M3=0
 S11Max=0 PtS11Max=0 x2S11Max=0 x3S11Max=0 S11Min=0 PtS11Min=0 x2S11Min=0 x3S11Min=0 FrameElem=46
 ElemStation=0.25
 Frame=46 Station=0.375 OutputCase=ACCLATSX CaseType=LinStatic P=0 V2=0 V3=0 T=0 M2=0 M3=0
 S11Max=0 PtS11Max=0 x2S11Max=0 x3S11Max=0 S11Min=0 PtS11Min=0 x2S11Min=0 x3S11Min=0 FrameElem=46
 ElemStation=0.375
 Frame=46 Station=0.5 OutputCase=ACCLATSX CaseType=LinStatic P=0 V2=0 V3=0 T=0 M2=0 M3=0
 S11Max=0 PtS11Max=0 x2S11Max=0 x3S11Max=0 S11Min=0 PtS11Min=0 x2S11Min=0 x3S11Min=0 FrameElem=46
 ElemStation=0.5
 Frame=46 Station=0 OutputCase=TERRCOST CaseType=LinStatic P=0 V2=0 V3=0 T=0 M2=0 M3=0
 S11Max=0 PtS11Max=0 x2S11Max=0 x3S11Max=0 S11Min=0 PtS11Min=0 x2S11Min=0 x3S11Min=0 FrameElem=46
 ElemStation=0
 Frame=46 Station=0.125 OutputCase=TERRCOST CaseType=LinStatic P=0 V2=0 V3=0 T=0 M2=0 M3=0
 S11Max=0 PtS11Max=0 x2S11Max=0 x3S11Max=0 S11Min=0 PtS11Min=0 x2S11Min=0 x3S11Min=0 FrameElem=46
 ElemStation=0.125
 Frame=46 Station=0.25 OutputCase=TERRCOST CaseType=LinStatic P=0 V2=0 V3=0 T=0 M2=0 M3=0
 S11Max=0 PtS11Max=0 x2S11Max=0 x3S11Max=0 S11Min=0 PtS11Min=0 x2S11Min=0 x3S11Min=0 FrameElem=46
 ElemStation=0.25
 Frame=46 Station=0.375 OutputCase=TERRCOST CaseType=LinStatic P=0 V2=0 V3=0 T=0 M2=0 M3=0
 S11Max=0 PtS11Max=0 x2S11Max=0 x3S11Max=0 S11Min=0 PtS11Min=0 x2S11Min=0 x3S11Min=0 FrameElem=46
 ElemStation=0.375
 Frame=46 Station=0.5 OutputCase=TERRCOST CaseType=LinStatic P=0 V2=0 V3=0 T=0 M2=0 M3=0
 S11Max=0 PtS11Max=0 x2S11Max=0 x3S11Max=0 S11Min=0 PtS11Min=0 x2S11Min=0 x3S11Min=0 FrameElem=46
 ElemStation=0.5
 Frame=46 Station=0 OutputCase=SOVRCOST CaseType=LinStatic P=0 V2=0 V3=0 T=0 M2=0 M3=0
 S11Max=0 PtS11Max=0 x2S11Max=0 x3S11Max=0 S11Min=0 PtS11Min=0 x2S11Min=0 x3S11Min=0 FrameElem=46
 ElemStation=0
 Frame=46 Station=0.125 OutputCase=SOVRCOST CaseType=LinStatic P=0 V2=0 V3=0 T=0 M2=0 M3=0
 S11Max=0 PtS11Max=0 x2S11Max=0 x3S11Max=0 S11Min=0 PtS11Min=0 x2S11Min=0 x3S11Min=0 FrameElem=46
 ElemStation=0.125
 Frame=46 Station=0.25 OutputCase=SOVRCOST CaseType=LinStatic P=0 V2=0 V3=0 T=0 M2=0 M3=0
 S11Max=0 PtS11Max=0 x2S11Max=0 x3S11Max=0 S11Min=0 PtS11Min=0 x2S11Min=0 x3S11Min=0 FrameElem=46
 ElemStation=0.25
 Frame=46 Station=0.375 OutputCase=SOVRCOST CaseType=LinStatic P=0 V2=0 V3=0 T=0 M2=0 M3=0
 S11Max=0 PtS11Max=0 x2S11Max=0 x3S11Max=0 S11Min=0 PtS11Min=0 x2S11Min=0 x3S11Min=0 FrameElem=46
 ElemStation=0.375
 Frame=46 Station=0.5 OutputCase=SOVRCOST CaseType=LinStatic P=0 V2=0 V3=0 T=0 M2=0 M3=0
 S11Max=0 PtS11Max=0 x2S11Max=0 x3S11Max=0 S11Min=0 PtS11Min=0 x2S11Min=0 x3S11Min=0 FrameElem=46
 ElemStation=0.5
 Frame=46 Station=0 OutputCase=ENVE CaseType=Combination StepType=Max P=-274.637838986978 V2=-
 261.424057648774 V3=0 T=0 M2=0 M3=-543.837915222221 S11Max=3137.67369734439 PtS11Max=3 x2S11Max=0.5
 x3S11Max=-0.5
 S11Min=-3649.56944444862 PtS11Min=1 x2S11Min=-0.5 x3S11Min=-0.5 FrameElem=46 ElemStation=0
 Frame=46 Station=0.125 OutputCase=ENVE CaseType=Combination StepType=Max P=-274.637838986978 V2=-
 258.299057648774 V3=0 T=0 M2=0 M3=-511.335510747913 S11Max=2942.77752910781 PtS11Max=3 x2S11Max=0.5
 x3S11Max=-0.5 S11Min=-3454.55501760278 PtS11Min=1 x2S11Min=-0.5 x3S11Min=-0.5 FrameElem=46
 ElemStation=0.125
 Frame=46 Station=0.25 OutputCase=ENVE CaseType=Combination StepType=Max P=-274.637838986978 V2=-
 255.174057648774 V3=0 T=0 M2=0 M3=-479.223731273606 S11Max=2750.22511087123 PtS11Max=3 x2S11Max=0.5
 x3S11Max=-0.5
 S11Min=-3261.88434075693 PtS11Min=1 x2S11Min=-0.5 x3S11Min=-0.5 FrameElem=46 ElemStation=0.25
 Frame=46 Station=0.375 OutputCase=ENVE CaseType=Combination StepType=Max P=-274.637838986978 V2=-
 252.049057648774 V3=0 T=0 M2=0 M3=-447.502576799299 S11Max=2560.01644263465 PtS11Max=3 x2S11Max=0.5
 x3S11Max=-0.5 S11Min=-3071.55741391109 PtS11Min=1 x2S11Min=-0.5 x3S11Min=-0.5 FrameElem=46
 ElemStation=0.375
 Frame=46 Station=0.5 OutputCase=ENVE CaseType=Combination StepType=Max P=-274.637838986978 V2=-
 248.924057648774 V3=0 T=0 M2=0 M3=-416.172047324991 S11Max=2372.15152439806 PtS11Max=3 x2S11Max=0.5
 x3S11Max=-0.5
 S11Min=-2883.57423706524 PtS11Min=1 x2S11Min=-0.5 x3S11Min=-0.5 FrameElem=46 ElemStation=0.5
 Frame=46 Station=0 OutputCase=ENVE CaseType=Combination StepType=Min P=-386.541953115295 V2=-
 261.581735794459 V3=0 T=0 M2=0 M3=-568.718589388561 S11Max=2876.48553821803 PtS11Max=3 x2S11Max=0.5
 x3S11Max=-0.5
 S11Min=-3686.94937531834 PtS11Min=1 x2S11Min=-0.5 x3S11Min=-0.5 FrameElem=46 ElemStation=0
 Frame=46 Station=0.125 OutputCase=ENVE CaseType=Combination StepType=Min P=-386.541953115295 V2=-
 258.456735794459 V3=0 T=0 M2=0 M3=-536.235894682464 S11Max=2681.47111137219 PtS11Max=3 x2S11Max=0.5
 x3S11Max=-0.5 S11Min=-3492.05320708176 PtS11Min=1 x2S11Min=-0.5 x3S11Min=-0.5 FrameElem=46
 ElemStation=0.125
 Frame=46 Station=0.25 OutputCase=ENVE CaseType=Combination StepType=Min P=-386.541953115295 V2=-
 255.331735794459 V3=0 T=0 M2=0 M3=-504.143824976367 S11Max=2488.80043452634 PtS11Max=3 x2S11Max=0.5
 x3S11Max=-0.5
 S11Min=-3299.50078884518 PtS11Min=1 x2S11Min=-0.5 x3S11Min=-0.5 FrameElem=46 ElemStation=0.25



Frame=46 Station=0.375 OutputCase=ENVE CaseType=Combination StepType=Min P=-386.541953115295 V2=-252.206735794459 V3=0 T=0 M2=0 M3=-472.442380270271 S11Max=2298.4735076805 PtS11Max=3 x2S11Max=0.5 x3S11Max=-0.5 _
 S11Min=-3109.2921206086 PtS11Min=1 x2S11Min=-0.5 x3S11Min=-0.5 FrameElem=46 ElemStation=0.375
 Frame=46 Station=0.5 OutputCase=ENVE CaseType=Combination StepType=Min P=-386.541953115295 V2=-249.081735794459 V3=0 T=0 M2=0 M3=-441.131560564174 S11Max=2110.49033083465 PtS11Max=3 x2S11Max=0.5 x3S11Max=-0.5 _
 S11Min=-2921.42720237202 PtS11Min=1 x2S11Min=-0.5 x3S11Min=-0.5 FrameElem=46 ElemStation=0.5
 Frame=46 Station=0 OutputCase=FESSUR CaseType=Combination P=-386.541953115295 V2=-261.581735794459 V3=0 T=0 M2=0 M3=-543.837915222221 S11Max=2876.48553821803 PtS11Max=3 x2S11Max=0.5 x3S11Max=-0.5 _
 S11Min=-3649.56944444862 PtS11Min=1 x2S11Min=-0.5 x3S11Min=-0.5 FrameElem=46 ElemStation=0
 Frame=46 Station=0.125 OutputCase=FESSUR CaseType=Combination P=-386.541953115295 V2=-258.456735794459 V3=0 T=0 M2=0 M3=-511.335510747913 S11Max=2681.47111137219 PtS11Max=3 x2S11Max=0.5 x3S11Max=-0.5 _
 S11Min=-3454.55501760278 PtS11Min=1 x2S11Min=-0.5 x3S11Min=-0.5 FrameElem=46 ElemStation=0.125
 Frame=46 Station=0.25 OutputCase=FESSUR CaseType=Combination P=-386.541953115295 V2=-255.331735794459 V3=0 T=0 M2=0 M3=-479.223731273606 S11Max=2488.80043452634 PtS11Max=3 x2S11Max=0.5 x3S11Max=-0.5 _
 S11Min=-3261.88434075693 PtS11Min=1 x2S11Min=-0.5 x3S11Min=-0.5 FrameElem=46 ElemStation=0.25
 Frame=46 Station=0.375 OutputCase=FESSUR CaseType=Combination P=-386.541953115295 V2=-252.206735794459 V3=0 T=0 M2=0 M3=-447.502576799299 S11Max=2298.4735076805 PtS11Max=3 x2S11Max=0.5 x3S11Max=-0.5 _
 S11Min=-3071.55741391109 PtS11Min=1 x2S11Min=-0.5 x3S11Min=-0.5 FrameElem=46 ElemStation=0.375
 Frame=46 Station=0.5 OutputCase=FESSUR CaseType=Combination P=-386.541953115295 V2=-249.081735794459 V3=0 T=0 M2=0 M3=-416.172047324991 S11Max=2110.49033083465 PtS11Max=3 x2S11Max=0.5 x3S11Max=-0.5 _
 S11Min=-2883.57423706524 PtS11Min=1 x2S11Min=-0.5 x3S11Min=-0.5 FrameElem=46 ElemStation=0.5
 Frame=47 Station=0 OutputCase=PESOPR CaseType=LinStatic P=-15.1709467361871 V2=-86.5605342360795 V3=0 T=0 M2=0 M3=-87.7825780374624 S11Max=511.524521488587 PtS11Max=3 x2S11Max=0.5 x3S11Max=-0.5 _
 S11Min=-541.866414960961 PtS11Min=1 x2S11Min=-0.5 x3S11Min=-0.5 FrameElem=47 ElemStation=0
 Frame=47 Station=0.125 OutputCase=PESOPR CaseType=LinStatic P=-15.1709467361871 V2=-83.4355342360795 V3=0 T=0 M2=0 M3=-77.1578237579524 S11Max=447.775995811527 PtS11Max=3 x2S11Max=0.5 x3S11Max=-0.5 _
 S11Min=-478.117889283902 PtS11Min=1 x2S11Min=-0.5 x3S11Min=-0.5 FrameElem=47 ElemStation=0.125
 Frame=47 Station=0.25 OutputCase=PESOPR CaseType=LinStatic P=-15.1709467361871 V2=-80.3105342360795 V3=0 T=0 M2=0 M3=-66.9236944784425 S11Max=386.371220134468 PtS11Max=3 x2S11Max=0.5 x3S11Max=-0.5 _
 S11Min=-416.713113606842 PtS11Min=1 x2S11Min=-0.5 x3S11Min=-0.5 FrameElem=47 ElemStation=0.25
 Frame=47 Station=0.375 OutputCase=PESOPR CaseType=LinStatic P=-15.1709467361871 V2=-77.1855342360795 V3=0 T=0 M2=0 M3=-57.0801901989325 S11Max=327.310194457408 PtS11Max=3 x2S11Max=0.5 x3S11Max=-0.5 _
 S11Min=-357.652087929782 PtS11Min=1 x2S11Min=-0.5 x3S11Min=-0.5 FrameElem=47 ElemStation=0.375
 Frame=47 Station=0.5 OutputCase=PESOPR CaseType=LinStatic P=-15.1709467361871 V2=-74.0605342360795 V3=0 T=0 M2=0 M3=-47.6273109194226 S11Max=270.592918780348 PtS11Max=3 x2S11Max=0.5 x3S11Max=-0.5 _
 S11Min=-300.934812252723 PtS11Min=1 x2S11Min=-0.5 x3S11Min=-0.5 FrameElem=47 ElemStation=0.5
 Frame=47 Station=0 OutputCase=TERRVERT CaseType=LinStatic P=1.64270738195066 V2=-345.641466260742 V3=0 T=0 M2=0 M3=-411.587846751449 S11Max=2471.16978789064 PtS11Max=3 x2S11Max=0.5 x3S11Max=-0.5 _
 S11Min=-2467.88437312674 PtS11Min=1 x2S11Min=-0.5 x3S11Min=-0.5 FrameElem=47 ElemStation=0
 Frame=47 Station=0.125 OutputCase=TERRVERT CaseType=LinStatic P=1.64270738195066 V2=-345.641466260742 V3=0 T=0 M2=0 M3=-368.382663468856 S11Max=2211.93868819509 PtS11Max=3 x2S11Max=0.5 x3S11Max=-0.5 _
 S11Min=-2208.65327343118 PtS11Min=1 x2S11Min=-0.5 x3S11Min=-0.5 FrameElem=47 ElemStation=0.125
 Frame=47 Station=0.25 OutputCase=TERRVERT CaseType=LinStatic P=1.64270738195066 V2=-345.641466260742 V3=0 T=0 M2=0 M3=-325.177480186263 S11Max=1952.70758849953 PtS11Max=3 x2S11Max=0.5 x3S11Max=-0.5 _
 S11Min=-1949.42217373563 PtS11Min=1 x2S11Min=-0.5 x3S11Min=-0.5 FrameElem=47 ElemStation=0.25
 Frame=47 Station=0.375 OutputCase=TERRVERT CaseType=LinStatic P=1.64270738195066 V2=-345.641466260742 V3=0 T=0 M2=0 M3=-281.97229690367 S11Max=1693.47648880397 PtS11Max=3 x2S11Max=0.5 x3S11Max=-0.5 _
 S11Min=-1690.19107404007 PtS11Min=1 x2S11Min=-0.5 x3S11Min=-0.5 FrameElem=47 ElemStation=0.375
 Frame=47 Station=0.5 OutputCase=TERRVERT CaseType=LinStatic P=1.64270738195066 V2=-345.641466260742 V3=0 T=0 M2=0 M3=-238.767113621077 S11Max=1434.24538910842 PtS11Max=3 x2S11Max=0.5 x3S11Max=-0.5 _
 S11Min=-1430.95997434451 PtS11Min=1 x2S11Min=-0.5 x3S11Min=-0.5 FrameElem=47 ElemStation=0.5
 Frame=47 Station=0 OutputCase=TERRLAT CaseType=LinStatic P=-373.013713761058 V2=-0.726763128745802 V3=0 T=0 M2=0 M3=83.1983774639414 S11Max=126.17655102259 PtS11Max=1 x2S11Max=-0.5 x3S11Max=-0.5 _
 S11Min=-872.203978544707 PtS11Min=3 x2S11Min=0.5 x3S11Min=-0.5 FrameElem=47 ElemStation=0
 Frame=47 Station=0.125 OutputCase=TERRLAT CaseType=LinStatic P=-373.013713761058 V2=-0.726763128745802 V3=0 T=0 M2=0 M3=83.2892228550346 S11Max=126.72162336915 PtS11Max=1 x2S11Max=-0.5 x3S11Max=-0.5 _
 S11Min=-872.749050891266 PtS11Min=3 x2S11Min=0.5 x3S11Min=-0.5 FrameElem=47 ElemStation=0.125
 Frame=47 Station=0.25 OutputCase=TERRLAT CaseType=LinStatic P=-373.013713761058 V2=-0.726763128745802 V3=0 T=0 M2=0 M3=83.3800682461278 S11Max=127.266695715709 PtS11Max=1 x2S11Max=-0.5 x3S11Max=-0.5 _
 S11Min=-873.294123237825 PtS11Min=3 x2S11Min=0.5 x3S11Min=-0.5 FrameElem=47 ElemStation=0.25
 Frame=47 Station=0.375 OutputCase=TERRLAT CaseType=LinStatic P=-373.013713761058 V2=-0.726763128745802 V3=0 T=0 M2=0 M3=83.4709136372211 S11Max=127.811768062268 PtS11Max=1 x2S11Max=-0.5 x3S11Max=-0.5 _
 S11Min=-873.839195584385 PtS11Min=3 x2S11Min=0.5 x3S11Min=-0.5 FrameElem=47 ElemStation=0.375
 Frame=47 Station=0.5 OutputCase=TERRLAT CaseType=LinStatic P=-373.013713761058 V2=-0.726763128745802 V3=0 T=0 M2=0 M3=83.5617590283143 S11Max=128.356840408828 PtS11Max=1 x2S11Max=-0.5 x3S11Max=-0.5 _
 S11Min=-874.384267930944 PtS11Min=3 x2S11Min=0.5 x3S11Min=-0.5 FrameElem=47 ElemStation=0.5
 Frame=47 Station=0 OutputCase=ACCVERT CaseType=LinStatic P=0 V2=0 V3=0 T=0 M2=0 M3=0 S11Max=0 PtS11Max=0 x2S11Max=0 x3S11Max=0 S11Min=0 PtS11Min=0 x2S11Min=0 x3S11Min=0 FrameElem=47
 ElemStation=0
 Frame=47 Station=0.125 OutputCase=ACCVERT CaseType=LinStatic P=0 V2=0 V3=0 T=0 M2=0 M3=0 S11Max=0 PtS11Max=0 x2S11Max=0 x3S11Max=0 S11Min=0 PtS11Min=0 x2S11Min=0 x3S11Min=0 FrameElem=47
 ElemStation=0.125
 Frame=47 Station=0.25 OutputCase=ACCVERT CaseType=LinStatic P=0 V2=0 V3=0 T=0 M2=0 M3=0 S11Max=0 PtS11Max=0 x2S11Max=0 x3S11Max=0 S11Min=0 PtS11Min=0 x2S11Min=0 x3S11Min=0 FrameElem=47
 ElemStation=0.25
 Frame=47 Station=0.375 OutputCase=ACCVERT CaseType=LinStatic P=0 V2=0 V3=0 T=0 M2=0 M3=0 S11Max=0 PtS11Max=0 x2S11Max=0 x3S11Max=0 S11Min=0 PtS11Min=0 x2S11Min=0 x3S11Min=0 FrameElem=47
 ElemStation=0.375

```

Frame=47 Station=0.5 OutputCase=ACCVERT CaseType=LinStatic P=0 V2=0 V3=0 T=0 M2=0 M3=0
S11Max=0 PtS11Max=0 x2S11Max=0 x3S11Max=0 S11Min=0 PtS11Min=0 x2S11Min=0 x3S11Min=0 FrameElem=47
ElemStation=0.5
Frame=47 Station=0 OutputCase=ACCLATDX CaseType=LinStatic P=0 V2=0 V3=0 T=0 M2=0 M3=0
S11Max=0 PtS11Max=0 x2S11Max=0 x3S11Max=0 S11Min=0 PtS11Min=0 x2S11Min=0 x3S11Min=0 FrameElem=47
ElemStation=0
Frame=47 Station=0.125 OutputCase=ACCLATDX CaseType=LinStatic P=0 V2=0 V3=0 T=0 M2=0 M3=0
S11Max=0 PtS11Max=0 x2S11Max=0 x3S11Max=0 S11Min=0 PtS11Min=0 x2S11Min=0 x3S11Min=0 FrameElem=47
ElemStation=0.125
Frame=47 Station=0.25 OutputCase=ACCLATDX CaseType=LinStatic P=0 V2=0 V3=0 T=0 M2=0 M3=0
S11Max=0 PtS11Max=0 x2S11Max=0 x3S11Max=0 S11Min=0 PtS11Min=0 x2S11Min=0 x3S11Min=0 FrameElem=47
ElemStation=0.25
Frame=47 Station=0.375 OutputCase=ACCLATDX CaseType=LinStatic P=0 V2=0 V3=0 T=0 M2=0 M3=0
S11Max=0 PtS11Max=0 x2S11Max=0 x3S11Max=0 S11Min=0 PtS11Min=0 x2S11Min=0 x3S11Min=0 FrameElem=47
ElemStation=0.375
Frame=47 Station=0.5 OutputCase=ACCLATDX CaseType=LinStatic P=0 V2=0 V3=0 T=0 M2=0 M3=0
S11Max=0 PtS11Max=0 x2S11Max=0 x3S11Max=0 S11Min=0 PtS11Min=0 x2S11Min=0 x3S11Min=0 FrameElem=47
ElemStation=0.5
Frame=47 Station=0 OutputCase=ACCLATSX CaseType=LinStatic P=0 V2=0 V3=0 T=0 M2=0 M3=0
S11Max=0 PtS11Max=0 x2S11Max=0 x3S11Max=0 S11Min=0 PtS11Min=0 x2S11Min=0 x3S11Min=0 FrameElem=47
ElemStation=0
Frame=47 Station=0.125 OutputCase=ACCLATSX CaseType=LinStatic P=0 V2=0 V3=0 T=0 M2=0 M3=0
S11Max=0 PtS11Max=0 x2S11Max=0 x3S11Max=0 S11Min=0 PtS11Min=0 x2S11Min=0 x3S11Min=0 FrameElem=47
ElemStation=0.125
Frame=47 Station=0.25 OutputCase=ACCLATSX CaseType=LinStatic P=0 V2=0 V3=0 T=0 M2=0 M3=0
S11Max=0 PtS11Max=0 x2S11Max=0 x3S11Max=0 S11Min=0 PtS11Min=0 x2S11Min=0 x3S11Min=0 FrameElem=47
ElemStation=0.25
Frame=47 Station=0.375 OutputCase=ACCLATSX CaseType=LinStatic P=0 V2=0 V3=0 T=0 M2=0 M3=0
S11Max=0 PtS11Max=0 x2S11Max=0 x3S11Max=0 S11Min=0 PtS11Min=0 x2S11Min=0 x3S11Min=0 FrameElem=47
ElemStation=0.375
Frame=47 Station=0.5 OutputCase=ACCLATSX CaseType=LinStatic P=0 V2=0 V3=0 T=0 M2=0 M3=0
S11Max=0 PtS11Max=0 x2S11Max=0 x3S11Max=0 S11Min=0 PtS11Min=0 x2S11Min=0 x3S11Min=0 FrameElem=47
ElemStation=0.5
Frame=47 Station=0 OutputCase=TERRCOST CaseType=LinStatic P=0 V2=0 V3=0 T=0 M2=0 M3=0
S11Max=0 PtS11Max=0 x2S11Max=0 x3S11Max=0 S11Min=0 PtS11Min=0 x2S11Min=0 x3S11Min=0 FrameElem=47
ElemStation=0
Frame=47 Station=0.125 OutputCase=TERRCOST CaseType=LinStatic P=0 V2=0 V3=0 T=0 M2=0 M3=0
S11Max=0 PtS11Max=0 x2S11Max=0 x3S11Max=0 S11Min=0 PtS11Min=0 x2S11Min=0 x3S11Min=0 FrameElem=47
ElemStation=0.125
Frame=47 Station=0.25 OutputCase=TERRCOST CaseType=LinStatic P=0 V2=0 V3=0 T=0 M2=0 M3=0
S11Max=0 PtS11Max=0 x2S11Max=0 x3S11Max=0 S11Min=0 PtS11Min=0 x2S11Min=0 x3S11Min=0 FrameElem=47
ElemStation=0.25
Frame=47 Station=0.375 OutputCase=TERRCOST CaseType=LinStatic P=0 V2=0 V3=0 T=0 M2=0 M3=0
S11Max=0 PtS11Max=0 x2S11Max=0 x3S11Max=0 S11Min=0 PtS11Min=0 x2S11Min=0 x3S11Min=0 FrameElem=47
ElemStation=0.375
Frame=47 Station=0.5 OutputCase=TERRCOST CaseType=LinStatic P=0 V2=0 V3=0 T=0 M2=0 M3=0
S11Max=0 PtS11Max=0 x2S11Max=0 x3S11Max=0 S11Min=0 PtS11Min=0 x2S11Min=0 x3S11Min=0 FrameElem=47
ElemStation=0.5
Frame=47 Station=0 OutputCase=SOVRCOST CaseType=LinStatic P=0 V2=0 V3=0 T=0 M2=0 M3=0
S11Max=0 PtS11Max=0 x2S11Max=0 x3S11Max=0 S11Min=0 PtS11Min=0 x2S11Min=0 x3S11Min=0 FrameElem=47
ElemStation=0
Frame=47 Station=0.125 OutputCase=SOVRCOST CaseType=LinStatic P=0 V2=0 V3=0 T=0 M2=0 M3=0
S11Max=0 PtS11Max=0 x2S11Max=0 x3S11Max=0 S11Min=0 PtS11Min=0 x2S11Min=0 x3S11Min=0 FrameElem=47
ElemStation=0.125
Frame=47 Station=0.25 OutputCase=SOVRCOST CaseType=LinStatic P=0 V2=0 V3=0 T=0 M2=0 M3=0
S11Max=0 PtS11Max=0 x2S11Max=0 x3S11Max=0 S11Min=0 PtS11Min=0 x2S11Min=0 x3S11Min=0 FrameElem=47
ElemStation=0.25
Frame=47 Station=0.375 OutputCase=SOVRCOST CaseType=LinStatic P=0 V2=0 V3=0 T=0 M2=0 M3=0
S11Max=0 PtS11Max=0 x2S11Max=0 x3S11Max=0 S11Min=0 PtS11Min=0 x2S11Min=0 x3S11Min=0 FrameElem=47
ElemStation=0.375
Frame=47 Station=0.5 OutputCase=SOVRCOST CaseType=LinStatic P=0 V2=0 V3=0 T=0 M2=0 M3=0
S11Max=0 PtS11Max=0 x2S11Max=0 x3S11Max=0 S11Min=0 PtS11Min=0 x2S11Min=0 x3S11Min=0 FrameElem=47
ElemStation=0.5
Frame=47 Station=0 OutputCase=ENVE CaseType=Combination StepType=Max P=-274.637838986977 V2=-
432.710734686944 V3=0 T=0 M2=0 M3=-416.17204732497 S11Max=2372.15152439793 PtS11Max=3 x2S11Max=0.5
x3S11Max=-0.5
S11Min=-2883.57423706511 PtS11Min=1 x2S11Min=-0.5 x3S11Min=-0.5 FrameElem=47 ElemStation=0
Frame=47 Station=0.125 OutputCase=ENVE CaseType=Combination StepType=Max P=-274.637838986977 V2=-
429.585734686944 V3=0 T=0 M2=0 M3=-362.251264371774 S11Max=2048.79034838273 PtS11Max=3 x2S11Max=0.5
x3S11Max=-0.5 S11Min=-2560.04953934594 PtS11Min=1 x2S11Min=-0.5 x3S11Min=-0.5 FrameElem=47
ElemStation=0.125
Frame=47 Station=0.25 OutputCase=ENVE CaseType=Combination StepType=Max P=-274.637838986977 V2=-
426.460734686944 V3=0 T=0 M2=0 M3=-308.721106418578 S11Max=1727.77292236752 PtS11Max=3 x2S11Max=0.5
x3S11Max=-0.5
S11Min=-2238.86859162676 PtS11Min=1 x2S11Min=-0.5 x3S11Min=-0.5 FrameElem=47 ElemStation=0.25
Frame=47 Station=0.375 OutputCase=ENVE CaseType=Combination StepType=Max P=-274.637838986977 V2=-
423.335734686944 V3=0 T=0 M2=0 M3=-255.581573465382 S11Max=1409.09924635231 PtS11Max=3 x2S11Max=0.5
x3S11Max=-0.5 S11Min=-1920.03139390758 PtS11Min=1 x2S11Min=-0.5 x3S11Min=-0.5 FrameElem=47
ElemStation=0.375
Frame=47 Station=0.5 OutputCase=ENVE CaseType=Combination StepType=Max P=-274.637838986977 V2=-
420.210734686944 V3=0 T=0 M2=0 M3=-202.832665512186 S11Max=1092.7693203371 PtS11Max=3 x2S11Max=0.5
x3S11Max=-0.5

```



S11Min=-1603.53794618841 PtS11Min=1 x2S11Min=-0.5 x3S11Min=-0.5 FrameElem=47 ElemStation=0.5
 Frame=47 Station=0 OutputCase=ENVE CaseType=Combination StepType=Min P=-386.541953115295 V2=-
 432.928763625568 V3=0 T=0 M2=0 M3=-441.131560564152 S11Max=2110.49033083452 PtS11Max=3 x2S11Max=0.5
 x3S11Max=-0.5 _
 S11Min=-2921.42720237189 PtS11Min=1 x2S11Min=-0.5 x3S11Min=-0.5 FrameElem=47 ElemStation=0
 Frame=47 Station=0.125 OutputCase=ENVE CaseType=Combination StepType=Min P=-386.541953115295 V2=-
 429.803763625568 V3=0 T=0 M2=0 M3=-387.238031228284 S11Max=1786.96563311535 PtS11Max=3 x2S11Max=0.5 _
 x3S11Max=-0.5 S11Min=-2598.06602635668 PtS11Min=1 x2S11Min=-0.5 x3S11Min=-0.5 FrameElem=47
 ElemStation=0.125
 Frame=47 Station=0.25 OutputCase=ENVE CaseType=Combination StepType=Min P=-386.541953115295 V2=-
 426.678763625568 V3=0 T=0 M2=0 M3=-333.735126892416 S11Max=1465.78468539617 PtS11Max=3 x2S11Max=0.5
 x3S11Max=-0.5 _
 S11Min=-2277.04860034147 PtS11Min=1 x2S11Min=-0.5 x3S11Min=-0.5 FrameElem=47 ElemStation=0.25
 Frame=47 Station=0.375 OutputCase=ENVE CaseType=Combination StepType=Min P=-386.541953115295 V2=-
 423.553763625568 V3=0 T=0 M2=0 M3=-280.622847556548 S11Max=1146.947487677 PtS11Max=3 x2S11Max=0.5
 x3S11Max=-0.5 _
 S11Min=-1958.37492432627 PtS11Min=1 x2S11Min=-0.5 x3S11Min=-0.5 FrameElem=47 ElemStation=0.375
 Frame=47 Station=0.5 OutputCase=ENVE CaseType=Combination StepType=Min P=-386.541953115295 V2=-
 420.428763625568 V3=0 T=0 M2=0 M3=-227.90119322068 S11Max=830.45403995782 PtS11Max=3 x2S11Max=0.5
 x3S11Max=-0.5 _
 S11Min=-1642.04499831106 PtS11Min=1 x2S11Min=-0.5 x3S11Min=-0.5 FrameElem=47 ElemStation=0.5
 Frame=47 Station=0 OutputCase=FESSUR CaseType=Combination P=-386.541953115295 V2=-432.928763625568
 V3=0 T=0 M2=0 M3=-416.17204732497 S11Max=2110.49033083452 PtS11Max=3 x2S11Max=0.5 x3S11Max=-0.5 _
 S11Min=-2883.57423706511 PtS11Min=1 x2S11Min=-0.5 x3S11Min=-0.5 FrameElem=47 ElemStation=0
 Frame=47 Station=0.125 OutputCase=FESSUR CaseType=Combination P=-386.541953115295 V2=-429.803763625568
 V3=0 T=0 M2=0 M3=-362.251264371774 S11Max=1786.96563311535 PtS11Max=3 x2S11Max=0.5 x3S11Max=-0.5 _
 S11Min=-2560.04953934594 PtS11Min=1 x2S11Min=-0.5 x3S11Min=-0.5 FrameElem=47 ElemStation=0.125
 Frame=47 Station=0.25 OutputCase=FESSUR CaseType=Combination P=-386.541953115295 V2=-426.678763625568
 V3=0 T=0 M2=0 M3=-308.721106418578 S11Max=1465.78468539617 PtS11Max=3 x2S11Max=0.5 x3S11Max=-0.5 _
 S11Min=-2238.86859162676 PtS11Min=1 x2S11Min=-0.5 x3S11Min=-0.5 FrameElem=47 ElemStation=0.25
 Frame=47 Station=0.375 OutputCase=FESSUR CaseType=Combination P=-386.541953115295 V2=-423.553763625568
 V3=0 T=0 M2=0 M3=-255.581573465382 S11Max=1146.947487677 PtS11Max=3 x2S11Max=0.5 x3S11Max=-0.5 _
 S11Min=-1920.03139390758 PtS11Min=1 x2S11Min=-0.5 x3S11Min=-0.5 FrameElem=47 ElemStation=0.375
 Frame=47 Station=0.5 OutputCase=FESSUR CaseType=Combination P=-386.541953115295 V2=-420.428763625568
 V3=0 T=0 M2=0 M3=-202.832665512186 S11Max=830.45403995782 PtS11Max=3 x2S11Max=0.5 x3S11Max=-0.5 _
 S11Min=-1603.53794618841 PtS11Min=1 x2S11Min=-0.5 x3S11Min=-0.5 FrameElem=47 ElemStation=0.5
 Frame=48 Station=0 OutputCase=PESOPR CaseType=LinStatic P=-15.1709467361872 V2=-119.133696004064 V3=0
 T=0 M2=0 M3=-47.6273109194226 S11Max=270.592918780348 PtS11Max=3 x2S11Max=0.5 x3S11Max=-0.5 _
 S11Min=-300.934812252723 PtS11Min=1 x2S11Min=-0.5 x3S11Min=-0.5 FrameElem=48 ElemStation=0
 Frame=48 Station=0.125 OutputCase=PESOPR CaseType=LinStatic P=-15.1709467361872 V2=-116.008696004064
 V3=0 T=0 M2=0 M3=-32.9309114189145 S11Max=182.4145217773 PtS11Max=3 x2S11Max=0.5 x3S11Max=-0.5 _
 S11Min=-212.756415249674 PtS11Min=1 x2S11Min=-0.5 x3S11Min=-0.5 FrameElem=48 ElemStation=0.125
 Frame=48 Station=0.25 OutputCase=PESOPR CaseType=LinStatic P=-15.1709467361872 V2=-112.883696004064
 V3=0 T=0 M2=0 M3=-18.6251369184065 S11Max=96.5798747742518 PtS11Max=3 x2S11Max=0.5 x3S11Max=-0.5 _
 S11Min=-126.921768246626 PtS11Min=1 x2S11Min=-0.5 x3S11Min=-0.5 FrameElem=48 ElemStation=0.25
 Frame=48 Station=0.375 OutputCase=PESOPR CaseType=LinStatic P=-15.1709467361872 V2=-109.758696004064
 V3=0 T=0 M2=0 M3=-4.70998741789845 S11Max=13.0889777712035 PtS11Max=3 x2S11Max=0.5 x3S11Max=-0.5 _
 S11Min=-43.4308712435778 PtS11Min=1 x2S11Min=-0.5 x3S11Min=-0.5 FrameElem=48 ElemStation=0.375
 Frame=48 Station=0.5 OutputCase=PESOPR CaseType=LinStatic P=-15.1709467361872 V2=-106.633696004064
 V3=0 T=0 M2=0 M3=8.8145370826096 S11Max=37.7162757594705 PtS11Max=1 x2S11Max=-0.5 x3S11Max=-0.5 _
 S11Min=-68.0581692318448 PtS11Min=3 x2S11Min=0.5 x3S11Min=-0.5 FrameElem=48 ElemStation=0.5
 Frame=48 Station=0 OutputCase=TERRVERT CaseType=LinStatic P=1.64270738195066 V2=-485.96659136255 V3=0
 T=0 M2=0 M3=-238.767113621085 S11Max=1434.24538910846 PtS11Max=3 x2S11Max=0.5 x3S11Max=-0.5 _
 S11Min=-1430.95997434456 PtS11Min=1 x2S11Min=-0.5 x3S11Min=-0.5 FrameElem=48 ElemStation=0
 Frame=48 Station=0.125 OutputCase=TERRVERT CaseType=LinStatic P=1.64270738195066 V2=-485.96659136255
 V3=0 T=0 M2=0 M3=-178.021289700766 S11Max=1069.77044558655 PtS11Max=3 x2S11Max=0.5 x3S11Max=-0.5 _
 S11Min=-1066.48503082264 PtS11Min=1 x2S11Min=-0.5 x3S11Min=-0.5 FrameElem=48 ElemStation=0.125
 Frame=48 Station=0.25 OutputCase=TERRVERT CaseType=LinStatic P=1.64270738195066 V2=-485.96659136255
 V3=0 T=0 M2=0 M3=-117.275465780447 S11Max=705.295502064633 PtS11Max=3 x2S11Max=0.5 x3S11Max=-0.5 _
 S11Min=-702.010087300732 PtS11Min=1 x2S11Min=-0.5 x3S11Min=-0.5 FrameElem=48 ElemStation=0.25
 Frame=48 Station=0.375 OutputCase=TERRVERT CaseType=LinStatic P=1.64270738195066 V2=-485.96659136255
 V3=0 T=0 M2=0 M3=-56.5296418601283 S11Max=340.820558542721 PtS11Max=3 x2S11Max=0.5 x3S11Max=-0.5 _
 S11Min=-337.535143778819 PtS11Min=1 x2S11Min=-0.5 x3S11Min=-0.5 FrameElem=48 ElemStation=0.375
 Frame=48 Station=0.5 OutputCase=TERRVERT CaseType=LinStatic P=1.64270738195066 V2=-485.96659136255
 V3=0 T=0 M2=0 M3=4.21618206019048 S11Max=26.9397997430935 PtS11Max=1 x2S11Max=-0.5 x3S11Max=-0.5 _
 S11Min=-23.6543849791922 PtS11Min=3 x2S11Min=0.5 x3S11Min=-0.5 FrameElem=48 ElemStation=0.5
 Frame=48 Station=0 OutputCase=TERRLAT CaseType=LinStatic P=-373.013713761059 V2=-0.703690157475592
 V3=0 T=0 M2=0 M3=83.5617590283143 S11Max=128.356840408827 PtS11Max=1 x2S11Max=-0.5 x3S11Max=-0.5 _
 S11Min=-874.384267930944 PtS11Min=3 x2S11Min=0.5 x3S11Min=-0.5 FrameElem=48 ElemStation=0
 Frame=48 Station=0.125 OutputCase=TERRLAT CaseType=LinStatic P=-373.013713761059 V2=-0.703690157475592
 V3=0 T=0 M2=0 M3=83.6497202979987 S11Max=128.884608026934 PtS11Max=1 x2S11Max=-0.5 x3S11Max=-0.5 _
 S11Min=-874.912035549051 PtS11Min=3 x2S11Min=0.5 x3S11Min=-0.5 FrameElem=48 ElemStation=0.125
 Frame=48 Station=0.25 OutputCase=TERRLAT CaseType=LinStatic P=-373.013713761059 V2=-0.703690157475592
 V3=0 T=0 M2=0 M3=83.7376815676832 S11Max=129.41237564504 PtS11Max=1 x2S11Max=-0.5 x3S11Max=-0.5 _
 S11Min=-875.439803167158 PtS11Min=3 x2S11Min=0.5 x3S11Min=-0.5 FrameElem=48 ElemStation=0.25
 Frame=48 Station=0.375 OutputCase=TERRLAT CaseType=LinStatic P=-373.013713761059 V2=-0.703690157475592
 V3=0 T=0 M2=0 M3=83.8256428373676 S11Max=129.940143263147 PtS11Max=1 x2S11Max=-0.5 x3S11Max=-0.5 _
 S11Min=-875.967570785264 PtS11Min=3 x2S11Min=0.5 x3S11Min=-0.5 FrameElem=48 ElemStation=0.375
 Frame=48 Station=0.5 OutputCase=TERRLAT CaseType=LinStatic P=-373.013713761059 V2=-0.703690157475592
 V3=0 T=0 M2=0 M3=83.9136041070521 S11Max=130.467910881254 PtS11Max=1 x2S11Max=-0.5 x3S11Max=-0.5 _
 S11Min=-876.495338403371 PtS11Min=3 x2S11Min=0.5 x3S11Min=-0.5 FrameElem=48 ElemStation=0.5



x3S11Max=-0.5 S11Min=-1150.35683804539 PtS11Min=1 x2S11Min=-0.5 x3S11Min=-0.5 FrameElem=48
 ElemStation=0.125
 Frame=48 Station=0.25 OutputCase=ENVE CaseType=Combination StepType=Max P=-274.637838986978 V2=-
 599.342870476848 V3=0 T=0 M2=0 M3=-52.1629211311704 S11Max=189.067514621875 PtS11Max=3 x2S11Max=-0.5
 x3S11Max=-0.5 _
 S11Min=-699.519479902318 PtS11Min=1 x2S11Min=-0.5 x3S11Min=-0.5 FrameElem=48 ElemStation=0.25
 Frame=48 Station=0.375 OutputCase=ENVE CaseType=Combination StepType=Max P=-274.637838986978 V2=-
 596.217870476848 V3=0 T=0 M2=0 M3=22.5860135593409 S11Max=-251.02587175925 PtS11Max=1 x2S11Max=-0.5 _
 x3S11Max=-0.5 S11Min=-274.637838986978 PtS11Min=0 x2S11Min=0 x3S11Min=0 FrameElem=48
 ElemStation=0.375
 Frame=48 Station=0.5 OutputCase=ENVE CaseType=Combination StepType=Max P=-274.637838986978 V2=-
 593.092870476848 V3=0 T=0 M2=0 M3=96.9443232498522 S11Max=195.123986383818 PtS11Max=1 x2S11Max=-0.5
 x3S11Max=-0.5 _
 S11Min=-705.259291093397 PtS11Min=3 x2S11Min=0.5 x3S11Min=-0.5 FrameElem=48 ElemStation=0.5
 Frame=48 Station=0 OutputCase=ENVE CaseType=Combination StepType=Min P=-386.541953115295 V2=-
 605.80397752409 V3=0 T=0 M2=0 M3=-227.901193220687 S11Max=830.454039957863 PtS11Max=3 x2S11Max=0.5
 x3S11Max=-0.5 _
 S11Min=-1642.0449983111 PtS11Min=1 x2S11Min=-0.5 x3S11Min=-0.5 FrameElem=48 ElemStation=0
 Frame=48 Station=0.125 OutputCase=ENVE CaseType=Combination StepType=Min P=-386.541953115295 V2=-
 602.67897752409 V3=0 T=0 M2=0 M3=-152.397396911081 S11Max=377.272931814795 PtS11Max=3 x2S11Max=0.5
 x3S11Max=-0.5 _
 S11Min=-1189.02222045347 PtS11Min=1 x2S11Min=-0.5 x3S11Min=-0.5 FrameElem=48 ElemStation=0.125
 Frame=48 Station=0.25 OutputCase=ENVE CaseType=Combination StepType=Min P=-386.541953115295 V2=-
 599.55397752409 V3=0 T=0 M2=0 M3=-77.2842256014754 S11Max=-73.5644263282725 PtS11Max=3 x2S11Max=0.5
 x3S11Max=-0.5 _
 S11Min=-738.34319259583 PtS11Min=1 x2S11Min=-0.5 x3S11Min=-0.5 FrameElem=48 ElemStation=0.25
 Frame=48 Station=0.375 OutputCase=ENVE CaseType=Combination StepType=Min P=-386.541953115295 V2=-
 596.42897752409 V3=0 T=0 M2=0 M3=-2.56167929186942 S11Max=-290.007914738194 PtS11Max=1 x2S11Max=-0.5 _
 x3S11Max=-0.5 S11Min=-522.05803447134 PtS11Min=3 x2S11Min=0.5 x3S11Min=-0.5 FrameElem=48
 ElemStation=0.375
 Frame=48 Station=0.5 OutputCase=ENVE CaseType=Combination StepType=Min P=-386.541953115295 V2=-
 593.30397752409 V3=0 T=0 M2=0 M3=71.7702420177365 S11Max=155.983613119442 PtS11Max=1 x2S11Max=-0.5
 x3S11Max=-0.5 _
 S11Min=-968.207892614408 PtS11Min=3 x2S11Min=0.5 x3S11Min=-0.5 FrameElem=48 ElemStation=0.5
 Frame=48 Station=0 OutputCase=FESSUR CaseType=Combination P=-386.541953115295 V2=-605.80397752409
 V3=0 T=0 M2=0 M3=-202.832665512193 S11Max=830.454039957863 PtS11Max=3 x2S11Max=0.5 x3S11Max=-0.5 _
 S11Min=-1603.53794618845 PtS11Min=1 x2S11Min=-0.5 x3S11Min=-0.5 FrameElem=48 ElemStation=0
 Frame=48 Station=0.125 OutputCase=FESSUR CaseType=Combination P=-386.541953115295 V2=-602.67897752409
 V3=0 T=0 M2=0 M3=-127.302480821682 S11Max=377.272931814795 PtS11Max=3 x2S11Max=0.5 x3S11Max=-0.5 _
 S11Min=-1150.35683804539 PtS11Min=1 x2S11Min=-0.5 x3S11Min=-0.5 FrameElem=48 ElemStation=0.125
 Frame=48 Station=0.25 OutputCase=FESSUR CaseType=Combination P=-386.541953115295 V2=-599.55397752409
 V3=0 T=0 M2=0 M3=-52.1629211311704 S11Max=-73.5644263282725 PtS11Max=3 x2S11Max=0.5 x3S11Max=-0.5 _
 S11Min=-699.519479902318 PtS11Min=1 x2S11Min=-0.5 x3S11Min=-0.5 FrameElem=48 ElemStation=0.25
 Frame=48 Station=0.375 OutputCase=FESSUR CaseType=Combination P=-386.541953115295 V2=-596.42897752409
 V3=0 T=0 M2=0 M3=22.5860135593409 S11Max=-251.02587175925 PtS11Max=1 x2S11Max=-0.5 x3S11Max=-0.5 _
 S11Min=-522.05803447134 PtS11Min=3 x2S11Min=0.5 x3S11Min=-0.5 FrameElem=48 ElemStation=0.375
 Frame=48 Station=0.5 OutputCase=FESSUR CaseType=Combination P=-386.541953115295 V2=-593.30397752409
 V3=0 T=0 M2=0 M3=96.9443232498522 S11Max=195.123986383818 PtS11Max=1 x2S11Max=-0.5 x3S11Max=-0.5 _
 S11Min=-968.207892614408 PtS11Min=3 x2S11Min=0.5 x3S11Min=-0.5 FrameElem=48 ElemStation=0.5
 Frame=69 Station=0 OutputCase=PESOPR CaseType=LinStatic P=-162.500000265485 V2=-15.1709312389792 V3=0
 T=0 M2=0 M3=-81.7553624960714 S11Max=328.032174710943 PtS11Max=3 x2S11Max=0.5 x3S11Max=-0.5 _
 S11Min=-653.032175241913 PtS11Min=1 x2S11Min=-0.5 x3S11Min=-0.5 FrameElem=69 ElemStation=0
 Frame=69 Station=0.2500000000000001 OutputCase=PESOPR CaseType=LinStatic P=-156.250000265485 V2=-
 15.1709318350256 V3=0 T=0 M2=0 M3=-77.9626296118208 S11Max=311.525777405439 PtS11Max=3 x2S11Max=0.5
 x3S11Max=-0.5 _
 S11Min=-624.02577793641 PtS11Min=1 x2S11Min=-0.5 x3S11Min=-0.5 FrameElem=69
 ElemStation=0.2500000000000001
 Frame=69 Station=0 OutputCase=TERRVERT CaseType=LinStatic P=-699.999993448611 V2=1.64277413915966
 V3=0 T=0 M2=0 M3=-318.35470557965 S11Max=1210.12824002929 PtS11Max=3 x2S11Max=0.5 x3S11Max=-0.5 _
 S11Min=-2610.12822692651 PtS11Min=1 x2S11Min=-0.5 x3S11Min=-0.5 FrameElem=69 ElemStation=0
 Frame=69 Station=0.2500000000000001 OutputCase=TERRVERT CaseType=LinStatic P=-699.999993448611
 V2=1.64277413915966 V3=0 T=0 M2=0 M3=-318.76539911444 S11Max=1212.59240123803 PtS11Max=3 x2S11Max=0.5
 x3S11Max=-0.5 _
 S11Min=-2612.59238813525 PtS11Min=1 x2S11Min=-0.5 x3S11Min=-0.5 FrameElem=69
 ElemStation=0.2500000000000001
 Frame=69 Station=0 OutputCase=TERRLAT CaseType=LinStatic P=-2.96409380098339E-05 V2=-293.063713761059
 V3=0 T=0 M2=0 M3=-84.0726613763916 S11Max=504.435938617411 PtS11Max=3 x2S11Max=0.5 x3S11Max=-0.5 _
 S11Min=-504.435997899287 PtS11Min=1 x2S11Min=-0.5 x3S11Min=-0.5 FrameElem=69 ElemStation=0
 Frame=69 Station=0.2500000000000001 OutputCase=TERRLAT CaseType=LinStatic P=-2.59045910638367E-05 V2=-
 253.885276262648 V3=0 T=0 M2=0 M3=-15.7151443943275 S11Max=94.2908404613739 PtS11Max=3 x2S11Max=0.5 _
 x3S11Max=-0.5 S11Min=-94.2908922705561 PtS11Min=1 x2S11Min=-0.5 x3S11Min=-0.5 FrameElem=69
 ElemStation=0.2500000000000001
 Frame=69 Station=0 OutputCase=ACCVERT CaseType=LinStatic P=0 V2=0 V3=0 T=0 M2=0 M3=0 S11Max=0
 PtS11Max=0 x2S11Max=0 x3S11Max=0 S11Min=0 PtS11Min=0 x2S11Min=0 x3S11Min=0 FrameElem=69
 ElemStation=0
 Frame=69 Station=0.2500000000000001 OutputCase=ACCVERT CaseType=LinStatic P=0 V2=0 V3=0 T=0 M2=0
 M3=0 S11Max=0 PtS11Max=0 x2S11Max=0 x3S11Max=0 S11Min=0 PtS11Min=0 x2S11Min=0 x3S11Min=0
 FrameElem=69 ElemStation=0.2500000000000001
 Frame=69 Station=0 OutputCase=ACCLATDX CaseType=LinStatic P=0 V2=0 V3=0 T=0 M2=0 M3=0
 S11Max=0 PtS11Max=0 x2S11Max=0 x3S11Max=0 S11Min=0 PtS11Min=0 x2S11Min=0 x3S11Min=0 FrameElem=69
 ElemStation=0



Frame=69 Station=0.250000000000001 OutputCase=ACCLATDX CaseType=LinStatic P=0 V2=0 V3=0 T=0 M2=0
 M3=0 S11Max=0 PtS11Max=0 x2S11Max=0 x3S11Max=0 S11Min=0 PtS11Min=0 x2S11Min=0 x3S11Min=0
 FrameElem=69 ElemStation=0.250000000000001
 Frame=69 Station=0 OutputCase=ACCLATSX CaseType=LinStatic P=0 V2=0 V3=0 T=0 M2=0 M3=0
 S11Max=0 PtS11Max=0 x2S11Max=0 x3S11Max=0 S11Min=0 PtS11Min=0 x2S11Min=0 x3S11Min=0 FrameElem=69
 ElemStation=0
 Frame=69 Station=0.250000000000001 OutputCase=ACCLATSX CaseType=LinStatic P=0 V2=0 V3=0 T=0 M2=0
 M3=0 S11Max=0 PtS11Max=0 x2S11Max=0 x3S11Max=0 S11Min=0 PtS11Min=0 x2S11Min=0 x3S11Min=0
 FrameElem=69 ElemStation=0.250000000000001
 Frame=69 Station=0 OutputCase=TERRCOST CaseType=LinStatic P=0 V2=0 V3=0 T=0 M2=0 M3=0
 S11Max=0 PtS11Max=0 x2S11Max=0 x3S11Max=0 S11Min=0 PtS11Min=0 x2S11Min=0 x3S11Min=0 FrameElem=69
 ElemStation=0
 Frame=69 Station=0.250000000000001 OutputCase=TERRCOST CaseType=LinStatic P=0 V2=0 V3=0 T=0 M2=0
 M3=0 S11Max=0 PtS11Max=0 x2S11Max=0 x3S11Max=0 S11Min=0 PtS11Min=0 x2S11Min=0 x3S11Min=0
 FrameElem=69 ElemStation=0.250000000000001
 Frame=69 Station=0 OutputCase=SOVRCOST CaseType=LinStatic P=0 V2=0 V3=0 T=0 M2=0 M3=0
 S11Max=0 PtS11Max=0 x2S11Max=0 x3S11Max=0 S11Min=0 PtS11Min=0 x2S11Min=0 x3S11Min=0 FrameElem=69
 ElemStation=0
 Frame=69 Station=0.250000000000001 OutputCase=SOVRCOST CaseType=LinStatic P=0 V2=0 V3=0 T=0 M2=0
 M3=0 S11Max=0 PtS11Max=0 x2S11Max=0 x3S11Max=0 S11Min=0 PtS11Min=0 x2S11Min=0 x3S11Min=0
 FrameElem=69 ElemStation=0.250000000000001
 Frame=69 Station=0 OutputCase=ENVE CaseType=Combination StepType=Max P=-862.500014462753 V2=-
 218.672756732561 V3=0 T=0 M2=0 M3=-458.960931039196 S11Max=2042.59635335764 PtS11Max=3 x2S11Max=0.5
 x3S11Max=-0.5 _
 S11Min=-3616.26560069793 PtS11Min=1 x2S11Min=-0.5 x3S11Min=-0.5 FrameElem=69 ElemStation=0
 Frame=69 Station=0.250000000000001 OutputCase=ENVE CaseType=Combination StepType=Max P=-856.25001184731
 V2=-191.247851079719 V3=0 T=0 M2=0 M3=-407.72862980229 S11Max=1618.40901910484 PtS11Max=3 x2S11Max=0.5
 _
 x3S11Max=-0.5 S11Min=-3302.62179066105 PtS11Min=1 x2S11Min=-0.5 x3S11Min=-0.5 FrameElem=69
 ElemStation=0.250000000000001
 Frame=69 Station=0 OutputCase=ENVE CaseType=Combination StepType=Min P=-862.500023355035 V2=-
 306.591870860878 V3=0 T=0 M2=0 M3=-484.182729452113 S11Max=1891.26557177242 PtS11Max=3 x2S11Max=0.5
 x3S11Max=-0.5 _
 S11Min=-3767.59640006771 PtS11Min=1 x2S11Min=-0.5 x3S11Min=-0.5 FrameElem=69 ElemStation=0
 Frame=69 Station=0.250000000000001 OutputCase=ENVE CaseType=Combination StepType=Min P=-
 856.250019618688 V2=-267.413433958514 V3=0 T=0 M2=0 M3=-412.443173120588 S11Max=1590.12176696643
 PtS11Max=3 x2S11Max=0.5 _
 x3S11Max=-0.5 S11Min=-3330.90905834222 PtS11Min=1 x2S11Min=-0.5 x3S11Min=-0.5 FrameElem=69
 ElemStation=0.250000000000001
 Frame=69 Station=0 OutputCase=FESSUR CaseType=Combination P=-862.500023355035 V2=-306.591870860878
 V3=0 T=0 M2=0 M3=-484.182729452113 S11Max=2042.59635335764 PtS11Max=3 x2S11Max=0.5 x3S11Max=-0.5 _
 S11Min=-3767.59640006771 PtS11Min=1 x2S11Min=-0.5 x3S11Min=-0.5 FrameElem=69 ElemStation=0
 Frame=69 Station=0.250000000000001 OutputCase=FESSUR CaseType=Combination P=-856.250019618688 V2=-
 267.413433958514 V3=0 T=0 M2=0 M3=-412.443173120588 S11Max=1618.40901910484 PtS11Max=3 x2S11Max=0.5
 x3S11Max=-0.5 _
 S11Min=-3330.90905834222 PtS11Min=1 x2S11Min=-0.5 x3S11Min=-0.5 FrameElem=69
 ElemStation=0.250000000000001
 Frame=70 Station=0 OutputCase=PESOPR CaseType=LinStatic P=-156.249998818617 V2=-15.1709467361864 V3=0
 T=0 M2=0 M3=-77.9626296118216 S11Max=311.525778852312 PtS11Max=3 x2S11Max=0.5 x3S11Max=-0.5 _
 S11Min=-624.025776489547 PtS11Min=1 x2S11Min=-0.5 x3S11Min=-0.5 FrameElem=70 ElemStation=0
 Frame=70 Station=0.25 OutputCase=PESOPR CaseType=LinStatic P=-149.999998818617 V2=-15.1709467361864
 V3=0 T=0 M2=0 M3=-74.169892927775 S11Max=295.019358748033 PtS11Max=3 x2S11Max=0.5 x3S11Max=-0.5 _
 S11Min=-595.019356385267 PtS11Min=1 x2S11Min=-0.5 x3S11Min=-0.5 FrameElem=70 ElemStation=0.25
 Frame=70 Station=0 OutputCase=TERRVERT CaseType=LinStatic P=-699.999993604841 V2=1.64270738195546
 V3=0 T=0 M2=0 M3=-318.765399114454 S11Max=1212.59240108189 PtS11Max=3 x2S11Max=0.5 x3S11Max=-0.5 _
 S11Min=-2612.59238829157 PtS11Min=1 x2S11Min=-0.5 x3S11Min=-0.5 FrameElem=70 ElemStation=0
 Frame=70 Station=0.25 OutputCase=TERRVERT CaseType=LinStatic P=-699.999993604841 V2=1.64270738195546
 V3=0 T=0 M2=0 M3=-319.176075959943 S11Max=1215.05646215482 PtS11Max=3 x2S11Max=0.5 x3S11Max=-0.5 _
 S11Min=-2615.0564493645 PtS11Min=1 x2S11Min=-0.5 x3S11Min=-0.5 FrameElem=70 ElemStation=0.25
 Frame=70 Station=0 OutputCase=TERRLAT CaseType=LinStatic P=-1.69220766110811E-06 V2=-253.885276262649
 V3=0 T=0 M2=0 M3=-15.7151443943278 S11Max=94.2908646737592 PtS11Max=3 x2S11Max=0.5 x3S11Max=-0.5 _
 S11Min=-94.2908680581745 PtS11Min=1 x2S11Min=-0.5 x3S11Min=-0.5 FrameElem=70 ElemStation=0
 Frame=70 Station=0.25 OutputCase=TERRLAT CaseType=LinStatic P=-1.69220766110811E-06 V2=-
 215.239963767416 V3=0 T=0 M2=0 M3=42.9144038385308 S11Max=257.486421338977 PtS11Max=1 x2S11Max=-0.5
 x3S11Max=-0.5 _
 S11Min=-257.486424723392 PtS11Min=3 x2S11Min=0.5 x3S11Min=-0.5 FrameElem=70 ElemStation=0.25
 Frame=70 Station=0 OutputCase=ACCVERT CaseType=LinStatic P=0 V2=0 V3=0 T=0 M2=0 M3=0 S11Max=0
 PtS11Max=0 x2S11Max=0 x3S11Max=0 S11Min=0 PtS11Min=0 x2S11Min=0 x3S11Min=0 FrameElem=70
 ElemStation=0
 Frame=70 Station=0.25 OutputCase=ACCVERT CaseType=LinStatic P=0 V2=0 V3=0 T=0 M2=0 M3=0
 S11Max=0 PtS11Max=0 x2S11Max=0 x3S11Max=0 S11Min=0 PtS11Min=0 x2S11Min=0 x3S11Min=0 FrameElem=70
 ElemStation=0.25
 Frame=70 Station=0 OutputCase=ACCLATDX CaseType=LinStatic P=0 V2=0 V3=0 T=0 M2=0 M3=0
 S11Max=0 PtS11Max=0 x2S11Max=0 x3S11Max=0 S11Min=0 PtS11Min=0 x2S11Min=0 x3S11Min=0 FrameElem=70
 ElemStation=0
 Frame=70 Station=0.25 OutputCase=ACCLATDX CaseType=LinStatic P=0 V2=0 V3=0 T=0 M2=0 M3=0
 S11Max=0 PtS11Max=0 x2S11Max=0 x3S11Max=0 S11Min=0 PtS11Min=0 x2S11Min=0 x3S11Min=0 FrameElem=70
 ElemStation=0.25
 Frame=70 Station=0 OutputCase=ACCLATSX CaseType=LinStatic P=0 V2=0 V3=0 T=0 M2=0 M3=0
 S11Max=0 PtS11Max=0 x2S11Max=0 x3S11Max=0 S11Min=0 PtS11Min=0 x2S11Min=0 x3S11Min=0 FrameElem=70
 ElemStation=0



Frame=70 Station=0.25 OutputCase=ACCLATSX CaseType=LinStatic P=0 V2=0 V3=0 T=0 M2=0 M3=0
 S11Max=0 PtS11Max=0 x2S11Max=0 x3S11Max=0 S11Min=0 PtS11Min=0 x2S11Min=0 x3S11Min=0 FrameElem=70
 ElemStation=0.25
 Frame=70 Station=0 OutputCase=TERRCOST CaseType=LinStatic P=0 V2=0 V3=0 T=0 M2=0 M3=0
 S11Max=0 PtS11Max=0 x2S11Max=0 x3S11Max=0 S11Min=0 PtS11Min=0 x2S11Min=0 x3S11Min=0 FrameElem=70
 ElemStation=0
 Frame=70 Station=0.25 OutputCase=TERRCOST CaseType=LinStatic P=0 V2=0 V3=0 T=0 M2=0 M3=0
 S11Max=0 PtS11Max=0 x2S11Max=0 x3S11Max=0 S11Min=0 PtS11Min=0 x2S11Min=0 x3S11Min=0 FrameElem=70
 ElemStation=0.25
 Frame=70 Station=0 OutputCase=SOVRCOST CaseType=LinStatic P=0 V2=0 V3=0 T=0 M2=0 M3=0
 S11Max=0 PtS11Max=0 x2S11Max=0 x3S11Max=0 S11Min=0 PtS11Min=0 x2S11Min=0 x3S11Min=0 FrameElem=70
 ElemStation=0
 Frame=70 Station=0.25 OutputCase=SOVRCOST CaseType=LinStatic P=0 V2=0 V3=0 T=0 M2=0 M3=0
 S11Max=0 PtS11Max=0 x2S11Max=0 x3S11Max=0 S11Min=0 PtS11Min=0 x2S11Min=0 x3S11Min=0 FrameElem=70
 ElemStation=0.25
 Frame=70 Station=0 OutputCase=ENVE CaseType=Combination StepType=Max P=-856.249993608003 V2=-
 191.247932738085 V3=0 T=0 M2=0 M3=-407.728629802305 S11Max=1618.40904460796 PtS11Max=3 x2S11Max=0.5
 x3S11Max=-0.5
 S11Min=-3302.62177242184 PtS11Min=1 x2S11Min=-0.5 x3S11Min=-0.5 FrameElem=70 ElemStation=0
 Frame=70 Station=0.25 OutputCase=ENVE CaseType=Combination StepType=Max P=-849.999993608003 V2=-
 164.196213991422 V3=0 T=0 M2=0 M3=-350.431565049187 S11Max=1329.83532359648 PtS11Max=3 x2S11Max=0.5
 x3S11Max=-0.5
 S11Min=-2952.58938441079 PtS11Min=1 x2S11Min=-0.5 x3S11Min=-0.5 FrameElem=70 ElemStation=0.25
 Frame=70 Station=0 OutputCase=ENVE CaseType=Combination StepType=Min P=-856.249994115666 V2=-
 267.41351561688 V3=0 T=0 M2=0 M3=-412.443173120604 S11Max=1590.12178520583 PtS11Max=3 x2S11Max=0.5
 x3S11Max=-0.5
 S11Min=-3330.90903283929 PtS11Min=1 x2S11Min=-0.5 x3S11Min=-0.5 FrameElem=70 ElemStation=0
 Frame=70 Station=0.25 OutputCase=ENVE CaseType=Combination StepType=Min P=-849.999994115666 V2=-
 228.768203121647 V3=0 T=0 M2=0 M3=-363.305886200747 S11Max=1252.58939617946 PtS11Max=3 x2S11Max=0.5
 x3S11Max=-0.5
 S11Min=-3029.83531081248 PtS11Min=1 x2S11Min=-0.5 x3S11Min=-0.5 FrameElem=70 ElemStation=0.25
 Frame=70 Station=0 OutputCase=FESSUR CaseType=Combination P=-856.249994115666 V2=-267.41351561688
 V3=0 T=0 M2=0 M3=-412.443173120604 S11Max=1618.40904460796 PtS11Max=3 x2S11Max=0.5 x3S11Max=-0.5
 S11Min=-3330.90903283929 PtS11Min=1 x2S11Min=-0.5 x3S11Min=-0.5 FrameElem=70 ElemStation=0
 Frame=70 Station=0.25 OutputCase=FESSUR CaseType=Combination P=-849.999994115666 V2=-228.768203121647
 V3=0 T=0 M2=0 M3=-350.431565049187 S11Max=1252.58939617946 PtS11Max=3 x2S11Max=0.5 x3S11Max=-0.5
 S11Min=-2952.58938441079 PtS11Min=1 x2S11Min=-0.5 x3S11Min=-0.5 FrameElem=70 ElemStation=0.25
 Frame=72 Station=0 OutputCase=PESOPR CaseType=LinStatic P=-75.0000002653687 V2=-15.1709395836284 V3=0
 T=0 M2=0 M3=-28.6570500370093 S11Max=96.9422999566871 PtS11Max=3 x2S11Max=0.5 x3S11Max=-0.5
 S11Min=-246.942300487425 PtS11Min=1 x2S11Min=-0.5 x3S11Min=-0.5 FrameElem=72 ElemStation=0
 Frame=72 Station=0.2500000000000002 OutputCase=PESOPR CaseType=LinStatic P=-68.7500002653687 V2=-
 15.1709401796749 V3=0 T=0 M2=0 M3=-24.8643150665964 S11Max=80.4358901342095 PtS11Max=3 x2S11Max=0.5
 x3S11Max=-0.5
 S11Min=-217.935890664947 PtS11Min=1 x2S11Min=-0.5 x3S11Min=-0.5 FrameElem=72
 ElemStation=0.2500000000000002
 Frame=72 Station=0 OutputCase=TERRVERT CaseType=LinStatic P=-699.99993447214 V2=1.6427741391617 V3=0
 T=0 M2=0 M3=-324.104181416514 S11Max=1244.62509505187 PtS11Max=3 x2S11Max=0.5 x3S11Max=-0.5
 S11Min=-2644.6250819463 PtS11Min=1 x2S11Min=-0.5 x3S11Min=-0.5 FrameElem=72 ElemStation=0
 Frame=72 Station=0.2500000000000002 OutputCase=TERRVERT CaseType=LinStatic P=-699.99993447214
 V2=1.6427741391617 V3=0 T=0 M2=0 M3=-324.514874951304 S11Max=1247.08925626061 PtS11Max=3 x2S11Max=0.5
 x3S11Max=-0.5
 S11Min=-2647.08924315504 PtS11Min=1 x2S11Min=-0.5 x3S11Min=-0.5 FrameElem=72
 ElemStation=0.2500000000000002
 Frame=72 Station=0 OutputCase=TERRLAT CaseType=LinStatic P=1.8041224393528E-05 V2=206.920035927522
 V3=0 T=0 M2=0 M3=36.2017954839701 S11Max=217.210790945045 PtS11Max=1 x2S11Max=-0.5 x3S11Max=-0.5
 S11Min=-217.210754862596 PtS11Min=3 x2S11Min=0.5 x3S11Min=-0.5 FrameElem=72 ElemStation=0
 Frame=72 Station=0.2500000000000002 OutputCase=TERRLAT CaseType=LinStatic P=2.10657726700265E-05
 V2=238.634723381446 V3=0 T=0 M2=0 M3=-19.5036562005507 S11Max=117.021958269077 PtS11Max=3 x2S11Max=0.5
 x3S11Max=-0.5
 S11Min=-117.021916137532 PtS11Min=1 x2S11Min=-0.5 x3S11Min=-0.5 FrameElem=72
 ElemStation=0.2500000000000002
 Frame=72 Station=0 OutputCase=ACCVERT CaseType=LinStatic P=0 V2=0 V3=0 T=0 M2=0 M3=0 S11Max=0
 PtS11Max=0 x2S11Max=0 x3S11Max=0 S11Min=0 PtS11Min=0 x2S11Min=0 x3S11Min=0 FrameElem=72
 ElemStation=0
 Frame=72 Station=0.2500000000000002 OutputCase=ACCVERT CaseType=LinStatic P=0 V2=0 V3=0 T=0 M2=0
 M3=0 S11Max=0 PtS11Max=0 x2S11Max=0 x3S11Max=0 S11Min=0 PtS11Min=0 x2S11Min=0 x3S11Min=0
 FrameElem=72 ElemStation=0.2500000000000002
 Frame=72 Station=0 OutputCase=ACCLATDX CaseType=LinStatic P=0 V2=0 V3=0 T=0 M2=0 M3=0
 S11Max=0 PtS11Max=0 x2S11Max=0 x3S11Max=0 S11Min=0 PtS11Min=0 x2S11Min=0 x3S11Min=0 FrameElem=72
 ElemStation=0
 Frame=72 Station=0.2500000000000002 OutputCase=ACCLATDX CaseType=LinStatic P=0 V2=0 V3=0 T=0 M2=0
 M3=0 S11Max=0 PtS11Max=0 x2S11Max=0 x3S11Max=0 S11Min=0 PtS11Min=0 x2S11Min=0 x3S11Min=0
 FrameElem=72 ElemStation=0.2500000000000002
 Frame=72 Station=0 OutputCase=ACCLATSX CaseType=LinStatic P=0 V2=0 V3=0 T=0 M2=0 M3=0
 S11Max=0 PtS11Max=0 x2S11Max=0 x3S11Max=0 S11Min=0 PtS11Min=0 x2S11Min=0 x3S11Min=0 FrameElem=72
 ElemStation=0
 Frame=72 Station=0.2500000000000002 OutputCase=ACCLATSX CaseType=LinStatic P=0 V2=0 V3=0 T=0 M2=0
 M3=0 S11Max=0 PtS11Max=0 x2S11Max=0 x3S11Max=0 S11Min=0 PtS11Min=0 x2S11Min=0 x3S11Min=0
 FrameElem=72 ElemStation=0.2500000000000002
 Frame=72 Station=0 OutputCase=TERRCOST CaseType=LinStatic P=0 V2=0 V3=0 T=0 M2=0 M3=0
 S11Max=0 PtS11Max=0 x2S11Max=0 x3S11Max=0 S11Min=0 PtS11Min=0 x2S11Min=0 x3S11Min=0 FrameElem=72
 ElemStation=0



```

Frame=72 Station=0.250000000000002 OutputCase=TERRCOST CaseType=LinStatic P=0 V2=0 V3=0 T=0 M2=0
M3=0 S11Max=0 PtS11Max=0 x2S11Max=0 x3S11Max=0 S11Min=0 PtS11Min=0 x2S11Min=0 x3S11Min=0
FrameElem=72 ElemStation=0.250000000000002
Frame=72 Station=0 OutputCase=SOVRCOST CaseType=LinStatic P=0 V2=0 V3=0 T=0 M2=0 M3=0
S11Max=0 PtS11Max=0 x2S11Max=0 x3S11Max=0 S11Min=0 PtS11Min=0 x2S11Min=0 x3S11Min=0 FrameElem=72
ElemStation=0
Frame=72 Station=0.250000000000002 OutputCase=SOVRCOST CaseType=LinStatic P=0 V2=0 V3=0 T=0 M2=0
M3=0 S11Max=0 PtS11Max=0 x2S11Max=0 x3S11Max=0 S11Min=0 PtS11Min=0 x2S11Min=0 x3S11Min=0
FrameElem=72 ElemStation=0.250000000000002
Frame=72 Station=0 OutputCase=ENVE CaseType=Combination StepType=Max P=-774.999975671359
V2=193.391870483055 V3=0 T=0 M2=0 M3=-316.559435969553 S11Max=1189.51986660474 PtS11Max=3 x2S11Max=0.5
x3S11Max=-0.5
S11Min=-2674.35659148868 PtS11Min=1 x2S11Min=-0.5 x3S11Min=-0.5 FrameElem=72 ElemStation=0
Frame=72 Station=0.250000000000002 OutputCase=ENVE CaseType=Combination StepType=Max P=-768.74997264681
V2=225.106557340933 V3=0 T=0 M2=0 M3=-363.031749358286 S11Max=1444.5471046639 PtS11Max=3 x2S11Max=0.5
x3S11Max=-0.5
S11Min=-2946.94047511626 PtS11Min=1 x2S11Min=-0.5 x3S11Min=-0.5 FrameElem=72
ElemStation=0.250000000000002
Frame=72 Station=0 OutputCase=ENVE CaseType=Combination StepType=Min P=-774.999981083726
V2=131.315859704799 V3=0 T=0 M2=0 M3=-327.419974614744 S11Max=1124.35664014596 PtS11Max=3 x2S11Max=0.5
x3S11Max=-0.5
S11Min=-2739.51982877219 PtS11Min=1 x2S11Min=-0.5 x3S11Min=-0.5 FrameElem=72 ElemStation=0
Frame=72 Station=0.250000000000002 OutputCase=ENVE CaseType=Combination StepType=Min P=-
768.749978966542 V2=153.516140326499 V3=0 T=0 M2=0 M3=-368.882846218451 S11Max=1409.44051718317
PtS11Max=3 x2S11Max=0.5
x3S11Max=-0.5 S11Min=-2982.04704995752 PtS11Min=1 x2S11Min=-0.5 x3S11Min=-0.5 FrameElem=72
ElemStation=0.250000000000002
Frame=72 Station=0 OutputCase=FESSUR CaseType=Combination P=-774.999975671359 V2=193.391870483055
V3=0 T=0 M2=0 M3=-316.559435969553 S11Max=1124.35664014596 PtS11Max=3 x2S11Max=0.5 x3S11Max=-0.5
S11Min=-2674.35659148868 PtS11Min=1 x2S11Min=-0.5 x3S11Min=-0.5 FrameElem=72 ElemStation=0
Frame=72 Station=0.250000000000002 OutputCase=FESSUR CaseType=Combination P=-768.74997264681
V2=225.106557340933 V3=0 T=0 M2=0 M3=-368.882846218451 S11Max=1444.5471046639 PtS11Max=3 x2S11Max=0.5
x3S11Max=-0.5
S11Min=-2982.04704995752 PtS11Min=1 x2S11Min=-0.5 x3S11Min=-0.5 FrameElem=72
ElemStation=0.250000000000002
Frame=73 Station=0 OutputCase=PESOPR CaseType=LinStatic P=-68.7499973718659 V2=-15.170953292697 V3=0
T=0 M2=0 M3=-24.8643150665962 S11Max=80.4358930277116 PtS11Max=3 x2S11Max=0.5 x3S11Max=-0.5
S11Min=-217.935887771443 PtS11Min=1 x2S11Min=-0.5 x3S11Min=-0.5 FrameElem=73 ElemStation=0
Frame=73 Station=0.249999976158143 OutputCase=PESOPR CaseType=LinStatic P=-62.4999979679124 V2=-
15.1709526966505 V3=0 T=0 M2=0 M3=-21.0715771796315 S11Max=63.9294651098767 PtS11Max=3 x2S11Max=0.5
x3S11Max=-0.5
S11Min=-188.929461045701 PtS11Min=1 x2S11Min=-0.5 x3S11Min=-0.5 FrameElem=73
ElemStation=0.249999976158143
Frame=73 Station=0 OutputCase=TERRVERT CaseType=LinStatic P=-699.999993761536 V2=1.64264062475445
V3=0 T=0 M2=0 M3=-324.514874951304 S11Max=1247.08925594629 PtS11Max=3 x2S11Max=0.5 x3S11Max=-0.5
S11Min=-2647.08924346936 PtS11Min=1 x2S11Min=-0.5 x3S11Min=-0.5 FrameElem=73 ElemStation=0
Frame=73 Station=0.249999976158143 OutputCase=TERRVERT CaseType=LinStatic P=-699.999993761536
V2=1.64264062475445 V3=0 T=0 M2=0 M3=-324.925535068329 S11Max=1249.55321664844 PtS11Max=3 x2S11Max=0.5
x3S11Max=-0.5
S11Min=-2649.55320417151 PtS11Min=1 x2S11Min=-0.5 x3S11Min=-0.5 FrameElem=73
ElemStation=0.249999976158143
Frame=73 Station=0 OutputCase=TERRLAT CaseType=LinStatic P=-2.44501861743629E-05 V2=238.634723381446
V3=0 T=0 M2=0 M3=-19.503656200551 S11Max=117.02191275312 PtS11Max=3 x2S11Max=0.5 x3S11Max=-0.5
S11Min=-117.021961653492 PtS11Min=1 x2S11Min=-0.5 x3S11Min=-0.5 FrameElem=73 ElemStation=0
Frame=73 Station=0.249999976158143 OutputCase=TERRLAT CaseType=LinStatic P=-2.74238916911788E-05
V2=269.816282883908 V3=0 T=0 M2=0 M3=-83.0711326902341 S11Max=498.426768717513 PtS11Max=3 x2S11Max=0.5
x3S11Max=-0.5
S11Min=-498.426823565296 PtS11Min=1 x2S11Min=-0.5 x3S11Min=-0.5 FrameElem=73
ElemStation=0.249999976158143
Frame=73 Station=0 OutputCase=ACCVERT CaseType=LinStatic P=0 V2=0 V3=0 T=0 M2=0 M3=0 S11Max=0
PtS11Max=0 x2S11Max=0 x3S11Max=0 S11Min=0 PtS11Min=0 x2S11Min=0 x3S11Min=0 FrameElem=73
ElemStation=0
Frame=73 Station=0.249999976158143 OutputCase=ACCVERT CaseType=LinStatic P=0 V2=0 V3=0 T=0 M2=0
M3=0 S11Max=0 PtS11Max=0 x2S11Max=0 x3S11Max=0 S11Min=0 PtS11Min=0 x2S11Min=0 x3S11Min=0
FrameElem=73 ElemStation=0.249999976158143
Frame=73 Station=0 OutputCase=ACCLATDX CaseType=LinStatic P=0 V2=0 V3=0 T=0 M2=0 M3=0
S11Max=0 PtS11Max=0 x2S11Max=0 x3S11Max=0 S11Min=0 PtS11Min=0 x2S11Min=0 x3S11Min=0 FrameElem=73
ElemStation=0
Frame=73 Station=0.249999976158143 OutputCase=ACCLATDX CaseType=LinStatic P=0 V2=0 V3=0 T=0 M2=0
M3=0 S11Max=0 PtS11Max=0 x2S11Max=0 x3S11Max=0 S11Min=0 PtS11Min=0 x2S11Min=0 x3S11Min=0
FrameElem=73 ElemStation=0.249999976158143
Frame=73 Station=0 OutputCase=ACCLATSX CaseType=LinStatic P=0 V2=0 V3=0 T=0 M2=0 M3=0
S11Max=0 PtS11Max=0 x2S11Max=0 x3S11Max=0 S11Min=0 PtS11Min=0 x2S11Min=0 x3S11Min=0 FrameElem=73
ElemStation=0
Frame=73 Station=0.249999976158143 OutputCase=ACCLATSX CaseType=LinStatic P=0 V2=0 V3=0 T=0 M2=0
M3=0 S11Max=0 PtS11Max=0 x2S11Max=0 x3S11Max=0 S11Min=0 PtS11Min=0 x2S11Min=0 x3S11Min=0
FrameElem=73 ElemStation=0.249999976158143
Frame=73 Station=0 OutputCase=TERRCOST CaseType=LinStatic P=0 V2=0 V3=0 T=0 M2=0 M3=0
S11Max=0 PtS11Max=0 x2S11Max=0 x3S11Max=0 S11Min=0 PtS11Min=0 x2S11Min=0 x3S11Min=0 FrameElem=73
ElemStation=0

```



Frame=73 Station=0.249999976158143 OutputCase=TERRCOST CaseType=LinStatic P=0 V2=0 V3=0 T=0 M2=0
 M3=0 S11Max=0 PtS11Max=0 x2S11Max=0 x3S11Max=0 S11Min=0 PtS11Min=0 x2S11Min=0 x3S11Min=0
 FrameElem=73 ElemStation=0.249999976158143
 Frame=73 Station=0 OutputCase=SOVRCOST CaseType=LinStatic P=0 V2=0 V3=0 T=0 M2=0 M3=0
 S11Max=0 PtS11Max=0 x2S11Max=0 x3S11Max=0 S11Min=0 PtS11Min=0 x2S11Min=0 x3S11Min=0 FrameElem=73
 ElemStation=0
 Frame=73 Station=0.249999976158143 OutputCase=SOVRCOST CaseType=LinStatic P=0 V2=0 V3=0 T=0 M2=0
 M3=0 S11Max=0 PtS11Max=0 x2S11Max=0 x3S11Max=0 S11Min=0 PtS11Min=0 x2S11Min=0 x3S11Min=0
 FrameElem=73 ElemStation=0.249999976158143
 Frame=73 Station=0 OutputCase=ENVE CaseType=Combination StepType=Max P=-768.750008248532
 V2=225.106410713504 V3=0 T=0 M2=0 M3=-363.031749358286 S11Max=1444.54706172712 PtS11Max=3 x2S11Max=0.5
 x3S11Max=-0.5
 S11Min=-2946.94050439825 PtS11Min=1 x2S11Min=-0.5 x3S11Min=-0.5 FrameElem=73 ElemStation=0
 Frame=73 Station=0.249999976158143 OutputCase=ENVE CaseType=Combination StepType=Max P=-
 762.500010926172 V2=256.287970812012 V3=0 T=0 M2=0 M3=-404.146905131125 S11Max=1811.90945047583
 PtS11Max=3 x2S11Max=0.5
 x3S11Max=-0.5 S11Min=-3187.38144171292 PtS11Min=1 x2S11Min=-0.5 x3S11Min=-0.5 FrameElem=73
 ElemStation=0.249999976158143
 Frame=73 Station=0 OutputCase=ENVE CaseType=Combination StepType=Min P=-768.750015583588
 V2=153.51599369907 V3=0 T=0 M2=0 M3=-368.882846218451 S11Max=1409.44048790118 PtS11Max=3 x2S11Max=0.5
 x3S11Max=-0.5
 S11Min=-2982.0470928943 PtS11Min=1 x2S11Min=-0.5 x3S11Min=-0.5 FrameElem=73 ElemStation=0
 Frame=73 Station=0.249999976158143 OutputCase=ENVE CaseType=Combination StepType=Min P=-762.50001915334
 V2=175.34308594684 V3=0 T=0 M2=0 M3=-429.068244938195 S11Max=1662.38141986057 PtS11Max=3 x2S11Max=0.5
 -
 x3S11Max=-0.5 S11Min=-3336.90948878251 PtS11Min=1 x2S11Min=-0.5 x3S11Min=-0.5 FrameElem=73
 ElemStation=0.249999976158143
 Frame=73 Station=0 OutputCase=FESSUR CaseType=Combination P=-768.750015583588 V2=225.106410713504
 V3=0 T=0 M2=0 M3=-368.882846218451 S11Max=1444.54706172712 PtS11Max=3 x2S11Max=0.5 x3S11Max=-0.5
 S11Min=-2982.0470928943 PtS11Min=1 x2S11Min=-0.5 x3S11Min=-0.5 FrameElem=73 ElemStation=0
 Frame=73 Station=0.249999976158143 OutputCase=FESSUR CaseType=Combination P=-762.50001915334
 V2=256.287970812012 V3=0 T=0 M2=0 M3=-429.068244938195 S11Max=1811.90945047583 PtS11Max=3 x2S11Max=0.5
 x3S11Max=-0.5
 S11Min=-3336.90948878251 PtS11Min=1 x2S11Min=-0.5 x3S11Min=-0.5 FrameElem=73
 ElemStation=0.249999976158143
 Frame=74 Station=0 OutputCase=PESOPR CaseType=LinStatic P=15.1709467361849 V2=-62.4999993927195 V3=0
 T=0 M2=0 M3=-21.071576762417 S11Max=141.600407310687 PtS11Max=3 x2S11Max=0.5 x3S11Max=-0.5
 S11Min=-111.25851383817 PtS11Min=1 x2S11Min=-0.5 x3S11Min=-0.5 FrameElem=74 ElemStation=0
 Frame=74 Station=6.24999940395355E-02 OutputCase=PESOPR CaseType=LinStatic P=15.1709467361849 V2=-
 60.9374995417311 V3=0 T=0 M2=0 M3=-17.2141552885878 S11Max=118.455878467712 PtS11Max=3 x2S11Max=0.5
 x3S11Max=-0.5
 S11Min=-88.1139849953418 PtS11Min=1 x2S11Min=-0.5 x3S11Min=-0.5 FrameElem=74
 ElemStation=6.24999940395355E-02
 Frame=74 Station=0.124999988079071 OutputCase=PESOPR CaseType=LinStatic P=15.1709467361849 V2=-
 59.3749996907427 V3=0 T=0 M2=0 M3=-13.4543900461322 S11Max=95.8972870129779 PtS11Max=3 x2S11Max=0.5
 x3S11Max=-0.5
 S11Min=-65.5553935406081 PtS11Min=1 x2S11Min=-0.5 x3S11Min=-0.5 FrameElem=74
 ElemStation=0.124999988079071
 Frame=74 Station=0.187499982118607 OutputCase=PESOPR CaseType=LinStatic P=15.1709467361849 V2=-
 57.8124998397543 V3=0 T=0 M2=0 M3=-9.7922810350501 S11Max=73.9246329464855 PtS11Max=3 x2S11Max=0.5
 x3S11Max=-0.5
 S11Min=-43.5827394741157 PtS11Min=1 x2S11Min=-0.5 x3S11Min=-0.5 FrameElem=74
 ElemStation=0.187499982118607
 Frame=74 Station=0.249999976158142 OutputCase=PESOPR CaseType=LinStatic P=15.1709467361849 V2=-
 56.2499999887659 V3=0 T=0 M2=0 M3=-6.22782825534158 S11Max=52.5379162682344 PtS11Max=3 x2S11Max=0.5
 x3S11Max=-0.5
 S11Min=-22.1960227958646 PtS11Min=1 x2S11Min=-0.5 x3S11Min=-0.5 FrameElem=74
 ElemStation=0.249999976158142
 Frame=74 Station=0 OutputCase=TERRVERT CaseType=LinStatic P=-1.64270738196324 V2=-699.99993042322
 V3=0 T=0 M2=0 M3=-324.925533699861 S11Max=1947.9104948172 PtS11Max=3 x2S11Max=0.5 x3S11Max=-0.5
 S11Min=-1951.19590958113 PtS11Min=1 x2S11Min=-0.5 x3S11Min=-0.5 FrameElem=74 ElemStation=0
 Frame=74 Station=6.24999940395355E-02 OutputCase=TERRVERT CaseType=LinStatic P=-1.64270738196324 V2=-
 682.499994711252 V3=0 T=0 M2=0 M3=-281.722413202733 S11Max=1688.69177183444 PtS11Max=3 x2S11Max=0.5
 x3S11Max=-0.5 S11Min=-1691.97718659836 PtS11Min=1 x2S11Min=-0.5 x3S11Min=-0.5 FrameElem=74
 ElemStation=6.24999940395355E-02
 Frame=74 Station=0.124999988079071 OutputCase=TERRVERT CaseType=LinStatic P=-1.64270738196324 V2=-
 664.999996380182 V3=0 T=0 M2=0 M3=-239.613042496989 S11Max=1436.03554759997 PtS11Max=3 x2S11Max=0.5
 x3S11Max=-0.5
 S11Min=-1439.3209623639 PtS11Min=1 x2S11Min=-0.5 x3S11Min=-0.5 FrameElem=74
 ElemStation=0.124999988079071
 Frame=74 Station=0.187499982118607 OutputCase=TERRVERT CaseType=LinStatic P=-1.64270738196324 V2=-
 647.499998049112 V3=0 T=0 M2=0 M3=-198.597421582628 S11Max=1189.9418221138 PtS11Max=3 x2S11Max=0.5
 x3S11Max=-0.5
 S11Min=-1193.22723687773 PtS11Min=1 x2S11Min=-0.5 x3S11Min=-0.5 FrameElem=74
 ElemStation=0.187499982118607
 Frame=74 Station=0.249999976158142 OutputCase=TERRVERT CaseType=LinStatic P=-1.64270738196324 V2=-
 629.99999718042 V3=0 T=0 M2=0 M3=-158.675550459651 S11Max=950.410595375943 PtS11Max=3 x2S11Max=0.5
 x3S11Max=-0.5
 S11Min=-953.69601013987 PtS11Min=1 x2S11Min=-0.5 x3S11Min=-0.5 FrameElem=74
 ElemStation=0.249999976158142
 Frame=74 Station=0 OutputCase=TERRLAT CaseType=LinStatic P=-330.586282883909 V2=1.69219583767699E-06
 V3=0 T=0 M2=0 M3=-83.0711321110314 S11Max=167.840509782279 PtS11Max=3 x2S11Max=0.5 x3S11Max=-0.5



S11Min=-829.013075550097 PtS11Min=1 x2S11Min=-0.5 x3S11Min=-0.5 FrameElem=74 ElemStation=0
 Frame=74 Station=6.24999940395355E-02 OutputCase=TERRLAT CaseType=LinStatic P=-330.586282883909
 V2=1.69219583767699E-06 V3=0 T=0 M2=0 M3=-83.0711322167936 S11Max=167.840510416853 PtS11Max=3
 x2S11Max=0.5 _
 x3S11Max=-0.5 S11Min=-829.013076184671 PtS11Min=1 x2S11Min=-0.5 x3S11Min=-0.5 FrameElem=74
 ElemStation=6.24999940395355E-02
 Frame=74 Station=0.124999988079071 OutputCase=TERRLAT CaseType=LinStatic P=-330.586282883909
 V2=1.69219583767699E-06 V3=0 T=0 M2=0 M3=-83.0711323225558 S11Max=167.840511051426 PtS11Max=3
 x2S11Max=0.5 _
 x3S11Max=-0.5 S11Min=-829.013076819244 PtS11Min=1 x2S11Min=-0.5 x3S11Min=-0.5 FrameElem=74
 ElemStation=0.124999988079071
 Frame=74 Station=0.187499982118607 OutputCase=TERRLAT CaseType=LinStatic P=-330.586282883909
 V2=1.69219583767699E-06 V3=0 T=0 M2=0 M3=-83.0711324283181 S11Max=167.840511685999 PtS11Max=3
 x2S11Max=0.5 _
 x3S11Max=-0.5 S11Min=-829.013077453817 PtS11Min=1 x2S11Min=-0.5 x3S11Min=-0.5 FrameElem=74
 ElemStation=0.187499982118607
 Frame=74 Station=0.249999976158142 OutputCase=TERRLAT CaseType=LinStatic P=-330.586282883909
 V2=1.69219583767699E-06 V3=0 T=0 M2=0 M3=-83.0711325340803 S11Max=167.840512320573 PtS11Max=3
 x2S11Max=0.5 _
 x3S11Max=-0.5 S11Min=-829.013078088391 PtS11Min=1 x2S11Min=-0.5 x3S11Min=-0.5 FrameElem=74
 ElemStation=0.249999976158142
 Frame=74 Station=0 OutputCase=ACCVERT CaseType=LinStatic P=0 V2=0 V3=0 T=0 M2=0 M3=0 S11Max=0
 PtS11Max=0 x2S11Max=0 x3S11Max=0 S11Min=0 PtS11Min=0 x2S11Min=0 x3S11Min=0 FrameElem=74
 ElemStation=0
 Frame=74 Station=6.24999940395355E-02 OutputCase=ACCVERT CaseType=LinStatic P=0 V2=0 V3=0 T=0
 M2=0 M3=0 S11Max=0 PtS11Max=0 x2S11Max=0 x3S11Max=0 S11Min=0 PtS11Min=0 x2S11Min=0 x3S11Min=0
 FrameElem=74 ElemStation=6.24999940395355E-02
 Frame=74 Station=0.124999988079071 OutputCase=ACCVERT CaseType=LinStatic P=0 V2=0 V3=0 T=0 M2=0
 M3=0 S11Max=0 PtS11Max=0 x2S11Max=0 x3S11Max=0 S11Min=0 PtS11Min=0 x2S11Min=0 x3S11Min=0
 FrameElem=74 ElemStation=0.124999988079071
 Frame=74 Station=0.187499982118607 OutputCase=ACCVERT CaseType=LinStatic P=0 V2=0 V3=0 T=0 M2=0
 M3=0 S11Max=0 PtS11Max=0 x2S11Max=0 x3S11Max=0 S11Min=0 PtS11Min=0 x2S11Min=0 x3S11Min=0
 FrameElem=74 ElemStation=0.187499982118607
 Frame=74 Station=0.249999976158142 OutputCase=ACCVERT CaseType=LinStatic P=0 V2=0 V3=0 T=0 M2=0
 M3=0 S11Max=0 PtS11Max=0 x2S11Max=0 x3S11Max=0 S11Min=0 PtS11Min=0 x2S11Min=0 x3S11Min=0
 FrameElem=74 ElemStation=0.249999976158142
 Frame=74 Station=0 OutputCase=ACCLATDX CaseType=LinStatic P=0 V2=0 V3=0 T=0 M2=0 M3=0
 S11Max=0 PtS11Max=0 x2S11Max=0 x3S11Max=0 S11Min=0 PtS11Min=0 x2S11Min=0 x3S11Min=0 FrameElem=74
 ElemStation=0
 Frame=74 Station=6.24999940395355E-02 OutputCase=ACCLATDX CaseType=LinStatic P=0 V2=0 V3=0 T=0
 M2=0 M3=0 S11Max=0 PtS11Max=0 x2S11Max=0 x3S11Max=0 S11Min=0 PtS11Min=0 x2S11Min=0 x3S11Min=0
 FrameElem=74 ElemStation=6.24999940395355E-02
 Frame=74 Station=0.124999988079071 OutputCase=ACCLATDX CaseType=LinStatic P=0 V2=0 V3=0 T=0 M2=0
 M3=0 S11Max=0 PtS11Max=0 x2S11Max=0 x3S11Max=0 S11Min=0 PtS11Min=0 x2S11Min=0 x3S11Min=0
 FrameElem=74 ElemStation=0.124999988079071
 Frame=74 Station=0.187499982118607 OutputCase=ACCLATDX CaseType=LinStatic P=0 V2=0 V3=0 T=0 M2=0
 M3=0 S11Max=0 PtS11Max=0 x2S11Max=0 x3S11Max=0 S11Min=0 PtS11Min=0 x2S11Min=0 x3S11Min=0
 FrameElem=74 ElemStation=0.187499982118607
 Frame=74 Station=0.249999976158142 OutputCase=ACCLATDX CaseType=LinStatic P=0 V2=0 V3=0 T=0 M2=0
 M3=0 S11Max=0 PtS11Max=0 x2S11Max=0 x3S11Max=0 S11Min=0 PtS11Min=0 x2S11Min=0 x3S11Min=0
 FrameElem=74 ElemStation=0.249999976158142
 Frame=74 Station=0 OutputCase=ACCLATSX CaseType=LinStatic P=0 V2=0 V3=0 T=0 M2=0 M3=0
 S11Max=0 PtS11Max=0 x2S11Max=0 x3S11Max=0 S11Min=0 PtS11Min=0 x2S11Min=0 x3S11Min=0 FrameElem=74
 ElemStation=0
 Frame=74 Station=6.24999940395355E-02 OutputCase=ACCLATSX CaseType=LinStatic P=0 V2=0 V3=0 T=0
 M2=0 M3=0 S11Max=0 PtS11Max=0 x2S11Max=0 x3S11Max=0 S11Min=0 PtS11Min=0 x2S11Min=0 x3S11Min=0
 FrameElem=74 ElemStation=6.24999940395355E-02
 Frame=74 Station=0.124999988079071 OutputCase=ACCLATSX CaseType=LinStatic P=0 V2=0 V3=0 T=0 M2=0
 M3=0 S11Max=0 PtS11Max=0 x2S11Max=0 x3S11Max=0 S11Min=0 PtS11Min=0 x2S11Min=0 x3S11Min=0
 FrameElem=74 ElemStation=0.124999988079071
 Frame=74 Station=0.187499982118607 OutputCase=ACCLATSX CaseType=LinStatic P=0 V2=0 V3=0 T=0 M2=0
 M3=0 S11Max=0 PtS11Max=0 x2S11Max=0 x3S11Max=0 S11Min=0 PtS11Min=0 x2S11Min=0 x3S11Min=0
 FrameElem=74 ElemStation=0.187499982118607
 Frame=74 Station=0.249999976158142 OutputCase=ACCLATSX CaseType=LinStatic P=0 V2=0 V3=0 T=0 M2=0
 M3=0 S11Max=0 PtS11Max=0 x2S11Max=0 x3S11Max=0 S11Min=0 PtS11Min=0 x2S11Min=0 x3S11Min=0
 FrameElem=74 ElemStation=0.249999976158142
 Frame=74 Station=0 OutputCase=TERRCOST CaseType=LinStatic P=0 V2=0 V3=0 T=0 M2=0 M3=0
 S11Max=0 PtS11Max=0 x2S11Max=0 x3S11Max=0 S11Min=0 PtS11Min=0 x2S11Min=0 x3S11Min=0 FrameElem=74
 ElemStation=0
 Frame=74 Station=6.24999940395355E-02 OutputCase=TERRCOST CaseType=LinStatic P=0 V2=0 V3=0 T=0
 M2=0 M3=0 S11Max=0 PtS11Max=0 x2S11Max=0 x3S11Max=0 S11Min=0 PtS11Min=0 x2S11Min=0 x3S11Min=0
 FrameElem=74 ElemStation=6.24999940395355E-02
 Frame=74 Station=0.124999988079071 OutputCase=TERRCOST CaseType=LinStatic P=0 V2=0 V3=0 T=0 M2=0
 M3=0 S11Max=0 PtS11Max=0 x2S11Max=0 x3S11Max=0 S11Min=0 PtS11Min=0 x2S11Min=0 x3S11Min=0
 FrameElem=74 ElemStation=0.124999988079071
 Frame=74 Station=0.187499982118607 OutputCase=TERRCOST CaseType=LinStatic P=0 V2=0 V3=0 T=0 M2=0
 M3=0 S11Max=0 PtS11Max=0 x2S11Max=0 x3S11Max=0 S11Min=0 PtS11Min=0 x2S11Min=0 x3S11Min=0
 FrameElem=74 ElemStation=0.187499982118607
 Frame=74 Station=0.249999976158142 OutputCase=TERRCOST CaseType=LinStatic P=0 V2=0 V3=0 T=0 M2=0
 M3=0 S11Max=0 PtS11Max=0 x2S11Max=0 x3S11Max=0 S11Min=0 PtS11Min=0 x2S11Min=0 x3S11Min=0
 FrameElem=74 ElemStation=0.249999976158142



Frame=74 Station=0 OutputCase=SOVRCOST CaseType=LinStatic P=0 V2=0 V3=0 T=0 M2=0 M3=0
 S11Max=0 PtS11Max=0 x2S11Max=0 x3S11Max=0 S11Min=0 PtS11Min=0 x2S11Min=0 x3S11Min=0 FrameElem=74
 ElemStation=0
 Frame=74 Station=6.24999940395355E-02 OutputCase=SOVRCOST CaseType=LinStatic P=0 V2=0 V3=0 T=0
 M2=0 M3=0 S11Max=0 PtS11Max=0 x2S11Max=0 x3S11Max=0 S11Min=0 PtS11Min=0 x2S11Min=0 x3S11Min=0
 FrameElem=74 ElemStation=6.24999940395355E-02
 Frame=74 Station=0.124999988079071 OutputCase=SOVRCOST CaseType=LinStatic P=0 V2=0 V3=0 T=0 M2=0
 M3=0 S11Max=0 PtS11Max=0 x2S11Max=0 x3S11Max=0 S11Min=0 PtS11Min=0 x2S11Min=0 x3S11Min=0
 FrameElem=74 ElemStation=0.124999988079071
 Frame=74 Station=0.187499982118607 OutputCase=SOVRCOST CaseType=LinStatic P=0 V2=0 V3=0 T=0 M2=0
 M3=0 S11Max=0 PtS11Max=0 x2S11Max=0 x3S11Max=0 S11Min=0 PtS11Min=0 x2S11Min=0 x3S11Min=0
 FrameElem=74 ElemStation=0.187499982118607
 Frame=74 Station=0.249999976158142 OutputCase=SOVRCOST CaseType=LinStatic P=0 V2=0 V3=0 T=0 M2=0
 M3=0 S11Max=0 PtS11Max=0 x2S11Max=0 x3S11Max=0 S11Min=0 PtS11Min=0 x2S11Min=0 x3S11Min=0
 FrameElem=74 ElemStation=0.249999976158142
 Frame=74 Station=0 OutputCase=ENVE CaseType=Combination StepType=Max P=-217.882158664515 V2=-
 762.499990742846 V3=0 T=0 M2=0 M3=-404.14690294 S11Max=2257.35141191017 PtS11Max=3 x2S11Max=0.5
 x3S11Max=-0.5 _
 S11Min=-2642.76357630452 PtS11Min=1 x2S11Min=-0.5 x3S11Min=-0.5 FrameElem=74 ElemStation=0
 Frame=74 Station=6.24999940395355E-02 OutputCase=ENVE CaseType=Combination StepType=Max P=-
 217.882158664515 V2=-743.437492560787 V3=0 T=0 M2=0 M3=-357.086361043076 S11Max=1974.988160719
 PtS11Max=3 x2S11Max=0.5 _
 x3S11Max=-0.5 S11Min=-2360.40032492297 PtS11Min=1 x2S11Min=-0.5 x3S11Min=-0.5 FrameElem=74
 ElemStation=6.24999940395355E-02
 Frame=74 Station=0.124999988079071 OutputCase=ENVE CaseType=Combination StepType=Max P=-
 217.882158664515 V2=-724.374994378729 V3=0 T=0 M2=0 M3=-311.21722516891 S11Max=1699.77334566437
 PtS11Max=3 x2S11Max=0.5 _
 x3S11Max=-0.5 S11Min=-2085.18550967797 PtS11Min=1 x2S11Min=-0.5 x3S11Min=-0.5 FrameElem=74
 ElemStation=0.124999988079071
 Frame=74 Station=0.187499982118607 OutputCase=ENVE CaseType=Combination StepType=Max P=-
 217.882158664515 V2=-705.312496196671 V3=0 T=0 M2=0 M3=-266.539495317501 S11Max=1431.70696674629
 PtS11Max=3 x2S11Max=0.5 _
 x3S11Max=-0.5 S11Min=-1817.11913056952 PtS11Min=1 x2S11Min=-0.5 x3S11Min=-0.5 FrameElem=74
 ElemStation=0.187499982118607
 Frame=74 Station=0.249999976158142 OutputCase=ENVE CaseType=Combination StepType=Max P=-
 217.882158664515 V2=-686.249998014612 V3=0 T=0 M2=0 M3=-223.053171488849 S11Max=1170.78902396475
 PtS11Max=3 x2S11Max=0.5 _
 x3S11Max=-0.5 S11Min=-1556.20118759761 PtS11Min=1 x2S11Min=-0.5 x3S11Min=-0.5 FrameElem=74
 ElemStation=0.249999976158142
 Frame=74 Station=0 OutputCase=ENVE CaseType=Combination StepType=Min P=-317.058043529687 V2=-
 762.499991250504 V3=0 T=0 M2=0 M3=-429.06824257331 S11Max=2206.99925897549 PtS11Max=3 x2S11Max=0.5
 x3S11Max=-0.5 _
 S11Min=-2891.46749896955 PtS11Min=1 x2S11Min=-0.5 x3S11Min=-0.5 FrameElem=74 ElemStation=0
 Frame=74 Station=6.24999940395355E-02 OutputCase=ENVE CaseType=Combination StepType=Min P=-
 317.058043529687 V2=-743.437493068446 V3=0 T=0 M2=0 M3=-382.007700708115 S11Max=1924.63600759394
 PtS11Max=3 x2S11Max=0.5 _
 x3S11Max=-0.5 S11Min=-2609.10424777837 PtS11Min=1 x2S11Min=-0.5 x3S11Min=-0.5 FrameElem=74
 ElemStation=6.24999940395355E-02
 Frame=74 Station=0.124999988079071 OutputCase=ENVE CaseType=Combination StepType=Min P=-
 317.058043529687 V2=-724.374994886388 V3=0 T=0 M2=0 M3=-336.138564865677 S11Max=1649.42119234894
 PtS11Max=3 x2S11Max=0.5 _
 x3S11Max=-0.5 S11Min=-2333.88943272375 PtS11Min=1 x2S11Min=-0.5 x3S11Min=-0.5 FrameElem=74
 ElemStation=0.124999988079071
 Frame=74 Station=0.187499982118607 OutputCase=ENVE CaseType=Combination StepType=Min P=-
 317.058043529687 V2=-705.312496704329 V3=0 T=0 M2=0 M3=-291.460835045996 S11Max=1381.35481324049
 PtS11Max=3 x2S11Max=0.5 _
 x3S11Max=-0.5 S11Min=-2065.82305380566 PtS11Min=1 x2S11Min=-0.5 x3S11Min=-0.5 FrameElem=74
 ElemStation=0.187499982118607
 Frame=74 Station=0.249999976158142 OutputCase=ENVE CaseType=Combination StepType=Min P=-
 317.058043529687 V2=-686.249998522271 V3=0 T=0 M2=0 M3=-247.974511249073 S11Max=1120.43687026858
 PtS11Max=3 x2S11Max=0.5 _
 x3S11Max=-0.5 S11Min=-1804.90511102413 PtS11Min=1 x2S11Min=-0.5 x3S11Min=-0.5 FrameElem=74
 ElemStation=0.249999976158142
 Frame=74 Station=0 OutputCase=FESSUR CaseType=Combination P=-317.058043529687 V2=-762.499990742846
 V3=0 T=0 M2=0 M3=-429.06824257331 S11Max=2257.35141191017 PtS11Max=3 x2S11Max=0.5 x3S11Max=-0.5 _
 S11Min=-2891.46749896955 PtS11Min=1 x2S11Min=-0.5 x3S11Min=-0.5 FrameElem=74 ElemStation=0
 Frame=74 Station=6.24999940395355E-02 OutputCase=FESSUR CaseType=Combination P=-317.058043529687 V2=-
 743.437492560787 V3=0 T=0 M2=0 M3=-382.007700708115 S11Max=1974.988160719 PtS11Max=3 x2S11Max=0.5 _
 x3S11Max=-0.5 S11Min=-2609.10424777837 PtS11Min=1 x2S11Min=-0.5 x3S11Min=-0.5 FrameElem=74
 ElemStation=6.24999940395355E-02
 Frame=74 Station=0.124999988079071 OutputCase=FESSUR CaseType=Combination P=-317.058043529687 V2=-
 724.374994378729 V3=0 T=0 M2=0 M3=-336.138564865677 S11Max=1699.77334566437 PtS11Max=3 x2S11Max=0.5
 x3S11Max=-0.5 _
 S11Min=-2333.88943272375 PtS11Min=1 x2S11Min=-0.5 x3S11Min=-0.5 FrameElem=74
 ElemStation=0.124999988079071
 Frame=74 Station=0.187499982118607 OutputCase=FESSUR CaseType=Combination P=-317.058043529687 V2=-
 705.312496196671 V3=0 T=0 M2=0 M3=-291.460835045996 S11Max=1431.70696674629 PtS11Max=3 x2S11Max=0.5
 x3S11Max=-0.5 _
 S11Min=-2065.82305380566 PtS11Min=1 x2S11Min=-0.5 x3S11Min=-0.5 FrameElem=74
 ElemStation=0.187499982118607

Frame=74 Station=0.249999976158142 OutputCase=FESSUR CaseType=Combination P=-317.058043529687 V2=-686.249998014612 V3=0 T=0 M2=0 M3=-247.974511249073 S11Max=1170.78902396475 PtS11Max=3 x2S11Max=0.5 x3S11Max=-0.5
 S11Min=-1804.90511102413 PtS11Min=1 x2S11Min=-0.5 x3S11Min=-0.5 FrameElem=74
 ElemStation=0.249999976158142
 Frame=75 Station=0 OutputCase=PESOPR CaseType=LinStatic P=15.1709467361842 V2=-56.2499999888532 V3=0 T=0 M2=0 M3=-6.22782825534159 S11Max=52.5379162682338 PtS11Max=3 x2S11Max=0.5 x3S11Max=-0.5
 S11Min=-22.1960227958653 PtS11Min=1 x2S11Min=-0.5 x3S11Min=-0.5 FrameElem=75 ElemStation=0
 Frame=75 Station=0.0625 OutputCase=PESOPR CaseType=LinStatic P=15.1709467361842 V2=-54.6874999888532 V3=0 T=0 M2=0 M3=-2.76103138103827 S11Max=31.7371350224138 PtS11Max=3 x2S11Max=0.5 x3S11Max=-0.5
 S11Min=-1.39524155004534 PtS11Min=1 x2S11Min=-0.5 x3S11Min=-0.5 FrameElem=75 ElemStation=0.0625
 Frame=75 Station=0.125 OutputCase=PESOPR CaseType=LinStatic P=15.1709467361842 V2=-53.1249999888532 V3=0 T=0 M2=0 M3=0.608109243265062 S11Max=18.8196021957746 PtS11Max=1 x2S11Max=-0.5 x3S11Max=-0.5
 S11Min=11.5222912765939 PtS11Min=3 x2S11Min=0.5 x3S11Min=-0.5 FrameElem=75 ElemStation=0.125
 Frame=75 Station=0.1875 OutputCase=PESOPR CaseType=LinStatic P=15.1709467361842 V2=-51.5624999888532 V3=0 T=0 M2=0 M3=3.87959361756839 S11Max=38.4485084415946 PtS11Max=1 x2S11Max=-0.5 x3S11Max=-0.5
 S11Min=-8.10661496922609 PtS11Min=3 x2S11Min=0.5 x3S11Min=-0.5 FrameElem=75 ElemStation=0.1875
 Frame=75 Station=0.25 OutputCase=PESOPR CaseType=LinStatic P=15.1709467361842 V2=-49.9999999888532 V3=0 T=0 M2=0 M3=7.05342174187172 S11Max=57.4914771874145 PtS11Max=1 x2S11Max=-0.5 x3S11Max=-0.5
 S11Min=-27.149583715046 PtS11Min=3 x2S11Min=0.5 x3S11Min=-0.5 FrameElem=75 ElemStation=0.25
 Frame=75 Station=0 OutputCase=TERRVERT CaseType=LinStatic P=-1.6427073819618 V2=-629.99999718159 V3=0 T=0 M2=0 M3=-158.675550459637 S11Max=950.410595375859 PtS11Max=3 x2S11Max=0.5 x3S11Max=-0.5
 S11Min=-953.696010139782 PtS11Min=1 x2S11Min=-0.5 x3S11Min=-0.5 FrameElem=75 ElemStation=0
 Frame=75 Station=0.0625 OutputCase=TERRVERT CaseType=LinStatic P=-1.6427073819618 V2=-612.49999718159 V3=0 T=0 M2=0 M3=-119.847425477252 S11Max=717.441845481549 PtS11Max=3 x2S11Max=0.5 x3S11Max=-0.5
 S11Min=-720.727260245473 PtS11Min=1 x2S11Min=-0.5 x3S11Min=-0.5 FrameElem=75 ElemStation=0.0625
 Frame=75 Station=0.125 OutputCase=TERRVERT CaseType=LinStatic P=-1.6427073819618 V2=-594.99999718159 V3=0 T=0 M2=0 M3=-82.1130504948669 S11Max=491.03559558724 PtS11Max=3 x2S11Max=0.5 x3S11Max=-0.5
 S11Min=-494.321010351163 PtS11Min=1 x2S11Min=-0.5 x3S11Min=-0.5 FrameElem=75 ElemStation=0.125
 Frame=75 Station=0.1875 OutputCase=TERRVERT CaseType=LinStatic P=-1.6427073819618 V2=-577.49999718159 V3=0 T=0 M2=0 M3=-45.472425512482 S11Max=271.19184569293 PtS11Max=3 x2S11Max=0.5 x3S11Max=-0.5
 S11Min=-274.477260456854 PtS11Min=1 x2S11Min=-0.5 x3S11Min=-0.5 FrameElem=75 ElemStation=0.1875
 Frame=75 Station=0.25 OutputCase=TERRVERT CaseType=LinStatic P=-1.6427073819618 V2=-559.99999718159 V3=0 T=0 M2=0 M3=-9.9255505300971 S11Max=57.9105957986208 PtS11Max=3 x2S11Max=0.5 x3S11Max=-0.5
 S11Min=-61.1960105625444 PtS11Min=1 x2S11Min=-0.5 x3S11Min=-0.5 FrameElem=75 ElemStation=0.25
 Frame=75 Station=0 OutputCase=TERRLAT CaseType=LinStatic P=-330.586282883909 V2=1.69219674717169E-06 V3=0 T=0 M2=0 M3=-83.0711325340803 S11Max=167.840512320573 PtS11Max=3 x2S11Max=0.5 x3S11Max=-0.5
 S11Min=-829.013078088291 PtS11Min=1 x2S11Min=-0.5 x3S11Min=-0.5 FrameElem=75 ElemStation=0
 Frame=75 Station=0.0625 OutputCase=TERRLAT CaseType=LinStatic P=-330.586282883909 V2=1.69219674717169E-06 V3=0 T=0 M2=0 M3=-83.0711326398426 S11Max=167.840512955147 PtS11Max=3 x2S11Max=0.5 x3S11Max=-0.5
 S11Min=-829.013078722965 PtS11Min=1 x2S11Min=-0.5 x3S11Min=-0.5 FrameElem=75 ElemStation=0.0625
 Frame=75 Station=0.125 OutputCase=TERRLAT CaseType=LinStatic P=-330.586282883909 V2=1.69219674717169E-06 V3=0 T=0 M2=0 M3=-83.0711327456049 S11Max=167.840513589721 PtS11Max=3 x2S11Max=0.5 x3S11Max=-0.5
 S11Min=-829.013079357538 PtS11Min=1 x2S11Min=-0.5 x3S11Min=-0.5 FrameElem=75 ElemStation=0.125
 Frame=75 Station=0.1875 OutputCase=TERRLAT CaseType=LinStatic P=-330.586282883909 V2=1.69219674717169E-06 V3=0 T=0 M2=0 M3=-83.0711328513672 S11Max=167.840514224294 PtS11Max=3 x2S11Max=0.5 x3S11Max=-0.5
 S11Min=-829.013079992112 PtS11Min=1 x2S11Min=-0.5 x3S11Min=-0.5 FrameElem=75 ElemStation=0.1875
 Frame=75 Station=0.25 OutputCase=TERRLAT CaseType=LinStatic P=-330.586282883909 V2=1.69219674717169E-06 V3=0 T=0 M2=0 M3=-83.0711329571295 S11Max=167.840514858868 PtS11Max=3 x2S11Max=0.5 x3S11Max=-0.5
 S11Min=-829.013080626686 PtS11Min=1 x2S11Min=-0.5 x3S11Min=-0.5 FrameElem=75 ElemStation=0.25
 Frame=75 Station=0 OutputCase=ACCVERT CaseType=LinStatic P=0 V2=0 V3=0 T=0 M2=0 M3=0 S11Max=0 PtS11Max=0 x2S11Max=0 x3S11Max=0 S11Min=0 PtS11Min=0 x2S11Min=0 x3S11Min=0 FrameElem=75
 ElemStation=0
 Frame=75 Station=0.0625 OutputCase=ACCVERT CaseType=LinStatic P=0 V2=0 V3=0 T=0 M2=0 M3=0 S11Max=0 PtS11Max=0 x2S11Max=0 x3S11Max=0 S11Min=0 PtS11Min=0 x2S11Min=0 x3S11Min=0 FrameElem=75
 ElemStation=0.0625
 Frame=75 Station=0.125 OutputCase=ACCVERT CaseType=LinStatic P=0 V2=0 V3=0 T=0 M2=0 M3=0 S11Max=0 PtS11Max=0 x2S11Max=0 x3S11Max=0 S11Min=0 PtS11Min=0 x2S11Min=0 x3S11Min=0 FrameElem=75
 ElemStation=0.125
 Frame=75 Station=0.1875 OutputCase=ACCVERT CaseType=LinStatic P=0 V2=0 V3=0 T=0 M2=0 M3=0 S11Max=0 PtS11Max=0 x2S11Max=0 x3S11Max=0 S11Min=0 PtS11Min=0 x2S11Min=0 x3S11Min=0 FrameElem=75
 ElemStation=0.1875
 Frame=75 Station=0.25 OutputCase=ACCVERT CaseType=LinStatic P=0 V2=0 V3=0 T=0 M2=0 M3=0 S11Max=0 PtS11Max=0 x2S11Max=0 x3S11Max=0 S11Min=0 PtS11Min=0 x2S11Min=0 x3S11Min=0 FrameElem=75
 ElemStation=0.25
 Frame=75 Station=0 OutputCase=ACCLATDX CaseType=LinStatic P=0 V2=0 V3=0 T=0 M2=0 M3=0 S11Max=0 PtS11Max=0 x2S11Max=0 x3S11Max=0 S11Min=0 PtS11Min=0 x2S11Min=0 x3S11Min=0 FrameElem=75
 ElemStation=0
 Frame=75 Station=0.0625 OutputCase=ACCLATDX CaseType=LinStatic P=0 V2=0 V3=0 T=0 M2=0 M3=0 S11Max=0 PtS11Max=0 x2S11Max=0 x3S11Max=0 S11Min=0 PtS11Min=0 x2S11Min=0 x3S11Min=0 FrameElem=75
 ElemStation=0.0625
 Frame=75 Station=0.125 OutputCase=ACCLATDX CaseType=LinStatic P=0 V2=0 V3=0 T=0 M2=0 M3=0 S11Max=0 PtS11Max=0 x2S11Max=0 x3S11Max=0 S11Min=0 PtS11Min=0 x2S11Min=0 x3S11Min=0 FrameElem=75
 ElemStation=0.125
 Frame=75 Station=0.1875 OutputCase=ACCLATDX CaseType=LinStatic P=0 V2=0 V3=0 T=0 M2=0 M3=0 S11Max=0 PtS11Max=0 x2S11Max=0 x3S11Max=0 S11Min=0 PtS11Min=0 x2S11Min=0 x3S11Min=0 FrameElem=75
 ElemStation=0.1875



Frame=75 Station=0.25 OutputCase=ACCLATDX CaseType=LinStatic P=0 V2=0 V3=0 T=0 M2=0 M3=0
 S11Max=0 PtS11Max=0 x2S11Max=0 x3S11Max=0 S11Min=0 PtS11Min=0 x2S11Min=0 x3S11Min=0 FrameElem=75
 ElemStation=0.25
 Frame=75 Station=0 OutputCase=ACCLATSX CaseType=LinStatic P=0 V2=0 V3=0 T=0 M2=0 M3=0
 S11Max=0 PtS11Max=0 x2S11Max=0 x3S11Max=0 S11Min=0 PtS11Min=0 x2S11Min=0 x3S11Min=0 FrameElem=75
 ElemStation=0
 Frame=75 Station=0.0625 OutputCase=ACCLATSX CaseType=LinStatic P=0 V2=0 V3=0 T=0 M2=0 M3=0
 S11Max=0 PtS11Max=0 x2S11Max=0 x3S11Max=0 S11Min=0 PtS11Min=0 x2S11Min=0 x3S11Min=0 FrameElem=75
 ElemStation=0.0625
 Frame=75 Station=0.125 OutputCase=ACCLATSX CaseType=LinStatic P=0 V2=0 V3=0 T=0 M2=0 M3=0
 S11Max=0 PtS11Max=0 x2S11Max=0 x3S11Max=0 S11Min=0 PtS11Min=0 x2S11Min=0 x3S11Min=0 FrameElem=75
 ElemStation=0.125
 Frame=75 Station=0.1875 OutputCase=ACCLATSX CaseType=LinStatic P=0 V2=0 V3=0 T=0 M2=0 M3=0
 S11Max=0 PtS11Max=0 x2S11Max=0 x3S11Max=0 S11Min=0 PtS11Min=0 x2S11Min=0 x3S11Min=0 FrameElem=75
 ElemStation=0.1875
 Frame=75 Station=0.25 OutputCase=ACCLATSX CaseType=LinStatic P=0 V2=0 V3=0 T=0 M2=0 M3=0
 S11Max=0 PtS11Max=0 x2S11Max=0 x3S11Max=0 S11Min=0 PtS11Min=0 x2S11Min=0 x3S11Min=0 FrameElem=75
 ElemStation=0.25
 Frame=75 Station=0 OutputCase=TERRCOST CaseType=LinStatic P=0 V2=0 V3=0 T=0 M2=0 M3=0
 S11Max=0 PtS11Max=0 x2S11Max=0 x3S11Max=0 S11Min=0 PtS11Min=0 x2S11Min=0 x3S11Min=0 FrameElem=75
 ElemStation=0
 Frame=75 Station=0.0625 OutputCase=TERRCOST CaseType=LinStatic P=0 V2=0 V3=0 T=0 M2=0 M3=0
 S11Max=0 PtS11Max=0 x2S11Max=0 x3S11Max=0 S11Min=0 PtS11Min=0 x2S11Min=0 x3S11Min=0 FrameElem=75
 ElemStation=0.0625
 Frame=75 Station=0.125 OutputCase=TERRCOST CaseType=LinStatic P=0 V2=0 V3=0 T=0 M2=0 M3=0
 S11Max=0 PtS11Max=0 x2S11Max=0 x3S11Max=0 S11Min=0 PtS11Min=0 x2S11Min=0 x3S11Min=0 FrameElem=75
 ElemStation=0.125
 Frame=75 Station=0.1875 OutputCase=TERRCOST CaseType=LinStatic P=0 V2=0 V3=0 T=0 M2=0 M3=0
 S11Max=0 PtS11Max=0 x2S11Max=0 x3S11Max=0 S11Min=0 PtS11Min=0 x2S11Min=0 x3S11Min=0 FrameElem=75
 ElemStation=0.1875
 Frame=75 Station=0.25 OutputCase=TERRCOST CaseType=LinStatic P=0 V2=0 V3=0 T=0 M2=0 M3=0
 S11Max=0 PtS11Max=0 x2S11Max=0 x3S11Max=0 S11Min=0 PtS11Min=0 x2S11Min=0 x3S11Min=0 FrameElem=75
 ElemStation=0.25
 Frame=75 Station=0 OutputCase=SOVRCOST CaseType=LinStatic P=0 V2=0 V3=0 T=0 M2=0 M3=0
 S11Max=0 PtS11Max=0 x2S11Max=0 x3S11Max=0 S11Min=0 PtS11Min=0 x2S11Min=0 x3S11Min=0 FrameElem=75
 ElemStation=0
 Frame=75 Station=0.0625 OutputCase=SOVRCOST CaseType=LinStatic P=0 V2=0 V3=0 T=0 M2=0 M3=0
 S11Max=0 PtS11Max=0 x2S11Max=0 x3S11Max=0 S11Min=0 PtS11Min=0 x2S11Min=0 x3S11Min=0 FrameElem=75
 ElemStation=0.0625
 Frame=75 Station=0.125 OutputCase=SOVRCOST CaseType=LinStatic P=0 V2=0 V3=0 T=0 M2=0 M3=0
 S11Max=0 PtS11Max=0 x2S11Max=0 x3S11Max=0 S11Min=0 PtS11Min=0 x2S11Min=0 x3S11Min=0 FrameElem=75
 ElemStation=0.125
 Frame=75 Station=0.1875 OutputCase=SOVRCOST CaseType=LinStatic P=0 V2=0 V3=0 T=0 M2=0 M3=0
 S11Max=0 PtS11Max=0 x2S11Max=0 x3S11Max=0 S11Min=0 PtS11Min=0 x2S11Min=0 x3S11Min=0 FrameElem=75
 ElemStation=0.1875
 Frame=75 Station=0.25 OutputCase=SOVRCOST CaseType=LinStatic P=0 V2=0 V3=0 T=0 M2=0 M3=0
 S11Max=0 PtS11Max=0 x2S11Max=0 x3S11Max=0 S11Min=0 PtS11Min=0 x2S11Min=0 x3S11Min=0 FrameElem=75
 ElemStation=0.25
 Frame=75 Station=0 OutputCase=ENVE CaseType=Combination StepType=Max P=-217.882158664514 V2=-
 686.249998014815 V3=0 T=0 M2=0 M3=-223.053171488835 S11Max=1170.78902396467 PtS11Max=3 x2S11Max=0.5
 x3S11Max=-0.5
 S11Min=-1556.20118759752 PtS11Min=1 x2S11Min=-0.5 x3S11Min=-0.5 FrameElem=75 ElemStation=0
 Frame=75 Station=0.0625 OutputCase=ENVE CaseType=Combination StepType=Max P=-217.882158664514 V2=-
 667.187498014815 V3=0 T=0 M2=0 M3=-180.75824970618 S11Max=917.01949345911 PtS11Max=3 x2S11Max=0.5
 x3S11Max=-0.5
 S11Min=-1302.43165690159 PtS11Min=1 x2S11Min=-0.5 x3S11Min=-0.5 FrameElem=75 ElemStation=0.0625
 Frame=75 Station=0.125 OutputCase=ENVE CaseType=Combination StepType=Max P=-217.882158664514 V2=-
 648.124998014815 V3=0 T=0 M2=0 M3=-139.654734173525 S11Max=670.398400453554 PtS11Max=3 x2S11Max=0.5
 x3S11Max=-0.5 S11Min=-1055.81056370567 PtS11Min=1 x2S11Min=-0.5 x3S11Min=-0.5 FrameElem=75
 ElemStation=0.125
 Frame=75 Station=0.1875 OutputCase=ENVE CaseType=Combination StepType=Max P=-217.882158664514 V2=-
 629.062498014815 V3=0 T=0 M2=0 M3=-99.7426248908707 S11Max=430.925744947999 PtS11Max=3 x2S11Max=0.5
 x3S11Max=-0.5 S11Min=-816.337908009738 PtS11Min=1 x2S11Min=-0.5 x3S11Min=-0.5 FrameElem=75
 ElemStation=0.1875
 Frame=75 Station=0.25 OutputCase=ENVE CaseType=Combination StepType=Max P=-217.882158664514 V2=-
 609.999998014815 V3=0 T=0 M2=0 M3=-61.021921858216 S11Max=198.601526942443 PtS11Max=3 x2S11Max=0.5
 x3S11Max=-0.5
 S11Min=-584.01368981381 PtS11Min=1 x2S11Min=-0.5 x3S11Min=-0.5 FrameElem=75 ElemStation=0.25
 Frame=75 Station=0 OutputCase=ENVE CaseType=Combination StepType=Min P=-317.058043529686 V2=-
 686.249998522474 V3=0 T=0 M2=0 M3=-247.974511249059 S11Max=1120.43687026849 PtS11Max=3 x2S11Max=0.5
 x3S11Max=-0.5
 S11Min=-1804.90511102404 PtS11Min=1 x2S11Min=-0.5 x3S11Min=-0.5 FrameElem=75 ElemStation=0
 Frame=75 Station=0.0625 OutputCase=ENVE CaseType=Combination StepType=Min P=-317.058043529686 V2=-
 667.187498522474 V3=0 T=0 M2=0 M3=-205.679589498133 S11Max=866.667339572566 PtS11Max=3 x2S11Max=0.5
 x3S11Max=-0.5 S11Min=-1551.13558051848 PtS11Min=1 x2S11Min=-0.5 x3S11Min=-0.5 FrameElem=75
 ElemStation=0.0625
 Frame=75 Station=0.125 OutputCase=ENVE CaseType=Combination StepType=Min P=-317.058043529686 V2=-
 648.124998522474 V3=0 T=0 M2=0 M3=-164.576073997207 S11Max=620.046246376638 PtS11Max=3 x2S11Max=0.5
 x3S11Max=-0.5 S11Min=-1304.51448751293 PtS11Min=1 x2S11Min=-0.5 x3S11Min=-0.5 FrameElem=75
 ElemStation=0.125
 Frame=75 Station=0.1875 OutputCase=ENVE CaseType=Combination StepType=Min P=-317.058043529686 V2=-
 629.062498522474 V3=0 T=0 M2=0 M3=-124.663964746281 S11Max=380.57359068071 PtS11Max=3 x2S11Max=0.5



x3S11Max=-0.5 S11Min=-1065.04183200737 PtS11Min=1 x2S11Min=-0.5 x3S11Min=-0.5 FrameElem=75
 ElemStation=0.1875
 Frame=75 Station=0.25 OutputCase=ENVE CaseType=Combination StepType=Min P=-317.058043529686 V2=-
 609.99998522474 V3=0 T=0 M2=0 M3=-85.9432617453549 S11Max=148.249372484782 PtS11Max=3 x2S11Max=0.5
 x3S11Max=-0.5 _
 S11Min=-832.717614001816 PtS11Min=1 x2S11Min=-0.5 x3S11Min=-0.5 FrameElem=75 ElemStation=0.25
 Frame=75 Station=0 OutputCase=FESSUR CaseType=Combination P=-317.058043529686 V2=-686.24998014815
 V3=0 T=0 M2=0 M3=-247.974511249059 S11Max=1170.78902396467 PtS11Max=3 x2S11Max=0.5 x3S11Max=-0.5 _
 S11Min=-1804.90511102404 PtS11Min=1 x2S11Min=-0.5 x3S11Min=-0.5 FrameElem=75 ElemStation=0
 Frame=75 Station=0.0625 OutputCase=FESSUR CaseType=Combination P=-317.058043529686 V2=-667.187498014815
 V3=0 T=0 M2=0 M3=-205.679589498133 S11Max=917.01949345911 PtS11Max=3 x2S11Max=0.5 x3S11Max=-0.5 _
 S11Min=-1551.13558051848 PtS11Min=1 x2S11Min=-0.5 x3S11Min=-0.5 FrameElem=75 ElemStation=0.0625
 Frame=75 Station=0.125 OutputCase=FESSUR CaseType=Combination P=-317.058043529686 V2=-629.062498014815
 V3=0 T=0 M2=0 M3=-164.576073997207 S11Max=670.398400453554 PtS11Max=3 x2S11Max=0.5 x3S11Max=-0.5 _
 S11Min=-1304.51448751293 PtS11Min=1 x2S11Min=-0.5 x3S11Min=-0.5 FrameElem=75 ElemStation=0.125
 Frame=75 Station=0.1875 OutputCase=FESSUR CaseType=Combination P=-317.058043529686 V2=-609.99998014815
 V3=0 T=0 M2=0 M3=-124.663964746281 S11Max=430.925744947999 PtS11Max=3 x2S11Max=0.5 x3S11Max=-0.5 _
 S11Min=-1065.04183200737 PtS11Min=1 x2S11Min=-0.5 x3S11Min=-0.5 FrameElem=75 ElemStation=0.1875
 Frame=75 Station=0.25 OutputCase=FESSUR CaseType=Combination P=-317.058043529686 V2=-609.99998014815
 V3=0 T=0 M2=0 M3=-85.9432617453549 S11Max=198.601526942443 PtS11Max=3 x2S11Max=0.5 x3S11Max=-0.5 _
 S11Min=-832.717614001816 PtS11Min=1 x2S11Min=-0.5 x3S11Min=-0.5 FrameElem=75 ElemStation=0.25
 Frame=77 Station=0 OutputCase=PESOPR CaseType=LinStatic P=15.1709467361835 V2=50.000000110304 V3=0
 T=0 M2=0 M3=7.05342169746655 S11Max=57.4914769209827 PtS11Max=1 x2S11Max=-0.5 x3S11Max=-0.5 _
 S11Min=-27.1495834486158 PtS11Min=3 x2S11Min=0.5 x3S11Min=-0.5 FrameElem=77 ElemStation=0
 Frame=77 Station=0.0625 OutputCase=PESOPR CaseType=LinStatic P=15.1709467361835 V2=51.5625000110304
 V3=0 T=0 M2=0 M3=3.87959357177715 S11Max=38.4485081668464 PtS11Max=1 x2S11Max=-0.5 x3S11Max=-0.5 _
 S11Min=-8.10661469447945 PtS11Min=3 x2S11Min=0.5 x3S11Min=-0.5 FrameElem=77 ElemStation=0.0625
 Frame=77 Station=0.125 OutputCase=PESOPR CaseType=LinStatic P=15.1709467361835 V2=53.1250000110304
 V3=0 T=0 M2=0 M3=0.608109196087753 S11Max=18.81960191271 PtS11Max=1 x2S11Max=-0.5 x3S11Max=-0.5 _
 S11Min=-11.5222915596569 PtS11Min=3 x2S11Min=0.5 x3S11Min=-0.5 FrameElem=77 ElemStation=0.125
 Frame=77 Station=0.1875 OutputCase=PESOPR CaseType=LinStatic P=15.1709467361835 V2=54.6875000110304
 V3=0 T=0 M2=0 M3=-2.76103142960164 S11Max=31.7371353137933 PtS11Max=3 x2S11Max=0.5 x3S11Max=-0.5 _
 S11Min=-1.39524184142641 PtS11Min=1 x2S11Min=-0.5 x3S11Min=-0.5 FrameElem=77 ElemStation=0.1875
 Frame=77 Station=0.25 OutputCase=PESOPR CaseType=LinStatic P=15.1709467361835 V2=56.2500000110304
 V3=0 T=0 M2=0 M3=-6.22782830529104 S11Max=52.5379165679297 PtS11Max=3 x2S11Max=0.5 x3S11Max=-0.5 _
 S11Min=-22.1960230955628 PtS11Min=1 x2S11Min=-0.5 x3S11Min=-0.5 FrameElem=77 ElemStation=0.25
 Frame=77 Station=0 OutputCase=TERRVERT CaseType=LinStatic P=-1.64270738196176 V2=560.00000281376
 V3=0 T=0 M2=0 M3=-9.9255516561534 S11Max=57.9106025549587 PtS11Max=3 x2S11Max=0.5 x3S11Max=-0.5 _
 S11Min=-61.1960173188822 PtS11Min=1 x2S11Min=-0.5 x3S11Min=-0.5 FrameElem=77 ElemStation=0
 Frame=77 Station=0.0625 OutputCase=TERRVERT CaseType=LinStatic P=-1.64270738196176 V2=577.500000281376
 V3=0 T=0 M2=0 M3=-45.4724266737394 S11Max=271.191852660475 PtS11Max=3 x2S11Max=0.5 x3S11Max=-0.5 _
 S11Min=-274.477267424398 PtS11Min=1 x2S11Min=-0.5 x3S11Min=-0.5 FrameElem=77 ElemStation=0.0625
 Frame=77 Station=0.125 OutputCase=TERRVERT CaseType=LinStatic P=-1.64270738196176 V2=595.000000281376
 V3=0 T=0 M2=0 M3=-82.1130516913254 S11Max=491.035602765991 PtS11Max=3 x2S11Max=0.5 x3S11Max=-0.5 _
 S11Min=-494.321017529914 PtS11Min=1 x2S11Min=-0.5 x3S11Min=-0.5 FrameElem=77 ElemStation=0.125
 Frame=77 Station=0.1875 OutputCase=TERRVERT CaseType=LinStatic P=-1.64270738196176 V2=612.500000281376
 V3=0 T=0 M2=0 M3=-119.847426708911 S11Max=717.441852871507 PtS11Max=3 x2S11Max=0.5 x3S11Max=-0.5 _
 S11Min=-720.72726763543 PtS11Min=1 x2S11Min=-0.5 x3S11Min=-0.5 FrameElem=77 ElemStation=0.1875
 Frame=77 Station=0.25 OutputCase=TERRVERT CaseType=LinStatic P=-1.64270738196176 V2=630.000000281376
 V3=0 T=0 M2=0 M3=-158.675551726497 S11Max=950.410602977022 PtS11Max=3 x2S11Max=0.5 x3S11Max=-0.5 _
 S11Min=-953.696017740946 PtS11Min=1 x2S11Min=-0.5 x3S11Min=-0.5 FrameElem=77 ElemStation=0.25
 Frame=77 Station=0 OutputCase=TERRLAT CaseType=LinStatic P=-330.58628288391 V2=1.6922012946452E-06
 V3=0 T=0 M2=0 M3=-83.071139725925 S11Max=167.84055547164 PtS11Max=3 x2S11Max=0.5 x3S11Max=-0.5 _
 S11Min=-829.01312123946 PtS11Min=1 x2S11Min=-0.5 x3S11Min=-0.5 FrameElem=77 ElemStation=0
 Frame=77 Station=0.0625 OutputCase=TERRLAT CaseType=LinStatic P=-330.58628288391 V2=1.6922012946452E-06
 V3=0 T=0 M2=0 M3=-83.0711398316876 S11Max=167.840556106215 PtS11Max=3 x2S11Max=0.5 x3S11Max=-0.5 _
 S11Min=-829.013121874035 PtS11Min=1 x2S11Min=-0.5 x3S11Min=-0.5 FrameElem=77 ElemStation=0.0625
 Frame=77 Station=0.125 OutputCase=TERRLAT CaseType=LinStatic P=-330.58628288391 V2=1.6922012946452E-06
 V3=0 T=0 M2=0 M3=-83.0711399374501 S11Max=167.840556740791 PtS11Max=3 x2S11Max=0.5 x3S11Max=-0.5 _
 S11Min=-829.013122508611 PtS11Min=1 x2S11Min=-0.5 x3S11Min=-0.5 FrameElem=77 ElemStation=0.125
 Frame=77 Station=0.1875 OutputCase=TERRLAT CaseType=LinStatic P=-330.58628288391 V2=1.6922012946452E-06
 V3=0 T=0 M2=0 M3=-83.0711400432127 S11Max=167.840557375366 PtS11Max=3 x2S11Max=0.5 x3S11Max=-0.5 _
 S11Min=-829.013123143186 PtS11Min=1 x2S11Min=-0.5 x3S11Min=-0.5 FrameElem=77 ElemStation=0.1875
 Frame=77 Station=0.25 OutputCase=TERRLAT CaseType=LinStatic P=-330.58628288391 V2=1.6922012946452E-06
 V3=0 T=0 M2=0 M3=-83.0711401489753 S11Max=167.840558009942 PtS11Max=3 x2S11Max=0.5 x3S11Max=-0.5 _
 S11Min=-829.013123777762 PtS11Min=1 x2S11Min=-0.5 x3S11Min=-0.5 FrameElem=77 ElemStation=0.25
 Frame=77 Station=0 OutputCase=ACCVERT CaseType=LinStatic P=0 V2=0 V3=0 T=0 M2=0 M3=0 S11Max=0
 PtS11Max=0 x2S11Max=0 x3S11Max=0 S11Min=0 PtS11Min=0 x2S11Min=0 x3S11Min=0 FrameElem=77
 ElemStation=0
 Frame=77 Station=0.0625 OutputCase=ACCVERT CaseType=LinStatic P=0 V2=0 V3=0 T=0 M2=0 M3=0
 S11Max=0 PtS11Max=0 x2S11Max=0 x3S11Max=0 S11Min=0 PtS11Min=0 x2S11Min=0 x3S11Min=0 FrameElem=77
 ElemStation=0.0625
 Frame=77 Station=0.125 OutputCase=ACCVERT CaseType=LinStatic P=0 V2=0 V3=0 T=0 M2=0 M3=0
 S11Max=0 PtS11Max=0 x2S11Max=0 x3S11Max=0 S11Min=0 PtS11Min=0 x2S11Min=0 x3S11Min=0 FrameElem=77
 ElemStation=0.125
 Frame=77 Station=0.1875 OutputCase=ACCVERT CaseType=LinStatic P=0 V2=0 V3=0 T=0 M2=0 M3=0
 S11Max=0 PtS11Max=0 x2S11Max=0 x3S11Max=0 S11Min=0 PtS11Min=0 x2S11Min=0 x3S11Min=0 FrameElem=77
 ElemStation=0.1875
 Frame=77 Station=0.25 OutputCase=ACCVERT CaseType=LinStatic P=0 V2=0 V3=0 T=0 M2=0 M3=0
 S11Max=0 PtS11Max=0 x2S11Max=0 x3S11Max=0 S11Min=0 PtS11Min=0 x2S11Min=0 x3S11Min=0 FrameElem=77
 ElemStation=0.25



```

Frame=77 Station=0 OutputCase=ACCLATDX CaseType=LinStatic P=0 V2=0 V3=0 T=0 M2=0 M3=0
S11Max=0 PtS11Max=0 x2S11Max=0 x3S11Max=0 S11Min=0 PtS11Min=0 x2S11Min=0 x3S11Min=0 FrameElem=77
ElemStation=0
Frame=77 Station=0.0625 OutputCase=ACCLATDX CaseType=LinStatic P=0 V2=0 V3=0 T=0 M2=0 M3=0
S11Max=0 PtS11Max=0 x2S11Max=0 x3S11Max=0 S11Min=0 PtS11Min=0 x2S11Min=0 x3S11Min=0 FrameElem=77
ElemStation=0.0625
Frame=77 Station=0.125 OutputCase=ACCLATDX CaseType=LinStatic P=0 V2=0 V3=0 T=0 M2=0 M3=0
S11Max=0 PtS11Max=0 x2S11Max=0 x3S11Max=0 S11Min=0 PtS11Min=0 x2S11Min=0 x3S11Min=0 FrameElem=77
ElemStation=0.125
Frame=77 Station=0.1875 OutputCase=ACCLATDX CaseType=LinStatic P=0 V2=0 V3=0 T=0 M2=0 M3=0
S11Max=0 PtS11Max=0 x2S11Max=0 x3S11Max=0 S11Min=0 PtS11Min=0 x2S11Min=0 x3S11Min=0 FrameElem=77
ElemStation=0.1875
Frame=77 Station=0.25 OutputCase=ACCLATDX CaseType=LinStatic P=0 V2=0 V3=0 T=0 M2=0 M3=0
S11Max=0 PtS11Max=0 x2S11Max=0 x3S11Max=0 S11Min=0 PtS11Min=0 x2S11Min=0 x3S11Min=0 FrameElem=77
ElemStation=0.25
Frame=77 Station=0 OutputCase=ACCLATSX CaseType=LinStatic P=0 V2=0 V3=0 T=0 M2=0 M3=0
S11Max=0 PtS11Max=0 x2S11Max=0 x3S11Max=0 S11Min=0 PtS11Min=0 x2S11Min=0 x3S11Min=0 FrameElem=77
ElemStation=0
Frame=77 Station=0.0625 OutputCase=ACCLATSX CaseType=LinStatic P=0 V2=0 V3=0 T=0 M2=0 M3=0
S11Max=0 PtS11Max=0 x2S11Max=0 x3S11Max=0 S11Min=0 PtS11Min=0 x2S11Min=0 x3S11Min=0 FrameElem=77
ElemStation=0.0625
Frame=77 Station=0.125 OutputCase=ACCLATSX CaseType=LinStatic P=0 V2=0 V3=0 T=0 M2=0 M3=0
S11Max=0 PtS11Max=0 x2S11Max=0 x3S11Max=0 S11Min=0 PtS11Min=0 x2S11Min=0 x3S11Min=0 FrameElem=77
ElemStation=0.125
Frame=77 Station=0.1875 OutputCase=ACCLATSX CaseType=LinStatic P=0 V2=0 V3=0 T=0 M2=0 M3=0
S11Max=0 PtS11Max=0 x2S11Max=0 x3S11Max=0 S11Min=0 PtS11Min=0 x2S11Min=0 x3S11Min=0 FrameElem=77
ElemStation=0.1875
Frame=77 Station=0.25 OutputCase=ACCLATSX CaseType=LinStatic P=0 V2=0 V3=0 T=0 M2=0 M3=0
S11Max=0 PtS11Max=0 x2S11Max=0 x3S11Max=0 S11Min=0 PtS11Min=0 x2S11Min=0 x3S11Min=0 FrameElem=77
ElemStation=0.25
Frame=77 Station=0 OutputCase=TERRCOST CaseType=LinStatic P=0 V2=0 V3=0 T=0 M2=0 M3=0
S11Max=0 PtS11Max=0 x2S11Max=0 x3S11Max=0 S11Min=0 PtS11Min=0 x2S11Min=0 x3S11Min=0 FrameElem=77
ElemStation=0
Frame=77 Station=0.0625 OutputCase=TERRCOST CaseType=LinStatic P=0 V2=0 V3=0 T=0 M2=0 M3=0
S11Max=0 PtS11Max=0 x2S11Max=0 x3S11Max=0 S11Min=0 PtS11Min=0 x2S11Min=0 x3S11Min=0 FrameElem=77
ElemStation=0.0625
Frame=77 Station=0.125 OutputCase=TERRCOST CaseType=LinStatic P=0 V2=0 V3=0 T=0 M2=0 M3=0
S11Max=0 PtS11Max=0 x2S11Max=0 x3S11Max=0 S11Min=0 PtS11Min=0 x2S11Min=0 x3S11Min=0 FrameElem=77
ElemStation=0.125
Frame=77 Station=0.1875 OutputCase=TERRCOST CaseType=LinStatic P=0 V2=0 V3=0 T=0 M2=0 M3=0
S11Max=0 PtS11Max=0 x2S11Max=0 x3S11Max=0 S11Min=0 PtS11Min=0 x2S11Min=0 x3S11Min=0 FrameElem=77
ElemStation=0.1875
Frame=77 Station=0.25 OutputCase=TERRCOST CaseType=LinStatic P=0 V2=0 V3=0 T=0 M2=0 M3=0
S11Max=0 PtS11Max=0 x2S11Max=0 x3S11Max=0 S11Min=0 PtS11Min=0 x2S11Min=0 x3S11Min=0 FrameElem=77
ElemStation=0.25
Frame=77 Station=0 OutputCase=SOVRCOST CaseType=LinStatic P=0 V2=0 V3=0 T=0 M2=0 M3=0
S11Max=0 PtS11Max=0 x2S11Max=0 x3S11Max=0 S11Min=0 PtS11Min=0 x2S11Min=0 x3S11Min=0 FrameElem=77
ElemStation=0
Frame=77 Station=0.0625 OutputCase=SOVRCOST CaseType=LinStatic P=0 V2=0 V3=0 T=0 M2=0 M3=0
S11Max=0 PtS11Max=0 x2S11Max=0 x3S11Max=0 S11Min=0 PtS11Min=0 x2S11Min=0 x3S11Min=0 FrameElem=77
ElemStation=0.0625
Frame=77 Station=0.125 OutputCase=SOVRCOST CaseType=LinStatic P=0 V2=0 V3=0 T=0 M2=0 M3=0
S11Max=0 PtS11Max=0 x2S11Max=0 x3S11Max=0 S11Min=0 PtS11Min=0 x2S11Min=0 x3S11Min=0 FrameElem=77
ElemStation=0.125
Frame=77 Station=0.1875 OutputCase=SOVRCOST CaseType=LinStatic P=0 V2=0 V3=0 T=0 M2=0 M3=0
S11Max=0 PtS11Max=0 x2S11Max=0 x3S11Max=0 S11Min=0 PtS11Min=0 x2S11Min=0 x3S11Min=0 FrameElem=77
ElemStation=0.1875
Frame=77 Station=0.25 OutputCase=SOVRCOST CaseType=LinStatic P=0 V2=0 V3=0 T=0 M2=0 M3=0
S11Max=0 PtS11Max=0 x2S11Max=0 x3S11Max=0 S11Min=0 PtS11Min=0 x2S11Min=0 x3S11Min=0 FrameElem=77
ElemStation=0.25
Frame=77 Station=0 OutputCase=ENVE CaseType=Combination StepType=Max P=-217.882158664515
V2=610.000001984607 V3=0 T=0 M2=0 M3=-61.0219277668343 S11Max=198.601574577983 PtS11Max=3 x2S11Max=0.5
x3S11Max=-0.5
S11Min=-584.013725265521 PtS11Min=1 x2S11Min=-0.5 x3S11Min=-0.5 FrameElem=77 ElemStation=0
Frame=77 Station=0.0625 OutputCase=ENVE CaseType=Combination StepType=Max P=-217.882158664515
V2=629.062501984607 V3=0 T=0 M2=0 M3=-99.7426309841435 S11Max=430.925794072211 PtS11Max=3 x2S11Max=0.5
x3S11Max=-0.5
S11Min=-816.337944569376 PtS11Min=1 x2S11Min=-0.5 x3S11Min=-0.5 FrameElem=77
ElemStation=0.0625
Frame=77 Station=0.125 OutputCase=ENVE CaseType=Combination StepType=Max P=-217.882158664515
V2=648.125001984607 V3=0 T=0 M2=0 M3=-139.654740451453 S11Max=670.398451066438 PtS11Max=3 x2S11Max=0.5
x3S11Max=-0.5
S11Min=-1055.81060137323 PtS11Min=1 x2S11Min=-0.5 x3S11Min=-0.5 FrameElem=77 ElemStation=0.125
Frame=77 Station=0.1875 OutputCase=ENVE CaseType=Combination StepType=Max P=-217.882158664515
V2=667.187501984607 V3=0 T=0 M2=0 M3=-180.758256168762 S11Max=917.019545560666 PtS11Max=3 x2S11Max=0.5
x3S11Max=-0.5
S11Min=-1302.43169567709 PtS11Min=1 x2S11Min=-0.5 x3S11Min=-0.5 FrameElem=77
ElemStation=0.1875
Frame=77 Station=0.25 OutputCase=ENVE CaseType=Combination StepType=Max P=-217.882158664515
V2=686.250001984607 V3=0 T=0 M2=0 M3=-223.053178136071 S11Max=1170.78907755489 PtS11Max=3 x2S11Max=0.5
x3S11Max=-0.5
S11Min=-1556.20122748094 PtS11Min=1 x2S11Min=-0.5 x3S11Min=-0.5 FrameElem=77 ElemStation=0.25

```



Frame=77 Station=0 OutputCase=ENVE CaseType=Combination StepType=Min P=-317.058043529688
 V2=610.000001476947 V3=0 T=0 M2=0 M3=-85.9432696846118 S11Max=148.249407936491 PtS11Max=3 x2S11Max=0.5
 x3S11Max=-0.5 _
 S11Min=-832.717661637359 PtS11Min=1 x2S11Min=-0.5 x3S11Min=-0.5 FrameElem=77 ElemStation=0
 Frame=77 Station=0.0625 OutputCase=ENVE CaseType=Combination StepType=Min P=-317.058043529688
 V2=629.062501476947 V3=0 T=0 M2=0 M3=-124.66397293365 S11Max=380.573627240346 PtS11Max=3 x2S11Max=0.5
 x3S11Max=-0.5 _
 S11Min=-1065.04188113159 PtS11Min=1 x2S11Min=-0.5 x3S11Min=-0.5 FrameElem=77 ElemStation=0.0625
 Frame=77 Station=0.125 OutputCase=ENVE CaseType=Combination StepType=Min P=-317.058043529688
 V2=648.125001476947 V3=0 T=0 M2=0 M3=-164.576082432688 S11Max=620.046284044201 PtS11Max=3 x2S11Max=0.5
 x3S11Max=-0.5 _
 S11Min=-1304.51453812581 PtS11Min=1 x2S11Min=-0.5 x3S11Min=-0.5 FrameElem=77 ElemStation=0.125
 Frame=77 Station=0.1875 OutputCase=ENVE CaseType=Combination StepType=Min P=-317.058043529688
 V2=667.187501476947 V3=0 T=0 M2=0 M3=-205.679598181726 S11Max=866.667378348056 PtS11Max=3 x2S11Max=0.5
 x3S11Max=-0.5 _
 S11Min=-1551.13563262004 PtS11Min=1 x2S11Min=-0.5 x3S11Min=-0.5 FrameElem=77
 ElemStation=0.1875
 Frame=77 Station=0.25 OutputCase=ENVE CaseType=Combination StepType=Min P=-317.058043529688
 V2=686.250001476947 V3=0 T=0 M2=0 M3=-247.974520180764 S11Max=1120.43691015191 PtS11Max=3 x2S11Max=0.5
 x3S11Max=-0.5 _
 S11Min=-1804.90516461427 PtS11Min=1 x2S11Min=-0.5 x3S11Min=-0.5 FrameElem=77 ElemStation=0.25
 Frame=77 Station=0 OutputCase=FESSUR CaseType=Combination P=-317.058043529688 V2=610.000001984607
 V3=0 T=0 M2=0 M3=-85.9432696846118 S11Max=198.601574577983 PtS11Max=3 x2S11Max=0.5 x3S11Max=-0.5 _
 S11Min=-832.717661637359 PtS11Min=1 x2S11Min=-0.5 x3S11Min=-0.5 FrameElem=77 ElemStation=0
 Frame=77 Station=0.0625 OutputCase=FESSUR CaseType=Combination P=-317.058043529688 V2=629.062501984607
 V3=0 T=0 M2=0 M3=-124.66397293365 S11Max=430.925794072211 PtS11Max=3 x2S11Max=0.5 x3S11Max=-0.5 _
 S11Min=-1065.04188113159 PtS11Min=1 x2S11Min=-0.5 x3S11Min=-0.5 FrameElem=77 ElemStation=0.0625
 Frame=77 Station=0.125 OutputCase=FESSUR CaseType=Combination P=-317.058043529688 V2=648.125001984607
 V3=0 T=0 M2=0 M3=-164.576082432688 S11Max=670.398451066438 PtS11Max=3 x2S11Max=0.5 x3S11Max=-0.5 _
 S11Min=-1304.51453812581 PtS11Min=1 x2S11Min=-0.5 x3S11Min=-0.5 FrameElem=77 ElemStation=0.125
 Frame=77 Station=0.1875 OutputCase=FESSUR CaseType=Combination P=-317.058043529688 V2=667.187501984607
 V3=0 T=0 M2=0 M3=-205.679598181726 S11Max=917.019545560666 PtS11Max=3 x2S11Max=0.5 x3S11Max=-0.5 _
 S11Min=-1551.13563262004 PtS11Min=1 x2S11Min=-0.5 x3S11Min=-0.5 FrameElem=77 ElemStation=0.1875
 Frame=77 Station=0.25 OutputCase=FESSUR CaseType=Combination P=-317.058043529688 V2=686.250001984607
 V3=0 T=0 M2=0 M3=-247.974520180764 S11Max=1170.78907755489 PtS11Max=3 x2S11Max=0.5 x3S11Max=-0.5 _
 S11Min=-1804.90516461427 PtS11Min=1 x2S11Min=-0.5 x3S11Min=-0.5 FrameElem=77 ElemStation=0.25
 Frame=78 Station=0 OutputCase=PESOPR CaseType=LinStatic P=15.1709413717648 V2=56.2500014577818 V3=0
 T=0 M2=0 M3=-6.22782830529468 S11Max=52.5379112035328 PtS11Max=3 x2S11Max=0.5 x3S11Max=-0.5 _
 S11Min=-22.1960284600033 PtS11Min=1 x2S11Min=-0.5 x3S11Min=-0.5 FrameElem=78 ElemStation=0
 Frame=78 Station=6.24999940395358E-02 OutputCase=PESOPR CaseType=LinStatic P=15.1709412227531
 V2=57.8125013087702 V3=0 T=0 M2=0 M3=-9.7922811768167 S11Max=73.9246282836533 PtS11Max=3 x2S11Max=0.5
 x3S11Max=-0.5 _
 S11Min=-43.582745838147 PtS11Min=1 x2S11Min=-0.5 x3S11Min=-0.5 FrameElem=78
 ElemStation=6.24999940395358E-02
 Frame=78 Station=0.124999988079072 OutputCase=PESOPR CaseType=LinStatic P=15.1709410737415
 V2=59.3750011597585 V3=0 T=0 M2=0 M3=-13.4543902797123 S11Max=95.8972827520151 PtS11Max=3 x2S11Max=0.5
 x3S11Max=-0.5 _
 S11Min=-65.555400604532 PtS11Min=1 x2S11Min=-0.5 x3S11Min=-0.5 FrameElem=78
 ElemStation=0.124999988079072
 Frame=78 Station=0.187499982118607 OutputCase=PESOPR CaseType=LinStatic P=15.1709409247299
 V2=60.9375010107469 V3=0 T=0 M2=0 M3=-17.2141556139814 S11Max=118.455874608618 PtS11Max=3 x2S11Max=0.5
 x3S11Max=-0.5 _
 S11Min=-88.1139927591583 PtS11Min=1 x2S11Min=-0.5 x3S11Min=-0.5 FrameElem=78
 ElemStation=0.187499982118607
 Frame=78 Station=0.249999976158143 OutputCase=PESOPR CaseType=LinStatic P=15.1709407757183
 V2=62.5000008617353 V3=0 T=0 M2=0 M3=-21.071577179624 S11Max=141.600403853463 PtS11Max=3 x2S11Max=0.5
 x3S11Max=-0.5 _
 S11Min=-111.258522302026 PtS11Min=1 x2S11Min=-0.5 x3S11Min=-0.5 FrameElem=78
 ElemStation=0.249999976158143
 Frame=78 Station=0 OutputCase=TERRVERT CaseType=LinStatic P=-1.64276746345034 V2=630.000000124448
 V3=0 T=0 M2=0 M3=-158.675551726483 S11Max=950.410542895447 PtS11Max=3 x2S11Max=0.5 x3S11Max=-0.5 _
 S11Min=-953.696077822347 PtS11Min=1 x2S11Min=-0.5 x3S11Min=-0.5 FrameElem=78 ElemStation=0
 Frame=78 Station=6.24999940395358E-02 OutputCase=TERRVERT CaseType=LinStatic P=-1.64276913238042
 V2=647.499998455518 V3=0 T=0 M2=0 M3=-198.59742287486 S11Max=1189.94176811678 PtS11Max=3 x2S11Max=0.5
 x3S11Max=-0.5 _
 S11Min=-1193.22730638154 PtS11Min=1 x2S11Min=-0.5 x3S11Min=-0.5 FrameElem=78
 ElemStation=6.24999940395358E-02
 Frame=78 Station=0.124999988079072 OutputCase=TERRVERT CaseType=LinStatic P=-1.6427708013105
 V2=664.999996786588 V3=0 T=0 M2=0 M3=-239.613043814621 S11Max=1436.03549208642 PtS11Max=3 x2S11Max=0.5
 x3S11Max=-0.5 _
 S11Min=-1439.32103368904 PtS11Min=1 x2S11Min=-0.5 x3S11Min=-0.5 FrameElem=78
 ElemStation=0.124999988079072
 Frame=78 Station=0.187499982118607 OutputCase=TERRVERT CaseType=LinStatic P=-1.64277247024058
 V2=682.499995117658 V3=0 T=0 M2=0 M3=-281.722414545766 S11Max=1688.69171480436 PtS11Max=3 x2S11Max=0.5
 x3S11Max=-0.5 _
 S11Min=-1691.97725974484 PtS11Min=1 x2S11Min=-0.5 x3S11Min=-0.5 FrameElem=78
 ElemStation=0.187499982118607
 Frame=78 Station=0.249999976158143 OutputCase=TERRVERT CaseType=LinStatic P=-1.64277413917066
 V2=699.999993448728 V3=0 T=0 M2=0 M3=-324.925535068295 S11Max=1947.9104362706 PtS11Max=3 x2S11Max=0.5
 x3S11Max=-0.5 _
 S11Min=-1951.19598454894 PtS11Min=1 x2S11Min=-0.5 x3S11Min=-0.5 FrameElem=78
 ElemStation=0.249999976158143

```

Frame=78 Station=0 OutputCase=TERRLAT CaseType=LinStatic P=-330.586282883906 V2=-2.98349664262787E-05
V3=0 T=0 M2=0 M3=-83.071140148975 S11Max=167.840558009944 PtS11Max=3 x2S11Max=0.5 x3S11Max=-0.5 _
S11Min=-829.013123777756 PtS11Min=1 x2S11Min=-0.5 x3S11Min=-0.5 FrameElem=78 ElemStation=0
Frame=78 Station=6.24999940395358E-02 OutputCase=TERRLAT CaseType=LinStatic P=-330.586282883906 V2=-
2.98349664262787E-05 V3=0 T=0 M2=0 M3=-83.0711382842898 S11Max=167.840546821833 PtS11Max=3
x2S11Max=0.5 _
x3S11Max=-0.5 S11Min=-829.013112589645 PtS11Min=1 x2S11Min=-0.5 x3S11Min=-0.5 FrameElem=78
ElemStation=6.24999940395358E-02
Frame=78 Station=0.124999988079072 OutputCase=TERRLAT CaseType=LinStatic P=-330.586282883906 V2=-
2.98349664262787E-05 V3=0 T=0 M2=0 M3=-83.0711364196046 S11Max=167.840535633721 PtS11Max=3
x2S11Max=0.5 _
x3S11Max=-0.5 S11Min=-829.013101401534 PtS11Min=1 x2S11Min=-0.5 x3S11Min=-0.5 FrameElem=78
ElemStation=0.124999988079072
Frame=78 Station=0.187499982118607 OutputCase=TERRLAT CaseType=LinStatic P=-330.586282883906 V2=-
2.98349664262787E-05 V3=0 T=0 M2=0 M3=-83.0711345549194 S11Max=167.84052444561 PtS11Max=3 x2S11Max=0.5
_
x3S11Max=-0.5 S11Min=-829.013090213423 PtS11Min=1 x2S11Min=-0.5 x3S11Min=-0.5 FrameElem=78
ElemStation=0.187499982118607
Frame=78 Station=0.249999976158143 OutputCase=TERRLAT CaseType=LinStatic P=-330.586282883906 V2=-
2.98349664262787E-05 V3=0 T=0 M2=0 M3=-83.0711326902342 S11Max=167.840513257499 PtS11Max=3
x2S11Max=0.5 _
x3S11Max=-0.5 S11Min=-829.013079025311 PtS11Min=1 x2S11Min=-0.5 x3S11Min=-0.5 FrameElem=78
ElemStation=0.249999976158143
Frame=78 Station=0 OutputCase=ACCVERT CaseType=LinStatic P=0 V2=0 V3=0 T=0 M2=0 M3=0 S11Max=0
PtS11Max=0 x2S11Max=0 x3S11Max=0 S11Min=0 PtS11Min=0 x2S11Min=0 x3S11Min=0 FrameElem=78
ElemStation=0
Frame=78 Station=6.24999940395358E-02 OutputCase=ACCVERT CaseType=LinStatic P=0 V2=0 V3=0 T=0
M2=0 M3=0 S11Max=0 PtS11Max=0 x2S11Max=0 x3S11Max=0 S11Min=0 PtS11Min=0 x2S11Min=0 x3S11Min=0
FrameElem=78 ElemStation=6.24999940395358E-02
Frame=78 Station=0.124999988079072 OutputCase=ACCVERT CaseType=LinStatic P=0 V2=0 V3=0 T=0 M2=0
M3=0 S11Max=0 PtS11Max=0 x2S11Max=0 x3S11Max=0 S11Min=0 PtS11Min=0 x2S11Min=0 x3S11Min=0
FrameElem=78 ElemStation=0.124999988079072
Frame=78 Station=0.187499982118607 OutputCase=ACCVERT CaseType=LinStatic P=0 V2=0 V3=0 T=0 M2=0
M3=0 S11Max=0 PtS11Max=0 x2S11Max=0 x3S11Max=0 S11Min=0 PtS11Min=0 x2S11Min=0 x3S11Min=0
FrameElem=78 ElemStation=0.187499982118607
Frame=78 Station=0.249999976158143 OutputCase=ACCVERT CaseType=LinStatic P=0 V2=0 V3=0 T=0 M2=0
M3=0 S11Max=0 PtS11Max=0 x2S11Max=0 x3S11Max=0 S11Min=0 PtS11Min=0 x2S11Min=0 x3S11Min=0
FrameElem=78 ElemStation=0.249999976158143
Frame=78 Station=0 OutputCase=ACCLATDX CaseType=LinStatic P=0 V2=0 V3=0 T=0 M2=0 M3=0
S11Max=0 PtS11Max=0 x2S11Max=0 x3S11Max=0 S11Min=0 PtS11Min=0 x2S11Min=0 x3S11Min=0 FrameElem=78
ElemStation=0
Frame=78 Station=6.24999940395358E-02 OutputCase=ACCLATDX CaseType=LinStatic P=0 V2=0 V3=0 T=0
M2=0 M3=0 S11Max=0 PtS11Max=0 x2S11Max=0 x3S11Max=0 S11Min=0 PtS11Min=0 x2S11Min=0 x3S11Min=0
FrameElem=78 ElemStation=6.24999940395358E-02
Frame=78 Station=0.124999988079072 OutputCase=ACCLATDX CaseType=LinStatic P=0 V2=0 V3=0 T=0 M2=0
M3=0 S11Max=0 PtS11Max=0 x2S11Max=0 x3S11Max=0 S11Min=0 PtS11Min=0 x2S11Min=0 x3S11Min=0
FrameElem=78 ElemStation=0.124999988079072
Frame=78 Station=0.187499982118607 OutputCase=ACCLATDX CaseType=LinStatic P=0 V2=0 V3=0 T=0 M2=0
M3=0 S11Max=0 PtS11Max=0 x2S11Max=0 x3S11Max=0 S11Min=0 PtS11Min=0 x2S11Min=0 x3S11Min=0
FrameElem=78 ElemStation=0.187499982118607
Frame=78 Station=0.249999976158143 OutputCase=ACCLATDX CaseType=LinStatic P=0 V2=0 V3=0 T=0 M2=0
M3=0 S11Max=0 PtS11Max=0 x2S11Max=0 x3S11Max=0 S11Min=0 PtS11Min=0 x2S11Min=0 x3S11Min=0
FrameElem=78 ElemStation=0.249999976158143
Frame=78 Station=0 OutputCase=ACCLATSX CaseType=LinStatic P=0 V2=0 V3=0 T=0 M2=0 M3=0
S11Max=0 PtS11Max=0 x2S11Max=0 x3S11Max=0 S11Min=0 PtS11Min=0 x2S11Min=0 x3S11Min=0 FrameElem=78
ElemStation=0
Frame=78 Station=6.24999940395358E-02 OutputCase=ACCLATSX CaseType=LinStatic P=0 V2=0 V3=0 T=0
M2=0 M3=0 S11Max=0 PtS11Max=0 x2S11Max=0 x3S11Max=0 S11Min=0 PtS11Min=0 x2S11Min=0 x3S11Min=0
FrameElem=78 ElemStation=6.24999940395358E-02
Frame=78 Station=0.124999988079072 OutputCase=ACCLATSX CaseType=LinStatic P=0 V2=0 V3=0 T=0 M2=0
M3=0 S11Max=0 PtS11Max=0 x2S11Max=0 x3S11Max=0 S11Min=0 PtS11Min=0 x2S11Min=0 x3S11Min=0
FrameElem=78 ElemStation=0.124999988079072
Frame=78 Station=0.187499982118607 OutputCase=ACCLATSX CaseType=LinStatic P=0 V2=0 V3=0 T=0 M2=0
M3=0 S11Max=0 PtS11Max=0 x2S11Max=0 x3S11Max=0 S11Min=0 PtS11Min=0 x2S11Min=0 x3S11Min=0
FrameElem=78 ElemStation=0.187499982118607
Frame=78 Station=0.249999976158143 OutputCase=ACCLATSX CaseType=LinStatic P=0 V2=0 V3=0 T=0 M2=0
M3=0 S11Max=0 PtS11Max=0 x2S11Max=0 x3S11Max=0 S11Min=0 PtS11Min=0 x2S11Min=0 x3S11Min=0
FrameElem=78 ElemStation=0.249999976158143
Frame=78 Station=0 OutputCase=TERRCOST CaseType=LinStatic P=0 V2=0 V3=0 T=0 M2=0 M3=0
S11Max=0 PtS11Max=0 x2S11Max=0 x3S11Max=0 S11Min=0 PtS11Min=0 x2S11Min=0 x3S11Min=0 FrameElem=78
ElemStation=0
Frame=78 Station=6.24999940395358E-02 OutputCase=TERRCOST CaseType=LinStatic P=0 V2=0 V3=0 T=0
M2=0 M3=0 S11Max=0 PtS11Max=0 x2S11Max=0 x3S11Max=0 S11Min=0 PtS11Min=0 x2S11Min=0 x3S11Min=0
FrameElem=78 ElemStation=6.24999940395358E-02
Frame=78 Station=0.124999988079072 OutputCase=TERRCOST CaseType=LinStatic P=0 V2=0 V3=0 T=0 M2=0
M3=0 S11Max=0 PtS11Max=0 x2S11Max=0 x3S11Max=0 S11Min=0 PtS11Min=0 x2S11Min=0 x3S11Min=0
FrameElem=78 ElemStation=0.124999988079072
Frame=78 Station=0.187499982118607 OutputCase=TERRCOST CaseType=LinStatic P=0 V2=0 V3=0 T=0 M2=0
M3=0 S11Max=0 PtS11Max=0 x2S11Max=0 x3S11Max=0 S11Min=0 PtS11Min=0 x2S11Min=0 x3S11Min=0
FrameElem=78 ElemStation=0.187499982118607

```



Frame=78 Station=0.249999976158143 OutputCase=TERRCOST CaseType=LinStatic P=0 V2=0 V3=0 T=0 M2=0
 M3=0 S11Max=0 PtS11Max=0 x2S11Max=0 x3S11Max=0 S11Min=0 PtS11Min=0 x2S11Min=0 x3S11Min=0
 FrameElem=78 ElemStation=0.249999976158143
 Frame=78 Station=0 OutputCase=SOVRCOST CaseType=LinStatic P=0 V2=0 V3=0 T=0 M2=0 M3=0
 S11Max=0 PtS11Max=0 x2S11Max=0 x3S11Max=0 S11Min=0 PtS11Min=0 x2S11Min=0 x3S11Min=0 FrameElem=78
 ElemStation=0
 Frame=78 Station=6.24999940395358E-02 OutputCase=SOVRCOST CaseType=LinStatic P=0 V2=0 V3=0 T=0
 M2=0 M3=0 S11Max=0 PtS11Max=0 x2S11Max=0 x3S11Max=0 S11Min=0 PtS11Min=0 x2S11Min=0 x3S11Min=0
 FrameElem=78 ElemStation=6.24999940395358E-02
 Frame=78 Station=0.124999988079072 OutputCase=SOVRCOST CaseType=LinStatic P=0 V2=0 V3=0 T=0 M2=0
 M3=0 S11Max=0 PtS11Max=0 x2S11Max=0 x3S11Max=0 S11Min=0 PtS11Min=0 x2S11Min=0 x3S11Min=0
 FrameElem=78 ElemStation=0.124999988079072
 Frame=78 Station=0.187499982118607 OutputCase=SOVRCOST CaseType=LinStatic P=0 V2=0 V3=0 T=0 M2=0
 M3=0 S11Max=0 PtS11Max=0 x2S11Max=0 x3S11Max=0 S11Min=0 PtS11Min=0 x2S11Min=0 x3S11Min=0
 FrameElem=78 ElemStation=0.187499982118607
 Frame=78 Station=0.249999976158143 OutputCase=SOVRCOST CaseType=LinStatic P=0 V2=0 V3=0 T=0 M2=0
 M3=0 S11Max=0 PtS11Max=0 x2S11Max=0 x3S11Max=0 S11Min=0 PtS11Min=0 x2S11Min=0 x3S11Min=0
 FrameElem=78 ElemStation=0.249999976158143
 Frame=78 Station=0 OutputCase=ENVE CaseType=Combination StepType=Max P=-217.88222411042
 V2=686.249980697753 V3=0 T=0 M2=0 M3=-223.05317813606 S11Max=1170.78901210892 PtS11Max=3 x2S11Max=0.5
 x3S11Max=-0.5
 S11Min=-1556.20129292678 PtS11Min=1 x2S11Min=-0.5 x3S11Min=-0.5 FrameElem=78 ElemStation=0
 Frame=78 Station=6.24999940395358E-02 OutputCase=ENVE CaseType=Combination StepType=Max P=-
 217.882225928362 V2=705.312478879812 V3=0 T=0 M2=0 M3=-266.53950085068 S11Max=1431.70694322227
 PtS11Max=3 x2S11Max=0.5
 x3S11Max=-0.5 S11Min=-1817.11923103244 PtS11Min=1 x2S11Min=-0.5 x3S11Min=-0.5 FrameElem=78
 ElemStation=6.24999940395358E-02
 Frame=78 Station=0.124999988079072 OutputCase=ENVE CaseType=Combination StepType=Max P=-
 217.882227746303 V2=724.37497706187 V3=0 T=0 M2=0 M3=-311.217229588057 S11Max=1699.77331047215
 PtS11Max=3 x2S11Max=0.5
 x3S11Max=-0.5 S11Min=-2085.18560527464 PtS11Min=1 x2S11Min=-0.5 x3S11Min=-0.5 FrameElem=78
 ElemStation=0.124999988079072
 Frame=78 Station=0.187499982118607 OutputCase=ENVE CaseType=Combination StepType=Max P=-
 217.882229564245 V2=743.437475243928 V3=0 T=0 M2=0 M3=-357.086364348191 S11Max=1974.98811385859
 PtS11Max=3 x2S11Max=0.5
 x3S11Max=-0.5 S11Min=-2360.40041565339 PtS11Min=1 x2S11Min=-0.5 x3S11Min=-0.5 FrameElem=78
 ElemStation=0.187499982118607
 Frame=78 Station=0.249999976158143 OutputCase=ENVE CaseType=Combination StepType=Max P=-
 217.882231382187 V2=762.499973425987 V3=0 T=0 M2=0 M3=-404.146905131083 S11Max=2257.35135338156
 PtS11Max=3 x2S11Max=0.5
 x3S11Max=-0.5 S11Min=-2642.76366216868 PtS11Min=1 x2S11Min=-0.5 x3S11Min=-0.5 FrameElem=78
 ElemStation=0.249999976158143
 Frame=78 Station=0 OutputCase=ENVE CaseType=Combination StepType=Min P=-317.058108975592
 V2=686.249971747263 V3=0 T=0 M2=0 M3=-247.974520180753 S11Max=1120.43684470594 PtS11Max=3 x2S11Max=0.5
 x3S11Max=-0.5
 S11Min=-1804.90523006011 PtS11Min=1 x2S11Min=-0.5 x3S11Min=-0.5 FrameElem=78 ElemStation=0
 Frame=78 Station=6.24999940395358E-02 OutputCase=ENVE CaseType=Combination StepType=Min P=-
 317.058110793534 V2=705.312469929322 V3=0 T=0 M2=0 M3=-291.460842335967 S11Max=1381.35477917572
 PtS11Max=3 x2S11Max=0.5
 x3S11Max=-0.5 S11Min=-2065.82316480933 PtS11Min=1 x2S11Min=-0.5 x3S11Min=-0.5 FrameElem=78
 ElemStation=6.24999940395358E-02
 Frame=78 Station=0.124999988079072 OutputCase=ENVE CaseType=Combination StepType=Min P=-
 317.058112611475 V2=724.37496811138 V3=0 T=0 M2=0 M3=-336.138570513938 S11Max=1649.42114978204
 PtS11Max=3 x2S11Max=0.5
 x3S11Max=-0.5 S11Min=-2333.8895356951 PtS11Min=1 x2S11Min=-0.5 x3S11Min=-0.5 FrameElem=78
 ElemStation=0.124999988079072
 Frame=78 Station=0.187499982118607 OutputCase=ENVE CaseType=Combination StepType=Min P=-
 317.058114429417 V2=743.437466293438 V3=0 T=0 M2=0 M3=-382.007704714667 S11Max=1924.6359565249
 PtS11Max=3 x2S11Max=0.5
 x3S11Max=-0.5 S11Min=-2609.10434271742 PtS11Min=1 x2S11Min=-0.5 x3S11Min=-0.5 FrameElem=78
 ElemStation=0.187499982118607
 Frame=78 Station=0.249999976158143 OutputCase=ENVE CaseType=Combination StepType=Min P=-
 317.058116247359 V2=762.499964475497 V3=0 T=0 M2=0 M3=-429.068244938153 S11Max=2206.99919940431
 PtS11Max=3 x2S11Max=0.5
 x3S11Max=-0.5 S11Min=-2891.46758587628 PtS11Min=1 x2S11Min=-0.5 x3S11Min=-0.5 FrameElem=78
 ElemStation=0.249999976158143
 Frame=78 Station=0 OutputCase=FESSUR CaseType=Combination P=-317.058108975592 V2=686.249971747263
 V3=0 T=0 M2=0 M3=-247.974520180753 S11Max=1170.78901210892 PtS11Max=3 x2S11Max=0.5 x3S11Max=-0.5
 S11Min=-1804.90523006011 PtS11Min=1 x2S11Min=-0.5 x3S11Min=-0.5 FrameElem=78 ElemStation=0
 Frame=78 Station=6.24999940395358E-02 OutputCase=FESSUR CaseType=Combination P=-317.058110793534
 V2=705.312469929322 V3=0 T=0 M2=0 M3=-291.460842335967 S11Max=1431.70694322227 PtS11Max=3 x2S11Max=0.5
 x3S11Max=-0.5 S11Min=-2065.82316480933 PtS11Min=1 x2S11Min=-0.5 x3S11Min=-0.5 FrameElem=78
 ElemStation=6.24999940395358E-02
 Frame=78 Station=0.124999988079072 OutputCase=FESSUR CaseType=Combination P=-317.058112611475
 V2=724.37496811138 V3=0 T=0 M2=0 M3=-336.138570513938 S11Max=1699.77331047215 PtS11Max=3 x2S11Max=0.5
 x3S11Max=-0.5
 S11Min=-2333.8895356951 PtS11Min=1 x2S11Min=-0.5 x3S11Min=-0.5 FrameElem=78
 ElemStation=0.124999988079072
 Frame=78 Station=0.187499982118607 OutputCase=FESSUR CaseType=Combination P=-317.058114429417
 V2=743.437466293438 V3=0 T=0 M2=0 M3=-382.007704714667 S11Max=1974.98811385859 PtS11Max=3 x2S11Max=0.5
 x3S11Max=-0.5



S11Min=-2609.10434271742 PtS11Min=1 x2S11Min=-0.5 x3S11Min=-0.5 FrameElem=78
 ElemStation=0.187499982118607
 Frame=78 Station=0.249999976158143 OutputCase=FESSUR CaseType=Combination P=-317.058116247359
 V2=762.499964475497 V3=0 T=0 M2=0 M3=-429.068244938153 S11Max=2257.35135338156 PtS11Max=3 x2S11Max=0.5
 x3S11Max=-0.5 _
 S11Min=-2891.46758587628 PtS11Min=1 x2S11Min=-0.5 x3S11Min=-0.5 FrameElem=78
 ElemStation=0.249999976158143
 Frame=79 Station=0 OutputCase=PESOPR CaseType=LinStatic P=-162.500000839762 V2=15.1709312389785 V3=0
 T=0 M2=0 M3=81.7553624405668 S11Max=328.032173803639 PtS11Max=1 x2S11Max=-0.5 x3S11Max=-0.5 _
 S11Min=-653.032175483163 PtS11Min=3 x2S11Min=0.5 x3S11Min=-0.5 FrameElem=79 ElemStation=0
 Frame=79 Station=0.250000000000001 OutputCase=PESOPR CaseType=LinStatic P=-156.250000839762
 V2=15.170931835025 V3=0 T=0 M2=0 M3=77.9626295563164 S11Max=311.525776498136 PtS11Max=1 x2S11Max=-0.5
 x3S11Max=-0.5 _
 S11Min=-624.02577817766 PtS11Min=3 x2S11Min=0.5 x3S11Min=-0.5 FrameElem=79
 ElemStation=0.250000000000001
 Frame=79 Station=0 OutputCase=TERRVERT CaseType=LinStatic P=-699.999992886325 V2=-1.64277413915647
 V3=0 T=0 M2=0 M3=318.354704172044 S11Max=1210.12823214594 PtS11Max=1 x2S11Max=-0.5 x3S11Max=-0.5 _
 S11Min=-2610.12821791859 PtS11Min=3 x2S11Min=0.5 x3S11Min=-0.5 FrameElem=79 ElemStation=0
 Frame=79 Station=0.250000000000001 OutputCase=TERRVERT CaseType=LinStatic P=-699.999992886325 V2=-
 1.64277413915647 V3=0 T=0 M2=0 M3=318.765397706833 S11Max=1212.59239335467 PtS11Max=1 x2S11Max=-0.5
 x3S11Max=-0.5 _
 S11Min=-2612.59237912732 PtS11Min=3 x2S11Min=0.5 x3S11Min=-0.5 FrameElem=79
 ElemStation=0.250000000000001
 Frame=79 Station=0 OutputCase=TERRLAT CaseType=LinStatic P=-2.62565336015541E-05 V2=293.06371711609
 V3=0 T=0 M2=0 M3=84.0726672420619 S11Max=504.435977195838 PtS11Max=1 x2S11Max=-0.5 x3S11Max=-0.5 _
 S11Min=-504.436029708905 PtS11Min=3 x2S11Min=0.5 x3S11Min=-0.5 FrameElem=79 ElemStation=0
 Frame=79 Station=0.250000000000001 OutputCase=TERRLAT CaseType=LinStatic P=-2.25201866554053E-05
 V2=253.88527961609 V3=0 T=0 M2=0 M3=15.7151494213725 S11Max=94.2908740080485 PtS11Max=1 x2S11Max=-0.5
 _
 x3S11Max=-0.5 S11Min=-94.2909190484218 PtS11Min=3 x2S11Min=0.5 x3S11Min=-0.5 FrameElem=79
 ElemStation=0.250000000000001
 Frame=79 Station=0 OutputCase=ACCVERT CaseType=LinStatic P=0 V2=0 V3=0 T=0 M2=0 M3=0 S11Max=0
 PtS11Max=0 x2S11Max=0 x3S11Max=0 S11Min=0 PtS11Min=0 x2S11Min=0 x3S11Min=0 FrameElem=79
 ElemStation=0
 Frame=79 Station=0.250000000000001 OutputCase=ACCVERT CaseType=LinStatic P=0 V2=0 V3=0 T=0 M2=0
 M3=0 S11Max=0 PtS11Max=0 x2S11Max=0 x3S11Max=0 S11Min=0 PtS11Min=0 x2S11Min=0 x3S11Min=0
 FrameElem=79 ElemStation=0.250000000000001
 Frame=79 Station=0 OutputCase=ACCLATDX CaseType=LinStatic P=0 V2=0 V3=0 T=0 M2=0 M3=0
 S11Max=0 PtS11Max=0 x2S11Max=0 x3S11Max=0 S11Min=0 PtS11Min=0 x2S11Min=0 x3S11Min=0 FrameElem=79
 ElemStation=0
 Frame=79 Station=0.250000000000001 OutputCase=ACCLATDX CaseType=LinStatic P=0 V2=0 V3=0 T=0 M2=0
 M3=0 S11Max=0 PtS11Max=0 x2S11Max=0 x3S11Max=0 S11Min=0 PtS11Min=0 x2S11Min=0 x3S11Min=0
 FrameElem=79 ElemStation=0.250000000000001
 Frame=79 Station=0 OutputCase=ACCLATSX CaseType=LinStatic P=0 V2=0 V3=0 T=0 M2=0 M3=0
 S11Max=0 PtS11Max=0 x2S11Max=0 x3S11Max=0 S11Min=0 PtS11Min=0 x2S11Min=0 x3S11Min=0 FrameElem=79
 ElemStation=0
 Frame=79 Station=0.250000000000001 OutputCase=ACCLATSX CaseType=LinStatic P=0 V2=0 V3=0 T=0 M2=0
 M3=0 S11Max=0 PtS11Max=0 x2S11Max=0 x3S11Max=0 S11Min=0 PtS11Min=0 x2S11Min=0 x3S11Min=0
 FrameElem=79 ElemStation=0.250000000000001
 Frame=79 Station=0 OutputCase=TERRCOST CaseType=LinStatic P=0 V2=0 V3=0 T=0 M2=0 M3=0
 S11Max=0 PtS11Max=0 x2S11Max=0 x3S11Max=0 S11Min=0 PtS11Min=0 x2S11Min=0 x3S11Min=0 FrameElem=79
 ElemStation=0
 Frame=79 Station=0.250000000000001 OutputCase=TERRCOST CaseType=LinStatic P=0 V2=0 V3=0 T=0 M2=0
 M3=0 S11Max=0 PtS11Max=0 x2S11Max=0 x3S11Max=0 S11Min=0 PtS11Min=0 x2S11Min=0 x3S11Min=0
 FrameElem=79 ElemStation=0.250000000000001
 Frame=79 Station=0 OutputCase=SOVRCOST CaseType=LinStatic P=0 V2=0 V3=0 T=0 M2=0 M3=0
 S11Max=0 PtS11Max=0 x2S11Max=0 x3S11Max=0 S11Min=0 PtS11Min=0 x2S11Min=0 x3S11Min=0 FrameElem=79
 ElemStation=0
 Frame=79 Station=0.250000000000001 OutputCase=SOVRCOST CaseType=LinStatic P=0 V2=0 V3=0 T=0 M2=0
 M3=0 S11Max=0 PtS11Max=0 x2S11Max=0 x3S11Max=0 S11Min=0 PtS11Min=0 x2S11Min=0 x3S11Min=0
 FrameElem=79 ElemStation=0.250000000000001
 Frame=79 Station=0 OutputCase=ENVE CaseType=Combination StepType=Max P=-862.500012105661
 V2=306.591874215912 V3=0 T=0 M2=0 M3=484.182733854673 S11Max=2042.59638314542 PtS11Max=1 x2S11Max=-0.5
 x3S11Max=-0.5 _
 S11Min=-3616.26561419799 PtS11Min=3 x2S11Min=0.5 x3S11Min=-0.5 FrameElem=79 ElemStation=0
 Frame=79 Station=0.250000000000001 OutputCase=ENVE CaseType=Combination StepType=Max P=-
 856.250009490218 V2=267.413437311958 V3=0 T=0 M2=0 M3=412.443176684522 S11Max=1618.40904386086
 PtS11Max=1 x2S11Max=-0.5 _
 x3S11Max=-0.5 S11Min=-3302.62180063888 PtS11Min=3 x2S11Min=0.5 x3S11Min=-0.5 FrameElem=79
 ElemStation=0.250000000000001
 Frame=79 Station=0 OutputCase=ENVE CaseType=Combination StepType=Min P=-862.500019982621
 V2=218.672759081085 V3=0 T=0 M2=0 M3=458.960933682054 S11Max=1891.26558998666 PtS11Max=1 x2S11Max=-0.5
 x3S11Max=-0.5 _
 S11Min=-3767.59642311066 PtS11Min=3 x2S11Min=0.5 x3S11Min=-0.5 FrameElem=79 ElemStation=0
 Frame=79 Station=0.250000000000001 OutputCase=ENVE CaseType=Combination StepType=Min P=-
 856.250016246274 V2=191.247853427131 V3=0 T=0 M2=0 M3=407.72863185811 S11Max=1590.12178165844
 PtS11Max=1 x2S11Max=-0.5 _
 x3S11Max=-0.5 S11Min=-3330.90907635341 PtS11Min=3 x2S11Min=0.5 x3S11Min=-0.5 FrameElem=79
 ElemStation=0.250000000000001
 Frame=79 Station=0 OutputCase=FESSUR CaseType=Combination P=-862.500019982621 V2=306.591874215912
 V3=0 T=0 M2=0 M3=484.182733854673 S11Max=2042.59638314542 PtS11Max=1 x2S11Max=-0.5 x3S11Max=-0.5 _
 S11Min=-3767.59642311066 PtS11Min=3 x2S11Min=0.5 x3S11Min=-0.5 FrameElem=79 ElemStation=0



Frame=79 Station=0.250000000000001 OutputCase=FESSUR CaseType=Combination P=-856.250016246274
 V2=267.413437311958 V3=0 T=0 M2=0 M3=412.443176684522 S11Max=1618.40904386086 PtS11Max=1 x2S11Max=-0.5
 x3S11Max=-0.5
 S11Min=-3330.90907635341 PtS11Min=3 x2S11Min=0.5 x3S11Min=-0.5 FrameElem=79
 ElemStation=0.250000000000001
 Frame=80 Station=0 OutputCase=PESOPR CaseType=LinStatic P=-156.249999392836 V2=15.1709467361861 V3=0
 T=0 M2=0 M3=77.9626295563166 S11Max=311.525777945064 PtS11Max=1 x2S11Max=-0.5 x3S11Max=-0.5
 S11Min=-624.025776730735 PtS11Min=3 x2S11Min=0.5 x3S11Min=-0.5 FrameElem=80 ElemStation=0
 Frame=80 Station=0.25 OutputCase=PESOPR CaseType=LinStatic P=-149.999999392836 V2=15.1709467361861
 V3=0 T=0 M2=0 M3=74.1698928722701 S11Max=295.019357840784 PtS11Max=1 x2S11Max=-0.5 x3S11Max=-0.5
 S11Min=-595.019356626456 PtS11Min=3 x2S11Min=0.5 x3S11Min=-0.5 FrameElem=80 ElemStation=0.25
 Frame=80 Station=0 OutputCase=TERRVERT CaseType=LinStatic P=-699.999993042322 V2=-1.64270738195546
 V3=0 T=0 M2=0 M3=318.765397706833 S11Max=1212.59239319868 PtS11Max=1 x2S11Max=-0.5 x3S11Max=-0.5
 S11Min=-2612.59237928332 PtS11Min=3 x2S11Min=0.5 x3S11Min=-0.5 FrameElem=80 ElemStation=0
 Frame=80 Station=0.25 OutputCase=TERRVERT CaseType=LinStatic P=-699.999993042322 V2=-1.64270738195546
 V3=0 T=0 M2=0 M3=319.176074552322 S11Max=1215.05645427161 PtS11Max=1 x2S11Max=-0.5 x3S11Max=-0.5
 S11Min=-2615.05644035626 PtS11Min=3 x2S11Min=0.5 x3S11Min=-0.5 FrameElem=80 ElemStation=0.25
 Frame=80 Station=0 OutputCase=TERRLAT CaseType=LinStatic P=1.69219674717169E-06 V2=253.88527961609
 V3=0 T=0 M2=0 M3=15.7151494213724 S11Max=94.2908982204312 PtS11Max=1 x2S11Max=-0.5 x3S11Max=-0.5
 S11Min=-94.2908948360378 PtS11Min=3 x2S11Min=0.5 x3S11Min=-0.5 FrameElem=80 ElemStation=0
 Frame=80 Station=0.25 OutputCase=TERRLAT CaseType=LinStatic P=1.69219674717169E-06 V2=215.23996711609
 V3=0 T=0 M2=0 M3=-42.9143996493169 S11Max=257.486399588098 PtS11Max=3 x2S11Max=0.5 x3S11Max=-0.5
 S11Min=-257.486396203704 PtS11Min=1 x2S11Min=-0.5 x3S11Min=-0.5 FrameElem=80 ElemStation=0.25
 Frame=80 Station=0 OutputCase=ACCVERT CaseType=LinStatic P=0 V2=0 V3=0 T=0 M2=0 M3=0
 PtS11Max=0 x2S11Max=0 x3S11Max=0 S11Min=0 PtS11Min=0 x2S11Min=0 x3S11Min=0 FrameElem=80
 ElemStation=0
 Frame=80 Station=0.25 OutputCase=ACCVERT CaseType=LinStatic P=0 V2=0 V3=0 T=0 M2=0 M3=0
 S11Max=0 PtS11Max=0 x2S11Max=0 x3S11Max=0 S11Min=0 PtS11Min=0 x2S11Min=0 x3S11Min=0 FrameElem=80
 ElemStation=0.25
 Frame=80 Station=0 OutputCase=ACCLATDX CaseType=LinStatic P=0 V2=0 V3=0 T=0 M2=0 M3=0
 S11Max=0 PtS11Max=0 x2S11Max=0 x3S11Max=0 S11Min=0 PtS11Min=0 x2S11Min=0 x3S11Min=0 FrameElem=80
 ElemStation=0
 Frame=80 Station=0.25 OutputCase=ACCLATDX CaseType=LinStatic P=0 V2=0 V3=0 T=0 M2=0 M3=0
 S11Max=0 PtS11Max=0 x2S11Max=0 x3S11Max=0 S11Min=0 PtS11Min=0 x2S11Min=0 x3S11Min=0 FrameElem=80
 ElemStation=0.25
 Frame=80 Station=0 OutputCase=ACCLATSX CaseType=LinStatic P=0 V2=0 V3=0 T=0 M2=0 M3=0
 S11Max=0 PtS11Max=0 x2S11Max=0 x3S11Max=0 S11Min=0 PtS11Min=0 x2S11Min=0 x3S11Min=0 FrameElem=80
 ElemStation=0
 Frame=80 Station=0.25 OutputCase=ACCLATSX CaseType=LinStatic P=0 V2=0 V3=0 T=0 M2=0 M3=0
 S11Max=0 PtS11Max=0 x2S11Max=0 x3S11Max=0 S11Min=0 PtS11Min=0 x2S11Min=0 x3S11Min=0 FrameElem=80
 ElemStation=0.25
 Frame=80 Station=0 OutputCase=TERRCOST CaseType=LinStatic P=0 V2=0 V3=0 T=0 M2=0 M3=0
 S11Max=0 PtS11Max=0 x2S11Max=0 x3S11Max=0 S11Min=0 PtS11Min=0 x2S11Min=0 x3S11Min=0 FrameElem=80
 ElemStation=0
 Frame=80 Station=0.25 OutputCase=TERRCOST CaseType=LinStatic P=0 V2=0 V3=0 T=0 M2=0 M3=0
 S11Max=0 PtS11Max=0 x2S11Max=0 x3S11Max=0 S11Min=0 PtS11Min=0 x2S11Min=0 x3S11Min=0 FrameElem=80
 ElemStation=0.25
 Frame=80 Station=0 OutputCase=SOVRCOST CaseType=LinStatic P=0 V2=0 V3=0 T=0 M2=0 M3=0
 S11Max=0 PtS11Max=0 x2S11Max=0 x3S11Max=0 S11Min=0 PtS11Min=0 x2S11Min=0 x3S11Min=0 FrameElem=80
 ElemStation=0
 Frame=80 Station=0.25 OutputCase=SOVRCOST CaseType=LinStatic P=0 V2=0 V3=0 T=0 M2=0 M3=0
 S11Max=0 PtS11Max=0 x2S11Max=0 x3S11Max=0 S11Min=0 PtS11Min=0 x2S11Min=0 x3S11Min=0 FrameElem=80
 ElemStation=0.25
 Frame=80 Station=0 OutputCase=ENVE CaseType=Combination StepType=Max P=-856.249990742961
 V2=267.413518970321 V3=0 T=0 M2=0 M3=412.443176684522 S11Max=1618.40906936417 PtS11Max=1 x2S11Max=-0.5
 x3S11Max=-0.5
 S11Min=-3302.62178239928 PtS11Min=3 x2S11Min=0.5 x3S11Min=-0.5 FrameElem=80 ElemStation=0
 Frame=80 Station=0.25 OutputCase=ENVE CaseType=Combination StepType=Max P=-849.999990742961
 V2=228.768206470321 V3=0 T=0 M2=0 M3=363.305887670071 S11Max=1329.8353347698 PtS11Max=1 x2S11Max=-0.5
 x3S11Max=-0.5
 S11Min=-2952.58939739461 PtS11Min=3 x2S11Min=0.5 x3S11Min=-0.5 FrameElem=80 ElemStation=0.25
 Frame=80 Station=0 OutputCase=ENVE CaseType=Combination StepType=Min P=-856.24999125062
 V2=191.247935085494 V3=0 T=0 M2=0 M3=407.728631858111 S11Max=1590.12179989804 PtS11Max=1 x2S11Max=-0.5
 x3S11Max=-0.5
 S11Min=-3330.9090508501 PtS11Min=3 x2S11Min=0.5 x3S11Min=-0.5 FrameElem=80 ElemStation=0
 Frame=80 Station=0.25 OutputCase=ENVE CaseType=Combination StepType=Min P=-849.99999125062
 V2=164.196216335494 V3=0 T=0 M2=0 M3=350.431567775276 S11Max=1252.58941590869 PtS11Max=1 x2S11Max=-0.5
 x3S11Max=-0.5
 S11Min=-3029.83531727104 PtS11Min=3 x2S11Min=0.5 x3S11Min=-0.5 FrameElem=80 ElemStation=0.25
 Frame=80 Station=0 OutputCase=FESSUR CaseType=Combination P=-856.249990742961 V2=267.413518970321
 V3=0 T=0 M2=0 M3=412.443176684522 S11Max=1618.40906936417 PtS11Max=1 x2S11Max=-0.5 x3S11Max=-0.5
 S11Min=-3330.9090508501 PtS11Min=3 x2S11Min=0.5 x3S11Min=-0.5 FrameElem=80 ElemStation=0
 Frame=80 Station=0.25 OutputCase=FESSUR CaseType=Combination P=-849.999990742961 V2=228.768206470321
 V3=0 T=0 M2=0 M3=350.431567775276 S11Max=1252.58941590869 PtS11Max=1 x2S11Max=-0.5 x3S11Max=-0.5
 S11Min=-2952.58939739461 PtS11Min=3 x2S11Min=0.5 x3S11Min=-0.5 FrameElem=80 ElemStation=0.25
 Frame=82 Station=0 OutputCase=PESOPR CaseType=LinStatic P=-75.0000008395873 V2=15.1709395836273 V3=0
 T=0 M2=0 M3=28.657049981506 S11Max=96.942299049449 PtS11Max=1 x2S11Max=-0.5 x3S11Max=-0.5
 S11Min=-246.942300728624 PtS11Min=3 x2S11Min=0.5 x3S11Min=-0.5 FrameElem=82 ElemStation=0
 Frame=82 Station=0.250000000000002 OutputCase=PESOPR CaseType=LinStatic P=-68.7500008395873
 V2=15.1709401796737 V3=0 T=0 M2=0 M3=24.8643150110934 S11Max=80.4358892269731 PtS11Max=1 x2S11Max=-0.5
 x3S11Max=-0.5



S11Min=-217.935890906148 PtS11Min=3 x2S11Min=0.5 x3S11Min=-0.5 FrameElem=82
 ElemStation=0.250000000000002
 Frame=82 Station=0 OutputCase=TERRVERT CaseType=LinStatic P=-699.99999288586 V2=-1.64277413916352
 V3=0 T=0 M2=0 M3=324.1041800089 S11Max=1244.62508716754 PtS11Max=1 x2S11Max=-0.5 x3S11Max=-0.5
 S11Min=-2644.62507293926 PtS11Min=3 x2S11Min=0.5 x3S11Min=-0.5 FrameElem=82 ElemStation=0
 Frame=82 Station=0.250000000000002 OutputCase=TERRVERT CaseType=LinStatic P=-699.99999288586 V2=-
 1.64277413916352 V3=0 T=0 M2=0 M3=324.514873543691 S11Max=1247.08924837629 PtS11Max=1 x2S11Max=-0.5
 x3S11Max=-0.5
 S11Min=-2647.08923414801 PtS11Min=3 x2S11Min=0.5 x3S11Min=-0.5 FrameElem=82
 ElemStation=0.250000000000002
 Frame=82 Station=0 OutputCase=TERRLAT CaseType=LinStatic P=2.14256288018078E-05 V2=-206.920032883907
 V3=0 T=0 M2=0 M3=-36.2018009975899 S11Max=217.21082741168 PtS11Max=3 x2S11Max=0.5 x3S11Max=-0.5
 S11Min=-217.210784559911 PtS11Min=1 x2S11Min=-0.5 x3S11Min=-0.5 FrameElem=82 ElemStation=0
 Frame=82 Station=0.250000000000002 OutputCase=TERRLAT CaseType=LinStatic P=2.44501770827005E-05 V2=-
 238.634720383907 V3=0 T=0 M2=0 M3=19.5036499317206 S11Max=117.021924040501 PtS11Max=1 x2S11Max=-0.5
 x3S11Max=-0.5 S11Min=-117.021875140147 PtS11Min=3 x2S11Min=0.5 x3S11Min=-0.5 FrameElem=82
 ElemStation=0.250000000000002
 Frame=82 Station=0 OutputCase=ACCVERT CaseType=LinStatic P=0 V2=0 V3=0 T=0 M2=0 M3=0 S11Max=0
 PtS11Max=0 x2S11Max=0 x3S11Max=0 S11Min=0 PtS11Min=0 x2S11Min=0 x3S11Min=0 FrameElem=82
 ElemStation=0
 Frame=82 Station=0.250000000000002 OutputCase=ACCVERT CaseType=LinStatic P=0 V2=0 V3=0 T=0 M2=0
 M3=0 S11Max=0 PtS11Max=0 x2S11Max=0 x3S11Max=0 S11Min=0 PtS11Min=0 x2S11Min=0 x3S11Min=0
 FrameElem=82 ElemStation=0.250000000000002
 Frame=82 Station=0 OutputCase=ACCLATDX CaseType=LinStatic P=0 V2=0 V3=0 T=0 M2=0 M3=0
 S11Max=0 PtS11Max=0 x2S11Max=0 x3S11Max=0 S11Min=0 PtS11Min=0 x2S11Min=0 x3S11Min=0 FrameElem=82
 ElemStation=0
 Frame=82 Station=0.250000000000002 OutputCase=ACCLATDX CaseType=LinStatic P=0 V2=0 V3=0 T=0 M2=0
 M3=0 S11Max=0 PtS11Max=0 x2S11Max=0 x3S11Max=0 S11Min=0 PtS11Min=0 x2S11Min=0 x3S11Min=0
 FrameElem=82 ElemStation=0.250000000000002
 Frame=82 Station=0 OutputCase=ACCLATSX CaseType=LinStatic P=0 V2=0 V3=0 T=0 M2=0 M3=0
 S11Max=0 PtS11Max=0 x2S11Max=0 x3S11Max=0 S11Min=0 PtS11Min=0 x2S11Min=0 x3S11Min=0 FrameElem=82
 ElemStation=0
 Frame=82 Station=0.250000000000002 OutputCase=ACCLATSX CaseType=LinStatic P=0 V2=0 V3=0 T=0 M2=0
 M3=0 S11Max=0 PtS11Max=0 x2S11Max=0 x3S11Max=0 S11Min=0 PtS11Min=0 x2S11Min=0 x3S11Min=0
 FrameElem=82 ElemStation=0.250000000000002
 Frame=82 Station=0 OutputCase=TERRCOST CaseType=LinStatic P=0 V2=0 V3=0 T=0 M2=0 M3=0
 S11Max=0 PtS11Max=0 x2S11Max=0 x3S11Max=0 S11Min=0 PtS11Min=0 x2S11Min=0 x3S11Min=0 FrameElem=82
 ElemStation=0
 Frame=82 Station=0.250000000000002 OutputCase=TERRCOST CaseType=LinStatic P=0 V2=0 V3=0 T=0 M2=0
 M3=0 S11Max=0 PtS11Max=0 x2S11Max=0 x3S11Max=0 S11Min=0 PtS11Min=0 x2S11Min=0 x3S11Min=0
 FrameElem=82 ElemStation=0.250000000000002
 Frame=82 Station=0 OutputCase=SOVRCOST CaseType=LinStatic P=0 V2=0 V3=0 T=0 M2=0 M3=0
 S11Max=0 PtS11Max=0 x2S11Max=0 x3S11Max=0 S11Min=0 PtS11Min=0 x2S11Min=0 x3S11Min=0 FrameElem=82
 ElemStation=0
 Frame=82 Station=0.250000000000002 OutputCase=SOVRCOST CaseType=LinStatic P=0 V2=0 V3=0 T=0 M2=0
 M3=0 S11Max=0 PtS11Max=0 x2S11Max=0 x3S11Max=0 S11Min=0 PtS11Min=0 x2S11Min=0 x3S11Min=0
 FrameElem=82 ElemStation=0.250000000000002
 Frame=82 Station=0 OutputCase=ENVE CaseType=Combination StepType=Max P=-774.999972299818 V2=-
 131.315857574271 V3=0 T=0 M2=0 M3=327.419969292093 S11Max=1189.51983702505 PtS11Max=1 x2S11Max=-0.5
 x3S11Max=-0.5
 S11Min=-2674.35654625672 PtS11Min=3 x2S11Min=0.5 x3S11Min=-0.5 FrameElem=82 ElemStation=0
 Frame=82 Station=0.250000000000002 OutputCase=ENVE CaseType=Combination StepType=Max P=-768.74996927527
 V2=-153.516138228225 V3=0 T=0 M2=0 M3=368.882838486505 S11Max=1444.54706164376 PtS11Max=1 x2S11Max=-
 0.5
 x3S11Max=-0.5 S11Min=-2946.94043765226 PtS11Min=3 x2S11Min=0.5 x3S11Min=-0.5 FrameElem=82
 ElemStation=0.250000000000002
 Frame=82 Station=0 OutputCase=ENVE CaseType=Combination StepType=Min P=-774.999978727507 V2=-
 193.391867439443 V3=0 T=0 M2=0 M3=316.559428992816 S11Max=1124.35660165708 PtS11Max=1 x2S11Max=-0.5
 x3S11Max=-0.5
 S11Min=-2739.51979448007 PtS11Min=3 x2S11Min=0.5 x3S11Min=-0.5 FrameElem=82 ElemStation=0
 Frame=82 Station=0.250000000000002 OutputCase=ENVE CaseType=Combination StepType=Min P=-
 768.749976610323 V2=-225.106554343397 V3=0 T=0 M2=0 M3=363.031743506989 S11Max=1409.44048443161
 PtS11Max=1 x2S11Max=-0.5
 x3S11Max=-0.5 S11Min=-2982.0470001943 PtS11Min=3 x2S11Min=0.5 x3S11Min=-0.5 FrameElem=82
 ElemStation=0.250000000000002
 Frame=82 Station=0 OutputCase=FESSUR CaseType=Combination P=-774.999972299818 V2=-193.391867439443
 V3=0 T=0 M2=0 M3=316.559428992816 S11Max=1124.35660165708 PtS11Max=1 x2S11Max=-0.5 x3S11Max=-0.5
 S11Min=-2674.35654625672 PtS11Min=3 x2S11Min=0.5 x3S11Min=-0.5 FrameElem=82 ElemStation=0
 Frame=82 Station=0.250000000000002 OutputCase=FESSUR CaseType=Combination P=-768.74996927527 V2=-
 225.106554343397 V3=0 T=0 M2=0 M3=368.882838486505 S11Max=1444.54706164376 PtS11Max=1 x2S11Max=-0.5
 x3S11Max=-0.5
 S11Min=-2982.0470001943 PtS11Min=3 x2S11Min=0.5 x3S11Min=-0.5 FrameElem=82
 ElemStation=0.250000000000002
 Frame=83 Station=0 OutputCase=PESOPR CaseType=LinStatic P=-68.7499979459681 V2=15.1709532926955 V3=0
 T=0 M2=0 M3=24.8643150110892 S11Max=80.4358921205669 PtS11Max=1 x2S11Max=-0.5 x3S11Max=-0.5
 S11Min=-217.935888012503 PtS11Min=3 x2S11Min=0.5 x3S11Min=-0.5 FrameElem=83 ElemStation=0
 Frame=83 Station=0.250000000000001 OutputCase=PESOPR CaseType=LinStatic P=-62.4999979459681
 V2=15.170952696649 V3=0 T=0 M2=0 M3=21.0715767624211 S11Max=63.9294626285584 PtS11Max=1 x2S11Max=-0.5
 x3S11Max=-0.5
 S11Min=-188.929458520495 PtS11Min=3 x2S11Min=0.5 x3S11Min=-0.5 FrameElem=83
 ElemStation=0.250000000000001



Frame=83 Station=0 OutputCase=TERRVERT CaseType=LinStatic P=-699.999993199017 V2=-1.64264062475854
 V3=0 T=0 M2=0 M3=324.514873543673 S11Max=1247.08924806302 PtS11Max=1 x2S11Max=-0.5 x3S11Max=-0.5 _
 S11Min=-2647.08923446105 PtS11Min=3 x2S11Min=0.5 x3S11Min=-0.5 FrameElem=83 ElemStation=0
 Frame=83 Station=0.2500000000000001 OutputCase=TERRVERT CaseType=LinStatic P=-699.999993199017 V2=-
 1.64264062475854 V3=0 T=0 M2=0 M3=324.925533699862 S11Max=1249.55320900016 PtS11Max=1 x2S11Max=-0.5
 x3S11Max=-0.5 _
 S11Min=-2649.55319539819 PtS11Min=3 x2S11Min=0.5 x3S11Min=-0.5 FrameElem=83
 ElemStation=0.2500000000000001
 Frame=83 Station=0 OutputCase=TERRLAT CaseType=LinStatic P=-2.10657854040619E-05 V2=-238.634720383908
 V3=0 T=0 M2=0 M3=19.5036499317208 S11Max=117.021878524539 PtS11Max=1 x2S11Max=-0.5 x3S11Max=-0.5 _
 S11Min=-117.02192065611 PtS11Min=3 x2S11Min=0.5 x3S11Min=-0.5 FrameElem=83 ElemStation=0
 Frame=83 Station=0.2500000000000001 OutputCase=TERRLAT CaseType=LinStatic P=-2.40394909231506E-05 V2=-
 269.816282883908 V3=0 T=0 M2=0 M3=83.0711321110313 S11Max=498.426768626697 PtS11Max=1 x2S11Max=-0.5 _
 x3S11Max=-0.5 S11Min=-498.426816705679 PtS11Min=3 x2S11Min=0.5 x3S11Min=-0.5 FrameElem=83
 ElemStation=0.2500000000000001
 Frame=83 Station=0 OutputCase=ACCVERT CaseType=LinStatic P=0 V2=0 V3=0 T=0 M2=0 M3=0 S11Max=0
 PtS11Max=0 x2S11Max=0 x3S11Max=0 S11Min=0 PtS11Min=0 x2S11Min=0 x3S11Min=0 FrameElem=83
 ElemStation=0
 Frame=83 Station=0.2500000000000001 OutputCase=ACCVERT CaseType=LinStatic P=0 V2=0 V3=0 T=0 M2=0
 M3=0 S11Max=0 PtS11Max=0 x2S11Max=0 x3S11Max=0 S11Min=0 PtS11Min=0 x2S11Min=0 x3S11Min=0
 FrameElem=83 ElemStation=0.2500000000000001
 Frame=83 Station=0 OutputCase=ACCLATDX CaseType=LinStatic P=0 V2=0 V3=0 T=0 M2=0 M3=0
 S11Max=0 PtS11Max=0 x2S11Max=0 x3S11Max=0 S11Min=0 PtS11Min=0 x2S11Min=0 x3S11Min=0 FrameElem=83
 ElemStation=0
 Frame=83 Station=0.2500000000000001 OutputCase=ACCLATDX CaseType=LinStatic P=0 V2=0 V3=0 T=0 M2=0
 M3=0 S11Max=0 PtS11Max=0 x2S11Max=0 x3S11Max=0 S11Min=0 PtS11Min=0 x2S11Min=0 x3S11Min=0
 FrameElem=83 ElemStation=0.2500000000000001
 Frame=83 Station=0 OutputCase=ACCLATSX CaseType=LinStatic P=0 V2=0 V3=0 T=0 M2=0 M3=0
 S11Max=0 PtS11Max=0 x2S11Max=0 x3S11Max=0 S11Min=0 PtS11Min=0 x2S11Min=0 x3S11Min=0 FrameElem=83
 ElemStation=0
 Frame=83 Station=0.2500000000000001 OutputCase=ACCLATSX CaseType=LinStatic P=0 V2=0 V3=0 T=0 M2=0
 M3=0 S11Max=0 PtS11Max=0 x2S11Max=0 x3S11Max=0 S11Min=0 PtS11Min=0 x2S11Min=0 x3S11Min=0
 FrameElem=83 ElemStation=0.2500000000000001
 Frame=83 Station=0 OutputCase=TERRCOST CaseType=LinStatic P=0 V2=0 V3=0 T=0 M2=0 M3=0
 S11Max=0 PtS11Max=0 x2S11Max=0 x3S11Max=0 S11Min=0 PtS11Min=0 x2S11Min=0 x3S11Min=0 FrameElem=83
 ElemStation=0
 Frame=83 Station=0.2500000000000001 OutputCase=TERRCOST CaseType=LinStatic P=0 V2=0 V3=0 T=0 M2=0
 M3=0 S11Max=0 PtS11Max=0 x2S11Max=0 x3S11Max=0 S11Min=0 PtS11Min=0 x2S11Min=0 x3S11Min=0
 FrameElem=83 ElemStation=0.2500000000000001
 Frame=83 Station=0 OutputCase=SOVRCOST CaseType=LinStatic P=0 V2=0 V3=0 T=0 M2=0 M3=0
 S11Max=0 PtS11Max=0 x2S11Max=0 x3S11Max=0 S11Min=0 PtS11Min=0 x2S11Min=0 x3S11Min=0 FrameElem=83
 ElemStation=0
 Frame=83 Station=0.2500000000000001 OutputCase=SOVRCOST CaseType=LinStatic P=0 V2=0 V3=0 T=0 M2=0
 M3=0 S11Max=0 PtS11Max=0 x2S11Max=0 x3S11Max=0 S11Min=0 PtS11Min=0 x2S11Min=0 x3S11Min=0
 FrameElem=83 ElemStation=0.2500000000000001
 Frame=83 Station=0 OutputCase=ENVE CaseType=Combination StepType=Max P=-768.750005891035 V2=-
 153.515991600798 V3=0 T=0 M2=0 M3=368.882838486483 S11Max=1444.54701870813 PtS11Max=1 x2S11Max=-0.5
 x3S11Max=-0.5 _
 S11Min=-2946.94046693283 PtS11Min=3 x2S11Min=0.5 x3S11Min=-0.5 FrameElem=83 ElemStation=0
 Frame=83 Station=0.2500000000000001 OutputCase=ENVE CaseType=Combination StepType=Max P=-
 762.500007972629 V2=-175.343085946845 V3=0 T=0 M2=0 M3=429.068242573315 S11Max=1811.90944025541
 PtS11Max=1 x2S11Max=-0.5 _
 x3S11Max=-0.5 S11Min=-3187.38142561266 PtS11Min=3 x2S11Min=0.5 x3S11Min=-0.5 FrameElem=83
 ElemStation=0.2500000000000001
 Frame=83 Station=0 OutputCase=ENVE CaseType=Combination StepType=Min P=-768.75001221077 V2=-
 225.106407715971 V3=0 T=0 M2=0 M3=363.031743506967 S11Max=1409.44045515076 PtS11Max=1 x2S11Max=-0.5
 x3S11Max=-0.5 _
 S11Min=-2982.04704312967 PtS11Min=3 x2S11Min=0.5 x3S11Min=-0.5 FrameElem=83 ElemStation=0
 Frame=83 Station=0.2500000000000001 OutputCase=ENVE CaseType=Combination StepType=Min P=-
 762.500015184476 V2=-256.287970812017 V3=0 T=0 M2=0 M3=404.146902940005 S11Max=1662.3814096674
 PtS11Max=1 x2S11Max=-0.5 _
 x3S11Max=-0.5 S11Min=-3336.90947062437 PtS11Min=3 x2S11Min=0.5 x3S11Min=-0.5 FrameElem=83
 ElemStation=0.2500000000000001
 Frame=83 Station=0 OutputCase=FESSUR CaseType=Combination P=-768.75001221077 V2=-225.106407715971
 V3=0 T=0 M2=0 M3=368.882838486483 S11Max=1444.54701870813 PtS11Max=1 x2S11Max=-0.5 x3S11Max=-0.5 _
 S11Min=-2982.04704312967 PtS11Min=3 x2S11Min=0.5 x3S11Min=-0.5 FrameElem=83 ElemStation=0
 Frame=83 Station=0.2500000000000001 OutputCase=FESSUR CaseType=Combination P=-762.500015184476 V2=-
 256.287970812017 V3=0 T=0 M2=0 M3=429.068242573315 S11Max=1811.90944025541 PtS11Max=1 x2S11Max=-0.5
 x3S11Max=-0.5 _
 S11Min=-3336.90947062437 PtS11Min=3 x2S11Min=0.5 x3S11Min=-0.5 FrameElem=83
 ElemStation=0.2500000000000001
 Frame=84 Station=0 OutputCase=PESOPR CaseType=LinStatic P=-149.99998697982 V2=-15.1709479282792 V3=0
 T=0 M2=0 M3=-74.169892927775 S11Max=295.019358868668 PtS11Max=3 x2S11Max=0.5 x3S11Max=-0.5 _
 S11Min=-595.019356264632 PtS11Min=1 x2S11Min=-0.5 x3S11Min=-0.5 FrameElem=84 ElemStation=0
 Frame=84 Station=0.5 OutputCase=PESOPR CaseType=LinStatic P=-137.49998697982 V2=-15.1709478289382
 V3=0 T=0 M2=0 M3=-66.5844189884706 S11Max=262.006515232842 PtS11Max=3 x2S11Max=0.5 x3S11Max=-0.5 _
 S11Min=-537.006512628806 PtS11Min=1 x2S11Min=-0.5 x3S11Min=-0.5 FrameElem=84 ElemStation=0.5
 Frame=84 Station=0 OutputCase=TERRVERT CaseType=LinStatic P=-699.999993617414 V2=1.64270181885558
 V3=0 T=0 M2=0 M3=-319.176075959943 S11Max=1215.05646214224 PtS11Max=3 x2S11Max=0.5 x3S11Max=-0.5 _
 S11Min=-2615.05644937707 PtS11Min=1 x2S11Min=-0.5 x3S11Min=-0.5 FrameElem=84 ElemStation=0
 Frame=84 Station=0.5 OutputCase=TERRVERT CaseType=LinStatic P=-699.999993617414 V2=1.64270181885558
 V3=0 T=0 M2=0 M3=-319.997426869371 S11Max=1219.98456759881 PtS11Max=3 x2S11Max=0.5 x3S11Max=-0.5 _



S11Min=-2619.98455483364 PtS11Min=1 x2S11Min=-0.5 x3S11Min=-0.5 FrameElem=84 ElemStation=0.5
 Frame=84 Station=0 OutputCase=TERRLAT CaseType=LinStatic P=1.83663360076025E-08 V2=-215.239963767415
 V3=0 T=0 M2=0 M3=42.9144038385307 S11Max=257.48642304955 PtS11Max=1 x2S11Max=-0.5 x3S11Max=-0.5 _
 S11Min=-257.486423012818 PtS11Min=3 x2S11Min=0.5 x3S11Min=-0.5 FrameElem=84 ElemStation=0
 Frame=84 Station=0.5 OutputCase=TERRLAT CaseType=LinStatic P=-5.83173637167E-07 V2=-139.548713786481
 V3=0 T=0 M2=0 M3=131.522719059808 S11Max=789.136313775676 PtS11Max=1 x2S11Max=-0.5 x3S11Max=-0.5 _
 S11Min=-789.136314942024 PtS11Min=3 x2S11Min=0.5 x3S11Min=-0.5 FrameElem=84 ElemStation=0.5
 Frame=84 Station=0 OutputCase=ACCVERT CaseType=LinStatic P=0 V2=0 V3=0 T=0 M2=0 M3=0 S11Max=0
 PtS11Max=0 x2S11Max=0 x3S11Max=0 S11Min=0 PtS11Min=0 x2S11Min=0 x3S11Min=0 FrameElem=84
 ElemStation=0
 Frame=84 Station=0.5 OutputCase=ACCVERT CaseType=LinStatic P=0 V2=0 V3=0 T=0 M2=0 M3=0
 S11Max=0 PtS11Max=0 x2S11Max=0 x3S11Max=0 S11Min=0 PtS11Min=0 x2S11Min=0 x3S11Min=0 FrameElem=84
 ElemStation=0.5
 Frame=84 Station=0 OutputCase=ACCLATDX CaseType=LinStatic P=0 V2=0 V3=0 T=0 M2=0 M3=0
 S11Max=0 PtS11Max=0 x2S11Max=0 x3S11Max=0 S11Min=0 PtS11Min=0 x2S11Min=0 x3S11Min=0 FrameElem=84
 ElemStation=0
 Frame=84 Station=0.5 OutputCase=ACCLATDX CaseType=LinStatic P=0 V2=0 V3=0 T=0 M2=0 M3=0
 S11Max=0 PtS11Max=0 x2S11Max=0 x3S11Max=0 S11Min=0 PtS11Min=0 x2S11Min=0 x3S11Min=0 FrameElem=84
 ElemStation=0.5
 Frame=84 Station=0 OutputCase=ACCLATSX CaseType=LinStatic P=0 V2=0 V3=0 T=0 M2=0 M3=0
 S11Max=0 PtS11Max=0 x2S11Max=0 x3S11Max=0 S11Min=0 PtS11Min=0 x2S11Min=0 x3S11Min=0 FrameElem=84
 ElemStation=0
 Frame=84 Station=0.5 OutputCase=ACCLATSX CaseType=LinStatic P=0 V2=0 V3=0 T=0 M2=0 M3=0
 S11Max=0 PtS11Max=0 x2S11Max=0 x3S11Max=0 S11Min=0 PtS11Min=0 x2S11Min=0 x3S11Min=0 FrameElem=84
 ElemStation=0.5
 Frame=84 Station=0 OutputCase=TERRCOST CaseType=LinStatic P=0 V2=0 V3=0 T=0 M2=0 M3=0
 S11Max=0 PtS11Max=0 x2S11Max=0 x3S11Max=0 S11Min=0 PtS11Min=0 x2S11Min=0 x3S11Min=0 FrameElem=84
 ElemStation=0
 Frame=84 Station=0.5 OutputCase=TERRCOST CaseType=LinStatic P=0 V2=0 V3=0 T=0 M2=0 M3=0
 S11Max=0 PtS11Max=0 x2S11Max=0 x3S11Max=0 S11Min=0 PtS11Min=0 x2S11Min=0 x3S11Min=0 FrameElem=84
 ElemStation=0.5
 Frame=84 Station=0 OutputCase=SOVRCOST CaseType=LinStatic P=0 V2=0 V3=0 T=0 M2=0 M3=0
 S11Max=0 PtS11Max=0 x2S11Max=0 x3S11Max=0 S11Min=0 PtS11Min=0 x2S11Min=0 x3S11Min=0 FrameElem=84
 ElemStation=0
 Frame=84 Station=0.5 OutputCase=SOVRCOST CaseType=LinStatic P=0 V2=0 V3=0 T=0 M2=0 M3=0
 S11Max=0 PtS11Max=0 x2S11Max=0 x3S11Max=0 S11Min=0 PtS11Min=0 x2S11Min=0 x3S11Min=0 FrameElem=84
 ElemStation=0.5
 Frame=84 Station=0 OutputCase=ENVE CaseType=Combination StepType=Max P=-849.999992297029 V2=-
 164.196220746614 V3=0 T=0 M2=0 M3=-350.431565049187 S11Max=1329.83532490194 PtS11Max=3 x2S11Max=0.5
 x3S11Max=-0.5 _
 S11Min=-2952.58938259215 PtS11Min=1 x2S11Min=-0.5 x3S11Min=-0.5 FrameElem=84 ElemStation=0
 Frame=84 Station=0.5 OutputCase=ENVE CaseType=Combination StepType=Max P=-837.499992723617 V2=-
 111.212345660619 V3=0 T=0 M2=0 M3=-255.059126798033 S11Max=929.595662372236 PtS11Max=3 x2S11Max=0.5
 x3S11Max=-0.5 _
 S11Min=-2367.85475368677 PtS11Min=1 x2S11Min=-0.5 x3S11Min=-0.5 FrameElem=84 ElemStation=0.5
 Frame=84 Station=0 OutputCase=ENVE CaseType=Combination StepType=Min P=-849.99992302539 V2=-
 228.768209876838 V3=0 T=0 M2=0 M3=-363.305886200746 S11Max=1252.58939799809 PtS11Max=3 x2S11Max=0.5
 x3S11Max=-0.5 _
 S11Min=-3029.83530950702 PtS11Min=1 x2S11Min=-0.5 x3S11Min=-0.5 FrameElem=84 ElemStation=0
 Frame=84 Station=0.5 OutputCase=ENVE CaseType=Combination StepType=Min P=-837.499992898569 V2=-
 153.076959796563 V3=0 T=0 M2=0 M3=-294.515942515976 S11Max=692.854767889629 PtS11Max=3 x2S11Max=0.5
 x3S11Max=-0.5 _
 S11Min=-2604.59564781947 PtS11Min=1 x2S11Min=-0.5 x3S11Min=-0.5 FrameElem=84 ElemStation=0.5
 Frame=84 Station=0 OutputCase=FESSUR CaseType=Combination P=-849.99992297029 V2=-228.768209876838
 V3=0 T=0 M2=0 M3=-350.431565049187 S11Max=1252.58939799809 PtS11Max=3 x2S11Max=0.5 x3S11Max=-0.5 _
 S11Min=-2952.58938259215 PtS11Min=1 x2S11Min=-0.5 x3S11Min=-0.5 FrameElem=84 ElemStation=0
 Frame=84 Station=0.5 OutputCase=FESSUR CaseType=Combination P=-837.499992898569 V2=-153.076959796563
 V3=0 T=0 M2=0 M3=-255.059126798033 S11Max=692.854767889629 PtS11Max=3 x2S11Max=0.5 x3S11Max=-0.5 _
 S11Min=-2367.85475368677 PtS11Min=1 x2S11Min=-0.5 x3S11Min=-0.5 FrameElem=84 ElemStation=0.5
 Frame=85 Station=0 OutputCase=PESOPR CaseType=LinStatic P=-137.499998698098 V2=-15.1709478289372 V3=0
 T=0 M2=0 M3=-66.5844189884699 S11Max=262.006515232721 PtS11Max=3 x2S11Max=0.5 x3S11Max=-0.5 _
 S11Min=-537.006512628918 PtS11Min=1 x2S11Min=-0.5 x3S11Min=-0.5 FrameElem=85 ElemStation=0
 Frame=85 Station=0.5 OutputCase=PESOPR CaseType=LinStatic P=-124.999998698098 V2=-15.1709477295961
 V3=0 T=0 M2=0 M3=-58.9989450988366 S11Max=228.993671894921 PtS11Max=3 x2S11Max=0.5 x3S11Max=-0.5 _
 S11Min=-478.993669291118 PtS11Min=1 x2S11Min=-0.5 x3S11Min=-0.5 FrameElem=85 ElemStation=0.5
 Frame=85 Station=0 OutputCase=TERRVERT CaseType=LinStatic P=-699.99999361753 V2=1.64270181885513 V3=0
 T=0 M2=0 M3=-319.99742686937 S11Max=1219.98456759869 PtS11Max=3 x2S11Max=0.5 x3S11Max=-0.5 _
 S11Min=-2619.98455483375 PtS11Min=1 x2S11Min=-0.5 x3S11Min=-0.5 FrameElem=85 ElemStation=0
 Frame=85 Station=0.5 OutputCase=TERRVERT CaseType=LinStatic P=-699.99999361753 V2=1.64270181885513
 V3=0 T=0 M2=0 M3=-320.818777778797 S11Max=1224.91267305525 PtS11Max=3 x2S11Max=0.5 x3S11Max=-0.5 _
 S11Min=-2624.91266029031 PtS11Min=1 x2S11Min=-0.5 x3S11Min=-0.5 FrameElem=85 ElemStation=0.5
 Frame=85 Station=0 OutputCase=TERRLAT CaseType=LinStatic P=-5.8317255025031E-07 V2=-139.548713786482
 V3=0 T=0 M2=0 M3=131.522719059808 S11Max=789.136313775676 PtS11Max=1 x2S11Max=-0.5 x3S11Max=-0.5 _
 S11Min=-789.136314942022 PtS11Min=3 x2S11Min=0.5 x3S11Min=-0.5 FrameElem=85 ElemStation=0
 Frame=85 Station=0.5 OutputCase=TERRLAT CaseType=LinStatic P=-1.16776500233621E-06 V2=-65.9899638182583
 V3=0 T=0 M2=0 M3=182.818534293797 S11Max=1096.91120459502 PtS11Max=1 x2S11Max=-0.5 x3S11Max=-0.5 _
 S11Min=-1096.91120693055 PtS11Min=3 x2S11Min=0.5 x3S11Min=-0.5 FrameElem=85 ElemStation=0.5
 Frame=85 Station=0 OutputCase=ACCVERT CaseType=LinStatic P=0 V2=0 V3=0 T=0 M2=0 M3=0 S11Max=0
 PtS11Max=0 x2S11Max=0 x3S11Max=0 S11Min=0 PtS11Min=0 x2S11Min=0 x3S11Min=0 FrameElem=85
 ElemStation=0

Frame=85 Station=0.5 OutputCase=ACCVERT CaseType=LinStatic P=0 V2=0 V3=0 T=0 M2=0 M3=0
 S11Max=0 PtS11Max=0 x2S11Max=0 x3S11Max=0 S11Min=0 PtS11Min=0 x2S11Min=0 x3S11Min=0 FrameElem=85
 ElemStation=0.5

Frame=85 Station=0 OutputCase=ACCLATDX CaseType=LinStatic P=0 V2=0 V3=0 T=0 M2=0 M3=0
 S11Max=0 PtS11Max=0 x2S11Max=0 x3S11Max=0 S11Min=0 PtS11Min=0 x2S11Min=0 x3S11Min=0 FrameElem=85
 ElemStation=0

Frame=85 Station=0.5 OutputCase=ACCLATDX CaseType=LinStatic P=0 V2=0 V3=0 T=0 M2=0 M3=0
 S11Max=0 PtS11Max=0 x2S11Max=0 x3S11Max=0 S11Min=0 PtS11Min=0 x2S11Min=0 x3S11Min=0 FrameElem=85
 ElemStation=0.5

Frame=85 Station=0 OutputCase=ACCLATSX CaseType=LinStatic P=0 V2=0 V3=0 T=0 M2=0 M3=0
 S11Max=0 PtS11Max=0 x2S11Max=0 x3S11Max=0 S11Min=0 PtS11Min=0 x2S11Min=0 x3S11Min=0 FrameElem=85
 ElemStation=0

Frame=85 Station=0.5 OutputCase=ACCLATSX CaseType=LinStatic P=0 V2=0 V3=0 T=0 M2=0 M3=0
 S11Max=0 PtS11Max=0 x2S11Max=0 x3S11Max=0 S11Min=0 PtS11Min=0 x2S11Min=0 x3S11Min=0 FrameElem=85
 ElemStation=0.5

Frame=85 Station=0 OutputCase=TERRCOST CaseType=LinStatic P=0 V2=0 V3=0 T=0 M2=0 M3=0
 S11Max=0 PtS11Max=0 x2S11Max=0 x3S11Max=0 S11Min=0 PtS11Min=0 x2S11Min=0 x3S11Min=0 FrameElem=85
 ElemStation=0

Frame=85 Station=0.5 OutputCase=TERRCOST CaseType=LinStatic P=0 V2=0 V3=0 T=0 M2=0 M3=0
 S11Max=0 PtS11Max=0 x2S11Max=0 x3S11Max=0 S11Min=0 PtS11Min=0 x2S11Min=0 x3S11Min=0 FrameElem=85
 ElemStation=0.5

Frame=85 Station=0 OutputCase=SOVRCOST CaseType=LinStatic P=0 V2=0 V3=0 T=0 M2=0 M3=0
 S11Max=0 PtS11Max=0 x2S11Max=0 x3S11Max=0 S11Min=0 PtS11Min=0 x2S11Min=0 x3S11Min=0 FrameElem=85
 ElemStation=0

Frame=85 Station=0.5 OutputCase=SOVRCOST CaseType=LinStatic P=0 V2=0 V3=0 T=0 M2=0 M3=0
 S11Max=0 PtS11Max=0 x2S11Max=0 x3S11Max=0 S11Min=0 PtS11Min=0 x2S11Min=0 x3S11Min=0 FrameElem=85
 ElemStation=0.5

Frame=85 Station=0 OutputCase=ENVE CaseType=Combination StepType=Max P=-837.499992723849 V2=-
 111.212345660619 V3=0 T=0 M2=0 M3=-255.059126798031 S11Max=929.595662371994 PtS11Max=3 x2S11Max=0.5
 x3S11Max=-0.5
 S11Min=-2367.85475368699 PtS11Min=1 x2S11Min=-0.5 x3S11Min=-0.5 FrameElem=85 ElemStation=0

Frame=85 Station=0.5 OutputCase=ENVE CaseType=Combination StepType=Max P=-824.999993133064 V2=-
 59.7212205835218 V3=0 T=0 M2=0 M3=-196.999188583837 S11Max=686.068500098792 PtS11Max=3 x2S11Max=0.5
 x3S11Max=-0.5
 S11Min=-2006.99512498642 PtS11Min=1 x2S11Min=-0.5 x3S11Min=-0.5 FrameElem=85 ElemStation=0.5

Frame=85 Station=0 OutputCase=ENVE CaseType=Combination StepType=Min P=-837.499992898801 V2=-
 153.076959796564 V3=0 T=0 M2=0 M3=-294.515942515974 S11Max=692.854767889388 PtS11Max=3 x2S11Max=0.5
 x3S11Max=-0.5
 S11Min=-2604.59564781969 PtS11Min=1 x2S11Min=-0.5 x3S11Min=-0.5 FrameElem=85 ElemStation=0

Frame=85 Station=0.5 OutputCase=ENVE CaseType=Combination StepType=Min P=-824.999993483393 V2=-
 79.5182097289993 V3=0 T=0 M2=0 M3=-251.844748871976 S11Max=356.995138019628 PtS11Max=3 x2S11Max=0.5
 x3S11Max=-0.5
 S11Min=-2336.06848636492 PtS11Min=1 x2S11Min=-0.5 x3S11Min=-0.5 FrameElem=85 ElemStation=0.5

Frame=85 Station=0 OutputCase=PESSUR CaseType=Combination P=-837.499992898801 V2=-153.076959796564
 V3=0 T=0 M2=0 M3=-255.059126798031 S11Max=692.854767889388 PtS11Max=3 x2S11Max=0.5 x3S11Max=-0.5
 S11Min=-2367.85475368699 PtS11Min=1 x2S11Min=-0.5 x3S11Min=-0.5 FrameElem=85 ElemStation=0

Frame=85 Station=0.5 OutputCase=PESSUR CaseType=Combination P=-824.999993483393 V2=-79.5182097289993
 V3=0 T=0 M2=0 M3=-196.999188583837 S11Max=356.995138019628 PtS11Max=3 x2S11Max=0.5 x3S11Max=-0.5
 S11Min=-2006.99512498642 PtS11Min=1 x2S11Min=-0.5 x3S11Min=-0.5 FrameElem=85 ElemStation=0.5

Frame=86 Station=0 OutputCase=PESOPR CaseType=LinStatic P=-124.999998697982 V2=-15.1709477295956 V3=0
 T=0 M2=0 M3=-58.9989450988365 S11Max=228.993671895037 PtS11Max=3 x2S11Max=0.5 x3S11Max=-0.5
 S11Min=-478.993669291001 PtS11Min=1 x2S11Min=-0.5 x3S11Min=-0.5 FrameElem=86 ElemStation=0

Frame=86 Station=0.5 OutputCase=PESOPR CaseType=LinStatic P=-112.499998697982 V2=-15.1709476302545
 V3=0 T=0 M2=0 M3=-51.413471258874 S11Max=195.980828855262 PtS11Max=3 x2S11Max=0.5 x3S11Max=-0.5
 S11Min=-420.980826251226 PtS11Min=1 x2S11Min=-0.5 x3S11Min=-0.5 FrameElem=86 ElemStation=0.5

Frame=86 Station=0 OutputCase=TERRVERT CaseType=LinStatic P=-699.99999361753 V2=1.64270181885786 V3=0
 T=0 M2=0 M3=-320.818777778797 S11Max=1224.91267305525 PtS11Max=3 x2S11Max=0.5 x3S11Max=-0.5
 S11Min=-2624.91266029031 PtS11Min=1 x2S11Min=-0.5 x3S11Min=-0.5 FrameElem=86 ElemStation=0

Frame=86 Station=0.5 OutputCase=TERRVERT CaseType=LinStatic P=-699.99999361753 V2=1.64270181885786
 V3=0 T=0 M2=0 M3=-321.640128688226 S11Max=1229.84077851183 PtS11Max=3 x2S11Max=0.5 x3S11Max=-0.5
 S11Min=-2629.84076574689 PtS11Min=1 x2S11Min=-0.5 x3S11Min=-0.5 FrameElem=86 ElemStation=0.5

Frame=86 Station=0 OutputCase=TERRLAT CaseType=LinStatic P=-1.16776482173009E-06 V2=-65.9899638182587
 V3=0 T=0 M2=0 M3=182.818534293797 S11Max=1096.91120459502 PtS11Max=1 x2S11Max=-0.5 x3S11Max=-0.5
 S11Min=-1096.91120693055 PtS11Min=3 x2S11Min=0.5 x3S11Min=-0.5 FrameElem=86 ElemStation=0

Frame=86 Station=0.5 OutputCase=TERRLAT CaseType=LinStatic P=-1.73540968549995E-06 V2=5.43628613725386
 V3=0 T=0 M2=0 M3=197.868099546852 S11Max=1187.2085955457 PtS11Max=1 x2S11Max=-0.5 x3S11Max=-0.5
 S11Min=-1187.20859901652 PtS11Min=3 x2S11Min=0.5 x3S11Min=-0.5 FrameElem=86 ElemStation=0.5

Frame=86 Station=0 OutputCase=ACCVERT CaseType=LinStatic P=0 V2=0 V3=0 T=0 M2=0 M3=0
 PtS11Max=0 x2S11Max=0 x3S11Max=0 S11Min=0 PtS11Min=0 x2S11Min=0 x3S11Min=0 FrameElem=86
 ElemStation=0

Frame=86 Station=0.5 OutputCase=ACCVERT CaseType=LinStatic P=0 V2=0 V3=0 T=0 M2=0 M3=0
 S11Max=0 PtS11Max=0 x2S11Max=0 x3S11Max=0 S11Min=0 PtS11Min=0 x2S11Min=0 x3S11Min=0 FrameElem=86
 ElemStation=0.5

Frame=86 Station=0 OutputCase=ACCLATDX CaseType=LinStatic P=0 V2=0 V3=0 T=0 M2=0 M3=0
 S11Max=0 PtS11Max=0 x2S11Max=0 x3S11Max=0 S11Min=0 PtS11Min=0 x2S11Min=0 x3S11Min=0 FrameElem=86
 ElemStation=0

Frame=86 Station=0.5 OutputCase=ACCLATDX CaseType=LinStatic P=0 V2=0 V3=0 T=0 M2=0 M3=0
 S11Max=0 PtS11Max=0 x2S11Max=0 x3S11Max=0 S11Min=0 PtS11Min=0 x2S11Min=0 x3S11Min=0 FrameElem=86
 ElemStation=0.5

Frame=86 Station=0 OutputCase=ACCLATSX CaseType=LinStatic P=0 V2=0 V3=0 T=0 M2=0 M3=0
 S11Max=0 PtS11Max=0 x2S11Max=0 x3S11Max=0 S11Min=0 PtS11Min=0 x2S11Min=0 x3S11Min=0 FrameElem=86
 ElemStation=0

Frame=86 Station=0.5 OutputCase=ACCLATSX CaseType=LinStatic P=0 V2=0 V3=0 T=0 M2=0 M3=0
S11Max=0 PtS11Max=0 x2S11Max=0 x3S11Max=0 S11Min=0 PtS11Min=0 x2S11Min=0 x3S11Min=0 FrameElem=86
ElemStation=0.5

Frame=86 Station=0 OutputCase=TERRCOST CaseType=LinStatic P=0 V2=0 V3=0 T=0 M2=0 M3=0
S11Max=0 PtS11Max=0 x2S11Max=0 x3S11Max=0 S11Min=0 PtS11Min=0 x2S11Min=0 x3S11Min=0 FrameElem=86
ElemStation=0

Frame=86 Station=0.5 OutputCase=TERRCOST CaseType=LinStatic P=0 V2=0 V3=0 T=0 M2=0 M3=0
S11Max=0 PtS11Max=0 x2S11Max=0 x3S11Max=0 S11Min=0 PtS11Min=0 x2S11Min=0 x3S11Min=0 FrameElem=86
ElemStation=0.5

Frame=86 Station=0 OutputCase=SOVRCOST CaseType=LinStatic P=0 V2=0 V3=0 T=0 M2=0 M3=0
S11Max=0 PtS11Max=0 x2S11Max=0 x3S11Max=0 S11Min=0 PtS11Min=0 x2S11Min=0 x3S11Min=0 FrameElem=86
ElemStation=0

Frame=86 Station=0.5 OutputCase=SOVRCOST CaseType=LinStatic P=0 V2=0 V3=0 T=0 M2=0 M3=0
S11Max=0 PtS11Max=0 x2S11Max=0 x3S11Max=0 S11Min=0 PtS11Min=0 x2S11Min=0 x3S11Min=0 FrameElem=86
ElemStation=0.5

Frame=86 Station=0 OutputCase=ENVE CaseType=Combination StepType=Max P=-824.999993132947 V2=-
59.7212205835188 V3=0 T=0 M2=0 M3=-196.999188583837 S11Max=686.068500098909 PtS11Max=3 x2S11Max=0.5
x3S11Max=-0.5 _
S11Min=-2006.9951249863 PtS11Min=1 x2S11Min=-0.5 x3S11Min=-0.5 FrameElem=86 ElemStation=0

Frame=86 Station=0.5 OutputCase=ENVE CaseType=Combination StepType=Max P=-812.499993530299 V2=-
8.09195967414279 V3=0 T=0 M2=0 M3=-175.185500400249 S11Max=594.775588055525 PtS11Max=3 x2S11Max=0.5
x3S11Max=-0.5 _
S11Min=-1863.61299645241 PtS11Min=1 x2S11Min=-0.5 x3S11Min=-0.5 FrameElem=86 ElemStation=0.5

Frame=86 Station=0 OutputCase=ENVE CaseType=Combination StepType=Min P=-824.999993483277 V2=-
79.5182097289965 V3=0 T=0 M2=0 M3=-251.844748871976 S11Max=356.995138019746 PtS11Max=3 x2S11Max=0.5
x3S11Max=-0.5 _
S11Min=-2336.0684863648 PtS11Min=1 x2S11Min=-0.5 x3S11Min=-0.5 FrameElem=86 ElemStation=0

Frame=86 Station=0.5 OutputCase=ENVE CaseType=Combination StepType=Min P=-812.499994050922 V2=-
9.72284551531894 V3=0 T=0 M2=0 M3=-234.545930264304 S11Max=238.613008350569 PtS11Max=3 x2S11Max=0.5
x3S11Max=-0.5 _
S11Min=-2219.77557511612 PtS11Min=1 x2S11Min=-0.5 x3S11Min=-0.5 FrameElem=86 ElemStation=0.5

Frame=86 Station=0 OutputCase=FESSUR CaseType=Combination P=-824.999993483277 V2=-79.5182097289965
V3=0 T=0 M2=0 M3=-196.999188583837 S11Max=356.995138019746 PtS11Max=3 x2S11Max=0.5 x3S11Max=-0.5 _
S11Min=-2006.9951249863 PtS11Min=1 x2S11Min=-0.5 x3S11Min=-0.5 FrameElem=86 ElemStation=0

Frame=86 Station=0.5 OutputCase=FESSUR CaseType=Combination P=-812.499994050922 V2=-8.09195967414279
V3=0 T=0 M2=0 M3=-175.185500400249 S11Max=594.775588055525 PtS11Max=3 x2S11Max=0.5 x3S11Max=-0.5 _
S11Min=-1863.61299645241 PtS11Min=1 x2S11Min=-0.5 x3S11Min=-0.5 FrameElem=86 ElemStation=0.5

Frame=87 Station=0 OutputCase=PESOPR CaseType=LinStatic P=-112.499998697982 V2=-15.1709476302543 V3=0
T=0 M2=0 M3=-51.413471258874 S11Max=195.980828855262 PtS11Max=3 x2S11Max=0.5 x3S11Max=-0.5 _
S11Min=-420.980826251226 PtS11Min=1 x2S11Min=-0.5 x3S11Min=-0.5 FrameElem=87 ElemStation=0

Frame=87 Station=0.5 OutputCase=PESOPR CaseType=LinStatic P=-99.999986979819 V2=-15.1709475309132
V3=0 T=0 M2=0 M3=-43.8279974685821 S11Max=162.967986113511 PtS11Max=3 x2S11Max=0.5 x3S11Max=-0.5 _
S11Min=-362.967983509474 PtS11Min=1 x2S11Min=-0.5 x3S11Min=-0.5 FrameElem=87 ElemStation=0.5

Frame=87 Station=0 OutputCase=TERRVERT CaseType=LinStatic P=-699.99999361753 V2=1.64270181885877 V3=0
T=0 M2=0 M3=-321.640128688226 S11Max=1229.84077851182 PtS11Max=3 x2S11Max=0.5 x3S11Max=-0.5 _
S11Min=-2629.84076574688 PtS11Min=1 x2S11Min=-0.5 x3S11Min=-0.5 FrameElem=87 ElemStation=0

Frame=87 Station=0.5 OutputCase=TERRVERT CaseType=LinStatic P=-699.99999361753 V2=1.64270181885877
V3=0 T=0 M2=0 M3=-322.461479597655 S11Max=1234.7688839684 PtS11Max=3 x2S11Max=0.5 x3S11Max=-0.5 _
S11Min=-2634.76887120346 PtS11Min=1 x2S11Min=-0.5 x3S11Min=-0.5 FrameElem=87 ElemStation=0.5

Frame=87 Station=0 OutputCase=TERRLAT CaseType=LinStatic P=-1.73541047843173E-06 V2=5.43628613725286
V3=0 T=0 M2=0 M3=197.868099546852 S11Max=1187.2085955457 PtS11Max=1 x2S11Max=-0.5 x3S11Max=-0.5 _
S11Min=-1187.20859901652 PtS11Min=3 x2S11Min=0.5 x3S11Min=-0.5 FrameElem=87 ElemStation=0

Frame=87 Station=0.5 OutputCase=TERRLAT CaseType=LinStatic P=-2.28610769234034E-06 V2=74.7300360800547
V3=0 T=0 M2=0 M3=177.737664825329 S11Max=1066.42598666586 PtS11Max=1 x2S11Max=-0.5 x3S11Max=-0.5 _
S11Min=-1066.42599123808 PtS11Min=3 x2S11Min=0.5 x3S11Min=-0.5 FrameElem=87 ElemStation=0.5

Frame=87 Station=0 OutputCase=ACCVERT CaseType=LinStatic P=0 V2=0 V3=0 T=0 M2=0 M3=0 S11Max=0
PtS11Max=0 x2S11Max=0 x3S11Max=0 S11Min=0 PtS11Min=0 x2S11Min=0 x3S11Min=0 FrameElem=87
ElemStation=0

Frame=87 Station=0.5 OutputCase=ACCVERT CaseType=LinStatic P=0 V2=0 V3=0 T=0 M2=0 M3=0
S11Max=0 PtS11Max=0 x2S11Max=0 x3S11Max=0 S11Min=0 PtS11Min=0 x2S11Min=0 x3S11Min=0 FrameElem=87
ElemStation=0.5

Frame=87 Station=0 OutputCase=ACCLATDX CaseType=LinStatic P=0 V2=0 V3=0 T=0 M2=0 M3=0
S11Max=0 PtS11Max=0 x2S11Max=0 x3S11Max=0 S11Min=0 PtS11Min=0 x2S11Min=0 x3S11Min=0 FrameElem=87
ElemStation=0

Frame=87 Station=0.5 OutputCase=ACCLATDX CaseType=LinStatic P=0 V2=0 V3=0 T=0 M2=0 M3=0
S11Max=0 PtS11Max=0 x2S11Max=0 x3S11Max=0 S11Min=0 PtS11Min=0 x2S11Min=0 x3S11Min=0 FrameElem=87
ElemStation=0.5

Frame=87 Station=0 OutputCase=ACCLATSX CaseType=LinStatic P=0 V2=0 V3=0 T=0 M2=0 M3=0
S11Max=0 PtS11Max=0 x2S11Max=0 x3S11Max=0 S11Min=0 PtS11Min=0 x2S11Min=0 x3S11Min=0 FrameElem=87
ElemStation=0

Frame=87 Station=0.5 OutputCase=ACCLATSX CaseType=LinStatic P=0 V2=0 V3=0 T=0 M2=0 M3=0
S11Max=0 PtS11Max=0 x2S11Max=0 x3S11Max=0 S11Min=0 PtS11Min=0 x2S11Min=0 x3S11Min=0 FrameElem=87
ElemStation=0.5

Frame=87 Station=0 OutputCase=TERRCOST CaseType=LinStatic P=0 V2=0 V3=0 T=0 M2=0 M3=0
S11Max=0 PtS11Max=0 x2S11Max=0 x3S11Max=0 S11Min=0 PtS11Min=0 x2S11Min=0 x3S11Min=0 FrameElem=87
ElemStation=0

Frame=87 Station=0.5 OutputCase=TERRCOST CaseType=LinStatic P=0 V2=0 V3=0 T=0 M2=0 M3=0
S11Max=0 PtS11Max=0 x2S11Max=0 x3S11Max=0 S11Min=0 PtS11Min=0 x2S11Min=0 x3S11Min=0 FrameElem=87
ElemStation=0.5

Frame=87 Station=0 OutputCase=SOVRCOST CaseType=LinStatic P=0 V2=0 V3=0 T=0 M2=0 M3=0
S11Max=0 PtS11Max=0 x2S11Max=0 x3S11Max=0 S11Min=0 PtS11Min=0 x2S11Min=0 x3S11Min=0 FrameElem=87
ElemStation=0



Frame=87 Station=0.5 OutputCase=SOVRCOST CaseType=LinStatic P=0 V2=0 V3=0 T=0 M2=0 M3=0
 S11Max=0 PtS11Max=0 x2S11Max=0 x3S11Max=0 S11Min=0 PtS11Min=0 x2S11Min=0 x3S11Min=0 FrameElem=87
 ElemStation=0.5
 Frame=87 Station=0 OutputCase=ENVE CaseType=Combination StepType=Max P=-812.499993530299 V2=-
 8.09195967414269 V3=0 T=0 M2=0 M3=-175.185500400248 S11Max=594.775588055521 PtS11Max=3 x2S11Max=0.5
 x3S11Max=-0.5
 S11Min=-1863.61299645241 PtS11Min=1 x2S11Min=-0.5 x3S11Min=-0.5 FrameElem=87 ElemStation=0
 Frame=87 Station=0.5 OutputCase=ENVE CaseType=Combination StepType=Max P=-799.999993915787
 V2=61.2017903680002 V3=0 T=0 M2=0 M3=-188.551812240908 S11Max=651.238676215255 PtS11Max=3 x2S11Max=0.5
 x3S11Max=-0.5
 S11Min=-1931.31086804707 PtS11Min=1 x2S11Min=-0.5 x3S11Min=-0.5 FrameElem=87 ElemStation=0.5
 Frame=87 Station=0 OutputCase=ENVE CaseType=Combination StepType=Min P=-812.499994050922 V2=-
 9.72284551531854 V3=0 T=0 M2=0 M3=-234.545930264303 S11Max=238.613008350564 PtS11Max=3 x2S11Max=0.5
 x3S11Max=-0.5
 S11Min=-2219.77557511612 PtS11Min=1 x2S11Min=-0.5 x3S11Min=-0.5 FrameElem=87 ElemStation=0
 Frame=87 Station=0.5 OutputCase=ENVE CaseType=Combination StepType=Min P=-799.99999460162
 V2=38.7827795439838 V3=0 T=0 M2=0 M3=-241.873111688507 S11Max=331.310878843831 PtS11Max=3 x2S11Max=0.5
 x3S11Max=-0.5
 S11Min=-2251.23866404683 PtS11Min=1 x2S11Min=-0.5 x3S11Min=-0.5 FrameElem=87 ElemStation=0.5
 Frame=87 Station=0 OutputCase=FESSUR CaseType=Combination P=-812.499994050922 V2=-8.09195967414269
 V3=0 T=0 M2=0 M3=-175.185500400248 S11Max=238.613008350564 PtS11Max=3 x2S11Max=0.5 x3S11Max=-0.5
 S11Min=-1863.61299645241 PtS11Min=1 x2S11Min=-0.5 x3S11Min=-0.5 FrameElem=87 ElemStation=0
 Frame=87 Station=0.5 OutputCase=FESSUR CaseType=Combination P=-799.99999460162 V2=61.2017903680002
 V3=0 T=0 M2=0 M3=-188.551812240908 S11Max=331.310878843831 PtS11Max=3 x2S11Max=0.5 x3S11Max=-0.5
 S11Min=-1931.31086804707 PtS11Min=1 x2S11Min=-0.5 x3S11Min=-0.5 FrameElem=87 ElemStation=0.5
 Frame=88 Station=0 OutputCase=PESOPR CaseType=LinStatic P=-99.9999986979819 V2=-15.1709475309133 V3=0
 T=0 M2=0 M3=-43.8279974685821 S11Max=162.967986113511 PtS11Max=3 x2S11Max=0.5 x3S11Max=-0.5
 S11Min=-362.967983509474 PtS11Min=1 x2S11Min=-0.5 x3S11Min=-0.5 FrameElem=88 ElemStation=0
 Frame=88 Station=0.5 OutputCase=PESOPR CaseType=LinStatic P=-87.4999986979819 V2=-15.1709474315722
 V3=0 T=0 M2=0 M3=-36.2425237279607 S11Max=129.955143669782 PtS11Max=3 x2S11Max=0.5 x3S11Max=-0.5
 S11Min=-304.955141065746 PtS11Min=1 x2S11Min=-0.5 x3S11Min=-0.5 FrameElem=88 ElemStation=0.5
 Frame=88 Station=0 OutputCase=TERRVERT CaseType=LinStatic P=-699.99999361753 V2=1.64270181885877 V3=0
 T=0 M2=0 M3=-322.461479597655 S11Max=1234.7688839684 PtS11Max=3 x2S11Max=0.5 x3S11Max=-0.5
 S11Min=-2634.76887120346 PtS11Min=1 x2S11Min=-0.5 x3S11Min=-0.5 FrameElem=88 ElemStation=0
 Frame=88 Station=0.5 OutputCase=TERRVERT CaseType=LinStatic P=-699.99999361753 V2=1.64270181885877
 V3=0 T=0 M2=0 M3=-323.282830507084 S11Max=1239.69698942498 PtS11Max=3 x2S11Max=0.5 x3S11Max=-0.5
 S11Min=-2639.69697666004 PtS11Min=1 x2S11Min=-0.5 x3S11Min=-0.5 FrameElem=88 ElemStation=0.5
 Frame=88 Station=0 OutputCase=TERRLAT CaseType=LinStatic P=-2.28610770136584E-06 V2=74.7300360800532
 V3=0 T=0 M2=0 M3=177.737664825329 S11Max=1066.42598666587 PtS11Max=1 x2S11Max=-0.5 x3S11Max=-0.5
 S11Min=-1066.42599123808 PtS11Min=3 x2S11Min=0.5 x3S11Min=-0.5 FrameElem=88 ElemStation=0
 Frame=88 Station=0.5 OutputCase=TERRLAT CaseType=LinStatic P=-2.81985732885245E-06 V2=141.891286010144
 V3=0 T=0 M2=0 M3=123.493480135583 S11Max=740.960877993642 PtS11Max=1 x2S11Max=-0.5 x3S11Max=-0.5
 S11Min=-740.960883633357 PtS11Min=3 x2S11Min=0.5 x3S11Min=-0.5 FrameElem=88 ElemStation=0.5
 Frame=88 Station=0 OutputCase=ACCVERT CaseType=LinStatic P=0 V2=0 V3=0 T=0 M2=0 M3=0 S11Max=0
 PtS11Max=0 x2S11Max=0 x3S11Max=0 S11Min=0 PtS11Min=0 x2S11Min=0 x3S11Min=0 FrameElem=88
 ElemStation=0
 Frame=88 Station=0.5 OutputCase=ACCVERT CaseType=LinStatic P=0 V2=0 V3=0 T=0 M2=0 M3=0
 S11Max=0 PtS11Max=0 x2S11Max=0 x3S11Max=0 S11Min=0 PtS11Min=0 x2S11Min=0 x3S11Min=0 FrameElem=88
 ElemStation=0.5
 Frame=88 Station=0 OutputCase=ACCLATDX CaseType=LinStatic P=0 V2=0 V3=0 T=0 M2=0 M3=0
 S11Max=0 PtS11Max=0 x2S11Max=0 x3S11Max=0 S11Min=0 PtS11Min=0 x2S11Min=0 x3S11Min=0 FrameElem=88
 ElemStation=0
 Frame=88 Station=0.5 OutputCase=ACCLATDX CaseType=LinStatic P=0 V2=0 V3=0 T=0 M2=0 M3=0
 S11Max=0 PtS11Max=0 x2S11Max=0 x3S11Max=0 S11Min=0 PtS11Min=0 x2S11Min=0 x3S11Min=0 FrameElem=88
 ElemStation=0.5
 Frame=88 Station=0 OutputCase=ACCLATSX CaseType=LinStatic P=0 V2=0 V3=0 T=0 M2=0 M3=0
 S11Max=0 PtS11Max=0 x2S11Max=0 x3S11Max=0 S11Min=0 PtS11Min=0 x2S11Min=0 x3S11Min=0 FrameElem=88
 ElemStation=0
 Frame=88 Station=0.5 OutputCase=ACCLATSX CaseType=LinStatic P=0 V2=0 V3=0 T=0 M2=0 M3=0
 S11Max=0 PtS11Max=0 x2S11Max=0 x3S11Max=0 S11Min=0 PtS11Min=0 x2S11Min=0 x3S11Min=0 FrameElem=88
 ElemStation=0.5
 Frame=88 Station=0 OutputCase=TERRCOST CaseType=LinStatic P=0 V2=0 V3=0 T=0 M2=0 M3=0
 S11Max=0 PtS11Max=0 x2S11Max=0 x3S11Max=0 S11Min=0 PtS11Min=0 x2S11Min=0 x3S11Min=0 FrameElem=88
 ElemStation=0
 Frame=88 Station=0.5 OutputCase=TERRCOST CaseType=LinStatic P=0 V2=0 V3=0 T=0 M2=0 M3=0
 S11Max=0 PtS11Max=0 x2S11Max=0 x3S11Max=0 S11Min=0 PtS11Min=0 x2S11Min=0 x3S11Min=0 FrameElem=88
 ElemStation=0.5
 Frame=88 Station=0 OutputCase=SOVRCOST CaseType=LinStatic P=0 V2=0 V3=0 T=0 M2=0 M3=0
 S11Max=0 PtS11Max=0 x2S11Max=0 x3S11Max=0 S11Min=0 PtS11Min=0 x2S11Min=0 x3S11Min=0 FrameElem=88
 ElemStation=0
 Frame=88 Station=0.5 OutputCase=SOVRCOST CaseType=LinStatic P=0 V2=0 V3=0 T=0 M2=0 M3=0
 S11Max=0 PtS11Max=0 x2S11Max=0 x3S11Max=0 S11Min=0 PtS11Min=0 x2S11Min=0 x3S11Min=0 FrameElem=88
 ElemStation=0.5
 Frame=88 Station=0 OutputCase=ENVE CaseType=Combination StepType=Max P=-799.999993915787
 V2=61.2017903679987 V3=0 T=0 M2=0 M3=-188.551812240908 S11Max=651.238676215254 PtS11Max=3 x2S11Max=0.5
 x3S11Max=-0.5
 S11Min=-1931.31086804707 PtS11Min=1 x2S11Min=-0.5 x3S11Min=-0.5 FrameElem=88 ElemStation=0
 Frame=88 Station=0.5 OutputCase=ENVE CaseType=Combination StepType=Max P=-787.499994289412
 V2=128.363040397431 V3=0 T=0 M2=0 M3=-236.031874099462 S11Max=850.979514551409 PtS11Max=3 x2S11Max=0.5
 x3S11Max=-0.5
 S11Min=-2203.69123973214 PtS11Min=1 x2S11Min=-0.5 x3S11Min=-0.5 FrameElem=88 ElemStation=0.5

Frame=88 Station=0 OutputCase=ENVE CaseType=Combination StepType=Min P=-799.99999460162
V2=38.7827795439827 V3=0 T=0 M2=0 M3=-241.873111688507 S11Max=331.31087884383 PtS11Max=3 x2S11Max=0.5
x3S11Max=-0.5 _
S11Min=-2251.23866404683 PtS11Min=1 x2S11Min=-0.5 x3S11Min=-0.5 FrameElem=88 ElemStation=0

Frame=88 Station=0.5 OutputCase=ENVE CaseType=Combination StepType=Min P=-787.499995135369
V2=85.7956545943876 V3=0 T=0 M2=0 M3=-273.079918140137 S11Max=628.691249461402 PtS11Max=3 x2S11Max=0.5
x3S11Max=-0.5 _
S11Min=-2425.97950313023 PtS11Min=1 x2S11Min=-0.5 x3S11Min=-0.5 FrameElem=88 ElemStation=0.5

Frame=88 Station=0 OutputCase=FESSUR CaseType=Combination P=-799.99999460162 V2=61.2017903679987 V3=0
T=0 M2=0 M3=-188.551812240908 S11Max=331.31087884383 PtS11Max=3 x2S11Max=0.5 x3S11Max=-0.5 _
S11Min=-1931.31086804707 PtS11Min=1 x2S11Min=-0.5 x3S11Min=-0.5 FrameElem=88 ElemStation=0

Frame=88 Station=0.5 OutputCase=FESSUR CaseType=Combination P=-787.499995135369 V2=128.363040397431
V3=0 T=0 M2=0 M3=-236.031874099462 S11Max=628.691249461402 PtS11Max=3 x2S11Max=0.5 x3S11Max=-0.5 _
S11Min=-2203.69123973214 PtS11Min=1 x2S11Min=-0.5 x3S11Min=-0.5 FrameElem=88 ElemStation=0.5

Frame=89 Station=0 OutputCase=PESOPR CaseType=LinStatic P=-87.4999986978946 V2=-15.1709474315734 V3=0
T=0 M2=0 M3=-36.2425237279608 S11Max=129.95514366987 PtS11Max=3 x2S11Max=0.5 x3S11Max=-0.5 _
S11Min=-304.955141065659 PtS11Min=1 x2S11Min=-0.5 x3S11Min=-0.5 FrameElem=89 ElemStation=0

Frame=89 Station=0.5 OutputCase=PESOPR CaseType=LinStatic P=-74.9999986978946 V2=-15.1709473322324
V3=0 T=0 M2=0 M3=-28.6570500370093 S11Max=96.9423015241613 PtS11Max=3 x2S11Max=0.5 x3S11Max=-0.5 _
S11Min=-246.942298919951 PtS11Min=1 x2S11Min=-0.5 x3S11Min=-0.5 FrameElem=89 ElemStation=0.5

Frame=89 Station=0 OutputCase=TERRVERT CaseType=LinStatic P=-699.99993617297 V2=1.64270181886013
V3=0 T=0 M2=0 M3=-323.282830507084 S11Max=1239.69698942521 PtS11Max=3 x2S11Max=0.5 x3S11Max=-0.5 _
S11Min=-2639.6969766598 PtS11Min=1 x2S11Min=-0.5 x3S11Min=-0.5 FrameElem=89 ElemStation=0

Frame=89 Station=0.5 OutputCase=TERRVERT CaseType=LinStatic P=-699.99993617297 V2=1.64270181886013
V3=0 T=0 M2=0 M3=-324.104181416514 S11Max=1244.62509488179 PtS11Max=3 x2S11Max=0.5 x3S11Max=-0.5 _
S11Min=-2644.62508211638 PtS11Min=1 x2S11Min=-0.5 x3S11Min=-0.5 FrameElem=89 ElemStation=0.5

Frame=89 Station=0 OutputCase=TERRLAT CaseType=LinStatic P=-2.81985921901651E-06 V2=141.891286010144
V3=0 T=0 M2=0 M3=123.493480135583 S11Max=740.96087799364 PtS11Max=1 x2S11Max=-0.5 x3S11Max=-0.5 _
S11Min=-740.960883633359 PtS11Min=3 x2S11Min=0.5 x3S11Min=-0.5 FrameElem=89 ElemStation=0

Frame=89 Station=0.5 OutputCase=TERRLAT CaseType=LinStatic P=-3.33666131783826E-06 V2=206.920035927524
V3=0 T=0 M2=0 M3=36.20179548397 S11Max=217.210769567159 PtS11Max=1 x2S11Max=-0.5 x3S11Max=-0.5 _
S11Min=-217.210776240481 PtS11Min=3 x2S11Min=0.5 x3S11Min=-0.5 FrameElem=89 ElemStation=0.5

Frame=89 Station=0 OutputCase=ACCVERT CaseType=LinStatic P=0 V2=0 V3=0 T=0 M2=0 M3=0
PtS11Max=0 x2S11Max=0 x3S11Max=0 S11Min=0 PtS11Min=0 x2S11Min=0 x3S11Min=0 FrameElem=89
ElemStation=0

Frame=89 Station=0.5 OutputCase=ACCVERT CaseType=LinStatic P=0 V2=0 V3=0 T=0 M2=0 M3=0
S11Max=0 PtS11Max=0 x2S11Max=0 x3S11Max=0 S11Min=0 PtS11Min=0 x2S11Min=0 x3S11Min=0 FrameElem=89
ElemStation=0.5

Frame=89 Station=0 OutputCase=ACCLATDX CaseType=LinStatic P=0 V2=0 V3=0 T=0 M2=0 M3=0
S11Max=0 PtS11Max=0 x2S11Max=0 x3S11Max=0 S11Min=0 PtS11Min=0 x2S11Min=0 x3S11Min=0 FrameElem=89
ElemStation=0

Frame=89 Station=0.5 OutputCase=ACCLATDX CaseType=LinStatic P=0 V2=0 V3=0 T=0 M2=0 M3=0
S11Max=0 PtS11Max=0 x2S11Max=0 x3S11Max=0 S11Min=0 PtS11Min=0 x2S11Min=0 x3S11Min=0 FrameElem=89
ElemStation=0.5

Frame=89 Station=0 OutputCase=ACCLATSX CaseType=LinStatic P=0 V2=0 V3=0 T=0 M2=0 M3=0
S11Max=0 PtS11Max=0 x2S11Max=0 x3S11Max=0 S11Min=0 PtS11Min=0 x2S11Min=0 x3S11Min=0 FrameElem=89
ElemStation=0

Frame=89 Station=0.5 OutputCase=ACCLATSX CaseType=LinStatic P=0 V2=0 V3=0 T=0 M2=0 M3=0
S11Max=0 PtS11Max=0 x2S11Max=0 x3S11Max=0 S11Min=0 PtS11Min=0 x2S11Min=0 x3S11Min=0 FrameElem=89
ElemStation=0.5

Frame=89 Station=0 OutputCase=TERRCOST CaseType=LinStatic P=0 V2=0 V3=0 T=0 M2=0 M3=0
S11Max=0 PtS11Max=0 x2S11Max=0 x3S11Max=0 S11Min=0 PtS11Min=0 x2S11Min=0 x3S11Min=0 FrameElem=89
ElemStation=0

Frame=89 Station=0.5 OutputCase=TERRCOST CaseType=LinStatic P=0 V2=0 V3=0 T=0 M2=0 M3=0
S11Max=0 PtS11Max=0 x2S11Max=0 x3S11Max=0 S11Min=0 PtS11Min=0 x2S11Min=0 x3S11Min=0 FrameElem=89
ElemStation=0.5

Frame=89 Station=0 OutputCase=SOVRCOST CaseType=LinStatic P=0 V2=0 V3=0 T=0 M2=0 M3=0
S11Max=0 PtS11Max=0 x2S11Max=0 x3S11Max=0 S11Min=0 PtS11Min=0 x2S11Min=0 x3S11Min=0 FrameElem=89
ElemStation=0

Frame=89 Station=0.5 OutputCase=SOVRCOST CaseType=LinStatic P=0 V2=0 V3=0 T=0 M2=0 M3=0
S11Max=0 PtS11Max=0 x2S11Max=0 x3S11Max=0 S11Min=0 PtS11Min=0 x2S11Min=0 x3S11Min=0 FrameElem=89
ElemStation=0.5

Frame=89 Station=0 OutputCase=ENVE CaseType=Combination StepType=Max P=-787.499994289093
V2=128.36304039743 V3=0 T=0 M2=0 M3=-236.031874099462 S11Max=850.979514551726 PtS11Max=3 x2S11Max=0.5
x3S11Max=-0.5 _
S11Min=-2203.69123973182 PtS11Min=1 x2S11Min=-0.5 x3S11Min=-0.5 FrameElem=89 ElemStation=0

Frame=89 Station=0.5 OutputCase=ENVE CaseType=Combination StepType=Max P=-774.999994650855
V2=193.391790414152 V3=0 T=0 M2=0 M3=-316.559435969553 S11Max=1189.51985303761 PtS11Max=3 x2S11Max=0.5
x3S11Max=-0.5 _
S11Min=-2674.35661146917 PtS11Min=1 x2S11Min=-0.5 x3S11Min=-0.5 FrameElem=89 ElemStation=0.5

Frame=89 Station=0 OutputCase=ENVE CaseType=Combination StepType=Min P=-787.499995135051
V2=85.7956545943872 V3=0 T=0 M2=0 M3=-273.079918140137 S11Max=628.691249461718 PtS11Max=3 x2S11Max=0.5
x3S11Max=-0.5 _
S11Min=-2425.97950312991 PtS11Min=1 x2S11Min=-0.5 x3S11Min=-0.5 FrameElem=89 ElemStation=0

Frame=89 Station=0.5 OutputCase=ENVE CaseType=Combination StepType=Min P=-774.999995651853
V2=131.315779635895 V3=0 T=0 M2=0 M3=-327.419974614744 S11Max=1124.35662016547 PtS11Max=3 x2S11Max=0.5
x3S11Max=-0.5 _
S11Min=-2739.51984233932 PtS11Min=1 x2S11Min=-0.5 x3S11Min=-0.5 FrameElem=89 ElemStation=0.5

Frame=89 Station=0 OutputCase=FESSUR CaseType=Combination P=-787.499995135051 V2=128.36304039743 V3=0
T=0 M2=0 M3=-236.031874099462 S11Max=628.691249461718 PtS11Max=3 x2S11Max=0.5 x3S11Max=-0.5 _
S11Min=-2203.69123973182 PtS11Min=1 x2S11Min=-0.5 x3S11Min=-0.5 FrameElem=89 ElemStation=0

```

Frame=89 Station=0.5 OutputCase=FESSUR CaseType=Combination P=-774.999995651853 V2=193.391790414152
V3=0 T=0 M2=0 M3=-316.559435969553 S11Max=1124.35662016547 PtS11Max=3 x2S11Max=0.5 x3S11Max=-0.5 _
S11Min=-2674.35661146917 PtS11Min=1 x2S11Min=-0.5 x3S11Min=-0.5 FrameElem=89 ElemStation=0.5
Frame=90 Station=0 OutputCase=PESOPR CaseType=LinStatic P=-149.999999272346 V2=15.1709479282789 V3=0
T=0 M2=0 M3=74.1698928722702 S11Max=295.019357961275 PtS11Max=1 x2S11Max=-0.5 x3S11Max=-0.5 _
S11Min=-595.019356505967 PtS11Min=3 x2S11Min=0.5 x3S11Min=-0.5 FrameElem=90 ElemStation=0
Frame=90 Station=0.5 OutputCase=PESOPR CaseType=LinStatic P=-137.499999272346 V2=15.1709478289378
V3=0 T=0 M2=0 M3=66.584418932966 S11Max=262.00651432545 PtS11Max=1 x2S11Max=-0.5 x3S11Max=-0.5 _
S11Min=-537.006512870142 PtS11Min=3 x2S11Min=0.5 x3S11Min=-0.5 FrameElem=90 ElemStation=0.5
Frame=90 Station=0 OutputCase=TERRVERT CaseType=LinStatic P=-699.999993055826 V2=-1.64270181885468
V3=0 T=0 M2=0 M3=319.176074552322 S11Max=1215.05645425811 PtS11Max=1 x2S11Max=-0.5 x3S11Max=-0.5 _
S11Min=-2615.05644036976 PtS11Min=3 x2S11Min=0.5 x3S11Min=-0.5 FrameElem=90 ElemStation=0
Frame=90 Station=0.5 OutputCase=TERRVERT CaseType=LinStatic P=-699.999993055826 V2=-1.64270181885468
V3=0 T=0 M2=0 M3=319.99742546175 S11Max=1219.98455971467 PtS11Max=1 x2S11Max=-0.5 x3S11Max=-0.5 _
S11Min=-2619.98454582632 PtS11Min=3 x2S11Min=0.5 x3S11Min=-0.5 FrameElem=90 ElemStation=0.5
Frame=90 Station=0 OutputCase=TERRLAT CaseType=LinStatic P=3.40277165378211E-06 V2=215.23996711609
V3=0 T=0 M2=0 M3=-42.9143996493173 S11Max=257.486401298675 PtS11Max=3 x2S11Max=0.5 x3S11Max=-0.5 _
S11Min=-257.486394493132 PtS11Min=1 x2S11Min=-0.5 x3S11Min=-0.5 FrameElem=90 ElemStation=0
Frame=90 Station=0.5 OutputCase=TERRLAT CaseType=LinStatic P=2.80123168045598E-06 V2=139.54871711609
V3=0 T=0 M2=0 M3=-131.522716540696 S11Max=789.136302045406 PtS11Max=3 x2S11Max=0.5 x3S11Max=-0.5 _
S11Min=-789.136296442943 PtS11Min=1 x2S11Min=-0.5 x3S11Min=-0.5 FrameElem=90 ElemStation=0.5
Frame=90 Station=0 OutputCase=ACCVERT CaseType=LinStatic P=0 V2=0 V3=0 T=0 M2=0 M3=0
PtS11Max=0 x2S11Max=0 x3S11Max=0 S11Min=0 PtS11Min=0 x2S11Min=0 x3S11Min=0 FrameElem=90
ElemStation=0
Frame=90 Station=0.5 OutputCase=ACCVERT CaseType=LinStatic P=0 V2=0 V3=0 T=0 M2=0 M3=0
S11Max=0 PtS11Max=0 x2S11Max=0 x3S11Max=0 S11Min=0 PtS11Min=0 x2S11Min=0 x3S11Min=0 FrameElem=90
ElemStation=0.5
Frame=90 Station=0 OutputCase=ACCLATDX CaseType=LinStatic P=0 V2=0 V3=0 T=0 M2=0 M3=0
S11Max=0 PtS11Max=0 x2S11Max=0 x3S11Max=0 S11Min=0 PtS11Min=0 x2S11Min=0 x3S11Min=0 FrameElem=90
ElemStation=0
Frame=90 Station=0.5 OutputCase=ACCLATDX CaseType=LinStatic P=0 V2=0 V3=0 T=0 M2=0 M3=0
S11Max=0 PtS11Max=0 x2S11Max=0 x3S11Max=0 S11Min=0 PtS11Min=0 x2S11Min=0 x3S11Min=0 FrameElem=90
ElemStation=0.5
Frame=90 Station=0 OutputCase=ACCLATSX CaseType=LinStatic P=0 V2=0 V3=0 T=0 M2=0 M3=0
S11Max=0 PtS11Max=0 x2S11Max=0 x3S11Max=0 S11Min=0 PtS11Min=0 x2S11Min=0 x3S11Min=0 FrameElem=90
ElemStation=0
Frame=90 Station=0.5 OutputCase=ACCLATSX CaseType=LinStatic P=0 V2=0 V3=0 T=0 M2=0 M3=0
S11Max=0 PtS11Max=0 x2S11Max=0 x3S11Max=0 S11Min=0 PtS11Min=0 x2S11Min=0 x3S11Min=0 FrameElem=90
ElemStation=0.5
Frame=90 Station=0 OutputCase=TERRCOST CaseType=LinStatic P=0 V2=0 V3=0 T=0 M2=0 M3=0
S11Max=0 PtS11Max=0 x2S11Max=0 x3S11Max=0 S11Min=0 PtS11Min=0 x2S11Min=0 x3S11Min=0 FrameElem=90
ElemStation=0
Frame=90 Station=0.5 OutputCase=TERRCOST CaseType=LinStatic P=0 V2=0 V3=0 T=0 M2=0 M3=0
S11Max=0 PtS11Max=0 x2S11Max=0 x3S11Max=0 S11Min=0 PtS11Min=0 x2S11Min=0 x3S11Min=0 FrameElem=90
ElemStation=0.5
Frame=90 Station=0 OutputCase=SOVRCOST CaseType=LinStatic P=0 V2=0 V3=0 T=0 M2=0 M3=0
S11Max=0 PtS11Max=0 x2S11Max=0 x3S11Max=0 S11Min=0 PtS11Min=0 x2S11Min=0 x3S11Min=0 FrameElem=90
ElemStation=0
Frame=90 Station=0.5 OutputCase=SOVRCOST CaseType=LinStatic P=0 V2=0 V3=0 T=0 M2=0 M3=0
S11Max=0 PtS11Max=0 x2S11Max=0 x3S11Max=0 S11Min=0 PtS11Min=0 x2S11Min=0 x3S11Min=0 FrameElem=90
ElemStation=0.5
Frame=90 Station=0 OutputCase=ENVE CaseType=Combination StepType=Max P=-849.999889254
V2=228.768213225515 V3=0 T=0 M2=0 M3=363.305887670071 S11Max=1329.83533607419 PtS11Max=1 x2S11Max=-0.5
x3S11Max=-0.5 _
S11Min=-2952.58939557705 PtS11Min=3 x2S11Min=0.5 x3S11Min=-0.5 FrameElem=90 ElemStation=0
Frame=90 Station=0.5 OutputCase=ENVE CaseType=Combination StepType=Max P=-837.49998952694
V2=153.076963126174 V3=0 T=0 M2=0 M3=294.515942816229 S11Max=929.595666530063 PtS11Max=1 x2S11Max=-0.5
x3S11Max=-0.5 _
S11Min=-2367.85475665106 PtS11Min=3 x2S11Min=0.5 x3S11Min=-0.5 FrameElem=90 ElemStation=0.5
Frame=90 Station=0 OutputCase=ENVE CaseType=Combination StepType=Min P=-849.99989946232
V2=164.196223090687 V3=0 T=0 M2=0 M3=350.431567775275 S11Max=1252.58941772625 PtS11Max=1 x2S11Max=-0.5
x3S11Max=-0.5 _
S11Min=-3029.83531596666 PtS11Min=3 x2S11Min=0.5 x3S11Min=-0.5 FrameElem=90 ElemStation=0
Frame=90 Station=0.5 OutputCase=ENVE CaseType=Combination StepType=Min P=-837.49999036731
V2=111.212347991346 V3=0 T=0 M2=0 M3=255.05912785402 S11Max=692.85477759718 PtS11Max=1 x2S11Max=-0.5
x3S11Max=-0.5 _
S11Min=-2604.59564726468 PtS11Min=3 x2S11Min=0.5 x3S11Min=-0.5 FrameElem=90 ElemStation=0.5
Frame=90 Station=0 OutputCase=FESSUR CaseType=Combination P=-849.999889254 V2=228.768213225515 V3=0
T=0 M2=0 M3=350.431567775275 S11Max=1252.58941772625 PtS11Max=1 x2S11Max=-0.5 x3S11Max=-0.5 _
S11Min=-2952.58939557705 PtS11Min=3 x2S11Min=0.5 x3S11Min=-0.5 FrameElem=90 ElemStation=0
Frame=90 Station=0.5 OutputCase=FESSUR CaseType=Combination P=-837.49998952694 V2=153.076963126174
V3=0 T=0 M2=0 M3=255.05912785402 S11Max=692.85477759718 PtS11Max=1 x2S11Max=-0.5 x3S11Max=-0.5 _
S11Min=-2367.85475665106 PtS11Min=3 x2S11Min=0.5 x3S11Min=-0.5 FrameElem=90 ElemStation=0.5
Frame=91 Station=0 OutputCase=PESOPR CaseType=LinStatic P=-137.499999272259 V2=15.170947828937 V3=0
T=0 M2=0 M3=66.584418932966 S11Max=262.006514325537 PtS11Max=1 x2S11Max=-0.5 x3S11Max=-0.5 _
S11Min=-537.006512870055 PtS11Min=3 x2S11Min=0.5 x3S11Min=-0.5 FrameElem=91 ElemStation=0
Frame=91 Station=0.5 OutputCase=PESOPR CaseType=LinStatic P=-124.999999272259 V2=15.1709477295959
V3=0 T=0 M2=0 M3=58.9989450433328 S11Max=228.993670987738 PtS11Max=1 x2S11Max=-0.5 x3S11Max=-0.5 _
S11Min=-478.993669532255 PtS11Min=3 x2S11Min=0.5 x3S11Min=-0.5 FrameElem=91 ElemStation=0.5
Frame=91 Station=0 OutputCase=TERRVERT CaseType=LinStatic P=-699.99999305571 V2=-1.64270181885877
V3=0 T=0 M2=0 M3=319.997425461749 S11Max=1219.98455971478 PtS11Max=1 x2S11Max=-0.5 x3S11Max=-0.5 _
S11Min=-2619.9845458262 PtS11Min=3 x2S11Min=0.5 x3S11Min=-0.5 FrameElem=91 ElemStation=0

```

```

Frame=91 Station=0.5 OutputCase=TERRVERT CaseType=LinStatic P=-699.99999305571 V2=-1.64270181885877
V3=0 T=0 M2=0 M3=320.818776371178 S11Max=1224.91266517136 PtS11Max=1 x2S11Max=-0.5 x3S11Max=-0.5 _
S11Min=-2624.91265128278 PtS11Min=3 x2S11Min=0.5 x3S11Min=-0.5 FrameElem=91 ElemStation=0.5
Frame=91 Station=0 OutputCase=TERRLAT CaseType=LinStatic P=2.80123094853479E-06 V2=139.548717116091
V3=0 T=0 M2=0 M3=-131.522716540695 S11Max=789.136302045404 PtS11Max=3 x2S11Max=0.5 x3S11Max=-0.5 _
S11Min=-789.136296442942 PtS11Min=1 x2S11Min=-0.5 x3S11Min=-0.5 FrameElem=91 ElemStation=0
Frame=91 Station=0.5 OutputCase=TERRLAT CaseType=LinStatic P=2.21663849619635E-06 V2=65.9899671160908
V3=0 T=0 M2=0 M3=-182.818533432074 S11Max=1096.91120280908 PtS11Max=3 x2S11Max=0.5 x3S11Max=-0.5 _
S11Min=-1096.91119837581 PtS11Min=1 x2S11Min=-0.5 x3S11Min=-0.5 FrameElem=91 ElemStation=0.5
Frame=91 Station=0 OutputCase=ACCVERT CaseType=LinStatic P=0 V2=0 V3=0 T=0 M2=0 M3=0 S11Max=0
PtS11Max=0 x2S11Max=0 x3S11Max=0 S11Min=0 PtS11Min=0 x2S11Min=0 x3S11Min=0 FrameElem=91
ElemStation=0
Frame=91 Station=0.5 OutputCase=ACCVERT CaseType=LinStatic P=0 V2=0 V3=0 T=0 M2=0 M3=0
S11Max=0 PtS11Max=0 x2S11Max=0 x3S11Max=0 S11Min=0 PtS11Min=0 x2S11Min=0 x3S11Min=0 FrameElem=91
ElemStation=0.5
Frame=91 Station=0 OutputCase=ACCLATDX CaseType=LinStatic P=0 V2=0 V3=0 T=0 M2=0 M3=0
S11Max=0 PtS11Max=0 x2S11Max=0 x3S11Max=0 S11Min=0 PtS11Min=0 x2S11Min=0 x3S11Min=0 FrameElem=91
ElemStation=0
Frame=91 Station=0.5 OutputCase=ACCLATDX CaseType=LinStatic P=0 V2=0 V3=0 T=0 M2=0 M3=0
S11Max=0 PtS11Max=0 x2S11Max=0 x3S11Max=0 S11Min=0 PtS11Min=0 x2S11Min=0 x3S11Min=0 FrameElem=91
ElemStation=0.5
Frame=91 Station=0 OutputCase=ACCLATSX CaseType=LinStatic P=0 V2=0 V3=0 T=0 M2=0 M3=0
S11Max=0 PtS11Max=0 x2S11Max=0 x3S11Max=0 S11Min=0 PtS11Min=0 x2S11Min=0 x3S11Min=0 FrameElem=91
ElemStation=0
Frame=91 Station=0.5 OutputCase=ACCLATSX CaseType=LinStatic P=0 V2=0 V3=0 T=0 M2=0 M3=0
S11Max=0 PtS11Max=0 x2S11Max=0 x3S11Max=0 S11Min=0 PtS11Min=0 x2S11Min=0 x3S11Min=0 FrameElem=91
ElemStation=0.5
Frame=91 Station=0 OutputCase=TERRCOST CaseType=LinStatic P=0 V2=0 V3=0 T=0 M2=0 M3=0
S11Max=0 PtS11Max=0 x2S11Max=0 x3S11Max=0 S11Min=0 PtS11Min=0 x2S11Min=0 x3S11Min=0 FrameElem=91
ElemStation=0
Frame=91 Station=0.5 OutputCase=TERRCOST CaseType=LinStatic P=0 V2=0 V3=0 T=0 M2=0 M3=0
S11Max=0 PtS11Max=0 x2S11Max=0 x3S11Max=0 S11Min=0 PtS11Min=0 x2S11Min=0 x3S11Min=0 FrameElem=91
ElemStation=0.5
Frame=91 Station=0 OutputCase=SOVRCOST CaseType=LinStatic P=0 V2=0 V3=0 T=0 M2=0 M3=0
S11Max=0 PtS11Max=0 x2S11Max=0 x3S11Max=0 S11Min=0 PtS11Min=0 x2S11Min=0 x3S11Min=0 FrameElem=91
ElemStation=0
Frame=91 Station=0.5 OutputCase=SOVRCOST CaseType=LinStatic P=0 V2=0 V3=0 T=0 M2=0 M3=0
S11Max=0 PtS11Max=0 x2S11Max=0 x3S11Max=0 S11Min=0 PtS11Min=0 x2S11Min=0 x3S11Min=0 FrameElem=91
ElemStation=0.5
Frame=91 Station=0 OutputCase=ENVE CaseType=Combination StepType=Max P=-837.499989526737
V2=153.076963126169 V3=0 T=0 M2=0 M3=294.515942816228 S11Max=929.595666530262 PtS11Max=1 x2S11Max=-0.5
x3S11Max=-0.5 _
S11Min=-2367.85475665085 PtS11Min=3 x2S11Min=0.5 x3S11Min=-0.5 FrameElem=91 ElemStation=0
Frame=91 Station=0.5 OutputCase=ENVE CaseType=Combination StepType=Max P=-824.99999011133
V2=79.5182130268279 V3=0 T=0 M2=0 M3=251.844748012059 S11Max=686.068497296033 PtS11Max=1 x2S11Max=-0.5
x3S11Max=-0.5 _
S11Min=-2006.99511800595 PtS11Min=3 x2S11Min=0.5 x3S11Min=-0.5 FrameElem=91 ElemStation=0.5
Frame=91 Station=0 OutputCase=ENVE CaseType=Combination StepType=Min P=-837.499990367107
V2=111.212347991342 V3=0 T=0 M2=0 M3=255.059127854019 S11Max=692.854777597379 PtS11Max=1 x2S11Max=-0.5
x3S11Max=-0.5 _
S11Min=-2604.59564726448 PtS11Min=3 x2S11Min=0.5 x3S11Min=-0.5 FrameElem=91 ElemStation=0
Frame=91 Station=0.5 OutputCase=ENVE CaseType=Combination StepType=Min P=-824.999990776321
V2=59.7212228920006 V3=0 T=0 M2=0 M3=196.999187982437 S11Max=356.995137783292 PtS11Max=1 x2S11Max=-0.5
x3S11Max=-0.5 _
S11Min=-2336.06847884868 PtS11Min=3 x2S11Min=0.5 x3S11Min=-0.5 FrameElem=91 ElemStation=0.5
Frame=91 Station=0 OutputCase=FESSUR CaseType=Combination P=-837.499989526737 V2=153.076963126169
V3=0 T=0 M2=0 M3=255.059127854019 S11Max=692.854777597379 PtS11Max=1 x2S11Max=-0.5 x3S11Max=-0.5 _
S11Min=-2367.85475665085 PtS11Min=3 x2S11Min=0.5 x3S11Min=-0.5 FrameElem=91 ElemStation=0
Frame=91 Station=0.5 OutputCase=FESSUR CaseType=Combination P=-824.99999011133 V2=79.5182130268279
V3=0 T=0 M2=0 M3=196.999187982437 S11Max=356.995137783292 PtS11Max=1 x2S11Max=-0.5 x3S11Max=-0.5 _
S11Min=-2006.99511800595 PtS11Min=3 x2S11Min=0.5 x3S11Min=-0.5 FrameElem=91 ElemStation=0.5
Frame=92 Station=0 OutputCase=PESOPR CaseType=LinStatic P=-124.99999272259 V2=15.1709477295958 V3=0
T=0 M2=0 M3=58.9989450433328 S11Max=228.993670987738 PtS11Max=1 x2S11Max=-0.5 x3S11Max=-0.5 _
S11Min=-478.993669532256 PtS11Min=3 x2S11Min=0.5 x3S11Min=-0.5 FrameElem=92 ElemStation=0
Frame=92 Station=0.5 OutputCase=PESOPR CaseType=LinStatic P=-112.49999272259 V2=15.1709476302547
V3=0 T=0 M2=0 M3=51.4134712033702 S11Max=195.980827947962 PtS11Max=1 x2S11Max=-0.5 x3S11Max=-0.5 _
S11Min=-420.98082649248 PtS11Min=3 x2S11Min=0.5 x3S11Min=-0.5 FrameElem=92 ElemStation=0.5
Frame=92 Station=0 OutputCase=TERRVERT CaseType=LinStatic P=-699.99999305571 V2=-1.64270181886059
V3=0 T=0 M2=0 M3=320.818776371179 S11Max=1224.91266517136 PtS11Max=1 x2S11Max=-0.5 x3S11Max=-0.5 _
S11Min=-2624.91265128278 PtS11Min=3 x2S11Min=0.5 x3S11Min=-0.5 FrameElem=92 ElemStation=0
Frame=92 Station=0.5 OutputCase=TERRVERT CaseType=LinStatic P=-699.99999305571 V2=-1.64270181886059
V3=0 T=0 M2=0 M3=321.640127280609 S11Max=1229.84077062794 PtS11Max=1 x2S11Max=-0.5 x3S11Max=-0.5 _
S11Min=-2629.84075673936 PtS11Min=3 x2S11Min=0.5 x3S11Min=-0.5 FrameElem=92 ElemStation=0.5
Frame=92 Station=0 OutputCase=TERRLAT CaseType=LinStatic P=2.21663776756031E-06 V2=65.9899671160906
V3=0 T=0 M2=0 M3=-182.818533432074 S11Max=1096.91120280908 PtS11Max=3 x2S11Max=0.5 x3S11Max=-0.5 _
S11Min=-1096.91119837581 PtS11Min=1 x2S11Min=-0.5 x3S11Min=-0.5 FrameElem=92 ElemStation=0
Frame=92 Station=0.5 OutputCase=TERRLAT CaseType=LinStatic P=1.6489929034369E-06 V2=-5.43628288390939
V3=0 T=0 M2=0 M3=-197.868100323453 S11Max=1187.20860358971 PtS11Max=3 x2S11Max=0.5 x3S11Max=-0.5 _
S11Min=-1187.20860029172 PtS11Min=1 x2S11Min=-0.5 x3S11Min=-0.5 FrameElem=92 ElemStation=0.5
Frame=92 Station=0 OutputCase=ACCVERT CaseType=LinStatic P=0 V2=0 V3=0 T=0 M2=0 M3=0 S11Max=0
PtS11Max=0 x2S11Max=0 x3S11Max=0 S11Min=0 PtS11Min=0 x2S11Min=0 x3S11Min=0 FrameElem=92
ElemStation=0

```

Frame=92 Station=0.5 OutputCase=ACCVERT CaseType=LinStatic P=0 V2=0 V3=0 T=0 M2=0 M3=0
 S11Max=0 PtS11Max=0 x2S11Max=0 x3S11Max=0 S11Min=0 PtS11Min=0 x2S11Min=0 x3S11Min=0 FrameElem=92
 ElemStation=0.5

Frame=92 Station=0 OutputCase=ACCLATDX CaseType=LinStatic P=0 V2=0 V3=0 T=0 M2=0 M3=0
 S11Max=0 PtS11Max=0 x2S11Max=0 x3S11Max=0 S11Min=0 PtS11Min=0 x2S11Min=0 x3S11Min=0 FrameElem=92
 ElemStation=0

Frame=92 Station=0.5 OutputCase=ACCLATDX CaseType=LinStatic P=0 V2=0 V3=0 T=0 M2=0 M3=0
 S11Max=0 PtS11Max=0 x2S11Max=0 x3S11Max=0 S11Min=0 PtS11Min=0 x2S11Min=0 x3S11Min=0 FrameElem=92
 ElemStation=0.5

Frame=92 Station=0 OutputCase=ACCLATSX CaseType=LinStatic P=0 V2=0 V3=0 T=0 M2=0 M3=0
 S11Max=0 PtS11Max=0 x2S11Max=0 x3S11Max=0 S11Min=0 PtS11Min=0 x2S11Min=0 x3S11Min=0 FrameElem=92
 ElemStation=0

Frame=92 Station=0.5 OutputCase=ACCLATSX CaseType=LinStatic P=0 V2=0 V3=0 T=0 M2=0 M3=0
 S11Max=0 PtS11Max=0 x2S11Max=0 x3S11Max=0 S11Min=0 PtS11Min=0 x2S11Min=0 x3S11Min=0 FrameElem=92
 ElemStation=0.5

Frame=92 Station=0 OutputCase=TERRCOST CaseType=LinStatic P=0 V2=0 V3=0 T=0 M2=0 M3=0
 S11Max=0 PtS11Max=0 x2S11Max=0 x3S11Max=0 S11Min=0 PtS11Min=0 x2S11Min=0 x3S11Min=0 FrameElem=92
 ElemStation=0

Frame=92 Station=0.5 OutputCase=TERRCOST CaseType=LinStatic P=0 V2=0 V3=0 T=0 M2=0 M3=0
 S11Max=0 PtS11Max=0 x2S11Max=0 x3S11Max=0 S11Min=0 PtS11Min=0 x2S11Min=0 x3S11Min=0 FrameElem=92
 ElemStation=0.5

Frame=92 Station=0 OutputCase=SOVRCOST CaseType=LinStatic P=0 V2=0 V3=0 T=0 M2=0 M3=0
 S11Max=0 PtS11Max=0 x2S11Max=0 x3S11Max=0 S11Min=0 PtS11Min=0 x2S11Min=0 x3S11Min=0 FrameElem=92
 ElemStation=0

Frame=92 Station=0.5 OutputCase=SOVRCOST CaseType=LinStatic P=0 V2=0 V3=0 T=0 M2=0 M3=0
 S11Max=0 PtS11Max=0 x2S11Max=0 x3S11Max=0 S11Min=0 PtS11Min=0 x2S11Min=0 x3S11Min=0 FrameElem=92
 ElemStation=0.5

Frame=92 Station=0 OutputCase=ENVE CaseType=Combination StepType=Max P=-824.999990111331
 V2=79.5182130268258 V3=0 T=0 M2=0 M3=251.84474801206 S11Max=686.068497296035 PtS11Max=1 x2S11Max=-0.5
 x3S11Max=-0.5
 S11Min=-2006.99511800595 PtS11Min=3 x2S11Min=0.5 x3S11Min=-0.5 FrameElem=92 ElemStation=0

Frame=92 Station=0.5 OutputCase=ENVE CaseType=Combination StepType=Max P=-812.499990678975
 V2=9.72284779265757 V3=0 T=0 M2=0 M3=234.545928257562 S11Max=594.775578371699 PtS11Max=1 x2S11Max=-0.5
 x3S11Max=-0.5
 S11Min=-1863.61297964213 PtS11Min=3 x2S11Min=0.5 x3S11Min=-0.5 FrameElem=92 ElemStation=0.5

Frame=92 Station=0 OutputCase=ENVE CaseType=Combination StepType=Min P=-824.999990776322
 V2=59.7212228919987 V3=0 T=0 M2=0 M3=196.999187982437 S11Max=356.995137783293 PtS11Max=1 x2S11Max=-0.5
 x3S11Max=-0.5
 S11Min=-2336.06847884868 PtS11Min=3 x2S11Min=0.5 x3S11Min=-0.5 FrameElem=92 ElemStation=0

Frame=92 Station=0.5 OutputCase=ENVE CaseType=Combination StepType=Min P=-812.499991173673
 V2=8.09196292748476 V3=0 T=0 M2=0 M3=175.185498160526 S11Max=238.612998284182 PtS11Max=1 x2S11Max=-0.5
 x3S11Max=-0.5
 S11Min=-2219.77556071905 PtS11Min=3 x2S11Min=0.5 x3S11Min=-0.5 FrameElem=92 ElemStation=0.5

Frame=92 Station=0 OutputCase=FESSUR CaseType=Combination StepType=Max P=-824.999990111331 V2=79.5182130268258
 V3=0 T=0 M2=0 M3=196.999187982437 S11Max=356.995137783293 PtS11Max=1 x2S11Max=-0.5 x3S11Max=-0.5
 S11Min=-2006.99511800595 PtS11Min=3 x2S11Min=0.5 x3S11Min=-0.5 FrameElem=92 ElemStation=0

Frame=92 Station=0.5 OutputCase=FESSUR CaseType=Combination StepType=Max P=-812.499990678975 V2=8.09196292748476
 V3=0 T=0 M2=0 M3=175.185498160526 S11Max=238.612998284182 PtS11Max=1 x2S11Max=-0.5 x3S11Max=-0.5
 S11Min=-1863.61297964213 PtS11Min=3 x2S11Min=0.5 x3S11Min=-0.5 FrameElem=92 ElemStation=0.5

Frame=93 Station=0 OutputCase=PESOPR CaseType=LinStatic P=-112.499999272171 V2=15.1709476302544 V3=0
 T=0 M2=0 M3=51.4134712033703 S11Max=195.98082794805 PtS11Max=1 x2S11Max=-0.5 x3S11Max=-0.5
 S11Min=-420.980826492393 PtS11Min=3 x2S11Min=0.5 x3S11Min=-0.5 FrameElem=93 ElemStation=0

Frame=93 Station=0.5 OutputCase=PESOPR CaseType=LinStatic P=-99.999999272171 V2=15.1709475309134
 V3=0 T=0 M2=0 M3=43.8279974130783 S11Max=162.967985206298 PtS11Max=1 x2S11Max=-0.5 x3S11Max=-0.5
 S11Min=-362.967983750641 PtS11Min=3 x2S11Min=0.5 x3S11Min=-0.5 FrameElem=93 ElemStation=0.5

Frame=93 Station=0 OutputCase=TERRVERT CaseType=LinStatic P=-699.99999305571 V2=-1.64270181886241
 V3=0 T=0 M2=0 M3=321.640127280608 S11Max=1229.84077062794 PtS11Max=1 x2S11Max=-0.5 x3S11Max=-0.5
 S11Min=-2629.84075673936 PtS11Min=3 x2S11Min=0.5 x3S11Min=-0.5 FrameElem=93 ElemStation=0

Frame=93 Station=0.5 OutputCase=TERRVERT CaseType=LinStatic P=-699.99999305571 V2=-1.64270181886241
 V3=0 T=0 M2=0 M3=322.46147819004 S11Max=1234.76887608453 PtS11Max=1 x2S11Max=-0.5 x3S11Max=-0.5
 S11Min=-2634.76886219595 PtS11Min=3 x2S11Min=0.5 x3S11Min=-0.5 FrameElem=93 ElemStation=0.5

Frame=93 Station=0 OutputCase=TERRLAT CaseType=LinStatic P=1.64899211085867E-06 V2=-5.43628288390892
 V3=0 T=0 M2=0 M3=-197.868100323453 S11Max=1187.20860358971 PtS11Max=3 x2S11Max=0.5 x3S11Max=-0.5
 S11Min=-1187.20860029172 PtS11Min=1 x2S11Min=-0.5 x3S11Min=-0.5 FrameElem=93 ElemStation=0

Frame=93 Station=0.5 OutputCase=TERRLAT CaseType=LinStatic P=1.09829489649549E-06 V2=-74.7300328839089
 V3=0 T=0 M2=0 M3=-177.737667214832 S11Max=1066.42600438728 PtS11Max=3 x2S11Max=0.5 x3S11Max=-0.5
 S11Min=-1066.42600219069 PtS11Min=1 x2S11Min=-0.5 x3S11Min=-0.5 FrameElem=93 ElemStation=0.5

Frame=93 Station=0 OutputCase=ACCVERT CaseType=LinStatic P=0 V2=0 V3=0 T=0 M2=0 M3=0
 PtS11Max=0 x2S11Max=0 x3S11Max=0 S11Min=0 PtS11Min=0 x2S11Min=0 x3S11Min=0 FrameElem=93
 ElemStation=0

Frame=93 Station=0.5 OutputCase=ACCVERT CaseType=LinStatic P=0 V2=0 V3=0 T=0 M2=0 M3=0
 S11Max=0 PtS11Max=0 x2S11Max=0 x3S11Max=0 S11Min=0 PtS11Min=0 x2S11Min=0 x3S11Min=0 FrameElem=93
 ElemStation=0.5

Frame=93 Station=0 OutputCase=ACCLATDX CaseType=LinStatic P=0 V2=0 V3=0 T=0 M2=0 M3=0
 S11Max=0 PtS11Max=0 x2S11Max=0 x3S11Max=0 S11Min=0 PtS11Min=0 x2S11Min=0 x3S11Min=0 FrameElem=93
 ElemStation=0

Frame=93 Station=0.5 OutputCase=ACCLATDX CaseType=LinStatic P=0 V2=0 V3=0 T=0 M2=0 M3=0
 S11Max=0 PtS11Max=0 x2S11Max=0 x3S11Max=0 S11Min=0 PtS11Min=0 x2S11Min=0 x3S11Min=0 FrameElem=93
 ElemStation=0.5

Frame=93 Station=0 OutputCase=ACCLATSX CaseType=LinStatic P=0 V2=0 V3=0 T=0 M2=0 M3=0
 S11Max=0 PtS11Max=0 x2S11Max=0 x3S11Max=0 S11Min=0 PtS11Min=0 x2S11Min=0 x3S11Min=0 FrameElem=93
 ElemStation=0

Frame=93 Station=0.5 OutputCase=ACCLATSX CaseType=LinStatic P=0 V2=0 V3=0 T=0 M2=0 M3=0
S11Max=0 PtS11Max=0 x2S11Max=0 x3S11Max=0 S11Min=0 PtS11Min=0 x2S11Min=0 x3S11Min=0 FrameElem=93
ElemStation=0.5

Frame=93 Station=0 OutputCase=TERRCOST CaseType=LinStatic P=0 V2=0 V3=0 T=0 M2=0 M3=0
S11Max=0 PtS11Max=0 x2S11Max=0 x3S11Max=0 S11Min=0 PtS11Min=0 x2S11Min=0 x3S11Min=0 FrameElem=93
ElemStation=0

Frame=93 Station=0.5 OutputCase=TERRCOST CaseType=LinStatic P=0 V2=0 V3=0 T=0 M2=0 M3=0
S11Max=0 PtS11Max=0 x2S11Max=0 x3S11Max=0 S11Min=0 PtS11Min=0 x2S11Min=0 x3S11Min=0 FrameElem=93
ElemStation=0.5

Frame=93 Station=0 OutputCase=SOVRCOST CaseType=LinStatic P=0 V2=0 V3=0 T=0 M2=0 M3=0
S11Max=0 PtS11Max=0 x2S11Max=0 x3S11Max=0 S11Min=0 PtS11Min=0 x2S11Min=0 x3S11Min=0 FrameElem=93
ElemStation=0

Frame=93 Station=0.5 OutputCase=SOVRCOST CaseType=LinStatic P=0 V2=0 V3=0 T=0 M2=0 M3=0
S11Max=0 PtS11Max=0 x2S11Max=0 x3S11Max=0 S11Min=0 PtS11Min=0 x2S11Min=0 x3S11Min=0 FrameElem=93
ElemStation=0.5

Frame=93 Station=0 OutputCase=ENVE CaseType=Combination StepType=Max P=-812.499990678889
V2=9.72284779265578 V3=0 T=0 M2=0 M3=234.545928257562 S11Max=594.775578371784 PtS11Max=1 x2S11Max=-0.5
x3S11Max=-0.5
S11Min=-1863.61297964204 PtS11Min=3 x2S11Min=0.5 x3S11Min=-0.5 FrameElem=93 ElemStation=0

Frame=93 Station=0.5 OutputCase=ENVE CaseType=Combination StepType=Max P=-799.999991229586 V2=-
38.7827773066852 V3=0 T=0 M2=0 M3=241.873108552736 S11Max=651.23865975734 PtS11Max=1 x2S11Max=-0.5
x3S11Max=-0.5
S11Min=-1931.3108415593 PtS11Min=3 x2S11Min=0.5 x3S11Min=-0.5 FrameElem=93 ElemStation=0.5

Frame=93 Station=0 OutputCase=ENVE CaseType=Combination StepType=Min P=-812.499991173587
V2=8.09196292748311 V3=0 T=0 M2=0 M3=175.185498160526 S11Max=238.612998284266 PtS11Max=1 x2S11Max=-0.5
x3S11Max=-0.5
S11Min=-2219.77556071896 PtS11Min=3 x2S11Min=0.5 x3S11Min=-0.5 FrameElem=93 ElemStation=0

Frame=93 Station=0.5 OutputCase=ENVE CaseType=Combination StepType=Min P=-799.999991559075 V2=-
61.2017871718579 V3=0 T=0 M2=0 M3=188.551808388286 S11Max=331.310859100131 PtS11Max=1 x2S11Max=-0.5
x3S11Max=-0.5
S11Min=-2251.23864287549 PtS11Min=3 x2S11Min=0.5 x3S11Min=-0.5 FrameElem=93 ElemStation=0.5

Frame=93 Station=0 OutputCase=FESSUR CaseType=Combination P=-812.499990678889 V2=8.09196292748311
V3=0 T=0 M2=0 M3=175.185498160526 S11Max=238.612998284266 PtS11Max=1 x2S11Max=-0.5 x3S11Max=-0.5
S11Min=-1863.61297964204 PtS11Min=3 x2S11Min=0.5 x3S11Min=-0.5 FrameElem=93 ElemStation=0

Frame=93 Station=0.5 OutputCase=FESSUR CaseType=Combination P=-799.999991229586 V2=-61.2017871718579
V3=0 T=0 M2=0 M3=188.551808388286 S11Max=331.310859100131 PtS11Max=1 x2S11Max=-0.5 x3S11Max=-0.5
S11Min=-1931.3108415593 PtS11Min=3 x2S11Min=0.5 x3S11Min=-0.5 FrameElem=93 ElemStation=0.5

Frame=94 Station=0 OutputCase=PESOPR CaseType=LinStatic P=-99.999992722296 V2=15.1709475309133 V3=0
T=0 M2=0 M3=43.8279974130783 S11Max=162.96798520624 PtS11Max=1 x2S11Max=-0.5 x3S11Max=-0.5
S11Min=-362.967983750699 PtS11Min=3 x2S11Min=0.5 x3S11Min=-0.5 FrameElem=94 ElemStation=0

Frame=94 Station=0.5 OutputCase=PESOPR CaseType=LinStatic P=-87.499992722296 V2=15.1709474315722
V3=0 T=0 M2=0 M3=36.2425236724569 S11Max=129.955142762512 PtS11Max=1 x2S11Max=-0.5 x3S11Max=-0.5
S11Min=-304.955141306971 PtS11Min=3 x2S11Min=0.5 x3S11Min=-0.5 FrameElem=94 ElemStation=0.5

Frame=94 Station=0 OutputCase=TERRVERT CaseType=LinStatic P=-699.999993055477 V2=-1.64270181886241
V3=0 T=0 M2=0 M3=322.461478190039 S11Max=1234.76887608476 PtS11Max=1 x2S11Max=-0.5 x3S11Max=-0.5
S11Min=-2634.76886219571 PtS11Min=3 x2S11Min=0.5 x3S11Min=-0.5 FrameElem=94 ElemStation=0

Frame=94 Station=0.5 OutputCase=TERRVERT CaseType=LinStatic P=-699.999993055477 V2=-1.64270181886241
V3=0 T=0 M2=0 M3=323.282829099471 S11Max=1239.69698154135 PtS11Max=1 x2S11Max=-0.5 x3S11Max=-0.5
S11Min=-2639.6969676523 PtS11Min=3 x2S11Min=0.5 x3S11Min=-0.5 FrameElem=94 ElemStation=0.5

Frame=94 Station=0 OutputCase=TERRLAT CaseType=LinStatic P=1.09829579741927E-06 V2=-74.7300328839083
V3=0 T=0 M2=0 M3=-177.737667214832 S11Max=1066.42600438729 PtS11Max=3 x2S11Max=0.5 x3S11Max=-0.5
S11Min=-1066.42600219069 PtS11Min=1 x2S11Min=-0.5 x3S11Min=-0.5 FrameElem=94 ElemStation=0

Frame=94 Station=0.5 OutputCase=TERRLAT CaseType=LinStatic P=5.64546169377067E-07 V2=-141.891282883908
V3=0 T=0 M2=0 M3=-123.493484106211 S11Max=740.960905201812 PtS11Max=3 x2S11Max=0.5 x3S11Max=-0.5
S11Min=-740.960904072719 PtS11Min=1 x2S11Min=-0.5 x3S11Min=-0.5 FrameElem=94 ElemStation=0.5

Frame=94 Station=0 OutputCase=ACCVERT CaseType=LinStatic P=0 V2=0 V3=0 T=0 M2=0 M3=0 S11Max=0
PtS11Max=0 x2S11Max=0 x3S11Max=0 S11Min=0 PtS11Min=0 x2S11Min=0 x3S11Min=0 FrameElem=94
ElemStation=0

Frame=94 Station=0.5 OutputCase=ACCVERT CaseType=LinStatic P=0 V2=0 V3=0 T=0 M2=0 M3=0
S11Max=0 PtS11Max=0 x2S11Max=0 x3S11Max=0 S11Min=0 PtS11Min=0 x2S11Min=0 x3S11Min=0 FrameElem=94
ElemStation=0.5

Frame=94 Station=0 OutputCase=ACCLATDX CaseType=LinStatic P=0 V2=0 V3=0 T=0 M2=0 M3=0
S11Max=0 PtS11Max=0 x2S11Max=0 x3S11Max=0 S11Min=0 PtS11Min=0 x2S11Min=0 x3S11Min=0 FrameElem=94
ElemStation=0

Frame=94 Station=0.5 OutputCase=ACCLATDX CaseType=LinStatic P=0 V2=0 V3=0 T=0 M2=0 M3=0
S11Max=0 PtS11Max=0 x2S11Max=0 x3S11Max=0 S11Min=0 PtS11Min=0 x2S11Min=0 x3S11Min=0 FrameElem=94
ElemStation=0.5

Frame=94 Station=0 OutputCase=ACCLATSX CaseType=LinStatic P=0 V2=0 V3=0 T=0 M2=0 M3=0
S11Max=0 PtS11Max=0 x2S11Max=0 x3S11Max=0 S11Min=0 PtS11Min=0 x2S11Min=0 x3S11Min=0 FrameElem=94
ElemStation=0

Frame=94 Station=0.5 OutputCase=ACCLATSX CaseType=LinStatic P=0 V2=0 V3=0 T=0 M2=0 M3=0
S11Max=0 PtS11Max=0 x2S11Max=0 x3S11Max=0 S11Min=0 PtS11Min=0 x2S11Min=0 x3S11Min=0 FrameElem=94
ElemStation=0.5

Frame=94 Station=0 OutputCase=TERRCOST CaseType=LinStatic P=0 V2=0 V3=0 T=0 M2=0 M3=0
S11Max=0 PtS11Max=0 x2S11Max=0 x3S11Max=0 S11Min=0 PtS11Min=0 x2S11Min=0 x3S11Min=0 FrameElem=94
ElemStation=0

Frame=94 Station=0.5 OutputCase=TERRCOST CaseType=LinStatic P=0 V2=0 V3=0 T=0 M2=0 M3=0
S11Max=0 PtS11Max=0 x2S11Max=0 x3S11Max=0 S11Min=0 PtS11Min=0 x2S11Min=0 x3S11Min=0 FrameElem=94
ElemStation=0.5

Frame=94 Station=0 OutputCase=SOVRCOST CaseType=LinStatic P=0 V2=0 V3=0 T=0 M2=0 M3=0
S11Max=0 PtS11Max=0 x2S11Max=0 x3S11Max=0 S11Min=0 PtS11Min=0 x2S11Min=0 x3S11Min=0 FrameElem=94
ElemStation=0



Frame=94 Station=0.5 OutputCase=SOVRCOST CaseType=LinStatic P=0 V2=0 V3=0 T=0 M2=0 M3=0
 S11Max=0 PtS11Max=0 x2S11Max=0 x3S11Max=0 S11Min=0 PtS11Min=0 x2S11Min=0 x3S11Min=0 FrameElem=94
 ElemStation=0.5
 Frame=94 Station=0 OutputCase=ENVE CaseType=Combination StepType=Max P=-799.999991229411 V2=-
 38.7827773066849 V3=0 T=0 M2=0 M3=241.873108552735 S11Max=651.238659757514 PtS11Max=1 x2S11Max=-0.5
 x3S11Max=-0.5
 S11Min=-1931.31084155913 PtS11Min=3 x2S11Min=0.5 x3S11Min=-0.5 FrameElem=94 ElemStation=0
 Frame=94 Station=0.5 OutputCase=ENVE CaseType=Combination StepType=Max P=-787.49999176316 V2=-
 85.795652406026 V3=0 T=0 M2=0 M3=273.07991389758 S11Max=850.979491452955 PtS11Max=1 x2S11Max=-0.5
 x3S11Max=-0.5
 S11Min=-2203.69120375746 PtS11Min=3 x2S11Min=0.5 x3S11Min=-0.5 FrameElem=94 ElemStation=0.5
 Frame=94 Station=0 OutputCase=ENVE CaseType=Combination StepType=Min P=-799.999991558899 V2=-
 61.2017871718574 V3=0 T=0 M2=0 M3=188.551808388286 S11Max=331.310859100305 PtS11Max=1 x2S11Max=-0.5
 x3S11Max=-0.5
 S11Min=-2251.23864287531 PtS11Min=3 x2S11Min=0.5 x3S11Min=-0.5 FrameElem=94 ElemStation=0
 Frame=94 Station=0.5 OutputCase=ENVE CaseType=Combination StepType=Min P=-787.499991932524 V2=-
 128.363037271198 V3=0 T=0 M2=0 M3=236.031868665717 S11Max=628.69122023114 PtS11Max=1 x2S11Max=-0.5
 x3S11Max=-0.5
 S11Min=-2425.979475318 PtS11Min=3 x2S11Min=0.5 x3S11Min=-0.5 FrameElem=94 ElemStation=0.5
 Frame=94 Station=0 OutputCase=FESSUR CaseType=Combination P=-799.999991229411 V2=-61.2017871718574
 V3=0 T=0 M2=0 M3=188.551808388286 S11Max=331.310859100305 PtS11Max=1 x2S11Max=-0.5 x3S11Max=-0.5
 S11Min=-1931.31084155913 PtS11Min=3 x2S11Min=0.5 x3S11Min=-0.5 FrameElem=94 ElemStation=0
 Frame=94 Station=0.5 OutputCase=FESSUR CaseType=Combination P=-787.49999176316 V2=-128.363037271198
 V3=0 T=0 M2=0 M3=236.031868665717 S11Max=628.69122023114 PtS11Max=1 x2S11Max=-0.5 x3S11Max=-0.5
 S11Min=-2203.69120375746 PtS11Min=3 x2S11Min=0.5 x3S11Min=-0.5 FrameElem=94 ElemStation=0.5
 Frame=95 Station=0 OutputCase=PESOPR CaseType=LinStatic P=-87.4999992722587 V2=15.1709474315721 V3=0
 T=0 M2=0 M3=36.2425236724569 S11Max=129.955142762483 PtS11Max=1 x2S11Max=-0.5 x3S11Max=-0.5
 S11Min=-304.955141307 PtS11Min=3 x2S11Min=0.5 x3S11Min=-0.5 FrameElem=95 ElemStation=0
 Frame=95 Station=0.5 OutputCase=PESOPR CaseType=LinStatic P=-74.999992722587 V2=15.1709473322311
 V3=0 T=0 M2=0 M3=28.6570499815061 S11Max=96.9423006167781 PtS11Max=1 x2S11Max=-0.5 x3S11Max=-0.5
 S11Min=-246.942299161296 PtS11Min=3 x2S11Min=0.5 x3S11Min=-0.5 FrameElem=95 ElemStation=0.5
 Frame=95 Station=0 OutputCase=TERRVERT CaseType=LinStatic P=-699.99999305571 V2=-1.6427018188615 V3=0
 T=0 M2=0 M3=323.28282909947 S11Max=1239.69698154111 PtS11Max=1 x2S11Max=-0.5 x3S11Max=-0.5
 S11Min=-2639.69696765253 PtS11Min=3 x2S11Min=0.5 x3S11Min=-0.5 FrameElem=95 ElemStation=0
 Frame=95 Station=0.5 OutputCase=TERRVERT CaseType=LinStatic P=-699.99999305571 V2=-1.6427018188615
 V3=0 T=0 M2=0 M3=324.104180008901 S11Max=1244.6250869977 PtS11Max=1 x2S11Max=-0.5 x3S11Max=-0.5
 S11Min=-2644.62507310911 PtS11Min=3 x2S11Min=0.5 x3S11Min=-0.5 FrameElem=95 ElemStation=0.5
 Frame=95 Station=0 OutputCase=TERRLAT CaseType=LinStatic P=5.64546098758001E-07 V2=-141.891282883908
 V3=0 T=0 M2=0 M3=-123.493484106211 S11Max=740.960905201811 PtS11Max=3 x2S11Max=0.5 x3S11Max=-0.5
 S11Min=-740.960904072719 PtS11Min=1 x2S11Min=-0.5 x3S11Min=-0.5 FrameElem=95 ElemStation=0
 Frame=95 Station=0.5 OutputCase=TERRLAT CaseType=LinStatic P=4.7743999279648E-08 V2=-206.920032883908
 V3=0 T=0 M2=0 M3=-36.2018009975902 S11Max=217.210806033285 PtS11Max=3 x2S11Max=0.5 x3S11Max=-0.5
 S11Min=-217.210805937797 PtS11Min=1 x2S11Min=-0.5 x3S11Min=-0.5 FrameElem=95 ElemStation=0.5
 Frame=95 Station=0 OutputCase=ACCVERT CaseType=LinStatic P=0 V2=0 V3=0 T=0 M2=0 M3=0 S11Max=0
 PtS11Max=0 x2S11Max=0 x3S11Max=0 S11Min=0 PtS11Min=0 x2S11Min=0 x3S11Min=0 FrameElem=95
 ElemStation=0
 Frame=95 Station=0.5 OutputCase=ACCVERT CaseType=LinStatic P=0 V2=0 V3=0 T=0 M2=0 M3=0
 S11Max=0 PtS11Max=0 x2S11Max=0 x3S11Max=0 S11Min=0 PtS11Min=0 x2S11Min=0 x3S11Min=0 FrameElem=95
 ElemStation=0.5
 Frame=95 Station=0 OutputCase=ACCLATDX CaseType=LinStatic P=0 V2=0 V3=0 T=0 M2=0 M3=0
 S11Max=0 PtS11Max=0 x2S11Max=0 x3S11Max=0 S11Min=0 PtS11Min=0 x2S11Min=0 x3S11Min=0 FrameElem=95
 ElemStation=0
 Frame=95 Station=0.5 OutputCase=ACCLATDX CaseType=LinStatic P=0 V2=0 V3=0 T=0 M2=0 M3=0
 S11Max=0 PtS11Max=0 x2S11Max=0 x3S11Max=0 S11Min=0 PtS11Min=0 x2S11Min=0 x3S11Min=0 FrameElem=95
 ElemStation=0.5
 Frame=95 Station=0 OutputCase=ACCLATSX CaseType=LinStatic P=0 V2=0 V3=0 T=0 M2=0 M3=0
 S11Max=0 PtS11Max=0 x2S11Max=0 x3S11Max=0 S11Min=0 PtS11Min=0 x2S11Min=0 x3S11Min=0 FrameElem=95
 ElemStation=0
 Frame=95 Station=0.5 OutputCase=ACCLATSX CaseType=LinStatic P=0 V2=0 V3=0 T=0 M2=0 M3=0
 S11Max=0 PtS11Max=0 x2S11Max=0 x3S11Max=0 S11Min=0 PtS11Min=0 x2S11Min=0 x3S11Min=0 FrameElem=95
 ElemStation=0.5
 Frame=95 Station=0 OutputCase=TERRCOST CaseType=LinStatic P=0 V2=0 V3=0 T=0 M2=0 M3=0
 S11Max=0 PtS11Max=0 x2S11Max=0 x3S11Max=0 S11Min=0 PtS11Min=0 x2S11Min=0 x3S11Min=0 FrameElem=95
 ElemStation=0
 Frame=95 Station=0.5 OutputCase=TERRCOST CaseType=LinStatic P=0 V2=0 V3=0 T=0 M2=0 M3=0
 S11Max=0 PtS11Max=0 x2S11Max=0 x3S11Max=0 S11Min=0 PtS11Min=0 x2S11Min=0 x3S11Min=0 FrameElem=95
 ElemStation=0.5
 Frame=95 Station=0 OutputCase=SOVRCOST CaseType=LinStatic P=0 V2=0 V3=0 T=0 M2=0 M3=0
 S11Max=0 PtS11Max=0 x2S11Max=0 x3S11Max=0 S11Min=0 PtS11Min=0 x2S11Min=0 x3S11Min=0 FrameElem=95
 ElemStation=0
 Frame=95 Station=0.5 OutputCase=SOVRCOST CaseType=LinStatic P=0 V2=0 V3=0 T=0 M2=0 M3=0
 S11Max=0 PtS11Max=0 x2S11Max=0 x3S11Max=0 S11Min=0 PtS11Min=0 x2S11Min=0 x3S11Min=0 FrameElem=95
 ElemStation=0.5
 Frame=95 Station=0 OutputCase=ENVE CaseType=Combination StepType=Max P=-787.499991763422 V2=-
 85.7956524060249 V3=0 T=0 M2=0 M3=273.079913897579 S11Max=850.97949145269 PtS11Max=1 x2S11Max=-0.5
 x3S11Max=-0.5
 S11Min=-2203.69120375772 PtS11Min=3 x2S11Min=0.5 x3S11Min=-0.5 FrameElem=95 ElemStation=0
 Frame=95 Station=0.5 OutputCase=ENVE CaseType=Combination StepType=Max P=-774.999992280224 V2=-
 131.315777505366 V3=0 T=0 M2=0 M3=327.419969292094 S11Max=1189.51982345802 PtS11Max=1 x2S11Max=-0.5
 x3S11Max=-0.5
 S11Min=-2674.35656623712 PtS11Min=3 x2S11Min=0.5 x3S11Min=-0.5 FrameElem=95 ElemStation=0.5



Frame=95 Station=0 OutputCase=ENVE CaseType=Combination StepType=Min P=-787.499991932786 V2=-128.363037271197 V3=0 T=0 M2=0 M3=236.031868665716 S11Max=628.691220230874 PtS11Max=1 x2S11Max=-0.5 x3S11Max=-0.5
 S11Min=-2425.97947531826 PtS11Min=3 x2S11Min=0.5 x3S11Min=-0.5 FrameElem=95 ElemStation=0
 Frame=95 Station=0.5 OutputCase=ENVE CaseType=Combination StepType=Min P=-774.999992294548 V2=-193.391787370538 V3=0 T=0 M2=0 M3=316.559428992817 S11Max=1124.35658167668 PtS11Max=1 x2S11Max=-0.5 x3S11Max=-0.5
 S11Min=-2739.51980804711 PtS11Min=3 x2S11Min=0.5 x3S11Min=-0.5 FrameElem=95 ElemStation=0.5
 Frame=95 Station=0 OutputCase=FESSUR CaseType=Combination StepType=Min P=-787.499991763422 V2=-128.363037271197 V3=0 T=0 M2=0 M3=236.031868665716 S11Max=628.691220230874 PtS11Max=1 x2S11Max=-0.5 x3S11Max=-0.5
 S11Min=-2203.69120375772 PtS11Min=3 x2S11Min=0.5 x3S11Min=-0.5 FrameElem=95 ElemStation=0
 Frame=95 Station=0.5 OutputCase=FESSUR CaseType=Combination StepType=Min P=-774.999992280224 V2=-193.391787370538 V3=0 T=0 M2=0 M3=316.559428992817 S11Max=1124.35658167668 PtS11Max=1 x2S11Max=-0.5 x3S11Max=-0.5
 S11Min=-2674.35656623712 PtS11Min=3 x2S11Min=0.5 x3S11Min=-0.5 FrameElem=95 ElemStation=0.5
 Frame=112 Station=0 OutputCase=PESOPR CaseType=LinStatic P=15.170946736185 V2=-49.999999888387 V3=0 T=0 M2=0 M3=7.05342174187172 S11Max=57.4914771874153 PtS11Max=1 x2S11Max=-0.5 x3S11Max=-0.5
 S11Min=-27.1495837150453 PtS11Min=3 x2S11Min=0.5 x3S11Min=-0.5 FrameElem=112 ElemStation=0
 Frame=112 Station=0.125 OutputCase=PESOPR CaseType=LinStatic P=15.170946736185 V2=-46.8749999888387 V3=0 T=0 M2=0 M3=13.1081092404766 S11Max=93.8196021790443 PtS11Max=1 x2S11Max=-0.5 x3S11Max=-0.5
 S11Min=-63.4777087066743 PtS11Min=3 x2S11Min=0.5 x3S11Min=-0.5 FrameElem=112 ElemStation=0.125
 Frame=112 Station=0.25 OutputCase=PESOPR CaseType=LinStatic P=15.170946736185 V2=-43.7499999888387 V3=0 T=0 M2=0 M3=18.7721717390814 S11Max=127.803977170673 PtS11Max=1 x2S11Max=-0.5 x3S11Max=-0.5
 S11Min=-97.4620836983033 PtS11Min=3 x2S11Min=0.5 x3S11Min=-0.5 FrameElem=112 ElemStation=0.25
 Frame=112 Station=0.375 OutputCase=PESOPR CaseType=LinStatic P=15.170946736185 V2=-40.6249999888387 V3=0 T=0 M2=0 M3=24.0456092376862 S11Max=159.444602162302 PtS11Max=1 x2S11Max=-0.5 x3S11Max=-0.5
 S11Min=-129.102708689932 PtS11Min=3 x2S11Min=0.5 x3S11Min=-0.5 FrameElem=112 ElemStation=0.375
 Frame=112 Station=0.5 OutputCase=PESOPR CaseType=LinStatic P=15.170946736185 V2=-37.4999999888387 V3=0 T=0 M2=0 M3=28.9284217362911 S11Max=188.741477153931 PtS11Max=1 x2S11Max=-0.5 x3S11Max=-0.5
 S11Min=-158.399583681561 PtS11Min=3 x2S11Min=0.5 x3S11Min=-0.5 FrameElem=112 ElemStation=0.5
 Frame=112 Station=0 OutputCase=TERRVERT CaseType=LinStatic P=-1.64270738195971 V2=-559.99999718333 V3=0 T=0 M2=0 M3=-9.92555053006799 S11Max=57.9105957984483 PtS11Max=3 x2S11Max=0.5 x3S11Max=-0.5
 S11Min=-61.1960105623677 PtS11Min=1 x2S11Min=-0.5 x3S11Min=-0.5 FrameElem=112 ElemStation=0
 Frame=112 Station=0.125 OutputCase=TERRVERT CaseType=LinStatic P=-1.64270738195971 V2=-524.99999718333 V3=0 T=0 M2=0 M3=57.8869494347236 S11Max=345.678989226382 PtS11Max=1 x2S11Max=-0.5 x3S11Max=-0.5
 S11Min=-348.964403990302 PtS11Min=3 x2S11Min=0.5 x3S11Min=-0.5 FrameElem=112 ElemStation=0.125
 Frame=112 Station=0.25 OutputCase=TERRVERT CaseType=LinStatic P=-1.64270738195971 V2=-489.99999718333 V3=0 T=0 M2=0 M3=121.324449399515 S11Max=726.303989015132 PtS11Max=1 x2S11Max=-0.5 x3S11Max=-0.5
 S11Min=-729.589403779051 PtS11Min=3 x2S11Min=0.5 x3S11Min=-0.5 FrameElem=112 ElemStation=0.25
 Frame=112 Station=0.375 OutputCase=TERRVERT CaseType=LinStatic P=-1.64270738195971 V2=-454.99999718333 V3=0 T=0 M2=0 M3=180.386949364307 S11Max=1080.67898880388 PtS11Max=1 x2S11Max=-0.5 x3S11Max=-0.5
 S11Min=-1083.9644035678 PtS11Min=3 x2S11Min=0.5 x3S11Min=-0.5 FrameElem=112 ElemStation=0.375
 Frame=112 Station=0.5 OutputCase=TERRVERT CaseType=LinStatic P=-1.64270738195971 V2=-419.99999718333 V3=0 T=0 M2=0 M3=235.074449329099 S11Max=1408.80398859263 PtS11Max=1 x2S11Max=-0.5 x3S11Max=-0.5
 S11Min=-1412.08940335655 PtS11Min=3 x2S11Min=0.5 x3S11Min=-0.5 FrameElem=112 ElemStation=0.5
 Frame=112 Station=0 OutputCase=TERRLAT CaseType=LinStatic P=-330.586282883909 V2=1.69219674717169E-06 V3=0 T=0 M2=0 M3=-83.0711329571296 S11Max=167.840514858869 PtS11Max=3 x2S11Max=0.5 x3S11Max=-0.5
 S11Min=-829.013080626687 PtS11Min=1 x2S11Min=-0.5 x3S11Min=-0.5 FrameElem=112 ElemStation=0
 Frame=112 Station=0.125 OutputCase=TERRLAT CaseType=LinStatic P=-330.586282883909 V2=1.69219674717169E-06 V3=0 T=0 M2=0 M3=-83.0711331686542 S11Max=167.840516128016 PtS11Max=3 x2S11Max=0.5 x3S11Max=-0.5
 S11Min=-829.013081895834 PtS11Min=1 x2S11Min=-0.5 x3S11Min=-0.5 FrameElem=112 ElemStation=0.125
 Frame=112 Station=0.25 OutputCase=TERRLAT CaseType=LinStatic P=-330.586282883909 V2=1.69219674717169E-06 V3=0 T=0 M2=0 M3=-83.0711333801788 S11Max=167.840517397164 PtS11Max=3 x2S11Max=0.5 x3S11Max=-0.5
 S11Min=-829.013083164982 PtS11Min=1 x2S11Min=-0.5 x3S11Min=-0.5 FrameElem=112 ElemStation=0.25
 Frame=112 Station=0.375 OutputCase=TERRLAT CaseType=LinStatic P=-330.586282883909 V2=1.69219674717169E-06 V3=0 T=0 M2=0 M3=-83.0711335917034 S11Max=167.840518666312 PtS11Max=3 x2S11Max=0.5 x3S11Max=-0.5
 S11Min=-829.013084434129 PtS11Min=1 x2S11Min=-0.5 x3S11Min=-0.5 FrameElem=112 ElemStation=0.375
 Frame=112 Station=0.5 OutputCase=TERRLAT CaseType=LinStatic P=-330.586282883909 V2=1.69219674717169E-06 V3=0 T=0 M2=0 M3=-83.071133803228 S11Max=167.840519935459 PtS11Max=3 x2S11Max=0.5 x3S11Max=-0.5
 S11Min=-829.013085703277 PtS11Min=1 x2S11Min=-0.5 x3S11Min=-0.5 FrameElem=112 ElemStation=0.5
 Frame=112 Station=0 OutputCase=ACCVERT CaseType=LinStatic P=0 V2=0 V3=0 T=0 M2=0 M3=0 S11Max=0 PtS11Max=0 x2S11Max=0 x3S11Max=0 S11Min=0 PtS11Min=0 x2S11Min=0 x3S11Min=0 FrameElem=112 ElemStation=0
 Frame=112 Station=0.125 OutputCase=ACCVERT CaseType=LinStatic P=0 V2=0 V3=0 T=0 M2=0 M3=0 S11Max=0 PtS11Max=0 x2S11Max=0 x3S11Max=0 S11Min=0 PtS11Min=0 x2S11Min=0 x3S11Min=0 FrameElem=112 ElemStation=0.125
 Frame=112 Station=0.25 OutputCase=ACCVERT CaseType=LinStatic P=0 V2=0 V3=0 T=0 M2=0 M3=0 S11Max=0 PtS11Max=0 x2S11Max=0 x3S11Max=0 S11Min=0 PtS11Min=0 x2S11Min=0 x3S11Min=0 FrameElem=112 ElemStation=0.25
 Frame=112 Station=0.375 OutputCase=ACCVERT CaseType=LinStatic P=0 V2=0 V3=0 T=0 M2=0 M3=0 S11Max=0 PtS11Max=0 x2S11Max=0 x3S11Max=0 S11Min=0 PtS11Min=0 x2S11Min=0 x3S11Min=0 FrameElem=112 ElemStation=0.375
 Frame=112 Station=0.5 OutputCase=ACCVERT CaseType=LinStatic P=0 V2=0 V3=0 T=0 M2=0 M3=0 S11Max=0 PtS11Max=0 x2S11Max=0 x3S11Max=0 S11Min=0 PtS11Min=0 x2S11Min=0 x3S11Min=0 FrameElem=112 ElemStation=0.5
 Frame=112 Station=0 OutputCase=ACCLATDX CaseType=LinStatic P=0 V2=0 V3=0 T=0 M2=0 M3=0 S11Max=0 PtS11Max=0 x2S11Max=0 x3S11Max=0 S11Min=0 PtS11Min=0 x2S11Min=0 x3S11Min=0 FrameElem=112 ElemStation=0



Frame=112 Station=0.125 OutputCase=ACCLATDX CaseType=LinStatic P=0 V2=0 V3=0 T=0 M2=0 M3=0
 S11Max=0 PtS11Max=0 x2S11Max=0 x3S11Max=0 S11Min=0 PtS11Min=0 x2S11Min=0 x3S11Min=0 FrameElem=112
 ElemStation=0.125
 Frame=112 Station=0.25 OutputCase=ACCLATDX CaseType=LinStatic P=0 V2=0 V3=0 T=0 M2=0 M3=0
 S11Max=0 PtS11Max=0 x2S11Max=0 x3S11Max=0 S11Min=0 PtS11Min=0 x2S11Min=0 x3S11Min=0 FrameElem=112
 ElemStation=0.25
 Frame=112 Station=0.375 OutputCase=ACCLATDX CaseType=LinStatic P=0 V2=0 V3=0 T=0 M2=0 M3=0
 S11Max=0 PtS11Max=0 x2S11Max=0 x3S11Max=0 S11Min=0 PtS11Min=0 x2S11Min=0 x3S11Min=0 FrameElem=112
 ElemStation=0.375
 Frame=112 Station=0.5 OutputCase=ACCLATDX CaseType=LinStatic P=0 V2=0 V3=0 T=0 M2=0 M3=0
 S11Max=0 PtS11Max=0 x2S11Max=0 x3S11Max=0 S11Min=0 PtS11Min=0 x2S11Min=0 x3S11Min=0 FrameElem=112
 ElemStation=0.5
 Frame=112 Station=0 OutputCase=ACCLATSX CaseType=LinStatic P=0 V2=0 V3=0 T=0 M2=0 M3=0
 S11Max=0 PtS11Max=0 x2S11Max=0 x3S11Max=0 S11Min=0 PtS11Min=0 x2S11Min=0 x3S11Min=0 FrameElem=112
 ElemStation=0
 Frame=112 Station=0.125 OutputCase=ACCLATSX CaseType=LinStatic P=0 V2=0 V3=0 T=0 M2=0 M3=0
 S11Max=0 PtS11Max=0 x2S11Max=0 x3S11Max=0 S11Min=0 PtS11Min=0 x2S11Min=0 x3S11Min=0 FrameElem=112
 ElemStation=0.125
 Frame=112 Station=0.25 OutputCase=ACCLATSX CaseType=LinStatic P=0 V2=0 V3=0 T=0 M2=0 M3=0
 S11Max=0 PtS11Max=0 x2S11Max=0 x3S11Max=0 S11Min=0 PtS11Min=0 x2S11Min=0 x3S11Min=0 FrameElem=112
 ElemStation=0.25
 Frame=112 Station=0.375 OutputCase=ACCLATSX CaseType=LinStatic P=0 V2=0 V3=0 T=0 M2=0 M3=0
 S11Max=0 PtS11Max=0 x2S11Max=0 x3S11Max=0 S11Min=0 PtS11Min=0 x2S11Min=0 x3S11Min=0 FrameElem=112
 ElemStation=0.375
 Frame=112 Station=0.5 OutputCase=ACCLATSX CaseType=LinStatic P=0 V2=0 V3=0 T=0 M2=0 M3=0
 S11Max=0 PtS11Max=0 x2S11Max=0 x3S11Max=0 S11Min=0 PtS11Min=0 x2S11Min=0 x3S11Min=0 FrameElem=112
 ElemStation=0.5
 Frame=112 Station=0 OutputCase=TERRCOST CaseType=LinStatic P=0 V2=0 V3=0 T=0 M2=0 M3=0
 S11Max=0 PtS11Max=0 x2S11Max=0 x3S11Max=0 S11Min=0 PtS11Min=0 x2S11Min=0 x3S11Min=0 FrameElem=112
 ElemStation=0
 Frame=112 Station=0.125 OutputCase=TERRCOST CaseType=LinStatic P=0 V2=0 V3=0 T=0 M2=0 M3=0
 S11Max=0 PtS11Max=0 x2S11Max=0 x3S11Max=0 S11Min=0 PtS11Min=0 x2S11Min=0 x3S11Min=0 FrameElem=112
 ElemStation=0.125
 Frame=112 Station=0.25 OutputCase=TERRCOST CaseType=LinStatic P=0 V2=0 V3=0 T=0 M2=0 M3=0
 S11Max=0 PtS11Max=0 x2S11Max=0 x3S11Max=0 S11Min=0 PtS11Min=0 x2S11Min=0 x3S11Min=0 FrameElem=112
 ElemStation=0.25
 Frame=112 Station=0.375 OutputCase=TERRCOST CaseType=LinStatic P=0 V2=0 V3=0 T=0 M2=0 M3=0
 S11Max=0 PtS11Max=0 x2S11Max=0 x3S11Max=0 S11Min=0 PtS11Min=0 x2S11Min=0 x3S11Min=0 FrameElem=112
 ElemStation=0.375
 Frame=112 Station=0.5 OutputCase=TERRCOST CaseType=LinStatic P=0 V2=0 V3=0 T=0 M2=0 M3=0
 S11Max=0 PtS11Max=0 x2S11Max=0 x3S11Max=0 S11Min=0 PtS11Min=0 x2S11Min=0 x3S11Min=0 FrameElem=112
 ElemStation=0.5
 Frame=112 Station=0 OutputCase=SOVRCOST CaseType=LinStatic P=0 V2=0 V3=0 T=0 M2=0 M3=0
 S11Max=0 PtS11Max=0 x2S11Max=0 x3S11Max=0 S11Min=0 PtS11Min=0 x2S11Min=0 x3S11Min=0 FrameElem=112
 ElemStation=0
 Frame=112 Station=0.125 OutputCase=SOVRCOST CaseType=LinStatic P=0 V2=0 V3=0 T=0 M2=0 M3=0
 S11Max=0 PtS11Max=0 x2S11Max=0 x3S11Max=0 S11Min=0 PtS11Min=0 x2S11Min=0 x3S11Min=0 FrameElem=112
 ElemStation=0.125
 Frame=112 Station=0.25 OutputCase=SOVRCOST CaseType=LinStatic P=0 V2=0 V3=0 T=0 M2=0 M3=0
 S11Max=0 PtS11Max=0 x2S11Max=0 x3S11Max=0 S11Min=0 PtS11Min=0 x2S11Min=0 x3S11Min=0 FrameElem=112
 ElemStation=0.25
 Frame=112 Station=0.375 OutputCase=SOVRCOST CaseType=LinStatic P=0 V2=0 V3=0 T=0 M2=0 M3=0
 S11Max=0 PtS11Max=0 x2S11Max=0 x3S11Max=0 S11Min=0 PtS11Min=0 x2S11Min=0 x3S11Min=0 FrameElem=112
 ElemStation=0.375
 Frame=112 Station=0.5 OutputCase=SOVRCOST CaseType=LinStatic P=0 V2=0 V3=0 T=0 M2=0 M3=0
 S11Max=0 PtS11Max=0 x2S11Max=0 x3S11Max=0 S11Min=0 PtS11Min=0 x2S11Min=0 x3S11Min=0 FrameElem=112
 ElemStation=0.5
 Frame=112 Station=0 OutputCase=ENVE CaseType=Combination StepType=Max P=-217.882158664511 V2=-
 609.99998014975 V3=0 T=0 M2=0 M3=-61.021921858187 S11Max=198.601526942272 PtS11Max=3 x2S11Max=0.5
 x3S11Max=-0.5
 S11Min=-584.013689813633 PtS11Min=1 x2S11Min=-0.5 x3S11Min=-0.5 FrameElem=112 ElemStation=0
 Frame=112 Station=0.125 OutputCase=ENVE CaseType=Combination StepType=Max P=-217.882158664511 V2=-
 571.874998014975 V3=0 T=0 M2=0 M3=12.8452654571422 S11Max=-140.810565921658 PtS11Max=1 x2S11Max=-0.5
 x3S11Max=-0.5 S11Min=-244.601596568959 PtS11Min=3 x2S11Min=0.5 x3S11Min=-0.5 FrameElem=112
 ElemStation=0.125
 Frame=112 Station=0.25 OutputCase=ENVE CaseType=Combination StepType=Max P=-217.882158664511 V2=-
 533.749998014975 V3=0 T=0 M2=0 M3=81.9468277724715 S11Max=273.798807970318 PtS11Max=1 x2S11Max=-0.5
 x3S11Max=-0.5 S11Min=-659.210970080191 PtS11Min=3 x2S11Min=0.5 x3S11Min=-0.5 FrameElem=112
 ElemStation=0.25
 Frame=112 Station=0.375 OutputCase=ENVE CaseType=Combination StepType=Max P=-217.882158664511 V2=-
 495.624998014975 V3=0 T=0 M2=0 M3=146.282765087801 S11Max=659.814431862294 PtS11Max=1 x2S11Max=-0.5
 x3S11Max=-0.5 S11Min=-1045.22659359142 PtS11Min=3 x2S11Min=0.5 x3S11Min=-0.5 FrameElem=112
 ElemStation=0.375
 Frame=112 Station=0.5 OutputCase=ENVE CaseType=Combination StepType=Max P=-217.882158664511 V2=-
 457.499998014975 V3=0 T=0 M2=0 M3=205.85307740313 S11Max=1017.23630575427 PtS11Max=1 x2S11Max=-0.5
 x3S11Max=-0.5
 S11Min=-1402.64846710265 PtS11Min=3 x2S11Min=0.5 x3S11Min=-0.5 FrameElem=112 ElemStation=0.5
 Frame=112 Station=0 OutputCase=ENVE CaseType=Combination StepType=Min P=-317.058043529684 V2=-
 609.99998522634 V3=0 T=0 M2=0 M3=-85.9432617453259 S11Max=148.249372484611 PtS11Max=3 x2S11Max=0.5
 x3S11Max=-0.5
 S11Min=-832.717614001639 PtS11Min=1 x2S11Min=-0.5 x3S11Min=-0.5 FrameElem=112 ElemStation=0



Frame=112 Station=0.125 OutputCase=ENVE CaseType=Combination StepType=Min P=-317.058043529684 V2=-571.874998522634 V3=0 T=0 M2=0 M3=-12.076074493454 S11Max=-294.953751407364 PtS11Max=3 x2S11Max=0.5 x3S11Max=-0.5 S11Min=-389.514490490408 PtS11Min=1 x2S11Min=-0.5 x3S11Min=-0.5 FrameElem=112 ElemStation=0.125
 Frame=112 Station=0.25 OutputCase=ENVE CaseType=Combination StepType=Min P=-317.058043529684 V2=-533.749998522634 V3=0 T=0 M2=0 M3=57.0254877584179 S11Max=25.0948830208235 PtS11Max=1 x2S11Max=-0.5 x3S11Max=-0.5 S11Min=-709.56312529934 PtS11Min=3 x2S11Min=0.5 x3S11Min=-0.5 FrameElem=112 ElemStation=0.25
 Frame=112 Station=0.375 OutputCase=ENVE CaseType=Combination StepType=Min P=-317.058043529684 V2=-495.624998522634 V3=0 T=0 M2=0 M3=121.36142501029 S11Max=411.110506532055 PtS11Max=1 x2S11Max=-0.5 x3S11Max=-0.5 S11Min=-1095.57874919132 PtS11Min=3 x2S11Min=0.5 x3S11Min=-0.5 FrameElem=112 ElemStation=0.375
 Frame=112 Station=0.5 OutputCase=ENVE CaseType=Combination StepType=Min P=-317.058043529684 V2=-457.499998522634 V3=0 T=0 M2=0 M3=180.931737262162 S11Max=768.532380043286 PtS11Max=1 x2S11Max=-0.5 x3S11Max=-0.5 S11Min=-1453.00062308329 PtS11Min=3 x2S11Min=0.5 x3S11Min=-0.5 FrameElem=112 ElemStation=0.5
 Frame=112 Station=0 OutputCase=FESSUR CaseType=Combination P=-317.058043529684 V2=-609.999998014975 V3=0 T=0 M2=0 M3=-85.9432617453259 S11Max=198.601526942272 PtS11Max=3 x2S11Max=0.5 x3S11Max=-0.5 S11Min=-832.717614001639 PtS11Min=1 x2S11Min=-0.5 x3S11Min=-0.5 FrameElem=112 ElemStation=0
 Frame=112 Station=0.125 OutputCase=FESSUR CaseType=Combination P=-317.058043529684 V2=-571.874998014975 V3=0 T=0 M2=0 M3=-12.076074493454 S11Max=-244.601596568959 PtS11Max=3 x2S11Max=0.5 x3S11Max=-0.5 S11Min=-389.514490490408 PtS11Min=1 x2S11Min=-0.5 x3S11Min=-0.5 FrameElem=112 ElemStation=0.125
 Frame=112 Station=0.25 OutputCase=FESSUR CaseType=Combination P=-317.058043529684 V2=-533.749998014975 V3=0 T=0 M2=0 M3=57.0254877584179 S11Max=25.0948830208235 PtS11Max=1 x2S11Max=-0.5 x3S11Max=-0.5 S11Min=-659.210970080191 PtS11Min=3 x2S11Min=0.5 x3S11Min=-0.5 FrameElem=112 ElemStation=0.25
 Frame=112 Station=0.375 OutputCase=FESSUR CaseType=Combination P=-317.058043529684 V2=-495.624998014975 V3=0 T=0 M2=0 M3=121.36142501029 S11Max=411.110506532055 PtS11Max=1 x2S11Max=-0.5 x3S11Max=-0.5 S11Min=-1045.22659359142 PtS11Min=3 x2S11Min=0.5 x3S11Min=-0.5 FrameElem=112 ElemStation=0.375
 Frame=112 Station=0.5 OutputCase=FESSUR CaseType=Combination P=-317.058043529684 V2=-457.499998014975 V3=0 T=0 M2=0 M3=180.931737262162 S11Max=768.532380043286 PtS11Max=1 x2S11Max=-0.5 x3S11Max=-0.5 S11Min=-1402.64846710265 PtS11Min=3 x2S11Min=0.5 x3S11Min=-0.5 FrameElem=112 ElemStation=0.5
 Frame=113 Station=0 OutputCase=PESOPR CaseType=LinStatic P=15.1709467361849 V2=-37.499999888387 V3=0 T=0 M2=0 M3=28.9284217362983 S11Max=188.741477153975 PtS11Max=1 x2S11Max=-0.5 x3S11Max=-0.5 S11Min=-158.399583681605 PtS11Min=3 x2S11Min=0.5 x3S11Min=-0.5 FrameElem=113 ElemStation=0
 Frame=113 Station=0.125 OutputCase=PESOPR CaseType=LinStatic P=15.1709467361849 V2=-34.3749999888387 V3=0 T=0 M2=0 M3=33.4206092349032 S11Max=215.694602145604 PtS11Max=1 x2S11Max=-0.5 x3S11Max=-0.5 S11Min=-185.352708673234 PtS11Min=3 x2S11Min=0.5 x3S11Min=-0.5 FrameElem=113 ElemStation=0.125
 Frame=113 Station=0.25 OutputCase=PESOPR CaseType=LinStatic P=15.1709467361849 V2=-31.2499999888387 V3=0 T=0 M2=0 M3=37.522171733508 S11Max=240.303977137233 PtS11Max=1 x2S11Max=-0.5 x3S11Max=-0.5 S11Min=-209.962083664863 PtS11Min=3 x2S11Min=0.5 x3S11Min=-0.5 FrameElem=113 ElemStation=0.25
 Frame=113 Station=0.375 OutputCase=PESOPR CaseType=LinStatic P=15.1709467361849 V2=-28.1249999888387 V3=0 T=0 M2=0 M3=41.2331092321128 S11Max=262.569602128862 PtS11Max=1 x2S11Max=-0.5 x3S11Max=-0.5 S11Min=-232.227708656492 PtS11Min=3 x2S11Min=0.5 x3S11Min=-0.5 FrameElem=113 ElemStation=0.375
 Frame=113 Station=0.5 OutputCase=PESOPR CaseType=LinStatic P=15.1709467361849 V2=-24.9999999888387 V3=0 T=0 M2=0 M3=44.5534217307177 S11Max=282.491477120491 PtS11Max=1 x2S11Max=-0.5 x3S11Max=-0.5 S11Min=-252.149583648121 PtS11Min=3 x2S11Min=0.5 x3S11Min=-0.5 FrameElem=113 ElemStation=0.5
 Frame=113 Station=0 OutputCase=TERRVERT CaseType=LinStatic P=-1.64270738195971 V2=-419.99999718333 V3=0 T=0 M2=0 M3=235.074449329099 S11Max=1408.80398859263 PtS11Max=1 x2S11Max=-0.5 x3S11Max=-0.5 S11Min=-1412.08940335655 PtS11Min=3 x2S11Min=0.5 x3S11Min=-0.5 FrameElem=113 ElemStation=0
 Frame=113 Station=0.125 OutputCase=TERRVERT CaseType=LinStatic P=-1.64270738195971 V2=-384.99999718333 V3=0 T=0 M2=0 M3=285.38694929389 S11Max=1710.67898838138 PtS11Max=1 x2S11Max=-0.5 x3S11Max=-0.5 S11Min=-1713.9644031453 PtS11Min=3 x2S11Min=0.5 x3S11Min=-0.5 FrameElem=113 ElemStation=0.125
 Frame=113 Station=0.25 OutputCase=TERRVERT CaseType=LinStatic P=-1.64270738195971 V2=-349.99999718333 V3=0 T=0 M2=0 M3=331.324449258682 S11Max=1986.30398817013 PtS11Max=1 x2S11Max=-0.5 x3S11Max=-0.5 S11Min=-1989.58940293405 PtS11Min=3 x2S11Min=0.5 x3S11Min=-0.5 FrameElem=113 ElemStation=0.25
 Frame=113 Station=0.375 OutputCase=TERRVERT CaseType=LinStatic P=-1.64270738195971 V2=-314.99999718333 V3=0 T=0 M2=0 M3=372.886949223473 S11Max=2235.67898795888 PtS11Max=1 x2S11Max=-0.5 x3S11Max=-0.5 S11Min=-2238.9644027228 PtS11Min=3 x2S11Min=0.5 x3S11Min=-0.5 FrameElem=113 ElemStation=0.375
 Frame=113 Station=0.5 OutputCase=TERRVERT CaseType=LinStatic P=-1.64270738195971 V2=-279.99999718333 V3=0 T=0 M2=0 M3=410.074449188265 S11Max=2458.80398774763 PtS11Max=1 x2S11Max=-0.5 x3S11Max=-0.5 S11Min=-2462.08940251155 PtS11Min=3 x2S11Min=0.5 x3S11Min=-0.5 FrameElem=113 ElemStation=0.5
 Frame=113 Station=0 OutputCase=TERRLAT CaseType=LinStatic P=-330.586282883909 V2=1.69219674717169E-06 V3=0 T=0 M2=0 M3=-83.071133803228 S11Max=167.840519935459 PtS11Max=3 x2S11Max=0.5 x3S11Max=-0.5 S11Min=-829.013085703277 PtS11Min=1 x2S11Min=-0.5 x3S11Min=-0.5 FrameElem=113 ElemStation=0
 Frame=113 Station=0.125 OutputCase=TERRLAT CaseType=LinStatic P=-330.586282883909 V2=1.69219674717169E-06 V3=0 T=0 M2=0 M3=-83.0711340147526 S11Max=167.840521204607 PtS11Max=3 x2S11Max=0.5 x3S11Max=-0.5 S11Min=-829.013086972425 PtS11Min=1 x2S11Min=-0.5 x3S11Min=-0.5 FrameElem=113 ElemStation=0.125
 Frame=113 Station=0.25 OutputCase=TERRLAT CaseType=LinStatic P=-330.586282883909 V2=1.69219674717169E-06 V3=0 T=0 M2=0 M3=-83.0711342262772 S11Max=167.840522473754 PtS11Max=3 x2S11Max=0.5 x3S11Max=-0.5 S11Min=-829.013088241572 PtS11Min=1 x2S11Min=-0.5 x3S11Min=-0.5 FrameElem=113 ElemStation=0.25
 Frame=113 Station=0.375 OutputCase=TERRLAT CaseType=LinStatic P=-330.586282883909 V2=1.69219674717169E-06 V3=0 T=0 M2=0 M3=-83.0711344378018 S11Max=167.840523742902 PtS11Max=3 x2S11Max=0.5 x3S11Max=-0.5 S11Min=-829.01308951072 PtS11Min=1 x2S11Min=-0.5 x3S11Min=-0.5 FrameElem=113 ElemStation=0.375
 Frame=113 Station=0.5 OutputCase=TERRLAT CaseType=LinStatic P=-330.586282883909 V2=1.69219674717169E-06 V3=0 T=0 M2=0 M3=-83.0711346493264 S11Max=167.840525012049 PtS11Max=3 x2S11Max=0.5 x3S11Max=-0.5 S11Min=-829.013090779867 PtS11Min=1 x2S11Min=-0.5 x3S11Min=-0.5 FrameElem=113 ElemStation=0.5
 Frame=113 Station=0 OutputCase=ACCVERT CaseType=LinStatic P=0 V2=0 V3=0 T=0 M2=0 M3=0 S11Max=0 PtS11Max=0 x2S11Max=0 x3S11Max=0 S11Min=0 PtS11Min=0 x2S11Min=0 x3S11Min=0 FrameElem=113 ElemStation=0



x3S11Max=-0.5 S11Min=-2031.71096412516 PtS11Min=3 x2S11Min=0.5 x3S11Min=-0.5 FrameElem=113
 ElemStation=0.25
 Frame=113 Station=0.375 OutputCase=ENVE CaseType=Combination StepType=Max P=-217.882158664511 V2=-
 343.124998014975 V3=0 T=0 M2=0 M3=355.970264349125 S11Max=1917.93942743024 PtS11Max=1 x2S11Max=-0.5 _
 x3S11Max=-0.5 S11Min=-2303.35158763639 PtS11Min=3 x2S11Min=0.5 x3S11Min=-0.5 FrameElem=113
 ElemStation=0.375
 Frame=113 Station=0.5 OutputCase=ENVE CaseType=Combination StepType=Max P=-217.882158664511 V2=-
 304.999998014975 V3=0 T=0 M2=0 M3=396.478076664454 S11Max=2160.98630132221 PtS11Max=1 x2S11Max=-0.5
 x3S11Max=-0.5 _
 S11Min=-2546.39846114762 PtS11Min=3 x2S11Min=0.5 x3S11Min=-0.5 FrameElem=113 ElemStation=0.5
 Frame=113 Station=0 OutputCase=ENVE CaseType=Combination StepType=Min P=-317.058043529684 V2=-
 457.499998522634 V3=0 T=0 M2=0 M3=180.931737262169 S11Max=768.53238004333 PtS11Max=1 x2S11Max=-0.5
 x3S11Max=-0.5 _
 S11Min=-1453.00062308333 PtS11Min=3 x2S11Min=0.5 x3S11Min=-0.5 FrameElem=113 ElemStation=0
 Frame=113 Station=0.125 OutputCase=ENVE CaseType=Combination StepType=Min P=-317.058043529684 V2=-
 419.374998522634 V3=0 T=0 M2=0 M3=235.736424514041 S11Max=1097.36050355456 PtS11Max=1 x2S11Max=-0.5 _
 x3S11Max=-0.5 S11Min=-1781.82874697531 PtS11Min=3 x2S11Min=0.5 x3S11Min=-0.5 FrameElem=113
 ElemStation=0.125
 Frame=113 Station=0.25 OutputCase=ENVE CaseType=Combination StepType=Min P=-317.058043529684 V2=-
 381.249998522634 V3=0 T=0 M2=0 M3=285.775486765913 S11Max=1397.59487706579 PtS11Max=1 x2S11Max=-0.5 _
 x3S11Max=-0.5 S11Min=-2082.06312086729 PtS11Min=3 x2S11Min=0.5 x3S11Min=-0.5 FrameElem=113
 ElemStation=0.25
 Frame=113 Station=0.375 OutputCase=ENVE CaseType=Combination StepType=Min P=-317.058043529684 V2=-
 343.124998522634 V3=0 T=0 M2=0 M3=331.048924017785 S11Max=1669.23550057702 PtS11Max=1 x2S11Max=-0.5 _
 x3S11Max=-0.5 S11Min=-2353.70374475926 PtS11Min=3 x2S11Min=0.5 x3S11Min=-0.5 FrameElem=113
 ElemStation=0.375
 Frame=113 Station=0.5 OutputCase=ENVE CaseType=Combination StepType=Min P=-317.058043529684 V2=-
 304.999998522634 V3=0 T=0 M2=0 M3=371.556736269656 S11Max=1912.28237408825 PtS11Max=1 x2S11Max=-0.5
 x3S11Max=-0.5 _
 S11Min=-2596.75061865124 PtS11Min=3 x2S11Min=0.5 x3S11Min=-0.5 FrameElem=113 ElemStation=0.5
 Frame=113 Station=0 OutputCase=FESSUR CaseType=Combination P=-317.058043529684 V2=-457.499998014975
 V3=0 T=0 M2=0 M3=180.931737262169 S11Max=768.53238004333 PtS11Max=1 x2S11Max=-0.5 x3S11Max=-0.5 _
 S11Min=-1402.6484671027 x2S11Min=0.5 x3S11Min=-0.5 FrameElem=113 ElemStation=0
 Frame=113 Station=0.125 OutputCase=FESSUR CaseType=Combination P=-317.058043529684 V2=-419.374998014975
 V3=0 T=0 M2=0 M3=235.736424514041 S11Max=1097.36050355456 PtS11Max=1 x2S11Max=-0.5 x3S11Max=-0.5 _
 S11Min=-1731.47659061393 x2S11Min=0.5 x3S11Min=-0.5 FrameElem=113 ElemStation=0.125
 Frame=113 Station=0.25 OutputCase=FESSUR CaseType=Combination P=-317.058043529684 V2=-381.249998014975
 V3=0 T=0 M2=0 M3=285.775486765913 S11Max=1397.59487706579 PtS11Max=1 x2S11Max=-0.5 x3S11Max=-0.5 _
 S11Min=-2031.71096412516 PtS11Min=3 x2S11Min=0.5 x3S11Min=-0.5 FrameElem=113 ElemStation=0.25
 Frame=113 Station=0.375 OutputCase=FESSUR CaseType=Combination P=-317.058043529684 V2=-343.124998014975
 V3=0 T=0 M2=0 M3=331.048924017785 S11Max=1669.23550057702 PtS11Max=1 x2S11Max=-0.5 x3S11Max=-0.5 _
 S11Min=-2303.35158763639 PtS11Min=3 x2S11Min=0.5 x3S11Min=-0.5 FrameElem=113 ElemStation=0.375
 Frame=113 Station=0.5 OutputCase=FESSUR CaseType=Combination P=-317.058043529684 V2=-304.999998014975
 V3=0 T=0 M2=0 M3=371.556736269656 S11Max=1912.28237408825 PtS11Max=1 x2S11Max=-0.5 x3S11Max=-0.5 _
 S11Min=-2546.39846114762 PtS11Min=3 x2S11Min=0.5 x3S11Min=-0.5 FrameElem=113 ElemStation=0.5
 Frame=114 Station=0 OutputCase=PESOPR CaseType=LinStatic P=15.1709467361849 V2=-24.999999888678 V3=0
 T=0 M2=0 M3=44.553421730714 S11Max=282.491477120469 PtS11Max=1 x2S11Max=-0.5 x3S11Max=-0.5 _
 S11Min=-252.149583648099 PtS11Min=3 x2S11Min=0.5 x3S11Min=-0.5 FrameElem=114 ElemStation=0
 Frame=114 Station=0.125 OutputCase=PESOPR CaseType=LinStatic P=15.1709467361849 V2=-21.8749999888678
 V3=0 T=0 M2=0 M3=47.4831092293225 S11Max=300.06960211212 PtS11Max=1 x2S11Max=-0.5 x3S11Max=-0.5 _
 S11Min=-269.72770863975 PtS11Min=3 x2S11Min=0.5 x3S11Min=-0.5 FrameElem=114 ElemStation=0.125
 Frame=114 Station=0.25 OutputCase=PESOPR CaseType=LinStatic P=15.1709467361849 V2=-18.7499999888678
 V3=0 T=0 M2=0 M3=50.022171727931 S11Max=315.303977103771 PtS11Max=1 x2S11Max=-0.5 x3S11Max=-0.5 _
 S11Min=-284.962083631401 PtS11Min=3 x2S11Min=0.5 x3S11Min=-0.5 FrameElem=114 ElemStation=0.25
 Frame=114 Station=0.375 OutputCase=PESOPR CaseType=LinStatic P=15.1709467361849 V2=-15.6249999888678
 V3=0 T=0 M2=0 M3=52.1706092265395 S11Max=328.194602095422 PtS11Max=1 x2S11Max=-0.5 x3S11Max=-0.5 _
 S11Min=-297.852708623052 PtS11Min=3 x2S11Min=0.5 x3S11Min=-0.5 FrameElem=114 ElemStation=0.375
 Frame=114 Station=0.5 OutputCase=PESOPR CaseType=LinStatic P=15.1709467361849 V2=-12.4999999888678
 V3=0 T=0 M2=0 M3=53.9284217251479 S11Max=338.741477087073 PtS11Max=1 x2S11Max=-0.5 x3S11Max=-0.5 _
 S11Min=-308.399583614703 PtS11Min=3 x2S11Min=0.5 x3S11Min=-0.5 FrameElem=114 ElemStation=0.5
 Frame=114 Station=0 OutputCase=TERRVERT CaseType=LinStatic P=-1.64270738195971 V2=-279.999999718391
 V3=0 T=0 M2=0 M3=410.074449188251 S11Max=2458.80398774754 PtS11Max=1 x2S11Max=-0.5 x3S11Max=-0.5 _
 S11Min=-2462.08940251146 PtS11Min=3 x2S11Min=0.5 x3S11Min=-0.5 FrameElem=114 ElemStation=0
 Frame=114 Station=0.125 OutputCase=TERRVERT CaseType=LinStatic P=-1.64270738195971 V2=-244.999999718391
 V3=0 T=0 M2=0 M3=442.88694915305 S11Max=2655.67898753634 PtS11Max=1 x2S11Max=-0.5 x3S11Max=-0.5 _
 S11Min=-2658.96440230026 PtS11Min=3 x2S11Min=0.5 x3S11Min=-0.5 FrameElem=114 ElemStation=0.125
 Frame=114 Station=0.25 OutputCase=TERRVERT CaseType=LinStatic P=-1.64270738195971 V2=-209.999999718391
 V3=0 T=0 M2=0 M3=471.324449117848 S11Max=2826.30398732513 PtS11Max=1 x2S11Max=-0.5 x3S11Max=-0.5 _
 S11Min=-2829.58940208905 PtS11Min=3 x2S11Min=0.5 x3S11Min=-0.5 FrameElem=114 ElemStation=0.25
 Frame=114 Station=0.375 OutputCase=TERRVERT CaseType=LinStatic P=-1.64270738195971 V2=-174.999999718391
 V3=0 T=0 M2=0 M3=495.386949082647 S11Max=2970.67898711392 PtS11Max=1 x2S11Max=-0.5 x3S11Max=-0.5 _
 S11Min=-2973.96440187784 PtS11Min=3 x2S11Min=0.5 x3S11Min=-0.5 FrameElem=114 ElemStation=0.375
 Frame=114 Station=0.5 OutputCase=TERRVERT CaseType=LinStatic P=-1.64270738195971 V2=-139.999999718391
 V3=0 T=0 M2=0 M3=515.074449047446 S11Max=3088.80398690272 PtS11Max=1 x2S11Max=-0.5 x3S11Max=-0.5 _
 S11Min=-3092.08940166664 PtS11Min=3 x2S11Min=0.5 x3S11Min=-0.5 FrameElem=114 ElemStation=0.5
 Frame=114 Station=0 OutputCase=TERRLAT CaseType=LinStatic P=-330.586282883909 V2=1.69219811141375E-06
 V3=0 T=0 M2=0 M3=-83.0711346493264 S11Max=167.84052501205 PtS11Max=3 x2S11Max=0.5 x3S11Max=-0.5 _
 S11Min=-829.013090779867 PtS11Min=1 x2S11Min=-0.5 x3S11Min=-0.5 FrameElem=114 ElemStation=0
 Frame=114 Station=0.125 OutputCase=TERRLAT CaseType=LinStatic P=-330.586282883909 V2=1.69219811141375E-
 06 V3=0 T=0 M2=0 M3=-83.0711348608511 S11Max=167.840526281198 PtS11Max=3 x2S11Max=0.5 x3S11Max=-0.5
 _
 S11Min=-829.013092049016 PtS11Min=1 x2S11Min=-0.5 x3S11Min=-0.5 FrameElem=114 ElemStation=0.125

```

Frame=114 Station=0.25 OutputCase=TERRLAT CaseType=LinStatic P=-330.586282883909 V2=1.69219811141375E-
06 V3=0 T=0 M2=0 M3=-83.0711350723759 S11Max=167.840527550347 PtS11Max=3 x2S11Max=0.5 x3S11Max=-0.5
-
S11Min=-829.013093318164 PtS11Min=1 x2S11Min=-0.5 x3S11Min=-0.5 FrameElem=114 ElemStation=0.25
Frame=114 Station=0.375 OutputCase=TERRLAT CaseType=LinStatic P=-330.586282883909 V2=1.69219811141375E-
06 V3=0 T=0 M2=0 M3=-83.0711352839007 S11Max=167.840528819495 PtS11Max=3 x2S11Max=0.5 x3S11Max=-0.5
-
S11Min=-829.013094587313 PtS11Min=1 x2S11Min=-0.5 x3S11Min=-0.5 FrameElem=114 ElemStation=0.375
Frame=114 Station=0.5 OutputCase=TERRLAT CaseType=LinStatic P=-330.586282883909 V2=1.69219811141375E-06
V3=0 T=0 M2=0 M3=-83.0711354954254 S11Max=167.840530088644 PtS11Max=3 x2S11Max=0.5 x3S11Max=-0.5
S11Min=-829.013095856461 PtS11Min=1 x2S11Min=-0.5 x3S11Min=-0.5 FrameElem=114 ElemStation=0.5
Frame=114 Station=0 OutputCase=ACCVERT CaseType=LinStatic P=0 V2=0 V3=0 T=0 M2=0 M3=0
S11Max=0 PtS11Max=0 x2S11Max=0 x3S11Max=0 S11Min=0 PtS11Min=0 x2S11Min=0 x3S11Min=0 FrameElem=114
ElemStation=0
Frame=114 Station=0.125 OutputCase=ACCVERT CaseType=LinStatic P=0 V2=0 V3=0 T=0 M2=0 M3=0
S11Max=0 PtS11Max=0 x2S11Max=0 x3S11Max=0 S11Min=0 PtS11Min=0 x2S11Min=0 x3S11Min=0 FrameElem=114
ElemStation=0.125
Frame=114 Station=0.25 OutputCase=ACCVERT CaseType=LinStatic P=0 V2=0 V3=0 T=0 M2=0 M3=0
S11Max=0 PtS11Max=0 x2S11Max=0 x3S11Max=0 S11Min=0 PtS11Min=0 x2S11Min=0 x3S11Min=0 FrameElem=114
ElemStation=0.25
Frame=114 Station=0.375 OutputCase=ACCVERT CaseType=LinStatic P=0 V2=0 V3=0 T=0 M2=0 M3=0
S11Max=0 PtS11Max=0 x2S11Max=0 x3S11Max=0 S11Min=0 PtS11Min=0 x2S11Min=0 x3S11Min=0 FrameElem=114
ElemStation=0.375
Frame=114 Station=0.5 OutputCase=ACCVERT CaseType=LinStatic P=0 V2=0 V3=0 T=0 M2=0 M3=0
S11Max=0 PtS11Max=0 x2S11Max=0 x3S11Max=0 S11Min=0 PtS11Min=0 x2S11Min=0 x3S11Min=0 FrameElem=114
ElemStation=0.5
Frame=114 Station=0 OutputCase=ACCLATDX CaseType=LinStatic P=0 V2=0 V3=0 T=0 M2=0 M3=0
S11Max=0 PtS11Max=0 x2S11Max=0 x3S11Max=0 S11Min=0 PtS11Min=0 x2S11Min=0 x3S11Min=0 FrameElem=114
ElemStation=0
Frame=114 Station=0.125 OutputCase=ACCLATDX CaseType=LinStatic P=0 V2=0 V3=0 T=0 M2=0 M3=0
S11Max=0 PtS11Max=0 x2S11Max=0 x3S11Max=0 S11Min=0 PtS11Min=0 x2S11Min=0 x3S11Min=0 FrameElem=114
ElemStation=0.125
Frame=114 Station=0.25 OutputCase=ACCLATDX CaseType=LinStatic P=0 V2=0 V3=0 T=0 M2=0 M3=0
S11Max=0 PtS11Max=0 x2S11Max=0 x3S11Max=0 S11Min=0 PtS11Min=0 x2S11Min=0 x3S11Min=0 FrameElem=114
ElemStation=0.25
Frame=114 Station=0.375 OutputCase=ACCLATDX CaseType=LinStatic P=0 V2=0 V3=0 T=0 M2=0 M3=0
S11Max=0 PtS11Max=0 x2S11Max=0 x3S11Max=0 S11Min=0 PtS11Min=0 x2S11Min=0 x3S11Min=0 FrameElem=114
ElemStation=0.375
Frame=114 Station=0.5 OutputCase=ACCLATDX CaseType=LinStatic P=0 V2=0 V3=0 T=0 M2=0 M3=0
S11Max=0 PtS11Max=0 x2S11Max=0 x3S11Max=0 S11Min=0 PtS11Min=0 x2S11Min=0 x3S11Min=0 FrameElem=114
ElemStation=0.5
Frame=114 Station=0 OutputCase=ACCLATSX CaseType=LinStatic P=0 V2=0 V3=0 T=0 M2=0 M3=0
S11Max=0 PtS11Max=0 x2S11Max=0 x3S11Max=0 S11Min=0 PtS11Min=0 x2S11Min=0 x3S11Min=0 FrameElem=114
ElemStation=0
Frame=114 Station=0.125 OutputCase=ACCLATSX CaseType=LinStatic P=0 V2=0 V3=0 T=0 M2=0 M3=0
S11Max=0 PtS11Max=0 x2S11Max=0 x3S11Max=0 S11Min=0 PtS11Min=0 x2S11Min=0 x3S11Min=0 FrameElem=114
ElemStation=0.125
Frame=114 Station=0.25 OutputCase=ACCLATSX CaseType=LinStatic P=0 V2=0 V3=0 T=0 M2=0 M3=0
S11Max=0 PtS11Max=0 x2S11Max=0 x3S11Max=0 S11Min=0 PtS11Min=0 x2S11Min=0 x3S11Min=0 FrameElem=114
ElemStation=0.25
Frame=114 Station=0.375 OutputCase=ACCLATSX CaseType=LinStatic P=0 V2=0 V3=0 T=0 M2=0 M3=0
S11Max=0 PtS11Max=0 x2S11Max=0 x3S11Max=0 S11Min=0 PtS11Min=0 x2S11Min=0 x3S11Min=0 FrameElem=114
ElemStation=0.375
Frame=114 Station=0.5 OutputCase=ACCLATSX CaseType=LinStatic P=0 V2=0 V3=0 T=0 M2=0 M3=0
S11Max=0 PtS11Max=0 x2S11Max=0 x3S11Max=0 S11Min=0 PtS11Min=0 x2S11Min=0 x3S11Min=0 FrameElem=114
ElemStation=0.5
Frame=114 Station=0 OutputCase=TERRCOST CaseType=LinStatic P=0 V2=0 V3=0 T=0 M2=0 M3=0
S11Max=0 PtS11Max=0 x2S11Max=0 x3S11Max=0 S11Min=0 PtS11Min=0 x2S11Min=0 x3S11Min=0 FrameElem=114
ElemStation=0
Frame=114 Station=0.125 OutputCase=TERRCOST CaseType=LinStatic P=0 V2=0 V3=0 T=0 M2=0 M3=0
S11Max=0 PtS11Max=0 x2S11Max=0 x3S11Max=0 S11Min=0 PtS11Min=0 x2S11Min=0 x3S11Min=0 FrameElem=114
ElemStation=0.125
Frame=114 Station=0.25 OutputCase=TERRCOST CaseType=LinStatic P=0 V2=0 V3=0 T=0 M2=0 M3=0
S11Max=0 PtS11Max=0 x2S11Max=0 x3S11Max=0 S11Min=0 PtS11Min=0 x2S11Min=0 x3S11Min=0 FrameElem=114
ElemStation=0.25
Frame=114 Station=0.375 OutputCase=TERRCOST CaseType=LinStatic P=0 V2=0 V3=0 T=0 M2=0 M3=0
S11Max=0 PtS11Max=0 x2S11Max=0 x3S11Max=0 S11Min=0 PtS11Min=0 x2S11Min=0 x3S11Min=0 FrameElem=114
ElemStation=0.375
Frame=114 Station=0.5 OutputCase=TERRCOST CaseType=LinStatic P=0 V2=0 V3=0 T=0 M2=0 M3=0
S11Max=0 PtS11Max=0 x2S11Max=0 x3S11Max=0 S11Min=0 PtS11Min=0 x2S11Min=0 x3S11Min=0 FrameElem=114
ElemStation=0.5
Frame=114 Station=0 OutputCase=SOVRCOST CaseType=LinStatic P=0 V2=0 V3=0 T=0 M2=0 M3=0
S11Max=0 PtS11Max=0 x2S11Max=0 x3S11Max=0 S11Min=0 PtS11Min=0 x2S11Min=0 x3S11Min=0 FrameElem=114
ElemStation=0
Frame=114 Station=0.125 OutputCase=SOVRCOST CaseType=LinStatic P=0 V2=0 V3=0 T=0 M2=0 M3=0
S11Max=0 PtS11Max=0 x2S11Max=0 x3S11Max=0 S11Min=0 PtS11Min=0 x2S11Min=0 x3S11Min=0 FrameElem=114
ElemStation=0.125
Frame=114 Station=0.25 OutputCase=SOVRCOST CaseType=LinStatic P=0 V2=0 V3=0 T=0 M2=0 M3=0
S11Max=0 PtS11Max=0 x2S11Max=0 x3S11Max=0 S11Min=0 PtS11Min=0 x2S11Min=0 x3S11Min=0 FrameElem=114
ElemStation=0.25

```



Frame=114 Station=0.375 OutputCase=SOVRCOST CaseType=LinStatic P=0 V2=0 V3=0 T=0 M2=0 M3=0
 S11Max=0 PtS11Max=0 x2S11Max=0 x3S11Max=0 S11Min=0 PtS11Min=0 x2S11Min=0 x3S11Min=0 FrameElem=114
 ElemStation=0.375
 Frame=114 Station=0.5 OutputCase=SOVRCOST CaseType=LinStatic P=0 V2=0 V3=0 T=0 M2=0 M3=0
 S11Max=0 PtS11Max=0 x2S11Max=0 x3S11Max=0 S11Min=0 PtS11Min=0 x2S11Min=0 x3S11Min=0 FrameElem=114
 ElemStation=0.5
 Frame=114 Station=0 OutputCase=ENVE CaseType=Combination StepType=Max P=-217.882158664511 V2=-
 304.99998015061 V3=0 T=0 M2=0 M3=396.478076664436 S11Max=2160.98630132211 PtS11Max=1 x2S11Max=-0.5
 x3S11Max=-0.5
 S11Min=-2546.39846114751 PtS11Min=3 x2S11Min=0.5 x3S11Min=-0.5 FrameElem=114 ElemStation=0
 Frame=114 Station=0.125 OutputCase=ENVE CaseType=Combination StepType=Max P=-217.882158664511 V2=-
 266.874998015061 V3=0 T=0 M2=0 M3=432.220263979776 S11Max=2375.43942521415 PtS11Max=1 x2S11Max=-0.5
 x3S11Max=-0.5 S11Min=-2760.85158465881 PtS11Min=3 x2S11Min=0.5 x3S11Min=-0.5 FrameElem=114
 ElemStation=0.125
 Frame=114 Station=0.25 OutputCase=ENVE CaseType=Combination StepType=Max P=-217.882158664511 V2=-
 228.749998015061 V3=0 T=0 M2=0 M3=463.196826295116 S11Max=2561.29879910619 PtS11Max=1 x2S11Max=-0.5
 x3S11Max=-0.5 S11Min=-2946.7109581701 PtS11Min=3 x2S11Min=0.5 x3S11Min=-0.5 FrameElem=114
 ElemStation=0.25
 Frame=114 Station=0.375 OutputCase=ENVE CaseType=Combination StepType=Max P=-217.882158664511 V2=-
 190.624998015061 V3=0 T=0 M2=0 M3=489.407763610456 S11Max=2718.56442299823 PtS11Max=1 x2S11Max=-0.5
 x3S11Max=-0.5 S11Min=-3103.9765816814 PtS11Min=3 x2S11Min=0.5 x3S11Min=-0.5 FrameElem=114
 ElemStation=0.375
 Frame=114 Station=0.5 OutputCase=ENVE CaseType=Combination StepType=Max P=-217.882158664511 V2=-
 152.499998015061 V3=0 T=0 M2=0 M3=510.853075925796 S11Max=2847.23629689027 PtS11Max=1 x2S11Max=-0.5
 x3S11Max=-0.5
 S11Min=-3232.6484551927 PtS11Min=3 x2S11Min=0.5 x3S11Min=-0.5 FrameElem=114 ElemStation=0.5
 Frame=114 Station=0 OutputCase=ENVE CaseType=Combination StepType=Min P=-317.058043529684 V2=-
 304.99999852272 V3=0 T=0 M2=0 M3=371.556736269638 S11Max=1912.28237408815 PtS11Max=1 x2S11Max=-0.5
 x3S11Max=-0.5
 S11Min=-2596.75061865113 PtS11Min=3 x2S11Min=0.5 x3S11Min=-0.5 FrameElem=114 ElemStation=0
 Frame=114 Station=0.125 OutputCase=ENVE CaseType=Combination StepType=Min P=-317.058043529684 V2=-
 266.87499852272 V3=0 T=0 M2=0 M3=407.298923521521 S11Max=2126.73549759944 PtS11Max=1 x2S11Max=-0.5
 x3S11Max=-0.5 S11Min=-2811.20374254317 PtS11Min=3 x2S11Min=0.5 x3S11Min=-0.5 FrameElem=114
 ElemStation=0.125
 Frame=114 Station=0.25 OutputCase=ENVE CaseType=Combination StepType=Min P=-317.058043529684 V2=-
 228.74999852272 V3=0 T=0 M2=0 M3=438.275485773403 S11Max=2312.59487111074 PtS11Max=1 x2S11Max=-0.5
 x3S11Max=-0.5
 S11Min=-2997.06311643521 PtS11Min=3 x2S11Min=0.5 x3S11Min=-0.5 FrameElem=114 ElemStation=0.25
 Frame=114 Station=0.375 OutputCase=ENVE CaseType=Combination StepType=Min P=-317.058043529684 V2=-
 190.62499852272 V3=0 T=0 M2=0 M3=464.486423025286 S11Max=2469.86049462203 PtS11Max=1 x2S11Max=-0.5
 x3S11Max=-0.5 S11Min=-3154.32874032725 PtS11Min=3 x2S11Min=0.5 x3S11Min=-0.5 FrameElem=114
 ElemStation=0.375
 Frame=114 Station=0.5 OutputCase=ENVE CaseType=Combination StepType=Min P=-317.058043529684 V2=-
 152.49999852272 V3=0 T=0 M2=0 M3=485.931735277169 S11Max=2598.53236813333 PtS11Max=1 x2S11Max=-0.5
 x3S11Max=-0.5
 S11Min=-3283.00061421929 PtS11Min=3 x2S11Min=0.5 x3S11Min=-0.5 FrameElem=114 ElemStation=0.5
 Frame=114 Station=0 OutputCase=FESSUR CaseType=Combination P=-317.058043529684 V2=-304.999998015061
 V3=0 T=0 M2=0 M3=371.556736269638 S11Max=1912.28237408815 PtS11Max=1 x2S11Max=-0.5 x3S11Max=-0.5
 S11Min=-2546.39846114751 PtS11Min=3 x2S11Min=0.5 x3S11Min=-0.5 FrameElem=114 ElemStation=0
 Frame=114 Station=0.125 OutputCase=FESSUR CaseType=Combination P=-317.058043529684 V2=-266.874998015061
 V3=0 T=0 M2=0 M3=407.298923521521 S11Max=2126.73549759944 PtS11Max=1 x2S11Max=-0.5 x3S11Max=-0.5
 S11Min=-2760.85158465881 PtS11Min=3 x2S11Min=0.5 x3S11Min=-0.5 FrameElem=114 ElemStation=0.125
 Frame=114 Station=0.25 OutputCase=FESSUR CaseType=Combination P=-317.058043529684 V2=-228.749998015061
 V3=0 T=0 M2=0 M3=438.275485773403 S11Max=2312.59487111074 PtS11Max=1 x2S11Max=-0.5 x3S11Max=-0.5
 S11Min=-2946.7109581701 PtS11Min=3 x2S11Min=0.5 x3S11Min=-0.5 FrameElem=114 ElemStation=0.25
 Frame=114 Station=0.375 OutputCase=FESSUR CaseType=Combination P=-317.058043529684 V2=-190.624998015061
 V3=0 T=0 M2=0 M3=464.486423025286 S11Max=2469.86049462203 PtS11Max=1 x2S11Max=-0.5 x3S11Max=-0.5
 S11Min=-3103.9765816814 PtS11Min=3 x2S11Min=0.5 x3S11Min=-0.5 FrameElem=114 ElemStation=0.375
 Frame=114 Station=0.5 OutputCase=FESSUR CaseType=Combination P=-317.058043529684 V2=-152.499998015061
 V3=0 T=0 M2=0 M3=485.931735277169 S11Max=2598.53236813333 PtS11Max=1 x2S11Max=-0.5 x3S11Max=-0.5
 S11Min=-3232.6484551927 PtS11Min=3 x2S11Min=0.5 x3S11Min=-0.5 FrameElem=114 ElemStation=0.5
 Frame=115 Station=0 OutputCase=PESOPR CaseType=LinStatic P=15.170946736185 V2=-12.499999888969 V3=0
 T=0 M2=0 M3=53.9284217251625 S11Max=338.74147708716 PtS11Max=1 x2S11Max=-0.5 x3S11Max=-0.5
 S11Min=-308.39958361479 PtS11Min=3 x2S11Min=0.5 x3S11Min=-0.5 FrameElem=115 ElemStation=0
 Frame=115 Station=0.125 OutputCase=PESOPR CaseType=LinStatic P=15.170946736185 V2=-9.37499998889689
 V3=0 T=0 M2=0 M3=55.2956092237746 S11Max=346.944602078833 PtS11Max=1 x2S11Max=-0.5 x3S11Max=-0.5
 S11Min=-316.602708606463 PtS11Min=3 x2S11Min=0.5 x3S11Min=-0.5 FrameElem=115 ElemStation=0.125
 Frame=115 Station=0.25 OutputCase=PESOPR CaseType=LinStatic P=15.170946736185 V2=-6.24999998889689
 V3=0 T=0 M2=0 M3=56.2721717223867 S11Max=352.803977070505 PtS11Max=1 x2S11Max=-0.5 x3S11Max=-0.5
 S11Min=-322.462083598135 PtS11Min=3 x2S11Min=0.5 x3S11Min=-0.5 FrameElem=115 ElemStation=0.25
 Frame=115 Station=0.375 OutputCase=PESOPR CaseType=LinStatic P=15.170946736185 V2=-3.12499998889689
 V3=0 T=0 M2=0 M3=56.8581092209988 S11Max=356.319602062178 PtS11Max=1 x2S11Max=-0.5 x3S11Max=-0.5
 S11Min=-325.977708589808 PtS11Min=3 x2S11Min=0.5 x3S11Min=-0.5 FrameElem=115 ElemStation=0.375
 Frame=115 Station=0.5 OutputCase=PESOPR CaseType=LinStatic P=15.170946736185 V2=-1.11031113192439E-08
 V3=0 T=0 M2=0 M3=57.0534217196109 S11Max=357.491477053851 PtS11Max=1 x2S11Max=-0.5 x3S11Max=-0.5
 S11Min=-327.149583581481 PtS11Min=3 x2S11Min=0.5 x3S11Min=-0.5 FrameElem=115 ElemStation=0.5
 Frame=115 Station=0 OutputCase=TERRVERT CaseType=LinStatic P=-1.64270738195971 V2=-139.999999718508
 V3=0 T=0 M2=0 M3=515.074449047475 S11Max=3088.80398690289 PtS11Max=1 x2S11Max=-0.5 x3S11Max=-0.5
 S11Min=-3092.08940166681 PtS11Min=3 x2S11Min=0.5 x3S11Min=-0.5 FrameElem=115 ElemStation=0
 Frame=115 Station=0.125 OutputCase=TERRVERT CaseType=LinStatic P=-1.64270738195971 V2=-104.999999718508
 V3=0 T=0 M2=0 M3=530.386949012289 S11Max=3180.67898669177 PtS11Max=1 x2S11Max=-0.5 x3S11Max=-0.5
 S11Min=-3183.96440145569 PtS11Min=3 x2S11Min=0.5 x3S11Min=-0.5 FrameElem=115 ElemStation=0.125

```

Frame=115 Station=0.25 OutputCase=TERRVERT CaseType=LinStatic P=-1.64270738195971 V2=-69.9999997185078
V3=0 T=0 M2=0 M3=541.324448977102 S11Max=3246.30398648065 PtS11Max=1 x2S11Max=-0.5 x3S11Max=-0.5 _
S11Min=-3249.58940124457 PtS11Min=3 x2S11Min=0.5 x3S11Min=-0.5 FrameElem=115 ElemStation=0.25
Frame=115 Station=0.375 OutputCase=TERRVERT CaseType=LinStatic P=-1.64270738195971 V2=-34.9999997185078
V3=0 T=0 M2=0 M3=547.886948941916 S11Max=3285.67898626954 PtS11Max=1 x2S11Max=-0.5 x3S11Max=-0.5 _
S11Min=-3288.96440103345 PtS11Min=3 x2S11Min=0.5 x3S11Min=-0.5 FrameElem=115 ElemStation=0.375
Frame=115 Station=0.5 OutputCase=TERRVERT CaseType=LinStatic P=-1.64270738195971 V2=2.81492248177528E-
07 V3=0 T=0 M2=0 M3=550.074448906729 S11Max=3298.80398605842 PtS11Max=1 x2S11Max=-0.5 x3S11Max=-0.5
-
S11Min=-3302.08940082233 PtS11Min=3 x2S11Min=0.5 x3S11Min=-0.5 FrameElem=115 ElemStation=0.5
Frame=115 Station=0 OutputCase=TERRLAT CaseType=LinStatic P=-330.586282883909 V2=1.69219902090845E-06
V3=0 T=0 M2=0 M3=-83.0711354954258 S11Max=167.840530088646 PtS11Max=3 x2S11Max=0.5 x3S11Max=-0.5 _
S11Min=-829.013095856464 PtS11Min=1 x2S11Min=-0.5 x3S11Min=-0.5 FrameElem=115 ElemStation=0
Frame=115 Station=0.125 OutputCase=TERRLAT CaseType=LinStatic P=-330.586282883909 V2=1.69219902090845E-
06 V3=0 T=0 M2=0 M3=-83.0711357069507 S11Max=167.840531357795 PtS11Max=3 x2S11Max=0.5 x3S11Max=-0.5
-
S11Min=-829.013097125613 PtS11Min=1 x2S11Min=-0.5 x3S11Min=-0.5 FrameElem=115 ElemStation=0.125
Frame=115 Station=0.25 OutputCase=TERRLAT CaseType=LinStatic P=-330.586282883909 V2=1.69219902090845E-
06 V3=0 T=0 M2=0 M3=-83.0711359184755 S11Max=167.840532626944 PtS11Max=3 x2S11Max=0.5 x3S11Max=-0.5
-
S11Min=-829.013098394762 PtS11Min=1 x2S11Min=-0.5 x3S11Min=-0.5 FrameElem=115 ElemStation=0.25
Frame=115 Station=0.375 OutputCase=TERRLAT CaseType=LinStatic P=-330.586282883909 V2=1.69219902090845E-
06 V3=0 T=0 M2=0 M3=-83.0711361300004 S11Max=167.840533896093 PtS11Max=3 x2S11Max=0.5 x3S11Max=-0.5
-
S11Min=-829.013099663911 PtS11Min=1 x2S11Min=-0.5 x3S11Min=-0.5 FrameElem=115 ElemStation=0.375
Frame=115 Station=0.5 OutputCase=TERRLAT CaseType=LinStatic P=-330.586282883909 V2=1.69219902090845E-06
V3=0 T=0 M2=0 M3=-83.0711363415253 S11Max=167.840535165243 PtS11Max=3 x2S11Max=0.5 x3S11Max=-0.5 _
S11Min=-829.013100933061 PtS11Min=1 x2S11Min=-0.5 x3S11Min=-0.5 FrameElem=115 ElemStation=0.5
Frame=115 Station=0 OutputCase=ACCVERT CaseType=LinStatic P=0 V2=0 V3=0 T=0 M2=0 M3=0
S11Max=0 PtS11Max=0 x2S11Max=0 x3S11Max=0 S11Min=0 PtS11Min=0 x2S11Min=0 x3S11Min=0 FrameElem=115
ElemStation=0
Frame=115 Station=0.125 OutputCase=ACCVERT CaseType=LinStatic P=0 V2=0 V3=0 T=0 M2=0 M3=0
S11Max=0 PtS11Max=0 x2S11Max=0 x3S11Max=0 S11Min=0 PtS11Min=0 x2S11Min=0 x3S11Min=0 FrameElem=115
ElemStation=0.125
Frame=115 Station=0.25 OutputCase=ACCVERT CaseType=LinStatic P=0 V2=0 V3=0 T=0 M2=0 M3=0
S11Max=0 PtS11Max=0 x2S11Max=0 x3S11Max=0 S11Min=0 PtS11Min=0 x2S11Min=0 x3S11Min=0 FrameElem=115
ElemStation=0.25
Frame=115 Station=0.375 OutputCase=ACCVERT CaseType=LinStatic P=0 V2=0 V3=0 T=0 M2=0 M3=0
S11Max=0 PtS11Max=0 x2S11Max=0 x3S11Max=0 S11Min=0 PtS11Min=0 x2S11Min=0 x3S11Min=0 FrameElem=115
ElemStation=0.375
Frame=115 Station=0.5 OutputCase=ACCVERT CaseType=LinStatic P=0 V2=0 V3=0 T=0 M2=0 M3=0
S11Max=0 PtS11Max=0 x2S11Max=0 x3S11Max=0 S11Min=0 PtS11Min=0 x2S11Min=0 x3S11Min=0 FrameElem=115
ElemStation=0.5
Frame=115 Station=0 OutputCase=ACCLATDX CaseType=LinStatic P=0 V2=0 V3=0 T=0 M2=0 M3=0
S11Max=0 PtS11Max=0 x2S11Max=0 x3S11Max=0 S11Min=0 PtS11Min=0 x2S11Min=0 x3S11Min=0 FrameElem=115
ElemStation=0
Frame=115 Station=0.125 OutputCase=ACCLATDX CaseType=LinStatic P=0 V2=0 V3=0 T=0 M2=0 M3=0
S11Max=0 PtS11Max=0 x2S11Max=0 x3S11Max=0 S11Min=0 PtS11Min=0 x2S11Min=0 x3S11Min=0 FrameElem=115
ElemStation=0.125
Frame=115 Station=0.25 OutputCase=ACCLATDX CaseType=LinStatic P=0 V2=0 V3=0 T=0 M2=0 M3=0
S11Max=0 PtS11Max=0 x2S11Max=0 x3S11Max=0 S11Min=0 PtS11Min=0 x2S11Min=0 x3S11Min=0 FrameElem=115
ElemStation=0.25
Frame=115 Station=0.375 OutputCase=ACCLATDX CaseType=LinStatic P=0 V2=0 V3=0 T=0 M2=0 M3=0
S11Max=0 PtS11Max=0 x2S11Max=0 x3S11Max=0 S11Min=0 PtS11Min=0 x2S11Min=0 x3S11Min=0 FrameElem=115
ElemStation=0.375
Frame=115 Station=0.5 OutputCase=ACCLATDX CaseType=LinStatic P=0 V2=0 V3=0 T=0 M2=0 M3=0
S11Max=0 PtS11Max=0 x2S11Max=0 x3S11Max=0 S11Min=0 PtS11Min=0 x2S11Min=0 x3S11Min=0 FrameElem=115
ElemStation=0.5
Frame=115 Station=0 OutputCase=ACCLATSX CaseType=LinStatic P=0 V2=0 V3=0 T=0 M2=0 M3=0
S11Max=0 PtS11Max=0 x2S11Max=0 x3S11Max=0 S11Min=0 PtS11Min=0 x2S11Min=0 x3S11Min=0 FrameElem=115
ElemStation=0
Frame=115 Station=0.125 OutputCase=ACCLATSX CaseType=LinStatic P=0 V2=0 V3=0 T=0 M2=0 M3=0
S11Max=0 PtS11Max=0 x2S11Max=0 x3S11Max=0 S11Min=0 PtS11Min=0 x2S11Min=0 x3S11Min=0 FrameElem=115
ElemStation=0.125
Frame=115 Station=0.25 OutputCase=ACCLATSX CaseType=LinStatic P=0 V2=0 V3=0 T=0 M2=0 M3=0
S11Max=0 PtS11Max=0 x2S11Max=0 x3S11Max=0 S11Min=0 PtS11Min=0 x2S11Min=0 x3S11Min=0 FrameElem=115
ElemStation=0.25
Frame=115 Station=0.375 OutputCase=ACCLATSX CaseType=LinStatic P=0 V2=0 V3=0 T=0 M2=0 M3=0
S11Max=0 PtS11Max=0 x2S11Max=0 x3S11Max=0 S11Min=0 PtS11Min=0 x2S11Min=0 x3S11Min=0 FrameElem=115
ElemStation=0.375
Frame=115 Station=0.5 OutputCase=ACCLATSX CaseType=LinStatic P=0 V2=0 V3=0 T=0 M2=0 M3=0
S11Max=0 PtS11Max=0 x2S11Max=0 x3S11Max=0 S11Min=0 PtS11Min=0 x2S11Min=0 x3S11Min=0 FrameElem=115
ElemStation=0.5
Frame=115 Station=0 OutputCase=TERRCOST CaseType=LinStatic P=0 V2=0 V3=0 T=0 M2=0 M3=0
S11Max=0 PtS11Max=0 x2S11Max=0 x3S11Max=0 S11Min=0 PtS11Min=0 x2S11Min=0 x3S11Min=0 FrameElem=115
ElemStation=0
Frame=115 Station=0.125 OutputCase=TERRCOST CaseType=LinStatic P=0 V2=0 V3=0 T=0 M2=0 M3=0
S11Max=0 PtS11Max=0 x2S11Max=0 x3S11Max=0 S11Min=0 PtS11Min=0 x2S11Min=0 x3S11Min=0 FrameElem=115
ElemStation=0.125
Frame=115 Station=0.25 OutputCase=TERRCOST CaseType=LinStatic P=0 V2=0 V3=0 T=0 M2=0 M3=0
S11Max=0 PtS11Max=0 x2S11Max=0 x3S11Max=0 S11Min=0 PtS11Min=0 x2S11Min=0 x3S11Min=0 FrameElem=115
ElemStation=0.25

```



Frame=115 Station=0.375 OutputCase=TERRCOST CaseType=LinStatic P=0 V2=0 V3=0 T=0 M2=0 M3=0
 S11Max=0 PtS11Max=0 x2S11Max=0 x3S11Max=0 S11Min=0 PtS11Min=0 x2S11Min=0 x3S11Min=0 FrameElem=115
 ElemStation=0.375
 Frame=115 Station=0.5 OutputCase=TERRCOST CaseType=LinStatic P=0 V2=0 V3=0 T=0 M2=0 M3=0
 S11Max=0 PtS11Max=0 x2S11Max=0 x3S11Max=0 S11Min=0 PtS11Min=0 x2S11Min=0 x3S11Min=0 FrameElem=115
 ElemStation=0.5
 Frame=115 Station=0 OutputCase=SOVRCOST CaseType=LinStatic P=0 V2=0 V3=0 T=0 M2=0 M3=0
 S11Max=0 PtS11Max=0 x2S11Max=0 x3S11Max=0 S11Min=0 PtS11Min=0 x2S11Min=0 x3S11Min=0 FrameElem=115
 ElemStation=0
 Frame=115 Station=0.125 OutputCase=SOVRCOST CaseType=LinStatic P=0 V2=0 V3=0 T=0 M2=0 M3=0
 S11Max=0 PtS11Max=0 x2S11Max=0 x3S11Max=0 S11Min=0 PtS11Min=0 x2S11Min=0 x3S11Min=0 FrameElem=115
 ElemStation=0.125
 Frame=115 Station=0.25 OutputCase=SOVRCOST CaseType=LinStatic P=0 V2=0 V3=0 T=0 M2=0 M3=0
 S11Max=0 PtS11Max=0 x2S11Max=0 x3S11Max=0 S11Min=0 PtS11Min=0 x2S11Min=0 x3S11Min=0 FrameElem=115
 ElemStation=0.25
 Frame=115 Station=0.375 OutputCase=SOVRCOST CaseType=LinStatic P=0 V2=0 V3=0 T=0 M2=0 M3=0
 S11Max=0 PtS11Max=0 x2S11Max=0 x3S11Max=0 S11Min=0 PtS11Min=0 x2S11Min=0 x3S11Min=0 FrameElem=115
 ElemStation=0.375
 Frame=115 Station=0.5 OutputCase=SOVRCOST CaseType=LinStatic P=0 V2=0 V3=0 T=0 M2=0 M3=0
 S11Max=0 PtS11Max=0 x2S11Max=0 x3S11Max=0 S11Min=0 PtS11Min=0 x2S11Min=0 x3S11Min=0 FrameElem=115
 ElemStation=0.5
 Frame=115 Station=0 OutputCase=ENVE CaseType=Combination StepType=Max P=-217.882158664511 V2=-
 152.499998015206 V3=0 T=0 M2=0 M3=510.85307592584 S11Max=2847.23629689053 PtS11Max=1 x2S11Max=-0.5
 x3S11Max=-0.5
 S11Min=-3232.64845519296 PtS11Min=3 x2S11Min=0.5 x3S11Min=-0.5 FrameElem=115 ElemStation=0
 Frame=115 Station=0.125 OutputCase=ENVE CaseType=Combination StepType=Max P=-217.882158664511 V2=-
 114.374998015206 V3=0 T=0 M2=0 M3=527.532763241198 S11Max=2947.31442078268 PtS11Max=1 x2S11Max=-0.5
 x3S11Max=-0.5 S11Min=-3332.72657870436 PtS11Min=3 x2S11Min=0.5 x3S11Min=-0.5 FrameElem=115
 ElemStation=0.125
 Frame=115 Station=0.25 OutputCase=ENVE CaseType=Combination StepType=Max P=-217.882158664511 V2=-
 76.2499980152056 V3=0 T=0 M2=0 M3=539.446825565656 S11Max=3018.79879467483 PtS11Max=1 x2S11Max=-0.5
 x3S11Max=-0.5 S11Min=-3404.21095221576 PtS11Min=3 x2S11Min=0.5 x3S11Min=-0.5 FrameElem=115
 ElemStation=0.25
 Frame=115 Station=0.375 OutputCase=ENVE CaseType=Combination StepType=Max P=-217.882158664511 V2=-
 38.1249980152056 V3=0 T=0 M2=0 M3=546.595262871914 S11Max=3061.68941856698 PtS11Max=1 x2S11Max=-0.5
 x3S11Max=-0.5 S11Min=-3447.10157572717 PtS11Min=3 x2S11Min=0.5 x3S11Min=-0.5 FrameElem=115
 ElemStation=0.375
 Frame=115 Station=0.5 OutputCase=ENVE CaseType=Combination StepType=Max P=-217.882158664511
 V2=-1.98479438040522E-06 V3=0 T=0 M2=0 M3=548.978075187272 S11Max=3075.98629245912 PtS11Max=1
 x2S11Max=-0.5
 x3S11Max=-0.5 S11Min=-3461.39844923857 PtS11Min=3 x2S11Min=0.5 x3S11Min=-0.5 FrameElem=115
 ElemStation=0.5
 Frame=115 Station=0 OutputCase=ENVE CaseType=Combination StepType=Min P=-317.058043529684 V2=-
 152.499998522865 V3=0 T=0 M2=0 M3=485.931735277212 S11Max=2598.53236813359 PtS11Max=1 x2S11Max=-0.5
 x3S11Max=-0.5
 S11Min=-3283.00061421955 PtS11Min=3 x2S11Min=0.5 x3S11Min=-0.5 FrameElem=115 ElemStation=0
 Frame=115 Station=0.125 OutputCase=ENVE CaseType=Combination StepType=Min P=-317.058043529684 V2=-
 114.374998522865 V3=0 T=0 M2=0 M3=502.611422529113 S11Max=2698.61049164499 PtS11Max=1 x2S11Max=-0.5
 x3S11Max=-0.5 S11Min=-3383.0787381117 PtS11Min=3 x2S11Min=0.5 x3S11Min=-0.5 FrameElem=115
 ElemStation=0.125
 Frame=115 Station=0.25 OutputCase=ENVE CaseType=Combination StepType=Min P=-317.058043529684 V2=-
 76.2499985228653 V3=0 T=0 M2=0 M3=514.525484781013 S11Max=2770.0948651564 PtS11Max=1 x2S11Max=-0.5
 x3S11Max=-0.5
 S11Min=-3454.56311200385 PtS11Min=3 x2S11Min=0.5 x3S11Min=-0.5 FrameElem=115 ElemStation=0.25
 Frame=115 Station=0.375 OutputCase=ENVE CaseType=Combination StepType=Min P=-317.058043529684 V2=-
 38.1249985228653 V3=0 T=0 M2=0 M3=521.673922032914 S11Max=2812.9854886678 PtS11Max=1 x2S11Max=-0.5
 x3S11Max=-0.5 S11Min=-3497.453735896 PtS11Min=3 x2S11Min=0.5 x3S11Min=-0.5 FrameElem=115
 ElemStation=0.375
 Frame=115 Station=0.5 OutputCase=ENVE CaseType=Combination StepType=Min P=-317.058043529684
 V2=-1.47713467413269E-06 V3=0 T=0 M2=0 M3=524.056734284815 S11Max=2827.28236217921 PtS11Max=1
 x2S11Max=-0.5
 x3S11Max=-0.5 S11Min=-3511.75060978815 PtS11Min=3 x2S11Min=0.5 x3S11Min=-0.5 FrameElem=115
 ElemStation=0.5
 Frame=115 Station=0 OutputCase=FESSUR CaseType=Combination P=-317.058043529684 V2=-152.499998015206
 V3=0 T=0 M2=0 M3=485.931735277212 S11Max=2598.53236813359 PtS11Max=1 x2S11Max=-0.5 x3S11Max=-0.5
 S11Min=-3232.64845519296 PtS11Min=3 x2S11Min=0.5 x3S11Min=-0.5 FrameElem=115 ElemStation=0
 Frame=115 Station=0.125 OutputCase=FESSUR CaseType=Combination P=-317.058043529684 V2=-114.374998015206
 V3=0 T=0 M2=0 M3=502.611422529113 S11Max=2698.61049164499 PtS11Max=1 x2S11Max=-0.5 x3S11Max=-0.5
 S11Min=-3332.72657870436 PtS11Min=3 x2S11Min=0.5 x3S11Min=-0.5 FrameElem=115 ElemStation=0.125
 Frame=115 Station=0.25 OutputCase=FESSUR CaseType=Combination P=-317.058043529684 V2=-76.2499980152056
 V3=0 T=0 M2=0 M3=514.525484781013 S11Max=2770.0948651564 PtS11Max=1 x2S11Max=-0.5 x3S11Max=-0.5
 S11Min=-3404.21095221576 PtS11Min=3 x2S11Min=0.5 x3S11Min=-0.5 FrameElem=115 ElemStation=0.25
 Frame=115 Station=0.375 OutputCase=FESSUR CaseType=Combination P=-317.058043529684 V2=-38.1249980152056
 V3=0 T=0 M2=0 M3=521.673922032914 S11Max=2812.9854886678 PtS11Max=1 x2S11Max=-0.5 x3S11Max=-0.5
 S11Min=-3447.10157572717 PtS11Min=3 x2S11Min=0.5 x3S11Min=-0.5 FrameElem=115 ElemStation=0.375
 Frame=115 Station=0.5 OutputCase=FESSUR CaseType=Combination P=-317.058043529684 V2=1.98479438040522E-
 06 V3=0 T=0 M2=0 M3=524.056734284815 S11Max=2827.28236217921 PtS11Max=1 x2S11Max=-0.5 x3S11Max=-0.5
 S11Min=-3461.39844923857 PtS11Min=3 x2S11Min=0.5 x3S11Min=-0.5 FrameElem=115 ElemStation=0.5
 Frame=116 Station=0 OutputCase=PESOPR CaseType=LinStatic P=15.170946736185 V2=1.10740074887872E-08
 V3=0 T=0 M2=0 M3=57.0534217196109 S11Max=357.49147705385 PtS11Max=1 x2S11Max=-0.5 x3S11Max=-0.5
 S11Min=-327.149583581481 PtS11Min=3 x2S11Min=0.5 x3S11Min=-0.5 FrameElem=116 ElemStation=0

```

Frame=116 Station=0.125 OutputCase=PESOPR CaseType=LinStatic P=15.170946736185 V2=3.12500001107401
V3=0 T=0 M2=0 M3=56.8581092182267 S11Max=356.319602045545 PtS11Max=1 x2S11Max=-0.5 x3S11Max=-0.5 _
S11Min=-325.977708573175 PtS11Min=3 x2S11Min=0.5 x3S11Min=-0.5 FrameElem=116 ElemStation=0.125
Frame=116 Station=0.25 OutputCase=PESOPR CaseType=LinStatic P=15.170946736185 V2=6.25000001107401
V3=0 T=0 M2=0 M3=56.2721717168424 S11Max=352.803977037239 PtS11Max=1 x2S11Max=-0.5 x3S11Max=-0.5 _
S11Min=-322.46208356487 PtS11Min=3 x2S11Min=0.5 x3S11Min=-0.5 FrameElem=116 ElemStation=0.25
Frame=116 Station=0.375 OutputCase=PESOPR CaseType=LinStatic P=15.170946736185 V2=9.37500001107401
V3=0 T=0 M2=0 M3=55.2956092154582 S11Max=346.944602028934 PtS11Max=1 x2S11Max=-0.5 x3S11Max=-0.5 _
S11Min=-316.602708556564 PtS11Min=3 x2S11Min=0.5 x3S11Min=-0.5 FrameElem=116 ElemStation=0.375
Frame=116 Station=0.5 OutputCase=PESOPR CaseType=LinStatic P=15.170946736185 V2=12.500000011074 V3=0
T=0 M2=0 M3=53.9284217140739 S11Max=338.741477020628 PtS11Max=1 x2S11Max=-0.5 x3S11Max=-0.5 _
S11Min=-308.399583548259 PtS11Min=3 x2S11Min=0.5 x3S11Min=-0.5 FrameElem=116 ElemStation=0.5
Frame=116 Station=0.125 OutputCase=TERRVERT CaseType=LinStatic P=-1.64270738195971 V2=2.81550455838442E-07
V3=0 T=0 M2=0 M3=550.074448906715 S11Max=3298.80398605833 PtS11Max=1 x2S11Max=-0.5 x3S11Max=-0.5 _
S11Min=-3302.08940082225 PtS11Min=3 x2S11Min=0.5 x3S11Min=-0.5 FrameElem=116 ElemStation=0
Frame=116 Station=0.125 OutputCase=TERRVERT CaseType=LinStatic P=-1.64270738195971 V2=35.0000002815505
V3=0 T=0 M2=0 M3=547.886948871521 S11Max=3285.67898584717 PtS11Max=1 x2S11Max=-0.5 x3S11Max=-0.5 _
S11Min=-3288.96440061108 PtS11Min=3 x2S11Min=0.5 x3S11Min=-0.5 FrameElem=116 ElemStation=0.125
Frame=116 Station=0.25 OutputCase=TERRVERT CaseType=LinStatic P=-1.64270738195971 V2=70.0000002815505
V3=0 T=0 M2=0 M3=541.324448836327 S11Max=3246.303985636 PtS11Max=1 x2S11Max=-0.5 x3S11Max=-0.5 _
S11Min=-3249.58940039992 PtS11Min=3 x2S11Min=0.5 x3S11Min=-0.5 FrameElem=116 ElemStation=0.25
Frame=116 Station=0.375 OutputCase=TERRVERT CaseType=LinStatic P=-1.64270738195971 V2=105.00000028155
V3=0 T=0 M2=0 M3=530.386948801133 S11Max=3180.67898542484 PtS11Max=1 x2S11Max=-0.5 x3S11Max=-0.5 _
S11Min=-3183.96440018876 PtS11Min=3 x2S11Min=0.5 x3S11Min=-0.5 FrameElem=116 ElemStation=0.375
Frame=116 Station=0.5 OutputCase=TERRVERT CaseType=LinStatic P=-1.64270738195971 V2=140.00000028155
V3=0 T=0 M2=0 M3=515.074448765939 S11Max=3088.80398521368 PtS11Max=1 x2S11Max=-0.5 x3S11Max=-0.5 _
S11Min=-3092.0893999776 PtS11Min=3 x2S11Min=0.5 x3S11Min=-0.5 FrameElem=116 ElemStation=0.5
Frame=116 Station=0 OutputCase=TERRLAT CaseType=LinStatic P=-330.586282883909 V2=1.6921985661611E-06
V3=0 T=0 M2=0 M3=-83.0711363415252 S11Max=167.840535165242 PtS11Max=3 x2S11Max=0.5 x3S11Max=-0.5 _
S11Min=-829.01310093306 PtS11Min=1 x2S11Min=-0.5 x3S11Min=-0.5 FrameElem=116 ElemStation=0
Frame=116 Station=0.125 OutputCase=TERRLAT CaseType=LinStatic P=-330.586282883909 V2=1.6921985661611E-06
06 V3=0 T=0 M2=0 M3=-83.07113655305 S11Max=167.840536434391 PtS11Max=3 x2S11Max=0.5 x3S11Max=-0.5 _
S11Min=-829.01310220209 PtS11Min=1 x2S11Min=-0.5 x3S11Min=-0.5 FrameElem=116 ElemStation=0.125
Frame=116 Station=0.25 OutputCase=TERRLAT CaseType=LinStatic P=-330.586282883909 V2=1.6921985661611E-06
V3=0 T=0 M2=0 M3=-83.0711367645748 S11Max=167.84053770354 PtS11Max=3 x2S11Max=0.5 x3S11Max=-0.5 _
S11Min=-829.013103471358 PtS11Min=1 x2S11Min=-0.5 x3S11Min=-0.5 FrameElem=116 ElemStation=0.25
Frame=116 Station=0.375 OutputCase=TERRLAT CaseType=LinStatic P=-330.586282883909 V2=1.6921985661611E-06
06 V3=0 T=0 M2=0 M3=-83.0711369760996 S11Max=167.840538972689 PtS11Max=3 x2S11Max=0.5 x3S11Max=-0.5
-
S11Min=-829.013104740507 PtS11Min=1 x2S11Min=-0.5 x3S11Min=-0.5 FrameElem=116 ElemStation=0.375
Frame=116 Station=0.5 OutputCase=TERRLAT CaseType=LinStatic P=-330.586282883909 V2=1.6921985661611E-06
V3=0 T=0 M2=0 M3=-83.0711371876245 S11Max=167.840540241838 PtS11Max=3 x2S11Max=0.5 x3S11Max=-0.5 _
S11Min=-829.013106009656 PtS11Min=1 x2S11Min=-0.5 x3S11Min=-0.5 FrameElem=116 ElemStation=0.5
Frame=116 Station=0 OutputCase=ACCVERT CaseType=LinStatic P=0 V2=0 V3=0 T=0 M2=0 M3=0
S11Max=0 PtS11Max=0 x2S11Max=0 x3S11Max=0 S11Min=0 PtS11Min=0 x2S11Min=0 x3S11Min=0 FrameElem=116
ElemStation=0
Frame=116 Station=0.125 OutputCase=ACCVERT CaseType=LinStatic P=0 V2=0 V3=0 T=0 M2=0 M3=0
S11Max=0 PtS11Max=0 x2S11Max=0 x3S11Max=0 S11Min=0 PtS11Min=0 x2S11Min=0 x3S11Min=0 FrameElem=116
ElemStation=0.125
Frame=116 Station=0.25 OutputCase=ACCVERT CaseType=LinStatic P=0 V2=0 V3=0 T=0 M2=0 M3=0
S11Max=0 PtS11Max=0 x2S11Max=0 x3S11Max=0 S11Min=0 PtS11Min=0 x2S11Min=0 x3S11Min=0 FrameElem=116
ElemStation=0.25
Frame=116 Station=0.375 OutputCase=ACCVERT CaseType=LinStatic P=0 V2=0 V3=0 T=0 M2=0 M3=0
S11Max=0 PtS11Max=0 x2S11Max=0 x3S11Max=0 S11Min=0 PtS11Min=0 x2S11Min=0 x3S11Min=0 FrameElem=116
ElemStation=0.375
Frame=116 Station=0.5 OutputCase=ACCVERT CaseType=LinStatic P=0 V2=0 V3=0 T=0 M2=0 M3=0
S11Max=0 PtS11Max=0 x2S11Max=0 x3S11Max=0 S11Min=0 PtS11Min=0 x2S11Min=0 x3S11Min=0 FrameElem=116
ElemStation=0.5
Frame=116 Station=0 OutputCase=ACCLATDX CaseType=LinStatic P=0 V2=0 V3=0 T=0 M2=0 M3=0
S11Max=0 PtS11Max=0 x2S11Max=0 x3S11Max=0 S11Min=0 PtS11Min=0 x2S11Min=0 x3S11Min=0 FrameElem=116
ElemStation=0
Frame=116 Station=0.125 OutputCase=ACCLATDX CaseType=LinStatic P=0 V2=0 V3=0 T=0 M2=0 M3=0
S11Max=0 PtS11Max=0 x2S11Max=0 x3S11Max=0 S11Min=0 PtS11Min=0 x2S11Min=0 x3S11Min=0 FrameElem=116
ElemStation=0.125
Frame=116 Station=0.25 OutputCase=ACCLATDX CaseType=LinStatic P=0 V2=0 V3=0 T=0 M2=0 M3=0
S11Max=0 PtS11Max=0 x2S11Max=0 x3S11Max=0 S11Min=0 PtS11Min=0 x2S11Min=0 x3S11Min=0 FrameElem=116
ElemStation=0.25
Frame=116 Station=0.375 OutputCase=ACCLATDX CaseType=LinStatic P=0 V2=0 V3=0 T=0 M2=0 M3=0
S11Max=0 PtS11Max=0 x2S11Max=0 x3S11Max=0 S11Min=0 PtS11Min=0 x2S11Min=0 x3S11Min=0 FrameElem=116
ElemStation=0.375
Frame=116 Station=0.5 OutputCase=ACCLATDX CaseType=LinStatic P=0 V2=0 V3=0 T=0 M2=0 M3=0
S11Max=0 PtS11Max=0 x2S11Max=0 x3S11Max=0 S11Min=0 PtS11Min=0 x2S11Min=0 x3S11Min=0 FrameElem=116
ElemStation=0.5
Frame=116 Station=0 OutputCase=ACCLATSX CaseType=LinStatic P=0 V2=0 V3=0 T=0 M2=0 M3=0
S11Max=0 PtS11Max=0 x2S11Max=0 x3S11Max=0 S11Min=0 PtS11Min=0 x2S11Min=0 x3S11Min=0 FrameElem=116
ElemStation=0
Frame=116 Station=0.125 OutputCase=ACCLATSX CaseType=LinStatic P=0 V2=0 V3=0 T=0 M2=0 M3=0
S11Max=0 PtS11Max=0 x2S11Max=0 x3S11Max=0 S11Min=0 PtS11Min=0 x2S11Min=0 x3S11Min=0 FrameElem=116
ElemStation=0.125
Frame=116 Station=0.25 OutputCase=ACCLATSX CaseType=LinStatic P=0 V2=0 V3=0 T=0 M2=0 M3=0
S11Max=0 PtS11Max=0 x2S11Max=0 x3S11Max=0 S11Min=0 PtS11Min=0 x2S11Min=0 x3S11Min=0 FrameElem=116
ElemStation=0.25

```



Frame=116 Station=0.375 OutputCase=ACCLATSX CaseType=LinStatic P=0 V2=0 V3=0 T=0 M2=0 M3=0
 S11Max=0 PtS11Max=0 x2S11Max=0 x3S11Max=0 S11Min=0 PtS11Min=0 x2S11Min=0 x3S11Min=0 FrameElem=116
 ElemStation=0.375
 Frame=116 Station=0.5 OutputCase=ACCLATSX CaseType=LinStatic P=0 V2=0 V3=0 T=0 M2=0 M3=0
 S11Max=0 PtS11Max=0 x2S11Max=0 x3S11Max=0 S11Min=0 PtS11Min=0 x2S11Min=0 x3S11Min=0 FrameElem=116
 ElemStation=0.5
 Frame=116 Station=0 OutputCase=TERRCOST CaseType=LinStatic P=0 V2=0 V3=0 T=0 M2=0 M3=0
 S11Max=0 PtS11Max=0 x2S11Max=0 x3S11Max=0 S11Min=0 PtS11Min=0 x2S11Min=0 x3S11Min=0 FrameElem=116
 ElemStation=0
 Frame=116 Station=0.125 OutputCase=TERRCOST CaseType=LinStatic P=0 V2=0 V3=0 T=0 M2=0 M3=0
 S11Max=0 PtS11Max=0 x2S11Max=0 x3S11Max=0 S11Min=0 PtS11Min=0 x2S11Min=0 x3S11Min=0 FrameElem=116
 ElemStation=0.125
 Frame=116 Station=0.25 OutputCase=TERRCOST CaseType=LinStatic P=0 V2=0 V3=0 T=0 M2=0 M3=0
 S11Max=0 PtS11Max=0 x2S11Max=0 x3S11Max=0 S11Min=0 PtS11Min=0 x2S11Min=0 x3S11Min=0 FrameElem=116
 ElemStation=0.25
 Frame=116 Station=0.375 OutputCase=TERRCOST CaseType=LinStatic P=0 V2=0 V3=0 T=0 M2=0 M3=0
 S11Max=0 PtS11Max=0 x2S11Max=0 x3S11Max=0 S11Min=0 PtS11Min=0 x2S11Min=0 x3S11Min=0 FrameElem=116
 ElemStation=0.375
 Frame=116 Station=0.5 OutputCase=TERRCOST CaseType=LinStatic P=0 V2=0 V3=0 T=0 M2=0 M3=0
 S11Max=0 PtS11Max=0 x2S11Max=0 x3S11Max=0 S11Min=0 PtS11Min=0 x2S11Min=0 x3S11Min=0 FrameElem=116
 ElemStation=0.5
 Frame=116 Station=0 OutputCase=SOVRCOST CaseType=LinStatic P=0 V2=0 V3=0 T=0 M2=0 M3=0
 S11Max=0 PtS11Max=0 x2S11Max=0 x3S11Max=0 S11Min=0 PtS11Min=0 x2S11Min=0 x3S11Min=0 FrameElem=116
 ElemStation=0
 Frame=116 Station=0.125 OutputCase=SOVRCOST CaseType=LinStatic P=0 V2=0 V3=0 T=0 M2=0 M3=0
 S11Max=0 PtS11Max=0 x2S11Max=0 x3S11Max=0 S11Min=0 PtS11Min=0 x2S11Min=0 x3S11Min=0 FrameElem=116
 ElemStation=0.125
 Frame=116 Station=0.25 OutputCase=SOVRCOST CaseType=LinStatic P=0 V2=0 V3=0 T=0 M2=0 M3=0
 S11Max=0 PtS11Max=0 x2S11Max=0 x3S11Max=0 S11Min=0 PtS11Min=0 x2S11Min=0 x3S11Min=0 FrameElem=116
 ElemStation=0.25
 Frame=116 Station=0.375 OutputCase=SOVRCOST CaseType=LinStatic P=0 V2=0 V3=0 T=0 M2=0 M3=0
 S11Max=0 PtS11Max=0 x2S11Max=0 x3S11Max=0 S11Min=0 PtS11Min=0 x2S11Min=0 x3S11Min=0 FrameElem=116
 ElemStation=0.375
 Frame=116 Station=0.5 OutputCase=SOVRCOST CaseType=LinStatic P=0 V2=0 V3=0 T=0 M2=0 M3=0
 S11Max=0 PtS11Max=0 x2S11Max=0 x3S11Max=0 S11Min=0 PtS11Min=0 x2S11Min=0 x3S11Min=0 FrameElem=116
 ElemStation=0.5
 Frame=116 Station=0 OutputCase=ENVE CaseType=Combination StepType=Max P=-217.882158664511
 V2=1.98482302948833E-06 V3=0 T=0 M2=0 M3=548.978075187258 S11Max=3075.98629245904 PtS11Max=1
 x2S11Max=-0.5 _
 x3S11Max=-0.5 S11Min=-3461.39844923849 PtS11Min=3 x2S11Min=0.5 x3S11Min=-0.5 FrameElem=116
 ElemStation=0
 Frame=116 Station=0.125 OutputCase=ENVE CaseType=Combination StepType=Max P=-217.882158664511
 V2=38.125001984823 V3=0 T=0 M2=0 M3=546.595262502613 S11Max=3061.68941635116 PtS11Max=1 x2S11Max=-0.5
 x3S11Max=-0.5 _
 S11Min=-3447.10157274987 PtS11Min=3 x2S11Min=0.5 x3S11Min=-0.5 FrameElem=116 ElemStation=0.125
 Frame=116 Station=0.25 OutputCase=ENVE CaseType=Combination StepType=Max P=-217.882158664511
 V2=76.250001984823 V3=0 T=0 M2=0 M3=539.446824817967 S11Max=3018.79879024329 PtS11Max=1 x2S11Max=-0.5
 x3S11Max=-0.5 _
 S11Min=-3404.21094626125 PtS11Min=3 x2S11Min=0.5 x3S11Min=-0.5 FrameElem=116 ElemStation=0.25
 Frame=116 Station=0.375 OutputCase=ENVE CaseType=Combination StepType=Max P=-217.882158664511
 V2=114.375001984823 V3=0 T=0 M2=0 M3=527.532762133322 S11Max=2947.31441413542 PtS11Max=1 x2S11Max=-0.5
 x3S11Max=-0.5 S11Min=-3332.72656977263 PtS11Min=3 x2S11Min=0.5 x3S11Min=-0.5 FrameElem=116
 ElemStation=0.375
 Frame=116 Station=0.5 OutputCase=ENVE CaseType=Combination StepType=Max P=-217.882158664511
 V2=152.500001984823 V3=0 T=0 M2=0 M3=510.853074448676 S11Max=2847.23628802755 PtS11Max=1 x2S11Max=-0.5
 x3S11Max=-0.5 _
 S11Min=-3232.64844328402 PtS11Min=3 x2S11Min=0.5 x3S11Min=-0.5 FrameElem=116 ElemStation=0.5
 Frame=116 Station=0 OutputCase=ENVE CaseType=Combination StepType=Min P=-317.058043529684
 V2=1.47716345964E-06 V3=0 T=0 M2=0 M3=524.0567342848 S11Max=2827.28236217912 PtS11Max=1 x2S11Max=-0.5
 x3S11Max=-0.5 _
 S11Min=-3511.75060978806 PtS11Min=3 x2S11Min=0.5 x3S11Min=-0.5 FrameElem=116 ElemStation=0
 Frame=116 Station=0.125 OutputCase=ENVE CaseType=Combination StepType=Min P=-317.058043529684
 V2=38.1250014771635 V3=0 T=0 M2=0 M3=521.673921536698 S11Max=2812.9854856905 PtS11Max=1 x2S11Max=-0.5
 x3S11Max=-0.5 _
 S11Min=-3497.45373368019 PtS11Min=3 x2S11Min=0.5 x3S11Min=-0.5 FrameElem=116 ElemStation=0.125
 Frame=116 Station=0.25 OutputCase=ENVE CaseType=Combination StepType=Min P=-317.058043529684
 V2=76.2500014771635 V3=0 T=0 M2=0 M3=514.525483788595 S11Max=2770.09485920188 PtS11Max=1 x2S11Max=-0.5
 x3S11Max=-0.5 _
 S11Min=-3454.56310757231 PtS11Min=3 x2S11Min=0.5 x3S11Min=-0.5 FrameElem=116 ElemStation=0.25
 Frame=116 Station=0.375 OutputCase=ENVE CaseType=Combination StepType=Min P=-317.058043529684
 V2=114.375001477163 V3=0 T=0 M2=0 M3=502.611421040492 S11Max=2698.61048271327 PtS11Max=1 x2S11Max=-0.5
 x3S11Max=-0.5 S11Min=-3383.07873146444 PtS11Min=3 x2S11Min=0.5 x3S11Min=-0.5 FrameElem=116
 ElemStation=0.375
 Frame=116 Station=0.5 OutputCase=ENVE CaseType=Combination StepType=Min P=-317.058043529684
 V2=152.500001477163 V3=0 T=0 M2=0 M3=485.931733292389 S11Max=2598.53235622465 PtS11Max=1 x2S11Max=-0.5
 x3S11Max=-0.5 _
 S11Min=-3283.00060535657 PtS11Min=3 x2S11Min=0.5 x3S11Min=-0.5 FrameElem=116 ElemStation=0.5
 Frame=116 Station=0 OutputCase=FESSUR CaseType=Combination P=-317.058043529684 V2=1.98482302948833E-06
 V3=0 T=0 M2=0 M3=524.0567342848 S11Max=2827.28236217912 PtS11Max=1 x2S11Max=-0.5 x3S11Max=-0.5 _
 S11Min=-3461.39844923849 PtS11Min=3 x2S11Min=0.5 x3S11Min=-0.5 FrameElem=116 ElemStation=0



Frame=116 Station=0.125 OutputCase=FESSUR CaseType=Combination P=-317.058043529684 V2=38.125001984823
 V3=0 T=0 M2=0 M3=521.673921536698 S11Max=2812.9854856905 PtS11Max=1 x2S11Max=-0.5 x3S11Max=-0.5 _
 S11Min=-3447.10157274987 PtS11Min=3 x2S11Min=0.5 x3S11Min=-0.5 FrameElem=116 ElemStation=0.125
 Frame=116 Station=0.25 OutputCase=FESSUR CaseType=Combination P=-317.058043529684 V2=76.250001984823
 V3=0 T=0 M2=0 M3=514.525483788595 S11Max=2770.09485920188 PtS11Max=1 x2S11Max=-0.5 x3S11Max=-0.5 _
 S11Min=-3404.21094626125 PtS11Min=3 x2S11Min=0.5 x3S11Min=-0.5 FrameElem=116 ElemStation=0.25
 Frame=116 Station=0.375 OutputCase=FESSUR CaseType=Combination P=-317.058043529684 V2=114.375001984823
 V3=0 T=0 M2=0 M3=502.611421040492 S11Max=2698.61048271327 PtS11Max=1 x2S11Max=-0.5 x3S11Max=-0.5 _
 S11Min=-3332.72656977263 PtS11Min=3 x2S11Min=0.5 x3S11Min=-0.5 FrameElem=116 ElemStation=0.375
 Frame=116 Station=0.5 OutputCase=FESSUR CaseType=Combination P=-317.058043529684 V2=152.500001984823
 V3=0 T=0 M2=0 M3=485.931733292389 S11Max=2598.53235622465 PtS11Max=1 x2S11Max=-0.5 x3S11Max=-0.5 _
 S11Min=-3232.64844328402 PtS11Min=3 x2S11Min=0.5 x3S11Min=-0.5 FrameElem=116 ElemStation=0.5
 Frame=117 Station=0 OutputCase=PESOPR CaseType=LinStatic P=15.1709467361835 V2=12.500000110595 V3=0
 T=0 M2=0 M3=53.928421714063 S11Max=338.741477020561 PtS11Max=1 x2S11Max=-0.5 x3S11Max=-0.5 _
 S11Min=-308.399583548195 PtS11Min=3 x2S11Min=0.5 x3S11Min=-0.5 FrameElem=117 ElemStation=0
 Frame=117 Station=0.125 OutputCase=PESOPR CaseType=LinStatic P=15.1709467361835 V2=15.6250000110595
 V3=0 T=0 M2=0 M3=52.1706092126806 S11Max=328.194602012267 PtS11Max=1 x2S11Max=-0.5 x3S11Max=-0.5 _
 S11Min=-297.8527085399 PtS11Min=3 x2S11Min=0.5 x3S11Min=-0.5 FrameElem=117 ElemStation=0.125
 Frame=117 Station=0.25 OutputCase=PESOPR CaseType=LinStatic P=15.1709467361835 V2=18.7500000110595
 V3=0 T=0 M2=0 M3=50.0221717112981 S11Max=315.303977003972 PtS11Max=1 x2S11Max=-0.5 x3S11Max=-0.5 _
 S11Min=-284.962083531605 PtS11Min=3 x2S11Min=0.5 x3S11Min=-0.5 FrameElem=117 ElemStation=0.25
 Frame=117 Station=0.375 OutputCase=PESOPR CaseType=LinStatic P=15.1709467361835 V2=21.8750000110595
 V3=0 T=0 M2=0 M3=47.4831092099157 S11Max=300.069601995678 PtS11Max=1 x2S11Max=-0.5 x3S11Max=-0.5 _
 S11Min=-269.727708523311 PtS11Min=3 x2S11Min=0.5 x3S11Min=-0.5 FrameElem=117 ElemStation=0.375
 Frame=117 Station=0.5 OutputCase=PESOPR CaseType=LinStatic P=15.1709467361835 V2=25.0000000110595
 V3=0 T=0 M2=0 M3=44.5534217085333 S11Max=282.491476987383 PtS11Max=1 x2S11Max=-0.5 x3S11Max=-0.5 _
 S11Min=-252.149583515016 PtS11Min=3 x2S11Min=0.5 x3S11Min=-0.5 FrameElem=117 ElemStation=0.5
 Frame=117 Station=0 OutputCase=TERRVERT CaseType=LinStatic P=-1.64270738196176 V2=140.000000281434
 V3=0 T=0 M2=0 M3=515.074448765969 S11Max=3088.80398521385 PtS11Max=1 x2S11Max=-0.5 x3S11Max=-0.5 _
 S11Min=-3092.0893997777 PtS11Min=3 x2S11Min=0.5 x3S11Min=-0.5 FrameElem=117 ElemStation=0
 Frame=117 Station=0.125 OutputCase=TERRVERT CaseType=LinStatic P=-1.64270738196176 V2=175.000000281434
 V3=0 T=0 M2=0 M3=495.386948730789 S11Max=2970.67898500277 PtS11Max=1 x2S11Max=-0.5 x3S11Max=-0.5 _
 S11Min=-2973.9643997667 PtS11Min=3 x2S11Min=0.5 x3S11Min=-0.5 FrameElem=117 ElemStation=0.125
 Frame=117 Station=0.25 OutputCase=TERRVERT CaseType=LinStatic P=-1.64270738196176 V2=210.000000281434
 V3=0 T=0 M2=0 M3=471.32444869561 S11Max=2826.3039847917 PtS11Max=1 x2S11Max=-0.5 x3S11Max=-0.5 _
 S11Min=-2829.5893995562 PtS11Min=3 x2S11Min=0.5 x3S11Min=-0.5 FrameElem=117 ElemStation=0.25
 Frame=117 Station=0.375 OutputCase=TERRVERT CaseType=LinStatic P=-1.64270738196176 V2=245.000000281434
 V3=0 T=0 M2=0 M3=442.886948660431 S11Max=2655.67898458062 PtS11Max=1 x2S11Max=-0.5 x3S11Max=-0.5 _
 S11Min=-2658.96439934455 PtS11Min=3 x2S11Min=0.5 x3S11Min=-0.5 FrameElem=117 ElemStation=0.375
 Frame=117 Station=0.5 OutputCase=TERRVERT CaseType=LinStatic P=-1.64270738196176 V2=280.000000281434
 V3=0 T=0 M2=0 M3=410.074448625252 S11Max=2458.80398436955 PtS11Max=1 x2S11Max=-0.5 x3S11Max=-0.5 _
 S11Min=-2462.08939913347 PtS11Min=3 x2S11Min=0.5 x3S11Min=-0.5 FrameElem=117 ElemStation=0.5
 Frame=117 Station=0 OutputCase=TERRLAT CaseType=LinStatic P=-330.586282883909 V2=1.6922003851505E-06
 V3=0 T=0 M2=0 M3=-83.0711371876243 S11Max=167.840540241837 PtS11Max=3 x2S11Max=0.5 x3S11Max=-0.5 _
 S11Min=-829.013106009656 PtS11Min=1 x2S11Min=-0.5 x3S11Min=-0.5 FrameElem=117 ElemStation=0
 Frame=117 Station=0.125 OutputCase=TERRLAT CaseType=LinStatic P=-330.586282883909 V2=1.6922003851505E-06
 V3=0 T=0 M2=0 M3=-83.0711373991494 S11Max=167.840541510987 PtS11Max=3 x2S11Max=0.5 x3S11Max=-0.5 _
 S11Min=-829.013107278806 PtS11Min=1 x2S11Min=-0.5 x3S11Min=-0.5 FrameElem=117 ElemStation=0.125
 Frame=117 Station=0.25 OutputCase=TERRLAT CaseType=LinStatic P=-330.586282883909 V2=1.6922003851505E-06
 V3=0 T=0 M2=0 M3=-83.0711376106744 S11Max=167.840542780137 PtS11Max=3 x2S11Max=0.5 x3S11Max=-0.5 _
 S11Min=-829.013108547956 PtS11Min=1 x2S11Min=-0.5 x3S11Min=-0.5 FrameElem=117 ElemStation=0.25
 Frame=117 Station=0.375 OutputCase=TERRLAT CaseType=LinStatic P=-330.586282883909 V2=1.6922003851505E-06
 V3=0 T=0 M2=0 M3=-83.0711378221995 S11Max=167.840544049287 PtS11Max=3 x2S11Max=0.5 x3S11Max=-0.5 _
 S11Min=-829.013109817106 PtS11Min=1 x2S11Min=-0.5 x3S11Min=-0.5 FrameElem=117 ElemStation=0.375
 Frame=117 Station=0.5 OutputCase=TERRLAT CaseType=LinStatic P=-330.586282883909 V2=1.6922003851505E-06
 V3=0 T=0 M2=0 M3=-83.0711380337245 S11Max=167.840545318438 PtS11Max=3 x2S11Max=0.5 x3S11Max=-0.5 _
 S11Min=-829.013111086257 PtS11Min=1 x2S11Min=-0.5 x3S11Min=-0.5 FrameElem=117 ElemStation=0.5
 Frame=117 Station=0 OutputCase=ACCVERT CaseType=LinStatic P=0 V2=0 V3=0 T=0 M2=0 M3=0
 S11Max=0 PtS11Max=0 x2S11Max=0 x3S11Max=0 S11Min=0 PtS11Min=0 x2S11Min=0 x3S11Min=0 FrameElem=117
 ElemStation=0
 Frame=117 Station=0.125 OutputCase=ACCVERT CaseType=LinStatic P=0 V2=0 V3=0 T=0 M2=0 M3=0
 S11Max=0 PtS11Max=0 x2S11Max=0 x3S11Max=0 S11Min=0 PtS11Min=0 x2S11Min=0 x3S11Min=0 FrameElem=117
 ElemStation=0.125
 Frame=117 Station=0.25 OutputCase=ACCVERT CaseType=LinStatic P=0 V2=0 V3=0 T=0 M2=0 M3=0
 S11Max=0 PtS11Max=0 x2S11Max=0 x3S11Max=0 S11Min=0 PtS11Min=0 x2S11Min=0 x3S11Min=0 FrameElem=117
 ElemStation=0.25
 Frame=117 Station=0.375 OutputCase=ACCVERT CaseType=LinStatic P=0 V2=0 V3=0 T=0 M2=0 M3=0
 S11Max=0 PtS11Max=0 x2S11Max=0 x3S11Max=0 S11Min=0 PtS11Min=0 x2S11Min=0 x3S11Min=0 FrameElem=117
 ElemStation=0.375
 Frame=117 Station=0.5 OutputCase=ACCVERT CaseType=LinStatic P=0 V2=0 V3=0 T=0 M2=0 M3=0
 S11Max=0 PtS11Max=0 x2S11Max=0 x3S11Max=0 S11Min=0 PtS11Min=0 x2S11Min=0 x3S11Min=0 FrameElem=117
 ElemStation=0.5
 Frame=117 Station=0 OutputCase=ACCLATDX CaseType=LinStatic P=0 V2=0 V3=0 T=0 M2=0 M3=0
 S11Max=0 PtS11Max=0 x2S11Max=0 x3S11Max=0 S11Min=0 PtS11Min=0 x2S11Min=0 x3S11Min=0 FrameElem=117
 ElemStation=0
 Frame=117 Station=0.125 OutputCase=ACCLATDX CaseType=LinStatic P=0 V2=0 V3=0 T=0 M2=0 M3=0
 S11Max=0 PtS11Max=0 x2S11Max=0 x3S11Max=0 S11Min=0 PtS11Min=0 x2S11Min=0 x3S11Min=0 FrameElem=117
 ElemStation=0.125



Frame=117 Station=0.25 OutputCase=ACCLATDX CaseType=LinStatic P=0 V2=0 V3=0 T=0 M2=0 M3=0
 S11Max=0 PtS11Max=0 x2S11Max=0 x3S11Max=0 S11Min=0 PtS11Min=0 x2S11Min=0 x3S11Min=0 FrameElem=117
 ElemStation=0.25
 Frame=117 Station=0.375 OutputCase=ACCLATDX CaseType=LinStatic P=0 V2=0 V3=0 T=0 M2=0 M3=0
 S11Max=0 PtS11Max=0 x2S11Max=0 x3S11Max=0 S11Min=0 PtS11Min=0 x2S11Min=0 x3S11Min=0 FrameElem=117
 ElemStation=0.375
 Frame=117 Station=0.5 OutputCase=ACCLATDX CaseType=LinStatic P=0 V2=0 V3=0 T=0 M2=0 M3=0
 S11Max=0 PtS11Max=0 x2S11Max=0 x3S11Max=0 S11Min=0 PtS11Min=0 x2S11Min=0 x3S11Min=0 FrameElem=117
 ElemStation=0.5
 Frame=117 Station=0 OutputCase=ACCLATSX CaseType=LinStatic P=0 V2=0 V3=0 T=0 M2=0 M3=0
 S11Max=0 PtS11Max=0 x2S11Max=0 x3S11Max=0 S11Min=0 PtS11Min=0 x2S11Min=0 x3S11Min=0 FrameElem=117
 ElemStation=0
 Frame=117 Station=0.125 OutputCase=ACCLATSX CaseType=LinStatic P=0 V2=0 V3=0 T=0 M2=0 M3=0
 S11Max=0 PtS11Max=0 x2S11Max=0 x3S11Max=0 S11Min=0 PtS11Min=0 x2S11Min=0 x3S11Min=0 FrameElem=117
 ElemStation=0.125
 Frame=117 Station=0.25 OutputCase=ACCLATSX CaseType=LinStatic P=0 V2=0 V3=0 T=0 M2=0 M3=0
 S11Max=0 PtS11Max=0 x2S11Max=0 x3S11Max=0 S11Min=0 PtS11Min=0 x2S11Min=0 x3S11Min=0 FrameElem=117
 ElemStation=0.25
 Frame=117 Station=0.375 OutputCase=ACCLATSX CaseType=LinStatic P=0 V2=0 V3=0 T=0 M2=0 M3=0
 S11Max=0 PtS11Max=0 x2S11Max=0 x3S11Max=0 S11Min=0 PtS11Min=0 x2S11Min=0 x3S11Min=0 FrameElem=117
 ElemStation=0.375
 Frame=117 Station=0.5 OutputCase=ACCLATSX CaseType=LinStatic P=0 V2=0 V3=0 T=0 M2=0 M3=0
 S11Max=0 PtS11Max=0 x2S11Max=0 x3S11Max=0 S11Min=0 PtS11Min=0 x2S11Min=0 x3S11Min=0 FrameElem=117
 ElemStation=0.5
 Frame=117 Station=0 OutputCase=TERRCOST CaseType=LinStatic P=0 V2=0 V3=0 T=0 M2=0 M3=0
 S11Max=0 PtS11Max=0 x2S11Max=0 x3S11Max=0 S11Min=0 PtS11Min=0 x2S11Min=0 x3S11Min=0 FrameElem=117
 ElemStation=0
 Frame=117 Station=0.125 OutputCase=TERRCOST CaseType=LinStatic P=0 V2=0 V3=0 T=0 M2=0 M3=0
 S11Max=0 PtS11Max=0 x2S11Max=0 x3S11Max=0 S11Min=0 PtS11Min=0 x2S11Min=0 x3S11Min=0 FrameElem=117
 ElemStation=0.125
 Frame=117 Station=0.25 OutputCase=TERRCOST CaseType=LinStatic P=0 V2=0 V3=0 T=0 M2=0 M3=0
 S11Max=0 PtS11Max=0 x2S11Max=0 x3S11Max=0 S11Min=0 PtS11Min=0 x2S11Min=0 x3S11Min=0 FrameElem=117
 ElemStation=0.25
 Frame=117 Station=0.375 OutputCase=TERRCOST CaseType=LinStatic P=0 V2=0 V3=0 T=0 M2=0 M3=0
 S11Max=0 PtS11Max=0 x2S11Max=0 x3S11Max=0 S11Min=0 PtS11Min=0 x2S11Min=0 x3S11Min=0 FrameElem=117
 ElemStation=0.375
 Frame=117 Station=0.5 OutputCase=TERRCOST CaseType=LinStatic P=0 V2=0 V3=0 T=0 M2=0 M3=0
 S11Max=0 PtS11Max=0 x2S11Max=0 x3S11Max=0 S11Min=0 PtS11Min=0 x2S11Min=0 x3S11Min=0 FrameElem=117
 ElemStation=0.5
 Frame=117 Station=0 OutputCase=SOVRCOST CaseType=LinStatic P=0 V2=0 V3=0 T=0 M2=0 M3=0
 S11Max=0 PtS11Max=0 x2S11Max=0 x3S11Max=0 S11Min=0 PtS11Min=0 x2S11Min=0 x3S11Min=0 FrameElem=117
 ElemStation=0
 Frame=117 Station=0.125 OutputCase=SOVRCOST CaseType=LinStatic P=0 V2=0 V3=0 T=0 M2=0 M3=0
 S11Max=0 PtS11Max=0 x2S11Max=0 x3S11Max=0 S11Min=0 PtS11Min=0 x2S11Min=0 x3S11Min=0 FrameElem=117
 ElemStation=0.125
 Frame=117 Station=0.25 OutputCase=SOVRCOST CaseType=LinStatic P=0 V2=0 V3=0 T=0 M2=0 M3=0
 S11Max=0 PtS11Max=0 x2S11Max=0 x3S11Max=0 S11Min=0 PtS11Min=0 x2S11Min=0 x3S11Min=0 FrameElem=117
 ElemStation=0.25
 Frame=117 Station=0.375 OutputCase=SOVRCOST CaseType=LinStatic P=0 V2=0 V3=0 T=0 M2=0 M3=0
 S11Max=0 PtS11Max=0 x2S11Max=0 x3S11Max=0 S11Min=0 PtS11Min=0 x2S11Min=0 x3S11Min=0 FrameElem=117
 ElemStation=0.375
 Frame=117 Station=0.5 OutputCase=SOVRCOST CaseType=LinStatic P=0 V2=0 V3=0 T=0 M2=0 M3=0
 S11Max=0 PtS11Max=0 x2S11Max=0 x3S11Max=0 S11Min=0 PtS11Min=0 x2S11Min=0 x3S11Min=0 FrameElem=117
 ElemStation=0.5
 Frame=117 Station=0 OutputCase=ENVE CaseType=Combination StepType=Max P=-217.882158664515
 V2=152.500001984694 V3=0 T=0 M2=0 M3=510.853074448695 S11Max=2847.23628802765 PtS11Max=1 x2S11Max=-0.5
 x3S11Max=-0.5
 S11Min=-3232.64844328413 PtS11Min=3 x2S11Min=0.5 x3S11Min=-0.5 FrameElem=117 ElemStation=0
 Frame=117 Station=0.125 OutputCase=ENVE CaseType=Combination StepType=Max P=-217.882158664515
 V2=190.625001984694 V3=0 T=0 M2=0 M3=489.407761764065 S11Max=2718.56441191988 PtS11Max=1 x2S11Max=-0.5
 x3S11Max=-0.5
 S11Min=-3103.97656679561 PtS11Min=3 x2S11Min=0.5 x3S11Min=-0.5 FrameElem=117
 ElemStation=0.125
 Frame=117 Station=0.25 OutputCase=ENVE CaseType=Combination StepType=Max P=-217.882158664515
 V2=228.750001984694 V3=0 T=0 M2=0 M3=463.196824079436 S11Max=2561.2987858121 PtS11Max=1 x2S11Max=-0.5
 x3S11Max=-0.5
 S11Min=-2946.71094030709 PtS11Min=3 x2S11Min=0.5 x3S11Min=-0.5 FrameElem=117 ElemStation=0.25
 Frame=117 Station=0.375 OutputCase=ENVE CaseType=Combination StepType=Max P=-217.882158664515
 V2=266.875001984694 V3=0 T=0 M2=0 M3=432.220261394807 S11Max=2375.43940970433 PtS11Max=1 x2S11Max=-0.5
 x3S11Max=-0.5
 S11Min=-2760.85156381857 PtS11Min=3 x2S11Min=0.5 x3S11Min=-0.5 FrameElem=117
 ElemStation=0.375
 Frame=117 Station=0.5 OutputCase=ENVE CaseType=Combination StepType=Max P=-217.882158664515
 V2=305.000001984694 V3=0 T=0 M2=0 M3=396.478073710178 S11Max=2160.98628359655 PtS11Max=1 x2S11Max=-0.5
 x3S11Max=-0.5
 S11Min=-2546.39843733005 PtS11Min=3 x2S11Min=0.5 x3S11Min=-0.5 FrameElem=117 ElemStation=0.5
 Frame=117 Station=0 OutputCase=ENVE CaseType=Combination StepType=Min P=-317.058043529688
 V2=152.500001477034 V3=0 T=0 M2=0 M3=485.931733292407 S11Max=2598.53235622476 PtS11Max=1 x2S11Max=-0.5
 x3S11Max=-0.5
 S11Min=-3283.00060535668 PtS11Min=3 x2S11Min=0.5 x3S11Min=-0.5 FrameElem=117 ElemStation=0

Frame=117 Station=0.125 OutputCase=ENVE CaseType=Combination StepType=Min P=-317.058043529688
V2=190.625001477034 V3=0 T=0 M2=0 M3=464.48642054432 S11Max=2469.86047973624 PtS11Max=1 x2S11Max=-0.5
x3S11Max=-0.5
S11Min=-3154.32872924891 PtS11Min=3 x2S11Min=0.5 x3S11Min=-0.5 FrameElem=117 ElemStation=0.125

Frame=117 Station=0.25 OutputCase=ENVE CaseType=Combination StepType=Min P=-317.058043529688
V2=228.750001477034 V3=0 T=0 M2=0 M3=438.275482796234 S11Max=2312.59485324771 PtS11Max=1 x2S11Max=-0.5
x3S11Max=-0.5
S11Min=-2997.06310314113 PtS11Min=3 x2S11Min=0.5 x3S11Min=-0.5 FrameElem=117 ElemStation=0.25

Frame=117 Station=0.375 OutputCase=ENVE CaseType=Combination StepType=Min P=-317.058043529688
V2=266.875001477034 V3=0 T=0 M2=0 M3=407.298920048147 S11Max=2126.73547675919 PtS11Max=1 x2S11Max=-0.5
x3S11Max=-0.5
S11Min=-2811.20372703336 PtS11Min=3 x2S11Min=0.5 x3S11Min=-0.5 FrameElem=117
ElemStation=0.375

Frame=117 Station=0.5 OutputCase=ENVE CaseType=Combination StepType=Min P=-317.058043529688
V2=305.000001477034 V3=0 T=0 M2=0 M3=371.55673230006 S11Max=1912.28235027067 PtS11Max=1 x2S11Max=-0.5
x3S11Max=-0.5
S11Min=-2596.75060092558 PtS11Min=3 x2S11Min=0.5 x3S11Min=-0.5 FrameElem=117 ElemStation=0.5

Frame=117 Station=0 OutputCase=FESSUR CaseType=Combination P=-317.058043529688 V2=152.500001984694
V3=0 T=0 M2=0 M3=485.931733292407 S11Max=2598.53235622476 PtS11Max=1 x2S11Max=-0.5 x3S11Max=-0.5
S11Min=-3232.64844328413 PtS11Min=3 x2S11Min=0.5 x3S11Min=-0.5 FrameElem=117 ElemStation=0

Frame=117 Station=0.125 OutputCase=FESSUR CaseType=Combination P=-317.058043529688 V2=190.625001984694
V3=0 T=0 M2=0 M3=464.48642054432 S11Max=2469.86047973624 PtS11Max=1 x2S11Max=-0.5 x3S11Max=-0.5
S11Min=-3103.97656679561 PtS11Min=3 x2S11Min=0.5 x3S11Min=-0.5 FrameElem=117 ElemStation=0.125

Frame=117 Station=0.25 OutputCase=FESSUR CaseType=Combination P=-317.058043529688 V2=228.750001984694
V3=0 T=0 M2=0 M3=438.275482796234 S11Max=2312.59485324771 PtS11Max=1 x2S11Max=-0.5 x3S11Max=-0.5
S11Min=-2946.71094030709 PtS11Min=3 x2S11Min=0.5 x3S11Min=-0.5 FrameElem=117 ElemStation=0.25

Frame=117 Station=0.375 OutputCase=FESSUR CaseType=Combination P=-317.058043529688 V2=266.875001984694
V3=0 T=0 M2=0 M3=407.298920048147 S11Max=2126.73547675919 PtS11Max=1 x2S11Max=-0.5 x3S11Max=-0.5
S11Min=-2760.85156381857 PtS11Min=3 x2S11Min=0.5 x3S11Min=-0.5 FrameElem=117 ElemStation=0.375

Frame=117 Station=0.5 OutputCase=FESSUR CaseType=Combination P=-317.058043529688 V2=305.000001984694
V3=0 T=0 M2=0 M3=371.55673230006 S11Max=1912.28235027067 PtS11Max=1 x2S11Max=-0.5 x3S11Max=-0.5
S11Min=-2546.39843733005 PtS11Min=3 x2S11Min=0.5 x3S11Min=-0.5 FrameElem=117 ElemStation=0.5

Frame=118 Station=0 OutputCase=PESOPR CaseType=LinStatic P=15.1709467361834 V2=25.0000000110886 V3=0
T=0 M2=0 M3=44.5534217085333 S11Max=282.491476987383 PtS11Max=1 x2S11Max=-0.5 x3S11Max=-0.5
S11Min=-252.149583515016 PtS11Min=3 x2S11Min=0.5 x3S11Min=-0.5 FrameElem=118 ElemStation=0

Frame=118 Station=0.125 OutputCase=PESOPR CaseType=LinStatic P=15.1709467361834 V2=28.1250000110886
V3=0 T=0 M2=0 M3=41.2331092071472 S11Max=262.569601979067 PtS11Max=1 x2S11Max=-0.5 x3S11Max=-0.5
S11Min=-232.2277085067 PtS11Min=3 x2S11Min=0.5 x3S11Min=-0.5 FrameElem=118 ElemStation=0.125

Frame=118 Station=0.25 OutputCase=PESOPR CaseType=LinStatic P=15.1709467361834 V2=31.2500000110886
V3=0 T=0 M2=0 M3=37.5221717057611 S11Max=240.30397697075 PtS11Max=1 x2S11Max=-0.5 x3S11Max=-0.5
S11Min=-209.962083498383 PtS11Min=3 x2S11Min=0.5 x3S11Min=-0.5 FrameElem=118 ElemStation=0.25

Frame=118 Station=0.375 OutputCase=PESOPR CaseType=LinStatic P=15.1709467361834 V2=34.3750000110886
V3=0 T=0 M2=0 M3=33.4206092043751 S11Max=215.694601962434 PtS11Max=1 x2S11Max=-0.5 x3S11Max=-0.5
S11Min=-185.352708490067 PtS11Min=3 x2S11Min=0.5 x3S11Min=-0.5 FrameElem=118 ElemStation=0.375

Frame=118 Station=0.5 OutputCase=PESOPR CaseType=LinStatic P=15.1709467361834 V2=37.5000000110886
V3=0 T=0 M2=0 M3=28.928421702989 S11Max=188.741476954117 PtS11Max=1 x2S11Max=-0.5 x3S11Max=-0.5
S11Min=-158.399583481751 PtS11Min=3 x2S11Min=0.5 x3S11Min=-0.5 FrameElem=118 ElemStation=0.5

Frame=118 Station=0 OutputCase=TERRVERT CaseType=LinStatic P=-1.64270738196176 V2=280.000000281376
V3=0 T=0 M2=0 M3=410.074448625252 S11Max=2458.80398436955 PtS11Max=1 x2S11Max=-0.5 x3S11Max=-0.5
S11Min=-2462.08939913347 PtS11Min=3 x2S11Min=0.5 x3S11Min=-0.5 FrameElem=118 ElemStation=0

Frame=118 Station=0.125 OutputCase=TERRVERT CaseType=LinStatic P=-1.64270738196176 V2=315.000000281376
V3=0 T=0 M2=0 M3=372.88694859008 S11Max=2235.67898415852 PtS11Max=1 x2S11Max=-0.5 x3S11Max=-0.5
S11Min=-2238.96439892244 PtS11Min=3 x2S11Min=0.5 x3S11Min=-0.5 FrameElem=118 ElemStation=0.125

Frame=118 Station=0.25 OutputCase=TERRVERT CaseType=LinStatic P=-1.64270738196176 V2=350.000000281376
V3=0 T=0 M2=0 M3=331.324448554908 S11Max=1986.30398394748 PtS11Max=1 x2S11Max=-0.5 x3S11Max=-0.5
S11Min=-1989.58939871141 PtS11Min=3 x2S11Min=0.5 x3S11Min=-0.5 FrameElem=118 ElemStation=0.25

Frame=118 Station=0.375 OutputCase=TERRVERT CaseType=LinStatic P=-1.64270738196176 V2=385.000000281376
V3=0 T=0 M2=0 M3=285.386948519736 S11Max=1710.67898373645 PtS11Max=1 x2S11Max=-0.5 x3S11Max=-0.5
S11Min=-1713.96439850038 PtS11Min=3 x2S11Min=0.5 x3S11Min=-0.5 FrameElem=118 ElemStation=0.375

Frame=118 Station=0.5 OutputCase=TERRVERT CaseType=LinStatic P=-1.64270738196176 V2=420.000000281376
V3=0 T=0 M2=0 M3=235.074448484564 S11Max=1408.80398352542 PtS11Max=1 x2S11Max=-0.5 x3S11Max=-0.5
S11Min=-1412.08939828934 PtS11Min=3 x2S11Min=0.5 x3S11Min=-0.5 FrameElem=118 ElemStation=0.5

Frame=118 Station=0 OutputCase=TERRLAT CaseType=LinStatic P=-330.586282883909 V2=1.6921994756558E-06
V3=0 T=0 M2=0 M3=-83.0711380337248 S11Max=167.84054531844 PtS11Max=3 x2S11Max=0.5 x3S11Max=-0.5
S11Min=-829.013111086258 PtS11Min=1 x2S11Min=-0.5 x3S11Min=-0.5 FrameElem=118 ElemStation=0

Frame=118 Station=0.125 OutputCase=TERRLAT CaseType=LinStatic P=-330.586282883909 V2=1.6921994756558E-06
V3=0 T=0 M2=0 M3=-83.0711382452497 S11Max=167.840546587589 PtS11Max=3 x2S11Max=0.5 x3S11Max=-0.5
S11Min=-829.013112355407 PtS11Min=1 x2S11Min=-0.5 x3S11Min=-0.5 FrameElem=118 ElemStation=0.125

Frame=118 Station=0.25 OutputCase=TERRLAT CaseType=LinStatic P=-330.586282883909 V2=1.6921994756558E-06
V3=0 T=0 M2=0 M3=-83.0711384567746 S11Max=167.840547856739 PtS11Max=3 x2S11Max=0.5 x3S11Max=-0.5
S11Min=-829.013113624557 PtS11Min=1 x2S11Min=-0.5 x3S11Min=-0.5 FrameElem=118 ElemStation=0.25

Frame=118 Station=0.375 OutputCase=TERRLAT CaseType=LinStatic P=-330.586282883909 V2=1.6921994756558E-06
V3=0 T=0 M2=0 M3=-83.0711386682996 S11Max=167.840549125888 PtS11Max=3 x2S11Max=0.5 x3S11Max=-0.5
S11Min=-829.013114893706 PtS11Min=1 x2S11Min=-0.5 x3S11Min=-0.5 FrameElem=118 ElemStation=0.375

Frame=118 Station=0.5 OutputCase=TERRLAT CaseType=LinStatic P=-330.586282883909 V2=1.6921994756558E-06
V3=0 T=0 M2=0 M3=-83.0711388798245 S11Max=167.840550395038 PtS11Max=3 x2S11Max=0.5 x3S11Max=-0.5
S11Min=-829.013116162856 PtS11Min=1 x2S11Min=-0.5 x3S11Min=-0.5 FrameElem=118 ElemStation=0.5

Frame=118 Station=0 OutputCase=ACCVERT CaseType=LinStatic P=0 V2=0 V3=0 T=0 M2=0 M3=0
S11Max=0 PtS11Max=0 x2S11Max=0 x3S11Max=0 S11Min=0 PtS11Min=0 x2S11Min=0 x3S11Min=0 FrameElem=118
ElemStation=0



Frame=118 Station=0.25 OutputCase=ENVE CaseType=Combination StepType=Max P=-217.882158664515
 V2=381.250001984664 V3=0 T=0 M2=0 M3=310.696823340926 S11Max=1646.29878138104 PtS11Max=1 x2S11Max=-0.5
 x3S11Max=-0.5 _
 S11Min=-2031.71093435305 PtS11Min=3 x2S11Min=0.5 x3S11Min=-0.5 FrameElem=118 ElemStation=0.25
 Frame=118 Station=0.375 OutputCase=ENVE CaseType=Combination StepType=Max P=-217.882158664515
 V2=419.375001984664 V3=0 T=0 M2=0 M3=260.657760656301 S11Max=1346.06440527329 PtS11Max=1 x2S11Max=-0.5
 _
 x3S11Max=-0.5 S11Min=-1731.47655786455 PtS11Min=3 x2S11Min=0.5 x3S11Min=-0.5 FrameElem=118
 ElemStation=0.375
 Frame=118 Station=0.5 OutputCase=ENVE CaseType=Combination StepType=Max P=-217.882158664515
 V2=457.500001984664 V3=0 T=0 M2=0 M3=205.853072971675 S11Max=1017.23627916554 PtS11Max=1 x2S11Max=-0.5
 x3S11Max=-0.5 _
 S11Min=-1402.64843137606 PtS11Min=3 x2S11Min=0.5 x3S11Min=-0.5 FrameElem=118 ElemStation=0.5
 Frame=118 Station=0 OutputCase=ENVE CaseType=Combination StepType=Min P=-317.058043529687
 V2=305.000001477004 V3=0 T=0 M2=0 M3=371.55673230006 S11Max=1912.28235027067 PtS11Max=1 x2S11Max=-0.5
 x3S11Max=-0.5 _
 S11Min=-2596.75060092558 PtS11Min=3 x2S11Min=0.5 x3S11Min=-0.5 FrameElem=118 ElemStation=0
 Frame=118 Station=0.125 OutputCase=ENVE CaseType=Combination StepType=Min P=-317.058043529687
 V2=343.125001477004 V3=0 T=0 M2=0 M3=331.048919551977 S11Max=1669.23547378217 PtS11Max=1 x2S11Max=-0.5
 _
 x3S11Max=-0.5 S11Min=-2353.70372481783 PtS11Min=3 x2S11Min=0.5 x3S11Min=-0.5 FrameElem=118
 ElemStation=0.125
 Frame=118 Station=0.25 OutputCase=ENVE CaseType=Combination StepType=Min P=-317.058043529687
 V2=381.250001477004 V3=0 T=0 M2=0 M3=285.775481803894 S11Max=1397.59484729368 PtS11Max=1 x2S11Max=-0.5
 x3S11Max=-0.5 _
 S11Min=-2082.06309871007 PtS11Min=3 x2S11Min=0.5 x3S11Min=-0.5 FrameElem=118 ElemStation=0.25
 Frame=118 Station=0.375 OutputCase=ENVE CaseType=Combination StepType=Min P=-317.058043529687
 V2=419.375001477004 V3=0 T=0 M2=0 M3=235.736419055811 S11Max=1097.36047080518 PtS11Max=1 x2S11Max=-0.5
 _
 x3S11Max=-0.5 S11Min=-1781.82872260232 PtS11Min=3 x2S11Min=0.5 x3S11Min=-0.5 FrameElem=118
 ElemStation=0.375
 Frame=118 Station=0.5 OutputCase=ENVE CaseType=Combination StepType=Min P=-317.058043529687
 V2=457.500001477004 V3=0 T=0 M2=0 M3=180.931731307728 S11Max=768.532344316681 PtS11Max=1 x2S11Max=-0.5
 x3S11Max=-0.5 _
 S11Min=-1453.00059649457 PtS11Min=3 x2S11Min=0.5 x3S11Min=-0.5 FrameElem=118 ElemStation=0.5
 Frame=118 Station=0 OutputCase=FESSUR CaseType=Combination P=-317.058043529687 V2=305.000001984664
 V3=0 T=0 M2=0 M3=371.55673230006 S11Max=1912.28235027067 PtS11Max=1 x2S11Max=-0.5 x3S11Max=-0.5 _
 S11Min=-2546.39843733005 PtS11Min=3 x2S11Min=0.5 x3S11Min=-0.5 FrameElem=118 ElemStation=0
 Frame=118 Station=0.125 OutputCase=FESSUR CaseType=Combination P=-317.058043529687 V2=343.125001984664
 V3=0 T=0 M2=0 M3=331.048919551977 S11Max=1669.23547378217 PtS11Max=1 x2S11Max=-0.5 x3S11Max=-0.5 _
 S11Min=-2303.35156084155 PtS11Min=3 x2S11Min=0.5 x3S11Min=-0.5 FrameElem=118 ElemStation=0.125
 Frame=118 Station=0.25 OutputCase=FESSUR CaseType=Combination P=-317.058043529687 V2=381.250001984664
 V3=0 T=0 M2=0 M3=285.775481803894 S11Max=1397.59484729368 PtS11Max=1 x2S11Max=-0.5 x3S11Max=-0.5 _
 S11Min=-2031.71093435305 PtS11Min=3 x2S11Min=0.5 x3S11Min=-0.5 FrameElem=118 ElemStation=0.25
 Frame=118 Station=0.375 OutputCase=FESSUR CaseType=Combination P=-317.058043529687 V2=419.375001984664
 V3=0 T=0 M2=0 M3=235.736419055811 S11Max=1097.36047080518 PtS11Max=1 x2S11Max=-0.5 x3S11Max=-0.5 _
 S11Min=-1731.47655786455 PtS11Min=3 x2S11Min=0.5 x3S11Min=-0.5 FrameElem=118 ElemStation=0.375
 Frame=118 Station=0.5 OutputCase=FESSUR CaseType=Combination P=-317.058043529687 V2=457.500001984664
 V3=0 T=0 M2=0 M3=180.931731307728 S11Max=768.532344316681 PtS11Max=1 x2S11Max=-0.5 x3S11Max=-0.5 _
 S11Min=-1402.64843137606 PtS11Min=3 x2S11Min=0.5 x3S11Min=-0.5 FrameElem=118 ElemStation=0.5
 Frame=119 Station=0 OutputCase=PESOPR CaseType=LinStatic P=15.1709467361835 V2=37.5000000110449 V3=0
 T=0 M2=0 M3=28.9284217029854 S11Max=188.741476954096 PtS11Max=1 x2S11Max=-0.5 x3S11Max=-0.5 _
 S11Min=-158.399583481729 PtS11Min=3 x2S11Min=0.5 x3S11Min=-0.5 FrameElem=119 ElemStation=0
 Frame=119 Station=0.125 OutputCase=PESOPR CaseType=LinStatic P=15.1709467361835 V2=40.6250000110449
 V3=0 T=0 M2=0 M3=24.0456092016047 S11Max=159.444601945812 PtS11Max=1 x2S11Max=-0.5 x3S11Max=-0.5 _
 S11Min=-129.102708473445 PtS11Min=3 x2S11Min=0.5 x3S11Min=-0.5 FrameElem=119 ElemStation=0.125
 Frame=119 Station=0.25 OutputCase=PESOPR CaseType=LinStatic P=15.1709467361835 V2=43.7500000110449
 V3=0 T=0 M2=0 M3=18.7721717002241 S11Max=127.803976937528 PtS11Max=1 x2S11Max=-0.5 x3S11Max=-0.5 _
 S11Min=-97.4620834651614 PtS11Min=3 x2S11Min=0.5 x3S11Min=-0.5 FrameElem=119 ElemStation=0.25
 Frame=119 Station=0.375 OutputCase=PESOPR CaseType=LinStatic P=15.1709467361835 V2=46.8750000110449
 V3=0 T=0 M2=0 M3=13.1081091988435 S11Max=93.8196019292446 PtS11Max=1 x2S11Max=-0.5 x3S11Max=-0.5 _
 S11Min=-63.4777084568777 PtS11Min=3 x2S11Min=0.5 x3S11Min=-0.5 FrameElem=119 ElemStation=0.375
 Frame=119 Station=0.5 OutputCase=PESOPR CaseType=LinStatic P=15.1709467361835 V2=50.0000000110449
 V3=0 T=0 M2=0 M3=7.05342169746291 S11Max=57.4914769209609 PtS11Max=1 x2S11Max=-0.5 x3S11Max=-0.5 _
 S11Min=-27.149583448594 PtS11Min=3 x2S11Min=0.5 x3S11Min=-0.5 FrameElem=119 ElemStation=0.5
 Frame=119 Station=0 OutputCase=TERRVERT CaseType=LinStatic P=-1.64270738196176 V2=420.000000281318
 V3=0 T=0 M2=0 M3=235.07444848452 S11Max=1408.80398352516 PtS11Max=1 x2S11Max=-0.5 x3S11Max=-0.5 _
 S11Min=-1412.08939828908 PtS11Min=3 x2S11Min=0.5 x3S11Min=-0.5 FrameElem=119 ElemStation=0
 Frame=119 Station=0.125 OutputCase=TERRVERT CaseType=LinStatic P=-1.64270738196176 V2=455.000000281318
 V3=0 T=0 M2=0 M3=180.386948449355 S11Max=1080.67898331417 PtS11Max=1 x2S11Max=-0.5 x3S11Max=-0.5 _
 S11Min=-1083.96439807809 PtS11Min=3 x2S11Min=0.5 x3S11Min=-0.5 FrameElem=119 ElemStation=0.125
 Frame=119 Station=0.25 OutputCase=TERRVERT CaseType=LinStatic P=-1.64270738196176 V2=490.000000281318
 V3=0 T=0 M2=0 M3=121.324448414191 S11Max=726.303983103182 PtS11Max=1 x2S11Max=-0.5 x3S11Max=-0.5 _
 S11Min=-729.589397867105 PtS11Min=3 x2S11Min=0.5 x3S11Min=-0.5 FrameElem=119 ElemStation=0.25
 Frame=119 Station=0.375 OutputCase=TERRVERT CaseType=LinStatic P=-1.64270738196176 V2=525.000000281318
 V3=0 T=0 M2=0 M3=57.8869483790259 S11Max=345.678982892193 PtS11Max=1 x2S11Max=-0.5 x3S11Max=-0.5 _
 S11Min=-348.964397656117 PtS11Min=3 x2S11Min=0.5 x3S11Min=-0.5 FrameElem=119 ElemStation=0.375
 Frame=119 Station=0.5 OutputCase=TERRVERT CaseType=LinStatic P=-1.64270738196176 V2=560.000000281318
 V3=0 T=0 M2=0 M3=-9.92555165613885 S11Max=57.9106025548713 PtS11Max=3 x2S11Max=0.5 x3S11Max=-0.5 _
 S11Min=-61.1960173187949 PtS11Min=1 x2S11Min=0.5 x3S11Min=-0.5 FrameElem=119 ElemStation=0.5
 Frame=119 Station=0 OutputCase=TERRLAT CaseType=LinStatic P=-330.586282883909 V2=1.6922003851505E-06
 V3=0 T=0 M2=0 M3=-83.0711388798246 S11Max=167.840550395039 PtS11Max=3 x2S11Max=0.5 x3S11Max=-0.5 _



S11Min=-829.013116162856 PtS11Min=1 x2S11Min=-0.5 x3S11Min=-0.5 FrameElem=119 ElemStation=0
 Frame=119 Station=0.125 OutputCase=TERRLAT CaseType=LinStatic P=-330.586282883909 V2=1.6922003851505E-
 06 V3=0 T=0 M2=0 M3=-83.0711390913497 S11Max=167.840551664189 PtS11Max=3 x2S11Max=0.5 x3S11Max=-0.5
 -
 S11Min=-829.013117432007 PtS11Min=1 x2S11Min=-0.5 x3S11Min=-0.5 FrameElem=119 ElemStation=0.125
 Frame=119 Station=0.25 OutputCase=TERRLAT CaseType=LinStatic P=-330.586282883909 V2=1.6922003851505E-06
 V3=0 T=0 M2=0 M3=-83.0711393028747 S11Max=167.84055293334 PtS11Max=3 x2S11Max=0.5 x3S11Max=-0.5
 S11Min=-829.013118701157 PtS11Min=1 x2S11Min=-0.5 x3S11Min=-0.5 FrameElem=119 ElemStation=0.25
 Frame=119 Station=0.375 OutputCase=TERRLAT CaseType=LinStatic P=-330.586282883909 V2=1.6922003851505E-
 06 V3=0 T=0 M2=0 M3=-83.0711395143998 S11Max=167.84055420249 PtS11Max=3 x2S11Max=0.5 x3S11Max=-0.5
 S11Min=-829.013119970307 PtS11Min=1 x2S11Min=-0.5 x3S11Min=-0.5 FrameElem=119 ElemStation=0.375
 Frame=119 Station=0.5 OutputCase=TERRLAT CaseType=LinStatic P=-330.586282883909 V2=1.6922003851505E-06
 V3=0 T=0 M2=0 M3=-83.0711397259248 S11Max=167.8405547164 PtS11Max=3 x2S11Max=0.5 x3S11Max=-0.5
 S11Min=-829.013121239457 PtS11Min=1 x2S11Min=-0.5 x3S11Min=-0.5 FrameElem=119 ElemStation=0.5
 Frame=119 Station=0 OutputCase=ACCVERT CaseType=LinStatic P=0 V2=0 V3=0 T=0 M2=0 M3=0
 S11Max=0 PtS11Max=0 x2S11Max=0 x3S11Max=0 S11Min=0 PtS11Min=0 x2S11Min=0 x3S11Min=0 FrameElem=119
 ElemStation=0
 Frame=119 Station=0.125 OutputCase=ACCVERT CaseType=LinStatic P=0 V2=0 V3=0 T=0 M2=0 M3=0
 S11Max=0 PtS11Max=0 x2S11Max=0 x3S11Max=0 S11Min=0 PtS11Min=0 x2S11Min=0 x3S11Min=0 FrameElem=119
 ElemStation=0.125
 Frame=119 Station=0.25 OutputCase=ACCVERT CaseType=LinStatic P=0 V2=0 V3=0 T=0 M2=0 M3=0
 S11Max=0 PtS11Max=0 x2S11Max=0 x3S11Max=0 S11Min=0 PtS11Min=0 x2S11Min=0 x3S11Min=0 FrameElem=119
 ElemStation=0.25
 Frame=119 Station=0.375 OutputCase=ACCVERT CaseType=LinStatic P=0 V2=0 V3=0 T=0 M2=0 M3=0
 S11Max=0 PtS11Max=0 x2S11Max=0 x3S11Max=0 S11Min=0 PtS11Min=0 x2S11Min=0 x3S11Min=0 FrameElem=119
 ElemStation=0.375
 Frame=119 Station=0.5 OutputCase=ACCVERT CaseType=LinStatic P=0 V2=0 V3=0 T=0 M2=0 M3=0
 S11Max=0 PtS11Max=0 x2S11Max=0 x3S11Max=0 S11Min=0 PtS11Min=0 x2S11Min=0 x3S11Min=0 FrameElem=119
 ElemStation=0.5
 Frame=119 Station=0 OutputCase=ACCLATDX CaseType=LinStatic P=0 V2=0 V3=0 T=0 M2=0 M3=0
 S11Max=0 PtS11Max=0 x2S11Max=0 x3S11Max=0 S11Min=0 PtS11Min=0 x2S11Min=0 x3S11Min=0 FrameElem=119
 ElemStation=0
 Frame=119 Station=0.125 OutputCase=ACCLATDX CaseType=LinStatic P=0 V2=0 V3=0 T=0 M2=0 M3=0
 S11Max=0 PtS11Max=0 x2S11Max=0 x3S11Max=0 S11Min=0 PtS11Min=0 x2S11Min=0 x3S11Min=0 FrameElem=119
 ElemStation=0.125
 Frame=119 Station=0.25 OutputCase=ACCLATDX CaseType=LinStatic P=0 V2=0 V3=0 T=0 M2=0 M3=0
 S11Max=0 PtS11Max=0 x2S11Max=0 x3S11Max=0 S11Min=0 PtS11Min=0 x2S11Min=0 x3S11Min=0 FrameElem=119
 ElemStation=0.25
 Frame=119 Station=0.375 OutputCase=ACCLATDX CaseType=LinStatic P=0 V2=0 V3=0 T=0 M2=0 M3=0
 S11Max=0 PtS11Max=0 x2S11Max=0 x3S11Max=0 S11Min=0 PtS11Min=0 x2S11Min=0 x3S11Min=0 FrameElem=119
 ElemStation=0.375
 Frame=119 Station=0.5 OutputCase=ACCLATDX CaseType=LinStatic P=0 V2=0 V3=0 T=0 M2=0 M3=0
 S11Max=0 PtS11Max=0 x2S11Max=0 x3S11Max=0 S11Min=0 PtS11Min=0 x2S11Min=0 x3S11Min=0 FrameElem=119
 ElemStation=0.5
 Frame=119 Station=0 OutputCase=ACCLATSX CaseType=LinStatic P=0 V2=0 V3=0 T=0 M2=0 M3=0
 S11Max=0 PtS11Max=0 x2S11Max=0 x3S11Max=0 S11Min=0 PtS11Min=0 x2S11Min=0 x3S11Min=0 FrameElem=119
 ElemStation=0
 Frame=119 Station=0.125 OutputCase=ACCLATSX CaseType=LinStatic P=0 V2=0 V3=0 T=0 M2=0 M3=0
 S11Max=0 PtS11Max=0 x2S11Max=0 x3S11Max=0 S11Min=0 PtS11Min=0 x2S11Min=0 x3S11Min=0 FrameElem=119
 ElemStation=0.125
 Frame=119 Station=0.25 OutputCase=ACCLATSX CaseType=LinStatic P=0 V2=0 V3=0 T=0 M2=0 M3=0
 S11Max=0 PtS11Max=0 x2S11Max=0 x3S11Max=0 S11Min=0 PtS11Min=0 x2S11Min=0 x3S11Min=0 FrameElem=119
 ElemStation=0.25
 Frame=119 Station=0.375 OutputCase=ACCLATSX CaseType=LinStatic P=0 V2=0 V3=0 T=0 M2=0 M3=0
 S11Max=0 PtS11Max=0 x2S11Max=0 x3S11Max=0 S11Min=0 PtS11Min=0 x2S11Min=0 x3S11Min=0 FrameElem=119
 ElemStation=0.375
 Frame=119 Station=0.5 OutputCase=ACCLATSX CaseType=LinStatic P=0 V2=0 V3=0 T=0 M2=0 M3=0
 S11Max=0 PtS11Max=0 x2S11Max=0 x3S11Max=0 S11Min=0 PtS11Min=0 x2S11Min=0 x3S11Min=0 FrameElem=119
 ElemStation=0.5
 Frame=119 Station=0 OutputCase=TERRCOST CaseType=LinStatic P=0 V2=0 V3=0 T=0 M2=0 M3=0
 S11Max=0 PtS11Max=0 x2S11Max=0 x3S11Max=0 S11Min=0 PtS11Min=0 x2S11Min=0 x3S11Min=0 FrameElem=119
 ElemStation=0
 Frame=119 Station=0.125 OutputCase=TERRCOST CaseType=LinStatic P=0 V2=0 V3=0 T=0 M2=0 M3=0
 S11Max=0 PtS11Max=0 x2S11Max=0 x3S11Max=0 S11Min=0 PtS11Min=0 x2S11Min=0 x3S11Min=0 FrameElem=119
 ElemStation=0.125
 Frame=119 Station=0.25 OutputCase=TERRCOST CaseType=LinStatic P=0 V2=0 V3=0 T=0 M2=0 M3=0
 S11Max=0 PtS11Max=0 x2S11Max=0 x3S11Max=0 S11Min=0 PtS11Min=0 x2S11Min=0 x3S11Min=0 FrameElem=119
 ElemStation=0.25
 Frame=119 Station=0.375 OutputCase=TERRCOST CaseType=LinStatic P=0 V2=0 V3=0 T=0 M2=0 M3=0
 S11Max=0 PtS11Max=0 x2S11Max=0 x3S11Max=0 S11Min=0 PtS11Min=0 x2S11Min=0 x3S11Min=0 FrameElem=119
 ElemStation=0.375
 Frame=119 Station=0.5 OutputCase=TERRCOST CaseType=LinStatic P=0 V2=0 V3=0 T=0 M2=0 M3=0
 S11Max=0 PtS11Max=0 x2S11Max=0 x3S11Max=0 S11Min=0 PtS11Min=0 x2S11Min=0 x3S11Min=0 FrameElem=119
 ElemStation=0.5
 Frame=119 Station=0 OutputCase=SOVRCOST CaseType=LinStatic P=0 V2=0 V3=0 T=0 M2=0 M3=0
 S11Max=0 PtS11Max=0 x2S11Max=0 x3S11Max=0 S11Min=0 PtS11Min=0 x2S11Min=0 x3S11Min=0 FrameElem=119
 ElemStation=0
 Frame=119 Station=0.125 OutputCase=SOVRCOST CaseType=LinStatic P=0 V2=0 V3=0 T=0 M2=0 M3=0
 S11Max=0 PtS11Max=0 x2S11Max=0 x3S11Max=0 S11Min=0 PtS11Min=0 x2S11Min=0 x3S11Min=0 FrameElem=119
 ElemStation=0.125



Frame=119 Station=0.25 OutputCase=SOVRCOST CaseType=LinStatic P=0 V2=0 V3=0 T=0 M2=0 M3=0
 S11Max=0 PtS11Max=0 x2S11Max=0 x3S11Max=0 S11Min=0 PtS11Min=0 x2S11Min=0 x3S11Min=0 FrameElem=119
 ElemStation=0.25
 Frame=119 Station=0.375 OutputCase=SOVRCOST CaseType=LinStatic P=0 V2=0 V3=0 T=0 M2=0 M3=0
 S11Max=0 PtS11Max=0 x2S11Max=0 x3S11Max=0 S11Min=0 PtS11Min=0 x2S11Min=0 x3S11Min=0 FrameElem=119
 ElemStation=0.375
 Frame=119 Station=0.5 OutputCase=SOVRCOST CaseType=LinStatic P=0 V2=0 V3=0 T=0 M2=0 M3=0
 S11Max=0 PtS11Max=0 x2S11Max=0 x3S11Max=0 S11Min=0 PtS11Min=0 x2S11Min=0 x3S11Min=0 FrameElem=119
 ElemStation=0.5
 Frame=119 Station=0 OutputCase=ENVE CaseType=Combination StepType=Max P=-217.882158664514
 V2=457.500001984563 V3=0 T=0 M2=0 M3=205.853072971628 S11Max=1017.23627916525 PtS11Max=1 x2S11Max=-0.5
 x3S11Max=-0.5
 S11Min=-1402.64843137577 PtS11Min=3 x2S11Min=0.5 x3S11Min=-0.5 FrameElem=119 ElemStation=0
 Frame=119 Station=0.125 OutputCase=ENVE CaseType=Combination StepType=Max P=-217.882158664514
 V2=495.625001984563 V3=0 T=0 M2=0 M3=146.282760287015 S11Max=659.814403057577 PtS11Max=1 x2S11Max=-0.5
 x3S11Max=-0.5
 S11Min=-1045.22655488735 PtS11Min=3 x2S11Min=0.5 x3S11Min=-0.5 FrameElem=119
 ElemStation=0.125
 Frame=119 Station=0.25 OutputCase=ENVE CaseType=Combination StepType=Max P=-217.882158664514
 V2=533.750001984563 V3=0 T=0 M2=0 M3=81.9468226024024 S11Max=273.7987769499 PtS11Max=1 x2S11Max=-0.5
 x3S11Max=-0.5
 S11Min=-659.210928398927 PtS11Min=3 x2S11Min=0.5 x3S11Min=-0.5 FrameElem=119 ElemStation=0.25
 Frame=119 Station=0.375 OutputCase=ENVE CaseType=Combination StepType=Max P=-217.882158664514
 V2=571.875001984563 V3=0 T=0 M2=0 M3=12.8452599177895 S11Max=-140.810599157777 PtS11Max=1 x2S11Max=-
 0.5
 x3S11Max=-0.5 S11Min=-244.601551910505 PtS11Min=3 x2S11Min=0.5 x3S11Min=-0.5 FrameElem=119
 ElemStation=0.375
 Frame=119 Station=0.5 OutputCase=ENVE CaseType=Combination StepType=Max P=-217.882158664514
 V2=610.000001984563 V3=0 T=0 M2=0 M3=-61.0219277668233 S11Max=198.601574577918 PtS11Max=3 x2S11Max=0.5
 x3S11Max=-0.5
 S11Min=-584.013725265454 PtS11Min=1 x2S11Min=-0.5 x3S11Min=-0.5 FrameElem=119 ElemStation=0.5
 Frame=119 Station=0 OutputCase=ENVE CaseType=Combination StepType=Min P=-317.058043529687
 V2=457.500001476903 V3=0 T=0 M2=0 M3=180.931731307681 S11Max=768.532344316397 PtS11Max=1 x2S11Max=-0.5
 x3S11Max=-0.5
 S11Min=-1453.00059649428 PtS11Min=3 x2S11Min=0.5 x3S11Min=-0.5 FrameElem=119 ElemStation=0
 Frame=119 Station=0.125 OutputCase=ENVE CaseType=Combination StepType=Min P=-317.058043529687
 V2=495.625001476903 V3=0 T=0 M2=0 M3=121.36141855961 S11Max=411.110467827975 PtS11Max=1 x2S11Max=-0.5
 x3S11Max=-0.5
 S11Min=-1095.57872038661 PtS11Min=3 x2S11Min=0.5 x3S11Min=-0.5 FrameElem=119 ElemStation=0.125
 Frame=119 Station=0.25 OutputCase=ENVE CaseType=Combination StepType=Min P=-317.058043529687
 V2=533.750001476903 V3=0 T=0 M2=0 M3=57.02548081154 S11Max=25.0948413395531 PtS11Max=1 x2S11Max=-0.5
 x3S11Max=-0.5
 S11Min=-709.563094278929 PtS11Min=3 x2S11Min=0.5 x3S11Min=-0.5 FrameElem=119 ElemStation=0.25
 Frame=119 Station=0.375 OutputCase=ENVE CaseType=Combination StepType=Min P=-317.058043529687
 V2=571.875001476903 V3=0 T=0 M2=0 M3=-12.0760819365304 S11Max=-294.953718171252 PtS11Max=3
 x2S11Max=0.5
 x3S11Max=-0.5 S11Min=-389.514535148869 PtS11Min=1 x2S11Min=-0.5 x3S11Min=-0.5 FrameElem=119
 ElemStation=0.375
 Frame=119 Station=0.5 OutputCase=ENVE CaseType=Combination StepType=Min P=-317.058043529687
 V2=610.000001476903 V3=0 T=0 M2=0 M3=-85.9432696846008 S11Max=148.249407936426 PtS11Max=3 x2S11Max=0.5
 x3S11Max=-0.5
 S11Min=-832.717661637291 PtS11Min=1 x2S11Min=-0.5 x3S11Min=-0.5 FrameElem=119 ElemStation=0.5
 Frame=119 Station=0 OutputCase=FESSUR CaseType=Combination P=-317.058043529687 V2=457.500001984563
 V3=0 T=0 M2=0 M3=180.931731307681 S11Max=768.532344316397 PtS11Max=1 x2S11Max=-0.5 x3S11Max=-0.5
 S11Min=-1402.64843137577 PtS11Min=3 x2S11Min=0.5 x3S11Min=-0.5 FrameElem=119 ElemStation=0
 Frame=119 Station=0.125 OutputCase=FESSUR CaseType=Combination P=-317.058043529687 V2=495.625001984563
 V3=0 T=0 M2=0 M3=121.36141855961 S11Max=411.110467827975 PtS11Max=1 x2S11Max=-0.5 x3S11Max=-0.5
 S11Min=-1045.22655488735 PtS11Min=3 x2S11Min=0.5 x3S11Min=-0.5 FrameElem=119 ElemStation=0.125
 Frame=119 Station=0.25 OutputCase=FESSUR CaseType=Combination P=-317.058043529687 V2=533.750001984563
 V3=0 T=0 M2=0 M3=57.02548081154 S11Max=25.0948413395531 PtS11Max=1 x2S11Max=-0.5 x3S11Max=-0.5
 S11Min=-659.210928398927 PtS11Min=3 x2S11Min=0.5 x3S11Min=-0.5 FrameElem=119 ElemStation=0.25
 Frame=119 Station=0.375 OutputCase=FESSUR CaseType=Combination P=-317.058043529687 V2=571.875001984563
 V3=0 T=0 M2=0 M3=-12.0760819365304 S11Max=-244.601551910505 PtS11Max=3 x2S11Max=0.5 x3S11Max=-0.5
 S11Min=-389.514535148869 PtS11Min=1 x2S11Min=-0.5 x3S11Min=-0.5 FrameElem=119 ElemStation=0.375
 Frame=119 Station=0.5 OutputCase=FESSUR CaseType=Combination P=-317.058043529687 V2=610.000001984563
 V3=0 T=0 M2=0 M3=-85.9432696846008 S11Max=198.601574577918 PtS11Max=3 x2S11Max=0.5 x3S11Max=-0.5
 S11Min=-832.717661637291 PtS11Min=1 x2S11Min=-0.5 x3S11Min=-0.5 FrameElem=119 ElemStation=0.5

TABLE: "ELEMENT STRESSES - FRAMES"

Frame=1 Station=0 OutputCase=PESOPR CaseType=LinStatic Point=0 X2=0 X3=0 S11=-15.1709467361864
 IsS11Max=No IsS11Min=No FrameElem=1 ElemStation=0
 Frame=1 Station=0 OutputCase=PESOPR CaseType=LinStatic Point=1 X2=-0.5 X3=-0.5 S11=475.361227907234
 IsS11Max=Yes IsS11Min=No FrameElem=1 ElemStation=0
 Frame=1 Station=0 OutputCase=PESOPR CaseType=LinStatic Point=2 X2=-0.5 X3=0.5 S11=475.361227907234
 IsS11Max=No IsS11Min=No FrameElem=1 ElemStation=0
 Frame=1 Station=0 OutputCase=PESOPR CaseType=LinStatic Point=3 X2=0.5 X3=-0.5 S11=-505.703121379607
 IsS11Max=No IsS11Min=Yes FrameElem=1 ElemStation=0
 Frame=1 Station=0 OutputCase=PESOPR CaseType=LinStatic Point=4 X2=0.5 X3=0.5 S11=-505.703121379607
 IsS11Max=No IsS11Min=No FrameElem=1 ElemStation=0
 Frame=1 Station=6.24999940395355E-02 OutputCase=PESOPR CaseType=LinStatic Point=0 X2=0 X3=0 S11=-
 15.1709467361864 IsS11Max=No IsS11Min=No FrameElem=1 ElemStation=6.24999940395355E-02



Frame=1 Station=6.24999940395355E-02 OutputCase=PESOPR CaseType=LinStatic Point=1 X2=-0.5 X3=-0.5
 S11=418.427311618539 IsS11Max=Yes IsS11Min=No FrameElem=1 ElemStation=6.24999940395355E-02
 Frame=1 Station=6.24999940395355E-02 OutputCase=PESOPR CaseType=LinStatic Point=2 X2=-0.5 X3=0.5
 S11=418.427311618539 IsS11Max=No IsS11Min=No FrameElem=1 ElemStation=6.24999940395355E-02
 Frame=1 Station=6.24999940395355E-02 OutputCase=PESOPR CaseType=LinStatic Point=3 X2=0.5 X3=-0.5
 S11=-448.769205090912 IsS11Max=No IsS11Min=Yes FrameElem=1 ElemStation=6.24999940395355E-02
 Frame=1 Station=6.24999940395355E-02 OutputCase=PESOPR CaseType=LinStatic Point=4 X2=0.5 X3=0.5
 S11=-448.769205090912 IsS11Max=No IsS11Min=No FrameElem=1 ElemStation=6.24999940395355E-02
 Frame=1 Station=0.124999988079071 OutputCase=PESOPR CaseType=LinStatic Point=0 X2=0 X3=0 S11=-
 15.1709467361864 IsS11Max=No IsS11Min=No FrameElem=1 ElemStation=0.124999988079071
 Frame=1 Station=0.124999988079071 OutputCase=PESOPR CaseType=LinStatic Point=1 X2=-0.5 X3=-0.5
 S11=360.907457941602 IsS11Max=Yes IsS11Min=No FrameElem=1 ElemStation=0.124999988079071
 Frame=1 Station=0.124999988079071 OutputCase=PESOPR CaseType=LinStatic Point=2 X2=-0.5 X3=0.5
 S11=360.907457941602 IsS11Max=No IsS11Min=No FrameElem=1 ElemStation=0.124999988079071
 Frame=1 Station=0.124999988079071 OutputCase=PESOPR CaseType=LinStatic Point=3 X2=0.5 X3=-0.5 S11=-
 391.249351413975 IsS11Max=No IsS11Min=Yes FrameElem=1 ElemStation=0.124999988079071
 Frame=1 Station=0.124999988079071 OutputCase=PESOPR CaseType=LinStatic Point=4 X2=0.5 X3=0.5 S11=-
 391.249351413975 IsS11Max=No IsS11Min=No FrameElem=1 ElemStation=0.124999988079071
 Frame=1 Station=0.187499982118607 OutputCase=PESOPR CaseType=LinStatic Point=0 X2=0 X3=0 S11=-
 15.1709467361864 IsS11Max=No IsS11Min=No FrameElem=1 ElemStation=0.187499982118607
 Frame=1 Station=0.187499982118607 OutputCase=PESOPR CaseType=LinStatic Point=1 X2=-0.5 X3=-0.5
 S11=302.801666876425 IsS11Max=Yes IsS11Min=No FrameElem=1 ElemStation=0.187499982118607
 Frame=1 Station=0.187499982118607 OutputCase=PESOPR CaseType=LinStatic Point=2 X2=-0.5 X3=0.5
 S11=302.801666876425 IsS11Max=No IsS11Min=No FrameElem=1 ElemStation=0.187499982118607
 Frame=1 Station=0.187499982118607 OutputCase=PESOPR CaseType=LinStatic Point=3 X2=0.5 X3=-0.5 S11=-
 333.143560348797 IsS11Max=No IsS11Min=Yes FrameElem=1 ElemStation=0.187499982118607
 Frame=1 Station=0.187499982118607 OutputCase=PESOPR CaseType=LinStatic Point=4 X2=0.5 X3=0.5 S11=-
 333.143560348797 IsS11Max=No IsS11Min=No FrameElem=1 ElemStation=0.187499982118607
 Frame=1 Station=0.249999976158142 OutputCase=PESOPR CaseType=LinStatic Point=0 X2=0 X3=0 S11=-
 15.1709467361864 IsS11Max=No IsS11Min=No FrameElem=1 ElemStation=0.249999976158142
 Frame=1 Station=0.249999976158142 OutputCase=PESOPR CaseType=LinStatic Point=1 X2=-0.5 X3=-0.5
 S11=244.109938423006 IsS11Max=Yes IsS11Min=No FrameElem=1 ElemStation=0.249999976158142
 Frame=1 Station=0.249999976158142 OutputCase=PESOPR CaseType=LinStatic Point=2 X2=-0.5 X3=0.5
 S11=244.109938423006 IsS11Max=No IsS11Min=No FrameElem=1 ElemStation=0.249999976158142
 Frame=1 Station=0.249999976158142 OutputCase=PESOPR CaseType=LinStatic Point=3 X2=0.5 X3=-0.5 S11=-
 274.451831895378 IsS11Max=No IsS11Min=Yes FrameElem=1 ElemStation=0.249999976158142
 Frame=1 Station=0.249999976158142 OutputCase=PESOPR CaseType=LinStatic Point=4 X2=0.5 X3=0.5 S11=-
 274.451831895378 IsS11Max=No IsS11Min=No FrameElem=1 ElemStation=0.249999976158142
 Frame=1 Station=0 OutputCase=TERRVERT CaseType=LinStatic Point=0 X2=0 X3=0 S11=1.64270738195018
 IsS11Max=No IsS11Min=No FrameElem=1 ElemStation=0
 Frame=1 Station=0 OutputCase=TERRVERT CaseType=LinStatic Point=1 X2=-0.5 X3=-0.5
 S11=1911.77093241431 IsS11Max=Yes IsS11Min=No FrameElem=1 ElemStation=0
 Frame=1 Station=0 OutputCase=TERRVERT CaseType=LinStatic Point=2 X2=-0.5 X3=0.5
 S11=1911.77093241431 IsS11Max=No IsS11Min=No FrameElem=1 ElemStation=0
 Frame=1 Station=0 OutputCase=TERRVERT CaseType=LinStatic Point=3 X2=0.5 X3=-0.5 S11=-
 1908.48551765041 IsS11Max=No IsS11Min=Yes FrameElem=1 ElemStation=0
 Frame=1 Station=0 OutputCase=TERRVERT CaseType=LinStatic Point=4 X2=0.5 X3=0.5 S11=-
 1908.48551765041 IsS11Max=No IsS11Min=No FrameElem=1 ElemStation=0
 Frame=1 Station=6.24999940395355E-02 OutputCase=TERRVERT CaseType=LinStatic Point=0 X2=0 X3=0
 S11=1.64270738195018 IsS11Max=No IsS11Min=No FrameElem=1 ElemStation=6.24999940395355E-02
 Frame=1 Station=6.24999940395355E-02 OutputCase=TERRVERT CaseType=LinStatic Point=1 X2=-0.5 X3=-0.5
 S11=1662.76089949701 IsS11Max=Yes IsS11Min=No FrameElem=1 ElemStation=6.24999940395355E-02
 Frame=1 Station=6.24999940395355E-02 OutputCase=TERRVERT CaseType=LinStatic Point=2 X2=-0.5 X3=0.5
 S11=1662.76089949701 IsS11Max=No IsS11Min=No FrameElem=1 ElemStation=6.24999940395355E-02
 Frame=1 Station=6.24999940395355E-02 OutputCase=TERRVERT CaseType=LinStatic Point=3 X2=0.5 X3=-0.5
 S11=-1659.47548473311 IsS11Max=No IsS11Min=Yes FrameElem=1 ElemStation=6.24999940395355E-02
 Frame=1 Station=6.24999940395355E-02 OutputCase=TERRVERT CaseType=LinStatic Point=4 X2=0.5 X3=0.5
 S11=-1659.47548473311 IsS11Max=No IsS11Min=No FrameElem=1 ElemStation=6.24999940395355E-02
 Frame=1 Station=0.124999988079071 OutputCase=TERRVERT CaseType=LinStatic Point=0 X2=0 X3=0
 S11=1.64270738195018 IsS11Max=No IsS11Min=No FrameElem=1 ElemStation=0.124999988079071
 Frame=1 Station=0.124999988079071 OutputCase=TERRVERT CaseType=LinStatic Point=1 X2=-0.5 X3=-0.5
 S11=1413.75086657972 IsS11Max=Yes IsS11Min=No FrameElem=1 ElemStation=0.124999988079071
 Frame=1 Station=0.124999988079071 OutputCase=TERRVERT CaseType=LinStatic Point=2 X2=-0.5 X3=0.5
 S11=1413.75086657972 IsS11Max=No IsS11Min=No FrameElem=1 ElemStation=0.124999988079071
 Frame=1 Station=0.124999988079071 OutputCase=TERRVERT CaseType=LinStatic Point=3 X2=0.5 X3=-0.5
 S11=-1410.46545181581 IsS11Max=No IsS11Min=Yes FrameElem=1 ElemStation=0.124999988079071
 Frame=1 Station=0.124999988079071 OutputCase=TERRVERT CaseType=LinStatic Point=4 X2=0.5 X3=0.5
 S11=-1410.46545181581 IsS11Max=No IsS11Min=No FrameElem=1 ElemStation=0.124999988079071
 Frame=1 Station=0.187499982118607 OutputCase=TERRVERT CaseType=LinStatic Point=0 X2=0 X3=0
 S11=1.64270738195018 IsS11Max=No IsS11Min=No FrameElem=1 ElemStation=0.187499982118607
 Frame=1 Station=0.187499982118607 OutputCase=TERRVERT CaseType=LinStatic Point=1 X2=-0.5 X3=-0.5
 S11=1164.74083366242 IsS11Max=Yes IsS11Min=No FrameElem=1 ElemStation=0.187499982118607
 Frame=1 Station=0.187499982118607 OutputCase=TERRVERT CaseType=LinStatic Point=2 X2=-0.5 X3=0.5
 S11=1164.74083366242 IsS11Max=No IsS11Min=No FrameElem=1 ElemStation=0.187499982118607
 Frame=1 Station=0.187499982118607 OutputCase=TERRVERT CaseType=LinStatic Point=3 X2=0.5 X3=-0.5
 S11=-1161.45541889852 IsS11Max=No IsS11Min=Yes FrameElem=1 ElemStation=0.187499982118607
 Frame=1 Station=0.187499982118607 OutputCase=TERRVERT CaseType=LinStatic Point=4 X2=0.5 X3=0.5
 S11=-1161.45541889852 IsS11Max=No IsS11Min=No FrameElem=1 ElemStation=0.187499982118607
 Frame=1 Station=0.249999976158142 OutputCase=TERRVERT CaseType=LinStatic Point=0 X2=0 X3=0
 S11=1.64270738195018 IsS11Max=No IsS11Min=No FrameElem=1 ElemStation=0.249999976158142
 Frame=1 Station=0.249999976158142 OutputCase=TERRVERT CaseType=LinStatic Point=1 X2=-0.5 X3=-0.5
 S11=915.730800745124 IsS11Max=Yes IsS11Min=No FrameElem=1 ElemStation=0.249999976158142



Frame=1 Station=0.249999976158142 OutputCase=TERRVERT CaseType=LinStatic Point=2 X2=-0.5 X3=0.5
 S11=915.730800745124 IsS11Max=No IsS11Min=No FrameElem=1 ElemStation=0.249999976158142
 Frame=1 Station=0.249999976158142 OutputCase=TERRVERT CaseType=LinStatic Point=3 X2=0.5 X3=-0.5
 S11=-912.445385981223 IsS11Max=No IsS11Min=Yes FrameElem=1 ElemStation=0.249999976158142
 Frame=1 Station=0.249999976158142 OutputCase=TERRVERT CaseType=LinStatic Point=4 X2=0.5 X3=0.5
 S11=-912.445385981223 IsS11Max=No IsS11Min=No FrameElem=1 ElemStation=0.249999976158142
 Frame=1 Station=0 OutputCase=TERRLAT CaseType=LinStatic Point=0 X2=0 X3=0 S11=-373.013713761058
 IsS11Max=No IsS11Min=No FrameElem=1 ElemStation=0
 Frame=1 Station=0 OutputCase=TERRLAT CaseType=LinStatic Point=1 X2=-0.5 X3=-0.5
 S11=131.422289691315 IsS11Max=Yes IsS11Min=No FrameElem=1 ElemStation=0
 Frame=1 Station=0 OutputCase=TERRLAT CaseType=LinStatic Point=2 X2=-0.5 X3=0.5 S11=131.422289691315
 IsS11Max=No IsS11Min=No FrameElem=1 ElemStation=0
 Frame=1 Station=0 OutputCase=TERRLAT CaseType=LinStatic Point=3 X2=0.5 X3=-0.5 S11=-
 877.449717213432 IsS11Max=No IsS11Min=Yes FrameElem=1 ElemStation=0
 Frame=1 Station=0 OutputCase=TERRLAT CaseType=LinStatic Point=4 X2=0.5 X3=0.5 S11=-877.449717213432
 IsS11Max=No IsS11Min=No FrameElem=1 ElemStation=0
 Frame=1 Station=6.24999940395355E-02 OutputCase=TERRLAT CaseType=LinStatic Point=0 X2=0 X3=0 S11=-
 373.013713761058 IsS11Max=No IsS11Min=No FrameElem=1 ElemStation=6.24999940395355E-02
 Frame=1 Station=6.24999940395355E-02 OutputCase=TERRLAT CaseType=LinStatic Point=1 X2=-0.5 X3=-0.5
 S11=131.352603551902 IsS11Max=Yes IsS11Min=No FrameElem=1 ElemStation=6.24999940395355E-02
 Frame=1 Station=6.24999940395355E-02 OutputCase=TERRLAT CaseType=LinStatic Point=2 X2=0.5 X3=0.5
 S11=131.352603551902 IsS11Max=No IsS11Min=No FrameElem=1 ElemStation=6.24999940395355E-02
 Frame=1 Station=6.24999940395355E-02 OutputCase=TERRLAT CaseType=LinStatic Point=3 X2=0.5 X3=-0.5
 S11=-877.380031074019 IsS11Max=Yes FrameElem=1 ElemStation=6.24999940395355E-02
 Frame=1 Station=6.24999940395355E-02 OutputCase=TERRLAT CaseType=LinStatic Point=4 X2=0.5 X3=0.5
 S11=-877.380031074019 IsS11Max=No IsS11Min=No FrameElem=1 ElemStation=6.24999940395355E-02
 Frame=1 Station=0.12499988079071 OutputCase=TERRLAT CaseType=LinStatic Point=0 X2=0 X3=0 S11=-
 373.013713761058 IsS11Max=No IsS11Min=No FrameElem=1 ElemStation=0.12499988079071
 Frame=1 Station=0.12499988079071 OutputCase=TERRLAT CaseType=LinStatic Point=1 X2=-0.5 X3=-0.5
 S11=131.28291741249 IsS11Max=Yes IsS11Min=No FrameElem=1 ElemStation=0.12499988079071
 Frame=1 Station=0.12499988079071 OutputCase=TERRLAT CaseType=LinStatic Point=2 X2=-0.5 X3=0.5
 S11=131.28291741249 IsS11Max=No IsS11Min=No FrameElem=1 ElemStation=0.12499988079071
 Frame=1 Station=0.12499988079071 OutputCase=TERRLAT CaseType=LinStatic Point=3 X2=0.5 X3=-0.5
 S11=-877.310344934606 IsS11Max=No IsS11Min=Yes FrameElem=1 ElemStation=0.12499988079071
 Frame=1 Station=0.12499988079071 OutputCase=TERRLAT CaseType=LinStatic Point=4 X2=0.5 X3=0.5 S11=-
 877.310344934606 IsS11Max=No IsS11Min=No FrameElem=1 ElemStation=0.12499988079071
 Frame=1 Station=0.187499982118607 OutputCase=TERRLAT CaseType=LinStatic Point=0 X2=0 X3=0 S11=-
 373.013713761058 IsS11Max=No IsS11Min=No FrameElem=1 ElemStation=0.187499982118607
 Frame=1 Station=0.187499982118607 OutputCase=TERRLAT CaseType=LinStatic Point=1 X2=-0.5 X3=-0.5
 S11=131.213231273077 IsS11Max=Yes IsS11Min=No FrameElem=1 ElemStation=0.187499982118607
 Frame=1 Station=0.187499982118607 OutputCase=TERRLAT CaseType=LinStatic Point=2 X2=-0.5 X3=0.5
 S11=131.213231273077 IsS11Max=No IsS11Min=No FrameElem=1 ElemStation=0.187499982118607
 Frame=1 Station=0.187499982118607 OutputCase=TERRLAT CaseType=LinStatic Point=3 X2=0.5 X3=-0.5
 S11=-877.240658795193 IsS11Max=No IsS11Min=Yes FrameElem=1 ElemStation=0.187499982118607
 Frame=1 Station=0.187499982118607 OutputCase=TERRLAT CaseType=LinStatic Point=4 X2=0.5 X3=0.5 S11=-
 877.240658795193 IsS11Max=No IsS11Min=No FrameElem=1 ElemStation=0.187499982118607
 Frame=1 Station=0.249999976158142 OutputCase=TERRLAT CaseType=LinStatic Point=0 X2=0 X3=0 S11=-
 373.013713761058 IsS11Max=No IsS11Min=No FrameElem=1 ElemStation=0.249999976158142
 Frame=1 Station=0.249999976158142 OutputCase=TERRLAT CaseType=LinStatic Point=1 X2=-0.5 X3=-0.5
 S11=131.143545133664 IsS11Max=Yes IsS11Min=No FrameElem=1 ElemStation=0.249999976158142
 Frame=1 Station=0.249999976158142 OutputCase=TERRLAT CaseType=LinStatic Point=2 X2=-0.5 X3=0.5
 S11=131.143545133664 IsS11Max=No IsS11Min=No FrameElem=1 ElemStation=0.249999976158142
 Frame=1 Station=0.249999976158142 OutputCase=TERRLAT CaseType=LinStatic Point=3 X2=0.5 X3=-0.5
 S11=-877.17097265578 IsS11Max=No IsS11Min=Yes FrameElem=1 ElemStation=0.249999976158142
 Frame=1 Station=0.249999976158142 OutputCase=TERRLAT CaseType=LinStatic Point=4 X2=0.5 X3=0.5 S11=-
 877.17097265578 IsS11Max=No IsS11Min=No FrameElem=1 ElemStation=0.249999976158142
 Frame=1 Station=0 OutputCase=ACCVERT CaseType=LinStatic Point=0 X2=0 X3=0 S11=0 IsS11Max=Yes
 IsS11Min=Yes FrameElem=1 ElemStation=0
 Frame=1 Station=0 OutputCase=ACCVERT CaseType=LinStatic Point=1 X2=-0.5 X3=-0.5 S11=0 IsS11Max=No
 IsS11Min=No FrameElem=1 ElemStation=0
 Frame=1 Station=0 OutputCase=ACCVERT CaseType=LinStatic Point=2 X2=-0.5 X3=0.5 S11=0 IsS11Max=No
 IsS11Min=No FrameElem=1 ElemStation=0
 Frame=1 Station=0 OutputCase=ACCVERT CaseType=LinStatic Point=3 X2=0.5 X3=-0.5 S11=0 IsS11Max=No
 IsS11Min=No FrameElem=1 ElemStation=0
 Frame=1 Station=0 OutputCase=ACCVERT CaseType=LinStatic Point=4 X2=0.5 X3=0.5 S11=0 IsS11Max=No
 IsS11Min=No FrameElem=1 ElemStation=0
 Frame=1 Station=6.24999940395355E-02 OutputCase=ACCVERT CaseType=LinStatic Point=0 X2=0 X3=0 S11=0
 IsS11Max=Yes IsS11Min=Yes FrameElem=1 ElemStation=6.24999940395355E-02
 Frame=1 Station=6.24999940395355E-02 OutputCase=ACCVERT CaseType=LinStatic Point=1 X2=-0.5 X3=-0.5
 S11=0 IsS11Max=No IsS11Min=No FrameElem=1 ElemStation=6.24999940395355E-02
 Frame=1 Station=6.24999940395355E-02 OutputCase=ACCVERT CaseType=LinStatic Point=2 X2=-0.5 X3=0.5
 S11=0 IsS11Max=No IsS11Min=No FrameElem=1 ElemStation=6.24999940395355E-02
 Frame=1 Station=6.24999940395355E-02 OutputCase=ACCVERT CaseType=LinStatic Point=3 X2=0.5 X3=-0.5
 S11=0 IsS11Max=No IsS11Min=No FrameElem=1 ElemStation=6.24999940395355E-02
 Frame=1 Station=6.24999940395355E-02 OutputCase=ACCVERT CaseType=LinStatic Point=4 X2=0.5 X3=0.5
 S11=0 IsS11Max=No IsS11Min=No FrameElem=1 ElemStation=6.24999940395355E-02
 Frame=1 Station=0.12499988079071 OutputCase=ACCVERT CaseType=LinStatic Point=0 X2=0 X3=0 S11=0
 IsS11Max=Yes IsS11Min=Yes FrameElem=1 ElemStation=0.12499988079071
 Frame=1 Station=0.12499988079071 OutputCase=ACCVERT CaseType=LinStatic Point=1 X2=-0.5 X3=-0.5
 S11=0 IsS11Max=No IsS11Min=No FrameElem=1 ElemStation=0.12499988079071
 Frame=1 Station=0.12499988079071 OutputCase=ACCVERT CaseType=LinStatic Point=2 X2=-0.5 X3=0.5
 S11=0 IsS11Max=No IsS11Min=No FrameElem=1 ElemStation=0.12499988079071

```

Frame=1 Station=0.24999976158142 OutputCase=TERRCOST CaseType=LinStatic Point=0 X2=0 X3=0 S11=0
IsS11Max=Yes IsS11Min=Yes FrameElem=1 ElemStation=0.24999976158142
Frame=1 Station=0.24999976158142 OutputCase=TERRCOST CaseType=LinStatic Point=1 X2=-0.5 X3=-0.5
S11=0 IsS11Max=No IsS11Min=No FrameElem=1 ElemStation=0.24999976158142
Frame=1 Station=0.24999976158142 OutputCase=TERRCOST CaseType=LinStatic Point=2 X2=-0.5 X3=0.5
S11=0 IsS11Max=No IsS11Min=No FrameElem=1 ElemStation=0.24999976158142
Frame=1 Station=0.24999976158142 OutputCase=TERRCOST CaseType=LinStatic Point=3 X2=0.5 X3=-0.5
S11=0 IsS11Max=No IsS11Min=No FrameElem=1 ElemStation=0.24999976158142
Frame=1 Station=0.24999976158142 OutputCase=TERRCOST CaseType=LinStatic Point=4 X2=0.5 X3=0.5
S11=0 IsS11Max=No IsS11Min=No FrameElem=1 ElemStation=0.24999976158142
Frame=1 Station=0 OutputCase=SOVRCOST CaseType=LinStatic Point=0 X2=0 X3=0 S11=0 IsS11Max=Yes
IsS11Min=Yes FrameElem=1 ElemStation=0
Frame=1 Station=0 OutputCase=SOVRCOST CaseType=LinStatic Point=1 X2=-0.5 X3=-0.5 S11=0
IsS11Max=No IsS11Min=No FrameElem=1 ElemStation=0
Frame=1 Station=0 OutputCase=SOVRCOST CaseType=LinStatic Point=2 X2=-0.5 X3=0.5 S11=0 IsS11Max=No
IsS11Min=No FrameElem=1 ElemStation=0
Frame=1 Station=0 OutputCase=SOVRCOST CaseType=LinStatic Point=3 X2=0.5 X3=-0.5 S11=0 IsS11Max=No
IsS11Min=No FrameElem=1 ElemStation=0
Frame=1 Station=0 OutputCase=SOVRCOST CaseType=LinStatic Point=4 X2=0.5 X3=0.5 S11=0 IsS11Max=No
IsS11Min=No FrameElem=1 ElemStation=0
Frame=1 Station=6.24999940395355E-02 OutputCase=SOVRCOST CaseType=LinStatic Point=0 X2=0 X3=0 S11=0
IsS11Max=Yes IsS11Min=Yes FrameElem=1 ElemStation=6.24999940395355E-02
Frame=1 Station=6.24999940395355E-02 OutputCase=SOVRCOST CaseType=LinStatic Point=1 X2=-0.5 X3=-0.5
S11=0 IsS11Max=No IsS11Min=No FrameElem=1 ElemStation=6.24999940395355E-02
Frame=1 Station=6.24999940395355E-02 OutputCase=SOVRCOST CaseType=LinStatic Point=2 X2=-0.5 X3=0.5
S11=0 IsS11Max=No IsS11Min=No FrameElem=1 ElemStation=6.24999940395355E-02
Frame=1 Station=6.24999940395355E-02 OutputCase=SOVRCOST CaseType=LinStatic Point=3 X2=0.5 X3=-0.5
S11=0 IsS11Max=No IsS11Min=No FrameElem=1 ElemStation=6.24999940395355E-02
Frame=1 Station=6.24999940395355E-02 OutputCase=SOVRCOST CaseType=LinStatic Point=4 X2=0.5 X3=0.5
S11=0 IsS11Max=No IsS11Min=No FrameElem=1 ElemStation=6.24999940395355E-02
Frame=1 Station=0.12499988079071 OutputCase=SOVRCOST CaseType=LinStatic Point=0 X2=0 X3=0 S11=0
IsS11Max=Yes IsS11Min=Yes FrameElem=1 ElemStation=0.12499988079071
Frame=1 Station=0.12499988079071 OutputCase=SOVRCOST CaseType=LinStatic Point=1 X2=-0.5 X3=-0.5
S11=0 IsS11Max=No IsS11Min=No FrameElem=1 ElemStation=0.12499988079071
Frame=1 Station=0.12499988079071 OutputCase=SOVRCOST CaseType=LinStatic Point=2 X2=-0.5 X3=0.5
S11=0 IsS11Max=No IsS11Min=No FrameElem=1 ElemStation=0.12499988079071
Frame=1 Station=0.12499988079071 OutputCase=SOVRCOST CaseType=LinStatic Point=3 X2=0.5 X3=-0.5
S11=0 IsS11Max=No IsS11Min=No FrameElem=1 ElemStation=0.12499988079071
Frame=1 Station=0.12499988079071 OutputCase=SOVRCOST CaseType=LinStatic Point=4 X2=0.5 X3=0.5
S11=0 IsS11Max=No IsS11Min=No FrameElem=1 ElemStation=0.12499988079071
Frame=1 Station=0.187499982118607 OutputCase=SOVRCOST CaseType=LinStatic Point=0 X2=0 X3=0 S11=0
IsS11Max=Yes IsS11Min=Yes FrameElem=1 ElemStation=0.187499982118607
Frame=1 Station=0.187499982118607 OutputCase=SOVRCOST CaseType=LinStatic Point=1 X2=-0.5 X3=-0.5
S11=0 IsS11Max=No IsS11Min=No FrameElem=1 ElemStation=0.187499982118607
Frame=1 Station=0.187499982118607 OutputCase=SOVRCOST CaseType=LinStatic Point=2 X2=-0.5 X3=0.5
S11=0 IsS11Max=No IsS11Min=No FrameElem=1 ElemStation=0.187499982118607
Frame=1 Station=0.187499982118607 OutputCase=SOVRCOST CaseType=LinStatic Point=3 X2=0.5 X3=-0.5
S11=0 IsS11Max=No IsS11Min=No FrameElem=1 ElemStation=0.187499982118607
Frame=1 Station=0.187499982118607 OutputCase=SOVRCOST CaseType=LinStatic Point=4 X2=0.5 X3=0.5
S11=0 IsS11Max=No IsS11Min=No FrameElem=1 ElemStation=0.187499982118607
Frame=1 Station=0.24999976158142 OutputCase=SOVRCOST CaseType=LinStatic Point=0 X2=0 X3=0 S11=0
IsS11Max=Yes IsS11Min=Yes FrameElem=1 ElemStation=0.24999976158142
Frame=1 Station=0.24999976158142 OutputCase=SOVRCOST CaseType=LinStatic Point=1 X2=-0.5 X3=-0.5
S11=0 IsS11Max=No IsS11Min=No FrameElem=1 ElemStation=0.24999976158142
Frame=1 Station=0.24999976158142 OutputCase=SOVRCOST CaseType=LinStatic Point=2 X2=-0.5 X3=0.5
S11=0 IsS11Max=No IsS11Min=No FrameElem=1 ElemStation=0.24999976158142
Frame=1 Station=0.24999976158142 OutputCase=SOVRCOST CaseType=LinStatic Point=3 X2=0.5 X3=-0.5
S11=0 IsS11Max=No IsS11Min=No FrameElem=1 ElemStation=0.24999976158142
Frame=1 Station=0.24999976158142 OutputCase=SOVRCOST CaseType=LinStatic Point=4 X2=0.5 X3=0.5
S11=0 IsS11Max=No IsS11Min=No FrameElem=1 ElemStation=0.24999976158142
Frame=1 Station=0 OutputCase=ENVE CaseType=Combination StepType=Max Point=0 X2=0 X3=0 S11=-
274.637838986977 IsS11Max=No IsS11Min=No FrameElem=1 ElemStation=0
Frame=1 Station=0 OutputCase=ENVE CaseType=Combination StepType=Max Point=1 X2=-0.5 X3=-0.5
S11=2518.55445001286 IsS11Max=Yes IsS11Min=No FrameElem=1 ElemStation=0
Frame=1 Station=0 OutputCase=ENVE CaseType=Combination StepType=Max Point=2 X2=-0.5 X3=0.5
S11=2518.55445001286 IsS11Max=No IsS11Min=No FrameElem=1 ElemStation=0
Frame=1 Station=0 OutputCase=ENVE CaseType=Combination StepType=Max Point=3 X2=0.5 X3=-0.5 S11=-
3028.40344107942 IsS11Max=No IsS11Min=Yes FrameElem=1 ElemStation=0
Frame=1 Station=0 OutputCase=ENVE CaseType=Combination StepType=Max Point=4 X2=0.5 X3=0.5 S11=-
3028.40344107942 IsS11Max=No IsS11Min=No FrameElem=1 ElemStation=0
Frame=1 Station=6.24999940395355E-02 OutputCase=ENVE CaseType=Combination StepType=Max Point=0 X2=0
X3=0 S11=-274.637838986977 IsS11Max=No IsS11Min=No FrameElem=1 ElemStation=6.24999940395355E-02
Frame=1 Station=6.24999940395355E-02 OutputCase=ENVE CaseType=Combination StepType=Max Point=1 X2=-
0.5 X3=-0.5 S11=2212.54081466745 IsS11Max=Yes IsS11Min=No FrameElem=1 ElemStation=6.24999940395355E-02
Frame=1 Station=6.24999940395355E-02 OutputCase=ENVE CaseType=Combination StepType=Max Point=2 X2=-
0.5 X3=0.5 S11=2212.54081466745 IsS11Max=No IsS11Min=No FrameElem=1 ElemStation=6.24999940395355E-02
Frame=1 Station=6.24999940395355E-02 OutputCase=ENVE CaseType=Combination StepType=Max Point=3 X2=0.5
X3=-0.5 S11=-2722.41071157584 IsS11Max=No IsS11Min=Yes FrameElem=1 ElemStation=6.24999940395355E-02
Frame=1 Station=6.24999940395355E-02 OutputCase=ENVE CaseType=Combination StepType=Max Point=4 X2=0.5
X3=0.5 S11=-2722.41071157584 IsS11Max=No IsS11Min=No FrameElem=1 ElemStation=6.24999940395355E-02
Frame=1 Station=0.12499988079071 OutputCase=ENVE CaseType=Combination StepType=Max Point=0 X2=0
X3=0 S11=-274.637838986977 IsS11Max=No IsS11Min=No FrameElem=1 ElemStation=0.12499988079071

```

Frame=1 Station=0 OutputCase=FESSUR CaseType=Combination Point=2 X2=-0.5 X3=0.5
S11=2518.55445001286 IsS11Max=No IsS11Min=No FrameElem=1 ElemStation=0
Frame=1 Station=0 OutputCase=FESSUR CaseType=Combination Point=3 X2=0.5 X3=-0.5 S11=-
3291.63835624344 IsS11Max=No IsS11Min=Yes FrameElem=1 ElemStation=0
Frame=1 Station=0 OutputCase=FESSUR CaseType=Combination Point=4 X2=0.5 X3=0.5 S11=-
3291.63835624344 IsS11Max=No IsS11Min=No FrameElem=1 ElemStation=0
Frame=1 Station=6.24999940395355E-02 OutputCase=FESSUR CaseType=Combination Point=0 X2=0 X3=0 S11=-
386.541953115295 IsS11Max=No IsS11Min=No FrameElem=1 ElemStation=6.24999940395355E-02
Frame=1 Station=6.24999940395355E-02 OutputCase=FESSUR CaseType=Combination Point=1 X2=-0.5 X3=-0.5
S11=2212.54081466745 IsS11Max=Yes IsS11Min=No FrameElem=1 ElemStation=6.24999940395355E-02
Frame=1 Station=6.24999940395355E-02 OutputCase=FESSUR CaseType=Combination Point=2 X2=-0.5 X3=0.5
S11=2212.54081466745 IsS11Max=No IsS11Min=No FrameElem=1 ElemStation=6.24999940395355E-02
Frame=1 Station=6.24999940395355E-02 OutputCase=FESSUR CaseType=Combination Point=3 X2=0.5 X3=-0.5
S11=-2985.62472089804 IsS11Max=No IsS11Min=Yes FrameElem=1 ElemStation=6.24999940395355E-02
Frame=1 Station=6.24999940395355E-02 OutputCase=FESSUR CaseType=Combination Point=4 X2=0.5 X3=0.5
S11=-2985.62472089804 IsS11Max=No IsS11Min=No FrameElem=1 ElemStation=6.24999940395355E-02
Frame=1 Station=0.124999988079071 OutputCase=FESSUR CaseType=Combination Point=0 X2=0 X3=0 S11=-
386.541953115295 IsS11Max=No IsS11Min=No FrameElem=1 ElemStation=0.124999988079071
Frame=1 Station=0.124999988079071 OutputCase=FESSUR CaseType=Combination Point=1 X2=-0.5 X3=-0.5
S11=1905.94124193381 IsS11Max=Yes IsS11Min=No FrameElem=1 ElemStation=0.124999988079071
Frame=1 Station=0.124999988079071 OutputCase=FESSUR CaseType=Combination Point=2 X2=-0.5 X3=0.5
S11=1905.94124193381 IsS11Max=No IsS11Min=No FrameElem=1 ElemStation=0.124999988079071
Frame=1 Station=0.124999988079071 OutputCase=FESSUR CaseType=Combination Point=3 X2=0.5 X3=-0.5
S11=-2679.0251481644 IsS11Max=No IsS11Min=Yes FrameElem=1 ElemStation=0.124999988079071
Frame=1 Station=0.124999988079071 OutputCase=FESSUR CaseType=Combination Point=4 X2=0.5 X3=0.5
S11=-2679.0251481644 IsS11Max=No IsS11Min=No FrameElem=1 ElemStation=0.124999988079071
Frame=1 Station=0.187499982118607 OutputCase=FESSUR CaseType=Combination Point=0 X2=0 X3=0 S11=-
386.541953115295 IsS11Max=No IsS11Min=No FrameElem=1 ElemStation=0.187499982118607
Frame=1 Station=0.187499982118607 OutputCase=FESSUR CaseType=Combination Point=1 X2=-0.5 X3=-0.5
S11=1598.75573181192 IsS11Max=Yes IsS11Min=No FrameElem=1 ElemStation=0.187499982118607
Frame=1 Station=0.187499982118607 OutputCase=FESSUR CaseType=Combination Point=2 X2=-0.5 X3=0.5
S11=1598.75573181192 IsS11Max=No IsS11Min=No FrameElem=1 ElemStation=0.187499982118607
Frame=1 Station=0.187499982118607 OutputCase=FESSUR CaseType=Combination Point=3 X2=0.5 X3=-0.5
S11=-2371.83963804251 IsS11Max=No IsS11Min=Yes FrameElem=1 ElemStation=0.187499982118607
Frame=1 Station=0.187499982118607 OutputCase=FESSUR CaseType=Combination Point=4 X2=0.5 X3=0.5
S11=-2371.83963804251 IsS11Max=No IsS11Min=No FrameElem=1 ElemStation=0.187499982118607
Frame=1 Station=0.249999976158142 OutputCase=FESSUR CaseType=Combination Point=0 X2=0 X3=0 S11=-
386.541953115295 IsS11Max=No IsS11Min=No FrameElem=1 ElemStation=0.249999976158142
Frame=1 Station=0.249999976158142 OutputCase=FESSUR CaseType=Combination Point=1 X2=-0.5 X3=-0.5
S11=1290.98428430179 IsS11Max=Yes IsS11Min=No FrameElem=1 ElemStation=0.249999976158142
Frame=1 Station=0.249999976158142 OutputCase=FESSUR CaseType=Combination Point=2 X2=-0.5 X3=0.5
S11=1290.98428430179 IsS11Max=No IsS11Min=No FrameElem=1 ElemStation=0.249999976158142
Frame=1 Station=0.249999976158142 OutputCase=FESSUR CaseType=Combination Point=3 X2=0.5 X3=-0.5
S11=-2064.06819053238 IsS11Max=No IsS11Min=Yes FrameElem=1 ElemStation=0.249999976158142
Frame=1 Station=0.249999976158142 OutputCase=FESSUR CaseType=Combination Point=4 X2=0.5 X3=0.5
S11=-2064.06819053238 IsS11Max=No IsS11Min=No FrameElem=1 ElemStation=0.249999976158142
Frame=2 Station=0 OutputCase=PESOPR CaseType=LinStatic Point=0 X2=0 X3=0 S11=-15.1709467361864
IsS11Max=No IsS11Min=No FrameElem=2 ElemStation=0
Frame=2 Station=0 OutputCase=PESOPR CaseType=LinStatic Point=1 X2=-0.5 X3=-0.5 S11=244.109938423063
IsS11Max=Yes IsS11Min=No FrameElem=2 ElemStation=0
Frame=2 Station=0 OutputCase=PESOPR CaseType=LinStatic Point=2 X2=-0.5 X3=0.5 S11=244.109938423063
IsS11Max=No IsS11Min=No FrameElem=2 ElemStation=0
Frame=2 Station=0 OutputCase=PESOPR CaseType=LinStatic Point=3 X2=0.5 X3=-0.5 S11=-274.451831895435
IsS11Max=No IsS11Min=Yes FrameElem=2 ElemStation=0
Frame=2 Station=0 OutputCase=PESOPR CaseType=LinStatic Point=4 X2=0.5 X3=0.5 S11=-274.451831895435
IsS11Max=No IsS11Min=No FrameElem=2 ElemStation=0
Frame=2 Station=0.0625 OutputCase=PESOPR CaseType=LinStatic Point=0 X2=0 X3=0 S11=-15.1709467361864
IsS11Max=No IsS11Min=No FrameElem=2 ElemStation=0.0625
Frame=2 Station=0.0625 OutputCase=PESOPR CaseType=LinStatic Point=1 X2=-0.5 X3=-0.5
S11=193.390428618863 IsS11Max=Yes IsS11Min=No FrameElem=2 ElemStation=0.0625
Frame=2 Station=0.0625 OutputCase=PESOPR CaseType=LinStatic Point=2 X2=-0.5 X3=0.5
S11=193.390428618863 IsS11Max=No IsS11Min=No FrameElem=2 ElemStation=0.0625
Frame=2 Station=0.0625 OutputCase=PESOPR CaseType=LinStatic Point=3 X2=0.5 X3=-0.5 S11=-
223.732322091236 IsS11Max=No IsS11Min=Yes FrameElem=2 ElemStation=0.0625
Frame=2 Station=0.0625 OutputCase=PESOPR CaseType=LinStatic Point=4 X2=0.5 X3=0.5 S11=-
223.732322091236 IsS11Max=No IsS11Min=No FrameElem=2 ElemStation=0.0625
Frame=2 Station=0.125 OutputCase=PESOPR CaseType=LinStatic Point=0 X2=0 X3=0 S11=-15.1709467361864
IsS11Max=No IsS11Min=No FrameElem=2 ElemStation=0.125
Frame=2 Station=0.125 OutputCase=PESOPR CaseType=LinStatic Point=1 X2=-0.5 X3=-0.5
S11=142.084981314664 IsS11Max=Yes IsS11Min=No FrameElem=2 ElemStation=0.125
Frame=2 Station=0.125 OutputCase=PESOPR CaseType=LinStatic Point=2 X2=-0.5 X3=0.5
S11=142.084981314664 IsS11Max=No IsS11Min=No FrameElem=2 ElemStation=0.125
Frame=2 Station=0.125 OutputCase=PESOPR CaseType=LinStatic Point=3 X2=0.5 X3=-0.5 S11=-
172.426874787037 IsS11Max=No IsS11Min=Yes FrameElem=2 ElemStation=0.125
Frame=2 Station=0.125 OutputCase=PESOPR CaseType=LinStatic Point=4 X2=0.5 X3=0.5 S11=-
172.426874787037 IsS11Max=No IsS11Min=No FrameElem=2 ElemStation=0.125
Frame=2 Station=0.1875 OutputCase=PESOPR CaseType=LinStatic Point=0 X2=0 X3=0 S11=-15.1709467361864
IsS11Max=No IsS11Min=No FrameElem=2 ElemStation=0.1875
Frame=2 Station=0.1875 OutputCase=PESOPR CaseType=LinStatic Point=1 X2=-0.5 X3=-0.5
S11=90.1935965104646 IsS11Max=Yes IsS11Min=No FrameElem=2 ElemStation=0.1875
Frame=2 Station=0.1875 OutputCase=PESOPR CaseType=LinStatic Point=2 X2=-0.5 X3=0.5
S11=90.1935965104646 IsS11Max=No IsS11Min=No FrameElem=2 ElemStation=0.1875

Frame=2	Station=0.1875	OutputCase=PESOPR	CaseType=LinStatic	Point=3	X2=0.5	X3=-0.5	S11=-
120.535489982837	IsS11Max=No	IsS11Min=Yes	FrameElem=2	ElemStation=0.1875			
Frame=2	Station=0.1875	OutputCase=PESOPR	CaseType=LinStatic	Point=4	X2=0.5	X3=0.5	S11=-
120.535489982837	IsS11Max=No	IsS11Min=No	FrameElem=2	ElemStation=0.1875			
Frame=2	Station=0.25	OutputCase=PESOPR	CaseType=LinStatic	Point=0	X2=0	X3=0	S11=-15.1709467361864
IsS11Max=No	IsS11Min=No	FrameElem=2	ElemStation=0.25				
Frame=2	Station=0.25	OutputCase=PESOPR	CaseType=LinStatic	Point=1	X2=-0.5	X3=-0.5	
S11=37.7162742062653	IsS11Max=Yes	IsS11Min=No	FrameElem=2	ElemStation=0.25			
Frame=2	Station=0.25	OutputCase=PESOPR	CaseType=LinStatic	Point=2	X2=-0.5	X3=0.5	
S11=37.7162742062653	IsS11Max=No	IsS11Min=No	FrameElem=2	ElemStation=0.25			
Frame=2	Station=0.25	OutputCase=PESOPR	CaseType=LinStatic	Point=3	X2=0.5	X3=-0.5	S11=-
68.0581676786381	IsS11Max=No	IsS11Min=Yes	FrameElem=2	ElemStation=0.25			
Frame=2	Station=0.25	OutputCase=PESOPR	CaseType=LinStatic	Point=4	X2=0.5	X3=0.5	S11=-
68.0581676786381	IsS11Max=No	IsS11Min=No	FrameElem=2	ElemStation=0.25			
Frame=2	Station=0	OutputCase=TERRVERT	CaseType=LinStatic	Point=0	X2=0	X3=0	S11=1.64270738195018
IsS11Max=No	IsS11Min=No	FrameElem=2	ElemStation=0				
Frame=2	Station=0	OutputCase=TERRVERT	CaseType=LinStatic	Point=1	X2=-0.5	X3=-0.5	
S11=915.730800745339	IsS11Max=Yes	IsS11Min=No	FrameElem=2	ElemStation=0			
Frame=2	Station=0	OutputCase=TERRVERT	CaseType=LinStatic	Point=2	X2=-0.5	X3=0.5	
S11=915.730800745339	IsS11Max=No	IsS11Min=No	FrameElem=2	ElemStation=0			
Frame=2	Station=0	OutputCase=TERRVERT	CaseType=LinStatic	Point=3	X2=0.5	X3=-0.5	S11=-
912.445385981439	IsS11Max=No	IsS11Min=Yes	FrameElem=2	ElemStation=0			
Frame=2	Station=0	OutputCase=TERRVERT	CaseType=LinStatic	Point=4	X2=0.5	X3=0.5	S11=-
912.445385981439	IsS11Max=No	IsS11Min=No	FrameElem=2	ElemStation=0			
Frame=2	Station=0.0625	OutputCase=TERRVERT	CaseType=LinStatic	Point=0	X2=0	X3=0	
S11=1.64270738195018	IsS11Max=No	IsS11Min=No	FrameElem=2	ElemStation=0.0625			
Frame=2	Station=0.0625	OutputCase=TERRVERT	CaseType=LinStatic	Point=1	X2=-0.5	X3=-0.5	
S11=693.533048805519	IsS11Max=Yes	IsS11Min=No	FrameElem=2	ElemStation=0.0625			
Frame=2	Station=0.0625	OutputCase=TERRVERT	CaseType=LinStatic	Point=2	X2=-0.5	X3=0.5	
S11=693.533048805519	IsS11Max=No	IsS11Min=No	FrameElem=2	ElemStation=0.0625			
Frame=2	Station=0.0625	OutputCase=TERRVERT	CaseType=LinStatic	Point=3	X2=0.5	X3=-0.5	S11=-
690.247634041618	IsS11Max=No	IsS11Min=Yes	FrameElem=2	ElemStation=0.0625			
Frame=2	Station=0.0625	OutputCase=TERRVERT	CaseType=LinStatic	Point=4	X2=0.5	X3=0.5	S11=-
690.247634041618	IsS11Max=No	IsS11Min=No	FrameElem=2	ElemStation=0.0625			
Frame=2	Station=0.125	OutputCase=TERRVERT	CaseType=LinStatic	Point=0	X2=0	X3=0	S11=1.64270738195018
IsS11Max=No	IsS11Min=No	FrameElem=2	ElemStation=0.125				
Frame=2	Station=0.125	OutputCase=TERRVERT	CaseType=LinStatic	Point=1	X2=-0.5	X3=-0.5	
S11=471.335296865698	IsS11Max=Yes	IsS11Min=No	FrameElem=2	ElemStation=0.125			
Frame=2	Station=0.125	OutputCase=TERRVERT	CaseType=LinStatic	Point=2	X2=-0.5	X3=0.5	
S11=471.335296865698	IsS11Max=No	IsS11Min=No	FrameElem=2	ElemStation=0.125			
Frame=2	Station=0.125	OutputCase=TERRVERT	CaseType=LinStatic	Point=3	X2=0.5	X3=-0.5	S11=-
468.049882101798	IsS11Max=No	IsS11Min=Yes	FrameElem=2	ElemStation=0.125			
Frame=2	Station=0.125	OutputCase=TERRVERT	CaseType=LinStatic	Point=4	X2=0.5	X3=0.5	S11=-
468.049882101798	IsS11Max=No	IsS11Min=No	FrameElem=2	ElemStation=0.125			
Frame=2	Station=0.1875	OutputCase=TERRVERT	CaseType=LinStatic	Point=0	X2=0	X3=0	
S11=1.64270738195018	IsS11Max=No	IsS11Min=No	FrameElem=2	ElemStation=0.1875			
Frame=2	Station=0.1875	OutputCase=TERRVERT	CaseType=LinStatic	Point=1	X2=-0.5	X3=-0.5	
S11=249.137544925877	IsS11Max=Yes	IsS11Min=No	FrameElem=2	ElemStation=0.1875			
Frame=2	Station=0.1875	OutputCase=TERRVERT	CaseType=LinStatic	Point=2	X2=-0.5	X3=0.5	
S11=249.137544925877	IsS11Max=No	IsS11Min=No	FrameElem=2	ElemStation=0.1875			
Frame=2	Station=0.1875	OutputCase=TERRVERT	CaseType=LinStatic	Point=3	X2=0.5	X3=-0.5	S11=-
245.852130161977	IsS11Max=No	IsS11Min=Yes	FrameElem=2	ElemStation=0.1875			
Frame=2	Station=0.1875	OutputCase=TERRVERT	CaseType=LinStatic	Point=4	X2=0.5	X3=0.5	S11=-
245.852130161977	IsS11Max=No	IsS11Min=No	FrameElem=2	ElemStation=0.1875			
Frame=2	Station=0.25	OutputCase=TERRVERT	CaseType=LinStatic	Point=0	X2=0	X3=0	S11=1.64270738195018
IsS11Max=No	IsS11Min=No	FrameElem=2	ElemStation=0.25				
Frame=2	Station=0.25	OutputCase=TERRVERT	CaseType=LinStatic	Point=1	X2=-0.5	X3=-0.5	
S11=26.9397929860567	IsS11Max=Yes	IsS11Min=No	FrameElem=2	ElemStation=0.25			
Frame=2	Station=0.25	OutputCase=TERRVERT	CaseType=LinStatic	Point=2	X2=-0.5	X3=0.5	
S11=26.9397929860567	IsS11Max=No	IsS11Min=No	FrameElem=2	ElemStation=0.25			
Frame=2	Station=0.25	OutputCase=TERRVERT	CaseType=LinStatic	Point=3	X2=0.5	X3=-0.5	S11=-
23.6543782221564	IsS11Max=No	IsS11Min=Yes	FrameElem=2	ElemStation=0.25			
Frame=2	Station=0.25	OutputCase=TERRVERT	CaseType=LinStatic	Point=4	X2=0.5	X3=0.5	S11=-
23.6543782221564	IsS11Max=No	IsS11Min=No	FrameElem=2	ElemStation=0.25			
Frame=2	Station=0	OutputCase=TERRLAT	CaseType=LinStatic	Point=0	X2=0	X3=0	S11=-373.013713761058
IsS11Max=No	IsS11Min=No	FrameElem=2	ElemStation=0				
Frame=2	Station=0	OutputCase=TERRLAT	CaseType=LinStatic	Point=1	X2=-0.5	X3=-0.5	
S11=131.143545133663	IsS11Max=Yes	IsS11Min=No	FrameElem=2	ElemStation=0			
Frame=2	Station=0	OutputCase=TERRLAT	CaseType=LinStatic	Point=2	X2=-0.5	X3=0.5	S11=131.143545133663
IsS11Max=No	IsS11Min=No	FrameElem=2	ElemStation=0				
Frame=2	Station=0	OutputCase=TERRLAT	CaseType=LinStatic	Point=3	X2=0.5	X3=-0.5	S11=-
877.170972655779	IsS11Max=No	IsS11Min=Yes	FrameElem=2	ElemStation=0			
Frame=2	Station=0	OutputCase=TERRLAT	CaseType=LinStatic	Point=4	X2=0.5	X3=0.5	S11=-877.170972655779
IsS11Max=No	IsS11Min=No	FrameElem=2	ElemStation=0				
Frame=2	Station=0.0625	OutputCase=TERRLAT	CaseType=LinStatic	Point=0	X2=0	X3=0	S11=-
373.013713761058	IsS11Max=No	IsS11Min=No	FrameElem=2	ElemStation=0.0625			
Frame=2	Station=0.0625	OutputCase=TERRLAT	CaseType=LinStatic	Point=1	X2=-0.5	X3=-0.5	
S11=130.974646697411	IsS11Max=Yes	IsS11Min=No	FrameElem=2	ElemStation=0.0625			
Frame=2	Station=0.0625	OutputCase=TERRLAT	CaseType=LinStatic	Point=2	X2=-0.5	X3=0.5	
S11=130.974646697411	IsS11Max=No	IsS11Min=No	FrameElem=2	ElemStation=0.0625			
Frame=2	Station=0.0625	OutputCase=TERRLAT	CaseType=LinStatic	Point=3	X2=0.5	X3=-0.5	S11=-
877.002074219528	IsS11Max=No	IsS11Min=Yes	FrameElem=2	ElemStation=0.0625			



Frame=2	Station=0.0625	OutputCase=TERRLAT	CaseType=LinStatic	Point=4	X2=0.5	X3=0.5	S11=-
877.002074219528	IsS11Max=No	IsS11Min=No	FrameElem=2	ElemStation=0.0625			
Frame=2	Station=0.125	OutputCase=TERRLAT	CaseType=LinStatic	Point=0	X2=0	X3=0	S11=-373.013713761058
IsS11Max=No	IsS11Min=No	FrameElem=2	ElemStation=0.125				
Frame=2	Station=0.125	OutputCase=TERRLAT	CaseType=LinStatic	Point=1	X2=-0.5	X3=-0.5	
S11=130.80574826116	IsS11Max=Yes	IsS11Min=No	FrameElem=2	ElemStation=0.125			
Frame=2	Station=0.125	OutputCase=TERRLAT	CaseType=LinStatic	Point=2	X2=-0.5	X3=0.5	
S11=130.80574826116	IsS11Max=No	IsS11Min=No	FrameElem=2	ElemStation=0.125			
Frame=2	Station=0.125	OutputCase=TERRLAT	CaseType=LinStatic	Point=3	X2=0.5	X3=-0.5	S11=-
876.833175783277	IsS11Max=No	IsS11Min=Yes	FrameElem=2	ElemStation=0.125			
Frame=2	Station=0.125	OutputCase=TERRLAT	CaseType=LinStatic	Point=4	X2=0.5	X3=0.5	S11=-
876.833175783277	IsS11Max=No	IsS11Min=No	FrameElem=2	ElemStation=0.125			
Frame=2	Station=0.1875	OutputCase=TERRLAT	CaseType=LinStatic	Point=0	X2=0	X3=0	S11=-
373.013713761058	IsS11Max=No	IsS11Min=No	FrameElem=2	ElemStation=0.1875			
Frame=2	Station=0.1875	OutputCase=TERRLAT	CaseType=LinStatic	Point=1	X2=-0.5	X3=-0.5	
S11=130.636849824909	IsS11Max=Yes	IsS11Min=No	FrameElem=2	ElemStation=0.1875			
Frame=2	Station=0.1875	OutputCase=TERRLAT	CaseType=LinStatic	Point=2	X2=-0.5	X3=0.5	
S11=130.636849824909	IsS11Max=No	IsS11Min=No	FrameElem=2	ElemStation=0.1875			
Frame=2	Station=0.1875	OutputCase=TERRLAT	CaseType=LinStatic	Point=3	X2=0.5	X3=-0.5	S11=-
876.664277347026	IsS11Max=No	IsS11Min=Yes	FrameElem=2	ElemStation=0.1875			
Frame=2	Station=0.1875	OutputCase=TERRLAT	CaseType=LinStatic	Point=4	X2=0.5	X3=0.5	S11=-
876.664277347026	IsS11Max=No	IsS11Min=No	FrameElem=2	ElemStation=0.1875			
Frame=2	Station=0.25	OutputCase=TERRLAT	CaseType=LinStatic	Point=0	X2=0	X3=0	S11=-373.013713761058
IsS11Max=No	IsS11Min=No	FrameElem=2	ElemStation=0.25				
Frame=2	Station=0.25	OutputCase=TERRLAT	CaseType=LinStatic	Point=1	X2=-0.5	X3=-0.5	
S11=130.467951388658	IsS11Max=Yes	IsS11Min=No	FrameElem=2	ElemStation=0.25			
Frame=2	Station=0.25	OutputCase=TERRLAT	CaseType=LinStatic	Point=2	X2=-0.5	X3=0.5	
S11=130.467951388658	IsS11Max=No	IsS11Min=No	FrameElem=2	ElemStation=0.25			
Frame=2	Station=0.25	OutputCase=TERRLAT	CaseType=LinStatic	Point=3	X2=0.5	X3=-0.5	S11=-
876.495378910775	IsS11Max=No	IsS11Min=Yes	FrameElem=2	ElemStation=0.25			
Frame=2	Station=0.25	OutputCase=TERRLAT	CaseType=LinStatic	Point=4	X2=0.5	X3=0.5	S11=-
876.495378910775	IsS11Max=No	IsS11Min=No	FrameElem=2	ElemStation=0.25			
Frame=2	Station=0	OutputCase=ACCVERT	CaseType=LinStatic	Point=0	X2=0	X3=0	S11=0
IsS11Min=Yes	FrameElem=2	ElemStation=0					IsS11Max=Yes
Frame=2	Station=0	OutputCase=ACCVERT	CaseType=LinStatic	Point=1	X2=-0.5	X3=-0.5	S11=0
IsS11Min=No	FrameElem=2	ElemStation=0					IsS11Max=No
Frame=2	Station=0	OutputCase=ACCVERT	CaseType=LinStatic	Point=2	X2=-0.5	X3=0.5	S11=0
IsS11Min=No	FrameElem=2	ElemStation=0					IsS11Max=No
Frame=2	Station=0	OutputCase=ACCVERT	CaseType=LinStatic	Point=3	X2=0.5	X3=-0.5	S11=0
IsS11Min=No	FrameElem=2	ElemStation=0					IsS11Max=No
Frame=2	Station=0	OutputCase=ACCVERT	CaseType=LinStatic	Point=4	X2=0.5	X3=0.5	S11=0
IsS11Min=No	FrameElem=2	ElemStation=0					IsS11Max=No
Frame=2	Station=0.0625	OutputCase=ACCVERT	CaseType=LinStatic	Point=0	X2=0	X3=0	S11=0
IsS11Min=Yes	FrameElem=2	ElemStation=0.0625					IsS11Max=Yes
Frame=2	Station=0.0625	OutputCase=ACCVERT	CaseType=LinStatic	Point=1	X2=-0.5	X3=-0.5	S11=0
IsS11Max=No	IsS11Min=No	FrameElem=2	ElemStation=0.0625				
Frame=2	Station=0.0625	OutputCase=ACCVERT	CaseType=LinStatic	Point=2	X2=-0.5	X3=0.5	S11=0
IsS11Max=No	IsS11Min=No	FrameElem=2	ElemStation=0.0625				
Frame=2	Station=0.0625	OutputCase=ACCVERT	CaseType=LinStatic	Point=3	X2=0.5	X3=-0.5	S11=0
IsS11Max=No	IsS11Min=No	FrameElem=2	ElemStation=0.0625				
Frame=2	Station=0.0625	OutputCase=ACCVERT	CaseType=LinStatic	Point=4	X2=0.5	X3=0.5	S11=0
IsS11Max=No	IsS11Min=No	FrameElem=2	ElemStation=0.0625				
Frame=2	Station=0.125	OutputCase=ACCVERT	CaseType=LinStatic	Point=0	X2=0	X3=0	S11=0
IsS11Min=Yes	FrameElem=2	ElemStation=0.125					IsS11Max=Yes
Frame=2	Station=0.125	OutputCase=ACCVERT	CaseType=LinStatic	Point=1	X2=-0.5	X3=-0.5	S11=0
IsS11Max=No	IsS11Min=No	FrameElem=2	ElemStation=0.125				
Frame=2	Station=0.125	OutputCase=ACCVERT	CaseType=LinStatic	Point=2	X2=-0.5	X3=0.5	S11=0
IsS11Max=No	IsS11Min=No	FrameElem=2	ElemStation=0.125				
Frame=2	Station=0.125	OutputCase=ACCVERT	CaseType=LinStatic	Point=3	X2=0.5	X3=-0.5	S11=0
IsS11Max=No	IsS11Min=No	FrameElem=2	ElemStation=0.125				
Frame=2	Station=0.125	OutputCase=ACCVERT	CaseType=LinStatic	Point=4	X2=0.5	X3=0.5	S11=0
IsS11Max=No	IsS11Min=No	FrameElem=2	ElemStation=0.125				
Frame=2	Station=0.1875	OutputCase=ACCVERT	CaseType=LinStatic	Point=0	X2=0	X3=0	S11=0
IsS11Min=Yes	FrameElem=2	ElemStation=0.1875					IsS11Max=Yes
Frame=2	Station=0.1875	OutputCase=ACCVERT	CaseType=LinStatic	Point=1	X2=-0.5	X3=-0.5	S11=0
IsS11Max=No	IsS11Min=No	FrameElem=2	ElemStation=0.1875				
Frame=2	Station=0.1875	OutputCase=ACCVERT	CaseType=LinStatic	Point=2	X2=-0.5	X3=0.5	S11=0
IsS11Max=No	IsS11Min=No	FrameElem=2	ElemStation=0.1875				
Frame=2	Station=0.1875	OutputCase=ACCVERT	CaseType=LinStatic	Point=3	X2=0.5	X3=-0.5	S11=0
IsS11Max=No	IsS11Min=No	FrameElem=2	ElemStation=0.1875				
Frame=2	Station=0.1875	OutputCase=ACCVERT	CaseType=LinStatic	Point=4	X2=0.5	X3=0.5	S11=0
IsS11Max=No	IsS11Min=No	FrameElem=2	ElemStation=0.1875				
Frame=2	Station=0.25	OutputCase=ACCVERT	CaseType=LinStatic	Point=0	X2=0	X3=0	S11=0
IsS11Min=Yes	FrameElem=2	ElemStation=0.25					IsS11Max=Yes
Frame=2	Station=0.25	OutputCase=ACCVERT	CaseType=LinStatic	Point=1	X2=-0.5	X3=-0.5	S11=0
IsS11Max=No	IsS11Min=No	FrameElem=2	ElemStation=0.25				
Frame=2	Station=0.25	OutputCase=ACCVERT	CaseType=LinStatic	Point=2	X2=-0.5	X3=0.5	S11=0
IsS11Max=No	IsS11Min=No	FrameElem=2	ElemStation=0.25				
Frame=2	Station=0.25	OutputCase=ACCVERT	CaseType=LinStatic	Point=3	X2=0.5	X3=-0.5	S11=0
IsS11Max=No	IsS11Min=No	FrameElem=2	ElemStation=0.25				
Frame=2	Station=0.25	OutputCase=ACCVERT	CaseType=LinStatic	Point=4	X2=0.5	X3=0.5	S11=0
IsS11Max=No	IsS11Min=No	FrameElem=2	ElemStation=0.25				

Frame=2	Station=0.0625	OutputCase=SOVRCOST	CaseType=LinStatic	Point=2	X2=-0.5	X3=0.5	S11=0	
IsS11Max=No	IsS11Min=No	FrameElem=2	ElemStation=0.0625					
Frame=2	Station=0.0625	OutputCase=SOVRCOST	CaseType=LinStatic	Point=3	X2=0.5	X3=-0.5	S11=0	
IsS11Max=No	IsS11Min=No	FrameElem=2	ElemStation=0.0625					
Frame=2	Station=0.0625	OutputCase=SOVRCOST	CaseType=LinStatic	Point=4	X2=0.5	X3=0.5	S11=0	
IsS11Max=No	IsS11Min=No	FrameElem=2	ElemStation=0.0625					
Frame=2	Station=0.125	OutputCase=SOVRCOST	CaseType=LinStatic	Point=0	X2=0	X3=0	S11=0	
IsS11Min=Yes	FrameElem=2	ElemStation=0.125					IsS11Max=Yes	
Frame=2	Station=0.125	OutputCase=SOVRCOST	CaseType=LinStatic	Point=1	X2=-0.5	X3=-0.5	S11=0	
IsS11Max=No	IsS11Min=No	FrameElem=2	ElemStation=0.125					
Frame=2	Station=0.125	OutputCase=SOVRCOST	CaseType=LinStatic	Point=2	X2=-0.5	X3=0.5	S11=0	
IsS11Max=No	IsS11Min=No	FrameElem=2	ElemStation=0.125					
Frame=2	Station=0.125	OutputCase=SOVRCOST	CaseType=LinStatic	Point=3	X2=0.5	X3=-0.5	S11=0	
IsS11Max=No	IsS11Min=No	FrameElem=2	ElemStation=0.125					
Frame=2	Station=0.125	OutputCase=SOVRCOST	CaseType=LinStatic	Point=4	X2=0.5	X3=0.5	S11=0	
IsS11Max=No	IsS11Min=No	FrameElem=2	ElemStation=0.125					
Frame=2	Station=0.1875	OutputCase=SOVRCOST	CaseType=LinStatic	Point=0	X2=0	X3=0	S11=0	
IsS11Max=Yes	IsS11Min=Yes	FrameElem=2	ElemStation=0.1875					
Frame=2	Station=0.1875	OutputCase=SOVRCOST	CaseType=LinStatic	Point=1	X2=-0.5	X3=-0.5	S11=0	
IsS11Max=No	IsS11Min=No	FrameElem=2	ElemStation=0.1875					
Frame=2	Station=0.1875	OutputCase=SOVRCOST	CaseType=LinStatic	Point=2	X2=-0.5	X3=0.5	S11=0	
IsS11Max=No	IsS11Min=No	FrameElem=2	ElemStation=0.1875					
Frame=2	Station=0.1875	OutputCase=SOVRCOST	CaseType=LinStatic	Point=3	X2=0.5	X3=-0.5	S11=0	
IsS11Max=No	IsS11Min=No	FrameElem=2	ElemStation=0.1875					
Frame=2	Station=0.1875	OutputCase=SOVRCOST	CaseType=LinStatic	Point=4	X2=0.5	X3=0.5	S11=0	
IsS11Max=No	IsS11Min=No	FrameElem=2	ElemStation=0.1875					
Frame=2	Station=0.25	OutputCase=SOVRCOST	CaseType=LinStatic	Point=0	X2=0	X3=0	S11=0	
IsS11Min=Yes	FrameElem=2	ElemStation=0.25					IsS11Max=Yes	
Frame=2	Station=0.25	OutputCase=SOVRCOST	CaseType=LinStatic	Point=1	X2=-0.5	X3=-0.5	S11=0	
IsS11Max=No	IsS11Min=No	FrameElem=2	ElemStation=0.25					
Frame=2	Station=0.25	OutputCase=SOVRCOST	CaseType=LinStatic	Point=2	X2=-0.5	X3=0.5	S11=0	
IsS11Max=No	IsS11Min=No	FrameElem=2	ElemStation=0.25					
Frame=2	Station=0.25	OutputCase=SOVRCOST	CaseType=LinStatic	Point=3	X2=0.5	X3=-0.5	S11=0	
IsS11Max=No	IsS11Min=No	FrameElem=2	ElemStation=0.25					
Frame=2	Station=0.25	OutputCase=SOVRCOST	CaseType=LinStatic	Point=4	X2=0.5	X3=0.5	S11=0	
IsS11Max=No	IsS11Min=No	FrameElem=2	ElemStation=0.25					
Frame=2	Station=0	OutputCase=ENVE	CaseType=Combination	StepType=Max	Point=0	X2=0	X3=0	S11=-
274.637838986977	IsS11Max=No	IsS11Min=No	FrameElem=2	ElemStation=0				
Frame=2	Station=0	OutputCase=ENVE	CaseType=Combination	StepType=Max	Point=1	X2=-0.5	X3=-0.5	
S11=1290.98428430206	IsS11Max=Yes	IsS11Min=No	FrameElem=2	ElemStation=0				
Frame=2	Station=0	OutputCase=ENVE	CaseType=Combination	StepType=Max	Point=2	X2=-0.5	X3=0.5	
S11=1290.98428430206	IsS11Max=No	IsS11Min=No	FrameElem=2	ElemStation=0				
Frame=2	Station=0	OutputCase=ENVE	CaseType=Combination	StepType=Max	Point=3	X2=0.5	X3=-0.5	S11=-
1800.91689873592	IsS11Max=No	IsS11Min=Yes	FrameElem=2	ElemStation=0				
Frame=2	Station=0	OutputCase=ENVE	CaseType=Combination	StepType=Max	Point=4	X2=0.5	X3=0.5	S11=-
1800.91689873592	IsS11Max=No	IsS11Min=No	FrameElem=2	ElemStation=0				
Frame=2	Station=0.0625	OutputCase=ENVE	CaseType=Combination	StepType=Max	Point=0	X2=0	X3=0	S11=-
274.637838986977	IsS11Max=No	IsS11Min=No	FrameElem=2	ElemStation=0.0625				
Frame=2	Station=0.0625	OutputCase=ENVE	CaseType=Combination	StepType=Max	Point=1	X2=-0.5	X3=-0.5	
S11=1017.89812412179	IsS11Max=Yes	IsS11Min=No	FrameElem=2	ElemStation=0.0625				
Frame=2	Station=0.0625	OutputCase=ENVE	CaseType=Combination	StepType=Max	Point=2	X2=-0.5	X3=0.5	
S11=1017.89812412179	IsS11Max=No	IsS11Min=No	FrameElem=2	ElemStation=0.0625				
Frame=2	Station=0.0625	OutputCase=ENVE	CaseType=Combination	StepType=Max	Point=3	X2=0.5	X3=-0.5	
S11=-1527.88140808652	IsS11Max=No	IsS11Min=Yes	FrameElem=2	ElemStation=0.0625				
Frame=2	Station=0.0625	OutputCase=ENVE	CaseType=Combination	StepType=Max	Point=4	X2=0.5	X3=0.5	
S11=-1527.88140808652	IsS11Max=No	IsS11Min=No	FrameElem=2	ElemStation=0.0625				
Frame=2	Station=0.125	OutputCase=ENVE	CaseType=Combination	StepType=Max	Point=0	X2=0	X3=0	S11=-
274.637838986977	IsS11Max=No	IsS11Min=No	FrameElem=2	ElemStation=0.125				
Frame=2	Station=0.125	OutputCase=ENVE	CaseType=Combination	StepType=Max	Point=1	X2=-0.5	X3=-0.5	
S11=744.226026441522	IsS11Max=Yes	IsS11Min=No	FrameElem=2	ElemStation=0.125				
Frame=2	Station=0.125	OutputCase=ENVE	CaseType=Combination	StepType=Max	Point=2	X2=-0.5	X3=0.5	
S11=744.226026441522	IsS11Max=No	IsS11Min=No	FrameElem=2	ElemStation=0.125				
Frame=2	Station=0.125	OutputCase=ENVE	CaseType=Combination	StepType=Max	Point=3	X2=0.5	X3=-0.5	
S11=-1254.25997993713	IsS11Max=No	IsS11Min=Yes	FrameElem=2	ElemStation=0.125				
Frame=2	Station=0.125	OutputCase=ENVE	CaseType=Combination	StepType=Max	Point=4	X2=0.5	X3=0.5	
S11=-1254.25997993713	IsS11Max=No	IsS11Min=No	FrameElem=2	ElemStation=0.125				
Frame=2	Station=0.1875	OutputCase=ENVE	CaseType=Combination	StepType=Max	Point=0	X2=0	X3=0	S11=-
274.637838986977	IsS11Max=No	IsS11Min=No	FrameElem=2	ElemStation=0.1875				
Frame=2	Station=0.1875	OutputCase=ENVE	CaseType=Combination	StepType=Max	Point=1	X2=-0.5	X3=-0.5	
S11=469.967991261251	IsS11Max=Yes	IsS11Min=No	FrameElem=2	ElemStation=0.1875				
Frame=2	Station=0.1875	OutputCase=ENVE	CaseType=Combination	StepType=Max	Point=2	X2=-0.5	X3=0.5	
S11=469.967991261251	IsS11Max=No	IsS11Min=No	FrameElem=2	ElemStation=0.1875				
Frame=2	Station=0.1875	OutputCase=ENVE	CaseType=Combination	StepType=Max	Point=3	X2=0.5	X3=-0.5	
S11=-980.052614287732	IsS11Max=No	IsS11Min=Yes	FrameElem=2	ElemStation=0.1875				
Frame=2	Station=0.1875	OutputCase=ENVE	CaseType=Combination	StepType=Max	Point=4	X2=0.5	X3=0.5	
S11=-980.052614287732	IsS11Max=No	IsS11Min=No	FrameElem=2	ElemStation=0.1875				
Frame=2	Station=0.25	OutputCase=ENVE	CaseType=Combination	StepType=Max	Point=0	X2=0	X3=0	S11=-
274.637838986977	IsS11Max=No	IsS11Min=No	FrameElem=2	ElemStation=0.25				
Frame=2	Station=0.25	OutputCase=ENVE	CaseType=Combination	StepType=Max	Point=1	X2=-0.5	X3=-0.5	
S11=195.12401858098	IsS11Max=Yes	IsS11Min=No	FrameElem=2	ElemStation=0.25				
Frame=2	Station=0.25	OutputCase=ENVE	CaseType=Combination	StepType=Max	Point=2	X2=-0.5	X3=0.5	
S11=195.12401858098	IsS11Max=No	IsS11Min=No	FrameElem=2	ElemStation=0.25				

Frame=2	Station=0.25	OutputCase=ENVE	CaseType=Combination	StepType=Max	Point=3	X2=0.5	X3=-0.5	
S11=-705.259311138337	IsS11Max=No	IsS11Min=Yes	FrameElem=2	ElemStation=0.25				
Frame=2	Station=0.25	OutputCase=ENVE	CaseType=Combination	StepType=Max	Point=4	X2=0.5	X3=0.5	
S11=-705.259311138337	IsS11Max=No	IsS11Min=No	FrameElem=2	ElemStation=0.25				
Frame=2	Station=0	OutputCase=ENVE	CaseType=Combination	StepType=Min	Point=0	X2=0	X3=0	S11=-
386.541953115295	IsS11Max=No	IsS11Min=No	FrameElem=2	ElemStation=0				
Frame=2	Station=0	OutputCase=ENVE	CaseType=Combination	StepType=Min	Point=1	X2=-0.5	X3=-0.5	
S11=1251.64122076197	IsS11Max=Yes	IsS11Min=No	FrameElem=2	ElemStation=0				
Frame=2	Station=0	OutputCase=ENVE	CaseType=Combination	StepType=Min	Point=2	X2=-0.5	X3=0.5	
S11=1251.64122076197	IsS11Max=No	IsS11Min=No	FrameElem=2	ElemStation=0				
Frame=2	Station=0	OutputCase=ENVE	CaseType=Combination	StepType=Min	Point=3	X2=0.5	X3=-0.5	S11=-
2064.06819053265	IsS11Max=No	IsS11Min=Yes	FrameElem=2	ElemStation=0				
Frame=2	Station=0	OutputCase=ENVE	CaseType=Combination	StepType=Min	Point=4	X2=0.5	X3=0.5	S11=-
2064.06819053265	IsS11Max=No	IsS11Min=No	FrameElem=2	ElemStation=0				
Frame=2	Station=0.0625	OutputCase=ENVE	CaseType=Combination	StepType=Min	Point=0	X2=0	X3=0	S11=-
386.541953115295	IsS11Max=No	IsS11Min=No	FrameElem=2	ElemStation=0.0625				
Frame=2	Station=0.0625	OutputCase=ENVE	CaseType=Combination	StepType=Min	Point=1	X2=-0.5	X3=-0.5	
S11=978.60573011257	IsS11Max=Yes	IsS11Min=No	FrameElem=2	ElemStation=0.0625				
Frame=2	Station=0.0625	OutputCase=ENVE	CaseType=Combination	StepType=Min	Point=2	X2=-0.5	X3=0.5	
S11=978.60573011257	IsS11Max=No	IsS11Min=No	FrameElem=2	ElemStation=0.0625				
Frame=2	Station=0.0625	OutputCase=ENVE	CaseType=Combination	StepType=Min	Point=3	X2=0.5	X3=-0.5	
S11=-1790.98203035238	IsS11Max=No	IsS11Min=Yes	FrameElem=2	ElemStation=0.0625				
Frame=2	Station=0.0625	OutputCase=ENVE	CaseType=Combination	StepType=Min	Point=4	X2=0.5	X3=0.5	
S11=-1790.98203035238	IsS11Max=No	IsS11Min=No	FrameElem=2	ElemStation=0.0625				
Frame=2	Station=0.125	OutputCase=ENVE	CaseType=Combination	StepType=Min	Point=0	X2=0	X3=0	S11=-
386.541953115295	IsS11Max=No	IsS11Min=No	FrameElem=2	ElemStation=0.125				
Frame=2	Station=0.125	OutputCase=ENVE	CaseType=Combination	StepType=Min	Point=1	X2=-0.5	X3=-0.5	
S11=704.984301963174	IsS11Max=Yes	IsS11Min=No	FrameElem=2	ElemStation=0.125				
Frame=2	Station=0.125	OutputCase=ENVE	CaseType=Combination	StepType=Min	Point=2	X2=-0.5	X3=0.5	
S11=704.984301963174	IsS11Max=No	IsS11Min=No	FrameElem=2	ElemStation=0.125				
Frame=2	Station=0.125	OutputCase=ENVE	CaseType=Combination	StepType=Min	Point=3	X2=0.5	X3=-0.5	
S11=-1517.30993267211	IsS11Max=No	IsS11Min=Yes	FrameElem=2	ElemStation=0.125				
Frame=2	Station=0.125	OutputCase=ENVE	CaseType=Combination	StepType=Min	Point=4	X2=0.5	X3=0.5	
S11=-1517.30993267211	IsS11Max=No	IsS11Min=No	FrameElem=2	ElemStation=0.125				
Frame=2	Station=0.1875	OutputCase=ENVE	CaseType=Combination	StepType=Min	Point=0	X2=0	X3=0	S11=-
386.541953115295	IsS11Max=No	IsS11Min=No	FrameElem=2	ElemStation=0.1875				
Frame=2	Station=0.1875	OutputCase=ENVE	CaseType=Combination	StepType=Min	Point=1	X2=-0.5	X3=-0.5	
S11=430.776936313778	IsS11Max=Yes	IsS11Min=No	FrameElem=2	ElemStation=0.1875				
Frame=2	Station=0.1875	OutputCase=ENVE	CaseType=Combination	StepType=Min	Point=2	X2=-0.5	X3=0.5	
S11=430.776936313778	IsS11Max=No	IsS11Min=No	FrameElem=2	ElemStation=0.1875				
Frame=2	Station=0.1875	OutputCase=ENVE	CaseType=Combination	StepType=Min	Point=3	X2=0.5	X3=-0.5	
S11=-1243.05189749184	IsS11Max=No	IsS11Min=Yes	FrameElem=2	ElemStation=0.1875				
Frame=2	Station=0.1875	OutputCase=ENVE	CaseType=Combination	StepType=Min	Point=4	X2=0.5	X3=0.5	
S11=-1243.05189749184	IsS11Max=No	IsS11Min=No	FrameElem=2	ElemStation=0.1875				
Frame=2	Station=0.25	OutputCase=ENVE	CaseType=Combination	StepType=Min	Point=0	X2=0	X3=0	S11=-
386.541953115295	IsS11Max=No	IsS11Min=No	FrameElem=2	ElemStation=0.25				
Frame=2	Station=0.25	OutputCase=ENVE	CaseType=Combination	StepType=Min	Point=1	X2=-0.5	X3=-0.5	
S11=155.983633164383	IsS11Max=Yes	IsS11Min=No	FrameElem=2	ElemStation=0.25				
Frame=2	Station=0.25	OutputCase=ENVE	CaseType=Combination	StepType=Min	Point=2	X2=-0.5	X3=0.5	
S11=155.983633164383	IsS11Max=No	IsS11Min=No	FrameElem=2	ElemStation=0.25				
Frame=2	Station=0.25	OutputCase=ENVE	CaseType=Combination	StepType=Min	Point=3	X2=0.5	X3=-0.5	
S11=-968.207924811569	IsS11Max=No	IsS11Min=Yes	FrameElem=2	ElemStation=0.25				
Frame=2	Station=0.25	OutputCase=ENVE	CaseType=Combination	StepType=Min	Point=4	X2=0.5	X3=0.5	
S11=-968.207924811569	IsS11Max=No	IsS11Min=No	FrameElem=2	ElemStation=0.25				
Frame=2	Station=0	OutputCase=FESSUR	CaseType=Combination	Point=0	X2=0	X3=0	S11=-386.541953115295	
IsS11Max=No	IsS11Min=No	FrameElem=2	ElemStation=0					
Frame=2	Station=0	OutputCase=FESSUR	CaseType=Combination	Point=1	X2=-0.5	X3=-0.5		
S11=1290.98428430206	IsS11Max=Yes	IsS11Min=No	FrameElem=2	ElemStation=0				
Frame=2	Station=0	OutputCase=FESSUR	CaseType=Combination	Point=2	X2=-0.5	X3=0.5		
S11=1290.98428430206	IsS11Max=No	IsS11Min=No	FrameElem=2	ElemStation=0				
Frame=2	Station=0	OutputCase=FESSUR	CaseType=Combination	Point=3	X2=0.5	X3=-0.5	S11=-	
2064.06819053265	IsS11Max=No	IsS11Min=Yes	FrameElem=2	ElemStation=0				
Frame=2	Station=0	OutputCase=FESSUR	CaseType=Combination	Point=4	X2=0.5	X3=0.5	S11=-	
2064.06819053265	IsS11Max=No	IsS11Min=No	FrameElem=2	ElemStation=0				
Frame=2	Station=0.0625	OutputCase=FESSUR	CaseType=Combination	Point=0	X2=0	X3=0	S11=-	
386.541953115295	IsS11Max=No	IsS11Min=No	FrameElem=2	ElemStation=0.0625				
Frame=2	Station=0.0625	OutputCase=FESSUR	CaseType=Combination	Point=1	X2=-0.5	X3=-0.5		
S11=1017.89812412179	IsS11Max=Yes	IsS11Min=No	FrameElem=2	ElemStation=0.0625				
Frame=2	Station=0.0625	OutputCase=FESSUR	CaseType=Combination	Point=2	X2=-0.5	X3=0.5		
S11=1017.89812412179	IsS11Max=No	IsS11Min=No	FrameElem=2	ElemStation=0.0625				
Frame=2	Station=0.0625	OutputCase=FESSUR	CaseType=Combination	Point=3	X2=0.5	X3=-0.5	S11=-	
1790.98203035238	IsS11Max=No	IsS11Min=Yes	FrameElem=2	ElemStation=0.0625				
Frame=2	Station=0.0625	OutputCase=FESSUR	CaseType=Combination	Point=4	X2=0.5	X3=0.5	S11=-	
1790.98203035238	IsS11Max=No	IsS11Min=No	FrameElem=2	ElemStation=0.0625				
Frame=2	Station=0.125	OutputCase=FESSUR	CaseType=Combination	Point=0	X2=0	X3=0	S11=-	
386.541953115295	IsS11Max=No	IsS11Min=No	FrameElem=2	ElemStation=0.125				
Frame=2	Station=0.125	OutputCase=FESSUR	CaseType=Combination	Point=1	X2=-0.5	X3=-0.5		
S11=744.226026441522	IsS11Max=Yes	IsS11Min=No	FrameElem=2	ElemStation=0.125				
Frame=2	Station=0.125	OutputCase=FESSUR	CaseType=Combination	Point=2	X2=-0.5	X3=0.5		
S11=744.226026441522	IsS11Max=No	IsS11Min=No	FrameElem=2	ElemStation=0.125				
Frame=2	Station=0.125	OutputCase=FESSUR	CaseType=Combination	Point=3	X2=0.5	X3=-0.5	S11=-	
1517.30993267211	IsS11Max=No	IsS11Min=Yes	FrameElem=2	ElemStation=0.125				

Frame=2	Station=0.125	OutputCase=FESSUR	CaseType=Combination	Point=4	X2=0.5	X3=0.5	S11=-
1517.30993267211	IsS11Max=No	IsS11Min=No	FrameElem=2	ElemStation=0.125			
Frame=2	Station=0.1875	OutputCase=FESSUR	CaseType=Combination	Point=0	X2=0	X3=0	S11=-
386.541953115295	IsS11Max=No	IsS11Min=No	FrameElem=2	ElemStation=0.1875			
Frame=2	Station=0.1875	OutputCase=FESSUR	CaseType=Combination	Point=1	X2=-0.5	X3=-0.5	
S11=469.967991261251	IsS11Max=Yes	IsS11Min=No	FrameElem=2	ElemStation=0.1875			
Frame=2	Station=0.1875	OutputCase=FESSUR	CaseType=Combination	Point=2	X2=-0.5	X3=0.5	
S11=469.967991261251	IsS11Max=No	IsS11Min=No	FrameElem=2	ElemStation=0.1875			
Frame=2	Station=0.1875	OutputCase=FESSUR	CaseType=Combination	Point=3	X2=0.5	X3=-0.5	S11=-
1243.05189749184	IsS11Max=No	IsS11Min=Yes	FrameElem=2	ElemStation=0.1875			
Frame=2	Station=0.1875	OutputCase=FESSUR	CaseType=Combination	Point=4	X2=0.5	X3=0.5	S11=-
1243.05189749184	IsS11Max=No	IsS11Min=No	FrameElem=2	ElemStation=0.1875			
Frame=2	Station=0.25	OutputCase=FESSUR	CaseType=Combination	Point=0	X2=0	X3=0	S11=-386.541953115295
IsS11Max=No	IsS11Min=No	FrameElem=2	ElemStation=0.25				
Frame=2	Station=0.25	OutputCase=FESSUR	CaseType=Combination	Point=1	X2=-0.5	X3=-0.5	
S11=195.12401858098	IsS11Max=Yes	IsS11Min=No	FrameElem=2	ElemStation=0.25			
Frame=2	Station=0.25	OutputCase=FESSUR	CaseType=Combination	Point=2	X2=-0.5	X3=0.5	
S11=195.12401858098	IsS11Max=No	IsS11Min=No	FrameElem=2	ElemStation=0.25			
Frame=2	Station=0.25	OutputCase=FESSUR	CaseType=Combination	Point=3	X2=0.5	X3=-0.5	S11=-
968.207924811569	IsS11Max=No	IsS11Min=Yes	FrameElem=2	ElemStation=0.25			
Frame=2	Station=0.25	OutputCase=FESSUR	CaseType=Combination	Point=4	X2=0.5	X3=0.5	S11=-
968.207924811569	IsS11Max=No	IsS11Min=No	FrameElem=2	ElemStation=0.25			
Frame=4	Station=0	OutputCase=PESOPR	CaseType=LinStatic	Point=0	X2=0	X3=0	S11=-15.1709467361871
IsS11Max=No	IsS11Min=No	FrameElem=4	ElemStation=0				
Frame=4	Station=0	OutputCase=PESOPR	CaseType=LinStatic	Point=1	X2=-0.5	X3=-0.5	S11=37.7162757594486
IsS11Max=Yes	IsS11Min=No	FrameElem=4	ElemStation=0				
Frame=4	Station=0	OutputCase=PESOPR	CaseType=LinStatic	Point=2	X2=-0.5	X3=0.5	S11=37.7162757594486
IsS11Max=No	IsS11Min=No	FrameElem=4	ElemStation=0				
Frame=4	Station=0	OutputCase=PESOPR	CaseType=LinStatic	Point=3	X2=0.5	X3=-0.5	S11=-68.0581692318229
IsS11Max=No	IsS11Min=Yes	FrameElem=4	ElemStation=0				
Frame=4	Station=0	OutputCase=PESOPR	CaseType=LinStatic	Point=4	X2=0.5	X3=0.5	S11=-68.0581692318229
IsS11Max=No	IsS11Min=No	FrameElem=4	ElemStation=0				
Frame=4	Station=0.0625	OutputCase=PESOPR	CaseType=LinStatic	Point=0	X2=0	X3=0	S11=-15.1709467361871
IsS11Max=No	IsS11Min=No	FrameElem=4	ElemStation=0.0625				
Frame=4	Station=0.0625	OutputCase=PESOPR	CaseType=LinStatic	Point=1	X2=-0.5	X3=-0.5	
S11=90.1935979408771	IsS11Max=Yes	IsS11Min=No	FrameElem=4	ElemStation=0.0625			
Frame=4	Station=0.0625	OutputCase=PESOPR	CaseType=LinStatic	Point=2	X2=-0.5	X3=0.5	
S11=90.1935979408771	IsS11Max=No	IsS11Min=No	FrameElem=4	ElemStation=0.0625			
Frame=4	Station=0.0625	OutputCase=PESOPR	CaseType=LinStatic	Point=3	X2=0.5	X3=-0.5	S11=-
120.535491413251	IsS11Max=No	IsS11Min=Yes	FrameElem=4	ElemStation=0.0625			
Frame=4	Station=0.0625	OutputCase=PESOPR	CaseType=LinStatic	Point=4	X2=0.5	X3=0.5	S11=-
120.535491413251	IsS11Max=No	IsS11Min=No	FrameElem=4	ElemStation=0.0625			
Frame=4	Station=0.125	OutputCase=PESOPR	CaseType=LinStatic	Point=0	X2=0	X3=0	S11=-15.1709467361871
IsS11Max=No	IsS11Min=No	FrameElem=4	ElemStation=0.125				
Frame=4	Station=0.125	OutputCase=PESOPR	CaseType=LinStatic	Point=1	X2=-0.5	X3=-0.5	
S11=142.084982622306	IsS11Max=Yes	IsS11Min=No	FrameElem=4	ElemStation=0.125			
Frame=4	Station=0.125	OutputCase=PESOPR	CaseType=LinStatic	Point=2	X2=-0.5	X3=0.5	
S11=142.084982622306	IsS11Max=No	IsS11Min=No	FrameElem=4	ElemStation=0.125			
Frame=4	Station=0.125	OutputCase=PESOPR	CaseType=LinStatic	Point=3	X2=0.5	X3=-0.5	S11=-
172.42687609468	IsS11Max=No	IsS11Min=Yes	FrameElem=4	ElemStation=0.125			
Frame=4	Station=0.125	OutputCase=PESOPR	CaseType=LinStatic	Point=4	X2=0.5	X3=0.5	S11=-
172.42687609468	IsS11Max=No	IsS11Min=No	FrameElem=4	ElemStation=0.125			
Frame=4	Station=0.1875	OutputCase=PESOPR	CaseType=LinStatic	Point=0	X2=0	X3=0	S11=-15.1709467361871
IsS11Max=No	IsS11Min=No	FrameElem=4	ElemStation=0.1875				
Frame=4	Station=0.1875	OutputCase=PESOPR	CaseType=LinStatic	Point=1	X2=-0.5	X3=-0.5	
S11=193.390429803734	IsS11Max=Yes	IsS11Min=No	FrameElem=4	ElemStation=0.1875			
Frame=4	Station=0.1875	OutputCase=PESOPR	CaseType=LinStatic	Point=2	X2=-0.5	X3=0.5	
S11=193.390429803734	IsS11Max=No	IsS11Min=No	FrameElem=4	ElemStation=0.1875			
Frame=4	Station=0.1875	OutputCase=PESOPR	CaseType=LinStatic	Point=3	X2=0.5	X3=-0.5	S11=-
223.732323276108	IsS11Max=No	IsS11Min=Yes	FrameElem=4	ElemStation=0.1875			
Frame=4	Station=0.1875	OutputCase=PESOPR	CaseType=LinStatic	Point=4	X2=0.5	X3=0.5	S11=-
223.732323276108	IsS11Max=No	IsS11Min=No	FrameElem=4	ElemStation=0.1875			
Frame=4	Station=0.25	OutputCase=PESOPR	CaseType=LinStatic	Point=0	X2=0	X3=0	S11=-15.1709467361871
IsS11Max=No	IsS11Min=No	FrameElem=4	ElemStation=0.25				
Frame=4	Station=0.25	OutputCase=PESOPR	CaseType=LinStatic	Point=1	X2=-0.5	X3=-0.5	
S11=244.109939485162	IsS11Max=Yes	IsS11Min=No	FrameElem=4	ElemStation=0.25			
Frame=4	Station=0.25	OutputCase=PESOPR	CaseType=LinStatic	Point=2	X2=-0.5	X3=0.5	
S11=244.109939485162	IsS11Max=No	IsS11Min=No	FrameElem=4	ElemStation=0.25			
Frame=4	Station=0.25	OutputCase=PESOPR	CaseType=LinStatic	Point=3	X2=0.5	X3=-0.5	S11=-
274.451832957537	IsS11Max=No	IsS11Min=Yes	FrameElem=4	ElemStation=0.25			
Frame=4	Station=0.25	OutputCase=PESOPR	CaseType=LinStatic	Point=4	X2=0.5	X3=0.5	S11=-
274.451832957537	IsS11Max=No	IsS11Min=No	FrameElem=4	ElemStation=0.25			
Frame=4	Station=0	OutputCase=TERRVERT	CaseType=LinStatic	Point=0	X2=0	X3=0	S11=1.64270738195066
IsS11Max=No	IsS11Min=No	FrameElem=4	ElemStation=0				
Frame=4	Station=0	OutputCase=TERRVERT	CaseType=LinStatic	Point=1	X2=-0.5	X3=-0.5	
S11=26.9397997431808	IsS11Max=Yes	IsS11Min=No	FrameElem=4	ElemStation=0			
Frame=4	Station=0	OutputCase=TERRVERT	CaseType=LinStatic	Point=2	X2=-0.5	X3=0.5	
S11=26.9397997431808	IsS11Max=No	IsS11Min=No	FrameElem=4	ElemStation=0			
Frame=4	Station=0	OutputCase=TERRVERT	CaseType=LinStatic	Point=3	X2=0.5	X3=-0.5	S11=-
23.6543849792795	IsS11Max=No	IsS11Min=Yes	FrameElem=4	ElemStation=0			
Frame=4	Station=0	OutputCase=TERRVERT	CaseType=LinStatic	Point=4	X2=0.5	X3=0.5	S11=-
23.6543849792795	IsS11Max=No	IsS11Min=No	FrameElem=4	ElemStation=0			



Frame=4	Station=0.0625	OutputCase=TERRVERT	CaseType=LinStatic	Point=0	X2=0	X3=0			
S11=1.64270738195066	IsS11Max=No	IsS11Min=No	FrameElem=4	ElemStation=0.0625					
Frame=4	Station=0.0625	OutputCase=TERRVERT	CaseType=LinStatic	Point=1	X2=-0.5	X3=-0.5			
S11=249.137551894208	IsS11Max=Yes	IsS11Min=No	FrameElem=4	ElemStation=0.0625					
Frame=4	Station=0.0625	OutputCase=TERRVERT	CaseType=LinStatic	Point=2	X2=-0.5	X3=0.5			
S11=249.137551894208	IsS11Max=No	IsS11Min=No	FrameElem=4	ElemStation=0.0625					
Frame=4	Station=0.0625	OutputCase=TERRVERT	CaseType=LinStatic	Point=3	X2=0.5	X3=-0.5	S11=-		
245.852137130307	IsS11Max=No	IsS11Min=Yes	FrameElem=4	ElemStation=0.0625					
Frame=4	Station=0.0625	OutputCase=TERRVERT	CaseType=LinStatic	Point=4	X2=0.5	X3=0.5	S11=-		
245.852137130307	IsS11Max=No	IsS11Min=No	FrameElem=4	ElemStation=0.0625					
Frame=4	Station=0.125	OutputCase=TERRVERT	CaseType=LinStatic	Point=0	X2=0	X3=0	S11=1.64270738195066		
IsS11Max=No	IsS11Min=No	FrameElem=4	ElemStation=0.125						
Frame=4	Station=0.125	OutputCase=TERRVERT	CaseType=LinStatic	Point=1	X2=-0.5	X3=-0.5			
S11=471.335304045235	IsS11Max=Yes	IsS11Min=No	FrameElem=4	ElemStation=0.125					
Frame=4	Station=0.125	OutputCase=TERRVERT	CaseType=LinStatic	Point=2	X2=-0.5	X3=0.5			
S11=471.335304045235	IsS11Max=No	IsS11Min=No	FrameElem=4	ElemStation=0.125					
Frame=4	Station=0.125	OutputCase=TERRVERT	CaseType=LinStatic	Point=3	X2=0.5	X3=-0.5	S11=-		
468.049889281334	IsS11Max=No	IsS11Min=Yes	FrameElem=4	ElemStation=0.125					
Frame=4	Station=0.125	OutputCase=TERRVERT	CaseType=LinStatic	Point=4	X2=0.5	X3=0.5	S11=-		
468.049889281334	IsS11Max=No	IsS11Min=No	FrameElem=4	ElemStation=0.125					
Frame=4	Station=0.1875	OutputCase=TERRVERT	CaseType=LinStatic	Point=0	X2=0	X3=0			
S11=1.64270738195066	IsS11Max=No	IsS11Min=No	FrameElem=4	ElemStation=0.1875					
Frame=4	Station=0.1875	OutputCase=TERRVERT	CaseType=LinStatic	Point=1	X2=-0.5	X3=-0.5			
S11=693.533056196262	IsS11Max=Yes	IsS11Min=No	FrameElem=4	ElemStation=0.1875					
Frame=4	Station=0.1875	OutputCase=TERRVERT	CaseType=LinStatic	Point=2	X2=-0.5	X3=0.5			
S11=693.533056196262	IsS11Max=No	IsS11Min=No	FrameElem=4	ElemStation=0.1875					
Frame=4	Station=0.1875	OutputCase=TERRVERT	CaseType=LinStatic	Point=3	X2=0.5	X3=-0.5	S11=-		
690.247641432361	IsS11Max=No	IsS11Min=Yes	FrameElem=4	ElemStation=0.1875					
Frame=4	Station=0.1875	OutputCase=TERRVERT	CaseType=LinStatic	Point=4	X2=0.5	X3=0.5	S11=-		
690.247641432361	IsS11Max=No	IsS11Min=No	FrameElem=4	ElemStation=0.1875					
Frame=4	Station=0.25	OutputCase=TERRVERT	CaseType=LinStatic	Point=0	X2=0	X3=0	S11=1.64270738195066		
IsS11Max=No	IsS11Min=No	FrameElem=4	ElemStation=0.25						
Frame=4	Station=0.25	OutputCase=TERRVERT	CaseType=LinStatic	Point=1	X2=-0.5	X3=-0.5			
S11=915.730808347289	IsS11Max=Yes	IsS11Min=No	FrameElem=4	ElemStation=0.25					
Frame=4	Station=0.25	OutputCase=TERRVERT	CaseType=LinStatic	Point=2	X2=-0.5	X3=0.5			
S11=915.730808347289	IsS11Max=No	IsS11Min=No	FrameElem=4	ElemStation=0.25					
Frame=4	Station=0.25	OutputCase=TERRVERT	CaseType=LinStatic	Point=3	X2=0.5	X3=-0.5	S11=-		
912.445393583388	IsS11Max=No	IsS11Min=Yes	FrameElem=4	ElemStation=0.25					
Frame=4	Station=0.25	OutputCase=TERRVERT	CaseType=LinStatic	Point=4	X2=0.5	X3=0.5	S11=-		
912.445393583388	IsS11Max=No	IsS11Min=No	FrameElem=4	ElemStation=0.25					
Frame=4	Station=0	OutputCase=TERRLAT	CaseType=LinStatic	Point=0	X2=0	X3=0	S11=-373.013713761059		
IsS11Max=No	IsS11Min=No	FrameElem=4	ElemStation=0						
Frame=4	Station=0	OutputCase=TERRLAT	CaseType=LinStatic	Point=1	X2=-0.5	X3=-0.5			
S11=130.467910881253	IsS11Max=Yes	IsS11Min=No	FrameElem=4	ElemStation=0					
Frame=4	Station=0	OutputCase=TERRLAT	CaseType=LinStatic	Point=2	X2=-0.5	X3=0.5	S11=130.467910881253		
IsS11Max=No	IsS11Min=No	FrameElem=4	ElemStation=0						
Frame=4	Station=0	OutputCase=TERRLAT	CaseType=LinStatic	Point=3	X2=0.5	X3=-0.5	S11=-		
876.495338403371	IsS11Max=No	IsS11Min=Yes	FrameElem=4	ElemStation=0					
Frame=4	Station=0	OutputCase=TERRLAT	CaseType=LinStatic	Point=4	X2=0.5	X3=0.5	S11=-876.495338403371		
IsS11Max=No	IsS11Min=No	FrameElem=4	ElemStation=0						
Frame=4	Station=0.0625	OutputCase=TERRLAT	CaseType=LinStatic	Point=0	X2=0	X3=0	S11=-		
373.013713761059	IsS11Max=No	IsS11Min=No	FrameElem=4	ElemStation=0.0625					
Frame=4	Station=0.0625	OutputCase=TERRLAT	CaseType=LinStatic	Point=1	X2=-0.5	X3=-0.5			
S11=130.636809695511	IsS11Max=Yes	IsS11Min=No	FrameElem=4	ElemStation=0.0625					
Frame=4	Station=0.0625	OutputCase=TERRLAT	CaseType=LinStatic	Point=2	X2=-0.5	X3=0.5			
S11=130.636809695511	IsS11Max=No	IsS11Min=No	FrameElem=4	ElemStation=0.0625					
Frame=4	Station=0.0625	OutputCase=TERRLAT	CaseType=LinStatic	Point=3	X2=0.5	X3=-0.5	S11=-		
876.664237217629	IsS11Max=No	IsS11Min=Yes	FrameElem=4	ElemStation=0.0625					
Frame=4	Station=0.0625	OutputCase=TERRLAT	CaseType=LinStatic	Point=4	X2=0.5	X3=0.5	S11=-		
876.664237217629	IsS11Max=No	IsS11Min=No	FrameElem=4	ElemStation=0.0625					
Frame=4	Station=0.125	OutputCase=TERRLAT	CaseType=LinStatic	Point=0	X2=0	X3=0	S11=-373.013713761059		
IsS11Max=No	IsS11Min=No	FrameElem=4	ElemStation=0.125						
Frame=4	Station=0.125	OutputCase=TERRLAT	CaseType=LinStatic	Point=1	X2=-0.5	X3=-0.5			
S11=130.805708509768	IsS11Max=Yes	IsS11Min=No	FrameElem=4	ElemStation=0.125					
Frame=4	Station=0.125	OutputCase=TERRLAT	CaseType=LinStatic	Point=2	X2=-0.5	X3=0.5			
S11=130.805708509768	IsS11Max=No	IsS11Min=No	FrameElem=4	ElemStation=0.125					
Frame=4	Station=0.125	OutputCase=TERRLAT	CaseType=LinStatic	Point=3	X2=0.5	X3=-0.5	S11=-		
876.833136031886	IsS11Max=No	IsS11Min=Yes	FrameElem=4	ElemStation=0.125					
Frame=4	Station=0.125	OutputCase=TERRLAT	CaseType=LinStatic	Point=4	X2=0.5	X3=0.5	S11=-		
876.833136031886	IsS11Max=No	IsS11Min=No	FrameElem=4	ElemStation=0.125					
Frame=4	Station=0.1875	OutputCase=TERRLAT	CaseType=LinStatic	Point=0	X2=0	X3=0	S11=-		
373.013713761059	IsS11Max=No	IsS11Min=No	FrameElem=4	ElemStation=0.1875					
Frame=4	Station=0.1875	OutputCase=TERRLAT	CaseType=LinStatic	Point=1	X2=-0.5	X3=-0.5			
S11=130.974607324026	IsS11Max=Yes	IsS11Min=No	FrameElem=4	ElemStation=0.1875					
Frame=4	Station=0.1875	OutputCase=TERRLAT	CaseType=LinStatic	Point=2	X2=-0.5	X3=0.5			
S11=130.974607324026	IsS11Max=No	IsS11Min=No	FrameElem=4	ElemStation=0.1875					
Frame=4	Station=0.1875	OutputCase=TERRLAT	CaseType=LinStatic	Point=3	X2=0.5	X3=-0.5	S11=-		
877.002034846144	IsS11Max=No	IsS11Min=Yes	FrameElem=4	ElemStation=0.1875					
Frame=4	Station=0.1875	OutputCase=TERRLAT	CaseType=LinStatic	Point=4	X2=0.5	X3=0.5	S11=-		
877.002034846144	IsS11Max=No	IsS11Min=No	FrameElem=4	ElemStation=0.1875					
Frame=4	Station=0.25	OutputCase=TERRLAT	CaseType=LinStatic	Point=0	X2=0	X3=0	S11=-373.013713761059		
IsS11Max=No	IsS11Min=No	FrameElem=4	ElemStation=0.25						



Frame=4	Station=0.1875	OutputCase=SOVRCOST	CaseType=LinStatic	Point=4	X2=0.5	X3=0.5	S11=0
IsS11Max=No	IsS11Min=No	FrameElem=4	ElemStation=0.1875				
Frame=4	Station=0.25	OutputCase=SOVRCOST	CaseType=LinStatic	Point=0	X2=0	X3=0	S11=0
IsS11Min=Yes	FrameElem=4	ElemStation=0.25					IsS11Max=Yes
Frame=4	Station=0.25	OutputCase=SOVRCOST	CaseType=LinStatic	Point=1	X2=-0.5	X3=-0.5	S11=0
IsS11Max=No	IsS11Min=No	FrameElem=4	ElemStation=0.25				
Frame=4	Station=0.25	OutputCase=SOVRCOST	CaseType=LinStatic	Point=2	X2=-0.5	X3=0.5	S11=0
IsS11Max=No	IsS11Min=No	FrameElem=4	ElemStation=0.25				
Frame=4	Station=0.25	OutputCase=SOVRCOST	CaseType=LinStatic	Point=3	X2=0.5	X3=-0.5	S11=0
IsS11Max=No	IsS11Min=No	FrameElem=4	ElemStation=0.25				
Frame=4	Station=0.25	OutputCase=SOVRCOST	CaseType=LinStatic	Point=4	X2=0.5	X3=0.5	S11=0
IsS11Max=No	IsS11Min=No	FrameElem=4	ElemStation=0.25				
Frame=4	Station=0	OutputCase=ENVE	CaseType=Combination	StepType=Max	Point=0	X2=0	X3=0
274.637838986978	IsS11Max=No	IsS11Min=No	FrameElem=4	ElemStation=0			S11=-
Frame=4	Station=0	OutputCase=ENVE	CaseType=Combination	StepType=Max	Point=1	X2=-0.5	X3=-0.5
S11=195.123986383883	IsS11Max=Yes	IsS11Min=No	FrameElem=4	ElemStation=0			
Frame=4	Station=0	OutputCase=ENVE	CaseType=Combination	StepType=Max	Point=2	X2=-0.5	X3=0.5
S11=195.123986383883	IsS11Max=No	IsS11Min=No	FrameElem=4	ElemStation=0			
Frame=4	Station=0	OutputCase=ENVE	CaseType=Combination	StepType=Max	Point=3	X2=0.5	X3=-0.5
705.259291093462	IsS11Max=No	IsS11Min=Yes	FrameElem=4	ElemStation=0			S11=-
Frame=4	Station=0	OutputCase=ENVE	CaseType=Combination	StepType=Max	Point=4	X2=0.5	X3=0.5
705.259291093462	IsS11Max=No	IsS11Min=No	FrameElem=4	ElemStation=0			S11=-
Frame=4	Station=0.0625	OutputCase=ENVE	CaseType=Combination	StepType=Max	Point=0	X2=0	X3=0
274.637838986978	IsS11Max=No	IsS11Min=No	FrameElem=4	ElemStation=0.0625			S11=-
Frame=4	Station=0.0625	OutputCase=ENVE	CaseType=Combination	StepType=Max	Point=1	X2=-0.5	X3=-0.5
S11=469.967959530596	IsS11Max=Yes	IsS11Min=No	FrameElem=4	ElemStation=0.0625			
Frame=4	Station=0.0625	OutputCase=ENVE	CaseType=Combination	StepType=Max	Point=2	X2=-0.5	X3=0.5
S11=469.967959530596	IsS11Max=No	IsS11Min=No	FrameElem=4	ElemStation=0.0625			
Frame=4	Station=0.0625	OutputCase=ENVE	CaseType=Combination	StepType=Max	Point=3	X2=0.5	X3=-0.5
S11=-980.052594595898	IsS11Max=No	IsS11Min=Yes	FrameElem=4	ElemStation=0.0625			
Frame=4	Station=0.0625	OutputCase=ENVE	CaseType=Combination	StepType=Max	Point=4	X2=0.5	X3=0.5
S11=-980.052594595898	IsS11Max=No	IsS11Min=No	FrameElem=4	ElemStation=0.0625			
Frame=4	Station=0.125	OutputCase=ENVE	CaseType=Combination	StepType=Max	Point=0	X2=0	X3=0
274.637838986978	IsS11Max=No	IsS11Min=No	FrameElem=4	ElemStation=0.125			S11=-
Frame=4	Station=0.125	OutputCase=ENVE	CaseType=Combination	StepType=Max	Point=1	X2=-0.5	X3=-0.5
S11=744.225995177309	IsS11Max=Yes	IsS11Min=No	FrameElem=4	ElemStation=0.125			
Frame=4	Station=0.125	OutputCase=ENVE	CaseType=Combination	StepType=Max	Point=2	X2=-0.5	X3=0.5
S11=744.225995177309	IsS11Max=No	IsS11Min=No	FrameElem=4	ElemStation=0.125			
Frame=4	Station=0.125	OutputCase=ENVE	CaseType=Combination	StepType=Max	Point=3	X2=0.5	X3=-0.5
S11=-1254.25996059833	IsS11Max=No	IsS11Min=Yes	FrameElem=4	ElemStation=0.125			
Frame=4	Station=0.125	OutputCase=ENVE	CaseType=Combination	StepType=Max	Point=4	X2=0.5	X3=0.5
S11=-1254.25996059833	IsS11Max=No	IsS11Min=No	FrameElem=4	ElemStation=0.125			
Frame=4	Station=0.1875	OutputCase=ENVE	CaseType=Combination	StepType=Max	Point=0	X2=0	X3=0
274.637838986978	IsS11Max=No	IsS11Min=No	FrameElem=4	ElemStation=0.1875			S11=-
Frame=4	Station=0.1875	OutputCase=ENVE	CaseType=Combination	StepType=Max	Point=1	X2=-0.5	X3=-0.5
S11=1017.89809332402	IsS11Max=Yes	IsS11Min=No	FrameElem=4	ElemStation=0.1875			
Frame=4	Station=0.1875	OutputCase=ENVE	CaseType=Combination	StepType=Max	Point=2	X2=-0.5	X3=0.5
S11=1017.89809332402	IsS11Max=No	IsS11Min=No	FrameElem=4	ElemStation=0.1875			
Frame=4	Station=0.1875	OutputCase=ENVE	CaseType=Combination	StepType=Max	Point=3	X2=0.5	X3=-0.5
S11=-1527.88138910077	IsS11Max=No	IsS11Min=Yes	FrameElem=4	ElemStation=0.1875			
Frame=4	Station=0.1875	OutputCase=ENVE	CaseType=Combination	StepType=Max	Point=4	X2=0.5	X3=0.5
S11=-1527.88138910077	IsS11Max=No	IsS11Min=No	FrameElem=4	ElemStation=0.1875			
Frame=4	Station=0.25	OutputCase=ENVE	CaseType=Combination	StepType=Max	Point=0	X2=0	X3=0
274.637838986978	IsS11Max=No	IsS11Min=No	FrameElem=4	ElemStation=0.25			S11=-
Frame=4	Station=0.25	OutputCase=ENVE	CaseType=Combination	StepType=Max	Point=1	X2=-0.5	X3=-0.5
S11=1290.98425397074	IsS11Max=Yes	IsS11Min=No	FrameElem=4	ElemStation=0.25			
Frame=4	Station=0.25	OutputCase=ENVE	CaseType=Combination	StepType=Max	Point=2	X2=-0.5	X3=0.5
S11=1290.98425397074	IsS11Max=No	IsS11Min=No	FrameElem=4	ElemStation=0.25			
Frame=4	Station=0.25	OutputCase=ENVE	CaseType=Combination	StepType=Max	Point=3	X2=0.5	X3=-0.5
S11=-1800.91688010321	IsS11Max=No	IsS11Min=Yes	FrameElem=4	ElemStation=0.25			
Frame=4	Station=0.25	OutputCase=ENVE	CaseType=Combination	StepType=Max	Point=4	X2=0.5	X3=0.5
S11=-1800.91688010321	IsS11Max=No	IsS11Min=No	FrameElem=4	ElemStation=0.25			
Frame=4	Station=0	OutputCase=ENVE	CaseType=Combination	StepType=Min	Point=0	X2=0	X3=0
386.541953115296	IsS11Max=No	IsS11Min=No	FrameElem=4	ElemStation=0			S11=-
Frame=4	Station=0	OutputCase=ENVE	CaseType=Combination	StepType=Min	Point=1	X2=-0.5	X3=-0.5
S11=155.983613119507	IsS11Max=Yes	IsS11Min=No	FrameElem=4	ElemStation=0			
Frame=4	Station=0	OutputCase=ENVE	CaseType=Combination	StepType=Min	Point=2	X2=-0.5	X3=0.5
S11=155.983613119507	IsS11Max=No	IsS11Min=No	FrameElem=4	ElemStation=0			
Frame=4	Station=0	OutputCase=ENVE	CaseType=Combination	StepType=Min	Point=3	X2=0.5	X3=-0.5
968.207892614474	IsS11Max=No	IsS11Min=Yes	FrameElem=4	ElemStation=0			S11=-
Frame=4	Station=0	OutputCase=ENVE	CaseType=Combination	StepType=Min	Point=4	X2=0.5	X3=0.5
968.207892614474	IsS11Max=No	IsS11Min=No	FrameElem=4	ElemStation=0			
Frame=4	Station=0.0625	OutputCase=ENVE	CaseType=Combination	StepType=Min	Point=0	X2=0	X3=0
386.541953115296	IsS11Max=No	IsS11Min=No	FrameElem=4	ElemStation=0.0625			S11=-
Frame=4	Station=0.0625	OutputCase=ENVE	CaseType=Combination	StepType=Min	Point=1	X2=-0.5	X3=-0.5
S11=430.776916621943	IsS11Max=Yes	IsS11Min=No	FrameElem=4	ElemStation=0.0625			
Frame=4	Station=0.0625	OutputCase=ENVE	CaseType=Combination	StepType=Min	Point=2	X2=-0.5	X3=0.5
S11=430.776916621943	IsS11Max=No	IsS11Min=No	FrameElem=4	ElemStation=0.0625			
Frame=4	Station=0.0625	OutputCase=ENVE	CaseType=Combination	StepType=Min	Point=3	X2=0.5	X3=-0.5
S11=-1243.05186576119	IsS11Max=No	IsS11Min=Yes	FrameElem=4	ElemStation=0.0625			
Frame=4	Station=0.0625	OutputCase=ENVE	CaseType=Combination	StepType=Min	Point=4	X2=0.5	X3=0.5
S11=-1243.05186576119	IsS11Max=No	IsS11Min=No	FrameElem=4	ElemStation=0.0625			

Frame=4	Station=0.125	OutputCase=ENVE	CaseType=Combination	StepType=Min	Point=0	X2=0	X3=0	S11=-
386.541953115296	IsS11Max=No	IsS11Min=No	FrameElem=4	ElemStation=0.125				
Frame=4	Station=0.125	OutputCase=ENVE	CaseType=Combination	StepType=Min	Point=1	X2=-0.5	X3=-0.5	
S11=704.984282624378	IsS11Max=Yes	IsS11Min=No	FrameElem=4	ElemStation=0.125				
Frame=4	Station=0.125	OutputCase=ENVE	CaseType=Combination	StepType=Min	Point=2	X2=-0.5	X3=0.5	
S11=704.984282624378	IsS11Max=No	IsS11Min=No	FrameElem=4	ElemStation=0.125				
Frame=4	Station=0.125	OutputCase=ENVE	CaseType=Combination	StepType=Min	Point=3	X2=0.5	X3=-0.5	
S11=-1517.3099014079	IsS11Max=No	IsS11Min=Yes	FrameElem=4	ElemStation=0.125				
Frame=4	Station=0.125	OutputCase=ENVE	CaseType=Combination	StepType=Min	Point=4	X2=0.5	X3=0.5	
S11=-1517.3099014079	IsS11Max=No	IsS11Min=No	FrameElem=4	ElemStation=0.125				
Frame=4	Station=0.1875	OutputCase=ENVE	CaseType=Combination	StepType=Min	Point=0	X2=0	X3=0	S11=-
386.541953115296	IsS11Max=No	IsS11Min=No	FrameElem=4	ElemStation=0.1875				
Frame=4	Station=0.1875	OutputCase=ENVE	CaseType=Combination	StepType=Min	Point=1	X2=-0.5	X3=-0.5	
S11=978.605711126814	IsS11Max=Yes	IsS11Min=No	FrameElem=4	ElemStation=0.1875				
Frame=4	Station=0.1875	OutputCase=ENVE	CaseType=Combination	StepType=Min	Point=2	X2=-0.5	X3=0.5	
S11=978.605711126814	IsS11Max=No	IsS11Min=No	FrameElem=4	ElemStation=0.1875				
Frame=4	Station=0.1875	OutputCase=ENVE	CaseType=Combination	StepType=Min	Point=3	X2=0.5	X3=-0.5	
S11=-1790.98199955461	IsS11Max=No	IsS11Min=Yes	FrameElem=4	ElemStation=0.1875				
Frame=4	Station=0.1875	OutputCase=ENVE	CaseType=Combination	StepType=Min	Point=4	X2=0.5	X3=0.5	
S11=-1790.98199955461	IsS11Max=No	IsS11Min=No	FrameElem=4	ElemStation=0.1875				
Frame=4	Station=0.25	OutputCase=ENVE	CaseType=Combination	StepType=Min	Point=0	X2=0	X3=0	S11=-
386.541953115296	IsS11Max=No	IsS11Min=No	FrameElem=4	ElemStation=0.25				
Frame=4	Station=0.25	OutputCase=ENVE	CaseType=Combination	StepType=Min	Point=1	X2=-0.5	X3=-0.5	
S11=1251.64120212925	IsS11Max=Yes	IsS11Min=No	FrameElem=4	ElemStation=0.25				
Frame=4	Station=0.25	OutputCase=ENVE	CaseType=Combination	StepType=Min	Point=2	X2=-0.5	X3=0.5	
S11=1251.64120212925	IsS11Max=No	IsS11Min=No	FrameElem=4	ElemStation=0.25				
Frame=4	Station=0.25	OutputCase=ENVE	CaseType=Combination	StepType=Min	Point=3	X2=0.5	X3=-0.5	
S11=-2064.06816020133	IsS11Max=No	IsS11Min=Yes	FrameElem=4	ElemStation=0.25				
Frame=4	Station=0.25	OutputCase=ENVE	CaseType=Combination	StepType=Min	Point=4	X2=0.5	X3=0.5	
S11=-2064.06816020133	IsS11Max=No	IsS11Min=No	FrameElem=4	ElemStation=0.25				
Frame=4	Station=0	OutputCase=FESSUR	CaseType=Combination	Point=0	X2=0	X3=0	S11=-386.541953115296	
IsS11Max=No	IsS11Min=No	FrameElem=4	ElemStation=0					
Frame=4	Station=0	OutputCase=FESSUR	CaseType=Combination	Point=1	X2=-0.5	X3=-0.5		
S11=195.123986383883	IsS11Max=Yes	IsS11Min=No	FrameElem=4	ElemStation=0				
Frame=4	Station=0	OutputCase=FESSUR	CaseType=Combination	Point=2	X2=-0.5	X3=0.5		
S11=195.123986383883	IsS11Max=No	IsS11Min=No	FrameElem=4	ElemStation=0				
Frame=4	Station=0	OutputCase=FESSUR	CaseType=Combination	Point=3	X2=0.5	X3=-0.5	S11=-	
968.207892614474	IsS11Max=No	IsS11Min=Yes	FrameElem=4	ElemStation=0				
Frame=4	Station=0	OutputCase=FESSUR	CaseType=Combination	Point=4	X2=0.5	X3=0.5	S11=-	
968.207892614474	IsS11Max=No	IsS11Min=No	FrameElem=4	ElemStation=0				
Frame=4	Station=0.0625	OutputCase=FESSUR	CaseType=Combination	Point=0	X2=0	X3=0	S11=-	
386.541953115296	IsS11Max=No	IsS11Min=No	FrameElem=4	ElemStation=0.0625				
Frame=4	Station=0.0625	OutputCase=FESSUR	CaseType=Combination	Point=1	X2=-0.5	X3=-0.5		
S11=469.967959530596	IsS11Max=Yes	IsS11Min=No	FrameElem=4	ElemStation=0.0625				
Frame=4	Station=0.0625	OutputCase=FESSUR	CaseType=Combination	Point=2	X2=-0.5	X3=0.5		
S11=469.967959530596	IsS11Max=No	IsS11Min=No	FrameElem=4	ElemStation=0.0625				
Frame=4	Station=0.0625	OutputCase=FESSUR	CaseType=Combination	Point=3	X2=0.5	X3=-0.5	S11=-	
1243.05186576119	IsS11Max=No	IsS11Min=Yes	FrameElem=4	ElemStation=0.0625				
Frame=4	Station=0.0625	OutputCase=FESSUR	CaseType=Combination	Point=4	X2=0.5	X3=0.5	S11=-	
1243.05186576119	IsS11Max=No	IsS11Min=No	FrameElem=4	ElemStation=0.0625				
Frame=4	Station=0.125	OutputCase=FESSUR	CaseType=Combination	Point=0	X2=0	X3=0	S11=-	
386.541953115296	IsS11Max=No	IsS11Min=No	FrameElem=4	ElemStation=0.125				
Frame=4	Station=0.125	OutputCase=FESSUR	CaseType=Combination	Point=1	X2=-0.5	X3=-0.5		
S11=744.225995177309	IsS11Max=Yes	IsS11Min=No	FrameElem=4	ElemStation=0.125				
Frame=4	Station=0.125	OutputCase=FESSUR	CaseType=Combination	Point=2	X2=-0.5	X3=0.5		
S11=744.225995177309	IsS11Max=No	IsS11Min=No	FrameElem=4	ElemStation=0.125				
Frame=4	Station=0.125	OutputCase=FESSUR	CaseType=Combination	Point=3	X2=0.5	X3=-0.5	S11=-	
1517.3099014079	IsS11Max=No	IsS11Min=Yes	FrameElem=4	ElemStation=0.125				
Frame=4	Station=0.125	OutputCase=FESSUR	CaseType=Combination	Point=4	X2=0.5	X3=0.5	S11=-	
1517.3099014079	IsS11Max=No	IsS11Min=No	FrameElem=4	ElemStation=0.125				
Frame=4	Station=0.1875	OutputCase=FESSUR	CaseType=Combination	Point=0	X2=0	X3=0	S11=-	
386.541953115296	IsS11Max=No	IsS11Min=No	FrameElem=4	ElemStation=0.1875				
Frame=4	Station=0.1875	OutputCase=FESSUR	CaseType=Combination	Point=1	X2=-0.5	X3=-0.5		
S11=1017.89809332402	IsS11Max=Yes	IsS11Min=No	FrameElem=4	ElemStation=0.1875				
Frame=4	Station=0.1875	OutputCase=FESSUR	CaseType=Combination	Point=2	X2=-0.5	X3=0.5		
S11=1017.89809332402	IsS11Max=No	IsS11Min=No	FrameElem=4	ElemStation=0.1875				
Frame=4	Station=0.1875	OutputCase=FESSUR	CaseType=Combination	Point=3	X2=0.5	X3=-0.5	S11=-	
1790.98199955461	IsS11Max=No	IsS11Min=Yes	FrameElem=4	ElemStation=0.1875				
Frame=4	Station=0.1875	OutputCase=FESSUR	CaseType=Combination	Point=4	X2=0.5	X3=0.5	S11=-	
1790.98199955461	IsS11Max=No	IsS11Min=No	FrameElem=4	ElemStation=0.1875				
Frame=4	Station=0.25	OutputCase=FESSUR	CaseType=Combination	Point=0	X2=0	X3=0	S11=-386.541953115296	
IsS11Max=No	IsS11Min=No	FrameElem=4	ElemStation=0.25					
Frame=4	Station=0.25	OutputCase=FESSUR	CaseType=Combination	Point=1	X2=-0.5	X3=-0.5		
S11=1290.98425397074	IsS11Max=Yes	IsS11Min=No	FrameElem=4	ElemStation=0.25				
Frame=4	Station=0.25	OutputCase=FESSUR	CaseType=Combination	Point=2	X2=-0.5	X3=0.5		
S11=1290.98425397074	IsS11Max=No	IsS11Min=No	FrameElem=4	ElemStation=0.25				
Frame=4	Station=0.25	OutputCase=FESSUR	CaseType=Combination	Point=3	X2=0.5	X3=-0.5	S11=-	
2064.06816020133	IsS11Max=No	IsS11Min=Yes	FrameElem=4	ElemStation=0.25				
Frame=4	Station=0.25	OutputCase=FESSUR	CaseType=Combination	Point=4	X2=0.5	X3=0.5	S11=-	
2064.06816020133	IsS11Max=No	IsS11Min=No	FrameElem=4	ElemStation=0.25				
Frame=5	Station=0	OutputCase=PESOPR	CaseType=LinStatic	Point=0	X2=0	X3=0	S11=-15.1709467361879	
IsS11Max=No	IsS11Min=No	FrameElem=5	ElemStation=0					



Frame=5	Station=0	OutputCase=PESOPR	CaseType=LinStatic	Point=1	X2=-0.5	X3=-0.5	S11=244.109939485118
IsS11Max=Yes	IsS11Min=No	FrameElem=5	ElemStation=0				
Frame=5	Station=0	OutputCase=PESOPR	CaseType=LinStatic	Point=2	X2=-0.5	X3=0.5	S11=244.109939485118
IsS11Max=No	IsS11Min=No	FrameElem=5	ElemStation=0				
Frame=5	Station=0	OutputCase=PESOPR	CaseType=LinStatic	Point=3	X2=0.5	X3=-0.5	S11=-274.451832957494
IsS11Max=No	IsS11Min=Yes	FrameElem=5	ElemStation=0				
Frame=5	Station=0	OutputCase=PESOPR	CaseType=LinStatic	Point=4	X2=0.5	X3=0.5	S11=-274.451832957494
IsS11Max=No	IsS11Min=No	FrameElem=5	ElemStation=0				
Frame=5	Station=6.24999940395355E-02	OutputCase=PESOPR	CaseType=LinStatic	Point=0	X2=0	X3=0	S11=-
15.1709467361879	IsS11Max=No	IsS11Min=No	FrameElem=5	ElemStation=6.24999940395355E-02			
Frame=5	Station=6.24999940395355E-02	OutputCase=PESOPR	CaseType=LinStatic	Point=1	X2=-0.5	X3=-0.5	
S11=302.801667756263	IsS11Max=Yes	IsS11Min=No	FrameElem=5	ElemStation=6.24999940395355E-02			
Frame=5	Station=6.24999940395355E-02	OutputCase=PESOPR	CaseType=LinStatic	Point=2	X2=-0.5	X3=0.5	
S11=302.801667756263	IsS11Max=No	IsS11Min=No	FrameElem=5	ElemStation=6.24999940395355E-02			
Frame=5	Station=6.24999940395355E-02	OutputCase=PESOPR	CaseType=LinStatic	Point=3	X2=0.5	X3=-0.5	
S11=-333.143561228639	IsS11Max=No	IsS11Min=Yes	FrameElem=5	ElemStation=6.24999940395355E-02			
Frame=5	Station=6.24999940395355E-02	OutputCase=PESOPR	CaseType=LinStatic	Point=4	X2=0.5	X3=0.5	
S11=-333.143561228639	IsS11Max=No	IsS11Min=No	FrameElem=5	ElemStation=6.24999940395355E-02			
Frame=5	Station=0.124999988079071	OutputCase=PESOPR	CaseType=LinStatic	Point=0	X2=0	X3=0	S11=-
15.1709467361879	IsS11Max=No	IsS11Min=No	FrameElem=5	ElemStation=0.124999988079071			
Frame=5	Station=0.124999988079071	OutputCase=PESOPR	CaseType=LinStatic	Point=1	X2=-0.5	X3=-0.5	
S11=360.907458639167	IsS11Max=Yes	IsS11Min=No	FrameElem=5	ElemStation=0.124999988079071			
Frame=5	Station=0.124999988079071	OutputCase=PESOPR	CaseType=LinStatic	Point=2	X2=-0.5	X3=0.5	
S11=360.907458639167	IsS11Max=No	IsS11Min=No	FrameElem=5	ElemStation=0.124999988079071			
Frame=5	Station=0.124999988079071	OutputCase=PESOPR	CaseType=LinStatic	Point=3	X2=0.5	X3=-0.5	S11=-
391.249352111543	IsS11Max=No	IsS11Min=Yes	FrameElem=5	ElemStation=0.124999988079071			
Frame=5	Station=0.124999988079071	OutputCase=PESOPR	CaseType=LinStatic	Point=4	X2=0.5	X3=0.5	S11=-
391.249352111543	IsS11Max=No	IsS11Min=No	FrameElem=5	ElemStation=0.124999988079071			
Frame=5	Station=0.187499982118607	OutputCase=PESOPR	CaseType=LinStatic	Point=0	X2=0	X3=0	S11=-
15.1709467361879	IsS11Max=No	IsS11Min=No	FrameElem=5	ElemStation=0.187499982118607			
Frame=5	Station=0.187499982118607	OutputCase=PESOPR	CaseType=LinStatic	Point=1	X2=-0.5	X3=-0.5	
S11=418.42731213383	IsS11Max=Yes	IsS11Min=No	FrameElem=5	ElemStation=0.187499982118607			
Frame=5	Station=0.187499982118607	OutputCase=PESOPR	CaseType=LinStatic	Point=2	X2=-0.5	X3=0.5	
S11=418.42731213383	IsS11Max=No	IsS11Min=No	FrameElem=5	ElemStation=0.187499982118607			
Frame=5	Station=0.187499982118607	OutputCase=PESOPR	CaseType=LinStatic	Point=3	X2=0.5	X3=-0.5	S11=-
448.769205606206	IsS11Max=No	IsS11Min=Yes	FrameElem=5	ElemStation=0.187499982118607			
Frame=5	Station=0.187499982118607	OutputCase=PESOPR	CaseType=LinStatic	Point=4	X2=0.5	X3=0.5	S11=-
448.769205606206	IsS11Max=No	IsS11Min=No	FrameElem=5	ElemStation=0.187499982118607			
Frame=5	Station=0.249999976158142	OutputCase=PESOPR	CaseType=LinStatic	Point=0	X2=0	X3=0	S11=-
15.1709467361879	IsS11Max=No	IsS11Min=No	FrameElem=5	ElemStation=0.249999976158142			
Frame=5	Station=0.249999976158142	OutputCase=PESOPR	CaseType=LinStatic	Point=1	X2=-0.5	X3=-0.5	
S11=475.361228240252	IsS11Max=Yes	IsS11Min=No	FrameElem=5	ElemStation=0.249999976158142			
Frame=5	Station=0.249999976158142	OutputCase=PESOPR	CaseType=LinStatic	Point=2	X2=-0.5	X3=0.5	
S11=475.361228240252	IsS11Max=No	IsS11Min=No	FrameElem=5	ElemStation=0.249999976158142			
Frame=5	Station=0.249999976158142	OutputCase=PESOPR	CaseType=LinStatic	Point=3	X2=0.5	X3=-0.5	S11=-
505.703121712627	IsS11Max=No	IsS11Min=Yes	FrameElem=5	ElemStation=0.249999976158142			
Frame=5	Station=0.249999976158142	OutputCase=PESOPR	CaseType=LinStatic	Point=4	X2=0.5	X3=0.5	S11=-
505.703121712627	IsS11Max=No	IsS11Min=No	FrameElem=5	ElemStation=0.249999976158142			
Frame=5	Station=0	OutputCase=TERRVERT	CaseType=LinStatic	Point=0	X2=0	X3=0	S11=1.64270738195467
IsS11Max=No	IsS11Min=No	FrameElem=5	ElemStation=0				
Frame=5	Station=0	OutputCase=TERRVERT	CaseType=LinStatic	Point=1	X2=-0.5	X3=-0.5	
S11=915.730808347555	IsS11Max=Yes	IsS11Min=No	FrameElem=5	ElemStation=0			
Frame=5	Station=0	OutputCase=TERRVERT	CaseType=LinStatic	Point=2	X2=-0.5	X3=0.5	
S11=915.730808347555	IsS11Max=No	IsS11Min=No	FrameElem=5	ElemStation=0			
Frame=5	Station=0	OutputCase=TERRVERT	CaseType=LinStatic	Point=3	X2=0.5	X3=-0.5	S11=-
912.445393583646	IsS11Max=No	IsS11Min=Yes	FrameElem=5	ElemStation=0			
Frame=5	Station=0	OutputCase=TERRVERT	CaseType=LinStatic	Point=4	X2=0.5	X3=0.5	S11=-
912.445393583646	IsS11Max=No	IsS11Min=No	FrameElem=5	ElemStation=0			
Frame=5	Station=6.24999940395355E-02	OutputCase=TERRVERT	CaseType=LinStatic	Point=0	X2=0	X3=0	
S11=1.64270738195467	IsS11Max=No	IsS11Min=No	FrameElem=5	ElemStation=6.24999940395355E-02			
Frame=5	Station=6.24999940395355E-02	OutputCase=TERRVERT	CaseType=LinStatic	Point=1	X2=-0.5	X3=-0.5	
S11=1164.74084147562	IsS11Max=Yes	IsS11Min=No	FrameElem=5	ElemStation=6.24999940395355E-02			
Frame=5	Station=6.24999940395355E-02	OutputCase=TERRVERT	CaseType=LinStatic	Point=2	X2=-0.5	X3=0.5	
S11=1164.74084147562	IsS11Max=No	IsS11Min=No	FrameElem=5	ElemStation=6.24999940395355E-02			
Frame=5	Station=6.24999940395355E-02	OutputCase=TERRVERT	CaseType=LinStatic	Point=3	X2=0.5	X3=-0.5	
S11=-1161.45542671171	IsS11Max=No	IsS11Min=Yes	FrameElem=5	ElemStation=6.24999940395355E-02			
Frame=5	Station=6.24999940395355E-02	OutputCase=TERRVERT	CaseType=LinStatic	Point=4	X2=0.5	X3=0.5	
S11=-1161.45542671171	IsS11Max=No	IsS11Min=No	FrameElem=5	ElemStation=6.24999940395355E-02			
Frame=5	Station=0.124999988079071	OutputCase=TERRVERT	CaseType=LinStatic	Point=0	X2=0	X3=0	
S11=1.64270738195467	IsS11Max=No	IsS11Min=No	FrameElem=5	ElemStation=0.124999988079071			
Frame=5	Station=0.124999988079071	OutputCase=TERRVERT	CaseType=LinStatic	Point=1	X2=-0.5	X3=-0.5	
S11=1413.75087460369	IsS11Max=Yes	IsS11Min=No	FrameElem=5	ElemStation=0.124999988079071			
Frame=5	Station=0.124999988079071	OutputCase=TERRVERT	CaseType=LinStatic	Point=2	X2=-0.5	X3=0.5	
S11=1413.75087460369	IsS11Max=No	IsS11Min=No	FrameElem=5	ElemStation=0.124999988079071			
Frame=5	Station=0.124999988079071	OutputCase=TERRVERT	CaseType=LinStatic	Point=3	X2=0.5	X3=-0.5	
S11=-1410.46545983978	IsS11Max=No	IsS11Min=Yes	FrameElem=5	ElemStation=0.124999988079071			
Frame=5	Station=0.124999988079071	OutputCase=TERRVERT	CaseType=LinStatic	Point=4	X2=0.5	X3=0.5	
S11=-1410.46545983978	IsS11Max=No	IsS11Min=No	FrameElem=5	ElemStation=0.124999988079071			
Frame=5	Station=0.187499982118607	OutputCase=TERRVERT	CaseType=LinStatic	Point=0	X2=0	X3=0	
S11=1.64270738195467	IsS11Max=No	IsS11Min=No	FrameElem=5	ElemStation=0.187499982118607			
Frame=5	Station=0.187499982118607	OutputCase=TERRVERT	CaseType=LinStatic	Point=1	X2=-0.5	X3=-0.5	
S11=1662.76090773175	IsS11Max=Yes	IsS11Min=No	FrameElem=5	ElemStation=0.187499982118607			



Frame=5 Station=0.187499982118607 OutputCase=TERRVERT CaseType=LinStatic Point=2 X2=-0.5 X3=0.5
 S11=1662.76090773175 IsS11Max=No IsS11Min=No FrameElem=5 ElemStation=0.187499982118607
 Frame=5 Station=0.187499982118607 OutputCase=TERRVERT CaseType=LinStatic Point=3 X2=0.5 X3=-0.5
 S11=-1659.47549296784 IsS11Max=No IsS11Min=Yes FrameElem=5 ElemStation=0.187499982118607
 Frame=5 Station=0.187499982118607 OutputCase=TERRVERT CaseType=LinStatic Point=4 X2=0.5 X3=0.5
 S11=-1659.47549296784 IsS11Max=No IsS11Min=No FrameElem=5 ElemStation=0.187499982118607
 Frame=5 Station=0.249999976158142 OutputCase=TERRVERT CaseType=LinStatic Point=0 X2=0 X3=0
 S11=1.64270738195467 IsS11Max=No IsS11Min=No FrameElem=5 ElemStation=0.249999976158142
 Frame=5 Station=0.249999976158142 OutputCase=TERRVERT CaseType=LinStatic Point=1 X2=-0.5 X3=-0.5
 S11=1911.77094085982 IsS11Max=Yes IsS11Min=No FrameElem=5 ElemStation=0.249999976158142
 Frame=5 Station=0.249999976158142 OutputCase=TERRVERT CaseType=LinStatic Point=2 X2=-0.5 X3=0.5
 S11=1911.77094085982 IsS11Max=No IsS11Min=No FrameElem=5 ElemStation=0.249999976158142
 Frame=5 Station=0.249999976158142 OutputCase=TERRVERT CaseType=LinStatic Point=3 X2=0.5 X3=-0.5
 S11=-1908.48552609591 IsS11Max=No IsS11Min=Yes FrameElem=5 ElemStation=0.249999976158142
 Frame=5 Station=0.249999976158142 OutputCase=TERRVERT CaseType=LinStatic Point=4 X2=0.5 X3=0.5
 S11=-1908.48552609591 IsS11Max=No IsS11Min=No FrameElem=5 ElemStation=0.249999976158142
 Frame=5 Station=0 OutputCase=TERRLAT CaseType=LinStatic Point=0 X2=0 X3=0 S11=-373.013713761061
 IsS11Max=No IsS11Min=No FrameElem=5 ElemStation=0
 Frame=5 Station=0 OutputCase=TERRLAT CaseType=LinStatic Point=1 X2=-0.5 X3=-0.5
 S11=131.143506138283 IsS11Max=Yes IsS11Min=No FrameElem=5 ElemStation=0
 Frame=5 Station=0 OutputCase=TERRLAT CaseType=LinStatic Point=2 X2=-0.5 X3=0.5 S11=131.143506138283
 IsS11Max=No IsS11Min=No FrameElem=5 ElemStation=0
 Frame=5 Station=0 OutputCase=TERRLAT CaseType=LinStatic Point=3 X2=0.5 X3=-0.5 S11=-
 877.170933660404 IsS11Max=No IsS11Min=Yes FrameElem=5 ElemStation=0
 Frame=5 Station=0 OutputCase=TERRLAT CaseType=LinStatic Point=4 X2=0.5 X3=0.5 S11=-877.170933660404
 IsS11Max=No IsS11Min=No FrameElem=5 ElemStation=0
 Frame=5 Station=6.24999940395355E-02 OutputCase=TERRLAT CaseType=LinStatic Point=0 X2=0 X3=0 S11=-
 373.013713761061 IsS11Max=No IsS11Min=No FrameElem=5 ElemStation=6.24999940395355E-02
 Frame=5 Station=6.24999940395355E-02 OutputCase=TERRLAT CaseType=LinStatic Point=1 X2=-0.5 X3=-0.5
 S11=131.213193228035 IsS11Max=Yes IsS11Min=No FrameElem=5 ElemStation=6.24999940395355E-02
 Frame=5 Station=6.24999940395355E-02 OutputCase=TERRLAT CaseType=LinStatic Point=2 X2=-0.5 X3=0.5
 S11=131.213193228035 IsS11Max=No IsS11Min=No FrameElem=5 ElemStation=6.24999940395355E-02
 Frame=5 Station=6.24999940395355E-02 OutputCase=TERRLAT CaseType=LinStatic Point=3 X2=0.5 X3=-0.5
 S11=-877.240620750157 IsS11Max=No IsS11Min=Yes FrameElem=5 ElemStation=6.24999940395355E-02
 Frame=5 Station=6.24999940395355E-02 OutputCase=TERRLAT CaseType=LinStatic Point=4 X2=0.5 X3=0.5
 S11=-877.240620750157 IsS11Max=No IsS11Min=No FrameElem=5 ElemStation=6.24999940395355E-02
 Frame=5 Station=0.124999988079071 OutputCase=TERRLAT CaseType=LinStatic Point=0 X2=0 X3=0 S11=-
 373.013713761061 IsS11Max=No IsS11Min=No FrameElem=5 ElemStation=0.124999988079071
 Frame=5 Station=0.124999988079071 OutputCase=TERRLAT CaseType=LinStatic Point=1 X2=-0.5 X3=-0.5
 S11=131.282880317787 IsS11Max=Yes IsS11Min=No FrameElem=5 ElemStation=0.124999988079071
 Frame=5 Station=0.124999988079071 OutputCase=TERRLAT CaseType=LinStatic Point=2 X2=-0.5 X3=0.5
 S11=131.282880317787 IsS11Max=No IsS11Min=No FrameElem=5 ElemStation=0.124999988079071
 Frame=5 Station=0.124999988079071 OutputCase=TERRLAT CaseType=LinStatic Point=3 X2=0.5 X3=-0.5
 S11=-877.310307839909 IsS11Max=No IsS11Min=Yes FrameElem=5 ElemStation=0.124999988079071
 Frame=5 Station=0.124999988079071 OutputCase=TERRLAT CaseType=LinStatic Point=4 X2=0.5 X3=0.5 S11=-
 877.310307839909 IsS11Max=No IsS11Min=No FrameElem=5 ElemStation=0.124999988079071
 Frame=5 Station=0.187499982118607 OutputCase=TERRLAT CaseType=LinStatic Point=0 X2=0 X3=0 S11=-
 373.013713761061 IsS11Max=No IsS11Min=No FrameElem=5 ElemStation=0.187499982118607
 Frame=5 Station=0.187499982118607 OutputCase=TERRLAT CaseType=LinStatic Point=1 X2=-0.5 X3=-0.5
 S11=131.352567407539 IsS11Max=Yes IsS11Min=No FrameElem=5 ElemStation=0.187499982118607
 Frame=5 Station=0.187499982118607 OutputCase=TERRLAT CaseType=LinStatic Point=2 X2=-0.5 X3=0.5
 S11=131.352567407539 IsS11Max=No IsS11Min=No FrameElem=5 ElemStation=0.187499982118607
 Frame=5 Station=0.187499982118607 OutputCase=TERRLAT CaseType=LinStatic Point=3 X2=0.5 X3=-0.5
 S11=-877.379994929661 IsS11Max=No IsS11Min=Yes FrameElem=5 ElemStation=0.187499982118607
 Frame=5 Station=0.187499982118607 OutputCase=TERRLAT CaseType=LinStatic Point=4 X2=0.5 X3=0.5 S11=-
 877.379994929661 IsS11Max=No IsS11Min=No FrameElem=5 ElemStation=0.187499982118607
 Frame=5 Station=0.249999976158142 OutputCase=TERRLAT CaseType=LinStatic Point=0 X2=0 X3=0 S11=-
 373.013713761061 IsS11Max=No IsS11Min=No FrameElem=5 ElemStation=0.249999976158142
 Frame=5 Station=0.249999976158142 OutputCase=TERRLAT CaseType=LinStatic Point=1 X2=-0.5 X3=-0.5
 S11=131.422254497291 IsS11Max=Yes IsS11Min=No FrameElem=5 ElemStation=0.249999976158142
 Frame=5 Station=0.249999976158142 OutputCase=TERRLAT CaseType=LinStatic Point=2 X2=-0.5 X3=0.5
 S11=131.422254497291 IsS11Max=No IsS11Min=No FrameElem=5 ElemStation=0.249999976158142
 Frame=5 Station=0.249999976158142 OutputCase=TERRLAT CaseType=LinStatic Point=3 X2=0.5 X3=-0.5
 S11=-877.449682019413 IsS11Max=No IsS11Min=Yes FrameElem=5 ElemStation=0.249999976158142
 Frame=5 Station=0.249999976158142 OutputCase=TERRLAT CaseType=LinStatic Point=4 X2=0.5 X3=0.5 S11=-
 877.449682019413 IsS11Max=No IsS11Min=No FrameElem=5 ElemStation=0.249999976158142
 Frame=5 Station=0 OutputCase=ACCVERT CaseType=LinStatic Point=0 X2=0 X3=0 S11=0 IsS11Max=Yes
 IsS11Min=Yes FrameElem=5 ElemStation=0
 Frame=5 Station=0 OutputCase=ACCVERT CaseType=LinStatic Point=1 X2=-0.5 X3=-0.5 S11=0 IsS11Max=No
 IsS11Min=No FrameElem=5 ElemStation=0
 Frame=5 Station=0 OutputCase=ACCVERT CaseType=LinStatic Point=2 X2=-0.5 X3=0.5 S11=0 IsS11Max=No
 IsS11Min=No FrameElem=5 ElemStation=0
 Frame=5 Station=0 OutputCase=ACCVERT CaseType=LinStatic Point=3 X2=0.5 X3=-0.5 S11=0 IsS11Max=No
 IsS11Min=No FrameElem=5 ElemStation=0
 Frame=5 Station=0 OutputCase=ACCVERT CaseType=LinStatic Point=4 X2=0.5 X3=0.5 S11=0 IsS11Max=No
 IsS11Min=No FrameElem=5 ElemStation=0
 Frame=5 Station=6.24999940395355E-02 OutputCase=ACCVERT CaseType=LinStatic Point=0 X2=0 X3=0 S11=0
 IsS11Max=Yes IsS11Min=Yes FrameElem=5 ElemStation=6.24999940395355E-02
 Frame=5 Station=6.24999940395355E-02 OutputCase=ACCVERT CaseType=LinStatic Point=1 X2=-0.5 X3=-0.5
 S11=0 IsS11Max=No IsS11Min=No FrameElem=5 ElemStation=6.24999940395355E-02
 Frame=5 Station=6.24999940395355E-02 OutputCase=ACCVERT CaseType=LinStatic Point=2 X2=-0.5 X3=0.5
 S11=0 IsS11Max=No IsS11Min=No FrameElem=5 ElemStation=6.24999940395355E-02



Frame=5 Station=0.249999976158142 OutputCase=ENVE CaseType=Combination StepType=Min Point=2 X2=-0.5
 X3=0.5 S11=2479.12774724817 IsS11Max=No IsS11Min=No FrameElem=5 ElemStation=0.249999976158142
 Frame=5 Station=0.249999976158142 OutputCase=ENVE CaseType=Combination StepType=Min Point=3 X2=0.5
 X3=-0.5 S11=-3291.63832982795 IsS11Max=No IsS11Min=Yes FrameElem=5 ElemStation=0.249999976158142
 Frame=5 Station=0.249999976158142 OutputCase=ENVE CaseType=Combination StepType=Min Point=4 X2=0.5
 X3=0.5 S11=-3291.63832982795 IsS11Max=No IsS11Min=No FrameElem=5 ElemStation=0.249999976158142
 Frame=5 Station=0 OutputCase=FESSUR CaseType=Combination Point=0 X2=0 X3=0 S11=-386.541953115294
 IsS11Max=No IsS11Min=No FrameElem=5 ElemStation=0
 Frame=5 Station=0 OutputCase=FESSUR CaseType=Combination Point=1 X2=-0.5 X3=-0.5
 S11=1290.98425397096 IsS11Max=Yes IsS11Min=No FrameElem=5 ElemStation=0
 Frame=5 Station=0 OutputCase=FESSUR CaseType=Combination Point=2 X2=-0.5 X3=0.5
 S11=1290.98425397096 IsS11Max=No IsS11Min=No FrameElem=5 ElemStation=0
 Frame=5 Station=0 OutputCase=FESSUR CaseType=Combination Point=3 X2=0.5 X3=-0.5 S11=-
 2064.06816020154 IsS11Max=No IsS11Min=Yes FrameElem=5 ElemStation=0
 Frame=5 Station=0 OutputCase=FESSUR CaseType=Combination Point=4 X2=0.5 X3=0.5 S11=-
 2064.06816020154 IsS11Max=No IsS11Min=No FrameElem=5 ElemStation=0
 Frame=5 Station=6.24999940395355E-02 OutputCase=FESSUR CaseType=Combination Point=0 X2=0 X3=0 S11=-
 386.541953115294 IsS11Max=No IsS11Min=No FrameElem=5 ElemStation=6.24999940395355E-02
 Frame=5 Station=6.24999940395355E-02 OutputCase=FESSUR CaseType=Combination Point=1 X2=-0.5 X3=-0.5
 S11=1598.75570245992 IsS11Max=Yes IsS11Min=No FrameElem=5 ElemStation=6.24999940395355E-02
 Frame=5 Station=6.24999940395355E-02 OutputCase=FESSUR CaseType=Combination Point=2 X2=-0.5 X3=0.5
 S11=1598.75570245992 IsS11Max=No IsS11Min=No FrameElem=5 ElemStation=6.24999940395355E-02
 Frame=5 Station=6.24999940395355E-02 OutputCase=FESSUR CaseType=Combination Point=3 X2=0.5 X3=-0.5
 S11=-2371.83960869051 IsS11Max=Yes IsS11Min=Yes FrameElem=5 ElemStation=6.24999940395355E-02
 Frame=5 Station=6.24999940395355E-02 OutputCase=FESSUR CaseType=Combination Point=4 X2=0.5 X3=0.5
 S11=-2371.83960869051 IsS11Max=No IsS11Min=No FrameElem=5 ElemStation=6.24999940395355E-02
 Frame=5 Station=0.124999988079071 OutputCase=FESSUR CaseType=Combination Point=0 X2=0 X3=0 S11=-
 386.541953115294 IsS11Max=No IsS11Min=No FrameElem=5 ElemStation=0.124999988079071
 Frame=5 Station=0.124999988079071 OutputCase=FESSUR CaseType=Combination Point=1 X2=-0.5 X3=-0.5
 S11=1905.94121356064 IsS11Max=Yes IsS11Min=No FrameElem=5 ElemStation=0.124999988079071
 Frame=5 Station=0.124999988079071 OutputCase=FESSUR CaseType=Combination Point=2 X2=-0.5 X3=0.5
 S11=1905.94121356064 IsS11Max=No IsS11Min=No FrameElem=5 ElemStation=0.124999988079071
 Frame=5 Station=0.124999988079071 OutputCase=FESSUR CaseType=Combination Point=3 X2=0.5 X3=-0.5
 S11=-2679.02511979123 IsS11Max=No IsS11Min=Yes FrameElem=5 ElemStation=0.124999988079071
 Frame=5 Station=0.124999988079071 OutputCase=FESSUR CaseType=Combination Point=4 X2=0.5 X3=0.5
 S11=-2679.02511979123 IsS11Max=No IsS11Min=No FrameElem=5 ElemStation=0.124999988079071
 Frame=5 Station=0.187499982118607 OutputCase=FESSUR CaseType=Combination Point=0 X2=0 X3=0 S11=-
 386.541953115294 IsS11Max=No IsS11Min=No FrameElem=5 ElemStation=0.187499982118607
 Frame=5 Station=0.187499982118607 OutputCase=FESSUR CaseType=Combination Point=1 X2=-0.5 X3=-0.5
 S11=2212.54078727312 IsS11Max=Yes IsS11Min=No FrameElem=5 ElemStation=0.187499982118607
 Frame=5 Station=0.187499982118607 OutputCase=FESSUR CaseType=Combination Point=2 X2=-0.5 X3=0.5
 S11=2212.54078727312 IsS11Max=No IsS11Min=No FrameElem=5 ElemStation=0.187499982118607
 Frame=5 Station=0.187499982118607 OutputCase=FESSUR CaseType=Combination Point=3 X2=0.5 X3=-0.5
 S11=-2985.62469350371 IsS11Max=No IsS11Min=Yes FrameElem=5 ElemStation=0.187499982118607
 Frame=5 Station=0.187499982118607 OutputCase=FESSUR CaseType=Combination Point=4 X2=0.5 X3=0.5
 S11=-2985.62469350371 IsS11Max=No IsS11Min=No FrameElem=5 ElemStation=0.187499982118607
 Frame=5 Station=0.249999976158142 OutputCase=FESSUR CaseType=Combination Point=0 X2=0 X3=0 S11=-
 386.541953115294 IsS11Max=No IsS11Min=No FrameElem=5 ElemStation=0.249999976158142
 Frame=5 Station=0.249999976158142 OutputCase=FESSUR CaseType=Combination Point=1 X2=-0.5 X3=-0.5
 S11=2518.55442359736 IsS11Max=Yes IsS11Min=No FrameElem=5 ElemStation=0.249999976158142
 Frame=5 Station=0.249999976158142 OutputCase=FESSUR CaseType=Combination Point=2 X2=-0.5 X3=0.5
 S11=2518.55442359736 IsS11Max=No IsS11Min=No FrameElem=5 ElemStation=0.249999976158142
 Frame=5 Station=0.249999976158142 OutputCase=FESSUR CaseType=Combination Point=3 X2=0.5 X3=-0.5
 S11=-3291.63832982795 IsS11Max=No IsS11Min=Yes FrameElem=5 ElemStation=0.249999976158142
 Frame=5 Station=0.249999976158142 OutputCase=FESSUR CaseType=Combination Point=4 X2=0.5 X3=0.5
 S11=-3291.63832982795 IsS11Max=No IsS11Min=No FrameElem=5 ElemStation=0.249999976158142
 Frame=41 Station=0 OutputCase=PESOPR CaseType=LinStatic Point=0 X2=0 X3=0 S11=-15.1709467361864
 IsS11Max=No IsS11Min=No FrameElem=41 ElemStation=0
 Frame=41 Station=0 OutputCase=PESOPR CaseType=LinStatic Point=1 X2=-0.5 X3=-0.5
 S11=37.7162742062653 IsS11Max=Yes IsS11Min=No FrameElem=41 ElemStation=0
 Frame=41 Station=0 OutputCase=PESOPR CaseType=LinStatic Point=2 X2=-0.5 X3=0.5 S11=37.7162742062653
 IsS11Max=No IsS11Min=No FrameElem=41 ElemStation=0
 Frame=41 Station=0 OutputCase=PESOPR CaseType=LinStatic Point=3 X2=0.5 X3=-0.5 S11=-
 68.0581676786381 IsS11Max=No IsS11Min=Yes FrameElem=41 ElemStation=0
 Frame=41 Station=0 OutputCase=PESOPR CaseType=LinStatic Point=4 X2=0.5 X3=0.5 S11=-68.0581676786381
 IsS11Max=No IsS11Min=No FrameElem=41 ElemStation=0
 Frame=41 Station=0.125 OutputCase=PESOPR CaseType=LinStatic Point=0 X2=0 X3=0 S11=-15.1709467361864
 IsS11Max=No IsS11Min=No FrameElem=41 ElemStation=0.125
 Frame=41 Station=0.125 OutputCase=PESOPR CaseType=LinStatic Point=1 X2=-0.5 X3=-0.5 S11=-
 43.4308728839199 IsS11Max=No IsS11Min=Yes FrameElem=41 ElemStation=0.125
 Frame=41 Station=0.125 OutputCase=PESOPR CaseType=LinStatic Point=2 X2=-0.5 X3=0.5 S11=-
 43.4308728839199 IsS11Max=No IsS11Min=No FrameElem=41 ElemStation=0.125
 Frame=41 Station=0.125 OutputCase=PESOPR CaseType=LinStatic Point=3 X2=0.5 X3=-0.5
 S11=13.0889794115471 IsS11Max=Yes IsS11Min=No FrameElem=41 ElemStation=0.125
 Frame=41 Station=0.125 OutputCase=PESOPR CaseType=LinStatic Point=4 X2=0.5 X3=0.5
 S11=13.0889794115471 IsS11Max=No IsS11Min=No FrameElem=41 ElemStation=0.125
 Frame=41 Station=0.25 OutputCase=PESOPR CaseType=LinStatic Point=0 X2=0 X3=0 S11=-15.1709467361864
 IsS11Max=No IsS11Min=No FrameElem=41 ElemStation=0.25
 Frame=41 Station=0.25 OutputCase=PESOPR CaseType=LinStatic Point=1 X2=-0.5 X3=-0.5 S11=-
 126.921769974105 IsS11Max=No IsS11Min=Yes FrameElem=41 ElemStation=0.25
 Frame=41 Station=0.25 OutputCase=PESOPR CaseType=LinStatic Point=2 X2=-0.5 X3=0.5 S11=-
 126.921769974105 IsS11Max=No IsS11Min=No FrameElem=41 ElemStation=0.25

```

Frame=41 Station=0.25 OutputCase=PESOPR CaseType=LinStatic Point=3 X2=0.5 X3=-0.5
S11=96.5798765017323 IsS11Max=Yes IsS11Min=No FrameElem=41 ElemStation=0.25
Frame=41 Station=0.25 OutputCase=PESOPR CaseType=LinStatic Point=4 X2=0.5 X3=0.5
S11=96.5798765017323 IsS11Max=No IsS11Min=No FrameElem=41 ElemStation=0.25
Frame=41 Station=0.375 OutputCase=PESOPR CaseType=LinStatic Point=0 X2=0 X3=0 S11=-15.1709467361864
IsS11Max=No IsS11Min=No FrameElem=41 ElemStation=0.375
Frame=41 Station=0.375 OutputCase=PESOPR CaseType=LinStatic Point=1 X2=-0.5 X3=-0.5 S11=-
212.75641706429 IsS11Max=No IsS11Min=Yes FrameElem=41 ElemStation=0.375
Frame=41 Station=0.375 OutputCase=PESOPR CaseType=LinStatic Point=2 X2=-0.5 X3=0.5 S11=-
212.75641706429 IsS11Max=No IsS11Min=No FrameElem=41 ElemStation=0.375
Frame=41 Station=0.375 OutputCase=PESOPR CaseType=LinStatic Point=3 X2=0.5 X3=-0.5
S11=182.414523591917 IsS11Max=Yes IsS11Min=No FrameElem=41 ElemStation=0.375
Frame=41 Station=0.375 OutputCase=PESOPR CaseType=LinStatic Point=4 X2=0.5 X3=0.5
S11=182.414523591917 IsS11Max=No IsS11Min=No FrameElem=41 ElemStation=0.375
Frame=41 Station=0.5 OutputCase=PESOPR CaseType=LinStatic Point=0 X2=0 X3=0 S11=-15.1709467361864
IsS11Max=No IsS11Min=No FrameElem=41 ElemStation=0.5
Frame=41 Station=0.5 OutputCase=PESOPR CaseType=LinStatic Point=1 X2=-0.5 X3=-0.5 S11=-
300.934814154475 IsS11Max=No IsS11Min=Yes FrameElem=41 ElemStation=0.5
Frame=41 Station=0.5 OutputCase=PESOPR CaseType=LinStatic Point=2 X2=-0.5 X3=0.5 S11=-
300.934814154475 IsS11Max=No IsS11Min=No FrameElem=41 ElemStation=0.5
Frame=41 Station=0.5 OutputCase=PESOPR CaseType=LinStatic Point=3 X2=0.5 X3=-0.5
S11=270.592920682103 IsS11Max=Yes IsS11Min=No FrameElem=41 ElemStation=0.5
Frame=41 Station=0.5 OutputCase=PESOPR CaseType=LinStatic Point=4 X2=0.5 X3=0.5
S11=270.592920682103 IsS11Max=No IsS11Min=No FrameElem=41 ElemStation=0.5
Frame=41 Station=0 OutputCase=TERRVERT CaseType=LinStatic Point=0 X2=0 X3=0 S11=1.64270738195018
IsS11Max=No IsS11Min=No FrameElem=41 ElemStation=0
Frame=41 Station=0 OutputCase=TERRVERT CaseType=LinStatic Point=1 X2=-0.5 X3=-0.5
S11=26.9397929859694 IsS11Max=Yes IsS11Min=No FrameElem=41 ElemStation=0
Frame=41 Station=0 OutputCase=TERRVERT CaseType=LinStatic Point=2 X2=-0.5 X3=0.5
S11=26.9397929859694 IsS11Max=No IsS11Min=No FrameElem=41 ElemStation=0
Frame=41 Station=0 OutputCase=TERRVERT CaseType=LinStatic Point=3 X2=0.5 X3=-0.5 S11=-
23.6543782220691 IsS11Max=No IsS11Min=Yes FrameElem=41 ElemStation=0
Frame=41 Station=0 OutputCase=TERRVERT CaseType=LinStatic Point=4 X2=0.5 X3=0.5 S11=-
23.6543782220691 IsS11Max=No IsS11Min=No FrameElem=41 ElemStation=0
Frame=41 Station=0.125 OutputCase=TERRVERT CaseType=LinStatic Point=0 X2=0 X3=0
S11=1.64270738195018 IsS11Max=No IsS11Min=No FrameElem=41 ElemStation=0.125
Frame=41 Station=0.125 OutputCase=TERRVERT CaseType=LinStatic Point=1 X2=-0.5 X3=-0.5 S11=-
337.535150112941 IsS11Max=No IsS11Min=Yes FrameElem=41 ElemStation=0.125
Frame=41 Station=0.125 OutputCase=TERRVERT CaseType=LinStatic Point=2 X2=-0.5 X3=0.5 S11=-
337.535150112941 IsS11Max=No IsS11Min=No FrameElem=41 ElemStation=0.125
Frame=41 Station=0.125 OutputCase=TERRVERT CaseType=LinStatic Point=3 X2=0.5 X3=-0.5
S11=340.820564876841 IsS11Max=Yes IsS11Min=No FrameElem=41 ElemStation=0.125
Frame=41 Station=0.125 OutputCase=TERRVERT CaseType=LinStatic Point=4 X2=0.5 X3=0.5
S11=340.820564876841 IsS11Max=No IsS11Min=No FrameElem=41 ElemStation=0.125
Frame=41 Station=0.25 OutputCase=TERRVERT CaseType=LinStatic Point=0 X2=0 X3=0 S11=1.64270738195018
IsS11Max=No IsS11Min=No FrameElem=41 ElemStation=0.25
Frame=41 Station=0.25 OutputCase=TERRVERT CaseType=LinStatic Point=1 X2=-0.5 X3=-0.5 S11=-
702.010093211851 IsS11Max=No IsS11Min=Yes FrameElem=41 ElemStation=0.25
Frame=41 Station=0.25 OutputCase=TERRVERT CaseType=LinStatic Point=2 X2=-0.5 X3=0.5 S11=-
702.010093211851 IsS11Max=No IsS11Min=No FrameElem=41 ElemStation=0.25
Frame=41 Station=0.25 OutputCase=TERRVERT CaseType=LinStatic Point=3 X2=0.5 X3=-0.5
S11=705.295507975752 IsS11Max=Yes IsS11Min=No FrameElem=41 ElemStation=0.25
Frame=41 Station=0.25 OutputCase=TERRVERT CaseType=LinStatic Point=4 X2=0.5 X3=0.5
S11=705.295507975752 IsS11Max=No IsS11Min=No FrameElem=41 ElemStation=0.25
Frame=41 Station=0.375 OutputCase=TERRVERT CaseType=LinStatic Point=0 X2=0 X3=0
S11=1.64270738195018 IsS11Max=No IsS11Min=No FrameElem=41 ElemStation=0.375
Frame=41 Station=0.375 OutputCase=TERRVERT CaseType=LinStatic Point=1 X2=-0.5 X3=-0.5 S11=-
1066.48503631076 IsS11Max=No IsS11Min=Yes FrameElem=41 ElemStation=0.375
Frame=41 Station=0.375 OutputCase=TERRVERT CaseType=LinStatic Point=2 X2=-0.5 X3=0.5 S11=-
1066.48503631076 IsS11Max=No IsS11Min=No FrameElem=41 ElemStation=0.375
Frame=41 Station=0.375 OutputCase=TERRVERT CaseType=LinStatic Point=3 X2=0.5 X3=-0.5
S11=1069.77045107466 IsS11Max=Yes IsS11Min=No FrameElem=41 ElemStation=0.375
Frame=41 Station=0.375 OutputCase=TERRVERT CaseType=LinStatic Point=4 X2=0.5 X3=0.5
S11=1069.77045107466 IsS11Max=No IsS11Min=No FrameElem=41 ElemStation=0.375
Frame=41 Station=0.5 OutputCase=TERRVERT CaseType=LinStatic Point=0 X2=0 X3=0 S11=1.64270738195018
IsS11Max=No IsS11Min=No FrameElem=41 ElemStation=0.5
Frame=41 Station=0.5 OutputCase=TERRVERT CaseType=LinStatic Point=1 X2=-0.5 X3=-0.5 S11=-
1430.95997940967 IsS11Max=No IsS11Min=Yes FrameElem=41 ElemStation=0.5
Frame=41 Station=0.5 OutputCase=TERRVERT CaseType=LinStatic Point=2 X2=-0.5 X3=0.5 S11=-
1430.95997940967 IsS11Max=No IsS11Min=No FrameElem=41 ElemStation=0.5
Frame=41 Station=0.5 OutputCase=TERRVERT CaseType=LinStatic Point=3 X2=0.5 X3=-0.5
S11=1434.24539417357 IsS11Max=Yes IsS11Min=No FrameElem=41 ElemStation=0.5
Frame=41 Station=0.5 OutputCase=TERRVERT CaseType=LinStatic Point=4 X2=0.5 X3=0.5
S11=1434.24539417357 IsS11Max=No IsS11Min=No FrameElem=41 ElemStation=0.5
Frame=41 Station=0 OutputCase=TERRLAT CaseType=LinStatic Point=0 X2=0 X3=0 S11=-373.013713761058
IsS11Max=No IsS11Min=No FrameElem=41 ElemStation=0
Frame=41 Station=0 OutputCase=TERRLAT CaseType=LinStatic Point=1 X2=-0.5 X3=-0.5
S11=130.467951388658 IsS11Max=Yes IsS11Min=No FrameElem=41 ElemStation=0
Frame=41 Station=0 OutputCase=TERRLAT CaseType=LinStatic Point=2 X2=-0.5 X3=0.5
S11=130.467951388658 IsS11Max=No IsS11Min=No FrameElem=41 ElemStation=0
Frame=41 Station=0 OutputCase=TERRLAT CaseType=LinStatic Point=3 X2=0.5 X3=-0.5 S11=-
876.495378910775 IsS11Max=No IsS11Min=Yes FrameElem=41 ElemStation=0

```

Frame=41	Station=0	OutputCase=TERRLAT	CaseType=LinStatic	Point=4	X2=0.5	X3=0.5	S11=-		
876.495378910775		IsS11Max=No	IsS11Min=No	FrameElem=41	ElemStation=0				
Frame=41	Station=0.125	OutputCase=TERRLAT	CaseType=LinStatic	Point=0	X2=0	X3=0	S11=-		
373.013713761058		IsS11Max=No	IsS11Min=No	FrameElem=41	ElemStation=0.125				
Frame=41	Station=0.125	OutputCase=TERRLAT	CaseType=LinStatic	Point=1	X2=-0.5	X3=-0.5			
S11=129.940183004251		IsS11Max=Yes	IsS11Min=No	FrameElem=41	ElemStation=0.125				
Frame=41	Station=0.125	OutputCase=TERRLAT	CaseType=LinStatic	Point=2	X2=-0.5	X3=0.5			
S11=129.940183004251		IsS11Max=No	IsS11Min=No	FrameElem=41	ElemStation=0.125				
Frame=41	Station=0.125	OutputCase=TERRLAT	CaseType=LinStatic	Point=3	X2=0.5	X3=-0.5	S11=-		
875.967610526368		IsS11Max=No	IsS11Min=Yes	FrameElem=41	ElemStation=0.125				
Frame=41	Station=0.125	OutputCase=TERRLAT	CaseType=LinStatic	Point=4	X2=0.5	X3=0.5	S11=-		
875.967610526368		IsS11Max=No	IsS11Min=No	FrameElem=41	ElemStation=0.125				
IsS11Max=No	IsS11Min=No	FrameElem=41	ElemStation=0.25	OutputCase=TERRLAT	CaseType=LinStatic	Point=0	X2=0	X3=0	S11=-373.013713761058
Frame=41	Station=0.25	OutputCase=TERRLAT	CaseType=LinStatic	Point=1	X2=-0.5	X3=-0.5			
S11=129.412414619844		IsS11Max=Yes	IsS11Min=No	FrameElem=41	ElemStation=0.25				
Frame=41	Station=0.25	OutputCase=TERRLAT	CaseType=LinStatic	Point=2	X2=-0.5	X3=0.5			
S11=129.412414619844		IsS11Max=No	IsS11Min=No	FrameElem=41	ElemStation=0.25				
Frame=41	Station=0.25	OutputCase=TERRLAT	CaseType=LinStatic	Point=3	X2=0.5	X3=-0.5	S11=-		
875.439842141961		IsS11Max=No	IsS11Min=Yes	FrameElem=41	ElemStation=0.25				
Frame=41	Station=0.25	OutputCase=TERRLAT	CaseType=LinStatic	Point=4	X2=0.5	X3=0.5	S11=-		
875.439842141961		IsS11Max=No	IsS11Min=No	FrameElem=41	ElemStation=0.25				
Frame=41	Station=0.375	OutputCase=TERRLAT	CaseType=LinStatic	Point=0	X2=0	X3=0	S11=-		
373.013713761058		IsS11Max=No	IsS11Min=No	FrameElem=41	ElemStation=0.375				
Frame=41	Station=0.375	OutputCase=TERRLAT	CaseType=LinStatic	Point=1	X2=-0.5	X3=-0.5			
S11=128.884646235437		IsS11Max=Yes	IsS11Min=No	FrameElem=41	ElemStation=0.375				
Frame=41	Station=0.375	OutputCase=TERRLAT	CaseType=LinStatic	Point=2	X2=-0.5	X3=0.5			
S11=128.884646235437		IsS11Max=No	IsS11Min=No	FrameElem=41	ElemStation=0.375				
Frame=41	Station=0.375	OutputCase=TERRLAT	CaseType=LinStatic	Point=3	X2=0.5	X3=-0.5	S11=-		
874.912073757554		IsS11Max=No	IsS11Min=Yes	FrameElem=41	ElemStation=0.375				
Frame=41	Station=0.375	OutputCase=TERRLAT	CaseType=LinStatic	Point=4	X2=0.5	X3=0.5	S11=-		
874.912073757554		IsS11Max=No	IsS11Min=No	FrameElem=41	ElemStation=0.375				
IsS11Max=No	IsS11Min=No	FrameElem=41	ElemStation=0.5	OutputCase=TERRLAT	CaseType=LinStatic	Point=0	X2=0	X3=0	S11=-373.013713761058
Frame=41	Station=0.5	OutputCase=TERRLAT	CaseType=LinStatic	Point=1	X2=-0.5	X3=-0.5			
S11=128.35687785103		IsS11Max=Yes	IsS11Min=No	FrameElem=41	ElemStation=0.5				
Frame=41	Station=0.5	OutputCase=TERRLAT	CaseType=LinStatic	Point=2	X2=-0.5	X3=0.5			
S11=128.35687785103		IsS11Max=No	IsS11Min=No	FrameElem=41	ElemStation=0.5				
Frame=41	Station=0.5	OutputCase=TERRLAT	CaseType=LinStatic	Point=3	X2=0.5	X3=-0.5	S11=-		
874.384305373147		IsS11Max=No	IsS11Min=Yes	FrameElem=41	ElemStation=0.5				
Frame=41	Station=0.5	OutputCase=TERRLAT	CaseType=LinStatic	Point=4	X2=0.5	X3=0.5	S11=-		
874.384305373147		IsS11Max=No	IsS11Min=No	FrameElem=41	ElemStation=0.5				
IsS11Min=Yes	FrameElem=41	ElemStation=0	OutputCase=ACCVERT	CaseType=LinStatic	Point=0	X2=0	X3=0	S11=0	IsS11Max=Yes
Frame=41	Station=0	OutputCase=ACCVERT	CaseType=LinStatic	Point=1	X2=-0.5	X3=-0.5	S11=0		
IsS11Max=No	IsS11Min=No	FrameElem=41	ElemStation=0	OutputCase=ACCVERT	CaseType=LinStatic	Point=2	X2=-0.5	X3=0.5	S11=0
IsS11Min=No	FrameElem=41	ElemStation=0	OutputCase=ACCVERT	CaseType=LinStatic	Point=3	X2=0.5	X3=-0.5	S11=0	IsS11Max=No
Frame=41	Station=0	OutputCase=ACCVERT	CaseType=LinStatic	Point=4	X2=0.5	X3=0.5	S11=0	IsS11Max=No	
IsS11Min=No	FrameElem=41	ElemStation=0	OutputCase=ACCVERT	CaseType=LinStatic	Point=0	X2=0	X3=0	S11=0	IsS11Max=Yes
Frame=41	Station=0.125	OutputCase=ACCVERT	CaseType=LinStatic	Point=1	X2=-0.5	X3=-0.5	S11=0		
IsS11Max=No	IsS11Min=No	FrameElem=41	ElemStation=0.125	OutputCase=ACCVERT	CaseType=LinStatic	Point=2	X2=-0.5	X3=0.5	S11=0
Frame=41	Station=0.125	OutputCase=ACCVERT	CaseType=LinStatic	Point=3	X2=0.5	X3=-0.5	S11=0		
IsS11Max=No	IsS11Min=No	FrameElem=41	ElemStation=0.125	OutputCase=ACCVERT	CaseType=LinStatic	Point=4	X2=0.5	X3=0.5	S11=0
Frame=41	Station=0.125	OutputCase=ACCVERT	CaseType=LinStatic	Point=0	X2=0	X3=0	S11=0	IsS11Max=Yes	
IsS11Min=Yes	FrameElem=41	ElemStation=0.25	OutputCase=ACCVERT	CaseType=LinStatic	Point=1	X2=-0.5	X3=-0.5	S11=0	
Frame=41	Station=0.25	OutputCase=ACCVERT	CaseType=LinStatic	Point=2	X2=-0.5	X3=0.5	S11=0		
IsS11Max=No	IsS11Min=No	FrameElem=41	ElemStation=0.25	OutputCase=ACCVERT	CaseType=LinStatic	Point=3	X2=0.5	X3=-0.5	S11=0
Frame=41	Station=0.25	OutputCase=ACCVERT	CaseType=LinStatic	Point=4	X2=0.5	X3=0.5	S11=0		
IsS11Max=No	IsS11Min=No	FrameElem=41	ElemStation=0.25	OutputCase=ACCVERT	CaseType=LinStatic	Point=0	X2=0	X3=0	S11=0
Frame=41	Station=0.375	OutputCase=ACCVERT	CaseType=LinStatic	Point=1	X2=-0.5	X3=-0.5	S11=0		
IsS11Max=No	IsS11Min=No	FrameElem=41	ElemStation=0.375	OutputCase=ACCVERT	CaseType=LinStatic	Point=2	X2=-0.5	X3=0.5	S11=0
Frame=41	Station=0.375	OutputCase=ACCVERT	CaseType=LinStatic	Point=3	X2=0.5	X3=-0.5	S11=0		
IsS11Max=No	IsS11Min=No	FrameElem=41	ElemStation=0.375	OutputCase=ACCVERT	CaseType=LinStatic	Point=4	X2=0.5	X3=0.5	S11=0
Frame=41	Station=0.375	OutputCase=ACCVERT	CaseType=LinStatic	Point=0	X2=0	X3=0	S11=0	IsS11Max=Yes	
IsS11Min=Yes	FrameElem=41	ElemStation=0.375	OutputCase=ACCVERT	CaseType=LinStatic	Point=1	X2=-0.5	X3=-0.5	S11=0	
Frame=41	Station=0.375	OutputCase=ACCVERT	CaseType=LinStatic	Point=2	X2=-0.5	X3=0.5	S11=0		
IsS11Max=No	IsS11Min=No	FrameElem=41	ElemStation=0.375	OutputCase=ACCVERT	CaseType=LinStatic	Point=3	X2=0.5	X3=-0.5	S11=0
Frame=41	Station=0.375	OutputCase=ACCVERT	CaseType=LinStatic	Point=4	X2=0.5	X3=0.5	S11=0		
IsS11Max=No	IsS11Min=No	FrameElem=41	ElemStation=0.375	OutputCase=ACCVERT	CaseType=LinStatic	Point=0	X2=0	X3=0	S11=0
Frame=41	Station=0.375	OutputCase=ACCVERT	CaseType=LinStatic	Point=1	X2=-0.5	X3=-0.5	S11=0		
IsS11Max=No	IsS11Min=No	FrameElem=41	ElemStation=0.375	OutputCase=ACCVERT	CaseType=LinStatic	Point=2	X2=-0.5	X3=0.5	S11=0
Frame=41	Station=0.375	OutputCase=ACCVERT	CaseType=LinStatic	Point=3	X2=0.5	X3=-0.5	S11=0		
IsS11Max=No	IsS11Min=No	FrameElem=41	ElemStation=0.375	OutputCase=ACCVERT	CaseType=LinStatic	Point=4	X2=0.5	X3=0.5	S11=0
Frame=41	Station=0.375	OutputCase=ACCVERT	CaseType=LinStatic	Point=0	X2=0	X3=0	S11=0	IsS11Max=Yes	
IsS11Min=Yes	FrameElem=41	ElemStation=0.375	OutputCase=ACCVERT	CaseType=LinStatic	Point=1	X2=-0.5	X3=-0.5	S11=0	
Frame=41	Station=0.375	OutputCase=ACCVERT	CaseType=LinStatic	Point=2	X2=-0.5	X3=0.5	S11=0		
IsS11Max=No	IsS11Min=No	FrameElem=41	ElemStation=0.375	OutputCase=ACCVERT	CaseType=LinStatic	Point=3	X2=0.5	X3=-0.5	S11=0
Frame=41	Station=0.375	OutputCase=ACCVERT	CaseType=LinStatic	Point=4	X2=0.5	X3=0.5	S11=0		
IsS11Max=No	IsS11Min=No	FrameElem=41	ElemStation=0.375	OutputCase=ACCVERT	CaseType=LinStatic	Point=0	X2=0	X3=0	S11=0

Frame=41	Station=0	OutputCase=SOVRCOST	CaseType=LinStatic	Point=2	X2=-0.5	X3=0.5	S11=0	
IsS11Max=No	IsS11Min=No	FrameElem=41	ElemStation=0					
Frame=41	Station=0	OutputCase=SOVRCOST	CaseType=LinStatic	Point=3	X2=0.5	X3=-0.5	S11=0	
IsS11Max=No	IsS11Min=No	FrameElem=41	ElemStation=0					
Frame=41	Station=0	OutputCase=SOVRCOST	CaseType=LinStatic	Point=4	X2=0.5	X3=0.5	S11=0	IsS11Max=No
IsS11Min=No	FrameElem=41	ElemStation=0						
Frame=41	Station=0.125	OutputCase=SOVRCOST	CaseType=LinStatic	Point=0	X2=0	X3=0	S11=0	
IsS11Max=Yes	IsS11Min=Yes	FrameElem=41	ElemStation=0.125					
Frame=41	Station=0.125	OutputCase=SOVRCOST	CaseType=LinStatic	Point=1	X2=-0.5	X3=-0.5	S11=0	
IsS11Max=No	IsS11Min=No	FrameElem=41	ElemStation=0.125					
Frame=41	Station=0.125	OutputCase=SOVRCOST	CaseType=LinStatic	Point=2	X2=-0.5	X3=0.5	S11=0	
IsS11Max=No	IsS11Min=No	FrameElem=41	ElemStation=0.125					
Frame=41	Station=0.125	OutputCase=SOVRCOST	CaseType=LinStatic	Point=3	X2=0.5	X3=-0.5	S11=0	
IsS11Max=No	IsS11Min=No	FrameElem=41	ElemStation=0.125					
Frame=41	Station=0.125	OutputCase=SOVRCOST	CaseType=LinStatic	Point=4	X2=0.5	X3=0.5	S11=0	
IsS11Max=No	IsS11Min=No	FrameElem=41	ElemStation=0.125					
Frame=41	Station=0.25	OutputCase=SOVRCOST	CaseType=LinStatic	Point=0	X2=0	X3=0	S11=0	IsS11Max=Yes
IsS11Min=Yes	FrameElem=41	ElemStation=0.25						
Frame=41	Station=0.25	OutputCase=SOVRCOST	CaseType=LinStatic	Point=1	X2=-0.5	X3=-0.5	S11=0	
IsS11Max=No	IsS11Min=No	FrameElem=41	ElemStation=0.25					
Frame=41	Station=0.25	OutputCase=SOVRCOST	CaseType=LinStatic	Point=2	X2=-0.5	X3=0.5	S11=0	
IsS11Max=No	IsS11Min=No	FrameElem=41	ElemStation=0.25					
Frame=41	Station=0.25	OutputCase=SOVRCOST	CaseType=LinStatic	Point=3	X2=0.5	X3=-0.5	S11=0	
IsS11Max=No	IsS11Min=No	FrameElem=41	ElemStation=0.25					
Frame=41	Station=0.25	OutputCase=SOVRCOST	CaseType=LinStatic	Point=4	X2=0.5	X3=0.5	S11=0	
IsS11Max=No	IsS11Min=No	FrameElem=41	ElemStation=0.25					
Frame=41	Station=0.375	OutputCase=SOVRCOST	CaseType=LinStatic	Point=0	X2=0	X3=0	S11=0	
IsS11Max=Yes	IsS11Min=Yes	FrameElem=41	ElemStation=0.375					
Frame=41	Station=0.375	OutputCase=SOVRCOST	CaseType=LinStatic	Point=1	X2=-0.5	X3=-0.5	S11=0	
IsS11Max=No	IsS11Min=No	FrameElem=41	ElemStation=0.375					
Frame=41	Station=0.375	OutputCase=SOVRCOST	CaseType=LinStatic	Point=2	X2=-0.5	X3=0.5	S11=0	
IsS11Max=No	IsS11Min=No	FrameElem=41	ElemStation=0.375					
Frame=41	Station=0.375	OutputCase=SOVRCOST	CaseType=LinStatic	Point=3	X2=0.5	X3=-0.5	S11=0	
IsS11Max=No	IsS11Min=No	FrameElem=41	ElemStation=0.375					
Frame=41	Station=0.375	OutputCase=SOVRCOST	CaseType=LinStatic	Point=4	X2=0.5	X3=0.5	S11=0	
IsS11Max=No	IsS11Min=No	FrameElem=41	ElemStation=0.375					
Frame=41	Station=0.5	OutputCase=SOVRCOST	CaseType=LinStatic	Point=0	X2=0	X3=0	S11=0	IsS11Max=Yes
IsS11Min=Yes	FrameElem=41	ElemStation=0.5						
Frame=41	Station=0.5	OutputCase=SOVRCOST	CaseType=LinStatic	Point=1	X2=-0.5	X3=-0.5	S11=0	
IsS11Max=No	IsS11Min=No	FrameElem=41	ElemStation=0.5					
Frame=41	Station=0.5	OutputCase=SOVRCOST	CaseType=LinStatic	Point=2	X2=-0.5	X3=0.5	S11=0	
IsS11Max=No	IsS11Min=No	FrameElem=41	ElemStation=0.5					
Frame=41	Station=0.5	OutputCase=SOVRCOST	CaseType=LinStatic	Point=3	X2=0.5	X3=-0.5	S11=0	
IsS11Max=No	IsS11Min=No	FrameElem=41	ElemStation=0.5					
Frame=41	Station=0.5	OutputCase=SOVRCOST	CaseType=LinStatic	Point=4	X2=0.5	X3=0.5	S11=0	
IsS11Max=No	IsS11Min=No	FrameElem=41	ElemStation=0.5					
Frame=41	Station=0	OutputCase=ENVE	CaseType=Combination	StepType=Max	Point=0	X2=0	X3=0	S11=-
IsS11Max=No	IsS11Min=No	FrameElem=41	ElemStation=0					
274.637838986977	IsS11Max=No	IsS11Min=No	FrameElem=41	ElemStation=0				
Frame=41	Station=0	OutputCase=ENVE	CaseType=Combination	StepType=Max	Point=1	X2=-0.5	X3=-0.5	
S11=195.124018580893	IsS11Max=Yes	IsS11Min=No	FrameElem=41	ElemStation=0				
Frame=41	Station=0	OutputCase=ENVE	CaseType=Combination	StepType=Max	Point=2	X2=-0.5	X3=0.5	
S11=195.124018580893	IsS11Max=No	IsS11Min=No	FrameElem=41	ElemStation=0				
Frame=41	Station=0	OutputCase=ENVE	CaseType=Combination	StepType=Max	Point=3	X2=0.5	X3=-0.5	S11=-
705.259311138249	IsS11Max=No	IsS11Min=Yes	FrameElem=41	ElemStation=0				
Frame=41	Station=0	OutputCase=ENVE	CaseType=Combination	StepType=Max	Point=4	X2=0.5	X3=0.5	S11=-
705.259311138249	IsS11Max=No	IsS11Min=No	FrameElem=41	ElemStation=0				
Frame=41	Station=0.125	OutputCase=ENVE	CaseType=Combination	StepType=Max	Point=0	X2=0	X3=0	S11=-
274.637838986977	IsS11Max=No	IsS11Min=Yes	FrameElem=41	ElemStation=0.125				
Frame=41	Station=0.125	OutputCase=ENVE	CaseType=Combination	StepType=Max	Point=1	X2=-0.5	X3=-0.5	
S11=-251.02583999261	IsS11Max=Yes	IsS11Min=No	FrameElem=41	ElemStation=0.125				
Frame=41	Station=0.125	OutputCase=ENVE	CaseType=Combination	StepType=Max	Point=2	X2=-0.5	X3=0.5	
S11=-251.02583999261	IsS11Max=No	IsS11Min=No	FrameElem=41	ElemStation=0.125				
Frame=41	Station=0.125	OutputCase=ENVE	CaseType=Combination	StepType=Max	Point=3	X2=0.5	X3=-0.5	
S11=-259.267783080069	IsS11Max=No	IsS11Min=No	FrameElem=41	ElemStation=0.125				
Frame=41	Station=0.125	OutputCase=ENVE	CaseType=Combination	StepType=Max	Point=4	X2=0.5	X3=0.5	
S11=-259.267783080069	IsS11Max=No	IsS11Min=No	FrameElem=41	ElemStation=0.125				
Frame=41	Station=0.25	OutputCase=ENVE	CaseType=Combination	StepType=Max	Point=0	X2=0	X3=0	S11=-
274.637838986977	IsS11Max=No	IsS11Min=No	FrameElem=41	ElemStation=0.25				
Frame=41	Station=0.25	OutputCase=ENVE	CaseType=Combination	StepType=Max	Point=1	X2=-0.5	X3=-0.5	
S11=-699.519448566112	IsS11Max=No	IsS11Min=Yes	FrameElem=41	ElemStation=0.25				
Frame=41	Station=0.25	OutputCase=ENVE	CaseType=Combination	StepType=Max	Point=2	X2=-0.5	X3=0.5	
S11=-699.519448566112	IsS11Max=No	IsS11Min=No	FrameElem=41	ElemStation=0.25				
Frame=41	Station=0.25	OutputCase=ENVE	CaseType=Combination	StepType=Max	Point=3	X2=0.5	X3=-0.5	
S11=189.067494978112	IsS11Max=Yes	IsS11Min=No	FrameElem=41	ElemStation=0.25				
Frame=41	Station=0.25	OutputCase=ENVE	CaseType=Combination	StepType=Max	Point=4	X2=0.5	X3=0.5	
S11=189.067494978112	IsS11Max=No	IsS11Min=No	FrameElem=41	ElemStation=0.25				
Frame=41	Station=0.375	OutputCase=ENVE	CaseType=Combination	StepType=Max	Point=0	X2=0	X3=0	S11=-
274.637838986977	IsS11Max=No	IsS11Min=No	FrameElem=41	ElemStation=0.375				
Frame=41	Station=0.375	OutputCase=ENVE	CaseType=Combination	StepType=Max	Point=1	X2=-0.5	X3=-0.5	
S11=-1150.35680713962	IsS11Max=No	IsS11Min=Yes	FrameElem=41	ElemStation=0.375				
Frame=41	Station=0.375	OutputCase=ENVE	CaseType=Combination	StepType=Max	Point=2	X2=-0.5	X3=0.5	
S11=-1150.35680713962	IsS11Max=No	IsS11Min=No	FrameElem=41	ElemStation=0.375				



Frame=41	Station=0.375	OutputCase=ENVE	CaseType=Combination	StepType=Max	Point=3	X2=0.5	X3=-0.5	
S11=639.746523036292	IsS11Max=Yes	IsS11Min=No	FrameElem=41	ElemStation=0.375				
Frame=41	Station=0.375	OutputCase=ENVE	CaseType=Combination	StepType=Max	Point=4	X2=0.5	X3=0.5	
S11=639.746523036292	IsS11Max=No	IsS11Min=No	FrameElem=41	ElemStation=0.375				
Frame=41	Station=0.5	OutputCase=ENVE	CaseType=Combination	StepType=Max	Point=0	X2=0	X3=0	S11=-
274.637838986977	IsS11Max=No	IsS11Min=No	FrameElem=41	ElemStation=0.5				
Frame=41	Station=0.5	OutputCase=ENVE	CaseType=Combination	StepType=Max	Point=1	X2=-0.5	X3=-0.5	
S11=-1603.53791571312	IsS11Max=No	IsS11Min=Yes	FrameElem=41	ElemStation=0.5				
Frame=41	Station=0.5	OutputCase=ENVE	CaseType=Combination	StepType=Max	Point=2	X2=-0.5	X3=0.5	
S11=-1603.53791571312	IsS11Max=No	IsS11Min=No	FrameElem=41	ElemStation=0.5				
Frame=41	Station=0.5	OutputCase=ENVE	CaseType=Combination	StepType=Max	Point=3	X2=0.5	X3=-0.5	
S11=1092.76930109447	IsS11Max=Yes	IsS11Min=No	FrameElem=41	ElemStation=0.5				
Frame=41	Station=0.5	OutputCase=ENVE	CaseType=Combination	StepType=Max	Point=4	X2=0.5	X3=0.5	
S11=1092.76930109447	IsS11Max=No	IsS11Min=No	FrameElem=41	ElemStation=0.5				
Frame=41	Station=0	OutputCase=ENVE	CaseType=Combination	StepType=Min	Point=0	X2=0	X3=0	S11=-
386.541953115295	IsS11Max=No	IsS11Min=No	FrameElem=41	ElemStation=0				
Frame=41	Station=0	OutputCase=ENVE	CaseType=Combination	StepType=Min	Point=1	X2=-0.5	X3=-0.5	
S11=155.983633164295	IsS11Max=Yes	IsS11Min=No	FrameElem=41	ElemStation=0				
Frame=41	Station=0	OutputCase=ENVE	CaseType=Combination	StepType=Min	Point=2	X2=-0.5	X3=0.5	
S11=155.983633164295	IsS11Max=No	IsS11Min=No	FrameElem=41	ElemStation=0				
Frame=41	Station=0	OutputCase=ENVE	CaseType=Combination	StepType=Min	Point=3	X2=0.5	X3=-0.5	S11=-
968.207924811482	IsS11Max=No	IsS11Min=Yes	FrameElem=41	ElemStation=0				
Frame=41	Station=0	OutputCase=ENVE	CaseType=Combination	StepType=Min	Point=4	X2=0.5	X3=0.5	S11=-
968.207924811482	IsS11Max=No	IsS11Min=No	FrameElem=41	ElemStation=0				
Frame=41	Station=0.125	OutputCase=ENVE	CaseType=Combination	StepType=Min	Point=0	X2=0	X3=0	S11=-
386.541953115295	IsS11Max=No	IsS11Min=No	FrameElem=41	ElemStation=0.125				
Frame=41	Station=0.125	OutputCase=ENVE	CaseType=Combination	StepType=Min	Point=1	X2=-0.5	X3=-0.5	
S11=-290.007894893885	IsS11Max=Yes	IsS11Min=No	FrameElem=41	ElemStation=0.125				
Frame=41	Station=0.125	OutputCase=ENVE	CaseType=Combination	StepType=Min	Point=2	X2=-0.5	X3=0.5	
S11=-290.007894893885	IsS11Max=No	IsS11Min=No	FrameElem=41	ElemStation=0.125				
Frame=41	Station=0.125	OutputCase=ENVE	CaseType=Combination	StepType=Min	Point=3	X2=0.5	X3=-0.5	
S11=-522.058066237979	IsS11Max=No	IsS11Min=Yes	FrameElem=41	ElemStation=0.125				
Frame=41	Station=0.125	OutputCase=ENVE	CaseType=Combination	StepType=Min	Point=4	X2=0.5	X3=0.5	
S11=-522.058066237979	IsS11Max=No	IsS11Min=No	FrameElem=41	ElemStation=0.125				
Frame=41	Station=0.25	OutputCase=ENVE	CaseType=Combination	StepType=Min	Point=0	X2=0	X3=0	S11=-
386.541953115295	IsS11Max=No	IsS11Min=No	FrameElem=41	ElemStation=0.25				
Frame=41	Station=0.25	OutputCase=ENVE	CaseType=Combination	StepType=Min	Point=1	X2=-0.5	X3=-0.5	
S11=-738.343172952066	IsS11Max=No	IsS11Min=Yes	FrameElem=41	ElemStation=0.25				
Frame=41	Station=0.25	OutputCase=ENVE	CaseType=Combination	StepType=Min	Point=2	X2=-0.5	X3=0.5	
S11=-738.343172952066	IsS11Max=No	IsS11Min=No	FrameElem=41	ElemStation=0.25				
Frame=41	Station=0.25	OutputCase=ENVE	CaseType=Combination	StepType=Min	Point=3	X2=0.5	X3=-0.5	
S11=-73.5644576644767	IsS11Max=Yes	IsS11Min=No	FrameElem=41	ElemStation=0.25				
Frame=41	Station=0.25	OutputCase=ENVE	CaseType=Combination	StepType=Min	Point=4	X2=0.5	X3=0.5	
S11=-73.5644576644767	IsS11Max=No	IsS11Min=No	FrameElem=41	ElemStation=0.25				
Frame=41	Station=0.375	OutputCase=ENVE	CaseType=Combination	StepType=Min	Point=0	X2=0	X3=0	S11=-
386.541953115295	IsS11Max=No	IsS11Min=No	FrameElem=41	ElemStation=0.375				
Frame=41	Station=0.375	OutputCase=ENVE	CaseType=Combination	StepType=Min	Point=1	X2=-0.5	X3=-0.5	
S11=-1189.02220101025	IsS11Max=No	IsS11Min=Yes	FrameElem=41	ElemStation=0.375				
Frame=41	Station=0.375	OutputCase=ENVE	CaseType=Combination	StepType=Min	Point=2	X2=-0.5	X3=0.5	
S11=-1189.02220101025	IsS11Max=No	IsS11Min=No	FrameElem=41	ElemStation=0.375				
Frame=41	Station=0.375	OutputCase=ENVE	CaseType=Combination	StepType=Min	Point=3	X2=0.5	X3=-0.5	
S11=377.272900909026	IsS11Max=Yes	IsS11Min=No	FrameElem=41	ElemStation=0.375				
Frame=41	Station=0.375	OutputCase=ENVE	CaseType=Combination	StepType=Min	Point=4	X2=0.5	X3=0.5	
S11=377.272900909026	IsS11Max=No	IsS11Min=No	FrameElem=41	ElemStation=0.375				
Frame=41	Station=0.5	OutputCase=ENVE	CaseType=Combination	StepType=Min	Point=0	X2=0	X3=0	S11=-
386.541953115295	IsS11Max=No	IsS11Min=No	FrameElem=41	ElemStation=0.5				
Frame=41	Station=0.5	OutputCase=ENVE	CaseType=Combination	StepType=Min	Point=1	X2=-0.5	X3=-0.5	
S11=-1642.04497906843	IsS11Max=No	IsS11Min=Yes	FrameElem=41	ElemStation=0.5				
Frame=41	Station=0.5	OutputCase=ENVE	CaseType=Combination	StepType=Min	Point=2	X2=-0.5	X3=0.5	
S11=-1642.04497906843	IsS11Max=No	IsS11Min=No	FrameElem=41	ElemStation=0.5				
Frame=41	Station=0.5	OutputCase=ENVE	CaseType=Combination	StepType=Min	Point=3	X2=0.5	X3=-0.5	
S11=830.454009482529	IsS11Max=Yes	IsS11Min=No	FrameElem=41	ElemStation=0.5				
Frame=41	Station=0.5	OutputCase=ENVE	CaseType=Combination	StepType=Min	Point=4	X2=0.5	X3=0.5	
S11=830.454009482529	IsS11Max=No	IsS11Min=No	FrameElem=41	ElemStation=0.5				
Frame=41	Station=0	OutputCase=FESSUR	CaseType=Combination	Point=0	X2=0	X3=0	S11=-386.541953115295	
IsS11Max=No	IsS11Min=No	FrameElem=41	ElemStation=0					
Frame=41	Station=0	OutputCase=FESSUR	CaseType=Combination	Point=1	X2=-0.5	X3=-0.5		
S11=195.124018580893	IsS11Max=Yes	IsS11Min=No	FrameElem=41	ElemStation=0				
Frame=41	Station=0	OutputCase=FESSUR	CaseType=Combination	Point=2	X2=-0.5	X3=0.5		
S11=195.124018580893	IsS11Max=No	IsS11Min=No	FrameElem=41	ElemStation=0				
Frame=41	Station=0	OutputCase=FESSUR	CaseType=Combination	Point=3	X2=0.5	X3=-0.5	S11=-	
968.207924811482	IsS11Max=No	IsS11Min=Yes	FrameElem=41	ElemStation=0				
Frame=41	Station=0	OutputCase=FESSUR	CaseType=Combination	Point=4	X2=0.5	X3=0.5	S11=-	
968.207924811482	IsS11Max=No	IsS11Min=No	FrameElem=41	ElemStation=0				
Frame=41	Station=0.125	OutputCase=FESSUR	CaseType=Combination	Point=0	X2=0	X3=0	S11=-	
386.541953115295	IsS11Max=No	IsS11Min=No	FrameElem=41	ElemStation=0.125				
Frame=41	Station=0.125	OutputCase=FESSUR	CaseType=Combination	Point=1	X2=-0.5	X3=-0.5	S11=-	
251.02583999261	IsS11Max=Yes	IsS11Min=No	FrameElem=41	ElemStation=0.125				
Frame=41	Station=0.125	OutputCase=FESSUR	CaseType=Combination	Point=2	X2=-0.5	X3=0.5	S11=-	
251.02583999261	IsS11Max=No	IsS11Min=No	FrameElem=41	ElemStation=0.125				
Frame=41	Station=0.125	OutputCase=FESSUR	CaseType=Combination	Point=3	X2=0.5	X3=-0.5	S11=-	
522.058066237979	IsS11Max=No	IsS11Min=Yes	FrameElem=41	ElemStation=0.125				

Frame=41	Station=0.125	OutputCase=FESSUR	CaseType=Combination	Point=4	X2=0.5	X3=0.5	S11=-
522.058066237979	IsS11Max=No	IsS11Min=No	FrameElem=41	ElemStation=0.125			
Frame=41	Station=0.25	OutputCase=FESSUR	CaseType=Combination	Point=0	X2=0	X3=0	S11=-
386.541953115295	IsS11Max=No	IsS11Min=No	FrameElem=41	ElemStation=0.25			
Frame=41	Station=0.25	OutputCase=FESSUR	CaseType=Combination	Point=1	X2=-0.5	X3=-0.5	S11=-
699.519448566112	IsS11Max=No	IsS11Min=Yes	FrameElem=41	ElemStation=0.25			
Frame=41	Station=0.25	OutputCase=FESSUR	CaseType=Combination	Point=2	X2=-0.5	X3=0.5	S11=-
699.519448566112	IsS11Max=No	IsS11Min=No	FrameElem=41	ElemStation=0.25			
Frame=41	Station=0.25	OutputCase=FESSUR	CaseType=Combination	Point=3	X2=0.5	X3=-0.5	S11=-
73.5644576644767	IsS11Max=Yes	IsS11Min=No	FrameElem=41	ElemStation=0.25			
Frame=41	Station=0.25	OutputCase=FESSUR	CaseType=Combination	Point=4	X2=0.5	X3=0.5	S11=-
73.5644576644767	IsS11Max=No	IsS11Min=No	FrameElem=41	ElemStation=0.25			
Frame=41	Station=0.375	OutputCase=FESSUR	CaseType=Combination	Point=0	X2=0	X3=0	S11=-
386.541953115295	IsS11Max=No	IsS11Min=No	FrameElem=41	ElemStation=0.375			
Frame=41	Station=0.375	OutputCase=FESSUR	CaseType=Combination	Point=1	X2=-0.5	X3=-0.5	S11=-
1150.35680713962	IsS11Max=No	IsS11Min=Yes	FrameElem=41	ElemStation=0.375			
Frame=41	Station=0.375	OutputCase=FESSUR	CaseType=Combination	Point=2	X2=-0.5	X3=0.5	S11=-
1150.35680713962	IsS11Max=No	IsS11Min=No	FrameElem=41	ElemStation=0.375			
Frame=41	Station=0.375	OutputCase=FESSUR	CaseType=Combination	Point=3	X2=0.5	X3=-0.5	
S11=377.272900909026	IsS11Max=Yes	IsS11Min=No	FrameElem=41	ElemStation=0.375			
Frame=41	Station=0.375	OutputCase=FESSUR	CaseType=Combination	Point=4	X2=0.5	X3=0.5	
S11=377.272900909026	IsS11Max=No	IsS11Min=No	FrameElem=41	ElemStation=0.375			
Frame=41	Station=0.5	OutputCase=FESSUR	CaseType=Combination	Point=0	X2=0	X3=0	S11=-386.541953115295
IsS11Max=No	IsS11Min=No	FrameElem=41	ElemStation=0.5				
Frame=41	Station=0.5	OutputCase=FESSUR	CaseType=Combination	Point=1	X2=-0.5	X3=-0.5	S11=-
1603.53791571312	IsS11Max=No	IsS11Min=Yes	FrameElem=41	ElemStation=0.5			
Frame=41	Station=0.5	OutputCase=FESSUR	CaseType=Combination	Point=2	X2=-0.5	X3=0.5	S11=-
1603.53791571312	IsS11Max=No	IsS11Min=No	FrameElem=41	ElemStation=0.5			
Frame=41	Station=0.5	OutputCase=FESSUR	CaseType=Combination	Point=3	X2=0.5	X3=-0.5	
S11=830.454009482529	IsS11Max=Yes	IsS11Min=No	FrameElem=41	ElemStation=0.5			
Frame=41	Station=0.5	OutputCase=FESSUR	CaseType=Combination	Point=4	X2=0.5	X3=0.5	
S11=830.454009482529	IsS11Max=No	IsS11Min=No	FrameElem=41	ElemStation=0.5			
Frame=42	Station=0	OutputCase=PESOPR	CaseType=LinStatic	Point=0	X2=0	X3=0	S11=-15.1709467361864
IsS11Max=No	IsS11Min=No	FrameElem=42	ElemStation=0				
Frame=42	Station=0	OutputCase=PESOPR	CaseType=LinStatic	Point=1	X2=-0.5	X3=-0.5	S11=-
300.934814154366	IsS11Max=No	IsS11Min=Yes	FrameElem=42	ElemStation=0			
Frame=42	Station=0	OutputCase=PESOPR	CaseType=LinStatic	Point=2	X2=-0.5	X3=0.5	S11=-
300.934814154366	IsS11Max=No	IsS11Min=No	FrameElem=42	ElemStation=0			
Frame=42	Station=0	OutputCase=PESOPR	CaseType=LinStatic	Point=3	X2=0.5	X3=-0.5	S11=270.592920681993
IsS11Max=Yes	IsS11Min=No	FrameElem=42	ElemStation=0				
Frame=42	Station=0	OutputCase=PESOPR	CaseType=LinStatic	Point=4	X2=0.5	X3=0.5	S11=270.592920681993
IsS11Max=No	IsS11Min=No	FrameElem=42	ElemStation=0				
Frame=42	Station=0.125	OutputCase=PESOPR	CaseType=LinStatic	Point=0	X2=0	X3=0	S11=-15.1709467361864
IsS11Max=No	IsS11Min=No	FrameElem=42	ElemStation=0.125				
Frame=42	Station=0.125	OutputCase=PESOPR	CaseType=LinStatic	Point=1	X2=-0.5	X3=-0.5	S11=-
357.652089760551	IsS11Max=No	IsS11Min=Yes	FrameElem=42	ElemStation=0.125			
Frame=42	Station=0.125	OutputCase=PESOPR	CaseType=LinStatic	Point=2	X2=-0.5	X3=0.5	S11=-
357.652089760551	IsS11Max=No	IsS11Min=No	FrameElem=42	ElemStation=0.125			
Frame=42	Station=0.125	OutputCase=PESOPR	CaseType=LinStatic	Point=3	X2=0.5	X3=-0.5	
S11=327.310196288178	IsS11Max=Yes	IsS11Min=No	FrameElem=42	ElemStation=0.125			
Frame=42	Station=0.125	OutputCase=PESOPR	CaseType=LinStatic	Point=4	X2=0.5	X3=0.5	
S11=327.310196288178	IsS11Max=No	IsS11Min=No	FrameElem=42	ElemStation=0.125			
Frame=42	Station=0.25	OutputCase=PESOPR	CaseType=LinStatic	Point=0	X2=0	X3=0	S11=-15.1709467361864
IsS11Max=No	IsS11Min=No	FrameElem=42	ElemStation=0.25				
Frame=42	Station=0.25	OutputCase=PESOPR	CaseType=LinStatic	Point=1	X2=-0.5	X3=-0.5	S11=-
416.713115366735	IsS11Max=No	IsS11Min=Yes	FrameElem=42	ElemStation=0.25			
Frame=42	Station=0.25	OutputCase=PESOPR	CaseType=LinStatic	Point=2	X2=-0.5	X3=0.5	S11=-
416.713115366735	IsS11Max=No	IsS11Min=No	FrameElem=42	ElemStation=0.25			
Frame=42	Station=0.25	OutputCase=PESOPR	CaseType=LinStatic	Point=3	X2=0.5	X3=-0.5	
S11=386.371221894363	IsS11Max=Yes	IsS11Min=No	FrameElem=42	ElemStation=0.25			
Frame=42	Station=0.25	OutputCase=PESOPR	CaseType=LinStatic	Point=4	X2=0.5	X3=0.5	
S11=386.371221894363	IsS11Max=No	IsS11Min=No	FrameElem=42	ElemStation=0.25			
Frame=42	Station=0.375	OutputCase=PESOPR	CaseType=LinStatic	Point=0	X2=0	X3=0	S11=-15.1709467361864
IsS11Max=No	IsS11Min=No	FrameElem=42	ElemStation=0.375				
Frame=42	Station=0.375	OutputCase=PESOPR	CaseType=LinStatic	Point=1	X2=-0.5	X3=-0.5	S11=-
478.11789097292	IsS11Max=No	IsS11Min=Yes	FrameElem=42	ElemStation=0.375			
Frame=42	Station=0.375	OutputCase=PESOPR	CaseType=LinStatic	Point=2	X2=-0.5	X3=0.5	S11=-
478.11789097292	IsS11Max=No	IsS11Min=No	FrameElem=42	ElemStation=0.375			
Frame=42	Station=0.375	OutputCase=PESOPR	CaseType=LinStatic	Point=3	X2=0.5	X3=-0.5	
S11=447.775997500547	IsS11Max=Yes	IsS11Min=No	FrameElem=42	ElemStation=0.375			
Frame=42	Station=0.375	OutputCase=PESOPR	CaseType=LinStatic	Point=4	X2=0.5	X3=0.5	
S11=447.775997500547	IsS11Max=No	IsS11Min=No	FrameElem=42	ElemStation=0.375			
Frame=42	Station=0.5	OutputCase=PESOPR	CaseType=LinStatic	Point=0	X2=0	X3=0	S11=-15.1709467361864
IsS11Max=No	IsS11Min=No	FrameElem=42	ElemStation=0.5				
Frame=42	Station=0.5	OutputCase=PESOPR	CaseType=LinStatic	Point=1	X2=-0.5	X3=-0.5	S11=-
541.866416579104	IsS11Max=No	IsS11Min=Yes	FrameElem=42	ElemStation=0.5			
Frame=42	Station=0.5	OutputCase=PESOPR	CaseType=LinStatic	Point=2	X2=-0.5	X3=0.5	S11=-
541.866416579104	IsS11Max=No	IsS11Min=No	FrameElem=42	ElemStation=0.5			
Frame=42	Station=0.5	OutputCase=PESOPR	CaseType=LinStatic	Point=3	X2=0.5	X3=-0.5	
S11=511.524523106732	IsS11Max=Yes	IsS11Min=No	FrameElem=42	ElemStation=0.5			
Frame=42	Station=0.5	OutputCase=PESOPR	CaseType=LinStatic	Point=4	X2=0.5	X3=0.5	
S11=511.524523106732	IsS11Max=No	IsS11Min=No	FrameElem=42	ElemStation=0.5			



Frame=42	Station=0	OutputCase=TERRVERT	CaseType=LinStatic	Point=0	X2=0	X3=0	S11=1.64270738195018
IsS11Max=No	IsS11Min=No	FrameElem=42	ElemStation=0				
Frame=42	Station=0	OutputCase=TERRVERT	CaseType=LinStatic	Point=1	X2=-0.5	X3=-0.5	S11=-
1430.95997940959	IsS11Max=No	IsS11Min=Yes	FrameElem=42	ElemStation=0			
Frame=42	Station=0	OutputCase=TERRVERT	CaseType=LinStatic	Point=2	X2=-0.5	X3=0.5	S11=-
1430.95997940959	IsS11Max=No	IsS11Min=No	FrameElem=42	ElemStation=0			
Frame=42	Station=0	OutputCase=TERRVERT	CaseType=LinStatic	Point=3	X2=0.5	X3=-0.5	
S11=1434.24539417349	IsS11Max=Yes	IsS11Min=No	FrameElem=42	ElemStation=0			
Frame=42	Station=0	OutputCase=TERRVERT	CaseType=LinStatic	Point=4	X2=0.5	X3=0.5	
S11=1434.24539417349	IsS11Max=No	IsS11Min=No	FrameElem=42	ElemStation=0			
Frame=42	Station=0.125	OutputCase=TERRVERT	CaseType=LinStatic	Point=0	X2=0	X3=0	
S11=1.64270738195018	IsS11Max=No	IsS11Min=No	FrameElem=42	ElemStation=0.125			
Frame=42	Station=0.125	OutputCase=TERRVERT	CaseType=LinStatic	Point=1	X2=-0.5	X3=-0.5	S11=-
1690.19107868251	IsS11Max=No	IsS11Min=Yes	FrameElem=42	ElemStation=0.125			
Frame=42	Station=0.125	OutputCase=TERRVERT	CaseType=LinStatic	Point=2	X2=-0.5	X3=0.5	S11=-
1690.19107868251	IsS11Max=No	IsS11Min=No	FrameElem=42	ElemStation=0.125			
Frame=42	Station=0.125	OutputCase=TERRVERT	CaseType=LinStatic	Point=3	X2=0.5	X3=-0.5	
S11=1693.47649344641	IsS11Max=Yes	IsS11Min=No	FrameElem=42	ElemStation=0.125			
Frame=42	Station=0.125	OutputCase=TERRVERT	CaseType=LinStatic	Point=4	X2=0.5	X3=0.5	
S11=1693.47649344641	IsS11Max=No	IsS11Min=No	FrameElem=42	ElemStation=0.125			
Frame=42	Station=0.25	OutputCase=TERRVERT	CaseType=LinStatic	Point=0	X2=0	X3=0	S11=1.64270738195018
IsS11Max=No	IsS11Min=No	FrameElem=42	ElemStation=0.25				
Frame=42	Station=0.25	OutputCase=TERRVERT	CaseType=LinStatic	Point=1	X2=-0.5	X3=-0.5	S11=-
1949.42217795544	IsS11Max=No	IsS11Min=Yes	FrameElem=42	ElemStation=0.25			
Frame=42	Station=0.25	OutputCase=TERRVERT	CaseType=LinStatic	Point=2	X2=-0.5	X3=0.5	S11=-
1949.42217795544	IsS11Max=No	IsS11Min=No	FrameElem=42	ElemStation=0.25			
Frame=42	Station=0.25	OutputCase=TERRVERT	CaseType=LinStatic	Point=3	X2=0.5	X3=-0.5	
S11=1952.70759271934	IsS11Max=Yes	IsS11Min=No	FrameElem=42	ElemStation=0.25			
Frame=42	Station=0.25	OutputCase=TERRVERT	CaseType=LinStatic	Point=4	X2=0.5	X3=0.5	
S11=1952.70759271934	IsS11Max=No	IsS11Min=No	FrameElem=42	ElemStation=0.25			
Frame=42	Station=0.375	OutputCase=TERRVERT	CaseType=LinStatic	Point=0	X2=0	X3=0	
S11=1.64270738195018	IsS11Max=No	IsS11Min=No	FrameElem=42	ElemStation=0.375			
Frame=42	Station=0.375	OutputCase=TERRVERT	CaseType=LinStatic	Point=1	X2=-0.5	X3=-0.5	S11=-
2208.65327722836	IsS11Max=No	IsS11Min=Yes	FrameElem=42	ElemStation=0.375			
Frame=42	Station=0.375	OutputCase=TERRVERT	CaseType=LinStatic	Point=2	X2=-0.5	X3=0.5	S11=-
2208.65327722836	IsS11Max=No	IsS11Min=No	FrameElem=42	ElemStation=0.375			
Frame=42	Station=0.375	OutputCase=TERRVERT	CaseType=LinStatic	Point=3	X2=0.5	X3=-0.5	
S11=2211.93869199226	IsS11Max=Yes	IsS11Min=No	FrameElem=42	ElemStation=0.375			
Frame=42	Station=0.375	OutputCase=TERRVERT	CaseType=LinStatic	Point=4	X2=0.5	X3=0.5	
S11=2211.93869199226	IsS11Max=No	IsS11Min=No	FrameElem=42	ElemStation=0.375			
Frame=42	Station=0.5	OutputCase=TERRVERT	CaseType=LinStatic	Point=0	X2=0	X3=0	S11=1.64270738195018
IsS11Max=No	IsS11Min=No	FrameElem=42	ElemStation=0.5				
Frame=42	Station=0.5	OutputCase=TERRVERT	CaseType=LinStatic	Point=1	X2=-0.5	X3=-0.5	S11=-
2467.88437650129	IsS11Max=No	IsS11Min=Yes	FrameElem=42	ElemStation=0.5			
Frame=42	Station=0.5	OutputCase=TERRVERT	CaseType=LinStatic	Point=2	X2=-0.5	X3=0.5	S11=-
2467.88437650129	IsS11Max=No	IsS11Min=No	FrameElem=42	ElemStation=0.5			
Frame=42	Station=0.5	OutputCase=TERRVERT	CaseType=LinStatic	Point=3	X2=0.5	X3=-0.5	
S11=2471.16979126519	IsS11Max=Yes	IsS11Min=No	FrameElem=42	ElemStation=0.5			
Frame=42	Station=0.5	OutputCase=TERRVERT	CaseType=LinStatic	Point=4	X2=0.5	X3=0.5	
S11=2471.16979126519	IsS11Max=No	IsS11Min=No	FrameElem=42	ElemStation=0.5			
Frame=42	Station=0	OutputCase=TERRLAT	CaseType=LinStatic	Point=0	X2=0	X3=0	S11=-373.013713761058
IsS11Max=No	IsS11Min=No	FrameElem=42	ElemStation=0				
Frame=42	Station=0	OutputCase=TERRLAT	CaseType=LinStatic	Point=1	X2=-0.5	X3=-0.5	
S11=128.356877851031	IsS11Max=Yes	IsS11Min=No	FrameElem=42	ElemStation=0			
Frame=42	Station=0	OutputCase=TERRLAT	CaseType=LinStatic	Point=2	X2=-0.5	X3=0.5	
S11=128.356877851031	IsS11Max=No	IsS11Min=No	FrameElem=42	ElemStation=0			
Frame=42	Station=0	OutputCase=TERRLAT	CaseType=LinStatic	Point=3	X2=0.5	X3=-0.5	S11=-
874.384305373147	IsS11Max=No	IsS11Min=Yes	FrameElem=42	ElemStation=0			
Frame=42	Station=0	OutputCase=TERRLAT	CaseType=LinStatic	Point=4	X2=0.5	X3=0.5	S11=-
874.384305373147	IsS11Max=No	IsS11Min=No	FrameElem=42	ElemStation=0			
Frame=42	Station=0.125	OutputCase=TERRLAT	CaseType=LinStatic	Point=0	X2=0	X3=0	S11=-
373.013713761058	IsS11Max=No	IsS11Min=No	FrameElem=42	ElemStation=0.125			
Frame=42	Station=0.125	OutputCase=TERRLAT	CaseType=LinStatic	Point=1	X2=-0.5	X3=-0.5	
S11=127.811803222802	IsS11Max=Yes	IsS11Min=No	FrameElem=42	ElemStation=0.125			
Frame=42	Station=0.125	OutputCase=TERRLAT	CaseType=LinStatic	Point=2	X2=-0.5	X3=0.5	
S11=127.811803222802	IsS11Max=No	IsS11Min=No	FrameElem=42	ElemStation=0.125			
Frame=42	Station=0.125	OutputCase=TERRLAT	CaseType=LinStatic	Point=3	X2=0.5	X3=-0.5	S11=-
873.839230744918	IsS11Max=No	IsS11Min=Yes	FrameElem=42	ElemStation=0.125			
Frame=42	Station=0.125	OutputCase=TERRLAT	CaseType=LinStatic	Point=4	X2=0.5	X3=0.5	S11=-
873.839230744918	IsS11Max=No	IsS11Min=No	FrameElem=42	ElemStation=0.125			
Frame=42	Station=0.25	OutputCase=TERRLAT	CaseType=LinStatic	Point=0	X2=0	X3=0	S11=-373.013713761058
IsS11Max=No	IsS11Min=No	FrameElem=42	ElemStation=0.25				
Frame=42	Station=0.25	OutputCase=TERRLAT	CaseType=LinStatic	Point=1	X2=-0.5	X3=-0.5	
S11=127.266728594573	IsS11Max=Yes	IsS11Min=No	FrameElem=42	ElemStation=0.25			
Frame=42	Station=0.25	OutputCase=TERRLAT	CaseType=LinStatic	Point=2	X2=-0.5	X3=0.5	
S11=127.266728594573	IsS11Max=No	IsS11Min=No	FrameElem=42	ElemStation=0.25			
Frame=42	Station=0.25	OutputCase=TERRLAT	CaseType=LinStatic	Point=3	X2=0.5	X3=-0.5	S11=-
873.29415611669	IsS11Max=No	IsS11Min=Yes	FrameElem=42	ElemStation=0.25			
Frame=42	Station=0.25	OutputCase=TERRLAT	CaseType=LinStatic	Point=4	X2=0.5	X3=0.5	S11=-
873.29415611669	IsS11Max=No	IsS11Min=No	FrameElem=42	ElemStation=0.25			
Frame=42	Station=0.375	OutputCase=TERRLAT	CaseType=LinStatic	Point=0	X2=0	X3=0	S11=-
373.013713761058	IsS11Max=No	IsS11Min=No	FrameElem=42	ElemStation=0.375			



Frame=42	Station=0.25	OutputCase=SOVRCOST	CaseType=LinStatic	Point=4	X2=0.5	X3=0.5	S11=0	
IsS11Max=No	IsS11Min=No	FrameElem=42	ElemStation=0.25					
Frame=42	Station=0.375	OutputCase=SOVRCOST	CaseType=LinStatic	Point=0	X2=0	X3=0	S11=0	
IsS11Max=Yes	IsS11Min=Yes	FrameElem=42	ElemStation=0.375					
Frame=42	Station=0.375	OutputCase=SOVRCOST	CaseType=LinStatic	Point=1	X2=-0.5	X3=-0.5	S11=0	
IsS11Max=No	IsS11Min=No	FrameElem=42	ElemStation=0.375					
Frame=42	Station=0.375	OutputCase=SOVRCOST	CaseType=LinStatic	Point=2	X2=-0.5	X3=0.5	S11=0	
IsS11Max=No	IsS11Min=No	FrameElem=42	ElemStation=0.375					
Frame=42	Station=0.375	OutputCase=SOVRCOST	CaseType=LinStatic	Point=3	X2=0.5	X3=-0.5	S11=0	
IsS11Max=No	IsS11Min=No	FrameElem=42	ElemStation=0.375					
Frame=42	Station=0.375	OutputCase=SOVRCOST	CaseType=LinStatic	Point=4	X2=0.5	X3=0.5	S11=0	
IsS11Max=No	IsS11Min=No	FrameElem=42	ElemStation=0.375					
Frame=42	Station=0.5	OutputCase=SOVRCOST	CaseType=LinStatic	Point=0	X2=0	X3=0	S11=0	
IsS11Min=Yes	FrameElem=42	ElemStation=0.5					IsS11Max=Yes	
Frame=42	Station=0.5	OutputCase=SOVRCOST	CaseType=LinStatic	Point=1	X2=-0.5	X3=-0.5	S11=0	
IsS11Max=No	IsS11Min=No	FrameElem=42	ElemStation=0.5					
Frame=42	Station=0.5	OutputCase=SOVRCOST	CaseType=LinStatic	Point=2	X2=-0.5	X3=0.5	S11=0	
IsS11Max=No	IsS11Min=No	FrameElem=42	ElemStation=0.5					
Frame=42	Station=0.5	OutputCase=SOVRCOST	CaseType=LinStatic	Point=3	X2=0.5	X3=-0.5	S11=0	
IsS11Max=No	IsS11Min=No	FrameElem=42	ElemStation=0.5					
Frame=42	Station=0.5	OutputCase=SOVRCOST	CaseType=LinStatic	Point=4	X2=0.5	X3=0.5	S11=0	
IsS11Max=No	IsS11Min=No	FrameElem=42	ElemStation=0.5					
Frame=42	Station=0	OutputCase=ENVE	CaseType=Combination	StepType=Max	Point=0	X2=0	X3=0	S11=-
274.637838986977	IsS11Max=No	IsS11Min=No	FrameElem=42	ElemStation=0				
Frame=42	Station=0	OutputCase=ENVE	CaseType=Combination	StepType=Max	Point=1	X2=-0.5	X3=-0.5	
S11=-1603.53791571292	IsS11Max=No	IsS11Min=Yes	FrameElem=42	ElemStation=0				
Frame=42	Station=0	OutputCase=ENVE	CaseType=Combination	StepType=Max	Point=2	X2=-0.5	X3=0.5	S11=-
1603.53791571292	IsS11Max=No	IsS11Min=No	FrameElem=42	ElemStation=0				
Frame=42	Station=0	OutputCase=ENVE	CaseType=Combination	StepType=Max	Point=3	X2=0.5	X3=-0.5	
S11=1092.76930109428	IsS11Max=Yes	IsS11Min=No	FrameElem=42	ElemStation=0				
Frame=42	Station=0	OutputCase=ENVE	CaseType=Combination	StepType=Max	Point=4	X2=0.5	X3=0.5	
S11=1092.76930109428	IsS11Max=No	IsS11Min=No	FrameElem=42	ElemStation=0				
Frame=42	Station=0.125	OutputCase=ENVE	CaseType=Combination	StepType=Max	Point=0	X2=0	X3=0	S11=-
274.637838986977	IsS11Max=No	IsS11Min=No	FrameElem=42	ElemStation=0.125				
Frame=42	Station=0.125	OutputCase=ENVE	CaseType=Combination	StepType=Max	Point=1	X2=-0.5	X3=-0.5	
S11=-1920.03136522026	IsS11Max=No	IsS11Min=Yes	FrameElem=42	ElemStation=0.125				
Frame=42	Station=0.125	OutputCase=ENVE	CaseType=Combination	StepType=Max	Point=2	X2=-0.5	X3=0.5	
S11=-1920.03136522026	IsS11Max=No	IsS11Min=No	FrameElem=42	ElemStation=0.125				
Frame=42	Station=0.125	OutputCase=ENVE	CaseType=Combination	StepType=Max	Point=3	X2=0.5	X3=-0.5	
S11=1409.09922821315	IsS11Max=Yes	IsS11Min=No	FrameElem=42	ElemStation=0.125				
Frame=42	Station=0.125	OutputCase=ENVE	CaseType=Combination	StepType=Max	Point=4	X2=0.5	X3=0.5	
S11=1409.09922821315	IsS11Max=No	IsS11Min=No	FrameElem=42	ElemStation=0.125				
Frame=42	Station=0.25	OutputCase=ENVE	CaseType=Combination	StepType=Max	Point=0	X2=0	X3=0	S11=-
274.637838986977	IsS11Max=No	IsS11Min=No	FrameElem=42	ElemStation=0.25				
Frame=42	Station=0.25	OutputCase=ENVE	CaseType=Combination	StepType=Max	Point=1	X2=-0.5	X3=-0.5	
S11=-2238.8685647276	IsS11Max=No	IsS11Min=Yes	FrameElem=42	ElemStation=0.25				
Frame=42	Station=0.25	OutputCase=ENVE	CaseType=Combination	StepType=Max	Point=2	X2=-0.5	X3=0.5	
S11=-2238.8685647276	IsS11Max=No	IsS11Min=No	FrameElem=42	ElemStation=0.25				
Frame=42	Station=0.25	OutputCase=ENVE	CaseType=Combination	StepType=Max	Point=3	X2=0.5	X3=-0.5	
S11=1727.77290533202	IsS11Max=Yes	IsS11Min=No	FrameElem=42	ElemStation=0.25				
Frame=42	Station=0.25	OutputCase=ENVE	CaseType=Combination	StepType=Max	Point=4	X2=0.5	X3=0.5	
S11=1727.77290533202	IsS11Max=No	IsS11Min=No	FrameElem=42	ElemStation=0.25				
Frame=42	Station=0.375	OutputCase=ENVE	CaseType=Combination	StepType=Max	Point=0	X2=0	X3=0	S11=-
274.637838986977	IsS11Max=No	IsS11Min=No	FrameElem=42	ElemStation=0.375				
Frame=42	Station=0.375	OutputCase=ENVE	CaseType=Combination	StepType=Max	Point=1	X2=-0.5	X3=-0.5	
S11=-2560.04951423494	IsS11Max=No	IsS11Min=Yes	FrameElem=42	ElemStation=0.375				
Frame=42	Station=0.375	OutputCase=ENVE	CaseType=Combination	StepType=Max	Point=2	X2=-0.5	X3=0.5	
S11=-2560.04951423494	IsS11Max=No	IsS11Min=No	FrameElem=42	ElemStation=0.375				
Frame=42	Station=0.375	OutputCase=ENVE	CaseType=Combination	StepType=Max	Point=3	X2=0.5	X3=-0.5	
S11=2048.79033245089	IsS11Max=Yes	IsS11Min=No	FrameElem=42	ElemStation=0.375				
Frame=42	Station=0.375	OutputCase=ENVE	CaseType=Combination	StepType=Max	Point=4	X2=0.5	X3=0.5	
S11=2048.79033245089	IsS11Max=No	IsS11Min=No	FrameElem=42	ElemStation=0.375				
Frame=42	Station=0.5	OutputCase=ENVE	CaseType=Combination	StepType=Max	Point=0	X2=0	X3=0	S11=-
274.637838986977	IsS11Max=No	IsS11Min=No	FrameElem=42	ElemStation=0.5				
Frame=42	Station=0.5	OutputCase=ENVE	CaseType=Combination	StepType=Max	Point=1	X2=-0.5	X3=-0.5	
S11=-2883.57421374228	IsS11Max=No	IsS11Min=Yes	FrameElem=42	ElemStation=0.5				
Frame=42	Station=0.5	OutputCase=ENVE	CaseType=Combination	StepType=Max	Point=2	X2=-0.5	X3=0.5	
S11=-2883.57421374228	IsS11Max=No	IsS11Min=No	FrameElem=42	ElemStation=0.5				
Frame=42	Station=0.5	OutputCase=ENVE	CaseType=Combination	StepType=Max	Point=3	X2=0.5	X3=-0.5	
S11=2372.15150956976	IsS11Max=Yes	IsS11Min=No	FrameElem=42	ElemStation=0.5				
Frame=42	Station=0.5	OutputCase=ENVE	CaseType=Combination	StepType=Max	Point=4	X2=0.5	X3=0.5	
S11=2372.15150956976	IsS11Max=No	IsS11Min=No	FrameElem=42	ElemStation=0.5				
Frame=42	Station=0	OutputCase=ENVE	CaseType=Combination	StepType=Min	Point=0	X2=0	X3=0	S11=-
386.541953115295	IsS11Max=No	IsS11Min=No	FrameElem=42	ElemStation=0				
Frame=42	Station=0	OutputCase=ENVE	CaseType=Combination	StepType=Min	Point=1	X2=-0.5	X3=-0.5	
S11=-1642.04497906823	IsS11Max=No	IsS11Min=Yes	FrameElem=42	ElemStation=0				
Frame=42	Station=0	OutputCase=ENVE	CaseType=Combination	StepType=Min	Point=2	X2=-0.5	X3=0.5	S11=-
1642.04497906823	IsS11Max=No	IsS11Min=No	FrameElem=42	ElemStation=0				
Frame=42	Station=0	OutputCase=ENVE	CaseType=Combination	StepType=Min	Point=3	X2=0.5	X3=-0.5	
S11=830.454009482332	IsS11Max=Yes	IsS11Min=No	FrameElem=42	ElemStation=0				
Frame=42	Station=0	OutputCase=ENVE	CaseType=Combination	StepType=Min	Point=4	X2=0.5	X3=0.5	
S11=830.454009482332	IsS11Max=No	IsS11Min=No	FrameElem=42	ElemStation=0				

Frame=42	Station=0.125	OutputCase=ENVE	CaseType=Combination	StepType=Min	Point=0	X2=0	X3=0	S11=-
386.541953115295	IsS11Max=No	IsS11Min=No	FrameElem=42	ElemStation=0.125				
Frame=42	Station=0.125	OutputCase=ENVE	CaseType=Combination	StepType=Min	Point=1	X2=-0.5	X3=-0.5	
S11=-1958.3749061871	IsS11Max=No	IsS11Min=Yes	FrameElem=42	ElemStation=0.125				
Frame=42	Station=0.125	OutputCase=ENVE	CaseType=Combination	StepType=Min	Point=2	X2=-0.5	X3=0.5	
S11=-1958.3749061871	IsS11Max=No	IsS11Min=No	FrameElem=42	ElemStation=0.125				
Frame=42	Station=0.125	OutputCase=ENVE	CaseType=Combination	StepType=Min	Point=3	X2=0.5	X3=-0.5	
S11=1146.94745898967	IsS11Max=Yes	IsS11Min=No	FrameElem=42	ElemStation=0.125				
Frame=42	Station=0.125	OutputCase=ENVE	CaseType=Combination	StepType=Min	Point=4	X2=0.5	X3=0.5	
S11=1146.94745898967	IsS11Max=No	IsS11Min=No	FrameElem=42	ElemStation=0.125				
Frame=42	Station=0.25	OutputCase=ENVE	CaseType=Combination	StepType=Min	Point=0	X2=0	X3=0	S11=-
386.541953115295	IsS11Max=No	IsS11Min=No	FrameElem=42	ElemStation=0.25				
Frame=42	Station=0.25	OutputCase=ENVE	CaseType=Combination	StepType=Min	Point=1	X2=-0.5	X3=-0.5	
S11=-2277.04858330597	IsS11Max=No	IsS11Min=Yes	FrameElem=42	ElemStation=0.25				
Frame=42	Station=0.25	OutputCase=ENVE	CaseType=Combination	StepType=Min	Point=2	X2=-0.5	X3=0.5	
S11=-2277.04858330597	IsS11Max=No	IsS11Min=No	FrameElem=42	ElemStation=0.25				
Frame=42	Station=0.25	OutputCase=ENVE	CaseType=Combination	StepType=Min	Point=3	X2=0.5	X3=-0.5	
S11=1465.78465849701	IsS11Max=Yes	IsS11Min=No	FrameElem=42	ElemStation=0.25				
Frame=42	Station=0.25	OutputCase=ENVE	CaseType=Combination	StepType=Min	Point=4	X2=0.5	X3=0.5	
S11=1465.78465849701	IsS11Max=No	IsS11Min=No	FrameElem=42	ElemStation=0.25				
Frame=42	Station=0.375	OutputCase=ENVE	CaseType=Combination	StepType=Min	Point=0	X2=0	X3=0	S11=-
386.541953115295	IsS11Max=No	IsS11Min=No	FrameElem=42	ElemStation=0.375				
Frame=42	Station=0.375	OutputCase=ENVE	CaseType=Combination	StepType=Min	Point=1	X2=-0.5	X3=-0.5	
S11=-2598.06601042484	IsS11Max=No	IsS11Min=Yes	FrameElem=42	ElemStation=0.375				
Frame=42	Station=0.375	OutputCase=ENVE	CaseType=Combination	StepType=Min	Point=2	X2=-0.5	X3=0.5	
S11=-2598.06601042484	IsS11Max=No	IsS11Min=No	FrameElem=42	ElemStation=0.375				
Frame=42	Station=0.375	OutputCase=ENVE	CaseType=Combination	StepType=Min	Point=3	X2=0.5	X3=-0.5	
S11=1786.96560800435	IsS11Max=Yes	IsS11Min=No	FrameElem=42	ElemStation=0.375				
Frame=42	Station=0.375	OutputCase=ENVE	CaseType=Combination	StepType=Min	Point=4	X2=0.5	X3=0.5	
S11=1786.96560800435	IsS11Max=No	IsS11Min=No	FrameElem=42	ElemStation=0.375				
Frame=42	Station=0.5	OutputCase=ENVE	CaseType=Combination	StepType=Min	Point=0	X2=0	X3=0	S11=-
386.541953115295	IsS11Max=No	IsS11Min=No	FrameElem=42	ElemStation=0.5				
Frame=42	Station=0.5	OutputCase=ENVE	CaseType=Combination	StepType=Min	Point=1	X2=-0.5	X3=-0.5	
S11=-2921.42718754371	IsS11Max=No	IsS11Min=Yes	FrameElem=42	ElemStation=0.5				
Frame=42	Station=0.5	OutputCase=ENVE	CaseType=Combination	StepType=Min	Point=2	X2=-0.5	X3=0.5	
S11=-2921.42718754371	IsS11Max=No	IsS11Min=No	FrameElem=42	ElemStation=0.5				
Frame=42	Station=0.5	OutputCase=ENVE	CaseType=Combination	StepType=Min	Point=3	X2=0.5	X3=-0.5	
S11=2110.49030751169	IsS11Max=Yes	IsS11Min=No	FrameElem=42	ElemStation=0.5				
Frame=42	Station=0.5	OutputCase=ENVE	CaseType=Combination	StepType=Min	Point=4	X2=0.5	X3=0.5	
S11=2110.49030751169	IsS11Max=No	IsS11Min=No	FrameElem=42	ElemStation=0.5				
Frame=42	Station=0	OutputCase=FESSUR	CaseType=Combination	Point=0	X2=0	X3=0	S11=-386.541953115295	
IsS11Max=No	IsS11Min=No	FrameElem=42	ElemStation=0					
Frame=42	Station=0	OutputCase=FESSUR	CaseType=Combination	Point=1	X2=-0.5	X3=-0.5	S11=-	
1603.53791571292	IsS11Max=No	IsS11Min=Yes	FrameElem=42	ElemStation=0				
Frame=42	Station=0	OutputCase=FESSUR	CaseType=Combination	Point=2	X2=-0.5	X3=0.5	S11=-	
1603.53791571292	IsS11Max=No	IsS11Min=No	FrameElem=42	ElemStation=0				
Frame=42	Station=0	OutputCase=FESSUR	CaseType=Combination	Point=3	X2=0.5	X3=-0.5		
S11=830.454009482332	IsS11Max=Yes	IsS11Min=No	FrameElem=42	ElemStation=0				
Frame=42	Station=0	OutputCase=FESSUR	CaseType=Combination	Point=4	X2=0.5	X3=0.5		
S11=830.454009482332	IsS11Max=No	IsS11Min=No	FrameElem=42	ElemStation=0				
Frame=42	Station=0.125	OutputCase=FESSUR	CaseType=Combination	Point=0	X2=0	X3=0	S11=-	
386.541953115295	IsS11Max=No	IsS11Min=No	FrameElem=42	ElemStation=0.125				
Frame=42	Station=0.125	OutputCase=FESSUR	CaseType=Combination	Point=1	X2=-0.5	X3=-0.5	S11=-	
1920.03136522026	IsS11Max=No	IsS11Min=Yes	FrameElem=42	ElemStation=0.125				
Frame=42	Station=0.125	OutputCase=FESSUR	CaseType=Combination	Point=2	X2=-0.5	X3=0.5	S11=-	
1920.03136522026	IsS11Max=No	IsS11Min=No	FrameElem=42	ElemStation=0.125				
Frame=42	Station=0.125	OutputCase=FESSUR	CaseType=Combination	Point=3	X2=0.5	X3=-0.5		
S11=1146.94745898967	IsS11Max=Yes	IsS11Min=No	FrameElem=42	ElemStation=0.125				
Frame=42	Station=0.125	OutputCase=FESSUR	CaseType=Combination	Point=4	X2=0.5	X3=0.5		
S11=1146.94745898967	IsS11Max=No	IsS11Min=No	FrameElem=42	ElemStation=0.125				
Frame=42	Station=0.25	OutputCase=FESSUR	CaseType=Combination	Point=0	X2=0	X3=0	S11=-	
386.541953115295	IsS11Max=No	IsS11Min=No	FrameElem=42	ElemStation=0.25				
Frame=42	Station=0.25	OutputCase=FESSUR	CaseType=Combination	Point=1	X2=-0.5	X3=-0.5	S11=-	
2238.8685647276	IsS11Max=No	IsS11Min=Yes	FrameElem=42	ElemStation=0.25				
Frame=42	Station=0.25	OutputCase=FESSUR	CaseType=Combination	Point=2	X2=-0.5	X3=0.5	S11=-	
2238.8685647276	IsS11Max=No	IsS11Min=No	FrameElem=42	ElemStation=0.25				
Frame=42	Station=0.25	OutputCase=FESSUR	CaseType=Combination	Point=3	X2=0.5	X3=-0.5		
S11=1465.78465849701	IsS11Max=Yes	IsS11Min=No	FrameElem=42	ElemStation=0.25				
Frame=42	Station=0.25	OutputCase=FESSUR	CaseType=Combination	Point=4	X2=0.5	X3=0.5		
S11=1465.78465849701	IsS11Max=No	IsS11Min=No	FrameElem=42	ElemStation=0.25				
Frame=42	Station=0.375	OutputCase=FESSUR	CaseType=Combination	Point=0	X2=0	X3=0	S11=-	
386.541953115295	IsS11Max=No	IsS11Min=No	FrameElem=42	ElemStation=0.375				
Frame=42	Station=0.375	OutputCase=FESSUR	CaseType=Combination	Point=1	X2=-0.5	X3=-0.5	S11=-	
2560.04951423494	IsS11Max=No	IsS11Min=Yes	FrameElem=42	ElemStation=0.375				
Frame=42	Station=0.375	OutputCase=FESSUR	CaseType=Combination	Point=2	X2=-0.5	X3=0.5	S11=-	
2560.04951423494	IsS11Max=No	IsS11Min=No	FrameElem=42	ElemStation=0.375				
Frame=42	Station=0.375	OutputCase=FESSUR	CaseType=Combination	Point=3	X2=0.5	X3=-0.5		
S11=1786.96560800435	IsS11Max=Yes	IsS11Min=No	FrameElem=42	ElemStation=0.375				
Frame=42	Station=0.375	OutputCase=FESSUR	CaseType=Combination	Point=4	X2=0.5	X3=0.5		
S11=1786.96560800435	IsS11Max=No	IsS11Min=No	FrameElem=42	ElemStation=0.375				
Frame=42	Station=0.5	OutputCase=FESSUR	CaseType=Combination	Point=0	X2=0	X3=0	S11=-386.541953115295	
IsS11Max=No	IsS11Min=No	FrameElem=42	ElemStation=0.5					

Frame=42	Station=0.5	OutputCase=FESSUR	CaseType=Combination	Point=1	X2=-0.5	X3=-0.5	S11=-
2883.57421374228	IsS11Max=No	IsS11Min=Yes	FrameElem=42	ElemStation=0.5			
Frame=42	Station=0.5	OutputCase=FESSUR	CaseType=Combination	Point=2	X2=-0.5	X3=0.5	S11=-
2883.57421374228	IsS11Max=No	IsS11Min=No	FrameElem=42	ElemStation=0.5			
Frame=42	Station=0.5	OutputCase=FESSUR	CaseType=Combination	Point=3	X2=0.5	X3=-0.5	
S11=2110.49030751169	IsS11Max=Yes	IsS11Min=No	FrameElem=42	ElemStation=0.5			
Frame=42	Station=0.5	OutputCase=FESSUR	CaseType=Combination	Point=4	X2=0.5	X3=0.5	
S11=2110.49030751169	IsS11Max=No	IsS11Min=No	FrameElem=42	ElemStation=0.5			
Frame=43	Station=0	OutputCase=PESOPR	CaseType=LinStatic	Point=0	X2=0	X3=0	S11=-15.1709467361864
IsS11Max=No	IsS11Min=No	FrameElem=43	ElemStation=0				
Frame=43	Station=0	OutputCase=PESOPR	CaseType=LinStatic	Point=1	X2=-0.5	X3=-0.5	S11=-
541.866416579083	IsS11Max=No	IsS11Min=Yes	FrameElem=43	ElemStation=0			
Frame=43	Station=0	OutputCase=PESOPR	CaseType=LinStatic	Point=2	X2=-0.5	X3=0.5	S11=-
541.866416579083	IsS11Max=No	IsS11Min=No	FrameElem=43	ElemStation=0			
Frame=43	Station=0	OutputCase=PESOPR	CaseType=LinStatic	Point=3	X2=0.5	X3=-0.5	S11=511.52452310671
IsS11Max=Yes	IsS11Min=No	FrameElem=43	ElemStation=0				
Frame=43	Station=0	OutputCase=PESOPR	CaseType=LinStatic	Point=4	X2=0.5	X3=0.5	S11=511.52452310671
IsS11Max=No	IsS11Min=No	FrameElem=43	ElemStation=0				
Frame=43	Station=0.125	OutputCase=PESOPR	CaseType=LinStatic	Point=0	X2=0	X3=0	S11=-15.1709467361864
IsS11Max=No	IsS11Min=No	FrameElem=43	ElemStation=0.125				
Frame=43	Station=0.125	OutputCase=PESOPR	CaseType=LinStatic	Point=1	X2=-0.5	X3=-0.5	S11=-
574.387853347528	IsS11Max=No	IsS11Min=Yes	FrameElem=43	ElemStation=0.125			
Frame=43	Station=0.125	OutputCase=PESOPR	CaseType=LinStatic	Point=2	X2=-0.5	X3=0.5	S11=-
574.387853347528	IsS11Max=No	IsS11Min=No	FrameElem=43	ElemStation=0.125			
Frame=43	Station=0.125	OutputCase=PESOPR	CaseType=LinStatic	Point=3	X2=0.5	X3=-0.5	
S11=544.045959875156	IsS11Max=Yes	IsS11Min=No	FrameElem=43	ElemStation=0.125			
Frame=43	Station=0.125	OutputCase=PESOPR	CaseType=LinStatic	Point=4	X2=0.5	X3=0.5	
S11=544.045959875156	IsS11Max=No	IsS11Min=No	FrameElem=43	ElemStation=0.125			
Frame=43	Station=0.25	OutputCase=PESOPR	CaseType=LinStatic	Point=0	X2=0	X3=0	S11=-15.1709467361864
IsS11Max=No	IsS11Min=No	FrameElem=43	ElemStation=0.25				
Frame=43	Station=0.25	OutputCase=PESOPR	CaseType=LinStatic	Point=1	X2=-0.5	X3=-0.5	S11=-
609.253040115974	IsS11Max=No	IsS11Min=Yes	FrameElem=43	ElemStation=0.25			
Frame=43	Station=0.25	OutputCase=PESOPR	CaseType=LinStatic	Point=2	X2=-0.5	X3=0.5	S11=-
609.253040115974	IsS11Max=No	IsS11Min=No	FrameElem=43	ElemStation=0.25			
Frame=43	Station=0.25	OutputCase=PESOPR	CaseType=LinStatic	Point=3	X2=0.5	X3=-0.5	
S11=578.911146643601	IsS11Max=Yes	IsS11Min=No	FrameElem=43	ElemStation=0.25			
Frame=43	Station=0.25	OutputCase=PESOPR	CaseType=LinStatic	Point=4	X2=0.5	X3=0.5	
S11=578.911146643601	IsS11Max=No	IsS11Min=No	FrameElem=43	ElemStation=0.25			
Frame=43	Station=0.375	OutputCase=PESOPR	CaseType=LinStatic	Point=0	X2=0	X3=0	S11=-15.1709467361864
IsS11Max=No	IsS11Min=No	FrameElem=43	ElemStation=0.375				
Frame=43	Station=0.375	OutputCase=PESOPR	CaseType=LinStatic	Point=1	X2=-0.5	X3=-0.5	S11=-
646.46197688442	IsS11Max=No	IsS11Min=Yes	FrameElem=43	ElemStation=0.375			
Frame=43	Station=0.375	OutputCase=PESOPR	CaseType=LinStatic	Point=2	X2=-0.5	X3=0.5	S11=-
646.46197688442	IsS11Max=No	IsS11Min=No	FrameElem=43	ElemStation=0.375			
Frame=43	Station=0.375	OutputCase=PESOPR	CaseType=LinStatic	Point=3	X2=0.5	X3=-0.5	
S11=616.120083412047	IsS11Max=Yes	IsS11Min=No	FrameElem=43	ElemStation=0.375			
Frame=43	Station=0.375	OutputCase=PESOPR	CaseType=LinStatic	Point=4	X2=0.5	X3=0.5	
S11=616.120083412047	IsS11Max=No	IsS11Min=No	FrameElem=43	ElemStation=0.375			
Frame=43	Station=0.5	OutputCase=PESOPR	CaseType=LinStatic	Point=0	X2=0	X3=0	S11=-15.1709467361864
IsS11Max=No	IsS11Min=No	FrameElem=43	ElemStation=0.5				
Frame=43	Station=0.5	OutputCase=PESOPR	CaseType=LinStatic	Point=1	X2=-0.5	X3=-0.5	S11=-
686.014663652865	IsS11Max=No	IsS11Min=Yes	FrameElem=43	ElemStation=0.5			
Frame=43	Station=0.5	OutputCase=PESOPR	CaseType=LinStatic	Point=2	X2=-0.5	X3=0.5	S11=-
686.014663652865	IsS11Max=No	IsS11Min=No	FrameElem=43	ElemStation=0.5			
Frame=43	Station=0.5	OutputCase=PESOPR	CaseType=LinStatic	Point=3	X2=0.5	X3=-0.5	
S11=655.672770180493	IsS11Max=Yes	IsS11Min=No	FrameElem=43	ElemStation=0.5			
Frame=43	Station=0.5	OutputCase=PESOPR	CaseType=LinStatic	Point=4	X2=0.5	X3=0.5	
S11=655.672770180493	IsS11Max=No	IsS11Min=No	FrameElem=43	ElemStation=0.5			
Frame=43	Station=0	OutputCase=TERRVERT	CaseType=LinStatic	Point=0	X2=0	X3=0	S11=1.64270738195018
IsS11Max=No	IsS11Min=No	FrameElem=43	ElemStation=0				
Frame=43	Station=0	OutputCase=TERRVERT	CaseType=LinStatic	Point=1	X2=-0.5	X3=-0.5	S11=-
2467.88437650129	IsS11Max=No	IsS11Min=Yes	FrameElem=43	ElemStation=0			
Frame=43	Station=0	OutputCase=TERRVERT	CaseType=LinStatic	Point=2	X2=-0.5	X3=0.5	S11=-
2467.88437650129	IsS11Max=No	IsS11Min=No	FrameElem=43	ElemStation=0			
Frame=43	Station=0	OutputCase=TERRVERT	CaseType=LinStatic	Point=3	X2=0.5	X3=-0.5	
S11=2471.16979126519	IsS11Max=Yes	IsS11Min=No	FrameElem=43	ElemStation=0			
Frame=43	Station=0	OutputCase=TERRVERT	CaseType=LinStatic	Point=4	X2=0.5	X3=0.5	
S11=2471.16979126519	IsS11Max=No	IsS11Min=No	FrameElem=43	ElemStation=0			
Frame=43	Station=0.125	OutputCase=TERRVERT	CaseType=LinStatic	Point=0	X2=0	X3=0	
S11=1.64270738195018	IsS11Max=No	IsS11Min=No	FrameElem=43	ElemStation=0.125			
Frame=43	Station=0.125	OutputCase=TERRVERT	CaseType=LinStatic	Point=1	X2=-0.5	X3=-0.5	S11=-
2622.95192061648	IsS11Max=No	IsS11Min=Yes	FrameElem=43	ElemStation=0.125			
Frame=43	Station=0.125	OutputCase=TERRVERT	CaseType=LinStatic	Point=2	X2=-0.5	X3=0.5	S11=-
2622.95192061648	IsS11Max=No	IsS11Min=No	FrameElem=43	ElemStation=0.125			
Frame=43	Station=0.125	OutputCase=TERRVERT	CaseType=LinStatic	Point=3	X2=0.5	X3=-0.5	
S11=2626.23733538038	IsS11Max=Yes	IsS11Min=No	FrameElem=43	ElemStation=0.125			
Frame=43	Station=0.125	OutputCase=TERRVERT	CaseType=LinStatic	Point=4	X2=0.5	X3=0.5	
S11=2626.23733538038	IsS11Max=No	IsS11Min=No	FrameElem=43	ElemStation=0.125			
Frame=43	Station=0.25	OutputCase=TERRVERT	CaseType=LinStatic	Point=0	X2=0	X3=0	S11=1.64270738195018
IsS11Max=No	IsS11Min=No	FrameElem=43	ElemStation=0.25				
Frame=43	Station=0.25	OutputCase=TERRVERT	CaseType=LinStatic	Point=1	X2=-0.5	X3=-0.5	S11=-
2778.01946473167	IsS11Max=No	IsS11Min=Yes	FrameElem=43	ElemStation=0.25			



Frame=43	Station=0.25	OutputCase=TERRVERT	CaseType=LinStatic	Point=2	X2=-0.5	X3=0.5	S11=-
2778.01946473167		IsS11Max=No	IsS11Min=No	FrameElem=43	ElemStation=0.25		
Frame=43	Station=0.25	OutputCase=TERRVERT	CaseType=LinStatic	Point=3	X2=0.5	X3=-0.5	
S11=2781.30487949557		IsS11Max=Yes	IsS11Min=No	FrameElem=43	ElemStation=0.25		
Frame=43	Station=0.25	OutputCase=TERRVERT	CaseType=LinStatic	Point=4	X2=0.5	X3=0.5	
S11=2781.30487949557		IsS11Max=No	IsS11Min=No	FrameElem=43	ElemStation=0.25		
Frame=43	Station=0.375	OutputCase=TERRVERT	CaseType=LinStatic	Point=0	X2=0	X3=0	
S11=1.64270738195018		IsS11Max=No	IsS11Min=No	FrameElem=43	ElemStation=0.375		
Frame=43	Station=0.375	OutputCase=TERRVERT	CaseType=LinStatic	Point=1	X2=-0.5	X3=-0.5	S11=-
2933.08700884686		IsS11Max=No	IsS11Min=Yes	FrameElem=43	ElemStation=0.375		
Frame=43	Station=0.375	OutputCase=TERRVERT	CaseType=LinStatic	Point=2	X2=-0.5	X3=0.5	S11=-
2933.08700884686		IsS11Max=No	IsS11Min=No	FrameElem=43	ElemStation=0.375		
Frame=43	Station=0.375	OutputCase=TERRVERT	CaseType=LinStatic	Point=3	X2=0.5	X3=-0.5	
S11=2936.37242361076		IsS11Max=Yes	IsS11Min=No	FrameElem=43	ElemStation=0.375		
Frame=43	Station=0.375	OutputCase=TERRVERT	CaseType=LinStatic	Point=4	X2=0.5	X3=0.5	
S11=2936.37242361076		IsS11Max=No	IsS11Min=No	FrameElem=43	ElemStation=0.375		
Frame=43	Station=0.5	OutputCase=TERRVERT	CaseType=LinStatic	Point=0	X2=0	X3=0	S11=1.64270738195018
IsS11Max=No	IsS11Min=No	FrameElem=43	ElemStation=0.5				
Frame=43	Station=0.5	OutputCase=TERRVERT	CaseType=LinStatic	Point=1	X2=-0.5	X3=-0.5	S11=-
3088.15455296205		IsS11Max=No	IsS11Min=Yes	FrameElem=43	ElemStation=0.5		
Frame=43	Station=0.5	OutputCase=TERRVERT	CaseType=LinStatic	Point=2	X2=-0.5	X3=0.5	S11=-
3088.15455296205		IsS11Max=No	IsS11Min=No	FrameElem=43	ElemStation=0.5		
Frame=43	Station=0.5	OutputCase=TERRVERT	CaseType=LinStatic	Point=3	X2=0.5	X3=-0.5	
S11=3091.43996772595		IsS11Max=Yes	IsS11Min=No	FrameElem=43	ElemStation=0.5		
Frame=43	Station=0.5	OutputCase=TERRVERT	CaseType=LinStatic	Point=4	X2=0.5	X3=0.5	
S11=3091.43996772595		IsS11Max=No	IsS11Min=No	FrameElem=43	ElemStation=0.5		
Frame=43	Station=0	OutputCase=TERRLAT	CaseType=LinStatic	Point=0	X2=0	X3=0	S11=-373.013713761059
IsS11Max=No	IsS11Min=No	FrameElem=43	ElemStation=0				
Frame=43	Station=0	OutputCase=TERRLAT	CaseType=LinStatic	Point=1	X2=-0.5	X3=-0.5	
S11=126.176579338115		IsS11Max=Yes	IsS11Min=No	FrameElem=43	ElemStation=0		
Frame=43	Station=0	OutputCase=TERRLAT	CaseType=LinStatic	Point=2	X2=-0.5	X3=0.5	
S11=126.176579338115		IsS11Max=No	IsS11Min=No	FrameElem=43	ElemStation=0		
Frame=43	Station=0	OutputCase=TERRLAT	CaseType=LinStatic	Point=3	X2=0.5	X3=-0.5	S11=-
872.204006860232		IsS11Max=No	IsS11Min=Yes	FrameElem=43	ElemStation=0		
Frame=43	Station=0	OutputCase=TERRLAT	CaseType=LinStatic	Point=4	X2=0.5	X3=0.5	S11=-
872.204006860232		IsS11Max=No	IsS11Min=No	FrameElem=43	ElemStation=0		
Frame=43	Station=0.125	OutputCase=TERRLAT	CaseType=LinStatic	Point=0	X2=0	X3=0	S11=-
373.013713761059		IsS11Max=No	IsS11Min=No	FrameElem=43	ElemStation=0.125		
Frame=43	Station=0.125	OutputCase=TERRLAT	CaseType=LinStatic	Point=1	X2=-0.5	X3=-0.5	
S11=125.782380685566		IsS11Max=Yes	IsS11Min=No	FrameElem=43	ElemStation=0.125		
Frame=43	Station=0.125	OutputCase=TERRLAT	CaseType=LinStatic	Point=2	X2=-0.5	X3=0.5	
S11=125.782380685566		IsS11Max=No	IsS11Min=No	FrameElem=43	ElemStation=0.125		
Frame=43	Station=0.125	OutputCase=TERRLAT	CaseType=LinStatic	Point=3	X2=0.5	X3=-0.5	S11=-
871.809808207683		IsS11Max=No	IsS11Min=Yes	FrameElem=43	ElemStation=0.125		
Frame=43	Station=0.125	OutputCase=TERRLAT	CaseType=LinStatic	Point=4	X2=0.5	X3=0.5	S11=-
871.809808207683		IsS11Max=No	IsS11Min=No	FrameElem=43	ElemStation=0.125		
Frame=43	Station=0.25	OutputCase=TERRLAT	CaseType=LinStatic	Point=0	X2=0	X3=0	S11=-373.013713761059
IsS11Max=No	IsS11Min=No	FrameElem=43	ElemStation=0.25				
Frame=43	Station=0.25	OutputCase=TERRLAT	CaseType=LinStatic	Point=1	X2=-0.5	X3=-0.5	
S11=125.388182033018		IsS11Max=Yes	IsS11Min=No	FrameElem=43	ElemStation=0.25		
Frame=43	Station=0.25	OutputCase=TERRLAT	CaseType=LinStatic	Point=2	X2=-0.5	X3=0.5	
S11=125.388182033018		IsS11Max=No	IsS11Min=No	FrameElem=43	ElemStation=0.25		
Frame=43	Station=0.25	OutputCase=TERRLAT	CaseType=LinStatic	Point=3	X2=0.5	X3=-0.5	S11=-
871.415609555135		IsS11Max=No	IsS11Min=Yes	FrameElem=43	ElemStation=0.25		
Frame=43	Station=0.25	OutputCase=TERRLAT	CaseType=LinStatic	Point=4	X2=0.5	X3=0.5	S11=-
871.415609555135		IsS11Max=No	IsS11Min=No	FrameElem=43	ElemStation=0.25		
Frame=43	Station=0.375	OutputCase=TERRLAT	CaseType=LinStatic	Point=0	X2=0	X3=0	S11=-
373.013713761059		IsS11Max=No	IsS11Min=No	FrameElem=43	ElemStation=0.375		
Frame=43	Station=0.375	OutputCase=TERRLAT	CaseType=LinStatic	Point=1	X2=-0.5	X3=-0.5	
S11=124.993983380469		IsS11Max=Yes	IsS11Min=No	FrameElem=43	ElemStation=0.375		
Frame=43	Station=0.375	OutputCase=TERRLAT	CaseType=LinStatic	Point=2	X2=-0.5	X3=0.5	
S11=124.993983380469		IsS11Max=No	IsS11Min=No	FrameElem=43	ElemStation=0.375		
Frame=43	Station=0.375	OutputCase=TERRLAT	CaseType=LinStatic	Point=3	X2=0.5	X3=-0.5	S11=-
871.021410902586		IsS11Max=No	IsS11Min=Yes	FrameElem=43	ElemStation=0.375		
Frame=43	Station=0.375	OutputCase=TERRLAT	CaseType=LinStatic	Point=4	X2=0.5	X3=0.5	S11=-
871.021410902586		IsS11Max=No	IsS11Min=No	FrameElem=43	ElemStation=0.375		
Frame=43	Station=0.5	OutputCase=TERRLAT	CaseType=LinStatic	Point=0	X2=0	X3=0	S11=-373.013713761059
IsS11Max=No	IsS11Min=No	FrameElem=43	ElemStation=0.5				
Frame=43	Station=0.5	OutputCase=TERRLAT	CaseType=LinStatic	Point=1	X2=-0.5	X3=-0.5	
S11=124.59978472792		IsS11Max=Yes	IsS11Min=No	FrameElem=43	ElemStation=0.5		
Frame=43	Station=0.5	OutputCase=TERRLAT	CaseType=LinStatic	Point=2	X2=-0.5	X3=0.5	
S11=124.59978472792		IsS11Max=No	IsS11Min=No	FrameElem=43	ElemStation=0.5		
Frame=43	Station=0.5	OutputCase=TERRLAT	CaseType=LinStatic	Point=3	X2=0.5	X3=-0.5	S11=-
870.627212250037		IsS11Max=No	IsS11Min=Yes	FrameElem=43	ElemStation=0.5		
Frame=43	Station=0.5	OutputCase=TERRLAT	CaseType=LinStatic	Point=4	X2=0.5	X3=0.5	S11=-
870.627212250037		IsS11Max=No	IsS11Min=No	FrameElem=43	ElemStation=0.5		
Frame=43	Station=0	OutputCase=ACCVERT	CaseType=LinStatic	Point=0	X2=0	X3=0	S11=0
IsS11Max=Yes	IsS11Min=Yes	FrameElem=43	ElemStation=0				
Frame=43	Station=0	OutputCase=ACCVERT	CaseType=LinStatic	Point=1	X2=-0.5	X3=-0.5	S11=0
IsS11Max=No	IsS11Min=No	FrameElem=43	ElemStation=0				
Frame=43	Station=0	OutputCase=ACCVERT	CaseType=LinStatic	Point=2	X2=-0.5	X3=0.5	S11=0
IsS11Max=No	IsS11Min=No	FrameElem=43	ElemStation=0				

Frame=43	Station=0	OutputCase=ENVE	CaseType=Combination	StepType=Max	Point=1	X2=-0.5	X3=-0.5		
S11=-2883.57421374225		IsS11Max=No	IsS11Min=Yes	FrameElem=43	ElemStation=0				
Frame=43	Station=0	OutputCase=ENVE	CaseType=Combination	StepType=Max	Point=2	X2=-0.5	X3=0.5	S11=-	
2883.57421374225		IsS11Max=No	IsS11Min=No	FrameElem=43	ElemStation=0				
Frame=43	Station=0	OutputCase=ENVE	CaseType=Combination	StepType=Max	Point=3	X2=0.5	X3=-0.5		
S11=2372.15150956973		IsS11Max=Yes	IsS11Min=No	FrameElem=43	ElemStation=0				
Frame=43	Station=0	OutputCase=ENVE	CaseType=Combination	StepType=Max	Point=4	X2=0.5	X3=0.5		
S11=2372.15150956973		IsS11Max=No	IsS11Min=No	FrameElem=43	ElemStation=0				
Frame=43	Station=0.125	OutputCase=ENVE	CaseType=Combination	StepType=Max	Point=0	X2=0	X3=0	S11=-	
274.637838986977		IsS11Max=No	IsS11Min=No	FrameElem=43	ElemStation=0.125				
Frame=43	Station=0.125	OutputCase=ENVE	CaseType=Combination	StepType=Max	Point=1	X2=-0.5	X3=-0.5		
S11=-3071.55739327844		IsS11Max=No	IsS11Min=Yes	FrameElem=43	ElemStation=0.125				
Frame=43	Station=0.125	OutputCase=ENVE	CaseType=Combination	StepType=Max	Point=2	X2=-0.5	X3=0.5		
S11=-3071.55739327844		IsS11Max=No	IsS11Min=No	FrameElem=43	ElemStation=0.125				
Frame=43	Station=0.125	OutputCase=ENVE	CaseType=Combination	StepType=Max	Point=3	X2=0.5	X3=-0.5		
S11=2560.01642951015		IsS11Max=Yes	IsS11Min=No	FrameElem=43	ElemStation=0.125				
Frame=43	Station=0.125	OutputCase=ENVE	CaseType=Combination	StepType=Max	Point=4	X2=0.5	X3=0.5		
S11=2560.01642951015		IsS11Max=No	IsS11Min=No	FrameElem=43	ElemStation=0.125				
Frame=43	Station=0.25	OutputCase=ENVE	CaseType=Combination	StepType=Max	Point=0	X2=0	X3=0	S11=-	
274.637838986977		IsS11Max=No	IsS11Min=No	FrameElem=43	ElemStation=0.25				
Frame=43	Station=0.25	OutputCase=ENVE	CaseType=Combination	StepType=Max	Point=1	X2=-0.5	X3=-0.5		
S11=-3261.88432281462		IsS11Max=No	IsS11Min=Yes	FrameElem=43	ElemStation=0.25				
Frame=43	Station=0.25	OutputCase=ENVE	CaseType=Combination	StepType=Max	Point=2	X2=-0.5	X3=0.5		
S11=-3261.88432281462		IsS11Max=No	IsS11Min=No	FrameElem=43	ElemStation=0.25				
Frame=43	Station=0.25	OutputCase=ENVE	CaseType=Combination	StepType=Max	Point=3	X2=0.5	X3=-0.5		
S11=2750.22509945057		IsS11Max=Yes	IsS11Min=No	FrameElem=43	ElemStation=0.25				
Frame=43	Station=0.25	OutputCase=ENVE	CaseType=Combination	StepType=Max	Point=4	X2=0.5	X3=0.5		
S11=2750.22509945057		IsS11Max=No	IsS11Min=No	FrameElem=43	ElemStation=0.25				
Frame=43	Station=0.375	OutputCase=ENVE	CaseType=Combination	StepType=Max	Point=0	X2=0	X3=0	S11=-	
274.637838986977		IsS11Max=No	IsS11Min=No	FrameElem=43	ElemStation=0.375				
Frame=43	Station=0.375	OutputCase=ENVE	CaseType=Combination	StepType=Max	Point=1	X2=-0.5	X3=-0.5		
S11=-3454.55500235081		IsS11Max=No	IsS11Min=Yes	FrameElem=43	ElemStation=0.375				
Frame=43	Station=0.375	OutputCase=ENVE	CaseType=Combination	StepType=Max	Point=2	X2=-0.5	X3=0.5		
S11=-3454.55500235081		IsS11Max=No	IsS11Min=No	FrameElem=43	ElemStation=0.375				
Frame=43	Station=0.375	OutputCase=ENVE	CaseType=Combination	StepType=Max	Point=3	X2=0.5	X3=-0.5		
S11=2942.777519391		IsS11Max=Yes	IsS11Min=No	FrameElem=43	ElemStation=0.375				
Frame=43	Station=0.375	OutputCase=ENVE	CaseType=Combination	StepType=Max	Point=4	X2=0.5	X3=0.5		
S11=2942.777519391		IsS11Max=No	IsS11Min=No	FrameElem=43	ElemStation=0.375				
Frame=43	Station=0.5	OutputCase=ENVE	CaseType=Combination	StepType=Max	Point=0	X2=0	X3=0	S11=-	
274.637838986977		IsS11Max=No	IsS11Min=No	FrameElem=43	ElemStation=0.5				
Frame=43	Station=0.5	OutputCase=ENVE	CaseType=Combination	StepType=Max	Point=1	X2=-0.5	X3=-0.5		
S11=-3649.56943188699		IsS11Max=No	IsS11Min=Yes	FrameElem=43	ElemStation=0.5				
Frame=43	Station=0.5	OutputCase=ENVE	CaseType=Combination	StepType=Max	Point=2	X2=-0.5	X3=0.5		
S11=-3649.56943188699		IsS11Max=No	IsS11Min=No	FrameElem=43	ElemStation=0.5				
Frame=43	Station=0.5	OutputCase=ENVE	CaseType=Combination	StepType=Max	Point=3	X2=0.5	X3=-0.5		
S11=3137.67368933142		IsS11Max=Yes	IsS11Min=No	FrameElem=43	ElemStation=0.5				
Frame=43	Station=0.5	OutputCase=ENVE	CaseType=Combination	StepType=Max	Point=4	X2=0.5	X3=0.5		
S11=3137.67368933142		IsS11Max=No	IsS11Min=No	FrameElem=43	ElemStation=0.5				
Frame=43	Station=0	OutputCase=ENVE	CaseType=Combination	StepType=Min	Point=0	X2=0	X3=0	S11=-	
386.541953115295		IsS11Max=No	IsS11Min=No	FrameElem=43	ElemStation=0				
Frame=43	Station=0	OutputCase=ENVE	CaseType=Combination	StepType=Min	Point=1	X2=-0.5	X3=-0.5		
S11=-2921.42718754369		IsS11Max=No	IsS11Min=Yes	FrameElem=43	ElemStation=0				
Frame=43	Station=0	OutputCase=ENVE	CaseType=Combination	StepType=Min	Point=2	X2=-0.5	X3=0.5	S11=-	
2921.42718754369		IsS11Max=No	IsS11Min=No	FrameElem=43	ElemStation=0				
Frame=43	Station=0	OutputCase=ENVE	CaseType=Combination	StepType=Min	Point=3	X2=0.5	X3=-0.5		
S11=2110.49030751166		IsS11Max=Yes	IsS11Min=No	FrameElem=43	ElemStation=0				
Frame=43	Station=0	OutputCase=ENVE	CaseType=Combination	StepType=Min	Point=4	X2=0.5	X3=0.5		
S11=2110.49030751166		IsS11Max=No	IsS11Min=No	FrameElem=43	ElemStation=0				
Frame=43	Station=0.125	OutputCase=ENVE	CaseType=Combination	StepType=Min	Point=0	X2=0	X3=0	S11=-	
386.541953115295		IsS11Max=No	IsS11Min=No	FrameElem=43	ElemStation=0.125				
Frame=43	Station=0.125	OutputCase=ENVE	CaseType=Combination	StepType=Min	Point=1	X2=-0.5	X3=-0.5		
S11=-3109.29210748411		IsS11Max=No	IsS11Min=Yes	FrameElem=43	ElemStation=0.125				
Frame=43	Station=0.125	OutputCase=ENVE	CaseType=Combination	StepType=Min	Point=2	X2=-0.5	X3=0.5		
S11=-3109.29210748411		IsS11Max=No	IsS11Min=No	FrameElem=43	ElemStation=0.125				
Frame=43	Station=0.125	OutputCase=ENVE	CaseType=Combination	StepType=Min	Point=3	X2=0.5	X3=-0.5		
S11=2298.47348704785		IsS11Max=Yes	IsS11Min=No	FrameElem=43	ElemStation=0.125				
Frame=43	Station=0.125	OutputCase=ENVE	CaseType=Combination	StepType=Min	Point=4	X2=0.5	X3=0.5		
S11=2298.47348704785		IsS11Max=No	IsS11Min=No	FrameElem=43	ElemStation=0.125				
Frame=43	Station=0.25	OutputCase=ENVE	CaseType=Combination	StepType=Min	Point=0	X2=0	X3=0	S11=-	
386.541953115295		IsS11Max=No	IsS11Min=No	FrameElem=43	ElemStation=0.25				
Frame=43	Station=0.25	OutputCase=ENVE	CaseType=Combination	StepType=Min	Point=1	X2=-0.5	X3=-0.5		
S11=-3299.50077742453		IsS11Max=No	IsS11Min=Yes	FrameElem=43	ElemStation=0.25				
Frame=43	Station=0.25	OutputCase=ENVE	CaseType=Combination	StepType=Min	Point=2	X2=-0.5	X3=0.5		
S11=-3299.50077742453		IsS11Max=No	IsS11Min=No	FrameElem=43	ElemStation=0.25				
Frame=43	Station=0.25	OutputCase=ENVE	CaseType=Combination	StepType=Min	Point=3	X2=0.5	X3=-0.5		
S11=2488.80041658403		IsS11Max=Yes	IsS11Min=No	FrameElem=43	ElemStation=0.25				
Frame=43	Station=0.25	OutputCase=ENVE	CaseType=Combination	StepType=Min	Point=4	X2=0.5	X3=0.5		
S11=2488.80041658403		IsS11Max=No	IsS11Min=No	FrameElem=43	ElemStation=0.25				
Frame=43	Station=0.375	OutputCase=ENVE	CaseType=Combination	StepType=Min	Point=0	X2=0	X3=0	S11=-	
386.541953115295		IsS11Max=No	IsS11Min=No	FrameElem=43	ElemStation=0.375				
Frame=43	Station=0.375	OutputCase=ENVE	CaseType=Combination	StepType=Min	Point=1	X2=-0.5	X3=-0.5		
S11=-3492.05319736495		IsS11Max=No	IsS11Min=Yes	FrameElem=43	ElemStation=0.375				



Frame=43	Station=0.375	OutputCase=ENVE	CaseType=Combination	StepType=Min	Point=2	X2=-0.5	X3=0.5	
S11=-3492.05319736495	IsS11Max=No	IsS11Min=No	FrameElem=43	ElemStation=0.375				
Frame=43	Station=0.375	OutputCase=ENVE	CaseType=Combination	StepType=Min	Point=3	X2=0.5	X3=-0.5	
S11=2681.47109612022	IsS11Max=Yes	IsS11Min=No	FrameElem=43	ElemStation=0.375				
Frame=43	Station=0.375	OutputCase=ENVE	CaseType=Combination	StepType=Min	Point=4	X2=0.5	X3=0.5	
S11=2681.47109612022	IsS11Max=No	IsS11Min=No	FrameElem=43	ElemStation=0.375				
Frame=43	Station=0.5	OutputCase=ENVE	CaseType=Combination	StepType=Min	Point=0	X2=0	X3=0	S11=-
386.541953115295	IsS11Max=No	IsS11Min=No	FrameElem=43	ElemStation=0.5				
Frame=43	Station=0.5	OutputCase=ENVE	CaseType=Combination	StepType=Min	Point=1	X2=-0.5	X3=-0.5	
S11=-3686.94936730537	IsS11Max=No	IsS11Min=Yes	FrameElem=43	ElemStation=0.5				
Frame=43	Station=0.5	OutputCase=ENVE	CaseType=Combination	StepType=Min	Point=2	X2=-0.5	X3=0.5	
S11=-3686.94936730537	IsS11Max=No	IsS11Min=No	FrameElem=43	ElemStation=0.5				
Frame=43	Station=0.5	OutputCase=ENVE	CaseType=Combination	StepType=Min	Point=3	X2=0.5	X3=-0.5	
S11=2876.4855256564	IsS11Max=Yes	IsS11Min=No	FrameElem=43	ElemStation=0.5				
Frame=43	Station=0.5	OutputCase=ENVE	CaseType=Combination	StepType=Min	Point=4	X2=0.5	X3=0.5	
S11=2876.4855256564	IsS11Max=No	IsS11Min=No	FrameElem=43	ElemStation=0.5				
Frame=43	Station=0	OutputCase=FESSUR	CaseType=Combination	Point=0	X2=0	X3=0	S11=-386.541953115295	
IsS11Max=No	IsS11Min=No	FrameElem=43	ElemStation=0					
Frame=43	Station=0	OutputCase=FESSUR	CaseType=Combination	Point=1	X2=-0.5	X3=-0.5	S11=-	
2883.57421374225	IsS11Max=No	IsS11Min=Yes	FrameElem=43	ElemStation=0				
Frame=43	Station=0	OutputCase=FESSUR	CaseType=Combination	Point=2	X2=-0.5	X3=0.5	S11=-	
2883.57421374225	IsS11Max=No	IsS11Min=No	FrameElem=43	ElemStation=0				
Frame=43	Station=0	OutputCase=FESSUR	CaseType=Combination	Point=3	X2=0.5	X3=-0.5		
S11=2110.49030751166	IsS11Max=Yes	IsS11Min=No	FrameElem=43	ElemStation=0				
Frame=43	Station=0	OutputCase=FESSUR	CaseType=Combination	Point=4	X2=0.5	X3=0.5		
S11=2110.49030751166	IsS11Max=No	IsS11Min=No	FrameElem=43	ElemStation=0				
Frame=43	Station=0.125	OutputCase=FESSUR	CaseType=Combination	Point=0	X2=0	X3=0	S11=-	
386.541953115295	IsS11Max=No	IsS11Min=No	FrameElem=43	ElemStation=0.125				
Frame=43	Station=0.125	OutputCase=FESSUR	CaseType=Combination	Point=1	X2=-0.5	X3=-0.5	S11=-	
3071.55739327844	IsS11Max=No	IsS11Min=Yes	FrameElem=43	ElemStation=0.125				
Frame=43	Station=0.125	OutputCase=FESSUR	CaseType=Combination	Point=2	X2=-0.5	X3=0.5	S11=-	
3071.55739327844	IsS11Max=No	IsS11Min=No	FrameElem=43	ElemStation=0.125				
Frame=43	Station=0.125	OutputCase=FESSUR	CaseType=Combination	Point=3	X2=0.5	X3=-0.5		
S11=2298.47348704785	IsS11Max=Yes	IsS11Min=No	FrameElem=43	ElemStation=0.125				
Frame=43	Station=0.125	OutputCase=FESSUR	CaseType=Combination	Point=4	X2=0.5	X3=0.5		
S11=2298.47348704785	IsS11Max=No	IsS11Min=No	FrameElem=43	ElemStation=0.125				
Frame=43	Station=0.25	OutputCase=FESSUR	CaseType=Combination	Point=0	X2=0	X3=0	S11=-	
386.541953115295	IsS11Max=No	IsS11Min=No	FrameElem=43	ElemStation=0.25				
Frame=43	Station=0.25	OutputCase=FESSUR	CaseType=Combination	Point=1	X2=-0.5	X3=-0.5	S11=-	
3261.88432281462	IsS11Max=No	IsS11Min=Yes	FrameElem=43	ElemStation=0.25				
Frame=43	Station=0.25	OutputCase=FESSUR	CaseType=Combination	Point=2	X2=-0.5	X3=0.5	S11=-	
3261.88432281462	IsS11Max=No	IsS11Min=No	FrameElem=43	ElemStation=0.25				
Frame=43	Station=0.25	OutputCase=FESSUR	CaseType=Combination	Point=3	X2=0.5	X3=-0.5		
S11=2488.80041658403	IsS11Max=Yes	IsS11Min=No	FrameElem=43	ElemStation=0.25				
Frame=43	Station=0.25	OutputCase=FESSUR	CaseType=Combination	Point=4	X2=0.5	X3=0.5		
S11=2488.80041658403	IsS11Max=No	IsS11Min=No	FrameElem=43	ElemStation=0.25				
Frame=43	Station=0.375	OutputCase=FESSUR	CaseType=Combination	Point=0	X2=0	X3=0	S11=-	
386.541953115295	IsS11Max=No	IsS11Min=No	FrameElem=43	ElemStation=0.375				
Frame=43	Station=0.375	OutputCase=FESSUR	CaseType=Combination	Point=1	X2=-0.5	X3=-0.5	S11=-	
3454.55500235081	IsS11Max=No	IsS11Min=Yes	FrameElem=43	ElemStation=0.375				
Frame=43	Station=0.375	OutputCase=FESSUR	CaseType=Combination	Point=2	X2=-0.5	X3=0.5	S11=-	
3454.55500235081	IsS11Max=No	IsS11Min=No	FrameElem=43	ElemStation=0.375				
Frame=43	Station=0.375	OutputCase=FESSUR	CaseType=Combination	Point=3	X2=0.5	X3=-0.5		
S11=2681.47109612022	IsS11Max=Yes	IsS11Min=No	FrameElem=43	ElemStation=0.375				
Frame=43	Station=0.375	OutputCase=FESSUR	CaseType=Combination	Point=4	X2=0.5	X3=0.5		
S11=2681.47109612022	IsS11Max=No	IsS11Min=No	FrameElem=43	ElemStation=0.375				
Frame=43	Station=0.5	OutputCase=FESSUR	CaseType=Combination	Point=0	X2=0	X3=0	S11=-386.541953115295	
IsS11Max=No	IsS11Min=No	FrameElem=43	ElemStation=0.5					
Frame=43	Station=0.5	OutputCase=FESSUR	CaseType=Combination	Point=1	X2=-0.5	X3=-0.5	S11=-	
3649.56943188699	IsS11Max=No	IsS11Min=Yes	FrameElem=43	ElemStation=0.5				
Frame=43	Station=0.5	OutputCase=FESSUR	CaseType=Combination	Point=2	X2=-0.5	X3=0.5	S11=-	
3649.56943188699	IsS11Max=No	IsS11Min=No	FrameElem=43	ElemStation=0.5				
Frame=43	Station=0.5	OutputCase=FESSUR	CaseType=Combination	Point=3	X2=0.5	X3=-0.5		
S11=2876.4855256564	IsS11Max=Yes	IsS11Min=No	FrameElem=43	ElemStation=0.5				
Frame=43	Station=0.5	OutputCase=FESSUR	CaseType=Combination	Point=4	X2=0.5	X3=0.5		
S11=2876.4855256564	IsS11Max=No	IsS11Min=No	FrameElem=43	ElemStation=0.5				
Frame=44	Station=0	OutputCase=PESOPR	CaseType=LinStatic	Point=0	X2=0	X3=0	S11=-15.1709467361872	
IsS11Max=No	IsS11Min=No	FrameElem=44	ElemStation=0					
Frame=44	Station=0	OutputCase=PESOPR	CaseType=LinStatic	Point=1	X2=-0.5	X3=-0.5	S11=-	
686.014663652866	IsS11Max=No	IsS11Min=Yes	FrameElem=44	ElemStation=0				
Frame=44	Station=0	OutputCase=PESOPR	CaseType=LinStatic	Point=2	X2=-0.5	X3=0.5	S11=-	
686.014663652866	IsS11Max=No	IsS11Min=No	FrameElem=44	ElemStation=0				
Frame=44	Station=0	OutputCase=PESOPR	CaseType=LinStatic	Point=3	X2=0.5	X3=-0.5	S11=655.672770180492	
IsS11Max=Yes	IsS11Min=No	FrameElem=44	ElemStation=0					
Frame=44	Station=0	OutputCase=PESOPR	CaseType=LinStatic	Point=4	X2=0.5	X3=0.5	S11=655.672770180492	
IsS11Max=No	IsS11Min=No	FrameElem=44	ElemStation=0					
Frame=44	Station=0.125	OutputCase=PESOPR	CaseType=LinStatic	Point=0	X2=0	X3=0	S11=-15.1709467361872	
IsS11Max=No	IsS11Min=No	FrameElem=44	ElemStation=0.125					
Frame=44	Station=0.125	OutputCase=PESOPR	CaseType=LinStatic	Point=1	X2=-0.5	X3=-0.5	S11=-	
694.493632767051	IsS11Max=No	IsS11Min=Yes	FrameElem=44	ElemStation=0.125				
Frame=44	Station=0.125	OutputCase=PESOPR	CaseType=LinStatic	Point=2	X2=-0.5	X3=0.5	S11=-	
694.493632767051	IsS11Max=No	IsS11Min=No	FrameElem=44	ElemStation=0.125				

Frame=44	Station=0.125	OutputCase=PESOPR	CaseType=LinStatic	Point=3	X2=0.5	X3=-0.5			
S11=664.151739294677	IsS11Max=Yes	IsS11Min=No	FrameElem=44	ElemStation=0.125					
Frame=44	Station=0.125	OutputCase=PESOPR	CaseType=LinStatic	Point=4	X2=0.5	X3=0.5			
S11=664.151739294677	IsS11Max=No	IsS11Min=No	FrameElem=44	ElemStation=0.125					
Frame=44	Station=0.25	OutputCase=PESOPR	CaseType=LinStatic	Point=0	X2=0	X3=0	S11=-15.1709467361872		
IsS11Max=No	IsS11Min=No	FrameElem=44	ElemStation=0.25						
Frame=44	Station=0.25	OutputCase=PESOPR	CaseType=LinStatic	Point=1	X2=-0.5	X3=-0.5	S11=-		
705.316351881236	IsS11Max=No	IsS11Min=Yes	FrameElem=44	ElemStation=0.25					
Frame=44	Station=0.25	OutputCase=PESOPR	CaseType=LinStatic	Point=2	X2=-0.5	X3=0.5	S11=-		
705.316351881236	IsS11Max=No	IsS11Min=No	FrameElem=44	ElemStation=0.25					
Frame=44	Station=0.25	OutputCase=PESOPR	CaseType=LinStatic	Point=3	X2=0.5	X3=-0.5			
S11=674.974458408862	IsS11Max=Yes	IsS11Min=No	FrameElem=44	ElemStation=0.25					
Frame=44	Station=0.25	OutputCase=PESOPR	CaseType=LinStatic	Point=4	X2=0.5	X3=0.5			
S11=674.974458408862	IsS11Max=No	IsS11Min=No	FrameElem=44	ElemStation=0.25					
Frame=44	Station=0.375	OutputCase=PESOPR	CaseType=LinStatic	Point=0	X2=0	X3=0	S11=-15.1709467361872		
IsS11Max=No	IsS11Min=No	FrameElem=44	ElemStation=0.375						
Frame=44	Station=0.375	OutputCase=PESOPR	CaseType=LinStatic	Point=1	X2=-0.5	X3=-0.5	S11=-		
718.482820995421	IsS11Max=No	IsS11Min=Yes	FrameElem=44	ElemStation=0.375					
Frame=44	Station=0.375	OutputCase=PESOPR	CaseType=LinStatic	Point=2	X2=-0.5	X3=0.5	S11=-		
718.482820995421	IsS11Max=No	IsS11Min=No	FrameElem=44	ElemStation=0.375					
Frame=44	Station=0.375	OutputCase=PESOPR	CaseType=LinStatic	Point=3	X2=0.5	X3=-0.5			
S11=688.140927523047	IsS11Max=Yes	IsS11Min=No	FrameElem=44	ElemStation=0.375					
Frame=44	Station=0.375	OutputCase=PESOPR	CaseType=LinStatic	Point=4	X2=0.5	X3=0.5			
S11=688.140927523047	IsS11Max=No	IsS11Min=No	FrameElem=44	ElemStation=0.375					
Frame=44	Station=0.5	OutputCase=PESOPR	CaseType=LinStatic	Point=0	X2=0	X3=0	S11=-15.1709467361872		
IsS11Max=No	IsS11Min=No	FrameElem=44	ElemStation=0.5						
Frame=44	Station=0.5	OutputCase=PESOPR	CaseType=LinStatic	Point=1	X2=-0.5	X3=-0.5	S11=-		
733.993040109606	IsS11Max=No	IsS11Min=Yes	FrameElem=44	ElemStation=0.5					
Frame=44	Station=0.5	OutputCase=PESOPR	CaseType=LinStatic	Point=2	X2=-0.5	X3=0.5	S11=-		
733.993040109606	IsS11Max=No	IsS11Min=No	FrameElem=44	ElemStation=0.5					
Frame=44	Station=0.5	OutputCase=PESOPR	CaseType=LinStatic	Point=3	X2=0.5	X3=-0.5			
S11=703.651146637232	IsS11Max=Yes	IsS11Min=No	FrameElem=44	ElemStation=0.5					
Frame=44	Station=0.5	OutputCase=PESOPR	CaseType=LinStatic	Point=4	X2=0.5	X3=0.5			
S11=703.651146637232	IsS11Max=No	IsS11Min=No	FrameElem=44	ElemStation=0.5					
Frame=44	Station=0	OutputCase=TERRVERT	CaseType=LinStatic	Point=0	X2=0	X3=0	S11=1.64270738195066		
IsS11Max=No	IsS11Min=No	FrameElem=44	ElemStation=0						
Frame=44	Station=0	OutputCase=TERRVERT	CaseType=LinStatic	Point=1	X2=-0.5	X3=-0.5	S11=-		
3088.15455296192	IsS11Max=No	IsS11Min=Yes	FrameElem=44	ElemStation=0					
Frame=44	Station=0	OutputCase=TERRVERT	CaseType=LinStatic	Point=2	X2=-0.5	X3=0.5	S11=-		
3088.15455296192	IsS11Max=No	IsS11Min=No	FrameElem=44	ElemStation=0					
Frame=44	Station=0	OutputCase=TERRVERT	CaseType=LinStatic	Point=3	X2=0.5	X3=-0.5			
S11=3091.43996772582	IsS11Max=Yes	IsS11Min=No	FrameElem=44	ElemStation=0					
Frame=44	Station=0	OutputCase=TERRVERT	CaseType=LinStatic	Point=4	X2=0.5	X3=0.5			
S11=3091.43996772582	IsS11Max=No	IsS11Min=No	FrameElem=44	ElemStation=0					
Frame=44	Station=0.125	OutputCase=TERRVERT	CaseType=LinStatic	Point=0	X2=0	X3=0			
S11=1.64270738195066	IsS11Max=No	IsS11Min=No	FrameElem=44	ElemStation=0.125					
Frame=44	Station=0.125	OutputCase=TERRVERT	CaseType=LinStatic	Point=1	X2=-0.5	X3=-0.5	S11=-		
3139.76243335211	IsS11Max=No	IsS11Min=Yes	FrameElem=44	ElemStation=0.125					
Frame=44	Station=0.125	OutputCase=TERRVERT	CaseType=LinStatic	Point=2	X2=-0.5	X3=0.5	S11=-		
3139.76243335211	IsS11Max=No	IsS11Min=No	FrameElem=44	ElemStation=0.125					
Frame=44	Station=0.125	OutputCase=TERRVERT	CaseType=LinStatic	Point=3	X2=0.5	X3=-0.5			
S11=3143.04784811601	IsS11Max=Yes	IsS11Min=No	FrameElem=44	ElemStation=0.125					
Frame=44	Station=0.125	OutputCase=TERRVERT	CaseType=LinStatic	Point=4	X2=0.5	X3=0.5			
S11=3143.04784811601	IsS11Max=No	IsS11Min=No	FrameElem=44	ElemStation=0.125					
Frame=44	Station=0.25	OutputCase=TERRVERT	CaseType=LinStatic	Point=0	X2=0	X3=0	S11=1.64270738195066		
IsS11Max=No	IsS11Min=No	FrameElem=44	ElemStation=0.25						
Frame=44	Station=0.25	OutputCase=TERRVERT	CaseType=LinStatic	Point=1	X2=-0.5	X3=-0.5	S11=-		
3191.3703137423	IsS11Max=No	IsS11Min=Yes	FrameElem=44	ElemStation=0.25					
Frame=44	Station=0.25	OutputCase=TERRVERT	CaseType=LinStatic	Point=2	X2=-0.5	X3=0.5	S11=-		
3191.3703137423	IsS11Max=No	IsS11Min=No	FrameElem=44	ElemStation=0.25					
Frame=44	Station=0.25	OutputCase=TERRVERT	CaseType=LinStatic	Point=3	X2=0.5	X3=-0.5			
S11=3194.6557285062	IsS11Max=Yes	IsS11Min=No	FrameElem=44	ElemStation=0.25					
Frame=44	Station=0.25	OutputCase=TERRVERT	CaseType=LinStatic	Point=4	X2=0.5	X3=0.5			
S11=3194.6557285062	IsS11Max=No	IsS11Min=No	FrameElem=44	ElemStation=0.25					
Frame=44	Station=0.375	OutputCase=TERRVERT	CaseType=LinStatic	Point=0	X2=0	X3=0			
S11=1.64270738195066	IsS11Max=No	IsS11Min=No	FrameElem=44	ElemStation=0.375					
Frame=44	Station=0.375	OutputCase=TERRVERT	CaseType=LinStatic	Point=1	X2=-0.5	X3=-0.5	S11=-		
3242.97819413249	IsS11Max=No	IsS11Min=Yes	FrameElem=44	ElemStation=0.375					
Frame=44	Station=0.375	OutputCase=TERRVERT	CaseType=LinStatic	Point=2	X2=-0.5	X3=0.5	S11=-		
3242.97819413249	IsS11Max=No	IsS11Min=No	FrameElem=44	ElemStation=0.375					
Frame=44	Station=0.375	OutputCase=TERRVERT	CaseType=LinStatic	Point=3	X2=0.5	X3=-0.5			
S11=3246.26360889639	IsS11Max=Yes	IsS11Min=No	FrameElem=44	ElemStation=0.375					
Frame=44	Station=0.375	OutputCase=TERRVERT	CaseType=LinStatic	Point=4	X2=0.5	X3=0.5			
S11=3246.26360889639	IsS11Max=No	IsS11Min=No	FrameElem=44	ElemStation=0.375					
Frame=44	Station=0.5	OutputCase=TERRVERT	CaseType=LinStatic	Point=0	X2=0	X3=0	S11=1.64270738195066		
IsS11Max=No	IsS11Min=No	FrameElem=44	ElemStation=0.5						
Frame=44	Station=0.5	OutputCase=TERRVERT	CaseType=LinStatic	Point=1	X2=-0.5	X3=-0.5	S11=-		
3294.58607452268	IsS11Max=No	IsS11Min=Yes	FrameElem=44	ElemStation=0.5					
Frame=44	Station=0.5	OutputCase=TERRVERT	CaseType=LinStatic	Point=2	X2=-0.5	X3=0.5	S11=-		
3294.58607452268	IsS11Max=No	IsS11Min=No	FrameElem=44	ElemStation=0.5					
Frame=44	Station=0.5	OutputCase=TERRVERT	CaseType=LinStatic	Point=3	X2=0.5	X3=-0.5			
S11=3297.87148928658	IsS11Max=Yes	IsS11Min=No	FrameElem=44	ElemStation=0.5					



Frame=44	Station=0.5	OutputCase=TERRVERT	CaseType=LinStatic	Point=4	X2=0.5	X3=0.5			
S11=3297.87148928658	Iss11Max=No	Iss11Min=No	FrameElem=44	ElemStation=0.5					
Frame=44	Station=0	OutputCase=TERRLAT	CaseType=LinStatic	Point=0	X2=0	X3=0	S11=-373.013713761058		
Iss11Max=No	Iss11Min=No	FrameElem=44	ElemStation=0						
Frame=44	Station=0	OutputCase=TERRLAT	CaseType=LinStatic	Point=1	X2=-0.5	X3=-0.5			
S11=124.59978472792	Iss11Max=Yes	Iss11Min=No	FrameElem=44	ElemStation=0					
Frame=44	Station=0	OutputCase=TERRLAT	CaseType=LinStatic	Point=2	X2=-0.5	X3=0.5	S11=124.59978472792		
Iss11Max=No	Iss11Min=No	FrameElem=44	ElemStation=0						
Frame=44	Station=0	OutputCase=TERRLAT	CaseType=LinStatic	Point=3	X2=0.5	X3=-0.5	S11=-		
870.627212250037	Iss11Max=No	Iss11Min=Yes	FrameElem=44	ElemStation=0					
Frame=44	Station=0	OutputCase=TERRLAT	CaseType=LinStatic	Point=4	X2=0.5	X3=0.5	S11=-		
870.627212250037	Iss11Max=No	Iss11Min=No	FrameElem=44	ElemStation=0					
Frame=44	Station=0.125	OutputCase=TERRLAT	CaseType=LinStatic	Point=0	X2=0	X3=0	S11=-		
373.013713761058	Iss11Max=No	Iss11Min=No	FrameElem=44	ElemStation=0.125					
Frame=44	Station=0.125	OutputCase=TERRLAT	CaseType=LinStatic	Point=1	X2=-0.5	X3=-0.5			
S11=124.457200756786	Iss11Max=Yes	Iss11Min=No	FrameElem=44	ElemStation=0.125					
Frame=44	Station=0.125	OutputCase=TERRLAT	CaseType=LinStatic	Point=2	X2=-0.5	X3=0.5			
S11=124.457200756786	Iss11Max=No	Iss11Min=No	FrameElem=44	ElemStation=0.125					
Frame=44	Station=0.125	OutputCase=TERRLAT	CaseType=LinStatic	Point=3	X2=0.5	X3=-0.5	S11=-		
870.484628278903	Iss11Max=No	Iss11Min=Yes	FrameElem=44	ElemStation=0.125					
Frame=44	Station=0.125	OutputCase=TERRLAT	CaseType=LinStatic	Point=4	X2=0.5	X3=0.5	S11=-		
870.484628278903	Iss11Max=No	Iss11Min=No	FrameElem=44	ElemStation=0.125					
Frame=44	Station=0.25	OutputCase=TERRLAT	CaseType=LinStatic	Point=0	X2=0	X3=0	S11=-373.013713761058		
Iss11Max=No	Iss11Min=No	FrameElem=44	ElemStation=0.25						
Frame=44	Station=0.25	OutputCase=TERRLAT	CaseType=LinStatic	Point=1	X2=-0.5	X3=-0.5			
S11=124.314616785652	Iss11Max=Yes	Iss11Min=No	FrameElem=44	ElemStation=0.25					
Frame=44	Station=0.25	OutputCase=TERRLAT	CaseType=LinStatic	Point=2	X2=-0.5	X3=0.5			
S11=124.314616785652	Iss11Max=No	Iss11Min=No	FrameElem=44	ElemStation=0.25					
Frame=44	Station=0.25	OutputCase=TERRLAT	CaseType=LinStatic	Point=3	X2=0.5	X3=-0.5	S11=-		
870.342044307769	Iss11Max=No	Iss11Min=Yes	FrameElem=44	ElemStation=0.25					
Frame=44	Station=0.25	OutputCase=TERRLAT	CaseType=LinStatic	Point=4	X2=0.5	X3=0.5	S11=-		
870.342044307769	Iss11Max=No	Iss11Min=No	FrameElem=44	ElemStation=0.25					
Frame=44	Station=0.375	OutputCase=TERRLAT	CaseType=LinStatic	Point=0	X2=0	X3=0	S11=-		
373.013713761058	Iss11Max=No	Iss11Min=No	FrameElem=44	ElemStation=0.375					
Frame=44	Station=0.375	OutputCase=TERRLAT	CaseType=LinStatic	Point=1	X2=-0.5	X3=-0.5			
S11=124.172032814518	Iss11Max=Yes	Iss11Min=No	FrameElem=44	ElemStation=0.375					
Frame=44	Station=0.375	OutputCase=TERRLAT	CaseType=LinStatic	Point=2	X2=-0.5	X3=0.5			
S11=124.172032814518	Iss11Max=No	Iss11Min=No	FrameElem=44	ElemStation=0.375					
Frame=44	Station=0.375	OutputCase=TERRLAT	CaseType=LinStatic	Point=3	X2=0.5	X3=-0.5	S11=-		
870.199460336635	Iss11Max=No	Iss11Min=Yes	FrameElem=44	ElemStation=0.375					
Frame=44	Station=0.375	OutputCase=TERRLAT	CaseType=LinStatic	Point=4	X2=0.5	X3=0.5	S11=-		
870.199460336635	Iss11Max=No	Iss11Min=No	FrameElem=44	ElemStation=0.375					
Frame=44	Station=0.5	OutputCase=TERRLAT	CaseType=LinStatic	Point=0	X2=0	X3=0	S11=-373.013713761058		
Iss11Max=No	Iss11Min=No	FrameElem=44	ElemStation=0.5						
Frame=44	Station=0.5	OutputCase=TERRLAT	CaseType=LinStatic	Point=1	X2=-0.5	X3=-0.5			
S11=124.029448843385	Iss11Max=Yes	Iss11Min=No	FrameElem=44	ElemStation=0.5					
Frame=44	Station=0.5	OutputCase=TERRLAT	CaseType=LinStatic	Point=2	X2=-0.5	X3=0.5			
S11=124.029448843385	Iss11Max=No	Iss11Min=No	FrameElem=44	ElemStation=0.5					
Frame=44	Station=0.5	OutputCase=TERRLAT	CaseType=LinStatic	Point=3	X2=0.5	X3=-0.5	S11=-		
870.056876365501	Iss11Max=No	Iss11Min=Yes	FrameElem=44	ElemStation=0.5					
Frame=44	Station=0.5	OutputCase=TERRLAT	CaseType=LinStatic	Point=4	X2=0.5	X3=0.5	S11=-		
870.056876365501	Iss11Max=No	Iss11Min=No	FrameElem=44	ElemStation=0.5					
Frame=44	Station=0	OutputCase=ACCVERT	CaseType=LinStatic	Point=0	X2=0	X3=0	S11=0	Iss11Max=Yes	
Iss11Min=Yes	FrameElem=44	ElemStation=0							
Frame=44	Station=0	OutputCase=ACCVERT	CaseType=LinStatic	Point=1	X2=-0.5	X3=-0.5	S11=0		
Iss11Max=No	Iss11Min=No	FrameElem=44	ElemStation=0						
Frame=44	Station=0	OutputCase=ACCVERT	CaseType=LinStatic	Point=2	X2=-0.5	X3=0.5	S11=0	Iss11Max=No	
Iss11Min=No	FrameElem=44	ElemStation=0							
Frame=44	Station=0	OutputCase=ACCVERT	CaseType=LinStatic	Point=3	X2=0.5	X3=-0.5	S11=0	Iss11Max=No	
Iss11Min=No	FrameElem=44	ElemStation=0							
Frame=44	Station=0	OutputCase=ACCVERT	CaseType=LinStatic	Point=4	X2=0.5	X3=0.5	S11=0	Iss11Max=No	
Iss11Min=No	FrameElem=44	ElemStation=0							
Frame=44	Station=0.125	OutputCase=ACCVERT	CaseType=LinStatic	Point=0	X2=0	X3=0	S11=0	Iss11Max=Yes	
Iss11Min=Yes	FrameElem=44	ElemStation=0.125							
Frame=44	Station=0.125	OutputCase=ACCVERT	CaseType=LinStatic	Point=1	X2=-0.5	X3=-0.5	S11=0		
Iss11Max=No	Iss11Min=No	FrameElem=44	ElemStation=0.125						
Frame=44	Station=0.125	OutputCase=ACCVERT	CaseType=LinStatic	Point=2	X2=-0.5	X3=0.5	S11=0		
Iss11Max=No	Iss11Min=No	FrameElem=44	ElemStation=0.125						
Frame=44	Station=0.125	OutputCase=ACCVERT	CaseType=LinStatic	Point=3	X2=0.5	X3=-0.5	S11=0		
Iss11Max=No	Iss11Min=No	FrameElem=44	ElemStation=0.125						
Frame=44	Station=0.125	OutputCase=ACCVERT	CaseType=LinStatic	Point=4	X2=0.5	X3=0.5	S11=0		
Iss11Max=No	Iss11Min=No	FrameElem=44	ElemStation=0.125						
Frame=44	Station=0.25	OutputCase=ACCVERT	CaseType=LinStatic	Point=0	X2=0	X3=0	S11=0	Iss11Max=Yes	
Iss11Min=Yes	FrameElem=44	ElemStation=0.25							
Frame=44	Station=0.25	OutputCase=ACCVERT	CaseType=LinStatic	Point=1	X2=-0.5	X3=-0.5	S11=0		
Iss11Max=No	Iss11Min=No	FrameElem=44	ElemStation=0.25						
Frame=44	Station=0.25	OutputCase=ACCVERT	CaseType=LinStatic	Point=2	X2=-0.5	X3=0.5	S11=0		
Iss11Max=No	Iss11Min=No	FrameElem=44	ElemStation=0.25						
Frame=44	Station=0.25	OutputCase=ACCVERT	CaseType=LinStatic	Point=3	X2=0.5	X3=-0.5	S11=0		
Iss11Max=No	Iss11Min=No	FrameElem=44	ElemStation=0.25						
Frame=44	Station=0.25	OutputCase=ACCVERT	CaseType=LinStatic	Point=4	X2=0.5	X3=0.5	S11=0		
Iss11Max=No	Iss11Min=No	FrameElem=44	ElemStation=0.25						

Frame=44	Station=0.5	OutputCase=TERRCOST	CaseType=LinStatic	Point=2	X2=-0.5	X3=0.5	S11=0	
IsS11Max=No	IsS11Min=No	FrameElem=44	ElemStation=0.5					
Frame=44	Station=0.5	OutputCase=TERRCOST	CaseType=LinStatic	Point=3	X2=0.5	X3=-0.5	S11=0	
IsS11Max=No	IsS11Min=No	FrameElem=44	ElemStation=0.5					
Frame=44	Station=0.5	OutputCase=TERRCOST	CaseType=LinStatic	Point=4	X2=0.5	X3=0.5	S11=0	
IsS11Max=No	IsS11Min=No	FrameElem=44	ElemStation=0.5					
Frame=44	Station=0	OutputCase=SOVRCOST	CaseType=LinStatic	Point=0	X2=0	X3=0	S11=0	IsS11Max=Yes
IsS11Min=Yes	FrameElem=44	ElemStation=0						
Frame=44	Station=0	OutputCase=SOVRCOST	CaseType=LinStatic	Point=1	X2=-0.5	X3=-0.5	S11=0	
IsS11Max=No	IsS11Min=No	FrameElem=44	ElemStation=0					
Frame=44	Station=0	OutputCase=SOVRCOST	CaseType=LinStatic	Point=2	X2=-0.5	X3=0.5	S11=0	
IsS11Max=No	IsS11Min=No	FrameElem=44	ElemStation=0					
Frame=44	Station=0	OutputCase=SOVRCOST	CaseType=LinStatic	Point=3	X2=0.5	X3=-0.5	S11=0	
IsS11Max=No	IsS11Min=No	FrameElem=44	ElemStation=0					
Frame=44	Station=0	OutputCase=SOVRCOST	CaseType=LinStatic	Point=4	X2=0.5	X3=0.5	S11=0	IsS11Max=No
IsS11Min=No	FrameElem=44	ElemStation=0						
Frame=44	Station=0.125	OutputCase=SOVRCOST	CaseType=LinStatic	Point=0	X2=0	X3=0	S11=0	
IsS11Max=Yes	IsS11Min=Yes	FrameElem=44	ElemStation=0.125					
Frame=44	Station=0.125	OutputCase=SOVRCOST	CaseType=LinStatic	Point=1	X2=-0.5	X3=-0.5	S11=0	
IsS11Max=No	IsS11Min=No	FrameElem=44	ElemStation=0.125					
Frame=44	Station=0.125	OutputCase=SOVRCOST	CaseType=LinStatic	Point=2	X2=-0.5	X3=0.5	S11=0	
IsS11Max=No	IsS11Min=No	FrameElem=44	ElemStation=0.125					
Frame=44	Station=0.125	OutputCase=SOVRCOST	CaseType=LinStatic	Point=3	X2=0.5	X3=-0.5	S11=0	
IsS11Max=No	IsS11Min=No	FrameElem=44	ElemStation=0.125					
Frame=44	Station=0.125	OutputCase=SOVRCOST	CaseType=LinStatic	Point=4	X2=0.5	X3=0.5	S11=0	
IsS11Max=No	IsS11Min=No	FrameElem=44	ElemStation=0.125					
Frame=44	Station=0.25	OutputCase=SOVRCOST	CaseType=LinStatic	Point=0	X2=0	X3=0	S11=0	IsS11Max=Yes
IsS11Min=Yes	FrameElem=44	ElemStation=0.25						
Frame=44	Station=0.25	OutputCase=SOVRCOST	CaseType=LinStatic	Point=1	X2=-0.5	X3=-0.5	S11=0	
IsS11Max=No	IsS11Min=No	FrameElem=44	ElemStation=0.25					
Frame=44	Station=0.25	OutputCase=SOVRCOST	CaseType=LinStatic	Point=2	X2=-0.5	X3=0.5	S11=0	
IsS11Max=No	IsS11Min=No	FrameElem=44	ElemStation=0.25					
Frame=44	Station=0.25	OutputCase=SOVRCOST	CaseType=LinStatic	Point=3	X2=0.5	X3=-0.5	S11=0	
IsS11Max=No	IsS11Min=No	FrameElem=44	ElemStation=0.25					
Frame=44	Station=0.25	OutputCase=SOVRCOST	CaseType=LinStatic	Point=4	X2=0.5	X3=0.5	S11=0	
IsS11Max=No	IsS11Min=No	FrameElem=44	ElemStation=0.25					
Frame=44	Station=0.375	OutputCase=SOVRCOST	CaseType=LinStatic	Point=0	X2=0	X3=0	S11=0	
IsS11Max=Yes	IsS11Min=Yes	FrameElem=44	ElemStation=0.375					
Frame=44	Station=0.375	OutputCase=SOVRCOST	CaseType=LinStatic	Point=1	X2=-0.5	X3=-0.5	S11=0	
IsS11Max=No	IsS11Min=No	FrameElem=44	ElemStation=0.375					
Frame=44	Station=0.375	OutputCase=SOVRCOST	CaseType=LinStatic	Point=2	X2=-0.5	X3=0.5	S11=0	
IsS11Max=No	IsS11Min=No	FrameElem=44	ElemStation=0.375					
Frame=44	Station=0.375	OutputCase=SOVRCOST	CaseType=LinStatic	Point=3	X2=0.5	X3=-0.5	S11=0	
IsS11Max=No	IsS11Min=No	FrameElem=44	ElemStation=0.375					
Frame=44	Station=0.375	OutputCase=SOVRCOST	CaseType=LinStatic	Point=4	X2=0.5	X3=0.5	S11=0	
IsS11Max=No	IsS11Min=No	FrameElem=44	ElemStation=0.375					
Frame=44	Station=0.5	OutputCase=SOVRCOST	CaseType=LinStatic	Point=0	X2=0	X3=0	S11=0	IsS11Max=Yes
IsS11Min=Yes	FrameElem=44	ElemStation=0.5						
Frame=44	Station=0.5	OutputCase=SOVRCOST	CaseType=LinStatic	Point=1	X2=-0.5	X3=-0.5	S11=0	
IsS11Max=No	IsS11Min=No	FrameElem=44	ElemStation=0.5					
Frame=44	Station=0.5	OutputCase=SOVRCOST	CaseType=LinStatic	Point=2	X2=-0.5	X3=0.5	S11=0	
IsS11Max=No	IsS11Min=No	FrameElem=44	ElemStation=0.5					
Frame=44	Station=0.5	OutputCase=SOVRCOST	CaseType=LinStatic	Point=3	X2=0.5	X3=-0.5	S11=0	
IsS11Max=No	IsS11Min=No	FrameElem=44	ElemStation=0.5					
Frame=44	Station=0.5	OutputCase=SOVRCOST	CaseType=LinStatic	Point=4	X2=0.5	X3=0.5	S11=0	
IsS11Max=No	IsS11Min=No	FrameElem=44	ElemStation=0.5					
Frame=44	Station=0	OutputCase=ENVE	CaseType=Combination	StepType=Max	Point=0	X2=0	X3=0	S11=-
274.637838986977	IsS11Max=No	IsS11Min=No	FrameElem=44	ElemStation=0				
Frame=44	Station=0	OutputCase=ENVE	CaseType=Combination	StepType=Max	Point=1	X2=-0.5	X3=-0.5	
S11=-3649.56943188686	IsS11Max=No	IsS11Min=Yes	FrameElem=44	ElemStation=0				
Frame=44	Station=0	OutputCase=ENVE	CaseType=Combination	StepType=Max	Point=2	X2=-0.5	X3=0.5	S11=-
3649.56943188686	IsS11Max=No	IsS11Min=No	FrameElem=44	ElemStation=0				
Frame=44	Station=0	OutputCase=ENVE	CaseType=Combination	StepType=Max	Point=3	X2=0.5	X3=-0.5	
S11=3137.67368933129	IsS11Max=Yes	IsS11Min=No	FrameElem=44	ElemStation=0				
Frame=44	Station=0	OutputCase=ENVE	CaseType=Combination	StepType=Max	Point=4	X2=0.5	X3=0.5	
S11=3137.67368933129	IsS11Max=No	IsS11Min=No	FrameElem=44	ElemStation=0				
Frame=44	Station=0.125	OutputCase=ENVE	CaseType=Combination	StepType=Max	Point=0	X2=0	X3=0	S11=-
274.637838986977	IsS11Max=No	IsS11Min=No	FrameElem=44	ElemStation=0.125				
Frame=44	Station=0.125	OutputCase=ENVE	CaseType=Combination	StepType=Max	Point=1	X2=-0.5	X3=-0.5	
S11=-3709.79886536237	IsS11Max=No	IsS11Min=Yes	FrameElem=44	ElemStation=0.125				
Frame=44	Station=0.125	OutputCase=ENVE	CaseType=Combination	StepType=Max	Point=2	X2=-0.5	X3=0.5	
S11=-3709.79886536237	IsS11Max=No	IsS11Min=No	FrameElem=44	ElemStation=0.125				
Frame=44	Station=0.125	OutputCase=ENVE	CaseType=Combination	StepType=Max	Point=3	X2=0.5	X3=-0.5	
S11=3197.86034761545	IsS11Max=Yes	IsS11Min=No	FrameElem=44	ElemStation=0.125				
Frame=44	Station=0.125	OutputCase=ENVE	CaseType=Combination	StepType=Max	Point=4	X2=0.5	X3=0.5	
S11=3197.86034761545	IsS11Max=No	IsS11Min=No	FrameElem=44	ElemStation=0.125				
Frame=44	Station=0.25	OutputCase=ENVE	CaseType=Combination	StepType=Max	Point=0	X2=0	X3=0	S11=-
274.637838986977	IsS11Max=No	IsS11Min=No	FrameElem=44	ElemStation=0.25				
Frame=44	Station=0.25	OutputCase=ENVE	CaseType=Combination	StepType=Max	Point=1	X2=-0.5	X3=-0.5	
S11=-3772.37204883788	IsS11Max=No	IsS11Min=Yes	FrameElem=44	ElemStation=0.25				
Frame=44	Station=0.25	OutputCase=ENVE	CaseType=Combination	StepType=Max	Point=2	X2=-0.5	X3=0.5	
S11=-3772.37204883788	IsS11Max=No	IsS11Min=No	FrameElem=44	ElemStation=0.25				

Frame=44	Station=0.25	OutputCase=ENVE	CaseType=Combination	StepType=Max	Point=3	X2=0.5	X3=-0.5	
S11=3260.39075589962	IsS11Max=Yes	IsS11Min=No	FrameElem=44	ElemStation=0.25				
Frame=44	Station=0.25	OutputCase=ENVE	CaseType=Combination	StepType=Max	Point=4	X2=0.5	X3=0.5	
S11=3260.39075589962	IsS11Max=No	IsS11Min=No	FrameElem=44	ElemStation=0.25				
Frame=44	Station=0.375	OutputCase=ENVE	CaseType=Combination	StepType=Max	Point=0	X2=0	X3=0	S11=-
274.637838986977	IsS11Max=No	IsS11Min=No	FrameElem=44	ElemStation=0.375				
Frame=44	Station=0.375	OutputCase=ENVE	CaseType=Combination	StepType=Max	Point=1	X2=-0.5	X3=-0.5	
S11=-3837.28898231339	IsS11Max=No	IsS11Min=Yes	FrameElem=44	ElemStation=0.375				
Frame=44	Station=0.375	OutputCase=ENVE	CaseType=Combination	StepType=Max	Point=2	X2=-0.5	X3=0.5	
S11=-3837.28898231339	IsS11Max=No	IsS11Min=No	FrameElem=44	ElemStation=0.375				
Frame=44	Station=0.375	OutputCase=ENVE	CaseType=Combination	StepType=Max	Point=3	X2=0.5	X3=-0.5	
S11=3325.26491418379	IsS11Max=Yes	IsS11Min=No	FrameElem=44	ElemStation=0.375				
Frame=44	Station=0.375	OutputCase=ENVE	CaseType=Combination	StepType=Max	Point=4	X2=0.5	X3=0.5	
S11=3325.26491418379	IsS11Max=No	IsS11Min=No	FrameElem=44	ElemStation=0.375				
Frame=44	Station=0.5	OutputCase=ENVE	CaseType=Combination	StepType=Max	Point=0	X2=0	X3=0	S11=-
274.637838986977	IsS11Max=No	IsS11Min=No	FrameElem=44	ElemStation=0.5				
Frame=44	Station=0.5	OutputCase=ENVE	CaseType=Combination	StepType=Max	Point=1	X2=-0.5	X3=-0.5	
S11=-3904.5496657889	IsS11Max=No	IsS11Min=Yes	FrameElem=44	ElemStation=0.5				
Frame=44	Station=0.5	OutputCase=ENVE	CaseType=Combination	StepType=Max	Point=2	X2=-0.5	X3=0.5	
S11=-3904.5496657889	IsS11Max=No	IsS11Min=No	FrameElem=44	ElemStation=0.5				
Frame=44	Station=0.5	OutputCase=ENVE	CaseType=Combination	StepType=Max	Point=3	X2=0.5	X3=-0.5	
S11=3392.48282246796	IsS11Max=Yes	IsS11Min=No	FrameElem=44	ElemStation=0.5				
Frame=44	Station=0.5	OutputCase=ENVE	CaseType=Combination	StepType=Max	Point=4	X2=0.5	X3=0.5	
S11=3392.48282246796	IsS11Max=No	IsS11Min=No	FrameElem=44	ElemStation=0.5				
Frame=44	Station=0	OutputCase=ENVE	CaseType=Combination	StepType=Min	Point=0	X2=0	X3=0	S11=-
386.541953115295	IsS11Max=No	IsS11Min=No	FrameElem=44	ElemStation=0				
Frame=44	Station=0	OutputCase=ENVE	CaseType=Combination	StepType=Min	Point=1	X2=-0.5	X3=-0.5	
S11=-3686.94936730524	IsS11Max=No	IsS11Min=Yes	FrameElem=44	ElemStation=0				
Frame=44	Station=0	OutputCase=ENVE	CaseType=Combination	StepType=Min	Point=2	X2=-0.5	X3=0.5	S11=-
3686.94936730524	IsS11Max=No	IsS11Min=No	FrameElem=44	ElemStation=0				
Frame=44	Station=0	OutputCase=ENVE	CaseType=Combination	StepType=Min	Point=3	X2=0.5	X3=-0.5	
S11=2876.48552565627	IsS11Max=Yes	IsS11Min=No	FrameElem=44	ElemStation=0				
Frame=44	Station=0	OutputCase=ENVE	CaseType=Combination	StepType=Min	Point=4	X2=0.5	X3=0.5	
S11=2876.48552565627	IsS11Max=No	IsS11Min=No	FrameElem=44	ElemStation=0				
Frame=44	Station=0.125	OutputCase=ENVE	CaseType=Combination	StepType=Min	Point=0	X2=0	X3=0	S11=-
386.541953115295	IsS11Max=No	IsS11Min=No	FrameElem=44	ElemStation=0.125				
Frame=44	Station=0.125	OutputCase=ENVE	CaseType=Combination	StepType=Min	Point=1	X2=-0.5	X3=-0.5	
S11=-3747.13602558941	IsS11Max=No	IsS11Min=Yes	FrameElem=44	ElemStation=0.125				
Frame=44	Station=0.125	OutputCase=ENVE	CaseType=Combination	StepType=Min	Point=2	X2=-0.5	X3=0.5	
S11=-3747.13602558941	IsS11Max=No	IsS11Min=No	FrameElem=44	ElemStation=0.125				
Frame=44	Station=0.125	OutputCase=ENVE	CaseType=Combination	StepType=Min	Point=3	X2=0.5	X3=-0.5	
S11=2936.71495913178	IsS11Max=Yes	IsS11Min=No	FrameElem=44	ElemStation=0.125				
Frame=44	Station=0.125	OutputCase=ENVE	CaseType=Combination	StepType=Min	Point=4	X2=0.5	X3=0.5	
S11=2936.71495913178	IsS11Max=No	IsS11Min=No	FrameElem=44	ElemStation=0.125				
Frame=44	Station=0.25	OutputCase=ENVE	CaseType=Combination	StepType=Min	Point=0	X2=0	X3=0	S11=-
386.541953115295	IsS11Max=No	IsS11Min=No	FrameElem=44	ElemStation=0.25				
Frame=44	Station=0.25	OutputCase=ENVE	CaseType=Combination	StepType=Min	Point=1	X2=-0.5	X3=-0.5	
S11=-3809.66643387358	IsS11Max=No	IsS11Min=Yes	FrameElem=44	ElemStation=0.25				
Frame=44	Station=0.25	OutputCase=ENVE	CaseType=Combination	StepType=Min	Point=2	X2=-0.5	X3=0.5	
S11=-3809.66643387358	IsS11Max=No	IsS11Min=No	FrameElem=44	ElemStation=0.25				
Frame=44	Station=0.25	OutputCase=ENVE	CaseType=Combination	StepType=Min	Point=3	X2=0.5	X3=-0.5	
S11=2999.28814260729	IsS11Max=Yes	IsS11Min=No	FrameElem=44	ElemStation=0.25				
Frame=44	Station=0.25	OutputCase=ENVE	CaseType=Combination	StepType=Min	Point=4	X2=0.5	X3=0.5	
S11=2999.28814260729	IsS11Max=No	IsS11Min=No	FrameElem=44	ElemStation=0.25				
Frame=44	Station=0.375	OutputCase=ENVE	CaseType=Combination	StepType=Min	Point=0	X2=0	X3=0	S11=-
386.541953115295	IsS11Max=No	IsS11Min=No	FrameElem=44	ElemStation=0.375				
Frame=44	Station=0.375	OutputCase=ENVE	CaseType=Combination	StepType=Min	Point=1	X2=-0.5	X3=-0.5	
S11=-3874.54059215775	IsS11Max=No	IsS11Min=Yes	FrameElem=44	ElemStation=0.375				
Frame=44	Station=0.375	OutputCase=ENVE	CaseType=Combination	StepType=Min	Point=2	X2=-0.5	X3=0.5	
S11=-3874.54059215775	IsS11Max=No	IsS11Min=No	FrameElem=44	ElemStation=0.375				
Frame=44	Station=0.375	OutputCase=ENVE	CaseType=Combination	StepType=Min	Point=3	X2=0.5	X3=-0.5	
S11=3064.2050760828	IsS11Max=Yes	IsS11Min=No	FrameElem=44	ElemStation=0.375				
Frame=44	Station=0.375	OutputCase=ENVE	CaseType=Combination	StepType=Min	Point=4	X2=0.5	X3=0.5	
S11=3064.2050760828	IsS11Max=No	IsS11Min=No	FrameElem=44	ElemStation=0.375				
Frame=44	Station=0.5	OutputCase=ENVE	CaseType=Combination	StepType=Min	Point=0	X2=0	X3=0	S11=-
386.541953115295	IsS11Max=No	IsS11Min=No	FrameElem=44	ElemStation=0.5				
Frame=44	Station=0.5	OutputCase=ENVE	CaseType=Combination	StepType=Min	Point=1	X2=-0.5	X3=-0.5	
S11=-3941.75850044192	IsS11Max=No	IsS11Min=Yes	FrameElem=44	ElemStation=0.5				
Frame=44	Station=0.5	OutputCase=ENVE	CaseType=Combination	StepType=Min	Point=2	X2=-0.5	X3=0.5	
S11=-3941.75850044192	IsS11Max=No	IsS11Min=No	FrameElem=44	ElemStation=0.5				
Frame=44	Station=0.5	OutputCase=ENVE	CaseType=Combination	StepType=Min	Point=3	X2=0.5	X3=-0.5	
S11=3131.46575955831	IsS11Max=Yes	IsS11Min=No	FrameElem=44	ElemStation=0.5				
Frame=44	Station=0.5	OutputCase=ENVE	CaseType=Combination	StepType=Min	Point=4	X2=0.5	X3=0.5	
S11=3131.46575955831	IsS11Max=No	IsS11Min=No	FrameElem=44	ElemStation=0.5				
Frame=44	Station=0	OutputCase=FESSUR	CaseType=Combination	Point=0	X2=0	X3=0	S11=-386.541953115295	
IsS11Max=No	IsS11Min=No	FrameElem=44	ElemStation=0					
Frame=44	Station=0	OutputCase=FESSUR	CaseType=Combination	Point=1	X2=-0.5	X3=-0.5	S11=-	
3649.56943188686	IsS11Max=No	IsS11Min=Yes	FrameElem=44	ElemStation=0				
Frame=44	Station=0	OutputCase=FESSUR	CaseType=Combination	Point=2	X2=-0.5	X3=0.5	S11=-	
3649.56943188686	IsS11Max=No	IsS11Min=No	FrameElem=44	ElemStation=0				
Frame=44	Station=0	OutputCase=FESSUR	CaseType=Combination	Point=3	X2=0.5	X3=-0.5		
S11=2876.48552565627	IsS11Max=Yes	IsS11Min=No	FrameElem=44	ElemStation=0				

```

Frame=44 Station=0 OutputCase=FESSUR CaseType=Combination Point=4 X2=0.5 X3=0.5
S11=2876.48552565627 IsS11Max=No IsS11Min=No FrameElem=44 ElemStation=0
Frame=44 Station=0.125 OutputCase=FESSUR CaseType=Combination Point=0 X2=0 X3=0 S11=-
386.541953115295 IsS11Max=No IsS11Min=No FrameElem=44 ElemStation=0.125
Frame=44 Station=0.125 OutputCase=FESSUR CaseType=Combination Point=1 X2=-0.5 X3=-0.5 S11=-
3709.79886536237 IsS11Max=No IsS11Min=Yes FrameElem=44 ElemStation=0.125
Frame=44 Station=0.125 OutputCase=FESSUR CaseType=Combination Point=2 X2=-0.5 X3=0.5 S11=-
3709.79886536237 IsS11Max=No IsS11Min=No FrameElem=44 ElemStation=0.125
Frame=44 Station=0.125 OutputCase=FESSUR CaseType=Combination Point=3 X2=0.5 X3=-0.5
S11=2936.71495913178 IsS11Max=Yes IsS11Min=No FrameElem=44 ElemStation=0.125
Frame=44 Station=0.125 OutputCase=FESSUR CaseType=Combination Point=4 X2=0.5 X3=0.5
S11=2936.71495913178 IsS11Max=No IsS11Min=No FrameElem=44 ElemStation=0.125
Frame=44 Station=0.25 OutputCase=FESSUR CaseType=Combination Point=0 X2=0 X3=0 S11=-
386.541953115295 IsS11Max=No IsS11Min=No FrameElem=44 ElemStation=0.25
Frame=44 Station=0.25 OutputCase=FESSUR CaseType=Combination Point=1 X2=-0.5 X3=-0.5 S11=-
3772.37204883788 IsS11Max=No IsS11Min=Yes FrameElem=44 ElemStation=0.25
Frame=44 Station=0.25 OutputCase=FESSUR CaseType=Combination Point=2 X2=-0.5 X3=0.5 S11=-
3772.37204883788 IsS11Max=No IsS11Min=No FrameElem=44 ElemStation=0.25
Frame=44 Station=0.25 OutputCase=FESSUR CaseType=Combination Point=3 X2=0.5 X3=-0.5
S11=2999.28814260729 IsS11Max=Yes IsS11Min=No FrameElem=44 ElemStation=0.25
Frame=44 Station=0.25 OutputCase=FESSUR CaseType=Combination Point=4 X2=0.5 X3=0.5
S11=2999.28814260729 IsS11Max=No IsS11Min=No FrameElem=44 ElemStation=0.25
Frame=44 Station=0.375 OutputCase=FESSUR CaseType=Combination Point=0 X2=0 X3=0 S11=-
386.541953115295 IsS11Max=No IsS11Min=No FrameElem=44 ElemStation=0.375
Frame=44 Station=0.375 OutputCase=FESSUR CaseType=Combination Point=1 X2=-0.5 X3=-0.5 S11=-
3837.28898231339 IsS11Max=No IsS11Min=Yes FrameElem=44 ElemStation=0.375
Frame=44 Station=0.375 OutputCase=FESSUR CaseType=Combination Point=2 X2=-0.5 X3=0.5 S11=-
3837.28898231339 IsS11Max=No IsS11Min=No FrameElem=44 ElemStation=0.375
Frame=44 Station=0.375 OutputCase=FESSUR CaseType=Combination Point=3 X2=0.5 X3=-0.5
S11=3064.2050760828 IsS11Max=Yes IsS11Min=No FrameElem=44 ElemStation=0.375
Frame=44 Station=0.375 OutputCase=FESSUR CaseType=Combination Point=4 X2=0.5 X3=0.5
S11=3064.2050760828 IsS11Max=No IsS11Min=No FrameElem=44 ElemStation=0.375
Frame=44 Station=0.5 OutputCase=FESSUR CaseType=Combination Point=0 X2=0 X3=0 S11=-386.541953115295
IsS11Max=No IsS11Min=No FrameElem=44 ElemStation=0.5
Frame=44 Station=0.5 OutputCase=FESSUR CaseType=Combination Point=1 X2=-0.5 X3=-0.5 S11=-
3904.5496657889 IsS11Max=No IsS11Min=Yes FrameElem=44 ElemStation=0.5
Frame=44 Station=0.5 OutputCase=FESSUR CaseType=Combination Point=2 X2=-0.5 X3=0.5 S11=-
3904.5496657889 IsS11Max=No IsS11Min=No FrameElem=44 ElemStation=0.5
Frame=44 Station=0.5 OutputCase=FESSUR CaseType=Combination Point=3 X2=0.5 X3=-0.5
S11=3131.46575955831 IsS11Max=Yes IsS11Min=No FrameElem=44 ElemStation=0.5
Frame=44 Station=0.5 OutputCase=FESSUR CaseType=Combination Point=4 X2=0.5 X3=0.5
S11=3131.46575955831 IsS11Max=No IsS11Min=No FrameElem=44 ElemStation=0.5
Frame=45 Station=0 OutputCase=PESOPR CaseType=LinStatic Point=0 X2=0 X3=0 S11=-15.1709467361871
IsS11Max=No IsS11Min=No FrameElem=45 ElemStation=0
Frame=45 Station=0 OutputCase=PESOPR CaseType=LinStatic Point=1 X2=-0.5 X3=-0.5 S11=-
733.993040109606 IsS11Max=No IsS11Min=Yes FrameElem=45 ElemStation=0
Frame=45 Station=0 OutputCase=PESOPR CaseType=LinStatic Point=2 X2=-0.5 X3=0.5 S11=-
733.993040109606 IsS11Max=No IsS11Min=No FrameElem=45 ElemStation=0
Frame=45 Station=0 OutputCase=PESOPR CaseType=LinStatic Point=3 X2=0.5 X3=-0.5 S11=703.651146637232
IsS11Max=Yes IsS11Min=No FrameElem=45 ElemStation=0
Frame=45 Station=0 OutputCase=PESOPR CaseType=LinStatic Point=4 X2=0.5 X3=0.5 S11=703.651146637232
IsS11Max=No IsS11Min=No FrameElem=45 ElemStation=0
Frame=45 Station=0.125 OutputCase=PESOPR CaseType=LinStatic Point=0 X2=0 X3=0 S11=-15.1709467361871
IsS11Max=No IsS11Min=No FrameElem=45 ElemStation=0.125
Frame=45 Station=0.125 OutputCase=PESOPR CaseType=LinStatic Point=1 X2=-0.5 X3=-0.5 S11=-
718.482820766905 IsS11Max=No IsS11Min=Yes FrameElem=45 ElemStation=0.125
Frame=45 Station=0.125 OutputCase=PESOPR CaseType=LinStatic Point=2 X2=-0.5 X3=0.5 S11=-
718.482820766905 IsS11Max=No IsS11Min=No FrameElem=45 ElemStation=0.125
Frame=45 Station=0.125 OutputCase=PESOPR CaseType=LinStatic Point=3 X2=0.5 X3=-0.5
S11=688.140927294531 IsS11Max=Yes IsS11Min=No FrameElem=45 ElemStation=0.125
Frame=45 Station=0.125 OutputCase=PESOPR CaseType=LinStatic Point=4 X2=0.5 X3=0.5
S11=688.140927294531 IsS11Max=No IsS11Min=No FrameElem=45 ElemStation=0.125
Frame=45 Station=0.25 OutputCase=PESOPR CaseType=LinStatic Point=0 X2=0 X3=0 S11=-15.1709467361871
IsS11Max=No IsS11Min=No FrameElem=45 ElemStation=0.25
Frame=45 Station=0.25 OutputCase=PESOPR CaseType=LinStatic Point=1 X2=-0.5 X3=-0.5 S11=-
705.316351424204 IsS11Max=No IsS11Min=Yes FrameElem=45 ElemStation=0.25
Frame=45 Station=0.25 OutputCase=PESOPR CaseType=LinStatic Point=2 X2=-0.5 X3=0.5 S11=-
705.316351424204 IsS11Max=No IsS11Min=No FrameElem=45 ElemStation=0.25
Frame=45 Station=0.25 OutputCase=PESOPR CaseType=LinStatic Point=3 X2=0.5 X3=-0.5
S11=674.97445795183 IsS11Max=Yes IsS11Min=No FrameElem=45 ElemStation=0.25
Frame=45 Station=0.25 OutputCase=PESOPR CaseType=LinStatic Point=4 X2=0.5 X3=0.5
S11=674.97445795183 IsS11Max=No IsS11Min=No FrameElem=45 ElemStation=0.25
Frame=45 Station=0.375 OutputCase=PESOPR CaseType=LinStatic Point=0 X2=0 X3=0 S11=-15.1709467361871
IsS11Max=No IsS11Min=No FrameElem=45 ElemStation=0.375
Frame=45 Station=0.375 OutputCase=PESOPR CaseType=LinStatic Point=1 X2=-0.5 X3=-0.5 S11=-
694.493632081503 IsS11Max=No IsS11Min=Yes FrameElem=45 ElemStation=0.375
Frame=45 Station=0.375 OutputCase=PESOPR CaseType=LinStatic Point=2 X2=-0.5 X3=0.5 S11=-
694.493632081503 IsS11Max=No IsS11Min=No FrameElem=45 ElemStation=0.375
Frame=45 Station=0.375 OutputCase=PESOPR CaseType=LinStatic Point=3 X2=0.5 X3=-0.5
S11=664.151738609129 IsS11Max=Yes IsS11Min=No FrameElem=45 ElemStation=0.375
Frame=45 Station=0.375 OutputCase=PESOPR CaseType=LinStatic Point=4 X2=0.5 X3=0.5
S11=664.151738609129 IsS11Max=No IsS11Min=No FrameElem=45 ElemStation=0.375

```

Frame=45	Station=0.5	OutputCase=PESOPR	CaseType=LinStatic	Point=0	X2=0	X3=0	S11=-15.1709467361871
IsS11Max=No	IsS11Min=No	FrameElem=45	ElemStation=0.5				
Frame=45	Station=0.5	OutputCase=PESOPR	CaseType=LinStatic	Point=1	X2=-0.5	X3=-0.5	S11=-
686.014662738802	IsS11Max=No	IsS11Min=Yes	FrameElem=45	ElemStation=0.5			
Frame=45	Station=0.5	OutputCase=PESOPR	CaseType=LinStatic	Point=2	X2=-0.5	X3=0.5	S11=-
686.014662738802	IsS11Max=No	IsS11Min=No	FrameElem=45	ElemStation=0.5			
Frame=45	Station=0.5	OutputCase=PESOPR	CaseType=LinStatic	Point=3	X2=0.5	X3=-0.5	
S11=655.672769266428	IsS11Max=Yes	IsS11Min=No	FrameElem=45	ElemStation=0.5			
Frame=45	Station=0.5	OutputCase=PESOPR	CaseType=LinStatic	Point=4	X2=0.5	X3=0.5	
S11=655.672769266428	IsS11Max=No	IsS11Min=No	FrameElem=45	ElemStation=0.5			
Frame=45	Station=0	OutputCase=TERRVERT	CaseType=LinStatic	Point=0	X2=0	X3=0	S11=1.64270738195066
IsS11Max=No	IsS11Min=No	FrameElem=45	ElemStation=0				
Frame=45	Station=0	OutputCase=TERRVERT	CaseType=LinStatic	Point=1	X2=-0.5	X3=-0.5	S11=-
3294.58607452268	IsS11Max=No	IsS11Min=Yes	FrameElem=45	ElemStation=0			
Frame=45	Station=0	OutputCase=TERRVERT	CaseType=LinStatic	Point=2	X2=-0.5	X3=0.5	S11=-
3294.58607452268	IsS11Max=No	IsS11Min=No	FrameElem=45	ElemStation=0			
Frame=45	Station=0	OutputCase=TERRVERT	CaseType=LinStatic	Point=3	X2=0.5	X3=-0.5	
S11=3297.87148928658	IsS11Max=Yes	IsS11Min=No	FrameElem=45	ElemStation=0			
Frame=45	Station=0	OutputCase=TERRVERT	CaseType=LinStatic	Point=4	X2=0.5	X3=0.5	
S11=3297.87148928658	IsS11Max=No	IsS11Min=No	FrameElem=45	ElemStation=0			
Frame=45	Station=0.125	OutputCase=TERRVERT	CaseType=LinStatic	Point=0	X2=0	X3=0	
S11=1.64270738195066	IsS11Max=No	IsS11Min=No	FrameElem=45	ElemStation=0.125			
Frame=45	Station=0.125	OutputCase=TERRVERT	CaseType=LinStatic	Point=1	X2=-0.5	X3=-0.5	S11=-
3242.97819371089	IsS11Max=No	IsS11Min=Yes	FrameElem=45	ElemStation=0.125			
Frame=45	Station=0.125	OutputCase=TERRVERT	CaseType=LinStatic	Point=2	X2=-0.5	X3=0.5	S11=-
3242.97819371089	IsS11Max=No	IsS11Min=No	FrameElem=45	ElemStation=0.125			
Frame=45	Station=0.125	OutputCase=TERRVERT	CaseType=LinStatic	Point=3	X2=0.5	X3=-0.5	
S11=3246.26360847479	IsS11Max=Yes	IsS11Min=No	FrameElem=45	ElemStation=0.125			
Frame=45	Station=0.125	OutputCase=TERRVERT	CaseType=LinStatic	Point=4	X2=0.5	X3=0.5	
S11=3246.26360847479	IsS11Max=No	IsS11Min=No	FrameElem=45	ElemStation=0.125			
Frame=45	Station=0.25	OutputCase=TERRVERT	CaseType=LinStatic	Point=0	X2=0	X3=0	S11=1.64270738195066
IsS11Max=No	IsS11Min=No	FrameElem=45	ElemStation=0.25				
Frame=45	Station=0.25	OutputCase=TERRVERT	CaseType=LinStatic	Point=1	X2=-0.5	X3=-0.5	S11=-
3191.37031289909	IsS11Max=No	IsS11Min=Yes	FrameElem=45	ElemStation=0.25			
Frame=45	Station=0.25	OutputCase=TERRVERT	CaseType=LinStatic	Point=2	X2=-0.5	X3=0.5	S11=-
3191.37031289909	IsS11Max=No	IsS11Min=No	FrameElem=45	ElemStation=0.25			
Frame=45	Station=0.25	OutputCase=TERRVERT	CaseType=LinStatic	Point=3	X2=0.5	X3=-0.5	
S11=3194.65572766299	IsS11Max=Yes	IsS11Min=No	FrameElem=45	ElemStation=0.25			
Frame=45	Station=0.25	OutputCase=TERRVERT	CaseType=LinStatic	Point=4	X2=0.5	X3=0.5	
S11=3194.65572766299	IsS11Max=No	IsS11Min=No	FrameElem=45	ElemStation=0.25			
Frame=45	Station=0.375	OutputCase=TERRVERT	CaseType=LinStatic	Point=0	X2=0	X3=0	
S11=1.64270738195066	IsS11Max=No	IsS11Min=No	FrameElem=45	ElemStation=0.375			
Frame=45	Station=0.375	OutputCase=TERRVERT	CaseType=LinStatic	Point=1	X2=-0.5	X3=-0.5	S11=-
3139.76243208729	IsS11Max=No	IsS11Min=Yes	FrameElem=45	ElemStation=0.375			
Frame=45	Station=0.375	OutputCase=TERRVERT	CaseType=LinStatic	Point=2	X2=-0.5	X3=0.5	S11=-
3139.76243208729	IsS11Max=No	IsS11Min=No	FrameElem=45	ElemStation=0.375			
Frame=45	Station=0.375	OutputCase=TERRVERT	CaseType=LinStatic	Point=3	X2=0.5	X3=-0.5	
S11=3143.04784685119	IsS11Max=Yes	IsS11Min=No	FrameElem=45	ElemStation=0.375			
Frame=45	Station=0.375	OutputCase=TERRVERT	CaseType=LinStatic	Point=4	X2=0.5	X3=0.5	
S11=3143.04784685119	IsS11Max=No	IsS11Min=No	FrameElem=45	ElemStation=0.375			
Frame=45	Station=0.5	OutputCase=TERRVERT	CaseType=LinStatic	Point=0	X2=0	X3=0	S11=1.64270738195066
IsS11Max=No	IsS11Min=No	FrameElem=45	ElemStation=0.5				
Frame=45	Station=0.5	OutputCase=TERRVERT	CaseType=LinStatic	Point=1	X2=-0.5	X3=-0.5	S11=-
3088.1545512755	IsS11Max=No	IsS11Min=Yes	FrameElem=45	ElemStation=0.5			
Frame=45	Station=0.5	OutputCase=TERRVERT	CaseType=LinStatic	Point=2	X2=-0.5	X3=0.5	S11=-
3088.1545512755	IsS11Max=No	IsS11Min=No	FrameElem=45	ElemStation=0.5			
Frame=45	Station=0.5	OutputCase=TERRVERT	CaseType=LinStatic	Point=3	X2=0.5	X3=-0.5	
S11=3091.4399660394	IsS11Max=Yes	IsS11Min=No	FrameElem=45	ElemStation=0.5			
Frame=45	Station=0.5	OutputCase=TERRVERT	CaseType=LinStatic	Point=4	X2=0.5	X3=0.5	
S11=3091.4399660394	IsS11Max=No	IsS11Min=No	FrameElem=45	ElemStation=0.5			
Frame=45	Station=0	OutputCase=TERRLAT	CaseType=LinStatic	Point=0	X2=0	X3=0	S11=-373.013713761058
IsS11Max=No	IsS11Min=No	FrameElem=45	ElemStation=0				
Frame=45	Station=0	OutputCase=TERRLAT	CaseType=LinStatic	Point=1	X2=-0.5	X3=-0.5	
S11=124.029448843384	IsS11Max=Yes	IsS11Min=No	FrameElem=45	ElemStation=0			
Frame=45	Station=0	OutputCase=TERRLAT	CaseType=LinStatic	Point=2	X2=-0.5	X3=0.5	
S11=124.029448843384	IsS11Max=No	IsS11Min=No	FrameElem=45	ElemStation=0			
Frame=45	Station=0	OutputCase=TERRLAT	CaseType=LinStatic	Point=3	X2=0.5	X3=-0.5	S11=-
870.056876365501	IsS11Max=No	IsS11Min=Yes	FrameElem=45	ElemStation=0			
Frame=45	Station=0	OutputCase=TERRLAT	CaseType=LinStatic	Point=4	X2=0.5	X3=0.5	S11=-
870.056876365501	IsS11Max=No	IsS11Min=No	FrameElem=45	ElemStation=0			
Frame=45	Station=0.125	OutputCase=TERRLAT	CaseType=LinStatic	Point=0	X2=0	X3=0	S11=-
373.013713761058	IsS11Max=No	IsS11Min=No	FrameElem=45	ElemStation=0.125			
Frame=45	Station=0.125	OutputCase=TERRLAT	CaseType=LinStatic	Point=1	X2=-0.5	X3=-0.5	
S11=124.172029023975	IsS11Max=Yes	IsS11Min=No	FrameElem=45	ElemStation=0.125			
Frame=45	Station=0.125	OutputCase=TERRLAT	CaseType=LinStatic	Point=2	X2=-0.5	X3=0.5	
S11=124.172029023975	IsS11Max=No	IsS11Min=No	FrameElem=45	ElemStation=0.125			
Frame=45	Station=0.125	OutputCase=TERRLAT	CaseType=LinStatic	Point=3	X2=0.5	X3=-0.5	S11=-
870.199456546091	IsS11Max=No	IsS11Min=Yes	FrameElem=45	ElemStation=0.125			
Frame=45	Station=0.125	OutputCase=TERRLAT	CaseType=LinStatic	Point=4	X2=0.5	X3=0.5	S11=-
870.199456546091	IsS11Max=No	IsS11Min=No	FrameElem=45	ElemStation=0.125			
Frame=45	Station=0.25	OutputCase=TERRLAT	CaseType=LinStatic	Point=0	X2=0	X3=0	S11=-373.013713761058
IsS11Max=No	IsS11Min=No	FrameElem=45	ElemStation=0.25				

Frame=45	Station=0.25	OutputCase=TERRLAT	CaseType=LinStatic	Point=1	X2=-0.5	X3=-0.5			
S11=124.314609204565	IsS11Max=Yes	IsS11Min=No	FrameElem=45	ElemStation=0.25					
Frame=45	Station=0.25	OutputCase=TERRLAT	CaseType=LinStatic	Point=2	X2=-0.5	X3=0.5			
S11=124.314609204565	IsS11Max=No	IsS11Min=No	FrameElem=45	ElemStation=0.25					
Frame=45	Station=0.25	OutputCase=TERRLAT	CaseType=LinStatic	Point=3	X2=0.5	X3=-0.5	S11=-		
870.342036726682	IsS11Max=No	IsS11Min=Yes	FrameElem=45	ElemStation=0.25					
Frame=45	Station=0.25	OutputCase=TERRLAT	CaseType=LinStatic	Point=4	X2=0.5	X3=0.5	S11=-		
870.342036726682	IsS11Max=No	IsS11Min=No	FrameElem=45	ElemStation=0.25					
Frame=45	Station=0.375	OutputCase=TERRLAT	CaseType=LinStatic	Point=0	X2=0	X3=0	S11=-		
373.013713761058	IsS11Max=No	IsS11Min=No	FrameElem=45	ElemStation=0.375					
Frame=45	Station=0.375	OutputCase=TERRLAT	CaseType=LinStatic	Point=1	X2=-0.5	X3=-0.5			
S11=124.457189385155	IsS11Max=Yes	IsS11Min=No	FrameElem=45	ElemStation=0.375					
Frame=45	Station=0.375	OutputCase=TERRLAT	CaseType=LinStatic	Point=2	X2=-0.5	X3=0.5			
S11=124.457189385155	IsS11Max=No	IsS11Min=No	FrameElem=45	ElemStation=0.375					
Frame=45	Station=0.375	OutputCase=TERRLAT	CaseType=LinStatic	Point=3	X2=0.5	X3=-0.5	S11=-		
870.484616907272	IsS11Max=No	IsS11Min=Yes	FrameElem=45	ElemStation=0.375					
Frame=45	Station=0.375	OutputCase=TERRLAT	CaseType=LinStatic	Point=4	X2=0.5	X3=0.5	S11=-		
870.484616907272	IsS11Max=No	IsS11Min=No	FrameElem=45	ElemStation=0.375					
Frame=45	Station=0.5	OutputCase=TERRLAT	CaseType=LinStatic	Point=0	X2=0	X3=0	S11=-373.013713761058		
IsS11Max=No	IsS11Min=No	FrameElem=45	ElemStation=0.5						
Frame=45	Station=0.5	OutputCase=TERRLAT	CaseType=LinStatic	Point=1	X2=-0.5	X3=-0.5			
S11=124.599769565745	IsS11Max=Yes	IsS11Min=No	FrameElem=45	ElemStation=0.5					
Frame=45	Station=0.5	OutputCase=TERRLAT	CaseType=LinStatic	Point=2	X2=-0.5	X3=0.5			
S11=124.599769565745	IsS11Max=No	IsS11Min=No	FrameElem=45	ElemStation=0.5					
Frame=45	Station=0.5	OutputCase=TERRLAT	CaseType=LinStatic	Point=3	X2=0.5	X3=-0.5	S11=-		
870.627197087862	IsS11Max=No	IsS11Min=Yes	FrameElem=45	ElemStation=0.5					
Frame=45	Station=0.5	OutputCase=TERRLAT	CaseType=LinStatic	Point=4	X2=0.5	X3=0.5	S11=-		
870.627197087862	IsS11Max=No	IsS11Min=No	FrameElem=45	ElemStation=0.5					
Frame=45	Station=0	OutputCase=ACCVERT	CaseType=LinStatic	Point=0	X2=0	X3=0	S11=0	IsS11Max=Yes	
IsS11Min=Yes	FrameElem=45	ElemStation=0							
Frame=45	Station=0	OutputCase=ACCVERT	CaseType=LinStatic	Point=1	X2=-0.5	X3=-0.5	S11=0		
IsS11Max=No	IsS11Min=No	FrameElem=45	ElemStation=0						
Frame=45	Station=0	OutputCase=ACCVERT	CaseType=LinStatic	Point=2	X2=-0.5	X3=0.5	S11=0	IsS11Max=No	
IsS11Min=No	FrameElem=45	ElemStation=0							
Frame=45	Station=0	OutputCase=ACCVERT	CaseType=LinStatic	Point=3	X2=0.5	X3=-0.5	S11=0	IsS11Max=No	
IsS11Min=No	FrameElem=45	ElemStation=0							
Frame=45	Station=0	OutputCase=ACCVERT	CaseType=LinStatic	Point=4	X2=0.5	X3=0.5	S11=0	IsS11Max=No	
IsS11Min=No	FrameElem=45	ElemStation=0							
Frame=45	Station=0.125	OutputCase=ACCVERT	CaseType=LinStatic	Point=0	X2=0	X3=0	S11=0	IsS11Max=Yes	
IsS11Min=Yes	FrameElem=45	ElemStation=0.125							
Frame=45	Station=0.125	OutputCase=ACCVERT	CaseType=LinStatic	Point=1	X2=-0.5	X3=-0.5	S11=0		
IsS11Max=No	IsS11Min=No	FrameElem=45	ElemStation=0.125						
Frame=45	Station=0.125	OutputCase=ACCVERT	CaseType=LinStatic	Point=2	X2=-0.5	X3=0.5	S11=0		
IsS11Max=No	IsS11Min=No	FrameElem=45	ElemStation=0.125						
Frame=45	Station=0.125	OutputCase=ACCVERT	CaseType=LinStatic	Point=3	X2=0.5	X3=-0.5	S11=0		
IsS11Max=No	IsS11Min=No	FrameElem=45	ElemStation=0.125						
Frame=45	Station=0.125	OutputCase=ACCVERT	CaseType=LinStatic	Point=4	X2=0.5	X3=0.5	S11=0		
IsS11Max=No	IsS11Min=No	FrameElem=45	ElemStation=0.125						
Frame=45	Station=0.25	OutputCase=ACCVERT	CaseType=LinStatic	Point=0	X2=0	X3=0	S11=0	IsS11Max=Yes	
IsS11Min=Yes	FrameElem=45	ElemStation=0.25							
Frame=45	Station=0.25	OutputCase=ACCVERT	CaseType=LinStatic	Point=1	X2=-0.5	X3=-0.5	S11=0		
IsS11Max=No	IsS11Min=No	FrameElem=45	ElemStation=0.25						
Frame=45	Station=0.25	OutputCase=ACCVERT	CaseType=LinStatic	Point=2	X2=-0.5	X3=0.5	S11=0		
IsS11Max=No	IsS11Min=No	FrameElem=45	ElemStation=0.25						
Frame=45	Station=0.25	OutputCase=ACCVERT	CaseType=LinStatic	Point=3	X2=0.5	X3=-0.5	S11=0		
IsS11Max=No	IsS11Min=No	FrameElem=45	ElemStation=0.25						
Frame=45	Station=0.25	OutputCase=ACCVERT	CaseType=LinStatic	Point=4	X2=0.5	X3=0.5	S11=0		
IsS11Max=No	IsS11Min=No	FrameElem=45	ElemStation=0.25						
Frame=45	Station=0.375	OutputCase=ACCVERT	CaseType=LinStatic	Point=0	X2=0	X3=0	S11=0	IsS11Max=Yes	
IsS11Min=Yes	FrameElem=45	ElemStation=0.375							
Frame=45	Station=0.375	OutputCase=ACCVERT	CaseType=LinStatic	Point=1	X2=-0.5	X3=-0.5	S11=0		
IsS11Max=No	IsS11Min=No	FrameElem=45	ElemStation=0.375						
Frame=45	Station=0.375	OutputCase=ACCVERT	CaseType=LinStatic	Point=2	X2=-0.5	X3=0.5	S11=0		
IsS11Max=No	IsS11Min=No	FrameElem=45	ElemStation=0.375						
Frame=45	Station=0.375	OutputCase=ACCVERT	CaseType=LinStatic	Point=3	X2=0.5	X3=-0.5	S11=0		
IsS11Max=No	IsS11Min=No	FrameElem=45	ElemStation=0.375						
Frame=45	Station=0.375	OutputCase=ACCVERT	CaseType=LinStatic	Point=4	X2=0.5	X3=0.5	S11=0		
IsS11Max=No	IsS11Min=No	FrameElem=45	ElemStation=0.375						
Frame=45	Station=0.5	OutputCase=ACCVERT	CaseType=LinStatic	Point=0	X2=0	X3=0	S11=0	IsS11Max=Yes	
IsS11Min=Yes	FrameElem=45	ElemStation=0.5							
Frame=45	Station=0.5	OutputCase=ACCVERT	CaseType=LinStatic	Point=1	X2=-0.5	X3=-0.5	S11=0		
IsS11Max=No	IsS11Min=No	FrameElem=45	ElemStation=0.5						
Frame=45	Station=0.5	OutputCase=ACCVERT	CaseType=LinStatic	Point=2	X2=-0.5	X3=0.5	S11=0		
IsS11Max=No	IsS11Min=No	FrameElem=45	ElemStation=0.5						
Frame=45	Station=0.5	OutputCase=ACCVERT	CaseType=LinStatic	Point=3	X2=0.5	X3=-0.5	S11=0		
IsS11Max=No	IsS11Min=No	FrameElem=45	ElemStation=0.5						
Frame=45	Station=0.5	OutputCase=ACCVERT	CaseType=LinStatic	Point=4	X2=0.5	X3=0.5	S11=0		
IsS11Max=No	IsS11Min=No	FrameElem=45	ElemStation=0.5						
Frame=45	Station=0	OutputCase=ACCLATDX	CaseType=LinStatic	Point=0	X2=0	X3=0	S11=0	IsS11Max=Yes	
IsS11Min=Yes	FrameElem=45	ElemStation=0							
Frame=45	Station=0	OutputCase=ACCLATDX	CaseType=LinStatic	Point=1	X2=-0.5	X3=-0.5	S11=0		
IsS11Max=No	IsS11Min=No	FrameElem=45	ElemStation=0						

Frame=45	Station=0.125	OutputCase=SOVRCOST	CaseType=LinStatic	Point=4	X2=0.5	X3=0.5	S11=0	
IsS11Max=No	IsS11Min=No	FrameElem=45	ElemStation=0.125					
Frame=45	Station=0.25	OutputCase=SOVRCOST	CaseType=LinStatic	Point=0	X2=0	X3=0	S11=0	IsS11Max=Yes
IsS11Min=Yes	FrameElem=45	ElemStation=0.25						
Frame=45	Station=0.25	OutputCase=SOVRCOST	CaseType=LinStatic	Point=1	X2=-0.5	X3=-0.5	S11=0	
IsS11Max=No	IsS11Min=No	FrameElem=45	ElemStation=0.25					
Frame=45	Station=0.25	OutputCase=SOVRCOST	CaseType=LinStatic	Point=2	X2=-0.5	X3=0.5	S11=0	
IsS11Max=No	IsS11Min=No	FrameElem=45	ElemStation=0.25					
Frame=45	Station=0.25	OutputCase=SOVRCOST	CaseType=LinStatic	Point=3	X2=0.5	X3=-0.5	S11=0	
IsS11Max=No	IsS11Min=No	FrameElem=45	ElemStation=0.25					
Frame=45	Station=0.25	OutputCase=SOVRCOST	CaseType=LinStatic	Point=4	X2=0.5	X3=0.5	S11=0	
IsS11Max=No	IsS11Min=No	FrameElem=45	ElemStation=0.25					
Frame=45	Station=0.375	OutputCase=SOVRCOST	CaseType=LinStatic	Point=0	X2=0	X3=0	S11=0	
IsS11Max=Yes	IsS11Min=Yes	FrameElem=45	ElemStation=0.375					
Frame=45	Station=0.375	OutputCase=SOVRCOST	CaseType=LinStatic	Point=1	X2=-0.5	X3=-0.5	S11=0	
IsS11Max=No	IsS11Min=No	FrameElem=45	ElemStation=0.375					
Frame=45	Station=0.375	OutputCase=SOVRCOST	CaseType=LinStatic	Point=2	X2=-0.5	X3=0.5	S11=0	
IsS11Max=No	IsS11Min=No	FrameElem=45	ElemStation=0.375					
Frame=45	Station=0.375	OutputCase=SOVRCOST	CaseType=LinStatic	Point=3	X2=0.5	X3=-0.5	S11=0	
IsS11Max=No	IsS11Min=No	FrameElem=45	ElemStation=0.375					
Frame=45	Station=0.375	OutputCase=SOVRCOST	CaseType=LinStatic	Point=4	X2=0.5	X3=0.5	S11=0	
IsS11Max=No	IsS11Min=No	FrameElem=45	ElemStation=0.375					
Frame=45	Station=0.5	OutputCase=SOVRCOST	CaseType=LinStatic	Point=0	X2=0	X3=0	S11=0	IsS11Max=Yes
IsS11Min=Yes	FrameElem=45	ElemStation=0.5						
Frame=45	Station=0.5	OutputCase=SOVRCOST	CaseType=LinStatic	Point=1	X2=-0.5	X3=-0.5	S11=0	
IsS11Max=No	IsS11Min=No	FrameElem=45	ElemStation=0.5					
Frame=45	Station=0.5	OutputCase=SOVRCOST	CaseType=LinStatic	Point=2	X2=-0.5	X3=0.5	S11=0	
IsS11Max=No	IsS11Min=No	FrameElem=45	ElemStation=0.5					
Frame=45	Station=0.5	OutputCase=SOVRCOST	CaseType=LinStatic	Point=3	X2=0.5	X3=-0.5	S11=0	
IsS11Max=No	IsS11Min=No	FrameElem=45	ElemStation=0.5					
Frame=45	Station=0.5	OutputCase=SOVRCOST	CaseType=LinStatic	Point=4	X2=0.5	X3=0.5	S11=0	
IsS11Max=No	IsS11Min=No	FrameElem=45	ElemStation=0.5					
Frame=45	Station=0	OutputCase=ENVE	CaseType=Combination	StepType=Max	Point=0	X2=0	X3=0	S11=-
274.637838986977	IsS11Max=No	IsS11Min=No	FrameElem=45	ElemStation=0				
Frame=45	Station=0	OutputCase=ENVE	CaseType=Combination	StepType=Max	Point=1	X2=-0.5	X3=-0.5	
S11=-3904.5496657889	IsS11Max=No	IsS11Min=Yes	FrameElem=45	ElemStation=0				
Frame=45	Station=0	OutputCase=ENVE	CaseType=Combination	StepType=Max	Point=2	X2=-0.5	X3=0.5	S11=-
3904.5496657889	IsS11Max=No	IsS11Min=No	FrameElem=45	ElemStation=0				
Frame=45	Station=0	OutputCase=ENVE	CaseType=Combination	StepType=Max	Point=3	X2=0.5	X3=-0.5	
S11=3392.48282246796	IsS11Max=Yes	IsS11Min=No	FrameElem=45	ElemStation=0				
Frame=45	Station=0	OutputCase=ENVE	CaseType=Combination	StepType=Max	Point=4	X2=0.5	X3=0.5	
S11=3392.48282246796	IsS11Max=No	IsS11Min=No	FrameElem=45	ElemStation=0				
Frame=45	Station=0.125	OutputCase=ENVE	CaseType=Combination	StepType=Max	Point=0	X2=0	X3=0	S11=-
274.637838986977	IsS11Max=No	IsS11Min=No	FrameElem=45	ElemStation=0.125				
Frame=45	Station=0.125	OutputCase=ENVE	CaseType=Combination	StepType=Max	Point=1	X2=-0.5	X3=-0.5	
S11=-3837.28898545382	IsS11Max=No	IsS11Min=Yes	FrameElem=45	ElemStation=0.125				
Frame=45	Station=0.125	OutputCase=ENVE	CaseType=Combination	StepType=Max	Point=2	X2=-0.5	X3=0.5	
S11=-3837.28898545382	IsS11Max=No	IsS11Min=No	FrameElem=45	ElemStation=0.125				
Frame=45	Station=0.125	OutputCase=ENVE	CaseType=Combination	StepType=Max	Point=3	X2=0.5	X3=-0.5	
S11=3325.26491618705	IsS11Max=Yes	IsS11Min=No	FrameElem=45	ElemStation=0.125				
Frame=45	Station=0.125	OutputCase=ENVE	CaseType=Combination	StepType=Max	Point=4	X2=0.5	X3=0.5	
S11=3325.26491618705	IsS11Max=No	IsS11Min=No	FrameElem=45	ElemStation=0.125				
Frame=45	Station=0.25	OutputCase=ENVE	CaseType=Combination	StepType=Max	Point=0	X2=0	X3=0	S11=-
274.637838986977	IsS11Max=No	IsS11Min=No	FrameElem=45	ElemStation=0.25				
Frame=45	Station=0.25	OutputCase=ENVE	CaseType=Combination	StepType=Max	Point=1	X2=-0.5	X3=-0.5	
S11=-3772.37205511873	IsS11Max=No	IsS11Min=Yes	FrameElem=45	ElemStation=0.25				
Frame=45	Station=0.25	OutputCase=ENVE	CaseType=Combination	StepType=Max	Point=2	X2=-0.5	X3=0.5	
S11=-3772.37205511873	IsS11Max=No	IsS11Min=No	FrameElem=45	ElemStation=0.25				
Frame=45	Station=0.25	OutputCase=ENVE	CaseType=Combination	StepType=Max	Point=3	X2=0.5	X3=-0.5	
S11=3260.39075990614	IsS11Max=Yes	IsS11Min=No	FrameElem=45	ElemStation=0.25				
Frame=45	Station=0.25	OutputCase=ENVE	CaseType=Combination	StepType=Max	Point=4	X2=0.5	X3=0.5	
S11=3260.39075990614	IsS11Max=No	IsS11Min=No	FrameElem=45	ElemStation=0.25				
Frame=45	Station=0.375	OutputCase=ENVE	CaseType=Combination	StepType=Max	Point=0	X2=0	X3=0	S11=-
274.637838986977	IsS11Max=No	IsS11Min=No	FrameElem=45	ElemStation=0.375				
Frame=45	Station=0.375	OutputCase=ENVE	CaseType=Combination	StepType=Max	Point=1	X2=-0.5	X3=-0.5	
S11=-3709.79887478364	IsS11Max=No	IsS11Min=Yes	FrameElem=45	ElemStation=0.375				
Frame=45	Station=0.375	OutputCase=ENVE	CaseType=Combination	StepType=Max	Point=2	X2=-0.5	X3=0.5	
S11=-3709.79887478364	IsS11Max=No	IsS11Min=No	FrameElem=45	ElemStation=0.375				
Frame=45	Station=0.375	OutputCase=ENVE	CaseType=Combination	StepType=Max	Point=3	X2=0.5	X3=-0.5	
S11=3197.86035362523	IsS11Max=Yes	IsS11Min=No	FrameElem=45	ElemStation=0.375				
Frame=45	Station=0.375	OutputCase=ENVE	CaseType=Combination	StepType=Max	Point=4	X2=0.5	X3=0.5	
S11=3197.86035362523	IsS11Max=No	IsS11Min=No	FrameElem=45	ElemStation=0.375				
Frame=45	Station=0.5	OutputCase=ENVE	CaseType=Combination	StepType=Max	Point=0	X2=0	X3=0	S11=-
274.637838986977	IsS11Max=No	IsS11Min=No	FrameElem=45	ElemStation=0.5				
Frame=45	Station=0.5	OutputCase=ENVE	CaseType=Combination	StepType=Max	Point=1	X2=-0.5	X3=-0.5	
S11=-3649.56944444855	IsS11Max=No	IsS11Min=Yes	FrameElem=45	ElemStation=0.5				
Frame=45	Station=0.5	OutputCase=ENVE	CaseType=Combination	StepType=Max	Point=2	X2=-0.5	X3=0.5	
S11=-3649.56944444855	IsS11Max=No	IsS11Min=No	FrameElem=45	ElemStation=0.5				
Frame=45	Station=0.5	OutputCase=ENVE	CaseType=Combination	StepType=Max	Point=3	X2=0.5	X3=-0.5	
S11=3137.67369734432	IsS11Max=Yes	IsS11Min=No	FrameElem=45	ElemStation=0.5				
Frame=45	Station=0.5	OutputCase=ENVE	CaseType=Combination	StepType=Max	Point=4	X2=0.5	X3=0.5	
S11=3137.67369734432	IsS11Max=No	IsS11Min=No	FrameElem=45	ElemStation=0.5				

Frame=45	Station=0	OutputCase=ENVE	CaseType=Combination	StepType=Min	Point=0	X2=0	X3=0	S11=-
386.541953115295	IsS11Max=No	IsS11Min=No	FrameElem=45	ElemStation=0				
Frame=45	Station=0	OutputCase=ENVE	CaseType=Combination	StepType=Min	Point=1	X2=-0.5	X3=-0.5	
S11=-3941.75850044192	IsS11Max=No	IsS11Min=Yes	FrameElem=45	ElemStation=0				
Frame=45	Station=0	OutputCase=ENVE	CaseType=Combination	StepType=Min	Point=2	X2=-0.5	X3=0.5	S11=-
3941.75850044192	IsS11Max=No	IsS11Min=No	FrameElem=45	ElemStation=0				
Frame=45	Station=0	OutputCase=ENVE	CaseType=Combination	StepType=Min	Point=3	X2=0.5	X3=-0.5	
S11=3131.46575955831	IsS11Max=Yes	IsS11Min=No	FrameElem=45	ElemStation=0				
Frame=45	Station=0	OutputCase=ENVE	CaseType=Combination	StepType=Min	Point=4	X2=0.5	X3=0.5	
S11=3131.46575955831	IsS11Max=No	IsS11Min=No	FrameElem=45	ElemStation=0				
Frame=45	Station=0.125	OutputCase=ENVE	CaseType=Combination	StepType=Min	Point=0	X2=0	X3=0	S11=-
386.541953115295	IsS11Max=No	IsS11Min=No	FrameElem=45	ElemStation=0.125				
Frame=45	Station=0.125	OutputCase=ENVE	CaseType=Combination	StepType=Min	Point=1	X2=-0.5	X3=-0.5	
S11=-3874.54059416101	IsS11Max=No	IsS11Min=Yes	FrameElem=45	ElemStation=0.125				
Frame=45	Station=0.125	OutputCase=ENVE	CaseType=Combination	StepType=Min	Point=2	X2=-0.5	X3=0.5	
S11=-3874.54059416101	IsS11Max=No	IsS11Min=No	FrameElem=45	ElemStation=0.125				
Frame=45	Station=0.125	OutputCase=ENVE	CaseType=Combination	StepType=Min	Point=3	X2=0.5	X3=-0.5	
S11=3064.20507922323	IsS11Max=Yes	IsS11Min=No	FrameElem=45	ElemStation=0.125				
Frame=45	Station=0.125	OutputCase=ENVE	CaseType=Combination	StepType=Min	Point=4	X2=0.5	X3=0.5	
S11=3064.20507922323	IsS11Max=No	IsS11Min=No	FrameElem=45	ElemStation=0.125				
Frame=45	Station=0.25	OutputCase=ENVE	CaseType=Combination	StepType=Min	Point=0	X2=0	X3=0	S11=-
386.541953115295	IsS11Max=No	IsS11Min=No	FrameElem=45	ElemStation=0.25				
Frame=45	Station=0.25	OutputCase=ENVE	CaseType=Combination	StepType=Min	Point=1	X2=-0.5	X3=-0.5	
S11=-3809.6664378801	IsS11Max=No	IsS11Min=Yes	FrameElem=45	ElemStation=0.25				
Frame=45	Station=0.25	OutputCase=ENVE	CaseType=Combination	StepType=Min	Point=2	X2=-0.5	X3=0.5	
S11=-3809.6664378801	IsS11Max=No	IsS11Min=No	FrameElem=45	ElemStation=0.25				
Frame=45	Station=0.25	OutputCase=ENVE	CaseType=Combination	StepType=Min	Point=3	X2=0.5	X3=-0.5	
S11=2999.28814888814	IsS11Max=Yes	IsS11Min=No	FrameElem=45	ElemStation=0.25				
Frame=45	Station=0.25	OutputCase=ENVE	CaseType=Combination	StepType=Min	Point=4	X2=0.5	X3=0.5	
S11=2999.28814888814	IsS11Max=No	IsS11Min=No	FrameElem=45	ElemStation=0.25				
Frame=45	Station=0.375	OutputCase=ENVE	CaseType=Combination	StepType=Min	Point=0	X2=0	X3=0	S11=-
386.541953115295	IsS11Max=No	IsS11Min=No	FrameElem=45	ElemStation=0.375				
Frame=45	Station=0.375	OutputCase=ENVE	CaseType=Combination	StepType=Min	Point=1	X2=-0.5	X3=-0.5	
S11=-3747.13603159919	IsS11Max=No	IsS11Min=Yes	FrameElem=45	ElemStation=0.375				
Frame=45	Station=0.375	OutputCase=ENVE	CaseType=Combination	StepType=Min	Point=2	X2=-0.5	X3=0.5	
S11=-3747.13603159919	IsS11Max=No	IsS11Min=No	FrameElem=45	ElemStation=0.375				
Frame=45	Station=0.375	OutputCase=ENVE	CaseType=Combination	StepType=Min	Point=3	X2=0.5	X3=-0.5	
S11=2936.71496855305	IsS11Max=Yes	IsS11Min=No	FrameElem=45	ElemStation=0.375				
Frame=45	Station=0.375	OutputCase=ENVE	CaseType=Combination	StepType=Min	Point=4	X2=0.5	X3=0.5	
S11=2936.71496855305	IsS11Max=No	IsS11Min=No	FrameElem=45	ElemStation=0.375				
Frame=45	Station=0.5	OutputCase=ENVE	CaseType=Combination	StepType=Min	Point=0	X2=0	X3=0	S11=-
386.541953115295	IsS11Max=No	IsS11Min=No	FrameElem=45	ElemStation=0.5				
Frame=45	Station=0.5	OutputCase=ENVE	CaseType=Combination	StepType=Min	Point=1	X2=-0.5	X3=-0.5	
S11=-3686.94937531828	IsS11Max=No	IsS11Min=Yes	FrameElem=45	ElemStation=0.5				
Frame=45	Station=0.5	OutputCase=ENVE	CaseType=Combination	StepType=Min	Point=2	X2=-0.5	X3=0.5	
S11=-3686.94937531828	IsS11Max=No	IsS11Min=No	FrameElem=45	ElemStation=0.5				
Frame=45	Station=0.5	OutputCase=ENVE	CaseType=Combination	StepType=Min	Point=3	X2=0.5	X3=-0.5	
S11=2876.48553821796	IsS11Max=Yes	IsS11Min=No	FrameElem=45	ElemStation=0.5				
Frame=45	Station=0.5	OutputCase=ENVE	CaseType=Combination	StepType=Min	Point=4	X2=0.5	X3=0.5	
S11=2876.48553821796	IsS11Max=No	IsS11Min=No	FrameElem=45	ElemStation=0.5				
Frame=45	Station=0	OutputCase=FESSUR	CaseType=Combination	Point=0	X2=0	X3=0	S11=-386.541953115295	
IsS11Max=No	IsS11Min=No	FrameElem=45	ElemStation=0					
Frame=45	Station=0	OutputCase=FESSUR	CaseType=Combination	Point=1	X2=-0.5	X3=-0.5	S11=-	
3904.5496657889	IsS11Max=No	IsS11Min=Yes	FrameElem=45	ElemStation=0				
Frame=45	Station=0	OutputCase=FESSUR	CaseType=Combination	Point=2	X2=-0.5	X3=0.5	S11=-	
3904.5496657889	IsS11Max=No	IsS11Min=No	FrameElem=45	ElemStation=0				
Frame=45	Station=0	OutputCase=FESSUR	CaseType=Combination	Point=3	X2=0.5	X3=-0.5		
S11=3131.46575955831	IsS11Max=Yes	IsS11Min=No	FrameElem=45	ElemStation=0				
Frame=45	Station=0	OutputCase=FESSUR	CaseType=Combination	Point=4	X2=0.5	X3=0.5		
S11=3131.46575955831	IsS11Max=No	IsS11Min=No	FrameElem=45	ElemStation=0				
Frame=45	Station=0.125	OutputCase=FESSUR	CaseType=Combination	Point=0	X2=0	X3=0	S11=-	
386.541953115295	IsS11Max=No	IsS11Min=No	FrameElem=45	ElemStation=0.125				
Frame=45	Station=0.125	OutputCase=FESSUR	CaseType=Combination	Point=1	X2=-0.5	X3=-0.5	S11=-	
3837.28898545382	IsS11Max=No	IsS11Min=Yes	FrameElem=45	ElemStation=0.125				
Frame=45	Station=0.125	OutputCase=FESSUR	CaseType=Combination	Point=2	X2=-0.5	X3=0.5	S11=-	
3837.28898545382	IsS11Max=No	IsS11Min=No	FrameElem=45	ElemStation=0.125				
Frame=45	Station=0.125	OutputCase=FESSUR	CaseType=Combination	Point=3	X2=0.5	X3=-0.5		
S11=3064.20507922323	IsS11Max=Yes	IsS11Min=No	FrameElem=45	ElemStation=0.125				
Frame=45	Station=0.125	OutputCase=FESSUR	CaseType=Combination	Point=4	X2=0.5	X3=0.5		
S11=3064.20507922323	IsS11Max=No	IsS11Min=No	FrameElem=45	ElemStation=0.125				
Frame=45	Station=0.25	OutputCase=FESSUR	CaseType=Combination	Point=0	X2=0	X3=0	S11=-	
386.541953115295	IsS11Max=No	IsS11Min=No	FrameElem=45	ElemStation=0.25				
Frame=45	Station=0.25	OutputCase=FESSUR	CaseType=Combination	Point=1	X2=-0.5	X3=-0.5	S11=-	
3772.37205511873	IsS11Max=No	IsS11Min=Yes	FrameElem=45	ElemStation=0.25				
Frame=45	Station=0.25	OutputCase=FESSUR	CaseType=Combination	Point=2	X2=-0.5	X3=0.5	S11=-	
3772.37205511873	IsS11Max=No	IsS11Min=No	FrameElem=45	ElemStation=0.25				
Frame=45	Station=0.25	OutputCase=FESSUR	CaseType=Combination	Point=3	X2=0.5	X3=-0.5		
S11=2999.28814888814	IsS11Max=Yes	IsS11Min=No	FrameElem=45	ElemStation=0.25				
Frame=45	Station=0.25	OutputCase=FESSUR	CaseType=Combination	Point=4	X2=0.5	X3=0.5		
S11=2999.28814888814	IsS11Max=No	IsS11Min=No	FrameElem=45	ElemStation=0.25				
Frame=45	Station=0.375	OutputCase=FESSUR	CaseType=Combination	Point=0	X2=0	X3=0	S11=-	
386.541953115295	IsS11Max=No	IsS11Min=No	FrameElem=45	ElemStation=0.375				

Frame=45	Station=0.375	OutputCase=FESSUR	CaseType=Combination	Point=1	X2=-0.5	X3=-0.5	S11=-
3709.79887478364	IsS11Max=No	IsS11Min=Yes	FrameElem=45	ElemStation=0.375			
Frame=45	Station=0.375	OutputCase=FESSUR	CaseType=Combination	Point=2	X2=-0.5	X3=0.5	S11=-
3709.79887478364	IsS11Max=No	IsS11Min=No	FrameElem=45	ElemStation=0.375			
Frame=45	Station=0.375	OutputCase=FESSUR	CaseType=Combination	Point=3	X2=0.5	X3=-0.5	
S11=2936.71496855305	IsS11Max=Yes	IsS11Min=No	FrameElem=45	ElemStation=0.375			
Frame=45	Station=0.375	OutputCase=FESSUR	CaseType=Combination	Point=4	X2=0.5	X3=0.5	
S11=2936.71496855305	IsS11Max=No	IsS11Min=No	FrameElem=45	ElemStation=0.375			
Frame=45	Station=0.5	OutputCase=FESSUR	CaseType=Combination	Point=0	X2=0	X3=0	S11=-386.541953115295
IsS11Max=No	IsS11Min=No	FrameElem=45	ElemStation=0.5				
Frame=45	Station=0.5	OutputCase=FESSUR	CaseType=Combination	Point=1	X2=-0.5	X3=-0.5	S11=-
3649.56944444855	IsS11Max=No	IsS11Min=Yes	FrameElem=45	ElemStation=0.5			
Frame=45	Station=0.5	OutputCase=FESSUR	CaseType=Combination	Point=2	X2=-0.5	X3=0.5	S11=-
3649.56944444855	IsS11Max=No	IsS11Min=No	FrameElem=45	ElemStation=0.5			
Frame=45	Station=0.5	OutputCase=FESSUR	CaseType=Combination	Point=3	X2=0.5	X3=-0.5	
S11=2876.48553821796	IsS11Max=Yes	IsS11Min=No	FrameElem=45	ElemStation=0.5			
Frame=45	Station=0.5	OutputCase=FESSUR	CaseType=Combination	Point=4	X2=0.5	X3=0.5	
S11=2876.48553821796	IsS11Max=No	IsS11Min=No	FrameElem=45	ElemStation=0.5			
Frame=46	Station=0	OutputCase=PESOPR	CaseType=LinStatic	Point=0	X2=0	X3=0	S11=-15.1709467361871
IsS11Max=No	IsS11Min=No	FrameElem=46	ElemStation=0				
Frame=46	Station=0	OutputCase=PESOPR	CaseType=LinStatic	Point=1	X2=-0.5	X3=-0.5	S11=-
686.014662738824	IsS11Max=No	IsS11Min=Yes	FrameElem=46	ElemStation=0			
Frame=46	Station=0	OutputCase=PESOPR	CaseType=LinStatic	Point=2	X2=-0.5	X3=0.5	S11=-
686.014662738824	IsS11Max=No	IsS11Min=No	FrameElem=46	ElemStation=0			
Frame=46	Station=0	OutputCase=PESOPR	CaseType=LinStatic	Point=3	X2=0.5	X3=-0.5	S11=655.67276926645
IsS11Max=Yes	IsS11Min=No	FrameElem=46	ElemStation=0				
Frame=46	Station=0	OutputCase=PESOPR	CaseType=LinStatic	Point=4	X2=0.5	X3=0.5	S11=655.67276926645
IsS11Max=No	IsS11Min=No	FrameElem=46	ElemStation=0				
Frame=46	Station=0.125	OutputCase=PESOPR	CaseType=LinStatic	Point=0	X2=0	X3=0	S11=-15.1709467361871
IsS11Max=No	IsS11Min=No	FrameElem=46	ElemStation=0.125				
Frame=46	Station=0.125	OutputCase=PESOPR	CaseType=LinStatic	Point=1	X2=-0.5	X3=-0.5	S11=-
646.461975794358	IsS11Max=No	IsS11Min=Yes	FrameElem=46	ElemStation=0.125			
Frame=46	Station=0.125	OutputCase=PESOPR	CaseType=LinStatic	Point=2	X2=-0.5	X3=0.5	S11=-
646.461975794358	IsS11Max=No	IsS11Min=No	FrameElem=46	ElemStation=0.125			
Frame=46	Station=0.125	OutputCase=PESOPR	CaseType=LinStatic	Point=3	X2=0.5	X3=-0.5	
S11=616.120082321984	IsS11Max=Yes	IsS11Min=No	FrameElem=46	ElemStation=0.125			
Frame=46	Station=0.125	OutputCase=PESOPR	CaseType=LinStatic	Point=4	X2=0.5	X3=0.5	
S11=616.120082321984	IsS11Max=No	IsS11Min=No	FrameElem=46	ElemStation=0.125			
Frame=46	Station=0.25	OutputCase=PESOPR	CaseType=LinStatic	Point=0	X2=0	X3=0	S11=-15.1709467361871
IsS11Max=No	IsS11Min=No	FrameElem=46	ElemStation=0.25				
Frame=46	Station=0.25	OutputCase=PESOPR	CaseType=LinStatic	Point=1	X2=-0.5	X3=-0.5	S11=-
609.253038849893	IsS11Max=No	IsS11Min=Yes	FrameElem=46	ElemStation=0.25			
Frame=46	Station=0.25	OutputCase=PESOPR	CaseType=LinStatic	Point=2	X2=-0.5	X3=0.5	S11=-
609.253038849893	IsS11Max=No	IsS11Min=No	FrameElem=46	ElemStation=0.25			
Frame=46	Station=0.25	OutputCase=PESOPR	CaseType=LinStatic	Point=3	X2=0.5	X3=-0.5	
S11=578.911145377518	IsS11Max=Yes	IsS11Min=No	FrameElem=46	ElemStation=0.25			
Frame=46	Station=0.25	OutputCase=PESOPR	CaseType=LinStatic	Point=4	X2=0.5	X3=0.5	
S11=578.911145377518	IsS11Max=No	IsS11Min=No	FrameElem=46	ElemStation=0.25			
Frame=46	Station=0.375	OutputCase=PESOPR	CaseType=LinStatic	Point=0	X2=0	X3=0	S11=-15.1709467361871
IsS11Max=No	IsS11Min=No	FrameElem=46	ElemStation=0.375				
Frame=46	Station=0.375	OutputCase=PESOPR	CaseType=LinStatic	Point=1	X2=-0.5	X3=-0.5	S11=-
574.387851905427	IsS11Max=No	IsS11Min=Yes	FrameElem=46	ElemStation=0.375			
Frame=46	Station=0.375	OutputCase=PESOPR	CaseType=LinStatic	Point=2	X2=-0.5	X3=0.5	S11=-
574.387851905427	IsS11Max=No	IsS11Min=No	FrameElem=46	ElemStation=0.375			
Frame=46	Station=0.375	OutputCase=PESOPR	CaseType=LinStatic	Point=3	X2=0.5	X3=-0.5	
S11=544.045958433053	IsS11Max=Yes	IsS11Min=No	FrameElem=46	ElemStation=0.375			
Frame=46	Station=0.375	OutputCase=PESOPR	CaseType=LinStatic	Point=4	X2=0.5	X3=0.5	
S11=544.045958433053	IsS11Max=No	IsS11Min=No	FrameElem=46	ElemStation=0.375			
Frame=46	Station=0.5	OutputCase=PESOPR	CaseType=LinStatic	Point=0	X2=0	X3=0	S11=-15.1709467361871
IsS11Max=No	IsS11Min=No	FrameElem=46	ElemStation=0.5				
Frame=46	Station=0.5	OutputCase=PESOPR	CaseType=LinStatic	Point=1	X2=-0.5	X3=-0.5	S11=-
541.866414960961	IsS11Max=No	IsS11Min=Yes	FrameElem=46	ElemStation=0.5			
Frame=46	Station=0.5	OutputCase=PESOPR	CaseType=LinStatic	Point=2	X2=-0.5	X3=0.5	S11=-
541.866414960961	IsS11Max=No	IsS11Min=No	FrameElem=46	ElemStation=0.5			
Frame=46	Station=0.5	OutputCase=PESOPR	CaseType=LinStatic	Point=3	X2=0.5	X3=-0.5	
S11=511.524521488587	IsS11Max=Yes	IsS11Min=No	FrameElem=46	ElemStation=0.5			
Frame=46	Station=0.5	OutputCase=PESOPR	CaseType=LinStatic	Point=4	X2=0.5	X3=0.5	
S11=511.524521488587	IsS11Max=No	IsS11Min=No	FrameElem=46	ElemStation=0.5			
Frame=46	Station=0	OutputCase=TERRVERT	CaseType=LinStatic	Point=0	X2=0	X3=0	S11=1.64270738195065
IsS11Max=No	IsS11Min=No	FrameElem=46	ElemStation=0				
Frame=46	Station=0	OutputCase=TERRVERT	CaseType=LinStatic	Point=1	X2=-0.5	X3=-0.5	S11=-
3088.15455127554	IsS11Max=No	IsS11Min=Yes	FrameElem=46	ElemStation=0			
Frame=46	Station=0	OutputCase=TERRVERT	CaseType=LinStatic	Point=2	X2=-0.5	X3=0.5	S11=-
3088.15455127554	IsS11Max=No	IsS11Min=No	FrameElem=46	ElemStation=0			
Frame=46	Station=0	OutputCase=TERRVERT	CaseType=LinStatic	Point=3	X2=0.5	X3=-0.5	
S11=3091.43996603944	IsS11Max=Yes	IsS11Min=No	FrameElem=46	ElemStation=0			
Frame=46	Station=0	OutputCase=TERRVERT	CaseType=LinStatic	Point=4	X2=0.5	X3=0.5	
S11=3091.43996603944	IsS11Max=No	IsS11Min=No	FrameElem=46	ElemStation=0			
Frame=46	Station=0.125	OutputCase=TERRVERT	CaseType=LinStatic	Point=0	X2=0	X3=0	
S11=1.64270738195065	IsS11Max=No	IsS11Min=No	FrameElem=46	ElemStation=0.125			
Frame=46	Station=0.125	OutputCase=TERRVERT	CaseType=LinStatic	Point=1	X2=-0.5	X3=-0.5	S11=-
2933.08700673837	IsS11Max=No	IsS11Min=Yes	FrameElem=46	ElemStation=0.125			

Frame=46	Station=0.125	OutputCase=TERRVERT	CaseType=LinStatic	Point=2	X2=-0.5	X3=0.5	S11=-
2933.08700673837	IsS11Max=No	IsS11Min=No	FrameElem=46	ElemStation=0.125			
Frame=46	Station=0.125	OutputCase=TERRVERT	CaseType=LinStatic	Point=3	X2=0.5	X3=-0.5	
S11=2936.37242150227	IsS11Max=Yes	IsS11Min=No	FrameElem=46	ElemStation=0.125			
Frame=46	Station=0.125	OutputCase=TERRVERT	CaseType=LinStatic	Point=4	X2=0.5	X3=0.5	
S11=2936.37242150227	IsS11Max=No	IsS11Min=No	FrameElem=46	ElemStation=0.125			
Frame=46	Station=0.25	OutputCase=TERRVERT	CaseType=LinStatic	Point=0	X2=0	X3=0	S11=1.64270738195065
IsS11Max=No	IsS11Min=No	FrameElem=46	ElemStation=0.25				
Frame=46	Station=0.25	OutputCase=TERRVERT	CaseType=LinStatic	Point=1	X2=-0.5	X3=-0.5	S11=-
2778.01946220121	IsS11Max=No	IsS11Min=Yes	FrameElem=46	ElemStation=0.25			
Frame=46	Station=0.25	OutputCase=TERRVERT	CaseType=LinStatic	Point=2	X2=-0.5	X3=0.5	S11=-
2778.01946220121	IsS11Max=No	IsS11Min=No	FrameElem=46	ElemStation=0.25			
Frame=46	Station=0.25	OutputCase=TERRVERT	CaseType=LinStatic	Point=3	X2=0.5	X3=-0.5	
S11=2781.30487696511	IsS11Max=Yes	IsS11Min=No	FrameElem=46	ElemStation=0.25			
Frame=46	Station=0.25	OutputCase=TERRVERT	CaseType=LinStatic	Point=4	X2=0.5	X3=0.5	
S11=2781.30487696511	IsS11Max=No	IsS11Min=No	FrameElem=46	ElemStation=0.25			
Frame=46	Station=0.375	OutputCase=TERRVERT	CaseType=LinStatic	Point=0	X2=0	X3=0	
S11=1.64270738195065	IsS11Max=No	IsS11Min=No	FrameElem=46	ElemStation=0.375			
Frame=46	Station=0.375	OutputCase=TERRVERT	CaseType=LinStatic	Point=1	X2=-0.5	X3=-0.5	S11=-
2622.95191766404	IsS11Max=No	IsS11Min=Yes	FrameElem=46	ElemStation=0.375			
Frame=46	Station=0.375	OutputCase=TERRVERT	CaseType=LinStatic	Point=2	X2=-0.5	X3=0.5	S11=-
2622.95191766404	IsS11Max=No	IsS11Min=No	FrameElem=46	ElemStation=0.375			
Frame=46	Station=0.375	OutputCase=TERRVERT	CaseType=LinStatic	Point=3	X2=0.5	X3=-0.5	
S11=2626.23733242794	IsS11Max=Yes	IsS11Min=No	FrameElem=46	ElemStation=0.375			
Frame=46	Station=0.375	OutputCase=TERRVERT	CaseType=LinStatic	Point=4	X2=0.5	X3=0.5	
S11=2626.23733242794	IsS11Max=No	IsS11Min=No	FrameElem=46	ElemStation=0.375			
Frame=46	Station=0.5	OutputCase=TERRVERT	CaseType=LinStatic	Point=0	X2=0	X3=0	S11=1.64270738195065
IsS11Max=No	IsS11Min=No	FrameElem=46	ElemStation=0.5				
Frame=46	Station=0.5	OutputCase=TERRVERT	CaseType=LinStatic	Point=1	X2=-0.5	X3=-0.5	S11=-
2467.88437312687	IsS11Max=No	IsS11Min=Yes	FrameElem=46	ElemStation=0.5			
Frame=46	Station=0.5	OutputCase=TERRVERT	CaseType=LinStatic	Point=2	X2=-0.5	X3=0.5	S11=-
2467.88437312687	IsS11Max=No	IsS11Min=No	FrameElem=46	ElemStation=0.5			
Frame=46	Station=0.5	OutputCase=TERRVERT	CaseType=LinStatic	Point=3	X2=0.5	X3=-0.5	
S11=2471.16978789077	IsS11Max=Yes	IsS11Min=No	FrameElem=46	ElemStation=0.5			
Frame=46	Station=0.5	OutputCase=TERRVERT	CaseType=LinStatic	Point=4	X2=0.5	X3=0.5	
S11=2471.16978789077	IsS11Max=No	IsS11Min=No	FrameElem=46	ElemStation=0.5			
Frame=46	Station=0	OutputCase=TERRLAT	CaseType=LinStatic	Point=0	X2=0	X3=0	S11=-373.013713761059
IsS11Max=No	IsS11Min=No	FrameElem=46	ElemStation=0				
Frame=46	Station=0	OutputCase=TERRLAT	CaseType=LinStatic	Point=1	X2=-0.5	X3=-0.5	
S11=124.599769565744	IsS11Max=Yes	IsS11Min=No	FrameElem=46	ElemStation=0			
Frame=46	Station=0	OutputCase=TERRLAT	CaseType=LinStatic	Point=2	X2=-0.5	X3=0.5	
S11=124.599769565744	IsS11Max=No	IsS11Min=No	FrameElem=46	ElemStation=0			
Frame=46	Station=0	OutputCase=TERRLAT	CaseType=LinStatic	Point=3	X2=0.5	X3=-0.5	S11=-
870.627197087862	IsS11Max=No	IsS11Min=Yes	FrameElem=46	ElemStation=0			
Frame=46	Station=0	OutputCase=TERRLAT	CaseType=LinStatic	Point=4	X2=0.5	X3=0.5	S11=-
870.627197087862	IsS11Max=No	IsS11Min=No	FrameElem=46	ElemStation=0			
Frame=46	Station=0.125	OutputCase=TERRLAT	CaseType=LinStatic	Point=0	X2=0	X3=0	S11=-
373.013713761059	IsS11Max=No	IsS11Min=No	FrameElem=46	ElemStation=0.125			
Frame=46	Station=0.125	OutputCase=TERRLAT	CaseType=LinStatic	Point=1	X2=-0.5	X3=-0.5	
S11=124.993964929956	IsS11Max=Yes	IsS11Min=No	FrameElem=46	ElemStation=0.125			
Frame=46	Station=0.125	OutputCase=TERRLAT	CaseType=LinStatic	Point=2	X2=-0.5	X3=0.5	
S11=124.993964929956	IsS11Max=No	IsS11Min=No	FrameElem=46	ElemStation=0.125			
Frame=46	Station=0.125	OutputCase=TERRLAT	CaseType=LinStatic	Point=3	X2=0.5	X3=-0.5	S11=-
871.021392452073	IsS11Max=No	IsS11Min=Yes	FrameElem=46	ElemStation=0.125			
Frame=46	Station=0.125	OutputCase=TERRLAT	CaseType=LinStatic	Point=4	X2=0.5	X3=0.5	S11=-
871.021392452073	IsS11Max=No	IsS11Min=No	FrameElem=46	ElemStation=0.125			
Frame=46	Station=0.25	OutputCase=TERRLAT	CaseType=LinStatic	Point=0	X2=0	X3=0	S11=-373.013713761059
IsS11Max=No	IsS11Min=No	FrameElem=46	ElemStation=0.25				
Frame=46	Station=0.25	OutputCase=TERRLAT	CaseType=LinStatic	Point=1	X2=-0.5	X3=-0.5	
S11=125.388160294167	IsS11Max=Yes	IsS11Min=No	FrameElem=46	ElemStation=0.25			
Frame=46	Station=0.25	OutputCase=TERRLAT	CaseType=LinStatic	Point=2	X2=-0.5	X3=0.5	
S11=125.388160294167	IsS11Max=No	IsS11Min=No	FrameElem=46	ElemStation=0.25			
Frame=46	Station=0.25	OutputCase=TERRLAT	CaseType=LinStatic	Point=3	X2=0.5	X3=-0.5	S11=-
871.415587816284	IsS11Max=No	IsS11Min=Yes	FrameElem=46	ElemStation=0.25			
Frame=46	Station=0.25	OutputCase=TERRLAT	CaseType=LinStatic	Point=4	X2=0.5	X3=0.5	S11=-
871.415587816284	IsS11Max=No	IsS11Min=No	FrameElem=46	ElemStation=0.25			
Frame=46	Station=0.375	OutputCase=TERRLAT	CaseType=LinStatic	Point=0	X2=0	X3=0	S11=-
373.013713761059	IsS11Max=No	IsS11Min=No	FrameElem=46	ElemStation=0.375			
Frame=46	Station=0.375	OutputCase=TERRLAT	CaseType=LinStatic	Point=1	X2=-0.5	X3=-0.5	
S11=125.782355658378	IsS11Max=Yes	IsS11Min=No	FrameElem=46	ElemStation=0.375			
Frame=46	Station=0.375	OutputCase=TERRLAT	CaseType=LinStatic	Point=2	X2=-0.5	X3=0.5	
S11=125.782355658378	IsS11Max=No	IsS11Min=No	FrameElem=46	ElemStation=0.375			
Frame=46	Station=0.375	OutputCase=TERRLAT	CaseType=LinStatic	Point=3	X2=0.5	X3=-0.5	S11=-
871.809783180496	IsS11Max=No	IsS11Min=Yes	FrameElem=46	ElemStation=0.375			
Frame=46	Station=0.375	OutputCase=TERRLAT	CaseType=LinStatic	Point=4	X2=0.5	X3=0.5	S11=-
871.809783180496	IsS11Max=No	IsS11Min=No	FrameElem=46	ElemStation=0.375			
Frame=46	Station=0.5	OutputCase=TERRLAT	CaseType=LinStatic	Point=0	X2=0	X3=0	S11=-373.013713761059
IsS11Max=No	IsS11Min=No	FrameElem=46	ElemStation=0.5				
Frame=46	Station=0.5	OutputCase=TERRLAT	CaseType=LinStatic	Point=1	X2=-0.5	X3=-0.5	
S11=126.17655102259	IsS11Max=Yes	IsS11Min=No	FrameElem=46	ElemStation=0.5			
Frame=46	Station=0.5	OutputCase=TERRLAT	CaseType=LinStatic	Point=2	X2=-0.5	X3=0.5	
S11=126.17655102259	IsS11Max=No	IsS11Min=No	FrameElem=46	ElemStation=0.5			

Frame=46	Station=0.5	OutputCase=SOVRCOST	CaseType=LinStatic	Point=1	X2=-0.5	X3=-0.5	S11=0	
IsS11Max=No	IsS11Min=No	FrameElem=46	ElemStation=0.5					
Frame=46	Station=0.5	OutputCase=SOVRCOST	CaseType=LinStatic	Point=2	X2=-0.5	X3=0.5	S11=0	
IsS11Max=No	IsS11Min=No	FrameElem=46	ElemStation=0.5					
Frame=46	Station=0.5	OutputCase=SOVRCOST	CaseType=LinStatic	Point=3	X2=0.5	X3=-0.5	S11=0	
IsS11Max=No	IsS11Min=No	FrameElem=46	ElemStation=0.5					
Frame=46	Station=0.5	OutputCase=SOVRCOST	CaseType=LinStatic	Point=4	X2=0.5	X3=0.5	S11=0	
IsS11Max=No	IsS11Min=No	FrameElem=46	ElemStation=0.5					
Frame=46	Station=0	OutputCase=ENVE	CaseType=Combination	StepType=Max	Point=0	X2=0	X3=0	S11=-
274.637838986978	IsS11Max=No	IsS11Min=No	FrameElem=46	ElemStation=0				
Frame=46	Station=0	OutputCase=ENVE	CaseType=Combination	StepType=Max	Point=1	X2=-0.5	X3=-0.5	
S11=-3649.56944444862	IsS11Max=No	IsS11Min=Yes	FrameElem=46	ElemStation=0				
Frame=46	Station=0	OutputCase=ENVE	CaseType=Combination	StepType=Max	Point=2	X2=-0.5	X3=0.5	S11=-
3649.56944444862	IsS11Max=No	IsS11Min=No	FrameElem=46	ElemStation=0				
Frame=46	Station=0	OutputCase=ENVE	CaseType=Combination	StepType=Max	Point=3	X2=0.5	X3=-0.5	
S11=3137.67369734439	IsS11Max=Yes	IsS11Min=No	FrameElem=46	ElemStation=0				
Frame=46	Station=0	OutputCase=ENVE	CaseType=Combination	StepType=Max	Point=4	X2=0.5	X3=0.5	
S11=3137.67369734439	IsS11Max=No	IsS11Min=No	FrameElem=46	ElemStation=0				
Frame=46	Station=0.125	OutputCase=ENVE	CaseType=Combination	StepType=Max	Point=0	X2=0	X3=0	S11=-
274.637838986978	IsS11Max=No	IsS11Min=No	FrameElem=46	ElemStation=0.125				
Frame=46	Station=0.125	OutputCase=ENVE	CaseType=Combination	StepType=Max	Point=1	X2=-0.5	X3=-0.5	
S11=-3454.55501760278	IsS11Max=No	IsS11Min=Yes	FrameElem=46	ElemStation=0.125				
Frame=46	Station=0.125	OutputCase=ENVE	CaseType=Combination	StepType=Max	Point=2	X2=-0.5	X3=0.5	
S11=-3454.55501760278	IsS11Max=No	IsS11Min=No	FrameElem=46	ElemStation=0.125				
Frame=46	Station=0.125	OutputCase=ENVE	CaseType=Combination	StepType=Max	Point=3	X2=0.5	X3=-0.5	
S11=2942.77752910781	IsS11Max=Yes	IsS11Min=No	FrameElem=46	ElemStation=0.125				
Frame=46	Station=0.125	OutputCase=ENVE	CaseType=Combination	StepType=Max	Point=4	X2=0.5	X3=0.5	
S11=2942.77752910781	IsS11Max=No	IsS11Min=No	FrameElem=46	ElemStation=0.125				
Frame=46	Station=0.25	OutputCase=ENVE	CaseType=Combination	StepType=Max	Point=0	X2=0	X3=0	S11=-
274.637838986978	IsS11Max=No	IsS11Min=No	FrameElem=46	ElemStation=0.25				
Frame=46	Station=0.25	OutputCase=ENVE	CaseType=Combination	StepType=Max	Point=1	X2=-0.5	X3=-0.5	
S11=-3261.88434075693	IsS11Max=No	IsS11Min=Yes	FrameElem=46	ElemStation=0.25				
Frame=46	Station=0.25	OutputCase=ENVE	CaseType=Combination	StepType=Max	Point=2	X2=-0.5	X3=0.5	
S11=-3261.88434075693	IsS11Max=No	IsS11Min=No	FrameElem=46	ElemStation=0.25				
Frame=46	Station=0.25	OutputCase=ENVE	CaseType=Combination	StepType=Max	Point=3	X2=0.5	X3=-0.5	
S11=2750.22511087123	IsS11Max=Yes	IsS11Min=No	FrameElem=46	ElemStation=0.25				
Frame=46	Station=0.25	OutputCase=ENVE	CaseType=Combination	StepType=Max	Point=4	X2=0.5	X3=0.5	
S11=2750.22511087123	IsS11Max=No	IsS11Min=No	FrameElem=46	ElemStation=0.25				
Frame=46	Station=0.375	OutputCase=ENVE	CaseType=Combination	StepType=Max	Point=0	X2=0	X3=0	S11=-
274.637838986978	IsS11Max=No	IsS11Min=No	FrameElem=46	ElemStation=0.375				
Frame=46	Station=0.375	OutputCase=ENVE	CaseType=Combination	StepType=Max	Point=1	X2=-0.5	X3=-0.5	
S11=-3071.55741391109	IsS11Max=No	IsS11Min=Yes	FrameElem=46	ElemStation=0.375				
Frame=46	Station=0.375	OutputCase=ENVE	CaseType=Combination	StepType=Max	Point=2	X2=-0.5	X3=0.5	
S11=-3071.55741391109	IsS11Max=No	IsS11Min=No	FrameElem=46	ElemStation=0.375				
Frame=46	Station=0.375	OutputCase=ENVE	CaseType=Combination	StepType=Max	Point=3	X2=0.5	X3=-0.5	
S11=2560.01644263465	IsS11Max=Yes	IsS11Min=No	FrameElem=46	ElemStation=0.375				
Frame=46	Station=0.375	OutputCase=ENVE	CaseType=Combination	StepType=Max	Point=4	X2=0.5	X3=0.5	
S11=2560.01644263465	IsS11Max=No	IsS11Min=No	FrameElem=46	ElemStation=0.375				
Frame=46	Station=0.5	OutputCase=ENVE	CaseType=Combination	StepType=Max	Point=0	X2=0	X3=0	S11=-
274.637838986978	IsS11Max=No	IsS11Min=No	FrameElem=46	ElemStation=0.5				
Frame=46	Station=0.5	OutputCase=ENVE	CaseType=Combination	StepType=Max	Point=1	X2=-0.5	X3=-0.5	
S11=-2883.57423706524	IsS11Max=No	IsS11Min=Yes	FrameElem=46	ElemStation=0.5				
Frame=46	Station=0.5	OutputCase=ENVE	CaseType=Combination	StepType=Max	Point=2	X2=-0.5	X3=0.5	
S11=-2883.57423706524	IsS11Max=No	IsS11Min=No	FrameElem=46	ElemStation=0.5				
Frame=46	Station=0.5	OutputCase=ENVE	CaseType=Combination	StepType=Max	Point=3	X2=0.5	X3=-0.5	
S11=2372.15152439806	IsS11Max=Yes	IsS11Min=No	FrameElem=46	ElemStation=0.5				
Frame=46	Station=0.5	OutputCase=ENVE	CaseType=Combination	StepType=Max	Point=4	X2=0.5	X3=0.5	
S11=2372.15152439806	IsS11Max=No	IsS11Min=No	FrameElem=46	ElemStation=0.5				
Frame=46	Station=0	OutputCase=ENVE	CaseType=Combination	StepType=Min	Point=0	X2=0	X3=0	S11=-
386.541953115295	IsS11Max=No	IsS11Min=No	FrameElem=46	ElemStation=0				
Frame=46	Station=0	OutputCase=ENVE	CaseType=Combination	StepType=Min	Point=1	X2=-0.5	X3=-0.5	
S11=-3686.94937531834	IsS11Max=No	IsS11Min=Yes	FrameElem=46	ElemStation=0				
Frame=46	Station=0	OutputCase=ENVE	CaseType=Combination	StepType=Min	Point=2	X2=-0.5	X3=0.5	S11=-
3686.94937531834	IsS11Max=No	IsS11Min=No	FrameElem=46	ElemStation=0				
Frame=46	Station=0	OutputCase=ENVE	CaseType=Combination	StepType=Min	Point=3	X2=0.5	X3=-0.5	
S11=2876.48553821803	IsS11Max=Yes	IsS11Min=No	FrameElem=46	ElemStation=0				
Frame=46	Station=0	OutputCase=ENVE	CaseType=Combination	StepType=Min	Point=4	X2=0.5	X3=0.5	
S11=2876.48553821803	IsS11Max=No	IsS11Min=No	FrameElem=46	ElemStation=0				
Frame=46	Station=0.125	OutputCase=ENVE	CaseType=Combination	StepType=Min	Point=0	X2=0	X3=0	S11=-
386.541953115295	IsS11Max=No	IsS11Min=No	FrameElem=46	ElemStation=0.125				
Frame=46	Station=0.125	OutputCase=ENVE	CaseType=Combination	StepType=Min	Point=1	X2=-0.5	X3=-0.5	
S11=-3492.05320708176	IsS11Max=No	IsS11Min=Yes	FrameElem=46	ElemStation=0.125				
Frame=46	Station=0.125	OutputCase=ENVE	CaseType=Combination	StepType=Min	Point=2	X2=-0.5	X3=0.5	
S11=-3492.05320708176	IsS11Max=No	IsS11Min=No	FrameElem=46	ElemStation=0.125				
Frame=46	Station=0.125	OutputCase=ENVE	CaseType=Combination	StepType=Min	Point=3	X2=0.5	X3=-0.5	
S11=2681.47111137219	IsS11Max=Yes	IsS11Min=No	FrameElem=46	ElemStation=0.125				
Frame=46	Station=0.125	OutputCase=ENVE	CaseType=Combination	StepType=Min	Point=4	X2=0.5	X3=0.5	
S11=2681.47111137219	IsS11Max=No	IsS11Min=No	FrameElem=46	ElemStation=0.125				
Frame=46	Station=0.25	OutputCase=ENVE	CaseType=Combination	StepType=Min	Point=0	X2=0	X3=0	S11=-
386.541953115295	IsS11Max=No	IsS11Min=No	FrameElem=46	ElemStation=0.25				
Frame=46	Station=0.25	OutputCase=ENVE	CaseType=Combination	StepType=Min	Point=1	X2=-0.5	X3=-0.5	
S11=-3299.50078884518	IsS11Max=No	IsS11Min=Yes	FrameElem=46	ElemStation=0.25				

Frame=46	Station=0.25	OutputCase=ENVE	CaseType=Combination	StepType=Min	Point=2	X2=-0.5	X3=0.5	
S11=-3299.50078884518	IsS11Max=No	IsS11Min=No	FrameElem=46	ElemStation=0.25				
Frame=46	Station=0.25	OutputCase=ENVE	CaseType=Combination	StepType=Min	Point=3	X2=0.5	X3=-0.5	
S11=2488.80043452634	IsS11Max=Yes	IsS11Min=No	FrameElem=46	ElemStation=0.25				
Frame=46	Station=0.25	OutputCase=ENVE	CaseType=Combination	StepType=Min	Point=4	X2=0.5	X3=0.5	
S11=2488.80043452634	IsS11Max=No	IsS11Min=No	FrameElem=46	ElemStation=0.25				
Frame=46	Station=0.375	OutputCase=ENVE	CaseType=Combination	StepType=Min	Point=0	X2=0	X3=0	S11=-
386.541953115295	IsS11Max=No	IsS11Min=No	FrameElem=46	ElemStation=0.375				
Frame=46	Station=0.375	OutputCase=ENVE	CaseType=Combination	StepType=Min	Point=1	X2=-0.5	X3=-0.5	
S11=-3109.2921206086	IsS11Max=No	IsS11Min=Yes	FrameElem=46	ElemStation=0.375				
Frame=46	Station=0.375	OutputCase=ENVE	CaseType=Combination	StepType=Min	Point=2	X2=-0.5	X3=0.5	
S11=-3109.2921206086	IsS11Max=No	IsS11Min=No	FrameElem=46	ElemStation=0.375				
Frame=46	Station=0.375	OutputCase=ENVE	CaseType=Combination	StepType=Min	Point=3	X2=0.5	X3=-0.5	
S11=2298.4735076805	IsS11Max=Yes	IsS11Min=No	FrameElem=46	ElemStation=0.375				
Frame=46	Station=0.375	OutputCase=ENVE	CaseType=Combination	StepType=Min	Point=4	X2=0.5	X3=0.5	
S11=2298.4735076805	IsS11Max=No	IsS11Min=No	FrameElem=46	ElemStation=0.375				
Frame=46	Station=0.5	OutputCase=ENVE	CaseType=Combination	StepType=Min	Point=0	X2=0	X3=0	S11=-
386.541953115295	IsS11Max=No	IsS11Min=No	FrameElem=46	ElemStation=0.5				
Frame=46	Station=0.5	OutputCase=ENVE	CaseType=Combination	StepType=Min	Point=1	X2=-0.5	X3=-0.5	
S11=-2921.42720237202	IsS11Max=No	IsS11Min=Yes	FrameElem=46	ElemStation=0.5				
Frame=46	Station=0.5	OutputCase=ENVE	CaseType=Combination	StepType=Min	Point=2	X2=-0.5	X3=0.5	
S11=-2921.42720237202	IsS11Max=No	IsS11Min=No	FrameElem=46	ElemStation=0.5				
Frame=46	Station=0.5	OutputCase=ENVE	CaseType=Combination	StepType=Min	Point=3	X2=0.5	X3=-0.5	
S11=2110.49033083465	IsS11Max=Yes	IsS11Min=No	FrameElem=46	ElemStation=0.5				
Frame=46	Station=0.5	OutputCase=ENVE	CaseType=Combination	StepType=Min	Point=4	X2=0.5	X3=0.5	
S11=2110.49033083465	IsS11Max=No	IsS11Min=No	FrameElem=46	ElemStation=0.5				
Frame=46	Station=0	OutputCase=FESSUR	CaseType=Combination	Point=0	X2=0	X3=0	S11=-386.541953115295	
IsS11Max=No	IsS11Min=No	FrameElem=46	ElemStation=0					
Frame=46	Station=0	OutputCase=FESSUR	CaseType=Combination	Point=1	X2=-0.5	X3=-0.5	S11=-	
3649.56944444862	IsS11Max=No	IsS11Min=Yes	FrameElem=46	ElemStation=0				
Frame=46	Station=0	OutputCase=FESSUR	CaseType=Combination	Point=2	X2=-0.5	X3=0.5	S11=-	
3649.56944444862	IsS11Max=No	IsS11Min=No	FrameElem=46	ElemStation=0				
Frame=46	Station=0	OutputCase=FESSUR	CaseType=Combination	Point=3	X2=0.5	X3=-0.5		
S11=2876.48553821803	IsS11Max=Yes	IsS11Min=No	FrameElem=46	ElemStation=0				
Frame=46	Station=0	OutputCase=FESSUR	CaseType=Combination	Point=4	X2=0.5	X3=0.5		
S11=2876.48553821803	IsS11Max=No	IsS11Min=No	FrameElem=46	ElemStation=0				
Frame=46	Station=0.125	OutputCase=FESSUR	CaseType=Combination	Point=0	X2=0	X3=0	S11=-	
386.541953115295	IsS11Max=No	IsS11Min=No	FrameElem=46	ElemStation=0.125				
Frame=46	Station=0.125	OutputCase=FESSUR	CaseType=Combination	Point=1	X2=-0.5	X3=-0.5	S11=-	
3454.55501760278	IsS11Max=No	IsS11Min=Yes	FrameElem=46	ElemStation=0.125				
Frame=46	Station=0.125	OutputCase=FESSUR	CaseType=Combination	Point=2	X2=-0.5	X3=0.5	S11=-	
3454.55501760278	IsS11Max=No	IsS11Min=No	FrameElem=46	ElemStation=0.125				
Frame=46	Station=0.125	OutputCase=FESSUR	CaseType=Combination	Point=3	X2=0.5	X3=-0.5		
S11=2681.47111137219	IsS11Max=Yes	IsS11Min=No	FrameElem=46	ElemStation=0.125				
Frame=46	Station=0.125	OutputCase=FESSUR	CaseType=Combination	Point=4	X2=0.5	X3=0.5		
S11=2681.47111137219	IsS11Max=No	IsS11Min=No	FrameElem=46	ElemStation=0.125				
Frame=46	Station=0.25	OutputCase=FESSUR	CaseType=Combination	Point=0	X2=0	X3=0	S11=-	
386.541953115295	IsS11Max=No	IsS11Min=No	FrameElem=46	ElemStation=0.25				
Frame=46	Station=0.25	OutputCase=FESSUR	CaseType=Combination	Point=1	X2=-0.5	X3=-0.5	S11=-	
3261.88434075693	IsS11Max=No	IsS11Min=Yes	FrameElem=46	ElemStation=0.25				
Frame=46	Station=0.25	OutputCase=FESSUR	CaseType=Combination	Point=2	X2=-0.5	X3=0.5	S11=-	
3261.88434075693	IsS11Max=No	IsS11Min=No	FrameElem=46	ElemStation=0.25				
Frame=46	Station=0.25	OutputCase=FESSUR	CaseType=Combination	Point=3	X2=0.5	X3=-0.5		
S11=2488.80043452634	IsS11Max=Yes	IsS11Min=No	FrameElem=46	ElemStation=0.25				
Frame=46	Station=0.25	OutputCase=FESSUR	CaseType=Combination	Point=4	X2=0.5	X3=0.5		
S11=2488.80043452634	IsS11Max=No	IsS11Min=No	FrameElem=46	ElemStation=0.25				
Frame=46	Station=0.375	OutputCase=FESSUR	CaseType=Combination	Point=0	X2=0	X3=0	S11=-	
386.541953115295	IsS11Max=No	IsS11Min=No	FrameElem=46	ElemStation=0.375				
Frame=46	Station=0.375	OutputCase=FESSUR	CaseType=Combination	Point=1	X2=-0.5	X3=-0.5	S11=-	
3071.55741391109	IsS11Max=No	IsS11Min=Yes	FrameElem=46	ElemStation=0.375				
Frame=46	Station=0.375	OutputCase=FESSUR	CaseType=Combination	Point=2	X2=-0.5	X3=0.5	S11=-	
3071.55741391109	IsS11Max=No	IsS11Min=No	FrameElem=46	ElemStation=0.375				
Frame=46	Station=0.375	OutputCase=FESSUR	CaseType=Combination	Point=3	X2=0.5	X3=-0.5		
S11=2298.4735076805	IsS11Max=Yes	IsS11Min=No	FrameElem=46	ElemStation=0.375				
Frame=46	Station=0.375	OutputCase=FESSUR	CaseType=Combination	Point=4	X2=0.5	X3=0.5		
S11=2298.4735076805	IsS11Max=No	IsS11Min=No	FrameElem=46	ElemStation=0.375				
Frame=46	Station=0.5	OutputCase=FESSUR	CaseType=Combination	Point=0	X2=0	X3=0	S11=-386.541953115295	
IsS11Max=No	IsS11Min=No	FrameElem=46	ElemStation=0.5					
Frame=46	Station=0.5	OutputCase=FESSUR	CaseType=Combination	Point=1	X2=-0.5	X3=-0.5	S11=-	
2883.57423706524	IsS11Max=No	IsS11Min=Yes	FrameElem=46	ElemStation=0.5				
Frame=46	Station=0.5	OutputCase=FESSUR	CaseType=Combination	Point=2	X2=-0.5	X3=0.5	S11=-	
2883.57423706524	IsS11Max=No	IsS11Min=No	FrameElem=46	ElemStation=0.5				
Frame=46	Station=0.5	OutputCase=FESSUR	CaseType=Combination	Point=3	X2=0.5	X3=-0.5		
S11=2110.49033083465	IsS11Max=Yes	IsS11Min=No	FrameElem=46	ElemStation=0.5				
Frame=46	Station=0.5	OutputCase=FESSUR	CaseType=Combination	Point=4	X2=0.5	X3=0.5		
S11=2110.49033083465	IsS11Max=No	IsS11Min=No	FrameElem=46	ElemStation=0.5				
Frame=47	Station=0	OutputCase=PESOPR	CaseType=LinStatic	Point=0	X2=0	X3=0	S11=-15.1709467361871	
IsS11Max=No	IsS11Min=No	FrameElem=47	ElemStation=0					
Frame=47	Station=0	OutputCase=PESOPR	CaseType=LinStatic	Point=1	X2=-0.5	X3=-0.5	S11=-	
541.866414960961	IsS11Max=No	IsS11Min=Yes	FrameElem=47	ElemStation=0				
Frame=47	Station=0	OutputCase=PESOPR	CaseType=LinStatic	Point=2	X2=-0.5	X3=0.5	S11=-	
541.866414960961	IsS11Max=No	IsS11Min=No	FrameElem=47	ElemStation=0				



Frame=47	Station=0	OutputCase=PESOPR	CaseType=LinStatic	Point=3	X2=0.5	X3=-0.5	S11=511.524521488587
IsS11Max=Yes	IsS11Min=No	FrameElem=47	ElemStation=0				
Frame=47	Station=0	OutputCase=PESOPR	CaseType=LinStatic	Point=4	X2=0.5	X3=0.5	S11=511.524521488587
IsS11Max=No	IsS11Min=No	FrameElem=47	ElemStation=0				
Frame=47	Station=0.125	OutputCase=PESOPR	CaseType=LinStatic	Point=0	X2=0	X3=0	S11=-15.1709467361871
IsS11Max=No	IsS11Min=No	FrameElem=47	ElemStation=0.125				
Frame=47	Station=0.125	OutputCase=PESOPR	CaseType=LinStatic	Point=1	X2=-0.5	X3=-0.5	S11=-
478.117889283902	IsS11Max=No	IsS11Min=Yes	FrameElem=47	ElemStation=0.125			
Frame=47	Station=0.125	OutputCase=PESOPR	CaseType=LinStatic	Point=2	X2=-0.5	X3=0.5	S11=-
478.117889283902	IsS11Max=No	IsS11Min=No	FrameElem=47	ElemStation=0.125			
Frame=47	Station=0.125	OutputCase=PESOPR	CaseType=LinStatic	Point=3	X2=0.5	X3=-0.5	
S11=447.775995811527	IsS11Max=Yes	IsS11Min=No	FrameElem=47	ElemStation=0.125			
Frame=47	Station=0.125	OutputCase=PESOPR	CaseType=LinStatic	Point=4	X2=0.5	X3=0.5	
S11=447.775995811527	IsS11Max=No	IsS11Min=No	FrameElem=47	ElemStation=0.125			
Frame=47	Station=0.25	OutputCase=PESOPR	CaseType=LinStatic	Point=0	X2=0	X3=0	S11=-15.1709467361871
IsS11Max=No	IsS11Min=No	FrameElem=47	ElemStation=0.25				
Frame=47	Station=0.25	OutputCase=PESOPR	CaseType=LinStatic	Point=1	X2=-0.5	X3=-0.5	S11=-
416.713113606842	IsS11Max=No	IsS11Min=Yes	FrameElem=47	ElemStation=0.25			
Frame=47	Station=0.25	OutputCase=PESOPR	CaseType=LinStatic	Point=2	X2=-0.5	X3=0.5	S11=-
416.713113606842	IsS11Max=No	IsS11Min=No	FrameElem=47	ElemStation=0.25			
Frame=47	Station=0.25	OutputCase=PESOPR	CaseType=LinStatic	Point=3	X2=0.5	X3=-0.5	
S11=386.371220134468	IsS11Max=Yes	IsS11Min=No	FrameElem=47	ElemStation=0.25			
Frame=47	Station=0.25	OutputCase=PESOPR	CaseType=LinStatic	Point=4	X2=0.5	X3=0.5	
S11=386.371220134468	IsS11Max=No	IsS11Min=No	FrameElem=47	ElemStation=0.25			
Frame=47	Station=0.375	OutputCase=PESOPR	CaseType=LinStatic	Point=0	X2=0	X3=0	S11=-15.1709467361871
IsS11Max=No	IsS11Min=No	FrameElem=47	ElemStation=0.375				
Frame=47	Station=0.375	OutputCase=PESOPR	CaseType=LinStatic	Point=1	X2=-0.5	X3=-0.5	S11=-
357.652087929782	IsS11Max=No	IsS11Min=Yes	FrameElem=47	ElemStation=0.375			
Frame=47	Station=0.375	OutputCase=PESOPR	CaseType=LinStatic	Point=2	X2=-0.5	X3=0.5	S11=-
357.652087929782	IsS11Max=No	IsS11Min=No	FrameElem=47	ElemStation=0.375			
Frame=47	Station=0.375	OutputCase=PESOPR	CaseType=LinStatic	Point=3	X2=0.5	X3=-0.5	
S11=327.310194457408	IsS11Max=Yes	IsS11Min=No	FrameElem=47	ElemStation=0.375			
Frame=47	Station=0.375	OutputCase=PESOPR	CaseType=LinStatic	Point=4	X2=0.5	X3=0.5	
S11=327.310194457408	IsS11Max=No	IsS11Min=No	FrameElem=47	ElemStation=0.375			
Frame=47	Station=0.5	OutputCase=PESOPR	CaseType=LinStatic	Point=0	X2=0	X3=0	S11=-15.1709467361871
IsS11Max=No	IsS11Min=No	FrameElem=47	ElemStation=0.5				
Frame=47	Station=0.5	OutputCase=PESOPR	CaseType=LinStatic	Point=1	X2=-0.5	X3=-0.5	S11=-
300.934812252723	IsS11Max=No	IsS11Min=Yes	FrameElem=47	ElemStation=0.5			
Frame=47	Station=0.5	OutputCase=PESOPR	CaseType=LinStatic	Point=2	X2=-0.5	X3=0.5	S11=-
300.934812252723	IsS11Max=No	IsS11Min=No	FrameElem=47	ElemStation=0.5			
Frame=47	Station=0.5	OutputCase=PESOPR	CaseType=LinStatic	Point=3	X2=0.5	X3=-0.5	
S11=270.592918780348	IsS11Max=Yes	IsS11Min=No	FrameElem=47	ElemStation=0.5			
Frame=47	Station=0.5	OutputCase=PESOPR	CaseType=LinStatic	Point=4	X2=0.5	X3=0.5	
S11=270.592918780348	IsS11Max=No	IsS11Min=No	FrameElem=47	ElemStation=0.5			
Frame=47	Station=0	OutputCase=TERRVERT	CaseType=LinStatic	Point=0	X2=0	X3=0	S11=1.64270738195066
IsS11Max=No	IsS11Min=No	FrameElem=47	ElemStation=0				
Frame=47	Station=0	OutputCase=TERRVERT	CaseType=LinStatic	Point=1	X2=-0.5	X3=-0.5	S11=-
2467.88437312674	IsS11Max=No	IsS11Min=Yes	FrameElem=47	ElemStation=0			
Frame=47	Station=0	OutputCase=TERRVERT	CaseType=LinStatic	Point=2	X2=-0.5	X3=0.5	S11=-
2467.88437312674	IsS11Max=No	IsS11Min=No	FrameElem=47	ElemStation=0			
Frame=47	Station=0	OutputCase=TERRVERT	CaseType=LinStatic	Point=3	X2=0.5	X3=-0.5	
S11=2471.16978789064	IsS11Max=Yes	IsS11Min=No	FrameElem=47	ElemStation=0			
Frame=47	Station=0	OutputCase=TERRVERT	CaseType=LinStatic	Point=4	X2=0.5	X3=0.5	
S11=2471.16978789064	IsS11Max=No	IsS11Min=No	FrameElem=47	ElemStation=0			
Frame=47	Station=0.125	OutputCase=TERRVERT	CaseType=LinStatic	Point=0	X2=0	X3=0	
S11=1.64270738195066	IsS11Max=No	IsS11Min=No	FrameElem=47	ElemStation=0.125			
Frame=47	Station=0.125	OutputCase=TERRVERT	CaseType=LinStatic	Point=1	X2=-0.5	X3=-0.5	S11=-
2208.65327343118	IsS11Max=No	IsS11Min=Yes	FrameElem=47	ElemStation=0.125			
Frame=47	Station=0.125	OutputCase=TERRVERT	CaseType=LinStatic	Point=2	X2=-0.5	X3=0.5	S11=-
2208.65327343118	IsS11Max=No	IsS11Min=No	FrameElem=47	ElemStation=0.125			
Frame=47	Station=0.125	OutputCase=TERRVERT	CaseType=LinStatic	Point=3	X2=0.5	X3=-0.5	
S11=2211.93868819509	IsS11Max=Yes	IsS11Min=No	FrameElem=47	ElemStation=0.125			
Frame=47	Station=0.125	OutputCase=TERRVERT	CaseType=LinStatic	Point=4	X2=0.5	X3=0.5	
S11=2211.93868819509	IsS11Max=No	IsS11Min=No	FrameElem=47	ElemStation=0.125			
Frame=47	Station=0.25	OutputCase=TERRVERT	CaseType=LinStatic	Point=0	X2=0	X3=0	S11=1.64270738195066
IsS11Max=No	IsS11Min=No	FrameElem=47	ElemStation=0.25				
Frame=47	Station=0.25	OutputCase=TERRVERT	CaseType=LinStatic	Point=1	X2=-0.5	X3=-0.5	S11=-
1949.42217373563	IsS11Max=No	IsS11Min=Yes	FrameElem=47	ElemStation=0.25			
Frame=47	Station=0.25	OutputCase=TERRVERT	CaseType=LinStatic	Point=2	X2=-0.5	X3=0.5	S11=-
1949.42217373563	IsS11Max=No	IsS11Min=No	FrameElem=47	ElemStation=0.25			
Frame=47	Station=0.25	OutputCase=TERRVERT	CaseType=LinStatic	Point=3	X2=0.5	X3=-0.5	
S11=1952.70758849953	IsS11Max=Yes	IsS11Min=No	FrameElem=47	ElemStation=0.25			
Frame=47	Station=0.25	OutputCase=TERRVERT	CaseType=LinStatic	Point=4	X2=0.5	X3=0.5	
S11=1952.70758849953	IsS11Max=No	IsS11Min=No	FrameElem=47	ElemStation=0.25			
Frame=47	Station=0.375	OutputCase=TERRVERT	CaseType=LinStatic	Point=0	X2=0	X3=0	
S11=1.64270738195066	IsS11Max=No	IsS11Min=No	FrameElem=47	ElemStation=0.375			
Frame=47	Station=0.375	OutputCase=TERRVERT	CaseType=LinStatic	Point=1	X2=-0.5	X3=-0.5	S11=-
1690.19107404007	IsS11Max=No	IsS11Min=Yes	FrameElem=47	ElemStation=0.375			
Frame=47	Station=0.375	OutputCase=TERRVERT	CaseType=LinStatic	Point=2	X2=-0.5	X3=0.5	S11=-
1690.19107404007	IsS11Max=No	IsS11Min=No	FrameElem=47	ElemStation=0.375			
Frame=47	Station=0.375	OutputCase=TERRVERT	CaseType=LinStatic	Point=3	X2=0.5	X3=-0.5	
S11=1693.47648880397	IsS11Max=Yes	IsS11Min=No	FrameElem=47	ElemStation=0.375			

```

Frame=47 Station=0.375 OutputCase=TERRVERT CaseType=LinStatic Point=4 X2=0.5 X3=0.5
S11=1693.47648880397 IsS11Max=No IsS11Min=No FrameElem=47 ElemStation=0.375
Frame=47 Station=0.5 OutputCase=TERRVERT CaseType=LinStatic Point=0 X2=0 X3=0 S11=1.64270738195066
IsS11Max=No IsS11Min=No FrameElem=47 ElemStation=0.5
Frame=47 Station=0.5 OutputCase=TERRVERT CaseType=LinStatic Point=1 X2=-0.5 X3=-0.5 S11=-
1430.95997434451 IsS11Max=No IsS11Min=Yes FrameElem=47 ElemStation=0.5
Frame=47 Station=0.5 OutputCase=TERRVERT CaseType=LinStatic Point=2 X2=-0.5 X3=0.5 S11=-
1430.95997434451 IsS11Max=No IsS11Min=No FrameElem=47 ElemStation=0.5
Frame=47 Station=0.5 OutputCase=TERRVERT CaseType=LinStatic Point=3 X2=0.5 X3=-0.5
S11=1434.24538910842 IsS11Max=Yes IsS11Min=No FrameElem=47 ElemStation=0.5
Frame=47 Station=0.5 OutputCase=TERRVERT CaseType=LinStatic Point=4 X2=0.5 X3=0.5
S11=1434.24538910842 IsS11Max=No IsS11Min=No FrameElem=47 ElemStation=0.5
Frame=47 Station=0 OutputCase=TERRLAT CaseType=LinStatic Point=0 X2=0 X3=0 S11=-373.013713761058
IsS11Max=No IsS11Min=No FrameElem=47 ElemStation=0
Frame=47 Station=0 OutputCase=TERRLAT CaseType=LinStatic Point=1 X2=-0.5 X3=-0.5
S11=126.17655102259 IsS11Max=Yes IsS11Min=No FrameElem=47 ElemStation=0
Frame=47 Station=0 OutputCase=TERRLAT CaseType=LinStatic Point=2 X2=-0.5 X3=0.5 S11=126.17655102259
IsS11Max=No IsS11Min=No FrameElem=47 ElemStation=0
Frame=47 Station=0 OutputCase=TERRLAT CaseType=LinStatic Point=3 X2=0.5 X3=-0.5 S11=-
872.203978544707 IsS11Max=No IsS11Min=Yes FrameElem=47 ElemStation=0
Frame=47 Station=0 OutputCase=TERRLAT CaseType=LinStatic Point=4 X2=0.5 X3=0.5 S11=-
872.203978544707 IsS11Max=No IsS11Min=No FrameElem=47 ElemStation=0
Frame=47 Station=0.125 OutputCase=TERRLAT CaseType=LinStatic Point=0 X2=0 X3=0 S11=-
373.013713761058 IsS11Max=No IsS11Min=No FrameElem=47 ElemStation=0.125
Frame=47 Station=0.125 OutputCase=TERRLAT CaseType=LinStatic Point=1 X2=-0.5 X3=-0.5
S11=126.72162336915 IsS11Max=Yes IsS11Min=No FrameElem=47 ElemStation=0.125
Frame=47 Station=0.125 OutputCase=TERRLAT CaseType=LinStatic Point=2 X2=-0.5 X3=0.5
S11=126.72162336915 IsS11Max=No IsS11Min=No FrameElem=47 ElemStation=0.125
Frame=47 Station=0.125 OutputCase=TERRLAT CaseType=LinStatic Point=3 X2=0.5 X3=-0.5 S11=-
872.749050891266 IsS11Max=No IsS11Min=Yes FrameElem=47 ElemStation=0.125
Frame=47 Station=0.125 OutputCase=TERRLAT CaseType=LinStatic Point=4 X2=0.5 X3=0.5 S11=-
872.749050891266 IsS11Max=No IsS11Min=No FrameElem=47 ElemStation=0.125
Frame=47 Station=0.25 OutputCase=TERRLAT CaseType=LinStatic Point=0 X2=0 X3=0 S11=-373.013713761058
IsS11Max=No IsS11Min=No FrameElem=47 ElemStation=0.25
Frame=47 Station=0.25 OutputCase=TERRLAT CaseType=LinStatic Point=1 X2=-0.5 X3=-0.5
S11=127.266695715709 IsS11Max=Yes IsS11Min=No FrameElem=47 ElemStation=0.25
Frame=47 Station=0.25 OutputCase=TERRLAT CaseType=LinStatic Point=2 X2=-0.5 X3=0.5
S11=127.266695715709 IsS11Max=No IsS11Min=No FrameElem=47 ElemStation=0.25
Frame=47 Station=0.25 OutputCase=TERRLAT CaseType=LinStatic Point=3 X2=0.5 X3=-0.5 S11=-
873.294123237825 IsS11Max=No IsS11Min=Yes FrameElem=47 ElemStation=0.25
Frame=47 Station=0.25 OutputCase=TERRLAT CaseType=LinStatic Point=4 X2=0.5 X3=0.5 S11=-
873.294123237825 IsS11Max=No IsS11Min=No FrameElem=47 ElemStation=0.25
Frame=47 Station=0.375 OutputCase=TERRLAT CaseType=LinStatic Point=0 X2=0 X3=0 S11=-
373.013713761058 IsS11Max=No IsS11Min=No FrameElem=47 ElemStation=0.375
Frame=47 Station=0.375 OutputCase=TERRLAT CaseType=LinStatic Point=1 X2=-0.5 X3=-0.5
S11=127.811768062268 IsS11Max=Yes IsS11Min=No FrameElem=47 ElemStation=0.375
Frame=47 Station=0.375 OutputCase=TERRLAT CaseType=LinStatic Point=2 X2=-0.5 X3=0.5
S11=127.811768062268 IsS11Max=No IsS11Min=No FrameElem=47 ElemStation=0.375
Frame=47 Station=0.375 OutputCase=TERRLAT CaseType=LinStatic Point=3 X2=0.5 X3=-0.5 S11=-
873.839195584385 IsS11Max=No IsS11Min=Yes FrameElem=47 ElemStation=0.375
Frame=47 Station=0.375 OutputCase=TERRLAT CaseType=LinStatic Point=4 X2=0.5 X3=0.5 S11=-
873.839195584385 IsS11Max=No IsS11Min=No FrameElem=47 ElemStation=0.375
Frame=47 Station=0.5 OutputCase=TERRLAT CaseType=LinStatic Point=0 X2=0 X3=0 S11=-373.013713761058
IsS11Max=No IsS11Min=No FrameElem=47 ElemStation=0.5
Frame=47 Station=0.5 OutputCase=TERRLAT CaseType=LinStatic Point=1 X2=-0.5 X3=-0.5
S11=128.356840408828 IsS11Max=Yes IsS11Min=No FrameElem=47 ElemStation=0.5
Frame=47 Station=0.5 OutputCase=TERRLAT CaseType=LinStatic Point=2 X2=-0.5 X3=0.5
S11=128.356840408828 IsS11Max=No IsS11Min=No FrameElem=47 ElemStation=0.5
Frame=47 Station=0.5 OutputCase=TERRLAT CaseType=LinStatic Point=3 X2=0.5 X3=-0.5 S11=-
874.384267930944 IsS11Max=No IsS11Min=Yes FrameElem=47 ElemStation=0.5
Frame=47 Station=0.5 OutputCase=TERRLAT CaseType=LinStatic Point=4 X2=0.5 X3=0.5 S11=-
874.384267930944 IsS11Max=No IsS11Min=No FrameElem=47 ElemStation=0.5
Frame=47 Station=0 OutputCase=ACCVERT CaseType=LinStatic Point=0 X2=0 X3=0 S11=0 IsS11Max=Yes
IsS11Min=Yes FrameElem=47 ElemStation=0
Frame=47 Station=0 OutputCase=ACCVERT CaseType=LinStatic Point=1 X2=-0.5 X3=-0.5 S11=0
IsS11Max=No IsS11Min=No FrameElem=47 ElemStation=0
Frame=47 Station=0 OutputCase=ACCVERT CaseType=LinStatic Point=2 X2=-0.5 X3=0.5 S11=0 IsS11Max=No
IsS11Min=No FrameElem=47 ElemStation=0
Frame=47 Station=0 OutputCase=ACCVERT CaseType=LinStatic Point=3 X2=0.5 X3=-0.5 S11=0 IsS11Max=No
IsS11Min=No FrameElem=47 ElemStation=0
Frame=47 Station=0 OutputCase=ACCVERT CaseType=LinStatic Point=4 X2=0.5 X3=0.5 S11=0 IsS11Max=No
IsS11Min=No FrameElem=47 ElemStation=0
Frame=47 Station=0.125 OutputCase=ACCVERT CaseType=LinStatic Point=0 X2=0 X3=0 S11=0 IsS11Max=Yes
IsS11Min=Yes FrameElem=47 ElemStation=0.125
Frame=47 Station=0.125 OutputCase=ACCVERT CaseType=LinStatic Point=1 X2=-0.5 X3=-0.5 S11=0
IsS11Max=No IsS11Min=No FrameElem=47 ElemStation=0.125
Frame=47 Station=0.125 OutputCase=ACCVERT CaseType=LinStatic Point=2 X2=-0.5 X3=0.5 S11=0
IsS11Max=No IsS11Min=No FrameElem=47 ElemStation=0.125
Frame=47 Station=0.125 OutputCase=ACCVERT CaseType=LinStatic Point=3 X2=0.5 X3=-0.5 S11=0
IsS11Max=No IsS11Min=No FrameElem=47 ElemStation=0.125
Frame=47 Station=0.125 OutputCase=ACCVERT CaseType=LinStatic Point=4 X2=0.5 X3=0.5 S11=0
IsS11Max=No IsS11Min=No FrameElem=47 ElemStation=0.125

```

Frame=47	Station=0.375	OutputCase=TERRCOST	CaseType=LinStatic	Point=2	X2=-0.5	X3=0.5	S11=0	
IsS11Max=No	IsS11Min=No	FrameElem=47	ElemStation=0.375					
Frame=47	Station=0.375	OutputCase=TERRCOST	CaseType=LinStatic	Point=3	X2=0.5	X3=-0.5	S11=0	
IsS11Max=No	IsS11Min=No	FrameElem=47	ElemStation=0.375					
Frame=47	Station=0.375	OutputCase=TERRCOST	CaseType=LinStatic	Point=4	X2=0.5	X3=0.5	S11=0	
IsS11Max=No	IsS11Min=No	FrameElem=47	ElemStation=0.375					
Frame=47	Station=0.5	OutputCase=TERRCOST	CaseType=LinStatic	Point=0	X2=0	X3=0	S11=0	IsS11Max=Yes
IsS11Min=Yes	FrameElem=47	ElemStation=0.5						
Frame=47	Station=0.5	OutputCase=TERRCOST	CaseType=LinStatic	Point=1	X2=-0.5	X3=-0.5	S11=0	
IsS11Max=No	IsS11Min=No	FrameElem=47	ElemStation=0.5					
Frame=47	Station=0.5	OutputCase=TERRCOST	CaseType=LinStatic	Point=2	X2=-0.5	X3=0.5	S11=0	
IsS11Max=No	IsS11Min=No	FrameElem=47	ElemStation=0.5					
Frame=47	Station=0.5	OutputCase=TERRCOST	CaseType=LinStatic	Point=3	X2=0.5	X3=-0.5	S11=0	
IsS11Max=No	IsS11Min=No	FrameElem=47	ElemStation=0.5					
Frame=47	Station=0.5	OutputCase=TERRCOST	CaseType=LinStatic	Point=4	X2=0.5	X3=0.5	S11=0	
IsS11Max=No	IsS11Min=No	FrameElem=47	ElemStation=0.5					
Frame=47	Station=0	OutputCase=SOVRCOST	CaseType=LinStatic	Point=0	X2=0	X3=0	S11=0	IsS11Max=Yes
IsS11Min=Yes	FrameElem=47	ElemStation=0						
Frame=47	Station=0	OutputCase=SOVRCOST	CaseType=LinStatic	Point=1	X2=-0.5	X3=-0.5	S11=0	
IsS11Max=No	IsS11Min=No	FrameElem=47	ElemStation=0					
Frame=47	Station=0	OutputCase=SOVRCOST	CaseType=LinStatic	Point=2	X2=-0.5	X3=0.5	S11=0	
IsS11Max=No	IsS11Min=No	FrameElem=47	ElemStation=0					
Frame=47	Station=0	OutputCase=SOVRCOST	CaseType=LinStatic	Point=3	X2=0.5	X3=-0.5	S11=0	
IsS11Max=No	IsS11Min=No	FrameElem=47	ElemStation=0					
Frame=47	Station=0	OutputCase=SOVRCOST	CaseType=LinStatic	Point=4	X2=0.5	X3=0.5	S11=0	IsS11Max=No
IsS11Min=No	FrameElem=47	ElemStation=0						
Frame=47	Station=0.125	OutputCase=SOVRCOST	CaseType=LinStatic	Point=0	X2=0	X3=0	S11=0	
IsS11Max=Yes	IsS11Min=Yes	FrameElem=47	ElemStation=0.125					
Frame=47	Station=0.125	OutputCase=SOVRCOST	CaseType=LinStatic	Point=1	X2=-0.5	X3=-0.5	S11=0	
IsS11Max=No	IsS11Min=No	FrameElem=47	ElemStation=0.125					
Frame=47	Station=0.125	OutputCase=SOVRCOST	CaseType=LinStatic	Point=2	X2=-0.5	X3=0.5	S11=0	
IsS11Max=No	IsS11Min=No	FrameElem=47	ElemStation=0.125					
Frame=47	Station=0.125	OutputCase=SOVRCOST	CaseType=LinStatic	Point=3	X2=0.5	X3=-0.5	S11=0	
IsS11Max=No	IsS11Min=No	FrameElem=47	ElemStation=0.125					
Frame=47	Station=0.125	OutputCase=SOVRCOST	CaseType=LinStatic	Point=4	X2=0.5	X3=0.5	S11=0	
IsS11Max=No	IsS11Min=No	FrameElem=47	ElemStation=0.125					
Frame=47	Station=0.25	OutputCase=SOVRCOST	CaseType=LinStatic	Point=0	X2=0	X3=0	S11=0	IsS11Max=Yes
IsS11Min=Yes	FrameElem=47	ElemStation=0.25						
Frame=47	Station=0.25	OutputCase=SOVRCOST	CaseType=LinStatic	Point=1	X2=-0.5	X3=-0.5	S11=0	
IsS11Max=No	IsS11Min=No	FrameElem=47	ElemStation=0.25					
Frame=47	Station=0.25	OutputCase=SOVRCOST	CaseType=LinStatic	Point=2	X2=-0.5	X3=0.5	S11=0	
IsS11Max=No	IsS11Min=No	FrameElem=47	ElemStation=0.25					
Frame=47	Station=0.25	OutputCase=SOVRCOST	CaseType=LinStatic	Point=3	X2=0.5	X3=-0.5	S11=0	
IsS11Max=No	IsS11Min=No	FrameElem=47	ElemStation=0.25					
Frame=47	Station=0.25	OutputCase=SOVRCOST	CaseType=LinStatic	Point=4	X2=0.5	X3=0.5	S11=0	
IsS11Max=No	IsS11Min=No	FrameElem=47	ElemStation=0.25					
Frame=47	Station=0.375	OutputCase=SOVRCOST	CaseType=LinStatic	Point=0	X2=0	X3=0	S11=0	
IsS11Max=Yes	IsS11Min=Yes	FrameElem=47	ElemStation=0.375					
Frame=47	Station=0.375	OutputCase=SOVRCOST	CaseType=LinStatic	Point=1	X2=-0.5	X3=-0.5	S11=0	
IsS11Max=No	IsS11Min=No	FrameElem=47	ElemStation=0.375					
Frame=47	Station=0.375	OutputCase=SOVRCOST	CaseType=LinStatic	Point=2	X2=-0.5	X3=0.5	S11=0	
IsS11Max=No	IsS11Min=No	FrameElem=47	ElemStation=0.375					
Frame=47	Station=0.375	OutputCase=SOVRCOST	CaseType=LinStatic	Point=3	X2=0.5	X3=-0.5	S11=0	
IsS11Max=No	IsS11Min=No	FrameElem=47	ElemStation=0.375					
Frame=47	Station=0.375	OutputCase=SOVRCOST	CaseType=LinStatic	Point=4	X2=0.5	X3=0.5	S11=0	
IsS11Max=No	IsS11Min=No	FrameElem=47	ElemStation=0.375					
Frame=47	Station=0.5	OutputCase=SOVRCOST	CaseType=LinStatic	Point=0	X2=0	X3=0	S11=0	IsS11Max=Yes
IsS11Min=Yes	FrameElem=47	ElemStation=0.5						
Frame=47	Station=0.5	OutputCase=SOVRCOST	CaseType=LinStatic	Point=1	X2=-0.5	X3=-0.5	S11=0	
IsS11Max=No	IsS11Min=No	FrameElem=47	ElemStation=0.5					
Frame=47	Station=0.5	OutputCase=SOVRCOST	CaseType=LinStatic	Point=2	X2=-0.5	X3=0.5	S11=0	
IsS11Max=No	IsS11Min=No	FrameElem=47	ElemStation=0.5					
Frame=47	Station=0.5	OutputCase=SOVRCOST	CaseType=LinStatic	Point=3	X2=0.5	X3=-0.5	S11=0	
IsS11Max=No	IsS11Min=No	FrameElem=47	ElemStation=0.5					
Frame=47	Station=0.5	OutputCase=SOVRCOST	CaseType=LinStatic	Point=4	X2=0.5	X3=0.5	S11=0	
IsS11Max=No	IsS11Min=No	FrameElem=47	ElemStation=0.5					
Frame=47	Station=0	OutputCase=ENVE	CaseType=Combination	StepType=Max	Point=0	X2=0	X3=0	S11=-
274.637838986977	IsS11Max=No	IsS11Min=No	FrameElem=47	ElemStation=0				
Frame=47	Station=0	OutputCase=ENVE	CaseType=Combination	StepType=Max	Point=1	X2=-0.5	X3=-0.5	
S11=-2883.57423706511	IsS11Max=No	IsS11Min=Yes	FrameElem=47	ElemStation=0				
Frame=47	Station=0	OutputCase=ENVE	CaseType=Combination	StepType=Max	Point=2	X2=-0.5	X3=0.5	S11=-
2883.57423706511	IsS11Max=No	IsS11Min=No	FrameElem=47	ElemStation=0				
Frame=47	Station=0	OutputCase=ENVE	CaseType=Combination	StepType=Max	Point=3	X2=0.5	X3=-0.5	
S11=2372.15152439793	IsS11Max=Yes	IsS11Min=No	FrameElem=47	ElemStation=0				
Frame=47	Station=0	OutputCase=ENVE	CaseType=Combination	StepType=Max	Point=4	X2=0.5	X3=0.5	
S11=2372.15152439793	IsS11Max=No	IsS11Min=No	FrameElem=47	ElemStation=0				
Frame=47	Station=0.125	OutputCase=ENVE	CaseType=Combination	StepType=Max	Point=0	X2=0	X3=0	S11=-
274.637838986977	IsS11Max=No	IsS11Min=No	FrameElem=47	ElemStation=0.125				
Frame=47	Station=0.125	OutputCase=ENVE	CaseType=Combination	StepType=Max	Point=1	X2=-0.5	X3=-0.5	
S11=-2560.04953934594	IsS11Max=No	IsS11Min=Yes	FrameElem=47	ElemStation=0.125				
Frame=47	Station=0.125	OutputCase=ENVE	CaseType=Combination	StepType=Max	Point=2	X2=-0.5	X3=0.5	
S11=-2560.04953934594	IsS11Max=No	IsS11Min=No	FrameElem=47	ElemStation=0.125				



Frame=47	Station=0.125	OutputCase=ENVE	CaseType=Combination	StepType=Max	Point=3	X2=0.5	X3=-0.5	
S11=2048.79034838273	IsS11Max=Yes	IsS11Min=No	FrameElem=47	ElemStation=0.125				
Frame=47	Station=0.125	OutputCase=ENVE	CaseType=Combination	StepType=Max	Point=4	X2=0.5	X3=0.5	
S11=2048.79034838273	IsS11Max=No	IsS11Min=No	FrameElem=47	ElemStation=0.125				
Frame=47	Station=0.25	OutputCase=ENVE	CaseType=Combination	StepType=Max	Point=0	X2=0	X3=0	S11=-
274.637838986977	IsS11Max=No	IsS11Min=No	FrameElem=47	ElemStation=0.25				
Frame=47	Station=0.25	OutputCase=ENVE	CaseType=Combination	StepType=Max	Point=1	X2=-0.5	X3=-0.5	
S11=-2238.86859162676	IsS11Max=No	IsS11Min=Yes	FrameElem=47	ElemStation=0.25				
Frame=47	Station=0.25	OutputCase=ENVE	CaseType=Combination	StepType=Max	Point=2	X2=-0.5	X3=0.5	
S11=-2238.86859162676	IsS11Max=No	IsS11Min=No	FrameElem=47	ElemStation=0.25				
Frame=47	Station=0.25	OutputCase=ENVE	CaseType=Combination	StepType=Max	Point=3	X2=0.5	X3=-0.5	
S11=1727.77292236752	IsS11Max=Yes	IsS11Min=No	FrameElem=47	ElemStation=0.25				
Frame=47	Station=0.25	OutputCase=ENVE	CaseType=Combination	StepType=Max	Point=4	X2=0.5	X3=0.5	
S11=1727.77292236752	IsS11Max=No	IsS11Min=No	FrameElem=47	ElemStation=0.25				
Frame=47	Station=0.375	OutputCase=ENVE	CaseType=Combination	StepType=Max	Point=0	X2=0	X3=0	S11=-
274.637838986977	IsS11Max=No	IsS11Min=No	FrameElem=47	ElemStation=0.375				
Frame=47	Station=0.375	OutputCase=ENVE	CaseType=Combination	StepType=Max	Point=1	X2=-0.5	X3=-0.5	
S11=-1920.03139390758	IsS11Max=No	IsS11Min=Yes	FrameElem=47	ElemStation=0.375				
Frame=47	Station=0.375	OutputCase=ENVE	CaseType=Combination	StepType=Max	Point=2	X2=-0.5	X3=0.5	
S11=-1920.03139390758	IsS11Max=No	IsS11Min=No	FrameElem=47	ElemStation=0.375				
Frame=47	Station=0.375	OutputCase=ENVE	CaseType=Combination	StepType=Max	Point=3	X2=0.5	X3=-0.5	
S11=1409.09924635231	IsS11Max=Yes	IsS11Min=No	FrameElem=47	ElemStation=0.375				
Frame=47	Station=0.375	OutputCase=ENVE	CaseType=Combination	StepType=Max	Point=4	X2=0.5	X3=0.5	
S11=1409.09924635231	IsS11Max=No	IsS11Min=No	FrameElem=47	ElemStation=0.375				
Frame=47	Station=0.5	OutputCase=ENVE	CaseType=Combination	StepType=Max	Point=0	X2=0	X3=0	S11=-
274.637838986977	IsS11Max=No	IsS11Min=No	FrameElem=47	ElemStation=0.5				
Frame=47	Station=0.5	OutputCase=ENVE	CaseType=Combination	StepType=Max	Point=1	X2=-0.5	X3=-0.5	
S11=-1603.53794618841	IsS11Max=No	IsS11Min=Yes	FrameElem=47	ElemStation=0.5				
Frame=47	Station=0.5	OutputCase=ENVE	CaseType=Combination	StepType=Max	Point=2	X2=-0.5	X3=0.5	
S11=-1603.53794618841	IsS11Max=No	IsS11Min=No	FrameElem=47	ElemStation=0.5				
Frame=47	Station=0.5	OutputCase=ENVE	CaseType=Combination	StepType=Max	Point=3	X2=0.5	X3=-0.5	
S11=1092.7693203371	IsS11Max=Yes	IsS11Min=No	FrameElem=47	ElemStation=0.5				
Frame=47	Station=0.5	OutputCase=ENVE	CaseType=Combination	StepType=Max	Point=4	X2=0.5	X3=0.5	
S11=1092.7693203371	IsS11Max=No	IsS11Min=No	FrameElem=47	ElemStation=0.5				
Frame=47	Station=0	OutputCase=ENVE	CaseType=Combination	StepType=Min	Point=0	X2=0	X3=0	S11=-
386.541953115295	IsS11Max=No	IsS11Min=No	FrameElem=47	ElemStation=0				
Frame=47	Station=0	OutputCase=ENVE	CaseType=Combination	StepType=Min	Point=1	X2=-0.5	X3=-0.5	
S11=-2921.42720237189	IsS11Max=No	IsS11Min=Yes	FrameElem=47	ElemStation=0				
Frame=47	Station=0	OutputCase=ENVE	CaseType=Combination	StepType=Min	Point=2	X2=-0.5	X3=0.5	S11=-
2921.42720237189	IsS11Max=No	IsS11Min=No	FrameElem=47	ElemStation=0				
Frame=47	Station=0	OutputCase=ENVE	CaseType=Combination	StepType=Min	Point=3	X2=0.5	X3=-0.5	
S11=2110.49033083452	IsS11Max=Yes	IsS11Min=No	FrameElem=47	ElemStation=0				
Frame=47	Station=0	OutputCase=ENVE	CaseType=Combination	StepType=Min	Point=4	X2=0.5	X3=0.5	
S11=2110.49033083452	IsS11Max=No	IsS11Min=No	FrameElem=47	ElemStation=0				
Frame=47	Station=0.125	OutputCase=ENVE	CaseType=Combination	StepType=Min	Point=0	X2=0	X3=0	S11=-
386.541953115295	IsS11Max=No	IsS11Min=No	FrameElem=47	ElemStation=0.125				
Frame=47	Station=0.125	OutputCase=ENVE	CaseType=Combination	StepType=Min	Point=1	X2=-0.5	X3=-0.5	
S11=-2598.06602635668	IsS11Max=No	IsS11Min=Yes	FrameElem=47	ElemStation=0.125				
Frame=47	Station=0.125	OutputCase=ENVE	CaseType=Combination	StepType=Min	Point=2	X2=-0.5	X3=0.5	
S11=-2598.06602635668	IsS11Max=No	IsS11Min=No	FrameElem=47	ElemStation=0.125				
Frame=47	Station=0.125	OutputCase=ENVE	CaseType=Combination	StepType=Min	Point=3	X2=0.5	X3=-0.5	
S11=1786.96563311535	IsS11Max=Yes	IsS11Min=No	FrameElem=47	ElemStation=0.125				
Frame=47	Station=0.125	OutputCase=ENVE	CaseType=Combination	StepType=Min	Point=4	X2=0.5	X3=0.5	
S11=1786.96563311535	IsS11Max=No	IsS11Min=No	FrameElem=47	ElemStation=0.125				
Frame=47	Station=0.25	OutputCase=ENVE	CaseType=Combination	StepType=Min	Point=0	X2=0	X3=0	S11=-
386.541953115295	IsS11Max=No	IsS11Min=No	FrameElem=47	ElemStation=0.25				
Frame=47	Station=0.25	OutputCase=ENVE	CaseType=Combination	StepType=Min	Point=1	X2=-0.5	X3=-0.5	
S11=-2277.04860034147	IsS11Max=No	IsS11Min=Yes	FrameElem=47	ElemStation=0.25				
Frame=47	Station=0.25	OutputCase=ENVE	CaseType=Combination	StepType=Min	Point=2	X2=-0.5	X3=0.5	
S11=-2277.04860034147	IsS11Max=No	IsS11Min=No	FrameElem=47	ElemStation=0.25				
Frame=47	Station=0.25	OutputCase=ENVE	CaseType=Combination	StepType=Min	Point=3	X2=0.5	X3=-0.5	
S11=1465.78468539617	IsS11Max=Yes	IsS11Min=No	FrameElem=47	ElemStation=0.25				
Frame=47	Station=0.25	OutputCase=ENVE	CaseType=Combination	StepType=Min	Point=4	X2=0.5	X3=0.5	
S11=1465.78468539617	IsS11Max=No	IsS11Min=No	FrameElem=47	ElemStation=0.25				
Frame=47	Station=0.375	OutputCase=ENVE	CaseType=Combination	StepType=Min	Point=0	X2=0	X3=0	S11=-
386.541953115295	IsS11Max=No	IsS11Min=No	FrameElem=47	ElemStation=0.375				
Frame=47	Station=0.375	OutputCase=ENVE	CaseType=Combination	StepType=Min	Point=1	X2=-0.5	X3=-0.5	
S11=-1958.37492432627	IsS11Max=No	IsS11Min=Yes	FrameElem=47	ElemStation=0.375				
Frame=47	Station=0.375	OutputCase=ENVE	CaseType=Combination	StepType=Min	Point=2	X2=-0.5	X3=0.5	
S11=-1958.37492432627	IsS11Max=No	IsS11Min=No	FrameElem=47	ElemStation=0.375				
Frame=47	Station=0.375	OutputCase=ENVE	CaseType=Combination	StepType=Min	Point=3	X2=0.5	X3=-0.5	
S11=1146.947487677	IsS11Max=Yes	IsS11Min=No	FrameElem=47	ElemStation=0.375				
Frame=47	Station=0.375	OutputCase=ENVE	CaseType=Combination	StepType=Min	Point=4	X2=0.5	X3=0.5	
S11=1146.947487677	IsS11Max=No	IsS11Min=No	FrameElem=47	ElemStation=0.375				
Frame=47	Station=0.5	OutputCase=ENVE	CaseType=Combination	StepType=Min	Point=0	X2=0	X3=0	S11=-
386.541953115295	IsS11Max=No	IsS11Min=No	FrameElem=47	ElemStation=0.5				
Frame=47	Station=0.5	OutputCase=ENVE	CaseType=Combination	StepType=Min	Point=1	X2=-0.5	X3=-0.5	
S11=-1642.04499831106	IsS11Max=No	IsS11Min=Yes	FrameElem=47	ElemStation=0.5				
Frame=47	Station=0.5	OutputCase=ENVE	CaseType=Combination	StepType=Min	Point=2	X2=-0.5	X3=0.5	
S11=-1642.04499831106	IsS11Max=No	IsS11Min=No	FrameElem=47	ElemStation=0.5				
Frame=47	Station=0.5	OutputCase=ENVE	CaseType=Combination	StepType=Min	Point=3	X2=0.5	X3=-0.5	
S11=830.45403995782	IsS11Max=Yes	IsS11Min=No	FrameElem=47	ElemStation=0.5				

Frame=47 Station=0.5 OutputCase=ENVE CaseType=Combination StepType=Min Point=4 X2=0.5 X3=0.5
 S11=830.45403995782 IsS11Max=No IsS11Min=No FrameElem=47 ElemStation=0.5
 Frame=47 Station=0 OutputCase=FESSUR CaseType=Combination Point=0 X2=0 X3=0 S11=-386.541953115295
 IsS11Max=No IsS11Min=No FrameElem=47 ElemStation=0
 Frame=47 Station=0 OutputCase=FESSUR CaseType=Combination Point=1 X2=-0.5 X3=-0.5 S11=-
 2883.57423706511 IsS11Max=No IsS11Min=Yes FrameElem=47 ElemStation=0
 Frame=47 Station=0 OutputCase=FESSUR CaseType=Combination Point=2 X2=-0.5 X3=0.5 S11=-
 2883.57423706511 IsS11Max=No IsS11Min=No FrameElem=47 ElemStation=0
 Frame=47 Station=0 OutputCase=FESSUR CaseType=Combination Point=3 X2=0.5 X3=-0.5
 S11=2110.49033083452 IsS11Max=Yes IsS11Min=No FrameElem=47 ElemStation=0
 Frame=47 Station=0 OutputCase=FESSUR CaseType=Combination Point=4 X2=0.5 X3=0.5
 S11=2110.49033083452 IsS11Max=No IsS11Min=No FrameElem=47 ElemStation=0
 Frame=47 Station=0.125 OutputCase=FESSUR CaseType=Combination Point=0 X2=0 X3=0 S11=-
 386.541953115295 IsS11Max=No IsS11Min=No FrameElem=47 ElemStation=0.125
 Frame=47 Station=0.125 OutputCase=FESSUR CaseType=Combination Point=1 X2=-0.5 X3=-0.5 S11=-
 2560.04953934594 IsS11Max=No IsS11Min=Yes FrameElem=47 ElemStation=0.125
 Frame=47 Station=0.125 OutputCase=FESSUR CaseType=Combination Point=2 X2=-0.5 X3=0.5 S11=-
 2560.04953934594 IsS11Max=No IsS11Min=No FrameElem=47 ElemStation=0.125
 Frame=47 Station=0.125 OutputCase=FESSUR CaseType=Combination Point=3 X2=0.5 X3=-0.5
 S11=1786.96563311535 IsS11Max=Yes IsS11Min=No FrameElem=47 ElemStation=0.125
 Frame=47 Station=0.125 OutputCase=FESSUR CaseType=Combination Point=4 X2=0.5 X3=0.5
 S11=1786.96563311535 IsS11Max=No IsS11Min=No FrameElem=47 ElemStation=0.125
 Frame=47 Station=0.25 OutputCase=FESSUR CaseType=Combination Point=0 X2=0 X3=0 S11=-
 386.541953115295 IsS11Max=No IsS11Min=No FrameElem=47 ElemStation=0.25
 Frame=47 Station=0.25 OutputCase=FESSUR CaseType=Combination Point=1 X2=-0.5 X3=-0.5 S11=-
 2238.86859162676 IsS11Max=No IsS11Min=Yes FrameElem=47 ElemStation=0.25
 Frame=47 Station=0.25 OutputCase=FESSUR CaseType=Combination Point=2 X2=-0.5 X3=0.5 S11=-
 2238.86859162676 IsS11Max=No IsS11Min=No FrameElem=47 ElemStation=0.25
 Frame=47 Station=0.25 OutputCase=FESSUR CaseType=Combination Point=3 X2=0.5 X3=-0.5
 S11=1465.78468539617 IsS11Max=Yes IsS11Min=No FrameElem=47 ElemStation=0.25
 Frame=47 Station=0.25 OutputCase=FESSUR CaseType=Combination Point=4 X2=0.5 X3=0.5
 S11=1465.78468539617 IsS11Max=No IsS11Min=No FrameElem=47 ElemStation=0.25
 Frame=47 Station=0.375 OutputCase=FESSUR CaseType=Combination Point=0 X2=0 X3=0 S11=-
 386.541953115295 IsS11Max=No IsS11Min=No FrameElem=47 ElemStation=0.375
 Frame=47 Station=0.375 OutputCase=FESSUR CaseType=Combination Point=1 X2=-0.5 X3=-0.5 S11=-
 1920.03139390758 IsS11Max=No IsS11Min=Yes FrameElem=47 ElemStation=0.375
 Frame=47 Station=0.375 OutputCase=FESSUR CaseType=Combination Point=2 X2=-0.5 X3=0.5 S11=-
 1920.03139390758 IsS11Max=No IsS11Min=No FrameElem=47 ElemStation=0.375
 Frame=47 Station=0.375 OutputCase=FESSUR CaseType=Combination Point=3 X2=0.5 X3=-0.5
 S11=1146.947487677 IsS11Max=Yes IsS11Min=No FrameElem=47 ElemStation=0.375
 Frame=47 Station=0.375 OutputCase=FESSUR CaseType=Combination Point=4 X2=0.5 X3=0.5
 S11=1146.947487677 IsS11Max=No IsS11Min=No FrameElem=47 ElemStation=0.375
 Frame=47 Station=0.5 OutputCase=FESSUR CaseType=Combination Point=0 X2=0 X3=0 S11=-386.541953115295
 IsS11Max=No IsS11Min=No FrameElem=47 ElemStation=0.5
 Frame=47 Station=0.5 OutputCase=FESSUR CaseType=Combination Point=1 X2=-0.5 X3=-0.5 S11=-
 1603.53794618841 IsS11Max=No IsS11Min=Yes FrameElem=47 ElemStation=0.5
 Frame=47 Station=0.5 OutputCase=FESSUR CaseType=Combination Point=2 X2=-0.5 X3=0.5 S11=-
 1603.53794618841 IsS11Max=No IsS11Min=No FrameElem=47 ElemStation=0.5
 Frame=47 Station=0.5 OutputCase=FESSUR CaseType=Combination Point=3 X2=0.5 X3=-0.5
 S11=830.45403995782 IsS11Max=Yes IsS11Min=No FrameElem=47 ElemStation=0.5
 Frame=47 Station=0.5 OutputCase=FESSUR CaseType=Combination Point=4 X2=0.5 X3=0.5
 S11=830.45403995782 IsS11Max=No IsS11Min=No FrameElem=47 ElemStation=0.5
 Frame=48 Station=0 OutputCase=PESOPR CaseType=LinStatic Point=0 X2=0 X3=0 S11=-15.1709467361872
 IsS11Max=No IsS11Min=No FrameElem=48 ElemStation=0
 Frame=48 Station=0 OutputCase=PESOPR CaseType=LinStatic Point=1 X2=-0.5 X3=-0.5 S11=-
 300.934812252723 IsS11Max=No IsS11Min=Yes FrameElem=48 ElemStation=0
 Frame=48 Station=0 OutputCase=PESOPR CaseType=LinStatic Point=2 X2=-0.5 X3=0.5 S11=-
 300.934812252723 IsS11Max=No IsS11Min=No FrameElem=48 ElemStation=0
 Frame=48 Station=0 OutputCase=PESOPR CaseType=LinStatic Point=3 X2=0.5 X3=-0.5 S11=270.592918780348
 IsS11Max=Yes IsS11Min=No FrameElem=48 ElemStation=0
 Frame=48 Station=0 OutputCase=PESOPR CaseType=LinStatic Point=4 X2=0.5 X3=0.5 S11=270.592918780348
 IsS11Max=No IsS11Min=No FrameElem=48 ElemStation=0
 Frame=48 Station=0.125 OutputCase=PESOPR CaseType=LinStatic Point=0 X2=0 X3=0 S11=-15.1709467361872
 IsS11Max=No IsS11Min=No FrameElem=48 ElemStation=0.125
 Frame=48 Station=0.125 OutputCase=PESOPR CaseType=LinStatic Point=1 X2=-0.5 X3=-0.5 S11=-
 212.756415249674 IsS11Max=No IsS11Min=Yes FrameElem=48 ElemStation=0.125
 Frame=48 Station=0.125 OutputCase=PESOPR CaseType=LinStatic Point=2 X2=-0.5 X3=0.5 S11=-
 212.756415249674 IsS11Max=No IsS11Min=No FrameElem=48 ElemStation=0.125
 Frame=48 Station=0.125 OutputCase=PESOPR CaseType=LinStatic Point=3 X2=0.5 X3=-0.5
 S11=182.4145217773 IsS11Max=Yes IsS11Min=No FrameElem=48 ElemStation=0.125
 Frame=48 Station=0.125 OutputCase=PESOPR CaseType=LinStatic Point=4 X2=0.5 X3=0.5
 S11=182.4145217773 IsS11Max=No IsS11Min=No FrameElem=48 ElemStation=0.125
 Frame=48 Station=0.25 OutputCase=PESOPR CaseType=LinStatic Point=0 X2=0 X3=0 S11=-15.1709467361872
 IsS11Max=No IsS11Min=No FrameElem=48 ElemStation=0.25
 Frame=48 Station=0.25 OutputCase=PESOPR CaseType=LinStatic Point=1 X2=-0.5 X3=-0.5 S11=-
 126.921768246626 IsS11Max=No IsS11Min=Yes FrameElem=48 ElemStation=0.25
 Frame=48 Station=0.25 OutputCase=PESOPR CaseType=LinStatic Point=2 X2=-0.5 X3=0.5 S11=-
 126.921768246626 IsS11Max=No IsS11Min=No FrameElem=48 ElemStation=0.25
 Frame=48 Station=0.25 OutputCase=PESOPR CaseType=LinStatic Point=3 X2=0.5 X3=-0.5
 S11=96.5798747742518 IsS11Max=Yes IsS11Min=No FrameElem=48 ElemStation=0.25
 Frame=48 Station=0.25 OutputCase=PESOPR CaseType=LinStatic Point=4 X2=0.5 X3=0.5
 S11=96.5798747742518 IsS11Max=No IsS11Min=No FrameElem=48 ElemStation=0.25

Frame=48	Station=0.375	OutputCase=PESOPR	CaseType=LinStatic	Point=0	X2=0	X3=0	S11=-15.1709467361872
IsS11Max=No	IsS11Min=No	FrameElem=48	ElemStation=0.375				
Frame=48	Station=0.375	OutputCase=PESOPR	CaseType=LinStatic	Point=1	X2=-0.5	X3=-0.5	S11=-
43.4308712435778	IsS11Max=No	IsS11Min=Yes	FrameElem=48	ElemStation=0.375			
Frame=48	Station=0.375	OutputCase=PESOPR	CaseType=LinStatic	Point=2	X2=-0.5	X3=0.5	S11=-
43.4308712435778	IsS11Max=No	IsS11Min=No	FrameElem=48	ElemStation=0.375			
Frame=48	Station=0.375	OutputCase=PESOPR	CaseType=LinStatic	Point=3	X2=0.5	X3=-0.5	
S11=13.0889777712035	IsS11Max=Yes	IsS11Min=No	FrameElem=48	ElemStation=0.375			
Frame=48	Station=0.375	OutputCase=PESOPR	CaseType=LinStatic	Point=4	X2=0.5	X3=0.5	
S11=13.0889777712035	IsS11Max=No	IsS11Min=No	FrameElem=48	ElemStation=0.375			
Frame=48	Station=0.5	OutputCase=PESOPR	CaseType=LinStatic	Point=0	X2=0	X3=0	S11=-15.1709467361872
IsS11Max=No	IsS11Min=No	FrameElem=48	ElemStation=0.5				
Frame=48	Station=0.5	OutputCase=PESOPR	CaseType=LinStatic	Point=1	X2=-0.5	X3=-0.5	
S11=37.7162757594705	IsS11Max=Yes	IsS11Min=No	FrameElem=48	ElemStation=0.5			
Frame=48	Station=0.5	OutputCase=PESOPR	CaseType=LinStatic	Point=2	X2=-0.5	X3=0.5	
S11=37.7162757594705	IsS11Max=No	IsS11Min=No	FrameElem=48	ElemStation=0.5			
Frame=48	Station=0.5	OutputCase=PESOPR	CaseType=LinStatic	Point=3	X2=0.5	X3=-0.5	S11=-
68.0581692318448	IsS11Max=No	IsS11Min=Yes	FrameElem=48	ElemStation=0.5			
Frame=48	Station=0.5	OutputCase=PESOPR	CaseType=LinStatic	Point=4	X2=0.5	X3=0.5	S11=-
68.0581692318448	IsS11Max=No	IsS11Min=No	FrameElem=48	ElemStation=0.5			
Frame=48	Station=0	OutputCase=TERRVERT	CaseType=LinStatic	Point=0	X2=0	X3=0	S11=1.64270738195066
IsS11Max=No	IsS11Min=No	FrameElem=48	ElemStation=0				
Frame=48	Station=0	OutputCase=TERRVERT	CaseType=LinStatic	Point=1	X2=-0.5	X3=-0.5	S11=-
1430.95997434456	IsS11Max=No	IsS11Min=Yes	FrameElem=48	ElemStation=0			
Frame=48	Station=0	OutputCase=TERRVERT	CaseType=LinStatic	Point=2	X2=-0.5	X3=0.5	S11=-
1430.95997434456	IsS11Max=No	IsS11Min=No	FrameElem=48	ElemStation=0			
Frame=48	Station=0	OutputCase=TERRVERT	CaseType=LinStatic	Point=3	X2=0.5	X3=-0.5	
S11=1434.24538910846	IsS11Max=Yes	IsS11Min=No	FrameElem=48	ElemStation=0			
Frame=48	Station=0	OutputCase=TERRVERT	CaseType=LinStatic	Point=4	X2=0.5	X3=0.5	
S11=1434.24538910846	IsS11Max=No	IsS11Min=No	FrameElem=48	ElemStation=0			
Frame=48	Station=0.125	OutputCase=TERRVERT	CaseType=LinStatic	Point=0	X2=0	X3=0	
S11=1.64270738195066	IsS11Max=No	IsS11Min=No	FrameElem=48	ElemStation=0.125			
Frame=48	Station=0.125	OutputCase=TERRVERT	CaseType=LinStatic	Point=1	X2=-0.5	X3=-0.5	S11=-
1066.48503082264	IsS11Max=No	IsS11Min=Yes	FrameElem=48	ElemStation=0.125			
Frame=48	Station=0.125	OutputCase=TERRVERT	CaseType=LinStatic	Point=2	X2=-0.5	X3=0.5	S11=-
1066.48503082264	IsS11Max=No	IsS11Min=No	FrameElem=48	ElemStation=0.125			
Frame=48	Station=0.125	OutputCase=TERRVERT	CaseType=LinStatic	Point=3	X2=0.5	X3=-0.5	
S11=1069.77044558655	IsS11Max=Yes	IsS11Min=No	FrameElem=48	ElemStation=0.125			
Frame=48	Station=0.125	OutputCase=TERRVERT	CaseType=LinStatic	Point=4	X2=0.5	X3=0.5	
S11=1069.77044558655	IsS11Max=No	IsS11Min=No	FrameElem=48	ElemStation=0.125			
Frame=48	Station=0.25	OutputCase=TERRVERT	CaseType=LinStatic	Point=0	X2=0	X3=0	S11=1.64270738195066
IsS11Max=No	IsS11Min=No	FrameElem=48	ElemStation=0.25				
Frame=48	Station=0.25	OutputCase=TERRVERT	CaseType=LinStatic	Point=1	X2=-0.5	X3=-0.5	S11=-
702.010087300732	IsS11Max=No	IsS11Min=Yes	FrameElem=48	ElemStation=0.25			
Frame=48	Station=0.25	OutputCase=TERRVERT	CaseType=LinStatic	Point=2	X2=-0.5	X3=0.5	S11=-
702.010087300732	IsS11Max=No	IsS11Min=No	FrameElem=48	ElemStation=0.25			
Frame=48	Station=0.25	OutputCase=TERRVERT	CaseType=LinStatic	Point=3	X2=0.5	X3=-0.5	
S11=705.295502064633	IsS11Max=Yes	IsS11Min=No	FrameElem=48	ElemStation=0.25			
Frame=48	Station=0.25	OutputCase=TERRVERT	CaseType=LinStatic	Point=4	X2=0.5	X3=0.5	
S11=705.295502064633	IsS11Max=No	IsS11Min=No	FrameElem=48	ElemStation=0.25			
Frame=48	Station=0.375	OutputCase=TERRVERT	CaseType=LinStatic	Point=0	X2=0	X3=0	
S11=1.64270738195066	IsS11Max=No	IsS11Min=No	FrameElem=48	ElemStation=0.375			
Frame=48	Station=0.375	OutputCase=TERRVERT	CaseType=LinStatic	Point=1	X2=-0.5	X3=-0.5	S11=-
337.535143778819	IsS11Max=No	IsS11Min=Yes	FrameElem=48	ElemStation=0.375			
Frame=48	Station=0.375	OutputCase=TERRVERT	CaseType=LinStatic	Point=2	X2=-0.5	X3=0.5	S11=-
337.535143778819	IsS11Max=No	IsS11Min=No	FrameElem=48	ElemStation=0.375			
Frame=48	Station=0.375	OutputCase=TERRVERT	CaseType=LinStatic	Point=3	X2=0.5	X3=-0.5	
S11=340.820558542721	IsS11Max=Yes	IsS11Min=No	FrameElem=48	ElemStation=0.375			
Frame=48	Station=0.375	OutputCase=TERRVERT	CaseType=LinStatic	Point=4	X2=0.5	X3=0.5	
S11=340.820558542721	IsS11Max=No	IsS11Min=No	FrameElem=48	ElemStation=0.375			
Frame=48	Station=0.5	OutputCase=TERRVERT	CaseType=LinStatic	Point=0	X2=0	X3=0	S11=1.64270738195066
IsS11Max=No	IsS11Min=No	FrameElem=48	ElemStation=0.5				
Frame=48	Station=0.5	OutputCase=TERRVERT	CaseType=LinStatic	Point=1	X2=-0.5	X3=-0.5	
S11=26.9397997430935	IsS11Max=Yes	IsS11Min=No	FrameElem=48	ElemStation=0.5			
Frame=48	Station=0.5	OutputCase=TERRVERT	CaseType=LinStatic	Point=2	X2=-0.5	X3=0.5	
S11=26.9397997430935	IsS11Max=No	IsS11Min=No	FrameElem=48	ElemStation=0.5			
Frame=48	Station=0.5	OutputCase=TERRVERT	CaseType=LinStatic	Point=3	X2=0.5	X3=-0.5	S11=-
23.6543849791922	IsS11Max=No	IsS11Min=Yes	FrameElem=48	ElemStation=0.5			
Frame=48	Station=0.5	OutputCase=TERRVERT	CaseType=LinStatic	Point=4	X2=0.5	X3=0.5	S11=-
23.6543849791922	IsS11Max=No	IsS11Min=No	FrameElem=48	ElemStation=0.5			
Frame=48	Station=0	OutputCase=TERRLAT	CaseType=LinStatic	Point=0	X2=0	X3=0	S11=-373.013713761059
IsS11Max=No	IsS11Min=No	FrameElem=48	ElemStation=0				
Frame=48	Station=0	OutputCase=TERRLAT	CaseType=LinStatic	Point=1	X2=-0.5	X3=-0.5	
S11=128.356840408827	IsS11Max=Yes	IsS11Min=No	FrameElem=48	ElemStation=0			
Frame=48	Station=0	OutputCase=TERRLAT	CaseType=LinStatic	Point=2	X2=-0.5	X3=0.5	
S11=128.356840408827	IsS11Max=No	IsS11Min=No	FrameElem=48	ElemStation=0			
Frame=48	Station=0	OutputCase=TERRLAT	CaseType=LinStatic	Point=3	X2=0.5	X3=-0.5	S11=-
874.384267930944	IsS11Max=No	IsS11Min=Yes	FrameElem=48	ElemStation=0			
Frame=48	Station=0	OutputCase=TERRLAT	CaseType=LinStatic	Point=4	X2=0.5	X3=0.5	S11=-
874.384267930944	IsS11Max=No	IsS11Min=No	FrameElem=48	ElemStation=0			
Frame=48	Station=0.125	OutputCase=TERRLAT	CaseType=LinStatic	Point=0	X2=0	X3=0	S11=-
373.013713761059	IsS11Max=No	IsS11Min=No	FrameElem=48	ElemStation=0.125			

Frame=48	Station=0.125	OutputCase=TERRLAT	CaseType=LinStatic	Point=1	X2=-0.5	X3=-0.5		
S11=128.884608026934	IsS11Max=Yes	IsS11Min=No	FrameElem=48	ElemStation=0.125				
Frame=48	Station=0.125	OutputCase=TERRLAT	CaseType=LinStatic	Point=2	X2=-0.5	X3=0.5		
S11=128.884608026934	IsS11Max=No	IsS11Min=No	FrameElem=48	ElemStation=0.125				
Frame=48	Station=0.125	OutputCase=TERRLAT	CaseType=LinStatic	Point=3	X2=0.5	X3=-0.5	S11=-	
874.912035549051	IsS11Max=No	IsS11Min=Yes	FrameElem=48	ElemStation=0.125				
Frame=48	Station=0.125	OutputCase=TERRLAT	CaseType=LinStatic	Point=4	X2=0.5	X3=0.5	S11=-	
874.912035549051	IsS11Max=No	IsS11Min=No	FrameElem=48	ElemStation=0.125				
Frame=48	Station=0.25	OutputCase=TERRLAT	CaseType=LinStatic	Point=0	X2=0	X3=0	S11=-373.013713761059	
IsS11Max=No	IsS11Min=No	FrameElem=48	ElemStation=0.25					
Frame=48	Station=0.25	OutputCase=TERRLAT	CaseType=LinStatic	Point=1	X2=-0.5	X3=-0.5		
S11=129.41237564504	IsS11Max=Yes	IsS11Min=No	FrameElem=48	ElemStation=0.25				
Frame=48	Station=0.25	OutputCase=TERRLAT	CaseType=LinStatic	Point=2	X2=-0.5	X3=0.5		
S11=129.41237564504	IsS11Max=No	IsS11Min=No	FrameElem=48	ElemStation=0.25				
Frame=48	Station=0.25	OutputCase=TERRLAT	CaseType=LinStatic	Point=3	X2=0.5	X3=-0.5	S11=-	
875.439803167158	IsS11Max=No	IsS11Min=Yes	FrameElem=48	ElemStation=0.25				
Frame=48	Station=0.25	OutputCase=TERRLAT	CaseType=LinStatic	Point=4	X2=0.5	X3=0.5	S11=-	
875.439803167158	IsS11Max=No	IsS11Min=No	FrameElem=48	ElemStation=0.25				
Frame=48	Station=0.375	OutputCase=TERRLAT	CaseType=LinStatic	Point=0	X2=0	X3=0	S11=-	
373.013713761059	IsS11Max=No	IsS11Min=No	FrameElem=48	ElemStation=0.375				
Frame=48	Station=0.375	OutputCase=TERRLAT	CaseType=LinStatic	Point=1	X2=-0.5	X3=-0.5		
S11=129.940143263147	IsS11Max=Yes	IsS11Min=No	FrameElem=48	ElemStation=0.375				
Frame=48	Station=0.375	OutputCase=TERRLAT	CaseType=LinStatic	Point=2	X2=-0.5	X3=0.5		
S11=129.940143263147	IsS11Max=No	IsS11Min=No	FrameElem=48	ElemStation=0.375				
Frame=48	Station=0.375	OutputCase=TERRLAT	CaseType=LinStatic	Point=3	X2=0.5	X3=-0.5	S11=-	
875.967570785264	IsS11Max=No	IsS11Min=Yes	FrameElem=48	ElemStation=0.375				
Frame=48	Station=0.375	OutputCase=TERRLAT	CaseType=LinStatic	Point=4	X2=0.5	X3=0.5	S11=-	
875.967570785264	IsS11Max=No	IsS11Min=No	FrameElem=48	ElemStation=0.375				
Frame=48	Station=0.5	OutputCase=TERRLAT	CaseType=LinStatic	Point=0	X2=0	X3=0	S11=-373.013713761059	
IsS11Max=No	IsS11Min=No	FrameElem=48	ElemStation=0.5					
Frame=48	Station=0.5	OutputCase=TERRLAT	CaseType=LinStatic	Point=1	X2=-0.5	X3=-0.5		
S11=130.467910881254	IsS11Max=Yes	IsS11Min=No	FrameElem=48	ElemStation=0.5				
Frame=48	Station=0.5	OutputCase=TERRLAT	CaseType=LinStatic	Point=2	X2=-0.5	X3=0.5		
S11=130.467910881254	IsS11Max=No	IsS11Min=No	FrameElem=48	ElemStation=0.5				
Frame=48	Station=0.5	OutputCase=TERRLAT	CaseType=LinStatic	Point=3	X2=0.5	X3=-0.5	S11=-	
876.495338403371	IsS11Max=No	IsS11Min=Yes	FrameElem=48	ElemStation=0.5				
Frame=48	Station=0.5	OutputCase=TERRLAT	CaseType=LinStatic	Point=4	X2=0.5	X3=0.5	S11=-	
876.495338403371	IsS11Max=No	IsS11Min=No	FrameElem=48	ElemStation=0.5				
Frame=48	Station=0	OutputCase=ACCVERT	CaseType=LinStatic	Point=0	X2=0	X3=0	S11=0	IsS11Max=Yes
IsS11Min=Yes	FrameElem=48	ElemStation=0						
Frame=48	Station=0	OutputCase=ACCVERT	CaseType=LinStatic	Point=1	X2=-0.5	X3=-0.5	S11=0	
IsS11Max=No	IsS11Min=No	FrameElem=48	ElemStation=0					
Frame=48	Station=0	OutputCase=ACCVERT	CaseType=LinStatic	Point=2	X2=-0.5	X3=0.5	S11=0	IsS11Max=No
IsS11Min=No	FrameElem=48	ElemStation=0						
Frame=48	Station=0	OutputCase=ACCVERT	CaseType=LinStatic	Point=3	X2=0.5	X3=-0.5	S11=0	IsS11Max=No
IsS11Min=No	FrameElem=48	ElemStation=0						
Frame=48	Station=0	OutputCase=ACCVERT	CaseType=LinStatic	Point=4	X2=0.5	X3=0.5	S11=0	IsS11Max=No
IsS11Min=No	FrameElem=48	ElemStation=0						
Frame=48	Station=0.125	OutputCase=ACCVERT	CaseType=LinStatic	Point=0	X2=0	X3=0	S11=0	IsS11Max=Yes
IsS11Min=Yes	FrameElem=48	ElemStation=0.125						
Frame=48	Station=0.125	OutputCase=ACCVERT	CaseType=LinStatic	Point=1	X2=-0.5	X3=-0.5	S11=0	
IsS11Max=No	IsS11Min=No	FrameElem=48	ElemStation=0.125					
Frame=48	Station=0.125	OutputCase=ACCVERT	CaseType=LinStatic	Point=2	X2=-0.5	X3=0.5	S11=0	
IsS11Max=No	IsS11Min=No	FrameElem=48	ElemStation=0.125					
Frame=48	Station=0.125	OutputCase=ACCVERT	CaseType=LinStatic	Point=3	X2=0.5	X3=-0.5	S11=0	
IsS11Max=No	IsS11Min=No	FrameElem=48	ElemStation=0.125					
Frame=48	Station=0.125	OutputCase=ACCVERT	CaseType=LinStatic	Point=4	X2=0.5	X3=0.5	S11=0	
IsS11Max=No	IsS11Min=No	FrameElem=48	ElemStation=0.125					
Frame=48	Station=0.25	OutputCase=ACCVERT	CaseType=LinStatic	Point=0	X2=0	X3=0	S11=0	IsS11Max=Yes
IsS11Min=Yes	FrameElem=48	ElemStation=0.25						
Frame=48	Station=0.25	OutputCase=ACCVERT	CaseType=LinStatic	Point=1	X2=-0.5	X3=-0.5	S11=0	
IsS11Max=No	IsS11Min=No	FrameElem=48	ElemStation=0.25					
Frame=48	Station=0.25	OutputCase=ACCVERT	CaseType=LinStatic	Point=2	X2=-0.5	X3=0.5	S11=0	
IsS11Max=No	IsS11Min=No	FrameElem=48	ElemStation=0.25					
Frame=48	Station=0.25	OutputCase=ACCVERT	CaseType=LinStatic	Point=3	X2=0.5	X3=-0.5	S11=0	
IsS11Max=No	IsS11Min=No	FrameElem=48	ElemStation=0.25					
Frame=48	Station=0.25	OutputCase=ACCVERT	CaseType=LinStatic	Point=4	X2=0.5	X3=0.5	S11=0	
IsS11Max=No	IsS11Min=No	FrameElem=48	ElemStation=0.25					
Frame=48	Station=0.375	OutputCase=ACCVERT	CaseType=LinStatic	Point=0	X2=0	X3=0	S11=0	IsS11Max=Yes
IsS11Min=Yes	FrameElem=48	ElemStation=0.375						
Frame=48	Station=0.375	OutputCase=ACCVERT	CaseType=LinStatic	Point=1	X2=-0.5	X3=-0.5	S11=0	
IsS11Max=No	IsS11Min=No	FrameElem=48	ElemStation=0.375					
Frame=48	Station=0.375	OutputCase=ACCVERT	CaseType=LinStatic	Point=2	X2=-0.5	X3=0.5	S11=0	
IsS11Max=No	IsS11Min=No	FrameElem=48	ElemStation=0.375					
Frame=48	Station=0.375	OutputCase=ACCVERT	CaseType=LinStatic	Point=3	X2=0.5	X3=-0.5	S11=0	
IsS11Max=No	IsS11Min=No	FrameElem=48	ElemStation=0.375					
Frame=48	Station=0.375	OutputCase=ACCVERT	CaseType=LinStatic	Point=4	X2=0.5	X3=0.5	S11=0	
IsS11Max=No	IsS11Min=No	FrameElem=48	ElemStation=0.375					
Frame=48	Station=0.5	OutputCase=ACCVERT	CaseType=LinStatic	Point=0	X2=0	X3=0	S11=0	IsS11Max=Yes
IsS11Min=Yes	FrameElem=48	ElemStation=0.5						
Frame=48	Station=0.5	OutputCase=ACCVERT	CaseType=LinStatic	Point=1	X2=-0.5	X3=-0.5	S11=0	
IsS11Max=No	IsS11Min=No	FrameElem=48	ElemStation=0.5					



Frame=48	Station=0	OutputCase=SOVRCOST	CaseType=LinStatic	Point=4	X2=0.5	X3=0.5	S11=0	IsS11Max=No
IsS11Min=No	FrameElem=48	ElemStation=0						
Frame=48	Station=0.125	OutputCase=SOVRCOST	CaseType=LinStatic	Point=0	X2=0	X3=0	S11=0	
IsS11Max=Yes	IsS11Min=Yes	FrameElem=48	ElemStation=0.125					
Frame=48	Station=0.125	OutputCase=SOVRCOST	CaseType=LinStatic	Point=1	X2=-0.5	X3=-0.5	S11=0	
IsS11Max=No	IsS11Min=No	FrameElem=48	ElemStation=0.125					
Frame=48	Station=0.125	OutputCase=SOVRCOST	CaseType=LinStatic	Point=2	X2=-0.5	X3=0.5	S11=0	
IsS11Max=No	IsS11Min=No	FrameElem=48	ElemStation=0.125					
Frame=48	Station=0.125	OutputCase=SOVRCOST	CaseType=LinStatic	Point=3	X2=0.5	X3=-0.5	S11=0	
IsS11Max=No	IsS11Min=No	FrameElem=48	ElemStation=0.125					
Frame=48	Station=0.125	OutputCase=SOVRCOST	CaseType=LinStatic	Point=4	X2=0.5	X3=0.5	S11=0	
IsS11Max=No	IsS11Min=No	FrameElem=48	ElemStation=0.125					
Frame=48	Station=0.25	OutputCase=SOVRCOST	CaseType=LinStatic	Point=0	X2=0	X3=0	S11=0	IsS11Max=Yes
IsS11Min=Yes	FrameElem=48	ElemStation=0.25						
Frame=48	Station=0.25	OutputCase=SOVRCOST	CaseType=LinStatic	Point=1	X2=-0.5	X3=-0.5	S11=0	
IsS11Max=No	IsS11Min=No	FrameElem=48	ElemStation=0.25					
Frame=48	Station=0.25	OutputCase=SOVRCOST	CaseType=LinStatic	Point=2	X2=-0.5	X3=0.5	S11=0	
IsS11Max=No	IsS11Min=No	FrameElem=48	ElemStation=0.25					
Frame=48	Station=0.25	OutputCase=SOVRCOST	CaseType=LinStatic	Point=3	X2=0.5	X3=-0.5	S11=0	
IsS11Max=No	IsS11Min=No	FrameElem=48	ElemStation=0.25					
Frame=48	Station=0.25	OutputCase=SOVRCOST	CaseType=LinStatic	Point=4	X2=0.5	X3=0.5	S11=0	
IsS11Max=No	IsS11Min=No	FrameElem=48	ElemStation=0.25					
Frame=48	Station=0.375	OutputCase=SOVRCOST	CaseType=LinStatic	Point=0	X2=0	X3=0	S11=0	
IsS11Max=Yes	IsS11Min=Yes	FrameElem=48	ElemStation=0.375					
Frame=48	Station=0.375	OutputCase=SOVRCOST	CaseType=LinStatic	Point=1	X2=-0.5	X3=-0.5	S11=0	
IsS11Max=No	IsS11Min=No	FrameElem=48	ElemStation=0.375					
Frame=48	Station=0.375	OutputCase=SOVRCOST	CaseType=LinStatic	Point=2	X2=-0.5	X3=0.5	S11=0	
IsS11Max=No	IsS11Min=No	FrameElem=48	ElemStation=0.375					
Frame=48	Station=0.375	OutputCase=SOVRCOST	CaseType=LinStatic	Point=3	X2=0.5	X3=-0.5	S11=0	
IsS11Max=No	IsS11Min=No	FrameElem=48	ElemStation=0.375					
Frame=48	Station=0.375	OutputCase=SOVRCOST	CaseType=LinStatic	Point=4	X2=0.5	X3=0.5	S11=0	
IsS11Max=No	IsS11Min=No	FrameElem=48	ElemStation=0.375					
Frame=48	Station=0.5	OutputCase=SOVRCOST	CaseType=LinStatic	Point=0	X2=0	X3=0	S11=0	IsS11Max=Yes
IsS11Min=Yes	FrameElem=48	ElemStation=0.5						
Frame=48	Station=0.5	OutputCase=SOVRCOST	CaseType=LinStatic	Point=1	X2=-0.5	X3=-0.5	S11=0	
IsS11Max=No	IsS11Min=No	FrameElem=48	ElemStation=0.5					
Frame=48	Station=0.5	OutputCase=SOVRCOST	CaseType=LinStatic	Point=2	X2=-0.5	X3=0.5	S11=0	
IsS11Max=No	IsS11Min=No	FrameElem=48	ElemStation=0.5					
Frame=48	Station=0.5	OutputCase=SOVRCOST	CaseType=LinStatic	Point=3	X2=0.5	X3=-0.5	S11=0	
IsS11Max=No	IsS11Min=No	FrameElem=48	ElemStation=0.5					
Frame=48	Station=0.5	OutputCase=SOVRCOST	CaseType=LinStatic	Point=4	X2=0.5	X3=0.5	S11=0	
IsS11Max=No	IsS11Min=No	FrameElem=48	ElemStation=0.5					
Frame=48	Station=0	OutputCase=ENVE	CaseType=Combination	StepType=Max	Point=0	X2=0	X3=0	S11=-
274.637838986978	IsS11Max=No	IsS11Min=No	FrameElem=48	ElemStation=0				
Frame=48	Station=0	OutputCase=ENVE	CaseType=Combination	StepType=Max	Point=1	X2=-0.5	X3=-0.5	
S11=-1603.53794618845	IsS11Max=No	IsS11Min=Yes	FrameElem=48	ElemStation=0				
Frame=48	Station=0	OutputCase=ENVE	CaseType=Combination	StepType=Max	Point=2	X2=-0.5	X3=0.5	S11=-
1603.53794618845	IsS11Max=No	IsS11Min=No	FrameElem=48	ElemStation=0				
Frame=48	Station=0	OutputCase=ENVE	CaseType=Combination	StepType=Max	Point=3	X2=0.5	X3=-0.5	
S11=1092.76932033715	IsS11Max=Yes	IsS11Min=No	FrameElem=48	ElemStation=0				
Frame=48	Station=0	OutputCase=ENVE	CaseType=Combination	StepType=Max	Point=4	X2=0.5	X3=0.5	
S11=1092.76932033715	IsS11Max=No	IsS11Min=No	FrameElem=48	ElemStation=0				
Frame=48	Station=0.125	OutputCase=ENVE	CaseType=Combination	StepType=Max	Point=0	X2=0	X3=0	S11=-
274.637838986978	IsS11Max=No	IsS11Min=No	FrameElem=48	ElemStation=0.125				
Frame=48	Station=0.125	OutputCase=ENVE	CaseType=Combination	StepType=Max	Point=1	X2=-0.5	X3=-0.5	
S11=-1150.35683804539	IsS11Max=No	IsS11Min=Yes	FrameElem=48	ElemStation=0.125				
Frame=48	Station=0.125	OutputCase=ENVE	CaseType=Combination	StepType=Max	Point=2	X2=-0.5	X3=0.5	
S11=-1150.35683804539	IsS11Max=No	IsS11Min=No	FrameElem=48	ElemStation=0.125				
Frame=48	Station=0.125	OutputCase=ENVE	CaseType=Combination	StepType=Max	Point=3	X2=0.5	X3=-0.5	
S11=639.746542479511	IsS11Max=Yes	IsS11Min=No	FrameElem=48	ElemStation=0.125				
Frame=48	Station=0.125	OutputCase=ENVE	CaseType=Combination	StepType=Max	Point=4	X2=0.5	X3=0.5	
S11=639.746542479511	IsS11Max=No	IsS11Min=No	FrameElem=48	ElemStation=0.125				
Frame=48	Station=0.25	OutputCase=ENVE	CaseType=Combination	StepType=Max	Point=0	X2=0	X3=0	S11=-
274.637838986978	IsS11Max=No	IsS11Min=No	FrameElem=48	ElemStation=0.25				
Frame=48	Station=0.25	OutputCase=ENVE	CaseType=Combination	StepType=Max	Point=1	X2=-0.5	X3=-0.5	
S11=-699.519479902318	IsS11Max=No	IsS11Min=Yes	FrameElem=48	ElemStation=0.25				
Frame=48	Station=0.25	OutputCase=ENVE	CaseType=Combination	StepType=Max	Point=2	X2=-0.5	X3=0.5	
S11=-699.519479902318	IsS11Max=No	IsS11Min=No	FrameElem=48	ElemStation=0.25				
Frame=48	Station=0.25	OutputCase=ENVE	CaseType=Combination	StepType=Max	Point=3	X2=0.5	X3=-0.5	
S11=189.067514621875	IsS11Max=Yes	IsS11Min=No	FrameElem=48	ElemStation=0.25				
Frame=48	Station=0.25	OutputCase=ENVE	CaseType=Combination	StepType=Max	Point=4	X2=0.5	X3=0.5	
S11=189.067514621875	IsS11Max=No	IsS11Min=No	FrameElem=48	ElemStation=0.25				
Frame=48	Station=0.375	OutputCase=ENVE	CaseType=Combination	StepType=Max	Point=0	X2=0	X3=0	S11=-
274.637838986978	IsS11Max=No	IsS11Min=Yes	FrameElem=48	ElemStation=0.375				
Frame=48	Station=0.375	OutputCase=ENVE	CaseType=Combination	StepType=Max	Point=1	X2=-0.5	X3=-0.5	
S11=-251.02587175925	IsS11Max=Yes	IsS11Min=No	FrameElem=48	ElemStation=0.375				
Frame=48	Station=0.375	OutputCase=ENVE	CaseType=Combination	StepType=Max	Point=2	X2=-0.5	X3=0.5	
S11=-251.02587175925	IsS11Max=No	IsS11Min=No	FrameElem=48	ElemStation=0.375				
Frame=48	Station=0.375	OutputCase=ENVE	CaseType=Combination	StepType=Max	Point=3	X2=0.5	X3=-0.5	
S11=-259.267763235761	IsS11Max=No	IsS11Min=No	FrameElem=48	ElemStation=0.375				
Frame=48	Station=0.375	OutputCase=ENVE	CaseType=Combination	StepType=Max	Point=4	X2=0.5	X3=0.5	
S11=-259.267763235761	IsS11Max=No	IsS11Min=No	FrameElem=48	ElemStation=0.375				

Frame=48	Station=0.5	OutputCase=ENVE	CaseType=Combination	StepType=Max	Point=0	X2=0	X3=0	S11=-
274.637838986978	IsS11Max=No	IsS11Min=No	FrameElem=48	ElemStation=0.5				
Frame=48	Station=0.5	OutputCase=ENVE	CaseType=Combination	StepType=Max	Point=1	X2=-0.5	X3=-0.5	
S11=195.123986383818	IsS11Max=Yes	IsS11Min=No	FrameElem=48	ElemStation=0.5				
Frame=48	Station=0.5	OutputCase=ENVE	CaseType=Combination	StepType=Max	Point=2	X2=-0.5	X3=0.5	
S11=195.123986383818	IsS11Max=No	IsS11Min=No	FrameElem=48	ElemStation=0.5				
Frame=48	Station=0.5	OutputCase=ENVE	CaseType=Combination	StepType=Max	Point=3	X2=0.5	X3=-0.5	
S11=-705.259291093397	IsS11Max=No	IsS11Min=Yes	FrameElem=48	ElemStation=0.5				
Frame=48	Station=0.5	OutputCase=ENVE	CaseType=Combination	StepType=Max	Point=4	X2=0.5	X3=0.5	
S11=-705.259291093397	IsS11Max=No	IsS11Min=No	FrameElem=48	ElemStation=0.5				
Frame=48	Station=0	OutputCase=ENVE	CaseType=Combination	StepType=Min	Point=0	X2=0	X3=0	S11=-
386.541953115295	IsS11Max=No	IsS11Min=No	FrameElem=48	ElemStation=0				
Frame=48	Station=0	OutputCase=ENVE	CaseType=Combination	StepType=Min	Point=1	X2=-0.5	X3=-0.5	
S11=-1642.0449983111	IsS11Max=No	IsS11Min=Yes	FrameElem=48	ElemStation=0				
Frame=48	Station=0	OutputCase=ENVE	CaseType=Combination	StepType=Min	Point=2	X2=-0.5	X3=0.5	S11=-
1642.0449983111	IsS11Max=No	IsS11Min=No	FrameElem=48	ElemStation=0				
Frame=48	Station=0	OutputCase=ENVE	CaseType=Combination	StepType=Min	Point=3	X2=0.5	X3=-0.5	
S11=830.454039957863	IsS11Max=Yes	IsS11Min=No	FrameElem=48	ElemStation=0				
Frame=48	Station=0	OutputCase=ENVE	CaseType=Combination	StepType=Min	Point=4	X2=0.5	X3=0.5	
S11=830.454039957863	IsS11Max=No	IsS11Min=No	FrameElem=48	ElemStation=0				
Frame=48	Station=0.125	OutputCase=ENVE	CaseType=Combination	StepType=Min	Point=0	X2=0	X3=0	S11=-
386.541953115295	IsS11Max=No	IsS11Min=No	FrameElem=48	ElemStation=0.125				
Frame=48	Station=0.125	OutputCase=ENVE	CaseType=Combination	StepType=Min	Point=1	X2=-0.5	X3=-0.5	
S11=-1189.02222045347	IsS11Max=No	IsS11Min=Yes	FrameElem=48	ElemStation=0.125				
Frame=48	Station=0.125	OutputCase=ENVE	CaseType=Combination	StepType=Min	Point=2	X2=-0.5	X3=0.5	
S11=-1189.02222045347	IsS11Max=No	IsS11Min=No	FrameElem=48	ElemStation=0.125				
Frame=48	Station=0.125	OutputCase=ENVE	CaseType=Combination	StepType=Min	Point=3	X2=0.5	X3=-0.5	
S11=377.272931814795	IsS11Max=Yes	IsS11Min=No	FrameElem=48	ElemStation=0.125				
Frame=48	Station=0.125	OutputCase=ENVE	CaseType=Combination	StepType=Min	Point=4	X2=0.5	X3=0.5	
S11=377.272931814795	IsS11Max=No	IsS11Min=No	FrameElem=48	ElemStation=0.125				
Frame=48	Station=0.25	OutputCase=ENVE	CaseType=Combination	StepType=Min	Point=0	X2=0	X3=0	S11=-
386.541953115295	IsS11Max=No	IsS11Min=No	FrameElem=48	ElemStation=0.25				
Frame=48	Station=0.25	OutputCase=ENVE	CaseType=Combination	StepType=Min	Point=1	X2=-0.5	X3=-0.5	
S11=-738.34319259583	IsS11Max=No	IsS11Min=Yes	FrameElem=48	ElemStation=0.25				
Frame=48	Station=0.25	OutputCase=ENVE	CaseType=Combination	StepType=Min	Point=2	X2=-0.5	X3=0.5	
S11=-738.34319259583	IsS11Max=No	IsS11Min=No	FrameElem=48	ElemStation=0.25				
Frame=48	Station=0.25	OutputCase=ENVE	CaseType=Combination	StepType=Min	Point=3	X2=0.5	X3=-0.5	
S11=-73.5644263282725	IsS11Max=Yes	IsS11Min=No	FrameElem=48	ElemStation=0.25				
Frame=48	Station=0.25	OutputCase=ENVE	CaseType=Combination	StepType=Min	Point=4	X2=0.5	X3=0.5	
S11=-73.5644263282725	IsS11Max=No	IsS11Min=No	FrameElem=48	ElemStation=0.25				
Frame=48	Station=0.375	OutputCase=ENVE	CaseType=Combination	StepType=Min	Point=0	X2=0	X3=0	S11=-
386.541953115295	IsS11Max=No	IsS11Min=No	FrameElem=48	ElemStation=0.375				
Frame=48	Station=0.375	OutputCase=ENVE	CaseType=Combination	StepType=Min	Point=1	X2=-0.5	X3=-0.5	
S11=-290.007914738194	IsS11Max=Yes	IsS11Min=No	FrameElem=48	ElemStation=0.375				
Frame=48	Station=0.375	OutputCase=ENVE	CaseType=Combination	StepType=Min	Point=2	X2=-0.5	X3=0.5	
S11=-290.007914738194	IsS11Max=No	IsS11Min=No	FrameElem=48	ElemStation=0.375				
Frame=48	Station=0.375	OutputCase=ENVE	CaseType=Combination	StepType=Min	Point=3	X2=0.5	X3=-0.5	
S11=-522.05803447134	IsS11Max=No	IsS11Min=Yes	FrameElem=48	ElemStation=0.375				
Frame=48	Station=0.375	OutputCase=ENVE	CaseType=Combination	StepType=Min	Point=4	X2=0.5	X3=0.5	
S11=-522.05803447134	IsS11Max=No	IsS11Min=No	FrameElem=48	ElemStation=0.375				
Frame=48	Station=0.5	OutputCase=ENVE	CaseType=Combination	StepType=Min	Point=0	X2=0	X3=0	S11=-
386.541953115295	IsS11Max=No	IsS11Min=No	FrameElem=48	ElemStation=0.5				
Frame=48	Station=0.5	OutputCase=ENVE	CaseType=Combination	StepType=Min	Point=1	X2=-0.5	X3=-0.5	
S11=155.983613119442	IsS11Max=Yes	IsS11Min=No	FrameElem=48	ElemStation=0.5				
Frame=48	Station=0.5	OutputCase=ENVE	CaseType=Combination	StepType=Min	Point=2	X2=-0.5	X3=0.5	
S11=155.983613119442	IsS11Max=No	IsS11Min=No	FrameElem=48	ElemStation=0.5				
Frame=48	Station=0.5	OutputCase=ENVE	CaseType=Combination	StepType=Min	Point=3	X2=0.5	X3=-0.5	
S11=-968.207892614408	IsS11Max=No	IsS11Min=Yes	FrameElem=48	ElemStation=0.5				
Frame=48	Station=0.5	OutputCase=ENVE	CaseType=Combination	StepType=Min	Point=4	X2=0.5	X3=0.5	
S11=-968.207892614408	IsS11Max=No	IsS11Min=No	FrameElem=48	ElemStation=0.5				
Frame=48	Station=0	OutputCase=FESSUR	CaseType=Combination	Point=0	X2=0	X3=0	S11=-386.541953115295	
IsS11Max=No	IsS11Min=No	FrameElem=48	ElemStation=0					
Frame=48	Station=0	OutputCase=FESSUR	CaseType=Combination	Point=1	X2=-0.5	X3=-0.5	S11=-	
1603.53794618845	IsS11Max=No	IsS11Min=Yes	FrameElem=48	ElemStation=0				
Frame=48	Station=0	OutputCase=FESSUR	CaseType=Combination	Point=2	X2=-0.5	X3=0.5	S11=-	
1603.53794618845	IsS11Max=No	IsS11Min=No	FrameElem=48	ElemStation=0				
Frame=48	Station=0	OutputCase=FESSUR	CaseType=Combination	Point=3	X2=0.5	X3=-0.5		
S11=830.454039957863	IsS11Max=Yes	IsS11Min=No	FrameElem=48	ElemStation=0				
Frame=48	Station=0	OutputCase=FESSUR	CaseType=Combination	Point=4	X2=0.5	X3=0.5		
S11=830.454039957863	IsS11Max=No	IsS11Min=No	FrameElem=48	ElemStation=0				
Frame=48	Station=0.125	OutputCase=FESSUR	CaseType=Combination	Point=0	X2=0	X3=0	S11=-	
386.541953115295	IsS11Max=No	IsS11Min=No	FrameElem=48	ElemStation=0.125				
Frame=48	Station=0.125	OutputCase=FESSUR	CaseType=Combination	Point=1	X2=-0.5	X3=-0.5	S11=-	
1150.35683804539	IsS11Max=No	IsS11Min=Yes	FrameElem=48	ElemStation=0.125				
Frame=48	Station=0.125	OutputCase=FESSUR	CaseType=Combination	Point=2	X2=-0.5	X3=0.5	S11=-	
1150.35683804539	IsS11Max=No	IsS11Min=No	FrameElem=48	ElemStation=0.125				
Frame=48	Station=0.125	OutputCase=FESSUR	CaseType=Combination	Point=3	X2=0.5	X3=-0.5		
S11=377.272931814795	IsS11Max=Yes	IsS11Min=No	FrameElem=48	ElemStation=0.125				
Frame=48	Station=0.125	OutputCase=FESSUR	CaseType=Combination	Point=4	X2=0.5	X3=0.5		
S11=377.272931814795	IsS11Max=No	IsS11Min=No	FrameElem=48	ElemStation=0.125				
Frame=48	Station=0.25	OutputCase=FESSUR	CaseType=Combination	Point=0	X2=0	X3=0	S11=-	
386.541953115295	IsS11Max=No	IsS11Min=No	FrameElem=48	ElemStation=0.25				



Frame=48	Station=0.25	OutputCase=FESSUR	CaseType=Combination	Point=1	X2=-0.5	X3=-0.5	S11=-
699.519479902318	IsS11Max=No	IsS11Min=Yes	FrameElem=48	ElemStation=0.25			
Frame=48	Station=0.25	OutputCase=FESSUR	CaseType=Combination	Point=2	X2=-0.5	X3=0.5	S11=-
699.519479902318	IsS11Max=No	IsS11Min=No	FrameElem=48	ElemStation=0.25			
Frame=48	Station=0.25	OutputCase=FESSUR	CaseType=Combination	Point=3	X2=0.5	X3=-0.5	S11=-
73.5644263282725	IsS11Max=Yes	IsS11Min=No	FrameElem=48	ElemStation=0.25			
Frame=48	Station=0.25	OutputCase=FESSUR	CaseType=Combination	Point=4	X2=0.5	X3=0.5	S11=-
73.5644263282725	IsS11Max=No	IsS11Min=No	FrameElem=48	ElemStation=0.25			
Frame=48	Station=0.375	OutputCase=FESSUR	CaseType=Combination	Point=0	X2=0	X3=0	S11=-
386.541953115295	IsS11Max=No	IsS11Min=No	FrameElem=48	ElemStation=0.375			
Frame=48	Station=0.375	OutputCase=FESSUR	CaseType=Combination	Point=1	X2=-0.5	X3=-0.5	S11=-
251.02587175925	IsS11Max=Yes	IsS11Min=No	FrameElem=48	ElemStation=0.375			
Frame=48	Station=0.375	OutputCase=FESSUR	CaseType=Combination	Point=2	X2=-0.5	X3=0.5	S11=-
251.02587175925	IsS11Max=No	IsS11Min=No	FrameElem=48	ElemStation=0.375			
Frame=48	Station=0.375	OutputCase=FESSUR	CaseType=Combination	Point=3	X2=0.5	X3=-0.5	S11=-
522.05803447134	IsS11Max=No	IsS11Min=Yes	FrameElem=48	ElemStation=0.375			
Frame=48	Station=0.375	OutputCase=FESSUR	CaseType=Combination	Point=4	X2=0.5	X3=0.5	S11=-
522.05803447134	IsS11Max=No	IsS11Min=No	FrameElem=48	ElemStation=0.375			
Frame=48	Station=0.5	OutputCase=FESSUR	CaseType=Combination	Point=0	X2=0	X3=0	S11=-386.541953115295
IsS11Max=No	IsS11Min=No	FrameElem=48	ElemStation=0.5				
Frame=48	Station=0.5	OutputCase=FESSUR	CaseType=Combination	Point=1	X2=-0.5	X3=-0.5	
S11=195.123986383818	IsS11Max=Yes	IsS11Min=No	FrameElem=48	ElemStation=0.5			
Frame=48	Station=0.5	OutputCase=FESSUR	CaseType=Combination	Point=2	X2=-0.5	X3=0.5	
S11=195.123986383818	IsS11Max=No	IsS11Min=No	FrameElem=48	ElemStation=0.5			
Frame=48	Station=0.5	OutputCase=FESSUR	CaseType=Combination	Point=3	X2=0.5	X3=-0.5	S11=-
968.207892614408	IsS11Max=No	IsS11Min=Yes	FrameElem=48	ElemStation=0.5			
Frame=48	Station=0.5	OutputCase=FESSUR	CaseType=Combination	Point=4	X2=0.5	X3=0.5	S11=-
968.207892614408	IsS11Max=No	IsS11Min=No	FrameElem=48	ElemStation=0.5			
Frame=69	Station=0	OutputCase=PESOPR	CaseType=LinStatic	Point=0	X2=0	X3=0	S11=-162.500000265485
IsS11Max=No	IsS11Min=No	FrameElem=69	ElemStation=0				
Frame=69	Station=0	OutputCase=PESOPR	CaseType=LinStatic	Point=1	X2=-0.5	X3=-0.5	S11=-
653.032175241913	IsS11Max=No	IsS11Min=Yes	FrameElem=69	ElemStation=0			
Frame=69	Station=0	OutputCase=PESOPR	CaseType=LinStatic	Point=2	X2=-0.5	X3=0.5	S11=-
653.032175241913	IsS11Max=No	IsS11Min=No	FrameElem=69	ElemStation=0			
Frame=69	Station=0	OutputCase=PESOPR	CaseType=LinStatic	Point=3	X2=0.5	X3=-0.5	S11=328.032174710943
IsS11Max=Yes	IsS11Min=No	FrameElem=69	ElemStation=0				
Frame=69	Station=0	OutputCase=PESOPR	CaseType=LinStatic	Point=4	X2=0.5	X3=0.5	S11=328.032174710943
IsS11Max=No	IsS11Min=No	FrameElem=69	ElemStation=0				
Frame=69	Station=0.2500000000000001	OutputCase=PESOPR	CaseType=LinStatic	Point=0	X2=0	X3=0	S11=-
156.250000265485	IsS11Max=No	IsS11Min=No	FrameElem=69	ElemStation=0.2500000000000001			
Frame=69	Station=0.2500000000000001	OutputCase=PESOPR	CaseType=LinStatic	Point=1	X2=-0.5	X3=-0.5	
S11=-624.02577793641	IsS11Max=No	IsS11Min=Yes	FrameElem=69	ElemStation=0.2500000000000001			
Frame=69	Station=0.2500000000000001	OutputCase=PESOPR	CaseType=LinStatic	Point=2	X2=-0.5	X3=0.5	
S11=-624.02577793641	IsS11Max=No	IsS11Min=No	FrameElem=69	ElemStation=0.2500000000000001			
Frame=69	Station=0.2500000000000001	OutputCase=PESOPR	CaseType=LinStatic	Point=3	X2=0.5	X3=-0.5	
S11=311.525777405439	IsS11Max=Yes	IsS11Min=No	FrameElem=69	ElemStation=0.2500000000000001			
Frame=69	Station=0.2500000000000001	OutputCase=PESOPR	CaseType=LinStatic	Point=4	X2=0.5	X3=0.5	
S11=311.525777405439	IsS11Max=No	IsS11Min=No	FrameElem=69	ElemStation=0.2500000000000001			
Frame=69	Station=0	OutputCase=TERRVERT	CaseType=LinStatic	Point=0	X2=0	X3=0	S11=-699.999993448611
IsS11Max=No	IsS11Min=No	FrameElem=69	ElemStation=0				
Frame=69	Station=0	OutputCase=TERRVERT	CaseType=LinStatic	Point=1	X2=-0.5	X3=-0.5	S11=-
2610.12822692651	IsS11Max=No	IsS11Min=Yes	FrameElem=69	ElemStation=0			
Frame=69	Station=0	OutputCase=TERRVERT	CaseType=LinStatic	Point=2	X2=-0.5	X3=0.5	S11=-
2610.12822692651	IsS11Max=No	IsS11Min=No	FrameElem=69	ElemStation=0			
Frame=69	Station=0	OutputCase=TERRVERT	CaseType=LinStatic	Point=3	X2=0.5	X3=-0.5	
S11=1210.12824002929	IsS11Max=Yes	IsS11Min=No	FrameElem=69	ElemStation=0			
Frame=69	Station=0	OutputCase=TERRVERT	CaseType=LinStatic	Point=4	X2=0.5	X3=0.5	
S11=1210.12824002929	IsS11Max=No	IsS11Min=No	FrameElem=69	ElemStation=0			
Frame=69	Station=0.2500000000000001	OutputCase=TERRVERT	CaseType=LinStatic	Point=0	X2=0	X3=0	S11=-
699.999993448611	IsS11Max=No	IsS11Min=No	FrameElem=69	ElemStation=0.2500000000000001			
Frame=69	Station=0.2500000000000001	OutputCase=TERRVERT	CaseType=LinStatic	Point=1	X2=-0.5	X3=-0.5	
S11=-2612.59238813525	IsS11Max=No	IsS11Min=Yes	FrameElem=69	ElemStation=0.2500000000000001			
Frame=69	Station=0.2500000000000001	OutputCase=TERRVERT	CaseType=LinStatic	Point=2	X2=-0.5	X3=0.5	
S11=-2612.59238813525	IsS11Max=No	IsS11Min=No	FrameElem=69	ElemStation=0.2500000000000001			
Frame=69	Station=0.2500000000000001	OutputCase=TERRVERT	CaseType=LinStatic	Point=3	X2=0.5	X3=-0.5	
S11=1212.59240123803	IsS11Max=Yes	IsS11Min=No	FrameElem=69	ElemStation=0.2500000000000001			
Frame=69	Station=0.2500000000000001	OutputCase=TERRVERT	CaseType=LinStatic	Point=4	X2=0.5	X3=0.5	
S11=1212.59240123803	IsS11Max=No	IsS11Min=No	FrameElem=69	ElemStation=0.2500000000000001			
Frame=69	Station=0	OutputCase=TERRLAT	CaseType=LinStatic	Point=0	X2=0	X3=0	S11=-2.96409380098339E-
05	IsS11Max=No	IsS11Min=No	FrameElem=69	ElemStation=0			
Frame=69	Station=0	OutputCase=TERRLAT	CaseType=LinStatic	Point=1	X2=-0.5	X3=-0.5	S11=-
504.435997899287	IsS11Max=No	IsS11Min=Yes	FrameElem=69	ElemStation=0			
Frame=69	Station=0	OutputCase=TERRLAT	CaseType=LinStatic	Point=2	X2=-0.5	X3=0.5	S11=-
504.435997899287	IsS11Max=No	IsS11Min=No	FrameElem=69	ElemStation=0			
Frame=69	Station=0	OutputCase=TERRLAT	CaseType=LinStatic	Point=3	X2=0.5	X3=-0.5	
S11=504.435938617411	IsS11Max=Yes	IsS11Min=No	FrameElem=69	ElemStation=0			
Frame=69	Station=0	OutputCase=TERRLAT	CaseType=LinStatic	Point=4	X2=0.5	X3=0.5	S11=504.435938617411
IsS11Max=No	IsS11Min=No	FrameElem=69	ElemStation=0				
Frame=69	Station=0.2500000000000001	OutputCase=TERRLAT	CaseType=LinStatic	Point=0	X2=0	X3=0	S11=-
2.59045910638367E-05	IsS11Max=No	IsS11Min=No	FrameElem=69	ElemStation=0.2500000000000001			
Frame=69	Station=0.2500000000000001	OutputCase=TERRLAT	CaseType=LinStatic	Point=1	X2=-0.5	X3=-0.5	
S11=-94.2908922705561	IsS11Max=No	IsS11Min=Yes	FrameElem=69	ElemStation=0.2500000000000001			

```

Frame=69 Station=0.250000000000001 OutputCase=TERRCOST CaseType=LinStatic Point=3 X2=0.5 X3=-0.5
S11=0 IsS11Max=No IsS11Min=No FrameElem=69 ElemStation=0.250000000000001
Frame=69 Station=0.250000000000001 OutputCase=TERRCOST CaseType=LinStatic Point=4 X2=0.5 X3=0.5
S11=0 IsS11Max=No IsS11Min=No FrameElem=69 ElemStation=0.250000000000001
Frame=69 Station=0 OutputCase=SOVRCOST CaseType=LinStatic Point=0 X2=0 X3=0 S11=0 IsS11Max=Yes
IsS11Min=Yes FrameElem=69 ElemStation=0
Frame=69 Station=0 OutputCase=SOVRCOST CaseType=LinStatic Point=1 X2=-0.5 X3=-0.5 S11=0
IsS11Max=No IsS11Min=No FrameElem=69 ElemStation=0
Frame=69 Station=0 OutputCase=SOVRCOST CaseType=LinStatic Point=2 X2=-0.5 X3=0.5 S11=0
IsS11Max=No IsS11Min=No FrameElem=69 ElemStation=0
Frame=69 Station=0 OutputCase=SOVRCOST CaseType=LinStatic Point=3 X2=0.5 X3=-0.5 S11=0
IsS11Max=No IsS11Min=No FrameElem=69 ElemStation=0
Frame=69 Station=0 OutputCase=SOVRCOST CaseType=LinStatic Point=4 X2=0.5 X3=0.5 S11=0 IsS11Max=No
IsS11Min=No FrameElem=69 ElemStation=0
Frame=69 Station=0.250000000000001 OutputCase=SOVRCOST CaseType=LinStatic Point=0 X2=0 X3=0 S11=0
IsS11Max=Yes IsS11Min=Yes FrameElem=69 ElemStation=0.250000000000001
Frame=69 Station=0.250000000000001 OutputCase=SOVRCOST CaseType=LinStatic Point=1 X2=-0.5 X3=-0.5
S11=0 IsS11Max=No IsS11Min=No FrameElem=69 ElemStation=0.250000000000001
Frame=69 Station=0.250000000000001 OutputCase=SOVRCOST CaseType=LinStatic Point=2 X2=-0.5 X3=0.5
S11=0 IsS11Max=No IsS11Min=No FrameElem=69 ElemStation=0.250000000000001
Frame=69 Station=0.250000000000001 OutputCase=SOVRCOST CaseType=LinStatic Point=3 X2=0.5 X3=-0.5
S11=0 IsS11Max=No IsS11Min=No FrameElem=69 ElemStation=0.250000000000001
Frame=69 Station=0.250000000000001 OutputCase=SOVRCOST CaseType=LinStatic Point=4 X2=0.5 X3=0.5
S11=0 IsS11Max=No IsS11Min=No FrameElem=69 ElemStation=0.250000000000001
Frame=69 Station=0 OutputCase=ENVE CaseType=Combination StepType=Max Point=0 X2=0 X3=0 S11=-
862.500014462753 IsS11Max=No IsS11Min=No FrameElem=69 ElemStation=0
Frame=69 Station=0 OutputCase=ENVE CaseType=Combination StepType=Max Point=1 X2=-0.5 X3=-0.5
S11=-3616.26560069793 IsS11Max=No IsS11Min=Yes FrameElem=69 ElemStation=0
Frame=69 Station=0 OutputCase=ENVE CaseType=Combination StepType=Max Point=2 X2=-0.5 X3=0.5 S11=-
3616.26560069793 IsS11Max=No IsS11Min=No FrameElem=69 ElemStation=0
Frame=69 Station=0 OutputCase=ENVE CaseType=Combination StepType=Max Point=3 X2=0.5 X3=-0.5
S11=2042.59635335764 IsS11Max=Yes IsS11Min=No FrameElem=69 ElemStation=0
Frame=69 Station=0 OutputCase=ENVE CaseType=Combination StepType=Max Point=4 X2=0.5 X3=0.5
S11=2042.59635335764 IsS11Max=No IsS11Min=No FrameElem=69 ElemStation=0
Frame=69 Station=0.250000000000001 OutputCase=ENVE CaseType=Combination StepType=Max Point=0 X2=0
X3=0 S11=-856.25001184731 IsS11Max=No IsS11Min=No FrameElem=69 ElemStation=0.250000000000001
Frame=69 Station=0.250000000000001 OutputCase=ENVE CaseType=Combination StepType=Max Point=1 X2=-0.5
X3=-0.5 S11=-3302.62179066105 IsS11Max=No IsS11Min=Yes FrameElem=69 ElemStation=0.250000000000001
Frame=69 Station=0.250000000000001 OutputCase=ENVE CaseType=Combination StepType=Max Point=2 X2=-0.5
X3=0.5 S11=-3302.62179066105 IsS11Max=No IsS11Min=No FrameElem=69 ElemStation=0.250000000000001
Frame=69 Station=0.250000000000001 OutputCase=ENVE CaseType=Combination StepType=Max Point=3 X2=0.5
X3=-0.5 S11=1618.40901910484 IsS11Max=Yes IsS11Min=No FrameElem=69 ElemStation=0.250000000000001
Frame=69 Station=0.250000000000001 OutputCase=ENVE CaseType=Combination StepType=Max Point=4 X2=0.5
X3=0.5 S11=1618.40901910484 IsS11Max=No IsS11Min=No FrameElem=69 ElemStation=0.250000000000001
Frame=69 Station=0 OutputCase=ENVE CaseType=Combination StepType=Min Point=0 X2=0 X3=0 S11=-
862.500023355035 IsS11Max=No IsS11Min=No FrameElem=69 ElemStation=0
Frame=69 Station=0 OutputCase=ENVE CaseType=Combination StepType=Min Point=1 X2=-0.5 X3=-0.5
S11=-3767.59640006771 IsS11Max=No IsS11Min=Yes FrameElem=69 ElemStation=0
Frame=69 Station=0 OutputCase=ENVE CaseType=Combination StepType=Min Point=2 X2=-0.5 X3=0.5 S11=-
3767.59640006771 IsS11Max=No IsS11Min=No FrameElem=69 ElemStation=0
Frame=69 Station=0 OutputCase=ENVE CaseType=Combination StepType=Min Point=3 X2=0.5 X3=-0.5
S11=1891.26557177242 IsS11Max=Yes IsS11Min=No FrameElem=69 ElemStation=0
Frame=69 Station=0 OutputCase=ENVE CaseType=Combination StepType=Min Point=4 X2=0.5 X3=0.5
S11=1891.26557177242 IsS11Max=No IsS11Min=No FrameElem=69 ElemStation=0
Frame=69 Station=0.250000000000001 OutputCase=ENVE CaseType=Combination StepType=Min Point=0 X2=0
X3=0 S11=-856.250019618688 IsS11Max=No IsS11Min=No FrameElem=69 ElemStation=0.250000000000001
Frame=69 Station=0.250000000000001 OutputCase=ENVE CaseType=Combination StepType=Min Point=1 X2=-0.5
X3=-0.5 S11=-3330.90905834222 IsS11Max=No IsS11Min=Yes FrameElem=69 ElemStation=0.250000000000001
Frame=69 Station=0.250000000000001 OutputCase=ENVE CaseType=Combination StepType=Min Point=2 X2=-0.5
X3=0.5 S11=-3330.90905834222 IsS11Max=No IsS11Min=No FrameElem=69 ElemStation=0.250000000000001
Frame=69 Station=0.250000000000001 OutputCase=ENVE CaseType=Combination StepType=Min Point=3 X2=0.5
X3=-0.5 S11=1590.12176696643 IsS11Max=Yes IsS11Min=No FrameElem=69 ElemStation=0.250000000000001
Frame=69 Station=0.250000000000001 OutputCase=ENVE CaseType=Combination StepType=Min Point=4 X2=0.5
X3=0.5 S11=1590.12176696643 IsS11Max=No IsS11Min=No FrameElem=69 ElemStation=0.250000000000001
Frame=69 Station=0 OutputCase=FESSUR CaseType=Combination Point=0 X2=0 X3=0 S11=-862.500023355035
IsS11Max=No IsS11Min=No FrameElem=69 ElemStation=0
Frame=69 Station=0 OutputCase=FESSUR CaseType=Combination Point=1 X2=-0.5 X3=-0.5 S11=-
3767.59640006771 IsS11Max=No IsS11Min=Yes FrameElem=69 ElemStation=0
Frame=69 Station=0 OutputCase=FESSUR CaseType=Combination Point=2 X2=-0.5 X3=0.5 S11=-
3767.59640006771 IsS11Max=No IsS11Min=No FrameElem=69 ElemStation=0
Frame=69 Station=0 OutputCase=FESSUR CaseType=Combination Point=3 X2=0.5 X3=-0.5
S11=2042.59635335764 IsS11Max=Yes IsS11Min=No FrameElem=69 ElemStation=0
Frame=69 Station=0 OutputCase=FESSUR CaseType=Combination Point=4 X2=0.5 X3=0.5
S11=2042.59635335764 IsS11Max=No IsS11Min=No FrameElem=69 ElemStation=0
Frame=69 Station=0.250000000000001 OutputCase=FESSUR CaseType=Combination Point=0 X2=0 X3=0 S11=-
856.250019618688 IsS11Max=No IsS11Min=No FrameElem=69 ElemStation=0.250000000000001
Frame=69 Station=0.250000000000001 OutputCase=FESSUR CaseType=Combination Point=1 X2=-0.5 X3=-0.5
S11=-3330.90905834222 IsS11Max=No IsS11Min=Yes FrameElem=69 ElemStation=0.250000000000001
Frame=69 Station=0.250000000000001 OutputCase=FESSUR CaseType=Combination Point=2 X2=-0.5 X3=0.5
S11=-3330.90905834222 IsS11Max=No IsS11Min=No FrameElem=69 ElemStation=0.250000000000001
Frame=69 Station=0.250000000000001 OutputCase=FESSUR CaseType=Combination Point=3 X2=0.5 X3=-0.5
S11=1618.40901910484 IsS11Max=Yes IsS11Min=No FrameElem=69 ElemStation=0.250000000000001

```



Frame=69 Station=0.250000000000001 OutputCase=FESSUR CaseType=Combination Point=4 X2=0.5 X3=0.5
 S11=1618.40901910484 IsS11Max=No IsS11Min=No FrameElem=69 ElemStation=0.250000000000001
 Frame=70 Station=0 OutputCase=PESOPR CaseType=LinStatic Point=0 X2=0 X3=0 S11=-156.249998818617
 IsS11Max=No IsS11Min=No FrameElem=70 ElemStation=0
 Frame=70 Station=0 OutputCase=PESOPR CaseType=LinStatic Point=1 X2=-0.5 X3=-0.5 S11=-
 624.025776489547 IsS11Max=No IsS11Min=Yes FrameElem=70 ElemStation=0
 Frame=70 Station=0 OutputCase=PESOPR CaseType=LinStatic Point=2 X2=-0.5 X3=0.5 S11=-
 624.025776489547 IsS11Max=No IsS11Min=No FrameElem=70 ElemStation=0
 Frame=70 Station=0 OutputCase=PESOPR CaseType=LinStatic Point=3 X2=0.5 X3=-0.5 S11=311.525778852312
 IsS11Max=Yes IsS11Min=No FrameElem=70 ElemStation=0
 Frame=70 Station=0 OutputCase=PESOPR CaseType=LinStatic Point=4 X2=0.5 X3=0.5 S11=311.525778852312
 IsS11Max=No IsS11Min=No FrameElem=70 ElemStation=0
 Frame=70 Station=0.25 OutputCase=PESOPR CaseType=LinStatic Point=0 X2=0 X3=0 S11=-149.999998818617
 IsS11Max=No IsS11Min=No FrameElem=70 ElemStation=0.25
 Frame=70 Station=0.25 OutputCase=PESOPR CaseType=LinStatic Point=1 X2=-0.5 X3=-0.5 S11=-
 595.019356385267 IsS11Max=No IsS11Min=Yes FrameElem=70 ElemStation=0.25
 Frame=70 Station=0.25 OutputCase=PESOPR CaseType=LinStatic Point=2 X2=-0.5 X3=0.5 S11=-
 595.019356385267 IsS11Max=No IsS11Min=No FrameElem=70 ElemStation=0.25
 Frame=70 Station=0.25 OutputCase=PESOPR CaseType=LinStatic Point=3 X2=0.5 X3=-0.5
 S11=295.019358748033 IsS11Max=Yes IsS11Min=No FrameElem=70 ElemStation=0.25
 Frame=70 Station=0.25 OutputCase=PESOPR CaseType=LinStatic Point=4 X2=0.5 X3=0.5
 S11=295.019358748033 IsS11Max=No IsS11Min=No FrameElem=70 ElemStation=0.25
 Frame=70 Station=0 OutputCase=TERRVERT CaseType=LinStatic Point=0 X2=0 X3=0 S11=-699.999993604841
 IsS11Max=No IsS11Min=No FrameElem=70 ElemStation=0
 Frame=70 Station=0 OutputCase=TERRVERT CaseType=LinStatic Point=1 X2=-0.5 X3=-0.5 S11=-
 2612.59238829157 IsS11Max=No IsS11Min=Yes FrameElem=70 ElemStation=0
 Frame=70 Station=0 OutputCase=TERRVERT CaseType=LinStatic Point=2 X2=-0.5 X3=0.5 S11=-
 2612.59238829157 IsS11Max=No IsS11Min=No FrameElem=70 ElemStation=0
 Frame=70 Station=0 OutputCase=TERRVERT CaseType=LinStatic Point=3 X2=0.5 X3=-0.5
 S11=1212.59240108189 IsS11Max=Yes IsS11Min=No FrameElem=70 ElemStation=0
 Frame=70 Station=0 OutputCase=TERRVERT CaseType=LinStatic Point=4 X2=0.5 X3=0.5
 S11=1212.59240108189 IsS11Max=No IsS11Min=No FrameElem=70 ElemStation=0
 Frame=70 Station=0.25 OutputCase=TERRVERT CaseType=LinStatic Point=0 X2=0 X3=0 S11=-
 699.999993604841 IsS11Max=No IsS11Min=No FrameElem=70 ElemStation=0.25
 Frame=70 Station=0.25 OutputCase=TERRVERT CaseType=LinStatic Point=1 X2=-0.5 X3=-0.5 S11=-
 2615.0564493645 IsS11Max=No IsS11Min=Yes FrameElem=70 ElemStation=0.25
 Frame=70 Station=0.25 OutputCase=TERRVERT CaseType=LinStatic Point=2 X2=-0.5 X3=0.5 S11=-
 2615.0564493645 IsS11Max=No IsS11Min=No FrameElem=70 ElemStation=0.25
 Frame=70 Station=0.25 OutputCase=TERRVERT CaseType=LinStatic Point=3 X2=0.5 X3=-0.5
 S11=1215.05646215482 IsS11Max=Yes IsS11Min=No FrameElem=70 ElemStation=0.25
 Frame=70 Station=0.25 OutputCase=TERRVERT CaseType=LinStatic Point=4 X2=0.5 X3=0.5
 S11=1215.05646215482 IsS11Max=No IsS11Min=No FrameElem=70 ElemStation=0.25
 Frame=70 Station=0 OutputCase=TERRLAT CaseType=LinStatic Point=0 X2=0 X3=0 S11=-1.69220766110811E-
 06 IsS11Max=No IsS11Min=No FrameElem=70 ElemStation=0
 Frame=70 Station=0 OutputCase=TERRLAT CaseType=LinStatic Point=1 X2=-0.5 X3=-0.5 S11=-
 94.2908680581745 IsS11Max=No IsS11Min=Yes FrameElem=70 ElemStation=0
 Frame=70 Station=0 OutputCase=TERRLAT CaseType=LinStatic Point=2 X2=-0.5 X3=0.5 S11=-
 94.2908680581745 IsS11Max=No IsS11Min=No FrameElem=70 ElemStation=0
 Frame=70 Station=0 OutputCase=TERRLAT CaseType=LinStatic Point=3 X2=0.5 X3=-0.5
 S11=94.2908646737592 IsS11Max=Yes IsS11Min=No FrameElem=70 ElemStation=0
 Frame=70 Station=0 OutputCase=TERRLAT CaseType=LinStatic Point=4 X2=0.5 X3=0.5 S11=94.2908646737592
 IsS11Max=No IsS11Min=No FrameElem=70 ElemStation=0
 Frame=70 Station=0.25 OutputCase=TERRLAT CaseType=LinStatic Point=0 X2=0 X3=0 S11=-
 1.69220766110811E-06 IsS11Max=No IsS11Min=No FrameElem=70 ElemStation=0.25
 Frame=70 Station=0.25 OutputCase=TERRLAT CaseType=LinStatic Point=1 X2=-0.5 X3=-0.5
 S11=257.486421338977 IsS11Max=Yes IsS11Min=No FrameElem=70 ElemStation=0.25
 Frame=70 Station=0.25 OutputCase=TERRLAT CaseType=LinStatic Point=2 X2=-0.5 X3=0.5
 S11=257.486421338977 IsS11Max=No IsS11Min=No FrameElem=70 ElemStation=0.25
 Frame=70 Station=0.25 OutputCase=TERRLAT CaseType=LinStatic Point=3 X2=0.5 X3=-0.5 S11=-
 257.486424723392 IsS11Max=No IsS11Min=Yes FrameElem=70 ElemStation=0.25
 Frame=70 Station=0.25 OutputCase=TERRLAT CaseType=LinStatic Point=4 X2=0.5 X3=0.5 S11=-
 257.486424723392 IsS11Max=No IsS11Min=No FrameElem=70 ElemStation=0.25
 Frame=70 Station=0 OutputCase=ACCVERT CaseType=LinStatic Point=0 X2=0 X3=0 S11=0 IsS11Max=Yes
 IsS11Min=Yes FrameElem=70 ElemStation=0
 Frame=70 Station=0 OutputCase=ACCVERT CaseType=LinStatic Point=1 X2=-0.5 X3=-0.5 S11=0
 IsS11Max=No IsS11Min=No FrameElem=70 ElemStation=0
 Frame=70 Station=0 OutputCase=ACCVERT CaseType=LinStatic Point=2 X2=-0.5 X3=0.5 S11=0 IsS11Max=No
 IsS11Min=No FrameElem=70 ElemStation=0
 Frame=70 Station=0 OutputCase=ACCVERT CaseType=LinStatic Point=3 X2=0.5 X3=-0.5 S11=0 IsS11Max=No
 IsS11Min=No FrameElem=70 ElemStation=0
 Frame=70 Station=0 OutputCase=ACCVERT CaseType=LinStatic Point=4 X2=0.5 X3=0.5 S11=0 IsS11Max=No
 IsS11Min=No FrameElem=70 ElemStation=0
 Frame=70 Station=0.25 OutputCase=ACCVERT CaseType=LinStatic Point=0 X2=0 X3=0 S11=0 IsS11Max=Yes
 IsS11Min=Yes FrameElem=70 ElemStation=0.25
 Frame=70 Station=0.25 OutputCase=ACCVERT CaseType=LinStatic Point=1 X2=-0.5 X3=-0.5 S11=0
 IsS11Max=No IsS11Min=No FrameElem=70 ElemStation=0.25
 Frame=70 Station=0.25 OutputCase=ACCVERT CaseType=LinStatic Point=2 X2=-0.5 X3=0.5 S11=0
 IsS11Max=No IsS11Min=No FrameElem=70 ElemStation=0.25
 Frame=70 Station=0.25 OutputCase=ACCVERT CaseType=LinStatic Point=3 X2=0.5 X3=-0.5 S11=0
 IsS11Max=No IsS11Min=No FrameElem=70 ElemStation=0.25
 Frame=70 Station=0.25 OutputCase=ACCVERT CaseType=LinStatic Point=4 X2=0.5 X3=0.5 S11=0
 IsS11Max=No IsS11Min=No FrameElem=70 ElemStation=0.25

Frame=70	Station=0	OutputCase=ENVE	CaseType=Combination	StepType=Max	Point=1	X2=-0.5	X3=-0.5		
S11=-3302.62177242184	IsS11Max=No	IsS11Min=Yes	FrameElem=70	ElemStation=0					
Frame=70	Station=0	OutputCase=ENVE	CaseType=Combination	StepType=Max	Point=2	X2=-0.5	X3=0.5	S11=-	
3302.62177242184	IsS11Max=No	IsS11Min=No	FrameElem=70	ElemStation=0					
Frame=70	Station=0	OutputCase=ENVE	CaseType=Combination	StepType=Max	Point=3	X2=0.5	X3=-0.5		
S11=1618.40904460796	IsS11Max=Yes	IsS11Min=No	FrameElem=70	ElemStation=0					
Frame=70	Station=0	OutputCase=ENVE	CaseType=Combination	StepType=Max	Point=4	X2=0.5	X3=0.5		
S11=1618.40904460796	IsS11Max=No	IsS11Min=No	FrameElem=70	ElemStation=0					
Frame=70	Station=0.25	OutputCase=ENVE	CaseType=Combination	StepType=Max	Point=0	X2=0	X3=0	S11=-	
849.999993608003	IsS11Max=No	IsS11Min=No	FrameElem=70	ElemStation=0.25					
Frame=70	Station=0.25	OutputCase=ENVE	CaseType=Combination	StepType=Max	Point=1	X2=-0.5	X3=-0.5		
S11=-2952.58938441079	IsS11Max=No	IsS11Min=Yes	FrameElem=70	ElemStation=0.25					
Frame=70	Station=0.25	OutputCase=ENVE	CaseType=Combination	StepType=Max	Point=2	X2=-0.5	X3=0.5		
S11=-2952.58938441079	IsS11Max=No	IsS11Min=No	FrameElem=70	ElemStation=0.25					
Frame=70	Station=0.25	OutputCase=ENVE	CaseType=Combination	StepType=Max	Point=3	X2=0.5	X3=-0.5		
S11=1329.83532359648	IsS11Max=Yes	IsS11Min=No	FrameElem=70	ElemStation=0.25					
Frame=70	Station=0.25	OutputCase=ENVE	CaseType=Combination	StepType=Max	Point=4	X2=0.5	X3=0.5		
S11=1329.83532359648	IsS11Max=No	IsS11Min=No	FrameElem=70	ElemStation=0.25					
Frame=70	Station=0	OutputCase=ENVE	CaseType=Combination	StepType=Min	Point=0	X2=0	X3=0	S11=-	
856.249994115666	IsS11Max=No	IsS11Min=No	FrameElem=70	ElemStation=0					
Frame=70	Station=0	OutputCase=ENVE	CaseType=Combination	StepType=Min	Point=1	X2=-0.5	X3=-0.5		
S11=-3330.90903283929	IsS11Max=No	IsS11Min=Yes	FrameElem=70	ElemStation=0					
Frame=70	Station=0	OutputCase=ENVE	CaseType=Combination	StepType=Min	Point=2	X2=-0.5	X3=0.5	S11=-	
3330.90903283929	IsS11Max=No	IsS11Min=No	FrameElem=70	ElemStation=0					
Frame=70	Station=0	OutputCase=ENVE	CaseType=Combination	StepType=Min	Point=3	X2=0.5	X3=-0.5		
S11=1590.12178520583	IsS11Max=Yes	IsS11Min=No	FrameElem=70	ElemStation=0					
Frame=70	Station=0	OutputCase=ENVE	CaseType=Combination	StepType=Min	Point=4	X2=0.5	X3=0.5		
S11=1590.12178520583	IsS11Max=No	IsS11Min=No	FrameElem=70	ElemStation=0					
Frame=70	Station=0.25	OutputCase=ENVE	CaseType=Combination	StepType=Min	Point=0	X2=0	X3=0	S11=-	
849.999994115666	IsS11Max=No	IsS11Min=No	FrameElem=70	ElemStation=0.25					
Frame=70	Station=0.25	OutputCase=ENVE	CaseType=Combination	StepType=Min	Point=1	X2=-0.5	X3=-0.5		
S11=-3029.83531081248	IsS11Max=No	IsS11Min=Yes	FrameElem=70	ElemStation=0.25					
Frame=70	Station=0.25	OutputCase=ENVE	CaseType=Combination	StepType=Min	Point=2	X2=-0.5	X3=0.5		
S11=-3029.83531081248	IsS11Max=No	IsS11Min=No	FrameElem=70	ElemStation=0.25					
Frame=70	Station=0.25	OutputCase=ENVE	CaseType=Combination	StepType=Min	Point=3	X2=0.5	X3=-0.5		
S11=1252.58939617946	IsS11Max=Yes	IsS11Min=No	FrameElem=70	ElemStation=0.25					
Frame=70	Station=0.25	OutputCase=ENVE	CaseType=Combination	StepType=Min	Point=4	X2=0.5	X3=0.5		
S11=1252.58939617946	IsS11Max=No	IsS11Min=No	FrameElem=70	ElemStation=0.25					
Frame=70	Station=0	OutputCase=FESSUR	CaseType=Combination	Point=0	X2=0	X3=0	S11=-856.249994115666		
IsS11Max=No	IsS11Min=No	FrameElem=70	ElemStation=0						
Frame=70	Station=0	OutputCase=FESSUR	CaseType=Combination	Point=1	X2=-0.5	X3=-0.5	S11=-		
3330.90903283929	IsS11Max=No	IsS11Min=Yes	FrameElem=70	ElemStation=0					
Frame=70	Station=0	OutputCase=FESSUR	CaseType=Combination	Point=2	X2=-0.5	X3=0.5	S11=-		
3330.90903283929	IsS11Max=No	IsS11Min=No	FrameElem=70	ElemStation=0					
Frame=70	Station=0	OutputCase=FESSUR	CaseType=Combination	Point=3	X2=0.5	X3=-0.5			
S11=1618.40904460796	IsS11Max=Yes	IsS11Min=No	FrameElem=70	ElemStation=0					
Frame=70	Station=0	OutputCase=FESSUR	CaseType=Combination	Point=4	X2=0.5	X3=0.5			
S11=1618.40904460796	IsS11Max=No	IsS11Min=No	FrameElem=70	ElemStation=0					
Frame=70	Station=0.25	OutputCase=FESSUR	CaseType=Combination	Point=0	X2=0	X3=0	S11=-		
849.999994115666	IsS11Max=No	IsS11Min=No	FrameElem=70	ElemStation=0.25					
Frame=70	Station=0.25	OutputCase=FESSUR	CaseType=Combination	Point=1	X2=-0.5	X3=-0.5	S11=-		
2952.58938441079	IsS11Max=No	IsS11Min=Yes	FrameElem=70	ElemStation=0.25					
Frame=70	Station=0.25	OutputCase=FESSUR	CaseType=Combination	Point=2	X2=-0.5	X3=0.5	S11=-		
2952.58938441079	IsS11Max=No	IsS11Min=No	FrameElem=70	ElemStation=0.25					
Frame=70	Station=0.25	OutputCase=FESSUR	CaseType=Combination	Point=3	X2=0.5	X3=-0.5			
S11=1252.58939617946	IsS11Max=Yes	IsS11Min=No	FrameElem=70	ElemStation=0.25					
Frame=70	Station=0.25	OutputCase=FESSUR	CaseType=Combination	Point=4	X2=0.5	X3=0.5			
S11=1252.58939617946	IsS11Max=No	IsS11Min=No	FrameElem=70	ElemStation=0.25					
Frame=72	Station=0	OutputCase=PESOPR	CaseType=LinStatic	Point=0	X2=0	X3=0	S11=-75.0000002653687		
IsS11Max=No	IsS11Min=No	FrameElem=72	ElemStation=0						
Frame=72	Station=0	OutputCase=PESOPR	CaseType=LinStatic	Point=1	X2=-0.5	X3=-0.5	S11=-		
246.942300487425	IsS11Max=No	IsS11Min=Yes	FrameElem=72	ElemStation=0					
Frame=72	Station=0	OutputCase=PESOPR	CaseType=LinStatic	Point=2	X2=-0.5	X3=0.5	S11=-		
246.942300487425	IsS11Max=No	IsS11Min=No	FrameElem=72	ElemStation=0					
Frame=72	Station=0	OutputCase=PESOPR	CaseType=LinStatic	Point=3	X2=0.5	X3=-0.5	S11=96.9422999566871		
IsS11Max=Yes	IsS11Min=No	FrameElem=72	ElemStation=0						
Frame=72	Station=0	OutputCase=PESOPR	CaseType=LinStatic	Point=4	X2=0.5	X3=0.5	S11=96.9422999566871		
IsS11Max=No	IsS11Min=No	FrameElem=72	ElemStation=0						
Frame=72	Station=0.250000000000002	OutputCase=PESOPR	CaseType=LinStatic	Point=0	X2=0	X3=0	S11=-		
68.7500002653687	IsS11Max=No	IsS11Min=No	FrameElem=72	ElemStation=0.250000000000002					
Frame=72	Station=0.250000000000002	OutputCase=PESOPR	CaseType=LinStatic	Point=1	X2=-0.5	X3=-0.5			
S11=-217.935890664947	IsS11Max=No	IsS11Min=Yes	FrameElem=72	ElemStation=0.250000000000002					
Frame=72	Station=0.250000000000002	OutputCase=PESOPR	CaseType=LinStatic	Point=2	X2=-0.5	X3=0.5			
S11=-217.935890664947	IsS11Max=No	IsS11Min=No	FrameElem=72	ElemStation=0.250000000000002					
Frame=72	Station=0.250000000000002	OutputCase=PESOPR	CaseType=LinStatic	Point=3	X2=0.5	X3=-0.5			
S11=80.4358901342095	IsS11Max=Yes	IsS11Min=No	FrameElem=72	ElemStation=0.250000000000002					
Frame=72	Station=0.250000000000002	OutputCase=PESOPR	CaseType=LinStatic	Point=4	X2=0.5	X3=0.5			
S11=80.4358901342095	IsS11Max=No	IsS11Min=No	FrameElem=72	ElemStation=0.250000000000002					
Frame=72	Station=0	OutputCase=TERRVERT	CaseType=LinStatic	Point=0	X2=0	X3=0	S11=-699.999993447214		
IsS11Max=No	IsS11Min=No	FrameElem=72	ElemStation=0						
Frame=72	Station=0	OutputCase=TERRVERT	CaseType=LinStatic	Point=1	X2=-0.5	X3=-0.5	S11=-		
2644.6250819463	IsS11Max=No	IsS11Min=Yes	FrameElem=72	ElemStation=0					



Frame=72 Station=0 OutputCase=ENVE CaseType=Combination StepType=Min Point=4 X2=0.5 X3=0.5
 S11=1124.35664014596 IsS11Max=No IsS11Min=No FrameElem=72 ElemStation=0
 Frame=72 Station=0.250000000000002 OutputCase=ENVE CaseType=Combination StepType=Min Point=0 X2=0
 X3=0 S11=-768.749978966542 IsS11Max=No IsS11Min=No FrameElem=72 ElemStation=0.250000000000002
 Frame=72 Station=0.250000000000002 OutputCase=ENVE CaseType=Combination StepType=Min Point=1 X2=-0.5
 X3=-0.5 S11=-2982.04704995752 IsS11Max=No IsS11Min=Yes FrameElem=72 ElemStation=0.250000000000002
 Frame=72 Station=0.250000000000002 OutputCase=ENVE CaseType=Combination StepType=Min Point=2 X2=-0.5
 X3=0.5 S11=-2982.04704995752 IsS11Max=No IsS11Min=No FrameElem=72 ElemStation=0.250000000000002
 Frame=72 Station=0.250000000000002 OutputCase=ENVE CaseType=Combination StepType=Min Point=3 X2=0.5
 X3=-0.5 S11=1409.44051718317 IsS11Max=Yes IsS11Min=No FrameElem=72 ElemStation=0.250000000000002
 Frame=72 Station=0.250000000000002 OutputCase=ENVE CaseType=Combination StepType=Min Point=4 X2=0.5
 X3=0.5 S11=1409.44051718317 IsS11Max=No IsS11Min=No FrameElem=72 ElemStation=0.250000000000002
 Frame=72 Station=0 OutputCase=FESSUR CaseType=Combination Point=0 X2=0 X3=0 S11=-774.999975671359
 IsS11Max=No IsS11Min=No FrameElem=72 ElemStation=0
 Frame=72 Station=0 OutputCase=FESSUR CaseType=Combination Point=1 X2=-0.5 X3=-0.5 S11=-
 2674.35659148868 IsS11Max=No IsS11Min=Yes FrameElem=72 ElemStation=0
 Frame=72 Station=0 OutputCase=FESSUR CaseType=Combination Point=2 X2=-0.5 X3=0.5 S11=-
 2674.35659148868 IsS11Max=No IsS11Min=No FrameElem=72 ElemStation=0
 Frame=72 Station=0 OutputCase=FESSUR CaseType=Combination Point=3 X2=0.5 X3=-0.5
 S11=1124.35664014596 IsS11Max=Yes IsS11Min=No FrameElem=72 ElemStation=0
 Frame=72 Station=0 OutputCase=FESSUR CaseType=Combination Point=4 X2=0.5 X3=0.5
 S11=1124.35664014596 IsS11Max=No IsS11Min=No FrameElem=72 ElemStation=0
 Frame=72 Station=0.250000000000002 OutputCase=FESSUR CaseType=Combination Point=0 X2=0 X3=0 S11=-
 768.74997264681 IsS11Max=No IsS11Min=No FrameElem=72 ElemStation=0.250000000000002
 Frame=72 Station=0.250000000000002 OutputCase=FESSUR CaseType=Combination Point=1 X2=-0.5 X3=-0.5
 S11=-2982.04704995752 IsS11Max=No IsS11Min=Yes FrameElem=72 ElemStation=0.250000000000002
 Frame=72 Station=0.250000000000002 OutputCase=FESSUR CaseType=Combination Point=2 X2=-0.5 X3=0.5
 S11=-2982.04704995752 IsS11Max=No IsS11Min=No FrameElem=72 ElemStation=0.250000000000002
 Frame=72 Station=0.250000000000002 OutputCase=FESSUR CaseType=Combination Point=3 X2=0.5 X3=-0.5
 S11=1444.5471046639 IsS11Max=Yes IsS11Min=No FrameElem=72 ElemStation=0.250000000000002
 Frame=72 Station=0.250000000000002 OutputCase=FESSUR CaseType=Combination Point=4 X2=0.5 X3=0.5
 S11=1444.5471046639 IsS11Max=No IsS11Min=No FrameElem=72 ElemStation=0.250000000000002
 Frame=73 Station=0 OutputCase=PESOPR CaseType=LinStatic Point=0 X2=0 X3=0 S11=-68.7499973718659
 IsS11Max=No IsS11Min=No FrameElem=73 ElemStation=0
 Frame=73 Station=0 OutputCase=PESOPR CaseType=LinStatic Point=1 X2=-0.5 X3=-0.5 S11=-
 217.935887771443 IsS11Max=No IsS11Min=Yes FrameElem=73 ElemStation=0
 Frame=73 Station=0 OutputCase=PESOPR CaseType=LinStatic Point=2 X2=-0.5 X3=0.5 S11=-
 217.935887771443 IsS11Max=No IsS11Min=No FrameElem=73 ElemStation=0
 Frame=73 Station=0 OutputCase=PESOPR CaseType=LinStatic Point=3 X2=0.5 X3=-0.5 S11=80.4358930277116
 IsS11Max=Yes IsS11Min=No FrameElem=73 ElemStation=0
 Frame=73 Station=0 OutputCase=PESOPR CaseType=LinStatic Point=4 X2=0.5 X3=0.5 S11=80.4358930277116
 IsS11Max=No IsS11Min=No FrameElem=73 ElemStation=0
 Frame=73 Station=0.249999976158143 OutputCase=PESOPR CaseType=LinStatic Point=0 X2=0 X3=0 S11=-
 62.4999979679124 IsS11Max=No IsS11Min=No FrameElem=73 ElemStation=0.249999976158143
 Frame=73 Station=0.249999976158143 OutputCase=PESOPR CaseType=LinStatic Point=1 X2=-0.5 X3=-0.5
 S11=-188.929461045701 IsS11Max=No IsS11Min=Yes FrameElem=73 ElemStation=0.249999976158143
 Frame=73 Station=0.249999976158143 OutputCase=PESOPR CaseType=LinStatic Point=2 X2=-0.5 X3=0.5
 S11=-188.929461045701 IsS11Max=No IsS11Min=No FrameElem=73 ElemStation=0.249999976158143
 Frame=73 Station=0.249999976158143 OutputCase=PESOPR CaseType=LinStatic Point=3 X2=0.5 X3=-0.5
 S11=63.9294651098767 IsS11Max=Yes IsS11Min=No FrameElem=73 ElemStation=0.249999976158143
 Frame=73 Station=0.249999976158143 OutputCase=PESOPR CaseType=LinStatic Point=4 X2=0.5 X3=0.5
 S11=63.9294651098767 IsS11Max=No IsS11Min=No FrameElem=73 ElemStation=0.249999976158143
 Frame=73 Station=0 OutputCase=TERRVERT CaseType=LinStatic Point=0 X2=0 X3=0 S11=-699.999993761536
 IsS11Max=No IsS11Min=No FrameElem=73 ElemStation=0
 Frame=73 Station=0 OutputCase=TERRVERT CaseType=LinStatic Point=1 X2=-0.5 X3=-0.5 S11=-
 2647.08924346936 IsS11Max=No IsS11Min=Yes FrameElem=73 ElemStation=0
 Frame=73 Station=0 OutputCase=TERRVERT CaseType=LinStatic Point=2 X2=-0.5 X3=0.5 S11=-
 2647.08924346936 IsS11Max=No IsS11Min=No FrameElem=73 ElemStation=0
 Frame=73 Station=0 OutputCase=TERRVERT CaseType=LinStatic Point=3 X2=0.5 X3=-0.5
 S11=1247.08925594629 IsS11Max=Yes IsS11Min=No FrameElem=73 ElemStation=0
 Frame=73 Station=0 OutputCase=TERRVERT CaseType=LinStatic Point=4 X2=0.5 X3=0.5
 S11=1247.08925594629 IsS11Max=No IsS11Min=No FrameElem=73 ElemStation=0
 Frame=73 Station=0.249999976158143 OutputCase=TERRVERT CaseType=LinStatic Point=0 X2=0 X3=0 S11=-
 699.999993761536 IsS11Max=No IsS11Min=No FrameElem=73 ElemStation=0.249999976158143
 Frame=73 Station=0.249999976158143 OutputCase=TERRVERT CaseType=LinStatic Point=1 X2=-0.5 X3=-0.5
 S11=-2649.55320417151 IsS11Max=No IsS11Min=Yes FrameElem=73 ElemStation=0.249999976158143
 Frame=73 Station=0.249999976158143 OutputCase=TERRVERT CaseType=LinStatic Point=2 X2=-0.5 X3=0.5
 S11=-2649.55320417151 IsS11Max=No IsS11Min=No FrameElem=73 ElemStation=0.249999976158143
 Frame=73 Station=0.249999976158143 OutputCase=TERRVERT CaseType=LinStatic Point=3 X2=0.5 X3=-0.5
 S11=1249.55321664844 IsS11Max=Yes IsS11Min=No FrameElem=73 ElemStation=0.249999976158143
 Frame=73 Station=0.249999976158143 OutputCase=TERRVERT CaseType=LinStatic Point=4 X2=0.5 X3=0.5
 S11=1249.55321664844 IsS11Max=No IsS11Min=No FrameElem=73 ElemStation=0.249999976158143
 Frame=73 Station=0 OutputCase=TERRLAT CaseType=LinStatic Point=0 X2=0 X3=0 S11=-2.44501861743629E-
 05 IsS11Max=No IsS11Min=No FrameElem=73 ElemStation=0
 Frame=73 Station=0 OutputCase=TERRLAT CaseType=LinStatic Point=1 X2=-0.5 X3=-0.5 S11=-
 117.021961653492 IsS11Max=No IsS11Min=Yes FrameElem=73 ElemStation=0
 Frame=73 Station=0 OutputCase=TERRLAT CaseType=LinStatic Point=2 X2=-0.5 X3=0.5 S11=-
 117.021961653492 IsS11Max=No IsS11Min=No FrameElem=73 ElemStation=0
 Frame=73 Station=0 OutputCase=TERRLAT CaseType=LinStatic Point=3 X2=0.5 X3=-0.5 S11=117.02191275312
 IsS11Max=Yes IsS11Min=No FrameElem=73 ElemStation=0
 Frame=73 Station=0 OutputCase=TERRLAT CaseType=LinStatic Point=4 X2=0.5 X3=0.5 S11=117.02191275312
 IsS11Max=No IsS11Min=No FrameElem=73 ElemStation=0



Frame=73 Station=0.249999976158143 OutputCase=FESSUR CaseType=Combination Point=2 X2=-0.5 X3=0.5
 S11=-3336.90948878251 IsS11Max=No IsS11Min=No FrameElem=73 ElemStation=0.249999976158143
 Frame=73 Station=0.249999976158143 OutputCase=FESSUR CaseType=Combination Point=3 X2=0.5 X3=-0.5
 S11=1811.90945047583 IsS11Max=Yes IsS11Min=No FrameElem=73 ElemStation=0.249999976158143
 Frame=73 Station=0.249999976158143 OutputCase=FESSUR CaseType=Combination Point=4 X2=0.5 X3=0.5
 S11=1811.90945047583 IsS11Max=No IsS11Min=No FrameElem=73 ElemStation=0.249999976158143
 Frame=74 Station=0 OutputCase=PESOPR CaseType=LinStatic Point=0 X2=0 X3=0 S11=15.1709467361849
 IsS11Max=No IsS11Min=No FrameElem=74 ElemStation=0
 Frame=74 Station=0 OutputCase=PESOPR CaseType=LinStatic Point=1 X2=-0.5 X3=-0.5 S11=-
 111.258513838317 IsS11Max=No IsS11Min=Yes FrameElem=74 ElemStation=0
 Frame=74 Station=0 OutputCase=PESOPR CaseType=LinStatic Point=2 X2=-0.5 X3=0.5 S11=-
 111.258513838317 IsS11Max=No IsS11Min=No FrameElem=74 ElemStation=0
 Frame=74 Station=0 OutputCase=PESOPR CaseType=LinStatic Point=3 X2=0.5 X3=-0.5 S11=141.600407310687
 IsS11Max=Yes IsS11Min=No FrameElem=74 ElemStation=0
 Frame=74 Station=0 OutputCase=PESOPR CaseType=LinStatic Point=4 X2=0.5 X3=0.5 S11=141.600407310687
 IsS11Max=No IsS11Min=No FrameElem=74 ElemStation=0
 Frame=74 Station=6.24999940395355E-02 OutputCase=PESOPR CaseType=LinStatic Point=0 X2=0 X3=0
 S11=15.1709467361849 IsS11Max=No IsS11Min=No FrameElem=74 ElemStation=6.24999940395355E-02
 Frame=74 Station=6.24999940395355E-02 OutputCase=PESOPR CaseType=LinStatic Point=1 X2=-0.5 X3=-0.5
 S11=-88.1139849953418 IsS11Max=No IsS11Min=Yes FrameElem=74 ElemStation=6.24999940395355E-02
 Frame=74 Station=6.24999940395355E-02 OutputCase=PESOPR CaseType=LinStatic Point=2 X2=-0.5 X3=0.5
 S11=-88.1139849953418 IsS11Max=No IsS11Min=No FrameElem=74 ElemStation=6.24999940395355E-02
 Frame=74 Station=6.24999940395355E-02 OutputCase=PESOPR CaseType=LinStatic Point=3 X2=0.5 X3=-0.5
 S11=118.455878467712 IsS11Max=Yes IsS11Min=No FrameElem=74 ElemStation=6.24999940395355E-02
 Frame=74 Station=6.24999940395355E-02 OutputCase=PESOPR CaseType=LinStatic Point=4 X2=0.5 X3=0.5
 S11=118.455878467712 IsS11Max=No IsS11Min=No FrameElem=74 ElemStation=6.24999940395355E-02
 Frame=74 Station=0.124999988079071 OutputCase=PESOPR CaseType=LinStatic Point=0 X2=0 X3=0
 S11=15.1709467361849 IsS11Max=No IsS11Min=No FrameElem=74 ElemStation=0.124999988079071
 Frame=74 Station=0.124999988079071 OutputCase=PESOPR CaseType=LinStatic Point=1 X2=-0.5 X3=-0.5
 S11=-65.5553935406081 IsS11Max=No IsS11Min=Yes FrameElem=74 ElemStation=0.124999988079071
 Frame=74 Station=0.124999988079071 OutputCase=PESOPR CaseType=LinStatic Point=2 X2=-0.5 X3=0.5
 S11=-65.5553935406081 IsS11Max=No IsS11Min=No FrameElem=74 ElemStation=0.124999988079071
 Frame=74 Station=0.124999988079071 OutputCase=PESOPR CaseType=LinStatic Point=3 X2=0.5 X3=-0.5
 S11=95.8972870129779 IsS11Max=Yes IsS11Min=No FrameElem=74 ElemStation=0.124999988079071
 Frame=74 Station=0.124999988079071 OutputCase=PESOPR CaseType=LinStatic Point=4 X2=0.5 X3=0.5
 S11=95.8972870129779 IsS11Max=No IsS11Min=No FrameElem=74 ElemStation=0.124999988079071
 Frame=74 Station=0.187499982118607 OutputCase=PESOPR CaseType=LinStatic Point=0 X2=0 X3=0
 S11=15.1709467361849 IsS11Max=No IsS11Min=No FrameElem=74 ElemStation=0.187499982118607
 Frame=74 Station=0.187499982118607 OutputCase=PESOPR CaseType=LinStatic Point=1 X2=-0.5 X3=-0.5
 S11=-43.5827394741157 IsS11Max=No IsS11Min=Yes FrameElem=74 ElemStation=0.187499982118607
 Frame=74 Station=0.187499982118607 OutputCase=PESOPR CaseType=LinStatic Point=2 X2=-0.5 X3=0.5
 S11=-43.5827394741157 IsS11Max=No IsS11Min=No FrameElem=74 ElemStation=0.187499982118607
 Frame=74 Station=0.187499982118607 OutputCase=PESOPR CaseType=LinStatic Point=3 X2=0.5 X3=-0.5
 S11=73.9246329464855 IsS11Max=Yes IsS11Min=No FrameElem=74 ElemStation=0.187499982118607
 Frame=74 Station=0.187499982118607 OutputCase=PESOPR CaseType=LinStatic Point=4 X2=0.5 X3=0.5
 S11=73.9246329464855 IsS11Max=No IsS11Min=No FrameElem=74 ElemStation=0.187499982118607
 Frame=74 Station=0.249999976158142 OutputCase=PESOPR CaseType=LinStatic Point=0 X2=0 X3=0
 S11=15.1709467361849 IsS11Max=No IsS11Min=No FrameElem=74 ElemStation=0.249999976158142
 Frame=74 Station=0.249999976158142 OutputCase=PESOPR CaseType=LinStatic Point=1 X2=-0.5 X3=-0.5
 S11=-22.1960227958646 IsS11Max=No IsS11Min=Yes FrameElem=74 ElemStation=0.249999976158142
 Frame=74 Station=0.249999976158142 OutputCase=PESOPR CaseType=LinStatic Point=2 X2=-0.5 X3=0.5
 S11=-22.1960227958646 IsS11Max=No IsS11Min=No FrameElem=74 ElemStation=0.249999976158142
 Frame=74 Station=0.249999976158142 OutputCase=PESOPR CaseType=LinStatic Point=3 X2=0.5 X3=-0.5
 S11=52.5379162682344 IsS11Max=Yes IsS11Min=No FrameElem=74 ElemStation=0.249999976158142
 Frame=74 Station=0.249999976158142 OutputCase=PESOPR CaseType=LinStatic Point=4 X2=0.5 X3=0.5
 S11=52.5379162682344 IsS11Max=No IsS11Min=No FrameElem=74 ElemStation=0.249999976158142
 Frame=74 Station=0 OutputCase=TERRVERT CaseType=LinStatic Point=0 X2=0 X3=0 S11=-1.64270738196324
 IsS11Max=No IsS11Min=No FrameElem=74 ElemStation=0
 Frame=74 Station=0 OutputCase=TERRVERT CaseType=LinStatic Point=1 X2=-0.5 X3=-0.5 S11=-
 1951.19590958113 IsS11Max=No IsS11Min=Yes FrameElem=74 ElemStation=0
 Frame=74 Station=0 OutputCase=TERRVERT CaseType=LinStatic Point=2 X2=-0.5 X3=0.5 S11=-
 1951.19590958113 IsS11Max=No IsS11Min=No FrameElem=74 ElemStation=0
 Frame=74 Station=0 OutputCase=TERRVERT CaseType=LinStatic Point=3 X2=0.5 X3=-0.5
 S11=1947.9104948172 IsS11Max=Yes IsS11Min=No FrameElem=74 ElemStation=0
 Frame=74 Station=0 OutputCase=TERRVERT CaseType=LinStatic Point=4 X2=0.5 X3=0.5 S11=1947.9104948172
 IsS11Max=No IsS11Min=No FrameElem=74 ElemStation=0
 Frame=74 Station=6.24999940395355E-02 OutputCase=TERRVERT CaseType=LinStatic Point=0 X2=0 X3=0
 S11=-1.64270738196324 IsS11Max=No IsS11Min=No FrameElem=74 ElemStation=6.24999940395355E-02
 Frame=74 Station=6.24999940395355E-02 OutputCase=TERRVERT CaseType=LinStatic Point=1 X2=-0.5 X3=-0.5
 S11=-1691.97718659836 IsS11Max=No IsS11Min=Yes FrameElem=74 ElemStation=6.24999940395355E-02
 Frame=74 Station=6.24999940395355E-02 OutputCase=TERRVERT CaseType=LinStatic Point=2 X2=-0.5 X3=0.5
 S11=-1691.97718659836 IsS11Max=No IsS11Min=No FrameElem=74 ElemStation=6.24999940395355E-02
 Frame=74 Station=6.24999940395355E-02 OutputCase=TERRVERT CaseType=LinStatic Point=3 X2=0.5 X3=-0.5
 S11=1688.69177183444 IsS11Max=Yes IsS11Min=No FrameElem=74 ElemStation=6.24999940395355E-02
 Frame=74 Station=6.24999940395355E-02 OutputCase=TERRVERT CaseType=LinStatic Point=4 X2=0.5 X3=0.5
 S11=1688.69177183444 IsS11Max=No IsS11Min=No FrameElem=74 ElemStation=6.24999940395355E-02
 Frame=74 Station=0.124999988079071 OutputCase=TERRVERT CaseType=LinStatic Point=0 X2=0 X3=0 S11=-
 1.64270738196324 IsS11Max=No IsS11Min=No FrameElem=74 ElemStation=0.124999988079071
 Frame=74 Station=0.124999988079071 OutputCase=TERRVERT CaseType=LinStatic Point=1 X2=-0.5 X3=-0.5
 S11=-1439.3209623639 IsS11Max=No IsS11Min=Yes FrameElem=74 ElemStation=0.124999988079071
 Frame=74 Station=0.124999988079071 OutputCase=TERRVERT CaseType=LinStatic Point=2 X2=-0.5 X3=0.5
 S11=-1439.3209623639 IsS11Max=No IsS11Min=No FrameElem=74 ElemStation=0.124999988079071



Frame=74 Station=0.124999988079071 OutputCase=TERRVERT CaseType=LinStatic Point=3 X2=0.5 X3=-0.5
 S11=1436.03554759997 IsS11Max=Yes IsS11Min=No FrameElem=74 ElemStation=0.124999988079071
 Frame=74 Station=0.124999988079071 OutputCase=TERRVERT CaseType=LinStatic Point=4 X2=0.5 X3=0.5
 S11=1436.03554759997 IsS11Max=No IsS11Min=No FrameElem=74 ElemStation=0.124999988079071
 Frame=74 Station=0.187499982118607 OutputCase=TERRVERT CaseType=LinStatic Point=0 X2=0 X3=0 S11=-
 1.64270738196324 IsS11Max=No IsS11Min=No FrameElem=74 ElemStation=0.187499982118607
 Frame=74 Station=0.187499982118607 OutputCase=TERRVERT CaseType=LinStatic Point=1 X2=-0.5 X3=-0.5
 S11=-1193.22723687773 IsS11Max=No IsS11Min=Yes FrameElem=74 ElemStation=0.187499982118607
 Frame=74 Station=0.187499982118607 OutputCase=TERRVERT CaseType=LinStatic Point=2 X2=-0.5 X3=0.5
 S11=-1193.22723687773 IsS11Max=No IsS11Min=No FrameElem=74 ElemStation=0.187499982118607
 Frame=74 Station=0.187499982118607 OutputCase=TERRVERT CaseType=LinStatic Point=3 X2=0.5 X3=-0.5
 S11=1189.9418221138 IsS11Max=Yes IsS11Min=No FrameElem=74 ElemStation=0.187499982118607
 Frame=74 Station=0.187499982118607 OutputCase=TERRVERT CaseType=LinStatic Point=4 X2=0.5 X3=0.5
 S11=1189.9418221138 IsS11Max=No IsS11Min=No FrameElem=74 ElemStation=0.187499982118607
 Frame=74 Station=0.249999976158142 OutputCase=TERRVERT CaseType=LinStatic Point=0 X2=0 X3=0 S11=-
 1.64270738196324 IsS11Max=No IsS11Min=No FrameElem=74 ElemStation=0.249999976158142
 Frame=74 Station=0.249999976158142 OutputCase=TERRVERT CaseType=LinStatic Point=1 X2=-0.5 X3=-0.5
 S11=-953.69601013987 IsS11Max=No IsS11Min=Yes FrameElem=74 ElemStation=0.249999976158142
 Frame=74 Station=0.249999976158142 OutputCase=TERRVERT CaseType=LinStatic Point=2 X2=-0.5 X3=0.5
 S11=-953.69601013987 IsS11Max=No IsS11Min=No FrameElem=74 ElemStation=0.249999976158142
 Frame=74 Station=0.249999976158142 OutputCase=TERRVERT CaseType=LinStatic Point=3 X2=0.5 X3=-0.5
 S11=950.410595375943 IsS11Max=Yes IsS11Min=No FrameElem=74 ElemStation=0.249999976158142
 Frame=74 Station=0.249999976158142 OutputCase=TERRVERT CaseType=LinStatic Point=4 X2=0.5 X3=0.5
 S11=950.410595375943 IsS11Max=No IsS11Min=No FrameElem=74 ElemStation=0.249999976158142
 Frame=74 Station=0 OutputCase=TERRLAT CaseType=LinStatic Point=0 X2=0 X3=0 S11=-330.586282883909
 IsS11Max=No IsS11Min=No FrameElem=74 ElemStation=0
 Frame=74 Station=0 OutputCase=TERRLAT CaseType=LinStatic Point=1 X2=-0.5 X3=-0.5 S11=-
 829.013075550097 IsS11Max=No IsS11Min=Yes FrameElem=74 ElemStation=0
 Frame=74 Station=0 OutputCase=TERRLAT CaseType=LinStatic Point=2 X2=-0.5 X3=0.5 S11=-
 829.013075550097 IsS11Max=No IsS11Min=No FrameElem=74 ElemStation=0
 Frame=74 Station=0 OutputCase=TERRLAT CaseType=LinStatic Point=3 X2=0.5 X3=-0.5
 S11=167.840509782279 IsS11Max=Yes IsS11Min=No FrameElem=74 ElemStation=0
 Frame=74 Station=0 OutputCase=TERRLAT CaseType=LinStatic Point=4 X2=0.5 X3=0.5 S11=167.840509782279
 IsS11Max=No IsS11Min=No FrameElem=74 ElemStation=0
 Frame=74 Station=6.24999940395355E-02 OutputCase=TERRLAT CaseType=LinStatic Point=0 X2=0 X3=0 S11=-
 330.586282883909 IsS11Max=No IsS11Min=No FrameElem=74 ElemStation=6.24999940395355E-02
 Frame=74 Station=6.24999940395355E-02 OutputCase=TERRLAT CaseType=LinStatic Point=1 X2=-0.5 X3=-0.5
 S11=-829.013076184671 IsS11Max=No IsS11Min=Yes FrameElem=74 ElemStation=6.24999940395355E-02
 Frame=74 Station=6.24999940395355E-02 OutputCase=TERRLAT CaseType=LinStatic Point=2 X2=-0.5 X3=0.5
 S11=-829.013076184671 IsS11Max=No IsS11Min=No FrameElem=74 ElemStation=6.24999940395355E-02
 Frame=74 Station=6.24999940395355E-02 OutputCase=TERRLAT CaseType=LinStatic Point=3 X2=0.5 X3=-0.5
 S11=167.840510416853 IsS11Max=Yes IsS11Min=No FrameElem=74 ElemStation=6.24999940395355E-02
 Frame=74 Station=6.24999940395355E-02 OutputCase=TERRLAT CaseType=LinStatic Point=4 X2=0.5 X3=0.5
 S11=167.840510416853 IsS11Max=No IsS11Min=No FrameElem=74 ElemStation=6.24999940395355E-02
 Frame=74 Station=0.124999988079071 OutputCase=TERRLAT CaseType=LinStatic Point=0 X2=0 X3=0 S11=-
 330.586282883909 IsS11Max=No IsS11Min=No FrameElem=74 ElemStation=0.124999988079071
 Frame=74 Station=0.124999988079071 OutputCase=TERRLAT CaseType=LinStatic Point=1 X2=-0.5 X3=-0.5
 S11=-829.013076819244 IsS11Max=No IsS11Min=Yes FrameElem=74 ElemStation=0.124999988079071
 Frame=74 Station=0.124999988079071 OutputCase=TERRLAT CaseType=LinStatic Point=2 X2=-0.5 X3=0.5
 S11=-829.013076819244 IsS11Max=No IsS11Min=No FrameElem=74 ElemStation=0.124999988079071
 Frame=74 Station=0.124999988079071 OutputCase=TERRLAT CaseType=LinStatic Point=3 X2=0.5 X3=-0.5
 S11=167.840511051426 IsS11Max=Yes IsS11Min=No FrameElem=74 ElemStation=0.124999988079071
 Frame=74 Station=0.124999988079071 OutputCase=TERRLAT CaseType=LinStatic Point=4 X2=0.5 X3=0.5
 S11=167.840511051426 IsS11Max=No IsS11Min=No FrameElem=74 ElemStation=0.124999988079071
 Frame=74 Station=0.187499982118607 OutputCase=TERRLAT CaseType=LinStatic Point=0 X2=0 X3=0 S11=-
 330.586282883909 IsS11Max=No IsS11Min=No FrameElem=74 ElemStation=0.187499982118607
 Frame=74 Station=0.187499982118607 OutputCase=TERRLAT CaseType=LinStatic Point=1 X2=-0.5 X3=-0.5
 S11=-829.013077453817 IsS11Max=No IsS11Min=Yes FrameElem=74 ElemStation=0.187499982118607
 Frame=74 Station=0.187499982118607 OutputCase=TERRLAT CaseType=LinStatic Point=2 X2=-0.5 X3=0.5
 S11=-829.013077453817 IsS11Max=No IsS11Min=No FrameElem=74 ElemStation=0.187499982118607
 Frame=74 Station=0.187499982118607 OutputCase=TERRLAT CaseType=LinStatic Point=3 X2=0.5 X3=-0.5
 S11=167.840511685999 IsS11Max=Yes IsS11Min=No FrameElem=74 ElemStation=0.187499982118607
 Frame=74 Station=0.187499982118607 OutputCase=TERRLAT CaseType=LinStatic Point=4 X2=0.5 X3=0.5
 S11=167.840511685999 IsS11Max=No IsS11Min=No FrameElem=74 ElemStation=0.187499982118607
 Frame=74 Station=0.249999976158142 OutputCase=TERRLAT CaseType=LinStatic Point=0 X2=0 X3=0 S11=-
 330.586282883909 IsS11Max=No IsS11Min=No FrameElem=74 ElemStation=0.249999976158142
 Frame=74 Station=0.249999976158142 OutputCase=TERRLAT CaseType=LinStatic Point=1 X2=-0.5 X3=-0.5
 S11=-829.013078088391 IsS11Max=No IsS11Min=Yes FrameElem=74 ElemStation=0.249999976158142
 Frame=74 Station=0.249999976158142 OutputCase=TERRLAT CaseType=LinStatic Point=2 X2=-0.5 X3=0.5
 S11=-829.013078088391 IsS11Max=No IsS11Min=No FrameElem=74 ElemStation=0.249999976158142
 Frame=74 Station=0.249999976158142 OutputCase=TERRLAT CaseType=LinStatic Point=3 X2=0.5 X3=-0.5
 S11=167.840512320573 IsS11Max=Yes IsS11Min=No FrameElem=74 ElemStation=0.249999976158142
 Frame=74 Station=0.249999976158142 OutputCase=TERRLAT CaseType=LinStatic Point=4 X2=0.5 X3=0.5
 S11=167.840512320573 IsS11Max=No IsS11Min=No FrameElem=74 ElemStation=0.249999976158142
 Frame=74 Station=0 OutputCase=ACCVERT CaseType=LinStatic Point=0 X2=0 X3=0 S11=0 IsS11Max=Yes
 IsS11Min=Yes FrameElem=74 ElemStation=0
 Frame=74 Station=0 OutputCase=ACCVERT CaseType=LinStatic Point=1 X2=-0.5 X3=-0.5 S11=0
 IsS11Max=No IsS11Min=No FrameElem=74 ElemStation=0
 Frame=74 Station=0 OutputCase=ACCVERT CaseType=LinStatic Point=2 X2=-0.5 X3=0.5 S11=0 IsS11Max=No
 IsS11Min=No FrameElem=74 ElemStation=0
 Frame=74 Station=0 OutputCase=ACCVERT CaseType=LinStatic Point=3 X2=0.5 X3=-0.5 S11=0 IsS11Max=No
 IsS11Min=No FrameElem=74 ElemStation=0

Frame=74 Station=0.187499982118607 OutputCase=ENVE CaseType=Combination StepType=Min Point=2 X2=-0.5
X3=0.5 S11=-2065.82305380566 IsS11Max=No IsS11Min=No FrameElem=74 ElemStation=0.187499982118607
Frame=74 Station=0.187499982118607 OutputCase=ENVE CaseType=Combination StepType=Min Point=3 X2=0.5
X3=-0.5 S11=1381.35481324049 IsS11Max=Yes IsS11Min=No FrameElem=74 ElemStation=0.187499982118607
Frame=74 Station=0.187499982118607 OutputCase=ENVE CaseType=Combination StepType=Min Point=4 X2=0.5
X3=0.5 S11=1381.35481324049 IsS11Max=No IsS11Min=No FrameElem=74 ElemStation=0.187499982118607
Frame=74 Station=0.249999976158142 OutputCase=ENVE CaseType=Combination StepType=Min Point=0 X2=0
X3=0 S11=-317.058043529687 IsS11Max=No IsS11Min=No FrameElem=74 ElemStation=0.249999976158142
Frame=74 Station=0.249999976158142 OutputCase=ENVE CaseType=Combination StepType=Min Point=1 X2=-0.5
X3=-0.5 S11=-1804.90511102413 IsS11Max=No IsS11Min=Yes FrameElem=74 ElemStation=0.249999976158142
Frame=74 Station=0.249999976158142 OutputCase=ENVE CaseType=Combination StepType=Min Point=2 X2=-0.5
X3=0.5 S11=-1804.90511102413 IsS11Max=No IsS11Min=No FrameElem=74 ElemStation=0.249999976158142
Frame=74 Station=0.249999976158142 OutputCase=ENVE CaseType=Combination StepType=Min Point=3 X2=0.5
X3=-0.5 S11=1120.43687026858 IsS11Max=Yes IsS11Min=No FrameElem=74 ElemStation=0.249999976158142
Frame=74 Station=0.249999976158142 OutputCase=ENVE CaseType=Combination StepType=Min Point=4 X2=0.5
X3=0.5 S11=1120.43687026858 IsS11Max=No IsS11Min=No FrameElem=74 ElemStation=0.249999976158142
Frame=74 Station=0 OutputCase=FESSUR CaseType=Combination Point=0 X2=0 X3=0 S11=-317.058043529687
IsS11Max=No IsS11Min=No FrameElem=74 ElemStation=0
Frame=74 Station=0 OutputCase=FESSUR CaseType=Combination Point=1 X2=-0.5 X3=-0.5 S11=-
2891.46749896955 IsS11Max=No IsS11Min=Yes FrameElem=74 ElemStation=0
Frame=74 Station=0 OutputCase=FESSUR CaseType=Combination Point=2 X2=-0.5 X3=0.5 S11=-
2891.46749896955 IsS11Max=No IsS11Min=No FrameElem=74 ElemStation=0
Frame=74 Station=0 OutputCase=FESSUR CaseType=Combination Point=3 X2=0.5 X3=-0.5
S11=2257.35141191017 IsS11Max=Yes IsS11Min=No FrameElem=74 ElemStation=0
Frame=74 Station=0 OutputCase=FESSUR CaseType=Combination Point=4 X2=0.5 X3=0.5
S11=2257.35141191017 IsS11Max=No IsS11Min=No FrameElem=74 ElemStation=0
Frame=74 Station=6.24999940395355E-02 OutputCase=FESSUR CaseType=Combination Point=0 X2=0 X3=0
S11=-317.058043529687 IsS11Max=No IsS11Min=No FrameElem=74 ElemStation=6.24999940395355E-02
Frame=74 Station=6.24999940395355E-02 OutputCase=FESSUR CaseType=Combination Point=1 X2=-0.5 X3=-0.5
S11=-2609.10424777837 IsS11Max=No IsS11Min=Yes FrameElem=74 ElemStation=6.24999940395355E-02
Frame=74 Station=6.24999940395355E-02 OutputCase=FESSUR CaseType=Combination Point=2 X2=-0.5 X3=0.5
S11=-2609.10424777837 IsS11Max=No IsS11Min=No FrameElem=74 ElemStation=6.24999940395355E-02
Frame=74 Station=6.24999940395355E-02 OutputCase=FESSUR CaseType=Combination Point=3 X2=0.5 X3=-0.5
S11=1974.988160719 IsS11Max=Yes IsS11Min=No FrameElem=74 ElemStation=6.24999940395355E-02
Frame=74 Station=6.24999940395355E-02 OutputCase=FESSUR CaseType=Combination Point=4 X2=0.5 X3=0.5
S11=1974.988160719 IsS11Max=No IsS11Min=No FrameElem=74 ElemStation=6.24999940395355E-02
Frame=74 Station=0.124999988079071 OutputCase=FESSUR CaseType=Combination Point=0 X2=0 X3=0 S11=-
317.058043529687 IsS11Max=No IsS11Min=No FrameElem=74 ElemStation=0.124999988079071
Frame=74 Station=0.124999988079071 OutputCase=FESSUR CaseType=Combination Point=1 X2=-0.5 X3=-0.5
S11=-2333.88943272375 IsS11Max=No IsS11Min=Yes FrameElem=74 ElemStation=0.124999988079071
Frame=74 Station=0.124999988079071 OutputCase=FESSUR CaseType=Combination Point=2 X2=-0.5 X3=0.5
S11=-2333.88943272375 IsS11Max=No IsS11Min=No FrameElem=74 ElemStation=0.124999988079071
Frame=74 Station=0.124999988079071 OutputCase=FESSUR CaseType=Combination Point=3 X2=0.5 X3=-0.5
S11=1699.77334566437 IsS11Max=Yes IsS11Min=No FrameElem=74 ElemStation=0.124999988079071
Frame=74 Station=0.124999988079071 OutputCase=FESSUR CaseType=Combination Point=4 X2=0.5 X3=0.5
S11=1699.77334566437 IsS11Max=No IsS11Min=No FrameElem=74 ElemStation=0.124999988079071
Frame=74 Station=0.187499982118607 OutputCase=FESSUR CaseType=Combination Point=0 X2=0 X3=0 S11=-
317.058043529687 IsS11Max=No IsS11Min=No FrameElem=74 ElemStation=0.187499982118607
Frame=74 Station=0.187499982118607 OutputCase=FESSUR CaseType=Combination Point=1 X2=-0.5 X3=-0.5
S11=-2065.82305380566 IsS11Max=No IsS11Min=Yes FrameElem=74 ElemStation=0.187499982118607
Frame=74 Station=0.187499982118607 OutputCase=FESSUR CaseType=Combination Point=2 X2=-0.5 X3=0.5
S11=-2065.82305380566 IsS11Max=No IsS11Min=No FrameElem=74 ElemStation=0.187499982118607
Frame=74 Station=0.187499982118607 OutputCase=FESSUR CaseType=Combination Point=3 X2=0.5 X3=-0.5
S11=1431.70696674629 IsS11Max=Yes IsS11Min=No FrameElem=74 ElemStation=0.187499982118607
Frame=74 Station=0.187499982118607 OutputCase=FESSUR CaseType=Combination Point=4 X2=0.5 X3=0.5
S11=1431.70696674629 IsS11Max=No IsS11Min=No FrameElem=74 ElemStation=0.187499982118607
Frame=74 Station=0.249999976158142 OutputCase=FESSUR CaseType=Combination Point=0 X2=0 X3=0 S11=-
317.058043529687 IsS11Max=No IsS11Min=No FrameElem=74 ElemStation=0.249999976158142
Frame=74 Station=0.249999976158142 OutputCase=FESSUR CaseType=Combination Point=1 X2=-0.5 X3=-0.5
S11=-1804.90511102413 IsS11Max=No IsS11Min=Yes FrameElem=74 ElemStation=0.249999976158142
Frame=74 Station=0.249999976158142 OutputCase=FESSUR CaseType=Combination Point=2 X2=-0.5 X3=0.5
S11=-1804.90511102413 IsS11Max=No IsS11Min=No FrameElem=74 ElemStation=0.249999976158142
Frame=74 Station=0.249999976158142 OutputCase=FESSUR CaseType=Combination Point=3 X2=0.5 X3=-0.5
S11=1170.78902396475 IsS11Max=Yes IsS11Min=No FrameElem=74 ElemStation=0.249999976158142
Frame=74 Station=0.249999976158142 OutputCase=FESSUR CaseType=Combination Point=4 X2=0.5 X3=0.5
S11=1170.78902396475 IsS11Max=No IsS11Min=No FrameElem=74 ElemStation=0.249999976158142
Frame=75 Station=0 OutputCase=PESOPR CaseType=LinStatic Point=0 X2=0 X3=0 S11=15.1709467361842
IsS11Max=No IsS11Min=No FrameElem=75 ElemStation=0
Frame=75 Station=0 OutputCase=PESOPR CaseType=LinStatic Point=1 X2=-0.5 X3=-0.5 S11=-
22.1960227958653 IsS11Max=No IsS11Min=Yes FrameElem=75 ElemStation=0
Frame=75 Station=0 OutputCase=PESOPR CaseType=LinStatic Point=2 X2=-0.5 X3=0.5 S11=-
22.1960227958653 IsS11Max=No IsS11Min=No FrameElem=75 ElemStation=0
Frame=75 Station=0 OutputCase=PESOPR CaseType=LinStatic Point=3 X2=0.5 X3=-0.5 S11=52.5379162682338
IsS11Max=Yes IsS11Min=No FrameElem=75 ElemStation=0
Frame=75 Station=0 OutputCase=PESOPR CaseType=LinStatic Point=4 X2=0.5 X3=0.5 S11=52.5379162682338
IsS11Max=No IsS11Min=No FrameElem=75 ElemStation=0
Frame=75 Station=0.0625 OutputCase=PESOPR CaseType=LinStatic Point=0 X2=0 X3=0 S11=15.1709467361842
IsS11Max=No IsS11Min=No FrameElem=75 ElemStation=0.0625
Frame=75 Station=0.0625 OutputCase=PESOPR CaseType=LinStatic Point=1 X2=-0.5 X3=-0.5 S11=-
1.39524155004534 IsS11Max=No IsS11Min=Yes FrameElem=75 ElemStation=0.0625
Frame=75 Station=0.0625 OutputCase=PESOPR CaseType=LinStatic Point=2 X2=-0.5 X3=0.5 S11=-
1.39524155004534 IsS11Max=No IsS11Min=No FrameElem=75 ElemStation=0.0625



Frame=75	Station=0.0625	OutputCase=PESOPR	CaseType=LinStatic	Point=3	X2=0.5	X3=-0.5	
S11=31.7371350224138	IsS11Max=Yes	IsS11Min=No	FrameElem=75	ElemStation=0.0625			
Frame=75	Station=0.0625	OutputCase=PESOPR	CaseType=LinStatic	Point=4	X2=0.5	X3=0.5	
S11=31.7371350224138	IsS11Max=No	IsS11Min=No	FrameElem=75	ElemStation=0.0625			
Frame=75	Station=0.125	OutputCase=PESOPR	CaseType=LinStatic	Point=0	X2=0	X3=0	S11=15.1709467361842
IsS11Max=No	IsS11Min=No	FrameElem=75	ElemStation=0.125				
Frame=75	Station=0.125	OutputCase=PESOPR	CaseType=LinStatic	Point=1	X2=-0.5	X3=-0.5	
S11=18.8196021957746	IsS11Max=Yes	IsS11Min=No	FrameElem=75	ElemStation=0.125			
Frame=75	Station=0.125	OutputCase=PESOPR	CaseType=LinStatic	Point=2	X2=-0.5	X3=0.5	
S11=18.8196021957746	IsS11Max=No	IsS11Min=No	FrameElem=75	ElemStation=0.125			
Frame=75	Station=0.125	OutputCase=PESOPR	CaseType=LinStatic	Point=3	X2=0.5	X3=-0.5	
S11=11.5222912765939	IsS11Max=No	IsS11Min=Yes	FrameElem=75	ElemStation=0.125			
Frame=75	Station=0.125	OutputCase=PESOPR	CaseType=LinStatic	Point=4	X2=0.5	X3=0.5	
S11=11.5222912765939	IsS11Max=No	IsS11Min=No	FrameElem=75	ElemStation=0.125			
Frame=75	Station=0.1875	OutputCase=PESOPR	CaseType=LinStatic	Point=0	X2=0	X3=0	S11=15.1709467361842
IsS11Max=No	IsS11Min=No	FrameElem=75	ElemStation=0.1875				
Frame=75	Station=0.1875	OutputCase=PESOPR	CaseType=LinStatic	Point=1	X2=-0.5	X3=-0.5	
S11=38.4485084415946	IsS11Max=Yes	IsS11Min=No	FrameElem=75	ElemStation=0.1875			
Frame=75	Station=0.1875	OutputCase=PESOPR	CaseType=LinStatic	Point=2	X2=-0.5	X3=0.5	
S11=38.4485084415946	IsS11Max=No	IsS11Min=No	FrameElem=75	ElemStation=0.1875			
Frame=75	Station=0.1875	OutputCase=PESOPR	CaseType=LinStatic	Point=3	X2=0.5	X3=-0.5	S11=-
8.10661496922609	IsS11Max=No	IsS11Min=Yes	FrameElem=75	ElemStation=0.1875			
Frame=75	Station=0.1875	OutputCase=PESOPR	CaseType=LinStatic	Point=4	X2=0.5	X3=0.5	S11=-
8.10661496922609	IsS11Max=No	IsS11Min=No	FrameElem=75	ElemStation=0.1875			
Frame=75	Station=0.25	OutputCase=PESOPR	CaseType=LinStatic	Point=0	X2=0	X3=0	S11=15.1709467361842
IsS11Max=No	IsS11Min=No	FrameElem=75	ElemStation=0.25				
Frame=75	Station=0.25	OutputCase=PESOPR	CaseType=LinStatic	Point=1	X2=-0.5	X3=-0.5	
S11=57.4914771874145	IsS11Max=Yes	IsS11Min=No	FrameElem=75	ElemStation=0.25			
Frame=75	Station=0.25	OutputCase=PESOPR	CaseType=LinStatic	Point=2	X2=-0.5	X3=0.5	
S11=57.4914771874145	IsS11Max=No	IsS11Min=No	FrameElem=75	ElemStation=0.25			
Frame=75	Station=0.25	OutputCase=PESOPR	CaseType=LinStatic	Point=3	X2=0.5	X3=-0.5	S11=-
27.149583715046	IsS11Max=No	IsS11Min=Yes	FrameElem=75	ElemStation=0.25			
Frame=75	Station=0.25	OutputCase=PESOPR	CaseType=LinStatic	Point=4	X2=0.5	X3=0.5	S11=-
27.149583715046	IsS11Max=No	IsS11Min=No	FrameElem=75	ElemStation=0.25			
Frame=75	Station=0	OutputCase=TERRVERT	CaseType=LinStatic	Point=0	X2=0	X3=0	S11=-1.6427073819618
IsS11Max=No	IsS11Min=No	FrameElem=75	ElemStation=0				
Frame=75	Station=0	OutputCase=TERRVERT	CaseType=LinStatic	Point=1	X2=-0.5	X3=-0.5	S11=-
953.696010139782	IsS11Max=No	IsS11Min=Yes	FrameElem=75	ElemStation=0			
Frame=75	Station=0	OutputCase=TERRVERT	CaseType=LinStatic	Point=2	X2=-0.5	X3=0.5	S11=-
953.696010139782	IsS11Max=No	IsS11Min=No	FrameElem=75	ElemStation=0			
Frame=75	Station=0	OutputCase=TERRVERT	CaseType=LinStatic	Point=3	X2=0.5	X3=-0.5	
S11=950.410595375859	IsS11Max=Yes	IsS11Min=No	FrameElem=75	ElemStation=0			
Frame=75	Station=0	OutputCase=TERRVERT	CaseType=LinStatic	Point=4	X2=0.5	X3=0.5	
S11=950.410595375859	IsS11Max=No	IsS11Min=No	FrameElem=75	ElemStation=0			
Frame=75	Station=0.0625	OutputCase=TERRVERT	CaseType=LinStatic	Point=0	X2=0	X3=0	S11=-
1.6427073819618	IsS11Max=No	IsS11Min=No	FrameElem=75	ElemStation=0.0625			
Frame=75	Station=0.0625	OutputCase=TERRVERT	CaseType=LinStatic	Point=1	X2=-0.5	X3=-0.5	S11=-
720.727260245473	IsS11Max=No	IsS11Min=Yes	FrameElem=75	ElemStation=0.0625			
Frame=75	Station=0.0625	OutputCase=TERRVERT	CaseType=LinStatic	Point=2	X2=-0.5	X3=0.5	S11=-
720.727260245473	IsS11Max=No	IsS11Min=No	FrameElem=75	ElemStation=0.0625			
Frame=75	Station=0.0625	OutputCase=TERRVERT	CaseType=LinStatic	Point=3	X2=0.5	X3=-0.5	
S11=717.441845481549	IsS11Max=Yes	IsS11Min=No	FrameElem=75	ElemStation=0.0625			
Frame=75	Station=0.0625	OutputCase=TERRVERT	CaseType=LinStatic	Point=4	X2=0.5	X3=0.5	
S11=717.441845481549	IsS11Max=No	IsS11Min=No	FrameElem=75	ElemStation=0.0625			
Frame=75	Station=0.125	OutputCase=TERRVERT	CaseType=LinStatic	Point=0	X2=0	X3=0	S11=-
1.6427073819618	IsS11Max=No	IsS11Min=No	FrameElem=75	ElemStation=0.125			
Frame=75	Station=0.125	OutputCase=TERRVERT	CaseType=LinStatic	Point=1	X2=-0.5	X3=-0.5	S11=-
494.321010351163	IsS11Max=No	IsS11Min=Yes	FrameElem=75	ElemStation=0.125			
Frame=75	Station=0.125	OutputCase=TERRVERT	CaseType=LinStatic	Point=2	X2=-0.5	X3=0.5	S11=-
494.321010351163	IsS11Max=No	IsS11Min=No	FrameElem=75	ElemStation=0.125			
Frame=75	Station=0.125	OutputCase=TERRVERT	CaseType=LinStatic	Point=3	X2=0.5	X3=-0.5	
S11=491.03559558724	IsS11Max=Yes	IsS11Min=No	FrameElem=75	ElemStation=0.125			
Frame=75	Station=0.125	OutputCase=TERRVERT	CaseType=LinStatic	Point=4	X2=0.5	X3=0.5	
S11=491.03559558724	IsS11Max=No	IsS11Min=No	FrameElem=75	ElemStation=0.125			
Frame=75	Station=0.1875	OutputCase=TERRVERT	CaseType=LinStatic	Point=0	X2=0	X3=0	S11=-
1.6427073819618	IsS11Max=No	IsS11Min=No	FrameElem=75	ElemStation=0.1875			
Frame=75	Station=0.1875	OutputCase=TERRVERT	CaseType=LinStatic	Point=1	X2=-0.5	X3=-0.5	S11=-
274.477260456854	IsS11Max=No	IsS11Min=Yes	FrameElem=75	ElemStation=0.1875			
Frame=75	Station=0.1875	OutputCase=TERRVERT	CaseType=LinStatic	Point=2	X2=-0.5	X3=0.5	S11=-
274.477260456854	IsS11Max=No	IsS11Min=No	FrameElem=75	ElemStation=0.1875			
Frame=75	Station=0.1875	OutputCase=TERRVERT	CaseType=LinStatic	Point=3	X2=0.5	X3=-0.5	
S11=271.19184569293	IsS11Max=Yes	IsS11Min=No	FrameElem=75	ElemStation=0.1875			
Frame=75	Station=0.1875	OutputCase=TERRVERT	CaseType=LinStatic	Point=4	X2=0.5	X3=0.5	
S11=271.19184569293	IsS11Max=No	IsS11Min=No	FrameElem=75	ElemStation=0.1875			
Frame=75	Station=0.25	OutputCase=TERRVERT	CaseType=LinStatic	Point=0	X2=0	X3=0	S11=-1.6427073819618
IsS11Max=No	IsS11Min=No	FrameElem=75	ElemStation=0.25				
Frame=75	Station=0.25	OutputCase=TERRVERT	CaseType=LinStatic	Point=1	X2=-0.5	X3=-0.5	S11=-
61.1960105625444	IsS11Max=No	IsS11Min=Yes	FrameElem=75	ElemStation=0.25			
Frame=75	Station=0.25	OutputCase=TERRVERT	CaseType=LinStatic	Point=2	X2=-0.5	X3=0.5	S11=-
61.1960105625444	IsS11Max=No	IsS11Min=No	FrameElem=75	ElemStation=0.25			
Frame=75	Station=0.25	OutputCase=TERRVERT	CaseType=LinStatic	Point=3	X2=0.5	X3=-0.5	
S11=57.9105957986208	IsS11Max=Yes	IsS11Min=No	FrameElem=75	ElemStation=0.25			



Frame=75 Station=0.25 OutputCase=TERRVERT CaseType=LinStatic Point=4 X2=0.5 X3=0.5
 S11=57.9105957986208 IsS11Max=No IsS11Min=No FrameElem=75 ElemStation=0.25
 Frame=75 Station=0 OutputCase=TERRLAT CaseType=LinStatic Point=0 X2=0 X3=0 S11=-330.586282883909
 IsS11Max=No IsS11Min=No FrameElem=75 ElemStation=0
 Frame=75 Station=0 OutputCase=TERRLAT CaseType=LinStatic Point=1 X2=-0.5 X3=-0.5 S11=-
 829.013078088391 IsS11Max=No IsS11Min=Yes FrameElem=75 ElemStation=0
 Frame=75 Station=0 OutputCase=TERRLAT CaseType=LinStatic Point=2 X2=-0.5 X3=0.5 S11=-
 829.013078088391 IsS11Max=No IsS11Min=No FrameElem=75 ElemStation=0
 Frame=75 Station=0 OutputCase=TERRLAT CaseType=LinStatic Point=3 X2=0.5 X3=-0.5
 S11=167.840512320573 IsS11Max=Yes IsS11Min=No FrameElem=75 ElemStation=0
 Frame=75 Station=0 OutputCase=TERRLAT CaseType=LinStatic Point=4 X2=0.5 X3=0.5 S11=167.840512320573
 IsS11Max=No IsS11Min=No FrameElem=75 ElemStation=0
 Frame=75 Station=0.0625 OutputCase=TERRLAT CaseType=LinStatic Point=0 X2=0 X3=0 S11=-
 330.586282883909 IsS11Max=No IsS11Min=No FrameElem=75 ElemStation=0.0625
 Frame=75 Station=0.0625 OutputCase=TERRLAT CaseType=LinStatic Point=1 X2=-0.5 X3=-0.5 S11=-
 829.013078722965 IsS11Max=No IsS11Min=Yes FrameElem=75 ElemStation=0.0625
 Frame=75 Station=0.0625 OutputCase=TERRLAT CaseType=LinStatic Point=2 X2=-0.5 X3=0.5 S11=-
 829.013078722965 IsS11Max=No IsS11Min=No FrameElem=75 ElemStation=0.0625
 Frame=75 Station=0.0625 OutputCase=TERRLAT CaseType=LinStatic Point=3 X2=0.5 X3=-0.5
 S11=167.840512955147 IsS11Max=Yes IsS11Min=No FrameElem=75 ElemStation=0.0625
 Frame=75 Station=0.0625 OutputCase=TERRLAT CaseType=LinStatic Point=4 X2=0.5 X3=0.5
 S11=167.840512955147 IsS11Max=No IsS11Min=No FrameElem=75 ElemStation=0.0625
 Frame=75 Station=0.125 OutputCase=TERRLAT CaseType=LinStatic Point=0 X2=0 X3=0 S11=-
 330.586282883909 IsS11Max=No IsS11Min=No FrameElem=75 ElemStation=0.125
 Frame=75 Station=0.125 OutputCase=TERRLAT CaseType=LinStatic Point=1 X2=-0.5 X3=-0.5 S11=-
 829.013079357538 IsS11Max=No IsS11Min=Yes FrameElem=75 ElemStation=0.125
 Frame=75 Station=0.125 OutputCase=TERRLAT CaseType=LinStatic Point=2 X2=-0.5 X3=0.5 S11=-
 829.013079357538 IsS11Max=No IsS11Min=No FrameElem=75 ElemStation=0.125
 Frame=75 Station=0.125 OutputCase=TERRLAT CaseType=LinStatic Point=3 X2=0.5 X3=-0.5
 S11=167.840513589721 IsS11Max=Yes IsS11Min=No FrameElem=75 ElemStation=0.125
 Frame=75 Station=0.125 OutputCase=TERRLAT CaseType=LinStatic Point=4 X2=0.5 X3=0.5
 S11=167.840513589721 IsS11Max=No IsS11Min=No FrameElem=75 ElemStation=0.125
 Frame=75 Station=0.1875 OutputCase=TERRLAT CaseType=LinStatic Point=0 X2=0 X3=0 S11=-
 330.586282883909 IsS11Max=No IsS11Min=No FrameElem=75 ElemStation=0.1875
 Frame=75 Station=0.1875 OutputCase=TERRLAT CaseType=LinStatic Point=1 X2=-0.5 X3=-0.5 S11=-
 829.013079992112 IsS11Max=No IsS11Min=Yes FrameElem=75 ElemStation=0.1875
 Frame=75 Station=0.1875 OutputCase=TERRLAT CaseType=LinStatic Point=2 X2=-0.5 X3=0.5 S11=-
 829.013079992112 IsS11Max=No IsS11Min=No FrameElem=75 ElemStation=0.1875
 Frame=75 Station=0.1875 OutputCase=TERRLAT CaseType=LinStatic Point=3 X2=0.5 X3=-0.5
 S11=167.840514224294 IsS11Max=Yes IsS11Min=No FrameElem=75 ElemStation=0.1875
 Frame=75 Station=0.1875 OutputCase=TERRLAT CaseType=LinStatic Point=4 X2=0.5 X3=0.5
 S11=167.840514224294 IsS11Max=No IsS11Min=No FrameElem=75 ElemStation=0.1875
 Frame=75 Station=0.25 OutputCase=TERRLAT CaseType=LinStatic Point=0 X2=0 X3=0 S11=-330.586282883909
 IsS11Max=No IsS11Min=No FrameElem=75 ElemStation=0.25
 Frame=75 Station=0.25 OutputCase=TERRLAT CaseType=LinStatic Point=1 X2=-0.5 X3=-0.5 S11=-
 829.013080626686 IsS11Max=No IsS11Min=Yes FrameElem=75 ElemStation=0.25
 Frame=75 Station=0.25 OutputCase=TERRLAT CaseType=LinStatic Point=2 X2=-0.5 X3=0.5 S11=-
 829.013080626686 IsS11Max=No IsS11Min=No FrameElem=75 ElemStation=0.25
 Frame=75 Station=0.25 OutputCase=TERRLAT CaseType=LinStatic Point=3 X2=0.5 X3=-0.5
 S11=167.840514858868 IsS11Max=Yes IsS11Min=No FrameElem=75 ElemStation=0.25
 Frame=75 Station=0.25 OutputCase=TERRLAT CaseType=LinStatic Point=4 X2=0.5 X3=0.5
 S11=167.840514858868 IsS11Max=No IsS11Min=No FrameElem=75 ElemStation=0.25
 Frame=75 Station=0 OutputCase=ACCVERT CaseType=LinStatic Point=0 X2=0 X3=0 S11=0 IsS11Max=Yes
 IsS11Min=Yes FrameElem=75 ElemStation=0
 Frame=75 Station=0 OutputCase=ACCVERT CaseType=LinStatic Point=1 X2=-0.5 X3=-0.5 S11=0
 IsS11Max=No IsS11Min=No FrameElem=75 ElemStation=0
 Frame=75 Station=0 OutputCase=ACCVERT CaseType=LinStatic Point=2 X2=-0.5 X3=0.5 S11=0 IsS11Max=No
 IsS11Min=No FrameElem=75 ElemStation=0
 Frame=75 Station=0 OutputCase=ACCVERT CaseType=LinStatic Point=3 X2=0.5 X3=-0.5 S11=0 IsS11Max=No
 IsS11Min=No FrameElem=75 ElemStation=0
 Frame=75 Station=0 OutputCase=ACCVERT CaseType=LinStatic Point=4 X2=0.5 X3=0.5 S11=0 IsS11Max=No
 IsS11Min=No FrameElem=75 ElemStation=0
 Frame=75 Station=0.0625 OutputCase=ACCVERT CaseType=LinStatic Point=0 X2=0 X3=0 S11=0
 IsS11Max=Yes IsS11Min=Yes FrameElem=75 ElemStation=0.0625
 Frame=75 Station=0.0625 OutputCase=ACCVERT CaseType=LinStatic Point=1 X2=-0.5 X3=-0.5 S11=0
 IsS11Max=No IsS11Min=No FrameElem=75 ElemStation=0.0625
 Frame=75 Station=0.0625 OutputCase=ACCVERT CaseType=LinStatic Point=2 X2=-0.5 X3=0.5 S11=0
 IsS11Max=No IsS11Min=No FrameElem=75 ElemStation=0.0625
 Frame=75 Station=0.0625 OutputCase=ACCVERT CaseType=LinStatic Point=3 X2=0.5 X3=-0.5 S11=0
 IsS11Max=No IsS11Min=No FrameElem=75 ElemStation=0.0625
 Frame=75 Station=0.0625 OutputCase=ACCVERT CaseType=LinStatic Point=4 X2=0.5 X3=0.5 S11=0
 IsS11Max=No IsS11Min=No FrameElem=75 ElemStation=0.0625
 Frame=75 Station=0.125 OutputCase=ACCVERT CaseType=LinStatic Point=0 X2=0 X3=0 S11=0 IsS11Max=Yes
 IsS11Min=Yes FrameElem=75 ElemStation=0.125
 Frame=75 Station=0.125 OutputCase=ACCVERT CaseType=LinStatic Point=1 X2=-0.5 X3=-0.5 S11=0
 IsS11Max=No IsS11Min=No FrameElem=75 ElemStation=0.125
 Frame=75 Station=0.125 OutputCase=ACCVERT CaseType=LinStatic Point=2 X2=-0.5 X3=0.5 S11=0
 IsS11Max=No IsS11Min=No FrameElem=75 ElemStation=0.125
 Frame=75 Station=0.125 OutputCase=ACCVERT CaseType=LinStatic Point=3 X2=0.5 X3=-0.5 S11=0
 IsS11Max=No IsS11Min=No FrameElem=75 ElemStation=0.125
 Frame=75 Station=0.125 OutputCase=ACCVERT CaseType=LinStatic Point=4 X2=0.5 X3=0.5 S11=0
 IsS11Max=No IsS11Min=No FrameElem=75 ElemStation=0.125

Frame=75	Station=0.25	OutputCase=TERRCOST	CaseType=LinStatic	Point=2	X2=-0.5	X3=0.5	S11=0	
IsS11Max=No	IsS11Min=No	FrameElem=75	ElemStation=0.25					
Frame=75	Station=0.25	OutputCase=TERRCOST	CaseType=LinStatic	Point=3	X2=0.5	X3=-0.5	S11=0	
IsS11Max=No	IsS11Min=No	FrameElem=75	ElemStation=0.25					
Frame=75	Station=0.25	OutputCase=TERRCOST	CaseType=LinStatic	Point=4	X2=0.5	X3=0.5	S11=0	
IsS11Max=No	IsS11Min=No	FrameElem=75	ElemStation=0.25					
Frame=75	Station=0	OutputCase=SOVRCOST	CaseType=LinStatic	Point=0	X2=0	X3=0	S11=0	
IsS11Min=Yes	FrameElem=75	ElemStation=0					IsS11Max=Yes	
Frame=75	Station=0	OutputCase=SOVRCOST	CaseType=LinStatic	Point=1	X2=-0.5	X3=-0.5	S11=0	
IsS11Max=No	IsS11Min=No	FrameElem=75	ElemStation=0					
Frame=75	Station=0	OutputCase=SOVRCOST	CaseType=LinStatic	Point=2	X2=-0.5	X3=0.5	S11=0	
IsS11Max=No	IsS11Min=No	FrameElem=75	ElemStation=0					
Frame=75	Station=0	OutputCase=SOVRCOST	CaseType=LinStatic	Point=3	X2=0.5	X3=-0.5	S11=0	
IsS11Max=No	IsS11Min=No	FrameElem=75	ElemStation=0					
Frame=75	Station=0	OutputCase=SOVRCOST	CaseType=LinStatic	Point=4	X2=0.5	X3=0.5	S11=0	
IsS11Min=No	FrameElem=75	ElemStation=0					IsS11Max=No	
Frame=75	Station=0.0625	OutputCase=SOVRCOST	CaseType=LinStatic	Point=0	X2=0	X3=0	S11=0	
IsS11Max=Yes	IsS11Min=Yes	FrameElem=75	ElemStation=0.0625					
Frame=75	Station=0.0625	OutputCase=SOVRCOST	CaseType=LinStatic	Point=1	X2=-0.5	X3=-0.5	S11=0	
IsS11Max=No	IsS11Min=No	FrameElem=75	ElemStation=0.0625					
Frame=75	Station=0.0625	OutputCase=SOVRCOST	CaseType=LinStatic	Point=2	X2=-0.5	X3=0.5	S11=0	
IsS11Max=No	IsS11Min=No	FrameElem=75	ElemStation=0.0625					
Frame=75	Station=0.0625	OutputCase=SOVRCOST	CaseType=LinStatic	Point=3	X2=0.5	X3=-0.5	S11=0	
IsS11Max=No	IsS11Min=No	FrameElem=75	ElemStation=0.0625					
Frame=75	Station=0.0625	OutputCase=SOVRCOST	CaseType=LinStatic	Point=4	X2=0.5	X3=0.5	S11=0	
IsS11Max=No	IsS11Min=No	FrameElem=75	ElemStation=0.0625					
Frame=75	Station=0.125	OutputCase=SOVRCOST	CaseType=LinStatic	Point=0	X2=0	X3=0	S11=0	
IsS11Max=Yes	IsS11Min=Yes	FrameElem=75	ElemStation=0.125					
Frame=75	Station=0.125	OutputCase=SOVRCOST	CaseType=LinStatic	Point=1	X2=-0.5	X3=-0.5	S11=0	
IsS11Max=No	IsS11Min=No	FrameElem=75	ElemStation=0.125					
Frame=75	Station=0.125	OutputCase=SOVRCOST	CaseType=LinStatic	Point=2	X2=-0.5	X3=0.5	S11=0	
IsS11Max=No	IsS11Min=No	FrameElem=75	ElemStation=0.125					
Frame=75	Station=0.125	OutputCase=SOVRCOST	CaseType=LinStatic	Point=3	X2=0.5	X3=-0.5	S11=0	
IsS11Max=No	IsS11Min=No	FrameElem=75	ElemStation=0.125					
Frame=75	Station=0.125	OutputCase=SOVRCOST	CaseType=LinStatic	Point=4	X2=0.5	X3=0.5	S11=0	
IsS11Max=No	IsS11Min=No	FrameElem=75	ElemStation=0.125					
Frame=75	Station=0.1875	OutputCase=SOVRCOST	CaseType=LinStatic	Point=0	X2=0	X3=0	S11=0	
IsS11Max=Yes	IsS11Min=Yes	FrameElem=75	ElemStation=0.1875					
Frame=75	Station=0.1875	OutputCase=SOVRCOST	CaseType=LinStatic	Point=1	X2=-0.5	X3=-0.5	S11=0	
IsS11Max=No	IsS11Min=No	FrameElem=75	ElemStation=0.1875					
Frame=75	Station=0.1875	OutputCase=SOVRCOST	CaseType=LinStatic	Point=2	X2=-0.5	X3=0.5	S11=0	
IsS11Max=No	IsS11Min=No	FrameElem=75	ElemStation=0.1875					
Frame=75	Station=0.1875	OutputCase=SOVRCOST	CaseType=LinStatic	Point=3	X2=0.5	X3=-0.5	S11=0	
IsS11Max=No	IsS11Min=No	FrameElem=75	ElemStation=0.1875					
Frame=75	Station=0.1875	OutputCase=SOVRCOST	CaseType=LinStatic	Point=4	X2=0.5	X3=0.5	S11=0	
IsS11Max=No	IsS11Min=No	FrameElem=75	ElemStation=0.1875					
Frame=75	Station=0.25	OutputCase=SOVRCOST	CaseType=LinStatic	Point=0	X2=0	X3=0	S11=0	
IsS11Min=Yes	FrameElem=75	ElemStation=0.25					IsS11Max=Yes	
Frame=75	Station=0.25	OutputCase=SOVRCOST	CaseType=LinStatic	Point=1	X2=-0.5	X3=-0.5	S11=0	
IsS11Max=No	IsS11Min=No	FrameElem=75	ElemStation=0.25					
Frame=75	Station=0.25	OutputCase=SOVRCOST	CaseType=LinStatic	Point=2	X2=-0.5	X3=0.5	S11=0	
IsS11Max=No	IsS11Min=No	FrameElem=75	ElemStation=0.25					
Frame=75	Station=0.25	OutputCase=SOVRCOST	CaseType=LinStatic	Point=3	X2=0.5	X3=-0.5	S11=0	
IsS11Max=No	IsS11Min=No	FrameElem=75	ElemStation=0.25					
Frame=75	Station=0.25	OutputCase=SOVRCOST	CaseType=LinStatic	Point=4	X2=0.5	X3=0.5	S11=0	
IsS11Max=No	IsS11Min=No	FrameElem=75	ElemStation=0.25					
Frame=75	Station=0	OutputCase=ENVE	CaseType=Combination	StepType=Max	Point=0	X2=0	X3=0	S11=-
217.882158664514	IsS11Max=No	IsS11Min=No	FrameElem=75	ElemStation=0				
Frame=75	Station=0	OutputCase=ENVE	CaseType=Combination	StepType=Max	Point=1	X2=-0.5	X3=-0.5	
S11=-1556.20118759752	IsS11Max=No	IsS11Min=Yes	FrameElem=75	ElemStation=0				
Frame=75	Station=0	OutputCase=ENVE	CaseType=Combination	StepType=Max	Point=2	X2=-0.5	X3=0.5	S11=-
1556.20118759752	IsS11Max=No	IsS11Min=No	FrameElem=75	ElemStation=0				
Frame=75	Station=0	OutputCase=ENVE	CaseType=Combination	StepType=Max	Point=3	X2=0.5	X3=-0.5	
S11=1170.78902396467	IsS11Max=Yes	IsS11Min=No	FrameElem=75	ElemStation=0				
Frame=75	Station=0	OutputCase=ENVE	CaseType=Combination	StepType=Max	Point=4	X2=0.5	X3=0.5	
S11=1170.78902396467	IsS11Max=No	IsS11Min=No	FrameElem=75	ElemStation=0				
Frame=75	Station=0.0625	OutputCase=ENVE	CaseType=Combination	StepType=Max	Point=0	X2=0	X3=0	S11=-
217.882158664514	IsS11Max=No	IsS11Min=No	FrameElem=75	ElemStation=0.0625				
Frame=75	Station=0.0625	OutputCase=ENVE	CaseType=Combination	StepType=Max	Point=1	X2=-0.5	X3=-0.5	
S11=-1302.43165690159	IsS11Max=No	IsS11Min=Yes	FrameElem=75	ElemStation=0.0625				
Frame=75	Station=0.0625	OutputCase=ENVE	CaseType=Combination	StepType=Max	Point=2	X2=-0.5	X3=0.5	
S11=-1302.43165690159	IsS11Max=No	IsS11Min=No	FrameElem=75	ElemStation=0.0625				
Frame=75	Station=0.0625	OutputCase=ENVE	CaseType=Combination	StepType=Max	Point=3	X2=0.5	X3=-0.5	
S11=917.01949345911	IsS11Max=Yes	IsS11Min=No	FrameElem=75	ElemStation=0.0625				
Frame=75	Station=0.0625	OutputCase=ENVE	CaseType=Combination	StepType=Max	Point=4	X2=0.5	X3=0.5	
S11=917.01949345911	IsS11Max=No	IsS11Min=No	FrameElem=75	ElemStation=0.0625				
Frame=75	Station=0.125	OutputCase=ENVE	CaseType=Combination	StepType=Max	Point=0	X2=0	X3=0	S11=-
217.882158664514	IsS11Max=No	IsS11Min=No	FrameElem=75	ElemStation=0.125				
Frame=75	Station=0.125	OutputCase=ENVE	CaseType=Combination	StepType=Max	Point=1	X2=-0.5	X3=-0.5	
S11=-1055.81056370567	IsS11Max=No	IsS11Min=Yes	FrameElem=75	ElemStation=0.125				
Frame=75	Station=0.125	OutputCase=ENVE	CaseType=Combination	StepType=Max	Point=2	X2=-0.5	X3=0.5	
S11=-1055.81056370567	IsS11Max=No	IsS11Min=No	FrameElem=75	ElemStation=0.125				

Frame=75	Station=0.125	OutputCase=ENVE	CaseType=Combination	StepType=Max	Point=3	X2=0.5	X3=-0.5	
S11=670.398400453554	IsS11Max=Yes	IsS11Min=No	FrameElem=75	ElemStation=0.125				
Frame=75	Station=0.125	OutputCase=ENVE	CaseType=Combination	StepType=Max	Point=4	X2=0.5	X3=0.5	
S11=670.398400453554	IsS11Max=No	IsS11Min=No	FrameElem=75	ElemStation=0.125				
Frame=75	Station=0.1875	OutputCase=ENVE	CaseType=Combination	StepType=Max	Point=0	X2=0	X3=0	S11=-
S11=217.882158664514	IsS11Max=No	IsS11Min=No	FrameElem=75	ElemStation=0.1875				
Frame=75	Station=0.1875	OutputCase=ENVE	CaseType=Combination	StepType=Max	Point=1	X2=-0.5	X3=-0.5	
S11=-816.337908009738	IsS11Max=No	IsS11Min=Yes	FrameElem=75	ElemStation=0.1875				
Frame=75	Station=0.1875	OutputCase=ENVE	CaseType=Combination	StepType=Max	Point=2	X2=-0.5	X3=0.5	
S11=-816.337908009738	IsS11Max=No	IsS11Min=No	FrameElem=75	ElemStation=0.1875				
Frame=75	Station=0.1875	OutputCase=ENVE	CaseType=Combination	StepType=Max	Point=3	X2=0.5	X3=-0.5	
S11=430.925744947999	IsS11Max=Yes	IsS11Min=No	FrameElem=75	ElemStation=0.1875				
Frame=75	Station=0.1875	OutputCase=ENVE	CaseType=Combination	StepType=Max	Point=4	X2=0.5	X3=0.5	
S11=430.925744947999	IsS11Max=No	IsS11Min=No	FrameElem=75	ElemStation=0.1875				
Frame=75	Station=0.25	OutputCase=ENVE	CaseType=Combination	StepType=Max	Point=0	X2=0	X3=0	S11=-
S11=217.882158664514	IsS11Max=No	IsS11Min=No	FrameElem=75	ElemStation=0.25				
Frame=75	Station=0.25	OutputCase=ENVE	CaseType=Combination	StepType=Max	Point=1	X2=-0.5	X3=-0.5	
S11=-584.01368981381	IsS11Max=No	IsS11Min=Yes	FrameElem=75	ElemStation=0.25				
Frame=75	Station=0.25	OutputCase=ENVE	CaseType=Combination	StepType=Max	Point=2	X2=-0.5	X3=0.5	
S11=-584.01368981381	IsS11Max=No	IsS11Min=No	FrameElem=75	ElemStation=0.25				
Frame=75	Station=0.25	OutputCase=ENVE	CaseType=Combination	StepType=Max	Point=3	X2=0.5	X3=-0.5	
S11=198.601526942443	IsS11Max=Yes	IsS11Min=No	FrameElem=75	ElemStation=0.25				
Frame=75	Station=0.25	OutputCase=ENVE	CaseType=Combination	StepType=Max	Point=4	X2=0.5	X3=0.5	
S11=198.601526942443	IsS11Max=No	IsS11Min=No	FrameElem=75	ElemStation=0.25				
Frame=75	Station=0	OutputCase=ENVE	CaseType=Combination	StepType=Min	Point=0	X2=0	X3=0	S11=-
S11=317.058043529686	IsS11Max=No	IsS11Min=No	FrameElem=75	ElemStation=0				
Frame=75	Station=0	OutputCase=ENVE	CaseType=Combination	StepType=Min	Point=1	X2=-0.5	X3=-0.5	
S11=-1804.90511102404	IsS11Max=No	IsS11Min=Yes	FrameElem=75	ElemStation=0				
Frame=75	Station=0	OutputCase=ENVE	CaseType=Combination	StepType=Min	Point=2	X2=-0.5	X3=0.5	S11=-
S11=1804.90511102404	IsS11Max=No	IsS11Min=No	FrameElem=75	ElemStation=0				
Frame=75	Station=0	OutputCase=ENVE	CaseType=Combination	StepType=Min	Point=3	X2=0.5	X3=-0.5	
S11=1120.43687026849	IsS11Max=Yes	IsS11Min=No	FrameElem=75	ElemStation=0				
Frame=75	Station=0	OutputCase=ENVE	CaseType=Combination	StepType=Min	Point=4	X2=0.5	X3=0.5	
S11=1120.43687026849	IsS11Max=No	IsS11Min=No	FrameElem=75	ElemStation=0				
Frame=75	Station=0.0625	OutputCase=ENVE	CaseType=Combination	StepType=Min	Point=0	X2=0	X3=0	S11=-
S11=317.058043529686	IsS11Max=No	IsS11Min=No	FrameElem=75	ElemStation=0.0625				
Frame=75	Station=0.0625	OutputCase=ENVE	CaseType=Combination	StepType=Min	Point=1	X2=-0.5	X3=-0.5	
S11=-1551.13558051848	IsS11Max=No	IsS11Min=Yes	FrameElem=75	ElemStation=0.0625				
Frame=75	Station=0.0625	OutputCase=ENVE	CaseType=Combination	StepType=Min	Point=2	X2=-0.5	X3=0.5	
S11=-1551.13558051848	IsS11Max=No	IsS11Min=No	FrameElem=75	ElemStation=0.0625				
Frame=75	Station=0.0625	OutputCase=ENVE	CaseType=Combination	StepType=Min	Point=3	X2=0.5	X3=-0.5	
S11=866.667339572566	IsS11Max=Yes	IsS11Min=No	FrameElem=75	ElemStation=0.0625				
Frame=75	Station=0.0625	OutputCase=ENVE	CaseType=Combination	StepType=Min	Point=4	X2=0.5	X3=0.5	
S11=866.667339572566	IsS11Max=No	IsS11Min=No	FrameElem=75	ElemStation=0.0625				
Frame=75	Station=0.125	OutputCase=ENVE	CaseType=Combination	StepType=Min	Point=0	X2=0	X3=0	S11=-
S11=317.058043529686	IsS11Max=No	IsS11Min=No	FrameElem=75	ElemStation=0.125				
Frame=75	Station=0.125	OutputCase=ENVE	CaseType=Combination	StepType=Min	Point=1	X2=-0.5	X3=-0.5	
S11=-1304.51448751293	IsS11Max=No	IsS11Min=Yes	FrameElem=75	ElemStation=0.125				
Frame=75	Station=0.125	OutputCase=ENVE	CaseType=Combination	StepType=Min	Point=2	X2=-0.5	X3=0.5	
S11=-1304.51448751293	IsS11Max=No	IsS11Min=No	FrameElem=75	ElemStation=0.125				
Frame=75	Station=0.125	OutputCase=ENVE	CaseType=Combination	StepType=Min	Point=3	X2=0.5	X3=-0.5	
S11=620.046246376638	IsS11Max=Yes	IsS11Min=No	FrameElem=75	ElemStation=0.125				
Frame=75	Station=0.125	OutputCase=ENVE	CaseType=Combination	StepType=Min	Point=4	X2=0.5	X3=0.5	
S11=620.046246376638	IsS11Max=No	IsS11Min=No	FrameElem=75	ElemStation=0.125				
Frame=75	Station=0.1875	OutputCase=ENVE	CaseType=Combination	StepType=Min	Point=0	X2=0	X3=0	S11=-
S11=317.058043529686	IsS11Max=No	IsS11Min=No	FrameElem=75	ElemStation=0.1875				
Frame=75	Station=0.1875	OutputCase=ENVE	CaseType=Combination	StepType=Min	Point=1	X2=-0.5	X3=-0.5	
S11=-1065.04183200737	IsS11Max=No	IsS11Min=Yes	FrameElem=75	ElemStation=0.1875				
Frame=75	Station=0.1875	OutputCase=ENVE	CaseType=Combination	StepType=Min	Point=2	X2=-0.5	X3=0.5	
S11=-1065.04183200737	IsS11Max=No	IsS11Min=No	FrameElem=75	ElemStation=0.1875				
Frame=75	Station=0.1875	OutputCase=ENVE	CaseType=Combination	StepType=Min	Point=3	X2=0.5	X3=-0.5	
S11=380.57359068071	IsS11Max=Yes	IsS11Min=No	FrameElem=75	ElemStation=0.1875				
Frame=75	Station=0.1875	OutputCase=ENVE	CaseType=Combination	StepType=Min	Point=4	X2=0.5	X3=0.5	
S11=380.57359068071	IsS11Max=No	IsS11Min=No	FrameElem=75	ElemStation=0.1875				
Frame=75	Station=0.25	OutputCase=ENVE	CaseType=Combination	StepType=Min	Point=0	X2=0	X3=0	S11=-
S11=317.058043529686	IsS11Max=No	IsS11Min=No	FrameElem=75	ElemStation=0.25				
Frame=75	Station=0.25	OutputCase=ENVE	CaseType=Combination	StepType=Min	Point=1	X2=-0.5	X3=-0.5	
S11=-832.717614001816	IsS11Max=No	IsS11Min=Yes	FrameElem=75	ElemStation=0.25				
Frame=75	Station=0.25	OutputCase=ENVE	CaseType=Combination	StepType=Min	Point=2	X2=-0.5	X3=0.5	
S11=-832.717614001816	IsS11Max=No	IsS11Min=No	FrameElem=75	ElemStation=0.25				
Frame=75	Station=0.25	OutputCase=ENVE	CaseType=Combination	StepType=Min	Point=3	X2=0.5	X3=-0.5	
S11=148.249372484782	IsS11Max=Yes	IsS11Min=No	FrameElem=75	ElemStation=0.25				
Frame=75	Station=0.25	OutputCase=ENVE	CaseType=Combination	StepType=Min	Point=4	X2=0.5	X3=0.5	
S11=148.249372484782	IsS11Max=No	IsS11Min=No	FrameElem=75	ElemStation=0.25				
Frame=75	Station=0	OutputCase=FESSUR	CaseType=Combination	Point=0	X2=0	X3=0	S11=-	317.058043529686
S11=1804.90511102404	IsS11Max=No	IsS11Min=Yes	FrameElem=75	ElemStation=0				
Frame=75	Station=0	OutputCase=FESSUR	CaseType=Combination	Point=2	X2=-0.5	X3=0.5	S11=-	
S11=1804.90511102404	IsS11Max=No	IsS11Min=No	FrameElem=75	ElemStation=0				
Frame=75	Station=0	OutputCase=FESSUR	CaseType=Combination	Point=3	X2=0.5	X3=-0.5		
S11=1170.78902396467	IsS11Max=Yes	IsS11Min=No	FrameElem=75	ElemStation=0				



Frame=75 Station=0 OutputCase=FESSUR CaseType=Combination Point=4 X2=0.5 X3=0.5
 S11=1170.78902396467 IsS11Max=No IsS11Min=No FrameElem=75 ElemStation=0
 Frame=75 Station=0.0625 OutputCase=FESSUR CaseType=Combination Point=0 X2=0 X3=0 S11=-
 317.058043529686 IsS11Max=No IsS11Min=No FrameElem=75 ElemStation=0.0625
 Frame=75 Station=0.0625 OutputCase=FESSUR CaseType=Combination Point=1 X2=-0.5 X3=-0.5 S11=-
 1551.13558051848 IsS11Max=No IsS11Min=Yes FrameElem=75 ElemStation=0.0625
 Frame=75 Station=0.0625 OutputCase=FESSUR CaseType=Combination Point=2 X2=-0.5 X3=0.5 S11=-
 1551.13558051848 IsS11Max=No IsS11Min=No FrameElem=75 ElemStation=0.0625
 Frame=75 Station=0.0625 OutputCase=FESSUR CaseType=Combination Point=3 X2=0.5 X3=-0.5
 S11=917.01949345911 IsS11Max=Yes IsS11Min=No FrameElem=75 ElemStation=0.0625
 Frame=75 Station=0.0625 OutputCase=FESSUR CaseType=Combination Point=4 X2=0.5 X3=0.5
 S11=917.01949345911 IsS11Max=No IsS11Min=No FrameElem=75 ElemStation=0.0625
 Frame=75 Station=0.125 OutputCase=FESSUR CaseType=Combination Point=0 X2=0 X3=0 S11=-
 317.058043529686 IsS11Max=No IsS11Min=No FrameElem=75 ElemStation=0.125
 Frame=75 Station=0.125 OutputCase=FESSUR CaseType=Combination Point=1 X2=-0.5 X3=-0.5 S11=-
 1304.51448751293 IsS11Max=No IsS11Min=Yes FrameElem=75 ElemStation=0.125
 Frame=75 Station=0.125 OutputCase=FESSUR CaseType=Combination Point=2 X2=-0.5 X3=0.5 S11=-
 1304.51448751293 IsS11Max=No IsS11Min=No FrameElem=75 ElemStation=0.125
 Frame=75 Station=0.125 OutputCase=FESSUR CaseType=Combination Point=3 X2=0.5 X3=-0.5
 S11=670.398400453554 IsS11Max=Yes IsS11Min=No FrameElem=75 ElemStation=0.125
 Frame=75 Station=0.125 OutputCase=FESSUR CaseType=Combination Point=4 X2=0.5 X3=0.5
 S11=670.398400453554 IsS11Max=No IsS11Min=No FrameElem=75 ElemStation=0.125
 Frame=75 Station=0.1875 OutputCase=FESSUR CaseType=Combination Point=0 X2=0 X3=0 S11=-
 317.058043529686 IsS11Max=No IsS11Min=No FrameElem=75 ElemStation=0.1875
 Frame=75 Station=0.1875 OutputCase=FESSUR CaseType=Combination Point=1 X2=-0.5 X3=-0.5 S11=-
 1065.04183200737 IsS11Max=No IsS11Min=Yes FrameElem=75 ElemStation=0.1875
 Frame=75 Station=0.1875 OutputCase=FESSUR CaseType=Combination Point=2 X2=-0.5 X3=0.5 S11=-
 1065.04183200737 IsS11Max=No IsS11Min=No FrameElem=75 ElemStation=0.1875
 Frame=75 Station=0.1875 OutputCase=FESSUR CaseType=Combination Point=3 X2=0.5 X3=-0.5
 S11=430.925744947999 IsS11Max=Yes IsS11Min=No FrameElem=75 ElemStation=0.1875
 Frame=75 Station=0.1875 OutputCase=FESSUR CaseType=Combination Point=4 X2=0.5 X3=0.5
 S11=430.925744947999 IsS11Max=No IsS11Min=No FrameElem=75 ElemStation=0.1875
 Frame=75 Station=0.25 OutputCase=FESSUR CaseType=Combination Point=0 X2=0 X3=0 S11=-
 317.058043529686 IsS11Max=No IsS11Min=No FrameElem=75 ElemStation=0.25
 Frame=75 Station=0.25 OutputCase=FESSUR CaseType=Combination Point=1 X2=-0.5 X3=-0.5 S11=-
 832.717614001816 IsS11Max=No IsS11Min=Yes FrameElem=75 ElemStation=0.25
 Frame=75 Station=0.25 OutputCase=FESSUR CaseType=Combination Point=2 X2=-0.5 X3=0.5 S11=-
 832.717614001816 IsS11Max=No IsS11Min=No FrameElem=75 ElemStation=0.25
 Frame=75 Station=0.25 OutputCase=FESSUR CaseType=Combination Point=3 X2=0.5 X3=-0.5
 S11=198.601526942443 IsS11Max=Yes IsS11Min=No FrameElem=75 ElemStation=0.25
 Frame=75 Station=0.25 OutputCase=FESSUR CaseType=Combination Point=4 X2=0.5 X3=0.5
 S11=198.601526942443 IsS11Max=No IsS11Min=No FrameElem=75 ElemStation=0.25
 Frame=77 Station=0 OutputCase=PESOPR CaseType=LinStatic Point=0 X2=0 X3=0 S11=15.1709467361835
 IsS11Max=No IsS11Min=No FrameElem=77 ElemStation=0
 Frame=77 Station=0 OutputCase=PESOPR CaseType=LinStatic Point=1 X2=-0.5 X3=-0.5
 S11=57.4914769209827 IsS11Max=Yes IsS11Min=No FrameElem=77 ElemStation=0
 Frame=77 Station=0 OutputCase=PESOPR CaseType=LinStatic Point=2 X2=-0.5 X3=0.5 S11=57.4914769209827
 IsS11Max=No IsS11Min=No FrameElem=77 ElemStation=0
 Frame=77 Station=0 OutputCase=PESOPR CaseType=LinStatic Point=3 X2=0.5 X3=-0.5 S11=-
 27.1495834486158 IsS11Max=No IsS11Min=Yes FrameElem=77 ElemStation=0
 Frame=77 Station=0 OutputCase=PESOPR CaseType=LinStatic Point=4 X2=0.5 X3=0.5 S11=-27.1495834486158
 IsS11Max=No IsS11Min=No FrameElem=77 ElemStation=0
 Frame=77 Station=0.0625 OutputCase=PESOPR CaseType=LinStatic Point=0 X2=0 X3=0 S11=15.1709467361835
 IsS11Max=No IsS11Min=No FrameElem=77 ElemStation=0.0625
 Frame=77 Station=0.0625 OutputCase=PESOPR CaseType=LinStatic Point=1 X2=-0.5 X3=-0.5
 S11=38.4485081668464 IsS11Max=Yes IsS11Min=No FrameElem=77 ElemStation=0.0625
 Frame=77 Station=0.0625 OutputCase=PESOPR CaseType=LinStatic Point=2 X2=-0.5 X3=0.5
 S11=38.4485081668464 IsS11Max=No IsS11Min=No FrameElem=77 ElemStation=0.0625
 Frame=77 Station=0.0625 OutputCase=PESOPR CaseType=LinStatic Point=3 X2=0.5 X3=-0.5 S11=-
 8.10661469447945 IsS11Max=No IsS11Min=Yes FrameElem=77 ElemStation=0.0625
 Frame=77 Station=0.0625 OutputCase=PESOPR CaseType=LinStatic Point=4 X2=0.5 X3=0.5 S11=-
 8.10661469447945 IsS11Max=No IsS11Min=No FrameElem=77 ElemStation=0.0625
 Frame=77 Station=0.125 OutputCase=PESOPR CaseType=LinStatic Point=0 X2=0 X3=0 S11=15.1709467361835
 IsS11Max=No IsS11Min=No FrameElem=77 ElemStation=0.125
 Frame=77 Station=0.125 OutputCase=PESOPR CaseType=LinStatic Point=1 X2=-0.5 X3=-0.5
 S11=18.81960191271 IsS11Max=Yes IsS11Min=No FrameElem=77 ElemStation=0.125
 Frame=77 Station=0.125 OutputCase=PESOPR CaseType=LinStatic Point=2 X2=-0.5 X3=0.5
 S11=18.81960191271 IsS11Max=No IsS11Min=No FrameElem=77 ElemStation=0.125
 Frame=77 Station=0.125 OutputCase=PESOPR CaseType=LinStatic Point=3 X2=0.5 X3=-0.5
 S11=11.522291596569 IsS11Max=No IsS11Min=Yes FrameElem=77 ElemStation=0.125
 Frame=77 Station=0.125 OutputCase=PESOPR CaseType=LinStatic Point=4 X2=0.5 X3=0.5
 S11=11.522291596569 IsS11Max=No IsS11Min=No FrameElem=77 ElemStation=0.125
 Frame=77 Station=0.1875 OutputCase=PESOPR CaseType=LinStatic Point=0 X2=0 X3=0 S11=15.1709467361835
 IsS11Max=No IsS11Min=No FrameElem=77 ElemStation=0.1875
 Frame=77 Station=0.1875 OutputCase=PESOPR CaseType=LinStatic Point=1 X2=-0.5 X3=-0.5 S11=-
 1.39524184142641 IsS11Max=No IsS11Min=Yes FrameElem=77 ElemStation=0.1875
 Frame=77 Station=0.1875 OutputCase=PESOPR CaseType=LinStatic Point=2 X2=-0.5 X3=0.5 S11=-
 1.39524184142641 IsS11Max=No IsS11Min=No FrameElem=77 ElemStation=0.1875
 Frame=77 Station=0.1875 OutputCase=PESOPR CaseType=LinStatic Point=3 X2=0.5 X3=-0.5
 S11=31.7371353137933 IsS11Max=Yes IsS11Min=No FrameElem=77 ElemStation=0.1875
 Frame=77 Station=0.1875 OutputCase=PESOPR CaseType=LinStatic Point=4 X2=0.5 X3=0.5
 S11=31.7371353137933 IsS11Max=No IsS11Min=No FrameElem=77 ElemStation=0.1875

Frame=77	Station=0.25	OutputCase=PESOPR	CaseType=LinStatic	Point=0	X2=0	X3=0	S11=15.1709467361835
IsS11Max=No	IsS11Min=No	FrameElem=77	ElemStation=0.25				
Frame=77	Station=0.25	OutputCase=PESOPR	CaseType=LinStatic	Point=1	X2=-0.5	X3=-0.5	S11=-
22.1960230955628	IsS11Max=No	IsS11Min=Yes	FrameElem=77	ElemStation=0.25			
Frame=77	Station=0.25	OutputCase=PESOPR	CaseType=LinStatic	Point=2	X2=-0.5	X3=0.5	S11=-
22.1960230955628	IsS11Max=No	IsS11Min=No	FrameElem=77	ElemStation=0.25			
Frame=77	Station=0.25	OutputCase=PESOPR	CaseType=LinStatic	Point=3	X2=0.5	X3=-0.5	
S11=52.5379165679297	IsS11Max=Yes	IsS11Min=No	FrameElem=77	ElemStation=0.25			
Frame=77	Station=0.25	OutputCase=PESOPR	CaseType=LinStatic	Point=4	X2=0.5	X3=0.5	
S11=52.5379165679297	IsS11Max=No	IsS11Min=No	FrameElem=77	ElemStation=0.25			
Frame=77	Station=0	OutputCase=TERRVERT	CaseType=LinStatic	Point=0	X2=0	X3=0	S11=-1.64270738196176
IsS11Max=No	IsS11Min=No	FrameElem=77	ElemStation=0				
Frame=77	Station=0	OutputCase=TERRVERT	CaseType=LinStatic	Point=1	X2=-0.5	X3=-0.5	S11=-
61.1960173188822	IsS11Max=No	IsS11Min=Yes	FrameElem=77	ElemStation=0			
Frame=77	Station=0	OutputCase=TERRVERT	CaseType=LinStatic	Point=2	X2=-0.5	X3=0.5	S11=-
61.1960173188822	IsS11Max=No	IsS11Min=No	FrameElem=77	ElemStation=0			
Frame=77	Station=0	OutputCase=TERRVERT	CaseType=LinStatic	Point=3	X2=0.5	X3=-0.5	
S11=57.9106025549587	IsS11Max=Yes	IsS11Min=No	FrameElem=77	ElemStation=0			
Frame=77	Station=0	OutputCase=TERRVERT	CaseType=LinStatic	Point=4	X2=0.5	X3=0.5	
S11=57.9106025549587	IsS11Max=No	IsS11Min=No	FrameElem=77	ElemStation=0			
Frame=77	Station=0.0625	OutputCase=TERRVERT	CaseType=LinStatic	Point=0	X2=0	X3=0	S11=-
1.64270738196176	IsS11Max=No	IsS11Min=No	FrameElem=77	ElemStation=0.0625			
Frame=77	Station=0.0625	OutputCase=TERRVERT	CaseType=LinStatic	Point=1	X2=-0.5	X3=-0.5	S11=-
274.477267424398	IsS11Max=No	IsS11Min=Yes	FrameElem=77	ElemStation=0.0625			
Frame=77	Station=0.0625	OutputCase=TERRVERT	CaseType=LinStatic	Point=2	X2=-0.5	X3=0.5	S11=-
274.477267424398	IsS11Max=No	IsS11Min=No	FrameElem=77	ElemStation=0.0625			
Frame=77	Station=0.0625	OutputCase=TERRVERT	CaseType=LinStatic	Point=3	X2=0.5	X3=-0.5	
S11=271.191852660475	IsS11Max=Yes	IsS11Min=No	FrameElem=77	ElemStation=0.0625			
Frame=77	Station=0.0625	OutputCase=TERRVERT	CaseType=LinStatic	Point=4	X2=0.5	X3=0.5	
S11=271.191852660475	IsS11Max=No	IsS11Min=No	FrameElem=77	ElemStation=0.0625			
Frame=77	Station=0.125	OutputCase=TERRVERT	CaseType=LinStatic	Point=0	X2=0	X3=0	S11=-
1.64270738196176	IsS11Max=No	IsS11Min=No	FrameElem=77	ElemStation=0.125			
Frame=77	Station=0.125	OutputCase=TERRVERT	CaseType=LinStatic	Point=1	X2=-0.5	X3=-0.5	S11=-
494.321017529914	IsS11Max=No	IsS11Min=Yes	FrameElem=77	ElemStation=0.125			
Frame=77	Station=0.125	OutputCase=TERRVERT	CaseType=LinStatic	Point=2	X2=-0.5	X3=0.5	S11=-
494.321017529914	IsS11Max=No	IsS11Min=No	FrameElem=77	ElemStation=0.125			
Frame=77	Station=0.125	OutputCase=TERRVERT	CaseType=LinStatic	Point=3	X2=0.5	X3=-0.5	
S11=491.035602765991	IsS11Max=Yes	IsS11Min=No	FrameElem=77	ElemStation=0.125			
Frame=77	Station=0.125	OutputCase=TERRVERT	CaseType=LinStatic	Point=4	X2=0.5	X3=0.5	
S11=491.035602765991	IsS11Max=No	IsS11Min=No	FrameElem=77	ElemStation=0.125			
Frame=77	Station=0.1875	OutputCase=TERRVERT	CaseType=LinStatic	Point=0	X2=0	X3=0	S11=-
1.64270738196176	IsS11Max=No	IsS11Min=No	FrameElem=77	ElemStation=0.1875			
Frame=77	Station=0.1875	OutputCase=TERRVERT	CaseType=LinStatic	Point=1	X2=-0.5	X3=-0.5	S11=-
720.72726763543	IsS11Max=No	IsS11Min=Yes	FrameElem=77	ElemStation=0.1875			
Frame=77	Station=0.1875	OutputCase=TERRVERT	CaseType=LinStatic	Point=2	X2=-0.5	X3=0.5	S11=-
720.72726763543	IsS11Max=No	IsS11Min=No	FrameElem=77	ElemStation=0.1875			
Frame=77	Station=0.1875	OutputCase=TERRVERT	CaseType=LinStatic	Point=3	X2=0.5	X3=-0.5	
S11=717.441852871507	IsS11Max=Yes	IsS11Min=No	FrameElem=77	ElemStation=0.1875			
Frame=77	Station=0.1875	OutputCase=TERRVERT	CaseType=LinStatic	Point=4	X2=0.5	X3=0.5	
S11=717.441852871507	IsS11Max=No	IsS11Min=No	FrameElem=77	ElemStation=0.1875			
Frame=77	Station=0.25	OutputCase=TERRVERT	CaseType=LinStatic	Point=0	X2=0	X3=0	S11=-
1.64270738196176	IsS11Max=No	IsS11Min=No	FrameElem=77	ElemStation=0.25			
Frame=77	Station=0.25	OutputCase=TERRVERT	CaseType=LinStatic	Point=1	X2=-0.5	X3=-0.5	S11=-
953.696017740946	IsS11Max=No	IsS11Min=Yes	FrameElem=77	ElemStation=0.25			
Frame=77	Station=0.25	OutputCase=TERRVERT	CaseType=LinStatic	Point=2	X2=-0.5	X3=0.5	S11=-
953.696017740946	IsS11Max=No	IsS11Min=No	FrameElem=77	ElemStation=0.25			
Frame=77	Station=0.25	OutputCase=TERRVERT	CaseType=LinStatic	Point=3	X2=0.5	X3=-0.5	
S11=950.410602977022	IsS11Max=Yes	IsS11Min=No	FrameElem=77	ElemStation=0.25			
Frame=77	Station=0.25	OutputCase=TERRVERT	CaseType=LinStatic	Point=4	X2=0.5	X3=0.5	
S11=950.410602977022	IsS11Max=No	IsS11Min=No	FrameElem=77	ElemStation=0.25			
Frame=77	Station=0	OutputCase=TERRLAT	CaseType=LinStatic	Point=0	X2=0	X3=0	S11=-330.58628288391
IsS11Max=No	IsS11Min=No	FrameElem=77	ElemStation=0				
Frame=77	Station=0	OutputCase=TERRLAT	CaseType=LinStatic	Point=1	X2=-0.5	X3=-0.5	S11=-
829.01312123946	IsS11Max=No	IsS11Min=Yes	FrameElem=77	ElemStation=0			
Frame=77	Station=0	OutputCase=TERRLAT	CaseType=LinStatic	Point=2	X2=-0.5	X3=0.5	S11=-
829.01312123946	IsS11Max=No	IsS11Min=No	FrameElem=77	ElemStation=0			
Frame=77	Station=0	OutputCase=TERRLAT	CaseType=LinStatic	Point=3	X2=0.5	X3=-0.5	S11=167.84055547164
IsS11Max=Yes	IsS11Min=No	FrameElem=77	ElemStation=0				
Frame=77	Station=0	OutputCase=TERRLAT	CaseType=LinStatic	Point=4	X2=0.5	X3=0.5	S11=167.84055547164
IsS11Max=No	IsS11Min=No	FrameElem=77	ElemStation=0				
Frame=77	Station=0.0625	OutputCase=TERRLAT	CaseType=LinStatic	Point=0	X2=0	X3=0	S11=-
330.58628288391	IsS11Max=No	IsS11Min=No	FrameElem=77	ElemStation=0.0625			
Frame=77	Station=0.0625	OutputCase=TERRLAT	CaseType=LinStatic	Point=1	X2=-0.5	X3=-0.5	S11=-
829.013121874035	IsS11Max=No	IsS11Min=Yes	FrameElem=77	ElemStation=0.0625			
Frame=77	Station=0.0625	OutputCase=TERRLAT	CaseType=LinStatic	Point=2	X2=-0.5	X3=0.5	S11=-
829.013121874035	IsS11Max=No	IsS11Min=No	FrameElem=77	ElemStation=0.0625			
Frame=77	Station=0.0625	OutputCase=TERRLAT	CaseType=LinStatic	Point=3	X2=0.5	X3=-0.5	
S11=167.840556106215	IsS11Max=Yes	IsS11Min=No	FrameElem=77	ElemStation=0.0625			
Frame=77	Station=0.0625	OutputCase=TERRLAT	CaseType=LinStatic	Point=4	X2=0.5	X3=0.5	
S11=167.840556106215	IsS11Max=No	IsS11Min=No	FrameElem=77	ElemStation=0.0625			
Frame=77	Station=0.125	OutputCase=TERRLAT	CaseType=LinStatic	Point=0	X2=0	X3=0	S11=-330.58628288391
IsS11Max=No	IsS11Min=No	FrameElem=77	ElemStation=0.125				

Frame=77	Station=0.125	OutputCase=TERRLAT	CaseType=LinStatic	Point=1	X2=-0.5	X3=-0.5	S11=-		
829.013122508611	IsS11Max=No	IsS11Min=Yes	FrameElem=77	ElemStation=0.125					
Frame=77	Station=0.125	OutputCase=TERRLAT	CaseType=LinStatic	Point=2	X2=-0.5	X3=0.5	S11=-		
829.013122508611	IsS11Max=No	IsS11Min=No	FrameElem=77	ElemStation=0.125					
Frame=77	Station=0.125	OutputCase=TERRLAT	CaseType=LinStatic	Point=3	X2=0.5	X3=-0.5			
S11=167.840556740791	IsS11Max=Yes	IsS11Min=No	FrameElem=77	ElemStation=0.125					
Frame=77	Station=0.125	OutputCase=TERRLAT	CaseType=LinStatic	Point=4	X2=0.5	X3=0.5			
S11=167.840556740791	IsS11Max=No	IsS11Min=No	FrameElem=77	ElemStation=0.125					
Frame=77	Station=0.1875	OutputCase=TERRLAT	CaseType=LinStatic	Point=0	X2=0	X3=0	S11=-		
330.58628288391	IsS11Max=No	IsS11Min=No	FrameElem=77	ElemStation=0.1875					
Frame=77	Station=0.1875	OutputCase=TERRLAT	CaseType=LinStatic	Point=1	X2=-0.5	X3=-0.5	S11=-		
829.013123143186	IsS11Max=No	IsS11Min=Yes	FrameElem=77	ElemStation=0.1875					
Frame=77	Station=0.1875	OutputCase=TERRLAT	CaseType=LinStatic	Point=2	X2=-0.5	X3=0.5	S11=-		
829.013123143186	IsS11Max=No	IsS11Min=No	FrameElem=77	ElemStation=0.1875					
Frame=77	Station=0.1875	OutputCase=TERRLAT	CaseType=LinStatic	Point=3	X2=0.5	X3=-0.5			
S11=167.840557375366	IsS11Max=Yes	IsS11Min=No	FrameElem=77	ElemStation=0.1875					
Frame=77	Station=0.1875	OutputCase=TERRLAT	CaseType=LinStatic	Point=4	X2=0.5	X3=0.5			
S11=167.840557375366	IsS11Max=No	IsS11Min=No	FrameElem=77	ElemStation=0.1875					
Frame=77	Station=0.25	OutputCase=TERRLAT	CaseType=LinStatic	Point=0	X2=0	X3=0	S11=-330.58628288391		
IsS11Max=No	IsS11Min=No	FrameElem=77	ElemStation=0.25						
Frame=77	Station=0.25	OutputCase=TERRLAT	CaseType=LinStatic	Point=1	X2=-0.5	X3=-0.5	S11=-		
829.013123777762	IsS11Max=No	IsS11Min=Yes	FrameElem=77	ElemStation=0.25					
Frame=77	Station=0.25	OutputCase=TERRLAT	CaseType=LinStatic	Point=2	X2=-0.5	X3=0.5	S11=-		
829.013123777762	IsS11Max=No	IsS11Min=No	FrameElem=77	ElemStation=0.25					
Frame=77	Station=0.25	OutputCase=TERRLAT	CaseType=LinStatic	Point=3	X2=0.5	X3=-0.5			
S11=167.840558009942	IsS11Max=Yes	IsS11Min=No	FrameElem=77	ElemStation=0.25					
Frame=77	Station=0.25	OutputCase=TERRLAT	CaseType=LinStatic	Point=4	X2=0.5	X3=0.5			
S11=167.840558009942	IsS11Max=No	IsS11Min=No	FrameElem=77	ElemStation=0.25					
Frame=77	Station=0	OutputCase=ACCVERT	CaseType=LinStatic	Point=0	X2=0	X3=0	S11=0	IsS11Max=Yes	
IsS11Min=Yes	FrameElem=77	ElemStation=0							
Frame=77	Station=0	OutputCase=ACCVERT	CaseType=LinStatic	Point=1	X2=-0.5	X3=-0.5	S11=0		
IsS11Max=No	IsS11Min=No	FrameElem=77	ElemStation=0						
Frame=77	Station=0	OutputCase=ACCVERT	CaseType=LinStatic	Point=2	X2=-0.5	X3=0.5	S11=0	IsS11Max=No	
IsS11Min=No	FrameElem=77	ElemStation=0							
Frame=77	Station=0	OutputCase=ACCVERT	CaseType=LinStatic	Point=3	X2=0.5	X3=-0.5	S11=0	IsS11Max=No	
IsS11Min=No	FrameElem=77	ElemStation=0							
Frame=77	Station=0	OutputCase=ACCVERT	CaseType=LinStatic	Point=4	X2=0.5	X3=0.5	S11=0	IsS11Max=No	
IsS11Min=No	FrameElem=77	ElemStation=0							
Frame=77	Station=0.0625	OutputCase=ACCVERT	CaseType=LinStatic	Point=0	X2=0	X3=0	S11=0		
IsS11Max=Yes	IsS11Min=Yes	FrameElem=77	ElemStation=0.0625						
Frame=77	Station=0.0625	OutputCase=ACCVERT	CaseType=LinStatic	Point=1	X2=-0.5	X3=-0.5	S11=0		
IsS11Max=No	IsS11Min=No	FrameElem=77	ElemStation=0.0625						
Frame=77	Station=0.0625	OutputCase=ACCVERT	CaseType=LinStatic	Point=2	X2=-0.5	X3=0.5	S11=0		
IsS11Max=No	IsS11Min=No	FrameElem=77	ElemStation=0.0625						
Frame=77	Station=0.0625	OutputCase=ACCVERT	CaseType=LinStatic	Point=3	X2=0.5	X3=-0.5	S11=0		
IsS11Max=No	IsS11Min=No	FrameElem=77	ElemStation=0.0625						
Frame=77	Station=0.0625	OutputCase=ACCVERT	CaseType=LinStatic	Point=4	X2=0.5	X3=0.5	S11=0		
IsS11Max=No	IsS11Min=No	FrameElem=77	ElemStation=0.0625						
Frame=77	Station=0.125	OutputCase=ACCVERT	CaseType=LinStatic	Point=0	X2=0	X3=0	S11=0	IsS11Max=Yes	
IsS11Min=Yes	FrameElem=77	ElemStation=0.125							
Frame=77	Station=0.125	OutputCase=ACCVERT	CaseType=LinStatic	Point=1	X2=-0.5	X3=-0.5	S11=0		
IsS11Max=No	IsS11Min=No	FrameElem=77	ElemStation=0.125						
Frame=77	Station=0.125	OutputCase=ACCVERT	CaseType=LinStatic	Point=2	X2=-0.5	X3=0.5	S11=0		
IsS11Max=No	IsS11Min=No	FrameElem=77	ElemStation=0.125						
Frame=77	Station=0.125	OutputCase=ACCVERT	CaseType=LinStatic	Point=3	X2=0.5	X3=-0.5	S11=0		
IsS11Max=No	IsS11Min=No	FrameElem=77	ElemStation=0.125						
Frame=77	Station=0.125	OutputCase=ACCVERT	CaseType=LinStatic	Point=4	X2=0.5	X3=0.5	S11=0		
IsS11Max=No	IsS11Min=No	FrameElem=77	ElemStation=0.125						
Frame=77	Station=0.1875	OutputCase=ACCVERT	CaseType=LinStatic	Point=0	X2=0	X3=0	S11=0		
IsS11Max=Yes	IsS11Min=Yes	FrameElem=77	ElemStation=0.1875						
Frame=77	Station=0.1875	OutputCase=ACCVERT	CaseType=LinStatic	Point=1	X2=-0.5	X3=-0.5	S11=0		
IsS11Max=No	IsS11Min=No	FrameElem=77	ElemStation=0.1875						
Frame=77	Station=0.1875	OutputCase=ACCVERT	CaseType=LinStatic	Point=2	X2=-0.5	X3=0.5	S11=0		
IsS11Max=No	IsS11Min=No	FrameElem=77	ElemStation=0.1875						
Frame=77	Station=0.1875	OutputCase=ACCVERT	CaseType=LinStatic	Point=3	X2=0.5	X3=-0.5	S11=0		
IsS11Max=No	IsS11Min=No	FrameElem=77	ElemStation=0.1875						
Frame=77	Station=0.1875	OutputCase=ACCVERT	CaseType=LinStatic	Point=4	X2=0.5	X3=0.5	S11=0		
IsS11Max=No	IsS11Min=No	FrameElem=77	ElemStation=0.1875						
Frame=77	Station=0.25	OutputCase=ACCVERT	CaseType=LinStatic	Point=0	X2=0	X3=0	S11=0	IsS11Max=Yes	
IsS11Min=Yes	FrameElem=77	ElemStation=0.25							
Frame=77	Station=0.25	OutputCase=ACCVERT	CaseType=LinStatic	Point=1	X2=-0.5	X3=-0.5	S11=0		
IsS11Max=No	IsS11Min=No	FrameElem=77	ElemStation=0.25						
Frame=77	Station=0.25	OutputCase=ACCVERT	CaseType=LinStatic	Point=2	X2=-0.5	X3=0.5	S11=0		
IsS11Max=No	IsS11Min=No	FrameElem=77	ElemStation=0.25						
Frame=77	Station=0.25	OutputCase=ACCVERT	CaseType=LinStatic	Point=3	X2=0.5	X3=-0.5	S11=0		
IsS11Max=No	IsS11Min=No	FrameElem=77	ElemStation=0.25						
Frame=77	Station=0.25	OutputCase=ACCVERT	CaseType=LinStatic	Point=4	X2=0.5	X3=0.5	S11=0		
IsS11Max=No	IsS11Min=No	FrameElem=77	ElemStation=0.25						
Frame=77	Station=0	OutputCase=ACCLATDX	CaseType=LinStatic	Point=0	X2=0	X3=0	S11=0	IsS11Max=Yes	
IsS11Min=Yes	FrameElem=77	ElemStation=0							
Frame=77	Station=0	OutputCase=ACCLATDX	CaseType=LinStatic	Point=1	X2=-0.5	X3=-0.5	S11=0		
IsS11Max=No	IsS11Min=No	FrameElem=77	ElemStation=0						



Frame=77	Station=0.0625	OutputCase=SOVRCOST	CaseType=LinStatic	Point=4	X2=0.5	X3=0.5	S11=0	
IsS11Max=No	IsS11Min=No	FrameElem=77	ElemStation=0.0625					
Frame=77	Station=0.125	OutputCase=SOVRCOST	CaseType=LinStatic	Point=0	X2=0	X3=0	S11=0	
IsS11Max=Yes	IsS11Min=Yes	FrameElem=77	ElemStation=0.125					
Frame=77	Station=0.125	OutputCase=SOVRCOST	CaseType=LinStatic	Point=1	X2=-0.5	X3=-0.5	S11=0	
IsS11Max=No	IsS11Min=No	FrameElem=77	ElemStation=0.125					
Frame=77	Station=0.125	OutputCase=SOVRCOST	CaseType=LinStatic	Point=2	X2=-0.5	X3=0.5	S11=0	
IsS11Max=No	IsS11Min=No	FrameElem=77	ElemStation=0.125					
Frame=77	Station=0.125	OutputCase=SOVRCOST	CaseType=LinStatic	Point=3	X2=0.5	X3=-0.5	S11=0	
IsS11Max=No	IsS11Min=No	FrameElem=77	ElemStation=0.125					
Frame=77	Station=0.125	OutputCase=SOVRCOST	CaseType=LinStatic	Point=4	X2=0.5	X3=0.5	S11=0	
IsS11Max=No	IsS11Min=No	FrameElem=77	ElemStation=0.125					
Frame=77	Station=0.1875	OutputCase=SOVRCOST	CaseType=LinStatic	Point=0	X2=0	X3=0	S11=0	
IsS11Max=Yes	IsS11Min=Yes	FrameElem=77	ElemStation=0.1875					
Frame=77	Station=0.1875	OutputCase=SOVRCOST	CaseType=LinStatic	Point=1	X2=-0.5	X3=-0.5	S11=0	
IsS11Max=No	IsS11Min=No	FrameElem=77	ElemStation=0.1875					
Frame=77	Station=0.1875	OutputCase=SOVRCOST	CaseType=LinStatic	Point=2	X2=-0.5	X3=0.5	S11=0	
IsS11Max=No	IsS11Min=No	FrameElem=77	ElemStation=0.1875					
Frame=77	Station=0.1875	OutputCase=SOVRCOST	CaseType=LinStatic	Point=3	X2=0.5	X3=-0.5	S11=0	
IsS11Max=No	IsS11Min=No	FrameElem=77	ElemStation=0.1875					
Frame=77	Station=0.1875	OutputCase=SOVRCOST	CaseType=LinStatic	Point=4	X2=0.5	X3=0.5	S11=0	
IsS11Max=No	IsS11Min=No	FrameElem=77	ElemStation=0.1875					
Frame=77	Station=0.25	OutputCase=SOVRCOST	CaseType=LinStatic	Point=0	X2=0	X3=0	S11=0	IsS11Max=Yes
IsS11Min=Yes	FrameElem=77	ElemStation=0.25						
Frame=77	Station=0.25	OutputCase=SOVRCOST	CaseType=LinStatic	Point=1	X2=-0.5	X3=-0.5	S11=0	
IsS11Max=No	IsS11Min=No	FrameElem=77	ElemStation=0.25					
Frame=77	Station=0.25	OutputCase=SOVRCOST	CaseType=LinStatic	Point=2	X2=-0.5	X3=0.5	S11=0	
IsS11Max=No	IsS11Min=No	FrameElem=77	ElemStation=0.25					
Frame=77	Station=0.25	OutputCase=SOVRCOST	CaseType=LinStatic	Point=3	X2=0.5	X3=-0.5	S11=0	
IsS11Max=No	IsS11Min=No	FrameElem=77	ElemStation=0.25					
Frame=77	Station=0.25	OutputCase=SOVRCOST	CaseType=LinStatic	Point=4	X2=0.5	X3=0.5	S11=0	
IsS11Max=No	IsS11Min=No	FrameElem=77	ElemStation=0.25					
Frame=77	Station=0	OutputCase=ENVE	CaseType=Combination	StepType=Max	Point=0	X2=0	X3=0	S11=-
217.882158664515	IsS11Max=No	IsS11Min=No	FrameElem=77	ElemStation=0				
Frame=77	Station=0	OutputCase=ENVE	CaseType=Combination	StepType=Max	Point=1	X2=-0.5	X3=-0.5	
S11=-584.013725265521	IsS11Max=No	IsS11Min=No	FrameElem=77	ElemStation=0				
Frame=77	Station=0	OutputCase=ENVE	CaseType=Combination	StepType=Max	Point=2	X2=-0.5	X3=0.5	S11=-
584.013725265521	IsS11Max=No	IsS11Min=No	FrameElem=77	ElemStation=0				
Frame=77	Station=0	OutputCase=ENVE	CaseType=Combination	StepType=Max	Point=3	X2=0.5	X3=-0.5	
S11=198.601574577983	IsS11Max=Yes	IsS11Min=No	FrameElem=77	ElemStation=0				
Frame=77	Station=0	OutputCase=ENVE	CaseType=Combination	StepType=Max	Point=4	X2=0.5	X3=0.5	
S11=198.601574577983	IsS11Max=No	IsS11Min=No	FrameElem=77	ElemStation=0				
Frame=77	Station=0.0625	OutputCase=ENVE	CaseType=Combination	StepType=Max	Point=0	X2=0	X3=0	S11=-
217.882158664515	IsS11Max=No	IsS11Min=No	FrameElem=77	ElemStation=0.0625				
Frame=77	Station=0.0625	OutputCase=ENVE	CaseType=Combination	StepType=Max	Point=1	X2=-0.5	X3=-0.5	
S11=-816.337944569376	IsS11Max=No	IsS11Min=Yes	FrameElem=77	ElemStation=0.0625				
Frame=77	Station=0.0625	OutputCase=ENVE	CaseType=Combination	StepType=Max	Point=2	X2=-0.5	X3=0.5	
S11=-816.337944569376	IsS11Max=No	IsS11Min=No	FrameElem=77	ElemStation=0.0625				
Frame=77	Station=0.0625	OutputCase=ENVE	CaseType=Combination	StepType=Max	Point=3	X2=0.5	X3=-0.5	
S11=430.925794072211	IsS11Max=Yes	IsS11Min=No	FrameElem=77	ElemStation=0.0625				
Frame=77	Station=0.0625	OutputCase=ENVE	CaseType=Combination	StepType=Max	Point=4	X2=0.5	X3=0.5	
S11=430.925794072211	IsS11Max=No	IsS11Min=No	FrameElem=77	ElemStation=0.0625				
Frame=77	Station=0.125	OutputCase=ENVE	CaseType=Combination	StepType=Max	Point=0	X2=0	X3=0	S11=-
217.882158664515	IsS11Max=No	IsS11Min=No	FrameElem=77	ElemStation=0.125				
Frame=77	Station=0.125	OutputCase=ENVE	CaseType=Combination	StepType=Max	Point=1	X2=-0.5	X3=-0.5	
S11=-1055.81060137323	IsS11Max=No	IsS11Min=Yes	FrameElem=77	ElemStation=0.125				
Frame=77	Station=0.125	OutputCase=ENVE	CaseType=Combination	StepType=Max	Point=2	X2=-0.5	X3=0.5	
S11=-1055.81060137323	IsS11Max=No	IsS11Min=No	FrameElem=77	ElemStation=0.125				
Frame=77	Station=0.125	OutputCase=ENVE	CaseType=Combination	StepType=Max	Point=3	X2=0.5	X3=-0.5	
S11=670.398451066438	IsS11Max=Yes	IsS11Min=No	FrameElem=77	ElemStation=0.125				
Frame=77	Station=0.125	OutputCase=ENVE	CaseType=Combination	StepType=Max	Point=4	X2=0.5	X3=0.5	
S11=670.398451066438	IsS11Max=No	IsS11Min=No	FrameElem=77	ElemStation=0.125				
Frame=77	Station=0.1875	OutputCase=ENVE	CaseType=Combination	StepType=Max	Point=0	X2=0	X3=0	S11=-
217.882158664515	IsS11Max=No	IsS11Min=No	FrameElem=77	ElemStation=0.1875				
Frame=77	Station=0.1875	OutputCase=ENVE	CaseType=Combination	StepType=Max	Point=1	X2=-0.5	X3=-0.5	
S11=-1302.43169567709	IsS11Max=No	IsS11Min=Yes	FrameElem=77	ElemStation=0.1875				
Frame=77	Station=0.1875	OutputCase=ENVE	CaseType=Combination	StepType=Max	Point=2	X2=-0.5	X3=0.5	
S11=-1302.43169567709	IsS11Max=No	IsS11Min=No	FrameElem=77	ElemStation=0.1875				
Frame=77	Station=0.1875	OutputCase=ENVE	CaseType=Combination	StepType=Max	Point=3	X2=0.5	X3=-0.5	
S11=917.019545560666	IsS11Max=Yes	IsS11Min=No	FrameElem=77	ElemStation=0.1875				
Frame=77	Station=0.1875	OutputCase=ENVE	CaseType=Combination	StepType=Max	Point=4	X2=0.5	X3=0.5	
S11=917.019545560666	IsS11Max=No	IsS11Min=No	FrameElem=77	ElemStation=0.1875				
Frame=77	Station=0.25	OutputCase=ENVE	CaseType=Combination	StepType=Max	Point=0	X2=0	X3=0	S11=-
217.882158664515	IsS11Max=No	IsS11Min=No	FrameElem=77	ElemStation=0.25				
Frame=77	Station=0.25	OutputCase=ENVE	CaseType=Combination	StepType=Max	Point=1	X2=-0.5	X3=-0.5	
S11=-1556.20122748094	IsS11Max=No	IsS11Min=Yes	FrameElem=77	ElemStation=0.25				
Frame=77	Station=0.25	OutputCase=ENVE	CaseType=Combination	StepType=Max	Point=2	X2=-0.5	X3=0.5	
S11=-1556.20122748094	IsS11Max=No	IsS11Min=No	FrameElem=77	ElemStation=0.25				
Frame=77	Station=0.25	OutputCase=ENVE	CaseType=Combination	StepType=Max	Point=3	X2=0.5	X3=-0.5	
S11=1170.78907755489	IsS11Max=Yes	IsS11Min=No	FrameElem=77	ElemStation=0.25				
Frame=77	Station=0.25	OutputCase=ENVE	CaseType=Combination	StepType=Max	Point=4	X2=0.5	X3=0.5	
S11=1170.78907755489	IsS11Max=No	IsS11Min=No	FrameElem=77	ElemStation=0.25				



Frame=77	Station=0	OutputCase=ENVE	CaseType=Combination	StepType=Min	Point=0	X2=0	X3=0	S11=-
317.058043529688	IsS11Max=No	IsS11Min=No	FrameElem=77	ElemStation=0				
Frame=77	Station=0	OutputCase=ENVE	CaseType=Combination	StepType=Min	Point=1	X2=-0.5	X3=-0.5	
S11=-832.717661637359	IsS11Max=No	IsS11Min=Yes	FrameElem=77	ElemStation=0				
Frame=77	Station=0	OutputCase=ENVE	CaseType=Combination	StepType=Min	Point=2	X2=-0.5	X3=0.5	S11=-
832.717661637359	IsS11Max=No	IsS11Min=No	FrameElem=77	ElemStation=0				
Frame=77	Station=0	OutputCase=ENVE	CaseType=Combination	StepType=Min	Point=3	X2=0.5	X3=-0.5	
S11=148.249407936491	IsS11Max=Yes	IsS11Min=No	FrameElem=77	ElemStation=0				
Frame=77	Station=0	OutputCase=ENVE	CaseType=Combination	StepType=Min	Point=4	X2=0.5	X3=0.5	
S11=148.249407936491	IsS11Max=No	IsS11Min=No	FrameElem=77	ElemStation=0				
Frame=77	Station=0.0625	OutputCase=ENVE	CaseType=Combination	StepType=Min	Point=0	X2=0	X3=0	S11=-
317.058043529688	IsS11Max=No	IsS11Min=No	FrameElem=77	ElemStation=0.0625				
Frame=77	Station=0.0625	OutputCase=ENVE	CaseType=Combination	StepType=Min	Point=1	X2=-0.5	X3=-0.5	
S11=-1065.04188113159	IsS11Max=No	IsS11Min=Yes	FrameElem=77	ElemStation=0.0625				
Frame=77	Station=0.0625	OutputCase=ENVE	CaseType=Combination	StepType=Min	Point=2	X2=-0.5	X3=0.5	
S11=-1065.04188113159	IsS11Max=No	IsS11Min=No	FrameElem=77	ElemStation=0.0625				
Frame=77	Station=0.0625	OutputCase=ENVE	CaseType=Combination	StepType=Min	Point=3	X2=0.5	X3=-0.5	
S11=380.573627240346	IsS11Max=Yes	IsS11Min=No	FrameElem=77	ElemStation=0.0625				
Frame=77	Station=0.0625	OutputCase=ENVE	CaseType=Combination	StepType=Min	Point=4	X2=0.5	X3=0.5	
S11=380.573627240346	IsS11Max=No	IsS11Min=No	FrameElem=77	ElemStation=0.0625				
Frame=77	Station=0.125	OutputCase=ENVE	CaseType=Combination	StepType=Min	Point=0	X2=0	X3=0	S11=-
317.058043529688	IsS11Max=No	IsS11Min=No	FrameElem=77	ElemStation=0.125				
Frame=77	Station=0.125	OutputCase=ENVE	CaseType=Combination	StepType=Min	Point=1	X2=-0.5	X3=-0.5	
S11=-1304.51453812581	IsS11Max=No	IsS11Min=Yes	FrameElem=77	ElemStation=0.125				
Frame=77	Station=0.125	OutputCase=ENVE	CaseType=Combination	StepType=Min	Point=2	X2=-0.5	X3=0.5	
S11=-1304.51453812581	IsS11Max=No	IsS11Min=No	FrameElem=77	ElemStation=0.125				
Frame=77	Station=0.125	OutputCase=ENVE	CaseType=Combination	StepType=Min	Point=3	X2=0.5	X3=-0.5	
S11=620.046284044201	IsS11Max=Yes	IsS11Min=No	FrameElem=77	ElemStation=0.125				
Frame=77	Station=0.125	OutputCase=ENVE	CaseType=Combination	StepType=Min	Point=4	X2=0.5	X3=0.5	
S11=620.046284044201	IsS11Max=No	IsS11Min=No	FrameElem=77	ElemStation=0.125				
Frame=77	Station=0.1875	OutputCase=ENVE	CaseType=Combination	StepType=Min	Point=0	X2=0	X3=0	S11=-
317.058043529688	IsS11Max=No	IsS11Min=No	FrameElem=77	ElemStation=0.1875				
Frame=77	Station=0.1875	OutputCase=ENVE	CaseType=Combination	StepType=Min	Point=1	X2=-0.5	X3=-0.5	
S11=-1551.13563262004	IsS11Max=No	IsS11Min=Yes	FrameElem=77	ElemStation=0.1875				
Frame=77	Station=0.1875	OutputCase=ENVE	CaseType=Combination	StepType=Min	Point=2	X2=-0.5	X3=0.5	
S11=-1551.13563262004	IsS11Max=No	IsS11Min=No	FrameElem=77	ElemStation=0.1875				
Frame=77	Station=0.1875	OutputCase=ENVE	CaseType=Combination	StepType=Min	Point=3	X2=0.5	X3=-0.5	
S11=866.667378348056	IsS11Max=Yes	IsS11Min=No	FrameElem=77	ElemStation=0.1875				
Frame=77	Station=0.1875	OutputCase=ENVE	CaseType=Combination	StepType=Min	Point=4	X2=0.5	X3=0.5	
S11=866.667378348056	IsS11Max=No	IsS11Min=No	FrameElem=77	ElemStation=0.1875				
Frame=77	Station=0.25	OutputCase=ENVE	CaseType=Combination	StepType=Min	Point=0	X2=0	X3=0	S11=-
317.058043529688	IsS11Max=No	IsS11Min=No	FrameElem=77	ElemStation=0.25				
Frame=77	Station=0.25	OutputCase=ENVE	CaseType=Combination	StepType=Min	Point=1	X2=-0.5	X3=-0.5	
S11=-1804.90516461427	IsS11Max=No	IsS11Min=Yes	FrameElem=77	ElemStation=0.25				
Frame=77	Station=0.25	OutputCase=ENVE	CaseType=Combination	StepType=Min	Point=2	X2=-0.5	X3=0.5	
S11=-1804.90516461427	IsS11Max=No	IsS11Min=No	FrameElem=77	ElemStation=0.25				
Frame=77	Station=0.25	OutputCase=ENVE	CaseType=Combination	StepType=Min	Point=3	X2=0.5	X3=-0.5	
S11=1120.43691015191	IsS11Max=Yes	IsS11Min=No	FrameElem=77	ElemStation=0.25				
Frame=77	Station=0.25	OutputCase=ENVE	CaseType=Combination	StepType=Min	Point=4	X2=0.5	X3=0.5	
S11=1120.43691015191	IsS11Max=No	IsS11Min=No	FrameElem=77	ElemStation=0.25				
Frame=77	Station=0	OutputCase=FESSUR	CaseType=Combination	Point=0	X2=0	X3=0	S11=-317.058043529688	
IsS11Max=No	IsS11Min=No	FrameElem=77	ElemStation=0					
Frame=77	Station=0	OutputCase=FESSUR	CaseType=Combination	Point=1	X2=-0.5	X3=-0.5	S11=-	
832.717661637359	IsS11Max=No	IsS11Min=Yes	FrameElem=77	ElemStation=0				
Frame=77	Station=0	OutputCase=FESSUR	CaseType=Combination	Point=2	X2=-0.5	X3=0.5	S11=-	
832.717661637359	IsS11Max=No	IsS11Min=No	FrameElem=77	ElemStation=0				
Frame=77	Station=0	OutputCase=FESSUR	CaseType=Combination	Point=3	X2=0.5	X3=-0.5		
S11=198.601574577983	IsS11Max=Yes	IsS11Min=No	FrameElem=77	ElemStation=0				
Frame=77	Station=0	OutputCase=FESSUR	CaseType=Combination	Point=4	X2=0.5	X3=0.5		
S11=198.601574577983	IsS11Max=No	IsS11Min=No	FrameElem=77	ElemStation=0				
Frame=77	Station=0.0625	OutputCase=FESSUR	CaseType=Combination	Point=0	X2=0	X3=0	S11=-	
317.058043529688	IsS11Max=No	IsS11Min=No	FrameElem=77	ElemStation=0.0625				
Frame=77	Station=0.0625	OutputCase=FESSUR	CaseType=Combination	Point=1	X2=-0.5	X3=-0.5	S11=-	
1065.04188113159	IsS11Max=No	IsS11Min=Yes	FrameElem=77	ElemStation=0.0625				
Frame=77	Station=0.0625	OutputCase=FESSUR	CaseType=Combination	Point=2	X2=-0.5	X3=0.5	S11=-	
1065.04188113159	IsS11Max=No	IsS11Min=No	FrameElem=77	ElemStation=0.0625				
Frame=77	Station=0.0625	OutputCase=FESSUR	CaseType=Combination	Point=3	X2=0.5	X3=-0.5		
S11=430.925794072211	IsS11Max=Yes	IsS11Min=No	FrameElem=77	ElemStation=0.0625				
Frame=77	Station=0.0625	OutputCase=FESSUR	CaseType=Combination	Point=4	X2=0.5	X3=0.5		
S11=430.925794072211	IsS11Max=No	IsS11Min=No	FrameElem=77	ElemStation=0.0625				
Frame=77	Station=0.125	OutputCase=FESSUR	CaseType=Combination	Point=0	X2=0	X3=0	S11=-	
317.058043529688	IsS11Max=No	IsS11Min=No	FrameElem=77	ElemStation=0.125				
Frame=77	Station=0.125	OutputCase=FESSUR	CaseType=Combination	Point=1	X2=-0.5	X3=-0.5	S11=-	
1304.51453812581	IsS11Max=No	IsS11Min=Yes	FrameElem=77	ElemStation=0.125				
Frame=77	Station=0.125	OutputCase=FESSUR	CaseType=Combination	Point=2	X2=-0.5	X3=0.5	S11=-	
1304.51453812581	IsS11Max=No	IsS11Min=No	FrameElem=77	ElemStation=0.125				
Frame=77	Station=0.125	OutputCase=FESSUR	CaseType=Combination	Point=3	X2=0.5	X3=-0.5		
S11=670.398451066438	IsS11Max=Yes	IsS11Min=No	FrameElem=77	ElemStation=0.125				
Frame=77	Station=0.125	OutputCase=FESSUR	CaseType=Combination	Point=4	X2=0.5	X3=0.5		
S11=670.398451066438	IsS11Max=No	IsS11Min=No	FrameElem=77	ElemStation=0.125				
Frame=77	Station=0.1875	OutputCase=FESSUR	CaseType=Combination	Point=0	X2=0	X3=0	S11=-	
317.058043529688	IsS11Max=No	IsS11Min=No	FrameElem=77	ElemStation=0.1875				

Frame=77 Station=0.1875 OutputCase=FESSUR CaseType=Combination Point=1 X2=-0.5 X3=-0.5 S11=-
 1551.13563262004 IsS11Max=No IsS11Min=Yes FrameElem=77 ElemStation=0.1875
 Frame=77 Station=0.1875 OutputCase=FESSUR CaseType=Combination Point=2 X2=-0.5 X3=0.5 S11=-
 1551.13563262004 IsS11Max=No IsS11Min=No FrameElem=77 ElemStation=0.1875
 Frame=77 Station=0.1875 OutputCase=FESSUR CaseType=Combination Point=3 X2=0.5 X3=-0.5
 S11=917.019545560666 IsS11Max=Yes IsS11Min=No FrameElem=77 ElemStation=0.1875
 Frame=77 Station=0.1875 OutputCase=FESSUR CaseType=Combination Point=4 X2=0.5 X3=0.5
 S11=917.019545560666 IsS11Max=No IsS11Min=No FrameElem=77 ElemStation=0.1875
 Frame=77 Station=0.25 OutputCase=FESSUR CaseType=Combination Point=0 X2=0 X3=0 S11=-
 317.058043529688 IsS11Max=No IsS11Min=No FrameElem=77 ElemStation=0.25
 Frame=77 Station=0.25 OutputCase=FESSUR CaseType=Combination Point=1 X2=-0.5 X3=-0.5 S11=-
 1804.90516461427 IsS11Max=No IsS11Min=Yes FrameElem=77 ElemStation=0.25
 Frame=77 Station=0.25 OutputCase=FESSUR CaseType=Combination Point=2 X2=-0.5 X3=0.5 S11=-
 1804.90516461427 IsS11Max=No IsS11Min=No FrameElem=77 ElemStation=0.25
 Frame=77 Station=0.25 OutputCase=FESSUR CaseType=Combination Point=3 X2=0.5 X3=-0.5
 S11=1170.78907755489 IsS11Max=Yes IsS11Min=No FrameElem=77 ElemStation=0.25
 Frame=77 Station=0.25 OutputCase=FESSUR CaseType=Combination Point=4 X2=0.5 X3=0.5
 S11=1170.78907755489 IsS11Max=No IsS11Min=No FrameElem=77 ElemStation=0.25
 Frame=78 Station=0 OutputCase=PESOPR CaseType=LinStatic Point=0 X2=0 X3=0 S11=15.1709413717648
 IsS11Max=No IsS11Min=No FrameElem=78 ElemStation=0
 Frame=78 Station=0 OutputCase=PESOPR CaseType=LinStatic Point=1 X2=-0.5 X3=-0.5 S11=-
 22.1960284600033 IsS11Max=No IsS11Min=Yes FrameElem=78 ElemStation=0
 Frame=78 Station=0 OutputCase=PESOPR CaseType=LinStatic Point=2 X2=-0.5 X3=0.5 S11=-
 22.1960284600033 IsS11Max=No IsS11Min=No FrameElem=78 ElemStation=0
 Frame=78 Station=0 OutputCase=PESOPR CaseType=LinStatic Point=3 X2=0.5 X3=-0.5 S11=52.5379112035328
 IsS11Max=Yes IsS11Min=No FrameElem=78 ElemStation=0
 Frame=78 Station=0 OutputCase=PESOPR CaseType=LinStatic Point=4 X2=0.5 X3=0.5 S11=52.5379112035328
 IsS11Max=No IsS11Min=No FrameElem=78 ElemStation=0
 Frame=78 Station=6.24999940395358E-02 OutputCase=PESOPR CaseType=LinStatic Point=0 X2=0 X3=0
 S11=15.1709412227531 IsS11Max=No IsS11Min=No FrameElem=78 ElemStation=6.24999940395358E-02
 Frame=78 Station=6.24999940395358E-02 OutputCase=PESOPR CaseType=LinStatic Point=1 X2=-0.5 X3=-0.5
 S11=-43.582745838147 IsS11Max=No IsS11Min=Yes FrameElem=78 ElemStation=6.24999940395358E-02
 Frame=78 Station=6.24999940395358E-02 OutputCase=PESOPR CaseType=LinStatic Point=2 X2=-0.5 X3=0.5
 S11=-43.582745838147 IsS11Max=No IsS11Min=No FrameElem=78 ElemStation=6.24999940395358E-02
 Frame=78 Station=6.24999940395358E-02 OutputCase=PESOPR CaseType=LinStatic Point=3 X2=0.5 X3=-0.5
 S11=73.9246282836533 IsS11Max=Yes IsS11Min=No FrameElem=78 ElemStation=6.24999940395358E-02
 Frame=78 Station=6.24999940395358E-02 OutputCase=PESOPR CaseType=LinStatic Point=4 X2=0.5 X3=0.5
 S11=73.9246282836533 IsS11Max=No IsS11Min=No FrameElem=78 ElemStation=6.24999940395358E-02
 Frame=78 Station=0.12499988079072 OutputCase=PESOPR CaseType=LinStatic Point=0 X2=0 X3=0
 S11=15.1709410737415 IsS11Max=No IsS11Min=No FrameElem=78 ElemStation=0.12499988079072
 Frame=78 Station=0.12499988079072 OutputCase=PESOPR CaseType=LinStatic Point=1 X2=-0.5 X3=-0.5
 S11=-65.555400604532 IsS11Max=No IsS11Min=Yes FrameElem=78 ElemStation=0.12499988079072
 Frame=78 Station=0.12499988079072 OutputCase=PESOPR CaseType=LinStatic Point=2 X2=-0.5 X3=0.5
 S11=-65.555400604532 IsS11Max=No IsS11Min=No FrameElem=78 ElemStation=0.12499988079072
 Frame=78 Station=0.12499988079072 OutputCase=PESOPR CaseType=LinStatic Point=3 X2=0.5 X3=-0.5
 S11=95.8972827520151 IsS11Max=Yes IsS11Min=No FrameElem=78 ElemStation=0.12499988079072
 Frame=78 Station=0.12499988079072 OutputCase=PESOPR CaseType=LinStatic Point=4 X2=0.5 X3=0.5
 S11=95.8972827520151 IsS11Max=No IsS11Min=No FrameElem=78 ElemStation=0.12499988079072
 Frame=78 Station=0.187499982118607 OutputCase=PESOPR CaseType=LinStatic Point=0 X2=0 X3=0
 S11=15.1709409247299 IsS11Max=No IsS11Min=No FrameElem=78 ElemStation=0.187499982118607
 Frame=78 Station=0.187499982118607 OutputCase=PESOPR CaseType=LinStatic Point=1 X2=-0.5 X3=-0.5
 S11=-88.1139927591583 IsS11Max=No IsS11Min=Yes FrameElem=78 ElemStation=0.187499982118607
 Frame=78 Station=0.187499982118607 OutputCase=PESOPR CaseType=LinStatic Point=2 X2=-0.5 X3=0.5
 S11=-88.1139927591583 IsS11Max=No IsS11Min=No FrameElem=78 ElemStation=0.187499982118607
 Frame=78 Station=0.187499982118607 OutputCase=PESOPR CaseType=LinStatic Point=3 X2=0.5 X3=-0.5
 S11=118.455874608618 IsS11Max=Yes IsS11Min=No FrameElem=78 ElemStation=0.187499982118607
 Frame=78 Station=0.187499982118607 OutputCase=PESOPR CaseType=LinStatic Point=4 X2=0.5 X3=0.5
 S11=118.455874608618 IsS11Max=No IsS11Min=No FrameElem=78 ElemStation=0.187499982118607
 Frame=78 Station=0.24999976158143 OutputCase=PESOPR CaseType=LinStatic Point=0 X2=0 X3=0
 S11=15.1709407757183 IsS11Max=No IsS11Min=No FrameElem=78 ElemStation=0.24999976158143
 Frame=78 Station=0.24999976158143 OutputCase=PESOPR CaseType=LinStatic Point=1 X2=-0.5 X3=-0.5
 S11=-111.258522302026 IsS11Max=No IsS11Min=Yes FrameElem=78 ElemStation=0.24999976158143
 Frame=78 Station=0.24999976158143 OutputCase=PESOPR CaseType=LinStatic Point=2 X2=-0.5 X3=0.5
 S11=-111.258522302026 IsS11Max=No IsS11Min=No FrameElem=78 ElemStation=0.24999976158143
 Frame=78 Station=0.24999976158143 OutputCase=PESOPR CaseType=LinStatic Point=3 X2=0.5 X3=-0.5
 S11=141.600403853463 IsS11Max=Yes IsS11Min=No FrameElem=78 ElemStation=0.24999976158143
 Frame=78 Station=0.24999976158143 OutputCase=PESOPR CaseType=LinStatic Point=4 X2=0.5 X3=0.5
 S11=141.600403853463 IsS11Max=No IsS11Min=No FrameElem=78 ElemStation=0.24999976158143
 Frame=78 Station=0 OutputCase=TERRVERT CaseType=LinStatic Point=0 X2=0 X3=0 S11=-1.64276746345034
 IsS11Max=No IsS11Min=No FrameElem=78 ElemStation=0
 Frame=78 Station=0 OutputCase=TERRVERT CaseType=LinStatic Point=1 X2=-0.5 X3=-0.5 S11=-
 953.696077822347 IsS11Max=No IsS11Min=Yes FrameElem=78 ElemStation=0
 Frame=78 Station=0 OutputCase=TERRVERT CaseType=LinStatic Point=2 X2=-0.5 X3=0.5 S11=-
 953.696077822347 IsS11Max=No IsS11Min=No FrameElem=78 ElemStation=0
 Frame=78 Station=0 OutputCase=TERRVERT CaseType=LinStatic Point=3 X2=0.5 X3=-0.5
 S11=950.410542895447 IsS11Max=Yes IsS11Min=No FrameElem=78 ElemStation=0
 Frame=78 Station=0 OutputCase=TERRVERT CaseType=LinStatic Point=4 X2=0.5 X3=0.5
 S11=950.410542895447 IsS11Max=No IsS11Min=No FrameElem=78 ElemStation=0
 Frame=78 Station=6.24999940395358E-02 OutputCase=TERRVERT CaseType=LinStatic Point=0 X2=0 X3=0
 S11=-1.64276913238042 IsS11Max=No IsS11Min=No FrameElem=78 ElemStation=6.24999940395358E-02
 Frame=78 Station=6.24999940395358E-02 OutputCase=TERRVERT CaseType=LinStatic Point=1 X2=-0.5 X3=-0.5
 S11=-1193.22730638154 IsS11Max=No IsS11Min=Yes FrameElem=78 ElemStation=6.24999940395358E-02



Frame=78 Station=6.24999940395358E-02 OutputCase=TERRVERT CaseType=LinStatic Point=2 X2=-0.5 X3=0.5
 S11=-1193.22730638154 IsS11Max=No IsS11Min=No FrameElem=78 ElemStation=6.24999940395358E-02
 Frame=78 Station=6.24999940395358E-02 OutputCase=TERRVERT CaseType=LinStatic Point=3 X2=0.5 X3=-0.5
 S11=1189.94176811678 IsS11Max=Yes IsS11Min=No FrameElem=78 ElemStation=6.24999940395358E-02
 Frame=78 Station=6.24999940395358E-02 OutputCase=TERRVERT CaseType=LinStatic Point=4 X2=0.5 X3=0.5
 S11=1189.94176811678 IsS11Max=No IsS11Min=No FrameElem=78 ElemStation=6.24999940395358E-02
 Frame=78 Station=0.124999988079072 OutputCase=TERRVERT CaseType=LinStatic Point=0 X2=0 X3=0 S11=-
 1.6427708013105 IsS11Max=No IsS11Min=No FrameElem=78 ElemStation=0.124999988079072
 Frame=78 Station=0.124999988079072 OutputCase=TERRVERT CaseType=LinStatic Point=1 X2=-0.5 X3=-0.5
 S11=-1439.32103368904 IsS11Max=No IsS11Min=Yes FrameElem=78 ElemStation=0.124999988079072
 Frame=78 Station=0.124999988079072 OutputCase=TERRVERT CaseType=LinStatic Point=2 X2=-0.5 X3=0.5
 S11=-1439.32103368904 IsS11Max=No IsS11Min=No FrameElem=78 ElemStation=0.124999988079072
 Frame=78 Station=0.124999988079072 OutputCase=TERRVERT CaseType=LinStatic Point=3 X2=0.5 X3=-0.5
 S11=1436.03549208642 IsS11Max=Yes IsS11Min=No FrameElem=78 ElemStation=0.124999988079072
 Frame=78 Station=0.124999988079072 OutputCase=TERRVERT CaseType=LinStatic Point=4 X2=0.5 X3=0.5
 S11=1436.03549208642 IsS11Max=No IsS11Min=No FrameElem=78 ElemStation=0.124999988079072
 Frame=78 Station=0.187499982118607 OutputCase=TERRVERT CaseType=LinStatic Point=0 X2=0 X3=0 S11=-
 1.64277247024058 IsS11Max=No IsS11Min=No FrameElem=78 ElemStation=0.187499982118607
 Frame=78 Station=0.187499982118607 OutputCase=TERRVERT CaseType=LinStatic Point=1 X2=-0.5 X3=-0.5
 S11=-1691.97725974484 IsS11Max=No IsS11Min=Yes FrameElem=78 ElemStation=0.187499982118607
 Frame=78 Station=0.187499982118607 OutputCase=TERRVERT CaseType=LinStatic Point=2 X2=-0.5 X3=0.5
 S11=-1691.97725974484 IsS11Max=No IsS11Min=No FrameElem=78 ElemStation=0.187499982118607
 Frame=78 Station=0.187499982118607 OutputCase=TERRVERT CaseType=LinStatic Point=3 X2=0.5 X3=-0.5
 S11=1688.69171480436 IsS11Max=Yes IsS11Min=No FrameElem=78 ElemStation=0.187499982118607
 Frame=78 Station=0.187499982118607 OutputCase=TERRVERT CaseType=LinStatic Point=4 X2=0.5 X3=0.5
 S11=1688.69171480436 IsS11Max=No IsS11Min=No FrameElem=78 ElemStation=0.187499982118607
 Frame=78 Station=0.249999976158143 OutputCase=TERRVERT CaseType=LinStatic Point=0 X2=0 X3=0 S11=-
 1.64277413917066 IsS11Max=No IsS11Min=No FrameElem=78 ElemStation=0.249999976158143
 Frame=78 Station=0.249999976158143 OutputCase=TERRVERT CaseType=LinStatic Point=1 X2=-0.5 X3=-0.5
 S11=-1951.19598454894 IsS11Max=No IsS11Min=Yes FrameElem=78 ElemStation=0.249999976158143
 Frame=78 Station=0.249999976158143 OutputCase=TERRVERT CaseType=LinStatic Point=2 X2=-0.5 X3=0.5
 S11=-1951.19598454894 IsS11Max=No IsS11Min=No FrameElem=78 ElemStation=0.249999976158143
 Frame=78 Station=0.249999976158143 OutputCase=TERRVERT CaseType=LinStatic Point=3 X2=0.5 X3=-0.5
 S11=1947.9104362706 IsS11Max=Yes IsS11Min=No FrameElem=78 ElemStation=0.249999976158143
 Frame=78 Station=0.249999976158143 OutputCase=TERRVERT CaseType=LinStatic Point=4 X2=0.5 X3=0.5
 S11=1947.9104362706 IsS11Max=No IsS11Min=No FrameElem=78 ElemStation=0.249999976158143
 Frame=78 Station=0 OutputCase=TERRLAT CaseType=LinStatic Point=0 X2=0 X3=0 S11=-330.586282883906
 IsS11Max=No IsS11Min=No FrameElem=78 ElemStation=0
 Frame=78 Station=0 OutputCase=TERRLAT CaseType=LinStatic Point=1 X2=-0.5 X3=-0.5 S11=-
 829.013123777756 IsS11Max=No IsS11Min=Yes FrameElem=78 ElemStation=0
 Frame=78 Station=0 OutputCase=TERRLAT CaseType=LinStatic Point=2 X2=-0.5 X3=0.5 S11=-
 829.013123777756 IsS11Max=No IsS11Min=No FrameElem=78 ElemStation=0
 Frame=78 Station=0 OutputCase=TERRLAT CaseType=LinStatic Point=3 X2=0.5 X3=-0.5
 S11=167.840558009944 IsS11Max=Yes IsS11Min=No FrameElem=78 ElemStation=0
 Frame=78 Station=0 OutputCase=TERRLAT CaseType=LinStatic Point=4 X2=0.5 X3=0.5 S11=167.840558009944
 IsS11Max=No IsS11Min=No FrameElem=78 ElemStation=0
 Frame=78 Station=6.24999940395358E-02 OutputCase=TERRLAT CaseType=LinStatic Point=0 X2=0 X3=0 S11=-
 330.586282883906 IsS11Max=No IsS11Min=No FrameElem=78 ElemStation=6.24999940395358E-02
 Frame=78 Station=6.24999940395358E-02 OutputCase=TERRLAT CaseType=LinStatic Point=1 X2=-0.5 X3=-0.5
 S11=-829.013112589645 IsS11Max=No IsS11Min=Yes FrameElem=78 ElemStation=6.24999940395358E-02
 Frame=78 Station=6.24999940395358E-02 OutputCase=TERRLAT CaseType=LinStatic Point=2 X2=-0.5 X3=0.5
 S11=-829.013112589645 IsS11Max=No IsS11Min=No FrameElem=78 ElemStation=6.24999940395358E-02
 Frame=78 Station=6.24999940395358E-02 OutputCase=TERRLAT CaseType=LinStatic Point=3 X2=0.5 X3=-0.5
 S11=167.840546821833 IsS11Max=Yes IsS11Min=No FrameElem=78 ElemStation=6.24999940395358E-02
 Frame=78 Station=6.24999940395358E-02 OutputCase=TERRLAT CaseType=LinStatic Point=4 X2=0.5 X3=0.5
 S11=167.840546821833 IsS11Max=No IsS11Min=No FrameElem=78 ElemStation=6.24999940395358E-02
 Frame=78 Station=0.124999988079072 OutputCase=TERRLAT CaseType=LinStatic Point=0 X2=0 X3=0 S11=-
 330.586282883906 IsS11Max=No IsS11Min=No FrameElem=78 ElemStation=0.124999988079072
 Frame=78 Station=0.124999988079072 OutputCase=TERRLAT CaseType=LinStatic Point=1 X2=-0.5 X3=-0.5
 S11=-829.013101401534 IsS11Max=No IsS11Min=Yes FrameElem=78 ElemStation=0.124999988079072
 Frame=78 Station=0.124999988079072 OutputCase=TERRLAT CaseType=LinStatic Point=2 X2=-0.5 X3=0.5
 S11=-829.013101401534 IsS11Max=No IsS11Min=No FrameElem=78 ElemStation=0.124999988079072
 Frame=78 Station=0.124999988079072 OutputCase=TERRLAT CaseType=LinStatic Point=3 X2=0.5 X3=-0.5
 S11=167.840535633721 IsS11Max=Yes IsS11Min=No FrameElem=78 ElemStation=0.124999988079072
 Frame=78 Station=0.124999988079072 OutputCase=TERRLAT CaseType=LinStatic Point=4 X2=0.5 X3=0.5
 S11=167.840535633721 IsS11Max=No IsS11Min=No FrameElem=78 ElemStation=0.124999988079072
 Frame=78 Station=0.187499982118607 OutputCase=TERRLAT CaseType=LinStatic Point=0 X2=0 X3=0 S11=-
 330.586282883906 IsS11Max=No IsS11Min=No FrameElem=78 ElemStation=0.187499982118607
 Frame=78 Station=0.187499982118607 OutputCase=TERRLAT CaseType=LinStatic Point=1 X2=-0.5 X3=-0.5
 S11=-829.013090213423 IsS11Max=No IsS11Min=Yes FrameElem=78 ElemStation=0.187499982118607
 Frame=78 Station=0.187499982118607 OutputCase=TERRLAT CaseType=LinStatic Point=2 X2=-0.5 X3=0.5
 S11=-829.013090213423 IsS11Max=No IsS11Min=No FrameElem=78 ElemStation=0.187499982118607
 Frame=78 Station=0.187499982118607 OutputCase=TERRLAT CaseType=LinStatic Point=3 X2=0.5 X3=-0.5
 S11=167.84052444561 IsS11Max=Yes IsS11Min=No FrameElem=78 ElemStation=0.187499982118607
 Frame=78 Station=0.187499982118607 OutputCase=TERRLAT CaseType=LinStatic Point=4 X2=0.5 X3=0.5
 S11=167.84052444561 IsS11Max=No IsS11Min=No FrameElem=78 ElemStation=0.187499982118607
 Frame=78 Station=0.249999976158143 OutputCase=TERRLAT CaseType=LinStatic Point=0 X2=0 X3=0 S11=-
 330.586282883906 IsS11Max=No IsS11Min=No FrameElem=78 ElemStation=0.249999976158143
 Frame=78 Station=0.249999976158143 OutputCase=TERRLAT CaseType=LinStatic Point=1 X2=-0.5 X3=-0.5
 S11=-829.013079025311 IsS11Max=No IsS11Min=Yes FrameElem=78 ElemStation=0.249999976158143
 Frame=78 Station=0.249999976158143 OutputCase=TERRLAT CaseType=LinStatic Point=2 X2=-0.5 X3=0.5
 S11=-829.013079025311 IsS11Max=No IsS11Min=No FrameElem=78 ElemStation=0.249999976158143



Frame=78 Station=0.249999976158143 OutputCase=SOVRCOST CaseType=LinStatic Point=1 X2=-0.5 X3=-0.5
 S11=0 IsS11Max=No IsS11Min=No FrameElem=78 ElemStation=0.249999976158143
 Frame=78 Station=0.249999976158143 OutputCase=SOVRCOST CaseType=LinStatic Point=2 X2=-0.5 X3=0.5
 S11=0 IsS11Max=No IsS11Min=No FrameElem=78 ElemStation=0.249999976158143
 Frame=78 Station=0.249999976158143 OutputCase=SOVRCOST CaseType=LinStatic Point=3 X2=0.5 X3=-0.5
 S11=0 IsS11Max=No IsS11Min=No FrameElem=78 ElemStation=0.249999976158143
 Frame=78 Station=0.249999976158143 OutputCase=SOVRCOST CaseType=LinStatic Point=4 X2=0.5 X3=0.5
 S11=0 IsS11Max=No IsS11Min=No FrameElem=78 ElemStation=0.249999976158143
 Frame=78 Station=0 OutputCase=ENVE CaseType=Combination StepType=Max Point=0 X2=0 X3=0 S11=-
 217.88222411042 IsS11Max=No IsS11Min=No FrameElem=78 ElemStation=0
 Frame=78 Station=0 OutputCase=ENVE CaseType=Combination StepType=Max Point=1 X2=-0.5 X3=-0.5
 S11=-1556.20129292678 IsS11Max=No IsS11Min=Yes FrameElem=78 ElemStation=0
 Frame=78 Station=0 OutputCase=ENVE CaseType=Combination StepType=Max Point=2 X2=-0.5 X3=0.5 S11=-
 1556.20129292678 IsS11Max=No IsS11Min=No FrameElem=78 ElemStation=0
 Frame=78 Station=0 OutputCase=ENVE CaseType=Combination StepType=Max Point=3 X2=0.5 X3=-0.5
 S11=1170.78901210892 IsS11Max=Yes IsS11Min=No FrameElem=78 ElemStation=0
 Frame=78 Station=0 OutputCase=ENVE CaseType=Combination StepType=Max Point=4 X2=0.5 X3=0.5
 S11=1170.78901210892 IsS11Max=No IsS11Min=No FrameElem=78 ElemStation=0
 Frame=78 Station=6.24999940395358E-02 OutputCase=ENVE CaseType=Combination StepType=Max Point=0 X2=0
 X3=0 S11=-217.882225928362 IsS11Max=No IsS11Min=No FrameElem=78 ElemStation=6.24999940395358E-02
 Frame=78 Station=6.24999940395358E-02 OutputCase=ENVE CaseType=Combination StepType=Max Point=1 X2=-
 0.5 X3=-0.5 S11=-1817.11923103244 IsS11Max=No IsS11Min=Yes FrameElem=78 ElemStation=6.24999940395358E-02
 Frame=78 Station=6.24999940395358E-02 OutputCase=ENVE CaseType=Combination StepType=Max Point=2 X2=-
 0.5 X3=0.5 S11=-1817.11923103244 IsS11Max=No IsS11Min=No FrameElem=78 ElemStation=6.24999940395358E-02
 Frame=78 Station=6.24999940395358E-02 OutputCase=ENVE CaseType=Combination StepType=Max Point=3
 X2=0.5 X3=-0.5 S11=1431.70694322227 IsS11Max=Yes IsS11Min=No FrameElem=78 ElemStation=6.24999940395358E-
 02
 Frame=78 Station=6.24999940395358E-02 OutputCase=ENVE CaseType=Combination StepType=Max Point=4
 X2=0.5 X3=0.5 S11=1431.70694322227 IsS11Max=No IsS11Min=No FrameElem=78 ElemStation=6.24999940395358E-02
 Frame=78 Station=0.12499988079072 OutputCase=ENVE CaseType=Combination StepType=Max Point=0 X2=0
 X3=0 S11=-217.882227746303 IsS11Max=No IsS11Min=No FrameElem=78 ElemStation=0.12499988079072
 Frame=78 Station=0.12499988079072 OutputCase=ENVE CaseType=Combination StepType=Max Point=1 X2=-0.5
 X3=-0.5 S11=-2085.18560527464 IsS11Max=No IsS11Min=Yes FrameElem=78 ElemStation=0.12499988079072
 Frame=78 Station=0.12499988079072 OutputCase=ENVE CaseType=Combination StepType=Max Point=2 X2=-0.5
 X3=0.5 S11=-2085.18560527464 IsS11Max=No IsS11Min=No FrameElem=78 ElemStation=0.12499988079072
 Frame=78 Station=0.12499988079072 OutputCase=ENVE CaseType=Combination StepType=Max Point=3 X2=0.5
 X3=-0.5 S11=1699.77331047215 IsS11Max=Yes IsS11Min=No FrameElem=78 ElemStation=0.12499988079072
 Frame=78 Station=0.12499988079072 OutputCase=ENVE CaseType=Combination StepType=Max Point=4 X2=0.5
 X3=0.5 S11=1699.77331047215 IsS11Max=No IsS11Min=No FrameElem=78 ElemStation=0.12499988079072
 Frame=78 Station=0.187499982118607 OutputCase=ENVE CaseType=Combination StepType=Max Point=0 X2=0
 X3=0 S11=-217.882229564245 IsS11Max=No IsS11Min=No FrameElem=78 ElemStation=0.187499982118607
 Frame=78 Station=0.187499982118607 OutputCase=ENVE CaseType=Combination StepType=Max Point=1 X2=-0.5
 X3=-0.5 S11=-2360.40041565339 IsS11Max=No IsS11Min=Yes FrameElem=78 ElemStation=0.187499982118607
 Frame=78 Station=0.187499982118607 OutputCase=ENVE CaseType=Combination StepType=Max Point=2 X2=-0.5
 X3=0.5 S11=-2360.40041565339 IsS11Max=No IsS11Min=No FrameElem=78 ElemStation=0.187499982118607
 Frame=78 Station=0.187499982118607 OutputCase=ENVE CaseType=Combination StepType=Max Point=3 X2=0.5
 X3=-0.5 S11=1974.98811385859 IsS11Max=Yes IsS11Min=No FrameElem=78 ElemStation=0.187499982118607
 Frame=78 Station=0.187499982118607 OutputCase=ENVE CaseType=Combination StepType=Max Point=4 X2=0.5
 X3=0.5 S11=1974.98811385859 IsS11Max=No IsS11Min=No FrameElem=78 ElemStation=0.187499982118607
 Frame=78 Station=0.249999976158143 OutputCase=ENVE CaseType=Combination StepType=Max Point=0 X2=0
 X3=0 S11=-217.882231382187 IsS11Max=No IsS11Min=No FrameElem=78 ElemStation=0.249999976158143
 Frame=78 Station=0.249999976158143 OutputCase=ENVE CaseType=Combination StepType=Max Point=1 X2=-0.5
 X3=-0.5 S11=-2642.76366216868 IsS11Max=No IsS11Min=Yes FrameElem=78 ElemStation=0.249999976158143
 Frame=78 Station=0.249999976158143 OutputCase=ENVE CaseType=Combination StepType=Max Point=2 X2=-0.5
 X3=0.5 S11=-2642.76366216868 IsS11Max=No IsS11Min=No FrameElem=78 ElemStation=0.249999976158143
 Frame=78 Station=0.249999976158143 OutputCase=ENVE CaseType=Combination StepType=Max Point=3 X2=0.5
 X3=-0.5 S11=2257.35135338156 IsS11Max=Yes IsS11Min=No FrameElem=78 ElemStation=0.249999976158143
 Frame=78 Station=0.249999976158143 OutputCase=ENVE CaseType=Combination StepType=Max Point=4 X2=0.5
 X3=0.5 S11=2257.35135338156 IsS11Max=No IsS11Min=No FrameElem=78 ElemStation=0.249999976158143
 Frame=78 Station=0 OutputCase=ENVE CaseType=Combination StepType=Min Point=0 X2=0 X3=0 S11=-
 317.058108975592 IsS11Max=No IsS11Min=No FrameElem=78 ElemStation=0
 Frame=78 Station=0 OutputCase=ENVE CaseType=Combination StepType=Min Point=1 X2=-0.5 X3=-0.5
 S11=-1804.90523006011 IsS11Max=No IsS11Min=Yes FrameElem=78 ElemStation=0
 Frame=78 Station=0 OutputCase=ENVE CaseType=Combination StepType=Min Point=2 X2=-0.5 X3=0.5 S11=-
 1804.90523006011 IsS11Max=No IsS11Min=No FrameElem=78 ElemStation=0
 Frame=78 Station=0 OutputCase=ENVE CaseType=Combination StepType=Min Point=3 X2=0.5 X3=-0.5
 S11=1120.43684470594 IsS11Max=Yes IsS11Min=No FrameElem=78 ElemStation=0
 Frame=78 Station=0 OutputCase=ENVE CaseType=Combination StepType=Min Point=4 X2=0.5 X3=0.5
 S11=1120.43684470594 IsS11Max=No IsS11Min=No FrameElem=78 ElemStation=0
 Frame=78 Station=6.24999940395358E-02 OutputCase=ENVE CaseType=Combination StepType=Min Point=0 X2=0
 X3=0 S11=-317.05810793534 IsS11Max=No IsS11Min=No FrameElem=78 ElemStation=6.24999940395358E-02
 Frame=78 Station=6.24999940395358E-02 OutputCase=ENVE CaseType=Combination StepType=Min Point=1 X2=-
 0.5 X3=-0.5 S11=-2065.82316480933 IsS11Max=No IsS11Min=Yes FrameElem=78 ElemStation=6.24999940395358E-02
 Frame=78 Station=6.24999940395358E-02 OutputCase=ENVE CaseType=Combination StepType=Min Point=2 X2=-
 0.5 X3=0.5 S11=-2065.82316480933 IsS11Max=No IsS11Min=No FrameElem=78 ElemStation=6.24999940395358E-02
 Frame=78 Station=6.24999940395358E-02 OutputCase=ENVE CaseType=Combination StepType=Min Point=3
 X2=0.5 X3=-0.5 S11=1381.35477917572 IsS11Max=Yes IsS11Min=No FrameElem=78 ElemStation=6.24999940395358E-
 02
 Frame=78 Station=6.24999940395358E-02 OutputCase=ENVE CaseType=Combination StepType=Min Point=4
 X2=0.5 X3=0.5 S11=1381.35477917572 IsS11Max=No IsS11Min=No FrameElem=78 ElemStation=6.24999940395358E-02
 Frame=78 Station=0.12499988079072 OutputCase=ENVE CaseType=Combination StepType=Min Point=0 X2=0
 X3=0 S11=-317.058112611475 IsS11Max=No IsS11Min=No FrameElem=78 ElemStation=0.12499988079072

Frame=78	Station=0.124999988079072	OutputCase=ENVE	CaseType=Combination	StepType=Min	Point=1	X2=-0.5		
X3=-0.5	S11=-2333.8895356951	IsS11Max=No	IsS11Min=Yes	FrameElem=78	ElemStation=0.124999988079072			
Frame=78	Station=0.124999988079072	OutputCase=ENVE	CaseType=Combination	StepType=Min	Point=2	X2=-0.5		
X3=0.5	S11=-2333.8895356951	IsS11Max=No	IsS11Min=No	FrameElem=78	ElemStation=0.124999988079072			
Frame=78	Station=0.124999988079072	OutputCase=ENVE	CaseType=Combination	StepType=Min	Point=3	X2=0.5		
X3=-0.5	S11=1649.42114978204	IsS11Max=Yes	IsS11Min=No	FrameElem=78	ElemStation=0.124999988079072			
Frame=78	Station=0.124999988079072	OutputCase=ENVE	CaseType=Combination	StepType=Min	Point=4	X2=0.5		
X3=0.5	S11=1649.42114978204	IsS11Max=No	IsS11Min=No	FrameElem=78	ElemStation=0.124999988079072			
Frame=78	Station=0.187499982118607	OutputCase=ENVE	CaseType=Combination	StepType=Min	Point=0	X2=0		
X3=0	S11=-317.058114429417	IsS11Max=No	IsS11Min=No	FrameElem=78	ElemStation=0.187499982118607			
Frame=78	Station=0.187499982118607	OutputCase=ENVE	CaseType=Combination	StepType=Min	Point=1	X2=-0.5		
X3=-0.5	S11=-2609.10434271742	IsS11Max=No	IsS11Min=Yes	FrameElem=78	ElemStation=0.187499982118607			
Frame=78	Station=0.187499982118607	OutputCase=ENVE	CaseType=Combination	StepType=Min	Point=2	X2=-0.5		
X3=0.5	S11=-2609.10434271742	IsS11Max=No	IsS11Min=No	FrameElem=78	ElemStation=0.187499982118607			
Frame=78	Station=0.187499982118607	OutputCase=ENVE	CaseType=Combination	StepType=Min	Point=3	X2=0.5		
X3=-0.5	S11=1924.6359565249	IsS11Max=Yes	IsS11Min=No	FrameElem=78	ElemStation=0.187499982118607			
Frame=78	Station=0.187499982118607	OutputCase=ENVE	CaseType=Combination	StepType=Min	Point=4	X2=0.5		
X3=0.5	S11=1924.6359565249	IsS11Max=No	IsS11Min=No	FrameElem=78	ElemStation=0.187499982118607			
Frame=78	Station=0.249999976158143	OutputCase=ENVE	CaseType=Combination	StepType=Min	Point=0	X2=0		
X3=0	S11=-317.058116247359	IsS11Max=No	IsS11Min=No	FrameElem=78	ElemStation=0.249999976158143			
Frame=78	Station=0.249999976158143	OutputCase=ENVE	CaseType=Combination	StepType=Min	Point=1	X2=-0.5		
X3=-0.5	S11=-2891.46758587628	IsS11Max=No	IsS11Min=Yes	FrameElem=78	ElemStation=0.249999976158143			
Frame=78	Station=0.249999976158143	OutputCase=ENVE	CaseType=Combination	StepType=Min	Point=2	X2=-0.5		
X3=0.5	S11=-2891.46758587628	IsS11Max=No	IsS11Min=No	FrameElem=78	ElemStation=0.249999976158143			
Frame=78	Station=0.249999976158143	OutputCase=ENVE	CaseType=Combination	StepType=Min	Point=3	X2=0.5		
X3=-0.5	S11=2206.99919940431	IsS11Max=Yes	IsS11Min=No	FrameElem=78	ElemStation=0.249999976158143			
Frame=78	Station=0.249999976158143	OutputCase=ENVE	CaseType=Combination	StepType=Min	Point=4	X2=0.5		
X3=0.5	S11=2206.99919940431	IsS11Max=No	IsS11Min=No	FrameElem=78	ElemStation=0.249999976158143			
Frame=78	Station=0	OutputCase=FESSUR	CaseType=Combination	Point=0	X2=0	X3=0	S11=-317.058108975592	
IsS11Max=No	IsS11Min=No	FrameElem=78	ElemStation=0					
Frame=78	Station=0	OutputCase=FESSUR	CaseType=Combination	Point=1	X2=-0.5	X3=-0.5	S11=-	
1804.90523006011	IsS11Max=No	IsS11Min=Yes	FrameElem=78	ElemStation=0				
Frame=78	Station=0	OutputCase=FESSUR	CaseType=Combination	Point=2	X2=-0.5	X3=0.5	S11=-	
1804.90523006011	IsS11Max=No	IsS11Min=No	FrameElem=78	ElemStation=0				
Frame=78	Station=0	OutputCase=FESSUR	CaseType=Combination	Point=3	X2=0.5	X3=-0.5		
S11=1170.78901210892	IsS11Max=Yes	IsS11Min=No	FrameElem=78	ElemStation=0				
Frame=78	Station=0	OutputCase=FESSUR	CaseType=Combination	Point=4	X2=0.5	X3=0.5		
S11=1170.78901210892	IsS11Max=No	IsS11Min=No	FrameElem=78	ElemStation=0				
Frame=78	Station=6.24999940395358E-02	OutputCase=FESSUR	CaseType=Combination	Point=0	X2=0	X3=0		
S11=-317.058110793534	IsS11Max=No	IsS11Min=No	FrameElem=78	ElemStation=6.24999940395358E-02				
Frame=78	Station=6.24999940395358E-02	OutputCase=FESSUR	CaseType=Combination	Point=1	X2=-0.5	X3=-0.5		
S11=-2065.82316480933	IsS11Max=No	IsS11Min=Yes	FrameElem=78	ElemStation=6.24999940395358E-02				
Frame=78	Station=6.24999940395358E-02	OutputCase=FESSUR	CaseType=Combination	Point=2	X2=-0.5	X3=0.5		
S11=-2065.82316480933	IsS11Max=No	IsS11Min=No	FrameElem=78	ElemStation=6.24999940395358E-02				
Frame=78	Station=6.24999940395358E-02	OutputCase=FESSUR	CaseType=Combination	Point=3	X2=0.5	X3=-0.5		
S11=1431.70694322227	IsS11Max=Yes	IsS11Min=No	FrameElem=78	ElemStation=6.24999940395358E-02				
Frame=78	Station=6.24999940395358E-02	OutputCase=FESSUR	CaseType=Combination	Point=4	X2=0.5	X3=0.5		
S11=1431.70694322227	IsS11Max=No	IsS11Min=No	FrameElem=78	ElemStation=6.24999940395358E-02				
Frame=78	Station=0.124999988079072	OutputCase=FESSUR	CaseType=Combination	Point=0	X2=0	X3=0	S11=-	
317.058112611475	IsS11Max=No	IsS11Min=No	FrameElem=78	ElemStation=0.124999988079072				
Frame=78	Station=0.124999988079072	OutputCase=FESSUR	CaseType=Combination	Point=1	X2=-0.5	X3=-0.5		
S11=-2333.8895356951	IsS11Max=No	IsS11Min=Yes	FrameElem=78	ElemStation=0.124999988079072				
Frame=78	Station=0.124999988079072	OutputCase=FESSUR	CaseType=Combination	Point=2	X2=-0.5	X3=0.5		
S11=-2333.8895356951	IsS11Max=No	IsS11Min=No	FrameElem=78	ElemStation=0.124999988079072				
Frame=78	Station=0.124999988079072	OutputCase=FESSUR	CaseType=Combination	Point=3	X2=0.5	X3=-0.5		
S11=1699.77331047215	IsS11Max=Yes	IsS11Min=No	FrameElem=78	ElemStation=0.124999988079072				
Frame=78	Station=0.124999988079072	OutputCase=FESSUR	CaseType=Combination	Point=4	X2=0.5	X3=0.5		
S11=1699.77331047215	IsS11Max=No	IsS11Min=No	FrameElem=78	ElemStation=0.124999988079072				
Frame=78	Station=0.187499982118607	OutputCase=FESSUR	CaseType=Combination	Point=0	X2=0	X3=0	S11=-	
317.058114429417	IsS11Max=No	IsS11Min=No	FrameElem=78	ElemStation=0.187499982118607				
Frame=78	Station=0.187499982118607	OutputCase=FESSUR	CaseType=Combination	Point=1	X2=-0.5	X3=-0.5		
S11=-2609.10434271742	IsS11Max=No	IsS11Min=Yes	FrameElem=78	ElemStation=0.187499982118607				
Frame=78	Station=0.187499982118607	OutputCase=FESSUR	CaseType=Combination	Point=2	X2=-0.5	X3=0.5		
S11=-2609.10434271742	IsS11Max=No	IsS11Min=No	FrameElem=78	ElemStation=0.187499982118607				
Frame=78	Station=0.187499982118607	OutputCase=FESSUR	CaseType=Combination	Point=3	X2=0.5	X3=-0.5		
S11=1974.98811385859	IsS11Max=Yes	IsS11Min=No	FrameElem=78	ElemStation=0.187499982118607				
Frame=78	Station=0.187499982118607	OutputCase=FESSUR	CaseType=Combination	Point=4	X2=0.5	X3=0.5		
S11=1974.98811385859	IsS11Max=No	IsS11Min=No	FrameElem=78	ElemStation=0.187499982118607				
Frame=78	Station=0.249999976158143	OutputCase=FESSUR	CaseType=Combination	Point=0	X2=0	X3=0	S11=-	
317.058116247359	IsS11Max=No	IsS11Min=No	FrameElem=78	ElemStation=0.249999976158143				
Frame=78	Station=0.249999976158143	OutputCase=FESSUR	CaseType=Combination	Point=1	X2=-0.5	X3=-0.5		
S11=-2891.46758587628	IsS11Max=No	IsS11Min=Yes	FrameElem=78	ElemStation=0.249999976158143				
Frame=78	Station=0.249999976158143	OutputCase=FESSUR	CaseType=Combination	Point=2	X2=-0.5	X3=0.5		
S11=-2891.46758587628	IsS11Max=No	IsS11Min=No	FrameElem=78	ElemStation=0.249999976158143				
Frame=78	Station=0.249999976158143	OutputCase=FESSUR	CaseType=Combination	Point=3	X2=0.5	X3=-0.5		
S11=2257.35135338156	IsS11Max=Yes	IsS11Min=No	FrameElem=78	ElemStation=0.249999976158143				
Frame=78	Station=0.249999976158143	OutputCase=FESSUR	CaseType=Combination	Point=4	X2=0.5	X3=0.5		
S11=2257.35135338156	IsS11Max=No	IsS11Min=No	FrameElem=78	ElemStation=0.249999976158143				
Frame=79	Station=0	OutputCase=PESOPR	CaseType=LinStatic	Point=0	X2=0	X3=0	S11=-162.500000839762	
IsS11Max=No	IsS11Min=No	FrameElem=79	ElemStation=0					
Frame=79	Station=0	OutputCase=PESOPR	CaseType=LinStatic	Point=1	X2=-0.5	X3=-0.5		
S11=328.032173803639	IsS11Max=Yes	IsS11Min=No	FrameElem=79	ElemStation=0				



Frame=79	Station=0	OutputCase=PESOPR	CaseType=LinStatic	Point=2	X2=-0.5	X3=0.5	S11=328.032173803639
IsS11Max=No	IsS11Min=No	FrameElem=79	ElemStation=0				
Frame=79	Station=0	OutputCase=PESOPR	CaseType=LinStatic	Point=3	X2=0.5	X3=-0.5	S11=-
653.032175483163	IsS11Max=No	IsS11Min=Yes	FrameElem=79	ElemStation=0			
Frame=79	Station=0	OutputCase=PESOPR	CaseType=LinStatic	Point=4	X2=0.5	X3=0.5	S11=-653.032175483163
IsS11Max=No	IsS11Min=No	FrameElem=79	ElemStation=0				
Frame=79	Station=0.2500000000000001	OutputCase=PESOPR	CaseType=LinStatic	Point=0	X2=0	X3=0	S11=-
156.250000839762	IsS11Max=No	IsS11Min=No	FrameElem=79	ElemStation=0.2500000000000001			
Frame=79	Station=0.2500000000000001	OutputCase=PESOPR	CaseType=LinStatic	Point=1	X2=-0.5	X3=-0.5	
S11=311.525776498136	IsS11Max=Yes	IsS11Min=No	FrameElem=79	ElemStation=0.2500000000000001			
Frame=79	Station=0.2500000000000001	OutputCase=PESOPR	CaseType=LinStatic	Point=2	X2=-0.5	X3=0.5	
S11=311.525776498136	IsS11Max=No	IsS11Min=No	FrameElem=79	ElemStation=0.2500000000000001			
Frame=79	Station=0.2500000000000001	OutputCase=PESOPR	CaseType=LinStatic	Point=3	X2=0.5	X3=-0.5	
S11=-624.02577817766	IsS11Max=No	IsS11Min=Yes	FrameElem=79	ElemStation=0.2500000000000001			
Frame=79	Station=0.2500000000000001	OutputCase=PESOPR	CaseType=LinStatic	Point=4	X2=0.5	X3=0.5	S11=-
624.02577817766	IsS11Max=No	IsS11Min=No	FrameElem=79	ElemStation=0.2500000000000001			
Frame=79	Station=0	OutputCase=TERRVERT	CaseType=LinStatic	Point=0	X2=0	X3=0	S11=-699.999992886325
IsS11Max=No	IsS11Min=No	FrameElem=79	ElemStation=0				
Frame=79	Station=0	OutputCase=TERRVERT	CaseType=LinStatic	Point=1	X2=-0.5	X3=-0.5	
S11=1210.12823214594	IsS11Max=Yes	IsS11Min=No	FrameElem=79	ElemStation=0			
Frame=79	Station=0	OutputCase=TERRVERT	CaseType=LinStatic	Point=2	X2=-0.5	X3=0.5	
S11=1210.12823214594	IsS11Max=No	IsS11Min=No	FrameElem=79	ElemStation=0			
Frame=79	Station=0	OutputCase=TERRVERT	CaseType=LinStatic	Point=3	X2=0.5	X3=-0.5	S11=-
2610.12821791859	IsS11Max=No	IsS11Min=Yes	FrameElem=79	ElemStation=0			
Frame=79	Station=0	OutputCase=TERRVERT	CaseType=LinStatic	Point=4	X2=0.5	X3=0.5	S11=-
2610.12821791859	IsS11Max=No	IsS11Min=No	FrameElem=79	ElemStation=0			
Frame=79	Station=0.2500000000000001	OutputCase=TERRVERT	CaseType=LinStatic	Point=0	X2=0	X3=0	S11=-
699.999992886325	IsS11Max=No	IsS11Min=No	FrameElem=79	ElemStation=0.2500000000000001			
Frame=79	Station=0.2500000000000001	OutputCase=TERRVERT	CaseType=LinStatic	Point=1	X2=-0.5	X3=-0.5	
S11=1212.59239335467	IsS11Max=Yes	IsS11Min=No	FrameElem=79	ElemStation=0.2500000000000001			
Frame=79	Station=0.2500000000000001	OutputCase=TERRVERT	CaseType=LinStatic	Point=2	X2=-0.5	X3=0.5	
S11=1212.59239335467	IsS11Max=No	IsS11Min=No	FrameElem=79	ElemStation=0.2500000000000001			
Frame=79	Station=0.2500000000000001	OutputCase=TERRVERT	CaseType=LinStatic	Point=3	X2=0.5	X3=-0.5	
S11=-2612.59237912732	IsS11Max=No	IsS11Min=Yes	FrameElem=79	ElemStation=0.2500000000000001			
Frame=79	Station=0.2500000000000001	OutputCase=TERRVERT	CaseType=LinStatic	Point=4	X2=0.5	X3=0.5	
S11=-2612.59237912732	IsS11Max=No	IsS11Min=No	FrameElem=79	ElemStation=0.2500000000000001			
Frame=79	Station=0	OutputCase=TERRLAT	CaseType=LinStatic	Point=0	X2=0	X3=0	S11=-2.62565336015541E-
05	IsS11Max=No	IsS11Min=No	FrameElem=79	ElemStation=0			
Frame=79	Station=0	OutputCase=TERRLAT	CaseType=LinStatic	Point=1	X2=-0.5	X3=-0.5	
S11=504.435977195838	IsS11Max=Yes	IsS11Min=No	FrameElem=79	ElemStation=0			
Frame=79	Station=0	OutputCase=TERRLAT	CaseType=LinStatic	Point=2	X2=-0.5	X3=0.5	
S11=504.435977195838	IsS11Max=No	IsS11Min=No	FrameElem=79	ElemStation=0			
Frame=79	Station=0	OutputCase=TERRLAT	CaseType=LinStatic	Point=3	X2=0.5	X3=-0.5	S11=-
504.436029708905	IsS11Max=No	IsS11Min=Yes	FrameElem=79	ElemStation=0			
Frame=79	Station=0	OutputCase=TERRLAT	CaseType=LinStatic	Point=4	X2=0.5	X3=0.5	S11=-
504.436029708905	IsS11Max=No	IsS11Min=No	FrameElem=79	ElemStation=0			
Frame=79	Station=0.2500000000000001	OutputCase=TERRLAT	CaseType=LinStatic	Point=0	X2=0	X3=0	S11=-
2.25201866554053E-05	IsS11Max=No	IsS11Min=No	FrameElem=79	ElemStation=0.2500000000000001			
Frame=79	Station=0.2500000000000001	OutputCase=TERRLAT	CaseType=LinStatic	Point=1	X2=-0.5	X3=-0.5	
S11=94.2908740080485	IsS11Max=Yes	IsS11Min=No	FrameElem=79	ElemStation=0.2500000000000001			
Frame=79	Station=0.2500000000000001	OutputCase=TERRLAT	CaseType=LinStatic	Point=2	X2=-0.5	X3=0.5	
S11=94.2908740080485	IsS11Max=No	IsS11Min=No	FrameElem=79	ElemStation=0.2500000000000001			
Frame=79	Station=0.2500000000000001	OutputCase=TERRLAT	CaseType=LinStatic	Point=3	X2=0.5	X3=-0.5	
S11=-94.2909190484218	IsS11Max=No	IsS11Min=Yes	FrameElem=79	ElemStation=0.2500000000000001			
Frame=79	Station=0.2500000000000001	OutputCase=TERRLAT	CaseType=LinStatic	Point=4	X2=0.5	X3=0.5	
S11=-94.2909190484218	IsS11Max=No	IsS11Min=No	FrameElem=79	ElemStation=0.2500000000000001			
Frame=79	Station=0	OutputCase=ACCVERT	CaseType=LinStatic	Point=0	X2=0	X3=0	S11=0
IsS11Min=Yes	FrameElem=79	ElemStation=0					
Frame=79	Station=0	OutputCase=ACCVERT	CaseType=LinStatic	Point=1	X2=-0.5	X3=-0.5	S11=0
IsS11Max=No	IsS11Min=No	FrameElem=79	ElemStation=0				
Frame=79	Station=0	OutputCase=ACCVERT	CaseType=LinStatic	Point=2	X2=-0.5	X3=0.5	S11=0
IsS11Min=No	FrameElem=79	ElemStation=0					IsS11Max=No
Frame=79	Station=0	OutputCase=ACCVERT	CaseType=LinStatic	Point=3	X2=0.5	X3=-0.5	S11=0
IsS11Min=No	FrameElem=79	ElemStation=0					IsS11Max=No
Frame=79	Station=0	OutputCase=ACCVERT	CaseType=LinStatic	Point=4	X2=0.5	X3=0.5	S11=0
IsS11Min=No	FrameElem=79	ElemStation=0					IsS11Max=No
Frame=79	Station=0.2500000000000001	OutputCase=ACCVERT	CaseType=LinStatic	Point=0	X2=0	X3=0	S11=0
IsS11Max=Yes	IsS11Min=Yes	FrameElem=79	ElemStation=0.2500000000000001				
Frame=79	Station=0.2500000000000001	OutputCase=ACCVERT	CaseType=LinStatic	Point=1	X2=-0.5	X3=-0.5	
S11=0	IsS11Max=No	IsS11Min=No	FrameElem=79	ElemStation=0.2500000000000001			
Frame=79	Station=0.2500000000000001	OutputCase=ACCVERT	CaseType=LinStatic	Point=2	X2=-0.5	X3=0.5	
S11=0	IsS11Max=No	IsS11Min=No	FrameElem=79	ElemStation=0.2500000000000001			
Frame=79	Station=0.2500000000000001	OutputCase=ACCVERT	CaseType=LinStatic	Point=3	X2=0.5	X3=-0.5	
S11=0	IsS11Max=No	IsS11Min=No	FrameElem=79	ElemStation=0.2500000000000001			
Frame=79	Station=0.2500000000000001	OutputCase=ACCVERT	CaseType=LinStatic	Point=4	X2=0.5	X3=0.5	
S11=0	IsS11Max=No	IsS11Min=No	FrameElem=79	ElemStation=0.2500000000000001			
Frame=79	Station=0	OutputCase=ACCLATDX	CaseType=LinStatic	Point=0	X2=0	X3=0	S11=0
IsS11Min=Yes	FrameElem=79	ElemStation=0					IsS11Max=Yes
Frame=79	Station=0	OutputCase=ACCLATDX	CaseType=LinStatic	Point=1	X2=-0.5	X3=-0.5	S11=0
IsS11Max=No	IsS11Min=No	FrameElem=79	ElemStation=0				
Frame=79	Station=0	OutputCase=ACCLATDX	CaseType=LinStatic	Point=2	X2=-0.5	X3=0.5	S11=0
IsS11Max=No	IsS11Min=No	FrameElem=79	ElemStation=0				

```

Frame=79 Station=0 OutputCase=ENVE CaseType=Combination StepType=Max Point=4 X2=0.5 X3=0.5 S11=-
3616.26561419799 IsS11Max=No IsS11Min=No FrameElem=79 ElemStation=0
Frame=79 Station=0.2500000000000001 OutputCase=ENVE CaseType=Combination StepType=Max Point=0 X2=0
X3=0 S11=-856.250009490218 IsS11Max=No IsS11Min=No FrameElem=79 ElemStation=0.2500000000000001
Frame=79 Station=0.2500000000000001 OutputCase=ENVE CaseType=Combination StepType=Max Point=1 X2=-0.5
X3=-0.5 S11=1618.40904386086 IsS11Max=Yes IsS11Min=No FrameElem=79 ElemStation=0.2500000000000001
Frame=79 Station=0.2500000000000001 OutputCase=ENVE CaseType=Combination StepType=Max Point=2 X2=-0.5
X3=0.5 S11=1618.40904386086 IsS11Max=No IsS11Min=No FrameElem=79 ElemStation=0.2500000000000001
Frame=79 Station=0.2500000000000001 OutputCase=ENVE CaseType=Combination StepType=Max Point=3 X2=0.5
X3=-0.5 S11=-3302.62180063888 IsS11Max=No IsS11Min=Yes FrameElem=79 ElemStation=0.2500000000000001
Frame=79 Station=0.2500000000000001 OutputCase=ENVE CaseType=Combination StepType=Max Point=4 X2=0.5
X3=0.5 S11=-3302.62180063888 IsS11Max=No IsS11Min=No FrameElem=79 ElemStation=0.2500000000000001
Frame=79 Station=0 OutputCase=ENVE CaseType=Combination StepType=Min Point=0 X2=0 X3=0 S11=-
862.500019982621 IsS11Max=No IsS11Min=No FrameElem=79 ElemStation=0
Frame=79 Station=0 OutputCase=ENVE CaseType=Combination StepType=Min Point=1 X2=-0.5 X3=-0.5
S11=1891.26558998666 IsS11Max=Yes IsS11Min=No FrameElem=79 ElemStation=0
Frame=79 Station=0 OutputCase=ENVE CaseType=Combination StepType=Min Point=2 X2=-0.5 X3=0.5
S11=1891.26558998666 IsS11Max=No IsS11Min=No FrameElem=79 ElemStation=0
Frame=79 Station=0 OutputCase=ENVE CaseType=Combination StepType=Min Point=3 X2=0.5 X3=-0.5 S11=-
3767.59642311066 IsS11Max=No IsS11Min=Yes FrameElem=79 ElemStation=0
Frame=79 Station=0 OutputCase=ENVE CaseType=Combination StepType=Min Point=4 X2=0.5 X3=0.5 S11=-
3767.59642311066 IsS11Max=No IsS11Min=No FrameElem=79 ElemStation=0
Frame=79 Station=0.2500000000000001 OutputCase=ENVE CaseType=Combination StepType=Min Point=0 X2=0
X3=0 S11=-856.250016246274 IsS11Max=No IsS11Min=No FrameElem=79 ElemStation=0.2500000000000001
Frame=79 Station=0.2500000000000001 OutputCase=ENVE CaseType=Combination StepType=Min Point=1 X2=-0.5
X3=-0.5 S11=1590.12178165844 IsS11Max=Yes IsS11Min=No FrameElem=79 ElemStation=0.2500000000000001
Frame=79 Station=0.2500000000000001 OutputCase=ENVE CaseType=Combination StepType=Min Point=2 X2=-0.5
X3=0.5 S11=1590.12178165844 IsS11Max=No IsS11Min=No FrameElem=79 ElemStation=0.2500000000000001
Frame=79 Station=0.2500000000000001 OutputCase=ENVE CaseType=Combination StepType=Min Point=3 X2=0.5
X3=-0.5 S11=-3330.90907635341 IsS11Max=No IsS11Min=Yes FrameElem=79 ElemStation=0.2500000000000001
Frame=79 Station=0.2500000000000001 OutputCase=ENVE CaseType=Combination StepType=Min Point=4 X2=0.5
X3=0.5 S11=-3330.90907635341 IsS11Max=No IsS11Min=No FrameElem=79 ElemStation=0.2500000000000001
Frame=79 Station=0 OutputCase=FESSUR CaseType=Combination Point=0 X2=0 X3=0 S11=-862.500019982621
IsS11Max=No IsS11Min=No FrameElem=79 ElemStation=0
Frame=79 Station=0 OutputCase=FESSUR CaseType=Combination Point=1 X2=-0.5 X3=-0.5
S11=2042.59638314542 IsS11Max=Yes IsS11Min=No FrameElem=79 ElemStation=0
Frame=79 Station=0 OutputCase=FESSUR CaseType=Combination Point=2 X2=-0.5 X3=0.5
S11=2042.59638314542 IsS11Max=No IsS11Min=No FrameElem=79 ElemStation=0
Frame=79 Station=0 OutputCase=FESSUR CaseType=Combination Point=3 X2=0.5 X3=-0.5 S11=-
3767.59642311066 IsS11Max=No IsS11Min=Yes FrameElem=79 ElemStation=0
Frame=79 Station=0 OutputCase=FESSUR CaseType=Combination Point=4 X2=0.5 X3=0.5 S11=-
3767.59642311066 IsS11Max=No IsS11Min=No FrameElem=79 ElemStation=0
Frame=79 Station=0.2500000000000001 OutputCase=FESSUR CaseType=Combination Point=0 X2=0 X3=0 S11=-
856.250016246274 IsS11Max=No IsS11Min=No FrameElem=79 ElemStation=0.2500000000000001
Frame=79 Station=0.2500000000000001 OutputCase=FESSUR CaseType=Combination Point=1 X2=-0.5 X3=-0.5
S11=1618.40904386086 IsS11Max=Yes IsS11Min=No FrameElem=79 ElemStation=0.2500000000000001
Frame=79 Station=0.2500000000000001 OutputCase=FESSUR CaseType=Combination Point=2 X2=-0.5 X3=0.5
S11=1618.40904386086 IsS11Max=No IsS11Min=No FrameElem=79 ElemStation=0.2500000000000001
Frame=79 Station=0.2500000000000001 OutputCase=FESSUR CaseType=Combination Point=3 X2=0.5 X3=-0.5
S11=-3330.90907635341 IsS11Max=No IsS11Min=Yes FrameElem=79 ElemStation=0.2500000000000001
Frame=79 Station=0.2500000000000001 OutputCase=FESSUR CaseType=Combination Point=4 X2=0.5 X3=0.5
S11=-3330.90907635341 IsS11Max=No IsS11Min=No FrameElem=79 ElemStation=0.2500000000000001
Frame=80 Station=0 OutputCase=PESOPR CaseType=LinStatic Point=0 X2=0 X3=0 S11=-156.249999392836
IsS11Max=No IsS11Min=No FrameElem=80 ElemStation=0
Frame=80 Station=0 OutputCase=PESOPR CaseType=LinStatic Point=1 X2=-0.5 X3=-0.5
S11=311.525777945064 IsS11Max=Yes IsS11Min=No FrameElem=80 ElemStation=0
Frame=80 Station=0 OutputCase=PESOPR CaseType=LinStatic Point=2 X2=-0.5 X3=0.5 S11=311.525777945064
IsS11Max=No IsS11Min=No FrameElem=80 ElemStation=0
Frame=80 Station=0 OutputCase=PESOPR CaseType=LinStatic Point=3 X2=0.5 X3=-0.5 S11=-
624.025776730735 IsS11Max=No IsS11Min=Yes FrameElem=80 ElemStation=0
Frame=80 Station=0 OutputCase=PESOPR CaseType=LinStatic Point=4 X2=0.5 X3=0.5 S11=-624.025776730735
IsS11Max=No IsS11Min=No FrameElem=80 ElemStation=0
Frame=80 Station=0.25 OutputCase=PESOPR CaseType=LinStatic Point=0 X2=0 X3=0 S11=-149.999999392836
IsS11Max=No IsS11Min=No FrameElem=80 ElemStation=0.25
Frame=80 Station=0.25 OutputCase=PESOPR CaseType=LinStatic Point=1 X2=-0.5 X3=-0.5
S11=295.019357840784 IsS11Max=Yes IsS11Min=No FrameElem=80 ElemStation=0.25
Frame=80 Station=0.25 OutputCase=PESOPR CaseType=LinStatic Point=2 X2=-0.5 X3=0.5
S11=295.019357840784 IsS11Max=No IsS11Min=No FrameElem=80 ElemStation=0.25
Frame=80 Station=0.25 OutputCase=PESOPR CaseType=LinStatic Point=3 X2=0.5 X3=-0.5 S11=-
595.019356626456 IsS11Max=No IsS11Min=Yes FrameElem=80 ElemStation=0.25
Frame=80 Station=0.25 OutputCase=PESOPR CaseType=LinStatic Point=4 X2=0.5 X3=0.5 S11=-
595.019356626456 IsS11Max=No IsS11Min=No FrameElem=80 ElemStation=0.25
Frame=80 Station=0 OutputCase=TERRVERT CaseType=LinStatic Point=0 X2=0 X3=0 S11=-699.999993042322
IsS11Max=No IsS11Min=No FrameElem=80 ElemStation=0
Frame=80 Station=0 OutputCase=TERRVERT CaseType=LinStatic Point=1 X2=-0.5 X3=-0.5
S11=1212.59239319868 IsS11Max=Yes IsS11Min=No FrameElem=80 ElemStation=0
Frame=80 Station=0 OutputCase=TERRVERT CaseType=LinStatic Point=2 X2=-0.5 X3=0.5
S11=1212.59239319868 IsS11Max=No IsS11Min=No FrameElem=80 ElemStation=0
Frame=80 Station=0 OutputCase=TERRVERT CaseType=LinStatic Point=3 X2=0.5 X3=-0.5 S11=-
2612.59237928332 IsS11Max=No IsS11Min=Yes FrameElem=80 ElemStation=0
Frame=80 Station=0 OutputCase=TERRVERT CaseType=LinStatic Point=4 X2=0.5 X3=0.5 S11=-
2612.59237928332 IsS11Max=No IsS11Min=No FrameElem=80 ElemStation=0

```

Frame=80	Station=0.25	OutputCase=TERRVERT	CaseType=LinStatic	Point=0	X2=0	X3=0	S11=-
699.99993042322	IsS11Max=No	IsS11Min=No	FrameElem=80	ElemStation=0.25			
Frame=80	Station=0.25	OutputCase=TERRVERT	CaseType=LinStatic	Point=1	X2=-0.5	X3=-0.5	
S11=1215.05645427161	IsS11Max=Yes	IsS11Min=No	FrameElem=80	ElemStation=0.25			
Frame=80	Station=0.25	OutputCase=TERRVERT	CaseType=LinStatic	Point=2	X2=-0.5	X3=0.5	
S11=1215.05645427161	IsS11Max=No	IsS11Min=No	FrameElem=80	ElemStation=0.25			
Frame=80	Station=0.25	OutputCase=TERRVERT	CaseType=LinStatic	Point=3	X2=0.5	X3=-0.5	S11=-
2615.05644035626	IsS11Max=No	IsS11Min=Yes	FrameElem=80	ElemStation=0.25			
Frame=80	Station=0.25	OutputCase=TERRVERT	CaseType=LinStatic	Point=4	X2=0.5	X3=0.5	S11=-
2615.05644035626	IsS11Max=No	IsS11Min=No	FrameElem=80	ElemStation=0.25			
Frame=80	Station=0	OutputCase=TERRLAT	CaseType=LinStatic	Point=0	X2=0	X3=0	S11=1.69219674717169E-06
IsS11Max=No	IsS11Min=No	FrameElem=80	ElemStation=0				
Frame=80	Station=0	OutputCase=TERRLAT	CaseType=LinStatic	Point=1	X2=-0.5	X3=-0.5	
S11=94.2908982204312	IsS11Max=Yes	IsS11Min=No	FrameElem=80	ElemStation=0			
Frame=80	Station=0	OutputCase=TERRLAT	CaseType=LinStatic	Point=2	X2=-0.5	X3=0.5	
S11=94.2908982204312	IsS11Max=No	IsS11Min=No	FrameElem=80	ElemStation=0			
Frame=80	Station=0	OutputCase=TERRLAT	CaseType=LinStatic	Point=3	X2=0.5	X3=-0.5	S11=-
94.2908948360378	IsS11Max=No	IsS11Min=Yes	FrameElem=80	ElemStation=0			
Frame=80	Station=0	OutputCase=TERRLAT	CaseType=LinStatic	Point=4	X2=0.5	X3=0.5	S11=-
94.2908948360378	IsS11Max=No	IsS11Min=No	FrameElem=80	ElemStation=0			
Frame=80	Station=0.25	OutputCase=TERRLAT	CaseType=LinStatic	Point=0	X2=0	X3=0	
S11=1.69219674717169E-06	IsS11Max=No	IsS11Min=No	FrameElem=80	ElemStation=0.25			
Frame=80	Station=0.25	OutputCase=TERRLAT	CaseType=LinStatic	Point=1	X2=-0.5	X3=-0.5	S11=-
257.486396203704	IsS11Max=No	IsS11Min=Yes	FrameElem=80	ElemStation=0.25			
Frame=80	Station=0.25	OutputCase=TERRLAT	CaseType=LinStatic	Point=2	X2=-0.5	X3=0.5	S11=-
257.486396203704	IsS11Max=No	IsS11Min=No	FrameElem=80	ElemStation=0.25			
Frame=80	Station=0.25	OutputCase=TERRLAT	CaseType=LinStatic	Point=3	X2=0.5	X3=-0.5	
S11=257.486399588098	IsS11Max=Yes	IsS11Min=No	FrameElem=80	ElemStation=0.25			
Frame=80	Station=0.25	OutputCase=TERRLAT	CaseType=LinStatic	Point=4	X2=0.5	X3=0.5	
S11=257.486399588098	IsS11Max=No	IsS11Min=No	FrameElem=80	ElemStation=0.25			
Frame=80	Station=0	OutputCase=ACCVERT	CaseType=LinStatic	Point=0	X2=0	X3=0	S11=0 IsS11Max=Yes
IsS11Min=Yes	FrameElem=80	ElemStation=0					
Frame=80	Station=0	OutputCase=ACCVERT	CaseType=LinStatic	Point=1	X2=-0.5	X3=-0.5	S11=0
IsS11Max=No	IsS11Min=No	FrameElem=80	ElemStation=0				
Frame=80	Station=0	OutputCase=ACCVERT	CaseType=LinStatic	Point=2	X2=-0.5	X3=0.5	S11=0 IsS11Max=No
IsS11Min=No	FrameElem=80	ElemStation=0					
Frame=80	Station=0	OutputCase=ACCVERT	CaseType=LinStatic	Point=3	X2=0.5	X3=-0.5	S11=0 IsS11Max=No
IsS11Min=No	FrameElem=80	ElemStation=0					
Frame=80	Station=0	OutputCase=ACCVERT	CaseType=LinStatic	Point=4	X2=0.5	X3=0.5	S11=0 IsS11Max=No
IsS11Min=No	FrameElem=80	ElemStation=0					
Frame=80	Station=0.25	OutputCase=ACCVERT	CaseType=LinStatic	Point=0	X2=0	X3=0	S11=0 IsS11Max=Yes
IsS11Min=Yes	FrameElem=80	ElemStation=0.25					
Frame=80	Station=0.25	OutputCase=ACCVERT	CaseType=LinStatic	Point=1	X2=-0.5	X3=-0.5	S11=0
IsS11Max=No	IsS11Min=No	FrameElem=80	ElemStation=0.25				
Frame=80	Station=0.25	OutputCase=ACCVERT	CaseType=LinStatic	Point=2	X2=-0.5	X3=0.5	S11=0
IsS11Max=No	IsS11Min=No	FrameElem=80	ElemStation=0.25				
Frame=80	Station=0.25	OutputCase=ACCVERT	CaseType=LinStatic	Point=3	X2=0.5	X3=-0.5	S11=0
IsS11Max=No	IsS11Min=No	FrameElem=80	ElemStation=0.25				
Frame=80	Station=0.25	OutputCase=ACCVERT	CaseType=LinStatic	Point=4	X2=0.5	X3=0.5	S11=0
IsS11Max=No	IsS11Min=No	FrameElem=80	ElemStation=0.25				
Frame=80	Station=0	OutputCase=ACCLATDX	CaseType=LinStatic	Point=0	X2=0	X3=0	S11=0 IsS11Max=Yes
IsS11Min=Yes	FrameElem=80	ElemStation=0					
Frame=80	Station=0	OutputCase=ACCLATDX	CaseType=LinStatic	Point=1	X2=-0.5	X3=-0.5	S11=0
IsS11Max=No	IsS11Min=No	FrameElem=80	ElemStation=0				
Frame=80	Station=0	OutputCase=ACCLATDX	CaseType=LinStatic	Point=2	X2=-0.5	X3=0.5	S11=0
IsS11Max=No	IsS11Min=No	FrameElem=80	ElemStation=0				
Frame=80	Station=0	OutputCase=ACCLATDX	CaseType=LinStatic	Point=3	X2=0.5	X3=-0.5	S11=0
IsS11Max=No	IsS11Min=No	FrameElem=80	ElemStation=0				
Frame=80	Station=0	OutputCase=ACCLATDX	CaseType=LinStatic	Point=4	X2=0.5	X3=0.5	S11=0 IsS11Max=No
IsS11Min=No	FrameElem=80	ElemStation=0					
Frame=80	Station=0.25	OutputCase=ACCLATDX	CaseType=LinStatic	Point=0	X2=0	X3=0	S11=0 IsS11Max=Yes
IsS11Min=Yes	FrameElem=80	ElemStation=0.25					
Frame=80	Station=0.25	OutputCase=ACCLATDX	CaseType=LinStatic	Point=1	X2=-0.5	X3=-0.5	S11=0
IsS11Max=No	IsS11Min=No	FrameElem=80	ElemStation=0.25				
Frame=80	Station=0.25	OutputCase=ACCLATDX	CaseType=LinStatic	Point=2	X2=-0.5	X3=0.5	S11=0
IsS11Max=No	IsS11Min=No	FrameElem=80	ElemStation=0.25				
Frame=80	Station=0.25	OutputCase=ACCLATDX	CaseType=LinStatic	Point=3	X2=0.5	X3=-0.5	S11=0
IsS11Max=No	IsS11Min=No	FrameElem=80	ElemStation=0.25				
Frame=80	Station=0.25	OutputCase=ACCLATDX	CaseType=LinStatic	Point=4	X2=0.5	X3=0.5	S11=0
IsS11Max=No	IsS11Min=No	FrameElem=80	ElemStation=0.25				
Frame=80	Station=0	OutputCase=ACCLATSX	CaseType=LinStatic	Point=0	X2=0	X3=0	S11=0 IsS11Max=Yes
IsS11Min=Yes	FrameElem=80	ElemStation=0					
Frame=80	Station=0	OutputCase=ACCLATSX	CaseType=LinStatic	Point=1	X2=-0.5	X3=-0.5	S11=0
IsS11Max=No	IsS11Min=No	FrameElem=80	ElemStation=0				
Frame=80	Station=0	OutputCase=ACCLATSX	CaseType=LinStatic	Point=2	X2=-0.5	X3=0.5	S11=0
IsS11Max=No	IsS11Min=No	FrameElem=80	ElemStation=0				
Frame=80	Station=0	OutputCase=ACCLATSX	CaseType=LinStatic	Point=3	X2=0.5	X3=-0.5	S11=0
IsS11Max=No	IsS11Min=No	FrameElem=80	ElemStation=0				
Frame=80	Station=0	OutputCase=ACCLATSX	CaseType=LinStatic	Point=4	X2=0.5	X3=0.5	S11=0 IsS11Max=No
IsS11Min=No	FrameElem=80	ElemStation=0					
Frame=80	Station=0.25	OutputCase=ACCLATSX	CaseType=LinStatic	Point=0	X2=0	X3=0	S11=0 IsS11Max=Yes
IsS11Min=Yes	FrameElem=80	ElemStation=0.25					



Frame=80	Station=0.25	OutputCase=ACCLATSX	CaseType=LinStatic	Point=1	X2=-0.5	X3=-0.5	S11=0	
IsS11Max=No	IsS11Min=No	FrameElem=80	ElemStation=0.25					
Frame=80	Station=0.25	OutputCase=ACCLATSX	CaseType=LinStatic	Point=2	X2=-0.5	X3=0.5	S11=0	
IsS11Max=No	IsS11Min=No	FrameElem=80	ElemStation=0.25					
Frame=80	Station=0.25	OutputCase=ACCLATSX	CaseType=LinStatic	Point=3	X2=0.5	X3=-0.5	S11=0	
IsS11Max=No	IsS11Min=No	FrameElem=80	ElemStation=0.25					
Frame=80	Station=0.25	OutputCase=ACCLATSX	CaseType=LinStatic	Point=4	X2=0.5	X3=0.5	S11=0	
IsS11Max=No	IsS11Min=No	FrameElem=80	ElemStation=0.25					
Frame=80	Station=0	OutputCase=TERRCOST	CaseType=LinStatic	Point=0	X2=0	X3=0	S11=0	
IsS11Min=Yes	FrameElem=80	ElemStation=0					IsS11Max=Yes	
Frame=80	Station=0	OutputCase=TERRCOST	CaseType=LinStatic	Point=1	X2=-0.5	X3=-0.5	S11=0	
IsS11Max=No	IsS11Min=No	FrameElem=80	ElemStation=0					
Frame=80	Station=0	OutputCase=TERRCOST	CaseType=LinStatic	Point=2	X2=-0.5	X3=0.5	S11=0	
IsS11Max=No	IsS11Min=No	FrameElem=80	ElemStation=0					
Frame=80	Station=0	OutputCase=TERRCOST	CaseType=LinStatic	Point=3	X2=0.5	X3=-0.5	S11=0	
IsS11Max=No	IsS11Min=No	FrameElem=80	ElemStation=0					
Frame=80	Station=0	OutputCase=TERRCOST	CaseType=LinStatic	Point=4	X2=0.5	X3=0.5	S11=0	
IsS11Max=No	IsS11Min=No	FrameElem=80	ElemStation=0				IsS11Max=No	
Frame=80	Station=0.25	OutputCase=TERRCOST	CaseType=LinStatic	Point=0	X2=0	X3=0	S11=0	
IsS11Min=Yes	FrameElem=80	ElemStation=0.25					IsS11Max=Yes	
Frame=80	Station=0.25	OutputCase=TERRCOST	CaseType=LinStatic	Point=1	X2=-0.5	X3=-0.5	S11=0	
IsS11Max=No	IsS11Min=No	FrameElem=80	ElemStation=0.25					
Frame=80	Station=0.25	OutputCase=TERRCOST	CaseType=LinStatic	Point=2	X2=-0.5	X3=0.5	S11=0	
IsS11Max=No	IsS11Min=No	FrameElem=80	ElemStation=0.25					
Frame=80	Station=0.25	OutputCase=TERRCOST	CaseType=LinStatic	Point=3	X2=0.5	X3=-0.5	S11=0	
IsS11Max=No	IsS11Min=No	FrameElem=80	ElemStation=0.25					
Frame=80	Station=0.25	OutputCase=TERRCOST	CaseType=LinStatic	Point=4	X2=0.5	X3=0.5	S11=0	
IsS11Max=No	IsS11Min=No	FrameElem=80	ElemStation=0.25					
Frame=80	Station=0	OutputCase=SOVRCOST	CaseType=LinStatic	Point=0	X2=0	X3=0	S11=0	
IsS11Min=Yes	FrameElem=80	ElemStation=0					IsS11Max=Yes	
Frame=80	Station=0	OutputCase=SOVRCOST	CaseType=LinStatic	Point=1	X2=-0.5	X3=-0.5	S11=0	
IsS11Max=No	IsS11Min=No	FrameElem=80	ElemStation=0					
Frame=80	Station=0	OutputCase=SOVRCOST	CaseType=LinStatic	Point=2	X2=-0.5	X3=0.5	S11=0	
IsS11Max=No	IsS11Min=No	FrameElem=80	ElemStation=0					
Frame=80	Station=0	OutputCase=SOVRCOST	CaseType=LinStatic	Point=3	X2=0.5	X3=-0.5	S11=0	
IsS11Max=No	IsS11Min=No	FrameElem=80	ElemStation=0					
Frame=80	Station=0	OutputCase=SOVRCOST	CaseType=LinStatic	Point=4	X2=0.5	X3=0.5	S11=0	
IsS11Max=No	IsS11Min=No	FrameElem=80	ElemStation=0				IsS11Max=No	
Frame=80	Station=0.25	OutputCase=SOVRCOST	CaseType=LinStatic	Point=0	X2=0	X3=0	S11=0	
IsS11Min=Yes	FrameElem=80	ElemStation=0.25					IsS11Max=Yes	
Frame=80	Station=0.25	OutputCase=SOVRCOST	CaseType=LinStatic	Point=1	X2=-0.5	X3=-0.5	S11=0	
IsS11Max=No	IsS11Min=No	FrameElem=80	ElemStation=0.25					
Frame=80	Station=0.25	OutputCase=SOVRCOST	CaseType=LinStatic	Point=2	X2=-0.5	X3=0.5	S11=0	
IsS11Max=No	IsS11Min=No	FrameElem=80	ElemStation=0.25					
Frame=80	Station=0.25	OutputCase=SOVRCOST	CaseType=LinStatic	Point=3	X2=0.5	X3=-0.5	S11=0	
IsS11Max=No	IsS11Min=No	FrameElem=80	ElemStation=0.25					
Frame=80	Station=0.25	OutputCase=SOVRCOST	CaseType=LinStatic	Point=4	X2=0.5	X3=0.5	S11=0	
IsS11Max=No	IsS11Min=No	FrameElem=80	ElemStation=0.25					
Frame=80	Station=0	OutputCase=ENVE	CaseType=Combination	StepType=Max	Point=0	X2=0	X3=0	S11=-
856.249990742961	IsS11Max=No	IsS11Min=No	FrameElem=80	ElemStation=0				
Frame=80	Station=0	OutputCase=ENVE	CaseType=Combination	StepType=Max	Point=1	X2=-0.5	X3=-0.5	
S11=1618.40906936417	IsS11Max=Yes	IsS11Min=No	FrameElem=80	ElemStation=0				
Frame=80	Station=0	OutputCase=ENVE	CaseType=Combination	StepType=Max	Point=2	X2=-0.5	X3=0.5	
S11=1618.40906936417	IsS11Max=No	IsS11Min=No	FrameElem=80	ElemStation=0				
Frame=80	Station=0	OutputCase=ENVE	CaseType=Combination	StepType=Max	Point=3	X2=0.5	X3=-0.5	S11=-
3302.62178239928	IsS11Max=No	IsS11Min=Yes	FrameElem=80	ElemStation=0				
Frame=80	Station=0	OutputCase=ENVE	CaseType=Combination	StepType=Max	Point=4	X2=0.5	X3=0.5	S11=-
3302.62178239928	IsS11Max=No	IsS11Min=No	FrameElem=80	ElemStation=0				
Frame=80	Station=0.25	OutputCase=ENVE	CaseType=Combination	StepType=Max	Point=0	X2=0	X3=0	S11=-
849.999990742961	IsS11Max=No	IsS11Min=No	FrameElem=80	ElemStation=0.25				
Frame=80	Station=0.25	OutputCase=ENVE	CaseType=Combination	StepType=Max	Point=1	X2=-0.5	X3=-0.5	
S11=1329.8353347698	IsS11Max=Yes	IsS11Min=No	FrameElem=80	ElemStation=0.25				
Frame=80	Station=0.25	OutputCase=ENVE	CaseType=Combination	StepType=Max	Point=2	X2=-0.5	X3=0.5	
S11=1329.8353347698	IsS11Max=No	IsS11Min=No	FrameElem=80	ElemStation=0.25				
Frame=80	Station=0.25	OutputCase=ENVE	CaseType=Combination	StepType=Max	Point=3	X2=0.5	X3=-0.5	
S11=-2952.58939739461	IsS11Max=No	IsS11Min=Yes	FrameElem=80	ElemStation=0.25				
Frame=80	Station=0.25	OutputCase=ENVE	CaseType=Combination	StepType=Max	Point=4	X2=0.5	X3=0.5	
S11=-2952.58939739461	IsS11Max=No	IsS11Min=No	FrameElem=80	ElemStation=0.25				
Frame=80	Station=0	OutputCase=ENVE	CaseType=Combination	StepType=Min	Point=0	X2=0	X3=0	S11=-
856.24999125062	IsS11Max=No	IsS11Min=No	FrameElem=80	ElemStation=0				
Frame=80	Station=0	OutputCase=ENVE	CaseType=Combination	StepType=Min	Point=1	X2=-0.5	X3=-0.5	
S11=1590.12179989804	IsS11Max=Yes	IsS11Min=No	FrameElem=80	ElemStation=0				
Frame=80	Station=0	OutputCase=ENVE	CaseType=Combination	StepType=Min	Point=2	X2=-0.5	X3=0.5	
S11=1590.12179989804	IsS11Max=No	IsS11Min=No	FrameElem=80	ElemStation=0				
Frame=80	Station=0	OutputCase=ENVE	CaseType=Combination	StepType=Min	Point=3	X2=0.5	X3=-0.5	S11=-
3330.9090508501	IsS11Max=No	IsS11Min=Yes	FrameElem=80	ElemStation=0				
Frame=80	Station=0	OutputCase=ENVE	CaseType=Combination	StepType=Min	Point=4	X2=0.5	X3=0.5	S11=-
3330.9090508501	IsS11Max=No	IsS11Min=No	FrameElem=80	ElemStation=0				
Frame=80	Station=0.25	OutputCase=ENVE	CaseType=Combination	StepType=Min	Point=0	X2=0	X3=0	S11=-
849.99999125062	IsS11Max=No	IsS11Min=No	FrameElem=80	ElemStation=0.25				
Frame=80	Station=0.25	OutputCase=ENVE	CaseType=Combination	StepType=Min	Point=1	X2=-0.5	X3=-0.5	
S11=1252.58941590869	IsS11Max=Yes	IsS11Min=No	FrameElem=80	ElemStation=0.25				



Frame=80 Station=0.25 OutputCase=ENVE CaseType=Combination StepType=Min Point=2 X2=-0.5 X3=0.5
 S11=1252.58941590869 IsS11Max=No IsS11Min=No FrameElem=80 ElemStation=0.25
 Frame=80 Station=0.25 OutputCase=ENVE CaseType=Combination StepType=Min Point=3 X2=0.5 X3=-0.5
 S11=-3029.83531727104 IsS11Max=No IsS11Min=Yes FrameElem=80 ElemStation=0.25
 Frame=80 Station=0.25 OutputCase=ENVE CaseType=Combination StepType=Min Point=4 X2=0.5 X3=0.5
 S11=-3029.83531727104 IsS11Max=No IsS11Min=No FrameElem=80 ElemStation=0.25
 Frame=80 Station=0 OutputCase=FESSUR CaseType=Combination Point=0 X2=0 X3=0 S11=-856.249990742961
 IsS11Max=No IsS11Min=No FrameElem=80 ElemStation=0
 Frame=80 Station=0 OutputCase=FESSUR CaseType=Combination Point=1 X2=-0.5 X3=-0.5
 S11=1618.40906936417 IsS11Max=Yes IsS11Min=No FrameElem=80 ElemStation=0
 Frame=80 Station=0 OutputCase=FESSUR CaseType=Combination Point=2 X2=-0.5 X3=0.5
 S11=1618.40906936417 IsS11Max=No IsS11Min=No FrameElem=80 ElemStation=0
 Frame=80 Station=0 OutputCase=FESSUR CaseType=Combination Point=3 X2=0.5 X3=-0.5 S11=-
 3330.9090508501 IsS11Max=No IsS11Min=Yes FrameElem=80 ElemStation=0
 Frame=80 Station=0 OutputCase=FESSUR CaseType=Combination Point=4 X2=0.5 X3=0.5 S11=-
 3330.9090508501 IsS11Max=No IsS11Min=No FrameElem=80 ElemStation=0
 Frame=80 Station=0.25 OutputCase=FESSUR CaseType=Combination Point=0 X2=0 X3=0 S11=-
 849.999990742961 IsS11Max=No IsS11Min=No FrameElem=80 ElemStation=0.25
 Frame=80 Station=0.25 OutputCase=FESSUR CaseType=Combination Point=1 X2=-0.5 X3=-0.5
 S11=1252.58941590869 IsS11Max=Yes IsS11Min=No FrameElem=80 ElemStation=0.25
 Frame=80 Station=0.25 OutputCase=FESSUR CaseType=Combination Point=2 X2=-0.5 X3=0.5
 S11=1252.58941590869 IsS11Max=No IsS11Min=No FrameElem=80 ElemStation=0.25
 Frame=80 Station=0.25 OutputCase=FESSUR CaseType=Combination Point=3 X2=0.5 X3=-0.5 S11=-
 2952.58939739461 IsS11Max=No IsS11Min=Yes FrameElem=80 ElemStation=0.25
 Frame=80 Station=0.25 OutputCase=FESSUR CaseType=Combination Point=4 X2=0.5 X3=0.5 S11=-
 2952.58939739461 IsS11Max=No IsS11Min=No FrameElem=80 ElemStation=0.25
 Frame=82 Station=0 OutputCase=PESOPR CaseType=LinStatic Point=0 X2=0 X3=0 S11=-75.0000008395873
 IsS11Max=No IsS11Min=No FrameElem=82 ElemStation=0
 Frame=82 Station=0 OutputCase=PESOPR CaseType=LinStatic Point=1 X2=-0.5 X3=-0.5 S11=96.942299049449
 IsS11Max=Yes IsS11Min=No FrameElem=82 ElemStation=0
 Frame=82 Station=0 OutputCase=PESOPR CaseType=LinStatic Point=2 X2=-0.5 X3=0.5 S11=96.942299049449
 IsS11Max=No IsS11Min=No FrameElem=82 ElemStation=0
 Frame=82 Station=0 OutputCase=PESOPR CaseType=LinStatic Point=3 X2=0.5 X3=-0.5 S11=-
 246.942300728624 IsS11Max=No IsS11Min=Yes FrameElem=82 ElemStation=0
 Frame=82 Station=0 OutputCase=PESOPR CaseType=LinStatic Point=4 X2=0.5 X3=0.5 S11=-246.942300728624
 IsS11Max=No IsS11Min=No FrameElem=82 ElemStation=0
 Frame=82 Station=0.2500000000000002 OutputCase=PESOPR CaseType=LinStatic Point=0 X2=0 X3=0 S11=-
 68.7500008395873 IsS11Max=No IsS11Min=No FrameElem=82 ElemStation=0.2500000000000002
 Frame=82 Station=0.2500000000000002 OutputCase=PESOPR CaseType=LinStatic Point=1 X2=-0.5 X3=-0.5
 S11=80.4358892269731 IsS11Max=Yes IsS11Min=No FrameElem=82 ElemStation=0.2500000000000002
 Frame=82 Station=0.2500000000000002 OutputCase=PESOPR CaseType=LinStatic Point=2 X2=-0.5 X3=0.5
 S11=80.4358892269731 IsS11Max=No IsS11Min=No FrameElem=82 ElemStation=0.2500000000000002
 Frame=82 Station=0.2500000000000002 OutputCase=PESOPR CaseType=LinStatic Point=3 X2=0.5 X3=-0.5
 S11=-217.935890906148 IsS11Max=No IsS11Min=Yes FrameElem=82 ElemStation=0.2500000000000002
 Frame=82 Station=0.2500000000000002 OutputCase=PESOPR CaseType=LinStatic Point=4 X2=0.5 X3=0.5 S11=-
 217.935890906148 IsS11Max=No IsS11Min=No FrameElem=82 ElemStation=0.2500000000000002
 Frame=82 Station=0 OutputCase=TERRVERT CaseType=LinStatic Point=0 X2=0 X3=0 S11=-699.99999288586
 IsS11Max=No IsS11Min=No FrameElem=82 ElemStation=0
 Frame=82 Station=0 OutputCase=TERRVERT CaseType=LinStatic Point=1 X2=-0.5 X3=-0.5
 S11=1244.62508716754 IsS11Max=Yes IsS11Min=No FrameElem=82 ElemStation=0
 Frame=82 Station=0 OutputCase=TERRVERT CaseType=LinStatic Point=2 X2=-0.5 X3=0.5
 S11=1244.62508716754 IsS11Max=No IsS11Min=No FrameElem=82 ElemStation=0
 Frame=82 Station=0 OutputCase=TERRVERT CaseType=LinStatic Point=3 X2=0.5 X3=-0.5 S11=-
 2644.62507293926 IsS11Max=No IsS11Min=Yes FrameElem=82 ElemStation=0
 Frame=82 Station=0 OutputCase=TERRVERT CaseType=LinStatic Point=4 X2=0.5 X3=0.5 S11=-
 2644.62507293926 IsS11Max=No IsS11Min=No FrameElem=82 ElemStation=0
 Frame=82 Station=0.2500000000000002 OutputCase=TERRVERT CaseType=LinStatic Point=0 X2=0 X3=0 S11=-
 699.99999288586 IsS11Max=No IsS11Min=No FrameElem=82 ElemStation=0.2500000000000002
 Frame=82 Station=0.2500000000000002 OutputCase=TERRVERT CaseType=LinStatic Point=1 X2=-0.5 X3=-0.5
 S11=1247.08924837629 IsS11Max=Yes IsS11Min=No FrameElem=82 ElemStation=0.2500000000000002
 Frame=82 Station=0.2500000000000002 OutputCase=TERRVERT CaseType=LinStatic Point=2 X2=-0.5 X3=0.5
 S11=1247.08924837629 IsS11Max=No IsS11Min=No FrameElem=82 ElemStation=0.2500000000000002
 Frame=82 Station=0.2500000000000002 OutputCase=TERRVERT CaseType=LinStatic Point=3 X2=0.5 X3=-0.5
 S11=-2647.08923414801 IsS11Max=No IsS11Min=Yes FrameElem=82 ElemStation=0.2500000000000002
 Frame=82 Station=0.2500000000000002 OutputCase=TERRVERT CaseType=LinStatic Point=4 X2=0.5 X3=0.5
 S11=-2647.08923414801 IsS11Max=No IsS11Min=No FrameElem=82 ElemStation=0.2500000000000002
 Frame=82 Station=0 OutputCase=TERRLAT CaseType=LinStatic Point=0 X2=0 X3=0 S11=2.14256288018078E-05
 IsS11Max=No IsS11Min=No FrameElem=82 ElemStation=0
 Frame=82 Station=0 OutputCase=TERRLAT CaseType=LinStatic Point=1 X2=-0.5 X3=-0.5 S11=-
 217.210784559911 IsS11Max=No IsS11Min=Yes FrameElem=82 ElemStation=0
 Frame=82 Station=0 OutputCase=TERRLAT CaseType=LinStatic Point=2 X2=-0.5 X3=0.5 S11=-
 217.210784559911 IsS11Max=No IsS11Min=No FrameElem=82 ElemStation=0
 Frame=82 Station=0 OutputCase=TERRLAT CaseType=LinStatic Point=3 X2=0.5 X3=-0.5
 S11=217.210827411168 IsS11Max=Yes IsS11Min=No FrameElem=82 ElemStation=0
 Frame=82 Station=0 OutputCase=TERRLAT CaseType=LinStatic Point=4 X2=0.5 X3=0.5 S11=217.210827411168
 IsS11Max=No IsS11Min=No FrameElem=82 ElemStation=0
 Frame=82 Station=0.2500000000000002 OutputCase=TERRLAT CaseType=LinStatic Point=0 X2=0 X3=0
 S11=2.44501770827005E-05 IsS11Max=No IsS11Min=No FrameElem=82 ElemStation=0.2500000000000002
 Frame=82 Station=0.2500000000000002 OutputCase=TERRLAT CaseType=LinStatic Point=1 X2=-0.5 X3=-0.5
 S11=117.021924040501 IsS11Max=Yes IsS11Min=No FrameElem=82 ElemStation=0.2500000000000002
 Frame=82 Station=0.2500000000000002 OutputCase=TERRLAT CaseType=LinStatic Point=2 X2=-0.5 X3=0.5
 S11=117.021924040501 IsS11Max=No IsS11Min=No FrameElem=82 ElemStation=0.2500000000000002

```

Frame=82 Station=0.250000000000002 OutputCase=TERRCOST CaseType=LinStatic Point=4 X2=0.5 X3=0.5
S11=0 IsS11Max=No IsS11Min=No FrameElem=82 ElemStation=0.250000000000002
Frame=82 Station=0 OutputCase=SOVRCOST CaseType=LinStatic Point=0 X2=0 X3=0 S11=0 IsS11Max=Yes
IsS11Min=Yes FrameElem=82 ElemStation=0
Frame=82 Station=0 OutputCase=SOVRCOST CaseType=LinStatic Point=1 X2=-0.5 X3=-0.5 S11=0
IsS11Max=No IsS11Min=No FrameElem=82 ElemStation=0
Frame=82 Station=0 OutputCase=SOVRCOST CaseType=LinStatic Point=2 X2=-0.5 X3=0.5 S11=0
IsS11Max=No IsS11Min=No FrameElem=82 ElemStation=0
Frame=82 Station=0 OutputCase=SOVRCOST CaseType=LinStatic Point=3 X2=0.5 X3=-0.5 S11=0
IsS11Max=No IsS11Min=No FrameElem=82 ElemStation=0
Frame=82 Station=0 OutputCase=SOVRCOST CaseType=LinStatic Point=4 X2=0.5 X3=0.5 S11=0 IsS11Max=No
IsS11Min=No FrameElem=82 ElemStation=0
Frame=82 Station=0.250000000000002 OutputCase=SOVRCOST CaseType=LinStatic Point=0 X2=0 X3=0 S11=0
IsS11Max=Yes IsS11Min=Yes FrameElem=82 ElemStation=0.250000000000002
Frame=82 Station=0.250000000000002 OutputCase=SOVRCOST CaseType=LinStatic Point=1 X2=-0.5 X3=-0.5
S11=0 IsS11Max=No IsS11Min=No FrameElem=82 ElemStation=0.250000000000002
Frame=82 Station=0.250000000000002 OutputCase=SOVRCOST CaseType=LinStatic Point=2 X2=-0.5 X3=0.5
S11=0 IsS11Max=No IsS11Min=No FrameElem=82 ElemStation=0.250000000000002
Frame=82 Station=0.250000000000002 OutputCase=SOVRCOST CaseType=LinStatic Point=3 X2=0.5 X3=-0.5
S11=0 IsS11Max=No IsS11Min=No FrameElem=82 ElemStation=0.250000000000002
Frame=82 Station=0.250000000000002 OutputCase=SOVRCOST CaseType=LinStatic Point=4 X2=0.5 X3=0.5
S11=0 IsS11Max=No IsS11Min=No FrameElem=82 ElemStation=0.250000000000002
Frame=82 Station=0 OutputCase=ENVE CaseType=Combination StepType=Max Point=0 X2=0 X3=0 S11=-
774.999972299818 IsS11Max=No IsS11Min=No FrameElem=82 ElemStation=0
Frame=82 Station=0 OutputCase=ENVE CaseType=Combination StepType=Max Point=1 X2=-0.5 X3=-0.5
S11=1189.51983702505 IsS11Max=Yes IsS11Min=No FrameElem=82 ElemStation=0
Frame=82 Station=0 OutputCase=ENVE CaseType=Combination StepType=Max Point=2 X2=-0.5 X3=0.5
S11=1189.51983702505 IsS11Max=No IsS11Min=No FrameElem=82 ElemStation=0
Frame=82 Station=0 OutputCase=ENVE CaseType=Combination StepType=Max Point=3 X2=0.5 X3=-0.5 S11=-
2674.35654625672 IsS11Max=No IsS11Min=Yes FrameElem=82 ElemStation=0
Frame=82 Station=0 OutputCase=ENVE CaseType=Combination StepType=Max Point=4 X2=0.5 X3=0.5 S11=-
2674.35654625672 IsS11Max=No IsS11Min=No FrameElem=82 ElemStation=0
Frame=82 Station=0.250000000000002 OutputCase=ENVE CaseType=Combination StepType=Max Point=0 X2=0
X3=0 S11=-768.74996927527 IsS11Max=No IsS11Min=No FrameElem=82 ElemStation=0.250000000000002
Frame=82 Station=0.250000000000002 OutputCase=ENVE CaseType=Combination StepType=Max Point=1 X2=-0.5
X3=-0.5 S11=1444.54706164376 IsS11Max=Yes IsS11Min=No FrameElem=82 ElemStation=0.250000000000002
Frame=82 Station=0.250000000000002 OutputCase=ENVE CaseType=Combination StepType=Max Point=2 X2=-0.5
X3=0.5 S11=1444.54706164376 IsS11Max=No IsS11Min=No FrameElem=82 ElemStation=0.250000000000002
Frame=82 Station=0.250000000000002 OutputCase=ENVE CaseType=Combination StepType=Max Point=3 X2=0.5
X3=-0.5 S11=-2946.94043765226 IsS11Max=No IsS11Min=Yes FrameElem=82 ElemStation=0.250000000000002
Frame=82 Station=0.250000000000002 OutputCase=ENVE CaseType=Combination StepType=Max Point=4 X2=0.5
X3=0.5 S11=-2946.94043765226 IsS11Max=No IsS11Min=No FrameElem=82 ElemStation=0.250000000000002
Frame=82 Station=0 OutputCase=ENVE CaseType=Combination StepType=Min Point=0 X2=0 X3=0 S11=-
774.999978727507 IsS11Max=No IsS11Min=No FrameElem=82 ElemStation=0
Frame=82 Station=0 OutputCase=ENVE CaseType=Combination StepType=Min Point=1 X2=-0.5 X3=-0.5
S11=1124.35660165708 IsS11Max=Yes IsS11Min=No FrameElem=82 ElemStation=0
Frame=82 Station=0 OutputCase=ENVE CaseType=Combination StepType=Min Point=2 X2=-0.5 X3=0.5
S11=1124.35660165708 IsS11Max=No IsS11Min=No FrameElem=82 ElemStation=0
Frame=82 Station=0 OutputCase=ENVE CaseType=Combination StepType=Min Point=3 X2=0.5 X3=-0.5 S11=-
2739.51979448007 IsS11Max=No IsS11Min=Yes FrameElem=82 ElemStation=0
Frame=82 Station=0 OutputCase=ENVE CaseType=Combination StepType=Min Point=4 X2=0.5 X3=0.5 S11=-
2739.51979448007 IsS11Max=No IsS11Min=No FrameElem=82 ElemStation=0
Frame=82 Station=0.250000000000002 OutputCase=ENVE CaseType=Combination StepType=Min Point=0 X2=0
X3=0 S11=-768.749976610323 IsS11Max=No IsS11Min=No FrameElem=82 ElemStation=0.250000000000002
Frame=82 Station=0.250000000000002 OutputCase=ENVE CaseType=Combination StepType=Min Point=1 X2=-0.5
X3=-0.5 S11=1409.44048443161 IsS11Max=Yes IsS11Min=No FrameElem=82 ElemStation=0.250000000000002
Frame=82 Station=0.250000000000002 OutputCase=ENVE CaseType=Combination StepType=Min Point=2 X2=-0.5
X3=0.5 S11=1409.44048443161 IsS11Max=No IsS11Min=No FrameElem=82 ElemStation=0.250000000000002
Frame=82 Station=0.250000000000002 OutputCase=ENVE CaseType=Combination StepType=Min Point=3 X2=0.5
X3=-0.5 S11=-2982.0470001943 IsS11Max=No IsS11Min=Yes FrameElem=82 ElemStation=0.250000000000002
Frame=82 Station=0.250000000000002 OutputCase=ENVE CaseType=Combination StepType=Min Point=4 X2=0.5
X3=0.5 S11=-2982.0470001943 IsS11Max=No IsS11Min=No FrameElem=82 ElemStation=0.250000000000002
Frame=82 Station=0 OutputCase=FESSUR CaseType=Combination Point=0 X2=0 X3=0 S11=-774.999972299818
IsS11Max=No IsS11Min=No FrameElem=82 ElemStation=0
Frame=82 Station=0 OutputCase=FESSUR CaseType=Combination Point=1 X2=-0.5 X3=-0.5
S11=1124.35660165708 IsS11Max=Yes IsS11Min=No FrameElem=82 ElemStation=0
Frame=82 Station=0 OutputCase=FESSUR CaseType=Combination Point=2 X2=-0.5 X3=0.5
S11=1124.35660165708 IsS11Max=No IsS11Min=No FrameElem=82 ElemStation=0
Frame=82 Station=0 OutputCase=FESSUR CaseType=Combination Point=3 X2=0.5 X3=-0.5 S11=-
2674.35654625672 IsS11Max=No IsS11Min=Yes FrameElem=82 ElemStation=0
Frame=82 Station=0 OutputCase=FESSUR CaseType=Combination Point=4 X2=0.5 X3=0.5 S11=-
2674.35654625672 IsS11Max=No IsS11Min=No FrameElem=82 ElemStation=0
Frame=82 Station=0.250000000000002 OutputCase=FESSUR CaseType=Combination Point=0 X2=0 X3=0 S11=-
768.74996927527 IsS11Max=No IsS11Min=No FrameElem=82 ElemStation=0.250000000000002
Frame=82 Station=0.250000000000002 OutputCase=FESSUR CaseType=Combination Point=1 X2=-0.5 X3=-0.5
S11=1444.54706164376 IsS11Max=Yes IsS11Min=No FrameElem=82 ElemStation=0.250000000000002
Frame=82 Station=0.250000000000002 OutputCase=FESSUR CaseType=Combination Point=2 X2=-0.5 X3=0.5
S11=1444.54706164376 IsS11Max=No IsS11Min=No FrameElem=82 ElemStation=0.250000000000002
Frame=82 Station=0.250000000000002 OutputCase=FESSUR CaseType=Combination Point=3 X2=0.5 X3=-0.5
S11=-2982.0470001943 IsS11Max=No IsS11Min=Yes FrameElem=82 ElemStation=0.250000000000002
Frame=82 Station=0.250000000000002 OutputCase=FESSUR CaseType=Combination Point=4 X2=0.5 X3=0.5
S11=-2982.0470001943 IsS11Max=No IsS11Min=No FrameElem=82 ElemStation=0.250000000000002

```



Frame=83 Station=0 OutputCase=PESOPR CaseType=LinStatic Point=0 X2=0 X3=0 S11=-68.7499979459681
 IsS11Max=No IsS11Min=No FrameElem=83 ElemStation=0
 Frame=83 Station=0 OutputCase=PESOPR CaseType=LinStatic Point=1 X2=-0.5 X3=-0.5
 S11=80.4358921205669 IsS11Max=Yes IsS11Min=No FrameElem=83 ElemStation=0
 Frame=83 Station=0 OutputCase=PESOPR CaseType=LinStatic Point=2 X2=-0.5 X3=0.5 S11=80.4358921205669
 IsS11Max=No IsS11Min=No FrameElem=83 ElemStation=0
 Frame=83 Station=0 OutputCase=PESOPR CaseType=LinStatic Point=3 X2=0.5 X3=-0.5 S11=-
 217.935888012503 IsS11Max=No IsS11Min=Yes FrameElem=83 ElemStation=0
 Frame=83 Station=0 OutputCase=PESOPR CaseType=LinStatic Point=4 X2=0.5 X3=0.5 S11=-217.935888012503
 IsS11Max=No IsS11Min=No FrameElem=83 ElemStation=0
 Frame=83 Station=0.250000000000001 OutputCase=PESOPR CaseType=LinStatic Point=0 X2=0 X3=0 S11=-
 62.4999979459681 IsS11Max=No IsS11Min=No FrameElem=83 ElemStation=0.250000000000001
 Frame=83 Station=0.250000000000001 OutputCase=PESOPR CaseType=LinStatic Point=1 X2=-0.5 X3=-0.5
 S11=63.9294626285584 IsS11Max=Yes IsS11Min=No FrameElem=83 ElemStation=0.250000000000001
 Frame=83 Station=0.250000000000001 OutputCase=PESOPR CaseType=LinStatic Point=2 X2=-0.5 X3=0.5
 S11=63.9294626285584 IsS11Max=No IsS11Min=No FrameElem=83 ElemStation=0.250000000000001
 Frame=83 Station=0.250000000000001 OutputCase=PESOPR CaseType=LinStatic Point=3 X2=0.5 X3=-0.5
 S11=-188.929458520495 IsS11Max=No IsS11Min=Yes FrameElem=83 ElemStation=0.250000000000001
 Frame=83 Station=0.250000000000001 OutputCase=PESOPR CaseType=LinStatic Point=4 X2=0.5 X3=0.5 S11=-
 188.929458520495 IsS11Max=No IsS11Min=No FrameElem=83 ElemStation=0.250000000000001
 Frame=83 Station=0 OutputCase=TERRVERT CaseType=LinStatic Point=0 X2=0 X3=0 S11=-699.999993199017
 IsS11Max=No IsS11Min=No FrameElem=83 ElemStation=0
 Frame=83 Station=0 OutputCase=TERRVERT CaseType=LinStatic Point=1 X2=-0.5 X3=-0.5
 S11=1247.08924806302 IsS11Max=Yes IsS11Min=No FrameElem=83 ElemStation=0
 Frame=83 Station=0 OutputCase=TERRVERT CaseType=LinStatic Point=2 X2=-0.5 X3=0.5
 S11=1247.08924806302 IsS11Max=No IsS11Min=No FrameElem=83 ElemStation=0
 Frame=83 Station=0 OutputCase=TERRVERT CaseType=LinStatic Point=3 X2=0.5 X3=-0.5 S11=-
 2647.08923446105 IsS11Max=No IsS11Min=Yes FrameElem=83 ElemStation=0
 Frame=83 Station=0 OutputCase=TERRVERT CaseType=LinStatic Point=4 X2=0.5 X3=0.5 S11=-
 2647.08923446105 IsS11Max=No IsS11Min=No FrameElem=83 ElemStation=0
 Frame=83 Station=0.250000000000001 OutputCase=TERRVERT CaseType=LinStatic Point=0 X2=0 X3=0 S11=-
 699.999993199017 IsS11Max=No IsS11Min=No FrameElem=83 ElemStation=0.250000000000001
 Frame=83 Station=0.250000000000001 OutputCase=TERRVERT CaseType=LinStatic Point=1 X2=-0.5 X3=-0.5
 S11=1249.55320900016 IsS11Max=Yes IsS11Min=No FrameElem=83 ElemStation=0.250000000000001
 Frame=83 Station=0.250000000000001 OutputCase=TERRVERT CaseType=LinStatic Point=2 X2=-0.5 X3=0.5
 S11=1249.55320900016 IsS11Max=No IsS11Min=No FrameElem=83 ElemStation=0.250000000000001
 Frame=83 Station=0.250000000000001 OutputCase=TERRVERT CaseType=LinStatic Point=3 X2=0.5 X3=-0.5
 S11=-2649.55319539819 IsS11Max=No IsS11Min=Yes FrameElem=83 ElemStation=0.250000000000001
 Frame=83 Station=0.250000000000001 OutputCase=TERRVERT CaseType=LinStatic Point=4 X2=0.5 X3=0.5
 S11=-2649.55319539819 IsS11Max=No IsS11Min=No FrameElem=83 ElemStation=0.250000000000001
 Frame=83 Station=0 OutputCase=TERRLAT CaseType=LinStatic Point=0 X2=0 X3=0 S11=-2.10657854040619E-
 05 IsS11Max=No IsS11Min=No FrameElem=83 ElemStation=0
 Frame=83 Station=0 OutputCase=TERRLAT CaseType=LinStatic Point=1 X2=-0.5 X3=-0.5
 S11=117.021878524539 IsS11Max=Yes IsS11Min=No FrameElem=83 ElemStation=0
 Frame=83 Station=0 OutputCase=TERRLAT CaseType=LinStatic Point=2 X2=-0.5 X3=0.5
 S11=117.021878524539 IsS11Max=No IsS11Min=No FrameElem=83 ElemStation=0
 Frame=83 Station=0 OutputCase=TERRLAT CaseType=LinStatic Point=3 X2=0.5 X3=-0.5 S11=-
 117.02192065611 IsS11Max=No IsS11Min=Yes FrameElem=83 ElemStation=0
 Frame=83 Station=0 OutputCase=TERRLAT CaseType=LinStatic Point=4 X2=0.5 X3=0.5 S11=-117.02192065611
 IsS11Max=No IsS11Min=No FrameElem=83 ElemStation=0
 Frame=83 Station=0.250000000000001 OutputCase=TERRLAT CaseType=LinStatic Point=0 X2=0 X3=0 S11=-
 2.40394909231506E-05 IsS11Max=No IsS11Min=No FrameElem=83 ElemStation=0.250000000000001
 Frame=83 Station=0.250000000000001 OutputCase=TERRLAT CaseType=LinStatic Point=1 X2=-0.5 X3=-0.5
 S11=498.426768626697 IsS11Max=Yes IsS11Min=No FrameElem=83 ElemStation=0.250000000000001
 Frame=83 Station=0.250000000000001 OutputCase=TERRLAT CaseType=LinStatic Point=2 X2=-0.5 X3=0.5
 S11=498.426768626697 IsS11Max=No IsS11Min=No FrameElem=83 ElemStation=0.250000000000001
 Frame=83 Station=0.250000000000001 OutputCase=TERRLAT CaseType=LinStatic Point=3 X2=0.5 X3=-0.5
 S11=-498.426816705679 IsS11Max=No IsS11Min=Yes FrameElem=83 ElemStation=0.250000000000001
 Frame=83 Station=0.250000000000001 OutputCase=TERRLAT CaseType=LinStatic Point=4 X2=0.5 X3=0.5
 S11=-498.426816705679 IsS11Max=No IsS11Min=No FrameElem=83 ElemStation=0.250000000000001
 Frame=83 Station=0 OutputCase=ACCVERT CaseType=LinStatic Point=0 X2=0 X3=0 S11=0 IsS11Max=Yes
 IsS11Min=Yes FrameElem=83 ElemStation=0
 Frame=83 Station=0 OutputCase=ACCVERT CaseType=LinStatic Point=1 X2=-0.5 X3=-0.5 S11=0
 IsS11Max=No IsS11Min=No FrameElem=83 ElemStation=0
 Frame=83 Station=0 OutputCase=ACCVERT CaseType=LinStatic Point=2 X2=-0.5 X3=0.5 S11=0 IsS11Max=No
 IsS11Min=No FrameElem=83 ElemStation=0
 Frame=83 Station=0 OutputCase=ACCVERT CaseType=LinStatic Point=3 X2=0.5 X3=-0.5 S11=0 IsS11Max=No
 IsS11Min=No FrameElem=83 ElemStation=0
 Frame=83 Station=0 OutputCase=ACCVERT CaseType=LinStatic Point=4 X2=0.5 X3=0.5 S11=0 IsS11Max=No
 IsS11Min=No FrameElem=83 ElemStation=0
 Frame=83 Station=0.250000000000001 OutputCase=ACCVERT CaseType=LinStatic Point=0 X2=0 X3=0 S11=0
 IsS11Max=Yes IsS11Min=Yes FrameElem=83 ElemStation=0.250000000000001
 Frame=83 Station=0.250000000000001 OutputCase=ACCVERT CaseType=LinStatic Point=1 X2=-0.5 X3=-0.5
 S11=0 IsS11Max=No IsS11Min=No FrameElem=83 ElemStation=0.250000000000001
 Frame=83 Station=0.250000000000001 OutputCase=ACCVERT CaseType=LinStatic Point=2 X2=-0.5 X3=0.5
 S11=0 IsS11Max=No IsS11Min=No FrameElem=83 ElemStation=0.250000000000001
 Frame=83 Station=0.250000000000001 OutputCase=ACCVERT CaseType=LinStatic Point=3 X2=0.5 X3=-0.5
 S11=0 IsS11Max=No IsS11Min=No FrameElem=83 ElemStation=0.250000000000001
 Frame=83 Station=0.250000000000001 OutputCase=ACCVERT CaseType=LinStatic Point=4 X2=0.5 X3=0.5
 S11=0 IsS11Max=No IsS11Min=No FrameElem=83 ElemStation=0.250000000000001
 Frame=83 Station=0 OutputCase=ACCLATDX CaseType=LinStatic Point=0 X2=0 X3=0 S11=0 IsS11Max=Yes
 IsS11Min=Yes FrameElem=83 ElemStation=0

```

Frame=83 Station=0 OutputCase=ENVE CaseType=Combination StepType=Max Point=2 X2=-0.5 X3=0.5
S11=1444.54701870813 IsS11Max=No IsS11Min=No FrameElem=83 ElemStation=0
Frame=83 Station=0 OutputCase=ENVE CaseType=Combination StepType=Max Point=3 X2=0.5 X3=-0.5 S11=-
2946.94046693283 IsS11Max=No IsS11Min=Yes FrameElem=83 ElemStation=0
Frame=83 Station=0 OutputCase=ENVE CaseType=Combination StepType=Max Point=4 X2=0.5 X3=0.5 S11=-
2946.94046693283 IsS11Max=No IsS11Min=No FrameElem=83 ElemStation=0
Frame=83 Station=0.2500000000000001 OutputCase=ENVE CaseType=Combination StepType=Max Point=0 X2=0
X3=0 S11=-762.500007972629 IsS11Max=No IsS11Min=No FrameElem=83 ElemStation=0.2500000000000001
Frame=83 Station=0.2500000000000001 OutputCase=ENVE CaseType=Combination StepType=Max Point=1 X2=-0.5
X3=-0.5 S11=1811.90944025541 IsS11Max=Yes IsS11Min=No FrameElem=83 ElemStation=0.2500000000000001
Frame=83 Station=0.2500000000000001 OutputCase=ENVE CaseType=Combination StepType=Max Point=2 X2=-0.5
X3=0.5 S11=1811.90944025541 IsS11Max=No IsS11Min=No FrameElem=83 ElemStation=0.2500000000000001
Frame=83 Station=0.2500000000000001 OutputCase=ENVE CaseType=Combination StepType=Max Point=3 X2=0.5
X3=-0.5 S11=-3187.38142561266 IsS11Max=No IsS11Min=Yes FrameElem=83 ElemStation=0.2500000000000001
Frame=83 Station=0.2500000000000001 OutputCase=ENVE CaseType=Combination StepType=Max Point=4 X2=0.5
X3=0.5 S11=-3187.38142561266 IsS11Max=No IsS11Min=No FrameElem=83 ElemStation=0.2500000000000001
Frame=83 Station=0 OutputCase=ENVE CaseType=Combination StepType=Min Point=0 X2=0 X3=0 S11=-
768.75001221077 IsS11Max=No IsS11Min=No FrameElem=83 ElemStation=0
Frame=83 Station=0 OutputCase=ENVE CaseType=Combination StepType=Min Point=1 X2=-0.5 X3=-0.5
S11=1409.44045515076 IsS11Max=Yes IsS11Min=No FrameElem=83 ElemStation=0
Frame=83 Station=0 OutputCase=ENVE CaseType=Combination StepType=Min Point=2 X2=-0.5 X3=0.5
S11=1409.44045515076 IsS11Max=No IsS11Min=No FrameElem=83 ElemStation=0
Frame=83 Station=0 OutputCase=ENVE CaseType=Combination StepType=Min Point=3 X2=0.5 X3=-0.5 S11=-
2982.04704312967 IsS11Max=No IsS11Min=Yes FrameElem=83 ElemStation=0
Frame=83 Station=0 OutputCase=ENVE CaseType=Combination StepType=Min Point=4 X2=0.5 X3=0.5 S11=-
2982.04704312967 IsS11Max=No IsS11Min=No FrameElem=83 ElemStation=0
Frame=83 Station=0.2500000000000001 OutputCase=ENVE CaseType=Combination StepType=Min Point=0 X2=0
X3=0 S11=-762.500015184476 IsS11Max=No IsS11Min=No FrameElem=83 ElemStation=0.2500000000000001
Frame=83 Station=0.2500000000000001 OutputCase=ENVE CaseType=Combination StepType=Min Point=1 X2=-0.5
X3=-0.5 S11=1662.3814096674 IsS11Max=Yes IsS11Min=No FrameElem=83 ElemStation=0.2500000000000001
Frame=83 Station=0.2500000000000001 OutputCase=ENVE CaseType=Combination StepType=Min Point=2 X2=-0.5
X3=0.5 S11=1662.3814096674 IsS11Max=No IsS11Min=No FrameElem=83 ElemStation=0.2500000000000001
Frame=83 Station=0.2500000000000001 OutputCase=ENVE CaseType=Combination StepType=Min Point=3 X2=0.5
X3=-0.5 S11=-3336.90947062437 IsS11Max=No IsS11Min=Yes FrameElem=83 ElemStation=0.2500000000000001
Frame=83 Station=0.2500000000000001 OutputCase=ENVE CaseType=Combination StepType=Min Point=4 X2=0.5
X3=0.5 S11=-3336.90947062437 IsS11Max=No IsS11Min=No FrameElem=83 ElemStation=0.2500000000000001
Frame=83 Station=0 OutputCase=FESSUR CaseType=Combination Point=0 X2=0 X3=0 S11=-768.75001221077
IsS11Max=No IsS11Min=No FrameElem=83 ElemStation=0
Frame=83 Station=0 OutputCase=FESSUR CaseType=Combination Point=1 X2=-0.5 X3=-0.5
S11=1444.54701870813 IsS11Max=Yes IsS11Min=No FrameElem=83 ElemStation=0
Frame=83 Station=0 OutputCase=FESSUR CaseType=Combination Point=2 X2=-0.5 X3=0.5
S11=1444.54701870813 IsS11Max=No IsS11Min=No FrameElem=83 ElemStation=0
Frame=83 Station=0 OutputCase=FESSUR CaseType=Combination Point=3 X2=0.5 X3=-0.5 S11=-
2982.04704312967 IsS11Max=No IsS11Min=Yes FrameElem=83 ElemStation=0
Frame=83 Station=0 OutputCase=FESSUR CaseType=Combination Point=4 X2=0.5 X3=0.5 S11=-
2982.04704312967 IsS11Max=No IsS11Min=No FrameElem=83 ElemStation=0
Frame=83 Station=0.2500000000000001 OutputCase=FESSUR CaseType=Combination Point=0 X2=0 X3=0 S11=-
762.500015184476 IsS11Max=No IsS11Min=No FrameElem=83 ElemStation=0.2500000000000001
Frame=83 Station=0.2500000000000001 OutputCase=FESSUR CaseType=Combination Point=1 X2=-0.5 X3=-0.5
S11=1811.90944025541 IsS11Max=Yes IsS11Min=No FrameElem=83 ElemStation=0.2500000000000001
Frame=83 Station=0.2500000000000001 OutputCase=FESSUR CaseType=Combination Point=2 X2=-0.5 X3=0.5
S11=1811.90944025541 IsS11Max=No IsS11Min=No FrameElem=83 ElemStation=0.2500000000000001
Frame=83 Station=0.2500000000000001 OutputCase=FESSUR CaseType=Combination Point=3 X2=0.5 X3=-0.5
S11=-3336.90947062437 IsS11Max=No IsS11Min=Yes FrameElem=83 ElemStation=0.2500000000000001
Frame=83 Station=0.2500000000000001 OutputCase=FESSUR CaseType=Combination Point=4 X2=0.5 X3=0.5
S11=-3336.90947062437 IsS11Max=No IsS11Min=No FrameElem=83 ElemStation=0.2500000000000001
Frame=84 Station=0 OutputCase=PESOPR CaseType=LinStatic Point=0 X2=0 X3=0 S11=-149.999998697982
IsS11Max=No IsS11Min=No FrameElem=84 ElemStation=0
Frame=84 Station=0 OutputCase=PESOPR CaseType=LinStatic Point=1 X2=-0.5 X3=-0.5 S11=-
595.019356264632 IsS11Max=No IsS11Min=Yes FrameElem=84 ElemStation=0
Frame=84 Station=0 OutputCase=PESOPR CaseType=LinStatic Point=2 X2=-0.5 X3=0.5 S11=-
595.019356264632 IsS11Max=No IsS11Min=No FrameElem=84 ElemStation=0
Frame=84 Station=0 OutputCase=PESOPR CaseType=LinStatic Point=3 X2=0.5 X3=-0.5 S11=295.019358868668
IsS11Max=Yes IsS11Min=No FrameElem=84 ElemStation=0
Frame=84 Station=0 OutputCase=PESOPR CaseType=LinStatic Point=4 X2=0.5 X3=0.5 S11=295.019358868668
IsS11Max=No IsS11Min=No FrameElem=84 ElemStation=0
Frame=84 Station=0.5 OutputCase=PESOPR CaseType=LinStatic Point=0 X2=0 X3=0 S11=-137.499998697982
IsS11Max=No IsS11Min=No FrameElem=84 ElemStation=0.5
Frame=84 Station=0.5 OutputCase=PESOPR CaseType=LinStatic Point=1 X2=-0.5 X3=-0.5 S11=-
537.006512628806 IsS11Max=No IsS11Min=Yes FrameElem=84 ElemStation=0.5
Frame=84 Station=0.5 OutputCase=PESOPR CaseType=LinStatic Point=2 X2=-0.5 X3=0.5 S11=-
537.006512628806 IsS11Max=No IsS11Min=No FrameElem=84 ElemStation=0.5
Frame=84 Station=0.5 OutputCase=PESOPR CaseType=LinStatic Point=3 X2=0.5 X3=-0.5
S11=262.006515232842 IsS11Max=Yes IsS11Min=No FrameElem=84 ElemStation=0.5
Frame=84 Station=0.5 OutputCase=PESOPR CaseType=LinStatic Point=4 X2=0.5 X3=0.5
S11=262.006515232842 IsS11Max=No IsS11Min=No FrameElem=84 ElemStation=0.5
Frame=84 Station=0 OutputCase=TERRVERT CaseType=LinStatic Point=0 X2=0 X3=0 S11=-699.999993617414
IsS11Max=No IsS11Min=No FrameElem=84 ElemStation=0
Frame=84 Station=0 OutputCase=TERRVERT CaseType=LinStatic Point=1 X2=-0.5 X3=-0.5 S11=-
2615.05644937707 IsS11Max=No IsS11Min=Yes FrameElem=84 ElemStation=0
Frame=84 Station=0 OutputCase=TERRVERT CaseType=LinStatic Point=2 X2=-0.5 X3=0.5 S11=-
2615.05644937707 IsS11Max=No IsS11Min=No FrameElem=84 ElemStation=0

```

Frame=84	Station=0	OutputCase=TERRVERT	CaseType=LinStatic	Point=3	X2=0.5	X3=-0.5			
S11=1215.05646214224	IsS11Max=Yes	IsS11Min=No	FrameElem=84	ElemStation=0					
Frame=84	Station=0	OutputCase=TERRVERT	CaseType=LinStatic	Point=4	X2=0.5	X3=0.5			
S11=1215.05646214224	IsS11Max=No	IsS11Min=No	FrameElem=84	ElemStation=0					
Frame=84	Station=0.5	OutputCase=TERRVERT	CaseType=LinStatic	Point=0	X2=0	X3=0	S11=-699.999993617414		
IsS11Max=No	IsS11Min=No	FrameElem=84	ElemStation=0.5						
Frame=84	Station=0.5	OutputCase=TERRVERT	CaseType=LinStatic	Point=1	X2=-0.5	X3=-0.5	S11=-		
2619.98455483364	IsS11Max=No	IsS11Min=Yes	FrameElem=84	ElemStation=0.5					
Frame=84	Station=0.5	OutputCase=TERRVERT	CaseType=LinStatic	Point=2	X2=-0.5	X3=0.5	S11=-		
2619.98455483364	IsS11Max=No	IsS11Min=No	FrameElem=84	ElemStation=0.5					
Frame=84	Station=0.5	OutputCase=TERRVERT	CaseType=LinStatic	Point=3	X2=0.5	X3=-0.5			
S11=1219.98456759881	IsS11Max=Yes	IsS11Min=No	FrameElem=84	ElemStation=0.5					
Frame=84	Station=0.5	OutputCase=TERRVERT	CaseType=LinStatic	Point=4	X2=0.5	X3=0.5			
S11=1219.98456759881	IsS11Max=No	IsS11Min=No	FrameElem=84	ElemStation=0.5					
Frame=84	Station=0	OutputCase=TERRLAT	CaseType=LinStatic	Point=0	X2=0	X3=0	S11=1.83663360076025E-08		
IsS11Max=No	IsS11Min=No	FrameElem=84	ElemStation=0						
Frame=84	Station=0	OutputCase=TERRLAT	CaseType=LinStatic	Point=1	X2=-0.5	X3=-0.5			
S11=257.48642304955	IsS11Max=Yes	IsS11Min=No	FrameElem=84	ElemStation=0					
Frame=84	Station=0	OutputCase=TERRLAT	CaseType=LinStatic	Point=2	X2=-0.5	X3=0.5	S11=257.48642304955		
IsS11Max=No	IsS11Min=No	FrameElem=84	ElemStation=0						
Frame=84	Station=0	OutputCase=TERRLAT	CaseType=LinStatic	Point=3	X2=0.5	X3=-0.5	S11=-		
257.486423012818	IsS11Max=No	IsS11Min=Yes	FrameElem=84	ElemStation=0					
Frame=84	Station=0	OutputCase=TERRLAT	CaseType=LinStatic	Point=4	X2=0.5	X3=0.5	S11=-		
257.486423012818	IsS11Max=No	IsS11Min=No	FrameElem=84	ElemStation=0					
Frame=84	Station=0.5	OutputCase=TERRLAT	CaseType=LinStatic	Point=0	X2=0	X3=0	S11=-5.83173637167E-07		
IsS11Max=No	IsS11Min=No	FrameElem=84	ElemStation=0.5						
Frame=84	Station=0.5	OutputCase=TERRLAT	CaseType=LinStatic	Point=1	X2=-0.5	X3=-0.5			
S11=789.136313775676	IsS11Max=Yes	IsS11Min=No	FrameElem=84	ElemStation=0.5					
Frame=84	Station=0.5	OutputCase=TERRLAT	CaseType=LinStatic	Point=2	X2=-0.5	X3=0.5			
S11=789.136313775676	IsS11Max=No	IsS11Min=No	FrameElem=84	ElemStation=0.5					
Frame=84	Station=0.5	OutputCase=TERRLAT	CaseType=LinStatic	Point=3	X2=0.5	X3=-0.5	S11=-		
789.136314942024	IsS11Max=No	IsS11Min=Yes	FrameElem=84	ElemStation=0.5					
Frame=84	Station=0.5	OutputCase=TERRLAT	CaseType=LinStatic	Point=4	X2=0.5	X3=0.5	S11=-		
789.136314942024	IsS11Max=No	IsS11Min=No	FrameElem=84	ElemStation=0.5					
Frame=84	Station=0	OutputCase=ACCVERT	CaseType=LinStatic	Point=0	X2=0	X3=0	S11=0	IsS11Max=Yes	
IsS11Min=Yes	FrameElem=84	ElemStation=0							
Frame=84	Station=0	OutputCase=ACCVERT	CaseType=LinStatic	Point=1	X2=-0.5	X3=-0.5	S11=0		
IsS11Max=No	IsS11Min=No	FrameElem=84	ElemStation=0						
Frame=84	Station=0	OutputCase=ACCVERT	CaseType=LinStatic	Point=2	X2=-0.5	X3=0.5	S11=0	IsS11Max=No	
IsS11Min=No	FrameElem=84	ElemStation=0							
Frame=84	Station=0	OutputCase=ACCVERT	CaseType=LinStatic	Point=3	X2=0.5	X3=-0.5	S11=0	IsS11Max=No	
IsS11Min=No	FrameElem=84	ElemStation=0							
Frame=84	Station=0	OutputCase=ACCVERT	CaseType=LinStatic	Point=4	X2=0.5	X3=0.5	S11=0	IsS11Max=No	
IsS11Min=No	FrameElem=84	ElemStation=0							
Frame=84	Station=0.5	OutputCase=ACCVERT	CaseType=LinStatic	Point=0	X2=0	X3=0	S11=0	IsS11Max=Yes	
IsS11Min=Yes	FrameElem=84	ElemStation=0.5							
Frame=84	Station=0.5	OutputCase=ACCVERT	CaseType=LinStatic	Point=1	X2=-0.5	X3=-0.5	S11=0		
IsS11Max=No	IsS11Min=No	FrameElem=84	ElemStation=0.5						
Frame=84	Station=0.5	OutputCase=ACCVERT	CaseType=LinStatic	Point=2	X2=-0.5	X3=0.5	S11=0		
IsS11Max=No	IsS11Min=No	FrameElem=84	ElemStation=0.5						
Frame=84	Station=0.5	OutputCase=ACCVERT	CaseType=LinStatic	Point=3	X2=0.5	X3=-0.5	S11=0		
IsS11Max=No	IsS11Min=No	FrameElem=84	ElemStation=0.5						
Frame=84	Station=0.5	OutputCase=ACCVERT	CaseType=LinStatic	Point=4	X2=0.5	X3=0.5	S11=0		
IsS11Max=No	IsS11Min=No	FrameElem=84	ElemStation=0.5						
Frame=84	Station=0	OutputCase=ACCLATDX	CaseType=LinStatic	Point=0	X2=0	X3=0	S11=0	IsS11Max=Yes	
IsS11Min=Yes	FrameElem=84	ElemStation=0							
Frame=84	Station=0	OutputCase=ACCLATDX	CaseType=LinStatic	Point=1	X2=-0.5	X3=-0.5	S11=0		
IsS11Max=No	IsS11Min=No	FrameElem=84	ElemStation=0						
Frame=84	Station=0	OutputCase=ACCLATDX	CaseType=LinStatic	Point=2	X2=-0.5	X3=0.5	S11=0		
IsS11Max=No	IsS11Min=No	FrameElem=84	ElemStation=0						
Frame=84	Station=0	OutputCase=ACCLATDX	CaseType=LinStatic	Point=3	X2=0.5	X3=-0.5	S11=0		
IsS11Max=No	IsS11Min=No	FrameElem=84	ElemStation=0						
Frame=84	Station=0	OutputCase=ACCLATDX	CaseType=LinStatic	Point=4	X2=0.5	X3=0.5	S11=0	IsS11Max=No	
IsS11Min=No	FrameElem=84	ElemStation=0							
Frame=84	Station=0.5	OutputCase=ACCLATDX	CaseType=LinStatic	Point=0	X2=0	X3=0	S11=0	IsS11Max=Yes	
IsS11Min=Yes	FrameElem=84	ElemStation=0.5							
Frame=84	Station=0.5	OutputCase=ACCLATDX	CaseType=LinStatic	Point=1	X2=-0.5	X3=-0.5	S11=0		
IsS11Max=No	IsS11Min=No	FrameElem=84	ElemStation=0.5						
Frame=84	Station=0.5	OutputCase=ACCLATDX	CaseType=LinStatic	Point=2	X2=-0.5	X3=0.5	S11=0		
IsS11Max=No	IsS11Min=No	FrameElem=84	ElemStation=0.5						
Frame=84	Station=0.5	OutputCase=ACCLATDX	CaseType=LinStatic	Point=3	X2=0.5	X3=-0.5	S11=0		
IsS11Max=No	IsS11Min=No	FrameElem=84	ElemStation=0.5						
Frame=84	Station=0.5	OutputCase=ACCLATDX	CaseType=LinStatic	Point=4	X2=0.5	X3=0.5	S11=0		
IsS11Max=No	IsS11Min=No	FrameElem=84	ElemStation=0.5						
Frame=84	Station=0	OutputCase=ACCLATSX	CaseType=LinStatic	Point=0	X2=0	X3=0	S11=0	IsS11Max=Yes	
IsS11Min=Yes	FrameElem=84	ElemStation=0							
Frame=84	Station=0	OutputCase=ACCLATSX	CaseType=LinStatic	Point=1	X2=-0.5	X3=-0.5	S11=0		
IsS11Max=No	IsS11Min=No	FrameElem=84	ElemStation=0						
Frame=84	Station=0	OutputCase=ACCLATSX	CaseType=LinStatic	Point=2	X2=-0.5	X3=0.5	S11=0		
IsS11Max=No	IsS11Min=No	FrameElem=84	ElemStation=0						
Frame=84	Station=0	OutputCase=ACCLATSX	CaseType=LinStatic	Point=3	X2=0.5	X3=-0.5	S11=0		
IsS11Max=No	IsS11Min=No	FrameElem=84	ElemStation=0						



Frame=84	Station=0	OutputCase=ACCLATSX	CaseType=LinStatic	Point=4	X2=0.5	X3=0.5	S11=0	IsS11Max=No
IsS11Min=No	FrameElem=84	ElemStation=0						
Frame=84	Station=0.5	OutputCase=ACCLATSX	CaseType=LinStatic	Point=0	X2=0	X3=0	S11=0	IsS11Max=Yes
IsS11Min=Yes	FrameElem=84	ElemStation=0.5						
Frame=84	Station=0.5	OutputCase=ACCLATSX	CaseType=LinStatic	Point=1	X2=-0.5	X3=-0.5	S11=0	
IsS11Max=No	IsS11Min=No	FrameElem=84	ElemStation=0.5					
Frame=84	Station=0.5	OutputCase=ACCLATSX	CaseType=LinStatic	Point=2	X2=-0.5	X3=0.5	S11=0	
IsS11Max=No	IsS11Min=No	FrameElem=84	ElemStation=0.5					
Frame=84	Station=0.5	OutputCase=ACCLATSX	CaseType=LinStatic	Point=3	X2=0.5	X3=-0.5	S11=0	
IsS11Max=No	IsS11Min=No	FrameElem=84	ElemStation=0.5					
Frame=84	Station=0.5	OutputCase=ACCLATSX	CaseType=LinStatic	Point=4	X2=0.5	X3=0.5	S11=0	
IsS11Max=No	IsS11Min=No	FrameElem=84	ElemStation=0.5					
Frame=84	Station=0	OutputCase=TERRCOST	CaseType=LinStatic	Point=0	X2=0	X3=0	S11=0	IsS11Max=Yes
IsS11Min=Yes	FrameElem=84	ElemStation=0						
Frame=84	Station=0	OutputCase=TERRCOST	CaseType=LinStatic	Point=1	X2=-0.5	X3=-0.5	S11=0	
IsS11Max=No	IsS11Min=No	FrameElem=84	ElemStation=0					
Frame=84	Station=0	OutputCase=TERRCOST	CaseType=LinStatic	Point=2	X2=-0.5	X3=0.5	S11=0	
IsS11Max=No	IsS11Min=No	FrameElem=84	ElemStation=0					
Frame=84	Station=0	OutputCase=TERRCOST	CaseType=LinStatic	Point=3	X2=0.5	X3=-0.5	S11=0	
IsS11Max=No	IsS11Min=No	FrameElem=84	ElemStation=0					
Frame=84	Station=0	OutputCase=TERRCOST	CaseType=LinStatic	Point=4	X2=0.5	X3=0.5	S11=0	IsS11Max=No
IsS11Min=No	FrameElem=84	ElemStation=0						
Frame=84	Station=0.5	OutputCase=TERRCOST	CaseType=LinStatic	Point=0	X2=0	X3=0	S11=0	IsS11Max=Yes
IsS11Min=Yes	FrameElem=84	ElemStation=0.5						
Frame=84	Station=0.5	OutputCase=TERRCOST	CaseType=LinStatic	Point=1	X2=-0.5	X3=-0.5	S11=0	
IsS11Max=No	IsS11Min=No	FrameElem=84	ElemStation=0.5					
Frame=84	Station=0.5	OutputCase=TERRCOST	CaseType=LinStatic	Point=2	X2=-0.5	X3=0.5	S11=0	
IsS11Max=No	IsS11Min=No	FrameElem=84	ElemStation=0.5					
Frame=84	Station=0.5	OutputCase=TERRCOST	CaseType=LinStatic	Point=3	X2=0.5	X3=-0.5	S11=0	
IsS11Max=No	IsS11Min=No	FrameElem=84	ElemStation=0.5					
Frame=84	Station=0.5	OutputCase=TERRCOST	CaseType=LinStatic	Point=4	X2=0.5	X3=0.5	S11=0	
IsS11Max=No	IsS11Min=No	FrameElem=84	ElemStation=0.5					
Frame=84	Station=0	OutputCase=SOVRCOST	CaseType=LinStatic	Point=0	X2=0	X3=0	S11=0	IsS11Max=Yes
IsS11Min=Yes	FrameElem=84	ElemStation=0						
Frame=84	Station=0	OutputCase=SOVRCOST	CaseType=LinStatic	Point=1	X2=-0.5	X3=-0.5	S11=0	
IsS11Max=No	IsS11Min=No	FrameElem=84	ElemStation=0					
Frame=84	Station=0	OutputCase=SOVRCOST	CaseType=LinStatic	Point=2	X2=-0.5	X3=0.5	S11=0	
IsS11Max=No	IsS11Min=No	FrameElem=84	ElemStation=0					
Frame=84	Station=0	OutputCase=SOVRCOST	CaseType=LinStatic	Point=3	X2=0.5	X3=-0.5	S11=0	
IsS11Max=No	IsS11Min=No	FrameElem=84	ElemStation=0					
Frame=84	Station=0	OutputCase=SOVRCOST	CaseType=LinStatic	Point=4	X2=0.5	X3=0.5	S11=0	IsS11Max=No
IsS11Min=No	FrameElem=84	ElemStation=0						
Frame=84	Station=0.5	OutputCase=SOVRCOST	CaseType=LinStatic	Point=0	X2=0	X3=0	S11=0	IsS11Max=Yes
IsS11Min=Yes	FrameElem=84	ElemStation=0.5						
Frame=84	Station=0.5	OutputCase=SOVRCOST	CaseType=LinStatic	Point=1	X2=-0.5	X3=-0.5	S11=0	
IsS11Max=No	IsS11Min=No	FrameElem=84	ElemStation=0.5					
Frame=84	Station=0.5	OutputCase=SOVRCOST	CaseType=LinStatic	Point=2	X2=-0.5	X3=0.5	S11=0	
IsS11Max=No	IsS11Min=No	FrameElem=84	ElemStation=0.5					
Frame=84	Station=0.5	OutputCase=SOVRCOST	CaseType=LinStatic	Point=3	X2=0.5	X3=-0.5	S11=0	
IsS11Max=No	IsS11Min=No	FrameElem=84	ElemStation=0.5					
Frame=84	Station=0.5	OutputCase=SOVRCOST	CaseType=LinStatic	Point=4	X2=0.5	X3=0.5	S11=0	
IsS11Max=No	IsS11Min=No	FrameElem=84	ElemStation=0.5					
Frame=84	Station=0	OutputCase=ENVE	CaseType=Combination	StepType=Max	Point=0	X2=0	X3=0	S11=-
849.999992297029	IsS11Max=No	IsS11Min=No	FrameElem=84	ElemStation=0				
Frame=84	Station=0	OutputCase=ENVE	CaseType=Combination	StepType=Max	Point=1	X2=-0.5	X3=-0.5	
S11=-2952.58938259215	IsS11Max=No	IsS11Min=Yes	FrameElem=84	ElemStation=0				
Frame=84	Station=0	OutputCase=ENVE	CaseType=Combination	StepType=Max	Point=2	X2=-0.5	X3=0.5	S11=-
2952.58938259215	IsS11Max=No	IsS11Min=No	FrameElem=84	ElemStation=0				
Frame=84	Station=0	OutputCase=ENVE	CaseType=Combination	StepType=Max	Point=3	X2=0.5	X3=-0.5	
S11=1329.83532490194	IsS11Max=Yes	IsS11Min=No	FrameElem=84	ElemStation=0				
Frame=84	Station=0	OutputCase=ENVE	CaseType=Combination	StepType=Max	Point=4	X2=0.5	X3=0.5	
S11=1329.83532490194	IsS11Max=No	IsS11Min=No	FrameElem=84	ElemStation=0				
Frame=84	Station=0.5	OutputCase=ENVE	CaseType=Combination	StepType=Max	Point=0	X2=0	X3=0	S11=-
837.499992723617	IsS11Max=No	IsS11Min=No	FrameElem=84	ElemStation=0.5				
Frame=84	Station=0.5	OutputCase=ENVE	CaseType=Combination	StepType=Max	Point=1	X2=-0.5	X3=-0.5	
S11=-2367.85475368677	IsS11Max=No	IsS11Min=Yes	FrameElem=84	ElemStation=0.5				
Frame=84	Station=0.5	OutputCase=ENVE	CaseType=Combination	StepType=Max	Point=2	X2=-0.5	X3=0.5	
S11=-2367.85475368677	IsS11Max=No	IsS11Min=No	FrameElem=84	ElemStation=0.5				
Frame=84	Station=0.5	OutputCase=ENVE	CaseType=Combination	StepType=Max	Point=3	X2=0.5	X3=-0.5	
S11=929.595662372236	IsS11Max=Yes	IsS11Min=No	FrameElem=84	ElemStation=0.5				
Frame=84	Station=0.5	OutputCase=ENVE	CaseType=Combination	StepType=Max	Point=4	X2=0.5	X3=0.5	
S11=929.595662372236	IsS11Max=No	IsS11Min=No	FrameElem=84	ElemStation=0.5				
Frame=84	Station=0	OutputCase=ENVE	CaseType=Combination	StepType=Min	Point=0	X2=0	X3=0	S11=-
849.999992302539	IsS11Max=No	IsS11Min=No	FrameElem=84	ElemStation=0				
Frame=84	Station=0	OutputCase=ENVE	CaseType=Combination	StepType=Min	Point=1	X2=-0.5	X3=-0.5	
S11=-3029.83530950702	IsS11Max=No	IsS11Min=Yes	FrameElem=84	ElemStation=0				
Frame=84	Station=0	OutputCase=ENVE	CaseType=Combination	StepType=Min	Point=2	X2=-0.5	X3=0.5	S11=-
3029.83530950702	IsS11Max=No	IsS11Min=No	FrameElem=84	ElemStation=0				
Frame=84	Station=0	OutputCase=ENVE	CaseType=Combination	StepType=Min	Point=3	X2=0.5	X3=-0.5	
S11=1252.58939799809	IsS11Max=Yes	IsS11Min=No	FrameElem=84	ElemStation=0				
Frame=84	Station=0	OutputCase=ENVE	CaseType=Combination	StepType=Min	Point=4	X2=0.5	X3=0.5	
S11=1252.58939799809	IsS11Max=No	IsS11Min=No	FrameElem=84	ElemStation=0				



Frame=84	Station=0.5	OutputCase=ENVE	CaseType=Combination	StepType=Min	Point=0	X2=0	X3=0	S11=-
837.499992898569		IsS11Max=No	IsS11Min=No	FrameElem=84	ElemStation=0.5			
Frame=84	Station=0.5	OutputCase=ENVE	CaseType=Combination	StepType=Min	Point=1	X2=-0.5	X3=-0.5	
S11=-2604.59564781947		IsS11Max=No	IsS11Min=Yes	FrameElem=84	ElemStation=0.5			
Frame=84	Station=0.5	OutputCase=ENVE	CaseType=Combination	StepType=Min	Point=2	X2=-0.5	X3=0.5	
S11=-2604.59564781947		IsS11Max=No	IsS11Min=No	FrameElem=84	ElemStation=0.5			
Frame=84	Station=0.5	OutputCase=ENVE	CaseType=Combination	StepType=Min	Point=3	X2=0.5	X3=-0.5	
S11=692.854767889629		IsS11Max=Yes	IsS11Min=No	FrameElem=84	ElemStation=0.5			
Frame=84	Station=0.5	OutputCase=ENVE	CaseType=Combination	StepType=Min	Point=4	X2=0.5	X3=0.5	
S11=692.854767889629		IsS11Max=No	IsS11Min=No	FrameElem=84	ElemStation=0.5			
Frame=84	Station=0	OutputCase=FESSUR	CaseType=Combination	Point=0	X2=0	X3=0	S11=-849.999992297029	
IsS11Max=No	IsS11Min=No	FrameElem=84	ElemStation=0					
Frame=84	Station=0	OutputCase=FESSUR	CaseType=Combination	Point=1	X2=-0.5	X3=-0.5	S11=-	
2952.58938259215		IsS11Max=No	IsS11Min=Yes	FrameElem=84	ElemStation=0			
Frame=84	Station=0	OutputCase=FESSUR	CaseType=Combination	Point=2	X2=-0.5	X3=0.5	S11=-	
2952.58938259215		IsS11Max=No	IsS11Min=No	FrameElem=84	ElemStation=0			
Frame=84	Station=0	OutputCase=FESSUR	CaseType=Combination	Point=3	X2=0.5	X3=-0.5		
S11=1252.58939799809		IsS11Max=Yes	IsS11Min=No	FrameElem=84	ElemStation=0			
Frame=84	Station=0	OutputCase=FESSUR	CaseType=Combination	Point=4	X2=0.5	X3=0.5		
S11=1252.58939799809		IsS11Max=No	IsS11Min=No	FrameElem=84	ElemStation=0			
Frame=84	Station=0.5	OutputCase=FESSUR	CaseType=Combination	Point=0	X2=0	X3=0	S11=-837.499992898569	
IsS11Max=No	IsS11Min=No	FrameElem=84	ElemStation=0.5					
Frame=84	Station=0.5	OutputCase=FESSUR	CaseType=Combination	Point=1	X2=-0.5	X3=-0.5	S11=-	
2367.85475368677		IsS11Max=No	IsS11Min=Yes	FrameElem=84	ElemStation=0.5			
Frame=84	Station=0.5	OutputCase=FESSUR	CaseType=Combination	Point=2	X2=-0.5	X3=0.5	S11=-	
2367.85475368677		IsS11Max=No	IsS11Min=No	FrameElem=84	ElemStation=0.5			
Frame=84	Station=0.5	OutputCase=FESSUR	CaseType=Combination	Point=3	X2=0.5	X3=-0.5		
S11=692.854767889629		IsS11Max=Yes	IsS11Min=No	FrameElem=84	ElemStation=0.5			
Frame=84	Station=0.5	OutputCase=FESSUR	CaseType=Combination	Point=4	X2=0.5	X3=0.5		
S11=692.854767889629		IsS11Max=No	IsS11Min=No	FrameElem=84	ElemStation=0.5			
Frame=85	Station=0	OutputCase=PESOPR	CaseType=LinStatic	Point=0	X2=0	X3=0	S11=-137.499998698098	
IsS11Max=No	IsS11Min=No	FrameElem=85	ElemStation=0					
Frame=85	Station=0	OutputCase=PESOPR	CaseType=LinStatic	Point=1	X2=-0.5	X3=-0.5	S11=-	
537.006512628918		IsS11Max=No	IsS11Min=Yes	FrameElem=85	ElemStation=0			
Frame=85	Station=0	OutputCase=PESOPR	CaseType=LinStatic	Point=2	X2=-0.5	X3=0.5	S11=-	
537.006512628918		IsS11Max=No	IsS11Min=No	FrameElem=85	ElemStation=0			
Frame=85	Station=0	OutputCase=PESOPR	CaseType=LinStatic	Point=3	X2=0.5	X3=-0.5	S11=262.006515232721	
IsS11Max=Yes	IsS11Min=No	FrameElem=85	ElemStation=0					
Frame=85	Station=0	OutputCase=PESOPR	CaseType=LinStatic	Point=4	X2=0.5	X3=0.5	S11=262.006515232721	
IsS11Max=No	IsS11Min=No	FrameElem=85	ElemStation=0					
Frame=85	Station=0.5	OutputCase=PESOPR	CaseType=LinStatic	Point=0	X2=0	X3=0	S11=-124.999998698098	
IsS11Max=No	IsS11Min=No	FrameElem=85	ElemStation=0.5					
Frame=85	Station=0.5	OutputCase=PESOPR	CaseType=LinStatic	Point=1	X2=-0.5	X3=-0.5	S11=-	
478.993669291118		IsS11Max=No	IsS11Min=Yes	FrameElem=85	ElemStation=0.5			
Frame=85	Station=0.5	OutputCase=PESOPR	CaseType=LinStatic	Point=2	X2=-0.5	X3=0.5	S11=-	
478.993669291118		IsS11Max=No	IsS11Min=No	FrameElem=85	ElemStation=0.5			
Frame=85	Station=0.5	OutputCase=PESOPR	CaseType=LinStatic	Point=3	X2=0.5	X3=-0.5		
S11=228.993671894921		IsS11Max=Yes	IsS11Min=No	FrameElem=85	ElemStation=0.5			
Frame=85	Station=0.5	OutputCase=PESOPR	CaseType=LinStatic	Point=4	X2=0.5	X3=0.5		
S11=228.993671894921		IsS11Max=No	IsS11Min=No	FrameElem=85	ElemStation=0.5			
Frame=85	Station=0	OutputCase=TERRVERT	CaseType=LinStatic	Point=0	X2=0	X3=0	S11=-699.99999361753	
IsS11Max=No	IsS11Min=No	FrameElem=85	ElemStation=0					
Frame=85	Station=0	OutputCase=TERRVERT	CaseType=LinStatic	Point=1	X2=-0.5	X3=-0.5	S11=-	
2619.98455483375		IsS11Max=No	IsS11Min=Yes	FrameElem=85	ElemStation=0			
Frame=85	Station=0	OutputCase=TERRVERT	CaseType=LinStatic	Point=2	X2=-0.5	X3=0.5	S11=-	
2619.98455483375		IsS11Max=No	IsS11Min=No	FrameElem=85	ElemStation=0			
Frame=85	Station=0	OutputCase=TERRVERT	CaseType=LinStatic	Point=3	X2=0.5	X3=-0.5		
S11=1219.98456759869		IsS11Max=Yes	IsS11Min=No	FrameElem=85	ElemStation=0			
Frame=85	Station=0	OutputCase=TERRVERT	CaseType=LinStatic	Point=4	X2=0.5	X3=0.5		
S11=1219.98456759869		IsS11Max=No	IsS11Min=No	FrameElem=85	ElemStation=0			
Frame=85	Station=0.5	OutputCase=TERRVERT	CaseType=LinStatic	Point=0	X2=0	X3=0	S11=-699.99999361753	
IsS11Max=No	IsS11Min=No	FrameElem=85	ElemStation=0.5					
Frame=85	Station=0.5	OutputCase=TERRVERT	CaseType=LinStatic	Point=1	X2=-0.5	X3=-0.5	S11=-	
2624.91266029031		IsS11Max=No	IsS11Min=Yes	FrameElem=85	ElemStation=0.5			
Frame=85	Station=0.5	OutputCase=TERRVERT	CaseType=LinStatic	Point=2	X2=-0.5	X3=0.5	S11=-	
2624.91266029031		IsS11Max=No	IsS11Min=No	FrameElem=85	ElemStation=0.5			
Frame=85	Station=0.5	OutputCase=TERRVERT	CaseType=LinStatic	Point=3	X2=0.5	X3=-0.5		
S11=1224.91267305525		IsS11Max=Yes	IsS11Min=No	FrameElem=85	ElemStation=0.5			
Frame=85	Station=0.5	OutputCase=TERRVERT	CaseType=LinStatic	Point=4	X2=0.5	X3=0.5		
S11=1224.91267305525		IsS11Max=No	IsS11Min=No	FrameElem=85	ElemStation=0.5			
Frame=85	Station=0	OutputCase=TERRLAT	CaseType=LinStatic	Point=0	X2=0	X3=0	S11=-5.8317255025031E-07	
IsS11Max=No	IsS11Min=No	FrameElem=85	ElemStation=0					
Frame=85	Station=0	OutputCase=TERRLAT	CaseType=LinStatic	Point=1	X2=-0.5	X3=-0.5		
S11=789.136313775677		IsS11Max=Yes	IsS11Min=No	FrameElem=85	ElemStation=0			
Frame=85	Station=0	OutputCase=TERRLAT	CaseType=LinStatic	Point=2	X2=-0.5	X3=0.5		
S11=789.136313775677		IsS11Max=No	IsS11Min=No	FrameElem=85	ElemStation=0			
Frame=85	Station=0	OutputCase=TERRLAT	CaseType=LinStatic	Point=3	X2=0.5	X3=-0.5	S11=-	
789.136314942022		IsS11Max=No	IsS11Min=Yes	FrameElem=85	ElemStation=0			
Frame=85	Station=0	OutputCase=TERRLAT	CaseType=LinStatic	Point=4	X2=0.5	X3=0.5	S11=-	
789.136314942022		IsS11Max=No	IsS11Min=No	FrameElem=85	ElemStation=0			
Frame=85	Station=0.5	OutputCase=TERRLAT	CaseType=LinStatic	Point=0	X2=0	X3=0	S11=-	
1.16776500233621E-06		IsS11Max=No	IsS11Min=No	FrameElem=85	ElemStation=0.5			

Frame=85	Station=0.5	OutputCase=TERRCOST	CaseType=LinStatic	Point=2	X2=-0.5	X3=0.5	S11=0	
IsS11Max=No	IsS11Min=No	FrameElem=85	ElemStation=0.5					
Frame=85	Station=0.5	OutputCase=TERRCOST	CaseType=LinStatic	Point=3	X2=0.5	X3=-0.5	S11=0	
IsS11Max=No	IsS11Min=No	FrameElem=85	ElemStation=0.5					
Frame=85	Station=0.5	OutputCase=TERRCOST	CaseType=LinStatic	Point=4	X2=0.5	X3=0.5	S11=0	
IsS11Max=No	IsS11Min=No	FrameElem=85	ElemStation=0.5					
Frame=85	Station=0	OutputCase=SOVRCOST	CaseType=LinStatic	Point=0	X2=0	X3=0	S11=0	
IsS11Min=Yes	FrameElem=85	ElemStation=0					IsS11Max=Yes	
Frame=85	Station=0	OutputCase=SOVRCOST	CaseType=LinStatic	Point=1	X2=-0.5	X3=-0.5	S11=0	
IsS11Max=No	IsS11Min=No	FrameElem=85	ElemStation=0					
Frame=85	Station=0	OutputCase=SOVRCOST	CaseType=LinStatic	Point=2	X2=-0.5	X3=0.5	S11=0	
IsS11Max=No	IsS11Min=No	FrameElem=85	ElemStation=0					
Frame=85	Station=0	OutputCase=SOVRCOST	CaseType=LinStatic	Point=3	X2=0.5	X3=-0.5	S11=0	
IsS11Max=No	IsS11Min=No	FrameElem=85	ElemStation=0					
Frame=85	Station=0	OutputCase=SOVRCOST	CaseType=LinStatic	Point=4	X2=0.5	X3=0.5	S11=0	
IsS11Min=No	FrameElem=85	ElemStation=0					IsS11Max=No	
Frame=85	Station=0.5	OutputCase=SOVRCOST	CaseType=LinStatic	Point=0	X2=0	X3=0	S11=0	
IsS11Min=Yes	FrameElem=85	ElemStation=0.5					IsS11Max=Yes	
Frame=85	Station=0.5	OutputCase=SOVRCOST	CaseType=LinStatic	Point=1	X2=-0.5	X3=-0.5	S11=0	
IsS11Max=No	IsS11Min=No	FrameElem=85	ElemStation=0.5					
Frame=85	Station=0.5	OutputCase=SOVRCOST	CaseType=LinStatic	Point=2	X2=-0.5	X3=0.5	S11=0	
IsS11Max=No	IsS11Min=No	FrameElem=85	ElemStation=0.5					
Frame=85	Station=0.5	OutputCase=SOVRCOST	CaseType=LinStatic	Point=3	X2=0.5	X3=-0.5	S11=0	
IsS11Max=No	IsS11Min=No	FrameElem=85	ElemStation=0.5					
Frame=85	Station=0.5	OutputCase=SOVRCOST	CaseType=LinStatic	Point=4	X2=0.5	X3=0.5	S11=0	
IsS11Max=No	IsS11Min=No	FrameElem=85	ElemStation=0.5					
Frame=85	Station=0	OutputCase=ENVE	CaseType=Combination	StepType=Max	Point=0	X2=0	X3=0	S11=-
837.499992723849	IsS11Max=No	IsS11Min=No	FrameElem=85	ElemStation=0				
Frame=85	Station=0	OutputCase=ENVE	CaseType=Combination	StepType=Max	Point=1	X2=-0.5	X3=-0.5	
S11=-2367.85475368699	IsS11Max=No	IsS11Min=Yes	FrameElem=85	ElemStation=0				
Frame=85	Station=0	OutputCase=ENVE	CaseType=Combination	StepType=Max	Point=2	X2=-0.5	X3=0.5	S11=-
2367.85475368699	IsS11Max=No	IsS11Min=No	FrameElem=85	ElemStation=0				
Frame=85	Station=0	OutputCase=ENVE	CaseType=Combination	StepType=Max	Point=3	X2=0.5	X3=-0.5	
S11=929.595662371994	IsS11Max=Yes	IsS11Min=No	FrameElem=85	ElemStation=0				
Frame=85	Station=0	OutputCase=ENVE	CaseType=Combination	StepType=Max	Point=4	X2=0.5	X3=0.5	
S11=929.595662371994	IsS11Max=No	IsS11Min=No	FrameElem=85	ElemStation=0				
Frame=85	Station=0.5	OutputCase=ENVE	CaseType=Combination	StepType=Max	Point=0	X2=0	X3=0	S11=-
824.999993133064	IsS11Max=No	IsS11Min=No	FrameElem=85	ElemStation=0.5				
Frame=85	Station=0.5	OutputCase=ENVE	CaseType=Combination	StepType=Max	Point=1	X2=-0.5	X3=-0.5	
S11=-2006.99512498642	IsS11Max=No	IsS11Min=Yes	FrameElem=85	ElemStation=0.5				
Frame=85	Station=0.5	OutputCase=ENVE	CaseType=Combination	StepType=Max	Point=2	X2=-0.5	X3=0.5	
S11=-2006.99512498642	IsS11Max=No	IsS11Min=No	FrameElem=85	ElemStation=0.5				
Frame=85	Station=0.5	OutputCase=ENVE	CaseType=Combination	StepType=Max	Point=3	X2=0.5	X3=-0.5	
S11=686.068500098792	IsS11Max=Yes	IsS11Min=No	FrameElem=85	ElemStation=0.5				
Frame=85	Station=0.5	OutputCase=ENVE	CaseType=Combination	StepType=Max	Point=4	X2=0.5	X3=0.5	
S11=686.068500098792	IsS11Max=No	IsS11Min=No	FrameElem=85	ElemStation=0.5				
Frame=85	Station=0	OutputCase=ENVE	CaseType=Combination	StepType=Min	Point=0	X2=0	X3=0	S11=-
837.499992898801	IsS11Max=No	IsS11Min=No	FrameElem=85	ElemStation=0				
Frame=85	Station=0	OutputCase=ENVE	CaseType=Combination	StepType=Min	Point=1	X2=-0.5	X3=-0.5	
S11=-2604.59564781969	IsS11Max=No	IsS11Min=Yes	FrameElem=85	ElemStation=0				
Frame=85	Station=0	OutputCase=ENVE	CaseType=Combination	StepType=Min	Point=2	X2=-0.5	X3=0.5	S11=-
2604.59564781969	IsS11Max=No	IsS11Min=No	FrameElem=85	ElemStation=0				
Frame=85	Station=0	OutputCase=ENVE	CaseType=Combination	StepType=Min	Point=3	X2=0.5	X3=-0.5	
S11=692.854767889388	IsS11Max=Yes	IsS11Min=No	FrameElem=85	ElemStation=0				
Frame=85	Station=0	OutputCase=ENVE	CaseType=Combination	StepType=Min	Point=4	X2=0.5	X3=0.5	
S11=692.854767889388	IsS11Max=No	IsS11Min=No	FrameElem=85	ElemStation=0				
Frame=85	Station=0.5	OutputCase=ENVE	CaseType=Combination	StepType=Min	Point=0	X2=0	X3=0	S11=-
824.999993483393	IsS11Max=No	IsS11Min=No	FrameElem=85	ElemStation=0.5				
Frame=85	Station=0.5	OutputCase=ENVE	CaseType=Combination	StepType=Min	Point=1	X2=-0.5	X3=-0.5	
S11=-2336.06848636492	IsS11Max=No	IsS11Min=Yes	FrameElem=85	ElemStation=0.5				
Frame=85	Station=0.5	OutputCase=ENVE	CaseType=Combination	StepType=Min	Point=2	X2=-0.5	X3=0.5	
S11=-2336.06848636492	IsS11Max=No	IsS11Min=No	FrameElem=85	ElemStation=0.5				
Frame=85	Station=0.5	OutputCase=ENVE	CaseType=Combination	StepType=Min	Point=3	X2=0.5	X3=-0.5	
S11=356.995138019628	IsS11Max=Yes	IsS11Min=No	FrameElem=85	ElemStation=0.5				
Frame=85	Station=0.5	OutputCase=ENVE	CaseType=Combination	StepType=Min	Point=4	X2=0.5	X3=0.5	
S11=356.995138019628	IsS11Max=No	IsS11Min=No	FrameElem=85	ElemStation=0.5				
Frame=85	Station=0	OutputCase=FESSUR	CaseType=Combination	Point=0	X2=0	X3=0	S11=-837.499992898801	
IsS11Max=No	IsS11Min=No	FrameElem=85	ElemStation=0					
Frame=85	Station=0	OutputCase=FESSUR	CaseType=Combination	Point=1	X2=-0.5	X3=-0.5	S11=-	
2367.85475368699	IsS11Max=No	IsS11Min=Yes	FrameElem=85	ElemStation=0				
Frame=85	Station=0	OutputCase=FESSUR	CaseType=Combination	Point=2	X2=-0.5	X3=0.5	S11=-	
2367.85475368699	IsS11Max=No	IsS11Min=No	FrameElem=85	ElemStation=0				
Frame=85	Station=0	OutputCase=FESSUR	CaseType=Combination	Point=3	X2=0.5	X3=-0.5		
S11=692.854767889388	IsS11Max=Yes	IsS11Min=No	FrameElem=85	ElemStation=0				
Frame=85	Station=0	OutputCase=FESSUR	CaseType=Combination	Point=4	X2=0.5	X3=0.5		
S11=692.854767889388	IsS11Max=No	IsS11Min=No	FrameElem=85	ElemStation=0				
Frame=85	Station=0.5	OutputCase=FESSUR	CaseType=Combination	Point=0	X2=0	X3=0	S11=-824.999993483393	
IsS11Max=No	IsS11Min=No	FrameElem=85	ElemStation=0.5					
Frame=85	Station=0.5	OutputCase=FESSUR	CaseType=Combination	Point=1	X2=-0.5	X3=-0.5	S11=-	
2006.99512498642	IsS11Max=No	IsS11Min=Yes	FrameElem=85	ElemStation=0.5				
Frame=85	Station=0.5	OutputCase=FESSUR	CaseType=Combination	Point=2	X2=-0.5	X3=0.5	S11=-	
2006.99512498642	IsS11Max=No	IsS11Min=No	FrameElem=85	ElemStation=0.5				

Frame=85	Station=0.5	OutputCase=FESSUR	CaseType=Combination	Point=3	X2=0.5	X3=-0.5		
S11=356.995138019628	IsS11Max=Yes	IsS11Min=No	FrameElem=85	ElemStation=0.5				
Frame=85	Station=0.5	OutputCase=FESSUR	CaseType=Combination	Point=4	X2=0.5	X3=0.5		
S11=356.995138019628	IsS11Max=No	IsS11Min=No	FrameElem=85	ElemStation=0.5				
Frame=86	Station=0	OutputCase=PESOPR	CaseType=LinStatic	Point=0	X2=0	X3=0	S11=-124.999998697982	
IsS11Max=No	IsS11Min=No	FrameElem=86	ElemStation=0					
Frame=86	Station=0	OutputCase=PESOPR	CaseType=LinStatic	Point=1	X2=-0.5	X3=-0.5	S11=-	
478.993669291001	IsS11Max=No	IsS11Min=Yes	FrameElem=86	ElemStation=0				
Frame=86	Station=0	OutputCase=PESOPR	CaseType=LinStatic	Point=2	X2=-0.5	X3=0.5	S11=-	
478.993669291001	IsS11Max=No	IsS11Min=No	FrameElem=86	ElemStation=0				
Frame=86	Station=0	OutputCase=PESOPR	CaseType=LinStatic	Point=3	X2=0.5	X3=-0.5	S11=228.993671895037	
IsS11Max=Yes	IsS11Min=No	FrameElem=86	ElemStation=0					
Frame=86	Station=0	OutputCase=PESOPR	CaseType=LinStatic	Point=4	X2=0.5	X3=0.5	S11=228.993671895037	
IsS11Max=No	IsS11Min=No	FrameElem=86	ElemStation=0					
Frame=86	Station=0.5	OutputCase=PESOPR	CaseType=LinStatic	Point=0	X2=0	X3=0	S11=-112.499998697982	
IsS11Max=No	IsS11Min=No	FrameElem=86	ElemStation=0.5					
Frame=86	Station=0.5	OutputCase=PESOPR	CaseType=LinStatic	Point=1	X2=-0.5	X3=-0.5	S11=-	
420.980826251226	IsS11Max=No	IsS11Min=Yes	FrameElem=86	ElemStation=0.5				
Frame=86	Station=0.5	OutputCase=PESOPR	CaseType=LinStatic	Point=2	X2=-0.5	X3=0.5	S11=-	
420.980826251226	IsS11Max=No	IsS11Min=No	FrameElem=86	ElemStation=0.5				
Frame=86	Station=0.5	OutputCase=PESOPR	CaseType=LinStatic	Point=3	X2=0.5	X3=-0.5		
S11=195.980828855262	IsS11Max=Yes	IsS11Min=No	FrameElem=86	ElemStation=0.5				
Frame=86	Station=0.5	OutputCase=PESOPR	CaseType=LinStatic	Point=4	X2=0.5	X3=0.5		
S11=195.980828855262	IsS11Max=No	IsS11Min=No	FrameElem=86	ElemStation=0.5				
Frame=86	Station=0	OutputCase=TERRVERT	CaseType=LinStatic	Point=0	X2=0	X3=0	S11=-699.99999361753	
IsS11Max=No	IsS11Min=No	FrameElem=86	ElemStation=0					
Frame=86	Station=0	OutputCase=TERRVERT	CaseType=LinStatic	Point=1	X2=-0.5	X3=-0.5	S11=-	
2624.91266029031	IsS11Max=No	IsS11Min=Yes	FrameElem=86	ElemStation=0				
Frame=86	Station=0	OutputCase=TERRVERT	CaseType=LinStatic	Point=2	X2=-0.5	X3=0.5	S11=-	
2624.91266029031	IsS11Max=No	IsS11Min=No	FrameElem=86	ElemStation=0				
Frame=86	Station=0	OutputCase=TERRVERT	CaseType=LinStatic	Point=3	X2=0.5	X3=-0.5		
S11=1224.91267305525	IsS11Max=Yes	IsS11Min=No	FrameElem=86	ElemStation=0				
Frame=86	Station=0	OutputCase=TERRVERT	CaseType=LinStatic	Point=4	X2=0.5	X3=0.5		
S11=1224.91267305525	IsS11Max=No	IsS11Min=No	FrameElem=86	ElemStation=0				
Frame=86	Station=0.5	OutputCase=TERRVERT	CaseType=LinStatic	Point=0	X2=0	X3=0	S11=-699.99999361753	
IsS11Max=No	IsS11Min=No	FrameElem=86	ElemStation=0.5					
Frame=86	Station=0.5	OutputCase=TERRVERT	CaseType=LinStatic	Point=1	X2=-0.5	X3=-0.5	S11=-	
2629.84076574689	IsS11Max=No	IsS11Min=Yes	FrameElem=86	ElemStation=0.5				
Frame=86	Station=0.5	OutputCase=TERRVERT	CaseType=LinStatic	Point=2	X2=-0.5	X3=0.5	S11=-	
2629.84076574689	IsS11Max=No	IsS11Min=No	FrameElem=86	ElemStation=0.5				
Frame=86	Station=0.5	OutputCase=TERRVERT	CaseType=LinStatic	Point=3	X2=0.5	X3=-0.5		
S11=1229.84077851183	IsS11Max=Yes	IsS11Min=No	FrameElem=86	ElemStation=0.5				
Frame=86	Station=0.5	OutputCase=TERRVERT	CaseType=LinStatic	Point=4	X2=0.5	X3=0.5		
S11=1229.84077851183	IsS11Max=No	IsS11Min=No	FrameElem=86	ElemStation=0.5				
Frame=86	Station=0	OutputCase=TERRLAT	CaseType=LinStatic	Point=0	X2=0	X3=0	S11=-1.16776482173009E-	
06	IsS11Max=No	IsS11Min=No	FrameElem=86	ElemStation=0				
Frame=86	Station=0	OutputCase=TERRLAT	CaseType=LinStatic	Point=1	X2=-0.5	X3=-0.5		
S11=1096.91120459502	IsS11Max=Yes	IsS11Min=No	FrameElem=86	ElemStation=0				
Frame=86	Station=0	OutputCase=TERRLAT	CaseType=LinStatic	Point=2	X2=-0.5	X3=0.5		
S11=1096.91120459502	IsS11Max=No	IsS11Min=No	FrameElem=86	ElemStation=0				
Frame=86	Station=0	OutputCase=TERRLAT	CaseType=LinStatic	Point=3	X2=0.5	X3=-0.5	S11=-	
1096.91120693055	IsS11Max=No	IsS11Min=Yes	FrameElem=86	ElemStation=0				
Frame=86	Station=0	OutputCase=TERRLAT	CaseType=LinStatic	Point=4	X2=0.5	X3=0.5	S11=-	
1096.91120693055	IsS11Max=No	IsS11Min=No	FrameElem=86	ElemStation=0				
Frame=86	Station=0.5	OutputCase=TERRLAT	CaseType=LinStatic	Point=0	X2=0	X3=0	S11=-	
1.73540968549995E-06	IsS11Max=No	IsS11Min=No	FrameElem=86	ElemStation=0.5				
Frame=86	Station=0.5	OutputCase=TERRLAT	CaseType=LinStatic	Point=1	X2=-0.5	X3=-0.5		
S11=1187.2085955457	IsS11Max=Yes	IsS11Min=No	FrameElem=86	ElemStation=0.5				
Frame=86	Station=0.5	OutputCase=TERRLAT	CaseType=LinStatic	Point=2	X2=-0.5	X3=0.5		
S11=1187.2085955457	IsS11Max=No	IsS11Min=No	FrameElem=86	ElemStation=0.5				
Frame=86	Station=0.5	OutputCase=TERRLAT	CaseType=LinStatic	Point=3	X2=0.5	X3=-0.5	S11=-	
1187.20859901652	IsS11Max=No	IsS11Min=Yes	FrameElem=86	ElemStation=0.5				
Frame=86	Station=0.5	OutputCase=TERRLAT	CaseType=LinStatic	Point=4	X2=0.5	X3=0.5	S11=-	
1187.20859901652	IsS11Max=No	IsS11Min=No	FrameElem=86	ElemStation=0.5				
Frame=86	Station=0	OutputCase=ACCVERT	CaseType=LinStatic	Point=0	X2=0	X3=0	S11=0	IsS11Max=Yes
IsS11Min=Yes	FrameElem=86	ElemStation=0						
Frame=86	Station=0	OutputCase=ACCVERT	CaseType=LinStatic	Point=1	X2=-0.5	X3=-0.5	S11=0	
IsS11Max=No	IsS11Min=No	FrameElem=86	ElemStation=0					
Frame=86	Station=0	OutputCase=ACCVERT	CaseType=LinStatic	Point=2	X2=-0.5	X3=0.5	S11=0	IsS11Max=No
IsS11Min=No	FrameElem=86	ElemStation=0						
Frame=86	Station=0	OutputCase=ACCVERT	CaseType=LinStatic	Point=3	X2=0.5	X3=-0.5	S11=0	IsS11Max=No
IsS11Min=No	FrameElem=86	ElemStation=0						
Frame=86	Station=0	OutputCase=ACCVERT	CaseType=LinStatic	Point=4	X2=0.5	X3=0.5	S11=0	IsS11Max=No
IsS11Min=No	FrameElem=86	ElemStation=0						
Frame=86	Station=0.5	OutputCase=ACCVERT	CaseType=LinStatic	Point=0	X2=0	X3=0	S11=0	IsS11Max=Yes
IsS11Min=Yes	FrameElem=86	ElemStation=0.5						
Frame=86	Station=0.5	OutputCase=ACCVERT	CaseType=LinStatic	Point=1	X2=-0.5	X3=-0.5	S11=0	
IsS11Max=No	IsS11Min=No	FrameElem=86	ElemStation=0.5					
Frame=86	Station=0.5	OutputCase=ACCVERT	CaseType=LinStatic	Point=2	X2=-0.5	X3=0.5	S11=0	
IsS11Max=No	IsS11Min=No	FrameElem=86	ElemStation=0.5					
Frame=86	Station=0.5	OutputCase=ACCVERT	CaseType=LinStatic	Point=3	X2=0.5	X3=-0.5	S11=0	
IsS11Max=No	IsS11Min=No	FrameElem=86	ElemStation=0.5					



Frame=86	Station=0	OutputCase=ENVE	CaseType=Combination	StepType=Max	Point=0	X2=0	X3=0	S11=-
824.999993132947	IsS11Max=No	IsS11Min=No	FrameElem=86	ElemStation=0				
Frame=86	Station=0	OutputCase=ENVE	CaseType=Combination	StepType=Max	Point=1	X2=-0.5	X3=-0.5	
S11=-2006.9951249863	IsS11Max=No	IsS11Min=Yes	FrameElem=86	ElemStation=0				
Frame=86	Station=0	OutputCase=ENVE	CaseType=Combination	StepType=Max	Point=2	X2=-0.5	X3=0.5	S11=-
2006.9951249863	IsS11Max=No	IsS11Min=No	FrameElem=86	ElemStation=0				
Frame=86	Station=0	OutputCase=ENVE	CaseType=Combination	StepType=Max	Point=3	X2=0.5	X3=-0.5	
S11=686.068500098909	IsS11Max=Yes	IsS11Min=No	FrameElem=86	ElemStation=0				
Frame=86	Station=0	OutputCase=ENVE	CaseType=Combination	StepType=Max	Point=4	X2=0.5	X3=0.5	
S11=686.068500098909	IsS11Max=No	IsS11Min=No	FrameElem=86	ElemStation=0				
Frame=86	Station=0.5	OutputCase=ENVE	CaseType=Combination	StepType=Max	Point=0	X2=0	X3=0	S11=-
812.499993530299	IsS11Max=No	IsS11Min=No	FrameElem=86	ElemStation=0.5				
Frame=86	Station=0.5	OutputCase=ENVE	CaseType=Combination	StepType=Max	Point=1	X2=-0.5	X3=-0.5	
S11=-1863.61299645241	IsS11Max=No	IsS11Min=Yes	FrameElem=86	ElemStation=0.5				
Frame=86	Station=0.5	OutputCase=ENVE	CaseType=Combination	StepType=Max	Point=2	X2=-0.5	X3=0.5	
S11=-1863.61299645241	IsS11Max=No	IsS11Min=No	FrameElem=86	ElemStation=0.5				
Frame=86	Station=0.5	OutputCase=ENVE	CaseType=Combination	StepType=Max	Point=3	X2=0.5	X3=-0.5	
S11=594.775588055525	IsS11Max=Yes	IsS11Min=No	FrameElem=86	ElemStation=0.5				
Frame=86	Station=0.5	OutputCase=ENVE	CaseType=Combination	StepType=Max	Point=4	X2=0.5	X3=0.5	
S11=594.775588055525	IsS11Max=No	IsS11Min=No	FrameElem=86	ElemStation=0.5				
Frame=86	Station=0	OutputCase=ENVE	CaseType=Combination	StepType=Min	Point=0	X2=0	X3=0	S11=-
824.999993483277	IsS11Max=No	IsS11Min=No	FrameElem=86	ElemStation=0				
Frame=86	Station=0	OutputCase=ENVE	CaseType=Combination	StepType=Min	Point=1	X2=-0.5	X3=-0.5	
S11=-2336.0684863648	IsS11Max=No	IsS11Min=Yes	FrameElem=86	ElemStation=0				
Frame=86	Station=0	OutputCase=ENVE	CaseType=Combination	StepType=Min	Point=2	X2=-0.5	X3=0.5	S11=-
2336.0684863648	IsS11Max=No	IsS11Min=No	FrameElem=86	ElemStation=0				
Frame=86	Station=0	OutputCase=ENVE	CaseType=Combination	StepType=Min	Point=3	X2=0.5	X3=-0.5	
S11=356.995138019746	IsS11Max=Yes	IsS11Min=No	FrameElem=86	ElemStation=0				
Frame=86	Station=0	OutputCase=ENVE	CaseType=Combination	StepType=Min	Point=4	X2=0.5	X3=0.5	
S11=356.995138019746	IsS11Max=No	IsS11Min=No	FrameElem=86	ElemStation=0				
Frame=86	Station=0.5	OutputCase=ENVE	CaseType=Combination	StepType=Min	Point=0	X2=0	X3=0	S11=-
812.499994050922	IsS11Max=No	IsS11Min=No	FrameElem=86	ElemStation=0.5				
Frame=86	Station=0.5	OutputCase=ENVE	CaseType=Combination	StepType=Min	Point=1	X2=-0.5	X3=-0.5	
S11=-2219.77557511612	IsS11Max=No	IsS11Min=Yes	FrameElem=86	ElemStation=0.5				
Frame=86	Station=0.5	OutputCase=ENVE	CaseType=Combination	StepType=Min	Point=2	X2=-0.5	X3=0.5	
S11=-2219.77557511612	IsS11Max=No	IsS11Min=No	FrameElem=86	ElemStation=0.5				
Frame=86	Station=0.5	OutputCase=ENVE	CaseType=Combination	StepType=Min	Point=3	X2=0.5	X3=-0.5	
S11=238.613008350569	IsS11Max=Yes	IsS11Min=No	FrameElem=86	ElemStation=0.5				
Frame=86	Station=0.5	OutputCase=ENVE	CaseType=Combination	StepType=Min	Point=4	X2=0.5	X3=0.5	
S11=238.613008350569	IsS11Max=No	IsS11Min=No	FrameElem=86	ElemStation=0.5				
Frame=86	Station=0	OutputCase=FESSUR	CaseType=Combination	Point=0	X2=0	X3=0	S11=-824.999993483277	
IsS11Max=No	IsS11Min=No	FrameElem=86	ElemStation=0					
Frame=86	Station=0	OutputCase=FESSUR	CaseType=Combination	Point=1	X2=-0.5	X3=-0.5	S11=-	
2006.9951249863	IsS11Max=No	IsS11Min=Yes	FrameElem=86	ElemStation=0				
Frame=86	Station=0	OutputCase=FESSUR	CaseType=Combination	Point=2	X2=-0.5	X3=0.5	S11=-	
2006.9951249863	IsS11Max=No	IsS11Min=No	FrameElem=86	ElemStation=0				
Frame=86	Station=0	OutputCase=FESSUR	CaseType=Combination	Point=3	X2=0.5	X3=-0.5		
S11=356.995138019746	IsS11Max=Yes	IsS11Min=No	FrameElem=86	ElemStation=0				
Frame=86	Station=0	OutputCase=FESSUR	CaseType=Combination	Point=4	X2=0.5	X3=0.5		
S11=356.995138019746	IsS11Max=No	IsS11Min=No	FrameElem=86	ElemStation=0				
Frame=86	Station=0.5	OutputCase=FESSUR	CaseType=Combination	Point=0	X2=0	X3=0	S11=-812.499994050922	
IsS11Max=No	IsS11Min=No	FrameElem=86	ElemStation=0.5					
Frame=86	Station=0.5	OutputCase=FESSUR	CaseType=Combination	Point=1	X2=-0.5	X3=-0.5	S11=-	
1863.61299645241	IsS11Max=No	IsS11Min=Yes	FrameElem=86	ElemStation=0.5				
Frame=86	Station=0.5	OutputCase=FESSUR	CaseType=Combination	Point=2	X2=-0.5	X3=0.5	S11=-	
1863.61299645241	IsS11Max=No	IsS11Min=No	FrameElem=86	ElemStation=0.5				
Frame=86	Station=0.5	OutputCase=FESSUR	CaseType=Combination	Point=3	X2=0.5	X3=-0.5		
S11=238.613008350569	IsS11Max=Yes	IsS11Min=No	FrameElem=86	ElemStation=0.5				
Frame=86	Station=0.5	OutputCase=FESSUR	CaseType=Combination	Point=4	X2=0.5	X3=0.5		
S11=238.613008350569	IsS11Max=No	IsS11Min=No	FrameElem=86	ElemStation=0.5				
Frame=87	Station=0	OutputCase=PESOPR	CaseType=LinStatic	Point=0	X2=0	X3=0	S11=-112.499998697982	
IsS11Max=No	IsS11Min=No	FrameElem=87	ElemStation=0					
Frame=87	Station=0	OutputCase=PESOPR	CaseType=LinStatic	Point=1	X2=-0.5	X3=-0.5	S11=-	
420.980826251226	IsS11Max=No	IsS11Min=Yes	FrameElem=87	ElemStation=0				
Frame=87	Station=0	OutputCase=PESOPR	CaseType=LinStatic	Point=2	X2=-0.5	X3=0.5	S11=-	
420.980826251226	IsS11Max=No	IsS11Min=No	FrameElem=87	ElemStation=0				
Frame=87	Station=0	OutputCase=PESOPR	CaseType=LinStatic	Point=3	X2=0.5	X3=-0.5	S11=195.980828855262	
IsS11Max=Yes	IsS11Min=No	FrameElem=87	ElemStation=0					
Frame=87	Station=0	OutputCase=PESOPR	CaseType=LinStatic	Point=4	X2=0.5	X3=0.5	S11=195.980828855262	
IsS11Max=No	IsS11Min=No	FrameElem=87	ElemStation=0					
Frame=87	Station=0.5	OutputCase=PESOPR	CaseType=LinStatic	Point=0	X2=0	X3=0	S11=-99.9999986979819	
IsS11Max=No	IsS11Min=No	FrameElem=87	ElemStation=0.5					
Frame=87	Station=0.5	OutputCase=PESOPR	CaseType=LinStatic	Point=1	X2=-0.5	X3=-0.5	S11=-	
362.967983509474	IsS11Max=No	IsS11Min=Yes	FrameElem=87	ElemStation=0.5				
Frame=87	Station=0.5	OutputCase=PESOPR	CaseType=LinStatic	Point=2	X2=-0.5	X3=0.5	S11=-	
362.967983509474	IsS11Max=No	IsS11Min=No	FrameElem=87	ElemStation=0.5				
Frame=87	Station=0.5	OutputCase=PESOPR	CaseType=LinStatic	Point=3	X2=0.5	X3=-0.5		
S11=162.967986113511	IsS11Max=Yes	IsS11Min=No	FrameElem=87	ElemStation=0.5				
Frame=87	Station=0.5	OutputCase=PESOPR	CaseType=LinStatic	Point=4	X2=0.5	X3=0.5		
S11=162.967986113511	IsS11Max=No	IsS11Min=No	FrameElem=87	ElemStation=0.5				
Frame=87	Station=0	OutputCase=TERRVERT	CaseType=LinStatic	Point=0	X2=0	X3=0	S11=-699.99999361753	
IsS11Max=No	IsS11Min=No	FrameElem=87	ElemStation=0					

Frame=87	Station=0	OutputCase=TERRVERT	CaseType=LinStatic	Point=1	X2=-0.5	X3=-0.5	S11=-
2629.84076574688	IsS11Max=No	IsS11Min=Yes	FrameElem=87	ElemStation=0			
Frame=87	Station=0	OutputCase=TERRVERT	CaseType=LinStatic	Point=2	X2=-0.5	X3=0.5	S11=-
2629.84076574688	IsS11Max=No	IsS11Min=No	FrameElem=87	ElemStation=0			
Frame=87	Station=0	OutputCase=TERRVERT	CaseType=LinStatic	Point=3	X2=0.5	X3=-0.5	
S11=1229.84077851182	IsS11Max=Yes	IsS11Min=No	FrameElem=87	ElemStation=0			
Frame=87	Station=0	OutputCase=TERRVERT	CaseType=LinStatic	Point=4	X2=0.5	X3=0.5	
S11=1229.84077851182	IsS11Max=No	IsS11Min=No	FrameElem=87	ElemStation=0			
Frame=87	Station=0.5	OutputCase=TERRVERT	CaseType=LinStatic	Point=0	X2=0	X3=0	S11=-699.99999361753
IsS11Max=No	IsS11Min=No	FrameElem=87	ElemStation=0.5				
Frame=87	Station=0.5	OutputCase=TERRVERT	CaseType=LinStatic	Point=1	X2=-0.5	X3=-0.5	S11=-
2634.76887120346	IsS11Max=No	IsS11Min=Yes	FrameElem=87	ElemStation=0.5			
Frame=87	Station=0.5	OutputCase=TERRVERT	CaseType=LinStatic	Point=2	X2=-0.5	X3=0.5	S11=-
2634.76887120346	IsS11Max=No	IsS11Min=No	FrameElem=87	ElemStation=0.5			
Frame=87	Station=0.5	OutputCase=TERRVERT	CaseType=LinStatic	Point=3	X2=0.5	X3=-0.5	
S11=1234.7688839684	IsS11Max=Yes	IsS11Min=No	FrameElem=87	ElemStation=0.5			
Frame=87	Station=0.5	OutputCase=TERRVERT	CaseType=LinStatic	Point=4	X2=0.5	X3=0.5	
S11=1234.7688839684	IsS11Max=No	IsS11Min=No	FrameElem=87	ElemStation=0.5			
Frame=87	Station=0	OutputCase=TERRLAT	CaseType=LinStatic	Point=0	X2=0	X3=0	S11=-1.73541047843173E-
06	IsS11Max=No	IsS11Min=No	FrameElem=87	ElemStation=0			
Frame=87	Station=0	OutputCase=TERRLAT	CaseType=LinStatic	Point=1	X2=-0.5	X3=-0.5	
S11=1187.2085955457	IsS11Max=Yes	IsS11Min=No	FrameElem=87	ElemStation=0			
Frame=87	Station=0	OutputCase=TERRLAT	CaseType=LinStatic	Point=2	X2=-0.5	X3=0.5	S11=1187.2085955457
IsS11Max=No	IsS11Min=No	FrameElem=87	ElemStation=0				
Frame=87	Station=0	OutputCase=TERRLAT	CaseType=LinStatic	Point=3	X2=0.5	X3=-0.5	S11=-
1187.20859901652	IsS11Max=No	IsS11Min=Yes	FrameElem=87	ElemStation=0			
Frame=87	Station=0	OutputCase=TERRLAT	CaseType=LinStatic	Point=4	X2=0.5	X3=0.5	S11=-
1187.20859901652	IsS11Max=No	IsS11Min=No	FrameElem=87	ElemStation=0			
Frame=87	Station=0.5	OutputCase=TERRLAT	CaseType=LinStatic	Point=0	X2=0	X3=0	S11=-
2.28610769234034E-06	IsS11Max=No	IsS11Min=No	FrameElem=87	ElemStation=0.5			
Frame=87	Station=0.5	OutputCase=TERRLAT	CaseType=LinStatic	Point=1	X2=-0.5	X3=-0.5	
S11=1066.42598666586	IsS11Max=Yes	IsS11Min=No	FrameElem=87	ElemStation=0.5			
Frame=87	Station=0.5	OutputCase=TERRLAT	CaseType=LinStatic	Point=2	X2=-0.5	X3=0.5	
S11=1066.42598666586	IsS11Max=No	IsS11Min=No	FrameElem=87	ElemStation=0.5			
Frame=87	Station=0.5	OutputCase=TERRLAT	CaseType=LinStatic	Point=3	X2=0.5	X3=-0.5	S11=-
1066.42599123808	IsS11Max=No	IsS11Min=Yes	FrameElem=87	ElemStation=0.5			
Frame=87	Station=0.5	OutputCase=TERRLAT	CaseType=LinStatic	Point=4	X2=0.5	X3=0.5	S11=-
1066.42599123808	IsS11Max=No	IsS11Min=No	FrameElem=87	ElemStation=0.5			
Frame=87	Station=0	OutputCase=ACCVERT	CaseType=LinStatic	Point=0	X2=0	X3=0	S11=0
IsS11Min=Yes	FrameElem=87	ElemStation=0					IsS11Max=Yes
Frame=87	Station=0	OutputCase=ACCVERT	CaseType=LinStatic	Point=1	X2=-0.5	X3=-0.5	S11=0
IsS11Max=No	IsS11Min=No	FrameElem=87	ElemStation=0				
Frame=87	Station=0	OutputCase=ACCVERT	CaseType=LinStatic	Point=2	X2=-0.5	X3=0.5	S11=0
IsS11Min=No	FrameElem=87	ElemStation=0					IsS11Max=No
Frame=87	Station=0	OutputCase=ACCVERT	CaseType=LinStatic	Point=3	X2=0.5	X3=-0.5	S11=0
IsS11Min=No	FrameElem=87	ElemStation=0					IsS11Max=No
Frame=87	Station=0	OutputCase=ACCVERT	CaseType=LinStatic	Point=4	X2=0.5	X3=0.5	S11=0
IsS11Min=No	FrameElem=87	ElemStation=0					IsS11Max=No
Frame=87	Station=0.5	OutputCase=ACCVERT	CaseType=LinStatic	Point=0	X2=0	X3=0	S11=0
IsS11Min=Yes	FrameElem=87	ElemStation=0.5					IsS11Max=Yes
Frame=87	Station=0.5	OutputCase=ACCVERT	CaseType=LinStatic	Point=1	X2=-0.5	X3=-0.5	S11=0
IsS11Max=No	IsS11Min=No	FrameElem=87	ElemStation=0.5				
Frame=87	Station=0.5	OutputCase=ACCVERT	CaseType=LinStatic	Point=2	X2=-0.5	X3=0.5	S11=0
IsS11Max=No	IsS11Min=No	FrameElem=87	ElemStation=0.5				
Frame=87	Station=0.5	OutputCase=ACCVERT	CaseType=LinStatic	Point=3	X2=0.5	X3=-0.5	S11=0
IsS11Max=No	IsS11Min=No	FrameElem=87	ElemStation=0.5				
Frame=87	Station=0.5	OutputCase=ACCVERT	CaseType=LinStatic	Point=4	X2=0.5	X3=0.5	S11=0
IsS11Max=No	IsS11Min=No	FrameElem=87	ElemStation=0.5				
Frame=87	Station=0	OutputCase=ACCLATDX	CaseType=LinStatic	Point=0	X2=0	X3=0	S11=0
IsS11Min=Yes	FrameElem=87	ElemStation=0					IsS11Max=Yes
Frame=87	Station=0	OutputCase=ACCLATDX	CaseType=LinStatic	Point=1	X2=-0.5	X3=-0.5	S11=0
IsS11Max=No	IsS11Min=No	FrameElem=87	ElemStation=0				
Frame=87	Station=0	OutputCase=ACCLATDX	CaseType=LinStatic	Point=2	X2=-0.5	X3=0.5	S11=0
IsS11Max=No	IsS11Min=No	FrameElem=87	ElemStation=0				
Frame=87	Station=0	OutputCase=ACCLATDX	CaseType=LinStatic	Point=3	X2=0.5	X3=-0.5	S11=0
IsS11Max=No	IsS11Min=No	FrameElem=87	ElemStation=0				
Frame=87	Station=0	OutputCase=ACCLATDX	CaseType=LinStatic	Point=4	X2=0.5	X3=0.5	S11=0
IsS11Min=No	FrameElem=87	ElemStation=0					IsS11Max=No
Frame=87	Station=0.5	OutputCase=ACCLATDX	CaseType=LinStatic	Point=0	X2=0	X3=0	S11=0
IsS11Min=Yes	FrameElem=87	ElemStation=0.5					IsS11Max=Yes
Frame=87	Station=0.5	OutputCase=ACCLATDX	CaseType=LinStatic	Point=1	X2=-0.5	X3=-0.5	S11=0
IsS11Max=No	IsS11Min=No	FrameElem=87	ElemStation=0.5				
Frame=87	Station=0.5	OutputCase=ACCLATDX	CaseType=LinStatic	Point=2	X2=-0.5	X3=0.5	S11=0
IsS11Max=No	IsS11Min=No	FrameElem=87	ElemStation=0.5				
Frame=87	Station=0.5	OutputCase=ACCLATDX	CaseType=LinStatic	Point=3	X2=0.5	X3=-0.5	S11=0
IsS11Max=No	IsS11Min=No	FrameElem=87	ElemStation=0.5				
Frame=87	Station=0.5	OutputCase=ACCLATDX	CaseType=LinStatic	Point=4	X2=0.5	X3=0.5	S11=0
IsS11Max=No	IsS11Min=No	FrameElem=87	ElemStation=0.5				
Frame=87	Station=0	OutputCase=ACCLATSX	CaseType=LinStatic	Point=0	X2=0	X3=0	S11=0
IsS11Min=Yes	FrameElem=87	ElemStation=0					IsS11Max=Yes
Frame=87	Station=0	OutputCase=ACCLATSX	CaseType=LinStatic	Point=1	X2=-0.5	X3=-0.5	S11=0
IsS11Max=No	IsS11Min=No	FrameElem=87	ElemStation=0				



Frame=87	Station=0	OutputCase=ACCLATSX	CaseType=LinStatic	Point=2	X2=-0.5	X3=0.5	S11=0		
IsS11Max=No	IsS11Min=No	FrameElem=87	ElemStation=0						
Frame=87	Station=0	OutputCase=ACCLATSX	CaseType=LinStatic	Point=3	X2=0.5	X3=-0.5	S11=0		
IsS11Max=No	IsS11Min=No	FrameElem=87	ElemStation=0						
Frame=87	Station=0	OutputCase=ACCLATSX	CaseType=LinStatic	Point=4	X2=0.5	X3=0.5	S11=0	IsS11Max=No	
IsS11Min=No	FrameElem=87	ElemStation=0							
Frame=87	Station=0.5	OutputCase=ACCLATSX	CaseType=LinStatic	Point=0	X2=0	X3=0	S11=0	IsS11Max=Yes	
IsS11Min=Yes	FrameElem=87	ElemStation=0.5							
Frame=87	Station=0.5	OutputCase=ACCLATSX	CaseType=LinStatic	Point=1	X2=-0.5	X3=-0.5	S11=0		
IsS11Max=No	IsS11Min=No	FrameElem=87	ElemStation=0.5						
Frame=87	Station=0.5	OutputCase=ACCLATSX	CaseType=LinStatic	Point=2	X2=-0.5	X3=0.5	S11=0		
IsS11Max=No	IsS11Min=No	FrameElem=87	ElemStation=0.5						
Frame=87	Station=0.5	OutputCase=ACCLATSX	CaseType=LinStatic	Point=3	X2=0.5	X3=-0.5	S11=0		
IsS11Max=No	IsS11Min=No	FrameElem=87	ElemStation=0.5						
Frame=87	Station=0.5	OutputCase=ACCLATSX	CaseType=LinStatic	Point=4	X2=0.5	X3=0.5	S11=0		
IsS11Max=No	IsS11Min=No	FrameElem=87	ElemStation=0.5						
Frame=87	Station=0	OutputCase=TERRCOST	CaseType=LinStatic	Point=0	X2=0	X3=0	S11=0	IsS11Max=Yes	
IsS11Min=Yes	FrameElem=87	ElemStation=0							
Frame=87	Station=0	OutputCase=TERRCOST	CaseType=LinStatic	Point=1	X2=-0.5	X3=-0.5	S11=0		
IsS11Max=No	IsS11Min=No	FrameElem=87	ElemStation=0						
Frame=87	Station=0	OutputCase=TERRCOST	CaseType=LinStatic	Point=2	X2=-0.5	X3=0.5	S11=0		
IsS11Max=No	IsS11Min=No	FrameElem=87	ElemStation=0						
Frame=87	Station=0	OutputCase=TERRCOST	CaseType=LinStatic	Point=3	X2=0.5	X3=-0.5	S11=0		
IsS11Max=No	IsS11Min=No	FrameElem=87	ElemStation=0						
Frame=87	Station=0	OutputCase=TERRCOST	CaseType=LinStatic	Point=4	X2=0.5	X3=0.5	S11=0	IsS11Max=No	
IsS11Min=No	FrameElem=87	ElemStation=0							
Frame=87	Station=0.5	OutputCase=TERRCOST	CaseType=LinStatic	Point=0	X2=0	X3=0	S11=0	IsS11Max=Yes	
IsS11Min=Yes	FrameElem=87	ElemStation=0.5							
Frame=87	Station=0.5	OutputCase=TERRCOST	CaseType=LinStatic	Point=1	X2=-0.5	X3=-0.5	S11=0		
IsS11Max=No	IsS11Min=No	FrameElem=87	ElemStation=0.5						
Frame=87	Station=0.5	OutputCase=TERRCOST	CaseType=LinStatic	Point=2	X2=-0.5	X3=0.5	S11=0		
IsS11Max=No	IsS11Min=No	FrameElem=87	ElemStation=0.5						
Frame=87	Station=0.5	OutputCase=TERRCOST	CaseType=LinStatic	Point=3	X2=0.5	X3=-0.5	S11=0		
IsS11Max=No	IsS11Min=No	FrameElem=87	ElemStation=0.5						
Frame=87	Station=0.5	OutputCase=TERRCOST	CaseType=LinStatic	Point=4	X2=0.5	X3=0.5	S11=0		
IsS11Max=No	IsS11Min=No	FrameElem=87	ElemStation=0.5						
Frame=87	Station=0	OutputCase=SOVRCOST	CaseType=LinStatic	Point=0	X2=0	X3=0	S11=0	IsS11Max=Yes	
IsS11Min=Yes	FrameElem=87	ElemStation=0							
Frame=87	Station=0	OutputCase=SOVRCOST	CaseType=LinStatic	Point=1	X2=-0.5	X3=-0.5	S11=0		
IsS11Max=No	IsS11Min=No	FrameElem=87	ElemStation=0						
Frame=87	Station=0	OutputCase=SOVRCOST	CaseType=LinStatic	Point=2	X2=-0.5	X3=0.5	S11=0		
IsS11Max=No	IsS11Min=No	FrameElem=87	ElemStation=0						
Frame=87	Station=0	OutputCase=SOVRCOST	CaseType=LinStatic	Point=3	X2=0.5	X3=-0.5	S11=0		
IsS11Max=No	IsS11Min=No	FrameElem=87	ElemStation=0						
Frame=87	Station=0	OutputCase=SOVRCOST	CaseType=LinStatic	Point=4	X2=0.5	X3=0.5	S11=0	IsS11Max=No	
IsS11Min=No	FrameElem=87	ElemStation=0							
Frame=87	Station=0.5	OutputCase=SOVRCOST	CaseType=LinStatic	Point=0	X2=0	X3=0	S11=0	IsS11Max=Yes	
IsS11Min=Yes	FrameElem=87	ElemStation=0.5							
Frame=87	Station=0.5	OutputCase=SOVRCOST	CaseType=LinStatic	Point=1	X2=-0.5	X3=-0.5	S11=0		
IsS11Max=No	IsS11Min=No	FrameElem=87	ElemStation=0.5						
Frame=87	Station=0.5	OutputCase=SOVRCOST	CaseType=LinStatic	Point=2	X2=-0.5	X3=0.5	S11=0		
IsS11Max=No	IsS11Min=No	FrameElem=87	ElemStation=0.5						
Frame=87	Station=0.5	OutputCase=SOVRCOST	CaseType=LinStatic	Point=3	X2=0.5	X3=-0.5	S11=0		
IsS11Max=No	IsS11Min=No	FrameElem=87	ElemStation=0.5						
Frame=87	Station=0.5	OutputCase=SOVRCOST	CaseType=LinStatic	Point=4	X2=0.5	X3=0.5	S11=0		
IsS11Max=No	IsS11Min=No	FrameElem=87	ElemStation=0.5						
Frame=87	Station=0	OutputCase=ENVE	CaseType=Combination	StepType=Max	Point=0	X2=0	X3=0	S11=-	
812.499993530299	IsS11Max=No	IsS11Min=No	FrameElem=87	ElemStation=0					
Frame=87	Station=0	OutputCase=ENVE	CaseType=Combination	StepType=Max	Point=1	X2=-0.5	X3=-0.5		
S11=-1863.61299645241	IsS11Max=No	IsS11Min=Yes	FrameElem=87	ElemStation=0					
Frame=87	Station=0	OutputCase=ENVE	CaseType=Combination	StepType=Max	Point=2	X2=-0.5	X3=0.5	S11=-	
1863.61299645241	IsS11Max=No	IsS11Min=No	FrameElem=87	ElemStation=0					
Frame=87	Station=0	OutputCase=ENVE	CaseType=Combination	StepType=Max	Point=3	X2=0.5	X3=-0.5		
S11=594.775588055521	IsS11Max=Yes	IsS11Min=No	FrameElem=87	ElemStation=0					
Frame=87	Station=0	OutputCase=ENVE	CaseType=Combination	StepType=Max	Point=4	X2=0.5	X3=0.5		
S11=594.775588055521	IsS11Max=No	IsS11Min=No	FrameElem=87	ElemStation=0					
Frame=87	Station=0.5	OutputCase=ENVE	CaseType=Combination	StepType=Max	Point=0	X2=0	X3=0	S11=-	
799.999993915787	IsS11Max=No	IsS11Min=No	FrameElem=87	ElemStation=0.5					
Frame=87	Station=0.5	OutputCase=ENVE	CaseType=Combination	StepType=Max	Point=1	X2=-0.5	X3=-0.5		
S11=-1931.31086804707	IsS11Max=No	IsS11Min=Yes	FrameElem=87	ElemStation=0.5					
Frame=87	Station=0.5	OutputCase=ENVE	CaseType=Combination	StepType=Max	Point=2	X2=-0.5	X3=0.5		
S11=-1931.31086804707	IsS11Max=No	IsS11Min=No	FrameElem=87	ElemStation=0.5					
Frame=87	Station=0.5	OutputCase=ENVE	CaseType=Combination	StepType=Max	Point=3	X2=0.5	X3=-0.5		
S11=651.238676215255	IsS11Max=Yes	IsS11Min=No	FrameElem=87	ElemStation=0.5					
Frame=87	Station=0.5	OutputCase=ENVE	CaseType=Combination	StepType=Max	Point=4	X2=0.5	X3=0.5		
S11=651.238676215255	IsS11Max=No	IsS11Min=No	FrameElem=87	ElemStation=0.5					
Frame=87	Station=0	OutputCase=ENVE	CaseType=Combination	StepType=Min	Point=0	X2=0	X3=0	S11=-	
812.499994050922	IsS11Max=No	IsS11Min=No	FrameElem=87	ElemStation=0					
Frame=87	Station=0	OutputCase=ENVE	CaseType=Combination	StepType=Min	Point=1	X2=-0.5	X3=-0.5		
S11=-2219.77557511612	IsS11Max=No	IsS11Min=Yes	FrameElem=87	ElemStation=0					
Frame=87	Station=0	OutputCase=ENVE	CaseType=Combination	StepType=Min	Point=2	X2=-0.5	X3=0.5	S11=-	
2219.77557511612	IsS11Max=No	IsS11Min=No	FrameElem=87	ElemStation=0					

Frame=87	Station=0	OutputCase=ENVE	CaseType=Combination	StepType=Min	Point=3	X2=0.5	X3=-0.5	
S11=238.613008350564	IsS11Max=Yes	IsS11Min=No	FrameElem=87	ElemStation=0				
Frame=87	Station=0	OutputCase=ENVE	CaseType=Combination	StepType=Min	Point=4	X2=0.5	X3=0.5	
S11=238.613008350564	IsS11Max=No	IsS11Min=No	FrameElem=87	ElemStation=0				
Frame=87	Station=0.5	OutputCase=ENVE	CaseType=Combination	StepType=Min	Point=0	X2=0	X3=0	S11=-
799.99999460162	IsS11Max=No	IsS11Min=No	FrameElem=87	ElemStation=0.5				
Frame=87	Station=0.5	OutputCase=ENVE	CaseType=Combination	StepType=Min	Point=1	X2=-0.5	X3=-0.5	
S11=-2251.23866404683	IsS11Max=No	IsS11Min=Yes	FrameElem=87	ElemStation=0.5				
Frame=87	Station=0.5	OutputCase=ENVE	CaseType=Combination	StepType=Min	Point=2	X2=-0.5	X3=0.5	
S11=-2251.23866404683	IsS11Max=No	IsS11Min=No	FrameElem=87	ElemStation=0.5				
Frame=87	Station=0.5	OutputCase=ENVE	CaseType=Combination	StepType=Min	Point=3	X2=0.5	X3=-0.5	
S11=331.310878843831	IsS11Max=Yes	IsS11Min=No	FrameElem=87	ElemStation=0.5				
Frame=87	Station=0.5	OutputCase=ENVE	CaseType=Combination	StepType=Min	Point=4	X2=0.5	X3=0.5	
S11=331.310878843831	IsS11Max=No	IsS11Min=No	FrameElem=87	ElemStation=0.5				
Frame=87	Station=0	OutputCase=FESSUR	CaseType=Combination	Point=0	X2=0	X3=0	S11=-812.499994050922	
IsS11Max=No	IsS11Min=No	FrameElem=87	ElemStation=0					
Frame=87	Station=0	OutputCase=FESSUR	CaseType=Combination	Point=1	X2=-0.5	X3=-0.5	S11=-	
1863.61299645241	IsS11Max=No	IsS11Min=Yes	FrameElem=87	ElemStation=0				
Frame=87	Station=0	OutputCase=FESSUR	CaseType=Combination	Point=2	X2=-0.5	X3=0.5	S11=-	
1863.61299645241	IsS11Max=No	IsS11Min=No	FrameElem=87	ElemStation=0				
Frame=87	Station=0	OutputCase=FESSUR	CaseType=Combination	Point=3	X2=0.5	X3=-0.5		
S11=238.613008350564	IsS11Max=Yes	IsS11Min=No	FrameElem=87	ElemStation=0				
Frame=87	Station=0	OutputCase=FESSUR	CaseType=Combination	Point=4	X2=0.5	X3=0.5		
S11=238.613008350564	IsS11Max=No	IsS11Min=No	FrameElem=87	ElemStation=0				
Frame=87	Station=0.5	OutputCase=FESSUR	CaseType=Combination	Point=0	X2=0	X3=0	S11=-799.99999460162	
IsS11Max=No	IsS11Min=No	FrameElem=87	ElemStation=0.5					
Frame=87	Station=0.5	OutputCase=FESSUR	CaseType=Combination	Point=1	X2=-0.5	X3=-0.5	S11=-	
1931.31086804707	IsS11Max=No	IsS11Min=Yes	FrameElem=87	ElemStation=0.5				
Frame=87	Station=0.5	OutputCase=FESSUR	CaseType=Combination	Point=2	X2=-0.5	X3=0.5	S11=-	
1931.31086804707	IsS11Max=No	IsS11Min=No	FrameElem=87	ElemStation=0.5				
Frame=87	Station=0.5	OutputCase=FESSUR	CaseType=Combination	Point=3	X2=0.5	X3=-0.5		
S11=331.310878843831	IsS11Max=Yes	IsS11Min=No	FrameElem=87	ElemStation=0.5				
Frame=87	Station=0.5	OutputCase=FESSUR	CaseType=Combination	Point=4	X2=0.5	X3=0.5		
S11=331.310878843831	IsS11Max=No	IsS11Min=No	FrameElem=87	ElemStation=0.5				
Frame=88	Station=0	OutputCase=PESOPR	CaseType=LinStatic	Point=0	X2=0	X3=0	S11=-99.9999986979819	
IsS11Max=No	IsS11Min=No	FrameElem=88	ElemStation=0					
Frame=88	Station=0	OutputCase=PESOPR	CaseType=LinStatic	Point=1	X2=-0.5	X3=-0.5	S11=-	
362.967983509474	IsS11Max=No	IsS11Min=Yes	FrameElem=88	ElemStation=0				
Frame=88	Station=0	OutputCase=PESOPR	CaseType=LinStatic	Point=2	X2=-0.5	X3=0.5	S11=-	
362.967983509474	IsS11Max=No	IsS11Min=No	FrameElem=88	ElemStation=0				
Frame=88	Station=0	OutputCase=PESOPR	CaseType=LinStatic	Point=3	X2=0.5	X3=-0.5	S11=162.967986113511	
IsS11Max=Yes	IsS11Min=No	FrameElem=88	ElemStation=0					
Frame=88	Station=0	OutputCase=PESOPR	CaseType=LinStatic	Point=4	X2=0.5	X3=0.5	S11=162.967986113511	
IsS11Max=No	IsS11Min=No	FrameElem=88	ElemStation=0					
Frame=88	Station=0.5	OutputCase=PESOPR	CaseType=LinStatic	Point=0	X2=0	X3=0	S11=-87.4999986979819	
IsS11Max=No	IsS11Min=No	FrameElem=88	ElemStation=0.5					
Frame=88	Station=0.5	OutputCase=PESOPR	CaseType=LinStatic	Point=1	X2=-0.5	X3=-0.5	S11=-	
304.955141065746	IsS11Max=No	IsS11Min=Yes	FrameElem=88	ElemStation=0.5				
Frame=88	Station=0.5	OutputCase=PESOPR	CaseType=LinStatic	Point=2	X2=-0.5	X3=0.5	S11=-	
304.955141065746	IsS11Max=No	IsS11Min=No	FrameElem=88	ElemStation=0.5				
Frame=88	Station=0.5	OutputCase=PESOPR	CaseType=LinStatic	Point=3	X2=0.5	X3=-0.5		
S11=129.955143669782	IsS11Max=Yes	IsS11Min=No	FrameElem=88	ElemStation=0.5				
Frame=88	Station=0.5	OutputCase=PESOPR	CaseType=LinStatic	Point=4	X2=0.5	X3=0.5		
S11=129.955143669782	IsS11Max=No	IsS11Min=No	FrameElem=88	ElemStation=0.5				
Frame=88	Station=0	OutputCase=TERRVERT	CaseType=LinStatic	Point=0	X2=0	X3=0	S11=-699.99999361753	
IsS11Max=No	IsS11Min=No	FrameElem=88	ElemStation=0					
Frame=88	Station=0	OutputCase=TERRVERT	CaseType=LinStatic	Point=1	X2=-0.5	X3=-0.5	S11=-	
2634.76887120346	IsS11Max=No	IsS11Min=Yes	FrameElem=88	ElemStation=0				
Frame=88	Station=0	OutputCase=TERRVERT	CaseType=LinStatic	Point=2	X2=-0.5	X3=0.5	S11=-	
2634.76887120346	IsS11Max=No	IsS11Min=No	FrameElem=88	ElemStation=0				
Frame=88	Station=0	OutputCase=TERRVERT	CaseType=LinStatic	Point=3	X2=0.5	X3=-0.5		
S11=1234.7688839684	IsS11Max=Yes	IsS11Min=No	FrameElem=88	ElemStation=0				
Frame=88	Station=0	OutputCase=TERRVERT	CaseType=LinStatic	Point=4	X2=0.5	X3=0.5	S11=1234.7688839684	
IsS11Max=No	IsS11Min=No	FrameElem=88	ElemStation=0					
Frame=88	Station=0.5	OutputCase=TERRVERT	CaseType=LinStatic	Point=0	X2=0	X3=0	S11=-699.99999361753	
IsS11Max=No	IsS11Min=No	FrameElem=88	ElemStation=0.5					
Frame=88	Station=0.5	OutputCase=TERRVERT	CaseType=LinStatic	Point=1	X2=-0.5	X3=-0.5	S11=-	
2639.69697666004	IsS11Max=No	IsS11Min=Yes	FrameElem=88	ElemStation=0.5				
Frame=88	Station=0.5	OutputCase=TERRVERT	CaseType=LinStatic	Point=2	X2=-0.5	X3=0.5	S11=-	
2639.69697666004	IsS11Max=No	IsS11Min=No	FrameElem=88	ElemStation=0.5				
Frame=88	Station=0.5	OutputCase=TERRVERT	CaseType=LinStatic	Point=3	X2=0.5	X3=-0.5		
S11=1239.69698942498	IsS11Max=Yes	IsS11Min=No	FrameElem=88	ElemStation=0.5				
Frame=88	Station=0.5	OutputCase=TERRVERT	CaseType=LinStatic	Point=4	X2=0.5	X3=0.5		
S11=1239.69698942498	IsS11Max=No	IsS11Min=No	FrameElem=88	ElemStation=0.5				
Frame=88	Station=0	OutputCase=TERRLAT	CaseType=LinStatic	Point=0	X2=0	X3=0	S11=-2.28610770136584E-	
06	IsS11Max=No	IsS11Min=No	FrameElem=88	ElemStation=0				
Frame=88	Station=0	OutputCase=TERRLAT	CaseType=LinStatic	Point=1	X2=-0.5	X3=-0.5		
S11=1066.42598666587	IsS11Max=Yes	IsS11Min=No	FrameElem=88	ElemStation=0				
Frame=88	Station=0	OutputCase=TERRLAT	CaseType=LinStatic	Point=2	X2=-0.5	X3=0.5		
S11=1066.42598666587	IsS11Max=No	IsS11Min=No	FrameElem=88	ElemStation=0				
Frame=88	Station=0	OutputCase=TERRLAT	CaseType=LinStatic	Point=3	X2=0.5	X3=-0.5	S11=-	
1066.42599123808	IsS11Max=No	IsS11Min=Yes	FrameElem=88	ElemStation=0				

Frame=88	Station=0	OutputCase=TERRLAT	CaseType=LinStatic	Point=4	X2=0.5	X3=0.5	S11=-		
1066.42599123808	IsS11Max=No	IsS11Min=No	FrameElem=88	ElemStation=0					
Frame=88	Station=0.5	OutputCase=TERRLAT	CaseType=LinStatic	Point=0	X2=0	X3=0	S11=-		
2.81985732885245E-06	IsS11Max=No	IsS11Min=No	FrameElem=88	ElemStation=0.5					
Frame=88	Station=0.5	OutputCase=TERRLAT	CaseType=LinStatic	Point=1	X2=-0.5	X3=-0.5			
S11=740.960877993642	IsS11Max=Yes	IsS11Min=No	FrameElem=88	ElemStation=0.5					
Frame=88	Station=0.5	OutputCase=TERRLAT	CaseType=LinStatic	Point=2	X2=-0.5	X3=0.5			
S11=740.960877993642	IsS11Max=No	IsS11Min=No	FrameElem=88	ElemStation=0.5					
Frame=88	Station=0.5	OutputCase=TERRLAT	CaseType=LinStatic	Point=3	X2=0.5	X3=-0.5	S11=-		
740.960883633357	IsS11Max=No	IsS11Min=Yes	FrameElem=88	ElemStation=0.5					
Frame=88	Station=0.5	OutputCase=TERRLAT	CaseType=LinStatic	Point=4	X2=0.5	X3=0.5	S11=-		
740.960883633357	IsS11Max=No	IsS11Min=No	FrameElem=88	ElemStation=0.5					
Frame=88	Station=0	OutputCase=ACCVERT	CaseType=LinStatic	Point=0	X2=0	X3=0	S11=0	IsS11Max=Yes	
IsS11Min=Yes	FrameElem=88	ElemStation=0							
Frame=88	Station=0	OutputCase=ACCVERT	CaseType=LinStatic	Point=1	X2=-0.5	X3=-0.5	S11=0		
IsS11Max=No	IsS11Min=No	FrameElem=88	ElemStation=0						
Frame=88	Station=0	OutputCase=ACCVERT	CaseType=LinStatic	Point=2	X2=-0.5	X3=0.5	S11=0	IsS11Max=No	
IsS11Min=No	FrameElem=88	ElemStation=0							
Frame=88	Station=0	OutputCase=ACCVERT	CaseType=LinStatic	Point=3	X2=0.5	X3=-0.5	S11=0	IsS11Max=No	
IsS11Min=No	FrameElem=88	ElemStation=0							
Frame=88	Station=0	OutputCase=ACCVERT	CaseType=LinStatic	Point=4	X2=0.5	X3=0.5	S11=0	IsS11Max=No	
IsS11Min=No	FrameElem=88	ElemStation=0							
Frame=88	Station=0.5	OutputCase=ACCVERT	CaseType=LinStatic	Point=0	X2=0	X3=0	S11=0	IsS11Max=Yes	
IsS11Min=Yes	FrameElem=88	ElemStation=0.5							
Frame=88	Station=0.5	OutputCase=ACCVERT	CaseType=LinStatic	Point=1	X2=-0.5	X3=-0.5	S11=0		
IsS11Max=No	IsS11Min=No	FrameElem=88	ElemStation=0.5						
Frame=88	Station=0.5	OutputCase=ACCVERT	CaseType=LinStatic	Point=2	X2=-0.5	X3=0.5	S11=0		
IsS11Max=No	IsS11Min=No	FrameElem=88	ElemStation=0.5						
Frame=88	Station=0.5	OutputCase=ACCVERT	CaseType=LinStatic	Point=3	X2=0.5	X3=-0.5	S11=0		
IsS11Max=No	IsS11Min=No	FrameElem=88	ElemStation=0.5						
Frame=88	Station=0.5	OutputCase=ACCVERT	CaseType=LinStatic	Point=4	X2=0.5	X3=0.5	S11=0		
IsS11Max=No	IsS11Min=No	FrameElem=88	ElemStation=0.5						
Frame=88	Station=0	OutputCase=ACCLATDX	CaseType=LinStatic	Point=0	X2=0	X3=0	S11=0	IsS11Max=Yes	
IsS11Min=Yes	FrameElem=88	ElemStation=0							
Frame=88	Station=0	OutputCase=ACCLATDX	CaseType=LinStatic	Point=1	X2=-0.5	X3=-0.5	S11=0		
IsS11Max=No	IsS11Min=No	FrameElem=88	ElemStation=0						
Frame=88	Station=0	OutputCase=ACCLATDX	CaseType=LinStatic	Point=2	X2=-0.5	X3=0.5	S11=0		
IsS11Max=No	IsS11Min=No	FrameElem=88	ElemStation=0						
Frame=88	Station=0	OutputCase=ACCLATDX	CaseType=LinStatic	Point=3	X2=0.5	X3=-0.5	S11=0		
IsS11Max=No	IsS11Min=No	FrameElem=88	ElemStation=0						
Frame=88	Station=0	OutputCase=ACCLATDX	CaseType=LinStatic	Point=4	X2=0.5	X3=0.5	S11=0	IsS11Max=No	
IsS11Min=No	FrameElem=88	ElemStation=0							
Frame=88	Station=0.5	OutputCase=ACCLATDX	CaseType=LinStatic	Point=0	X2=0	X3=0	S11=0	IsS11Max=Yes	
IsS11Min=Yes	FrameElem=88	ElemStation=0.5							
Frame=88	Station=0.5	OutputCase=ACCLATDX	CaseType=LinStatic	Point=1	X2=-0.5	X3=-0.5	S11=0		
IsS11Max=No	IsS11Min=No	FrameElem=88	ElemStation=0.5						
Frame=88	Station=0.5	OutputCase=ACCLATDX	CaseType=LinStatic	Point=2	X2=-0.5	X3=0.5	S11=0		
IsS11Max=No	IsS11Min=No	FrameElem=88	ElemStation=0.5						
Frame=88	Station=0.5	OutputCase=ACCLATDX	CaseType=LinStatic	Point=3	X2=0.5	X3=-0.5	S11=0		
IsS11Max=No	IsS11Min=No	FrameElem=88	ElemStation=0.5						
Frame=88	Station=0.5	OutputCase=ACCLATDX	CaseType=LinStatic	Point=4	X2=0.5	X3=0.5	S11=0		
IsS11Max=No	IsS11Min=No	FrameElem=88	ElemStation=0.5						
Frame=88	Station=0	OutputCase=ACCLATSX	CaseType=LinStatic	Point=0	X2=0	X3=0	S11=0	IsS11Max=Yes	
IsS11Min=Yes	FrameElem=88	ElemStation=0							
Frame=88	Station=0	OutputCase=ACCLATSX	CaseType=LinStatic	Point=1	X2=-0.5	X3=-0.5	S11=0		
IsS11Max=No	IsS11Min=No	FrameElem=88	ElemStation=0						
Frame=88	Station=0	OutputCase=ACCLATSX	CaseType=LinStatic	Point=2	X2=-0.5	X3=0.5	S11=0		
IsS11Max=No	IsS11Min=No	FrameElem=88	ElemStation=0						
Frame=88	Station=0	OutputCase=ACCLATSX	CaseType=LinStatic	Point=3	X2=0.5	X3=-0.5	S11=0		
IsS11Max=No	IsS11Min=No	FrameElem=88	ElemStation=0						
Frame=88	Station=0	OutputCase=ACCLATSX	CaseType=LinStatic	Point=4	X2=0.5	X3=0.5	S11=0	IsS11Max=No	
IsS11Min=No	FrameElem=88	ElemStation=0							
Frame=88	Station=0.5	OutputCase=ACCLATSX	CaseType=LinStatic	Point=0	X2=0	X3=0	S11=0	IsS11Max=Yes	
IsS11Min=Yes	FrameElem=88	ElemStation=0.5							
Frame=88	Station=0.5	OutputCase=ACCLATSX	CaseType=LinStatic	Point=1	X2=-0.5	X3=-0.5	S11=0		
IsS11Max=No	IsS11Min=No	FrameElem=88	ElemStation=0.5						
Frame=88	Station=0.5	OutputCase=ACCLATSX	CaseType=LinStatic	Point=2	X2=-0.5	X3=0.5	S11=0		
IsS11Max=No	IsS11Min=No	FrameElem=88	ElemStation=0.5						
Frame=88	Station=0.5	OutputCase=ACCLATSX	CaseType=LinStatic	Point=3	X2=0.5	X3=-0.5	S11=0		
IsS11Max=No	IsS11Min=No	FrameElem=88	ElemStation=0.5						
Frame=88	Station=0.5	OutputCase=ACCLATSX	CaseType=LinStatic	Point=4	X2=0.5	X3=0.5	S11=0		
IsS11Max=No	IsS11Min=No	FrameElem=88	ElemStation=0.5						
Frame=88	Station=0	OutputCase=TERRCOST	CaseType=LinStatic	Point=0	X2=0	X3=0	S11=0	IsS11Max=Yes	
IsS11Min=Yes	FrameElem=88	ElemStation=0							
Frame=88	Station=0	OutputCase=TERRCOST	CaseType=LinStatic	Point=1	X2=-0.5	X3=-0.5	S11=0		
IsS11Max=No	IsS11Min=No	FrameElem=88	ElemStation=0						
Frame=88	Station=0	OutputCase=TERRCOST	CaseType=LinStatic	Point=2	X2=-0.5	X3=0.5	S11=0		
IsS11Max=No	IsS11Min=No	FrameElem=88	ElemStation=0						
Frame=88	Station=0	OutputCase=TERRCOST	CaseType=LinStatic	Point=3	X2=0.5	X3=-0.5	S11=0		
IsS11Max=No	IsS11Min=No	FrameElem=88	ElemStation=0						
Frame=88	Station=0	OutputCase=TERRCOST	CaseType=LinStatic	Point=4	X2=0.5	X3=0.5	S11=0	IsS11Max=No	
IsS11Min=No	FrameElem=88	ElemStation=0							

Frame=88	Station=0.5	OutputCase=TERRCOST	CaseType=LinStatic	Point=0	X2=0	X3=0	S11=0	IsS11Max=Yes
IsS11Min=Yes	FrameElem=88	ElemStation=0.5						
Frame=88	Station=0.5	OutputCase=TERRCOST	CaseType=LinStatic	Point=1	X2=-0.5	X3=-0.5	S11=0	
IsS11Max=No	IsS11Min=No	FrameElem=88	ElemStation=0.5					
Frame=88	Station=0.5	OutputCase=TERRCOST	CaseType=LinStatic	Point=2	X2=-0.5	X3=0.5	S11=0	
IsS11Max=No	IsS11Min=No	FrameElem=88	ElemStation=0.5					
Frame=88	Station=0.5	OutputCase=TERRCOST	CaseType=LinStatic	Point=3	X2=0.5	X3=-0.5	S11=0	
IsS11Max=No	IsS11Min=No	FrameElem=88	ElemStation=0.5					
Frame=88	Station=0.5	OutputCase=TERRCOST	CaseType=LinStatic	Point=4	X2=0.5	X3=0.5	S11=0	
IsS11Max=No	IsS11Min=No	FrameElem=88	ElemStation=0.5					
Frame=88	Station=0	OutputCase=SOVRCOST	CaseType=LinStatic	Point=0	X2=0	X3=0	S11=0	IsS11Max=Yes
IsS11Min=Yes	FrameElem=88	ElemStation=0						
Frame=88	Station=0	OutputCase=SOVRCOST	CaseType=LinStatic	Point=1	X2=-0.5	X3=-0.5	S11=0	
IsS11Max=No	IsS11Min=No	FrameElem=88	ElemStation=0					
Frame=88	Station=0	OutputCase=SOVRCOST	CaseType=LinStatic	Point=2	X2=-0.5	X3=0.5	S11=0	
IsS11Max=No	IsS11Min=No	FrameElem=88	ElemStation=0					
Frame=88	Station=0	OutputCase=SOVRCOST	CaseType=LinStatic	Point=3	X2=0.5	X3=-0.5	S11=0	
IsS11Max=No	IsS11Min=No	FrameElem=88	ElemStation=0					
Frame=88	Station=0	OutputCase=SOVRCOST	CaseType=LinStatic	Point=4	X2=0.5	X3=0.5	S11=0	IsS11Max=No
IsS11Min=No	FrameElem=88	ElemStation=0						
Frame=88	Station=0.5	OutputCase=SOVRCOST	CaseType=LinStatic	Point=0	X2=0	X3=0	S11=0	IsS11Max=Yes
IsS11Min=Yes	FrameElem=88	ElemStation=0.5						
Frame=88	Station=0.5	OutputCase=SOVRCOST	CaseType=LinStatic	Point=1	X2=-0.5	X3=-0.5	S11=0	
IsS11Max=No	IsS11Min=No	FrameElem=88	ElemStation=0.5					
Frame=88	Station=0.5	OutputCase=SOVRCOST	CaseType=LinStatic	Point=2	X2=-0.5	X3=0.5	S11=0	
IsS11Max=No	IsS11Min=No	FrameElem=88	ElemStation=0.5					
Frame=88	Station=0.5	OutputCase=SOVRCOST	CaseType=LinStatic	Point=3	X2=0.5	X3=-0.5	S11=0	
IsS11Max=No	IsS11Min=No	FrameElem=88	ElemStation=0.5					
Frame=88	Station=0.5	OutputCase=SOVRCOST	CaseType=LinStatic	Point=4	X2=0.5	X3=0.5	S11=0	
IsS11Max=No	IsS11Min=No	FrameElem=88	ElemStation=0.5					
Frame=88	Station=0	OutputCase=ENVE	CaseType=Combination	StepType=Max	Point=0	X2=0	X3=0	S11=-
799.999993915787	IsS11Max=No	IsS11Min=No	FrameElem=88	ElemStation=0				
Frame=88	Station=0	OutputCase=ENVE	CaseType=Combination	StepType=Max	Point=1	X2=-0.5	X3=-0.5	
S11=-1931.31086804707	IsS11Max=No	IsS11Min=Yes	FrameElem=88	ElemStation=0				
Frame=88	Station=0	OutputCase=ENVE	CaseType=Combination	StepType=Max	Point=2	X2=-0.5	X3=0.5	S11=-
1931.31086804707	IsS11Max=No	IsS11Min=No	FrameElem=88	ElemStation=0				
Frame=88	Station=0	OutputCase=ENVE	CaseType=Combination	StepType=Max	Point=3	X2=0.5	X3=-0.5	
S11=651.238676215254	IsS11Max=Yes	IsS11Min=No	FrameElem=88	ElemStation=0				
Frame=88	Station=0	OutputCase=ENVE	CaseType=Combination	StepType=Max	Point=4	X2=0.5	X3=0.5	
S11=651.238676215254	IsS11Max=No	IsS11Min=No	FrameElem=88	ElemStation=0				
Frame=88	Station=0.5	OutputCase=ENVE	CaseType=Combination	StepType=Max	Point=0	X2=0	X3=0	S11=-
787.499994289412	IsS11Max=No	IsS11Min=No	FrameElem=88	ElemStation=0.5				
Frame=88	Station=0.5	OutputCase=ENVE	CaseType=Combination	StepType=Max	Point=1	X2=-0.5	X3=-0.5	
S11=-2203.69123973214	IsS11Max=No	IsS11Min=Yes	FrameElem=88	ElemStation=0.5				
Frame=88	Station=0.5	OutputCase=ENVE	CaseType=Combination	StepType=Max	Point=2	X2=-0.5	X3=0.5	
S11=-2203.69123973214	IsS11Max=No	IsS11Min=No	FrameElem=88	ElemStation=0.5				
Frame=88	Station=0.5	OutputCase=ENVE	CaseType=Combination	StepType=Max	Point=3	X2=0.5	X3=-0.5	
S11=850.979514551409	IsS11Max=Yes	IsS11Min=No	FrameElem=88	ElemStation=0.5				
Frame=88	Station=0.5	OutputCase=ENVE	CaseType=Combination	StepType=Max	Point=4	X2=0.5	X3=0.5	
S11=850.979514551409	IsS11Max=No	IsS11Min=No	FrameElem=88	ElemStation=0.5				
Frame=88	Station=0	OutputCase=ENVE	CaseType=Combination	StepType=Min	Point=0	X2=0	X3=0	S11=-
799.99999460162	IsS11Max=No	IsS11Min=No	FrameElem=88	ElemStation=0				
Frame=88	Station=0	OutputCase=ENVE	CaseType=Combination	StepType=Min	Point=1	X2=-0.5	X3=-0.5	
S11=-2251.23866404683	IsS11Max=No	IsS11Min=Yes	FrameElem=88	ElemStation=0				
Frame=88	Station=0	OutputCase=ENVE	CaseType=Combination	StepType=Min	Point=2	X2=-0.5	X3=0.5	S11=-
2251.23866404683	IsS11Max=No	IsS11Min=No	FrameElem=88	ElemStation=0				
Frame=88	Station=0	OutputCase=ENVE	CaseType=Combination	StepType=Min	Point=3	X2=0.5	X3=-0.5	
S11=331.31087884383	IsS11Max=Yes	IsS11Min=No	FrameElem=88	ElemStation=0				
Frame=88	Station=0	OutputCase=ENVE	CaseType=Combination	StepType=Min	Point=4	X2=0.5	X3=0.5	
S11=331.31087884383	IsS11Max=No	IsS11Min=No	FrameElem=88	ElemStation=0				
Frame=88	Station=0.5	OutputCase=ENVE	CaseType=Combination	StepType=Min	Point=0	X2=0	X3=0	S11=-
787.499995135369	IsS11Max=No	IsS11Min=No	FrameElem=88	ElemStation=0.5				
Frame=88	Station=0.5	OutputCase=ENVE	CaseType=Combination	StepType=Min	Point=1	X2=-0.5	X3=-0.5	
S11=-2425.97950313023	IsS11Max=No	IsS11Min=Yes	FrameElem=88	ElemStation=0.5				
Frame=88	Station=0.5	OutputCase=ENVE	CaseType=Combination	StepType=Min	Point=2	X2=-0.5	X3=0.5	
S11=-2425.97950313023	IsS11Max=No	IsS11Min=No	FrameElem=88	ElemStation=0.5				
Frame=88	Station=0.5	OutputCase=ENVE	CaseType=Combination	StepType=Min	Point=3	X2=0.5	X3=-0.5	
S11=628.691249461402	IsS11Max=Yes	IsS11Min=No	FrameElem=88	ElemStation=0.5				
Frame=88	Station=0.5	OutputCase=ENVE	CaseType=Combination	StepType=Min	Point=4	X2=0.5	X3=0.5	
S11=628.691249461402	IsS11Max=No	IsS11Min=No	FrameElem=88	ElemStation=0.5				
Frame=88	Station=0	OutputCase=FESSUR	CaseType=Combination	Point=0	X2=0	X3=0	S11=-799.99999460162	
IsS11Max=No	IsS11Min=No	FrameElem=88	ElemStation=0					
Frame=88	Station=0	OutputCase=FESSUR	CaseType=Combination	Point=1	X2=-0.5	X3=-0.5	S11=-	
1931.31086804707	IsS11Max=No	IsS11Min=Yes	FrameElem=88	ElemStation=0				
Frame=88	Station=0	OutputCase=FESSUR	CaseType=Combination	Point=2	X2=-0.5	X3=0.5	S11=-	
1931.31086804707	IsS11Max=No	IsS11Min=No	FrameElem=88	ElemStation=0				
Frame=88	Station=0	OutputCase=FESSUR	CaseType=Combination	Point=3	X2=0.5	X3=-0.5		
S11=331.31087884383	IsS11Max=Yes	IsS11Min=No	FrameElem=88	ElemStation=0				
Frame=88	Station=0	OutputCase=FESSUR	CaseType=Combination	Point=4	X2=0.5	X3=0.5	S11=331.31087884383	
IsS11Max=No	IsS11Min=No	FrameElem=88	ElemStation=0					
Frame=88	Station=0.5	OutputCase=FESSUR	CaseType=Combination	Point=0	X2=0	X3=0	S11=-787.499995135369	
IsS11Max=No	IsS11Min=No	FrameElem=88	ElemStation=0.5					

Frame=88	Station=0.5	OutputCase=FESSUR	CaseType=Combination	Point=1	X2=-0.5	X3=-0.5	S11=-
2203.69123973214	IsS11Max=No	IsS11Min=Yes	FrameElem=88	ElemStation=0.5			
Frame=88	Station=0.5	OutputCase=FESSUR	CaseType=Combination	Point=2	X2=-0.5	X3=0.5	S11=-
2203.69123973214	IsS11Max=No	IsS11Min=No	FrameElem=88	ElemStation=0.5			
Frame=88	Station=0.5	OutputCase=FESSUR	CaseType=Combination	Point=3	X2=0.5	X3=-0.5	
S11=628.691249461402	IsS11Max=Yes	IsS11Min=No	FrameElem=88	ElemStation=0.5			
Frame=88	Station=0.5	OutputCase=FESSUR	CaseType=Combination	Point=4	X2=0.5	X3=0.5	
S11=628.691249461402	IsS11Max=No	IsS11Min=No	FrameElem=88	ElemStation=0.5			
Frame=89	Station=0	OutputCase=PESOPR	CaseType=LinStatic	Point=0	X2=0	X3=0	S11=-87.4999986978946
IsS11Max=No	IsS11Min=No	FrameElem=89	ElemStation=0				
Frame=89	Station=0	OutputCase=PESOPR	CaseType=LinStatic	Point=1	X2=-0.5	X3=-0.5	S11=-
304.955141065659	IsS11Max=No	IsS11Min=Yes	FrameElem=89	ElemStation=0			
Frame=89	Station=0	OutputCase=PESOPR	CaseType=LinStatic	Point=2	X2=-0.5	X3=0.5	S11=-
304.955141065659	IsS11Max=No	IsS11Min=No	FrameElem=89	ElemStation=0			
Frame=89	Station=0	OutputCase=PESOPR	CaseType=LinStatic	Point=3	X2=0.5	X3=-0.5	S11=129.95514366987
IsS11Max=Yes	IsS11Min=No	FrameElem=89	ElemStation=0				
Frame=89	Station=0	OutputCase=PESOPR	CaseType=LinStatic	Point=4	X2=0.5	X3=0.5	S11=129.95514366987
IsS11Max=No	IsS11Min=No	FrameElem=89	ElemStation=0				
Frame=89	Station=0.5	OutputCase=PESOPR	CaseType=LinStatic	Point=0	X2=0	X3=0	S11=-74.9999986978946
IsS11Max=No	IsS11Min=No	FrameElem=89	ElemStation=0.5				
Frame=89	Station=0.5	OutputCase=PESOPR	CaseType=LinStatic	Point=1	X2=-0.5	X3=-0.5	S11=-
246.942298919951	IsS11Max=No	IsS11Min=Yes	FrameElem=89	ElemStation=0.5			
Frame=89	Station=0.5	OutputCase=PESOPR	CaseType=LinStatic	Point=2	X2=-0.5	X3=0.5	S11=-
246.942298919951	IsS11Max=No	IsS11Min=No	FrameElem=89	ElemStation=0.5			
Frame=89	Station=0.5	OutputCase=PESOPR	CaseType=LinStatic	Point=3	X2=0.5	X3=-0.5	
S11=96.9423015241613	IsS11Max=Yes	IsS11Min=No	FrameElem=89	ElemStation=0.5			
Frame=89	Station=0.5	OutputCase=PESOPR	CaseType=LinStatic	Point=4	X2=0.5	X3=0.5	
S11=96.9423015241613	IsS11Max=No	IsS11Min=No	FrameElem=89	ElemStation=0.5			
Frame=89	Station=0	OutputCase=TERRVERT	CaseType=LinStatic	Point=0	X2=0	X3=0	S11=-699.999993617297
IsS11Max=No	IsS11Min=No	FrameElem=89	ElemStation=0				
Frame=89	Station=0	OutputCase=TERRVERT	CaseType=LinStatic	Point=1	X2=-0.5	X3=-0.5	S11=-
2639.6969766598	IsS11Max=No	IsS11Min=Yes	FrameElem=89	ElemStation=0			
Frame=89	Station=0	OutputCase=TERRVERT	CaseType=LinStatic	Point=2	X2=-0.5	X3=0.5	S11=-
2639.6969766598	IsS11Max=No	IsS11Min=No	FrameElem=89	ElemStation=0			
Frame=89	Station=0	OutputCase=TERRVERT	CaseType=LinStatic	Point=3	X2=0.5	X3=-0.5	
S11=1239.69698942521	IsS11Max=Yes	IsS11Min=No	FrameElem=89	ElemStation=0			
Frame=89	Station=0	OutputCase=TERRVERT	CaseType=LinStatic	Point=4	X2=0.5	X3=0.5	
S11=1239.69698942521	IsS11Max=No	IsS11Min=No	FrameElem=89	ElemStation=0			
Frame=89	Station=0.5	OutputCase=TERRVERT	CaseType=LinStatic	Point=0	X2=0	X3=0	S11=-699.999993617297
IsS11Max=No	IsS11Min=No	FrameElem=89	ElemStation=0.5				
Frame=89	Station=0.5	OutputCase=TERRVERT	CaseType=LinStatic	Point=1	X2=-0.5	X3=-0.5	S11=-
2644.62508211638	IsS11Max=No	IsS11Min=Yes	FrameElem=89	ElemStation=0.5			
Frame=89	Station=0.5	OutputCase=TERRVERT	CaseType=LinStatic	Point=2	X2=-0.5	X3=0.5	S11=-
2644.62508211638	IsS11Max=No	IsS11Min=No	FrameElem=89	ElemStation=0.5			
Frame=89	Station=0.5	OutputCase=TERRVERT	CaseType=LinStatic	Point=3	X2=0.5	X3=-0.5	
S11=1244.62509488179	IsS11Max=Yes	IsS11Min=No	FrameElem=89	ElemStation=0.5			
Frame=89	Station=0.5	OutputCase=TERRVERT	CaseType=LinStatic	Point=4	X2=0.5	X3=0.5	
S11=1244.62509488179	IsS11Max=No	IsS11Min=No	FrameElem=89	ElemStation=0.5			
Frame=89	Station=0	OutputCase=TERRLAT	CaseType=LinStatic	Point=0	X2=0	X3=0	S11=-2.81985921901651E-
06	IsS11Max=No	IsS11Min=No	FrameElem=89	ElemStation=0			
Frame=89	Station=0	OutputCase=TERRLAT	CaseType=LinStatic	Point=1	X2=-0.5	X3=-0.5	
S11=740.96087799364	IsS11Max=Yes	IsS11Min=No	FrameElem=89	ElemStation=0			
Frame=89	Station=0	OutputCase=TERRLAT	CaseType=LinStatic	Point=2	X2=-0.5	X3=0.5	S11=740.96087799364
IsS11Max=No	IsS11Min=No	FrameElem=89	ElemStation=0				
Frame=89	Station=0	OutputCase=TERRLAT	CaseType=LinStatic	Point=3	X2=0.5	X3=-0.5	S11=-
740.960883633359	IsS11Max=No	IsS11Min=Yes	FrameElem=89	ElemStation=0			
Frame=89	Station=0	OutputCase=TERRLAT	CaseType=LinStatic	Point=4	X2=0.5	X3=0.5	S11=-
740.960883633359	IsS11Max=No	IsS11Min=No	FrameElem=89	ElemStation=0			
Frame=89	Station=0.5	OutputCase=TERRLAT	CaseType=LinStatic	Point=0	X2=0	X3=0	S11=-
3.33666131783826E-06	IsS11Max=No	IsS11Min=No	FrameElem=89	ElemStation=0.5			
Frame=89	Station=0.5	OutputCase=TERRLAT	CaseType=LinStatic	Point=1	X2=-0.5	X3=-0.5	
S11=217.210769567159	IsS11Max=Yes	IsS11Min=No	FrameElem=89	ElemStation=0.5			
Frame=89	Station=0.5	OutputCase=TERRLAT	CaseType=LinStatic	Point=2	X2=-0.5	X3=0.5	
S11=217.210769567159	IsS11Max=No	IsS11Min=No	FrameElem=89	ElemStation=0.5			
Frame=89	Station=0.5	OutputCase=TERRLAT	CaseType=LinStatic	Point=3	X2=0.5	X3=-0.5	S11=-
217.210776240481	IsS11Max=No	IsS11Min=Yes	FrameElem=89	ElemStation=0.5			
Frame=89	Station=0.5	OutputCase=TERRLAT	CaseType=LinStatic	Point=4	X2=0.5	X3=0.5	S11=-
217.210776240481	IsS11Max=No	IsS11Min=No	FrameElem=89	ElemStation=0.5			
Frame=89	Station=0	OutputCase=ACCVERT	CaseType=LinStatic	Point=0	X2=0	X3=0	S11=0
IsS11Min=Yes	FrameElem=89	ElemStation=0					IsS11Max=Yes
Frame=89	Station=0	OutputCase=ACCVERT	CaseType=LinStatic	Point=1	X2=-0.5	X3=-0.5	S11=0
IsS11Max=No	IsS11Min=No	FrameElem=89	ElemStation=0				
Frame=89	Station=0	OutputCase=ACCVERT	CaseType=LinStatic	Point=2	X2=-0.5	X3=0.5	S11=0
IsS11Min=No	FrameElem=89	ElemStation=0					IsS11Max=No
Frame=89	Station=0	OutputCase=ACCVERT	CaseType=LinStatic	Point=3	X2=0.5	X3=-0.5	S11=0
IsS11Min=No	FrameElem=89	ElemStation=0					IsS11Max=No
Frame=89	Station=0	OutputCase=ACCVERT	CaseType=LinStatic	Point=4	X2=0.5	X3=0.5	S11=0
IsS11Min=No	FrameElem=89	ElemStation=0					IsS11Max=No
Frame=89	Station=0.5	OutputCase=ACCVERT	CaseType=LinStatic	Point=0	X2=0	X3=0	S11=0
IsS11Min=Yes	FrameElem=89	ElemStation=0.5					IsS11Max=Yes
Frame=89	Station=0.5	OutputCase=ACCVERT	CaseType=LinStatic	Point=1	X2=-0.5	X3=-0.5	S11=0
IsS11Max=No	IsS11Min=No	FrameElem=89	ElemStation=0.5				

Frame=89	Station=0.5	OutputCase=SOVRCOST	CaseType=LinStatic	Point=3	X2=0.5	X3=-0.5	S11=0	
IsS11Max=No	IsS11Min=No	FrameElem=89	ElemStation=0.5					
Frame=89	Station=0.5	OutputCase=SOVRCOST	CaseType=LinStatic	Point=4	X2=0.5	X3=0.5	S11=0	
IsS11Max=No	IsS11Min=No	FrameElem=89	ElemStation=0.5					
Frame=89	Station=0	OutputCase=ENVE	CaseType=Combination	StepType=Max	Point=0	X2=0	X3=0	S11=-
787.499994289093	IsS11Max=No	IsS11Min=No	FrameElem=89	ElemStation=0				
Frame=89	Station=0	OutputCase=ENVE	CaseType=Combination	StepType=Max	Point=1	X2=-0.5	X3=-0.5	
S11=-2203.69123973182	IsS11Max=No	IsS11Min=Yes	FrameElem=89	ElemStation=0				
Frame=89	Station=0	OutputCase=ENVE	CaseType=Combination	StepType=Max	Point=2	X2=-0.5	X3=0.5	S11=-
2203.69123973182	IsS11Max=No	IsS11Min=No	FrameElem=89	ElemStation=0				
Frame=89	Station=0	OutputCase=ENVE	CaseType=Combination	StepType=Max	Point=3	X2=0.5	X3=-0.5	
S11=850.979514551726	IsS11Max=Yes	IsS11Min=No	FrameElem=89	ElemStation=0				
Frame=89	Station=0	OutputCase=ENVE	CaseType=Combination	StepType=Max	Point=4	X2=0.5	X3=0.5	
S11=850.979514551726	IsS11Max=No	IsS11Min=No	FrameElem=89	ElemStation=0				
Frame=89	Station=0.5	OutputCase=ENVE	CaseType=Combination	StepType=Max	Point=0	X2=0	X3=0	S11=-
774.999994650855	IsS11Max=No	IsS11Min=No	FrameElem=89	ElemStation=0.5				
Frame=89	Station=0.5	OutputCase=ENVE	CaseType=Combination	StepType=Max	Point=1	X2=-0.5	X3=-0.5	
S11=-2674.35661146917	IsS11Max=No	IsS11Min=Yes	FrameElem=89	ElemStation=0.5				
Frame=89	Station=0.5	OutputCase=ENVE	CaseType=Combination	StepType=Max	Point=2	X2=-0.5	X3=0.5	
S11=-2674.35661146917	IsS11Max=No	IsS11Min=No	FrameElem=89	ElemStation=0.5				
Frame=89	Station=0.5	OutputCase=ENVE	CaseType=Combination	StepType=Max	Point=3	X2=0.5	X3=-0.5	
S11=1189.51985303761	IsS11Max=Yes	IsS11Min=No	FrameElem=89	ElemStation=0.5				
Frame=89	Station=0.5	OutputCase=ENVE	CaseType=Combination	StepType=Max	Point=4	X2=0.5	X3=0.5	
S11=1189.51985303761	IsS11Max=No	IsS11Min=No	FrameElem=89	ElemStation=0.5				
Frame=89	Station=0	OutputCase=ENVE	CaseType=Combination	StepType=Min	Point=0	X2=0	X3=0	S11=-
787.499995135051	IsS11Max=No	IsS11Min=No	FrameElem=89	ElemStation=0				
Frame=89	Station=0	OutputCase=ENVE	CaseType=Combination	StepType=Min	Point=1	X2=-0.5	X3=-0.5	
S11=-2425.97950312991	IsS11Max=No	IsS11Min=Yes	FrameElem=89	ElemStation=0				
Frame=89	Station=0	OutputCase=ENVE	CaseType=Combination	StepType=Min	Point=2	X2=-0.5	X3=0.5	S11=-
2425.97950312991	IsS11Max=No	IsS11Min=No	FrameElem=89	ElemStation=0				
Frame=89	Station=0	OutputCase=ENVE	CaseType=Combination	StepType=Min	Point=3	X2=0.5	X3=-0.5	
S11=628.691249461718	IsS11Max=Yes	IsS11Min=No	FrameElem=89	ElemStation=0				
Frame=89	Station=0	OutputCase=ENVE	CaseType=Combination	StepType=Min	Point=4	X2=0.5	X3=0.5	
S11=628.691249461718	IsS11Max=No	IsS11Min=No	FrameElem=89	ElemStation=0				
Frame=89	Station=0.5	OutputCase=ENVE	CaseType=Combination	StepType=Min	Point=0	X2=0	X3=0	S11=-
774.999995651853	IsS11Max=No	IsS11Min=No	FrameElem=89	ElemStation=0.5				
Frame=89	Station=0.5	OutputCase=ENVE	CaseType=Combination	StepType=Min	Point=1	X2=-0.5	X3=-0.5	
S11=-2739.51984233932	IsS11Max=No	IsS11Min=Yes	FrameElem=89	ElemStation=0.5				
Frame=89	Station=0.5	OutputCase=ENVE	CaseType=Combination	StepType=Min	Point=2	X2=-0.5	X3=0.5	
S11=-2739.51984233932	IsS11Max=No	IsS11Min=No	FrameElem=89	ElemStation=0.5				
Frame=89	Station=0.5	OutputCase=ENVE	CaseType=Combination	StepType=Min	Point=3	X2=0.5	X3=-0.5	
S11=1124.35662016547	IsS11Max=Yes	IsS11Min=No	FrameElem=89	ElemStation=0.5				
Frame=89	Station=0.5	OutputCase=ENVE	CaseType=Combination	StepType=Min	Point=4	X2=0.5	X3=0.5	
S11=1124.35662016547	IsS11Max=No	IsS11Min=No	FrameElem=89	ElemStation=0.5				
Frame=89	Station=0	OutputCase=FESSUR	CaseType=Combination	Point=0	X2=0	X3=0	S11=-787.499995135051	
IsS11Max=No	IsS11Min=No	FrameElem=89	ElemStation=0					
Frame=89	Station=0	OutputCase=FESSUR	CaseType=Combination	Point=1	X2=-0.5	X3=-0.5	S11=-	
2203.69123973182	IsS11Max=No	IsS11Min=Yes	FrameElem=89	ElemStation=0				
Frame=89	Station=0	OutputCase=FESSUR	CaseType=Combination	Point=2	X2=-0.5	X3=0.5	S11=-	
2203.69123973182	IsS11Max=No	IsS11Min=No	FrameElem=89	ElemStation=0				
Frame=89	Station=0	OutputCase=FESSUR	CaseType=Combination	Point=3	X2=0.5	X3=-0.5		
S11=628.691249461718	IsS11Max=Yes	IsS11Min=No	FrameElem=89	ElemStation=0				
Frame=89	Station=0	OutputCase=FESSUR	CaseType=Combination	Point=4	X2=0.5	X3=0.5		
S11=628.691249461718	IsS11Max=No	IsS11Min=No	FrameElem=89	ElemStation=0				
Frame=89	Station=0.5	OutputCase=FESSUR	CaseType=Combination	Point=0	X2=0	X3=0	S11=-774.999995651853	
IsS11Max=No	IsS11Min=No	FrameElem=89	ElemStation=0.5					
Frame=89	Station=0.5	OutputCase=FESSUR	CaseType=Combination	Point=1	X2=-0.5	X3=-0.5	S11=-	
2674.35661146917	IsS11Max=No	IsS11Min=Yes	FrameElem=89	ElemStation=0.5				
Frame=89	Station=0.5	OutputCase=FESSUR	CaseType=Combination	Point=2	X2=-0.5	X3=0.5	S11=-	
2674.35661146917	IsS11Max=No	IsS11Min=No	FrameElem=89	ElemStation=0.5				
Frame=89	Station=0.5	OutputCase=FESSUR	CaseType=Combination	Point=3	X2=0.5	X3=-0.5		
S11=1124.35662016547	IsS11Max=Yes	IsS11Min=No	FrameElem=89	ElemStation=0.5				
Frame=89	Station=0.5	OutputCase=FESSUR	CaseType=Combination	Point=4	X2=0.5	X3=0.5		
S11=1124.35662016547	IsS11Max=No	IsS11Min=No	FrameElem=89	ElemStation=0.5				
Frame=90	Station=0	OutputCase=PESOPR	CaseType=LinStatic	Point=0	X2=0	X3=0	S11=-149.99999272346	
IsS11Max=No	IsS11Min=No	FrameElem=90	ElemStation=0					
Frame=90	Station=0	OutputCase=PESOPR	CaseType=LinStatic	Point=1	X2=-0.5	X3=-0.5		
S11=295.019357961275	IsS11Max=Yes	IsS11Min=No	FrameElem=90	ElemStation=0				
Frame=90	Station=0	OutputCase=PESOPR	CaseType=LinStatic	Point=2	X2=-0.5	X3=0.5	S11=295.019357961275	
IsS11Max=No	IsS11Min=No	FrameElem=90	ElemStation=0					
Frame=90	Station=0	OutputCase=PESOPR	CaseType=LinStatic	Point=3	X2=0.5	X3=-0.5	S11=-	
595.019356505967	IsS11Max=No	IsS11Min=Yes	FrameElem=90	ElemStation=0				
Frame=90	Station=0	OutputCase=PESOPR	CaseType=LinStatic	Point=4	X2=0.5	X3=0.5	S11=-595.019356505967	
IsS11Max=No	IsS11Min=No	FrameElem=90	ElemStation=0					
Frame=90	Station=0.5	OutputCase=PESOPR	CaseType=LinStatic	Point=0	X2=0	X3=0	S11=-137.499999272346	
IsS11Max=No	IsS11Min=No	FrameElem=90	ElemStation=0.5					
Frame=90	Station=0.5	OutputCase=PESOPR	CaseType=LinStatic	Point=1	X2=-0.5	X3=-0.5		
S11=262.00651432545	IsS11Max=Yes	IsS11Min=No	FrameElem=90	ElemStation=0.5				
Frame=90	Station=0.5	OutputCase=PESOPR	CaseType=LinStatic	Point=2	X2=-0.5	X3=0.5		
S11=262.00651432545	IsS11Max=No	IsS11Min=No	FrameElem=90	ElemStation=0.5				
Frame=90	Station=0.5	OutputCase=PESOPR	CaseType=LinStatic	Point=3	X2=0.5	X3=-0.5	S11=-	
537.006512870142	IsS11Max=No	IsS11Min=Yes	FrameElem=90	ElemStation=0.5				



Frame=90	Station=0.5	OutputCase=PESOPR	CaseType=LinStatic	Point=4	X2=0.5	X3=0.5	S11=-
537.006512870142	IsS11Max=No	IsS11Min=No	FrameElem=90	ElemStation=0.5			
Frame=90	Station=0	OutputCase=TERRVERT	CaseType=LinStatic	Point=0	X2=0	X3=0	S11=-699.999993055826
IsS11Max=No	IsS11Min=No	FrameElem=90	ElemStation=0				
Frame=90	Station=0	OutputCase=TERRVERT	CaseType=LinStatic	Point=1	X2=-0.5	X3=-0.5	
S11=1215.05645425811	IsS11Max=Yes	IsS11Min=No	FrameElem=90	ElemStation=0			
Frame=90	Station=0	OutputCase=TERRVERT	CaseType=LinStatic	Point=2	X2=-0.5	X3=0.5	
S11=1215.05645425811	IsS11Max=No	IsS11Min=No	FrameElem=90	ElemStation=0			
Frame=90	Station=0	OutputCase=TERRVERT	CaseType=LinStatic	Point=3	X2=0.5	X3=-0.5	S11=-
2615.05644036976	IsS11Max=Yes	IsS11Min=Yes	FrameElem=90	ElemStation=0			
Frame=90	Station=0	OutputCase=TERRVERT	CaseType=LinStatic	Point=4	X2=0.5	X3=0.5	S11=-
2615.05644036976	IsS11Max=No	IsS11Min=No	FrameElem=90	ElemStation=0			
Frame=90	Station=0.5	OutputCase=TERRVERT	CaseType=LinStatic	Point=0	X2=0	X3=0	S11=-699.999993055826
IsS11Max=No	IsS11Min=No	FrameElem=90	ElemStation=0.5				
Frame=90	Station=0.5	OutputCase=TERRVERT	CaseType=LinStatic	Point=1	X2=-0.5	X3=-0.5	
S11=1219.98455971467	IsS11Max=Yes	IsS11Min=No	FrameElem=90	ElemStation=0.5			
Frame=90	Station=0.5	OutputCase=TERRVERT	CaseType=LinStatic	Point=2	X2=-0.5	X3=0.5	
S11=1219.98455971467	IsS11Max=No	IsS11Min=No	FrameElem=90	ElemStation=0.5			
Frame=90	Station=0.5	OutputCase=TERRVERT	CaseType=LinStatic	Point=3	X2=0.5	X3=-0.5	S11=-
2619.98454582632	IsS11Max=No	IsS11Min=Yes	FrameElem=90	ElemStation=0.5			
Frame=90	Station=0.5	OutputCase=TERRVERT	CaseType=LinStatic	Point=4	X2=0.5	X3=0.5	S11=-
2619.98454582632	IsS11Max=No	IsS11Min=No	FrameElem=90	ElemStation=0.5			
Frame=90	Station=0	OutputCase=TERRLAT	CaseType=LinStatic	Point=0	X2=0	X3=0	S11=3.40277165378211E-06
IsS11Max=No	IsS11Min=No	FrameElem=90	ElemStation=0				
Frame=90	Station=0	OutputCase=TERRLAT	CaseType=LinStatic	Point=1	X2=-0.5	X3=-0.5	S11=-
257.486394493132	IsS11Max=No	IsS11Min=Yes	FrameElem=90	ElemStation=0			
Frame=90	Station=0	OutputCase=TERRLAT	CaseType=LinStatic	Point=2	X2=-0.5	X3=0.5	S11=-
257.486394493132	IsS11Max=No	IsS11Min=No	FrameElem=90	ElemStation=0			
Frame=90	Station=0	OutputCase=TERRLAT	CaseType=LinStatic	Point=3	X2=0.5	X3=-0.5	
S11=257.486401298675	IsS11Max=Yes	IsS11Min=No	FrameElem=90	ElemStation=0			
Frame=90	Station=0	OutputCase=TERRLAT	CaseType=LinStatic	Point=4	X2=0.5	X3=0.5	S11=257.486401298675
IsS11Max=No	IsS11Min=No	FrameElem=90	ElemStation=0				
Frame=90	Station=0.5	OutputCase=TERRLAT	CaseType=LinStatic	Point=0	X2=0	X3=0	S11=2.80123168045598E-06
06	IsS11Max=No	IsS11Min=No	FrameElem=90	ElemStation=0.5			
Frame=90	Station=0.5	OutputCase=TERRLAT	CaseType=LinStatic	Point=1	X2=-0.5	X3=-0.5	S11=-
789.136296442943	IsS11Max=No	IsS11Min=Yes	FrameElem=90	ElemStation=0.5			
Frame=90	Station=0.5	OutputCase=TERRLAT	CaseType=LinStatic	Point=2	X2=-0.5	X3=0.5	S11=-
789.136296442943	IsS11Max=No	IsS11Min=No	FrameElem=90	ElemStation=0.5			
Frame=90	Station=0.5	OutputCase=TERRLAT	CaseType=LinStatic	Point=3	X2=0.5	X3=-0.5	
S11=789.136302045406	IsS11Max=Yes	IsS11Min=No	FrameElem=90	ElemStation=0.5			
Frame=90	Station=0.5	OutputCase=TERRLAT	CaseType=LinStatic	Point=4	X2=0.5	X3=0.5	
S11=789.136302045406	IsS11Max=No	IsS11Min=No	FrameElem=90	ElemStation=0.5			
Frame=90	Station=0	OutputCase=ACCVERT	CaseType=LinStatic	Point=0	X2=0	X3=0	S11=0
IsS11Min=Yes	FrameElem=90	ElemStation=0					IsS11Max=Yes
Frame=90	Station=0	OutputCase=ACCVERT	CaseType=LinStatic	Point=1	X2=-0.5	X3=-0.5	S11=0
IsS11Max=No	IsS11Min=No	FrameElem=90	ElemStation=0				
Frame=90	Station=0	OutputCase=ACCVERT	CaseType=LinStatic	Point=2	X2=-0.5	X3=0.5	S11=0
IsS11Min=No	FrameElem=90	ElemStation=0					IsS11Max=No
Frame=90	Station=0	OutputCase=ACCVERT	CaseType=LinStatic	Point=3	X2=0.5	X3=-0.5	S11=0
IsS11Min=No	FrameElem=90	ElemStation=0					IsS11Max=No
Frame=90	Station=0	OutputCase=ACCVERT	CaseType=LinStatic	Point=4	X2=0.5	X3=0.5	S11=0
IsS11Min=No	FrameElem=90	ElemStation=0					IsS11Max=No
Frame=90	Station=0.5	OutputCase=ACCVERT	CaseType=LinStatic	Point=0	X2=0	X3=0	S11=0
IsS11Min=Yes	FrameElem=90	ElemStation=0.5					IsS11Max=Yes
Frame=90	Station=0.5	OutputCase=ACCVERT	CaseType=LinStatic	Point=1	X2=-0.5	X3=-0.5	S11=0
IsS11Max=No	IsS11Min=No	FrameElem=90	ElemStation=0.5				
Frame=90	Station=0.5	OutputCase=ACCVERT	CaseType=LinStatic	Point=2	X2=-0.5	X3=0.5	S11=0
IsS11Max=No	IsS11Min=No	FrameElem=90	ElemStation=0.5				
Frame=90	Station=0.5	OutputCase=ACCVERT	CaseType=LinStatic	Point=3	X2=0.5	X3=-0.5	S11=0
IsS11Max=No	IsS11Min=No	FrameElem=90	ElemStation=0.5				
Frame=90	Station=0.5	OutputCase=ACCVERT	CaseType=LinStatic	Point=4	X2=0.5	X3=0.5	S11=0
IsS11Max=No	IsS11Min=No	FrameElem=90	ElemStation=0.5				
Frame=90	Station=0	OutputCase=ACCLATDX	CaseType=LinStatic	Point=0	X2=0	X3=0	S11=0
IsS11Min=Yes	FrameElem=90	ElemStation=0					IsS11Max=Yes
Frame=90	Station=0	OutputCase=ACCLATDX	CaseType=LinStatic	Point=1	X2=-0.5	X3=-0.5	S11=0
IsS11Max=No	IsS11Min=No	FrameElem=90	ElemStation=0				
Frame=90	Station=0	OutputCase=ACCLATDX	CaseType=LinStatic	Point=2	X2=-0.5	X3=0.5	S11=0
IsS11Max=No	IsS11Min=No	FrameElem=90	ElemStation=0				
Frame=90	Station=0	OutputCase=ACCLATDX	CaseType=LinStatic	Point=3	X2=0.5	X3=-0.5	S11=0
IsS11Max=No	IsS11Min=No	FrameElem=90	ElemStation=0				
Frame=90	Station=0	OutputCase=ACCLATDX	CaseType=LinStatic	Point=4	X2=0.5	X3=0.5	S11=0
IsS11Max=No	IsS11Min=No	FrameElem=90	ElemStation=0				IsS11Max=No
Frame=90	Station=0.5	OutputCase=ACCLATDX	CaseType=LinStatic	Point=0	X2=0	X3=0	S11=0
IsS11Min=Yes	FrameElem=90	ElemStation=0.5					IsS11Max=Yes
Frame=90	Station=0.5	OutputCase=ACCLATDX	CaseType=LinStatic	Point=1	X2=-0.5	X3=-0.5	S11=0
IsS11Max=No	IsS11Min=No	FrameElem=90	ElemStation=0.5				
Frame=90	Station=0.5	OutputCase=ACCLATDX	CaseType=LinStatic	Point=2	X2=-0.5	X3=0.5	S11=0
IsS11Max=No	IsS11Min=No	FrameElem=90	ElemStation=0.5				
Frame=90	Station=0.5	OutputCase=ACCLATDX	CaseType=LinStatic	Point=3	X2=0.5	X3=-0.5	S11=0
IsS11Max=No	IsS11Min=No	FrameElem=90	ElemStation=0.5				
Frame=90	Station=0.5	OutputCase=ACCLATDX	CaseType=LinStatic	Point=4	X2=0.5	X3=0.5	S11=0
IsS11Max=No	IsS11Min=No	FrameElem=90	ElemStation=0.5				



Frame=90	Station=0	OutputCase=ENVE	CaseType=Combination	StepType=Min	Point=1	X2=-0.5	X3=-0.5		
S11=1252.58941772625	IsS11Max=Yes	IsS11Min=No	FrameElem=90	ElemStation=0					
Frame=90	Station=0	OutputCase=ENVE	CaseType=Combination	StepType=Min	Point=2	X2=-0.5	X3=0.5		
S11=1252.58941772625	IsS11Max=No	IsS11Min=No	FrameElem=90	ElemStation=0					
Frame=90	Station=0	OutputCase=ENVE	CaseType=Combination	StepType=Min	Point=3	X2=0.5	X3=-0.5	S11=-	
3029.83531596666	IsS11Max=No	IsS11Min=Yes	FrameElem=90	ElemStation=0					
Frame=90	Station=0	OutputCase=ENVE	CaseType=Combination	StepType=Min	Point=4	X2=0.5	X3=0.5	S11=-	
3029.83531596666	IsS11Max=No	IsS11Min=No	FrameElem=90	ElemStation=0					
Frame=90	Station=0.5	OutputCase=ENVE	CaseType=Combination	StepType=Min	Point=0	X2=0	X3=0	S11=-	
837.49999036731	IsS11Max=No	IsS11Min=No	FrameElem=90	ElemStation=0.5					
Frame=90	Station=0.5	OutputCase=ENVE	CaseType=Combination	StepType=Min	Point=1	X2=-0.5	X3=-0.5		
S11=692.85477759718	IsS11Max=Yes	IsS11Min=No	FrameElem=90	ElemStation=0.5					
Frame=90	Station=0.5	OutputCase=ENVE	CaseType=Combination	StepType=Min	Point=2	X2=-0.5	X3=0.5		
S11=692.85477759718	IsS11Max=No	IsS11Min=No	FrameElem=90	ElemStation=0.5					
Frame=90	Station=0.5	OutputCase=ENVE	CaseType=Combination	StepType=Min	Point=3	X2=0.5	X3=-0.5		
S11=-2604.59564726468	IsS11Max=No	IsS11Min=Yes	FrameElem=90	ElemStation=0.5					
Frame=90	Station=0.5	OutputCase=ENVE	CaseType=Combination	StepType=Min	Point=4	X2=0.5	X3=0.5		
S11=-2604.59564726468	IsS11Max=No	IsS11Min=No	FrameElem=90	ElemStation=0.5					
Frame=90	Station=0	OutputCase=FESSUR	CaseType=Combination	Point=0	X2=0	X3=0	S11=-849.9999889254		
IsS11Max=No	IsS11Min=No	FrameElem=90	ElemStation=0						
Frame=90	Station=0	OutputCase=FESSUR	CaseType=Combination	Point=1	X2=-0.5	X3=-0.5			
S11=1252.58941772625	IsS11Max=Yes	IsS11Min=No	FrameElem=90	ElemStation=0					
Frame=90	Station=0	OutputCase=FESSUR	CaseType=Combination	Point=2	X2=-0.5	X3=0.5			
S11=1252.58941772625	IsS11Max=No	IsS11Min=No	FrameElem=90	ElemStation=0					
Frame=90	Station=0	OutputCase=FESSUR	CaseType=Combination	Point=3	X2=0.5	X3=-0.5	S11=-		
2952.58939557705	IsS11Max=No	IsS11Min=Yes	FrameElem=90	ElemStation=0					
Frame=90	Station=0	OutputCase=FESSUR	CaseType=Combination	Point=4	X2=0.5	X3=0.5	S11=-		
2952.58939557705	IsS11Max=No	IsS11Min=No	FrameElem=90	ElemStation=0					
Frame=90	Station=0.5	OutputCase=FESSUR	CaseType=Combination	Point=0	X2=0	X3=0	S11=-837.49998952694		
IsS11Max=No	IsS11Min=No	FrameElem=90	ElemStation=0.5						
Frame=90	Station=0.5	OutputCase=FESSUR	CaseType=Combination	Point=1	X2=-0.5	X3=-0.5			
S11=692.85477759718	IsS11Max=Yes	IsS11Min=No	FrameElem=90	ElemStation=0.5					
Frame=90	Station=0.5	OutputCase=FESSUR	CaseType=Combination	Point=2	X2=-0.5	X3=0.5			
S11=692.85477759718	IsS11Max=No	IsS11Min=No	FrameElem=90	ElemStation=0.5					
Frame=90	Station=0.5	OutputCase=FESSUR	CaseType=Combination	Point=3	X2=0.5	X3=-0.5	S11=-		
2367.85475665106	IsS11Max=No	IsS11Min=Yes	FrameElem=90	ElemStation=0.5					
Frame=90	Station=0.5	OutputCase=FESSUR	CaseType=Combination	Point=4	X2=0.5	X3=0.5	S11=-		
2367.85475665106	IsS11Max=No	IsS11Min=No	FrameElem=90	ElemStation=0.5					
Frame=91	Station=0	OutputCase=PESOPR	CaseType=LinStatic	Point=0	X2=0	X3=0	S11=-137.499999272259		
IsS11Max=No	IsS11Min=No	FrameElem=91	ElemStation=0						
Frame=91	Station=0	OutputCase=PESOPR	CaseType=LinStatic	Point=1	X2=-0.5	X3=-0.5			
S11=262.006514325537	IsS11Max=Yes	IsS11Min=No	FrameElem=91	ElemStation=0					
Frame=91	Station=0	OutputCase=PESOPR	CaseType=LinStatic	Point=2	X2=-0.5	X3=0.5	S11=262.006514325537		
IsS11Max=No	IsS11Min=No	FrameElem=91	ElemStation=0						
Frame=91	Station=0	OutputCase=PESOPR	CaseType=LinStatic	Point=3	X2=0.5	X3=-0.5	S11=-		
537.006512870055	IsS11Max=No	IsS11Min=Yes	FrameElem=91	ElemStation=0					
Frame=91	Station=0	OutputCase=PESOPR	CaseType=LinStatic	Point=4	X2=0.5	X3=0.5	S11=-537.006512870055		
IsS11Max=No	IsS11Min=No	FrameElem=91	ElemStation=0						
Frame=91	Station=0.5	OutputCase=PESOPR	CaseType=LinStatic	Point=0	X2=0	X3=0	S11=-124.999999272259		
IsS11Max=No	IsS11Min=No	FrameElem=91	ElemStation=0.5						
Frame=91	Station=0.5	OutputCase=PESOPR	CaseType=LinStatic	Point=1	X2=-0.5	X3=-0.5			
S11=228.993670987738	IsS11Max=Yes	IsS11Min=No	FrameElem=91	ElemStation=0.5					
Frame=91	Station=0.5	OutputCase=PESOPR	CaseType=LinStatic	Point=2	X2=-0.5	X3=0.5			
S11=228.993670987738	IsS11Max=No	IsS11Min=No	FrameElem=91	ElemStation=0.5					
Frame=91	Station=0.5	OutputCase=PESOPR	CaseType=LinStatic	Point=3	X2=0.5	X3=-0.5	S11=-		
478.993669532255	IsS11Max=No	IsS11Min=Yes	FrameElem=91	ElemStation=0.5					
Frame=91	Station=0.5	OutputCase=PESOPR	CaseType=LinStatic	Point=4	X2=0.5	X3=0.5	S11=-		
478.993669532255	IsS11Max=No	IsS11Min=No	FrameElem=91	ElemStation=0.5					
Frame=91	Station=0	OutputCase=TERRVERT	CaseType=LinStatic	Point=0	X2=0	X3=0	S11=-699.99999305571		
IsS11Max=No	IsS11Min=No	FrameElem=91	ElemStation=0						
Frame=91	Station=0	OutputCase=TERRVERT	CaseType=LinStatic	Point=1	X2=-0.5	X3=-0.5			
S11=1219.98455971478	IsS11Max=Yes	IsS11Min=No	FrameElem=91	ElemStation=0					
Frame=91	Station=0	OutputCase=TERRVERT	CaseType=LinStatic	Point=2	X2=-0.5	X3=0.5			
S11=1219.98455971478	IsS11Max=No	IsS11Min=No	FrameElem=91	ElemStation=0					
Frame=91	Station=0	OutputCase=TERRVERT	CaseType=LinStatic	Point=3	X2=0.5	X3=-0.5	S11=-		
2619.9845458262	IsS11Max=No	IsS11Min=Yes	FrameElem=91	ElemStation=0					
Frame=91	Station=0	OutputCase=TERRVERT	CaseType=LinStatic	Point=4	X2=0.5	X3=0.5	S11=-		
2619.9845458262	IsS11Max=No	IsS11Min=No	FrameElem=91	ElemStation=0					
Frame=91	Station=0.5	OutputCase=TERRVERT	CaseType=LinStatic	Point=0	X2=0	X3=0	S11=-699.99999305571		
IsS11Max=No	IsS11Min=No	FrameElem=91	ElemStation=0.5						
Frame=91	Station=0.5	OutputCase=TERRVERT	CaseType=LinStatic	Point=1	X2=-0.5	X3=-0.5			
S11=1224.91266517136	IsS11Max=Yes	IsS11Min=No	FrameElem=91	ElemStation=0.5					
Frame=91	Station=0.5	OutputCase=TERRVERT	CaseType=LinStatic	Point=2	X2=-0.5	X3=0.5			
S11=1224.91266517136	IsS11Max=No	IsS11Min=No	FrameElem=91	ElemStation=0.5					
Frame=91	Station=0.5	OutputCase=TERRVERT	CaseType=LinStatic	Point=3	X2=0.5	X3=-0.5	S11=-		
2624.91265128278	IsS11Max=No	IsS11Min=Yes	FrameElem=91	ElemStation=0.5					
Frame=91	Station=0.5	OutputCase=TERRVERT	CaseType=LinStatic	Point=4	X2=0.5	X3=0.5	S11=-		
2624.91265128278	IsS11Max=No	IsS11Min=No	FrameElem=91	ElemStation=0.5					
Frame=91	Station=0	OutputCase=TERRLAT	CaseType=LinStatic	Point=0	X2=0	X3=0	S11=2.80123094853479E-06		
IsS11Max=No	IsS11Min=No	FrameElem=91	ElemStation=0						
Frame=91	Station=0	OutputCase=TERRLAT	CaseType=LinStatic	Point=1	X2=-0.5	X3=-0.5	S11=-		
789.136296442942	IsS11Max=No	IsS11Min=Yes	FrameElem=91	ElemStation=0					

Frame=91	Station=0	OutputCase=TERRLAT	CaseType=LinStatic	Point=2	X2=-0.5	X3=0.5	S11=-		
789.136296442942	IsS11Max=No	IsS11Min=No	FrameElem=91	ElemStation=0					
Frame=91	Station=0	OutputCase=TERRLAT	CaseType=LinStatic	Point=3	X2=0.5	X3=-0.5			
S11=789.136302045404	IsS11Max=Yes	IsS11Min=No	FrameElem=91	ElemStation=0					
Frame=91	Station=0	OutputCase=TERRLAT	CaseType=LinStatic	Point=4	X2=0.5	X3=0.5	S11=789.136302045404		
IsS11Max=No	IsS11Min=No	FrameElem=91	ElemStation=0						
Frame=91	Station=0.5	OutputCase=TERRLAT	CaseType=LinStatic	Point=0	X2=0	X3=0	S11=2.21663849619635E-		
06	IsS11Max=No	IsS11Min=No	FrameElem=91	ElemStation=0.5					
Frame=91	Station=0.5	OutputCase=TERRLAT	CaseType=LinStatic	Point=1	X2=-0.5	X3=-0.5	S11=-		
1096.91119837581	IsS11Max=No	IsS11Min=Yes	FrameElem=91	ElemStation=0.5					
Frame=91	Station=0.5	OutputCase=TERRLAT	CaseType=LinStatic	Point=2	X2=-0.5	X3=0.5	S11=-		
1096.91119837581	IsS11Max=No	IsS11Min=No	FrameElem=91	ElemStation=0.5					
Frame=91	Station=0.5	OutputCase=TERRLAT	CaseType=LinStatic	Point=3	X2=0.5	X3=-0.5			
S11=1096.91120280908	IsS11Max=Yes	IsS11Min=No	FrameElem=91	ElemStation=0.5					
Frame=91	Station=0.5	OutputCase=TERRLAT	CaseType=LinStatic	Point=4	X2=0.5	X3=0.5			
S11=1096.91120280908	IsS11Max=No	IsS11Min=No	FrameElem=91	ElemStation=0.5					
Frame=91	Station=0	OutputCase=ACCVERT	CaseType=LinStatic	Point=0	X2=0	X3=0	S11=0	IsS11Max=Yes	
IsS11Min=Yes	FrameElem=91	ElemStation=0							
Frame=91	Station=0	OutputCase=ACCVERT	CaseType=LinStatic	Point=1	X2=-0.5	X3=-0.5	S11=0		
IsS11Max=No	IsS11Min=No	FrameElem=91	ElemStation=0						
Frame=91	Station=0	OutputCase=ACCVERT	CaseType=LinStatic	Point=2	X2=-0.5	X3=0.5	S11=0	IsS11Max=No	
IsS11Min=No	FrameElem=91	ElemStation=0							
Frame=91	Station=0	OutputCase=ACCVERT	CaseType=LinStatic	Point=3	X2=0.5	X3=-0.5	S11=0	IsS11Max=No	
IsS11Min=No	FrameElem=91	ElemStation=0							
Frame=91	Station=0	OutputCase=ACCVERT	CaseType=LinStatic	Point=4	X2=0.5	X3=0.5	S11=0	IsS11Max=No	
IsS11Min=No	FrameElem=91	ElemStation=0							
Frame=91	Station=0.5	OutputCase=ACCVERT	CaseType=LinStatic	Point=0	X2=0	X3=0	S11=0	IsS11Max=Yes	
IsS11Min=Yes	FrameElem=91	ElemStation=0.5							
Frame=91	Station=0.5	OutputCase=ACCVERT	CaseType=LinStatic	Point=1	X2=-0.5	X3=-0.5	S11=0		
IsS11Max=No	IsS11Min=No	FrameElem=91	ElemStation=0.5						
Frame=91	Station=0.5	OutputCase=ACCVERT	CaseType=LinStatic	Point=2	X2=-0.5	X3=0.5	S11=0		
IsS11Max=No	IsS11Min=No	FrameElem=91	ElemStation=0.5						
Frame=91	Station=0.5	OutputCase=ACCVERT	CaseType=LinStatic	Point=3	X2=0.5	X3=-0.5	S11=0		
IsS11Max=No	IsS11Min=No	FrameElem=91	ElemStation=0.5						
Frame=91	Station=0.5	OutputCase=ACCVERT	CaseType=LinStatic	Point=4	X2=0.5	X3=0.5	S11=0		
IsS11Max=No	IsS11Min=No	FrameElem=91	ElemStation=0.5						
Frame=91	Station=0	OutputCase=ACCLATDX	CaseType=LinStatic	Point=0	X2=0	X3=0	S11=0	IsS11Max=Yes	
IsS11Min=Yes	FrameElem=91	ElemStation=0							
Frame=91	Station=0	OutputCase=ACCLATDX	CaseType=LinStatic	Point=1	X2=-0.5	X3=-0.5	S11=0		
IsS11Max=No	IsS11Min=No	FrameElem=91	ElemStation=0						
Frame=91	Station=0	OutputCase=ACCLATDX	CaseType=LinStatic	Point=2	X2=-0.5	X3=0.5	S11=0		
IsS11Max=No	IsS11Min=No	FrameElem=91	ElemStation=0						
Frame=91	Station=0	OutputCase=ACCLATDX	CaseType=LinStatic	Point=3	X2=0.5	X3=-0.5	S11=0		
IsS11Max=No	IsS11Min=No	FrameElem=91	ElemStation=0						
Frame=91	Station=0	OutputCase=ACCLATDX	CaseType=LinStatic	Point=4	X2=0.5	X3=0.5	S11=0	IsS11Max=No	
IsS11Min=No	FrameElem=91	ElemStation=0							
Frame=91	Station=0.5	OutputCase=ACCLATDX	CaseType=LinStatic	Point=0	X2=0	X3=0	S11=0	IsS11Max=Yes	
IsS11Min=Yes	FrameElem=91	ElemStation=0.5							
Frame=91	Station=0.5	OutputCase=ACCLATDX	CaseType=LinStatic	Point=1	X2=-0.5	X3=-0.5	S11=0		
IsS11Max=No	IsS11Min=No	FrameElem=91	ElemStation=0.5						
Frame=91	Station=0.5	OutputCase=ACCLATDX	CaseType=LinStatic	Point=2	X2=-0.5	X3=0.5	S11=0		
IsS11Max=No	IsS11Min=No	FrameElem=91	ElemStation=0.5						
Frame=91	Station=0.5	OutputCase=ACCLATDX	CaseType=LinStatic	Point=3	X2=0.5	X3=-0.5	S11=0		
IsS11Max=No	IsS11Min=No	FrameElem=91	ElemStation=0.5						
Frame=91	Station=0.5	OutputCase=ACCLATDX	CaseType=LinStatic	Point=4	X2=0.5	X3=0.5	S11=0		
IsS11Max=No	IsS11Min=No	FrameElem=91	ElemStation=0.5						
Frame=91	Station=0	OutputCase=ACCLATSX	CaseType=LinStatic	Point=0	X2=0	X3=0	S11=0	IsS11Max=Yes	
IsS11Min=Yes	FrameElem=91	ElemStation=0							
Frame=91	Station=0	OutputCase=ACCLATSX	CaseType=LinStatic	Point=1	X2=-0.5	X3=-0.5	S11=0		
IsS11Max=No	IsS11Min=No	FrameElem=91	ElemStation=0						
Frame=91	Station=0	OutputCase=ACCLATSX	CaseType=LinStatic	Point=2	X2=-0.5	X3=0.5	S11=0		
IsS11Max=No	IsS11Min=No	FrameElem=91	ElemStation=0						
Frame=91	Station=0	OutputCase=ACCLATSX	CaseType=LinStatic	Point=3	X2=0.5	X3=-0.5	S11=0		
IsS11Max=No	IsS11Min=No	FrameElem=91	ElemStation=0						
Frame=91	Station=0	OutputCase=ACCLATSX	CaseType=LinStatic	Point=4	X2=0.5	X3=0.5	S11=0	IsS11Max=No	
IsS11Min=No	FrameElem=91	ElemStation=0							
Frame=91	Station=0.5	OutputCase=ACCLATSX	CaseType=LinStatic	Point=0	X2=0	X3=0	S11=0	IsS11Max=Yes	
IsS11Min=Yes	FrameElem=91	ElemStation=0.5							
Frame=91	Station=0.5	OutputCase=ACCLATSX	CaseType=LinStatic	Point=1	X2=-0.5	X3=-0.5	S11=0		
IsS11Max=No	IsS11Min=No	FrameElem=91	ElemStation=0.5						
Frame=91	Station=0.5	OutputCase=ACCLATSX	CaseType=LinStatic	Point=2	X2=-0.5	X3=0.5	S11=0		
IsS11Max=No	IsS11Min=No	FrameElem=91	ElemStation=0.5						
Frame=91	Station=0.5	OutputCase=ACCLATSX	CaseType=LinStatic	Point=3	X2=0.5	X3=-0.5	S11=0		
IsS11Max=No	IsS11Min=No	FrameElem=91	ElemStation=0.5						
Frame=91	Station=0.5	OutputCase=ACCLATSX	CaseType=LinStatic	Point=4	X2=0.5	X3=0.5	S11=0		
IsS11Max=No	IsS11Min=No	FrameElem=91	ElemStation=0.5						
Frame=91	Station=0	OutputCase=TERRCOST	CaseType=LinStatic	Point=0	X2=0	X3=0	S11=0	IsS11Max=Yes	
IsS11Min=Yes	FrameElem=91	ElemStation=0							
Frame=91	Station=0	OutputCase=TERRCOST	CaseType=LinStatic	Point=1	X2=-0.5	X3=-0.5	S11=0		
IsS11Max=No	IsS11Min=No	FrameElem=91	ElemStation=0						
Frame=91	Station=0	OutputCase=TERRCOST	CaseType=LinStatic	Point=2	X2=-0.5	X3=0.5	S11=0		
IsS11Max=No	IsS11Min=No	FrameElem=91	ElemStation=0						



Frame=91	Station=0	OutputCase=TERRCOST	CaseType=LinStatic	Point=3	X2=0.5	X3=-0.5	S11=0		
IsS11Max=No	IsS11Min=No	FrameElem=91	ElemStation=0						
Frame=91	Station=0	OutputCase=TERRCOST	CaseType=LinStatic	Point=4	X2=0.5	X3=0.5	S11=0	IsS11Max=No	
IsS11Min=No	FrameElem=91	ElemStation=0							
Frame=91	Station=0.5	OutputCase=TERRCOST	CaseType=LinStatic	Point=0	X2=0	X3=0	S11=0	IsS11Max=Yes	
IsS11Min=Yes	FrameElem=91	ElemStation=0.5							
Frame=91	Station=0.5	OutputCase=TERRCOST	CaseType=LinStatic	Point=1	X2=-0.5	X3=-0.5	S11=0		
IsS11Max=No	IsS11Min=No	FrameElem=91	ElemStation=0.5						
Frame=91	Station=0.5	OutputCase=TERRCOST	CaseType=LinStatic	Point=2	X2=-0.5	X3=0.5	S11=0		
IsS11Max=No	IsS11Min=No	FrameElem=91	ElemStation=0.5						
Frame=91	Station=0.5	OutputCase=TERRCOST	CaseType=LinStatic	Point=3	X2=0.5	X3=-0.5	S11=0		
IsS11Max=No	IsS11Min=No	FrameElem=91	ElemStation=0.5						
Frame=91	Station=0.5	OutputCase=TERRCOST	CaseType=LinStatic	Point=4	X2=0.5	X3=0.5	S11=0		
IsS11Max=No	IsS11Min=No	FrameElem=91	ElemStation=0.5						
Frame=91	Station=0	OutputCase=SOVRCOST	CaseType=LinStatic	Point=0	X2=0	X3=0	S11=0	IsS11Max=Yes	
IsS11Min=Yes	FrameElem=91	ElemStation=0							
Frame=91	Station=0	OutputCase=SOVRCOST	CaseType=LinStatic	Point=1	X2=-0.5	X3=-0.5	S11=0		
IsS11Max=No	IsS11Min=No	FrameElem=91	ElemStation=0						
Frame=91	Station=0	OutputCase=SOVRCOST	CaseType=LinStatic	Point=2	X2=-0.5	X3=0.5	S11=0		
IsS11Max=No	IsS11Min=No	FrameElem=91	ElemStation=0						
Frame=91	Station=0	OutputCase=SOVRCOST	CaseType=LinStatic	Point=3	X2=0.5	X3=-0.5	S11=0		
IsS11Max=No	IsS11Min=No	FrameElem=91	ElemStation=0						
Frame=91	Station=0	OutputCase=SOVRCOST	CaseType=LinStatic	Point=4	X2=0.5	X3=0.5	S11=0	IsS11Max=No	
IsS11Min=No	FrameElem=91	ElemStation=0							
Frame=91	Station=0.5	OutputCase=SOVRCOST	CaseType=LinStatic	Point=0	X2=0	X3=0	S11=0	IsS11Max=Yes	
IsS11Min=Yes	FrameElem=91	ElemStation=0.5							
Frame=91	Station=0.5	OutputCase=SOVRCOST	CaseType=LinStatic	Point=1	X2=-0.5	X3=-0.5	S11=0		
IsS11Max=No	IsS11Min=No	FrameElem=91	ElemStation=0.5						
Frame=91	Station=0.5	OutputCase=SOVRCOST	CaseType=LinStatic	Point=2	X2=-0.5	X3=0.5	S11=0		
IsS11Max=No	IsS11Min=No	FrameElem=91	ElemStation=0.5						
Frame=91	Station=0.5	OutputCase=SOVRCOST	CaseType=LinStatic	Point=3	X2=0.5	X3=-0.5	S11=0		
IsS11Max=No	IsS11Min=No	FrameElem=91	ElemStation=0.5						
Frame=91	Station=0.5	OutputCase=SOVRCOST	CaseType=LinStatic	Point=4	X2=0.5	X3=0.5	S11=0		
IsS11Max=No	IsS11Min=No	FrameElem=91	ElemStation=0.5						
Frame=91	Station=0	OutputCase=ENVE	CaseType=Combination	StepType=Max	Point=0	X2=0	X3=0	S11=-	
837.499989526737	IsS11Max=No	IsS11Min=No	FrameElem=91	ElemStation=0					
Frame=91	Station=0	OutputCase=ENVE	CaseType=Combination	StepType=Max	Point=1	X2=-0.5	X3=-0.5		
S11=929.595666530262	IsS11Max=Yes	IsS11Min=No	FrameElem=91	ElemStation=0					
Frame=91	Station=0	OutputCase=ENVE	CaseType=Combination	StepType=Max	Point=2	X2=-0.5	X3=0.5		
S11=929.595666530262	IsS11Max=No	IsS11Min=No	FrameElem=91	ElemStation=0					
Frame=91	Station=0	OutputCase=ENVE	CaseType=Combination	StepType=Max	Point=3	X2=0.5	X3=-0.5	S11=-	
2367.85475665085	IsS11Max=No	IsS11Min=Yes	FrameElem=91	ElemStation=0					
Frame=91	Station=0	OutputCase=ENVE	CaseType=Combination	StepType=Max	Point=4	X2=0.5	X3=0.5	S11=-	
2367.85475665085	IsS11Max=No	IsS11Min=No	FrameElem=91	ElemStation=0					
Frame=91	Station=0.5	OutputCase=ENVE	CaseType=Combination	StepType=Max	Point=0	X2=0	X3=0	S11=-	
824.99999011133	IsS11Max=No	IsS11Min=No	FrameElem=91	ElemStation=0.5					
Frame=91	Station=0.5	OutputCase=ENVE	CaseType=Combination	StepType=Max	Point=1	X2=-0.5	X3=-0.5		
S11=686.068497296033	IsS11Max=Yes	IsS11Min=No	FrameElem=91	ElemStation=0.5					
Frame=91	Station=0.5	OutputCase=ENVE	CaseType=Combination	StepType=Max	Point=2	X2=-0.5	X3=0.5		
S11=686.068497296033	IsS11Max=No	IsS11Min=No	FrameElem=91	ElemStation=0.5					
Frame=91	Station=0.5	OutputCase=ENVE	CaseType=Combination	StepType=Max	Point=3	X2=0.5	X3=-0.5		
S11=-2006.99511800595	IsS11Max=No	IsS11Min=Yes	FrameElem=91	ElemStation=0.5					
Frame=91	Station=0.5	OutputCase=ENVE	CaseType=Combination	StepType=Max	Point=4	X2=0.5	X3=0.5		
S11=-2006.99511800595	IsS11Max=No	IsS11Min=No	FrameElem=91	ElemStation=0.5					
Frame=91	Station=0	OutputCase=ENVE	CaseType=Combination	StepType=Min	Point=0	X2=0	X3=0	S11=-	
837.499990367107	IsS11Max=No	IsS11Min=No	FrameElem=91	ElemStation=0					
Frame=91	Station=0	OutputCase=ENVE	CaseType=Combination	StepType=Min	Point=1	X2=-0.5	X3=-0.5		
S11=692.854777597379	IsS11Max=Yes	IsS11Min=No	FrameElem=91	ElemStation=0					
Frame=91	Station=0	OutputCase=ENVE	CaseType=Combination	StepType=Min	Point=2	X2=-0.5	X3=0.5		
S11=692.854777597379	IsS11Max=No	IsS11Min=No	FrameElem=91	ElemStation=0					
Frame=91	Station=0	OutputCase=ENVE	CaseType=Combination	StepType=Min	Point=3	X2=0.5	X3=-0.5	S11=-	
2604.59564726448	IsS11Max=No	IsS11Min=Yes	FrameElem=91	ElemStation=0					
Frame=91	Station=0	OutputCase=ENVE	CaseType=Combination	StepType=Min	Point=4	X2=0.5	X3=0.5	S11=-	
2604.59564726448	IsS11Max=No	IsS11Min=No	FrameElem=91	ElemStation=0					
Frame=91	Station=0.5	OutputCase=ENVE	CaseType=Combination	StepType=Min	Point=0	X2=0	X3=0	S11=-	
824.999990776321	IsS11Max=No	IsS11Min=No	FrameElem=91	ElemStation=0.5					
Frame=91	Station=0.5	OutputCase=ENVE	CaseType=Combination	StepType=Min	Point=1	X2=-0.5	X3=-0.5		
S11=356.995137783292	IsS11Max=Yes	IsS11Min=No	FrameElem=91	ElemStation=0.5					
Frame=91	Station=0.5	OutputCase=ENVE	CaseType=Combination	StepType=Min	Point=2	X2=-0.5	X3=0.5		
S11=356.995137783292	IsS11Max=No	IsS11Min=No	FrameElem=91	ElemStation=0.5					
Frame=91	Station=0.5	OutputCase=ENVE	CaseType=Combination	StepType=Min	Point=3	X2=0.5	X3=-0.5		
S11=-2336.06847884868	IsS11Max=No	IsS11Min=Yes	FrameElem=91	ElemStation=0.5					
Frame=91	Station=0.5	OutputCase=ENVE	CaseType=Combination	StepType=Min	Point=4	X2=0.5	X3=0.5		
S11=-2336.06847884868	IsS11Max=No	IsS11Min=No	FrameElem=91	ElemStation=0.5					
Frame=91	Station=0	OutputCase=FESSUR	CaseType=Combination	Point=0	X2=0	X3=0	S11=-837.499989526737		
IsS11Max=No	IsS11Min=No	FrameElem=91	ElemStation=0						
Frame=91	Station=0	OutputCase=FESSUR	CaseType=Combination	Point=1	X2=-0.5	X3=-0.5			
S11=692.854777597379	IsS11Max=Yes	IsS11Min=No	FrameElem=91	ElemStation=0					
Frame=91	Station=0	OutputCase=FESSUR	CaseType=Combination	Point=2	X2=-0.5	X3=0.5			
S11=692.854777597379	IsS11Max=No	IsS11Min=No	FrameElem=91	ElemStation=0					
Frame=91	Station=0	OutputCase=FESSUR	CaseType=Combination	Point=3	X2=0.5	X3=-0.5	S11=-		
2367.85475665085	IsS11Max=No	IsS11Min=Yes	FrameElem=91	ElemStation=0					

Frame=91	Station=0	OutputCase=FESSUR	CaseType=Combination	Point=4	X2=0.5	X3=0.5	S11=-
2367.85475665085	IsS11Max=No	IsS11Min=No	FrameElem=91	ElemStation=0			
Frame=91	Station=0.5	OutputCase=FESSUR	CaseType=Combination	Point=0	X2=0	X3=0	S11=-824.99999011133
IsS11Max=No	IsS11Min=No	FrameElem=91	ElemStation=0.5				
Frame=91	Station=0.5	OutputCase=FESSUR	CaseType=Combination	Point=1	X2=-0.5	X3=-0.5	
S11=356.995137783292	IsS11Max=Yes	IsS11Min=No	FrameElem=91	ElemStation=0.5			
Frame=91	Station=0.5	OutputCase=FESSUR	CaseType=Combination	Point=2	X2=-0.5	X3=0.5	
S11=356.995137783292	IsS11Max=No	IsS11Min=No	FrameElem=91	ElemStation=0.5			
Frame=91	Station=0.5	OutputCase=FESSUR	CaseType=Combination	Point=3	X2=0.5	X3=-0.5	S11=-
2006.99511800595	IsS11Max=No	IsS11Min=Yes	FrameElem=91	ElemStation=0.5			
Frame=91	Station=0.5	OutputCase=FESSUR	CaseType=Combination	Point=4	X2=0.5	X3=0.5	S11=-
2006.99511800595	IsS11Max=No	IsS11Min=No	FrameElem=91	ElemStation=0.5			
Frame=92	Station=0	OutputCase=PESOPR	CaseType=LinStatic	Point=0	X2=0	X3=0	S11=-124.99999272259
IsS11Max=No	IsS11Min=No	FrameElem=92	ElemStation=0				
Frame=92	Station=0	OutputCase=PESOPR	CaseType=LinStatic	Point=1	X2=-0.5	X3=-0.5	
S11=228.993670987738	IsS11Max=Yes	IsS11Min=No	FrameElem=92	ElemStation=0			
Frame=92	Station=0	OutputCase=PESOPR	CaseType=LinStatic	Point=2	X2=-0.5	X3=0.5	S11=228.993670987738
IsS11Max=No	IsS11Min=No	FrameElem=92	ElemStation=0				
Frame=92	Station=0	OutputCase=PESOPR	CaseType=LinStatic	Point=3	X2=0.5	X3=-0.5	S11=-
478.993669532256	IsS11Max=No	IsS11Min=Yes	FrameElem=92	ElemStation=0			
Frame=92	Station=0	OutputCase=PESOPR	CaseType=LinStatic	Point=4	X2=0.5	X3=0.5	S11=-478.993669532256
IsS11Max=No	IsS11Min=No	FrameElem=92	ElemStation=0				
Frame=92	Station=0.5	OutputCase=PESOPR	CaseType=LinStatic	Point=0	X2=0	X3=0	S11=-112.49999272259
IsS11Max=No	IsS11Min=No	FrameElem=92	ElemStation=0.5				
Frame=92	Station=0.5	OutputCase=PESOPR	CaseType=LinStatic	Point=1	X2=-0.5	X3=-0.5	
S11=195.980827947962	IsS11Max=Yes	IsS11Min=No	FrameElem=92	ElemStation=0.5			
Frame=92	Station=0.5	OutputCase=PESOPR	CaseType=LinStatic	Point=2	X2=-0.5	X3=0.5	
S11=195.980827947962	IsS11Max=No	IsS11Min=No	FrameElem=92	ElemStation=0.5			
Frame=92	Station=0.5	OutputCase=PESOPR	CaseType=LinStatic	Point=3	X2=0.5	X3=-0.5	S11=-
420.98082649248	IsS11Max=No	IsS11Min=Yes	FrameElem=92	ElemStation=0.5			
Frame=92	Station=0.5	OutputCase=PESOPR	CaseType=LinStatic	Point=4	X2=0.5	X3=0.5	S11=-
420.98082649248	IsS11Max=No	IsS11Min=No	FrameElem=92	ElemStation=0.5			
Frame=92	Station=0	OutputCase=TERRVERT	CaseType=LinStatic	Point=0	X2=0	X3=0	S11=-699.99999305571
IsS11Max=No	IsS11Min=No	FrameElem=92	ElemStation=0				
Frame=92	Station=0	OutputCase=TERRVERT	CaseType=LinStatic	Point=1	X2=-0.5	X3=-0.5	
S11=1224.91266517136	IsS11Max=Yes	IsS11Min=No	FrameElem=92	ElemStation=0			
Frame=92	Station=0	OutputCase=TERRVERT	CaseType=LinStatic	Point=2	X2=-0.5	X3=0.5	
S11=1224.91266517136	IsS11Max=No	IsS11Min=No	FrameElem=92	ElemStation=0			
Frame=92	Station=0	OutputCase=TERRVERT	CaseType=LinStatic	Point=3	X2=0.5	X3=-0.5	S11=-
2624.91265128278	IsS11Max=No	IsS11Min=Yes	FrameElem=92	ElemStation=0			
Frame=92	Station=0	OutputCase=TERRVERT	CaseType=LinStatic	Point=4	X2=0.5	X3=0.5	S11=-
2624.91265128278	IsS11Max=No	IsS11Min=No	FrameElem=92	ElemStation=0			
Frame=92	Station=0.5	OutputCase=TERRVERT	CaseType=LinStatic	Point=0	X2=0	X3=0	S11=-699.99999305571
IsS11Max=No	IsS11Min=No	FrameElem=92	ElemStation=0.5				
Frame=92	Station=0.5	OutputCase=TERRVERT	CaseType=LinStatic	Point=1	X2=-0.5	X3=-0.5	
S11=1229.84077062794	IsS11Max=Yes	IsS11Min=No	FrameElem=92	ElemStation=0.5			
Frame=92	Station=0.5	OutputCase=TERRVERT	CaseType=LinStatic	Point=2	X2=-0.5	X3=0.5	
S11=1229.84077062794	IsS11Max=No	IsS11Min=No	FrameElem=92	ElemStation=0.5			
Frame=92	Station=0.5	OutputCase=TERRVERT	CaseType=LinStatic	Point=3	X2=0.5	X3=-0.5	S11=-
2629.84075673936	IsS11Max=No	IsS11Min=Yes	FrameElem=92	ElemStation=0.5			
Frame=92	Station=0.5	OutputCase=TERRVERT	CaseType=LinStatic	Point=4	X2=0.5	X3=0.5	S11=-
2629.84075673936	IsS11Max=No	IsS11Min=No	FrameElem=92	ElemStation=0.5			
Frame=92	Station=0	OutputCase=TERRLAT	CaseType=LinStatic	Point=0	X2=0	X3=0	S11=2.21663776756031E-06
IsS11Max=No	IsS11Min=No	FrameElem=92	ElemStation=0				
Frame=92	Station=0	OutputCase=TERRLAT	CaseType=LinStatic	Point=1	X2=-0.5	X3=-0.5	S11=-
1096.91119837581	IsS11Max=No	IsS11Min=Yes	FrameElem=92	ElemStation=0			
Frame=92	Station=0	OutputCase=TERRLAT	CaseType=LinStatic	Point=2	X2=-0.5	X3=0.5	S11=-
1096.91119837581	IsS11Max=No	IsS11Min=No	FrameElem=92	ElemStation=0			
Frame=92	Station=0	OutputCase=TERRLAT	CaseType=LinStatic	Point=3	X2=0.5	X3=-0.5	
S11=1096.91120280908	IsS11Max=Yes	IsS11Min=No	FrameElem=92	ElemStation=0			
Frame=92	Station=0	OutputCase=TERRLAT	CaseType=LinStatic	Point=4	X2=0.5	X3=0.5	S11=1096.91120280908
IsS11Max=No	IsS11Min=No	FrameElem=92	ElemStation=0				
Frame=92	Station=0.5	OutputCase=TERRLAT	CaseType=LinStatic	Point=0	X2=0	X3=0	S11=1.6489929034369E-06
IsS11Max=No	IsS11Min=No	FrameElem=92	ElemStation=0.5				
Frame=92	Station=0.5	OutputCase=TERRLAT	CaseType=LinStatic	Point=1	X2=-0.5	X3=-0.5	S11=-
1187.20860029172	IsS11Max=No	IsS11Min=Yes	FrameElem=92	ElemStation=0.5			
Frame=92	Station=0.5	OutputCase=TERRLAT	CaseType=LinStatic	Point=2	X2=-0.5	X3=0.5	S11=-
1187.20860029172	IsS11Max=No	IsS11Min=No	FrameElem=92	ElemStation=0.5			
Frame=92	Station=0.5	OutputCase=TERRLAT	CaseType=LinStatic	Point=3	X2=0.5	X3=-0.5	
S11=1187.20860358971	IsS11Max=Yes	IsS11Min=No	FrameElem=92	ElemStation=0.5			
Frame=92	Station=0.5	OutputCase=TERRLAT	CaseType=LinStatic	Point=4	X2=0.5	X3=0.5	
S11=1187.20860358971	IsS11Max=No	IsS11Min=No	FrameElem=92	ElemStation=0.5			
Frame=92	Station=0	OutputCase=ACCVERT	CaseType=LinStatic	Point=0	X2=0	X3=0	S11=0
IsS11Min=Yes	FrameElem=92	ElemStation=0					IsS11Max=Yes
Frame=92	Station=0	OutputCase=ACCVERT	CaseType=LinStatic	Point=1	X2=-0.5	X3=-0.5	S11=0
IsS11Max=No	IsS11Min=No	FrameElem=92	ElemStation=0				
Frame=92	Station=0	OutputCase=ACCVERT	CaseType=LinStatic	Point=2	X2=-0.5	X3=0.5	S11=0
IsS11Min=No	FrameElem=92	ElemStation=0					IsS11Max=No
Frame=92	Station=0	OutputCase=ACCVERT	CaseType=LinStatic	Point=3	X2=0.5	X3=-0.5	S11=0
IsS11Min=No	FrameElem=92	ElemStation=0					IsS11Max=No
Frame=92	Station=0	OutputCase=ACCVERT	CaseType=LinStatic	Point=4	X2=0.5	X3=0.5	S11=0
IsS11Min=No	FrameElem=92	ElemStation=0					IsS11Max=No



Frame=92	Station=0.5	OutputCase=SOVRCOST	CaseType=LinStatic	Point=1	X2=-0.5	X3=-0.5	S11=0	
IsS11Max=No	IsS11Min=No	FrameElem=92	ElemStation=0.5					
Frame=92	Station=0.5	OutputCase=SOVRCOST	CaseType=LinStatic	Point=2	X2=-0.5	X3=0.5	S11=0	
IsS11Max=No	IsS11Min=No	FrameElem=92	ElemStation=0.5					
Frame=92	Station=0.5	OutputCase=SOVRCOST	CaseType=LinStatic	Point=3	X2=0.5	X3=-0.5	S11=0	
IsS11Max=No	IsS11Min=No	FrameElem=92	ElemStation=0.5					
Frame=92	Station=0.5	OutputCase=SOVRCOST	CaseType=LinStatic	Point=4	X2=0.5	X3=0.5	S11=0	
IsS11Max=No	IsS11Min=No	FrameElem=92	ElemStation=0.5					
Frame=92	Station=0	OutputCase=ENVE	CaseType=Combination	StepType=Max	Point=0	X2=0	X3=0	S11=-
824.999990111331	IsS11Max=No	IsS11Min=No	FrameElem=92	ElemStation=0				
Frame=92	Station=0	OutputCase=ENVE	CaseType=Combination	StepType=Max	Point=1	X2=-0.5	X3=-0.5	
S11=686.068497296035	IsS11Max=Yes	IsS11Min=No	FrameElem=92	ElemStation=0				
Frame=92	Station=0	OutputCase=ENVE	CaseType=Combination	StepType=Max	Point=2	X2=-0.5	X3=0.5	
S11=686.068497296035	IsS11Max=No	IsS11Min=No	FrameElem=92	ElemStation=0				
Frame=92	Station=0	OutputCase=ENVE	CaseType=Combination	StepType=Max	Point=3	X2=0.5	X3=-0.5	S11=-
2006.99511800595	IsS11Max=No	IsS11Min=Yes	FrameElem=92	ElemStation=0				
Frame=92	Station=0	OutputCase=ENVE	CaseType=Combination	StepType=Max	Point=4	X2=0.5	X3=0.5	S11=-
2006.99511800595	IsS11Max=No	IsS11Min=No	FrameElem=92	ElemStation=0				
Frame=92	Station=0.5	OutputCase=ENVE	CaseType=Combination	StepType=Max	Point=0	X2=0	X3=0	S11=-
812.499990678975	IsS11Max=No	IsS11Min=No	FrameElem=92	ElemStation=0.5				
Frame=92	Station=0.5	OutputCase=ENVE	CaseType=Combination	StepType=Max	Point=1	X2=-0.5	X3=-0.5	
S11=594.775578371699	IsS11Max=Yes	IsS11Min=No	FrameElem=92	ElemStation=0.5				
Frame=92	Station=0.5	OutputCase=ENVE	CaseType=Combination	StepType=Max	Point=2	X2=-0.5	X3=0.5	
S11=594.775578371699	IsS11Max=No	IsS11Min=No	FrameElem=92	ElemStation=0.5				
Frame=92	Station=0.5	OutputCase=ENVE	CaseType=Combination	StepType=Max	Point=3	X2=0.5	X3=-0.5	
S11=-1863.61297964213	IsS11Max=No	IsS11Min=Yes	FrameElem=92	ElemStation=0.5				
Frame=92	Station=0.5	OutputCase=ENVE	CaseType=Combination	StepType=Max	Point=4	X2=0.5	X3=0.5	
S11=-1863.61297964213	IsS11Max=No	IsS11Min=No	FrameElem=92	ElemStation=0.5				
Frame=92	Station=0	OutputCase=ENVE	CaseType=Combination	StepType=Min	Point=0	X2=0	X3=0	S11=-
824.999990776322	IsS11Max=No	IsS11Min=No	FrameElem=92	ElemStation=0				
Frame=92	Station=0	OutputCase=ENVE	CaseType=Combination	StepType=Min	Point=1	X2=-0.5	X3=-0.5	
S11=356.995137783293	IsS11Max=Yes	IsS11Min=No	FrameElem=92	ElemStation=0				
Frame=92	Station=0	OutputCase=ENVE	CaseType=Combination	StepType=Min	Point=2	X2=-0.5	X3=0.5	
S11=356.995137783293	IsS11Max=No	IsS11Min=No	FrameElem=92	ElemStation=0				
Frame=92	Station=0	OutputCase=ENVE	CaseType=Combination	StepType=Min	Point=3	X2=0.5	X3=-0.5	S11=-
2336.06847884868	IsS11Max=No	IsS11Min=Yes	FrameElem=92	ElemStation=0				
Frame=92	Station=0	OutputCase=ENVE	CaseType=Combination	StepType=Min	Point=4	X2=0.5	X3=0.5	S11=-
2336.06847884868	IsS11Max=No	IsS11Min=No	FrameElem=92	ElemStation=0				
Frame=92	Station=0.5	OutputCase=ENVE	CaseType=Combination	StepType=Min	Point=0	X2=0	X3=0	S11=-
812.499991173673	IsS11Max=No	IsS11Min=No	FrameElem=92	ElemStation=0.5				
Frame=92	Station=0.5	OutputCase=ENVE	CaseType=Combination	StepType=Min	Point=1	X2=-0.5	X3=-0.5	
S11=238.612998284182	IsS11Max=Yes	IsS11Min=No	FrameElem=92	ElemStation=0.5				
Frame=92	Station=0.5	OutputCase=ENVE	CaseType=Combination	StepType=Min	Point=2	X2=-0.5	X3=0.5	
S11=238.612998284182	IsS11Max=No	IsS11Min=No	FrameElem=92	ElemStation=0.5				
Frame=92	Station=0.5	OutputCase=ENVE	CaseType=Combination	StepType=Min	Point=3	X2=0.5	X3=-0.5	
S11=-2219.77556071905	IsS11Max=No	IsS11Min=Yes	FrameElem=92	ElemStation=0.5				
Frame=92	Station=0.5	OutputCase=ENVE	CaseType=Combination	StepType=Min	Point=4	X2=0.5	X3=0.5	
S11=-2219.77556071905	IsS11Max=No	IsS11Min=No	FrameElem=92	ElemStation=0.5				
Frame=92	Station=0	OutputCase=FESSUR	CaseType=Combination	Point=0	X2=0	X3=0	S11=-824.999990111331	
IsS11Max=No	IsS11Min=No	FrameElem=92	ElemStation=0					
Frame=92	Station=0	OutputCase=FESSUR	CaseType=Combination	Point=1	X2=-0.5	X3=-0.5		
S11=356.995137783293	IsS11Max=Yes	IsS11Min=No	FrameElem=92	ElemStation=0				
Frame=92	Station=0	OutputCase=FESSUR	CaseType=Combination	Point=2	X2=-0.5	X3=0.5		
S11=356.995137783293	IsS11Max=No	IsS11Min=No	FrameElem=92	ElemStation=0				
Frame=92	Station=0	OutputCase=FESSUR	CaseType=Combination	Point=3	X2=0.5	X3=-0.5	S11=-	
2006.99511800595	IsS11Max=No	IsS11Min=Yes	FrameElem=92	ElemStation=0				
Frame=92	Station=0	OutputCase=FESSUR	CaseType=Combination	Point=4	X2=0.5	X3=0.5	S11=-	
2006.99511800595	IsS11Max=No	IsS11Min=No	FrameElem=92	ElemStation=0				
Frame=92	Station=0.5	OutputCase=FESSUR	CaseType=Combination	Point=0	X2=0	X3=0	S11=-812.499990678975	
IsS11Max=No	IsS11Min=No	FrameElem=92	ElemStation=0.5					
Frame=92	Station=0.5	OutputCase=FESSUR	CaseType=Combination	Point=1	X2=-0.5	X3=-0.5		
S11=238.612998284182	IsS11Max=Yes	IsS11Min=No	FrameElem=92	ElemStation=0.5				
Frame=92	Station=0.5	OutputCase=FESSUR	CaseType=Combination	Point=2	X2=-0.5	X3=0.5		
S11=238.612998284182	IsS11Max=No	IsS11Min=No	FrameElem=92	ElemStation=0.5				
Frame=92	Station=0.5	OutputCase=FESSUR	CaseType=Combination	Point=3	X2=0.5	X3=-0.5	S11=-	
1863.61297964213	IsS11Max=No	IsS11Min=Yes	FrameElem=92	ElemStation=0.5				
Frame=92	Station=0.5	OutputCase=FESSUR	CaseType=Combination	Point=4	X2=0.5	X3=0.5	S11=-	
1863.61297964213	IsS11Max=No	IsS11Min=No	FrameElem=92	ElemStation=0.5				
Frame=93	Station=0	OutputCase=PESOPR	CaseType=LinStatic	Point=0	X2=0	X3=0	S11=-112.499999272171	
IsS11Max=No	IsS11Min=No	FrameElem=93	ElemStation=0					
Frame=93	Station=0	OutputCase=PESOPR	CaseType=LinStatic	Point=1	X2=-0.5	X3=-0.5	S11=195.98082794805	
IsS11Max=Yes	IsS11Min=No	FrameElem=93	ElemStation=0					
Frame=93	Station=0	OutputCase=PESOPR	CaseType=LinStatic	Point=2	X2=-0.5	X3=0.5	S11=195.98082794805	
IsS11Max=No	IsS11Min=No	FrameElem=93	ElemStation=0					
Frame=93	Station=0	OutputCase=PESOPR	CaseType=LinStatic	Point=3	X2=0.5	X3=-0.5	S11=-	
420.980826492393	IsS11Max=No	IsS11Min=Yes	FrameElem=93	ElemStation=0				
Frame=93	Station=0	OutputCase=PESOPR	CaseType=LinStatic	Point=4	X2=0.5	X3=0.5	S11=-420.980826492393	
IsS11Max=No	IsS11Min=No	FrameElem=93	ElemStation=0					
Frame=93	Station=0.5	OutputCase=PESOPR	CaseType=LinStatic	Point=0	X2=0	X3=0	S11=-99.9999992721714	
IsS11Max=No	IsS11Min=No	FrameElem=93	ElemStation=0.5					
Frame=93	Station=0.5	OutputCase=PESOPR	CaseType=LinStatic	Point=1	X2=-0.5	X3=-0.5		
S11=162.967985206298	IsS11Max=Yes	IsS11Min=No	FrameElem=93	ElemStation=0.5				

Frame=93	Station=0.5	OutputCase=PESOPR	CaseType=LinStatic	Point=2	X2=-0.5	X3=0.5		
S11=162.967985206298	IsS11Max=No	IsS11Min=No	FrameElem=93	ElemStation=0.5				
Frame=93	Station=0.5	OutputCase=PESOPR	CaseType=LinStatic	Point=3	X2=0.5	X3=-0.5	S11=-	
362.967983750641	IsS11Max=No	IsS11Min=Yes	FrameElem=93	ElemStation=0.5				
Frame=93	Station=0.5	OutputCase=PESOPR	CaseType=LinStatic	Point=4	X2=0.5	X3=0.5	S11=-	
362.967983750641	IsS11Max=No	IsS11Min=No	FrameElem=93	ElemStation=0.5				
Frame=93	Station=0	OutputCase=TERRVERT	CaseType=LinStatic	Point=0	X2=0	X3=0	S11=-699.99999305571	
IsS11Max=No	IsS11Min=No	FrameElem=93	ElemStation=0					
Frame=93	Station=0	OutputCase=TERRVERT	CaseType=LinStatic	Point=1	X2=-0.5	X3=-0.5		
S11=1229.84077062794	IsS11Max=Yes	IsS11Min=No	FrameElem=93	ElemStation=0				
Frame=93	Station=0	OutputCase=TERRVERT	CaseType=LinStatic	Point=2	X2=-0.5	X3=0.5		
S11=1229.84077062794	IsS11Max=No	IsS11Min=No	FrameElem=93	ElemStation=0				
Frame=93	Station=0	OutputCase=TERRVERT	CaseType=LinStatic	Point=3	X2=0.5	X3=-0.5	S11=-	
2629.84075673936	IsS11Max=No	IsS11Min=Yes	FrameElem=93	ElemStation=0				
Frame=93	Station=0	OutputCase=TERRVERT	CaseType=LinStatic	Point=4	X2=0.5	X3=0.5	S11=-	
2629.84075673936	IsS11Max=No	IsS11Min=No	FrameElem=93	ElemStation=0				
Frame=93	Station=0.5	OutputCase=TERRVERT	CaseType=LinStatic	Point=0	X2=0	X3=0	S11=-699.99999305571	
IsS11Max=No	IsS11Min=No	FrameElem=93	ElemStation=0.5					
Frame=93	Station=0.5	OutputCase=TERRVERT	CaseType=LinStatic	Point=1	X2=-0.5	X3=-0.5		
S11=1234.76887608453	IsS11Max=Yes	IsS11Min=No	FrameElem=93	ElemStation=0.5				
Frame=93	Station=0.5	OutputCase=TERRVERT	CaseType=LinStatic	Point=2	X2=-0.5	X3=0.5		
S11=1234.76887608453	IsS11Max=No	IsS11Min=No	FrameElem=93	ElemStation=0.5				
Frame=93	Station=0.5	OutputCase=TERRVERT	CaseType=LinStatic	Point=3	X2=0.5	X3=-0.5	S11=-	
2634.76886219595	IsS11Max=No	IsS11Min=Yes	FrameElem=93	ElemStation=0.5				
Frame=93	Station=0.5	OutputCase=TERRVERT	CaseType=LinStatic	Point=4	X2=0.5	X3=0.5	S11=-	
2634.76886219595	IsS11Max=No	IsS11Min=No	FrameElem=93	ElemStation=0.5				
Frame=93	Station=0	OutputCase=TERRLAT	CaseType=LinStatic	Point=0	X2=0	X3=0	S11=1.64899211085867E-06	
IsS11Max=No	IsS11Min=No	FrameElem=93	ElemStation=0					
Frame=93	Station=0	OutputCase=TERRLAT	CaseType=LinStatic	Point=1	X2=-0.5	X3=-0.5	S11=-	
1187.20860029172	IsS11Max=No	IsS11Min=Yes	FrameElem=93	ElemStation=0				
Frame=93	Station=0	OutputCase=TERRLAT	CaseType=LinStatic	Point=2	X2=-0.5	X3=0.5	S11=-	
1187.20860029172	IsS11Max=No	IsS11Min=No	FrameElem=93	ElemStation=0				
Frame=93	Station=0	OutputCase=TERRLAT	CaseType=LinStatic	Point=3	X2=0.5	X3=-0.5		
S11=1187.20860358971	IsS11Max=Yes	IsS11Min=No	FrameElem=93	ElemStation=0				
Frame=93	Station=0	OutputCase=TERRLAT	CaseType=LinStatic	Point=4	X2=0.5	X3=0.5	S11=1187.20860358971	
IsS11Max=No	IsS11Min=No	FrameElem=93	ElemStation=0					
Frame=93	Station=0.5	OutputCase=TERRLAT	CaseType=LinStatic	Point=0	X2=0	X3=0	S11=1.09829489649549E-06	
IsS11Max=No	IsS11Min=No	FrameElem=93	ElemStation=0.5					
Frame=93	Station=0.5	OutputCase=TERRLAT	CaseType=LinStatic	Point=1	X2=-0.5	X3=-0.5	S11=-	
1066.42600219069	IsS11Max=No	IsS11Min=Yes	FrameElem=93	ElemStation=0.5				
Frame=93	Station=0.5	OutputCase=TERRLAT	CaseType=LinStatic	Point=2	X2=-0.5	X3=0.5	S11=-	
1066.42600219069	IsS11Max=No	IsS11Min=No	FrameElem=93	ElemStation=0.5				
Frame=93	Station=0.5	OutputCase=TERRLAT	CaseType=LinStatic	Point=3	X2=0.5	X3=-0.5		
S11=1066.42600438728	IsS11Max=Yes	IsS11Min=No	FrameElem=93	ElemStation=0.5				
Frame=93	Station=0.5	OutputCase=TERRLAT	CaseType=LinStatic	Point=4	X2=0.5	X3=0.5		
S11=1066.42600438728	IsS11Max=No	IsS11Min=No	FrameElem=93	ElemStation=0.5				
Frame=93	Station=0	OutputCase=ACCVERT	CaseType=LinStatic	Point=0	X2=0	X3=0	S11=0	IsS11Max=Yes
IsS11Min=Yes	FrameElem=93	ElemStation=0						
Frame=93	Station=0	OutputCase=ACCVERT	CaseType=LinStatic	Point=1	X2=-0.5	X3=-0.5	S11=0	
IsS11Max=No	IsS11Min=No	FrameElem=93	ElemStation=0					
Frame=93	Station=0	OutputCase=ACCVERT	CaseType=LinStatic	Point=2	X2=-0.5	X3=0.5	S11=0	IsS11Max=No
IsS11Min=No	FrameElem=93	ElemStation=0						
Frame=93	Station=0	OutputCase=ACCVERT	CaseType=LinStatic	Point=3	X2=0.5	X3=-0.5	S11=0	IsS11Max=No
IsS11Min=No	FrameElem=93	ElemStation=0						
Frame=93	Station=0	OutputCase=ACCVERT	CaseType=LinStatic	Point=4	X2=0.5	X3=0.5	S11=0	IsS11Max=No
IsS11Min=No	FrameElem=93	ElemStation=0						
Frame=93	Station=0.5	OutputCase=ACCVERT	CaseType=LinStatic	Point=0	X2=0	X3=0	S11=0	IsS11Max=Yes
IsS11Min=Yes	FrameElem=93	ElemStation=0.5						
Frame=93	Station=0.5	OutputCase=ACCVERT	CaseType=LinStatic	Point=1	X2=-0.5	X3=-0.5	S11=0	
IsS11Max=No	IsS11Min=No	FrameElem=93	ElemStation=0.5					
Frame=93	Station=0.5	OutputCase=ACCVERT	CaseType=LinStatic	Point=2	X2=-0.5	X3=0.5	S11=0	
IsS11Max=No	IsS11Min=No	FrameElem=93	ElemStation=0.5					
Frame=93	Station=0.5	OutputCase=ACCVERT	CaseType=LinStatic	Point=3	X2=0.5	X3=-0.5	S11=0	
IsS11Max=No	IsS11Min=No	FrameElem=93	ElemStation=0.5					
Frame=93	Station=0.5	OutputCase=ACCVERT	CaseType=LinStatic	Point=4	X2=0.5	X3=0.5	S11=0	
IsS11Max=No	IsS11Min=No	FrameElem=93	ElemStation=0.5					
Frame=93	Station=0	OutputCase=ACCLATDX	CaseType=LinStatic	Point=0	X2=0	X3=0	S11=0	IsS11Max=Yes
IsS11Min=Yes	FrameElem=93	ElemStation=0						
Frame=93	Station=0	OutputCase=ACCLATDX	CaseType=LinStatic	Point=1	X2=-0.5	X3=-0.5	S11=0	
IsS11Max=No	IsS11Min=No	FrameElem=93	ElemStation=0					
Frame=93	Station=0	OutputCase=ACCLATDX	CaseType=LinStatic	Point=2	X2=-0.5	X3=0.5	S11=0	
IsS11Max=No	IsS11Min=No	FrameElem=93	ElemStation=0					
Frame=93	Station=0	OutputCase=ACCLATDX	CaseType=LinStatic	Point=3	X2=0.5	X3=-0.5	S11=0	
IsS11Max=No	IsS11Min=No	FrameElem=93	ElemStation=0					
Frame=93	Station=0	OutputCase=ACCLATDX	CaseType=LinStatic	Point=4	X2=0.5	X3=0.5	S11=0	IsS11Max=No
IsS11Min=No	FrameElem=93	ElemStation=0						
Frame=93	Station=0.5	OutputCase=ACCLATDX	CaseType=LinStatic	Point=0	X2=0	X3=0	S11=0	IsS11Max=Yes
IsS11Min=Yes	FrameElem=93	ElemStation=0.5						
Frame=93	Station=0.5	OutputCase=ACCLATDX	CaseType=LinStatic	Point=1	X2=-0.5	X3=-0.5	S11=0	
IsS11Max=No	IsS11Min=No	FrameElem=93	ElemStation=0.5					
Frame=93	Station=0.5	OutputCase=ACCLATDX	CaseType=LinStatic	Point=2	X2=-0.5	X3=0.5	S11=0	
IsS11Max=No	IsS11Min=No	FrameElem=93	ElemStation=0.5					

Frame=93 Station=0.5 OutputCase=ENVE CaseType=Combination StepType=Max Point=4 X2=0.5 X3=0.5
 S11=-1931.3108415593 IsS11Max=No IsS11Min=No FrameElem=93 ElemStation=0.5
 Frame=93 Station=0 OutputCase=ENVE CaseType=Combination StepType=Min Point=0 X2=0 X3=0 S11=-
 812.499991173587 IsS11Max=No IsS11Min=No FrameElem=93 ElemStation=0
 Frame=93 Station=0 OutputCase=ENVE CaseType=Combination StepType=Min Point=1 X2=-0.5 X3=-0.5
 S11=238.612998284266 IsS11Max=Yes IsS11Min=No FrameElem=93 ElemStation=0
 Frame=93 Station=0 OutputCase=ENVE CaseType=Combination StepType=Min Point=2 X2=-0.5 X3=0.5
 S11=238.612998284266 IsS11Max=No IsS11Min=No FrameElem=93 ElemStation=0
 Frame=93 Station=0 OutputCase=ENVE CaseType=Combination StepType=Min Point=3 X2=0.5 X3=-0.5 S11=-
 2219.77556071896 IsS11Max=No IsS11Min=Yes FrameElem=93 ElemStation=0
 Frame=93 Station=0 OutputCase=ENVE CaseType=Combination StepType=Min Point=4 X2=0.5 X3=0.5 S11=-
 2219.77556071896 IsS11Max=No IsS11Min=No FrameElem=93 ElemStation=0
 Frame=93 Station=0.5 OutputCase=ENVE CaseType=Combination StepType=Min Point=0 X2=0 X3=0 S11=-
 799.999991559075 IsS11Max=No IsS11Min=No FrameElem=93 ElemStation=0.5
 Frame=93 Station=0.5 OutputCase=ENVE CaseType=Combination StepType=Min Point=1 X2=-0.5 X3=-0.5
 S11=331.310859100131 IsS11Max=Yes IsS11Min=No FrameElem=93 ElemStation=0.5
 Frame=93 Station=0.5 OutputCase=ENVE CaseType=Combination StepType=Min Point=2 X2=-0.5 X3=0.5
 S11=331.310859100131 IsS11Max=No IsS11Min=No FrameElem=93 ElemStation=0.5
 Frame=93 Station=0.5 OutputCase=ENVE CaseType=Combination StepType=Min Point=3 X2=0.5 X3=-0.5
 S11=-2251.23864287549 IsS11Max=No IsS11Min=Yes FrameElem=93 ElemStation=0.5
 Frame=93 Station=0.5 OutputCase=ENVE CaseType=Combination StepType=Min Point=4 X2=0.5 X3=0.5
 S11=-2251.23864287549 IsS11Max=No IsS11Min=No FrameElem=93 ElemStation=0.5
 Frame=93 Station=0 OutputCase=FESSUR CaseType=Combination Point=0 X2=0 X3=0 S11=-812.499990678889
 IsS11Max=No IsS11Min=No FrameElem=93 ElemStation=0
 Frame=93 Station=0 OutputCase=FESSUR CaseType=Combination Point=1 X2=-0.5 X3=-0.5
 S11=238.612998284266 IsS11Max=Yes IsS11Min=No FrameElem=93 ElemStation=0
 Frame=93 Station=0 OutputCase=FESSUR CaseType=Combination Point=2 X2=-0.5 X3=0.5
 S11=238.612998284266 IsS11Max=No IsS11Min=No FrameElem=93 ElemStation=0
 Frame=93 Station=0 OutputCase=FESSUR CaseType=Combination Point=3 X2=0.5 X3=-0.5 S11=-
 1863.61297964204 IsS11Max=No IsS11Min=Yes FrameElem=93 ElemStation=0
 Frame=93 Station=0 OutputCase=FESSUR CaseType=Combination Point=4 X2=0.5 X3=0.5 S11=-
 1863.61297964204 IsS11Max=No IsS11Min=No FrameElem=93 ElemStation=0
 Frame=93 Station=0.5 OutputCase=FESSUR CaseType=Combination Point=0 X2=0 X3=0 S11=-799.999991229586
 IsS11Max=No IsS11Min=No FrameElem=93 ElemStation=0.5
 Frame=93 Station=0.5 OutputCase=FESSUR CaseType=Combination Point=1 X2=-0.5 X3=-0.5
 S11=331.310859100131 IsS11Max=Yes IsS11Min=No FrameElem=93 ElemStation=0.5
 Frame=93 Station=0.5 OutputCase=FESSUR CaseType=Combination Point=2 X2=-0.5 X3=0.5
 S11=331.310859100131 IsS11Max=No IsS11Min=No FrameElem=93 ElemStation=0.5
 Frame=93 Station=0.5 OutputCase=FESSUR CaseType=Combination Point=3 X2=0.5 X3=-0.5 S11=-
 1931.3108415593 IsS11Max=No IsS11Min=Yes FrameElem=93 ElemStation=0.5
 Frame=93 Station=0.5 OutputCase=FESSUR CaseType=Combination Point=4 X2=0.5 X3=0.5 S11=-
 1931.3108415593 IsS11Max=No IsS11Min=No FrameElem=93 ElemStation=0.5
 Frame=94 Station=0 OutputCase=PESOPR CaseType=LinStatic Point=0 X2=0 X3=0 S11=-99.999992722296
 IsS11Max=No IsS11Min=No FrameElem=94 ElemStation=0
 Frame=94 Station=0 OutputCase=PESOPR CaseType=LinStatic Point=1 X2=-0.5 X3=-0.5 S11=162.96798520624
 IsS11Max=Yes IsS11Min=No FrameElem=94 ElemStation=0
 Frame=94 Station=0 OutputCase=PESOPR CaseType=LinStatic Point=2 X2=-0.5 X3=0.5 S11=162.96798520624
 IsS11Max=No IsS11Min=No FrameElem=94 ElemStation=0
 Frame=94 Station=0 OutputCase=PESOPR CaseType=LinStatic Point=3 X2=0.5 X3=-0.5 S11=-
 362.967983750699 IsS11Max=No IsS11Min=Yes FrameElem=94 ElemStation=0
 Frame=94 Station=0 OutputCase=PESOPR CaseType=LinStatic Point=4 X2=0.5 X3=0.5 S11=-362.967983750699
 IsS11Max=No IsS11Min=No FrameElem=94 ElemStation=0
 Frame=94 Station=0.5 OutputCase=PESOPR CaseType=LinStatic Point=0 X2=0 X3=0 S11=-87.4999992722296
 IsS11Max=No IsS11Min=No FrameElem=94 ElemStation=0.5
 Frame=94 Station=0.5 OutputCase=PESOPR CaseType=LinStatic Point=1 X2=-0.5 X3=-0.5
 S11=129.955142762512 IsS11Max=Yes IsS11Min=No FrameElem=94 ElemStation=0.5
 Frame=94 Station=0.5 OutputCase=PESOPR CaseType=LinStatic Point=2 X2=-0.5 X3=0.5
 S11=129.955142762512 IsS11Max=No IsS11Min=No FrameElem=94 ElemStation=0.5
 Frame=94 Station=0.5 OutputCase=PESOPR CaseType=LinStatic Point=3 X2=0.5 X3=-0.5 S11=-
 304.955141306971 IsS11Max=No IsS11Min=Yes FrameElem=94 ElemStation=0.5
 Frame=94 Station=0.5 OutputCase=PESOPR CaseType=LinStatic Point=4 X2=0.5 X3=0.5 S11=-
 304.955141306971 IsS11Max=No IsS11Min=No FrameElem=94 ElemStation=0.5
 Frame=94 Station=0 OutputCase=TERRVERT CaseType=LinStatic Point=0 X2=0 X3=0 S11=-699.999993055477
 IsS11Max=No IsS11Min=No FrameElem=94 ElemStation=0
 Frame=94 Station=0 OutputCase=TERRVERT CaseType=LinStatic Point=1 X2=-0.5 X3=-0.5
 S11=1234.76887608476 IsS11Max=Yes IsS11Min=No FrameElem=94 ElemStation=0
 Frame=94 Station=0 OutputCase=TERRVERT CaseType=LinStatic Point=2 X2=-0.5 X3=0.5
 S11=1234.76887608476 IsS11Max=No IsS11Min=No FrameElem=94 ElemStation=0
 Frame=94 Station=0 OutputCase=TERRVERT CaseType=LinStatic Point=3 X2=0.5 X3=-0.5 S11=-
 2634.76886219571 IsS11Max=No IsS11Min=Yes FrameElem=94 ElemStation=0
 Frame=94 Station=0 OutputCase=TERRVERT CaseType=LinStatic Point=4 X2=0.5 X3=0.5 S11=-
 2634.76886219571 IsS11Max=No IsS11Min=No FrameElem=94 ElemStation=0
 Frame=94 Station=0.5 OutputCase=TERRVERT CaseType=LinStatic Point=0 X2=0 X3=0 S11=-699.999993055477
 IsS11Max=No IsS11Min=No FrameElem=94 ElemStation=0.5
 Frame=94 Station=0.5 OutputCase=TERRVERT CaseType=LinStatic Point=1 X2=-0.5 X3=-0.5
 S11=1239.69698154135 IsS11Max=Yes IsS11Min=No FrameElem=94 ElemStation=0.5
 Frame=94 Station=0.5 OutputCase=TERRVERT CaseType=LinStatic Point=2 X2=-0.5 X3=0.5
 S11=1239.69698154135 IsS11Max=No IsS11Min=No FrameElem=94 ElemStation=0.5
 Frame=94 Station=0.5 OutputCase=TERRVERT CaseType=LinStatic Point=3 X2=0.5 X3=-0.5 S11=-
 2639.6969676523 IsS11Max=No IsS11Min=Yes FrameElem=94 ElemStation=0.5
 Frame=94 Station=0.5 OutputCase=TERRVERT CaseType=LinStatic Point=4 X2=0.5 X3=0.5 S11=-
 2639.6969676523 IsS11Max=No IsS11Min=No FrameElem=94 ElemStation=0.5

Frame=94	Station=0	OutputCase=TERRLAT	CaseType=LinStatic	Point=0	X2=0	X3=0	S11=1.09829579741927E-06		
IsS11Max=No	IsS11Min=No	FrameElem=94	ElemStation=0						
Frame=94	Station=0	OutputCase=TERRLAT	CaseType=LinStatic	Point=1	X2=-0.5	X3=-0.5	S11=-		
1066.42600219069	IsS11Max=No	IsS11Min=Yes	FrameElem=94	ElemStation=0					
Frame=94	Station=0	OutputCase=TERRLAT	CaseType=LinStatic	Point=2	X2=-0.5	X3=0.5	S11=-		
1066.42600219069	IsS11Max=No	IsS11Min=No	FrameElem=94	ElemStation=0					
Frame=94	Station=0	OutputCase=TERRLAT	CaseType=LinStatic	Point=3	X2=0.5	X3=-0.5	S11=-		
S11=1066.42600438729	IsS11Max=Yes	IsS11Min=No	FrameElem=94	ElemStation=0					
Frame=94	Station=0	OutputCase=TERRLAT	CaseType=LinStatic	Point=4	X2=0.5	X3=0.5	S11=1066.42600438729		
IsS11Max=No	IsS11Min=No	FrameElem=94	ElemStation=0						
Frame=94	Station=0.5	OutputCase=TERRLAT	CaseType=LinStatic	Point=0	X2=0	X3=0	S11=5.64546169377067E-		
07	IsS11Max=No	IsS11Min=No	FrameElem=94	ElemStation=0.5					
Frame=94	Station=0.5	OutputCase=TERRLAT	CaseType=LinStatic	Point=1	X2=-0.5	X3=-0.5	S11=-		
740.960904072719	IsS11Max=No	IsS11Min=Yes	FrameElem=94	ElemStation=0.5					
Frame=94	Station=0.5	OutputCase=TERRLAT	CaseType=LinStatic	Point=2	X2=-0.5	X3=0.5	S11=-		
740.960904072719	IsS11Max=No	IsS11Min=No	FrameElem=94	ElemStation=0.5					
Frame=94	Station=0.5	OutputCase=TERRLAT	CaseType=LinStatic	Point=3	X2=0.5	X3=-0.5	S11=-		
S11=740.960905201812	IsS11Max=Yes	IsS11Min=No	FrameElem=94	ElemStation=0.5					
Frame=94	Station=0.5	OutputCase=TERRLAT	CaseType=LinStatic	Point=4	X2=0.5	X3=0.5	S11=-		
S11=740.960905201812	IsS11Max=No	IsS11Min=No	FrameElem=94	ElemStation=0.5					
Frame=94	Station=0	OutputCase=ACCVERT	CaseType=LinStatic	Point=0	X2=0	X3=0	S11=0	IsS11Max=Yes	
IsS11Min=Yes	FrameElem=94	ElemStation=0							
Frame=94	Station=0	OutputCase=ACCVERT	CaseType=LinStatic	Point=1	X2=-0.5	X3=-0.5	S11=0		
IsS11Max=No	IsS11Min=No	FrameElem=94	ElemStation=0						
Frame=94	Station=0	OutputCase=ACCVERT	CaseType=LinStatic	Point=2	X2=-0.5	X3=0.5	S11=0	IsS11Max=No	
IsS11Min=No	FrameElem=94	ElemStation=0							
Frame=94	Station=0	OutputCase=ACCVERT	CaseType=LinStatic	Point=3	X2=0.5	X3=-0.5	S11=0	IsS11Max=No	
IsS11Min=No	FrameElem=94	ElemStation=0							
Frame=94	Station=0	OutputCase=ACCVERT	CaseType=LinStatic	Point=4	X2=0.5	X3=0.5	S11=0	IsS11Max=No	
IsS11Min=No	FrameElem=94	ElemStation=0							
Frame=94	Station=0.5	OutputCase=ACCVERT	CaseType=LinStatic	Point=0	X2=0	X3=0	S11=0	IsS11Max=Yes	
IsS11Min=Yes	FrameElem=94	ElemStation=0.5							
Frame=94	Station=0.5	OutputCase=ACCVERT	CaseType=LinStatic	Point=1	X2=-0.5	X3=-0.5	S11=0		
IsS11Max=No	IsS11Min=No	FrameElem=94	ElemStation=0.5						
Frame=94	Station=0.5	OutputCase=ACCVERT	CaseType=LinStatic	Point=2	X2=-0.5	X3=0.5	S11=0		
IsS11Max=No	IsS11Min=No	FrameElem=94	ElemStation=0.5						
Frame=94	Station=0.5	OutputCase=ACCVERT	CaseType=LinStatic	Point=3	X2=0.5	X3=-0.5	S11=0		
IsS11Max=No	IsS11Min=No	FrameElem=94	ElemStation=0.5						
Frame=94	Station=0.5	OutputCase=ACCVERT	CaseType=LinStatic	Point=4	X2=0.5	X3=0.5	S11=0		
IsS11Max=No	IsS11Min=No	FrameElem=94	ElemStation=0.5						
Frame=94	Station=0	OutputCase=ACCLATDX	CaseType=LinStatic	Point=0	X2=0	X3=0	S11=0	IsS11Max=Yes	
IsS11Min=Yes	FrameElem=94	ElemStation=0							
Frame=94	Station=0	OutputCase=ACCLATDX	CaseType=LinStatic	Point=1	X2=-0.5	X3=-0.5	S11=0		
IsS11Max=No	IsS11Min=No	FrameElem=94	ElemStation=0						
Frame=94	Station=0	OutputCase=ACCLATDX	CaseType=LinStatic	Point=2	X2=-0.5	X3=0.5	S11=0		
IsS11Max=No	IsS11Min=No	FrameElem=94	ElemStation=0						
Frame=94	Station=0	OutputCase=ACCLATDX	CaseType=LinStatic	Point=3	X2=0.5	X3=-0.5	S11=0		
IsS11Max=No	IsS11Min=No	FrameElem=94	ElemStation=0						
Frame=94	Station=0	OutputCase=ACCLATDX	CaseType=LinStatic	Point=4	X2=0.5	X3=0.5	S11=0	IsS11Max=No	
IsS11Min=No	FrameElem=94	ElemStation=0							
Frame=94	Station=0.5	OutputCase=ACCLATDX	CaseType=LinStatic	Point=0	X2=0	X3=0	S11=0	IsS11Max=Yes	
IsS11Min=Yes	FrameElem=94	ElemStation=0.5							
Frame=94	Station=0.5	OutputCase=ACCLATDX	CaseType=LinStatic	Point=1	X2=-0.5	X3=-0.5	S11=0		
IsS11Max=No	IsS11Min=No	FrameElem=94	ElemStation=0.5						
Frame=94	Station=0.5	OutputCase=ACCLATDX	CaseType=LinStatic	Point=2	X2=-0.5	X3=0.5	S11=0		
IsS11Max=No	IsS11Min=No	FrameElem=94	ElemStation=0.5						
Frame=94	Station=0.5	OutputCase=ACCLATDX	CaseType=LinStatic	Point=3	X2=0.5	X3=-0.5	S11=0		
IsS11Max=No	IsS11Min=No	FrameElem=94	ElemStation=0.5						
Frame=94	Station=0.5	OutputCase=ACCLATDX	CaseType=LinStatic	Point=4	X2=0.5	X3=0.5	S11=0		
IsS11Max=No	IsS11Min=No	FrameElem=94	ElemStation=0.5						
Frame=94	Station=0	OutputCase=ACCLATSX	CaseType=LinStatic	Point=0	X2=0	X3=0	S11=0	IsS11Max=Yes	
IsS11Min=Yes	FrameElem=94	ElemStation=0							
Frame=94	Station=0	OutputCase=ACCLATSX	CaseType=LinStatic	Point=1	X2=-0.5	X3=-0.5	S11=0		
IsS11Max=No	IsS11Min=No	FrameElem=94	ElemStation=0						
Frame=94	Station=0	OutputCase=ACCLATSX	CaseType=LinStatic	Point=2	X2=-0.5	X3=0.5	S11=0		
IsS11Max=No	IsS11Min=No	FrameElem=94	ElemStation=0						
Frame=94	Station=0	OutputCase=ACCLATSX	CaseType=LinStatic	Point=3	X2=0.5	X3=-0.5	S11=0		
IsS11Max=No	IsS11Min=No	FrameElem=94	ElemStation=0						
Frame=94	Station=0	OutputCase=ACCLATSX	CaseType=LinStatic	Point=4	X2=0.5	X3=0.5	S11=0	IsS11Max=No	
IsS11Min=No	FrameElem=94	ElemStation=0							
Frame=94	Station=0.5	OutputCase=ACCLATSX	CaseType=LinStatic	Point=0	X2=0	X3=0	S11=0	IsS11Max=Yes	
IsS11Min=Yes	FrameElem=94	ElemStation=0.5							
Frame=94	Station=0.5	OutputCase=ACCLATSX	CaseType=LinStatic	Point=1	X2=-0.5	X3=-0.5	S11=0		
IsS11Max=No	IsS11Min=No	FrameElem=94	ElemStation=0.5						
Frame=94	Station=0.5	OutputCase=ACCLATSX	CaseType=LinStatic	Point=2	X2=-0.5	X3=0.5	S11=0		
IsS11Max=No	IsS11Min=No	FrameElem=94	ElemStation=0.5						
Frame=94	Station=0.5	OutputCase=ACCLATSX	CaseType=LinStatic	Point=3	X2=0.5	X3=-0.5	S11=0		
IsS11Max=No	IsS11Min=No	FrameElem=94	ElemStation=0.5						
Frame=94	Station=0.5	OutputCase=ACCLATSX	CaseType=LinStatic	Point=4	X2=0.5	X3=0.5	S11=0		
IsS11Max=No	IsS11Min=No	FrameElem=94	ElemStation=0.5						
Frame=94	Station=0	OutputCase=TERRCOST	CaseType=LinStatic	Point=0	X2=0	X3=0	S11=0	IsS11Max=Yes	
IsS11Min=Yes	FrameElem=94	ElemStation=0							



Frame=94	Station=0	OutputCase=TERRCOST	CaseType=LinStatic	Point=1	X2=-0.5	X3=-0.5	S11=0		
IsS11Max=No	IsS11Min=No	FrameElem=94	ElemStation=0						
Frame=94	Station=0	OutputCase=TERRCOST	CaseType=LinStatic	Point=2	X2=-0.5	X3=0.5	S11=0		
IsS11Max=No	IsS11Min=No	FrameElem=94	ElemStation=0						
Frame=94	Station=0	OutputCase=TERRCOST	CaseType=LinStatic	Point=3	X2=0.5	X3=-0.5	S11=0		
IsS11Max=No	IsS11Min=No	FrameElem=94	ElemStation=0						
Frame=94	Station=0	OutputCase=TERRCOST	CaseType=LinStatic	Point=4	X2=0.5	X3=0.5	S11=0	IsS11Max=No	
IsS11Min=No	FrameElem=94	ElemStation=0							
Frame=94	Station=0.5	OutputCase=TERRCOST	CaseType=LinStatic	Point=0	X2=0	X3=0	S11=0	IsS11Max=Yes	
IsS11Min=Yes	FrameElem=94	ElemStation=0.5							
Frame=94	Station=0.5	OutputCase=TERRCOST	CaseType=LinStatic	Point=1	X2=-0.5	X3=-0.5	S11=0		
IsS11Max=No	IsS11Min=No	FrameElem=94	ElemStation=0.5						
Frame=94	Station=0.5	OutputCase=TERRCOST	CaseType=LinStatic	Point=2	X2=-0.5	X3=0.5	S11=0		
IsS11Max=No	IsS11Min=No	FrameElem=94	ElemStation=0.5						
Frame=94	Station=0.5	OutputCase=TERRCOST	CaseType=LinStatic	Point=3	X2=0.5	X3=-0.5	S11=0		
IsS11Max=No	IsS11Min=No	FrameElem=94	ElemStation=0.5						
Frame=94	Station=0.5	OutputCase=TERRCOST	CaseType=LinStatic	Point=4	X2=0.5	X3=0.5	S11=0		
IsS11Max=No	IsS11Min=No	FrameElem=94	ElemStation=0.5						
Frame=94	Station=0	OutputCase=SOVRCOST	CaseType=LinStatic	Point=0	X2=0	X3=0	S11=0	IsS11Max=Yes	
IsS11Min=Yes	FrameElem=94	ElemStation=0							
Frame=94	Station=0	OutputCase=SOVRCOST	CaseType=LinStatic	Point=1	X2=-0.5	X3=-0.5	S11=0		
IsS11Max=No	IsS11Min=No	FrameElem=94	ElemStation=0						
Frame=94	Station=0	OutputCase=SOVRCOST	CaseType=LinStatic	Point=2	X2=-0.5	X3=0.5	S11=0		
IsS11Max=No	IsS11Min=No	FrameElem=94	ElemStation=0						
Frame=94	Station=0	OutputCase=SOVRCOST	CaseType=LinStatic	Point=3	X2=0.5	X3=-0.5	S11=0		
IsS11Max=No	IsS11Min=No	FrameElem=94	ElemStation=0						
Frame=94	Station=0	OutputCase=SOVRCOST	CaseType=LinStatic	Point=4	X2=0.5	X3=0.5	S11=0	IsS11Max=No	
IsS11Min=No	FrameElem=94	ElemStation=0							
Frame=94	Station=0.5	OutputCase=SOVRCOST	CaseType=LinStatic	Point=0	X2=0	X3=0	S11=0	IsS11Max=Yes	
IsS11Min=Yes	FrameElem=94	ElemStation=0.5							
Frame=94	Station=0.5	OutputCase=SOVRCOST	CaseType=LinStatic	Point=1	X2=-0.5	X3=-0.5	S11=0		
IsS11Max=No	IsS11Min=No	FrameElem=94	ElemStation=0.5						
Frame=94	Station=0.5	OutputCase=SOVRCOST	CaseType=LinStatic	Point=2	X2=-0.5	X3=0.5	S11=0		
IsS11Max=No	IsS11Min=No	FrameElem=94	ElemStation=0.5						
Frame=94	Station=0.5	OutputCase=SOVRCOST	CaseType=LinStatic	Point=3	X2=0.5	X3=-0.5	S11=0		
IsS11Max=No	IsS11Min=No	FrameElem=94	ElemStation=0.5						
Frame=94	Station=0.5	OutputCase=SOVRCOST	CaseType=LinStatic	Point=4	X2=0.5	X3=0.5	S11=0		
IsS11Max=No	IsS11Min=No	FrameElem=94	ElemStation=0.5						
Frame=94	Station=0	OutputCase=ENVE	CaseType=Combination	StepType=Max	Point=0	X2=0	X3=0	S11=-	
799.999991229411	IsS11Max=No	IsS11Min=No	FrameElem=94	ElemStation=0					
Frame=94	Station=0	OutputCase=ENVE	CaseType=Combination	StepType=Max	Point=1	X2=-0.5	X3=-0.5		
S11=651.238659757514	IsS11Max=Yes	IsS11Min=No	FrameElem=94	ElemStation=0					
Frame=94	Station=0	OutputCase=ENVE	CaseType=Combination	StepType=Max	Point=2	X2=-0.5	X3=0.5		
S11=651.238659757514	IsS11Max=No	IsS11Min=No	FrameElem=94	ElemStation=0					
Frame=94	Station=0	OutputCase=ENVE	CaseType=Combination	StepType=Max	Point=3	X2=0.5	X3=-0.5	S11=-	
1931.31084155913	IsS11Max=No	IsS11Min=Yes	FrameElem=94	ElemStation=0					
Frame=94	Station=0	OutputCase=ENVE	CaseType=Combination	StepType=Max	Point=4	X2=0.5	X3=0.5	S11=-	
1931.31084155913	IsS11Max=No	IsS11Min=No	FrameElem=94	ElemStation=0					
Frame=94	Station=0.5	OutputCase=ENVE	CaseType=Combination	StepType=Max	Point=0	X2=0	X3=0	S11=-	
787.49999176316	IsS11Max=No	IsS11Min=No	FrameElem=94	ElemStation=0.5					
Frame=94	Station=0.5	OutputCase=ENVE	CaseType=Combination	StepType=Max	Point=1	X2=-0.5	X3=-0.5		
S11=850.979491452955	IsS11Max=Yes	IsS11Min=No	FrameElem=94	ElemStation=0.5					
Frame=94	Station=0.5	OutputCase=ENVE	CaseType=Combination	StepType=Max	Point=2	X2=-0.5	X3=0.5		
S11=850.979491452955	IsS11Max=No	IsS11Min=No	FrameElem=94	ElemStation=0.5					
Frame=94	Station=0.5	OutputCase=ENVE	CaseType=Combination	StepType=Max	Point=3	X2=0.5	X3=-0.5		
S11=-2203.69120375746	IsS11Max=No	IsS11Min=Yes	FrameElem=94	ElemStation=0.5					
Frame=94	Station=0.5	OutputCase=ENVE	CaseType=Combination	StepType=Max	Point=4	X2=0.5	X3=0.5		
S11=-2203.69120375746	IsS11Max=No	IsS11Min=No	FrameElem=94	ElemStation=0.5					
Frame=94	Station=0	OutputCase=ENVE	CaseType=Combination	StepType=Min	Point=0	X2=0	X3=0	S11=-	
799.999991558899	IsS11Max=No	IsS11Min=No	FrameElem=94	ElemStation=0					
Frame=94	Station=0	OutputCase=ENVE	CaseType=Combination	StepType=Min	Point=1	X2=-0.5	X3=-0.5		
S11=331.310859100305	IsS11Max=Yes	IsS11Min=No	FrameElem=94	ElemStation=0					
Frame=94	Station=0	OutputCase=ENVE	CaseType=Combination	StepType=Min	Point=2	X2=-0.5	X3=0.5		
S11=331.310859100305	IsS11Max=No	IsS11Min=No	FrameElem=94	ElemStation=0					
Frame=94	Station=0	OutputCase=ENVE	CaseType=Combination	StepType=Min	Point=3	X2=0.5	X3=-0.5	S11=-	
2251.23864287531	IsS11Max=No	IsS11Min=Yes	FrameElem=94	ElemStation=0					
Frame=94	Station=0	OutputCase=ENVE	CaseType=Combination	StepType=Min	Point=4	X2=0.5	X3=0.5	S11=-	
2251.23864287531	IsS11Max=No	IsS11Min=No	FrameElem=94	ElemStation=0					
Frame=94	Station=0.5	OutputCase=ENVE	CaseType=Combination	StepType=Min	Point=0	X2=0	X3=0	S11=-	
787.499991932524	IsS11Max=No	IsS11Min=No	FrameElem=94	ElemStation=0.5					
Frame=94	Station=0.5	OutputCase=ENVE	CaseType=Combination	StepType=Min	Point=1	X2=-0.5	X3=-0.5		
S11=628.69122023114	IsS11Max=Yes	IsS11Min=No	FrameElem=94	ElemStation=0.5					
Frame=94	Station=0.5	OutputCase=ENVE	CaseType=Combination	StepType=Min	Point=2	X2=-0.5	X3=0.5		
S11=628.69122023114	IsS11Max=No	IsS11Min=No	FrameElem=94	ElemStation=0.5					
Frame=94	Station=0.5	OutputCase=ENVE	CaseType=Combination	StepType=Min	Point=3	X2=0.5	X3=-0.5		
S11=-2425.979475318	IsS11Max=No	IsS11Min=Yes	FrameElem=94	ElemStation=0.5					
Frame=94	Station=0.5	OutputCase=ENVE	CaseType=Combination	StepType=Min	Point=4	X2=0.5	X3=0.5		
S11=-2425.979475318	IsS11Max=No	IsS11Min=No	FrameElem=94	ElemStation=0.5					
Frame=94	Station=0	OutputCase=FESSUR	CaseType=Combination	Point=0	X2=0	X3=0	S11=-799.999991229411		
IsS11Max=No	IsS11Min=No	FrameElem=94	ElemStation=0						
Frame=94	Station=0	OutputCase=FESSUR	CaseType=Combination	Point=1	X2=-0.5	X3=-0.5			
S11=331.310859100305	IsS11Max=Yes	IsS11Min=No	FrameElem=94	ElemStation=0					

Frame=94	Station=0	OutputCase=FESSUR	CaseType=Combination	Point=2	X2=-0.5	X3=0.5		
S11=331.310859100305	IsS11Max=No	IsS11Min=No	FrameElem=94	ElemStation=0				
Frame=94	Station=0	OutputCase=FESSUR	CaseType=Combination	Point=3	X2=0.5	X3=-0.5	S11=-	
1931.31084155913	IsS11Max=No	IsS11Min=Yes	FrameElem=94	ElemStation=0				
Frame=94	Station=0	OutputCase=FESSUR	CaseType=Combination	Point=4	X2=0.5	X3=0.5	S11=-	
1931.31084155913	IsS11Max=No	IsS11Min=No	FrameElem=94	ElemStation=0				
Frame=94	Station=0.5	OutputCase=FESSUR	CaseType=Combination	Point=0	X2=0	X3=0	S11=-787.49999176316	
IsS11Max=No	IsS11Min=No	FrameElem=94	ElemStation=0.5					
Frame=94	Station=0.5	OutputCase=FESSUR	CaseType=Combination	Point=1	X2=-0.5	X3=-0.5		
S11=628.69122023114	IsS11Max=Yes	IsS11Min=No	FrameElem=94	ElemStation=0.5				
Frame=94	Station=0.5	OutputCase=FESSUR	CaseType=Combination	Point=2	X2=-0.5	X3=0.5		
S11=628.69122023114	IsS11Max=No	IsS11Min=No	FrameElem=94	ElemStation=0.5				
Frame=94	Station=0.5	OutputCase=FESSUR	CaseType=Combination	Point=3	X2=0.5	X3=-0.5	S11=-	
2203.69120375746	IsS11Max=No	IsS11Min=Yes	FrameElem=94	ElemStation=0.5				
Frame=94	Station=0.5	OutputCase=FESSUR	CaseType=Combination	Point=4	X2=0.5	X3=0.5	S11=-	
2203.69120375746	IsS11Max=No	IsS11Min=No	FrameElem=94	ElemStation=0.5				
Frame=95	Station=0	OutputCase=PESOPR	CaseType=LinStatic	Point=0	X2=0	X3=0	S11=-87.4999992722587	
IsS11Max=No	IsS11Min=No	FrameElem=95	ElemStation=0					
Frame=95	Station=0	OutputCase=PESOPR	CaseType=LinStatic	Point=1	X2=-0.5	X3=-0.5		
S11=129.955142762483	IsS11Max=Yes	IsS11Min=No	FrameElem=95	ElemStation=0				
Frame=95	Station=0	OutputCase=PESOPR	CaseType=LinStatic	Point=2	X2=-0.5	X3=0.5	S11=129.955142762483	
IsS11Max=No	IsS11Min=No	FrameElem=95	ElemStation=0					
Frame=95	Station=0	OutputCase=PESOPR	CaseType=LinStatic	Point=3	X2=0.5	X3=-0.5	S11=-304.955141307	
IsS11Max=No	IsS11Min=Yes	FrameElem=95	ElemStation=0					
Frame=95	Station=0.5	OutputCase=PESOPR	CaseType=LinStatic	Point=4	X2=0.5	X3=0.5	S11=-304.955141307	
IsS11Max=No	IsS11Min=No	FrameElem=95	ElemStation=0					
Frame=95	Station=0.5	OutputCase=PESOPR	CaseType=LinStatic	Point=0	X2=0	X3=0	S11=-74.9999992722587	
IsS11Max=No	IsS11Min=No	FrameElem=95	ElemStation=0.5					
Frame=95	Station=0.5	OutputCase=PESOPR	CaseType=LinStatic	Point=1	X2=-0.5	X3=-0.5		
S11=96.9423006167781	IsS11Max=Yes	IsS11Min=No	FrameElem=95	ElemStation=0.5				
Frame=95	Station=0.5	OutputCase=PESOPR	CaseType=LinStatic	Point=2	X2=-0.5	X3=0.5		
S11=96.9423006167781	IsS11Max=No	IsS11Min=No	FrameElem=95	ElemStation=0.5				
Frame=95	Station=0.5	OutputCase=PESOPR	CaseType=LinStatic	Point=3	X2=0.5	X3=-0.5	S11=-	
246.942299161296	IsS11Max=No	IsS11Min=Yes	FrameElem=95	ElemStation=0.5				
Frame=95	Station=0.5	OutputCase=PESOPR	CaseType=LinStatic	Point=4	X2=0.5	X3=0.5	S11=-	
246.942299161296	IsS11Max=No	IsS11Min=No	FrameElem=95	ElemStation=0.5				
Frame=95	Station=0	OutputCase=TERRVERT	CaseType=LinStatic	Point=0	X2=0	X3=0	S11=-699.99999305571	
IsS11Max=No	IsS11Min=No	FrameElem=95	ElemStation=0					
Frame=95	Station=0	OutputCase=TERRVERT	CaseType=LinStatic	Point=1	X2=-0.5	X3=-0.5		
S11=1239.69698154111	IsS11Max=Yes	IsS11Min=No	FrameElem=95	ElemStation=0				
Frame=95	Station=0	OutputCase=TERRVERT	CaseType=LinStatic	Point=2	X2=-0.5	X3=0.5		
S11=1239.69698154111	IsS11Max=No	IsS11Min=No	FrameElem=95	ElemStation=0				
Frame=95	Station=0	OutputCase=TERRVERT	CaseType=LinStatic	Point=3	X2=0.5	X3=-0.5	S11=-	
2639.69696765253	IsS11Max=No	IsS11Min=Yes	FrameElem=95	ElemStation=0				
Frame=95	Station=0	OutputCase=TERRVERT	CaseType=LinStatic	Point=4	X2=0.5	X3=0.5	S11=-	
2639.69696765253	IsS11Max=No	IsS11Min=No	FrameElem=95	ElemStation=0				
Frame=95	Station=0.5	OutputCase=TERRVERT	CaseType=LinStatic	Point=0	X2=0	X3=0	S11=-699.99999305571	
IsS11Max=No	IsS11Min=No	FrameElem=95	ElemStation=0.5					
Frame=95	Station=0.5	OutputCase=TERRVERT	CaseType=LinStatic	Point=1	X2=-0.5	X3=-0.5		
S11=1244.6250869977	IsS11Max=Yes	IsS11Min=No	FrameElem=95	ElemStation=0.5				
Frame=95	Station=0.5	OutputCase=TERRVERT	CaseType=LinStatic	Point=2	X2=-0.5	X3=0.5		
S11=1244.6250869977	IsS11Max=No	IsS11Min=No	FrameElem=95	ElemStation=0.5				
Frame=95	Station=0.5	OutputCase=TERRVERT	CaseType=LinStatic	Point=3	X2=0.5	X3=-0.5	S11=-	
2644.62507310911	IsS11Max=No	IsS11Min=Yes	FrameElem=95	ElemStation=0.5				
Frame=95	Station=0.5	OutputCase=TERRVERT	CaseType=LinStatic	Point=4	X2=0.5	X3=0.5	S11=-	
2644.62507310911	IsS11Max=No	IsS11Min=No	FrameElem=95	ElemStation=0.5				
Frame=95	Station=0	OutputCase=TERRLAT	CaseType=LinStatic	Point=0	X2=0	X3=0	S11=5.64546098758001E-07	
IsS11Max=No	IsS11Min=No	FrameElem=95	ElemStation=0					
Frame=95	Station=0	OutputCase=TERRLAT	CaseType=LinStatic	Point=1	X2=-0.5	X3=-0.5	S11=-	
740.960904072719	IsS11Max=No	IsS11Min=Yes	FrameElem=95	ElemStation=0				
Frame=95	Station=0	OutputCase=TERRLAT	CaseType=LinStatic	Point=2	X2=-0.5	X3=0.5	S11=-	
740.960904072719	IsS11Max=No	IsS11Min=No	FrameElem=95	ElemStation=0				
Frame=95	Station=0	OutputCase=TERRLAT	CaseType=LinStatic	Point=3	X2=0.5	X3=-0.5		
S11=740.960905201811	IsS11Max=Yes	IsS11Min=No	FrameElem=95	ElemStation=0				
Frame=95	Station=0	OutputCase=TERRLAT	CaseType=LinStatic	Point=4	X2=0.5	X3=0.5	S11=740.960905201811	
IsS11Max=No	IsS11Min=No	FrameElem=95	ElemStation=0					
Frame=95	Station=0.5	OutputCase=TERRLAT	CaseType=LinStatic	Point=0	X2=0	X3=0	S11=4.7743999279648E-08	
IsS11Max=No	IsS11Min=No	FrameElem=95	ElemStation=0.5					
Frame=95	Station=0.5	OutputCase=TERRLAT	CaseType=LinStatic	Point=1	X2=-0.5	X3=-0.5	S11=-	
217.210805937797	IsS11Max=No	IsS11Min=Yes	FrameElem=95	ElemStation=0.5				
Frame=95	Station=0.5	OutputCase=TERRLAT	CaseType=LinStatic	Point=2	X2=-0.5	X3=0.5	S11=-	
217.210805937797	IsS11Max=No	IsS11Min=No	FrameElem=95	ElemStation=0.5				
Frame=95	Station=0.5	OutputCase=TERRLAT	CaseType=LinStatic	Point=3	X2=0.5	X3=-0.5		
S11=217.210806033285	IsS11Max=Yes	IsS11Min=No	FrameElem=95	ElemStation=0.5				
Frame=95	Station=0.5	OutputCase=TERRLAT	CaseType=LinStatic	Point=4	X2=0.5	X3=0.5		
S11=217.210806033285	IsS11Max=No	IsS11Min=No	FrameElem=95	ElemStation=0.5				
Frame=95	Station=0	OutputCase=ACCVERT	CaseType=LinStatic	Point=0	X2=0	X3=0	S11=0	IsS11Max=Yes
IsS11Min=Yes	FrameElem=95	ElemStation=0						
Frame=95	Station=0	OutputCase=ACCVERT	CaseType=LinStatic	Point=1	X2=-0.5	X3=-0.5	S11=0	
IsS11Max=No	IsS11Min=No	FrameElem=95	ElemStation=0					
Frame=95	Station=0	OutputCase=ACCVERT	CaseType=LinStatic	Point=2	X2=-0.5	X3=0.5	S11=0	IsS11Max=No
IsS11Min=No	FrameElem=95	ElemStation=0						

Frame=95	Station=0	OutputCase=SOVRCOST	CaseType=LinStatic	Point=4	X2=0.5	X3=0.5	S11=0	IsS11Max=No
IsS11Min=No	FrameElem=95	ElemStation=0						
Frame=95	Station=0.5	OutputCase=SOVRCOST	CaseType=LinStatic	Point=0	X2=0	X3=0	S11=0	IsS11Max=Yes
IsS11Min=Yes	FrameElem=95	ElemStation=0.5						
Frame=95	Station=0.5	OutputCase=SOVRCOST	CaseType=LinStatic	Point=1	X2=-0.5	X3=-0.5	S11=0	
IsS11Max=No	IsS11Min=No	FrameElem=95	ElemStation=0.5					
Frame=95	Station=0.5	OutputCase=SOVRCOST	CaseType=LinStatic	Point=2	X2=-0.5	X3=0.5	S11=0	
IsS11Max=No	IsS11Min=No	FrameElem=95	ElemStation=0.5					
Frame=95	Station=0.5	OutputCase=SOVRCOST	CaseType=LinStatic	Point=3	X2=0.5	X3=-0.5	S11=0	
IsS11Max=No	IsS11Min=No	FrameElem=95	ElemStation=0.5					
Frame=95	Station=0.5	OutputCase=SOVRCOST	CaseType=LinStatic	Point=4	X2=0.5	X3=0.5	S11=0	
IsS11Max=No	IsS11Min=No	FrameElem=95	ElemStation=0.5					
Frame=95	Station=0	OutputCase=ENVE	CaseType=Combination	StepType=Max	Point=0	X2=0	X3=0	S11=-
787.499991763422	IsS11Max=No	IsS11Min=No	FrameElem=95	ElemStation=0				
Frame=95	Station=0	OutputCase=ENVE	CaseType=Combination	StepType=Max	Point=1	X2=-0.5	X3=-0.5	
S11=850.97949145269	IsS11Max=Yes	IsS11Min=No	FrameElem=95	ElemStation=0				
Frame=95	Station=0	OutputCase=ENVE	CaseType=Combination	StepType=Max	Point=2	X2=-0.5	X3=0.5	
S11=850.97949145269	IsS11Max=No	IsS11Min=No	FrameElem=95	ElemStation=0				
Frame=95	Station=0	OutputCase=ENVE	CaseType=Combination	StepType=Max	Point=3	X2=0.5	X3=-0.5	S11=-
2203.69120375772	IsS11Max=No	IsS11Min=Yes	FrameElem=95	ElemStation=0				
Frame=95	Station=0	OutputCase=ENVE	CaseType=Combination	StepType=Max	Point=4	X2=0.5	X3=0.5	S11=-
2203.69120375772	IsS11Max=No	IsS11Min=No	FrameElem=95	ElemStation=0				
Frame=95	Station=0.5	OutputCase=ENVE	CaseType=Combination	StepType=Max	Point=0	X2=0	X3=0	S11=-
774.999992280224	IsS11Max=No	IsS11Min=No	FrameElem=95	ElemStation=0.5				
Frame=95	Station=0.5	OutputCase=ENVE	CaseType=Combination	StepType=Max	Point=1	X2=-0.5	X3=-0.5	
S11=1189.51982345802	IsS11Max=Yes	IsS11Min=No	FrameElem=95	ElemStation=0.5				
Frame=95	Station=0.5	OutputCase=ENVE	CaseType=Combination	StepType=Max	Point=2	X2=-0.5	X3=0.5	
S11=1189.51982345802	IsS11Max=No	IsS11Min=No	FrameElem=95	ElemStation=0.5				
Frame=95	Station=0.5	OutputCase=ENVE	CaseType=Combination	StepType=Max	Point=3	X2=0.5	X3=-0.5	
S11=-2674.35656623712	IsS11Max=No	IsS11Min=Yes	FrameElem=95	ElemStation=0.5				
Frame=95	Station=0.5	OutputCase=ENVE	CaseType=Combination	StepType=Max	Point=4	X2=0.5	X3=0.5	
S11=-2674.35656623712	IsS11Max=No	IsS11Min=No	FrameElem=95	ElemStation=0.5				
Frame=95	Station=0	OutputCase=ENVE	CaseType=Combination	StepType=Min	Point=0	X2=0	X3=0	S11=-
787.499991932786	IsS11Max=No	IsS11Min=No	FrameElem=95	ElemStation=0				
Frame=95	Station=0	OutputCase=ENVE	CaseType=Combination	StepType=Min	Point=1	X2=-0.5	X3=-0.5	
S11=628.691220230874	IsS11Max=Yes	IsS11Min=No	FrameElem=95	ElemStation=0				
Frame=95	Station=0	OutputCase=ENVE	CaseType=Combination	StepType=Min	Point=2	X2=-0.5	X3=0.5	
S11=628.691220230874	IsS11Max=No	IsS11Min=No	FrameElem=95	ElemStation=0				
Frame=95	Station=0	OutputCase=ENVE	CaseType=Combination	StepType=Min	Point=3	X2=0.5	X3=-0.5	S11=-
2425.97947531826	IsS11Max=No	IsS11Min=Yes	FrameElem=95	ElemStation=0				
Frame=95	Station=0	OutputCase=ENVE	CaseType=Combination	StepType=Min	Point=4	X2=0.5	X3=0.5	S11=-
2425.97947531826	IsS11Max=No	IsS11Min=No	FrameElem=95	ElemStation=0				
Frame=95	Station=0.5	OutputCase=ENVE	CaseType=Combination	StepType=Min	Point=0	X2=0	X3=0	S11=-
774.999992294548	IsS11Max=No	IsS11Min=No	FrameElem=95	ElemStation=0.5				
Frame=95	Station=0.5	OutputCase=ENVE	CaseType=Combination	StepType=Min	Point=1	X2=-0.5	X3=-0.5	
S11=1124.35658167668	IsS11Max=Yes	IsS11Min=No	FrameElem=95	ElemStation=0.5				
Frame=95	Station=0.5	OutputCase=ENVE	CaseType=Combination	StepType=Min	Point=2	X2=-0.5	X3=0.5	
S11=1124.35658167668	IsS11Max=No	IsS11Min=No	FrameElem=95	ElemStation=0.5				
Frame=95	Station=0.5	OutputCase=ENVE	CaseType=Combination	StepType=Min	Point=3	X2=0.5	X3=-0.5	
S11=-2739.51980804711	IsS11Max=No	IsS11Min=Yes	FrameElem=95	ElemStation=0.5				
Frame=95	Station=0.5	OutputCase=ENVE	CaseType=Combination	StepType=Min	Point=4	X2=0.5	X3=0.5	
S11=-2739.51980804711	IsS11Max=No	IsS11Min=No	FrameElem=95	ElemStation=0.5				
Frame=95	Station=0	OutputCase=FESSUR	CaseType=Combination	Point=0	X2=0	X3=0	S11=-787.499991763422	
IsS11Max=No	IsS11Min=No	FrameElem=95	ElemStation=0					
Frame=95	Station=0	OutputCase=FESSUR	CaseType=Combination	Point=1	X2=-0.5	X3=-0.5		
S11=628.691220230874	IsS11Max=Yes	IsS11Min=No	FrameElem=95	ElemStation=0				
Frame=95	Station=0	OutputCase=FESSUR	CaseType=Combination	Point=2	X2=-0.5	X3=0.5		
S11=628.691220230874	IsS11Max=No	IsS11Min=No	FrameElem=95	ElemStation=0				
Frame=95	Station=0	OutputCase=FESSUR	CaseType=Combination	Point=3	X2=0.5	X3=-0.5	S11=-	
2203.69120375772	IsS11Max=No	IsS11Min=Yes	FrameElem=95	ElemStation=0				
Frame=95	Station=0	OutputCase=FESSUR	CaseType=Combination	Point=4	X2=0.5	X3=0.5	S11=-	
2203.69120375772	IsS11Max=No	IsS11Min=No	FrameElem=95	ElemStation=0				
Frame=95	Station=0.5	OutputCase=FESSUR	CaseType=Combination	Point=0	X2=0	X3=0	S11=-774.999992280224	
IsS11Max=No	IsS11Min=No	FrameElem=95	ElemStation=0.5					
Frame=95	Station=0.5	OutputCase=FESSUR	CaseType=Combination	Point=1	X2=-0.5	X3=-0.5		
S11=1124.35658167668	IsS11Max=Yes	IsS11Min=No	FrameElem=95	ElemStation=0.5				
Frame=95	Station=0.5	OutputCase=FESSUR	CaseType=Combination	Point=2	X2=-0.5	X3=0.5		
S11=1124.35658167668	IsS11Max=No	IsS11Min=No	FrameElem=95	ElemStation=0.5				
Frame=95	Station=0.5	OutputCase=FESSUR	CaseType=Combination	Point=3	X2=0.5	X3=-0.5	S11=-	
2674.35656623712	IsS11Max=No	IsS11Min=Yes	FrameElem=95	ElemStation=0.5				
Frame=95	Station=0.5	OutputCase=FESSUR	CaseType=Combination	Point=4	X2=0.5	X3=0.5	S11=-	
2674.35656623712	IsS11Max=No	IsS11Min=No	FrameElem=95	ElemStation=0.5				
Frame=112	Station=0	OutputCase=PESOPR	CaseType=LinStatic	Point=0	X2=0	X3=0	S11=15.170946736185	
IsS11Max=No	IsS11Min=No	FrameElem=112	ElemStation=0					
Frame=112	Station=0	OutputCase=PESOPR	CaseType=LinStatic	Point=1	X2=-0.5	X3=-0.5		
S11=57.4914771874153	IsS11Max=Yes	IsS11Min=No	FrameElem=112	ElemStation=0				
Frame=112	Station=0	OutputCase=PESOPR	CaseType=LinStatic	Point=2	X2=-0.5	X3=0.5		
S11=57.4914771874153	IsS11Max=No	IsS11Min=No	FrameElem=112	ElemStation=0				
Frame=112	Station=0	OutputCase=PESOPR	CaseType=LinStatic	Point=3	X2=0.5	X3=-0.5	S11=-	
27.1495837150453	IsS11Max=No	IsS11Min=Yes	FrameElem=112	ElemStation=0				
Frame=112	Station=0	OutputCase=PESOPR	CaseType=LinStatic	Point=4	X2=0.5	X3=0.5	S11=-	
27.1495837150453	IsS11Max=No	IsS11Min=No	FrameElem=112	ElemStation=0				

```

Frame=112 Station=0.125 OutputCase=PESOPR CaseType=LinStatic Point=0 X2=0 X3=0 S11=15.170946736185
IsS11Max=No IsS11Min=No FrameElem=112 ElemStation=0.125
Frame=112 Station=0.125 OutputCase=PESOPR CaseType=LinStatic Point=1 X2=-0.5 X3=-0.5
S11=93.8196021790443 IsS11Max=Yes IsS11Min=No FrameElem=112 ElemStation=0.125
Frame=112 Station=0.125 OutputCase=PESOPR CaseType=LinStatic Point=2 X2=-0.5 X3=0.5
S11=93.8196021790443 IsS11Max=No IsS11Min=No FrameElem=112 ElemStation=0.125
Frame=112 Station=0.125 OutputCase=PESOPR CaseType=LinStatic Point=3 X2=0.5 X3=-0.5 S11=-
63.4777087066743 IsS11Max=No IsS11Min=Yes FrameElem=112 ElemStation=0.125
Frame=112 Station=0.125 OutputCase=PESOPR CaseType=LinStatic Point=4 X2=0.5 X3=0.5 S11=-
63.4777087066743 IsS11Max=No IsS11Min=No FrameElem=112 ElemStation=0.125
Frame=112 Station=0.25 OutputCase=PESOPR CaseType=LinStatic Point=0 X2=0 X3=0 S11=15.170946736185
IsS11Max=No IsS11Min=No FrameElem=112 ElemStation=0.25
Frame=112 Station=0.25 OutputCase=PESOPR CaseType=LinStatic Point=1 X2=-0.5 X3=-0.5
S11=127.803977170673 IsS11Max=Yes IsS11Min=No FrameElem=112 ElemStation=0.25
Frame=112 Station=0.25 OutputCase=PESOPR CaseType=LinStatic Point=2 X2=-0.5 X3=0.5
S11=127.803977170673 IsS11Max=No IsS11Min=No FrameElem=112 ElemStation=0.25
Frame=112 Station=0.25 OutputCase=PESOPR CaseType=LinStatic Point=3 X2=0.5 X3=-0.5 S11=-
97.4620836983033 IsS11Max=No IsS11Min=Yes FrameElem=112 ElemStation=0.25
Frame=112 Station=0.25 OutputCase=PESOPR CaseType=LinStatic Point=4 X2=0.5 X3=0.5 S11=-
97.4620836983033 IsS11Max=No IsS11Min=No FrameElem=112 ElemStation=0.25
Frame=112 Station=0.375 OutputCase=PESOPR CaseType=LinStatic Point=0 X2=0 X3=0 S11=15.170946736185
IsS11Max=No IsS11Min=No FrameElem=112 ElemStation=0.375
Frame=112 Station=0.375 OutputCase=PESOPR CaseType=LinStatic Point=1 X2=-0.5 X3=-0.5
S11=159.444602162302 IsS11Max=Yes IsS11Min=No FrameElem=112 ElemStation=0.375
Frame=112 Station=0.375 OutputCase=PESOPR CaseType=LinStatic Point=2 X2=-0.5 X3=0.5
S11=159.444602162302 IsS11Max=No IsS11Min=No FrameElem=112 ElemStation=0.375
Frame=112 Station=0.375 OutputCase=PESOPR CaseType=LinStatic Point=3 X2=0.5 X3=-0.5 S11=-
129.102708689932 IsS11Max=No IsS11Min=Yes FrameElem=112 ElemStation=0.375
Frame=112 Station=0.375 OutputCase=PESOPR CaseType=LinStatic Point=4 X2=0.5 X3=0.5 S11=-
129.102708689932 IsS11Max=No IsS11Min=No FrameElem=112 ElemStation=0.375
Frame=112 Station=0.5 OutputCase=PESOPR CaseType=LinStatic Point=0 X2=0 X3=0 S11=15.170946736185
IsS11Max=No IsS11Min=No FrameElem=112 ElemStation=0.5
Frame=112 Station=0.5 OutputCase=PESOPR CaseType=LinStatic Point=1 X2=-0.5 X3=-0.5
S11=188.741477153931 IsS11Max=Yes IsS11Min=No FrameElem=112 ElemStation=0.5
Frame=112 Station=0.5 OutputCase=PESOPR CaseType=LinStatic Point=2 X2=-0.5 X3=0.5
S11=188.741477153931 IsS11Max=No IsS11Min=No FrameElem=112 ElemStation=0.5
Frame=112 Station=0.5 OutputCase=PESOPR CaseType=LinStatic Point=3 X2=0.5 X3=-0.5 S11=-
158.399583681561 IsS11Max=No IsS11Min=Yes FrameElem=112 ElemStation=0.5
Frame=112 Station=0.5 OutputCase=PESOPR CaseType=LinStatic Point=4 X2=0.5 X3=0.5 S11=-
158.399583681561 IsS11Max=No IsS11Min=No FrameElem=112 ElemStation=0.5
Frame=112 Station=0 OutputCase=TERRVERT CaseType=LinStatic Point=0 X2=0 X3=0 S11=-1.64270738195971
IsS11Max=No IsS11Min=No FrameElem=112 ElemStation=0
Frame=112 Station=0 OutputCase=TERRVERT CaseType=LinStatic Point=1 X2=-0.5 X3=-0.5 S11=-
61.1960105623677 IsS11Max=No IsS11Min=Yes FrameElem=112 ElemStation=0
Frame=112 Station=0 OutputCase=TERRVERT CaseType=LinStatic Point=2 X2=-0.5 X3=0.5 S11=-
61.1960105623677 IsS11Max=No IsS11Min=No FrameElem=112 ElemStation=0
Frame=112 Station=0 OutputCase=TERRVERT CaseType=LinStatic Point=3 X2=0.5 X3=-0.5
S11=57.9105957984483 IsS11Max=Yes IsS11Min=No FrameElem=112 ElemStation=0
Frame=112 Station=0 OutputCase=TERRVERT CaseType=LinStatic Point=4 X2=0.5 X3=0.5
S11=57.9105957984483 IsS11Max=No IsS11Min=No FrameElem=112 ElemStation=0
Frame=112 Station=0.125 OutputCase=TERRVERT CaseType=LinStatic Point=0 X2=0 X3=0 S11=-
1.64270738195971 IsS11Max=No IsS11Min=No FrameElem=112 ElemStation=0.125
Frame=112 Station=0.125 OutputCase=TERRVERT CaseType=LinStatic Point=1 X2=-0.5 X3=-0.5
S11=345.678989226382 IsS11Max=Yes IsS11Min=No FrameElem=112 ElemStation=0.125
Frame=112 Station=0.125 OutputCase=TERRVERT CaseType=LinStatic Point=2 X2=-0.5 X3=0.5
S11=345.678989226382 IsS11Max=No IsS11Min=No FrameElem=112 ElemStation=0.125
Frame=112 Station=0.125 OutputCase=TERRVERT CaseType=LinStatic Point=3 X2=0.5 X3=-0.5 S11=-
348.964403990302 IsS11Max=No IsS11Min=Yes FrameElem=112 ElemStation=0.125
Frame=112 Station=0.125 OutputCase=TERRVERT CaseType=LinStatic Point=4 X2=0.5 X3=0.5 S11=-
348.964403990302 IsS11Max=No IsS11Min=No FrameElem=112 ElemStation=0.125
Frame=112 Station=0.25 OutputCase=TERRVERT CaseType=LinStatic Point=0 X2=0 X3=0 S11=-
1.64270738195971 IsS11Max=No IsS11Min=No FrameElem=112 ElemStation=0.25
Frame=112 Station=0.25 OutputCase=TERRVERT CaseType=LinStatic Point=1 X2=-0.5 X3=-0.5
S11=726.303989015132 IsS11Max=Yes IsS11Min=No FrameElem=112 ElemStation=0.25
Frame=112 Station=0.25 OutputCase=TERRVERT CaseType=LinStatic Point=2 X2=-0.5 X3=0.5
S11=726.303989015132 IsS11Max=No IsS11Min=No FrameElem=112 ElemStation=0.25
Frame=112 Station=0.25 OutputCase=TERRVERT CaseType=LinStatic Point=3 X2=0.5 X3=-0.5 S11=-
729.589403779051 IsS11Max=No IsS11Min=Yes FrameElem=112 ElemStation=0.25
Frame=112 Station=0.25 OutputCase=TERRVERT CaseType=LinStatic Point=4 X2=0.5 X3=0.5 S11=-
729.589403779051 IsS11Max=No IsS11Min=No FrameElem=112 ElemStation=0.25
Frame=112 Station=0.375 OutputCase=TERRVERT CaseType=LinStatic Point=0 X2=0 X3=0 S11=-
1.64270738195971 IsS11Max=No IsS11Min=No FrameElem=112 ElemStation=0.375
Frame=112 Station=0.375 OutputCase=TERRVERT CaseType=LinStatic Point=1 X2=-0.5 X3=-0.5
S11=1080.67898880388 IsS11Max=Yes IsS11Min=No FrameElem=112 ElemStation=0.375
Frame=112 Station=0.375 OutputCase=TERRVERT CaseType=LinStatic Point=2 X2=-0.5 X3=0.5
S11=1080.67898880388 IsS11Max=No IsS11Min=No FrameElem=112 ElemStation=0.375
Frame=112 Station=0.375 OutputCase=TERRVERT CaseType=LinStatic Point=3 X2=0.5 X3=-0.5 S11=-
1083.9644035678 IsS11Max=No IsS11Min=Yes FrameElem=112 ElemStation=0.375
Frame=112 Station=0.375 OutputCase=TERRVERT CaseType=LinStatic Point=4 X2=0.5 X3=0.5 S11=-
1083.9644035678 IsS11Max=No IsS11Min=No FrameElem=112 ElemStation=0.375
Frame=112 Station=0.5 OutputCase=TERRVERT CaseType=LinStatic Point=0 X2=0 X3=0 S11=-
1.64270738195971 IsS11Max=No IsS11Min=No FrameElem=112 ElemStation=0.5

```

Frame=112	Station=0.5	OutputCase=TERRVERT	CaseType=LinStatic	Point=1	X2=-0.5	X3=-0.5		
S11=1408.80398859263	IsS11Max=Yes	IsS11Min=No	FrameElem=112	ElemStation=0.5				
Frame=112	Station=0.5	OutputCase=TERRVERT	CaseType=LinStatic	Point=2	X2=-0.5	X3=0.5		
S11=1408.80398859263	IsS11Max=No	IsS11Min=No	FrameElem=112	ElemStation=0.5				
Frame=112	Station=0.5	OutputCase=TERRVERT	CaseType=LinStatic	Point=3	X2=0.5	X3=-0.5	S11=-	
1412.08940335655	IsS11Max=No	IsS11Min=Yes	FrameElem=112	ElemStation=0.5				
Frame=112	Station=0.5	OutputCase=TERRVERT	CaseType=LinStatic	Point=4	X2=0.5	X3=0.5	S11=-	
1412.08940335655	IsS11Max=No	IsS11Min=No	FrameElem=112	ElemStation=0.5				
Frame=112	Station=0	OutputCase=TERRLAT	CaseType=LinStatic	Point=0	X2=0	X3=0	S11=-330.586282883909	
IsS11Max=No	IsS11Min=No	FrameElem=112	ElemStation=0					
Frame=112	Station=0	OutputCase=TERRLAT	CaseType=LinStatic	Point=1	X2=-0.5	X3=-0.5	S11=-	
829.013080626687	IsS11Max=No	IsS11Min=Yes	FrameElem=112	ElemStation=0				
Frame=112	Station=0	OutputCase=TERRLAT	CaseType=LinStatic	Point=2	X2=-0.5	X3=0.5	S11=-	
829.013080626687	IsS11Max=No	IsS11Min=No	FrameElem=112	ElemStation=0				
Frame=112	Station=0	OutputCase=TERRLAT	CaseType=LinStatic	Point=3	X2=0.5	X3=-0.5		
S11=167.840514858869	IsS11Max=Yes	IsS11Min=No	FrameElem=112	ElemStation=0				
Frame=112	Station=0	OutputCase=TERRLAT	CaseType=LinStatic	Point=4	X2=0.5	X3=0.5		
S11=167.840514858869	IsS11Max=No	IsS11Min=No	FrameElem=112	ElemStation=0				
Frame=112	Station=0.125	OutputCase=TERRLAT	CaseType=LinStatic	Point=0	X2=0	X3=0	S11=-	
330.586282883909	IsS11Max=No	IsS11Min=No	FrameElem=112	ElemStation=0.125				
Frame=112	Station=0.125	OutputCase=TERRLAT	CaseType=LinStatic	Point=1	X2=-0.5	X3=-0.5	S11=-	
829.013081895834	IsS11Max=No	IsS11Min=Yes	FrameElem=112	ElemStation=0.125				
Frame=112	Station=0.125	OutputCase=TERRLAT	CaseType=LinStatic	Point=2	X2=-0.5	X3=0.5	S11=-	
829.013081895834	IsS11Max=No	IsS11Min=No	FrameElem=112	ElemStation=0.125				
Frame=112	Station=0.125	OutputCase=TERRLAT	CaseType=LinStatic	Point=3	X2=0.5	X3=-0.5		
S11=167.840516128016	IsS11Max=Yes	IsS11Min=No	FrameElem=112	ElemStation=0.125				
Frame=112	Station=0.125	OutputCase=TERRLAT	CaseType=LinStatic	Point=4	X2=0.5	X3=0.5		
S11=167.840516128016	IsS11Max=No	IsS11Min=No	FrameElem=112	ElemStation=0.125				
Frame=112	Station=0.25	OutputCase=TERRLAT	CaseType=LinStatic	Point=0	X2=0	X3=0	S11=-	
330.586282883909	IsS11Max=No	IsS11Min=No	FrameElem=112	ElemStation=0.25				
Frame=112	Station=0.25	OutputCase=TERRLAT	CaseType=LinStatic	Point=1	X2=-0.5	X3=-0.5	S11=-	
829.013083164982	IsS11Max=No	IsS11Min=Yes	FrameElem=112	ElemStation=0.25				
Frame=112	Station=0.25	OutputCase=TERRLAT	CaseType=LinStatic	Point=2	X2=-0.5	X3=0.5	S11=-	
829.013083164982	IsS11Max=No	IsS11Min=No	FrameElem=112	ElemStation=0.25				
Frame=112	Station=0.25	OutputCase=TERRLAT	CaseType=LinStatic	Point=3	X2=0.5	X3=-0.5		
S11=167.840517397164	IsS11Max=Yes	IsS11Min=No	FrameElem=112	ElemStation=0.25				
Frame=112	Station=0.25	OutputCase=TERRLAT	CaseType=LinStatic	Point=4	X2=0.5	X3=0.5		
S11=167.840517397164	IsS11Max=No	IsS11Min=No	FrameElem=112	ElemStation=0.25				
Frame=112	Station=0.375	OutputCase=TERRLAT	CaseType=LinStatic	Point=0	X2=0	X3=0	S11=-	
330.586282883909	IsS11Max=No	IsS11Min=No	FrameElem=112	ElemStation=0.375				
Frame=112	Station=0.375	OutputCase=TERRLAT	CaseType=LinStatic	Point=1	X2=-0.5	X3=-0.5	S11=-	
829.013084434129	IsS11Max=No	IsS11Min=Yes	FrameElem=112	ElemStation=0.375				
Frame=112	Station=0.375	OutputCase=TERRLAT	CaseType=LinStatic	Point=2	X2=-0.5	X3=0.5	S11=-	
829.013084434129	IsS11Max=No	IsS11Min=No	FrameElem=112	ElemStation=0.375				
Frame=112	Station=0.375	OutputCase=TERRLAT	CaseType=LinStatic	Point=3	X2=0.5	X3=-0.5		
S11=167.840518666312	IsS11Max=Yes	IsS11Min=No	FrameElem=112	ElemStation=0.375				
Frame=112	Station=0.375	OutputCase=TERRLAT	CaseType=LinStatic	Point=4	X2=0.5	X3=0.5		
S11=167.840518666312	IsS11Max=No	IsS11Min=No	FrameElem=112	ElemStation=0.375				
Frame=112	Station=0.5	OutputCase=TERRLAT	CaseType=LinStatic	Point=0	X2=0	X3=0	S11=-330.586282883909	
IsS11Max=No	IsS11Min=No	FrameElem=112	ElemStation=0.5					
Frame=112	Station=0.5	OutputCase=TERRLAT	CaseType=LinStatic	Point=1	X2=-0.5	X3=-0.5	S11=-	
829.013085703277	IsS11Max=No	IsS11Min=Yes	FrameElem=112	ElemStation=0.5				
Frame=112	Station=0.5	OutputCase=TERRLAT	CaseType=LinStatic	Point=2	X2=-0.5	X3=0.5	S11=-	
829.013085703277	IsS11Max=No	IsS11Min=No	FrameElem=112	ElemStation=0.5				
Frame=112	Station=0.5	OutputCase=TERRLAT	CaseType=LinStatic	Point=3	X2=0.5	X3=-0.5		
S11=167.840519935459	IsS11Max=Yes	IsS11Min=No	FrameElem=112	ElemStation=0.5				
Frame=112	Station=0.5	OutputCase=TERRLAT	CaseType=LinStatic	Point=4	X2=0.5	X3=0.5		
S11=167.840519935459	IsS11Max=No	IsS11Min=No	FrameElem=112	ElemStation=0.5				
Frame=112	Station=0	OutputCase=ACCVERT	CaseType=LinStatic	Point=0	X2=0	X3=0	S11=0	IsS11Max=Yes
IsS11Min=Yes	FrameElem=112	ElemStation=0						
Frame=112	Station=0	OutputCase=ACCVERT	CaseType=LinStatic	Point=1	X2=-0.5	X3=-0.5	S11=0	
IsS11Max=No	IsS11Min=No	FrameElem=112	ElemStation=0					
Frame=112	Station=0	OutputCase=ACCVERT	CaseType=LinStatic	Point=2	X2=-0.5	X3=0.5	S11=0	
IsS11Max=No	IsS11Min=No	FrameElem=112	ElemStation=0					
Frame=112	Station=0	OutputCase=ACCVERT	CaseType=LinStatic	Point=3	X2=0.5	X3=-0.5	S11=0	
IsS11Max=No	IsS11Min=No	FrameElem=112	ElemStation=0					
Frame=112	Station=0	OutputCase=ACCVERT	CaseType=LinStatic	Point=4	X2=0.5	X3=0.5	S11=0	IsS11Max=No
IsS11Min=No	FrameElem=112	ElemStation=0						
Frame=112	Station=0.125	OutputCase=ACCVERT	CaseType=LinStatic	Point=0	X2=0	X3=0	S11=0	
IsS11Max=Yes	IsS11Min=Yes	FrameElem=112	ElemStation=0.125					
Frame=112	Station=0.125	OutputCase=ACCVERT	CaseType=LinStatic	Point=1	X2=-0.5	X3=-0.5	S11=0	
IsS11Max=No	IsS11Min=No	FrameElem=112	ElemStation=0.125					
Frame=112	Station=0.125	OutputCase=ACCVERT	CaseType=LinStatic	Point=2	X2=-0.5	X3=0.5	S11=0	
IsS11Max=No	IsS11Min=No	FrameElem=112	ElemStation=0.125					
Frame=112	Station=0.125	OutputCase=ACCVERT	CaseType=LinStatic	Point=3	X2=0.5	X3=-0.5	S11=0	
IsS11Max=No	IsS11Min=No	FrameElem=112	ElemStation=0.125					
Frame=112	Station=0.125	OutputCase=ACCVERT	CaseType=LinStatic	Point=4	X2=0.5	X3=0.5	S11=0	
IsS11Max=No	IsS11Min=No	FrameElem=112	ElemStation=0.125					
Frame=112	Station=0.25	OutputCase=ACCVERT	CaseType=LinStatic	Point=0	X2=0	X3=0	S11=0	IsS11Max=Yes
IsS11Min=Yes	FrameElem=112	ElemStation=0.25						
Frame=112	Station=0.25	OutputCase=ACCVERT	CaseType=LinStatic	Point=1	X2=-0.5	X3=-0.5	S11=0	
IsS11Max=No	IsS11Min=No	FrameElem=112	ElemStation=0.25					



Frame=112	Station=0.25	OutputCase=ENVE	CaseType=Combination	StepType=Max	Point=0	X2=0	X3=0	S11=-
217.882158664511	Iss11Max=No	Iss11Min=No	FrameElem=112	ElemStation=0.25	Point=1	X2=-0.5	X3=-0.5	
Frame=112	Station=0.25	OutputCase=ENVE	CaseType=Combination	StepType=Max	Point=1	X2=-0.5	X3=-0.5	
S11=273.798807970318	Iss11Max=Yes	Iss11Min=No	FrameElem=112	ElemStation=0.25	Point=2	X2=-0.5	X3=0.5	
Frame=112	Station=0.25	OutputCase=ENVE	CaseType=Combination	StepType=Max	Point=2	X2=-0.5	X3=0.5	
S11=273.798807970318	Iss11Max=No	Iss11Min=No	FrameElem=112	ElemStation=0.25	Point=3	X2=0.5	X3=-0.5	
Frame=112	Station=0.25	OutputCase=ENVE	CaseType=Combination	StepType=Max	Point=3	X2=0.5	X3=-0.5	
S11=-659.210970080191	Iss11Max=No	Iss11Min=Yes	FrameElem=112	ElemStation=0.25	Point=4	X2=0.5	X3=0.5	
Frame=112	Station=0.25	OutputCase=ENVE	CaseType=Combination	StepType=Max	Point=4	X2=0.5	X3=0.5	
S11=-659.210970080191	Iss11Max=No	Iss11Min=No	FrameElem=112	ElemStation=0.25	Point=0	X2=0	X3=0	S11=-
Frame=112	Station=0.375	OutputCase=ENVE	CaseType=Combination	StepType=Max	Point=0	X2=0	X3=0	S11=-
217.882158664511	Iss11Max=No	Iss11Min=No	FrameElem=112	ElemStation=0.375	Point=1	X2=-0.5	X3=-0.5	
Frame=112	Station=0.375	OutputCase=ENVE	CaseType=Combination	StepType=Max	Point=1	X2=-0.5	X3=-0.5	
S11=659.814431862294	Iss11Max=Yes	Iss11Min=No	FrameElem=112	ElemStation=0.375	Point=2	X2=-0.5	X3=0.5	
Frame=112	Station=0.375	OutputCase=ENVE	CaseType=Combination	StepType=Max	Point=2	X2=-0.5	X3=0.5	
S11=659.814431862294	Iss11Max=No	Iss11Min=No	FrameElem=112	ElemStation=0.375	Point=3	X2=0.5	X3=-0.5	
Frame=112	Station=0.375	OutputCase=ENVE	CaseType=Combination	StepType=Max	Point=3	X2=0.5	X3=-0.5	
S11=-1045.22659359142	Iss11Max=No	Iss11Min=Yes	FrameElem=112	ElemStation=0.375	Point=4	X2=0.5	X3=0.5	
Frame=112	Station=0.375	OutputCase=ENVE	CaseType=Combination	StepType=Max	Point=4	X2=0.5	X3=0.5	
S11=-1045.22659359142	Iss11Max=No	Iss11Min=No	FrameElem=112	ElemStation=0.375	Point=0	X2=0	X3=0	S11=-
Frame=112	Station=0.5	OutputCase=ENVE	CaseType=Combination	StepType=Max	Point=0	X2=0	X3=0	S11=-
217.882158664511	Iss11Max=No	Iss11Min=No	FrameElem=112	ElemStation=0.5	Point=1	X2=-0.5	X3=-0.5	
Frame=112	Station=0.5	OutputCase=ENVE	CaseType=Combination	StepType=Max	Point=1	X2=-0.5	X3=-0.5	
S11=1017.23630575427	Iss11Max=Yes	Iss11Min=No	FrameElem=112	ElemStation=0.5	Point=2	X2=-0.5	X3=0.5	
Frame=112	Station=0.5	OutputCase=ENVE	CaseType=Combination	StepType=Max	Point=2	X2=-0.5	X3=0.5	
S11=1017.23630575427	Iss11Max=No	Iss11Min=No	FrameElem=112	ElemStation=0.5	Point=3	X2=0.5	X3=-0.5	
Frame=112	Station=0.5	OutputCase=ENVE	CaseType=Combination	StepType=Max	Point=3	X2=0.5	X3=-0.5	
S11=-1402.64846710265	Iss11Max=No	Iss11Min=Yes	FrameElem=112	ElemStation=0.5	Point=4	X2=0.5	X3=0.5	
Frame=112	Station=0.5	OutputCase=ENVE	CaseType=Combination	StepType=Max	Point=4	X2=0.5	X3=0.5	
S11=-1402.64846710265	Iss11Max=No	Iss11Min=No	FrameElem=112	ElemStation=0.5	Point=0	X2=0	X3=0	S11=-
Frame=112	Station=0	OutputCase=ENVE	CaseType=Combination	StepType=Min	Point=0	X2=0	X3=0	S11=-
317.058043529684	Iss11Max=No	Iss11Min=No	FrameElem=112	ElemStation=0	Point=1	X2=-0.5	X3=-0.5	
Frame=112	Station=0	OutputCase=ENVE	CaseType=Combination	StepType=Min	Point=1	X2=-0.5	X3=-0.5	
S11=-832.717614001639	Iss11Max=No	Iss11Min=Yes	FrameElem=112	ElemStation=0	Point=2	X2=-0.5	X3=0.5	
Frame=112	Station=0	OutputCase=ENVE	CaseType=Combination	StepType=Min	Point=2	X2=-0.5	X3=0.5	
S11=-832.717614001639	Iss11Max=No	Iss11Min=No	FrameElem=112	ElemStation=0	Point=3	X2=0.5	X3=-0.5	
Frame=112	Station=0	OutputCase=ENVE	CaseType=Combination	StepType=Min	Point=3	X2=0.5	X3=-0.5	
S11=148.249372484611	Iss11Max=Yes	Iss11Min=No	FrameElem=112	ElemStation=0	Point=4	X2=0.5	X3=0.5	
Frame=112	Station=0	OutputCase=ENVE	CaseType=Combination	StepType=Min	Point=4	X2=0.5	X3=0.5	
S11=148.249372484611	Iss11Max=No	Iss11Min=No	FrameElem=112	ElemStation=0	Point=0	X2=0	X3=0	S11=-
Frame=112	Station=0.125	OutputCase=ENVE	CaseType=Combination	StepType=Min	Point=0	X2=0	X3=0	S11=-
317.058043529684	Iss11Max=No	Iss11Min=No	FrameElem=112	ElemStation=0.125	Point=1	X2=-0.5	X3=-0.5	
Frame=112	Station=0.125	OutputCase=ENVE	CaseType=Combination	StepType=Min	Point=1	X2=-0.5	X3=-0.5	
S11=-389.514490490408	Iss11Max=No	Iss11Min=Yes	FrameElem=112	ElemStation=0.125	Point=2	X2=-0.5	X3=0.5	
Frame=112	Station=0.125	OutputCase=ENVE	CaseType=Combination	StepType=Min	Point=2	X2=-0.5	X3=0.5	
S11=-389.514490490408	Iss11Max=No	Iss11Min=No	FrameElem=112	ElemStation=0.125	Point=3	X2=0.5	X3=-0.5	
Frame=112	Station=0.125	OutputCase=ENVE	CaseType=Combination	StepType=Min	Point=3	X2=0.5	X3=-0.5	
S11=-294.953751407364	Iss11Max=Yes	Iss11Min=No	FrameElem=112	ElemStation=0.125	Point=4	X2=0.5	X3=0.5	
Frame=112	Station=0.125	OutputCase=ENVE	CaseType=Combination	StepType=Min	Point=4	X2=0.5	X3=0.5	
S11=-294.953751407364	Iss11Max=No	Iss11Min=No	FrameElem=112	ElemStation=0.125	Point=0	X2=0	X3=0	S11=-
Frame=112	Station=0.25	OutputCase=ENVE	CaseType=Combination	StepType=Min	Point=0	X2=0	X3=0	S11=-
317.058043529684	Iss11Max=No	Iss11Min=No	FrameElem=112	ElemStation=0.25	Point=1	X2=-0.5	X3=-0.5	
Frame=112	Station=0.25	OutputCase=ENVE	CaseType=Combination	StepType=Min	Point=1	X2=-0.5	X3=-0.5	
S11=25.0948830208235	Iss11Max=Yes	Iss11Min=No	FrameElem=112	ElemStation=0.25	Point=2	X2=-0.5	X3=0.5	
Frame=112	Station=0.25	OutputCase=ENVE	CaseType=Combination	StepType=Min	Point=2	X2=-0.5	X3=0.5	
S11=25.0948830208235	Iss11Max=No	Iss11Min=No	FrameElem=112	ElemStation=0.25	Point=3	X2=0.5	X3=-0.5	
Frame=112	Station=0.25	OutputCase=ENVE	CaseType=Combination	StepType=Min	Point=3	X2=0.5	X3=-0.5	
S11=-709.56312529934	Iss11Max=No	Iss11Min=Yes	FrameElem=112	ElemStation=0.25	Point=4	X2=0.5	X3=0.5	
Frame=112	Station=0.25	OutputCase=ENVE	CaseType=Combination	StepType=Min	Point=4	X2=0.5	X3=0.5	
S11=-709.56312529934	Iss11Max=No	Iss11Min=No	FrameElem=112	ElemStation=0.25	Point=0	X2=0	X3=0	S11=-
Frame=112	Station=0.375	OutputCase=ENVE	CaseType=Combination	StepType=Min	Point=0	X2=0	X3=0	S11=-
317.058043529684	Iss11Max=No	Iss11Min=No	FrameElem=112	ElemStation=0.375	Point=1	X2=-0.5	X3=-0.5	
Frame=112	Station=0.375	OutputCase=ENVE	CaseType=Combination	StepType=Min	Point=1	X2=-0.5	X3=-0.5	
S11=411.110506532055	Iss11Max=Yes	Iss11Min=No	FrameElem=112	ElemStation=0.375	Point=2	X2=-0.5	X3=0.5	
Frame=112	Station=0.375	OutputCase=ENVE	CaseType=Combination	StepType=Min	Point=2	X2=-0.5	X3=0.5	
S11=411.110506532055	Iss11Max=No	Iss11Min=No	FrameElem=112	ElemStation=0.375	Point=3	X2=0.5	X3=-0.5	
Frame=112	Station=0.375	OutputCase=ENVE	CaseType=Combination	StepType=Min	Point=3	X2=0.5	X3=-0.5	
S11=-1095.57874919132	Iss11Max=No	Iss11Min=Yes	FrameElem=112	ElemStation=0.375	Point=4	X2=0.5	X3=0.5	
Frame=112	Station=0.375	OutputCase=ENVE	CaseType=Combination	StepType=Min	Point=4	X2=0.5	X3=0.5	
S11=-1095.57874919132	Iss11Max=No	Iss11Min=No	FrameElem=112	ElemStation=0.375	Point=0	X2=0	X3=0	S11=-
Frame=112	Station=0.5	OutputCase=ENVE	CaseType=Combination	StepType=Min	Point=0	X2=0	X3=0	S11=-
317.058043529684	Iss11Max=No	Iss11Min=No	FrameElem=112	ElemStation=0.5	Point=1	X2=-0.5	X3=-0.5	
Frame=112	Station=0.5	OutputCase=ENVE	CaseType=Combination	StepType=Min	Point=1	X2=-0.5	X3=-0.5	
S11=768.532380043286	Iss11Max=Yes	Iss11Min=No	FrameElem=112	ElemStation=0.5	Point=2	X2=-0.5	X3=0.5	
Frame=112	Station=0.5	OutputCase=ENVE	CaseType=Combination	StepType=Min	Point=2	X2=-0.5	X3=0.5	
S11=768.532380043286	Iss11Max=No	Iss11Min=No	FrameElem=112	ElemStation=0.5	Point=3	X2=0.5	X3=-0.5	
Frame=112	Station=0.5	OutputCase=ENVE	CaseType=Combination	StepType=Min	Point=3	X2=0.5	X3=-0.5	
S11=-1453.00062308329	Iss11Max=No	Iss11Min=Yes	FrameElem=112	ElemStation=0.5	Point=4	X2=0.5	X3=0.5	
Frame=112	Station=0.5	OutputCase=ENVE	CaseType=Combination	StepType=Min	Point=4	X2=0.5	X3=0.5	
S11=-1453.00062308329	Iss11Max=No	Iss11Min=No	FrameElem=112	ElemStation=0.5	Point=0	X2=0	X3=0	S11=-
Frame=112	Station=0	OutputCase=FESSUR	CaseType=Combination	Point=0	X2=0	X3=0	S11=-	317.058043529684
Iss11Max=No	Iss11Min=No	FrameElem=112	ElemStation=0					

Frame=112	Station=0	OutputCase=FESSUR	CaseType=Combination	Point=1	X2=-0.5	X3=-0.5	S11=-
832.717614001639	IsS11Max=No	IsS11Min=Yes	FrameElem=112	ElemStation=0			
Frame=112	Station=0	OutputCase=FESSUR	CaseType=Combination	Point=2	X2=-0.5	X3=0.5	S11=-
832.717614001639	IsS11Max=No	IsS11Min=No	FrameElem=112	ElemStation=0			
Frame=112	Station=0	OutputCase=FESSUR	CaseType=Combination	Point=3	X2=0.5	X3=-0.5	
S11=198.601526942272	IsS11Max=Yes	IsS11Min=No	FrameElem=112	ElemStation=0			
Frame=112	Station=0	OutputCase=FESSUR	CaseType=Combination	Point=4	X2=0.5	X3=0.5	
S11=198.601526942272	IsS11Max=No	IsS11Min=No	FrameElem=112	ElemStation=0			
Frame=112	Station=0.125	OutputCase=FESSUR	CaseType=Combination	Point=0	X2=0	X3=0	S11=-
317.058043529684	IsS11Max=No	IsS11Min=No	FrameElem=112	ElemStation=0.125			
Frame=112	Station=0.125	OutputCase=FESSUR	CaseType=Combination	Point=1	X2=-0.5	X3=-0.5	S11=-
389.514490490408	IsS11Max=No	IsS11Min=Yes	FrameElem=112	ElemStation=0.125			
Frame=112	Station=0.125	OutputCase=FESSUR	CaseType=Combination	Point=2	X2=-0.5	X3=0.5	S11=-
389.514490490408	IsS11Max=No	IsS11Min=No	FrameElem=112	ElemStation=0.125			
Frame=112	Station=0.125	OutputCase=FESSUR	CaseType=Combination	Point=3	X2=0.5	X3=-0.5	S11=-
244.601596568959	IsS11Max=Yes	IsS11Min=No	FrameElem=112	ElemStation=0.125			
Frame=112	Station=0.125	OutputCase=FESSUR	CaseType=Combination	Point=4	X2=0.5	X3=0.5	S11=-
244.601596568959	IsS11Max=No	IsS11Min=No	FrameElem=112	ElemStation=0.125			
Frame=112	Station=0.25	OutputCase=FESSUR	CaseType=Combination	Point=0	X2=0	X3=0	S11=-
317.058043529684	IsS11Max=No	IsS11Min=No	FrameElem=112	ElemStation=0.25			
Frame=112	Station=0.25	OutputCase=FESSUR	CaseType=Combination	Point=1	X2=-0.5	X3=-0.5	
S11=25.0948830208235	IsS11Max=Yes	IsS11Min=No	FrameElem=112	ElemStation=0.25			
Frame=112	Station=0.25	OutputCase=FESSUR	CaseType=Combination	Point=2	X2=-0.5	X3=0.5	
S11=25.0948830208235	IsS11Max=No	IsS11Min=No	FrameElem=112	ElemStation=0.25			
Frame=112	Station=0.25	OutputCase=FESSUR	CaseType=Combination	Point=3	X2=0.5	X3=-0.5	S11=-
659.210970080191	IsS11Max=No	IsS11Min=Yes	FrameElem=112	ElemStation=0.25			
Frame=112	Station=0.25	OutputCase=FESSUR	CaseType=Combination	Point=4	X2=0.5	X3=0.5	S11=-
659.210970080191	IsS11Max=No	IsS11Min=No	FrameElem=112	ElemStation=0.25			
Frame=112	Station=0.375	OutputCase=FESSUR	CaseType=Combination	Point=0	X2=0	X3=0	S11=-
317.058043529684	IsS11Max=No	IsS11Min=No	FrameElem=112	ElemStation=0.375			
Frame=112	Station=0.375	OutputCase=FESSUR	CaseType=Combination	Point=1	X2=-0.5	X3=-0.5	
S11=411.110506532055	IsS11Max=Yes	IsS11Min=No	FrameElem=112	ElemStation=0.375			
Frame=112	Station=0.375	OutputCase=FESSUR	CaseType=Combination	Point=2	X2=-0.5	X3=0.5	
S11=411.110506532055	IsS11Max=No	IsS11Min=No	FrameElem=112	ElemStation=0.375			
Frame=112	Station=0.375	OutputCase=FESSUR	CaseType=Combination	Point=3	X2=0.5	X3=-0.5	S11=-
1045.22659359142	IsS11Max=No	IsS11Min=Yes	FrameElem=112	ElemStation=0.375			
Frame=112	Station=0.375	OutputCase=FESSUR	CaseType=Combination	Point=4	X2=0.5	X3=0.5	S11=-
1045.22659359142	IsS11Max=No	IsS11Min=No	FrameElem=112	ElemStation=0.375			
Frame=112	Station=0.5	OutputCase=FESSUR	CaseType=Combination	Point=0	X2=0	X3=0	S11=-
317.058043529684	IsS11Max=No	IsS11Min=No	FrameElem=112	ElemStation=0.5			
Frame=112	Station=0.5	OutputCase=FESSUR	CaseType=Combination	Point=1	X2=-0.5	X3=-0.5	
S11=768.532380043286	IsS11Max=Yes	IsS11Min=No	FrameElem=112	ElemStation=0.5			
Frame=112	Station=0.5	OutputCase=FESSUR	CaseType=Combination	Point=2	X2=-0.5	X3=0.5	
S11=768.532380043286	IsS11Max=No	IsS11Min=No	FrameElem=112	ElemStation=0.5			
Frame=112	Station=0.5	OutputCase=FESSUR	CaseType=Combination	Point=3	X2=0.5	X3=-0.5	S11=-
1402.64846710265	IsS11Max=No	IsS11Min=Yes	FrameElem=112	ElemStation=0.5			
Frame=112	Station=0.5	OutputCase=FESSUR	CaseType=Combination	Point=4	X2=0.5	X3=0.5	S11=-
1402.64846710265	IsS11Max=No	IsS11Min=No	FrameElem=112	ElemStation=0.5			
Frame=113	Station=0	OutputCase=PESOPR	CaseType=LinStatic	Point=0	X2=0	X3=0	S11=15.1709467361849
IsS11Max=No	IsS11Min=No	FrameElem=113	ElemStation=0				
Frame=113	Station=0	OutputCase=PESOPR	CaseType=LinStatic	Point=1	X2=-0.5	X3=-0.5	
S11=188.741477153975	IsS11Max=Yes	IsS11Min=No	FrameElem=113	ElemStation=0			
Frame=113	Station=0	OutputCase=PESOPR	CaseType=LinStatic	Point=2	X2=-0.5	X3=0.5	
S11=188.741477153975	IsS11Max=No	IsS11Min=No	FrameElem=113	ElemStation=0			
Frame=113	Station=0	OutputCase=PESOPR	CaseType=LinStatic	Point=3	X2=0.5	X3=-0.5	S11=-
158.399583681605	IsS11Max=No	IsS11Min=Yes	FrameElem=113	ElemStation=0			
Frame=113	Station=0	OutputCase=PESOPR	CaseType=LinStatic	Point=4	X2=0.5	X3=0.5	S11=-
158.399583681605	IsS11Max=No	IsS11Min=No	FrameElem=113	ElemStation=0			
Frame=113	Station=0.125	OutputCase=PESOPR	CaseType=LinStatic	Point=0	X2=0	X3=0	S11=15.1709467361849
IsS11Max=No	IsS11Min=No	FrameElem=113	ElemStation=0.125				
Frame=113	Station=0.125	OutputCase=PESOPR	CaseType=LinStatic	Point=1	X2=-0.5	X3=-0.5	
S11=215.694602145604	IsS11Max=Yes	IsS11Min=No	FrameElem=113	ElemStation=0.125			
Frame=113	Station=0.125	OutputCase=PESOPR	CaseType=LinStatic	Point=2	X2=-0.5	X3=0.5	
S11=215.694602145604	IsS11Max=No	IsS11Min=No	FrameElem=113	ElemStation=0.125			
Frame=113	Station=0.125	OutputCase=PESOPR	CaseType=LinStatic	Point=3	X2=0.5	X3=-0.5	S11=-
185.352708673234	IsS11Max=No	IsS11Min=Yes	FrameElem=113	ElemStation=0.125			
Frame=113	Station=0.125	OutputCase=PESOPR	CaseType=LinStatic	Point=4	X2=0.5	X3=0.5	S11=-
185.352708673234	IsS11Max=No	IsS11Min=No	FrameElem=113	ElemStation=0.125			
Frame=113	Station=0.25	OutputCase=PESOPR	CaseType=LinStatic	Point=0	X2=0	X3=0	S11=15.1709467361849
IsS11Max=No	IsS11Min=No	FrameElem=113	ElemStation=0.25				
Frame=113	Station=0.25	OutputCase=PESOPR	CaseType=LinStatic	Point=1	X2=-0.5	X3=-0.5	
S11=240.303977137233	IsS11Max=Yes	IsS11Min=No	FrameElem=113	ElemStation=0.25			
Frame=113	Station=0.25	OutputCase=PESOPR	CaseType=LinStatic	Point=2	X2=-0.5	X3=0.5	
S11=240.303977137233	IsS11Max=No	IsS11Min=No	FrameElem=113	ElemStation=0.25			
Frame=113	Station=0.25	OutputCase=PESOPR	CaseType=LinStatic	Point=3	X2=0.5	X3=-0.5	S11=-
209.962083664863	IsS11Max=No	IsS11Min=Yes	FrameElem=113	ElemStation=0.25			
Frame=113	Station=0.25	OutputCase=PESOPR	CaseType=LinStatic	Point=4	X2=0.5	X3=0.5	S11=-
209.962083664863	IsS11Max=No	IsS11Min=No	FrameElem=113	ElemStation=0.25			
Frame=113	Station=0.375	OutputCase=PESOPR	CaseType=LinStatic	Point=0	X2=0	X3=0	S11=15.1709467361849
IsS11Max=No	IsS11Min=No	FrameElem=113	ElemStation=0.375				
Frame=113	Station=0.375	OutputCase=PESOPR	CaseType=LinStatic	Point=1	X2=-0.5	X3=-0.5	
S11=262.569602128862	IsS11Max=Yes	IsS11Min=No	FrameElem=113	ElemStation=0.375			

Frame=113 Station=0.375 OutputCase=PESOPR CaseType=LinStatic Point=2 X2=-0.5 X3=0.5
 S11=262.569602128862 IsS11Max=No IsS11Min=No FrameElem=113 ElemStation=0.375
 Frame=113 Station=0.375 OutputCase=PESOPR CaseType=LinStatic Point=3 X2=0.5 X3=-0.5 S11=-
 232.227708656492 IsS11Max=No IsS11Min=Yes FrameElem=113 ElemStation=0.375
 Frame=113 Station=0.375 OutputCase=PESOPR CaseType=LinStatic Point=4 X2=0.5 X3=0.5 S11=-
 232.227708656492 IsS11Max=No IsS11Min=No FrameElem=113 ElemStation=0.375
 Frame=113 Station=0.5 OutputCase=PESOPR CaseType=LinStatic Point=0 X2=0 X3=0 S11=15.1709467361849
 IsS11Max=No IsS11Min=No FrameElem=113 ElemStation=0.5
 Frame=113 Station=0.5 OutputCase=PESOPR CaseType=LinStatic Point=1 X2=-0.5 X3=-0.5
 S11=282.491477120491 IsS11Max=Yes IsS11Min=No FrameElem=113 ElemStation=0.5
 Frame=113 Station=0.5 OutputCase=PESOPR CaseType=LinStatic Point=2 X2=-0.5 X3=0.5
 S11=282.491477120491 IsS11Max=No IsS11Min=No FrameElem=113 ElemStation=0.5
 Frame=113 Station=0.5 OutputCase=PESOPR CaseType=LinStatic Point=3 X2=0.5 X3=-0.5 S11=-
 252.149583648121 IsS11Max=No IsS11Min=Yes FrameElem=113 ElemStation=0.5
 Frame=113 Station=0.5 OutputCase=PESOPR CaseType=LinStatic Point=4 X2=0.5 X3=0.5 S11=-
 252.149583648121 IsS11Max=No IsS11Min=No FrameElem=113 ElemStation=0.5
 Frame=113 Station=0 OutputCase=TERRVERT CaseType=LinStatic Point=0 X2=0 X3=0 S11=-1.64270738195971
 IsS11Max=No IsS11Min=No FrameElem=113 ElemStation=0
 Frame=113 Station=0 OutputCase=TERRVERT CaseType=LinStatic Point=1 X2=-0.5 X3=-0.5
 S11=1408.80398859263 IsS11Max=Yes IsS11Min=No FrameElem=113 ElemStation=0
 Frame=113 Station=0 OutputCase=TERRVERT CaseType=LinStatic Point=2 X2=-0.5 X3=0.5
 S11=1408.80398859263 IsS11Max=No IsS11Min=No FrameElem=113 ElemStation=0
 Frame=113 Station=0 OutputCase=TERRVERT CaseType=LinStatic Point=3 X2=0.5 X3=-0.5 S11=-
 1412.08940335655 IsS11Max=No IsS11Min=Yes FrameElem=113 ElemStation=0
 Frame=113 Station=0 OutputCase=TERRVERT CaseType=LinStatic Point=4 X2=0.5 X3=0.5 S11=-
 1412.08940335655 IsS11Max=No IsS11Min=No FrameElem=113 ElemStation=0
 Frame=113 Station=0.125 OutputCase=TERRVERT CaseType=LinStatic Point=0 X2=0 X3=0 S11=-
 1.64270738195971 IsS11Max=No IsS11Min=No FrameElem=113 ElemStation=0.125
 Frame=113 Station=0.125 OutputCase=TERRVERT CaseType=LinStatic Point=1 X2=-0.5 X3=-0.5
 S11=1710.67898838138 IsS11Max=Yes IsS11Min=No FrameElem=113 ElemStation=0.125
 Frame=113 Station=0.125 OutputCase=TERRVERT CaseType=LinStatic Point=2 X2=-0.5 X3=0.5
 S11=1710.67898838138 IsS11Max=No IsS11Min=No FrameElem=113 ElemStation=0.125
 Frame=113 Station=0.125 OutputCase=TERRVERT CaseType=LinStatic Point=3 X2=0.5 X3=-0.5 S11=-
 1713.9644031453 IsS11Max=No IsS11Min=Yes FrameElem=113 ElemStation=0.125
 Frame=113 Station=0.125 OutputCase=TERRVERT CaseType=LinStatic Point=4 X2=0.5 X3=0.5 S11=-
 1713.9644031453 IsS11Max=No IsS11Min=No FrameElem=113 ElemStation=0.125
 Frame=113 Station=0.25 OutputCase=TERRVERT CaseType=LinStatic Point=0 X2=0 X3=0 S11=-
 1.64270738195971 IsS11Max=No IsS11Min=No FrameElem=113 ElemStation=0.25
 Frame=113 Station=0.25 OutputCase=TERRVERT CaseType=LinStatic Point=1 X2=-0.5 X3=-0.5
 S11=1986.30398817013 IsS11Max=Yes IsS11Min=No FrameElem=113 ElemStation=0.25
 Frame=113 Station=0.25 OutputCase=TERRVERT CaseType=LinStatic Point=2 X2=-0.5 X3=0.5
 S11=1986.30398817013 IsS11Max=No IsS11Min=No FrameElem=113 ElemStation=0.25
 Frame=113 Station=0.25 OutputCase=TERRVERT CaseType=LinStatic Point=3 X2=0.5 X3=-0.5 S11=-
 1989.58940293405 IsS11Max=No IsS11Min=Yes FrameElem=113 ElemStation=0.25
 Frame=113 Station=0.25 OutputCase=TERRVERT CaseType=LinStatic Point=4 X2=0.5 X3=0.5 S11=-
 1989.58940293405 IsS11Max=No IsS11Min=No FrameElem=113 ElemStation=0.25
 Frame=113 Station=0.375 OutputCase=TERRVERT CaseType=LinStatic Point=0 X2=0 X3=0 S11=-
 1.64270738195971 IsS11Max=No IsS11Min=No FrameElem=113 ElemStation=0.375
 Frame=113 Station=0.375 OutputCase=TERRVERT CaseType=LinStatic Point=1 X2=-0.5 X3=-0.5
 S11=2235.67898795888 IsS11Max=Yes IsS11Min=No FrameElem=113 ElemStation=0.375
 Frame=113 Station=0.375 OutputCase=TERRVERT CaseType=LinStatic Point=2 X2=-0.5 X3=0.5
 S11=2235.67898795888 IsS11Max=No IsS11Min=No FrameElem=113 ElemStation=0.375
 Frame=113 Station=0.375 OutputCase=TERRVERT CaseType=LinStatic Point=3 X2=0.5 X3=-0.5 S11=-
 2238.9644027228 IsS11Max=No IsS11Min=Yes FrameElem=113 ElemStation=0.375
 Frame=113 Station=0.375 OutputCase=TERRVERT CaseType=LinStatic Point=4 X2=0.5 X3=0.5 S11=-
 2238.9644027228 IsS11Max=No IsS11Min=No FrameElem=113 ElemStation=0.375
 Frame=113 Station=0.5 OutputCase=TERRVERT CaseType=LinStatic Point=0 X2=0 X3=0 S11=-
 1.64270738195971 IsS11Max=No IsS11Min=No FrameElem=113 ElemStation=0.5
 Frame=113 Station=0.5 OutputCase=TERRVERT CaseType=LinStatic Point=1 X2=-0.5 X3=-0.5
 S11=2458.80398774763 IsS11Max=Yes IsS11Min=No FrameElem=113 ElemStation=0.5
 Frame=113 Station=0.5 OutputCase=TERRVERT CaseType=LinStatic Point=2 X2=-0.5 X3=0.5
 S11=2458.80398774763 IsS11Max=No IsS11Min=No FrameElem=113 ElemStation=0.5
 Frame=113 Station=0.5 OutputCase=TERRVERT CaseType=LinStatic Point=3 X2=0.5 X3=-0.5 S11=-
 2462.08940251155 IsS11Max=No IsS11Min=Yes FrameElem=113 ElemStation=0.5
 Frame=113 Station=0.5 OutputCase=TERRVERT CaseType=LinStatic Point=4 X2=0.5 X3=0.5 S11=-
 2462.08940251155 IsS11Max=No IsS11Min=No FrameElem=113 ElemStation=0.5
 Frame=113 Station=0 OutputCase=TERRLAT CaseType=LinStatic Point=0 X2=0 X3=0 S11=-330.586282883909
 IsS11Max=No IsS11Min=No FrameElem=113 ElemStation=0
 Frame=113 Station=0 OutputCase=TERRLAT CaseType=LinStatic Point=1 X2=-0.5 X3=-0.5 S11=-
 829.013085703277 IsS11Max=No IsS11Min=Yes FrameElem=113 ElemStation=0
 Frame=113 Station=0 OutputCase=TERRLAT CaseType=LinStatic Point=2 X2=-0.5 X3=0.5 S11=-
 829.013085703277 IsS11Max=No IsS11Min=No FrameElem=113 ElemStation=0
 Frame=113 Station=0 OutputCase=TERRLAT CaseType=LinStatic Point=3 X2=0.5 X3=-0.5
 S11=167.840519935459 IsS11Max=Yes IsS11Min=No FrameElem=113 ElemStation=0
 Frame=113 Station=0 OutputCase=TERRLAT CaseType=LinStatic Point=4 X2=0.5 X3=0.5
 S11=167.840519935459 IsS11Max=No IsS11Min=No FrameElem=113 ElemStation=0
 Frame=113 Station=0.125 OutputCase=TERRLAT CaseType=LinStatic Point=0 X2=0 X3=0 S11=-
 330.586282883909 IsS11Max=No IsS11Min=No FrameElem=113 ElemStation=0.125
 Frame=113 Station=0.125 OutputCase=TERRLAT CaseType=LinStatic Point=1 X2=-0.5 X3=-0.5 S11=-
 829.013086972425 IsS11Max=No IsS11Min=Yes FrameElem=113 ElemStation=0.125
 Frame=113 Station=0.125 OutputCase=TERRLAT CaseType=LinStatic Point=2 X2=-0.5 X3=0.5 S11=-
 829.013086972425 IsS11Max=No IsS11Min=No FrameElem=113 ElemStation=0.125

Frame=113	Station=0.125	OutputCase=TERRLAT	CaseType=LinStatic	Point=3	X2=0.5	X3=-0.5		
S11=167.840521204607	IsS11Max=Yes	IsS11Min=No	FrameElem=113	ElemStation=0.125				
Frame=113	Station=0.125	OutputCase=TERRLAT	CaseType=LinStatic	Point=4	X2=0.5	X3=0.5		
S11=167.840521204607	IsS11Max=No	IsS11Min=No	FrameElem=113	ElemStation=0.125				
Frame=113	Station=0.25	OutputCase=TERRLAT	CaseType=LinStatic	Point=0	X2=0	X3=0	S11=-	
330.586282883909	IsS11Max=No	IsS11Min=No	FrameElem=113	ElemStation=0.25				
Frame=113	Station=0.25	OutputCase=TERRLAT	CaseType=LinStatic	Point=1	X2=-0.5	X3=-0.5	S11=-	
829.013088241572	IsS11Max=No	IsS11Min=Yes	FrameElem=113	ElemStation=0.25				
Frame=113	Station=0.25	OutputCase=TERRLAT	CaseType=LinStatic	Point=2	X2=-0.5	X3=0.5	S11=-	
829.013088241572	IsS11Max=No	IsS11Min=No	FrameElem=113	ElemStation=0.25				
Frame=113	Station=0.25	OutputCase=TERRLAT	CaseType=LinStatic	Point=3	X2=0.5	X3=-0.5		
S11=167.840522473754	IsS11Max=Yes	IsS11Min=No	FrameElem=113	ElemStation=0.25				
Frame=113	Station=0.25	OutputCase=TERRLAT	CaseType=LinStatic	Point=4	X2=0.5	X3=0.5		
S11=167.840522473754	IsS11Max=No	IsS11Min=No	FrameElem=113	ElemStation=0.25				
Frame=113	Station=0.375	OutputCase=TERRLAT	CaseType=LinStatic	Point=0	X2=0	X3=0	S11=-	
330.586282883909	IsS11Max=No	IsS11Min=No	FrameElem=113	ElemStation=0.375				
Frame=113	Station=0.375	OutputCase=TERRLAT	CaseType=LinStatic	Point=1	X2=-0.5	X3=-0.5	S11=-	
829.01308951072	IsS11Max=No	IsS11Min=Yes	FrameElem=113	ElemStation=0.375				
Frame=113	Station=0.375	OutputCase=TERRLAT	CaseType=LinStatic	Point=2	X2=-0.5	X3=0.5	S11=-	
829.01308951072	IsS11Max=No	IsS11Min=No	FrameElem=113	ElemStation=0.375				
Frame=113	Station=0.375	OutputCase=TERRLAT	CaseType=LinStatic	Point=3	X2=0.5	X3=-0.5		
S11=167.840523742902	IsS11Max=Yes	IsS11Min=No	FrameElem=113	ElemStation=0.375				
Frame=113	Station=0.375	OutputCase=TERRLAT	CaseType=LinStatic	Point=4	X2=0.5	X3=0.5		
S11=167.840523742902	IsS11Max=No	IsS11Min=No	FrameElem=113	ElemStation=0.375				
Frame=113	Station=0.5	OutputCase=TERRLAT	CaseType=LinStatic	Point=0	X2=0	X3=0	S11=-330.586282883909	
IsS11Max=No	IsS11Min=No	FrameElem=113	ElemStation=0.5					
Frame=113	Station=0.5	OutputCase=TERRLAT	CaseType=LinStatic	Point=1	X2=-0.5	X3=-0.5	S11=-	
829.013090779867	IsS11Max=No	IsS11Min=Yes	FrameElem=113	ElemStation=0.5				
Frame=113	Station=0.5	OutputCase=TERRLAT	CaseType=LinStatic	Point=2	X2=-0.5	X3=0.5	S11=-	
829.013090779867	IsS11Max=No	IsS11Min=No	FrameElem=113	ElemStation=0.5				
Frame=113	Station=0.5	OutputCase=TERRLAT	CaseType=LinStatic	Point=3	X2=0.5	X3=-0.5		
S11=167.840525012049	IsS11Max=Yes	IsS11Min=No	FrameElem=113	ElemStation=0.5				
Frame=113	Station=0.5	OutputCase=TERRLAT	CaseType=LinStatic	Point=4	X2=0.5	X3=0.5		
S11=167.840525012049	IsS11Max=No	IsS11Min=No	FrameElem=113	ElemStation=0.5				
Frame=113	Station=0	OutputCase=ACCVERT	CaseType=LinStatic	Point=0	X2=0	X3=0	S11=0	IsS11Max=Yes
IsS11Min=Yes	FrameElem=113	ElemStation=0						
Frame=113	Station=0	OutputCase=ACCVERT	CaseType=LinStatic	Point=1	X2=-0.5	X3=-0.5	S11=0	
IsS11Max=No	IsS11Min=No	FrameElem=113	ElemStation=0					
Frame=113	Station=0	OutputCase=ACCVERT	CaseType=LinStatic	Point=2	X2=-0.5	X3=0.5	S11=0	
IsS11Max=No	IsS11Min=No	FrameElem=113	ElemStation=0					
Frame=113	Station=0	OutputCase=ACCVERT	CaseType=LinStatic	Point=3	X2=0.5	X3=-0.5	S11=0	
IsS11Max=No	IsS11Min=No	FrameElem=113	ElemStation=0					
Frame=113	Station=0	OutputCase=ACCVERT	CaseType=LinStatic	Point=4	X2=0.5	X3=0.5	S11=0	IsS11Max=No
IsS11Min=No	FrameElem=113	ElemStation=0						
Frame=113	Station=0.125	OutputCase=ACCVERT	CaseType=LinStatic	Point=0	X2=0	X3=0	S11=0	
IsS11Max=Yes	IsS11Min=Yes	FrameElem=113	ElemStation=0.125					
Frame=113	Station=0.125	OutputCase=ACCVERT	CaseType=LinStatic	Point=1	X2=-0.5	X3=-0.5	S11=0	
IsS11Max=No	IsS11Min=No	FrameElem=113	ElemStation=0.125					
Frame=113	Station=0.125	OutputCase=ACCVERT	CaseType=LinStatic	Point=2	X2=-0.5	X3=0.5	S11=0	
IsS11Max=No	IsS11Min=No	FrameElem=113	ElemStation=0.125					
Frame=113	Station=0.125	OutputCase=ACCVERT	CaseType=LinStatic	Point=3	X2=0.5	X3=-0.5	S11=0	
IsS11Max=No	IsS11Min=No	FrameElem=113	ElemStation=0.125					
Frame=113	Station=0.125	OutputCase=ACCVERT	CaseType=LinStatic	Point=4	X2=0.5	X3=0.5	S11=0	
IsS11Max=No	IsS11Min=No	FrameElem=113	ElemStation=0.125					
Frame=113	Station=0.25	OutputCase=ACCVERT	CaseType=LinStatic	Point=0	X2=0	X3=0	S11=0	IsS11Max=Yes
IsS11Min=Yes	FrameElem=113	ElemStation=0.25						
Frame=113	Station=0.25	OutputCase=ACCVERT	CaseType=LinStatic	Point=1	X2=-0.5	X3=-0.5	S11=0	
IsS11Max=No	IsS11Min=No	FrameElem=113	ElemStation=0.25					
Frame=113	Station=0.25	OutputCase=ACCVERT	CaseType=LinStatic	Point=2	X2=-0.5	X3=0.5	S11=0	
IsS11Max=No	IsS11Min=No	FrameElem=113	ElemStation=0.25					
Frame=113	Station=0.25	OutputCase=ACCVERT	CaseType=LinStatic	Point=3	X2=0.5	X3=-0.5	S11=0	
IsS11Max=No	IsS11Min=No	FrameElem=113	ElemStation=0.25					
Frame=113	Station=0.25	OutputCase=ACCVERT	CaseType=LinStatic	Point=4	X2=0.5	X3=0.5	S11=0	
IsS11Max=No	IsS11Min=No	FrameElem=113	ElemStation=0.25					
Frame=113	Station=0.375	OutputCase=ACCVERT	CaseType=LinStatic	Point=0	X2=0	X3=0	S11=0	
IsS11Max=Yes	IsS11Min=Yes	FrameElem=113	ElemStation=0.375					
Frame=113	Station=0.375	OutputCase=ACCVERT	CaseType=LinStatic	Point=1	X2=-0.5	X3=-0.5	S11=0	
IsS11Max=No	IsS11Min=No	FrameElem=113	ElemStation=0.375					
Frame=113	Station=0.375	OutputCase=ACCVERT	CaseType=LinStatic	Point=2	X2=-0.5	X3=0.5	S11=0	
IsS11Max=No	IsS11Min=No	FrameElem=113	ElemStation=0.375					
Frame=113	Station=0.375	OutputCase=ACCVERT	CaseType=LinStatic	Point=3	X2=0.5	X3=-0.5	S11=0	
IsS11Max=No	IsS11Min=No	FrameElem=113	ElemStation=0.375					
Frame=113	Station=0.375	OutputCase=ACCVERT	CaseType=LinStatic	Point=4	X2=0.5	X3=0.5	S11=0	
IsS11Max=No	IsS11Min=No	FrameElem=113	ElemStation=0.375					
Frame=113	Station=0.5	OutputCase=ACCVERT	CaseType=LinStatic	Point=0	X2=0	X3=0	S11=0	IsS11Max=Yes
IsS11Min=Yes	FrameElem=113	ElemStation=0.5						
Frame=113	Station=0.5	OutputCase=ACCVERT	CaseType=LinStatic	Point=1	X2=-0.5	X3=-0.5	S11=0	
IsS11Max=No	IsS11Min=No	FrameElem=113	ElemStation=0.5					
Frame=113	Station=0.5	OutputCase=ACCVERT	CaseType=LinStatic	Point=2	X2=-0.5	X3=0.5	S11=0	
IsS11Max=No	IsS11Min=No	FrameElem=113	ElemStation=0.5					
Frame=113	Station=0.5	OutputCase=ACCVERT	CaseType=LinStatic	Point=3	X2=0.5	X3=-0.5	S11=0	
IsS11Max=No	IsS11Min=No	FrameElem=113	ElemStation=0.5					

Frame=113	Station=0.5	OutputCase=ENVE	CaseType=Combination	StepType=Max	Point=2	X2=-0.5	X3=0.5	
S11=2160.98630132221	IsS11Max=No	IsS11Min=No	FrameElem=113	ElemStation=0.5				
Frame=113	Station=0.5	OutputCase=ENVE	CaseType=Combination	StepType=Max	Point=3	X2=0.5	X3=-0.5	
S11=-2546.39846114762	IsS11Max=No	IsS11Min=Yes	FrameElem=113	ElemStation=0.5				
Frame=113	Station=0.5	OutputCase=ENVE	CaseType=Combination	StepType=Max	Point=4	X2=0.5	X3=0.5	
S11=-2546.39846114762	IsS11Max=No	IsS11Min=No	FrameElem=113	ElemStation=0.5				
Frame=113	Station=0	OutputCase=ENVE	CaseType=Combination	StepType=Min	Point=0	X2=0	X3=0	S11=-
317.058043529684	IsS11Max=No	IsS11Min=No	FrameElem=113	ElemStation=0				
Frame=113	Station=0	OutputCase=ENVE	CaseType=Combination	StepType=Min	Point=1	X2=-0.5	X3=-0.5	
S11=768.53238004333	IsS11Max=Yes	IsS11Min=No	FrameElem=113	ElemStation=0				
Frame=113	Station=0	OutputCase=ENVE	CaseType=Combination	StepType=Min	Point=2	X2=-0.5	X3=0.5	
S11=768.53238004333	IsS11Max=No	IsS11Min=No	FrameElem=113	ElemStation=0				
Frame=113	Station=0	OutputCase=ENVE	CaseType=Combination	StepType=Min	Point=3	X2=0.5	X3=-0.5	
S11=-1453.00062308333	IsS11Max=No	IsS11Min=Yes	FrameElem=113	ElemStation=0				
Frame=113	Station=0	OutputCase=ENVE	CaseType=Combination	StepType=Min	Point=4	X2=0.5	X3=0.5	S11=-
1453.00062308333	IsS11Max=No	IsS11Min=No	FrameElem=113	ElemStation=0				
Frame=113	Station=0.125	OutputCase=ENVE	CaseType=Combination	StepType=Min	Point=0	X2=0	X3=0	S11=-
317.058043529684	IsS11Max=No	IsS11Min=No	FrameElem=113	ElemStation=0.125				
Frame=113	Station=0.125	OutputCase=ENVE	CaseType=Combination	StepType=Min	Point=1	X2=-0.5	X3=-0.5	
S11=1097.36050355456	IsS11Max=Yes	IsS11Min=No	FrameElem=113	ElemStation=0.125				
Frame=113	Station=0.125	OutputCase=ENVE	CaseType=Combination	StepType=Min	Point=2	X2=-0.5	X3=0.5	
S11=1097.36050355456	IsS11Max=No	IsS11Min=No	FrameElem=113	ElemStation=0.125				
Frame=113	Station=0.125	OutputCase=ENVE	CaseType=Combination	StepType=Min	Point=3	X2=0.5	X3=-0.5	
S11=-1781.82874697531	IsS11Max=No	IsS11Min=Yes	FrameElem=113	ElemStation=0.125				
Frame=113	Station=0.125	OutputCase=ENVE	CaseType=Combination	StepType=Min	Point=4	X2=0.5	X3=0.5	
S11=-1781.82874697531	IsS11Max=No	IsS11Min=No	FrameElem=113	ElemStation=0.125				
Frame=113	Station=0.25	OutputCase=ENVE	CaseType=Combination	StepType=Min	Point=0	X2=0	X3=0	S11=-
317.058043529684	IsS11Max=No	IsS11Min=No	FrameElem=113	ElemStation=0.25				
Frame=113	Station=0.25	OutputCase=ENVE	CaseType=Combination	StepType=Min	Point=1	X2=-0.5	X3=-0.5	
S11=1397.59487706579	IsS11Max=Yes	IsS11Min=No	FrameElem=113	ElemStation=0.25				
Frame=113	Station=0.25	OutputCase=ENVE	CaseType=Combination	StepType=Min	Point=2	X2=-0.5	X3=0.5	
S11=1397.59487706579	IsS11Max=No	IsS11Min=No	FrameElem=113	ElemStation=0.25				
Frame=113	Station=0.25	OutputCase=ENVE	CaseType=Combination	StepType=Min	Point=3	X2=0.5	X3=-0.5	
S11=-2082.06312086729	IsS11Max=No	IsS11Min=Yes	FrameElem=113	ElemStation=0.25				
Frame=113	Station=0.25	OutputCase=ENVE	CaseType=Combination	StepType=Min	Point=4	X2=0.5	X3=0.5	
S11=-2082.06312086729	IsS11Max=No	IsS11Min=No	FrameElem=113	ElemStation=0.25				
Frame=113	Station=0.375	OutputCase=ENVE	CaseType=Combination	StepType=Min	Point=0	X2=0	X3=0	S11=-
317.058043529684	IsS11Max=No	IsS11Min=No	FrameElem=113	ElemStation=0.375				
Frame=113	Station=0.375	OutputCase=ENVE	CaseType=Combination	StepType=Min	Point=1	X2=-0.5	X3=-0.5	
S11=1669.23550057702	IsS11Max=Yes	IsS11Min=No	FrameElem=113	ElemStation=0.375				
Frame=113	Station=0.375	OutputCase=ENVE	CaseType=Combination	StepType=Min	Point=2	X2=-0.5	X3=0.5	
S11=1669.23550057702	IsS11Max=No	IsS11Min=No	FrameElem=113	ElemStation=0.375				
Frame=113	Station=0.375	OutputCase=ENVE	CaseType=Combination	StepType=Min	Point=3	X2=0.5	X3=-0.5	
S11=-2353.70374475926	IsS11Max=No	IsS11Min=Yes	FrameElem=113	ElemStation=0.375				
Frame=113	Station=0.375	OutputCase=ENVE	CaseType=Combination	StepType=Min	Point=4	X2=0.5	X3=0.5	
S11=-2353.70374475926	IsS11Max=No	IsS11Min=No	FrameElem=113	ElemStation=0.375				
Frame=113	Station=0.5	OutputCase=ENVE	CaseType=Combination	StepType=Min	Point=0	X2=0	X3=0	S11=-
317.058043529684	IsS11Max=No	IsS11Min=No	FrameElem=113	ElemStation=0.5				
Frame=113	Station=0.5	OutputCase=ENVE	CaseType=Combination	StepType=Min	Point=1	X2=-0.5	X3=-0.5	
S11=1912.28237408825	IsS11Max=Yes	IsS11Min=No	FrameElem=113	ElemStation=0.5				
Frame=113	Station=0.5	OutputCase=ENVE	CaseType=Combination	StepType=Min	Point=2	X2=-0.5	X3=0.5	
S11=1912.28237408825	IsS11Max=No	IsS11Min=No	FrameElem=113	ElemStation=0.5				
Frame=113	Station=0.5	OutputCase=ENVE	CaseType=Combination	StepType=Min	Point=3	X2=0.5	X3=-0.5	
S11=-2596.75061865124	IsS11Max=No	IsS11Min=Yes	FrameElem=113	ElemStation=0.5				
Frame=113	Station=0.5	OutputCase=ENVE	CaseType=Combination	StepType=Min	Point=4	X2=0.5	X3=0.5	
S11=-2596.75061865124	IsS11Max=No	IsS11Min=No	FrameElem=113	ElemStation=0.5				
Frame=113	Station=0	OutputCase=FESSUR	CaseType=Combination	Point=0	X2=0	X3=0	S11=-	317.058043529684
IsS11Max=No	IsS11Min=No	FrameElem=113	ElemStation=0					
Frame=113	Station=0	OutputCase=FESSUR	CaseType=Combination	Point=1	X2=-0.5	X3=-0.5		
S11=768.53238004333	IsS11Max=Yes	IsS11Min=No	FrameElem=113	ElemStation=0				
Frame=113	Station=0	OutputCase=FESSUR	CaseType=Combination	Point=2	X2=-0.5	X3=0.5		
S11=768.53238004333	IsS11Max=No	IsS11Min=No	FrameElem=113	ElemStation=0				
Frame=113	Station=0	OutputCase=FESSUR	CaseType=Combination	Point=3	X2=0.5	X3=-0.5	S11=-	
1402.6484671027	IsS11Max=No	IsS11Min=Yes	FrameElem=113	ElemStation=0				
Frame=113	Station=0	OutputCase=FESSUR	CaseType=Combination	Point=4	X2=0.5	X3=0.5	S11=-	
1402.6484671027	IsS11Max=No	IsS11Min=No	FrameElem=113	ElemStation=0				
Frame=113	Station=0.125	OutputCase=FESSUR	CaseType=Combination	Point=0	X2=0	X3=0	S11=-	
317.058043529684	IsS11Max=No	IsS11Min=No	FrameElem=113	ElemStation=0.125				
Frame=113	Station=0.125	OutputCase=FESSUR	CaseType=Combination	Point=1	X2=-0.5	X3=-0.5		
S11=1097.36050355456	IsS11Max=Yes	IsS11Min=No	FrameElem=113	ElemStation=0.125				
Frame=113	Station=0.125	OutputCase=FESSUR	CaseType=Combination	Point=2	X2=-0.5	X3=0.5		
S11=1097.36050355456	IsS11Max=No	IsS11Min=No	FrameElem=113	ElemStation=0.125				
Frame=113	Station=0.125	OutputCase=FESSUR	CaseType=Combination	Point=3	X2=0.5	X3=-0.5	S11=-	
1731.47659061393	IsS11Max=No	IsS11Min=Yes	FrameElem=113	ElemStation=0.125				
Frame=113	Station=0.125	OutputCase=FESSUR	CaseType=Combination	Point=4	X2=0.5	X3=0.5	S11=-	
1731.47659061393	IsS11Max=No	IsS11Min=No	FrameElem=113	ElemStation=0.125				
Frame=113	Station=0.25	OutputCase=FESSUR	CaseType=Combination	Point=0	X2=0	X3=0	S11=-	
317.058043529684	IsS11Max=No	IsS11Min=No	FrameElem=113	ElemStation=0.25				
Frame=113	Station=0.25	OutputCase=FESSUR	CaseType=Combination	Point=1	X2=-0.5	X3=-0.5		
S11=1397.59487706579	IsS11Max=Yes	IsS11Min=No	FrameElem=113	ElemStation=0.25				
Frame=113	Station=0.25	OutputCase=FESSUR	CaseType=Combination	Point=2	X2=-0.5	X3=0.5		
S11=1397.59487706579	IsS11Max=No	IsS11Min=No	FrameElem=113	ElemStation=0.25				

Frame=113	Station=0.25	OutputCase=FESSUR	CaseType=Combination	Point=3	X2=0.5	X3=-0.5	S11=-
2031.71096412516	IsS11Max=No	IsS11Min=Yes	FrameElem=113	ElemStation=0.25			
Frame=113	Station=0.25	OutputCase=FESSUR	CaseType=Combination	Point=4	X2=0.5	X3=0.5	S11=-
2031.71096412516	IsS11Max=No	IsS11Min=No	FrameElem=113	ElemStation=0.25			
Frame=113	Station=0.375	OutputCase=FESSUR	CaseType=Combination	Point=0	X2=0	X3=0	S11=-
317.058043529684	IsS11Max=No	IsS11Min=No	FrameElem=113	ElemStation=0.375			
Frame=113	Station=0.375	OutputCase=FESSUR	CaseType=Combination	Point=1	X2=-0.5	X3=-0.5	
S11=1669.23550057702	IsS11Max=Yes	IsS11Min=No	FrameElem=113	ElemStation=0.375			
Frame=113	Station=0.375	OutputCase=FESSUR	CaseType=Combination	Point=2	X2=-0.5	X3=0.5	
S11=1669.23550057702	IsS11Max=No	IsS11Min=No	FrameElem=113	ElemStation=0.375			
Frame=113	Station=0.375	OutputCase=FESSUR	CaseType=Combination	Point=3	X2=0.5	X3=-0.5	S11=-
2303.35158763639	IsS11Max=No	IsS11Min=Yes	FrameElem=113	ElemStation=0.375			
Frame=113	Station=0.375	OutputCase=FESSUR	CaseType=Combination	Point=4	X2=0.5	X3=0.5	S11=-
2303.35158763639	IsS11Max=No	IsS11Min=No	FrameElem=113	ElemStation=0.375			
Frame=113	Station=0.5	OutputCase=FESSUR	CaseType=Combination	Point=0	X2=0	X3=0	S11=-
317.058043529684	IsS11Max=No	IsS11Min=No	FrameElem=113	ElemStation=0.5			
Frame=113	Station=0.5	OutputCase=FESSUR	CaseType=Combination	Point=1	X2=-0.5	X3=-0.5	
S11=1912.28237408825	IsS11Max=Yes	IsS11Min=No	FrameElem=113	ElemStation=0.5			
Frame=113	Station=0.5	OutputCase=FESSUR	CaseType=Combination	Point=2	X2=-0.5	X3=0.5	
S11=1912.28237408825	IsS11Max=No	IsS11Min=No	FrameElem=113	ElemStation=0.5			
Frame=113	Station=0.5	OutputCase=FESSUR	CaseType=Combination	Point=3	X2=0.5	X3=-0.5	S11=-
2546.39846114762	IsS11Max=No	IsS11Min=Yes	FrameElem=113	ElemStation=0.5			
Frame=113	Station=0.5	OutputCase=FESSUR	CaseType=Combination	Point=4	X2=0.5	X3=0.5	S11=-
2546.39846114762	IsS11Max=No	IsS11Min=No	FrameElem=113	ElemStation=0.5			
Frame=114	Station=0	OutputCase=PESOPR	CaseType=LinStatic	Point=0	X2=0	X3=0	S11=15.1709467361849
IsS11Max=No	IsS11Min=No	FrameElem=114	ElemStation=0				
Frame=114	Station=0	OutputCase=PESOPR	CaseType=LinStatic	Point=1	X2=-0.5	X3=-0.5	
S11=282.491477120469	IsS11Max=Yes	IsS11Min=No	FrameElem=114	ElemStation=0			
Frame=114	Station=0	OutputCase=PESOPR	CaseType=LinStatic	Point=2	X2=-0.5	X3=0.5	
S11=282.491477120469	IsS11Max=No	IsS11Min=No	FrameElem=114	ElemStation=0			
Frame=114	Station=0	OutputCase=PESOPR	CaseType=LinStatic	Point=3	X2=0.5	X3=-0.5	S11=-
252.149583648099	IsS11Max=No	IsS11Min=Yes	FrameElem=114	ElemStation=0			
Frame=114	Station=0	OutputCase=PESOPR	CaseType=LinStatic	Point=4	X2=0.5	X3=0.5	S11=-
252.149583648099	IsS11Max=No	IsS11Min=No	FrameElem=114	ElemStation=0			
Frame=114	Station=0.125	OutputCase=PESOPR	CaseType=LinStatic	Point=0	X2=0	X3=0	S11=15.1709467361849
IsS11Max=No	IsS11Min=No	FrameElem=114	ElemStation=0.125				
Frame=114	Station=0.125	OutputCase=PESOPR	CaseType=LinStatic	Point=1	X2=-0.5	X3=-0.5	
S11=300.06960211212	IsS11Max=Yes	IsS11Min=No	FrameElem=114	ElemStation=0.125			
Frame=114	Station=0.125	OutputCase=PESOPR	CaseType=LinStatic	Point=2	X2=-0.5	X3=0.5	
S11=300.06960211212	IsS11Max=No	IsS11Min=No	FrameElem=114	ElemStation=0.125			
Frame=114	Station=0.125	OutputCase=PESOPR	CaseType=LinStatic	Point=3	X2=0.5	X3=-0.5	S11=-
269.72770863975	IsS11Max=No	IsS11Min=Yes	FrameElem=114	ElemStation=0.125			
Frame=114	Station=0.125	OutputCase=PESOPR	CaseType=LinStatic	Point=4	X2=0.5	X3=0.5	S11=-
269.72770863975	IsS11Max=No	IsS11Min=No	FrameElem=114	ElemStation=0.125			
Frame=114	Station=0.25	OutputCase=PESOPR	CaseType=LinStatic	Point=0	X2=0	X3=0	S11=15.1709467361849
IsS11Max=No	IsS11Min=No	FrameElem=114	ElemStation=0.25				
Frame=114	Station=0.25	OutputCase=PESOPR	CaseType=LinStatic	Point=1	X2=-0.5	X3=-0.5	
S11=315.303977103771	IsS11Max=Yes	IsS11Min=No	FrameElem=114	ElemStation=0.25			
Frame=114	Station=0.25	OutputCase=PESOPR	CaseType=LinStatic	Point=2	X2=-0.5	X3=0.5	
S11=315.303977103771	IsS11Max=No	IsS11Min=No	FrameElem=114	ElemStation=0.25			
Frame=114	Station=0.25	OutputCase=PESOPR	CaseType=LinStatic	Point=3	X2=0.5	X3=-0.5	S11=-
284.962083631401	IsS11Max=No	IsS11Min=Yes	FrameElem=114	ElemStation=0.25			
Frame=114	Station=0.25	OutputCase=PESOPR	CaseType=LinStatic	Point=4	X2=0.5	X3=0.5	S11=-
284.962083631401	IsS11Max=No	IsS11Min=No	FrameElem=114	ElemStation=0.25			
Frame=114	Station=0.375	OutputCase=PESOPR	CaseType=LinStatic	Point=0	X2=0	X3=0	S11=15.1709467361849
IsS11Max=No	IsS11Min=No	FrameElem=114	ElemStation=0.375				
Frame=114	Station=0.375	OutputCase=PESOPR	CaseType=LinStatic	Point=1	X2=-0.5	X3=-0.5	
S11=328.194602095422	IsS11Max=Yes	IsS11Min=No	FrameElem=114	ElemStation=0.375			
Frame=114	Station=0.375	OutputCase=PESOPR	CaseType=LinStatic	Point=2	X2=-0.5	X3=0.5	
S11=328.194602095422	IsS11Max=No	IsS11Min=No	FrameElem=114	ElemStation=0.375			
Frame=114	Station=0.375	OutputCase=PESOPR	CaseType=LinStatic	Point=3	X2=0.5	X3=-0.5	S11=-
297.852708623052	IsS11Max=No	IsS11Min=Yes	FrameElem=114	ElemStation=0.375			
Frame=114	Station=0.375	OutputCase=PESOPR	CaseType=LinStatic	Point=4	X2=0.5	X3=0.5	S11=-
297.852708623052	IsS11Max=No	IsS11Min=No	FrameElem=114	ElemStation=0.375			
Frame=114	Station=0.5	OutputCase=PESOPR	CaseType=LinStatic	Point=0	X2=0	X3=0	S11=15.1709467361849
IsS11Max=No	IsS11Min=No	FrameElem=114	ElemStation=0.5				
Frame=114	Station=0.5	OutputCase=PESOPR	CaseType=LinStatic	Point=1	X2=-0.5	X3=-0.5	
S11=338.741477087073	IsS11Max=Yes	IsS11Min=No	FrameElem=114	ElemStation=0.5			
Frame=114	Station=0.5	OutputCase=PESOPR	CaseType=LinStatic	Point=2	X2=-0.5	X3=0.5	
S11=338.741477087073	IsS11Max=No	IsS11Min=No	FrameElem=114	ElemStation=0.5			
Frame=114	Station=0.5	OutputCase=PESOPR	CaseType=LinStatic	Point=3	X2=0.5	X3=-0.5	S11=-
308.399583614703	IsS11Max=No	IsS11Min=Yes	FrameElem=114	ElemStation=0.5			
Frame=114	Station=0.5	OutputCase=PESOPR	CaseType=LinStatic	Point=4	X2=0.5	X3=0.5	S11=-
308.399583614703	IsS11Max=No	IsS11Min=No	FrameElem=114	ElemStation=0.5			
Frame=114	Station=0	OutputCase=TERRVERT	CaseType=LinStatic	Point=0	X2=0	X3=0	S11=-1.64270738195971
IsS11Max=No	IsS11Min=No	FrameElem=114	ElemStation=0				
Frame=114	Station=0	OutputCase=TERRVERT	CaseType=LinStatic	Point=1	X2=-0.5	X3=-0.5	
S11=2458.80398774754	IsS11Max=Yes	IsS11Min=No	FrameElem=114	ElemStation=0			
Frame=114	Station=0	OutputCase=TERRVERT	CaseType=LinStatic	Point=2	X2=-0.5	X3=0.5	
S11=2458.80398774754	IsS11Max=No	IsS11Min=No	FrameElem=114	ElemStation=0			
Frame=114	Station=0	OutputCase=TERRVERT	CaseType=LinStatic	Point=3	X2=0.5	X3=-0.5	S11=-
2462.08940251146	IsS11Max=No	IsS11Min=Yes	FrameElem=114	ElemStation=0			

```

Frame=114 Station=0 OutputCase=TERRVERT CaseType=LinStatic Point=4 X2=0.5 X3=0.5 S11=-
2462.08940251146 IsS11Max=No IsS11Min=No FrameElem=114 ElemStation=0
Frame=114 Station=0.125 OutputCase=TERRVERT CaseType=LinStatic Point=0 X2=0 X3=0 S11=-
1.64270738195971 IsS11Max=No IsS11Min=No FrameElem=114 ElemStation=0.125
Frame=114 Station=0.125 OutputCase=TERRVERT CaseType=LinStatic Point=1 X2=-0.5 X3=-0.5
S11=2655.67898753634 IsS11Max=Yes IsS11Min=No FrameElem=114 ElemStation=0.125
Frame=114 Station=0.125 OutputCase=TERRVERT CaseType=LinStatic Point=2 X2=-0.5 X3=0.5
S11=2655.67898753634 IsS11Max=No IsS11Min=No FrameElem=114 ElemStation=0.125
Frame=114 Station=0.125 OutputCase=TERRVERT CaseType=LinStatic Point=3 X2=0.5 X3=-0.5 S11=-
2658.96440230026 IsS11Max=No IsS11Min=Yes FrameElem=114 ElemStation=0.125
Frame=114 Station=0.125 OutputCase=TERRVERT CaseType=LinStatic Point=4 X2=0.5 X3=0.5 S11=-
2658.96440230026 IsS11Max=No IsS11Min=No FrameElem=114 ElemStation=0.125
Frame=114 Station=0.25 OutputCase=TERRVERT CaseType=LinStatic Point=0 X2=0 X3=0 S11=-
1.64270738195971 IsS11Max=No IsS11Min=No FrameElem=114 ElemStation=0.25
Frame=114 Station=0.25 OutputCase=TERRVERT CaseType=LinStatic Point=1 X2=-0.5 X3=-0.5
S11=2826.30398732513 IsS11Max=Yes IsS11Min=No FrameElem=114 ElemStation=0.25
Frame=114 Station=0.25 OutputCase=TERRVERT CaseType=LinStatic Point=2 X2=-0.5 X3=0.5
S11=2826.30398732513 IsS11Max=No IsS11Min=No FrameElem=114 ElemStation=0.25
Frame=114 Station=0.25 OutputCase=TERRVERT CaseType=LinStatic Point=3 X2=0.5 X3=-0.5 S11=-
2829.58940208905 IsS11Max=No IsS11Min=Yes FrameElem=114 ElemStation=0.25
Frame=114 Station=0.25 OutputCase=TERRVERT CaseType=LinStatic Point=4 X2=0.5 X3=0.5 S11=-
2829.58940208905 IsS11Max=No IsS11Min=No FrameElem=114 ElemStation=0.25
Frame=114 Station=0.375 OutputCase=TERRVERT CaseType=LinStatic Point=0 X2=0 X3=0 S11=-
1.64270738195971 IsS11Max=No IsS11Min=No FrameElem=114 ElemStation=0.375
Frame=114 Station=0.375 OutputCase=TERRVERT CaseType=LinStatic Point=1 X2=-0.5 X3=-0.5
S11=2970.67898711392 IsS11Max=Yes IsS11Min=No FrameElem=114 ElemStation=0.375
Frame=114 Station=0.375 OutputCase=TERRVERT CaseType=LinStatic Point=2 X2=-0.5 X3=0.5
S11=2970.67898711392 IsS11Max=No IsS11Min=No FrameElem=114 ElemStation=0.375
Frame=114 Station=0.375 OutputCase=TERRVERT CaseType=LinStatic Point=3 X2=0.5 X3=-0.5 S11=-
2973.96440187784 IsS11Max=No IsS11Min=Yes FrameElem=114 ElemStation=0.375
Frame=114 Station=0.375 OutputCase=TERRVERT CaseType=LinStatic Point=4 X2=0.5 X3=0.5 S11=-
2973.96440187784 IsS11Max=No IsS11Min=No FrameElem=114 ElemStation=0.375
Frame=114 Station=0.5 OutputCase=TERRVERT CaseType=LinStatic Point=0 X2=0 X3=0 S11=-
1.64270738195971 IsS11Max=No IsS11Min=No FrameElem=114 ElemStation=0.5
Frame=114 Station=0.5 OutputCase=TERRVERT CaseType=LinStatic Point=1 X2=-0.5 X3=-0.5
S11=3088.80398690272 IsS11Max=Yes IsS11Min=No FrameElem=114 ElemStation=0.5
Frame=114 Station=0.5 OutputCase=TERRVERT CaseType=LinStatic Point=2 X2=-0.5 X3=0.5
S11=3088.80398690272 IsS11Max=No IsS11Min=No FrameElem=114 ElemStation=0.5
Frame=114 Station=0.5 OutputCase=TERRVERT CaseType=LinStatic Point=3 X2=0.5 X3=-0.5 S11=-
3092.08940166664 IsS11Max=No IsS11Min=Yes FrameElem=114 ElemStation=0.5
Frame=114 Station=0.5 OutputCase=TERRVERT CaseType=LinStatic Point=4 X2=0.5 X3=0.5 S11=-
3092.08940166664 IsS11Max=No IsS11Min=No FrameElem=114 ElemStation=0.5
Frame=114 Station=0 OutputCase=TERRLAT CaseType=LinStatic Point=0 X2=0 X3=0 S11=-330.586282883909
IsS11Max=No IsS11Min=No FrameElem=114 ElemStation=0
Frame=114 Station=0 OutputCase=TERRLAT CaseType=LinStatic Point=1 X2=-0.5 X3=-0.5 S11=-
829.013090779867 IsS11Max=No IsS11Min=Yes FrameElem=114 ElemStation=0
Frame=114 Station=0 OutputCase=TERRLAT CaseType=LinStatic Point=2 X2=-0.5 X3=0.5 S11=-
829.013090779867 IsS11Max=No IsS11Min=No FrameElem=114 ElemStation=0
Frame=114 Station=0 OutputCase=TERRLAT CaseType=LinStatic Point=3 X2=0.5 X3=-0.5
S11=167.84052501205 IsS11Max=Yes IsS11Min=No FrameElem=114 ElemStation=0
Frame=114 Station=0 OutputCase=TERRLAT CaseType=LinStatic Point=4 X2=0.5 X3=0.5 S11=167.84052501205
IsS11Max=No IsS11Min=No FrameElem=114 ElemStation=0
Frame=114 Station=0.125 OutputCase=TERRLAT CaseType=LinStatic Point=0 X2=0 X3=0 S11=-
330.586282883909 IsS11Max=No IsS11Min=No FrameElem=114 ElemStation=0.125
Frame=114 Station=0.125 OutputCase=TERRLAT CaseType=LinStatic Point=1 X2=-0.5 X3=-0.5 S11=-
829.013092049016 IsS11Max=No IsS11Min=Yes FrameElem=114 ElemStation=0.125
Frame=114 Station=0.125 OutputCase=TERRLAT CaseType=LinStatic Point=2 X2=-0.5 X3=0.5 S11=-
829.013092049016 IsS11Max=No IsS11Min=No FrameElem=114 ElemStation=0.125
Frame=114 Station=0.125 OutputCase=TERRLAT CaseType=LinStatic Point=3 X2=0.5 X3=-0.5
S11=167.840526281198 IsS11Max=Yes IsS11Min=No FrameElem=114 ElemStation=0.125
Frame=114 Station=0.125 OutputCase=TERRLAT CaseType=LinStatic Point=4 X2=0.5 X3=0.5
S11=167.840526281198 IsS11Max=No IsS11Min=No FrameElem=114 ElemStation=0.125
Frame=114 Station=0.25 OutputCase=TERRLAT CaseType=LinStatic Point=0 X2=0 X3=0 S11=-
330.586282883909 IsS11Max=No IsS11Min=No FrameElem=114 ElemStation=0.25
Frame=114 Station=0.25 OutputCase=TERRLAT CaseType=LinStatic Point=1 X2=-0.5 X3=-0.5 S11=-
829.013093318164 IsS11Max=No IsS11Min=Yes FrameElem=114 ElemStation=0.25
Frame=114 Station=0.25 OutputCase=TERRLAT CaseType=LinStatic Point=2 X2=-0.5 X3=0.5 S11=-
829.013093318164 IsS11Max=No IsS11Min=No FrameElem=114 ElemStation=0.25
Frame=114 Station=0.25 OutputCase=TERRLAT CaseType=LinStatic Point=3 X2=0.5 X3=-0.5
S11=167.84052750347 IsS11Max=Yes IsS11Min=No FrameElem=114 ElemStation=0.25
Frame=114 Station=0.25 OutputCase=TERRLAT CaseType=LinStatic Point=4 X2=0.5 X3=0.5
S11=167.84052750347 IsS11Max=No IsS11Min=No FrameElem=114 ElemStation=0.25
Frame=114 Station=0.375 OutputCase=TERRLAT CaseType=LinStatic Point=0 X2=0 X3=0 S11=-
330.586282883909 IsS11Max=No IsS11Min=No FrameElem=114 ElemStation=0.375
Frame=114 Station=0.375 OutputCase=TERRLAT CaseType=LinStatic Point=1 X2=-0.5 X3=-0.5 S11=-
829.013094587313 IsS11Max=No IsS11Min=Yes FrameElem=114 ElemStation=0.375
Frame=114 Station=0.375 OutputCase=TERRLAT CaseType=LinStatic Point=2 X2=-0.5 X3=0.5 S11=-
829.013094587313 IsS11Max=No IsS11Min=No FrameElem=114 ElemStation=0.375
Frame=114 Station=0.375 OutputCase=TERRLAT CaseType=LinStatic Point=3 X2=0.5 X3=-0.5
S11=167.840528819495 IsS11Max=Yes IsS11Min=No FrameElem=114 ElemStation=0.375
Frame=114 Station=0.375 OutputCase=TERRLAT CaseType=LinStatic Point=4 X2=0.5 X3=0.5
S11=167.840528819495 IsS11Max=No IsS11Min=No FrameElem=114 ElemStation=0.375

```

Frame=114	Station=0.375	OutputCase=SOVRCOST	CaseType=LinStatic	Point=3	X2=0.5	X3=-0.5	S11=0
IsS11Max=No	IsS11Min=No	FrameElem=114	ElemStation=0.375				
Frame=114	Station=0.375	OutputCase=SOVRCOST	CaseType=LinStatic	Point=4	X2=0.5	X3=0.5	S11=0
IsS11Max=No	IsS11Min=No	FrameElem=114	ElemStation=0.375				
Frame=114	Station=0.5	OutputCase=SOVRCOST	CaseType=LinStatic	Point=0	X2=0	X3=0	S11=0
IsS11Min=Yes	FrameElem=114	ElemStation=0.5					IsS11Max=Yes
Frame=114	Station=0.5	OutputCase=SOVRCOST	CaseType=LinStatic	Point=1	X2=-0.5	X3=-0.5	S11=0
IsS11Max=No	IsS11Min=No	FrameElem=114	ElemStation=0.5				
Frame=114	Station=0.5	OutputCase=SOVRCOST	CaseType=LinStatic	Point=2	X2=-0.5	X3=0.5	S11=0
IsS11Max=No	IsS11Min=No	FrameElem=114	ElemStation=0.5				
Frame=114	Station=0.5	OutputCase=SOVRCOST	CaseType=LinStatic	Point=3	X2=0.5	X3=-0.5	S11=0
IsS11Max=No	IsS11Min=No	FrameElem=114	ElemStation=0.5				
Frame=114	Station=0.5	OutputCase=SOVRCOST	CaseType=LinStatic	Point=4	X2=0.5	X3=0.5	S11=0
IsS11Max=No	IsS11Min=No	FrameElem=114	ElemStation=0.5				
Frame=114	Station=0	OutputCase=ENVE	CaseType=Combination	StepType=Max	Point=0	X2=0	X3=0
217.882158664511	IsS11Max=No	IsS11Min=No	FrameElem=114	ElemStation=0			
Frame=114	Station=0	OutputCase=ENVE	CaseType=Combination	StepType=Max	Point=1	X2=-0.5	X3=-0.5
S11=2160.98630132211	IsS11Max=Yes	IsS11Min=No	FrameElem=114	ElemStation=0			
Frame=114	Station=0	OutputCase=ENVE	CaseType=Combination	StepType=Max	Point=2	X2=-0.5	X3=0.5
S11=2160.98630132211	IsS11Max=No	IsS11Min=No	FrameElem=114	ElemStation=0			
Frame=114	Station=0	OutputCase=ENVE	CaseType=Combination	StepType=Max	Point=3	X2=0.5	X3=-0.5
S11=-2546.39846114751	IsS11Max=No	IsS11Min=Yes	FrameElem=114	ElemStation=0			
Frame=114	Station=0	OutputCase=ENVE	CaseType=Combination	StepType=Max	Point=4	X2=0.5	X3=0.5
S11=-2546.39846114751	IsS11Max=No	IsS11Min=No	FrameElem=114	ElemStation=0			
Frame=114	Station=0.125	OutputCase=ENVE	CaseType=Combination	StepType=Max	Point=0	X2=0	X3=0
217.882158664511	IsS11Max=No	IsS11Min=No	FrameElem=114	ElemStation=0.125			
Frame=114	Station=0.125	OutputCase=ENVE	CaseType=Combination	StepType=Max	Point=1	X2=-0.5	X3=-0.5
S11=2375.43942521415	IsS11Max=Yes	IsS11Min=No	FrameElem=114	ElemStation=0.125			
Frame=114	Station=0.125	OutputCase=ENVE	CaseType=Combination	StepType=Max	Point=2	X2=-0.5	X3=0.5
S11=2375.43942521415	IsS11Max=No	IsS11Min=No	FrameElem=114	ElemStation=0.125			
Frame=114	Station=0.125	OutputCase=ENVE	CaseType=Combination	StepType=Max	Point=3	X2=0.5	X3=-0.5
S11=-2760.85158465881	IsS11Max=No	IsS11Min=Yes	FrameElem=114	ElemStation=0.125			
Frame=114	Station=0.125	OutputCase=ENVE	CaseType=Combination	StepType=Max	Point=4	X2=0.5	X3=0.5
S11=-2760.85158465881	IsS11Max=No	IsS11Min=No	FrameElem=114	ElemStation=0.125			
Frame=114	Station=0.25	OutputCase=ENVE	CaseType=Combination	StepType=Max	Point=0	X2=0	X3=0
217.882158664511	IsS11Max=No	IsS11Min=No	FrameElem=114	ElemStation=0.25			
Frame=114	Station=0.25	OutputCase=ENVE	CaseType=Combination	StepType=Max	Point=1	X2=-0.5	X3=-0.5
S11=2561.29879910619	IsS11Max=Yes	IsS11Min=No	FrameElem=114	ElemStation=0.25			
Frame=114	Station=0.25	OutputCase=ENVE	CaseType=Combination	StepType=Max	Point=2	X2=-0.5	X3=0.5
S11=2561.29879910619	IsS11Max=No	IsS11Min=No	FrameElem=114	ElemStation=0.25			
Frame=114	Station=0.25	OutputCase=ENVE	CaseType=Combination	StepType=Max	Point=3	X2=0.5	X3=-0.5
S11=-2946.7109581701	IsS11Max=No	IsS11Min=Yes	FrameElem=114	ElemStation=0.25			
Frame=114	Station=0.25	OutputCase=ENVE	CaseType=Combination	StepType=Max	Point=4	X2=0.5	X3=0.5
S11=-2946.7109581701	IsS11Max=No	IsS11Min=No	FrameElem=114	ElemStation=0.25			
Frame=114	Station=0.375	OutputCase=ENVE	CaseType=Combination	StepType=Max	Point=0	X2=0	X3=0
217.882158664511	IsS11Max=No	IsS11Min=No	FrameElem=114	ElemStation=0.375			
Frame=114	Station=0.375	OutputCase=ENVE	CaseType=Combination	StepType=Max	Point=1	X2=-0.5	X3=-0.5
S11=2718.56442299823	IsS11Max=Yes	IsS11Min=No	FrameElem=114	ElemStation=0.375			
Frame=114	Station=0.375	OutputCase=ENVE	CaseType=Combination	StepType=Max	Point=2	X2=-0.5	X3=0.5
S11=2718.56442299823	IsS11Max=No	IsS11Min=No	FrameElem=114	ElemStation=0.375			
Frame=114	Station=0.375	OutputCase=ENVE	CaseType=Combination	StepType=Max	Point=3	X2=0.5	X3=-0.5
S11=-3103.9765816814	IsS11Max=No	IsS11Min=Yes	FrameElem=114	ElemStation=0.375			
Frame=114	Station=0.375	OutputCase=ENVE	CaseType=Combination	StepType=Max	Point=4	X2=0.5	X3=0.5
S11=-3103.9765816814	IsS11Max=No	IsS11Min=No	FrameElem=114	ElemStation=0.375			
Frame=114	Station=0.5	OutputCase=ENVE	CaseType=Combination	StepType=Max	Point=0	X2=0	X3=0
217.882158664511	IsS11Max=No	IsS11Min=No	FrameElem=114	ElemStation=0.5			
Frame=114	Station=0.5	OutputCase=ENVE	CaseType=Combination	StepType=Max	Point=1	X2=-0.5	X3=-0.5
S11=2847.23629689027	IsS11Max=Yes	IsS11Min=No	FrameElem=114	ElemStation=0.5			
Frame=114	Station=0.5	OutputCase=ENVE	CaseType=Combination	StepType=Max	Point=2	X2=-0.5	X3=0.5
S11=2847.23629689027	IsS11Max=No	IsS11Min=No	FrameElem=114	ElemStation=0.5			
Frame=114	Station=0.5	OutputCase=ENVE	CaseType=Combination	StepType=Max	Point=3	X2=0.5	X3=-0.5
S11=-3232.6484551927	IsS11Max=No	IsS11Min=Yes	FrameElem=114	ElemStation=0.5			
Frame=114	Station=0.5	OutputCase=ENVE	CaseType=Combination	StepType=Max	Point=4	X2=0.5	X3=0.5
S11=-3232.6484551927	IsS11Max=No	IsS11Min=No	FrameElem=114	ElemStation=0.5			
Frame=114	Station=0	OutputCase=ENVE	CaseType=Combination	StepType=Min	Point=0	X2=0	X3=0
317.058043529684	IsS11Max=No	IsS11Min=No	FrameElem=114	ElemStation=0			
Frame=114	Station=0	OutputCase=ENVE	CaseType=Combination	StepType=Min	Point=1	X2=-0.5	X3=-0.5
S11=1912.28237408815	IsS11Max=Yes	IsS11Min=No	FrameElem=114	ElemStation=0			
Frame=114	Station=0	OutputCase=ENVE	CaseType=Combination	StepType=Min	Point=2	X2=-0.5	X3=0.5
S11=1912.28237408815	IsS11Max=No	IsS11Min=No	FrameElem=114	ElemStation=0			
Frame=114	Station=0	OutputCase=ENVE	CaseType=Combination	StepType=Min	Point=3	X2=0.5	X3=-0.5
S11=-2596.75061865113	IsS11Max=No	IsS11Min=Yes	FrameElem=114	ElemStation=0			
Frame=114	Station=0	OutputCase=ENVE	CaseType=Combination	StepType=Min	Point=4	X2=0.5	X3=0.5
S11=-2596.75061865113	IsS11Max=No	IsS11Min=No	FrameElem=114	ElemStation=0			
Frame=114	Station=0.125	OutputCase=ENVE	CaseType=Combination	StepType=Min	Point=0	X2=0	X3=0
317.058043529684	IsS11Max=No	IsS11Min=No	FrameElem=114	ElemStation=0.125			
Frame=114	Station=0.125	OutputCase=ENVE	CaseType=Combination	StepType=Min	Point=1	X2=-0.5	X3=-0.5
S11=2126.73549759944	IsS11Max=Yes	IsS11Min=No	FrameElem=114	ElemStation=0.125			
Frame=114	Station=0.125	OutputCase=ENVE	CaseType=Combination	StepType=Min	Point=2	X2=-0.5	X3=0.5
S11=2126.73549759944	IsS11Max=No	IsS11Min=No	FrameElem=114	ElemStation=0.125			
Frame=114	Station=0.125	OutputCase=ENVE	CaseType=Combination	StepType=Min	Point=3	X2=0.5	X3=-0.5
S11=-2811.20374254317	IsS11Max=No	IsS11Min=Yes	FrameElem=114	ElemStation=0.125			



Frame=114 Station=0.125 OutputCase=ENVE CaseType=Combination StepType=Min Point=4 X2=0.5 X3=0.5
 S11=-2811.20374254317 IsS11Max=No IsS11Min=No FrameElem=114 ElemStation=0.125
 Frame=114 Station=0.25 OutputCase=ENVE CaseType=Combination StepType=Min Point=0 X2=0 X3=0 S11=-
 317.058043529684 IsS11Max=No IsS11Min=No FrameElem=114 ElemStation=0.25
 Frame=114 Station=0.25 OutputCase=ENVE CaseType=Combination StepType=Min Point=1 X2=-0.5 X3=-0.5
 S11=2312.59487111074 IsS11Max=Yes IsS11Min=No FrameElem=114 ElemStation=0.25
 Frame=114 Station=0.25 OutputCase=ENVE CaseType=Combination StepType=Min Point=2 X2=-0.5 X3=0.5
 S11=2312.59487111074 IsS11Max=No IsS11Min=No FrameElem=114 ElemStation=0.25
 Frame=114 Station=0.25 OutputCase=ENVE CaseType=Combination StepType=Min Point=3 X2=0.5 X3=-0.5
 S11=-2997.06311643521 IsS11Max=No IsS11Min=Yes FrameElem=114 ElemStation=0.25
 Frame=114 Station=0.25 OutputCase=ENVE CaseType=Combination StepType=Min Point=4 X2=0.5 X3=0.5
 S11=-2997.06311643521 IsS11Max=No IsS11Min=No FrameElem=114 ElemStation=0.25
 Frame=114 Station=0.375 OutputCase=ENVE CaseType=Combination StepType=Min Point=0 X2=0 X3=0 S11=-
 317.058043529684 IsS11Max=No IsS11Min=No FrameElem=114 ElemStation=0.375
 Frame=114 Station=0.375 OutputCase=ENVE CaseType=Combination StepType=Min Point=1 X2=-0.5 X3=-0.5
 S11=2469.86049462203 IsS11Max=Yes IsS11Min=No FrameElem=114 ElemStation=0.375
 Frame=114 Station=0.375 OutputCase=ENVE CaseType=Combination StepType=Min Point=2 X2=-0.5 X3=0.5
 S11=2469.86049462203 IsS11Max=No IsS11Min=No FrameElem=114 ElemStation=0.375
 Frame=114 Station=0.375 OutputCase=ENVE CaseType=Combination StepType=Min Point=3 X2=0.5 X3=-0.5
 S11=-3154.32874032725 IsS11Max=No IsS11Min=Yes FrameElem=114 ElemStation=0.375
 Frame=114 Station=0.375 OutputCase=ENVE CaseType=Combination StepType=Min Point=4 X2=0.5 X3=0.5
 S11=-3154.32874032725 IsS11Max=No IsS11Min=No FrameElem=114 ElemStation=0.375
 Frame=114 Station=0.5 OutputCase=ENVE CaseType=Combination StepType=Min Point=0 X2=0 X3=0 S11=-
 317.058043529684 IsS11Max=No IsS11Min=No FrameElem=114 ElemStation=0.5
 Frame=114 Station=0.5 OutputCase=ENVE CaseType=Combination StepType=Min Point=1 X2=-0.5 X3=-0.5
 S11=2598.53236813333 IsS11Max=Yes IsS11Min=No FrameElem=114 ElemStation=0.5
 Frame=114 Station=0.5 OutputCase=ENVE CaseType=Combination StepType=Min Point=2 X2=-0.5 X3=0.5
 S11=2598.53236813333 IsS11Max=No IsS11Min=No FrameElem=114 ElemStation=0.5
 Frame=114 Station=0.5 OutputCase=ENVE CaseType=Combination StepType=Min Point=3 X2=0.5 X3=-0.5
 S11=-3283.00061421929 IsS11Max=No IsS11Min=Yes FrameElem=114 ElemStation=0.5
 Frame=114 Station=0.5 OutputCase=ENVE CaseType=Combination StepType=Min Point=4 X2=0.5 X3=0.5
 S11=-3283.00061421929 IsS11Max=No IsS11Min=No FrameElem=114 ElemStation=0.5
 Frame=114 Station=0 OutputCase=FESSUR CaseType=Combination Point=0 X2=0 X3=0 S11=-317.058043529684
 IsS11Max=No IsS11Min=No FrameElem=114 ElemStation=0
 Frame=114 Station=0 OutputCase=FESSUR CaseType=Combination Point=1 X2=-0.5 X3=-0.5
 S11=1912.28237408815 IsS11Max=Yes IsS11Min=No FrameElem=114 ElemStation=0
 Frame=114 Station=0 OutputCase=FESSUR CaseType=Combination Point=2 X2=-0.5 X3=0.5
 S11=1912.28237408815 IsS11Max=No IsS11Min=No FrameElem=114 ElemStation=0
 Frame=114 Station=0 OutputCase=FESSUR CaseType=Combination Point=3 X2=0.5 X3=-0.5 S11=-
 2546.39846114751 IsS11Max=No IsS11Min=Yes FrameElem=114 ElemStation=0
 Frame=114 Station=0 OutputCase=FESSUR CaseType=Combination Point=4 X2=0.5 X3=0.5 S11=-
 2546.39846114751 IsS11Max=No IsS11Min=No FrameElem=114 ElemStation=0
 Frame=114 Station=0.125 OutputCase=FESSUR CaseType=Combination Point=0 X2=0 X3=0 S11=-
 317.058043529684 IsS11Max=No IsS11Min=No FrameElem=114 ElemStation=0.125
 Frame=114 Station=0.125 OutputCase=FESSUR CaseType=Combination Point=1 X2=-0.5 X3=-0.5
 S11=2126.73549759944 IsS11Max=Yes IsS11Min=No FrameElem=114 ElemStation=0.125
 Frame=114 Station=0.125 OutputCase=FESSUR CaseType=Combination Point=2 X2=-0.5 X3=0.5
 S11=2126.73549759944 IsS11Max=No IsS11Min=No FrameElem=114 ElemStation=0.125
 Frame=114 Station=0.125 OutputCase=FESSUR CaseType=Combination Point=3 X2=0.5 X3=-0.5 S11=-
 2760.85158465881 IsS11Max=No IsS11Min=Yes FrameElem=114 ElemStation=0.125
 Frame=114 Station=0.125 OutputCase=FESSUR CaseType=Combination Point=4 X2=0.5 X3=0.5 S11=-
 2760.85158465881 IsS11Max=No IsS11Min=No FrameElem=114 ElemStation=0.125
 Frame=114 Station=0.25 OutputCase=FESSUR CaseType=Combination Point=0 X2=0 X3=0 S11=-
 317.058043529684 IsS11Max=No IsS11Min=No FrameElem=114 ElemStation=0.25
 Frame=114 Station=0.25 OutputCase=FESSUR CaseType=Combination Point=1 X2=-0.5 X3=-0.5
 S11=2312.59487111074 IsS11Max=Yes IsS11Min=No FrameElem=114 ElemStation=0.25
 Frame=114 Station=0.25 OutputCase=FESSUR CaseType=Combination Point=2 X2=-0.5 X3=0.5
 S11=2312.59487111074 IsS11Max=No IsS11Min=No FrameElem=114 ElemStation=0.25
 Frame=114 Station=0.25 OutputCase=FESSUR CaseType=Combination Point=3 X2=0.5 X3=-0.5 S11=-
 2946.7109581701 IsS11Max=No IsS11Min=Yes FrameElem=114 ElemStation=0.25
 Frame=114 Station=0.25 OutputCase=FESSUR CaseType=Combination Point=4 X2=0.5 X3=0.5 S11=-
 2946.7109581701 IsS11Max=No IsS11Min=No FrameElem=114 ElemStation=0.25
 Frame=114 Station=0.375 OutputCase=FESSUR CaseType=Combination Point=0 X2=0 X3=0 S11=-
 317.058043529684 IsS11Max=No IsS11Min=No FrameElem=114 ElemStation=0.375
 Frame=114 Station=0.375 OutputCase=FESSUR CaseType=Combination Point=1 X2=-0.5 X3=-0.5
 S11=2469.86049462203 IsS11Max=Yes IsS11Min=No FrameElem=114 ElemStation=0.375
 Frame=114 Station=0.375 OutputCase=FESSUR CaseType=Combination Point=2 X2=-0.5 X3=0.5
 S11=2469.86049462203 IsS11Max=No IsS11Min=No FrameElem=114 ElemStation=0.375
 Frame=114 Station=0.375 OutputCase=FESSUR CaseType=Combination Point=3 X2=0.5 X3=-0.5 S11=-
 3103.9765816814 IsS11Max=No IsS11Min=Yes FrameElem=114 ElemStation=0.375
 Frame=114 Station=0.375 OutputCase=FESSUR CaseType=Combination Point=4 X2=0.5 X3=0.5 S11=-
 3103.9765816814 IsS11Max=No IsS11Min=No FrameElem=114 ElemStation=0.375
 Frame=114 Station=0.5 OutputCase=FESSUR CaseType=Combination Point=0 X2=0 X3=0 S11=-
 317.058043529684 IsS11Max=No IsS11Min=No FrameElem=114 ElemStation=0.5
 Frame=114 Station=0.5 OutputCase=FESSUR CaseType=Combination Point=1 X2=-0.5 X3=-0.5
 S11=2598.53236813333 IsS11Max=Yes IsS11Min=No FrameElem=114 ElemStation=0.5
 Frame=114 Station=0.5 OutputCase=FESSUR CaseType=Combination Point=2 X2=-0.5 X3=0.5
 S11=2598.53236813333 IsS11Max=No IsS11Min=No FrameElem=114 ElemStation=0.5
 Frame=114 Station=0.5 OutputCase=FESSUR CaseType=Combination Point=3 X2=0.5 X3=-0.5 S11=-
 3232.6484551927 IsS11Max=No IsS11Min=Yes FrameElem=114 ElemStation=0.5
 Frame=114 Station=0.5 OutputCase=FESSUR CaseType=Combination Point=4 X2=0.5 X3=0.5 S11=-
 3232.6484551927 IsS11Max=No IsS11Min=No FrameElem=114 ElemStation=0.5



Frame=115	Station=0	OutputCase=PESOPR	CaseType=LinStatic	Point=0	X2=0	X3=0	S11=15.170946736185
IsS11Max=No	IsS11Min=No	FrameElem=115	ElemStation=0				
Frame=115	Station=0	OutputCase=PESOPR	CaseType=LinStatic	Point=1	X2=-0.5	X3=-0.5	
S11=338.74147708716	IsS11Max=Yes	IsS11Min=No	FrameElem=115	ElemStation=0			
Frame=115	Station=0	OutputCase=PESOPR	CaseType=LinStatic	Point=2	X2=-0.5	X3=0.5	S11=338.74147708716
IsS11Max=No	IsS11Min=No	FrameElem=115	ElemStation=0				
Frame=115	Station=0	OutputCase=PESOPR	CaseType=LinStatic	Point=3	X2=0.5	X3=-0.5	S11=-
308.39958361479	IsS11Max=No	IsS11Min=Yes	FrameElem=115	ElemStation=0			
Frame=115	Station=0	OutputCase=PESOPR	CaseType=LinStatic	Point=4	X2=0.5	X3=0.5	S11=-308.39958361479
IsS11Max=No	IsS11Min=No	FrameElem=115	ElemStation=0				
Frame=115	Station=0.125	OutputCase=PESOPR	CaseType=LinStatic	Point=0	X2=0	X3=0	S11=15.170946736185
IsS11Max=No	IsS11Min=No	FrameElem=115	ElemStation=0.125				
Frame=115	Station=0.125	OutputCase=PESOPR	CaseType=LinStatic	Point=1	X2=-0.5	X3=-0.5	
S11=346.944602078833	IsS11Max=Yes	IsS11Min=No	FrameElem=115	ElemStation=0.125			
Frame=115	Station=0.125	OutputCase=PESOPR	CaseType=LinStatic	Point=2	X2=-0.5	X3=0.5	
S11=346.944602078833	IsS11Max=No	IsS11Min=No	FrameElem=115	ElemStation=0.125			
Frame=115	Station=0.125	OutputCase=PESOPR	CaseType=LinStatic	Point=3	X2=0.5	X3=-0.5	S11=-
316.602708606463	IsS11Max=No	IsS11Min=Yes	FrameElem=115	ElemStation=0.125			
Frame=115	Station=0.125	OutputCase=PESOPR	CaseType=LinStatic	Point=4	X2=0.5	X3=0.5	S11=-
316.602708606463	IsS11Max=No	IsS11Min=No	FrameElem=115	ElemStation=0.125			
Frame=115	Station=0.25	OutputCase=PESOPR	CaseType=LinStatic	Point=0	X2=0	X3=0	S11=15.170946736185
IsS11Max=No	IsS11Min=No	FrameElem=115	ElemStation=0.25				
Frame=115	Station=0.25	OutputCase=PESOPR	CaseType=LinStatic	Point=1	X2=-0.5	X3=-0.5	
S11=352.803977070505	IsS11Max=Yes	IsS11Min=No	FrameElem=115	ElemStation=0.25			
Frame=115	Station=0.25	OutputCase=PESOPR	CaseType=LinStatic	Point=2	X2=-0.5	X3=0.5	
S11=352.803977070505	IsS11Max=No	IsS11Min=No	FrameElem=115	ElemStation=0.25			
Frame=115	Station=0.25	OutputCase=PESOPR	CaseType=LinStatic	Point=3	X2=0.5	X3=-0.5	S11=-
322.462083598135	IsS11Max=No	IsS11Min=Yes	FrameElem=115	ElemStation=0.25			
Frame=115	Station=0.25	OutputCase=PESOPR	CaseType=LinStatic	Point=4	X2=0.5	X3=0.5	S11=-
322.462083598135	IsS11Max=No	IsS11Min=No	FrameElem=115	ElemStation=0.25			
Frame=115	Station=0.375	OutputCase=PESOPR	CaseType=LinStatic	Point=0	X2=0	X3=0	S11=15.170946736185
IsS11Max=No	IsS11Min=No	FrameElem=115	ElemStation=0.375				
Frame=115	Station=0.375	OutputCase=PESOPR	CaseType=LinStatic	Point=1	X2=-0.5	X3=-0.5	
S11=356.319602062178	IsS11Max=Yes	IsS11Min=No	FrameElem=115	ElemStation=0.375			
Frame=115	Station=0.375	OutputCase=PESOPR	CaseType=LinStatic	Point=2	X2=-0.5	X3=0.5	
S11=356.319602062178	IsS11Max=No	IsS11Min=No	FrameElem=115	ElemStation=0.375			
Frame=115	Station=0.375	OutputCase=PESOPR	CaseType=LinStatic	Point=3	X2=0.5	X3=-0.5	S11=-
325.977708589808	IsS11Max=No	IsS11Min=Yes	FrameElem=115	ElemStation=0.375			
Frame=115	Station=0.375	OutputCase=PESOPR	CaseType=LinStatic	Point=4	X2=0.5	X3=0.5	S11=-
325.977708589808	IsS11Max=No	IsS11Min=No	FrameElem=115	ElemStation=0.375			
Frame=115	Station=0.5	OutputCase=PESOPR	CaseType=LinStatic	Point=0	X2=0	X3=0	S11=15.170946736185
IsS11Max=No	IsS11Min=No	FrameElem=115	ElemStation=0.5				
Frame=115	Station=0.5	OutputCase=PESOPR	CaseType=LinStatic	Point=1	X2=-0.5	X3=-0.5	
S11=357.491477053851	IsS11Max=Yes	IsS11Min=No	FrameElem=115	ElemStation=0.5			
Frame=115	Station=0.5	OutputCase=PESOPR	CaseType=LinStatic	Point=2	X2=-0.5	X3=0.5	
S11=357.491477053851	IsS11Max=No	IsS11Min=No	FrameElem=115	ElemStation=0.5			
Frame=115	Station=0.5	OutputCase=PESOPR	CaseType=LinStatic	Point=3	X2=0.5	X3=-0.5	S11=-
327.149583581481	IsS11Max=No	IsS11Min=Yes	FrameElem=115	ElemStation=0.5			
Frame=115	Station=0.5	OutputCase=PESOPR	CaseType=LinStatic	Point=4	X2=0.5	X3=0.5	S11=-
327.149583581481	IsS11Max=No	IsS11Min=No	FrameElem=115	ElemStation=0.5			
Frame=115	Station=0	OutputCase=TERRVERT	CaseType=LinStatic	Point=0	X2=0	X3=0	S11=-1.64270738195971
IsS11Max=No	IsS11Min=No	FrameElem=115	ElemStation=0				
Frame=115	Station=0	OutputCase=TERRVERT	CaseType=LinStatic	Point=1	X2=-0.5	X3=-0.5	
S11=3088.80398690289	IsS11Max=Yes	IsS11Min=No	FrameElem=115	ElemStation=0			
Frame=115	Station=0	OutputCase=TERRVERT	CaseType=LinStatic	Point=2	X2=-0.5	X3=0.5	
S11=3088.80398690289	IsS11Max=No	IsS11Min=No	FrameElem=115	ElemStation=0			
Frame=115	Station=0	OutputCase=TERRVERT	CaseType=LinStatic	Point=3	X2=0.5	X3=-0.5	S11=-
3092.08940166681	IsS11Max=No	IsS11Min=Yes	FrameElem=115	ElemStation=0			
Frame=115	Station=0	OutputCase=TERRVERT	CaseType=LinStatic	Point=4	X2=0.5	X3=0.5	S11=-
3092.08940166681	IsS11Max=No	IsS11Min=No	FrameElem=115	ElemStation=0			
Frame=115	Station=0.125	OutputCase=TERRVERT	CaseType=LinStatic	Point=0	X2=0	X3=0	S11=-
1.64270738195971	IsS11Max=No	IsS11Min=No	FrameElem=115	ElemStation=0.125			
Frame=115	Station=0.125	OutputCase=TERRVERT	CaseType=LinStatic	Point=1	X2=-0.5	X3=-0.5	
S11=3180.67898669177	IsS11Max=Yes	IsS11Min=No	FrameElem=115	ElemStation=0.125			
Frame=115	Station=0.125	OutputCase=TERRVERT	CaseType=LinStatic	Point=2	X2=-0.5	X3=0.5	
S11=3180.67898669177	IsS11Max=No	IsS11Min=No	FrameElem=115	ElemStation=0.125			
Frame=115	Station=0.125	OutputCase=TERRVERT	CaseType=LinStatic	Point=3	X2=0.5	X3=-0.5	S11=-
3183.96440145569	IsS11Max=No	IsS11Min=Yes	FrameElem=115	ElemStation=0.125			
Frame=115	Station=0.125	OutputCase=TERRVERT	CaseType=LinStatic	Point=4	X2=0.5	X3=0.5	S11=-
3183.96440145569	IsS11Max=No	IsS11Min=No	FrameElem=115	ElemStation=0.125			
Frame=115	Station=0.25	OutputCase=TERRVERT	CaseType=LinStatic	Point=0	X2=0	X3=0	S11=-
1.64270738195971	IsS11Max=No	IsS11Min=No	FrameElem=115	ElemStation=0.25			
Frame=115	Station=0.25	OutputCase=TERRVERT	CaseType=LinStatic	Point=1	X2=-0.5	X3=-0.5	
S11=3246.30398648065	IsS11Max=Yes	IsS11Min=No	FrameElem=115	ElemStation=0.25			
Frame=115	Station=0.25	OutputCase=TERRVERT	CaseType=LinStatic	Point=2	X2=-0.5	X3=0.5	
S11=3246.30398648065	IsS11Max=No	IsS11Min=No	FrameElem=115	ElemStation=0.25			
Frame=115	Station=0.25	OutputCase=TERRVERT	CaseType=LinStatic	Point=3	X2=0.5	X3=-0.5	S11=-
3249.58940124457	IsS11Max=No	IsS11Min=Yes	FrameElem=115	ElemStation=0.25			
Frame=115	Station=0.25	OutputCase=TERRVERT	CaseType=LinStatic	Point=4	X2=0.5	X3=0.5	S11=-
3249.58940124457	IsS11Max=No	IsS11Min=No	FrameElem=115	ElemStation=0.25			
Frame=115	Station=0.375	OutputCase=TERRVERT	CaseType=LinStatic	Point=0	X2=0	X3=0	S11=-
1.64270738195971	IsS11Max=No	IsS11Min=No	FrameElem=115	ElemStation=0.375			



Frame=115	Station=0.375	OutputCase=TERRVERT	CaseType=LinStatic	Point=1	X2=-0.5	X3=-0.5		
S11=3285.67898626954	IsS11Max=Yes	IsS11Min=No	FrameElem=115	ElemStation=0.375				
Frame=115	Station=0.375	OutputCase=TERRVERT	CaseType=LinStatic	Point=2	X2=-0.5	X3=0.5		
S11=3285.67898626954	IsS11Max=No	IsS11Min=No	FrameElem=115	ElemStation=0.375				
Frame=115	Station=0.375	OutputCase=TERRVERT	CaseType=LinStatic	Point=3	X2=0.5	X3=-0.5	S11=-	
3288.96440103345	IsS11Max=No	IsS11Min=Yes	FrameElem=115	ElemStation=0.375				
Frame=115	Station=0.375	OutputCase=TERRVERT	CaseType=LinStatic	Point=4	X2=0.5	X3=0.5	S11=-	
3288.96440103345	IsS11Max=No	IsS11Min=No	FrameElem=115	ElemStation=0.375				
Frame=115	Station=0.5	OutputCase=TERRVERT	CaseType=LinStatic	Point=0	X2=0	X3=0	S11=-	
1.64270738195971	IsS11Max=No	IsS11Min=No	FrameElem=115	ElemStation=0.5				
Frame=115	Station=0.5	OutputCase=TERRVERT	CaseType=LinStatic	Point=1	X2=-0.5	X3=-0.5		
S11=3298.80398605842	IsS11Max=Yes	IsS11Min=No	FrameElem=115	ElemStation=0.5				
Frame=115	Station=0.5	OutputCase=TERRVERT	CaseType=LinStatic	Point=2	X2=-0.5	X3=0.5		
S11=3298.80398605842	IsS11Max=No	IsS11Min=No	FrameElem=115	ElemStation=0.5				
Frame=115	Station=0.5	OutputCase=TERRVERT	CaseType=LinStatic	Point=3	X2=0.5	X3=-0.5	S11=-	
3302.08940082233	IsS11Max=No	IsS11Min=Yes	FrameElem=115	ElemStation=0.5				
Frame=115	Station=0.5	OutputCase=TERRVERT	CaseType=LinStatic	Point=4	X2=0.5	X3=0.5	S11=-	
3302.08940082233	IsS11Max=No	IsS11Min=No	FrameElem=115	ElemStation=0.5				
Frame=115	Station=0	OutputCase=TERRLAT	CaseType=LinStatic	Point=0	X2=0	X3=0	S11=-	330.586282883909
IsS11Max=No	IsS11Min=No	FrameElem=115	ElemStation=0					
Frame=115	Station=0	OutputCase=TERRLAT	CaseType=LinStatic	Point=1	X2=-0.5	X3=-0.5	S11=-	
829.013095856464	IsS11Max=No	IsS11Min=Yes	FrameElem=115	ElemStation=0				
Frame=115	Station=0	OutputCase=TERRLAT	CaseType=LinStatic	Point=2	X2=-0.5	X3=0.5	S11=-	
829.013095856464	IsS11Max=No	IsS11Min=No	FrameElem=115	ElemStation=0				
Frame=115	Station=0	OutputCase=TERRLAT	CaseType=LinStatic	Point=3	X2=0.5	X3=-0.5		
S11=167.840530088646	IsS11Max=Yes	IsS11Min=No	FrameElem=115	ElemStation=0				
Frame=115	Station=0	OutputCase=TERRLAT	CaseType=LinStatic	Point=4	X2=0.5	X3=0.5		
S11=167.840530088646	IsS11Max=No	IsS11Min=No	FrameElem=115	ElemStation=0				
Frame=115	Station=0.125	OutputCase=TERRLAT	CaseType=LinStatic	Point=0	X2=0	X3=0	S11=-	
330.586282883909	IsS11Max=No	IsS11Min=No	FrameElem=115	ElemStation=0.125				
Frame=115	Station=0.125	OutputCase=TERRLAT	CaseType=LinStatic	Point=1	X2=-0.5	X3=-0.5	S11=-	
829.013097125613	IsS11Max=No	IsS11Min=Yes	FrameElem=115	ElemStation=0.125				
Frame=115	Station=0.125	OutputCase=TERRLAT	CaseType=LinStatic	Point=2	X2=-0.5	X3=0.5	S11=-	
829.013097125613	IsS11Max=No	IsS11Min=No	FrameElem=115	ElemStation=0.125				
Frame=115	Station=0.125	OutputCase=TERRLAT	CaseType=LinStatic	Point=3	X2=0.5	X3=-0.5		
S11=167.840531357795	IsS11Max=Yes	IsS11Min=No	FrameElem=115	ElemStation=0.125				
Frame=115	Station=0.125	OutputCase=TERRLAT	CaseType=LinStatic	Point=4	X2=0.5	X3=0.5		
S11=167.840531357795	IsS11Max=No	IsS11Min=No	FrameElem=115	ElemStation=0.125				
Frame=115	Station=0.25	OutputCase=TERRLAT	CaseType=LinStatic	Point=0	X2=0	X3=0	S11=-	
330.586282883909	IsS11Max=No	IsS11Min=No	FrameElem=115	ElemStation=0.25				
Frame=115	Station=0.25	OutputCase=TERRLAT	CaseType=LinStatic	Point=1	X2=-0.5	X3=-0.5	S11=-	
829.013098394762	IsS11Max=No	IsS11Min=Yes	FrameElem=115	ElemStation=0.25				
Frame=115	Station=0.25	OutputCase=TERRLAT	CaseType=LinStatic	Point=2	X2=-0.5	X3=0.5	S11=-	
829.013098394762	IsS11Max=No	IsS11Min=No	FrameElem=115	ElemStation=0.25				
Frame=115	Station=0.25	OutputCase=TERRLAT	CaseType=LinStatic	Point=3	X2=0.5	X3=-0.5		
S11=167.840532626944	IsS11Max=Yes	IsS11Min=No	FrameElem=115	ElemStation=0.25				
Frame=115	Station=0.25	OutputCase=TERRLAT	CaseType=LinStatic	Point=4	X2=0.5	X3=0.5		
S11=167.840532626944	IsS11Max=No	IsS11Min=No	FrameElem=115	ElemStation=0.25				
Frame=115	Station=0.375	OutputCase=TERRLAT	CaseType=LinStatic	Point=0	X2=0	X3=0	S11=-	
330.586282883909	IsS11Max=No	IsS11Min=No	FrameElem=115	ElemStation=0.375				
Frame=115	Station=0.375	OutputCase=TERRLAT	CaseType=LinStatic	Point=1	X2=-0.5	X3=-0.5	S11=-	
829.013099663911	IsS11Max=No	IsS11Min=Yes	FrameElem=115	ElemStation=0.375				
Frame=115	Station=0.375	OutputCase=TERRLAT	CaseType=LinStatic	Point=2	X2=-0.5	X3=0.5	S11=-	
829.013099663911	IsS11Max=No	IsS11Min=No	FrameElem=115	ElemStation=0.375				
Frame=115	Station=0.375	OutputCase=TERRLAT	CaseType=LinStatic	Point=3	X2=0.5	X3=-0.5		
S11=167.840533896093	IsS11Max=Yes	IsS11Min=No	FrameElem=115	ElemStation=0.375				
Frame=115	Station=0.375	OutputCase=TERRLAT	CaseType=LinStatic	Point=4	X2=0.5	X3=0.5		
S11=167.840533896093	IsS11Max=No	IsS11Min=No	FrameElem=115	ElemStation=0.375				
Frame=115	Station=0.5	OutputCase=TERRLAT	CaseType=LinStatic	Point=0	X2=0	X3=0	S11=-	330.586282883909
IsS11Max=No	IsS11Min=No	FrameElem=115	ElemStation=0.5					
Frame=115	Station=0.5	OutputCase=TERRLAT	CaseType=LinStatic	Point=1	X2=-0.5	X3=-0.5	S11=-	
829.013100933061	IsS11Max=No	IsS11Min=Yes	FrameElem=115	ElemStation=0.5				
Frame=115	Station=0.5	OutputCase=TERRLAT	CaseType=LinStatic	Point=2	X2=-0.5	X3=0.5	S11=-	
829.013100933061	IsS11Max=No	IsS11Min=No	FrameElem=115	ElemStation=0.5				
Frame=115	Station=0.5	OutputCase=TERRLAT	CaseType=LinStatic	Point=3	X2=0.5	X3=-0.5		
S11=167.840535165243	IsS11Max=Yes	IsS11Min=No	FrameElem=115	ElemStation=0.5				
Frame=115	Station=0.5	OutputCase=TERRLAT	CaseType=LinStatic	Point=4	X2=0.5	X3=0.5		
S11=167.840535165243	IsS11Max=No	IsS11Min=No	FrameElem=115	ElemStation=0.5				
Frame=115	Station=0	OutputCase=ACCVERT	CaseType=LinStatic	Point=0	X2=0	X3=0	S11=0	IsS11Max=Yes
IsS11Min=Yes	FrameElem=115	ElemStation=0						
Frame=115	Station=0	OutputCase=ACCVERT	CaseType=LinStatic	Point=1	X2=-0.5	X3=-0.5	S11=0	
IsS11Max=No	IsS11Min=No	FrameElem=115	ElemStation=0					
Frame=115	Station=0	OutputCase=ACCVERT	CaseType=LinStatic	Point=2	X2=-0.5	X3=0.5	S11=0	
IsS11Max=No	IsS11Min=No	FrameElem=115	ElemStation=0					
Frame=115	Station=0	OutputCase=ACCVERT	CaseType=LinStatic	Point=3	X2=0.5	X3=-0.5	S11=0	
IsS11Max=No	IsS11Min=No	FrameElem=115	ElemStation=0					
Frame=115	Station=0	OutputCase=ACCVERT	CaseType=LinStatic	Point=4	X2=0.5	X3=0.5	S11=0	IsS11Max=No
IsS11Min=No	FrameElem=115	ElemStation=0						
Frame=115	Station=0.125	OutputCase=ACCVERT	CaseType=LinStatic	Point=0	X2=0	X3=0	S11=0	
IsS11Max=Yes	IsS11Min=Yes	FrameElem=115	ElemStation=0.125					
Frame=115	Station=0.125	OutputCase=ACCVERT	CaseType=LinStatic	Point=1	X2=-0.5	X3=-0.5	S11=0	
IsS11Max=No	IsS11Min=No	FrameElem=115	ElemStation=0.125					

Frame=115	Station=0.25	OutputCase=TERRCOST	CaseType=LinStatic	Point=4	X2=0.5	X3=0.5	S11=0	
IsS11Max=No	IsS11Min=No	FrameElem=115	ElemStation=0.25					
Frame=115	Station=0.375	OutputCase=TERRCOST	CaseType=LinStatic	Point=0	X2=0	X3=0	S11=0	
IsS11Max=Yes	IsS11Min=Yes	FrameElem=115	ElemStation=0.375					
Frame=115	Station=0.375	OutputCase=TERRCOST	CaseType=LinStatic	Point=1	X2=-0.5	X3=-0.5	S11=0	
IsS11Max=No	IsS11Min=No	FrameElem=115	ElemStation=0.375					
Frame=115	Station=0.375	OutputCase=TERRCOST	CaseType=LinStatic	Point=2	X2=-0.5	X3=0.5	S11=0	
IsS11Max=No	IsS11Min=No	FrameElem=115	ElemStation=0.375					
Frame=115	Station=0.375	OutputCase=TERRCOST	CaseType=LinStatic	Point=3	X2=0.5	X3=-0.5	S11=0	
IsS11Max=No	IsS11Min=No	FrameElem=115	ElemStation=0.375					
Frame=115	Station=0.375	OutputCase=TERRCOST	CaseType=LinStatic	Point=4	X2=0.5	X3=0.5	S11=0	
IsS11Max=No	IsS11Min=No	FrameElem=115	ElemStation=0.375					
Frame=115	Station=0.5	OutputCase=TERRCOST	CaseType=LinStatic	Point=0	X2=0	X3=0	S11=0	IsS11Max=Yes
IsS11Min=Yes	FrameElem=115	ElemStation=0.5						
Frame=115	Station=0.5	OutputCase=TERRCOST	CaseType=LinStatic	Point=1	X2=-0.5	X3=-0.5	S11=0	
IsS11Max=No	IsS11Min=No	FrameElem=115	ElemStation=0.5					
Frame=115	Station=0.5	OutputCase=TERRCOST	CaseType=LinStatic	Point=2	X2=-0.5	X3=0.5	S11=0	
IsS11Max=No	IsS11Min=No	FrameElem=115	ElemStation=0.5					
Frame=115	Station=0.5	OutputCase=TERRCOST	CaseType=LinStatic	Point=3	X2=0.5	X3=-0.5	S11=0	
IsS11Max=No	IsS11Min=No	FrameElem=115	ElemStation=0.5					
Frame=115	Station=0.5	OutputCase=TERRCOST	CaseType=LinStatic	Point=4	X2=0.5	X3=0.5	S11=0	
IsS11Max=No	IsS11Min=No	FrameElem=115	ElemStation=0.5					
Frame=115	Station=0	OutputCase=SOVRCOST	CaseType=LinStatic	Point=0	X2=0	X3=0	S11=0	IsS11Max=Yes
IsS11Min=Yes	FrameElem=115	ElemStation=0						
Frame=115	Station=0	OutputCase=SOVRCOST	CaseType=LinStatic	Point=1	X2=-0.5	X3=-0.5	S11=0	
IsS11Max=No	IsS11Min=No	FrameElem=115	ElemStation=0					
Frame=115	Station=0	OutputCase=SOVRCOST	CaseType=LinStatic	Point=2	X2=-0.5	X3=0.5	S11=0	
IsS11Max=No	IsS11Min=No	FrameElem=115	ElemStation=0					
Frame=115	Station=0	OutputCase=SOVRCOST	CaseType=LinStatic	Point=3	X2=0.5	X3=-0.5	S11=0	
IsS11Max=No	IsS11Min=No	FrameElem=115	ElemStation=0					
Frame=115	Station=0	OutputCase=SOVRCOST	CaseType=LinStatic	Point=4	X2=0.5	X3=0.5	S11=0	
IsS11Max=No	IsS11Min=No	FrameElem=115	ElemStation=0					
Frame=115	Station=0.125	OutputCase=SOVRCOST	CaseType=LinStatic	Point=0	X2=0	X3=0	S11=0	
IsS11Max=Yes	IsS11Min=Yes	FrameElem=115	ElemStation=0.125					
Frame=115	Station=0.125	OutputCase=SOVRCOST	CaseType=LinStatic	Point=1	X2=-0.5	X3=-0.5	S11=0	
IsS11Max=No	IsS11Min=No	FrameElem=115	ElemStation=0.125					
Frame=115	Station=0.125	OutputCase=SOVRCOST	CaseType=LinStatic	Point=2	X2=-0.5	X3=0.5	S11=0	
IsS11Max=No	IsS11Min=No	FrameElem=115	ElemStation=0.125					
Frame=115	Station=0.125	OutputCase=SOVRCOST	CaseType=LinStatic	Point=3	X2=0.5	X3=-0.5	S11=0	
IsS11Max=No	IsS11Min=No	FrameElem=115	ElemStation=0.125					
Frame=115	Station=0.125	OutputCase=SOVRCOST	CaseType=LinStatic	Point=4	X2=0.5	X3=0.5	S11=0	
IsS11Max=No	IsS11Min=No	FrameElem=115	ElemStation=0.125					
Frame=115	Station=0.25	OutputCase=SOVRCOST	CaseType=LinStatic	Point=0	X2=0	X3=0	S11=0	
IsS11Max=Yes	IsS11Min=Yes	FrameElem=115	ElemStation=0.25					
Frame=115	Station=0.25	OutputCase=SOVRCOST	CaseType=LinStatic	Point=1	X2=-0.5	X3=-0.5	S11=0	
IsS11Max=No	IsS11Min=No	FrameElem=115	ElemStation=0.25					
Frame=115	Station=0.25	OutputCase=SOVRCOST	CaseType=LinStatic	Point=2	X2=-0.5	X3=0.5	S11=0	
IsS11Max=No	IsS11Min=No	FrameElem=115	ElemStation=0.25					
Frame=115	Station=0.25	OutputCase=SOVRCOST	CaseType=LinStatic	Point=3	X2=0.5	X3=-0.5	S11=0	
IsS11Max=No	IsS11Min=No	FrameElem=115	ElemStation=0.25					
Frame=115	Station=0.375	OutputCase=SOVRCOST	CaseType=LinStatic	Point=0	X2=0	X3=0	S11=0	
IsS11Max=Yes	IsS11Min=Yes	FrameElem=115	ElemStation=0.375					
Frame=115	Station=0.375	OutputCase=SOVRCOST	CaseType=LinStatic	Point=1	X2=-0.5	X3=-0.5	S11=0	
IsS11Max=No	IsS11Min=No	FrameElem=115	ElemStation=0.375					
Frame=115	Station=0.375	OutputCase=SOVRCOST	CaseType=LinStatic	Point=2	X2=-0.5	X3=0.5	S11=0	
IsS11Max=No	IsS11Min=No	FrameElem=115	ElemStation=0.375					
Frame=115	Station=0.375	OutputCase=SOVRCOST	CaseType=LinStatic	Point=3	X2=0.5	X3=-0.5	S11=0	
IsS11Max=No	IsS11Min=No	FrameElem=115	ElemStation=0.375					
Frame=115	Station=0.375	OutputCase=SOVRCOST	CaseType=LinStatic	Point=4	X2=0.5	X3=0.5	S11=0	
IsS11Max=No	IsS11Min=No	FrameElem=115	ElemStation=0.375					
Frame=115	Station=0.5	OutputCase=SOVRCOST	CaseType=LinStatic	Point=0	X2=0	X3=0	S11=0	IsS11Max=Yes
IsS11Min=Yes	FrameElem=115	ElemStation=0.5						
Frame=115	Station=0.5	OutputCase=SOVRCOST	CaseType=LinStatic	Point=1	X2=-0.5	X3=-0.5	S11=0	
IsS11Max=No	IsS11Min=No	FrameElem=115	ElemStation=0.5					
Frame=115	Station=0.5	OutputCase=SOVRCOST	CaseType=LinStatic	Point=2	X2=-0.5	X3=0.5	S11=0	
IsS11Max=No	IsS11Min=No	FrameElem=115	ElemStation=0.5					
Frame=115	Station=0.5	OutputCase=SOVRCOST	CaseType=LinStatic	Point=3	X2=0.5	X3=-0.5	S11=0	
IsS11Max=No	IsS11Min=No	FrameElem=115	ElemStation=0.5					
Frame=115	Station=0.5	OutputCase=SOVRCOST	CaseType=LinStatic	Point=4	X2=0.5	X3=0.5	S11=0	
IsS11Max=No	IsS11Min=No	FrameElem=115	ElemStation=0.5					
Frame=115	Station=0	OutputCase=ENVE	CaseType=Combination	StepType=Max	Point=0	X2=0	X3=0	S11=-
217.882158664511	IsS11Max=No	IsS11Min=No	FrameElem=115	ElemStation=0				
Frame=115	Station=0	OutputCase=ENVE	CaseType=Combination	StepType=Max	Point=1	X2=-0.5	X3=-0.5	
S11=2847.23629689053	IsS11Max=Yes	IsS11Min=No	FrameElem=115	ElemStation=0				
Frame=115	Station=0	OutputCase=ENVE	CaseType=Combination	StepType=Max	Point=2	X2=-0.5	X3=0.5	
S11=2847.23629689053	IsS11Max=No	IsS11Min=No	FrameElem=115	ElemStation=0				
Frame=115	Station=0	OutputCase=ENVE	CaseType=Combination	StepType=Max	Point=3	X2=0.5	X3=-0.5	
S11=-3232.64845519296	IsS11Max=No	IsS11Min=Yes	FrameElem=115	ElemStation=0				
Frame=115	Station=0	OutputCase=ENVE	CaseType=Combination	StepType=Max	Point=4	X2=0.5	X3=0.5	S11=-
3232.64845519296	IsS11Max=No	IsS11Min=No	FrameElem=115	ElemStation=0				

Frame=115	Station=0.125	OutputCase=ENVE	CaseType=Combination	StepType=Max	Point=0	X2=0	X3=0	S11=-
217.882158664511	IssS11Max=No	IssS11Min=No	FrameElem=115	ElemStation=0.125				
Frame=115	Station=0.125	OutputCase=ENVE	CaseType=Combination	StepType=Max	Point=1	X2=-0.5	X3=-0.5	
S11=2947.31442078268	IssS11Max=Yes	IssS11Min=No	FrameElem=115	ElemStation=0.125				
Frame=115	Station=0.125	OutputCase=ENVE	CaseType=Combination	StepType=Max	Point=2	X2=-0.5	X3=0.5	
S11=2947.31442078268	IssS11Max=No	IssS11Min=No	FrameElem=115	ElemStation=0.125				
Frame=115	Station=0.125	OutputCase=ENVE	CaseType=Combination	StepType=Max	Point=3	X2=0.5	X3=-0.5	
S11=-3332.72657870436	IssS11Max=No	IssS11Min=Yes	FrameElem=115	ElemStation=0.125				
Frame=115	Station=0.125	OutputCase=ENVE	CaseType=Combination	StepType=Max	Point=4	X2=0.5	X3=0.5	
S11=-3332.72657870436	IssS11Max=No	IssS11Min=No	FrameElem=115	ElemStation=0.125				
Frame=115	Station=0.25	OutputCase=ENVE	CaseType=Combination	StepType=Max	Point=0	X2=0	X3=0	S11=-
217.882158664511	IssS11Max=No	IssS11Min=No	FrameElem=115	ElemStation=0.25				
Frame=115	Station=0.25	OutputCase=ENVE	CaseType=Combination	StepType=Max	Point=1	X2=-0.5	X3=-0.5	
S11=3018.79879467483	IssS11Max=Yes	IssS11Min=No	FrameElem=115	ElemStation=0.25				
Frame=115	Station=0.25	OutputCase=ENVE	CaseType=Combination	StepType=Max	Point=2	X2=-0.5	X3=0.5	
S11=3018.79879467483	IssS11Max=No	IssS11Min=No	FrameElem=115	ElemStation=0.25				
Frame=115	Station=0.25	OutputCase=ENVE	CaseType=Combination	StepType=Max	Point=3	X2=0.5	X3=-0.5	
S11=-3404.21095221576	IssS11Max=No	IssS11Min=Yes	FrameElem=115	ElemStation=0.25				
Frame=115	Station=0.25	OutputCase=ENVE	CaseType=Combination	StepType=Max	Point=4	X2=0.5	X3=0.5	
S11=-3404.21095221576	IssS11Max=No	IssS11Min=No	FrameElem=115	ElemStation=0.25				
Frame=115	Station=0.375	OutputCase=ENVE	CaseType=Combination	StepType=Max	Point=0	X2=0	X3=0	S11=-
217.882158664511	IssS11Max=No	IssS11Min=No	FrameElem=115	ElemStation=0.375				
Frame=115	Station=0.375	OutputCase=ENVE	CaseType=Combination	StepType=Max	Point=1	X2=-0.5	X3=-0.5	
S11=3061.68941856698	IssS11Max=Yes	IssS11Min=No	FrameElem=115	ElemStation=0.375				
Frame=115	Station=0.375	OutputCase=ENVE	CaseType=Combination	StepType=Max	Point=2	X2=-0.5	X3=0.5	
S11=3061.68941856698	IssS11Max=No	IssS11Min=No	FrameElem=115	ElemStation=0.375				
Frame=115	Station=0.375	OutputCase=ENVE	CaseType=Combination	StepType=Max	Point=3	X2=0.5	X3=-0.5	
S11=-3447.10157572717	IssS11Max=No	IssS11Min=Yes	FrameElem=115	ElemStation=0.375				
Frame=115	Station=0.375	OutputCase=ENVE	CaseType=Combination	StepType=Max	Point=4	X2=0.5	X3=0.5	
S11=-3447.10157572717	IssS11Max=No	IssS11Min=No	FrameElem=115	ElemStation=0.375				
Frame=115	Station=0.5	OutputCase=ENVE	CaseType=Combination	StepType=Max	Point=0	X2=0	X3=0	S11=-
217.882158664511	IssS11Max=No	IssS11Min=No	FrameElem=115	ElemStation=0.5				
Frame=115	Station=0.5	OutputCase=ENVE	CaseType=Combination	StepType=Max	Point=1	X2=-0.5	X3=-0.5	
S11=3075.98629245912	IssS11Max=Yes	IssS11Min=No	FrameElem=115	ElemStation=0.5				
Frame=115	Station=0.5	OutputCase=ENVE	CaseType=Combination	StepType=Max	Point=2	X2=-0.5	X3=0.5	
S11=3075.98629245912	IssS11Max=No	IssS11Min=No	FrameElem=115	ElemStation=0.5				
Frame=115	Station=0.5	OutputCase=ENVE	CaseType=Combination	StepType=Max	Point=3	X2=0.5	X3=-0.5	
S11=-3461.39844923857	IssS11Max=No	IssS11Min=Yes	FrameElem=115	ElemStation=0.5				
Frame=115	Station=0.5	OutputCase=ENVE	CaseType=Combination	StepType=Max	Point=4	X2=0.5	X3=0.5	
S11=-3461.39844923857	IssS11Max=No	IssS11Min=No	FrameElem=115	ElemStation=0.5				
Frame=115	Station=0	OutputCase=ENVE	CaseType=Combination	StepType=Min	Point=0	X2=0	X3=0	S11=-
317.058043529684	IssS11Max=No	IssS11Min=No	FrameElem=115	ElemStation=0				
Frame=115	Station=0	OutputCase=ENVE	CaseType=Combination	StepType=Min	Point=1	X2=-0.5	X3=-0.5	
S11=2598.53236813359	IssS11Max=Yes	IssS11Min=No	FrameElem=115	ElemStation=0				
Frame=115	Station=0	OutputCase=ENVE	CaseType=Combination	StepType=Min	Point=2	X2=-0.5	X3=0.5	
S11=2598.53236813359	IssS11Max=No	IssS11Min=No	FrameElem=115	ElemStation=0				
Frame=115	Station=0	OutputCase=ENVE	CaseType=Combination	StepType=Min	Point=3	X2=0.5	X3=-0.5	
S11=-3283.00061421955	IssS11Max=No	IssS11Min=Yes	FrameElem=115	ElemStation=0				
Frame=115	Station=0	OutputCase=ENVE	CaseType=Combination	StepType=Min	Point=4	X2=0.5	X3=0.5	S11=-
3283.00061421955	IssS11Max=No	IssS11Min=No	FrameElem=115	ElemStation=0				
Frame=115	Station=0.125	OutputCase=ENVE	CaseType=Combination	StepType=Min	Point=0	X2=0	X3=0	S11=-
317.058043529684	IssS11Max=No	IssS11Min=No	FrameElem=115	ElemStation=0.125				
Frame=115	Station=0.125	OutputCase=ENVE	CaseType=Combination	StepType=Min	Point=1	X2=-0.5	X3=-0.5	
S11=2698.61049164499	IssS11Max=Yes	IssS11Min=No	FrameElem=115	ElemStation=0.125				
Frame=115	Station=0.125	OutputCase=ENVE	CaseType=Combination	StepType=Min	Point=2	X2=-0.5	X3=0.5	
S11=2698.61049164499	IssS11Max=No	IssS11Min=No	FrameElem=115	ElemStation=0.125				
Frame=115	Station=0.125	OutputCase=ENVE	CaseType=Combination	StepType=Min	Point=3	X2=0.5	X3=-0.5	
S11=-3383.0787381117	IssS11Max=No	IssS11Min=Yes	FrameElem=115	ElemStation=0.125				
Frame=115	Station=0.125	OutputCase=ENVE	CaseType=Combination	StepType=Min	Point=4	X2=0.5	X3=0.5	
S11=-3383.0787381117	IssS11Max=No	IssS11Min=No	FrameElem=115	ElemStation=0.125				
Frame=115	Station=0.25	OutputCase=ENVE	CaseType=Combination	StepType=Min	Point=0	X2=0	X3=0	S11=-
317.058043529684	IssS11Max=No	IssS11Min=No	FrameElem=115	ElemStation=0.25				
Frame=115	Station=0.25	OutputCase=ENVE	CaseType=Combination	StepType=Min	Point=1	X2=-0.5	X3=-0.5	
S11=2770.0948651564	IssS11Max=Yes	IssS11Min=No	FrameElem=115	ElemStation=0.25				
Frame=115	Station=0.25	OutputCase=ENVE	CaseType=Combination	StepType=Min	Point=2	X2=-0.5	X3=0.5	
S11=2770.0948651564	IssS11Max=No	IssS11Min=No	FrameElem=115	ElemStation=0.25				
Frame=115	Station=0.25	OutputCase=ENVE	CaseType=Combination	StepType=Min	Point=3	X2=0.5	X3=-0.5	
S11=-3454.56311200385	IssS11Max=No	IssS11Min=Yes	FrameElem=115	ElemStation=0.25				
Frame=115	Station=0.25	OutputCase=ENVE	CaseType=Combination	StepType=Min	Point=4	X2=0.5	X3=0.5	
S11=-3454.56311200385	IssS11Max=No	IssS11Min=No	FrameElem=115	ElemStation=0.25				
Frame=115	Station=0.375	OutputCase=ENVE	CaseType=Combination	StepType=Min	Point=0	X2=0	X3=0	S11=-
317.058043529684	IssS11Max=No	IssS11Min=No	FrameElem=115	ElemStation=0.375				
Frame=115	Station=0.375	OutputCase=ENVE	CaseType=Combination	StepType=Min	Point=1	X2=-0.5	X3=-0.5	
S11=2812.9854886678	IssS11Max=Yes	IssS11Min=No	FrameElem=115	ElemStation=0.375				
Frame=115	Station=0.375	OutputCase=ENVE	CaseType=Combination	StepType=Min	Point=2	X2=-0.5	X3=0.5	
S11=2812.9854886678	IssS11Max=No	IssS11Min=No	FrameElem=115	ElemStation=0.375				
Frame=115	Station=0.375	OutputCase=ENVE	CaseType=Combination	StepType=Min	Point=3	X2=0.5	X3=-0.5	
S11=-3497.453735896	IssS11Max=No	IssS11Min=Yes	FrameElem=115	ElemStation=0.375				
Frame=115	Station=0.375	OutputCase=ENVE	CaseType=Combination	StepType=Min	Point=4	X2=0.5	X3=0.5	
S11=-3497.453735896	IssS11Max=No	IssS11Min=No	FrameElem=115	ElemStation=0.375				
Frame=115	Station=0.5	OutputCase=ENVE	CaseType=Combination	StepType=Min	Point=0	X2=0	X3=0	S11=-
317.058043529684	IssS11Max=No	IssS11Min=No	FrameElem=115	ElemStation=0.5				

Frame=115	Station=0.5	OutputCase=ENVE	CaseType=Combination	StepType=Min	Point=1	X2=-0.5	X3=-0.5	
S11=2827.28236217921	IsS11Max=Yes	IsS11Min=No	FrameElem=115	ElemStation=0.5				
Frame=115	Station=0.5	OutputCase=ENVE	CaseType=Combination	StepType=Min	Point=2	X2=-0.5	X3=0.5	
S11=2827.28236217921	IsS11Max=No	IsS11Min=No	FrameElem=115	ElemStation=0.5				
Frame=115	Station=0.5	OutputCase=ENVE	CaseType=Combination	StepType=Min	Point=3	X2=0.5	X3=-0.5	
S11=-3511.75060978815	IsS11Max=No	IsS11Min=Yes	FrameElem=115	ElemStation=0.5				
Frame=115	Station=0.5	OutputCase=ENVE	CaseType=Combination	StepType=Min	Point=4	X2=0.5	X3=0.5	
S11=-3511.75060978815	IsS11Max=No	IsS11Min=No	FrameElem=115	ElemStation=0.5				
Frame=115	Station=0	OutputCase=FESSUR	CaseType=Combination	Point=0	X2=0	X3=0	S11=-317.058043529684	
IsS11Max=No	IsS11Min=No	FrameElem=115	ElemStation=0					
Frame=115	Station=0	OutputCase=FESSUR	CaseType=Combination	Point=1	X2=-0.5	X3=-0.5		
S11=2598.53236813359	IsS11Max=Yes	IsS11Min=No	FrameElem=115	ElemStation=0				
Frame=115	Station=0	OutputCase=FESSUR	CaseType=Combination	Point=2	X2=-0.5	X3=0.5		
S11=2598.53236813359	IsS11Max=No	IsS11Min=No	FrameElem=115	ElemStation=0				
Frame=115	Station=0	OutputCase=FESSUR	CaseType=Combination	Point=3	X2=0.5	X3=-0.5	S11=-	
3232.64845519296	IsS11Max=No	IsS11Min=Yes	FrameElem=115	ElemStation=0				
Frame=115	Station=0	OutputCase=FESSUR	CaseType=Combination	Point=4	X2=0.5	X3=0.5	S11=-	
3232.64845519296	IsS11Max=No	IsS11Min=No	FrameElem=115	ElemStation=0				
Frame=115	Station=0.125	OutputCase=FESSUR	CaseType=Combination	Point=0	X2=0	X3=0	S11=-	
317.058043529684	IsS11Max=No	IsS11Min=No	FrameElem=115	ElemStation=0.125				
Frame=115	Station=0.125	OutputCase=FESSUR	CaseType=Combination	Point=1	X2=-0.5	X3=-0.5		
S11=2698.61049164499	IsS11Max=Yes	IsS11Min=No	FrameElem=115	ElemStation=0.125				
Frame=115	Station=0.125	OutputCase=FESSUR	CaseType=Combination	Point=2	X2=-0.5	X3=0.5		
S11=2698.61049164499	IsS11Max=No	IsS11Min=No	FrameElem=115	ElemStation=0.125				
Frame=115	Station=0.125	OutputCase=FESSUR	CaseType=Combination	Point=3	X2=0.5	X3=-0.5	S11=-	
3332.72657870436	IsS11Max=No	IsS11Min=Yes	FrameElem=115	ElemStation=0.125				
Frame=115	Station=0.125	OutputCase=FESSUR	CaseType=Combination	Point=4	X2=0.5	X3=0.5	S11=-	
3332.72657870436	IsS11Max=No	IsS11Min=No	FrameElem=115	ElemStation=0.125				
Frame=115	Station=0.25	OutputCase=FESSUR	CaseType=Combination	Point=0	X2=0	X3=0	S11=-	
317.058043529684	IsS11Max=No	IsS11Min=No	FrameElem=115	ElemStation=0.25				
Frame=115	Station=0.25	OutputCase=FESSUR	CaseType=Combination	Point=1	X2=-0.5	X3=-0.5		
S11=2770.0948651564	IsS11Max=Yes	IsS11Min=No	FrameElem=115	ElemStation=0.25				
Frame=115	Station=0.25	OutputCase=FESSUR	CaseType=Combination	Point=2	X2=-0.5	X3=0.5		
S11=2770.0948651564	IsS11Max=No	IsS11Min=No	FrameElem=115	ElemStation=0.25				
Frame=115	Station=0.25	OutputCase=FESSUR	CaseType=Combination	Point=3	X2=0.5	X3=-0.5	S11=-	
3404.21095221576	IsS11Max=No	IsS11Min=Yes	FrameElem=115	ElemStation=0.25				
Frame=115	Station=0.25	OutputCase=FESSUR	CaseType=Combination	Point=4	X2=0.5	X3=0.5	S11=-	
3404.21095221576	IsS11Max=No	IsS11Min=No	FrameElem=115	ElemStation=0.25				
Frame=115	Station=0.375	OutputCase=FESSUR	CaseType=Combination	Point=0	X2=0	X3=0	S11=-	
317.058043529684	IsS11Max=No	IsS11Min=No	FrameElem=115	ElemStation=0.375				
Frame=115	Station=0.375	OutputCase=FESSUR	CaseType=Combination	Point=1	X2=-0.5	X3=-0.5		
S11=2812.9854886678	IsS11Max=Yes	IsS11Min=No	FrameElem=115	ElemStation=0.375				
Frame=115	Station=0.375	OutputCase=FESSUR	CaseType=Combination	Point=2	X2=-0.5	X3=0.5		
S11=2812.9854886678	IsS11Max=No	IsS11Min=No	FrameElem=115	ElemStation=0.375				
Frame=115	Station=0.375	OutputCase=FESSUR	CaseType=Combination	Point=3	X2=0.5	X3=-0.5	S11=-	
3447.10157572717	IsS11Max=No	IsS11Min=Yes	FrameElem=115	ElemStation=0.375				
Frame=115	Station=0.375	OutputCase=FESSUR	CaseType=Combination	Point=4	X2=0.5	X3=0.5	S11=-	
3447.10157572717	IsS11Max=No	IsS11Min=No	FrameElem=115	ElemStation=0.375				
Frame=115	Station=0.5	OutputCase=FESSUR	CaseType=Combination	Point=0	X2=0	X3=0	S11=-	
317.058043529684	IsS11Max=No	IsS11Min=No	FrameElem=115	ElemStation=0.5				
Frame=115	Station=0.5	OutputCase=FESSUR	CaseType=Combination	Point=1	X2=-0.5	X3=-0.5		
S11=2827.28236217921	IsS11Max=Yes	IsS11Min=No	FrameElem=115	ElemStation=0.5				
Frame=115	Station=0.5	OutputCase=FESSUR	CaseType=Combination	Point=2	X2=-0.5	X3=0.5		
S11=2827.28236217921	IsS11Max=No	IsS11Min=No	FrameElem=115	ElemStation=0.5				
Frame=115	Station=0.5	OutputCase=FESSUR	CaseType=Combination	Point=3	X2=0.5	X3=-0.5	S11=-	
3461.39844923857	IsS11Max=No	IsS11Min=Yes	FrameElem=115	ElemStation=0.5				
Frame=115	Station=0.5	OutputCase=FESSUR	CaseType=Combination	Point=4	X2=0.5	X3=0.5	S11=-	
3461.39844923857	IsS11Max=No	IsS11Min=No	FrameElem=115	ElemStation=0.5				
Frame=116	Station=0	OutputCase=PESOPR	CaseType=LinStatic	Point=0	X2=0	X3=0	S11=15.170946736185	
IsS11Max=No	IsS11Min=No	FrameElem=116	ElemStation=0					
Frame=116	Station=0	OutputCase=PESOPR	CaseType=LinStatic	Point=1	X2=-0.5	X3=-0.5		
S11=357.49147705385	IsS11Max=Yes	IsS11Min=No	FrameElem=116	ElemStation=0				
Frame=116	Station=0	OutputCase=PESOPR	CaseType=LinStatic	Point=2	X2=-0.5	X3=0.5	S11=357.49147705385	
IsS11Max=No	IsS11Min=No	FrameElem=116	ElemStation=0					
Frame=116	Station=0	OutputCase=PESOPR	CaseType=LinStatic	Point=3	X2=0.5	X3=-0.5	S11=-	
327.149583581481	IsS11Max=No	IsS11Min=Yes	FrameElem=116	ElemStation=0				
Frame=116	Station=0	OutputCase=PESOPR	CaseType=LinStatic	Point=4	X2=0.5	X3=0.5	S11=-	
327.149583581481	IsS11Max=No	IsS11Min=No	FrameElem=116	ElemStation=0				
Frame=116	Station=0.125	OutputCase=PESOPR	CaseType=LinStatic	Point=0	X2=0	X3=0	S11=15.170946736185	
IsS11Max=No	IsS11Min=No	FrameElem=116	ElemStation=0.125					
Frame=116	Station=0.125	OutputCase=PESOPR	CaseType=LinStatic	Point=1	X2=-0.5	X3=-0.5		
S11=356.319602045545	IsS11Max=Yes	IsS11Min=No	FrameElem=116	ElemStation=0.125				
Frame=116	Station=0.125	OutputCase=PESOPR	CaseType=LinStatic	Point=2	X2=-0.5	X3=0.5		
S11=356.319602045545	IsS11Max=No	IsS11Min=No	FrameElem=116	ElemStation=0.125				
Frame=116	Station=0.125	OutputCase=PESOPR	CaseType=LinStatic	Point=3	X2=0.5	X3=-0.5	S11=-	
325.977708573175	IsS11Max=No	IsS11Min=Yes	FrameElem=116	ElemStation=0.125				
Frame=116	Station=0.125	OutputCase=PESOPR	CaseType=LinStatic	Point=4	X2=0.5	X3=0.5	S11=-	
325.977708573175	IsS11Max=No	IsS11Min=No	FrameElem=116	ElemStation=0.125				
Frame=116	Station=0.25	OutputCase=PESOPR	CaseType=LinStatic	Point=0	X2=0	X3=0	S11=15.170946736185	
IsS11Max=No	IsS11Min=No	FrameElem=116	ElemStation=0.25					
Frame=116	Station=0.25	OutputCase=PESOPR	CaseType=LinStatic	Point=1	X2=-0.5	X3=-0.5		
S11=352.803977037239	IsS11Max=Yes	IsS11Min=No	FrameElem=116	ElemStation=0.25				

Frame=116 Station=0.25 OutputCase=PESOPR CaseType=LinStatic Point=2 X2=-0.5 X3=0.5
 S11=352.803977037239 IsS11Max=No IsS11Min=No FrameElem=116 ElemStation=0.25
 Frame=116 Station=0.25 OutputCase=PESOPR CaseType=LinStatic Point=3 X2=0.5 X3=-0.5 S11=-
 322.46208356487 IsS11Max=No IsS11Min=Yes FrameElem=116 ElemStation=0.25
 Frame=116 Station=0.25 OutputCase=PESOPR CaseType=LinStatic Point=4 X2=0.5 X3=0.5 S11=-
 322.46208356487 IsS11Max=No IsS11Min=No FrameElem=116 ElemStation=0.25
 Frame=116 Station=0.375 OutputCase=PESOPR CaseType=LinStatic Point=0 X2=0 X3=0 S11=15.170946736185
 IsS11Max=No IsS11Min=No FrameElem=116 ElemStation=0.375
 Frame=116 Station=0.375 OutputCase=PESOPR CaseType=LinStatic Point=1 X2=-0.5 X3=-0.5
 S11=346.944602028934 IsS11Max=Yes IsS11Min=No FrameElem=116 ElemStation=0.375
 Frame=116 Station=0.375 OutputCase=PESOPR CaseType=LinStatic Point=2 X2=-0.5 X3=0.5
 S11=346.944602028934 IsS11Max=No IsS11Min=No FrameElem=116 ElemStation=0.375
 Frame=116 Station=0.375 OutputCase=PESOPR CaseType=LinStatic Point=3 X2=0.5 X3=-0.5 S11=-
 316.602708556564 IsS11Max=No IsS11Min=Yes FrameElem=116 ElemStation=0.375
 Frame=116 Station=0.375 OutputCase=PESOPR CaseType=LinStatic Point=4 X2=0.5 X3=0.5 S11=-
 316.602708556564 IsS11Max=No IsS11Min=No FrameElem=116 ElemStation=0.375
 Frame=116 Station=0.5 OutputCase=PESOPR CaseType=LinStatic Point=0 X2=0 X3=0 S11=15.170946736185
 IsS11Max=No IsS11Min=No FrameElem=116 ElemStation=0.5
 Frame=116 Station=0.5 OutputCase=PESOPR CaseType=LinStatic Point=1 X2=-0.5 X3=-0.5
 S11=338.741477020628 IsS11Max=Yes IsS11Min=No FrameElem=116 ElemStation=0.5
 Frame=116 Station=0.5 OutputCase=PESOPR CaseType=LinStatic Point=2 X2=-0.5 X3=0.5
 S11=338.741477020628 IsS11Max=No IsS11Min=No FrameElem=116 ElemStation=0.5
 Frame=116 Station=0.5 OutputCase=PESOPR CaseType=LinStatic Point=3 X2=0.5 X3=-0.5 S11=-
 308.399583548259 IsS11Max=No IsS11Min=Yes FrameElem=116 ElemStation=0.5
 Frame=116 Station=0.5 OutputCase=PESOPR CaseType=LinStatic Point=4 X2=0.5 X3=0.5 S11=-
 308.399583548259 IsS11Max=No IsS11Min=No FrameElem=116 ElemStation=0.5
 Frame=116 Station=0 OutputCase=TERRVERT CaseType=LinStatic Point=0 X2=0 X3=0 S11=-1.64270738195971
 IsS11Max=No IsS11Min=No FrameElem=116 ElemStation=0
 Frame=116 Station=0 OutputCase=TERRVERT CaseType=LinStatic Point=1 X2=-0.5 X3=-0.5
 S11=3298.80398605833 IsS11Max=Yes IsS11Min=No FrameElem=116 ElemStation=0
 Frame=116 Station=0 OutputCase=TERRVERT CaseType=LinStatic Point=2 X2=-0.5 X3=0.5
 S11=3298.80398605833 IsS11Max=No IsS11Min=No FrameElem=116 ElemStation=0
 Frame=116 Station=0 OutputCase=TERRVERT CaseType=LinStatic Point=3 X2=0.5 X3=-0.5 S11=-
 3302.08940082225 IsS11Max=No IsS11Min=Yes FrameElem=116 ElemStation=0
 Frame=116 Station=0 OutputCase=TERRVERT CaseType=LinStatic Point=4 X2=0.5 X3=0.5 S11=-
 3302.08940082225 IsS11Max=No IsS11Min=No FrameElem=116 ElemStation=0
 Frame=116 Station=0.125 OutputCase=TERRVERT CaseType=LinStatic Point=0 X2=0 X3=0 S11=-
 1.64270738195971 IsS11Max=No IsS11Min=No FrameElem=116 ElemStation=0.125
 Frame=116 Station=0.125 OutputCase=TERRVERT CaseType=LinStatic Point=1 X2=-0.5 X3=-0.5
 S11=3285.67898584717 IsS11Max=Yes IsS11Min=No FrameElem=116 ElemStation=0.125
 Frame=116 Station=0.125 OutputCase=TERRVERT CaseType=LinStatic Point=2 X2=-0.5 X3=0.5
 S11=3285.67898584717 IsS11Max=No IsS11Min=No FrameElem=116 ElemStation=0.125
 Frame=116 Station=0.125 OutputCase=TERRVERT CaseType=LinStatic Point=3 X2=0.5 X3=-0.5 S11=-
 3288.96440061108 IsS11Max=No IsS11Min=Yes FrameElem=116 ElemStation=0.125
 Frame=116 Station=0.125 OutputCase=TERRVERT CaseType=LinStatic Point=4 X2=0.5 X3=0.5 S11=-
 3288.96440061108 IsS11Max=No IsS11Min=No FrameElem=116 ElemStation=0.125
 Frame=116 Station=0.25 OutputCase=TERRVERT CaseType=LinStatic Point=0 X2=0 X3=0 S11=-
 1.64270738195971 IsS11Max=No IsS11Min=No FrameElem=116 ElemStation=0.25
 Frame=116 Station=0.25 OutputCase=TERRVERT CaseType=LinStatic Point=1 X2=-0.5 X3=-0.5
 S11=3246.303985636 IsS11Max=Yes IsS11Min=No FrameElem=116 ElemStation=0.25
 Frame=116 Station=0.25 OutputCase=TERRVERT CaseType=LinStatic Point=2 X2=-0.5 X3=0.5
 S11=3246.303985636 IsS11Max=No IsS11Min=No FrameElem=116 ElemStation=0.25
 Frame=116 Station=0.25 OutputCase=TERRVERT CaseType=LinStatic Point=3 X2=0.5 X3=-0.5 S11=-
 3249.58940039992 IsS11Max=No IsS11Min=Yes FrameElem=116 ElemStation=0.25
 Frame=116 Station=0.25 OutputCase=TERRVERT CaseType=LinStatic Point=4 X2=0.5 X3=0.5 S11=-
 3249.58940039992 IsS11Max=No IsS11Min=No FrameElem=116 ElemStation=0.25
 Frame=116 Station=0.375 OutputCase=TERRVERT CaseType=LinStatic Point=0 X2=0 X3=0 S11=-
 1.64270738195971 IsS11Max=No IsS11Min=No FrameElem=116 ElemStation=0.375
 Frame=116 Station=0.375 OutputCase=TERRVERT CaseType=LinStatic Point=1 X2=-0.5 X3=-0.5
 S11=3180.67898542484 IsS11Max=Yes IsS11Min=No FrameElem=116 ElemStation=0.375
 Frame=116 Station=0.375 OutputCase=TERRVERT CaseType=LinStatic Point=2 X2=-0.5 X3=0.5
 S11=3180.67898542484 IsS11Max=No IsS11Min=No FrameElem=116 ElemStation=0.375
 Frame=116 Station=0.375 OutputCase=TERRVERT CaseType=LinStatic Point=3 X2=0.5 X3=-0.5 S11=-
 3183.96440018876 IsS11Max=No IsS11Min=Yes FrameElem=116 ElemStation=0.375
 Frame=116 Station=0.375 OutputCase=TERRVERT CaseType=LinStatic Point=4 X2=0.5 X3=0.5 S11=-
 3183.96440018876 IsS11Max=No IsS11Min=No FrameElem=116 ElemStation=0.375
 Frame=116 Station=0.5 OutputCase=TERRVERT CaseType=LinStatic Point=0 X2=0 X3=0 S11=-
 1.64270738195971 IsS11Max=No IsS11Min=No FrameElem=116 ElemStation=0.5
 Frame=116 Station=0.5 OutputCase=TERRVERT CaseType=LinStatic Point=1 X2=-0.5 X3=-0.5
 S11=3088.80398521368 IsS11Max=Yes IsS11Min=No FrameElem=116 ElemStation=0.5
 Frame=116 Station=0.5 OutputCase=TERRVERT CaseType=LinStatic Point=2 X2=-0.5 X3=0.5
 S11=3088.80398521368 IsS11Max=No IsS11Min=No FrameElem=116 ElemStation=0.5
 Frame=116 Station=0.5 OutputCase=TERRVERT CaseType=LinStatic Point=3 X2=0.5 X3=-0.5 S11=-
 3092.0893999776 IsS11Max=No IsS11Min=Yes FrameElem=116 ElemStation=0.5
 Frame=116 Station=0.5 OutputCase=TERRVERT CaseType=LinStatic Point=4 X2=0.5 X3=0.5 S11=-
 3092.0893999776 IsS11Max=No IsS11Min=No FrameElem=116 ElemStation=0.5
 Frame=116 Station=0 OutputCase=TERRLAT CaseType=LinStatic Point=0 X2=0 X3=0 S11=-330.586282883909
 IsS11Max=No IsS11Min=No FrameElem=116 ElemStation=0
 Frame=116 Station=0 OutputCase=TERRLAT CaseType=LinStatic Point=1 X2=-0.5 X3=-0.5 S11=-
 829.01310093306 IsS11Max=No IsS11Min=Yes FrameElem=116 ElemStation=0
 Frame=116 Station=0 OutputCase=TERRLAT CaseType=LinStatic Point=2 X2=-0.5 X3=0.5 S11=-
 829.01310093306 IsS11Max=No IsS11Min=No FrameElem=116 ElemStation=0

```

Frame=116 Station=0 OutputCase=TERRLAT CaseType=LinStatic Point=3 X2=0.5 X3=-0.5
S11=167.840535165242 IsS11Max=Yes IsS11Min=No FrameElem=116 ElemStation=0
Frame=116 Station=0 OutputCase=TERRLAT CaseType=LinStatic Point=4 X2=0.5 X3=0.5
S11=167.840535165242 IsS11Max=No IsS11Min=No FrameElem=116 ElemStation=0
Frame=116 Station=0.125 OutputCase=TERRLAT CaseType=LinStatic Point=0 X2=0 X3=0 S11=-
330.586282883909 IsS11Max=No IsS11Min=No FrameElem=116 ElemStation=0.125
Frame=116 Station=0.125 OutputCase=TERRLAT CaseType=LinStatic Point=1 X2=-0.5 X3=-0.5 S11=-
829.013102202209 IsS11Max=No IsS11Min=Yes FrameElem=116 ElemStation=0.125
Frame=116 Station=0.125 OutputCase=TERRLAT CaseType=LinStatic Point=2 X2=-0.5 X3=0.5 S11=-
829.013102202209 IsS11Max=No IsS11Min=No FrameElem=116 ElemStation=0.125
Frame=116 Station=0.125 OutputCase=TERRLAT CaseType=LinStatic Point=3 X2=0.5 X3=-0.5
S11=167.840536434391 IsS11Max=Yes IsS11Min=No FrameElem=116 ElemStation=0.125
Frame=116 Station=0.125 OutputCase=TERRLAT CaseType=LinStatic Point=4 X2=0.5 X3=0.5
S11=167.840536434391 IsS11Max=No IsS11Min=No FrameElem=116 ElemStation=0.125
Frame=116 Station=0.25 OutputCase=TERRLAT CaseType=LinStatic Point=0 X2=0 X3=0 S11=-
330.586282883909 IsS11Max=No IsS11Min=No FrameElem=116 ElemStation=0.25
Frame=116 Station=0.25 OutputCase=TERRLAT CaseType=LinStatic Point=1 X2=-0.5 X3=-0.5 S11=-
829.013103471358 IsS11Max=No IsS11Min=Yes FrameElem=116 ElemStation=0.25
Frame=116 Station=0.25 OutputCase=TERRLAT CaseType=LinStatic Point=2 X2=-0.5 X3=0.5 S11=-
829.013103471358 IsS11Max=No IsS11Min=No FrameElem=116 ElemStation=0.25
Frame=116 Station=0.25 OutputCase=TERRLAT CaseType=LinStatic Point=3 X2=0.5 X3=-0.5
S11=167.84053770354 IsS11Max=Yes IsS11Min=No FrameElem=116 ElemStation=0.25
Frame=116 Station=0.25 OutputCase=TERRLAT CaseType=LinStatic Point=4 X2=0.5 X3=0.5
S11=167.84053770354 IsS11Max=No IsS11Min=No FrameElem=116 ElemStation=0.25
Frame=116 Station=0.375 OutputCase=TERRLAT CaseType=LinStatic Point=0 X2=0 X3=0 S11=-
330.586282883909 IsS11Max=No IsS11Min=No FrameElem=116 ElemStation=0.375
Frame=116 Station=0.375 OutputCase=TERRLAT CaseType=LinStatic Point=1 X2=-0.5 X3=-0.5 S11=-
829.013104740507 IsS11Max=No IsS11Min=Yes FrameElem=116 ElemStation=0.375
Frame=116 Station=0.375 OutputCase=TERRLAT CaseType=LinStatic Point=2 X2=-0.5 X3=0.5 S11=-
829.013104740507 IsS11Max=No IsS11Min=No FrameElem=116 ElemStation=0.375
Frame=116 Station=0.375 OutputCase=TERRLAT CaseType=LinStatic Point=3 X2=0.5 X3=-0.5
S11=167.840538972689 IsS11Max=Yes IsS11Min=No FrameElem=116 ElemStation=0.375
Frame=116 Station=0.375 OutputCase=TERRLAT CaseType=LinStatic Point=4 X2=0.5 X3=0.5
S11=167.840538972689 IsS11Max=No IsS11Min=No FrameElem=116 ElemStation=0.375
Frame=116 Station=0.5 OutputCase=TERRLAT CaseType=LinStatic Point=0 X2=0 X3=0 S11=-330.586282883909
IsS11Max=No IsS11Min=No FrameElem=116 ElemStation=0.5
Frame=116 Station=0.5 OutputCase=TERRLAT CaseType=LinStatic Point=1 X2=-0.5 X3=-0.5 S11=-
829.013106009656 IsS11Max=No IsS11Min=Yes FrameElem=116 ElemStation=0.5
Frame=116 Station=0.5 OutputCase=TERRLAT CaseType=LinStatic Point=2 X2=-0.5 X3=0.5 S11=-
829.013106009656 IsS11Max=No IsS11Min=No FrameElem=116 ElemStation=0.5
Frame=116 Station=0.5 OutputCase=TERRLAT CaseType=LinStatic Point=3 X2=0.5 X3=-0.5
S11=167.840540241838 IsS11Max=Yes IsS11Min=No FrameElem=116 ElemStation=0.5
Frame=116 Station=0.5 OutputCase=TERRLAT CaseType=LinStatic Point=4 X2=0.5 X3=0.5
S11=167.840540241838 IsS11Max=No IsS11Min=No FrameElem=116 ElemStation=0.5
Frame=116 Station=0 OutputCase=ACCVERT CaseType=LinStatic Point=0 X2=0 X3=0 S11=0 IsS11Max=Yes
IsS11Min=Yes FrameElem=116 ElemStation=0
Frame=116 Station=0 OutputCase=ACCVERT CaseType=LinStatic Point=1 X2=-0.5 X3=-0.5 S11=0
IsS11Max=No IsS11Min=No FrameElem=116 ElemStation=0
Frame=116 Station=0 OutputCase=ACCVERT CaseType=LinStatic Point=2 X2=-0.5 X3=0.5 S11=0
IsS11Max=No IsS11Min=No FrameElem=116 ElemStation=0
Frame=116 Station=0 OutputCase=ACCVERT CaseType=LinStatic Point=3 X2=0.5 X3=-0.5 S11=0
IsS11Max=No IsS11Min=No FrameElem=116 ElemStation=0
Frame=116 Station=0 OutputCase=ACCVERT CaseType=LinStatic Point=4 X2=0.5 X3=0.5 S11=0 IsS11Max=No
IsS11Min=No FrameElem=116 ElemStation=0
Frame=116 Station=0.125 OutputCase=ACCVERT CaseType=LinStatic Point=0 X2=0 X3=0 S11=0
IsS11Max=Yes IsS11Min=Yes FrameElem=116 ElemStation=0.125
Frame=116 Station=0.125 OutputCase=ACCVERT CaseType=LinStatic Point=1 X2=-0.5 X3=-0.5 S11=0
IsS11Max=No IsS11Min=No FrameElem=116 ElemStation=0.125
Frame=116 Station=0.125 OutputCase=ACCVERT CaseType=LinStatic Point=2 X2=-0.5 X3=0.5 S11=0
IsS11Max=No IsS11Min=No FrameElem=116 ElemStation=0.125
Frame=116 Station=0.125 OutputCase=ACCVERT CaseType=LinStatic Point=3 X2=0.5 X3=-0.5 S11=0
IsS11Max=No IsS11Min=No FrameElem=116 ElemStation=0.125
Frame=116 Station=0.125 OutputCase=ACCVERT CaseType=LinStatic Point=4 X2=0.5 X3=0.5 S11=0
IsS11Max=No IsS11Min=No FrameElem=116 ElemStation=0.125
Frame=116 Station=0.25 OutputCase=ACCVERT CaseType=LinStatic Point=0 X2=0 X3=0 S11=0 IsS11Max=Yes
IsS11Min=Yes FrameElem=116 ElemStation=0.25
Frame=116 Station=0.25 OutputCase=ACCVERT CaseType=LinStatic Point=1 X2=-0.5 X3=-0.5 S11=0
IsS11Max=No IsS11Min=No FrameElem=116 ElemStation=0.25
Frame=116 Station=0.25 OutputCase=ACCVERT CaseType=LinStatic Point=2 X2=-0.5 X3=0.5 S11=0
IsS11Max=No IsS11Min=No FrameElem=116 ElemStation=0.25
Frame=116 Station=0.25 OutputCase=ACCVERT CaseType=LinStatic Point=3 X2=0.5 X3=-0.5 S11=0
IsS11Max=No IsS11Min=No FrameElem=116 ElemStation=0.25
Frame=116 Station=0.25 OutputCase=ACCVERT CaseType=LinStatic Point=4 X2=0.5 X3=0.5 S11=0
IsS11Max=No IsS11Min=No FrameElem=116 ElemStation=0.25
Frame=116 Station=0.375 OutputCase=ACCVERT CaseType=LinStatic Point=0 X2=0 X3=0 S11=0
IsS11Max=Yes IsS11Min=Yes FrameElem=116 ElemStation=0.375
Frame=116 Station=0.375 OutputCase=ACCVERT CaseType=LinStatic Point=1 X2=-0.5 X3=-0.5 S11=0
IsS11Max=No IsS11Min=No FrameElem=116 ElemStation=0.375
Frame=116 Station=0.375 OutputCase=ACCVERT CaseType=LinStatic Point=2 X2=-0.5 X3=0.5 S11=0
IsS11Max=No IsS11Min=No FrameElem=116 ElemStation=0.375
Frame=116 Station=0.375 OutputCase=ACCVERT CaseType=LinStatic Point=3 X2=0.5 X3=-0.5 S11=0
IsS11Max=No IsS11Min=No FrameElem=116 ElemStation=0.375
Frame=116 Station=0.375 OutputCase=ACCVERT CaseType=LinStatic Point=4 X2=0.5 X3=0.5 S11=0
IsS11Max=No IsS11Min=No FrameElem=116 ElemStation=0.375

```

Frame=116	Station=0	OutputCase=SOVRCOST	CaseType=LinStatic	Point=1	X2=-0.5	X3=-0.5	S11=0	
IsS11Max=No	IsS11Min=No	FrameElem=116	ElemStation=0					
Frame=116	Station=0	OutputCase=SOVRCOST	CaseType=LinStatic	Point=2	X2=-0.5	X3=0.5	S11=0	
IsS11Max=No	IsS11Min=No	FrameElem=116	ElemStation=0					
Frame=116	Station=0	OutputCase=SOVRCOST	CaseType=LinStatic	Point=3	X2=0.5	X3=-0.5	S11=0	
IsS11Max=No	IsS11Min=No	FrameElem=116	ElemStation=0					
Frame=116	Station=0	OutputCase=SOVRCOST	CaseType=LinStatic	Point=4	X2=0.5	X3=0.5	S11=0	
IsS11Max=No	IsS11Min=No	FrameElem=116	ElemStation=0					
Frame=116	Station=0.125	OutputCase=SOVRCOST	CaseType=LinStatic	Point=0	X2=0	X3=0	S11=0	
IsS11Max=Yes	IsS11Min=Yes	FrameElem=116	ElemStation=0.125					
Frame=116	Station=0.125	OutputCase=SOVRCOST	CaseType=LinStatic	Point=1	X2=-0.5	X3=-0.5	S11=0	
IsS11Max=No	IsS11Min=No	FrameElem=116	ElemStation=0.125					
Frame=116	Station=0.125	OutputCase=SOVRCOST	CaseType=LinStatic	Point=2	X2=-0.5	X3=0.5	S11=0	
IsS11Max=No	IsS11Min=No	FrameElem=116	ElemStation=0.125					
Frame=116	Station=0.125	OutputCase=SOVRCOST	CaseType=LinStatic	Point=3	X2=0.5	X3=-0.5	S11=0	
IsS11Max=No	IsS11Min=No	FrameElem=116	ElemStation=0.125					
Frame=116	Station=0.125	OutputCase=SOVRCOST	CaseType=LinStatic	Point=4	X2=0.5	X3=0.5	S11=0	
IsS11Max=No	IsS11Min=No	FrameElem=116	ElemStation=0.125					
Frame=116	Station=0.25	OutputCase=SOVRCOST	CaseType=LinStatic	Point=0	X2=0	X3=0	S11=0	
IsS11Max=Yes	IsS11Min=Yes	FrameElem=116	ElemStation=0.25					
Frame=116	Station=0.25	OutputCase=SOVRCOST	CaseType=LinStatic	Point=1	X2=-0.5	X3=-0.5	S11=0	
IsS11Max=No	IsS11Min=No	FrameElem=116	ElemStation=0.25					
Frame=116	Station=0.25	OutputCase=SOVRCOST	CaseType=LinStatic	Point=2	X2=-0.5	X3=0.5	S11=0	
IsS11Max=No	IsS11Min=No	FrameElem=116	ElemStation=0.25					
Frame=116	Station=0.25	OutputCase=SOVRCOST	CaseType=LinStatic	Point=3	X2=0.5	X3=-0.5	S11=0	
IsS11Max=No	IsS11Min=No	FrameElem=116	ElemStation=0.25					
Frame=116	Station=0.25	OutputCase=SOVRCOST	CaseType=LinStatic	Point=4	X2=0.5	X3=0.5	S11=0	
IsS11Max=No	IsS11Min=No	FrameElem=116	ElemStation=0.25					
Frame=116	Station=0.375	OutputCase=SOVRCOST	CaseType=LinStatic	Point=0	X2=0	X3=0	S11=0	
IsS11Max=Yes	IsS11Min=Yes	FrameElem=116	ElemStation=0.375					
Frame=116	Station=0.375	OutputCase=SOVRCOST	CaseType=LinStatic	Point=1	X2=-0.5	X3=-0.5	S11=0	
IsS11Max=No	IsS11Min=No	FrameElem=116	ElemStation=0.375					
Frame=116	Station=0.375	OutputCase=SOVRCOST	CaseType=LinStatic	Point=2	X2=-0.5	X3=0.5	S11=0	
IsS11Max=No	IsS11Min=No	FrameElem=116	ElemStation=0.375					
Frame=116	Station=0.375	OutputCase=SOVRCOST	CaseType=LinStatic	Point=3	X2=0.5	X3=-0.5	S11=0	
IsS11Max=No	IsS11Min=No	FrameElem=116	ElemStation=0.375					
Frame=116	Station=0.375	OutputCase=SOVRCOST	CaseType=LinStatic	Point=4	X2=0.5	X3=0.5	S11=0	
IsS11Max=No	IsS11Min=No	FrameElem=116	ElemStation=0.375					
Frame=116	Station=0.5	OutputCase=SOVRCOST	CaseType=LinStatic	Point=0	X2=0	X3=0	S11=0	IsS11Max=Yes
IsS11Min=Yes	FrameElem=116	ElemStation=0.5						
Frame=116	Station=0.5	OutputCase=SOVRCOST	CaseType=LinStatic	Point=1	X2=-0.5	X3=-0.5	S11=0	
IsS11Max=No	IsS11Min=No	FrameElem=116	ElemStation=0.5					
Frame=116	Station=0.5	OutputCase=SOVRCOST	CaseType=LinStatic	Point=2	X2=-0.5	X3=0.5	S11=0	
IsS11Max=No	IsS11Min=No	FrameElem=116	ElemStation=0.5					
Frame=116	Station=0.5	OutputCase=SOVRCOST	CaseType=LinStatic	Point=3	X2=0.5	X3=-0.5	S11=0	
IsS11Max=No	IsS11Min=No	FrameElem=116	ElemStation=0.5					
Frame=116	Station=0.5	OutputCase=SOVRCOST	CaseType=LinStatic	Point=4	X2=0.5	X3=0.5	S11=0	
IsS11Max=No	IsS11Min=No	FrameElem=116	ElemStation=0.5					
Frame=116	Station=0	OutputCase=ENVE	CaseType=Combination	StepType=Max	Point=0	X2=0	X3=0	S11=-
217.882158664511	IsS11Max=No	IsS11Min=No	FrameElem=116	ElemStation=0				
Frame=116	Station=0	OutputCase=ENVE	CaseType=Combination	StepType=Max	Point=1	X2=-0.5	X3=-0.5	
S11=3075.98629245904	IsS11Max=Yes	IsS11Min=No	FrameElem=116	ElemStation=0				
Frame=116	Station=0	OutputCase=ENVE	CaseType=Combination	StepType=Max	Point=2	X2=-0.5	X3=0.5	
S11=3075.98629245904	IsS11Max=No	IsS11Min=No	FrameElem=116	ElemStation=0				
Frame=116	Station=0	OutputCase=ENVE	CaseType=Combination	StepType=Max	Point=3	X2=0.5	X3=-0.5	
S11=-3461.39844923849	IsS11Max=No	IsS11Min=Yes	FrameElem=116	ElemStation=0				
Frame=116	Station=0	OutputCase=ENVE	CaseType=Combination	StepType=Max	Point=4	X2=0.5	X3=0.5	S11=-
3461.39844923849	IsS11Max=No	IsS11Min=No	FrameElem=116	ElemStation=0				
Frame=116	Station=0.125	OutputCase=ENVE	CaseType=Combination	StepType=Max	Point=0	X2=0	X3=0	S11=-
217.882158664511	IsS11Max=No	IsS11Min=No	FrameElem=116	ElemStation=0.125				
Frame=116	Station=0.125	OutputCase=ENVE	CaseType=Combination	StepType=Max	Point=1	X2=-0.5	X3=-0.5	
S11=3061.68941635116	IsS11Max=Yes	IsS11Min=No	FrameElem=116	ElemStation=0.125				
Frame=116	Station=0.125	OutputCase=ENVE	CaseType=Combination	StepType=Max	Point=2	X2=-0.5	X3=0.5	
S11=3061.68941635116	IsS11Max=No	IsS11Min=No	FrameElem=116	ElemStation=0.125				
Frame=116	Station=0.125	OutputCase=ENVE	CaseType=Combination	StepType=Max	Point=3	X2=0.5	X3=-0.5	
S11=-3447.10157274987	IsS11Max=No	IsS11Min=Yes	FrameElem=116	ElemStation=0.125				
Frame=116	Station=0.125	OutputCase=ENVE	CaseType=Combination	StepType=Max	Point=4	X2=0.5	X3=0.5	
S11=-3447.10157274987	IsS11Max=No	IsS11Min=No	FrameElem=116	ElemStation=0.125				
Frame=116	Station=0.25	OutputCase=ENVE	CaseType=Combination	StepType=Max	Point=0	X2=0	X3=0	S11=-
217.882158664511	IsS11Max=No	IsS11Min=No	FrameElem=116	ElemStation=0.25				
Frame=116	Station=0.25	OutputCase=ENVE	CaseType=Combination	StepType=Max	Point=1	X2=-0.5	X3=-0.5	
S11=3018.79879024329	IsS11Max=Yes	IsS11Min=No	FrameElem=116	ElemStation=0.25				
Frame=116	Station=0.25	OutputCase=ENVE	CaseType=Combination	StepType=Max	Point=2	X2=-0.5	X3=0.5	
S11=3018.79879024329	IsS11Max=No	IsS11Min=No	FrameElem=116	ElemStation=0.25				
Frame=116	Station=0.25	OutputCase=ENVE	CaseType=Combination	StepType=Max	Point=3	X2=0.5	X3=-0.5	
S11=-3404.21094626125	IsS11Max=No	IsS11Min=Yes	FrameElem=116	ElemStation=0.25				
Frame=116	Station=0.25	OutputCase=ENVE	CaseType=Combination	StepType=Max	Point=4	X2=0.5	X3=0.5	
S11=-3404.21094626125	IsS11Max=No	IsS11Min=No	FrameElem=116	ElemStation=0.25				
Frame=116	Station=0.375	OutputCase=ENVE	CaseType=Combination	StepType=Max	Point=0	X2=0	X3=0	S11=-
217.882158664511	IsS11Max=No	IsS11Min=No	FrameElem=116	ElemStation=0.375				
Frame=116	Station=0.375	OutputCase=ENVE	CaseType=Combination	StepType=Max	Point=1	X2=-0.5	X3=-0.5	
S11=2947.31441413542	IsS11Max=Yes	IsS11Min=No	FrameElem=116	ElemStation=0.375				



Frame=116	Station=0.375	OutputCase=ENVE	CaseType=Combination	StepType=Max	Point=2	X2=-0.5	X3=0.5	
S11=2947.31441413542	IsS11Max=No	IsS11Min=No	FrameElem=116	ElemStation=0.375				
Frame=116	Station=0.375	OutputCase=ENVE	CaseType=Combination	StepType=Max	Point=3	X2=0.5	X3=-0.5	
S11=-3332.72656977263	IsS11Max=No	IsS11Min=Yes	FrameElem=116	ElemStation=0.375				
Frame=116	Station=0.375	OutputCase=ENVE	CaseType=Combination	StepType=Max	Point=4	X2=0.5	X3=0.5	
S11=-3332.72656977263	IsS11Max=No	IsS11Min=No	FrameElem=116	ElemStation=0.375				
Frame=116	Station=0.5	OutputCase=ENVE	CaseType=Combination	StepType=Max	Point=0	X2=0	X3=0	S11=-
217.882158664511	IsS11Max=No	IsS11Min=No	FrameElem=116	ElemStation=0.5				
Frame=116	Station=0.5	OutputCase=ENVE	CaseType=Combination	StepType=Max	Point=1	X2=-0.5	X3=-0.5	
S11=2847.23628802755	IsS11Max=Yes	IsS11Min=No	FrameElem=116	ElemStation=0.5				
Frame=116	Station=0.5	OutputCase=ENVE	CaseType=Combination	StepType=Max	Point=2	X2=-0.5	X3=0.5	
S11=2847.23628802755	IsS11Max=No	IsS11Min=No	FrameElem=116	ElemStation=0.5				
Frame=116	Station=0.5	OutputCase=ENVE	CaseType=Combination	StepType=Max	Point=3	X2=0.5	X3=-0.5	
S11=-3232.64844328402	IsS11Max=No	IsS11Min=Yes	FrameElem=116	ElemStation=0.5				
Frame=116	Station=0.5	OutputCase=ENVE	CaseType=Combination	StepType=Max	Point=4	X2=0.5	X3=0.5	
S11=-3232.64844328402	IsS11Max=No	IsS11Min=No	FrameElem=116	ElemStation=0.5				
Frame=116	Station=0	OutputCase=ENVE	CaseType=Combination	StepType=Min	Point=0	X2=0	X3=0	S11=-
317.058043529684	IsS11Max=No	IsS11Min=No	FrameElem=116	ElemStation=0				
Frame=116	Station=0	OutputCase=ENVE	CaseType=Combination	StepType=Min	Point=1	X2=-0.5	X3=-0.5	
S11=2827.28236217912	IsS11Max=Yes	IsS11Min=No	FrameElem=116	ElemStation=0				
Frame=116	Station=0	OutputCase=ENVE	CaseType=Combination	StepType=Min	Point=2	X2=-0.5	X3=0.5	
S11=2827.28236217912	IsS11Max=No	IsS11Min=No	FrameElem=116	ElemStation=0				
Frame=116	Station=0	OutputCase=ENVE	CaseType=Combination	StepType=Min	Point=3	X2=0.5	X3=-0.5	
S11=-3511.75060978806	IsS11Max=No	IsS11Min=Yes	FrameElem=116	ElemStation=0				
Frame=116	Station=0	OutputCase=ENVE	CaseType=Combination	StepType=Min	Point=4	X2=0.5	X3=0.5	S11=-
3511.75060978806	IsS11Max=No	IsS11Min=No	FrameElem=116	ElemStation=0				
Frame=116	Station=0.125	OutputCase=ENVE	CaseType=Combination	StepType=Min	Point=0	X2=0	X3=0	S11=-
317.058043529684	IsS11Max=No	IsS11Min=No	FrameElem=116	ElemStation=0.125				
Frame=116	Station=0.125	OutputCase=ENVE	CaseType=Combination	StepType=Min	Point=1	X2=-0.5	X3=-0.5	
S11=2812.9854856905	IsS11Max=Yes	IsS11Min=No	FrameElem=116	ElemStation=0.125				
Frame=116	Station=0.125	OutputCase=ENVE	CaseType=Combination	StepType=Min	Point=2	X2=-0.5	X3=0.5	
S11=2812.9854856905	IsS11Max=No	IsS11Min=No	FrameElem=116	ElemStation=0.125				
Frame=116	Station=0.125	OutputCase=ENVE	CaseType=Combination	StepType=Min	Point=3	X2=0.5	X3=-0.5	
S11=-3497.45373368019	IsS11Max=No	IsS11Min=Yes	FrameElem=116	ElemStation=0.125				
Frame=116	Station=0.125	OutputCase=ENVE	CaseType=Combination	StepType=Min	Point=4	X2=0.5	X3=0.5	
S11=-3497.45373368019	IsS11Max=No	IsS11Min=No	FrameElem=116	ElemStation=0.125				
Frame=116	Station=0.25	OutputCase=ENVE	CaseType=Combination	StepType=Min	Point=0	X2=0	X3=0	S11=-
317.058043529684	IsS11Max=No	IsS11Min=No	FrameElem=116	ElemStation=0.25				
Frame=116	Station=0.25	OutputCase=ENVE	CaseType=Combination	StepType=Min	Point=1	X2=-0.5	X3=-0.5	
S11=2770.09485920188	IsS11Max=Yes	IsS11Min=No	FrameElem=116	ElemStation=0.25				
Frame=116	Station=0.25	OutputCase=ENVE	CaseType=Combination	StepType=Min	Point=2	X2=-0.5	X3=0.5	
S11=2770.09485920188	IsS11Max=No	IsS11Min=No	FrameElem=116	ElemStation=0.25				
Frame=116	Station=0.25	OutputCase=ENVE	CaseType=Combination	StepType=Min	Point=3	X2=0.5	X3=-0.5	
S11=-3454.56310757231	IsS11Max=No	IsS11Min=Yes	FrameElem=116	ElemStation=0.25				
Frame=116	Station=0.25	OutputCase=ENVE	CaseType=Combination	StepType=Min	Point=4	X2=0.5	X3=0.5	
S11=-3454.56310757231	IsS11Max=No	IsS11Min=No	FrameElem=116	ElemStation=0.25				
Frame=116	Station=0.375	OutputCase=ENVE	CaseType=Combination	StepType=Min	Point=0	X2=0	X3=0	S11=-
317.058043529684	IsS11Max=No	IsS11Min=No	FrameElem=116	ElemStation=0.375				
Frame=116	Station=0.375	OutputCase=ENVE	CaseType=Combination	StepType=Min	Point=1	X2=-0.5	X3=-0.5	
S11=2698.61048271327	IsS11Max=Yes	IsS11Min=No	FrameElem=116	ElemStation=0.375				
Frame=116	Station=0.375	OutputCase=ENVE	CaseType=Combination	StepType=Min	Point=2	X2=-0.5	X3=0.5	
S11=2698.61048271327	IsS11Max=No	IsS11Min=No	FrameElem=116	ElemStation=0.375				
Frame=116	Station=0.375	OutputCase=ENVE	CaseType=Combination	StepType=Min	Point=3	X2=0.5	X3=-0.5	
S11=-3383.07873146444	IsS11Max=No	IsS11Min=Yes	FrameElem=116	ElemStation=0.375				
Frame=116	Station=0.375	OutputCase=ENVE	CaseType=Combination	StepType=Min	Point=4	X2=0.5	X3=0.5	
S11=-3383.07873146444	IsS11Max=No	IsS11Min=No	FrameElem=116	ElemStation=0.375				
Frame=116	Station=0.5	OutputCase=ENVE	CaseType=Combination	StepType=Min	Point=0	X2=0	X3=0	S11=-
317.058043529684	IsS11Max=No	IsS11Min=No	FrameElem=116	ElemStation=0.5				
Frame=116	Station=0.5	OutputCase=ENVE	CaseType=Combination	StepType=Min	Point=1	X2=-0.5	X3=-0.5	
S11=2598.53235622465	IsS11Max=Yes	IsS11Min=No	FrameElem=116	ElemStation=0.5				
Frame=116	Station=0.5	OutputCase=ENVE	CaseType=Combination	StepType=Min	Point=2	X2=-0.5	X3=0.5	
S11=2598.53235622465	IsS11Max=No	IsS11Min=No	FrameElem=116	ElemStation=0.5				
Frame=116	Station=0.5	OutputCase=ENVE	CaseType=Combination	StepType=Min	Point=3	X2=0.5	X3=-0.5	
S11=-3283.00060535657	IsS11Max=No	IsS11Min=Yes	FrameElem=116	ElemStation=0.5				
Frame=116	Station=0.5	OutputCase=ENVE	CaseType=Combination	StepType=Min	Point=4	X2=0.5	X3=0.5	
S11=-3283.00060535657	IsS11Max=No	IsS11Min=No	FrameElem=116	ElemStation=0.5				
Frame=116	Station=0	OutputCase=FESSUR	CaseType=Combination	Point=0	X2=0	X3=0	S11=-	317.058043529684
IsS11Max=No	IsS11Min=No	FrameElem=116	ElemStation=0					
Frame=116	Station=0	OutputCase=FESSUR	CaseType=Combination	Point=1	X2=-0.5	X3=-0.5		
S11=2827.28236217912	IsS11Max=Yes	IsS11Min=No	FrameElem=116	ElemStation=0				
Frame=116	Station=0	OutputCase=FESSUR	CaseType=Combination	Point=2	X2=-0.5	X3=0.5		
S11=2827.28236217912	IsS11Max=No	IsS11Min=No	FrameElem=116	ElemStation=0				
Frame=116	Station=0	OutputCase=FESSUR	CaseType=Combination	Point=3	X2=0.5	X3=-0.5	S11=-	
3461.39844923849	IsS11Max=No	IsS11Min=Yes	FrameElem=116	ElemStation=0				
Frame=116	Station=0	OutputCase=FESSUR	CaseType=Combination	Point=4	X2=0.5	X3=0.5	S11=-	
3461.39844923849	IsS11Max=No	IsS11Min=No	FrameElem=116	ElemStation=0				
Frame=116	Station=0.125	OutputCase=FESSUR	CaseType=Combination	Point=0	X2=0	X3=0	S11=-	
317.058043529684	IsS11Max=No	IsS11Min=No	FrameElem=116	ElemStation=0.125				
Frame=116	Station=0.125	OutputCase=FESSUR	CaseType=Combination	Point=1	X2=-0.5	X3=-0.5		
S11=2812.9854856905	IsS11Max=Yes	IsS11Min=No	FrameElem=116	ElemStation=0.125				
Frame=116	Station=0.125	OutputCase=FESSUR	CaseType=Combination	Point=2	X2=-0.5	X3=0.5		
S11=2812.9854856905	IsS11Max=No	IsS11Min=No	FrameElem=116	ElemStation=0.125				

Frame=116	Station=0.125	OutputCase=FESSUR	CaseType=Combination	Point=3	X2=0.5	X3=-0.5	S11=-
3447.10157274987	IsS11Max=No	IsS11Min=Yes	FrameElem=116	ElemStation=0.125			
Frame=116	Station=0.125	OutputCase=FESSUR	CaseType=Combination	Point=4	X2=0.5	X3=0.5	S11=-
3447.10157274987	IsS11Max=No	IsS11Min=No	FrameElem=116	ElemStation=0.125			
Frame=116	Station=0.25	OutputCase=FESSUR	CaseType=Combination	Point=0	X2=0	X3=0	S11=-
317.058043529684	IsS11Max=No	IsS11Min=No	FrameElem=116	ElemStation=0.25			
Frame=116	Station=0.25	OutputCase=FESSUR	CaseType=Combination	Point=1	X2=-0.5	X3=-0.5	
S11=2770.09485920188	IsS11Max=Yes	IsS11Min=No	FrameElem=116	ElemStation=0.25			
Frame=116	Station=0.25	OutputCase=FESSUR	CaseType=Combination	Point=2	X2=-0.5	X3=0.5	
S11=2770.09485920188	IsS11Max=No	IsS11Min=No	FrameElem=116	ElemStation=0.25			
Frame=116	Station=0.25	OutputCase=FESSUR	CaseType=Combination	Point=3	X2=0.5	X3=-0.5	S11=-
3404.21094626125	IsS11Max=No	IsS11Min=Yes	FrameElem=116	ElemStation=0.25			
Frame=116	Station=0.25	OutputCase=FESSUR	CaseType=Combination	Point=4	X2=0.5	X3=0.5	S11=-
3404.21094626125	IsS11Max=No	IsS11Min=No	FrameElem=116	ElemStation=0.25			
Frame=116	Station=0.375	OutputCase=FESSUR	CaseType=Combination	Point=0	X2=0	X3=0	S11=-
317.058043529684	IsS11Max=No	IsS11Min=No	FrameElem=116	ElemStation=0.375			
Frame=116	Station=0.375	OutputCase=FESSUR	CaseType=Combination	Point=1	X2=-0.5	X3=-0.5	
S11=2698.61048271327	IsS11Max=Yes	IsS11Min=No	FrameElem=116	ElemStation=0.375			
Frame=116	Station=0.375	OutputCase=FESSUR	CaseType=Combination	Point=2	X2=-0.5	X3=0.5	
S11=2698.61048271327	IsS11Max=No	IsS11Min=No	FrameElem=116	ElemStation=0.375			
Frame=116	Station=0.375	OutputCase=FESSUR	CaseType=Combination	Point=3	X2=0.5	X3=-0.5	S11=-
3332.72656977263	IsS11Max=No	IsS11Min=Yes	FrameElem=116	ElemStation=0.375			
Frame=116	Station=0.375	OutputCase=FESSUR	CaseType=Combination	Point=4	X2=0.5	X3=0.5	S11=-
3332.72656977263	IsS11Max=No	IsS11Min=No	FrameElem=116	ElemStation=0.375			
Frame=116	Station=0.5	OutputCase=FESSUR	CaseType=Combination	Point=0	X2=0	X3=0	S11=-
317.058043529684	IsS11Max=No	IsS11Min=No	FrameElem=116	ElemStation=0.5			
Frame=116	Station=0.5	OutputCase=FESSUR	CaseType=Combination	Point=1	X2=-0.5	X3=-0.5	
S11=2598.53235622465	IsS11Max=Yes	IsS11Min=No	FrameElem=116	ElemStation=0.5			
Frame=116	Station=0.5	OutputCase=FESSUR	CaseType=Combination	Point=2	X2=-0.5	X3=0.5	
S11=2598.53235622465	IsS11Max=No	IsS11Min=No	FrameElem=116	ElemStation=0.5			
Frame=116	Station=0.5	OutputCase=FESSUR	CaseType=Combination	Point=3	X2=0.5	X3=-0.5	S11=-
3232.64844328402	IsS11Max=No	IsS11Min=Yes	FrameElem=116	ElemStation=0.5			
Frame=116	Station=0.5	OutputCase=FESSUR	CaseType=Combination	Point=4	X2=0.5	X3=0.5	S11=-
3232.64844328402	IsS11Max=No	IsS11Min=No	FrameElem=116	ElemStation=0.5			
Frame=117	Station=0	OutputCase=PESOPR	CaseType=LinStatic	Point=0	X2=0	X3=0	S11=15.1709467361835
IsS11Max=No	IsS11Min=No	FrameElem=117	ElemStation=0				
Frame=117	Station=0	OutputCase=PESOPR	CaseType=LinStatic	Point=1	X2=-0.5	X3=-0.5	
S11=338.741477020561	IsS11Max=Yes	IsS11Min=No	FrameElem=117	ElemStation=0			
Frame=117	Station=0	OutputCase=PESOPR	CaseType=LinStatic	Point=2	X2=-0.5	X3=0.5	
S11=338.741477020561	IsS11Max=No	IsS11Min=No	FrameElem=117	ElemStation=0			
Frame=117	Station=0	OutputCase=PESOPR	CaseType=LinStatic	Point=3	X2=0.5	X3=-0.5	S11=-
308.399583548195	IsS11Max=No	IsS11Min=Yes	FrameElem=117	ElemStation=0			
Frame=117	Station=0	OutputCase=PESOPR	CaseType=LinStatic	Point=4	X2=0.5	X3=0.5	S11=-
308.399583548195	IsS11Max=No	IsS11Min=No	FrameElem=117	ElemStation=0			
Frame=117	Station=0.125	OutputCase=PESOPR	CaseType=LinStatic	Point=0	X2=0	X3=0	S11=15.1709467361835
IsS11Max=No	IsS11Min=No	FrameElem=117	ElemStation=0.125				
Frame=117	Station=0.125	OutputCase=PESOPR	CaseType=LinStatic	Point=1	X2=-0.5	X3=-0.5	
S11=328.194602012267	IsS11Max=Yes	IsS11Min=No	FrameElem=117	ElemStation=0.125			
Frame=117	Station=0.125	OutputCase=PESOPR	CaseType=LinStatic	Point=2	X2=-0.5	X3=0.5	
S11=328.194602012267	IsS11Max=No	IsS11Min=No	FrameElem=117	ElemStation=0.125			
Frame=117	Station=0.125	OutputCase=PESOPR	CaseType=LinStatic	Point=3	X2=0.5	X3=-0.5	S11=-
297.8527085399	IsS11Max=No	IsS11Min=Yes	FrameElem=117	ElemStation=0.125			
Frame=117	Station=0.125	OutputCase=PESOPR	CaseType=LinStatic	Point=4	X2=0.5	X3=0.5	S11=-
297.8527085399	IsS11Max=No	IsS11Min=No	FrameElem=117	ElemStation=0.125			
Frame=117	Station=0.25	OutputCase=PESOPR	CaseType=LinStatic	Point=0	X2=0	X3=0	S11=15.1709467361835
IsS11Max=No	IsS11Min=No	FrameElem=117	ElemStation=0.25				
Frame=117	Station=0.25	OutputCase=PESOPR	CaseType=LinStatic	Point=1	X2=-0.5	X3=-0.5	
S11=315.303977003972	IsS11Max=Yes	IsS11Min=No	FrameElem=117	ElemStation=0.25			
Frame=117	Station=0.25	OutputCase=PESOPR	CaseType=LinStatic	Point=2	X2=-0.5	X3=0.5	
S11=315.303977003972	IsS11Max=No	IsS11Min=No	FrameElem=117	ElemStation=0.25			
Frame=117	Station=0.25	OutputCase=PESOPR	CaseType=LinStatic	Point=3	X2=0.5	X3=-0.5	S11=-
284.962083531605	IsS11Max=No	IsS11Min=Yes	FrameElem=117	ElemStation=0.25			
Frame=117	Station=0.25	OutputCase=PESOPR	CaseType=LinStatic	Point=4	X2=0.5	X3=0.5	S11=-
284.962083531605	IsS11Max=No	IsS11Min=No	FrameElem=117	ElemStation=0.25			
Frame=117	Station=0.375	OutputCase=PESOPR	CaseType=LinStatic	Point=0	X2=0	X3=0	S11=15.1709467361835
IsS11Max=No	IsS11Min=No	FrameElem=117	ElemStation=0.375				
Frame=117	Station=0.375	OutputCase=PESOPR	CaseType=LinStatic	Point=1	X2=-0.5	X3=-0.5	
S11=300.069601995678	IsS11Max=Yes	IsS11Min=No	FrameElem=117	ElemStation=0.375			
Frame=117	Station=0.375	OutputCase=PESOPR	CaseType=LinStatic	Point=2	X2=-0.5	X3=0.5	
S11=300.069601995678	IsS11Max=No	IsS11Min=No	FrameElem=117	ElemStation=0.375			
Frame=117	Station=0.375	OutputCase=PESOPR	CaseType=LinStatic	Point=3	X2=0.5	X3=-0.5	S11=-
269.727708523311	IsS11Max=No	IsS11Min=Yes	FrameElem=117	ElemStation=0.375			
Frame=117	Station=0.375	OutputCase=PESOPR	CaseType=LinStatic	Point=4	X2=0.5	X3=0.5	S11=-
269.727708523311	IsS11Max=No	IsS11Min=No	FrameElem=117	ElemStation=0.375			
Frame=117	Station=0.5	OutputCase=PESOPR	CaseType=LinStatic	Point=0	X2=0	X3=0	S11=15.1709467361835
IsS11Max=No	IsS11Min=No	FrameElem=117	ElemStation=0.5				
Frame=117	Station=0.5	OutputCase=PESOPR	CaseType=LinStatic	Point=1	X2=-0.5	X3=-0.5	
S11=282.491476987383	IsS11Max=Yes	IsS11Min=No	FrameElem=117	ElemStation=0.5			
Frame=117	Station=0.5	OutputCase=PESOPR	CaseType=LinStatic	Point=2	X2=-0.5	X3=0.5	
S11=282.491476987383	IsS11Max=No	IsS11Min=No	FrameElem=117	ElemStation=0.5			
Frame=117	Station=0.5	OutputCase=PESOPR	CaseType=LinStatic	Point=3	X2=0.5	X3=-0.5	S11=-
252.149583515016	IsS11Max=No	IsS11Min=Yes	FrameElem=117	ElemStation=0.5			



Frame=117 Station=0.5 OutputCase=PESOPR CaseType=LinStatic Point=4 X2=0.5 X3=0.5 S11=-
 252.149583515016 IsS11Max=No IsS11Min=No FrameElem=117 ElemStation=0.5
 Frame=117 Station=0 OutputCase=TERRVERT CaseType=LinStatic Point=0 X2=0 X3=0 S11=-1.64270738196176
 IsS11Max=No IsS11Min=No FrameElem=117 ElemStation=0
 Frame=117 Station=0 OutputCase=TERRVERT CaseType=LinStatic Point=1 X2=-0.5 X3=-0.5
 S11=3088.80398521385 IsS11Max=Yes IsS11Min=No FrameElem=117 ElemStation=0
 Frame=117 Station=0 OutputCase=TERRVERT CaseType=LinStatic Point=2 X2=-0.5 X3=0.5
 S11=3088.80398521385 IsS11Max=No IsS11Min=No FrameElem=117 ElemStation=0
 Frame=117 Station=0 OutputCase=TERRVERT CaseType=LinStatic Point=3 X2=0.5 X3=-0.5 S11=-
 3092.08939997777 IsS11Max=No IsS11Min=Yes FrameElem=117 ElemStation=0
 Frame=117 Station=0 OutputCase=TERRVERT CaseType=LinStatic Point=4 X2=0.5 X3=0.5 S11=-
 3092.08939997777 IsS11Max=No IsS11Min=No FrameElem=117 ElemStation=0
 Frame=117 Station=0.125 OutputCase=TERRVERT CaseType=LinStatic Point=0 X2=0 X3=0 S11=-
 1.64270738196176 IsS11Max=No IsS11Min=No FrameElem=117 ElemStation=0.125
 Frame=117 Station=0.125 OutputCase=TERRVERT CaseType=LinStatic Point=1 X2=-0.5 X3=-0.5
 S11=2970.67898500277 IsS11Max=Yes IsS11Min=No FrameElem=117 ElemStation=0.125
 Frame=117 Station=0.125 OutputCase=TERRVERT CaseType=LinStatic Point=2 X2=-0.5 X3=0.5
 S11=2970.67898500277 IsS11Max=No IsS11Min=No FrameElem=117 ElemStation=0.125
 Frame=117 Station=0.125 OutputCase=TERRVERT CaseType=LinStatic Point=3 X2=0.5 X3=-0.5 S11=-
 2973.9643997667 IsS11Max=No IsS11Min=Yes FrameElem=117 ElemStation=0.125
 Frame=117 Station=0.125 OutputCase=TERRVERT CaseType=LinStatic Point=4 X2=0.5 X3=0.5 S11=-
 2973.9643997667 IsS11Max=No IsS11Min=No FrameElem=117 ElemStation=0.125
 Frame=117 Station=0.25 OutputCase=TERRVERT CaseType=LinStatic Point=0 X2=0 X3=0 S11=-
 1.64270738196176 IsS11Max=No IsS11Min=No FrameElem=117 ElemStation=0.25
 Frame=117 Station=0.25 OutputCase=TERRVERT CaseType=LinStatic Point=1 X2=-0.5 X3=-0.5
 S11=2826.3039847917 IsS11Max=Yes IsS11Min=No FrameElem=117 ElemStation=0.25
 Frame=117 Station=0.25 OutputCase=TERRVERT CaseType=LinStatic Point=2 X2=-0.5 X3=0.5
 S11=2826.3039847917 IsS11Max=No IsS11Min=No FrameElem=117 ElemStation=0.25
 Frame=117 Station=0.25 OutputCase=TERRVERT CaseType=LinStatic Point=3 X2=0.5 X3=-0.5 S11=-
 2829.58939955562 IsS11Max=No IsS11Min=Yes FrameElem=117 ElemStation=0.25
 Frame=117 Station=0.25 OutputCase=TERRVERT CaseType=LinStatic Point=4 X2=0.5 X3=0.5 S11=-
 2829.58939955562 IsS11Max=No IsS11Min=No FrameElem=117 ElemStation=0.25
 Frame=117 Station=0.375 OutputCase=TERRVERT CaseType=LinStatic Point=0 X2=0 X3=0 S11=-
 1.64270738196176 IsS11Max=No IsS11Min=No FrameElem=117 ElemStation=0.375
 Frame=117 Station=0.375 OutputCase=TERRVERT CaseType=LinStatic Point=1 X2=-0.5 X3=-0.5
 S11=2655.67898458062 IsS11Max=Yes IsS11Min=No FrameElem=117 ElemStation=0.375
 Frame=117 Station=0.375 OutputCase=TERRVERT CaseType=LinStatic Point=2 X2=-0.5 X3=0.5
 S11=2655.67898458062 IsS11Max=No IsS11Min=No FrameElem=117 ElemStation=0.375
 Frame=117 Station=0.375 OutputCase=TERRVERT CaseType=LinStatic Point=3 X2=0.5 X3=-0.5 S11=-
 2658.96439934455 IsS11Max=No IsS11Min=Yes FrameElem=117 ElemStation=0.375
 Frame=117 Station=0.375 OutputCase=TERRVERT CaseType=LinStatic Point=4 X2=0.5 X3=0.5 S11=-
 2658.96439934455 IsS11Max=No IsS11Min=No FrameElem=117 ElemStation=0.375
 Frame=117 Station=0.5 OutputCase=TERRVERT CaseType=LinStatic Point=0 X2=0 X3=0 S11=-
 1.64270738196176 IsS11Max=No IsS11Min=No FrameElem=117 ElemStation=0.5
 Frame=117 Station=0.5 OutputCase=TERRVERT CaseType=LinStatic Point=1 X2=-0.5 X3=-0.5
 S11=2458.80398436955 IsS11Max=Yes IsS11Min=No FrameElem=117 ElemStation=0.5
 Frame=117 Station=0.5 OutputCase=TERRVERT CaseType=LinStatic Point=2 X2=-0.5 X3=0.5
 S11=2458.80398436955 IsS11Max=No IsS11Min=No FrameElem=117 ElemStation=0.5
 Frame=117 Station=0.5 OutputCase=TERRVERT CaseType=LinStatic Point=3 X2=0.5 X3=-0.5 S11=-
 2462.08939913347 IsS11Max=No IsS11Min=Yes FrameElem=117 ElemStation=0.5
 Frame=117 Station=0.5 OutputCase=TERRVERT CaseType=LinStatic Point=4 X2=0.5 X3=0.5 S11=-
 2462.08939913347 IsS11Max=No IsS11Min=No FrameElem=117 ElemStation=0.5
 Frame=117 Station=0 OutputCase=TERRLAT CaseType=LinStatic Point=0 X2=0 X3=0 S11=-330.586282883909
 IsS11Max=No IsS11Min=No FrameElem=117 ElemStation=0
 Frame=117 Station=0 OutputCase=TERRLAT CaseType=LinStatic Point=1 X2=-0.5 X3=-0.5 S11=-
 829.013106009656 IsS11Max=No IsS11Min=Yes FrameElem=117 ElemStation=0
 Frame=117 Station=0 OutputCase=TERRLAT CaseType=LinStatic Point=2 X2=-0.5 X3=0.5 S11=-
 829.013106009656 IsS11Max=No IsS11Min=No FrameElem=117 ElemStation=0
 Frame=117 Station=0 OutputCase=TERRLAT CaseType=LinStatic Point=3 X2=0.5 X3=-0.5
 S11=167.840540241837 IsS11Max=Yes IsS11Min=No FrameElem=117 ElemStation=0
 Frame=117 Station=0 OutputCase=TERRLAT CaseType=LinStatic Point=4 X2=0.5 X3=0.5
 S11=167.840540241837 IsS11Max=No IsS11Min=No FrameElem=117 ElemStation=0
 Frame=117 Station=0.125 OutputCase=TERRLAT CaseType=LinStatic Point=0 X2=0 X3=0 S11=-
 330.586282883909 IsS11Max=No IsS11Min=No FrameElem=117 ElemStation=0.125
 Frame=117 Station=0.125 OutputCase=TERRLAT CaseType=LinStatic Point=1 X2=-0.5 X3=-0.5 S11=-
 829.013107278806 IsS11Max=No IsS11Min=Yes FrameElem=117 ElemStation=0.125
 Frame=117 Station=0.125 OutputCase=TERRLAT CaseType=LinStatic Point=2 X2=-0.5 X3=0.5 S11=-
 829.013107278806 IsS11Max=No IsS11Min=No FrameElem=117 ElemStation=0.125
 Frame=117 Station=0.125 OutputCase=TERRLAT CaseType=LinStatic Point=3 X2=0.5 X3=-0.5
 S11=167.840541510987 IsS11Max=Yes IsS11Min=No FrameElem=117 ElemStation=0.125
 Frame=117 Station=0.125 OutputCase=TERRLAT CaseType=LinStatic Point=4 X2=0.5 X3=0.5
 S11=167.840541510987 IsS11Max=No IsS11Min=No FrameElem=117 ElemStation=0.125
 Frame=117 Station=0.25 OutputCase=TERRLAT CaseType=LinStatic Point=0 X2=0 X3=0 S11=-
 330.586282883909 IsS11Max=No IsS11Min=No FrameElem=117 ElemStation=0.25
 Frame=117 Station=0.25 OutputCase=TERRLAT CaseType=LinStatic Point=1 X2=-0.5 X3=-0.5 S11=-
 829.013108547956 IsS11Max=No IsS11Min=Yes FrameElem=117 ElemStation=0.25
 Frame=117 Station=0.25 OutputCase=TERRLAT CaseType=LinStatic Point=2 X2=-0.5 X3=0.5 S11=-
 829.013108547956 IsS11Max=No IsS11Min=No FrameElem=117 ElemStation=0.25
 Frame=117 Station=0.25 OutputCase=TERRLAT CaseType=LinStatic Point=3 X2=0.5 X3=-0.5
 S11=167.840542780137 IsS11Max=Yes IsS11Min=No FrameElem=117 ElemStation=0.25
 Frame=117 Station=0.25 OutputCase=TERRLAT CaseType=LinStatic Point=4 X2=0.5 X3=0.5
 S11=167.840542780137 IsS11Max=No IsS11Min=No FrameElem=117 ElemStation=0.25

Frame=117	Station=0.375	OutputCase=TERRLAT	CaseType=LinStatic	Point=0	X2=0	X3=0	S11=-	
330.586282883909	IsS11Max=No	IsS11Min=No	FrameElem=117	ElemStation=0.375				
Frame=117	Station=0.375	OutputCase=TERRLAT	CaseType=LinStatic	Point=1	X2=-0.5	X3=-0.5	S11=-	
829.013109817106	IsS11Max=No	IsS11Min=Yes	FrameElem=117	ElemStation=0.375				
Frame=117	Station=0.375	OutputCase=TERRLAT	CaseType=LinStatic	Point=2	X2=-0.5	X3=0.5	S11=-	
829.013109817106	IsS11Max=No	IsS11Min=No	FrameElem=117	ElemStation=0.375				
Frame=117	Station=0.375	OutputCase=TERRLAT	CaseType=LinStatic	Point=3	X2=0.5	X3=-0.5	S11=-	
S11=167.840544049287	IsS11Max=Yes	IsS11Min=No	FrameElem=117	ElemStation=0.375				
Frame=117	Station=0.375	OutputCase=TERRLAT	CaseType=LinStatic	Point=4	X2=0.5	X3=0.5	S11=-	
S11=167.840544049287	IsS11Max=No	IsS11Min=No	FrameElem=117	ElemStation=0.375				
Frame=117	Station=0.5	OutputCase=TERRLAT	CaseType=LinStatic	Point=0	X2=0	X3=0	S11=-330.586282883909	
IsS11Max=No	IsS11Min=No	FrameElem=117	ElemStation=0.5					
Frame=117	Station=0.5	OutputCase=TERRLAT	CaseType=LinStatic	Point=1	X2=-0.5	X3=-0.5	S11=-	
829.013111086257	IsS11Max=No	IsS11Min=Yes	FrameElem=117	ElemStation=0.5				
Frame=117	Station=0.5	OutputCase=TERRLAT	CaseType=LinStatic	Point=2	X2=-0.5	X3=0.5	S11=-	
829.013111086257	IsS11Max=No	IsS11Min=No	FrameElem=117	ElemStation=0.5				
Frame=117	Station=0.5	OutputCase=TERRLAT	CaseType=LinStatic	Point=3	X2=0.5	X3=-0.5	S11=-	
S11=167.840545318438	IsS11Max=Yes	IsS11Min=No	FrameElem=117	ElemStation=0.5				
Frame=117	Station=0.5	OutputCase=TERRLAT	CaseType=LinStatic	Point=4	X2=0.5	X3=0.5	S11=-	
S11=167.840545318438	IsS11Max=No	IsS11Min=No	FrameElem=117	ElemStation=0.5				
Frame=117	Station=0	OutputCase=ACCVERT	CaseType=LinStatic	Point=0	X2=0	X3=0	S11=0	IsS11Max=Yes
IsS11Min=Yes	FrameElem=117	ElemStation=0						
Frame=117	Station=0	OutputCase=ACCVERT	CaseType=LinStatic	Point=1	X2=-0.5	X3=-0.5	S11=0	
IsS11Max=No	IsS11Min=No	FrameElem=117	ElemStation=0					
Frame=117	Station=0	OutputCase=ACCVERT	CaseType=LinStatic	Point=2	X2=-0.5	X3=0.5	S11=0	
IsS11Max=No	IsS11Min=No	FrameElem=117	ElemStation=0					
Frame=117	Station=0	OutputCase=ACCVERT	CaseType=LinStatic	Point=3	X2=0.5	X3=-0.5	S11=0	
IsS11Max=No	IsS11Min=No	FrameElem=117	ElemStation=0					
Frame=117	Station=0	OutputCase=ACCVERT	CaseType=LinStatic	Point=4	X2=0.5	X3=0.5	S11=0	IsS11Max=No
IsS11Min=No	FrameElem=117	ElemStation=0						
Frame=117	Station=0.125	OutputCase=ACCVERT	CaseType=LinStatic	Point=0	X2=0	X3=0	S11=0	
IsS11Max=Yes	IsS11Min=Yes	FrameElem=117	ElemStation=0.125					
Frame=117	Station=0.125	OutputCase=ACCVERT	CaseType=LinStatic	Point=1	X2=-0.5	X3=-0.5	S11=0	
IsS11Max=No	IsS11Min=No	FrameElem=117	ElemStation=0.125					
Frame=117	Station=0.125	OutputCase=ACCVERT	CaseType=LinStatic	Point=2	X2=-0.5	X3=0.5	S11=0	
IsS11Max=No	IsS11Min=No	FrameElem=117	ElemStation=0.125					
Frame=117	Station=0.125	OutputCase=ACCVERT	CaseType=LinStatic	Point=3	X2=0.5	X3=-0.5	S11=0	
IsS11Max=No	IsS11Min=No	FrameElem=117	ElemStation=0.125					
Frame=117	Station=0.125	OutputCase=ACCVERT	CaseType=LinStatic	Point=4	X2=0.5	X3=0.5	S11=0	
IsS11Max=No	IsS11Min=No	FrameElem=117	ElemStation=0.125					
Frame=117	Station=0.25	OutputCase=ACCVERT	CaseType=LinStatic	Point=0	X2=0	X3=0	S11=0	IsS11Max=Yes
IsS11Min=Yes	FrameElem=117	ElemStation=0.25						
Frame=117	Station=0.25	OutputCase=ACCVERT	CaseType=LinStatic	Point=1	X2=-0.5	X3=-0.5	S11=0	
IsS11Max=No	IsS11Min=No	FrameElem=117	ElemStation=0.25					
Frame=117	Station=0.25	OutputCase=ACCVERT	CaseType=LinStatic	Point=2	X2=-0.5	X3=0.5	S11=0	
IsS11Max=No	IsS11Min=No	FrameElem=117	ElemStation=0.25					
Frame=117	Station=0.25	OutputCase=ACCVERT	CaseType=LinStatic	Point=3	X2=0.5	X3=-0.5	S11=0	
IsS11Max=No	IsS11Min=No	FrameElem=117	ElemStation=0.25					
Frame=117	Station=0.25	OutputCase=ACCVERT	CaseType=LinStatic	Point=4	X2=0.5	X3=0.5	S11=0	
IsS11Max=No	IsS11Min=No	FrameElem=117	ElemStation=0.25					
Frame=117	Station=0.375	OutputCase=ACCVERT	CaseType=LinStatic	Point=0	X2=0	X3=0	S11=0	
IsS11Max=Yes	IsS11Min=Yes	FrameElem=117	ElemStation=0.375					
Frame=117	Station=0.375	OutputCase=ACCVERT	CaseType=LinStatic	Point=1	X2=-0.5	X3=-0.5	S11=0	
IsS11Max=No	IsS11Min=No	FrameElem=117	ElemStation=0.375					
Frame=117	Station=0.375	OutputCase=ACCVERT	CaseType=LinStatic	Point=2	X2=-0.5	X3=0.5	S11=0	
IsS11Max=No	IsS11Min=No	FrameElem=117	ElemStation=0.375					
Frame=117	Station=0.375	OutputCase=ACCVERT	CaseType=LinStatic	Point=3	X2=0.5	X3=-0.5	S11=0	
IsS11Max=No	IsS11Min=No	FrameElem=117	ElemStation=0.375					
Frame=117	Station=0.375	OutputCase=ACCVERT	CaseType=LinStatic	Point=4	X2=0.5	X3=0.5	S11=0	
IsS11Max=No	IsS11Min=No	FrameElem=117	ElemStation=0.375					
Frame=117	Station=0.5	OutputCase=ACCVERT	CaseType=LinStatic	Point=0	X2=0	X3=0	S11=0	IsS11Max=Yes
IsS11Min=Yes	FrameElem=117	ElemStation=0.5						
Frame=117	Station=0.5	OutputCase=ACCVERT	CaseType=LinStatic	Point=1	X2=-0.5	X3=-0.5	S11=0	
IsS11Max=No	IsS11Min=No	FrameElem=117	ElemStation=0.5					
Frame=117	Station=0.5	OutputCase=ACCVERT	CaseType=LinStatic	Point=2	X2=-0.5	X3=0.5	S11=0	
IsS11Max=No	IsS11Min=No	FrameElem=117	ElemStation=0.5					
Frame=117	Station=0.5	OutputCase=ACCVERT	CaseType=LinStatic	Point=3	X2=0.5	X3=-0.5	S11=0	
IsS11Max=No	IsS11Min=No	FrameElem=117	ElemStation=0.5					
Frame=117	Station=0.5	OutputCase=ACCVERT	CaseType=LinStatic	Point=4	X2=0.5	X3=0.5	S11=0	
IsS11Max=No	IsS11Min=No	FrameElem=117	ElemStation=0.5					
Frame=117	Station=0	OutputCase=ACCLATDX	CaseType=LinStatic	Point=0	X2=0	X3=0	S11=0	IsS11Max=Yes
IsS11Min=Yes	FrameElem=117	ElemStation=0						
Frame=117	Station=0	OutputCase=ACCLATDX	CaseType=LinStatic	Point=1	X2=-0.5	X3=-0.5	S11=0	
IsS11Max=No	IsS11Min=No	FrameElem=117	ElemStation=0					
Frame=117	Station=0	OutputCase=ACCLATDX	CaseType=LinStatic	Point=2	X2=-0.5	X3=0.5	S11=0	
IsS11Max=No	IsS11Min=No	FrameElem=117	ElemStation=0					
Frame=117	Station=0	OutputCase=ACCLATDX	CaseType=LinStatic	Point=3	X2=0.5	X3=-0.5	S11=0	
IsS11Max=No	IsS11Min=No	FrameElem=117	ElemStation=0					
Frame=117	Station=0	OutputCase=ACCLATDX	CaseType=LinStatic	Point=4	X2=0.5	X3=0.5	S11=0	
IsS11Max=No	IsS11Min=No	FrameElem=117	ElemStation=0					
Frame=117	Station=0.125	OutputCase=ACCLATDX	CaseType=LinStatic	Point=0	X2=0	X3=0	S11=0	
IsS11Max=Yes	IsS11Min=Yes	FrameElem=117	ElemStation=0.125					



Frame=117	Station=0.25	OutputCase=SOVRCOST	CaseType=LinStatic	Point=3	X2=0.5	X3=-0.5	S11=0	
IsS11Max=No	IsS11Min=No	FrameElem=117	ElemStation=0.25					
Frame=117	Station=0.25	OutputCase=SOVRCOST	CaseType=LinStatic	Point=4	X2=0.5	X3=0.5	S11=0	
IsS11Max=No	IsS11Min=No	FrameElem=117	ElemStation=0.25					
Frame=117	Station=0.375	OutputCase=SOVRCOST	CaseType=LinStatic	Point=0	X2=0	X3=0	S11=0	
IsS11Max=Yes	IsS11Min=Yes	FrameElem=117	ElemStation=0.375					
Frame=117	Station=0.375	OutputCase=SOVRCOST	CaseType=LinStatic	Point=1	X2=-0.5	X3=-0.5	S11=0	
IsS11Max=No	IsS11Min=No	FrameElem=117	ElemStation=0.375					
Frame=117	Station=0.375	OutputCase=SOVRCOST	CaseType=LinStatic	Point=2	X2=-0.5	X3=0.5	S11=0	
IsS11Max=No	IsS11Min=No	FrameElem=117	ElemStation=0.375					
Frame=117	Station=0.375	OutputCase=SOVRCOST	CaseType=LinStatic	Point=3	X2=0.5	X3=-0.5	S11=0	
IsS11Max=No	IsS11Min=No	FrameElem=117	ElemStation=0.375					
Frame=117	Station=0.375	OutputCase=SOVRCOST	CaseType=LinStatic	Point=4	X2=0.5	X3=0.5	S11=0	
IsS11Max=No	IsS11Min=No	FrameElem=117	ElemStation=0.375					
Frame=117	Station=0.5	OutputCase=SOVRCOST	CaseType=LinStatic	Point=0	X2=0	X3=0	S11=0	
IsS11Max=Yes	IsS11Min=Yes	FrameElem=117	ElemStation=0.5				IsS11Max=Yes	
Frame=117	Station=0.5	OutputCase=SOVRCOST	CaseType=LinStatic	Point=1	X2=-0.5	X3=-0.5	S11=0	
IsS11Max=No	IsS11Min=No	FrameElem=117	ElemStation=0.5					
Frame=117	Station=0.5	OutputCase=SOVRCOST	CaseType=LinStatic	Point=2	X2=-0.5	X3=0.5	S11=0	
IsS11Max=No	IsS11Min=No	FrameElem=117	ElemStation=0.5					
Frame=117	Station=0.5	OutputCase=SOVRCOST	CaseType=LinStatic	Point=3	X2=0.5	X3=-0.5	S11=0	
IsS11Max=No	IsS11Min=No	FrameElem=117	ElemStation=0.5					
Frame=117	Station=0.5	OutputCase=SOVRCOST	CaseType=LinStatic	Point=4	X2=0.5	X3=0.5	S11=0	
IsS11Max=No	IsS11Min=No	FrameElem=117	ElemStation=0.5					
Frame=117	Station=0	OutputCase=ENVE	CaseType=Combination	StepType=Max	Point=0	X2=0	X3=0	S11=-
217.882158664515	IsS11Max=No	IsS11Min=No	FrameElem=117	ElemStation=0				
Frame=117	Station=0	OutputCase=ENVE	CaseType=Combination	StepType=Max	Point=1	X2=-0.5	X3=-0.5	
S11=2847.23628802765	IsS11Max=Yes	IsS11Min=No	FrameElem=117	ElemStation=0				
Frame=117	Station=0	OutputCase=ENVE	CaseType=Combination	StepType=Max	Point=2	X2=-0.5	X3=0.5	
S11=2847.23628802765	IsS11Max=No	IsS11Min=No	FrameElem=117	ElemStation=0				
Frame=117	Station=0	OutputCase=ENVE	CaseType=Combination	StepType=Max	Point=3	X2=0.5	X3=-0.5	
S11=-3232.64844328413	IsS11Max=No	IsS11Min=Yes	FrameElem=117	ElemStation=0				
Frame=117	Station=0	OutputCase=ENVE	CaseType=Combination	StepType=Max	Point=4	X2=0.5	X3=0.5	S11=-
3232.64844328413	IsS11Max=No	IsS11Min=No	FrameElem=117	ElemStation=0				
Frame=117	Station=0.125	OutputCase=ENVE	CaseType=Combination	StepType=Max	Point=0	X2=0	X3=0	S11=-
217.882158664515	IsS11Max=No	IsS11Min=No	FrameElem=117	ElemStation=0.125				
Frame=117	Station=0.125	OutputCase=ENVE	CaseType=Combination	StepType=Max	Point=1	X2=-0.5	X3=-0.5	
S11=2718.56441191988	IsS11Max=Yes	IsS11Min=No	FrameElem=117	ElemStation=0.125				
Frame=117	Station=0.125	OutputCase=ENVE	CaseType=Combination	StepType=Max	Point=2	X2=-0.5	X3=0.5	
S11=2718.56441191988	IsS11Max=No	IsS11Min=No	FrameElem=117	ElemStation=0.125				
Frame=117	Station=0.125	OutputCase=ENVE	CaseType=Combination	StepType=Max	Point=3	X2=0.5	X3=-0.5	
S11=-3103.97656679561	IsS11Max=No	IsS11Min=Yes	FrameElem=117	ElemStation=0.125				
Frame=117	Station=0.125	OutputCase=ENVE	CaseType=Combination	StepType=Max	Point=4	X2=0.5	X3=0.5	
S11=-3103.97656679561	IsS11Max=No	IsS11Min=No	FrameElem=117	ElemStation=0.125				
Frame=117	Station=0.25	OutputCase=ENVE	CaseType=Combination	StepType=Max	Point=0	X2=0	X3=0	S11=-
217.882158664515	IsS11Max=No	IsS11Min=No	FrameElem=117	ElemStation=0.25				
Frame=117	Station=0.25	OutputCase=ENVE	CaseType=Combination	StepType=Max	Point=1	X2=-0.5	X3=-0.5	
S11=2561.2987858121	IsS11Max=Yes	IsS11Min=No	FrameElem=117	ElemStation=0.25				
Frame=117	Station=0.25	OutputCase=ENVE	CaseType=Combination	StepType=Max	Point=2	X2=-0.5	X3=0.5	
S11=2561.2987858121	IsS11Max=No	IsS11Min=No	FrameElem=117	ElemStation=0.25				
Frame=117	Station=0.25	OutputCase=ENVE	CaseType=Combination	StepType=Max	Point=3	X2=0.5	X3=-0.5	
S11=-2946.71094030709	IsS11Max=No	IsS11Min=Yes	FrameElem=117	ElemStation=0.25				
Frame=117	Station=0.25	OutputCase=ENVE	CaseType=Combination	StepType=Max	Point=4	X2=0.5	X3=0.5	
S11=-2946.71094030709	IsS11Max=No	IsS11Min=No	FrameElem=117	ElemStation=0.25				
Frame=117	Station=0.375	OutputCase=ENVE	CaseType=Combination	StepType=Max	Point=0	X2=0	X3=0	S11=-
217.882158664515	IsS11Max=No	IsS11Min=No	FrameElem=117	ElemStation=0.375				
Frame=117	Station=0.375	OutputCase=ENVE	CaseType=Combination	StepType=Max	Point=1	X2=-0.5	X3=-0.5	
S11=2375.43940970433	IsS11Max=Yes	IsS11Min=No	FrameElem=117	ElemStation=0.375				
Frame=117	Station=0.375	OutputCase=ENVE	CaseType=Combination	StepType=Max	Point=2	X2=-0.5	X3=0.5	
S11=2375.43940970433	IsS11Max=No	IsS11Min=No	FrameElem=117	ElemStation=0.375				
Frame=117	Station=0.375	OutputCase=ENVE	CaseType=Combination	StepType=Max	Point=3	X2=0.5	X3=-0.5	
S11=-2760.85156381857	IsS11Max=No	IsS11Min=Yes	FrameElem=117	ElemStation=0.375				
Frame=117	Station=0.375	OutputCase=ENVE	CaseType=Combination	StepType=Max	Point=4	X2=0.5	X3=0.5	
S11=-2760.85156381857	IsS11Max=No	IsS11Min=No	FrameElem=117	ElemStation=0.375				
Frame=117	Station=0.5	OutputCase=ENVE	CaseType=Combination	StepType=Max	Point=0	X2=0	X3=0	S11=-
217.882158664515	IsS11Max=No	IsS11Min=No	FrameElem=117	ElemStation=0.5				
Frame=117	Station=0.5	OutputCase=ENVE	CaseType=Combination	StepType=Max	Point=1	X2=-0.5	X3=-0.5	
S11=2160.98628359655	IsS11Max=Yes	IsS11Min=No	FrameElem=117	ElemStation=0.5				
Frame=117	Station=0.5	OutputCase=ENVE	CaseType=Combination	StepType=Max	Point=2	X2=-0.5	X3=0.5	
S11=2160.98628359655	IsS11Max=No	IsS11Min=No	FrameElem=117	ElemStation=0.5				
Frame=117	Station=0.5	OutputCase=ENVE	CaseType=Combination	StepType=Max	Point=3	X2=0.5	X3=-0.5	
S11=-2546.39843733005	IsS11Max=No	IsS11Min=Yes	FrameElem=117	ElemStation=0.5				
Frame=117	Station=0.5	OutputCase=ENVE	CaseType=Combination	StepType=Max	Point=4	X2=0.5	X3=0.5	
S11=-2546.39843733005	IsS11Max=No	IsS11Min=No	FrameElem=117	ElemStation=0.5				
Frame=117	Station=0	OutputCase=ENVE	CaseType=Combination	StepType=Min	Point=0	X2=0	X3=0	S11=-
317.058043529688	IsS11Max=No	IsS11Min=No	FrameElem=117	ElemStation=0				
Frame=117	Station=0	OutputCase=ENVE	CaseType=Combination	StepType=Min	Point=1	X2=-0.5	X3=-0.5	
S11=2598.53235622476	IsS11Max=Yes	IsS11Min=No	FrameElem=117	ElemStation=0				
Frame=117	Station=0	OutputCase=ENVE	CaseType=Combination	StepType=Min	Point=2	X2=-0.5	X3=0.5	
S11=2598.53235622476	IsS11Max=No	IsS11Min=No	FrameElem=117	ElemStation=0				
Frame=117	Station=0	OutputCase=ENVE	CaseType=Combination	StepType=Min	Point=3	X2=0.5	X3=-0.5	
S11=-3283.00060535668	IsS11Max=No	IsS11Min=Yes	FrameElem=117	ElemStation=0				

Frame=117	Station=0	OutputCase=ENVE	CaseType=Combination	StepType=Min	Point=4	X2=0.5	X3=0.5	S11=-
3283.00060535668	Iss11Max=No	Iss11Min=No	FrameElem=117	ElemStation=0				
Frame=117	Station=0.125	OutputCase=ENVE	CaseType=Combination	StepType=Min	Point=0	X2=0	X3=0	S11=-
317.058043529688	Iss11Max=No	Iss11Min=No	FrameElem=117	ElemStation=0.125				
Frame=117	Station=0.125	OutputCase=ENVE	CaseType=Combination	StepType=Min	Point=1	X2=-0.5	X3=-0.5	
S11=2469.86047973624	Iss11Max=Yes	Iss11Min=No	FrameElem=117	ElemStation=0.125				
Frame=117	Station=0.125	OutputCase=ENVE	CaseType=Combination	StepType=Min	Point=2	X2=-0.5	X3=0.5	
S11=2469.86047973624	Iss11Max=No	Iss11Min=No	FrameElem=117	ElemStation=0.125				
Frame=117	Station=0.125	OutputCase=ENVE	CaseType=Combination	StepType=Min	Point=3	X2=0.5	X3=-0.5	
S11=-3154.32872924891	Iss11Max=No	Iss11Min=Yes	FrameElem=117	ElemStation=0.125				
Frame=117	Station=0.125	OutputCase=ENVE	CaseType=Combination	StepType=Min	Point=4	X2=0.5	X3=0.5	
S11=-3154.32872924891	Iss11Max=No	Iss11Min=No	FrameElem=117	ElemStation=0.125				
Frame=117	Station=0.25	OutputCase=ENVE	CaseType=Combination	StepType=Min	Point=0	X2=0	X3=0	S11=-
317.058043529688	Iss11Max=No	Iss11Min=No	FrameElem=117	ElemStation=0.25				
Frame=117	Station=0.25	OutputCase=ENVE	CaseType=Combination	StepType=Min	Point=1	X2=-0.5	X3=-0.5	
S11=2312.59485324771	Iss11Max=Yes	Iss11Min=No	FrameElem=117	ElemStation=0.25				
Frame=117	Station=0.25	OutputCase=ENVE	CaseType=Combination	StepType=Min	Point=2	X2=-0.5	X3=0.5	
S11=2312.59485324771	Iss11Max=No	Iss11Min=No	FrameElem=117	ElemStation=0.25				
Frame=117	Station=0.25	OutputCase=ENVE	CaseType=Combination	StepType=Min	Point=3	X2=0.5	X3=-0.5	
S11=-2997.06310314113	Iss11Max=No	Iss11Min=Yes	FrameElem=117	ElemStation=0.25				
Frame=117	Station=0.25	OutputCase=ENVE	CaseType=Combination	StepType=Min	Point=4	X2=0.5	X3=0.5	
S11=-2997.06310314113	Iss11Max=No	Iss11Min=No	FrameElem=117	ElemStation=0.25				
Frame=117	Station=0.375	OutputCase=ENVE	CaseType=Combination	StepType=Min	Point=0	X2=0	X3=0	S11=-
317.058043529688	Iss11Max=No	Iss11Min=No	FrameElem=117	ElemStation=0.375				
Frame=117	Station=0.375	OutputCase=ENVE	CaseType=Combination	StepType=Min	Point=1	X2=-0.5	X3=-0.5	
S11=2126.73547675919	Iss11Max=Yes	Iss11Min=No	FrameElem=117	ElemStation=0.375				
Frame=117	Station=0.375	OutputCase=ENVE	CaseType=Combination	StepType=Min	Point=2	X2=-0.5	X3=0.5	
S11=2126.73547675919	Iss11Max=No	Iss11Min=No	FrameElem=117	ElemStation=0.375				
Frame=117	Station=0.375	OutputCase=ENVE	CaseType=Combination	StepType=Min	Point=3	X2=0.5	X3=-0.5	
S11=-2811.20372703336	Iss11Max=No	Iss11Min=Yes	FrameElem=117	ElemStation=0.375				
Frame=117	Station=0.375	OutputCase=ENVE	CaseType=Combination	StepType=Min	Point=4	X2=0.5	X3=0.5	
S11=-2811.20372703336	Iss11Max=No	Iss11Min=No	FrameElem=117	ElemStation=0.375				
Frame=117	Station=0.5	OutputCase=ENVE	CaseType=Combination	StepType=Min	Point=0	X2=0	X3=0	S11=-
317.058043529688	Iss11Max=No	Iss11Min=No	FrameElem=117	ElemStation=0.5				
Frame=117	Station=0.5	OutputCase=ENVE	CaseType=Combination	StepType=Min	Point=1	X2=-0.5	X3=-0.5	
S11=1912.28235027067	Iss11Max=Yes	Iss11Min=No	FrameElem=117	ElemStation=0.5				
Frame=117	Station=0.5	OutputCase=ENVE	CaseType=Combination	StepType=Min	Point=2	X2=-0.5	X3=0.5	
S11=1912.28235027067	Iss11Max=No	Iss11Min=No	FrameElem=117	ElemStation=0.5				
Frame=117	Station=0.5	OutputCase=ENVE	CaseType=Combination	StepType=Min	Point=3	X2=0.5	X3=-0.5	
S11=-2596.75060092558	Iss11Max=No	Iss11Min=Yes	FrameElem=117	ElemStation=0.5				
Frame=117	Station=0.5	OutputCase=ENVE	CaseType=Combination	StepType=Min	Point=4	X2=0.5	X3=0.5	
S11=-2596.75060092558	Iss11Max=No	Iss11Min=No	FrameElem=117	ElemStation=0.5				
Frame=117	Station=0	OutputCase=FESSUR	CaseType=Combination	Point=0	X2=0	X3=0	S11=-317.058043529688	
Iss11Max=No	Iss11Min=No	FrameElem=117	ElemStation=0					
Frame=117	Station=0	OutputCase=FESSUR	CaseType=Combination	Point=1	X2=-0.5	X3=-0.5		
S11=2598.53235622476	Iss11Max=Yes	Iss11Min=No	FrameElem=117	ElemStation=0				
Frame=117	Station=0	OutputCase=FESSUR	CaseType=Combination	Point=2	X2=-0.5	X3=0.5		
S11=2598.53235622476	Iss11Max=No	Iss11Min=No	FrameElem=117	ElemStation=0				
Frame=117	Station=0	OutputCase=FESSUR	CaseType=Combination	Point=3	X2=0.5	X3=-0.5	S11=-	
3232.64844328413	Iss11Max=No	Iss11Min=Yes	FrameElem=117	ElemStation=0				
Frame=117	Station=0	OutputCase=FESSUR	CaseType=Combination	Point=4	X2=0.5	X3=0.5	S11=-	
3232.64844328413	Iss11Max=No	Iss11Min=No	FrameElem=117	ElemStation=0				
Frame=117	Station=0.125	OutputCase=FESSUR	CaseType=Combination	Point=0	X2=0	X3=0	S11=-	
317.058043529688	Iss11Max=No	Iss11Min=No	FrameElem=117	ElemStation=0.125				
Frame=117	Station=0.125	OutputCase=FESSUR	CaseType=Combination	Point=1	X2=-0.5	X3=-0.5		
S11=2469.86047973624	Iss11Max=Yes	Iss11Min=No	FrameElem=117	ElemStation=0.125				
Frame=117	Station=0.125	OutputCase=FESSUR	CaseType=Combination	Point=2	X2=-0.5	X3=0.5		
S11=2469.86047973624	Iss11Max=No	Iss11Min=No	FrameElem=117	ElemStation=0.125				
Frame=117	Station=0.125	OutputCase=FESSUR	CaseType=Combination	Point=3	X2=0.5	X3=-0.5	S11=-	
3103.97656679561	Iss11Max=No	Iss11Min=Yes	FrameElem=117	ElemStation=0.125				
Frame=117	Station=0.125	OutputCase=FESSUR	CaseType=Combination	Point=4	X2=0.5	X3=0.5	S11=-	
3103.97656679561	Iss11Max=No	Iss11Min=No	FrameElem=117	ElemStation=0.125				
Frame=117	Station=0.25	OutputCase=FESSUR	CaseType=Combination	Point=0	X2=0	X3=0	S11=-	
317.058043529688	Iss11Max=No	Iss11Min=No	FrameElem=117	ElemStation=0.25				
Frame=117	Station=0.25	OutputCase=FESSUR	CaseType=Combination	Point=1	X2=-0.5	X3=-0.5		
S11=2312.59485324771	Iss11Max=Yes	Iss11Min=No	FrameElem=117	ElemStation=0.25				
Frame=117	Station=0.25	OutputCase=FESSUR	CaseType=Combination	Point=2	X2=-0.5	X3=0.5		
S11=2312.59485324771	Iss11Max=No	Iss11Min=No	FrameElem=117	ElemStation=0.25				
Frame=117	Station=0.25	OutputCase=FESSUR	CaseType=Combination	Point=3	X2=0.5	X3=-0.5	S11=-	
2946.71094030709	Iss11Max=No	Iss11Min=Yes	FrameElem=117	ElemStation=0.25				
Frame=117	Station=0.25	OutputCase=FESSUR	CaseType=Combination	Point=4	X2=0.5	X3=0.5	S11=-	
2946.71094030709	Iss11Max=No	Iss11Min=No	FrameElem=117	ElemStation=0.25				
Frame=117	Station=0.375	OutputCase=FESSUR	CaseType=Combination	Point=0	X2=0	X3=0	S11=-	
317.058043529688	Iss11Max=No	Iss11Min=No	FrameElem=117	ElemStation=0.375				
Frame=117	Station=0.375	OutputCase=FESSUR	CaseType=Combination	Point=1	X2=-0.5	X3=-0.5		
S11=2126.73547675919	Iss11Max=Yes	Iss11Min=No	FrameElem=117	ElemStation=0.375				
Frame=117	Station=0.375	OutputCase=FESSUR	CaseType=Combination	Point=2	X2=-0.5	X3=0.5		
S11=2126.73547675919	Iss11Max=No	Iss11Min=No	FrameElem=117	ElemStation=0.375				
Frame=117	Station=0.375	OutputCase=FESSUR	CaseType=Combination	Point=3	X2=0.5	X3=-0.5	S11=-	
2760.85156381857	Iss11Max=No	Iss11Min=Yes	FrameElem=117	ElemStation=0.375				
Frame=117	Station=0.375	OutputCase=FESSUR	CaseType=Combination	Point=4	X2=0.5	X3=0.5	S11=-	
2760.85156381857	Iss11Max=No	Iss11Min=No	FrameElem=117	ElemStation=0.375				

```

Frame=117 Station=0.5 OutputCase=FESSUR CaseType=Combination Point=0 X2=0 X3=0 S11=-
317.058043529688 IsS11Max=No IsS11Min=No FrameElem=117 ElemStation=0.5
Frame=117 Station=0.5 OutputCase=FESSUR CaseType=Combination Point=1 X2=-0.5 X3=-0.5
S11=1912.28235027067 IsS11Max=Yes IsS11Min=No FrameElem=117 ElemStation=0.5
Frame=117 Station=0.5 OutputCase=FESSUR CaseType=Combination Point=2 X2=-0.5 X3=0.5
S11=1912.28235027067 IsS11Max=No IsS11Min=No FrameElem=117 ElemStation=0.5
Frame=117 Station=0.5 OutputCase=FESSUR CaseType=Combination Point=3 X2=0.5 X3=-0.5 S11=-
2546.39843733005 IsS11Max=No IsS11Min=Yes FrameElem=117 ElemStation=0.5
Frame=117 Station=0.5 OutputCase=FESSUR CaseType=Combination Point=4 X2=0.5 X3=0.5 S11=-
2546.39843733005 IsS11Max=No IsS11Min=No FrameElem=117 ElemStation=0.5
Frame=118 Station=0 OutputCase=PESOPR CaseType=LinStatic Point=0 X2=0 X3=0 S11=15.1709467361834
IsS11Max=No IsS11Min=No FrameElem=118 ElemStation=0
Frame=118 Station=0 OutputCase=PESOPR CaseType=LinStatic Point=1 X2=-0.5 X3=-0.5
S11=282.491476987383 IsS11Max=Yes IsS11Min=No FrameElem=118 ElemStation=0
Frame=118 Station=0 OutputCase=PESOPR CaseType=LinStatic Point=2 X2=-0.5 X3=0.5
S11=282.491476987383 IsS11Max=No IsS11Min=No FrameElem=118 ElemStation=0
Frame=118 Station=0 OutputCase=PESOPR CaseType=LinStatic Point=3 X2=0.5 X3=-0.5 S11=-
252.149583515016 IsS11Max=No IsS11Min=Yes FrameElem=118 ElemStation=0
Frame=118 Station=0 OutputCase=PESOPR CaseType=LinStatic Point=4 X2=0.5 X3=0.5 S11=-
252.149583515016 IsS11Max=No IsS11Min=No FrameElem=118 ElemStation=0
Frame=118 Station=0.125 OutputCase=PESOPR CaseType=LinStatic Point=0 X2=0 X3=0 S11=15.1709467361834
IsS11Max=No IsS11Min=No FrameElem=118 ElemStation=0.125
Frame=118 Station=0.125 OutputCase=PESOPR CaseType=LinStatic Point=1 X2=-0.5 X3=-0.5
S11=262.569601979067 IsS11Max=Yes IsS11Min=No FrameElem=118 ElemStation=0.125
Frame=118 Station=0.125 OutputCase=PESOPR CaseType=LinStatic Point=2 X2=-0.5 X3=0.5
S11=262.569601979067 IsS11Max=No IsS11Min=No FrameElem=118 ElemStation=0.125
Frame=118 Station=0.125 OutputCase=PESOPR CaseType=LinStatic Point=3 X2=0.5 X3=-0.5 S11=-
232.2277085067 IsS11Max=No IsS11Min=Yes FrameElem=118 ElemStation=0.125
Frame=118 Station=0.125 OutputCase=PESOPR CaseType=LinStatic Point=4 X2=0.5 X3=0.5 S11=-
232.2277085067 IsS11Max=No IsS11Min=No FrameElem=118 ElemStation=0.125
Frame=118 Station=0.25 OutputCase=PESOPR CaseType=LinStatic Point=0 X2=0 X3=0 S11=15.1709467361834
IsS11Max=No IsS11Min=No FrameElem=118 ElemStation=0.25
Frame=118 Station=0.25 OutputCase=PESOPR CaseType=LinStatic Point=1 X2=-0.5 X3=-0.5
S11=240.30397697075 IsS11Max=Yes IsS11Min=No FrameElem=118 ElemStation=0.25
Frame=118 Station=0.25 OutputCase=PESOPR CaseType=LinStatic Point=2 X2=-0.5 X3=0.5
S11=240.30397697075 IsS11Max=No IsS11Min=No FrameElem=118 ElemStation=0.25
Frame=118 Station=0.25 OutputCase=PESOPR CaseType=LinStatic Point=3 X2=0.5 X3=-0.5 S11=-
209.962083498383 IsS11Max=No IsS11Min=Yes FrameElem=118 ElemStation=0.25
Frame=118 Station=0.25 OutputCase=PESOPR CaseType=LinStatic Point=4 X2=0.5 X3=0.5 S11=-
209.962083498383 IsS11Max=No IsS11Min=No FrameElem=118 ElemStation=0.25
Frame=118 Station=0.375 OutputCase=PESOPR CaseType=LinStatic Point=0 X2=0 X3=0 S11=15.1709467361834
IsS11Max=No IsS11Min=No FrameElem=118 ElemStation=0.375
Frame=118 Station=0.375 OutputCase=PESOPR CaseType=LinStatic Point=1 X2=-0.5 X3=-0.5
S11=215.694601962434 IsS11Max=Yes IsS11Min=No FrameElem=118 ElemStation=0.375
Frame=118 Station=0.375 OutputCase=PESOPR CaseType=LinStatic Point=2 X2=-0.5 X3=0.5
S11=215.694601962434 IsS11Max=No IsS11Min=No FrameElem=118 ElemStation=0.375
Frame=118 Station=0.375 OutputCase=PESOPR CaseType=LinStatic Point=3 X2=0.5 X3=-0.5 S11=-
185.352708490067 IsS11Max=No IsS11Min=Yes FrameElem=118 ElemStation=0.375
Frame=118 Station=0.375 OutputCase=PESOPR CaseType=LinStatic Point=4 X2=0.5 X3=0.5 S11=-
185.352708490067 IsS11Max=No IsS11Min=No FrameElem=118 ElemStation=0.375
Frame=118 Station=0.5 OutputCase=PESOPR CaseType=LinStatic Point=0 X2=0 X3=0 S11=15.1709467361834
IsS11Max=No IsS11Min=No FrameElem=118 ElemStation=0.5
Frame=118 Station=0.5 OutputCase=PESOPR CaseType=LinStatic Point=1 X2=-0.5 X3=-0.5
S11=188.741476954117 IsS11Max=Yes IsS11Min=No FrameElem=118 ElemStation=0.5
Frame=118 Station=0.5 OutputCase=PESOPR CaseType=LinStatic Point=2 X2=-0.5 X3=0.5
S11=188.741476954117 IsS11Max=No IsS11Min=No FrameElem=118 ElemStation=0.5
Frame=118 Station=0.5 OutputCase=PESOPR CaseType=LinStatic Point=3 X2=0.5 X3=-0.5 S11=-
158.399583481751 IsS11Max=No IsS11Min=Yes FrameElem=118 ElemStation=0.5
Frame=118 Station=0.5 OutputCase=PESOPR CaseType=LinStatic Point=4 X2=0.5 X3=0.5 S11=-
158.399583481751 IsS11Max=No IsS11Min=No FrameElem=118 ElemStation=0.5
Frame=118 Station=0 OutputCase=TERRVERT CaseType=LinStatic Point=0 X2=0 X3=0 S11=-1.64270738196176
IsS11Max=No IsS11Min=No FrameElem=118 ElemStation=0
Frame=118 Station=0 OutputCase=TERRVERT CaseType=LinStatic Point=1 X2=-0.5 X3=-0.5
S11=2458.80398436955 IsS11Max=Yes IsS11Min=No FrameElem=118 ElemStation=0
Frame=118 Station=0 OutputCase=TERRVERT CaseType=LinStatic Point=2 X2=-0.5 X3=0.5
S11=2458.80398436955 IsS11Max=No IsS11Min=No FrameElem=118 ElemStation=0
Frame=118 Station=0 OutputCase=TERRVERT CaseType=LinStatic Point=3 X2=0.5 X3=-0.5 S11=-
2462.08939913347 IsS11Max=No IsS11Min=Yes FrameElem=118 ElemStation=0
Frame=118 Station=0 OutputCase=TERRVERT CaseType=LinStatic Point=4 X2=0.5 X3=0.5 S11=-
2462.08939913347 IsS11Max=No IsS11Min=No FrameElem=118 ElemStation=0
Frame=118 Station=0.125 OutputCase=TERRVERT CaseType=LinStatic Point=0 X2=0 X3=0 S11=-
1.64270738196176 IsS11Max=No IsS11Min=No FrameElem=118 ElemStation=0.125
Frame=118 Station=0.125 OutputCase=TERRVERT CaseType=LinStatic Point=1 X2=-0.5 X3=-0.5
S11=2235.67898415852 IsS11Max=Yes IsS11Min=No FrameElem=118 ElemStation=0.125
Frame=118 Station=0.125 OutputCase=TERRVERT CaseType=LinStatic Point=2 X2=-0.5 X3=0.5
S11=2235.67898415852 IsS11Max=No IsS11Min=No FrameElem=118 ElemStation=0.125
Frame=118 Station=0.125 OutputCase=TERRVERT CaseType=LinStatic Point=3 X2=0.5 X3=-0.5 S11=-
2238.96439892244 IsS11Max=No IsS11Min=Yes FrameElem=118 ElemStation=0.125
Frame=118 Station=0.125 OutputCase=TERRVERT CaseType=LinStatic Point=4 X2=0.5 X3=0.5 S11=-
2238.96439892244 IsS11Max=No IsS11Min=No FrameElem=118 ElemStation=0.125
Frame=118 Station=0.25 OutputCase=TERRVERT CaseType=LinStatic Point=0 X2=0 X3=0 S11=-
1.64270738196176 IsS11Max=No IsS11Min=No FrameElem=118 ElemStation=0.25

```



Frame=118	Station=0.25	OutputCase=TERRVERT	CaseType=LinStatic	Point=1	X2=-0.5	X3=-0.5		
S11=1986.30398394748	IsS11Max=Yes	IsS11Min=No	FrameElem=118	ElemStation=0.25				
Frame=118	Station=0.25	OutputCase=TERRVERT	CaseType=LinStatic	Point=2	X2=-0.5	X3=0.5		
S11=1986.30398394748	IsS11Max=No	IsS11Min=No	FrameElem=118	ElemStation=0.25				
Frame=118	Station=0.25	OutputCase=TERRVERT	CaseType=LinStatic	Point=3	X2=0.5	X3=-0.5	S11=-	
1989.58939871141	IsS11Max=No	IsS11Min=Yes	FrameElem=118	ElemStation=0.25				
Frame=118	Station=0.25	OutputCase=TERRVERT	CaseType=LinStatic	Point=4	X2=0.5	X3=0.5	S11=-	
1989.58939871141	IsS11Max=No	IsS11Min=No	FrameElem=118	ElemStation=0.25				
Frame=118	Station=0.375	OutputCase=TERRVERT	CaseType=LinStatic	Point=0	X2=0	X3=0	S11=-	
1.64270738196176	IsS11Max=No	IsS11Min=No	FrameElem=118	ElemStation=0.375				
Frame=118	Station=0.375	OutputCase=TERRVERT	CaseType=LinStatic	Point=1	X2=-0.5	X3=-0.5		
S11=1710.67898373645	IsS11Max=Yes	IsS11Min=No	FrameElem=118	ElemStation=0.375				
Frame=118	Station=0.375	OutputCase=TERRVERT	CaseType=LinStatic	Point=2	X2=-0.5	X3=0.5		
S11=1710.67898373645	IsS11Max=No	IsS11Min=No	FrameElem=118	ElemStation=0.375				
Frame=118	Station=0.375	OutputCase=TERRVERT	CaseType=LinStatic	Point=3	X2=0.5	X3=-0.5	S11=-	
1713.96439850038	IsS11Max=No	IsS11Min=Yes	FrameElem=118	ElemStation=0.375				
Frame=118	Station=0.375	OutputCase=TERRVERT	CaseType=LinStatic	Point=4	X2=0.5	X3=0.5	S11=-	
1713.96439850038	IsS11Max=No	IsS11Min=No	FrameElem=118	ElemStation=0.375				
Frame=118	Station=0.5	OutputCase=TERRVERT	CaseType=LinStatic	Point=0	X2=0	X3=0	S11=-	
1.64270738196176	IsS11Max=No	IsS11Min=No	FrameElem=118	ElemStation=0.5				
Frame=118	Station=0.5	OutputCase=TERRVERT	CaseType=LinStatic	Point=1	X2=-0.5	X3=-0.5		
S11=1408.80398352542	IsS11Max=Yes	IsS11Min=No	FrameElem=118	ElemStation=0.5				
Frame=118	Station=0.5	OutputCase=TERRVERT	CaseType=LinStatic	Point=2	X2=-0.5	X3=0.5		
S11=1408.80398352542	IsS11Max=No	IsS11Min=No	FrameElem=118	ElemStation=0.5				
Frame=118	Station=0.5	OutputCase=TERRVERT	CaseType=LinStatic	Point=3	X2=0.5	X3=-0.5	S11=-	
1412.08939828934	IsS11Max=No	IsS11Min=Yes	FrameElem=118	ElemStation=0.5				
Frame=118	Station=0.5	OutputCase=TERRVERT	CaseType=LinStatic	Point=4	X2=0.5	X3=0.5	S11=-	
1412.08939828934	IsS11Max=No	IsS11Min=No	FrameElem=118	ElemStation=0.5				
Frame=118	Station=0	OutputCase=TERRLAT	CaseType=LinStatic	Point=0	X2=0	X3=0	S11=-330.586282883909	
IsS11Max=No	IsS11Min=No	FrameElem=118	ElemStation=0					
Frame=118	Station=0	OutputCase=TERRLAT	CaseType=LinStatic	Point=1	X2=-0.5	X3=-0.5	S11=-	
829.013111086258	IsS11Max=No	IsS11Min=Yes	FrameElem=118	ElemStation=0				
Frame=118	Station=0	OutputCase=TERRLAT	CaseType=LinStatic	Point=2	X2=-0.5	X3=0.5	S11=-	
829.013111086258	IsS11Max=No	IsS11Min=No	FrameElem=118	ElemStation=0				
Frame=118	Station=0	OutputCase=TERRLAT	CaseType=LinStatic	Point=3	X2=0.5	X3=-0.5	S11=-	
S11=167.84054531844	IsS11Max=Yes	IsS11Min=No	FrameElem=118	ElemStation=0				
Frame=118	Station=0	OutputCase=TERRLAT	CaseType=LinStatic	Point=4	X2=0.5	X3=0.5	S11=167.84054531844	
IsS11Max=No	IsS11Min=No	FrameElem=118	ElemStation=0					
Frame=118	Station=0.125	OutputCase=TERRLAT	CaseType=LinStatic	Point=0	X2=0	X3=0	S11=-	
330.586282883909	IsS11Max=No	IsS11Min=No	FrameElem=118	ElemStation=0.125				
Frame=118	Station=0.125	OutputCase=TERRLAT	CaseType=LinStatic	Point=1	X2=-0.5	X3=-0.5	S11=-	
829.013112355407	IsS11Max=No	IsS11Min=Yes	FrameElem=118	ElemStation=0.125				
Frame=118	Station=0.125	OutputCase=TERRLAT	CaseType=LinStatic	Point=2	X2=-0.5	X3=0.5	S11=-	
829.013112355407	IsS11Max=No	IsS11Min=No	FrameElem=118	ElemStation=0.125				
Frame=118	Station=0.125	OutputCase=TERRLAT	CaseType=LinStatic	Point=3	X2=0.5	X3=-0.5	S11=-	
S11=167.840546587589	IsS11Max=Yes	IsS11Min=No	FrameElem=118	ElemStation=0.125				
Frame=118	Station=0.125	OutputCase=TERRLAT	CaseType=LinStatic	Point=4	X2=0.5	X3=0.5	S11=-	
S11=167.840546587589	IsS11Max=No	IsS11Min=No	FrameElem=118	ElemStation=0.125				
Frame=118	Station=0.25	OutputCase=TERRLAT	CaseType=LinStatic	Point=0	X2=0	X3=0	S11=-	
330.586282883909	IsS11Max=No	IsS11Min=No	FrameElem=118	ElemStation=0.25				
Frame=118	Station=0.25	OutputCase=TERRLAT	CaseType=LinStatic	Point=1	X2=-0.5	X3=-0.5	S11=-	
829.013113624557	IsS11Max=No	IsS11Min=Yes	FrameElem=118	ElemStation=0.25				
Frame=118	Station=0.25	OutputCase=TERRLAT	CaseType=LinStatic	Point=2	X2=-0.5	X3=0.5	S11=-	
829.013113624557	IsS11Max=No	IsS11Min=No	FrameElem=118	ElemStation=0.25				
Frame=118	Station=0.25	OutputCase=TERRLAT	CaseType=LinStatic	Point=3	X2=0.5	X3=-0.5	S11=-	
S11=167.840547856739	IsS11Max=Yes	IsS11Min=No	FrameElem=118	ElemStation=0.25				
Frame=118	Station=0.25	OutputCase=TERRLAT	CaseType=LinStatic	Point=4	X2=0.5	X3=0.5	S11=-	
S11=167.840547856739	IsS11Max=No	IsS11Min=No	FrameElem=118	ElemStation=0.25				
Frame=118	Station=0.375	OutputCase=TERRLAT	CaseType=LinStatic	Point=0	X2=0	X3=0	S11=-	
330.586282883909	IsS11Max=No	IsS11Min=No	FrameElem=118	ElemStation=0.375				
Frame=118	Station=0.375	OutputCase=TERRLAT	CaseType=LinStatic	Point=1	X2=-0.5	X3=-0.5	S11=-	
829.013114893706	IsS11Max=No	IsS11Min=Yes	FrameElem=118	ElemStation=0.375				
Frame=118	Station=0.375	OutputCase=TERRLAT	CaseType=LinStatic	Point=2	X2=-0.5	X3=0.5	S11=-	
829.013114893706	IsS11Max=No	IsS11Min=No	FrameElem=118	ElemStation=0.375				
Frame=118	Station=0.375	OutputCase=TERRLAT	CaseType=LinStatic	Point=3	X2=0.5	X3=-0.5	S11=-	
S11=167.840549125888	IsS11Max=Yes	IsS11Min=No	FrameElem=118	ElemStation=0.375				
Frame=118	Station=0.375	OutputCase=TERRLAT	CaseType=LinStatic	Point=4	X2=0.5	X3=0.5	S11=-	
S11=167.840549125888	IsS11Max=No	IsS11Min=No	FrameElem=118	ElemStation=0.375				
Frame=118	Station=0.5	OutputCase=TERRLAT	CaseType=LinStatic	Point=0	X2=0	X3=0	S11=-330.586282883909	
IsS11Max=No	IsS11Min=No	FrameElem=118	ElemStation=0.5					
Frame=118	Station=0.5	OutputCase=TERRLAT	CaseType=LinStatic	Point=1	X2=-0.5	X3=-0.5	S11=-	
829.013116162856	IsS11Max=No	IsS11Min=Yes	FrameElem=118	ElemStation=0.5				
Frame=118	Station=0.5	OutputCase=TERRLAT	CaseType=LinStatic	Point=2	X2=-0.5	X3=0.5	S11=-	
829.013116162856	IsS11Max=No	IsS11Min=No	FrameElem=118	ElemStation=0.5				
Frame=118	Station=0.5	OutputCase=TERRLAT	CaseType=LinStatic	Point=3	X2=0.5	X3=-0.5	S11=-	
S11=167.840550395038	IsS11Max=Yes	IsS11Min=No	FrameElem=118	ElemStation=0.5				
Frame=118	Station=0.5	OutputCase=TERRLAT	CaseType=LinStatic	Point=4	X2=0.5	X3=0.5	S11=-	
S11=167.840550395038	IsS11Max=No	IsS11Min=No	FrameElem=118	ElemStation=0.5				
Frame=118	Station=0	OutputCase=ACCVERT	CaseType=LinStatic	Point=0	X2=0	X3=0	S11=0	IsS11Max=Yes
IsS11Min=Yes	FrameElem=118	ElemStation=0						
Frame=118	Station=0	OutputCase=ACCVERT	CaseType=LinStatic	Point=1	X2=-0.5	X3=-0.5	S11=0	
IsS11Max=No	IsS11Min=No	FrameElem=118	ElemStation=0					

Frame=118	Station=0	OutputCase=ENVE	CaseType=Combination	StepType=Max	Point=0	X2=0	X3=0	S11=-
217.882158664515		IsS11Max=No	IsS11Min=No	FrameElem=118	ElemStation=0			
Frame=118	Station=0	OutputCase=ENVE	CaseType=Combination	StepType=Max	Point=1	X2=-0.5	X3=-0.5	
S11=2160.98628359655		IsS11Max=Yes	IsS11Min=No	FrameElem=118	ElemStation=0			
Frame=118	Station=0	OutputCase=ENVE	CaseType=Combination	StepType=Max	Point=2	X2=-0.5	X3=0.5	
S11=2160.98628359655		IsS11Max=No	IsS11Min=No	FrameElem=118	ElemStation=0			
Frame=118	Station=0	OutputCase=ENVE	CaseType=Combination	StepType=Max	Point=3	X2=0.5	X3=-0.5	
S11=-2546.39843733005		IsS11Max=No	IsS11Min=Yes	FrameElem=118	ElemStation=0			
Frame=118	Station=0	OutputCase=ENVE	CaseType=Combination	StepType=Max	Point=4	X2=0.5	X3=0.5	S11=-
2546.39843733005		IsS11Max=No	IsS11Min=No	FrameElem=118	ElemStation=0			
Frame=118	Station=0.125	OutputCase=ENVE	CaseType=Combination	StepType=Max	Point=0	X2=0	X3=0	S11=-
217.882158664515		IsS11Max=No	IsS11Min=No	FrameElem=118	ElemStation=0.125			
Frame=118	Station=0.125	OutputCase=ENVE	CaseType=Combination	StepType=Max	Point=1	X2=-0.5	X3=-0.5	
S11=1917.9394074888		IsS11Max=Yes	IsS11Min=No	FrameElem=118	ElemStation=0.125			
Frame=118	Station=0.125	OutputCase=ENVE	CaseType=Combination	StepType=Max	Point=2	X2=-0.5	X3=0.5	
S11=1917.9394074888		IsS11Max=No	IsS11Min=No	FrameElem=118	ElemStation=0.125			
Frame=118	Station=0.125	OutputCase=ENVE	CaseType=Combination	StepType=Max	Point=3	X2=0.5	X3=-0.5	
S11=-2303.35156084155		IsS11Max=No	IsS11Min=Yes	FrameElem=118	ElemStation=0.125			
Frame=118	Station=0.125	OutputCase=ENVE	CaseType=Combination	StepType=Max	Point=4	X2=0.5	X3=0.5	
S11=-2303.35156084155		IsS11Max=No	IsS11Min=No	FrameElem=118	ElemStation=0.125			
Frame=118	Station=0.25	OutputCase=ENVE	CaseType=Combination	StepType=Max	Point=0	X2=0	X3=0	S11=-
217.882158664515		IsS11Max=No	IsS11Min=No	FrameElem=118	ElemStation=0.25			
Frame=118	Station=0.25	OutputCase=ENVE	CaseType=Combination	StepType=Max	Point=1	X2=-0.5	X3=-0.5	
S11=1646.29878138104		IsS11Max=Yes	IsS11Min=No	FrameElem=118	ElemStation=0.25			
Frame=118	Station=0.25	OutputCase=ENVE	CaseType=Combination	StepType=Max	Point=2	X2=-0.5	X3=0.5	
S11=1646.29878138104		IsS11Max=No	IsS11Min=No	FrameElem=118	ElemStation=0.25			
Frame=118	Station=0.25	OutputCase=ENVE	CaseType=Combination	StepType=Max	Point=3	X2=0.5	X3=-0.5	
S11=-2031.71093435305		IsS11Max=No	IsS11Min=Yes	FrameElem=118	ElemStation=0.25			
Frame=118	Station=0.25	OutputCase=ENVE	CaseType=Combination	StepType=Max	Point=4	X2=0.5	X3=0.5	
S11=-2031.71093435305		IsS11Max=No	IsS11Min=No	FrameElem=118	ElemStation=0.25			
Frame=118	Station=0.375	OutputCase=ENVE	CaseType=Combination	StepType=Max	Point=0	X2=0	X3=0	S11=-
217.882158664515		IsS11Max=No	IsS11Min=No	FrameElem=118	ElemStation=0.375			
Frame=118	Station=0.375	OutputCase=ENVE	CaseType=Combination	StepType=Max	Point=1	X2=-0.5	X3=-0.5	
S11=1346.06440527329		IsS11Max=Yes	IsS11Min=No	FrameElem=118	ElemStation=0.375			
Frame=118	Station=0.375	OutputCase=ENVE	CaseType=Combination	StepType=Max	Point=2	X2=-0.5	X3=0.5	
S11=1346.06440527329		IsS11Max=No	IsS11Min=No	FrameElem=118	ElemStation=0.375			
Frame=118	Station=0.375	OutputCase=ENVE	CaseType=Combination	StepType=Max	Point=3	X2=0.5	X3=-0.5	
S11=-1731.47655786455		IsS11Max=No	IsS11Min=Yes	FrameElem=118	ElemStation=0.375			
Frame=118	Station=0.375	OutputCase=ENVE	CaseType=Combination	StepType=Max	Point=4	X2=0.5	X3=0.5	
S11=-1731.47655786455		IsS11Max=No	IsS11Min=No	FrameElem=118	ElemStation=0.375			
Frame=118	Station=0.5	OutputCase=ENVE	CaseType=Combination	StepType=Max	Point=0	X2=0	X3=0	S11=-
217.882158664515		IsS11Max=No	IsS11Min=No	FrameElem=118	ElemStation=0.5			
Frame=118	Station=0.5	OutputCase=ENVE	CaseType=Combination	StepType=Max	Point=1	X2=-0.5	X3=-0.5	
S11=1017.23627916554		IsS11Max=Yes	IsS11Min=No	FrameElem=118	ElemStation=0.5			
Frame=118	Station=0.5	OutputCase=ENVE	CaseType=Combination	StepType=Max	Point=2	X2=-0.5	X3=0.5	
S11=1017.23627916554		IsS11Max=No	IsS11Min=No	FrameElem=118	ElemStation=0.5			
Frame=118	Station=0.5	OutputCase=ENVE	CaseType=Combination	StepType=Max	Point=3	X2=0.5	X3=-0.5	
S11=-1402.64843137606		IsS11Max=No	IsS11Min=Yes	FrameElem=118	ElemStation=0.5			
Frame=118	Station=0.5	OutputCase=ENVE	CaseType=Combination	StepType=Max	Point=4	X2=0.5	X3=0.5	
S11=-1402.64843137606		IsS11Max=No	IsS11Min=No	FrameElem=118	ElemStation=0.5			
Frame=118	Station=0	OutputCase=ENVE	CaseType=Combination	StepType=Min	Point=0	X2=0	X3=0	S11=-
317.058043529687		IsS11Max=No	IsS11Min=No	FrameElem=118	ElemStation=0			
Frame=118	Station=0	OutputCase=ENVE	CaseType=Combination	StepType=Min	Point=1	X2=-0.5	X3=-0.5	
S11=1912.28235027067		IsS11Max=Yes	IsS11Min=No	FrameElem=118	ElemStation=0			
Frame=118	Station=0	OutputCase=ENVE	CaseType=Combination	StepType=Min	Point=2	X2=-0.5	X3=0.5	
S11=1912.28235027067		IsS11Max=No	IsS11Min=No	FrameElem=118	ElemStation=0			
Frame=118	Station=0	OutputCase=ENVE	CaseType=Combination	StepType=Min	Point=3	X2=0.5	X3=-0.5	
S11=-2596.75060092558		IsS11Max=No	IsS11Min=Yes	FrameElem=118	ElemStation=0			
Frame=118	Station=0	OutputCase=ENVE	CaseType=Combination	StepType=Min	Point=4	X2=0.5	X3=0.5	S11=-
2596.75060092558		IsS11Max=No	IsS11Min=No	FrameElem=118	ElemStation=0			
Frame=118	Station=0.125	OutputCase=ENVE	CaseType=Combination	StepType=Min	Point=0	X2=0	X3=0	S11=-
317.058043529687		IsS11Max=No	IsS11Min=No	FrameElem=118	ElemStation=0.125			
Frame=118	Station=0.125	OutputCase=ENVE	CaseType=Combination	StepType=Min	Point=1	X2=-0.5	X3=-0.5	
S11=1669.23547378217		IsS11Max=Yes	IsS11Min=No	FrameElem=118	ElemStation=0.125			
Frame=118	Station=0.125	OutputCase=ENVE	CaseType=Combination	StepType=Min	Point=2	X2=-0.5	X3=0.5	
S11=1669.23547378217		IsS11Max=No	IsS11Min=No	FrameElem=118	ElemStation=0.125			
Frame=118	Station=0.125	OutputCase=ENVE	CaseType=Combination	StepType=Min	Point=3	X2=0.5	X3=-0.5	
S11=-2353.70372481783		IsS11Max=No	IsS11Min=Yes	FrameElem=118	ElemStation=0.125			
Frame=118	Station=0.125	OutputCase=ENVE	CaseType=Combination	StepType=Min	Point=4	X2=0.5	X3=0.5	
S11=-2353.70372481783		IsS11Max=No	IsS11Min=No	FrameElem=118	ElemStation=0.125			
Frame=118	Station=0.25	OutputCase=ENVE	CaseType=Combination	StepType=Min	Point=0	X2=0	X3=0	S11=-
317.058043529687		IsS11Max=No	IsS11Min=No	FrameElem=118	ElemStation=0.25			
Frame=118	Station=0.25	OutputCase=ENVE	CaseType=Combination	StepType=Min	Point=1	X2=-0.5	X3=-0.5	
S11=1397.59484729368		IsS11Max=Yes	IsS11Min=No	FrameElem=118	ElemStation=0.25			
Frame=118	Station=0.25	OutputCase=ENVE	CaseType=Combination	StepType=Min	Point=2	X2=-0.5	X3=0.5	
S11=1397.59484729368		IsS11Max=No	IsS11Min=No	FrameElem=118	ElemStation=0.25			
Frame=118	Station=0.25	OutputCase=ENVE	CaseType=Combination	StepType=Min	Point=3	X2=0.5	X3=-0.5	
S11=-2082.06309871007		IsS11Max=No	IsS11Min=Yes	FrameElem=118	ElemStation=0.25			
Frame=118	Station=0.25	OutputCase=ENVE	CaseType=Combination	StepType=Min	Point=4	X2=0.5	X3=0.5	
S11=-2082.06309871007		IsS11Max=No	IsS11Min=No	FrameElem=118	ElemStation=0.25			
Frame=118	Station=0.375	OutputCase=ENVE	CaseType=Combination	StepType=Min	Point=0	X2=0	X3=0	S11=-
317.058043529687		IsS11Max=No	IsS11Min=No	FrameElem=118	ElemStation=0.375			

Frame=118	Station=0.375	OutputCase=ENVE	CaseType=Combination	StepType=Min	Point=1	X2=-0.5	X3=-0.5	
S11=1097.36047080518	IsS11Max=Yes	IsS11Min=No	FrameElem=118	ElemStation=0.375				
Frame=118	Station=0.375	OutputCase=ENVE	CaseType=Combination	StepType=Min	Point=2	X2=-0.5	X3=0.5	
S11=1097.36047080518	IsS11Max=No	IsS11Min=No	FrameElem=118	ElemStation=0.375				
Frame=118	Station=0.375	OutputCase=ENVE	CaseType=Combination	StepType=Min	Point=3	X2=0.5	X3=-0.5	
S11=-1781.82872260232	IsS11Max=No	IsS11Min=Yes	FrameElem=118	ElemStation=0.375				
Frame=118	Station=0.375	OutputCase=ENVE	CaseType=Combination	StepType=Min	Point=4	X2=0.5	X3=0.5	
S11=-1781.82872260232	IsS11Max=No	IsS11Min=No	FrameElem=118	ElemStation=0.375				
Frame=118	Station=0.5	OutputCase=ENVE	CaseType=Combination	StepType=Min	Point=0	X2=0	X3=0	S11=-
S11=317.058043529687	IsS11Max=No	IsS11Min=No	FrameElem=118	ElemStation=0.5				
Frame=118	Station=0.5	OutputCase=ENVE	CaseType=Combination	StepType=Min	Point=1	X2=-0.5	X3=-0.5	
S11=768.532344316681	IsS11Max=Yes	IsS11Min=No	FrameElem=118	ElemStation=0.5				
Frame=118	Station=0.5	OutputCase=ENVE	CaseType=Combination	StepType=Min	Point=2	X2=-0.5	X3=0.5	
S11=768.532344316681	IsS11Max=No	IsS11Min=No	FrameElem=118	ElemStation=0.5				
Frame=118	Station=0.5	OutputCase=ENVE	CaseType=Combination	StepType=Min	Point=3	X2=0.5	X3=-0.5	
S11=-1453.00059649457	IsS11Max=No	IsS11Min=Yes	FrameElem=118	ElemStation=0.5				
Frame=118	Station=0.5	OutputCase=ENVE	CaseType=Combination	StepType=Min	Point=4	X2=0.5	X3=0.5	
S11=-1453.00059649457	IsS11Max=No	IsS11Min=No	FrameElem=118	ElemStation=0.5				
Frame=118	Station=0	OutputCase=FESSUR	CaseType=Combination	Point=0	X2=0	X3=0	S11=-317.058043529687	
IsS11Max=No	IsS11Min=No	FrameElem=118	ElemStation=0					
Frame=118	Station=0	OutputCase=FESSUR	CaseType=Combination	Point=1	X2=-0.5	X3=-0.5		
S11=1912.28235027067	IsS11Max=Yes	IsS11Min=No	FrameElem=118	ElemStation=0				
Frame=118	Station=0	OutputCase=FESSUR	CaseType=Combination	Point=2	X2=-0.5	X3=0.5		
S11=1912.28235027067	IsS11Max=No	IsS11Min=No	FrameElem=118	ElemStation=0				
Frame=118	Station=0	OutputCase=FESSUR	CaseType=Combination	Point=3	X2=0.5	X3=-0.5	S11=-	
S11=2546.39843733005	IsS11Max=No	IsS11Min=Yes	FrameElem=118	ElemStation=0				
Frame=118	Station=0	OutputCase=FESSUR	CaseType=Combination	Point=4	X2=0.5	X3=0.5	S11=-	
S11=2546.39843733005	IsS11Max=No	IsS11Min=No	FrameElem=118	ElemStation=0				
Frame=118	Station=0.125	OutputCase=FESSUR	CaseType=Combination	Point=0	X2=0	X3=0	S11=-	
S11=317.058043529687	IsS11Max=No	IsS11Min=No	FrameElem=118	ElemStation=0.125				
Frame=118	Station=0.125	OutputCase=FESSUR	CaseType=Combination	Point=1	X2=-0.5	X3=-0.5		
S11=1669.23547378217	IsS11Max=Yes	IsS11Min=No	FrameElem=118	ElemStation=0.125				
Frame=118	Station=0.125	OutputCase=FESSUR	CaseType=Combination	Point=2	X2=-0.5	X3=0.5		
S11=1669.23547378217	IsS11Max=No	IsS11Min=No	FrameElem=118	ElemStation=0.125				
Frame=118	Station=0.125	OutputCase=FESSUR	CaseType=Combination	Point=3	X2=0.5	X3=-0.5	S11=-	
S11=2303.35156084155	IsS11Max=No	IsS11Min=Yes	FrameElem=118	ElemStation=0.125				
Frame=118	Station=0.125	OutputCase=FESSUR	CaseType=Combination	Point=4	X2=0.5	X3=0.5	S11=-	
S11=2303.35156084155	IsS11Max=No	IsS11Min=No	FrameElem=118	ElemStation=0.125				
Frame=118	Station=0.25	OutputCase=FESSUR	CaseType=Combination	Point=0	X2=0	X3=0	S11=-	
S11=317.058043529687	IsS11Max=No	IsS11Min=No	FrameElem=118	ElemStation=0.25				
Frame=118	Station=0.25	OutputCase=FESSUR	CaseType=Combination	Point=1	X2=-0.5	X3=-0.5		
S11=1397.59484729368	IsS11Max=Yes	IsS11Min=No	FrameElem=118	ElemStation=0.25				
Frame=118	Station=0.25	OutputCase=FESSUR	CaseType=Combination	Point=2	X2=-0.5	X3=0.5		
S11=1397.59484729368	IsS11Max=No	IsS11Min=No	FrameElem=118	ElemStation=0.25				
Frame=118	Station=0.25	OutputCase=FESSUR	CaseType=Combination	Point=3	X2=0.5	X3=-0.5	S11=-	
S11=2031.71093435305	IsS11Max=No	IsS11Min=Yes	FrameElem=118	ElemStation=0.25				
Frame=118	Station=0.25	OutputCase=FESSUR	CaseType=Combination	Point=4	X2=0.5	X3=0.5	S11=-	
S11=2031.71093435305	IsS11Max=No	IsS11Min=No	FrameElem=118	ElemStation=0.25				
Frame=118	Station=0.375	OutputCase=FESSUR	CaseType=Combination	Point=0	X2=0	X3=0	S11=-	
S11=317.058043529687	IsS11Max=No	IsS11Min=No	FrameElem=118	ElemStation=0.375				
Frame=118	Station=0.375	OutputCase=FESSUR	CaseType=Combination	Point=1	X2=-0.5	X3=-0.5		
S11=1097.36047080518	IsS11Max=Yes	IsS11Min=No	FrameElem=118	ElemStation=0.375				
Frame=118	Station=0.375	OutputCase=FESSUR	CaseType=Combination	Point=2	X2=-0.5	X3=0.5		
S11=1097.36047080518	IsS11Max=No	IsS11Min=No	FrameElem=118	ElemStation=0.375				
Frame=118	Station=0.375	OutputCase=FESSUR	CaseType=Combination	Point=3	X2=0.5	X3=-0.5	S11=-	
S11=1731.47655786455	IsS11Max=No	IsS11Min=Yes	FrameElem=118	ElemStation=0.375				
Frame=118	Station=0.5	OutputCase=FESSUR	CaseType=Combination	Point=4	X2=0.5	X3=0.5	S11=-	
S11=1731.47655786455	IsS11Max=No	IsS11Min=No	FrameElem=118	ElemStation=0.375				
Frame=118	Station=0.5	OutputCase=FESSUR	CaseType=Combination	Point=0	X2=0	X3=0	S11=-	
S11=317.058043529687	IsS11Max=No	IsS11Min=No	FrameElem=118	ElemStation=0.5				
Frame=118	Station=0.5	OutputCase=FESSUR	CaseType=Combination	Point=1	X2=-0.5	X3=-0.5		
S11=768.532344316681	IsS11Max=Yes	IsS11Min=No	FrameElem=118	ElemStation=0.5				
Frame=118	Station=0.5	OutputCase=FESSUR	CaseType=Combination	Point=2	X2=-0.5	X3=0.5		
S11=768.532344316681	IsS11Max=No	IsS11Min=No	FrameElem=118	ElemStation=0.5				
Frame=118	Station=0.5	OutputCase=FESSUR	CaseType=Combination	Point=3	X2=0.5	X3=-0.5	S11=-	
S11=1402.64843137606	IsS11Max=No	IsS11Min=Yes	FrameElem=118	ElemStation=0.5				
Frame=118	Station=0.5	OutputCase=FESSUR	CaseType=Combination	Point=4	X2=0.5	X3=0.5	S11=-	
S11=1402.64843137606	IsS11Max=No	IsS11Min=No	FrameElem=118	ElemStation=0.5				
Frame=119	Station=0	OutputCase=PESOPR	CaseType=LinStatic	Point=0	X2=0	X3=0	S11=15.1709467361835	
IsS11Max=No	IsS11Min=No	FrameElem=119	ElemStation=0					
Frame=119	Station=0	OutputCase=PESOPR	CaseType=LinStatic	Point=1	X2=-0.5	X3=-0.5		
S11=188.741476954096	IsS11Max=Yes	IsS11Min=No	FrameElem=119	ElemStation=0				
Frame=119	Station=0	OutputCase=PESOPR	CaseType=LinStatic	Point=2	X2=-0.5	X3=0.5		
S11=188.741476954096	IsS11Max=No	IsS11Min=No	FrameElem=119	ElemStation=0				
Frame=119	Station=0	OutputCase=PESOPR	CaseType=LinStatic	Point=3	X2=0.5	X3=-0.5	S11=-	
S11=158.399583481729	IsS11Max=No	IsS11Min=Yes	FrameElem=119	ElemStation=0				
Frame=119	Station=0	OutputCase=PESOPR	CaseType=LinStatic	Point=4	X2=0.5	X3=0.5	S11=-	
S11=158.399583481729	IsS11Max=No	IsS11Min=No	FrameElem=119	ElemStation=0				
Frame=119	Station=0.125	OutputCase=PESOPR	CaseType=LinStatic	Point=0	X2=0	X3=0	S11=15.1709467361835	
IsS11Max=No	IsS11Min=No	FrameElem=119	ElemStation=0.125					
Frame=119	Station=0.125	OutputCase=PESOPR	CaseType=LinStatic	Point=1	X2=-0.5	X3=-0.5		
S11=159.444601945812	IsS11Max=Yes	IsS11Min=No	FrameElem=119	ElemStation=0.125				



Frame=119 Station=0.125 OutputCase=PESOPR CaseType=LinStatic Point=2 X2=-0.5 X3=0.5
 S11=159.444601945812 IsS11Max=No IsS11Min=No FrameElem=119 ElemStation=0.125
 Frame=119 Station=0.125 OutputCase=PESOPR CaseType=LinStatic Point=3 X2=0.5 X3=-0.5 S11=-
 129.102708473445 IsS11Max=No IsS11Min=Yes FrameElem=119 ElemStation=0.125
 Frame=119 Station=0.125 OutputCase=PESOPR CaseType=LinStatic Point=4 X2=0.5 X3=0.5 S11=-
 129.102708473445 IsS11Max=No IsS11Min=No FrameElem=119 ElemStation=0.125
 Frame=119 Station=0.25 OutputCase=PESOPR CaseType=LinStatic Point=0 X2=0 X3=0 S11=15.1709467361835
 IsS11Max=No IsS11Min=No FrameElem=119 ElemStation=0.25
 Frame=119 Station=0.25 OutputCase=PESOPR CaseType=LinStatic Point=1 X2=-0.5 X3=-0.5
 S11=127.803976937528 IsS11Max=Yes IsS11Min=No FrameElem=119 ElemStation=0.25
 Frame=119 Station=0.25 OutputCase=PESOPR CaseType=LinStatic Point=2 X2=-0.5 X3=0.5
 S11=127.803976937528 IsS11Max=No IsS11Min=No FrameElem=119 ElemStation=0.25
 Frame=119 Station=0.25 OutputCase=PESOPR CaseType=LinStatic Point=3 X2=0.5 X3=-0.5 S11=-
 97.4620834651614 IsS11Max=No IsS11Min=Yes FrameElem=119 ElemStation=0.25
 Frame=119 Station=0.25 OutputCase=PESOPR CaseType=LinStatic Point=4 X2=0.5 X3=0.5 S11=-
 97.4620834651614 IsS11Max=No IsS11Min=No FrameElem=119 ElemStation=0.25
 Frame=119 Station=0.375 OutputCase=PESOPR CaseType=LinStatic Point=0 X2=0 X3=0 S11=15.1709467361835
 IsS11Max=No IsS11Min=No FrameElem=119 ElemStation=0.375
 Frame=119 Station=0.375 OutputCase=PESOPR CaseType=LinStatic Point=1 X2=-0.5 X3=-0.5
 S11=93.8196019292446 IsS11Max=Yes IsS11Min=No FrameElem=119 ElemStation=0.375
 Frame=119 Station=0.375 OutputCase=PESOPR CaseType=LinStatic Point=2 X2=-0.5 X3=0.5
 S11=93.8196019292446 IsS11Max=No IsS11Min=No FrameElem=119 ElemStation=0.375
 Frame=119 Station=0.375 OutputCase=PESOPR CaseType=LinStatic Point=3 X2=0.5 X3=-0.5 S11=-
 63.4777084568777 IsS11Max=No IsS11Min=Yes FrameElem=119 ElemStation=0.375
 Frame=119 Station=0.375 OutputCase=PESOPR CaseType=LinStatic Point=4 X2=0.5 X3=0.5 S11=-
 63.4777084568777 IsS11Max=No IsS11Min=No FrameElem=119 ElemStation=0.375
 Frame=119 Station=0.5 OutputCase=PESOPR CaseType=LinStatic Point=0 X2=0 X3=0 S11=15.1709467361835
 IsS11Max=No IsS11Min=No FrameElem=119 ElemStation=0.5
 Frame=119 Station=0.5 OutputCase=PESOPR CaseType=LinStatic Point=1 X2=-0.5 X3=-0.5
 S11=57.4914769209609 IsS11Max=Yes IsS11Min=No FrameElem=119 ElemStation=0.5
 Frame=119 Station=0.5 OutputCase=PESOPR CaseType=LinStatic Point=2 X2=-0.5 X3=0.5
 S11=57.4914769209609 IsS11Max=No IsS11Min=No FrameElem=119 ElemStation=0.5
 Frame=119 Station=0.5 OutputCase=PESOPR CaseType=LinStatic Point=3 X2=0.5 X3=-0.5 S11=-
 27.149583448594 IsS11Max=No IsS11Min=Yes FrameElem=119 ElemStation=0.5
 Frame=119 Station=0.5 OutputCase=PESOPR CaseType=LinStatic Point=4 X2=0.5 X3=0.5 S11=-
 27.149583448594 IsS11Max=No IsS11Min=No FrameElem=119 ElemStation=0.5
 Frame=119 Station=0 OutputCase=TERRVERT CaseType=LinStatic Point=0 X2=0 X3=0 S11=-1.64270738196176
 IsS11Max=No IsS11Min=No FrameElem=119 ElemStation=0
 Frame=119 Station=0 OutputCase=TERRVERT CaseType=LinStatic Point=1 X2=-0.5 X3=-0.5
 S11=1408.80398352516 IsS11Max=Yes IsS11Min=No FrameElem=119 ElemStation=0
 Frame=119 Station=0 OutputCase=TERRVERT CaseType=LinStatic Point=2 X2=-0.5 X3=0.5
 S11=1408.80398352516 IsS11Max=No IsS11Min=No FrameElem=119 ElemStation=0
 Frame=119 Station=0 OutputCase=TERRVERT CaseType=LinStatic Point=3 X2=0.5 X3=-0.5 S11=-
 1412.08939828908 IsS11Max=No IsS11Min=Yes FrameElem=119 ElemStation=0
 Frame=119 Station=0 OutputCase=TERRVERT CaseType=LinStatic Point=4 X2=0.5 X3=0.5 S11=-
 1412.08939828908 IsS11Max=No IsS11Min=No FrameElem=119 ElemStation=0
 Frame=119 Station=0.125 OutputCase=TERRVERT CaseType=LinStatic Point=0 X2=0 X3=0 S11=-
 1.64270738196176 IsS11Max=No IsS11Min=No FrameElem=119 ElemStation=0.125
 Frame=119 Station=0.125 OutputCase=TERRVERT CaseType=LinStatic Point=1 X2=-0.5 X3=-0.5
 S11=1080.67898331417 IsS11Max=Yes IsS11Min=No FrameElem=119 ElemStation=0.125
 Frame=119 Station=0.125 OutputCase=TERRVERT CaseType=LinStatic Point=2 X2=-0.5 X3=0.5
 S11=1080.67898331417 IsS11Max=No IsS11Min=No FrameElem=119 ElemStation=0.125
 Frame=119 Station=0.125 OutputCase=TERRVERT CaseType=LinStatic Point=3 X2=0.5 X3=-0.5 S11=-
 1083.96439807809 IsS11Max=No IsS11Min=Yes FrameElem=119 ElemStation=0.125
 Frame=119 Station=0.125 OutputCase=TERRVERT CaseType=LinStatic Point=4 X2=0.5 X3=0.5 S11=-
 1083.96439807809 IsS11Max=No IsS11Min=No FrameElem=119 ElemStation=0.125
 Frame=119 Station=0.25 OutputCase=TERRVERT CaseType=LinStatic Point=0 X2=0 X3=0 S11=-
 1.64270738196176 IsS11Max=No IsS11Min=No FrameElem=119 ElemStation=0.25
 Frame=119 Station=0.25 OutputCase=TERRVERT CaseType=LinStatic Point=1 X2=-0.5 X3=-0.5
 S11=726.303983103182 IsS11Max=Yes IsS11Min=No FrameElem=119 ElemStation=0.25
 Frame=119 Station=0.25 OutputCase=TERRVERT CaseType=LinStatic Point=2 X2=-0.5 X3=0.5
 S11=726.303983103182 IsS11Max=No IsS11Min=No FrameElem=119 ElemStation=0.25
 Frame=119 Station=0.25 OutputCase=TERRVERT CaseType=LinStatic Point=3 X2=0.5 X3=-0.5 S11=-
 729.589397867105 IsS11Max=No IsS11Min=Yes FrameElem=119 ElemStation=0.25
 Frame=119 Station=0.25 OutputCase=TERRVERT CaseType=LinStatic Point=4 X2=0.5 X3=0.5 S11=-
 729.589397867105 IsS11Max=No IsS11Min=No FrameElem=119 ElemStation=0.25
 Frame=119 Station=0.375 OutputCase=TERRVERT CaseType=LinStatic Point=0 X2=0 X3=0 S11=-
 1.64270738196176 IsS11Max=No IsS11Min=No FrameElem=119 ElemStation=0.375
 Frame=119 Station=0.375 OutputCase=TERRVERT CaseType=LinStatic Point=1 X2=-0.5 X3=-0.5
 S11=345.678982892193 IsS11Max=Yes IsS11Min=No FrameElem=119 ElemStation=0.375
 Frame=119 Station=0.375 OutputCase=TERRVERT CaseType=LinStatic Point=2 X2=-0.5 X3=0.5
 S11=345.678982892193 IsS11Max=No IsS11Min=No FrameElem=119 ElemStation=0.375
 Frame=119 Station=0.375 OutputCase=TERRVERT CaseType=LinStatic Point=3 X2=0.5 X3=-0.5 S11=-
 348.964397656117 IsS11Max=No IsS11Min=Yes FrameElem=119 ElemStation=0.375
 Frame=119 Station=0.375 OutputCase=TERRVERT CaseType=LinStatic Point=4 X2=0.5 X3=0.5 S11=-
 348.964397656117 IsS11Max=No IsS11Min=No FrameElem=119 ElemStation=0.375
 Frame=119 Station=0.5 OutputCase=TERRVERT CaseType=LinStatic Point=0 X2=0 X3=0 S11=-
 1.64270738196176 IsS11Max=No IsS11Min=No FrameElem=119 ElemStation=0.5
 Frame=119 Station=0.5 OutputCase=TERRVERT CaseType=LinStatic Point=1 X2=-0.5 X3=-0.5 S11=-
 61.1960173187949 IsS11Max=No IsS11Min=Yes FrameElem=119 ElemStation=0.5
 Frame=119 Station=0.5 OutputCase=TERRVERT CaseType=LinStatic Point=2 X2=-0.5 X3=0.5 S11=-
 61.1960173187949 IsS11Max=No IsS11Min=No FrameElem=119 ElemStation=0.5

```

Frame=119 Station=0.5 OutputCase=TERRVERT CaseType=LinStatic Point=3 X2=0.5 X3=-0.5
S11=57.9106025548713 IsS11Max=Yes IsS11Min=No FrameElem=119 ElemStation=0.5
Frame=119 Station=0.5 OutputCase=TERRVERT CaseType=LinStatic Point=4 X2=0.5 X3=0.5
S11=57.9106025548713 IsS11Max=No IsS11Min=No FrameElem=119 ElemStation=0.5
Frame=119 Station=0 OutputCase=TERRLAT CaseType=LinStatic Point=0 X2=0 X3=0 S11=-330.586282883909
IsS11Max=No IsS11Min=No FrameElem=119 ElemStation=0
Frame=119 Station=0 OutputCase=TERRLAT CaseType=LinStatic Point=1 X2=-0.5 X3=-0.5 S11=-
829.013116162856 IsS11Max=No IsS11Min=Yes FrameElem=119 ElemStation=0
Frame=119 Station=0 OutputCase=TERRLAT CaseType=LinStatic Point=2 X2=-0.5 X3=0.5 S11=-
829.013116162856 IsS11Max=No IsS11Min=No FrameElem=119 ElemStation=0
Frame=119 Station=0 OutputCase=TERRLAT CaseType=LinStatic Point=3 X2=0.5 X3=-0.5
S11=167.840550395039 IsS11Max=Yes IsS11Min=No FrameElem=119 ElemStation=0
Frame=119 Station=0 OutputCase=TERRLAT CaseType=LinStatic Point=4 X2=0.5 X3=0.5
S11=167.840550395039 IsS11Max=No IsS11Min=No FrameElem=119 ElemStation=0
Frame=119 Station=0.125 OutputCase=TERRLAT CaseType=LinStatic Point=0 X2=0 X3=0 S11=-
330.586282883909 IsS11Max=No IsS11Min=No FrameElem=119 ElemStation=0.125
Frame=119 Station=0.125 OutputCase=TERRLAT CaseType=LinStatic Point=1 X2=-0.5 X3=-0.5 S11=-
829.013117432007 IsS11Max=No IsS11Min=Yes FrameElem=119 ElemStation=0.125
Frame=119 Station=0.125 OutputCase=TERRLAT CaseType=LinStatic Point=2 X2=-0.5 X3=0.5 S11=-
829.013117432007 IsS11Max=No IsS11Min=No FrameElem=119 ElemStation=0.125
Frame=119 Station=0.125 OutputCase=TERRLAT CaseType=LinStatic Point=3 X2=0.5 X3=-0.5
S11=167.840551664189 IsS11Max=Yes IsS11Min=No FrameElem=119 ElemStation=0.125
Frame=119 Station=0.125 OutputCase=TERRLAT CaseType=LinStatic Point=4 X2=0.5 X3=0.5
S11=167.840551664189 IsS11Max=No IsS11Min=No FrameElem=119 ElemStation=0.125
Frame=119 Station=0.25 OutputCase=TERRLAT CaseType=LinStatic Point=0 X2=0 X3=0 S11=-
330.586282883909 IsS11Max=No IsS11Min=No FrameElem=119 ElemStation=0.25
Frame=119 Station=0.25 OutputCase=TERRLAT CaseType=LinStatic Point=1 X2=-0.5 X3=-0.5 S11=-
829.013118701157 IsS11Max=No IsS11Min=Yes FrameElem=119 ElemStation=0.25
Frame=119 Station=0.25 OutputCase=TERRLAT CaseType=LinStatic Point=2 X2=-0.5 X3=0.5 S11=-
829.013118701157 IsS11Max=No IsS11Min=No FrameElem=119 ElemStation=0.25
Frame=119 Station=0.25 OutputCase=TERRLAT CaseType=LinStatic Point=3 X2=0.5 X3=-0.5
S11=167.84055293334 IsS11Max=Yes IsS11Min=No FrameElem=119 ElemStation=0.25
Frame=119 Station=0.25 OutputCase=TERRLAT CaseType=LinStatic Point=4 X2=0.5 X3=0.5
S11=167.84055293334 IsS11Max=No IsS11Min=No FrameElem=119 ElemStation=0.25
Frame=119 Station=0.375 OutputCase=TERRLAT CaseType=LinStatic Point=0 X2=0 X3=0 S11=-
330.586282883909 IsS11Max=No IsS11Min=No FrameElem=119 ElemStation=0.375
Frame=119 Station=0.375 OutputCase=TERRLAT CaseType=LinStatic Point=1 X2=-0.5 X3=-0.5 S11=-
829.013119970307 IsS11Max=No IsS11Min=Yes FrameElem=119 ElemStation=0.375
Frame=119 Station=0.375 OutputCase=TERRLAT CaseType=LinStatic Point=2 X2=-0.5 X3=0.5 S11=-
829.013119970307 IsS11Max=No IsS11Min=No FrameElem=119 ElemStation=0.375
Frame=119 Station=0.375 OutputCase=TERRLAT CaseType=LinStatic Point=3 X2=0.5 X3=-0.5
S11=167.84055420249 IsS11Max=Yes IsS11Min=No FrameElem=119 ElemStation=0.375
Frame=119 Station=0.375 OutputCase=TERRLAT CaseType=LinStatic Point=4 X2=0.5 X3=0.5
S11=167.84055420249 IsS11Max=No IsS11Min=No FrameElem=119 ElemStation=0.375
Frame=119 Station=0.5 OutputCase=TERRLAT CaseType=LinStatic Point=0 X2=0 X3=0 S11=-330.586282883909
IsS11Max=No IsS11Min=No FrameElem=119 ElemStation=0.5
Frame=119 Station=0.5 OutputCase=TERRLAT CaseType=LinStatic Point=1 X2=-0.5 X3=-0.5 S11=-
829.013121239457 IsS11Max=No IsS11Min=Yes FrameElem=119 ElemStation=0.5
Frame=119 Station=0.5 OutputCase=TERRLAT CaseType=LinStatic Point=2 X2=-0.5 X3=0.5 S11=-
829.013121239457 IsS11Max=No IsS11Min=No FrameElem=119 ElemStation=0.5
Frame=119 Station=0.5 OutputCase=TERRLAT CaseType=LinStatic Point=3 X2=0.5 X3=-0.5
S11=167.84055547164 IsS11Max=Yes IsS11Min=No FrameElem=119 ElemStation=0.5
Frame=119 Station=0.5 OutputCase=TERRLAT CaseType=LinStatic Point=4 X2=0.5 X3=0.5
S11=167.84055547164 IsS11Max=No IsS11Min=No FrameElem=119 ElemStation=0.5
Frame=119 Station=0 OutputCase=ACCVERT CaseType=LinStatic Point=0 X2=0 X3=0 S11=0 IsS11Max=Yes
IsS11Min=Yes FrameElem=119 ElemStation=0
Frame=119 Station=0 OutputCase=ACCVERT CaseType=LinStatic Point=1 X2=-0.5 X3=-0.5 S11=0
IsS11Max=No IsS11Min=No FrameElem=119 ElemStation=0
Frame=119 Station=0 OutputCase=ACCVERT CaseType=LinStatic Point=2 X2=-0.5 X3=0.5 S11=0
IsS11Max=No IsS11Min=No FrameElem=119 ElemStation=0
Frame=119 Station=0 OutputCase=ACCVERT CaseType=LinStatic Point=3 X2=0.5 X3=-0.5 S11=0
IsS11Max=No IsS11Min=No FrameElem=119 ElemStation=0
Frame=119 Station=0 OutputCase=ACCVERT CaseType=LinStatic Point=4 X2=0.5 X3=0.5 S11=0 IsS11Max=No
IsS11Min=No FrameElem=119 ElemStation=0
Frame=119 Station=0.125 OutputCase=ACCVERT CaseType=LinStatic Point=0 X2=0 X3=0 S11=0
IsS11Max=Yes IsS11Min=Yes FrameElem=119 ElemStation=0.125
Frame=119 Station=0.125 OutputCase=ACCVERT CaseType=LinStatic Point=1 X2=-0.5 X3=-0.5 S11=0
IsS11Max=No IsS11Min=No FrameElem=119 ElemStation=0.125
Frame=119 Station=0.125 OutputCase=ACCVERT CaseType=LinStatic Point=2 X2=-0.5 X3=0.5 S11=0
IsS11Max=No IsS11Min=No FrameElem=119 ElemStation=0.125
Frame=119 Station=0.125 OutputCase=ACCVERT CaseType=LinStatic Point=3 X2=0.5 X3=-0.5 S11=0
IsS11Max=No IsS11Min=No FrameElem=119 ElemStation=0.125
Frame=119 Station=0.125 OutputCase=ACCVERT CaseType=LinStatic Point=4 X2=0.5 X3=0.5 S11=0
IsS11Max=No IsS11Min=No FrameElem=119 ElemStation=0.125
Frame=119 Station=0.25 OutputCase=ACCVERT CaseType=LinStatic Point=0 X2=0 X3=0 S11=0 IsS11Max=Yes
IsS11Min=Yes FrameElem=119 ElemStation=0.25
Frame=119 Station=0.25 OutputCase=ACCVERT CaseType=LinStatic Point=1 X2=-0.5 X3=-0.5 S11=0
IsS11Max=No IsS11Min=No FrameElem=119 ElemStation=0.25
Frame=119 Station=0.25 OutputCase=ACCVERT CaseType=LinStatic Point=2 X2=-0.5 X3=0.5 S11=0
IsS11Max=No IsS11Min=No FrameElem=119 ElemStation=0.25
Frame=119 Station=0.25 OutputCase=ACCVERT CaseType=LinStatic Point=3 X2=0.5 X3=-0.5 S11=0
IsS11Max=No IsS11Min=No FrameElem=119 ElemStation=0.25

```

Frame=119	Station=0.25	OutputCase=ENVE	CaseType=Combination	StepType=Max	Point=2	X2=-0.5	X3=0.5	
S11=273.7987769499	IsS11Max=No	IsS11Min=No	FrameElem=119	ElemStation=0.25				
Frame=119	Station=0.25	OutputCase=ENVE	CaseType=Combination	StepType=Max	Point=3	X2=0.5	X3=-0.5	
S11=-659.210928398927	IsS11Max=No	IsS11Min=Yes	FrameElem=119	ElemStation=0.25				
Frame=119	Station=0.25	OutputCase=ENVE	CaseType=Combination	StepType=Max	Point=4	X2=0.5	X3=0.5	
S11=-659.210928398927	IsS11Max=No	IsS11Min=No	FrameElem=119	ElemStation=0.25				
Frame=119	Station=0.375	OutputCase=ENVE	CaseType=Combination	StepType=Max	Point=0	X2=0	X3=0	S11=-
217.882158664514	IsS11Max=No	IsS11Min=No	FrameElem=119	ElemStation=0.375				
Frame=119	Station=0.375	OutputCase=ENVE	CaseType=Combination	StepType=Max	Point=1	X2=-0.5	X3=-0.5	
S11=-140.810599157777	IsS11Max=Yes	IsS11Min=No	FrameElem=119	ElemStation=0.375				
Frame=119	Station=0.375	OutputCase=ENVE	CaseType=Combination	StepType=Max	Point=2	X2=-0.5	X3=0.5	
S11=-140.810599157777	IsS11Max=No	IsS11Min=No	FrameElem=119	ElemStation=0.375				
Frame=119	Station=0.375	OutputCase=ENVE	CaseType=Combination	StepType=Max	Point=3	X2=0.5	X3=-0.5	
S11=-244.601551910505	IsS11Max=No	IsS11Min=Yes	FrameElem=119	ElemStation=0.375				
Frame=119	Station=0.375	OutputCase=ENVE	CaseType=Combination	StepType=Max	Point=4	X2=0.5	X3=0.5	
S11=-244.601551910505	IsS11Max=No	IsS11Min=No	FrameElem=119	ElemStation=0.375				
Frame=119	Station=0.5	OutputCase=ENVE	CaseType=Combination	StepType=Max	Point=0	X2=0	X3=0	S11=-
217.882158664514	IsS11Max=No	IsS11Min=No	FrameElem=119	ElemStation=0.5				
Frame=119	Station=0.5	OutputCase=ENVE	CaseType=Combination	StepType=Max	Point=1	X2=-0.5	X3=-0.5	
S11=-584.013725265454	IsS11Max=No	IsS11Min=Yes	FrameElem=119	ElemStation=0.5				
Frame=119	Station=0.5	OutputCase=ENVE	CaseType=Combination	StepType=Max	Point=2	X2=-0.5	X3=0.5	
S11=-584.013725265454	IsS11Max=No	IsS11Min=No	FrameElem=119	ElemStation=0.5				
Frame=119	Station=0.5	OutputCase=ENVE	CaseType=Combination	StepType=Max	Point=3	X2=0.5	X3=-0.5	
S11=198.601574577918	IsS11Max=Yes	IsS11Min=No	FrameElem=119	ElemStation=0.5				
Frame=119	Station=0.5	OutputCase=ENVE	CaseType=Combination	StepType=Max	Point=4	X2=0.5	X3=0.5	
S11=198.601574577918	IsS11Max=No	IsS11Min=No	FrameElem=119	ElemStation=0.5				
Frame=119	Station=0	OutputCase=ENVE	CaseType=Combination	StepType=Min	Point=0	X2=0	X3=0	S11=-
317.058043529687	IsS11Max=No	IsS11Min=No	FrameElem=119	ElemStation=0				
Frame=119	Station=0	OutputCase=ENVE	CaseType=Combination	StepType=Min	Point=1	X2=-0.5	X3=-0.5	
S11=768.532344316397	IsS11Max=Yes	IsS11Min=No	FrameElem=119	ElemStation=0				
Frame=119	Station=0	OutputCase=ENVE	CaseType=Combination	StepType=Min	Point=2	X2=-0.5	X3=0.5	
S11=768.532344316397	IsS11Max=No	IsS11Min=No	FrameElem=119	ElemStation=0				
Frame=119	Station=0	OutputCase=ENVE	CaseType=Combination	StepType=Min	Point=3	X2=0.5	X3=-0.5	
S11=-1453.00059649428	IsS11Max=No	IsS11Min=Yes	FrameElem=119	ElemStation=0				
Frame=119	Station=0	OutputCase=ENVE	CaseType=Combination	StepType=Min	Point=4	X2=0.5	X3=0.5	S11=-
1453.00059649428	IsS11Max=No	IsS11Min=No	FrameElem=119	ElemStation=0				
Frame=119	Station=0.125	OutputCase=ENVE	CaseType=Combination	StepType=Min	Point=0	X2=0	X3=0	S11=-
317.058043529687	IsS11Max=No	IsS11Min=No	FrameElem=119	ElemStation=0.125				
Frame=119	Station=0.125	OutputCase=ENVE	CaseType=Combination	StepType=Min	Point=1	X2=-0.5	X3=-0.5	
S11=411.110467827975	IsS11Max=Yes	IsS11Min=No	FrameElem=119	ElemStation=0.125				
Frame=119	Station=0.125	OutputCase=ENVE	CaseType=Combination	StepType=Min	Point=2	X2=-0.5	X3=0.5	
S11=411.110467827975	IsS11Max=No	IsS11Min=No	FrameElem=119	ElemStation=0.125				
Frame=119	Station=0.125	OutputCase=ENVE	CaseType=Combination	StepType=Min	Point=3	X2=0.5	X3=-0.5	
S11=-1095.57872038661	IsS11Max=No	IsS11Min=Yes	FrameElem=119	ElemStation=0.125				
Frame=119	Station=0.125	OutputCase=ENVE	CaseType=Combination	StepType=Min	Point=4	X2=0.5	X3=0.5	
S11=-1095.57872038661	IsS11Max=No	IsS11Min=No	FrameElem=119	ElemStation=0.125				
Frame=119	Station=0.25	OutputCase=ENVE	CaseType=Combination	StepType=Min	Point=0	X2=0	X3=0	S11=-
317.058043529687	IsS11Max=No	IsS11Min=No	FrameElem=119	ElemStation=0.25				
Frame=119	Station=0.25	OutputCase=ENVE	CaseType=Combination	StepType=Min	Point=1	X2=-0.5	X3=-0.5	
S11=25.0948413395531	IsS11Max=Yes	IsS11Min=No	FrameElem=119	ElemStation=0.25				
Frame=119	Station=0.25	OutputCase=ENVE	CaseType=Combination	StepType=Min	Point=2	X2=-0.5	X3=0.5	
S11=25.0948413395531	IsS11Max=No	IsS11Min=No	FrameElem=119	ElemStation=0.25				
Frame=119	Station=0.25	OutputCase=ENVE	CaseType=Combination	StepType=Min	Point=3	X2=0.5	X3=-0.5	
S11=-709.563094278929	IsS11Max=No	IsS11Min=Yes	FrameElem=119	ElemStation=0.25				
Frame=119	Station=0.25	OutputCase=ENVE	CaseType=Combination	StepType=Min	Point=4	X2=0.5	X3=0.5	
S11=-709.563094278929	IsS11Max=No	IsS11Min=No	FrameElem=119	ElemStation=0.25				
Frame=119	Station=0.375	OutputCase=ENVE	CaseType=Combination	StepType=Min	Point=0	X2=0	X3=0	S11=-
317.058043529687	IsS11Max=No	IsS11Min=No	FrameElem=119	ElemStation=0.375				
Frame=119	Station=0.375	OutputCase=ENVE	CaseType=Combination	StepType=Min	Point=1	X2=-0.5	X3=-0.5	
S11=-389.514535148869	IsS11Max=No	IsS11Min=Yes	FrameElem=119	ElemStation=0.375				
Frame=119	Station=0.375	OutputCase=ENVE	CaseType=Combination	StepType=Min	Point=2	X2=-0.5	X3=0.5	
S11=-389.514535148869	IsS11Max=No	IsS11Min=No	FrameElem=119	ElemStation=0.375				
Frame=119	Station=0.375	OutputCase=ENVE	CaseType=Combination	StepType=Min	Point=3	X2=0.5	X3=-0.5	
S11=-294.953718171252	IsS11Max=Yes	IsS11Min=No	FrameElem=119	ElemStation=0.375				
Frame=119	Station=0.375	OutputCase=ENVE	CaseType=Combination	StepType=Min	Point=4	X2=0.5	X3=0.5	
S11=-294.953718171252	IsS11Max=No	IsS11Min=No	FrameElem=119	ElemStation=0.375				
Frame=119	Station=0.5	OutputCase=ENVE	CaseType=Combination	StepType=Min	Point=0	X2=0	X3=0	S11=-
317.058043529687	IsS11Max=No	IsS11Min=No	FrameElem=119	ElemStation=0.5				
Frame=119	Station=0.5	OutputCase=ENVE	CaseType=Combination	StepType=Min	Point=1	X2=-0.5	X3=-0.5	
S11=-832.717661637291	IsS11Max=No	IsS11Min=Yes	FrameElem=119	ElemStation=0.5				
Frame=119	Station=0.5	OutputCase=ENVE	CaseType=Combination	StepType=Min	Point=2	X2=-0.5	X3=0.5	
S11=-832.717661637291	IsS11Max=No	IsS11Min=No	FrameElem=119	ElemStation=0.5				
Frame=119	Station=0.5	OutputCase=ENVE	CaseType=Combination	StepType=Min	Point=3	X2=0.5	X3=-0.5	
S11=148.249407936426	IsS11Max=Yes	IsS11Min=No	FrameElem=119	ElemStation=0.5				
Frame=119	Station=0.5	OutputCase=ENVE	CaseType=Combination	StepType=Min	Point=4	X2=0.5	X3=0.5	
S11=148.249407936426	IsS11Max=No	IsS11Min=No	FrameElem=119	ElemStation=0.5				
Frame=119	Station=0	OutputCase=FESSUR	CaseType=Combination	Point=0	X2=0	X3=0	S11=-317.058043529687	
IsS11Max=No	IsS11Min=No	FrameElem=119	ElemStation=0					
Frame=119	Station=0	OutputCase=FESSUR	CaseType=Combination	Point=1	X2=-0.5	X3=-0.5		
S11=768.532344316397	IsS11Max=Yes	IsS11Min=No	FrameElem=119	ElemStation=0				
Frame=119	Station=0	OutputCase=FESSUR	CaseType=Combination	Point=2	X2=-0.5	X3=0.5		
S11=768.532344316397	IsS11Max=No	IsS11Min=No	FrameElem=119	ElemStation=0				

Frame=119	Station=0	OutputCase=FESSUR	CaseType=Combination	Point=3	X2=0.5	X3=-0.5	S11=-
1402.64843137577	IsS11Max=No	IsS11Min=Yes	FrameElem=119	ElemStation=0			
Frame=119	Station=0	OutputCase=FESSUR	CaseType=Combination	Point=4	X2=0.5	X3=0.5	S11=-
1402.64843137577	IsS11Max=No	IsS11Min=No	FrameElem=119	ElemStation=0			
Frame=119	Station=0.125	OutputCase=FESSUR	CaseType=Combination	Point=0	X2=0	X3=0	S11=-
317.058043529687	IsS11Max=No	IsS11Min=No	FrameElem=119	ElemStation=0.125			
Frame=119	Station=0.125	OutputCase=FESSUR	CaseType=Combination	Point=1	X2=-0.5	X3=-0.5	
S11=411.110467827975	IsS11Max=Yes	IsS11Min=No	FrameElem=119	ElemStation=0.125			
Frame=119	Station=0.125	OutputCase=FESSUR	CaseType=Combination	Point=2	X2=-0.5	X3=0.5	
S11=411.110467827975	IsS11Max=No	IsS11Min=No	FrameElem=119	ElemStation=0.125			
Frame=119	Station=0.125	OutputCase=FESSUR	CaseType=Combination	Point=3	X2=0.5	X3=-0.5	S11=-
1045.22655488735	IsS11Max=No	IsS11Min=Yes	FrameElem=119	ElemStation=0.125			
Frame=119	Station=0.125	OutputCase=FESSUR	CaseType=Combination	Point=4	X2=0.5	X3=0.5	S11=-
1045.22655488735	IsS11Max=No	IsS11Min=No	FrameElem=119	ElemStation=0.125			
Frame=119	Station=0.25	OutputCase=FESSUR	CaseType=Combination	Point=0	X2=0	X3=0	S11=-
317.058043529687	IsS11Max=No	IsS11Min=No	FrameElem=119	ElemStation=0.25			
Frame=119	Station=0.25	OutputCase=FESSUR	CaseType=Combination	Point=1	X2=-0.5	X3=-0.5	
S11=25.0948413395531	IsS11Max=Yes	IsS11Min=No	FrameElem=119	ElemStation=0.25			
Frame=119	Station=0.25	OutputCase=FESSUR	CaseType=Combination	Point=2	X2=-0.5	X3=0.5	
S11=25.0948413395531	IsS11Max=No	IsS11Min=No	FrameElem=119	ElemStation=0.25			
Frame=119	Station=0.25	OutputCase=FESSUR	CaseType=Combination	Point=3	X2=0.5	X3=-0.5	S11=-
659.210928398927	IsS11Max=No	IsS11Min=Yes	FrameElem=119	ElemStation=0.25			
Frame=119	Station=0.25	OutputCase=FESSUR	CaseType=Combination	Point=4	X2=0.5	X3=0.5	S11=-
659.210928398927	IsS11Max=No	IsS11Min=No	FrameElem=119	ElemStation=0.25			
Frame=119	Station=0.375	OutputCase=FESSUR	CaseType=Combination	Point=0	X2=0	X3=0	S11=-
317.058043529687	IsS11Max=No	IsS11Min=No	FrameElem=119	ElemStation=0.375			
Frame=119	Station=0.375	OutputCase=FESSUR	CaseType=Combination	Point=1	X2=-0.5	X3=-0.5	S11=-
389.514535148869	IsS11Max=No	IsS11Min=Yes	FrameElem=119	ElemStation=0.375			
Frame=119	Station=0.375	OutputCase=FESSUR	CaseType=Combination	Point=2	X2=-0.5	X3=0.5	S11=-
389.514535148869	IsS11Max=No	IsS11Min=No	FrameElem=119	ElemStation=0.375			
Frame=119	Station=0.375	OutputCase=FESSUR	CaseType=Combination	Point=3	X2=0.5	X3=-0.5	S11=-
244.601551910505	IsS11Max=Yes	IsS11Min=No	FrameElem=119	ElemStation=0.375			
Frame=119	Station=0.375	OutputCase=FESSUR	CaseType=Combination	Point=4	X2=0.5	X3=0.5	S11=-
244.601551910505	IsS11Max=No	IsS11Min=No	FrameElem=119	ElemStation=0.375			
Frame=119	Station=0.5	OutputCase=FESSUR	CaseType=Combination	Point=0	X2=0	X3=0	S11=-
317.058043529687	IsS11Max=No	IsS11Min=No	FrameElem=119	ElemStation=0.5			
Frame=119	Station=0.5	OutputCase=FESSUR	CaseType=Combination	Point=1	X2=-0.5	X3=-0.5	S11=-
832.717661637291	IsS11Max=No	IsS11Min=Yes	FrameElem=119	ElemStation=0.5			
Frame=119	Station=0.5	OutputCase=FESSUR	CaseType=Combination	Point=2	X2=-0.5	X3=0.5	S11=-
832.717661637291	IsS11Max=No	IsS11Min=No	FrameElem=119	ElemStation=0.5			
Frame=119	Station=0.5	OutputCase=FESSUR	CaseType=Combination	Point=3	X2=0.5	X3=-0.5	
S11=198.601574577918	IsS11Max=Yes	IsS11Min=No	FrameElem=119	ElemStation=0.5			
Frame=119	Station=0.5	OutputCase=FESSUR	CaseType=Combination	Point=4	X2=0.5	X3=0.5	
S11=198.601574577918	IsS11Max=No	IsS11Min=No	FrameElem=119	ElemStation=0.5			

TABLE: "ELEMENT JOINT FORCES - FRAMES"

Frame=1	Joint=1	OutputCase=PESOPR	CaseType=LinStatic	F1=15.1709467361864	F2=0	F3=-151.042541323392			
M1=0	M2=81.7553624405726	M3=0	FrameElem=1						
Frame=1	Joint=30	OutputCase=PESOPR	CaseType=LinStatic	F1=-15.1709467361864	F2=0	F3=157.292540727346			
M1=0	M2=-43.2134808598674	M3=0	FrameElem=1						
Frame=1	Joint=1	OutputCase=TERRVERT	CaseType=LinStatic	F1=-1.64270738195018	F2=0	F3=-664.026817772688			
M1=0	M2=318.354704172064	M3=0	FrameElem=1						
Frame=1	Joint=30	OutputCase=TERRVERT	CaseType=LinStatic	F1=1.64270738195018	F2=0	F3=664.026817772688			
M1=0	M2=-152.348015560538	M3=0	FrameElem=1						
Frame=1	Joint=1	OutputCase=TERRLAT	CaseType=LinStatic	F1=373.013713761058	F2=0	F3=-0.18582972282303			
M1=0	M2=84.0726672420623	M3=0	FrameElem=1						
Frame=1	Joint=30	OutputCase=TERRLAT	CaseType=LinStatic	F1=-373.013713761058	F2=0	F3=0.18582972282303			
M1=0	M2=-84.0262098157871	M3=0	FrameElem=1						
Frame=1	Joint=1	OutputCase=ACCVERT	CaseType=LinStatic	F1=0	F2=0	F3=0	M1=0	M2=0	M3=0
FrameElem=1									
Frame=1	Joint=30	OutputCase=ACCVERT	CaseType=LinStatic	F1=0	F2=0	F3=0	M1=0	M2=0	M3=0
FrameElem=1									
Frame=1	Joint=1	OutputCase=ACCLATDX	CaseType=LinStatic	F1=0	F2=0	F3=0	M1=0	M2=0	M3=0
FrameElem=1									
Frame=1	Joint=30	OutputCase=ACCLATDX	CaseType=LinStatic	F1=0	F2=0	F3=0	M1=0	M2=0	M3=0
FrameElem=1									
Frame=1	Joint=1	OutputCase=ACCLATSX	CaseType=LinStatic	F1=0	F2=0	F3=0	M1=0	M2=0	M3=0
FrameElem=1									
Frame=1	Joint=30	OutputCase=ACCLATSX	CaseType=LinStatic	F1=0	F2=0	F3=0	M1=0	M2=0	M3=0
FrameElem=1									
Frame=1	Joint=1	OutputCase=TERRCOST	CaseType=LinStatic	F1=0	F2=0	F3=0	M1=0	M2=0	M3=0
FrameElem=1									
Frame=1	Joint=30	OutputCase=TERRCOST	CaseType=LinStatic	F1=0	F2=0	F3=0	M1=0	M2=0	M3=0
FrameElem=1									
Frame=1	Joint=1	OutputCase=SOVRCOST	CaseType=LinStatic	F1=0	F2=0	F3=0	M1=0	M2=0	M3=0
FrameElem=1									
Frame=1	Joint=30	OutputCase=SOVRCOST	CaseType=LinStatic	F1=0	F2=0	F3=0	M1=0	M2=0	M3=0
FrameElem=1									
Frame=1	Joint=1	OutputCase=ENVE	CaseType=Combination	StepType=Max	F1=386.541953115295	F2=0	F3=-		
815.199439902057	M1=0	M2=484.182733854699	M3=0	FrameElem=1					
Frame=1	Joint=30	OutputCase=ENVE	CaseType=Combination	StepType=Max	F1=-274.637838986977	F2=0			
F3=821.505188222857	M1=0	M2=-254.379843291457	M3=0	FrameElem=1					

Frame=1 Joint=1 OutputCase=ENVE CaseType=Combination StepType=Min F1=274.637838986977 F2=0 F3=-
 815.255188818904 M1=0 M2=458.960933682081 M3=0 FrameElem=1
 Frame=1 Joint=30 OutputCase=ENVE CaseType=Combination StepType=Min F1=-386.541953115295 F2=0
 F3=821.449439306011 M1=0 M2=-279.587706236193 M3=0 FrameElem=1
 Frame=1 Joint=1 OutputCase=FESSUR CaseType=Combination F1=386.541953115295 F2=0 F3=-815.255188818904
 M1=0 M2=484.182733854699 M3=0 FrameElem=1
 Frame=1 Joint=30 OutputCase=FESSUR CaseType=Combination F1=-386.541953115295 F2=0 F3=821.505188222857
 M1=0 M2=-279.587706236193 M3=0 FrameElem=1
 Frame=2 Joint=30 OutputCase=PESOPR CaseType=LinStatic F1=15.1709467361864 F2=0 F3=-134.470776144527
 M1=0 M2=43.2134808598738 M3=0 FrameElem=2
 Frame=2 Joint=31 OutputCase=PESOPR CaseType=LinStatic F1=-15.1709467361864 F2=0 F3=140.720776144527
 M1=0 M2=-8.81453682374221 M3=0 FrameElem=2
 Frame=2 Joint=30 OutputCase=TERRVERT CaseType=LinStatic F1=-1.64270738195018 F2=0 F3=-
 592.527338506229 M1=0 M2=152.348015560566 M3=0 FrameElem=2
 Frame=2 Joint=31 OutputCase=TERRVERT CaseType=LinStatic F1=1.64270738195018 F2=0 F3=592.527338506229
 M1=0 M2=-4.21618093399411 M3=0 FrameElem=2
 Frame=2 Joint=30 OutputCase=TERRLAT CaseType=LinStatic F1=373.013713761058 F2=0 F3=-0.45039583000306
 M1=0 M2=84.0262098157868 M3=0 FrameElem=2
 Frame=2 Joint=31 OutputCase=TERRLAT CaseType=LinStatic F1=-373.013713761058 F2=0 F3=0.45039583000306
 M1=0 M2=-83.913610858286 M3=0 FrameElem=2
 Frame=2 Joint=30 OutputCase=ACCVERT CaseType=LinStatic F1=0 F2=0 F3=0 M1=0 M2=0 M3=0
 FrameElem=2
 Frame=2 Joint=31 OutputCase=ACCVERT CaseType=LinStatic F1=0 F2=0 F3=0 M1=0 M2=0 M3=0
 FrameElem=2
 Frame=2 Joint=30 OutputCase=ACCLATDX CaseType=LinStatic F1=0 F2=0 F3=0 M1=0 M2=0 M3=0
 FrameElem=2
 Frame=2 Joint=31 OutputCase=ACCLATDX CaseType=LinStatic F1=0 F2=0 F3=0 M1=0 M2=0 M3=0
 FrameElem=2
 Frame=2 Joint=30 OutputCase=ACCLATSX CaseType=LinStatic F1=0 F2=0 F3=0 M1=0 M2=0 M3=0
 FrameElem=2
 Frame=2 Joint=31 OutputCase=ACCLATSX CaseType=LinStatic F1=0 F2=0 F3=0 M1=0 M2=0 M3=0
 FrameElem=2
 Frame=2 Joint=30 OutputCase=TERRCOST CaseType=LinStatic F1=0 F2=0 F3=0 M1=0 M2=0 M3=0
 FrameElem=2
 Frame=2 Joint=31 OutputCase=TERRCOST CaseType=LinStatic F1=0 F2=0 F3=0 M1=0 M2=0 M3=0
 FrameElem=2
 Frame=2 Joint=30 OutputCase=SOVRCOST CaseType=LinStatic F1=0 F2=0 F3=0 M1=0 M2=0 M3=0
 FrameElem=2
 Frame=2 Joint=31 OutputCase=SOVRCOST CaseType=LinStatic F1=0 F2=0 F3=0 M1=0 M2=0 M3=0
 FrameElem=2
 Frame=2 Joint=30 OutputCase=ENVE CaseType=Combination StepType=Max F1=386.541953115295 F2=0 F3=-
 727.313391731758 M1=0 M2=279.587706236227 M3=0 FrameElem=2
 Frame=2 Joint=31 OutputCase=ENVE CaseType=Combination StepType=Max F1=-274.637838986977 F2=0
 F3=733.698510480758 M1=0 M2=-71.7702453585365 M3=0 FrameElem=2
 Frame=2 Joint=30 OutputCase=ENVE CaseType=Combination StepType=Min F1=274.637838986977 F2=0 F3=-
 727.448510480758 M1=0 M2=254.379843291491 M3=0 FrameElem=2
 Frame=2 Joint=31 OutputCase=ENVE CaseType=Combination StepType=Min F1=-386.541953115295 F2=0
 F3=733.563391731758 M1=0 M2=-96.9443286160223 M3=0 FrameElem=2
 Frame=2 Joint=30 OutputCase=FESSUR CaseType=Combination F1=386.541953115295 F2=0 F3=-727.448510480758
 M1=0 M2=279.587706236227 M3=0 FrameElem=2
 Frame=2 Joint=31 OutputCase=FESSUR CaseType=Combination F1=-386.541953115295 F2=0 F3=733.698510480758
 M1=0 M2=-96.9443286160223 M3=0 FrameElem=2
 Frame=4 Joint=32 OutputCase=PESOPR CaseType=LinStatic F1=15.1709467361871 F2=0 F3=140.720775817134
 M1=0 M2=8.81453708260373 M3=0 FrameElem=4
 Frame=4 Joint=33 OutputCase=PESOPR CaseType=LinStatic F1=-15.1709467361871 F2=0 F3=-134.470775817134
 M1=0 M2=-43.2134810368872 M3=0 FrameElem=4
 Frame=4 Joint=32 OutputCase=TERRVERT CaseType=LinStatic F1=-1.64270738195066 F2=0 F3=592.527339069401
 M1=0 M2=4.21618206019912 M3=0 FrameElem=4
 Frame=4 Joint=33 OutputCase=TERRVERT CaseType=LinStatic F1=1.64270738195066 F2=0 F3=-592.527339069401
 M1=0 M2=-152.34801682755 M3=0 FrameElem=4
 Frame=4 Joint=32 OutputCase=TERRLAT CaseType=LinStatic F1=373.013713761059 F2=0 F3=0.450396838020254
 M1=0 M2=83.9136041070522 M3=0 FrameElem=4
 Frame=4 Joint=33 OutputCase=TERRLAT CaseType=LinStatic F1=-373.013713761059 F2=0 F3=-
 0.450396838020254 M1=0 M2=-84.0262033165571 M3=0 FrameElem=4
 Frame=4 Joint=32 OutputCase=ACCVERT CaseType=LinStatic F1=0 F2=0 F3=0 M1=0 M2=0 M3=0
 FrameElem=4
 Frame=4 Joint=33 OutputCase=ACCVERT CaseType=LinStatic F1=0 F2=0 F3=0 M1=0 M2=0 M3=0
 FrameElem=4
 Frame=4 Joint=32 OutputCase=ACCLATDX CaseType=LinStatic F1=0 F2=0 F3=0 M1=0 M2=0 M3=0
 FrameElem=4
 Frame=4 Joint=33 OutputCase=ACCLATDX CaseType=LinStatic F1=0 F2=0 F3=0 M1=0 M2=0 M3=0
 FrameElem=4
 Frame=4 Joint=32 OutputCase=ACCLATSX CaseType=LinStatic F1=0 F2=0 F3=0 M1=0 M2=0 M3=0
 FrameElem=4
 Frame=4 Joint=33 OutputCase=ACCLATSX CaseType=LinStatic F1=0 F2=0 F3=0 M1=0 M2=0 M3=0
 FrameElem=4
 Frame=4 Joint=32 OutputCase=TERRCOST CaseType=LinStatic F1=0 F2=0 F3=0 M1=0 M2=0 M3=0
 FrameElem=4
 Frame=4 Joint=33 OutputCase=TERRCOST CaseType=LinStatic F1=0 F2=0 F3=0 M1=0 M2=0 M3=0
 FrameElem=4
 Frame=4 Joint=32 OutputCase=SOVRCOST CaseType=LinStatic F1=0 F2=0 F3=0 M1=0 M2=0 M3=0
 FrameElem=4



Frame=43	Joint=37	OutputCase=ACCLATDX	CaseType=LinStatic	F1=0	F2=0	F3=0	M1=0	M2=0	M3=0
FrameElem=43									
Frame=43	Joint=36	OutputCase=ACCLATSX	CaseType=LinStatic	F1=0	F2=0	F3=0	M1=0	M2=0	M3=0
FrameElem=43									
Frame=43	Joint=37	OutputCase=ACCLATSX	CaseType=LinStatic	F1=0	F2=0	F3=0	M1=0	M2=0	M3=0
FrameElem=43									
Frame=43	Joint=36	OutputCase=TERRCOST	CaseType=LinStatic	F1=0	F2=0	F3=0	M1=0	M2=0	M3=0
FrameElem=43									
Frame=43	Joint=37	OutputCase=TERRCOST	CaseType=LinStatic	F1=0	F2=0	F3=0	M1=0	M2=0	M3=0
FrameElem=43									
Frame=43	Joint=36	OutputCase=SOVRCOST	CaseType=LinStatic	F1=0	F2=0	F3=0	M1=0	M2=0	M3=0
FrameElem=43									
Frame=43	Joint=37	OutputCase=SOVRCOST	CaseType=LinStatic	F1=0	F2=0	F3=0	M1=0	M2=0	M3=0
FrameElem=43									
Frame=43	Joint=36	OutputCase=ENVE	CaseType=Combination	StepType=Max	F1=386.541953115295	F2=0	F3=-		
248.924059920548	M1=0	M2=-416.172043437825	M3=0	FrameElem=43					
Frame=43	Joint=37	OutputCase=ENVE	CaseType=Combination	StepType=Max	F1=-274.637838986977	F2=0	F3=-		
F3=261.581739381568	M1=0	M2=568.718588053057	M3=0	FrameElem=43					
Frame=43	Joint=36	OutputCase=ENVE	CaseType=Combination	StepType=Min	F1=274.637838986977	F2=0	F3=-		
249.081739381567	M1=0	M2=-441.131558092783	M3=0	FrameElem=43					
Frame=43	Joint=37	OutputCase=ENVE	CaseType=Combination	StepType=Min	F1=-386.541953115295	F2=0	F3=-		
F3=261.424059920548	M1=0	M2=543.837913128608	M3=0	FrameElem=43					
Frame=43	Joint=36	OutputCase=FESSUR	CaseType=Combination	F1=386.541953115295	F2=0	F3=-			
249.081739381567	M1=0	M2=-416.172043437825	M3=0	FrameElem=43					
Frame=43	Joint=37	OutputCase=FESSUR	CaseType=Combination	F1=-386.541953115295	F2=0	F3=-			
F3=261.581739381568	M1=0	M2=543.837913128608	M3=0	FrameElem=43					
Frame=44	Joint=37	OutputCase=PESOPR	CaseType=LinStatic	F1=15.1709467361872	F2=0	F3=-9.74279215225236			
M1=0	M2=-111.807286152781	M3=0	FrameElem=44						
Frame=44	Joint=38	OutputCase=PESOPR	CaseType=LinStatic	F1=-15.1709467361872	F2=0	F3=22.2427921522524			
M1=0	M2=119.803682228907	M3=0	FrameElem=44						
Frame=44	Joint=37	OutputCase=TERRVERT	CaseType=LinStatic	F1=-1.64270738195066	F2=0	F3=-			
68.810507186925	M1=0	M2=-514.966210057309	M3=0	FrameElem=44					
Frame=44	Joint=38	OutputCase=TERRVERT	CaseType=LinStatic	F1=1.64270738195066	F2=0	F3=68.810507186925			
M1=0	M2=549.371463650764	M3=0	FrameElem=44						
Frame=44	Joint=37	OutputCase=TERRLAT	CaseType=LinStatic	F1=373.013713761058	F2=0	F3=-			
0.190111961511868	M1=0	M2=82.9355830814964	M3=0	FrameElem=44					
Frame=44	Joint=38	OutputCase=TERRLAT	CaseType=LinStatic	F1=-373.013713761058	F2=0	F3=-			
F3=0.190111961511868	M1=0	M2=-82.8405271007404	M3=0	FrameElem=44					
Frame=44	Joint=37	OutputCase=ACCVERT	CaseType=LinStatic	F1=0	F2=0	F3=0	M1=0	M2=0	M3=0
FrameElem=44									
Frame=44	Joint=38	OutputCase=ACCVERT	CaseType=LinStatic	F1=0	F2=0	F3=0	M1=0	M2=0	M3=0
FrameElem=44									
Frame=44	Joint=37	OutputCase=ACCLATDX	CaseType=LinStatic	F1=0	F2=0	F3=0	M1=0	M2=0	M3=0
FrameElem=44									
Frame=44	Joint=38	OutputCase=ACCLATDX	CaseType=LinStatic	F1=0	F2=0	F3=0	M1=0	M2=0	M3=0
FrameElem=44									
Frame=44	Joint=37	OutputCase=ACCLATSX	CaseType=LinStatic	F1=0	F2=0	F3=0	M1=0	M2=0	M3=0
FrameElem=44									
Frame=44	Joint=38	OutputCase=ACCLATSX	CaseType=LinStatic	F1=0	F2=0	F3=0	M1=0	M2=0	M3=0
FrameElem=44									
Frame=44	Joint=37	OutputCase=TERRCOST	CaseType=LinStatic	F1=0	F2=0	F3=0	M1=0	M2=0	M3=0
FrameElem=44									
Frame=44	Joint=38	OutputCase=TERRCOST	CaseType=LinStatic	F1=0	F2=0	F3=0	M1=0	M2=0	M3=0
FrameElem=44									
Frame=44	Joint=37	OutputCase=SOVRCOST	CaseType=LinStatic	F1=0	F2=0	F3=0	M1=0	M2=0	M3=0
FrameElem=44									
Frame=44	Joint=38	OutputCase=SOVRCOST	CaseType=LinStatic	F1=0	F2=0	F3=0	M1=0	M2=0	M3=0
FrameElem=44									
Frame=44	Joint=37	OutputCase=ENVE	CaseType=Combination	StepType=Max	F1=386.541953115295	F2=0	F3=-		
78.6863777122357	M1=0	M2=-543.837913128594	M3=0	FrameElem=44					
Frame=44	Joint=38	OutputCase=ENVE	CaseType=Combination	StepType=Max	F1=-274.637838986977	F2=0	F3=-		
F3=91.2434113006893	M1=0	M2=611.186776909153	M3=0	FrameElem=44					
Frame=44	Joint=37	OutputCase=ENVE	CaseType=Combination	StepType=Min	F1=274.637838986977	F2=0	F3=-		
78.7434113006893	M1=0	M2=-568.718588053043	M3=0	FrameElem=44					
Frame=44	Joint=38	OutputCase=ENVE	CaseType=Combination	StepType=Min	F1=-386.541953115295	F2=0	F3=-		
F3=91.1863777122357	M1=0	M2=586.334618778931	M3=0	FrameElem=44					
Frame=44	Joint=37	OutputCase=FESSUR	CaseType=Combination	F1=386.541953115295	F2=0	F3=-			
78.7434113006893	M1=0	M2=-543.837913128594	M3=0	FrameElem=44					
Frame=44	Joint=38	OutputCase=FESSUR	CaseType=Combination	F1=-386.541953115295	F2=0	F3=-			
F3=91.2434113006893	M1=0	M2=586.334618778931	M3=0	FrameElem=44					
Frame=45	Joint=38	OutputCase=PESOPR	CaseType=LinStatic	F1=15.1709467361871	F2=0	F3=22.2427924569361			
M1=0	M2=-119.803682228906	M3=0	FrameElem=45						
Frame=45	Joint=41	OutputCase=PESOPR	CaseType=LinStatic	F1=-15.1709467361871	F2=0	F3=-9.74279245693606			
M1=0	M2=111.807286000441	M3=0	FrameElem=45						
Frame=45	Joint=38	OutputCase=TERRVERT	CaseType=LinStatic	F1=-1.64270738195066	F2=0	F3=-			
F3=68.8105077490613	M1=0	M2=-549.37146365077	M3=0	FrameElem=45					
Frame=45	Joint=41	OutputCase=TERRVERT	CaseType=LinStatic	F1=1.64270738195066	F2=0	F3=-			
68.8105077490613	M1=0	M2=514.96620977624	M3=0	FrameElem=45					
Frame=45	Joint=38	OutputCase=TERRLAT	CaseType=LinStatic	F1=373.013713761058	F2=0	F3=0.190106907453412			
M1=0	M2=82.8405271007405	M3=0	FrameElem=45						
Frame=45	Joint=41	OutputCase=TERRLAT	CaseType=LinStatic	F1=-373.013713761058	F2=0	F3=-			
0.190106907453412	M1=0	M2=-82.9355805544672	M3=0	FrameElem=45					

Frame=45	Joint=38	OutputCase=ACCVERT	CaseType=LinStatic	F1=0	F2=0	F3=0	M1=0	M2=0	M3=0
FrameElem=45									
Frame=45	Joint=41	OutputCase=ACCVERT	CaseType=LinStatic	F1=0	F2=0	F3=0	M1=0	M2=0	M3=0
FrameElem=45									
Frame=45	Joint=38	OutputCase=ACCLATDX	CaseType=LinStatic	F1=0	F2=0	F3=0	M1=0	M2=0	M3=0
FrameElem=45									
Frame=45	Joint=41	OutputCase=ACCLATDX	CaseType=LinStatic	F1=0	F2=0	F3=0	M1=0	M2=0	M3=0
FrameElem=45									
Frame=45	Joint=38	OutputCase=ACCLATSX	CaseType=LinStatic	F1=0	F2=0	F3=0	M1=0	M2=0	M3=0
FrameElem=45									
Frame=45	Joint=41	OutputCase=ACCLATSX	CaseType=LinStatic	F1=0	F2=0	F3=0	M1=0	M2=0	M3=0
FrameElem=45									
Frame=45	Joint=38	OutputCase=TERRCOST	CaseType=LinStatic	F1=0	F2=0	F3=0	M1=0	M2=0	M3=0
FrameElem=45									
Frame=45	Joint=41	OutputCase=TERRCOST	CaseType=LinStatic	F1=0	F2=0	F3=0	M1=0	M2=0	M3=0
FrameElem=45									
Frame=45	Joint=38	OutputCase=SOVRCOST	CaseType=LinStatic	F1=0	F2=0	F3=0	M1=0	M2=0	M3=0
FrameElem=45									
Frame=45	Joint=41	OutputCase=SOVRCOST	CaseType=LinStatic	F1=0	F2=0	F3=0	M1=0	M2=0	M3=0
FrameElem=45									
Frame=45	Joint=38	OutputCase=ENVE	CaseType=Combination	StepType=Max	F1=386.541953115295	F2=0			
F3=91.2434071134508	M1=0	M2=-586.334618778936	M3=0	FrameElem=45					
Frame=45	Joint=41	OutputCase=ENVE	CaseType=Combination	StepType=Max	F1=-274.637838986977	F2=0	F3=-		
78.6863750412148	M1=0	M2=568.718589388554	M3=0	FrameElem=45					
Frame=45	Joint=38	OutputCase=ENVE	CaseType=Combination	StepType=Min	F1=274.637838986977	F2=0			
F3=91.1863750412148	M1=0	M2=-611.186776909158	M3=0	FrameElem=45					
Frame=45	Joint=41	OutputCase=ENVE	CaseType=Combination	StepType=Min	F1=-386.541953115295	F2=0	F3=-		
78.7434071134508	M1=0	M2=543.837915222214	M3=0	FrameElem=45					
Frame=45	Joint=38	OutputCase=FESSUR	CaseType=Combination	F1=386.541953115295	F2=0	F3=91.2434071134508			
M1=0	M2=-586.334618778936	M3=0	FrameElem=45						
Frame=45	Joint=41	OutputCase=FESSUR	CaseType=Combination	F1=-386.541953115295	F2=0	F3=-			
78.7434071134508	M1=0	M2=543.837915222214	M3=0	FrameElem=45					
Frame=46	Joint=41	OutputCase=PESOPR	CaseType=LinStatic	F1=15.1709467361871	F2=0	F3=54.2994159259497			
M1=0	M2=-111.80728600044	M3=0	FrameElem=46						
Frame=46	Joint=42	OutputCase=PESOPR	CaseType=LinStatic	F1=-15.1709467361871	F2=0	F3=-41.7994159259497			
M1=0	M2=87.7825780374647	M3=0	FrameElem=46						
Frame=46	Joint=41	OutputCase=TERRVERT	CaseType=LinStatic	F1=-1.64270738195065	F2=0				
F3=206.756726049568	M1=0	M2=-514.966209776245	M3=0	FrameElem=46					
Frame=46	Joint=42	OutputCase=TERRVERT	CaseType=LinStatic	F1=1.64270738195065	F2=0	F3=-			
206.756726049568	M1=0	M2=411.587846751461	M3=0	FrameElem=46					
Frame=46	Joint=41	OutputCase=TERRLAT	CaseType=LinStatic	F1=373.013713761059	F2=0	F3=0.525593818948494			
M1=0	M2=82.9355805544672	M3=0	FrameElem=46						
Frame=46	Joint=42	OutputCase=TERRLAT	CaseType=LinStatic	F1=-373.013713761059	F2=0	F3=-			
0.525593818948494	M1=0	M2=-83.1983774639413	M3=0	FrameElem=46					
Frame=46	Joint=41	OutputCase=ACCVERT	CaseType=LinStatic	F1=0	F2=0	F3=0	M1=0	M2=0	M3=0
FrameElem=46									
Frame=46	Joint=42	OutputCase=ACCVERT	CaseType=LinStatic	F1=0	F2=0	F3=0	M1=0	M2=0	M3=0
FrameElem=46									
Frame=46	Joint=41	OutputCase=ACCLATDX	CaseType=LinStatic	F1=0	F2=0	F3=0	M1=0	M2=0	M3=0
FrameElem=46									
Frame=46	Joint=42	OutputCase=ACCLATDX	CaseType=LinStatic	F1=0	F2=0	F3=0	M1=0	M2=0	M3=0
FrameElem=46									
Frame=46	Joint=41	OutputCase=ACCLATSX	CaseType=LinStatic	F1=0	F2=0	F3=0	M1=0	M2=0	M3=0
FrameElem=46									
Frame=46	Joint=42	OutputCase=ACCLATSX	CaseType=LinStatic	F1=0	F2=0	F3=0	M1=0	M2=0	M3=0
FrameElem=46									
Frame=46	Joint=41	OutputCase=TERRCOST	CaseType=LinStatic	F1=0	F2=0	F3=0	M1=0	M2=0	M3=0
FrameElem=46									
Frame=46	Joint=42	OutputCase=TERRCOST	CaseType=LinStatic	F1=0	F2=0	F3=0	M1=0	M2=0	M3=0
FrameElem=46									
Frame=46	Joint=41	OutputCase=SOVRCOST	CaseType=LinStatic	F1=0	F2=0	F3=0	M1=0	M2=0	M3=0
FrameElem=46									
Frame=46	Joint=42	OutputCase=SOVRCOST	CaseType=LinStatic	F1=0	F2=0	F3=0	M1=0	M2=0	M3=0
FrameElem=46									
Frame=46	Joint=41	OutputCase=ENVE	CaseType=Combination	StepType=Max	F1=386.541953115295	F2=0			
F3=261.581735794467	M1=0	M2=-543.837915222217	M3=0	FrameElem=46					
Frame=46	Joint=42	OutputCase=ENVE	CaseType=Combination	StepType=Max	F1=-274.637838986978	F2=0	F3=-		
248.924057648782	M1=0	M2=441.131560564166	M3=0	FrameElem=46					
Frame=46	Joint=41	OutputCase=ENVE	CaseType=Combination	StepType=Min	F1=274.637838986978	F2=0			
F3=261.424057648782	M1=0	M2=-568.718589388557	M3=0	FrameElem=46					
Frame=46	Joint=42	OutputCase=ENVE	CaseType=Combination	StepType=Min	F1=-386.541953115295	F2=0	F3=-		
249.081735794466	M1=0	M2=416.172047324984	M3=0	FrameElem=46					
Frame=46	Joint=41	OutputCase=FESSUR	CaseType=Combination	F1=386.541953115295	F2=0	F3=261.581735794467			
M1=0	M2=-543.837915222217	M3=0	FrameElem=46						
Frame=46	Joint=42	OutputCase=FESSUR	CaseType=Combination	F1=-386.541953115295	F2=0	F3=-			
249.081735794466	M1=0	M2=416.172047324984	M3=0	FrameElem=46					
Frame=47	Joint=42	OutputCase=PESOPR	CaseType=LinStatic	F1=15.1709467361871	F2=0	F3=86.560534236079			
M1=0	M2=-87.7825780374626	M3=0	FrameElem=47						
Frame=47	Joint=43	OutputCase=PESOPR	CaseType=LinStatic	F1=-15.1709467361871	F2=0	F3=-74.060534236079			
M1=0	M2=47.6273109194231	M3=0	FrameElem=47						
Frame=47	Joint=42	OutputCase=TERRVERT	CaseType=LinStatic	F1=-1.64270738195066	F2=0				
F3=345.641466260744	M1=0	M2=-411.587846751453	M3=0	FrameElem=47					



Frame=47	Joint=43	OutputCase=TERRVERT	CaseType=LinStatic	F1=1.64270738195066	F2=0	F3=-
345.641466260744	M1=0	M2=238.767113621073	M3=0	FrameElem=47		
Frame=47	Joint=42	OutputCase=TERRLAT	CaseType=LinStatic	F1=373.013713761058	F2=0	F3=0.726763128745802
M1=0	M2=83.1983774639414	M3=0	FrameElem=47			
Frame=47	Joint=43	OutputCase=TERRLAT	CaseType=LinStatic	F1=-373.013713761058	F2=0	F3=-
0.726763128745802	M1=0	M2=-83.5617590283143	M3=0	FrameElem=47		
Frame=47	Joint=42	OutputCase=ACCVERT	CaseType=LinStatic	F1=0	F2=0	F3=0
M1=0	M2=0	M3=0				
FrameElem=47						
Frame=47	Joint=43	OutputCase=ACCVERT	CaseType=LinStatic	F1=0	F2=0	F3=0
M1=0	M2=0	M3=0				
FrameElem=47						
Frame=47	Joint=42	OutputCase=ACCLATDX	CaseType=LinStatic	F1=0	F2=0	F3=0
M1=0	M2=0	M3=0				
FrameElem=47						
Frame=47	Joint=43	OutputCase=ACCLATDX	CaseType=LinStatic	F1=0	F2=0	F3=0
M1=0	M2=0	M3=0				
FrameElem=47						
Frame=47	Joint=42	OutputCase=ACCLATSX	CaseType=LinStatic	F1=0	F2=0	F3=0
M1=0	M2=0	M3=0				
FrameElem=47						
Frame=47	Joint=43	OutputCase=ACCLATSX	CaseType=LinStatic	F1=0	F2=0	F3=0
M1=0	M2=0	M3=0				
FrameElem=47						
Frame=47	Joint=42	OutputCase=TERRCOST	CaseType=LinStatic	F1=0	F2=0	F3=0
M1=0	M2=0	M3=0				
FrameElem=47						
Frame=47	Joint=43	OutputCase=TERRCOST	CaseType=LinStatic	F1=0	F2=0	F3=0
M1=0	M2=0	M3=0				
FrameElem=47						
Frame=47	Joint=42	OutputCase=SOVRCOST	CaseType=LinStatic	F1=0	F2=0	F3=0
M1=0	M2=0	M3=0				
FrameElem=47						
Frame=47	Joint=43	OutputCase=SOVRCOST	CaseType=LinStatic	F1=0	F2=0	F3=0
M1=0	M2=0	M3=0				
FrameElem=47						
Frame=47	Joint=42	OutputCase=ENVE	CaseType=Combination	StepType=Max	F1=386.541953115295	F2=0
F3=432.928763625569	M1=0	M2=-416.172047324974	M3=0	FrameElem=47		
Frame=47	Joint=43	OutputCase=ENVE	CaseType=Combination	StepType=Max	F1=-274.637838986977	F2=0
F3=-	M1=0	M2=227.901193220676	M3=0	FrameElem=47		
420.210734686945						
Frame=47	Joint=42	OutputCase=ENVE	CaseType=Combination	StepType=Min	F1=274.637838986977	F2=0
F3=432.710734686945	M1=0	M2=-441.131560564156	M3=0	FrameElem=47		
Frame=47	Joint=43	OutputCase=ENVE	CaseType=Combination	StepType=Min	F1=-386.541953115295	F2=0
F3=-	M1=0	M2=202.832665512182	M3=0	FrameElem=47		
420.428763625569						
Frame=47	Joint=42	OutputCase=FESSUR	CaseType=Combination	F1=386.541953115295	F2=0	F3=432.928763625569
M1=0	M2=-416.172047324974	M3=0	FrameElem=47			
Frame=47	Joint=43	OutputCase=FESSUR	CaseType=Combination	F1=-386.541953115295	F2=0	F3=-
420.428763625569	M1=0	M2=202.832665512182	M3=0	FrameElem=47		
Frame=48	Joint=43	OutputCase=PESOPR	CaseType=LinStatic	F1=15.1709467361872	F2=0	F3=119.133696004063
M1=0	M2=-47.6273109194242	M3=0	FrameElem=48			
Frame=48	Joint=32	OutputCase=PESOPR	CaseType=LinStatic	F1=-15.1709467361872	F2=0	F3=-106.633696004063
M1=0	M2=-8.81453708260754	M3=0	FrameElem=48			
Frame=48	Joint=43	OutputCase=TERRVERT	CaseType=LinStatic	F1=-1.64270738195066	F2=0	F3=-
F3=485.966591362548	M1=0	M2=-238.767113621091	M3=0	FrameElem=48		
Frame=48	Joint=32	OutputCase=TERRVERT	CaseType=LinStatic	F1=1.64270738195066	F2=0	F3=-
485.966591362548	M1=0	M2=-4.21618206019002	M3=0	FrameElem=48		
Frame=48	Joint=43	OutputCase=TERRLAT	CaseType=LinStatic	F1=373.013713761059	F2=0	F3=0.703690157475592
M1=0	M2=83.5617590283143	M3=0	FrameElem=48			
Frame=48	Joint=32	OutputCase=TERRLAT	CaseType=LinStatic	F1=-373.013713761059	F2=0	F3=-
0.703690157475592	M1=0	M2=-83.9136041070521	M3=0	FrameElem=48		
Frame=48	Joint=43	OutputCase=ACCVERT	CaseType=LinStatic	F1=0	F2=0	F3=0
M1=0	M2=0	M3=0				
FrameElem=48						
Frame=48	Joint=32	OutputCase=ACCVERT	CaseType=LinStatic	F1=0	F2=0	F3=0
M1=0	M2=0	M3=0				
FrameElem=48						
Frame=48	Joint=43	OutputCase=ACCLATDX	CaseType=LinStatic	F1=0	F2=0	F3=0
M1=0	M2=0	M3=0				
FrameElem=48						
Frame=48	Joint=32	OutputCase=ACCLATDX	CaseType=LinStatic	F1=0	F2=0	F3=0
M1=0	M2=0	M3=0				
FrameElem=48						
Frame=48	Joint=43	OutputCase=ACCLATSX	CaseType=LinStatic	F1=0	F2=0	F3=0
M1=0	M2=0	M3=0				
FrameElem=48						
Frame=48	Joint=32	OutputCase=ACCLATSX	CaseType=LinStatic	F1=0	F2=0	F3=0
M1=0	M2=0	M3=0				
FrameElem=48						
Frame=48	Joint=43	OutputCase=TERRCOST	CaseType=LinStatic	F1=0	F2=0	F3=0
M1=0	M2=0	M3=0				
FrameElem=48						
Frame=48	Joint=32	OutputCase=TERRCOST	CaseType=LinStatic	F1=0	F2=0	F3=0
M1=0	M2=0	M3=0				
FrameElem=48						
Frame=48	Joint=43	OutputCase=SOVRCOST	CaseType=LinStatic	F1=0	F2=0	F3=0
M1=0	M2=0	M3=0				
FrameElem=48						
Frame=48	Joint=32	OutputCase=SOVRCOST	CaseType=LinStatic	F1=0	F2=0	F3=0
M1=0	M2=0	M3=0				
FrameElem=48						
Frame=48	Joint=43	OutputCase=ENVE	CaseType=Combination	StepType=Max	F1=386.541953115295	F2=0
F3=605.803977524087	M1=0	M2=-202.832665512201	M3=0	FrameElem=48		
Frame=48	Joint=32	OutputCase=ENVE	CaseType=Combination	StepType=Max	F1=-274.637838986978	F2=0
F3=-	M1=0	M2=-71.770242017734	M3=0	FrameElem=48		
593.092870476844						
Frame=48	Joint=43	OutputCase=ENVE	CaseType=Combination	StepType=Min	F1=274.637838986978	F2=0
F3=605.592870476844	M1=0	M2=-227.901193220695	M3=0	FrameElem=48		
Frame=48	Joint=32	OutputCase=ENVE	CaseType=Combination	StepType=Min	F1=-386.541953115295	F2=0
F3=-	M1=0	M2=-96.9443232498497	M3=0	FrameElem=48		
593.303977524087						
Frame=48	Joint=43	OutputCase=FESSUR	CaseType=Combination	F1=386.541953115295	F2=0	F3=605.803977524087
M1=0	M2=-202.832665512201	M3=0	FrameElem=48			
Frame=48	Joint=32	OutputCase=FESSUR	CaseType=Combination	F1=-386.541953115295	F2=0	F3=-
593.303977524087	M1=0	M2=-96.9443232498497	M3=0	FrameElem=48		



Frame=69	Joint=15	OutputCase=PESOPR	CaseType=LinStatic	F1=15.1709467361867	F2=0	F3=162.499998818719		
M1=0	M2=81.7553624960715	M3=0	FrameElem=69					
Frame=69	Joint=28	OutputCase=PESOPR	CaseType=LinStatic	F1=-15.1709467361867	F2=0	F3=-156.249998818719		
M1=0	M2=-77.9626296118209	M3=0	FrameElem=69					
Frame=69	Joint=15	OutputCase=TERRVERT	CaseType=LinStatic	F1=-1.64270738195842	F2=0	F3=699.999993605		
M1=0	M2=318.35470557965	M3=0	FrameElem=69					
Frame=69	Joint=28	OutputCase=TERRVERT	CaseType=LinStatic	F1=1.64270738195842	F2=0	F3=-699.999993605		
M1=0	M2=-318.765399114441	M3=0	FrameElem=69					
Frame=69	Joint=15	OutputCase=TERRLAT	CaseType=LinStatic	F1=293.063713761061	F2=0			
F3=1.69220310835479E-06	M1=0	M2=84.0726613763917	M3=0	FrameElem=69				
Frame=69	Joint=28	OutputCase=TERRLAT	CaseType=LinStatic	F1=-253.885276262649	F2=0	F3=-		
1.69220310835479E-06	M1=0	M2=-15.7151443943275	M3=0	FrameElem=69				
Frame=69	Joint=15	OutputCase=ACCVERT	CaseType=LinStatic	F1=0	F2=0	F3=0	M1=0	M2=0
FrameElem=69							M3=0	
Frame=69	Joint=28	OutputCase=ACCVERT	CaseType=LinStatic	F1=0	F2=0	F3=0	M1=0	M2=0
FrameElem=69							M3=0	
Frame=69	Joint=15	OutputCase=ACCLATDX	CaseType=LinStatic	F1=0	F2=0	F3=0	M1=0	M2=0
FrameElem=69							M3=0	
Frame=69	Joint=28	OutputCase=ACCLATDX	CaseType=LinStatic	F1=0	F2=0	F3=0	M1=0	M2=0
FrameElem=69							M3=0	
Frame=69	Joint=15	OutputCase=ACCLATSX	CaseType=LinStatic	F1=0	F2=0	F3=0	M1=0	M2=0
FrameElem=69							M3=0	
Frame=69	Joint=28	OutputCase=ACCLATSX	CaseType=LinStatic	F1=0	F2=0	F3=0	M1=0	M2=0
FrameElem=69							M3=0	
Frame=69	Joint=15	OutputCase=TERRCOST	CaseType=LinStatic	F1=0	F2=0	F3=0	M1=0	M2=0
FrameElem=69							M3=0	
Frame=69	Joint=28	OutputCase=TERRCOST	CaseType=LinStatic	F1=0	F2=0	F3=0	M1=0	M2=0
FrameElem=69							M3=0	
Frame=69	Joint=15	OutputCase=SOVRCOST	CaseType=LinStatic	F1=0	F2=0	F3=0	M1=0	M2=0
FrameElem=69							M3=0	
Frame=69	Joint=28	OutputCase=SOVRCOST	CaseType=LinStatic	F1=0	F2=0	F3=0	M1=0	M2=0
FrameElem=69							M3=0	
Frame=69	Joint=15	OutputCase=ENVE	CaseType=Combination	StepType=Max	F1=306.591953115289	F2=0		
F3=862.499994115922	M1=0	M2=484.182729452113	M3=0	FrameElem=69				
Frame=69	Joint=28	OutputCase=ENVE	CaseType=Combination	StepType=Max	F1=-191.247932738083	F2=0	F3=-	
856.249993608261	M1=0	M2=-407.728629802291	M3=0	FrameElem=69				
Frame=69	Joint=15	OutputCase=ENVE	CaseType=Combination	StepType=Min	F1=218.672838986971	F2=0		
F3=862.499993608261	M1=0	M2=458.960931039196	M3=0	FrameElem=69				
Frame=69	Joint=28	OutputCase=ENVE	CaseType=Combination	StepType=Min	F1=-267.413515616878	F2=0	F3=-	
856.249994115922	M1=0	M2=-412.443173120589	M3=0	FrameElem=69				
Frame=69	Joint=15	OutputCase=PESSUR	CaseType=Combination	F1=306.591953115289	F2=0	F3=862.499994115922		
M1=0	M2=484.182729452113	M3=0	FrameElem=69					
Frame=69	Joint=28	OutputCase=PESSUR	CaseType=Combination	F1=-267.413515616878	F2=0	F3=-		
856.249994115922	M1=0	M2=-412.443173120589	M3=0	FrameElem=69				
Frame=70	Joint=28	OutputCase=PESOPR	CaseType=LinStatic	F1=15.1709467361864	F2=0	F3=156.249998818617		
M1=0	M2=77.9626296118216	M3=0	FrameElem=70					
Frame=70	Joint=29	OutputCase=PESOPR	CaseType=LinStatic	F1=-15.1709467361864	F2=0	F3=-149.999998818617		
M1=0	M2=-74.169892927775	M3=0	FrameElem=70					
Frame=70	Joint=28	OutputCase=TERRVERT	CaseType=LinStatic	F1=-1.64270738195557	F2=0			
F3=699.999993604841	M1=0	M2=318.765399114454	M3=0	FrameElem=70				
Frame=70	Joint=29	OutputCase=TERRVERT	CaseType=LinStatic	F1=1.64270738195557	F2=0	F3=-		
699.999993604841	M1=0	M2=-319.176075959943	M3=0	FrameElem=70				
Frame=70	Joint=28	OutputCase=TERRLAT	CaseType=LinStatic	F1=253.88527626265	F2=0	F3=1.69220766110811E-		
06	M1=0	M2=15.7151443943278	M3=0	FrameElem=70				
Frame=70	Joint=29	OutputCase=TERRLAT	CaseType=LinStatic	F1=-215.239963767416	F2=0	F3=-		
1.69220766110811E-06	M1=0	M2=42.9144038385309	M3=0	FrameElem=70				
Frame=70	Joint=28	OutputCase=ACCVERT	CaseType=LinStatic	F1=0	F2=0	F3=0	M1=0	M2=0
FrameElem=70							M3=0	
Frame=70	Joint=29	OutputCase=ACCVERT	CaseType=LinStatic	F1=0	F2=0	F3=0	M1=0	M2=0
FrameElem=70							M3=0	
Frame=70	Joint=28	OutputCase=ACCLATDX	CaseType=LinStatic	F1=0	F2=0	F3=0	M1=0	M2=0
FrameElem=70							M3=0	
Frame=70	Joint=29	OutputCase=ACCLATDX	CaseType=LinStatic	F1=0	F2=0	F3=0	M1=0	M2=0
FrameElem=70							M3=0	
Frame=70	Joint=28	OutputCase=ACCLATSX	CaseType=LinStatic	F1=0	F2=0	F3=0	M1=0	M2=0
FrameElem=70							M3=0	
Frame=70	Joint=29	OutputCase=ACCLATSX	CaseType=LinStatic	F1=0	F2=0	F3=0	M1=0	M2=0
FrameElem=70							M3=0	
Frame=70	Joint=28	OutputCase=TERRCOST	CaseType=LinStatic	F1=0	F2=0	F3=0	M1=0	M2=0
FrameElem=70							M3=0	
Frame=70	Joint=29	OutputCase=TERRCOST	CaseType=LinStatic	F1=0	F2=0	F3=0	M1=0	M2=0
FrameElem=70							M3=0	
Frame=70	Joint=28	OutputCase=SOVRCOST	CaseType=LinStatic	F1=0	F2=0	F3=0	M1=0	M2=0
FrameElem=70							M3=0	
Frame=70	Joint=29	OutputCase=SOVRCOST	CaseType=LinStatic	F1=0	F2=0	F3=0	M1=0	M2=0
FrameElem=70							M3=0	
Frame=70	Joint=28	OutputCase=ENVE	CaseType=Combination	StepType=Max	F1=267.41351561688	F2=0		
F3=856.249994115666	M1=0	M2=412.443173120604	M3=0	FrameElem=70				
Frame=70	Joint=29	OutputCase=ENVE	CaseType=Combination	StepType=Max	F1=-164.196213991422	F2=0	F3=-	
849.999993608003	M1=0	M2=-350.431565049188	M3=0	FrameElem=70				
Frame=70	Joint=28	OutputCase=ENVE	CaseType=Combination	StepType=Min	F1=191.247932738086	F2=0		
F3=856.249993608003	M1=0	M2=407.728629802305	M3=0	FrameElem=70				



Frame=70	Joint=29	OutputCase=ENVE	CaseType=Combination	StepType=Min	F1=-228.768203121647	F2=0	F3=-
849.999994115666	M1=0	M2=-363.305886200747	M3=0	FrameElem=70			
Frame=70	Joint=28	OutputCase=FESSUR	CaseType=Combination		F1=267.41351561688	F2=0	F3=856.249994115666
M1=0	M2=412.443173120604	M3=0	FrameElem=70				
Frame=70	Joint=29	OutputCase=FESSUR	CaseType=Combination		F1=-228.768203121647	F2=0	F3=-
849.999994115666	M1=0	M2=-350.431565049188	M3=0	FrameElem=70			
Frame=72	Joint=35	OutputCase=PESOPR	CaseType=LinStatic		F1=15.1709467361858	F2=0	F3=74.9999988185725
M1=0	M2=28.6570500370093	M3=0	FrameElem=72				
Frame=72	Joint=23	OutputCase=PESOPR	CaseType=LinStatic		F1=-15.1709467361858	F2=0	F3=-68.7499988185725
M1=0	M2=-24.8643150665963	M3=0	FrameElem=72				
Frame=72	Joint=35	OutputCase=TERRVERT	CaseType=LinStatic		F1=-1.64270738196001	F2=0	
F3=699.999993603802	M1=0	M2=324.104181416514	M3=0	FrameElem=72			
Frame=72	Joint=23	OutputCase=TERRVERT	CaseType=LinStatic		F1=1.64270738196001	F2=0	F3=-
699.999993603802	M1=0	M2=-324.514874951305	M3=0	FrameElem=72			
Frame=72	Joint=35	OutputCase=TERRLAT	CaseType=LinStatic		F1=-206.920035927523	F2=0	
F3=1.69220735268298E-06	M1=0	M2=-36.2017954839702	M3=0	FrameElem=72			
Frame=72	Joint=23	OutputCase=TERRLAT	CaseType=LinStatic		F1=238.634723381447	F2=0	F3=-
1.69220735268298E-06	M1=0	M2=-19.5036562005511	M3=0	FrameElem=72			
Frame=72	Joint=35	OutputCase=ACCVERT	CaseType=LinStatic		F1=0	F2=0	F3=0
FrameElem=72					M1=0	M2=0	M3=0
Frame=72	Joint=23	OutputCase=ACCVERT	CaseType=LinStatic		F1=0	F2=0	F3=0
FrameElem=72					M1=0	M2=0	M3=0
Frame=72	Joint=35	OutputCase=ACCLATDX	CaseType=LinStatic		F1=0	F2=0	F3=0
FrameElem=72					M1=0	M2=0	M3=0
Frame=72	Joint=23	OutputCase=ACCLATDX	CaseType=LinStatic		F1=0	F2=0	F3=0
FrameElem=72					M1=0	M2=0	M3=0
Frame=72	Joint=35	OutputCase=ACCLATSX	CaseType=LinStatic		F1=0	F2=0	F3=0
FrameElem=72					M1=0	M2=0	M3=0
Frame=72	Joint=23	OutputCase=ACCLATSX	CaseType=LinStatic		F1=0	F2=0	F3=0
FrameElem=72					M1=0	M2=0	M3=0
Frame=72	Joint=35	OutputCase=TERRCOST	CaseType=LinStatic		F1=0	F2=0	F3=0
FrameElem=72					M1=0	M2=0	M3=0
Frame=72	Joint=23	OutputCase=TERRCOST	CaseType=LinStatic		F1=0	F2=0	F3=0
FrameElem=72					M1=0	M2=0	M3=0
Frame=72	Joint=35	OutputCase=SOVRCOST	CaseType=LinStatic		F1=0	F2=0	F3=0
FrameElem=72					M1=0	M2=0	M3=0
Frame=72	Joint=23	OutputCase=SOVRCOST	CaseType=LinStatic		F1=0	F2=0	F3=0
FrameElem=72					M1=0	M2=0	M3=0
Frame=72	Joint=35	OutputCase=ENVE	CaseType=Combination	StepType=Max	F1=-131.315785795041	F2=0	
F3=774.999994114581	M1=0	M2=327.419974614744	M3=0	FrameElem=72			
Frame=72	Joint=23	OutputCase=ENVE	CaseType=Combination	StepType=Max	F1=225.106484027222	F2=0	F3=-
768.749993606919	M1=0	M2=-363.031749358287	M3=0	FrameElem=72			
Frame=72	Joint=35	OutputCase=ENVE	CaseType=Combination	StepType=Min	F1=-193.391796573298	F2=0	
F3=774.999993606919	M1=0	M2=316.559435969553	M3=0	FrameElem=72			
Frame=72	Joint=23	OutputCase=ENVE	CaseType=Combination	StepType=Min	F1=153.516067012787	F2=0	F3=-
768.749994114581	M1=0	M2=-368.882846218452	M3=0	FrameElem=72			
Frame=72	Joint=35	OutputCase=FESSUR	CaseType=Combination		F1=-193.391796573298	F2=0	
F3=774.999994114581	M1=0	M2=316.559435969553	M3=0	FrameElem=72			
Frame=72	Joint=23	OutputCase=FESSUR	CaseType=Combination		F1=225.106484027222	F2=0	F3=-
768.749994114581	M1=0	M2=-368.882846218452	M3=0	FrameElem=72			
Frame=73	Joint=23	OutputCase=PESOPR	CaseType=LinStatic		F1=15.1709467361857	F2=0	F3=68.7499988188009
M1=0	M2=24.8643150665963	M3=0	FrameElem=73				
Frame=73	Joint=21	OutputCase=PESOPR	CaseType=LinStatic		F1=-15.1709467361857	F2=0	F3=-62.4999994148473
M1=0	M2=-21.0715771796315	M3=0	FrameElem=73				
Frame=73	Joint=23	OutputCase=TERRVERT	CaseType=LinStatic		F1=-1.64270738196228	F2=0	
F3=699.999993604963	M1=0	M2=324.514874951304	M3=0	FrameElem=73			
Frame=73	Joint=21	OutputCase=TERRVERT	CaseType=LinStatic		F1=1.64270738196228	F2=0	F3=-
699.999993604963	M1=0	M2=-324.925535068329	M3=0	FrameElem=73			
Frame=73	Joint=23	OutputCase=TERRLAT	CaseType=LinStatic		F1=-238.634723381447	F2=0	
F3=1.6922009218712E-06	M1=0	M2=19.5036562005511	M3=0	FrameElem=73			
Frame=73	Joint=21	OutputCase=TERRLAT	CaseType=LinStatic		F1=269.816282883909	F2=0	F3=-
1.6922009218712E-06	M1=0	M2=-83.0711326902338	M3=0	FrameElem=73			
Frame=73	Joint=23	OutputCase=ACCVERT	CaseType=LinStatic		F1=0	F2=0	F3=0
FrameElem=73					M1=0	M2=0	M3=0
Frame=73	Joint=21	OutputCase=ACCVERT	CaseType=LinStatic		F1=0	F2=0	F3=0
FrameElem=73					M1=0	M2=0	M3=0
Frame=73	Joint=23	OutputCase=ACCLATDX	CaseType=LinStatic		F1=0	F2=0	F3=0
FrameElem=73					M1=0	M2=0	M3=0
Frame=73	Joint=21	OutputCase=ACCLATDX	CaseType=LinStatic		F1=0	F2=0	F3=0
FrameElem=73					M1=0	M2=0	M3=0
Frame=73	Joint=23	OutputCase=ACCLATSX	CaseType=LinStatic		F1=0	F2=0	F3=0
FrameElem=73					M1=0	M2=0	M3=0
Frame=73	Joint=21	OutputCase=ACCLATSX	CaseType=LinStatic		F1=0	F2=0	F3=0
FrameElem=73					M1=0	M2=0	M3=0
Frame=73	Joint=23	OutputCase=TERRCOST	CaseType=LinStatic		F1=0	F2=0	F3=0
FrameElem=73					M1=0	M2=0	M3=0
Frame=73	Joint=21	OutputCase=TERRCOST	CaseType=LinStatic		F1=0	F2=0	F3=0
FrameElem=73					M1=0	M2=0	M3=0
Frame=73	Joint=23	OutputCase=SOVRCOST	CaseType=LinStatic		F1=0	F2=0	F3=0
FrameElem=73					M1=0	M2=0	M3=0
Frame=73	Joint=21	OutputCase=SOVRCOST	CaseType=LinStatic		F1=0	F2=0	F3=0
FrameElem=73					M1=0	M2=0	M3=0



Frame=80	Joint=27	OutputCase=ACCVERT	CaseType=LinStatic	F1=0	F2=0	F3=0	M1=0	M2=0	M3=0
FrameElem=80									
Frame=80	Joint=26	OutputCase=ACCLATDX	CaseType=LinStatic	F1=0	F2=0	F3=0	M1=0	M2=0	M3=0
FrameElem=80									
Frame=80	Joint=27	OutputCase=ACCLATDX	CaseType=LinStatic	F1=0	F2=0	F3=0	M1=0	M2=0	M3=0
FrameElem=80									
Frame=80	Joint=26	OutputCase=ACCLATSX	CaseType=LinStatic	F1=0	F2=0	F3=0	M1=0	M2=0	M3=0
FrameElem=80									
Frame=80	Joint=27	OutputCase=ACCLATSX	CaseType=LinStatic	F1=0	F2=0	F3=0	M1=0	M2=0	M3=0
FrameElem=80									
Frame=80	Joint=26	OutputCase=TERRCOST	CaseType=LinStatic	F1=0	F2=0	F3=0	M1=0	M2=0	M3=0
FrameElem=80									
Frame=80	Joint=27	OutputCase=TERRCOST	CaseType=LinStatic	F1=0	F2=0	F3=0	M1=0	M2=0	M3=0
FrameElem=80									
Frame=80	Joint=26	OutputCase=SOVRCOST	CaseType=LinStatic	F1=0	F2=0	F3=0	M1=0	M2=0	M3=0
FrameElem=80									
Frame=80	Joint=27	OutputCase=SOVRCOST	CaseType=LinStatic	F1=0	F2=0	F3=0	M1=0	M2=0	M3=0
FrameElem=80									
Frame=80	Joint=26	OutputCase=ENVE	CaseType=Combination	StepType=Max	F1=-191.247935085494	F2=0			
F3=856.24999125062	M1=0	M2=-407.72863185811	M3=0	FrameElem=80					
Frame=80	Joint=27	OutputCase=ENVE	CaseType=Combination	StepType=Max	F1=228.768206470321	F2=0	F3=-		
849.999990742961	M1=0	M2=363.305887670071	M3=0	FrameElem=80					
Frame=80	Joint=26	OutputCase=ENVE	CaseType=Combination	StepType=Min	F1=-267.413518970321	F2=0			
F3=856.249990742961	M1=0	M2=-412.443176684522	M3=0	FrameElem=80					
Frame=80	Joint=27	OutputCase=ENVE	CaseType=Combination	StepType=Min	F1=164.196216335494	F2=0	F3=-		
849.99999125062	M1=0	M2=350.431567775276	M3=0	FrameElem=80					
Frame=80	Joint=26	OutputCase=FESSUR	CaseType=Combination	F1=-267.413518970321	F2=0				
F3=856.249990742961	M1=0	M2=-412.443176684522	M3=0	FrameElem=80					
Frame=80	Joint=27	OutputCase=FESSUR	CaseType=Combination	F1=228.768206470321	F2=0	F3=-			
849.999990742961	M1=0	M2=350.431567775276	M3=0	FrameElem=80					
Frame=82	Joint=34	OutputCase=PESOPR	CaseType=LinStatic	F1=-15.1709467361846	F2=0	F3=74.9999993927844			
M1=0	M2=-28.6570499815061	M3=0	FrameElem=82						
Frame=82	Joint=22	OutputCase=PESOPR	CaseType=LinStatic	F1=15.1709467361846	F2=0	F3=-68.7499993927844			
M1=0	M2=24.8643150110934	M3=0	FrameElem=82						
Frame=82	Joint=34	OutputCase=TERRVERT	CaseType=LinStatic	F1=1.64270738196205	F2=0	F3=699.999993042445			
M1=0	M2=-324.1041800089	M3=0	FrameElem=82						
Frame=82	Joint=22	OutputCase=TERRVERT	CaseType=LinStatic	F1=-1.64270738196205	F2=0	F3=-			
699.999993042445	M1=0	M2=324.514873543691	M3=0	FrameElem=82					
Frame=82	Joint=34	OutputCase=TERRLAT	CaseType=LinStatic	F1=206.920032883908	F2=0	F3=-			
1.69219748545139E-06	M1=0	M2=36.2018009975901	M3=0	FrameElem=82					
Frame=82	Joint=22	OutputCase=TERRLAT	CaseType=LinStatic	F1=-238.634720383908	F2=0				
F3=1.69219748545139E-06	M1=0	M2=19.5036499317207	M3=0	FrameElem=82					
Frame=82	Joint=34	OutputCase=ACCVERT	CaseType=LinStatic	F1=0	F2=0	F3=0	M1=0	M2=0	M3=0
FrameElem=82									
Frame=82	Joint=22	OutputCase=ACCVERT	CaseType=LinStatic	F1=0	F2=0	F3=0	M1=0	M2=0	M3=0
FrameElem=82									
Frame=82	Joint=34	OutputCase=ACCLATDX	CaseType=LinStatic	F1=0	F2=0	F3=0	M1=0	M2=0	M3=0
FrameElem=82									
Frame=82	Joint=22	OutputCase=ACCLATDX	CaseType=LinStatic	F1=0	F2=0	F3=0	M1=0	M2=0	M3=0
FrameElem=82									
Frame=82	Joint=34	OutputCase=ACCLATSX	CaseType=LinStatic	F1=0	F2=0	F3=0	M1=0	M2=0	M3=0
FrameElem=82									
Frame=82	Joint=22	OutputCase=ACCLATSX	CaseType=LinStatic	F1=0	F2=0	F3=0	M1=0	M2=0	M3=0
FrameElem=82									
Frame=82	Joint=34	OutputCase=TERRCOST	CaseType=LinStatic	F1=0	F2=0	F3=0	M1=0	M2=0	M3=0
FrameElem=82									
Frame=82	Joint=22	OutputCase=TERRCOST	CaseType=LinStatic	F1=0	F2=0	F3=0	M1=0	M2=0	M3=0
FrameElem=82									
Frame=82	Joint=34	OutputCase=SOVRCOST	CaseType=LinStatic	F1=0	F2=0	F3=0	M1=0	M2=0	M3=0
FrameElem=82									
Frame=82	Joint=22	OutputCase=SOVRCOST	CaseType=LinStatic	F1=0	F2=0	F3=0	M1=0	M2=0	M3=0
FrameElem=82									
Frame=82	Joint=34	OutputCase=ENVE	CaseType=Combination	StepType=Max	F1=193.391793529686	F2=0			
F3=774.999991250692	M1=0	M2=-316.559428992816	M3=0	FrameElem=82					
Frame=82	Joint=22	OutputCase=ENVE	CaseType=Combination	StepType=Max	F1=-153.516064914513	F2=0	F3=-		
768.749990743032	M1=0	M2=368.882838486505	M3=0	FrameElem=82					
Frame=82	Joint=34	OutputCase=ENVE	CaseType=Combination	StepType=Min	F1=131.315783664513	F2=0			
F3=774.999990743032	M1=0	M2=-327.419969292093	M3=0	FrameElem=82					
Frame=82	Joint=22	OutputCase=ENVE	CaseType=Combination	StepType=Min	F1=-225.106481029686	F2=0	F3=-		
768.749991250692	M1=0	M2=363.031743506989	M3=0	FrameElem=82					
Frame=82	Joint=34	OutputCase=FESSUR	CaseType=Combination	F1=193.391793529686	F2=0	F3=774.999990743032			
M1=0	M2=-316.559428992816	M3=0	FrameElem=82						
Frame=82	Joint=22	OutputCase=FESSUR	CaseType=Combination	F1=-225.106481029686	F2=0	F3=-			
768.749990743032	M1=0	M2=368.882838486505	M3=0	FrameElem=82					
Frame=83	Joint=22	OutputCase=PESOPR	CaseType=LinStatic	F1=-15.1709467361849	F2=0	F3=68.7499993926784			
M1=0	M2=-24.8643150110892	M3=0	FrameElem=83						
Frame=83	Joint=20	OutputCase=PESOPR	CaseType=LinStatic	F1=15.1709467361849	F2=0	F3=-62.4999993926783			
M1=0	M2=21.071576762421	M3=0	FrameElem=83						
Frame=83	Joint=22	OutputCase=TERRVERT	CaseType=LinStatic	F1=1.64270738195933	F2=0	F3=699.999993042458			
M1=0	M2=-324.514873543673	M3=0	FrameElem=83						
Frame=83	Joint=20	OutputCase=TERRVERT	CaseType=LinStatic	F1=-1.64270738195933	F2=0	F3=-			
699.999993042458	M1=0	M2=324.925533699862	M3=0	FrameElem=83					

Frame=83	Joint=22	OutputCase=TERRLAT	CaseType=LinStatic	F1=238.634720383909	F2=0	F3=-
1.69219458156493E-06	M1=0	M2=-19.5036499317208	M3=0	FrameElem=83		
Frame=83	Joint=20	OutputCase=TERRLAT	CaseType=LinStatic	F1=-269.816282883909	F2=0	
F3=1.69219458156493E-06	M1=0	M2=83.0711321110314	M3=0	FrameElem=83		
Frame=83	Joint=22	OutputCase=ACCVERT	CaseType=LinStatic	F1=0	F2=0	F3=0
FrameElem=83				M1=0	M2=0	M3=0
Frame=83	Joint=20	OutputCase=ACCVERT	CaseType=LinStatic	F1=0	F2=0	F3=0
FrameElem=83				M1=0	M2=0	M3=0
Frame=83	Joint=22	OutputCase=ACCLATDX	CaseType=LinStatic	F1=0	F2=0	F3=0
FrameElem=83				M1=0	M2=0	M3=0
Frame=83	Joint=20	OutputCase=ACCLATDX	CaseType=LinStatic	F1=0	F2=0	F3=0
FrameElem=83				M1=0	M2=0	M3=0
Frame=83	Joint=22	OutputCase=ACCLATSX	CaseType=LinStatic	F1=0	F2=0	F3=0
FrameElem=83				M1=0	M2=0	M3=0
Frame=83	Joint=20	OutputCase=ACCLATSX	CaseType=LinStatic	F1=0	F2=0	F3=0
FrameElem=83				M1=0	M2=0	M3=0
Frame=83	Joint=22	OutputCase=TERRCOST	CaseType=LinStatic	F1=0	F2=0	F3=0
FrameElem=83				M1=0	M2=0	M3=0
Frame=83	Joint=20	OutputCase=TERRCOST	CaseType=LinStatic	F1=0	F2=0	F3=0
FrameElem=83				M1=0	M2=0	M3=0
Frame=83	Joint=22	OutputCase=SOVRCOST	CaseType=LinStatic	F1=0	F2=0	F3=0
FrameElem=83				M1=0	M2=0	M3=0
Frame=83	Joint=20	OutputCase=SOVRCOST	CaseType=LinStatic	F1=0	F2=0	F3=0
FrameElem=83				M1=0	M2=0	M3=0
Frame=83	Joint=22	OutputCase=ENVE	CaseType=Combination	StepType=Max	F1=225.106481029683	F2=0
F3=768.7499912506	M1=0	M2=-363.031743506967	M3=0	FrameElem=83		
Frame=83	Joint=20	OutputCase=ENVE	CaseType=Combination	StepType=Max	F1=-175.343158664511	F2=0
762.499990742941	M1=0	M2=429.068242573315	M3=0	FrameElem=83		F3=-
Frame=83	Joint=22	OutputCase=ENVE	CaseType=Combination	StepType=Min	F1=153.51606491451	F2=0
F3=768.749990742941	M1=0	M2=-368.882838486483	M3=0	FrameElem=83		
Frame=83	Joint=20	OutputCase=ENVE	CaseType=Combination	StepType=Min	F1=-256.288043529683	F2=0
762.4999912506	M1=0	M2=404.146902940005	M3=0	FrameElem=83		F3=-
Frame=83	Joint=22	OutputCase=FESSUR	CaseType=Combination	F1=225.106481029683	F2=0	F3=768.749990742941
M1=0	M2=-368.882838486483	M3=0	FrameElem=83			
Frame=83	Joint=20	OutputCase=FESSUR	CaseType=Combination	F1=-256.288043529683	F2=0	F3=-
762.499990742941	M1=0	M2=429.068242573315	M3=0	FrameElem=83		
Frame=84	Joint=29	OutputCase=PESOPR	CaseType=LinStatic	F1=15.1709467361863	F2=0	F3=149.99998818545
M1=0	M2=74.169892927775	M3=0	FrameElem=84			
Frame=84	Joint=61	OutputCase=PESOPR	CaseType=LinStatic	F1=-15.1709467361863	F2=0	F3=-137.499998818545
M1=0	M2=-66.5844189884707	M3=0	FrameElem=84			
Frame=84	Joint=29	OutputCase=TERRVERT	CaseType=LinStatic	F1=-1.64270738195444	F2=0	
F3=699.999993604405	M1=0	M2=319.176075959943	M3=0	FrameElem=84		
Frame=84	Joint=61	OutputCase=TERRVERT	CaseType=LinStatic	F1=1.64270738195444	F2=0	F3=-
699.999993604405	M1=0	M2=-319.997426869371	M3=0	FrameElem=84		
Frame=84	Joint=29	OutputCase=TERRLAT	CaseType=LinStatic	F1=215.239963767414	F2=0	
F3=1.69220747032753E-06	M1=0	M2=-42.9144038385308	M3=0	FrameElem=84		
Frame=84	Joint=61	OutputCase=TERRLAT	CaseType=LinStatic	F1=-139.54871378648	F2=0	F3=-
1.69220747032753E-06	M1=0	M2=131.522719059808	M3=0	FrameElem=84		
Frame=84	Joint=29	OutputCase=ACCVERT	CaseType=LinStatic	F1=0	F2=0	F3=0
FrameElem=84				M1=0	M2=0	M3=0
Frame=84	Joint=61	OutputCase=ACCVERT	CaseType=LinStatic	F1=0	F2=0	F3=0
FrameElem=84				M1=0	M2=0	M3=0
Frame=84	Joint=29	OutputCase=ACCLATDX	CaseType=LinStatic	F1=0	F2=0	F3=0
FrameElem=84				M1=0	M2=0	M3=0
Frame=84	Joint=61	OutputCase=ACCLATDX	CaseType=LinStatic	F1=0	F2=0	F3=0
FrameElem=84				M1=0	M2=0	M3=0
Frame=84	Joint=29	OutputCase=ACCLATSX	CaseType=LinStatic	F1=0	F2=0	F3=0
FrameElem=84				M1=0	M2=0	M3=0
Frame=84	Joint=61	OutputCase=ACCLATSX	CaseType=LinStatic	F1=0	F2=0	F3=0
FrameElem=84				M1=0	M2=0	M3=0
Frame=84	Joint=29	OutputCase=TERRCOST	CaseType=LinStatic	F1=0	F2=0	F3=0
FrameElem=84				M1=0	M2=0	M3=0
Frame=84	Joint=61	OutputCase=TERRCOST	CaseType=LinStatic	F1=0	F2=0	F3=0
FrameElem=84				M1=0	M2=0	M3=0
Frame=84	Joint=29	OutputCase=SOVRCOST	CaseType=LinStatic	F1=0	F2=0	F3=0
FrameElem=84				M1=0	M2=0	M3=0
Frame=84	Joint=61	OutputCase=SOVRCOST	CaseType=LinStatic	F1=0	F2=0	F3=0
FrameElem=84				M1=0	M2=0	M3=0
Frame=84	Joint=29	OutputCase=ENVE	CaseType=Combination	StepType=Max	F1=228.768203121646	F2=0
F3=849.999994115157	M1=0	M2=363.305886200747	M3=0	FrameElem=84		
Frame=84	Joint=61	OutputCase=ENVE	CaseType=Combination	StepType=Max	F1=-111.212339004768	F2=0
837.499993607495	M1=0	M2=-255.059126798033	M3=0	FrameElem=84		F3=-
Frame=84	Joint=29	OutputCase=ENVE	CaseType=Combination	StepType=Min	F1=164.196213991422	F2=0
F3=849.999993607495	M1=0	M2=350.431565049187	M3=0	FrameElem=84		
Frame=84	Joint=61	OutputCase=ENVE	CaseType=Combination	StepType=Min	F1=-153.076953140712	F2=0
837.499994115157	M1=0	M2=-294.515942515975	M3=0	FrameElem=84		F3=-
Frame=84	Joint=29	OutputCase=FESSUR	CaseType=Combination	F1=228.768203121646	F2=0	F3=849.999994115157
M1=0	M2=350.431565049187	M3=0	FrameElem=84			
Frame=84	Joint=61	OutputCase=FESSUR	CaseType=Combination	F1=-153.076953140712	F2=0	F3=-
837.499994115157	M1=0	M2=-255.059126798033	M3=0	FrameElem=84		
Frame=85	Joint=61	OutputCase=PESOPR	CaseType=LinStatic	F1=15.1709467361854	F2=0	F3=137.49999881868
M1=0	M2=66.5844189884699	M3=0	FrameElem=85			

Frame=85	Joint=62	OutputCase=PESOPR	CaseType=LinStatic	F1=-15.1709467361854	F2=0	F3=-124.99999881868			
M1=0	M2=-58.9989450988366	M3=0	FrameElem=85						
Frame=85	Joint=61	OutputCase=TERRVERT	CaseType=LinStatic	F1=-1.64270738195654	F2=0				
F3=699.999993604461	M1=0	M2=319.99742686937	M3=0	FrameElem=85					
Frame=85	Joint=62	OutputCase=TERRVERT	CaseType=LinStatic	F1=1.64270738195654	F2=0	F3=-			
699.999993604461	M1=0	M2=-320.818777778797	M3=0	FrameElem=85					
Frame=85	Joint=61	OutputCase=TERRLAT	CaseType=LinStatic	F1=139.548713786482	F2=0	F3=1.6922073427327E-			
06	M1=0	M2=-131.522719059808	M3=0	FrameElem=85					
Frame=85	Joint=62	OutputCase=TERRLAT	CaseType=LinStatic	F1=-65.9899638182589	F2=0	F3=-			
1.6922073427327E-06	M1=0	M2=182.818534293797	M3=0	FrameElem=85					
Frame=85	Joint=61	OutputCase=ACCVERT	CaseType=LinStatic	F1=0	F2=0	F3=0	M1=0	M2=0	M3=0
FrameElem=85									
Frame=85	Joint=62	OutputCase=ACCVERT	CaseType=LinStatic	F1=0	F2=0	F3=0	M1=0	M2=0	M3=0
FrameElem=85									
Frame=85	Joint=61	OutputCase=ACCLATDX	CaseType=LinStatic	F1=0	F2=0	F3=0	M1=0	M2=0	M3=0
FrameElem=85									
Frame=85	Joint=62	OutputCase=ACCLATDX	CaseType=LinStatic	F1=0	F2=0	F3=0	M1=0	M2=0	M3=0
FrameElem=85									
Frame=85	Joint=61	OutputCase=ACCLATSX	CaseType=LinStatic	F1=0	F2=0	F3=0	M1=0	M2=0	M3=0
FrameElem=85									
Frame=85	Joint=62	OutputCase=ACCLATSX	CaseType=LinStatic	F1=0	F2=0	F3=0	M1=0	M2=0	M3=0
FrameElem=85									
Frame=85	Joint=61	OutputCase=TERRCOST	CaseType=LinStatic	F1=0	F2=0	F3=0	M1=0	M2=0	M3=0
FrameElem=85									
Frame=85	Joint=62	OutputCase=TERRCOST	CaseType=LinStatic	F1=0	F2=0	F3=0	M1=0	M2=0	M3=0
FrameElem=85									
Frame=85	Joint=61	OutputCase=SOVRCOST	CaseType=LinStatic	F1=0	F2=0	F3=0	M1=0	M2=0	M3=0
FrameElem=85									
Frame=85	Joint=62	OutputCase=SOVRCOST	CaseType=LinStatic	F1=0	F2=0	F3=0	M1=0	M2=0	M3=0
FrameElem=85									
Frame=85	Joint=61	OutputCase=ENVE	CaseType=Combination	StepType=Max	F1=153.076953140711	F2=0			
F3=837.499994115348	M1=0	M2=294.515942515974	M3=0	FrameElem=85					
Frame=85	Joint=62	OutputCase=ENVE	CaseType=Combination	StepType=Max	F1=-59.72121402701	F2=0	F3=-		
824.999993607686	M1=0	M2=-196.999188583837	M3=0	FrameElem=85					
Frame=85	Joint=61	OutputCase=ENVE	CaseType=Combination	StepType=Min	F1=111.212339004766	F2=0			
F3=837.499993607686	M1=0	M2=255.059126798031	M3=0	FrameElem=85					
Frame=85	Joint=62	OutputCase=ENVE	CaseType=Combination	StepType=Min	F1=-79.5182031724877	F2=0	F3=-		
824.999994115348	M1=0	M2=-251.844748871976	M3=0	FrameElem=85					
Frame=85	Joint=61	OutputCase=FESSUR	CaseType=Combination	F1=153.076953140711	F2=0	F3=837.499994115348			
M1=0	M2=255.059126798031	M3=0	FrameElem=85						
Frame=85	Joint=62	OutputCase=FESSUR	CaseType=Combination	F1=-79.5182031724877	F2=0	F3=-			
824.999994115348	M1=0	M2=-196.999188583837	M3=0	FrameElem=85					
Frame=86	Joint=62	OutputCase=PESOPR	CaseType=LinStatic	F1=15.1709467361848	F2=0	F3=124.999998818538			
M1=0	M2=58.9989450988366	M3=0	FrameElem=86						
Frame=86	Joint=63	OutputCase=PESOPR	CaseType=LinStatic	F1=-15.1709467361848	F2=0	F3=-112.499998818538			
M1=0	M2=-51.413471258874	M3=0	FrameElem=86						
Frame=86	Joint=62	OutputCase=TERRVERT	CaseType=LinStatic	F1=-1.64270738195712	F2=0				
F3=699.999993604413	M1=0	M2=320.818777778797	M3=0	FrameElem=86					
Frame=86	Joint=63	OutputCase=TERRVERT	CaseType=LinStatic	F1=1.64270738195712	F2=0	F3=-			
699.999993604413	M1=0	M2=-321.640128688226	M3=0	FrameElem=86					
Frame=86	Joint=62	OutputCase=TERRLAT	CaseType=LinStatic	F1=65.9899638182587	F2=0				
F3=1.69220711107789E-06	M1=0	M2=-182.818534293797	M3=0	FrameElem=86					
Frame=86	Joint=63	OutputCase=TERRLAT	CaseType=LinStatic	F1=5.43628613725393	F2=0	F3=-			
1.69220711107789E-06	M1=0	M2=197.868099546852	M3=0	FrameElem=86					
Frame=86	Joint=62	OutputCase=ACCVERT	CaseType=LinStatic	F1=0	F2=0	F3=0	M1=0	M2=0	M3=0
FrameElem=86									
Frame=86	Joint=63	OutputCase=ACCVERT	CaseType=LinStatic	F1=0	F2=0	F3=0	M1=0	M2=0	M3=0
FrameElem=86									
Frame=86	Joint=62	OutputCase=ACCLATDX	CaseType=LinStatic	F1=0	F2=0	F3=0	M1=0	M2=0	M3=0
FrameElem=86									
Frame=86	Joint=63	OutputCase=ACCLATDX	CaseType=LinStatic	F1=0	F2=0	F3=0	M1=0	M2=0	M3=0
FrameElem=86									
Frame=86	Joint=62	OutputCase=ACCLATSX	CaseType=LinStatic	F1=0	F2=0	F3=0	M1=0	M2=0	M3=0
FrameElem=86									
Frame=86	Joint=63	OutputCase=ACCLATSX	CaseType=LinStatic	F1=0	F2=0	F3=0	M1=0	M2=0	M3=0
FrameElem=86									
Frame=86	Joint=62	OutputCase=TERRCOST	CaseType=LinStatic	F1=0	F2=0	F3=0	M1=0	M2=0	M3=0
FrameElem=86									
Frame=86	Joint=63	OutputCase=TERRCOST	CaseType=LinStatic	F1=0	F2=0	F3=0	M1=0	M2=0	M3=0
FrameElem=86									
Frame=86	Joint=62	OutputCase=SOVRCOST	CaseType=LinStatic	F1=0	F2=0	F3=0	M1=0	M2=0	M3=0
FrameElem=86									
Frame=86	Joint=63	OutputCase=SOVRCOST	CaseType=LinStatic	F1=0	F2=0	F3=0	M1=0	M2=0	M3=0
FrameElem=86									
Frame=86	Joint=62	OutputCase=ENVE	CaseType=Combination	StepType=Max	F1=79.5182031724864	F2=0			
F3=824.999994115158	M1=0	M2=251.844748871976	M3=0	FrameElem=86					
Frame=86	Joint=63	OutputCase=ENVE	CaseType=Combination	StepType=Max	F1=-8.0919532169738	F2=0	F3=-		
812.499993607496	M1=0	M2=-175.185500400248	M3=0	FrameElem=86					
Frame=86	Joint=62	OutputCase=ENVE	CaseType=Combination	StepType=Min	F1=59.7212140270088	F2=0			
F3=824.999993607496	M1=0	M2=196.999188583837	M3=0	FrameElem=86					
Frame=86	Joint=63	OutputCase=ENVE	CaseType=Combination	StepType=Min	F1=-9.72283905814997	F2=0	F3=-		
812.499994115158	M1=0	M2=-234.545930264304	M3=0	FrameElem=86					



Frame=86	Joint=62	OutputCase=FESSUR	CaseType=Combination	F1=79.5182031724864	F2=0	F3=824.999994115158			
M1=0	M2=196.999188583837	M3=0	FrameElem=86						
Frame=86	Joint=63	OutputCase=FESSUR	CaseType=Combination	F1=-8.0919532169738	F2=0	F3=-			
812.499994115158	M1=0	M2=-175.185500400248	M3=0	FrameElem=86					
Frame=87	Joint=63	OutputCase=PESOPR	CaseType=LinStatic	F1=15.1709467361847	F2=0	F3=112.499998818583			
M1=0	M2=51.413471258874	M3=0	FrameElem=87						
Frame=87	Joint=64	OutputCase=PESOPR	CaseType=LinStatic	F1=-15.1709467361847	F2=0	F3=-99.9999988185832			
M1=0	M2=-43.8279974685821	M3=0	FrameElem=87						
Frame=87	Joint=63	OutputCase=TERRVERT	CaseType=LinStatic	F1=-1.64270738195791	F2=0				
F3=699.999993604495	M1=0	M2=321.640128688226	M3=0	FrameElem=87					
Frame=87	Joint=64	OutputCase=TERRVERT	CaseType=LinStatic	F1=1.64270738195791	F2=0	F3=-			
699.999993604495	M1=0	M2=-322.461479597655	M3=0	FrameElem=87					
Frame=87	Joint=63	OutputCase=TERRLAT	CaseType=LinStatic	F1=-5.43628613725177	F2=0				
F3=1.69220783995186E-06	M1=0	M2=-197.868099546852	M3=0	FrameElem=87					
Frame=87	Joint=64	OutputCase=TERRLAT	CaseType=LinStatic	F1=74.7300360800536	F2=0	F3=-			
1.69220783995186E-06	M1=0	M2=177.737664825329	M3=0	FrameElem=87					
Frame=87	Joint=63	OutputCase=ACCVERT	CaseType=LinStatic	F1=0	F2=0	F3=0	M1=0	M2=0	M3=0
FrameElem=87									
Frame=87	Joint=64	OutputCase=ACCVERT	CaseType=LinStatic	F1=0	F2=0	F3=0	M1=0	M2=0	M3=0
FrameElem=87									
Frame=87	Joint=63	OutputCase=ACCLATDX	CaseType=LinStatic	F1=0	F2=0	F3=0	M1=0	M2=0	M3=0
FrameElem=87									
Frame=87	Joint=64	OutputCase=ACCLATDX	CaseType=LinStatic	F1=0	F2=0	F3=0	M1=0	M2=0	M3=0
FrameElem=87									
Frame=87	Joint=63	OutputCase=ACCLATSX	CaseType=LinStatic	F1=0	F2=0	F3=0	M1=0	M2=0	M3=0
FrameElem=87									
Frame=87	Joint=64	OutputCase=ACCLATSX	CaseType=LinStatic	F1=0	F2=0	F3=0	M1=0	M2=0	M3=0
FrameElem=87									
Frame=87	Joint=63	OutputCase=TERRCOST	CaseType=LinStatic	F1=0	F2=0	F3=0	M1=0	M2=0	M3=0
FrameElem=87									
Frame=87	Joint=64	OutputCase=TERRCOST	CaseType=LinStatic	F1=0	F2=0	F3=0	M1=0	M2=0	M3=0
FrameElem=87									
Frame=87	Joint=63	OutputCase=SOVRCOST	CaseType=LinStatic	F1=0	F2=0	F3=0	M1=0	M2=0	M3=0
FrameElem=87									
Frame=87	Joint=64	OutputCase=SOVRCOST	CaseType=LinStatic	F1=0	F2=0	F3=0	M1=0	M2=0	M3=0
FrameElem=87									
Frame=87	Joint=63	OutputCase=ENVE	CaseType=Combination	StepType=Max	F1=9.72283905815052	F2=0			
F3=812.499994115286	M1=0	M2=234.545930264304	M3=0	FrameElem=87					
Frame=87	Joint=64	OutputCase=ENVE	CaseType=Combination	StepType=Max	F1=61.2017967258269	F2=0	F3=-		
799.999993607624	M1=0	M2=-188.551812240908	M3=0	FrameElem=87					
Frame=87	Joint=63	OutputCase=ENVE	CaseType=Combination	StepType=Min	F1=8.09195321697499	F2=0			
F3=812.499993607624	M1=0	M2=175.185500400248	M3=0	FrameElem=87					
Frame=87	Joint=64	OutputCase=ENVE	CaseType=Combination	StepType=Min	F1=38.7827859018108	F2=0	F3=-		
799.999994115286	M1=0	M2=-241.873111688507	M3=0	FrameElem=87					
Frame=87	Joint=63	OutputCase=FESSUR	CaseType=Combination	F1=8.09195321697499	F2=0	F3=812.499994115286			
M1=0	M2=175.185500400248	M3=0	FrameElem=87						
Frame=87	Joint=64	OutputCase=FESSUR	CaseType=Combination	F1=61.2017967258269	F2=0	F3=-			
799.999994115286	M1=0	M2=-188.551812240908	M3=0	FrameElem=87					
Frame=88	Joint=64	OutputCase=PESOPR	CaseType=LinStatic	F1=15.1709467361846	F2=0	F3=99.9999988185257			
M1=0	M2=43.8279974685821	M3=0	FrameElem=88						
Frame=88	Joint=65	OutputCase=PESOPR	CaseType=LinStatic	F1=-15.1709467361846	F2=0	F3=-87.4999988185257			
M1=0	M2=-36.2425237279608	M3=0	FrameElem=88						
Frame=88	Joint=64	OutputCase=TERRVERT	CaseType=LinStatic	F1=-1.64270738195853	F2=0				
F3=699.999993604358	M1=0	M2=322.461479597655	M3=0	FrameElem=88					
Frame=88	Joint=65	OutputCase=TERRVERT	CaseType=LinStatic	F1=1.64270738195853	F2=0	F3=-			
699.999993604358	M1=0	M2=-323.282830507084	M3=0	FrameElem=88					
Frame=88	Joint=64	OutputCase=TERRLAT	CaseType=LinStatic	F1=-74.7300360800537	F2=0				
F3=1.69220682111011E-06	M1=0	M2=-177.737664825329	M3=0	FrameElem=88					
Frame=88	Joint=65	OutputCase=TERRLAT	CaseType=LinStatic	F1=141.891286010145	F2=0	F3=-			
1.69220682111011E-06	M1=0	M2=123.493480135583	M3=0	FrameElem=88					
Frame=88	Joint=64	OutputCase=ACCVERT	CaseType=LinStatic	F1=0	F2=0	F3=0	M1=0	M2=0	M3=0
FrameElem=88									
Frame=88	Joint=65	OutputCase=ACCVERT	CaseType=LinStatic	F1=0	F2=0	F3=0	M1=0	M2=0	M3=0
FrameElem=88									
Frame=88	Joint=64	OutputCase=ACCLATDX	CaseType=LinStatic	F1=0	F2=0	F3=0	M1=0	M2=0	M3=0
FrameElem=88									
Frame=88	Joint=65	OutputCase=ACCLATDX	CaseType=LinStatic	F1=0	F2=0	F3=0	M1=0	M2=0	M3=0
FrameElem=88									
Frame=88	Joint=64	OutputCase=ACCLATSX	CaseType=LinStatic	F1=0	F2=0	F3=0	M1=0	M2=0	M3=0
FrameElem=88									
Frame=88	Joint=65	OutputCase=ACCLATSX	CaseType=LinStatic	F1=0	F2=0	F3=0	M1=0	M2=0	M3=0
FrameElem=88									
Frame=88	Joint=64	OutputCase=TERRCOST	CaseType=LinStatic	F1=0	F2=0	F3=0	M1=0	M2=0	M3=0
FrameElem=88									
Frame=88	Joint=65	OutputCase=TERRCOST	CaseType=LinStatic	F1=0	F2=0	F3=0	M1=0	M2=0	M3=0
FrameElem=88									
Frame=88	Joint=64	OutputCase=SOVRCOST	CaseType=LinStatic	F1=0	F2=0	F3=0	M1=0	M2=0	M3=0
FrameElem=88									
Frame=88	Joint=65	OutputCase=SOVRCOST	CaseType=LinStatic	F1=0	F2=0	F3=0	M1=0	M2=0	M3=0
FrameElem=88									
Frame=88	Joint=64	OutputCase=ENVE	CaseType=Combination	StepType=Max	F1=-38.7827859018115	F2=0			
F3=799.999994115091	M1=0	M2=241.873111688507	M3=0	FrameElem=88					

Frame=88	Joint=65	OutputCase=ENVE	CaseType=Combination	StepType=Max	F1=128.363046655919	F2=0	F3=-
787.499993607429	M1=0	M2=-236.031874099462	M3=0	FrameElem=88			
Frame=88	Joint=64	OutputCase=ENVE	CaseType=Combination	StepType=Min	F1=-61.2017967258277	F2=0	
F3=799.999993607429	M1=0	M2=188.551812240908	M3=0	FrameElem=88			
Frame=88	Joint=65	OutputCase=ENVE	CaseType=Combination	StepType=Min	F1=85.7956608528754	F2=0	F3=-
787.499994115091	M1=0	M2=-273.079918140137	M3=0	FrameElem=88			
Frame=88	Joint=64	OutputCase=FESSUR	CaseType=Combination		F1=-61.2017967258277	F2=0	
F3=799.999994115091	M1=0	M2=188.551812240908	M3=0	FrameElem=88			
Frame=88	Joint=65	OutputCase=FESSUR	CaseType=Combination		F1=128.363046655919	F2=0	F3=-
787.499994115091	M1=0	M2=-236.031874099462	M3=0	FrameElem=88			
Frame=89	Joint=65	OutputCase=PESOPR	CaseType=LinStatic		F1=15.170946736186	F2=0	F3=87.4999988184815
M1=0	M2=36.2425237279608	M3=0	FrameElem=89				
Frame=89	Joint=35	OutputCase=PESOPR	CaseType=LinStatic		F1=-15.170946736186	F2=0	F3=-74.9999988184815
M1=0	M2=-28.6570500370093	M3=0	FrameElem=89				
Frame=89	Joint=65	OutputCase=TERRVERT	CaseType=LinStatic		F1=-1.64270738196092	F2=0	F3=699.99999360435
M1=0	M2=323.282830507084	M3=0	FrameElem=89				
Frame=89	Joint=35	OutputCase=TERRVERT	CaseType=LinStatic		F1=1.64270738196092	F2=0	F3=-699.99999360435
M1=0	M2=-324.104181416514	M3=0	FrameElem=89				
Frame=89	Joint=65	OutputCase=TERRLAT	CaseType=LinStatic		F1=-141.891286010143	F2=0	
F3=1.69221070424918E-06	M1=0	M2=-123.493480135583	M3=0	FrameElem=89			
Frame=89	Joint=35	OutputCase=TERRLAT	CaseType=LinStatic		F1=206.920035927524	F2=0	F3=-
1.69221070424918E-06	M1=0	M2=36.2017954839698	M3=0	FrameElem=89			
Frame=89	Joint=65	OutputCase=ACCVERT	CaseType=LinStatic		F1=0	F2=0	F3=0
FrameElem=89					M1=0	M2=0	M3=0
Frame=89	Joint=35	OutputCase=ACCVERT	CaseType=LinStatic		F1=0	F2=0	F3=0
FrameElem=89					M1=0	M2=0	M3=0
Frame=89	Joint=65	OutputCase=ACCLATDX	CaseType=LinStatic		F1=0	F2=0	F3=0
FrameElem=89					M1=0	M2=0	M3=0
Frame=89	Joint=35	OutputCase=ACCLATDX	CaseType=LinStatic		F1=0	F2=0	F3=0
FrameElem=89					M1=0	M2=0	M3=0
Frame=89	Joint=65	OutputCase=ACCLATSX	CaseType=LinStatic		F1=0	F2=0	F3=0
FrameElem=89					M1=0	M2=0	M3=0
Frame=89	Joint=35	OutputCase=ACCLATSX	CaseType=LinStatic		F1=0	F2=0	F3=0
FrameElem=89					M1=0	M2=0	M3=0
Frame=89	Joint=65	OutputCase=TERRCOST	CaseType=LinStatic		F1=0	F2=0	F3=0
FrameElem=89					M1=0	M2=0	M3=0
Frame=89	Joint=35	OutputCase=TERRCOST	CaseType=LinStatic		F1=0	F2=0	F3=0
FrameElem=89					M1=0	M2=0	M3=0
Frame=89	Joint=65	OutputCase=SOVRCOST	CaseType=LinStatic		F1=0	F2=0	F3=0
FrameElem=89					M1=0	M2=0	M3=0
Frame=89	Joint=35	OutputCase=SOVRCOST	CaseType=LinStatic		F1=0	F2=0	F3=0
FrameElem=89					M1=0	M2=0	M3=0
Frame=89	Joint=65	OutputCase=ENVE	CaseType=Combination	StepType=Max	F1=-85.7956608528754	F2=0	
F3=787.499994115042	M1=0	M2=273.079918140136	M3=0	FrameElem=89			
Frame=89	Joint=35	OutputCase=ENVE	CaseType=Combination	StepType=Max	F1=193.391796573299	F2=0	F3=-
774.999993607379	M1=0	M2=-316.559435969553	M3=0	FrameElem=89			
Frame=89	Joint=65	OutputCase=ENVE	CaseType=Combination	StepType=Min	F1=-128.363046655918	F2=0	
F3=787.499993607379	M1=0	M2=236.031874099461	M3=0	FrameElem=89			
Frame=89	Joint=35	OutputCase=ENVE	CaseType=Combination	StepType=Min	F1=131.315785795042	F2=0	F3=-
774.999994115042	M1=0	M2=-327.419974614744	M3=0	FrameElem=89			
Frame=89	Joint=65	OutputCase=FESSUR	CaseType=Combination		F1=-128.363046655918	F2=0	
F3=787.499994115042	M1=0	M2=236.031874099461	M3=0	FrameElem=89			
Frame=89	Joint=35	OutputCase=FESSUR	CaseType=Combination		F1=193.391796573299	F2=0	F3=-
774.999994115042	M1=0	M2=-316.559435969553	M3=0	FrameElem=89			
Frame=90	Joint=27	OutputCase=PESOPR	CaseType=LinStatic		F1=-15.1709467361862	F2=0	F3=149.9999939288
M1=0	M2=-74.1698928722702	M3=0	FrameElem=90				
Frame=90	Joint=66	OutputCase=PESOPR	CaseType=LinStatic		F1=15.1709467361862	F2=0	F3=-137.4999939288
M1=0	M2=66.584418932966	M3=0	FrameElem=90				
Frame=90	Joint=27	OutputCase=TERRVERT	CaseType=LinStatic		F1=1.64270738195364	F2=0	F3=699.999993042818
M1=0	M2=-319.176074552322	M3=0	FrameElem=90				
Frame=90	Joint=66	OutputCase=TERRVERT	CaseType=LinStatic		F1=-1.64270738195364	F2=0	F3=-
699.999993042818	M1=0	M2=319.99742546175	M3=0	FrameElem=90			
Frame=90	Joint=27	OutputCase=TERRLAT	CaseType=LinStatic		F1=-215.239967116091	F2=0	F3=-
1.6921984684175E-06	M1=0	M2=42.9143996493173	M3=0	FrameElem=90			
Frame=90	Joint=66	OutputCase=TERRLAT	CaseType=LinStatic		F1=139.548717116091	F2=0	F3=1.6921984684175E-
06	M1=0	M2=-131.522716540696	M3=0	FrameElem=90			
Frame=90	Joint=27	OutputCase=ACCVERT	CaseType=LinStatic		F1=0	F2=0	F3=0
FrameElem=90					M1=0	M2=0	M3=0
Frame=90	Joint=66	OutputCase=ACCVERT	CaseType=LinStatic		F1=0	F2=0	F3=0
FrameElem=90					M1=0	M2=0	M3=0
Frame=90	Joint=27	OutputCase=ACCLATDX	CaseType=LinStatic		F1=0	F2=0	F3=0
FrameElem=90					M1=0	M2=0	M3=0
Frame=90	Joint=66	OutputCase=ACCLATDX	CaseType=LinStatic		F1=0	F2=0	F3=0
FrameElem=90					M1=0	M2=0	M3=0
Frame=90	Joint=27	OutputCase=ACCLATSX	CaseType=LinStatic		F1=0	F2=0	F3=0
FrameElem=90					M1=0	M2=0	M3=0
Frame=90	Joint=66	OutputCase=ACCLATSX	CaseType=LinStatic		F1=0	F2=0	F3=0
FrameElem=90					M1=0	M2=0	M3=0
Frame=90	Joint=27	OutputCase=TERRCOST	CaseType=LinStatic		F1=0	F2=0	F3=0
FrameElem=90					M1=0	M2=0	M3=0
Frame=90	Joint=66	OutputCase=TERRCOST	CaseType=LinStatic		F1=0	F2=0	F3=0
FrameElem=90					M1=0	M2=0	M3=0



Frame=94	Joint=69	OutputCase=ACCLATDX	CaseType=LinStatic	F1=0	F2=0	F3=0	M1=0	M2=0	M3=0
FrameElem=94									
Frame=94	Joint=70	OutputCase=ACCLATDX	CaseType=LinStatic	F1=0	F2=0	F3=0	M1=0	M2=0	M3=0
FrameElem=94									
Frame=94	Joint=69	OutputCase=ACCLATSX	CaseType=LinStatic	F1=0	F2=0	F3=0	M1=0	M2=0	M3=0
FrameElem=94									
Frame=94	Joint=70	OutputCase=ACCLATSX	CaseType=LinStatic	F1=0	F2=0	F3=0	M1=0	M2=0	M3=0
FrameElem=94									
Frame=94	Joint=69	OutputCase=TERRCOST	CaseType=LinStatic	F1=0	F2=0	F3=0	M1=0	M2=0	M3=0
FrameElem=94									
Frame=94	Joint=70	OutputCase=TERRCOST	CaseType=LinStatic	F1=0	F2=0	F3=0	M1=0	M2=0	M3=0
FrameElem=94									
Frame=94	Joint=69	OutputCase=SOVRCOST	CaseType=LinStatic	F1=0	F2=0	F3=0	M1=0	M2=0	M3=0
FrameElem=94									
Frame=94	Joint=70	OutputCase=SOVRCOST	CaseType=LinStatic	F1=0	F2=0	F3=0	M1=0	M2=0	M3=0
FrameElem=94									
Frame=94	Joint=69	OutputCase=ENVE	CaseType=Combination	StepType=Max	F1=61.2017935296859		F2=0		
F3=799.999991250687	M1=0	M2=-188.551808388286	M3=0	FrameElem=94					
Frame=94	Joint=70	OutputCase=ENVE	CaseType=Combination	StepType=Max	F1=-85.7956586645134		F2=0	F3=-	
787.499990743027	M1=0	M2=273.07991389758	M3=0	FrameElem=94					
Frame=94	Joint=69	OutputCase=ENVE	CaseType=Combination	StepType=Min	F1=38.7827836645134		F2=0		
F3=799.999990743027	M1=0	M2=-241.873108552736	M3=0	FrameElem=94					
Frame=94	Joint=70	OutputCase=ENVE	CaseType=Combination	StepType=Min	F1=-128.363043529686		F2=0	F3=-	
787.499991250687	M1=0	M2=236.031868665716	M3=0	FrameElem=94					
Frame=94	Joint=69	OutputCase=FESSUR	CaseType=Combination	F1=61.2017935296859	F2=0	F3=799.999990743027			
M1=0	M2=-188.551808388286	M3=0	FrameElem=94						
Frame=94	Joint=70	OutputCase=FESSUR	CaseType=Combination	F1=-128.363043529686	F2=0	F3=-			
787.499990743027	M1=0	M2=236.031868665716	M3=0	FrameElem=94					
Frame=95	Joint=70	OutputCase=PESOPR	CaseType=LinStatic	F1=-15.1709467361846	F2=0	F3=87.4999993928461			
M1=0	M2=-36.2425236724569	M3=0	FrameElem=95						
Frame=95	Joint=34	OutputCase=PESOPR	CaseType=LinStatic	F1=15.1709467361846	F2=0	F3=-74.9999993928461			
M1=0	M2=28.6570499815061	M3=0	FrameElem=95						
Frame=95	Joint=70	OutputCase=TERRVERT	CaseType=LinStatic	F1=1.64270738196205	F2=0	F3=699.999993042763			
M1=0	M2=-323.28282909947	M3=0	FrameElem=95						
Frame=95	Joint=34	OutputCase=TERRVERT	CaseType=LinStatic	F1=-1.64270738196205	F2=0	F3=-			
699.999993042763	M1=0	M2=324.104180008901	M3=0	FrameElem=95					
Frame=95	Joint=70	OutputCase=TERRLAT	CaseType=LinStatic	F1=141.891282883908	F2=0	F3=-			
1.69219699182826E-06	M1=0	M2=123.493484106211	M3=0	FrameElem=95					
Frame=95	Joint=34	OutputCase=TERRLAT	CaseType=LinStatic	F1=-206.920032883908	F2=0				
F3=1.69219699182826E-06	M1=0	M2=-36.2018009975902	M3=0	FrameElem=95					
Frame=95	Joint=70	OutputCase=ACCVERT	CaseType=LinStatic	F1=0	F2=0	F3=0	M1=0	M2=0	M3=0
FrameElem=95									
Frame=95	Joint=34	OutputCase=ACCVERT	CaseType=LinStatic	F1=0	F2=0	F3=0	M1=0	M2=0	M3=0
FrameElem=95									
Frame=95	Joint=70	OutputCase=ACCLATDX	CaseType=LinStatic	F1=0	F2=0	F3=0	M1=0	M2=0	M3=0
FrameElem=95									
Frame=95	Joint=34	OutputCase=ACCLATDX	CaseType=LinStatic	F1=0	F2=0	F3=0	M1=0	M2=0	M3=0
FrameElem=95									
Frame=95	Joint=70	OutputCase=ACCLATSX	CaseType=LinStatic	F1=0	F2=0	F3=0	M1=0	M2=0	M3=0
FrameElem=95									
Frame=95	Joint=34	OutputCase=ACCLATSX	CaseType=LinStatic	F1=0	F2=0	F3=0	M1=0	M2=0	M3=0
FrameElem=95									
Frame=95	Joint=70	OutputCase=TERRCOST	CaseType=LinStatic	F1=0	F2=0	F3=0	M1=0	M2=0	M3=0
FrameElem=95									
Frame=95	Joint=34	OutputCase=TERRCOST	CaseType=LinStatic	F1=0	F2=0	F3=0	M1=0	M2=0	M3=0
FrameElem=95									
Frame=95	Joint=70	OutputCase=SOVRCOST	CaseType=LinStatic	F1=0	F2=0	F3=0	M1=0	M2=0	M3=0
FrameElem=95									
Frame=95	Joint=34	OutputCase=SOVRCOST	CaseType=LinStatic	F1=0	F2=0	F3=0	M1=0	M2=0	M3=0
FrameElem=95									
Frame=95	Joint=70	OutputCase=ENVE	CaseType=Combination	StepType=Max	F1=128.363043529685		F2=0		
F3=787.499991251071	M1=0	M2=-236.031868665716	M3=0	FrameElem=95					
Frame=95	Joint=34	OutputCase=ENVE	CaseType=Combination	StepType=Max	F1=-131.315783664513		F2=0	F3=-	
774.999990743412	M1=0	M2=327.419969292094	M3=0	FrameElem=95					
Frame=95	Joint=70	OutputCase=ENVE	CaseType=Combination	StepType=Min	F1=85.795658664513		F2=0		
F3=787.499990743412	M1=0	M2=-273.07991389758	M3=0	FrameElem=95					
Frame=95	Joint=34	OutputCase=ENVE	CaseType=Combination	StepType=Min	F1=-193.391793529685		F2=0	F3=-	
774.999991251071	M1=0	M2=316.559428992817	M3=0	FrameElem=95					
Frame=95	Joint=70	OutputCase=FESSUR	CaseType=Combination	F1=128.363043529685	F2=0	F3=787.499990743412			
M1=0	M2=-236.031868665716	M3=0	FrameElem=95						
Frame=95	Joint=34	OutputCase=FESSUR	CaseType=Combination	F1=-193.391793529685	F2=0	F3=-			
774.999990743412	M1=0	M2=316.559428992817	M3=0	FrameElem=95					
Frame=112	Joint=40	OutputCase=PESOPR	CaseType=LinStatic	F1=-15.170946736185	F2=0	F3=49.999999888454			
M1=0	M2=7.05342174187174	M3=0	FrameElem=112						
Frame=112	Joint=85	OutputCase=PESOPR	CaseType=LinStatic	F1=15.170946736185	F2=0	F3=-37.499999888454			
M1=0	M2=-28.9284217362945	M3=0	FrameElem=112						
Frame=112	Joint=40	OutputCase=TERRVERT	CaseType=LinStatic	F1=1.64270738195971	F2=0				
F3=559.99999718358	M1=0	M2=-9.92555053006785	M3=0	FrameElem=112					
Frame=112	Joint=85	OutputCase=TERRVERT	CaseType=LinStatic	F1=-1.64270738195971	F2=0	F3=-			
419.99999718358	M1=0	M2=-235.074449329097	M3=0	FrameElem=112					
Frame=112	Joint=40	OutputCase=TERRLAT	CaseType=LinStatic	F1=330.586282883909	F2=0	F3=-			
1.69219674717169E-06	M1=0	M2=-83.0711329571296	M3=0	FrameElem=112					

Frame=112	Joint=85	OutputCase=TERRLAT	CaseType=LinStatic	F1=-330.586282883909	F2=0				
F3=1.69219674717169E-06		M1=0 M2=83.0711338032281	M3=0	FrameElem=112					
Frame=112	Joint=40	OutputCase=ACCVERT	CaseType=LinStatic	F1=0	F2=0	F3=0	M1=0	M2=0	M3=0
FrameElem=112									
Frame=112	Joint=85	OutputCase=ACCVERT	CaseType=LinStatic	F1=0	F2=0	F3=0	M1=0	M2=0	M3=0
FrameElem=112									
Frame=112	Joint=40	OutputCase=ACCLATDX	CaseType=LinStatic	F1=0	F2=0	F3=0	M1=0	M2=0	M3=0
FrameElem=112									
Frame=112	Joint=85	OutputCase=ACCLATDX	CaseType=LinStatic	F1=0	F2=0	F3=0	M1=0	M2=0	M3=0
FrameElem=112									
Frame=112	Joint=40	OutputCase=ACCLATSX	CaseType=LinStatic	F1=0	F2=0	F3=0	M1=0	M2=0	M3=0
FrameElem=112									
Frame=112	Joint=85	OutputCase=ACCLATSX	CaseType=LinStatic	F1=0	F2=0	F3=0	M1=0	M2=0	M3=0
FrameElem=112									
Frame=112	Joint=40	OutputCase=TERRCOST	CaseType=LinStatic	F1=0	F2=0	F3=0	M1=0	M2=0	M3=0
FrameElem=112									
Frame=112	Joint=85	OutputCase=TERRCOST	CaseType=LinStatic	F1=0	F2=0	F3=0	M1=0	M2=0	M3=0
FrameElem=112									
Frame=112	Joint=40	OutputCase=SOVRCOST	CaseType=LinStatic	F1=0	F2=0	F3=0	M1=0	M2=0	M3=0
FrameElem=112									
Frame=112	Joint=85	OutputCase=SOVRCOST	CaseType=LinStatic	F1=0	F2=0	F3=0	M1=0	M2=0	M3=0
FrameElem=112									
Frame=112	Joint=40	OutputCase=ENVE	CaseType=Combination	StepType=Max	F1=317.058043529684	F2=0			
F3=609.999998522666	M1=0	M2=-61.0219218581868	M3=0	FrameElem=112					
Frame=112	Joint=85	OutputCase=ENVE	CaseType=Combination	StepType=Max	F1=-217.882158664511	F2=0	F3=-		
457.499998015007	M1=0	M2=-180.931737262163	M3=0	FrameElem=112					
Frame=112	Joint=40	OutputCase=ENVE	CaseType=Combination	StepType=Min	F1=217.882158664511	F2=0			
F3=609.999998015007	M1=0	M2=-85.9432617453257	M3=0	FrameElem=112					
Frame=112	Joint=85	OutputCase=ENVE	CaseType=Combination	StepType=Min	F1=-317.058043529684	F2=0	F3=-		
457.499998522666	M1=0	M2=-205.853077403132	M3=0	FrameElem=112					
Frame=112	Joint=40	OutputCase=FESSUR	CaseType=Combination	F1=317.058043529684	F2=0				
F3=609.999998015007	M1=0	M2=-85.9432617453257	M3=0	FrameElem=112					
Frame=112	Joint=85	OutputCase=FESSUR	CaseType=Combination	F1=-317.058043529684	F2=0	F3=-			
457.499998015007	M1=0	M2=-180.931737262163	M3=0	FrameElem=112					
Frame=113	Joint=85	OutputCase=PESOPR	CaseType=LinStatic	F1=-15.1709467361849	F2=0	F3=37.4999999888413			
M1=0	M2=28.9284217362979	M3=0	FrameElem=113						
Frame=113	Joint=86	OutputCase=PESOPR	CaseType=LinStatic	F1=15.1709467361849	F2=0	F3=-24.9999999888413			
M1=0	M2=-44.5534217307222	M3=0	FrameElem=113						
Frame=113	Joint=85	OutputCase=TERRVERT	CaseType=LinStatic	F1=1.64270738195971	F2=0				
F3=419.99999718337	M1=0	M2=235.074449329087	M3=0	FrameElem=113					
Frame=113	Joint=86	OutputCase=TERRVERT	CaseType=LinStatic	F1=-1.64270738195971	F2=0	F3=-			
279.99999718337	M1=0	M2=-410.07444918827	M3=0	FrameElem=113					
Frame=113	Joint=85	OutputCase=TERRLAT	CaseType=LinStatic	F1=330.586282883909	F2=0	F3=-			
1.69219688928024E-06	M1=0	M2=-83.071133803228	M3=0	FrameElem=113					
Frame=113	Joint=86	OutputCase=TERRLAT	CaseType=LinStatic	F1=-330.586282883909	F2=0				
F3=1.69219688928024E-06	M1=0	M2=83.0711346493265	M3=0	FrameElem=113					
Frame=113	Joint=85	OutputCase=ACCVERT	CaseType=LinStatic	F1=0	F2=0	F3=0	M1=0	M2=0	M3=0
FrameElem=113									
Frame=113	Joint=86	OutputCase=ACCVERT	CaseType=LinStatic	F1=0	F2=0	F3=0	M1=0	M2=0	M3=0
FrameElem=113									
Frame=113	Joint=85	OutputCase=ACCLATDX	CaseType=LinStatic	F1=0	F2=0	F3=0	M1=0	M2=0	M3=0
FrameElem=113									
Frame=113	Joint=86	OutputCase=ACCLATDX	CaseType=LinStatic	F1=0	F2=0	F3=0	M1=0	M2=0	M3=0
FrameElem=113									
Frame=113	Joint=85	OutputCase=ACCLATSX	CaseType=LinStatic	F1=0	F2=0	F3=0	M1=0	M2=0	M3=0
FrameElem=113									
Frame=113	Joint=86	OutputCase=ACCLATSX	CaseType=LinStatic	F1=0	F2=0	F3=0	M1=0	M2=0	M3=0
FrameElem=113									
Frame=113	Joint=85	OutputCase=TERRCOST	CaseType=LinStatic	F1=0	F2=0	F3=0	M1=0	M2=0	M3=0
FrameElem=113									
Frame=113	Joint=86	OutputCase=TERRCOST	CaseType=LinStatic	F1=0	F2=0	F3=0	M1=0	M2=0	M3=0
FrameElem=113									
Frame=113	Joint=85	OutputCase=SOVRCOST	CaseType=LinStatic	F1=0	F2=0	F3=0	M1=0	M2=0	M3=0
FrameElem=113									
Frame=113	Joint=86	OutputCase=SOVRCOST	CaseType=LinStatic	F1=0	F2=0	F3=0	M1=0	M2=0	M3=0
FrameElem=113									
Frame=113	Joint=85	OutputCase=ENVE	CaseType=Combination	StepType=Max	F1=317.058043529684	F2=0			
F3=457.49999852264	M1=0	M2=205.853077403126	M3=0	FrameElem=113					
Frame=113	Joint=86	OutputCase=ENVE	CaseType=Combination	StepType=Max	F1=-217.882158664511	F2=0	F3=-		
304.999998014981	M1=0	M2=-371.556736269666	M3=0	FrameElem=113					
Frame=113	Joint=85	OutputCase=ENVE	CaseType=Combination	StepType=Min	F1=217.882158664511	F2=0			
F3=457.499998014981	M1=0	M2=180.931737262157	M3=0	FrameElem=113					
Frame=113	Joint=86	OutputCase=ENVE	CaseType=Combination	StepType=Min	F1=-317.058043529684	F2=0	F3=-		
304.99999852264	M1=0	M2=-396.478076664464	M3=0	FrameElem=113					
Frame=113	Joint=85	OutputCase=FESSUR	CaseType=Combination	F1=317.058043529684	F2=0				
F3=457.499998014981	M1=0	M2=180.931737262157	M3=0	FrameElem=113					
Frame=113	Joint=86	OutputCase=FESSUR	CaseType=Combination	F1=-317.058043529684	F2=0	F3=-			
304.999998014981	M1=0	M2=-371.556736269666	M3=0	FrameElem=113					
Frame=114	Joint=86	OutputCase=PESOPR	CaseType=LinStatic	F1=-15.1709467361849	F2=0	F3=24.9999999888727			
M1=0	M2=44.5534217307144	M3=0	FrameElem=114						
Frame=114	Joint=87	OutputCase=PESOPR	CaseType=LinStatic	F1=15.1709467361849	F2=0	F3=-12.4999999888727			
M1=0	M2=-53.9284217251543	M3=0	FrameElem=114						



Frame=114	Joint=86	OutputCase=TERRVERT	CaseType=LinStatic	F1=1.64270738195971	F2=0					
F3=279.999999718368	M1=0	M2=410.074449188253	M3=0	FrameElem=114						
Frame=114	Joint=87	OutputCase=TERRVERT	CaseType=LinStatic	F1=-1.64270738195971	F2=0	F3=-				
139.999999718368	M1=0	M2=-515.074449047437	M3=0	FrameElem=114						
Frame=114	Joint=86	OutputCase=TERRLAT	CaseType=LinStatic	F1=330.586282883909	F2=0	F3=-				
1.69219813983545E-06	M1=0	M2=-83.0711346493264	M3=0	FrameElem=114						
Frame=114	Joint=87	OutputCase=TERRLAT	CaseType=LinStatic	F1=-330.586282883909	F2=0					
F3=1.69219813983545E-06	M1=0	M2=83.0711354954256	M3=0	FrameElem=114						
Frame=114	Joint=86	OutputCase=ACCVERT	CaseType=LinStatic	F1=0	F2=0	F3=0	M1=0	M2=0	M3=0	
FrameElem=114										
Frame=114	Joint=87	OutputCase=ACCVERT	CaseType=LinStatic	F1=0	F2=0	F3=0	M1=0	M2=0	M3=0	
FrameElem=114										
Frame=114	Joint=86	OutputCase=ACCLATDX	CaseType=LinStatic	F1=0	F2=0	F3=0	M1=0	M2=0	M3=0	
FrameElem=114										
Frame=114	Joint=87	OutputCase=ACCLATDX	CaseType=LinStatic	F1=0	F2=0	F3=0	M1=0	M2=0	M3=0	
FrameElem=114										
Frame=114	Joint=86	OutputCase=ACCLATSX	CaseType=LinStatic	F1=0	F2=0	F3=0	M1=0	M2=0	M3=0	
FrameElem=114										
Frame=114	Joint=87	OutputCase=ACCLATSX	CaseType=LinStatic	F1=0	F2=0	F3=0	M1=0	M2=0	M3=0	
FrameElem=114										
Frame=114	Joint=86	OutputCase=TERRCOST	CaseType=LinStatic	F1=0	F2=0	F3=0	M1=0	M2=0	M3=0	
FrameElem=114										
Frame=114	Joint=87	OutputCase=TERRCOST	CaseType=LinStatic	F1=0	F2=0	F3=0	M1=0	M2=0	M3=0	
FrameElem=114										
Frame=114	Joint=86	OutputCase=SOVRCOST	CaseType=LinStatic	F1=0	F2=0	F3=0	M1=0	M2=0	M3=0	
FrameElem=114										
Frame=114	Joint=87	OutputCase=SOVRCOST	CaseType=LinStatic	F1=0	F2=0	F3=0	M1=0	M2=0	M3=0	
FrameElem=114										
Frame=114	Joint=86	OutputCase=ENVE	CaseType=Combination	StepType=Max	F1=317.058043529684	F2=0				
F3=304.999998522702	M1=0	M2=396.478076664439	M3=0	FrameElem=114						
Frame=114	Joint=87	OutputCase=ENVE	CaseType=Combination	StepType=Max	F1=-217.882158664511	F2=0	F3=-			
152.499998015043	M1=0	M2=-485.931735277166	M3=0	FrameElem=114						
Frame=114	Joint=86	OutputCase=ENVE	CaseType=Combination	StepType=Min	F1=217.882158664511	F2=0				
F3=304.999998015043	M1=0	M2=371.556736269641	M3=0	FrameElem=114						
Frame=114	Joint=87	OutputCase=ENVE	CaseType=Combination	StepType=Min	F1=-317.058043529684	F2=0	F3=-			
152.499998522702	M1=0	M2=-510.853075925793	M3=0	FrameElem=114						
Frame=114	Joint=86	OutputCase=FESSUR	CaseType=Combination	F1=317.058043529684	F2=0					
F3=304.999998015043	M1=0	M2=371.556736269641	M3=0	FrameElem=114						
Frame=114	Joint=87	OutputCase=ENVE	CaseType=Combination	F1=-317.058043529684	F2=0	F3=-				
152.499998015043	M1=0	M2=-485.931735277166	M3=0	FrameElem=114						
Frame=115	Joint=87	OutputCase=PESOPR	CaseType=LinStatic	F1=-15.170946736185	F2=0	F3=12.4999999888899				
M1=0	M2=53.9284217251619	M3=0	FrameElem=115							
Frame=115	Joint=88	OutputCase=PESOPR	CaseType=LinStatic	F1=15.170946736185	F2=0	F3=1.11101465805064E-08				
M1=0	M2=-57.0534217196105	M3=0	FrameElem=115							
Frame=115	Joint=87	OutputCase=TERRVERT	CaseType=LinStatic	F1=1.64270738195971	F2=0					
F3=139.999999718515	M1=0	M2=515.074449047466	M3=0	FrameElem=115						
Frame=115	Joint=88	OutputCase=TERRVERT	CaseType=LinStatic	F1=-1.64270738195971	F2=0					
F3=2.81484730635384E-07	M1=0	M2=-550.074448906724	M3=0	FrameElem=115						
Frame=115	Joint=87	OutputCase=TERRLAT	CaseType=LinStatic	F1=330.586282883909	F2=0	F3=-				
1.69219892135137E-06	M1=0	M2=-83.0711354954258	M3=0	FrameElem=115						
Frame=115	Joint=88	OutputCase=TERRLAT	CaseType=LinStatic	F1=-330.586282883909	F2=0					
F3=1.69219892135137E-06	M1=0	M2=83.0711363415252	M3=0	FrameElem=115						
Frame=115	Joint=87	OutputCase=ACCVERT	CaseType=LinStatic	F1=0	F2=0	F3=0	M1=0	M2=0	M3=0	
FrameElem=115										
Frame=115	Joint=88	OutputCase=ACCVERT	CaseType=LinStatic	F1=0	F2=0	F3=0	M1=0	M2=0	M3=0	
FrameElem=115										
Frame=115	Joint=87	OutputCase=ACCLATDX	CaseType=LinStatic	F1=0	F2=0	F3=0	M1=0	M2=0	M3=0	
FrameElem=115										
Frame=115	Joint=88	OutputCase=ACCLATDX	CaseType=LinStatic	F1=0	F2=0	F3=0	M1=0	M2=0	M3=0	
FrameElem=115										
Frame=115	Joint=87	OutputCase=ACCLATSX	CaseType=LinStatic	F1=0	F2=0	F3=0	M1=0	M2=0	M3=0	
FrameElem=115										
Frame=115	Joint=88	OutputCase=ACCLATSX	CaseType=LinStatic	F1=0	F2=0	F3=0	M1=0	M2=0	M3=0	
FrameElem=115										
Frame=115	Joint=87	OutputCase=TERRCOST	CaseType=LinStatic	F1=0	F2=0	F3=0	M1=0	M2=0	M3=0	
FrameElem=115										
Frame=115	Joint=88	OutputCase=TERRCOST	CaseType=LinStatic	F1=0	F2=0	F3=0	M1=0	M2=0	M3=0	
FrameElem=115										
Frame=115	Joint=87	OutputCase=SOVRCOST	CaseType=LinStatic	F1=0	F2=0	F3=0	M1=0	M2=0	M3=0	
FrameElem=115										
Frame=115	Joint=88	OutputCase=SOVRCOST	CaseType=LinStatic	F1=0	F2=0	F3=0	M1=0	M2=0	M3=0	
FrameElem=115										
Frame=115	Joint=87	OutputCase=ENVE	CaseType=Combination	StepType=Max	F1=317.058043529684	F2=0				
F3=152.499998522866	M1=0	M2=510.85307592583	M3=0	FrameElem=115						
Frame=115	Joint=88	OutputCase=ENVE	CaseType=Combination	StepType=Max	F1=-217.882158664511	F2=0				
F3=1.98479379856726E-06	M1=0	M2=-524.056734284809	M3=0	FrameElem=115						
Frame=115	Joint=87	OutputCase=ENVE	CaseType=Combination	StepType=Min	F1=217.882158664511	F2=0				
F3=152.499998015206	M1=0	M2=485.931735277202	M3=0	FrameElem=115						
Frame=115	Joint=88	OutputCase=ENVE	CaseType=Combination	StepType=Min	F1=-317.058043529684	F2=0				
F3=1.47713412216185E-06	M1=0	M2=-548.978075187267	M3=0	FrameElem=115						
Frame=115	Joint=87	OutputCase=FESSUR	CaseType=Combination	F1=317.058043529684	F2=0					
F3=152.499998015206	M1=0	M2=485.931735277202	M3=0	FrameElem=115						



Frame=115	Joint=88	OutputCase=FESSUR	CaseType=Combination	F1=-317.058043529684	F2=0				
F3=1.98479379856726E-06	M1=0	M2=-524.056734284809	M3=0	FrameElem=115					
Frame=116	Joint=88	OutputCase=PESOPR	CaseType=LinStatic	F1=-15.170946736185	F2=0	F3=-			
1.10789999396843E-08	M1=0	M2=57.0534217196088	M3=0	FrameElem=116					
Frame=116	Joint=89	OutputCase=PESOPR	CaseType=LinStatic	F1=15.170946736185	F2=0	F3=12.500000011079			
M1=0	M2=-53.9284217140657	M3=0	FrameElem=116						
Frame=116	Joint=88	OutputCase=TERRVERT	CaseType=LinStatic	F1=1.64270738195971	F2=0	F3=-			
2.8153282016774E-07	M1=0	M2=550.074448906706	M3=0	FrameElem=116					
Frame=116	Joint=89	OutputCase=TERRVERT	CaseType=LinStatic	F1=-1.64270738195971	F2=0				
F3=140.00000281533	M1=0	M2=-515.07444876594	M3=0	FrameElem=116					
Frame=116	Joint=88	OutputCase=TERRLAT	CaseType=LinStatic	F1=330.586282883909	F2=0	F3=-			
1.69219867984793E-06	M1=0	M2=-83.0711363415252	M3=0	FrameElem=116					
Frame=116	Joint=89	OutputCase=TERRLAT	CaseType=LinStatic	F1=-330.586282883909	F2=0				
F3=1.69219867984793E-06	M1=0	M2=83.0711371876244	M3=0	FrameElem=116					
Frame=116	Joint=88	OutputCase=ACCVERT	CaseType=LinStatic	F1=0	F2=0	F3=0	M1=0	M2=0	M3=0
FrameElem=116									
Frame=116	Joint=89	OutputCase=ACCVERT	CaseType=LinStatic	F1=0	F2=0	F3=0	M1=0	M2=0	M3=0
FrameElem=116									
Frame=116	Joint=88	OutputCase=ACCLATDX	CaseType=LinStatic	F1=0	F2=0	F3=0	M1=0	M2=0	M3=0
FrameElem=116									
Frame=116	Joint=89	OutputCase=ACCLATDX	CaseType=LinStatic	F1=0	F2=0	F3=0	M1=0	M2=0	M3=0
FrameElem=116									
Frame=116	Joint=88	OutputCase=ACCLATSX	CaseType=LinStatic	F1=0	F2=0	F3=0	M1=0	M2=0	M3=0
FrameElem=116									
Frame=116	Joint=89	OutputCase=ACCLATSX	CaseType=LinStatic	F1=0	F2=0	F3=0	M1=0	M2=0	M3=0
FrameElem=116									
Frame=116	Joint=88	OutputCase=TERRCOST	CaseType=LinStatic	F1=0	F2=0	F3=0	M1=0	M2=0	M3=0
FrameElem=116									
Frame=116	Joint=89	OutputCase=TERRCOST	CaseType=LinStatic	F1=0	F2=0	F3=0	M1=0	M2=0	M3=0
FrameElem=116									
Frame=116	Joint=88	OutputCase=SOVRCOST	CaseType=LinStatic	F1=0	F2=0	F3=0	M1=0	M2=0	M3=0
FrameElem=116									
Frame=116	Joint=89	OutputCase=SOVRCOST	CaseType=LinStatic	F1=0	F2=0	F3=0	M1=0	M2=0	M3=0
FrameElem=116									
Frame=116	Joint=88	OutputCase=ENVE	CaseType=Combination	StepType=Max	F1=317.058043529684	F2=0	F3=-		
1.47715089600098E-06	M1=0	M2=548.978075187247	M3=0	FrameElem=116					
Frame=116	Joint=89	OutputCase=ENVE	CaseType=Combination	StepType=Max	F1=-217.882158664511	F2=0			
F3=152.500001984811	M1=0	M2=-485.931733292381	M3=0	FrameElem=116					
Frame=116	Joint=88	OutputCase=ENVE	CaseType=Combination	StepType=Min	F1=217.882158664511	F2=0	F3=-		
1.98481049995536E-06	M1=0	M2=524.05673428479	M3=0	FrameElem=116					
Frame=116	Joint=89	OutputCase=ENVE	CaseType=Combination	StepType=Min	F1=-317.058043529684	F2=0			
F3=152.500001477151	M1=0	M2=-510.853074448668	M3=0	FrameElem=116					
Frame=116	Joint=88	OutputCase=FESSUR	CaseType=Combination	F1=317.058043529684	F2=0	F3=-			
1.98481049995536E-06	M1=0	M2=524.05673428479	M3=0	FrameElem=116					
Frame=116	Joint=89	OutputCase=FESSUR	CaseType=Combination	F1=-317.058043529684	F2=0				
F3=152.500001984811	M1=0	M2=-485.931733292381	M3=0	FrameElem=116					
Frame=117	Joint=89	OutputCase=PESOPR	CaseType=LinStatic	F1=-15.170946736185	F2=0	F3=-			
12.5000000110574	M1=0	M2=53.9284217140609	M3=0	FrameElem=117					
Frame=117	Joint=90	OutputCase=PESOPR	CaseType=LinStatic	F1=15.170946736185	F2=0	F3=25.0000000110574			
M1=0	M2=-44.5534217085285	M3=0	FrameElem=117						
Frame=117	Joint=89	OutputCase=TERRVERT	CaseType=LinStatic	F1=1.64270738196176	F2=0	F3=-			
140.00000281453	M1=0	M2=515.074448765959	M3=0	FrameElem=117					
Frame=117	Joint=90	OutputCase=TERRVERT	CaseType=LinStatic	F1=-1.64270738196176	F2=0				
F3=280.00000281453	M1=0	M2=-410.074448625232	M3=0	FrameElem=117					
Frame=117	Joint=89	OutputCase=TERRLAT	CaseType=LinStatic	F1=330.586282883909	F2=0	F3=-			
1.69220061252418E-06	M1=0	M2=-83.0711371876244	M3=0	FrameElem=117					
Frame=117	Joint=90	OutputCase=TERRLAT	CaseType=LinStatic	F1=-330.586282883909	F2=0				
F3=1.69220061252418E-06	M1=0	M2=83.0711380337248	M3=0	FrameElem=117					
Frame=117	Joint=89	OutputCase=ACCVERT	CaseType=LinStatic	F1=0	F2=0	F3=0	M1=0	M2=0	M3=0
FrameElem=117									
Frame=117	Joint=90	OutputCase=ACCVERT	CaseType=LinStatic	F1=0	F2=0	F3=0	M1=0	M2=0	M3=0
FrameElem=117									
Frame=117	Joint=89	OutputCase=ACCLATDX	CaseType=LinStatic	F1=0	F2=0	F3=0	M1=0	M2=0	M3=0
FrameElem=117									
Frame=117	Joint=90	OutputCase=ACCLATDX	CaseType=LinStatic	F1=0	F2=0	F3=0	M1=0	M2=0	M3=0
FrameElem=117									
Frame=117	Joint=89	OutputCase=ACCLATSX	CaseType=LinStatic	F1=0	F2=0	F3=0	M1=0	M2=0	M3=0
FrameElem=117									
Frame=117	Joint=90	OutputCase=ACCLATSX	CaseType=LinStatic	F1=0	F2=0	F3=0	M1=0	M2=0	M3=0
FrameElem=117									
Frame=117	Joint=89	OutputCase=TERRCOST	CaseType=LinStatic	F1=0	F2=0	F3=0	M1=0	M2=0	M3=0
FrameElem=117									
Frame=117	Joint=90	OutputCase=TERRCOST	CaseType=LinStatic	F1=0	F2=0	F3=0	M1=0	M2=0	M3=0
FrameElem=117									
Frame=117	Joint=89	OutputCase=SOVRCOST	CaseType=LinStatic	F1=0	F2=0	F3=0	M1=0	M2=0	M3=0
FrameElem=117									
Frame=117	Joint=90	OutputCase=SOVRCOST	CaseType=LinStatic	F1=0	F2=0	F3=0	M1=0	M2=0	M3=0
FrameElem=117									
Frame=117	Joint=89	OutputCase=ENVE	CaseType=Combination	StepType=Max	F1=317.058043529688	F2=0	F3=-		
152.500001477051	M1=0	M2=510.853074448683	M3=0	FrameElem=117					
Frame=117	Joint=90	OutputCase=ENVE	CaseType=Combination	StepType=Max	F1=-217.882158664515	F2=0			
F3=305.000001984712	M1=0	M2=-371.556732300036	M3=0	FrameElem=117					

Frame=117	Joint=89	OutputCase=ENVE	CaseType=Combination	StepType=Min	F1=217.882158664515	F2=0	F3=-
152.500001984712	M1=0	M2=485.931733292396	M3=0	FrameElem=117			
Frame=117	Joint=90	OutputCase=ENVE	CaseType=Combination	StepType=Min	F1=-317.058043529688	F2=0	
F3=305.000001477051	M1=0	M2=-396.478073710154	M3=0	FrameElem=117			
Frame=117	Joint=89	OutputCase=FESSUR	CaseType=Combination		F1=317.058043529688	F2=0	F3=-
152.500001984712	M1=0	M2=485.931733292396	M3=0	FrameElem=117			
Frame=117	Joint=90	OutputCase=FESSUR	CaseType=Combination		F1=-317.058043529688	F2=0	
F3=305.000001984712	M1=0	M2=-371.556732300036	M3=0	FrameElem=117			
Frame=118	Joint=90	OutputCase=PESOPR	CaseType=LinStatic		F1=-15.1709467361834	F2=0	F3=-25.000000011084
M1=0	M2=44.5534217085308	M3=0	FrameElem=118				
Frame=118	Joint=91	OutputCase=PESOPR	CaseType=LinStatic		F1=15.1709467361834	F2=0	F3=37.500000011084
M1=0	M2=-28.9284217029888	M3=0	FrameElem=118				
Frame=118	Joint=90	OutputCase=TERRVERT	CaseType=LinStatic		F1=1.64270738196176	F2=0	F3=-
280.000000281401	M1=0	M2=410.074448625248	M3=0	FrameElem=118			
Frame=118	Joint=91	OutputCase=TERRVERT	CaseType=LinStatic		F1=-1.64270738196176	F2=0	
F3=420.000000281401	M1=0	M2=-235.074448484533	M3=0	FrameElem=118			
Frame=118	Joint=90	OutputCase=TERRLAT	CaseType=LinStatic		F1=330.586282883909	F2=0	F3=-
1.6921994756558E-06	M1=0	M2=-83.0711380337248	M3=0	FrameElem=118			
Frame=118	Joint=91	OutputCase=TERRLAT	CaseType=LinStatic		F1=-330.586282883909	F2=0	
F3=1.6921994756558E-06	M1=0	M2=83.0711388798246	M3=0	FrameElem=118			
Frame=118	Joint=90	OutputCase=ACCVERT	CaseType=LinStatic		F1=0	F2=0	F3=0
FrameElem=118					M1=0	M2=0	M3=0
Frame=118	Joint=91	OutputCase=ACCVERT	CaseType=LinStatic		F1=0	F2=0	F3=0
FrameElem=118					M1=0	M2=0	M3=0
Frame=118	Joint=90	OutputCase=ACCLATDX	CaseType=LinStatic		F1=0	F2=0	F3=0
FrameElem=118					M1=0	M2=0	M3=0
Frame=118	Joint=91	OutputCase=ACCLATDX	CaseType=LinStatic		F1=0	F2=0	F3=0
FrameElem=118					M1=0	M2=0	M3=0
Frame=118	Joint=90	OutputCase=ACCLATSX	CaseType=LinStatic		F1=0	F2=0	F3=0
FrameElem=118					M1=0	M2=0	M3=0
Frame=118	Joint=91	OutputCase=ACCLATSX	CaseType=LinStatic		F1=0	F2=0	F3=0
FrameElem=118					M1=0	M2=0	M3=0
Frame=118	Joint=90	OutputCase=TERRCOST	CaseType=LinStatic		F1=0	F2=0	F3=0
FrameElem=118					M1=0	M2=0	M3=0
Frame=118	Joint=91	OutputCase=TERRCOST	CaseType=LinStatic		F1=0	F2=0	F3=0
FrameElem=118					M1=0	M2=0	M3=0
Frame=118	Joint=90	OutputCase=SOVRCOST	CaseType=LinStatic		F1=0	F2=0	F3=0
FrameElem=118					M1=0	M2=0	M3=0
Frame=118	Joint=91	OutputCase=SOVRCOST	CaseType=LinStatic		F1=0	F2=0	F3=0
FrameElem=118					M1=0	M2=0	M3=0
Frame=118	Joint=90	OutputCase=ENVE	CaseType=Combination	StepType=Max	F1=317.058043529687	F2=0	F3=-
305.000001477025	M1=0	M2=396.478073710171	M3=0	FrameElem=118			
Frame=118	Joint=91	OutputCase=ENVE	CaseType=Combination	StepType=Max	F1=-217.882158664515	F2=0	
F3=457.500001984684	M1=0	M2=-180.931731307697	M3=0	FrameElem=118			
Frame=118	Joint=90	OutputCase=ENVE	CaseType=Combination	StepType=Min	F1=217.882158664515	F2=0	F3=-
305.000001984684	M1=0	M2=371.556732300054	M3=0	FrameElem=118			
Frame=118	Joint=91	OutputCase=ENVE	CaseType=Combination	StepType=Min	F1=-317.058043529687	F2=0	
F3=457.500001477025	M1=0	M2=-205.853072971644	M3=0	FrameElem=118			
Frame=118	Joint=90	OutputCase=FESSUR	CaseType=Combination		F1=317.058043529687	F2=0	F3=-
305.000001984684	M1=0	M2=371.556732300054	M3=0	FrameElem=118			
Frame=118	Joint=91	OutputCase=FESSUR	CaseType=Combination		F1=-317.058043529687	F2=0	
F3=457.500001984684	M1=0	M2=-180.931731307697	M3=0	FrameElem=118			
Frame=119	Joint=91	OutputCase=PESOPR	CaseType=LinStatic		F1=-15.1709467361835	F2=0	F3=-
37.5000000110446	M1=0	M2=28.9284217029858	M3=0	FrameElem=119			
Frame=119	Joint=24	OutputCase=PESOPR	CaseType=LinStatic		F1=15.1709467361835	F2=0	F3=50.0000000110446
M1=0	M2=-7.05342169746352	M3=0	FrameElem=119				
Frame=119	Joint=91	OutputCase=TERRVERT	CaseType=LinStatic		F1=1.64270738196176	F2=0	F3=-
420.000000281339	M1=0	M2=235.074448484518	M3=0	FrameElem=119			
Frame=119	Joint=24	OutputCase=TERRVERT	CaseType=LinStatic		F1=-1.64270738196176	F2=0	
F3=560.000000281339	M1=0	M2=9.92555165616598	M3=0	FrameElem=119			
Frame=119	Joint=91	OutputCase=TERRLAT	CaseType=LinStatic		F1=330.586282883909	F2=0	F3=-
1.69220032830708E-06	M1=0	M2=-83.0711388798246	M3=0	FrameElem=119			
Frame=119	Joint=24	OutputCase=TERRLAT	CaseType=LinStatic		F1=-330.586282883909	F2=0	
F3=1.69220032830708E-06	M1=0	M2=83.0711397259248	M3=0	FrameElem=119			
Frame=119	Joint=91	OutputCase=ACCVERT	CaseType=LinStatic		F1=0	F2=0	F3=0
FrameElem=119					M1=0	M2=0	M3=0
Frame=119	Joint=24	OutputCase=ACCVERT	CaseType=LinStatic		F1=0	F2=0	F3=0
FrameElem=119					M1=0	M2=0	M3=0
Frame=119	Joint=91	OutputCase=ACCLATDX	CaseType=LinStatic		F1=0	F2=0	F3=0
FrameElem=119					M1=0	M2=0	M3=0
Frame=119	Joint=24	OutputCase=ACCLATDX	CaseType=LinStatic		F1=0	F2=0	F3=0
FrameElem=119					M1=0	M2=0	M3=0
Frame=119	Joint=91	OutputCase=ACCLATSX	CaseType=LinStatic		F1=0	F2=0	F3=0
FrameElem=119					M1=0	M2=0	M3=0
Frame=119	Joint=24	OutputCase=ACCLATSX	CaseType=LinStatic		F1=0	F2=0	F3=0
FrameElem=119					M1=0	M2=0	M3=0
Frame=119	Joint=91	OutputCase=TERRCOST	CaseType=LinStatic		F1=0	F2=0	F3=0
FrameElem=119					M1=0	M2=0	M3=0
Frame=119	Joint=24	OutputCase=TERRCOST	CaseType=LinStatic		F1=0	F2=0	F3=0
FrameElem=119					M1=0	M2=0	M3=0
Frame=119	Joint=91	OutputCase=SOVRCOST	CaseType=LinStatic		F1=0	F2=0	F3=0
FrameElem=119					M1=0	M2=0	M3=0



Frame=119 Joint=24 OutputCase=SOVRCOST CaseType=LinStatic F1=0 F2=0 F3=0 M1=0 M2=0 M3=0
 FrameElem=119
 Frame=119 Joint=91 OutputCase=ENVE CaseType=Combination StepType=Max F1=317.058043529687 F2=0 F3=-
 457.500001476924 M1=0 M2=205.853072971627 M3=0 FrameElem=119
 Frame=119 Joint=24 OutputCase=ENVE CaseType=Combination StepType=Max F1=-217.882158664514 F2=0
 F3=610.000001984584 M1=0 M2=85.9432696846272 M3=0 FrameElem=119
 Frame=119 Joint=91 OutputCase=ENVE CaseType=Combination StepType=Min F1=217.882158664514 F2=0 F3=-
 457.500001984584 M1=0 M2=180.931731307679 M3=0 FrameElem=119
 Frame=119 Joint=24 OutputCase=ENVE CaseType=Combination StepType=Min F1=-317.058043529687 F2=0
 F3=610.000001476924 M1=0 M2=61.0219277668498 M3=0 FrameElem=119
 Frame=119 Joint=91 OutputCase=FESSUR CaseType=Combination F1=317.058043529687 F2=0 F3=-
 457.500001984584 M1=0 M2=180.931731307679 M3=0 FrameElem=119
 Frame=119 Joint=24 OutputCase=FESSUR CaseType=Combination F1=-317.058043529687 F2=0
 F3=610.000001984584 M1=0 M2=85.9432696846272 M3=0 FrameElem=119

TABLE: "OBJECTS AND ELEMENTS - JOINTS"

JointElem=1	JointObject=1	GlobalX=-2.49999997615814	GlobalY=0	GlobalZ=0
JointElem=15	JointObject=15	GlobalX=2.49999997615814	GlobalY=0	GlobalZ=0
JointElem=35	JointObject=35	GlobalX=2.49999997615814	GlobalY=0	GlobalZ=3.5
JointElem=40	JointObject=40	GlobalX=-2	GlobalY=0	GlobalZ=4
JointElem=39	JointObject=39	GlobalX=-2.25	GlobalY=0	GlobalZ=4
JointElem=34	JointObject=34	GlobalX=-2.49999997615814	GlobalY=0	GlobalZ=3.5
JointElem=20	JointObject=20	GlobalX=-2.49999997615814	GlobalY=0	GlobalZ=4
JointElem=21	JointObject=21	GlobalX=2.49999997615814	GlobalY=0	GlobalZ=3.99999997615814
JointElem=22	JointObject=22	GlobalX=-2.5	GlobalY=0	GlobalZ=3.75
JointElem=23	JointObject=23	GlobalX=2.5	GlobalY=0	GlobalZ=3.75
JointElem=24	JointObject=24	GlobalX=2	GlobalY=0	GlobalZ=4
JointElem=25	JointObject=25	GlobalX=2.25	GlobalY=0	GlobalZ=4
JointElem=26	JointObject=26	GlobalX=-2.5	GlobalY=0	GlobalZ=0.25
JointElem=27	JointObject=27	GlobalX=-2.5	GlobalY=0	GlobalZ=0.5
JointElem=28	JointObject=28	GlobalX=2.5	GlobalY=0	GlobalZ=0.25
JointElem=29	JointObject=29	GlobalX=2.5	GlobalY=0	GlobalZ=0.5
JointElem=30	JointObject=30	GlobalX=-2.25	GlobalY=0	GlobalZ=0
JointElem=31	JointObject=31	GlobalX=-2	GlobalY=0	GlobalZ=0
JointElem=32	JointObject=32	GlobalX=2	GlobalY=0	GlobalZ=0
JointElem=33	JointObject=33	GlobalX=2.25	GlobalY=0	GlobalZ=0
JointElem=19	JointObject=19	GlobalX=-1.5	GlobalY=0	GlobalZ=0
JointElem=36	JointObject=36	GlobalX=-1	GlobalY=0	GlobalZ=0
JointElem=37	JointObject=37	GlobalX=-0.5	GlobalY=0	GlobalZ=0
JointElem=38	JointObject=38	GlobalX=0	GlobalY=0	GlobalZ=0
JointElem=41	JointObject=41	GlobalX=0.5	GlobalY=0	GlobalZ=0
JointElem=42	JointObject=42	GlobalX=1	GlobalY=0	GlobalZ=0
JointElem=43	JointObject=43	GlobalX=1.5	GlobalY=0	GlobalZ=0
JointElem=61	JointObject=61	GlobalX=2.4999999602636	GlobalY=0	GlobalZ=1
JointElem=62	JointObject=62	GlobalX=2.4999999205271	GlobalY=0	GlobalZ=1.5
JointElem=63	JointObject=63	GlobalX=2.4999998807907	GlobalY=0	GlobalZ=2
JointElem=64	JointObject=64	GlobalX=2.4999998410543	GlobalY=0	GlobalZ=2.5
JointElem=65	JointObject=65	GlobalX=2.4999998013179	GlobalY=0	GlobalZ=3
JointElem=66	JointObject=66	GlobalX=-2.4999999602636	GlobalY=0	GlobalZ=1
JointElem=67	JointObject=67	GlobalX=-2.4999999205271	GlobalY=0	GlobalZ=1.5
JointElem=68	JointObject=68	GlobalX=-2.4999998807907	GlobalY=0	GlobalZ=2
JointElem=69	JointObject=69	GlobalX=-2.4999998410543	GlobalY=0	GlobalZ=2.5
JointElem=70	JointObject=70	GlobalX=-2.4999998013179	GlobalY=0	GlobalZ=3
JointElem=85	JointObject=85	GlobalX=-1.5	GlobalY=0	GlobalZ=4
JointElem=86	JointObject=86	GlobalX=-1	GlobalY=0	GlobalZ=4
JointElem=87	JointObject=87	GlobalX=-0.5	GlobalY=0	GlobalZ=4
JointElem=88	JointObject=88	GlobalX=0	GlobalY=0	GlobalZ=4
JointElem=89	JointObject=89	GlobalX=0.5	GlobalY=0	GlobalZ=4
JointElem=90	JointObject=90	GlobalX=1	GlobalY=0	GlobalZ=4
JointElem=91	JointObject=91	GlobalX=1.5	GlobalY=0	GlobalZ=4

TABLE: "OBJECTS AND ELEMENTS - FRAMES"

FrameElem=1	FrameObject=1	ElemJtI=1	ElemJtJ=30
FrameElem=2	FrameObject=2	ElemJtI=30	ElemJtJ=31
FrameElem=4	FrameObject=4	ElemJtI=32	ElemJtJ=33
FrameElem=5	FrameObject=5	ElemJtI=33	ElemJtJ=15
FrameElem=41	FrameObject=41	ElemJtI=31	ElemJtJ=19
FrameElem=42	FrameObject=42	ElemJtI=19	ElemJtJ=36
FrameElem=43	FrameObject=43	ElemJtI=36	ElemJtJ=37
FrameElem=44	FrameObject=44	ElemJtI=37	ElemJtJ=38
FrameElem=45	FrameObject=45	ElemJtI=38	ElemJtJ=41
FrameElem=46	FrameObject=46	ElemJtI=41	ElemJtJ=42
FrameElem=47	FrameObject=47	ElemJtI=42	ElemJtJ=43
FrameElem=48	FrameObject=48	ElemJtI=43	ElemJtJ=32
FrameElem=69	FrameObject=69	ElemJtI=15	ElemJtJ=28
FrameElem=70	FrameObject=70	ElemJtI=28	ElemJtJ=29
FrameElem=72	FrameObject=72	ElemJtI=35	ElemJtJ=23
FrameElem=73	FrameObject=73	ElemJtI=23	ElemJtJ=21
FrameElem=74	FrameObject=74	ElemJtI=20	ElemJtJ=39
FrameElem=75	FrameObject=75	ElemJtI=39	ElemJtJ=40
FrameElem=77	FrameObject=77	ElemJtI=24	ElemJtJ=25
FrameElem=78	FrameObject=78	ElemJtI=25	ElemJtJ=21



FrameElem=79	FrameObject=79	ElemJtI=1	ElemJtJ=26
FrameElem=80	FrameObject=80	ElemJtI=26	ElemJtJ=27
FrameElem=82	FrameObject=82	ElemJtI=34	ElemJtJ=22
FrameElem=83	FrameObject=83	ElemJtI=22	ElemJtJ=20
FrameElem=84	FrameObject=84	ElemJtI=29	ElemJtJ=61
FrameElem=85	FrameObject=85	ElemJtI=61	ElemJtJ=62
FrameElem=86	FrameObject=86	ElemJtI=62	ElemJtJ=63
FrameElem=87	FrameObject=87	ElemJtI=63	ElemJtJ=64
FrameElem=88	FrameObject=88	ElemJtI=64	ElemJtJ=65
FrameElem=89	FrameObject=89	ElemJtI=65	ElemJtJ=35
FrameElem=90	FrameObject=90	ElemJtI=27	ElemJtJ=66
FrameElem=91	FrameObject=91	ElemJtI=66	ElemJtJ=67
FrameElem=92	FrameObject=92	ElemJtI=67	ElemJtJ=68
FrameElem=93	FrameObject=93	ElemJtI=68	ElemJtJ=69
FrameElem=94	FrameObject=94	ElemJtI=69	ElemJtJ=70
FrameElem=95	FrameObject=95	ElemJtI=70	ElemJtJ=34
FrameElem=112	FrameObject=112	ElemJtI=40	ElemJtJ=85
FrameElem=113	FrameObject=113	ElemJtI=85	ElemJtJ=86
FrameElem=114	FrameObject=114	ElemJtI=86	ElemJtJ=87
FrameElem=115	FrameObject=115	ElemJtI=87	ElemJtJ=88
FrameElem=116	FrameObject=116	ElemJtI=88	ElemJtJ=89
FrameElem=117	FrameObject=117	ElemJtI=89	ElemJtJ=90
FrameElem=118	FrameObject=118	ElemJtI=90	ElemJtJ=91
FrameElem=119	FrameObject=119	ElemJtI=91	ElemJtJ=24

TABLE: "BASE REACTIONS"

```

OutputCase=PESOPR CaseType=LinStatic GlobalFX=3.89022147828655E-13 GlobalFY=0 GlobalFZ=449.999997019476
GlobalMX=0 GlobalMY=1.49119897940864E-06 GlobalMZ=0 GlobalX=0 GlobalY=0 GlobalZ=0 XCentroidFX=0
YCentroidFY=0
ZCentroidFZ=0 XCentroidFY=0 YCentroidFY=0 ZCentroidFY=0 XCentroidFZ=-3.31377553174539E-09
YCentroidFZ=0 ZCentroidFZ=0
OutputCase=TERRVERT CaseType=LinStatic GlobalFX=4.82969220172436E-12 GlobalFY=0 GlobalFZ=1399.99998664763
GlobalMX=0 GlobalMY=3.41927375302475E-09 GlobalMZ=0 GlobalX=0 GlobalY=0 GlobalZ=0 XCentroidFX=0
YCentroidFY=0 ZCentroidFZ=0 XCentroidFY=0 YCentroidFY=0 ZCentroidFZ=-
2.44233841831126E-12 YCentroidFZ=0 ZCentroidFZ=0
OutputCase=TERRLAT CaseType=LinStatic GlobalFX=-3.35503261794656E-06 GlobalFY=0
GlobalFZ=7.20634663053943E-12 GlobalMX=0 GlobalMY=-1.43266824958466E-05 GlobalMZ=0 GlobalX=0 GlobalY=0
GlobalZ=0
XCentroidFX=-2.49999998305727 YCentroidFY=0 ZCentroidFZ=0 XCentroidFY=0 YCentroidFY=0
ZCentroidFY=0 XCentroidFZ=1988064.58117518 YCentroidFZ=0 ZCentroidFZ=0
OutputCase=ACCVERT CaseType=LinStatic GlobalFX=0 GlobalFY=0 GlobalFZ=0 GlobalMX=0 GlobalMY=0
GlobalMZ=0 GlobalX=0 GlobalY=0 GlobalZ=0 XCentroidFX=0 YCentroidFY=0 ZCentroidFZ=0 XCentroidFY=0
YCentroidFZ=0
ZCentroidFZ=0 XCentroidFZ=0 YCentroidFZ=0 ZCentroidFZ=0
OutputCase=ACCLATDX CaseType=LinStatic GlobalFX=0 GlobalFY=0 GlobalFZ=0 GlobalMX=0 GlobalMY=0
GlobalMZ=0 GlobalX=0 GlobalY=0 GlobalZ=0 XCentroidFX=0 YCentroidFY=0 ZCentroidFZ=0 XCentroidFY=0
YCentroidFZ=0
ZCentroidFZ=0 XCentroidFZ=0 YCentroidFZ=0 ZCentroidFZ=0
OutputCase=ACCLATSX CaseType=LinStatic GlobalFX=0 GlobalFY=0 GlobalFZ=0 GlobalMX=0 GlobalMY=0
GlobalMZ=0 GlobalX=0 GlobalY=0 GlobalZ=0 XCentroidFX=0 YCentroidFY=0 ZCentroidFZ=0 XCentroidFY=0
YCentroidFZ=0
ZCentroidFZ=0 XCentroidFZ=0 YCentroidFZ=0 ZCentroidFZ=0
OutputCase=TERRCOST CaseType=LinStatic GlobalFX=0 GlobalFY=0 GlobalFZ=0 GlobalMX=0 GlobalMY=0
GlobalMZ=0 GlobalX=0 GlobalY=0 GlobalZ=0 XCentroidFX=0 YCentroidFY=0 ZCentroidFZ=0 XCentroidFY=0
YCentroidFZ=0
ZCentroidFZ=0 XCentroidFZ=0 YCentroidFZ=0 ZCentroidFZ=0
OutputCase=SOVRCOST CaseType=LinStatic GlobalFX=0 GlobalFY=0 GlobalFZ=0 GlobalMX=0 GlobalMY=0
GlobalMZ=0 GlobalX=0 GlobalY=0 GlobalZ=0 XCentroidFX=0 YCentroidFY=0 ZCentroidFZ=0 XCentroidFY=0
YCentroidFZ=0
ZCentroidFZ=0 XCentroidFZ=0 YCentroidFZ=0 ZCentroidFZ=0
OutputCase=ENVE CaseType=Combination StepType=Max GlobalFX=-2.34851761384824E-06 GlobalFY=0
GlobalFZ=1849.99998366711 GlobalMX=0 GlobalMY=-8.53405949393093E-06 GlobalMZ=0 GlobalX=0 GlobalY=0
GlobalZ=0
XCentroidFX=0 YCentroidFY=0 ZCentroidFZ=0 XCentroidFY=0 YCentroidFY=0 ZCentroidFY=0
XCentroidFZ=0 YCentroidFZ=0 ZCentroidFZ=0
OutputCase=ENVE CaseType=Combination StepType=Min GlobalFX=-3.35502739923221E-06 GlobalFY=0
GlobalFZ=1849.99998366711 GlobalMX=0 GlobalMY=-1.28320642426849E-05 GlobalMZ=0 GlobalX=0 GlobalY=0
GlobalZ=0
XCentroidFX=0 YCentroidFY=0 ZCentroidFZ=0 XCentroidFY=0 YCentroidFY=0 ZCentroidFY=0
XCentroidFZ=0 YCentroidFZ=0 ZCentroidFZ=0
OutputCase=FESSUR CaseType=Combination GlobalFX=-3.35502739923221E-06 GlobalFY=0
GlobalFZ=1849.99998366711 GlobalMX=0 GlobalMY=-1.28320642426849E-05 GlobalMZ=0 GlobalX=0 GlobalY=0
GlobalZ=0
XCentroidFX=-2.49999998262705 YCentroidFY=0 ZCentroidFZ=0 XCentroidFY=0 YCentroidFY=0
ZCentroidFY=0 XCentroidFZ=6.93625100322914E-09 YCentroidFZ=0 ZCentroidFZ=0

```

END TABLE DATA

<p>GENERAL CONTRACTOR</p>  <p>Consorzio Collegamenti Integrati Veloci</p>	<p>ALTA SORVEGLIANZA</p>  <p>GRUPPO FERROVIE DELLO STATO ITALIANE</p>	
<p>IG51-02-E-CV-CL-IN11-0X-001_A00 Relazione di calcolo</p>		
		<p>Foglio 647 di 929</p>

1.3. Dati di input scatolare – caso D

File D:\13_15_COClV\01_Calcoli\IN11\giorgio\IN11_situazione4-input.txt was saved on 9/17/13 at 11.47.05

TABLE: "PROGRAM CONTROL"

ProgramName=SAP2000 Version=15.0.0 ProgLevel=Ultimate LicenseNum=266BC LicenseOS=Yes LicenseSC=Yes
LicenseBR=No LicenseHT=No CurrUnits="KN, m, C" SteelCode=AISC-ASD89 ConcCode="ACI 318-99" AlumCode="AA-ASD
2000" - ColdCode=AISI-ASD96 BridgeCode="AASHTO LRFD 2007" RegenHinge=No

TABLE: "ACTIVE DEGREES OF FREEDOM"

UX=Yes UY=Yes UZ=Yes RX=Yes RY=Yes RZ=Yes

TABLE: "ANALYSIS OPTIONS"

Solver=Advanced SolverProc=Auto Force32Bit=No StiffCase=None GeomMod=No

TABLE: "COORDINATE SYSTEMS"

Name=GLOBAL Type=Cartesian X=0 Y=0 Z=0 AboutZ=0 AboutY=0 AboutX=0

TABLE: "GRID LINES"

CoordSys=GLOBAL AxisDir=X XXYZCoord=-2.5 LineType=Primary LineColor=Gray4 Visible=Yes BubbleLoc=End
AllVisible=Yes BubbleSize=1
CoordSys=GLOBAL AxisDir=X XXYZCoord=-2.25 LineType=Primary LineColor=Gray4 Visible=Yes BubbleLoc=End
CoordSys=GLOBAL AxisDir=X XXYZCoord=-2 LineType=Primary LineColor=Gray4 Visible=Yes BubbleLoc=End
CoordSys=GLOBAL AxisDir=X XXYZCoord=0 LineType=Primary LineColor=Gray4 Visible=Yes BubbleLoc=End
CoordSys=GLOBAL AxisDir=X XXYZCoord=2 LineType=Primary LineColor=Gray4 Visible=Yes BubbleLoc=End
CoordSys=GLOBAL AxisDir=X XXYZCoord=2.25 LineType=Primary LineColor=Gray4 Visible=Yes BubbleLoc=End
CoordSys=GLOBAL AxisDir=X XXYZCoord=2.5 LineType=Primary LineColor=Gray4 Visible=Yes BubbleLoc=End
CoordSys=GLOBAL AxisDir=Y XXYZCoord=0 LineType=Primary LineColor=Gray4 Visible=Yes BubbleLoc=End
CoordSys=GLOBAL AxisDir=Z XXYZCoord=0 LineType=Primary LineColor=Gray8Dark Visible=Yes BubbleLoc=End
CoordSys=GLOBAL AxisDir=Z XXYZCoord=0.25 LineType=Primary LineColor=Gray8Dark Visible=Yes
BubbleLoc=End
CoordSys=GLOBAL AxisDir=Z XXYZCoord=0.5 LineType=Primary LineColor=Gray8Dark Visible=Yes
BubbleLoc=End
CoordSys=GLOBAL AxisDir=Z XXYZCoord=3.5 LineType=Primary LineColor=Gray8Dark Visible=Yes
BubbleLoc=End
CoordSys=GLOBAL AxisDir=Z XXYZCoord=3.75 LineType=Primary LineColor=Gray8Dark Visible=Yes
BubbleLoc=End
CoordSys=GLOBAL AxisDir=Z XXYZCoord=4 LineType=Primary LineColor=Gray8Dark Visible=Yes BubbleLoc=End

TABLE: "MATERIAL PROPERTIES 01 - GENERAL"

Material=A416Gr270 Type=Tendon SymType=Uniaxial TempDepend=No Color=Blue Notes="ASTM A416 Grade 270
added 30/07/2013 14.54.57"
Material=A615Gr60 Type=Rebar SymType=Uniaxial TempDepend=No Color=Red Notes="ASTM A615 Grade 60 added
04/07/2013 15.33.53"
Material=CONC Type=Concrete SymType=Isotropic TempDepend=No Color=Black Notes="Normalweight f'c = 4 ksi
added 04/07/2013 15.33.53"
Material=OTHER Type=Other SymType=Isotropic TempDepend=No Color=Black Notes="Material added 04/07/2013
15.33.53"
Material=REBAR Type=Rebar SymType=Uniaxial TempDepend=No Color=Red Notes="ASTM A615 Grade 60 added
04/07/2013 15.33.53"
Material=STEEL Type=Steel SymType=Isotropic TempDepend=No Color=Black Notes="ASTM A36 added 04/07/2013
15.33.53"

TABLE: "MATERIAL PROPERTIES 02 - BASIC MECHANICAL PROPERTIES"

Material=A416Gr270 UnitWeight=76.9728639422648 UnitMass=7.84904737995992 E1=196500599.8512 A1=0.0000117
Material=A615Gr60 UnitWeight=76.9728639422648 UnitMass=7.84904737995992 E1=199947978.795958 A1=0.0000117
Material=CONC UnitWeight=25 UnitMass=2.5 E1=36049965 G12=15673897.826087 U12=0.15
A1=9.8999989542412E-06
Material=OTHER UnitWeight=23.5616130828857 UnitMass=2.40067982673645 E1=24821126 G12=10342135.8076484
U12=0.20000002980232 A1=9.8999989542412E-06
Material=REBAR UnitWeight=76.9728639422648 UnitMass=7.84904737995992 E1=199947978.795958 A1=0.0000117
Material=STEEL UnitWeight=76.8195419311523 UnitMass=7.82709980010986 E1=199947968 G12=76903063.9101877
U12=0.30000011920929 A1=1.1699999049597E-05

TABLE: "MATERIAL PROPERTIES 03A - STEEL DATA"

Material=STEEL Fy=248211.265625 Fu=310264.08203125 EffFy=372316.8984375 EffFu=341290.490234375
SSCurveOpt="User Defined" SSHysType=Kinematic

TABLE: "MATERIAL PROPERTIES 03B - CONCRETE DATA"

Material=CONC Fc=27579 LtWtConc=No SSCurveOpt="User Defined" SSHysType=Kinematic FAngle=0 DAngle=0

TABLE: "MATERIAL PROPERTIES 03E - REBAR DATA"

Material=A615Gr60 Fy=413685.473370947 Fu=620528.21005642 EffFy=455054.020708041 EffFu=682581.031062062
SSCurveOpt=Simple SSHysType=Kinematic SHard=0.01 SCap=0.09 FinalSlope=-0.1 UseCTDef=No
Material=REBAR Fy=275790 Fu=413685 EffFy=303369 EffFu=455053.5 SSCurveOpt=Simple SSHysType=Kinematic
SHard=0.01 SCap=0.09 FinalSlope=-0.1 UseCTDef=No

TABLE: "MATERIAL PROPERTIES 03F - TENDON DATA"

Material=A416Gr270 Fy=1689905.15872032 Fu=1861584.63016926 SSCurveOpt="270 ksi" SSHysType=Kinematic
FinalSlope=-0.1

<p>GENERAL CONTRACTOR</p>  <p>Consorzio Collegamenti Integrati Veloci</p>	<p>ALTA SORVEGLIANZA</p>  <p>GRUPPO FERROVIE DELLO STATO ITALIANE</p>	
<p>IG51-02-E-CV-CL-IN11-0X-001_A00</p> <p>Relazione di calcolo</p>		
		<p>Foglio 648 di 929</p>

TABLE: "MATERIAL PROPERTIES 03G - OTHER DATA"
Material=OTHER SSHysType=Elastic FAngle=0 DAngle=0

TABLE: "MATERIAL PROPERTIES 04 - USER STRESS-STRAIN CURVES"

Material=CONC	Point=1	Strain=-4.32412541870706E-02	Stress=0	PointID=-E
Material=CONC	Point=2	Strain=-3.02688779309494E-02	Stress=-206842.736685473	PointID=-D
Material=CONC	Point=3	Strain=-1.72965016748283E-02	Stress=-413685.473370947	PointID=-C
Material=CONC	Point=4	Strain=-1.78929327670637E-03	Stress=-413685.473370947	PointID=-B
Material=CONC	Point=5	Strain=0	Stress=0	PointID=A
Material=CONC	Point=6	Strain=1.78929327670637E-03	Stress=413685.473370947	PointID=B
Material=CONC	Point=7	Strain=1.72965016748283E-02	Stress=413685.473370947	PointID=C
Material=CONC	Point=8	Strain=4.32412541870706E-02	Stress=517106.841713683	PointID=C
Material=CONC	Point=9	Strain=0.069186006699313	Stress=517106.841713683	PointID=D
Material=CONC	Point=10	Strain=8.64825083741413E-02	Stress=413685.473370947	PointID=E
Material=OTHER	Point=1	Strain=-4.02882608951745E-08	Stress=-1	PointID=A
Material=OTHER	Point=2	Strain=0	Stress=0	PointID=A
Material=OTHER	Point=3	Strain=4.02882608951745E-08	Stress=1	PointID=A
Material=STEEL	Point=1	Strain=-0.05	Stress=0	PointID=-E
Material=STEEL	Point=2	Strain=-0.035	Stress=-124105.642011284	PointID=-D
Material=STEEL	Point=3	Strain=-0.02	Stress=-248211.284022568	PointID=-C
Material=STEEL	Point=4	Strain=-1.24137931034483E-03	Stress=-248211.284022568	PointID=-B
Material=STEEL	Point=5	Strain=0	Stress=0	PointID=A
Material=STEEL	Point=6	Strain=1.24137931034483E-03	Stress=248211.284022568	PointID=B
Material=STEEL	Point=7	Strain=0.02	Stress=248211.284022568	PointID=C
Material=STEEL	Point=8	Strain=0.05	Stress=399895.957591915	PointID=C
Material=STEEL	Point=9	Strain=0.08	Stress=399895.957591915	PointID=D
Material=STEEL	Point=10	Strain=0.1	Stress=248211.284022568	PointID=E

TABLE: "MATERIAL PROPERTIES 06 - DAMPING PARAMETERS"

Material=A416Gr270	ModalRatio=0	VisMass=0	VisStiff=0	HysMass=0	HysStiff=0
Material=A615Gr60	ModalRatio=0	VisMass=0	VisStiff=0	HysMass=0	HysStiff=0
Material=CONC	ModalRatio=0	VisMass=0	VisStiff=0	HysMass=0	HysStiff=0
Material=OTHER	ModalRatio=0	VisMass=0	VisStiff=0	HysMass=0	HysStiff=0
Material=REBAR	ModalRatio=0	VisMass=0	VisStiff=0	HysMass=0	HysStiff=0
Material=STEEL	ModalRatio=0	VisMass=0	VisStiff=0	HysMass=0	HysStiff=0

TABLE: "FRAME SECTION PROPERTIES 01 - GENERAL"

SectionName=1000x1000 Material=CONC Shape=Rectangular t3=1 t2=1 Area=1 TorsConst=0.1408333333333333
I33=8.33333333333333E-02 I22=8.33333333333333E-02 AS2=0.833333333333333 AS3=0.833333333333333
S33=0.166666666666667
S22=0.166666666666667 Z33=0.25 Z22=0.25 R33=0.288675134594813 R22=0.288675134594813 ConcCol=No
ConcBeam=Yes Color=8421440 TotalWt=449.999997019768 TotalMass=44.9999997019768 FromFile=No AMod=1
A2Mod=1
A3Mod=1 JMod=1 I2Mod=1 I3Mod=1 MMod=1 WMod=1

TABLE: "FRAME SECTION PROPERTIES 03 - CONCRETE BEAM"

SectionName=1000x1000 RebarMatL=A615Gr60 RebarMatC=REBAR TopCover=0 BotCover=0 TopLeftArea=0
TopRghtArea=0 BotLeftArea=0 BotRghtArea=0

TABLE: "LOAD PATTERN DEFINITIONS"

LoadPat=PESOPR	DesignType=DEAD	SelfWtMult=1
LoadPat=TERRVERT	DesignType=OTHER	SelfWtMult=0
LoadPat=TERRLAT	DesignType=OTHER	SelfWtMult=0
LoadPat=ACCVERT	DesignType=OTHER	SelfWtMult=0
LoadPat=ACCLATDX	DesignType=OTHER	SelfWtMult=0
LoadPat=ACCLATSX	DesignType=OTHER	SelfWtMult=0

TABLE: "AUTO WAVE 3 - WAVE CHARACTERISTICS - GENERAL"

WaveChar=Default WaveType="From Theory" KinFactor=1 SWaterDepth=1800 WaveHeight=720 WavePeriod=12
WaveTheory=Linear

TABLE: "COMBINATION DEFINITIONS"

ComboName=PERM1	ComboType="Linear Add"	AutoDesign=No	CaseType="Linear Static"	CaseName=PESOPR
ScaleFactor=1	SteelDesign=None	ConcDesign=None	AlumDesign=None	ColdDesign=None
ComboName=PERM1	CaseType="Linear Static"	CaseName=TERRVERT	ScaleFactor=1	
ComboName=PERM1	CaseType="Linear Static"	CaseName=TERRLAT	ScaleFactor=1	
ComboName=PERM2	ComboType="Linear Add"	AutoDesign=No	CaseType="Linear Static"	CaseName=PESOPR
ScaleFactor=1	SteelDesign=None	ConcDesign=None	AlumDesign=None	ColdDesign=None
ComboName=PERM2	CaseType="Linear Static"	CaseName=TERRVERT	ScaleFactor=1	
ComboName=PERM2	CaseType="Linear Static"	CaseName=TERRLAT	ScaleFactor=0.7	
ComboName=ACCC1	ComboType="Linear Add"	AutoDesign=No	CaseType="Linear Static"	CaseName=PESOPR
ScaleFactor=1	SteelDesign=None	ConcDesign=None	AlumDesign=None	ColdDesign=None
ComboName=ACCC1	CaseType="Linear Static"	CaseName=TERRVERT	ScaleFactor=1	
ComboName=ACCC1	CaseType="Linear Static"	CaseName=TERRLAT	ScaleFactor=1	
ComboName=ACCC1	CaseType="Linear Static"	CaseName=ACCVERT	ScaleFactor=1	
ComboName=ACCC1	CaseType="Linear Static"	CaseName=ACCLATDX	ScaleFactor=1	
ComboName=ACCC1	CaseType="Linear Static"	CaseName=ACCLATSX	ScaleFactor=1	
ComboName=ACCC2	ComboType="Linear Add"	AutoDesign=No	CaseType="Linear Static"	CaseName=PESOPR
ScaleFactor=1	SteelDesign=None	ConcDesign=None	AlumDesign=None	ColdDesign=None
ComboName=ACCC2	CaseType="Linear Static"	CaseName=TERRVERT	ScaleFactor=1	
ComboName=ACCC2	CaseType="Linear Static"	CaseName=TERRLAT	ScaleFactor=0.7	

<p>GENERAL CONTRACTOR</p> 	<p>ALTA SORVEGLIANZA</p> 
<p>IG51-02-E-CV-CL-IN11-0X-001_A00 Relazione di calcolo</p>	
<p>Foglio 649 di 929</p>	

```

ComboName=ACC2 CaseType="Linear Static" CaseName=ACCVERT ScaleFactor=1
ComboName=ACC2 CaseType="Linear Static" CaseName=ACCLATDX ScaleFactor=1
ComboName=ACC2 CaseType="Linear Static" CaseName=ACCLATSX ScaleFactor=1
ComboName=ACCSX1 ComboType="Linear Add" AutoDesign=No CaseType="Linear Static" CaseName=PESOPR
ScaleFactor=1 SteelDesign=None ConcDesign=None AlumDesign=None ColdDesign=None
ComboName=ACCSX1 CaseType="Linear Static" CaseName=TERRVERT ScaleFactor=1
ComboName=ACCSX1 CaseType="Linear Static" CaseName=TERRLAT ScaleFactor=1
ComboName=ACCSX1 CaseType="Linear Static" CaseName=ACCLATSX ScaleFactor=1
ComboName=ACCSX2 ComboType="Linear Add" AutoDesign=No CaseType="Linear Static" CaseName=PESOPR
ScaleFactor=1 SteelDesign=None ConcDesign=None AlumDesign=None ColdDesign=None
ComboName=ACCSX2 CaseType="Linear Static" CaseName=TERRVERT ScaleFactor=1
ComboName=ACCSX2 CaseType="Linear Static" CaseName=TERRLAT ScaleFactor=0.7
ComboName=ACCSX2 CaseType="Linear Static" CaseName=ACCLATSX ScaleFactor=1
ComboName=ENVE ComboType=Envelope AutoDesign=No CaseType="Response Combo" CaseName=PERM1 ScaleFactor=1
SteelDesign=None ConcDesign=None AlumDesign=None ColdDesign=None
ComboName=ENVE CaseType="Response Combo" CaseName=PERM2 ScaleFactor=1
ComboName=ENVE CaseType="Response Combo" CaseName=ACC1 ScaleFactor=1
ComboName=ENVE CaseType="Response Combo" CaseName=ACC2 ScaleFactor=1
ComboName=ENVE CaseType="Response Combo" CaseName=ACCSX1 ScaleFactor=1
ComboName=ENVE CaseType="Response Combo" CaseName=ACCSX2 ScaleFactor=1
ComboName=FESSUR ComboType="Linear Add" AutoDesign=No CaseType="Linear Static" CaseName=PESOPR
ScaleFactor=1 SteelDesign=None ConcDesign=None AlumDesign=None ColdDesign=None
ComboName=FESSUR CaseType="Linear Static" CaseName=TERRVERT ScaleFactor=1
ComboName=FESSUR CaseType="Linear Static" CaseName=TERRLAT ScaleFactor=1
ComboName=FESSUR CaseType="Linear Static" CaseName=ACCVERT ScaleFactor=0.7
ComboName=FESSUR CaseType="Linear Static" CaseName=ACCLATDX ScaleFactor=0.7
ComboName=FESSUR CaseType="Linear Static" CaseName=ACCLATSX ScaleFactor=0.7

```

TABLE: "CONSTRAINT DEFINITIONS - BEAM"

Name=BEAM1 CoordSys=GLOBAL Axis=Auto

TABLE: "CONSTRAINT DEFINITIONS - BODY"

Name=BODY1 CoordSys=GLOBAL UX=Yes UY=Yes UZ=Yes RX=Yes RY=Yes RZ=Yes

TABLE: "CONSTRAINT DEFINITIONS - DIAPHRAGM"

Name=DIAPH1 CoordSys=GLOBAL Axis=Z MultiLevel=No

TABLE: "CONSTRAINT DEFINITIONS - EQUAL"

Name=EQUAL1 CoordSys=GLOBAL UX=Yes UY=Yes UZ=Yes RX=Yes RY=Yes RZ=Yes

TABLE: "CONSTRAINT DEFINITIONS - LOCAL"

Name=LOCAL1 U1=Yes U2=Yes U3=Yes R1=Yes R2=Yes R3=Yes

TABLE: "CONSTRAINT DEFINITIONS - PLATE"

Name=PLATE1 CoordSys=GLOBAL Axis=Auto

TABLE: "CONSTRAINT DEFINITIONS - ROD"

Name=ROD1 CoordSys=GLOBAL Axis=Auto

TABLE: "CONSTRAINT DEFINITIONS - WELD"

Name=WELD1 CoordSys=GLOBAL UX=Yes UY=Yes UZ=Yes RX=Yes RY=Yes RZ=Yes Tolerance=2.53999996930361E-02

TABLE: "GROUPS 1 - DEFINITIONS"

GroupName=ALL Selection=Yes SectionCut=Yes Steel=Yes Concrete=Yes Aluminum=Yes ColdFormed=Yes
Stage=Yes Bridge=Yes AutoSeismic=No AutoWind=No SelDesSteel=No SelDesAlum=No SelDesCold=No
MassWeight=Yes Color=Yellow

TABLE: "GROUPS 3 - MASSES AND WEIGHTS"

GroupName=ALL SelfMass=44.9999997019768 SelfWeight=449.999997019768 TotalMassX=44.9999997019768
TotalMassY=44.9999997019768 TotalMassZ=44.9999997019768

TABLE: "JOINT PATTERN DEFINITIONS"

Pattern=DEFAULT

TABLE: "MASSES 1 - MASS SOURCE"

MassFrom=Elements

TABLE: "FUNCTION - PLOT FUNCTIONS"

PlotFunc="Input Energy" Type=Energy Component=Input Mode=All

TABLE: "LOAD CASE DEFINITIONS"

```

Case=PESOPR Type=LinStatic InitialCond=Zero DesTypeOpt="Prog Det" DesignType=DEAD DesActOpt="Prog Det"
DesignAct=Non-Composite AutoType=None RunCase=Yes CaseStatus=Finished
Case=TERRVERT Type=LinStatic InitialCond=Zero DesTypeOpt="Prog Det" DesignType=OTHER DesActOpt="Prog
Det" DesignAct=Other AutoType=None RunCase=Yes CaseStatus=Finished
Case=TERRLAT Type=LinStatic InitialCond=Zero DesTypeOpt="Prog Det" DesignType=OTHER DesActOpt="Prog
Det" DesignAct=Other AutoType=None RunCase=Yes CaseStatus=Finished
Case=ACCVERT Type=LinStatic InitialCond=Zero DesTypeOpt="Prog Det" DesignType=OTHER DesActOpt="Prog
Det" DesignAct=Other AutoType=None RunCase=Yes CaseStatus=Finished
Case=ACCLATDX Type=LinStatic InitialCond=Zero DesTypeOpt="Prog Det" DesignType=OTHER DesActOpt="Prog
Det" DesignAct=Other AutoType=None RunCase=Yes CaseStatus=Finished

```



Case=ACCLATXSX Type=LinStatic InitialCond=Zero DesTypeOpt="Prog Det" DesignType=OTHER DesActOpt="Prog Det" DesignAct=Other AutoType=None RunCase=Yes CaseStatus=Finished
 Case=TERRCOST Type=LinStatic InitialCond=Zero DesTypeOpt="Prog Det" DesignType=OTHER DesActOpt="Prog Det" DesignAct=Other AutoType=None RunCase=Yes CaseStatus=Finished
 Case=SOVRCOST Type=LinStatic InitialCond=Zero DesTypeOpt="Prog Det" DesignType=OTHER DesActOpt="Prog Det" DesignAct=Other AutoType=None RunCase=Yes CaseStatus=Finished

TABLE: "CASE - STATIC 1 - LOAD ASSIGNMENTS"

Case=PESOPR LoadType="Load pattern" LoadName=PESOPR LoadSF=1
 Case=TERRVERT LoadType="Load pattern" LoadName=TERRVERT LoadSF=1
 Case=TERRLAT LoadType="Load pattern" LoadName=TERRLAT LoadSF=1
 Case=ACCVERT LoadType="Load pattern" LoadName=ACCVERT LoadSF=1
 Case=ACCLATDX LoadType="Load pattern" LoadName=ACCLATDX LoadSF=1
 Case=ACCLATXSX LoadType="Load pattern" LoadName=ACCLATXSX LoadSF=1

TABLE: "JOINT COORDINATES"

Joint=1 CoordSys=GLOBAL CoordType=Cartesian XorR=-2.49999997615814 Y=0 Z=0 SpecialJt=No GlobalX=-2.49999997615814 GlobalY=0 GlobalZ=0
 Joint=2 CoordSys=GLOBAL CoordType=Cartesian XorR=2.49999999602636 Y=0 Z=1 SpecialJt=No GlobalX=2.4999999602636 GlobalY=0 GlobalZ=1
 Joint=3 CoordSys=GLOBAL CoordType=Cartesian XorR=2.4999999205271 Y=0 Z=1.5 SpecialJt=No GlobalX=2.4999999205271 GlobalY=0 GlobalZ=1.5
 Joint=4 CoordSys=GLOBAL CoordType=Cartesian XorR=2.49999998807907 Y=0 Z=2 SpecialJt=No GlobalX=2.49999998807907 GlobalY=0 GlobalZ=2
 Joint=5 CoordSys=GLOBAL CoordType=Cartesian XorR=2.49999998410543 Y=0 Z=2.5 SpecialJt=No GlobalX=2.49999998410543 GlobalY=0 GlobalZ=2.5
 Joint=6 CoordSys=GLOBAL CoordType=Cartesian XorR=2.49999998013179 Y=0 Z=3 SpecialJt=No GlobalX=2.49999998013179 GlobalY=0 GlobalZ=3
 Joint=7 CoordSys=GLOBAL CoordType=Cartesian XorR=-2.4999999602636 Y=0 Z=1 SpecialJt=No GlobalX=-2.4999999602636 GlobalY=0 GlobalZ=1
 Joint=8 CoordSys=GLOBAL CoordType=Cartesian XorR=-2.4999999205271 Y=0 Z=1.5 SpecialJt=No GlobalX=-2.4999999205271 GlobalY=0 GlobalZ=1.5
 Joint=9 CoordSys=GLOBAL CoordType=Cartesian XorR=-2.49999998807907 Y=0 Z=2 SpecialJt=No GlobalX=-2.49999998807907 GlobalY=0 GlobalZ=2
 Joint=10 CoordSys=GLOBAL CoordType=Cartesian XorR=-2.49999998410543 Y=0 Z=2.5 SpecialJt=No GlobalX=-2.49999998410543 GlobalY=0 GlobalZ=2.5
 Joint=11 CoordSys=GLOBAL CoordType=Cartesian XorR=-2.49999998013179 Y=0 Z=3 SpecialJt=No GlobalX=-2.49999998013179 GlobalY=0 GlobalZ=3
 Joint=15 CoordSys=GLOBAL CoordType=Cartesian XorR=2.49999997615814 Y=0 Z=0 SpecialJt=No GlobalX=2.49999997615814 GlobalY=0 GlobalZ=0
 Joint=19 CoordSys=GLOBAL CoordType=Cartesian XorR=-1.5 Y=0 Z=0 SpecialJt=No GlobalX=-1.5 GlobalY=0 GlobalZ=0
 Joint=20 CoordSys=GLOBAL CoordType=Cartesian XorR=-2.49999997615814 Y=0 Z=4 SpecialJt=No GlobalX=-2.49999997615814 GlobalY=0 GlobalZ=4
 Joint=21 CoordSys=GLOBAL CoordType=Cartesian XorR=2.49999997615814 Y=0 Z=3.99999997615814 SpecialJt=No GlobalX=2.49999997615814 GlobalY=0 GlobalZ=3.99999997615814
 Joint=22 CoordSys=GLOBAL CoordType=Cartesian XorR=-2.5 Y=0 Z=3.75 SpecialJt=Yes GlobalX=-2.5 GlobalY=0 GlobalZ=3.75
 Joint=23 CoordSys=GLOBAL CoordType=Cartesian XorR=2.5 Y=0 Z=3.75 SpecialJt=Yes GlobalX=2.5 GlobalY=0 GlobalZ=3.75
 Joint=24 CoordSys=GLOBAL CoordType=Cartesian XorR=2 Y=0 Z=4 SpecialJt=Yes GlobalX=2 GlobalY=0 GlobalZ=4
 Joint=25 CoordSys=GLOBAL CoordType=Cartesian XorR=2.25 Y=0 Z=4 SpecialJt=Yes GlobalX=2.25 GlobalY=0 GlobalZ=4
 Joint=26 CoordSys=GLOBAL CoordType=Cartesian XorR=-2.5 Y=0 Z=0.25 SpecialJt=Yes GlobalX=-2.5 GlobalY=0 GlobalZ=0.25
 Joint=27 CoordSys=GLOBAL CoordType=Cartesian XorR=-2.5 Y=0 Z=0.5 SpecialJt=Yes GlobalX=-2.5 GlobalY=0 GlobalZ=0.5
 Joint=28 CoordSys=GLOBAL CoordType=Cartesian XorR=2.5 Y=0 Z=0.25 SpecialJt=Yes GlobalX=2.5 GlobalY=0 GlobalZ=0.25
 Joint=29 CoordSys=GLOBAL CoordType=Cartesian XorR=2.5 Y=0 Z=0.5 SpecialJt=Yes GlobalX=2.5 GlobalY=0 GlobalZ=0.5
 Joint=30 CoordSys=GLOBAL CoordType=Cartesian XorR=-2.25 Y=0 Z=0 SpecialJt=Yes GlobalX=-2.25 GlobalY=0 GlobalZ=0
 Joint=31 CoordSys=GLOBAL CoordType=Cartesian XorR=-2 Y=0 Z=0 SpecialJt=Yes GlobalX=-2 GlobalY=0 GlobalZ=0
 Joint=32 CoordSys=GLOBAL CoordType=Cartesian XorR=2 Y=0 Z=0 SpecialJt=Yes GlobalX=2 GlobalY=0 GlobalZ=0
 Joint=33 CoordSys=GLOBAL CoordType=Cartesian XorR=2.25 Y=0 Z=0 SpecialJt=Yes GlobalX=2.25 GlobalY=0 GlobalZ=0
 Joint=34 CoordSys=GLOBAL CoordType=Cartesian XorR=-2.49999997615814 Y=0 Z=3.5 SpecialJt=Yes GlobalX=-2.49999997615814 GlobalY=0 GlobalZ=3.5
 Joint=35 CoordSys=GLOBAL CoordType=Cartesian XorR=2.49999997615814 Y=0 Z=3.5 SpecialJt=Yes GlobalX=2.49999997615814 GlobalY=0 GlobalZ=3.5
 Joint=36 CoordSys=GLOBAL CoordType=Cartesian XorR=-1 Y=0 Z=0 SpecialJt=No GlobalX=-1 GlobalY=0 GlobalZ=0
 Joint=37 CoordSys=GLOBAL CoordType=Cartesian XorR=-0.5 Y=0 Z=0 SpecialJt=No GlobalX=-0.5 GlobalY=0 GlobalZ=0
 Joint=38 CoordSys=GLOBAL CoordType=Cartesian XorR=0 Y=0 Z=0 SpecialJt=No GlobalX=0 GlobalY=0 GlobalZ=0
 Joint=39 CoordSys=GLOBAL CoordType=Cartesian XorR=-2.25 Y=0 Z=4 SpecialJt=Yes GlobalX=-2.25 GlobalY=0 GlobalZ=4



Joint=40	CoordSys=GLOBAL	CoordType=Cartesian	XorR=-2	Y=0	Z=4	SpecialJt=Yes	GlobalX=-2	GlobalY=0	GlobalZ=4
Joint=41	CoordSys=GLOBAL	CoordType=Cartesian	XorR=0.5	Y=0	Z=0	SpecialJt=No	GlobalX=0.5	GlobalY=0	GlobalZ=0
Joint=42	CoordSys=GLOBAL	CoordType=Cartesian	XorR=1	Y=0	Z=0	SpecialJt=No	GlobalX=1	GlobalY=0	GlobalZ=0
Joint=43	CoordSys=GLOBAL	CoordType=Cartesian	XorR=1.5	Y=0	Z=0	SpecialJt=No	GlobalX=1.5	GlobalY=0	GlobalZ=0
Joint=85	CoordSys=GLOBAL	CoordType=Cartesian	XorR=-1.5	Y=0	Z=4	SpecialJt=No	GlobalX=-1.5	GlobalY=0	GlobalZ=4
Joint=86	CoordSys=GLOBAL	CoordType=Cartesian	XorR=-1	Y=0	Z=4	SpecialJt=No	GlobalX=-1	GlobalY=0	GlobalZ=4
Joint=87	CoordSys=GLOBAL	CoordType=Cartesian	XorR=-0.5	Y=0	Z=4	SpecialJt=No	GlobalX=-0.5	GlobalY=0	GlobalZ=4
Joint=88	CoordSys=GLOBAL	CoordType=Cartesian	XorR=0	Y=0	Z=4	SpecialJt=No	GlobalX=0	GlobalY=0	GlobalZ=4
Joint=89	CoordSys=GLOBAL	CoordType=Cartesian	XorR=0.5	Y=0	Z=4	SpecialJt=No	GlobalX=0.5	GlobalY=0	GlobalZ=4
Joint=90	CoordSys=GLOBAL	CoordType=Cartesian	XorR=1	Y=0	Z=4	SpecialJt=No	GlobalX=1	GlobalY=0	GlobalZ=4
Joint=91	CoordSys=GLOBAL	CoordType=Cartesian	XorR=1.5	Y=0	Z=4	SpecialJt=No	GlobalX=1.5	GlobalY=0	GlobalZ=4

TABLE: "CONNECTIVITY - FRAME"

Frame=1	JointI=1	JointJ=30	IsCurved=No	Length=0.249999976158142	CentroidX=-2.37499998807907	CentroidY=0	CentroidZ=0
Frame=2	JointI=30	JointJ=31	IsCurved=No	Length=0.25	CentroidX=-2.125	CentroidY=0	CentroidZ=0
Frame=3	JointI=15	JointJ=28	IsCurved=No	Length=0.250000000000001	CentroidX=2.49999998807907	CentroidY=0	CentroidZ=0.125
Frame=4	JointI=32	JointJ=33	IsCurved=No	Length=0.25	CentroidX=2.125	CentroidY=0	CentroidZ=0
Frame=5	JointI=33	JointJ=15	IsCurved=No	Length=0.249999976158142	CentroidX=2.37499998807907	CentroidY=0	CentroidZ=0
Frame=6	JointI=28	JointJ=29	IsCurved=No	Length=0.25	CentroidX=2.5	CentroidY=0	CentroidZ=0.375
Frame=9	JointI=35	JointJ=23	IsCurved=No	Length=0.250000000000002	CentroidX=2.49999998807907	CentroidY=0	CentroidZ=3.625
Frame=10	JointI=23	JointJ=21	IsCurved=No	Length=0.249999976158143	CentroidX=2.49999998807907	CentroidY=0	CentroidZ=3.87499998807907
Frame=11	JointI=1	JointJ=26	IsCurved=No	Length=0.250000000000001	CentroidX=-2.49999998807907	CentroidY=0	CentroidZ=0.125
Frame=12	JointI=26	JointJ=27	IsCurved=No	Length=0.25	CentroidX=-2.5	CentroidY=0	CentroidZ=0.375
Frame=15	JointI=34	JointJ=22	IsCurved=No	Length=0.250000000000002	CentroidX=-2.49999998807907	CentroidY=0	CentroidZ=3.625
Frame=16	JointI=22	JointJ=20	IsCurved=No	Length=0.250000000000001	CentroidX=-2.49999998807907	CentroidY=0	CentroidZ=3.875
Frame=17	JointI=29	JointJ=2	IsCurved=No	Length=0.5	CentroidX=2.4999999801318	CentroidY=0	CentroidZ=0.75
Frame=18	JointI=2	JointJ=3	IsCurved=No	Length=0.5	CentroidX=2.4999999403954	CentroidY=0	CentroidZ=1.25
Frame=19	JointI=3	JointJ=4	IsCurved=No	Length=0.5	CentroidX=2.4999999006589	CentroidY=0	CentroidZ=1.75
Frame=20	JointI=4	JointJ=5	IsCurved=No	Length=0.5	CentroidX=2.4999998609225	CentroidY=0	CentroidZ=2.25
Frame=21	JointI=5	JointJ=6	IsCurved=No	Length=0.5	CentroidX=2.4999998211861	CentroidY=0	CentroidZ=2.75
Frame=22	JointI=6	JointJ=35	IsCurved=No	Length=0.5	CentroidX=2.4999997814496	CentroidY=0	CentroidZ=3.25
Frame=23	JointI=27	JointJ=7	IsCurved=No	Length=0.5	CentroidX=-2.4999999801318	CentroidY=0	CentroidZ=0.75
Frame=24	JointI=7	JointJ=8	IsCurved=No	Length=0.5	CentroidX=-2.4999999403954	CentroidY=0	CentroidZ=1.25
Frame=25	JointI=8	JointJ=9	IsCurved=No	Length=0.5	CentroidX=-2.4999999006589	CentroidY=0	CentroidZ=1.75
Frame=26	JointI=9	JointJ=10	IsCurved=No	Length=0.5	CentroidX=-2.4999998609225	CentroidY=0	CentroidZ=2.25
Frame=27	JointI=10	JointJ=11	IsCurved=No	Length=0.5	CentroidX=-2.4999998211861	CentroidY=0	CentroidZ=2.75
Frame=28	JointI=11	JointJ=34	IsCurved=No	Length=0.5	CentroidX=-2.4999997814496	CentroidY=0	CentroidZ=3.25
Frame=41	JointI=31	JointJ=19	IsCurved=No	Length=0.5	CentroidX=-1.75	CentroidY=0	CentroidZ=0
Frame=42	JointI=19	JointJ=36	IsCurved=No	Length=0.5	CentroidX=-1.25	CentroidY=0	CentroidZ=0
Frame=43	JointI=36	JointJ=37	IsCurved=No	Length=0.5	CentroidX=-0.75	CentroidY=0	CentroidZ=0
Frame=44	JointI=37	JointJ=38	IsCurved=No	Length=0.5	CentroidX=-0.25	CentroidY=0	CentroidZ=0
Frame=45	JointI=38	JointJ=41	IsCurved=No	Length=0.5	CentroidX=0.25	CentroidY=0	CentroidZ=0
Frame=46	JointI=41	JointJ=42	IsCurved=No	Length=0.5	CentroidX=0.75	CentroidY=0	CentroidZ=0
Frame=47	JointI=42	JointJ=43	IsCurved=No	Length=0.5	CentroidX=1.25	CentroidY=0	CentroidZ=0
Frame=48	JointI=43	JointJ=32	IsCurved=No	Length=0.5	CentroidX=1.75	CentroidY=0	CentroidZ=0
Frame=74	JointI=20	JointJ=39	IsCurved=No	Length=0.249999976158142	CentroidX=-2.37499998807907	CentroidY=0	CentroidZ=4
Frame=75	JointI=39	JointJ=40	IsCurved=No	Length=0.25	CentroidX=-2.125	CentroidY=0	CentroidZ=4
Frame=77	JointI=24	JointJ=25	IsCurved=No	Length=0.25	CentroidX=2.125	CentroidY=0	CentroidZ=4
Frame=78	JointI=25	JointJ=21	IsCurved=No	Length=0.249999976158143	CentroidX=2.37499998807907	CentroidY=0	CentroidZ=3.99999998807907



Frame=112	JointI=40	JointJ=85	IsCurved=No	Length=0.5	CentroidX=-1.75	CentroidY=0	CentroidZ=4
Frame=113	JointI=85	JointJ=86	IsCurved=No	Length=0.5	CentroidX=-1.25	CentroidY=0	CentroidZ=4
Frame=114	JointI=86	JointJ=87	IsCurved=No	Length=0.5	CentroidX=-0.75	CentroidY=0	CentroidZ=4
Frame=115	JointI=87	JointJ=88	IsCurved=No	Length=0.5	CentroidX=-0.25	CentroidY=0	CentroidZ=4
Frame=116	JointI=88	JointJ=89	IsCurved=No	Length=0.5	CentroidX=0.25	CentroidY=0	CentroidZ=4
Frame=117	JointI=89	JointJ=90	IsCurved=No	Length=0.5	CentroidX=0.75	CentroidY=0	CentroidZ=4
Frame=118	JointI=90	JointJ=91	IsCurved=No	Length=0.5	CentroidX=1.25	CentroidY=0	CentroidZ=4
Frame=119	JointI=91	JointJ=24	IsCurved=No	Length=0.5	CentroidX=1.75	CentroidY=0	CentroidZ=4

TABLE: "JOINT RESTRAINT ASSIGNMENTS"

Joint=1	U1=Yes	U2=Yes	U3=No	R1=Yes	R2=No	R3=Yes
Joint=15	U1=No	U2=Yes	U3=No	R1=Yes	R2=No	R3=Yes

TABLE: "JOINT SPRING ASSIGNMENTS 1 - UNCOUPLED"

Joint=1	CoordSys=Local	U1=0	U2=0	U3=0	R1=0	R2=0	R3=0
Joint=15	CoordSys=Local	U1=0	U2=0	U3=0	R1=0	R2=0	R3=0

TABLE: "JOINT LOADS - FORCE"

Joint=1	LoadPat=TERRLAT	CoordSys=GLOBAL	F1=49.68	F2=0	F3=0	M1=0	M2=0	M3=0
Joint=15	LoadPat=TERRLAT	CoordSys=GLOBAL	F1=-49.68	F2=0	F3=0	M1=0	M2=0	M3=0
Joint=20	LoadPat=TERRLAT	CoordSys=GLOBAL	F1=30.49	F2=0	F3=0	M1=0	M2=0	M3=0
Joint=21	LoadPat=TERRLAT	CoordSys=GLOBAL	F1=-30.49	F2=0	F3=0	M1=0	M2=0	M3=0

TABLE: "FRAME SECTION ASSIGNMENTS"

Frame=1	SectionType=Rectangular	AutoSelect=N.A.	AnalSect=1000x1000	DesignSect=1000x1000	MatProp=Default
Frame=2	SectionType=Rectangular	AutoSelect=N.A.	AnalSect=1000x1000	DesignSect=1000x1000	MatProp=Default
Frame=3	SectionType=Rectangular	AutoSelect=N.A.	AnalSect=1000x1000	DesignSect=1000x1000	MatProp=Default
Frame=4	SectionType=Rectangular	AutoSelect=N.A.	AnalSect=1000x1000	DesignSect=1000x1000	MatProp=Default
Frame=5	SectionType=Rectangular	AutoSelect=N.A.	AnalSect=1000x1000	DesignSect=1000x1000	MatProp=Default
Frame=6	SectionType=Rectangular	AutoSelect=N.A.	AnalSect=1000x1000	DesignSect=1000x1000	MatProp=Default
Frame=9	SectionType=Rectangular	AutoSelect=N.A.	AnalSect=1000x1000	DesignSect=1000x1000	MatProp=Default
Frame=10	SectionType=Rectangular	AutoSelect=N.A.	AnalSect=1000x1000	DesignSect=1000x1000	MatProp=Default
Frame=11	SectionType=Rectangular	AutoSelect=N.A.	AnalSect=1000x1000	DesignSect=1000x1000	MatProp=Default
Frame=12	SectionType=Rectangular	AutoSelect=N.A.	AnalSect=1000x1000	DesignSect=1000x1000	MatProp=Default
Frame=15	SectionType=Rectangular	AutoSelect=N.A.	AnalSect=1000x1000	DesignSect=1000x1000	MatProp=Default
Frame=16	SectionType=Rectangular	AutoSelect=N.A.	AnalSect=1000x1000	DesignSect=1000x1000	MatProp=Default
Frame=17	SectionType=Rectangular	AutoSelect=N.A.	AnalSect=1000x1000	DesignSect=1000x1000	MatProp=Default
Frame=18	SectionType=Rectangular	AutoSelect=N.A.	AnalSect=1000x1000	DesignSect=1000x1000	MatProp=Default
Frame=19	SectionType=Rectangular	AutoSelect=N.A.	AnalSect=1000x1000	DesignSect=1000x1000	MatProp=Default
Frame=20	SectionType=Rectangular	AutoSelect=N.A.	AnalSect=1000x1000	DesignSect=1000x1000	MatProp=Default
Frame=21	SectionType=Rectangular	AutoSelect=N.A.	AnalSect=1000x1000	DesignSect=1000x1000	MatProp=Default
Frame=22	SectionType=Rectangular	AutoSelect=N.A.	AnalSect=1000x1000	DesignSect=1000x1000	MatProp=Default
Frame=23	SectionType=Rectangular	AutoSelect=N.A.	AnalSect=1000x1000	DesignSect=1000x1000	MatProp=Default
Frame=24	SectionType=Rectangular	AutoSelect=N.A.	AnalSect=1000x1000	DesignSect=1000x1000	MatProp=Default
Frame=25	SectionType=Rectangular	AutoSelect=N.A.	AnalSect=1000x1000	DesignSect=1000x1000	MatProp=Default
Frame=26	SectionType=Rectangular	AutoSelect=N.A.	AnalSect=1000x1000	DesignSect=1000x1000	MatProp=Default
Frame=27	SectionType=Rectangular	AutoSelect=N.A.	AnalSect=1000x1000	DesignSect=1000x1000	MatProp=Default
Frame=28	SectionType=Rectangular	AutoSelect=N.A.	AnalSect=1000x1000	DesignSect=1000x1000	MatProp=Default
Frame=41	SectionType=Rectangular	AutoSelect=N.A.	AnalSect=1000x1000	DesignSect=1000x1000	MatProp=Default
Frame=42	SectionType=Rectangular	AutoSelect=N.A.	AnalSect=1000x1000	DesignSect=1000x1000	MatProp=Default
Frame=43	SectionType=Rectangular	AutoSelect=N.A.	AnalSect=1000x1000	DesignSect=1000x1000	MatProp=Default
Frame=44	SectionType=Rectangular	AutoSelect=N.A.	AnalSect=1000x1000	DesignSect=1000x1000	MatProp=Default
Frame=45	SectionType=Rectangular	AutoSelect=N.A.	AnalSect=1000x1000	DesignSect=1000x1000	MatProp=Default
Frame=46	SectionType=Rectangular	AutoSelect=N.A.	AnalSect=1000x1000	DesignSect=1000x1000	MatProp=Default
Frame=47	SectionType=Rectangular	AutoSelect=N.A.	AnalSect=1000x1000	DesignSect=1000x1000	MatProp=Default
Frame=48	SectionType=Rectangular	AutoSelect=N.A.	AnalSect=1000x1000	DesignSect=1000x1000	MatProp=Default



Frame=74	SectionType=Rectangular	AutoSelect=N.A.	AnalSect=1000x1000	DesignSect=1000x1000
MatProp=Default				
Frame=75	SectionType=Rectangular	AutoSelect=N.A.	AnalSect=1000x1000	DesignSect=1000x1000
MatProp=Default				
Frame=77	SectionType=Rectangular	AutoSelect=N.A.	AnalSect=1000x1000	DesignSect=1000x1000
MatProp=Default				
Frame=78	SectionType=Rectangular	AutoSelect=N.A.	AnalSect=1000x1000	DesignSect=1000x1000
MatProp=Default				
Frame=112	SectionType=Rectangular	AutoSelect=N.A.	AnalSect=1000x1000	DesignSect=1000x1000
MatProp=Default				
Frame=113	SectionType=Rectangular	AutoSelect=N.A.	AnalSect=1000x1000	DesignSect=1000x1000
MatProp=Default				
Frame=114	SectionType=Rectangular	AutoSelect=N.A.	AnalSect=1000x1000	DesignSect=1000x1000
MatProp=Default				
Frame=115	SectionType=Rectangular	AutoSelect=N.A.	AnalSect=1000x1000	DesignSect=1000x1000
MatProp=Default				
Frame=116	SectionType=Rectangular	AutoSelect=N.A.	AnalSect=1000x1000	DesignSect=1000x1000
MatProp=Default				
Frame=117	SectionType=Rectangular	AutoSelect=N.A.	AnalSect=1000x1000	DesignSect=1000x1000
MatProp=Default				
Frame=118	SectionType=Rectangular	AutoSelect=N.A.	AnalSect=1000x1000	DesignSect=1000x1000
MatProp=Default				
Frame=119	SectionType=Rectangular	AutoSelect=N.A.	AnalSect=1000x1000	DesignSect=1000x1000
MatProp=Default				

TABLE: "FRAME INSERTION POINT ASSIGNMENTS"

Frame=1	CardinalPt="10 (centroid)"	Mirror2=No	Transform=No
Frame=2	CardinalPt="10 (centroid)"	Mirror2=No	Transform=No
Frame=3	CardinalPt="10 (centroid)"	Mirror2=No	Transform=No
Frame=4	CardinalPt="10 (centroid)"	Mirror2=No	Transform=No
Frame=5	CardinalPt="10 (centroid)"	Mirror2=No	Transform=No
Frame=6	CardinalPt="10 (centroid)"	Mirror2=No	Transform=No
Frame=9	CardinalPt="10 (centroid)"	Mirror2=No	Transform=No
Frame=10	CardinalPt="10 (centroid)"	Mirror2=No	Transform=No
Frame=11	CardinalPt="10 (centroid)"	Mirror2=No	Transform=No
Frame=12	CardinalPt="10 (centroid)"	Mirror2=No	Transform=No
Frame=15	CardinalPt="10 (centroid)"	Mirror2=No	Transform=No
Frame=16	CardinalPt="10 (centroid)"	Mirror2=No	Transform=No
Frame=17	CardinalPt="10 (centroid)"	Mirror2=No	Transform=No
Frame=18	CardinalPt="10 (centroid)"	Mirror2=No	Transform=No
Frame=19	CardinalPt="10 (centroid)"	Mirror2=No	Transform=No
Frame=20	CardinalPt="10 (centroid)"	Mirror2=No	Transform=No
Frame=21	CardinalPt="10 (centroid)"	Mirror2=No	Transform=No
Frame=22	CardinalPt="10 (centroid)"	Mirror2=No	Transform=No
Frame=23	CardinalPt="10 (centroid)"	Mirror2=No	Transform=No
Frame=24	CardinalPt="10 (centroid)"	Mirror2=No	Transform=No
Frame=25	CardinalPt="10 (centroid)"	Mirror2=No	Transform=No
Frame=26	CardinalPt="10 (centroid)"	Mirror2=No	Transform=No
Frame=27	CardinalPt="10 (centroid)"	Mirror2=No	Transform=No
Frame=28	CardinalPt="10 (centroid)"	Mirror2=No	Transform=No
Frame=41	CardinalPt="10 (centroid)"	Mirror2=No	Transform=No
Frame=42	CardinalPt="10 (centroid)"	Mirror2=No	Transform=No
Frame=43	CardinalPt="10 (centroid)"	Mirror2=No	Transform=No
Frame=44	CardinalPt="10 (centroid)"	Mirror2=No	Transform=No
Frame=45	CardinalPt="10 (centroid)"	Mirror2=No	Transform=No
Frame=46	CardinalPt="10 (centroid)"	Mirror2=No	Transform=No
Frame=47	CardinalPt="10 (centroid)"	Mirror2=No	Transform=No
Frame=48	CardinalPt="10 (centroid)"	Mirror2=No	Transform=No
Frame=74	CardinalPt="10 (centroid)"	Mirror2=No	Transform=No
Frame=75	CardinalPt="10 (centroid)"	Mirror2=No	Transform=No
Frame=77	CardinalPt="10 (centroid)"	Mirror2=No	Transform=No
Frame=78	CardinalPt="10 (centroid)"	Mirror2=No	Transform=No
Frame=112	CardinalPt="10 (centroid)"	Mirror2=No	Transform=No
Frame=113	CardinalPt="10 (centroid)"	Mirror2=No	Transform=No
Frame=114	CardinalPt="10 (centroid)"	Mirror2=No	Transform=No
Frame=115	CardinalPt="10 (centroid)"	Mirror2=No	Transform=No
Frame=116	CardinalPt="10 (centroid)"	Mirror2=No	Transform=No
Frame=117	CardinalPt="10 (centroid)"	Mirror2=No	Transform=No
Frame=118	CardinalPt="10 (centroid)"	Mirror2=No	Transform=No
Frame=119	CardinalPt="10 (centroid)"	Mirror2=No	Transform=No

TABLE: "FRAME OFFSET ALONG LENGTH ASSIGNMENTS"

Frame=1	Type=User	LengthI=0	LengthJ=0	RigidFactor=1
Frame=2	Type=User	LengthI=0	LengthJ=0	RigidFactor=1
Frame=3	Type=User	LengthI=0	LengthJ=0	RigidFactor=1
Frame=4	Type=User	LengthI=0	LengthJ=0	RigidFactor=1
Frame=5	Type=User	LengthI=0	LengthJ=0	RigidFactor=1
Frame=6	Type=User	LengthI=0	LengthJ=0	RigidFactor=1
Frame=9	Type=User	LengthI=0	LengthJ=0	RigidFactor=1
Frame=10	Type=User	LengthI=0	LengthJ=0	RigidFactor=1
Frame=11	Type=User	LengthI=0	LengthJ=0	RigidFactor=1
Frame=12	Type=User	LengthI=0	LengthJ=0	RigidFactor=1



Frame=1	Type=Simple	Stiffness=26000	SimpleType="Tension and Compression"	Dir1Type="User Vector"
CoordSys=GLOBAL	VecX=0	VecY=0 VecZ=1		
Frame=2	Type=Simple	Stiffness=26000	SimpleType="Tension and Compression"	Dir1Type="User Vector"
CoordSys=GLOBAL	VecX=0	VecY=0 VecZ=1		
Frame=4	Type=Simple	Stiffness=26000	SimpleType="Tension and Compression"	Dir1Type="User Vector"
CoordSys=GLOBAL	VecX=0	VecY=0 VecZ=1		
Frame=5	Type=Simple	Stiffness=26000	SimpleType="Tension and Compression"	Dir1Type="User Vector"
CoordSys=GLOBAL	VecX=0	VecY=0 VecZ=1		
Frame=41	Type=Simple	Stiffness=26000	SimpleType="Tension and Compression"	Dir1Type="User Vector"
CoordSys=GLOBAL	VecX=0	VecY=0 VecZ=1		
Frame=42	Type=Simple	Stiffness=26000	SimpleType="Tension and Compression"	Dir1Type="User Vector"
CoordSys=GLOBAL	VecX=0	VecY=0 VecZ=1		
Frame=43	Type=Simple	Stiffness=26000	SimpleType="Tension and Compression"	Dir1Type="User Vector"
CoordSys=GLOBAL	VecX=0	VecY=0 VecZ=1		
Frame=44	Type=Simple	Stiffness=26000	SimpleType="Tension and Compression"	Dir1Type="User Vector"
CoordSys=GLOBAL	VecX=0	VecY=0 VecZ=1		
Frame=45	Type=Simple	Stiffness=26000	SimpleType="Tension and Compression"	Dir1Type="User Vector"
CoordSys=GLOBAL	VecX=0	VecY=0 VecZ=1		
Frame=46	Type=Simple	Stiffness=26000	SimpleType="Tension and Compression"	Dir1Type="User Vector"
CoordSys=GLOBAL	VecX=0	VecY=0 VecZ=1		
Frame=47	Type=Simple	Stiffness=26000	SimpleType="Tension and Compression"	Dir1Type="User Vector"
CoordSys=GLOBAL	VecX=0	VecY=0 VecZ=1		
Frame=48	Type=Simple	Stiffness=26000	SimpleType="Tension and Compression"	Dir1Type="User Vector"
CoordSys=GLOBAL	VecX=0	VecY=0 VecZ=1		

TABLE: "FRAME AUTO MESH ASSIGNMENTS"

Frame=1	AutoMesh=No	AtJoints=No	AtFrames=No	NumSegments=0	MaxLength=0	MaxDegrees=0
Frame=2	AutoMesh=No	AtJoints=No	AtFrames=No	NumSegments=0	MaxLength=0	MaxDegrees=0
Frame=3	AutoMesh=No	AtJoints=No	AtFrames=No	NumSegments=0	MaxLength=0	MaxDegrees=0
Frame=4	AutoMesh=No	AtJoints=No	AtFrames=No	NumSegments=0	MaxLength=0	MaxDegrees=0
Frame=5	AutoMesh=No	AtJoints=No	AtFrames=No	NumSegments=0	MaxLength=0	MaxDegrees=0
Frame=6	AutoMesh=No	AtJoints=No	AtFrames=No	NumSegments=0	MaxLength=0	MaxDegrees=0
Frame=9	AutoMesh=No	AtJoints=No	AtFrames=No	NumSegments=0	MaxLength=0	MaxDegrees=0
Frame=10	AutoMesh=No	AtJoints=No	AtFrames=No	NumSegments=0	MaxLength=0	MaxDegrees=0
Frame=11	AutoMesh=No	AtJoints=No	AtFrames=No	NumSegments=0	MaxLength=0	MaxDegrees=0
Frame=12	AutoMesh=No	AtJoints=No	AtFrames=No	NumSegments=0	MaxLength=0	MaxDegrees=0
Frame=15	AutoMesh=No	AtJoints=No	AtFrames=No	NumSegments=0	MaxLength=0	MaxDegrees=0
Frame=16	AutoMesh=No	AtJoints=No	AtFrames=No	NumSegments=0	MaxLength=0	MaxDegrees=0
Frame=17	AutoMesh=No	AtJoints=No	AtFrames=No	NumSegments=0	MaxLength=0	MaxDegrees=0
Frame=18	AutoMesh=No	AtJoints=No	AtFrames=No	NumSegments=0	MaxLength=0	MaxDegrees=0
Frame=19	AutoMesh=No	AtJoints=No	AtFrames=No	NumSegments=0	MaxLength=0	MaxDegrees=0
Frame=20	AutoMesh=No	AtJoints=No	AtFrames=No	NumSegments=0	MaxLength=0	MaxDegrees=0
Frame=21	AutoMesh=No	AtJoints=No	AtFrames=No	NumSegments=0	MaxLength=0	MaxDegrees=0
Frame=22	AutoMesh=No	AtJoints=No	AtFrames=No	NumSegments=0	MaxLength=0	MaxDegrees=0
Frame=23	AutoMesh=No	AtJoints=No	AtFrames=No	NumSegments=0	MaxLength=0	MaxDegrees=0
Frame=24	AutoMesh=No	AtJoints=No	AtFrames=No	NumSegments=0	MaxLength=0	MaxDegrees=0
Frame=25	AutoMesh=No	AtJoints=No	AtFrames=No	NumSegments=0	MaxLength=0	MaxDegrees=0
Frame=26	AutoMesh=No	AtJoints=No	AtFrames=No	NumSegments=0	MaxLength=0	MaxDegrees=0
Frame=27	AutoMesh=No	AtJoints=No	AtFrames=No	NumSegments=0	MaxLength=0	MaxDegrees=0
Frame=28	AutoMesh=No	AtJoints=No	AtFrames=No	NumSegments=0	MaxLength=0	MaxDegrees=0
Frame=41	AutoMesh=No	AtJoints=No	AtFrames=No	NumSegments=0	MaxLength=0	MaxDegrees=0
Frame=42	AutoMesh=No	AtJoints=No	AtFrames=No	NumSegments=0	MaxLength=0	MaxDegrees=0
Frame=43	AutoMesh=No	AtJoints=No	AtFrames=No	NumSegments=0	MaxLength=0	MaxDegrees=0
Frame=44	AutoMesh=No	AtJoints=No	AtFrames=No	NumSegments=0	MaxLength=0	MaxDegrees=0
Frame=45	AutoMesh=No	AtJoints=No	AtFrames=No	NumSegments=0	MaxLength=0	MaxDegrees=0
Frame=46	AutoMesh=No	AtJoints=No	AtFrames=No	NumSegments=0	MaxLength=0	MaxDegrees=0
Frame=47	AutoMesh=No	AtJoints=No	AtFrames=No	NumSegments=0	MaxLength=0	MaxDegrees=0
Frame=48	AutoMesh=No	AtJoints=No	AtFrames=No	NumSegments=0	MaxLength=0	MaxDegrees=0
Frame=74	AutoMesh=No	AtJoints=No	AtFrames=No	NumSegments=0	MaxLength=0	MaxDegrees=0
Frame=75	AutoMesh=No	AtJoints=No	AtFrames=No	NumSegments=0	MaxLength=0	MaxDegrees=0
Frame=77	AutoMesh=No	AtJoints=No	AtFrames=No	NumSegments=0	MaxLength=0	MaxDegrees=0
Frame=78	AutoMesh=No	AtJoints=No	AtFrames=No	NumSegments=0	MaxLength=0	MaxDegrees=0
Frame=112	AutoMesh=No	AtJoints=No	AtFrames=No	NumSegments=0	MaxLength=0	MaxDegrees=0
Frame=113	AutoMesh=No	AtJoints=No	AtFrames=No	NumSegments=0	MaxLength=0	MaxDegrees=0
Frame=114	AutoMesh=No	AtJoints=No	AtFrames=No	NumSegments=0	MaxLength=0	MaxDegrees=0
Frame=115	AutoMesh=No	AtJoints=No	AtFrames=No	NumSegments=0	MaxLength=0	MaxDegrees=0
Frame=116	AutoMesh=No	AtJoints=No	AtFrames=No	NumSegments=0	MaxLength=0	MaxDegrees=0
Frame=117	AutoMesh=No	AtJoints=No	AtFrames=No	NumSegments=0	MaxLength=0	MaxDegrees=0
Frame=118	AutoMesh=No	AtJoints=No	AtFrames=No	NumSegments=0	MaxLength=0	MaxDegrees=0
Frame=119	AutoMesh=No	AtJoints=No	AtFrames=No	NumSegments=0	MaxLength=0	MaxDegrees=0

TABLE: "FRAME LOADS - DISTRIBUTED"

Frame=74	LoadPat=TERRVERT	CoordSys=GLOBAL	Type=Force	Dir=Gravity	DistType=RelDist	RelDistA=0
RelDistB=1	AbsDistA=0	AbsDistB=0.24999976158142	FOverLA=138	FOverLB=138		
Frame=74	LoadPat=ACCVERT	CoordSys=GLOBAL	Type=Force	Dir=Gravity	DistType=RelDist	RelDistA=0
RelDistB=1	AbsDistA=0	AbsDistB=0.24999976158142	FOverLA=5.42	FOverLB=5.42		
Frame=75	LoadPat=TERRVERT	CoordSys=GLOBAL	Type=Force	Dir=Gravity	DistType=RelDist	RelDistA=0
RelDistB=1	AbsDistA=0	AbsDistB=0.25	FOverLA=138	FOverLB=138		
Frame=75	LoadPat=ACCVERT	CoordSys=GLOBAL	Type=Force	Dir=Gravity	DistType=RelDist	RelDistA=0
RelDistB=1	AbsDistA=0	AbsDistB=0.25	FOverLA=5.42	FOverLB=5.42		
Frame=77	LoadPat=TERRVERT	CoordSys=GLOBAL	Type=Force	Dir=Gravity	DistType=RelDist	RelDistA=0
RelDistB=1	AbsDistA=0	AbsDistB=0.25	FOverLA=138	FOverLB=138		

Frame=77	LoadPat=ACCVERT	CoordSys=GLOBAL	Type=Force	Dir=Gravity	DistType=RelDist	RelDistA=0		
RelDistB=1	AbsDistA=0	AbsDistB=0.25	FOverLA=5.42	FOverLB=5.42				
Frame=78	LoadPat=TERRVERT	CoordSys=GLOBAL	Type=Force	Dir=Gravity	DistType=RelDist	RelDistA=0		
RelDistB=1	AbsDistA=0	AbsDistB=0.249999976158143	FOverLA=138	FOverLB=138				
Frame=78	LoadPat=ACCVERT	CoordSys=GLOBAL	Type=Force	Dir=Gravity	DistType=RelDist	RelDistA=0		
RelDistB=1	AbsDistA=0	AbsDistB=0.249999976158143	FOverLA=5.42	FOverLB=5.42				
Frame=112	LoadPat=TERRVERT	CoordSys=GLOBAL	Type=Force	Dir=Gravity	DistType=RelDist	RelDistA=0		
RelDistB=1	AbsDistA=0	AbsDistB=0.5	FOverLA=138	FOverLB=138				
Frame=112	LoadPat=ACCVERT	CoordSys=GLOBAL	Type=Force	Dir=Gravity	DistType=RelDist	RelDistA=0		
RelDistB=1	AbsDistA=0	AbsDistB=0.5	FOverLA=5.42	FOverLB=5.42				
Frame=113	LoadPat=TERRVERT	CoordSys=GLOBAL	Type=Force	Dir=Gravity	DistType=RelDist	RelDistA=0		
RelDistB=1	AbsDistA=0	AbsDistB=0.5	FOverLA=138	FOverLB=138				
Frame=113	LoadPat=ACCVERT	CoordSys=GLOBAL	Type=Force	Dir=Gravity	DistType=RelDist	RelDistA=0		
RelDistB=1	AbsDistA=0	AbsDistB=0.5	FOverLA=5.42	FOverLB=5.42				
Frame=114	LoadPat=TERRVERT	CoordSys=GLOBAL	Type=Force	Dir=Gravity	DistType=RelDist	RelDistA=0		
RelDistB=1	AbsDistA=0	AbsDistB=0.5	FOverLA=138	FOverLB=138				
Frame=114	LoadPat=ACCVERT	CoordSys=GLOBAL	Type=Force	Dir=Gravity	DistType=RelDist	RelDistA=0		
RelDistB=1	AbsDistA=0	AbsDistB=0.5	FOverLA=5.42	FOverLB=5.42				
Frame=115	LoadPat=TERRVERT	CoordSys=GLOBAL	Type=Force	Dir=Gravity	DistType=RelDist	RelDistA=0		
RelDistB=1	AbsDistA=0	AbsDistB=0.5	FOverLA=138	FOverLB=138				
Frame=115	LoadPat=ACCVERT	CoordSys=GLOBAL	Type=Force	Dir=Gravity	DistType=RelDist	RelDistA=0		
RelDistB=1	AbsDistA=0	AbsDistB=0.5	FOverLA=5.42	FOverLB=5.42				
Frame=116	LoadPat=TERRVERT	CoordSys=GLOBAL	Type=Force	Dir=Gravity	DistType=RelDist	RelDistA=0		
RelDistB=1	AbsDistA=0	AbsDistB=0.5	FOverLA=138	FOverLB=138				
Frame=116	LoadPat=ACCVERT	CoordSys=GLOBAL	Type=Force	Dir=Gravity	DistType=RelDist	RelDistA=0		
RelDistB=1	AbsDistA=0	AbsDistB=0.5	FOverLA=5.42	FOverLB=5.42				
Frame=117	LoadPat=TERRVERT	CoordSys=GLOBAL	Type=Force	Dir=Gravity	DistType=RelDist	RelDistA=0		
RelDistB=1	AbsDistA=0	AbsDistB=0.5	FOverLA=138	FOverLB=138				
Frame=117	LoadPat=ACCVERT	CoordSys=GLOBAL	Type=Force	Dir=Gravity	DistType=RelDist	RelDistA=0		
RelDistB=1	AbsDistA=0	AbsDistB=0.5	FOverLA=5.42	FOverLB=5.42				
Frame=118	LoadPat=TERRVERT	CoordSys=GLOBAL	Type=Force	Dir=Gravity	DistType=RelDist	RelDistA=0		
RelDistB=1	AbsDistA=0	AbsDistB=0.5	FOverLA=138	FOverLB=138				
Frame=118	LoadPat=ACCVERT	CoordSys=GLOBAL	Type=Force	Dir=Gravity	DistType=RelDist	RelDistA=0		
RelDistB=1	AbsDistA=0	AbsDistB=0.5	FOverLA=5.42	FOverLB=5.42				
Frame=119	LoadPat=TERRVERT	CoordSys=GLOBAL	Type=Force	Dir=Gravity	DistType=RelDist	RelDistA=0		
RelDistB=1	AbsDistA=0	AbsDistB=0.5	FOverLA=138	FOverLB=138				
Frame=119	LoadPat=ACCVERT	CoordSys=GLOBAL	Type=Force	Dir=Gravity	DistType=RelDist	RelDistA=0		
RelDistB=1	AbsDistA=0	AbsDistB=0.5	FOverLA=5.42	FOverLB=5.42				
Frame=3	LoadPat=TERRLAT	CoordSys=GLOBAL	Type=Force	Dir=X	DistType=RelDist	RelDistA=0	RelDistB=1	
AbsDistA=0	AbsDistB=0.250000000000001	FOverLA=-97.22	FOverLB=-95.088124987293					
Frame=3	LoadPat=ACCLATDX	CoordSys=GLOBAL	Type=Force	Dir=X	DistType=RelDist	RelDistA=0	RelDistB=1	
AbsDistA=0	AbsDistB=0.250000000000001	FOverLA=-2.31	FOverLB=-2.31					
Frame=6	LoadPat=TERRLAT	CoordSys=GLOBAL	Type=Force	Dir=X	DistType=RelDist	RelDistA=0	RelDistB=1	
AbsDistA=0	AbsDistB=0.25	FOverLA=-95.088124987293	FOverLB=-92.9562499745861					
Frame=6	LoadPat=ACCLATDX	CoordSys=GLOBAL	Type=Force	Dir=X	DistType=RelDist	RelDistA=0	RelDistB=1	
AbsDistA=0	AbsDistB=0.25	FOverLA=-2.31	FOverLB=-2.31					
Frame=9	LoadPat=TERRLAT	CoordSys=GLOBAL	Type=Force	Dir=X	DistType=RelDist	RelDistA=0	RelDistB=1	
AbsDistA=0	AbsDistB=0.250000000000002	FOverLA=-67.3737498221025	FOverLB=-65.2418748093955					
Frame=9	LoadPat=ACCLATDX	CoordSys=GLOBAL	Type=Force	Dir=X	DistType=RelDist	RelDistA=0	RelDistB=1	
AbsDistA=0	AbsDistB=0.250000000000002	FOverLA=-2.31	FOverLB=-2.31					
Frame=10	LoadPat=TERRLAT	CoordSys=GLOBAL	Type=Force	Dir=X	DistType=RelDist	RelDistA=0	RelDistB=1	
AbsDistA=0	AbsDistB=0.249999976158143	FOverLA=-65.2418748093955	FOverLB=-63.11					
Frame=10	LoadPat=ACCLATDX	CoordSys=GLOBAL	Type=Force	Dir=X	DistType=RelDist	RelDistA=0	RelDistB=1	
AbsDistA=0	AbsDistB=0.249999976158143	FOverLA=-2.31	FOverLB=-2.31					
Frame=11	LoadPat=TERRLAT	CoordSys=GLOBAL	Type=Force	Dir=X	DistType=RelDist	RelDistA=0	RelDistB=1	
AbsDistA=0	AbsDistB=0.250000000000001	FOverLA=97.22	FOverLB=95.088125					
Frame=11	LoadPat=ACCLATDX	CoordSys=GLOBAL	Type=Force	Dir=X	DistType=RelDist	RelDistA=0	RelDistB=1	
AbsDistA=0	AbsDistB=0.250000000000001	FOverLA=2.31	FOverLB=2.31					
Frame=12	LoadPat=TERRLAT	CoordSys=GLOBAL	Type=Force	Dir=X	DistType=RelDist	RelDistA=0	RelDistB=1	
AbsDistA=0	AbsDistB=0.25	FOverLA=95.088125	FOverLB=92.95625					
Frame=12	LoadPat=ACCLATDX	CoordSys=GLOBAL	Type=Force	Dir=X	DistType=RelDist	RelDistA=0	RelDistB=1	
AbsDistA=0	AbsDistB=0.25	FOverLA=2.31	FOverLB=2.31					
Frame=15	LoadPat=TERRLAT	CoordSys=GLOBAL	Type=Force	Dir=X	DistType=RelDist	RelDistA=0	RelDistB=1	
AbsDistA=0	AbsDistB=0.250000000000002	FOverLA=67.37375	FOverLB=65.241875					
Frame=15	LoadPat=ACCLATDX	CoordSys=GLOBAL	Type=Force	Dir=X	DistType=RelDist	RelDistA=0	RelDistB=1	
AbsDistA=0	AbsDistB=0.250000000000002	FOverLA=2.31	FOverLB=2.31					
Frame=16	LoadPat=TERRLAT	CoordSys=GLOBAL	Type=Force	Dir=X	DistType=RelDist	RelDistA=0	RelDistB=1	
AbsDistA=0	AbsDistB=0.250000000000001	FOverLA=65.241875	FOverLB=63.11					
Frame=16	LoadPat=ACCLATDX	CoordSys=GLOBAL	Type=Force	Dir=X	DistType=RelDist	RelDistA=0	RelDistB=1	
AbsDistA=0	AbsDistB=0.250000000000001	FOverLA=2.31	FOverLB=2.31					
Frame=17	LoadPat=TERRLAT	CoordSys=GLOBAL	Type=Force	Dir=X	DistType=RelDist	RelDistA=0	RelDistB=1	
AbsDistA=0	AbsDistB=0.5	FOverLA=-92.9562499745861	FOverLB=-88.6924999491721					
Frame=17	LoadPat=ACCLATDX	CoordSys=GLOBAL	Type=Force	Dir=X	DistType=RelDist	RelDistA=0	RelDistB=1	
AbsDistA=0	AbsDistB=0.5	FOverLA=-2.31	FOverLB=-2.31					
Frame=18	LoadPat=TERRLAT	CoordSys=GLOBAL	Type=Force	Dir=X	DistType=RelDist	RelDistA=0	RelDistB=1	
AbsDistA=0	AbsDistB=0.5	FOverLA=-88.6924999491721	FOverLB=-84.4287499237582					
Frame=18	LoadPat=ACCLATDX	CoordSys=GLOBAL	Type=Force	Dir=X	DistType=RelDist	RelDistA=0	RelDistB=1	
AbsDistA=0	AbsDistB=0.5	FOverLA=-2.31	FOverLB=-2.31					
Frame=19	LoadPat=TERRLAT	CoordSys=GLOBAL	Type=Force	Dir=X	DistType=RelDist	RelDistA=0	RelDistB=1	
AbsDistA=0	AbsDistB=0.5	FOverLA=-84.4287499237582	FOverLB=-80.1649998983443					
Frame=19	LoadPat=ACCLATDX	CoordSys=GLOBAL	Type=Force	Dir=X	DistType=RelDist	RelDistA=0	RelDistB=1	
AbsDistA=0	AbsDistB=0.5	FOverLA=-2.31	FOverLB=-2.31					



Frame=20	LoadPat=TERRLAT	CoordSys=GLOBAL	Type=Force	Dir=X	DistType=RelDist	RelDistA=0	RelDistB=1
AbsDistA=0	AbsDistB=0.5	FOverLA=-80.1649998983443	FOverLB=-75.9012498729304				
Frame=20	LoadPat=ACCLATDX	CoordSys=GLOBAL	Type=Force	Dir=X	DistType=RelDist	RelDistA=0	RelDistB=1
AbsDistA=0	AbsDistB=0.5	FOverLA=-2.31	FOverLB=-2.31				
Frame=21	LoadPat=TERRLAT	CoordSys=GLOBAL	Type=Force	Dir=X	DistType=RelDist	RelDistA=0	RelDistB=1
AbsDistA=0	AbsDistB=0.5	FOverLA=-75.9012498729304	FOverLB=-71.6374998475164				
Frame=21	LoadPat=ACCLATDX	CoordSys=GLOBAL	Type=Force	Dir=X	DistType=RelDist	RelDistA=0	RelDistB=1
AbsDistA=0	AbsDistB=0.5	FOverLA=-2.31	FOverLB=-2.31				
Frame=22	LoadPat=TERRLAT	CoordSys=GLOBAL	Type=Force	Dir=X	DistType=RelDist	RelDistA=0	RelDistB=1
AbsDistA=0	AbsDistB=0.5	FOverLA=-71.6374998475164	FOverLB=-67.3737498221025				
Frame=22	LoadPat=ACCLATDX	CoordSys=GLOBAL	Type=Force	Dir=X	DistType=RelDist	RelDistA=0	RelDistB=1
AbsDistA=0	AbsDistB=0.5	FOverLA=-2.31	FOverLB=-2.31				
Frame=23	LoadPat=TERRLAT	CoordSys=GLOBAL	Type=Force	Dir=X	DistType=RelDist	RelDistA=0	RelDistB=1
AbsDistA=0	AbsDistB=0.5	FOverLA=92.95625	FOverLB=88.6925				
Frame=23	LoadPat=ACCLATDX	CoordSys=GLOBAL	Type=Force	Dir=X	DistType=RelDist	RelDistA=0	RelDistB=1
AbsDistA=0	AbsDistB=0.5	FOverLA=2.31	FOverLB=2.31				
Frame=24	LoadPat=TERRLAT	CoordSys=GLOBAL	Type=Force	Dir=X	DistType=RelDist	RelDistA=0	RelDistB=1
AbsDistA=0	AbsDistB=0.5	FOverLA=88.6925	FOverLB=84.42875				
Frame=24	LoadPat=ACCLATDX	CoordSys=GLOBAL	Type=Force	Dir=X	DistType=RelDist	RelDistA=0	RelDistB=1
AbsDistA=0	AbsDistB=0.5	FOverLA=2.31	FOverLB=2.31				
Frame=25	LoadPat=TERRLAT	CoordSys=GLOBAL	Type=Force	Dir=X	DistType=RelDist	RelDistA=0	RelDistB=1
AbsDistA=0	AbsDistB=0.5	FOverLA=84.42875	FOverLB=80.165				
Frame=25	LoadPat=ACCLATDX	CoordSys=GLOBAL	Type=Force	Dir=X	DistType=RelDist	RelDistA=0	RelDistB=1
AbsDistA=0	AbsDistB=0.5	FOverLA=2.31	FOverLB=2.31				
Frame=26	LoadPat=TERRLAT	CoordSys=GLOBAL	Type=Force	Dir=X	DistType=RelDist	RelDistA=0	RelDistB=1
AbsDistA=0	AbsDistB=0.5	FOverLA=80.165	FOverLB=75.90125				
Frame=26	LoadPat=ACCLATDX	CoordSys=GLOBAL	Type=Force	Dir=X	DistType=RelDist	RelDistA=0	RelDistB=1
AbsDistA=0	AbsDistB=0.5	FOverLA=2.31	FOverLB=2.31				
Frame=27	LoadPat=TERRLAT	CoordSys=GLOBAL	Type=Force	Dir=X	DistType=RelDist	RelDistA=0	RelDistB=1
AbsDistA=0	AbsDistB=0.5	FOverLA=75.90125	FOverLB=71.6375				
Frame=27	LoadPat=ACCLATDX	CoordSys=GLOBAL	Type=Force	Dir=X	DistType=RelDist	RelDistA=0	RelDistB=1
AbsDistA=0	AbsDistB=0.5	FOverLA=2.31	FOverLB=2.31				
Frame=28	LoadPat=TERRLAT	CoordSys=GLOBAL	Type=Force	Dir=X	DistType=RelDist	RelDistA=0	RelDistB=1
AbsDistA=0	AbsDistB=0.5	FOverLA=71.6375	FOverLB=67.37375				
Frame=28	LoadPat=ACCLATDX	CoordSys=GLOBAL	Type=Force	Dir=X	DistType=RelDist	RelDistA=0	RelDistB=1
AbsDistA=0	AbsDistB=0.5	FOverLA=2.31	FOverLB=2.31				

TABLE: "FRAME DESIGN PROCEDURES"

Frame=1	DesignProc="From Material"
Frame=2	DesignProc="From Material"
Frame=3	DesignProc="From Material"
Frame=4	DesignProc="From Material"
Frame=5	DesignProc="From Material"
Frame=6	DesignProc="From Material"
Frame=9	DesignProc="From Material"
Frame=10	DesignProc="From Material"
Frame=11	DesignProc="From Material"
Frame=12	DesignProc="From Material"
Frame=15	DesignProc="From Material"
Frame=16	DesignProc="From Material"
Frame=17	DesignProc="From Material"
Frame=18	DesignProc="From Material"
Frame=19	DesignProc="From Material"
Frame=20	DesignProc="From Material"
Frame=21	DesignProc="From Material"
Frame=22	DesignProc="From Material"
Frame=23	DesignProc="From Material"
Frame=24	DesignProc="From Material"
Frame=25	DesignProc="From Material"
Frame=26	DesignProc="From Material"
Frame=27	DesignProc="From Material"
Frame=28	DesignProc="From Material"
Frame=41	DesignProc="From Material"
Frame=42	DesignProc="From Material"
Frame=43	DesignProc="From Material"
Frame=44	DesignProc="From Material"
Frame=45	DesignProc="From Material"
Frame=46	DesignProc="From Material"
Frame=47	DesignProc="From Material"
Frame=48	DesignProc="From Material"
Frame=74	DesignProc="From Material"
Frame=75	DesignProc="From Material"
Frame=77	DesignProc="From Material"
Frame=78	DesignProc="From Material"
Frame=112	DesignProc="From Material"
Frame=113	DesignProc="From Material"
Frame=114	DesignProc="From Material"
Frame=115	DesignProc="From Material"
Frame=116	DesignProc="From Material"
Frame=117	DesignProc="From Material"
Frame=118	DesignProc="From Material"
Frame=119	DesignProc="From Material"



IG51-02-E-CV-CL-IN11-0X-001_A00
Relazione di calcolo

Foglio
659 di 929

1.4. Dati di output scatolare – Caso D

File D:\13_15_CO CIV\01_Calcoli\IN11\giorgio\IN11_situazione4-output.txt was saved on 9/17/13 at 11.47.25

TABLE: "PROGRAM CONTROL"

ProgramName=SAP2000 Version=15.0.0 ProgLevel=Ultimate LicenseNum=266BC LicenseOS=Yes LicenseSC=Yes
LicenseBR=No LicenseHT=No CurrUnits="KN, m, C" SteelCode=AISC-ASD89 ConcCode="ACI 318-99" AlumCode="AA-ASD
2000" - ColdCode=AISI-ASD96 BridgeCode="AASHTO LRFD 2007" RegenHinge=No

TABLE: "JOINT DISPLACEMENTS"

Joint	OutputCase	CaseType	U1	U2	U3	R1	R2	R3
1.08098613657261E-04	PERM1	Combination	0	0	-8.94799706440553E-03	0	-	0
1.1998949085625E-04	PERM2	Combination	0	0	-8.95779153613702E-03	0	-	0
1.11089843037751E-04	ACC1	Combination	0	0	-9.16131913193041E-03	0	-	0
1.22980720236741E-04	ACC2	Combination	0	0	-9.1711136036619E-03	0	-	0
3.77244179432609E-05	ACCSX1	Combination	0	0	-8.77854432464148E-03	0	-	0
4.96152951422507E-05	ACCSX2	Combination	0	0	-8.78833879637297E-03	0	-	0
R2=-3.77244179432609E-05	ENVE	Combination	Max	0	0	-8.77854432464148E-03	0	0
R2=-1.22980720236741E-04	ENVE	Combination	Min	0	0	-9.1711136036619E-03	0	0
1.10192474223604E-04	FESSUR	Combination	0	0	-9.09732251167294E-03	0	-	0
R1=0 R2=3.84015454809194E-05	PERM1	Combination	0	2.60252311904277E-05	0	-8.96172812455121E-03	0	0
R1=0 R2=4.80858124923613E-05	PERM2	Combination	0	4.99333325234797E-05	0	-8.97152255368204E-03	0	0
R1=0 R2=3.95193005557163E-05	ACC1	Combination	0	2.70847861473406E-05	0	-9.17542606336274E-03	0	0
R1=0 R2=4.92035675671582E-05	ACC2	Combination	0	5.09928874803926E-05	0	-9.18522049249356E-03	0	0
R1=0 R2=1.08704207590793E-04	ACCSX1	Combination	0	9.62880112029269E-05	0	-9.13018841953889E-03	0	0
R1=0 R2=1.18388474602235E-04	ACCSX2	Combination	0	1.20196112535979E-04	0	-9.13998284866972E-03	0	0
R1=0 R2=1.18388474602235E-04	ENVE	Combination	Max	1.20196112535979E-04	0	0	0	-
R1=0 R2=1.18388474602235E-04	ENVE	Combination	Min	2.60252311904277E-05	0	0	0	-
R1=0 R2=3.84015454809194E-05	FESSUR	Combination	0	2.67669196602667E-05	0	-9.11131668171928E-03	0	0
R1=0 R2=3.91839740332772E-05	PERM1	Combination	0	3.69192663159061E-05	0	-8.9683335399763E-03	0	0
R1=0 R2=1.71113667395711E-05	PERM2	Combination	0	6.52266420062213E-05	0	-8.97812796907025E-03	0	0
R1=0 R2=2.21626271037636E-05	ACC1	Combination	0	3.83156025588279E-05	0	-9.18221941239184E-03	0	0
R1=0 R2=1.76250739859135E-05	ACC2	Combination	0	6.66229782491431E-05	0	-9.1920138414858E-03	0	0
R1=0 R2=2.2676334350106E-05	ACCSX1	Combination	0	1.42505375549577E-04	0	-9.13681483439329E-03	0	0
R1=0 R2=8.77224859487707E-05	ACCSX2	Combination	0	1.70812751239892E-04	0	-9.14660926348725E-03	0	0
R1=0 R2=9.27737463129631E-05	ENVE	Combination	Max	1.70812751239892E-04	0	0	0	-
R1=0 R2=9.27737463129631E-05	ENVE	Combination	Min	3.69192663159061E-05	0	0	0	-
R1=0 R2=1.71113667395711E-05	FESSUR	Combination	0	3.78967016859514E-05	0	-9.11805365066718E-03	0	0
R1=0 R2=1.74709618120108E-05	PERM1	Combination	0	3.99749425843194E-05	0	-8.97476558498101E-03	0	0
R1=0 R2=-1.28757282684615E-09	PERM2	Combination	0	6.96127040656517E-05	0	-8.98456001406109E-03	0	0
R1=0 R2=-4.77755542047051E-07	ACC1	Combination	0	4.14776641853268E-05	0	-9.18883939100254E-03	0	0
R1=0 R2=2.00981661201876E-09	ACC2	Combination	0	7.1115425666659E-05	0	-9.19863382008261E-03	0	0
R1=0 R2=-4.74458152608187E-07	ACCSX1	Combination	0	1.80991325257643E-04	0	-9.14326787882647E-03	0	0
R1=0 R2=7.07291514109751E-05	ACCSX2	Combination	0	2.10629086738976E-04	0	-9.15306230790654E-03	0	0
R1=0 R2=7.02526834417549E-05	ENVE	Combination	Max	2.10629086738976E-04	0	0	0	-
R1=0 R2=7.07291514109751E-05	ENVE	Combination	Min	3.99749425843194E-05	0	0	0	-
R1=0 R2=-4.77755542047051E-07	ENVE	Combination	Max	3.99749425843194E-05	0	0	0	-



Joint=4	OutputCase=FESSUR	CaseType=Combination	U1=4.10268477050246E-05	U2=0	U3=-9.12461724919608E-03	
R1=0	R2=1.02059978036081E-09	R3=0				
Joint=5	OutputCase=PERM1	CaseType=Combination	U1=3.63359505558356E-05	U2=0	U3=-8.98102425955603E-03	
R1=0	R2=-1.6360701298564E-05	R3=0				
Joint=5	OutputCase=PERM2	CaseType=Combination	U1=6.40713699145293E-05	U2=0	U3=-8.99081868864659E-03	
R1=0	R2=-2.2232341371534E-05	R3=0				
Joint=5	OutputCase=ACC1	CaseType=Combination	U1=3.77374514232376E-05	U2=0	U3=-9.19528599918531E-03	
R1=0	R2=-1.68702923926492E-05	R3=0				
Joint=5	OutputCase=ACC2	CaseType=Combination	U1=6.54728707819312E-05	U2=0	U3=-9.20508042827587E-03	
R1=0	R2=-2.27419252312385E-05	R3=0				
Joint=5	OutputCase=ACCSX1	CaseType=Combination	U1=2.12794982224934E-04	U2=0	U3=-9.14954755282984E-03	
R1=0	R2=5.4299920135117E-05	R3=0				
Joint=5	OutputCase=ACCSX2	CaseType=Combination	U1=2.40530401583627E-04	U2=0	U3=-9.1593419819204E-03	
R1=0	R2=4.84282872965276E-05	R3=0				
Joint=5	OutputCase=ENVE	CaseType=Combination	StepType=Max	U1=2.40530401583627E-04	U2=0	U3=-
R1=0	R2=8.98102425955603E-03	R1=0	R2=5.4299920135117E-05	R3=0		
Joint=5	OutputCase=ENVE	CaseType=Combination	StepType=Min	U1=3.63359505558356E-05	U2=0	U3=-
R1=0	R2=9.20508042827587E-03	R1=0	R2=-2.27419252312385E-05	R3=0		
Joint=5	OutputCase=FESSUR	CaseType=Combination	U1=3.7317001163017E-05	U2=0	U3=-9.13100747729653E-03	
R1=0	R2=-1.67174150644236E-05	R3=0				
Joint=6	OutputCase=PERM1	CaseType=Combination	U1=2.54781913746611E-05	U2=0	U3=-8.98710956370527E-03	
R1=0	R2=-3.52137482591954E-05	R3=0				
Joint=6	OutputCase=PERM2	CaseType=Combination	U1=4.84150381731994E-05	U2=0	U3=-8.99690399282808E-03	
R1=0	R2=-4.5373920359124E-05	R3=0				
Joint=6	OutputCase=ACC1	CaseType=Combination	U1=2.65455969539136E-05	U2=0	U3=-9.20155923694428E-03	
R1=0	R2=-3.63348230615966E-05	R3=0				
Joint=6	OutputCase=ACC2	CaseType=Combination	U1=4.9482443752452E-05	U2=0	U3=-9.21135366606709E-03	
R1=0	R2=-4.64949951615252E-05	R3=0				
Joint=6	OutputCase=ACCSX1	CaseType=Combination	U1=2.37297678933291E-04	U2=0	U3=-9.1556538564081E-03	
R1=0	R2=3.51879182996411E-05	R3=0				
Joint=6	OutputCase=ACCSX2	CaseType=Combination	U1=2.6023452573183E-04	U2=0	U3=-9.16544828553091E-03	
R1=0	R2=2.50277461997125E-05	R3=0				
Joint=6	OutputCase=ENVE	CaseType=Combination	StepType=Max	U1=2.6023452573183E-04	U2=0	U3=-
R1=0	R2=8.98710956370527E-03	R1=0	R2=3.51879182996411E-05	R3=0		
Joint=6	OutputCase=ENVE	CaseType=Combination	StepType=Min	U1=2.54781913746611E-05	U2=0	U3=-
R1=0	R2=9.21135366606709E-03	R1=0	R2=-4.64949951615252E-05	R3=0		
Joint=6	OutputCase=FESSUR	CaseType=Combination	U1=2.62253752801378E-05	U2=0	U3=-9.13722433497258E-03	
R1=0	R2=-3.59985006208763E-05	R3=0				
Joint=7	OutputCase=PERM1	CaseType=Combination	U1=-5.87490389603174E-05	U2=0	U3=-8.9617280087845E-03	
R1=0	R2=-3.84014975599001E-05	R3=0				
Joint=7	OutputCase=PERM2	CaseType=Combination	U1=-7.34375606058727E-05	U2=0	U3=-8.97152248082258E-03	
R1=0	R2=-4.8085782385444E-05	R3=0				
Joint=7	OutputCase=ACC1	CaseType=Combination	U1=-6.04452385197129E-05	U2=0	U3=-9.17542594357529E-03	
R1=0	R2=-3.95192509802455E-05	R3=0				
Joint=7	OutputCase=ACC2	CaseType=Combination	U1=-7.51337601652681E-05	U2=0	U3=-9.18522041561336E-03	
R1=0	R2=-4.92035358057894E-05	R3=0				
Joint=7	OutputCase=ACCSX1	CaseType=Combination	U1=1.27500980111019E-05	U2=0	U3=-8.79223326819403E-03	
R1=0	R2=3.30101589856521E-05	R3=0				
Joint=7	OutputCase=ACCSX2	CaseType=Combination	U1=-1.93842363445334E-06	U2=0	U3=-8.8020277402321E-03	
R1=0	R2=2.33258741601082E-05	R3=0				
Joint=7	OutputCase=ENVE	CaseType=Combination	StepType=Max	U1=1.27500980111019E-05	U2=0	U3=-
R1=0	R2=8.79223326819403E-03	R1=0	R2=3.30101589856521E-05	R3=0		
Joint=7	OutputCase=ENVE	CaseType=Combination	StepType=Min	U1=-7.51337601652681E-05	U2=0	U3=-
R1=0	R2=9.18522041561336E-03	R1=0	R2=-4.92035358057894E-05	R3=0		
Joint=7	OutputCase=FESSUR	CaseType=Combination	U1=-5.99363786518942E-05	U2=0	U3=-9.11131656313805E-03	
R1=0	R2=-3.91839249541419E-05	R3=0				
Joint=8	OutputCase=PERM1	CaseType=Combination	U1=-6.96430500412695E-05	U2=0	U3=-8.96833342418838E-03	
R1=0	R2=-1.71113187949349E-05	R3=0				
Joint=8	OutputCase=PERM2	CaseType=Combination	U1=-8.87308549856969E-05	U2=0	U3=-8.97812789619718E-03	
R1=0	R2=-2.21625970177264E-05	R3=0				
Joint=8	OutputCase=ACC1	CaseType=Combination	U1=-7.16760300571402E-05	U2=0	U3=-9.18221929258235E-03	
R1=0	R2=-1.76250243867907E-05	R3=0				
Joint=8	OutputCase=ACC2	CaseType=Combination	U1=-9.07638350015676E-05	U2=0	U3=-9.19201376459115E-03	
R1=0	R2=-2.26763026095822E-05	R3=0				
Joint=8	OutputCase=ACCSX1	CaseType=Combination	U1=3.77045652051987E-05	U2=0	U3=-8.79881768417257E-03	
R1=0	R2=5.41896664728526E-05	R3=0				
Joint=8	OutputCase=ACCSX2	CaseType=Combination	U1=1.86167602607713E-05	U2=0	U3=-8.80861215618137E-03	
R1=0	R2=4.91383882500612E-05	R3=0				
Joint=8	OutputCase=ENVE	CaseType=Combination	StepType=Max	U1=3.77045652051987E-05	U2=0	U3=-
R1=0	R2=8.79881768417257E-03	R1=0	R2=5.41896664728526E-05	R3=0		
Joint=8	OutputCase=ENVE	CaseType=Combination	StepType=Min	U1=-9.07638350015676E-05	U2=0	U3=-
R1=0	R2=9.19201376459115E-03	R1=0	R2=-2.26763026095822E-05	R3=0		
Joint=8	OutputCase=FESSUR	CaseType=Combination	U1=-7.1066136052379E-05	U2=0	U3=-9.11805353206416E-03	
R1=0	R2=-1.74709127092339E-05	R3=0				
Joint=9	OutputCase=PERM1	CaseType=Combination	U1=-7.26987022934911E-05	U2=0	U3=-8.97476546917187E-03	
R1=0	R2=1.33538687365723E-09	R3=0				
Joint=9	OutputCase=PERM2	CaseType=Combination	U1=-9.31169019807501E-05	U2=0	U3=-8.9845599411744E-03	
R1=0	R2=4.77785499259647E-07	R3=0				
Joint=9	OutputCase=ACC1	CaseType=Combination	U1=-7.48380668390417E-05	U2=0	U3=-9.18883927117098E-03	
R1=0	R2=-1.96035262652603E-09	R3=0				
Joint=9	OutputCase=ACC2	CaseType=Combination	U1=-9.52562665263008E-05	U2=0	U3=-9.1986337431735E-03	
R1=0	R2=4.74489759759463E-07	R3=0				



Joint=9	OutputCase=ACCSX1	CaseType=Combination	U1=7.0320975679695E-05	U2=0	U3=-8.80522872972946E-03	
R1=0	R2=7.09002037127655E-05	R3=0				
Joint=9	OutputCase=ACCSX2	CaseType=Combination	U1=4.99027759924359E-05	U2=0	U3=-8.81502320173198E-03	
R1=0	R2=7.13766538251515E-05	R3=0				
Joint=9	OutputCase=ENVE	CaseType=Combination	StepType=Max	U1=7.0320975679695E-05	U2=0	U3=-
8.80522872972946E-03	R1=0	R2=7.13766538251515E-05	R3=0			
Joint=9	OutputCase=ENVE	CaseType=Combination	StepType=Min	U1=-9.52562665263008E-05	U2=0	U3=-
9.1986337431735E-03	R1=0	R2=-1.96035262652603E-09	R3=0			
Joint=9	OutputCase=FESSUR	CaseType=Combination	U1=-7.41962574753766E-05	U2=0	U3=-9.12461713057125E-03	
R1=0	R2=-9.71630776473698E-10	R3=0				
Joint=10	OutputCase=PERM1	CaseType=Combination	U1=-6.90596863538585E-05	U2=0	U3=-8.98102414372567E-03	
R1=0	R2=1.63607488315162E-05	R3=0				
Joint=10	OutputCase=PERM2	CaseType=Combination	U1=-8.7575528574867E-05	U2=0	U3=-8.99081861574628E-03	
R1=0	R2=2.22323638601877E-05	R3=0				
Joint=10	OutputCase=ACC1	CaseType=Combination	U1=-7.1097829340818E-05	U2=0	U3=-9.1952858793317E-03	
R1=0	R2=1.68703415664088E-05	R3=0				
Joint=10	OutputCase=ACC2	CaseType=Combination	U1=-8.96136958444462E-05	U2=0	U3=-9.20508035135231E-03	
R1=0	R2=2.27419565950803E-05	R3=0				
Joint=10	OutputCase=ACCSX1	CaseType=Combination	U1=1.09333945115192E-04	U2=0	U3=-8.8114664048544E-03	
R1=0	R2=8.66621711495526E-05	R3=0				
Joint=10	OutputCase=ACCSX2	CaseType=Combination	U1=9.08180786115634E-05	U2=0	U3=-8.82126087687501E-03	
R1=0	R2=9.25337861782241E-05	R3=0				
Joint=10	OutputCase=ENVE	CaseType=Combination	StepType=Max	U1=1.09333945115192E-04	U2=0	U3=-
8.8114664048544E-03	R1=0	R2=9.25337861782241E-05	R3=0			
Joint=10	OutputCase=ENVE	CaseType=Combination	StepType=Min	U1=-8.96136958444462E-05	U2=0	U3=-
9.20508035135231E-03	R1=0	R2=1.63607488315162E-05	R3=0			
Joint=10	OutputCase=FESSUR	CaseType=Combination	U1=-7.04863864447302E-05	U2=0	U3=-9.13100735864989E-03	
R1=0	R2=1.6717463745941E-05	R3=0				
Joint=11	OutputCase=PERM1	CaseType=Combination	U1=-5.82019034411716E-05	U2=0	U3=-8.9871094478537E-03	
R1=0	R2=3.52137953653063E-05	R3=0				
Joint=11	OutputCase=PERM2	CaseType=Combination	U1=-7.19192062884673E-05	U2=0	U3=-8.99690391991416E-03	
R1=0	R2=4.53739497459574E-05	R3=0				
Joint=11	OutputCase=ACC1	CaseType=Combination	U1=-5.99059503207073E-05	U2=0	U3=-9.20155911706862E-03	
R1=0	R2=3.63348717948006E-05	R3=0				
Joint=11	OutputCase=ACC2	CaseType=Combination	U1=-7.3623253168003E-05	U2=0	U3=-9.21135358912907E-03	
R1=0	R2=4.64950261754517E-05	R3=0				
Joint=11	OutputCase=ACCSX1	CaseType=Combination	U1=1.55193936909452E-04	U2=0	U3=-8.81753070955075E-03	
R1=0	R2=1.04818559207699E-04	R3=0				
Joint=11	OutputCase=ACCSX2	CaseType=Combination	U1=1.41476634062156E-04	U2=0	U3=-8.82732518161121E-03	
R1=0	R2=1.1497871358835E-04	R3=0				
Joint=11	OutputCase=ENVE	CaseType=Combination	StepType=Max	U1=1.55193936909452E-04	U2=0	U3=-
8.81753070955075E-03	R1=0	R2=1.1497871358835E-04	R3=0			
Joint=11	OutputCase=ENVE	CaseType=Combination	StepType=Min	U1=-7.3623253168003E-05	U2=0	U3=-
9.21135358912907E-03	R1=0	R2=3.52137953653063E-05	R3=0			
Joint=11	OutputCase=FESSUR	CaseType=Combination	U1=-5.93947362568466E-05	U2=0	U3=-9.13722421630414E-03	
R1=0	R2=3.59985488659523E-05	R3=0				
Joint=15	OutputCase=PERM1	CaseType=Combination	U1=-3.27238556297103E-05	U2=0	U3=-8.9479971801298E-03	
R1=0	R2=1.0809866105891E-04	R3=0				
Joint=15	OutputCase=PERM2	CaseType=Combination	U1=-2.35042581838832E-05	U2=0	U3=-8.95779160896925E-03	
R1=0	R2=1.19989520674432E-04	R3=0				
Joint=15	OutputCase=ACC1	CaseType=Combination	U1=-3.33605018854787E-05	U2=0	U3=-9.16131925167375E-03	
R1=0	R2=1.11089892080032E-04	R3=0				
Joint=15	OutputCase=ACC2	CaseType=Combination	U1=-2.41409044396515E-05	U2=0	U3=-9.17111368051319E-03	
R1=0	R2=1.22980751695554E-04	R3=0				
Joint=15	OutputCase=ACCSX1	CaseType=Combination	U1=-3.24086267565088E-05	U2=0	U3=-9.11641547432177E-03	
R1=0	R2=1.7721699699396E-04	R3=0				
Joint=15	OutputCase=ACCSX2	CaseType=Combination	U1=-2.31890293106816E-05	U2=0	U3=-9.12620990316122E-03	
R1=0	R2=1.89107856609482E-04	R3=0				
Joint=15	OutputCase=ENVE	CaseType=Combination	StepType=Max	U1=-2.31890293106816E-05	U2=0	U3=-
8.9479971801298E-03	R1=0	R2=1.89107856609482E-04	R3=0			
Joint=15	OutputCase=ENVE	CaseType=Combination	StepType=Min	U1=-3.33605018854787E-05	U2=0	U3=-
9.17111368051319E-03	R1=0	R2=1.0809866105891E-04	R3=0			
Joint=15	OutputCase=FESSUR	CaseType=Combination	U1=-3.31695080087482E-05	U2=0	U3=-9.09732263021056E-03	
R1=0	R2=1.10192522773695E-04	R3=0				
Joint=19	OutputCase=PERM1	CaseType=Combination	U1=-6.54477103231834E-06	U2=0	U3=-8.78617129070752E-03	
R1=0	R2=-1.31526618174231E-04	R3=0				
Joint=19	OutputCase=PERM2	CaseType=Combination	U1=-4.70085156953038E-06	U2=0	U3=-8.78647533904468E-03	
R1=0	R2=-1.38635079514185E-04	R3=0				
Joint=19	OutputCase=ACC1	CaseType=Combination	U1=-6.67210028165055E-06	U2=0	U3=-8.99508789519162E-03	
R1=0	R2=-1.35102151472577E-04	R3=0				
Joint=19	OutputCase=ACC2	CaseType=Combination	U1=-4.8281808188626E-06	U2=0	U3=-8.99539194352878E-03	
R1=0	R2=-1.42210612812532E-04	R3=0				
Joint=19	OutputCase=ACCSX1	CaseType=Combination	U1=-6.48172525857991E-06	U2=0	U3=-8.68600391058971E-03	
R1=0	R2=-6.32346461750691E-05	R3=0				
Joint=19	OutputCase=ACCSX2	CaseType=Combination	U1=-4.63780579579195E-06	U2=0	U3=-8.68630795892687E-03	
R1=0	R2=-7.0343107515024E-05	R3=0				
Joint=19	OutputCase=ENVE	CaseType=Combination	StepType=Max	U1=-4.63780579579195E-06	U2=0	U3=-
8.68600391058971E-03	R1=0	R2=-6.32346461750691E-05	R3=0			
Joint=19	OutputCase=ENVE	CaseType=Combination	StepType=Min	U1=-6.67210028165055E-06	U2=0	U3=-
8.99539194352878E-03	R1=0	R2=-1.42210612812532E-04	R3=0			
Joint=19	OutputCase=FESSUR	CaseType=Combination	U1=-6.63390150685089E-06	U2=0	U3=-8.93241291384639E-03	
R1=0	R2=-1.34029491483073E-04	R3=0				



Joint=20	OutputCase=PERM1	CaseType=Combination	U1=-4.92692439749978E-06	U2=0	U3=-8.99875994500635E-03	
R1=0	R2=9.25012338780152E-05	R3=0				
Joint=20	OutputCase=PERM2	CaseType=Combination	U1=-4.04641343227379E-06	U2=0	U3=-9.00855441712419E-03	
R1=0	R2=1.04288456717567E-04	R3=0				
Joint=20	OutputCase=ACC1	CaseType=Combination	U1=-4.9227900731764E-06	U2=0	U3=-9.21358548145115E-03	
R1=0	R2=9.55255297813895E-05	R3=0				
Joint=20	OutputCase=ACC2	CaseType=Combination	U1=-4.0422791079504E-06	U2=0	U3=-9.22337995356899E-03	
R1=0	R2=1.07312752620941E-04	R3=0				
Joint=20	OutputCase=ACCSX1	CaseType=Combination	U1=2.77303849834537E-04	U2=0	U3=-8.82913920755098E-03	
R1=0	R2=1.60799509754936E-04	R3=0				
Joint=20	OutputCase=ACCSX2	CaseType=Combination	U1=2.78184360799763E-04	U2=0	U3=-8.83893367966882E-03	
R1=0	R2=1.72586732594488E-04	R3=0				
Joint=20	OutputCase=ENVE	CaseType=Combination	StepType=Max	U1=2.78184360799763E-04	U2=0	U3=-
8.82913920755098E-03	R1=0	R2=1.72586732594488E-04	R3=0			
Joint=20	OutputCase=ENVE	CaseType=Combination	StepType=Min	U1=-4.92692439749978E-06	U2=0	U3=-
9.22337995356899E-03	R1=0	R2=9.25012338780152E-05	R3=0			
Joint=20	OutputCase=FESSUR	CaseType=Combination	U1=-4.9240303704734E-06	U2=0	U3=-9.14913782051771E-03	
R1=0	R2=9.46182410103772E-05	R3=0				
Joint=21	OutputCase=PERM1	CaseType=Combination	U1=-2.77967390694504E-05	U2=0	U3=-8.99876006063085E-03	
R1=0	R2=-9.25011862256414E-05	R3=0				
Joint=21	OutputCase=PERM2	CaseType=Combination	U1=-1.94577233376441E-05	U2=0	U3=-9.00855448979584E-03	
R1=0	R2=-1.04288426591726E-04	R3=0				
Joint=21	OutputCase=ACC1	CaseType=Combination	U1=-2.84375130181916E-05	U2=0	U3=-9.21358560109247E-03	
R1=0	R2=-9.55254804823294E-05	R3=0				
Joint=21	OutputCase=ACC2	CaseType=Combination	U1=-2.00984972863853E-05	U2=0	U3=-9.22338003025745E-03	
R1=0	R2=-1.07312720848414E-04	R3=0				
Joint=21	OutputCase=ACCSX1	CaseType=Combination	U1=2.54118804642754E-04	U2=0	U3=-9.16734635248048E-03	
R1=0	R2=-2.31848413592743E-05	R3=0				
Joint=21	OutputCase=ACCSX2	CaseType=Combination	U1=2.6245782037456E-04	U2=0	U3=-9.17714078164547E-03	
R1=0	R2=-3.49720817253589E-05	R3=0				
Joint=21	OutputCase=ENVE	CaseType=Combination	StepType=Max	U1=2.6245782037456E-04	U2=0	U3=-
8.99876006063085E-03	R1=0	R2=-2.31848413592743E-05	R3=0			
Joint=21	OutputCase=ENVE	CaseType=Combination	StepType=Min	U1=-2.84375130181916E-05	U2=0	U3=-
9.22338003025745E-03	R1=0	R2=-1.07312720848414E-04	R3=0			
Joint=21	OutputCase=FESSUR	CaseType=Combination	U1=-2.82452808335693E-05	U2=0	U3=-9.14913793895398E-03	
R1=0	R2=-9.4618192205323E-05	R3=0				
Joint=22	OutputCase=PERM1	CaseType=Combination	U1=-2.33693771146058E-05	U2=0	U3=-8.99591233294399E-03	
R1=0	R2=7.48348691820425E-05	R3=0				
Joint=22	OutputCase=PERM2	CaseType=Combination	U1=-2.63537500043522E-05	U2=0	U3=-9.00570680471928E-03	
R1=0	R2=8.73531272055856E-05	R3=0				
Joint=22	OutputCase=ACC1	CaseType=Combination	U1=-2.3962096841933E-05	U2=0	U3=-9.21064390252596E-03	
R1=0	R2=7.72682922643928E-05	R3=0				
Joint=22	OutputCase=ACC2	CaseType=Combination	U1=-2.69464697316794E-05	U2=0	U3=-9.22043837430125E-03	
R1=0	R2=8.9786550287936E-05	R3=0				
Joint=22	OutputCase=ACCSX1	CaseType=Combination	U1=2.41789946477494E-04	U2=0	U3=-8.82630209371413E-03	
R1=0	R2=1.43418876990739E-04	R3=0				
Joint=22	OutputCase=ACCSX2	CaseType=Combination	U1=2.38805573587747E-04	U2=0	U3=-8.83609656548942E-03	
R1=0	R2=1.55937135014282E-04	R3=0				
Joint=22	OutputCase=ENVE	CaseType=Combination	StepType=Max	U1=2.41789946477494E-04	U2=0	U3=-
8.82630209371413E-03	R1=0	R2=1.55937135014282E-04	R3=0			
Joint=22	OutputCase=ENVE	CaseType=Combination	StepType=Min	U1=-2.69464697316794E-05	U2=0	U3=-
9.22043837430125E-03	R1=0	R2=7.48348691820425E-05	R3=0			
Joint=22	OutputCase=FESSUR	CaseType=Combination	U1=-2.37842809237348E-05	U2=0	U3=-9.14622443165137E-03	
R1=0	R2=7.65382653396877E-05	R3=0				
Joint=23	OutputCase=PERM1	CaseType=Combination	U1=-9.35429984799164E-06	U2=0	U3=-8.99591244882738E-03	
R1=0	R2=-7.48348229764574E-05	R3=0				
Joint=23	OutputCase=PERM2	CaseType=Combination	U1=2.84960375019604E-06	U2=0	U3=-9.00570687765362E-03	
R1=0	R2=-8.73530985052386E-05	R3=0				
Joint=23	OutputCase=ACC1	CaseType=Combination	U1=-9.39822020775788E-06	U2=0	U3=-9.21064402243471E-03	
R1=0	R2=-7.72682444608799E-05	R3=0				
Joint=23	OutputCase=ACC2	CaseType=Combination	U1=2.80568339042979E-06	U2=0	U3=-9.22043845126095E-03	
R1=0	R2=-8.97865199896611E-05	R3=0				
Joint=23	OutputCase=ACCSX1	CaseType=Combination	U1=2.55144890523592E-04	U2=0	U3=-9.16448824248257E-03	
R1=0	R2=-5.17622121537147E-06	R3=0				
Joint=23	OutputCase=ACCSX2	CaseType=Combination	U1=2.6734879412178E-04	U2=0	U3=-9.17428267130881E-03	
R1=0	R2=-1.76944967441526E-05	R3=0				
Joint=23	OutputCase=ENVE	CaseType=Combination	StepType=Max	U1=2.6734879412178E-04	U2=0	U3=-
8.99591244882738E-03	R1=0	R2=-5.17622121537147E-06	R3=0			
Joint=23	OutputCase=ENVE	CaseType=Combination	StepType=Min	U1=-9.39822020775788E-06	U2=0	U3=-
9.22043845126095E-03	R1=0	R2=-8.97865199896611E-05	R3=0			
Joint=23	OutputCase=FESSUR	CaseType=Combination	U1=-9.38504409982803E-06	U2=0	U3=-9.14622455035251E-03	
R1=0	R2=-7.65382180155532E-05	R3=0				
Joint=24	OutputCase=PERM1	CaseType=Combination	U1=-2.55097602542906E-05	U2=0	U3=-9.06586990675514E-03	
R1=0	R2=-1.14694463800193E-04	R3=0				
Joint=24	OutputCase=PERM2	CaseType=Combination	U1=-1.79165952109708E-05	U2=0	U3=-9.08096859433898E-03	
R1=0	R2=-1.24124257881045E-04	R3=0				
Joint=24	OutputCase=ACC1	CaseType=Combination	U1=-2.60860434624188E-05	U2=0	U3=-9.28290377210342E-03	
R1=0	R2=-1.18467020978886E-04	R3=0				
Joint=24	OutputCase=ACC2	CaseType=Combination	U1=-1.8492878419099E-05	U2=0	U3=-9.29800245968726E-03	
R1=0	R2=-1.27896815059738E-04	R3=0				
Joint=24	OutputCase=ACCSX1	CaseType=Combination	U1=2.56437307990663E-04	U2=0	U3=-9.20002843669295E-03	
R1=0	R2=-4.60469179609867E-05	R3=0				



Joint=24	OutputCase=ACCSX2	CaseType=Combination	U1=2.64030473033983E-04	U2=0	U3=-9.21512712427679E-03	
R1=0	R2=-5.54767120418384E-05	R3=0				
Joint=24	OutputCase=ENVE	CaseType=Combination	StepType=Max	U1=2.64030473033983E-04	U2=0	U3=-
9.06586990675514E-03	R1=0	R2=-4.60469179609867E-05	R3=0			
Joint=24	OutputCase=ENVE	CaseType=Combination	StepType=Min	U1=-2.60860434624188E-05	U2=0	U3=-
9.29800245968726E-03	R1=0	R2=-1.27896815059738E-04	R3=0			
Joint=24	OutputCase=FESSUR	CaseType=Combination	U1=-2.59131584999803E-05	U2=0	U3=-9.21779361249894E-03	
R1=0	R2=-1.17335253825278E-04	R3=0				
Joint=25	OutputCase=PERM1	CaseType=Combination	U1=-2.66532511412818E-05	U2=0	U3=-9.03132671279068E-03	
R1=0	R2=-1.07412841609281E-04	R3=0				
Joint=25	OutputCase=PERM2	CaseType=Combination	U1=-1.86871608694254E-05	U2=0	U3=-9.04392061145684E-03	
R1=0	R2=-1.18021358912778E-04	R3=0				
Joint=25	OutputCase=ACC1	CaseType=Combination	U1=-2.72617797680504E-05	U2=0	U3=-9.24722291027321E-03	
R1=0	R2=-1.10938122480167E-04	R3=0				
Joint=25	OutputCase=ACC2	CaseType=Combination	U1=-1.9295689496194E-05	U2=0	U3=-9.25981680893937E-03	
R1=0	R2=-1.21546639783665E-04	R3=0				
Joint=25	OutputCase=ACCSX1	CaseType=Combination	U1=2.55278055659861E-04	U2=0	U3=-9.18265732456658E-03	
R1=0	R2=-3.84466460202572E-05	R3=0				
Joint=25	OutputCase=ACCSX2	CaseType=Combination	U1=2.63244145931718E-04	U2=0	U3=-9.19525122323274E-03	
R1=0	R2=-4.90551633237546E-05	R3=0				
Joint=25	OutputCase=ENVE	CaseType=Combination	StepType=Max	U1=2.63244145931718E-04	U2=0	U3=-
9.03132671279068E-03	R1=0	R2=-3.84466460202572E-05	R3=0			
Joint=25	OutputCase=ENVE	CaseType=Combination	StepType=Min	U1=-2.72617797680504E-05	U2=0	U3=-
9.25981680893937E-03	R1=0	R2=-1.21546639783665E-04	R3=0			
Joint=25	OutputCase=FESSUR	CaseType=Combination	U1=-2.70792211800198E-05	U2=0	U3=-9.18245405102845E-03	
R1=0	R2=-1.09880538218901E-04	R3=0				
Joint=26	OutputCase=PERM1	CaseType=Combination	U1=-2.08648234672459E-05	U2=0	U3=-8.95149481605796E-03	
R1=0	R2=-8.60968401430764E-05	R3=0				
Joint=26	OutputCase=PERM2	CaseType=Combination	U1=-2.48619885680764E-05	U2=0	U3=-8.96128928814084E-03	
R1=0	R2=-9.86748668648561E-05	R3=0				
Joint=26	OutputCase=ACC1	CaseType=Combination	U1=-2.14557387357884E-05	U2=0	U3=-9.16491085044507E-03	
R1=0	R2=-8.85064915687877E-05	R3=0				
Joint=26	OutputCase=ACC2	CaseType=Combination	U1=-2.54529038366189E-05	U2=0	U3=-9.17470532252795E-03	
R1=0	R2=-1.01084518290567E-04	R3=0				
Joint=26	OutputCase=ACCSX1	CaseType=Combination	U1=-3.08470966073256E-06	U2=0	U3=-8.78203157474779E-03	
R1=0	R2=-1.52758923597481E-05	R3=0				
Joint=26	OutputCase=ACCSX2	CaseType=Combination	U1=-7.08187476156305E-06	U2=0	U3=-8.79182604683067E-03	
R1=0	R2=-2.78539190815279E-05	R3=0				
Joint=26	OutputCase=ENVE	CaseType=Combination	StepType=Max	U1=-3.08470966073256E-06	U2=0	U3=-
8.78203157474779E-03	R1=0	R2=-1.52758923597481E-05	R3=0			
Joint=26	OutputCase=ENVE	CaseType=Combination	StepType=Min	U1=-2.54529038366189E-05	U2=0	U3=-
9.17470532252795E-03	R1=0	R2=-1.01084518290567E-04	R3=0			
Joint=26	OutputCase=FESSUR	CaseType=Combination	U1=-2.12784641552256E-05	U2=0	U3=-9.10088604012894E-03	
R1=0	R2=-8.77835961410743E-05	R3=0				
Joint=27	OutputCase=PERM1	CaseType=Combination	U1=-3.71164839858444E-05	U2=0	U3=-8.95494922298354E-03	
R1=0	R2=-6.74708947736897E-05	R3=0				
Joint=27	OutputCase=PERM2	CaseType=Combination	U1=-4.50276214740432E-05	U2=0	U3=-8.96474369506832E-03	
R1=0	R2=-7.98129563123407E-05	R3=0				
Joint=27	OutputCase=ACC1	CaseType=Combination	U1=-3.81746590243594E-05	U2=0	U3=-9.16845922417366E-03	
R1=0	R2=-6.93824505968303E-05	R3=0				
Joint=27	OutputCase=ACC2	CaseType=Combination	U1=-4.60857965125582E-05	U2=0	U3=-9.17825369625844E-03	
R1=0	R2=-8.17245121354814E-05	R3=0				
Joint=27	OutputCase=ACCSX1	CaseType=Combination	U1=-1.47248885619668E-06	U2=0	U3=-8.78547548181847E-03	
R1=0	R2=3.66387078732466E-06	R3=0				
Joint=27	OutputCase=ACCSX2	CaseType=Combination	U1=-9.38362634439547E-06	U2=0	U3=-8.79526995390325E-03	
R1=0	R2=-8.67819075132638E-06	R3=0				
Joint=27	OutputCase=ENVE	CaseType=Combination	StepType=Max	U1=-1.47248885619668E-06	U2=0	U3=-
8.78547548181847E-03	R1=0	R2=3.66387078732466E-06	R3=0			
Joint=27	OutputCase=ENVE	CaseType=Combination	StepType=Min	U1=-4.60857965125582E-05	U2=0	U3=-
9.17825369625844E-03	R1=0	R2=-8.17245121354814E-05	R3=0			
Joint=27	OutputCase=FESSUR	CaseType=Combination	U1=-3.78572065128049E-05	U2=0	U3=-9.10440622381663E-03	
R1=0	R2=-6.88089838498881E-05	R3=0				
Joint=28	OutputCase=PERM1	CaseType=Combination	U1=-1.18590202509877E-05	U2=0	U3=-8.95149493179285E-03	
R1=0	R2=8.60968877340397E-05	R3=0				
Joint=28	OutputCase=PERM2	CaseType=Combination	U1=1.35773787914561E-06	U2=0	U3=-8.96128936097988E-03	
R1=0	R2=9.86748967968522E-05	R3=0				
Joint=28	OutputCase=ACC1	CaseType=Combination	U1=-1.19047508263309E-05	U2=0	U3=-9.16491097019943E-03	
R1=0	R2=8.85065408055563E-05	R3=0				
Joint=28	OutputCase=ACC2	CaseType=Combination	U1=1.31200730380236E-06	U2=0	U3=-9.17470539938646E-03	
R1=0	R2=1.01084549868369E-04	R3=0				
Joint=28	OutputCase=ACCSX1	CaseType=Combination	U1=5.82615528818784E-06	U2=0	U3=-9.11992372749473E-03	
R1=0	R2=1.55582231710944E-04	R3=0				
Joint=28	OutputCase=ACCSX2	CaseType=Combination	U1=1.90429134183211E-05	U2=0	U3=-9.12971815668176E-03	
R1=0	R2=1.68160240773756E-04	R3=0				
Joint=28	OutputCase=ENVE	CaseType=Combination	StepType=Max	U1=1.90429134183211E-05	U2=0	U3=-
8.95149493179285E-03	R1=0	R2=1.68160240773756E-04	R3=0			
Joint=28	OutputCase=ENVE	CaseType=Combination	StepType=Min	U1=-1.19047508263309E-05	U2=0	U3=-
9.17470539938646E-03	R1=0	R2=8.60968877340397E-05	R3=0			
Joint=28	OutputCase=FESSUR	CaseType=Combination	U1=-1.18910316537279E-05	U2=0	U3=-9.10088615867746E-03	
R1=0	R2=8.77836448841013E-05	R3=0				
Joint=29	OutputCase=PERM1	CaseType=Combination	U1=4.39265222138837E-06	U2=0	U3=-8.95494933872903E-03	
R1=0	R2=6.74709425142422E-05	R3=0				



Joint=29 R1=0	OutputCase=PERM2 R2=7.98129863303432E-05	CaseType=Combination R3=0	U1=2.15233783049989E-05	U2=0	U3=-8.96474376791416E-03
Joint=29 R1=0	OutputCase=ACC1 R2=6.93824999872159E-05	CaseType=Combination R3=0	U1=4.81418182905042E-06	U2=0	U3=-9.16845934393906E-03
Joint=29 R1=0	OutputCase=ACC2 R2=8.1724543803317E-05	CaseType=Combination R3=0	U1=2.19449079126609E-05	U2=0	U3=-9.17825377312419E-03
Joint=29 R1=0	OutputCase=ACCSX1 R2=1.37276010200067E-04	CaseType=Combination R3=0	U1=3.95336158935598E-05	U2=0	U3=-9.1233886342858E-03
Joint=29 R1=0	OutputCase=ACCSX2 R2=1.49618054016168E-04	CaseType=Combination R3=0	U1=5.66643419771703E-05	U2=0	U3=-9.13318306347093E-03
Joint=29 R1=0	OutputCase=ENVE R2=1.49618054016168E-04	CaseType=Combination R3=0	StepType=Max U1=5.66643419771703E-05	U2=0	U3=-
Joint=29 R1=0	OutputCase=ENVE R2=6.74709425142422E-05	CaseType=Combination R3=0	StepType=Min U1=4.39265222138837E-06	U2=0	U3=-
Joint=29 R1=0	OutputCase=FESSUR R2=6.88090327453238E-05	CaseType=Combination R3=0	U1=4.6877229467518E-06	U2=0	U3=-9.10440634237605E-03
Joint=30 R1=0	OutputCase=PERM1 R2=-1.26955782930733E-04	CaseType=Combination R3=0	U1=-1.63619264104996E-06	U2=0	U3=-8.90918975345824E-03
Joint=30 R1=0	OutputCase=PERM2 R2=-1.37648550862561E-04	CaseType=Combination R3=0	U1=-1.17521280832482E-06	U2=0	U3=-8.9161618928773E-03
Joint=30 R1=0	OutputCase=ACC1 R2=-1.30440597885509E-04	CaseType=Combination R3=0	U1=-1.66802495110619E-06	U2=0	U3=-9.12145066450341E-03
Joint=30 R1=0	OutputCase=ACC2 R2=-1.41133365817337E-04	CaseType=Combination R3=0	U1=-1.20704511838105E-06	U2=0	U3=-9.12842280392248E-03
Joint=30 R1=0	OutputCase=ACCSX1 R2=-5.71088322922436E-05	CaseType=Combination R3=0	U1=-1.6204311987427E-06	U2=0	U3=-8.75728351159543E-03
Joint=30 R1=0	OutputCase=ACCSX2 R2=-6.78016002240718E-05	CaseType=Combination R3=0	U1=-1.15945136601756E-06	U2=0	U3=-8.76425565101449E-03
Joint=30 R1=0	OutputCase=ENVE R2=5.75728351159543E-05	CaseType=Combination R3=0	StepType=Max U1=-1.15945136601756E-06	U2=0	U3=-
Joint=30 R1=0	OutputCase=ENVE R2=-1.41133365817337E-04	CaseType=Combination R3=0	StepType=Min U1=-1.66802495110619E-06	U2=0	U3=-
Joint=30 R1=0	OutputCase=FESSUR R2=-1.29395153399076E-04	CaseType=Combination R3=0	U1=-1.65847525808932E-06	U2=0	U3=-9.05777239118986E-03
Joint=31 R1=0	OutputCase=PERM1 R2=-1.36332068545282E-04	CaseType=Combination R3=0	U1=-3.27238543813942E-06	U2=0	U3=-8.86786442010006E-03
Joint=31 R1=0	OutputCase=PERM2 R2=-1.45827860755733E-04	CaseType=Combination R3=0	U1=-2.35042572872667E-06	U2=0	U3=-8.87231449961195E-03
Joint=31 R1=0	OutputCase=ACC1 R2=-1.40057344299115E-04	CaseType=Combination R3=0	U1=-3.33605006128764E-06	U2=0	U3=-9.07899942428209E-03
Joint=31 R1=0	OutputCase=ACC2 R2=-1.49553136509566E-04	CaseType=Combination R3=0	U1=-2.4140903518749E-06	U2=0	U3=-9.08344950379398E-03
Joint=31 R1=0	OutputCase=ACCSX1 R2=-6.70221340742209E-05	CaseType=Combination R3=0	U1=-3.24086255202177E-06	U2=0	U3=-8.73335231844046E-03
Joint=31 R1=0	OutputCase=ACCSX2 R2=-7.65179262846719E-05	CaseType=Combination R3=0	U1=-2.31890284260902E-06	U2=0	U3=-8.73780239795235E-03
Joint=31 R1=0	OutputCase=ENVE R2=8.73335231844046E-03	CaseType=Combination R3=0	StepType=Max U1=-2.31890284260902E-06	U2=0	U3=-
Joint=31 R1=0	OutputCase=ENVE R2=-1.49553136509566E-04	CaseType=Combination R3=0	StepType=Min U1=-3.33605006128764E-06	U2=0	U3=-
Joint=31 R1=0	OutputCase=FESSUR R2=-1.38939761572965E-04	CaseType=Combination R3=0	U1=-3.31695067434317E-06	U2=0	U3=-9.01565892302748E-03
Joint=32 R1=0	OutputCase=PERM1 R2=1.36332115487566E-04	CaseType=Combination R3=0	U1=-2.94514701915709E-05	U2=0	U3=-8.86786451220429E-03
Joint=32 R1=0	OutputCase=PERM2 R2=1.45827890291877E-04	CaseType=Combination R3=0	U1=-2.11538324551565E-05	U2=0	U3=-8.87231455758337E-03
Joint=32 R1=0	OutputCase=ACC1 R2=1.40057392868808E-04	CaseType=Combination R3=0	U1=-3.00244518241911E-05	U2=0	U3=-9.07899951958688E-03
Joint=32 R1=0	OutputCase=ACC2 R2=1.49553167673119E-04	CaseType=Combination R3=0	U1=-2.1726814087766E-05	U2=0	U3=-9.08344956496596E-03
Joint=32 R1=0	OutputCase=ACCSX1 R2=2.04639148221924E-04	CaseType=Combination R3=0	U1=-2.9167764204487E-05	U2=0	U3=-9.00190661838085E-03
Joint=32 R1=0	OutputCase=ACCSX2 R2=2.14134923026234E-04	CaseType=Combination R3=0	U1=-2.08701264680726E-05	U2=0	U3=-9.00635666375993E-03
Joint=32 R1=0	OutputCase=ENVE R2=8.86786451220429E-03	CaseType=Combination R3=0	StepType=Max U1=-2.08701264680726E-05	U2=0	U3=-
Joint=32 R1=0	OutputCase=ENVE R2=9.08344956496596E-03	CaseType=Combination R3=0	StepType=Min U1=-3.00244518241911E-05	U2=0	U3=-
Joint=32 R1=0	OutputCase=FESSUR R2=1.38939809654436E-04	CaseType=Combination R3=0	U1=-2.9852557334405E-05	U2=0	U3=-9.0156590173721E-03
Joint=33 R1=0	OutputCase=PERM1 R2=1.26955830111189E-04	CaseType=Combination R3=0	U1=-3.10876629886604E-05	U2=0	U3=-8.90918985733717E-03
Joint=33 R1=0	OutputCase=PERM2 R2=1.37648580545264E-04	CaseType=Combination R3=0	U1=-2.23290453755584E-05	U2=0	U3=-8.91616195825734E-03
Joint=33 R1=0	OutputCase=ACC1 R2=1.30440646700357E-04	CaseType=Combination R3=0	U1=-3.16924769343725E-05	U2=0	U3=-9.1214507719911E-03
Joint=33 R1=0	OutputCase=ACC2 R2=1.41133397134432E-04	CaseType=Combination R3=0	U1=-2.29338593212705E-05	U2=0	U3=-9.12842287291127E-03
Joint=33 R1=0	OutputCase=ACCSX1 R2=1.95673459851998E-04	CaseType=Combination R3=0	U1=-3.07881955577661E-05	U2=0	U3=-9.06035973537887E-03
Joint=33 R1=0	OutputCase=ACCSX2 R2=2.06366210286073E-04	CaseType=Combination R3=0	U1=-2.20295779446641E-05	U2=0	U3=-9.06733183629904E-03

Joint=33	OutputCase=ENVE	CaseType=Combination	StepType=Max	U1=-2.20295779446641E-05	U2=0	U3=-
8.90918985733717E-03	R1=0	R2=2.06366210286073E-04	R3=0			
Joint=33	OutputCase=ENVE	CaseType=Combination	StepType=Min	U1=-3.16924769343725E-05	U2=0	U3=-
9.12842287291127E-03	R1=0	R2=1.26955830111189E-04	R3=0			
Joint=33	OutputCase=FESSUR	CaseType=Combination		U1=-3.15110327506589E-05	U2=0	U3=-9.05777249759492E-03
R1=0	R2=1.29395201723606E-04	R3=0				
Joint=34	OutputCase=PERM1	CaseType=Combination		U1=-3.80221703659929E-05	U2=0	U3=-8.99302138157244E-03
R1=0	R2=5.96299387948809E-05	R3=0				
Joint=34	OutputCase=PERM2	CaseType=Combination		U1=-4.48549018592466E-05	U2=0	U3=-9.00281585368814E-03
R1=0	R2=7.20511678236946E-05	R3=0				
Joint=34	OutputCase=ACC1	CaseType=Combination		U1=-3.9085919829625E-05	U2=0	U3=-9.20765898439881E-03
R1=0	R2=6.1557210737357E-05	R3=0				
Joint=34	OutputCase=ACC2	CaseType=Combination		U1=-4.59186513228787E-05	U2=0	U3=-9.21745345651451E-03
R1=0	R2=7.39784397661707E-05	R3=0				
Joint=34	OutputCase=ACCSX1	CaseType=Combination		U1=2.09978557167562E-04	U2=0	U3=-8.82342164383478E-03
R1=0	R2=1.28534948292013E-04	R3=0				
Joint=34	OutputCase=ACCSX2	CaseType=Combination		U1=2.03145825674308E-04	U2=0	U3=-8.83321611595048E-03
R1=0	R2=1.40956177320827E-04	R3=0				
Joint=34	OutputCase=ENVE	CaseType=Combination	StepType=Max	U1=2.09978557167562E-04	U2=0	U3=-
8.82342164383478E-03	R1=0	R2=1.40956177320827E-04	R3=0			
Joint=34	OutputCase=ENVE	CaseType=Combination	StepType=Min	U1=-4.59186513228787E-05	U2=0	U3=-
9.21745345651451E-03	R1=0	R2=5.96299387948809E-05	R3=0			
Joint=34	OutputCase=FESSUR	CaseType=Combination		U1=-3.87667949905353E-05	U2=0	U3=-9.1432677035509E-03
R1=0	R2=6.09790291546141E-05	R3=0				
Joint=35	OutputCase=PERM1	CaseType=Combination		U1=5.29848177940856E-06	U2=0	U3=-8.99302149744522E-03
R1=0	R2=-5.96298922555422E-05	R3=0				
Joint=35	OutputCase=PERM2	CaseType=Combination		U1=2.1350748376852E-05	U2=0	U3=-9.00281592661567E-03
R1=0	R2=-7.2051138871014E-05	R3=0				
Joint=35	OutputCase=ACC1	CaseType=Combination		U1=5.72559075402888E-06	U2=0	U3=-9.20765910429653E-03
R1=0	R2=-6.15571625892229E-05	R3=0				
Joint=35	OutputCase=ACC2	CaseType=Combination		U1=2.17778573514723E-05	U2=0	U3=-9.21745353346698E-03
R1=0	R2=-7.39784092046947E-05	R3=0				
Joint=35	OutputCase=ACCSX1	CaseType=Combination		U1=2.52301663458968E-04	U2=0	U3=-9.16158678957847E-03
R1=0	R2=1.03236821037262E-05	R3=0				
Joint=35	OutputCase=ACCSX2	CaseType=Combination		U1=2.68353930056412E-04	U2=0	U3=-9.17138121874892E-03
R1=0	R2=-2.0975645117455E-06	R3=0				
Joint=35	OutputCase=ENVE	CaseType=Combination	StepType=Max	U1=2.68353930056412E-04	U2=0	U3=-
8.99302149744522E-03	R1=0	R2=1.03236821037262E-05	R3=0			
Joint=35	OutputCase=ENVE	CaseType=Combination	StepType=Min	U1=5.29848177940856E-06	U2=0	U3=-
9.21745353346698E-03	R1=0	R2=-7.39784092046947E-05	R3=0			
Joint=35	OutputCase=FESSUR	CaseType=Combination		U1=5.59745806164277E-06	U2=0	U3=-9.14326782224114E-03
R1=0	R2=-6.09789814891187E-05	R3=0				
Joint=36	OutputCase=PERM1	CaseType=Combination		U1=-9.81715662649726E-06	U2=0	U3=-8.71740910906018E-03
R1=0	R2=-1.01594584353202E-04	R3=0				
Joint=36	OutputCase=PERM2	CaseType=Combination		U1=-7.05127741033409E-06	U2=0	U3=-8.71475840780723E-03
R1=0	R2=-1.06325910276352E-04	R3=0				
Joint=36	OutputCase=ACC1	CaseType=Combination		U1=-1.00081505020135E-05	U2=0	U3=-8.92446326206543E-03
R1=0	R2=-1.04349599251236E-04	R3=0				
Joint=36	OutputCase=ACC2	CaseType=Combination		U1=-7.2422712858503E-06	U2=0	U3=-8.92181256081247E-03
R1=0	R2=-1.09080925174386E-04	R3=0				
Joint=36	OutputCase=ACCSX1	CaseType=Combination		U1=-9.72258796513805E-06	U2=0	U3=-8.65106443696462E-03
R1=0	R2=-3.4155253009409E-05	R3=0				
Joint=36	OutputCase=ACCSX2	CaseType=Combination		U1=-6.95670874897488E-06	U2=0	U3=-8.64841373571167E-03
R1=0	R2=-3.88865789325591E-05	R3=0				
Joint=36	OutputCase=ENVE	CaseType=Combination	StepType=Max	U1=-6.95670874897488E-06	U2=0	U3=-
8.64841373571167E-03	R1=0	R2=-3.4155253009409E-05	R3=0			
Joint=36	OutputCase=ENVE	CaseType=Combination	StepType=Min	U1=-1.00081505020135E-05	U2=0	U3=-
8.92446326206543E-03	R1=0	R2=-1.09080925174386E-04	R3=0			
Joint=36	OutputCase=FESSUR	CaseType=Combination		U1=-9.95085233935861E-06	U2=0	U3=-8.86234701616385E-03
R1=0	R2=-1.03523094781826E-04	R3=0				
Joint=37	OutputCase=PERM1	CaseType=Combination		U1=-1.30895422206762E-05	U2=0	U3=-8.67199691274759E-03
R1=0	R2=-5.49637094612953E-05	R3=0				
Joint=37	OutputCase=PERM2	CaseType=Combination		U1=-9.4017032511378E-06	U2=0	U3=-8.66757635949913E-03
R1=0	R2=-5.73268260794099E-05	R3=0				
Joint=37	OutputCase=ACC1	CaseType=Combination		U1=-1.33442007223764E-05	U2=0	U3=-8.87782268837644E-03
R1=0	R2=-5.64524352193573E-05	R3=0				
Joint=37	OutputCase=ACC2	CaseType=Combination		U1=-9.656361752838E-06	U2=0	U3=-8.87340213512798E-03
R1=0	R2=-5.88155518374718E-05	R3=0				
Joint=37	OutputCase=ACCSX1	CaseType=Combination		U1=-1.29634506716962E-05	U2=0	U3=-8.6390764695434E-03
R1=0	R2=1.18783720636489E-05	R3=0				
Joint=37	OutputCase=ACCSX2	CaseType=Combination		U1=-9.27561170215782E-06	U2=0	U3=-8.63465591629494E-03
R1=0	R2=9.51525544553435E-06	R3=0				
Joint=37	OutputCase=ENVE	CaseType=Combination	StepType=Max	U1=-9.27561170215782E-06	U2=0	U3=-
8.63465591629494E-03	R1=0	R2=1.18783720636489E-05	R3=0			
Joint=37	OutputCase=ENVE	CaseType=Combination	StepType=Min	U1=-1.33442007223764E-05	U2=0	U3=-
8.87782268837644E-03	R1=0	R2=-5.88155518374718E-05	R3=0			
Joint=37	OutputCase=FESSUR	CaseType=Combination		U1=-1.32678031718663E-05	U2=0	U3=-8.8160749568779E-03
R1=0	R2=-5.60058174919387E-05	R3=0				
Joint=38	OutputCase=PERM1	CaseType=Combination		U1=-1.63619278148551E-05	U2=0	U3=-8.65616798033455E-03
R1=0	R2=2.2861137052359E-11	R3=0				
Joint=38	OutputCase=PERM2	CaseType=Combination		U1=-1.17521290919415E-05	U2=0	U3=-8.65115800533557E-03
R1=0	R2=1.43904259335362E-11	R3=0				



Joint=38	OutputCase=ACC1	CaseType=Combination	U1=-1.66802509427393E-05	U2=0	U3=-8.86156583806392E-03	
R1=0	R2=2.36560766364146E-11	R3=0				
Joint=38	OutputCase=ACC2	CaseType=Combination	U1=-1.20704522198257E-05	U2=0	U3=-8.85655586306494E-03	
R1=0	R2=1.51853655111544E-11	R3=0				
Joint=38	OutputCase=ACCSX1	CaseType=Combination	U1=-1.62043133782544E-05	U2=0	U3=-8.65643254579258E-03	
R1=0	R2=6.65539394849622E-05	R3=0				
Joint=38	OutputCase=ACCSX2	CaseType=Combination	U1=-1.15945146553408E-05	U2=0	U3=-8.6514225707936E-03	
R1=0	R2=6.65539310142511E-05	R3=0				
Joint=38	OutputCase=ENVE	CaseType=Combination	StepType=Max	U1=-1.15945146553408E-05	U2=0	U3=-
8.65115800533557E-03	R1=0	R2=6.65539394849622E-05	R3=0			
Joint=38	OutputCase=ENVE	CaseType=Combination	StepType=Min	U1=-1.66802509427393E-05	U2=0	U3=-
8.86156583806392E-03	R1=0	R2=1.43904259335362E-11	R3=0			
Joint=38	OutputCase=FESSUR	CaseType=Combination	U1=-1.65847540043741E-05	U2=0	U3=-8.79994648074511E-03	
R1=0	R2=2.34175947608369E-11	R3=0				
Joint=39	OutputCase=PERM1	CaseType=Combination	U1=-6.07041517543925E-06	U2=0	U3=-9.0313266092043E-03	
R1=0	R2=1.07412889004955E-04	R3=0				
Joint=39	OutputCase=PERM2	CaseType=Combination	U1=-4.81697901724159E-06	U2=0	U3=-9.04392054639446E-03	
R1=0	R2=1.18021388836884E-04	R3=0				
Joint=39	OutputCase=ACC1	CaseType=Combination	U1=-6.09852626668101E-06	U2=0	U3=-9.2472228030852E-03	
R1=0	R2=1.10938171515183E-04	R3=0				
Joint=39	OutputCase=ACC2	CaseType=Combination	U1=-4.84509010848335E-06	U2=0	U3=-9.25981674027536E-03	
R1=0	R2=1.21546671347112E-04	R3=0				
Joint=39	OutputCase=ACCSX1	CaseType=Combination	U1=2.76144597614291E-04	U2=0	U3=-8.87871976045664E-03	
R1=0	R2=1.75462822492709E-04	R3=0				
Joint=39	OutputCase=ACCSX2	CaseType=Combination	U1=2.77398033772488E-04	U2=0	U3=-8.8913136976468E-03	
R1=0	R2=1.86071322324638E-04	R3=0				
Joint=39	OutputCase=ENVE	CaseType=Combination	StepType=Max	U1=2.77398033772488E-04	U2=0	U3=-
8.87871976045664E-03	R1=0	R2=1.86071322324638E-04	R3=0			
Joint=39	OutputCase=ENVE	CaseType=Combination	StepType=Min	U1=-6.09852626668101E-06	U2=0	U3=-
9.25981674027536E-03	R1=0	R2=1.07412889004955E-04	R3=0			
Joint=39	OutputCase=FESSUR	CaseType=Combination	U1=-6.0900929393085E-06	U2=0	U3=-9.18245394492093E-03	
R1=0	R2=1.09880586762115E-04	R3=0				
Joint=40	OutputCase=PERM1	CaseType=Combination	U1=-7.21390606243049E-06	U2=0	U3=-9.06586981492906E-03	
R1=0	R2=1.14694510819828E-04	R3=0				
Joint=40	OutputCase=PERM2	CaseType=Combination	U1=-5.58754467569624E-06	U2=0	U3=-9.08096853669185E-03	
R1=0	R2=1.24124287526022E-04	R3=0				
Joint=40	OutputCase=ACC1	CaseType=Combination	U1=-7.27426257231256E-06	U2=0	U3=-9.28290367708302E-03	
R1=0	R2=1.18467069627165E-04	R3=0				
Joint=40	OutputCase=ACC2	CaseType=Combination	U1=-5.64790118557832E-06	U2=0	U3=-9.29800239884581E-03	
R1=0	R2=1.27896846333359E-04	R3=0				
Joint=40	OutputCase=ACCSX1	CaseType=Combination	U1=2.74985345283489E-04	U2=0	U3=-8.93021870835669E-03	
R1=0	R2=1.82527601457906E-04	R3=0				
Joint=40	OutputCase=ACCSX2	CaseType=Combination	U1=2.76611706670223E-04	U2=0	U3=-8.94531743011948E-03	
R1=0	R2=1.919573781641E-04	R3=0				
Joint=40	OutputCase=ENVE	CaseType=Combination	StepType=Max	U1=2.76611706670223E-04	U2=0	U3=-
8.93021870835669E-03	R1=0	R2=1.919573781641E-04	R3=0			
Joint=40	OutputCase=ENVE	CaseType=Combination	StepType=Min	U1=-7.27426257231256E-06	U2=0	U3=-
9.29800239884581E-03	R1=0	R2=1.14694510819828E-04	R3=0			
Joint=40	OutputCase=FESSUR	CaseType=Combination	U1=-7.25615561934795E-06	U2=0	U3=-9.21779351843683E-03	
R1=0	R2=1.17335301984964E-04	R3=0				
Joint=41	OutputCase=PERM1	CaseType=Combination	U1=-1.96343134090341E-05	U2=0	U3=-8.67199693553966E-03	
R1=0	R2=5.49637552752566E-05	R3=0				
Joint=41	OutputCase=PERM2	CaseType=Combination	U1=-1.41025549327453E-05	U2=0	U3=-8.66757637384668E-03	
R1=0	R2=5.73268549171841E-05	R3=0				
Joint=41	OutputCase=ACC1	CaseType=Combination	U1=-2.00163011631023E-05	U2=0	U3=-8.87782271196128E-03	
R1=0	R2=5.64524826260802E-05	R3=0				
Joint=41	OutputCase=ACC2	CaseType=Combination	U1=-1.44845426868135E-05	U2=0	U3=-8.8734021502683E-03	
R1=0	R2=5.88155822680077E-05	R3=0				
Joint=41	OutputCase=ACCSX1	CaseType=Combination	U1=-1.94451760848125E-05	U2=0	U3=-8.70538425804453E-03	
R1=0	R2=1.21556255999862E-04	R3=0				
Joint=41	OutputCase=ACCSX2	CaseType=Combination	U1=-1.39134176085237E-05	U2=0	U3=-8.70096369635154E-03	
R1=0	R2=1.23919355641789E-04	R3=0				
Joint=41	OutputCase=ENVE	CaseType=Combination	StepType=Max	U1=-1.39134176085237E-05	U2=0	U3=-
8.66757637384668E-03	R1=0	R2=1.23919355641789E-04	R3=0			
Joint=41	OutputCase=ENVE	CaseType=Combination	StepType=Min	U1=-2.00163011631023E-05	U2=0	U3=-
8.87782271196128E-03	R1=0	R2=5.49637552752566E-05	R3=0			
Joint=41	OutputCase=FESSUR	CaseType=Combination	U1=-1.99017048368818E-05	U2=0	U3=-8.81607497903479E-03	
R1=0	R2=5.60058644208331E-05	R3=0				
Joint=42	OutputCase=PERM1	CaseType=Combination	U1=-2.2906699003213E-05	U2=0	U3=-8.71740915474528E-03	
R1=0	R2=1.01594630429898E-04	R3=0				
Joint=42	OutputCase=PERM2	CaseType=Combination	U1=-1.6452980773549E-05	U2=0	U3=-8.71475843656508E-03	
R1=0	R2=1.06325939277135E-04	R3=0				
Joint=42	OutputCase=ACC1	CaseType=Combination	U1=-2.33523513834652E-05	U2=0	U3=-8.92446330933927E-03	
R1=0	R2=1.04349646928913E-04	R3=0				
Joint=42	OutputCase=ACC2	CaseType=Combination	U1=-1.68986331538012E-05	U2=0	U3=-8.92181259115907E-03	
R1=0	R2=1.09080955776149E-04	R3=0				
Joint=42	OutputCase=ACCSX1	CaseType=Combination	U1=-2.26860387913707E-05	U2=0	U3=-8.78403378282076E-03	
R1=0	R2=1.6853426141523E-04	R3=0				
Joint=42	OutputCase=ACCSX2	CaseType=Combination	U1=-1.62323205617067E-05	U2=0	U3=-8.78138306464056E-03	
R1=0	R2=1.73265570262466E-04	R3=0				
Joint=42	OutputCase=ENVE	CaseType=Combination	StepType=Max	U1=-1.62323205617067E-05	U2=0	U3=-
8.71475843656508E-03	R1=0	R2=1.73265570262466E-04	R3=0			

Joint=42	OutputCase=ENVE	CaseType=Combination	StepType=Min	U1=-2.33523513834652E-05	U2=0	U3=-
8.92446330933927E-03	R1=0	R2=1.01594630429898E-04	R3=0			
Joint=42	OutputCase=FESSUR	CaseType=Combination	StepType=Min	U1=-2.32186556693895E-05	U2=0	U3=-8.86234706296108E-03
R1=0	R2=1.03523141979208E-04	R3=0				
Joint=43	OutputCase=PERM1	CaseType=Combination	StepType=Min	U1=-2.6179084597392E-05	U2=0	U3=-8.78617135947533E-03
R1=0	R2=1.3152666464767E-04	R3=0				
Joint=43	OutputCase=PERM2	CaseType=Combination	StepType=Min	U1=-1.88034066143527E-05	U2=0	U3=-8.78647538233065E-03
R1=0	R2=1.38635108760747E-04	R3=0				
Joint=43	OutputCase=ACC1	CaseType=Combination	StepType=Min	U1=-2.66884016038281E-05	U2=0	U3=-8.99508796635013E-03
R1=0	R2=1.35102199559263E-04	R3=0				
Joint=43	OutputCase=ACC2	CaseType=Combination	StepType=Min	U1=-1.93127236207889E-05	U2=0	U3=-8.99539198920545E-03
R1=0	R2=1.4221064367234E-04	R3=0				
Joint=43	OutputCase=ACCSX1	CaseType=Combination	StepType=Min	U1=-2.59269014979289E-05	U2=0	U3=-8.88630662872745E-03
R1=0	R2=1.99067873997371E-04	R3=0				
Joint=43	OutputCase=ACCSX2	CaseType=Combination	StepType=Min	U1=-1.85512235148896E-05	U2=0	U3=-8.88661065158277E-03
R1=0	R2=2.06176318110448E-04	R3=0				
Joint=43	OutputCase=ENVE	CaseType=Combination	StepType=Max	U1=-1.85512235148896E-05	U2=0	U3=-
8.78617135947533E-03	R1=0	R2=2.06176318110448E-04	R3=0			
Joint=43	OutputCase=ENVE	CaseType=Combination	StepType=Min	U1=-2.66884016038281E-05	U2=0	U3=-
8.99539198920545E-03	R1=0	R2=1.3152666464767E-04	R3=0			
Joint=43	OutputCase=FESSUR	CaseType=Combination	StepType=Min	U1=-2.65356065018973E-05	U2=0	U3=-8.93241298428769E-03
R1=0	R2=1.34029539085785E-04	R3=0				
Joint=85	OutputCase=PERM1	CaseType=Combination	StepType=Min	U1=-9.50088783641301E-06	U2=0	U3=-9.13389164324862E-03
R1=0	R2=1.09758775806802E-04	R3=0				
Joint=85	OutputCase=PERM2	CaseType=Combination	StepType=Min	U1=-7.12867599260556E-06	U2=0	U3=-9.1531158918088E-03
R1=0	R2=1.16831106244424E-04	R3=0				
Joint=85	OutputCase=ACC1	CaseType=Combination	StepType=Min	U1=-9.62573518357583E-06	U2=0	U3=-9.35316930632948E-03
R1=0	R2=1.13377516261755E-04	R3=0				
Joint=85	OutputCase=ACC2	CaseType=Combination	StepType=Min	U1=-7.2535233976836E-06	U2=0	U3=-9.37239355488966E-03
R1=0	R2=1.20449846699377E-04	R3=0				
Joint=85	OutputCase=ACCSX1	CaseType=Combination	StepType=Min	U1=2.72666840621886E-04	U2=0	U3=-9.03200907611751E-03
R1=0	R2=1.77252679439556E-04	R3=0				
Joint=85	OutputCase=ACCSX2	CaseType=Combination	StepType=Min	U1=2.75039052465693E-04	U2=0	U3=-9.05123332467769E-03
R1=0	R2=1.84325009877178E-04	R3=0				
Joint=85	OutputCase=ENVE	CaseType=Combination	StepType=Max	U1=2.75039052465693E-04	U2=0	U3=-
9.03200907611751E-03	R1=0	R2=1.84325009877178E-04	R3=0			
Joint=85	OutputCase=ENVE	CaseType=Combination	StepType=Min	U1=-9.62573518357583E-06	U2=0	U3=-
9.37239355488966E-03	R1=0	R2=1.09758775806802E-04	R3=0			
Joint=85	OutputCase=FESSUR	CaseType=Combination	StepType=Min	U1=-9.58828097942697E-06	U2=0	U3=-9.28738600740522E-03
R1=0	R2=1.12291894125269E-04	R3=0				
Joint=86	OutputCase=PERM1	CaseType=Combination	StepType=Min	U1=-1.17878696103955E-05	U2=0	U3=-9.19095648349795E-03
R1=0	R2=8.44762804901196E-05	R3=0				
Joint=86	OutputCase=PERM2	CaseType=Combination	StepType=Min	U1=-8.66980730951488E-06	U2=0	U3=-9.21312753571554E-03
R1=0	R2=8.91911646363672E-05	R3=0				
Joint=86	OutputCase=ACC1	CaseType=Combination	StepType=Min	U1=-1.19772077948392E-05	U2=0	U3=-9.41211876205056E-03
R1=0	R2=8.72646416054803E-05	R3=0				
Joint=86	OutputCase=ACC2	CaseType=Combination	StepType=Min	U1=-8.85914549395852E-06	U2=0	U3=-9.43428981426815E-03
R1=0	R2=9.19795257517279E-05	R3=0				
Joint=86	OutputCase=ACCSX1	CaseType=Combination	StepType=Min	U1=2.70348335960283E-04	U2=0	U3=-9.12270436187011E-03
R1=0	R2=1.51756995376254E-04	R3=0				
Joint=86	OutputCase=ACCSX2	CaseType=Combination	StepType=Min	U1=2.73466398261163E-04	U2=0	U3=-9.1448754140877E-03
R1=0	R2=1.56471879522501E-04	R3=0				
Joint=86	OutputCase=ENVE	CaseType=Combination	StepType=Max	U1=2.73466398261163E-04	U2=0	U3=-
9.12270436187011E-03	R1=0	R2=1.56471879522501E-04	R3=0			
Joint=86	OutputCase=ENVE	CaseType=Combination	StepType=Min	U1=-1.19772077948392E-05	U2=0	U3=-
9.43428981426815E-03	R1=0	R2=8.44762804901196E-05	R3=0			
Joint=86	OutputCase=FESSUR	CaseType=Combination	StepType=Min	U1=-1.19204063395061E-05	U2=0	U3=-9.34577007848478E-03
R1=0	R2=8.64281332708721E-05	R3=0				
Joint=87	OutputCase=PERM1	CaseType=Combination	StepType=Min	U1=-1.4074851384378E-05	U2=0	U3=-9.22858651889125E-03
R1=0	R2=4.56292783338286E-05	R3=0				
Joint=87	OutputCase=PERM2	CaseType=Combination	StepType=Min	U1=-1.02109386264242E-05	U2=0	U3=-9.25252565161486E-03
R1=0	R2=4.79867161658992E-05	R3=0				
Joint=87	OutputCase=ACC1	CaseType=Combination	StepType=Min	U1=-1.43286804061024E-05	U2=0	U3=-9.4509923270493E-03
R1=0	R2=4.71362194522965E-05	R3=0				
Joint=87	OutputCase=ACC2	CaseType=Combination	StepType=Min	U1=-1.04647676481486E-05	U2=0	U3=-9.47493145977291E-03
R1=0	R2=4.94936572843671E-05	R3=0				
Joint=87	OutputCase=ACCSX1	CaseType=Combination	StepType=Min	U1=2.68029831298679E-04	U2=0	U3=-9.19388974795804E-03
R1=0	R2=1.12822802732047E-04	R3=0				
Joint=87	OutputCase=ACCSX2	CaseType=Combination	StepType=Min	U1=2.71893744056633E-04	U2=0	U3=-9.21782888068165E-03
R1=0	R2=1.15180240564118E-04	R3=0				
Joint=87	OutputCase=ENVE	CaseType=Combination	StepType=Max	U1=2.71893744056633E-04	U2=0	U3=-
9.19388974795804E-03	R1=0	R2=1.15180240564118E-04	R3=0			
Joint=87	OutputCase=ENVE	CaseType=Combination	StepType=Min	U1=-1.43286804061024E-05	U2=0	U3=-
9.47493145977291E-03	R1=0	R2=4.56292783338286E-05	R3=0			
Joint=87	OutputCase=FESSUR	CaseType=Combination	StepType=Min	U1=-1.42525316995851E-05	U2=0	U3=-9.38427058460189E-03
R1=0	R2=4.66841371167561E-05	R3=0				
Joint=88	OutputCase=PERM1	CaseType=Combination	StepType=Min	U1=-1.63618331583605E-05	U2=0	U3=-9.24169505937471E-03
R1=0	R2=2.28019718859332E-11	R3=0				
Joint=88	OutputCase=PERM2	CaseType=Combination	StepType=Min	U1=-1.17520699433335E-05	U2=0	U3=-9.26622354944154E-03
R1=0	R2=1.42970630685231E-11	R3=0				
Joint=88	OutputCase=ACC1	CaseType=Combination	StepType=Min	U1=-1.66801530173656E-05	U2=0	U3=-9.46453417102575E-03
R1=0	R2=2.35961555741619E-11	R3=0				



Joint=88	OutputCase=ACC2	CaseType=Combination	U1=-1.20703898023386E-05	U2=0	U3=-9.48906266109259E-03		
R1=0	R2=1.50912467608176E-11	R3=0					
Joint=88	OutputCase=ACCSX1	CaseType=Combination	U1=2.65711326637076E-04	U2=0	U3=-9.24054154345686E-03		
R1=0	R2=6.72323549709791E-05	R3=0					
Joint=88	OutputCase=ACCSX2	CaseType=Combination	U1=2.70321089852103E-04	U2=0	U3=-9.2650700335237E-03		
R1=0	R2=6.72323464660702E-05	R3=0					
Joint=88	OutputCase=ENVE	CaseType=Combination	StepType=Max	U1=2.70321089852103E-04	U2=0	U3=-	
9.24054154345686E-03	R1=0	R2=6.72323549709791E-05	R3=0				
Joint=88	OutputCase=ENVE	CaseType=Combination	StepType=Min	U1=-1.66801530173656E-05	U2=0	U3=-	
9.48906266109259E-03	R1=0	R2=1.42970630685231E-11	R3=0				
Joint=88	OutputCase=FESSUR	CaseType=Combination	U1=-1.65846570596641E-05	U2=0	U3=-9.39768243753044E-03		
R1=0	R2=2.33579004662449E-11	R3=0					
Joint=89	OutputCase=PERM1	CaseType=Combination	U1=-1.86488149323431E-05	U2=0	U3=-9.22858654162656E-03		
R1=0	R2=-4.56292326414038E-05	R3=0					
Joint=89	OutputCase=PERM2	CaseType=Combination	U1=-1.32932012602428E-05	U2=0	U3=-9.25252566586244E-03		
R1=0	R2=-4.79866875060946E-05	R3=0					
Joint=89	OutputCase=ACC1	CaseType=Combination	U1=-1.9031625628629E-05	U2=0	U3=-9.4509923505769E-03		
R1=0	R2=-4.71361721689871E-05	R3=0					
Joint=89	OutputCase=ACC2	CaseType=Combination	U1=-1.36760119565287E-05	U2=0	U3=-9.47493147481278E-03		
R1=0	R2=-4.94936270336779E-05	R3=0					
Joint=89	OutputCase=ACCSX1	CaseType=Combination	U1=2.63392821975473E-04	U2=0	U3=-9.26102718417414E-03		
R1=0	R2=2.17679055570966E-05	R3=0					
Joint=89	OutputCase=ACCSX2	CaseType=Combination	U1=2.68748435647573E-04	U2=0	U3=-9.28496630841002E-03		
R1=0	R2=1.94104506924058E-05	R3=0					
Joint=89	OutputCase=ENVE	CaseType=Combination	StepType=Max	U1=2.68748435647573E-04	U2=0	U3=-	
9.22858654162656E-03	R1=0	R2=2.17679055570966E-05	R3=0				
Joint=89	OutputCase=ENVE	CaseType=Combination	StepType=Min	U1=-1.9031625628629E-05	U2=0	U3=-	
9.47493147481278E-03	R1=0	R2=-4.94936270336779E-05	R3=0				
Joint=89	OutputCase=FESSUR	CaseType=Combination	U1=-1.89167824197432E-05	U2=0	U3=-9.3842706078918E-03		
R1=0	R2=-4.66840903107121E-05	R3=0					
Joint=90	OutputCase=PERM1	CaseType=Combination	U1=-2.09357967063256E-05	U2=0	U3=-9.19095652905707E-03		
R1=0	R2=-8.44762345322514E-05	R3=0					
Joint=90	OutputCase=PERM2	CaseType=Combination	U1=-1.48343325771522E-05	U2=0	U3=-9.21312756427639E-03		
R1=0	R2=-8.91911357795266E-05	R3=0					
Joint=90	OutputCase=ACC1	CaseType=Combination	U1=-2.13830982398922E-05	U2=0	U3=-9.41211880919676E-03		
R1=0	R2=-8.72645940491757E-05	R3=0					
Joint=90	OutputCase=ACC2	CaseType=Combination	U1=-1.52816341107188E-05	U2=0	U3=-9.43428984441609E-03		
R1=0	R2=-9.19794952964509E-05	R3=0					
Joint=90	OutputCase=ACCSX1	CaseType=Combination	U1=2.6107431731387E-04	U2=0	U3=-9.2571052326495E-03		
R1=0	R2=-1.67882920455535E-05	R3=0					
Joint=90	OutputCase=ACCSX2	CaseType=Combination	U1=2.67175781443043E-04	U2=0	U3=-9.27927626786882E-03		
R1=0	R2=-2.15031932928287E-05	R3=0					
Joint=90	OutputCase=ENVE	CaseType=Combination	StepType=Max	U1=2.67175781443043E-04	U2=0	U3=-	
9.19095652905707E-03	R1=0	R2=-1.67882920455535E-05	R3=0				
Joint=90	OutputCase=ENVE	CaseType=Combination	StepType=Min	U1=-2.13830982398922E-05	U2=0	U3=-	
9.43428984441609E-03	R1=0	R2=-9.19794952964509E-05	R3=0				
Joint=90	OutputCase=FESSUR	CaseType=Combination	U1=-2.12489077798222E-05	U2=0	U3=-9.34577012515486E-03		
R1=0	R2=-8.64280861940984E-05	R3=0					
Joint=91	OutputCase=PERM1	CaseType=Combination	U1=-2.32227784803081E-05	U2=0	U3=-9.13389171180849E-03		
R1=0	R2=-1.0975872940653E-04	R3=0					
Joint=91	OutputCase=PERM2	CaseType=Combination	U1=-1.63754638940615E-05	U2=0	U3=-9.15311593481427E-03		
R1=0	R2=-1.16831077059192E-04	R3=0					
Joint=91	OutputCase=ACC1	CaseType=Combination	U1=-2.37345708511555E-05	U2=0	U3=-9.35316937727629E-03		
R1=0	R2=-1.1337746825046E-04	R3=0					
Joint=91	OutputCase=ACC2	CaseType=Combination	U1=-1.68872562649089E-05	U2=0	U3=-9.37239360028207E-03		
R1=0	R2=-1.20449815903123E-04	R3=0					
Joint=91	OutputCase=ACCSX1	CaseType=Combination	U1=2.58755812652266E-04	U2=0	U3=-9.23392537815455E-03		
R1=0	R2=-4.16539843729302E-05	R3=0					
Joint=91	OutputCase=ACCSX2	CaseType=Combination	U1=2.65603127238513E-04	U2=0	U3=-9.25314960116033E-03		
R1=0	R2=-4.87263320255925E-05	R3=0					
Joint=91	OutputCase=ENVE	CaseType=Combination	StepType=Max	U1=2.65603127238513E-04	U2=0	U3=-	
9.13389171180849E-03	R1=0	R2=-4.16539843729302E-05	R3=0				
Joint=91	OutputCase=ENVE	CaseType=Combination	StepType=Min	U1=-2.37345708511555E-05	U2=0	U3=-	
9.37239360028207E-03	R1=0	R2=-1.20449815903123E-04	R3=0				
Joint=91	OutputCase=FESSUR	CaseType=Combination	U1=-2.35810331399013E-05	U2=0	U3=-9.28738607763595E-03		
R1=0	R2=-1.12291846597281E-04	R3=0					

TABLE: "JOINT REACTIONS"

Joint=1	OutputCase=PERM1	CaseType=Combination	F1=-1.91128271032071E-06	F2=0	F3=29.0809876859386	M1=0	M2=0	M3=0
Joint=1	OutputCase=PERM2	CaseType=Combination	F1=-1.33789783793858E-06	F2=0	F3=29.1128197160302	M1=0	M2=0	M3=0
Joint=1	OutputCase=ACC1	CaseType=Combination	F1=-1.96635745908225E-06	F2=0	F3=29.7742843392765	M1=0	M2=0	M3=0
Joint=1	OutputCase=ACC2	CaseType=Combination	F1=-1.3929725870554E-06	F2=0	F3=29.8061163693682	M1=0	M2=0	M3=0
Joint=1	OutputCase=ACCSX1	CaseType=Combination	F1=-9.24000191128112	F2=0	F3=28.5302663342263	M1=0	M2=0	M3=0
Joint=1	OutputCase=ACCSX2	CaseType=Combination	F1=-9.24000133789625	F2=0	F3=28.5620983643179	M1=0	M2=0	M3=0
Joint=1	OutputCase=ENVE	CaseType=Combination	StepType=Max	F1=-1.33789783793858E-06	F2=0	F3=29.8061163693682	M1=0	M2=0
F3=29.8061163693682	M1=0	M2=0	M3=0					



Joint=1	OutputCase=ENVE	CaseType=Combination	StepType=Min	F1=-9.24000191128112	F2=0			
F3=28.5302663342263	M1=0	M2=0	M3=0					
Joint=1	OutputCase=FESSUR	CaseType=Combination		F1=-1.94983503476465E-06	F2=0	F3=29.5662953432752	M1=0	
M2=0	M3=0							
Joint=15	OutputCase=PERM1	CaseType=Combination		F1=0	F2=0	F3=29.0809880620425	M1=0	M2=0
Joint=15	OutputCase=PERM2	CaseType=Combination		F1=0	F2=0	F3=29.1128199527349	M1=0	M2=0
Joint=15	OutputCase=ACC1	CaseType=Combination		F1=0	F2=0	F3=29.7742847284424	M1=0	M2=0
Joint=15	OutputCase=ACC2	CaseType=Combination		F1=0	F2=0	F3=29.8061166191348	M1=0	M2=0
Joint=15	OutputCase=ACCSX1	CaseType=Combination		F1=0	F2=0	F3=29.6283474659661	M1=0	M2=0
Joint=15	OutputCase=ACCSX2	CaseType=Combination		F1=0	F2=0	F3=29.6601793566586	M1=0	M2=0
Joint=15	OutputCase=ENVE	CaseType=Combination	StepType=Max	F1=0	F2=0	F3=29.8061166191348	M1=0	
M2=0	M3=0							
Joint=15	OutputCase=ENVE	CaseType=Combination	StepType=Min	F1=0	F2=0	F3=29.0809880620425	M1=0	
M2=0	M3=0							
Joint=15	OutputCase=FESSUR	CaseType=Combination		F1=0	F2=0	F3=29.5662957285224	M1=0	M2=0
Joint=19	OutputCase=PERM1	CaseType=Combination		F1=0	F2=0	F3=114.220226779198	M1=0	M2=0
Joint=19	OutputCase=PERM2	CaseType=Combination		F1=0	F2=0	F3=114.224179407581	M1=0	M2=0
Joint=19	OutputCase=ACC1	CaseType=Combination		F1=0	F2=0	F3=116.936142637491	M1=0	M2=0
Joint=19	OutputCase=ACC2	CaseType=Combination		F1=0	F2=0	F3=116.940095265874	M1=0	M2=0
Joint=19	OutputCase=ACCSX1	CaseType=Combination		F1=0	F2=0	F3=112.918050837666	M1=0	M2=0
Joint=19	OutputCase=ACCSX2	CaseType=Combination		F1=0	F2=0	F3=112.922003466049	M1=0	M2=0
Joint=19	OutputCase=ENVE	CaseType=Combination	StepType=Max	F1=0	F2=0	F3=116.940095265874	M1=0	
M2=0	M3=0							
Joint=19	OutputCase=ENVE	CaseType=Combination	StepType=Min	F1=0	F2=0	F3=112.918050837666	M1=0	
M2=0	M3=0							
Joint=19	OutputCase=FESSUR	CaseType=Combination		F1=0	F2=0	F3=116.121367880003	M1=0	M2=0
Joint=30	OutputCase=PERM1	CaseType=Combination		F1=0	F2=0	F3=57.9097306361273	M1=0	M2=0
Joint=30	OutputCase=PERM2	CaseType=Combination		F1=0	F2=0	F3=57.9550495401902	M1=0	M2=0
Joint=30	OutputCase=ACC1	CaseType=Combination		F1=0	F2=0	F3=59.2894264921319	M1=0	M2=0
Joint=30	OutputCase=ACC2	CaseType=Combination		F1=0	F2=0	F3=59.3347453961948	M1=0	M2=0
Joint=30	OutputCase=ACCSX1	CaseType=Combination		F1=0	F2=0	F3=56.9223401111015	M1=0	M2=0
Joint=30	OutputCase=ACCSX2	CaseType=Combination		F1=0	F2=0	F3=56.9676590151644	M1=0	M2=0
Joint=30	OutputCase=ENVE	CaseType=Combination	StepType=Max	F1=0	F2=0	F3=59.3347453961948	M1=0	
M2=0	M3=0							
Joint=30	OutputCase=ENVE	CaseType=Combination	StepType=Min	F1=0	F2=0	F3=56.9223401111015	M1=0	
M2=0	M3=0							
Joint=30	OutputCase=FESSUR	CaseType=Combination		F1=0	F2=0	F3=58.8755177353305	M1=0	M2=0
Joint=31	OutputCase=PERM1	CaseType=Combination		F1=0	F2=0	F3=86.4616780959756	M1=0	M2=0
Joint=31	OutputCase=PERM2	CaseType=Combination		F1=0	F2=0	F3=86.5050663712165	M1=0	M2=0
Joint=31	OutputCase=ACC1	CaseType=Combination		F1=0	F2=0	F3=88.5202443867504	M1=0	M2=0
Joint=31	OutputCase=ACC2	CaseType=Combination		F1=0	F2=0	F3=88.5636326619913	M1=0	M2=0
Joint=31	OutputCase=ACCSX1	CaseType=Combination		F1=0	F2=0	F3=85.1501851047945	M1=0	M2=0
Joint=31	OutputCase=ACCSX2	CaseType=Combination		F1=0	F2=0	F3=85.1935733800354	M1=0	M2=0
Joint=31	OutputCase=ENVE	CaseType=Combination	StepType=Max	F1=0	F2=0	F3=88.5636326619913	M1=0	
M2=0	M3=0							
Joint=31	OutputCase=ENVE	CaseType=Combination	StepType=Min	F1=0	F2=0	F3=85.1501851047945	M1=0	
M2=0	M3=0							
Joint=31	OutputCase=FESSUR	CaseType=Combination		F1=0	F2=0	F3=87.9026744995179	M1=0	M2=0
Joint=32	OutputCase=PERM1	CaseType=Combination		F1=0	F2=0	F3=86.4616789939918	M1=0	M2=0
Joint=32	OutputCase=PERM2	CaseType=Combination		F1=0	F2=0	F3=86.5050669364378	M1=0	M2=0
Joint=32	OutputCase=ACC1	CaseType=Combination		F1=0	F2=0	F3=88.520245315972	M1=0	M2=0
Joint=32	OutputCase=ACC2	CaseType=Combination		F1=0	F2=0	F3=88.5636332584181	M1=0	M2=0
Joint=32	OutputCase=ACCSX1	CaseType=Combination		F1=0	F2=0	F3=87.7685895292133	M1=0	M2=0
Joint=32	OutputCase=ACCSX2	CaseType=Combination		F1=0	F2=0	F3=87.8119774716593	M1=0	M2=0
Joint=32	OutputCase=ENVE	CaseType=Combination	StepType=Max	F1=0	F2=0	F3=88.5636332584181	M1=0	
M2=0	M3=0							
Joint=32	OutputCase=ENVE	CaseType=Combination	StepType=Min	F1=0	F2=0	F3=86.4616789939918	M1=0	
M2=0	M3=0							
Joint=32	OutputCase=FESSUR	CaseType=Combination		F1=0	F2=0	F3=87.902675419378	M1=0	M2=0
Joint=33	OutputCase=PERM1	CaseType=Combination		F1=0	F2=0	F3=57.9097313113403	M1=0	M2=0
Joint=33	OutputCase=PERM2	CaseType=Combination		F1=0	F2=0	F3=57.9550499651605	M1=0	M2=0
Joint=33	OutputCase=ACC1	CaseType=Combination		F1=0	F2=0	F3=59.2894271908018	M1=0	M2=0
Joint=33	OutputCase=ACC2	CaseType=Combination		F1=0	F2=0	F3=59.334745844622	M1=0	M2=0
Joint=33	OutputCase=ACCSX1	CaseType=Combination		F1=0	F2=0	F3=58.8923354717571	M1=0	M2=0
Joint=33	OutputCase=ACCSX2	CaseType=Combination		F1=0	F2=0	F3=58.9376541255773	M1=0	M2=0
Joint=33	OutputCase=ENVE	CaseType=Combination	StepType=Max	F1=0	F2=0	F3=59.334745844622	M1=0	M2=0
M3=0								
Joint=33	OutputCase=ENVE	CaseType=Combination	StepType=Min	F1=0	F2=0	F3=57.9097313113403	M1=0	
M2=0	M3=0							
Joint=33	OutputCase=FESSUR	CaseType=Combination		F1=0	F2=0	F3=58.8755184269634	M1=0	M2=0
Joint=36	OutputCase=PERM1	CaseType=Combination		F1=0	F2=0	F3=113.326318417782	M1=0	M2=0
Joint=36	OutputCase=PERM2	CaseType=Combination		F1=0	F2=0	F3=113.291859301494	M1=0	M2=0
Joint=36	OutputCase=ACC1	CaseType=Combination		F1=0	F2=0	F3=116.018022406851	M1=0	M2=0
Joint=36	OutputCase=ACC2	CaseType=Combination		F1=0	F2=0	F3=115.983563290562	M1=0	M2=0
Joint=36	OutputCase=ACCSX1	CaseType=Combination		F1=0	F2=0	F3=112.46383768054	M1=0	M2=0
Joint=36	OutputCase=ACCSX2	CaseType=Combination		F1=0	F2=0	F3=112.429378564252	M1=0	M2=0
Joint=36	OutputCase=ENVE	CaseType=Combination	StepType=Max	F1=0	F2=0	F3=116.018022406851	M1=0	
M2=0	M3=0							
Joint=36	OutputCase=ENVE	CaseType=Combination	StepType=Min	F1=0	F2=0	F3=112.429378564252	M1=0	
M2=0	M3=0							
Joint=36	OutputCase=FESSUR	CaseType=Combination		F1=0	F2=0	F3=115.21051121013	M1=0	M2=0
Joint=37	OutputCase=PERM1	CaseType=Combination		F1=0	F2=0	F3=112.735959865719	M1=0	M2=0



Joint=37	OutputCase=PERM2	CaseType=Combination	F1=0	F2=0	F3=112.678492673489	M1=0	M2=0	M3=0
Joint=37	OutputCase=ACC1	CaseType=Combination	F1=0	F2=0	F3=115.411694948894	M1=0	M2=0	M3=0
Joint=37	OutputCase=ACC2	CaseType=Combination	F1=0	F2=0	F3=115.354227756664	M1=0	M2=0	M3=0
Joint=37	OutputCase=ACCSX1	CaseType=Combination	F1=0	F2=0	F3=112.307994104064	M1=0	M2=0	M3=0
Joint=37	OutputCase=ACCSX2	CaseType=Combination	F1=0	F2=0	F3=112.250526911834	M1=0	M2=0	M3=0
Joint=37	OutputCase=ENVE	CaseType=Combination	StepType=Max	F1=0	F2=0	F3=115.411694948894	M1=0	
M2=0	M3=0							
Joint=37	OutputCase=ENVE	CaseType=Combination	StepType=Min	F1=0	F2=0	F3=112.250526911834	M1=0	
M2=0	M3=0							
Joint=37	OutputCase=FESSUR	CaseType=Combination	F1=0	F2=0	F3=114.608974423941	M1=0	M2=0	M3=0
Joint=38	OutputCase=PERM1	CaseType=Combination	F1=0	F2=0	F3=112.530183744349	M1=0	M2=0	M3=0
Joint=38	OutputCase=PERM2	CaseType=Combination	F1=0	F2=0	F3=112.465054069362	M1=0	M2=0	M3=0
Joint=38	OutputCase=ACC1	CaseType=Combination	F1=0	F2=0	F3=115.200355894831	M1=0	M2=0	M3=0
Joint=38	OutputCase=ACC2	CaseType=Combination	F1=0	F2=0	F3=115.135226219844	M1=0	M2=0	M3=0
Joint=38	OutputCase=ACCSX1	CaseType=Combination	F1=0	F2=0	F3=112.533623095304	M1=0	M2=0	M3=0
Joint=38	OutputCase=ACCSX2	CaseType=Combination	F1=0	F2=0	F3=112.468493420317	M1=0	M2=0	M3=0
Joint=38	OutputCase=ENVE	CaseType=Combination	StepType=Max	F1=0	F2=0	F3=115.200355894831	M1=0	
M2=0	M3=0							
Joint=38	OutputCase=ENVE	CaseType=Combination	StepType=Min	F1=0	F2=0	F3=112.465054069362	M1=0	
M2=0	M3=0							
Joint=38	OutputCase=FESSUR	CaseType=Combination	F1=0	F2=0	F3=114.399304249686	M1=0	M2=0	M3=0
Joint=41	OutputCase=PERM1	CaseType=Combination	F1=0	F2=0	F3=112.735960162016	M1=0	M2=0	M3=0
Joint=41	OutputCase=PERM2	CaseType=Combination	F1=0	F2=0	F3=112.678492860007	M1=0	M2=0	M3=0
Joint=41	OutputCase=ACC1	CaseType=Combination	F1=0	F2=0	F3=115.411695255497	M1=0	M2=0	M3=0
Joint=41	OutputCase=ACC2	CaseType=Combination	F1=0	F2=0	F3=115.354227953488	M1=0	M2=0	M3=0
Joint=41	OutputCase=ACCSX1	CaseType=Combination	F1=0	F2=0	F3=113.169995354579	M1=0	M2=0	M3=0
Joint=41	OutputCase=ACCSX2	CaseType=Combination	F1=0	F2=0	F3=113.11252805257	M1=0	M2=0	M3=0
Joint=41	OutputCase=ENVE	CaseType=Combination	StepType=Max	F1=0	F2=0	F3=115.411695255497	M1=0	
M2=0	M3=0							
Joint=41	OutputCase=ENVE	CaseType=Combination	StepType=Min	F1=0	F2=0	F3=112.678492860007	M1=0	
M2=0	M3=0							
Joint=41	OutputCase=FESSUR	CaseType=Combination	F1=0	F2=0	F3=114.608974727452	M1=0	M2=0	M3=0
Joint=42	OutputCase=PERM1	CaseType=Combination	F1=0	F2=0	F3=113.326319011689	M1=0	M2=0	M3=0
Joint=42	OutputCase=PERM2	CaseType=Combination	F1=0	F2=0	F3=113.291859675346	M1=0	M2=0	M3=0
Joint=42	OutputCase=ACC1	CaseType=Combination	F1=0	F2=0	F3=116.018023021411	M1=0	M2=0	M3=0
Joint=42	OutputCase=ACC2	CaseType=Combination	F1=0	F2=0	F3=115.983563685068	M1=0	M2=0	M3=0
Joint=42	OutputCase=ACCSX1	CaseType=Combination	F1=0	F2=0	F3=114.19243917667	M1=0	M2=0	M3=0
Joint=42	OutputCase=ACCSX2	CaseType=Combination	F1=0	F2=0	F3=114.157979840327	M1=0	M2=0	M3=0
Joint=42	OutputCase=ENVE	CaseType=Combination	StepType=Max	F1=0	F2=0	F3=116.018023021411	M1=0	
M2=0	M3=0							
Joint=42	OutputCase=ENVE	CaseType=Combination	StepType=Min	F1=0	F2=0	F3=113.291859675346	M1=0	
M2=0	M3=0							
Joint=42	OutputCase=FESSUR	CaseType=Combination	F1=0	F2=0	F3=115.210511818494	M1=0	M2=0	M3=0
Joint=43	OutputCase=PERM1	CaseType=Combination	F1=0	F2=0	F3=114.220227673179	M1=0	M2=0	M3=0
Joint=43	OutputCase=PERM2	CaseType=Combination	F1=0	F2=0	F3=114.224179970298	M1=0	M2=0	M3=0
Joint=43	OutputCase=ACC1	CaseType=Combination	F1=0	F2=0	F3=116.936143562552	M1=0	M2=0	M3=0
Joint=43	OutputCase=ACC2	CaseType=Combination	F1=0	F2=0	F3=116.940095859671	M1=0	M2=0	M3=0
Joint=43	OutputCase=ACCSX1	CaseType=Combination	F1=0	F2=0	F3=115.521986173457	M1=0	M2=0	M3=0
Joint=43	OutputCase=ACCSX2	CaseType=Combination	F1=0	F2=0	F3=115.525938470576	M1=0	M2=0	M3=0
Joint=43	OutputCase=ENVE	CaseType=Combination	StepType=Max	F1=0	F2=0	F3=116.940095859671	M1=0	
M2=0	M3=0							
Joint=43	OutputCase=ENVE	CaseType=Combination	StepType=Min	F1=0	F2=0	F3=114.220227673179	M1=0	
M2=0	M3=0							
Joint=43	OutputCase=FESSUR	CaseType=Combination	F1=0	F2=0	F3=116.12136879574	M1=0	M2=0	M3=0

TABLE: "ASSEMBLED JOINT MASSES"

Joint=1	U1=0.624999970197679	U2=0.624999970197679	U3=0.624999970197679	R1=0	R2=0	R3=0
Joint=2	U1=1.25	U2=1.25	U3=1.25	R1=0	R2=0	R3=0
Joint=3	U1=1.25	U2=1.25	U3=1.25	R1=0	R2=0	R3=0
Joint=4	U1=1.25	U2=1.25	U3=1.25	R1=0	R2=0	R3=0
Joint=5	U1=1.25	U2=1.25	U3=1.25	R1=0	R2=0	R3=0
Joint=6	U1=1.25	U2=1.25	U3=1.25	R1=0	R2=0	R3=0
Joint=7	U1=1.25	U2=1.25	U3=1.25	R1=0	R2=0	R3=0
Joint=8	U1=1.25	U2=1.25	U3=1.25	R1=0	R2=0	R3=0
Joint=9	U1=1.25	U2=1.25	U3=1.25	R1=0	R2=0	R3=0
Joint=10	U1=1.25	U2=1.25	U3=1.25	R1=0	R2=0	R3=0
Joint=11	U1=1.25	U2=1.25	U3=1.25	R1=0	R2=0	R3=0
Joint=15	U1=0.624999970197679	U2=0.624999970197679	U3=0.624999970197679	R1=0	R2=0	R3=0
Joint=19	U1=1.25	U2=1.25	U3=1.25	R1=0	R2=0	R3=0
Joint=20	U1=0.624999970197679	U2=0.624999970197679	U3=0.624999970197679	R1=0	R2=0	R3=0
Joint=21	U1=0.624999940395358	U2=0.624999940395358	U3=0.624999940395358	R1=0	R2=0	R3=0
Joint=22	U1=0.625000000000003	U2=0.625000000000003	U3=0.625000000000003	R1=0	R2=0	R3=0
Joint=23	U1=0.624999970197681	U2=0.624999970197681	U3=0.624999970197681	R1=0	R2=0	R3=0
Joint=24	U1=0.9375	U2=0.9375	U3=0.9375	R1=0	R2=0	R3=0
Joint=25	U1=0.624999970197679	U2=0.624999970197679	U3=0.624999970197679	R1=0	R2=0	R3=0
Joint=26	U1=0.625000000000001	U2=0.625000000000001	U3=0.625000000000001	R1=0	R2=0	R3=0
Joint=27	U1=0.9375	U2=0.9375	U3=0.9375	R1=0	R2=0	R3=0
Joint=28	U1=0.625000000000001	U2=0.625000000000001	U3=0.625000000000001	R1=0	R2=0	R3=0
Joint=29	U1=0.9375	U2=0.9375	U3=0.9375	R1=0	R2=0	R3=0
Joint=30	U1=0.624999970197678	U2=0.624999970197678	U3=0.624999970197678	R1=0	R2=0	R3=0
Joint=31	U1=0.9375	U2=0.9375	U3=0.9375	R1=0	R2=0	R3=0
Joint=32	U1=0.9375	U2=0.9375	U3=0.9375	R1=0	R2=0	R3=0



Joint=33 U1=0.624999970197678 U2=0.624999970197678 U3=0.624999970197678 R1=0 R2=0 R3=0
 Joint=34 U1=0.937500000000002 U2=0.937500000000002 U3=0.937500000000002 R1=0 R2=0 R3=0
 Joint=35 U1=0.937500000000002 U2=0.937500000000002 U3=0.937500000000002 R1=0 R2=0 R3=0
 Joint=36 U1=1.25 U2=1.25 U3=1.25 R1=0 R2=0 R3=0
 Joint=37 U1=1.25 U2=1.25 U3=1.25 R1=0 R2=0 R3=0
 Joint=38 U1=1.25 U2=1.25 U3=1.25 R1=0 R2=0 R3=0
 Joint=39 U1=0.624999970197678 U2=0.624999970197678 U3=0.624999970197678 R1=0 R2=0 R3=0
 Joint=40 U1=0.9375 U2=0.9375 U3=0.9375 R1=0 R2=0 R3=0
 Joint=41 U1=1.25 U2=1.25 U3=1.25 R1=0 R2=0 R3=0
 Joint=42 U1=1.25 U2=1.25 U3=1.25 R1=0 R2=0 R3=0
 Joint=43 U1=1.25 U2=1.25 U3=1.25 R1=0 R2=0 R3=0
 Joint=85 U1=1.25 U2=1.25 U3=1.25 R1=0 R2=0 R3=0
 Joint=86 U1=1.25 U2=1.25 U3=1.25 R1=0 R2=0 R3=0
 Joint=87 U1=1.25 U2=1.25 U3=1.25 R1=0 R2=0 R3=0
 Joint=88 U1=1.25 U2=1.25 U3=1.25 R1=0 R2=0 R3=0
 Joint=89 U1=1.25 U2=1.25 U3=1.25 R1=0 R2=0 R3=0
 Joint=90 U1=1.25 U2=1.25 U3=1.25 R1=0 R2=0 R3=0
 Joint=91 U1=1.25 U2=1.25 U3=1.25 R1=0 R2=0 R3=0

TABLE: "ELEMENT FORCES - FRAMES"

Frame=1 Station=0 OutputCase=PERM1 CaseType=Combination P=-235.938772273309 V2=478.419007364985 V3=0
 T=0 M2=0 M3=286.66290588061 S11Max=1484.03866301035 PtS11Max=1 x2S11Max=-0.5 x3S11Max=-0.5
 S11Min=-1955.91620755697 PtS11Min=3 x2S11Min=0.5 x3S11Min=-0.5 FrameElem=1 ElemStation=0
 Frame=1 Station=6.24999940395355E-02 OutputCase=PERM1 CaseType=Combination P=-235.938772273309
 V2=479.981507215973 V3=0 T=0 M2=0 M3=256.712892656211 S11Max=1304.33858366396 PtS11Max=1 x2S11Max=-0.5
 x3S11Max=-0.5
 S11Min=-1776.21612821058 PtS11Min=3 x2S11Min=0.5 x3S11Min=-0.5 FrameElem=1
 ElemStation=6.24999940395355E-02
 Frame=1 Station=0.124999988079071 OutputCase=PERM1 CaseType=Combination P=-235.938772273309
 V2=481.544007066962 V3=0 T=0 M2=0 M3=226.665223200439 S11Max=1124.05256692932 PtS11Max=1 x2S11Max=-0.5
 x3S11Max=-0.5
 S11Min=-1595.93011147594 PtS11Min=3 x2S11Min=0.5 x3S11Min=-0.5 FrameElem=1
 ElemStation=0.124999988079071
 Frame=1 Station=0.187499982118607 OutputCase=PERM1 CaseType=Combination P=-235.938772273309
 V2=483.10650691795 V3=0 T=0 M2=0 M3=196.519897513293 S11Max=943.180612806448 PtS11Max=1 x2S11Max=-0.5
 x3S11Max=-0.5
 S11Min=-1415.05815735307 PtS11Min=3 x2S11Min=0.5 x3S11Min=-0.5 FrameElem=1
 ElemStation=0.187499982118607
 Frame=1 Station=0.249999976158142 OutputCase=PERM1 CaseType=Combination P=-235.938772273309
 V2=484.669006768938 V3=0 T=0 M2=0 M3=166.276915594773 S11Max=761.722721295332 PtS11Max=1 x2S11Max=-0.5
 x3S11Max=-0.5
 S11Min=-1233.60026584195 PtS11Min=3 x2S11Min=0.5 x3S11Min=-0.5 FrameElem=1
 ElemStation=0.249999976158142
 Frame=1 Station=0 OutputCase=PERM2 CaseType=Combination P=-169.465538592139 V2=478.387175608904 V3=0
 T=0 M2=0 M3=272.261659822665 S11Max=1464.10442034385 PtS11Max=1 x2S11Max=-0.5 x3S11Max=-0.5
 S11Min=-1803.03549752813 PtS11Min=3 x2S11Min=0.5 x3S11Min=-0.5 FrameElem=1 ElemStation=0
 Frame=1 Station=6.24999940395355E-02 OutputCase=PERM2 CaseType=Combination P=-169.465538592139
 V2=479.949675459892 V3=0 T=0 M2=0 M3=242.313636082832 S11Max=1284.41627790485 PtS11Max=1 x2S11Max=-0.5
 x3S11Max=-0.5
 S11Min=-1623.34735508913 PtS11Min=3 x2S11Min=0.5 x3S11Min=-0.5 FrameElem=1
 ElemStation=6.24999940395355E-02
 Frame=1 Station=0.124999988079071 OutputCase=PERM2 CaseType=Combination P=-169.465538592139
 V2=481.51217531088 V3=0 T=0 M2=0 M3=212.267956111625 S11Max=1104.14219807761 PtS11Max=1 x2S11Max=-0.5
 x3S11Max=-0.5
 S11Min=-1443.07327526189 PtS11Min=3 x2S11Min=0.5 x3S11Min=-0.5 FrameElem=1
 ElemStation=0.124999988079071
 Frame=1 Station=0.187499982118607 OutputCase=PERM2 CaseType=Combination P=-169.465538592139
 V2=483.074675161869 V3=0 T=0 M2=0 M3=182.124619909044 S11Max=923.282180862126 PtS11Max=1 x2S11Max=-0.5
 x3S11Max=-0.5
 S11Min=-1262.2132580464 PtS11Min=3 x2S11Min=0.5 x3S11Min=-0.5 FrameElem=1
 ElemStation=0.187499982118607
 Frame=1 Station=0.249999976158142 OutputCase=PERM2 CaseType=Combination P=-169.465538592139
 V2=484.637175012857 V3=0 T=0 M2=0 M3=151.88362747509 S11Max=741.836226258401 PtS11Max=1 x2S11Max=-0.5
 x3S11Max=-0.5
 S11Min=-1080.76730344268 PtS11Min=3 x2S11Min=0.5 x3S11Min=-0.5 FrameElem=1
 ElemStation=0.249999976158142
 Frame=1 Station=0 OutputCase=ACCL CaseType=Combination P=-240.528987364651 V2=491.275710552183 V3=0
 T=0 M2=0 M3=294.201241750567 S11Max=1524.67846313875 PtS11Max=1 x2S11Max=-0.5 x3S11Max=-0.5
 S11Min=-2005.73643786805 PtS11Min=3 x2S11Min=0.5 x3S11Min=-0.5 FrameElem=1 ElemStation=0
 Frame=1 Station=6.24999940395355E-02 OutputCase=ACCL CaseType=Combination P=-240.528987364651
 V2=492.838210403171 V3=0 T=0 M2=0 M3=263.4476846536 S11Max=1340.15712055695 PtS11Max=1 x2S11Max=-0.5
 x3S11Max=-0.5
 S11Min=-1821.21509528625 PtS11Min=3 x2S11Min=0.5 x3S11Min=-0.5 FrameElem=1
 ElemStation=6.24999940395355E-02
 Frame=1 Station=0.124999988079071 OutputCase=ACCL CaseType=Combination P=-240.528987364651
 V2=494.40071025416 V3=0 T=0 M2=0 M3=232.59647132526 S11Max=1155.04984058691 PtS11Max=1 x2S11Max=-0.5
 x3S11Max=-0.5
 S11Min=-1636.10781531621 PtS11Min=3 x2S11Min=0.5 x3S11Min=-0.5 FrameElem=1
 ElemStation=0.124999988079071
 Frame=1 Station=0.187499982118607 OutputCase=ACCL CaseType=Combination P=-240.528987364651
 V2=495.963210105148 V3=0 T=0 M2=0 M3=201.647601765546 S11Max=969.356623228626 PtS11Max=1 x2S11Max=-0.5
 x3S11Max=-0.5



S11Min=-1450.41459795793 PtS11Min=3 x2S11Min=0.5 x3S11Min=-0.5 FrameElem=1
 ElemStation=0.187499982118607
 Frame=1 Station=0.249999976158142 OutputCase=ACC1 CaseType=Combination P=-240.528987364651
 V2=497.525709956136 V3=0 T=0 M2=0 M3=170.601075974459 S11Max=783.077468482102 PtS11Max=1 x2S11Max=-0.5
 x3S11Max=-0.5 _
 S11Min=-1264.1354432114 PtS11Min=3 x2S11Min=0.5 x3S11Min=-0.5 FrameElem=1
 ElemStation=0.249999976158142
 Frame=1 Station=0 OutputCase=ACC2 CaseType=Combination P=-174.055753683481 V2=491.243878796102 V3=0
 T=0 M2=0 M3=279.799995692622 S11Max=1504.74422047225 PtS11Max=1 x2S11Max=-0.5 x3S11Max=-0.5 _
 S11Min=-1852.85572783921 PtS11Min=3 x2S11Min=0.5 x3S11Min=-0.5 FrameElem=1 ElemStation=0
 Frame=1 Station=6.24999940395355E-02 OutputCase=ACC2 CaseType=Combination P=-174.055753683481
 V2=492.80637864709 V3=0 T=0 M2=0 M3=249.048428080221 S11Max=1320.23481479785 PtS11Max=1 x2S11Max=-0.5
 x3S11Max=-0.5 _
 S11Min=-1668.34632216481 PtS11Min=3 x2S11Min=0.5 x3S11Min=-0.5 FrameElem=1
 ElemStation=6.24999940395355E-02
 Frame=1 Station=0.124999988079071 OutputCase=ACC2 CaseType=Combination P=-174.055753683481
 V2=494.368878498078 V3=0 T=0 M2=0 M3=218.199204236446 S11Max=1135.1394717352 PtS11Max=1 x2S11Max=-0.5
 x3S11Max=-0.5 _
 S11Min=-1483.25097910216 PtS11Min=3 x2S11Min=0.5 x3S11Min=-0.5 FrameElem=1
 ElemStation=0.124999988079071
 Frame=1 Station=0.187499982118607 OutputCase=ACC2 CaseType=Combination P=-174.055753683481
 V2=495.931378349067 V3=0 T=0 M2=0 M3=187.252324161297 S11Max=949.458191284304 PtS11Max=1 x2S11Max=-0.5
 x3S11Max=-0.5 _
 S11Min=-1297.56969865126 PtS11Min=3 x2S11Min=0.5 x3S11Min=-0.5 FrameElem=1
 ElemStation=0.187499982118607
 Frame=1 Station=0.249999976158142 OutputCase=ACC2 CaseType=Combination P=-174.055753683481
 V2=497.493878200055 V3=0 T=0 M2=0 M3=156.207787854775 S11Max=763.190973445171 PtS11Max=1 x2S11Max=-0.5
 x3S11Max=-0.5 _
 S11Min=-1111.30248081213 PtS11Min=3 x2S11Min=0.5 x3S11Min=-0.5 FrameElem=1
 ElemStation=0.249999976158142
 Frame=1 Station=0 OutputCase=ACCSX1 CaseType=Combination P=-233.665974282453 V2=477.455651111236 V3=0
 T=0 M2=0 M3=292.878209137458 S11Max=1523.60328054229 PtS11Max=1 x2S11Max=-0.5 x3S11Max=-0.5 _
 S11Min=-1990.9352291072 PtS11Min=3 x2S11Min=0.5 x3S11Min=-0.5 FrameElem=1 ElemStation=0
 Frame=1 Station=6.24999940395355E-02 OutputCase=ACCSX1 CaseType=Combination P=-233.665974282453
 V2=479.018150962224 V3=0 T=0 M2=0 M3=262.988405673176 S11Max=1344.26445975661 PtS11Max=1 x2S11Max=-0.5
 x3S11Max=-0.5 S11Min=-1811.59640832151 PtS11Min=3 x2S11Min=0.5 x3S11Min=-0.5 FrameElem=1
 ElemStation=6.24999940395355E-02
 Frame=1 Station=0.124999988079071 OutputCase=ACCSX1 CaseType=Combination P=-233.665974282453
 V2=480.580650813212 V3=0 T=0 M2=0 M3=233.000945977521 S11Max=1164.33970158267 PtS11Max=1 x2S11Max=-0.5
 x3S11Max=-0.5 _
 S11Min=-1631.67165014758 PtS11Min=3 x2S11Min=0.5 x3S11Min=-0.5 FrameElem=1
 ElemStation=0.124999988079071
 Frame=1 Station=0.187499982118607 OutputCase=ACCSX1 CaseType=Combination P=-233.665974282453
 V2=482.143150664201 V3=0 T=0 M2=0 M3=202.915830050493 S11Max=983.829006020503 PtS11Max=1 x2S11Max=-0.5
 x3S11Max=-0.5 _
 S11Min=-1451.16095458541 PtS11Min=3 x2S11Min=0.5 x3S11Min=-0.5 FrameElem=1
 ElemStation=0.187499982118607
 Frame=1 Station=0.249999976158142 OutputCase=ACCSX1 CaseType=Combination P=-233.665974282453
 V2=483.705650515189 V3=0 T=0 M2=0 M3=172.73305789209 S11Max=802.73237307009 PtS11Max=1 x2S11Max=-0.5
 x3S11Max=-0.5 _
 S11Min=-1270.06432163499 PtS11Min=3 x2S11Min=0.5 x3S11Min=-0.5 FrameElem=1
 ElemStation=0.249999976158142
 Frame=1 Station=0 OutputCase=ACCSX2 CaseType=Combination P=-167.192740601283 V2=477.423819355154 V3=0
 T=0 M2=0 M3=278.476963079513 S11Max=1503.6690378758 PtS11Max=1 x2S11Max=-0.5 x3S11Max=-0.5 _
 S11Min=-1838.05451907836 PtS11Min=3 x2S11Min=0.5 x3S11Min=-0.5 FrameElem=1 ElemStation=0
 Frame=1 Station=6.24999940395355E-02 OutputCase=ACCSX2 CaseType=Combination P=-167.192740601283
 V2=478.986319206143 V3=0 T=0 M2=0 M3=248.589149099797 S11Max=1324.3421539975 PtS11Max=1 x2S11Max=-0.5
 x3S11Max=-0.5 _
 S11Min=-1658.72763520006 PtS11Min=3 x2S11Min=0.5 x3S11Min=-0.5 FrameElem=1
 ElemStation=6.24999940395355E-02
 Frame=1 Station=0.124999988079071 OutputCase=ACCSX2 CaseType=Combination P=-167.192740601283
 V2=480.548819057131 V3=0 T=0 M2=0 M3=218.603678888707 S11Max=1144.42933273096 PtS11Max=1 x2S11Max=-0.5
 x3S11Max=-0.5 _
 S11Min=-1478.81481393353 PtS11Min=3 x2S11Min=0.5 x3S11Min=-0.5 FrameElem=1
 ElemStation=0.124999988079071
 Frame=1 Station=0.187499982118607 OutputCase=ACCSX2 CaseType=Combination P=-167.192740601283
 V2=482.11131890812 V3=0 T=0 M2=0 M3=188.520552446244 S11Max=963.93057407618 PtS11Max=1 x2S11Max=-0.5
 x3S11Max=-0.5 _
 S11Min=-1298.31605527875 PtS11Min=3 x2S11Min=0.5 x3S11Min=-0.5 FrameElem=1
 ElemStation=0.187499982118607
 Frame=1 Station=0.249999976158142 OutputCase=ACCSX2 CaseType=Combination P=-167.192740601283
 V2=483.673818759108 V3=0 T=0 M2=0 M3=158.339769772407 S11Max=782.845878033159 PtS11Max=1 x2S11Max=-0.5
 x3S11Max=-0.5 _
 S11Min=-1117.23135923572 PtS11Min=3 x2S11Min=0.5 x3S11Min=-0.5 FrameElem=1
 ElemStation=0.249999976158142
 Frame=1 Station=0 OutputCase=ENVE CaseType=Combination StepType=Max P=-167.192740601283
 V2=491.275710552183 V3=0 T=0 M2=0 M3=294.201241750567 S11Max=1524.67846313875 PtS11Max=1 x2S11Max=-0.5
 x3S11Max=-0.5 _
 S11Min=-1803.03549752813 PtS11Min=3 x2S11Min=0.5 x3S11Min=-0.5 FrameElem=1 ElemStation=0



Frame=1 Station=6.24999940395355E-02 OutputCase=ENVE CaseType=Combination StepType=Max P=-167.192740601283 V2=492.838210403171 V3=0 T=0 M2=0 M3=263.4476846536 S11Max=1344.26445975661
 PtS11Max=1 x2S11Max=-0.5
 x3S11Max=-0.5 S11Min=-1623.34735508913 PtS11Min=3 x2S11Min=0.5 x3S11Min=-0.5 FrameElem=1
 ElemStation=6.24999940395355E-02
 Frame=1 Station=0.124999988079071 OutputCase=ENVE CaseType=Combination StepType=Max P=-167.192740601283 V2=494.40071025416 V3=0 T=0 M2=0 M3=233.000945977521 S11Max=1164.33970158267 PtS11Max=1 x2S11Max=-0.5
 x3S11Max=-0.5 S11Min=-1443.07327526189 PtS11Min=3 x2S11Min=0.5 x3S11Min=-0.5 FrameElem=1
 ElemStation=0.124999988079071
 Frame=1 Station=0.187499982118607 OutputCase=ENVE CaseType=Combination StepType=Max P=-167.192740601283 V2=495.963210105148 V3=0 T=0 M2=0 M3=202.915830050493 S11Max=983.829006020503 PtS11Max=1 x2S11Max=-0.5
 x3S11Max=-0.5 S11Min=-1262.2132580464 PtS11Min=3 x2S11Min=0.5 x3S11Min=-0.5 FrameElem=1
 ElemStation=0.187499982118607
 Frame=1 Station=0.249999976158142 OutputCase=ENVE CaseType=Combination StepType=Max P=-167.192740601283 V2=497.525709956136 V3=0 T=0 M2=0 M3=172.73305789209 S11Max=802.73237307009 PtS11Max=1 x2S11Max=-0.5
 x3S11Max=-0.5 S11Min=-1080.76730344268 PtS11Min=3 x2S11Min=0.5 x3S11Min=-0.5 FrameElem=1
 ElemStation=0.249999976158142
 Frame=1 Station=0 OutputCase=ENVE CaseType=Combination StepType=Min P=-240.528987364651 V2=477.423819355154 V3=0 T=0 M2=0 M3=272.261659822665 S11Max=1464.10442034385 PtS11Max=1 x2S11Max=-0.5
 x3S11Max=-0.5 S11Min=-2005.73643786805 PtS11Min=3 x2S11Min=0.5 x3S11Min=-0.5 FrameElem=1 ElemStation=0
 Frame=1 Station=6.24999940395355E-02 OutputCase=ENVE CaseType=Combination StepType=Min P=-240.528987364651 V2=478.986319206143 V3=0 T=0 M2=0 M3=242.313636082832 S11Max=1284.41627790485
 PtS11Max=1 x2S11Max=-0.5
 x3S11Max=-0.5 S11Min=-1821.21509528625 PtS11Min=3 x2S11Min=0.5 x3S11Min=-0.5 FrameElem=1
 ElemStation=6.24999940395355E-02
 Frame=1 Station=0.124999988079071 OutputCase=ENVE CaseType=Combination StepType=Min P=-240.528987364651 V2=480.548819057131 V3=0 T=0 M2=0 M3=212.267956111625 S11Max=1104.14219807761 PtS11Max=1 x2S11Max=-0.5
 x3S11Max=-0.5 S11Min=-1636.10781531621 PtS11Min=3 x2S11Min=0.5 x3S11Min=-0.5 FrameElem=1
 ElemStation=0.124999988079071
 Frame=1 Station=0.187499982118607 OutputCase=ENVE CaseType=Combination StepType=Min P=-240.528987364651 V2=482.11131890812 V3=0 T=0 M2=0 M3=182.124619909044 S11Max=923.282180862126 PtS11Max=1 x2S11Max=-0.5
 x3S11Max=-0.5 S11Min=-1451.16095458541 PtS11Min=3 x2S11Min=0.5 x3S11Min=-0.5 FrameElem=1
 ElemStation=0.187499982118607
 Frame=1 Station=0.249999976158142 OutputCase=ENVE CaseType=Combination StepType=Min P=-240.528987364651 V2=483.673818759108 V3=0 T=0 M2=0 M3=151.88362747509 S11Max=741.836226258401 PtS11Max=1 x2S11Max=-0.5
 x3S11Max=-0.5 S11Min=-1270.06432163499 PtS11Min=3 x2S11Min=0.5 x3S11Min=-0.5 FrameElem=1
 ElemStation=0.249999976158142
 Frame=1 Station=0 OutputCase=FESSUR CaseType=Combination StepType=Min P=-239.151922837248 V2=487.418699596023 V3=0 T=0 M2=0 M3=291.93974098958 S11Max=1512.48652310023 PtS11Max=1 x2S11Max=-0.5 x3S11Max=-0.5
 S11Min=-1990.79036877473 PtS11Min=3 x2S11Min=0.5 x3S11Min=-0.5 FrameElem=1 ElemStation=0
 Frame=1 Station=6.24999940395355E-02 OutputCase=FESSUR CaseType=Combination StepType=Min P=-239.151922837248 V2=488.981199447012 V3=0 T=0 M2=0 M3=261.427247054384 S11Max=1329.41155948905 PtS11Max=1 x2S11Max=-0.5
 x3S11Max=-0.5 S11Min=-1807.71540516355 PtS11Min=3 x2S11Min=0.5 x3S11Min=-0.5 FrameElem=1
 ElemStation=6.24999940395355E-02
 Frame=1 Station=0.124999988079071 OutputCase=FESSUR CaseType=Combination StepType=Min P=-239.151922837248 V2=490.543699298 V3=0 T=0 M2=0 M3=230.817096887814 S11Max=1145.75065848963 PtS11Max=1 x2S11Max=-0.5
 x3S11Max=-0.5 S11Min=-1624.05450416413 PtS11Min=3 x2S11Min=0.5 x3S11Min=-0.5 FrameElem=1
 ElemStation=0.124999988079071
 Frame=1 Station=0.187499982118607 OutputCase=FESSUR CaseType=Combination StepType=Min P=-239.151922837248 V2=492.106199148989 V3=0 T=0 M2=0 M3=200.10929048987 S11Max=961.503820101973 PtS11Max=1 x2S11Max=-0.5
 x3S11Max=-0.5 S11Min=-1439.80766577647 PtS11Min=3 x2S11Min=0.5 x3S11Min=-0.5 FrameElem=1
 ElemStation=0.187499982118607
 Frame=1 Station=0.249999976158142 OutputCase=FESSUR CaseType=Combination StepType=Min P=-239.151922837248 V2=493.668698999977 V3=0 T=0 M2=0 M3=169.303827860553 S11Max=776.671044326071 PtS11Max=1 x2S11Max=-0.5
 x3S11Max=-0.5 S11Min=-1254.97489000057 PtS11Min=3 x2S11Min=0.5 x3S11Min=-0.5 FrameElem=1
 ElemStation=0.249999976158142
 Frame=2 Station=0 OutputCase=PERM1 CaseType=Combination StepType=Min P=-235.938772273309 V2=426.759276132757 V3=0 T=0 M2=0 M3=166.276915594761 S11Max=761.722721295257 PtS11Max=1 x2S11Max=-0.5 x3S11Max=-0.5
 S11Min=-1233.60026584187 PtS11Min=3 x2S11Min=0.5 x3S11Min=-0.5 FrameElem=2 ElemStation=0
 Frame=2 Station=0.0625 OutputCase=PERM1 CaseType=Combination StepType=Min P=-235.938772273309 V2=428.321776132757 V3=0 T=0 M2=0 M3=139.555632711464 S11Max=601.395023995473 PtS11Max=1 x2S11Max=-0.5 x3S11Max=-0.5
 S11Min=-1073.27256854209 PtS11Min=3 x2S11Min=0.5 x3S11Min=-0.5 FrameElem=2 ElemStation=0.0625
 Frame=2 Station=0.125 OutputCase=PERM1 CaseType=Combination StepType=Min P=-235.938772273309 V2=429.884276132757 V3=0 T=0 M2=0 M3=112.736693578166 S11Max=440.481389195689 PtS11Max=1 x2S11Max=-0.5 x3S11Max=-0.5
 S11Min=-912.358933742307 PtS11Min=3 x2S11Min=0.5 x3S11Min=-0.5 FrameElem=2 ElemStation=0.125
 Frame=2 Station=0.1875 OutputCase=PERM1 CaseType=Combination StepType=Min P=-235.938772273309 V2=431.446776132757 V3=0 T=0 M2=0 M3=85.820098194869 S11Max=278.981816895905 PtS11Max=1 x2S11Max=-0.5 x3S11Max=-0.5
 S11Min=-750.859361442523 PtS11Min=3 x2S11Min=0.5 x3S11Min=-0.5 FrameElem=2 ElemStation=0.1875
 Frame=2 Station=0.25 OutputCase=PERM1 CaseType=Combination StepType=Min P=-235.938772273309 V2=433.009276132757 V3=0 T=0 M2=0 M3=58.8058465615717 S11Max=116.896307096122 PtS11Max=1 x2S11Max=-0.5 x3S11Max=-0.5
 S11Min=-588.773851642739 PtS11Min=3 x2S11Min=0.5 x3S11Min=-0.5 FrameElem=2 ElemStation=0.25

```

Frame=2 Station=0 OutputCase=PERM2 CaseType=Combination P=-169.465538592139 V2=426.682125472612 V3=0
T=0 M2=0 M3=151.883627475078 S11Max=741.836226258327 PtS11Max=1 x2S11Max=-0.5 x3S11Max=-0.5 _
S11Min=-1080.7673034426 PtS11Min=3 x2S11Min=0.5 x3S11Min=-0.5 FrameElem=2 ElemStation=0
Frame=2 Station=0.0625 OutputCase=PERM2 CaseType=Combination P=-169.465538592139 V2=428.244625472612
V3=0 T=0 M2=0 M3=125.167166508039 S11Max=581.537460456097 PtS11Max=1 x2S11Max=-0.5 x3S11Max=-0.5 _
S11Min=-920.468537640374 PtS11Min=3 x2S11Min=0.5 x3S11Min=-0.5 FrameElem=2 ElemStation=0.0625
Frame=2 Station=0.125 OutputCase=PERM2 CaseType=Combination P=-169.465538592139 V2=429.807125472612
V3=0 T=0 M2=0 M3=98.353049291001 S11Max=420.652757153867 PtS11Max=1 x2S11Max=-0.5 x3S11Max=-0.5 _
S11Min=-759.583834338144 PtS11Min=3 x2S11Min=0.5 x3S11Min=-0.5 FrameElem=2 ElemStation=0.125
Frame=2 Station=0.1875 OutputCase=PERM2 CaseType=Combination P=-169.465538592139 V2=431.369625472612
V3=0 T=0 M2=0 M3=71.4412758239627 S11Max=259.182116351637 PtS11Max=1 x2S11Max=-0.5 x3S11Max=-0.5 _
S11Min=-598.113193535915 PtS11Min=3 x2S11Min=0.5 x3S11Min=-0.5 FrameElem=2 ElemStation=0.1875
Frame=2 Station=0.25 OutputCase=PERM2 CaseType=Combination P=-169.465538592139 V2=432.932125472612
V3=0 T=0 M2=0 M3=44.4318461069244 S11Max=97.1255380494078 PtS11Max=1 x2S11Max=-0.5 x3S11Max=-0.5 _
S11Min=-436.056615233685 PtS11Min=3 x2S11Min=0.5 x3S11Min=-0.5 FrameElem=2 ElemStation=0.25
Frame=2 Station=0 OutputCase=ACC1 CaseType=Combination P=-240.528987364651 V2=438.236283463951 V3=0
T=0 M2=0 M3=170.601075974447 S11Max=783.077468482029 PtS11Max=1 x2S11Max=-0.5 x3S11Max=-0.5 _
S11Min=-1264.13544321133 PtS11Min=3 x2S11Min=0.5 x3S11Min=-0.5 FrameElem=2 ElemStation=0
Frame=2 Station=0.0625 OutputCase=ACC1 CaseType=Combination P=-240.528987364651 V2=439.798783463951
V3=0 T=0 M2=0 M3=143.16248013295 S11Max=618.445893433047 PtS11Max=1 x2S11Max=-0.5 x3S11Max=-0.5 _
S11Min=-1099.50386816235 PtS11Min=3 x2S11Min=0.5 x3S11Min=-0.5 FrameElem=2 ElemStation=0.0625
Frame=2 Station=0.125 OutputCase=ACC1 CaseType=Combination P=-240.528987364651 V2=441.361283463951
V3=0 T=0 M2=0 M3=115.626228041453 S11Max=453.228380884066 PtS11Max=1 x2S11Max=-0.5 x3S11Max=-0.5 _
S11Min=-934.286355613367 PtS11Min=3 x2S11Min=0.5 x3S11Min=-0.5 FrameElem=2 ElemStation=0.125
Frame=2 Station=0.1875 OutputCase=ACC1 CaseType=Combination P=-240.528987364651 V2=442.923783463951
V3=0 T=0 M2=0 M3=87.9923196999558 S11Max=287.424930835084 PtS11Max=1 x2S11Max=-0.5 x3S11Max=-0.5 _
S11Min=-768.482905564385 PtS11Min=3 x2S11Min=0.5 x3S11Min=-0.5 FrameElem=2 ElemStation=0.1875
Frame=2 Station=0.25 OutputCase=ACC1 CaseType=Combination P=-240.528987364651 V2=444.486283463951
V3=0 T=0 M2=0 M3=60.2607551084589 S11Max=121.035543286103 PtS11Max=1 x2S11Max=-0.5 x3S11Max=-0.5 _
S11Min=-602.093518015404 PtS11Min=3 x2S11Min=0.5 x3S11Min=-0.5 FrameElem=2 ElemStation=0.25
Frame=2 Station=0 OutputCase=ACC2 CaseType=Combination P=-174.055753683481 V2=438.159132803806 V3=0
T=0 M2=0 M3=156.207787854763 S11Max=763.190973445098 PtS11Max=1 x2S11Max=-0.5 x3S11Max=-0.5 _
S11Min=-1111.30248081206 PtS11Min=3 x2S11Min=0.5 x3S11Min=-0.5 FrameElem=2 ElemStation=0
Frame=2 Station=0.0625 OutputCase=ACC2 CaseType=Combination P=-174.055753683481 V2=439.721632803806
V3=0 T=0 M2=0 M3=128.7740132929525 S11Max=598.588329893671 PtS11Max=1 x2S11Max=-0.5 x3S11Max=-0.5 _
S11Min=-946.699837260632 PtS11Min=3 x2S11Min=0.5 x3S11Min=-0.5 FrameElem=2 ElemStation=0.0625
Frame=2 Station=0.125 OutputCase=ACC2 CaseType=Combination P=-174.055753683481 V2=441.284132803806
V3=0 T=0 M2=0 M3=101.242583754287 S11Max=433.399748842244 PtS11Max=1 x2S11Max=-0.5 x3S11Max=-0.5 _
S11Min=-781.511256209205 PtS11Min=3 x2S11Min=0.5 x3S11Min=-0.5 FrameElem=2 ElemStation=0.125
Frame=2 Station=0.1875 OutputCase=ACC2 CaseType=Combination P=-174.055753683481 V2=442.846632803806
V3=0 T=0 M2=0 M3=73.6134973290495 S11Max=267.625230290816 PtS11Max=1 x2S11Max=-0.5 x3S11Max=-0.5 _
S11Min=-615.736737657777 PtS11Min=3 x2S11Min=0.5 x3S11Min=-0.5 FrameElem=2 ElemStation=0.1875
Frame=2 Station=0.25 OutputCase=ACC2 CaseType=Combination P=-174.055753683481 V2=444.409132803806
V3=0 T=0 M2=0 M3=45.8867546538116 S11Max=101.264774239389 PtS11Max=1 x2S11Max=-0.5 x3S11Max=-0.5 _
S11Min=-449.37628160635 PtS11Min=3 x2S11Min=0.5 x3S11Min=-0.5 FrameElem=2 ElemStation=0.25
Frame=2 Station=0 OutputCase=ACCSX1 CaseType=Combination P=-233.665974282453 V2=426.783310404036 V3=0
T=0 M2=0 M3=172.733057892078 S11Max=802.732373070014 PtS11Max=1 x2S11Max=-0.5 x3S11Max=-0.5 _
S11Min=-1270.06432163492 PtS11Min=3 x2S11Min=0.5 x3S11Min=-0.5 FrameElem=2 ElemStation=0
Frame=2 Station=0.0625 OutputCase=ACCSX1 CaseType=Combination P=-233.665974282453 V2=428.345810404036
V3=0 T=0 M2=0 M3=146.010272866826 S11Max=642.395662918501 PtS11Max=1 x2S11Max=-0.5 x3S11Max=-0.5 _
S11Min=-1109.72761148341 PtS11Min=3 x2S11Min=0.5 x3S11Min=-0.5 FrameElem=2 ElemStation=0.0625
Frame=2 Station=0.125 OutputCase=ACCSX1 CaseType=Combination P=-233.665974282453 V2=429.908310404036
V3=0 T=0 M2=0 M3=119.189831591573 S11Max=481.473015266987 PtS11Max=1 x2S11Max=-0.5 x3S11Max=-0.5 _
S11Min=-948.804963831892 PtS11Min=3 x2S11Min=0.5 x3S11Min=-0.5 FrameElem=2 ElemStation=0.125
Frame=2 Station=0.1875 OutputCase=ACCSX1 CaseType=Combination P=-233.665974282453 V2=431.470810404036
V3=0 T=0 M2=0 M3=92.271734066321 S11Max=319.964430115473 PtS11Max=1 x2S11Max=-0.5 x3S11Max=-0.5 _
S11Min=-787.296378680378 PtS11Min=3 x2S11Min=0.5 x3S11Min=-0.5 FrameElem=2 ElemStation=0.1875
Frame=2 Station=0.25 OutputCase=ACCSX1 CaseType=Combination P=-233.665974282453 V2=433.033310404036
V3=0 T=0 M2=0 M3=65.2559802910687 S11Max=157.86990746396 PtS11Max=1 x2S11Max=-0.5 x3S11Max=-0.5 _
S11Min=-625.201856028865 PtS11Min=3 x2S11Min=0.5 x3S11Min=-0.5 FrameElem=2 ElemStation=0.25
Frame=2 Station=0 OutputCase=ACCSX2 CaseType=Combination P=-167.192740601283 V2=426.706159743892 V3=0
T=0 M2=0 M3=158.339769772394 S11Max=782.845878033084 PtS11Max=1 x2S11Max=-0.5 x3S11Max=-0.5 _
S11Min=-1117.23135923565 PtS11Min=3 x2S11Min=0.5 x3S11Min=-0.5 FrameElem=2 ElemStation=0
Frame=2 Station=0.0625 OutputCase=ACCSX2 CaseType=Combination P=-167.192740601283 V2=428.268659743892
V3=0 T=0 M2=0 M3=131.621806663401 S11Max=622.538099379124 PtS11Max=1 x2S11Max=-0.5 x3S11Max=-0.5 _
S11Min=-956.92358058169 PtS11Min=3 x2S11Min=0.5 x3S11Min=-0.5 FrameElem=2 ElemStation=0.0625
Frame=2 Station=0.125 OutputCase=ACCSX2 CaseType=Combination P=-167.192740601283 V2=429.831159743892
V3=0 T=0 M2=0 M3=104.806187304408 S11Max=461.644383225165 PtS11Max=1 x2S11Max=-0.5 x3S11Max=-0.5 _
S11Min=-796.02986442773 PtS11Min=3 x2S11Min=0.5 x3S11Min=-0.5 FrameElem=2 ElemStation=0.125
Frame=2 Station=0.1875 OutputCase=ACCSX2 CaseType=Combination P=-167.192740601283 V2=431.393659743892
V3=0 T=0 M2=0 M3=77.8929116954147 S11Max=300.164729571205 PtS11Max=1 x2S11Max=-0.5 x3S11Max=-0.5 _
S11Min=-634.550210773771 PtS11Min=3 x2S11Min=0.5 x3S11Min=-0.5 FrameElem=2 ElemStation=0.1875
Frame=2 Station=0.25 OutputCase=ACCSX2 CaseType=Combination P=-167.192740601283 V2=432.956159743892
V3=0 T=0 M2=0 M3=50.8819798364214 S11Max=138.099138417246 PtS11Max=1 x2S11Max=-0.5 x3S11Max=-0.5 _
S11Min=-472.484619619811 PtS11Min=3 x2S11Min=0.5 x3S11Min=-0.5 FrameElem=2 ElemStation=0.25
Frame=2 Station=0 OutputCase=ENVE CaseType=Combination StepType=Max P=-167.192740601283
V2=438.236283463951 V3=0 T=0 M2=0 M3=172.733057892078 S11Max=802.732373070014 PtS11Max=1 x2S11Max=-0.5
x3S11Max=-0.5 _
S11Min=-1080.7673034426 PtS11Min=3 x2S11Min=0.5 x3S11Min=-0.5 FrameElem=2 ElemStation=0
Frame=2 Station=0.0625 OutputCase=ENVE CaseType=Combination StepType=Max P=-167.192740601283
V2=439.798783463951 V3=0 T=0 M2=0 M3=146.010272866826 S11Max=642.395662918501 PtS11Max=1 x2S11Max=-0.5
x3S11Max=-0.5 _

```



S11Min=-920.468537640374 PtS11Min=3 x2S11Min=0.5 x3S11Min=-0.5 FrameElem=2 ElemStation=0.0625
 Frame=2 Station=0.125 OutputCase=ENVE CaseType=Combination StepType=Max P=-167.192740601283
 V2=441.361283463951 V3=0 T=0 M2=0 M3=119.189831591573 S11Max=481.473015266987 PtS11Max=1 x2S11Max=-0.5
 x3S11Max=-0.5 _
 S11Min=-759.583834338144 PtS11Min=3 x2S11Min=0.5 x3S11Min=-0.5 FrameElem=2 ElemStation=0.125
 Frame=2 Station=0.1875 OutputCase=ENVE CaseType=Combination StepType=Max P=-167.192740601283
 V2=442.923783463951 V3=0 T=0 M2=0 M3=92.271734066321 S11Max=319.964430115473 PtS11Max=1 x2S11Max=-0.5
 x3S11Max=-0.5 _
 S11Min=-598.113193535915 PtS11Min=3 x2S11Min=0.5 x3S11Min=-0.5 FrameElem=2 ElemStation=0.1875
 Frame=2 Station=0.25 OutputCase=ENVE CaseType=Combination StepType=Max P=-167.192740601283
 V2=444.486283463951 V3=0 T=0 M2=0 M3=65.2559802910687 S11Max=157.86990746396 PtS11Max=1 x2S11Max=-0.5
 x3S11Max=-0.5 _
 S11Min=-436.056615233685 PtS11Min=3 x2S11Min=0.5 x3S11Min=-0.5 FrameElem=2 ElemStation=0.25
 Frame=2 Station=0 OutputCase=ENVE CaseType=Combination StepType=Min P=-240.528987364651
 V2=426.682125472612 V3=0 T=0 M2=0 M3=151.883627475078 S11Max=741.836226258327 PtS11Max=1 x2S11Max=-0.5
 x3S11Max=-0.5 _
 S11Min=-1270.06432163492 PtS11Min=3 x2S11Min=0.5 x3S11Min=-0.5 FrameElem=2 ElemStation=0
 Frame=2 Station=0.0625 OutputCase=ENVE CaseType=Combination StepType=Min P=-240.528987364651
 V2=428.244625472612 V3=0 T=0 M2=0 M3=125.167166508039 S11Max=581.537460456097 PtS11Max=1 x2S11Max=-0.5
 x3S11Max=-0.5 _
 S11Min=-1109.72761148341 PtS11Min=3 x2S11Min=0.5 x3S11Min=-0.5 FrameElem=2 ElemStation=0.0625
 Frame=2 Station=0.125 OutputCase=ENVE CaseType=Combination StepType=Min P=-240.528987364651
 V2=429.807125472612 V3=0 T=0 M2=0 M3=98.353049291001 S11Max=420.652757153867 PtS11Max=1 x2S11Max=-0.5
 x3S11Max=-0.5 _
 S11Min=-948.804963831892 PtS11Min=3 x2S11Min=0.5 x3S11Min=-0.5 FrameElem=2 ElemStation=0.125
 Frame=2 Station=0.1875 OutputCase=ENVE CaseType=Combination StepType=Min P=-240.528987364651
 V2=431.369625472612 V3=0 T=0 M2=0 M3=71.4412758239627 S11Max=259.182116351637 PtS11Max=1 x2S11Max=-0.5
 x3S11Max=-0.5 _
 S11Min=-787.296378680378 PtS11Min=3 x2S11Min=0.5 x3S11Min=-0.5 FrameElem=2 ElemStation=0.1875
 Frame=2 Station=0.25 OutputCase=ENVE CaseType=Combination StepType=Min P=-240.528987364651
 V2=432.932125472612 V3=0 T=0 M2=0 M3=44.4318461069244 S11Max=97.1255380494078 PtS11Max=1 x2S11Max=-0.5
 x3S11Max=-0.5 _
 S11Min=-625.201856028865 PtS11Min=3 x2S11Min=0.5 x3S11Min=-0.5 FrameElem=2 ElemStation=0.25
 Frame=2 Station=0 OutputCase=FESSUR CaseType=Combination P=-239.151922837248 V2=434.793181264592 V3=0
 T=0 M2=0 M3=169.303827860541 S11Max=776.671044325997 PtS11Max=1 x2S11Max=-0.5 x3S11Max=-0.5 _
 S11Min=-1254.97489000049 PtS11Min=3 x2S11Min=0.5 x3S11Min=-0.5 FrameElem=2 ElemStation=0
 Frame=2 Station=0.0625 OutputCase=FESSUR CaseType=Combination P=-239.151922837248 V2=436.355681264592
 V3=0 T=0 M2=0 M3=142.08425906504 S11Max=613.330632601775 PtS11Max=1 x2S11Max=-0.5 x3S11Max=-0.5 _
 S11Min=-1091.63447827627 PtS11Min=3 x2S11Min=0.5 x3S11Min=-0.5 FrameElem=2 ElemStation=0.0625
 Frame=2 Station=0.125 OutputCase=FESSUR CaseType=Combination P=-239.151922837248 V2=437.918181264592
 V3=0 T=0 M2=0 M3=114.759367702467 S11Max=449.404283377553 PtS11Max=1 x2S11Max=-0.5 x3S11Max=-0.5 _
 S11Min=-927.708129052049 PtS11Min=3 x2S11Min=0.5 x3S11Min=-0.5 FrameElem=2 ElemStation=0.125
 Frame=2 Station=0.1875 OutputCase=FESSUR CaseType=Combination P=-239.151922837248 V2=439.480681264592
 V3=0 T=0 M2=0 M3=87.3406532484298 S11Max=284.891996653331 PtS11Max=1 x2S11Max=-0.5 x3S11Max=-0.5 _
 S11Min=-763.195842327827 PtS11Min=3 x2S11Min=0.5 x3S11Min=-0.5 FrameElem=2 ElemStation=0.1875
 Frame=2 Station=0.25 OutputCase=FESSUR CaseType=Combination P=-239.151922837248 V2=441.043181264592
 V3=0 T=0 M2=0 M3=59.8242825443927 S11Max=119.793772429108 PtS11Max=1 x2S11Max=-0.5 x3S11Max=-0.5 _
 S11Min=-598.097618103604 PtS11Min=3 x2S11Min=0.5 x3S11Min=-0.5 FrameElem=2 ElemStation=0.25
 Frame=3 Station=0 OutputCase=PERM1 CaseType=Combination P=-507.500014343842 V2=-186.258723874336 V3=0
 T=0 M2=0 M3=-286.662903366804 S11Max=1212.47740585698 PtS11Max=3 x2S11Max=0.5 x3S11Max=-0.5 _
 S11Min=-2227.47743454467 PtS11Min=1 x2S11Min=-0.5 x3S11Min=-0.5 FrameElem=3 ElemStation=0
 Frame=3 Station=0.2500000000000001 OutputCase=PERM1 CaseType=Combination P=-501.25001205135 V2=-
 162.22020884697 V3=0 T=0 M2=0 M3=-243.114140292332 S11Max=957.434829702641 PtS11Max=3 x2S11Max=0.5
 x3S11Max=-0.5 _
 S11Min=-1959.93485380534 PtS11Min=1 x2S11Min=-0.5 x3S11Min=-0.5 FrameElem=3
 ElemStation=0.2500000000000001
 Frame=3 Station=0 OutputCase=PERM2 CaseType=Combination P=-507.500009151806 V2=-134.689490193166 V3=0
 T=0 M2=0 M3=-272.261658287781 S11Max=1126.06994057488 PtS11Max=3 x2S11Max=0.5 x3S11Max=-0.5 _
 S11Min=-2141.06995887849 PtS11Min=1 x2S11Min=-0.5 x3S11Min=-0.5 FrameElem=3 ElemStation=0
 Frame=3 Station=0.2500000000000001 OutputCase=PERM2 CaseType=Combination P=-501.250007547062 V2=-
 117.862529852824 V3=0 T=0 M2=0 M3=-240.700428243016 S11Max=942.952561911034 PtS11Max=3 x2S11Max=0.5
 x3S11Max=-0.5 _
 S11Min=-1945.45257700516 PtS11Min=1 x2S11Min=-0.5 x3S11Min=-0.5 FrameElem=3
 ElemStation=0.2500000000000001
 Frame=3 Station=0 OutputCase=ACC1 CaseType=Combination P=-521.05001468261 V2=-190.848937673449 V3=0
 T=0 M2=0 M3=-294.201239167707 S11Max=1244.15742032363 PtS11Max=3 x2S11Max=0.5 x3S11Max=-0.5 _
 S11Min=-2286.25744968885 PtS11Min=1 x2S11Min=-0.5 x3S11Min=-0.5 FrameElem=3 ElemStation=0
 Frame=3 Station=0.2500000000000001 OutputCase=ACC1 CaseType=Combination P=-514.800012335044 V2=-
 166.232922646083 V3=0 T=0 M2=0 M3=-249.577110143456 S11Max=982.662648525693 PtS11Max=3 x2S11Max=0.5
 x3S11Max=-0.5 _
 S11Min=-2012.26267319578 PtS11Min=1 x2S11Min=-0.5 x3S11Min=-0.5 FrameElem=3
 ElemStation=0.2500000000000001
 Frame=3 Station=0 OutputCase=ACC2 CaseType=Combination P=-521.050009490574 V2=-139.279703992279 V3=0
 T=0 M2=0 M3=-279.799994088684 S11Max=1157.74995504153 PtS11Max=3 x2S11Max=0.5 x3S11Max=-0.5 _
 S11Min=-2199.84997402268 PtS11Min=1 x2S11Min=-0.5 x3S11Min=-0.5 FrameElem=3 ElemStation=0
 Frame=3 Station=0.2500000000000001 OutputCase=ACC2 CaseType=Combination P=-514.800007830755 V2=-
 121.875243651937 V3=0 T=0 M2=0 M3=-247.16339809414 S11Max=968.180380734086 PtS11Max=3 x2S11Max=0.5
 x3S11Max=-0.5 _
 S11Min=-1997.7803963956 PtS11Min=1 x2S11Min=-0.5 x3S11Min=-0.5 FrameElem=3
 ElemStation=0.2500000000000001
 Frame=3 Station=0 OutputCase=ACCSX1 CaseType=Combination P=-509.014091732538 V2=-183.985925739086
 V3=0 T=0 M2=0 M3=-281.968594578711 S11Max=1182.79747573973 PtS11Max=3 x2S11Max=0.5 x3S11Max=-0.5 _



S11Min=-2200.8256592048 PtS11Min=1 x2S11Min=-0.5 x3S11Min=-0.5 FrameElem=3 ElemStation=0
 Frame=3 Station=0.250000000000001 OutputCase=ACCSX1 CaseType=Combination P=-502.764089440046 V2=-
 159.947410711721 V3=0 T=0 M2=0 M3=-238.988031038051 S11Max=931.164096788261 PtS11Max=3 x2S11Max=0.5
 x3S11Max=-0.5 _
 S11Min=-1936.69227566835 PtS11Min=1 x2S11Min=-0.5 x3S11Min=-0.5 FrameElem=3
 ElemStation=0.250000000000001
 Frame=3 Station=0 OutputCase=ACCSX2 CaseType=Combination P=-509.014086540502 V2=-132.416692057916
 V3=0 T=0 M2=0 M3=-267.567349499688 S11Max=1096.39001045763 PtS11Max=3 x2S11Max=0.5 x3S11Max=-0.5 _
 S11Min=-2114.41818353863 PtS11Min=1 x2S11Min=-0.5 x3S11Min=-0.5 FrameElem=3 ElemStation=0
 Frame=3 Station=0.250000000000001 OutputCase=ACCSX2 CaseType=Combination P=-502.764084935758 V2=-
 115.589731717574 V3=0 T=0 M2=0 M3=-236.574318988735 S11Max=916.681828996654 PtS11Max=3 x2S11Max=0.5
 x3S11Max=-0.5 _
 S11Min=-1922.20999886817 PtS11Min=1 x2S11Min=-0.5 x3S11Min=-0.5 FrameElem=3
 ElemStation=0.250000000000001
 Frame=3 Station=0 OutputCase=ENVE CaseType=Combination StepType=Max P=-507.500009151806 V2=-
 132.416692057916 V3=0 T=0 M2=0 M3=-267.567349499688 S11Max=1244.15742032363 PtS11Max=3 x2S11Max=0.5
 x3S11Max=-0.5 _
 S11Min=-2114.41818353863 PtS11Min=1 x2S11Min=-0.5 x3S11Min=-0.5 FrameElem=3 ElemStation=0
 Frame=3 Station=0.250000000000001 OutputCase=ENVE CaseType=Combination StepType=Max P=-501.250007547062
 V2=-115.589731717574 V3=0 T=0 M2=0 M3=-236.574318988735 S11Max=982.662648525693 PtS11Max=3
 x2S11Max=0.5 _
 x3S11Max=-0.5 S11Min=-1922.20999886817 PtS11Min=1 x2S11Min=-0.5 x3S11Min=-0.5 FrameElem=3
 ElemStation=0.250000000000001
 Frame=3 Station=0 OutputCase=ENVE CaseType=Combination StepType=Min P=-521.05001468261 V2=-
 190.848937673449 V3=0 T=0 M2=0 M3=-294.201239167707 S11Max=1096.39001045763 PtS11Max=3 x2S11Max=0.5
 x3S11Max=-0.5 _
 S11Min=-2286.25744968885 PtS11Min=1 x2S11Min=-0.5 x3S11Min=-0.5 FrameElem=3 ElemStation=0
 Frame=3 Station=0.250000000000001 OutputCase=ENVE CaseType=Combination StepType=Min P=-514.800012335044
 V2=-166.232922646083 V3=0 T=0 M2=0 M3=-249.577110143456 S11Max=916.681828996654 PtS11Max=3
 x2S11Max=0.5 _
 x3S11Max=-0.5 S11Min=-2012.26267319578 PtS11Min=1 x2S11Min=-0.5 x3S11Min=-0.5 FrameElem=3
 ElemStation=0.250000000000001
 Frame=3 Station=0 OutputCase=FESSUR CaseType=Combination P=-516.985014580979 V2=-189.471873533715
 V3=0 T=0 M2=0 M3=-291.939738427436 S11Max=1234.65341598364 PtS11Max=3 x2S11Max=0.5 x3S11Max=-0.5 _
 S11Min=-2268.62344514559 PtS11Min=1 x2S11Min=-0.5 x3S11Min=-0.5 FrameElem=3 ElemStation=0
 Frame=3 Station=0.250000000000001 OutputCase=FESSUR CaseType=Combination P=-510.735012249936 V2=-
 165.02910850635 V3=0 T=0 M2=0 M3=-247.638219188119 S11Max=975.094302878777 PtS11Max=3 x2S11Max=0.5
 x3S11Max=-0.5 _
 S11Min=-1996.56432737865 PtS11Min=1 x2S11Min=-0.5 x3S11Min=-0.5 FrameElem=3
 ElemStation=0.250000000000001
 Frame=4 Station=0 OutputCase=PERM1 CaseType=Combination P=-235.938772273311 V2=-433.009276611268 V3=0
 T=0 M2=0 M3=58.8058436397312 S11Max=116.896289565076 PtS11Max=1 x2S11Max=-0.5 x3S11Max=-0.5 _
 S11Min=-588.773834111698 PtS11Min=3 x2S11Min=0.5 x3S11Min=-0.5 FrameElem=4 ElemStation=0
 Frame=4 Station=0.0625 OutputCase=PERM1 CaseType=Combination P=-235.938772273311 V2=-431.446776611268
 V3=0 T=0 M2=0 M3=85.8200953029354 S11Max=278.981799544302 PtS11Max=1 x2S11Max=-0.5 x3S11Max=-0.5 _
 S11Min=-750.859344090924 PtS11Min=3 x2S11Min=0.5 x3S11Min=-0.5 FrameElem=4 ElemStation=0.0625
 Frame=4 Station=0.125 OutputCase=PERM1 CaseType=Combination P=-235.938772273311 V2=-429.884276611268
 V3=0 T=0 M2=0 M3=112.73669071614 S11Max=440.481372023527 PtS11Max=1 x2S11Max=-0.5 x3S11Max=-0.5 _
 S11Min=-912.358916570149 PtS11Min=3 x2S11Min=0.5 x3S11Min=-0.5 FrameElem=4 ElemStation=0.125
 Frame=4 Station=0.1875 OutputCase=PERM1 CaseType=Combination P=-235.938772273311 V2=-428.321776611268
 V3=0 T=0 M2=0 M3=139.555629879344 S11Max=601.395007002752 PtS11Max=1 x2S11Max=-0.5 x3S11Max=-0.5 _
 S11Min=-1073.27255154937 PtS11Min=3 x2S11Min=0.5 x3S11Min=-0.5 FrameElem=4 ElemStation=0.1875
 Frame=4 Station=0.25 OutputCase=PERM1 CaseType=Combination P=-235.938772273311 V2=-426.759276611268
 V3=0 T=0 M2=0 M3=166.276912792548 S11Max=761.722704481978 PtS11Max=1 x2S11Max=-0.5 x3S11Max=-0.5 _
 S11Min=-1233.6002490286 PtS11Min=3 x2S11Min=0.5 x3S11Min=-0.5 FrameElem=4 ElemStation=0.25
 Frame=4 Station=0 OutputCase=PERM2 CaseType=Combination P=-169.465538592141 V2=-432.932125792745 V3=0
 T=0 M2=0 M3=44.4318443057557 S11Max=97.1255272423934 PtS11Max=1 x2S11Max=-0.5 x3S11Max=-0.5 _
 S11Min=-436.056604426675 PtS11Min=3 x2S11Min=0.5 x3S11Min=-0.5 FrameElem=4 ElemStation=0
 Frame=4 Station=0.0625 OutputCase=PERM2 CaseType=Combination P=-169.465538592141 V2=-431.369625792745
 V3=0 T=0 M2=0 M3=71.4412740428022 S11Max=259.182105664673 PtS11Max=1 x2S11Max=-0.5 x3S11Max=-0.5 _
 S11Min=-598.113182848954 PtS11Min=3 x2S11Min=0.5 x3S11Min=-0.5 FrameElem=4 ElemStation=0.0625
 Frame=4 Station=0.125 OutputCase=PERM2 CaseType=Combination P=-169.465538592141 V2=-429.807125792745
 V3=0 T=0 M2=0 M3=98.3530475298488 S11Max=420.652746586952 PtS11Max=1 x2S11Max=-0.5 x3S11Max=-0.5 _
 S11Min=-759.583823771234 PtS11Min=3 x2S11Min=0.5 x3S11Min=-0.5 FrameElem=4 ElemStation=0.125
 Frame=4 Station=0.1875 OutputCase=PERM2 CaseType=Combination P=-169.465538592141 V2=-428.244625792745
 V3=0 T=0 M2=0 M3=125.167164766895 S11Max=581.537450009231 PtS11Max=1 x2S11Max=-0.5 x3S11Max=-0.5 _
 S11Min=-920.468527193513 PtS11Min=3 x2S11Min=0.5 x3S11Min=-0.5 FrameElem=4 ElemStation=0.1875
 Frame=4 Station=0.25 OutputCase=PERM2 CaseType=Combination P=-169.465538592141 V2=-426.682125792745
 V3=0 T=0 M2=0 M3=151.883625753942 S11Max=741.83621593151 PtS11Max=1 x2S11Max=-0.5 x3S11Max=-0.5 _
 S11Min=-1080.76729311579 PtS11Min=3 x2S11Min=0.5 x3S11Min=-0.5 FrameElem=4 ElemStation=0.25
 Frame=4 Station=0 OutputCase=ACCL CaseType=Combination P=-240.528987364653 V2=-444.486283966427 V3=0
 T=0 M2=0 M3=60.2607520997167 S11Max=121.035525233648 PtS11Max=1 x2S11Max=-0.5 x3S11Max=-0.5 _
 S11Min=-602.093499962953 PtS11Min=3 x2S11Min=0.5 x3S11Min=-0.5 FrameElem=4 ElemStation=0
 Frame=4 Station=0.0625 OutputCase=ACCL CaseType=Combination P=-240.528987364653 V2=-442.923783966427
 V3=0 T=0 M2=0 M3=87.9923167226184 S11Max=287.424912971057 PtS11Max=1 x2S11Max=-0.5 x3S11Max=-0.5 _
 S11Min=-768.482887700363 PtS11Min=3 x2S11Min=0.5 x3S11Min=-0.5 FrameElem=4 ElemStation=0.0625
 Frame=4 Station=0.125 OutputCase=ACCL CaseType=Combination P=-240.528987364653 V2=-441.361283966427
 V3=0 T=0 M2=0 M3=115.62622509552 S11Max=453.228363208467 PtS11Max=1 x2S11Max=-0.5 x3S11Max=-0.5 _
 S11Min=-934.286337937773 PtS11Min=3 x2S11Min=0.5 x3S11Min=-0.5 FrameElem=4 ElemStation=0.125
 Frame=4 Station=0.1875 OutputCase=ACCL CaseType=Combination P=-240.528987364653 V2=-439.798783966427
 V3=0 T=0 M2=0 M3=143.162477218422 S11Max=618.445875945877 PtS11Max=1 x2S11Max=-0.5 x3S11Max=-0.5 _
 S11Min=-1099.50385067518 PtS11Min=3 x2S11Min=0.5 x3S11Min=-0.5 FrameElem=4 ElemStation=0.1875



Frame=4 Station=0.25 OutputCase=ACC1 CaseType=Combination P=-240.528987364653 V2=-438.236283966427
 V3=0 T=0 M2=0 M3=170.601073091323 S11Max=783.077451183287 PtS11Max=1 x2S11Max=-0.5 x3S11Max=-0.5 _
 S11Min=-1264.13542591259 PtS11Min=3 x2S11Min=0.5 x3S11Min=-0.5 FrameElem=4 ElemStation=0.25
 Frame=4 Station=0 OutputCase=ACC2 CaseType=Combination P=-174.055753683483 V2=-444.409133147904 V3=0
 T=0 M2=0 M3=45.8867527657412 S11Max=101.264762910965 PtS11Max=1 x2S11Max=-0.5 x3S11Max=-0.5 _
 S11Min=-449.376270277793 PtS11Min=3 x2S11Min=0.5 x3S11Min=-0.5 FrameElem=4 ElemStation=0
 Frame=4 Station=0.0625 OutputCase=ACC2 CaseType=Combination P=-174.055753683483 V2=-442.846633147904
 V3=0 T=0 M2=0 M3=73.6134954624852 S11Max=267.625219091428 PtS11Max=1 x2S11Max=-0.5 x3S11Max=-0.5 _
 S11Min=-615.736726458394 PtS11Min=3 x2S11Min=0.5 x3S11Min=-0.5 FrameElem=4 ElemStation=0.0625
 Frame=4 Station=0.1875 OutputCase=ACC2 CaseType=Combination P=-174.055753683483 V2=-441.284133147904
 V3=0 T=0 M2=0 M3=101.242581909229 S11Max=433.399737771892 PtS11Max=1 x2S11Max=-0.5 x3S11Max=-0.5 _
 S11Min=-781.511245138858 PtS11Min=3 x2S11Min=0.5 x3S11Min=-0.5 FrameElem=4 ElemStation=0.125
 Frame=4 Station=0.1875 OutputCase=ACC2 CaseType=Combination P=-174.055753683483 V2=-439.721633147904
 V3=0 T=0 M2=0 M3=128.774012105973 S11Max=598.588318952356 PtS11Max=1 x2S11Max=-0.5 x3S11Max=-0.5 _
 S11Min=-946.699826319322 PtS11Min=3 x2S11Min=0.5 x3S11Min=-0.5 FrameElem=4 ElemStation=0.1875
 Frame=4 Station=0.25 OutputCase=ACC2 CaseType=Combination P=-174.055753683483 V2=-438.159133147904
 V3=0 T=0 M2=0 M3=156.207786052717 S11Max=763.19096263282 PtS11Max=1 x2S11Max=-0.5 x3S11Max=-0.5 _
 S11Min=-1111.30246999979 PtS11Min=3 x2S11Min=0.5 x3S11Min=-0.5 FrameElem=4 ElemStation=0.25
 Frame=4 Station=0 OutputCase=ACCSX1 CaseType=Combination P=-233.665974282455 V2=-432.993390652374
 V3=0 T=0 M2=0 M3=53.873826814029 S11Max=89.5769866017188 PtS11Max=1 x2S11Max=-0.5 x3S11Max=-0.5 _
 S11Min=-556.908935166629 PtS11Min=3 x2S11Min=0.5 x3S11Min=-0.5 FrameElem=4 ElemStation=0
 Frame=4 Station=0.0625 OutputCase=ACCSX1 CaseType=Combination P=-233.665974282455 V2=-431.430890652374
 V3=0 T=0 M2=0 M3=80.8870856048023 S11Max=251.656539346359 PtS11Max=1 x2S11Max=-0.5 x3S11Max=-0.5 _
 S11Min=-718.988487911269 PtS11Min=3 x2S11Min=0.5 x3S11Min=-0.5 FrameElem=4 ElemStation=0.0625
 Frame=4 Station=0.125 OutputCase=ACCSX1 CaseType=Combination P=-233.665974282455 V2=-429.868390652374
 V3=0 T=0 M2=0 M3=107.802688145576 S11Max=413.150154590999 PtS11Max=1 x2S11Max=-0.5 x3S11Max=-0.5 _
 S11Min=-880.482103155909 PtS11Min=3 x2S11Min=0.5 x3S11Min=-0.5 FrameElem=4 ElemStation=0.125
 Frame=4 Station=0.1875 OutputCase=ACCSX1 CaseType=Combination P=-233.665974282455 V2=-428.305890652374
 V3=0 T=0 M2=0 M3=134.620634436349 S11Max=574.057832335639 PtS11Max=1 x2S11Max=-0.5 x3S11Max=-0.5 _
 S11Min=-1041.38978090055 PtS11Min=3 x2S11Min=0.5 x3S11Min=-0.5 FrameElem=4 ElemStation=0.1875
 Frame=4 Station=0.25 OutputCase=ACCSX1 CaseType=Combination P=-233.665974282455 V2=-426.743390652374
 V3=0 T=0 M2=0 M3=161.340924477122 S11Max=734.37957258028 PtS11Max=1 x2S11Max=-0.5 x3S11Max=-0.5 _
 S11Min=-1201.71152114519 PtS11Min=3 x2S11Min=0.5 x3S11Min=-0.5 FrameElem=4 ElemStation=0.25
 Frame=4 Station=0 OutputCase=ACCSX2 CaseType=Combination P=-167.192740601285 V2=-432.916239833851
 V3=0 T=0 M2=0 M3=39.4998274800535 S11Max=69.8062242790359 PtS11Max=1 x2S11Max=-0.5 x3S11Max=-0.5 _
 S11Min=-404.191705481606 PtS11Min=3 x2S11Min=0.5 x3S11Min=-0.5 FrameElem=4 ElemStation=0
 Frame=4 Station=0.0625 OutputCase=ACCSX2 CaseType=Combination P=-167.192740601285 V2=-431.353739833851
 V3=0 T=0 M2=0 M3=66.5082643446691 S11Max=231.85684546673 PtS11Max=1 x2S11Max=-0.5 x3S11Max=-0.5 _
 S11Min=-566.2423266693 PtS11Min=3 x2S11Min=0.5 x3S11Min=-0.5 FrameElem=4 ElemStation=0.0625
 Frame=4 Station=0.125 OutputCase=ACCSX2 CaseType=Combination P=-167.192740601285 V2=-429.791239833851
 V3=0 T=0 M2=0 M3=93.4190449592848 S11Max=393.321529154424 PtS11Max=1 x2S11Max=-0.5 x3S11Max=-0.5 _
 S11Min=-727.707010356994 PtS11Min=3 x2S11Min=0.5 x3S11Min=-0.5 FrameElem=4 ElemStation=0.125
 Frame=4 Station=0.1875 OutputCase=ACCSX2 CaseType=Combination P=-167.192740601285 V2=-428.228739833851
 V3=0 T=0 M2=0 M3=120.2321693239 S11Max=554.200275342118 PtS11Max=1 x2S11Max=-0.5 x3S11Max=-0.5 _
 S11Min=-888.585756544688 PtS11Min=3 x2S11Min=0.5 x3S11Min=-0.5 FrameElem=4 ElemStation=0.1875
 Frame=4 Station=0.25 OutputCase=ACCSX2 CaseType=Combination P=-167.192740601285 V2=-426.666239833851
 V3=0 T=0 M2=0 M3=146.947637438516 S11Max=714.493084029812 PtS11Max=1 x2S11Max=-0.5 x3S11Max=-0.5 _
 S11Min=-1048.87856523238 PtS11Min=3 x2S11Min=0.5 x3S11Min=-0.5 FrameElem=4 ElemStation=0.25
 Frame=4 Station=0 OutputCase=ENVE CaseType=Combination StepType=Max P=-167.192740601285 V2=-
 432.916239833851 V3=0 T=0 M2=0 M3=60.2607520997167 S11Max=121.035525233648 PtS11Max=1 x2S11Max=-0.5
 x3S11Max=-0.5 _
 S11Min=-404.191705481606 PtS11Min=3 x2S11Min=0.5 x3S11Min=-0.5 FrameElem=4 ElemStation=0
 Frame=4 Station=0.0625 OutputCase=ENVE CaseType=Combination StepType=Max P=-167.192740601285 V2=-
 431.353739833851 V3=0 T=0 M2=0 M3=87.9923167226184 S11Max=287.424912971057 PtS11Max=1 x2S11Max=-0.5 _
 x3S11Max=-0.5 S11Min=-566.2423266693 PtS11Min=3 x2S11Min=0.5 x3S11Min=-0.5 FrameElem=4
 ElemStation=0.0625
 Frame=4 Station=0.125 OutputCase=ENVE CaseType=Combination StepType=Max P=-167.192740601285 V2=-
 429.791239833851 V3=0 T=0 M2=0 M3=115.62622509552 S11Max=453.228363208467 PtS11Max=1 x2S11Max=-0.5
 x3S11Max=-0.5 _
 S11Min=-727.707010356994 PtS11Min=3 x2S11Min=0.5 x3S11Min=-0.5 FrameElem=4 ElemStation=0.125
 Frame=4 Station=0.1875 OutputCase=ENVE CaseType=Combination StepType=Max P=-167.192740601285 V2=-
 428.228739833851 V3=0 T=0 M2=0 M3=143.162477218422 S11Max=618.445875945877 PtS11Max=1 x2S11Max=-0.5 _
 x3S11Max=-0.5 S11Min=-888.585756544688 PtS11Min=3 x2S11Min=0.5 x3S11Min=-0.5 FrameElem=4
 ElemStation=0.1875
 Frame=4 Station=0.25 OutputCase=ENVE CaseType=Combination StepType=Max P=-167.192740601285 V2=-
 426.666239833851 V3=0 T=0 M2=0 M3=170.601073091323 S11Max=783.077451183287 PtS11Max=1 x2S11Max=-0.5
 x3S11Max=-0.5 _
 S11Min=-1048.87856523238 PtS11Min=3 x2S11Min=0.5 x3S11Min=-0.5 FrameElem=4 ElemStation=0.25
 Frame=4 Station=0 OutputCase=ENVE CaseType=Combination StepType=Min P=-240.528987364653 V2=-
 444.486283966427 V3=0 T=0 M2=0 M3=39.4998274800535 S11Max=69.8062242790359 PtS11Max=1 x2S11Max=-0.5
 x3S11Max=-0.5 _
 S11Min=-602.093499962953 PtS11Min=3 x2S11Min=0.5 x3S11Min=-0.5 FrameElem=4 ElemStation=0
 Frame=4 Station=0.0625 OutputCase=ENVE CaseType=Combination StepType=Min P=-240.528987364653 V2=-
 442.923783966427 V3=0 T=0 M2=0 M3=66.5082643446691 S11Max=231.85684546673 PtS11Max=1 x2S11Max=-0.5
 x3S11Max=-0.5 _
 S11Min=-768.482887700363 PtS11Min=3 x2S11Min=0.5 x3S11Min=-0.5 FrameElem=4 ElemStation=0.0625
 Frame=4 Station=0.125 OutputCase=ENVE CaseType=Combination StepType=Min P=-240.528987364653 V2=-
 441.361283966427 V3=0 T=0 M2=0 M3=93.4190449592848 S11Max=393.321529154424 PtS11Max=1 x2S11Max=-0.5
 x3S11Max=-0.5 _
 S11Min=-934.286337937773 PtS11Min=3 x2S11Min=0.5 x3S11Min=-0.5 FrameElem=4 ElemStation=0.125



Frame=4 Station=0.1875 OutputCase=ENVE CaseType=Combination StepType=Min P=-240.528987364653 V2=-439.798783966427 V3=0 T=0 M2=0 M3=120.2321693239 S11Max=554.200275342118 PtS11Max=1 x2S11Max=-0.5 x3S11Max=-0.5
 S11Min=-1099.50385067518 PtS11Min=3 x2S11Min=0.5 x3S11Min=-0.5 FrameElem=4 ElemStation=0.1875
 Frame=4 Station=0.25 OutputCase=ENVE CaseType=Combination StepType=Min P=-240.528987364653 V2=-438.236283966427 V3=0 T=0 M2=0 M3=146.947637438516 S11Max=714.493084029812 PtS11Max=1 x2S11Max=-0.5 x3S11Max=-0.5
 S11Min=-1264.13542591259 PtS11Min=3 x2S11Min=0.5 x3S11Min=-0.5 FrameElem=4 ElemStation=0.25
 Frame=4 Station=0 OutputCase=FESSUR CaseType=Combination P=-239.15192283725 V2=-441.043181759879 V3=0 T=0 M2=0 M3=59.8242795617211 S11Max=119.793754533076 PtS11Max=1 x2S11Max=-0.5 x3S11Max=-0.5
 S11Min=-598.097600207577 PtS11Min=3 x2S11Min=0.5 x3S11Min=-0.5 FrameElem=4 ElemStation=0
 Frame=4 Station=0.0625 OutputCase=FESSUR CaseType=Combination P=-239.15192283725 V2=-439.480681759879 V3=0 T=0 M2=0 M3=87.3406502967135 S11Max=284.891978943031 PtS11Max=1 x2S11Max=-0.5 x3S11Max=-0.5
 S11Min=-763.195824617532 PtS11Min=3 x2S11Min=0.5 x3S11Min=-0.5 FrameElem=4 ElemStation=0.0625
 Frame=4 Station=0.125 OutputCase=FESSUR CaseType=Combination P=-239.15192283725 V2=-437.918181759879 V3=0 T=0 M2=0 M3=114.759364781706 S11Max=449.404265852985 PtS11Max=1 x2S11Max=-0.5 x3S11Max=-0.5
 S11Min=-927.70811527486 PtS11Min=3 x2S11Min=0.5 x3S11Min=-0.5 FrameElem=4 ElemStation=0.125
 Frame=4 Station=0.1875 OutputCase=FESSUR CaseType=Combination P=-239.15192283725 V2=-436.355681759879 V3=0 T=0 M2=0 M3=142.080423016698 S11Max=613.33061526294 PtS11Max=1 x2S11Max=-0.5 x3S11Max=-0.5
 S11Min=-1091.63446093744 PtS11Min=3 x2S11Min=0.5 x3S11Min=-0.5 FrameElem=4 ElemStation=0.1875
 Frame=4 Station=0.25 OutputCase=FESSUR CaseType=Combination P=-239.15192283725 V2=-434.793181759879 V3=0 T=0 M2=0 M3=169.303825001691 S11Max=776.671027172894 PtS11Max=1 x2S11Max=-0.5 x3S11Max=-0.5
 S11Min=-1254.9748728474 PtS11Min=3 x2S11Min=0.5 x3S11Min=-0.5 FrameElem=4 ElemStation=0.25
 Frame=5 Station=0 OutputCase=PERM1 CaseType=Combination P=-235.938772273306 V2=-484.669007922395 V3=0 T=0 M2=0 M3=166.276912792588 S11Max=761.722704482222 PtS11Max=1 x2S11Max=-0.5 x3S11Max=-0.5
 S11Min=-1233.60024902883 PtS11Min=3 x2S11Min=0.5 x3S11Min=-0.5 FrameElem=5 ElemStation=0
 Frame=5 Station=6.24999940395355E-02 OutputCase=PERM1 CaseType=Combination P=-235.938772273306 V2=-483.106508071406 V3=0 T=0 M2=0 M3=196.519894783199 S11Max=943.180596425885 PtS11Max=1 x2S11Max=-0.5 x3S11Max=-0.5
 S11Min=-1415.0581409725 PtS11Min=3 x2S11Min=0.5 x3S11Min=-0.5 FrameElem=5
 ElemStation=6.24999940395355E-02
 Frame=5 Station=0.124999988079071 OutputCase=PERM1 CaseType=Combination P=-235.938772273306 V2=-481.544008220418 V3=0 T=0 M2=0 M3=226.665220542436 S11Max=1124.05255098131 PtS11Max=1 x2S11Max=-0.5 x3S11Max=-0.5
 S11Min=-1595.93009552792 PtS11Min=3 x2S11Min=0.5 x3S11Min=-0.5 FrameElem=5
 ElemStation=0.124999988079071
 Frame=5 Station=0.187499982118607 OutputCase=PERM1 CaseType=Combination P=-235.938772273306 V2=-479.98150836943 V3=0 T=0 M2=0 M3=256.712890070299 S11Max=1304.33856814849 PtS11Max=1 x2S11Max=-0.5 x3S11Max=-0.5
 S11Min=-1776.2161126951 PtS11Min=3 x2S11Min=0.5 x3S11Min=-0.5 FrameElem=5
 ElemStation=0.187499982118607
 Frame=5 Station=0.249999976158142 OutputCase=PERM1 CaseType=Combination P=-235.938772273306 V2=-478.419008518441 V3=0 T=0 M2=0 M3=286.662903366789 S11Max=1484.03864792743 PtS11Max=1 x2S11Max=-0.5 x3S11Max=-0.5
 S11Min=-1955.91619247404 PtS11Min=3 x2S11Min=0.5 x3S11Min=-0.5 FrameElem=5
 ElemStation=0.249999976158142
 Frame=5 Station=0 OutputCase=PERM2 CaseType=Combination P=-169.465538592137 V2=-484.637175757692 V3=0 T=0 M2=0 M3=151.883625753982 S11Max=741.836215931754 PtS11Max=1 x2S11Max=-0.5 x3S11Max=-0.5
 S11Min=-1080.76729311603 PtS11Min=3 x2S11Min=0.5 x3S11Min=-0.5 FrameElem=5 ElemStation=0
 Frame=5 Station=6.24999940395355E-02 OutputCase=PERM2 CaseType=Combination P=-169.465538592137 V2=-483.074675906703 V3=0 T=0 M2=0 M3=182.124618234488 S11Max=923.282170814792 PtS11Max=1 x2S11Max=-0.5 x3S11Max=-0.5
 S11Min=-1262.21324799907 PtS11Min=3 x2S11Min=0.5 x3S11Min=-0.5 FrameElem=5
 ElemStation=6.24999940395355E-02
 Frame=5 Station=0.124999988079071 OutputCase=PERM2 CaseType=Combination P=-169.465538592137 V2=-481.512176055715 V3=0 T=0 M2=0 M3=212.267954483621 S11Max=1104.14218830959 PtS11Max=1 x2S11Max=-0.5 x3S11Max=-0.5
 S11Min=-1443.07326549386 PtS11Min=3 x2S11Min=0.5 x3S11Min=-0.5 FrameElem=5
 ElemStation=0.124999988079071
 Frame=5 Station=0.187499982118607 OutputCase=PERM2 CaseType=Combination P=-169.465538592137 V2=-479.949676204727 V3=0 T=0 M2=0 M3=242.31363450138 S11Max=1284.41626841614 PtS11Max=1 x2S11Max=-0.5 x3S11Max=-0.5
 S11Min=-1623.34734560042 PtS11Min=3 x2S11Min=0.5 x3S11Min=-0.5 FrameElem=5
 ElemStation=0.187499982118607
 Frame=5 Station=0.249999976158142 OutputCase=PERM2 CaseType=Combination P=-169.465538592137 V2=-478.387176353738 V3=0 T=0 M2=0 M3=272.261658287766 S11Max=1464.10441113446 PtS11Max=1 x2S11Max=-0.5 x3S11Max=-0.5
 S11Min=-1803.03548831873 PtS11Min=3 x2S11Min=0.5 x3S11Min=-0.5 FrameElem=5
 ElemStation=0.249999976158142
 Frame=5 Station=0 OutputCase=ACC1 CaseType=Combination P=-240.528987364648 V2=-497.525711157012 V3=0 T=0 M2=0 M3=170.601073091364 S11Max=783.077451183533 PtS11Max=1 x2S11Max=-0.5 x3S11Max=-0.5
 S11Min=-1264.13542591283 PtS11Min=3 x2S11Min=0.5 x3S11Min=-0.5 FrameElem=5 ElemStation=0
 Frame=5 Station=6.24999940395355E-02 OutputCase=ACC1 CaseType=Combination P=-240.528987364648 V2=-495.963211306024 V3=0 T=0 M2=0 M3=201.647598957506 S11Max=969.356606380386 PtS11Max=1 x2S11Max=-0.5 x3S11Max=-0.5
 S11Min=-1450.41458110968 PtS11Min=3 x2S11Min=0.5 x3S11Min=-0.5 FrameElem=5
 ElemStation=6.24999940395355E-02
 Frame=5 Station=0.124999988079071 OutputCase=ACC1 CaseType=Combination P=-240.528987364648 V2=-494.400711455035 V3=0 T=0 M2=0 M3=232.596468592274 S11Max=1155.049824189 PtS11Max=1 x2S11Max=-0.5 x3S11Max=-0.5
 S11Min=-1636.10779891829 PtS11Min=3 x2S11Min=0.5 x3S11Min=-0.5 FrameElem=5
 ElemStation=0.124999988079071



Frame=5 Station=0.187499982118607 OutputCase=ACC1 CaseType=Combination P=-240.528987364648 V2=-
 492.838211604047 V3=0 T=0 M2=0 M3=263.447681995669 S11Max=1340.15710460937 PtS11Max=1 x2S11Max=-0.5
 x3S11Max=-0.5 _
 S11Min=-1821.21507933866 PtS11Min=3 x2S11Min=0.5 x3S11Min=-0.5 FrameElem=5
 ElemStation=0.187499982118607
 Frame=5 Station=0.249999976158142 OutputCase=ACC1 CaseType=Combination P=-240.528987364648 V2=-
 491.275711753058 V3=0 T=0 M2=0 M3=294.201239167691 S11Max=1524.6784476415 PtS11Max=1 x2S11Max=-0.5
 x3S11Max=-0.5 _
 S11Min=-2005.73642237079 PtS11Min=3 x2S11Min=0.5 x3S11Min=-0.5 FrameElem=5
 ElemStation=0.249999976158142
 Frame=5 Station=0 OutputCase=ACC2 CaseType=Combination P=-174.055753683479 V2=-497.493878992309 V3=0
 T=0 M2=0 M3=156.207786052757 S11Max=763.190962633065 PtS11Max=1 x2S11Max=-0.5 x3S11Max=-0.5 _
 S11Min=-1111.30247000002 PtS11Min=3 x2S11Min=0.5 x3S11Min=-0.5 FrameElem=5 ElemStation=0
 Frame=5 Station=6.24999940395355E-02 OutputCase=ACC2 CaseType=Combination P=-174.055753683479 V2=-
 495.931379141321 V3=0 T=0 M2=0 M3=187.252322408795 S11Max=949.458180769293 PtS11Max=1 x2S11Max=-0.5
 x3S11Max=-0.5 _
 S11Min=-1297.56968813625 PtS11Min=3 x2S11Min=0.5 x3S11Min=-0.5 FrameElem=5
 ElemStation=6.24999940395355E-02
 Frame=5 Station=0.124999988079071 OutputCase=ACC2 CaseType=Combination P=-174.055753683479 V2=-
 494.368879290332 V3=0 T=0 M2=0 M3=218.19920253346 S11Max=1135.13946151728 PtS11Max=1 x2S11Max=-0.5
 x3S11Max=-0.5 _
 S11Min=-1483.25096888424 PtS11Min=3 x2S11Min=0.5 x3S11Min=-0.5 FrameElem=5
 ElemStation=0.124999988079071
 Frame=5 Station=0.187499982118607 OutputCase=ACC2 CaseType=Combination P=-174.055753683479 V2=-
 492.806379439344 V3=0 T=0 M2=0 M3=249.048426426751 S11Max=1320.23480487702 PtS11Max=1 x2S11Max=-0.5
 x3S11Max=-0.5 _
 S11Min=-1668.34631224398 PtS11Min=3 x2S11Min=0.5 x3S11Min=-0.5 FrameElem=5
 ElemStation=0.187499982118607
 Frame=5 Station=0.249999976158142 OutputCase=ACC2 CaseType=Combination P=-174.055753683479 V2=-
 491.243879588355 V3=0 T=0 M2=0 M3=279.799994088668 S11Max=1504.74421084853 PtS11Max=1 x2S11Max=-0.5
 x3S11Max=-0.5 _
 S11Min=-1852.85571821549 PtS11Min=3 x2S11Min=0.5 x3S11Min=-0.5 FrameElem=5
 ElemStation=0.249999976158142
 Frame=5 Station=0 OutputCase=ACCSX1 CaseType=Combination P=-233.66597428245 V2=-485.635726123917 V3=0
 T=0 M2=0 M3=161.340924477163 S11Max=734.379572580527 PtS11Max=1 x2S11Max=-0.5 x3S11Max=-0.5 _
 S11Min=-1201.71152114543 PtS11Min=3 x2S11Min=0.5 x3S11Min=-0.5 FrameElem=5 ElemStation=0
 Frame=5 Station=6.24999940395355E-02 OutputCase=ACCSX1 CaseType=Combination P=-233.66597428245 V2=-
 484.073226272929 V3=0 T=0 M2=0 M3=191.644326349606 S11Max=916.199983815188 PtS11Max=1 x2S11Max=-0.5 _
 x3S11Max=-0.5 S11Min=-1383.53193238009 PtS11Min=3 x2S11Min=0.5 x3S11Min=-0.5 FrameElem=5
 ElemStation=6.24999940395355E-02
 Frame=5 Station=0.124999988079071 OutputCase=ACCSX1 CaseType=Combination P=-233.66597428245 V2=-
 482.510726421941 V3=0 T=0 M2=0 M3=221.850071990676 S11Max=1097.43445766161 PtS11Max=1 x2S11Max=-0.5
 x3S11Max=-0.5 _
 S11Min=-1564.76640622651 PtS11Min=3 x2S11Min=0.5 x3S11Min=-0.5 FrameElem=5
 ElemStation=0.124999988079071
 Frame=5 Station=0.187499982118607 OutputCase=ACCSX1 CaseType=Combination P=-233.66597428245 V2=-
 480.948226570952 V3=0 T=0 M2=0 M3=251.958161400373 S11Max=1278.08299411979 PtS11Max=1 x2S11Max=-0.5
 x3S11Max=-0.5 _
 S11Min=-1745.41494268469 PtS11Min=3 x2S11Min=0.5 x3S11Min=-0.5 FrameElem=5
 ElemStation=0.187499982118607
 Frame=5 Station=0.249999976158142 OutputCase=ACCSX1 CaseType=Combination P=-233.66597428245 V2=-
 479.385726719964 V3=0 T=0 M2=0 M3=281.968594578696 S11Max=1458.14559318972 PtS11Max=1 x2S11Max=-0.5
 x3S11Max=-0.5 _
 S11Min=-1925.47754175463 PtS11Min=3 x2S11Min=0.5 x3S11Min=-0.5 FrameElem=5
 ElemStation=0.249999976158142
 Frame=5 Station=0 OutputCase=ACCSX2 CaseType=Combination P=-167.192740601281 V2=-485.603893959215
 V3=0 T=0 M2=0 M3=146.947637438557 S11Max=714.493084030059 PtS11Max=1 x2S11Max=-0.5 x3S11Max=-0.5 _
 S11Min=-1048.87856523262 PtS11Min=3 x2S11Min=0.5 x3S11Min=-0.5 FrameElem=5 ElemStation=0
 Frame=5 Station=6.24999940395355E-02 OutputCase=ACCSX2 CaseType=Combination P=-167.192740601281 V2=-
 484.041394108226 V3=0 T=0 M2=0 M3=177.249049800896 S11Max=896.301558204095 PtS11Max=1 x2S11Max=-0.5 _
 x3S11Max=-0.5 S11Min=-1230.68703940666 PtS11Min=3 x2S11Min=0.5 x3S11Min=-0.5 FrameElem=5
 ElemStation=6.24999940395355E-02
 Frame=5 Station=0.124999988079071 OutputCase=ACCSX2 CaseType=Combination P=-167.192740601281 V2=-
 482.478894257238 V3=0 T=0 M2=0 M3=207.452805931862 S11Max=1077.52409498989 PtS11Max=1 x2S11Max=-0.5
 x3S11Max=-0.5 _
 S11Min=-1411.90957619245 PtS11Min=3 x2S11Min=0.5 x3S11Min=-0.5 FrameElem=5
 ElemStation=0.124999988079071
 Frame=5 Station=0.187499982118607 OutputCase=ACCSX2 CaseType=Combination P=-167.192740601281 V2=-
 480.916394406249 V3=0 T=0 M2=0 M3=237.558905831454 S11Max=1258.16069438744 PtS11Max=1 x2S11Max=-0.5
 x3S11Max=-0.5 _
 S11Min=-1592.54617559001 PtS11Min=3 x2S11Min=0.5 x3S11Min=-0.5 FrameElem=5
 ElemStation=0.187499982118607
 Frame=5 Station=0.249999976158142 OutputCase=ACCSX2 CaseType=Combination P=-167.192740601281 V2=-
 479.35389455261 V3=0 T=0 M2=0 M3=267.567349499673 S11Max=1438.21135639676 PtS11Max=1 x2S11Max=-0.5
 x3S11Max=-0.5 _
 S11Min=-1772.59683759932 PtS11Min=3 x2S11Min=0.5 x3S11Min=-0.5 FrameElem=5
 ElemStation=0.249999976158142
 Frame=5 Station=0 OutputCase=ENVE CaseType=Combination StepType=Max P=-167.192740601281 V2=-
 484.637175757692 V3=0 T=0 M2=0 M3=170.601073091364 S11Max=783.077451183533 PtS11Max=1 x2S11Max=-0.5
 x3S11Max=-0.5 _
 S11Min=-1048.87856523262 PtS11Min=3 x2S11Min=0.5 x3S11Min=-0.5 FrameElem=5 ElemStation=0



Frame=5 Station=6.24999940395355E-02 OutputCase=ENVE CaseType=Combination StepType=Max P=-167.192740601281 V2=-483.074675906703 V3=0 T=0 M2=0 M3=201.647598957506 S11Max=969.356606380386
 PtS11Max=1 x2S11Max=-0.5
 x3S11Max=-0.5 S11Min=-1230.68703940666 PtS11Min=3 x2S11Min=0.5 x3S11Min=-0.5 FrameElem=5
 ElemStation=6.24999940395355E-02
 Frame=5 Station=0.124999988079071 OutputCase=ENVE CaseType=Combination StepType=Max P=-167.192740601281 V2=-481.512176055715 V3=0 T=0 M2=0 M3=232.596468592274 S11Max=1155.049824189 PtS11Max=1 x2S11Max=-0.5
 x3S11Max=-0.5 S11Min=-1411.90957619245 PtS11Min=3 x2S11Min=0.5 x3S11Min=-0.5 FrameElem=5
 ElemStation=0.124999988079071
 Frame=5 Station=0.187499982118607 OutputCase=ENVE CaseType=Combination StepType=Max P=-167.192740601281 V2=-479.949676204727 V3=0 T=0 M2=0 M3=263.447681995669 S11Max=1340.15710460937 PtS11Max=1 x2S11Max=-0.5
 x3S11Max=-0.5 S11Min=-1592.54617559001 PtS11Min=3 x2S11Min=0.5 x3S11Min=-0.5 FrameElem=5
 ElemStation=0.187499982118607
 Frame=5 Station=0.249999976158142 OutputCase=ENVE CaseType=Combination StepType=Max P=-167.192740601281 V2=-478.387176353738 V3=0 T=0 M2=0 M3=294.201239167691 S11Max=1524.6784476415 PtS11Max=1 x2S11Max=-0.5
 x3S11Max=-0.5 S11Min=-1772.59683759932 PtS11Min=3 x2S11Min=0.5 x3S11Min=-0.5 FrameElem=5
 ElemStation=0.249999976158142
 Frame=5 Station=0 OutputCase=ENVE CaseType=Combination StepType=Min P=-240.528987364648 V2=-497.525711157012 V3=0 T=0 M2=0 M3=146.947637438557 S11Max=714.493084030059 PtS11Max=1 x2S11Max=-0.5
 x3S11Max=-0.5
 S11Min=-1264.13542591283 PtS11Min=3 x2S11Min=0.5 x3S11Min=-0.5 FrameElem=5 ElemStation=0
 Frame=5 Station=6.24999940395355E-02 OutputCase=ENVE CaseType=Combination StepType=Min P=-240.528987364648 V2=-497.525711157012 V3=0 T=0 M2=0 M3=177.249049800896 S11Max=896.301558204095
 PtS11Max=1 x2S11Max=-0.5
 x3S11Max=-0.5 S11Min=-1450.41458110968 PtS11Min=3 x2S11Min=0.5 x3S11Min=-0.5 FrameElem=5
 ElemStation=6.24999940395355E-02
 Frame=5 Station=0.124999988079071 OutputCase=ENVE CaseType=Combination StepType=Min P=-240.528987364648 V2=-494.400711455035 V3=0 T=0 M2=0 M3=207.452805931862 S11Max=1077.52409498989 PtS11Max=1 x2S11Max=-0.5
 x3S11Max=-0.5 S11Min=-1636.10779891829 PtS11Min=3 x2S11Min=0.5 x3S11Min=-0.5 FrameElem=5
 ElemStation=0.124999988079071
 Frame=5 Station=0.187499982118607 OutputCase=ENVE CaseType=Combination StepType=Min P=-240.528987364648 V2=-492.838211604047 V3=0 T=0 M2=0 M3=237.558905831454 S11Max=1258.16069438744 PtS11Max=1 x2S11Max=-0.5
 x3S11Max=-0.5 S11Min=-1821.21507933866 PtS11Min=3 x2S11Min=0.5 x3S11Min=-0.5 FrameElem=5
 ElemStation=0.187499982118607
 Frame=5 Station=0.249999976158142 OutputCase=ENVE CaseType=Combination StepType=Min P=-240.528987364648 V2=-491.275711753058 V3=0 T=0 M2=0 M3=267.567349499673 S11Max=1438.21135639676 PtS11Max=1 x2S11Max=-0.5
 x3S11Max=-0.5 S11Min=-2005.73642237079 PtS11Min=3 x2S11Min=0.5 x3S11Min=-0.5 FrameElem=5
 ElemStation=0.249999976158142
 Frame=5 Station=0 OutputCase=FESSUR CaseType=Combination P=-239.151922837246 V2=-493.668700186627 V3=0 T=0 M2=0 M3=169.303825001731 S11Max=776.67102717314 PtS11Max=1 x2S11Max=-0.5 x3S11Max=-0.5
 S11Min=-1254.97487284763 PtS11Min=3 x2S11Min=0.5 x3S11Min=-0.5 FrameElem=5 ElemStation=0
 Frame=5 Station=6.24999940395355E-02 OutputCase=FESSUR CaseType=Combination P=-239.151922837246 V2=-492.106200335638 V3=0 T=0 M2=0 M3=200.109287705214 S11Max=961.503803394036 PtS11Max=1 x2S11Max=-0.5
 x3S11Max=-0.5 S11Min=-1439.80764906853 PtS11Min=3 x2S11Min=0.5 x3S11Min=-0.5 FrameElem=5
 ElemStation=6.24999940395355E-02
 Frame=5 Station=0.124999988079071 OutputCase=FESSUR CaseType=Combination P=-239.151922837246 V2=-490.54370048465 V3=0 T=0 M2=0 M3=230.817094177323 S11Max=1145.75064222669 PtS11Max=1 x2S11Max=-0.5
 x3S11Max=-0.5 S11Min=-1624.05448790118 PtS11Min=3 x2S11Min=0.5 x3S11Min=-0.5 FrameElem=5
 ElemStation=0.124999988079071
 Frame=5 Station=0.187499982118607 OutputCase=FESSUR CaseType=Combination P=-239.151922837246 V2=-488.981200633662 V3=0 T=0 M2=0 M3=261.427244418058 S11Max=1329.4115436711 PtS11Max=1 x2S11Max=-0.5
 x3S11Max=-0.5 S11Min=-1807.7153893456 PtS11Min=3 x2S11Min=0.5 x3S11Min=-0.5 FrameElem=5
 ElemStation=0.187499982118607
 Frame=5 Station=0.249999976158142 OutputCase=FESSUR CaseType=Combination P=-239.151922837246 V2=-487.418700782673 V3=0 T=0 M2=0 M3=291.93973842742 S11Max=1512.48650772728 PtS11Max=1 x2S11Max=-0.5
 x3S11Max=-0.5 S11Min=-1990.79035340177 PtS11Min=3 x2S11Min=0.5 x3S11Min=-0.5 FrameElem=5
 ElemStation=0.249999976158142
 Frame=6 Station=0 OutputCase=PERM1 CaseType=Combination P=-501.24999658045 V2=-162.220256649895 V3=0 T=0 M2=0 M3=-243.114140292338 S11Max=957.43484517358 PtS11Max=3 x2S11Max=0.5 x3S11Max=-0.5
 S11Min=-1959.93483833448 PtS11Min=1 x2S11Min=-0.5 x3S11Min=-0.5 FrameElem=6 ElemStation=0
 Frame=6 Station=0.25 OutputCase=PERM1 CaseType=Combination P=-494.99999658045 V2=-138.71470977966 V3=0 T=0 M2=0 M3=-205.508373004335 S11Max=738.050241445561 PtS11Max=3 x2S11Max=0.5 x3S11Max=-0.5
 S11Min=-1728.05023460646 PtS11Min=1 x2S11Min=-0.5 x3S11Min=-0.5 FrameElem=6 ElemStation=0.25
 Frame=6 Station=0 OutputCase=PERM2 CaseType=Combination P=-501.249996306439 V2=-117.862577655749 V3=0 T=0 M2=0 M3=-240.700428243023 S11Max=942.952573151696 PtS11Max=3 x2S11Max=0.5 x3S11Max=-0.5
 S11Min=-1945.45256576457 PtS11Min=1 x2S11Min=-0.5 x3S11Min=-0.5 FrameElem=6 ElemStation=0
 Frame=6 Station=0.25 OutputCase=PERM2 CaseType=Combination P=-494.999996306439 V2=-101.408694846584 V3=0 T=0 M2=0 M3=-213.299291641215 S11Max=784.79575354085 PtS11Max=3 x2S11Max=0.5 x3S11Max=-0.5
 S11Min=-1774.79574615373 PtS11Min=1 x2S11Min=-0.5 x3S11Min=-0.5 FrameElem=6 ElemStation=0.25
 Frame=6 Station=0 OutputCase=ACCL CaseType=Combination P=-514.799996481456 V2=-166.232971741238 V3=0 T=0 M2=0 M3=-249.577110143463 S11Max=982.662664379322 PtS11Max=3 x2S11Max=0.5 x3S11Max=-0.5
 S11Min=-2012.26265734223 PtS11Min=1 x2S11Min=-0.5 x3S11Min=-0.5 FrameElem=6 ElemStation=0

```

Frame=6 Station=0.25 OutputCase=ACC1 CaseType=Combination P=-508.549996481456 V2=-142.149924871003
V3=0 T=0 M2=0 M3=-211.040351582624 S11Max=757.692113014288 PtS11Max=3 x2S11Max=0.5 x3S11Max=-0.5 _
S11Min=-1774.7921059772 PtS11Min=1 x2S11Min=-0.5 x3S11Min=-0.5 FrameElem=6 ElemStation=0.25
Frame=6 Station=0 OutputCase=ACC2 CaseType=Combination P=-514.799996207445 V2=-121.875292747091 V3=0
T=0 M2=0 M3=-247.163398094147 S11Max=968.180392357438 PtS11Max=3 x2S11Max=0.5 x3S11Max=-0.5 _
S11Min=-1997.78038477233 PtS11Min=1 x2S11Min=-0.5 x3S11Min=-0.5 FrameElem=6 ElemStation=0
Frame=6 Station=0.25 OutputCase=ACC2 CaseType=Combination P=-508.549996207445 V2=-104.843909937927
V3=0 T=0 M2=0 M3=-218.831270219504 S11Max=804.437625109577 PtS11Max=3 x2S11Max=0.5 x3S11Max=-0.5 _
S11Min=-1821.53761752447 PtS11Min=1 x2S11Min=-0.5 x3S11Min=-0.5 FrameElem=6 ElemStation=0.25
Frame=6 Station=0.25 OutputCase=ACCSX1 CaseType=Combination P=-502.76407418589 V2=-159.94745865904 V3=0
T=0 M2=0 M3=-238.988031038058 S11Max=931.164112042461 PtS11Max=3 x2S11Max=0.5 x3S11Max=-0.5 _
S11Min=-1936.69226041424 PtS11Min=1 x2S11Min=-0.5 x3S11Min=-0.5 FrameElem=6 ElemStation=0
Frame=6 Station=0.25 OutputCase=ACCSX1 CaseType=Combination P=-496.51407418589 V2=-115.589779664893
V3=0 T=0 M2=0 M3=-201.950463247769 S11Max=715.188705300725 PtS11Max=3 x2S11Max=0.5 x3S11Max=-0.5 _
S11Min=-1708.2168536725 PtS11Min=1 x2S11Min=-0.5 x3S11Min=-0.5 FrameElem=6 ElemStation=0.25
Frame=6 Station=0.25 OutputCase=ACCSX2 CaseType=Combination P=-502.764073911878 V2=-115.589779664893
V3=0 T=0 M2=0 M3=-236.574318988743 S11Max=916.681840020577 PtS11Max=3 x2S11Max=0.5 x3S11Max=-0.5 _
S11Min=-1922.20998784433 PtS11Min=1 x2S11Min=-0.5 x3S11Min=-0.5 FrameElem=6 ElemStation=0
Frame=6 Station=0.25 OutputCase=ACCSX2 CaseType=Combination P=-496.514073911878 V2=-99.1358968557285
V3=0 T=0 M2=0 M3=-209.741381884649 S11Max=761.934217396014 PtS11Max=3 x2S11Max=0.5 x3S11Max=-0.5 _
S11Min=-1754.96236521977 PtS11Min=1 x2S11Min=-0.5 x3S11Min=-0.5 FrameElem=6 ElemStation=0.25
Frame=6 Station=0 OutputCase=ENVE CaseType=Combination StepType=Max P=-501.249996306439 V2=-
115.589779664893 V3=0 T=0 M2=0 M3=-236.574318988743 S11Max=982.662664379322 PtS11Max=3 x2S11Max=0.5
x3S11Max=-0.5 _
S11Min=-1922.20998784433 PtS11Min=1 x2S11Min=-0.5 x3S11Min=-0.5 FrameElem=6 ElemStation=0
Frame=6 Station=0.25 OutputCase=ENVE CaseType=Combination StepType=Max P=-494.999996306439 V2=-
99.1358968557285 V3=0 T=0 M2=0 M3=-201.950463247769 S11Max=804.437625109577 PtS11Max=3 x2S11Max=0.5
x3S11Max=-0.5 _
S11Min=-1708.2168536725 PtS11Min=1 x2S11Min=-0.5 x3S11Min=-0.5 FrameElem=6 ElemStation=0.25
Frame=6 Station=0 OutputCase=ENVE CaseType=Combination StepType=Min P=-514.799996481456 V2=-
166.232971741238 V3=0 T=0 M2=0 M3=-249.577110143463 S11Max=916.681840020577 PtS11Max=3 x2S11Max=0.5
x3S11Max=-0.5 _
S11Min=-2012.26265734223 PtS11Min=1 x2S11Min=-0.5 x3S11Min=-0.5 FrameElem=6 ElemStation=0
Frame=6 Station=0.25 OutputCase=ENVE CaseType=Combination StepType=Min P=-508.549996481456 V2=-
142.149924871003 V3=0 T=0 M2=0 M3=-218.831270219504 S11Max=715.188705300725 PtS11Max=3 x2S11Max=0.5
x3S11Max=-0.5 _
S11Min=-1821.53761752447 PtS11Min=1 x2S11Min=-0.5 x3S11Min=-0.5 FrameElem=6 ElemStation=0.25
Frame=6 Station=0 OutputCase=FESSUR CaseType=Combination P=-510.734996511154 V2=-165.029157213835
V3=0 T=0 M2=0 M3=-247.638219188126 S11Max=975.094318617599 PtS11Max=3 x2S11Max=0.5 x3S11Max=-0.5 _
S11Min=-1996.56431163991 PtS11Min=1 x2S11Min=-0.5 x3S11Min=-0.5 FrameElem=6 ElemStation=0
Frame=6 Station=0.25 OutputCase=FESSUR CaseType=Combination P=-504.484996511154 V2=-141.1193603436
V3=0 T=0 M2=0 M3=-209.380758009137 S11Max=751.79955154367 PtS11Max=3 x2S11Max=0.5 x3S11Max=-0.5 _
S11Min=-1760.76954456598 PtS11Min=1 x2S11Min=-0.5 x3S11Min=-0.5 FrameElem=6 ElemStation=0.25
Frame=9 Station=0 OutputCase=PERM1 CaseType=Combination P=-419.999986873483 V2=101.7803299697 V3=0
T=0 M2=0 M3=-169.293607414626 S11Max=595.761657614272 PtS11Max=3 x2S11Max=0.5 x3S11Max=-0.5 _
S11Min=-1435.76163136124 PtS11Min=1 x2S11Min=-0.5 x3S11Min=-0.5 FrameElem=9 ElemStation=0
Frame=9 Station=0.2500000000000002 OutputCase=PERM1 CaseType=Combination P=-413.749985292582
V2=118.357282452591 V3=0 T=0 M2=0 M3=-196.821912483104 S11Max=767.18148960604 PtS11Max=3 x2S11Max=0.5
x3S11Max=-0.5 _
S11Min=-1594.6814601912 PtS11Min=1 x2S11Min=-0.5 x3S11Min=-0.5 FrameElem=9
ElemStation=0.2500000000000002
Frame=9 Station=0 OutputCase=PERM2 CaseType=Combination P=-419.99998992231 V2=66.9378449942669 V3=0
T=0 M2=0 M3=-175.02375845366 S11Max=630.14256079965 PtS11Max=3 x2S11Max=0.5 x3S11Max=-0.5 _
S11Min=-1470.14254064427 PtS11Min=1 x2S11Min=-0.5 x3S11Min=-0.5 FrameElem=9 ElemStation=0
Frame=9 Station=0.2500000000000002 OutputCase=PERM2 CaseType=Combination P=-413.749988815679
V2=78.5417115534765 V3=0 T=0 M2=0 M3=-193.216475483112 S11Max=745.548864082992 PtS11Max=3 x2S11Max=0.5
x3S11Max=-0.5 _
S11Min=-1573.04884171435 PtS11Min=1 x2S11Min=-0.5 x3S11Min=-0.5 FrameElem=9
ElemStation=0.2500000000000002
Frame=9 Station=0 OutputCase=ACC1 CaseType=Combination P=-433.549986441189 V2=105.275116170585 V3=0
T=0 M2=0 M3=-174.914940395832 S11Max=615.939655933802 PtS11Max=3 x2S11Max=0.5 x3S11Max=-0.5 _
S11Min=-1483.03962881618 PtS11Min=1 x2S11Min=-0.5 x3S11Min=-0.5 FrameElem=9 ElemStation=0
Frame=9 Station=0.2500000000000002 OutputCase=ACC1 CaseType=Combination P=-427.299984805212
V2=122.429568653476 V3=0 T=0 M2=0 M3=-203.389129514531 S11Max=793.034792281973 PtS11Max=3 x2S11Max=0.5
x3S11Max=-0.5 _
S11Min=-1647.6347618924 PtS11Min=1 x2S11Min=-0.5 x3S11Min=-0.5 FrameElem=9
ElemStation=0.2500000000000002
Frame=9 Station=0 OutputCase=ACC2 CaseType=Combination P=-433.549989490016 V2=70.4326311951515 V3=0
T=0 M2=0 M3=-180.645091434866 S11Max=650.32055911918 PtS11Max=3 x2S11Max=0.5 x3S11Max=-0.5 _
S11Min=-1517.42053809921 PtS11Min=1 x2S11Min=-0.5 x3S11Min=-0.5 FrameElem=9 ElemStation=0
Frame=9 Station=0.2500000000000002 OutputCase=ACC2 CaseType=Combination P=-427.29998832831
V2=82.6139977543611 V3=0 T=0 M2=0 M3=-199.783692514539 S11Max=771.402166758924 PtS11Max=3 x2S11Max=0.5
x3S11Max=-0.5 _
S11Min=-1626.00214341554 PtS11Min=1 x2S11Min=-0.5 x3S11Min=-0.5 FrameElem=9
ElemStation=0.2500000000000002
Frame=9 Station=0 OutputCase=ACCSX1 CaseType=Combination P=-421.514064262161 V2=104.053128104946 V3=0
T=0 M2=0 M3=-172.554091594532 S11Max=613.810485305034 PtS11Max=3 x2S11Max=0.5 x3S11Max=-0.5 _
S11Min=-1456.83861382936 PtS11Min=1 x2S11Min=-0.5 x3S11Min=-0.5 FrameElem=9 ElemStation=0
Frame=9 Station=0.2500000000000002 OutputCase=ACCSX1 CaseType=Combination P=-415.264062681259
V2=120.630080587837 V3=0 T=0 M2=0 M3=-200.650596196822 S11Max=788.63951449967 PtS11Max=3 x2S11Max=0.5
x3S11Max=-0.5 _

```



S11Min=-1619.16763986219 PtS11Min=1 x2S11Min=-0.5 x3S11Min=-0.5 FrameElem=9
 ElemStation=0.250000000000002
 Frame=9 Station=0 OutputCase=ACCSX2 CaseType=Combination P=-421.514067310988 V2=69.2106431295123 V3=0
 T=0 M2=0 M3=-178.284242633567 S11Max=648.191388490411 PtS11Max=3 x2S11Max=0.5 x3S11Max=-0.5 _
 S11Min=-1491.21952311239 PtS11Min=1 x2S11Min=-0.5 x3S11Min=-0.5 FrameElem=9 ElemStation=0
 Frame=9 Station=0.250000000000002 OutputCase=ACCSX2 CaseType=Combination P=-415.264066204357
 V2=80.814509688722 V3=0 T=0 M2=0 M3=-197.04515919683 S11Max=767.006888976622 PtS11Max=3 x2S11Max=0.5
 x3S11Max=-0.5 _
 S11Min=-1597.53502138534 PtS11Min=1 x2S11Min=-0.5 x3S11Min=-0.5 FrameElem=9
 ElemStation=0.250000000000002
 Frame=9 Station=0 OutputCase=ENVE CaseType=Combination StepType=Max P=-419.99986873483
 V2=105.275116170585 V3=0 T=0 M2=0 M3=-169.293607414626 S11Max=650.32055911918 PtS11Max=3 x2S11Max=0.5
 x3S11Max=-0.5 _
 S11Min=-1435.76163136124 PtS11Min=1 x2S11Min=-0.5 x3S11Min=-0.5 FrameElem=9 ElemStation=0
 Frame=9 Station=0.250000000000002 OutputCase=ENVE CaseType=Combination StepType=Max P=-413.749985292582
 V2=122.429568653476 V3=0 T=0 M2=0 M3=-193.216475483112 S11Max=793.034792281973 PtS11Max=3 x2S11Max=0.5
 -
 x3S11Max=-0.5 S11Min=-1573.04884171435 PtS11Min=1 x2S11Min=-0.5 x3S11Min=-0.5 FrameElem=9
 ElemStation=0.250000000000002
 Frame=9 Station=0 OutputCase=ENVE CaseType=Combination StepType=Min P=-433.549989490016
 V2=66.9378449942669 V3=0 T=0 M2=0 M3=-180.645091434866 S11Max=595.761657614272 PtS11Max=3 x2S11Max=0.5
 x3S11Max=-0.5 _
 S11Min=-1517.42053809921 PtS11Min=1 x2S11Min=-0.5 x3S11Min=-0.5 FrameElem=9 ElemStation=0
 Frame=9 Station=0.250000000000002 OutputCase=ENVE CaseType=Combination StepType=Min P=-427.29998832831
 V2=78.5417115534765 V3=0 T=0 M2=0 M3=-203.389129514531 S11Max=745.548864082992 PtS11Max=3 x2S11Max=0.5
 -
 x3S11Max=-0.5 S11Min=-1647.6347618924 PtS11Min=1 x2S11Min=-0.5 x3S11Min=-0.5 FrameElem=9
 ElemStation=0.250000000000002
 Frame=9 Station=0 OutputCase=FESSUR CaseType=Combination P=-429.484986570877 V2=104.22668031032 V3=0
 T=0 M2=0 M3=-173.22854050147 S11Max=609.886256437943 PtS11Max=3 x2S11Max=0.5 x3S11Max=-0.5 _
 S11Min=-1468.8562295797 PtS11Min=1 x2S11Min=-0.5 x3S11Min=-0.5 FrameElem=9 ElemStation=0
 Frame=9 Station=0.250000000000002 OutputCase=FESSUR CaseType=Combination P=-423.234984951423
 V2=121.207882793211 V3=0 T=0 M2=0 M3=-201.418964405103 S11Max=785.278801479193 PtS11Max=3 x2S11Max=0.5
 x3S11Max=-0.5 _
 S11Min=-1631.74877138204 PtS11Min=1 x2S11Min=-0.5 x3S11Min=-0.5 FrameElem=9
 ElemStation=0.250000000000002
 Frame=10 Station=0 OutputCase=PERM1 CaseType=Combination P=-413.750007867853 V2=118.357203536039 V3=0
 T=0 M2=0 M3=-196.821912483103 S11Max=767.181467030767 PtS11Max=3 x2S11Max=0.5 x3S11Max=-0.5 _
 S11Min=-1594.68148276647 PtS11Min=1 x2S11Min=-0.5 x3S11Min=-0.5 FrameElem=10 ElemStation=0
 Frame=10 Station=0.249999976158143 OutputCase=PERM1 CaseType=Combination P=-407.50009993973
 V2=134.401186953186 V3=0 T=0 M2=0 M3=-228.427811793656 S11Max=963.066860767965 PtS11Max=3 x2S11Max=0.5
 x3S11Max=-0.5 _
 S11Min=-1778.06688075591 PtS11Min=1 x2S11Min=-0.5 x3S11Min=-0.5 FrameElem=10
 ElemStation=0.249999976158143
 Frame=10 Station=0 OutputCase=PERM2 CaseType=Combination P=-413.750003796733 V2=78.5416326369244 V3=0
 T=0 M2=0 M3=-193.216475483111 S11Max=745.548849101936 PtS11Max=3 x2S11Max=0.5 x3S11Max=-0.5 _
 S11Min=-1573.0488566954 PtS11Min=1 x2S11Min=-0.5 x3S11Min=-0.5 FrameElem=10 ElemStation=0
 Frame=10 Station=0.249999976158143 OutputCase=PERM2 CaseType=Combination P=-407.500005463831
 V2=89.7724212077414 V3=0 T=0 M2=0 M3=-214.263502665995 S11Max=878.081010532139 PtS11Max=3 x2S11Max=0.5
 x3S11Max=-0.5 _
 S11Min=-1693.0810214598 PtS11Min=1 x2S11Min=-0.5 x3S11Min=-0.5 FrameElem=10
 ElemStation=0.249999976158143
 Frame=10 Station=0 OutputCase=ACC1 CaseType=Combination P=-427.300008157243 V2=122.429487152466 V3=0
 T=0 M2=0 M3=-203.389129514532 S11Max=793.034768929948 PtS11Max=3 x2S11Max=0.5 x3S11Max=-0.5 _
 S11Min=-1647.63478524443 PtS11Min=1 x2S11Min=-0.5 x3S11Min=-0.5 FrameElem=10 ElemStation=0
 Frame=10 Station=0.249999976158143 OutputCase=ACC1 CaseType=Combination P=-421.050010338437
 V2=139.050970514538 V3=0 T=0 M2=0 M3=-236.085287118332 S11Max=995.461712371554 PtS11Max=3 x2S11Max=0.5
 x3S11Max=-0.5 _
 S11Min=-1837.56173304843 PtS11Min=1 x2S11Min=-0.5 x3S11Min=-0.5 FrameElem=10
 ElemStation=0.249999976158143
 Frame=10 Station=0 OutputCase=ACC2 CaseType=Combination P=-427.300004086123 V2=82.6139162533509 V3=0
 T=0 M2=0 M3=-199.78369251454 S11Max=771.402151001117 PtS11Max=3 x2S11Max=0.5 x3S11Max=-0.5 _
 S11Min=-1626.00215917336 PtS11Min=1 x2S11Min=-0.5 x3S11Min=-0.5 FrameElem=10 ElemStation=0
 Frame=10 Station=0.249999976158143 OutputCase=ACC2 CaseType=Combination P=-421.050005808296
 V2=94.4222047690932 V3=0 T=0 M2=0 M3=-221.920977990671 S11Max=910.475862135728 PtS11Max=3 x2S11Max=0.5
 x3S11Max=-0.5 _
 S11Min=-1752.57587375232 PtS11Min=1 x2S11Min=-0.5 x3S11Min=-0.5 FrameElem=10
 ElemStation=0.249999976158143
 Frame=10 Station=0 OutputCase=ACCSX1 CaseType=Combination P=-415.264085690051 V2=120.6300013825 V3=0
 T=0 M2=0 M3=-200.650596196822 S11Max=788.639491490883 PtS11Max=3 x2S11Max=0.5 x3S11Max=-0.5 _
 S11Min=-1619.16766287098 PtS11Min=1 x2S11Min=-0.5 x3S11Min=-0.5 FrameElem=10 ElemStation=0
 Frame=10 Station=0.249999976158143 OutputCase=ACCSX1 CaseType=Combination P=-409.014087816171
 V2=136.673984799647 V3=0 T=0 M2=0 M3=-232.824694914803 S11Max=987.934081672645 PtS11Max=3 x2S11Max=0.5
 x3S11Max=-0.5 _
 S11Min=-1805.96225730499 PtS11Min=1 x2S11Min=-0.5 x3S11Min=-0.5 FrameElem=10
 ElemStation=0.249999976158143
 Frame=10 Station=0 OutputCase=ACCSX2 CaseType=Combination P=-415.264081618931 V2=80.8144304833853
 V3=0 T=0 M2=0 M3=-197.04515919683 S11Max=767.006873562051 PtS11Max=3 x2S11Max=0.5 x3S11Max=-0.5 _
 S11Min=-1597.53503679991 PtS11Min=1 x2S11Min=-0.5 x3S11Min=-0.5 FrameElem=10 ElemStation=0
 Frame=10 Station=0.249999976158143 OutputCase=ACCSX2 CaseType=Combination P=-409.014083286029
 V2=92.0452190542023 V3=0 T=0 M2=0 M3=-218.660385787141 S11Max=902.948231436819 PtS11Max=3 x2S11Max=0.5
 x3S11Max=-0.5 _



S11Min=-1720.97639800888 PtS11Min=1 x2S11Min=-0.5 x3S11Min=-0.5 FrameElem=10
 ElemStation=0.24999976158143
 Frame=10 Station=0 OutputCase=ENVE CaseType=Combination StepType=Max P=-413.750003796733
 V2=122.429487152466 V3=0 T=0 M2=0 M3=-193.216475483111 S11Max=793.034768929948 PtS11Max=3 x2S11Max=0.5
 x3S11Max=-0.5 _
 S11Min=-1573.0488566954 PtS11Min=1 x2S11Min=-0.5 x3S11Min=-0.5 FrameElem=10 ElemStation=0
 Frame=10 Station=0.24999976158143 OutputCase=ENVE CaseType=Combination StepType=Max P=-
 407.500005463831 V2=139.050970514538 V3=0 T=0 M2=0 M3=-214.263502665995 S11Max=995.461712371554
 PtS11Max=3 x2S11Max=0.5 _
 x3S11Max=-0.5 S11Min=-1693.0810214598 PtS11Min=1 x2S11Min=-0.5 x3S11Min=-0.5 FrameElem=10
 ElemStation=0.24999976158143
 Frame=10 Station=0 OutputCase=ENVE CaseType=Combination StepType=Min P=-427.300008157243
 V2=78.5416326369244 V3=0 T=0 M2=0 M3=-203.389129514532 S11Max=745.548849101936 PtS11Max=3 x2S11Max=0.5
 x3S11Max=-0.5 _
 S11Min=-1647.63478524443 PtS11Min=1 x2S11Min=-0.5 x3S11Min=-0.5 FrameElem=10 ElemStation=0
 Frame=10 Station=0.24999976158143 OutputCase=ENVE CaseType=Combination StepType=Min P=-
 421.050010338437 V2=89.7724212077414 V3=0 T=0 M2=0 M3=-236.085287118332 S11Max=878.081010532139
 PtS11Max=3 x2S11Max=0.5 _
 x3S11Max=-0.5 S11Min=-1837.56173304843 PtS11Min=1 x2S11Min=-0.5 x3S11Min=-0.5 FrameElem=10
 ElemStation=0.24999976158143
 Frame=10 Station=0 OutputCase=FESSUR CaseType=Combination P=-423.235008070426 V2=121.207802067538
 V3=0 T=0 M2=0 M3=-201.418964405103 S11Max=785.278778360194 PtS11Max=3 x2S11Max=0.5 x3S11Max=-0.5 _
 S11Min=-1631.74879450105 PtS11Min=1 x2S11Min=-0.5 x3S11Min=-0.5 FrameElem=10 ElemStation=0
 Frame=10 Station=0.24999976158143 OutputCase=FESSUR CaseType=Combination P=-416.985010235098
 V2=137.656035446133 V3=0 T=0 M2=0 M3=-233.788044520929 S11Max=985.743256890477 PtS11Max=3 x2S11Max=0.5
 x3S11Max=-0.5 _
 S11Min=-1819.71327736067 PtS11Min=1 x2S11Min=-0.5 x3S11Min=-0.5 FrameElem=10
 ElemStation=0.24999976158143
 Frame=11 Station=0 OutputCase=PERM1 CaseType=Combination P=-507.500012814082 V2=186.258725785619 V3=0
 T=0 M2=0 M3=286.662905880606 S11Max=1212.47742246955 PtS11Max=1 x2S11Max=-0.5 x3S11Max=-0.5 _
 S11Min=-2227.47744809772 PtS11Min=3 x2S11Min=0.5 x3S11Min=-0.5 FrameElem=11 ElemStation=0
 Frame=11 Station=0.250000000000001 OutputCase=PERM1 CaseType=Combination P=-501.25001052159
 V2=162.220210756666 V3=0 T=0 M2=0 M3=243.114142328445 S11Max=957.434843449079 PtS11Max=1 x2S11Max=-0.5
 x3S11Max=-0.5 _
 S11Min=-1959.93486449226 PtS11Min=3 x2S11Min=0.5 x3S11Min=-0.5 FrameElem=11
 ElemStation=0.250000000000001
 Frame=11 Station=0 OutputCase=PERM2 CaseType=Combination P=-507.500008170067 V2=134.689491531065 V3=0
 T=0 M2=0 M3=272.261659822661 S11Max=1126.0699507659 PtS11Max=1 x2S11Max=-0.5 x3S11Max=-0.5 _
 S11Min=-2141.06996710603 PtS11Min=3 x2S11Min=0.5 x3S11Min=-0.5 FrameElem=11 ElemStation=0
 Frame=11 Station=0.250000000000001 OutputCase=PERM2 CaseType=Combination P=-501.250006565323
 V2=117.862531189611 V3=0 T=0 M2=0 M3=240.700429443514 S11Max=942.952570095761 PtS11Max=1 x2S11Max=-0.5
 x3S11Max=-0.5 _
 S11Min=-1945.45258322641 PtS11Min=3 x2S11Min=0.5 x3S11Min=-0.5 FrameElem=11
 ElemStation=0.250000000000001
 Frame=11 Station=0 OutputCase=ACC1 CaseType=Combination P=-521.050013092376 V2=190.848939639807 V3=0
 T=0 M2=0 M3=294.201241750563 S11Max=1244.157437411 PtS11Max=1 x2S11Max=-0.5 x3S11Max=-0.5 _
 S11Min=-2286.25746359576 PtS11Min=3 x2S11Min=0.5 x3S11Min=-0.5 FrameElem=11 ElemStation=0
 Frame=11 Station=0.250000000000001 OutputCase=ACC1 CaseType=Combination P=-514.800010744809
 V2=166.232924610854 V3=0 T=0 M2=0 M3=249.577112234855 S11Max=982.662662664323 PtS11Max=1 x2S11Max=-0.5
 x3S11Max=-0.5 _
 S11Min=-2012.26268415394 PtS11Min=3 x2S11Min=0.5 x3S11Min=-0.5 FrameElem=11
 ElemStation=0.250000000000001
 Frame=11 Station=0 OutputCase=ACC2 CaseType=Combination P=-521.05000844836 V2=139.279705385253 V3=0
 T=0 M2=0 M3=279.799995692619 S11Max=1157.74996570735 PtS11Max=1 x2S11Max=-0.5 x3S11Max=-0.5 _
 S11Min=-2199.84998260407 PtS11Min=3 x2S11Min=0.5 x3S11Min=-0.5 FrameElem=11 ElemStation=0
 Frame=11 Station=0.250000000000001 OutputCase=ACC2 CaseType=Combination P=-514.800006788542
 V2=121.875245043799 V3=0 T=0 M2=0 M3=247.163399349924 S11Max=968.1803893111005 PtS11Max=1 x2S11Max=-0.5
 x3S11Max=-0.5 _
 S11Min=-1997.78040288809 PtS11Min=3 x2S11Min=0.5 x3S11Min=-0.5 FrameElem=11
 ElemStation=0.250000000000001
 Frame=11 Station=0 OutputCase=ACCSX1 CaseType=Combination P=-505.985935873061 V2=193.225927939155
 V3=0 T=0 M2=0 M3=292.878209137454 S11Max=1251.28331895166 PtS11Max=1 x2S11Max=-0.5 x3S11Max=-0.5 _
 S11Min=-2263.25519069778 PtS11Min=3 x2S11Min=0.5 x3S11Min=-0.5 FrameElem=11 ElemStation=0
 Frame=11 Station=0.250000000000001 OutputCase=ACCSX1 CaseType=Combination P=-499.735933525495
 V2=168.609912910202 V3=0 T=0 M2=0 M3=247.659832546909 S11Max=986.223061755958 PtS11Max=1 x2S11Max=-0.5
 x3S11Max=-0.5 _
 S11Min=-1985.69492880695 PtS11Min=3 x2S11Min=0.5 x3S11Min=-0.5 FrameElem=11
 ElemStation=0.250000000000001
 Frame=11 Station=0 OutputCase=ACCSX2 CaseType=Combination P=-505.985931229046 V2=141.656693684601
 V3=0 T=0 M2=0 M3=278.476963079509 S11Max=1164.87584724801 PtS11Max=1 x2S11Max=-0.5 x3S11Max=-0.5 _
 S11Min=-2176.8477097061 PtS11Min=3 x2S11Min=0.5 x3S11Min=-0.5 FrameElem=11 ElemStation=0
 Frame=11 Station=0.250000000000001 OutputCase=ACCSX2 CaseType=Combination P=-499.735929569227
 V2=124.25223343147 V3=0 T=0 M2=0 M3=245.246119661978 S11Max=971.740788402639 PtS11Max=1 x2S11Max=-0.5
 x3S11Max=-0.5 _
 S11Min=-1971.21264754109 PtS11Min=3 x2S11Min=0.5 x3S11Min=-0.5 FrameElem=11
 ElemStation=0.250000000000001
 Frame=11 Station=0 OutputCase=ENVE CaseType=Combination StepType=Max P=-505.985931229046
 V2=193.225927939155 V3=0 T=0 M2=0 M3=294.201241750563 S11Max=1251.28331895166 PtS11Max=1 x2S11Max=-0.5
 x3S11Max=-0.5 _
 S11Min=-2141.06996710603 PtS11Min=3 x2S11Min=0.5 x3S11Min=-0.5 FrameElem=11 ElemStation=0



Frame=11 Station=0.250000000000001 OutputCase=ENVE CaseType=Combination StepType=Max P=-
 499.735929569227 V2=168.609912910202 V3=0 T=0 M2=0 M3=249.577112234855 S11Max=986.223061755958
 PtS11Max=1 x2S11Max=-0.5 _
 x3S11Max=-0.5 S11Min=-1945.45258322641 PtS11Min=3 x2S11Min=0.5 x3S11Min=-0.5 FrameElem=11
 ElemStation=0.250000000000001
 Frame=11 Station=0 OutputCase=ENVE CaseType=Combination StepType=Min P=-521.050013092376
 V2=134.689491531065 V3=0 T=0 M2=0 M3=272.261659822661 S11Max=1126.0699507659 PtS11Max=1 x2S11Max=-0.5
 x3S11Max=-0.5 _
 S11Min=-2286.25746359576 PtS11Min=3 x2S11Min=0.5 x3S11Min=-0.5 FrameElem=11 ElemStation=0
 Frame=11 Station=0.250000000000001 OutputCase=ENVE CaseType=Combination StepType=Min P=-
 514.800010744809 V2=117.862531189611 V3=0 T=0 M2=0 M3=240.700429443514 S11Max=942.952570095761
 PtS11Max=1 x2S11Max=-0.5 _
 x3S11Max=-0.5 S11Min=-2012.26268415394 PtS11Min=3 x2S11Min=0.5 x3S11Min=-0.5 FrameElem=11
 ElemStation=0.250000000000001
 Frame=11 Station=0 OutputCase=FESSUR CaseType=Combination P=-516.985013008887 V2=189.471875483551
 V3=0 T=0 M2=0 M3=291.939740989576 S11Max=1234.65343292857 PtS11Max=1 x2S11Max=-0.5 x3S11Max=-0.5 _
 S11Min=-2268.62345894634 PtS11Min=3 x2S11Min=0.5 x3S11Min=-0.5 FrameElem=11 ElemStation=0
 Frame=11 Station=0.250000000000001 OutputCase=FESSUR CaseType=Combination P=-510.735010677844
 V2=165.029110454597 V3=0 T=0 M2=0 M3=247.638221262932 S11Max=975.09431689975 PtS11Max=1 x2S11Max=-0.5
 x3S11Max=-0.5 _
 S11Min=-1996.56433825544 PtS11Min=3 x2S11Min=0.5 x3S11Min=-0.5 FrameElem=11
 ElemStation=0.250000000000001
 Frame=12 Station=0 OutputCase=PERM1 CaseType=Combination P=-501.249995050805 V2=162.220258559592 V3=0
 T=0 M2=0 M3=243.114142328445 S11Max=957.434858919867 PtS11Max=1 x2S11Max=-0.5 x3S11Max=-0.5 _
 S11Min=-1959.93484902148 PtS11Min=3 x2S11Min=0.5 x3S11Min=-0.5 FrameElem=12 ElemStation=0
 Frame=12 Station=0.25 OutputCase=PERM1 CaseType=Combination P=-494.999995050805 V2=138.714711684592
 V3=0 T=0 M2=0 M3=205.508374563548 S11Max=738.05025233048 PtS11Max=1 x2S11Max=-0.5 x3S11Max=-0.5 _
 S11Min=-1728.05024243209 PtS11Min=3 x2S11Min=0.5 x3S11Min=-0.5 FrameElem=12 ElemStation=0.25
 Frame=12 Station=0 OutputCase=PERM2 CaseType=Combination P=-501.249995324815 V2=117.862578992537 V3=0
 T=0 M2=0 M3=240.700429443514 S11Max=942.952581336271 PtS11Max=1 x2S11Max=-0.5 x3S11Max=-0.5 _
 S11Min=-1945.4525719859 PtS11Min=3 x2S11Min=0.5 x3S11Min=-0.5 FrameElem=12 ElemStation=0
 Frame=12 Station=0.25 OutputCase=PERM2 CaseType=Combination P=-494.999995324815 V2=101.408696180037
 V3=0 T=0 M2=0 M3=213.2992250788 S11Max=784.795759722466 PtS11Max=1 x2S11Max=-0.5 x3S11Max=-0.5 _
 S11Min=-1774.7957503721 PtS11Min=3 x2S11Min=0.5 x3S11Min=-0.5 FrameElem=12 ElemStation=0.25
 Frame=12 Station=0 OutputCase=ACC1 CaseType=Combination P=-514.799994891334 V2=166.232973706008 V3=0
 T=0 M2=0 M3=249.577112234856 S11Max=982.662678517803 PtS11Max=1 x2S11Max=-0.5 x3S11Max=-0.5 _
 S11Min=-2012.26266830047 PtS11Min=3 x2S11Min=0.5 x3S11Min=-0.5 FrameElem=12 ElemStation=0
 Frame=12 Station=0.25 OutputCase=ACC1 CaseType=Combination P=-508.549994891334 V2=142.149926831008
 V3=0 T=0 M2=0 M3=211.040353183354 S11Max=757.692124208792 PtS11Max=1 x2S11Max=-0.5 x3S11Max=-0.5 _
 S11Min=-1774.79211399146 PtS11Min=3 x2S11Min=0.5 x3S11Min=-0.5 FrameElem=12 ElemStation=0.25
 Frame=12 Station=0 OutputCase=ACC2 CaseType=Combination P=-514.799995165344 V2=121.875294138953 V3=0
 T=0 M2=0 M3=247.163399349925 S11Max=968.180400934208 PtS11Max=1 x2S11Max=-0.5 x3S11Max=-0.5 _
 S11Min=-1997.7803912649 PtS11Min=3 x2S11Min=0.5 x3S11Min=-0.5 FrameElem=12 ElemStation=0
 Frame=12 Station=0.25 OutputCase=ACC2 CaseType=Combination P=-508.549995165344 V2=104.843911326453
 V3=0 T=0 M2=0 M3=218.831271127687 S11Max=804.437631600778 PtS11Max=1 x2S11Max=-0.5 x3S11Max=-0.5 _
 S11Min=-1821.53762193147 PtS11Min=3 x2S11Min=0.5 x3S11Min=-0.5 FrameElem=12 ElemStation=0.25
 Frame=12 Station=0 OutputCase=ACCSX1 CaseType=Combination P=-499.735917445348 V2=168.609960568733
 V3=0 T=0 M2=0 M3=247.659832546909 S11Max=986.223077836107 PtS11Max=1 x2S11Max=-0.5 x3S11Max=-0.5 _
 S11Min=-1985.6949127268 PtS11Min=3 x2S11Min=0.5 x3S11Min=-0.5 FrameElem=12 ElemStation=0
 Frame=12 Station=0.25 OutputCase=ACCSX1 CaseType=Combination P=-493.485917445348 V2=144.526913693733
 V3=0 T=0 M2=0 M3=208.528826779726 S11Max=757.687043233007 PtS11Max=1 x2S11Max=-0.5 x3S11Max=-0.5 _
 S11Min=-1744.6588781237 PtS11Min=3 x2S11Min=0.5 x3S11Min=-0.5 FrameElem=12 ElemStation=0.25
 Frame=12 Station=0 OutputCase=ACCSX2 CaseType=Combination P=-499.735917719358 V2=124.252281001678
 V3=0 T=0 M2=0 M3=245.246119661978 S11Max=971.740800252511 PtS11Max=1 x2S11Max=-0.5 x3S11Max=-0.5 _
 S11Min=-1971.21263569123 PtS11Min=3 x2S11Min=0.5 x3S11Min=-0.5 FrameElem=12 ElemStation=0
 Frame=12 Station=0.25 OutputCase=ACCSX2 CaseType=Combination P=-493.485917719358 V2=107.220898189178
 V3=0 T=0 M2=0 M3=216.319744724059 S11Max=804.432550624994 PtS11Max=1 x2S11Max=-0.5 x3S11Max=-0.5 _
 S11Min=-1791.40438606371 PtS11Min=3 x2S11Min=0.5 x3S11Min=-0.5 FrameElem=12 ElemStation=0.25
 Frame=12 Station=0 OutputCase=ENVE CaseType=Combination StepType=Max P=-499.735917445348
 V2=168.609960568733 V3=0 T=0 M2=0 M3=249.577112234856 S11Max=986.223077836107 PtS11Max=1 x2S11Max=-0.5
 x3S11Max=-0.5 _
 S11Min=-1945.4525719859 PtS11Min=3 x2S11Min=0.5 x3S11Min=-0.5 FrameElem=12 ElemStation=0
 Frame=12 Station=0.25 OutputCase=ENVE CaseType=Combination StepType=Max P=-493.485917445348
 V2=144.526913693733 V3=0 T=0 M2=0 M3=218.831271127687 S11Max=804.437631600778 PtS11Max=1 x2S11Max=-0.5
 x3S11Max=-0.5 _
 S11Min=-1728.05024243209 PtS11Min=3 x2S11Min=0.5 x3S11Min=-0.5 FrameElem=12 ElemStation=0.25
 Frame=12 Station=0 OutputCase=ENVE CaseType=Combination StepType=Min P=-514.799995165344
 V2=117.862578992537 V3=0 T=0 M2=0 M3=240.700429443514 S11Max=942.952581336271 PtS11Max=1 x2S11Max=-0.5
 x3S11Max=-0.5 _
 S11Min=-2012.26266830047 PtS11Min=3 x2S11Min=0.5 x3S11Min=-0.5 FrameElem=12 ElemStation=0
 Frame=12 Station=0.25 OutputCase=ENVE CaseType=Combination StepType=Min P=-508.549995165344
 V2=101.408696180037 V3=0 T=0 M2=0 M3=205.508374563548 S11Max=738.05025233048 PtS11Max=1 x2S11Max=-0.5
 x3S11Max=-0.5 _
 S11Min=-1821.53762193147 PtS11Min=3 x2S11Min=0.5 x3S11Min=-0.5 FrameElem=12 ElemStation=0.25
 Frame=12 Station=0 OutputCase=FESSUR CaseType=Combination P=-510.734994939175 V2=165.029159162083
 V3=0 T=0 M2=0 M3=247.638221262933 S11Max=975.094332638423 PtS11Max=1 x2S11Max=-0.5 x3S11Max=-0.5 _
 S11Min=-1996.56432251677 PtS11Min=3 x2S11Min=0.5 x3S11Min=-0.5 FrameElem=12 ElemStation=0
 Frame=12 Station=0.25 OutputCase=FESSUR CaseType=Combination P=-504.484994939175 V2=141.119362287083
 V3=0 T=0 M2=0 M3=209.380759597412 S11Max=751.799562645298 PtS11Max=1 x2S11Max=-0.5 x3S11Max=-0.5 _
 S11Min=-1760.76955252365 PtS11Min=3 x2S11Min=0.5 x3S11Min=-0.5 FrameElem=12 ElemStation=0.25
 Frame=15 Station=0 OutputCase=PERM1 CaseType=Combination P=-419.999985343839 V2=-101.780328369733
 V3=0 T=0 M2=0 M3=169.293603602134 S11Max=595.761636268962 PtS11Max=1 x2S11Max=-0.5 x3S11Max=-0.5 _



S11Min=-1435.76160695664 PtS11Min=3 x2S11Min=0.5 x3S11Min=-0.5 FrameElem=15 ElemStation=0
 Frame=15 Station=0.250000000000002 OutputCase=PERM1 CaseType=Combination P=-413.749983762938 V2=-
 118.357280898687 V3=0 T=0 M2=0 M3=196.821908276311 S11Max=767.181465894929 PtS11Max=1 x2S11Max=-0.5
 x3S11Max=-0.5 _
 S11Min=-1594.6814334208 PtS11Min=3 x2S11Min=0.5 x3S11Min=-0.5 FrameElem=15
 ElemStation=0.250000000000002
 Frame=15 Station=0 OutputCase=PERM2 CaseType=Combination P=-419.99988940687 V2=-66.9378438742883
 V3=0 T=0 M2=0 M3=175.023755560131 S11Max=630.142544420096 PtS11Max=1 x2S11Max=-0.5 x3S11Max=-0.5 _
 S11Min=-1470.14252230147 PtS11Min=3 x2S11Min=0.5 x3S11Min=-0.5 FrameElem=15 ElemStation=0
 Frame=15 Station=0.250000000000002 OutputCase=PERM2 CaseType=Combination P=-413.749987834056 V2=-
 78.5417104657419 V3=0 T=0 M2=0 M3=193.216472313572 S11Max=745.548846047376 PtS11Max=1 x2S11Max=-0.5
 x3S11Max=-0.5 _
 S11Min=-1573.04882171549 PtS11Min=3 x2S11Min=0.5 x3S11Min=-0.5 FrameElem=15
 ElemStation=0.250000000000002
 Frame=15 Station=0 OutputCase=ACC1 CaseType=Combination P=-433.549984851082 V2=-105.275114515546 V3=0
 T=0 M2=0 M3=174.914936459633 S11Max=615.939633906715 PtS11Max=1 x2S11Max=-0.5 x3S11Max=-0.5 _
 S11Min=-1483.03960360888 PtS11Min=3 x2S11Min=0.5 x3S11Min=-0.5 FrameElem=15 ElemStation=0
 Frame=15 Station=0.250000000000002 OutputCase=ACC1 CaseType=Combination P=-427.299983215106 V2=-
 122.4295670445 V3=0 T=0 M2=0 M3=203.389125170264 S11Max=793.034767806476 PtS11Max=1 x2S11Max=-0.5
 x3S11Max=-0.5 _
 S11Min=-1647.63473423669 PtS11Min=3 x2S11Min=0.5 x3S11Min=-0.5 FrameElem=15
 ElemStation=0.250000000000002
 Frame=15 Station=0 OutputCase=ACC2 CaseType=Combination P=-433.54998844793 V2=-70.4326300201011 V3=0
 T=0 M2=0 M3=180.64508841763 S11Max=650.320542057849 PtS11Max=1 x2S11Max=-0.5 x3S11Max=-0.5 _
 S11Min=-1517.42051895371 PtS11Min=3 x2S11Min=0.5 x3S11Min=-0.5 FrameElem=15 ElemStation=0
 Frame=15 Station=0.250000000000002 OutputCase=ACC2 CaseType=Combination P=-427.299987286224 V2=-
 82.6139966115547 V3=0 T=0 M2=0 M3=199.783689207524 S11Max=771.402147958922 PtS11Max=1 x2S11Max=-0.5
 x3S11Max=-0.5 _
 S11Min=-1626.00212253137 PtS11Min=3 x2S11Min=0.5 x3S11Min=-0.5 FrameElem=15
 ElemStation=0.250000000000002
 Frame=15 Station=0 OutputCase=ACCSX1 CaseType=Combination P=-418.485907631785 V2=-102.898126216199
 V3=0 T=0 M2=0 M3=165.272449826981 S11Max=573.148791330101 PtS11Max=1 x2S11Max=-0.5 x3S11Max=-0.5 _
 S11Min=-1410.12060659367 PtS11Min=3 x2S11Min=0.5 x3S11Min=-0.5 FrameElem=15 ElemStation=0
 Frame=15 Station=0.250000000000002 OutputCase=ACCSX1 CaseType=Combination P=-412.235905995809 V2=-
 120.052578745152 V3=0 T=0 M2=0 M3=193.152391462775 S11Max=746.678442780842 PtS11Max=1 x2S11Max=-0.5
 x3S11Max=-0.5 _
 S11Min=-1571.15025477246 PtS11Min=3 x2S11Min=0.5 x3S11Min=-0.5 FrameElem=15
 ElemStation=0.250000000000002
 Frame=15 Station=0 OutputCase=ACCSX2 CaseType=Combination P=-418.485911228633 V2=-68.055641720754
 V3=0 T=0 M2=0 M3=171.002601784978 S11Max=607.529699481236 PtS11Max=1 x2S11Max=-0.5 x3S11Max=-0.5 _
 S11Min=-1444.5015219385 PtS11Min=3 x2S11Min=0.5 x3S11Min=-0.5 FrameElem=15 ElemStation=0
 Frame=15 Station=0.250000000000002 OutputCase=ACCSX2 CaseType=Combination P=-412.235910066927 V2=-
 80.2370083122076 V3=0 T=0 M2=0 M3=189.546955500036 S11Max=725.045822933288 PtS11Max=1 x2S11Max=-0.5
 x3S11Max=-0.5 _
 S11Min=-1549.51764306714 PtS11Min=3 x2S11Min=0.5 x3S11Min=-0.5 FrameElem=15
 ElemStation=0.250000000000002
 Frame=15 Station=0 OutputCase=ENVE CaseType=Combination StepType=Max P=-418.485907631785 V2=-
 66.9378438742883 V3=0 T=0 M2=0 M3=180.64508841763 S11Max=650.320542057849 PtS11Max=1 x2S11Max=-0.5
 x3S11Max=-0.5 _
 S11Min=-1410.12060659367 PtS11Min=3 x2S11Min=0.5 x3S11Min=-0.5 FrameElem=15 ElemStation=0
 Frame=15 Station=0.250000000000002 OutputCase=ENVE CaseType=Combination StepType=Max P=-
 412.235905995809 V2=-78.5417104657419 V3=0 T=0 M2=0 M3=203.389125170264 S11Max=793.034767806476
 PtS11Max=1 x2S11Max=-0.5 _
 x3S11Max=-0.5 S11Min=-1549.51764306714 PtS11Min=3 x2S11Min=0.5 x3S11Min=-0.5 FrameElem=15
 ElemStation=0.250000000000002
 Frame=15 Station=0 OutputCase=ENVE CaseType=Combination StepType=Min P=-433.54998844793 V2=-
 105.275114515546 V3=0 T=0 M2=0 M3=165.272449826981 S11Max=573.148791330101 PtS11Max=1 x2S11Max=-0.5
 x3S11Max=-0.5 _
 S11Min=-1517.42051895371 PtS11Min=3 x2S11Min=0.5 x3S11Min=-0.5 FrameElem=15 ElemStation=0
 Frame=15 Station=0.250000000000002 OutputCase=ENVE CaseType=Combination StepType=Min P=-
 427.299987286224 V2=-122.4295670445 V3=0 T=0 M2=0 M3=189.546955500036 S11Max=725.045822933288
 PtS11Max=1 x2S11Max=-0.5 _
 x3S11Max=-0.5 S11Min=-1647.63473423669 PtS11Min=3 x2S11Min=0.5 x3S11Min=-0.5 FrameElem=15
 ElemStation=0.250000000000002
 Frame=15 Station=0 OutputCase=FESSUR CaseType=Combination P=-429.484984998909 V2=-104.226678671802
 V3=0 T=0 M2=0 M3=173.228536602383 S11Max=609.886234615389 PtS11Max=1 x2S11Max=-0.5 x3S11Max=-0.5 _
 S11Min=-1468.85620461321 PtS11Min=3 x2S11Min=0.5 x3S11Min=-0.5 FrameElem=15 ElemStation=0
 Frame=15 Station=0.250000000000002 OutputCase=FESSUR CaseType=Combination P=-423.234983379455 V2=-
 121.207881200756 V3=0 T=0 M2=0 M3=201.418960102078 S11Max=785.278777233012 PtS11Max=1 x2S11Max=-0.5
 x3S11Max=-0.5 _
 S11Min=-1631.74874399192 PtS11Min=3 x2S11Min=0.5 x3S11Min=-0.5 FrameElem=15
 ElemStation=0.250000000000002
 Frame=16 Station=0 OutputCase=PERM1 CaseType=Combination P=-413.750006338093 V2=-118.35720198214 V3=0
 T=0 M2=0 M3=196.821908276309 S11Max=767.181443319762 PtS11Max=1 x2S11Max=-0.5 x3S11Max=-0.5 _
 S11Min=-1594.68145599595 PtS11Min=3 x2S11Min=0.5 x3S11Min=-0.5 FrameElem=16 ElemStation=0
 Frame=16 Station=0.250000000000001 OutputCase=PERM1 CaseType=Combination P=-407.500007868167 V2=-
 134.401186953187 V3=0 T=0 M2=0 M3=228.42781040885 S11Max=963.066854584935 PtS11Max=1 x2S11Max=-0.5
 x3S11Max=-0.5 _
 S11Min=-1778.06687032127 PtS11Min=3 x2S11Min=0.5 x3S11Min=-0.5 FrameElem=16
 ElemStation=0.250000000000001
 Frame=16 Station=0 OutputCase=PERM2 CaseType=Combination P=-413.750002814994 V2=-78.5416315491953
 V3=0 T=0 M2=0 M3=193.21647231357 S11Max=745.548831066426 PtS11Max=1 x2S11Max=-0.5 x3S11Max=-0.5 _



S11Min=-1573.04883669641 PtS11Min=3 x2S11Min=0.5 x3S11Min=-0.5 FrameElem=16 ElemStation=0
 Frame=16 Station=0.250000000000001 OutputCase=PERM2 CaseType=Combination P=-407.500003886045 V2=-
 89.7724212077418 V3=0 T=0 M2=0 M3=214.263501369125 S11Max=878.081004328703 PtS11Max=1 x2S11Max=-0.5
 x3S11Max=-0.5 _
 S11Min=-1693.08101210079 PtS11Min=3 x2S11Min=0.5 x3S11Min=-0.5 FrameElem=16
 ElemStation=0.250000000000001
 Frame=16 Station=0 OutputCase=ACC1 CaseType=Combination P=-427.300006566987 V2=-122.429485543499 V3=0
 T=0 M2=0 M3=203.389125170261 S11Max=793.03474445458 PtS11Max=1 x2S11Max=-0.5 x3S11Max=-0.5 _
 S11Min=-1647.63475758855 PtS11Min=3 x2S11Min=0.5 x3S11Min=-0.5 FrameElem=16 ElemStation=0
 Frame=16 Station=0.250000000000001 OutputCase=ACC1 CaseType=Combination P=-421.050008152135 V2=-
 139.050970514545 V3=0 T=0 M2=0 M3=236.085285693142 S11Max=995.461706006715 PtS11Max=1 x2S11Max=-0.5
 x3S11Max=-0.5 _
 S11Min=-1837.56172231099 PtS11Min=3 x2S11Min=0.5 x3S11Min=-0.5 FrameElem=16
 ElemStation=0.250000000000001
 Frame=16 Station=0 OutputCase=ACC2 CaseType=Combination P=-427.300003043888 V2=-82.6139151105539 V3=0
 T=0 M2=0 M3=199.783689207522 S11Max=771.402132201243 PtS11Max=1 x2S11Max=-0.5 x3S11Max=-0.5 _
 S11Min=-1626.00213828902 PtS11Min=3 x2S11Min=0.5 x3S11Min=-0.5 FrameElem=16 ElemStation=0
 Frame=16 Station=0.250000000000001 OutputCase=ACC2 CaseType=Combination P=-421.050004170014 V2=-
 94.4222047691004 V3=0 T=0 M2=0 M3=221.920976653416 S11Max=910.475855750483 PtS11Max=1 x2S11Max=-0.5
 x3S11Max=-0.5 _
 S11Min=-1752.57586409051 PtS11Min=3 x2S11Min=0.5 x3S11Min=-0.5 FrameElem=16
 ElemStation=0.250000000000001
 Frame=16 Station=0 OutputCase=ACCSX1 CaseType=Combination P=-412.235928894322 V2=-120.052500117399
 V3=0 T=0 M2=0 M3=193.152391462772 S11Max=746.678419882309 PtS11Max=1 x2S11Max=-0.5 x3S11Max=-0.5 _
 S11Min=-1571.15027767095 PtS11Min=3 x2S11Min=0.5 x3S11Min=-0.5 FrameElem=16 ElemStation=0
 Frame=16 Station=0.250000000000001 OutputCase=ACCSX1 CaseType=Combination P=-405.98593047947 V2=-
 136.673985088446 V3=0 T=0 M2=0 M3=225.254305629127 S11Max=945.539903295295 PtS11Max=1 x2S11Max=-0.5
 x3S11Max=-0.5 _
 S11Min=-1757.51176425423 PtS11Min=3 x2S11Min=0.5 x3S11Min=-0.5 FrameElem=16
 ElemStation=0.250000000000001
 Frame=16 Station=0 OutputCase=ACCSX2 CaseType=Combination P=-412.235925371222 V2=-80.2369296844541
 V3=0 T=0 M2=0 M3=189.546955500032 S11Max=725.045807628972 PtS11Max=1 x2S11Max=-0.5 x3S11Max=-0.5 _
 S11Min=-1549.51765837142 PtS11Min=3 x2S11Min=0.5 x3S11Min=-0.5 FrameElem=16 ElemStation=0
 Frame=16 Station=0.250000000000001 OutputCase=ACCSX2 CaseType=Combination P=-405.985926497349 V2=-
 92.0452193430006 V3=0 T=0 M2=0 M3=211.089996589402 S11Max=860.554053039063 PtS11Max=1 x2S11Max=-0.5
 x3S11Max=-0.5 _
 S11Min=-1672.52590603376 PtS11Min=3 x2S11Min=0.5 x3S11Min=-0.5 FrameElem=16
 ElemStation=0.250000000000001
 Frame=16 Station=0 OutputCase=ENVE CaseType=Combination StepType=Max P=-412.235925371222 V2=-
 78.5416315491953 V3=0 T=0 M2=0 M3=203.389125170261 S11Max=793.03474445458 PtS11Max=1 x2S11Max=-0.5
 x3S11Max=-0.5 _
 S11Min=-1549.51765837142 PtS11Min=3 x2S11Min=0.5 x3S11Min=-0.5 FrameElem=16 ElemStation=0
 Frame=16 Station=0.250000000000001 OutputCase=ENVE CaseType=Combination StepType=Max P=-
 405.985926497349 V2=-89.7724212077418 V3=0 T=0 M2=0 M3=236.085285693142 S11Max=995.461706006715
 PtS11Max=1 x2S11Max=-0.5 _
 x3S11Max=-0.5 S11Min=-1672.52590603376 PtS11Min=3 x2S11Min=0.5 x3S11Min=-0.5 FrameElem=16
 ElemStation=0.250000000000001
 Frame=16 Station=0 OutputCase=ENVE CaseType=Combination StepType=Min P=-427.300006566987 V2=-
 122.429485543499 V3=0 T=0 M2=0 M3=189.546955500032 S11Max=725.045807628972 PtS11Max=1 x2S11Max=-0.5
 x3S11Max=-0.5 _
 S11Min=-1647.63475758855 PtS11Min=3 x2S11Min=0.5 x3S11Min=-0.5 FrameElem=16 ElemStation=0
 Frame=16 Station=0.250000000000001 OutputCase=ENVE CaseType=Combination StepType=Min P=-
 421.050008152135 V2=-139.050970514545 V3=0 T=0 M2=0 M3=211.089996589402 S11Max=860.554053039063
 PtS11Max=1 x2S11Max=-0.5 _
 x3S11Max=-0.5 S11Min=-1837.56172231099 PtS11Min=3 x2S11Min=0.5 x3S11Min=-0.5 FrameElem=16
 ElemStation=0.250000000000001
 Frame=16 Station=0 OutputCase=FESSUR CaseType=Combination P=-423.235006498319 V2=-121.207800475091
 V3=0 T=0 M2=0 M3=201.418960102075 S11Max=785.278754114135 PtS11Max=1 x2S11Max=-0.5 x3S11Max=-0.5 _
 S11Min=-1631.74876711077 PtS11Min=3 x2S11Min=0.5 x3S11Min=-0.5 FrameElem=16 ElemStation=0
 Frame=16 Station=0.250000000000001 OutputCase=FESSUR CaseType=Combination P=-416.985008066944 V2=-
 137.656035446138 V3=0 T=0 M2=0 M3=233.788043107854 S11Max=985.743250580181 PtS11Max=1 x2S11Max=-0.5
 x3S11Max=-0.5 _
 S11Min=-1819.71326671407 PtS11Min=3 x2S11Min=0.5 x3S11Min=-0.5 FrameElem=16
 ElemStation=0.250000000000001
 Frame=17 Station=0 OutputCase=PERM1 CaseType=Combination P=-494.999995477887 V2=-138.714713713567
 V3=0 T=0 M2=0 M3=-205.508373004335 S11Max=738.050242548124 PtS11Max=3 x2S11Max=0.5 x3S11Max=-0.5 _
 S11Min=-1728.0502335039 PtS11Min=1 x2S11Min=-0.5 x3S11Min=-0.5 FrameElem=17 ElemStation=0
 Frame=17 Station=0.5 OutputCase=PERM1 CaseType=Combination P=-482.499995838791 V2=-93.3025261332865
 V3=0 T=0 M2=0 M3=-147.592891168151 S11Max=403.057351170117 PtS11Max=3 x2S11Max=0.5 x3S11Max=-0.5 _
 S11Min=-1368.0573428477 PtS11Min=1 x2S11Min=-0.5 x3S11Min=-0.5 FrameElem=17 ElemStation=0.5
 Frame=17 Station=0 OutputCase=PERM2 CaseType=Combination P=-494.999995500358 V2=-101.408698780491
 V3=0 T=0 M2=0 M3=-213.299291641215 S11Max=784.795754346931 PtS11Max=3 x2S11Max=0.5 x3S11Max=-0.5 _
 S11Min=-1774.79574534765 PtS11Min=1 x2S11Min=-0.5 x3S11Min=-0.5 FrameElem=17 ElemStation=0
 Frame=17 Station=0.5 OutputCase=PERM2 CaseType=Combination P=-482.49999575299 V2=-69.6201674444923
 V3=0 T=0 M2=0 M3=-170.60425477284 S11Max=541.125532884047 PtS11Max=3 x2S11Max=0.5 x3S11Max=-0.5 _
 S11Min=-1506.12552439003 PtS11Min=1 x2S11Min=-0.5 x3S11Min=-0.5 FrameElem=17 ElemStation=0.5
 Frame=17 Station=0 OutputCase=ACC1 CaseType=Combination P=-508.549995351594 V2=-142.149928912595 V3=0
 T=0 M2=0 M3=-211.040351582624 S11Max=757.692114144152 PtS11Max=3 x2S11Max=0.5 x3S11Max=-0.5 _
 S11Min=-1774.79210484734 PtS11Min=1 x2S11Min=-0.5 x3S11Min=-0.5 FrameElem=17 ElemStation=0
 Frame=17 Station=0.5 OutputCase=ACC1 CaseType=Combination P=-496.049995721677 V2=-95.5827413323143
 V3=0 T=0 M2=0 M3=-151.696012146927 S11Max=414.126077159882 PtS11Max=3 x2S11Max=0.5 x3S11Max=-0.5 _
 S11Min=-1406.22606860324 PtS11Min=1 x2S11Min=-0.5 x3S11Min=-0.5 FrameElem=17 ElemStation=0.5

Frame=17 Station=0 OutputCase=ACC2 CaseType=Combination P=-508.549995374065 V2=-104.843913979519 V3=0
T=0 M2=0 M3=-218.831270219504 S11Max=804.437625942959 PtS11Max=3 x2S11Max=0.5 x3S11Max=-0.5 _
S11Min=-1821.53761669109 PtS11Min=1 x2S11Min=-0.5 x3S11Min=-0.5 FrameElem=17 ElemStation=0
Frame=17 Station=0.5 OutputCase=ACC2 CaseType=Combination P=-496.049995635876 V2=-71.9003826435201
V3=0 T=0 M2=0 M3=-174.707375751615 S11Max=552.194258873812 PtS11Max=3 x2S11Max=0.5 x3S11Max=-0.5 _
S11Min=-1544.29425014557 PtS11Min=1 x2S11Min=-0.5 x3S11Min=-0.5 FrameElem=17 ElemStation=0.5
Frame=17 Station=0 OutputCase=ACCSX1 CaseType=Combination P=-496.514073101389 V2=-136.441915734744
V3=0 T=0 M2=0 M3=-201.950463247769 S11Max=715.188706385226 PtS11Max=3 x2S11Max=0.5 x3S11Max=-0.5 _
S11Min=-1708.216852588 PtS11Min=1 x2S11Min=-0.5 x3S11Min=-0.5 FrameElem=17 ElemStation=0
Frame=17 Station=0.5 OutputCase=ACCSX1 CaseType=Combination P=-484.014073462293 V2=-91.0297281544634
V3=0 T=0 M2=0 M3=-145.171380400997 S11Max=387.014208943688 PtS11Max=3 x2S11Max=0.5 x3S11Max=-0.5 _
S11Min=-1355.04235586827 PtS11Min=1 x2S11Min=-0.5 x3S11Min=-0.5 FrameElem=17 ElemStation=0.5
Frame=17 Station=0 OutputCase=ACCSX2 CaseType=Combination P=-496.51407312386 V2=-99.135900801668 V3=0
T=0 M2=0 M3=-209.741381884649 S11Max=761.934218184032 PtS11Max=3 x2S11Max=0.5 x3S11Max=-0.5 _
S11Min=-1754.96236443175 PtS11Min=1 x2S11Min=-0.5 x3S11Min=-0.5 FrameElem=17 ElemStation=0
Frame=17 Station=0.5 OutputCase=ACCSX2 CaseType=Combination P=-484.014073376492 V2=-67.3473694656693
V3=0 T=0 M2=0 M3=-168.182744005685 S11Max=525.082390657618 PtS11Max=3 x2S11Max=0.5 x3S11Max=-0.5 _
S11Min=-1493.1105374106 PtS11Min=1 x2S11Min=-0.5 x3S11Min=-0.5 FrameElem=17 ElemStation=0.5
Frame=17 Station=0 OutputCase=ENVE CaseType=Combination StepType=Max P=-494.999995477887 V2=-
99.135900801668 V3=0 T=0 M2=0 M3=-201.950463247769 S11Max=804.437625942959 PtS11Max=3 x2S11Max=0.5
x3S11Max=-0.5 _
S11Min=-1708.216852588 PtS11Min=1 x2S11Min=-0.5 x3S11Min=-0.5 FrameElem=17 ElemStation=0
Frame=17 Station=0.5 OutputCase=ENVE CaseType=Combination StepType=Max P=-482.49999575299 V2=-
67.3473694656693 V3=0 T=0 M2=0 M3=-145.171380400997 S11Max=552.194258873812 PtS11Max=3 x2S11Max=0.5
x3S11Max=-0.5 _
S11Min=-1355.04235586827 PtS11Min=1 x2S11Min=-0.5 x3S11Min=-0.5 FrameElem=17 ElemStation=0.5
Frame=17 Station=0 OutputCase=ENVE CaseType=Combination StepType=Min P=-508.549995374065 V2=-
142.149928912595 V3=0 T=0 M2=0 M3=-218.831270219504 S11Max=715.188706385226 PtS11Max=3 x2S11Max=0.5
x3S11Max=-0.5 _
S11Min=-1821.53761669109 PtS11Min=1 x2S11Min=-0.5 x3S11Min=-0.5 FrameElem=17 ElemStation=0
Frame=17 Station=0.5 OutputCase=ENVE CaseType=Combination StepType=Min P=-496.049995721677 V2=-
95.5827413323143 V3=0 T=0 M2=0 M3=-174.707375751615 S11Max=387.014208943688 PtS11Max=3 x2S11Max=0.5
x3S11Max=-0.5 _
S11Min=-1544.29425014557 PtS11Min=1 x2S11Min=-0.5 x3S11Min=-0.5 FrameElem=17 ElemStation=0.5
Frame=17 Station=0 OutputCase=FESSUR CaseType=Combination P=-504.484995389482 V2=-141.119364352887
V3=0 T=0 M2=0 M3=-209.380758009138 S11Max=751.799552665343 PtS11Max=3 x2S11Max=0.5 x3S11Max=-0.5 _
S11Min=-1760.76954344431 PtS11Min=1 x2S11Min=-0.5 x3S11Min=-0.5 FrameElem=17 ElemStation=0
Frame=17 Station=0.5 OutputCase=FESSUR CaseType=Combination P=-491.984995756811 V2=-94.898676772606
V3=0 T=0 M2=0 M3=-150.465075853294 S11Max=410.805459362953 PtS11Max=3 x2S11Max=0.5 x3S11Max=-0.5 _
S11Min=-1394.77545087657 PtS11Min=1 x2S11Min=-0.5 x3S11Min=-0.5 FrameElem=17 ElemStation=0.5
Frame=18 Station=0 OutputCase=PERM1 CaseType=Combination P=-482.499995838791 V2=-93.3025261332828
V3=0 T=0 M2=0 M3=-147.59289116815 S11Max=403.057351170109 PtS11Max=3 x2S11Max=0.5 x3S11Max=-0.5 _
S11Min=-1368.05734284769 PtS11Min=1 x2S11Min=-0.5 x3S11Min=-0.5 FrameElem=18 ElemStation=0
Frame=18 Station=0.5 OutputCase=PERM1 CaseType=Combination P=-469.999996182752 V2=-50.02221335657091
V3=0 T=0 M2=0 M3=-111.850534368931 S11Max=201.103210030837 PtS11Max=3 x2S11Max=0.5 x3S11Max=-0.5 _
S11Min=-1141.10320239634 PtS11Min=1 x2S11Min=-0.5 x3S11Min=-0.5 FrameElem=18 ElemStation=0.5
Frame=18 Station=0 OutputCase=PERM2 CaseType=Combination P=-482.49999575299 V2=-69.6201674444887 V3=0
T=0 M2=0 M3=-170.604254772838 S11Max=541.125532884039 PtS11Max=3 x2S11Max=0.5 x3S11Max=-0.5 _
S11Min=-1506.12552439002 PtS11Min=1 x2S11Min=-0.5 x3S11Min=-0.5 FrameElem=18 ElemStation=0
Frame=18 Station=0.5 OutputCase=PERM2 CaseType=Combination P=-469.999995993763 V2=-39.3239486173849
V3=0 T=0 M2=0 M3=-143.43040544524 S11Max=390.582436677679 PtS11Max=3 x2S11Max=0.5 x3S11Max=-0.5 _
S11Min=-1330.58242866521 PtS11Min=1 x2S11Min=-0.5 x3S11Min=-0.5 FrameElem=18 ElemStation=0.5
Frame=18 Station=0 OutputCase=ACC1 CaseType=Combination P=-496.049995721678 V2=-95.5827413323105 V3=0
T=0 M2=0 M3=-151.696012146925 S11Max=414.126077159874 PtS11Max=3 x2S11Max=0.5 x3S11Max=-0.5 _
S11Min=-1406.22606860323 PtS11Min=1 x2S11Min=-0.5 x3S11Min=-0.5 FrameElem=18 ElemStation=0
Frame=18 Station=0.5 OutputCase=ACC1 CaseType=Combination P=-483.549996074818 V2=-51.1474287647368
V3=0 T=0 M2=0 M3=-115.102297748193 S11Max=207.06379041434 PtS11Max=3 x2S11Max=0.5 x3S11Max=-0.5 _
S11Min=-1174.16378256398 PtS11Min=1 x2S11Min=-0.5 x3S11Min=-0.5 FrameElem=18 ElemStation=0.5
Frame=18 Station=0 OutputCase=ACC2 CaseType=Combination P=-496.049995635878 V2=-71.9003826435165 V3=0
T=0 M2=0 M3=-174.707375751614 S11Max=552.194258873804 PtS11Max=3 x2S11Max=0.5 x3S11Max=-0.5 _
S11Min=-1544.29425014556 PtS11Min=1 x2S11Min=-0.5 x3S11Min=-0.5 FrameElem=18 ElemStation=0
Frame=18 Station=0.5 OutputCase=ACC2 CaseType=Combination P=-483.549995885829 V2=-40.4491638164126
V3=0 T=0 M2=0 M3=-146.682168824502 S11Max=396.543017061182 PtS11Max=3 x2S11Max=0.5 x3S11Max=-0.5 _
S11Min=-1363.64300883284 PtS11Min=1 x2S11Min=-0.5 x3S11Min=-0.5 FrameElem=18 ElemStation=0.5
Frame=18 Station=0 OutputCase=ACCSX1 CaseType=Combination P=-484.014073462293 V2=-91.0297281544599
V3=0 T=0 M2=0 M3=-145.171380400995 S11Max=387.014208943688 PtS11Max=3 x2S11Max=0.5 x3S11Max=-0.5 _
S11Min=-1355.04235586827 PtS11Min=1 x2S11Min=-0.5 x3S11Min=-0.5 FrameElem=18 ElemStation=0
Frame=18 Station=0.5 OutputCase=ACCSX1 CaseType=Combination P=-471.514073806254 V2=-47.7494155868863
V3=0 T=0 M2=0 M3=-110.565422591188 S11Max=191.878461740876 PtS11Max=3 x2S11Max=0.5 x3S11Max=-0.5 _
S11Min=-1134.90660935338 PtS11Min=1 x2S11Min=-0.5 x3S11Min=-0.5 FrameElem=18 ElemStation=0.5
Frame=18 Station=0 OutputCase=ACCSX2 CaseType=Combination P=-484.014073376492 V2=-67.3473694656659
V3=0 T=0 M2=0 M3=-168.182744005684 S11Max=525.082390657618 PtS11Max=3 x2S11Max=0.5 x3S11Max=-0.5 _
S11Min=-1493.11053741059 PtS11Min=1 x2S11Min=-0.5 x3S11Min=-0.5 FrameElem=18 ElemStation=0
Frame=18 Station=0.5 OutputCase=ACCSX2 CaseType=Combination P=-471.514073617265 V2=-37.051150638562
V3=0 T=0 M2=0 M3=-142.145293667497 S11Max=381.357688387719 PtS11Max=3 x2S11Max=0.5 x3S11Max=-0.5 _
S11Min=-1324.38583562225 PtS11Min=1 x2S11Min=-0.5 x3S11Min=-0.5 FrameElem=18 ElemStation=0.5
Frame=18 Station=0 OutputCase=ENVE CaseType=Combination StepType=Max P=-482.49999575299 V2=-
67.3473694656659 V3=0 T=0 M2=0 M3=-145.171380400995 S11Max=552.194258873804 PtS11Max=3 x2S11Max=0.5
x3S11Max=-0.5 _
S11Min=-1355.04235586827 PtS11Min=1 x2S11Min=-0.5 x3S11Min=-0.5 FrameElem=18 ElemStation=0

Frame=18 Station=0.5 OutputCase=ENVE CaseType=Combination StepType=Max P=-469.999995993763 V2=-37.051150638562 V3=0 T=0 M2=0 M3=-110.565422591188 S11Max=396.543017061182 PtS11Max=3 x2S11Max=0.5 x3S11Max=-0.5 _
 S11Min=-1134.90660935338 PtS11Min=1 x2S11Min=-0.5 x3S11Min=-0.5 FrameElem=18 ElemStation=0.5
 Frame=18 Station=0 OutputCase=ENVE CaseType=Combination StepType=Min P=-496.049995721678 V2=-95.5827413323105 V3=0 T=0 M2=0 M3=-174.707375751614 S11Max=387.01420894368 PtS11Max=3 x2S11Max=0.5 x3S11Max=-0.5 _
 S11Min=-1544.29425014556 PtS11Min=1 x2S11Min=-0.5 x3S11Min=-0.5 FrameElem=18 ElemStation=0
 Frame=18 Station=0.5 OutputCase=ENVE CaseType=Combination StepType=Min P=-483.549996074818 V2=-51.1474287647368 V3=0 T=0 M2=0 M3=-146.682168824502 S11Max=191.878461740876 PtS11Max=3 x2S11Max=0.5 x3S11Max=-0.5 _
 S11Min=-1363.64300883284 PtS11Min=1 x2S11Min=-0.5 x3S11Min=-0.5 FrameElem=18 ElemStation=0.5
 Frame=18 Station=0 OutputCase=FESSUR CaseType=Combination P=-491.984995756812 V2=-94.8986767726022 V3=0 T=0 M2=0 M3=-150.465075853293 S11Max=410.805459362944 PtS11Max=3 x2S11Max=0.5 x3S11Max=-0.5 _
 S11Min=-1394.77545087657 PtS11Min=1 x2S11Min=-0.5 x3S11Min=-0.5 FrameElem=18 ElemStation=0
 Frame=18 Station=0.5 OutputCase=FESSUR CaseType=Combination P=-479.484996107198 V2=-50.8098642050285 V3=0 T=0 M2=0 M3=-114.126768734414 S11Max=205.275616299289 PtS11Max=3 x2S11Max=0.5 x3S11Max=-0.5 _
 S11Min=-1164.24560851369 PtS11Min=1 x2S11Min=-0.5 x3S11Min=-0.5 FrameElem=18 ElemStation=0.5
 Frame=19 Station=0 OutputCase=PERM1 CaseType=Combination P=-469.999996182606 V2=-50.0222135657089 V3=0 T=0 M2=0 M3=-111.850534368931 S11Max=201.103210030981 PtS11Max=3 x2S11Max=0.5 x3S11Max=-0.5 _
 S11Min=-1141.10320239619 PtS11Min=1 x2S11Min=-0.5 x3S11Min=-0.5 FrameElem=19 ElemStation=0
 Frame=19 Station=0.5 OutputCase=PERM1 CaseType=Combination P=-457.499996509625 V2=-8.87377601084215 V3=0 T=0 M2=0 M3=-97.2153651003228 S11Max=125.792194092313 PtS11Max=3 x2S11Max=0.5 x3S11Max=-0.5 _
 S11Min=-1040.79218711156 PtS11Min=1 x2S11Min=-0.5 x3S11Min=-0.5 FrameElem=19 ElemStation=0.5
 Frame=19 Station=0 OutputCase=PERM2 CaseType=Combination P=-469.999995993617 V2=-39.3239486173845 V3=0 T=0 M2=0 M3=-143.43040544524 S11Max=390.582436677824 PtS11Max=3 x2S11Max=0.5 x3S11Max=-0.5 _
 S11Min=-1330.58242866506 PtS11Min=1 x2S11Min=-0.5 x3S11Min=-0.5 FrameElem=19 ElemStation=0
 Frame=19 Station=0.5 OutputCase=PERM2 CaseType=Combination P=-457.49999622253 V2=-10.5200422991755 V3=0 T=0 M2=0 M3=-131.031587403971 S11Max=328.689528201295 PtS11Max=3 x2S11Max=0.5 x3S11Max=-0.5 _
 S11Min=-1243.68952064636 PtS11Min=1 x2S11Min=-0.5 x3S11Min=-0.5 FrameElem=19 ElemStation=0.5
 Frame=19 Station=0 OutputCase=ACC1 CaseType=Combination P=-483.549996074672 V2=-51.1474287647359 V3=0 T=0 M2=0 M3=-110.565422591188 S11Max=207.063790414484 PtS11Max=3 x2S11Max=0.5 x3S11Max=-0.5 _
 S11Min=-1174.16378256383 PtS11Min=1 x2S11Min=-0.5 x3S11Min=-0.5 FrameElem=19 ElemStation=0
 Frame=19 Station=0.5 OutputCase=ACC1 CaseType=Combination P=-471.04999641087 V2=-8.8439912098692 V3=0 T=0 M2=0 M3=-100.193270880071 S11Max=130.109628869555 PtS11Max=3 x2S11Max=0.5 x3S11Max=-0.5 _
 S11Min=-1072.20962169129 PtS11Min=1 x2S11Min=-0.5 x3S11Min=-0.5 FrameElem=19 ElemStation=0.5
 Frame=19 Station=0 OutputCase=ACC2 CaseType=Combination P=-483.549995885683 V2=-40.4491638164116 V3=0 T=0 M2=0 M3=-146.682168824502 S11Max=396.543017061327 PtS11Max=3 x2S11Max=0.5 x3S11Max=-0.5 _
 S11Min=-1363.64300883269 PtS11Min=1 x2S11Min=-0.5 x3S11Min=-0.5 FrameElem=19 ElemStation=0
 Frame=19 Station=0.5 OutputCase=ACC2 CaseType=Combination P=-471.049996123775 V2=-10.4902574982026 V3=0 T=0 M2=0 M3=-134.009493183719 S11Max=333.006962978537 PtS11Max=3 x2S11Max=0.5 x3S11Max=-0.5 _
 S11Min=-1275.10695522609 PtS11Min=1 x2S11Min=-0.5 x3S11Min=-0.5 FrameElem=19 ElemStation=0.5
 Frame=19 Station=0 OutputCase=ACCSX1 CaseType=Combination P=-471.514073806106 V2=-47.7494155868851 V3=0 T=0 M2=0 M3=-110.565422591188 S11Max=191.878461741022 PtS11Max=3 x2S11Max=0.5 x3S11Max=-0.5 _
 S11Min=-1134.90660935323 PtS11Min=1 x2S11Min=-0.5 x3S11Min=-0.5 FrameElem=19 ElemStation=0
 Frame=19 Station=0.5 OutputCase=ACCSX1 CaseType=Combination P=-459.014074133125 V2=-6.6009780320184 V3=0 T=0 M2=0 M3=-97.0666523119915 S11Max=123.385839738825 PtS11Max=3 x2S11Max=0.5 x3S11Max=-0.5 _
 S11Min=-1041.41398803269 PtS11Min=1 x2S11Min=-0.5 x3S11Min=-0.5 FrameElem=19 ElemStation=0.5
 Frame=19 Station=0 OutputCase=ACCSX2 CaseType=Combination P=-471.514073617118 V2=-37.0511506385608 V3=0 T=0 M2=0 M3=-142.145293667497 S11Max=381.357688387864 PtS11Max=3 x2S11Max=0.5 x3S11Max=-0.5 _
 S11Min=-1324.3858356221 PtS11Min=1 x2S11Min=-0.5 x3S11Min=-0.5 FrameElem=19 ElemStation=0
 Frame=19 Station=0.5 OutputCase=ACCSX2 CaseType=Combination P=-459.014073846031 V2=-8.24724432035177 V3=0 T=0 M2=0 M3=-130.882874615639 S11Max=326.283173847806 PtS11Max=3 x2S11Max=0.5 x3S11Max=-0.5 _
 S11Min=-1244.31132153987 PtS11Min=1 x2S11Min=-0.5 x3S11Min=-0.5 FrameElem=19 ElemStation=0.5
 Frame=19 Station=0 OutputCase=ENVE CaseType=Combination StepType=Max P=-469.999995993617 V2=-37.0511506385608 V3=0 T=0 M2=0 M3=-110.565422591188 S11Max=396.543017061327 PtS11Max=3 x2S11Max=0.5 x3S11Max=-0.5 _
 S11Min=-1134.90660935323 PtS11Min=1 x2S11Min=-0.5 x3S11Min=-0.5 FrameElem=19 ElemStation=0
 Frame=19 Station=0.5 OutputCase=ENVE CaseType=Combination StepType=Max P=-457.49999622253 V2=-6.6009780320184 V3=0 T=0 M2=0 M3=-97.0666523119915 S11Max=333.006962978537 PtS11Max=3 x2S11Max=0.5 x3S11Max=-0.5 _
 S11Min=-1040.79218711156 PtS11Min=1 x2S11Min=-0.5 x3S11Min=-0.5 FrameElem=19 ElemStation=0.5
 Frame=19 Station=0 OutputCase=ENVE CaseType=Combination StepType=Min P=-483.549996074672 V2=-51.1474287647359 V3=0 T=0 M2=0 M3=-146.682168824502 S11Max=191.878461741022 PtS11Max=3 x2S11Max=0.5 x3S11Max=-0.5 _
 S11Min=-1363.64300883269 PtS11Min=1 x2S11Min=-0.5 x3S11Min=-0.5 FrameElem=19 ElemStation=0
 Frame=19 Station=0.5 OutputCase=ENVE CaseType=Combination StepType=Min P=-471.04999641087 V2=-10.5200422991755 V3=0 T=0 M2=0 M3=-134.009493183719 S11Max=123.385839738825 PtS11Max=3 x2S11Max=0.5 x3S11Max=-0.5 _
 S11Min=-1275.10695522609 PtS11Min=1 x2S11Min=-0.5 x3S11Min=-0.5 FrameElem=19 ElemStation=0.5
 Frame=19 Station=0 OutputCase=FESSUR CaseType=Combination P=-479.484996107052 V2=-50.8098642050278 V3=0 T=0 M2=0 M3=-114.126768734414 S11Max=205.275616299433 PtS11Max=3 x2S11Max=0.5 x3S11Max=-0.5 _
 S11Min=-1164.24560851354 PtS11Min=1 x2S11Min=-0.5 x3S11Min=-0.5 FrameElem=19 ElemStation=0
 Frame=19 Station=0.5 OutputCase=FESSUR CaseType=Combination P=-466.984996440496 V2=-8.85292665016109 V3=0 T=0 M2=0 M3=-99.2998991461464 S11Max=128.814398436383 PtS11Max=3 x2S11Max=0.5 x3S11Max=-0.5 _
 S11Min=-1062.78439131737 PtS11Min=1 x2S11Min=-0.5 x3S11Min=-0.5 FrameElem=19 ElemStation=0.5
 Frame=20 Station=0 OutputCase=PERM1 CaseType=Combination P=-457.499996509712 V2=-8.87377601084097 V3=0 T=0 M2=0 M3=-97.2153651003229 S11Max=125.792194092226 PtS11Max=3 x2S11Max=0.5 x3S11Max=-0.5 _
 S11Min=-1040.79218711165 PtS11Min=1 x2S11Min=-0.5 x3S11Min=-0.5 FrameElem=20 ElemStation=0
 Frame=20 Station=0.5 OutputCase=PERM1 CaseType=Combination P=-444.99996819788 V2=30.1427865313187 V3=0 T=0 M2=0 M3=-102.621445855972 S11Max=170.728678316043 PtS11Max=3 x2S11Max=0.5 x3S11Max=-0.5 _
 S11Min=-1060.72867195562 PtS11Min=1 x2S11Min=-0.5 x3S11Min=-0.5 FrameElem=20 ElemStation=0.5

```

Frame=20 Station=0 OutputCase=PERM2 CaseType=Combination P=-457.499996222618 V2=-10.5200422991744
V3=0 T=0 M2=0 M3=-131.031587403971 S11Max=328.689528201208 PtS11Max=3 x2S11Max=0.5 x3S11Max=-0.5 _
S11Min=-1243.68952064644 PtS11Min=1 x2S11Min=-0.5 x3S11Min=-0.5 FrameElem=20 ElemStation=0
Frame=20 Station=0.5 OutputCase=PERM2 CaseType=Combination P=-444.999996439671 V2=16.7915515101398
V3=0 T=0 M2=0 M3=-132.661644394583 S11Max=350.969869927826 PtS11Max=3 x2S11Max=0.5 x3S11Max=-0.5 _
S11Min=-1240.96986280717 PtS11Min=1 x2S11Min=-0.5 x3S11Min=-0.5 FrameElem=20 ElemStation=0.5
Frame=20 Station=0 OutputCase=ACC1 CaseType=Combination P=-471.049996410956 V2=-8.8439912098678 V3=0
T=0 M2=0 M3=-100.193270880071 S11Max=130.109628869467 PtS11Max=3 x2S11Max=0.5 x3S11Max=-0.5 _
S11Min=-1072.20962169138 PtS11Min=1 x2S11Min=-0.5 x3S11Min=-0.5 FrameElem=20 ElemStation=0
Frame=20 Station=0.5 OutputCase=ACC1 CaseType=Combination P=-458.549996730211 V2=31.3275713322919
V3=0 T=0 M2=0 M3=-105.902994036206 S11Max=176.867967487025 PtS11Max=3 x2S11Max=0.5 x3S11Max=-0.5 _
S11Min=-1093.96796094745 PtS11Min=1 x2S11Min=-0.5 x3S11Min=-0.5 FrameElem=20 ElemStation=0.5
Frame=20 Station=0 OutputCase=ACC2 CaseType=Combination P=-471.049996123862 V2=-10.4902574982012 V3=0
T=0 M2=0 M3=-134.009493183718 S11Max=333.006962978449 PtS11Max=3 x2S11Max=0.5 x3S11Max=-0.5 _
S11Min=-1275.10695522617 PtS11Min=1 x2S11Min=-0.5 x3S11Min=-0.5 FrameElem=20 ElemStation=0
Frame=20 Station=0.5 OutputCase=ACC2 CaseType=Combination P=-458.549996350094 V2=17.9763363111129
V3=0 T=0 M2=0 M3=-135.943192574817 S11Max=357.109159098808 PtS11Max=3 x2S11Max=0.5 x3S11Max=-0.5 _
S11Min=-1274.209151799 PtS11Min=1 x2S11Min=-0.5 x3S11Min=-0.5 FrameElem=20 ElemStation=0.5
Frame=20 Station=0 OutputCase=ACCSX1 CaseType=Combination P=-459.014074133212 V2=-6.60097803201631
V3=0 T=0 M2=0 M3=-97.0666523119914 S11Max=123.385839738737 PtS11Max=3 x2S11Max=0.5 x3S11Max=-0.5 _
S11Min=-1041.41398800516 PtS11Min=1 x2S11Min=-0.5 x3S11Min=-0.5 FrameElem=20 ElemStation=0
Frame=20 Station=0.5 OutputCase=ACCSX1 CaseType=Combination P=-446.514074443288 V2=32.4155845101434
V3=0 T=0 M2=0 M3=-103.609132057053 S11Max=175.140717899028 PtS11Max=3 x2S11Max=0.5 x3S11Max=-0.5 _
S11Min=-1068.1688667856 PtS11Min=1 x2S11Min=-0.5 x3S11Min=-0.5 FrameElem=20 ElemStation=0.5
Frame=20 Station=0 OutputCase=ACCSX2 CaseType=Combination P=-459.014073846118 V2=-8.2472443203497
V3=0 T=0 M2=0 M3=-130.882874615639 S11Max=326.283173847718 PtS11Max=3 x2S11Max=0.5 x3S11Max=-0.5 _
S11Min=-1244.31132153995 PtS11Min=1 x2S11Min=-0.5 x3S11Min=-0.5 FrameElem=20 ElemStation=0
Frame=20 Station=0.5 OutputCase=ACCSX2 CaseType=Combination P=-446.514074063171 V2=19.0643494889644
V3=0 T=0 M2=0 M3=-133.649330595664 S11Max=355.381909510811 PtS11Max=3 x2S11Max=0.5 x3S11Max=-0.5 _
S11Min=-1248.41005763715 PtS11Min=1 x2S11Min=-0.5 x3S11Min=-0.5 FrameElem=20 ElemStation=0.5
Frame=20 Station=0 OutputCase=ENVE CaseType=Combination StepType=Max P=-457.499996222618 V2=-
6.60097803201631 V3=0 T=0 M2=0 M3=-97.0666523119914 S11Max=333.006962978449 PtS11Max=3 x2S11Max=0.5
x3S11Max=-0.5 _
S11Min=-1040.79218711165 PtS11Min=1 x2S11Min=-0.5 x3S11Min=-0.5 FrameElem=20 ElemStation=0
Frame=20 Station=0.5 OutputCase=ENVE CaseType=Combination StepType=Max P=-444.999996439671
V2=32.4155845101434 V3=0 T=0 M2=0 M3=-102.621445855972 S11Max=357.109159098808 PtS11Max=3 x2S11Max=0.5
x3S11Max=-0.5 _
S11Min=-1060.72867195562 PtS11Min=1 x2S11Min=-0.5 x3S11Min=-0.5 FrameElem=20 ElemStation=0.5
Frame=20 Station=0 OutputCase=ENVE CaseType=Combination StepType=Min P=-471.049996410956 V2=-
10.5200422991744 V3=0 T=0 M2=0 M3=-134.009493183718 S11Max=123.385839738737 PtS11Max=3 x2S11Max=0.5
x3S11Max=-0.5 _
S11Min=-1275.10695522617 PtS11Min=1 x2S11Min=-0.5 x3S11Min=-0.5 FrameElem=20 ElemStation=0
Frame=20 Station=0.5 OutputCase=ENVE CaseType=Combination StepType=Min P=-458.549996730211
V2=16.7915515101398 V3=0 T=0 M2=0 M3=-135.943192574817 S11Max=170.728678316043 PtS11Max=3 x2S11Max=0.5
x3S11Max=-0.5 _
S11Min=-1274.209151799 PtS11Min=1 x2S11Min=-0.5 x3S11Min=-0.5 FrameElem=20 ElemStation=0.5
Frame=20 Station=0 OutputCase=FESSUR CaseType=Combination P=-466.984996440583 V2=-8.85292665015975
V3=0 T=0 M2=0 M3=-99.2998991461463 S11Max=128.814398436295 PtS11Max=3 x2S11Max=0.5 x3S11Max=-0.5 _
S11Min=-1062.78439131746 PtS11Min=1 x2S11Min=-0.5 x3S11Min=-0.5 FrameElem=20 ElemStation=0
Frame=20 Station=0.5 OutputCase=FESSUR CaseType=Combination P=-454.484996757084 V2=30.972135892 V3=0
T=0 M2=0 M3=-104.918529582136 S11Max=175.026180735731 PtS11Max=3 x2S11Max=0.5 x3S11Max=-0.5 _
S11Min=-1083.9961742499 PtS11Min=1 x2S11Min=-0.5 x3S11Min=-0.5 FrameElem=20 ElemStation=0.5
Frame=21 Station=0 OutputCase=PERM1 CaseType=Combination P=-444.99999681973 V2=30.142786531317 V3=0
T=0 M2=0 M3=-102.621445855971 S11Max=170.728678316099 PtS11Max=3 x2S11Max=0.5 x3S11Max=-0.5 _
S11Min=-1060.72867195556 PtS11Min=1 x2S11Min=-0.5 x3S11Min=-0.5 FrameElem=21 ElemStation=0
Frame=21 Station=0.5 OutputCase=PERM1 CaseType=Combination P=-432.499997112863 V2=67.0274740607698
V3=0 T=0 M2=0 M3=-127.002839129523 S11Max=329.517037664273 PtS11Max=3 x2S11Max=0.5 x3S11Max=-0.5 _
S11Min=-1194.51703189 PtS11Min=1 x2S11Min=-0.5 x3S11Min=-0.5 FrameElem=21 ElemStation=0.5
Frame=21 Station=0 OutputCase=PERM2 CaseType=Combination P=-444.999996439613 V2=16.7915515101382 V3=0
T=0 M2=0 M3=-132.661644394582 S11Max=350.969869927882 PtS11Max=3 x2S11Max=0.5 x3S11Max=-0.5 _
S11Min=-1240.96986280711 PtS11Min=1 x2S11Min=-0.5 x3S11Min=-0.5 FrameElem=21 ElemStation=0
Frame=21 Station=0.5 OutputCase=PERM2 CaseType=Combination P=-432.499996644806 V2=42.6108328105575
V3=0 T=0 M2=0 M3=-147.574420162627 S11Max=452.946524330956 PtS11Max=3 x2S11Max=0.5 x3S11Max=-0.5 _
S11Min=-1317.94651762057 PtS11Min=1 x2S11Min=-0.5 x3S11Min=-0.5 FrameElem=21 ElemStation=0.5
Frame=21 Station=0 OutputCase=ACC1 CaseType=Combination P=-458.549996730157 V2=31.3275713322895 V3=0
T=0 M2=0 M3=-105.902994036205 S11Max=176.867967487075 PtS11Max=3 x2S11Max=0.5 x3S11Max=-0.5 _
S11Min=-1093.96796094739 PtS11Min=1 x2S11Min=-0.5 x3S11Min=-0.5 FrameElem=21 ElemStation=0
Frame=21 Station=0.5 OutputCase=ACC1 CaseType=Combination P=-446.049997032469 V2=69.3672588617422
V3=0 T=0 M2=0 M3=-131.165529710243 S11Max=340.943181228986 PtS11Max=3 x2S11Max=0.5 x3S11Max=-0.5 _
S11Min=-1233.04317529392 PtS11Min=1 x2S11Min=-0.5 x3S11Min=-0.5 FrameElem=21 ElemStation=0.5
Frame=21 Station=0 OutputCase=ACC2 CaseType=Combination P=-458.54999635004 V2=17.9763363111107 V3=0
T=0 M2=0 M3=-135.943192574816 S11Max=357.109159098858 PtS11Max=3 x2S11Max=0.5 x3S11Max=-0.5 _
S11Min=-1274.20915179894 PtS11Min=1 x2S11Min=-0.5 x3S11Min=-0.5 FrameElem=21 ElemStation=0
Frame=21 Station=0.5 OutputCase=ACC2 CaseType=Combination P=-446.049996564412 V2=44.9506176115299
V3=0 T=0 M2=0 M3=-151.737110743347 S11Max=464.37266789567 PtS11Max=3 x2S11Max=0.5 x3S11Max=-0.5 _
S11Min=-1356.47266102449 PtS11Min=1 x2S11Min=-0.5 x3S11Min=-0.5 FrameElem=21 ElemStation=0.5
Frame=21 Station=0 OutputCase=ACCSX1 CaseType=Combination P=-446.514074443232 V2=32.4155845101412
V3=0 T=0 M2=0 M3=-103.609132057052 S11Max=175.14071789908 PtS11Max=3 x2S11Max=0.5 x3S11Max=-0.5 _
S11Min=-1068.16886678554 PtS11Min=1 x2S11Min=-0.5 x3S11Min=-0.5 FrameElem=21 ElemStation=0
Frame=21 Station=0.5 OutputCase=ACCSX1 CaseType=Combination P=-434.014074736365 V2=69.300272039594
V3=0 T=0 M2=0 M3=-129.126924320015 S11Max=340.747471183727 PtS11Max=3 x2S11Max=0.5 x3S11Max=-0.5 _
S11Min=-1208.77562065646 PtS11Min=1 x2S11Min=-0.5 x3S11Min=-0.5 FrameElem=21 ElemStation=0.5

```



Frame=21 Station=0 OutputCase=ACCSX2 CaseType=Combination P=-446.514074063115 V2=19.0643494889624
 V3=0 T=0 M2=0 M3=-133.649330595663 S11Max=355.381909510864 PtS11Max=3 x2S11Max=0.5 x3S11Max=-0.5 _
 S11Min=-1248.41005763709 PtS11Min=1 x2S11Min=-0.5 x3S11Min=-0.5 FrameElem=21 ElemStation=0
 Frame=21 Station=0.5 OutputCase=ACCSX2 CaseType=Combination P=-434.014074268308 V2=44.8836307893817
 V3=0 T=0 M2=0 M3=-149.69850535312 S11Max=464.17695785041 PtS11Max=3 x2S11Max=0.5 x3S11Max=-0.5 _
 S11Min=-1332.20510638703 PtS11Min=1 x2S11Min=-0.5 x3S11Min=-0.5 FrameElem=21 ElemStation=0.5
 Frame=21 Station=0 OutputCase=ENVE CaseType=Combination StepType=Max P=-444.999996439613
 V2=32.4155845101412 V3=0 T=0 M2=0 M3=-102.621445855971 S11Max=357.109159098858 PtS11Max=3 x2S11Max=0.5
 x3S11Max=-0.5 _
 S11Min=-1060.72867195556 PtS11Min=1 x2S11Min=-0.5 x3S11Min=-0.5 FrameElem=21 ElemStation=0
 Frame=21 Station=0.5 OutputCase=ENVE CaseType=Combination StepType=Max P=-432.499996644806
 V2=69.3672588617422 V3=0 T=0 M2=0 M3=-127.002839129523 S11Max=464.37266789567 PtS11Max=3 x2S11Max=0.5
 x3S11Max=-0.5 _
 S11Min=-1194.51703189 PtS11Min=1 x2S11Min=-0.5 x3S11Min=-0.5 FrameElem=21 ElemStation=0.5
 Frame=21 Station=0 OutputCase=ENVE CaseType=Combination StepType=Min P=-458.549996730157
 V2=16.7915515101382 V3=0 T=0 M2=0 M3=-135.943192574816 S11Max=170.728678316099 PtS11Max=3 x2S11Max=0.5
 x3S11Max=-0.5 _
 S11Min=-1274.20915179894 PtS11Min=1 x2S11Min=-0.5 x3S11Min=-0.5 FrameElem=21 ElemStation=0
 Frame=21 Station=0.5 OutputCase=ENVE CaseType=Combination StepType=Min P=-446.049997032469
 V2=42.6108328105575 V3=0 T=0 M2=0 M3=-151.737110743347 S11Max=329.517037664273 PtS11Max=3 x2S11Max=0.5
 x3S11Max=-0.5 _
 S11Min=-1356.47266102449 PtS11Min=1 x2S11Min=-0.5 x3S11Min=-0.5 FrameElem=21 ElemStation=0.5
 Frame=21 Station=0 OutputCase=FESSUR CaseType=Combination P=-454.484996757029 V2=30.9721358919977
 V3=0 T=0 M2=0 M3=-104.918529582135 S11Max=175.026180735782 PtS11Max=3 x2S11Max=0.5 x3S11Max=-0.5 _
 S11Min=-1083.99617424984 PtS11Min=1 x2S11Min=-0.5 x3S11Min=-0.5 FrameElem=21 ElemStation=0
 Frame=21 Station=0.5 OutputCase=FESSUR CaseType=Combination P=-441.984997056587 V2=68.6653234214505
 V3=0 T=0 M2=0 M3=-129.916722536027 S11Max=337.515338159572 PtS11Max=3 x2S11Max=0.5 x3S11Max=-0.5 _
 S11Min=-1221.48533227275 PtS11Min=1 x2S11Min=-0.5 x3S11Min=-0.5 FrameElem=21 ElemStation=0.5
 Frame=22 Station=0 OutputCase=PERM1 CaseType=Combination P=-432.49999711266 V2=67.0274740607739 V3=0
 T=0 M2=0 M3=-127.002839129524 S11Max=329.517037664481 PtS11Max=3 x2S11Max=0.5 x3S11Max=-0.5 _
 S11Min=-1194.5170318898 PtS11Min=1 x2S11Min=-0.5 x3S11Min=-0.5 FrameElem=22 ElemStation=0
 Frame=22 Station=0.5 OutputCase=PERM1 CaseType=Combination P=-419.999997388851 V2=101.78028657752
 V3=0 T=0 M2=0 M3=-169.293607414626 S11Max=595.761647098908 PtS11Max=3 x2S11Max=0.5 x3S11Max=-0.5 _
 S11Min=-1435.76164187661 PtS11Min=1 x2S11Min=-0.5 x3S11Min=-0.5 FrameElem=22 ElemStation=0.5
 Frame=22 Station=0 OutputCase=PERM2 CaseType=Combination P=-432.499996644603 V2=42.6108328105617 V3=0
 T=0 M2=0 M3=-147.574420162628 S11Max=452.946524331165 PtS11Max=3 x2S11Max=0.5 x3S11Max=-0.5 _
 S11Min=-1317.94651762037 PtS11Min=1 x2S11Min=-0.5 x3S11Min=-0.5 FrameElem=22 ElemStation=0
 Frame=22 Station=0.5 OutputCase=PERM2 CaseType=Combination P=-419.999996837936 V2=66.9378016020861
 V3=0 T=0 M2=0 M3=-175.023758453661 S11Max=630.142553884027 PtS11Max=3 x2S11Max=0.5 x3S11Max=-0.5 _
 S11Min=-1470.1425475599 PtS11Min=1 x2S11Min=-0.5 x3S11Min=-0.5 FrameElem=22 ElemStation=0.5
 Frame=22 Station=0 OutputCase=ACCL CaseType=Combination P=-446.049997032253 V2=69.367258861748 V3=0
 T=0 M2=0 M3=-131.165529710244 S11Max=340.943181229209 PtS11Max=3 x2S11Max=0.5 x3S11Max=-0.5 _
 S11Min=-1233.04317529372 PtS11Min=1 x2S11Min=-0.5 x3S11Min=-0.5 FrameElem=22 ElemStation=0
 Frame=22 Station=0.5 OutputCase=ACCL CaseType=Combination P=-433.549997317623 V2=105.275071378494
 V3=0 T=0 M2=0 M3=-174.914940395834 S11Max=615.939645057379 PtS11Max=3 x2S11Max=0.5 x3S11Max=-0.5 _
 S11Min=-1483.03963969262 PtS11Min=1 x2S11Min=-0.5 x3S11Min=-0.5 FrameElem=22 ElemStation=0.5
 Frame=22 Station=0 OutputCase=ACC2 CaseType=Combination P=-446.049996564196 V2=44.9506176115358 V3=0
 T=0 M2=0 M3=-151.737110743348 S11Max=464.372667895893 PtS11Max=3 x2S11Max=0.5 x3S11Max=-0.5 _
 S11Min=-1356.47266102428 PtS11Min=1 x2S11Min=-0.5 x3S11Min=-0.5 FrameElem=22 ElemStation=0
 Frame=22 Station=0.5 OutputCase=ACC2 CaseType=Combination P=-433.549996766708 V2=70.4325864030602
 V3=0 T=0 M2=0 M3=-180.645091434868 S11Max=650.320551842499 PtS11Max=3 x2S11Max=0.5 x3S11Max=-0.5 _
 S11Min=-1517.42054537592 PtS11Min=1 x2S11Min=-0.5 x3S11Min=-0.5 FrameElem=22 ElemStation=0.5
 Frame=22 Station=0 OutputCase=ACCSX1 CaseType=Combination P=-434.014074736159 V2=69.3002720395999
 V3=0 T=0 M2=0 M3=-129.126924320017 S11Max=340.747471183943 PtS11Max=3 x2S11Max=0.5 x3S11Max=-0.5 _
 S11Min=-1208.77562065626 PtS11Min=1 x2S11Min=-0.5 x3S11Min=-0.5 FrameElem=22 ElemStation=0
 Frame=22 Station=0.5 OutputCase=ACCSX1 CaseType=Combination P=-421.514075012349 V2=104.053084556346
 V3=0 T=0 M2=0 M3=-172.554091594533 S11Max=613.810474554848 PtS11Max=3 x2S11Max=0.5 x3S11Max=-0.5 _
 S11Min=-1456.83862457955 PtS11Min=1 x2S11Min=-0.5 x3S11Min=-0.5 FrameElem=22 ElemStation=0.5
 Frame=22 Station=0 OutputCase=ACCSX2 CaseType=Combination P=-434.014074268101 V2=44.8836307893877
 V3=0 T=0 M2=0 M3=-149.698505353121 S11Max=464.176957850627 PtS11Max=3 x2S11Max=0.5 x3S11Max=-0.5 _
 S11Min=-1332.20510638683 PtS11Min=1 x2S11Min=-0.5 x3S11Min=-0.5 FrameElem=22 ElemStation=0
 Frame=22 Station=0.5 OutputCase=ACCSX2 CaseType=Combination P=-421.514074461435 V2=69.2105995809121
 V3=0 T=0 M2=0 M3=-178.284242633567 S11Max=648.191381339967 PtS11Max=3 x2S11Max=0.5 x3S11Max=-0.5 _
 S11Min=-1491.21953026284 PtS11Min=1 x2S11Min=-0.5 x3S11Min=-0.5 FrameElem=22 ElemStation=0.5
 Frame=22 Station=0 OutputCase=ENVE CaseType=Combination StepType=Max P=-432.499996644603
 V2=69.367258861748 V3=0 T=0 M2=0 M3=-127.002839129524 S11Max=464.372667895893 PtS11Max=3 x2S11Max=0.5
 x3S11Max=-0.5 _
 S11Min=-1194.5170318898 PtS11Min=1 x2S11Min=-0.5 x3S11Min=-0.5 FrameElem=22 ElemStation=0
 Frame=22 Station=0.5 OutputCase=ENVE CaseType=Combination StepType=Max P=-419.999996837936
 V2=105.275071378494 V3=0 T=0 M2=0 M3=-169.293607414626 S11Max=650.320551842499 PtS11Max=3 x2S11Max=0.5
 x3S11Max=-0.5 _
 S11Min=-1435.76164187661 PtS11Min=1 x2S11Min=-0.5 x3S11Min=-0.5 FrameElem=22 ElemStation=0.5
 Frame=22 Station=0 OutputCase=ENVE CaseType=Combination StepType=Min P=-446.049997032253
 V2=42.6108328105617 V3=0 T=0 M2=0 M3=-151.737110743348 S11Max=329.517037664481 PtS11Max=3 x2S11Max=0.5
 x3S11Max=-0.5 _
 S11Min=-1356.47266102428 PtS11Min=1 x2S11Min=-0.5 x3S11Min=-0.5 FrameElem=22 ElemStation=0
 Frame=22 Station=0.5 OutputCase=ENVE CaseType=Combination StepType=Min P=-433.549997317623
 V2=66.9378016020861 V3=0 T=0 M2=0 M3=-180.645091434868 S11Max=595.761647098908 PtS11Max=3 x2S11Max=0.5
 x3S11Max=-0.5 _
 S11Min=-1517.42054537592 PtS11Min=1 x2S11Min=-0.5 x3S11Min=-0.5 FrameElem=22 ElemStation=0.5
 Frame=22 Station=0 OutputCase=FESSUR CaseType=Combination P=-441.984997056375 V2=68.6653234214558
 V3=0 T=0 M2=0 M3=-129.916722536028 S11Max=337.515338159791 PtS11Max=3 x2S11Max=0.5 x3S11Max=-0.5 _



S11Min=-1221.48533227254 PtS11Min=1 x2S11Min=-0.5 x3S11Min=-0.5 FrameElem=22 ElemStation=0
 Frame=22 Station=0.5 OutputCase=FESSUR CaseType=Combination P=-429.484997338991 V2=104.226635938202
 V3=0 T=0 M2=0 M3=-173.228540501471 S11Max=609.886245669838 PtS11Max=3 x2S11Max=0.5 x3S11Max=-0.5 _
 S11Min=-1468.85624034782 PtS11Min=1 x2S11Min=-0.5 x3S11Min=-0.5 FrameElem=22 ElemStation=0.5
 Frame=23 Station=0 OutputCase=PERM1 CaseType=Combination P=-494.999993948185 V2=138.714715618497 V3=0
 T=0 M2=0 M3=205.508374563548 S11Max=738.050253433101 PtS11Max=1 x2S11Max=-0.5 x3S11Max=-0.5 _
 S11Min=-1728.05024132947 PtS11Min=3 x2S11Min=0.5 x3S11Min=-0.5 FrameElem=23 ElemStation=0
 Frame=23 Station=0.5 OutputCase=PERM1 CaseType=Combination P=-482.499994309088 V2=93.3025280191563
 V3=0 T=0 M2=0 M3=147.592891779134 S11Max=403.057356365717 PtS11Max=1 x2S11Max=-0.5 x3S11Max=-0.5 _
 S11Min=-1368.05734498389 PtS11Min=3 x2S11Min=0.5 x3S11Min=-0.5 FrameElem=23 ElemStation=0.5
 Frame=23 Station=0 OutputCase=PERM2 CaseType=Combination P=-494.999994518676 V2=101.408700113943 V3=0
 T=0 M2=0 M3=213.29929250788 S11Max=784.795760528606 PtS11Max=1 x2S11Max=-0.5 x3S11Max=-0.5 _
 S11Min=-1774.79574956596 PtS11Min=3 x2S11Min=0.5 x3S11Min=-0.5 FrameElem=23 ElemStation=0
 Frame=23 Station=0.5 OutputCase=PERM2 CaseType=Combination P=-482.499994771309 V2=69.6201687646017
 V3=0 T=0 M2=0 M3=170.604254975744 S11Max=541.125535083157 PtS11Max=1 x2S11Max=-0.5 x3S11Max=-0.5 _
 S11Min=-1506.12552462577 PtS11Min=3 x2S11Min=0.5 x3S11Min=-0.5 FrameElem=23 ElemStation=0.5
 Frame=23 Station=0 OutputCase=ACC1 CaseType=Combination P=-508.549993761414 V2=142.1499308726 V3=0
 T=0 M2=0 M3=211.040353183354 S11Max=757.692125338711 PtS11Max=1 x2S11Max=-0.5 x3S11Max=-0.5 _
 S11Min=-1774.79211286154 PtS11Min=3 x2S11Min=0.5 x3S11Min=-0.5 FrameElem=23 ElemStation=0
 Frame=23 Station=0.5 OutputCase=ACC1 CaseType=Combination P=-496.049994131496 V2=95.5827432732586
 V3=0 T=0 M2=0 M3=151.69601277189 S11Max=414.126082499841 PtS11Max=1 x2S11Max=-0.5 x3S11Max=-0.5 _
 S11Min=-1406.22607076283 PtS11Min=3 x2S11Min=0.5 x3S11Min=-0.5 FrameElem=23 ElemStation=0.5
 Frame=23 Station=0 OutputCase=ACC2 CaseType=Combination P=-508.549994331905 V2=104.843915368045 V3=0
 T=0 M2=0 M3=218.831271127687 S11Max=804.43763243216 PtS11Max=1 x2S11Max=-0.5 x3S11Max=-0.5 _
 S11Min=-1821.53762109803 PtS11Min=3 x2S11Min=0.5 x3S11Min=-0.5 FrameElem=23 ElemStation=0
 Frame=23 Station=0.5 OutputCase=ACC2 CaseType=Combination P=-496.049994593717 V2=71.9003840187039
 V3=0 T=0 M2=0 M3=174.7073759685 S11Max=552.194261217281 PtS11Max=1 x2S11Max=-0.5 x3S11Max=-0.5 _
 S11Min=-1544.29425040471 PtS11Min=3 x2S11Min=0.5 x3S11Min=-0.5 FrameElem=23 ElemStation=0.5
 Frame=23 Station=0 OutputCase=ACCSX1 CaseType=Combination P=-493.485916296544 V2=144.526917615606
 V3=0 T=0 M2=0 M3=208.528826779726 S11Max=757.687044381811 PtS11Max=1 x2S11Max=-0.5 x3S11Max=-0.5 _
 S11Min=-1744.6588769749 PtS11Min=3 x2S11Min=0.5 x3S11Min=-0.5 FrameElem=23 ElemStation=0
 Frame=23 Station=0.5 OutputCase=ACCSX1 CaseType=Combination P=-480.985916666627 V2=97.9597300162654
 V3=0 T=0 M2=0 M3=147.995992996758 S11Max=406.99004131392 PtS11Max=1 x2S11Max=-0.5 x3S11Max=-0.5 _
 S11Min=-1368.96187464717 PtS11Min=3 x2S11Min=0.5 x3S11Min=-0.5 FrameElem=23 ElemStation=0.5
 Frame=23 Station=0 OutputCase=ACCSX2 CaseType=Combination P=-493.485916867036 V2=107.220902111052
 V3=0 T=0 M2=0 M3=216.319744724059 S11Max=804.432551477316 PtS11Max=1 x2S11Max=-0.5 x3S11Max=-0.5 _
 S11Min=-1791.40438521139 PtS11Min=3 x2S11Min=0.5 x3S11Min=-0.5 FrameElem=23 ElemStation=0
 Frame=23 Station=0.5 OutputCase=ACCSX2 CaseType=Combination P=-480.985917128848 V2=74.2773707617107
 V3=0 T=0 M2=0 M3=171.007356193368 S11Max=545.05822003136 PtS11Max=1 x2S11Max=-0.5 x3S11Max=-0.5 _
 S11Min=-1507.03005428906 PtS11Min=3 x2S11Min=0.5 x3S11Min=-0.5 FrameElem=23 ElemStation=0.5
 Frame=23 Station=0 OutputCase=ENVE CaseType=Combination StepType=Max P=-493.485916296544
 V2=144.526917615606 V3=0 T=0 M2=0 M3=218.831271127687 S11Max=804.437632434216 PtS11Max=1 x2S11Max=-0.5
 x3S11Max=-0.5 _
 S11Min=-1728.05024132947 PtS11Min=3 x2S11Min=0.5 x3S11Min=-0.5 FrameElem=23 ElemStation=0
 Frame=23 Station=0.5 OutputCase=ENVE CaseType=Combination StepType=Max P=-480.985916666627
 V2=97.9597300162654 V3=0 T=0 M2=0 M3=174.7073759685 S11Max=552.194261217281 PtS11Max=1 x2S11Max=-0.5
 x3S11Max=-0.5 _
 S11Min=-1368.05734498389 PtS11Min=3 x2S11Min=0.5 x3S11Min=-0.5 FrameElem=23 ElemStation=0.5
 Frame=23 Station=0 OutputCase=ENVE CaseType=Combination StepType=Min P=-508.549994331905
 V2=101.408700113943 V3=0 T=0 M2=0 M3=205.508374563548 S11Max=738.050253433101 PtS11Max=1 x2S11Max=-0.5
 x3S11Max=-0.5 _
 S11Min=-1821.53762109803 PtS11Min=3 x2S11Min=0.5 x3S11Min=-0.5 FrameElem=23 ElemStation=0
 Frame=23 Station=0.5 OutputCase=ENVE CaseType=Combination StepType=Min P=-496.049994593717
 V2=69.6201687646017 V3=0 T=0 M2=0 M3=147.592891779134 S11Max=403.057356365717 PtS11Max=1 x2S11Max=-0.5
 x3S11Max=-0.5 _
 S11Min=-1544.29425040471 PtS11Min=3 x2S11Min=0.5 x3S11Min=-0.5 FrameElem=23 ElemStation=0.5
 Frame=23 Station=0 OutputCase=FESSUR CaseType=Combination P=-504.484993817445 V2=141.119366296369
 V3=0 T=0 M2=0 M3=209.380759597412 S11Max=751.799563767028 PtS11Max=1 x2S11Max=-0.5 x3S11Max=-0.5 _
 S11Min=-1760.76955140192 PtS11Min=3 x2S11Min=0.5 x3S11Min=-0.5 FrameElem=23 ElemStation=0
 Frame=23 Station=0.5 OutputCase=FESSUR CaseType=Combination P=-491.984994184774 V2=94.8986786970279
 V3=0 T=0 M2=0 M3=150.465076474063 S11Max=410.805464659604 PtS11Max=1 x2S11Max=-0.5 x3S11Max=-0.5 _
 S11Min=-1394.77545302915 PtS11Min=3 x2S11Min=0.5 x3S11Min=-0.5 FrameElem=23 ElemStation=0.5
 Frame=24 Station=0 OutputCase=PERM1 CaseType=Combination P=-482.499994309117 V2=93.3025280191534 V3=0
 T=0 M2=0 M3=147.592891779133 S11Max=403.057356365681 PtS11Max=1 x2S11Max=-0.5 x3S11Max=-0.5 _
 S11Min=-1368.05734498391 PtS11Min=3 x2S11Min=0.5 x3S11Min=-0.5 FrameElem=24 ElemStation=0
 Frame=24 Station=0.5 OutputCase=PERM1 CaseType=Combination P=-469.999994653078 V2=50.0222154198124
 V3=0 T=0 M2=0 M3=111.850534044392 S11Max=201.103209613271 PtS11Max=1 x2S11Max=-0.5 x3S11Max=-0.5 _
 S11Min=-1141.10319891943 PtS11Min=3 x2S11Min=0.5 x3S11Min=-0.5 FrameElem=24 ElemStation=0.5
 Frame=24 Station=0 OutputCase=PERM2 CaseType=Combination P=-482.499994771338 V2=69.6201687645988 V3=0
 T=0 M2=0 M3=170.604254975743 S11Max=541.125535083121 PtS11Max=1 x2S11Max=-0.5 x3S11Max=-0.5 _
 S11Min=-1506.1255246258 PtS11Min=3 x2S11Min=0.5 x3S11Min=-0.5 FrameElem=24 ElemStation=0
 Frame=24 Station=0.5 OutputCase=PERM2 CaseType=Combination P=-469.99999501211 V2=39.3239499152577
 V3=0 T=0 M2=0 M3=143.430404993279 S11Max=390.582434947564 PtS11Max=1 x2S11Max=-0.5 x3S11Max=-0.5 _
 S11Min=-1330.58242497178 PtS11Min=3 x2S11Min=0.5 x3S11Min=-0.5 FrameElem=24 ElemStation=0.5
 Frame=24 Station=0 OutputCase=ACC1 CaseType=Combination P=-496.04999413153 V2=95.5827432732557 V3=0
 T=0 M2=0 M3=151.696012771888 S11Max=414.126082499798 PtS11Max=1 x2S11Max=-0.5 x3S11Max=-0.5 _
 S11Min=-1406.22607076286 PtS11Min=3 x2S11Min=0.5 x3S11Min=-0.5 FrameElem=24 ElemStation=0
 Frame=24 Station=0.5 OutputCase=ACC1 CaseType=Combination P=-483.54999448467 V2=51.1474306739146 V3=0
 T=0 M2=0 M3=115.102297410095 S11Max=207.063789975902 PtS11Max=1 x2S11Max=-0.5 x3S11Max=-0.5 _
 S11Min=-1174.16377894524 PtS11Min=3 x2S11Min=0.5 x3S11Min=-0.5 FrameElem=24 ElemStation=0.5
 Frame=24 Station=0 OutputCase=ACC2 CaseType=Combination P=-496.049994593751 V2=71.900384018701 V3=0
 T=0 M2=0 M3=174.707375968498 S11Max=552.194261217238 PtS11Max=1 x2S11Max=-0.5 x3S11Max=-0.5 _

S11Min=-1544.29425040474 PtS11Min=3 x2S11Min=0.5 x3S11Min=-0.5 FrameElem=24 ElemStation=0
Frame=24 Station=0.5 OutputCase=ACC2 CaseType=Combination P=-483.549994843703 V2=40.4491651693599
V3=0 T=0 M2=0 M3=146.682168358983 S11Max=396.543015310195 PtS11Max=1 x2S11Max=-0.5 x3S11Max=-0.5
S11Min=-1363.6430049976 PtS11Min=3 x2S11Min=0.5 x3S11Min=-0.5 FrameElem=24 ElemStation=0
Frame=24 Station=0 OutputCase=ACCSX1 CaseType=Combination P=-480.985916666652 V2=97.9597300162625
V3=0 T=0 M2=0 M3=147.995992996757 S11Max=406.990041313889 PtS11Max=1 x2S11Max=-0.5 x3S11Max=-0.5
S11Min=-1368.96187464719 PtS11Min=3 x2S11Min=0.5 x3S11Min=-0.5 FrameElem=24 ElemStation=0
Frame=24 Station=0.5 OutputCase=ACCSX1 CaseType=Combination P=-468.485917019792 V2=53.5244174169214
V3=0 T=0 M2=0 M3=110.213784263461 S11Max=192.796788560973 PtS11Max=1 x2S11Max=-0.5 x3S11Max=-0.5
S11Min=-1129.76862260056 PtS11Min=3 x2S11Min=0.5 x3S11Min=-0.5 FrameElem=24 ElemStation=0
Frame=24 Station=0 OutputCase=ACCSX2 CaseType=Combination P=-480.985917128872 V2=74.2773707617078
V3=0 T=0 M2=0 M3=171.007356193367 S11Max=545.058220031329 PtS11Max=1 x2S11Max=-0.5 x3S11Max=-0.5
S11Min=-1507.03005428907 PtS11Min=3 x2S11Min=0.5 x3S11Min=-0.5 FrameElem=24 ElemStation=0
Frame=24 Station=0.5 OutputCase=ACCSX2 CaseType=Combination P=-468.485917378824 V2=42.8261519123667
V3=0 T=0 M2=0 M3=141.793655212348 S11Max=382.276013895266 PtS11Max=1 x2S11Max=-0.5 x3S11Max=-0.5
S11Min=-1319.24784865291 PtS11Min=3 x2S11Min=0.5 x3S11Min=-0.5 FrameElem=24 ElemStation=0
Frame=24 Station=0 OutputCase=ENVE CaseType=Combination StepType=Max P=-480.985916666652
V2=97.9597300162625 V3=0 T=0 M2=0 M3=174.707375968498 S11Max=552.194261217238 PtS11Max=1 x2S11Max=-0.5
x3S11Max=-0.5
S11Min=-1368.05734498391 PtS11Min=3 x2S11Min=0.5 x3S11Min=-0.5 FrameElem=24 ElemStation=0
Frame=24 Station=0.5 OutputCase=ENVE CaseType=Combination StepType=Max P=-468.485917019792
V2=53.5244174169214 V3=0 T=0 M2=0 M3=146.682168358983 S11Max=396.543015310195 PtS11Max=1 x2S11Max=-0.5
x3S11Max=-0.5
S11Min=-1129.76862260056 PtS11Min=3 x2S11Min=0.5 x3S11Min=-0.5 FrameElem=24 ElemStation=0.5
Frame=24 Station=0 OutputCase=ENVE CaseType=Combination StepType=Min P=-496.049994593751
V2=69.6201687645988 V3=0 T=0 M2=0 M3=147.592891779133 S11Max=403.057356365681 PtS11Max=1 x2S11Max=-0.5
x3S11Max=-0.5
S11Min=-1544.29425040474 PtS11Min=3 x2S11Min=0.5 x3S11Min=-0.5 FrameElem=24 ElemStation=0
Frame=24 Station=0.5 OutputCase=ENVE CaseType=Combination StepType=Min P=-483.549994843703
V2=39.3239499152577 V3=0 T=0 M2=0 M3=110.213784263461 S11Max=192.796788560973 PtS11Max=1 x2S11Max=-0.5
x3S11Max=-0.5
S11Min=-1363.6430049976 PtS11Min=3 x2S11Min=0.5 x3S11Min=-0.5 FrameElem=24 ElemStation=0.5
Frame=24 Station=0 OutputCase=FESSUR CaseType=Combination P=-491.984994184806 V2=94.898678697025 V3=0
T=0 M2=0 M3=150.465076474061 S11Max=410.805464659563 PtS11Max=1 x2S11Max=-0.5 x3S11Max=-0.5
S11Min=-1394.77545302918 PtS11Min=3 x2S11Min=0.5 x3S11Min=-0.5 FrameElem=24 ElemStation=0
Frame=24 Station=0.5 OutputCase=FESSUR CaseType=Combination P=-479.484994535193 V2=50.8098660976839
V3=0 T=0 M2=0 M3=114.126768400384 S11Max=205.275615867113 PtS11Max=1 x2S11Max=-0.5 x3S11Max=-0.5
S11Min=-1164.2456049375 PtS11Min=3 x2S11Min=0.5 x3S11Min=-0.5 FrameElem=24 ElemStation=0.5
Frame=25 Station=0 OutputCase=PERM1 CaseType=Combination P=-469.99999465305 V2=50.0222154198117 V3=0
T=0 M2=0 M3=111.850534044392 S11Max=201.103209613301 PtS11Max=1 x2S11Max=-0.5 x3S11Max=-0.5
S11Min=-1141.1031989194 PtS11Min=3 x2S11Min=0.5 x3S11Min=-0.5 FrameElem=25 ElemStation=0
Frame=25 Station=0.5 OutputCase=PERM1 CaseType=Combination P=-457.499994980068 V2=8.87377782047061
V3=0 T=0 M2=0 M3=97.2153638593212 S11Max=125.792188175859 PtS11Max=1 x2S11Max=-0.5 x3S11Max=-0.5
S11Min=-1040.792178136 PtS11Min=3 x2S11Min=0.5 x3S11Min=-0.5 FrameElem=25 ElemStation=0.5
Frame=25 Station=0 OutputCase=PERM2 CaseType=Combination P=-469.999995012082 V2=39.3239499152568 V3=0
T=0 M2=0 M3=143.430404993279 S11Max=390.582434947593 PtS11Max=1 x2S11Max=-0.5 x3S11Max=-0.5
S11Min=-1330.58242497176 PtS11Min=3 x2S11Min=0.5 x3S11Min=-0.5 FrameElem=25 ElemStation=0
Frame=25 Station=0.5 OutputCase=PERM2 CaseType=Combination P=-457.499995240995 V2=10.5200435659157
V3=0 T=0 M2=0 M3=131.031586310486 S11Max=328.689522621922 PtS11Max=1 x2S11Max=-0.5 x3S11Max=-0.5
S11Min=-1243.68951310391 PtS11Min=3 x2S11Min=0.5 x3S11Min=-0.5 FrameElem=25 ElemStation=0.5
Frame=25 Station=0 OutputCase=ACCL CaseType=Combination P=-483.549994484629 V2=51.1474306739146 V3=0
T=0 M2=0 M3=115.102297410096 S11Max=207.063789975949 PtS11Max=1 x2S11Max=-0.5 x3S11Max=-0.5
S11Min=-1174.16377894521 PtS11Min=3 x2S11Min=0.5 x3S11Min=-0.5 FrameElem=25 ElemStation=0
Frame=25 Station=0.5 OutputCase=ACCL CaseType=Combination P=-471.049994820826 V2=8.84399307457352
V3=0 T=0 M2=0 M3=100.193269597974 S11Max=130.109622767019 PtS11Max=1 x2S11Max=-0.5 x3S11Max=-0.5
S11Min=-1072.20961240867 PtS11Min=3 x2S11Min=0.5 x3S11Min=-0.5 FrameElem=25 ElemStation=0.5
Frame=25 Station=0 OutputCase=ACC2 CaseType=Combination P=-483.549994843661 V2=40.4491651693597 V3=0
T=0 M2=0 M3=146.682168358984 S11Max=396.543015310241 PtS11Max=1 x2S11Max=-0.5 x3S11Max=-0.5
S11Min=-1363.64300499756 PtS11Min=3 x2S11Min=0.5 x3S11Min=-0.5 FrameElem=25 ElemStation=0
Frame=25 Station=0.5 OutputCase=ACC2 CaseType=Combination P=-471.049995081753 V2=10.4902588200187
V3=0 T=0 M2=0 M3=134.009492049139 S11Max=333.006957213081 PtS11Max=1 x2S11Max=-0.5 x3S11Max=-0.5
S11Min=-1275.10694737659 PtS11Min=3 x2S11Min=0.5 x3S11Min=-0.5 FrameElem=25 ElemStation=0.5
Frame=25 Station=0 OutputCase=ACCSX1 CaseType=Combination P=-468.485917019765 V2=53.5244174169214
V3=0 T=0 M2=0 M3=110.213784263461 S11Max=192.796788561004 PtS11Max=1 x2S11Max=-0.5 x3S11Max=-0.5
S11Min=-1129.76862260053 PtS11Min=3 x2S11Min=0.5 x3S11Min=-0.5 FrameElem=25 ElemStation=0
Frame=25 Station=0.5 OutputCase=ACCSX1 CaseType=Combination P=-455.985917355963 V2=11.2209798175804
V3=0 T=0 M2=0 M3=94.116263079836 S11Max=108.711661123054 PtS11Max=1 x2S11Max=-0.5 x3S11Max=-0.5
S11Min=-1020.68349583498 PtS11Min=3 x2S11Min=0.5 x3S11Min=-0.5 FrameElem=25 ElemStation=0.5
Frame=25 Station=0 OutputCase=ACCSX2 CaseType=Combination P=-468.485917378797 V2=42.8261519123666
V3=0 T=0 M2=0 M3=141.793655212349 S11Max=382.276013895296 PtS11Max=1 x2S11Max=-0.5 x3S11Max=-0.5
S11Min=-1319.24784865289 PtS11Min=3 x2S11Min=0.5 x3S11Min=-0.5 FrameElem=25 ElemStation=0
Frame=25 Station=0.5 OutputCase=ACCSX2 CaseType=Combination P=-455.985917616889 V2=12.8672455630255
V3=0 T=0 M2=0 M3=127.932485531001 S11Max=311.608995569116 PtS11Max=1 x2S11Max=-0.5 x3S11Max=-0.5
S11Min=-1223.58083080289 PtS11Min=3 x2S11Min=0.5 x3S11Min=-0.5 FrameElem=25 ElemStation=0.5
Frame=25 Station=0 OutputCase=ENVE CaseType=Combination StepType=Max P=-468.485917019765
V2=53.5244174169214 V3=0 T=0 M2=0 M3=146.682168358984 S11Max=396.543015310241 PtS11Max=1 x2S11Max=-0.5
x3S11Max=-0.5
S11Min=-1129.76862260053 PtS11Min=3 x2S11Min=0.5 x3S11Min=-0.5 FrameElem=25 ElemStation=0
Frame=25 Station=0.5 OutputCase=ENVE CaseType=Combination StepType=Max P=-455.985917355963
V2=12.8672455630255 V3=0 T=0 M2=0 M3=134.009492049139 S11Max=333.006957213081 PtS11Max=1 x2S11Max=-0.5
x3S11Max=-0.5
S11Min=-1020.68349583498 PtS11Min=3 x2S11Min=0.5 x3S11Min=-0.5 FrameElem=25 ElemStation=0.5



Frame=25 Station=0 OutputCase=ENVE CaseType=Combination StepType=Min P=-483.549994843661
 V2=39.3239499152568 V3=0 T=0 M2=0 M3=110.213784263461 S11Max=192.796788561004 PtS11Max=1 x2S11Max=-0.5
 x3S11Max=-0.5
 S11Min=-1363.64300499756 PtS11Min=3 x2S11Min=0.5 x3S11Min=-0.5 FrameElem=25 ElemStation=0
 Frame=25 Station=0.5 OutputCase=ENVE CaseType=Combination StepType=Min P=-471.049995081753
 V2=8.84399307457352 V3=0 T=0 M2=0 M3=94.116263079836 S11Max=108.711661123054 PtS11Max=1 x2S11Max=-0.5
 x3S11Max=-0.5
 S11Min=-1275.10694737659 PtS11Min=3 x2S11Min=0.5 x3S11Min=-0.5 FrameElem=25 ElemStation=0.5
 Frame=25 Station=0 OutputCase=FESSUR CaseType=Combination StepType=Min P=-479.484994535155 V2=50.8098660976837
 V3=0 T=0 M2=0 M3=114.126768400385 S11Max=205.275615867154 PtS11Max=1 x2S11Max=-0.5 x3S11Max=-0.5
 S11Min=-1164.24560493746 PtS11Min=3 x2S11Min=0.5 x3S11Min=-0.5 FrameElem=25 ElemStation=0
 Frame=25 Station=0.5 OutputCase=FESSUR CaseType=Combination StepType=Min P=-466.984994868599 V2=8.85292849834265
 V3=0 T=0 M2=0 M3=99.2998978763783 S11Max=128.814392389671 PtS11Max=1 x2S11Max=-0.5 x3S11Max=-0.5
 S11Min=-1062.78438212687 PtS11Min=3 x2S11Min=0.5 x3S11Min=-0.5 FrameElem=25 ElemStation=0.5
 Frame=26 Station=0 OutputCase=PERM1 CaseType=Combination StepType=Min P=-457.499994979952 V2=8.8737778204694 V3=0
 T=0 M2=0 M3=97.215363859321 S11Max=125.792188175974 PtS11Max=1 x2S11Max=-0.5 x3S11Max=-0.5
 S11Min=-1040.79217813588 PtS11Min=3 x2S11Min=0.5 x3S11Min=-0.5 FrameElem=26 ElemStation=0
 Frame=26 Station=0.5 OutputCase=PERM1 CaseType=Combination StepType=Min P=-444.99995290028 V2=-30.1427847788717
 V3=0 T=0 M2=0 M3=102.621443723922 S11Max=170.728667053502 PtS11Max=1 x2S11Max=-0.5 x3S11Max=-0.5
 S11Min=-1060.72865763356 PtS11Min=3 x2S11Min=0.5 x3S11Min=-0.5 FrameElem=26 ElemStation=0.5
 Frame=26 Station=0 OutputCase=PERM2 CaseType=Combination StepType=Min P=-457.499995240878 V2=10.5200435659146 V3=0
 T=0 M2=0 M3=131.031586310486 S11Max=328.689522622036 PtS11Max=1 x2S11Max=-0.5 x3S11Max=-0.5
 S11Min=-1243.68951310379 PtS11Min=3 x2S11Min=0.5 x3S11Min=-0.5 FrameElem=26 ElemStation=0
 Frame=26 Station=0.5 OutputCase=PERM2 CaseType=Combination StepType=Min P=-444.99995457931 V2=-16.7915502834265
 V3=0 T=0 M2=0 M3=132.661642677364 S11Max=350.969860606251 PtS11Max=1 x2S11Max=-0.5 x3S11Max=-0.5
 S11Min=-1240.96985152211 PtS11Min=3 x2S11Min=0.5 x3S11Min=-0.5 FrameElem=26 ElemStation=0.5
 Frame=26 Station=0 OutputCase=ACCL CaseType=Combination StepType=Min P=-471.049994820715 V2=8.84399307457025 V3=0
 T=0 M2=0 M3=100.193269597974 S11Max=130.109622767129 PtS11Max=1 x2S11Max=-0.5 x3S11Max=-0.5
 S11Min=-1072.20961240856 PtS11Min=3 x2S11Min=0.5 x3S11Min=-0.5 FrameElem=26 ElemStation=0
 Frame=26 Station=0.5 OutputCase=ACCL CaseType=Combination StepType=Min P=-458.54999513997 V2=-31.3275695247708
 V3=0 T=0 M2=0 M3=105.902991835524 S11Max=176.867955873175 PtS11Max=1 x2S11Max=-0.5 x3S11Max=-0.5
 S11Min=-1093.96794615312 PtS11Min=3 x2S11Min=0.5 x3S11Min=-0.5 FrameElem=26 ElemStation=0.5
 Frame=26 Station=0 OutputCase=ACC2 CaseType=Combination StepType=Min P=-471.049995081642 V2=10.4902588200155 V3=0
 T=0 M2=0 M3=134.009492049139 S11Max=333.006957213192 PtS11Max=1 x2S11Max=-0.5 x3S11Max=-0.5
 S11Min=-1275.10694737648 PtS11Min=3 x2S11Min=0.5 x3S11Min=-0.5 FrameElem=26 ElemStation=0
 Frame=26 Station=0.5 OutputCase=ACC2 CaseType=Combination StepType=Min P=-458.549995307874 V2=-17.9763350293256
 V3=0 T=0 M2=0 M3=135.943190788966 S11Max=357.109149425925 PtS11Max=1 x2S11Max=-0.5 x3S11Max=-0.5
 S11Min=-1274.20914004167 PtS11Min=3 x2S11Min=0.5 x3S11Min=-0.5 FrameElem=26 ElemStation=0.5
 Frame=26 Station=0 OutputCase=ACCSX1 CaseType=Combination StepType=Min P=-455.98591735585 V2=11.2209798175794 V3=0
 T=0 M2=0 M3=94.1162630798355 S11Max=108.711661123163 PtS11Max=1 x2S11Max=-0.5 x3S11Max=-0.5
 S11Min=-1020.68349583486 PtS11Min=3 x2S11Min=0.5 x3S11Min=-0.5 FrameElem=26 ElemStation=0
 Frame=26 Station=0.5 OutputCase=ACCSX1 CaseType=Combination StepType=Min P=-443.485917675105 V2=12.9505827817617
 V3=0 T=0 M2=0 M3=98.637491945881 S11Max=148.339034000182 PtS11Max=1 x2S11Max=-0.5 x3S11Max=-0.5
 S11Min=-1035.31086935039 PtS11Min=3 x2S11Min=0.5 x3S11Min=-0.5 FrameElem=26 ElemStation=0.5
 Frame=26 Station=0 OutputCase=ACCSX2 CaseType=Combination StepType=Min P=-455.985917616776 V2=12.8672455630246
 V3=0 T=0 M2=0 M3=127.932485531 S11Max=311.608995569226 PtS11Max=1 x2S11Max=-0.5 x3S11Max=-0.5
 S11Min=-1223.58083080278 PtS11Min=3 x2S11Min=0.5 x3S11Min=-0.5 FrameElem=26 ElemStation=0
 Frame=26 Station=0.5 OutputCase=ACCSX2 CaseType=Combination StepType=Min P=-443.485917843008 V2=-15.5993482863164
 V3=0 T=0 M2=0 M3=128.677690899323 S11Max=328.580227552931 PtS11Max=1 x2S11Max=-0.5 x3S11Max=-0.5
 S11Min=-1215.55206323895 PtS11Min=3 x2S11Min=0.5 x3S11Min=-0.5 FrameElem=26 ElemStation=0.5
 Frame=26 Station=0 OutputCase=ENVE CaseType=Combination StepType=Max P=-455.98591735585
 V2=12.8672455630246 V3=0 T=0 M2=0 M3=134.009492049139 S11Max=333.006957213192 PtS11Max=1 x2S11Max=-0.5
 x3S11Max=-0.5
 S11Min=-1020.68349583486 PtS11Min=3 x2S11Min=0.5 x3S11Min=-0.5 FrameElem=26 ElemStation=0
 Frame=26 Station=0.5 OutputCase=ENVE CaseType=Combination StepType=Max P=-443.485917675105 V2=-
 15.5993482863164 V3=0 T=0 M2=0 M3=135.943190788966 S11Max=357.109149425925 PtS11Max=1 x2S11Max=-0.5
 x3S11Max=-0.5
 S11Min=-1035.31086935039 PtS11Min=3 x2S11Min=0.5 x3S11Min=-0.5 FrameElem=26 ElemStation=0.5
 Frame=26 Station=0 OutputCase=ENVE CaseType=Combination StepType=Min P=-471.049995081642
 V2=8.84399307457025 V3=0 T=0 M2=0 M3=94.1162630798355 S11Max=108.711661123163 PtS11Max=1 x2S11Max=-0.5
 x3S11Max=-0.5
 S11Min=-1275.10694737648 PtS11Min=3 x2S11Min=0.5 x3S11Min=-0.5 FrameElem=26 ElemStation=0
 Frame=26 Station=0.5 OutputCase=ENVE CaseType=Combination StepType=Min P=-458.549995307874 V2=-
 31.3275695247708 V3=0 T=0 M2=0 M3=98.637491945881 S11Max=148.339034000182 PtS11Max=1 x2S11Max=-0.5
 x3S11Max=-0.5
 S11Min=-1274.20914004167 PtS11Min=3 x2S11Min=0.5 x3S11Min=-0.5 FrameElem=26 ElemStation=0.5
 Frame=26 Station=0 OutputCase=FESSUR CaseType=Combination StepType=Min P=-466.984994868486 V2=8.85292849833999
 V3=0 T=0 M2=0 M3=99.2998978763782 S11Max=128.814392389783 PtS11Max=1 x2S11Max=-0.5 x3S11Max=-0.5
 S11Min=-1062.78438212676 PtS11Min=3 x2S11Min=0.5 x3S11Min=-0.5 FrameElem=26 ElemStation=0
 Frame=26 Station=0.5 OutputCase=FESSUR CaseType=Combination StepType=Min P=-454.484995184987 V2=-30.9721341010011
 V3=0 T=0 M2=0 M3=104.918527402043 S11Max=175.026169227273 PtS11Max=1 x2S11Max=-0.5 x3S11Max=-0.5
 S11Min=-1083.99615959725 PtS11Min=3 x2S11Min=0.5 x3S11Min=-0.5 FrameElem=26 ElemStation=0.5
 Frame=27 Station=0 OutputCase=PERM1 CaseType=Combination StepType=Min P=-444.99995289998 V2=-30.1427847788708
 V3=0 T=0 M2=0 M3=102.621443723922 S11Max=170.728667053532 PtS11Max=1 x2S11Max=-0.5 x3S11Max=-0.5
 S11Min=-1060.72865763353 PtS11Min=3 x2S11Min=0.5 x3S11Min=-0.5 FrameElem=27 ElemStation=0
 Frame=27 Station=0.5 OutputCase=PERM1 CaseType=Combination StepType=Min P=-432.499995583131 V2=-67.0274723782119
 V3=0 T=0 M2=0 M3=127.002836138192 S11Max=329.517021246023 PtS11Max=1 x2S11Max=-0.5 x3S11Max=-0.5
 S11Min=-1194.51701241228 PtS11Min=3 x2S11Min=0.5 x3S11Min=-0.5 FrameElem=27 ElemStation=0.5
 Frame=27 Station=0 OutputCase=PERM2 CaseType=Combination StepType=Min P=-444.99995457901 V2=-16.7915502834257
 V3=0 T=0 M2=0 M3=132.661642677364 S11Max=350.969860606282 PtS11Max=1 x2S11Max=-0.5 x3S11Max=-0.5
 S11Min=-1240.96985152208 PtS11Min=3 x2S11Min=0.5 x3S11Min=-0.5 FrameElem=27 ElemStation=0

Frame=27 Station=0.5 OutputCase=PERM2 CaseType=Combination P=-432.499995663095 V2=-42.6108316327668
V3=0 T=0 M2=0 M3=147.574417843912 S11Max=452.946511400377 PtS11Max=1 x2S11Max=-0.5 x3S11Max=-0.5 _
S11Min=-1317.94650272657 PtS11Min=3 x2S11Min=0.5 x3S11Min=-0.5 FrameElem=27 ElemStation=0.5

Frame=27 Station=0.5 OutputCase=ACC1 CaseType=Combination P=-458.549995139939 V2=-31.3275695247679 V3=0
T=0 M2=0 M3=105.902991835524 S11Max=176.867955873205 PtS11Max=1 x2S11Max=-0.5 x3S11Max=-0.5 _
S11Min=-1093.96794615308 PtS11Min=3 x2S11Min=0.5 x3S11Min=-0.5 FrameElem=27 ElemStation=0

Frame=27 Station=0.5 OutputCase=ACC1 CaseType=Combination P=-446.049995442252 V2=-17.9763350293228
V3=0 T=0 M2=0 M3=131.165526622743 S11Max=340.943164294208 PtS11Max=1 x2S11Max=-0.5 x3S11Max=-0.5 _
S11Min=-1233.04315517871 PtS11Min=3 x2S11Min=0.5 x3S11Min=-0.5 FrameElem=27 ElemStation=0.5

Frame=27 Station=0.5 OutputCase=ACC2 CaseType=Combination P=-458.549995307843 V2=-17.9763350293228 V3=0
T=0 M2=0 M3=135.943190788966 S11Max=357.109149425954 PtS11Max=1 x2S11Max=-0.5 x3S11Max=-0.5 _
S11Min=-1274.20914004164 PtS11Min=3 x2S11Min=0.5 x3S11Min=-0.5 FrameElem=27 ElemStation=0

Frame=27 Station=0.5 OutputCase=ACC2 CaseType=Combination P=-446.049995522216 V2=-44.9506163786639
V3=0 T=0 M2=0 M3=151.737108328463 S11Max=464.372654448562 PtS11Max=1 x2S11Max=-0.5 x3S11Max=-0.5 _
S11Min=-1356.47264549299 PtS11Min=3 x2S11Min=0.5 x3S11Min=-0.5 FrameElem=27 ElemStation=0.5

Frame=27 Station=0.5 OutputCase=ACCSX1 CaseType=Combination P=-443.485917675074 V2=-28.9505827817601
V3=0 T=0 M2=0 M3=98.6374919458811 S11Max=148.339034000213 PtS11Max=1 x2S11Max=-0.5 x3S11Max=-0.5 _
S11Min=-1035.31086935036 PtS11Min=3 x2S11Min=0.5 x3S11Min=-0.5 FrameElem=27 ElemStation=0

Frame=27 Station=0.5 OutputCase=ACCSX1 CaseType=Combination P=-430.985917977386 V2=-66.9902703811012
V3=0 T=0 M2=0 M3=122.711533361596 S11Max=305.283282192192 PtS11Max=1 x2S11Max=-0.5 x3S11Max=-0.5 _
S11Min=-1167.25511814696 PtS11Min=3 x2S11Min=0.5 x3S11Min=-0.5 FrameElem=27 ElemStation=0.5

Frame=27 Station=0.5 OutputCase=ACCSX2 CaseType=Combination P=-443.485917842978 V2=-15.599348286315
V3=0 T=0 M2=0 M3=128.677690899323 S11Max=328.580227552962 PtS11Max=1 x2S11Max=-0.5 x3S11Max=-0.5 _
S11Min=-1215.55206323892 PtS11Min=3 x2S11Min=0.5 x3S11Min=-0.5 FrameElem=27 ElemStation=0

Frame=27 Station=0.5 OutputCase=ACCSX2 CaseType=Combination P=-430.98591805735 V2=-42.5736296356561
V3=0 T=0 M2=0 M3=143.283115067316 S11Max=428.712772346546 PtS11Max=1 x2S11Max=-0.5 x3S11Max=-0.5 _
S11Min=-1290.68460846125 PtS11Min=3 x2S11Min=0.5 x3S11Min=-0.5 FrameElem=27 ElemStation=0.5

Frame=27 Station=0.5 OutputCase=ENVE CaseType=Combination StepType=Max P=-443.485917675074 V2=-
15.599348286315 V3=0 T=0 M2=0 M3=135.943190788966 S11Max=357.109149425954 PtS11Max=1 x2S11Max=-0.5
x3S11Max=-0.5 _
S11Min=-1035.31086935036 PtS11Min=3 x2S11Min=0.5 x3S11Min=-0.5 FrameElem=27 ElemStation=0

Frame=27 Station=0.5 OutputCase=ENVE CaseType=Combination StepType=Max P=-430.985917977386 V2=-
42.5736296356561 V3=0 T=0 M2=0 M3=151.737108328463 S11Max=464.372654448562 PtS11Max=1 x2S11Max=-0.5
x3S11Max=-0.5 _
S11Min=-1167.25511814696 PtS11Min=3 x2S11Min=0.5 x3S11Min=-0.5 FrameElem=27 ElemStation=0.5

Frame=27 Station=0.5 OutputCase=ENVE CaseType=Combination StepType=Min P=-458.549995307843 V2=-
31.3275695247679 V3=0 T=0 M2=0 M3=98.6374919458811 S11Max=148.339034000213 PtS11Max=1 x2S11Max=-0.5
x3S11Max=-0.5 _
S11Min=-1274.20914004164 PtS11Min=3 x2S11Min=0.5 x3S11Min=-0.5 FrameElem=27 ElemStation=0

Frame=27 Station=0.5 OutputCase=ENVE CaseType=Combination StepType=Min P=-446.049995522216 V2=-
69.3672571241089 V3=0 T=0 M2=0 M3=122.711533361596 S11Max=305.283282192192 PtS11Max=1 x2S11Max=-0.5
x3S11Max=-0.5 _
S11Min=-1356.47264549299 PtS11Min=3 x2S11Min=0.5 x3S11Min=-0.5 FrameElem=27 ElemStation=0.5

Frame=27 Station=0.5 OutputCase=FESSUR CaseType=Combination P=-454.484995184957 V2=-30.9721341009988
V3=0 T=0 M2=0 M3=104.918527402043 S11Max=175.026169227303 PtS11Max=1 x2S11Max=-0.5 x3S11Max=-0.5 _
S11Min=-1083.99615959722 PtS11Min=3 x2S11Min=0.5 x3S11Min=-0.5 FrameElem=27 ElemStation=0

Frame=27 Station=0.5 OutputCase=FESSUR CaseType=Combination P=-441.984995484515 V2=-68.6653217003398
V3=0 T=0 M2=0 M3=129.916719477378 S11Max=337.515321379753 PtS11Max=1 x2S11Max=-0.5 x3S11Max=-0.5 _
S11Min=-1221.48531234878 PtS11Min=3 x2S11Min=0.5 x3S11Min=-0.5 FrameElem=27 ElemStation=0.5

Frame=28 Station=0.5 OutputCase=PERM1 CaseType=Combination P=-432.49999558316 V2=-67.0274723782122 V3=0
T=0 M2=0 M3=127.002836138193 S11Max=329.517021245995 PtS11Max=1 x2S11Max=-0.5 x3S11Max=-0.5 _
S11Min=-1194.51701241232 PtS11Min=3 x2S11Min=0.5 x3S11Min=-0.5 FrameElem=28 ElemStation=0

Frame=28 Station=0.5 OutputCase=PERM1 CaseType=Combination P=-419.999995859351 V2=-101.780284977553
V3=0 T=0 M2=0 M3=169.293603602134 S11Max=595.761625753452 PtS11Max=1 x2S11Max=-0.5 x3S11Max=-0.5 _
S11Min=-1435.76161747215 PtS11Min=3 x2S11Min=0.5 x3S11Min=-0.5 FrameElem=28 ElemStation=0.5

Frame=28 Station=0.5 OutputCase=PERM2 CaseType=Combination P=-432.499995663124 V2=-42.6108316327671
V3=0 T=0 M2=0 M3=147.574417843912 S11Max=452.946511400349 PtS11Max=1 x2S11Max=-0.5 x3S11Max=-0.5 _
S11Min=-1317.9465027266 PtS11Min=3 x2S11Min=0.5 x3S11Min=-0.5 FrameElem=28 ElemStation=0

Frame=28 Station=0.5 OutputCase=PERM2 CaseType=Combination P=-419.999995856458 V2=-66.9378004821081
V3=0 T=0 M2=0 M3=175.023755560131 S11Max=630.142537504328 PtS11Max=1 x2S11Max=-0.5 x3S11Max=-0.5 _
S11Min=-1470.14252921724 PtS11Min=3 x2S11Min=0.5 x3S11Min=-0.5 FrameElem=28 ElemStation=0.5

Frame=28 Station=0.5 OutputCase=ACC1 CaseType=Combination P=-446.049995442284 V2=-69.3672571241099 V3=0
T=0 M2=0 M3=131.165526622743 S11Max=340.943164294174 PtS11Max=1 x2S11Max=-0.5 x3S11Max=-0.5 _
S11Min=-1233.04315517874 PtS11Min=3 x2S11Min=0.5 x3S11Min=-0.5 FrameElem=28 ElemStation=0

Frame=28 Station=0.5 OutputCase=ACC1 CaseType=Combination P=-433.549995727654 V2=-105.275069723451
V3=0 T=0 M2=0 M3=174.914936459633 S11Max=615.939623030146 PtS11Max=1 x2S11Max=-0.5 x3S11Max=-0.5 _
S11Min=-1483.03961448545 PtS11Min=3 x2S11Min=0.5 x3S11Min=-0.5 FrameElem=28 ElemStation=0.5

Frame=28 Station=0.5 OutputCase=ACC2 CaseType=Combination P=-446.049995522248 V2=-44.9506163786648 V3=0
T=0 M2=0 M3=151.737108328463 S11Max=464.372654448528 PtS11Max=1 x2S11Max=-0.5 x3S11Max=-0.5 _
S11Min=-1356.47264549302 PtS11Min=3 x2S11Min=0.5 x3S11Min=-0.5 FrameElem=28 ElemStation=0

Frame=28 Station=0.5 OutputCase=ACC2 CaseType=Combination P=-433.549995724761 V2=-70.4325852280059
V3=0 T=0 M2=0 M3=180.64508841763 S11Max=650.320534781022 PtS11Max=1 x2S11Max=-0.5 x3S11Max=-0.5 _
S11Min=-1517.42052623054 PtS11Min=3 x2S11Min=0.5 x3S11Min=-0.5 FrameElem=28 ElemStation=0.5

Frame=28 Station=0.5 OutputCase=ACCSX1 CaseType=Combination P=-430.985917977413 V2=-66.9902703811021
V3=0 T=0 M2=0 M3=122.711533361596 S11Max=305.283282192163 PtS11Max=1 x2S11Max=-0.5 x3S11Max=-0.5 _
S11Min=-1167.25511814699 PtS11Min=3 x2S11Min=0.5 x3S11Min=-0.5 FrameElem=28 ElemStation=0

Frame=28 Station=0.5 OutputCase=ACCSX1 CaseType=Combination P=-418.485918262783 V2=-102.898082980443
V3=0 T=0 M2=0 M3=165.272449826982 S11Max=573.148780699111 PtS11Max=1 x2S11Max=-0.5 x3S11Max=-0.5 _
S11Min=-1410.12061722468 PtS11Min=3 x2S11Min=0.5 x3S11Min=-0.5 FrameElem=28 ElemStation=0.5

Frame=28 Station=0.5 OutputCase=ACCSX2 CaseType=Combination P=-430.985918057377 V2=-42.573629635657
V3=0 T=0 M2=0 M3=143.283115067316 S11Max=428.712772346517 PtS11Max=1 x2S11Max=-0.5 x3S11Max=-0.5 _
S11Min=-1290.68460846127 PtS11Min=3 x2S11Min=0.5 x3S11Min=-0.5 FrameElem=28 ElemStation=0



Frame=28 Station=0.5 OutputCase=ACCSX2 CaseType=Combination P=-418.48591825989 V2=-68.0555984849981
 V3=0 T=0 M2=0 M3=171.002601784979 S11Max=607.529692449987 PtS11Max=1 x2S11Max=-0.5 x3S11Max=-0.5 _
 S11Min=-1444.50152896977 PtS11Min=3 x2S11Min=0.5 x3S11Min=-0.5 FrameElem=28 ElemStation=0.5
 Frame=28 Station=0 OutputCase=ENVE CaseType=Combination StepType=Max P=-430.985917977413 V2=-
 42.573629635657 V3=0 T=0 M2=0 M3=151.737108328463 S11Max=464.372654448528 PtS11Max=1 x2S11Max=-0.5
 x3S11Max=-0.5 _
 S11Min=-1167.25511814699 PtS11Min=3 x2S11Min=0.5 x3S11Min=-0.5 FrameElem=28 ElemStation=0
 Frame=28 Station=0.5 OutputCase=ENVE CaseType=Combination StepType=Max P=-418.48591825989 V2=-
 66.9378004821081 V3=0 T=0 M2=0 M3=180.64508841763 S11Max=650.320534781022 PtS11Max=1 x2S11Max=-0.5
 x3S11Max=-0.5 _
 S11Min=-1410.12061722468 PtS11Min=3 x2S11Min=0.5 x3S11Min=-0.5 FrameElem=28 ElemStation=0.5
 Frame=28 Station=0 OutputCase=ENVE CaseType=Combination StepType=Min P=-446.049995522248 V2=-
 69.3672571241099 V3=0 T=0 M2=0 M3=122.711533361596 S11Max=305.283282192163 PtS11Max=1 x2S11Max=-0.5
 x3S11Max=-0.5 _
 S11Min=-1356.47264549302 PtS11Min=3 x2S11Min=0.5 x3S11Min=-0.5 FrameElem=28 ElemStation=0
 Frame=28 Station=0.5 OutputCase=ENVE CaseType=Combination StepType=Min P=-433.549995727654 V2=-
 105.275069723451 V3=0 T=0 M2=0 M3=165.272449826982 S11Max=573.148780699111 PtS11Max=1 x2S11Max=-0.5
 x3S11Max=-0.5 _
 S11Min=-1517.42052623054 PtS11Min=3 x2S11Min=0.5 x3S11Min=-0.5 FrameElem=28 ElemStation=0.5
 Frame=28 Station=0 OutputCase=FESSUR CaseType=Combination P=-441.984995484547 V2=-68.6653217003406
 V3=0 T=0 M2=0 M3=129.916719477378 S11Max=337.51532137972 PtS11Max=1 x2S11Max=-0.5 x3S11Max=-0.5 _
 S11Min=-1221.48531234881 PtS11Min=3 x2S11Min=0.5 x3S11Min=-0.5 FrameElem=28 ElemStation=0
 Frame=28 Station=0.5 OutputCase=FESSUR CaseType=Combination P=-429.484995767163 V2=-104.226634299682
 V3=0 T=0 M2=0 M3=173.228536602384 S11Max=609.886223847138 PtS11Max=1 x2S11Max=-0.5 x3S11Max=-0.5 _
 S11Min=-1468.85621538146 PtS11Min=3 x2S11Min=0.5 x3S11Min=-0.5 FrameElem=28 ElemStation=0.5
 Frame=41 Station=0 OutputCase=PERM1 CaseType=Combination P=-235.938772273309 V2=346.547598036699 V3=0
 T=0 M2=0 M3=58.8058465615717 S11Max=116.896307096121 PtS11Max=1 x2S11Max=-0.5 x3S11Max=-0.5 _
 S11Min=-588.773851642738 PtS11Min=3 x2S11Min=0.5 x3S11Min=-0.5 FrameElem=41 ElemStation=0
 Frame=41 Station=0.125 OutputCase=PERM1 CaseType=Combination P=-235.938772273309 V2=349.672598036699
 V3=0 T=0 M2=0 M3=15.2920843069843 S11Max=-144.186266431403 PtS11Max=1 x2S11Max=-0.5 x3S11Max=-0.5 _
 S11Min=-327.691278115214 PtS11Min=3 x2S11Min=0.5 x3S11Min=-0.5 FrameElem=41 ElemStation=0.125
 Frame=41 Station=0.25 OutputCase=PERM1 CaseType=Combination P=-235.938772273309 V2=352.797598036699
 V3=0 T=0 M2=0 M3=-28.6123029476031 S11Max=-64.2649545876898 PtS11Max=3 x2S11Max=0.5 x3S11Max=-0.5 _
 S11Min=-407.612589958927 PtS11Min=1 x2S11Min=-0.5 x3S11Min=-0.5 FrameElem=41 ElemStation=0.25
 Frame=41 Station=0.375 OutputCase=PERM1 CaseType=Combination P=-235.938772273309 V2=355.922598036699
 V3=0 T=0 M2=0 M3=-72.9073152021905 S11Max=201.505118939835 PtS11Max=3 x2S11Max=0.5 x3S11Max=-0.5 _
 S11Min=-673.382663486452 PtS11Min=1 x2S11Min=-0.5 x3S11Min=-0.5 FrameElem=41 ElemStation=0.375
 Frame=41 Station=0.5 OutputCase=PERM1 CaseType=Combination P=-235.938772273309 V2=359.047598036699
 V3=0 T=0 M2=0 M3=-117.592952456778 S11Max=469.618942467359 PtS11Max=3 x2S11Max=0.5 x3S11Max=-0.5 _
 S11Min=-941.496487013976 PtS11Min=1 x2S11Min=-0.5 x3S11Min=-0.5 FrameElem=41 ElemStation=0.5
 Frame=41 Station=0 OutputCase=PERM2 CaseType=Combination P=-169.465538592139 V2=346.427059101314 V3=0
 T=0 M2=0 M3=44.4318461069244 S11Max=97.1255380494076 PtS11Max=1 x2S11Max=-0.5 x3S11Max=-0.5 _
 S11Min=-436.056615233685 PtS11Min=3 x2S11Min=0.5 x3S11Min=-0.5 FrameElem=41 ElemStation=0
 Frame=41 Station=0.125 OutputCase=PERM2 CaseType=Combination P=-169.465538592139 V2=349.552059101314
 V3=0 T=0 M2=0 M3=0.933151219260132 S11Max=-163.866631276578 PtS11Max=1 x2S11Max=-0.5 x3S11Max=-0.5 _
 S11Min=-175.064445907699 PtS11Min=3 x2S11Min=0.5 x3S11Min=-0.5 FrameElem=41 ElemStation=0.125
 Frame=41 Station=0.25 OutputCase=PERM2 CaseType=Combination P=-169.465538592139 V2=352.677059101314
 V3=0 T=0 M2=0 M3=-42.9561686684041 S11Max=88.271473418286 PtS11Max=3 x2S11Max=0.5 x3S11Max=-0.5 _
 S11Min=-427.202550602563 PtS11Min=1 x2S11Min=-0.5 x3S11Min=-0.5 FrameElem=41 ElemStation=0.25
 Frame=41 Station=0.375 OutputCase=PERM2 CaseType=Combination P=-169.465538592139 V2=355.802059101314
 V3=0 T=0 M2=0 M3=-87.2361135560683 S11Max=353.951142744271 PtS11Max=3 x2S11Max=0.5 x3S11Max=-0.5 _
 S11Min=-692.882219928549 PtS11Min=1 x2S11Min=-0.5 x3S11Min=-0.5 FrameElem=41 ElemStation=0.375
 Frame=41 Station=0.5 OutputCase=PERM2 CaseType=Combination P=-169.465538592139 V2=358.927059101314
 V3=0 T=0 M2=0 M3=-131.906683443733 S11Max=621.974562070257 PtS11Max=3 x2S11Max=0.5 x3S11Max=-0.5 _
 S11Min=-960.905639254534 PtS11Min=1 x2S11Min=-0.5 x3S11Min=-0.5 FrameElem=41 ElemStation=0.5
 Frame=41 Station=0 OutputCase=ACC1 CaseType=Combination P=-240.528987364651 V2=355.966039077116 V3=0
 T=0 M2=0 M3=60.2607551084588 S11Max=121.035543286102 PtS11Max=1 x2S11Max=-0.5 x3S11Max=-0.5 _
 S11Min=-602.093518015403 PtS11Min=3 x2S11Min=0.5 x3S11Min=-0.5 FrameElem=41 ElemStation=0
 Frame=41 Station=0.125 OutputCase=ACC1 CaseType=Combination P=-240.528987364651 V2=359.091039077116
 V3=0 T=0 M2=0 M3=15.5696877238194 S11Max=-147.110861021734 PtS11Max=1 x2S11Max=-0.5 x3S11Max=-0.5 _
 S11Min=-333.947113707567 PtS11Min=3 x2S11Min=0.5 x3S11Min=-0.5 FrameElem=41 ElemStation=0.125
 Frame=41 Station=0.25 OutputCase=ACC1 CaseType=Combination P=-240.528987364651 V2=362.216039077116
 V3=0 T=0 M2=0 M3=-29.5120046608201 S11Max=-63.4569593997302 PtS11Max=3 x2S11Max=0.5 x3S11Max=-0.5 _
 S11Min=-417.601015329571 PtS11Min=1 x2S11Min=-0.5 x3S11Min=-0.5 FrameElem=41 ElemStation=0.25
 Frame=41 Station=0.375 OutputCase=ACC1 CaseType=Combination P=-240.528987364651 V2=365.341039077116
 V3=0 T=0 M2=0 M3=-74.9843220454595 S11Max=209.376944908107 PtS11Max=3 x2S11Max=0.5 x3S11Max=-0.5 _
 S11Min=-690.434919637407 PtS11Min=1 x2S11Min=-0.5 x3S11Min=-0.5 FrameElem=41 ElemStation=0.375
 Frame=41 Station=0.5 OutputCase=ACC1 CaseType=Combination P=-240.528987364651 V2=368.466039077116
 V3=0 T=0 M2=0 M3=-120.847264430099 S11Max=484.554599215943 PtS11Max=3 x2S11Max=0.5 x3S11Max=-0.5 _
 S11Min=-965.612573945244 PtS11Min=1 x2S11Min=-0.5 x3S11Min=-0.5 FrameElem=41 ElemStation=0.5
 Frame=41 Station=0 OutputCase=ACC2 CaseType=Combination P=-174.055753683481 V2=355.84550014173 V3=0
 T=0 M2=0 M3=45.8867546538115 S11Max=101.264774239389 PtS11Max=1 x2S11Max=-0.5 x3S11Max=-0.5 _
 S11Min=-449.37628160635 PtS11Min=3 x2S11Min=0.5 x3S11Min=-0.5 FrameElem=41 ElemStation=0
 Frame=41 Station=0.125 OutputCase=ACC2 CaseType=Combination P=-174.055753683481 V2=358.97050014173
 V3=0 T=0 M2=0 M3=1.21075463609525 S11Max=-166.791225866909 PtS11Max=1 x2S11Max=-0.5 x3S11Max=-0.5 _
 S11Min=-181.320281500052 PtS11Min=3 x2S11Min=0.5 x3S11Min=-0.5 FrameElem=41 ElemStation=0.125
 Frame=41 Station=0.25 OutputCase=ACC2 CaseType=Combination P=-174.055753683481 V2=362.09550014173
 V3=0 T=0 M2=0 M3=-43.855870381621 S11Max=89.0794686062456 PtS11Max=3 x2S11Max=0.5 x3S11Max=-0.5 _
 S11Min=-437.190975973207 PtS11Min=1 x2S11Min=-0.5 x3S11Min=-0.5 FrameElem=41 ElemStation=0.25
 Frame=41 Station=0.375 OutputCase=ACC2 CaseType=Combination P=-174.055753683481 V2=365.22050014173
 V3=0 T=0 M2=0 M3=-89.3131203993373 S11Max=361.822968712543 PtS11Max=3 x2S11Max=0.5 x3S11Max=-0.5 _
 S11Min=-709.934476079505 PtS11Min=1 x2S11Min=-0.5 x3S11Min=-0.5 FrameElem=41 ElemStation=0.375

Frame=41 Station=0.5 OutputCase=ACC2 CaseType=Combination P=-174.055753683481 V2=368.34550014173 V3=0
T=0 M2=0 M3=-135.160995417054 S11Max=636.910218818841 PtS11Max=3 x2S11Max=0.5 x3S11Max=-0.5 _
S11Min=-985.021726185802 PtS11Min=1 x2S11Min=-0.5 x3S11Min=-0.5 FrameElem=41 ElemStation=0.5
Frame=41 Station=0 OutputCase=ACCSX1 CaseType=Combination P=-233.665974282453 V2=347.883125299161
V3=0 T=0 M2=0 M3=65.2559802910685 S11Max=157.869907463959 PtS11Max=1 x2S11Max=-0.5 x3S11Max=-0.5 _
S11Min=-625.201856028864 PtS11Min=3 x2S11Min=0.5 x3S11Min=-0.5 FrameElem=41 ElemStation=0
Frame=41 Station=0.125 OutputCase=ACCSX1 CaseType=Combination P=-233.665974282453 V2=351.008125299161
V3=0 T=0 M2=0 M3=21.5752771286734 S11Max=-104.214311510412 PtS11Max=1 x2S11Max=-0.5 x3S11Max=-0.5 _
S11Min=-363.117637054493 PtS11Min=3 x2S11Min=0.5 x3S11Min=-0.5 FrameElem=41 ElemStation=0.125
Frame=41 Station=0.375 OutputCase=ACCSX1 CaseType=Combination P=-233.665974282453 V2=354.133125299161
V3=0 T=0 M2=0 M3=-22.4960510337217 S11Max=-98.6896680801225 PtS11Max=3 x2S11Max=0.5 x3S11Max=-0.5 _
S11Min=-368.642280484783 PtS11Min=1 x2S11Min=-0.5 x3S11Min=-0.5 FrameElem=41 ElemStation=0.25
Frame=41 Station=0.5 OutputCase=ACCSX1 CaseType=Combination P=-233.665974282453 V2=357.258125299161
V3=0 T=0 M2=0 M3=-66.9580041961168 S11Max=168.082050894248 PtS11Max=3 x2S11Max=0.5 x3S11Max=-0.5 _
S11Min=-635.413999459153 PtS11Min=1 x2S11Min=-0.5 x3S11Min=-0.5 FrameElem=41 ElemStation=0.375
Frame=41 Station=0.75 OutputCase=ACCSX1 CaseType=Combination P=-233.665974282453 V2=360.383125299161
V3=0 T=0 M2=0 M3=-111.810582358512 S11Max=437.197519868619 PtS11Max=3 x2S11Max=0.5 x3S11Max=-0.5 _
S11Min=-904.529468433524 PtS11Min=1 x2S11Min=-0.5 x3S11Min=-0.5 FrameElem=41 ElemStation=0.5
Frame=41 Station=0 OutputCase=ACCSX2 CaseType=Combination P=-167.192740601283 V2=347.762586363776
V3=0 T=0 M2=0 M3=50.8819798364213 S11Max=138.099138417245 PtS11Max=1 x2S11Max=-0.5 x3S11Max=-0.5 _
S11Min=-472.48461961981 PtS11Min=3 x2S11Min=0.5 x3S11Min=-0.5 FrameElem=41 ElemStation=0
Frame=41 Station=0.25 OutputCase=ACCSX2 CaseType=Combination P=-167.192740601283 V2=350.887586363776
V3=0 T=0 M2=0 M3=7.2163440409493 S11Max=-123.894676355587 PtS11Max=1 x2S11Max=-0.5 x3S11Max=-0.5 _
S11Min=-210.490804846978 PtS11Min=3 x2S11Min=0.5 x3S11Min=-0.5 FrameElem=41 ElemStation=0.125
Frame=41 Station=0.5 OutputCase=ACCSX2 CaseType=Combination P=-167.192740601283 V2=354.012586363776
V3=0 T=0 M2=0 M3=-36.8399167545227 S11Max=53.8467599258533 PtS11Max=3 x2S11Max=0.5 x3S11Max=-0.5 _
S11Min=-388.232241128418 PtS11Min=1 x2S11Min=-0.5 x3S11Min=-0.5 FrameElem=41 ElemStation=0.25
Frame=41 Station=0.75 OutputCase=ACCSX2 CaseType=Combination P=-167.192740601283 V2=357.137586363776
V3=0 T=0 M2=0 M3=-81.2868025499946 S11Max=320.528074698685 PtS11Max=3 x2S11Max=0.5 x3S11Max=-0.5 _
S11Min=-654.9135590125 PtS11Min=1 x2S11Min=-0.5 x3S11Min=-0.5 FrameElem=41 ElemStation=0.375
Frame=41 Station=0.5 OutputCase=ACCSX2 CaseType=Combination P=-167.192740601283 V2=360.262586363776
V3=0 T=0 M2=0 M3=-126.124313345467 S11Max=589.553139471517 PtS11Max=3 x2S11Max=0.5 x3S11Max=-0.5 _
S11Min=-923.938620674082 PtS11Min=1 x2S11Min=-0.5 x3S11Min=-0.5 FrameElem=41 ElemStation=0.5
Frame=41 Station=0 OutputCase=ENVE CaseType=Combination StepType=Max P=-167.192740601283
V2=355.966039077116 V3=0 T=0 M2=0 M3=65.2559802910685 S11Max=157.869907463959 PtS11Max=1 x2S11Max=-0.5
x3S11Max=-0.5 _
S11Min=-436.056615233685 PtS11Min=3 x2S11Min=0.5 x3S11Min=-0.5 FrameElem=41 ElemStation=0
Frame=41 Station=0.125 OutputCase=ENVE CaseType=Combination StepType=Max P=-167.192740601283
V2=359.091039077116 V3=0 T=0 M2=0 M3=21.5752771286734 S11Max=-104.214311510412 PtS11Max=1 x2S11Max=-
0.5 _
x3S11Max=-0.5 S11Min=-175.064445907699 PtS11Min=3 x2S11Min=0.5 x3S11Min=-0.5 FrameElem=41
ElemStation=0.125
Frame=41 Station=0.25 OutputCase=ENVE CaseType=Combination StepType=Max P=-167.192740601283
V2=362.216039077116 V3=0 T=0 M2=0 M3=-22.4960510337217 S11Max=89.0794686062456 PtS11Max=3 x2S11Max=0.5
x3S11Max=-0.5 _
S11Min=-368.642280484783 PtS11Min=1 x2S11Min=-0.5 x3S11Min=-0.5 FrameElem=41 ElemStation=0.25
Frame=41 Station=0.375 OutputCase=ENVE CaseType=Combination StepType=Max P=-167.192740601283
V2=365.341039077116 V3=0 T=0 M2=0 M3=-66.9580041961168 S11Max=361.822968712543 PtS11Max=3 x2S11Max=0.5
x3S11Max=-0.5 _
S11Min=-635.413999459153 PtS11Min=1 x2S11Min=-0.5 x3S11Min=-0.5 FrameElem=41 ElemStation=0.375
Frame=41 Station=0.5 OutputCase=ENVE CaseType=Combination StepType=Max P=-167.192740601283
V2=368.466039077116 V3=0 T=0 M2=0 M3=-111.810582358512 S11Max=636.910218818841 PtS11Max=3 x2S11Max=0.5
x3S11Max=-0.5 _
S11Min=-904.529468433524 PtS11Min=1 x2S11Min=-0.5 x3S11Min=-0.5 FrameElem=41 ElemStation=0.5
Frame=41 Station=0 OutputCase=ENVE CaseType=Combination StepType=Min P=-240.528987364651
V2=346.427059101314 V3=0 T=0 M2=0 M3=44.4318461069244 S11Max=97.1255380494076 PtS11Max=1 x2S11Max=-0.5
x3S11Max=-0.5 _
S11Min=-625.201856028864 PtS11Min=3 x2S11Min=0.5 x3S11Min=-0.5 FrameElem=41 ElemStation=0
Frame=41 Station=0.125 OutputCase=ENVE CaseType=Combination StepType=Min P=-240.528987364651
V2=349.552059101314 V3=0 T=0 M2=0 M3=0.933151219260132 S11Max=-166.791225866909 PtS11Max=1 x2S11Max=-
0.5 _
x3S11Max=-0.5 S11Min=-363.117637054493 PtS11Min=3 x2S11Min=0.5 x3S11Min=-0.5 FrameElem=41
ElemStation=0.125
Frame=41 Station=0.25 OutputCase=ENVE CaseType=Combination StepType=Min P=-240.528987364651
V2=352.677059101314 V3=0 T=0 M2=0 M3=-43.855870381621 S11Max=-98.6896680801225 PtS11Max=3 x2S11Max=0.5
x3S11Max=-0.5 _
S11Min=-437.190975973207 PtS11Min=1 x2S11Min=-0.5 x3S11Min=-0.5 FrameElem=41 ElemStation=0.25
Frame=41 Station=0.375 OutputCase=ENVE CaseType=Combination StepType=Min P=-240.528987364651
V2=355.802059101314 V3=0 T=0 M2=0 M3=-89.3131203993373 S11Max=168.082050894248 PtS11Max=3 x2S11Max=0.5
x3S11Max=-0.5 _
S11Min=-709.934476079505 PtS11Min=1 x2S11Min=-0.5 x3S11Min=-0.5 FrameElem=41 ElemStation=0.375
Frame=41 Station=0.5 OutputCase=ENVE CaseType=Combination StepType=Min P=-240.528987364651
V2=358.927059101314 V3=0 T=0 M2=0 M3=-135.160995417054 S11Max=437.197519868619 PtS11Max=3 x2S11Max=0.5
x3S11Max=-0.5 _
S11Min=-985.021726185802 PtS11Min=1 x2S11Min=-0.5 x3S11Min=-0.5 FrameElem=41 ElemStation=0.5
Frame=41 Station=0 OutputCase=FESSUR CaseType=Combination P=-239.151922837248 V2=353.140506764991
V3=0 T=0 M2=0 M3=59.8242825443927 S11Max=119.793772429108 PtS11Max=1 x2S11Max=-0.5 x3S11Max=-0.5 _
S11Min=-598.097618103604 PtS11Min=3 x2S11Min=0.5 x3S11Min=-0.5 FrameElem=41 ElemStation=0
Frame=41 Station=0.125 OutputCase=FESSUR CaseType=Combination P=-239.151922837248 V2=356.265506764991
V3=0 T=0 M2=0 M3=15.4864066987688 S11Max=-146.233482644635 PtS11Max=1 x2S11Max=-0.5 x3S11Max=-0.5 _
S11Min=-332.070363029861 PtS11Min=3 x2S11Min=0.5 x3S11Min=-0.5 FrameElem=41 ElemStation=0.125

Frame=41 Station=0.25 OutputCase=FESSUR CaseType=Combination P=-239.151922837248 V2=359.390506764991
V3=0 T=0 M2=0 M3=-29.242094146855 S11Max=-63.6993579561181 PtS11Max=3 x2S11Max=0.5 x3S11Max=-0.5 _
S11Min=-414.604487718378 PtS11Min=1 x2S11Min=-0.5 x3S11Min=-0.5 FrameElem=41 ElemStation=0.25

Frame=41 Station=0.375 OutputCase=FESSUR CaseType=Combination P=-239.151922837248 V2=362.515506764991
V3=0 T=0 M2=0 M3=-74.3612199924788 S11Max=207.015397117625 PtS11Max=3 x2S11Max=0.5 x3S11Max=-0.5 _
S11Min=-685.319242792121 PtS11Min=1 x2S11Min=-0.5 x3S11Min=-0.5 FrameElem=41 ElemStation=0.375

Frame=41 Station=0.5 OutputCase=FESSUR CaseType=Combination P=-239.151922837248 V2=365.640506764991
V3=0 T=0 M2=0 M3=-119.870970838103 S11Max=480.073902191368 PtS11Max=3 x2S11Max=0.5 x3S11Max=-0.5 _
S11Min=-958.377747865864 PtS11Min=1 x2S11Min=-0.5 x3S11Min=-0.5 FrameElem=41 ElemStation=0.5

Frame=42 Station=0 OutputCase=PERM1 CaseType=Combination P=-235.938772273309 V2=244.827371257454 V3=0
T=0 M2=0 M3=-117.592952456782 S11Max=469.618942467381 PtS11Max=3 x2S11Max=0.5 x3S11Max=-0.5 _
S11Min=-941.496487013998 PtS11Min=1 x2S11Min=-0.5 x3S11Min=-0.5 FrameElem=42 ElemStation=0

Frame=42 Station=0.125 OutputCase=PERM1 CaseType=Combination P=-235.938772273309 V2=247.952371257454
V3=0 T=0 M2=0 M3=-148.391686363963 S11Max=654.411345910472 PtS11Max=3 x2S11Max=0.5 x3S11Max=-0.5 _
S11Min=-1126.28889045709 PtS11Min=1 x2S11Min=-0.5 x3S11Min=-0.5 FrameElem=42 ElemStation=0.125

Frame=42 Station=0.25 OutputCase=PERM1 CaseType=Combination P=-235.938772273309 V2=251.077371257454
V3=0 T=0 M2=0 M3=-179.581045271145 S11Max=841.547499353562 PtS11Max=3 x2S11Max=0.5 x3S11Max=-0.5 _
S11Min=-1313.42504390018 PtS11Min=1 x2S11Min=-0.5 x3S11Min=-0.5 FrameElem=42 ElemStation=0.25

Frame=42 Station=0.375 OutputCase=PERM1 CaseType=Combination P=-235.938772273309 V2=254.202371257454
V3=0 T=0 M2=0 M3=-211.161029178327 S11Max=1031.02740279665 PtS11Max=3 x2S11Max=0.5 x3S11Max=-0.5 _
S11Min=-1502.90494734327 PtS11Min=1 x2S11Min=-0.5 x3S11Min=-0.5 FrameElem=42 ElemStation=0.375

Frame=42 Station=0.5 OutputCase=PERM1 CaseType=Combination P=-235.938772273309 V2=257.327371257454
V3=0 T=0 M2=0 M3=-243.131638085509 S11Max=1222.85105623974 PtS11Max=3 x2S11Max=0.5 x3S11Max=-0.5 _
S11Min=-1694.72860078636 PtS11Min=1 x2S11Min=-0.5 x3S11Min=-0.5 FrameElem=42 ElemStation=0.5

Frame=42 Station=0 OutputCase=PERM2 CaseType=Combination P=-169.465538592139 V2=244.702879693686 V3=0
T=0 M2=0 M3=-131.906683443736 S11Max=621.974562070279 PtS11Max=3 x2S11Max=0.5 x3S11Max=-0.5 _
S11Min=-960.905639254556 PtS11Min=1 x2S11Min=-0.5 x3S11Min=-0.5 FrameElem=42 ElemStation=0

Frame=42 Station=0.125 OutputCase=PERM2 CaseType=Combination P=-169.465538592139 V2=247.827879693686
V3=0 T=0 M2=0 M3=-162.689855905447 S11Max=806.673596840543 PtS11Max=3 x2S11Max=0.5 x3S11Max=-0.5 _
S11Min=-1145.60467402482 PtS11Min=1 x2S11Min=-0.5 x3S11Min=-0.5 FrameElem=42 ElemStation=0.125

Frame=42 Station=0.25 OutputCase=PERM2 CaseType=Combination P=-169.465538592139 V2=250.952879693686
V3=0 T=0 M2=0 M3=-193.863653367158 S11Max=993.716381610808 PtS11Max=3 x2S11Max=0.5 x3S11Max=-0.5 _
S11Min=-1332.64745879509 PtS11Min=1 x2S11Min=-0.5 x3S11Min=-0.5 FrameElem=42 ElemStation=0.25

Frame=42 Station=0.375 OutputCase=PERM2 CaseType=Combination P=-169.465538592139 V2=254.077879693686
V3=0 T=0 M2=0 M3=-225.428075828869 S11Max=1183.10291638107 PtS11Max=3 x2S11Max=0.5 x3S11Max=-0.5 _
S11Min=-1522.03399356535 PtS11Min=1 x2S11Min=-0.5 x3S11Min=-0.5 FrameElem=42 ElemStation=0.375

Frame=42 Station=0.5 OutputCase=PERM2 CaseType=Combination P=-169.465538592139 V2=257.202879693686
V3=0 T=0 M2=0 M3=-257.383123290579 S11Max=1374.83320115134 PtS11Max=3 x2S11Max=0.5 x3S11Max=-0.5 _
S11Min=-1713.76427833561 PtS11Min=1 x2S11Min=-0.5 x3S11Min=-0.5 FrameElem=42 ElemStation=0.5

Frame=42 Station=0 OutputCase=ACC1 CaseType=Combination P=-240.528987364651 V2=251.529896439577 V3=0
T=0 M2=0 M3=-120.8472644430103 S11Max=484.554599215966 PtS11Max=3 x2S11Max=0.5 x3S11Max=-0.5 _
S11Min=-965.612573945267 PtS11Min=1 x2S11Min=-0.5 x3S11Min=-0.5 FrameElem=42 ElemStation=0

Frame=42 Station=0.125 OutputCase=ACC1 CaseType=Combination P=-240.528987364651 V2=254.654896439577
V3=0 T=0 M2=0 M3=-152.48381398505 S11Max=674.373896545649 PtS11Max=3 x2S11Max=0.5 x3S11Max=-0.5 _
S11Min=-1155.43187127495 PtS11Min=1 x2S11Min=-0.5 x3S11Min=-0.5 FrameElem=42 ElemStation=0.125

Frame=42 Station=0.25 OutputCase=ACC1 CaseType=Combination P=-240.528987364651 V2=257.779896439577
V3=0 T=0 M2=0 M3=-184.510988539997 S11Max=866.536943875332 PtS11Max=3 x2S11Max=0.5 x3S11Max=-0.5 _
S11Min=-1347.59491860463 PtS11Min=1 x2S11Min=-0.5 x3S11Min=-0.5 FrameElem=42 ElemStation=0.25

Frame=42 Station=0.375 OutputCase=ACC1 CaseType=Combination P=-240.528987364651 V2=260.904896439577
V3=0 T=0 M2=0 M3=-216.928788094944 S11Max=1061.04374120502 PtS11Max=3 x2S11Max=0.5 x3S11Max=-0.5 _
S11Min=-1542.10171593432 PtS11Min=1 x2S11Min=-0.5 x3S11Min=-0.5 FrameElem=42 ElemStation=0.375

Frame=42 Station=0.5 OutputCase=ACC1 CaseType=Combination P=-240.528987364651 V2=264.029896439577
V3=0 T=0 M2=0 M3=-249.737212649891 S11Max=1257.8942885347 PtS11Max=3 x2S11Max=0.5 x3S11Max=-0.5 _
S11Min=-1738.952263264 PtS11Min=1 x2S11Min=-0.5 x3S11Min=-0.5 FrameElem=42 ElemStation=0.5

Frame=42 Station=0 OutputCase=ACC2 CaseType=Combination P=-174.055753683481 V2=251.405404875809 V3=0
T=0 M2=0 M3=-135.160995417057 S11Max=636.910218818864 PtS11Max=3 x2S11Max=0.5 x3S11Max=-0.5 _
S11Min=-985.021726185825 PtS11Min=1 x2S11Min=-0.5 x3S11Min=-0.5 FrameElem=42 ElemStation=0

Frame=42 Station=0.125 OutputCase=ACC2 CaseType=Combination P=-174.055753683481 V2=254.530404875809
V3=0 T=0 M2=0 M3=-166.781983526534 S11Max=826.636147475721 PtS11Max=3 x2S11Max=0.5 x3S11Max=-0.5 _
S11Min=-1174.74765484268 PtS11Min=1 x2S11Min=-0.5 x3S11Min=-0.5 FrameElem=42 ElemStation=0.125

Frame=42 Station=0.25 OutputCase=ACC2 CaseType=Combination P=-174.055753683481 V2=257.655404875809
V3=0 T=0 M2=0 M3=-198.79359663601 S11Max=1018.70582613258 PtS11Max=3 x2S11Max=0.5 x3S11Max=-0.5 _
S11Min=-1366.81733349954 PtS11Min=1 x2S11Min=-0.5 x3S11Min=-0.5 FrameElem=42 ElemStation=0.25

Frame=42 Station=0.375 OutputCase=ACC2 CaseType=Combination P=-174.055753683481 V2=260.780404875809
V3=0 T=0 M2=0 M3=-231.195834745486 S11Max=1213.11925478943 PtS11Max=3 x2S11Max=0.5 x3S11Max=-0.5 _
S11Min=-1561.2307621564 PtS11Min=1 x2S11Min=-0.5 x3S11Min=-0.5 FrameElem=42 ElemStation=0.375

Frame=42 Station=0.5 OutputCase=ACC2 CaseType=Combination P=-174.055753683481 V2=263.905404875809
V3=0 T=0 M2=0 M3=-263.988697854962 S11Max=1409.87643344629 PtS11Max=3 x2S11Max=0.5 x3S11Max=-0.5 _
S11Min=-1757.98794081325 PtS11Min=1 x2S11Min=-0.5 x3S11Min=-0.5 FrameElem=42 ElemStation=0.5

Frame=42 Station=0 OutputCase=ACCSX1 CaseType=Combination P=-233.665974282453 V2=247.465074461448
V3=0 T=0 M2=0 M3=-111.810582358516 S11Max=437.197519868641 PtS11Max=3 x2S11Max=0.5 x3S11Max=-0.5 _
S11Min=-904.529468433546 PtS11Min=1 x2S11Min=-0.5 x3S11Min=-0.5 FrameElem=42 ElemStation=0

Frame=42 Station=0.125 OutputCase=ACCSX1 CaseType=Combination P=-233.665974282453 V2=250.590074461448
V3=0 T=0 M2=0 M3=-142.939029166197 S11Max=623.968200714727 PtS11Max=3 x2S11Max=0.5 x3S11Max=-0.5 _
S11Min=-1091.30014927963 PtS11Min=1 x2S11Min=-0.5 x3S11Min=-0.5 FrameElem=42 ElemStation=0.125

Frame=42 Station=0.25 OutputCase=ACCSX1 CaseType=Combination P=-233.665974282453 V2=253.715074461448
V3=0 T=0 M2=0 M3=-174.458100973878 S11Max=813.082631560813 PtS11Max=3 x2S11Max=0.5 x3S11Max=-0.5 _
S11Min=-1280.41458012572 PtS11Min=1 x2S11Min=-0.5 x3S11Min=-0.5 FrameElem=42 ElemStation=0.25

Frame=42 Station=0.375 OutputCase=ACCSX1 CaseType=Combination P=-233.665974282453 V2=256.840074461448
V3=0 T=0 M2=0 M3=-206.367797781559 S11Max=1004.5408124069 PtS11Max=3 x2S11Max=0.5 x3S11Max=-0.5 _
S11Min=-1471.8727609718 PtS11Min=1 x2S11Min=-0.5 x3S11Min=-0.5 FrameElem=42 ElemStation=0.375



Frame=42 Station=0.5 OutputCase=ACCSX1 CaseType=Combination P=-233.665974282453 V2=259.965074461448
 V3=0 T=0 M2=0 M3=-238.66811958924 S11Max=1198.34274325298 PtS11Max=3 x2S11Max=0.5 x3S11Max=-0.5 _
 S11Min=-1665.67469181789 PtS11Min=1 x2S11Min=-0.5 x3S11Min=-0.5 FrameElem=42 ElemStation=0.5
 Frame=42 Station=0 OutputCase=ACCSX2 CaseType=Combination P=-167.192740601283 V2=247.34058289768 V3=0
 T=0 M2=0 M3=-126.12431334547 S11Max=589.553139471539 PtS11Max=3 x2S11Max=0.5 x3S11Max=-0.5 _
 S11Min=-923.938620674104 PtS11Min=1 x2S11Min=-0.5 x3S11Min=-0.5 FrameElem=42 ElemStation=0
 Frame=42 Station=0.125 OutputCase=ACCSX2 CaseType=Combination P=-167.192740601283 V2=250.46558289768
 V3=0 T=0 M2=0 M3=-157.23719870768 S11Max=776.230451644799 PtS11Max=3 x2S11Max=0.5 x3S11Max=-0.5 _
 S11Min=-1110.61593284736 PtS11Min=1 x2S11Min=-0.5 x3S11Min=-0.5 FrameElem=42 ElemStation=0.125
 Frame=42 Station=0.25 OutputCase=ACCSX2 CaseType=Combination P=-167.192740601283 V2=255.84058289768
 V3=0 T=0 M2=0 M3=-188.74070906989 S11Max=965.251513818059 PtS11Max=3 x2S11Max=0.5 x3S11Max=-0.5 _
 S11Min=-1299.63699502062 PtS11Min=1 x2S11Min=-0.5 x3S11Min=-0.5 FrameElem=42 ElemStation=0.25
 Frame=42 Station=0.375 OutputCase=ACCSX2 CaseType=Combination P=-167.192740601283 V2=256.71558289768
 V3=0 T=0 M2=0 M3=-220.6348444321 S11Max=1156.61632599132 PtS11Max=3 x2S11Max=0.5 x3S11Max=-0.5 _
 S11Min=-1491.00180719388 PtS11Min=1 x2S11Min=-0.5 x3S11Min=-0.5 FrameElem=42 ElemStation=0.375
 Frame=42 Station=0.5 OutputCase=ACCSX2 CaseType=Combination P=-167.192740601283 V2=259.84058289768
 V3=0 T=0 M2=0 M3=-252.91960479431 S11Max=1350.32488816458 PtS11Max=3 x2S11Max=0.5 x3S11Max=-0.5 _
 S11Min=-1684.71036936714 PtS11Min=1 x2S11Min=-0.5 x3S11Min=-0.5 FrameElem=42 ElemStation=0.5
 Frame=42 Station=0 OutputCase=ENVE CaseType=Combination StepType=Max P=-167.192740601283
 V2=251.529896439577 V3=0 T=0 M2=0 M3=-111.810582358516 S11Max=636.910218818864 PtS11Max=3 x2S11Max=0.5
 x3S11Max=-0.5 _
 S11Min=-904.529468433546 PtS11Min=1 x2S11Min=-0.5 x3S11Min=-0.5 FrameElem=42 ElemStation=0
 Frame=42 Station=0.125 OutputCase=ENVE CaseType=Combination StepType=Max P=-167.192740601283
 V2=254.654896439577 V3=0 T=0 M2=0 M3=-142.939029166197 S11Max=826.636147475721 PtS11Max=3 x2S11Max=0.5
 x3S11Max=-0.5 _
 S11Min=-1091.30014927963 PtS11Min=1 x2S11Min=-0.5 x3S11Min=-0.5 FrameElem=42 ElemStation=0.125
 Frame=42 Station=0.25 OutputCase=ENVE CaseType=Combination StepType=Max P=-167.192740601283
 V2=257.779896439577 V3=0 T=0 M2=0 M3=-174.458100973878 S11Max=1018.70582613258 PtS11Max=3 x2S11Max=0.5
 x3S11Max=-0.5 _
 S11Min=-1280.41458012572 PtS11Min=1 x2S11Min=-0.5 x3S11Min=-0.5 FrameElem=42 ElemStation=0.25
 Frame=42 Station=0.375 OutputCase=ENVE CaseType=Combination StepType=Max P=-167.192740601283
 V2=260.904896439577 V3=0 T=0 M2=0 M3=-206.367797781559 S11Max=1213.11925478943 PtS11Max=3 x2S11Max=0.5
 x3S11Max=-0.5 _
 S11Min=-1471.8727609718 PtS11Min=1 x2S11Min=-0.5 x3S11Min=-0.5 FrameElem=42 ElemStation=0.375
 Frame=42 Station=0.5 OutputCase=ENVE CaseType=Combination StepType=Max P=-167.192740601283
 V2=264.029896439577 V3=0 T=0 M2=0 M3=-238.66811958924 S11Max=1409.87643344629 PtS11Max=3 x2S11Max=0.5
 x3S11Max=-0.5 _
 S11Min=-1665.67469181789 PtS11Min=1 x2S11Min=-0.5 x3S11Min=-0.5 FrameElem=42 ElemStation=0.5
 Frame=42 Station=0 OutputCase=ENVE CaseType=Combination StepType=Min P=-240.528987364651
 V2=244.702879693686 V3=0 T=0 M2=0 M3=-135.160995417057 S11Max=437.197519868641 PtS11Max=3 x2S11Max=0.5
 x3S11Max=-0.5 _
 S11Min=-985.021726185825 PtS11Min=1 x2S11Min=-0.5 x3S11Min=-0.5 FrameElem=42 ElemStation=0
 Frame=42 Station=0.125 OutputCase=ENVE CaseType=Combination StepType=Min P=-240.528987364651
 V2=247.827879693686 V3=0 T=0 M2=0 M3=-166.781983526534 S11Max=623.968200714727 PtS11Max=3 x2S11Max=0.5
 x3S11Max=-0.5 _
 S11Min=-1174.74765484268 PtS11Min=1 x2S11Min=-0.5 x3S11Min=-0.5 FrameElem=42 ElemStation=0.125
 Frame=42 Station=0.25 OutputCase=ENVE CaseType=Combination StepType=Min P=-240.528987364651
 V2=250.952879693686 V3=0 T=0 M2=0 M3=-198.79359663601 S11Max=813.082631560813 PtS11Max=3 x2S11Max=0.5
 x3S11Max=-0.5 _
 S11Min=-1366.81733349954 PtS11Min=1 x2S11Min=-0.5 x3S11Min=-0.5 FrameElem=42 ElemStation=0.25
 Frame=42 Station=0.375 OutputCase=ENVE CaseType=Combination StepType=Min P=-240.528987364651
 V2=254.077879693686 V3=0 T=0 M2=0 M3=-231.195834745486 S11Max=1004.5408124069 PtS11Max=3 x2S11Max=0.5
 x3S11Max=-0.5 _
 S11Min=-1561.2307621564 PtS11Min=1 x2S11Min=-0.5 x3S11Min=-0.5 FrameElem=42 ElemStation=0.375
 Frame=42 Station=0.5 OutputCase=ENVE CaseType=Combination StepType=Min P=-240.528987364651
 V2=257.202879693686 V3=0 T=0 M2=0 M3=-263.988697854962 S11Max=1198.34274325298 PtS11Max=3 x2S11Max=0.5
 x3S11Max=-0.5 _
 S11Min=-1757.98794081325 PtS11Min=1 x2S11Min=-0.5 x3S11Min=-0.5 FrameElem=42 ElemStation=0.5
 Frame=42 Station=0 OutputCase=FESSUR CaseType=Combination P=-239.151922837248 V2=249.51913888494 V3=0
 T=0 M2=0 M3=-119.870970838106 S11Max=480.073902191391 PtS11Max=3 x2S11Max=0.5 x3S11Max=-0.5 _
 S11Min=-958.377747865886 PtS11Min=1 x2S11Min=-0.5 x3S11Min=-0.5 FrameElem=42 ElemStation=0
 Frame=42 Station=0.125 OutputCase=FESSUR CaseType=Combination P=-239.151922837248 V2=252.64413888494
 V3=0 T=0 M2=0 M3=-151.256175698724 S11Max=668.385131355096 PtS11Max=3 x2S11Max=0.5 x3S11Max=-0.5 _
 S11Min=-1146.68897702959 PtS11Min=1 x2S11Min=-0.5 x3S11Min=-0.5 FrameElem=42 ElemStation=0.125
 Frame=42 Station=0.25 OutputCase=FESSUR CaseType=Combination P=-239.151922837248 V2=255.76913888494
 V3=0 T=0 M2=0 M3=-183.032005559342 S11Max=859.040110518801 PtS11Max=3 x2S11Max=0.5 x3S11Max=-0.5 _
 S11Min=-1337.3439561933 PtS11Min=1 x2S11Min=-0.5 x3S11Min=-0.5 FrameElem=42 ElemStation=0.25
 Frame=42 Station=0.375 OutputCase=FESSUR CaseType=Combination P=-239.151922837248 V2=258.89413888494
 V3=0 T=0 M2=0 M3=-215.198460419959 S11Max=1052.03883968251 PtS11Max=3 x2S11Max=0.5 x3S11Max=-0.5 _
 S11Min=-1530.342685357 PtS11Min=1 x2S11Min=-0.5 x3S11Min=-0.5 FrameElem=42 ElemStation=0.375
 Frame=42 Station=0.5 OutputCase=FESSUR CaseType=Combination P=-239.151922837248 V2=262.01913888494
 V3=0 T=0 M2=0 M3=-247.755540280577 S11Max=1247.38131884621 PtS11Max=3 x2S11Max=0.5 x3S11Max=-0.5 _
 S11Min=-1725.68516452071 PtS11Min=1 x2S11Min=-0.5 x3S11Min=-0.5 FrameElem=42 ElemStation=0.5
 Frame=43 Station=0 OutputCase=PERM1 CaseType=Combination P=-235.938772273309 V2=144.001052839685 V3=0
 T=0 M2=0 M3=-243.131638085512 S11Max=1222.85105623977 PtS11Max=3 x2S11Max=0.5 x3S11Max=-0.5 _
 S11Min=-1694.72860078638 PtS11Min=1 x2S11Min=-0.5 x3S11Min=-0.5 FrameElem=43 ElemStation=0
 Frame=43 Station=0.125 OutputCase=PERM1 CaseType=Combination P=-235.938772273309 V2=147.126052839685
 V3=0 T=0 M2=0 M3=-261.327082190473 S11Max=1332.02372086953 PtS11Max=3 x2S11Max=0.5 x3S11Max=-0.5 _
 S11Min=-1803.90126541615 PtS11Min=1 x2S11Min=-0.5 x3S11Min=-0.5 FrameElem=43 ElemStation=0.125
 Frame=43 Station=0.25 OutputCase=PERM1 CaseType=Combination P=-235.938772273309 V2=150.251052839685
 V3=0 T=0 M2=0 M3=-279.913151295434 S11Max=1443.54013549929 PtS11Max=3 x2S11Max=0.5 x3S11Max=-0.5 _
 S11Min=-1915.41768004591 PtS11Min=1 x2S11Min=-0.5 x3S11Min=-0.5 FrameElem=43 ElemStation=0.25

```

Frame=43 Station=0.375 OutputCase=PERM1 CaseType=Combination P=-235.938772273309 V2=153.376052839685
V3=0 T=0 M2=0 M3=-298.889845400394 S11Max=1557.40030012906 PtS11Max=3 x2S11Max=0.5 x3S11Max=-0.5 _
S11Min=-2029.27784467567 PtS11Min=1 x2S11Min=-0.5 x3S11Min=-0.5 FrameElem=43 ElemStation=0.375
Frame=43 Station=0.5 OutputCase=PERM1 CaseType=Combination P=-235.938772273309 V2=156.501052839685
V3=0 T=0 M2=0 M3=-318.257164505355 S11Max=1673.60421475882 PtS11Max=3 x2S11Max=0.5 x3S11Max=-0.5 _
S11Min=-2145.48175930544 PtS11Min=1 x2S11Min=-0.5 x3S11Min=-0.5 FrameElem=43 ElemStation=0.5
Frame=43 Station=0 OutputCase=PERM2 CaseType=Combination P=-169.465538592139 V2=143.911020392206 V3=0
T=0 M2=0 M3=-257.383123290583 S11Max=1374.83320115136 PtS11Max=3 x2S11Max=0.5 x3S11Max=-0.5 _
S11Min=-1713.76427833564 PtS11Min=1 x2S11Min=-0.5 x3S11Min=-0.5 FrameElem=43 ElemStation=0
Frame=43 Station=0.125 OutputCase=PERM2 CaseType=Combination P=-169.465538592139 V2=147.036020392206
V3=0 T=0 M2=0 M3=-275.567313339609 S11Max=1483.93834144551 PtS11Max=3 x2S11Max=0.5 x3S11Max=-0.5 _
S11Min=-1822.86941862979 PtS11Min=1 x2S11Min=-0.5 x3S11Min=-0.5 FrameElem=43 ElemStation=0.125
Frame=43 Station=0.25 OutputCase=PERM2 CaseType=Combination P=-169.465538592139 V2=150.161020392206
V3=0 T=0 M2=0 M3=-294.142128388634 S11Max=1595.38723173967 PtS11Max=3 x2S11Max=0.5 x3S11Max=-0.5 _
S11Min=-1934.31830892394 PtS11Min=1 x2S11Min=-0.5 x3S11Min=-0.5 FrameElem=43 ElemStation=0.25
Frame=43 Station=0.375 OutputCase=PERM2 CaseType=Combination P=-169.465538592139 V2=153.286020392206
V3=0 T=0 M2=0 M3=-313.10756843766 S11Max=1709.17987203382 PtS11Max=3 x2S11Max=0.5 x3S11Max=-0.5 _
S11Min=-2048.1109492181 PtS11Min=1 x2S11Min=-0.5 x3S11Min=-0.5 FrameElem=43 ElemStation=0.375
Frame=43 Station=0.5 OutputCase=PERM2 CaseType=Combination P=-169.465538592139 V2=156.411020392206
V3=0 T=0 M2=0 M3=-332.463633486686 S11Max=1825.31626232798 PtS11Max=3 x2S11Max=0.5 x3S11Max=-0.5 _
S11Min=-2164.24733951225 PtS11Min=1 x2S11Min=-0.5 x3S11Min=-0.5 FrameElem=43 ElemStation=0.5
Frame=43 Station=0 OutputCase=ACC1 CaseType=Combination P=-240.528987364651 V2=148.01187403274 V3=0
T=0 M2=0 M3=-249.737212649895 S11Max=1257.89428853472 PtS11Max=3 x2S11Max=0.5 x3S11Max=-0.5 _
S11Min=-1738.95226326402 PtS11Min=1 x2S11Min=-0.5 x3S11Min=-0.5 FrameElem=43 ElemStation=0
Frame=43 Station=0.125 OutputCase=ACC1 CaseType=Combination P=-240.528987364651 V2=151.13687403274
V3=0 T=0 M2=0 M3=-268.434009403988 S11Max=1370.07506905927 PtS11Max=3 x2S11Max=0.5 x3S11Max=-0.5 _
S11Min=-1851.13304378858 PtS11Min=1 x2S11Min=-0.5 x3S11Min=-0.5 FrameElem=43 ElemStation=0.125
Frame=43 Station=0.25 OutputCase=ACC1 CaseType=Combination P=-240.528987364651 V2=154.26187403274
V3=0 T=0 M2=0 M3=-287.52143115808 S11Max=1484.5995958383 PtS11Max=3 x2S11Max=0.5 x3S11Max=-0.5 _
S11Min=-1965.657574431313 PtS11Min=1 x2S11Min=-0.5 x3S11Min=-0.5 FrameElem=43 ElemStation=0.25
Frame=43 Station=0.375 OutputCase=ACC1 CaseType=Combination P=-240.528987364651 V2=157.38687403274
V3=0 T=0 M2=0 M3=-306.999477912172 S11Max=1601.46788010838 PtS11Max=3 x2S11Max=0.5 x3S11Max=-0.5 _
S11Min=-2082.52585483769 PtS11Min=1 x2S11Min=-0.5 x3S11Min=-0.5 FrameElem=43 ElemStation=0.375
Frame=43 Station=0.5 OutputCase=ACC1 CaseType=Combination P=-240.528987364651 V2=160.51187403274 V3=0
T=0 M2=0 M3=-326.868149666265 S11Max=1720.67991063294 PtS11Max=3 x2S11Max=0.5 x3S11Max=-0.5 _
S11Min=-2201.73788536224 PtS11Min=1 x2S11Min=-0.5 x3S11Min=-0.5 FrameElem=43 ElemStation=0.5
Frame=43 Station=0 OutputCase=ACC2 CaseType=Combination P=-174.055753683481 V2=147.92184158526 V3=0
T=0 M2=0 M3=-263.988697854966 S11Max=1409.87643344631 PtS11Max=3 x2S11Max=0.5 x3S11Max=-0.5 _
S11Min=-1757.98794081327 PtS11Min=1 x2S11Min=-0.5 x3S11Min=-0.5 FrameElem=43 ElemStation=0
Frame=43 Station=0.125 OutputCase=ACC2 CaseType=Combination P=-174.055753683481 V2=151.04684158526
V3=0 T=0 M2=0 M3=-282.674240553123 S11Max=1521.98968963526 PtS11Max=3 x2S11Max=0.5 x3S11Max=-0.5 _
S11Min=-1870.10119700222 PtS11Min=1 x2S11Min=-0.5 x3S11Min=-0.5 FrameElem=43 ElemStation=0.125
Frame=43 Station=0.25 OutputCase=ACC2 CaseType=Combination P=-174.055753683481 V2=154.17184158526
V3=0 T=0 M2=0 M3=-301.750408251281 S11Max=1636.4466958242 PtS11Max=3 x2S11Max=0.5 x3S11Max=-0.5 _
S11Min=-1984.55820319116 PtS11Min=1 x2S11Min=-0.5 x3S11Min=-0.5 FrameElem=43 ElemStation=0.25
Frame=43 Station=0.375 OutputCase=ACC2 CaseType=Combination P=-174.055753683481 V2=157.29684158526
V3=0 T=0 M2=0 M3=-321.217200949438 S11Max=1753.24745201315 PtS11Max=3 x2S11Max=0.5 x3S11Max=-0.5 _
S11Min=-2101.35895938011 PtS11Min=1 x2S11Min=-0.5 x3S11Min=-0.5 FrameElem=43 ElemStation=0.375
Frame=43 Station=0.5 OutputCase=ACC2 CaseType=Combination P=-174.055753683481 V2=160.42184158526 V3=0
T=0 M2=0 M3=-341.074618647596 S11Max=1872.39195820209 PtS11Max=3 x2S11Max=0.5 x3S11Max=-0.5 _
S11Min=-2220.50346556905 PtS11Min=1 x2S11Min=-0.5 x3S11Min=-0.5 FrameElem=43 ElemStation=0.5
Frame=43 Station=0 OutputCase=ACCSX1 CaseType=Combination P=-233.665974282453 V2=147.501236780921
V3=0 T=0 M2=0 M3=-238.668119589243 S11Max=1198.34274325301 PtS11Max=3 x2S11Max=0.5 x3S11Max=-0.5 _
S11Min=-1665.67469181791 PtS11Min=1 x2S11Min=-0.5 x3S11Min=-0.5 FrameElem=43 ElemStation=0
Frame=43 Station=0.125 OutputCase=ACCSX1 CaseType=Combination P=-233.665974282453 V2=150.626236780921
V3=0 T=0 M2=0 M3=-257.301086686859 S11Max=1310.1405458387 PtS11Max=3 x2S11Max=0.5 x3S11Max=-0.5 _
S11Min=-1777.4724944036 PtS11Min=1 x2S11Min=-0.5 x3S11Min=-0.5 FrameElem=43 ElemStation=0.125
Frame=43 Station=0.25 OutputCase=ACCSX1 CaseType=Combination P=-233.665974282453 V2=153.751236780921
V3=0 T=0 M2=0 M3=-276.324678784474 S11Max=1424.28209842439 PtS11Max=3 x2S11Max=0.5 x3S11Max=-0.5 _
S11Min=-1891.61404698929 PtS11Min=1 x2S11Min=-0.5 x3S11Min=-0.5 FrameElem=43 ElemStation=0.25
Frame=43 Station=0.375 OutputCase=ACCSX1 CaseType=Combination P=-233.665974282453 V2=156.876236780921
V3=0 T=0 M2=0 M3=-295.738895882089 S11Max=1540.76740101008 PtS11Max=3 x2S11Max=0.5 x3S11Max=-0.5 _
S11Min=-2008.09934957499 PtS11Min=1 x2S11Min=-0.5 x3S11Min=-0.5 FrameElem=43 ElemStation=0.375
Frame=43 Station=0.5 OutputCase=ACCSX1 CaseType=Combination P=-233.665974282453 V2=160.001236780921
V3=0 T=0 M2=0 M3=-315.543737979704 S11Max=1659.59645359577 PtS11Max=3 x2S11Max=0.5 x3S11Max=-0.5 _
S11Min=-2126.92840216068 PtS11Min=1 x2S11Min=-0.5 x3S11Min=-0.5 FrameElem=43 ElemStation=0.5
Frame=43 Station=0 OutputCase=ACCSX2 CaseType=Combination P=-167.192740601283 V2=147.411204333441
V3=0 T=0 M2=0 M3=-252.919604794314 S11Max=1350.3248881646 PtS11Max=3 x2S11Max=0.5 x3S11Max=-0.5 _
S11Min=-1684.71036936717 PtS11Min=1 x2S11Min=-0.5 x3S11Min=-0.5 FrameElem=43 ElemStation=0
Frame=43 Station=0.125 OutputCase=ACCSX2 CaseType=Combination P=-167.192740601283 V2=150.536204333441
V3=0 T=0 M2=0 M3=-271.541317835994 S11Max=1462.05516641468 PtS11Max=3 x2S11Max=0.5 x3S11Max=-0.5 _
S11Min=-1796.44064761725 PtS11Min=1 x2S11Min=-0.5 x3S11Min=-0.5 FrameElem=43 ElemStation=0.125
Frame=43 Station=0.25 OutputCase=ACCSX2 CaseType=Combination P=-167.192740601283 V2=153.661204333441
V3=0 T=0 M2=0 M3=-290.55365877674 S11Max=1576.12919466476 PtS11Max=3 x2S11Max=0.5 x3S11Max=-0.5 _
S11Min=-1910.51467586733 PtS11Min=1 x2S11Min=-0.5 x3S11Min=-0.5 FrameElem=43 ElemStation=0.25
Frame=43 Station=0.375 OutputCase=ACCSX2 CaseType=Combination P=-167.192740601283 V2=156.786204333441
V3=0 T=0 M2=0 M3=-309.956618919354 S11Max=1692.54697291484 PtS11Max=3 x2S11Max=0.5 x3S11Max=-0.5 _
S11Min=-2026.93245411741 PtS11Min=1 x2S11Min=-0.5 x3S11Min=-0.5 FrameElem=43 ElemStation=0.375
Frame=43 Station=0.5 OutputCase=ACCSX2 CaseType=Combination P=-167.192740601283 V2=159.911204333441
V3=0 T=0 M2=0 M3=-329.750206961034 S11Max=1811.30850116492 PtS11Max=3 x2S11Max=0.5 x3S11Max=-0.5 _
S11Min=-2145.69398236749 PtS11Min=1 x2S11Min=-0.5 x3S11Min=-0.5 FrameElem=43 ElemStation=0.5

```

Frame=43 Station=0 OutputCase=ENVE CaseType=Combination StepType=Max P=-167.192740601283
V2=148.01187403274 V3=0 T=0 M2=0 M3=-238.668119589243 S11Max=1409.87643344631 PtS11Max=3 x2S11Max=0.5
x3S11Max=-0.5
S11Min=-1665.67469181791 PtS11Min=1 x2S11Min=-0.5 x3S11Min=-0.5 FrameElem=43 ElemStation=0

Frame=43 Station=0.125 OutputCase=ENVE CaseType=Combination StepType=Max P=-167.192740601283
V2=151.13687403274 V3=0 T=0 M2=0 M3=-257.301086686859 S11Max=1521.98968963526 PtS11Max=3 x2S11Max=0.5
x3S11Max=-0.5
S11Min=-1777.4724944036 PtS11Min=1 x2S11Min=-0.5 x3S11Min=-0.5 FrameElem=43 ElemStation=0.125

Frame=43 Station=0.25 OutputCase=ENVE CaseType=Combination StepType=Max P=-167.192740601283
V2=154.26187403274 V3=0 T=0 M2=0 M3=-276.324678784474 S11Max=1636.4466958242 PtS11Max=3 x2S11Max=0.5
x3S11Max=-0.5
S11Min=-1891.61404698929 PtS11Min=1 x2S11Min=-0.5 x3S11Min=-0.5 FrameElem=43 ElemStation=0.25

Frame=43 Station=0.375 OutputCase=ENVE CaseType=Combination StepType=Max P=-167.192740601283
V2=157.38687403274 V3=0 T=0 M2=0 M3=-295.738895882089 S11Max=1753.24745201315 PtS11Max=3 x2S11Max=0.5
x3S11Max=-0.5
S11Min=-2008.09934957499 PtS11Min=1 x2S11Min=-0.5 x3S11Min=-0.5 FrameElem=43 ElemStation=0.375

Frame=43 Station=0.5 OutputCase=ENVE CaseType=Combination StepType=Max P=-167.192740601283
V2=160.51187403274 V3=0 T=0 M2=0 M3=-315.543737979704 S11Max=1872.39195820209 PtS11Max=3 x2S11Max=0.5
x3S11Max=-0.5
S11Min=-2126.92840216068 PtS11Min=1 x2S11Min=-0.5 x3S11Min=-0.5 FrameElem=43 ElemStation=0.5

Frame=43 Station=0 OutputCase=ENVE CaseType=Combination StepType=Min P=-240.528987364651
V2=143.911020392206 V3=0 T=0 M2=0 M3=-263.988697854966 S11Max=1198.34274325301 PtS11Max=3 x2S11Max=0.5
x3S11Max=-0.5
S11Min=-1757.98794081327 PtS11Min=1 x2S11Min=-0.5 x3S11Min=-0.5 FrameElem=43 ElemStation=0

Frame=43 Station=0.125 OutputCase=ENVE CaseType=Combination StepType=Min P=-240.528987364651
V2=147.036020392206 V3=0 T=0 M2=0 M3=-282.674240553123 S11Max=1310.1405458387 PtS11Max=3 x2S11Max=0.5
x3S11Max=-0.5
S11Min=-1870.10119700222 PtS11Min=1 x2S11Min=-0.5 x3S11Min=-0.5 FrameElem=43 ElemStation=0.125

Frame=43 Station=0.25 OutputCase=ENVE CaseType=Combination StepType=Min P=-240.528987364651
V2=150.161020392206 V3=0 T=0 M2=0 M3=-301.750408251281 S11Max=1424.28209842439 PtS11Max=3 x2S11Max=0.5
x3S11Max=-0.5
S11Min=-1984.55820319116 PtS11Min=1 x2S11Min=-0.5 x3S11Min=-0.5 FrameElem=43 ElemStation=0.25

Frame=43 Station=0.375 OutputCase=ENVE CaseType=Combination StepType=Min P=-240.528987364651
V2=153.286020392206 V3=0 T=0 M2=0 M3=-321.217200949438 S11Max=1540.76740101008 PtS11Max=3 x2S11Max=0.5
x3S11Max=-0.5
S11Min=-2101.35895938011 PtS11Min=1 x2S11Min=-0.5 x3S11Min=-0.5 FrameElem=43 ElemStation=0.375

Frame=43 Station=0.5 OutputCase=ENVE CaseType=Combination StepType=Min P=-240.528987364651
V2=156.411020392206 V3=0 T=0 M2=0 M3=-341.074618647596 S11Max=1659.59645359577 PtS11Max=3 x2S11Max=0.5
x3S11Max=-0.5
S11Min=-2220.50346556905 PtS11Min=1 x2S11Min=-0.5 x3S11Min=-0.5 FrameElem=43 ElemStation=0.5

Frame=43 Station=0 OutputCase=FESSUR CaseType=Combination P=-239.151922837248 V2=146.808627674823
V3=0 T=0 M2=0 M3=-247.75554028058 S11Max=1247.38131884623 PtS11Max=3 x2S11Max=0.5 x3S11Max=-0.5
S11Min=-1725.68516452073 PtS11Min=1 x2S11Min=-0.5 x3S11Min=-0.5 FrameElem=43 ElemStation=0

Frame=43 Station=0.125 OutputCase=FESSUR CaseType=Combination P=-239.151922837248 V2=149.933627674823
V3=0 T=0 M2=0 M3=-266.301931239933 S11Max=1358.65966460235 PtS11Max=3 x2S11Max=0.5 x3S11Max=-0.5
S11Min=-1836.96351027685 PtS11Min=1 x2S11Min=-0.5 x3S11Min=-0.5 FrameElem=43 ElemStation=0.125

Frame=43 Station=0.25 OutputCase=FESSUR CaseType=Combination P=-239.151922837248 V2=153.058627674823
V3=0 T=0 M2=0 M3=-285.238947199286 S11Max=1472.28176035847 PtS11Max=3 x2S11Max=0.5 x3S11Max=-0.5
S11Min=-1950.58560603296 PtS11Min=1 x2S11Min=-0.5 x3S11Min=-0.5 FrameElem=43 ElemStation=0.25

Frame=43 Station=0.375 OutputCase=FESSUR CaseType=Combination P=-239.151922837248 V2=156.183627674823
V3=0 T=0 M2=0 M3=-304.566588158639 S11Max=1588.24760611459 PtS11Max=3 x2S11Max=0.5 x3S11Max=-0.5
S11Min=-2066.55145178908 PtS11Min=1 x2S11Min=-0.5 x3S11Min=-0.5 FrameElem=43 ElemStation=0.375

Frame=43 Station=0.5 OutputCase=FESSUR CaseType=Combination P=-239.151922837248 V2=159.308627674823
V3=0 T=0 M2=0 M3=-324.284854117992 S11Max=1706.5572018707 PtS11Max=3 x2S11Max=0.5 x3S11Max=-0.5
S11Min=-2184.8610475452 PtS11Min=1 x2S11Min=-0.5 x3S11Min=-0.5 FrameElem=43 ElemStation=0.5

Frame=44 Station=0 OutputCase=PERM1 CaseType=Combination P=-235.938772273311 V2=43.7650929739684 V3=0
T=0 M2=0 M3=-318.257164505351 S11Max=1673.6042147588 PtS11Max=3 x2S11Max=0.5 x3S11Max=-0.5
S11Min=-2145.48175930542 PtS11Min=1 x2S11Min=-0.5 x3S11Min=-0.5 FrameElem=44 ElemStation=0

Frame=44 Station=0.125 OutputCase=PERM1 CaseType=Combination P=-235.938772273311 V2=46.8900929739684
V3=0 T=0 M2=0 M3=-323.923113627098 S11Max=1707.59990948927 PtS11Max=3 x2S11Max=0.5 x3S11Max=-0.5
S11Min=-2179.4774540359 PtS11Min=1 x2S11Min=-0.5 x3S11Min=-0.5 FrameElem=44 ElemStation=0.125

Frame=44 Station=0.25 OutputCase=PERM1 CaseType=Combination P=-235.938772273311 V2=50.0150929739684
V3=0 T=0 M2=0 M3=-329.979687748844 S11Max=1743.93935421975 PtS11Max=3 x2S11Max=0.5 x3S11Max=-0.5
S11Min=-2215.81689876637 PtS11Min=1 x2S11Min=-0.5 x3S11Min=-0.5 FrameElem=44 ElemStation=0.25

Frame=44 Station=0.375 OutputCase=PERM1 CaseType=Combination P=-235.938772273311 V2=53.1400929739684
V3=0 T=0 M2=0 M3=-336.42688687059 S11Max=1782.62254895023 PtS11Max=3 x2S11Max=0.5 x3S11Max=-0.5
S11Min=-2254.50009349685 PtS11Min=1 x2S11Min=-0.5 x3S11Min=-0.5 FrameElem=44 ElemStation=0.375

Frame=44 Station=0.5 OutputCase=PERM1 CaseType=Combination P=-235.938772273311 V2=56.2650929739684
V3=0 T=0 M2=0 M3=-343.264710992336 S11Max=1823.6494936807 PtS11Max=3 x2S11Max=0.5 x3S11Max=-0.5
S11Min=-2295.52703822732 PtS11Min=1 x2S11Min=-0.5 x3S11Min=-0.5 FrameElem=44 ElemStation=0.5

Frame=44 Station=0 OutputCase=PERM2 CaseType=Combination P=-169.465538592141 V2=43.7325277187184 V3=0
T=0 M2=0 M3=-332.463633486682 S11Max=1825.31626232795 PtS11Max=3 x2S11Max=0.5 x3S11Max=-0.5
S11Min=-2164.24733951223 PtS11Min=1 x2S11Min=-0.5 x3S11Min=-0.5 FrameElem=44 ElemStation=0

Frame=44 Station=0.125 OutputCase=PERM2 CaseType=Combination P=-169.465538592141 V2=46.8575277187184
V3=0 T=0 M2=0 M3=-338.125511951522 S11Max=1859.28753311699 PtS11Max=3 x2S11Max=0.5 x3S11Max=-0.5
S11Min=-2198.21861030127 PtS11Min=1 x2S11Min=-0.5 x3S11Min=-0.5 FrameElem=44 ElemStation=0.125

Frame=44 Station=0.25 OutputCase=PERM2 CaseType=Combination P=-169.465538592141 V2=49.9825277187184
V3=0 T=0 M2=0 M3=-344.178015416362 S11Max=1895.60255390603 PtS11Max=3 x2S11Max=0.5 x3S11Max=-0.5
S11Min=-2234.53363109031 PtS11Min=1 x2S11Min=-0.5 x3S11Min=-0.5 FrameElem=44 ElemStation=0.25

Frame=44 Station=0.375 OutputCase=PERM2 CaseType=Combination P=-169.465538592141 V2=53.1075277187184
V3=0 T=0 M2=0 M3=-350.621143881201 S11Max=1934.26132469507 PtS11Max=3 x2S11Max=0.5 x3S11Max=-0.5
S11Min=-2273.19240187935 PtS11Min=1 x2S11Min=-0.5 x3S11Min=-0.5 FrameElem=44 ElemStation=0.375



Frame=44 Station=0.5 OutputCase=PERM2 CaseType=Combination P=-169.465538592141 V2=56.2325277187184
 V3=0 T=0 M2=0 M3=-357.454897346041 S11Max=1975.26384548411 PtS11Max=3 x2S11Max=0.5 x3S11Max=-0.5 _
 S11Min=-2314.19492266839 PtS11Min=1 x2S11Min=-0.5 x3S11Min=-0.5 FrameElem=44 ElemStation=0.5
 Frame=44 Station=0 OutputCase=ACC1 CaseType=Combination P=-240.528987364653 V2=45.100179083847 V3=0
 T=0 M2=0 M3=-326.868149666261 S11Max=1720.67991063292 PtS11Max=3 x2S11Max=0.5 x3S11Max=-0.5 _
 S11Min=-2201.73788536222 PtS11Min=1 x2S11Min=-0.5 x3S11Min=-0.5 FrameElem=44 ElemStation=0
 Frame=44 Station=0.125 OutputCase=ACC1 CaseType=Combination P=-240.528987364653 V2=48.225179083847
 V3=0 T=0 M2=0 M3=-332.700984551742 S11Max=1755.6769199458 PtS11Max=3 x2S11Max=0.5 x3S11Max=-0.5 _
 S11Min=-2236.73489467511 PtS11Min=1 x2S11Min=-0.5 x3S11Min=-0.5 FrameElem=44 ElemStation=0.125
 Frame=44 Station=0.375 OutputCase=ACC1 CaseType=Combination P=-240.528987364653 V2=45.100179083847
 V3=0 T=0 M2=0 M3=-338.924444437223 S11Max=1793.01767925869 PtS11Max=3 x2S11Max=0.5 x3S11Max=-0.5 _
 S11Min=-2274.07565398799 PtS11Min=1 x2S11Min=-0.5 x3S11Min=-0.5 FrameElem=44 ElemStation=0.25
 Frame=44 Station=0 OutputCase=ACC1 CaseType=Combination P=-240.528987364653 V2=54.475179083847
 V3=0 T=0 M2=0 M3=-345.538529322704 S11Max=1832.70218857157 PtS11Max=3 x2S11Max=0.5 x3S11Max=-0.5 _
 S11Min=-2313.76016330088 PtS11Min=1 x2S11Min=-0.5 x3S11Min=-0.5 FrameElem=44 ElemStation=0.375
 Frame=44 Station=0.25 OutputCase=ACC1 CaseType=Combination P=-240.528987364653 V2=45.0676138285971 V3=0
 T=0 M2=0 M3=-352.543239208185 S11Max=1874.73044788446 PtS11Max=3 x2S11Max=0.5 x3S11Max=-0.5 _
 S11Min=-2355.78842261376 PtS11Min=1 x2S11Min=-0.5 x3S11Min=-0.5 FrameElem=44 ElemStation=0.5
 Frame=44 Station=0 OutputCase=ACC2 CaseType=Combination P=-174.055753683483 V2=45.0676138285971 V3=0
 T=0 M2=0 M3=-341.074618647592 S11Max=1872.39195820207 PtS11Max=3 x2S11Max=0.5 x3S11Max=-0.5 _
 S11Min=-2220.50346556903 PtS11Min=1 x2S11Min=-0.5 x3S11Min=-0.5 FrameElem=44 ElemStation=0
 Frame=44 Station=0.125 OutputCase=ACC2 CaseType=Combination P=-174.055753683483 V2=48.1926138285971
 V3=0 T=0 M2=0 M3=-346.903382876167 S11Max=1907.36454357352 PtS11Max=3 x2S11Max=0.5 x3S11Max=-0.5 _
 S11Min=-2255.47605094048 PtS11Min=1 x2S11Min=-0.5 x3S11Min=-0.5 FrameElem=44 ElemStation=0.125
 Frame=44 Station=0.375 OutputCase=ACC2 CaseType=Combination P=-174.055753683483 V2=51.3176138285971
 V3=0 T=0 M2=0 M3=-353.122772104741 S11Max=1944.68087894497 PtS11Max=3 x2S11Max=0.5 x3S11Max=-0.5 _
 S11Min=-2292.79238631193 PtS11Min=1 x2S11Min=-0.5 x3S11Min=-0.5 FrameElem=44 ElemStation=0.25
 Frame=44 Station=0 OutputCase=ACC2 CaseType=Combination P=-174.055753683483 V2=54.4426138285971
 V3=0 T=0 M2=0 M3=-359.732786333316 S11Max=1984.34096431641 PtS11Max=3 x2S11Max=0.5 x3S11Max=-0.5 _
 S11Min=-2332.45247168338 PtS11Min=1 x2S11Min=-0.5 x3S11Min=-0.5 FrameElem=44 ElemStation=0.375
 Frame=44 Station=0.5 OutputCase=ACC2 CaseType=Combination P=-174.055753683483 V2=57.5676138285971
 V3=0 T=0 M2=0 M3=-366.733425561891 S11Max=2026.34479968786 PtS11Max=3 x2S11Max=0.5 x3S11Max=-0.5 _
 S11Min=-2374.45630705483 PtS11Min=1 x2S11Min=-0.5 x3S11Min=-0.5 FrameElem=44 ElemStation=0.5
 Frame=44 Station=0 OutputCase=ACCSX1 CaseType=Combination P=-233.665974282455 V2=47.6932426768591
 V3=0 T=0 M2=0 M3=-315.543737979701 S11Max=1659.59645359575 PtS11Max=3 x2S11Max=0.5 x3S11Max=-0.5 _
 S11Min=-2126.92840216066 PtS11Min=1 x2S11Min=-0.5 x3S11Min=-0.5 FrameElem=44 ElemStation=0
 Frame=44 Station=0.125 OutputCase=ACCSX1 CaseType=Combination P=-233.665974282455 V2=50.8182426768591
 V3=0 T=0 M2=0 M3=-321.700705814308 S11Max=1696.53826060339 PtS11Max=3 x2S11Max=0.5 x3S11Max=-0.5 _
 S11Min=-2163.8702091683 PtS11Min=1 x2S11Min=-0.5 x3S11Min=-0.5 FrameElem=44 ElemStation=0.125
 Frame=44 Station=0.25 OutputCase=ACCSX1 CaseType=Combination P=-233.665974282455 V2=53.9432426768591
 V3=0 T=0 M2=0 M3=-328.248298648915 S11Max=1735.82381761104 PtS11Max=3 x2S11Max=0.5 x3S11Max=-0.5 _
 S11Min=-2203.15576617595 PtS11Min=1 x2S11Min=-0.5 x3S11Min=-0.5 FrameElem=44 ElemStation=0.25
 Frame=44 Station=0.375 OutputCase=ACCSX1 CaseType=Combination P=-233.665974282455 V2=57.0682426768591
 V3=0 T=0 M2=0 M3=-335.186516483523 S11Max=1777.45312461868 PtS11Max=3 x2S11Max=0.5 x3S11Max=-0.5 _
 S11Min=-2244.78507318359 PtS11Min=1 x2S11Min=-0.5 x3S11Min=-0.5 FrameElem=44 ElemStation=0.375
 Frame=44 Station=0.5 OutputCase=ACCSX1 CaseType=Combination P=-233.665974282455 V2=60.1932426768591
 V3=0 T=0 M2=0 M3=-342.51535931813 S11Max=1821.42618162633 PtS11Max=3 x2S11Max=0.5 x3S11Max=-0.5 _
 S11Min=-2288.75813019124 PtS11Min=1 x2S11Min=-0.5 x3S11Min=-0.5 FrameElem=44 ElemStation=0.5
 Frame=44 Station=0 OutputCase=ACCSX2 CaseType=Combination P=-167.192740601285 V2=47.6606774216092
 V3=0 T=0 M2=0 M3=-329.750206961031 S11Max=1811.3085011649 PtS11Max=3 x2S11Max=0.5 x3S11Max=-0.5 _
 S11Min=-2145.69398236747 PtS11Min=1 x2S11Min=-0.5 x3S11Min=-0.5 FrameElem=44 ElemStation=0
 Frame=44 Station=0.125 OutputCase=ACCSX2 CaseType=Combination P=-167.192740601285 V2=50.7856774216092
 V3=0 T=0 M2=0 M3=-335.903104138732 S11Max=1848.22588423111 PtS11Max=3 x2S11Max=0.5 x3S11Max=-0.5 _
 S11Min=-2182.61136543368 PtS11Min=1 x2S11Min=-0.5 x3S11Min=-0.5 FrameElem=44 ElemStation=0.125
 Frame=44 Station=0.25 OutputCase=ACCSX2 CaseType=Combination P=-167.192740601285 V2=53.9106774216092
 V3=0 T=0 M2=0 M3=-342.446626316433 S11Max=1887.48701729732 PtS11Max=3 x2S11Max=0.5 x3S11Max=-0.5 _
 S11Min=-2221.87249849988 PtS11Min=1 x2S11Min=-0.5 x3S11Min=-0.5 FrameElem=44 ElemStation=0.25
 Frame=44 Station=0.375 OutputCase=ACCSX2 CaseType=Combination P=-167.192740601285 V2=57.0356774216092
 V3=0 T=0 M2=0 M3=-349.380773494135 S11Max=1929.09190036352 PtS11Max=3 x2S11Max=0.5 x3S11Max=-0.5 _
 S11Min=-2263.47738156609 PtS11Min=1 x2S11Min=-0.5 x3S11Min=-0.5 FrameElem=44 ElemStation=0.375
 Frame=44 Station=0.5 OutputCase=ACCSX2 CaseType=Combination P=-167.192740601285 V2=60.1606774216092
 V3=0 T=0 M2=0 M3=-356.705545671836 S11Max=1973.04053342973 PtS11Max=3 x2S11Max=0.5 x3S11Max=-0.5 _
 S11Min=-2307.4260146323 PtS11Min=1 x2S11Min=-0.5 x3S11Min=-0.5 FrameElem=44 ElemStation=0.5
 Frame=44 Station=0 OutputCase=ENVE CaseType=Combination StepType=Max P=-167.192740601285
 V2=47.6932426768591 V3=0 T=0 M2=0 M3=-315.543737979701 S11Max=1872.39195820207 PtS11Max=3 x2S11Max=0.5
 x3S11Max=-0.5 _
 S11Min=-2126.92840216066 PtS11Min=1 x2S11Min=-0.5 x3S11Min=-0.5 FrameElem=44 ElemStation=0
 Frame=44 Station=0.125 OutputCase=ENVE CaseType=Combination StepType=Max P=-167.192740601285
 V2=50.8182426768591 V3=0 T=0 M2=0 M3=-321.700705814308 S11Max=1907.36454357352 PtS11Max=3 x2S11Max=0.5
 x3S11Max=-0.5 _
 S11Min=-2163.8702091683 PtS11Min=1 x2S11Min=-0.5 x3S11Min=-0.5 FrameElem=44 ElemStation=0.125
 Frame=44 Station=0.25 OutputCase=ENVE CaseType=Combination StepType=Max P=-167.192740601285
 V2=53.9432426768591 V3=0 T=0 M2=0 M3=-328.248298648915 S11Max=1944.68087894497 PtS11Max=3 x2S11Max=0.5
 x3S11Max=-0.5 _
 S11Min=-2203.15576617595 PtS11Min=1 x2S11Min=-0.5 x3S11Min=-0.5 FrameElem=44 ElemStation=0.25
 Frame=44 Station=0.375 OutputCase=ENVE CaseType=Combination StepType=Max P=-167.192740601285
 V2=57.0682426768591 V3=0 T=0 M2=0 M3=-335.186516483523 S11Max=1984.34096431641 PtS11Max=3 x2S11Max=0.5
 x3S11Max=-0.5 _
 S11Min=-2244.78507318359 PtS11Min=1 x2S11Min=-0.5 x3S11Min=-0.5 FrameElem=44 ElemStation=0.375
 Frame=44 Station=0.5 OutputCase=ENVE CaseType=Combination StepType=Max P=-167.192740601285
 V2=60.1932426768591 V3=0 T=0 M2=0 M3=-342.51535931813 S11Max=2026.34479968786 PtS11Max=3 x2S11Max=0.5
 x3S11Max=-0.5 _



S11Min=-2288.75813019124 PtS11Min=1 x2S11Min=-0.5 x3S11Min=-0.5 FrameElem=44 ElemStation=0.5
 Frame=44 Station=0 OutputCase=ENVE CaseType=Combination StepType=Min P=-240.528987364653
 V2=43.7325277187184 V3=0 T=0 M2=0 M3=-341.074618647592 S11Max=1659.59645359575 PtS11Max=3 x2S11Max=0.5
 x3S11Max=-0.5 _
 S11Min=-2220.50346556903 PtS11Min=1 x2S11Min=-0.5 x3S11Min=-0.5 FrameElem=44 ElemStation=0
 Frame=44 Station=0.125 OutputCase=ENVE CaseType=Combination StepType=Min P=-240.528987364653
 V2=46.8575277187184 V3=0 T=0 M2=0 M3=-346.903382876167 S11Max=1696.53826060339 PtS11Max=3 x2S11Max=0.5
 x3S11Max=-0.5 _
 S11Min=-2255.47605094048 PtS11Min=1 x2S11Min=-0.5 x3S11Min=-0.5 FrameElem=44 ElemStation=0.125
 Frame=44 Station=0.25 OutputCase=ENVE CaseType=Combination StepType=Min P=-240.528987364653
 V2=49.9825277187184 V3=0 T=0 M2=0 M3=-353.122772104741 S11Max=1735.82381761104 PtS11Max=3 x2S11Max=0.5
 x3S11Max=-0.5 _
 S11Min=-2292.79238631193 PtS11Min=1 x2S11Min=-0.5 x3S11Min=-0.5 FrameElem=44 ElemStation=0.25
 Frame=44 Station=0.375 OutputCase=ENVE CaseType=Combination StepType=Min P=-240.528987364653
 V2=53.1075277187184 V3=0 T=0 M2=0 M3=-359.732786333316 S11Max=1777.45312461868 PtS11Max=3 x2S11Max=0.5
 x3S11Max=-0.5 _
 S11Min=-2332.45247168338 PtS11Min=1 x2S11Min=-0.5 x3S11Min=-0.5 FrameElem=44 ElemStation=0.375
 Frame=44 Station=0.5 OutputCase=ENVE CaseType=Combination StepType=Min P=-240.528987364653
 V2=56.2325277187184 V3=0 T=0 M2=0 M3=-366.733425561891 S11Max=1821.42618162633 PtS11Max=3 x2S11Max=0.5
 x3S11Max=-0.5 _
 S11Min=-2374.45630705483 PtS11Min=1 x2S11Min=-0.5 x3S11Min=-0.5 FrameElem=44 ElemStation=0.5
 Frame=44 Station=0 OutputCase=FESSUR CaseType=Combination P=-239.15192283725 V2=44.6996532508834 V3=0
 T=0 M2=0 M3=-324.284854117988 S11Max=1706.55720187068 PtS11Max=3 x2S11Max=0.5 x3S11Max=-0.5 _
 S11Min=-2184.86104754518 PtS11Min=1 x2S11Min=-0.5 x3S11Min=-0.5 FrameElem=44 ElemStation=0
 Frame=44 Station=0.125 OutputCase=FESSUR CaseType=Combination P=-239.15192283725 V2=47.8246532508834
 V3=0 T=0 M2=0 M3=-330.067623274349 S11Max=1741.25381680884 PtS11Max=3 x2S11Max=0.5 x3S11Max=-0.5 _
 S11Min=-2219.55766248334 PtS11Min=1 x2S11Min=-0.5 x3S11Min=-0.5 FrameElem=44 ElemStation=0.125
 Frame=44 Station=0.25 OutputCase=FESSUR CaseType=Combination P=-239.15192283725 V2=50.9496532508834
 V3=0 T=0 M2=0 M3=-336.241017430709 S11Max=1778.29418174701 PtS11Max=3 x2S11Max=0.5 x3S11Max=-0.5 _
 S11Min=-2256.5980274215 PtS11Min=1 x2S11Min=-0.5 x3S11Min=-0.5 FrameElem=44 ElemStation=0.25
 Frame=44 Station=0.375 OutputCase=FESSUR CaseType=Combination P=-239.15192283725 V2=54.0746532508834
 V3=0 T=0 M2=0 M3=-342.80503658707 S11Max=1817.67829668517 PtS11Max=3 x2S11Max=0.5 x3S11Max=-0.5 _
 S11Min=-2295.98214235967 PtS11Min=1 x2S11Min=-0.5 x3S11Min=-0.5 FrameElem=44 ElemStation=0.375
 Frame=44 Station=0.5 OutputCase=FESSUR CaseType=Combination P=-239.15192283725 V2=57.1996532508834
 V3=0 T=0 M2=0 M3=-349.75968074343 S11Max=1859.40616162333 PtS11Max=3 x2S11Max=0.5 x3S11Max=-0.5 _
 S11Min=-2337.71000729783 PtS11Min=1 x2S11Min=-0.5 x3S11Min=-0.5 FrameElem=44 ElemStation=0.5
 Frame=45 Station=0 OutputCase=PERM1 CaseType=Combination P=-235.93877227331 V2=-56.2650907703757 V3=0
 T=0 M2=0 M3=-343.264710992325 S11Max=1823.64949368064 PtS11Max=3 x2S11Max=0.5 x3S11Max=-0.5 _
 S11Min=-2295.52703822726 PtS11Min=1 x2S11Min=-0.5 x3S11Min=-0.5 FrameElem=45 ElemStation=0
 Frame=45 Station=0.125 OutputCase=PERM1 CaseType=Combination P=-235.93877227331 V2=-53.1400907703757
 V3=0 T=0 M2=0 M3=-336.426887146028 S11Max=1782.62255060286 PtS11Max=3 x2S11Max=0.5 x3S11Max=-0.5 _
 S11Min=-2254.50009514948 PtS11Min=1 x2S11Min=-0.5 x3S11Min=-0.5 FrameElem=45 ElemStation=0.125
 Frame=45 Station=0.25 OutputCase=PERM1 CaseType=Combination P=-235.93877227331 V2=-50.0150907703757
 V3=0 T=0 M2=0 M3=-329.979688299731 S11Max=1743.93935752507 PtS11Max=3 x2S11Max=0.5 x3S11Max=-0.5 _
 S11Min=-2215.8169020717 PtS11Min=1 x2S11Min=-0.5 x3S11Min=-0.5 FrameElem=45 ElemStation=0.25
 Frame=45 Station=0.375 OutputCase=PERM1 CaseType=Combination P=-235.93877227331 V2=-46.8900907703757
 V3=0 T=0 M2=0 M3=-323.923114453434 S11Max=1707.59991444729 PtS11Max=3 x2S11Max=0.5 x3S11Max=-0.5 _
 S11Min=-2179.47745899391 PtS11Min=1 x2S11Min=-0.5 x3S11Min=-0.5 FrameElem=45 ElemStation=0.375
 Frame=45 Station=0.5 OutputCase=PERM1 CaseType=Combination P=-235.93877227331 V2=-43.7650907703757
 V3=0 T=0 M2=0 M3=-318.257165607137 S11Max=1673.60422136951 PtS11Max=3 x2S11Max=0.5 x3S11Max=-0.5 _
 S11Min=-2145.48176591613 PtS11Min=1 x2S11Min=-0.5 x3S11Min=-0.5 FrameElem=45 ElemStation=0.5
 Frame=45 Station=0 OutputCase=PERM2 CaseType=Combination P=-169.46553859214 V2=-56.2325263506389 V3=0
 T=0 M2=0 M3=-357.45489734603 S11Max=1975.26384548404 PtS11Max=3 x2S11Max=0.5 x3S11Max=-0.5 _
 S11Min=-2314.19492266832 PtS11Min=1 x2S11Min=-0.5 x3S11Min=-0.5 FrameElem=45 ElemStation=0
 Frame=45 Station=0.125 OutputCase=PERM2 CaseType=Combination P=-169.46553859214 V2=-53.1075263506389
 V3=0 T=0 M2=0 M3=-350.6211440522 S11Max=1934.26132572106 PtS11Max=3 x2S11Max=0.5 x3S11Max=-0.5 _
 S11Min=-2273.19240290534 PtS11Min=1 x2S11Min=-0.5 x3S11Min=-0.5 FrameElem=45 ElemStation=0.125
 Frame=45 Station=0.25 OutputCase=PERM2 CaseType=Combination P=-169.46553859214 V2=-49.9825263506389
 V3=0 T=0 M2=0 M3=-344.178015758371 S11Max=1895.60255595808 PtS11Max=3 x2S11Max=0.5 x3S11Max=-0.5 _
 S11Min=-2234.53363314236 PtS11Min=1 x2S11Min=-0.5 x3S11Min=-0.5 FrameElem=45 ElemStation=0.25
 Frame=45 Station=0.375 OutputCase=PERM2 CaseType=Combination P=-169.46553859214 V2=-46.8575263506389
 V3=0 T=0 M2=0 M3=-338.125512464541 S11Max=1859.2875361951 PtS11Max=3 x2S11Max=0.5 x3S11Max=-0.5 _
 S11Min=-2198.21861337938 PtS11Min=1 x2S11Min=-0.5 x3S11Min=-0.5 FrameElem=45 ElemStation=0.375
 Frame=45 Station=0.5 OutputCase=PERM2 CaseType=Combination P=-169.46553859214 V2=-43.7325263506389
 V3=0 T=0 M2=0 M3=-332.463634170711 S11Max=1825.31626643213 PtS11Max=3 x2S11Max=0.5 x3S11Max=-0.5 _
 S11Min=-2164.24734361641 PtS11Min=1 x2S11Min=-0.5 x3S11Min=-0.5 FrameElem=45 ElemStation=0.5
 Frame=45 Station=0 OutputCase=ACCL CaseType=Combination P=-240.528987364652 V2=-57.6001768109779 V3=0
 T=0 M2=0 M3=-352.543239208174 S11Max=1874.73044788439 PtS11Max=3 x2S11Max=0.5 x3S11Max=-0.5 _
 S11Min=-2355.78842261369 PtS11Min=1 x2S11Min=-0.5 x3S11Min=-0.5 FrameElem=45 ElemStation=0
 Frame=45 Station=0.125 OutputCase=ACCL CaseType=Combination P=-240.528987364652 V2=-54.4751768109779
 V3=0 T=0 M2=0 M3=-345.538529606801 S11Max=1832.70219027616 PtS11Max=3 x2S11Max=0.5 x3S11Max=-0.5 _
 S11Min=-2313.76016500546 PtS11Min=1 x2S11Min=-0.5 x3S11Min=-0.5 FrameElem=45 ElemStation=0.125
 Frame=45 Station=0.25 OutputCase=ACCL CaseType=Combination P=-240.528987364652 V2=-51.3501768109779
 V3=0 T=0 M2=0 M3=-338.924445005429 S11Max=1793.01768266792 PtS11Max=3 x2S11Max=0.5 x3S11Max=-0.5 _
 S11Min=-2274.07565739723 PtS11Min=1 x2S11Min=-0.5 x3S11Min=-0.5 FrameElem=45 ElemStation=0.25
 Frame=45 Station=0.375 OutputCase=ACCL CaseType=Combination P=-240.528987364652 V2=-48.2251768109779
 V3=0 T=0 M2=0 M3=-332.700985404057 S11Max=1755.67692505969 PtS11Max=3 x2S11Max=0.5 x3S11Max=-0.5 _
 S11Min=-2236.73489978899 PtS11Min=1 x2S11Min=-0.5 x3S11Min=-0.5 FrameElem=45 ElemStation=0.375
 Frame=45 Station=0.5 OutputCase=ACCL CaseType=Combination P=-240.528987364652 V2=-45.1001768109779
 V3=0 T=0 M2=0 M3=-326.868150802685 S11Max=1720.67991745146 PtS11Max=3 x2S11Max=0.5 x3S11Max=-0.5 _
 S11Min=-2201.73789218076 PtS11Min=1 x2S11Min=-0.5 x3S11Min=-0.5 FrameElem=45 ElemStation=0.5

Frame=45 Station=0 OutputCase=ACC2 CaseType=Combination P=-174.055753683482 V2=-57.567612391241 V3=0
 T=0 M2=0 M3=-366.733425561879 S11Max=2026.34479968779 PtS11Max=3 x2S11Max=0.5 x3S11Max=-0.5 _
 S11Min=-2374.45630705476 PtS11Min=1 x2S11Min=-0.5 x3S11Min=-0.5 FrameElem=45 ElemStation=0
 Frame=45 Station=0.125 OutputCase=ACC2 CaseType=Combination P=-174.055753683482 V2=-54.442612391241
 V3=0 T=0 M2=0 M3=-359.732786512974 S11Max=1984.34096539436 PtS11Max=3 x2S11Max=0.5 x3S11Max=-0.5 _
 S11Min=-2332.45247276133 PtS11Min=1 x2S11Min=-0.5 x3S11Min=-0.5 FrameElem=45 ElemStation=0.125
 Frame=45 Station=0.25 OutputCase=ACC2 CaseType=Combination P=-174.055753683482 V2=-51.317612391241
 V3=0 T=0 M2=0 M3=-353.122772464069 S11Max=1944.68088110093 PtS11Max=3 x2S11Max=0.5 x3S11Max=-0.5 _
 S11Min=-2292.7923884679 PtS11Min=1 x2S11Min=-0.5 x3S11Min=-0.5 FrameElem=45 ElemStation=0.25
 Frame=45 Station=0.375 OutputCase=ACC2 CaseType=Combination P=-174.055753683482 V2=-48.192612391241
 V3=0 T=0 M2=0 M3=-346.903383415164 S11Max=1907.3645468075 PtS11Max=3 x2S11Max=0.5 x3S11Max=-0.5 _
 S11Min=-2255.47605417446 PtS11Min=1 x2S11Min=-0.5 x3S11Min=-0.5 FrameElem=45 ElemStation=0.375
 Frame=45 Station=0.5 OutputCase=ACC2 CaseType=Combination P=-174.055753683482 V2=-45.067612391241
 V3=0 T=0 M2=0 M3=-341.074619366259 S11Max=1872.39196251407 PtS11Max=3 x2S11Max=0.5 x3S11Max=-0.5 _
 S11Min=-2220.50346988104 PtS11Min=1 x2S11Min=-0.5 x3S11Min=-0.5 FrameElem=45 ElemStation=0.5
 Frame=45 Station=0.75 OutputCase=ACC2 CaseType=Combination P=-174.055753683482 V2=-42.3403804184394
 V3=0 T=0 M2=0 M3=-342.515359318119 S11Max=1821.42618162626 PtS11Max=3 x2S11Max=0.5 x3S11Max=-0.5 _
 S11Min=-2288.75813019117 PtS11Min=1 x2S11Min=-0.5 x3S11Min=-0.5 FrameElem=45 ElemStation=0
 Frame=45 Station=0.125 OutputCase=ACCSX1 CaseType=Combination P=-233.665974282454 V2=-49.2153804184394
 V3=0 T=0 M2=0 M3=-336.168124265814 S11Max=1783.34277131243 PtS11Max=3 x2S11Max=0.5 x3S11Max=-0.5 _
 S11Min=-2250.67471987734 PtS11Min=1 x2S11Min=-0.5 x3S11Min=-0.5 FrameElem=45 ElemStation=0.125
 Frame=45 Station=0.25 OutputCase=ACCSX1 CaseType=Combination P=-233.665974282454 V2=-46.0903804184394
 V3=0 T=0 M2=0 M3=-330.211514213509 S11Max=1747.6031109986 PtS11Max=3 x2S11Max=0.5 x3S11Max=-0.5 _
 S11Min=-2214.93505956351 PtS11Min=1 x2S11Min=-0.5 x3S11Min=-0.5 FrameElem=45 ElemStation=0.25
 Frame=45 Station=0.375 OutputCase=ACCSX1 CaseType=Combination P=-233.665974282454 V2=-42.9653804184394
 V3=0 T=0 M2=0 M3=-324.645529161204 S11Max=1714.20720068477 PtS11Max=3 x2S11Max=0.5 x3S11Max=-0.5 _
 S11Min=-2181.53914924968 PtS11Min=1 x2S11Min=-0.5 x3S11Min=-0.5 FrameElem=45 ElemStation=0.375
 Frame=45 Station=0.5 OutputCase=ACCSX1 CaseType=Combination P=-233.665974282454 V2=-39.8403804184394
 V3=0 T=0 M2=0 M3=-319.470169108899 S11Max=1683.15504037094 PtS11Max=3 x2S11Max=0.5 x3S11Max=-0.5 _
 S11Min=-2150.48698893585 PtS11Min=1 x2S11Min=-0.5 x3S11Min=-0.5 FrameElem=45 ElemStation=0.5
 Frame=45 Station=0.75 OutputCase=ACCSX2 CaseType=Combination P=-167.192740601284 V2=-52.3078159987025
 V3=0 T=0 M2=0 M3=-356.705545671825 S11Max=1973.04053342966 PtS11Max=3 x2S11Max=0.5 x3S11Max=-0.5 _
 S11Min=-2307.426601463223 PtS11Min=1 x2S11Min=-0.5 x3S11Min=-0.5 FrameElem=45 ElemStation=0
 Frame=45 Station=0.125 OutputCase=ACCSX2 CaseType=Combination P=-167.192740601284 V2=-49.1828159987025
 V3=0 T=0 M2=0 M3=-350.362381171987 S11Max=1934.98154643064 PtS11Max=3 x2S11Max=0.5 x3S11Max=-0.5 _
 S11Min=-2269.36702763321 PtS11Min=1 x2S11Min=-0.5 x3S11Min=-0.5 FrameElem=45 ElemStation=0.125
 Frame=45 Station=0.25 OutputCase=ACCSX2 CaseType=Combination P=-167.192740601284 V2=-46.0578159987025
 V3=0 T=0 M2=0 M3=-344.409841672149 S11Max=1899.26630943161 PtS11Max=3 x2S11Max=0.5 x3S11Max=-0.5 _
 S11Min=-2233.65179063418 PtS11Min=1 x2S11Min=-0.5 x3S11Min=-0.5 FrameElem=45 ElemStation=0.25
 Frame=45 Station=0.375 OutputCase=ACCSX2 CaseType=Combination P=-167.192740601284 V2=-42.9328159987025
 V3=0 T=0 M2=0 M3=-338.847927172311 S11Max=1865.89482243258 PtS11Max=3 x2S11Max=0.5 x3S11Max=-0.5 _
 S11Min=-2200.28030363515 PtS11Min=1 x2S11Min=-0.5 x3S11Min=-0.5 FrameElem=45 ElemStation=0.375
 Frame=45 Station=0.5 OutputCase=ACCSX2 CaseType=Combination P=-167.192740601284 V2=-39.8078159987025
 V3=0 T=0 M2=0 M3=-333.676637672473 S11Max=1834.86708543356 PtS11Max=3 x2S11Max=0.5 x3S11Max=-0.5 _
 S11Min=-2169.25256663613 PtS11Min=1 x2S11Min=-0.5 x3S11Min=-0.5 FrameElem=45 ElemStation=0.5
 Frame=45 Station=0 OutputCase=ENVE CaseType=Combination StepType=Max P=-167.192740601284 V2=-
 52.3078159987025 V3=0 T=0 M2=0 M3=-342.515359318119 S11Max=2026.34479968779 PtS11Max=3 x2S11Max=0.5
 x3S11Max=-0.5 _
 S11Min=-2288.75813019117 PtS11Min=1 x2S11Min=-0.5 x3S11Min=-0.5 FrameElem=45 ElemStation=0
 Frame=45 Station=0.125 OutputCase=ENVE CaseType=Combination StepType=Max P=-167.192740601284 V2=-
 49.1828159987025 V3=0 T=0 M2=0 M3=-336.168124265814 S11Max=1984.34096539436 PtS11Max=3 x2S11Max=0.5
 x3S11Max=-0.5 S11Min=-2250.67471987734 PtS11Min=1 x2S11Min=-0.5 x3S11Min=-0.5 FrameElem=45
 ElemStation=0.125
 Frame=45 Station=0.25 OutputCase=ENVE CaseType=Combination StepType=Max P=-167.192740601284 V2=-
 46.0578159987025 V3=0 T=0 M2=0 M3=-329.979688299731 S11Max=1944.68088110093 PtS11Max=3 x2S11Max=0.5
 x3S11Max=-0.5 _
 S11Min=-2214.93505956351 PtS11Min=1 x2S11Min=-0.5 x3S11Min=-0.5 FrameElem=45 ElemStation=0.25
 Frame=45 Station=0.375 OutputCase=ENVE CaseType=Combination StepType=Max P=-167.192740601284 V2=-
 42.9328159987025 V3=0 T=0 M2=0 M3=-323.923114453434 S11Max=1907.3645468075 PtS11Max=3 x2S11Max=0.5
 x3S11Max=-0.5 _
 S11Min=-2179.47745899391 PtS11Min=1 x2S11Min=-0.5 x3S11Min=-0.5 FrameElem=45 ElemStation=0.375
 Frame=45 Station=0.5 OutputCase=ENVE CaseType=Combination StepType=Max P=-167.192740601284 V2=-
 39.8078159987025 V3=0 T=0 M2=0 M3=-318.257165607137 S11Max=1872.39196251407 PtS11Max=3 x2S11Max=0.5
 x3S11Max=-0.5 _
 S11Min=-2145.48176591613 PtS11Min=1 x2S11Min=-0.5 x3S11Min=-0.5 FrameElem=45 ElemStation=0.5
 Frame=45 Station=0 OutputCase=ENVE CaseType=Combination StepType=Min P=-240.528987364652 V2=-
 57.6001768109779 V3=0 T=0 M2=0 M3=-366.733425561879 S11Max=1821.42618162626 PtS11Max=3 x2S11Max=0.5
 x3S11Max=-0.5 _
 S11Min=-2374.45630705476 PtS11Min=1 x2S11Min=-0.5 x3S11Min=-0.5 FrameElem=45 ElemStation=0
 Frame=45 Station=0.125 OutputCase=ENVE CaseType=Combination StepType=Min P=-240.528987364652 V2=-
 54.4751768109779 V3=0 T=0 M2=0 M3=-359.732786512974 S11Max=1782.62255060286 PtS11Max=3 x2S11Max=0.5
 x3S11Max=-0.5 S11Min=-2332.45247276133 PtS11Min=1 x2S11Min=-0.5 x3S11Min=-0.5 FrameElem=45
 ElemStation=0.125
 Frame=45 Station=0.25 OutputCase=ENVE CaseType=Combination StepType=Min P=-240.528987364652 V2=-
 51.3501768109779 V3=0 T=0 M2=0 M3=-353.122772464069 S11Max=1743.93935752507 PtS11Max=3 x2S11Max=0.5
 x3S11Max=-0.5 _
 S11Min=-2292.7923884679 PtS11Min=1 x2S11Min=-0.5 x3S11Min=-0.5 FrameElem=45 ElemStation=0.25
 Frame=45 Station=0.375 OutputCase=ENVE CaseType=Combination StepType=Min P=-240.528987364652 V2=-
 48.2251768109779 V3=0 T=0 M2=0 M3=-346.903383415164 S11Max=1707.59991444729 PtS11Max=3 x2S11Max=0.5
 x3S11Max=-0.5 S11Min=-2255.47605417446 PtS11Min=1 x2S11Min=-0.5 x3S11Min=-0.5 FrameElem=45
 ElemStation=0.375

Frame=45 Station=0.5 OutputCase=ENVE CaseType=Combination StepType=Min P=-240.528987364652 V2=-45.1001768109779 V3=0 T=0 M2=0 M3=-341.074619366259 S11Max=1673.60422136951 PtS11Max=3 x2S11Max=0.5 x3S11Max=-0.5
 S11Min=-2220.50346988104 PtS11Min=1 x2S11Min=-0.5 x3S11Min=-0.5 FrameElem=45 ElemStation=0.5

Frame=45 Station=0 OutputCase=FESSUR CaseType=Combination P=-239.15192283725 V2=-57.1996509987972 V3=0 T=0 M2=0 M3=-349.759680743419 S11Max=1859.40616162326 PtS11Max=3 x2S11Max=0.5 x3S11Max=-0.5
 S11Min=-2337.71000729776 PtS11Min=1 x2S11Min=-0.5 x3S11Min=-0.5 FrameElem=45 ElemStation=0

Frame=45 Station=0.125 OutputCase=FESSUR CaseType=Combination P=-239.15192283725 V2=-54.0746509987972 V3=0 T=0 M2=0 M3=-342.805036868569 S11Max=1817.67829837417 PtS11Max=3 x2S11Max=0.5 x3S11Max=-0.5
 S11Min=-2295.59803079957 PtS11Min=1 x2S11Min=-0.5 x3S11Min=-0.5 FrameElem=45 ElemStation=0.125

Frame=45 Station=0.25 OutputCase=FESSUR CaseType=Combination P=-239.15192283725 V2=-50.9496509987972 V3=0 T=0 M2=0 M3=-336.24101799372 S11Max=1778.29418512507 PtS11Max=3 x2S11Max=0.5 x3S11Max=-0.5
 S11Min=-2256.59803079957 PtS11Min=1 x2S11Min=-0.5 x3S11Min=-0.5 FrameElem=45 ElemStation=0.25

Frame=45 Station=0.375 OutputCase=FESSUR CaseType=Combination P=-239.15192283725 V2=-47.8246509987972 V3=0 T=0 M2=0 M3=-330.06762411887 S11Max=1741.25382187597 PtS11Max=3 x2S11Max=0.5 x3S11Max=-0.5
 S11Min=-2219.55766755047 PtS11Min=1 x2S11Min=-0.5 x3S11Min=-0.5 FrameElem=45 ElemStation=0.375

Frame=45 Station=0.5 OutputCase=FESSUR CaseType=Combination P=-239.15192283725 V2=-44.6996509987972 V3=0 T=0 M2=0 M3=-324.28485524402 S11Max=1706.55720862687 PtS11Max=3 x2S11Max=0.5 x3S11Max=-0.5
 S11Min=-2184.86105430137 PtS11Min=1 x2S11Min=-0.5 x3S11Min=-0.5 FrameElem=45 ElemStation=0.5

Frame=46 Station=0 OutputCase=PERM1 CaseType=Combination P=-235.938772273311 V2=-156.501050932406 V3=0 T=0 M2=0 M3=-318.257165607133 S11Max=1673.60422136949 PtS11Max=3 x2S11Max=0.5 x3S11Max=-0.5
 S11Min=-2145.48176591611 PtS11Min=1 x2S11Min=-0.5 x3S11Min=-0.5 FrameElem=46 ElemStation=0

Frame=46 Station=0.125 OutputCase=PERM1 CaseType=Combination P=-235.938772273311 V2=-153.376050932406 V3=0 T=0 M2=0 M3=-298.889846740582 S11Max=1557.40030817018 PtS11Max=3 x2S11Max=0.5 x3S11Max=-0.5
 S11Min=-2029.27785271681 PtS11Min=1 x2S11Min=-0.5 x3S11Min=-0.5 FrameElem=46 ElemStation=0.125

Frame=46 Station=0.25 OutputCase=PERM1 CaseType=Combination P=-235.938772273311 V2=-150.251050932406 V3=0 T=0 M2=0 M3=-279.913152874032 S11Max=1443.54014497088 PtS11Max=3 x2S11Max=0.5 x3S11Max=-0.5
 S11Min=-1915.4176895175 PtS11Min=1 x2S11Min=-0.5 x3S11Min=-0.5 FrameElem=46 ElemStation=0.25

Frame=46 Station=0.375 OutputCase=PERM1 CaseType=Combination P=-235.938772273311 V2=-147.126050932406 V3=0 T=0 M2=0 M3=-261.327084007481 S11Max=1332.02373177158 PtS11Max=3 x2S11Max=0.5 x3S11Max=-0.5
 S11Min=-1803.9012763182 PtS11Min=1 x2S11Min=-0.5 x3S11Min=-0.5 FrameElem=46 ElemStation=0.375

Frame=46 Station=0.5 OutputCase=PERM1 CaseType=Combination P=-235.938772273311 V2=-144.001050932406 V3=0 T=0 M2=0 M3=-243.13164014093 S11Max=1222.85106857227 PtS11Max=3 x2S11Max=0.5 x3S11Max=-0.5
 S11Min=-1694.72861311889 PtS11Min=1 x2S11Min=-0.5 x3S11Min=-0.5 FrameElem=46 ElemStation=0.5

Frame=46 Station=0 OutputCase=PERM2 CaseType=Combination P=-169.465538592141 V2=-156.41101921066 V3=0 T=0 M2=0 M3=-332.463634170707 S11Max=1825.3162664321 PtS11Max=3 x2S11Max=0.5 x3S11Max=-0.5
 S11Min=-2164.24734361638 PtS11Min=1 x2S11Min=-0.5 x3S11Min=-0.5 FrameElem=46 ElemStation=0

Frame=46 Station=0.125 OutputCase=PERM2 CaseType=Combination P=-169.465538592141 V2=-153.28601921066 V3=0 T=0 M2=0 M3=-313.107569269375 S11Max=1709.17987702411 PtS11Max=3 x2S11Max=0.5 x3S11Max=-0.5
 S11Min=-2048.11095420839 PtS11Min=1 x2S11Min=-0.5 x3S11Min=-0.5 FrameElem=46 ElemStation=0.125

Frame=46 Station=0.25 OutputCase=PERM2 CaseType=Combination P=-169.465538592141 V2=-150.16101921066 V3=0 T=0 M2=0 M3=-294.142129368042 S11Max=1595.38723761611 PtS11Max=3 x2S11Max=0.5 x3S11Max=-0.5
 S11Min=-1934.31831480039 PtS11Min=1 x2S11Min=-0.5 x3S11Min=-0.5 FrameElem=46 ElemStation=0.25

Frame=46 Station=0.375 OutputCase=PERM2 CaseType=Combination P=-169.465538592141 V2=-147.03601921066 V3=0 T=0 M2=0 M3=-275.56731446671 S11Max=1483.93834820812 PtS11Max=3 x2S11Max=0.5 x3S11Max=-0.5
 S11Min=-1822.8694253924 PtS11Min=1 x2S11Min=-0.5 x3S11Min=-0.5 FrameElem=46 ElemStation=0.375

Frame=46 Station=0.5 OutputCase=PERM2 CaseType=Combination P=-169.465538592141 V2=-143.91101921066 V3=0 T=0 M2=0 M3=-257.383124565377 S11Max=1374.83320880012 PtS11Max=3 x2S11Max=0.5 x3S11Max=-0.5
 S11Min=-1713.7642859844 PtS11Min=1 x2S11Min=-0.5 x3S11Min=-0.5 FrameElem=46 ElemStation=0.5

Frame=46 Station=0 OutputCase=ACC1 CaseType=Combination P=-240.528987364652 V2=-160.511872066491 V3=0 T=0 M2=0 M3=-326.868150802681 S11Max=1720.67991745143 PtS11Max=3 x2S11Max=0.5 x3S11Max=-0.5
 S11Min=-2201.73789218074 PtS11Min=1 x2S11Min=-0.5 x3S11Min=-0.5 FrameElem=46 ElemStation=0

Frame=46 Station=0.125 OutputCase=ACC1 CaseType=Combination P=-240.528987364652 V2=-157.386872066491 V3=0 T=0 M2=0 M3=-306.99947929437 S11Max=1601.46788840157 PtS11Max=3 x2S11Max=0.5 x3S11Max=-0.5
 S11Min=-2082.52586313087 PtS11Min=1 x2S11Min=-0.5 x3S11Min=-0.5 FrameElem=46 ElemStation=0.125

Frame=46 Station=0.25 OutputCase=ACC1 CaseType=Combination P=-240.528987364652 V2=-154.261872066491 V3=0 T=0 M2=0 M3=-287.521432786058 S11Max=1484.5996093517 PtS11Max=3 x2S11Max=0.5 x3S11Max=-0.5
 S11Min=-1965.657584081 PtS11Min=1 x2S11Min=-0.5 x3S11Min=-0.5 FrameElem=46 ElemStation=0.25

Frame=46 Station=0.375 OutputCase=ACC1 CaseType=Combination P=-240.528987364652 V2=-151.136872066491 V3=0 T=0 M2=0 M3=-268.434011277747 S11Max=1370.07508030183 PtS11Max=3 x2S11Max=0.5 x3S11Max=-0.5
 S11Min=-1851.13305503113 PtS11Min=1 x2S11Min=-0.5 x3S11Min=-0.5 FrameElem=46 ElemStation=0.375

Frame=46 Station=0.5 OutputCase=ACC1 CaseType=Combination P=-240.528987364652 V2=-148.011872066491 V3=0 T=0 M2=0 M3=-249.737214769436 S11Max=1257.89430125196 PtS11Max=3 x2S11Max=0.5 x3S11Max=-0.5
 S11Min=-1738.95227598127 PtS11Min=1 x2S11Min=-0.5 x3S11Min=-0.5 FrameElem=46 ElemStation=0.5

Frame=46 Station=0 OutputCase=ACC2 CaseType=Combination P=-174.055753683482 V2=-160.421840344745 V3=0 T=0 M2=0 M3=-341.074619366255 S11Max=1872.39196251405 PtS11Max=3 x2S11Max=0.5 x3S11Max=-0.5
 S11Min=-2220.50346988104 PtS11Min=1 x2S11Min=-0.5 x3S11Min=-0.5 FrameElem=46 ElemStation=0

Frame=46 Station=0.125 OutputCase=ACC2 CaseType=Combination P=-174.055753683482 V2=-157.296840344745 V3=0 T=0 M2=0 M3=-321.217201823162 S11Max=1753.24745725549 PtS11Max=3 x2S11Max=0.5 x3S11Max=-0.5
 S11Min=-2101.35896462245 PtS11Min=1 x2S11Min=-0.5 x3S11Min=-0.5 FrameElem=46 ElemStation=0.125

Frame=46 Station=0.25 OutputCase=ACC2 CaseType=Combination P=-174.055753683482 V2=-154.171840344745 V3=0 T=0 M2=0 M3=-301.750409280069 S11Max=1636.44670199693 PtS11Max=3 x2S11Max=0.5 x3S11Max=-0.5
 S11Min=-1984.55820936389 PtS11Min=1 x2S11Min=-0.5 x3S11Min=-0.5 FrameElem=46 ElemStation=0.25

Frame=46 Station=0.375 OutputCase=ACC2 CaseType=Combination P=-174.055753683482 V2=-151.046840344745 V3=0 T=0 M2=0 M3=-282.674241736976 S11Max=1521.98969673837 PtS11Max=3 x2S11Max=0.5 x3S11Max=-0.5
 S11Min=-1870.10120410534 PtS11Min=1 x2S11Min=-0.5 x3S11Min=-0.5 FrameElem=46 ElemStation=0.375

Frame=46 Station=0.5 OutputCase=ACC2 CaseType=Combination P=-174.055753683482 V2=-147.921840344745 V3=0 T=0 M2=0 M3=-263.988699193882 S11Max=1409.87644147981 PtS11Max=3 x2S11Max=0.5 x3S11Max=-0.5
 S11Min=-1757.98794884678 PtS11Min=1 x2S11Min=-0.5 x3S11Min=-0.5 FrameElem=46 ElemStation=0.5

Frame=46 Station=0 OutputCase=ACCSX1 CaseType=Combination P=-233.665974282455 V2=-153.010375773033 V3=0 T=0 M2=0 M3=-319.470169108896 S11Max=1683.15504037092 PtS11Max=3 x2S11Max=0.5 x3S11Max=-0.5
 S11Min=-2150.48698893583 PtS11Min=1 x2S11Min=-0.5 x3S11Min=-0.5 FrameElem=46 ElemStation=0



Frame=46 Station=0.125 OutputCase=ACCSX1 CaseType=Combination P=-233.665974282455 V2=-149.885375773033
 V3=0 T=0 M2=0 M3=-300.539184637266 S11Max=1569.56913354114 PtS11Max=3 x2S11Max=0.5 x3S11Max=-0.5 _
 S11Min=-2036.90108210605 PtS11Min=1 x2S11Min=-0.5 x3S11Min=-0.5 FrameElem=46 ElemStation=0.125
 Frame=46 Station=0.25 OutputCase=ACCSX1 CaseType=Combination P=-233.665974282455 V2=-146.760375773033
 V3=0 T=0 M2=0 M3=-281.998825165637 S11Max=1458.32697671137 PtS11Max=3 x2S11Max=0.5 x3S11Max=-0.5 _
 S11Min=-1925.65892527628 PtS11Min=1 x2S11Min=-0.5 x3S11Min=-0.5 FrameElem=46 ElemStation=0.25
 Frame=46 Station=0.375 OutputCase=ACCSX1 CaseType=Combination P=-233.665974282455 V2=-143.635375773033
 V3=0 T=0 M2=0 M3=-263.849090694008 S11Max=1349.4285698816 PtS11Max=3 x2S11Max=0.5 x3S11Max=-0.5 _
 S11Min=-1816.7605184465 PtS11Min=1 x2S11Min=-0.5 x3S11Min=-0.5 FrameElem=46 ElemStation=0.375
 Frame=46 Station=0.5 OutputCase=ACCSX2 CaseType=Combination P=-233.665974282455 V2=-140.510375773033
 V3=0 T=0 M2=0 M3=-246.089981222379 S11Max=1242.87391305182 PtS11Max=3 x2S11Max=0.5 x3S11Max=-0.5 _
 S11Min=-1710.20586161673 PtS11Min=1 x2S11Min=-0.5 x3S11Min=-0.5 FrameElem=46 ElemStation=0.5
 Frame=46 Station=0.75 OutputCase=ACCSX2 CaseType=Combination P=-167.192740601285 V2=-152.920344051287
 V3=0 T=0 M2=0 M3=-333.67663767247 S11Max=1834.86708543353 PtS11Max=3 x2S11Max=0.5 x3S11Max=-0.5 _
 S11Min=-2169.2525666361 PtS11Min=1 x2S11Min=-0.5 x3S11Min=-0.5 FrameElem=46 ElemStation=0
 Frame=46 Station=0.125 OutputCase=ACCSX2 CaseType=Combination P=-167.192740601285 V2=-149.795344051287
 V3=0 T=0 M2=0 M3=-314.756907166059 S11Max=1721.34870239507 PtS11Max=3 x2S11Max=0.5 x3S11Max=-0.5 _
 S11Min=-2055.73418359764 PtS11Min=1 x2S11Min=-0.5 x3S11Min=-0.5 FrameElem=46 ElemStation=0.125
 Frame=46 Station=0.25 OutputCase=ACCSX2 CaseType=Combination P=-167.192740601285 V2=-146.670344051287
 V3=0 T=0 M2=0 M3=-296.227801659648 S11Max=1610.1740693566 PtS11Max=3 x2S11Max=0.5 x3S11Max=-0.5 _
 S11Min=-1944.55955055917 PtS11Min=1 x2S11Min=-0.5 x3S11Min=-0.5 FrameElem=46 ElemStation=0.25
 Frame=46 Station=0.375 OutputCase=ACCSX2 CaseType=Combination P=-167.192740601285 V2=-143.545344051287
 V3=0 T=0 M2=0 M3=-278.089321153237 S11Max=1501.34318631814 PtS11Max=3 x2S11Max=0.5 x3S11Max=-0.5 _
 S11Min=-1835.72866752071 PtS11Min=1 x2S11Min=-0.5 x3S11Min=-0.5 FrameElem=46 ElemStation=0.375
 Frame=46 Station=0.5 OutputCase=ACCSX2 CaseType=Combination P=-167.192740601285 V2=-140.420344051287
 V3=0 T=0 M2=0 M3=-260.341465646826 S11Max=1394.85605327967 PtS11Max=3 x2S11Max=0.5 x3S11Max=-0.5 _
 S11Min=-1729.24153448224 PtS11Min=1 x2S11Min=-0.5 x3S11Min=-0.5 FrameElem=46 ElemStation=0.5
 Frame=46 Station=0 OutputCase=ENVE CaseType=Combination StepType=Max P=-167.192740601285 V2=-
 152.920344051287 V3=0 T=0 M2=0 M3=-318.257165607133 S11Max=1872.39196251405 PtS11Max=3 x2S11Max=0.5
 x3S11Max=-0.5 _
 S11Min=-2145.48176591611 PtS11Min=1 x2S11Min=-0.5 x3S11Min=-0.5 FrameElem=46 ElemStation=0
 Frame=46 Station=0.125 OutputCase=ENVE CaseType=Combination StepType=Max P=-167.192740601285 V2=-
 149.795344051287 V3=0 T=0 M2=0 M3=-298.889846740582 S11Max=1753.24745725549 PtS11Max=3 x2S11Max=0.5
 x3S11Max=-0.5 S11Min=-2029.27785271681 PtS11Min=1 x2S11Min=-0.5 x3S11Min=-0.5 FrameElem=46
 ElemStation=0.125
 Frame=46 Station=0.25 OutputCase=ENVE CaseType=Combination StepType=Max P=-167.192740601285 V2=-
 146.670344051287 V3=0 T=0 M2=0 M3=-279.913152874032 S11Max=1636.44670199693 PtS11Max=3 x2S11Max=0.5
 x3S11Max=-0.5 _
 S11Min=-1915.4176895175 PtS11Min=1 x2S11Min=-0.5 x3S11Min=-0.5 FrameElem=46 ElemStation=0.25
 Frame=46 Station=0.375 OutputCase=ENVE CaseType=Combination StepType=Max P=-167.192740601285 V2=-
 143.545344051287 V3=0 T=0 M2=0 M3=-261.327084007481 S11Max=1521.98969673837 PtS11Max=3 x2S11Max=0.5
 x3S11Max=-0.5 S11Min=-1803.9012763182 PtS11Min=1 x2S11Min=-0.5 x3S11Min=-0.5 FrameElem=46
 ElemStation=0.375
 Frame=46 Station=0.5 OutputCase=ENVE CaseType=Combination StepType=Max P=-167.192740601285 V2=-
 140.420344051287 V3=0 T=0 M2=0 M3=-243.13164014093 S11Max=1409.87644147981 PtS11Max=3 x2S11Max=0.5
 x3S11Max=-0.5 _
 S11Min=-1694.72861311889 PtS11Min=1 x2S11Min=-0.5 x3S11Min=-0.5 FrameElem=46 ElemStation=0.5
 Frame=46 Station=0 OutputCase=ENVE CaseType=Combination StepType=Min P=-240.528987364652 V2=-
 160.511872066491 V3=0 T=0 M2=0 M3=-341.074619366255 S11Max=1673.60422136949 PtS11Max=3 x2S11Max=0.5
 x3S11Max=-0.5 _
 S11Min=-2220.50346988101 PtS11Min=1 x2S11Min=-0.5 x3S11Min=-0.5 FrameElem=46 ElemStation=0
 Frame=46 Station=0.125 OutputCase=ENVE CaseType=Combination StepType=Min P=-240.528987364652 V2=-
 157.386872066491 V3=0 T=0 M2=0 M3=-321.217201823162 S11Max=1557.40030817018 PtS11Max=3 x2S11Max=0.5
 x3S11Max=-0.5 S11Min=-2101.35896462245 PtS11Min=1 x2S11Min=-0.5 x3S11Min=-0.5 FrameElem=46
 ElemStation=0.125
 Frame=46 Station=0.25 OutputCase=ENVE CaseType=Combination StepType=Min P=-240.528987364652 V2=-
 154.261872066491 V3=0 T=0 M2=0 M3=-301.750409280069 S11Max=1443.54014497088 PtS11Max=3 x2S11Max=0.5
 x3S11Max=-0.5 _
 S11Min=-1984.55820936389 PtS11Min=1 x2S11Min=-0.5 x3S11Min=-0.5 FrameElem=46 ElemStation=0.25
 Frame=46 Station=0.375 OutputCase=ENVE CaseType=Combination StepType=Min P=-240.528987364652 V2=-
 151.136872066491 V3=0 T=0 M2=0 M3=-282.674241736976 S11Max=1332.02373177158 PtS11Max=3 x2S11Max=0.5
 x3S11Max=-0.5 S11Min=-1870.10120410534 PtS11Min=1 x2S11Min=-0.5 x3S11Min=-0.5 FrameElem=46
 ElemStation=0.375
 Frame=46 Station=0.5 OutputCase=ENVE CaseType=Combination StepType=Min P=-240.528987364652 V2=-
 148.011872066491 V3=0 T=0 M2=0 M3=-263.988699193882 S11Max=1222.85106857227 PtS11Max=3 x2S11Max=0.5
 x3S11Max=-0.5 _
 S11Min=-1757.98794884678 PtS11Min=1 x2S11Min=-0.5 x3S11Min=-0.5 FrameElem=46 ElemStation=0.5
 Frame=46 Station=0 OutputCase=FESSUR CaseType=Combination P=-239.15192283725 V2=-159.308625726265
 V3=0 T=0 M2=0 M3=-324.284855244017 S11Max=1706.55720862685 PtS11Max=3 x2S11Max=0.5 x3S11Max=-0.5 _
 S11Min=-2184.86105430135 PtS11Min=1 x2S11Min=-0.5 x3S11Min=-0.5 FrameElem=46 ElemStation=0
 Frame=46 Station=0.125 OutputCase=FESSUR CaseType=Combination P=-239.15192283725 V2=-156.183625726265
 V3=0 T=0 M2=0 M3=-304.566589528233 S11Max=1588.24761433215 PtS11Max=3 x2S11Max=0.5 x3S11Max=-0.5 _
 S11Min=-2066.55146000665 PtS11Min=1 x2S11Min=-0.5 x3S11Min=-0.5 FrameElem=46 ElemStation=0.125
 Frame=46 Station=0.25 OutputCase=FESSUR CaseType=Combination P=-239.15192283725 V2=-153.058625726265
 V3=0 T=0 M2=0 M3=-285.23894881245 S11Max=1472.28177003745 PtS11Max=3 x2S11Max=0.5 x3S11Max=-0.5 _
 S11Min=-1950.58561571195 PtS11Min=1 x2S11Min=-0.5 x3S11Min=-0.5 FrameElem=46 ElemStation=0.25
 Frame=46 Station=0.375 OutputCase=FESSUR CaseType=Combination P=-239.15192283725 V2=-149.933625726265
 V3=0 T=0 M2=0 M3=-266.301933096667 S11Max=1358.65967574275 PtS11Max=3 x2S11Max=0.5 x3S11Max=-0.5 _
 S11Min=-1836.96352141725 PtS11Min=1 x2S11Min=-0.5 x3S11Min=-0.5 FrameElem=46 ElemStation=0.375
 Frame=46 Station=0.5 OutputCase=FESSUR CaseType=Combination P=-239.15192283725 V2=-146.808625726265
 V3=0 T=0 M2=0 M3=-247.755542380884 S11Max=1247.38133144805 PtS11Max=3 x2S11Max=0.5 x3S11Max=-0.5 _
 S11Min=-1725.68517712255 PtS11Min=1 x2S11Min=-0.5 x3S11Min=-0.5 FrameElem=46 ElemStation=0.5

```

Frame=47 Station=0 OutputCase=PERM1 CaseType=Combination P=-235.93877227331 V2=-257.327369944063 V3=0
T=0 M2=0 M3=-243.131640140927 S11Max=1222.85106857225 PtS11Max=3 x2S11Max=0.5 x3S11Max=-0.5 _
S11Min=-1694.72861311887 PtS11Min=1 x2S11Min=-0.5 x3S11Min=-0.5 FrameElem=47 ElemStation=0
Frame=47 Station=0.125 OutputCase=PERM1 CaseType=Combination P=-235.93877227331 V2=-254.202369944063
V3=0 T=0 M2=0 M3=-211.161031397919 S11Max=1031.0274161142 PtS11Max=3 x2S11Max=0.5 x3S11Max=-0.5 _
S11Min=-1502.90496066082 PtS11Min=1 x2S11Min=-0.5 x3S11Min=-0.5 FrameElem=47 ElemStation=0.125
Frame=47 Station=0.25 OutputCase=PERM1 CaseType=Combination P=-235.93877227331 V2=-251.077369944063
V3=0 T=0 M2=0 M3=-179.581047654911 S11Max=841.547513656155 PtS11Max=3 x2S11Max=0.5 x3S11Max=-0.5 _
S11Min=-1313.42505820278 PtS11Min=1 x2S11Min=-0.5 x3S11Min=-0.5 FrameElem=47 ElemStation=0.25
Frame=47 Station=0.375 OutputCase=PERM1 CaseType=Combination P=-235.93877227331 V2=-244.952369944063
V3=0 T=0 M2=0 M3=-148.391688911903 S11Max=654.411361198108 PtS11Max=3 x2S11Max=0.5 x3S11Max=-0.5 _
S11Min=-1126.28890574473 PtS11Min=1 x2S11Min=-0.5 x3S11Min=-0.5 FrameElem=47 ElemStation=0.375
Frame=47 Station=0.5 OutputCase=PERM1 CaseType=Combination P=-235.93877227331 V2=-244.827369944063
V3=0 T=0 M2=0 M3=-117.592955168895 S11Max=469.61895874006 PtS11Max=3 x2S11Max=0.5 x3S11Max=-0.5 _
S11Min=-941.496503286681 PtS11Min=1 x2S11Min=-0.5 x3S11Min=-0.5 FrameElem=47 ElemStation=0.5
Frame=47 Station=0.75 OutputCase=PERM2 CaseType=Combination P=-169.46553859214 V2=-257.202878885975 V3=0
T=0 M2=0 M3=-257.383124565374 S11Max=1374.8332088001 PtS11Max=3 x2S11Max=0.5 x3S11Max=-0.5 _
S11Min=-1713.76428598438 PtS11Min=1 x2S11Min=-0.5 x3S11Min=-0.5 FrameElem=47 ElemStation=0
Frame=47 Station=0.125 OutputCase=PERM2 CaseType=Combination P=-169.46553859214 V2=-254.077878885975
V3=0 T=0 M2=0 M3=-225.428077204627 S11Max=1183.10292463562 PtS11Max=3 x2S11Max=0.5 x3S11Max=-0.5 _
S11Min=-1522.0340018199 PtS11Min=1 x2S11Min=-0.5 x3S11Min=-0.5 FrameElem=47 ElemStation=0.125
Frame=47 Station=0.25 OutputCase=PERM2 CaseType=Combination P=-169.46553859214 V2=-250.952878885975
V3=0 T=0 M2=0 M3=-193.86365484388 S11Max=993.716390471139 PtS11Max=3 x2S11Max=0.5 x3S11Max=-0.5 _
S11Min=-1332.64746765542 PtS11Min=1 x2S11Min=-0.5 x3S11Min=-0.5 FrameElem=47 ElemStation=0.25
Frame=47 Station=0.375 OutputCase=PERM2 CaseType=Combination P=-169.46553859214 V2=-247.827878885975
V3=0 T=0 M2=0 M3=-162.689857483133 S11Max=806.673606306658 PtS11Max=3 x2S11Max=0.5 x3S11Max=-0.5 _
S11Min=-1145.60468349094 PtS11Min=1 x2S11Min=-0.5 x3S11Min=-0.5 FrameElem=47 ElemStation=0.375
Frame=47 Station=0.5 OutputCase=PERM2 CaseType=Combination P=-169.46553859214 V2=-244.702878885975
V3=0 T=0 M2=0 M3=-131.906685122386 S11Max=621.974572142176 PtS11Max=3 x2S11Max=0.5 x3S11Max=-0.5 _
S11Min=-960.905649326457 PtS11Min=1 x2S11Min=-0.5 x3S11Min=-0.5 FrameElem=47 ElemStation=0.5
Frame=47 Station=0 OutputCase=ACC1 CaseType=Combination P=-240.528987364652 V2=-264.029895087868 V3=0
T=0 M2=0 M3=-249.737214769432 S11Max=1257.89430125194 PtS11Max=3 x2S11Max=0.5 x3S11Max=-0.5 _
S11Min=-1738.95277981824 PtS11Min=1 x2S11Min=-0.5 x3S11Min=-0.5 FrameElem=47 ElemStation=0
Frame=47 Station=0.125 OutputCase=ACC1 CaseType=Combination P=-240.528987364652 V2=-260.904895087868
V3=0 T=0 M2=0 M3=-216.928790383448 S11Max=1061.04375493604 PtS11Max=3 x2S11Max=0.5 x3S11Max=-0.5 _
S11Min=-1542.10172966534 PtS11Min=1 x2S11Min=-0.5 x3S11Min=-0.5 FrameElem=47 ElemStation=0.125
Frame=47 Station=0.25 OutputCase=ACC1 CaseType=Combination P=-240.528987364652 V2=-257.779895087868
V3=0 T=0 M2=0 M3=-184.510990997465 S11Max=866.536958620137 PtS11Max=3 x2S11Max=0.5 x3S11Max=-0.5 _
S11Min=-1347.59493334944 PtS11Min=1 x2S11Min=-0.5 x3S11Min=-0.5 FrameElem=47 ElemStation=0.25
Frame=47 Station=0.375 OutputCase=ACC1 CaseType=Combination P=-240.528987364652 V2=-254.654895087868
V3=0 T=0 M2=0 M3=-152.483816611481 S11Max=674.373912304236 PtS11Max=3 x2S11Max=0.5 x3S11Max=-0.5 _
S11Min=-1155.43188703354 PtS11Min=1 x2S11Min=-0.5 x3S11Min=-0.5 FrameElem=47 ElemStation=0.375
Frame=47 Station=0.5 OutputCase=ACC1 CaseType=Combination P=-240.528987364652 V2=-251.529895087868
V3=0 T=0 M2=0 M3=-120.847267225498 S11Max=484.554615988335 PtS11Max=3 x2S11Max=0.5 x3S11Max=-0.5 _
S11Min=-965.612590717639 PtS11Min=1 x2S11Min=-0.5 x3S11Min=-0.5 FrameElem=47 ElemStation=0.5
Frame=47 Station=0 OutputCase=ACC2 CaseType=Combination P=-174.055753683482 V2=-263.90540402978 V3=0
T=0 M2=0 M3=-263.988699193879 S11Max=1409.87644147979 PtS11Max=3 x2S11Max=0.5 x3S11Max=-0.5 _
S11Min=-1757.98794884675 PtS11Min=1 x2S11Min=-0.5 x3S11Min=-0.5 FrameElem=47 ElemStation=0
Frame=47 Station=0.125 OutputCase=ACC2 CaseType=Combination P=-174.055753683482 V2=-260.78040402978
V3=0 T=0 M2=0 M3=-231.195836190156 S11Max=1213.11926345746 PtS11Max=3 x2S11Max=0.5 x3S11Max=-0.5 _
S11Min=-1561.23077082442 PtS11Min=1 x2S11Min=-0.5 x3S11Min=-0.5 FrameElem=47 ElemStation=0.125
Frame=47 Station=0.25 OutputCase=ACC2 CaseType=Combination P=-174.055753683482 V2=-257.65540402978
V3=0 T=0 M2=0 M3=-198.793598186434 S11Max=1018.70583543512 PtS11Max=3 x2S11Max=0.5 x3S11Max=-0.5 _
S11Min=-1366.81734280209 PtS11Min=1 x2S11Min=-0.5 x3S11Min=-0.5 FrameElem=47 ElemStation=0.25
Frame=47 Station=0.375 OutputCase=ACC2 CaseType=Combination P=-174.055753683482 V2=-254.53040402978
V3=0 T=0 M2=0 M3=-166.781985182711 S11Max=826.636157412786 PtS11Max=3 x2S11Max=0.5 x3S11Max=-0.5 _
S11Min=-1174.74766477975 PtS11Min=1 x2S11Min=-0.5 x3S11Min=-0.5 FrameElem=47 ElemStation=0.375
Frame=47 Station=0.5 OutputCase=ACC2 CaseType=Combination P=-174.055753683482 V2=-251.40540402978
V3=0 T=0 M2=0 M3=-135.160997178989 S11Max=636.910229390451 PtS11Max=3 x2S11Max=0.5 x3S11Max=-0.5 _
S11Min=-985.021736757416 PtS11Min=1 x2S11Min=-0.5 x3S11Min=-0.5 FrameElem=47 ElemStation=0.5
Frame=47 Station=0 OutputCase=ACCSX1 CaseType=Combination P=-233.665974282454 V2=-254.702814949671
V3=0 T=0 M2=0 M3=-246.089981222376 S11Max=1242.8739130518 PtS11Max=3 x2S11Max=0.5 x3S11Max=-0.5 _
S11Min=-1710.20586161671 PtS11Min=1 x2S11Min=-0.5 x3S11Min=-0.5 FrameElem=47 ElemStation=0
Frame=47 Station=0.125 OutputCase=ACCSX1 CaseType=Combination P=-233.665974282454 V2=-251.577814949671
V3=0 T=0 M2=0 M3=-214.447441853667 S11Max=1053.01867683955 PtS11Max=3 x2S11Max=0.5 x3S11Max=-0.5 _
S11Min=-1520.35062540446 PtS11Min=1 x2S11Min=-0.5 x3S11Min=-0.5 FrameElem=47 ElemStation=0.125
Frame=47 Station=0.25 OutputCase=ACCSX1 CaseType=Combination P=-233.665974282454 V2=-248.452814949671
V3=0 T=0 M2=0 M3=-183.195527484958 S11Max=865.507190627294 PtS11Max=3 x2S11Max=0.5 x3S11Max=-0.5 _
S11Min=-1332.8391391922 PtS11Min=1 x2S11Min=-0.5 x3S11Min=-0.5 FrameElem=47 ElemStation=0.25
Frame=47 Station=0.375 OutputCase=ACCSX1 CaseType=Combination P=-233.665974282454 V2=-245.327814949671
V3=0 T=0 M2=0 M3=-152.334238116249 S11Max=680.33945441504 PtS11Max=3 x2S11Max=0.5 x3S11Max=-0.5 _
S11Min=-1147.67140297995 PtS11Min=1 x2S11Min=-0.5 x3S11Min=-0.5 FrameElem=47 ElemStation=0.375
Frame=47 Station=0.5 OutputCase=ACCSX1 CaseType=Combination P=-233.665974282454 V2=-242.202814949671
V3=0 T=0 M2=0 M3=-121.86357374754 S11Max=497.515468202787 PtS11Max=3 x2S11Max=0.5 x3S11Max=-0.5 _
S11Min=-964.847416767696 PtS11Min=1 x2S11Min=-0.5 x3S11Min=-0.5 FrameElem=47 ElemStation=0.5
Frame=47 Station=0 OutputCase=ACCSX2 CaseType=Combination P=-167.192740601284 V2=-254.578323891583
V3=0 T=0 M2=0 M3=-260.341465646823 S11Max=1394.85605327965 PtS11Max=3 x2S11Max=0.5 x3S11Max=-0.5 _
S11Min=-1729.24153448222 PtS11Min=1 x2S11Min=-0.5 x3S11Min=-0.5 FrameElem=47 ElemStation=0
Frame=47 Station=0.125 OutputCase=ACCSX2 CaseType=Combination P=-167.192740601284 V2=-251.453323891583
V3=0 T=0 M2=0 M3=-228.714487660375 S11Max=1205.09418536096 PtS11Max=3 x2S11Max=0.5 x3S11Max=-0.5 _
S11Min=-1539.47966656353 PtS11Min=1 x2S11Min=-0.5 x3S11Min=-0.5 FrameElem=47 ElemStation=0.125

```



Frame=47 Station=0.25 OutputCase=ACCSX2 CaseType=Combination P=-167.192740601284 V2=-248.328323891583
 V3=0 T=0 M2=0 M3=-197.478134673927 S11Max=1017.67606744228 PtS11Max=3 x2S11Max=0.5 x3S11Max=-0.5 _
 S11Min=-1352.06154864485 PtS11Min=1 x2S11Min=-0.5 x3S11Min=-0.5 FrameElem=47 ElemStation=0.25
 Frame=47 Station=0.375 OutputCase=ACCSX2 CaseType=Combination P=-167.192740601284 V2=-245.203323891583
 V3=0 T=0 M2=0 M3=-166.632406687479 S11Max=832.60169952359 PtS11Max=3 x2S11Max=0.5 x3S11Max=-0.5 _
 S11Min=-1166.98718072616 PtS11Min=1 x2S11Min=-0.5 x3S11Min=-0.5 FrameElem=47 ElemStation=0.375
 Frame=47 Station=0.5 OutputCase=ACCSX2 CaseType=Combination P=-167.192740601284 V2=-242.078323891583
 V3=0 T=0 M2=0 M3=-136.177303701031 S11Max=649.871081604903 PtS11Max=3 x2S11Max=0.5 x3S11Max=-0.5 _
 S11Min=-984.256562807472 PtS11Min=1 x2S11Min=-0.5 x3S11Min=-0.5 FrameElem=47 ElemStation=0.5
 Frame=47 Station=0 OutputCase=ENVE CaseType=Combination StepType=Max P=-167.192740601284 V2=-
 254.578323891583 V3=0 T=0 M2=0 M3=-243.131640140927 S11Max=1409.87644147979 PtS11Max=3 x2S11Max=0.5
 x3S11Max=-0.5 _
 S11Min=-1694.72861311887 PtS11Min=1 x2S11Min=-0.5 x3S11Min=-0.5 FrameElem=47 ElemStation=0
 Frame=47 Station=0.125 OutputCase=ENVE CaseType=Combination StepType=Max P=-167.192740601284 V2=-
 251.453323891583 V3=0 T=0 M2=0 M3=-211.161031397919 S11Max=1213.11926345746 PtS11Max=3 x2S11Max=0.5 _
 x3S11Max=-0.5 S11Min=-1502.90496066082 PtS11Min=1 x2S11Min=-0.5 x3S11Min=-0.5 FrameElem=47
 ElemStation=0.125
 Frame=47 Station=0.25 OutputCase=ENVE CaseType=Combination StepType=Max P=-167.192740601284 V2=-
 248.328323891583 V3=0 T=0 M2=0 M3=-179.581047654911 S11Max=1018.70583543512 PtS11Max=3 x2S11Max=0.5
 x3S11Max=-0.5 _
 S11Min=-1313.42505820278 PtS11Min=1 x2S11Min=-0.5 x3S11Min=-0.5 FrameElem=47 ElemStation=0.25
 Frame=47 Station=0.375 OutputCase=ENVE CaseType=Combination StepType=Max P=-167.192740601284 V2=-
 245.203323891583 V3=0 T=0 M2=0 M3=-148.391688911903 S11Max=832.60169952359 PtS11Max=3 x2S11Max=0.5
 x3S11Max=-0.5 _
 S11Min=-1126.28890574473 PtS11Min=1 x2S11Min=-0.5 x3S11Min=-0.5 FrameElem=47 ElemStation=0.375
 Frame=47 Station=0.5 OutputCase=ENVE CaseType=Combination StepType=Max P=-167.192740601284 V2=-
 242.078323891583 V3=0 T=0 M2=0 M3=-117.592955168895 S11Max=649.871081604903 PtS11Max=3 x2S11Max=0.5
 x3S11Max=-0.5 _
 S11Min=-941.496503286681 PtS11Min=1 x2S11Min=-0.5 x3S11Min=-0.5 FrameElem=47 ElemStation=0.5
 Frame=47 Station=0 OutputCase=ENVE CaseType=Combination StepType=Min P=-240.528987364652 V2=-
 264.029895087868 V3=0 T=0 M2=0 M3=-263.988699193879 S11Max=1222.85106857225 PtS11Max=3 x2S11Max=0.5
 x3S11Max=-0.5 _
 S11Min=-1757.98794884675 PtS11Min=1 x2S11Min=-0.5 x3S11Min=-0.5 FrameElem=47 ElemStation=0
 Frame=47 Station=0.125 OutputCase=ENVE CaseType=Combination StepType=Min P=-240.528987364652 V2=-
 260.904895087868 V3=0 T=0 M2=0 M3=-231.195836190156 S11Max=1031.0274161142 PtS11Max=3 x2S11Max=0.5
 x3S11Max=-0.5 _
 S11Min=-1561.23077082442 PtS11Min=1 x2S11Min=-0.5 x3S11Min=-0.5 FrameElem=47 ElemStation=0.125
 Frame=47 Station=0.25 OutputCase=ENVE CaseType=Combination StepType=Min P=-240.528987364652 V2=-
 257.779895087868 V3=0 T=0 M2=0 M3=-198.793598186434 S11Max=841.547513656155 PtS11Max=3 x2S11Max=0.5
 x3S11Max=-0.5 _
 S11Min=-1366.81734280209 PtS11Min=1 x2S11Min=-0.5 x3S11Min=-0.5 FrameElem=47 ElemStation=0.25
 Frame=47 Station=0.375 OutputCase=ENVE CaseType=Combination StepType=Min P=-240.528987364652 V2=-
 254.654895087868 V3=0 T=0 M2=0 M3=-166.781985182711 S11Max=654.411361198108 PtS11Max=3 x2S11Max=0.5 _
 x3S11Max=-0.5 S11Min=-1174.747666477975 PtS11Min=1 x2S11Min=-0.5 x3S11Min=-0.5 FrameElem=47
 ElemStation=0.375
 Frame=47 Station=0.5 OutputCase=ENVE CaseType=Combination StepType=Min P=-240.528987364652 V2=-
 251.529895087868 V3=0 T=0 M2=0 M3=-136.177303701031 S11Max=469.61895874006 PtS11Max=3 x2S11Max=0.5
 x3S11Max=-0.5 _
 S11Min=-985.021736757416 PtS11Min=1 x2S11Min=-0.5 x3S11Min=-0.5 FrameElem=47 ElemStation=0.5
 Frame=47 Station=0 OutputCase=FESSUR CaseType=Combination P=-239.15192283725 V2=-262.019137544726
 V3=0 T=0 M2=0 M3=-247.75554238088 S11Max=1247.38133144803 PtS11Max=3 x2S11Max=0.5 x3S11Max=-0.5 _
 S11Min=-1725.68517712253 PtS11Min=1 x2S11Min=-0.5 x3S11Min=-0.5 FrameElem=47 ElemStation=0
 Frame=47 Station=0.125 OutputCase=FESSUR CaseType=Combination P=-239.15192283725 V2=-258.894137544726
 V3=0 T=0 M2=0 M3=-215.198462687789 S11Max=1052.03885328949 PtS11Max=3 x2S11Max=0.5 x3S11Max=-0.5 _
 S11Min=-1530.34269896399 PtS11Min=1 x2S11Min=-0.5 x3S11Min=-0.5 FrameElem=47 ElemStation=0.125
 Frame=47 Station=0.25 OutputCase=FESSUR CaseType=Combination P=-239.15192283725 V2=-255.769137544726
 V3=0 T=0 M2=0 M3=-183.032007994699 S11Max=859.040125130942 PtS11Max=3 x2S11Max=0.5 x3S11Max=-0.5 _
 S11Min=-1337.34397080544 PtS11Min=1 x2S11Min=-0.5 x3S11Min=-0.5 FrameElem=47 ElemStation=0.25
 Frame=47 Station=0.375 OutputCase=FESSUR CaseType=Combination P=-239.15192283725 V2=-252.644137544726
 V3=0 T=0 M2=0 M3=-151.256178301608 S11Max=668.385146972398 PtS11Max=3 x2S11Max=0.5 x3S11Max=-0.5 _
 S11Min=-1146.68899226469 PtS11Min=1 x2S11Min=-0.5 x3S11Min=-0.5 FrameElem=47 ElemStation=0.375
 Frame=47 Station=0.5 OutputCase=FESSUR CaseType=Combination P=-239.15192283725 V2=-249.519137544726
 V3=0 T=0 M2=0 M3=-119.870973608517 S11Max=480.073918813853 PtS11Max=3 x2S11Max=0.5 x3S11Max=-0.5 _
 S11Min=-958.377764488352 PtS11Min=1 x2S11Min=-0.5 x3S11Min=-0.5 FrameElem=47 ElemStation=0.5
 Frame=48 Station=0 OutputCase=PERM1 CaseType=Combination P=-235.938772273311 V2=-359.047597617231
 V3=0 T=0 M2=0 M3=-117.592955168891 S11Max=469.618958740038 PtS11Max=3 x2S11Max=0.5 x3S11Max=-0.5 _
 S11Min=-941.49650328666 PtS11Min=1 x2S11Min=-0.5 x3S11Min=-0.5 FrameElem=48 ElemStation=0
 Frame=48 Station=0.125 OutputCase=PERM1 CaseType=Combination P=-235.938772273311 V2=-355.922597617231
 V3=0 T=0 M2=0 M3=-72.9073179667376 S11Max=201.505135527115 PtS11Max=3 x2S11Max=0.5 x3S11Max=-0.5 _
 S11Min=-673.382680073736 PtS11Min=1 x2S11Min=-0.5 x3S11Min=-0.5 FrameElem=48 ElemStation=0.125
 Frame=48 Station=0.25 OutputCase=PERM1 CaseType=Combination P=-235.938772273311 V2=-352.797597617231
 V3=0 T=0 M2=0 M3=-28.6123057645837 S11Max=-64.2649376858085 PtS11Max=3 x2S11Max=0.5 x3S11Max=-0.5 _
 S11Min=-407.612606860813 PtS11Min=1 x2S11Min=-0.5 x3S11Min=-0.5 FrameElem=48 ElemStation=0.25
 Frame=48 Station=0.375 OutputCase=PERM1 CaseType=Combination P=-235.938772273311 V2=-349.672597617231
 V3=0 T=0 M2=0 M3=15.2920814375702 S11Max=-144.18628364789 PtS11Max=1 x2S11Max=-0.5 x3S11Max=-0.5 _
 S11Min=-327.691260898732 PtS11Min=3 x2S11Min=-0.5 x3S11Min=-0.5 FrameElem=48 ElemStation=0.375
 Frame=48 Station=0.5 OutputCase=PERM1 CaseType=Combination P=-235.938772273311 V2=-346.547597617231
 V3=0 T=0 M2=0 M3=58.8058436397241 S11Max=116.896289565034 PtS11Max=1 x2S11Max=-0.5 x3S11Max=-0.5 _
 S11Min=-588.773834111655 PtS11Min=3 x2S11Min=-0.5 x3S11Min=-0.5 FrameElem=48 ElemStation=0.5
 Frame=48 Station=0 OutputCase=PERM2 CaseType=Combination P=-169.465538592141 V2=-358.927058856262
 V3=0 T=0 M2=0 M3=-131.906685122382 S11Max=621.974572142154 PtS11Max=3 x2S11Max=0.5 x3S11Max=-0.5 _
 S11Min=-960.905649326436 PtS11Min=1 x2S11Min=-0.5 x3S11Min=-0.5 FrameElem=48 ElemStation=0



Frame=48 Station=0.125 OutputCase=PERM2 CaseType=Combination P=-169.465538592141 V2=-355.802058856262
 V3=0 T=0 M2=0 M3=-87.2361152653497 S11Max=353.951152999958 PtS11Max=3 x2S11Max=0.5 x3S11Max=-0.5 _
 S11Min=-692.882230184239 PtS11Min=1 x2S11Min=-0.5 x3S11Min=-0.5 FrameElem=48 ElemStation=0.125
 Frame=48 Station=0.25 OutputCase=PERM2 CaseType=Combination P=-169.465538592141 V2=-352.677058856262
 V3=0 T=0 M2=0 M3=-42.956170408317 S11Max=88.2714838577611 PtS11Max=3 x2S11Max=0.5 x3S11Max=-0.5 _
 S11Min=-427.202561042043 PtS11Min=1 x2S11Min=-0.5 x3S11Min=-0.5 FrameElem=48 ElemStation=0.25
 Frame=48 Station=0.375 OutputCase=PERM2 CaseType=Combination P=-169.465538592141 V2=-349.552058856262
 V3=0 T=0 M2=0 M3=0.933149448715774 S11Max=-163.866641899846 PtS11Max=1 x2S11Max=-0.5 x3S11Max=-0.5 _
 S11Min=-175.064435284435 PtS11Min=3 x2S11Min=0.5 x3S11Min=-0.5 FrameElem=48 ElemStation=0.375
 Frame=48 Station=0 OutputCase=ACC1 CaseType=Combination P=-169.465538592141 V2=-346.427058856262
 V3=0 T=0 M2=0 M3=44.4318443057485 S11Max=97.1255272423504 PtS11Max=1 x2S11Max=-0.5 x3S11Max=-0.5 _
 S11Min=-436.056604426632 PtS11Min=3 x2S11Min=0.5 x3S11Min=-0.5 FrameElem=48 ElemStation=0.5
 Frame=48 Station=0 OutputCase=ACC1 CaseType=Combination P=-240.528987364653 V2=-368.46603865041 V3=0
 T=0 M2=0 M3=-120.847267225494 S11Max=484.554615988314 PtS11Max=3 x2S11Max=0.5 x3S11Max=-0.5 _
 S11Min=-965.612590717619 PtS11Min=1 x2S11Min=-0.5 x3S11Min=-0.5 FrameElem=48 ElemStation=0
 Frame=48 Station=0.125 OutputCase=ACC1 CaseType=Combination P=-240.528987364653 V2=-365.34103865041
 V3=0 T=0 M2=0 M3=-74.9843248941932 S11Max=209.376962000506 PtS11Max=3 x2S11Max=0.5 x3S11Max=-0.5 _
 S11Min=-690.434936729812 PtS11Min=1 x2S11Min=-0.5 x3S11Min=-0.5 FrameElem=48 ElemStation=0.125
 Frame=48 Station=0.25 OutputCase=ACC1 CaseType=Combination P=-240.528987364653 V2=-362.21603865041
 V3=0 T=0 M2=0 M3=-29.5120075628919 S11Max=-63.4569419873011 PtS11Max=3 x2S11Max=0.5 x3S11Max=-0.5 _
 S11Min=-417.601032742004 PtS11Min=1 x2S11Min=-0.5 x3S11Min=-0.5 FrameElem=48 ElemStation=0.25
 Frame=48 Station=0.375 OutputCase=ACC1 CaseType=Combination P=-240.528987364653 V2=-359.09103865041
 V3=0 T=0 M2=0 M3=15.5696847684093 S11Max=-147.110878754197 PtS11Max=1 x2S11Max=-0.5 x3S11Max=-0.5 _
 S11Min=-333.947095975108 PtS11Min=3 x2S11Min=0.5 x3S11Min=-0.5 FrameElem=48 ElemStation=0.375
 Frame=48 Station=0 OutputCase=ACC1 CaseType=Combination P=-240.528987364653 V2=-355.96603865041
 V3=0 T=0 M2=0 M3=60.2607520997105 S11Max=121.03552523361 PtS11Max=1 x2S11Max=-0.5 x3S11Max=-0.5 _
 S11Min=-602.093499962916 PtS11Min=3 x2S11Min=0.5 x3S11Min=-0.5 FrameElem=48 ElemStation=0.5
 Frame=48 Station=0 OutputCase=ACC2 CaseType=Combination P=-174.055753683483 V2=-368.345499889441 V3=0
 T=0 M2=0 M3=-135.160997178985 S11Max=636.91022939043 PtS11Max=3 x2S11Max=0.5 x3S11Max=-0.5 _
 S11Min=-985.021736757395 PtS11Min=1 x2S11Min=-0.5 x3S11Min=-0.5 FrameElem=48 ElemStation=0
 Frame=48 Station=0.125 OutputCase=ACC2 CaseType=Combination P=-174.055753683483 V2=-365.220499889441
 V3=0 T=0 M2=0 M3=-89.3131221928053 S11Max=361.822979473349 PtS11Max=3 x2S11Max=0.5 x3S11Max=-0.5 _
 S11Min=-709.934486840314 PtS11Min=1 x2S11Min=-0.5 x3S11Min=-0.5 FrameElem=48 ElemStation=0.125
 Frame=48 Station=0.25 OutputCase=ACC2 CaseType=Combination P=-174.055753683483 V2=-362.095499889441
 V3=0 T=0 M2=0 M3=-43.8558722066252 S11Max=89.0794795562686 PtS11Max=3 x2S11Max=0.5 x3S11Max=-0.5 _
 S11Min=-437.190986923234 PtS11Min=1 x2S11Min=-0.5 x3S11Min=-0.5 FrameElem=48 ElemStation=0.25
 Frame=48 Station=0.375 OutputCase=ACC2 CaseType=Combination P=-174.055753683483 V2=-358.970499889441
 V3=0 T=0 M2=0 M3=1.21075277955487 S11Max=-166.791237006153 PtS11Max=1 x2S11Max=-0.5 x3S11Max=-0.5 _
 S11Min=-181.320270360814 PtS11Min=3 x2S11Min=-0.5 x3S11Min=-0.5 FrameElem=48 ElemStation=0.375
 Frame=48 Station=0.5 OutputCase=ACC2 CaseType=Combination P=-174.055753683483 V2=-355.845499889441
 V3=0 T=0 M2=0 M3=45.8867527657349 S11Max=101.264762910927 PtS11Max=1 x2S11Max=-0.5 x3S11Max=-0.5 _
 S11Min=-449.376270277892 PtS11Min=3 x2S11Min=0.5 x3S11Min=-0.5 FrameElem=48 ElemStation=0.5
 Frame=48 Station=0 OutputCase=ACCSX1 CaseType=Combination P=-233.665974282455 V2=-357.724801123118
 V3=0 T=0 M2=0 M3=-121.863573747537 S11Max=497.515468202765 PtS11Max=3 x2S11Max=0.5 x3S11Max=-0.5 _
 S11Min=-964.847416767674 PtS11Min=1 x2S11Min=-0.5 x3S11Min=-0.5 FrameElem=48 ElemStation=0
 Frame=48 Station=0.125 OutputCase=ACCSX1 CaseType=Combination P=-233.665974282455 V2=-354.599801123118
 V3=0 T=0 M2=0 M3=-77.3432861071469 S11Max=230.393742360426 PtS11Max=3 x2S11Max=0.5 x3S11Max=-0.5 _
 S11Min=-697.925690925336 PtS11Min=1 x2S11Min=-0.5 x3S11Min=-0.5 FrameElem=48 ElemStation=0.125
 Frame=48 Station=0.25 OutputCase=ACCSX1 CaseType=Combination P=-233.665974282455 V2=-351.474801123118
 V3=0 T=0 M2=0 M3=-33.2136234667572 S11Max=-34.3842334819119 PtS11Max=3 x2S11Max=0.5 x3S11Max=-0.5 _
 S11Min=-432.947715082998 PtS11Min=1 x2S11Min=-0.5 x3S11Min=-0.5 FrameElem=48 ElemStation=0.25
 Frame=48 Station=0.375 OutputCase=ACCSX1 CaseType=Combination P=-233.665974282455 V2=-348.349801123118
 V3=0 T=0 M2=0 M3=10.5254141736326 S11Max=-170.513489240659 PtS11Max=1 x2S11Max=-0.5 x3S11Max=-0.5 _
 S11Min=-296.81845932425 PtS11Min=3 x2S11Min=0.5 x3S11Min=-0.5 FrameElem=48 ElemStation=0.375
 Frame=48 Station=0.5 OutputCase=ACCSX1 CaseType=Combination P=-233.665974282455 V2=-345.224801123118
 V3=0 T=0 M2=0 M3=53.8738268140223 S11Max=89.5769866016788 PtS11Max=1 x2S11Max=-0.5 x3S11Max=-0.5 _
 S11Min=-556.908935166588 PtS11Min=3 x2S11Min=0.5 x3S11Min=-0.5 FrameElem=48 ElemStation=0.5
 Frame=48 Station=0 OutputCase=ACCSX2 CaseType=Combination P=-167.192740601285 V2=-357.604262362149
 V3=0 T=0 M2=0 M3=-136.177303701028 S11Max=649.871081604881 PtS11Max=3 x2S11Max=0.5 x3S11Max=-0.5 _
 S11Min=-984.25656280745 PtS11Min=1 x2S11Min=-0.5 x3S11Min=-0.5 FrameElem=48 ElemStation=0
 Frame=48 Station=0.125 OutputCase=ACCSX2 CaseType=Combination P=-167.192740601285 V2=-354.479262362149
 V3=0 T=0 M2=0 M3=-91.672083405759 S11Max=382.839759833269 PtS11Max=3 x2S11Max=0.5 x3S11Max=-0.5 _
 S11Min=-717.225241035839 PtS11Min=1 x2S11Min=-0.5 x3S11Min=-0.5 FrameElem=48 ElemStation=0.125
 Frame=48 Station=0.25 OutputCase=ACCSX2 CaseType=Combination P=-167.192740601285 V2=-351.354262362149
 V3=0 T=0 M2=0 M3=-47.5574881104904 S11Max=118.152188061658 PtS11Max=3 x2S11Max=0.5 x3S11Max=-0.5 _
 S11Min=-452.537669264227 PtS11Min=1 x2S11Min=-0.5 x3S11Min=-0.5 FrameElem=48 ElemStation=0.25
 Frame=48 Station=0.375 OutputCase=ACCSX2 CaseType=Combination P=-167.192740601285 V2=-348.229262362149
 V3=0 T=0 M2=0 M3=-3.83351781522185 S11Max=-144.191633709954 PtS11Max=3 x2S11Max=0.5 x3S11Max=-0.5 _
 S11Min=-190.193847492616 PtS11Min=1 x2S11Min=-0.5 x3S11Min=-0.5 FrameElem=48 ElemStation=0.375
 Frame=48 Station=0.5 OutputCase=ACCSX2 CaseType=Combination P=-167.192740601285 V2=-345.104262362149
 V3=0 T=0 M2=0 M3=39.4998274800467 S11Max=69.8062242789956 PtS11Max=1 x2S11Max=-0.5 x3S11Max=-0.5 _
 S11Min=-404.191705481565 PtS11Min=3 x2S11Min=0.5 x3S11Min=-0.5 FrameElem=48 ElemStation=0.5
 Frame=48 Station=0 OutputCase=ENVE CaseType=Combination StepType=Max P=-167.192740601285 V2=-
 357.604262362149 V3=0 T=0 M2=0 M3=-117.592955168891 S11Max=649.871081604881 PtS11Max=3 x2S11Max=0.5
 x3S11Max=-0.5 _
 S11Min=-941.49650328666 PtS11Min=1 x2S11Min=-0.5 x3S11Min=-0.5 FrameElem=48 ElemStation=0
 Frame=48 Station=0.125 OutputCase=ENVE CaseType=Combination StepType=Max P=-167.192740601285 V2=-
 354.479262362149 V3=0 T=0 M2=0 M3=-72.9073179667376 S11Max=382.839759833269 PtS11Max=3 x2S11Max=0.5 _
 x3S11Max=-0.5 S11Min=-673.382680073736 PtS11Min=1 x2S11Min=-0.5 x3S11Min=-0.5 FrameElem=48
 ElemStation=0.125



Frame=48 Station=0.25 OutputCase=ENVE CaseType=Combination StepType=Max P=-167.192740601285 V2=-351.354262362149 V3=0 T=0 M2=0 M3=-28.6123057645837 S11Max=118.152188061658 PtS11Max=3 x2S11Max=0.5 x3S11Max=-0.5 _
 S11Min=-407.612606860813 PtS11Min=1 x2S11Min=-0.5 x3S11Min=-0.5 FrameElem=48 ElemStation=0.25
 Frame=48 Station=0.375 OutputCase=ENVE CaseType=Combination StepType=Max P=-167.192740601285 V2=-348.229262362149 V3=0 T=0 M2=0 M3=15.5696847684093 S11Max=-144.18628364789 PtS11Max=1 x2S11Max=-0.5 _
 x3S11Max=-0.5 S11Min=-167.192740601285 PtS11Min=0 x2S11Min=0 x3S11Min=0 FrameElem=48
 ElemStation=0.375
 Frame=48 Station=0.5 OutputCase=ENVE CaseType=Combination StepType=Max P=-167.192740601285 V2=-345.104262362149 V3=0 T=0 M2=0 M3=60.2607520997105 S11Max=121.03552523361 PtS11Max=1 x2S11Max=-0.5 x3S11Max=-0.5 _
 S11Min=-404.191705481565 PtS11Min=3 x2S11Min=0.5 x3S11Min=-0.5 FrameElem=48 ElemStation=0.5
 Frame=48 Station=0.5 OutputCase=ENVE CaseType=Combination StepType=Min P=-240.528987364653 V2=-368.46603865041 V3=0 T=0 M2=0 M3=-136.177303701028 S11Max=469.618958740038 PtS11Max=3 x2S11Max=0.5 x3S11Max=-0.5 _
 S11Min=-985.021736757395 PtS11Min=1 x2S11Min=-0.5 x3S11Min=-0.5 FrameElem=48 ElemStation=0
 Frame=48 Station=0.125 OutputCase=ENVE CaseType=Combination StepType=Min P=-240.528987364653 V2=-365.34103865041 V3=0 T=0 M2=0 M3=-91.672083405759 S11Max=201.505135527115 PtS11Max=3 x2S11Max=0.5 x3S11Max=-0.5 _
 S11Min=-717.225241035839 PtS11Min=1 x2S11Min=-0.5 x3S11Min=-0.5 FrameElem=48 ElemStation=0.125
 Frame=48 Station=0.25 OutputCase=ENVE CaseType=Combination StepType=Min P=-240.528987364653 V2=-362.21603865041 V3=0 T=0 M2=0 M3=-47.5574881104904 S11Max=-64.2649376858085 PtS11Max=3 x2S11Max=0.5 x3S11Max=-0.5 _
 S11Min=-452.537669264227 PtS11Min=1 x2S11Min=-0.5 x3S11Min=-0.5 FrameElem=48 ElemStation=0.25
 Frame=48 Station=0.375 OutputCase=ENVE CaseType=Combination StepType=Min P=-240.528987364653 V2=-359.09103865041 V3=0 T=0 M2=0 M3=-3.83351781522185 S11Max=-190.193847492616 PtS11Max=1 x2S11Max=-0.5 _
 x3S11Max=-0.5 S11Min=-333.947095975108 PtS11Min=3 x2S11Min=0.5 x3S11Min=-0.5 FrameElem=48
 ElemStation=0.375
 Frame=48 Station=0.5 OutputCase=ENVE CaseType=Combination StepType=Min P=-240.528987364653 V2=-355.96603865041 V3=0 T=0 M2=0 M3=39.4998274800467 S11Max=69.8062242789956 PtS11Max=1 x2S11Max=-0.5 x3S11Max=-0.5 _
 S11Min=-602.093499962916 PtS11Min=3 x2S11Min=0.5 x3S11Min=-0.5 FrameElem=48 ElemStation=0.5
 Frame=48 Station=0 OutputCase=FESSUR CaseType=Combination StepType=Min P=-239.15192283725 V2=-365.640506340456 V3=0 T=0 M2=0 M3=-119.870973608513 S11Max=480.073918813831 PtS11Max=3 x2S11Max=0.5 x3S11Max=-0.5 _
 S11Min=-958.377764488331 PtS11Min=1 x2S11Min=-0.5 x3S11Min=-0.5 FrameElem=48 ElemStation=0
 Frame=48 Station=0.125 OutputCase=FESSUR CaseType=Combination StepType=Min P=-239.15192283725 V2=-362.515506340456 V3=0 T=0 M2=0 M3=-74.3612228159565 S11Max=207.015414058489 PtS11Max=3 x2S11Max=0.5 x3S11Max=-0.5 _
 S11Min=-685.319259732989 PtS11Min=1 x2S11Min=-0.5 x3S11Min=-0.5 FrameElem=48 ElemStation=0.125
 Frame=48 Station=0.25 OutputCase=FESSUR CaseType=Combination StepType=Min P=-239.15192283725 V2=-359.390506340456 V3=0 T=0 M2=0 M3=-29.2420970233995 S11Max=-63.6993406968533 PtS11Max=3 x2S11Max=0.5 x3S11Max=-0.5 _
 S11Min=-414.604504977647 PtS11Min=1 x2S11Min=-0.5 x3S11Min=-0.5 FrameElem=48 ElemStation=0.25
 Frame=48 Station=0.375 OutputCase=FESSUR CaseType=Combination StepType=Min P=-239.15192283725 V2=-356.265506340456 V3=0 T=0 M2=0 M3=15.4864037691575 S11Max=-146.233500222305 PtS11Max=1 x2S11Max=-0.5 x3S11Max=-0.5 _
 S11Min=-332.070345452195 PtS11Min=3 x2S11Min=0.5 x3S11Min=-0.5 FrameElem=48 ElemStation=0.375
 Frame=48 Station=0.5 OutputCase=FESSUR CaseType=Combination StepType=Min P=-239.15192283725 V2=-353.140506340456 V3=0 T=0 M2=0 M3=59.8242795617146 S11Max=119.793754533037 PtS11Max=1 x2S11Max=-0.5 x3S11Max=-0.5 _
 S11Min=-598.097600207537 PtS11Min=3 x2S11Min=0.5 x3S11Min=-0.5 FrameElem=48 ElemStation=0.5
 Frame=74 Station=0 OutputCase=PERM1 CaseType=Combination StepType=Min P=-164.891225815415 V2=-407.499995050427 V3=0 T=0 M2=0 M3=-228.427810408838 S11Max=1205.67563663761 PtS11Max=3 x2S11Max=0.5 x3S11Max=-0.5 _
 S11Min=-1535.45808826844 PtS11Min=1 x2S11Min=-0.5 x3S11Min=-0.5 FrameElem=74 ElemStation=0
 Frame=74 Station=6.24999940395355E-02 OutputCase=PERM1 CaseType=Combination StepType=Min P=-164.891225815415 V2=-397.312496021983 V3=0 T=0 M2=0 M3=-203.277422461353 S11Max=1054.7733089527 PtS11Max=3 x2S11Max=0.5 _
 x3S11Max=-0.5 S11Min=-1384.55576058353 PtS11Min=1 x2S11Min=-0.5 x3S11Min=-0.5 FrameElem=74
 ElemStation=6.24999940395355E-02
 Frame=74 Station=0.124999988079071 OutputCase=PERM1 CaseType=Combination StepType=Min P=-164.891225815415 V2=-387.124996993539 V3=0 T=0 M2=0 M3=-178.763753142424 S11Max=907.691293039128 PtS11Max=3 x2S11Max=0.5 x3S11Max=-0.5 _
 S11Min=-1237.47374466996 PtS11Min=1 x2S11Min=-0.5 x3S11Min=-0.5 FrameElem=74
 ElemStation=0.124999988079071
 Frame=74 Station=0.187499982118607 OutputCase=PERM1 CaseType=Combination StepType=Min P=-164.891225815415 V2=-376.937497965094 V3=0 T=0 M2=0 M3=-154.88680245205 S11Max=764.429588896886 PtS11Max=3 x2S11Max=0.5 x3S11Max=-0.5 _
 S11Min=-1094.21204052772 PtS11Min=1 x2S11Min=-0.5 x3S11Min=-0.5 FrameElem=74
 ElemStation=0.187499982118607
 Frame=74 Station=0.249999976158142 OutputCase=PERM1 CaseType=Combination StepType=Min P=-164.891225815415 V2=-366.74999893665 V3=0 T=0 M2=0 M3=-131.646570390232 S11Max=624.988196525978 PtS11Max=3 x2S11Max=0.5 x3S11Max=-0.5 _
 S11Min=-954.770648156808 PtS11Min=1 x2S11Min=-0.5 x3S11Min=-0.5 FrameElem=74
 ElemStation=0.249999976158142
 Frame=74 Station=0 OutputCase=PERM2 CaseType=Combination StepType=Min P=-111.11546006997 V2=-407.499995324437 V3=0 T=0 M2=0 M3=-214.263501369112 S11Max=1174.4655481447 PtS11Max=3 x2S11Max=0.5 x3S11Max=-0.5 _
 S11Min=-1396.69646828464 PtS11Min=1 x2S11Min=-0.5 x3S11Min=-0.5 FrameElem=74 ElemStation=0
 Frame=74 Station=6.24999940395355E-02 OutputCase=PERM2 CaseType=Combination StepType=Min P=-111.11546006997 V2=-397.312496295993 V3=0 T=0 M2=0 M3=-189.113113404502 S11Max=1023.56322035704 PtS11Max=3 x2S11Max=0.5 _
 x3S11Max=-0.5 S11Min=-1245.79414049698 PtS11Min=1 x2S11Min=-0.5 x3S11Min=-0.5 FrameElem=74
 ElemStation=6.24999940395355E-02
 Frame=74 Station=0.124999988079071 OutputCase=PERM2 CaseType=Combination StepType=Min P=-111.11546006997 V2=-387.124997267549 V3=0 T=0 M2=0 M3=-164.599444068447 S11Max=876.481204340712 PtS11Max=3 x2S11Max=0.5 x3S11Max=-0.5 _
 S11Min=-1098.71212448065 PtS11Min=1 x2S11Min=-0.5 x3S11Min=-0.5 FrameElem=74
 ElemStation=0.124999988079071



Frame=74 Station=0.187499982118607 OutputCase=PERM2 CaseType=Combination P=-111.11546006997 V2=-376.937498239104 V3=0 T=0 M2=0 M3=-140.722493360948 S11Max=733.219500095717 PtS11Max=3 x2S11Max=0.5 x3S11Max=-0.5
 S11Min=-955.450420235656 PtS11Min=1 x2S11Min=-0.5 x3S11Min=-0.5 FrameElem=74
 ElemStation=0.187499982118607
 Frame=74 Station=0.249999976158142 OutputCase=PERM2 CaseType=Combination P=-111.11546006997 V2=-366.74999921066 V3=0 T=0 M2=0 M3=-117.482261282004 S11Max=593.778107622054 PtS11Max=3 x2S11Max=0.5 x3S11Max=-0.5
 S11Min=-816.009027761994 PtS11Min=1 x2S11Min=-0.5 x3S11Min=-0.5 FrameElem=74
 ElemStation=0.249999976158142
 Frame=74 Station=0 OutputCase=ACC1 CaseType=Combination P=-169.541010668991 V2=-421.049994890958 V3=0 T=0 M2=0 M3=-236.085285693129 S11Max=1246.97070348978 PtS11Max=3 x2S11Max=0.5 x3S11Max=-0.5
 S11Min=-1586.05272482776 PtS11Min=1 x2S11Min=-0.5 x3S11Min=-0.5 FrameElem=74 ElemStation=0
 Frame=74 Station=6.24999940395355E-02 OutputCase=ACC1 CaseType=Combination P=-169.541010668991 V2=-410.523745894819 V3=0 T=0 M2=0 M3=-210.098608771856 S11Max=1091.05064196215 PtS11Max=3 x2S11Max=0.5 x3S11Max=-0.5
 S11Min=-1430.13266330013 PtS11Min=1 x2S11Min=-0.5 x3S11Min=-0.5 FrameElem=74
 ElemStation=6.24999940395355E-02
 Frame=74 Station=0.12499988079071 OutputCase=ACC1 CaseType=Combination P=-169.541010668991 V2=-399.99749689868 V3=0 T=0 M2=0 M3=-184.769822350101 S11Max=939.077923431613 PtS11Max=3 x2S11Max=0.5 x3S11Max=-0.5
 S11Min=-1278.15994476959 PtS11Min=1 x2S11Min=-0.5 x3S11Min=-0.5 FrameElem=74
 ElemStation=0.12499988079071
 Frame=74 Station=0.187499982118607 OutputCase=ACC1 CaseType=Combination P=-169.541010668991 V2=-389.471247902542 V3=0 T=0 M2=0 M3=-160.098926427863 S11Max=791.052547898185 PtS11Max=3 x2S11Max=0.5 x3S11Max=-0.5
 S11Min=-1130.13456923617 PtS11Min=1 x2S11Min=-0.5 x3S11Min=-0.5 FrameElem=74
 ElemStation=0.187499982118607
 Frame=74 Station=0.249999976158142 OutputCase=ACC1 CaseType=Combination P=-169.541010668991 V2=-378.944998906403 V3=0 T=0 M2=0 M3=-136.085921005142 S11Max=646.974515361861 PtS11Max=3 x2S11Max=0.5 x3S11Max=-0.5
 S11Min=-986.056536699842 PtS11Min=1 x2S11Min=-0.5 x3S11Min=-0.5 FrameElem=74
 ElemStation=0.249999976158142
 Frame=74 Station=0 OutputCase=ACC2 CaseType=Combination P=-115.765244923546 V2=-421.049995164967 V3=0 T=0 M2=0 M3=-221.920976653403 S11Max=1215.76061499687 PtS11Max=3 x2S11Max=0.5 x3S11Max=-0.5
 S11Min=-1447.29110484396 PtS11Min=1 x2S11Min=-0.5 x3S11Min=-0.5 FrameElem=74 ElemStation=0
 Frame=74 Station=6.24999940395355E-02 OutputCase=ACC2 CaseType=Combination P=-115.765244923546 V2=-410.523746168829 V3=0 T=0 M2=0 M3=-195.934299715005 S11Max=1059.84055336648 PtS11Max=3 x2S11Max=0.5 x3S11Max=-0.5
 S11Min=-1291.37104321357 PtS11Min=1 x2S11Min=-0.5 x3S11Min=-0.5 FrameElem=74
 ElemStation=6.24999940395355E-02
 Frame=74 Station=0.12499988079071 OutputCase=ACC2 CaseType=Combination P=-115.765244923546 V2=-399.99749717269 V3=0 T=0 M2=0 M3=-170.605513276124 S11Max=907.867834733197 PtS11Max=3 x2S11Max=0.5 x3S11Max=-0.5
 S11Min=-1139.39832458029 PtS11Min=1 x2S11Min=-0.5 x3S11Min=-0.5 FrameElem=74
 ElemStation=0.12499988079071
 Frame=74 Station=0.187499982118607 OutputCase=ACC2 CaseType=Combination P=-115.765244923546 V2=-389.471248176552 V3=0 T=0 M2=0 M3=-145.93461733676 S11Max=759.84245907016 PtS11Max=3 x2S11Max=0.5 x3S11Max=-0.5
 S11Min=-991.372948944107 PtS11Min=1 x2S11Min=-0.5 x3S11Min=-0.5 FrameElem=74
 ElemStation=0.187499982118607
 Frame=74 Station=0.249999976158142 OutputCase=ACC2 CaseType=Combination P=-115.765244923546 V2=-378.944999180413 V3=0 T=0 M2=0 M3=-121.921611896914 S11Max=615.764426457938 PtS11Max=3 x2S11Max=0.5 x3S11Max=-0.5
 S11Min=-847.294916305029 PtS11Min=1 x2S11Min=-0.5 x3S11Min=-0.5 FrameElem=74
 ElemStation=0.249999976158142
 Frame=74 Station=0 OutputCase=ACCSX1 CaseType=Combination P=-167.164023806267 V2=-405.985917444979 V3=0 T=0 M2=0 M3=-225.254305629115 S11Max=1184.36180996842 PtS11Max=3 x2S11Max=0.5 x3S11Max=-0.5
 S11Min=-1518.68985758096 PtS11Min=1 x2S11Min=-0.5 x3S11Min=-0.5 FrameElem=74 ElemStation=0
 Frame=74 Station=6.24999940395355E-02 OutputCase=ACCSX1 CaseType=Combination P=-167.164023806267 V2=-395.798418416534 V3=0 T=0 M2=0 M3=-200.198547522946 S11Max=1034.02726133141 PtS11Max=3 x2S11Max=0.5 x3S11Max=-0.5
 S11Min=-1368.35530894394 PtS11Min=1 x2S11Min=-0.5 x3S11Min=-0.5 FrameElem=74
 ElemStation=6.24999940395355E-02
 Frame=74 Station=0.12499988079071 OutputCase=ACCSX1 CaseType=Combination P=-167.164023806267 V2=-385.61091938809 V3=0 T=0 M2=0 M3=-175.779508045333 S11Max=887.513024465729 PtS11Max=3 x2S11Max=0.5 x3S11Max=-0.5
 S11Min=-1221.84107207826 PtS11Min=1 x2S11Min=-0.5 x3S11Min=-0.5 FrameElem=74
 ElemStation=0.12499988079071
 Frame=74 Station=0.187499982118607 OutputCase=ACCSX1 CaseType=Combination P=-167.164023806267 V2=-375.423420359646 V3=0 T=0 M2=0 M3=-151.997187196275 S11Max=744.819099371383 PtS11Max=3 x2S11Max=0.5 x3S11Max=-0.5
 S11Min=-1079.14714698392 PtS11Min=1 x2S11Min=-0.5 x3S11Min=-0.5 FrameElem=74
 ElemStation=0.187499982118607
 Frame=74 Station=0.249999976158142 OutputCase=ACCSX1 CaseType=Combination P=-167.164023806267 V2=-365.235921331202 V3=0 T=0 M2=0 M3=-128.851584975773 S11Max=605.94548604837 PtS11Max=3 x2S11Max=0.5 x3S11Max=-0.5
 S11Min=-940.273533660904 PtS11Min=1 x2S11Min=-0.5 x3S11Min=-0.5 FrameElem=74
 ElemStation=0.249999976158142
 Frame=74 Station=0 OutputCase=ACCSX2 CaseType=Combination P=-113.388258060822 V2=-405.985917718989 V3=0 T=0 M2=0 M3=-211.089996589389 S11Max=1153.15172147551 PtS11Max=3 x2S11Max=0.5 x3S11Max=-0.5
 S11Min=-1379.92823759716 PtS11Min=1 x2S11Min=-0.5 x3S11Min=-0.5 FrameElem=74 ElemStation=0
 Frame=74 Station=6.24999940395355E-02 OutputCase=ACCSX2 CaseType=Combination P=-113.388258060822 V2=-395.798418690544 V3=0 T=0 M2=0 M3=-186.034238466095 S11Max=1002.81717273575 PtS11Max=3 x2S11Max=0.5



x3S11Max=-0.5 S11Min=-1229.59368885739 PtS11Min=1 x2S11Min=-0.5 x3S11Min=-0.5 FrameElem=74
 ElemStation=6.24999940395355E-02
 Frame=74 Station=0.124999988079071 OutputCase=ACCSX2 CaseType=Combination P=-113.388258060822 V2=-
 385.6109196621 V3=0 T=0 M2=0 M3=-161.615198971356 S11Max=856.302935767313 PtS11Max=3 x2S11Max=0.5
 x3S11Max=-0.5 _
 S11Min=-1083.07945188896 PtS11Min=1 x2S11Min=-0.5 x3S11Min=-0.5 FrameElem=74
 ElemStation=0.124999988079071
 Frame=74 Station=0.187499982118607 OutputCase=ACCSX2 CaseType=Combination P=-113.388258060822 V2=-
 375.423420633656 V3=0 T=0 M2=0 M3=-137.832878105173 S11Max=713.609010570213 PtS11Max=3 x2S11Max=0.5
 x3S11Max=-0.5 _
 S11Min=-940.385526691858 PtS11Min=1 x2S11Min=-0.5 x3S11Min=-0.5 FrameElem=74
 ElemStation=0.187499982118607
 Frame=74 Station=0.249999976158142 OutputCase=ACCSX2 CaseType=Combination P=-113.388258060822 V2=-
 365.235921605211 V3=0 T=0 M2=0 M3=-114.687275867545 S11Max=574.735397144447 PtS11Max=3 x2S11Max=0.5
 x3S11Max=-0.5 _
 S11Min=-801.511913266091 PtS11Min=1 x2S11Min=-0.5 x3S11Min=-0.5 FrameElem=74
 ElemStation=0.249999976158142
 Frame=74 Station=0 OutputCase=ENVE CaseType=Combination StepType=Max P=-111.11546006997 V2=-
 405.985917444979 V3=0 T=0 M2=0 M3=-211.089996589389 S11Max=1246.97070348978 PtS11Max=3 x2S11Max=0.5
 x3S11Max=-0.5 _
 S11Min=-1379.92823759716 PtS11Min=1 x2S11Min=-0.5 x3S11Min=-0.5 FrameElem=74 ElemStation=0
 Frame=74 Station=6.24999940395355E-02 OutputCase=ENVE CaseType=Combination StepType=Max P=-
 111.11546006997 V2=-395.798418416534 V3=0 T=0 M2=0 M3=-186.034238466095 S11Max=1091.05064196215
 PtS11Max=3 x2S11Max=0.5 _
 x3S11Max=-0.5 S11Min=-1229.59368885739 PtS11Min=1 x2S11Min=-0.5 x3S11Min=-0.5 FrameElem=74
 ElemStation=6.24999940395355E-02
 Frame=74 Station=0.124999988079071 OutputCase=ENVE CaseType=Combination StepType=Max P=-111.11546006997
 V2=-385.61091938809 V3=0 T=0 M2=0 M3=-161.615198971356 S11Max=939.077923431613 PtS11Max=3 x2S11Max=0.5
 -
 x3S11Max=-0.5 S11Min=-1083.07945188896 PtS11Min=1 x2S11Min=-0.5 x3S11Min=-0.5 FrameElem=74
 ElemStation=0.124999988079071
 Frame=74 Station=0.187499982118607 OutputCase=ENVE CaseType=Combination StepType=Max P=-111.11546006997
 V2=-375.423420359646 V3=0 T=0 M2=0 M3=-137.832878105173 S11Max=791.052547898185 PtS11Max=3
 x2S11Max=0.5 _
 x3S11Max=-0.5 S11Min=-940.385526691858 PtS11Min=1 x2S11Min=-0.5 x3S11Min=-0.5 FrameElem=74
 ElemStation=0.187499982118607
 Frame=74 Station=0.249999976158142 OutputCase=ENVE CaseType=Combination StepType=Max P=-111.11546006997
 V2=-365.235921331202 V3=0 T=0 M2=0 M3=-114.687275867545 S11Max=646.974515361861 PtS11Max=3
 x2S11Max=0.5 _
 x3S11Max=-0.5 S11Min=-801.511913266091 PtS11Min=1 x2S11Min=-0.5 x3S11Min=-0.5 FrameElem=74
 ElemStation=0.249999976158142
 Frame=74 Station=0 OutputCase=ENVE CaseType=Combination StepType=Min P=-169.541010668991 V2=-
 421.049995164967 V3=0 T=0 M2=0 M3=-236.085285693129 S11Max=1153.15172147551 PtS11Max=3 x2S11Max=0.5
 x3S11Max=-0.5 _
 S11Min=-1586.05272482776 PtS11Min=1 x2S11Min=-0.5 x3S11Min=-0.5 FrameElem=74 ElemStation=0
 Frame=74 Station=6.24999940395355E-02 OutputCase=ENVE CaseType=Combination StepType=Min P=-
 169.541010668991 V2=-410.523746168829 V3=0 T=0 M2=0 M3=-210.098608771856 S11Max=1002.81717273575
 PtS11Max=3 x2S11Max=0.5 _
 x3S11Max=-0.5 S11Min=-1430.13266330013 PtS11Min=1 x2S11Min=-0.5 x3S11Min=-0.5 FrameElem=74
 ElemStation=6.24999940395355E-02
 Frame=74 Station=0.124999988079071 OutputCase=ENVE CaseType=Combination StepType=Min P=-
 169.541010668991 V2=-399.99749717269 V3=0 T=0 M2=0 M3=-184.769822350101 S11Max=856.302935767313
 PtS11Max=3 x2S11Max=0.5 _
 x3S11Max=-0.5 S11Min=-1278.15994476959 PtS11Min=1 x2S11Min=-0.5 x3S11Min=-0.5 FrameElem=74
 ElemStation=0.124999988079071
 Frame=74 Station=0.187499982118607 OutputCase=ENVE CaseType=Combination StepType=Min P=-
 169.541010668991 V2=-389.471248176552 V3=0 T=0 M2=0 M3=-160.098926427863 S11Max=713.609010570213
 PtS11Max=3 x2S11Max=0.5 _
 x3S11Max=-0.5 S11Min=-1130.13456923617 PtS11Min=1 x2S11Min=-0.5 x3S11Min=-0.5 FrameElem=74
 ElemStation=0.187499982118607
 Frame=74 Station=0.249999976158142 OutputCase=ENVE CaseType=Combination StepType=Min P=-
 169.541010668991 V2=-378.944999180413 V3=0 T=0 M2=0 M3=-136.085921005142 S11Max=574.735397144447
 PtS11Max=3 x2S11Max=0.5 _
 x3S11Max=-0.5 S11Min=-986.056536699842 PtS11Min=1 x2S11Min=-0.5 x3S11Min=-0.5 FrameElem=74
 ElemStation=0.249999976158142
 Frame=74 Station=0 OutputCase=FESSUR CaseType=Combination P=-168.146075212918 V2=-416.984994938798
 V3=0 T=0 M2=0 M3=-233.788043107841 S11Max=1234.58218343413 PtS11Max=3 x2S11Max=0.5 x3S11Max=-0.5 _
 S11Min=-1570.87433385997 PtS11Min=1 x2S11Min=-0.5 x3S11Min=-0.5 FrameElem=74 ElemStation=0
 Frame=74 Station=6.24999940395355E-02 OutputCase=FESSUR CaseType=Combination P=-168.146075212918 V2=-
 406.560370932968 V3=0 T=0 M2=0 M3=-208.052252878705 S11Max=1080.16744205931 PtS11Max=3 x2S11Max=0.5 _
 x3S11Max=-0.5 S11Min=-1416.45959248515 PtS11Min=1 x2S11Min=-0.5 x3S11Min=-0.5 FrameElem=74
 ElemStation=6.24999940395355E-02
 Frame=74 Station=0.124999988079071 OutputCase=FESSUR CaseType=Combination P=-168.146075212918 V2=-
 396.135746927138 V3=0 T=0 M2=0 M3=-182.968001587798 S11Max=929.661934313868 PtS11Max=3 x2S11Max=0.5
 x3S11Max=-0.5 _
 S11Min=-1265.9540847397 PtS11Min=1 x2S11Min=-0.5 x3S11Min=-0.5 FrameElem=74
 ElemStation=0.124999988079071
 Frame=74 Station=0.187499982118607 OutputCase=FESSUR CaseType=Combination P=-168.146075212918 V2=-
 385.711122921308 V3=0 T=0 M2=0 M3=-158.535289235119 S11Max=783.065660197795 PtS11Max=3 x2S11Max=0.5
 x3S11Max=-0.5 _
 S11Min=-1119.35781062363 PtS11Min=1 x2S11Min=-0.5 x3S11Min=-0.5 FrameElem=74
 ElemStation=0.187499982118607



Frame=74 Station=0.249999976158142 OutputCase=FESSUR CaseType=Combination P=-168.146075212918 V2=-375.286498915477 V3=0 T=0 M2=0 M3=-134.754115820669 S11Max=640.378619711096 PtS11Max=3 x2S11Max=0.5 x3S11Max=-0.5
 S11Min=-976.670770136932 PtS11Min=1 x2S11Min=-0.5 x3S11Min=-0.5 FrameElem=74
 ElemStation=0.249999976158142
 Frame=75 Station=0 OutputCase=PERM1 CaseType=Combination P=-164.891225815413 V2=-366.749998936662 V3=0 T=0 M2=0 M3=-131.646570390229 S11Max=624.988196525962 PtS11Max=3 x2S11Max=0.5 x3S11Max=-0.5
 S11Min=-954.770648156789 PtS11Min=1 x2S11Min=-0.5 x3S11Min=-0.5 FrameElem=75 ElemStation=0
 Frame=75 Station=0.0625 OutputCase=PERM1 CaseType=Combination P=-164.891225815413 V2=-356.562498936662 V3=0 T=0 M2=0 M3=-109.043054831688 S11Max=489.367103174714 PtS11Max=3 x2S11Max=0.5 x3S11Max=-0.5
 S11Min=-819.149554805541 PtS11Min=1 x2S11Min=-0.5 x3S11Min=-0.5 FrameElem=75 ElemStation=0.0625
 Frame=75 Station=0.125 OutputCase=PERM1 CaseType=Combination P=-164.891225815413 V2=-346.374998936662 V3=0 T=0 M2=0 M3=-87.0762580231466 S11Max=357.566322323466 PtS11Max=3 x2S11Max=0.5 x3S11Max=-0.5
 S11Min=-687.348773954293 PtS11Min=1 x2S11Min=-0.5 x3S11Min=-0.5 FrameElem=75 ElemStation=0.125
 Frame=75 Station=0.1875 OutputCase=PERM1 CaseType=Combination P=-164.891225815413 V2=-336.187498936662 V3=0 T=0 M2=0 M3=-65.7461799646052 S11Max=229.585853972218 PtS11Max=3 x2S11Max=0.5 x3S11Max=-0.5
 S11Min=-559.368305603045 PtS11Min=1 x2S11Min=-0.5 x3S11Min=-0.5 FrameElem=75 ElemStation=0.1875
 Frame=75 Station=0.25 OutputCase=PERM1 CaseType=Combination P=-164.891225815413 V2=-325.99998936662 V3=0 T=0 M2=0 M3=-45.0528206560639 S11Max=105.42569812097 PtS11Max=3 x2S11Max=0.5 x3S11Max=-0.5
 S11Min=-435.208149751797 PtS11Min=1 x2S11Min=-0.5 x3S11Min=-0.5 FrameElem=75 ElemStation=0.25
 Frame=75 Station=0 OutputCase=PERM2 CaseType=Combination P=-111.115460069968 V2=-366.74999210671 V3=0 T=0 M2=0 M3=-117.482261282001 S11Max=593.778107622039 PtS11Max=3 x2S11Max=0.5 x3S11Max=-0.5
 S11Min=-816.009027761976 PtS11Min=1 x2S11Min=-0.5 x3S11Min=-0.5 FrameElem=75 ElemStation=0
 Frame=75 Station=0.0625 OutputCase=PERM2 CaseType=Combination P=-111.115460069968 V2=-356.562499210671 V3=0 T=0 M2=0 M3=-94.8787457063343 S11Max=458.157014168037 PtS11Max=3 x2S11Max=0.5 x3S11Max=-0.5
 S11Min=-680.387934307974 PtS11Min=1 x2S11Min=-0.5 x3S11Min=-0.5 FrameElem=75 ElemStation=0.0625
 Frame=75 Station=0.125 OutputCase=PERM2 CaseType=Combination P=-111.115460069968 V2=-346.374999210671 V3=0 T=0 M2=0 M3=-72.9119488806673 S11Max=326.356233214036 PtS11Max=3 x2S11Max=0.5 x3S11Max=-0.5
 S11Min=-548.587153353972 PtS11Min=1 x2S11Min=-0.5 x3S11Min=-0.5 FrameElem=75 ElemStation=0.125
 Frame=75 Station=0.1875 OutputCase=PERM2 CaseType=Combination P=-111.115460069968 V2=-336.187499210671 V3=0 T=0 M2=0 M3=-51.5818708050003 S11Max=198.375764760034 PtS11Max=3 x2S11Max=0.5 x3S11Max=-0.5
 S11Min=-420.60668489997 PtS11Min=1 x2S11Min=-0.5 x3S11Min=-0.5 FrameElem=75 ElemStation=0.1875
 Frame=75 Station=0.25 OutputCase=PERM2 CaseType=Combination P=-111.115460069968 V2=-325.99999210671 V3=0 T=0 M2=0 M3=-30.8885114793334 S11Max=74.2156088060319 PtS11Max=3 x2S11Max=0.5 x3S11Max=-0.5
 S11Min=-296.446528945969 PtS11Min=1 x2S11Min=-0.5 x3S11Min=-0.5 FrameElem=75 ElemStation=0.25
 Frame=75 Station=0 OutputCase=ACC1 CaseType=Combination P=-169.541010668989 V2=-378.94499890641 V3=0 T=0 M2=0 M3=-136.08592100514 S11Max=646.974515361853 PtS11Max=3 x2S11Max=0.5 x3S11Max=-0.5
 S11Min=-986.056536699831 PtS11Min=1 x2S11Min=-0.5 x3S11Min=-0.5 FrameElem=75 ElemStation=0
 Frame=75 Station=0.0625 OutputCase=ACC1 CaseType=Combination P=-169.541010668989 V2=-368.41874890641 V3=0 T=0 M2=0 M3=-112.73080388599 S11Max=506.843812646949 PtS11Max=3 x2S11Max=0.5 x3S11Max=-0.5
 S11Min=-845.925833984928 PtS11Min=1 x2S11Min=-0.5 x3S11Min=-0.5 FrameElem=75 ElemStation=0.0625
 Frame=75 Station=0.125 OutputCase=ACC1 CaseType=Combination P=-169.541010668989 V2=-357.89249890641 V3=0 T=0 M2=0 M3=-90.0335773918391 S11Max=370.660453682046 PtS11Max=3 x2S11Max=0.5 x3S11Max=-0.5
 S11Min=-709.742475020024 PtS11Min=1 x2S11Min=-0.5 x3S11Min=-0.5 FrameElem=75 ElemStation=0.125
 Frame=75 Station=0.1875 OutputCase=ACC1 CaseType=Combination P=-169.541010668989 V2=-347.36624890641 V3=0 T=0 M2=0 M3=-67.9942415226885 S11Max=238.424438467142 PtS11Max=3 x2S11Max=0.5 x3S11Max=-0.5
 S11Min=-577.50645980512 PtS11Min=1 x2S11Min=-0.5 x3S11Min=-0.5 FrameElem=75 ElemStation=0.1875
 Frame=75 Station=0.25 OutputCase=ACC1 CaseType=Combination P=-169.541010668989 V2=-336.83999890641 V3=0 T=0 M2=0 M3=-46.6127962785379 S11Max=110.135767002238 PtS11Max=3 x2S11Max=0.5 x3S11Max=-0.5
 S11Min=-449.217788340217 PtS11Min=1 x2S11Min=-0.5 x3S11Min=-0.5 FrameElem=75 ElemStation=0.25
 Frame=75 Station=0 OutputCase=ACC2 CaseType=Combination P=-115.765244923544 V2=-378.94499918042 V3=0 T=0 M2=0 M3=-121.921611896912 S11Max=615.76442645793 PtS11Max=3 x2S11Max=0.5 x3S11Max=-0.5
 S11Min=-847.294916305018 PtS11Min=1 x2S11Min=-0.5 x3S11Min=-0.5 FrameElem=75 ElemStation=0
 Frame=75 Station=0.0625 OutputCase=ACC2 CaseType=Combination P=-115.765244923544 V2=-368.41874918042 V3=0 T=0 M2=0 M3=-98.5664947606361 S11Max=475.633723640272 PtS11Max=3 x2S11Max=0.5 x3S11Max=-0.5
 S11Min=-707.16421348736 PtS11Min=1 x2S11Min=-0.5 x3S11Min=-0.5 FrameElem=75 ElemStation=0.0625
 Frame=75 Station=0.125 OutputCase=ACC2 CaseType=Combination P=-115.765244923544 V2=-357.89249918042 V3=0 T=0 M2=0 M3=-75.8692682493598 S11Max=339.450364572615 PtS11Max=3 x2S11Max=0.5 x3S11Max=-0.5
 S11Min=-570.980854419703 PtS11Min=1 x2S11Min=-0.5 x3S11Min=-0.5 FrameElem=75 ElemStation=0.125
 Frame=75 Station=0.1875 OutputCase=ACC2 CaseType=Combination P=-115.765244923544 V2=-347.36624918042 V3=0 T=0 M2=0 M3=-53.8299323630836 S11Max=207.214349254958 PtS11Max=3 x2S11Max=0.5 x3S11Max=-0.5
 S11Min=-438.744839102046 PtS11Min=1 x2S11Min=-0.5 x3S11Min=-0.5 FrameElem=75 ElemStation=0.1875
 Frame=75 Station=0.25 OutputCase=ACC2 CaseType=Combination P=-115.765244923544 V2=-336.83999918042 V3=0 T=0 M2=0 M3=-32.4484871018074 S11Max=78.9256776873005 PtS11Max=3 x2S11Max=0.5 x3S11Max=-0.5
 S11Min=-310.456167534389 PtS11Min=1 x2S11Min=-0.5 x3S11Min=-0.5 FrameElem=75 ElemStation=0.25
 Frame=75 Station=0 OutputCase=ACCSX1 CaseType=Combination P=-167.164023806258 V2=-365.235921331209 V3=0 T=0 M2=0 M3=-128.85158497577 S11Max=605.945486048365 PtS11Max=3 x2S11Max=0.5 x3S11Max=-0.5
 S11Min=-940.273533660881 PtS11Min=1 x2S11Min=-0.5 x3S11Min=-0.5 FrameElem=75 ElemStation=0
 Frame=75 Station=0.0625 OutputCase=ACCSX1 CaseType=Combination P=-167.164023806258 V2=-355.048421331209 V3=0 T=0 M2=0 M3=-106.34269926757 S11Max=470.892171799161 PtS11Max=3 x2S11Max=0.5 x3S11Max=-0.5
 S11Min=-805.220219411678 PtS11Min=1 x2S11Min=-0.5 x3S11Min=-0.5 FrameElem=75 ElemStation=0.0625
 Frame=75 Station=0.125 OutputCase=ACCSX1 CaseType=Combination P=-167.164023806258 V2=-344.860921331209 V3=0 T=0 M2=0 M3=-84.4705323093693 S11Max=339.659170049958 PtS11Max=3 x2S11Max=0.5 x3S11Max=-0.5
 S11Min=-673.987217662474 PtS11Min=1 x2S11Min=-0.5 x3S11Min=-0.5 FrameElem=75 ElemStation=0.125
 Frame=75 Station=0.1875 OutputCase=ACCSX1 CaseType=Combination P=-167.164023806258 V2=-334.673421331209 V3=0 T=0 M2=0 M3=-63.2350841011688 S11Max=212.246480800754 PtS11Max=3 x2S11Max=0.5 x3S11Max=-0.5
 S11Min=-546.574528413271 PtS11Min=1 x2S11Min=-0.5 x3S11Min=-0.5 FrameElem=75 ElemStation=0.1875
 Frame=75 Station=0.25 OutputCase=ACCSX1 CaseType=Combination P=-167.164023806258 V2=-324.485921331209 V3=0 T=0 M2=0 M3=-42.6363546429682 S11Max=88.6541040515505 PtS11Max=3 x2S11Max=0.5 x3S11Max=-0.5
 S11Min=-422.982151664068 PtS11Min=1 x2S11Min=-0.5 x3S11Min=-0.5 FrameElem=75 ElemStation=0.25
 Frame=75 Station=0 OutputCase=ACCSX2 CaseType=Combination P=-113.388258060813 V2=-365.235921605219 V3=0 T=0 M2=0 M3=-114.687275867542 S11Max=574.735397144441 PtS11Max=3 x2S11Max=0.5 x3S11Max=-0.5



S11Min=-801.511913266068 PtS11Min=1 x2S11Min=-0.5 x3S11Min=-0.5 FrameElem=75 ElemStation=0
 Frame=75 Station=0.0625 OutputCase=ACCSX2 CaseType=Combination P=-113.388258060813 V2=-355.048421605219
 V3=0 T=0 M2=0 M3=-92.1783901422163 S11Max=439.682082792484 PtS11Max=3 x2S11Max=0.5 x3S11Max=-0.5
 S11Min=-666.458598914111 PtS11Min=1 x2S11Min=-0.5 x3S11Min=-0.5 FrameElem=75 ElemStation=0.0625
 Frame=75 Station=0.125 OutputCase=ACCSX2 CaseType=Combination P=-113.388258060813 V2=-344.860921605219
 V3=0 T=0 M2=0 M3=-70.30622316689 S11Max=308.449080940527 PtS11Max=3 x2S11Max=0.5 x3S11Max=-0.5
 S11Min=-535.225597062154 PtS11Min=1 x2S11Min=-0.5 x3S11Min=-0.5 FrameElem=75 ElemStation=0.125
 Frame=75 Station=0.1875 OutputCase=ACCSX2 CaseType=Combination P=-113.388258060813 V2=-334.673421605219
 V3=0 T=0 M2=0 M3=-49.0707749415639 S11Max=181.03639158857 PtS11Max=3 x2S11Max=0.5 x3S11Max=-0.5
 S11Min=-407.812907710196 PtS11Min=1 x2S11Min=-0.5 x3S11Min=-0.5 FrameElem=75 ElemStation=0.1875
 Frame=75 Station=0.25 OutputCase=ACCSX2 CaseType=Combination P=-113.388258060813 V2=-324.485921605219
 V3=0 T=0 M2=0 M3=-28.4720454662377 S11Max=57.4440147366126 PtS11Max=3 x2S11Max=0.5 x3S11Max=-0.5
 S11Min=-284.220530858239 PtS11Min=1 x2S11Min=-0.5 x3S11Min=-0.5 FrameElem=75 ElemStation=0.25
 Frame=75 Station=0 OutputCase=ENVE CaseType=Combination StepType=Max P=-111.115460069968 V2=-
 365.235921331209 V3=0 T=0 M2=0 M3=-114.687275867542 S11Max=646.974515361853 PtS11Max=3 x2S11Max=0.5
 x3S11Max=-0.5
 S11Min=-801.511913266068 PtS11Min=1 x2S11Min=-0.5 x3S11Min=-0.5 FrameElem=75 ElemStation=0
 Frame=75 Station=0.0625 OutputCase=ENVE CaseType=Combination StepType=Max P=-111.115460069968 V2=-
 355.048421331209 V3=0 T=0 M2=0 M3=-92.1783901422163 S11Max=506.843812646949 PtS11Max=3 x2S11Max=0.5
 x3S11Max=-0.5 S11Min=-666.458598914111 PtS11Min=1 x2S11Min=-0.5 x3S11Min=-0.5 FrameElem=75
 ElemStation=0.0625
 Frame=75 Station=0.125 OutputCase=ENVE CaseType=Combination StepType=Max P=-111.115460069968 V2=-
 344.860921331209 V3=0 T=0 M2=0 M3=-70.30622316689 S11Max=370.660453682046 PtS11Max=3 x2S11Max=0.5
 x3S11Max=-0.5
 S11Min=-535.225597062154 PtS11Min=1 x2S11Min=-0.5 x3S11Min=-0.5 FrameElem=75 ElemStation=0.125
 Frame=75 Station=0.1875 OutputCase=ENVE CaseType=Combination StepType=Max P=-111.115460069968 V2=-
 334.673421331209 V3=0 T=0 M2=0 M3=-49.0707749415639 S11Max=238.424438467142 PtS11Max=3 x2S11Max=0.5
 x3S11Max=-0.5 S11Min=-407.812907710196 PtS11Min=1 x2S11Min=-0.5 x3S11Min=-0.5 FrameElem=75
 ElemStation=0.1875
 Frame=75 Station=0.25 OutputCase=ENVE CaseType=Combination StepType=Max P=-111.115460069968 V2=-
 324.485921331209 V3=0 T=0 M2=0 M3=-28.4720454662377 S11Max=110.135767002238 PtS11Max=3 x2S11Max=0.5
 x3S11Max=-0.5
 S11Min=-284.220530858239 PtS11Min=1 x2S11Min=-0.5 x3S11Min=-0.5 FrameElem=75 ElemStation=0.25
 Frame=75 Station=0 OutputCase=ENVE CaseType=Combination StepType=Min P=-169.541010668989 V2=-
 378.94499918042 V3=0 T=0 M2=0 M3=-136.08592100514 S11Max=574.735397144441 PtS11Max=3 x2S11Max=0.5
 x3S11Max=-0.5
 S11Min=-986.056536699831 PtS11Min=1 x2S11Min=-0.5 x3S11Min=-0.5 FrameElem=75 ElemStation=0
 Frame=75 Station=0.0625 OutputCase=ENVE CaseType=Combination StepType=Min P=-169.541010668989 V2=-
 368.41874918042 V3=0 T=0 M2=0 M3=-112.73080388599 S11Max=439.682082792484 PtS11Max=3 x2S11Max=0.5
 x3S11Max=-0.5
 S11Min=-845.925833984928 PtS11Min=1 x2S11Min=-0.5 x3S11Min=-0.5 FrameElem=75 ElemStation=0.0625
 Frame=75 Station=0.125 OutputCase=ENVE CaseType=Combination StepType=Min P=-169.541010668989 V2=-
 357.89249918042 V3=0 T=0 M2=0 M3=-90.0335773918391 S11Max=308.449080940527 PtS11Max=3 x2S11Max=0.5
 x3S11Max=-0.5
 S11Min=-709.742475020024 PtS11Min=1 x2S11Min=-0.5 x3S11Min=-0.5 FrameElem=75 ElemStation=0.125
 Frame=75 Station=0.1875 OutputCase=ENVE CaseType=Combination StepType=Min P=-169.541010668989 V2=-
 347.36624918042 V3=0 T=0 M2=0 M3=-67.9942415226885 S11Max=181.03639158857 PtS11Max=3 x2S11Max=0.5
 x3S11Max=-0.5
 S11Min=-577.50645980512 PtS11Min=1 x2S11Min=-0.5 x3S11Min=-0.5 FrameElem=75 ElemStation=0.1875
 Frame=75 Station=0.25 OutputCase=ENVE CaseType=Combination StepType=Min P=-169.541010668989 V2=-
 336.83999918042 V3=0 T=0 M2=0 M3=-46.6127962785379 S11Max=57.4440147366126 PtS11Max=3 x2S11Max=0.5
 x3S11Max=-0.5
 S11Min=-449.217788340217 PtS11Min=1 x2S11Min=-0.5 x3S11Min=-0.5 FrameElem=75 ElemStation=0.25
 Frame=75 Station=0 OutputCase=FESSUR CaseType=Combination P=-168.146075212916 V2=-375.286498915485
 V3=0 T=0 M2=0 M3=-134.754115820667 S11Max=640.378619711086 PtS11Max=3 x2S11Max=0.5 x3S11Max=-0.5
 S11Min=-976.670770136919 PtS11Min=1 x2S11Min=-0.5 x3S11Min=-0.5 FrameElem=75 ElemStation=0
 Frame=75 Station=0.0625 OutputCase=FESSUR CaseType=Combination P=-168.146075212916 V2=-364.861873915485
 V3=0 T=0 M2=0 M3=-111.624479169699 S11Max=501.600799805279 PtS11Max=3 x2S11Max=0.5 x3S11Max=-0.5
 S11Min=-837.892950231112 PtS11Min=1 x2S11Min=-0.5 x3S11Min=-0.5 FrameElem=75 ElemStation=0.0625
 Frame=75 Station=0.125 OutputCase=FESSUR CaseType=Combination P=-168.146075212916 V2=-354.437248915485
 V3=0 T=0 M2=0 M3=-89.1463815812314 S11Max=366.732214274472 PtS11Max=3 x2S11Max=0.5 x3S11Max=-0.5
 S11Min=-703.024364700305 PtS11Min=1 x2S11Min=-0.5 x3S11Min=-0.5 FrameElem=75 ElemStation=0.125
 Frame=75 Station=0.1875 OutputCase=FESSUR CaseType=Combination P=-168.146075212916 V2=-344.012623915485
 V3=0 T=0 M2=0 M3=-67.3198230552635 S11Max=235.772863118665 PtS11Max=3 x2S11Max=0.5 x3S11Max=-0.5
 S11Min=-572.065013544498 PtS11Min=1 x2S11Min=-0.5 x3S11Min=-0.5 FrameElem=75 ElemStation=0.1875
 Frame=75 Station=0.25 OutputCase=FESSUR CaseType=Combination P=-168.146075212916 V2=-333.587998915485
 V3=0 T=0 M2=0 M3=-46.1448035917957 S11Max=108.722746337858 PtS11Max=3 x2S11Max=0.5 x3S11Max=-0.5
 S11Min=-445.014896763691 PtS11Min=1 x2S11Min=-0.5 x3S11Min=-0.5 FrameElem=75 ElemStation=0.25
 Frame=77 Station=0 OutputCase=PERM1 CaseType=Combination P=-164.891225815414 V2=326.000001063164 V3=0
 T=0 M2=0 M3=-45.052824908978 S11Max=105.425723638454 PtS11Max=3 x2S11Max=0.5 x3S11Max=-0.5
 S11Min=-435.208175269283 PtS11Min=1 x2S11Min=-0.5 x3S11Min=-0.5 FrameElem=77 ElemStation=0
 Frame=77 Station=0.0625 OutputCase=PERM1 CaseType=Combination P=-164.891225815414 V2=336.187501063164
 V3=0 T=0 M2=0 M3=-65.7461843504258 S11Max=229.58588028714 PtS11Max=3 x2S11Max=0.5 x3S11Max=-0.5
 S11Min=-559.368331917969 PtS11Min=1 x2S11Min=-0.5 x3S11Min=-0.5 FrameElem=77 ElemStation=0.0625
 Frame=77 Station=0.125 OutputCase=PERM1 CaseType=Combination P=-164.891225815414 V2=346.375001063164
 V3=0 T=0 M2=0 M3=-87.0762625418736 S11Max=357.566349435827 PtS11Max=3 x2S11Max=0.5 x3S11Max=-0.5
 S11Min=-687.348801066656 PtS11Min=1 x2S11Min=-0.5 x3S11Min=-0.5 FrameElem=77 ElemStation=0.125
 Frame=77 Station=0.1875 OutputCase=PERM1 CaseType=Combination P=-164.891225815414 V2=356.562501063164
 V3=0 T=0 M2=0 M3=-109.043059483321 S11Max=489.367131084514 PtS11Max=3 x2S11Max=0.5 x3S11Max=-0.5
 S11Min=-819.149582715342 PtS11Min=1 x2S11Min=-0.5 x3S11Min=-0.5 FrameElem=77 ElemStation=0.1875
 Frame=77 Station=0.25 OutputCase=PERM1 CaseType=Combination P=-164.891225815414 V2=366.750001063164
 V3=0 T=0 M2=0 M3=-131.646575174769 S11Max=624.9882252332 PtS11Max=3 x2S11Max=0.5 x3S11Max=-0.5

S11Min=-954.770676864029 PtS11Min=1 x2S11Min=-0.5 x3S11Min=-0.5 FrameElem=77 ElemStation=0.25
 Frame=77 Station=0 OutputCase=PERM2 CaseType=Combination P=-111.115460069969 V2=326.00000789154 V3=0
 T=0 M2=0 M3=-30.8885146362077 S11Max=74.2156277472768 PtS11Max=3 x2S11Max=0.5 x3S11Max=-0.5 _
 S11Min=-296.446547887215 PtS11Min=1 x2S11Min=-0.5 x3S11Min=-0.5 FrameElem=77 ElemStation=0
 Frame=77 Station=0.0625 OutputCase=PERM2 CaseType=Combination P=-111.115460069969 V2=336.187500789154
 V3=0 T=0 M2=0 M3=-51.5818740605298 S11Max=198.37578429321 PtS11Max=3 x2S11Max=0.5 x3S11Max=-0.5 _
 S11Min=-420.606704433148 PtS11Min=1 x2S11Min=-0.5 x3S11Min=-0.5 FrameElem=77 ElemStation=0.0625
 Frame=77 Station=0.125 OutputCase=PERM2 CaseType=Combination P=-111.115460069969 V2=346.375000789154
 V3=0 T=0 M2=0 M3=-72.911952234852 S11Max=326.356253339142 PtS11Max=3 x2S11Max=0.5 x3S11Max=-0.5 _
 S11Min=-548.587173479081 PtS11Min=1 x2S11Min=-0.5 x3S11Min=-0.5 FrameElem=77 ElemStation=0.125
 Frame=77 Station=0.1875 OutputCase=PERM2 CaseType=Combination P=-111.115460069969 V2=356.562500789154
 V3=0 T=0 M2=0 M3=-94.8787491591741 S11Max=458.157034885075 PtS11Max=3 x2S11Max=0.5 x3S11Max=-0.5 _
 S11Min=-680.387955025014 PtS11Min=1 x2S11Min=-0.5 x3S11Min=-0.5 FrameElem=77 ElemStation=0.1875
 Frame=77 Station=0.25 OutputCase=PERM2 CaseType=Combination P=-111.115460069969 V2=366.750000789154
 V3=0 T=0 M2=0 M3=-117.482264833496 S11Max=593.778128931008 PtS11Max=3 x2S11Max=0.5 x3S11Max=-0.5 _
 S11Min=-816.009049070947 PtS11Min=1 x2S11Min=-0.5 x3S11Min=-0.5 FrameElem=77 ElemStation=0.25
 Frame=77 Station=0.0 OutputCase=ACC1 CaseType=Combination P=-169.541010668997 V2=336.840001093412 V3=0
 T=0 M2=0 M3=-46.6128006524478 S11Max=110.135793245689 PtS11Max=3 x2S11Max=0.5 x3S11Max=-0.5 _
 S11Min=-449.217814583684 PtS11Min=1 x2S11Min=-0.5 x3S11Min=-0.5 FrameElem=77 ElemStation=0
 Frame=77 Station=0.0625 OutputCase=ACC1 CaseType=Combination P=-169.541010668997 V2=347.366251093412
 V3=0 T=0 M2=0 M3=-67.994246033286 S11Max=238.424465530719 PtS11Max=3 x2S11Max=0.5 x3S11Max=-0.5 _
 S11Min=-577.506486868713 PtS11Min=1 x2S11Min=-0.5 x3S11Min=-0.5 FrameElem=77 ElemStation=0.0625
 Frame=77 Station=0.125 OutputCase=ACC1 CaseType=Combination P=-169.541010668997 V2=357.892501093412
 V3=0 T=0 M2=0 M3=-90.0335820391242 S11Max=370.660481565748 PtS11Max=3 x2S11Max=0.5 x3S11Max=-0.5 _
 S11Min=-709.752502903743 PtS11Min=1 x2S11Min=-0.5 x3S11Min=-0.5 FrameElem=77 ElemStation=0.125
 Frame=77 Station=0.1875 OutputCase=ACC1 CaseType=Combination P=-169.541010668997 V2=368.418751093412
 V3=0 T=0 M2=0 M3=-112.730808669962 S11Max=506.843841350777 PtS11Max=3 x2S11Max=0.5 x3S11Max=-0.5 _
 S11Min=-845.925862688772 PtS11Min=1 x2S11Min=-0.5 x3S11Min=-0.5 FrameElem=77 ElemStation=0.1875
 Frame=77 Station=0.25 OutputCase=ACC1 CaseType=Combination P=-169.541010668997 V2=378.945001093412
 V3=0 T=0 M2=0 M3=-136.085925925801 S11Max=646.974544885807 PtS11Max=3 x2S11Max=0.5 x3S11Max=-0.5 _
 S11Min=-986.056566223801 PtS11Min=1 x2S11Min=-0.5 x3S11Min=-0.5 FrameElem=77 ElemStation=0.25
 Frame=77 Station=0.0 OutputCase=ACC2 CaseType=Combination P=-115.765244923552 V2=336.840000819401 V3=0
 T=0 M2=0 M3=-32.4484903796774 S11Max=78.9256973545123 PtS11Max=3 x2S11Max=0.5 x3S11Max=-0.5 _
 S11Min=-310.456187201617 PtS11Min=1 x2S11Min=-0.5 x3S11Min=-0.5 FrameElem=77 ElemStation=0
 Frame=77 Station=0.0625 OutputCase=ACC2 CaseType=Combination P=-115.765244923552 V2=347.366250819401
 V3=0 T=0 M2=0 M3=-53.82993574339 S11Max=207.214369536788 PtS11Max=3 x2S11Max=0.5 x3S11Max=-0.5 _
 S11Min=-438.744859383892 PtS11Min=1 x2S11Min=-0.5 x3S11Min=-0.5 FrameElem=77 ElemStation=0.0625
 Frame=77 Station=0.125 OutputCase=ACC2 CaseType=Combination P=-115.765244923552 V2=357.892500819401
 V3=0 T=0 M2=0 M3=-75.8692717321026 S11Max=339.450385469063 PtS11Max=3 x2S11Max=0.5 x3S11Max=-0.5 _
 S11Min=-570.980875316168 PtS11Min=1 x2S11Min=-0.5 x3S11Min=-0.5 FrameElem=77 ElemStation=0.125
 Frame=77 Station=0.1875 OutputCase=ACC2 CaseType=Combination P=-115.765244923552 V2=368.418750819401
 V3=0 T=0 M2=0 M3=-98.5664983458152 S11Max=475.633745151339 PtS11Max=3 x2S11Max=0.5 x3S11Max=-0.5 _
 S11Min=-707.164234998443 PtS11Min=1 x2S11Min=-0.5 x3S11Min=-0.5 FrameElem=77 ElemStation=0.1875
 Frame=77 Station=0.25 OutputCase=ACC2 CaseType=Combination P=-115.765244923552 V2=378.945000819401
 V3=0 T=0 M2=0 M3=-121.921615584528 S11Max=615.764448583614 PtS11Max=3 x2S11Max=0.5 x3S11Max=-0.5 _
 S11Min=-847.294938430719 PtS11Min=1 x2S11Min=-0.5 x3S11Min=-0.5 FrameElem=77 ElemStation=0.25
 Frame=77 Station=0.0 OutputCase=ACCSX1 CaseType=Combination P=-167.164023806274 V2=327.514078668614
 V3=0 T=0 M2=0 M3=-48.6926693176868 S11Max=124.991992099847 PtS11Max=3 x2S11Max=0.5 x3S11Max=-0.5 _
 S11Min=-459.320039712395 PtS11Min=1 x2S11Min=-0.5 x3S11Min=-0.5 FrameElem=77 ElemStation=0
 Frame=77 Station=0.0625 OutputCase=ACCSX1 CaseType=Combination P=-167.164023806274 V2=337.701578668614
 V3=0 T=0 M2=0 M3=-69.4806586094752 S11Max=249.719927850577 PtS11Max=3 x2S11Max=0.5 x3S11Max=-0.5 _
 S11Min=-584.047975463125 PtS11Min=1 x2S11Min=-0.5 x3S11Min=-0.5 FrameElem=77 ElemStation=0.0625
 Frame=77 Station=0.125 OutputCase=ACCSX1 CaseType=Combination P=-167.164023806274 V2=347.889078668614
 V3=0 T=0 M2=0 M3=-90.9053666512635 S11Max=378.268176101307 PtS11Max=3 x2S11Max=0.5 x3S11Max=-0.5 _
 S11Min=-712.596223713855 PtS11Min=1 x2S11Min=-0.5 x3S11Min=-0.5 FrameElem=77 ElemStation=0.125
 Frame=77 Station=0.1875 OutputCase=ACCSX1 CaseType=Combination P=-167.164023806274 V2=358.076578668614
 V3=0 T=0 M2=0 M3=-112.966793443052 S11Max=510.636736852038 PtS11Max=3 x2S11Max=0.5 x3S11Max=-0.5 _
 S11Min=-844.964784464585 PtS11Min=1 x2S11Min=-0.5 x3S11Min=-0.5 FrameElem=77 ElemStation=0.1875
 Frame=77 Station=0.25 OutputCase=ACCSX1 CaseType=Combination P=-167.164023806274 V2=368.264078668614
 V3=0 T=0 M2=0 M3=-135.66493898484 S11Max=646.825610102768 PtS11Max=3 x2S11Max=0.5 x3S11Max=-0.5 _
 S11Min=-981.153657715315 PtS11Min=1 x2S11Min=-0.5 x3S11Min=-0.5 FrameElem=77 ElemStation=0.25
 Frame=77 Station=0.0 OutputCase=ACCSX2 CaseType=Combination P=-113.388258060829 V2=327.514078394604
 V3=0 T=0 M2=0 M3=-34.5283590449164 S11Max=93.7818962086698 PtS11Max=3 x2S11Max=0.5 x3S11Max=-0.5 _
 S11Min=-320.558412330327 PtS11Min=1 x2S11Min=-0.5 x3S11Min=-0.5 FrameElem=77 ElemStation=0
 Frame=77 Station=0.0625 OutputCase=ACCSX2 CaseType=Combination P=-113.388258060829 V2=337.701578394604
 V3=0 T=0 M2=0 M3=-55.3163483195792 S11Max=218.509831856646 PtS11Max=3 x2S11Max=0.5 x3S11Max=-0.5 _
 S11Min=-445.286347978304 PtS11Min=1 x2S11Min=-0.5 x3S11Min=-0.5 FrameElem=77 ElemStation=0.0625
 Frame=77 Station=0.125 OutputCase=ACCSX2 CaseType=Combination P=-113.388258060829 V2=347.889078394604
 V3=0 T=0 M2=0 M3=-76.7410563442419 S11Max=347.058080004623 PtS11Max=3 x2S11Max=0.5 x3S11Max=-0.5 _
 S11Min=-573.83459612628 PtS11Min=1 x2S11Min=-0.5 x3S11Min=-0.5 FrameElem=77 ElemStation=0.125
 Frame=77 Station=0.1875 OutputCase=ACCSX2 CaseType=Combination P=-113.388258060829 V2=358.076578394604
 V3=0 T=0 M2=0 M3=-98.8024831189046 S11Max=479.426640652599 PtS11Max=3 x2S11Max=0.5 x3S11Max=-0.5 _
 S11Min=-706.203156774257 PtS11Min=1 x2S11Min=-0.5 x3S11Min=-0.5 FrameElem=77 ElemStation=0.1875
 Frame=77 Station=0.25 OutputCase=ACCSX2 CaseType=Combination P=-113.388258060829 V2=368.264078394604
 V3=0 T=0 M2=0 M3=-121.500628643567 S11Max=615.615513800575 PtS11Max=3 x2S11Max=0.5 x3S11Max=-0.5 _
 S11Min=-842.392029922233 PtS11Min=1 x2S11Min=-0.5 x3S11Min=-0.5 FrameElem=77 ElemStation=0.25
 Frame=77 Station=0 OutputCase=ENVE CaseType=Combination StepType=Max P=-111.115460069969
 V2=336.840001093412 V3=0 T=0 M2=0 M3=-30.8885146362077 S11Max=124.991992099847 PtS11Max=3 x2S11Max=0.5
 x3S11Max=-0.5 _
 S11Min=-296.446547887215 PtS11Min=1 x2S11Min=-0.5 x3S11Min=-0.5 FrameElem=77 ElemStation=0



Frame=77 Station=0.0625 OutputCase=ENVE CaseType=Combination StepType=Max P=-111.115460069969
 V2=347.366251093412 V3=0 T=0 M2=0 M3=-51.5818740605298 S11Max=249.719927850577 PtS11Max=3 x2S11Max=0.5
 -
 x3S11Max=-0.5 S11Min=-420.606704433148 PtS11Min=1 x2S11Min=-0.5 x3S11Min=-0.5 FrameElem=77
 ElemStation=0.0625
 Frame=77 Station=0.125 OutputCase=ENVE CaseType=Combination StepType=Max P=-111.115460069969
 V2=357.892501093412 V3=0 T=0 M2=0 M3=-72.911952234852 S11Max=378.268176101307 PtS11Max=3 x2S11Max=0.5
 x3S11Max=-0.5
 S11Min=-548.587173479081 PtS11Min=1 x2S11Min=-0.5 x3S11Min=-0.5 FrameElem=77 ElemStation=0.125
 Frame=77 Station=0.1875 OutputCase=ENVE CaseType=Combination StepType=Max P=-111.115460069969
 V2=368.418751093412 V3=0 T=0 M2=0 M3=-94.8787491591741 S11Max=510.636736852038 PtS11Max=3 x2S11Max=0.5
 -
 x3S11Max=-0.5 S11Min=-680.387955025014 PtS11Min=1 x2S11Min=-0.5 x3S11Min=-0.5 FrameElem=77
 ElemStation=0.1875
 Frame=77 Station=0.25 OutputCase=ENVE CaseType=Combination StepType=Max P=-111.115460069969
 V2=378.945001093412 V3=0 T=0 M2=0 M3=-117.482264833496 S11Max=646.974544885807 PtS11Max=3 x2S11Max=0.5
 x3S11Max=-0.5
 S11Min=-816.009049070947 PtS11Min=1 x2S11Min=-0.5 x3S11Min=-0.5 FrameElem=77 ElemStation=0.25
 Frame=77 Station=0 OutputCase=ENVE CaseType=Combination StepType=Min P=-169.541010668997
 V2=326.000000789154 V3=0 T=0 M2=0 M3=-48.6926693176868 S11Max=74.2156277472768 PtS11Max=3 x2S11Max=0.5
 x3S11Max=-0.5
 S11Min=-459.320039712395 PtS11Min=1 x2S11Min=-0.5 x3S11Min=-0.5 FrameElem=77 ElemStation=0
 Frame=77 Station=0.0625 OutputCase=ENVE CaseType=Combination StepType=Min P=-169.541010668997
 V2=336.187500789154 V3=0 T=0 M2=0 M3=-69.4806586094752 S11Max=198.37578429321 PtS11Max=3 x2S11Max=0.5
 x3S11Max=-0.5
 S11Min=-584.047975463125 PtS11Min=1 x2S11Min=-0.5 x3S11Min=-0.5 FrameElem=77 ElemStation=0.0625
 Frame=77 Station=0.125 OutputCase=ENVE CaseType=Combination StepType=Min P=-169.541010668997
 V2=346.375000789154 V3=0 T=0 M2=0 M3=-90.9053666512635 S11Max=326.356253339142 PtS11Max=3 x2S11Max=0.5
 x3S11Max=-0.5
 S11Min=-712.596223713855 PtS11Min=1 x2S11Min=-0.5 x3S11Min=-0.5 FrameElem=77 ElemStation=0.125
 Frame=77 Station=0.1875 OutputCase=ENVE CaseType=Combination StepType=Min P=-169.541010668997
 V2=356.562500789154 V3=0 T=0 M2=0 M3=-112.966793443052 S11Max=458.157034885075 PtS11Max=3 x2S11Max=0.5
 -
 x3S11Max=-0.5 S11Min=-845.925862688772 PtS11Min=1 x2S11Min=-0.5 x3S11Min=-0.5 FrameElem=77
 ElemStation=0.1875
 Frame=77 Station=0.25 OutputCase=ENVE CaseType=Combination StepType=Min P=-169.541010668997
 V2=366.750000789154 V3=0 T=0 M2=0 M3=-136.085925925801 S11Max=593.778128931008 PtS11Max=3 x2S11Max=0.5
 x3S11Max=-0.5
 S11Min=-986.056566223801 PtS11Min=1 x2S11Min=-0.5 x3S11Min=-0.5 FrameElem=77 ElemStation=0.25
 Frame=77 Station=0 OutputCase=FESSUR CaseType=Combination P=-168.146075212922 V2=333.588001084337
 V3=0 T=0 M2=0 M3=-46.1448079294069 S11Max=108.722772363519 PtS11Max=3 x2S11Max=0.5 x3S11Max=-0.5
 S11Min=-445.014922789364 PtS11Min=1 x2S11Min=-0.5 x3S11Min=-0.5 FrameElem=77 ElemStation=0
 Frame=77 Station=0.0625 OutputCase=FESSUR CaseType=Combination P=-168.146075212922 V2=344.012626084337
 V3=0 T=0 M2=0 M3=-67.319827528428 S11Max=235.772889957645 PtS11Max=3 x2S11Max=0.5 x3S11Max=-0.5
 S11Min=-572.06504038349 PtS11Min=1 x2S11Min=-0.5 x3S11Min=-0.5 FrameElem=77 ElemStation=0.0625
 Frame=77 Station=0.125 OutputCase=FESSUR CaseType=Combination P=-168.146075212922 V2=354.437251084337
 V3=0 T=0 M2=0 M3=-89.146386189949 S11Max=366.732241926772 PtS11Max=3 x2S11Max=0.5 x3S11Max=-0.5
 S11Min=-703.024392352617 PtS11Min=1 x2S11Min=-0.5 x3S11Min=-0.5 FrameElem=77 ElemStation=0.125
 Frame=77 Station=0.1875 OutputCase=FESSUR CaseType=Combination P=-168.146075212922 V2=364.861876084337
 V3=0 T=0 M2=0 M3=-111.62448391397 S11Max=501.600828270898 PtS11Max=3 x2S11Max=0.5 x3S11Max=-0.5
 S11Min=-837.892978696743 PtS11Min=1 x2S11Min=-0.5 x3S11Min=-0.5 FrameElem=77 ElemStation=0.1875
 Frame=77 Station=0.25 OutputCase=FESSUR CaseType=Combination P=-168.146075212922 V2=375.286501084337
 V3=0 T=0 M2=0 M3=-134.754120700491 S11Max=640.378648990025 PtS11Max=3 x2S11Max=0.5 x3S11Max=-0.5
 S11Min=-976.67079941587 PtS11Min=1 x2S11Min=-0.5 x3S11Min=-0.5 FrameElem=77 ElemStation=0.25
 Frame=78 Station=0 OutputCase=PERM1 CaseType=Combination P=-164.891260791424 V2=366.74998533776 V3=0
 T=0 M2=0 M3=-131.646575174769 S11Max=624.988190257191 PtS11Max=3 x2S11Max=0.5 x3S11Max=-0.5
 S11Min=-954.770711840039 PtS11Min=1 x2S11Min=-0.5 x3S11Min=-0.5 FrameElem=78 ElemStation=0
 Frame=78 Station=6.24999940395358E-02 OutputCase=PERM1 CaseType=Combination P=-164.891261762298
 V2=376.937484366204 V3=0 T=0 M2=0 M3=-154.886806386657 S11Max=764.429576556961 PtS11Max=3 x2S11Max=0.5
 x3S11Max=-0.5
 S11Min=-1094.21210008292 PtS11Min=1 x2S11Min=-0.5 x3S11Min=-0.5 FrameElem=78
 ElemStation=6.24999940395358E-02
 Frame=78 Station=0.124999988079072 OutputCase=PERM1 CaseType=Combination P=-164.891262734535
 V2=387.124983394648 V3=0 T=0 M2=0 M3=-178.7637562271 S11Max=907.691274628064 PtS11Max=3 x2S11Max=0.5
 x3S11Max=-0.5
 S11Min=-1237.47380009713 PtS11Min=1 x2S11Min=-0.5 x3S11Min=-0.5 FrameElem=78
 ElemStation=0.124999988079072
 Frame=78 Station=0.187499982118607 OutputCase=PERM1 CaseType=Combination P=-164.891263706091
 V2=397.312482423093 V3=0 T=0 M2=0 M3=-203.277424696099 S11Max=1054.7732844705 PtS11Max=3 x2S11Max=0.5
 x3S11Max=-0.5
 S11Min=-1384.55581188268 PtS11Min=1 x2S11Min=-0.5 x3S11Min=-0.5 FrameElem=78
 ElemStation=0.187499982118607
 Frame=78 Station=0.249999976158143 OutputCase=PERM1 CaseType=Combination P=-164.891264677647
 V2=407.499981451537 V3=0 T=0 M2=0 M3=-228.427811793653 S11Max=1205.67560608427 PtS11Max=3 x2S11Max=0.5
 x3S11Max=-0.5
 S11Min=-1535.45813543956 PtS11Min=1 x2S11Min=-0.5 x3S11Min=-0.5 FrameElem=78
 ElemStation=0.249999976158143
 Frame=78 Station=0 OutputCase=PERM2 CaseType=Combination P=-111.115495045979 V2=366.749990192207 V3=0
 T=0 M2=0 M3=-117.482264833496 S11Max=593.778093954999 PtS11Max=3 x2S11Max=0.5 x3S11Max=-0.5
 S11Min=-816.009084046956 PtS11Min=1 x2S11Min=-0.5 x3S11Min=-0.5 FrameElem=78 ElemStation=0



Frame=78 Station=6.24999940395358E-02 OutputCase=PERM2 CaseType=Combination P=-111.115496017534
 V2=376.937489220651 V3=0 T=0 M2=0 M3=-140.722496348787 S11Max=733.219482075186 PtS11Max=3 x2S11Max=0.5
 -
 x3S11Max=-0.5 S11Min=-955.450474110255 PtS11Min=1 x2S11Min=-0.5 x3S11Min=-0.5 FrameElem=78
 ElemStation=6.24999940395358E-02
 Frame=78 Station=0.124999988079072 OutputCase=PERM2 CaseType=Combination P=-111.11549698909
 V2=387.124988249095 V3=0 T=0 M2=0 M3=-164.599446492633 S11Max=876.481181966707 PtS11Max=3 x2S11Max=0.5
 x3S11Max=-0.5
 S11Min=-1098.71217594489 PtS11Min=1 x2S11Min=-0.5 x3S11Min=-0.5 FrameElem=78
 ElemStation=0.124999988079072
 Frame=78 Station=0.187499982118607 OutputCase=PERM2 CaseType=Combination P=-111.115497960646
 V2=397.312487277539 V3=0 T=0 M2=0 M3=-189.113115265034 S11Max=1023.56319362956 PtS11Max=3 x2S11Max=0.5
 x3S11Max=-0.5
 S11Min=-1245.79418955085 PtS11Min=1 x2S11Min=-0.5 x3S11Min=-0.5 FrameElem=78
 ElemStation=0.187499982118607
 Frame=78 Station=0.249999976158143 OutputCase=PERM2 CaseType=Combination P=-111.115498932202
 V2=407.499986305984 V3=0 T=0 M2=0 M3=-214.263502665992 S11Max=1174.46551706375 PtS11Max=3 x2S11Max=0.5
 x3S11Max=-0.5
 S11Min=-1396.69651492815 PtS11Min=1 x2S11Min=-0.5 x3S11Min=-0.5 FrameElem=78
 ElemStation=0.249999976158143
 Frame=78 Station=0 OutputCase=ACC1 CaseType=Combination P=-169.541046808013 V2=378.944984924567 V3=0
 T=0 M2=0 M3=-136.085925925801 S11Max=646.974508746792 PtS11Max=3 x2S11Max=0.5 x3S11Max=-0.5
 S11Min=-986.056602362818 PtS11Min=1 x2S11Min=-0.5 x3S11Min=-0.5 FrameElem=78 ElemStation=0
 Frame=78 Station=6.24999940395358E-02 OutputCase=ACC1 CaseType=Combination P=-169.541047811874
 V2=389.471233920706 V3=0 T=0 M2=0 M3=-160.098930474657 S11Max=791.052535036068 PtS11Max=3 x2S11Max=0.5
 x3S11Max=-0.5
 S11Min=-1130.13463065982 PtS11Min=1 x2S11Min=-0.5 x3S11Min=-0.5 FrameElem=78
 ElemStation=6.24999940395358E-02
 Frame=78 Station=0.124999988079072 OutputCase=ACC1 CaseType=Combination P=-169.541048815736
 V2=399.997482916844 V3=0 T=0 M2=0 M3=-184.76982552303 S11Max=939.077904322447 PtS11Max=3 x2S11Max=0.5
 x3S11Max=-0.5
 S11Min=-1278.16000195392 PtS11Min=1 x2S11Min=-0.5 x3S11Min=-0.5 FrameElem=78
 ElemStation=0.124999988079072
 Frame=78 Station=0.187499982118607 OutputCase=ACC1 CaseType=Combination P=-169.541049819597
 V2=410.523731912983 V3=0 T=0 M2=0 M3=-210.098611070921 S11Max=1091.05061660593 PtS11Max=3 x2S11Max=0.5
 x3S11Max=-0.5
 S11Min=-1430.13271624512 PtS11Min=1 x2S11Min=-0.5 x3S11Min=-0.5 FrameElem=78
 ElemStation=0.187499982118607
 Frame=78 Station=0.249999976158143 OutputCase=ACC1 CaseType=Combination P=-169.541050823459
 V2=421.049980909121 V3=0 T=0 M2=0 M3=-236.085287118329 S11Max=1246.97067188652 PtS11Max=3 x2S11Max=0.5
 x3S11Max=-0.5
 S11Min=-1586.05277353343 PtS11Min=1 x2S11Min=-0.5 x3S11Min=-0.5 FrameElem=78
 ElemStation=0.249999976158143
 Frame=78 Station=0 OutputCase=ACC2 CaseType=Combination P=-115.765281062568 V2=378.944989779014 V3=0
 T=0 M2=0 M3=-121.921615584528 S11Max=615.7644124446 PtS11Max=3 x2S11Max=0.5 x3S11Max=-0.5
 S11Min=-847.294974569735 PtS11Min=1 x2S11Min=-0.5 x3S11Min=-0.5 FrameElem=78 ElemStation=0
 Frame=78 Station=6.24999940395358E-02 OutputCase=ACC2 CaseType=Combination P=-115.765282066429
 V2=389.471238775152 V3=0 T=0 M2=0 M3=-145.934620436787 S11Max=759.842440554293 PtS11Max=3 x2S11Max=0.5
 x3S11Max=-0.5
 S11Min=-991.373004687151 PtS11Min=1 x2S11Min=-0.5 x3S11Min=-0.5 FrameElem=78
 ElemStation=6.24999940395358E-02
 Frame=78 Station=0.124999988079072 OutputCase=ACC2 CaseType=Combination P=-115.765283070291
 V2=399.997487771291 V3=0 T=0 M2=0 M3=-170.605515788563 S11Max=907.867811661089 PtS11Max=3 x2S11Max=0.5
 x3S11Max=-0.5
 S11Min=-1139.39837780167 PtS11Min=1 x2S11Min=-0.5 x3S11Min=-0.5 FrameElem=78
 ElemStation=0.124999988079072
 Frame=78 Station=0.187499982118607 OutputCase=ACC2 CaseType=Combination P=-115.765284074152
 V2=410.523736767429 V3=0 T=0 M2=0 M3=-195.934301639857 S11Max=1059.84052576499 PtS11Max=3 x2S11Max=0.5
 x3S11Max=-0.5
 S11Min=-1291.37109391329 PtS11Min=1 x2S11Min=-0.5 x3S11Min=-0.5 FrameElem=78
 ElemStation=0.187499982118607
 Frame=78 Station=0.249999976158143 OutputCase=ACC2 CaseType=Combination P=-115.765285078013
 V2=421.049985763568 V3=0 T=0 M2=0 M3=-221.920977990668 S11Max=1215.76058286599 PtS11Max=3 x2S11Max=0.5
 x3S11Max=-0.5
 S11Min=-1447.29115302202 PtS11Min=1 x2S11Min=-0.5 x3S11Min=-0.5 FrameElem=78
 ElemStation=0.249999976158143
 Frame=78 Station=0 OutputCase=ACCSX1 CaseType=Combination P=-167.164058926675 V2=368.26406272646 V3=0
 T=0 M2=0 M3=-135.66493898484 S11Max=646.825574982368 PtS11Max=3 x2S11Max=0.5 x3S11Max=-0.5
 S11Min=-981.153692835718 PtS11Min=1 x2S11Min=-0.5 x3S11Min=-0.5 FrameElem=78 ElemStation=0
 Frame=78 Station=6.24999940395358E-02 OutputCase=ACCSX1 CaseType=Combination P=-167.16405989823
 V2=378.451561754904 V3=0 T=0 M2=0 M3=-158.999800024497 S11Max=786.834740248753 PtS11Max=3 x2S11Max=0.5
 -
 x3S11Max=-0.5 S11Min=-1121.16286004521 PtS11Min=1 x2S11Min=-0.5 x3S11Min=-0.5 FrameElem=78
 ElemStation=6.24999940395358E-02
 Frame=78 Station=0.124999988079072 OutputCase=ACCSX1 CaseType=Combination P=-167.164060869786
 V2=388.639060783348 V3=0 T=0 M2=0 M3=-182.97137969271 S11Max=930.664217286471 PtS11Max=3 x2S11Max=0.5
 x3S11Max=-0.5
 S11Min=-1264.99233902604 PtS11Min=1 x2S11Min=-0.5 x3S11Min=-0.5 FrameElem=78
 ElemStation=0.124999988079072
 Frame=78 Station=0.187499982118607 OutputCase=ACCSX1 CaseType=Combination P=-167.164061841342
 V2=398.826559811792 V3=0 T=0 M2=0 M3=-207.579677989477 S11Max=1078.31400609552 PtS11Max=3 x2S11Max=0.5
 x3S11Max=-0.5



S11Min=-1412.64212977821 PtS11Min=1 x2S11Min=-0.5 x3S11Min=-0.5 FrameElem=78
 ElemStation=0.187499982118607
 Frame=78 Station=0.249999976158143 OutputCase=ACCSX1 CaseType=Combination P=-167.164062812898
 V2=409.014058840237 V3=0 T=0 M2=0 M3=-232.824694914801 S11Max=1229.78410667591 PtS11Max=3 x2S11Max=0.5
 x3S11Max=-0.5 _
 S11Min=-1564.1122323017 PtS11Min=1 x2S11Min=-0.5 x3S11Min=-0.5 FrameElem=78
 ElemStation=0.249999976158143
 Frame=78 Station=0 OutputCase=ACCSX2 CaseType=Combination P=-113.38829318123 V2=368.264067580906 V3=0
 T=0 M2=0 M3=-121.500628643568 S11Max=615.615478680176 PtS11Max=3 x2S11Max=0.5 x3S11Max=-0.5 _
 S11Min=-842.392065042635 PtS11Min=1 x2S11Min=-0.5 x3S11Min=-0.5 FrameElem=78 ElemStation=0
 Frame=78 Station=6.24999940395358E-02 OutputCase=ACCSX2 CaseType=Combination P=-113.388294152785
 V2=378.451566609351 V3=0 T=0 M2=0 M3=-144.835489986627 S11Max=755.624645766978 PtS11Max=3 x2S11Max=0.5
 _
 x3S11Max=-0.5 S11Min=-982.401234072549 PtS11Min=1 x2S11Min=-0.5 x3S11Min=-0.5 FrameElem=78
 ElemStation=6.24999940395358E-02
 Frame=78 Station=0.124999988079072 OutputCase=ACCSX2 CaseType=Combination P=-113.388295124341
 V2=388.639065637795 V3=0 T=0 M2=0 M3=-168.807069958242 S11Max=899.454124625113 PtS11Max=3 x2S11Max=0.5
 x3S11Max=-0.5 _
 S11Min=-1126.2307148738 PtS11Min=1 x2S11Min=-0.5 x3S11Min=-0.5 FrameElem=78
 ElemStation=0.124999988079072
 Frame=78 Station=0.187499982118607 OutputCase=ACCSX2 CaseType=Combination P=-113.388296095897
 V2=398.826564666239 V3=0 T=0 M2=0 M3=-193.415368558413 S11Max=1047.10391525458 PtS11Max=3 x2S11Max=0.5
 x3S11Max=-0.5 _
 S11Min=-1273.88050744638 PtS11Min=1 x2S11Min=-0.5 x3S11Min=-0.5 FrameElem=78
 ElemStation=0.187499982118607
 Frame=78 Station=0.249999976158143 OutputCase=ACCSX2 CaseType=Combination P=-113.388297067453
 V2=409.014063694683 V3=0 T=0 M2=0 M3=-218.660385787139 S11Max=1198.57401765538 PtS11Max=3 x2S11Max=0.5
 x3S11Max=-0.5 _
 S11Min=-1425.35061179029 PtS11Min=1 x2S11Min=-0.5 x3S11Min=-0.5 FrameElem=78
 ElemStation=0.249999976158143
 Frame=78 Station=0 OutputCase=ENVE CaseType=Combination StepType=Max P=-111.115495045979
 V2=378.944989779014 V3=0 T=0 M2=0 M3=-117.482264833496 S11Max=646.974508746792 PtS11Max=3 x2S11Max=0.5
 x3S11Max=-0.5 _
 S11Min=-816.009084046956 PtS11Min=1 x2S11Min=-0.5 x3S11Min=-0.5 FrameElem=78 ElemStation=0
 Frame=78 Station=6.24999940395358E-02 OutputCase=ENVE CaseType=Combination StepType=Max P=-
 111.115496017534 V2=389.471238775152 V3=0 T=0 M2=0 M3=-140.722496348787 S11Max=791.052535036068
 PtS11Max=3 x2S11Max=0.5 _
 x3S11Max=-0.5 S11Min=-955.450474110255 PtS11Min=1 x2S11Min=-0.5 x3S11Min=-0.5 FrameElem=78
 ElemStation=6.24999940395358E-02
 Frame=78 Station=0.124999988079072 OutputCase=ENVE CaseType=Combination StepType=Max P=-111.11549698909
 V2=399.997487771291 V3=0 T=0 M2=0 M3=-164.599446492633 S11Max=939.077904322447 PtS11Max=3 x2S11Max=0.5
 _
 x3S11Max=-0.5 S11Min=-1098.71217594489 PtS11Min=1 x2S11Min=-0.5 x3S11Min=-0.5 FrameElem=78
 ElemStation=0.124999988079072
 Frame=78 Station=0.187499982118607 OutputCase=ENVE CaseType=Combination StepType=Max P=-
 111.115497960646 V2=410.523736767429 V3=0 T=0 M2=0 M3=-189.113115265034 S11Max=1091.05061660593
 PtS11Max=3 x2S11Max=0.5 _
 x3S11Max=-0.5 S11Min=-1245.79418955085 PtS11Min=1 x2S11Min=-0.5 x3S11Min=-0.5 FrameElem=78
 ElemStation=0.187499982118607
 Frame=78 Station=0.249999976158143 OutputCase=ENVE CaseType=Combination StepType=Max P=-
 111.115498932202 V2=421.049985763568 V3=0 T=0 M2=0 M3=-214.263502665992 S11Max=1246.97067188652
 PtS11Max=3 x2S11Max=0.5 _
 x3S11Max=-0.5 S11Min=-1396.69651492815 PtS11Min=1 x2S11Min=-0.5 x3S11Min=-0.5 FrameElem=78
 ElemStation=0.249999976158143
 Frame=78 Station=0 OutputCase=ENVE CaseType=Combination StepType=Min P=-169.541046808013
 V2=366.74998533776 V3=0 T=0 M2=0 M3=-136.085925925801 S11Max=593.778093954999 PtS11Max=3 x2S11Max=0.5
 x3S11Max=-0.5 _
 S11Min=-986.056602362818 PtS11Min=1 x2S11Min=-0.5 x3S11Min=-0.5 FrameElem=78 ElemStation=0
 Frame=78 Station=6.24999940395358E-02 OutputCase=ENVE CaseType=Combination StepType=Min P=-
 169.541047811874 V2=376.937484366204 V3=0 T=0 M2=0 M3=-160.098930474657 S11Max=733.219482075186
 PtS11Max=3 x2S11Max=0.5 _
 x3S11Max=-0.5 S11Min=-1130.13463065982 PtS11Min=1 x2S11Min=-0.5 x3S11Min=-0.5 FrameElem=78
 ElemStation=6.24999940395358E-02
 Frame=78 Station=0.124999988079072 OutputCase=ENVE CaseType=Combination StepType=Min P=-
 169.541048815736 V2=387.124983394648 V3=0 T=0 M2=0 M3=-184.76982552303 S11Max=876.481181966707
 PtS11Max=3 x2S11Max=0.5 _
 x3S11Max=-0.5 S11Min=-1278.16000195392 PtS11Min=1 x2S11Min=-0.5 x3S11Min=-0.5 FrameElem=78
 ElemStation=0.124999988079072
 Frame=78 Station=0.187499982118607 OutputCase=ENVE CaseType=Combination StepType=Min P=-
 169.541049819597 V2=397.312482423093 V3=0 T=0 M2=0 M3=-210.098611070921 S11Max=1023.56319362956
 PtS11Max=3 x2S11Max=0.5 _
 x3S11Max=-0.5 S11Min=-1430.13271624512 PtS11Min=1 x2S11Min=-0.5 x3S11Min=-0.5 FrameElem=78
 ElemStation=0.187499982118607
 Frame=78 Station=0.249999976158143 OutputCase=ENVE CaseType=Combination StepType=Min P=-
 169.541050823459 V2=407.499981451537 V3=0 T=0 M2=0 M3=-236.085287118329 S11Max=1174.46551706375
 PtS11Max=3 x2S11Max=0.5 _
 x3S11Max=-0.5 S11Min=-1586.05277353343 PtS11Min=1 x2S11Min=-0.5 x3S11Min=-0.5 FrameElem=78
 ElemStation=0.249999976158143
 Frame=78 Station=0 OutputCase=FESSUR CaseType=Combination P=-168.146111003036 V2=375.286485048525
 V3=0 T=0 M2=0 M3=-134.754120700491 S11Max=640.378613199912 PtS11Max=3 x2S11Max=0.5 x3S11Max=-0.5 _
 S11Min=-976.670835205984 PtS11Min=1 x2S11Min=-0.5 x3S11Min=-0.5 FrameElem=78 ElemStation=0



Frame=78 Station=6.24999940395358E-02 OutputCase=FESSUR CaseType=Combination P=-168.146111997206
 V2=385.711109054355 V3=0 T=0 M2=0 M3=-158.535293248257 S11Max=783.065647492336 PtS11Max=3 x2S11Max=0.5
 -
 x3S11Max=-0.5 S11Min=-1119.35787148675 PtS11Min=1 x2S11Min=-0.5 x3S11Min=-0.5 FrameElem=78
 ElemStation=6.24999940395358E-02
 Frame=78 Station=0.124999988079072 OutputCase=FESSUR CaseType=Combination P=-168.146112991376
 V2=396.135733060185 V3=0 T=0 M2=0 M3=-182.968004734251 S11Max=929.661915414132 PtS11Max=3 x2S11Max=0.5
 x3S11Max=-0.5
 S11Min=-1265.95414139688 PtS11Min=1 x2S11Min=-0.5 x3S11Min=-0.5 FrameElem=78
 ElemStation=0.124999988079072
 Frame=78 Station=0.187499982118607 OutputCase=FESSUR CaseType=Combination P=-168.146113985545
 V2=406.560357066016 V3=0 T=0 M2=0 M3=-208.052255158474 S11Max=1080.1674169653 PtS11Max=3 x2S11Max=0.5
 x3S11Max=-0.5
 S11Min=-1416.45964493639 PtS11Min=1 x2S11Min=-0.5 x3S11Min=-0.5 FrameElem=78
 ElemStation=0.187499982118607
 Frame=78 Station=0.249999976158143 OutputCase=FESSUR CaseType=Combination P=-168.146114979715
 V2=416.984981071846 V3=0 T=0 M2=0 M3=-233.788044520926 S11Max=1234.58215214584 PtS11Max=3 x2S11Max=0.5
 x3S11Max=-0.5
 S11Min=-1570.87438210527 PtS11Min=1 x2S11Min=-0.5 x3S11Min=-0.5 FrameElem=78
 ElemStation=0.249999976158143
 Frame=112 Station=0 OutputCase=PERM1 CaseType=Combination P=-164.891225815415 V2=-325.99999893672
 V3=0 T=0 M2=0 M3=-45.0528206560384 S11Max=105.425698120815 PtS11Max=3 x2S11Max=0.5 x3S11Max=-0.5
 S11Min=-435.208149751646 PtS11Min=1 x2S11Min=-0.5 x3S11Min=-0.5 FrameElem=112 ElemStation=0
 Frame=112 Station=0.125 OutputCase=PERM1 CaseType=Combination P=-164.891225815415 V2=-305.62499893672
 V3=0 T=0 M2=0 M3=-5.57625828894842 S11Max=-131.433676081725 PtS11Max=3 x2S11Max=0.5 x3S11Max=-0.5
 S11Min=-198.348775549106 PtS11Min=1 x2S11Min=-0.5 x3S11Min=-0.5 FrameElem=112 ElemStation=0.125
 Frame=112 Station=0.25 OutputCase=PERM1 CaseType=Combination P=-164.891225815415 V2=-285.24999893672
 V3=0 T=0 M2=0 M3=31.3534290781416 S11Max=23.2293486534343 PtS11Max=1 x2S11Max=-0.5 x3S11Max=-0.5
 S11Min=-353.011800284265 PtS11Min=3 x2S11Min=0.5 x3S11Min=-0.5 FrameElem=112 ElemStation=0.25
 Frame=112 Station=0.375 OutputCase=PERM1 CaseType=Combination P=-164.891225815415 V2=-264.87499893672
 V3=0 T=0 M2=0 M3=65.7362414452316 S11Max=229.526222855974 PtS11Max=1 x2S11Max=-0.5 x3S11Max=-0.5
 S11Min=-559.308674486805 PtS11Min=3 x2S11Min=0.5 x3S11Min=-0.5 FrameElem=112 ElemStation=0.375
 Frame=112 Station=0.5 OutputCase=PERM1 CaseType=Combination P=-164.891225815415 V2=-244.49999893672
 V3=0 T=0 M2=0 M3=97.5721788123216 S11Max=420.541847058514 PtS11Max=1 x2S11Max=-0.5 x3S11Max=-0.5
 S11Min=-750.324298689344 PtS11Min=3 x2S11Min=0.5 x3S11Min=-0.5 FrameElem=112 ElemStation=0.5
 Frame=112 Station=0.75 OutputCase=PERM2 CaseType=Combination P=-111.11546006997 V2=-325.99999921073 V3=0
 T=0 M2=0 M3=-30.8885114793079 S11Max=74.2156088058775 PtS11Max=3 x2S11Max=0.5 x3S11Max=-0.5
 S11Min=-296.446528945817 PtS11Min=1 x2S11Min=-0.5 x3S11Min=-0.5 FrameElem=112 ElemStation=0
 Frame=112 Station=0.125 OutputCase=PERM2 CaseType=Combination P=-111.11546006997 V2=-305.62499921073
 V3=0 T=0 M2=0 M3=8.58805092203333 S11Max=-59.5871545377699 PtS11Max=1 x2S11Max=-0.5 x3S11Max=-0.5
 S11Min=-162.64376560217 PtS11Min=3 x2S11Min=0.5 x3S11Min=-0.5 FrameElem=112 ElemStation=0.125
 Frame=112 Station=0.25 OutputCase=PERM2 CaseType=Combination P=-111.11546006997 V2=-285.24999921073
 V3=0 T=0 M2=0 M3=45.5177383233746 S11Max=161.990969870277 PtS11Max=1 x2S11Max=-0.5 x3S11Max=-0.5
 S11Min=-384.221890010217 PtS11Min=3 x2S11Min=0.5 x3S11Min=-0.5 FrameElem=112 ElemStation=0.25
 Frame=112 Station=0.375 OutputCase=PERM2 CaseType=Combination P=-111.11546006997 V2=-264.87499921073
 V3=0 T=0 M2=0 M3=79.9005507247158 S11Max=368.287844278325 PtS11Max=1 x2S11Max=-0.5 x3S11Max=-0.5
 S11Min=-590.518764418265 PtS11Min=3 x2S11Min=0.5 x3S11Min=-0.5 FrameElem=112 ElemStation=0.375
 Frame=112 Station=0.5 OutputCase=PERM2 CaseType=Combination P=-111.11546006997 V2=-244.49999921073
 V3=0 T=0 M2=0 M3=111.736488126057 S11Max=559.303468686372 PtS11Max=1 x2S11Max=-0.5 x3S11Max=-0.5
 S11Min=-781.534388826312 PtS11Min=3 x2S11Min=0.5 x3S11Min=-0.5 FrameElem=112 ElemStation=0.5
 Frame=112 Station=0.75 OutputCase=ACC1 CaseType=Combination P=-169.541010668994 V2=-336.83999890647 V3=0
 T=0 M2=0 M3=-46.6127962785127 S11Max=110.135767002082 PtS11Max=3 x2S11Max=0.5 x3S11Max=-0.5
 S11Min=-449.217788340071 PtS11Min=1 x2S11Min=-0.5 x3S11Min=-0.5 FrameElem=112 ElemStation=0
 Frame=112 Station=0.125 OutputCase=ACC1 CaseType=Combination P=-169.541010668994 V2=-315.78749890647
 V3=0 T=0 M2=0 M3=-5.8235776652039 S11Max=-134.599544677771 PtS11Max=3 x2S11Max=0.5 x3S11Max=-0.5
 S11Min=-204.482476660218 PtS11Min=1 x2S11Min=-0.5 x3S11Min=-0.5 FrameElem=112 ElemStation=0.125
 Frame=112 Station=0.25 OutputCase=ACC1 CaseType=Combination P=-169.541010668994 V2=-294.73499890647
 V3=0 T=0 M2=0 M3=32.3340784481049 S11Max=24.4634600196349 PtS11Max=1 x2S11Max=-0.5 x3S11Max=-0.5
 S11Min=-363.545481357624 PtS11Min=3 x2S11Min=0.5 x3S11Min=-0.5 FrameElem=112 ElemStation=0.25
 Frame=112 Station=0.375 OutputCase=ACC1 CaseType=Combination P=-169.541010668994 V2=-273.68249890647
 V3=0 T=0 M2=0 M3=67.8601720614137 S11Max=237.620021699488 PtS11Max=1 x2S11Max=-0.5 x3S11Max=-0.5
 S11Min=-576.702043037477 PtS11Min=3 x2S11Min=0.5 x3S11Min=-0.5 FrameElem=112 ElemStation=0.375
 Frame=112 Station=0.5 OutputCase=ACC1 CaseType=Combination P=-169.541010668994 V2=-252.62999890647
 V3=0 T=0 M2=0 M3=100.754703174722 S11Max=434.98720837934 PtS11Max=1 x2S11Max=-0.5 x3S11Max=-0.5
 S11Min=-774.069229717329 PtS11Min=3 x2S11Min=0.5 x3S11Min=-0.5 FrameElem=112 ElemStation=0.5
 Frame=112 Station=0.75 OutputCase=ACC2 CaseType=Combination P=-115.765244923549 V2=-336.83999918048 V3=0
 T=0 M2=0 M3=-32.4484871017822 S11Max=78.9256776871438 PtS11Max=3 x2S11Max=0.5 x3S11Max=-0.5
 S11Min=-310.456167534242 PtS11Min=1 x2S11Min=-0.5 x3S11Min=-0.5 FrameElem=112 ElemStation=0
 Frame=112 Station=0.125 OutputCase=ACC2 CaseType=Combination P=-115.765244923549 V2=-315.78749918048
 V3=0 T=0 M2=0 M3=8.34073154577785 S11Max=-65.7208556488822 PtS11Max=1 x2S11Max=-0.5 x3S11Max=-0.5
 S11Min=-165.809634198216 PtS11Min=3 x2S11Min=0.5 x3S11Min=-0.5 FrameElem=112 ElemStation=0.125
 Frame=112 Station=0.25 OutputCase=ACC2 CaseType=Combination P=-115.765244923549 V2=-294.73499918048
 V3=0 T=0 M2=0 M3=46.4983876933379 S11Max=163.225081236478 PtS11Max=1 x2S11Max=-0.5 x3S11Max=-0.5
 S11Min=-394.755571083577 PtS11Min=3 x2S11Min=0.5 x3S11Min=-0.5 FrameElem=112 ElemStation=0.25
 Frame=112 Station=0.375 OutputCase=ACC2 CaseType=Combination P=-115.765244923549 V2=-273.68249918048
 V3=0 T=0 M2=0 M3=82.0244813408979 S11Max=376.381643121838 PtS11Max=1 x2S11Max=-0.5 x3S11Max=-0.5
 S11Min=-607.912132968937 PtS11Min=3 x2S11Min=0.5 x3S11Min=-0.5 FrameElem=112 ElemStation=0.375
 Frame=112 Station=0.5 OutputCase=ACC2 CaseType=Combination P=-115.765244923549 V2=-252.62999918048
 V3=0 T=0 M2=0 M3=114.919012488458 S11Max=573.748830007198 PtS11Max=1 x2S11Max=-0.5 x3S11Max=-0.5
 S11Min=-805.279319854297 PtS11Min=3 x2S11Min=0.5 x3S11Min=-0.5 FrameElem=112 ElemStation=0.5
 Frame=112 Station=0 OutputCase=ACCSX1 CaseType=Combination P=-167.164023806267 V2=-324.485921331269
 V3=0 T=0 M2=0 M3=-42.6363546429427 S11Max=88.6541040513889 PtS11Max=3 x2S11Max=0.5 x3S11Max=-0.5



S11Min=-422.982151663924 PtS11Min=1 x2S11Min=-0.5 x3S11Min=-0.5 FrameElem=112 ElemStation=0
 Frame=112 Station=0.125 OutputCase=ACCSX1 CaseType=Combination P=-167.164023806267 V2=-304.110921331269
 V3=0 T=0 M2=0 M3=-3.34905197653407 S11Max=-147.069711947063 PtS11Max=3 x2S11Max=0.5 x3S11Max=-0.5
 S11Min=-187.258335665472 PtS11Min=1 x2S11Min=-0.5 x3S11Min=-0.5 FrameElem=112 ElemStation=0.125
 Frame=112 Station=0.25 OutputCase=ACCSX1 CaseType=Combination P=-167.164023806267 V2=-283.735921331269
 V3=0 T=0 M2=0 M3=33.3913756898746 S11Max=33.18423033298 PtS11Max=1 x2S11Max=-0.5 x3S11Max=-0.5
 S11Min=-367.512277945515 PtS11Min=3 x2S11Min=0.5 x3S11Min=-0.5 FrameElem=112 ElemStation=0.25
 Frame=112 Station=0.375 OutputCase=ACCSX1 CaseType=Combination P=-167.164023806267 V2=-263.360921331269
 V3=0 T=0 M2=0 M3=67.5849283562832 S11Max=238.345546331432 PtS11Max=1 x2S11Max=-0.5 x3S11Max=-0.5
 S11Min=-572.673593943967 PtS11Min=3 x2S11Min=0.5 x3S11Min=-0.5 FrameElem=112 ElemStation=0.375
 Frame=112 Station=0.5 OutputCase=ACCSX1 CaseType=Combination P=-167.164023806267 V2=-242.985921331269
 V3=0 T=0 M2=0 M3=99.2316060226918 S11Max=428.225612329884 PtS11Max=1 x2S11Max=-0.5 x3S11Max=-0.5
 S11Min=-762.553659942418 PtS11Min=3 x2S11Min=0.5 x3S11Min=-0.5 FrameElem=112 ElemStation=0.5
 Frame=112 Station=0 OutputCase=ACCSX2 CaseType=Combination P=-113.388258060822 V2=-324.485921605279
 V3=0 T=0 M2=0 M3=-28.4720454662122 S11Max=57.444014736451 PtS11Max=3 x2S11Max=0.5 x3S11Max=-0.5
 S11Min=-284.220530858095 PtS11Min=1 x2S11Min=0.5 x3S11Min=-0.5 FrameElem=112 ElemStation=0
 Frame=112 Station=0.125 OutputCase=ACCSX2 CaseType=Combination P=-113.388258060822 V2=-304.110921605279
 V3=0 T=0 M2=0 M3=10.8152572344477 S11Max=-48.4967146541361 PtS11Max=1 x2S11Max=-0.5 x3S11Max=-0.5
 S11Min=-178.279801467508 PtS11Min=3 x2S11Min=0.5 x3S11Min=-0.5 FrameElem=112 ElemStation=0.125
 Frame=112 Station=0.25 OutputCase=ACCSX2 CaseType=Combination P=-113.388258060822 V2=-283.735921605279
 V3=0 T=0 M2=0 M3=47.5556849351075 S11Max=171.945851549823 PtS11Max=1 x2S11Max=-0.5 x3S11Max=-0.5
 S11Min=-398.722367671468 PtS11Min=3 x2S11Min=0.5 x3S11Min=-0.5 FrameElem=112 ElemStation=0.25
 Frame=112 Station=0.375 OutputCase=ACCSX2 CaseType=Combination P=-113.388258060822 V2=-263.360921605279
 V3=0 T=0 M2=0 M3=81.7492376357674 S11Max=377.107167753782 PtS11Max=1 x2S11Max=-0.5 x3S11Max=-0.5
 S11Min=-603.883683875427 PtS11Min=3 x2S11Min=0.5 x3S11Min=-0.5 FrameElem=112 ElemStation=0.375
 Frame=112 Station=0.5 OutputCase=ACCSX2 CaseType=Combination P=-113.388258060822 V2=-242.985921605279
 V3=0 T=0 M2=0 M3=113.395915336427 S11Max=566.987233957741 PtS11Max=1 x2S11Max=-0.5 x3S11Max=-0.5
 S11Min=-793.763750079386 PtS11Min=3 x2S11Min=0.5 x3S11Min=-0.5 FrameElem=112 ElemStation=0.5
 Frame=112 Station=0 OutputCase=ENVE CaseType=Combination StepType=Max P=-111.11546006997 V2=-
 324.485921331269 V3=0 T=0 M2=0 M3=-28.4720454662122 S11Max=110.135767002082 PtS11Max=3 x2S11Max=0.5
 x3S11Max=-0.5
 S11Min=-284.220530858095 PtS11Min=1 x2S11Min=-0.5 x3S11Min=-0.5 FrameElem=112 ElemStation=0
 Frame=112 Station=0.125 OutputCase=ENVE CaseType=Combination StepType=Max P=-111.11546006997 V2=-
 304.110921331269 V3=0 T=0 M2=0 M3=10.8152572344477 S11Max=-48.4967146541361 PtS11Max=1 x2S11Max=-0.5
 x3S11Max=-0.5 S11Min=-131.433676081725 PtS11Min=3 x2S11Min=0.5 x3S11Min=-0.5 FrameElem=112
 ElemStation=0.125
 Frame=112 Station=0.25 OutputCase=ENVE CaseType=Combination StepType=Max P=-111.11546006997 V2=-
 283.735921331269 V3=0 T=0 M2=0 M3=47.5556849351075 S11Max=171.945851549823 PtS11Max=1 x2S11Max=-0.5
 x3S11Max=-0.5
 S11Min=-353.011800284265 PtS11Min=3 x2S11Min=0.5 x3S11Min=-0.5 FrameElem=112 ElemStation=0.25
 Frame=112 Station=0.375 OutputCase=ENVE CaseType=Combination StepType=Max P=-111.11546006997 V2=-
 263.360921331269 V3=0 T=0 M2=0 M3=82.0244813408979 S11Max=377.107167753782 PtS11Max=1 x2S11Max=-0.5
 x3S11Max=-0.5 S11Min=-559.308674486805 PtS11Min=3 x2S11Min=0.5 x3S11Min=-0.5 FrameElem=112
 ElemStation=0.375
 Frame=112 Station=0.5 OutputCase=ENVE CaseType=Combination StepType=Max P=-111.11546006997 V2=-
 242.985921331269 V3=0 T=0 M2=0 M3=114.919012488458 S11Max=573.748830007198 PtS11Max=1 x2S11Max=-0.5
 x3S11Max=-0.5
 S11Min=-750.324298689344 PtS11Min=3 x2S11Min=0.5 x3S11Min=-0.5 FrameElem=112 ElemStation=0.5
 Frame=112 Station=0 OutputCase=ENVE CaseType=Combination StepType=Min P=-169.541010668994 V2=-
 336.83999918048 V3=0 T=0 M2=0 M3=-46.6127962785127 S11Max=57.444014736451 PtS11Max=3 x2S11Max=0.5
 x3S11Max=-0.5
 S11Min=-449.217788340071 PtS11Min=1 x2S11Min=-0.5 x3S11Min=-0.5 FrameElem=112 ElemStation=0
 Frame=112 Station=0.125 OutputCase=ENVE CaseType=Combination StepType=Min P=-169.541010668994 V2=-
 315.78749918048 V3=0 T=0 M2=0 M3=-5.8235776652039 S11Max=-169.541010668994 PtS11Max=0 x2S11Max=0
 x3S11Max=0
 S11Min=-204.482476660218 PtS11Min=1 x2S11Min=-0.5 x3S11Min=-0.5 FrameElem=112 ElemStation=0.125
 Frame=112 Station=0.25 OutputCase=ENVE CaseType=Combination StepType=Min P=-169.541010668994 V2=-
 294.73499918048 V3=0 T=0 M2=0 M3=31.3534290781416 S11Max=23.2293486534343 PtS11Max=1 x2S11Max=-0.5
 x3S11Max=-0.5
 S11Min=-398.722367671468 PtS11Min=3 x2S11Min=0.5 x3S11Min=-0.5 FrameElem=112 ElemStation=0.25
 Frame=112 Station=0.375 OutputCase=ENVE CaseType=Combination StepType=Min P=-169.541010668994 V2=-
 273.68249918048 V3=0 T=0 M2=0 M3=65.7362414452316 S11Max=229.526222855974 PtS11Max=1 x2S11Max=-0.5
 x3S11Max=-0.5 S11Min=-607.912132968937 PtS11Min=3 x2S11Min=0.5 x3S11Min=-0.5 FrameElem=112
 ElemStation=0.375
 Frame=112 Station=0.5 OutputCase=ENVE CaseType=Combination StepType=Min P=-169.541010668994 V2=-
 252.62999918048 V3=0 T=0 M2=0 M3=97.5721788123216 S11Max=420.541847058514 PtS11Max=1 x2S11Max=-0.5
 x3S11Max=-0.5
 S11Min=-805.279319854297 PtS11Min=3 x2S11Min=0.5 x3S11Min=-0.5 FrameElem=112 ElemStation=0.5
 Frame=112 Station=0 OutputCase=FESSUR CaseType=Combination P=-168.146075212921 V2=-333.587998915545
 V3=0 T=0 M2=0 M3=-46.1448035917704 S11Max=108.722746337702 PtS11Max=3 x2S11Max=0.5 x3S11Max=-0.5
 S11Min=-445.014896763543 PtS11Min=1 x2S11Min=-0.5 x3S11Min=-0.5 FrameElem=112 ElemStation=0
 Frame=112 Station=0.125 OutputCase=FESSUR CaseType=Combination P=-168.146075212921 V2=-312.738748915545
 V3=0 T=0 M2=0 M3=-5.74938185232726 S11Max=-133.649784098957 PtS11Max=3 x2S11Max=0.5 x3S11Max=-0.5
 S11Min=-202.642366326884 PtS11Min=1 x2S11Min=-0.5 x3S11Min=-0.5 FrameElem=112 ElemStation=0.125
 Frame=112 Station=0.25 OutputCase=FESSUR CaseType=Combination P=-168.146075212921 V2=-291.889498915545
 V3=0 T=0 M2=0 M3=32.0398836371159 S11Max=24.0932266097747 PtS11Max=1 x2S11Max=-0.5 x3S11Max=-0.5
 S11Min=-360.385377035616 PtS11Min=3 x2S11Min=0.5 x3S11Min=-0.5 FrameElem=112 ElemStation=0.25
 Frame=112 Station=0.375 OutputCase=FESSUR CaseType=Combination P=-168.146075212921 V2=-271.040248915545
 V3=0 T=0 M2=0 M3=67.222992876559 S11Max=235.191882046434 PtS11Max=1 x2S11Max=-0.5 x3S11Max=-0.5
 S11Min=-571.484032472275 PtS11Min=3 x2S11Min=0.5 x3S11Min=-0.5 FrameElem=112 ElemStation=0.375
 Frame=112 Station=0.5 OutputCase=FESSUR CaseType=Combination P=-168.146075212921 V2=-250.190998915545
 V3=0 T=0 M2=0 M3=99.7999458660022 S11Max=430.653599983093 PtS11Max=1 x2S11Max=-0.5 x3S11Max=-0.5

S11Min=-766.945750408934 PtS11Min=3 x2S11Min=0.5 x3S11Min=-0.5 FrameElem=112 ElemStation=0.5
 Frame=113 Station=0 OutputCase=PERM1 CaseType=Combination P=-164.891225815415 V2=-244.499998936763
 V3=0 T=0 M2=0 M3=97.5721788123215 S11Max=420.541847058514 PtS11Max=1 x2S11Max=-0.5 x3S11Max=-0.5 _
 S11Min=-750.324298689344 PtS11Min=3 x2S11Min=0.5 x3S11Min=-0.5 FrameElem=113 ElemStation=0
 Frame=113 Station=0.125 OutputCase=PERM1 CaseType=Combination P=-164.891225815415 V2=-224.124998936763
 V3=0 T=0 M2=0 M3=126.861241179417 S11Max=596.276221261086 PtS11Max=1 x2S11Max=-0.5 x3S11Max=-0.5 _
 S11Min=-926.058672891916 PtS11Min=3 x2S11Min=0.5 x3S11Min=-0.5 FrameElem=113 ElemStation=0
 Frame=113 Station=0.25 OutputCase=PERM1 CaseType=Combination P=-164.891225815415 V2=-203.749998936763
 V3=0 T=0 M2=0 M3=153.603428546512 S11Max=756.729345463659 PtS11Max=1 x2S11Max=-0.5 x3S11Max=-0.5 _
 S11Min=-1086.51179709449 PtS11Min=3 x2S11Min=0.5 x3S11Min=-0.5 FrameElem=113 ElemStation=0
 Frame=113 Station=0.375 OutputCase=PERM1 CaseType=Combination P=-164.891225815415 V2=-183.374998936763
 V3=0 T=0 M2=0 M3=177.798740913608 S11Max=901.901219666231 PtS11Max=1 x2S11Max=-0.5 x3S11Max=-0.5 _
 S11Min=-1231.68367129706 PtS11Min=3 x2S11Min=0.5 x3S11Min=-0.5 FrameElem=113 ElemStation=0.375
 Frame=113 Station=0.5 OutputCase=PERM1 CaseType=Combination P=-164.891225815415 V2=-162.999998936763
 V3=0 T=0 M2=0 M3=199.447178280703 S11Max=1031.7918438688 PtS11Max=1 x2S11Max=-0.5 x3S11Max=-0.5 _
 S11Min=-1361.57429549963 PtS11Min=3 x2S11Min=0.5 x3S11Min=-0.5 FrameElem=113 ElemStation=0.5
 Frame=113 Station=0 OutputCase=PERM2 CaseType=Combination P=-111.11546006997 V2=-244.49999210773
 V3=0 T=0 M2=0 M3=111.736488126057 S11Max=559.303468686372 PtS11Max=1 x2S11Max=-0.5 x3S11Max=-0.5 _
 S11Min=-781.534388826311 PtS11Min=3 x2S11Min=0.5 x3S11Min=-0.5 FrameElem=113 ElemStation=0
 Frame=113 Station=0.125 OutputCase=PERM2 CaseType=Combination P=-111.11546006997 V2=-224.124999210773
 V3=0 T=0 M2=0 M3=141.025550527404 S11Max=735.037843094452 PtS11Max=1 x2S11Max=-0.5 x3S11Max=-0.5 _
 S11Min=-957.268763234391 PtS11Min=3 x2S11Min=0.5 x3S11Min=-0.5 FrameElem=113 ElemStation=0.125
 Frame=113 Station=0.25 OutputCase=PERM2 CaseType=Combination P=-111.11546006997 V2=-203.749999210773
 V3=0 T=0 M2=0 M3=167.76773792875 S11Max=895.490967502532 PtS11Max=1 x2S11Max=-0.5 x3S11Max=-0.5 _
 S11Min=-1117.72188764247 PtS11Min=3 x2S11Min=0.5 x3S11Min=-0.5 FrameElem=113 ElemStation=0.25
 Frame=113 Station=0.375 OutputCase=PERM2 CaseType=Combination P=-111.11546006997 V2=-183.374999210773
 V3=0 T=0 M2=0 M3=191.963050330097 S11Max=1040.66284191061 PtS11Max=1 x2S11Max=-0.5 x3S11Max=-0.5 _
 S11Min=-1262.89376205055 PtS11Min=3 x2S11Min=0.5 x3S11Min=-0.5 FrameElem=113 ElemStation=0.375
 Frame=113 Station=0.5 OutputCase=PERM2 CaseType=Combination P=-111.11546006997 V2=-162.999999210773
 V3=0 T=0 M2=0 M3=213.611487731444 S11Max=1170.55346631869 PtS11Max=1 x2S11Max=-0.5 x3S11Max=-0.5 _
 S11Min=-1392.78438645863 PtS11Min=3 x2S11Min=0.5 x3S11Min=-0.5 FrameElem=113 ElemStation=0.5
 Frame=113 Station=0 OutputCase=ACC1 CaseType=Combination P=-169.541010669002 V2=-252.629998906513
 V3=0 T=0 M2=0 M3=100.754703174723 S11Max=434.987208379336 PtS11Max=1 x2S11Max=-0.5 x3S11Max=-0.5 _
 S11Min=-774.06922971734 PtS11Min=3 x2S11Min=0.5 x3S11Min=-0.5 FrameElem=113 ElemStation=0
 Frame=113 Station=0.125 OutputCase=ACC1 CaseType=Combination P=-169.541010669002 V2=-231.577498906513
 V3=0 T=0 M2=0 M3=131.017671788037 S11Max=616.565020059221 PtS11Max=1 x2S11Max=-0.5 x3S11Max=-0.5 _
 S11Min=-955.647041397224 PtS11Min=3 x2S11Min=0.5 x3S11Min=-0.5 FrameElem=113 ElemStation=0.125
 Frame=113 Station=0.25 OutputCase=ACC1 CaseType=Combination P=-169.541010669002 V2=-210.524998906513
 V3=0 T=0 M2=0 M3=158.649077901351 S11Max=782.353456739105 PtS11Max=1 x2S11Max=-0.5 x3S11Max=-0.5 _
 S11Min=-1121.43547807711 PtS11Min=3 x2S11Min=0.5 x3S11Min=-0.5 FrameElem=113 ElemStation=0.25
 Frame=113 Station=0.375 OutputCase=ACC1 CaseType=Combination P=-169.541010669002 V2=-189.472498906513
 V3=0 T=0 M2=0 M3=183.648921514665 S11Max=932.35251841899 PtS11Max=1 x2S11Max=-0.5 x3S11Max=-0.5 _
 S11Min=-1271.43453975699 PtS11Min=3 x2S11Min=0.5 x3S11Min=-0.5 FrameElem=113 ElemStation=0.375
 Frame=113 Station=0.5 OutputCase=ACC1 CaseType=Combination P=-169.541010669002 V2=-168.419998906513
 V3=0 T=0 M2=0 M3=206.017202627979 S11Max=1066.56220509887 PtS11Max=1 x2S11Max=-0.5 x3S11Max=-0.5 _
 S11Min=-1405.64422643688 PtS11Min=3 x2S11Min=0.5 x3S11Min=-0.5 FrameElem=113 ElemStation=0.5
 Frame=113 Station=0 OutputCase=ACC2 CaseType=Combination P=-115.765244923557 V2=-252.629999180523
 V3=0 T=0 M2=0 M3=114.919012488459 S11Max=573.748830007195 PtS11Max=1 x2S11Max=-0.5 x3S11Max=-0.5 _
 S11Min=-805.279319854308 PtS11Min=3 x2S11Min=0.5 x3S11Min=-0.5 FrameElem=113 ElemStation=0
 Frame=113 Station=0.125 OutputCase=ACC2 CaseType=Combination P=-115.765244923557 V2=-231.577499180522
 V3=0 T=0 M2=0 M3=145.181981136024 S11Max=755.326641892587 PtS11Max=1 x2S11Max=-0.5 x3S11Max=-0.5 _
 S11Min=-986.8571317397 PtS11Min=3 x2S11Min=0.5 x3S11Min=-0.5 FrameElem=113 ElemStation=0.125
 Frame=113 Station=0.25 OutputCase=ACC2 CaseType=Combination P=-115.765244923557 V2=-210.524999180523
 V3=0 T=0 M2=0 M3=172.813387283589 S11Max=921.115078777978 PtS11Max=1 x2S11Max=-0.5 x3S11Max=-0.5 _
 S11Min=-1152.64556862509 PtS11Min=3 x2S11Min=0.5 x3S11Min=-0.5 FrameElem=113 ElemStation=0.25
 Frame=113 Station=0.375 OutputCase=ACC2 CaseType=Combination P=-115.765244923557 V2=-189.472499180523
 V3=0 T=0 M2=0 M3=197.813230931154 S11Max=1071.11414066337 PtS11Max=1 x2S11Max=-0.5 x3S11Max=-0.5 _
 S11Min=-1302.64463051048 PtS11Min=3 x2S11Min=0.5 x3S11Min=-0.5 FrameElem=113 ElemStation=0.375
 Frame=113 Station=0.5 OutputCase=ACC2 CaseType=Combination P=-115.765244923557 V2=-168.419999180522
 V3=0 T=0 M2=0 M3=220.18151207872 S11Max=1205.32382754876 PtS11Max=1 x2S11Max=-0.5 x3S11Max=-0.5 _
 S11Min=-1436.85431739588 PtS11Min=3 x2S11Min=0.5 x3S11Min=-0.5 FrameElem=113 ElemStation=0.5
 Frame=113 Station=0 OutputCase=ACCSX1 CaseType=Combination P=-167.164023806271 V2=-242.985921331312
 V3=0 T=0 M2=0 M3=99.2316060226917 S11Max=428.225612329879 PtS11Max=1 x2S11Max=-0.5 x3S11Max=-0.5 _
 S11Min=-762.553659942421 PtS11Min=3 x2S11Min=0.5 x3S11Min=-0.5 FrameElem=113 ElemStation=0
 Frame=113 Station=0.125 OutputCase=ACCSX1 CaseType=Combination P=-167.164023806271 V2=-222.610921331312
 V3=0 T=0 M2=0 M3=128.331408689106 S11Max=602.824428328363 PtS11Max=1 x2S11Max=-0.5 x3S11Max=-0.5 _
 S11Min=-937.152475940905 PtS11Min=3 x2S11Min=0.5 x3S11Min=-0.5 FrameElem=113 ElemStation=0.125
 Frame=113 Station=0.25 OutputCase=ACCSX1 CaseType=Combination P=-167.164023806271 V2=-202.235921331312
 V3=0 T=0 M2=0 M3=154.88433635552 S11Max=762.141994326846 PtS11Max=1 x2S11Max=-0.5 x3S11Max=-0.5 _
 S11Min=-1096.47004193939 PtS11Min=3 x2S11Min=0.5 x3S11Min=-0.5 FrameElem=113 ElemStation=0.25
 Frame=113 Station=0.375 OutputCase=ACCSX1 CaseType=Combination P=-167.164023806271 V2=-181.860921331312
 V3=0 T=0 M2=0 M3=178.890389021934 S11Max=906.17831032533 PtS11Max=1 x2S11Max=-0.5 x3S11Max=-0.5 _
 S11Min=-1240.50635793787 PtS11Min=3 x2S11Min=0.5 x3S11Min=-0.5 FrameElem=113 ElemStation=0.375
 Frame=113 Station=0.5 OutputCase=ACCSX1 CaseType=Combination P=-167.164023806271 V2=-161.485921331312
 V3=0 T=0 M2=0 M3=200.349566688347 S11Max=1034.93337632381 PtS11Max=1 x2S11Max=-0.5 x3S11Max=-0.5 _
 S11Min=-1369.26142393636 PtS11Min=3 x2S11Min=0.5 x3S11Min=-0.5 FrameElem=113 ElemStation=0.5
 Frame=113 Station=0 OutputCase=ACCSX2 CaseType=Combination P=-113.388258060826 V2=-242.985921605322
 V3=0 T=0 M2=0 M3=113.395915336427 S11Max=566.987233957737 PtS11Max=1 x2S11Max=-0.5 x3S11Max=-0.5 _
 S11Min=-793.763750079389 PtS11Min=3 x2S11Min=0.5 x3S11Min=-0.5 FrameElem=113 ElemStation=0
 Frame=113 Station=0.125 OutputCase=ACCSX2 CaseType=Combination P=-113.388258060826 V2=-222.610921605322
 V3=0 T=0 M2=0 M3=142.495718037092 S11Max=741.586050161728 PtS11Max=1 x2S11Max=-0.5 x3S11Max=-0.5 _
 S11Min=-968.36256628338 PtS11Min=3 x2S11Min=0.5 x3S11Min=-0.5 FrameElem=113 ElemStation=0.125



Frame=113 Station=0.25 OutputCase=ACCSX2 CaseType=Combination P=-113.388258060826 V2=-202.235921605322
 V3=0 T=0 M2=0 M3=169.048645737758 S11Max=900.903616365719 PtS11Max=1 x2S11Max=-0.5 x3S11Max=-0.5 _
 S11Min=-1127.68013248737 PtS11Min=3 x2S11Min=0.5 x3S11Min=-0.5 FrameElem=113 ElemStation=0.25
 Frame=113 Station=0.375 OutputCase=ACCSX2 CaseType=Combination P=-113.388258060826 V2=-181.860921605322
 V3=0 T=0 M2=0 M3=193.054698438423 S11Max=1044.93993256971 PtS11Max=1 x2S11Max=-0.5 x3S11Max=-0.5 _
 S11Min=-1271.71644869136 PtS11Min=3 x2S11Min=0.5 x3S11Min=-0.5 FrameElem=113 ElemStation=0.375
 Frame=113 Station=0.5 OutputCase=ACCSX2 CaseType=Combination P=-113.388258060826 V2=-161.485921605322
 V3=0 T=0 M2=0 M3=214.513876139088 S11Max=1173.6949987737 PtS11Max=1 x2S11Max=-0.5 x3S11Max=-0.5 _
 S11Min=-1400.47151489535 PtS11Min=3 x2S11Min=0.5 x3S11Min=-0.5 FrameElem=113 ElemStation=0.5
 Frame=113 Station=0 OutputCase=ENVE CaseType=Combination StepType=Max P=-111.11546006997 V2=-
 242.985921331312 V3=0 T=0 M2=0 M3=114.919012488459 S11Max=573.748830007195 PtS11Max=1 x2S11Max=-0.5
 x3S11Max=-0.5 _
 S11Min=-750.324298689344 PtS11Min=3 x2S11Min=0.5 x3S11Min=-0.5 FrameElem=113 ElemStation=0
 Frame=113 Station=0.125 OutputCase=ENVE CaseType=Combination StepType=Max P=-111.11546006997 V2=-
 222.610921331312 V3=0 T=0 M2=0 M3=145.181981136024 S11Max=755.326641892587 PtS11Max=1 x2S11Max=-0.5 _
 x3S11Max=-0.5 S11Min=-926.058672891916 PtS11Min=3 x2S11Min=0.5 x3S11Min=-0.5 FrameElem=113
 ElemStation=0.125
 Frame=113 Station=0.25 OutputCase=ENVE CaseType=Combination StepType=Max P=-111.11546006997 V2=-
 202.235921331312 V3=0 T=0 M2=0 M3=172.813387283589 S11Max=921.115078777978 PtS11Max=1 x2S11Max=-0.5
 x3S11Max=-0.5 _
 S11Min=-1086.51179709449 PtS11Min=3 x2S11Min=0.5 x3S11Min=-0.5 FrameElem=113 ElemStation=0.25
 Frame=113 Station=0.375 OutputCase=ENVE CaseType=Combination StepType=Max P=-111.11546006997 V2=-
 181.860921331312 V3=0 T=0 M2=0 M3=197.813230931154 S11Max=1071.11414066337 PtS11Max=1 x2S11Max=-0.5 _
 x3S11Max=-0.5 S11Min=-1231.68367129706 PtS11Min=3 x2S11Min=0.5 x3S11Min=-0.5 FrameElem=113
 ElemStation=0.375
 Frame=113 Station=0.5 OutputCase=ENVE CaseType=Combination StepType=Max P=-111.11546006997 V2=-
 161.485921331312 V3=0 T=0 M2=0 M3=220.18151207872 S11Max=1205.32382754876 PtS11Max=1 x2S11Max=-0.5
 x3S11Max=-0.5 _
 S11Min=-1361.57429549963 PtS11Min=3 x2S11Min=0.5 x3S11Min=-0.5 FrameElem=113 ElemStation=0.5
 Frame=113 Station=0 OutputCase=ENVE CaseType=Combination StepType=Min P=-169.541010669002 V2=-
 252.629999180523 V3=0 T=0 M2=0 M3=97.5721788123215 S11Max=420.541847058514 PtS11Max=1 x2S11Max=-0.5
 x3S11Max=-0.5 _
 S11Min=-805.279319854308 PtS11Min=3 x2S11Min=0.5 x3S11Min=-0.5 FrameElem=113 ElemStation=0
 Frame=113 Station=0.125 OutputCase=ENVE CaseType=Combination StepType=Min P=-169.541010669002 V2=-
 231.577499180522 V3=0 T=0 M2=0 M3=126.861241179417 S11Max=596.276221261086 PtS11Max=1 x2S11Max=-0.5 _
 x3S11Max=-0.5 S11Min=-986.8571317397 PtS11Min=3 x2S11Min=0.5 x3S11Min=-0.5 FrameElem=113
 ElemStation=0.125
 Frame=113 Station=0.25 OutputCase=ENVE CaseType=Combination StepType=Min P=-169.541010669002 V2=-
 210.524999180523 V3=0 T=0 M2=0 M3=153.603428546512 S11Max=756.729345463659 PtS11Max=1 x2S11Max=-0.5
 x3S11Max=-0.5 S11Min=-1152.64556862509 PtS11Min=3 x2S11Min=0.5 x3S11Min=-0.5 FrameElem=113
 ElemStation=0.25
 Frame=113 Station=0.375 OutputCase=ENVE CaseType=Combination StepType=Min P=-169.541010669002 V2=-
 189.472499180523 V3=0 T=0 M2=0 M3=177.798740913608 S11Max=901.901219666231 PtS11Max=1 x2S11Max=-0.5
 x3S11Max=-0.5 S11Min=-1302.64463051048 PtS11Min=3 x2S11Min=0.5 x3S11Min=-0.5 FrameElem=113
 ElemStation=0.375
 Frame=113 Station=0.5 OutputCase=ENVE CaseType=Combination StepType=Min P=-169.541010669002 V2=-
 168.419999180522 V3=0 T=0 M2=0 M3=199.447178280703 S11Max=1031.7918438688 PtS11Max=1 x2S11Max=-0.5
 x3S11Max=-0.5 _
 S11Min=-1436.85431739588 PtS11Min=3 x2S11Min=0.5 x3S11Min=-0.5 FrameElem=113 ElemStation=0.5
 Frame=113 Station=0 OutputCase=FESSUR CaseType=Combination P=-168.146075212926 V2=-250.190998915588
 V3=0 T=0 M2=0 M3=99.7999458660026 S11Max=430.65359998309 PtS11Max=1 x2S11Max=-0.5 x3S11Max=-0.5 _
 S11Min=-766.945750408941 PtS11Min=3 x2S11Min=0.5 x3S11Min=-0.5 FrameElem=113 ElemStation=0
 Frame=113 Station=0.125 OutputCase=FESSUR CaseType=Combination P=-168.146075212926 V2=-229.341748915588
 V3=0 T=0 M2=0 M3=129.770742605451 S11Max=610.47838041978 PtS11Max=1 x2S11Max=-0.5 x3S11Max=-0.5 _
 S11Min=-946.770530845632 PtS11Min=3 x2S11Min=0.5 x3S11Min=-0.5 FrameElem=113 ElemStation=0.125
 Frame=113 Station=0.25 OutputCase=FESSUR CaseType=Combination P=-168.146075212926 V2=-208.492498915588
 V3=0 T=0 M2=0 M3=157.1353830949 S11Max=774.666223356472 PtS11Max=1 x2S11Max=-0.5 x3S11Max=-0.5 _
 S11Min=-1110.95837378232 PtS11Min=3 x2S11Min=0.5 x3S11Min=-0.5 FrameElem=113 ElemStation=0.25
 Frame=113 Station=0.375 OutputCase=FESSUR CaseType=Combination P=-168.146075212926 V2=-187.643248915588
 V3=0 T=0 M2=0 M3=181.893867334348 S11Max=923.217128793162 PtS11Max=1 x2S11Max=-0.5 x3S11Max=-0.5 _
 S11Min=-1259.50927921901 PtS11Min=3 x2S11Min=0.5 x3S11Min=-0.5 FrameElem=113 ElemStation=0.375
 Frame=113 Station=0.5 OutputCase=FESSUR CaseType=Combination P=-168.146075212926 V2=-166.793998915588
 V3=0 T=0 M2=0 M3=204.046195323796 S11Max=1056.13109672985 PtS11Max=1 x2S11Max=-0.5 x3S11Max=-0.5 _
 S11Min=-1392.4232471557 PtS11Min=3 x2S11Min=0.5 x3S11Min=-0.5 FrameElem=113 ElemStation=0.5
 Frame=114 Station=0 OutputCase=PERM1 CaseType=Combination P=-164.891225815415 V2=-162.99998936719
 V3=0 T=0 M2=0 M3=199.447178280692 S11Max=1031.79184386874 PtS11Max=1 x2S11Max=-0.5 x3S11Max=-0.5 _
 S11Min=-1361.57429549957 PtS11Min=3 x2S11Min=0.5 x3S11Min=-0.5 FrameElem=114 ElemStation=0
 Frame=114 Station=0.125 OutputCase=PERM1 CaseType=Combination P=-164.891225815415 V2=-142.624998936719
 V3=0 T=0 M2=0 M3=218.548740647782 S11Max=1146.40121807128 PtS11Max=1 x2S11Max=-0.5 x3S11Max=-0.5 _
 S11Min=-1476.18366970211 PtS11Min=3 x2S11Min=0.5 x3S11Min=-0.5 FrameElem=114 ElemStation=0.125
 Frame=114 Station=0.25 OutputCase=PERM1 CaseType=Combination P=-164.891225815415 V2=-122.249998936719
 V3=0 T=0 M2=0 M3=235.103428014872 S11Max=1245.72934227382 PtS11Max=1 x2S11Max=-0.5 x3S11Max=-0.5 _
 S11Min=-1575.51179390465 PtS11Min=3 x2S11Min=0.5 x3S11Min=-0.5 FrameElem=114 ElemStation=0.25
 Frame=114 Station=0.375 OutputCase=PERM1 CaseType=Combination P=-164.891225815415 V2=-101.874998936719
 V3=0 T=0 M2=0 M3=249.111240381962 S11Max=1329.77621647636 PtS11Max=1 x2S11Max=-0.5 x3S11Max=-0.5 _
 S11Min=-1659.55866810719 PtS11Min=3 x2S11Min=0.5 x3S11Min=-0.5 FrameElem=114 ElemStation=0.375
 Frame=114 Station=0.5 OutputCase=PERM1 CaseType=Combination P=-164.891225815415 V2=-81.499998936719
 V3=0 T=0 M2=0 M3=260.572177749052 S11Max=1398.5418406789 PtS11Max=1 x2S11Max=-0.5 x3S11Max=-0.5 _
 S11Min=-1728.32429230973 PtS11Min=3 x2S11Min=0.5 x3S11Min=-0.5 FrameElem=114 ElemStation=0.5
 Frame=114 Station=0 OutputCase=PERM2 CaseType=Combination P=-111.11546006997 V2=-162.99999210729
 V3=0 T=0 M2=0 M3=213.611487731433 S11Max=1170.55346631863 PtS11Max=1 x2S11Max=-0.5 x3S11Max=-0.5 _
 S11Min=-1392.78438645857 PtS11Min=3 x2S11Min=0.5 x3S11Min=-0.5 FrameElem=114 ElemStation=0



Frame=114 Station=0.125 OutputCase=PERM2 CaseType=Combination P=-111.11546006997 V2=-142.624999210729
 V3=0 T=0 M2=0 M3=232.713050132774 S11Max=1285.16284072667 PtS11Max=1 x2S11Max=-0.5 x3S11Max=-0.5 _
 S11Min=-1507.39376086661 PtS11Min=3 x2S11Min=0.5 x3S11Min=-0.5 FrameElem=114 ElemStation=0.125
 Frame=114 Station=0.25 OutputCase=PERM2 CaseType=Combination P=-111.11546006997 V2=-122.249999210729
 V3=0 T=0 M2=0 M3=249.267737534115 S11Max=1384.49096513472 PtS11Max=1 x2S11Max=-0.5 x3S11Max=-0.5 _
 S11Min=-1606.72188527466 PtS11Min=3 x2S11Min=0.5 x3S11Min=-0.5 FrameElem=114 ElemStation=0.25
 Frame=114 Station=0.375 OutputCase=PERM2 CaseType=Combination P=-111.11546006997 V2=-101.874999210729
 V3=0 T=0 M2=0 M3=263.275549935456 S11Max=1468.53783954277 PtS11Max=1 x2S11Max=-0.5 x3S11Max=-0.5 _
 S11Min=-1690.76875968271 PtS11Min=3 x2S11Min=0.5 x3S11Min=-0.5 FrameElem=114 ElemStation=0.375
 Frame=114 Station=0.5 OutputCase=PERM2 CaseType=Combination P=-111.11546006997 V2=-81.499999210729
 V3=0 T=0 M2=0 M3=274.736487336798 S11Max=1537.30346395082 PtS11Max=1 x2S11Max=-0.5 x3S11Max=-0.5 _
 S11Min=-1759.53438409075 PtS11Min=3 x2S11Min=0.5 x3S11Min=-0.5 FrameElem=114 ElemStation=0.5
 Frame=114 Station=0 OutputCase=ACC1 CaseType=Combination P=-169.541010669005 V2=-168.41999890647 V3=0
 T=0 M2=0 M3=206.017202627969 S11Max=1066.56220509881 PtS11Max=1 x2S11Max=-0.5 x3S11Max=-0.5 _
 S11Min=-1405.64422643682 PtS11Min=3 x2S11Min=0.5 x3S11Min=-0.5 FrameElem=114 ElemStation=0
 Frame=114 Station=0.125 OutputCase=ACC1 CaseType=Combination P=-169.541010669005 V2=-147.36749890647
 V3=0 T=0 M2=0 M3=225.753921241278 S11Max=1184.98251677866 PtS11Max=1 x2S11Max=-0.5 x3S11Max=-0.5 _
 S11Min=-1524.06453811667 PtS11Min=3 x2S11Min=0.5 x3S11Min=-0.5 FrameElem=114 ElemStation=0.125
 Frame=114 Station=0.25 OutputCase=ACC1 CaseType=Combination P=-169.541010669005 V2=-126.31499890647
 V3=0 T=0 M2=0 M3=242.859077354586 S11Max=1287.61345345851 PtS11Max=1 x2S11Max=-0.5 x3S11Max=-0.5 _
 S11Min=-1626.69547479652 PtS11Min=3 x2S11Min=0.5 x3S11Min=-0.5 FrameElem=114 ElemStation=0.25
 Frame=114 Station=0.375 OutputCase=ACC1 CaseType=Combination P=-169.541010669005 V2=-105.26249890647
 V3=0 T=0 M2=0 M3=257.332670967895 S11Max=1374.45501513836 PtS11Max=1 x2S11Max=-0.5 x3S11Max=-0.5 _
 S11Min=-1713.53703647638 PtS11Min=3 x2S11Min=0.5 x3S11Min=-0.5 FrameElem=114 ElemStation=0.375
 Frame=114 Station=0.5 OutputCase=ACC1 CaseType=Combination P=-169.541010669005 V2=-84.2099989064696
 V3=0 T=0 M2=0 M3=269.174702081204 S11Max=1445.50720181822 PtS11Max=1 x2S11Max=-0.5 x3S11Max=-0.5 _
 S11Min=-1784.58922315623 PtS11Min=3 x2S11Min=0.5 x3S11Min=-0.5 FrameElem=114 ElemStation=0.5
 Frame=114 Station=0 OutputCase=ACC2 CaseType=Combination P=-115.76524492356 V2=-168.41999918048 V3=0
 T=0 M2=0 M3=220.181512078709 S11Max=1205.3238275487 PtS11Max=1 x2S11Max=-0.5 x3S11Max=-0.5 _
 S11Min=-1436.85431739582 PtS11Min=3 x2S11Min=0.5 x3S11Min=-0.5 FrameElem=114 ElemStation=0
 Frame=114 Station=0.125 OutputCase=ACC2 CaseType=Combination P=-115.76524492356 V2=-147.36749918048
 V3=0 T=0 M2=0 M3=239.918230726269 S11Max=1323.74413943406 PtS11Max=1 x2S11Max=-0.5 x3S11Max=-0.5 _
 S11Min=-1555.27462928118 PtS11Min=3 x2S11Min=0.5 x3S11Min=-0.5 FrameElem=114 ElemStation=0.125
 Frame=114 Station=0.25 OutputCase=ACC2 CaseType=Combination P=-115.76524492356 V2=-126.31499918048
 V3=0 T=0 M2=0 M3=257.023386873829 S11Max=1426.37507631942 PtS11Max=1 x2S11Max=-0.5 x3S11Max=-0.5 _
 S11Min=-1657.90556616653 PtS11Min=3 x2S11Min=0.5 x3S11Min=-0.5 FrameElem=114 ElemStation=0.25
 Frame=114 Station=0.375 OutputCase=ACC2 CaseType=Combination P=-115.76524492356 V2=-105.26249918048
 V3=0 T=0 M2=0 M3=271.496980521389 S11Max=1513.21663820477 PtS11Max=1 x2S11Max=-0.5 x3S11Max=-0.5 _
 S11Min=-1744.74712805189 PtS11Min=3 x2S11Min=0.5 x3S11Min=-0.5 FrameElem=114 ElemStation=0.375
 Frame=114 Station=0.5 OutputCase=ACC2 CaseType=Combination P=-115.76524492356 V2=-84.2099991804796
 V3=0 T=0 M2=0 M3=283.339011668949 S11Max=1584.26882509013 PtS11Max=1 x2S11Max=-0.5 x3S11Max=-0.5 _
 S11Min=-1815.79931493725 PtS11Min=3 x2S11Min=0.5 x3S11Min=-0.5 FrameElem=114 ElemStation=0.5
 Frame=114 Station=0 OutputCase=ACCSX1 CaseType=Combination P=-167.164023806275 V2=-161.485921331268
 V3=0 T=0 M2=0 M3=200.349566688337 S11Max=1034.93337632375 PtS11Max=1 x2S11Max=-0.5 x3S11Max=-0.5 _
 S11Min=-1369.26142393475 PtS11Min=3 x2S11Min=0.5 x3S11Min=-0.5 FrameElem=114 ElemStation=0
 Frame=114 Station=0.125 OutputCase=ACCSX1 CaseType=Combination P=-167.164023806275 V2=-141.110921331268
 V3=0 T=0 M2=0 M3=219.261869354745 S11Max=1148.4071923222 PtS11Max=1 x2S11Max=-0.5 x3S11Max=-0.5 _
 S11Min=-1482.73523993475 PtS11Min=3 x2S11Min=0.5 x3S11Min=-0.5 FrameElem=114 ElemStation=0.125
 Frame=114 Station=0.25 OutputCase=ACCSX1 CaseType=Combination P=-167.164023806275 V2=-120.735921331268
 V3=0 T=0 M2=0 M3=235.627297021154 S11Max=1246.59975832065 PtS11Max=1 x2S11Max=-0.5 x3S11Max=-0.5 _
 S11Min=-1580.9278059332 PtS11Min=3 x2S11Min=0.5 x3S11Min=-0.5 FrameElem=114 ElemStation=0.25
 Frame=114 Station=0.375 OutputCase=ACCSX1 CaseType=Combination P=-167.164023806275 V2=-100.360921331268
 V3=0 T=0 M2=0 M3=249.445849687562 S11Max=1329.5110743191 PtS11Max=1 x2S11Max=-0.5 x3S11Max=-0.5 _
 S11Min=-1663.83912193165 PtS11Min=3 x2S11Min=0.5 x3S11Min=-0.5 FrameElem=114 ElemStation=0.375
 Frame=114 Station=0.5 OutputCase=ACCSX1 CaseType=Combination P=-167.164023806275 V2=-79.9859213312679
 V3=0 T=0 M2=0 M3=260.717527353971 S11Max=1397.14114031755 PtS11Max=1 x2S11Max=-0.5 x3S11Max=-0.5 _
 S11Min=-1731.4691879301 PtS11Min=3 x2S11Min=0.5 x3S11Min=-0.5 FrameElem=114 ElemStation=0.5
 Frame=114 Station=0 OutputCase=ACCSX2 CaseType=Combination P=-113.388258060829 V2=-161.485921605278
 V3=0 T=0 M2=0 M3=214.513876139077 S11Max=1173.69499877363 PtS11Max=1 x2S11Max=-0.5 x3S11Max=-0.5 _
 S11Min=-1400.47151489529 PtS11Min=3 x2S11Min=0.5 x3S11Min=-0.5 FrameElem=114 ElemStation=0
 Frame=114 Station=0.125 OutputCase=ACCSX2 CaseType=Combination P=-113.388258060829 V2=-141.110921605278
 V3=0 T=0 M2=0 M3=233.426178839737 S11Max=1287.16881497759 PtS11Max=1 x2S11Max=-0.5 x3S11Max=-0.5 _
 S11Min=-1513.94533109925 PtS11Min=3 x2S11Min=0.5 x3S11Min=-0.5 FrameElem=114 ElemStation=0.125
 Frame=114 Station=0.25 OutputCase=ACCSX2 CaseType=Combination P=-113.388258060829 V2=-120.735921605278
 V3=0 T=0 M2=0 M3=249.791606540397 S11Max=1385.36138118155 PtS11Max=1 x2S11Max=-0.5 x3S11Max=-0.5 _
 S11Min=-1612.13789730321 PtS11Min=3 x2S11Min=0.5 x3S11Min=-0.5 FrameElem=114 ElemStation=0.25
 Frame=114 Station=0.375 OutputCase=ACCSX2 CaseType=Combination P=-113.388258060829 V2=-100.360921605278
 V3=0 T=0 M2=0 M3=263.610159241057 S11Max=1468.27269738551 PtS11Max=1 x2S11Max=-0.5 x3S11Max=-0.5 _
 S11Min=-1695.04921350717 PtS11Min=3 x2S11Min=0.5 x3S11Min=-0.5 FrameElem=114 ElemStation=0.375
 Frame=114 Station=0.5 OutputCase=ACCSX2 CaseType=Combination P=-113.388258060829 V2=-79.985921605278
 V3=0 T=0 M2=0 M3=274.881836941716 S11Max=1535.90276358947 PtS11Max=1 x2S11Max=-0.5 x3S11Max=-0.5 _
 S11Min=-1762.67927971113 PtS11Min=3 x2S11Min=0.5 x3S11Min=-0.5 FrameElem=114 ElemStation=0.5
 Frame=114 Station=0 OutputCase=ENVE CaseType=Combination StepType=Max P=-111.11546006997 V2=-
 161.485921331268 V3=0 T=0 M2=0 M3=220.181512078709 S11Max=1205.3238275487 PtS11Max=1 x2S11Max=-0.5
 x3S11Max=-0.5 _
 S11Min=-1361.57429549957 PtS11Min=3 x2S11Min=0.5 x3S11Min=-0.5 FrameElem=114 ElemStation=0
 Frame=114 Station=0.125 OutputCase=ENVE CaseType=Combination StepType=Max P=-111.11546006997 V2=-
 141.110921331268 V3=0 T=0 M2=0 M3=239.918230726269 S11Max=1323.74413943406 PtS11Max=1 x2S11Max=-0.5 _
 x3S11Max=-0.5 S11Min=-1476.18366970211 PtS11Min=3 x2S11Min=0.5 x3S11Min=-0.5 FrameElem=114
 ElemStation=0.125



Frame=114 Station=0.25 OutputCase=ENVE CaseType=Combination StepType=Max P=-111.11546006997 V2=-120.735921331268 V3=0 T=0 M2=0 M3=257.023386873829 S11Max=1426.37507631942 PtS11Max=1 x2S11Max=-0.5 x3S11Max=-0.5
 S11Min=-1575.51179390465 PtS11Min=3 x2S11Min=0.5 x3S11Min=-0.5 FrameElem=114 ElemStation=0.25
 Frame=114 Station=0.375 OutputCase=ENVE CaseType=Combination StepType=Max P=-111.11546006997 V2=-100.360921331268 V3=0 T=0 M2=0 M3=271.496980521389 S11Max=1513.21663820477 PtS11Max=1 x2S11Max=-0.5 x3S11Max=-0.5
 x3S11Max=-0.5 S11Min=-1659.55866810719 PtS11Min=3 x2S11Min=0.5 x3S11Min=-0.5 FrameElem=114 ElemStation=0.375
 Frame=114 Station=0.5 OutputCase=ENVE CaseType=Combination StepType=Max P=-111.11546006997 V2=-79.9859213312679 V3=0 T=0 M2=0 M3=283.339011668949 S11Max=1584.26882509013 PtS11Max=1 x2S11Max=-0.5 x3S11Max=-0.5
 S11Min=-1728.32429230973 PtS11Min=3 x2S11Min=0.5 x3S11Min=-0.5 FrameElem=114 ElemStation=0.5
 Frame=114 Station=0 OutputCase=ENVE CaseType=Combination StepType=Min P=-169.541010669005 V2=-168.41999918048 V3=0 T=0 M2=0 M3=199.447178280692 S11Max=1031.79184386874 PtS11Max=1 x2S11Max=-0.5 x3S11Max=-0.5
 S11Min=-1436.85431739582 PtS11Min=3 x2S11Min=0.5 x3S11Min=-0.5 FrameElem=114 ElemStation=0
 Frame=114 Station=0.125 OutputCase=ENVE CaseType=Combination StepType=Min P=-169.541010669005 V2=-147.36749918048 V3=0 T=0 M2=0 M3=218.548740647782 S11Max=1146.40121807128 PtS11Max=1 x2S11Max=-0.5 x3S11Max=-0.5
 x3S11Max=-0.5 S11Min=-1555.27462928118 PtS11Min=3 x2S11Min=0.5 x3S11Min=-0.5 FrameElem=114 ElemStation=0.125
 Frame=114 Station=0.25 OutputCase=ENVE CaseType=Combination StepType=Min P=-169.541010669005 V2=-126.31499918048 V3=0 T=0 M2=0 M3=235.103428014872 S11Max=1245.72934227382 PtS11Max=1 x2S11Max=-0.5 x3S11Max=-0.5
 S11Min=-1657.90556616653 PtS11Min=3 x2S11Min=0.5 x3S11Min=-0.5 FrameElem=114 ElemStation=0.25
 Frame=114 Station=0.375 OutputCase=ENVE CaseType=Combination StepType=Min P=-169.541010669005 V2=-105.26249918048 V3=0 T=0 M2=0 M3=249.111240381962 S11Max=1329.5110743191 PtS11Max=1 x2S11Max=-0.5 x3S11Max=-0.5
 S11Min=-1744.74712805189 PtS11Min=3 x2S11Min=0.5 x3S11Min=-0.5 FrameElem=114 ElemStation=0.375
 Frame=114 Station=0.5 OutputCase=ENVE CaseType=Combination StepType=Min P=-169.541010669005 V2=-84.2099991804796 V3=0 T=0 M2=0 M3=260.572177749052 S11Max=1397.14114031755 PtS11Max=1 x2S11Max=-0.5 x3S11Max=-0.5
 S11Min=-1815.79931493725 PtS11Min=3 x2S11Min=0.5 x3S11Min=-0.5 FrameElem=114 ElemStation=0.5
 Frame=114 Station=0 OutputCase=FESSUR CaseType=Combination P=-168.146075212928 V2=-166.793998915544 V3=0 T=0 M2=0 M3=204.046195323786 S11Max=1056.13109672979 PtS11Max=1 x2S11Max=-0.5 x3S11Max=-0.5
 S11Min=-1392.42324715564 PtS11Min=3 x2S11Min=0.5 x3S11Min=-0.5 FrameElem=114 ElemStation=0
 Frame=114 Station=0.125 OutputCase=FESSUR CaseType=Combination P=-168.146075212928 V2=-145.944748915544 V3=0 T=0 M2=0 M3=223.592367063229 S11Max=1173.40812716645 PtS11Max=1 x2S11Max=-0.5 x3S11Max=-0.5
 S11Min=-1509.7002775923 PtS11Min=3 x2S11Min=0.5 x3S11Min=-0.5 FrameElem=114 ElemStation=0.125
 Frame=114 Station=0.25 OutputCase=FESSUR CaseType=Combination P=-168.146075212928 V2=-125.095498915544 V3=0 T=0 M2=0 M3=240.532382552672 S11Max=1275.0482201031 PtS11Max=1 x2S11Max=-0.5 x3S11Max=-0.5
 S11Min=-1611.34037052896 PtS11Min=3 x2S11Min=0.5 x3S11Min=-0.5 FrameElem=114 ElemStation=0.25
 Frame=114 Station=0.375 OutputCase=FESSUR CaseType=Combination P=-168.146075212928 V2=-104.246248915544 V3=0 T=0 M2=0 M3=254.866241792115 S11Max=1361.05137553976 PtS11Max=1 x2S11Max=-0.5 x3S11Max=-0.5
 S11Min=-1697.343252596562 PtS11Min=3 x2S11Min=0.5 x3S11Min=-0.5 FrameElem=114 ElemStation=0.375
 Frame=114 Station=0.5 OutputCase=FESSUR CaseType=Combination P=-168.146075212928 V2=-83.396998915544 V3=0 T=0 M2=0 M3=266.593944781558 S11Max=1431.41759347642 PtS11Max=1 x2S11Max=-0.5 x3S11Max=-0.5
 S11Min=-1767.70974390228 PtS11Min=3 x2S11Min=0.5 x3S11Min=-0.5 FrameElem=114 ElemStation=0.5
 Frame=115 Station=0 OutputCase=PERM1 CaseType=Combination P=-164.891225815415 V2=-81.499998936778 V3=0 T=0 M2=0 M3=260.572177749059 S11Max=1398.54184067894 PtS11Max=1 x2S11Max=-0.5 x3S11Max=-0.5
 S11Min=-1728.32429230977 PtS11Min=3 x2S11Min=0.5 x3S11Min=-0.5 FrameElem=115 ElemStation=0
 Frame=115 Station=0.125 OutputCase=PERM1 CaseType=Combination P=-164.891225815415 V2=-61.124998936778 V3=0 T=0 M2=0 M3=269.486240116157 S11Max=1452.02621488152 PtS11Max=1 x2S11Max=-0.5 x3S11Max=-0.5
 S11Min=-1781.80866651235 PtS11Min=3 x2S11Min=0.5 x3S11Min=-0.5 FrameElem=115 ElemStation=0.125
 Frame=115 Station=0.25 OutputCase=PERM1 CaseType=Combination P=-164.891225815415 V2=-40.749998936778 V3=0 T=0 M2=0 M3=275.853427483254 S11Max=1490.22933908411 PtS11Max=1 x2S11Max=-0.5 x3S11Max=-0.5
 S11Min=-1820.01179071494 PtS11Min=3 x2S11Min=0.5 x3S11Min=-0.5 FrameElem=115 ElemStation=0.25
 Frame=115 Station=0.375 OutputCase=PERM1 CaseType=Combination P=-164.891225815415 V2=-20.374998936778 V3=0 T=0 M2=0 M3=279.673739850351 S11Max=1513.15121328669 PtS11Max=1 x2S11Max=-0.5 x3S11Max=-0.5
 S11Min=-1842.93366491752 PtS11Min=3 x2S11Min=0.5 x3S11Min=-0.5 FrameElem=115 ElemStation=0.375
 Frame=115 Station=0.5 OutputCase=PERM1 CaseType=Combination P=-164.891225815415 V2=1.0632220437401E-06 V3=0 T=0 M2=0 M3=280.947177217448 S11Max=1520.79183748927 PtS11Max=1 x2S11Max=-0.5 x3S11Max=-0.5
 S11Min=-1850.57428912011 PtS11Min=3 x2S11Min=0.5 x3S11Min=-0.5 FrameElem=115 ElemStation=0.5
 Frame=115 Station=0 OutputCase=PERM2 CaseType=Combination P=-111.11546006997 V2=-81.4999992107879 V3=0 T=0 M2=0 M3=274.736487336805 S11Max=1537.30346395086 PtS11Max=1 x2S11Max=-0.5 x3S11Max=-0.5
 S11Min=-1759.5343840908 PtS11Min=3 x2S11Min=0.5 x3S11Min=-0.5 FrameElem=115 ElemStation=0
 Frame=115 Station=0.375 OutputCase=PERM2 CaseType=Combination P=-111.11546006997 V2=-61.1249992107879 V3=0 T=0 M2=0 M3=283.650549738153 S11Max=1590.78783835895 PtS11Max=1 x2S11Max=-0.5 x3S11Max=-0.5
 S11Min=-1813.01875849889 PtS11Min=3 x2S11Min=0.5 x3S11Min=-0.5 FrameElem=115 ElemStation=0.375
 Frame=115 Station=0.25 OutputCase=PERM2 CaseType=Combination P=-111.11546006997 V2=-40.7499992107879 V3=0 T=0 M2=0 M3=290.017737139502 S11Max=1628.99096276704 PtS11Max=1 x2S11Max=-0.5 x3S11Max=-0.5
 S11Min=-1851.22188290698 PtS11Min=3 x2S11Min=0.5 x3S11Min=-0.5 FrameElem=115 ElemStation=0.25
 Frame=115 Station=0.375 OutputCase=PERM2 CaseType=Combination P=-111.11546006997 V2=-20.3749992107879 V3=0 T=0 M2=0 M3=293.83804954085 S11Max=1651.91283717513 PtS11Max=1 x2S11Max=-0.5 x3S11Max=-0.5
 S11Min=-1874.14375731507 PtS11Min=3 x2S11Min=0.5 x3S11Min=-0.5 FrameElem=115 ElemStation=0.375
 Frame=115 Station=0.5 OutputCase=PERM2 CaseType=Combination P=-111.11546006997 V2=7.89212117524585E-07 V3=0 T=0 M2=0 M3=295.111486942199 S11Max=1659.55346158322 PtS11Max=1 x2S11Max=-0.5 x3S11Max=-0.5
 S11Min=-1881.78438172316 PtS11Min=3 x2S11Min=0.5 x3S11Min=-0.5 FrameElem=115 ElemStation=0.5
 Frame=115 Station=0 OutputCase=ACC1 CaseType=Combination P=-169.541010668994 V2=-84.2099989065292 V3=0 T=0 M2=0 M3=269.174702081211 S11Max=1445.50720181827 PtS11Max=1 x2S11Max=-0.5 x3S11Max=-0.5
 S11Min=-1784.58922315626 PtS11Min=3 x2S11Min=0.5 x3S11Min=-0.5 FrameElem=115 ElemStation=0
 Frame=115 Station=0.125 OutputCase=ACC1 CaseType=Combination P=-169.541010668994 V2=-63.1574989065292 V3=0 T=0 M2=0 M3=278.385170694527 S11Max=1500.77001349817 PtS11Max=1 x2S11Max=-0.5 x3S11Max=-0.5



S11Min=-1839.85203483615 PtS11Min=3 x2S11Min=0.5 x3S11Min=-0.5 FrameElem=115 ElemStation=0.125
 Frame=115 Station=0.25 OutputCase=ACC1 CaseType=Combination P=-169.541010668994 V2=-42.1049989065292
 V3=0 T=0 M2=0 M3=284.964076807843 S11Max=1540.24345017806 PtS11Max=1 x2S11Max=-0.5 x3S11Max=-0.5
 S11Min=-1879.32547151605 PtS11Min=3 x2S11Min=0.5 x3S11Min=-0.5 FrameElem=115 ElemStation=0.25
 Frame=115 Station=0.375 OutputCase=ACC1 CaseType=Combination P=-169.541010668994 V2=-21.0524989065292
 V3=0 T=0 M2=0 M3=288.911420421159 S11Max=1563.92751185796 PtS11Max=1 x2S11Max=-0.5 x3S11Max=-0.5
 S11Min=-1903.00953319595 PtS11Min=3 x2S11Min=0.5 x3S11Min=-0.5 FrameElem=115 ElemStation=0.375
 Frame=115 Station=0.5 OutputCase=ACC1 CaseType=Combination P=-169.541010668994 V2=1.09347083498967E-06
 V3=0 T=0 M2=0 M3=290.227201534475 S11Max=1571.82219853786 PtS11Max=1 x2S11Max=-0.5 x3S11Max=-0.5
 S11Min=-1910.90421987585 PtS11Min=3 x2S11Min=0.5 x3S11Min=-0.5 FrameElem=115 ElemStation=0.5
 Frame=115 Station=0 OutputCase=ACC2 CaseType=Combination P=-115.765244923549 V2=-84.2099991805391
 V3=0 T=0 M2=0 M3=283.339011668956 S11Max=1584.26882509019 PtS11Max=1 x2S11Max=-0.5 x3S11Max=-0.5
 S11Min=-1815.79931493729 PtS11Min=3 x2S11Min=0.5 x3S11Min=-0.5 FrameElem=115 ElemStation=0
 Frame=115 Station=0.125 OutputCase=ACC2 CaseType=Combination P=-115.765244923549 V2=-63.1574991805391
 V3=0 T=0 M2=0 M3=292.549480316523 S11Max=1639.53163697559 PtS11Max=1 x2S11Max=-0.5 x3S11Max=-0.5
 S11Min=-1871.06212682269 PtS11Min=3 x2S11Min=0.5 x3S11Min=-0.5 FrameElem=115 ElemStation=0.125
 Frame=115 Station=0.25 OutputCase=ACC2 CaseType=Combination P=-115.765244923549 V2=-42.1049991805391
 V3=0 T=0 M2=0 M3=299.128386464091 S11Max=1679.005073861 PtS11Max=1 x2S11Max=-0.5 x3S11Max=-0.5
 S11Min=-1910.53556370809 PtS11Min=3 x2S11Min=0.5 x3S11Min=-0.5 FrameElem=115 ElemStation=0.25
 Frame=115 Station=0.375 OutputCase=ACC2 CaseType=Combination P=-115.765244923549 V2=-21.0524991805391
 V3=0 T=0 M2=0 M3=303.075730111658 S11Max=1702.6891357464 PtS11Max=1 x2S11Max=-0.5 x3S11Max=-0.5
 S11Min=-1934.2196255935 PtS11Min=3 x2S11Min=0.5 x3S11Min=-0.5 FrameElem=115 ElemStation=0.375
 Frame=115 Station=0.5 OutputCase=ACC2 CaseType=Combination P=-115.765244923549 V2=8.19460908685343E-07
 V3=0 T=0 M2=0 M3=304.391511259226 S11Max=1710.5838226318 PtS11Max=1 x2S11Max=-0.5 x3S11Max=-0.5
 S11Min=-1942.1143124789 PtS11Min=3 x2S11Min=0.5 x3S11Min=-0.5 FrameElem=115 ElemStation=0.5
 Frame=115 Station=0 OutputCase=ACCSX1 CaseType=Combination P=-167.164023806267 V2=-79.9859213313264
 V3=0 T=0 M2=0 M3=260.717527353978 S11Max=1397.1411403176 PtS11Max=1 x2S11Max=-0.5 x3S11Max=-0.5
 S11Min=-1731.46918793014 PtS11Min=3 x2S11Min=0.5 x3S11Min=-0.5 FrameElem=115 ElemStation=0
 Frame=115 Station=0.125 OutputCase=ACCSX1 CaseType=Combination P=-167.164023806267 V2=-59.6109213313264
 V3=0 T=0 M2=0 M3=269.442330020394 S11Max=1449.4899563161 PtS11Max=1 x2S11Max=-0.5 x3S11Max=-0.5
 S11Min=-1783.81800392863 PtS11Min=3 x2S11Min=0.5 x3S11Min=-0.5 FrameElem=115 ElemStation=0.125
 Frame=115 Station=0.25 OutputCase=ACCSX1 CaseType=Combination P=-167.164023806267 V2=-39.2359213313264
 V3=0 T=0 M2=0 M3=275.62025768681 S11Max=1486.55752231459 PtS11Max=1 x2S11Max=-0.5 x3S11Max=-0.5
 S11Min=-1820.88556992713 PtS11Min=3 x2S11Min=0.5 x3S11Min=-0.5 FrameElem=115 ElemStation=0.25
 Frame=115 Station=0.375 OutputCase=ACCSX1 CaseType=Combination P=-167.164023806267 V2=-18.8609213313264
 V3=0 T=0 M2=0 M3=279.251310353226 S11Max=1508.34383831309 PtS11Max=1 x2S11Max=-0.5 x3S11Max=-0.5
 S11Min=-1842.67188592562 PtS11Min=3 x2S11Min=0.5 x3S11Min=-0.5 FrameElem=115 ElemStation=0.375
 Frame=115 Station=0.5 OutputCase=ACCSX1 CaseType=Combination P=-167.164023806267 V2=1.51407866867362
 V3=0 T=0 M2=0 M3=280.335488019641 S11Max=1514.84890431158 PtS11Max=1 x2S11Max=-0.5 x3S11Max=-0.5
 S11Min=-1849.17695192412 PtS11Min=3 x2S11Min=0.5 x3S11Min=-0.5 FrameElem=115 ElemStation=0.5
 Frame=115 Station=0 OutputCase=ACCSX2 CaseType=Combination P=-113.388258060822 V2=-79.9859216053363
 V3=0 T=0 M2=0 M3=274.881836941724 S11Max=1535.90276358952 PtS11Max=1 x2S11Max=-0.5 x3S11Max=-0.5
 S11Min=-1762.67927971116 PtS11Min=3 x2S11Min=0.5 x3S11Min=-0.5 FrameElem=115 ElemStation=0
 Frame=115 Station=0.125 OutputCase=ACCSX2 CaseType=Combination P=-113.388258060822 V2=-59.6109216053363
 V3=0 T=0 M2=0 M3=283.606639642391 S11Max=1588.25157979352 PtS11Max=1 x2S11Max=-0.5 x3S11Max=-0.5
 S11Min=-1815.02809591517 PtS11Min=3 x2S11Min=0.5 x3S11Min=-0.5 FrameElem=115 ElemStation=0.125
 Frame=115 Station=0.25 OutputCase=ACCSX2 CaseType=Combination P=-113.388258060822 V2=-39.2359216053363
 V3=0 T=0 M2=0 M3=289.784567343058 S11Max=1625.31914599752 PtS11Max=1 x2S11Max=-0.5 x3S11Max=-0.5
 S11Min=-1852.09566211917 PtS11Min=3 x2S11Min=0.5 x3S11Min=-0.5 FrameElem=115 ElemStation=0.25
 Frame=115 Station=0.375 OutputCase=ACCSX2 CaseType=Combination P=-113.388258060822 V2=-18.8609216053363
 V3=0 T=0 M2=0 M3=293.415620043725 S11Max=1647.10546220153 PtS11Max=1 x2S11Max=-0.5 x3S11Max=-0.5
 S11Min=-1873.88197832317 PtS11Min=3 x2S11Min=0.5 x3S11Min=-0.5 FrameElem=115 ElemStation=0.375
 Frame=115 Station=0.5 OutputCase=ACCSX2 CaseType=Combination P=-113.388258060822 V2=1.51407839466369
 V3=0 T=0 M2=0 M3=294.499797744392 S11Max=1653.61052840553 PtS11Max=1 x2S11Max=-0.5 x3S11Max=-0.5
 S11Min=-1880.38704452717 PtS11Min=3 x2S11Min=0.5 x3S11Min=-0.5 FrameElem=115 ElemStation=0.5
 Frame=115 Station=0 OutputCase=ENVE CaseType=Combination StepType=Max P=-111.11546006997 V2=-
 79.9859213313264 V3=0 T=0 M2=0 M3=283.339011668956 S11Max=1584.26882509019 PtS11Max=1 x2S11Max=-0.5
 x3S11Max=-0.5
 S11Min=-1728.32429230977 PtS11Min=3 x2S11Min=0.5 x3S11Min=-0.5 FrameElem=115 ElemStation=0
 Frame=115 Station=0.125 OutputCase=ENVE CaseType=Combination StepType=Max P=-111.11546006997 V2=-
 59.6109213313264 V3=0 T=0 M2=0 M3=292.549480316523 S11Max=1639.53163697559 PtS11Max=1 x2S11Max=-0.5
 x3S11Max=-0.5 S11Min=-1781.80866651235 PtS11Min=3 x2S11Min=0.5 x3S11Min=-0.5 FrameElem=115
 ElemStation=0.125
 Frame=115 Station=0.25 OutputCase=ENVE CaseType=Combination StepType=Max P=-111.11546006997 V2=-
 39.2359213313264 V3=0 T=0 M2=0 M3=299.128386464091 S11Max=1679.005073861 PtS11Max=1 x2S11Max=-0.5
 x3S11Max=-0.5
 S11Min=-1820.01179071494 PtS11Min=3 x2S11Min=0.5 x3S11Min=-0.5 FrameElem=115 ElemStation=0.25
 Frame=115 Station=0.375 OutputCase=ENVE CaseType=Combination StepType=Max P=-111.11546006997 V2=-
 18.8609213313264 V3=0 T=0 M2=0 M3=303.075730111658 S11Max=1702.6891357464 PtS11Max=1 x2S11Max=-0.5
 x3S11Max=-0.5
 S11Min=-1842.67188592562 PtS11Min=3 x2S11Min=0.5 x3S11Min=-0.5 FrameElem=115 ElemStation=0.375
 Frame=115 Station=0.5 OutputCase=ENVE CaseType=Combination StepType=Max P=-111.11546006997
 V2=1.51407866867362 V3=0 T=0 M2=0 M3=304.391511259226 S11Max=1710.5838226318 PtS11Max=1 x2S11Max=-0.5
 x3S11Max=-0.5
 S11Min=-1849.17695192412 PtS11Min=3 x2S11Min=0.5 x3S11Min=-0.5 FrameElem=115 ElemStation=0.5
 Frame=115 Station=0 OutputCase=ENVE CaseType=Combination StepType=Min P=-169.541010668994 V2=-
 84.2099991805391 V3=0 T=0 M2=0 M3=260.572177749059 S11Max=1397.1411403176 PtS11Max=1 x2S11Max=-0.5
 x3S11Max=-0.5
 S11Min=-1815.79931493729 PtS11Min=3 x2S11Min=0.5 x3S11Min=-0.5 FrameElem=115 ElemStation=0
 Frame=115 Station=0.125 OutputCase=ENVE CaseType=Combination StepType=Min P=-169.541010668994 V2=-
 63.1574991805391 V3=0 T=0 M2=0 M3=269.442330020394 S11Max=1449.4899563161 PtS11Max=1 x2S11Max=-0.5



x3S11Max=-0.5 S11Min=-1871.06212682269 PtS11Min=3 x2S11Min=0.5 x3S11Min=-0.5 FrameElem=115
 ElemStation=0.125
 Frame=115 Station=0.25 OutputCase=ENVE CaseType=Combination StepType=Min P=-169.541010668994 V2=-
 42.1049991805391 V3=0 T=0 M2=0 M3=275.62025768681 S11Max=1486.55752231459 PtS11Max=1 x2S11Max=-0.5
 x3S11Max=-0.5 _
 S11Min=-1910.53556370809 PtS11Min=3 x2S11Min=0.5 x3S11Min=-0.5 FrameElem=115 ElemStation=0.25
 Frame=115 Station=0.375 OutputCase=ENVE CaseType=Combination StepType=Min P=-169.541010668994 V2=-
 21.0524991805391 V3=0 T=0 M2=0 M3=279.251310353226 S11Max=1508.34383831309 PtS11Max=1 x2S11Max=-0.5 _
 x3S11Max=-0.5 S11Min=-1934.2196255935 PtS11Min=3 x2S11Min=0.5 x3S11Min=-0.5 FrameElem=115
 ElemStation=0.375
 Frame=115 Station=0.5 OutputCase=ENVE CaseType=Combination StepType=Min P=-169.541010668994
 V2=7.89212117524585E-07 V3=0 T=0 M2=0 M3=280.335488019641 S11Max=1514.84890431158 PtS11Max=1
 x2S11Max=-0.5 _
 x3S11Max=-0.5 S11Min=-1942.1143124789 PtS11Min=3 x2S11Min=0.5 x3S11Min=-0.5 FrameElem=115
 ElemStation=0.5
 Frame=115 Station=0 OutputCase=FESSUR CaseType=Combination P=-168.146075212921 V2=-83.3969989156038
 V3=0 T=0 M2=0 M3=266.593944781565 S11Max=1431.41759347647 PtS11Max=1 x2S11Max=-0.5 x3S11Max=-0.5 _
 S11Min=-1767.70974390231 PtS11Min=3 x2S11Min=0.5 x3S11Min=-0.5 FrameElem=115 ElemStation=0
 Frame=115 Station=0.125 OutputCase=FESSUR CaseType=Combination P=-168.146075212921 V2=-62.5477489156038
 V3=0 T=0 M2=0 M3=275.715491521016 S11Max=1486.14687391317 PtS11Max=1 x2S11Max=-0.5 x3S11Max=-0.5 _
 S11Min=-1822.43902433901 PtS11Min=3 x2S11Min=0.5 x3S11Min=-0.5 FrameElem=115 ElemStation=0.125
 Frame=115 Station=0.25 OutputCase=FESSUR CaseType=Combination P=-168.146075212921 V2=-41.6984989156038
 V3=0 T=0 M2=0 M3=282.230882010466 S11Max=1525.23921684988 PtS11Max=1 x2S11Max=-0.5 x3S11Max=-0.5 _
 S11Min=-1861.53136727572 PtS11Min=3 x2S11Min=0.5 x3S11Min=-0.5 FrameElem=115 ElemStation=0.25
 Frame=115 Station=0.375 OutputCase=FESSUR CaseType=Combination P=-168.146075212921 V2=-20.8492489156038
 V3=0 T=0 M2=0 M3=286.140116249917 S11Max=1548.69462228658 PtS11Max=1 x2S11Max=-0.5 x3S11Max=-0.5 _
 S11Min=-1884.98677271242 PtS11Min=3 x2S11Min=0.5 x3S11Min=-0.5 FrameElem=115 ElemStation=0.375
 Frame=115 Station=0.5 OutputCase=FESSUR CaseType=Combination P=-168.146075212921 V2=1.08439619750378E-
 06 V3=0 T=0 M2=0 M3=287.443194239367 S11Max=1556.51309022328 PtS11Max=1 x2S11Max=-0.5 x3S11Max=-0.5
 _
 S11Min=-1892.80524064912 PtS11Min=3 x2S11Min=0.5 x3S11Min=-0.5 FrameElem=115 ElemStation=0.5
 Frame=116 Station=0 OutputCase=PERM1 CaseType=Combination P=-164.891225815415 V2=1.06323705040268E-06
 V3=0 T=0 M2=0 M3=280.947177217441 S11Max=1520.79183748923 PtS11Max=1 x2S11Max=-0.5 x3S11Max=-0.5 _
 S11Min=-1850.57428912006 PtS11Min=3 x2S11Min=0.5 x3S11Min=-0.5 FrameElem=116 ElemStation=0
 Frame=116 Station=0.125 OutputCase=PERM1 CaseType=Combination P=-164.891225815415 V2=20.3750010632371
 V3=0 T=0 M2=0 M3=279.673739584537 S11Max=1513.1512116918 PtS11Max=1 x2S11Max=-0.5 x3S11Max=-0.5 _
 S11Min=-1842.93366332263 PtS11Min=3 x2S11Min=0.5 x3S11Min=-0.5 FrameElem=116 ElemStation=0.125
 Frame=116 Station=0.25 OutputCase=PERM1 CaseType=Combination P=-164.891225815415 V2=40.7500010632371
 V3=0 T=0 M2=0 M3=275.853426951632 S11Max=1490.22933589438 PtS11Max=1 x2S11Max=-0.5 x3S11Max=-0.5 _
 S11Min=-1820.01178752521 PtS11Min=3 x2S11Min=0.5 x3S11Min=-0.5 FrameElem=116 ElemStation=0.25
 Frame=116 Station=0.375 OutputCase=PERM1 CaseType=Combination P=-164.891225815415 V2=61.1250010632371
 V3=0 T=0 M2=0 M3=269.486239318727 S11Max=1452.02621009695 PtS11Max=1 x2S11Max=-0.5 x3S11Max=-0.5 _
 S11Min=-1781.80866172778 PtS11Min=3 x2S11Min=0.5 x3S11Min=-0.5 FrameElem=116 ElemStation=0.375
 Frame=116 Station=0.5 OutputCase=PERM1 CaseType=Combination P=-164.891225815415 V2=81.5000010632371
 V3=0 T=0 M2=0 M3=260.572176685823 S11Max=1398.54183429952 PtS11Max=1 x2S11Max=-0.5 x3S11Max=-0.5 _
 S11Min=-1728.32428593035 PtS11Min=3 x2S11Min=0.5 x3S11Min=-0.5 FrameElem=116 ElemStation=0.5
 Frame=116 Station=0 OutputCase=PERM2 CaseType=Combination P=-111.11546006997 V2=7.89226987762959E-07
 V3=0 T=0 M2=0 M3=295.111486942192 S11Max=1659.55346158318 PtS11Max=1 x2S11Max=-0.5 x3S11Max=-0.5 _
 S11Min=-1881.78438172312 PtS11Min=3 x2S11Min=0.5 x3S11Min=-0.5 FrameElem=116 ElemStation=0
 Frame=116 Station=0.125 OutputCase=PERM2 CaseType=Combination P=-111.11546006997 V2=20.375000789227
 V3=0 T=0 M2=0 M3=293.838049343538 S11Max=1651.91283599126 PtS11Max=1 x2S11Max=-0.5 x3S11Max=-0.5 _
 S11Min=-1874.1437561312 PtS11Min=3 x2S11Min=0.5 x3S11Min=-0.5 FrameElem=116 ElemStation=0.125
 Frame=116 Station=0.25 OutputCase=PERM2 CaseType=Combination P=-111.11546006997 V2=40.750000789227
 V3=0 T=0 M2=0 M3=290.017736744885 S11Max=1628.99096039934 PtS11Max=1 x2S11Max=-0.5 x3S11Max=-0.5 _
 S11Min=-1851.22188053928 PtS11Min=3 x2S11Min=0.5 x3S11Min=-0.5 FrameElem=116 ElemStation=0.25
 Frame=116 Station=0.375 OutputCase=PERM2 CaseType=Combination P=-111.11546006997 V2=61.125000789227
 V3=0 T=0 M2=0 M3=283.650549146231 S11Max=1590.78783480742 PtS11Max=1 x2S11Max=-0.5 x3S11Max=-0.5 _
 S11Min=-1813.01875494736 PtS11Min=3 x2S11Min=0.5 x3S11Min=-0.5 FrameElem=116 ElemStation=0.375
 Frame=116 Station=0.5 OutputCase=PERM2 CaseType=Combination P=-111.11546006997 V2=81.500000789227
 V3=0 T=0 M2=0 M3=274.736486547578 S11Max=1537.3034592155 PtS11Max=1 x2S11Max=-0.5 x3S11Max=-0.5 _
 S11Min=-1759.53437935544 PtS11Min=3 x2S11Min=0.5 x3S11Min=-0.5 FrameElem=116 ElemStation=0.5
 Frame=116 Station=0 OutputCase=ACC1 CaseType=Combination P=-169.541010668998 V2=1.09348667365339E-06
 V3=0 T=0 M2=0 M3=290.227201534468 S11Max=1571.82219853781 PtS11Max=1 x2S11Max=-0.5 x3S11Max=-0.5 _
 S11Min=-1910.90421987581 PtS11Min=3 x2S11Min=0.5 x3S11Min=-0.5 FrameElem=116 ElemStation=0
 Frame=116 Station=0.125 OutputCase=ACC1 CaseType=Combination P=-169.541010668998 V2=21.0525010934867
 V3=0 T=0 M2=0 M3=288.911420147783 S11Max=1563.9275102177 PtS11Max=1 x2S11Max=-0.5 x3S11Max=-0.5 _
 S11Min=-1903.00953155569 PtS11Min=3 x2S11Min=0.5 x3S11Min=-0.5 FrameElem=116 ElemStation=0.125
 Frame=116 Station=0.25 OutputCase=ACC1 CaseType=Combination P=-169.541010668998 V2=42.1050010934867
 V3=0 T=0 M2=0 M3=284.964076261097 S11Max=1540.24344689758 PtS11Max=1 x2S11Max=-0.5 x3S11Max=-0.5 _
 S11Min=-1879.32546823558 PtS11Min=3 x2S11Min=0.5 x3S11Min=-0.5 FrameElem=116 ElemStation=0.25
 Frame=116 Station=0.375 OutputCase=ACC1 CaseType=Combination P=-169.541010668998 V2=63.1575010934867
 V3=0 T=0 M2=0 M3=278.385169874411 S11Max=1500.77000857747 PtS11Max=1 x2S11Max=-0.5 x3S11Max=-0.5 _
 S11Min=-1839.85202991546 PtS11Min=3 x2S11Min=0.5 x3S11Min=-0.5 FrameElem=116 ElemStation=0.375
 Frame=116 Station=0.5 OutputCase=ACC1 CaseType=Combination P=-169.541010668998 V2=84.2100010934867
 V3=0 T=0 M2=0 M3=269.174700987725 S11Max=1445.50719525735 PtS11Max=1 x2S11Max=-0.5 x3S11Max=-0.5 _
 S11Min=-1784.58921659535 PtS11Min=3 x2S11Min=0.5 x3S11Min=-0.5 FrameElem=116 ElemStation=0.5
 Frame=116 Station=0 OutputCase=ACC2 CaseType=Combination P=-115.765244923553 V2=8.1947661101367E-07
 V3=0 T=0 M2=0 M3=304.391511259219 S11Max=1710.58382263176 PtS11Max=1 x2S11Max=-0.5 x3S11Max=-0.5 _
 S11Min=-1942.11431247887 PtS11Min=3 x2S11Min=0.5 x3S11Min=-0.5 FrameElem=116 ElemStation=0
 Frame=116 Station=0.125 OutputCase=ACC2 CaseType=Combination P=-115.765244923553 V2=21.0525008194766
 V3=0 T=0 M2=0 M3=303.075729906784 S11Max=1702.68913451715 PtS11Max=1 x2S11Max=-0.5 x3S11Max=-0.5 _
 S11Min=-1934.21962436426 PtS11Min=3 x2S11Min=0.5 x3S11Min=-0.5 FrameElem=116 ElemStation=0.125

Frame=116 Station=0.25 OutputCase=ACC2 CaseType=Combination P=-115.765244923553 V2=42.1050008194766
 V3=0 T=0 M2=0 M3=299.12838605435 S11Max=1679.00507140254 PtS11Max=1 x2S11Max=-0.5 x3S11Max=-0.5 _
 S11Min=-1910.53556124965 PtS11Min=3 x2S11Min=0.5 x3S11Min=-0.5 FrameElem=116 ElemStation=0.25
 Frame=116 Station=0.375 OutputCase=ACC2 CaseType=Combination P=-115.765244923553 V2=63.1575008194766
 V3=0 T=0 M2=0 M3=292.549479701915 S11Max=1639.53163328794 PtS11Max=1 x2S11Max=-0.5 x3S11Max=-0.5 _
 S11Min=-1871.06212313504 PtS11Min=3 x2S11Min=0.5 x3S11Min=-0.5 FrameElem=116 ElemStation=0.375
 Frame=116 Station=0.5 OutputCase=ACC2 CaseType=Combination P=-115.765244923553 V2=84.2100008194766
 V3=0 T=0 M2=0 M3=283.33901084948 S11Max=1584.26882017333 PtS11Max=1 x2S11Max=-0.5 x3S11Max=-0.5 _
 S11Min=-1815.79931002044 PtS11Min=3 x2S11Min=0.5 x3S11Min=-0.5 FrameElem=116 ElemStation=0.5
 Frame=116 Station=0 OutputCase=ACCSX1 CaseType=Combination P=-167.164023806267 V2=1.51407866868851
 V3=0 T=0 M2=0 M3=280.335488019634 S11Max=1514.84890431154 PtS11Max=1 x2S11Max=-0.5 x3S11Max=-0.5 _
 S11Min=-1849.17695192407 PtS11Min=3 x2S11Min=0.5 x3S11Min=-0.5 FrameElem=116 ElemStation=0
 Frame=116 Station=0.125 OutputCase=ACCSX1 CaseType=Combination P=-167.164023806267 V2=21.8890786686885
 V3=0 T=0 M2=0 M3=278.872790686048 S11Max=1506.07272031002 PtS11Max=1 x2S11Max=-0.5 x3S11Max=-0.5 _
 S11Min=-1840.40076792256 PtS11Min=3 x2S11Min=0.5 x3S11Min=-0.5 FrameElem=116 ElemStation=0.125
 Frame=116 Station=0.25 OutputCase=ACCSX1 CaseType=Combination P=-167.164023806267 V2=42.2640786686885
 V3=0 T=0 M2=0 M3=274.863218352462 S11Max=1482.0152863085 PtS11Max=1 x2S11Max=-0.5 x3S11Max=-0.5 _
 S11Min=-1816.34333392104 PtS11Min=3 x2S11Min=0.5 x3S11Min=-0.5 FrameElem=116 ElemStation=0.25
 Frame=116 Station=0.375 OutputCase=ACCSX1 CaseType=Combination P=-167.164023806267 V2=62.6390786686885
 V3=0 T=0 M2=0 M3=268.306771018876 S11Max=1442.67660230699 PtS11Max=1 x2S11Max=-0.5 x3S11Max=-0.5 _
 S11Min=-1777.00464991952 PtS11Min=3 x2S11Min=0.5 x3S11Min=-0.5 FrameElem=116 ElemStation=0.375
 Frame=116 Station=0.5 OutputCase=ACCSX1 CaseType=Combination P=-167.164023806267 V2=83.0140786686885
 V3=0 T=0 M2=0 M3=259.20344868529 S11Max=1388.05666830547 PtS11Max=1 x2S11Max=-0.5 x3S11Max=-0.5 _
 S11Min=-1722.38471591801 PtS11Min=3 x2S11Min=0.5 x3S11Min=-0.5 FrameElem=116 ElemStation=0.5
 Frame=116 Station=0 OutputCase=ACCSX2 CaseType=Combination P=-113.388258060822 V2=1.51407839467845
 V3=0 T=0 M2=0 M3=294.499797744385 S11Max=1653.61052840548 PtS11Max=1 x2S11Max=-0.5 x3S11Max=-0.5 _
 S11Min=-1880.38704452713 PtS11Min=3 x2S11Min=0.5 x3S11Min=-0.5 FrameElem=116 ElemStation=0
 Frame=116 Station=0.125 OutputCase=ACCSX2 CaseType=Combination P=-113.388258060822 V2=21.8890783946785
 V3=0 T=0 M2=0 M3=293.03710044505 S11Max=1644.83434460948 PtS11Max=1 x2S11Max=-0.5 x3S11Max=-0.5 _
 S11Min=-1871.61086073112 PtS11Min=3 x2S11Min=0.5 x3S11Min=-0.5 FrameElem=116 ElemStation=0.125
 Frame=116 Station=0.25 OutputCase=ACCSX2 CaseType=Combination P=-113.388258060822 V2=42.2640783946785
 V3=0 T=0 M2=0 M3=289.027528145715 S11Max=1620.77691081347 PtS11Max=1 x2S11Max=-0.5 x3S11Max=-0.5 _
 S11Min=-1847.55342693511 PtS11Min=3 x2S11Min=0.5 x3S11Min=-0.5 FrameElem=116 ElemStation=0.25
 Frame=116 Station=0.375 OutputCase=ACCSX2 CaseType=Combination P=-113.388258060822 V2=62.6390783946785
 V3=0 T=0 M2=0 M3=282.47108084638 S11Max=1581.43822701746 PtS11Max=1 x2S11Max=-0.5 x3S11Max=-0.5 _
 S11Min=-1808.2147431391 PtS11Min=3 x2S11Min=0.5 x3S11Min=-0.5 FrameElem=116 ElemStation=0.375
 Frame=116 Station=0.5 OutputCase=ACCSX2 CaseType=Combination P=-113.388258060822 V2=83.0140783946785
 V3=0 T=0 M2=0 M3=273.367758547045 S11Max=1526.81829322145 PtS11Max=1 x2S11Max=-0.5 x3S11Max=-0.5 _
 S11Min=-1753.59480934309 PtS11Min=3 x2S11Min=0.5 x3S11Min=-0.5 FrameElem=116 ElemStation=0.5
 Frame=116 Station=0 OutputCase=ENVE CaseType=Combination StepType=Max P=-111.11546006997
 V2=1.51407866868851 V3=0 T=0 M2=0 M3=304.391511259219 S11Max=1710.58382263176 PtS11Max=1 x2S11Max=-0.5
 x3S11Max=-0.5 _
 S11Min=-1849.17695192407 PtS11Min=3 x2S11Min=0.5 x3S11Min=-0.5 FrameElem=116 ElemStation=0
 Frame=116 Station=0.125 OutputCase=ENVE CaseType=Combination StepType=Max P=-111.11546006997
 V2=21.8890786686885 V3=0 T=0 M2=0 M3=303.075729906784 S11Max=1702.68913451715 PtS11Max=1 x2S11Max=-0.5
 x3S11Max=-0.5 _
 S11Min=-1840.40076792256 PtS11Min=3 x2S11Min=0.5 x3S11Min=-0.5 FrameElem=116 ElemStation=0.125
 Frame=116 Station=0.25 OutputCase=ENVE CaseType=Combination StepType=Max P=-111.11546006997
 V2=42.2640786686885 V3=0 T=0 M2=0 M3=299.12838605435 S11Max=1679.00507140254 PtS11Max=1 x2S11Max=-0.5
 x3S11Max=-0.5 _
 S11Min=-1816.34333392104 PtS11Min=3 x2S11Min=0.5 x3S11Min=-0.5 FrameElem=116 ElemStation=0.25
 Frame=116 Station=0.375 OutputCase=ENVE CaseType=Combination StepType=Max P=-111.11546006997
 V2=63.1575010934867 V3=0 T=0 M2=0 M3=292.549479701915 S11Max=1639.53163328794 PtS11Max=1 x2S11Max=-0.5
 x3S11Max=-0.5 _
 S11Min=-1777.00464991952 PtS11Min=3 x2S11Min=0.5 x3S11Min=-0.5 FrameElem=116 ElemStation=0.375
 Frame=116 Station=0.5 OutputCase=ENVE CaseType=Combination StepType=Max P=-111.11546006997
 V2=84.2100010934867 V3=0 T=0 M2=0 M3=283.33901084948 S11Max=1584.26882017333 PtS11Max=1 x2S11Max=-0.5
 x3S11Max=-0.5 _
 S11Min=-1722.38471591801 PtS11Min=3 x2S11Min=0.5 x3S11Min=-0.5 FrameElem=116 ElemStation=0.5
 Frame=116 Station=0 OutputCase=ENVE CaseType=Combination StepType=Min P=-169.541010668998
 V2=7.89226987762959E-07 V3=0 T=0 M2=0 M3=280.335488019634 S11Max=1514.84890431154 PtS11Max=1
 x2S11Max=-0.5 _
 x3S11Max=-0.5 S11Min=-1942.11431247887 PtS11Min=3 x2S11Min=0.5 x3S11Min=-0.5 FrameElem=116
 ElemStation=0
 Frame=116 Station=0.125 OutputCase=ENVE CaseType=Combination StepType=Min P=-169.541010668998
 V2=20.375000789227 V3=0 T=0 M2=0 M3=278.872790686048 S11Max=1506.07272031002 PtS11Max=1 x2S11Max=-0.5
 x3S11Max=-0.5 _
 S11Min=-1934.21962436426 PtS11Min=3 x2S11Min=0.5 x3S11Min=-0.5 FrameElem=116 ElemStation=0.125
 Frame=116 Station=0.25 OutputCase=ENVE CaseType=Combination StepType=Min P=-169.541010668998
 V2=40.750000789227 V3=0 T=0 M2=0 M3=274.863218352462 S11Max=1482.0152863085 PtS11Max=1 x2S11Max=-0.5
 x3S11Max=-0.5 _
 S11Min=-1910.53556124965 PtS11Min=3 x2S11Min=0.5 x3S11Min=-0.5 FrameElem=116 ElemStation=0.25
 Frame=116 Station=0.375 OutputCase=ENVE CaseType=Combination StepType=Min P=-169.541010668998
 V2=61.125000789227 V3=0 T=0 M2=0 M3=268.306771018876 S11Max=1442.67660230699 PtS11Max=1 x2S11Max=-0.5
 x3S11Max=-0.5 _
 S11Min=-1871.06212313504 PtS11Min=3 x2S11Min=0.5 x3S11Min=-0.5 FrameElem=116 ElemStation=0.375
 Frame=116 Station=0.5 OutputCase=ENVE CaseType=Combination StepType=Min P=-169.541010668998
 V2=81.500000789227 V3=0 T=0 M2=0 M3=259.20344868529 S11Max=1388.05666830547 PtS11Max=1 x2S11Max=-0.5
 x3S11Max=-0.5 _
 S11Min=-1815.79931002044 PtS11Min=3 x2S11Min=0.5 x3S11Min=-0.5 FrameElem=116 ElemStation=0.5
 Frame=116 Station=0 OutputCase=FESSUR CaseType=Combination P=-168.146075212923 V2=1.0844117868114E-06
 V3=0 T=0 M2=0 M3=287.44319423936 S11Max=1556.51309022324 PtS11Max=1 x2S11Max=-0.5 x3S11Max=-0.5 _



S11Min=-1892.80524064908 PtS11Min=3 x2S11Min=0.5 x3S11Min=-0.5 FrameElem=116 ElemStation=0
 Frame=116 Station=0.125 OutputCase=FESSUR CaseType=Combination P=-168.146075212923 V2=20.8492510844118
 V3=0 T=0 M2=0 M3=286.140115978809 S11Max=1548.69462065993 PtS11Max=1 x2S11Max=-0.5 x3S11Max=-0.5
 S11Min=-1884.98677108578 PtS11Min=3 x2S11Min=0.5 x3S11Min=-0.5 FrameElem=116 ElemStation=0.125
 Frame=116 Station=0.25 OutputCase=FESSUR CaseType=Combination P=-168.146075212923 V2=41.6985010844118
 V3=0 T=0 M2=0 M3=282.230881468257 S11Max=1525.23921359662 PtS11Max=1 x2S11Max=-0.5 x3S11Max=-0.5
 S11Min=-1861.53136402247 PtS11Min=3 x2S11Min=0.5 x3S11Min=-0.5 FrameElem=116 ElemStation=0.25
 Frame=116 Station=0.375 OutputCase=FESSUR CaseType=Combination P=-168.146075212923 V2=62.5477510844118
 V3=0 T=0 M2=0 M3=275.715490707706 S11Max=1486.14686903331 PtS11Max=1 x2S11Max=-0.5 x3S11Max=-0.5
 S11Min=-1822.43901945927 PtS11Min=3 x2S11Min=0.5 x3S11Min=-0.5 FrameElem=116 ElemStation=0.375
 Frame=116 Station=0.5 OutputCase=FESSUR CaseType=Combination P=-168.146075212923 V2=83.3970010844118
 V3=0 T=0 M2=0 M3=266.593943697154 S11Max=1431.41758697 PtS11Max=1 x2S11Max=-0.5 x3S11Max=-0.5
 S11Min=-1767.70973739585 PtS11Min=3 x2S11Min=0.5 x3S11Min=-0.5 FrameElem=116 ElemStation=0.5
 Frame=117 Station=0 OutputCase=PERM1 CaseType=Combination P=-164.891225815414 V2=81.5000010632079
 V3=0 T=0 M2=0 M3=260.572176685798 S11Max=1398.54183429937 PtS11Max=1 x2S11Max=-0.5 x3S11Max=-0.5
 S11Min=-1728.3242859302 PtS11Min=3 x2S11Min=0.5 x3S11Min=-0.5 FrameElem=117 ElemStation=0
 Frame=117 Station=0.125 OutputCase=PERM1 CaseType=Combination P=-164.891225815414 V2=101.875001063208
 V3=0 T=0 M2=0 M3=249.111239052897 S11Max=1329.77620850196 PtS11Max=1 x2S11Max=-0.5 x3S11Max=-0.5
 S11Min=-1659.55866013279 PtS11Min=3 x2S11Min=0.5 x3S11Min=-0.5 FrameElem=117 ElemStation=0.125
 Frame=117 Station=0.25 OutputCase=PERM1 CaseType=Combination P=-164.891225815414 V2=122.250001063208
 V3=0 T=0 M2=0 M3=235.10342641996 S11Max=1245.72933270456 PtS11Max=1 x2S11Max=-0.5 x3S11Max=-0.5
 S11Min=-1575.51178433539 PtS11Min=3 x2S11Min=0.5 x3S11Min=-0.5 FrameElem=117 ElemStation=0.25
 Frame=117 Station=0.375 OutputCase=PERM1 CaseType=Combination P=-164.891225815414 V2=142.625001063208
 V3=0 T=0 M2=0 M3=218.548738787095 S11Max=1146.40120690715 PtS11Max=1 x2S11Max=-0.5 x3S11Max=-0.5
 S11Min=-1476.18365853798 PtS11Min=3 x2S11Min=0.5 x3S11Min=-0.5 FrameElem=117 ElemStation=0.375
 Frame=117 Station=0.5 OutputCase=PERM1 CaseType=Combination P=-164.891225815414 V2=163.000001063208
 V3=0 T=0 M2=0 M3=199.447176154194 S11Max=1031.79183110975 PtS11Max=1 x2S11Max=-0.5 x3S11Max=-0.5
 S11Min=-1361.57428274058 PtS11Min=3 x2S11Min=0.5 x3S11Min=-0.5 FrameElem=117 ElemStation=0.5
 Frame=117 Station=0 OutputCase=PERM2 CaseType=Combination P=-111.115460069969 V2=81.5000007891979
 V3=0 T=0 M2=0 M3=274.736486547553 S11Max=1537.30345921535 PtS11Max=1 x2S11Max=-0.5 x3S11Max=-0.5
 S11Min=-1759.53437935529 PtS11Min=3 x2S11Min=0.5 x3S11Min=-0.5 FrameElem=117 ElemStation=0
 Frame=117 Station=0.125 OutputCase=PERM2 CaseType=Combination P=-111.115460069969 V2=101.875000789198
 V3=0 T=0 M2=0 M3=263.275548948903 S11Max=1468.53783362345 PtS11Max=1 x2S11Max=-0.5 x3S11Max=-0.5
 S11Min=-1690.76875376339 PtS11Min=3 x2S11Min=0.5 x3S11Min=-0.5 FrameElem=117 ElemStation=0.125
 Frame=117 Station=0.25 OutputCase=PERM2 CaseType=Combination P=-111.115460069969 V2=122.250000789198
 V3=0 T=0 M2=0 M3=249.267736350253 S11Max=1384.49095803155 PtS11Max=1 x2S11Max=-0.5 x3S11Max=-0.5
 S11Min=-1606.72187817149 PtS11Min=3 x2S11Min=0.5 x3S11Min=-0.5 FrameElem=117 ElemStation=0.25
 Frame=117 Station=0.375 OutputCase=PERM2 CaseType=Combination P=-111.115460069969 V2=142.625000789198
 V3=0 T=0 M2=0 M3=232.713048751604 S11Max=1285.16283243965 PtS11Max=1 x2S11Max=-0.5 x3S11Max=-0.5
 S11Min=-1507.39375257959 PtS11Min=3 x2S11Min=0.5 x3S11Min=-0.5 FrameElem=117 ElemStation=0.375
 Frame=117 Station=0.5 OutputCase=PERM2 CaseType=Combination P=-111.115460069969 V2=163.000000789198
 V3=0 T=0 M2=0 M3=213.611486152954 S11Max=1170.55345684775 PtS11Max=1 x2S11Max=-0.5 x3S11Max=-0.5
 S11Min=-1392.78437698769 PtS11Min=3 x2S11Min=0.5 x3S11Min=-0.5 FrameElem=117 ElemStation=0.5
 Frame=117 Station=0 OutputCase=ACC1 CaseType=Combination P=-169.541010668997 V2=84.2100010934569 V3=0
 T=0 M2=0 M3=269.1747009877 S11Max=1445.5071952572 PtS11Max=1 x2S11Max=-0.5 x3S11Max=-0.5
 S11Min=-1784.5892165952 PtS11Min=3 x2S11Min=0.5 x3S11Min=-0.5 FrameElem=117 ElemStation=0
 Frame=117 Station=0.125 OutputCase=ACC1 CaseType=Combination P=-169.541010668997 V2=105.262501093457
 V3=0 T=0 M2=0 M3=257.332669601018 S11Max=1374.45500693711 PtS11Max=1 x2S11Max=-0.5 x3S11Max=-0.5
 S11Min=-1713.5370282751 PtS11Min=3 x2S11Min=0.5 x3S11Min=-0.5 FrameElem=117 ElemStation=0.125
 Frame=117 Station=0.25 OutputCase=ACC1 CaseType=Combination P=-169.541010668997 V2=126.315001093457
 V3=0 T=0 M2=0 M3=242.859075714335 S11Max=1287.61344361702 PtS11Max=1 x2S11Max=-0.5 x3S11Max=-0.5
 S11Min=-1626.69546495501 PtS11Min=3 x2S11Min=0.5 x3S11Min=-0.5 FrameElem=117 ElemStation=0.25
 Frame=117 Station=0.375 OutputCase=ACC1 CaseType=Combination P=-169.541010668997 V2=147.367501093457
 V3=0 T=0 M2=0 M3=225.753919327653 S11Max=1184.98250529692 PtS11Max=1 x2S11Max=-0.5 x3S11Max=-0.5
 S11Min=-1524.06452663492 PtS11Min=3 x2S11Min=0.5 x3S11Min=-0.5 FrameElem=117 ElemStation=0.375
 Frame=117 Station=0.5 OutputCase=ACC1 CaseType=Combination P=-169.541010668997 V2=168.420001093457
 V3=0 T=0 M2=0 M3=206.017200440971 S11Max=1066.56219197683 PtS11Max=1 x2S11Max=-0.5 x3S11Max=-0.5
 S11Min=-1405.64421331482 PtS11Min=3 x2S11Min=0.5 x3S11Min=-0.5 FrameElem=117 ElemStation=0.5
 Frame=117 Station=0 OutputCase=ACC2 CaseType=Combination P=-115.765244923552 V2=84.2100008194468 V3=0
 T=0 M2=0 M3=283.339010849455 S11Max=1584.26882017318 PtS11Max=1 x2S11Max=-0.5 x3S11Max=-0.5
 S11Min=-1815.79931002028 PtS11Min=3 x2S11Min=0.5 x3S11Min=-0.5 FrameElem=117 ElemStation=0
 Frame=117 Station=0.125 OutputCase=ACC2 CaseType=Combination P=-115.765244923552 V2=105.262500819447
 V3=0 T=0 M2=0 M3=271.496979497024 S11Max=1513.21663205859 PtS11Max=1 x2S11Max=-0.5 x3S11Max=-0.5
 S11Min=-1744.7471219057 PtS11Min=3 x2S11Min=0.5 x3S11Min=-0.5 FrameElem=117 ElemStation=0.125
 Frame=117 Station=0.25 OutputCase=ACC2 CaseType=Combination P=-115.765244923552 V2=126.315000819447
 V3=0 T=0 M2=0 M3=257.023385644593 S11Max=1426.37506894401 PtS11Max=1 x2S11Max=-0.5 x3S11Max=-0.5
 S11Min=-1657.90555879111 PtS11Min=3 x2S11Min=0.5 x3S11Min=-0.5 FrameElem=117 ElemStation=0.25
 Frame=117 Station=0.375 OutputCase=ACC2 CaseType=Combination P=-115.765244923552 V2=147.367500819447
 V3=0 T=0 M2=0 M3=239.918229292162 S11Max=1323.74413082942 PtS11Max=1 x2S11Max=-0.5 x3S11Max=-0.5
 S11Min=-1555.27462067653 PtS11Min=3 x2S11Min=0.5 x3S11Min=-0.5 FrameElem=117 ElemStation=0.375
 Frame=117 Station=0.5 OutputCase=ACC2 CaseType=Combination P=-115.765244923552 V2=168.420000819447
 V3=0 T=0 M2=0 M3=220.181510439731 S11Max=1205.32381771484 PtS11Max=1 x2S11Max=-0.5 x3S11Max=-0.5
 S11Min=-1436.85430756194 PtS11Min=3 x2S11Min=0.5 x3S11Min=-0.5 FrameElem=117 ElemStation=0.5
 Frame=117 Station=0 OutputCase=ACCSX1 CaseType=Combination P=-167.16402380627 V2=83.0140786686588
 V3=0 T=0 M2=0 M3=259.203448685265 S11Max=1388.05666830532 PtS11Max=1 x2S11Max=-0.5 x3S11Max=-0.5
 S11Min=-1722.38471591786 PtS11Min=3 x2S11Min=0.5 x3S11Min=-0.5 FrameElem=117 ElemStation=0
 Frame=117 Station=0.125 OutputCase=ACCSX1 CaseType=Combination P=-167.16402380627 V2=103.389078668659
 V3=0 T=0 M2=0 M3=247.553251351682 S11Max=1318.15548430382 PtS11Max=1 x2S11Max=-0.5 x3S11Max=-0.5
 S11Min=-1652.48353191637 PtS11Min=3 x2S11Min=0.5 x3S11Min=-0.5 FrameElem=117 ElemStation=0.125
 Frame=117 Station=0.25 OutputCase=ACCSX1 CaseType=Combination P=-167.16402380627 V2=123.764078668659
 V3=0 T=0 M2=0 M3=233.3561790181 S11Max=1232.97305030233 PtS11Max=1 x2S11Max=-0.5 x3S11Max=-0.5
 S11Min=-1567.30109791487 PtS11Min=3 x2S11Min=0.5 x3S11Min=-0.5 FrameElem=117 ElemStation=0.25



Frame=117 Station=0.375 OutputCase=ACCSX1 CaseType=Combination P=-167.16402380627 V2=144.139078668659
 V3=0 T=0 M2=0 M3=216.612231684518 S11Max=1132.50936630084 PtS11Max=1 x2S11Max=-0.5 x3S11Max=-0.5 _
 S11Min=-1466.83741391338 PtS11Min=3 x2S11Min=0.5 x3S11Min=-0.5 FrameElem=117 ElemStation=0.375
 Frame=117 Station=0.5 OutputCase=ACCSX1 CaseType=Combination P=-167.16402380627 V2=164.514078668659
 V3=0 T=0 M2=0 M3=197.321409350935 S11Max=1016.76443229934 PtS11Max=1 x2S11Max=-0.5 x3S11Max=-0.5 _
 S11Min=-1351.09247991188 PtS11Min=3 x2S11Min=0.5 x3S11Min=-0.5 FrameElem=117 ElemStation=0.5
 Frame=117 Station=0 OutputCase=ACCSX2 CaseType=Combination P=-113.388258060825 V2=83.0140783946488
 V3=0 T=0 M2=0 M3=273.36775854702 S11Max=1526.8182932213 PtS11Max=1 x2S11Max=-0.5 x3S11Max=-0.5 _
 S11Min=-1753.59480934295 PtS11Min=3 x2S11Min=0.5 x3S11Min=-0.5 FrameElem=117 ElemStation=0
 Frame=117 Station=0.125 OutputCase=ACCSX2 CaseType=Combination P=-113.388258060825 V2=103.389078394649
 V3=0 T=0 M2=0 M3=261.717561247689 S11Max=1456.91710942531 PtS11Max=1 x2S11Max=-0.5 x3S11Max=-0.5 _
 S11Min=-1683.69362554696 PtS11Min=3 x2S11Min=0.5 x3S11Min=-0.5 FrameElem=117 ElemStation=0.125
 Frame=117 Station=0.25 OutputCase=ACCSX2 CaseType=Combination P=-113.388258060825 V2=123.764078394649
 V3=0 T=0 M2=0 M3=247.520488948358 S11Max=1371.73467562932 PtS11Max=1 x2S11Max=-0.5 x3S11Max=-0.5 _
 S11Min=-1598.5119175097 PtS11Min=3 x2S11Min=0.5 x3S11Min=-0.5 FrameElem=117 ElemStation=0.25
 Frame=117 Station=0.375 OutputCase=ACCSX2 CaseType=Combination P=-113.388258060825 V2=144.139078394649
 V3=0 T=0 M2=0 M3=230.776541649027 S11Max=1271.27099183334 PtS11Max=1 x2S11Max=-0.5 x3S11Max=-0.5 _
 S11Min=-1498.04750795499 PtS11Min=3 x2S11Min=0.5 x3S11Min=-0.5 FrameElem=117 ElemStation=0.375
 Frame=117 Station=0.5 OutputCase=ACCSX2 CaseType=Combination P=-113.388258060825 V2=164.514078394649
 V3=0 T=0 M2=0 M3=211.485719349696 S11Max=1155.52605803735 PtS11Max=1 x2S11Max=-0.5 x3S11Max=-0.5 _
 S11Min=-1382.302574159 PtS11Min=3 x2S11Min=0.5 x3S11Min=-0.5 FrameElem=117 ElemStation=0.5
 Frame=117 Station=0 OutputCase=ENVE CaseType=Combination StepType=Max P=-111.115460069969
 V2=84.2100010934569 V3=0 T=0 M2=0 M3=283.339010849455 S11Max=1584.26882017318 PtS11Max=1 x2S11Max=-0.5
 x3S11Max=-0.5 _
 S11Min=-1722.38471591786 PtS11Min=3 x2S11Min=0.5 x3S11Min=-0.5 FrameElem=117 ElemStation=0
 Frame=117 Station=0.125 OutputCase=ENVE CaseType=Combination StepType=Max P=-111.115460069969
 V2=105.262501093457 V3=0 T=0 M2=0 M3=271.496979497024 S11Max=1513.21663205859 PtS11Max=1 x2S11Max=-0.5
 _
 x3S11Max=-0.5 S11Min=-1652.48353191637 PtS11Min=3 x2S11Min=0.5 x3S11Min=-0.5 FrameElem=117
 ElemStation=0.125
 Frame=117 Station=0.25 OutputCase=ENVE CaseType=Combination StepType=Max P=-111.115460069969
 V2=126.315001093457 V3=0 T=0 M2=0 M3=257.023385644593 S11Max=1426.37506894401 PtS11Max=1 x2S11Max=-0.5
 x3S11Max=-0.5 _
 S11Min=-1567.30109791487 PtS11Min=3 x2S11Min=0.5 x3S11Min=-0.5 FrameElem=117 ElemStation=0.25
 Frame=117 Station=0.375 OutputCase=ENVE CaseType=Combination StepType=Max P=-111.115460069969
 V2=147.367501093457 V3=0 T=0 M2=0 M3=239.918229292162 S11Max=1323.74413082942 PtS11Max=1 x2S11Max=-0.5
 _
 x3S11Max=-0.5 S11Min=-1466.83741391338 PtS11Min=3 x2S11Min=0.5 x3S11Min=-0.5 FrameElem=117
 ElemStation=0.375
 Frame=117 Station=0.5 OutputCase=ENVE CaseType=Combination StepType=Max P=-111.115460069969
 V2=168.420001093457 V3=0 T=0 M2=0 M3=220.181510439731 S11Max=1205.32381771484 PtS11Max=1 x2S11Max=-0.5
 x3S11Max=-0.5 _
 S11Min=-1351.09247991188 PtS11Min=3 x2S11Min=0.5 x3S11Min=-0.5 FrameElem=117 ElemStation=0.5
 Frame=117 Station=0 OutputCase=ENVE CaseType=Combination StepType=Min P=-169.541010668997
 V2=81.5000007891979 V3=0 T=0 M2=0 M3=259.203448685265 S11Max=1388.05666830532 PtS11Max=1 x2S11Max=-0.5
 x3S11Max=-0.5 _
 S11Min=-1815.79931002028 PtS11Min=3 x2S11Min=0.5 x3S11Min=-0.5 FrameElem=117 ElemStation=0
 Frame=117 Station=0.125 OutputCase=ENVE CaseType=Combination StepType=Min P=-169.541010668997
 V2=101.875000789198 V3=0 T=0 M2=0 M3=247.553251351682 S11Max=1318.15548430382 PtS11Max=1 x2S11Max=-0.5
 _
 x3S11Max=-0.5 S11Min=-1744.7471219057 PtS11Min=3 x2S11Min=0.5 x3S11Min=-0.5 FrameElem=117
 ElemStation=0.125
 Frame=117 Station=0.25 OutputCase=ENVE CaseType=Combination StepType=Min P=-169.541010668997
 V2=122.250000789198 V3=0 T=0 M2=0 M3=233.3561790181 S11Max=1232.97305030233 PtS11Max=1 x2S11Max=-0.5
 x3S11Max=-0.5 _
 S11Min=-1657.90555879111 PtS11Min=3 x2S11Min=0.5 x3S11Min=-0.5 FrameElem=117 ElemStation=0.25
 Frame=117 Station=0.375 OutputCase=ENVE CaseType=Combination StepType=Min P=-169.541010668997
 V2=142.625000789198 V3=0 T=0 M2=0 M3=216.612231684518 S11Max=1132.50936630084 PtS11Max=1 x2S11Max=-0.5
 _
 x3S11Max=-0.5 S11Min=-1555.27462067653 PtS11Min=3 x2S11Min=0.5 x3S11Min=-0.5 FrameElem=117
 ElemStation=0.375
 Frame=117 Station=0.5 OutputCase=ENVE CaseType=Combination StepType=Min P=-169.541010668997
 V2=163.000000789198 V3=0 T=0 M2=0 M3=197.321409350935 S11Max=1016.76443229934 PtS11Max=1 x2S11Max=-0.5
 x3S11Max=-0.5 _
 S11Min=-1436.85430756194 PtS11Min=3 x2S11Min=0.5 x3S11Min=-0.5 FrameElem=117 ElemStation=0.5
 Frame=117 Station=0 OutputCase=FESSUR CaseType=Combination P=-168.146075212922 V2=83.3970010843822
 V3=0 T=0 M2=0 M3=266.593943697129 S11Max=1431.41758696985 PtS11Max=1 x2S11Max=-0.5 x3S11Max=-0.5 _
 S11Min=-1767.7097373957 PtS11Min=3 x2S11Min=0.5 x3S11Min=-0.5 FrameElem=117 ElemStation=0
 Frame=117 Station=0.125 OutputCase=FESSUR CaseType=Combination P=-168.146075212922 V2=104.246251084382
 V3=0 T=0 M2=0 M3=254.866240436581 S11Max=1361.05136740656 PtS11Max=1 x2S11Max=-0.5 x3S11Max=-0.5 _
 S11Min=-1697.34351783241 PtS11Min=3 x2S11Min=0.5 x3S11Min=-0.5 FrameElem=117 ElemStation=0.125
 Frame=117 Station=0.25 OutputCase=FESSUR CaseType=Combination P=-168.146075212922 V2=125.095501084382
 V3=0 T=0 M2=0 M3=240.532380926033 S11Max=1275.04821034328 PtS11Max=1 x2S11Max=-0.5 x3S11Max=-0.5 _
 S11Min=-1611.34036076912 PtS11Min=3 x2S11Min=0.5 x3S11Min=-0.5 FrameElem=117 ElemStation=0.25
 Frame=117 Station=0.375 OutputCase=FESSUR CaseType=Combination P=-168.146075212922 V2=145.944751084382
 V3=0 T=0 M2=0 M3=223.592365165486 S11Max=1173.40811577999 PtS11Max=1 x2S11Max=-0.5 x3S11Max=-0.5 _
 S11Min=-1509.70026620584 PtS11Min=3 x2S11Min=0.5 x3S11Min=-0.5 FrameElem=117 ElemStation=0.375
 Frame=117 Station=0.5 OutputCase=FESSUR CaseType=Combination P=-168.146075212922 V2=166.794001084382
 V3=0 T=0 M2=0 M3=204.046193154938 S11Max=1056.13108371671 PtS11Max=1 x2S11Max=-0.5 x3S11Max=-0.5 _
 S11Min=-1392.42323414255 PtS11Min=3 x2S11Min=0.5 x3S11Min=-0.5 FrameElem=117 ElemStation=0.5
 Frame=118 Station=0 OutputCase=PERM1 CaseType=Combination P=-164.891225815415 V2=163.00000106315 V3=0
 T=0 M2=0 M3=199.447176154197 S11Max=1031.79183110977 PtS11Max=1 x2S11Max=-0.5 x3S11Max=-0.5 _

S11Min=-1361.5742827406 PtS11Min=3 x2S11Min=0.5 x3S11Min=-0.5 FrameElem=118 ElemStation=0
 Frame=118 Station=0.125 OutputCase=PERM1 CaseType=Combination P=-164.891225815415 V2=183.37500106315
 V3=0 T=0 M2=0 M3=177.798738521303 S11Max=901.901205312406 PtS11Max=1 x2S11Max=-0.5 x3S11Max=-0.5
 S11Min=-1231.68365694324 PtS11Min=3 x2S11Min=0.5 x3S11Min=-0.5 FrameElem=118 ElemStation=0.125
 Frame=118 Station=0.25 OutputCase=PERM1 CaseType=Combination P=-164.891225815415 V2=203.75000106315
 V3=0 T=0 M2=0 M3=153.60342588841 S11Max=756.729329515044 PtS11Max=1 x2S11Max=-0.5 x3S11Max=-0.5
 S11Min=-1086.51178114587 PtS11Min=3 x2S11Min=0.5 x3S11Min=-0.5 FrameElem=118 ElemStation=0.25
 Frame=118 Station=0.375 OutputCase=PERM1 CaseType=Combination P=-164.891225815415 V2=224.12500106315
 V3=0 T=0 M2=0 M3=126.861238255516 S11Max=596.276203717681 PtS11Max=1 x2S11Max=-0.5 x3S11Max=-0.5
 S11Min=-926.058655348511 PtS11Min=3 x2S11Min=0.5 x3S11Min=-0.5 FrameElem=118 ElemStation=0.375
 Frame=118 Station=0.5 OutputCase=PERM1 CaseType=Combination P=-164.891225815415 V2=244.50000106315
 V3=0 T=0 M2=0 M3=97.5721756226223 S11Max=420.541827920319 PtS11Max=1 x2S11Max=-0.5 x3S11Max=-0.5
 S11Min=-750.324279551148 PtS11Min=3 x2S11Min=0.5 x3S11Min=-0.5 FrameElem=118 ElemStation=0.5
 Frame=118 Station=0 OutputCase=PERM2 CaseType=Combination P=-111.115460069969 V2=163.00000078914 V3=0
 T=0 M2=0 M3=213.611486152957 S11Max=1170.55345684778 PtS11Max=1 x2S11Max=-0.5 x3S11Max=-0.5
 S11Min=-1392.78437698771 PtS11Min=3 x2S11Min=0.5 x3S11Min=-0.5 FrameElem=118 ElemStation=0
 Frame=118 Station=0.125 OutputCase=PERM2 CaseType=Combination P=-111.115460069969 V2=183.37500078914
 V3=0 T=0 M2=0 M3=191.963048554315 S11Max=1040.66283125592 PtS11Max=1 x2S11Max=-0.5 x3S11Max=-0.5
 S11Min=-1262.89375139586 PtS11Min=3 x2S11Min=0.5 x3S11Min=-0.5 FrameElem=118 ElemStation=0.125
 Frame=118 Station=0.25 OutputCase=PERM2 CaseType=Combination P=-111.115460069969 V2=203.75000078914
 V3=0 T=0 M2=0 M3=167.767735955673 S11Max=895.490955664066 PtS11Max=1 x2S11Max=-0.5 x3S11Max=-0.5
 S11Min=-1117.721875804 PtS11Min=3 x2S11Min=0.5 x3S11Min=-0.5 FrameElem=118 ElemStation=0.25
 Frame=118 Station=0.375 OutputCase=PERM2 CaseType=Combination P=-111.115460069969 V2=224.12500078914
 V3=0 T=0 M2=0 M3=141.02554835703 S11Max=735.037830072211 PtS11Max=1 x2S11Max=-0.5 x3S11Max=-0.5
 S11Min=-957.26875021215 PtS11Min=3 x2S11Min=0.5 x3S11Min=-0.5 FrameElem=118 ElemStation=0.375
 Frame=118 Station=0.5 OutputCase=PERM2 CaseType=Combination P=-111.115460069969 V2=244.50000078914
 V3=0 T=0 M2=0 M3=111.736485758388 S11Max=559.303454480356 PtS11Max=1 x2S11Max=-0.5 x3S11Max=-0.5
 S11Min=-781.534374620295 PtS11Min=3 x2S11Min=0.5 x3S11Min=-0.5 FrameElem=118 ElemStation=0.5
 Frame=118 Station=0 OutputCase=ACC1 CaseType=Combination P=-169.541010668998 V2=168.420001093398 V3=0
 T=0 M2=0 M3=206.017200440975 S11Max=1066.56219197685 PtS11Max=1 x2S11Max=-0.5 x3S11Max=-0.5
 S11Min=-1405.64421331485 PtS11Min=3 x2S11Min=0.5 x3S11Min=-0.5 FrameElem=118 ElemStation=0
 Frame=118 Station=0.125 OutputCase=ACC1 CaseType=Combination P=-169.541010668998 V2=189.472501093398
 V3=0 T=0 M2=0 M3=183.6489190543 S11Max=932.352503656805 PtS11Max=1 x2S11Max=-0.5 x3S11Max=-0.5
 S11Min=-1271.4345249948 PtS11Min=3 x2S11Min=0.5 x3S11Min=-0.5 FrameElem=118 ElemStation=0.125
 Frame=118 Station=0.25 OutputCase=ACC1 CaseType=Combination P=-169.541010668998 V2=210.525001093398
 V3=0 T=0 M2=0 M3=158.649075167626 S11Max=782.353440336756 PtS11Max=1 x2S11Max=-0.5 x3S11Max=-0.5
 S11Min=-1121.43546167475 PtS11Min=3 x2S11Min=0.5 x3S11Min=-0.5 FrameElem=118 ElemStation=0.25
 Frame=118 Station=0.375 OutputCase=ACC1 CaseType=Combination P=-169.541010668998 V2=231.577501093398
 V3=0 T=0 M2=0 M3=131.017668780951 S11Max=616.565002016707 PtS11Max=1 x2S11Max=-0.5 x3S11Max=-0.5
 S11Min=-955.647023354702 PtS11Min=3 x2S11Min=0.5 x3S11Min=-0.5 FrameElem=118 ElemStation=0.375
 Frame=118 Station=0.5 OutputCase=ACC1 CaseType=Combination P=-169.541010668998 V2=252.630001093398
 V3=0 T=0 M2=0 M3=100.754699894276 S11Max=434.987188696658 PtS11Max=1 x2S11Max=-0.5 x3S11Max=-0.5
 S11Min=-774.069210034653 PtS11Min=3 x2S11Min=0.5 x3S11Min=-0.5 FrameElem=118 ElemStation=0.5
 Frame=118 Station=0 OutputCase=ACC2 CaseType=Combination P=-115.765244923552 V2=168.420000819388 V3=0
 T=0 M2=0 M3=220.181510439735 S11Max=1205.32381771486 PtS11Max=1 x2S11Max=-0.5 x3S11Max=-0.5
 S11Min=-1436.85430756197 PtS11Min=3 x2S11Min=0.5 x3S11Min=-0.5 FrameElem=118 ElemStation=0
 Frame=118 Station=0.125 OutputCase=ACC2 CaseType=Combination P=-115.765244923552 V2=189.472500819388
 V3=0 T=0 M2=0 M3=197.813229087312 S11Max=1071.11412960032 PtS11Max=1 x2S11Max=-0.5 x3S11Max=-0.5
 S11Min=-1302.64461944742 PtS11Min=3 x2S11Min=0.5 x3S11Min=-0.5 FrameElem=118 ElemStation=0.125
 Frame=118 Station=0.25 OutputCase=ACC2 CaseType=Combination P=-115.765244923552 V2=210.525000819388
 V3=0 T=0 M2=0 M3=172.813385234888 S11Max=921.115066485778 PtS11Max=1 x2S11Max=-0.5 x3S11Max=-0.5
 S11Min=-1152.64555633288 PtS11Min=3 x2S11Min=0.5 x3S11Min=-0.5 FrameElem=118 ElemStation=0.25
 Frame=118 Station=0.375 OutputCase=ACC2 CaseType=Combination P=-115.765244923552 V2=231.577500819388
 V3=0 T=0 M2=0 M3=145.181978882465 S11Max=755.326628371236 PtS11Max=1 x2S11Max=-0.5 x3S11Max=-0.5
 S11Min=-986.857118218341 PtS11Min=3 x2S11Min=0.5 x3S11Min=-0.5 FrameElem=118 ElemStation=0.375
 Frame=118 Station=0.5 OutputCase=ACC2 CaseType=Combination P=-115.765244923552 V2=252.630000819388
 V3=0 T=0 M2=0 M3=114.919010030041 S11Max=573.748815256695 PtS11Max=1 x2S11Max=-0.5 x3S11Max=-0.5
 S11Min=-805.2793051038 PtS11Min=3 x2S11Min=0.5 x3S11Min=-0.5 FrameElem=118 ElemStation=0.5
 Frame=118 Station=0 OutputCase=ACCSX1 CaseType=Combination P=-167.16402380627 V2=164.514078668601
 V3=0 T=0 M2=0 M3=197.321409350939 S11Max=1016.76443229936 PtS11Max=1 x2S11Max=-0.5 x3S11Max=-0.5
 S11Min=-1351.09247991191 PtS11Min=3 x2S11Min=0.5 x3S11Min=-0.5 FrameElem=118 ElemStation=0
 Frame=118 Station=0.125 OutputCase=ACCSX1 CaseType=Combination P=-167.16402380627 V2=184.889078668601
 V3=0 T=0 M2=0 M3=175.483712017364 S11Max=885.738248297914 PtS11Max=1 x2S11Max=-0.5 x3S11Max=-0.5
 S11Min=-1220.06629591045 PtS11Min=3 x2S11Min=0.5 x3S11Min=-0.5 FrameElem=118 ElemStation=0.125
 Frame=118 Station=0.25 OutputCase=ACCSX1 CaseType=Combination P=-167.16402380627 V2=205.264078668601
 V3=0 T=0 M2=0 M3=151.099139683789 S11Max=739.430814296463 PtS11Max=1 x2S11Max=-0.5 x3S11Max=-0.5
 S11Min=-1073.758861909 PtS11Min=3 x2S11Min=0.5 x3S11Min=-0.5 FrameElem=118 ElemStation=0.25
 Frame=118 Station=0.375 OutputCase=ACCSX1 CaseType=Combination P=-167.16402380627 V2=225.639078668601
 V3=0 T=0 M2=0 M3=124.167692350214 S11Max=577.842130295012 PtS11Max=1 x2S11Max=-0.5 x3S11Max=-0.5
 S11Min=-912.170177907553 PtS11Min=3 x2S11Min=0.5 x3S11Min=-0.5 FrameElem=118 ElemStation=0.375
 Frame=118 Station=0.5 OutputCase=ACCSX1 CaseType=Combination P=-167.16402380627 V2=246.014078668601
 V3=0 T=0 M2=0 M3=94.6893700166386 S11Max=400.972196293561 PtS11Max=1 x2S11Max=-0.5 x3S11Max=-0.5
 S11Min=-735.300243906102 PtS11Min=3 x2S11Min=0.5 x3S11Min=-0.5 FrameElem=118 ElemStation=0.5
 Frame=118 Station=0 OutputCase=ACCSX2 CaseType=Combination P=-113.388258060825 V2=164.514078394591
 V3=0 T=0 M2=0 M3=211.485719349699 S11Max=1155.52605803737 PtS11Max=1 x2S11Max=-0.5 x3S11Max=-0.5
 S11Min=-1382.30257415902 PtS11Min=3 x2S11Min=0.5 x3S11Min=-0.5 FrameElem=118 ElemStation=0
 Frame=118 Station=0.125 OutputCase=ACCSX2 CaseType=Combination P=-113.388258060825 V2=184.889078394591
 V3=0 T=0 M2=0 M3=189.648022050376 S11Max=1024.49987424143 PtS11Max=1 x2S11Max=-0.5 x3S11Max=-0.5
 S11Min=-1251.27639036308 PtS11Min=3 x2S11Min=0.5 x3S11Min=-0.5 FrameElem=118 ElemStation=0.125
 Frame=118 Station=0.25 OutputCase=ACCSX2 CaseType=Combination P=-113.388258060825 V2=205.264078394591
 V3=0 T=0 M2=0 M3=165.263449751052 S11Max=878.192440445485 PtS11Max=1 x2S11Max=-0.5 x3S11Max=-0.5
 S11Min=-1104.96895656714 PtS11Min=3 x2S11Min=0.5 x3S11Min=-0.5 FrameElem=118 ElemStation=0.25



Frame=118 Station=0.375 OutputCase=ACCSX2 CaseType=Combination P=-113.388258060825 V2=225.639078394591
 V3=0 T=0 M2=0 M3=138.332002451728 S11Max=716.603756649542 PtS11Max=1 x2S11Max=-0.5 x3S11Max=-0.5 _
 S11Min=-943.380272771192 PtS11Min=3 x2S11Min=0.5 x3S11Min=-0.5 FrameElem=118 ElemStation=0.375
 Frame=118 Station=0.5 OutputCase=ACCSX2 CaseType=Combination P=-113.388258060825 V2=246.014078394591
 V3=0 T=0 M2=0 M3=108.853680152404 S11Max=539.733822853598 PtS11Max=1 x2S11Max=-0.5 x3S11Max=-0.5 _
 S11Min=-766.510338975249 PtS11Min=3 x2S11Min=0.5 x3S11Min=-0.5 FrameElem=118 ElemStation=0.5
 Frame=118 Station=0 OutputCase=ENVE CaseType=Combination StepType=Max P=-111.115460069969
 V2=168.420001093398 V3=0 T=0 M2=0 M3=220.181510439735 S11Max=1205.32381771486 PtS11Max=1 x2S11Max=-0.5
 x3S11Max=-0.5 _
 S11Min=-1351.09247991191 PtS11Min=3 x2S11Min=0.5 x3S11Min=-0.5 FrameElem=118 ElemStation=0
 Frame=118 Station=0.125 OutputCase=ENVE CaseType=Combination StepType=Max P=-111.115460069969
 V2=189.472501093398 V3=0 T=0 M2=0 M3=197.813229087312 S11Max=1071.11412960032 PtS11Max=1 x2S11Max=-0.5
 _
 x3S11Max=-0.5 S11Min=-1220.06629591045 PtS11Min=3 x2S11Min=0.5 x3S11Min=-0.5 FrameElem=118
 ElemStation=0.125
 Frame=118 Station=0.25 OutputCase=ENVE CaseType=Combination StepType=Max P=-111.115460069969
 V2=210.525001093398 V3=0 T=0 M2=0 M3=172.813385234888 S11Max=921.115066485778 PtS11Max=1 x2S11Max=-0.5
 x3S11Max=-0.5 _
 S11Min=-1073.758861909 PtS11Min=3 x2S11Min=0.5 x3S11Min=-0.5 FrameElem=118 ElemStation=0.25
 Frame=118 Station=0.375 OutputCase=ENVE CaseType=Combination StepType=Max P=-111.115460069969
 V2=231.577501093398 V3=0 T=0 M2=0 M3=145.181978882465 S11Max=755.326628371236 PtS11Max=1 x2S11Max=-0.5
 _
 x3S11Max=-0.5 S11Min=-912.170177907553 PtS11Min=3 x2S11Min=0.5 x3S11Min=-0.5 FrameElem=118
 ElemStation=0.375
 Frame=118 Station=0.5 OutputCase=ENVE CaseType=Combination StepType=Max P=-111.115460069969
 V2=252.630001093398 V3=0 T=0 M2=0 M3=114.919010030041 S11Max=573.748815256695 PtS11Max=1 x2S11Max=-0.5
 x3S11Max=-0.5 _
 S11Min=-735.300243906102 PtS11Min=3 x2S11Min=0.5 x3S11Min=-0.5 FrameElem=118 ElemStation=0.5
 Frame=118 Station=0 OutputCase=ENVE CaseType=Combination StepType=Min P=-169.541010668998
 V2=163.00000078914 V3=0 T=0 M2=0 M3=197.321409350939 S11Max=1016.76443229936 PtS11Max=1 x2S11Max=-0.5
 x3S11Max=-0.5 _
 S11Min=-1436.85430756197 PtS11Min=3 x2S11Min=0.5 x3S11Min=-0.5 FrameElem=118 ElemStation=0
 Frame=118 Station=0.125 OutputCase=ENVE CaseType=Combination StepType=Min P=-169.541010668998
 V2=183.37500078914 V3=0 T=0 M2=0 M3=175.483712017364 S11Max=885.738248297914 PtS11Max=1 x2S11Max=-0.5
 x3S11Max=-0.5 _
 S11Min=-1302.64461944742 PtS11Min=3 x2S11Min=0.5 x3S11Min=-0.5 FrameElem=118 ElemStation=0.125
 Frame=118 Station=0.25 OutputCase=ENVE CaseType=Combination StepType=Min P=-169.541010668998
 V2=203.75000078914 V3=0 T=0 M2=0 M3=151.099139683789 S11Max=739.430814296463 PtS11Max=1 x2S11Max=-0.5
 x3S11Max=-0.5 _
 S11Min=-1152.64555633288 PtS11Min=3 x2S11Min=0.5 x3S11Min=-0.5 FrameElem=118 ElemStation=0.25
 Frame=118 Station=0.375 OutputCase=ENVE CaseType=Combination StepType=Min P=-169.541010668998
 V2=224.12500078914 V3=0 T=0 M2=0 M3=124.167692350214 S11Max=577.842130295012 PtS11Max=1 x2S11Max=-0.5
 x3S11Max=-0.5 _
 S11Min=-986.857118218341 PtS11Min=3 x2S11Min=0.5 x3S11Min=-0.5 FrameElem=118 ElemStation=0.375
 Frame=118 Station=0.5 OutputCase=ENVE CaseType=Combination StepType=Min P=-169.541010668998
 V2=244.50000078914 V3=0 T=0 M2=0 M3=94.6893700166386 S11Max=400.972196293561 PtS11Max=1 x2S11Max=-0.5
 x3S11Max=-0.5 _
 S11Min=-805.2793051038 PtS11Min=3 x2S11Min=0.5 x3S11Min=-0.5 FrameElem=118 ElemStation=0.5
 Frame=118 Station=0 OutputCase=FESSUR CaseType=Combination P=-168.146075212923 V2=166.794001084324
 V3=0 T=0 M2=0 M3=204.046193154942 S11Max=1056.13108371673 PtS11Max=1 x2S11Max=-0.5 x3S11Max=-0.5 _
 S11Min=-1392.42323414257 PtS11Min=3 x2S11Min=0.5 x3S11Min=-0.5 FrameElem=118 ElemStation=0
 Frame=118 Station=0.125 OutputCase=FESSUR CaseType=Combination P=-168.146075212923 V2=187.643251084324
 V3=0 T=0 M2=0 M3=181.893864894401 S11Max=923.217114153485 PtS11Max=1 x2S11Max=-0.5 x3S11Max=-0.5 _
 S11Min=-1259.50926457933 PtS11Min=3 x2S11Min=0.5 x3S11Min=-0.5 FrameElem=118 ElemStation=0.125
 Frame=118 Station=0.25 OutputCase=FESSUR CaseType=Combination P=-168.146075212923 V2=208.492501084324
 V3=0 T=0 M2=0 M3=157.135380383861 S11Max=774.666207090242 PtS11Max=1 x2S11Max=-0.5 x3S11Max=-0.5 _
 S11Min=-1110.95835751609 PtS11Min=3 x2S11Min=0.5 x3S11Min=-0.5 FrameElem=118 ElemStation=0.25
 Frame=118 Station=0.375 OutputCase=FESSUR CaseType=Combination P=-168.146075212923 V2=229.341751084324
 V3=0 T=0 M2=0 M3=129.77073962332 S11Max=610.478362526999 PtS11Max=1 x2S11Max=-0.5 x3S11Max=-0.5 _
 S11Min=-946.770512952845 PtS11Min=3 x2S11Min=0.5 x3S11Min=-0.5 FrameElem=118 ElemStation=0.375
 Frame=118 Station=0.5 OutputCase=FESSUR CaseType=Combination P=-168.146075212923 V2=250.191001084324
 V3=0 T=0 M2=0 M3=99.7999426127798 S11Max=430.653580463756 PtS11Max=1 x2S11Max=-0.5 x3S11Max=-0.5 _
 S11Min=-766.945730889602 PtS11Min=3 x2S11Min=0.5 x3S11Min=-0.5 FrameElem=118 ElemStation=0.5
 Frame=119 Station=0 OutputCase=PERM1 CaseType=Combination P=-164.891225815415 V2=244.50000106315 V3=0
 T=0 M2=0 M3=97.5721756226006 S11Max=420.541827920189 PtS11Max=1 x2S11Max=-0.5 x3S11Max=-0.5 _
 S11Min=-750.324279551018 PtS11Min=3 x2S11Min=0.5 x3S11Min=-0.5 FrameElem=119 ElemStation=0
 Frame=119 Station=0.125 OutputCase=PERM1 CaseType=Combination P=-164.891225815415 V2=264.87500106315
 V3=0 T=0 M2=0 M3=65.7362379897069 S11Max=229.526202122826 PtS11Max=1 x2S11Max=-0.5 x3S11Max=-0.5 _
 S11Min=-559.308653753656 PtS11Min=3 x2S11Min=0.5 x3S11Min=-0.5 FrameElem=119 ElemStation=0.125
 Frame=119 Station=0.25 OutputCase=PERM1 CaseType=Combination P=-164.891225815415 V2=285.25000106315
 V3=0 T=0 M2=0 M3=31.3534253568131 S11Max=23.2293263254639 PtS11Max=1 x2S11Max=-0.5 x3S11Max=-0.5 _
 S11Min=-353.011777956293 PtS11Min=3 x2S11Min=0.5 x3S11Min=-0.5 FrameElem=119 ElemStation=0.25
 Frame=119 Station=0.375 OutputCase=PERM1 CaseType=Combination P=-164.891225815415 V2=305.62500106315
 V3=0 T=0 M2=0 M3=-5.5762627608063 S11Max=-131.433652158931 PtS11Max=3 x2S11Max=0.5 x3S11Max=-0.5 _
 S11Min=-198.348799471899 PtS11Min=1 x2S11Min=-0.5 x3S11Min=-0.5 FrameElem=119 ElemStation=0.375
 Frame=119 Station=0.5 OutputCase=PERM1 CaseType=Combination P=-164.891225815415 V2=326.00000106315
 V3=0 T=0 M2=0 M3=-45.0528249089744 S11Max=105.425723638431 PtS11Max=3 x2S11Max=0.5 x3S11Max=-0.5 _
 S11Min=-435.208175269261 PtS11Min=1 x2S11Min=-0.5 x3S11Min=-0.5 FrameElem=119 ElemStation=0.5
 Frame=119 Station=0 OutputCase=PERM2 CaseType=Combination P=-111.11546006997 V2=244.50000078914 V3=0
 T=0 M2=0 M3=111.736485758366 S11Max=559.303454480226 PtS11Max=1 x2S11Max=-0.5 x3S11Max=-0.5 _
 S11Min=-781.534374620165 PtS11Min=3 x2S11Min=0.5 x3S11Min=-0.5 FrameElem=119 ElemStation=0

Frame=119 Station=0.125 OutputCase=PERM2 CaseType=Combination P=-111.11546006997 V2=264.87500078914
 V3=0 T=0 M2=0 M3=79.9005481597234 S11Max=368.287828888371 PtS11Max=1 x2S11Max=-0.5 x3S11Max=-0.5
 S11Min=-590.51874902831 PtS11Min=3 x2S11Min=0.5 x3S11Min=-0.5 FrameElem=119 ElemStation=0.125
 Frame=119 Station=0.25 OutputCase=PERM2 CaseType=Combination P=-111.11546006997 V2=285.25000078914
 V3=0 T=0 M2=0 M3=45.5177355610809 S11Max=161.990953296516 PtS11Max=1 x2S11Max=-0.5 x3S11Max=-0.5
 S11Min=-384.221873436455 PtS11Min=3 x2S11Min=0.5 x3S11Min=-0.5 FrameElem=119 ElemStation=0.25
 Frame=119 Station=0.375 OutputCase=PERM2 CaseType=Combination P=-111.11546006997 V2=305.62500078914
 V3=0 T=0 M2=0 M3=8.58804796243847 S11Max=-59.5871722953387 PtS11Max=1 x2S11Max=-0.5 x3S11Max=-0.5
 S11Min=-162.6437478446 PtS11Min=3 x2S11Min=0.5 x3S11Min=-0.5 FrameElem=119 ElemStation=0.375
 Frame=119 Station=0.5 OutputCase=PERM2 CaseType=Combination P=-111.11546006997 V2=326.00000078914
 V3=0 T=0 M2=0 M3=-30.888514636204 S11Max=74.2156277472545 PtS11Max=3 x2S11Max=0.5 x3S11Max=-0.5
 S11Min=-296.446547887194 PtS11Min=1 x2S11Min=-0.5 x3S11Min=-0.5 FrameElem=119 ElemStation=0.5
 T=0 M2=0 M3=100.754699894254 S11Max=434.987188696519 PtS11Max=1 x2S11Max=-0.5 x3S11Max=-0.5
 S11Min=-774.069210034529 PtS11Min=3 x2S11Min=0.5 x3S11Min=-0.5 FrameElem=119 ElemStation=0
 Frame=119 Station=0.125 OutputCase=ACC1 CaseType=Combination P=-169.541010669005 V2=294.735001093397
 V3=0 T=0 M2=0 M3=67.8601685075794 S11Max=237.620000376471 PtS11Max=1 x2S11Max=-0.5 x3S11Max=-0.5
 S11Min=-576.702021714481 PtS11Min=3 x2S11Min=0.5 x3S11Min=-0.5 FrameElem=119 ElemStation=0.125
 Frame=119 Station=0.25 OutputCase=ACC1 CaseType=Combination P=-169.541010669005 V2=294.735001093397
 V3=0 T=0 M2=0 M3=32.3340746209047 S11Max=24.4634370564233 PtS11Max=1 x2S11Max=-0.5 x3S11Max=-0.5
 S11Min=-363.545458394433 PtS11Min=3 x2S11Min=0.5 x3S11Min=-0.5 FrameElem=119 ElemStation=0.25
 Frame=119 Station=0.375 OutputCase=ACC1 CaseType=Combination P=-169.541010669005 V2=315.787501093397
 V3=0 T=0 M2=0 M3=-5.82358176576992 S11Max=-134.599520074386 PtS11Max=3 x2S11Max=0.5 x3S11Max=-0.5
 S11Min=-204.482501263625 PtS11Min=1 x2S11Min=-0.5 x3S11Min=-0.5 FrameElem=119 ElemStation=0.375
 Frame=119 Station=0.5 OutputCase=ACC1 CaseType=Combination P=-169.541010669005 V2=336.840001093397
 V3=0 T=0 M2=0 M3=-46.6128006524446 S11Max=110.135793245662 PtS11Max=3 x2S11Max=0.5 x3S11Max=-0.5
 S11Min=-449.217814583672 PtS11Min=1 x2S11Min=-0.5 x3S11Min=-0.5 FrameElem=119 ElemStation=0.5
 Frame=119 Station=0 OutputCase=ACC2 CaseType=Combination P=-115.76524492356 V2=252.630000819387 V3=0
 T=0 M2=0 M3=114.919010030019 S11Max=573.748815256556 PtS11Max=1 x2S11Max=-0.5 x3S11Max=-0.5
 S11Min=-805.279305103676 PtS11Min=3 x2S11Min=0.5 x3S11Min=-0.5 FrameElem=119 ElemStation=0
 Frame=119 Station=0.125 OutputCase=ACC2 CaseType=Combination P=-115.76524492356 V2=273.682500819387
 V3=0 T=0 M2=0 M3=82.0244786775959 S11Max=376.381627142016 PtS11Max=1 x2S11Max=-0.5 x3S11Max=-0.5
 S11Min=-607.912116989135 PtS11Min=3 x2S11Min=0.5 x3S11Min=-0.5 FrameElem=119 ElemStation=0.125
 Frame=119 Station=0.25 OutputCase=ACC2 CaseType=Combination P=-115.76524492356 V2=294.735000819387
 V3=0 T=0 M2=0 M3=46.4983848251725 S11Max=163.225064027475 PtS11Max=1 x2S11Max=-0.5 x3S11Max=-0.5
 S11Min=-394.71662593075 S11Max=163.225064027475 PtS11Max=1 x2S11Max=-0.5 x3S11Max=-0.5
 S11Min=-394.71662593075 PtS11Min=3 x2S11Min=0.5 x3S11Min=-0.5 FrameElem=119 ElemStation=0.25
 Frame=119 Station=0.375 OutputCase=ACC2 CaseType=Combination P=-115.76524492356 V2=315.787500819387
 V3=0 T=0 M2=0 M3=8.34072847274918 S11Max=-65.7208740870648 PtS11Max=1 x2S11Max=-0.5 x3S11Max=-0.5
 S11Min=-165.809615760055 PtS11Min=3 x2S11Min=0.5 x3S11Min=-0.5 FrameElem=119 ElemStation=0.375
 Frame=119 Station=0.5 OutputCase=ACC2 CaseType=Combination P=-115.76524492356 V2=336.840000819387
 V3=0 T=0 M2=0 M3=-32.4484903796742 S11Max=78.9256973544854 PtS11Max=3 x2S11Max=0.5 x3S11Max=-0.5
 S11Min=-310.456187201605 PtS11Min=1 x2S11Min=-0.5 x3S11Min=-0.5 FrameElem=119 ElemStation=0.5
 Frame=119 Station=0 OutputCase=ACCSX1 CaseType=Combination P=-167.164023806274 V2=246.0140786686 V3=0
 T=0 M2=0 M3=94.6893700166168 S11Max=400.972196293427 PtS11Max=1 x2S11Max=-0.5 x3S11Max=-0.5
 S11Min=-735.300243905975 PtS11Min=3 x2S11Min=0.5 x3S11Min=-0.5 FrameElem=119 ElemStation=0
 Frame=119 Station=0.125 OutputCase=ACCSX1 CaseType=Combination P=-167.164023806274 V2=266.3890786686
 V3=0 T=0 M2=0 M3=62.6641726830418 S11Max=208.821012291977 PtS11Max=1 x2S11Max=-0.5 x3S11Max=-0.5
 S11Min=-543.149059904525 PtS11Min=3 x2S11Min=0.5 x3S11Min=-0.5 FrameElem=119 ElemStation=0.125
 Frame=119 Station=0.25 OutputCase=ACCSX1 CaseType=Combination P=-167.164023806274 V2=286.7640786686
 V3=0 T=0 M2=0 M3=28.0921003494668 S11Max=1.38857829052677 PtS11Max=1 x2S11Max=-0.5 x3S11Max=-0.5
 S11Min=-335.71662593075 PtS11Min=3 x2S11Min=0.5 x3S11Min=-0.5 FrameElem=119 ElemStation=0.25
 Frame=119 Station=0.375 OutputCase=ACCSX1 CaseType=Combination P=-167.164023806274 V2=307.1390786686
 V3=0 T=0 M2=0 M3=-9.02684698410815 S11Max=-113.002941901625 PtS11Max=3 x2S11Max=0.5 x3S11Max=-0.5
 S11Min=-221.325105710923 PtS11Min=1 x2S11Min=-0.5 x3S11Min=-0.5 FrameElem=119 ElemStation=0.375
 Frame=119 Station=0.5 OutputCase=ACCSX1 CaseType=Combination P=-167.164023806274 V2=327.5140786686
 V3=0 T=0 M2=0 M3=-48.6926693176831 S11Max=124.991992099825 PtS11Max=3 x2S11Max=0.5 x3S11Max=-0.5
 S11Min=-459.320039712373 PtS11Min=1 x2S11Min=-0.5 x3S11Min=-0.5 FrameElem=119 ElemStation=0.5
 Frame=119 Station=0 OutputCase=ACCSX2 CaseType=Combination P=-113.388258060829 V2=246.01407839459
 V3=0 T=0 M2=0 M3=108.853680152382 S11Max=539.733822853464 PtS11Max=1 x2S11Max=-0.5 x3S11Max=-0.5
 S11Min=-766.510338975122 PtS11Min=3 x2S11Min=0.5 x3S11Min=-0.5 FrameElem=119 ElemStation=0
 Frame=119 Station=0.125 OutputCase=ACCSX2 CaseType=Combination P=-113.388258060829 V2=266.38907839459
 V3=0 T=0 M2=0 M3=76.8284828530584 S11Max=347.582639057521 PtS11Max=1 x2S11Max=-0.5 x3S11Max=-0.5
 S11Min=-574.35915517918 PtS11Min=3 x2S11Min=0.5 x3S11Min=-0.5 FrameElem=119 ElemStation=0.125
 Frame=119 Station=0.25 OutputCase=ACCSX2 CaseType=Combination P=-113.388258060829 V2=286.76407839459
 V3=0 T=0 M2=0 M3=42.2564105537347 S11Max=140.150205261579 PtS11Max=1 x2S11Max=-0.5 x3S11Max=-0.5
 S11Min=-366.926721383237 PtS11Min=3 x2S11Min=0.5 x3S11Min=-0.5 FrameElem=119 ElemStation=0.25
 Frame=119 Station=0.375 OutputCase=ACCSX2 CaseType=Combination P=-113.388258060829 V2=307.13907839459
 V3=0 T=0 M2=0 M3=5.13746325441095 S11Max=-82.5634785343634 PtS11Max=1 x2S11Max=-0.5 x3S11Max=-0.5
 S11Min=-144.213037587295 PtS11Min=3 x2S11Min=0.5 x3S11Min=-0.5 FrameElem=119 ElemStation=0.375
 Frame=119 Station=0.5 OutputCase=ACCSX2 CaseType=Combination P=-113.388258060829 V2=327.51407839459
 V3=0 T=0 M2=0 M3=-34.5283590449128 S11Max=93.7818962086476 PtS11Max=3 x2S11Max=0.5 x3S11Max=-0.5
 S11Min=-320.558412330306 PtS11Min=1 x2S11Min=-0.5 x3S11Min=-0.5 FrameElem=119 ElemStation=0.5
 Frame=119 Station=0 OutputCase=ENVE CaseType=Combination StepType=Max P=-111.11546006997
 V2=252.630001093397 V3=0 T=0 M2=0 M3=114.919010030019 S11Max=573.748815256556 PtS11Max=1 x2S11Max=-0.5
 x3S11Max=-0.5
 S11Min=-735.300243905975 PtS11Min=3 x2S11Min=0.5 x3S11Min=-0.5 FrameElem=119 ElemStation=0
 Frame=119 Station=0.125 OutputCase=ENVE CaseType=Combination StepType=Max P=-111.11546006997
 V2=273.682501093397 V3=0 T=0 M2=0 M3=82.0244786775959 S11Max=376.381627142016 PtS11Max=1 x2S11Max=-0.5
 x3S11Max=-0.5
 S11Min=-543.149059904525 PtS11Min=3 x2S11Min=0.5 x3S11Min=-0.5 FrameElem=119 ElemStation=0.125



Frame=119 Station=0.25 OutputCase=ENVE CaseType=Combination StepType=Max P=-111.11546006997
V2=294.735001093397 V3=0 T=0 M2=0 M3=46.4983848251725 S11Max=163.225064027475 PtS11Max=1 x2S11Max=-0.5
x3S11Max=-0.5
S11Min=-335.716625903075 PtS11Min=3 x2S11Min=0.5 x3S11Min=-0.5 FrameElem=119 ElemStation=0.25
Frame=119 Station=0.375 OutputCase=ENVE CaseType=Combination StepType=Max P=-111.11546006997
V2=315.787501093397 V3=0 T=0 M2=0 M3=8.58804796243847 S11Max=-59.5871722953387 PtS11Max=1 x2S11Max=-0.5
x3S11Max=-0.5 S11Min=-113.002941901625 PtS11Min=3 x2S11Min=0.5 x3S11Min=-0.5 FrameElem=119
ElemStation=0.375
Frame=119 Station=0.5 OutputCase=ENVE CaseType=Combination StepType=Max P=-111.11546006997
V2=336.840001093397 V3=0 T=0 M2=0 M3=-30.888514636204 S11Max=124.991992099825 PtS11Max=3 x2S11Max=0.5
x3S11Max=-0.5
S11Min=-296.446547887194 PtS11Min=1 x2S11Min=-0.5 x3S11Min=-0.5 FrameElem=119 ElemStation=0.5
Frame=119 Station=0 OutputCase=ENVE CaseType=Combination StepType=Min P=-169.541010669005
V2=244.50000078914 V3=0 T=0 M2=0 M3=94.6893700166168 S11Max=400.972196293427 PtS11Max=1 x2S11Max=-0.5
x3S11Max=-0.5
S11Min=-805.279305103676 PtS11Min=3 x2S11Min=0.5 x3S11Min=-0.5 FrameElem=119 ElemStation=0
Frame=119 Station=0.125 OutputCase=ENVE CaseType=Combination StepType=Min P=-169.541010669005
V2=264.87500078914 V3=0 T=0 M2=0 M3=62.6641726830418 S11Max=208.821012291977 PtS11Max=1 x2S11Max=-0.5
x3S11Max=-0.5
S11Min=-607.912116989135 PtS11Min=3 x2S11Min=0.5 x3S11Min=-0.5 FrameElem=119 ElemStation=0.125
Frame=119 Station=0.25 OutputCase=ENVE CaseType=Combination StepType=Min P=-169.541010669005
V2=285.25000078914 V3=0 T=0 M2=0 M3=28.0921003494668 S11Max=1.38857829052677 PtS11Max=1 x2S11Max=-0.5
x3S11Max=-0.5
S11Min=-394.75553874595 PtS11Min=3 x2S11Min=0.5 x3S11Min=-0.5 FrameElem=119 ElemStation=0.25
Frame=119 Station=0.375 OutputCase=ENVE CaseType=Combination StepType=Min P=-169.541010669005
V2=305.62500078914 V3=0 T=0 M2=0 M3=-9.02684698410815 S11Max=-165.809615760055 PtS11Max=3 x2S11Max=0.5
x3S11Max=-0.5 S11Min=-221.325105710923 PtS11Min=1 x2S11Min=-0.5 x3S11Min=-0.5 FrameElem=119
ElemStation=0.375
Frame=119 Station=0.5 OutputCase=ENVE CaseType=Combination StepType=Min P=-169.541010669005
V2=326.00000078914 V3=0 T=0 M2=0 M3=-48.6926693176831 S11Max=74.2156277472545 PtS11Max=3 x2S11Max=0.5
x3S11Max=-0.5
S11Min=-459.320039712373 PtS11Min=1 x2S11Min=-0.5 x3S11Min=-0.5 FrameElem=119 ElemStation=0.5
Frame=119 Station=0 OutputCase=FESSUR CaseType=Combination P=-168.146075212928 V2=250.191001084323
V3=0 T=0 M2=0 M3=99.799942612758 S11Max=430.65358046362 PtS11Max=1 x2S11Max=-0.5 x3S11Max=-0.5
S11Min=-766.945730889476 PtS11Min=3 x2S11Min=0.5 x3S11Min=-0.5 FrameElem=119 ElemStation=0
Frame=119 Station=0.125 OutputCase=FESSUR CaseType=Combination P=-168.146075212928 V2=271.040251084323
V3=0 T=0 M2=0 M3=67.2229893522176 S11Max=235.191860900378 PtS11Max=1 x2S11Max=-0.5 x3S11Max=-0.5
S11Min=-571.484011326234 PtS11Min=3 x2S11Min=0.5 x3S11Min=-0.5 FrameElem=119 ElemStation=0.125
Frame=119 Station=0.25 OutputCase=FESSUR CaseType=Combination P=-168.146075212928 V2=291.889501084323
V3=0 T=0 M2=0 M3=32.0398798416772 S11Max=24.0932038371355 PtS11Max=1 x2S11Max=-0.5 x3S11Max=-0.5
S11Min=-360.385354262991 PtS11Min=3 x2S11Min=0.5 x3S11Min=-0.5 FrameElem=119 ElemStation=0.25
Frame=119 Station=0.375 OutputCase=FESSUR CaseType=Combination P=-168.146075212928 V2=312.738751084323
V3=0 T=0 M2=0 M3=-5.74938591886314 S11Max=-133.649759699749 PtS11Max=3 x2S11Max=0.5 x3S11Max=-0.5
S11Min=-202.642390726107 PtS11Min=1 x2S11Min=-0.5 x3S11Min=-0.5 FrameElem=119 ElemStation=0.375
Frame=119 Station=0.5 OutputCase=FESSUR CaseType=Combination P=-168.146075212928 V2=333.588001084323
V3=0 T=0 M2=0 M3=-46.1448079294035 S11Max=108.722772363493 PtS11Max=3 x2S11Max=0.5 x3S11Max=-0.5
S11Min=-445.014922789349 PtS11Min=1 x2S11Min=-0.5 x3S11Min=-0.5 FrameElem=119 ElemStation=0.5

TABLE: "ELEMENT STRESSES - FRAMES"

Frame=1 Station=0 OutputCase=PERM1 CaseType=Combination Point=0 X2=0 X3=0 S11=-235.938772273309
IsS11Max=No IsS11Min=No FrameElem=1 ElemStation=0
Frame=1 Station=0 OutputCase=PERM1 CaseType=Combination Point=1 X2=-0.5 X3=-0.5
S11=1484.03866301035 IsS11Max=Yes IsS11Min=No FrameElem=1 ElemStation=0
Frame=1 Station=0 OutputCase=PERM1 CaseType=Combination Point=2 X2=-0.5 X3=0.5 S11=1484.03866301035
IsS11Max=No IsS11Min=No FrameElem=1 ElemStation=0
Frame=1 Station=0 OutputCase=PERM1 CaseType=Combination Point=3 X2=0.5 X3=-0.5 S11=-
1955.91620755697 IsS11Max=No IsS11Min=Yes FrameElem=1 ElemStation=0
Frame=1 Station=0 OutputCase=PERM1 CaseType=Combination Point=4 X2=0.5 X3=0.5 S11=-1955.91620755697
IsS11Max=No IsS11Min=No FrameElem=1 ElemStation=0
Frame=1 Station=6.24999940395355E-02 OutputCase=PERM1 CaseType=Combination Point=0 X2=0 X3=0 S11=-
235.938772273309 IsS11Max=No IsS11Min=No FrameElem=1 ElemStation=6.24999940395355E-02
Frame=1 Station=6.24999940395355E-02 OutputCase=PERM1 CaseType=Combination Point=1 X2=-0.5 X3=-0.5
S11=1304.33858366396 IsS11Max=Yes IsS11Min=No FrameElem=1 ElemStation=6.24999940395355E-02
Frame=1 Station=6.24999940395355E-02 OutputCase=PERM1 CaseType=Combination Point=2 X2=-0.5 X3=0.5
S11=1304.33858366396 IsS11Max=No IsS11Min=No FrameElem=1 ElemStation=6.24999940395355E-02
Frame=1 Station=6.24999940395355E-02 OutputCase=PERM1 CaseType=Combination Point=3 X2=0.5 X3=-0.5
S11=-1776.21612821058 IsS11Max=No IsS11Min=Yes FrameElem=1 ElemStation=6.24999940395355E-02
Frame=1 Station=6.24999940395355E-02 OutputCase=PERM1 CaseType=Combination Point=4 X2=0.5 X3=0.5
S11=-1776.21612821058 IsS11Max=No IsS11Min=No FrameElem=1 ElemStation=6.24999940395355E-02
Frame=1 Station=0.12499988079071 OutputCase=PERM1 CaseType=Combination Point=0 X2=0 X3=0 S11=-
235.938772273309 IsS11Max=No IsS11Min=No FrameElem=1 ElemStation=0.12499988079071
Frame=1 Station=0.12499988079071 OutputCase=PERM1 CaseType=Combination Point=1 X2=-0.5 X3=-0.5
S11=1124.05256692932 IsS11Max=Yes IsS11Min=No FrameElem=1 ElemStation=0.12499988079071
Frame=1 Station=0.12499988079071 OutputCase=PERM1 CaseType=Combination Point=2 X2=-0.5 X3=0.5
S11=1124.05256692932 IsS11Max=No IsS11Min=No FrameElem=1 ElemStation=0.12499988079071
Frame=1 Station=0.12499988079071 OutputCase=PERM1 CaseType=Combination Point=3 X2=0.5 X3=-0.5
S11=-1595.93011147594 IsS11Max=No IsS11Min=Yes FrameElem=1 ElemStation=0.12499988079071
Frame=1 Station=0.12499988079071 OutputCase=PERM1 CaseType=Combination Point=4 X2=0.5 X3=0.5 S11=-
1595.93011147594 IsS11Max=No IsS11Min=No FrameElem=1 ElemStation=0.12499988079071

```

Frame=1 Station=0.187499982118607 OutputCase=PERM1 CaseType=Combination Point=0 X2=0 X3=0 S11=-
235.938772273309 IsS11Max=No IsS11Min=No FrameElem=1 ElemStation=0.187499982118607
Frame=1 Station=0.187499982118607 OutputCase=PERM1 CaseType=Combination Point=1 X2=-0.5 X3=-0.5
S11=943.180612806448 IsS11Max=Yes IsS11Min=No FrameElem=1 ElemStation=0.187499982118607
Frame=1 Station=0.187499982118607 OutputCase=PERM1 CaseType=Combination Point=2 X2=-0.5 X3=0.5
S11=943.180612806448 IsS11Max=No IsS11Min=No FrameElem=1 ElemStation=0.187499982118607
Frame=1 Station=0.187499982118607 OutputCase=PERM1 CaseType=Combination Point=3 X2=0.5 X3=-0.5
S11=-1415.05815735307 IsS11Max=No IsS11Min=Yes FrameElem=1 ElemStation=0.187499982118607
Frame=1 Station=0.187499982118607 OutputCase=PERM1 CaseType=Combination Point=4 X2=0.5 X3=0.5 S11=-
1415.05815735307 IsS11Max=No IsS11Min=No FrameElem=1 ElemStation=0.187499982118607
Frame=1 Station=0.249999976158142 OutputCase=PERM1 CaseType=Combination Point=0 X2=0 X3=0 S11=-
235.938772273309 IsS11Max=No IsS11Min=No FrameElem=1 ElemStation=0.249999976158142
Frame=1 Station=0.249999976158142 OutputCase=PERM1 CaseType=Combination Point=1 X2=-0.5 X3=-0.5
S11=761.722721295332 IsS11Max=Yes IsS11Min=No FrameElem=1 ElemStation=0.249999976158142
Frame=1 Station=0.249999976158142 OutputCase=PERM1 CaseType=Combination Point=2 X2=-0.5 X3=0.5
S11=761.722721295332 IsS11Max=No IsS11Min=No FrameElem=1 ElemStation=0.249999976158142
Frame=1 Station=0.249999976158142 OutputCase=PERM1 CaseType=Combination Point=3 X2=0.5 X3=-0.5
S11=-1233.60026584195 IsS11Max=No IsS11Min=Yes FrameElem=1 ElemStation=0.249999976158142
Frame=1 Station=0.249999976158142 OutputCase=PERM1 CaseType=Combination Point=4 X2=0.5 X3=0.5 S11=-
1233.60026584195 IsS11Max=No IsS11Min=No FrameElem=1 ElemStation=0.249999976158142
Frame=1 Station=0 OutputCase=PERM2 CaseType=Combination Point=0 X2=0 X3=0 S11=-169.465538592139
IsS11Max=No IsS11Min=No FrameElem=1 ElemStation=0
Frame=1 Station=0 OutputCase=PERM2 CaseType=Combination Point=1 X2=-0.5 X3=-0.5
S11=1464.10442034385 IsS11Max=Yes IsS11Min=No FrameElem=1 ElemStation=0
Frame=1 Station=0 OutputCase=PERM2 CaseType=Combination Point=2 X2=-0.5 X3=0.5 S11=1464.10442034385
IsS11Max=No IsS11Min=No FrameElem=1 ElemStation=0
Frame=1 Station=0 OutputCase=PERM2 CaseType=Combination Point=3 X2=0.5 X3=-0.5 S11=-
1803.03549752813 IsS11Max=No IsS11Min=Yes FrameElem=1 ElemStation=0
Frame=1 Station=0 OutputCase=PERM2 CaseType=Combination Point=4 X2=0.5 X3=0.5 S11=-1803.03549752813
IsS11Max=No IsS11Min=No FrameElem=1 ElemStation=0
Frame=1 Station=6.24999940395355E-02 OutputCase=PERM2 CaseType=Combination Point=0 X2=0 X3=0 S11=-
169.465538592139 IsS11Max=No IsS11Min=No FrameElem=1 ElemStation=6.24999940395355E-02
Frame=1 Station=6.24999940395355E-02 OutputCase=PERM2 CaseType=Combination Point=1 X2=-0.5 X3=-0.5
S11=1284.41627790485 IsS11Max=Yes IsS11Min=No FrameElem=1 ElemStation=6.24999940395355E-02
Frame=1 Station=6.24999940395355E-02 OutputCase=PERM2 CaseType=Combination Point=2 X2=-0.5 X3=0.5
S11=1284.41627790485 IsS11Max=No IsS11Min=No FrameElem=1 ElemStation=6.24999940395355E-02
Frame=1 Station=6.24999940395355E-02 OutputCase=PERM2 CaseType=Combination Point=3 X2=0.5 X3=-0.5
S11=-1623.34735508913 IsS11Max=No IsS11Min=Yes FrameElem=1 ElemStation=6.24999940395355E-02
Frame=1 Station=6.24999940395355E-02 OutputCase=PERM2 CaseType=Combination Point=4 X2=0.5 X3=0.5
S11=-1623.34735508913 IsS11Max=No IsS11Min=No FrameElem=1 ElemStation=6.24999940395355E-02
Frame=1 Station=0.124999988079071 OutputCase=PERM2 CaseType=Combination Point=0 X2=0 X3=0 S11=-
169.465538592139 IsS11Max=No IsS11Min=No FrameElem=1 ElemStation=0.124999988079071
Frame=1 Station=0.124999988079071 OutputCase=PERM2 CaseType=Combination Point=1 X2=-0.5 X3=-0.5
S11=1104.14219807761 IsS11Max=Yes IsS11Min=No FrameElem=1 ElemStation=0.124999988079071
Frame=1 Station=0.124999988079071 OutputCase=PERM2 CaseType=Combination Point=2 X2=-0.5 X3=0.5
S11=1104.14219807761 IsS11Max=No IsS11Min=No FrameElem=1 ElemStation=0.124999988079071
Frame=1 Station=0.124999988079071 OutputCase=PERM2 CaseType=Combination Point=3 X2=0.5 X3=-0.5
S11=-1443.07327526189 IsS11Max=No IsS11Min=Yes FrameElem=1 ElemStation=0.124999988079071
Frame=1 Station=0.124999988079071 OutputCase=PERM2 CaseType=Combination Point=4 X2=0.5 X3=0.5 S11=-
1443.07327526189 IsS11Max=No IsS11Min=No FrameElem=1 ElemStation=0.124999988079071
Frame=1 Station=0.187499982118607 OutputCase=PERM2 CaseType=Combination Point=0 X2=0 X3=0 S11=-
169.465538592139 IsS11Max=No IsS11Min=No FrameElem=1 ElemStation=0.187499982118607
Frame=1 Station=0.187499982118607 OutputCase=PERM2 CaseType=Combination Point=1 X2=-0.5 X3=-0.5
S11=923.282180862126 IsS11Max=Yes IsS11Min=No FrameElem=1 ElemStation=0.187499982118607
Frame=1 Station=0.187499982118607 OutputCase=PERM2 CaseType=Combination Point=2 X2=-0.5 X3=0.5
S11=923.282180862126 IsS11Max=No IsS11Min=No FrameElem=1 ElemStation=0.187499982118607
Frame=1 Station=0.187499982118607 OutputCase=PERM2 CaseType=Combination Point=3 X2=0.5 X3=-0.5
S11=-1262.2132580464 IsS11Max=No IsS11Min=Yes FrameElem=1 ElemStation=0.187499982118607
Frame=1 Station=0.187499982118607 OutputCase=PERM2 CaseType=Combination Point=4 X2=0.5 X3=0.5 S11=-
1262.2132580464 IsS11Max=No IsS11Min=No FrameElem=1 ElemStation=0.187499982118607
Frame=1 Station=0.249999976158142 OutputCase=PERM2 CaseType=Combination Point=0 X2=0 X3=0 S11=-
169.465538592139 IsS11Max=No IsS11Min=No FrameElem=1 ElemStation=0.249999976158142
Frame=1 Station=0.249999976158142 OutputCase=PERM2 CaseType=Combination Point=1 X2=-0.5 X3=-0.5
S11=741.836226258401 IsS11Max=Yes IsS11Min=No FrameElem=1 ElemStation=0.249999976158142
Frame=1 Station=0.249999976158142 OutputCase=PERM2 CaseType=Combination Point=2 X2=-0.5 X3=0.5
S11=741.836226258401 IsS11Max=No IsS11Min=No FrameElem=1 ElemStation=0.249999976158142
Frame=1 Station=0.249999976158142 OutputCase=PERM2 CaseType=Combination Point=3 X2=0.5 X3=-0.5
S11=-1080.76730344268 IsS11Max=No IsS11Min=Yes FrameElem=1 ElemStation=0.249999976158142
Frame=1 Station=0.249999976158142 OutputCase=PERM2 CaseType=Combination Point=4 X2=0.5 X3=0.5 S11=-
1080.76730344268 IsS11Max=No IsS11Min=No FrameElem=1 ElemStation=0.249999976158142
Frame=1 Station=0 OutputCase=ACCL1 CaseType=Combination Point=0 X2=0 X3=0 S11=-240.528987364651
IsS11Max=No IsS11Min=No FrameElem=1 ElemStation=0
Frame=1 Station=0 OutputCase=ACCL1 CaseType=Combination Point=1 X2=-0.5 X3=-0.5 S11=1524.67846313875
IsS11Max=Yes IsS11Min=No FrameElem=1 ElemStation=0
Frame=1 Station=0 OutputCase=ACCL1 CaseType=Combination Point=2 X2=-0.5 X3=0.5 S11=1524.67846313875
IsS11Max=No IsS11Min=No FrameElem=1 ElemStation=0
Frame=1 Station=0 OutputCase=ACCL1 CaseType=Combination Point=3 X2=0.5 X3=-0.5 S11=-2005.73643786805
IsS11Max=No IsS11Min=Yes FrameElem=1 ElemStation=0
Frame=1 Station=0 OutputCase=ACCL1 CaseType=Combination Point=4 X2=0.5 X3=0.5 S11=-2005.73643786805
IsS11Max=No IsS11Min=No FrameElem=1 ElemStation=0
Frame=1 Station=6.24999940395355E-02 OutputCase=ACCL1 CaseType=Combination Point=0 X2=0 X3=0 S11=-
240.528987364651 IsS11Max=No IsS11Min=No FrameElem=1 ElemStation=6.24999940395355E-02

```

Frame=1 Station=6.24999940395355E-02 OutputCase=ACC1 CaseType=Combination Point=1 X2=-0.5 X3=-0.5
 S11=1340.15712055695 IsS11Max=Yes IsS11Min=No FrameElem=1 ElemStation=6.24999940395355E-02
 Frame=1 Station=6.24999940395355E-02 OutputCase=ACC1 CaseType=Combination Point=2 X2=-0.5 X3=0.5
 S11=1340.15712055695 IsS11Max=No IsS11Min=No FrameElem=1 ElemStation=6.24999940395355E-02
 Frame=1 Station=6.24999940395355E-02 OutputCase=ACC1 CaseType=Combination Point=3 X2=0.5 X3=-0.5
 S11=-1821.21509528625 IsS11Max=No IsS11Min=Yes FrameElem=1 ElemStation=6.24999940395355E-02
 Frame=1 Station=6.24999940395355E-02 OutputCase=ACC1 CaseType=Combination Point=4 X2=0.5 X3=0.5
 S11=-1821.21509528625 IsS11Max=No IsS11Min=No FrameElem=1 ElemStation=6.24999940395355E-02
 Frame=1 Station=0.124999988079071 OutputCase=ACC1 CaseType=Combination Point=0 X2=0 X3=0 S11=-
 240.528987364651 IsS11Max=No IsS11Min=No FrameElem=1 ElemStation=0.124999988079071
 Frame=1 Station=0.124999988079071 OutputCase=ACC1 CaseType=Combination Point=1 X2=-0.5 X3=-0.5
 S11=1155.04984058691 IsS11Max=Yes IsS11Min=No FrameElem=1 ElemStation=0.124999988079071
 Frame=1 Station=0.124999988079071 OutputCase=ACC1 CaseType=Combination Point=2 X2=-0.5 X3=0.5
 S11=1155.04984058691 IsS11Max=No IsS11Min=No FrameElem=1 ElemStation=0.124999988079071
 Frame=1 Station=0.124999988079071 OutputCase=ACC1 CaseType=Combination Point=3 X2=0.5 X3=-0.5 S11=-
 1636.10781531621 IsS11Max=No IsS11Min=Yes FrameElem=1 ElemStation=0.124999988079071
 Frame=1 Station=0.124999988079071 OutputCase=ACC1 CaseType=Combination Point=4 X2=0.5 X3=0.5 S11=-
 1636.10781531621 IsS11Max=No IsS11Min=No FrameElem=1 ElemStation=0.124999988079071
 Frame=1 Station=0.187499982118607 OutputCase=ACC1 CaseType=Combination Point=0 X2=0 X3=0 S11=-
 240.528987364651 IsS11Max=No IsS11Min=No FrameElem=1 ElemStation=0.187499982118607
 Frame=1 Station=0.187499982118607 OutputCase=ACC1 CaseType=Combination Point=1 X2=-0.5 X3=-0.5
 S11=969.356623228626 IsS11Max=Yes IsS11Min=No FrameElem=1 ElemStation=0.187499982118607
 Frame=1 Station=0.187499982118607 OutputCase=ACC1 CaseType=Combination Point=2 X2=-0.5 X3=0.5
 S11=969.356623228626 IsS11Max=No IsS11Min=No FrameElem=1 ElemStation=0.187499982118607
 Frame=1 Station=0.187499982118607 OutputCase=ACC1 CaseType=Combination Point=3 X2=0.5 X3=-0.5 S11=-
 1450.41459795793 IsS11Max=No IsS11Min=Yes FrameElem=1 ElemStation=0.187499982118607
 Frame=1 Station=0.187499982118607 OutputCase=ACC1 CaseType=Combination Point=4 X2=0.5 X3=0.5 S11=-
 1450.41459795793 IsS11Max=No IsS11Min=No FrameElem=1 ElemStation=0.187499982118607
 Frame=1 Station=0.249999976158142 OutputCase=ACC1 CaseType=Combination Point=0 X2=0 X3=0 S11=-
 240.528987364651 IsS11Max=No IsS11Min=No FrameElem=1 ElemStation=0.249999976158142
 Frame=1 Station=0.249999976158142 OutputCase=ACC1 CaseType=Combination Point=1 X2=-0.5 X3=-0.5
 S11=783.077468482102 IsS11Max=Yes IsS11Min=No FrameElem=1 ElemStation=0.249999976158142
 Frame=1 Station=0.249999976158142 OutputCase=ACC1 CaseType=Combination Point=2 X2=-0.5 X3=0.5
 S11=783.077468482102 IsS11Max=No IsS11Min=No FrameElem=1 ElemStation=0.249999976158142
 Frame=1 Station=0.249999976158142 OutputCase=ACC1 CaseType=Combination Point=3 X2=0.5 X3=-0.5 S11=-
 1264.1354432114 IsS11Max=No IsS11Min=Yes FrameElem=1 ElemStation=0.249999976158142
 Frame=1 Station=0.249999976158142 OutputCase=ACC1 CaseType=Combination Point=4 X2=0.5 X3=0.5 S11=-
 1264.1354432114 IsS11Max=No IsS11Min=No FrameElem=1 ElemStation=0.249999976158142
 Frame=1 Station=0 OutputCase=ACC2 CaseType=Combination Point=0 X2=0 X3=0 S11=-174.055753683481
 IsS11Max=No IsS11Min=No FrameElem=1 ElemStation=0
 Frame=1 Station=0 OutputCase=ACC2 CaseType=Combination Point=1 X2=-0.5 X3=-0.5 S11=1504.74422047225
 IsS11Max=Yes IsS11Min=No FrameElem=1 ElemStation=0
 Frame=1 Station=0 OutputCase=ACC2 CaseType=Combination Point=2 X2=-0.5 X3=0.5 S11=1504.74422047225
 IsS11Max=No IsS11Min=No FrameElem=1 ElemStation=0
 Frame=1 Station=0 OutputCase=ACC2 CaseType=Combination Point=3 X2=0.5 X3=-0.5 S11=-1852.85572783921
 IsS11Max=No IsS11Min=Yes FrameElem=1 ElemStation=0
 Frame=1 Station=0 OutputCase=ACC2 CaseType=Combination Point=4 X2=0.5 X3=0.5 S11=-1852.85572783921
 IsS11Max=No IsS11Min=No FrameElem=1 ElemStation=0
 Frame=1 Station=6.24999940395355E-02 OutputCase=ACC2 CaseType=Combination Point=0 X2=0 X3=0 S11=-
 174.055753683481 IsS11Max=No IsS11Min=No FrameElem=1 ElemStation=6.24999940395355E-02
 Frame=1 Station=6.24999940395355E-02 OutputCase=ACC2 CaseType=Combination Point=1 X2=-0.5 X3=-0.5
 S11=1320.23481479785 IsS11Max=Yes IsS11Min=No FrameElem=1 ElemStation=6.24999940395355E-02
 Frame=1 Station=6.24999940395355E-02 OutputCase=ACC2 CaseType=Combination Point=2 X2=-0.5 X3=0.5
 S11=1320.23481479785 IsS11Max=No IsS11Min=No FrameElem=1 ElemStation=6.24999940395355E-02
 Frame=1 Station=6.24999940395355E-02 OutputCase=ACC2 CaseType=Combination Point=3 X2=0.5 X3=-0.5
 S11=-1668.34632216481 IsS11Max=No IsS11Min=Yes FrameElem=1 ElemStation=6.24999940395355E-02
 Frame=1 Station=6.24999940395355E-02 OutputCase=ACC2 CaseType=Combination Point=4 X2=0.5 X3=0.5
 S11=-1668.34632216481 IsS11Max=No IsS11Min=No FrameElem=1 ElemStation=6.24999940395355E-02
 Frame=1 Station=0.124999988079071 OutputCase=ACC2 CaseType=Combination Point=0 X2=0 X3=0 S11=-
 174.055753683481 IsS11Max=No IsS11Min=No FrameElem=1 ElemStation=0.124999988079071
 Frame=1 Station=0.124999988079071 OutputCase=ACC2 CaseType=Combination Point=1 X2=-0.5 X3=-0.5
 S11=1135.1394717352 IsS11Max=Yes IsS11Min=No FrameElem=1 ElemStation=0.124999988079071
 Frame=1 Station=0.124999988079071 OutputCase=ACC2 CaseType=Combination Point=2 X2=-0.5 X3=0.5
 S11=1135.1394717352 IsS11Max=No IsS11Min=No FrameElem=1 ElemStation=0.124999988079071
 Frame=1 Station=0.124999988079071 OutputCase=ACC2 CaseType=Combination Point=3 X2=0.5 X3=-0.5 S11=-
 1483.25097910216 IsS11Max=No IsS11Min=Yes FrameElem=1 ElemStation=0.124999988079071
 Frame=1 Station=0.124999988079071 OutputCase=ACC2 CaseType=Combination Point=4 X2=0.5 X3=0.5 S11=-
 1483.25097910216 IsS11Max=No IsS11Min=No FrameElem=1 ElemStation=0.124999988079071
 Frame=1 Station=0.187499982118607 OutputCase=ACC2 CaseType=Combination Point=0 X2=0 X3=0 S11=-
 174.055753683481 IsS11Max=No IsS11Min=No FrameElem=1 ElemStation=0.187499982118607
 Frame=1 Station=0.187499982118607 OutputCase=ACC2 CaseType=Combination Point=1 X2=-0.5 X3=-0.5
 S11=949.458191284304 IsS11Max=Yes IsS11Min=No FrameElem=1 ElemStation=0.187499982118607
 Frame=1 Station=0.187499982118607 OutputCase=ACC2 CaseType=Combination Point=2 X2=-0.5 X3=0.5
 S11=949.458191284304 IsS11Max=No IsS11Min=No FrameElem=1 ElemStation=0.187499982118607
 Frame=1 Station=0.187499982118607 OutputCase=ACC2 CaseType=Combination Point=3 X2=0.5 X3=-0.5 S11=-
 1297.56969865126 IsS11Max=No IsS11Min=Yes FrameElem=1 ElemStation=0.187499982118607
 Frame=1 Station=0.187499982118607 OutputCase=ACC2 CaseType=Combination Point=4 X2=0.5 X3=0.5 S11=-
 1297.56969865126 IsS11Max=No IsS11Min=No FrameElem=1 ElemStation=0.187499982118607
 Frame=1 Station=0.249999976158142 OutputCase=ACC2 CaseType=Combination Point=0 X2=0 X3=0 S11=-
 174.055753683481 IsS11Max=No IsS11Min=No FrameElem=1 ElemStation=0.249999976158142
 Frame=1 Station=0.249999976158142 OutputCase=ACC2 CaseType=Combination Point=1 X2=-0.5 X3=-0.5
 S11=763.190973445171 IsS11Max=Yes IsS11Min=No FrameElem=1 ElemStation=0.249999976158142



Frame=1 Station=0.249999976158142 OutputCase=ACC2 CaseType=Combination Point=2 X2=-0.5 X3=0.5
 S11=763.190973445171 IsS11Max=No IsS11Min=No FrameElem=1 ElemStation=0.249999976158142
 Frame=1 Station=0.249999976158142 OutputCase=ACC2 CaseType=Combination Point=3 X2=0.5 X3=-0.5 S11=-
 1111.30248081213 IsS11Max=No IsS11Min=Yes FrameElem=1 ElemStation=0.249999976158142
 Frame=1 Station=0.249999976158142 OutputCase=ACC2 CaseType=Combination Point=4 X2=0.5 X3=0.5 S11=-
 1111.30248081213 IsS11Max=No IsS11Min=No FrameElem=1 ElemStation=0.249999976158142
 Frame=1 Station=0 OutputCase=ACCSX1 CaseType=Combination Point=0 X2=0 X3=0 S11=-233.665974282453
 IsS11Max=No IsS11Min=No FrameElem=1 ElemStation=0
 Frame=1 Station=0 OutputCase=ACCSX1 CaseType=Combination Point=1 X2=-0.5 X3=-0.5
 S11=1523.60328054229 IsS11Max=Yes IsS11Min=No FrameElem=1 ElemStation=0
 Frame=1 Station=0 OutputCase=ACCSX1 CaseType=Combination Point=2 X2=-0.5 X3=0.5
 S11=1523.60328054229 IsS11Max=No IsS11Min=No FrameElem=1 ElemStation=0
 Frame=1 Station=0 OutputCase=ACCSX1 CaseType=Combination Point=3 X2=0.5 X3=-0.5 S11=-
 1990.9352291072 IsS11Max=No IsS11Min=Yes FrameElem=1 ElemStation=0
 Frame=1 Station=0 OutputCase=ACCSX1 CaseType=Combination Point=4 X2=0.5 X3=0.5 S11=-1990.9352291072
 IsS11Max=No IsS11Min=No FrameElem=1 ElemStation=0
 Frame=1 Station=6.24999940395355E-02 OutputCase=ACCSX1 CaseType=Combination Point=0 X2=0 X3=0 S11=-
 233.665974282453 IsS11Max=No IsS11Min=No FrameElem=1 ElemStation=6.24999940395355E-02
 Frame=1 Station=6.24999940395355E-02 OutputCase=ACCSX1 CaseType=Combination Point=1 X2=-0.5 X3=-0.5
 S11=1344.26445975661 IsS11Max=Yes IsS11Min=No FrameElem=1 ElemStation=6.24999940395355E-02
 Frame=1 Station=6.24999940395355E-02 OutputCase=ACCSX1 CaseType=Combination Point=2 X2=-0.5 X3=0.5
 S11=1344.26445975661 IsS11Max=No IsS11Min=No FrameElem=1 ElemStation=6.24999940395355E-02
 Frame=1 Station=6.24999940395355E-02 OutputCase=ACCSX1 CaseType=Combination Point=3 X2=0.5 X3=-0.5
 S11=-1811.59640832151 IsS11Max=No IsS11Min=Yes FrameElem=1 ElemStation=6.24999940395355E-02
 Frame=1 Station=6.24999940395355E-02 OutputCase=ACCSX1 CaseType=Combination Point=4 X2=0.5 X3=0.5
 S11=-1811.59640832151 IsS11Max=No IsS11Min=No FrameElem=1 ElemStation=6.24999940395355E-02
 Frame=1 Station=0.124999988079071 OutputCase=ACCSX1 CaseType=Combination Point=0 X2=0 X3=0 S11=-
 233.665974282453 IsS11Max=No IsS11Min=No FrameElem=1 ElemStation=0.124999988079071
 Frame=1 Station=0.124999988079071 OutputCase=ACCSX1 CaseType=Combination Point=1 X2=-0.5 X3=-0.5
 S11=1164.33970158267 IsS11Max=Yes IsS11Min=No FrameElem=1 ElemStation=0.124999988079071
 Frame=1 Station=0.124999988079071 OutputCase=ACCSX1 CaseType=Combination Point=2 X2=-0.5 X3=0.5
 S11=1164.33970158267 IsS11Max=No IsS11Min=No FrameElem=1 ElemStation=0.124999988079071
 Frame=1 Station=0.124999988079071 OutputCase=ACCSX1 CaseType=Combination Point=3 X2=0.5 X3=-0.5
 S11=-1631.67165014758 IsS11Max=No IsS11Min=Yes FrameElem=1 ElemStation=0.124999988079071
 Frame=1 Station=0.124999988079071 OutputCase=ACCSX1 CaseType=Combination Point=4 X2=0.5 X3=0.5
 S11=-1631.67165014758 IsS11Max=No IsS11Min=No FrameElem=1 ElemStation=0.124999988079071
 Frame=1 Station=0.187499982118607 OutputCase=ACCSX1 CaseType=Combination Point=0 X2=0 X3=0 S11=-
 233.665974282453 IsS11Max=No IsS11Min=No FrameElem=1 ElemStation=0.187499982118607
 Frame=1 Station=0.187499982118607 OutputCase=ACCSX1 CaseType=Combination Point=1 X2=-0.5 X3=-0.5
 S11=983.829006020503 IsS11Max=Yes IsS11Min=No FrameElem=1 ElemStation=0.187499982118607
 Frame=1 Station=0.187499982118607 OutputCase=ACCSX1 CaseType=Combination Point=2 X2=-0.5 X3=0.5
 S11=983.829006020503 IsS11Max=No IsS11Min=No FrameElem=1 ElemStation=0.187499982118607
 Frame=1 Station=0.187499982118607 OutputCase=ACCSX1 CaseType=Combination Point=3 X2=0.5 X3=-0.5
 S11=-1451.16095458541 IsS11Max=No IsS11Min=Yes FrameElem=1 ElemStation=0.187499982118607
 Frame=1 Station=0.187499982118607 OutputCase=ACCSX1 CaseType=Combination Point=4 X2=0.5 X3=0.5
 S11=-1451.16095458541 IsS11Max=No IsS11Min=No FrameElem=1 ElemStation=0.187499982118607
 Frame=1 Station=0.249999976158142 OutputCase=ACCSX1 CaseType=Combination Point=0 X2=0 X3=0 S11=-
 233.665974282453 IsS11Max=No IsS11Min=No FrameElem=1 ElemStation=0.249999976158142
 Frame=1 Station=0.249999976158142 OutputCase=ACCSX1 CaseType=Combination Point=1 X2=-0.5 X3=-0.5
 S11=802.73237307009 IsS11Max=Yes IsS11Min=No FrameElem=1 ElemStation=0.249999976158142
 Frame=1 Station=0.249999976158142 OutputCase=ACCSX1 CaseType=Combination Point=2 X2=-0.5 X3=0.5
 S11=802.73237307009 IsS11Max=No IsS11Min=No FrameElem=1 ElemStation=0.249999976158142
 Frame=1 Station=0.249999976158142 OutputCase=ACCSX1 CaseType=Combination Point=3 X2=0.5 X3=-0.5
 S11=-1270.06432163499 IsS11Max=No IsS11Min=Yes FrameElem=1 ElemStation=0.249999976158142
 Frame=1 Station=0.249999976158142 OutputCase=ACCSX1 CaseType=Combination Point=4 X2=0.5 X3=0.5
 S11=-1270.06432163499 IsS11Max=No IsS11Min=No FrameElem=1 ElemStation=0.249999976158142
 Frame=1 Station=0 OutputCase=ACCSX2 CaseType=Combination Point=0 X2=0 X3=0 S11=-167.192740601283
 IsS11Max=No IsS11Min=No FrameElem=1 ElemStation=0
 Frame=1 Station=0 OutputCase=ACCSX2 CaseType=Combination Point=1 X2=-0.5 X3=-0.5
 S11=1503.6690378758 IsS11Max=Yes IsS11Min=No FrameElem=1 ElemStation=0
 Frame=1 Station=0 OutputCase=ACCSX2 CaseType=Combination Point=2 X2=-0.5 X3=0.5 S11=1503.6690378758
 IsS11Max=No IsS11Min=No FrameElem=1 ElemStation=0
 Frame=1 Station=0 OutputCase=ACCSX2 CaseType=Combination Point=3 X2=0.5 X3=-0.5 S11=-
 1838.05451907836 IsS11Max=No IsS11Min=Yes FrameElem=1 ElemStation=0
 Frame=1 Station=0 OutputCase=ACCSX2 CaseType=Combination Point=4 X2=0.5 X3=0.5 S11=-
 1838.05451907836 IsS11Max=No IsS11Min=No FrameElem=1 ElemStation=0
 Frame=1 Station=6.24999940395355E-02 OutputCase=ACCSX2 CaseType=Combination Point=0 X2=0 X3=0 S11=-
 167.192740601283 IsS11Max=No IsS11Min=No FrameElem=1 ElemStation=6.24999940395355E-02
 Frame=1 Station=6.24999940395355E-02 OutputCase=ACCSX2 CaseType=Combination Point=1 X2=-0.5 X3=-0.5
 S11=1324.3421539975 IsS11Max=Yes IsS11Min=No FrameElem=1 ElemStation=6.24999940395355E-02
 Frame=1 Station=6.24999940395355E-02 OutputCase=ACCSX2 CaseType=Combination Point=2 X2=-0.5 X3=0.5
 S11=1324.3421539975 IsS11Max=No IsS11Min=No FrameElem=1 ElemStation=6.24999940395355E-02
 Frame=1 Station=6.24999940395355E-02 OutputCase=ACCSX2 CaseType=Combination Point=3 X2=0.5 X3=-0.5
 S11=-1658.72763520006 IsS11Max=No IsS11Min=Yes FrameElem=1 ElemStation=6.24999940395355E-02
 Frame=1 Station=6.24999940395355E-02 OutputCase=ACCSX2 CaseType=Combination Point=4 X2=0.5 X3=0.5
 S11=-1658.72763520006 IsS11Max=No IsS11Min=No FrameElem=1 ElemStation=6.24999940395355E-02
 Frame=1 Station=0.124999988079071 OutputCase=ACCSX2 CaseType=Combination Point=0 X2=0 X3=0 S11=-
 167.192740601283 IsS11Max=No IsS11Min=No FrameElem=1 ElemStation=0.124999988079071
 Frame=1 Station=0.124999988079071 OutputCase=ACCSX2 CaseType=Combination Point=1 X2=-0.5 X3=-0.5
 S11=1144.42933273096 IsS11Max=Yes IsS11Min=No FrameElem=1 ElemStation=0.124999988079071
 Frame=1 Station=0.124999988079071 OutputCase=ACCSX2 CaseType=Combination Point=2 X2=-0.5 X3=0.5
 S11=1144.42933273096 IsS11Max=No IsS11Min=No FrameElem=1 ElemStation=0.124999988079071

Frame=1 Station=0.124999988079071 OutputCase=ACCSX2 CaseType=Combination Point=3 X2=0.5 X3=-0.5
 S11=-1478.81481393353 IsS11Max=No IsS11Min=Yes FrameElem=1 ElemStation=0.124999988079071
 Frame=1 Station=0.124999988079071 OutputCase=ACCSX2 CaseType=Combination Point=4 X2=0.5 X3=0.5
 S11=-1478.81481393353 IsS11Max=No IsS11Min=No FrameElem=1 ElemStation=0.124999988079071
 Frame=1 Station=0.187499982118607 OutputCase=ACCSX2 CaseType=Combination Point=0 X2=0 X3=0 S11=-
 167.192740601283 IsS11Max=No IsS11Min=No FrameElem=1 ElemStation=0.187499982118607
 Frame=1 Station=0.187499982118607 OutputCase=ACCSX2 CaseType=Combination Point=1 X2=-0.5 X3=-0.5
 S11=963.93057407618 IsS11Max=Yes IsS11Min=No FrameElem=1 ElemStation=0.187499982118607
 Frame=1 Station=0.187499982118607 OutputCase=ACCSX2 CaseType=Combination Point=2 X2=-0.5 X3=0.5
 S11=963.93057407618 IsS11Max=No IsS11Min=No FrameElem=1 ElemStation=0.187499982118607
 Frame=1 Station=0.187499982118607 OutputCase=ACCSX2 CaseType=Combination Point=3 X2=0.5 X3=-0.5
 S11=-1298.31605527875 IsS11Max=No IsS11Min=Yes FrameElem=1 ElemStation=0.187499982118607
 Frame=1 Station=0.187499982118607 OutputCase=ACCSX2 CaseType=Combination Point=4 X2=0.5 X3=0.5
 S11=-1298.31605527875 IsS11Max=No IsS11Min=No FrameElem=1 ElemStation=0.187499982118607
 Frame=1 Station=0.249999976158142 OutputCase=ACCSX2 CaseType=Combination Point=0 X2=0 X3=0 S11=-
 167.192740601283 IsS11Max=No IsS11Min=No FrameElem=1 ElemStation=0.249999976158142
 Frame=1 Station=0.249999976158142 OutputCase=ACCSX2 CaseType=Combination Point=1 X2=-0.5 X3=-0.5
 S11=782.845878033159 IsS11Max=Yes IsS11Min=No FrameElem=1 ElemStation=0.249999976158142
 Frame=1 Station=0.249999976158142 OutputCase=ACCSX2 CaseType=Combination Point=2 X2=-0.5 X3=0.5
 S11=782.845878033159 IsS11Max=No IsS11Min=No FrameElem=1 ElemStation=0.249999976158142
 Frame=1 Station=0.249999976158142 OutputCase=ACCSX2 CaseType=Combination Point=3 X2=0.5 X3=-0.5
 S11=-1117.23135923572 IsS11Max=No IsS11Min=Yes FrameElem=1 ElemStation=0.249999976158142
 Frame=1 Station=0.249999976158142 OutputCase=ACCSX2 CaseType=Combination Point=4 X2=0.5 X3=0.5
 S11=-1117.23135923572 IsS11Max=No IsS11Min=No FrameElem=1 ElemStation=0.249999976158142
 Frame=1 Station=0 OutputCase=ENVE CaseType=Combination StepType=Max Point=0 X2=0 X3=0 S11=-
 167.192740601283 IsS11Max=No IsS11Min=No FrameElem=1 ElemStation=0
 Frame=1 Station=0 OutputCase=ENVE CaseType=Combination StepType=Max Point=1 X2=-0.5 X3=-0.5
 S11=1524.67846313875 IsS11Max=Yes IsS11Min=No FrameElem=1 ElemStation=0
 Frame=1 Station=0 OutputCase=ENVE CaseType=Combination StepType=Max Point=2 X2=-0.5 X3=0.5
 S11=1524.67846313875 IsS11Max=No IsS11Min=No FrameElem=1 ElemStation=0
 Frame=1 Station=0 OutputCase=ENVE CaseType=Combination StepType=Max Point=3 X2=0.5 X3=-0.5 S11=-
 1803.03549752813 IsS11Max=No IsS11Min=Yes FrameElem=1 ElemStation=0
 Frame=1 Station=0 OutputCase=ENVE CaseType=Combination StepType=Max Point=4 X2=0.5 X3=0.5 S11=-
 1803.03549752813 IsS11Max=No IsS11Min=No FrameElem=1 ElemStation=0
 Frame=1 Station=6.24999940395355E-02 OutputCase=ENVE CaseType=Combination StepType=Max Point=0 X2=0
 X3=0 S11=-167.192740601283 IsS11Max=No IsS11Min=No FrameElem=1 ElemStation=6.24999940395355E-02
 Frame=1 Station=6.24999940395355E-02 OutputCase=ENVE CaseType=Combination StepType=Max Point=1 X2=-
 0.5 X3=-0.5 S11=1344.26445975661 IsS11Max=Yes IsS11Min=No FrameElem=1 ElemStation=6.24999940395355E-02
 Frame=1 Station=6.24999940395355E-02 OutputCase=ENVE CaseType=Combination StepType=Max Point=2 X2=-
 0.5 X3=0.5 S11=1344.26445975661 IsS11Max=No IsS11Min=No FrameElem=1 ElemStation=6.24999940395355E-02
 Frame=1 Station=6.24999940395355E-02 OutputCase=ENVE CaseType=Combination StepType=Max Point=3 X2=0.5
 X3=-0.5 S11=-1623.34735508913 IsS11Max=No IsS11Min=Yes FrameElem=1 ElemStation=6.24999940395355E-02
 Frame=1 Station=6.24999940395355E-02 OutputCase=ENVE CaseType=Combination StepType=Max Point=4 X2=0.5
 X3=0.5 S11=-1623.34735508913 IsS11Max=No IsS11Min=No FrameElem=1 ElemStation=6.24999940395355E-02
 Frame=1 Station=0.124999988079071 OutputCase=ENVE CaseType=Combination StepType=Max Point=0 X2=0
 X3=0 S11=-167.192740601283 IsS11Max=No IsS11Min=No FrameElem=1 ElemStation=0.124999988079071
 Frame=1 Station=0.124999988079071 OutputCase=ENVE CaseType=Combination StepType=Max Point=1 X2=-0.5
 X3=-0.5 S11=1164.33970158267 IsS11Max=Yes IsS11Min=No FrameElem=1 ElemStation=0.124999988079071
 Frame=1 Station=0.124999988079071 OutputCase=ENVE CaseType=Combination StepType=Max Point=2 X2=-0.5
 X3=0.5 S11=1164.33970158267 IsS11Max=No IsS11Min=No FrameElem=1 ElemStation=0.124999988079071
 Frame=1 Station=0.124999988079071 OutputCase=ENVE CaseType=Combination StepType=Max Point=3 X2=0.5
 X3=-0.5 S11=-1443.07327526189 IsS11Max=No IsS11Min=Yes FrameElem=1 ElemStation=0.124999988079071
 Frame=1 Station=0.124999988079071 OutputCase=ENVE CaseType=Combination StepType=Max Point=4 X2=0.5
 X3=0.5 S11=-1443.07327526189 IsS11Max=No IsS11Min=No FrameElem=1 ElemStation=0.124999988079071
 Frame=1 Station=0.187499982118607 OutputCase=ENVE CaseType=Combination StepType=Max Point=0 X2=0
 X3=0 S11=-167.192740601283 IsS11Max=No IsS11Min=No FrameElem=1 ElemStation=0.187499982118607
 Frame=1 Station=0.187499982118607 OutputCase=ENVE CaseType=Combination StepType=Max Point=1 X2=-0.5
 X3=-0.5 S11=983.829006020503 IsS11Max=Yes IsS11Min=No FrameElem=1 ElemStation=0.187499982118607
 Frame=1 Station=0.187499982118607 OutputCase=ENVE CaseType=Combination StepType=Max Point=2 X2=-0.5
 X3=0.5 S11=983.829006020503 IsS11Max=No IsS11Min=No FrameElem=1 ElemStation=0.187499982118607
 Frame=1 Station=0.187499982118607 OutputCase=ENVE CaseType=Combination StepType=Max Point=3 X2=0.5
 X3=-0.5 S11=-1262.2132580464 IsS11Max=No IsS11Min=Yes FrameElem=1 ElemStation=0.187499982118607
 Frame=1 Station=0.187499982118607 OutputCase=ENVE CaseType=Combination StepType=Max Point=4 X2=0.5
 X3=0.5 S11=-1262.2132580464 IsS11Max=No IsS11Min=No FrameElem=1 ElemStation=0.187499982118607
 Frame=1 Station=0.249999976158142 OutputCase=ENVE CaseType=Combination StepType=Max Point=0 X2=0
 X3=0 S11=-167.192740601283 IsS11Max=No IsS11Min=No FrameElem=1 ElemStation=0.249999976158142
 Frame=1 Station=0.249999976158142 OutputCase=ENVE CaseType=Combination StepType=Max Point=1 X2=-0.5
 X3=-0.5 S11=802.73237307009 IsS11Max=Yes IsS11Min=No FrameElem=1 ElemStation=0.249999976158142
 Frame=1 Station=0.249999976158142 OutputCase=ENVE CaseType=Combination StepType=Max Point=2 X2=-0.5
 X3=0.5 S11=802.73237307009 IsS11Max=No IsS11Min=No FrameElem=1 ElemStation=0.249999976158142
 Frame=1 Station=0.249999976158142 OutputCase=ENVE CaseType=Combination StepType=Max Point=3 X2=0.5
 X3=-0.5 S11=-1080.76730344268 IsS11Max=No IsS11Min=Yes FrameElem=1 ElemStation=0.249999976158142
 Frame=1 Station=0.249999976158142 OutputCase=ENVE CaseType=Combination StepType=Max Point=4 X2=0.5
 X3=0.5 S11=-1080.76730344268 IsS11Max=No IsS11Min=No FrameElem=1 ElemStation=0.249999976158142
 Frame=1 Station=0 OutputCase=ENVE CaseType=Combination StepType=Min Point=0 X2=0 X3=0 S11=-
 240.528987364651 IsS11Max=No IsS11Min=No FrameElem=1 ElemStation=0
 Frame=1 Station=0 OutputCase=ENVE CaseType=Combination StepType=Min Point=1 X2=-0.5 X3=-0.5
 S11=1464.10442034385 IsS11Max=Yes IsS11Min=No FrameElem=1 ElemStation=0
 Frame=1 Station=0 OutputCase=ENVE CaseType=Combination StepType=Min Point=2 X2=-0.5 X3=0.5
 S11=1464.10442034385 IsS11Max=No IsS11Min=No FrameElem=1 ElemStation=0
 Frame=1 Station=0 OutputCase=ENVE CaseType=Combination StepType=Min Point=3 X2=0.5 X3=-0.5 S11=-
 2005.73643786805 IsS11Max=No IsS11Min=Yes FrameElem=1 ElemStation=0

Frame=1 Station=0 OutputCase=ENVE CaseType=Combination StepType=Min Point=4 X2=0.5 X3=0.5 S11=-2005.73643786805 IsS11Max=No IsS11Min=No FrameElem=1 ElemStation=0

Frame=1 Station=6.24999940395355E-02 OutputCase=ENVE CaseType=Combination StepType=Min Point=0 X2=0 X3=0 S11=-240.528987364651 IsS11Max=No IsS11Min=No FrameElem=1 ElemStation=6.24999940395355E-02

Frame=1 Station=6.24999940395355E-02 OutputCase=ENVE CaseType=Combination StepType=Min Point=1 X2=0.5 X3=-0.5 S11=1284.41627790485 IsS11Max=Yes IsS11Min=No FrameElem=1 ElemStation=6.24999940395355E-02

Frame=1 Station=6.24999940395355E-02 OutputCase=ENVE CaseType=Combination StepType=Min Point=2 X2=-0.5 X3=0.5 S11=1284.41627790485 IsS11Max=No IsS11Min=No FrameElem=1 ElemStation=6.24999940395355E-02

Frame=1 Station=6.24999940395355E-02 OutputCase=ENVE CaseType=Combination StepType=Min Point=3 X2=0.5 X3=-0.5 S11=-1821.21509528625 IsS11Max=No IsS11Min=Yes FrameElem=1 ElemStation=6.24999940395355E-02

Frame=1 Station=6.24999940395355E-02 OutputCase=ENVE CaseType=Combination StepType=Min Point=4 X2=0.5 X3=0.5 S11=-1821.21509528625 IsS11Max=No IsS11Min=No FrameElem=1 ElemStation=6.24999940395355E-02

Frame=1 Station=0.124999988079071 OutputCase=ENVE CaseType=Combination StepType=Min Point=0 X2=0 X3=0 S11=-240.528987364651 IsS11Max=No IsS11Min=No FrameElem=1 ElemStation=0.124999988079071

Frame=1 Station=0.124999988079071 OutputCase=ENVE CaseType=Combination StepType=Min Point=1 X2=-0.5 X3=-0.5 S11=1104.14219807761 IsS11Max=Yes IsS11Min=No FrameElem=1 ElemStation=0.124999988079071

Frame=1 Station=0.124999988079071 OutputCase=ENVE CaseType=Combination StepType=Min Point=2 X2=-0.5 X3=0.5 S11=1104.14219807761 IsS11Max=No IsS11Min=No FrameElem=1 ElemStation=0.124999988079071

Frame=1 Station=0.124999988079071 OutputCase=ENVE CaseType=Combination StepType=Min Point=3 X2=0.5 X3=-0.5 S11=-1636.10781531621 IsS11Max=No IsS11Min=Yes FrameElem=1 ElemStation=0.124999988079071

Frame=1 Station=0.124999988079071 OutputCase=ENVE CaseType=Combination StepType=Min Point=4 X2=0.5 X3=0.5 S11=-1636.10781531621 IsS11Max=No IsS11Min=No FrameElem=1 ElemStation=0.124999988079071

Frame=1 Station=0.187499982118607 OutputCase=ENVE CaseType=Combination StepType=Min Point=0 X2=0 X3=0 S11=-240.528987364651 IsS11Max=No IsS11Min=No FrameElem=1 ElemStation=0.187499982118607

Frame=1 Station=0.187499982118607 OutputCase=ENVE CaseType=Combination StepType=Min Point=1 X2=-0.5 X3=-0.5 S11=923.282180862126 IsS11Max=Yes IsS11Min=No FrameElem=1 ElemStation=0.187499982118607

Frame=1 Station=0.187499982118607 OutputCase=ENVE CaseType=Combination StepType=Min Point=2 X2=-0.5 X3=0.5 S11=923.282180862126 IsS11Max=No IsS11Min=No FrameElem=1 ElemStation=0.187499982118607

Frame=1 Station=0.187499982118607 OutputCase=ENVE CaseType=Combination StepType=Min Point=3 X2=0.5 X3=-0.5 S11=-1451.16095458541 IsS11Max=No IsS11Min=Yes FrameElem=1 ElemStation=0.187499982118607

Frame=1 Station=0.187499982118607 OutputCase=ENVE CaseType=Combination StepType=Min Point=4 X2=0.5 X3=0.5 S11=-1451.16095458541 IsS11Max=No IsS11Min=No FrameElem=1 ElemStation=0.187499982118607

Frame=1 Station=0.24999976158142 OutputCase=ENVE CaseType=Combination StepType=Min Point=0 X2=0 X3=0 S11=-240.528987364651 IsS11Max=No IsS11Min=No FrameElem=1 ElemStation=0.24999976158142

Frame=1 Station=0.24999976158142 OutputCase=ENVE CaseType=Combination StepType=Min Point=1 X2=-0.5 X3=-0.5 S11=741.836226258401 IsS11Max=Yes IsS11Min=No FrameElem=1 ElemStation=0.24999976158142

Frame=1 Station=0.24999976158142 OutputCase=ENVE CaseType=Combination StepType=Min Point=2 X2=-0.5 X3=0.5 S11=741.836226258401 IsS11Max=No IsS11Min=No FrameElem=1 ElemStation=0.24999976158142

Frame=1 Station=0.24999976158142 OutputCase=ENVE CaseType=Combination StepType=Min Point=3 X2=0.5 X3=-0.5 S11=-1270.06432163499 IsS11Max=No IsS11Min=Yes FrameElem=1 ElemStation=0.24999976158142

Frame=1 Station=0.24999976158142 OutputCase=ENVE CaseType=Combination StepType=Min Point=4 X2=0.5 X3=0.5 S11=-1270.06432163499 IsS11Max=No IsS11Min=No FrameElem=1 ElemStation=0.24999976158142

Frame=1 Station=0 OutputCase=FESSUR CaseType=Combination Point=0 X2=0 X3=0 S11=-239.151922837248 IsS11Max=No IsS11Min=No FrameElem=1 ElemStation=0

Frame=1 Station=0 OutputCase=FESSUR CaseType=Combination Point=1 X2=-0.5 X3=-0.5 S11=1512.48652310023 IsS11Max=Yes IsS11Min=No FrameElem=1 ElemStation=0

Frame=1 Station=0 OutputCase=FESSUR CaseType=Combination Point=2 X2=-0.5 X3=0.5 S11=1512.48652310023 IsS11Max=No IsS11Min=No FrameElem=1 ElemStation=0

Frame=1 Station=0 OutputCase=FESSUR CaseType=Combination Point=3 X2=0.5 X3=-0.5 S11=-1990.79036877473 IsS11Max=No IsS11Min=Yes FrameElem=1 ElemStation=0

Frame=1 Station=0 OutputCase=FESSUR CaseType=Combination Point=4 X2=0.5 X3=0.5 S11=-1990.79036877473 IsS11Max=No IsS11Min=No FrameElem=1 ElemStation=0

Frame=1 Station=6.24999940395355E-02 OutputCase=FESSUR CaseType=Combination Point=0 X2=0 X3=0 S11=-239.151922837248 IsS11Max=No IsS11Min=No FrameElem=1 ElemStation=6.24999940395355E-02

Frame=1 Station=6.24999940395355E-02 OutputCase=FESSUR CaseType=Combination Point=1 X2=-0.5 X3=-0.5 S11=1329.41155948905 IsS11Max=Yes IsS11Min=No FrameElem=1 ElemStation=6.24999940395355E-02

Frame=1 Station=6.24999940395355E-02 OutputCase=FESSUR CaseType=Combination Point=2 X2=-0.5 X3=0.5 S11=1329.41155948905 IsS11Max=No IsS11Min=No FrameElem=1 ElemStation=6.24999940395355E-02

Frame=1 Station=6.24999940395355E-02 OutputCase=FESSUR CaseType=Combination Point=3 X2=0.5 X3=-0.5 S11=-1807.71540516355 IsS11Max=No IsS11Min=Yes FrameElem=1 ElemStation=6.24999940395355E-02

Frame=1 Station=6.24999940395355E-02 OutputCase=FESSUR CaseType=Combination Point=4 X2=0.5 X3=0.5 S11=-1807.71540516355 IsS11Max=No IsS11Min=No FrameElem=1 ElemStation=6.24999940395355E-02

Frame=1 Station=0.124999988079071 OutputCase=FESSUR CaseType=Combination Point=0 X2=0 X3=0 S11=-239.151922837248 IsS11Max=No IsS11Min=No FrameElem=1 ElemStation=0.124999988079071

Frame=1 Station=0.124999988079071 OutputCase=FESSUR CaseType=Combination Point=1 X2=-0.5 X3=-0.5 S11=1145.75065848963 IsS11Max=Yes IsS11Min=No FrameElem=1 ElemStation=0.124999988079071

Frame=1 Station=0.124999988079071 OutputCase=FESSUR CaseType=Combination Point=2 X2=-0.5 X3=0.5 S11=1145.75065848963 IsS11Max=No IsS11Min=No FrameElem=1 ElemStation=0.124999988079071

Frame=1 Station=0.124999988079071 OutputCase=FESSUR CaseType=Combination Point=3 X2=0.5 X3=-0.5 S11=-1624.05450416413 IsS11Max=No IsS11Min=Yes FrameElem=1 ElemStation=0.124999988079071

Frame=1 Station=0.124999988079071 OutputCase=FESSUR CaseType=Combination Point=4 X2=0.5 X3=0.5 S11=-1624.05450416413 IsS11Max=No IsS11Min=No FrameElem=1 ElemStation=0.124999988079071

Frame=1 Station=0.187499982118607 OutputCase=FESSUR CaseType=Combination Point=0 X2=0 X3=0 S11=-239.151922837248 IsS11Max=No IsS11Min=No FrameElem=1 ElemStation=0.187499982118607

Frame=1 Station=0.187499982118607 OutputCase=FESSUR CaseType=Combination Point=1 X2=-0.5 X3=-0.5 S11=961.503820101973 IsS11Max=Yes IsS11Min=No FrameElem=1 ElemStation=0.187499982118607

Frame=1 Station=0.187499982118607 OutputCase=FESSUR CaseType=Combination Point=2 X2=-0.5 X3=0.5 S11=961.503820101973 IsS11Max=No IsS11Min=No FrameElem=1 ElemStation=0.187499982118607

Frame=1 Station=0.187499982118607 OutputCase=FESSUR CaseType=Combination Point=3 X2=0.5 X3=-0.5 S11=-1439.80766577647 IsS11Max=No IsS11Min=Yes FrameElem=1 ElemStation=0.187499982118607

Frame=1 Station=0.187499982118607 OutputCase=FESSUR CaseType=Combination Point=4 X2=0.5 X3=0.5 S11=-1439.80766577647 IsS11Max=No IsS11Min=No FrameElem=1 ElemStation=0.187499982118607

Frame=1 Station=0.24999976158142 OutputCase=FESSUR CaseType=Combination Point=0 X2=0 X3=0 S11=-
 239.151922837248 IsS11Max=No IsS11Min=No FrameElem=1 ElemStation=0.24999976158142
 Frame=1 Station=0.24999976158142 OutputCase=FESSUR CaseType=Combination Point=1 X2=-0.5 X3=-0.5
 S11=776.671044326071 IsS11Max=Yes IsS11Min=No FrameElem=1 ElemStation=0.24999976158142
 Frame=1 Station=0.24999976158142 OutputCase=FESSUR CaseType=Combination Point=2 X2=-0.5 X3=0.5
 S11=776.671044326071 IsS11Max=No IsS11Min=No FrameElem=1 ElemStation=0.24999976158142
 Frame=1 Station=0.24999976158142 OutputCase=FESSUR CaseType=Combination Point=3 X2=0.5 X3=-0.5
 S11=-1254.97489000057 IsS11Max=No IsS11Min=Yes FrameElem=1 ElemStation=0.24999976158142
 Frame=1 Station=0.24999976158142 OutputCase=FESSUR CaseType=Combination Point=4 X2=0.5 X3=0.5
 S11=-1254.97489000057 IsS11Max=No IsS11Min=No FrameElem=1 ElemStation=0.24999976158142
 Frame=2 Station=0 OutputCase=PERM1 CaseType=Combination Point=0 X2=0 X3=0 S11=-235.938772273309
 IsS11Max=No IsS11Min=No FrameElem=2 ElemStation=0
 Frame=2 Station=0 OutputCase=PERM1 CaseType=Combination Point=1 X2=-0.5 X3=-0.5
 S11=761.722721295257 IsS11Max=Yes IsS11Min=No FrameElem=2 ElemStation=0
 Frame=2 Station=0 OutputCase=PERM1 CaseType=Combination Point=2 X2=-0.5 X3=0.5 S11=761.722721295257
 IsS11Max=No IsS11Min=No FrameElem=2 ElemStation=0
 Frame=2 Station=0 OutputCase=PERM1 CaseType=Combination Point=3 X2=0.5 X3=-0.5 S11=-
 1233.60026584187 IsS11Max=No IsS11Min=Yes FrameElem=2 ElemStation=0
 Frame=2 Station=0 OutputCase=PERM1 CaseType=Combination Point=4 X2=0.5 X3=0.5 S11=-1233.60026584187
 IsS11Max=No IsS11Min=No FrameElem=2 ElemStation=0
 Frame=2 Station=0.0625 OutputCase=PERM1 CaseType=Combination Point=0 X2=0 X3=0 S11=-
 235.938772273309 IsS11Max=No IsS11Min=No FrameElem=2 ElemStation=0.0625
 Frame=2 Station=0.0625 OutputCase=PERM1 CaseType=Combination Point=1 X2=-0.5 X3=-0.5
 S11=601.395023995473 IsS11Max=Yes IsS11Min=No FrameElem=2 ElemStation=0.0625
 Frame=2 Station=0.0625 OutputCase=PERM1 CaseType=Combination Point=2 X2=-0.5 X3=0.5
 S11=601.395023995473 IsS11Max=No IsS11Min=No FrameElem=2 ElemStation=0.0625
 Frame=2 Station=0.0625 OutputCase=PERM1 CaseType=Combination Point=3 X2=0.5 X3=-0.5 S11=-
 1073.27256854209 IsS11Max=No IsS11Min=Yes FrameElem=2 ElemStation=0.0625
 Frame=2 Station=0.0625 OutputCase=PERM1 CaseType=Combination Point=4 X2=0.5 X3=0.5 S11=-
 1073.27256854209 IsS11Max=No IsS11Min=No FrameElem=2 ElemStation=0.0625
 Frame=2 Station=0.125 OutputCase=PERM1 CaseType=Combination Point=0 X2=0 X3=0 S11=-235.938772273309
 IsS11Max=No IsS11Min=No FrameElem=2 ElemStation=0.125
 Frame=2 Station=0.125 OutputCase=PERM1 CaseType=Combination Point=1 X2=-0.5 X3=-0.5
 S11=440.481389195689 IsS11Max=Yes IsS11Min=No FrameElem=2 ElemStation=0.125
 Frame=2 Station=0.125 OutputCase=PERM1 CaseType=Combination Point=2 X2=-0.5 X3=0.5
 S11=440.481389195689 IsS11Max=No IsS11Min=No FrameElem=2 ElemStation=0.125
 Frame=2 Station=0.125 OutputCase=PERM1 CaseType=Combination Point=3 X2=0.5 X3=-0.5 S11=-
 912.358933742307 IsS11Max=No IsS11Min=Yes FrameElem=2 ElemStation=0.125
 Frame=2 Station=0.125 OutputCase=PERM1 CaseType=Combination Point=4 X2=0.5 X3=0.5 S11=-
 912.358933742307 IsS11Max=No IsS11Min=No FrameElem=2 ElemStation=0.125
 Frame=2 Station=0.1875 OutputCase=PERM1 CaseType=Combination Point=0 X2=0 X3=0 S11=-
 235.938772273309 IsS11Max=No IsS11Min=No FrameElem=2 ElemStation=0.1875
 Frame=2 Station=0.1875 OutputCase=PERM1 CaseType=Combination Point=1 X2=-0.5 X3=-0.5
 S11=278.981816895905 IsS11Max=Yes IsS11Min=No FrameElem=2 ElemStation=0.1875
 Frame=2 Station=0.1875 OutputCase=PERM1 CaseType=Combination Point=2 X2=-0.5 X3=0.5
 S11=278.981816895905 IsS11Max=No IsS11Min=No FrameElem=2 ElemStation=0.1875
 Frame=2 Station=0.1875 OutputCase=PERM1 CaseType=Combination Point=3 X2=0.5 X3=-0.5 S11=-
 750.859361442523 IsS11Max=No IsS11Min=Yes FrameElem=2 ElemStation=0.1875
 Frame=2 Station=0.1875 OutputCase=PERM1 CaseType=Combination Point=4 X2=0.5 X3=0.5 S11=-
 750.859361442523 IsS11Max=No IsS11Min=No FrameElem=2 ElemStation=0.1875
 Frame=2 Station=0.25 OutputCase=PERM1 CaseType=Combination Point=0 X2=0 X3=0 S11=-235.938772273309
 IsS11Max=No IsS11Min=No FrameElem=2 ElemStation=0.25
 Frame=2 Station=0.25 OutputCase=PERM1 CaseType=Combination Point=1 X2=-0.5 X3=-0.5
 S11=116.896307096122 IsS11Max=Yes IsS11Min=No FrameElem=2 ElemStation=0.25
 Frame=2 Station=0.25 OutputCase=PERM1 CaseType=Combination Point=2 X2=-0.5 X3=0.5
 S11=116.896307096122 IsS11Max=No IsS11Min=No FrameElem=2 ElemStation=0.25
 Frame=2 Station=0.25 OutputCase=PERM1 CaseType=Combination Point=3 X2=0.5 X3=-0.5 S11=-
 588.773851642739 IsS11Max=No IsS11Min=Yes FrameElem=2 ElemStation=0.25
 Frame=2 Station=0.25 OutputCase=PERM1 CaseType=Combination Point=4 X2=0.5 X3=0.5 S11=-
 588.773851642739 IsS11Max=No IsS11Min=No FrameElem=2 ElemStation=0.25
 Frame=2 Station=0 OutputCase=PERM2 CaseType=Combination Point=0 X2=0 X3=0 S11=-169.465538592139
 IsS11Max=No IsS11Min=No FrameElem=2 ElemStation=0
 Frame=2 Station=0 OutputCase=PERM2 CaseType=Combination Point=1 X2=-0.5 X3=-0.5
 S11=741.836226258327 IsS11Max=Yes IsS11Min=No FrameElem=2 ElemStation=0
 Frame=2 Station=0 OutputCase=PERM2 CaseType=Combination Point=2 X2=-0.5 X3=0.5 S11=741.836226258327
 IsS11Max=No IsS11Min=No FrameElem=2 ElemStation=0
 Frame=2 Station=0 OutputCase=PERM2 CaseType=Combination Point=3 X2=0.5 X3=-0.5 S11=-1080.7673034426
 IsS11Max=No IsS11Min=Yes FrameElem=2 ElemStation=0
 Frame=2 Station=0 OutputCase=PERM2 CaseType=Combination Point=4 X2=0.5 X3=0.5 S11=-1080.7673034426
 IsS11Max=No IsS11Min=No FrameElem=2 ElemStation=0
 Frame=2 Station=0.0625 OutputCase=PERM2 CaseType=Combination Point=0 X2=0 X3=0 S11=-
 169.465538592139 IsS11Max=No IsS11Min=No FrameElem=2 ElemStation=0.0625
 Frame=2 Station=0.0625 OutputCase=PERM2 CaseType=Combination Point=1 X2=-0.5 X3=-0.5
 S11=581.537460456097 IsS11Max=Yes IsS11Min=No FrameElem=2 ElemStation=0.0625
 Frame=2 Station=0.0625 OutputCase=PERM2 CaseType=Combination Point=2 X2=-0.5 X3=0.5
 S11=581.537460456097 IsS11Max=No IsS11Min=No FrameElem=2 ElemStation=0.0625
 Frame=2 Station=0.0625 OutputCase=PERM2 CaseType=Combination Point=3 X2=0.5 X3=-0.5 S11=-
 920.468537640374 IsS11Max=No IsS11Min=Yes FrameElem=2 ElemStation=0.0625
 Frame=2 Station=0.0625 OutputCase=PERM2 CaseType=Combination Point=4 X2=0.5 X3=0.5 S11=-
 920.468537640374 IsS11Max=No IsS11Min=No FrameElem=2 ElemStation=0.0625
 Frame=2 Station=0.125 OutputCase=PERM2 CaseType=Combination Point=0 X2=0 X3=0 S11=-169.465538592139
 IsS11Max=No IsS11Min=No FrameElem=2 ElemStation=0.125

Frame=2	Station=0.125	OutputCase=PERM2	CaseType=Combination	Point=1	X2=-0.5	X3=-0.5	
S11=420.652757153867	IsS11Max=Yes	IsS11Min=No	FrameElem=2	ElemStation=0.125			
Frame=2	Station=0.125	OutputCase=PERM2	CaseType=Combination	Point=2	X2=-0.5	X3=0.5	
S11=420.652757153867	IsS11Max=No	IsS11Min=No	FrameElem=2	ElemStation=0.125			
Frame=2	Station=0.125	OutputCase=PERM2	CaseType=Combination	Point=3	X2=0.5	X3=-0.5	S11=-
759.583834338144	IsS11Max=No	IsS11Min=Yes	FrameElem=2	ElemStation=0.125			
Frame=2	Station=0.125	OutputCase=PERM2	CaseType=Combination	Point=4	X2=0.5	X3=0.5	S11=-
759.583834338144	IsS11Max=No	IsS11Min=No	FrameElem=2	ElemStation=0.125			
Frame=2	Station=0.1875	OutputCase=PERM2	CaseType=Combination	Point=0	X2=0	X3=0	S11=-
169.465538592139	IsS11Max=No	IsS11Min=Yes	FrameElem=2	ElemStation=0.1875			
Frame=2	Station=0.1875	OutputCase=PERM2	CaseType=Combination	Point=1	X2=-0.5	X3=-0.5	
S11=259.182116351637	IsS11Max=Yes	IsS11Min=No	FrameElem=2	ElemStation=0.1875			
Frame=2	Station=0.1875	OutputCase=PERM2	CaseType=Combination	Point=2	X2=-0.5	X3=0.5	
S11=259.182116351637	IsS11Max=No	IsS11Min=No	FrameElem=2	ElemStation=0.1875			
Frame=2	Station=0.1875	OutputCase=PERM2	CaseType=Combination	Point=3	X2=0.5	X3=-0.5	S11=-
598.113193535915	IsS11Max=No	IsS11Min=Yes	FrameElem=2	ElemStation=0.1875			
Frame=2	Station=0.1875	OutputCase=PERM2	CaseType=Combination	Point=4	X2=0.5	X3=0.5	S11=-
598.113193535915	IsS11Max=No	IsS11Min=No	FrameElem=2	ElemStation=0.1875			
Frame=2	Station=0.25	OutputCase=PERM2	CaseType=Combination	Point=0	X2=0	X3=0	S11=-169.465538592139
IsS11Max=No	IsS11Min=No	FrameElem=2	ElemStation=0.25				
Frame=2	Station=0.25	OutputCase=PERM2	CaseType=Combination	Point=1	X2=-0.5	X3=-0.5	
S11=97.1255380494078	IsS11Max=Yes	IsS11Min=No	FrameElem=2	ElemStation=0.25			
Frame=2	Station=0.25	OutputCase=PERM2	CaseType=Combination	Point=2	X2=-0.5	X3=0.5	
S11=97.1255380494078	IsS11Max=No	IsS11Min=No	FrameElem=2	ElemStation=0.25			
Frame=2	Station=0.25	OutputCase=PERM2	CaseType=Combination	Point=3	X2=0.5	X3=-0.5	S11=-
436.056615233685	IsS11Max=No	IsS11Min=Yes	FrameElem=2	ElemStation=0.25			
Frame=2	Station=0.25	OutputCase=PERM2	CaseType=Combination	Point=4	X2=0.5	X3=0.5	S11=-
436.056615233685	IsS11Max=No	IsS11Min=No	FrameElem=2	ElemStation=0.25			
Frame=2	Station=0	OutputCase=ACC1	CaseType=Combination	Point=0	X2=0	X3=0	S11=-240.528987364651
IsS11Max=No	IsS11Min=No	FrameElem=2	ElemStation=0				
Frame=2	Station=0	OutputCase=ACC1	CaseType=Combination	Point=1	X2=-0.5	X3=-0.5	S11=783.077468482029
IsS11Max=Yes	IsS11Min=No	FrameElem=2	ElemStation=0				
Frame=2	Station=0	OutputCase=ACC1	CaseType=Combination	Point=2	X2=-0.5	X3=0.5	S11=783.077468482029
IsS11Max=No	IsS11Min=No	FrameElem=2	ElemStation=0				
Frame=2	Station=0	OutputCase=ACC1	CaseType=Combination	Point=3	X2=0.5	X3=-0.5	S11=-1264.13544321133
IsS11Max=No	IsS11Min=Yes	FrameElem=2	ElemStation=0				
Frame=2	Station=0	OutputCase=ACC1	CaseType=Combination	Point=4	X2=0.5	X3=0.5	S11=-1264.13544321133
IsS11Max=No	IsS11Min=No	FrameElem=2	ElemStation=0				
Frame=2	Station=0.0625	OutputCase=ACC1	CaseType=Combination	Point=0	X2=0	X3=0	S11=-240.528987364651
IsS11Max=No	IsS11Min=No	FrameElem=2	ElemStation=0.0625				
Frame=2	Station=0.0625	OutputCase=ACC1	CaseType=Combination	Point=1	X2=-0.5	X3=-0.5	
S11=618.445893433047	IsS11Max=Yes	IsS11Min=No	FrameElem=2	ElemStation=0.0625			
Frame=2	Station=0.0625	OutputCase=ACC1	CaseType=Combination	Point=2	X2=-0.5	X3=0.5	
S11=618.445893433047	IsS11Max=No	IsS11Min=No	FrameElem=2	ElemStation=0.0625			
Frame=2	Station=0.0625	OutputCase=ACC1	CaseType=Combination	Point=3	X2=0.5	X3=-0.5	S11=-
1099.50386816235	IsS11Max=No	IsS11Min=Yes	FrameElem=2	ElemStation=0.0625			
Frame=2	Station=0.0625	OutputCase=ACC1	CaseType=Combination	Point=4	X2=0.5	X3=0.5	S11=-
1099.50386816235	IsS11Max=No	IsS11Min=No	FrameElem=2	ElemStation=0.0625			
Frame=2	Station=0.125	OutputCase=ACC1	CaseType=Combination	Point=0	X2=0	X3=0	S11=-240.528987364651
IsS11Max=No	IsS11Min=No	FrameElem=2	ElemStation=0.125				
Frame=2	Station=0.125	OutputCase=ACC1	CaseType=Combination	Point=1	X2=-0.5	X3=-0.5	
S11=453.228380884066	IsS11Max=Yes	IsS11Min=No	FrameElem=2	ElemStation=0.125			
Frame=2	Station=0.125	OutputCase=ACC1	CaseType=Combination	Point=2	X2=-0.5	X3=0.5	
S11=453.228380884066	IsS11Max=No	IsS11Min=No	FrameElem=2	ElemStation=0.125			
Frame=2	Station=0.125	OutputCase=ACC1	CaseType=Combination	Point=3	X2=0.5	X3=-0.5	S11=-
934.286355613367	IsS11Max=No	IsS11Min=Yes	FrameElem=2	ElemStation=0.125			
Frame=2	Station=0.125	OutputCase=ACC1	CaseType=Combination	Point=4	X2=0.5	X3=0.5	S11=-
934.286355613367	IsS11Max=No	IsS11Min=No	FrameElem=2	ElemStation=0.125			
Frame=2	Station=0.1875	OutputCase=ACC1	CaseType=Combination	Point=0	X2=0	X3=0	S11=-240.528987364651
IsS11Max=No	IsS11Min=No	FrameElem=2	ElemStation=0.1875				
Frame=2	Station=0.1875	OutputCase=ACC1	CaseType=Combination	Point=1	X2=-0.5	X3=-0.5	
S11=287.424930835084	IsS11Max=Yes	IsS11Min=No	FrameElem=2	ElemStation=0.1875			
Frame=2	Station=0.1875	OutputCase=ACC1	CaseType=Combination	Point=2	X2=-0.5	X3=0.5	
S11=287.424930835084	IsS11Max=No	IsS11Min=No	FrameElem=2	ElemStation=0.1875			
Frame=2	Station=0.1875	OutputCase=ACC1	CaseType=Combination	Point=3	X2=0.5	X3=-0.5	S11=-
768.482905564385	IsS11Max=No	IsS11Min=Yes	FrameElem=2	ElemStation=0.1875			
Frame=2	Station=0.1875	OutputCase=ACC1	CaseType=Combination	Point=4	X2=0.5	X3=0.5	S11=-
768.482905564385	IsS11Max=No	IsS11Min=No	FrameElem=2	ElemStation=0.1875			
Frame=2	Station=0.25	OutputCase=ACC1	CaseType=Combination	Point=0	X2=0	X3=0	S11=-240.528987364651
IsS11Max=No	IsS11Min=No	FrameElem=2	ElemStation=0.25				
Frame=2	Station=0.25	OutputCase=ACC1	CaseType=Combination	Point=1	X2=-0.5	X3=-0.5	
S11=121.035543286103	IsS11Max=Yes	IsS11Min=No	FrameElem=2	ElemStation=0.25			
Frame=2	Station=0.25	OutputCase=ACC1	CaseType=Combination	Point=2	X2=-0.5	X3=0.5	
S11=121.035543286103	IsS11Max=No	IsS11Min=No	FrameElem=2	ElemStation=0.25			
Frame=2	Station=0.25	OutputCase=ACC1	CaseType=Combination	Point=3	X2=0.5	X3=-0.5	S11=-
602.093518015404	IsS11Max=No	IsS11Min=Yes	FrameElem=2	ElemStation=0.25			
Frame=2	Station=0.25	OutputCase=ACC1	CaseType=Combination	Point=4	X2=0.5	X3=0.5	S11=-
602.093518015404	IsS11Max=No	IsS11Min=No	FrameElem=2	ElemStation=0.25			
Frame=2	Station=0	OutputCase=ACC2	CaseType=Combination	Point=0	X2=0	X3=0	S11=-174.055753683481
IsS11Max=No	IsS11Min=No	FrameElem=2	ElemStation=0				
Frame=2	Station=0	OutputCase=ACC2	CaseType=Combination	Point=1	X2=-0.5	X3=-0.5	S11=763.190973445098
IsS11Max=Yes	IsS11Min=No	FrameElem=2	ElemStation=0				



Frame=2	Station=0	OutputCase=ACC2	CaseType=Combination	Point=2	X2=-0.5	X3=0.5	S11=763.190973445098
IsS11Max=No	IsS11Min=No	FrameElem=2	ElemStation=0				
Frame=2	Station=0	OutputCase=ACC2	CaseType=Combination	Point=3	X2=0.5	X3=-0.5	S11=-1111.30248081206
IsS11Max=No	IsS11Min=Yes	FrameElem=2	ElemStation=0				
Frame=2	Station=0	OutputCase=ACC2	CaseType=Combination	Point=4	X2=0.5	X3=0.5	S11=-1111.30248081206
IsS11Max=No	IsS11Min=No	FrameElem=2	ElemStation=0				
Frame=2	Station=0.0625	OutputCase=ACC2	CaseType=Combination	Point=0	X2=0	X3=0	S11=-174.055753683481
IsS11Max=No	IsS11Min=No	FrameElem=2	ElemStation=0.0625				
Frame=2	Station=0.0625	OutputCase=ACC2	CaseType=Combination	Point=1	X2=-0.5	X3=-0.5	
S11=598.588329893671	IsS11Max=Yes	IsS11Min=No	FrameElem=2	ElemStation=0.0625			
Frame=2	Station=0.0625	OutputCase=ACC2	CaseType=Combination	Point=2	X2=-0.5	X3=0.5	
S11=598.588329893671	IsS11Max=No	IsS11Min=No	FrameElem=2	ElemStation=0.0625			
Frame=2	Station=0.0625	OutputCase=ACC2	CaseType=Combination	Point=3	X2=0.5	X3=-0.5	S11=-
946.699837260632	IsS11Max=No	IsS11Min=Yes	FrameElem=2	ElemStation=0.0625			
Frame=2	Station=0.0625	OutputCase=ACC2	CaseType=Combination	Point=4	X2=0.5	X3=0.5	S11=-
946.699837260632	IsS11Max=No	IsS11Min=No	FrameElem=2	ElemStation=0.0625			
Frame=2	Station=0.125	OutputCase=ACC2	CaseType=Combination	Point=0	X2=0	X3=0	S11=-174.055753683481
IsS11Max=No	IsS11Min=No	FrameElem=2	ElemStation=0.125				
Frame=2	Station=0.125	OutputCase=ACC2	CaseType=Combination	Point=1	X2=-0.5	X3=-0.5	
S11=433.399748842244	IsS11Max=Yes	IsS11Min=No	FrameElem=2	ElemStation=0.125			
Frame=2	Station=0.125	OutputCase=ACC2	CaseType=Combination	Point=2	X2=-0.5	X3=0.5	
S11=433.399748842244	IsS11Max=No	IsS11Min=No	FrameElem=2	ElemStation=0.125			
Frame=2	Station=0.125	OutputCase=ACC2	CaseType=Combination	Point=3	X2=0.5	X3=-0.5	S11=-
781.511256209205	IsS11Max=No	IsS11Min=Yes	FrameElem=2	ElemStation=0.125			
Frame=2	Station=0.125	OutputCase=ACC2	CaseType=Combination	Point=4	X2=0.5	X3=0.5	S11=-
781.511256209205	IsS11Max=No	IsS11Min=No	FrameElem=2	ElemStation=0.125			
Frame=2	Station=0.1875	OutputCase=ACC2	CaseType=Combination	Point=0	X2=0	X3=0	S11=-174.055753683481
IsS11Max=No	IsS11Min=No	FrameElem=2	ElemStation=0.1875				
Frame=2	Station=0.1875	OutputCase=ACC2	CaseType=Combination	Point=1	X2=-0.5	X3=-0.5	
S11=267.625230290816	IsS11Max=Yes	IsS11Min=No	FrameElem=2	ElemStation=0.1875			
Frame=2	Station=0.1875	OutputCase=ACC2	CaseType=Combination	Point=2	X2=-0.5	X3=0.5	
S11=267.625230290816	IsS11Max=No	IsS11Min=No	FrameElem=2	ElemStation=0.1875			
Frame=2	Station=0.1875	OutputCase=ACC2	CaseType=Combination	Point=3	X2=0.5	X3=-0.5	S11=-
615.736737657777	IsS11Max=No	IsS11Min=Yes	FrameElem=2	ElemStation=0.1875			
Frame=2	Station=0.1875	OutputCase=ACC2	CaseType=Combination	Point=4	X2=0.5	X3=0.5	S11=-
615.736737657777	IsS11Max=No	IsS11Min=No	FrameElem=2	ElemStation=0.1875			
Frame=2	Station=0.25	OutputCase=ACC2	CaseType=Combination	Point=0	X2=0	X3=0	S11=-174.055753683481
IsS11Max=No	IsS11Min=No	FrameElem=2	ElemStation=0.25				
Frame=2	Station=0.25	OutputCase=ACC2	CaseType=Combination	Point=1	X2=-0.5	X3=-0.5	
S11=101.264774239389	IsS11Max=Yes	IsS11Min=No	FrameElem=2	ElemStation=0.25			
Frame=2	Station=0.25	OutputCase=ACC2	CaseType=Combination	Point=2	X2=-0.5	X3=0.5	
S11=101.264774239389	IsS11Max=No	IsS11Min=No	FrameElem=2	ElemStation=0.25			
Frame=2	Station=0.25	OutputCase=ACC2	CaseType=Combination	Point=3	X2=0.5	X3=-0.5	S11=-
449.37628160635	IsS11Max=No	IsS11Min=Yes	FrameElem=2	ElemStation=0.25			
Frame=2	Station=0.25	OutputCase=ACC2	CaseType=Combination	Point=4	X2=0.5	X3=0.5	S11=-
449.37628160635	IsS11Max=No	IsS11Min=No	FrameElem=2	ElemStation=0.25			
Frame=2	Station=0	OutputCase=ACCSX1	CaseType=Combination	Point=0	X2=0	X3=0	S11=-233.665974282453
IsS11Max=No	IsS11Min=No	FrameElem=2	ElemStation=0				
Frame=2	Station=0	OutputCase=ACCSX1	CaseType=Combination	Point=1	X2=-0.5	X3=-0.5	
S11=802.732373070014	IsS11Max=Yes	IsS11Min=No	FrameElem=2	ElemStation=0			
Frame=2	Station=0	OutputCase=ACCSX1	CaseType=Combination	Point=2	X2=-0.5	X3=0.5	
S11=802.732373070014	IsS11Max=No	IsS11Min=No	FrameElem=2	ElemStation=0			
Frame=2	Station=0	OutputCase=ACCSX1	CaseType=Combination	Point=3	X2=0.5	X3=-0.5	S11=-
1270.06432163492	IsS11Max=No	IsS11Min=Yes	FrameElem=2	ElemStation=0			
Frame=2	Station=0	OutputCase=ACCSX1	CaseType=Combination	Point=4	X2=0.5	X3=0.5	S11=-
1270.06432163492	IsS11Max=No	IsS11Min=No	FrameElem=2	ElemStation=0			
Frame=2	Station=0.0625	OutputCase=ACCSX1	CaseType=Combination	Point=0	X2=0	X3=0	S11=-
233.665974282453	IsS11Max=No	IsS11Min=No	FrameElem=2	ElemStation=0.0625			
Frame=2	Station=0.0625	OutputCase=ACCSX1	CaseType=Combination	Point=1	X2=-0.5	X3=-0.5	
S11=642.395662918501	IsS11Max=Yes	IsS11Min=No	FrameElem=2	ElemStation=0.0625			
Frame=2	Station=0.0625	OutputCase=ACCSX1	CaseType=Combination	Point=2	X2=-0.5	X3=0.5	
S11=642.395662918501	IsS11Max=No	IsS11Min=No	FrameElem=2	ElemStation=0.0625			
Frame=2	Station=0.0625	OutputCase=ACCSX1	CaseType=Combination	Point=3	X2=0.5	X3=-0.5	S11=-
1109.72761148341	IsS11Max=No	IsS11Min=Yes	FrameElem=2	ElemStation=0.0625			
Frame=2	Station=0.0625	OutputCase=ACCSX1	CaseType=Combination	Point=4	X2=0.5	X3=0.5	S11=-
1109.72761148341	IsS11Max=No	IsS11Min=No	FrameElem=2	ElemStation=0.0625			
Frame=2	Station=0.125	OutputCase=ACCSX1	CaseType=Combination	Point=0	X2=0	X3=0	S11=-
233.665974282453	IsS11Max=No	IsS11Min=No	FrameElem=2	ElemStation=0.125			
Frame=2	Station=0.125	OutputCase=ACCSX1	CaseType=Combination	Point=1	X2=-0.5	X3=-0.5	
S11=481.473015266987	IsS11Max=Yes	IsS11Min=No	FrameElem=2	ElemStation=0.125			
Frame=2	Station=0.125	OutputCase=ACCSX1	CaseType=Combination	Point=2	X2=-0.5	X3=0.5	
S11=481.473015266987	IsS11Max=No	IsS11Min=No	FrameElem=2	ElemStation=0.125			
Frame=2	Station=0.125	OutputCase=ACCSX1	CaseType=Combination	Point=3	X2=0.5	X3=-0.5	S11=-
948.804963831892	IsS11Max=No	IsS11Min=Yes	FrameElem=2	ElemStation=0.125			
Frame=2	Station=0.125	OutputCase=ACCSX1	CaseType=Combination	Point=4	X2=0.5	X3=0.5	S11=-
948.804963831892	IsS11Max=No	IsS11Min=No	FrameElem=2	ElemStation=0.125			
Frame=2	Station=0.1875	OutputCase=ACCSX1	CaseType=Combination	Point=0	X2=0	X3=0	S11=-
233.665974282453	IsS11Max=No	IsS11Min=No	FrameElem=2	ElemStation=0.1875			
Frame=2	Station=0.1875	OutputCase=ACCSX1	CaseType=Combination	Point=1	X2=-0.5	X3=-0.5	
S11=319.964430115473	IsS11Max=Yes	IsS11Min=No	FrameElem=2	ElemStation=0.1875			
Frame=2	Station=0.1875	OutputCase=ACCSX1	CaseType=Combination	Point=2	X2=-0.5	X3=0.5	
S11=319.964430115473	IsS11Max=No	IsS11Min=No	FrameElem=2	ElemStation=0.1875			

Frame=2	Station=0.1875	OutputCase=ACCSX1	CaseType=Combination	Point=3	X2=0.5	X3=-0.5	S11=-	
787.296378680378	IsS11Max=No	IsS11Min=Yes	FrameElem=2	ElemStation=0.1875				
Frame=2	Station=0.1875	OutputCase=ACCSX1	CaseType=Combination	Point=4	X2=0.5	X3=0.5	S11=-	
787.296378680378	IsS11Max=No	IsS11Min=No	FrameElem=2	ElemStation=0.1875				
Frame=2	Station=0.25	OutputCase=ACCSX1	CaseType=Combination	Point=0	X2=0	X3=0	S11=-233.665974282453	
IsS11Max=No	IsS11Min=No	FrameElem=2	ElemStation=0.25					
Frame=2	Station=0.25	OutputCase=ACCSX1	CaseType=Combination	Point=1	X2=-0.5	X3=-0.5		
S11=157.86990746396	IsS11Max=Yes	IsS11Min=No	FrameElem=2	ElemStation=0.25				
Frame=2	Station=0.25	OutputCase=ACCSX1	CaseType=Combination	Point=2	X2=-0.5	X3=0.5		
S11=157.86990746396	IsS11Max=No	IsS11Min=No	FrameElem=2	ElemStation=0.25				
Frame=2	Station=0.25	OutputCase=ACCSX1	CaseType=Combination	Point=3	X2=0.5	X3=-0.5	S11=-	
625.201856028865	IsS11Max=No	IsS11Min=Yes	FrameElem=2	ElemStation=0.25				
Frame=2	Station=0.25	OutputCase=ACCSX1	CaseType=Combination	Point=4	X2=0.5	X3=0.5	S11=-	
625.201856028865	IsS11Max=No	IsS11Min=No	FrameElem=2	ElemStation=0.25				
Frame=2	Station=0	OutputCase=ACCSX2	CaseType=Combination	Point=0	X2=0	X3=0	S11=-167.192740601283	
IsS11Max=No	IsS11Min=No	FrameElem=2	ElemStation=0					
Frame=2	Station=0	OutputCase=ACCSX2	CaseType=Combination	Point=1	X2=-0.5	X3=-0.5		
S11=782.845878033084	IsS11Max=Yes	IsS11Min=No	FrameElem=2	ElemStation=0				
Frame=2	Station=0	OutputCase=ACCSX2	CaseType=Combination	Point=2	X2=-0.5	X3=0.5		
S11=782.845878033084	IsS11Max=No	IsS11Min=No	FrameElem=2	ElemStation=0				
Frame=2	Station=0	OutputCase=ACCSX2	CaseType=Combination	Point=3	X2=0.5	X3=-0.5	S11=-	
1117.23135923565	IsS11Max=No	IsS11Min=Yes	FrameElem=2	ElemStation=0				
Frame=2	Station=0	OutputCase=ACCSX2	CaseType=Combination	Point=4	X2=0.5	X3=0.5	S11=-	
1117.23135923565	IsS11Max=No	IsS11Min=No	FrameElem=2	ElemStation=0				
Frame=2	Station=0.0625	OutputCase=ACCSX2	CaseType=Combination	Point=0	X2=0	X3=0	S11=-	
167.192740601283	IsS11Max=No	IsS11Min=No	FrameElem=2	ElemStation=0.0625				
Frame=2	Station=0.0625	OutputCase=ACCSX2	CaseType=Combination	Point=1	X2=-0.5	X3=-0.5		
S11=622.538099379124	IsS11Max=Yes	IsS11Min=No	FrameElem=2	ElemStation=0.0625				
Frame=2	Station=0.0625	OutputCase=ACCSX2	CaseType=Combination	Point=2	X2=-0.5	X3=0.5		
S11=622.538099379124	IsS11Max=No	IsS11Min=No	FrameElem=2	ElemStation=0.0625				
Frame=2	Station=0.0625	OutputCase=ACCSX2	CaseType=Combination	Point=3	X2=0.5	X3=-0.5	S11=-	
956.92358058169	IsS11Max=No	IsS11Min=Yes	FrameElem=2	ElemStation=0.0625				
Frame=2	Station=0.0625	OutputCase=ACCSX2	CaseType=Combination	Point=4	X2=0.5	X3=0.5	S11=-	
956.92358058169	IsS11Max=No	IsS11Min=No	FrameElem=2	ElemStation=0.0625				
Frame=2	Station=0.125	OutputCase=ACCSX2	CaseType=Combination	Point=0	X2=0	X3=0	S11=-	
167.192740601283	IsS11Max=No	IsS11Min=No	FrameElem=2	ElemStation=0.125				
Frame=2	Station=0.125	OutputCase=ACCSX2	CaseType=Combination	Point=1	X2=-0.5	X3=-0.5		
S11=461.644383225165	IsS11Max=Yes	IsS11Min=No	FrameElem=2	ElemStation=0.125				
Frame=2	Station=0.125	OutputCase=ACCSX2	CaseType=Combination	Point=2	X2=-0.5	X3=0.5		
S11=461.644383225165	IsS11Max=No	IsS11Min=No	FrameElem=2	ElemStation=0.125				
Frame=2	Station=0.125	OutputCase=ACCSX2	CaseType=Combination	Point=3	X2=0.5	X3=-0.5	S11=-	
796.02986442773	IsS11Max=No	IsS11Min=Yes	FrameElem=2	ElemStation=0.125				
Frame=2	Station=0.125	OutputCase=ACCSX2	CaseType=Combination	Point=4	X2=0.5	X3=0.5	S11=-	
796.02986442773	IsS11Max=No	IsS11Min=No	FrameElem=2	ElemStation=0.125				
Frame=2	Station=0.1875	OutputCase=ACCSX2	CaseType=Combination	Point=0	X2=0	X3=0	S11=-	
167.192740601283	IsS11Max=No	IsS11Min=No	FrameElem=2	ElemStation=0.1875				
Frame=2	Station=0.1875	OutputCase=ACCSX2	CaseType=Combination	Point=1	X2=-0.5	X3=-0.5		
S11=300.164729571205	IsS11Max=Yes	IsS11Min=No	FrameElem=2	ElemStation=0.1875				
Frame=2	Station=0.1875	OutputCase=ACCSX2	CaseType=Combination	Point=2	X2=-0.5	X3=0.5		
S11=300.164729571205	IsS11Max=No	IsS11Min=No	FrameElem=2	ElemStation=0.1875				
Frame=2	Station=0.1875	OutputCase=ACCSX2	CaseType=Combination	Point=3	X2=0.5	X3=-0.5	S11=-	
634.550210773771	IsS11Max=No	IsS11Min=Yes	FrameElem=2	ElemStation=0.1875				
Frame=2	Station=0.1875	OutputCase=ACCSX2	CaseType=Combination	Point=4	X2=0.5	X3=0.5	S11=-	
634.550210773771	IsS11Max=No	IsS11Min=No	FrameElem=2	ElemStation=0.1875				
Frame=2	Station=0.25	OutputCase=ACCSX2	CaseType=Combination	Point=0	X2=0	X3=0	S11=-167.192740601283	
IsS11Max=No	IsS11Min=No	FrameElem=2	ElemStation=0.25					
Frame=2	Station=0.25	OutputCase=ACCSX2	CaseType=Combination	Point=1	X2=-0.5	X3=-0.5		
S11=138.099138417246	IsS11Max=Yes	IsS11Min=No	FrameElem=2	ElemStation=0.25				
Frame=2	Station=0.25	OutputCase=ACCSX2	CaseType=Combination	Point=2	X2=-0.5	X3=0.5		
S11=138.099138417246	IsS11Max=No	IsS11Min=No	FrameElem=2	ElemStation=0.25				
Frame=2	Station=0.25	OutputCase=ACCSX2	CaseType=Combination	Point=3	X2=0.5	X3=-0.5	S11=-	
472.484619619811	IsS11Max=No	IsS11Min=Yes	FrameElem=2	ElemStation=0.25				
Frame=2	Station=0.25	OutputCase=ACCSX2	CaseType=Combination	Point=4	X2=0.5	X3=0.5	S11=-	
472.484619619811	IsS11Max=No	IsS11Min=No	FrameElem=2	ElemStation=0.25				
Frame=2	Station=0	OutputCase=ENVE	CaseType=Combination	StepType=Max	Point=0	X2=0	X3=0	S11=-
167.192740601283	IsS11Max=No	IsS11Min=No	FrameElem=2	ElemStation=0				
Frame=2	Station=0	OutputCase=ENVE	CaseType=Combination	StepType=Max	Point=1	X2=-0.5	X3=-0.5	
S11=802.732373070014	IsS11Max=Yes	IsS11Min=No	FrameElem=2	ElemStation=0				
Frame=2	Station=0	OutputCase=ENVE	CaseType=Combination	StepType=Max	Point=2	X2=-0.5	X3=0.5	
S11=802.732373070014	IsS11Max=No	IsS11Min=No	FrameElem=2	ElemStation=0				
Frame=2	Station=0	OutputCase=ENVE	CaseType=Combination	StepType=Max	Point=3	X2=0.5	X3=-0.5	S11=-
1080.7673034426	IsS11Max=No	IsS11Min=Yes	FrameElem=2	ElemStation=0				
Frame=2	Station=0	OutputCase=ENVE	CaseType=Combination	StepType=Max	Point=4	X2=0.5	X3=0.5	S11=-
1080.7673034426	IsS11Max=No	IsS11Min=No	FrameElem=2	ElemStation=0				
Frame=2	Station=0.0625	OutputCase=ENVE	CaseType=Combination	StepType=Max	Point=0	X2=0	X3=0	S11=-
167.192740601283	IsS11Max=No	IsS11Min=No	FrameElem=2	ElemStation=0.0625				
Frame=2	Station=0.0625	OutputCase=ENVE	CaseType=Combination	StepType=Max	Point=1	X2=-0.5	X3=-0.5	
S11=642.395662918501	IsS11Max=Yes	IsS11Min=No	FrameElem=2	ElemStation=0.0625				
Frame=2	Station=0.0625	OutputCase=ENVE	CaseType=Combination	StepType=Max	Point=2	X2=-0.5	X3=0.5	
S11=642.395662918501	IsS11Max=No	IsS11Min=No	FrameElem=2	ElemStation=0.0625				
Frame=2	Station=0.0625	OutputCase=ENVE	CaseType=Combination	StepType=Max	Point=3	X2=0.5	X3=-0.5	
S11=-920.468537640374	IsS11Max=No	IsS11Min=Yes	FrameElem=2	ElemStation=0.0625				



Frame=2	Station=0.0625	OutputCase=ENVE	CaseType=Combination	StepType=Max	Point=4	X2=0.5	X3=0.5	
S11=-920.468537640374	IsS11Max=No	IsS11Min=No	FrameElem=2	ElemStation=0.0625				
Frame=2	Station=0.125	OutputCase=ENVE	CaseType=Combination	StepType=Max	Point=0	X2=0	X3=0	S11=-
167.192740601283	IsS11Max=No	IsS11Min=No	FrameElem=2	ElemStation=0.125				
Frame=2	Station=0.125	OutputCase=ENVE	CaseType=Combination	StepType=Max	Point=1	X2=-0.5	X3=-0.5	
S11=481.473015266987	IsS11Max=Yes	IsS11Min=No	FrameElem=2	ElemStation=0.125				
Frame=2	Station=0.125	OutputCase=ENVE	CaseType=Combination	StepType=Max	Point=2	X2=-0.5	X3=0.5	
S11=481.473015266987	IsS11Max=No	IsS11Min=No	FrameElem=2	ElemStation=0.125				
Frame=2	Station=0.125	OutputCase=ENVE	CaseType=Combination	StepType=Max	Point=3	X2=0.5	X3=-0.5	
S11=-759.583834338144	IsS11Max=No	IsS11Min=Yes	FrameElem=2	ElemStation=0.125				
Frame=2	Station=0.125	OutputCase=ENVE	CaseType=Combination	StepType=Max	Point=4	X2=0.5	X3=0.5	
S11=-759.583834338144	IsS11Max=No	IsS11Min=No	FrameElem=2	ElemStation=0.125				
Frame=2	Station=0.1875	OutputCase=ENVE	CaseType=Combination	StepType=Max	Point=0	X2=0	X3=0	S11=-
167.192740601283	IsS11Max=No	IsS11Min=No	FrameElem=2	ElemStation=0.1875				
Frame=2	Station=0.1875	OutputCase=ENVE	CaseType=Combination	StepType=Max	Point=1	X2=-0.5	X3=-0.5	
S11=319.964430115473	IsS11Max=Yes	IsS11Min=No	FrameElem=2	ElemStation=0.1875				
Frame=2	Station=0.1875	OutputCase=ENVE	CaseType=Combination	StepType=Max	Point=2	X2=-0.5	X3=0.5	
S11=319.964430115473	IsS11Max=No	IsS11Min=No	FrameElem=2	ElemStation=0.1875				
Frame=2	Station=0.1875	OutputCase=ENVE	CaseType=Combination	StepType=Max	Point=3	X2=0.5	X3=-0.5	
S11=-598.113193535915	IsS11Max=No	IsS11Min=Yes	FrameElem=2	ElemStation=0.1875				
Frame=2	Station=0.1875	OutputCase=ENVE	CaseType=Combination	StepType=Max	Point=4	X2=0.5	X3=0.5	
S11=-598.113193535915	IsS11Max=No	IsS11Min=No	FrameElem=2	ElemStation=0.1875				
Frame=2	Station=0.25	OutputCase=ENVE	CaseType=Combination	StepType=Max	Point=0	X2=0	X3=0	S11=-
167.192740601283	IsS11Max=No	IsS11Min=No	FrameElem=2	ElemStation=0.25				
Frame=2	Station=0.25	OutputCase=ENVE	CaseType=Combination	StepType=Max	Point=1	X2=-0.5	X3=-0.5	
S11=157.86990746396	IsS11Max=Yes	IsS11Min=No	FrameElem=2	ElemStation=0.25				
Frame=2	Station=0.25	OutputCase=ENVE	CaseType=Combination	StepType=Max	Point=2	X2=-0.5	X3=0.5	
S11=157.86990746396	IsS11Max=No	IsS11Min=No	FrameElem=2	ElemStation=0.25				
Frame=2	Station=0.25	OutputCase=ENVE	CaseType=Combination	StepType=Max	Point=3	X2=0.5	X3=-0.5	
S11=-436.056615233685	IsS11Max=No	IsS11Min=Yes	FrameElem=2	ElemStation=0.25				
Frame=2	Station=0.25	OutputCase=ENVE	CaseType=Combination	StepType=Max	Point=4	X2=0.5	X3=0.5	
S11=-436.056615233685	IsS11Max=No	IsS11Min=No	FrameElem=2	ElemStation=0.25				
Frame=2	Station=0	OutputCase=ENVE	CaseType=Combination	StepType=Min	Point=0	X2=0	X3=0	S11=-
240.528987364651	IsS11Max=No	IsS11Min=No	FrameElem=2	ElemStation=0				
Frame=2	Station=0	OutputCase=ENVE	CaseType=Combination	StepType=Min	Point=1	X2=-0.5	X3=-0.5	
S11=741.836226258327	IsS11Max=Yes	IsS11Min=No	FrameElem=2	ElemStation=0				
Frame=2	Station=0	OutputCase=ENVE	CaseType=Combination	StepType=Min	Point=2	X2=-0.5	X3=0.5	
S11=741.836226258327	IsS11Max=No	IsS11Min=No	FrameElem=2	ElemStation=0				
Frame=2	Station=0	OutputCase=ENVE	CaseType=Combination	StepType=Min	Point=3	X2=0.5	X3=-0.5	S11=-
1270.06432163492	IsS11Max=No	IsS11Min=Yes	FrameElem=2	ElemStation=0				
Frame=2	Station=0	OutputCase=ENVE	CaseType=Combination	StepType=Min	Point=4	X2=0.5	X3=0.5	S11=-
1270.06432163492	IsS11Max=No	IsS11Min=No	FrameElem=2	ElemStation=0				
Frame=2	Station=0.0625	OutputCase=ENVE	CaseType=Combination	StepType=Min	Point=0	X2=0	X3=0	S11=-
240.528987364651	IsS11Max=No	IsS11Min=No	FrameElem=2	ElemStation=0.0625				
Frame=2	Station=0.0625	OutputCase=ENVE	CaseType=Combination	StepType=Min	Point=1	X2=-0.5	X3=-0.5	
S11=581.537460456097	IsS11Max=Yes	IsS11Min=No	FrameElem=2	ElemStation=0.0625				
Frame=2	Station=0.0625	OutputCase=ENVE	CaseType=Combination	StepType=Min	Point=2	X2=-0.5	X3=0.5	
S11=581.537460456097	IsS11Max=No	IsS11Min=No	FrameElem=2	ElemStation=0.0625				
Frame=2	Station=0.0625	OutputCase=ENVE	CaseType=Combination	StepType=Min	Point=3	X2=0.5	X3=-0.5	
S11=-1109.72761148341	IsS11Max=No	IsS11Min=Yes	FrameElem=2	ElemStation=0.0625				
Frame=2	Station=0.0625	OutputCase=ENVE	CaseType=Combination	StepType=Min	Point=4	X2=0.5	X3=0.5	
S11=-1109.72761148341	IsS11Max=No	IsS11Min=No	FrameElem=2	ElemStation=0.0625				
Frame=2	Station=0.125	OutputCase=ENVE	CaseType=Combination	StepType=Min	Point=0	X2=0	X3=0	S11=-
240.528987364651	IsS11Max=No	IsS11Min=No	FrameElem=2	ElemStation=0.125				
Frame=2	Station=0.125	OutputCase=ENVE	CaseType=Combination	StepType=Min	Point=1	X2=-0.5	X3=-0.5	
S11=420.652757153867	IsS11Max=Yes	IsS11Min=No	FrameElem=2	ElemStation=0.125				
Frame=2	Station=0.125	OutputCase=ENVE	CaseType=Combination	StepType=Min	Point=2	X2=-0.5	X3=0.5	
S11=420.652757153867	IsS11Max=No	IsS11Min=No	FrameElem=2	ElemStation=0.125				
Frame=2	Station=0.125	OutputCase=ENVE	CaseType=Combination	StepType=Min	Point=3	X2=0.5	X3=-0.5	
S11=-948.804963831892	IsS11Max=No	IsS11Min=Yes	FrameElem=2	ElemStation=0.125				
Frame=2	Station=0.125	OutputCase=ENVE	CaseType=Combination	StepType=Min	Point=4	X2=0.5	X3=0.5	
S11=-948.804963831892	IsS11Max=No	IsS11Min=No	FrameElem=2	ElemStation=0.125				
Frame=2	Station=0.1875	OutputCase=ENVE	CaseType=Combination	StepType=Min	Point=0	X2=0	X3=0	S11=-
240.528987364651	IsS11Max=No	IsS11Min=No	FrameElem=2	ElemStation=0.1875				
Frame=2	Station=0.1875	OutputCase=ENVE	CaseType=Combination	StepType=Min	Point=1	X2=-0.5	X3=-0.5	
S11=259.182116351637	IsS11Max=Yes	IsS11Min=No	FrameElem=2	ElemStation=0.1875				
Frame=2	Station=0.1875	OutputCase=ENVE	CaseType=Combination	StepType=Min	Point=2	X2=-0.5	X3=0.5	
S11=259.182116351637	IsS11Max=No	IsS11Min=No	FrameElem=2	ElemStation=0.1875				
Frame=2	Station=0.1875	OutputCase=ENVE	CaseType=Combination	StepType=Min	Point=3	X2=0.5	X3=-0.5	
S11=-787.296378680378	IsS11Max=No	IsS11Min=Yes	FrameElem=2	ElemStation=0.1875				
Frame=2	Station=0.1875	OutputCase=ENVE	CaseType=Combination	StepType=Min	Point=4	X2=0.5	X3=0.5	
S11=-787.296378680378	IsS11Max=No	IsS11Min=No	FrameElem=2	ElemStation=0.1875				
Frame=2	Station=0.25	OutputCase=ENVE	CaseType=Combination	StepType=Min	Point=0	X2=0	X3=0	S11=-
240.528987364651	IsS11Max=No	IsS11Min=No	FrameElem=2	ElemStation=0.25				
Frame=2	Station=0.25	OutputCase=ENVE	CaseType=Combination	StepType=Min	Point=1	X2=-0.5	X3=-0.5	
S11=97.1255380494078	IsS11Max=Yes	IsS11Min=No	FrameElem=2	ElemStation=0.25				
Frame=2	Station=0.25	OutputCase=ENVE	CaseType=Combination	StepType=Min	Point=2	X2=-0.5	X3=0.5	
S11=97.1255380494078	IsS11Max=No	IsS11Min=No	FrameElem=2	ElemStation=0.25				
Frame=2	Station=0.25	OutputCase=ENVE	CaseType=Combination	StepType=Min	Point=3	X2=0.5	X3=-0.5	
S11=-625.201856028865	IsS11Max=No	IsS11Min=Yes	FrameElem=2	ElemStation=0.25				
Frame=2	Station=0.25	OutputCase=ENVE	CaseType=Combination	StepType=Min	Point=4	X2=0.5	X3=0.5	
S11=-625.201856028865	IsS11Max=No	IsS11Min=No	FrameElem=2	ElemStation=0.25				

```

Frame=2 Station=0 OutputCase=FESSUR CaseType=Combination Point=0 X2=0 X3=0 S11=-239.151922837248
IsS11Max=No IsS11Min=No FrameElem=2 ElemStation=0
Frame=2 Station=0 OutputCase=FESSUR CaseType=Combination Point=1 X2=-0.5 X3=-0.5
S11=776.671044325997 IsS11Max=Yes IsS11Min=No FrameElem=2 ElemStation=0
Frame=2 Station=0 OutputCase=FESSUR CaseType=Combination Point=2 X2=-0.5 X3=0.5
S11=776.671044325997 IsS11Max=No IsS11Min=No FrameElem=2 ElemStation=0
Frame=2 Station=0 OutputCase=FESSUR CaseType=Combination Point=3 X2=0.5 X3=-0.5 S11=-
1254.97489000049 IsS11Max=No IsS11Min=Yes FrameElem=2 ElemStation=0
Frame=2 Station=0 OutputCase=FESSUR CaseType=Combination Point=4 X2=0.5 X3=0.5 S11=-
1254.97489000049 IsS11Max=No IsS11Min=No FrameElem=2 ElemStation=0
Frame=2 Station=0.0625 OutputCase=FESSUR CaseType=Combination Point=0 X2=0 X3=0 S11=-
239.151922837248 IsS11Max=No IsS11Min=No FrameElem=2 ElemStation=0.0625
Frame=2 Station=0.0625 OutputCase=FESSUR CaseType=Combination Point=1 X2=-0.5 X3=-0.5
S11=613.330632601775 IsS11Max=Yes IsS11Min=No FrameElem=2 ElemStation=0.0625
Frame=2 Station=0.0625 OutputCase=FESSUR CaseType=Combination Point=2 X2=-0.5 X3=0.5
S11=613.330632601775 IsS11Max=No IsS11Min=No FrameElem=2 ElemStation=0.0625
Frame=2 Station=0.0625 OutputCase=FESSUR CaseType=Combination Point=3 X2=0.5 X3=-0.5 S11=-
1091.63447827627 IsS11Max=No IsS11Min=Yes FrameElem=2 ElemStation=0.0625
Frame=2 Station=0.0625 OutputCase=FESSUR CaseType=Combination Point=4 X2=0.5 X3=0.5 S11=-
1091.63447827627 IsS11Max=No IsS11Min=No FrameElem=2 ElemStation=0.0625
Frame=2 Station=0.125 OutputCase=FESSUR CaseType=Combination Point=0 X2=0 X3=0 S11=-
239.151922837248 IsS11Max=No IsS11Min=No FrameElem=2 ElemStation=0.125
Frame=2 Station=0.125 OutputCase=FESSUR CaseType=Combination Point=1 X2=-0.5 X3=-0.5
S11=449.404283377553 IsS11Max=Yes IsS11Min=No FrameElem=2 ElemStation=0.125
Frame=2 Station=0.125 OutputCase=FESSUR CaseType=Combination Point=2 X2=-0.5 X3=0.5
S11=449.404283377553 IsS11Max=No IsS11Min=No FrameElem=2 ElemStation=0.125
Frame=2 Station=0.125 OutputCase=FESSUR CaseType=Combination Point=3 X2=0.5 X3=-0.5 S11=-
927.708129052049 IsS11Max=No IsS11Min=Yes FrameElem=2 ElemStation=0.125
Frame=2 Station=0.125 OutputCase=FESSUR CaseType=Combination Point=4 X2=0.5 X3=0.5 S11=-
927.708129052049 IsS11Max=No IsS11Min=No FrameElem=2 ElemStation=0.125
Frame=2 Station=0.1875 OutputCase=FESSUR CaseType=Combination Point=0 X2=0 X3=0 S11=-
239.151922837248 IsS11Max=No IsS11Min=No FrameElem=2 ElemStation=0.1875
Frame=2 Station=0.1875 OutputCase=FESSUR CaseType=Combination Point=1 X2=-0.5 X3=-0.5
S11=284.891996653331 IsS11Max=Yes IsS11Min=No FrameElem=2 ElemStation=0.1875
Frame=2 Station=0.1875 OutputCase=FESSUR CaseType=Combination Point=2 X2=-0.5 X3=0.5
S11=284.891996653331 IsS11Max=No IsS11Min=No FrameElem=2 ElemStation=0.1875
Frame=2 Station=0.1875 OutputCase=FESSUR CaseType=Combination Point=3 X2=0.5 X3=-0.5 S11=-
763.195842327827 IsS11Max=No IsS11Min=Yes FrameElem=2 ElemStation=0.1875
Frame=2 Station=0.1875 OutputCase=FESSUR CaseType=Combination Point=4 X2=0.5 X3=0.5 S11=-
763.195842327827 IsS11Max=No IsS11Min=No FrameElem=2 ElemStation=0.1875
Frame=2 Station=0.25 OutputCase=FESSUR CaseType=Combination Point=0 X2=0 X3=0 S11=-239.151922837248
IsS11Max=No IsS11Min=No FrameElem=2 ElemStation=0.25
Frame=2 Station=0.25 OutputCase=FESSUR CaseType=Combination Point=1 X2=-0.5 X3=-0.5
S11=119.793772429108 IsS11Max=Yes IsS11Min=No FrameElem=2 ElemStation=0.25
Frame=2 Station=0.25 OutputCase=FESSUR CaseType=Combination Point=2 X2=-0.5 X3=0.5
S11=119.793772429108 IsS11Max=No IsS11Min=No FrameElem=2 ElemStation=0.25
Frame=2 Station=0.25 OutputCase=FESSUR CaseType=Combination Point=3 X2=0.5 X3=-0.5 S11=-
598.097618103604 IsS11Max=No IsS11Min=Yes FrameElem=2 ElemStation=0.25
Frame=2 Station=0.25 OutputCase=FESSUR CaseType=Combination Point=4 X2=0.5 X3=0.5 S11=-
598.097618103604 IsS11Max=No IsS11Min=No FrameElem=2 ElemStation=0.25
Frame=3 Station=0 OutputCase=PERM1 CaseType=Combination Point=0 X2=0 X3=0 S11=-507.500014343842
IsS11Max=No IsS11Min=No FrameElem=3 ElemStation=0
Frame=3 Station=0 OutputCase=PERM1 CaseType=Combination Point=1 X2=-0.5 X3=-0.5 S11=-
2227.47743454467 IsS11Max=No IsS11Min=Yes FrameElem=3 ElemStation=0
Frame=3 Station=0 OutputCase=PERM1 CaseType=Combination Point=2 X2=-0.5 X3=0.5 S11=-
2227.47743454467 IsS11Max=No IsS11Min=No FrameElem=3 ElemStation=0
Frame=3 Station=0 OutputCase=PERM1 CaseType=Combination Point=3 X2=0.5 X3=-0.5 S11=1212.47740585698
IsS11Max=Yes IsS11Min=No FrameElem=3 ElemStation=0
Frame=3 Station=0 OutputCase=PERM1 CaseType=Combination Point=4 X2=0.5 X3=0.5 S11=1212.47740585698
IsS11Max=No IsS11Min=No FrameElem=3 ElemStation=0
Frame=3 Station=0.2500000000000001 OutputCase=PERM1 CaseType=Combination Point=0 X2=0 X3=0 S11=-
501.25001205135 IsS11Max=No IsS11Min=No FrameElem=3 ElemStation=0.2500000000000001
Frame=3 Station=0.2500000000000001 OutputCase=PERM1 CaseType=Combination Point=1 X2=-0.5 X3=-0.5
S11=-1959.93485380534 IsS11Max=No IsS11Min=Yes FrameElem=3 ElemStation=0.2500000000000001
Frame=3 Station=0.2500000000000001 OutputCase=PERM1 CaseType=Combination Point=2 X2=-0.5 X3=0.5
S11=-1959.93485380534 IsS11Max=No IsS11Min=No FrameElem=3 ElemStation=0.2500000000000001
Frame=3 Station=0.2500000000000001 OutputCase=PERM1 CaseType=Combination Point=3 X2=0.5 X3=-0.5
S11=957.434829702641 IsS11Max=Yes IsS11Min=No FrameElem=3 ElemStation=0.2500000000000001
Frame=3 Station=0.2500000000000001 OutputCase=PERM1 CaseType=Combination Point=4 X2=0.5 X3=0.5
S11=957.434829702641 IsS11Max=No IsS11Min=No FrameElem=3 ElemStation=0.2500000000000001
Frame=3 Station=0 OutputCase=PERM2 CaseType=Combination Point=0 X2=0 X3=0 S11=-507.500009151806
IsS11Max=No IsS11Min=No FrameElem=3 ElemStation=0
Frame=3 Station=0 OutputCase=PERM2 CaseType=Combination Point=1 X2=-0.5 X3=-0.5 S11=-
2141.06995887849 IsS11Max=No IsS11Min=Yes FrameElem=3 ElemStation=0
Frame=3 Station=0 OutputCase=PERM2 CaseType=Combination Point=2 X2=-0.5 X3=0.5 S11=-
2141.06995887849 IsS11Max=No IsS11Min=No FrameElem=3 ElemStation=0
Frame=3 Station=0 OutputCase=PERM2 CaseType=Combination Point=3 X2=0.5 X3=-0.5 S11=1126.06994057488
IsS11Max=Yes IsS11Min=No FrameElem=3 ElemStation=0
Frame=3 Station=0 OutputCase=PERM2 CaseType=Combination Point=4 X2=0.5 X3=0.5 S11=1126.06994057488
IsS11Max=No IsS11Min=No FrameElem=3 ElemStation=0
Frame=3 Station=0.2500000000000001 OutputCase=PERM2 CaseType=Combination Point=0 X2=0 X3=0 S11=-
501.250007547062 IsS11Max=No IsS11Min=No FrameElem=3 ElemStation=0.2500000000000001

```



Frame=3 Station=0.250000000000001 OutputCase=PERM2 CaseType=Combination Point=1 X2=-0.5 X3=-0.5
 S11=-1945.45257700516 IsS11Max=No IsS11Min=Yes FrameElem=3 ElemStation=0.250000000000001
 Frame=3 Station=0.250000000000001 OutputCase=PERM2 CaseType=Combination Point=2 X2=-0.5 X3=0.5
 S11=-1945.45257700516 IsS11Max=No IsS11Min=No FrameElem=3 ElemStation=0.250000000000001
 Frame=3 Station=0.250000000000001 OutputCase=PERM2 CaseType=Combination Point=3 X2=0.5 X3=-0.5
 S11=942.952561911034 IsS11Max=Yes IsS11Min=No FrameElem=3 ElemStation=0.250000000000001
 Frame=3 Station=0.250000000000001 OutputCase=PERM2 CaseType=Combination Point=4 X2=0.5 X3=0.5
 S11=942.952561911034 IsS11Max=No IsS11Min=No FrameElem=3 ElemStation=0.250000000000001
 Frame=3 Station=0 OutputCase=ACC1 CaseType=Combination Point=0 X2=0 X3=0 S11=-521.05001468261
 IsS11Max=No IsS11Min=No FrameElem=3 ElemStation=0
 Frame=3 Station=0 OutputCase=ACC1 CaseType=Combination Point=1 X2=-0.5 X3=-0.5 S11=-
 2286.25744968885 IsS11Max=No IsS11Min=Yes FrameElem=3 ElemStation=0
 Frame=3 Station=0 OutputCase=ACC1 CaseType=Combination Point=2 X2=-0.5 X3=0.5 S11=-2286.25744968885
 IsS11Max=No IsS11Min=No FrameElem=3 ElemStation=0
 Frame=3 Station=0 OutputCase=ACC1 CaseType=Combination Point=3 X2=0.5 X3=-0.5 S11=1244.15742032363
 IsS11Max=Yes IsS11Min=No FrameElem=3 ElemStation=0
 Frame=3 Station=0 OutputCase=ACC1 CaseType=Combination Point=4 X2=0.5 X3=0.5 S11=1244.15742032363
 IsS11Max=No IsS11Min=No FrameElem=3 ElemStation=0
 Frame=3 Station=0.250000000000001 OutputCase=ACC1 CaseType=Combination Point=0 X2=0 X3=0 S11=-
 514.800012335044 IsS11Max=No IsS11Min=No FrameElem=3 ElemStation=0.250000000000001
 Frame=3 Station=0.250000000000001 OutputCase=ACC1 CaseType=Combination Point=1 X2=-0.5 X3=-0.5
 S11=-2012.26267319578 IsS11Max=No IsS11Min=Yes FrameElem=3 ElemStation=0.250000000000001
 Frame=3 Station=0.250000000000001 OutputCase=ACC1 CaseType=Combination Point=2 X2=-0.5 X3=0.5 S11=-
 2012.26267319578 IsS11Max=No IsS11Min=No FrameElem=3 ElemStation=0.250000000000001
 Frame=3 Station=0.250000000000001 OutputCase=ACC1 CaseType=Combination Point=3 X2=0.5 X3=-0.5
 S11=982.662648525693 IsS11Max=Yes IsS11Min=No FrameElem=3 ElemStation=0.250000000000001
 Frame=3 Station=0.250000000000001 OutputCase=ACC1 CaseType=Combination Point=4 X2=0.5 X3=0.5
 S11=982.662648525693 IsS11Max=No IsS11Min=No FrameElem=3 ElemStation=0.250000000000001
 Frame=3 Station=0 OutputCase=ACC2 CaseType=Combination Point=0 X2=0 X3=0 S11=-521.050009490574
 IsS11Max=No IsS11Min=No FrameElem=3 ElemStation=0
 Frame=3 Station=0 OutputCase=ACC2 CaseType=Combination Point=1 X2=-0.5 X3=-0.5 S11=-
 2199.84997402268 IsS11Max=No IsS11Min=Yes FrameElem=3 ElemStation=0
 Frame=3 Station=0 OutputCase=ACC2 CaseType=Combination Point=2 X2=-0.5 X3=0.5 S11=-2199.84997402268
 IsS11Max=No IsS11Min=No FrameElem=3 ElemStation=0
 Frame=3 Station=0 OutputCase=ACC2 CaseType=Combination Point=3 X2=0.5 X3=-0.5 S11=1157.74995504153
 IsS11Max=Yes IsS11Min=No FrameElem=3 ElemStation=0
 Frame=3 Station=0 OutputCase=ACC2 CaseType=Combination Point=4 X2=0.5 X3=0.5 S11=1157.74995504153
 IsS11Max=No IsS11Min=No FrameElem=3 ElemStation=0
 Frame=3 Station=0.250000000000001 OutputCase=ACC2 CaseType=Combination Point=0 X2=0 X3=0 S11=-
 514.800007830755 IsS11Max=No IsS11Min=No FrameElem=3 ElemStation=0.250000000000001
 Frame=3 Station=0.250000000000001 OutputCase=ACC2 CaseType=Combination Point=1 X2=-0.5 X3=-0.5
 S11=-1997.7803963956 IsS11Max=No IsS11Min=Yes FrameElem=3 ElemStation=0.250000000000001
 Frame=3 Station=0.250000000000001 OutputCase=ACC2 CaseType=Combination Point=2 X2=-0.5 X3=0.5 S11=-
 1997.7803963956 IsS11Max=No IsS11Min=No FrameElem=3 ElemStation=0.250000000000001
 Frame=3 Station=0.250000000000001 OutputCase=ACC2 CaseType=Combination Point=3 X2=0.5 X3=-0.5
 S11=968.180380734086 IsS11Max=Yes IsS11Min=No FrameElem=3 ElemStation=0.250000000000001
 Frame=3 Station=0.250000000000001 OutputCase=ACC2 CaseType=Combination Point=4 X2=0.5 X3=0.5
 S11=968.180380734086 IsS11Max=No IsS11Min=No FrameElem=3 ElemStation=0.250000000000001
 Frame=3 Station=0 OutputCase=ACCSX1 CaseType=Combination Point=0 X2=0 X3=0 S11=-509.014091732538
 IsS11Max=No IsS11Min=No FrameElem=3 ElemStation=0
 Frame=3 Station=0 OutputCase=ACCSX1 CaseType=Combination Point=1 X2=-0.5 X3=-0.5 S11=-
 2200.8256592048 IsS11Max=No IsS11Min=Yes FrameElem=3 ElemStation=0
 Frame=3 Station=0 OutputCase=ACCSX1 CaseType=Combination Point=2 X2=-0.5 X3=0.5 S11=-
 2200.8256592048 IsS11Max=No IsS11Min=No FrameElem=3 ElemStation=0
 Frame=3 Station=0 OutputCase=ACCSX1 CaseType=Combination Point=3 X2=0.5 X3=-0.5
 S11=1182.79747573973 IsS11Max=Yes IsS11Min=No FrameElem=3 ElemStation=0
 Frame=3 Station=0 OutputCase=ACCSX1 CaseType=Combination Point=4 X2=0.5 X3=0.5 S11=1182.79747573973
 IsS11Max=No IsS11Min=No FrameElem=3 ElemStation=0
 Frame=3 Station=0.250000000000001 OutputCase=ACCSX1 CaseType=Combination Point=0 X2=0 X3=0 S11=-
 502.764089440046 IsS11Max=No IsS11Min=No FrameElem=3 ElemStation=0.250000000000001
 Frame=3 Station=0.250000000000001 OutputCase=ACCSX1 CaseType=Combination Point=1 X2=-0.5 X3=-0.5
 S11=-1936.69227566835 IsS11Max=No IsS11Min=Yes FrameElem=3 ElemStation=0.250000000000001
 Frame=3 Station=0.250000000000001 OutputCase=ACCSX1 CaseType=Combination Point=2 X2=-0.5 X3=0.5
 S11=-1936.69227566835 IsS11Max=No IsS11Min=No FrameElem=3 ElemStation=0.250000000000001
 Frame=3 Station=0.250000000000001 OutputCase=ACCSX1 CaseType=Combination Point=3 X2=0.5 X3=-0.5
 S11=931.164096788261 IsS11Max=Yes IsS11Min=No FrameElem=3 ElemStation=0.250000000000001
 Frame=3 Station=0.250000000000001 OutputCase=ACCSX1 CaseType=Combination Point=4 X2=0.5 X3=0.5
 S11=931.164096788261 IsS11Max=No IsS11Min=No FrameElem=3 ElemStation=0.250000000000001
 Frame=3 Station=0 OutputCase=ACCSX2 CaseType=Combination Point=0 X2=0 X3=0 S11=-509.014086540502
 IsS11Max=No IsS11Min=No FrameElem=3 ElemStation=0
 Frame=3 Station=0 OutputCase=ACCSX2 CaseType=Combination Point=1 X2=-0.5 X3=-0.5 S11=-
 2114.41818353863 IsS11Max=No IsS11Min=Yes FrameElem=3 ElemStation=0
 Frame=3 Station=0 OutputCase=ACCSX2 CaseType=Combination Point=2 X2=-0.5 X3=0.5 S11=-
 2114.41818353863 IsS11Max=No IsS11Min=No FrameElem=3 ElemStation=0
 Frame=3 Station=0 OutputCase=ACCSX2 CaseType=Combination Point=3 X2=0.5 X3=-0.5
 S11=1096.39001045763 IsS11Max=Yes IsS11Min=No FrameElem=3 ElemStation=0
 Frame=3 Station=0 OutputCase=ACCSX2 CaseType=Combination Point=4 X2=0.5 X3=0.5 S11=1096.39001045763
 IsS11Max=No IsS11Min=No FrameElem=3 ElemStation=0
 Frame=3 Station=0.250000000000001 OutputCase=ACCSX2 CaseType=Combination Point=0 X2=0 X3=0 S11=-
 502.764084935758 IsS11Max=No IsS11Min=No FrameElem=3 ElemStation=0.250000000000001
 Frame=3 Station=0.250000000000001 OutputCase=ACCSX2 CaseType=Combination Point=1 X2=-0.5 X3=-0.5
 S11=-1922.20999886817 IsS11Max=No IsS11Min=Yes FrameElem=3 ElemStation=0.250000000000001



Frame=3 Station=0.250000000000001 OutputCase=ACCSX2 CaseType=Combination Point=2 X2=-0.5 X3=0.5
 S11=-1922.20999886817 IsS11Max=No IsS11Min=No FrameElem=3 ElemStation=0.250000000000001
 Frame=3 Station=0.250000000000001 OutputCase=ACCSX2 CaseType=Combination Point=3 X2=0.5 X3=-0.5
 S11=916.681828996654 IsS11Max=Yes IsS11Min=No FrameElem=3 ElemStation=0.250000000000001
 Frame=3 Station=0.250000000000001 OutputCase=ACCSX2 CaseType=Combination Point=4 X2=0.5 X3=0.5
 S11=916.681828996654 IsS11Max=No IsS11Min=No FrameElem=3 ElemStation=0.250000000000001
 Frame=3 Station=0 OutputCase=ENVE CaseType=Combination StepType=Max Point=0 X2=0 X3=0 S11=-
 507.500009151806 IsS11Max=No IsS11Min=No FrameElem=3 ElemStation=0
 Frame=3 Station=0 OutputCase=ENVE CaseType=Combination StepType=Max Point=1 X2=-0.5 X3=-0.5 S11=-
 2114.41818353863 IsS11Max=No IsS11Min=Yes FrameElem=3 ElemStation=0
 Frame=3 Station=0 OutputCase=ENVE CaseType=Combination StepType=Max Point=2 X2=-0.5 X3=0.5 S11=-
 2114.41818353863 IsS11Max=No IsS11Min=No FrameElem=3 ElemStation=0
 Frame=3 Station=0 OutputCase=ENVE CaseType=Combination StepType=Max Point=3 X2=0.5 X3=-0.5
 S11=1244.15742032363 IsS11Max=Yes IsS11Min=No FrameElem=3 ElemStation=0
 Frame=3 Station=0 OutputCase=ENVE CaseType=Combination StepType=Max Point=4 X2=0.5 X3=0.5
 S11=1244.15742032363 IsS11Max=No IsS11Min=No FrameElem=3 ElemStation=0
 Frame=3 Station=0.250000000000001 OutputCase=ENVE CaseType=Combination StepType=Max Point=0 X2=0
 X3=0 S11=-501.250007547062 IsS11Max=No IsS11Min=No FrameElem=3 ElemStation=0.250000000000001
 Frame=3 Station=0.250000000000001 OutputCase=ENVE CaseType=Combination StepType=Max Point=1 X2=-0.5
 X3=-0.5 S11=-1922.20999886817 IsS11Max=No IsS11Min=Yes FrameElem=3 ElemStation=0.250000000000001
 Frame=3 Station=0.250000000000001 OutputCase=ENVE CaseType=Combination StepType=Max Point=2 X2=-0.5
 X3=0.5 S11=-1922.20999886817 IsS11Max=No IsS11Min=No FrameElem=3 ElemStation=0.250000000000001
 Frame=3 Station=0.250000000000001 OutputCase=ENVE CaseType=Combination StepType=Max Point=3 X2=0.5
 X3=-0.5 S11=982.662648525693 IsS11Max=Yes IsS11Min=No FrameElem=3 ElemStation=0.250000000000001
 Frame=3 Station=0.250000000000001 OutputCase=ENVE CaseType=Combination StepType=Max Point=4 X2=0.5
 X3=0.5 S11=982.662648525693 IsS11Max=No IsS11Min=No FrameElem=3 ElemStation=0.250000000000001
 Frame=3 Station=0 OutputCase=ENVE CaseType=Combination StepType=Min Point=0 X2=0 X3=0 S11=-
 521.05001468261 IsS11Max=No IsS11Min=No FrameElem=3 ElemStation=0
 Frame=3 Station=0 OutputCase=ENVE CaseType=Combination StepType=Min Point=1 X2=-0.5 X3=-0.5 S11=-
 2286.25744968885 IsS11Max=No IsS11Min=Yes FrameElem=3 ElemStation=0
 Frame=3 Station=0 OutputCase=ENVE CaseType=Combination StepType=Min Point=2 X2=-0.5 X3=0.5 S11=-
 2286.25744968885 IsS11Max=No IsS11Min=No FrameElem=3 ElemStation=0
 Frame=3 Station=0 OutputCase=ENVE CaseType=Combination StepType=Min Point=3 X2=0.5 X3=-0.5
 S11=1096.39001045763 IsS11Max=Yes IsS11Min=No FrameElem=3 ElemStation=0
 Frame=3 Station=0 OutputCase=ENVE CaseType=Combination StepType=Min Point=4 X2=0.5 X3=0.5
 S11=1096.39001045763 IsS11Max=No IsS11Min=No FrameElem=3 ElemStation=0
 Frame=3 Station=0.250000000000001 OutputCase=ENVE CaseType=Combination StepType=Min Point=0 X2=0
 X3=0 S11=-514.800012335044 IsS11Max=No IsS11Min=No FrameElem=3 ElemStation=0.250000000000001
 Frame=3 Station=0.250000000000001 OutputCase=ENVE CaseType=Combination StepType=Min Point=1 X2=-0.5
 X3=-0.5 S11=-2012.26267319578 IsS11Max=No IsS11Min=Yes FrameElem=3 ElemStation=0.250000000000001
 Frame=3 Station=0.250000000000001 OutputCase=ENVE CaseType=Combination StepType=Min Point=2 X2=-0.5
 X3=0.5 S11=-2012.26267319578 IsS11Max=No IsS11Min=No FrameElem=3 ElemStation=0.250000000000001
 Frame=3 Station=0.250000000000001 OutputCase=ENVE CaseType=Combination StepType=Min Point=3 X2=0.5
 X3=-0.5 S11=916.681828996654 IsS11Max=Yes IsS11Min=No FrameElem=3 ElemStation=0.250000000000001
 Frame=3 Station=0.250000000000001 OutputCase=ENVE CaseType=Combination StepType=Min Point=4 X2=0.5
 X3=0.5 S11=916.681828996654 IsS11Max=No IsS11Min=No FrameElem=3 ElemStation=0.250000000000001
 Frame=3 Station=0 OutputCase=FESSUR CaseType=Combination Point=0 X2=0 X3=0 S11=-516.985014580979
 IsS11Max=No IsS11Min=No FrameElem=3 ElemStation=0
 Frame=3 Station=0 OutputCase=FESSUR CaseType=Combination Point=1 X2=-0.5 X3=-0.5 S11=-
 2268.62344514559 IsS11Max=No IsS11Min=Yes FrameElem=3 ElemStation=0
 Frame=3 Station=0 OutputCase=FESSUR CaseType=Combination Point=2 X2=-0.5 X3=0.5 S11=-
 2268.62344514559 IsS11Max=No IsS11Min=No FrameElem=3 ElemStation=0
 Frame=3 Station=0 OutputCase=FESSUR CaseType=Combination Point=3 X2=0.5 X3=-0.5
 S11=1234.65341598364 IsS11Max=Yes IsS11Min=No FrameElem=3 ElemStation=0
 Frame=3 Station=0 OutputCase=FESSUR CaseType=Combination Point=4 X2=0.5 X3=0.5 S11=1234.65341598364
 IsS11Max=No IsS11Min=No FrameElem=3 ElemStation=0
 Frame=3 Station=0.250000000000001 OutputCase=FESSUR CaseType=Combination Point=0 X2=0 X3=0 S11=-
 510.735012249936 IsS11Max=No IsS11Min=No FrameElem=3 ElemStation=0.250000000000001
 Frame=3 Station=0.250000000000001 OutputCase=FESSUR CaseType=Combination Point=1 X2=-0.5 X3=-0.5
 S11=-1996.56432737865 IsS11Max=No IsS11Min=Yes FrameElem=3 ElemStation=0.250000000000001
 Frame=3 Station=0.250000000000001 OutputCase=FESSUR CaseType=Combination Point=2 X2=-0.5 X3=0.5
 S11=-1996.56432737865 IsS11Max=No IsS11Min=No FrameElem=3 ElemStation=0.250000000000001
 Frame=3 Station=0.250000000000001 OutputCase=FESSUR CaseType=Combination Point=3 X2=0.5 X3=-0.5
 S11=975.094302878777 IsS11Max=Yes IsS11Min=No FrameElem=3 ElemStation=0.250000000000001
 Frame=3 Station=0.250000000000001 OutputCase=FESSUR CaseType=Combination Point=4 X2=0.5 X3=0.5
 S11=975.094302878777 IsS11Max=No IsS11Min=No FrameElem=3 ElemStation=0.250000000000001
 Frame=4 Station=0 OutputCase=PERM1 CaseType=Combination Point=0 X2=0 X3=0 S11=-235.938772273311
 IsS11Max=No IsS11Min=No FrameElem=4 ElemStation=0
 Frame=4 Station=0 OutputCase=PERM1 CaseType=Combination Point=1 X2=-0.5 X3=-0.5
 S11=116.896289565076 IsS11Max=Yes IsS11Min=No FrameElem=4 ElemStation=0
 Frame=4 Station=0 OutputCase=PERM1 CaseType=Combination Point=2 X2=-0.5 X3=0.5 S11=116.896289565076
 IsS11Max=No IsS11Min=No FrameElem=4 ElemStation=0
 Frame=4 Station=0 OutputCase=PERM1 CaseType=Combination Point=3 X2=0.5 X3=-0.5 S11=-
 588.773834111698 IsS11Max=No IsS11Min=Yes FrameElem=4 ElemStation=0
 Frame=4 Station=0 OutputCase=PERM1 CaseType=Combination Point=4 X2=0.5 X3=0.5 S11=-588.773834111698
 IsS11Max=No IsS11Min=No FrameElem=4 ElemStation=0
 Frame=4 Station=0.0625 OutputCase=PERM1 CaseType=Combination Point=0 X2=0 X3=0 S11=-
 235.938772273311 IsS11Max=No IsS11Min=No FrameElem=4 ElemStation=0.0625
 Frame=4 Station=0.0625 OutputCase=PERM1 CaseType=Combination Point=1 X2=-0.5 X3=-0.5
 S11=278.981799544302 IsS11Max=Yes IsS11Min=No FrameElem=4 ElemStation=0.0625
 Frame=4 Station=0.0625 OutputCase=PERM1 CaseType=Combination Point=2 X2=-0.5 X3=0.5
 S11=278.981799544302 IsS11Max=No IsS11Min=No FrameElem=4 ElemStation=0.0625

Frame=4	Station=0.0625	OutputCase=PERM1	CaseType=Combination	Point=3	X2=0.5	X3=-0.5	S11=-
750.859344090924	IsS11Max=No	IsS11Min=Yes	FrameElem=4	ElemStation=0.0625			
Frame=4	Station=0.0625	OutputCase=PERM1	CaseType=Combination	Point=4	X2=0.5	X3=0.5	S11=-
750.859344090924	IsS11Max=No	IsS11Min=No	FrameElem=4	ElemStation=0.0625			
Frame=4	Station=0.125	OutputCase=PERM1	CaseType=Combination	Point=0	X2=0	X3=0	S11=-235.938772273311
IsS11Max=No	IsS11Min=No	FrameElem=4	ElemStation=0.125				
Frame=4	Station=0.125	OutputCase=PERM1	CaseType=Combination	Point=1	X2=-0.5	X3=-0.5	
S11=440.481372023527	IsS11Max=Yes	IsS11Min=No	FrameElem=4	ElemStation=0.125			
Frame=4	Station=0.125	OutputCase=PERM1	CaseType=Combination	Point=2	X2=-0.5	X3=0.5	
S11=440.481372023527	IsS11Max=No	IsS11Min=No	FrameElem=4	ElemStation=0.125			
Frame=4	Station=0.125	OutputCase=PERM1	CaseType=Combination	Point=3	X2=0.5	X3=-0.5	S11=-
912.358916570149	IsS11Max=No	IsS11Min=Yes	FrameElem=4	ElemStation=0.125			
Frame=4	Station=0.125	OutputCase=PERM1	CaseType=Combination	Point=4	X2=0.5	X3=0.5	S11=-
912.358916570149	IsS11Max=No	IsS11Min=No	FrameElem=4	ElemStation=0.125			
Frame=4	Station=0.1875	OutputCase=PERM1	CaseType=Combination	Point=0	X2=0	X3=0	S11=-
235.938772273311	IsS11Max=No	IsS11Min=No	FrameElem=4	ElemStation=0.1875			
Frame=4	Station=0.1875	OutputCase=PERM1	CaseType=Combination	Point=1	X2=-0.5	X3=-0.5	
S11=601.395007002752	IsS11Max=Yes	IsS11Min=No	FrameElem=4	ElemStation=0.1875			
Frame=4	Station=0.1875	OutputCase=PERM1	CaseType=Combination	Point=2	X2=-0.5	X3=0.5	
S11=601.395007002752	IsS11Max=No	IsS11Min=No	FrameElem=4	ElemStation=0.1875			
Frame=4	Station=0.1875	OutputCase=PERM1	CaseType=Combination	Point=3	X2=0.5	X3=-0.5	S11=-
1073.27255154937	IsS11Max=No	IsS11Min=Yes	FrameElem=4	ElemStation=0.1875			
Frame=4	Station=0.1875	OutputCase=PERM1	CaseType=Combination	Point=4	X2=0.5	X3=0.5	S11=-
1073.27255154937	IsS11Max=No	IsS11Min=No	FrameElem=4	ElemStation=0.1875			
Frame=4	Station=0.25	OutputCase=PERM1	CaseType=Combination	Point=0	X2=0	X3=0	S11=-235.938772273311
IsS11Max=No	IsS11Min=No	FrameElem=4	ElemStation=0.25				
Frame=4	Station=0.25	OutputCase=PERM1	CaseType=Combination	Point=1	X2=-0.5	X3=-0.5	
S11=761.722704481978	IsS11Max=Yes	IsS11Min=No	FrameElem=4	ElemStation=0.25			
Frame=4	Station=0.25	OutputCase=PERM1	CaseType=Combination	Point=2	X2=-0.5	X3=0.5	
S11=761.722704481978	IsS11Max=No	IsS11Min=No	FrameElem=4	ElemStation=0.25			
Frame=4	Station=0.25	OutputCase=PERM1	CaseType=Combination	Point=3	X2=0.5	X3=-0.5	S11=-
1233.6002490286	IsS11Max=No	IsS11Min=Yes	FrameElem=4	ElemStation=0.25			
Frame=4	Station=0.25	OutputCase=PERM1	CaseType=Combination	Point=4	X2=0.5	X3=0.5	S11=-
1233.6002490286	IsS11Max=No	IsS11Min=No	FrameElem=4	ElemStation=0.25			
Frame=4	Station=0	OutputCase=PERM2	CaseType=Combination	Point=0	X2=0	X3=0	S11=-169.465538592141
IsS11Max=No	IsS11Min=No	FrameElem=4	ElemStation=0				
Frame=4	Station=0	OutputCase=PERM2	CaseType=Combination	Point=1	X2=-0.5	X3=-0.5	
S11=97.1255272423934	IsS11Max=Yes	IsS11Min=No	FrameElem=4	ElemStation=0			
Frame=4	Station=0	OutputCase=PERM2	CaseType=Combination	Point=2	X2=-0.5	X3=0.5	S11=97.1255272423934
IsS11Max=No	IsS11Min=No	FrameElem=4	ElemStation=0				
Frame=4	Station=0	OutputCase=PERM2	CaseType=Combination	Point=3	X2=0.5	X3=-0.5	S11=-
436.056604426675	IsS11Max=No	IsS11Min=Yes	FrameElem=4	ElemStation=0			
Frame=4	Station=0	OutputCase=PERM2	CaseType=Combination	Point=4	X2=0.5	X3=0.5	S11=-436.056604426675
IsS11Max=No	IsS11Min=No	FrameElem=4	ElemStation=0				
Frame=4	Station=0.0625	OutputCase=PERM2	CaseType=Combination	Point=0	X2=0	X3=0	S11=-
169.465538592141	IsS11Max=No	IsS11Min=No	FrameElem=4	ElemStation=0.0625			
Frame=4	Station=0.0625	OutputCase=PERM2	CaseType=Combination	Point=1	X2=-0.5	X3=-0.5	
S11=259.182105664673	IsS11Max=Yes	IsS11Min=No	FrameElem=4	ElemStation=0.0625			
Frame=4	Station=0.0625	OutputCase=PERM2	CaseType=Combination	Point=2	X2=-0.5	X3=0.5	
S11=259.182105664673	IsS11Max=No	IsS11Min=No	FrameElem=4	ElemStation=0.0625			
Frame=4	Station=0.0625	OutputCase=PERM2	CaseType=Combination	Point=3	X2=0.5	X3=-0.5	S11=-
598.113182848954	IsS11Max=No	IsS11Min=Yes	FrameElem=4	ElemStation=0.0625			
Frame=4	Station=0.0625	OutputCase=PERM2	CaseType=Combination	Point=4	X2=0.5	X3=0.5	S11=-
598.113182848954	IsS11Max=No	IsS11Min=No	FrameElem=4	ElemStation=0.0625			
Frame=4	Station=0.125	OutputCase=PERM2	CaseType=Combination	Point=0	X2=0	X3=0	S11=-169.465538592141
IsS11Max=No	IsS11Min=No	FrameElem=4	ElemStation=0.125				
Frame=4	Station=0.125	OutputCase=PERM2	CaseType=Combination	Point=1	X2=-0.5	X3=-0.5	
S11=420.652746586952	IsS11Max=Yes	IsS11Min=No	FrameElem=4	ElemStation=0.125			
Frame=4	Station=0.125	OutputCase=PERM2	CaseType=Combination	Point=2	X2=-0.5	X3=0.5	
S11=420.652746586952	IsS11Max=No	IsS11Min=No	FrameElem=4	ElemStation=0.125			
Frame=4	Station=0.125	OutputCase=PERM2	CaseType=Combination	Point=3	X2=0.5	X3=-0.5	S11=-
759.583823771234	IsS11Max=No	IsS11Min=Yes	FrameElem=4	ElemStation=0.125			
Frame=4	Station=0.125	OutputCase=PERM2	CaseType=Combination	Point=4	X2=0.5	X3=0.5	S11=-
759.583823771234	IsS11Max=No	IsS11Min=No	FrameElem=4	ElemStation=0.125			
Frame=4	Station=0.1875	OutputCase=PERM2	CaseType=Combination	Point=0	X2=0	X3=0	S11=-
169.465538592141	IsS11Max=No	IsS11Min=No	FrameElem=4	ElemStation=0.1875			
Frame=4	Station=0.1875	OutputCase=PERM2	CaseType=Combination	Point=1	X2=-0.5	X3=-0.5	
S11=581.537450009231	IsS11Max=Yes	IsS11Min=No	FrameElem=4	ElemStation=0.1875			
Frame=4	Station=0.1875	OutputCase=PERM2	CaseType=Combination	Point=2	X2=-0.5	X3=0.5	
S11=581.537450009231	IsS11Max=No	IsS11Min=No	FrameElem=4	ElemStation=0.1875			
Frame=4	Station=0.1875	OutputCase=PERM2	CaseType=Combination	Point=3	X2=0.5	X3=-0.5	S11=-
920.468527193513	IsS11Max=No	IsS11Min=Yes	FrameElem=4	ElemStation=0.1875			
Frame=4	Station=0.1875	OutputCase=PERM2	CaseType=Combination	Point=4	X2=0.5	X3=0.5	S11=-
920.468527193513	IsS11Max=No	IsS11Min=No	FrameElem=4	ElemStation=0.1875			
Frame=4	Station=0.25	OutputCase=PERM2	CaseType=Combination	Point=0	X2=0	X3=0	S11=-169.465538592141
IsS11Max=No	IsS11Min=No	FrameElem=4	ElemStation=0.25				
Frame=4	Station=0.25	OutputCase=PERM2	CaseType=Combination	Point=1	X2=-0.5	X3=-0.5	
S11=741.83621593151	IsS11Max=Yes	IsS11Min=No	FrameElem=4	ElemStation=0.25			
Frame=4	Station=0.25	OutputCase=PERM2	CaseType=Combination	Point=2	X2=-0.5	X3=0.5	
S11=741.83621593151	IsS11Max=No	IsS11Min=No	FrameElem=4	ElemStation=0.25			
Frame=4	Station=0.25	OutputCase=PERM2	CaseType=Combination	Point=3	X2=0.5	X3=-0.5	S11=-
1080.76729311579	IsS11Max=No	IsS11Min=Yes	FrameElem=4	ElemStation=0.25			

Frame=4	Station=0.25	OutputCase=PERM2	CaseType=Combination	Point=4	X2=0.5	X3=0.5	S11=-
1080.76729311579	IsS11Max=No	IsS11Min=No	FrameElem=4	ElemStation=0.25			
Frame=4	Station=0	OutputCase=ACC1	CaseType=Combination	Point=0	X2=0	X3=0	S11=-240.528987364653
IsS11Max=No	IsS11Min=No	FrameElem=4	ElemStation=0				
Frame=4	Station=0	OutputCase=ACC1	CaseType=Combination	Point=1	X2=-0.5	X3=-0.5	S11=121.035525233648
IsS11Max=Yes	IsS11Min=No	FrameElem=4	ElemStation=0				
Frame=4	Station=0	OutputCase=ACC1	CaseType=Combination	Point=2	X2=-0.5	X3=0.5	S11=121.035525233648
IsS11Max=No	IsS11Min=No	FrameElem=4	ElemStation=0				
Frame=4	Station=0	OutputCase=ACC1	CaseType=Combination	Point=3	X2=0.5	X3=-0.5	S11=-602.093499962953
IsS11Max=No	IsS11Min=Yes	FrameElem=4	ElemStation=0				
Frame=4	Station=0	OutputCase=ACC1	CaseType=Combination	Point=4	X2=0.5	X3=0.5	S11=-602.093499962953
IsS11Max=No	IsS11Min=No	FrameElem=4	ElemStation=0				
Frame=4	Station=0.0625	OutputCase=ACC1	CaseType=Combination	Point=0	X2=0	X3=0	S11=-240.528987364653
IsS11Max=No	IsS11Min=No	FrameElem=4	ElemStation=0.0625				
Frame=4	Station=0.0625	OutputCase=ACC1	CaseType=Combination	Point=1	X2=-0.5	X3=-0.5	
S11=287.424912971057	IsS11Max=Yes	IsS11Min=No	FrameElem=4	ElemStation=0.0625			
Frame=4	Station=0.0625	OutputCase=ACC1	CaseType=Combination	Point=2	X2=-0.5	X3=0.5	
S11=287.424912971057	IsS11Max=No	IsS11Min=No	FrameElem=4	ElemStation=0.0625			
Frame=4	Station=0.0625	OutputCase=ACC1	CaseType=Combination	Point=3	X2=0.5	X3=-0.5	S11=-
768.482887700363	IsS11Max=No	IsS11Min=Yes	FrameElem=4	ElemStation=0.0625			
Frame=4	Station=0.0625	OutputCase=ACC1	CaseType=Combination	Point=4	X2=0.5	X3=0.5	S11=-
768.482887700363	IsS11Max=No	IsS11Min=No	FrameElem=4	ElemStation=0.0625			
Frame=4	Station=0.125	OutputCase=ACC1	CaseType=Combination	Point=0	X2=0	X3=0	S11=-240.528987364653
IsS11Max=No	IsS11Min=No	FrameElem=4	ElemStation=0.125				
Frame=4	Station=0.125	OutputCase=ACC1	CaseType=Combination	Point=1	X2=-0.5	X3=-0.5	
S11=453.228363208467	IsS11Max=Yes	IsS11Min=No	FrameElem=4	ElemStation=0.125			
Frame=4	Station=0.125	OutputCase=ACC1	CaseType=Combination	Point=2	X2=-0.5	X3=0.5	
S11=453.228363208467	IsS11Max=No	IsS11Min=No	FrameElem=4	ElemStation=0.125			
Frame=4	Station=0.125	OutputCase=ACC1	CaseType=Combination	Point=3	X2=0.5	X3=-0.5	S11=-
934.286337937773	IsS11Max=No	IsS11Min=Yes	FrameElem=4	ElemStation=0.125			
Frame=4	Station=0.125	OutputCase=ACC1	CaseType=Combination	Point=4	X2=0.5	X3=0.5	S11=-
934.286337937773	IsS11Max=No	IsS11Min=No	FrameElem=4	ElemStation=0.125			
Frame=4	Station=0.1875	OutputCase=ACC1	CaseType=Combination	Point=0	X2=0	X3=0	S11=-240.528987364653
IsS11Max=No	IsS11Min=No	FrameElem=4	ElemStation=0.1875				
Frame=4	Station=0.1875	OutputCase=ACC1	CaseType=Combination	Point=1	X2=-0.5	X3=-0.5	
S11=618.445875945877	IsS11Max=Yes	IsS11Min=No	FrameElem=4	ElemStation=0.1875			
Frame=4	Station=0.1875	OutputCase=ACC1	CaseType=Combination	Point=2	X2=-0.5	X3=0.5	
S11=618.445875945877	IsS11Max=No	IsS11Min=No	FrameElem=4	ElemStation=0.1875			
Frame=4	Station=0.1875	OutputCase=ACC1	CaseType=Combination	Point=3	X2=0.5	X3=-0.5	S11=-
1099.50385067518	IsS11Max=No	IsS11Min=Yes	FrameElem=4	ElemStation=0.1875			
Frame=4	Station=0.1875	OutputCase=ACC1	CaseType=Combination	Point=4	X2=0.5	X3=0.5	S11=-
1099.50385067518	IsS11Max=No	IsS11Min=No	FrameElem=4	ElemStation=0.1875			
Frame=4	Station=0.25	OutputCase=ACC1	CaseType=Combination	Point=0	X2=0	X3=0	S11=-240.528987364653
IsS11Max=No	IsS11Min=No	FrameElem=4	ElemStation=0.25				
Frame=4	Station=0.25	OutputCase=ACC1	CaseType=Combination	Point=1	X2=-0.5	X3=-0.5	
S11=783.077451183287	IsS11Max=Yes	IsS11Min=No	FrameElem=4	ElemStation=0.25			
Frame=4	Station=0.25	OutputCase=ACC1	CaseType=Combination	Point=2	X2=-0.5	X3=0.5	
S11=783.077451183287	IsS11Max=No	IsS11Min=No	FrameElem=4	ElemStation=0.25			
Frame=4	Station=0.25	OutputCase=ACC1	CaseType=Combination	Point=3	X2=0.5	X3=-0.5	S11=-
1264.13542591259	IsS11Max=No	IsS11Min=Yes	FrameElem=4	ElemStation=0.25			
Frame=4	Station=0.25	OutputCase=ACC1	CaseType=Combination	Point=4	X2=0.5	X3=0.5	S11=-
1264.13542591259	IsS11Max=No	IsS11Min=No	FrameElem=4	ElemStation=0.25			
Frame=4	Station=0	OutputCase=ACC2	CaseType=Combination	Point=0	X2=0	X3=0	S11=-174.055753683483
IsS11Max=No	IsS11Min=No	FrameElem=4	ElemStation=0				
Frame=4	Station=0	OutputCase=ACC2	CaseType=Combination	Point=1	X2=-0.5	X3=-0.5	S11=101.264762910965
IsS11Max=Yes	IsS11Min=No	FrameElem=4	ElemStation=0				
Frame=4	Station=0	OutputCase=ACC2	CaseType=Combination	Point=2	X2=-0.5	X3=0.5	S11=101.264762910965
IsS11Max=No	IsS11Min=No	FrameElem=4	ElemStation=0				
Frame=4	Station=0	OutputCase=ACC2	CaseType=Combination	Point=3	X2=0.5	X3=-0.5	S11=-449.37627027793
IsS11Max=No	IsS11Min=Yes	FrameElem=4	ElemStation=0				
Frame=4	Station=0	OutputCase=ACC2	CaseType=Combination	Point=4	X2=0.5	X3=0.5	S11=-449.37627027793
IsS11Max=No	IsS11Min=No	FrameElem=4	ElemStation=0				
Frame=4	Station=0.0625	OutputCase=ACC2	CaseType=Combination	Point=0	X2=0	X3=0	S11=-174.055753683483
IsS11Max=No	IsS11Min=No	FrameElem=4	ElemStation=0.0625				
Frame=4	Station=0.0625	OutputCase=ACC2	CaseType=Combination	Point=1	X2=-0.5	X3=-0.5	
S11=267.625219091428	IsS11Max=Yes	IsS11Min=No	FrameElem=4	ElemStation=0.0625			
Frame=4	Station=0.0625	OutputCase=ACC2	CaseType=Combination	Point=2	X2=-0.5	X3=0.5	
S11=267.625219091428	IsS11Max=No	IsS11Min=No	FrameElem=4	ElemStation=0.0625			
Frame=4	Station=0.0625	OutputCase=ACC2	CaseType=Combination	Point=3	X2=0.5	X3=-0.5	S11=-
615.736726458394	IsS11Max=No	IsS11Min=Yes	FrameElem=4	ElemStation=0.0625			
Frame=4	Station=0.0625	OutputCase=ACC2	CaseType=Combination	Point=4	X2=0.5	X3=0.5	S11=-
615.736726458394	IsS11Max=No	IsS11Min=No	FrameElem=4	ElemStation=0.0625			
Frame=4	Station=0.125	OutputCase=ACC2	CaseType=Combination	Point=0	X2=0	X3=0	S11=-174.055753683483
IsS11Max=No	IsS11Min=No	FrameElem=4	ElemStation=0.125				
Frame=4	Station=0.125	OutputCase=ACC2	CaseType=Combination	Point=1	X2=-0.5	X3=-0.5	
S11=433.399737771892	IsS11Max=Yes	IsS11Min=No	FrameElem=4	ElemStation=0.125			
Frame=4	Station=0.125	OutputCase=ACC2	CaseType=Combination	Point=2	X2=-0.5	X3=0.5	
S11=433.399737771892	IsS11Max=No	IsS11Min=No	FrameElem=4	ElemStation=0.125			
Frame=4	Station=0.125	OutputCase=ACC2	CaseType=Combination	Point=3	X2=0.5	X3=-0.5	S11=-
781.511245138858	IsS11Max=No	IsS11Min=Yes	FrameElem=4	ElemStation=0.125			
Frame=4	Station=0.125	OutputCase=ACC2	CaseType=Combination	Point=4	X2=0.5	X3=0.5	S11=-
781.511245138858	IsS11Max=No	IsS11Min=No	FrameElem=4	ElemStation=0.125			

```

Frame=4 Station=0.1875 OutputCase=ACC2 CaseType=Combination Point=0 X2=0 X3=0 S11=-174.055753683483
IsS11Max=No IsS11Min=No FrameElem=4 ElemStation=0.1875
Frame=4 Station=0.1875 OutputCase=ACC2 CaseType=Combination Point=1 X2=-0.5 X3=-0.5
S11=598.588318952356 IsS11Max=Yes IsS11Min=No FrameElem=4 ElemStation=0.1875
Frame=4 Station=0.1875 OutputCase=ACC2 CaseType=Combination Point=2 X2=-0.5 X3=0.5
S11=598.588318952356 IsS11Max=No IsS11Min=No FrameElem=4 ElemStation=0.1875
Frame=4 Station=0.1875 OutputCase=ACC2 CaseType=Combination Point=3 X2=0.5 X3=-0.5 S11=-
946.699826319322 IsS11Max=No IsS11Min=Yes FrameElem=4 ElemStation=0.1875
Frame=4 Station=0.1875 OutputCase=ACC2 CaseType=Combination Point=4 X2=0.5 X3=0.5 S11=-
946.699826319322 IsS11Max=No IsS11Min=No FrameElem=4 ElemStation=0.1875
Frame=4 Station=0.25 OutputCase=ACC2 CaseType=Combination Point=0 X2=0 X3=0 S11=-174.055753683483
IsS11Max=No IsS11Min=No FrameElem=4 ElemStation=0.25
Frame=4 Station=0.25 OutputCase=ACC2 CaseType=Combination Point=1 X2=-0.5 X3=-0.5
S11=763.19096263282 IsS11Max=Yes IsS11Min=No FrameElem=4 ElemStation=0.25
Frame=4 Station=0.25 OutputCase=ACC2 CaseType=Combination Point=2 X2=-0.5 X3=0.5
S11=763.19096263282 IsS11Max=No IsS11Min=No FrameElem=4 ElemStation=0.25
Frame=4 Station=0.25 OutputCase=ACC2 CaseType=Combination Point=3 X2=0.5 X3=-0.5 S11=-
1111.30246999979 IsS11Max=No IsS11Min=Yes FrameElem=4 ElemStation=0.25
Frame=4 Station=0.25 OutputCase=ACC2 CaseType=Combination Point=4 X2=0.5 X3=0.5 S11=-
1111.30246999979 IsS11Max=No IsS11Min=No FrameElem=4 ElemStation=0.25
Frame=4 Station=0 OutputCase=ACCSX1 CaseType=Combination Point=0 X2=0 X3=0 S11=-233.665974282455
IsS11Max=No IsS11Min=No FrameElem=4 ElemStation=0
Frame=4 Station=0 OutputCase=ACCSX1 CaseType=Combination Point=1 X2=-0.5 X3=-0.5
S11=89.5769866017188 IsS11Max=Yes IsS11Min=No FrameElem=4 ElemStation=0
Frame=4 Station=0 OutputCase=ACCSX1 CaseType=Combination Point=2 X2=-0.5 X3=0.5
S11=89.5769866017188 IsS11Max=No IsS11Min=No FrameElem=4 ElemStation=0
Frame=4 Station=0 OutputCase=ACCSX1 CaseType=Combination Point=3 X2=0.5 X3=-0.5 S11=-
556.908935166629 IsS11Max=No IsS11Min=Yes FrameElem=4 ElemStation=0
Frame=4 Station=0 OutputCase=ACCSX1 CaseType=Combination Point=4 X2=0.5 X3=0.5 S11=-
556.908935166629 IsS11Max=No IsS11Min=No FrameElem=4 ElemStation=0
Frame=4 Station=0.0625 OutputCase=ACCSX1 CaseType=Combination Point=0 X2=0 X3=0 S11=-
233.665974282455 IsS11Max=No IsS11Min=No FrameElem=4 ElemStation=0.0625
Frame=4 Station=0.0625 OutputCase=ACCSX1 CaseType=Combination Point=1 X2=-0.5 X3=-0.5
S11=251.656539346359 IsS11Max=Yes IsS11Min=No FrameElem=4 ElemStation=0.0625
Frame=4 Station=0.0625 OutputCase=ACCSX1 CaseType=Combination Point=2 X2=-0.5 X3=0.5
S11=251.656539346359 IsS11Max=No IsS11Min=No FrameElem=4 ElemStation=0.0625
Frame=4 Station=0.0625 OutputCase=ACCSX1 CaseType=Combination Point=3 X2=0.5 X3=-0.5 S11=-
718.988487911269 IsS11Max=No IsS11Min=Yes FrameElem=4 ElemStation=0.0625
Frame=4 Station=0.0625 OutputCase=ACCSX1 CaseType=Combination Point=4 X2=0.5 X3=0.5 S11=-
718.988487911269 IsS11Max=No IsS11Min=No FrameElem=4 ElemStation=0.0625
Frame=4 Station=0.125 OutputCase=ACCSX1 CaseType=Combination Point=0 X2=0 X3=0 S11=-
233.665974282455 IsS11Max=No IsS11Min=No FrameElem=4 ElemStation=0.125
Frame=4 Station=0.125 OutputCase=ACCSX1 CaseType=Combination Point=1 X2=-0.5 X3=-0.5
S11=413.150154590999 IsS11Max=Yes IsS11Min=No FrameElem=4 ElemStation=0.125
Frame=4 Station=0.125 OutputCase=ACCSX1 CaseType=Combination Point=2 X2=-0.5 X3=0.5
S11=413.150154590999 IsS11Max=No IsS11Min=No FrameElem=4 ElemStation=0.125
Frame=4 Station=0.125 OutputCase=ACCSX1 CaseType=Combination Point=3 X2=0.5 X3=-0.5 S11=-
880.482103155909 IsS11Max=No IsS11Min=Yes FrameElem=4 ElemStation=0.125
Frame=4 Station=0.125 OutputCase=ACCSX1 CaseType=Combination Point=4 X2=0.5 X3=0.5 S11=-
880.482103155909 IsS11Max=No IsS11Min=No FrameElem=4 ElemStation=0.125
Frame=4 Station=0.1875 OutputCase=ACCSX1 CaseType=Combination Point=0 X2=0 X3=0 S11=-
233.665974282455 IsS11Max=No IsS11Min=No FrameElem=4 ElemStation=0.1875
Frame=4 Station=0.1875 OutputCase=ACCSX1 CaseType=Combination Point=1 X2=-0.5 X3=-0.5
S11=574.057832335639 IsS11Max=Yes IsS11Min=No FrameElem=4 ElemStation=0.1875
Frame=4 Station=0.1875 OutputCase=ACCSX1 CaseType=Combination Point=2 X2=-0.5 X3=0.5
S11=574.057832335639 IsS11Max=No IsS11Min=No FrameElem=4 ElemStation=0.1875
Frame=4 Station=0.1875 OutputCase=ACCSX1 CaseType=Combination Point=3 X2=0.5 X3=-0.5 S11=-
1041.38978090055 IsS11Max=No IsS11Min=Yes FrameElem=4 ElemStation=0.1875
Frame=4 Station=0.1875 OutputCase=ACCSX1 CaseType=Combination Point=4 X2=0.5 X3=0.5 S11=-
1041.38978090055 IsS11Max=No IsS11Min=No FrameElem=4 ElemStation=0.1875
Frame=4 Station=0.25 OutputCase=ACCSX1 CaseType=Combination Point=0 X2=0 X3=0 S11=-233.665974282455
IsS11Max=No IsS11Min=No FrameElem=4 ElemStation=0.25
Frame=4 Station=0.25 OutputCase=ACCSX1 CaseType=Combination Point=1 X2=-0.5 X3=-0.5
S11=734.37957258028 IsS11Max=Yes IsS11Min=No FrameElem=4 ElemStation=0.25
Frame=4 Station=0.25 OutputCase=ACCSX1 CaseType=Combination Point=2 X2=-0.5 X3=0.5
S11=734.37957258028 IsS11Max=No IsS11Min=No FrameElem=4 ElemStation=0.25
Frame=4 Station=0.25 OutputCase=ACCSX1 CaseType=Combination Point=3 X2=0.5 X3=-0.5 S11=-
1201.71152114519 IsS11Max=No IsS11Min=Yes FrameElem=4 ElemStation=0.25
Frame=4 Station=0.25 OutputCase=ACCSX1 CaseType=Combination Point=4 X2=0.5 X3=0.5 S11=-
1201.71152114519 IsS11Max=No IsS11Min=No FrameElem=4 ElemStation=0.25
Frame=4 Station=0 OutputCase=ACCSX2 CaseType=Combination Point=0 X2=0 X3=0 S11=-167.192740601285
IsS11Max=No IsS11Min=No FrameElem=4 ElemStation=0
Frame=4 Station=0 OutputCase=ACCSX2 CaseType=Combination Point=1 X2=-0.5 X3=-0.5
S11=69.8062242790359 IsS11Max=Yes IsS11Min=No FrameElem=4 ElemStation=0
Frame=4 Station=0 OutputCase=ACCSX2 CaseType=Combination Point=2 X2=-0.5 X3=0.5
S11=69.8062242790359 IsS11Max=No IsS11Min=No FrameElem=4 ElemStation=0
Frame=4 Station=0 OutputCase=ACCSX2 CaseType=Combination Point=3 X2=0.5 X3=-0.5 S11=-
404.191705481606 IsS11Max=No IsS11Min=Yes FrameElem=4 ElemStation=0
Frame=4 Station=0 OutputCase=ACCSX2 CaseType=Combination Point=4 X2=0.5 X3=0.5 S11=-
404.191705481606 IsS11Max=No IsS11Min=No FrameElem=4 ElemStation=0
Frame=4 Station=0.0625 OutputCase=ACCSX2 CaseType=Combination Point=0 X2=0 X3=0 S11=-
167.192740601285 IsS11Max=No IsS11Min=No FrameElem=4 ElemStation=0.0625

```

Frame=4	Station=0.0625	OutputCase=ACCSX2	CaseType=Combination	Point=1	X2=-0.5	X3=-0.5		
S11=231.85684546673	IsS11Max=Yes	IsS11Min=No	FrameElem=4	ElemStation=0.0625				
Frame=4	Station=0.0625	OutputCase=ACCSX2	CaseType=Combination	Point=2	X2=-0.5	X3=0.5		
S11=231.85684546673	IsS11Max=No	IsS11Min=No	FrameElem=4	ElemStation=0.0625				
Frame=4	Station=0.0625	OutputCase=ACCSX2	CaseType=Combination	Point=3	X2=0.5	X3=-0.5	S11=-	
566.2423266693	IsS11Max=No	IsS11Min=Yes	FrameElem=4	ElemStation=0.0625				
Frame=4	Station=0.0625	OutputCase=ACCSX2	CaseType=Combination	Point=4	X2=0.5	X3=0.5	S11=-	
566.2423266693	IsS11Max=No	IsS11Min=No	FrameElem=4	ElemStation=0.0625				
Frame=4	Station=0.125	OutputCase=ACCSX2	CaseType=Combination	Point=0	X2=0	X3=0	S11=-	
167.192740601285	IsS11Max=No	IsS11Min=No	FrameElem=4	ElemStation=0.125				
Frame=4	Station=0.125	OutputCase=ACCSX2	CaseType=Combination	Point=1	X2=-0.5	X3=-0.5		
S11=393.321529154424	IsS11Max=Yes	IsS11Min=No	FrameElem=4	ElemStation=0.125				
Frame=4	Station=0.125	OutputCase=ACCSX2	CaseType=Combination	Point=2	X2=-0.5	X3=0.5		
S11=393.321529154424	IsS11Max=No	IsS11Min=No	FrameElem=4	ElemStation=0.125				
Frame=4	Station=0.125	OutputCase=ACCSX2	CaseType=Combination	Point=3	X2=0.5	X3=-0.5	S11=-	
727.707010356994	IsS11Max=No	IsS11Min=Yes	FrameElem=4	ElemStation=0.125				
Frame=4	Station=0.125	OutputCase=ACCSX2	CaseType=Combination	Point=4	X2=0.5	X3=0.5	S11=-	
727.707010356994	IsS11Max=No	IsS11Min=No	FrameElem=4	ElemStation=0.125				
Frame=4	Station=0.1875	OutputCase=ACCSX2	CaseType=Combination	Point=0	X2=0	X3=0	S11=-	
167.192740601285	IsS11Max=No	IsS11Min=No	FrameElem=4	ElemStation=0.1875				
Frame=4	Station=0.1875	OutputCase=ACCSX2	CaseType=Combination	Point=1	X2=-0.5	X3=-0.5		
S11=554.200275342118	IsS11Max=Yes	IsS11Min=No	FrameElem=4	ElemStation=0.1875				
Frame=4	Station=0.1875	OutputCase=ACCSX2	CaseType=Combination	Point=2	X2=-0.5	X3=0.5		
S11=554.200275342118	IsS11Max=No	IsS11Min=No	FrameElem=4	ElemStation=0.1875				
Frame=4	Station=0.1875	OutputCase=ACCSX2	CaseType=Combination	Point=3	X2=0.5	X3=-0.5	S11=-	
888.585756544688	IsS11Max=No	IsS11Min=Yes	FrameElem=4	ElemStation=0.1875				
Frame=4	Station=0.1875	OutputCase=ACCSX2	CaseType=Combination	Point=4	X2=0.5	X3=0.5	S11=-	
888.585756544688	IsS11Max=No	IsS11Min=No	FrameElem=4	ElemStation=0.1875				
Frame=4	Station=0.25	OutputCase=ACCSX2	CaseType=Combination	Point=0	X2=0	X3=0	S11=-167.192740601285	
IsS11Max=No	IsS11Min=No	FrameElem=4	ElemStation=0.25					
Frame=4	Station=0.25	OutputCase=ACCSX2	CaseType=Combination	Point=1	X2=-0.5	X3=-0.5		
S11=714.493084029812	IsS11Max=Yes	IsS11Min=No	FrameElem=4	ElemStation=0.25				
Frame=4	Station=0.25	OutputCase=ACCSX2	CaseType=Combination	Point=2	X2=-0.5	X3=0.5		
S11=714.493084029812	IsS11Max=No	IsS11Min=No	FrameElem=4	ElemStation=0.25				
Frame=4	Station=0.25	OutputCase=ACCSX2	CaseType=Combination	Point=3	X2=0.5	X3=-0.5	S11=-	
1048.87856523238	IsS11Max=No	IsS11Min=Yes	FrameElem=4	ElemStation=0.25				
Frame=4	Station=0.25	OutputCase=ACCSX2	CaseType=Combination	Point=4	X2=0.5	X3=0.5	S11=-	
1048.87856523238	IsS11Max=No	IsS11Min=No	FrameElem=4	ElemStation=0.25				
Frame=4	Station=0	OutputCase=ENVE	CaseType=Combination	StepType=Max	Point=0	X2=0	X3=0	S11=-
167.192740601285	IsS11Max=No	IsS11Min=No	FrameElem=4	ElemStation=0				
Frame=4	Station=0	OutputCase=ENVE	CaseType=Combination	StepType=Max	Point=1	X2=-0.5	X3=-0.5	
S11=121.035525233648	IsS11Max=Yes	IsS11Min=No	FrameElem=4	ElemStation=0				
Frame=4	Station=0	OutputCase=ENVE	CaseType=Combination	StepType=Max	Point=2	X2=-0.5	X3=0.5	
S11=121.035525233648	IsS11Max=No	IsS11Min=No	FrameElem=4	ElemStation=0				
Frame=4	Station=0	OutputCase=ENVE	CaseType=Combination	StepType=Max	Point=3	X2=0.5	X3=-0.5	S11=-
404.191705481606	IsS11Max=No	IsS11Min=Yes	FrameElem=4	ElemStation=0				
Frame=4	Station=0	OutputCase=ENVE	CaseType=Combination	StepType=Max	Point=4	X2=0.5	X3=0.5	S11=-
404.191705481606	IsS11Max=No	IsS11Min=No	FrameElem=4	ElemStation=0				
Frame=4	Station=0.0625	OutputCase=ENVE	CaseType=Combination	StepType=Max	Point=0	X2=0	X3=0	S11=-
167.192740601285	IsS11Max=No	IsS11Min=No	FrameElem=4	ElemStation=0.0625				
Frame=4	Station=0.0625	OutputCase=ENVE	CaseType=Combination	StepType=Max	Point=1	X2=-0.5	X3=-0.5	
S11=287.424912971057	IsS11Max=Yes	IsS11Min=No	FrameElem=4	ElemStation=0.0625				
Frame=4	Station=0.0625	OutputCase=ENVE	CaseType=Combination	StepType=Max	Point=2	X2=-0.5	X3=0.5	
S11=287.424912971057	IsS11Max=No	IsS11Min=No	FrameElem=4	ElemStation=0.0625				
Frame=4	Station=0.0625	OutputCase=ENVE	CaseType=Combination	StepType=Max	Point=3	X2=0.5	X3=-0.5	
S11=-566.2423266693	IsS11Max=No	IsS11Min=Yes	FrameElem=4	ElemStation=0.0625				
Frame=4	Station=0.0625	OutputCase=ENVE	CaseType=Combination	StepType=Max	Point=4	X2=0.5	X3=0.5	
S11=-566.2423266693	IsS11Max=No	IsS11Min=No	FrameElem=4	ElemStation=0.0625				
Frame=4	Station=0.125	OutputCase=ENVE	CaseType=Combination	StepType=Max	Point=0	X2=0	X3=0	S11=-
167.192740601285	IsS11Max=No	IsS11Min=No	FrameElem=4	ElemStation=0.125				
Frame=4	Station=0.125	OutputCase=ENVE	CaseType=Combination	StepType=Max	Point=1	X2=-0.5	X3=-0.5	
S11=453.228363208467	IsS11Max=Yes	IsS11Min=No	FrameElem=4	ElemStation=0.125				
Frame=4	Station=0.125	OutputCase=ENVE	CaseType=Combination	StepType=Max	Point=2	X2=-0.5	X3=0.5	
S11=453.228363208467	IsS11Max=No	IsS11Min=No	FrameElem=4	ElemStation=0.125				
Frame=4	Station=0.125	OutputCase=ENVE	CaseType=Combination	StepType=Max	Point=3	X2=0.5	X3=-0.5	
S11=-727.707010356994	IsS11Max=No	IsS11Min=Yes	FrameElem=4	ElemStation=0.125				
Frame=4	Station=0.125	OutputCase=ENVE	CaseType=Combination	StepType=Max	Point=4	X2=0.5	X3=0.5	
S11=-727.707010356994	IsS11Max=No	IsS11Min=No	FrameElem=4	ElemStation=0.125				
Frame=4	Station=0.1875	OutputCase=ENVE	CaseType=Combination	StepType=Max	Point=0	X2=0	X3=0	S11=-
167.192740601285	IsS11Max=No	IsS11Min=No	FrameElem=4	ElemStation=0.1875				
Frame=4	Station=0.1875	OutputCase=ENVE	CaseType=Combination	StepType=Max	Point=1	X2=-0.5	X3=-0.5	
S11=618.445875945877	IsS11Max=Yes	IsS11Min=No	FrameElem=4	ElemStation=0.1875				
Frame=4	Station=0.1875	OutputCase=ENVE	CaseType=Combination	StepType=Max	Point=2	X2=-0.5	X3=0.5	
S11=618.445875945877	IsS11Max=No	IsS11Min=No	FrameElem=4	ElemStation=0.1875				
Frame=4	Station=0.1875	OutputCase=ENVE	CaseType=Combination	StepType=Max	Point=3	X2=0.5	X3=-0.5	
S11=-888.585756544688	IsS11Max=No	IsS11Min=Yes	FrameElem=4	ElemStation=0.1875				
Frame=4	Station=0.1875	OutputCase=ENVE	CaseType=Combination	StepType=Max	Point=4	X2=0.5	X3=0.5	
S11=-888.585756544688	IsS11Max=No	IsS11Min=No	FrameElem=4	ElemStation=0.1875				
Frame=4	Station=0.25	OutputCase=ENVE	CaseType=Combination	StepType=Max	Point=0	X2=0	X3=0	S11=-
167.192740601285	IsS11Max=No	IsS11Min=No	FrameElem=4	ElemStation=0.25				
Frame=4	Station=0.25	OutputCase=ENVE	CaseType=Combination	StepType=Max	Point=1	X2=-0.5	X3=-0.5	
S11=783.077451183287	IsS11Max=Yes	IsS11Min=No	FrameElem=4	ElemStation=0.25				

Frame=4	Station=0.25	OutputCase=ENVE	CaseType=Combination	StepType=Max	Point=2	X2=-0.5	X3=0.5	
S11=783.077451183287	IsS11Max=No	IsS11Min=No	FrameElem=4	ElemStation=0.25				
Frame=4	Station=0.25	OutputCase=ENVE	CaseType=Combination	StepType=Max	Point=3	X2=0.5	X3=-0.5	
S11=-1048.87856523238	IsS11Max=No	IsS11Min=Yes	FrameElem=4	ElemStation=0.25				
Frame=4	Station=0.25	OutputCase=ENVE	CaseType=Combination	StepType=Max	Point=4	X2=0.5	X3=0.5	
S11=-1048.87856523238	IsS11Max=No	IsS11Min=No	FrameElem=4	ElemStation=0.25				
Frame=4	Station=0	OutputCase=ENVE	CaseType=Combination	StepType=Min	Point=0	X2=0	X3=0	S11=-
240.528987364653	IsS11Max=No	IsS11Min=No	FrameElem=4	ElemStation=0				
Frame=4	Station=0	OutputCase=ENVE	CaseType=Combination	StepType=Min	Point=1	X2=-0.5	X3=-0.5	
S11=69.8062242790359	IsS11Max=Yes	IsS11Min=No	FrameElem=4	ElemStation=0				
Frame=4	Station=0	OutputCase=ENVE	CaseType=Combination	StepType=Min	Point=2	X2=-0.5	X3=0.5	
S11=69.8062242790359	IsS11Max=No	IsS11Min=No	FrameElem=4	ElemStation=0				
Frame=4	Station=0	OutputCase=ENVE	CaseType=Combination	StepType=Min	Point=3	X2=0.5	X3=-0.5	S11=-
602.093499962953	IsS11Max=No	IsS11Min=Yes	FrameElem=4	ElemStation=0				
Frame=4	Station=0	OutputCase=ENVE	CaseType=Combination	StepType=Min	Point=4	X2=0.5	X3=0.5	S11=-
602.093499962953	IsS11Max=No	IsS11Min=No	FrameElem=4	ElemStation=0				
Frame=4	Station=0.0625	OutputCase=ENVE	CaseType=Combination	StepType=Min	Point=0	X2=0	X3=0	S11=-
240.528987364653	IsS11Max=No	IsS11Min=No	FrameElem=4	ElemStation=0.0625				
Frame=4	Station=0.0625	OutputCase=ENVE	CaseType=Combination	StepType=Min	Point=1	X2=-0.5	X3=-0.5	
S11=231.85684546673	IsS11Max=Yes	IsS11Min=No	FrameElem=4	ElemStation=0.0625				
Frame=4	Station=0.0625	OutputCase=ENVE	CaseType=Combination	StepType=Min	Point=2	X2=-0.5	X3=0.5	
S11=231.85684546673	IsS11Max=No	IsS11Min=No	FrameElem=4	ElemStation=0.0625				
Frame=4	Station=0.0625	OutputCase=ENVE	CaseType=Combination	StepType=Min	Point=3	X2=0.5	X3=-0.5	
S11=-768.482887700363	IsS11Max=No	IsS11Min=Yes	FrameElem=4	ElemStation=0.0625				
Frame=4	Station=0.0625	OutputCase=ENVE	CaseType=Combination	StepType=Min	Point=4	X2=0.5	X3=0.5	
S11=-768.482887700363	IsS11Max=No	IsS11Min=No	FrameElem=4	ElemStation=0.0625				
Frame=4	Station=0.125	OutputCase=ENVE	CaseType=Combination	StepType=Min	Point=0	X2=0	X3=0	S11=-
240.528987364653	IsS11Max=No	IsS11Min=No	FrameElem=4	ElemStation=0.125				
Frame=4	Station=0.125	OutputCase=ENVE	CaseType=Combination	StepType=Min	Point=1	X2=-0.5	X3=-0.5	
S11=393.321529154424	IsS11Max=Yes	IsS11Min=No	FrameElem=4	ElemStation=0.125				
Frame=4	Station=0.125	OutputCase=ENVE	CaseType=Combination	StepType=Min	Point=2	X2=-0.5	X3=0.5	
S11=393.321529154424	IsS11Max=No	IsS11Min=No	FrameElem=4	ElemStation=0.125				
Frame=4	Station=0.125	OutputCase=ENVE	CaseType=Combination	StepType=Min	Point=3	X2=0.5	X3=-0.5	
S11=-934.286337937773	IsS11Max=No	IsS11Min=Yes	FrameElem=4	ElemStation=0.125				
Frame=4	Station=0.125	OutputCase=ENVE	CaseType=Combination	StepType=Min	Point=4	X2=0.5	X3=0.5	
S11=-934.286337937773	IsS11Max=No	IsS11Min=No	FrameElem=4	ElemStation=0.125				
Frame=4	Station=0.1875	OutputCase=ENVE	CaseType=Combination	StepType=Min	Point=0	X2=0	X3=0	S11=-
240.528987364653	IsS11Max=No	IsS11Min=No	FrameElem=4	ElemStation=0.1875				
Frame=4	Station=0.1875	OutputCase=ENVE	CaseType=Combination	StepType=Min	Point=1	X2=-0.5	X3=-0.5	
S11=554.200275342118	IsS11Max=Yes	IsS11Min=No	FrameElem=4	ElemStation=0.1875				
Frame=4	Station=0.1875	OutputCase=ENVE	CaseType=Combination	StepType=Min	Point=2	X2=-0.5	X3=0.5	
S11=554.200275342118	IsS11Max=No	IsS11Min=No	FrameElem=4	ElemStation=0.1875				
Frame=4	Station=0.1875	OutputCase=ENVE	CaseType=Combination	StepType=Min	Point=3	X2=0.5	X3=-0.5	
S11=-1099.50385067518	IsS11Max=No	IsS11Min=Yes	FrameElem=4	ElemStation=0.1875				
Frame=4	Station=0.1875	OutputCase=ENVE	CaseType=Combination	StepType=Min	Point=4	X2=0.5	X3=0.5	
S11=-1099.50385067518	IsS11Max=No	IsS11Min=No	FrameElem=4	ElemStation=0.1875				
Frame=4	Station=0.25	OutputCase=ENVE	CaseType=Combination	StepType=Min	Point=0	X2=0	X3=0	S11=-
240.528987364653	IsS11Max=No	IsS11Min=No	FrameElem=4	ElemStation=0.25				
Frame=4	Station=0.25	OutputCase=ENVE	CaseType=Combination	StepType=Min	Point=1	X2=-0.5	X3=-0.5	
S11=714.493084029812	IsS11Max=Yes	IsS11Min=No	FrameElem=4	ElemStation=0.25				
Frame=4	Station=0.25	OutputCase=ENVE	CaseType=Combination	StepType=Min	Point=2	X2=-0.5	X3=0.5	
S11=714.493084029812	IsS11Max=No	IsS11Min=No	FrameElem=4	ElemStation=0.25				
Frame=4	Station=0.25	OutputCase=ENVE	CaseType=Combination	StepType=Min	Point=3	X2=0.5	X3=-0.5	
S11=-1264.13542591259	IsS11Max=No	IsS11Min=Yes	FrameElem=4	ElemStation=0.25				
Frame=4	Station=0.25	OutputCase=ENVE	CaseType=Combination	StepType=Min	Point=4	X2=0.5	X3=0.5	
S11=-1264.13542591259	IsS11Max=No	IsS11Min=No	FrameElem=4	ElemStation=0.25				
Frame=4	Station=0	OutputCase=FESSUR	CaseType=Combination	Point=0	X2=0	X3=0	S11=-239.15192283725	
IsS11Max=No	IsS11Min=No	FrameElem=4	ElemStation=0					
Frame=4	Station=0	OutputCase=FESSUR	CaseType=Combination	Point=1	X2=-0.5	X3=-0.5		
S11=119.793754533076	IsS11Max=Yes	IsS11Min=No	FrameElem=4	ElemStation=0				
Frame=4	Station=0	OutputCase=FESSUR	CaseType=Combination	Point=2	X2=-0.5	X3=0.5		
S11=119.793754533076	IsS11Max=No	IsS11Min=No	FrameElem=4	ElemStation=0				
Frame=4	Station=0	OutputCase=FESSUR	CaseType=Combination	Point=3	X2=0.5	X3=-0.5	S11=-	
598.097600207577	IsS11Max=No	IsS11Min=Yes	FrameElem=4	ElemStation=0				
Frame=4	Station=0	OutputCase=FESSUR	CaseType=Combination	Point=4	X2=0.5	X3=0.5	S11=-	
598.097600207577	IsS11Max=No	IsS11Min=No	FrameElem=4	ElemStation=0				
Frame=4	Station=0.0625	OutputCase=FESSUR	CaseType=Combination	Point=0	X2=0	X3=0	S11=-	
239.15192283725	IsS11Max=No	IsS11Min=No	FrameElem=4	ElemStation=0.0625				
Frame=4	Station=0.0625	OutputCase=FESSUR	CaseType=Combination	Point=1	X2=-0.5	X3=-0.5		
S11=284.891978943031	IsS11Max=Yes	IsS11Min=No	FrameElem=4	ElemStation=0.0625				
Frame=4	Station=0.0625	OutputCase=FESSUR	CaseType=Combination	Point=2	X2=-0.5	X3=0.5		
S11=284.891978943031	IsS11Max=No	IsS11Min=No	FrameElem=4	ElemStation=0.0625				
Frame=4	Station=0.0625	OutputCase=FESSUR	CaseType=Combination	Point=3	X2=0.5	X3=-0.5	S11=-	
763.195824617532	IsS11Max=No	IsS11Min=Yes	FrameElem=4	ElemStation=0.0625				
Frame=4	Station=0.0625	OutputCase=FESSUR	CaseType=Combination	Point=4	X2=0.5	X3=0.5	S11=-	
763.195824617532	IsS11Max=No	IsS11Min=No	FrameElem=4	ElemStation=0.0625				
Frame=4	Station=0.125	OutputCase=FESSUR	CaseType=Combination	Point=0	X2=0	X3=0	S11=-239.15192283725	
IsS11Max=No	IsS11Min=No	FrameElem=4	ElemStation=0.125					
Frame=4	Station=0.125	OutputCase=FESSUR	CaseType=Combination	Point=1	X2=-0.5	X3=-0.5		
S11=449.404265852985	IsS11Max=Yes	IsS11Min=No	FrameElem=4	ElemStation=0.125				
Frame=4	Station=0.125	OutputCase=FESSUR	CaseType=Combination	Point=2	X2=-0.5	X3=0.5		
S11=449.404265852985	IsS11Max=No	IsS11Min=No	FrameElem=4	ElemStation=0.125				

Frame=4	Station=0.125	OutputCase=FESSUR	CaseType=Combination	Point=3	X2=0.5	X3=-0.5	S11=-
927.708111527486	IsS11Max=No	IsS11Min=Yes	FrameElem=4	ElemStation=0.125			
Frame=4	Station=0.125	OutputCase=FESSUR	CaseType=Combination	Point=4	X2=0.5	X3=0.5	S11=-
927.708111527486	IsS11Max=No	IsS11Min=No	FrameElem=4	ElemStation=0.125			
Frame=4	Station=0.1875	OutputCase=FESSUR	CaseType=Combination	Point=0	X2=0	X3=0	S11=-
239.15192283725	IsS11Max=No	IsS11Min=No	FrameElem=4	ElemStation=0.1875			
Frame=4	Station=0.1875	OutputCase=FESSUR	CaseType=Combination	Point=1	X2=-0.5	X3=-0.5	
S11=613.33061526294	IsS11Max=Yes	IsS11Min=No	FrameElem=4	ElemStation=0.1875			
Frame=4	Station=0.1875	OutputCase=FESSUR	CaseType=Combination	Point=2	X2=-0.5	X3=0.5	
S11=613.33061526294	IsS11Max=No	IsS11Min=No	FrameElem=4	ElemStation=0.1875			
Frame=4	Station=0.1875	OutputCase=FESSUR	CaseType=Combination	Point=3	X2=0.5	X3=-0.5	S11=-
1091.63446093744	IsS11Max=No	IsS11Min=Yes	FrameElem=4	ElemStation=0.1875			
Frame=4	Station=0.1875	OutputCase=FESSUR	CaseType=Combination	Point=4	X2=0.5	X3=0.5	S11=-
1091.63446093744	IsS11Max=No	IsS11Min=No	FrameElem=4	ElemStation=0.1875			
Frame=4	Station=0.25	OutputCase=FESSUR	CaseType=Combination	Point=0	X2=0	X3=0	S11=-239.15192283725
IsS11Max=No	IsS11Min=No	FrameElem=4	ElemStation=0.25				
Frame=4	Station=0.25	OutputCase=FESSUR	CaseType=Combination	Point=1	X2=-0.5	X3=-0.5	
S11=776.671027172894	IsS11Max=Yes	IsS11Min=No	FrameElem=4	ElemStation=0.25			
Frame=4	Station=0.25	OutputCase=FESSUR	CaseType=Combination	Point=2	X2=-0.5	X3=0.5	
S11=776.671027172894	IsS11Max=No	IsS11Min=No	FrameElem=4	ElemStation=0.25			
Frame=4	Station=0.25	OutputCase=FESSUR	CaseType=Combination	Point=3	X2=0.5	X3=-0.5	S11=-
1254.9748728474	IsS11Max=No	IsS11Min=Yes	FrameElem=4	ElemStation=0.25			
Frame=4	Station=0.25	OutputCase=FESSUR	CaseType=Combination	Point=4	X2=0.5	X3=0.5	S11=-
1254.9748728474	IsS11Max=No	IsS11Min=No	FrameElem=4	ElemStation=0.25			
Frame=5	Station=0	OutputCase=PERM1	CaseType=Combination	Point=0	X2=0	X3=0	S11=-235.938772273306
IsS11Max=No	IsS11Min=No	FrameElem=5	ElemStation=0				
Frame=5	Station=0	OutputCase=PERM1	CaseType=Combination	Point=1	X2=-0.5	X3=-0.5	
S11=761.722704482222	IsS11Max=Yes	IsS11Min=No	FrameElem=5	ElemStation=0			
Frame=5	Station=0	OutputCase=PERM1	CaseType=Combination	Point=2	X2=-0.5	X3=0.5	S11=761.722704482222
IsS11Max=No	IsS11Min=No	FrameElem=5	ElemStation=0				
Frame=5	Station=0	OutputCase=PERM1	CaseType=Combination	Point=3	X2=0.5	X3=-0.5	S11=-
1233.60024902883	IsS11Max=No	IsS11Min=Yes	FrameElem=5	ElemStation=0			
Frame=5	Station=0	OutputCase=PERM1	CaseType=Combination	Point=4	X2=0.5	X3=0.5	S11=-1233.60024902883
IsS11Max=No	IsS11Min=No	FrameElem=5	ElemStation=0				
Frame=5	Station=6.24999940395355E-02	OutputCase=PERM1	CaseType=Combination	Point=0	X2=0	X3=0	S11=-
235.938772273306	IsS11Max=No	IsS11Min=No	FrameElem=5	ElemStation=6.24999940395355E-02			
Frame=5	Station=6.24999940395355E-02	OutputCase=PERM1	CaseType=Combination	Point=1	X2=-0.5	X3=-0.5	
S11=943.180596425885	IsS11Max=Yes	IsS11Min=No	FrameElem=5	ElemStation=6.24999940395355E-02			
Frame=5	Station=6.24999940395355E-02	OutputCase=PERM1	CaseType=Combination	Point=2	X2=-0.5	X3=0.5	
S11=943.180596425885	IsS11Max=No	IsS11Min=No	FrameElem=5	ElemStation=6.24999940395355E-02			
Frame=5	Station=6.24999940395355E-02	OutputCase=PERM1	CaseType=Combination	Point=3	X2=0.5	X3=-0.5	
S11=-1415.0581409725	IsS11Max=No	IsS11Min=Yes	FrameElem=5	ElemStation=6.24999940395355E-02			
Frame=5	Station=6.24999940395355E-02	OutputCase=PERM1	CaseType=Combination	Point=4	X2=0.5	X3=0.5	
S11=-1415.0581409725	IsS11Max=No	IsS11Min=No	FrameElem=5	ElemStation=6.24999940395355E-02			
Frame=5	Station=0.124999988079071	OutputCase=PERM1	CaseType=Combination	Point=0	X2=0	X3=0	S11=-
235.938772273306	IsS11Max=No	IsS11Min=No	FrameElem=5	ElemStation=0.124999988079071			
Frame=5	Station=0.124999988079071	OutputCase=PERM1	CaseType=Combination	Point=1	X2=-0.5	X3=-0.5	
S11=1124.05255098131	IsS11Max=Yes	IsS11Min=No	FrameElem=5	ElemStation=0.124999988079071			
Frame=5	Station=0.124999988079071	OutputCase=PERM1	CaseType=Combination	Point=2	X2=-0.5	X3=0.5	
S11=1124.05255098131	IsS11Max=No	IsS11Min=No	FrameElem=5	ElemStation=0.124999988079071			
Frame=5	Station=0.124999988079071	OutputCase=PERM1	CaseType=Combination	Point=3	X2=0.5	X3=-0.5	
S11=-1595.93009552792	IsS11Max=No	IsS11Min=Yes	FrameElem=5	ElemStation=0.124999988079071			
Frame=5	Station=0.124999988079071	OutputCase=PERM1	CaseType=Combination	Point=4	X2=0.5	X3=0.5	S11=-
1595.93009552792	IsS11Max=No	IsS11Min=No	FrameElem=5	ElemStation=0.124999988079071			
Frame=5	Station=0.187499982118607	OutputCase=PERM1	CaseType=Combination	Point=0	X2=0	X3=0	S11=-
235.938772273306	IsS11Max=No	IsS11Min=No	FrameElem=5	ElemStation=0.187499982118607			
Frame=5	Station=0.187499982118607	OutputCase=PERM1	CaseType=Combination	Point=1	X2=-0.5	X3=-0.5	
S11=1304.33856814849	IsS11Max=Yes	IsS11Min=No	FrameElem=5	ElemStation=0.187499982118607			
Frame=5	Station=0.187499982118607	OutputCase=PERM1	CaseType=Combination	Point=2	X2=-0.5	X3=0.5	
S11=1304.33856814849	IsS11Max=No	IsS11Min=No	FrameElem=5	ElemStation=0.187499982118607			
Frame=5	Station=0.187499982118607	OutputCase=PERM1	CaseType=Combination	Point=3	X2=0.5	X3=-0.5	
S11=-1776.2161126951	IsS11Max=No	IsS11Min=Yes	FrameElem=5	ElemStation=0.187499982118607			
Frame=5	Station=0.187499982118607	OutputCase=PERM1	CaseType=Combination	Point=4	X2=0.5	X3=0.5	S11=-
1776.2161126951	IsS11Max=No	IsS11Min=No	FrameElem=5	ElemStation=0.187499982118607			
Frame=5	Station=0.249999976158142	OutputCase=PERM1	CaseType=Combination	Point=0	X2=0	X3=0	S11=-
235.938772273306	IsS11Max=No	IsS11Min=No	FrameElem=5	ElemStation=0.249999976158142			
Frame=5	Station=0.249999976158142	OutputCase=PERM1	CaseType=Combination	Point=1	X2=-0.5	X3=-0.5	
S11=1484.03864792743	IsS11Max=Yes	IsS11Min=No	FrameElem=5	ElemStation=0.249999976158142			
Frame=5	Station=0.249999976158142	OutputCase=PERM1	CaseType=Combination	Point=2	X2=-0.5	X3=0.5	
S11=1484.03864792743	IsS11Max=No	IsS11Min=No	FrameElem=5	ElemStation=0.249999976158142			
Frame=5	Station=0.249999976158142	OutputCase=PERM1	CaseType=Combination	Point=3	X2=0.5	X3=-0.5	
S11=-1955.91619247404	IsS11Max=No	IsS11Min=Yes	FrameElem=5	ElemStation=0.249999976158142			
Frame=5	Station=0.249999976158142	OutputCase=PERM1	CaseType=Combination	Point=4	X2=0.5	X3=0.5	S11=-
1955.91619247404	IsS11Max=No	IsS11Min=No	FrameElem=5	ElemStation=0.249999976158142			
Frame=5	Station=0	OutputCase=PERM2	CaseType=Combination	Point=0	X2=0	X3=0	S11=-169.465538592137
IsS11Max=No	IsS11Min=No	FrameElem=5	ElemStation=0				
Frame=5	Station=0	OutputCase=PERM2	CaseType=Combination	Point=1	X2=-0.5	X3=-0.5	
S11=741.836215931754	IsS11Max=Yes	IsS11Min=No	FrameElem=5	ElemStation=0			
Frame=5	Station=0	OutputCase=PERM2	CaseType=Combination	Point=2	X2=-0.5	X3=0.5	S11=741.836215931754
IsS11Max=No	IsS11Min=No	FrameElem=5	ElemStation=0				
Frame=5	Station=0	OutputCase=PERM2	CaseType=Combination	Point=3	X2=0.5	X3=-0.5	S11=-
1080.76729311603	IsS11Max=No	IsS11Min=Yes	FrameElem=5	ElemStation=0			

Frame=5 Station=0 OutputCase=PERM2 CaseType=Combination Point=4 X2=0.5 X3=0.5 S11=-1080.76729311603
 IsS11Max=No IsS11Min=No FrameElem=5 ElemStation=0
 Frame=5 Station=6.24999940395355E-02 OutputCase=PERM2 CaseType=Combination Point=0 X2=0 X3=0 S11=-
 169.465538592137 IsS11Max=No IsS11Min=No FrameElem=5 ElemStation=6.24999940395355E-02
 Frame=5 Station=6.24999940395355E-02 OutputCase=PERM2 CaseType=Combination Point=1 X2=-0.5 X3=-0.5
 S11=923.282170814792 IsS11Max=Yes IsS11Min=No FrameElem=5 ElemStation=6.24999940395355E-02
 Frame=5 Station=6.24999940395355E-02 OutputCase=PERM2 CaseType=Combination Point=2 X2=-0.5 X3=0.5
 S11=923.282170814792 IsS11Max=No IsS11Min=No FrameElem=5 ElemStation=6.24999940395355E-02
 Frame=5 Station=6.24999940395355E-02 OutputCase=PERM2 CaseType=Combination Point=3 X2=0.5 X3=-0.5
 S11=-1262.21324799907 IsS11Max=No IsS11Min=Yes FrameElem=5 ElemStation=6.24999940395355E-02
 Frame=5 Station=6.24999940395355E-02 OutputCase=PERM2 CaseType=Combination Point=4 X2=0.5 X3=0.5
 S11=-1262.21324799907 IsS11Max=No IsS11Min=No FrameElem=5 ElemStation=6.24999940395355E-02
 Frame=5 Station=0.124999988079071 OutputCase=PERM2 CaseType=Combination Point=0 X2=0 X3=0 S11=-
 169.465538592137 IsS11Max=No IsS11Min=No FrameElem=5 ElemStation=0.124999988079071
 Frame=5 Station=0.124999988079071 OutputCase=PERM2 CaseType=Combination Point=1 X2=-0.5 X3=-0.5
 S11=1104.14218830959 IsS11Max=Yes IsS11Min=No FrameElem=5 ElemStation=0.124999988079071
 Frame=5 Station=0.124999988079071 OutputCase=PERM2 CaseType=Combination Point=2 X2=-0.5 X3=0.5
 S11=1104.14218830959 IsS11Max=No IsS11Min=No FrameElem=5 ElemStation=0.124999988079071
 Frame=5 Station=0.124999988079071 OutputCase=PERM2 CaseType=Combination Point=3 X2=0.5 X3=-0.5
 S11=-1443.07326549386 IsS11Max=No IsS11Min=Yes FrameElem=5 ElemStation=0.124999988079071
 Frame=5 Station=0.124999988079071 OutputCase=PERM2 CaseType=Combination Point=4 X2=0.5 X3=0.5 S11=-
 1443.07326549386 IsS11Max=No IsS11Min=No FrameElem=5 ElemStation=0.124999988079071
 Frame=5 Station=0.187499982118607 OutputCase=PERM2 CaseType=Combination Point=0 X2=0 X3=0 S11=-
 169.465538592137 IsS11Max=No IsS11Min=No FrameElem=5 ElemStation=0.187499982118607
 Frame=5 Station=0.187499982118607 OutputCase=PERM2 CaseType=Combination Point=1 X2=-0.5 X3=-0.5
 S11=1284.41626841614 IsS11Max=Yes IsS11Min=No FrameElem=5 ElemStation=0.187499982118607
 Frame=5 Station=0.187499982118607 OutputCase=PERM2 CaseType=Combination Point=2 X2=-0.5 X3=0.5
 S11=1284.41626841614 IsS11Max=No IsS11Min=No FrameElem=5 ElemStation=0.187499982118607
 Frame=5 Station=0.187499982118607 OutputCase=PERM2 CaseType=Combination Point=3 X2=0.5 X3=-0.5
 S11=-1623.34734560042 IsS11Max=No IsS11Min=Yes FrameElem=5 ElemStation=0.187499982118607
 Frame=5 Station=0.187499982118607 OutputCase=PERM2 CaseType=Combination Point=4 X2=0.5 X3=0.5 S11=-
 1623.34734560042 IsS11Max=No IsS11Min=No FrameElem=5 ElemStation=0.187499982118607
 Frame=5 Station=0.249999976158142 OutputCase=PERM2 CaseType=Combination Point=0 X2=0 X3=0 S11=-
 169.465538592137 IsS11Max=No IsS11Min=No FrameElem=5 ElemStation=0.249999976158142
 Frame=5 Station=0.249999976158142 OutputCase=PERM2 CaseType=Combination Point=1 X2=-0.5 X3=-0.5
 S11=1464.10441113446 IsS11Max=Yes IsS11Min=No FrameElem=5 ElemStation=0.249999976158142
 Frame=5 Station=0.249999976158142 OutputCase=PERM2 CaseType=Combination Point=2 X2=-0.5 X3=0.5
 S11=1464.10441113446 IsS11Max=No IsS11Min=No FrameElem=5 ElemStation=0.249999976158142
 Frame=5 Station=0.249999976158142 OutputCase=PERM2 CaseType=Combination Point=3 X2=0.5 X3=-0.5
 S11=-1803.03548831873 IsS11Max=No IsS11Min=Yes FrameElem=5 ElemStation=0.249999976158142
 Frame=5 Station=0.249999976158142 OutputCase=PERM2 CaseType=Combination Point=4 X2=0.5 X3=0.5 S11=-
 1803.03548831873 IsS11Max=No IsS11Min=No FrameElem=5 ElemStation=0.249999976158142
 Frame=5 Station=0 OutputCase=ACC1 CaseType=Combination Point=0 X2=0 X3=0 S11=-240.528987364648
 IsS11Max=No IsS11Min=No FrameElem=5 ElemStation=0
 Frame=5 Station=0 OutputCase=ACC1 CaseType=Combination Point=1 X2=-0.5 X3=-0.5 S11=783.077451183533
 IsS11Max=Yes IsS11Min=No FrameElem=5 ElemStation=0
 Frame=5 Station=0 OutputCase=ACC1 CaseType=Combination Point=2 X2=-0.5 X3=0.5 S11=783.077451183533
 IsS11Max=No IsS11Min=No FrameElem=5 ElemStation=0
 Frame=5 Station=0 OutputCase=ACC1 CaseType=Combination Point=3 X2=0.5 X3=-0.5 S11=-1264.13542591283
 IsS11Max=No IsS11Min=Yes FrameElem=5 ElemStation=0
 Frame=5 Station=0 OutputCase=ACC1 CaseType=Combination Point=4 X2=0.5 X3=0.5 S11=-1264.13542591283
 IsS11Max=No IsS11Min=No FrameElem=5 ElemStation=0
 Frame=5 Station=6.24999940395355E-02 OutputCase=ACC1 CaseType=Combination Point=0 X2=0 X3=0 S11=-
 240.528987364648 IsS11Max=No IsS11Min=No FrameElem=5 ElemStation=6.24999940395355E-02
 Frame=5 Station=6.24999940395355E-02 OutputCase=ACC1 CaseType=Combination Point=1 X2=-0.5 X3=-0.5
 S11=969.356606380386 IsS11Max=Yes IsS11Min=No FrameElem=5 ElemStation=6.24999940395355E-02
 Frame=5 Station=6.24999940395355E-02 OutputCase=ACC1 CaseType=Combination Point=2 X2=-0.5 X3=0.5
 S11=969.356606380386 IsS11Max=No IsS11Min=No FrameElem=5 ElemStation=6.24999940395355E-02
 Frame=5 Station=6.24999940395355E-02 OutputCase=ACC1 CaseType=Combination Point=3 X2=0.5 X3=-0.5
 S11=-1450.41458110968 IsS11Max=No IsS11Min=Yes FrameElem=5 ElemStation=6.24999940395355E-02
 Frame=5 Station=6.24999940395355E-02 OutputCase=ACC1 CaseType=Combination Point=4 X2=0.5 X3=0.5
 S11=-1450.41458110968 IsS11Max=No IsS11Min=No FrameElem=5 ElemStation=6.24999940395355E-02
 Frame=5 Station=0.124999988079071 OutputCase=ACC1 CaseType=Combination Point=0 X2=0 X3=0 S11=-
 240.528987364648 IsS11Max=No IsS11Min=No FrameElem=5 ElemStation=0.124999988079071
 Frame=5 Station=0.124999988079071 OutputCase=ACC1 CaseType=Combination Point=1 X2=-0.5 X3=-0.5
 S11=1155.049824189 IsS11Max=Yes IsS11Min=No FrameElem=5 ElemStation=0.124999988079071
 Frame=5 Station=0.124999988079071 OutputCase=ACC1 CaseType=Combination Point=2 X2=-0.5 X3=0.5
 S11=1155.049824189 IsS11Max=No IsS11Min=No FrameElem=5 ElemStation=0.124999988079071
 Frame=5 Station=0.124999988079071 OutputCase=ACC1 CaseType=Combination Point=3 X2=0.5 X3=-0.5 S11=-
 1636.10779891829 IsS11Max=No IsS11Min=Yes FrameElem=5 ElemStation=0.124999988079071
 Frame=5 Station=0.124999988079071 OutputCase=ACC1 CaseType=Combination Point=4 X2=0.5 X3=0.5 S11=-
 1636.10779891829 IsS11Max=No IsS11Min=No FrameElem=5 ElemStation=0.124999988079071
 Frame=5 Station=0.187499982118607 OutputCase=ACC1 CaseType=Combination Point=0 X2=0 X3=0 S11=-
 240.528987364648 IsS11Max=No IsS11Min=No FrameElem=5 ElemStation=0.187499982118607
 Frame=5 Station=0.187499982118607 OutputCase=ACC1 CaseType=Combination Point=1 X2=-0.5 X3=-0.5
 S11=1340.15710460937 IsS11Max=Yes IsS11Min=No FrameElem=5 ElemStation=0.187499982118607
 Frame=5 Station=0.187499982118607 OutputCase=ACC1 CaseType=Combination Point=2 X2=-0.5 X3=0.5
 S11=1340.15710460937 IsS11Max=No IsS11Min=No FrameElem=5 ElemStation=0.187499982118607
 Frame=5 Station=0.187499982118607 OutputCase=ACC1 CaseType=Combination Point=3 X2=0.5 X3=-0.5 S11=-
 1821.21507933866 IsS11Max=No IsS11Min=Yes FrameElem=5 ElemStation=0.187499982118607
 Frame=5 Station=0.187499982118607 OutputCase=ACC1 CaseType=Combination Point=4 X2=0.5 X3=0.5 S11=-
 1821.21507933866 IsS11Max=No IsS11Min=No FrameElem=5 ElemStation=0.187499982118607



Frame=5 Station=0.249999976158142 OutputCase=ACC1 CaseType=Combination Point=0 X2=0 X3=0 S11=-
 240.528987364648 IsS11Max=No IsS11Min=No FrameElem=5 ElemStation=0.249999976158142
 Frame=5 Station=0.249999976158142 OutputCase=ACC1 CaseType=Combination Point=1 X2=-0.5 X3=-0.5
 S11=1524.6784476415 IsS11Max=Yes IsS11Min=No FrameElem=5 ElemStation=0.249999976158142
 Frame=5 Station=0.249999976158142 OutputCase=ACC1 CaseType=Combination Point=2 X2=-0.5 X3=0.5
 S11=1524.6784476415 IsS11Max=No IsS11Min=No FrameElem=5 ElemStation=0.249999976158142
 Frame=5 Station=0.249999976158142 OutputCase=ACC1 CaseType=Combination Point=3 X2=0.5 X3=-0.5 S11=-
 2005.73642237079 IsS11Max=No IsS11Min=Yes FrameElem=5 ElemStation=0.249999976158142
 Frame=5 Station=0.249999976158142 OutputCase=ACC1 CaseType=Combination Point=4 X2=0.5 X3=0.5 S11=-
 2005.73642237079 IsS11Max=No IsS11Min=No FrameElem=5 ElemStation=0.249999976158142
 Frame=5 Station=0 OutputCase=ACC2 CaseType=Combination Point=0 X2=0 X3=0 S11=-174.055753683479
 IsS11Max=No IsS11Min=No FrameElem=5 ElemStation=0
 Frame=5 Station=0 OutputCase=ACC2 CaseType=Combination Point=1 X2=-0.5 X3=-0.5 S11=763.190962633065
 IsS11Max=Yes IsS11Min=No FrameElem=5 ElemStation=0
 Frame=5 Station=0 OutputCase=ACC2 CaseType=Combination Point=2 X2=-0.5 X3=0.5 S11=763.190962633065
 IsS11Max=No IsS11Min=No FrameElem=5 ElemStation=0
 Frame=5 Station=0 OutputCase=ACC2 CaseType=Combination Point=3 X2=0.5 X3=-0.5 S11=-1111.30247000002
 IsS11Max=No IsS11Min=Yes FrameElem=5 ElemStation=0
 Frame=5 Station=0 OutputCase=ACC2 CaseType=Combination Point=4 X2=0.5 X3=0.5 S11=-1111.30247000002
 IsS11Max=No IsS11Min=No FrameElem=5 ElemStation=0
 Frame=5 Station=6.24999940395355E-02 OutputCase=ACC2 CaseType=Combination Point=0 X2=0 X3=0 S11=-
 174.055753683479 IsS11Max=No IsS11Min=No FrameElem=5 ElemStation=6.24999940395355E-02
 Frame=5 Station=6.24999940395355E-02 OutputCase=ACC2 CaseType=Combination Point=1 X2=-0.5 X3=-0.5
 S11=949.458180769293 IsS11Max=Yes IsS11Min=No FrameElem=5 ElemStation=6.24999940395355E-02
 Frame=5 Station=6.24999940395355E-02 OutputCase=ACC2 CaseType=Combination Point=2 X2=-0.5 X3=0.5
 S11=949.458180769293 IsS11Max=No IsS11Min=No FrameElem=5 ElemStation=6.24999940395355E-02
 Frame=5 Station=6.24999940395355E-02 OutputCase=ACC2 CaseType=Combination Point=3 X2=0.5 X3=-0.5
 S11=-1297.56968813625 IsS11Max=No IsS11Min=Yes FrameElem=5 ElemStation=6.24999940395355E-02
 Frame=5 Station=6.24999940395355E-02 OutputCase=ACC2 CaseType=Combination Point=4 X2=0.5 X3=0.5
 S11=-1297.56968813625 IsS11Max=No IsS11Min=No FrameElem=5 ElemStation=6.24999940395355E-02
 Frame=5 Station=0.124999988079071 OutputCase=ACC2 CaseType=Combination Point=0 X2=0 X3=0 S11=-
 174.055753683479 IsS11Max=No IsS11Min=No FrameElem=5 ElemStation=0.124999988079071
 Frame=5 Station=0.124999988079071 OutputCase=ACC2 CaseType=Combination Point=1 X2=-0.5 X3=-0.5
 S11=1135.13946151728 IsS11Max=Yes IsS11Min=No FrameElem=5 ElemStation=0.124999988079071
 Frame=5 Station=0.124999988079071 OutputCase=ACC2 CaseType=Combination Point=2 X2=-0.5 X3=0.5
 S11=1135.13946151728 IsS11Max=No IsS11Min=No FrameElem=5 ElemStation=0.124999988079071
 Frame=5 Station=0.124999988079071 OutputCase=ACC2 CaseType=Combination Point=3 X2=0.5 X3=-0.5 S11=-
 1483.25096888424 IsS11Max=No IsS11Min=Yes FrameElem=5 ElemStation=0.124999988079071
 Frame=5 Station=0.124999988079071 OutputCase=ACC2 CaseType=Combination Point=4 X2=0.5 X3=0.5 S11=-
 1483.25096888424 IsS11Max=No IsS11Min=No FrameElem=5 ElemStation=0.124999988079071
 Frame=5 Station=0.187499982118607 OutputCase=ACC2 CaseType=Combination Point=0 X2=0 X3=0 S11=-
 174.055753683479 IsS11Max=No IsS11Min=No FrameElem=5 ElemStation=0.187499982118607
 Frame=5 Station=0.187499982118607 OutputCase=ACC2 CaseType=Combination Point=1 X2=-0.5 X3=-0.5
 S11=1320.23480487702 IsS11Max=Yes IsS11Min=No FrameElem=5 ElemStation=0.187499982118607
 Frame=5 Station=0.187499982118607 OutputCase=ACC2 CaseType=Combination Point=2 X2=-0.5 X3=0.5
 S11=1320.23480487702 IsS11Max=No IsS11Min=No FrameElem=5 ElemStation=0.187499982118607
 Frame=5 Station=0.187499982118607 OutputCase=ACC2 CaseType=Combination Point=3 X2=0.5 X3=-0.5 S11=-
 1668.34631224398 IsS11Max=No IsS11Min=Yes FrameElem=5 ElemStation=0.187499982118607
 Frame=5 Station=0.187499982118607 OutputCase=ACC2 CaseType=Combination Point=4 X2=0.5 X3=0.5 S11=-
 1668.34631224398 IsS11Max=No IsS11Min=No FrameElem=5 ElemStation=0.187499982118607
 Frame=5 Station=0.249999976158142 OutputCase=ACC2 CaseType=Combination Point=0 X2=0 X3=0 S11=-
 174.055753683479 IsS11Max=No IsS11Min=No FrameElem=5 ElemStation=0.249999976158142
 Frame=5 Station=0.249999976158142 OutputCase=ACC2 CaseType=Combination Point=1 X2=-0.5 X3=-0.5
 S11=1504.74421084853 IsS11Max=Yes IsS11Min=No FrameElem=5 ElemStation=0.249999976158142
 Frame=5 Station=0.249999976158142 OutputCase=ACC2 CaseType=Combination Point=2 X2=-0.5 X3=0.5
 S11=1504.74421084853 IsS11Max=No IsS11Min=No FrameElem=5 ElemStation=0.249999976158142
 Frame=5 Station=0.249999976158142 OutputCase=ACC2 CaseType=Combination Point=3 X2=0.5 X3=-0.5 S11=-
 1852.85571821549 IsS11Max=No IsS11Min=Yes FrameElem=5 ElemStation=0.249999976158142
 Frame=5 Station=0.249999976158142 OutputCase=ACC2 CaseType=Combination Point=4 X2=0.5 X3=0.5 S11=-
 1852.85571821549 IsS11Max=No IsS11Min=No FrameElem=5 ElemStation=0.249999976158142
 Frame=5 Station=0 OutputCase=ACCSX1 CaseType=Combination Point=0 X2=0 X3=0 S11=-233.66597428245
 IsS11Max=No IsS11Min=No FrameElem=5 ElemStation=0
 Frame=5 Station=0 OutputCase=ACCSX1 CaseType=Combination Point=1 X2=-0.5 X3=-0.5
 S11=734.379572580527 IsS11Max=Yes IsS11Min=No FrameElem=5 ElemStation=0
 Frame=5 Station=0 OutputCase=ACCSX1 CaseType=Combination Point=2 X2=-0.5 X3=0.5
 S11=734.379572580527 IsS11Max=No IsS11Min=No FrameElem=5 ElemStation=0
 Frame=5 Station=0 OutputCase=ACCSX1 CaseType=Combination Point=3 X2=0.5 X3=-0.5 S11=-
 1201.71152114543 IsS11Max=No IsS11Min=Yes FrameElem=5 ElemStation=0
 Frame=5 Station=0 OutputCase=ACCSX1 CaseType=Combination Point=4 X2=0.5 X3=0.5 S11=-
 1201.71152114543 IsS11Max=No IsS11Min=No FrameElem=5 ElemStation=0
 Frame=5 Station=6.24999940395355E-02 OutputCase=ACCSX1 CaseType=Combination Point=0 X2=0 X3=0 S11=-
 233.66597428245 IsS11Max=No IsS11Min=No FrameElem=5 ElemStation=6.24999940395355E-02
 Frame=5 Station=6.24999940395355E-02 OutputCase=ACCSX1 CaseType=Combination Point=1 X2=-0.5 X3=-0.5
 S11=916.199983815188 IsS11Max=Yes IsS11Min=No FrameElem=5 ElemStation=6.24999940395355E-02
 Frame=5 Station=6.24999940395355E-02 OutputCase=ACCSX1 CaseType=Combination Point=2 X2=-0.5 X3=0.5
 S11=916.199983815188 IsS11Max=No IsS11Min=No FrameElem=5 ElemStation=6.24999940395355E-02
 Frame=5 Station=6.24999940395355E-02 OutputCase=ACCSX1 CaseType=Combination Point=3 X2=0.5 X3=-0.5
 S11=-1383.53193238009 IsS11Max=No IsS11Min=Yes FrameElem=5 ElemStation=6.24999940395355E-02
 Frame=5 Station=6.24999940395355E-02 OutputCase=ACCSX1 CaseType=Combination Point=4 X2=0.5 X3=0.5
 S11=-1383.53193238009 IsS11Max=No IsS11Min=No FrameElem=5 ElemStation=6.24999940395355E-02
 Frame=5 Station=0.124999988079071 OutputCase=ACCSX1 CaseType=Combination Point=0 X2=0 X3=0 S11=-
 233.66597428245 IsS11Max=No IsS11Min=No FrameElem=5 ElemStation=0.124999988079071



Frame=5 Station=0.124999988079071 OutputCase=ACCSX1 CaseType=Combination Point=1 X2=-0.5 X3=-0.5
 S11=1097.43445766161 IsS11Max=Yes IsS11Min=No FrameElem=5 ElemStation=0.124999988079071
 Frame=5 Station=0.124999988079071 OutputCase=ACCSX1 CaseType=Combination Point=2 X2=-0.5 X3=0.5
 S11=1097.43445766161 IsS11Max=No IsS11Min=No FrameElem=5 ElemStation=0.124999988079071
 Frame=5 Station=0.124999988079071 OutputCase=ACCSX1 CaseType=Combination Point=3 X2=0.5 X3=-0.5
 S11=-1564.76640622651 IsS11Max=No IsS11Min=Yes FrameElem=5 ElemStation=0.124999988079071
 Frame=5 Station=0.124999988079071 OutputCase=ACCSX1 CaseType=Combination Point=4 X2=0.5 X3=0.5
 S11=-1564.76640622651 IsS11Max=No IsS11Min=No FrameElem=5 ElemStation=0.124999988079071
 Frame=5 Station=0.187499982118607 OutputCase=ACCSX1 CaseType=Combination Point=0 X2=0 X3=0 S11=-
 233.66597428245 IsS11Max=No IsS11Min=No FrameElem=5 ElemStation=0.187499982118607
 Frame=5 Station=0.187499982118607 OutputCase=ACCSX1 CaseType=Combination Point=1 X2=-0.5 X3=-0.5
 S11=1278.08299411979 IsS11Max=Yes IsS11Min=No FrameElem=5 ElemStation=0.187499982118607
 Frame=5 Station=0.187499982118607 OutputCase=ACCSX1 CaseType=Combination Point=2 X2=-0.5 X3=0.5
 S11=1278.08299411979 IsS11Max=No IsS11Min=No FrameElem=5 ElemStation=0.187499982118607
 Frame=5 Station=0.187499982118607 OutputCase=ACCSX1 CaseType=Combination Point=3 X2=0.5 X3=-0.5
 S11=-1745.41494268469 IsS11Max=No IsS11Min=Yes FrameElem=5 ElemStation=0.187499982118607
 Frame=5 Station=0.187499982118607 OutputCase=ACCSX1 CaseType=Combination Point=4 X2=0.5 X3=0.5
 S11=-1745.41494268469 IsS11Max=No IsS11Min=No FrameElem=5 ElemStation=0.187499982118607
 Frame=5 Station=0.249999976158142 OutputCase=ACCSX1 CaseType=Combination Point=0 X2=0 X3=0 S11=-
 233.66597428245 IsS11Max=No IsS11Min=No FrameElem=5 ElemStation=0.249999976158142
 Frame=5 Station=0.249999976158142 OutputCase=ACCSX1 CaseType=Combination Point=1 X2=-0.5 X3=-0.5
 S11=1458.14559318972 IsS11Max=Yes IsS11Min=No FrameElem=5 ElemStation=0.249999976158142
 Frame=5 Station=0.249999976158142 OutputCase=ACCSX1 CaseType=Combination Point=2 X2=-0.5 X3=0.5
 S11=1458.14559318972 IsS11Max=No IsS11Min=No FrameElem=5 ElemStation=0.249999976158142
 Frame=5 Station=0.249999976158142 OutputCase=ACCSX1 CaseType=Combination Point=3 X2=0.5 X3=-0.5
 S11=-1925.47754175463 IsS11Max=No IsS11Min=Yes FrameElem=5 ElemStation=0.249999976158142
 Frame=5 Station=0.249999976158142 OutputCase=ACCSX1 CaseType=Combination Point=4 X2=0.5 X3=0.5
 S11=-1925.47754175463 IsS11Max=No IsS11Min=No FrameElem=5 ElemStation=0.249999976158142
 Frame=5 Station=0 OutputCase=ACCSX2 CaseType=Combination Point=0 X2=0 X3=0 S11=-167.192740601281
 IsS11Max=No IsS11Min=No FrameElem=5 ElemStation=0
 Frame=5 Station=0 OutputCase=ACCSX2 CaseType=Combination Point=1 X2=-0.5 X3=-0.5
 S11=714.493084030059 IsS11Max=Yes IsS11Min=No FrameElem=5 ElemStation=0
 Frame=5 Station=0 OutputCase=ACCSX2 CaseType=Combination Point=2 X2=-0.5 X3=0.5
 S11=714.493084030059 IsS11Max=No IsS11Min=No FrameElem=5 ElemStation=0
 Frame=5 Station=0 OutputCase=ACCSX2 CaseType=Combination Point=3 X2=0.5 X3=-0.5 S11=-
 1048.87856523262 IsS11Max=No IsS11Min=Yes FrameElem=5 ElemStation=0
 Frame=5 Station=0 OutputCase=ACCSX2 CaseType=Combination Point=4 X2=0.5 X3=0.5 S11=-
 1048.87856523262 IsS11Max=No IsS11Min=No FrameElem=5 ElemStation=0
 Frame=5 Station=6.24999940395355E-02 OutputCase=ACCSX2 CaseType=Combination Point=0 X2=0 X3=0 S11=-
 167.192740601281 IsS11Max=No IsS11Min=No FrameElem=5 ElemStation=6.24999940395355E-02
 Frame=5 Station=6.24999940395355E-02 OutputCase=ACCSX2 CaseType=Combination Point=1 X2=-0.5 X3=-0.5
 S11=896.301558204095 IsS11Max=Yes IsS11Min=No FrameElem=5 ElemStation=6.24999940395355E-02
 Frame=5 Station=6.24999940395355E-02 OutputCase=ACCSX2 CaseType=Combination Point=2 X2=-0.5 X3=0.5
 S11=896.301558204095 IsS11Max=No IsS11Min=No FrameElem=5 ElemStation=6.24999940395355E-02
 Frame=5 Station=6.24999940395355E-02 OutputCase=ACCSX2 CaseType=Combination Point=3 X2=0.5 X3=-0.5
 S11=-1230.68703940666 IsS11Max=No IsS11Min=Yes FrameElem=5 ElemStation=6.24999940395355E-02
 Frame=5 Station=6.24999940395355E-02 OutputCase=ACCSX2 CaseType=Combination Point=4 X2=0.5 X3=0.5
 S11=-1230.68703940666 IsS11Max=No IsS11Min=No FrameElem=5 ElemStation=6.24999940395355E-02
 Frame=5 Station=0.124999988079071 OutputCase=ACCSX2 CaseType=Combination Point=0 X2=0 X3=0 S11=-
 167.192740601281 IsS11Max=No IsS11Min=No FrameElem=5 ElemStation=0.124999988079071
 Frame=5 Station=0.124999988079071 OutputCase=ACCSX2 CaseType=Combination Point=1 X2=-0.5 X3=-0.5
 S11=1077.52409498989 IsS11Max=Yes IsS11Min=No FrameElem=5 ElemStation=0.124999988079071
 Frame=5 Station=0.124999988079071 OutputCase=ACCSX2 CaseType=Combination Point=2 X2=-0.5 X3=0.5
 S11=1077.52409498989 IsS11Max=No IsS11Min=No FrameElem=5 ElemStation=0.124999988079071
 Frame=5 Station=0.124999988079071 OutputCase=ACCSX2 CaseType=Combination Point=3 X2=0.5 X3=-0.5
 S11=-1411.90957619245 IsS11Max=No IsS11Min=Yes FrameElem=5 ElemStation=0.124999988079071
 Frame=5 Station=0.124999988079071 OutputCase=ACCSX2 CaseType=Combination Point=4 X2=0.5 X3=0.5
 S11=-1411.90957619245 IsS11Max=No IsS11Min=No FrameElem=5 ElemStation=0.124999988079071
 Frame=5 Station=0.187499982118607 OutputCase=ACCSX2 CaseType=Combination Point=0 X2=0 X3=0 S11=-
 167.192740601281 IsS11Max=No IsS11Min=No FrameElem=5 ElemStation=0.187499982118607
 Frame=5 Station=0.187499982118607 OutputCase=ACCSX2 CaseType=Combination Point=1 X2=-0.5 X3=-0.5
 S11=1258.16069438744 IsS11Max=Yes IsS11Min=No FrameElem=5 ElemStation=0.187499982118607
 Frame=5 Station=0.187499982118607 OutputCase=ACCSX2 CaseType=Combination Point=2 X2=-0.5 X3=0.5
 S11=1258.16069438744 IsS11Max=No IsS11Min=No FrameElem=5 ElemStation=0.187499982118607
 Frame=5 Station=0.187499982118607 OutputCase=ACCSX2 CaseType=Combination Point=3 X2=0.5 X3=-0.5
 S11=-1592.54617559001 IsS11Max=No IsS11Min=Yes FrameElem=5 ElemStation=0.187499982118607
 Frame=5 Station=0.187499982118607 OutputCase=ACCSX2 CaseType=Combination Point=4 X2=0.5 X3=0.5
 S11=-1592.54617559001 IsS11Max=No IsS11Min=No FrameElem=5 ElemStation=0.187499982118607
 Frame=5 Station=0.249999976158142 OutputCase=ACCSX2 CaseType=Combination Point=0 X2=0 X3=0 S11=-
 167.192740601281 IsS11Max=No IsS11Min=No FrameElem=5 ElemStation=0.249999976158142
 Frame=5 Station=0.249999976158142 OutputCase=ACCSX2 CaseType=Combination Point=1 X2=-0.5 X3=-0.5
 S11=1438.21135639676 IsS11Max=Yes IsS11Min=No FrameElem=5 ElemStation=0.249999976158142
 Frame=5 Station=0.249999976158142 OutputCase=ACCSX2 CaseType=Combination Point=2 X2=-0.5 X3=0.5
 S11=1438.21135639676 IsS11Max=No IsS11Min=No FrameElem=5 ElemStation=0.249999976158142
 Frame=5 Station=0.249999976158142 OutputCase=ACCSX2 CaseType=Combination Point=3 X2=0.5 X3=-0.5
 S11=-1772.59683759932 IsS11Max=No IsS11Min=Yes FrameElem=5 ElemStation=0.249999976158142
 Frame=5 Station=0.249999976158142 OutputCase=ACCSX2 CaseType=Combination Point=4 X2=0.5 X3=0.5
 S11=-1772.59683759932 IsS11Max=No IsS11Min=No FrameElem=5 ElemStation=0.249999976158142
 Frame=5 Station=0 OutputCase=ENVE CaseType=Combination StepType=Max Point=0 X2=0 X3=0 S11=-
 167.192740601281 IsS11Max=No IsS11Min=No FrameElem=5 ElemStation=0
 Frame=5 Station=0 OutputCase=ENVE CaseType=Combination StepType=Max Point=1 X2=-0.5 X3=-0.5
 S11=783.077451183533 IsS11Max=Yes IsS11Min=No FrameElem=5 ElemStation=0

```

Frame=5 Station=0 OutputCase=ENVE CaseType=Combination StepType=Max Point=2 X2=-0.5 X3=0.5
S11=783.077451183533 IsS11Max=No IsS11Min=No FrameElem=5 ElemStation=0
Frame=5 Station=0 OutputCase=ENVE CaseType=Combination StepType=Max Point=3 X2=0.5 X3=-0.5 S11=-
1048.87856523262 IsS11Max=No IsS11Min=Yes FrameElem=5 ElemStation=0
Frame=5 Station=0 OutputCase=ENVE CaseType=Combination StepType=Max Point=4 X2=0.5 X3=0.5 S11=-
1048.87856523262 IsS11Max=No IsS11Min=No FrameElem=5 ElemStation=0
Frame=5 Station=6.24999940395355E-02 OutputCase=ENVE CaseType=Combination StepType=Max Point=0 X2=0
X3=0 S11=-167.192740601281 IsS11Max=No IsS11Min=No FrameElem=5 ElemStation=6.24999940395355E-02
Frame=5 Station=6.24999940395355E-02 OutputCase=ENVE CaseType=Combination StepType=Max Point=1 X2=-
0.5 X3=-0.5 S11=969.356606380386 IsS11Max=Yes IsS11Min=No FrameElem=5 ElemStation=6.24999940395355E-02
Frame=5 Station=6.24999940395355E-02 OutputCase=ENVE CaseType=Combination StepType=Max Point=2 X2=-
0.5 X3=0.5 S11=969.356606380386 IsS11Max=No IsS11Min=No FrameElem=5 ElemStation=6.24999940395355E-02
Frame=5 Station=6.24999940395355E-02 OutputCase=ENVE CaseType=Combination StepType=Max Point=3 X2=0.5
X3=-0.5 S11=-1230.68703940666 IsS11Max=No IsS11Min=Yes FrameElem=5 ElemStation=6.24999940395355E-02
Frame=5 Station=6.24999940395355E-02 OutputCase=ENVE CaseType=Combination StepType=Max Point=4 X2=0.5
X3=0.5 S11=-1230.68703940666 IsS11Max=No IsS11Min=No FrameElem=5 ElemStation=6.24999940395355E-02
Frame=5 Station=0.124999988079071 OutputCase=ENVE CaseType=Combination StepType=Max Point=0 X2=0
X3=0 S11=-167.192740601281 IsS11Max=No IsS11Min=No FrameElem=5 ElemStation=0.124999988079071
Frame=5 Station=0.124999988079071 OutputCase=ENVE CaseType=Combination StepType=Max Point=1 X2=-0.5
X3=-0.5 S11=1155.049824189 IsS11Max=Yes IsS11Min=No FrameElem=5 ElemStation=0.124999988079071
Frame=5 Station=0.124999988079071 OutputCase=ENVE CaseType=Combination StepType=Max Point=2 X2=-0.5
X3=0.5 S11=1155.049824189 IsS11Max=No IsS11Min=No FrameElem=5 ElemStation=0.124999988079071
Frame=5 Station=0.124999988079071 OutputCase=ENVE CaseType=Combination StepType=Max Point=3 X2=0.5
X3=-0.5 S11=-1411.90957619245 IsS11Max=No IsS11Min=Yes FrameElem=5 ElemStation=0.124999988079071
Frame=5 Station=0.124999988079071 OutputCase=ENVE CaseType=Combination StepType=Max Point=4 X2=0.5
X3=0.5 S11=-1411.90957619245 IsS11Max=No IsS11Min=No FrameElem=5 ElemStation=0.124999988079071
Frame=5 Station=0.187499982118607 OutputCase=ENVE CaseType=Combination StepType=Max Point=0 X2=0
X3=0 S11=-167.192740601281 IsS11Max=No IsS11Min=No FrameElem=5 ElemStation=0.187499982118607
Frame=5 Station=0.187499982118607 OutputCase=ENVE CaseType=Combination StepType=Max Point=1 X2=-0.5
X3=-0.5 S11=1340.15710460937 IsS11Max=Yes IsS11Min=No FrameElem=5 ElemStation=0.187499982118607
Frame=5 Station=0.187499982118607 OutputCase=ENVE CaseType=Combination StepType=Max Point=2 X2=-0.5
X3=0.5 S11=1340.15710460937 IsS11Max=No IsS11Min=No FrameElem=5 ElemStation=0.187499982118607
Frame=5 Station=0.187499982118607 OutputCase=ENVE CaseType=Combination StepType=Max Point=3 X2=0.5
X3=-0.5 S11=-1592.54617559001 IsS11Max=No IsS11Min=Yes FrameElem=5 ElemStation=0.187499982118607
Frame=5 Station=0.187499982118607 OutputCase=ENVE CaseType=Combination StepType=Max Point=4 X2=0.5
X3=0.5 S11=-1592.54617559001 IsS11Max=No IsS11Min=No FrameElem=5 ElemStation=0.187499982118607
Frame=5 Station=0.249999976158142 OutputCase=ENVE CaseType=Combination StepType=Max Point=0 X2=0
X3=0 S11=-167.192740601281 IsS11Max=No IsS11Min=No FrameElem=5 ElemStation=0.249999976158142
Frame=5 Station=0.249999976158142 OutputCase=ENVE CaseType=Combination StepType=Max Point=1 X2=-0.5
X3=-0.5 S11=1524.6784476415 IsS11Max=Yes IsS11Min=No FrameElem=5 ElemStation=0.249999976158142
Frame=5 Station=0.249999976158142 OutputCase=ENVE CaseType=Combination StepType=Max Point=2 X2=-0.5
X3=0.5 S11=1524.6784476415 IsS11Max=No IsS11Min=No FrameElem=5 ElemStation=0.249999976158142
Frame=5 Station=0.249999976158142 OutputCase=ENVE CaseType=Combination StepType=Max Point=3 X2=0.5
X3=-0.5 S11=-1772.59683759932 IsS11Max=No IsS11Min=Yes FrameElem=5 ElemStation=0.249999976158142
Frame=5 Station=0.249999976158142 OutputCase=ENVE CaseType=Combination StepType=Max Point=4 X2=0.5
X3=0.5 S11=-1772.59683759932 IsS11Max=No IsS11Min=No FrameElem=5 ElemStation=0.249999976158142
Frame=5 Station=0 OutputCase=ENVE CaseType=Combination StepType=Min Point=0 X2=0 X3=0 S11=-
240.528987364648 IsS11Max=No IsS11Min=No FrameElem=5 ElemStation=0
Frame=5 Station=0 OutputCase=ENVE CaseType=Combination StepType=Min Point=1 X2=-0.5 X3=-0.5
S11=714.493084030059 IsS11Max=Yes IsS11Min=No FrameElem=5 ElemStation=0
Frame=5 Station=0 OutputCase=ENVE CaseType=Combination StepType=Min Point=2 X2=-0.5 X3=0.5
S11=714.493084030059 IsS11Max=No IsS11Min=No FrameElem=5 ElemStation=0
Frame=5 Station=0 OutputCase=ENVE CaseType=Combination StepType=Min Point=3 X2=0.5 X3=-0.5 S11=-
1264.13542591283 IsS11Max=No IsS11Min=Yes FrameElem=5 ElemStation=0
Frame=5 Station=0 OutputCase=ENVE CaseType=Combination StepType=Min Point=4 X2=0.5 X3=0.5 S11=-
1264.13542591283 IsS11Max=No IsS11Min=No FrameElem=5 ElemStation=0
Frame=5 Station=6.24999940395355E-02 OutputCase=ENVE CaseType=Combination StepType=Min Point=0 X2=0
X3=0 S11=-240.528987364648 IsS11Max=No IsS11Min=No FrameElem=5 ElemStation=6.24999940395355E-02
Frame=5 Station=6.24999940395355E-02 OutputCase=ENVE CaseType=Combination StepType=Min Point=1 X2=-
0.5 X3=-0.5 S11=896.301558204095 IsS11Max=Yes IsS11Min=No FrameElem=5 ElemStation=6.24999940395355E-02
Frame=5 Station=6.24999940395355E-02 OutputCase=ENVE CaseType=Combination StepType=Min Point=2 X2=-
0.5 X3=0.5 S11=896.301558204095 IsS11Max=No IsS11Min=No FrameElem=5 ElemStation=6.24999940395355E-02
Frame=5 Station=6.24999940395355E-02 OutputCase=ENVE CaseType=Combination StepType=Min Point=3 X2=0.5
X3=-0.5 S11=-1450.41458110968 IsS11Max=No IsS11Min=Yes FrameElem=5 ElemStation=6.24999940395355E-02
Frame=5 Station=6.24999940395355E-02 OutputCase=ENVE CaseType=Combination StepType=Min Point=4 X2=0.5
X3=0.5 S11=-1450.41458110968 IsS11Max=No IsS11Min=No FrameElem=5 ElemStation=6.24999940395355E-02
Frame=5 Station=0.124999988079071 OutputCase=ENVE CaseType=Combination StepType=Min Point=0 X2=0
X3=0 S11=-240.528987364648 IsS11Max=No IsS11Min=No FrameElem=5 ElemStation=0.124999988079071
Frame=5 Station=0.124999988079071 OutputCase=ENVE CaseType=Combination StepType=Min Point=1 X2=-0.5
X3=-0.5 S11=1077.52409498989 IsS11Max=Yes IsS11Min=No FrameElem=5 ElemStation=0.124999988079071
Frame=5 Station=0.124999988079071 OutputCase=ENVE CaseType=Combination StepType=Min Point=2 X2=-0.5
X3=0.5 S11=1077.52409498989 IsS11Max=No IsS11Min=No FrameElem=5 ElemStation=0.124999988079071
Frame=5 Station=0.124999988079071 OutputCase=ENVE CaseType=Combination StepType=Min Point=3 X2=0.5
X3=-0.5 S11=-1636.10779891829 IsS11Max=No IsS11Min=Yes FrameElem=5 ElemStation=0.124999988079071
Frame=5 Station=0.124999988079071 OutputCase=ENVE CaseType=Combination StepType=Min Point=4 X2=0.5
X3=0.5 S11=-1636.10779891829 IsS11Max=No IsS11Min=No FrameElem=5 ElemStation=0.124999988079071
Frame=5 Station=0.187499982118607 OutputCase=ENVE CaseType=Combination StepType=Min Point=0 X2=0
X3=0 S11=-240.528987364648 IsS11Max=No IsS11Min=No FrameElem=5 ElemStation=0.187499982118607
Frame=5 Station=0.187499982118607 OutputCase=ENVE CaseType=Combination StepType=Min Point=1 X2=-0.5
X3=-0.5 S11=1258.16069438744 IsS11Max=Yes IsS11Min=No FrameElem=5 ElemStation=0.187499982118607
Frame=5 Station=0.187499982118607 OutputCase=ENVE CaseType=Combination StepType=Min Point=2 X2=-0.5
X3=0.5 S11=1258.16069438744 IsS11Max=No IsS11Min=No FrameElem=5 ElemStation=0.187499982118607

```



Frame=5 Station=0.187499982118607 OutputCase=ENVE CaseType=Combination StepType=Min Point=3 X2=0.5
 X3=-0.5 S11=-1821.21507933866 IsS11Max=No IsS11Min=Yes FrameElem=5 ElemStation=0.187499982118607
 Frame=5 Station=0.187499982118607 OutputCase=ENVE CaseType=Combination StepType=Min Point=4 X2=0.5
 X3=0.5 S11=-1821.21507933866 IsS11Max=No IsS11Min=No FrameElem=5 ElemStation=0.187499982118607
 Frame=5 Station=0.249999976158142 OutputCase=ENVE CaseType=Combination StepType=Min Point=0 X2=0
 X3=0 S11=-240.528987364648 IsS11Max=No IsS11Min=No FrameElem=5 ElemStation=0.249999976158142
 Frame=5 Station=0.249999976158142 OutputCase=ENVE CaseType=Combination StepType=Min Point=1 X2=-0.5
 X3=-0.5 S11=1438.21135639676 IsS11Max=Yes IsS11Min=No FrameElem=5 ElemStation=0.249999976158142
 Frame=5 Station=0.249999976158142 OutputCase=ENVE CaseType=Combination StepType=Min Point=2 X2=-0.5
 X3=0.5 S11=1438.21135639676 IsS11Max=No IsS11Min=No FrameElem=5 ElemStation=0.249999976158142
 Frame=5 Station=0.249999976158142 OutputCase=ENVE CaseType=Combination StepType=Min Point=3 X2=0.5
 X3=-0.5 S11=-2005.73642237079 IsS11Max=No IsS11Min=Yes FrameElem=5 ElemStation=0.249999976158142
 Frame=5 Station=0.249999976158142 OutputCase=ENVE CaseType=Combination StepType=Min Point=4 X2=0.5
 X3=0.5 S11=-2005.73642237079 IsS11Max=No IsS11Min=No FrameElem=5 ElemStation=0.249999976158142
 Frame=5 Station=0 OutputCase=FESSUR CaseType=Combination Point=0 X2=0 X3=0 S11=-239.151922837246
 IsS11Max=No IsS11Min=No FrameElem=5 ElemStation=0
 Frame=5 Station=0 OutputCase=FESSUR CaseType=Combination Point=1 X2=-0.5 X3=-0.5
 S11=776.67102717314 IsS11Max=Yes IsS11Min=No FrameElem=5 ElemStation=0
 Frame=5 Station=0 OutputCase=FESSUR CaseType=Combination Point=2 X2=-0.5 X3=0.5 S11=776.67102717314
 IsS11Max=No IsS11Min=No FrameElem=5 ElemStation=0
 Frame=5 Station=0 OutputCase=FESSUR CaseType=Combination Point=3 X2=0.5 X3=-0.5 S11=-
 1254.97487284763 IsS11Max=No IsS11Min=Yes FrameElem=5 ElemStation=0
 Frame=5 Station=0 OutputCase=FESSUR CaseType=Combination Point=4 X2=0.5 X3=0.5 S11=-
 1254.97487284763 IsS11Max=No IsS11Min=No FrameElem=5 ElemStation=0
 Frame=5 Station=6.24999940395355E-02 OutputCase=FESSUR CaseType=Combination Point=0 X2=0 X3=0 S11=-
 239.151922837246 IsS11Max=No IsS11Min=No FrameElem=5 ElemStation=6.24999940395355E-02
 Frame=5 Station=6.24999940395355E-02 OutputCase=FESSUR CaseType=Combination Point=1 X2=-0.5 X3=-0.5
 S11=961.503803394036 IsS11Max=Yes IsS11Min=No FrameElem=5 ElemStation=6.24999940395355E-02
 Frame=5 Station=6.24999940395355E-02 OutputCase=FESSUR CaseType=Combination Point=2 X2=-0.5 X3=0.5
 S11=961.503803394036 IsS11Max=No IsS11Min=No FrameElem=5 ElemStation=6.24999940395355E-02
 Frame=5 Station=6.24999940395355E-02 OutputCase=FESSUR CaseType=Combination Point=3 X2=0.5 X3=-0.5
 S11=-1439.80764906853 IsS11Max=No IsS11Min=Yes FrameElem=5 ElemStation=6.24999940395355E-02
 Frame=5 Station=6.24999940395355E-02 OutputCase=FESSUR CaseType=Combination Point=4 X2=0.5 X3=0.5
 S11=-1439.80764906853 IsS11Max=No IsS11Min=No FrameElem=5 ElemStation=6.24999940395355E-02
 Frame=5 Station=0.124999988079071 OutputCase=FESSUR CaseType=Combination Point=0 X2=0 X3=0 S11=-
 239.151922837246 IsS11Max=No IsS11Min=No FrameElem=5 ElemStation=0.124999988079071
 Frame=5 Station=0.124999988079071 OutputCase=FESSUR CaseType=Combination Point=1 X2=-0.5 X3=-0.5
 S11=1145.75064222669 IsS11Max=Yes IsS11Min=No FrameElem=5 ElemStation=0.124999988079071
 Frame=5 Station=0.124999988079071 OutputCase=FESSUR CaseType=Combination Point=2 X2=-0.5 X3=0.5
 S11=1145.75064222669 IsS11Max=No IsS11Min=No FrameElem=5 ElemStation=0.124999988079071
 Frame=5 Station=0.124999988079071 OutputCase=FESSUR CaseType=Combination Point=3 X2=0.5 X3=-0.5
 S11=-1624.05448790118 IsS11Max=No IsS11Min=Yes FrameElem=5 ElemStation=0.124999988079071
 Frame=5 Station=0.124999988079071 OutputCase=FESSUR CaseType=Combination Point=4 X2=0.5 X3=0.5
 S11=-1624.05448790118 IsS11Max=No IsS11Min=No FrameElem=5 ElemStation=0.124999988079071
 Frame=5 Station=0.187499982118607 OutputCase=FESSUR CaseType=Combination Point=0 X2=0 X3=0 S11=-
 239.151922837246 IsS11Max=No IsS11Min=No FrameElem=5 ElemStation=0.187499982118607
 Frame=5 Station=0.187499982118607 OutputCase=FESSUR CaseType=Combination Point=1 X2=-0.5 X3=-0.5
 S11=1329.4115436711 IsS11Max=Yes IsS11Min=No FrameElem=5 ElemStation=0.187499982118607
 Frame=5 Station=0.187499982118607 OutputCase=FESSUR CaseType=Combination Point=2 X2=-0.5 X3=0.5
 S11=1329.4115436711 IsS11Max=No IsS11Min=No FrameElem=5 ElemStation=0.187499982118607
 Frame=5 Station=0.187499982118607 OutputCase=FESSUR CaseType=Combination Point=3 X2=0.5 X3=-0.5
 S11=-1807.7153893456 IsS11Max=No IsS11Min=Yes FrameElem=5 ElemStation=0.187499982118607
 Frame=5 Station=0.187499982118607 OutputCase=FESSUR CaseType=Combination Point=4 X2=0.5 X3=0.5
 S11=-1807.7153893456 IsS11Max=No IsS11Min=No FrameElem=5 ElemStation=0.187499982118607
 Frame=5 Station=0.249999976158142 OutputCase=FESSUR CaseType=Combination Point=0 X2=0 X3=0 S11=-
 239.151922837246 IsS11Max=No IsS11Min=No FrameElem=5 ElemStation=0.249999976158142
 Frame=5 Station=0.249999976158142 OutputCase=FESSUR CaseType=Combination Point=1 X2=-0.5 X3=-0.5
 S11=1512.48650772728 IsS11Max=Yes IsS11Min=No FrameElem=5 ElemStation=0.249999976158142
 Frame=5 Station=0.249999976158142 OutputCase=FESSUR CaseType=Combination Point=2 X2=-0.5 X3=0.5
 S11=1512.48650772728 IsS11Max=No IsS11Min=No FrameElem=5 ElemStation=0.249999976158142
 Frame=5 Station=0.249999976158142 OutputCase=FESSUR CaseType=Combination Point=3 X2=0.5 X3=-0.5
 S11=-1990.79035340177 IsS11Max=No IsS11Min=Yes FrameElem=5 ElemStation=0.249999976158142
 Frame=5 Station=0.249999976158142 OutputCase=FESSUR CaseType=Combination Point=4 X2=0.5 X3=0.5
 S11=-1990.79035340177 IsS11Max=No IsS11Min=No FrameElem=5 ElemStation=0.249999976158142
 Frame=6 Station=0 OutputCase=PERM1 CaseType=Combination Point=0 X2=0 X3=0 S11=-501.24999658045
 IsS11Max=No IsS11Min=No FrameElem=6 ElemStation=0
 Frame=6 Station=0 OutputCase=PERM1 CaseType=Combination Point=1 X2=-0.5 X3=-0.5 S11=-
 1959.93483833448 IsS11Max=No IsS11Min=Yes FrameElem=6 ElemStation=0
 Frame=6 Station=0 OutputCase=PERM1 CaseType=Combination Point=2 X2=-0.5 X3=0.5 S11=-
 1959.93483833448 IsS11Max=No IsS11Min=No FrameElem=6 ElemStation=0
 Frame=6 Station=0 OutputCase=PERM1 CaseType=Combination Point=3 X2=0.5 X3=-0.5 S11=957.43484517358
 IsS11Max=Yes IsS11Min=No FrameElem=6 ElemStation=0
 Frame=6 Station=0 OutputCase=PERM1 CaseType=Combination Point=4 X2=0.5 X3=0.5 S11=957.43484517358
 IsS11Max=No IsS11Min=No FrameElem=6 ElemStation=0
 Frame=6 Station=0.25 OutputCase=PERM1 CaseType=Combination Point=0 X2=0 X3=0 S11=-494.99999658045
 IsS11Max=No IsS11Min=No FrameElem=6 ElemStation=0.25
 Frame=6 Station=0.25 OutputCase=PERM1 CaseType=Combination Point=1 X2=-0.5 X3=-0.5 S11=-
 1728.05023460646 IsS11Max=No IsS11Min=Yes FrameElem=6 ElemStation=0.25
 Frame=6 Station=0.25 OutputCase=PERM1 CaseType=Combination Point=2 X2=-0.5 X3=0.5 S11=-
 1728.05023460646 IsS11Max=No IsS11Min=No FrameElem=6 ElemStation=0.25
 Frame=6 Station=0.25 OutputCase=PERM1 CaseType=Combination Point=3 X2=0.5 X3=-0.5
 S11=738.050241445561 IsS11Max=Yes IsS11Min=No FrameElem=6 ElemStation=0.25

Frame=6 Station=0.25 OutputCase=PERM1 CaseType=Combination Point=4 X2=0.5 X3=0.5
S11=738.050241445561 IsS11Max=No IsS11Min=No FrameElem=6 ElemStation=0.25
Frame=6 Station=0 OutputCase=PERM2 CaseType=Combination Point=0 X2=0 X3=0 S11=-501.249996306439
IsS11Max=No IsS11Min=No FrameElem=6 ElemStation=0
Frame=6 Station=0 OutputCase=PERM2 CaseType=Combination Point=1 X2=-0.5 X3=-0.5 S11=-
1945.45256576457 IsS11Max=No IsS11Min=Yes FrameElem=6 ElemStation=0
Frame=6 Station=0 OutputCase=PERM2 CaseType=Combination Point=2 X2=-0.5 X3=0.5 S11=-
1945.45256576457 IsS11Max=No IsS11Min=No FrameElem=6 ElemStation=0
Frame=6 Station=0 OutputCase=PERM2 CaseType=Combination Point=3 X2=0.5 X3=-0.5 S11=942.952573151696
IsS11Max=Yes IsS11Min=No FrameElem=6 ElemStation=0
Frame=6 Station=0 OutputCase=PERM2 CaseType=Combination Point=4 X2=0.5 X3=0.5 S11=942.952573151696
IsS11Max=No IsS11Min=No FrameElem=6 ElemStation=0
Frame=6 Station=0.25 OutputCase=PERM2 CaseType=Combination Point=0 X2=0 X3=0 S11=-494.999996306439
IsS11Max=No IsS11Min=No FrameElem=6 ElemStation=0.25
Frame=6 Station=0.25 OutputCase=PERM2 CaseType=Combination Point=1 X2=-0.5 X3=-0.5 S11=-
1774.79574615373 IsS11Max=No IsS11Min=Yes FrameElem=6 ElemStation=0.25
Frame=6 Station=0.25 OutputCase=PERM2 CaseType=Combination Point=2 X2=-0.5 X3=0.5 S11=-
1774.79574615373 IsS11Max=No IsS11Min=No FrameElem=6 ElemStation=0.25
Frame=6 Station=0.25 OutputCase=PERM2 CaseType=Combination Point=3 X2=0.5 X3=-0.5
S11=784.79575354085 IsS11Max=Yes IsS11Min=No FrameElem=6 ElemStation=0.25
Frame=6 Station=0.25 OutputCase=PERM2 CaseType=Combination Point=4 X2=0.5 X3=0.5
S11=784.79575354085 IsS11Max=No IsS11Min=No FrameElem=6 ElemStation=0.25
Frame=6 Station=0 OutputCase=ACC1 CaseType=Combination Point=0 X2=0 X3=0 S11=-514.799996481456
IsS11Max=No IsS11Min=No FrameElem=6 ElemStation=0
Frame=6 Station=0 OutputCase=ACC1 CaseType=Combination Point=1 X2=-0.5 X3=-0.5 S11=-
2012.26265734223 IsS11Max=No IsS11Min=Yes FrameElem=6 ElemStation=0
Frame=6 Station=0 OutputCase=ACC1 CaseType=Combination Point=2 X2=-0.5 X3=0.5 S11=-2012.26265734223
IsS11Max=No IsS11Min=No FrameElem=6 ElemStation=0
Frame=6 Station=0 OutputCase=ACC1 CaseType=Combination Point=3 X2=0.5 X3=-0.5 S11=982.662664379322
IsS11Max=Yes IsS11Min=No FrameElem=6 ElemStation=0
Frame=6 Station=0 OutputCase=ACC1 CaseType=Combination Point=4 X2=0.5 X3=0.5 S11=982.662664379322
IsS11Max=No IsS11Min=No FrameElem=6 ElemStation=0
Frame=6 Station=0.25 OutputCase=ACC1 CaseType=Combination Point=0 X2=0 X3=0 S11=-508.549996481456
IsS11Max=No IsS11Min=No FrameElem=6 ElemStation=0.25
Frame=6 Station=0.25 OutputCase=ACC1 CaseType=Combination Point=1 X2=-0.5 X3=-0.5 S11=-
1774.7921059772 IsS11Max=No IsS11Min=Yes FrameElem=6 ElemStation=0.25
Frame=6 Station=0.25 OutputCase=ACC1 CaseType=Combination Point=2 X2=-0.5 X3=0.5 S11=-
1774.7921059772 IsS11Max=No IsS11Min=No FrameElem=6 ElemStation=0.25
Frame=6 Station=0.25 OutputCase=ACC1 CaseType=Combination Point=3 X2=0.5 X3=-0.5
S11=757.692113014288 IsS11Max=Yes IsS11Min=No FrameElem=6 ElemStation=0.25
Frame=6 Station=0.25 OutputCase=ACC1 CaseType=Combination Point=4 X2=0.5 X3=0.5
S11=757.692113014288 IsS11Max=No IsS11Min=No FrameElem=6 ElemStation=0.25
Frame=6 Station=0 OutputCase=ACC2 CaseType=Combination Point=0 X2=0 X3=0 S11=-514.799996207445
IsS11Max=No IsS11Min=No FrameElem=6 ElemStation=0
Frame=6 Station=0 OutputCase=ACC2 CaseType=Combination Point=1 X2=-0.5 X3=-0.5 S11=-
1997.78038477233 IsS11Max=No IsS11Min=Yes FrameElem=6 ElemStation=0
Frame=6 Station=0 OutputCase=ACC2 CaseType=Combination Point=2 X2=-0.5 X3=0.5 S11=-1997.78038477233
IsS11Max=No IsS11Min=No FrameElem=6 ElemStation=0
Frame=6 Station=0 OutputCase=ACC2 CaseType=Combination Point=3 X2=0.5 X3=-0.5 S11=968.180392357438
IsS11Max=Yes IsS11Min=No FrameElem=6 ElemStation=0
Frame=6 Station=0 OutputCase=ACC2 CaseType=Combination Point=4 X2=0.5 X3=0.5 S11=968.180392357438
IsS11Max=No IsS11Min=No FrameElem=6 ElemStation=0
Frame=6 Station=0.25 OutputCase=ACC2 CaseType=Combination Point=0 X2=0 X3=0 S11=-508.549996207445
IsS11Max=No IsS11Min=No FrameElem=6 ElemStation=0.25
Frame=6 Station=0.25 OutputCase=ACC2 CaseType=Combination Point=1 X2=-0.5 X3=-0.5 S11=-
1821.53761752447 IsS11Max=No IsS11Min=Yes FrameElem=6 ElemStation=0.25
Frame=6 Station=0.25 OutputCase=ACC2 CaseType=Combination Point=2 X2=-0.5 X3=0.5 S11=-
1821.53761752447 IsS11Max=No IsS11Min=No FrameElem=6 ElemStation=0.25
Frame=6 Station=0.25 OutputCase=ACC2 CaseType=Combination Point=3 X2=0.5 X3=-0.5
S11=804.437625109577 IsS11Max=Yes IsS11Min=No FrameElem=6 ElemStation=0.25
Frame=6 Station=0.25 OutputCase=ACC2 CaseType=Combination Point=4 X2=0.5 X3=0.5
S11=804.437625109577 IsS11Max=No IsS11Min=No FrameElem=6 ElemStation=0.25
Frame=6 Station=0 OutputCase=ACCSX1 CaseType=Combination Point=0 X2=0 X3=0 S11=-502.76407418589
IsS11Max=No IsS11Min=No FrameElem=6 ElemStation=0
Frame=6 Station=0 OutputCase=ACCSX1 CaseType=Combination Point=1 X2=-0.5 X3=-0.5 S11=-
1936.69226041424 IsS11Max=No IsS11Min=Yes FrameElem=6 ElemStation=0
Frame=6 Station=0 OutputCase=ACCSX1 CaseType=Combination Point=2 X2=-0.5 X3=0.5 S11=-
1936.69226041424 IsS11Max=No IsS11Min=No FrameElem=6 ElemStation=0
Frame=6 Station=0 OutputCase=ACCSX1 CaseType=Combination Point=3 X2=0.5 X3=-0.5
S11=931.164112042461 IsS11Max=Yes IsS11Min=No FrameElem=6 ElemStation=0
Frame=6 Station=0 OutputCase=ACCSX1 CaseType=Combination Point=4 X2=0.5 X3=0.5 S11=931.164112042461
IsS11Max=No IsS11Min=No FrameElem=6 ElemStation=0
Frame=6 Station=0.25 OutputCase=ACCSX1 CaseType=Combination Point=0 X2=0 X3=0 S11=-496.51407418589
IsS11Max=No IsS11Min=No FrameElem=6 ElemStation=0.25
Frame=6 Station=0.25 OutputCase=ACCSX1 CaseType=Combination Point=1 X2=-0.5 X3=-0.5 S11=-
1708.2168536725 IsS11Max=No IsS11Min=Yes FrameElem=6 ElemStation=0.25
Frame=6 Station=0.25 OutputCase=ACCSX1 CaseType=Combination Point=2 X2=-0.5 X3=0.5 S11=-
1708.2168536725 IsS11Max=No IsS11Min=No FrameElem=6 ElemStation=0.25
Frame=6 Station=0.25 OutputCase=ACCSX1 CaseType=Combination Point=3 X2=0.5 X3=-0.5
S11=715.188705300725 IsS11Max=Yes IsS11Min=No FrameElem=6 ElemStation=0.25
Frame=6 Station=0.25 OutputCase=ACCSX1 CaseType=Combination Point=4 X2=0.5 X3=0.5
S11=715.188705300725 IsS11Max=No IsS11Min=No FrameElem=6 ElemStation=0.25

Frame=6	Station=0	OutputCase=ACCSX2	CaseType=Combination	Point=0	X2=0	X3=0	S11=-502.764073911878	
IsS11Max=No	IsS11Min=No	FrameElem=6	ElemStation=0					
Frame=6	Station=0	OutputCase=ACCSX2	CaseType=Combination	Point=1	X2=-0.5	X3=-0.5	S11=-	
1922.20998784433	IsS11Max=No	IsS11Min=Yes	FrameElem=6	ElemStation=0				
Frame=6	Station=0	OutputCase=ACCSX2	CaseType=Combination	Point=2	X2=-0.5	X3=0.5	S11=-	
1922.20998784433	IsS11Max=No	IsS11Min=No	FrameElem=6	ElemStation=0				
Frame=6	Station=0	OutputCase=ACCSX2	CaseType=Combination	Point=3	X2=0.5	X3=-0.5		
S11=916.681840020577	IsS11Max=Yes	IsS11Min=No	FrameElem=6	ElemStation=0				
Frame=6	Station=0	OutputCase=ACCSX2	CaseType=Combination	Point=4	X2=0.5	X3=0.5	S11=916.681840020577	
IsS11Max=No	IsS11Min=No	FrameElem=6	ElemStation=0					
Frame=6	Station=0.25	OutputCase=ACCSX2	CaseType=Combination	Point=0	X2=0	X3=0	S11=-496.514073911878	
IsS11Max=No	IsS11Min=No	FrameElem=6	ElemStation=0.25					
Frame=6	Station=0.25	OutputCase=ACCSX2	CaseType=Combination	Point=1	X2=-0.5	X3=-0.5	S11=-	
1754.96236521977	IsS11Max=No	IsS11Min=Yes	FrameElem=6	ElemStation=0.25				
Frame=6	Station=0.25	OutputCase=ACCSX2	CaseType=Combination	Point=2	X2=-0.5	X3=0.5	S11=-	
1754.96236521977	IsS11Max=No	IsS11Min=No	FrameElem=6	ElemStation=0.25				
Frame=6	Station=0.25	OutputCase=ACCSX2	CaseType=Combination	Point=3	X2=0.5	X3=-0.5		
S11=761.934217396014	IsS11Max=Yes	IsS11Min=No	FrameElem=6	ElemStation=0.25				
Frame=6	Station=0.25	OutputCase=ACCSX2	CaseType=Combination	Point=4	X2=0.5	X3=0.5		
S11=761.934217396014	IsS11Max=No	IsS11Min=No	FrameElem=6	ElemStation=0.25				
Frame=6	Station=0	OutputCase=ENVE	CaseType=Combination	StepType=Max	Point=0	X2=0	X3=0	S11=-
501.249996306439	IsS11Max=No	IsS11Min=No	FrameElem=6	ElemStation=0				
Frame=6	Station=0	OutputCase=ENVE	CaseType=Combination	StepType=Max	Point=1	X2=-0.5	X3=-0.5	S11=-
1922.20998784433	IsS11Max=No	IsS11Min=Yes	FrameElem=6	ElemStation=0				
Frame=6	Station=0	OutputCase=ENVE	CaseType=Combination	StepType=Max	Point=2	X2=-0.5	X3=0.5	S11=-
1922.20998784433	IsS11Max=No	IsS11Min=No	FrameElem=6	ElemStation=0				
Frame=6	Station=0	OutputCase=ENVE	CaseType=Combination	StepType=Max	Point=3	X2=0.5	X3=-0.5	
S11=982.662664379322	IsS11Max=Yes	IsS11Min=No	FrameElem=6	ElemStation=0				
Frame=6	Station=0	OutputCase=ENVE	CaseType=Combination	StepType=Max	Point=4	X2=0.5	X3=0.5	
S11=982.662664379322	IsS11Max=No	IsS11Min=No	FrameElem=6	ElemStation=0				
Frame=6	Station=0.25	OutputCase=ENVE	CaseType=Combination	StepType=Max	Point=0	X2=0	X3=0	S11=-
494.999996306439	IsS11Max=No	IsS11Min=No	FrameElem=6	ElemStation=0.25				
Frame=6	Station=0.25	OutputCase=ENVE	CaseType=Combination	StepType=Max	Point=1	X2=-0.5	X3=-0.5	
S11=-1708.2168536725	IsS11Max=No	IsS11Min=Yes	FrameElem=6	ElemStation=0.25				
Frame=6	Station=0.25	OutputCase=ENVE	CaseType=Combination	StepType=Max	Point=2	X2=-0.5	X3=0.5	
S11=-1708.2168536725	IsS11Max=No	IsS11Min=No	FrameElem=6	ElemStation=0.25				
Frame=6	Station=0.25	OutputCase=ENVE	CaseType=Combination	StepType=Max	Point=3	X2=0.5	X3=-0.5	
S11=804.437625109577	IsS11Max=Yes	IsS11Min=No	FrameElem=6	ElemStation=0.25				
Frame=6	Station=0.25	OutputCase=ENVE	CaseType=Combination	StepType=Max	Point=4	X2=0.5	X3=0.5	
S11=804.437625109577	IsS11Max=No	IsS11Min=No	FrameElem=6	ElemStation=0.25				
Frame=6	Station=0	OutputCase=ENVE	CaseType=Combination	StepType=Min	Point=0	X2=0	X3=0	S11=-
514.799996481456	IsS11Max=No	IsS11Min=No	FrameElem=6	ElemStation=0				
Frame=6	Station=0	OutputCase=ENVE	CaseType=Combination	StepType=Min	Point=1	X2=-0.5	X3=-0.5	S11=-
2012.26265734223	IsS11Max=No	IsS11Min=Yes	FrameElem=6	ElemStation=0				
Frame=6	Station=0	OutputCase=ENVE	CaseType=Combination	StepType=Min	Point=2	X2=-0.5	X3=0.5	S11=-
2012.26265734223	IsS11Max=No	IsS11Min=No	FrameElem=6	ElemStation=0				
Frame=6	Station=0	OutputCase=ENVE	CaseType=Combination	StepType=Min	Point=3	X2=0.5	X3=-0.5	
S11=916.681840020577	IsS11Max=Yes	IsS11Min=No	FrameElem=6	ElemStation=0				
Frame=6	Station=0	OutputCase=ENVE	CaseType=Combination	StepType=Min	Point=4	X2=0.5	X3=0.5	
S11=916.681840020577	IsS11Max=No	IsS11Min=No	FrameElem=6	ElemStation=0				
Frame=6	Station=0.25	OutputCase=ENVE	CaseType=Combination	StepType=Min	Point=0	X2=0	X3=0	S11=-
508.549996481456	IsS11Max=No	IsS11Min=No	FrameElem=6	ElemStation=0.25				
Frame=6	Station=0.25	OutputCase=ENVE	CaseType=Combination	StepType=Min	Point=1	X2=-0.5	X3=-0.5	
S11=-1821.53761752447	IsS11Max=No	IsS11Min=Yes	FrameElem=6	ElemStation=0.25				
Frame=6	Station=0.25	OutputCase=ENVE	CaseType=Combination	StepType=Min	Point=2	X2=-0.5	X3=0.5	
S11=-1821.53761752447	IsS11Max=No	IsS11Min=No	FrameElem=6	ElemStation=0.25				
Frame=6	Station=0.25	OutputCase=ENVE	CaseType=Combination	StepType=Min	Point=3	X2=0.5	X3=-0.5	
S11=715.188705300725	IsS11Max=Yes	IsS11Min=No	FrameElem=6	ElemStation=0.25				
Frame=6	Station=0.25	OutputCase=ENVE	CaseType=Combination	StepType=Min	Point=4	X2=0.5	X3=0.5	
S11=715.188705300725	IsS11Max=No	IsS11Min=No	FrameElem=6	ElemStation=0.25				
Frame=6	Station=0	OutputCase=FESSUR	CaseType=Combination	Point=0	X2=0	X3=0	S11=-510.734996511154	
IsS11Max=No	IsS11Min=No	FrameElem=6	ElemStation=0					
Frame=6	Station=0	OutputCase=FESSUR	CaseType=Combination	Point=1	X2=-0.5	X3=-0.5	S11=-	
1996.56431163991	IsS11Max=No	IsS11Min=Yes	FrameElem=6	ElemStation=0				
Frame=6	Station=0	OutputCase=FESSUR	CaseType=Combination	Point=2	X2=-0.5	X3=0.5	S11=-	
1996.56431163991	IsS11Max=No	IsS11Min=No	FrameElem=6	ElemStation=0				
Frame=6	Station=0	OutputCase=FESSUR	CaseType=Combination	Point=3	X2=0.5	X3=-0.5		
S11=975.094318617599	IsS11Max=Yes	IsS11Min=No	FrameElem=6	ElemStation=0				
Frame=6	Station=0	OutputCase=FESSUR	CaseType=Combination	Point=4	X2=0.5	X3=0.5	S11=975.094318617599	
IsS11Max=No	IsS11Min=No	FrameElem=6	ElemStation=0					
Frame=6	Station=0.25	OutputCase=FESSUR	CaseType=Combination	Point=0	X2=0	X3=0	S11=-504.484996511154	
IsS11Max=No	IsS11Min=No	FrameElem=6	ElemStation=0.25					
Frame=6	Station=0.25	OutputCase=FESSUR	CaseType=Combination	Point=1	X2=-0.5	X3=-0.5	S11=-	
1760.76954456598	IsS11Max=No	IsS11Min=Yes	FrameElem=6	ElemStation=0.25				
Frame=6	Station=0.25	OutputCase=FESSUR	CaseType=Combination	Point=2	X2=-0.5	X3=0.5	S11=-	
1760.76954456598	IsS11Max=No	IsS11Min=No	FrameElem=6	ElemStation=0.25				
Frame=6	Station=0.25	OutputCase=FESSUR	CaseType=Combination	Point=3	X2=0.5	X3=-0.5		
S11=751.79955154367	IsS11Max=Yes	IsS11Min=No	FrameElem=6	ElemStation=0.25				
Frame=6	Station=0.25	OutputCase=FESSUR	CaseType=Combination	Point=4	X2=0.5	X3=0.5		
S11=751.79955154367	IsS11Max=No	IsS11Min=No	FrameElem=6	ElemStation=0.25				
Frame=9	Station=0	OutputCase=PERM1	CaseType=Combination	Point=0	X2=0	X3=0	S11=-419.999986873483	
IsS11Max=No	IsS11Min=No	FrameElem=9	ElemStation=0					



Frame=9 Station=0 OutputCase=PERM1 CaseType=Combination Point=1 X2=-0.5 X3=-0.5 S11=-
 1435.76163136124 IsS11Max=No IsS11Min=Yes FrameElem=9 ElemStation=0
 Frame=9 Station=0 OutputCase=PERM1 CaseType=Combination Point=2 X2=-0.5 X3=0.5 S11=-
 1435.76163136124 IsS11Max=No IsS11Min=No FrameElem=9 ElemStation=0
 Frame=9 Station=0 OutputCase=PERM1 CaseType=Combination Point=3 X2=0.5 X3=-0.5 S11=595.761657614272
 IsS11Max=Yes IsS11Min=No FrameElem=9 ElemStation=0
 Frame=9 Station=0 OutputCase=PERM1 CaseType=Combination Point=4 X2=0.5 X3=0.5 S11=595.761657614272
 IsS11Max=No IsS11Min=No FrameElem=9 ElemStation=0
 Frame=9 Station=0.250000000000002 OutputCase=PERM1 CaseType=Combination Point=0 X2=0 X3=0 S11=-
 413.749985292582 IsS11Max=No IsS11Min=No FrameElem=9 ElemStation=0.250000000000002
 Frame=9 Station=0.250000000000002 OutputCase=PERM1 CaseType=Combination Point=1 X2=-0.5 X3=-0.5
 S11=-1594.6814601912 IsS11Max=No IsS11Min=Yes FrameElem=9 ElemStation=0.250000000000002
 Frame=9 Station=0.250000000000002 OutputCase=PERM1 CaseType=Combination Point=2 X2=-0.5 X3=0.5
 S11=-1594.6814601912 IsS11Max=No IsS11Min=No FrameElem=9 ElemStation=0.250000000000002
 Frame=9 Station=0.250000000000002 OutputCase=PERM1 CaseType=Combination Point=3 X2=0.5 X3=-0.5
 S11=767.18148960604 IsS11Max=Yes IsS11Min=No FrameElem=9 ElemStation=0.250000000000002
 Frame=9 Station=0.250000000000002 OutputCase=PERM1 CaseType=Combination Point=4 X2=0.5 X3=0.5
 S11=767.18148960604 IsS11Max=No IsS11Min=No FrameElem=9 ElemStation=0.250000000000002
 Frame=9 Station=0 OutputCase=PERM2 CaseType=Combination Point=0 X2=0 X3=0 S11=-419.99998992231
 IsS11Max=No IsS11Min=No FrameElem=9 ElemStation=0
 Frame=9 Station=0 OutputCase=PERM2 CaseType=Combination Point=1 X2=-0.5 X3=-0.5 S11=-
 1470.14254064427 IsS11Max=No IsS11Min=Yes FrameElem=9 ElemStation=0
 Frame=9 Station=0 OutputCase=PERM2 CaseType=Combination Point=2 X2=-0.5 X3=0.5 S11=-
 1470.14254064427 IsS11Max=No IsS11Min=No FrameElem=9 ElemStation=0
 Frame=9 Station=0 OutputCase=PERM2 CaseType=Combination Point=3 X2=0.5 X3=-0.5 S11=630.14256079965
 IsS11Max=Yes IsS11Min=No FrameElem=9 ElemStation=0
 Frame=9 Station=0 OutputCase=PERM2 CaseType=Combination Point=4 X2=0.5 X3=0.5 S11=630.14256079965
 IsS11Max=No IsS11Min=No FrameElem=9 ElemStation=0
 Frame=9 Station=0.250000000000002 OutputCase=PERM2 CaseType=Combination Point=0 X2=0 X3=0 S11=-
 413.749988815679 IsS11Max=No IsS11Min=No FrameElem=9 ElemStation=0.250000000000002
 Frame=9 Station=0.250000000000002 OutputCase=PERM2 CaseType=Combination Point=1 X2=-0.5 X3=-0.5
 S11=-1573.04884171435 IsS11Max=No IsS11Min=Yes FrameElem=9 ElemStation=0.250000000000002
 Frame=9 Station=0.250000000000002 OutputCase=PERM2 CaseType=Combination Point=2 X2=-0.5 X3=0.5
 S11=-1573.04884171435 IsS11Max=No IsS11Min=No FrameElem=9 ElemStation=0.250000000000002
 Frame=9 Station=0.250000000000002 OutputCase=PERM2 CaseType=Combination Point=3 X2=0.5 X3=-0.5
 S11=745.548864082992 IsS11Max=Yes IsS11Min=No FrameElem=9 ElemStation=0.250000000000002
 Frame=9 Station=0.250000000000002 OutputCase=PERM2 CaseType=Combination Point=4 X2=0.5 X3=0.5
 S11=745.548864082992 IsS11Max=No IsS11Min=No FrameElem=9 ElemStation=0.250000000000002
 Frame=9 Station=0 OutputCase=ACC1 CaseType=Combination Point=0 X2=0 X3=0 S11=-433.549986441189
 IsS11Max=No IsS11Min=No FrameElem=9 ElemStation=0
 Frame=9 Station=0 OutputCase=ACC1 CaseType=Combination Point=1 X2=-0.5 X3=-0.5 S11=-
 1483.03962881618 IsS11Max=No IsS11Min=Yes FrameElem=9 ElemStation=0
 Frame=9 Station=0 OutputCase=ACC1 CaseType=Combination Point=2 X2=-0.5 X3=0.5 S11=-1483.03962881618
 IsS11Max=No IsS11Min=No FrameElem=9 ElemStation=0
 Frame=9 Station=0 OutputCase=ACC1 CaseType=Combination Point=3 X2=0.5 X3=-0.5 S11=615.939655933802
 IsS11Max=Yes IsS11Min=No FrameElem=9 ElemStation=0
 Frame=9 Station=0 OutputCase=ACC1 CaseType=Combination Point=4 X2=0.5 X3=0.5 S11=615.939655933802
 IsS11Max=No IsS11Min=No FrameElem=9 ElemStation=0
 Frame=9 Station=0.250000000000002 OutputCase=ACC1 CaseType=Combination Point=0 X2=0 X3=0 S11=-
 427.299984805212 IsS11Max=No IsS11Min=No FrameElem=9 ElemStation=0.250000000000002
 Frame=9 Station=0.250000000000002 OutputCase=ACC1 CaseType=Combination Point=1 X2=-0.5 X3=-0.5
 S11=-1647.6347618924 IsS11Max=No IsS11Min=Yes FrameElem=9 ElemStation=0.250000000000002
 Frame=9 Station=0.250000000000002 OutputCase=ACC1 CaseType=Combination Point=2 X2=-0.5 X3=0.5 S11=-
 1647.6347618924 IsS11Max=No IsS11Min=No FrameElem=9 ElemStation=0.250000000000002
 Frame=9 Station=0.250000000000002 OutputCase=ACC1 CaseType=Combination Point=3 X2=0.5 X3=-0.5
 S11=793.034792281973 IsS11Max=Yes IsS11Min=No FrameElem=9 ElemStation=0.250000000000002
 Frame=9 Station=0.250000000000002 OutputCase=ACC1 CaseType=Combination Point=4 X2=0.5 X3=0.5
 S11=793.034792281973 IsS11Max=No IsS11Min=No FrameElem=9 ElemStation=0.250000000000002
 Frame=9 Station=0 OutputCase=ACC2 CaseType=Combination Point=0 X2=0 X3=0 S11=-433.549989490016
 IsS11Max=No IsS11Min=No FrameElem=9 ElemStation=0
 Frame=9 Station=0 OutputCase=ACC2 CaseType=Combination Point=1 X2=-0.5 X3=-0.5 S11=-
 1517.42053809921 IsS11Max=No IsS11Min=Yes FrameElem=9 ElemStation=0
 Frame=9 Station=0 OutputCase=ACC2 CaseType=Combination Point=2 X2=-0.5 X3=0.5 S11=-1517.42053809921
 IsS11Max=No IsS11Min=No FrameElem=9 ElemStation=0
 Frame=9 Station=0 OutputCase=ACC2 CaseType=Combination Point=3 X2=0.5 X3=-0.5 S11=650.32055911918
 IsS11Max=Yes IsS11Min=No FrameElem=9 ElemStation=0
 Frame=9 Station=0 OutputCase=ACC2 CaseType=Combination Point=4 X2=0.5 X3=0.5 S11=650.32055911918
 IsS11Max=No IsS11Min=No FrameElem=9 ElemStation=0
 Frame=9 Station=0.250000000000002 OutputCase=ACC2 CaseType=Combination Point=0 X2=0 X3=0 S11=-
 427.29998832831 IsS11Max=No IsS11Min=No FrameElem=9 ElemStation=0.250000000000002
 Frame=9 Station=0.250000000000002 OutputCase=ACC2 CaseType=Combination Point=1 X2=-0.5 X3=-0.5
 S11=-1626.00214341554 IsS11Max=No IsS11Min=Yes FrameElem=9 ElemStation=0.250000000000002
 Frame=9 Station=0.250000000000002 OutputCase=ACC2 CaseType=Combination Point=2 X2=-0.5 X3=0.5 S11=-
 1626.00214341554 IsS11Max=No IsS11Min=No FrameElem=9 ElemStation=0.250000000000002
 Frame=9 Station=0.250000000000002 OutputCase=ACC2 CaseType=Combination Point=3 X2=0.5 X3=-0.5
 S11=771.402166758924 IsS11Max=Yes IsS11Min=No FrameElem=9 ElemStation=0.250000000000002
 Frame=9 Station=0.250000000000002 OutputCase=ACC2 CaseType=Combination Point=4 X2=0.5 X3=0.5
 S11=771.402166758924 IsS11Max=No IsS11Min=No FrameElem=9 ElemStation=0.250000000000002
 Frame=9 Station=0 OutputCase=ACCSX1 CaseType=Combination Point=0 X2=0 X3=0 S11=-421.514064262161
 IsS11Max=No IsS11Min=No FrameElem=9 ElemStation=0
 Frame=9 Station=0 OutputCase=ACCSX1 CaseType=Combination Point=1 X2=-0.5 X3=-0.5 S11=-
 1456.83861382936 IsS11Max=No IsS11Min=Yes FrameElem=9 ElemStation=0

Frame=9 Station=0 OutputCase=ACCSX1 CaseType=Combination Point=2 X2=-0.5 X3=0.5 S11=-
1456.83861382936 IsS11Max=No IsS11Min=No FrameElem=9 ElemStation=0
Frame=9 Station=0 OutputCase=ACCSX1 CaseType=Combination Point=3 X2=0.5 X3=-0.5
S11=613.810485305034 IsS11Max=No IsS11Min=No FrameElem=9 ElemStation=0
Frame=9 Station=0 OutputCase=ACCSX1 CaseType=Combination Point=4 X2=0.5 X3=0.5 S11=613.810485305034
IsS11Max=No IsS11Min=No FrameElem=9 ElemStation=0
Frame=9 Station=0.250000000000002 OutputCase=ACCSX1 CaseType=Combination Point=0 X2=0 X3=0 S11=-
415.264062681259 IsS11Max=No IsS11Min=No FrameElem=9 ElemStation=0.250000000000002
Frame=9 Station=0.250000000000002 OutputCase=ACCSX1 CaseType=Combination Point=1 X2=-0.5 X3=-0.5
S11=-1619.16763986219 IsS11Max=No IsS11Min=Yes FrameElem=9 ElemStation=0.250000000000002
Frame=9 Station=0.250000000000002 OutputCase=ACCSX1 CaseType=Combination Point=2 X2=-0.5 X3=0.5
S11=-1619.16763986219 IsS11Max=No IsS11Min=No FrameElem=9 ElemStation=0.250000000000002
Frame=9 Station=0.250000000000002 OutputCase=ACCSX1 CaseType=Combination Point=3 X2=0.5 X3=-0.5
S11=788.63951449967 IsS11Max=Yes IsS11Min=No FrameElem=9 ElemStation=0.250000000000002
Frame=9 Station=0.250000000000002 OutputCase=ACCSX1 CaseType=Combination Point=4 X2=0.5 X3=0.5
S11=788.63951449967 IsS11Max=No IsS11Min=No FrameElem=9 ElemStation=0.250000000000002
Frame=9 Station=0 OutputCase=ACCSX2 CaseType=Combination Point=0 X2=0 X3=0 S11=-421.514067310988
IsS11Max=No IsS11Min=No FrameElem=9 ElemStation=0
Frame=9 Station=0 OutputCase=ACCSX2 CaseType=Combination Point=1 X2=-0.5 X3=-0.5 S11=-
1491.21952311239 IsS11Max=No IsS11Min=Yes FrameElem=9 ElemStation=0
Frame=9 Station=0 OutputCase=ACCSX2 CaseType=Combination Point=2 X2=-0.5 X3=0.5 S11=-
1491.21952311239 IsS11Max=No IsS11Min=No FrameElem=9 ElemStation=0
Frame=9 Station=0 OutputCase=ACCSX2 CaseType=Combination Point=3 X2=0.5 X3=-0.5
S11=648.191388490411 IsS11Max=Yes IsS11Min=No FrameElem=9 ElemStation=0
Frame=9 Station=0 OutputCase=ACCSX2 CaseType=Combination Point=4 X2=0.5 X3=0.5 S11=648.191388490411
IsS11Max=No IsS11Min=No FrameElem=9 ElemStation=0
Frame=9 Station=0.250000000000002 OutputCase=ACCSX2 CaseType=Combination Point=0 X2=0 X3=0 S11=-
415.264066204357 IsS11Max=No IsS11Min=No FrameElem=9 ElemStation=0.250000000000002
Frame=9 Station=0.250000000000002 OutputCase=ACCSX2 CaseType=Combination Point=1 X2=-0.5 X3=-0.5
S11=-1597.53502138534 IsS11Max=No IsS11Min=Yes FrameElem=9 ElemStation=0.250000000000002
Frame=9 Station=0.250000000000002 OutputCase=ACCSX2 CaseType=Combination Point=2 X2=-0.5 X3=0.5
S11=-1597.53502138534 IsS11Max=No IsS11Min=No FrameElem=9 ElemStation=0.250000000000002
Frame=9 Station=0.250000000000002 OutputCase=ACCSX2 CaseType=Combination Point=3 X2=0.5 X3=-0.5
S11=767.006888976622 IsS11Max=Yes IsS11Min=No FrameElem=9 ElemStation=0.250000000000002
Frame=9 Station=0.250000000000002 OutputCase=ACCSX2 CaseType=Combination Point=4 X2=0.5 X3=0.5
S11=767.006888976622 IsS11Max=No IsS11Min=No FrameElem=9 ElemStation=0.250000000000002
Frame=9 Station=0 OutputCase=ENVE CaseType=Combination StepType=Max Point=0 X2=0 X3=0 S11=-
419.999986873483 IsS11Max=No IsS11Min=No FrameElem=9 ElemStation=0
Frame=9 Station=0 OutputCase=ENVE CaseType=Combination StepType=Max Point=1 X2=-0.5 X3=-0.5 S11=-
1435.76163136124 IsS11Max=No IsS11Min=Yes FrameElem=9 ElemStation=0
Frame=9 Station=0 OutputCase=ENVE CaseType=Combination StepType=Max Point=2 X2=-0.5 X3=0.5 S11=-
1435.76163136124 IsS11Max=No IsS11Min=No FrameElem=9 ElemStation=0
Frame=9 Station=0 OutputCase=ENVE CaseType=Combination StepType=Max Point=3 X2=0.5 X3=-0.5
S11=650.32055911918 IsS11Max=Yes IsS11Min=No FrameElem=9 ElemStation=0
Frame=9 Station=0 OutputCase=ENVE CaseType=Combination StepType=Max Point=4 X2=0.5 X3=0.5
S11=650.32055911918 IsS11Max=No IsS11Min=No FrameElem=9 ElemStation=0
Frame=9 Station=0.250000000000002 OutputCase=ENVE CaseType=Combination StepType=Max Point=0 X2=0
X3=0 S11=-413.749985292582 IsS11Max=No IsS11Min=No FrameElem=9 ElemStation=0.250000000000002
Frame=9 Station=0.250000000000002 OutputCase=ENVE CaseType=Combination StepType=Max Point=1 X2=-0.5
X3=-0.5 S11=-1573.04884171435 IsS11Max=No IsS11Min=Yes FrameElem=9 ElemStation=0.250000000000002
Frame=9 Station=0.250000000000002 OutputCase=ENVE CaseType=Combination StepType=Max Point=2 X2=-0.5
X3=0.5 S11=-1573.04884171435 IsS11Max=No IsS11Min=No FrameElem=9 ElemStation=0.250000000000002
Frame=9 Station=0.250000000000002 OutputCase=ENVE CaseType=Combination StepType=Max Point=3 X2=0.5
X3=-0.5 S11=793.034792281973 IsS11Max=Yes IsS11Min=No FrameElem=9 ElemStation=0.250000000000002
Frame=9 Station=0.250000000000002 OutputCase=ENVE CaseType=Combination StepType=Max Point=4 X2=0.5
X3=0.5 S11=793.034792281973 IsS11Max=No IsS11Min=No FrameElem=9 ElemStation=0.250000000000002
Frame=9 Station=0 OutputCase=ENVE CaseType=Combination StepType=Min Point=0 X2=0 X3=0 S11=-
433.549989490016 IsS11Max=No IsS11Min=No FrameElem=9 ElemStation=0
Frame=9 Station=0 OutputCase=ENVE CaseType=Combination StepType=Min Point=1 X2=-0.5 X3=-0.5 S11=-
1517.42053809921 IsS11Max=No IsS11Min=Yes FrameElem=9 ElemStation=0
Frame=9 Station=0 OutputCase=ENVE CaseType=Combination StepType=Min Point=2 X2=-0.5 X3=0.5 S11=-
1517.42053809921 IsS11Max=No IsS11Min=No FrameElem=9 ElemStation=0
Frame=9 Station=0 OutputCase=ENVE CaseType=Combination StepType=Min Point=3 X2=0.5 X3=-0.5
S11=595.761657614272 IsS11Max=Yes IsS11Min=No FrameElem=9 ElemStation=0
Frame=9 Station=0 OutputCase=ENVE CaseType=Combination StepType=Min Point=4 X2=0.5 X3=0.5
S11=595.761657614272 IsS11Max=No IsS11Min=No FrameElem=9 ElemStation=0
Frame=9 Station=0.250000000000002 OutputCase=ENVE CaseType=Combination StepType=Min Point=0 X2=0
X3=0 S11=-427.29998832831 IsS11Max=No IsS11Min=No FrameElem=9 ElemStation=0.250000000000002
Frame=9 Station=0.250000000000002 OutputCase=ENVE CaseType=Combination StepType=Min Point=1 X2=-0.5
X3=-0.5 S11=-1647.6347618924 IsS11Max=No IsS11Min=Yes FrameElem=9 ElemStation=0.250000000000002
Frame=9 Station=0.250000000000002 OutputCase=ENVE CaseType=Combination StepType=Min Point=2 X2=-0.5
X3=0.5 S11=-1647.6347618924 IsS11Max=No IsS11Min=No FrameElem=9 ElemStation=0.250000000000002
Frame=9 Station=0.250000000000002 OutputCase=ENVE CaseType=Combination StepType=Min Point=3 X2=0.5
X3=-0.5 S11=745.548864082992 IsS11Max=Yes IsS11Min=No FrameElem=9 ElemStation=0.250000000000002
Frame=9 Station=0.250000000000002 OutputCase=ENVE CaseType=Combination StepType=Min Point=4 X2=0.5
X3=0.5 S11=745.548864082992 IsS11Max=No IsS11Min=No FrameElem=9 ElemStation=0.250000000000002
Frame=9 Station=0 OutputCase=FESSUR CaseType=Combination Point=0 X2=0 X3=0 S11=-429.484986570877
IsS11Max=No IsS11Min=No FrameElem=9 ElemStation=0
Frame=9 Station=0 OutputCase=FESSUR CaseType=Combination Point=1 X2=-0.5 X3=-0.5 S11=-
1468.8562295797 IsS11Max=No IsS11Min=Yes FrameElem=9 ElemStation=0
Frame=9 Station=0 OutputCase=FESSUR CaseType=Combination Point=2 X2=-0.5 X3=0.5 S11=-
1468.8562295797 IsS11Max=No IsS11Min=No FrameElem=9 ElemStation=0



Frame=9 Station=0 OutputCase=FESSUR CaseType=Combination Point=3 X2=0.5 X3=-0.5
 S11=609.886256437943 IsS11Max=Yes IsS11Min=No FrameElem=9 ElemStation=0
 Frame=9 Station=0 OutputCase=FESSUR CaseType=Combination Point=4 X2=0.5 X3=0.5 S11=609.886256437943
 IsS11Max=No IsS11Min=No FrameElem=9 ElemStation=0
 Frame=9 Station=0.250000000000002 OutputCase=FESSUR CaseType=Combination Point=0 X2=0 X3=0 S11=-
 423.234984951423 IsS11Max=No IsS11Min=No FrameElem=9 ElemStation=0.250000000000002
 Frame=9 Station=0.250000000000002 OutputCase=FESSUR CaseType=Combination Point=1 X2=-0.5 X3=-0.5
 S11=-1631.74877138204 IsS11Max=No IsS11Min=Yes FrameElem=9 ElemStation=0.250000000000002
 Frame=9 Station=0.250000000000002 OutputCase=FESSUR CaseType=Combination Point=2 X2=-0.5 X3=0.5
 S11=-1631.74877138204 IsS11Max=No IsS11Min=No FrameElem=9 ElemStation=0.250000000000002
 Frame=9 Station=0.250000000000002 OutputCase=FESSUR CaseType=Combination Point=3 X2=0.5 X3=-0.5
 S11=785.278801479193 IsS11Max=Yes IsS11Min=No FrameElem=9 ElemStation=0.250000000000002
 Frame=9 Station=0.250000000000002 OutputCase=FESSUR CaseType=Combination Point=4 X2=0.5 X3=0.5
 S11=785.278801479193 IsS11Max=No IsS11Min=No FrameElem=9 ElemStation=0.250000000000002
 Frame=10 Station=0 OutputCase=PERM1 CaseType=Combination Point=0 X2=0 X3=0 S11=-413.750007867853
 IsS11Max=No IsS11Min=No FrameElem=10 ElemStation=0
 Frame=10 Station=0 OutputCase=PERM1 CaseType=Combination Point=1 X2=-0.5 X3=-0.5 S11=-
 1594.68148276647 IsS11Max=No IsS11Min=Yes FrameElem=10 ElemStation=0
 Frame=10 Station=0 OutputCase=PERM1 CaseType=Combination Point=2 X2=-0.5 X3=0.5 S11=-
 1594.68148276647 IsS11Max=No IsS11Min=No FrameElem=10 ElemStation=0
 Frame=10 Station=0 OutputCase=PERM1 CaseType=Combination Point=3 X2=0.5 X3=-0.5
 S11=767.181467030767 IsS11Max=Yes IsS11Min=No FrameElem=10 ElemStation=0
 Frame=10 Station=0 OutputCase=PERM1 CaseType=Combination Point=4 X2=0.5 X3=0.5 S11=767.181467030767
 IsS11Max=No IsS11Min=No FrameElem=10 ElemStation=0
 Frame=10 Station=0.249999976158143 OutputCase=PERM1 CaseType=Combination Point=0 X2=0 X3=0 S11=-
 407.50009993973 IsS11Max=No IsS11Min=No FrameElem=10 ElemStation=0.249999976158143
 Frame=10 Station=0.249999976158143 OutputCase=PERM1 CaseType=Combination Point=1 X2=-0.5 X3=-0.5
 S11=-1778.06688075591 IsS11Max=No IsS11Min=Yes FrameElem=10 ElemStation=0.249999976158143
 Frame=10 Station=0.249999976158143 OutputCase=PERM1 CaseType=Combination Point=2 X2=-0.5 X3=0.5
 S11=-1778.06688075591 IsS11Max=No IsS11Min=No FrameElem=10 ElemStation=0.249999976158143
 Frame=10 Station=0.249999976158143 OutputCase=PERM1 CaseType=Combination Point=3 X2=0.5 X3=-0.5
 S11=963.066860767965 IsS11Max=Yes IsS11Min=No FrameElem=10 ElemStation=0.249999976158143
 Frame=10 Station=0.249999976158143 OutputCase=PERM1 CaseType=Combination Point=4 X2=0.5 X3=0.5
 S11=963.066860767965 IsS11Max=No IsS11Min=No FrameElem=10 ElemStation=0.249999976158143
 Frame=10 Station=0 OutputCase=PERM2 CaseType=Combination Point=0 X2=0 X3=0 S11=-413.750003796733
 IsS11Max=No IsS11Min=No FrameElem=10 ElemStation=0
 Frame=10 Station=0 OutputCase=PERM2 CaseType=Combination Point=1 X2=-0.5 X3=-0.5 S11=-
 1573.0488566954 IsS11Max=No IsS11Min=Yes FrameElem=10 ElemStation=0
 Frame=10 Station=0 OutputCase=PERM2 CaseType=Combination Point=2 X2=-0.5 X3=0.5 S11=-
 1573.0488566954 IsS11Max=No IsS11Min=No FrameElem=10 ElemStation=0
 Frame=10 Station=0 OutputCase=PERM2 CaseType=Combination Point=3 X2=0.5 X3=-0.5
 S11=745.548849101936 IsS11Max=Yes IsS11Min=No FrameElem=10 ElemStation=0
 Frame=10 Station=0 OutputCase=PERM2 CaseType=Combination Point=4 X2=0.5 X3=0.5 S11=745.548849101936
 IsS11Max=No IsS11Min=No FrameElem=10 ElemStation=0
 Frame=10 Station=0.249999976158143 OutputCase=PERM2 CaseType=Combination Point=0 X2=0 X3=0 S11=-
 407.50005463831 IsS11Max=No IsS11Min=No FrameElem=10 ElemStation=0.249999976158143
 Frame=10 Station=0.249999976158143 OutputCase=PERM2 CaseType=Combination Point=1 X2=-0.5 X3=-0.5
 S11=-1693.0810214598 IsS11Max=No IsS11Min=Yes FrameElem=10 ElemStation=0.249999976158143
 Frame=10 Station=0.249999976158143 OutputCase=PERM2 CaseType=Combination Point=2 X2=-0.5 X3=0.5
 S11=-1693.0810214598 IsS11Max=No IsS11Min=No FrameElem=10 ElemStation=0.249999976158143
 Frame=10 Station=0.249999976158143 OutputCase=PERM2 CaseType=Combination Point=3 X2=0.5 X3=-0.5
 S11=878.081010532139 IsS11Max=Yes IsS11Min=No FrameElem=10 ElemStation=0.249999976158143
 Frame=10 Station=0.249999976158143 OutputCase=PERM2 CaseType=Combination Point=4 X2=0.5 X3=0.5
 S11=878.081010532139 IsS11Max=No IsS11Min=No FrameElem=10 ElemStation=0.249999976158143
 Frame=10 Station=0 OutputCase=ACC1 CaseType=Combination Point=0 X2=0 X3=0 S11=-427.300008157243
 IsS11Max=No IsS11Min=No FrameElem=10 ElemStation=0
 Frame=10 Station=0 OutputCase=ACC1 CaseType=Combination Point=1 X2=-0.5 X3=-0.5 S11=-
 1647.63478524443 IsS11Max=No IsS11Min=Yes FrameElem=10 ElemStation=0
 Frame=10 Station=0 OutputCase=ACC1 CaseType=Combination Point=2 X2=-0.5 X3=0.5 S11=-
 1647.63478524443 IsS11Max=No IsS11Min=No FrameElem=10 ElemStation=0
 Frame=10 Station=0 OutputCase=ACC1 CaseType=Combination Point=3 X2=0.5 X3=-0.5 S11=793.034768929948
 IsS11Max=Yes IsS11Min=No FrameElem=10 ElemStation=0
 Frame=10 Station=0 OutputCase=ACC1 CaseType=Combination Point=4 X2=0.5 X3=0.5 S11=793.034768929948
 IsS11Max=No IsS11Min=No FrameElem=10 ElemStation=0
 Frame=10 Station=0.249999976158143 OutputCase=ACC1 CaseType=Combination Point=0 X2=0 X3=0 S11=-
 421.050010338437 IsS11Max=No IsS11Min=No FrameElem=10 ElemStation=0.249999976158143
 Frame=10 Station=0.249999976158143 OutputCase=ACC1 CaseType=Combination Point=1 X2=-0.5 X3=-0.5
 S11=-1837.56173304843 IsS11Max=No IsS11Min=Yes FrameElem=10 ElemStation=0.249999976158143
 Frame=10 Station=0.249999976158143 OutputCase=ACC1 CaseType=Combination Point=2 X2=-0.5 X3=0.5
 S11=-1837.56173304843 IsS11Max=No IsS11Min=No FrameElem=10 ElemStation=0.249999976158143
 Frame=10 Station=0.249999976158143 OutputCase=ACC1 CaseType=Combination Point=3 X2=0.5 X3=-0.5
 S11=995.461712371554 IsS11Max=Yes IsS11Min=No FrameElem=10 ElemStation=0.249999976158143
 Frame=10 Station=0.249999976158143 OutputCase=ACC1 CaseType=Combination Point=4 X2=0.5 X3=0.5
 S11=995.461712371554 IsS11Max=No IsS11Min=No FrameElem=10 ElemStation=0.249999976158143
 Frame=10 Station=0 OutputCase=ACC2 CaseType=Combination Point=0 X2=0 X3=0 S11=-427.300004086123
 IsS11Max=No IsS11Min=No FrameElem=10 ElemStation=0
 Frame=10 Station=0 OutputCase=ACC2 CaseType=Combination Point=1 X2=-0.5 X3=-0.5 S11=-
 1626.00215917336 IsS11Max=No IsS11Min=Yes FrameElem=10 ElemStation=0
 Frame=10 Station=0 OutputCase=ACC2 CaseType=Combination Point=2 X2=-0.5 X3=0.5 S11=-
 1626.00215917336 IsS11Max=No IsS11Min=No FrameElem=10 ElemStation=0
 Frame=10 Station=0 OutputCase=ACC2 CaseType=Combination Point=3 X2=0.5 X3=-0.5 S11=771.402151001117
 IsS11Max=Yes IsS11Min=No FrameElem=10 ElemStation=0



Frame=10 Station=0 OutputCase=ACC2 CaseType=Combination Point=4 X2=0.5 X3=0.5 S11=771.402151001117
 IsS11Max=No IsS11Min=No FrameElem=10 ElemStation=0
 Frame=10 Station=0.249999976158143 OutputCase=ACC2 CaseType=Combination Point=0 X2=0 X3=0 S11=-
 421.050005808296 IsS11Max=No IsS11Min=No FrameElem=10 ElemStation=0.249999976158143
 Frame=10 Station=0.249999976158143 OutputCase=ACC2 CaseType=Combination Point=1 X2=-0.5 X3=-0.5
 S11=-1752.57587375232 IsS11Max=No IsS11Min=Yes FrameElem=10 ElemStation=0.249999976158143
 Frame=10 Station=0.249999976158143 OutputCase=ACC2 CaseType=Combination Point=2 X2=-0.5 X3=0.5
 S11=-1752.57587375232 IsS11Max=No IsS11Min=No FrameElem=10 ElemStation=0.249999976158143
 Frame=10 Station=0.249999976158143 OutputCase=ACC2 CaseType=Combination Point=3 X2=0.5 X3=-0.5
 S11=910.475862135728 IsS11Max=Yes IsS11Min=No FrameElem=10 ElemStation=0.249999976158143
 Frame=10 Station=0.249999976158143 OutputCase=ACC2 CaseType=Combination Point=4 X2=0.5 X3=0.5
 S11=910.475862135728 IsS11Max=No IsS11Min=No FrameElem=10 ElemStation=0.249999976158143
 Frame=10 Station=0 OutputCase=ACCSX1 CaseType=Combination Point=0 X2=0 X3=0 S11=-415.264085690051
 IsS11Max=No IsS11Min=No FrameElem=10 ElemStation=0
 Frame=10 Station=0 OutputCase=ACCSX1 CaseType=Combination Point=1 X2=-0.5 X3=-0.5 S11=-
 1619.16766287098 IsS11Max=No IsS11Min=Yes FrameElem=10 ElemStation=0
 Frame=10 Station=0 OutputCase=ACCSX1 CaseType=Combination Point=2 X2=-0.5 X3=0.5 S11=-
 1619.16766287098 IsS11Max=No IsS11Min=No FrameElem=10 ElemStation=0
 Frame=10 Station=0 OutputCase=ACCSX1 CaseType=Combination Point=3 X2=0.5 X3=-0.5
 S11=788.639491490883 IsS11Max=Yes IsS11Min=No FrameElem=10 ElemStation=0
 Frame=10 Station=0 OutputCase=ACCSX1 CaseType=Combination Point=4 X2=0.5 X3=0.5
 S11=788.639491490883 IsS11Max=No IsS11Min=No FrameElem=10 ElemStation=0
 Frame=10 Station=0.249999976158143 OutputCase=ACCSX1 CaseType=Combination Point=0 X2=0 X3=0 S11=-
 409.014087816171 IsS11Max=No IsS11Min=No FrameElem=10 ElemStation=0.249999976158143
 Frame=10 Station=0.249999976158143 OutputCase=ACCSX1 CaseType=Combination Point=1 X2=-0.5 X3=-0.5
 S11=-1805.96225730499 IsS11Max=No IsS11Min=Yes FrameElem=10 ElemStation=0.249999976158143
 Frame=10 Station=0.249999976158143 OutputCase=ACCSX1 CaseType=Combination Point=2 X2=-0.5 X3=0.5
 S11=-1805.96225730499 IsS11Max=No IsS11Min=No FrameElem=10 ElemStation=0.249999976158143
 Frame=10 Station=0.249999976158143 OutputCase=ACCSX1 CaseType=Combination Point=3 X2=0.5 X3=-0.5
 S11=987.934081672645 IsS11Max=Yes IsS11Min=No FrameElem=10 ElemStation=0.249999976158143
 Frame=10 Station=0.249999976158143 OutputCase=ACCSX1 CaseType=Combination Point=4 X2=0.5 X3=0.5
 S11=987.934081672645 IsS11Max=No IsS11Min=No FrameElem=10 ElemStation=0.249999976158143
 Frame=10 Station=0 OutputCase=ACCSX2 CaseType=Combination Point=0 X2=0 X3=0 S11=-415.264081618931
 IsS11Max=No IsS11Min=No FrameElem=10 ElemStation=0
 Frame=10 Station=0 OutputCase=ACCSX2 CaseType=Combination Point=1 X2=-0.5 X3=-0.5 S11=-
 1597.53503679991 IsS11Max=No IsS11Min=Yes FrameElem=10 ElemStation=0
 Frame=10 Station=0 OutputCase=ACCSX2 CaseType=Combination Point=2 X2=-0.5 X3=0.5 S11=-
 1597.53503679991 IsS11Max=No IsS11Min=No FrameElem=10 ElemStation=0
 Frame=10 Station=0 OutputCase=ACCSX2 CaseType=Combination Point=3 X2=0.5 X3=-0.5
 S11=767.006873562051 IsS11Max=Yes IsS11Min=No FrameElem=10 ElemStation=0
 Frame=10 Station=0 OutputCase=ACCSX2 CaseType=Combination Point=4 X2=0.5 X3=0.5
 S11=767.006873562051 IsS11Max=No IsS11Min=No FrameElem=10 ElemStation=0
 Frame=10 Station=0.249999976158143 OutputCase=ACCSX2 CaseType=Combination Point=0 X2=0 X3=0 S11=-
 409.014083286029 IsS11Max=No IsS11Min=No FrameElem=10 ElemStation=0.249999976158143
 Frame=10 Station=0.249999976158143 OutputCase=ACCSX2 CaseType=Combination Point=1 X2=-0.5 X3=-0.5
 S11=-1720.97639800888 IsS11Max=No IsS11Min=Yes FrameElem=10 ElemStation=0.249999976158143
 Frame=10 Station=0.249999976158143 OutputCase=ACCSX2 CaseType=Combination Point=2 X2=-0.5 X3=0.5
 S11=-1720.97639800888 IsS11Max=No IsS11Min=No FrameElem=10 ElemStation=0.249999976158143
 Frame=10 Station=0.249999976158143 OutputCase=ACCSX2 CaseType=Combination Point=3 X2=0.5 X3=-0.5
 S11=902.948231436819 IsS11Max=Yes IsS11Min=No FrameElem=10 ElemStation=0.249999976158143
 Frame=10 Station=0.249999976158143 OutputCase=ACCSX2 CaseType=Combination Point=4 X2=0.5 X3=0.5
 S11=902.948231436819 IsS11Max=No IsS11Min=No FrameElem=10 ElemStation=0.249999976158143
 Frame=10 Station=0 OutputCase=ENVE CaseType=Combination StepType=Max Point=0 X2=0 X3=0 S11=-
 413.750003796733 IsS11Max=No IsS11Min=No FrameElem=10 ElemStation=0
 Frame=10 Station=0 OutputCase=ENVE CaseType=Combination StepType=Max Point=1 X2=-0.5 X3=-0.5
 S11=-1573.0488566954 IsS11Max=No IsS11Min=Yes FrameElem=10 ElemStation=0
 Frame=10 Station=0 OutputCase=ENVE CaseType=Combination StepType=Max Point=2 X2=-0.5 X3=0.5 S11=-
 1573.0488566954 IsS11Max=No IsS11Min=No FrameElem=10 ElemStation=0
 Frame=10 Station=0 OutputCase=ENVE CaseType=Combination StepType=Max Point=3 X2=0.5 X3=-0.5
 S11=793.034768929948 IsS11Max=Yes IsS11Min=No FrameElem=10 ElemStation=0
 Frame=10 Station=0 OutputCase=ENVE CaseType=Combination StepType=Max Point=4 X2=0.5 X3=0.5
 S11=793.034768929948 IsS11Max=No IsS11Min=No FrameElem=10 ElemStation=0
 Frame=10 Station=0.249999976158143 OutputCase=ENVE CaseType=Combination StepType=Max Point=0 X2=0
 X3=0 S11=-407.500005463831 IsS11Max=No IsS11Min=No FrameElem=10 ElemStation=0.249999976158143
 Frame=10 Station=0.249999976158143 OutputCase=ENVE CaseType=Combination StepType=Max Point=1 X2=-0.5
 X3=-0.5 S11=-1693.0810214598 IsS11Max=No IsS11Min=Yes FrameElem=10 ElemStation=0.249999976158143
 Frame=10 Station=0.249999976158143 OutputCase=ENVE CaseType=Combination StepType=Max Point=2 X2=-0.5
 X3=0.5 S11=-1693.0810214598 IsS11Max=No IsS11Min=No FrameElem=10 ElemStation=0.249999976158143
 Frame=10 Station=0.249999976158143 OutputCase=ENVE CaseType=Combination StepType=Max Point=3 X2=0.5
 X3=-0.5 S11=995.461712371554 IsS11Max=Yes IsS11Min=No FrameElem=10 ElemStation=0.249999976158143
 Frame=10 Station=0.249999976158143 OutputCase=ENVE CaseType=Combination StepType=Max Point=4 X2=0.5
 X3=0.5 S11=995.461712371554 IsS11Max=No IsS11Min=No FrameElem=10 ElemStation=0.249999976158143
 Frame=10 Station=0 OutputCase=ENVE CaseType=Combination StepType=Min Point=0 X2=0 X3=0 S11=-
 427.300008157243 IsS11Max=No IsS11Min=No FrameElem=10 ElemStation=0
 Frame=10 Station=0 OutputCase=ENVE CaseType=Combination StepType=Min Point=1 X2=-0.5 X3=-0.5
 S11=-1647.63478524443 IsS11Max=No IsS11Min=Yes FrameElem=10 ElemStation=0
 Frame=10 Station=0 OutputCase=ENVE CaseType=Combination StepType=Min Point=2 X2=-0.5 X3=0.5 S11=-
 1647.63478524443 IsS11Max=No IsS11Min=No FrameElem=10 ElemStation=0
 Frame=10 Station=0 OutputCase=ENVE CaseType=Combination StepType=Min Point=3 X2=0.5 X3=-0.5
 S11=745.548849101936 IsS11Max=Yes IsS11Min=No FrameElem=10 ElemStation=0
 Frame=10 Station=0 OutputCase=ENVE CaseType=Combination StepType=Min Point=4 X2=0.5 X3=0.5
 S11=745.548849101936 IsS11Max=No IsS11Min=No FrameElem=10 ElemStation=0



Frame=10 Station=0.249999976158143 OutputCase=ENVE CaseType=Combination StepType=Min Point=0 X2=0
 X3=0 S11=-421.050010338437 IsS11Max=No IsS11Min=No FrameElem=10 ElemStation=0.249999976158143
 Frame=10 Station=0.249999976158143 OutputCase=ENVE CaseType=Combination StepType=Min Point=1 X2=-0.5
 X3=-0.5 S11=-1837.56173304843 IsS11Max=No IsS11Min=Yes FrameElem=10 ElemStation=0.249999976158143
 Frame=10 Station=0.249999976158143 OutputCase=ENVE CaseType=Combination StepType=Min Point=2 X2=-0.5
 X3=0.5 S11=-1837.56173304843 IsS11Max=No IsS11Min=No FrameElem=10 ElemStation=0.249999976158143
 Frame=10 Station=0.249999976158143 OutputCase=ENVE CaseType=Combination StepType=Min Point=3 X2=0.5
 X3=-0.5 S11=878.081010532139 IsS11Max=Yes IsS11Min=No FrameElem=10 ElemStation=0.249999976158143
 Frame=10 Station=0.249999976158143 OutputCase=ENVE CaseType=Combination StepType=Min Point=4 X2=0.5
 X3=0.5 S11=878.081010532139 IsS11Max=No IsS11Min=No FrameElem=10 ElemStation=0.249999976158143
 Frame=10 Station=0 OutputCase=FESSUR CaseType=Combination Point=0 X2=0 X3=0 S11=-423.235008070426
 IsS11Max=No IsS11Min=No FrameElem=10 ElemStation=0
 Frame=10 Station=0 OutputCase=FESSUR CaseType=Combination Point=1 X2=-0.5 X3=-0.5 S11=-
 1631.74879450105 IsS11Max=No IsS11Min=Yes FrameElem=10 ElemStation=0
 Frame=10 Station=0 OutputCase=FESSUR CaseType=Combination Point=2 X2=-0.5 X3=0.5 S11=-
 1631.74879450105 IsS11Max=No IsS11Min=No FrameElem=10 ElemStation=0
 Frame=10 Station=0 OutputCase=FESSUR CaseType=Combination Point=3 X2=0.5 X3=-0.5
 S11=785.278778360194 IsS11Max=Yes IsS11Min=No FrameElem=10 ElemStation=0
 Frame=10 Station=0 OutputCase=FESSUR CaseType=Combination Point=4 X2=0.5 X3=0.5
 S11=785.278778360194 IsS11Max=No IsS11Min=No FrameElem=10 ElemStation=0
 Frame=10 Station=0.249999976158143 OutputCase=FESSUR CaseType=Combination Point=0 X2=0 X3=0 S11=-
 416.985010235098 IsS11Max=No IsS11Min=No FrameElem=10 ElemStation=0.249999976158143
 Frame=10 Station=0.249999976158143 OutputCase=FESSUR CaseType=Combination Point=1 X2=-0.5 X3=-0.5
 S11=-1819.71327736067 IsS11Max=No IsS11Min=Yes FrameElem=10 ElemStation=0.249999976158143
 Frame=10 Station=0.249999976158143 OutputCase=FESSUR CaseType=Combination Point=2 X2=-0.5 X3=0.5
 S11=-1819.71327736067 IsS11Max=No IsS11Min=No FrameElem=10 ElemStation=0.249999976158143
 Frame=10 Station=0.249999976158143 OutputCase=FESSUR CaseType=Combination Point=3 X2=0.5 X3=-0.5
 S11=985.743256890477 IsS11Max=Yes IsS11Min=No FrameElem=10 ElemStation=0.249999976158143
 Frame=10 Station=0.249999976158143 OutputCase=FESSUR CaseType=Combination Point=4 X2=0.5 X3=0.5
 S11=985.743256890477 IsS11Max=No IsS11Min=No FrameElem=10 ElemStation=0.249999976158143
 Frame=11 Station=0 OutputCase=PERM1 CaseType=Combination Point=0 X2=0 X3=0 S11=-507.500012814082
 IsS11Max=No IsS11Min=No FrameElem=11 ElemStation=0
 Frame=11 Station=0 OutputCase=PERM1 CaseType=Combination Point=1 X2=-0.5 X3=-0.5
 S11=1212.47742246955 IsS11Max=Yes IsS11Min=No FrameElem=11 ElemStation=0
 Frame=11 Station=0 OutputCase=PERM1 CaseType=Combination Point=2 X2=-0.5 X3=0.5
 S11=1212.47742246955 IsS11Max=No IsS11Min=No FrameElem=11 ElemStation=0
 Frame=11 Station=0 OutputCase=PERM1 CaseType=Combination Point=3 X2=0.5 X3=-0.5 S11=-
 2227.47744809772 IsS11Max=No IsS11Min=Yes FrameElem=11 ElemStation=0
 Frame=11 Station=0 OutputCase=PERM1 CaseType=Combination Point=4 X2=0.5 X3=0.5 S11=-
 2227.47744809772 IsS11Max=No IsS11Min=No FrameElem=11 ElemStation=0
 Frame=11 Station=0.2500000000000001 OutputCase=PERM1 CaseType=Combination Point=0 X2=0 X3=0 S11=-
 501.25001052159 IsS11Max=No IsS11Min=No FrameElem=11 ElemStation=0.2500000000000001
 Frame=11 Station=0.2500000000000001 OutputCase=PERM1 CaseType=Combination Point=1 X2=-0.5 X3=-0.5
 S11=957.434843449079 IsS11Max=Yes IsS11Min=No FrameElem=11 ElemStation=0.2500000000000001
 Frame=11 Station=0.2500000000000001 OutputCase=PERM1 CaseType=Combination Point=2 X2=-0.5 X3=0.5
 S11=957.434843449079 IsS11Max=No IsS11Min=No FrameElem=11 ElemStation=0.2500000000000001
 Frame=11 Station=0.2500000000000001 OutputCase=PERM1 CaseType=Combination Point=3 X2=0.5 X3=-0.5
 S11=-1959.93486449226 IsS11Max=No IsS11Min=Yes FrameElem=11 ElemStation=0.2500000000000001
 Frame=11 Station=0.2500000000000001 OutputCase=PERM1 CaseType=Combination Point=4 X2=0.5 X3=0.5
 S11=-1959.93486449226 IsS11Max=No IsS11Min=No FrameElem=11 ElemStation=0.2500000000000001
 Frame=11 Station=0 OutputCase=PERM2 CaseType=Combination Point=0 X2=0 X3=0 S11=-507.500008170067
 IsS11Max=No IsS11Min=No FrameElem=11 ElemStation=0
 Frame=11 Station=0 OutputCase=PERM2 CaseType=Combination Point=1 X2=-0.5 X3=-0.5
 S11=1126.0699507659 IsS11Max=Yes IsS11Min=No FrameElem=11 ElemStation=0
 Frame=11 Station=0 OutputCase=PERM2 CaseType=Combination Point=2 X2=-0.5 X3=0.5 S11=1126.0699507659
 IsS11Max=No IsS11Min=No FrameElem=11 ElemStation=0
 Frame=11 Station=0 OutputCase=PERM2 CaseType=Combination Point=3 X2=0.5 X3=-0.5 S11=-
 2141.06996710603 IsS11Max=No IsS11Min=Yes FrameElem=11 ElemStation=0
 Frame=11 Station=0 OutputCase=PERM2 CaseType=Combination Point=4 X2=0.5 X3=0.5 S11=-
 2141.06996710603 IsS11Max=No IsS11Min=No FrameElem=11 ElemStation=0
 Frame=11 Station=0.2500000000000001 OutputCase=PERM2 CaseType=Combination Point=0 X2=0 X3=0 S11=-
 501.250006565323 IsS11Max=No IsS11Min=No FrameElem=11 ElemStation=0.2500000000000001
 Frame=11 Station=0.2500000000000001 OutputCase=PERM2 CaseType=Combination Point=1 X2=-0.5 X3=-0.5
 S11=942.952570095761 IsS11Max=Yes IsS11Min=No FrameElem=11 ElemStation=0.2500000000000001
 Frame=11 Station=0.2500000000000001 OutputCase=PERM2 CaseType=Combination Point=2 X2=-0.5 X3=0.5
 S11=942.952570095761 IsS11Max=No IsS11Min=No FrameElem=11 ElemStation=0.2500000000000001
 Frame=11 Station=0.2500000000000001 OutputCase=PERM2 CaseType=Combination Point=3 X2=0.5 X3=-0.5
 S11=-1945.45258322641 IsS11Max=No IsS11Min=Yes FrameElem=11 ElemStation=0.2500000000000001
 Frame=11 Station=0.2500000000000001 OutputCase=PERM2 CaseType=Combination Point=4 X2=0.5 X3=0.5
 S11=-1945.45258322641 IsS11Max=No IsS11Min=No FrameElem=11 ElemStation=0.2500000000000001
 Frame=11 Station=0 OutputCase=ACC1 CaseType=Combination Point=0 X2=0 X3=0 S11=-521.050013092376
 IsS11Max=No IsS11Min=No FrameElem=11 ElemStation=0
 Frame=11 Station=0 OutputCase=ACC1 CaseType=Combination Point=1 X2=-0.5 X3=-0.5 S11=1244.157437411
 IsS11Max=Yes IsS11Min=No FrameElem=11 ElemStation=0
 Frame=11 Station=0 OutputCase=ACC1 CaseType=Combination Point=2 X2=-0.5 X3=0.5 S11=1244.157437411
 IsS11Max=No IsS11Min=No FrameElem=11 ElemStation=0
 Frame=11 Station=0 OutputCase=ACC1 CaseType=Combination Point=3 X2=0.5 X3=-0.5 S11=-
 2286.25746359576 IsS11Max=No IsS11Min=Yes FrameElem=11 ElemStation=0
 Frame=11 Station=0 OutputCase=ACC1 CaseType=Combination Point=4 X2=0.5 X3=0.5 S11=-2286.25746359576
 IsS11Max=No IsS11Min=No FrameElem=11 ElemStation=0
 Frame=11 Station=0.2500000000000001 OutputCase=ACC1 CaseType=Combination Point=0 X2=0 X3=0 S11=-
 514.800010744809 IsS11Max=No IsS11Min=No FrameElem=11 ElemStation=0.2500000000000001



Frame=11 Station=0.250000000000001 OutputCase=ACC1 CaseType=Combination Point=1 X2=-0.5 X3=-0.5
 S11=982.662662664323 IsS11Max=Yes IsS11Min=No FrameElem=11 ElemStation=0.250000000000001
 Frame=11 Station=0.250000000000001 OutputCase=ACC1 CaseType=Combination Point=2 X2=-0.5 X3=0.5
 S11=982.662662664323 IsS11Max=No IsS11Min=No FrameElem=11 ElemStation=0.250000000000001
 Frame=11 Station=0.250000000000001 OutputCase=ACC1 CaseType=Combination Point=3 X2=0.5 X3=-0.5
 S11=-2012.26268415394 IsS11Max=No IsS11Min=Yes FrameElem=11 ElemStation=0.250000000000001
 Frame=11 Station=0.250000000000001 OutputCase=ACC1 CaseType=Combination Point=4 X2=0.5 X3=0.5 S11=-
 2012.26268415394 IsS11Max=No IsS11Min=No FrameElem=11 ElemStation=0.250000000000001
 Frame=11 Station=0 OutputCase=ACC2 CaseType=Combination Point=0 X2=0 X3=0 S11=-521.05000844836
 IsS11Max=No IsS11Min=No FrameElem=11 ElemStation=0
 Frame=11 Station=0 OutputCase=ACC2 CaseType=Combination Point=1 X2=-0.5 X3=-0.5
 S11=1157.74996570735 IsS11Max=Yes IsS11Min=No FrameElem=11 ElemStation=0
 Frame=11 Station=0 OutputCase=ACC2 CaseType=Combination Point=2 X2=-0.5 X3=0.5 S11=1157.74996570735
 IsS11Max=No IsS11Min=No FrameElem=11 ElemStation=0
 Frame=11 Station=0 OutputCase=ACC2 CaseType=Combination Point=3 X2=0.5 X3=-0.5 S11=-
 2199.84998260407 IsS11Max=No IsS11Min=Yes FrameElem=11 ElemStation=0
 Frame=11 Station=0 OutputCase=ACC2 CaseType=Combination Point=4 X2=0.5 X3=0.5 S11=-2199.84998260407
 IsS11Max=No IsS11Min=No FrameElem=11 ElemStation=0
 Frame=11 Station=0.250000000000001 OutputCase=ACC2 CaseType=Combination Point=0 X2=0 X3=0 S11=-
 514.800006788542 IsS11Max=No IsS11Min=No FrameElem=11 ElemStation=0.250000000000001
 Frame=11 Station=0.250000000000001 OutputCase=ACC2 CaseType=Combination Point=1 X2=-0.5 X3=-0.5
 S11=968.180389311005 IsS11Max=Yes IsS11Min=No FrameElem=11 ElemStation=0.250000000000001
 Frame=11 Station=0.250000000000001 OutputCase=ACC2 CaseType=Combination Point=2 X2=-0.5 X3=0.5
 S11=968.180389311005 IsS11Max=No IsS11Min=No FrameElem=11 ElemStation=0.250000000000001
 Frame=11 Station=0.250000000000001 OutputCase=ACC2 CaseType=Combination Point=3 X2=0.5 X3=-0.5
 S11=-1997.78040288809 IsS11Max=No IsS11Min=Yes FrameElem=11 ElemStation=0.250000000000001
 Frame=11 Station=0.250000000000001 OutputCase=ACC2 CaseType=Combination Point=4 X2=0.5 X3=0.5 S11=-
 1997.78040288809 IsS11Max=No IsS11Min=No FrameElem=11 ElemStation=0.250000000000001
 Frame=11 Station=0 OutputCase=ACCSX1 CaseType=Combination Point=0 X2=0 X3=0 S11=-505.985935873061
 IsS11Max=No IsS11Min=No FrameElem=11 ElemStation=0
 Frame=11 Station=0 OutputCase=ACCSX1 CaseType=Combination Point=1 X2=-0.5 X3=-0.5
 S11=1251.28331895166 IsS11Max=Yes IsS11Min=No FrameElem=11 ElemStation=0
 Frame=11 Station=0 OutputCase=ACCSX1 CaseType=Combination Point=2 X2=-0.5 X3=0.5
 S11=1251.28331895166 IsS11Max=No IsS11Min=No FrameElem=11 ElemStation=0
 Frame=11 Station=0 OutputCase=ACCSX1 CaseType=Combination Point=3 X2=0.5 X3=-0.5 S11=-
 2263.25519069778 IsS11Max=No IsS11Min=Yes FrameElem=11 ElemStation=0
 Frame=11 Station=0 OutputCase=ACCSX1 CaseType=Combination Point=4 X2=0.5 X3=0.5 S11=-
 2263.25519069778 IsS11Max=No IsS11Min=No FrameElem=11 ElemStation=0
 Frame=11 Station=0.250000000000001 OutputCase=ACCSX1 CaseType=Combination Point=0 X2=0 X3=0 S11=-
 499.735933525495 IsS11Max=No IsS11Min=No FrameElem=11 ElemStation=0.250000000000001
 Frame=11 Station=0.250000000000001 OutputCase=ACCSX1 CaseType=Combination Point=1 X2=-0.5 X3=-0.5
 S11=986.223061755958 IsS11Max=Yes IsS11Min=No FrameElem=11 ElemStation=0.250000000000001
 Frame=11 Station=0.250000000000001 OutputCase=ACCSX1 CaseType=Combination Point=2 X2=-0.5 X3=0.5
 S11=986.223061755958 IsS11Max=No IsS11Min=No FrameElem=11 ElemStation=0.250000000000001
 Frame=11 Station=0.250000000000001 OutputCase=ACCSX1 CaseType=Combination Point=3 X2=0.5 X3=-0.5
 S11=-1985.69492880695 IsS11Max=No IsS11Min=Yes FrameElem=11 ElemStation=0.250000000000001
 Frame=11 Station=0.250000000000001 OutputCase=ACCSX1 CaseType=Combination Point=4 X2=0.5 X3=0.5
 S11=-1985.69492880695 IsS11Max=No IsS11Min=No FrameElem=11 ElemStation=0.250000000000001
 Frame=11 Station=0 OutputCase=ACCSX2 CaseType=Combination Point=0 X2=0 X3=0 S11=-505.985931229046
 IsS11Max=No IsS11Min=No FrameElem=11 ElemStation=0
 Frame=11 Station=0 OutputCase=ACCSX2 CaseType=Combination Point=1 X2=-0.5 X3=-0.5
 S11=1164.87584724801 IsS11Max=Yes IsS11Min=No FrameElem=11 ElemStation=0
 Frame=11 Station=0 OutputCase=ACCSX2 CaseType=Combination Point=2 X2=-0.5 X3=0.5
 S11=1164.87584724801 IsS11Max=No IsS11Min=No FrameElem=11 ElemStation=0
 Frame=11 Station=0 OutputCase=ACCSX2 CaseType=Combination Point=3 X2=0.5 X3=-0.5 S11=-
 2176.8477097061 IsS11Max=No IsS11Min=Yes FrameElem=11 ElemStation=0
 Frame=11 Station=0 OutputCase=ACCSX2 CaseType=Combination Point=4 X2=0.5 X3=0.5 S11=-
 2176.8477097061 IsS11Max=No IsS11Min=No FrameElem=11 ElemStation=0
 Frame=11 Station=0.250000000000001 OutputCase=ACCSX2 CaseType=Combination Point=0 X2=0 X3=0 S11=-
 499.735929569227 IsS11Max=No IsS11Min=No FrameElem=11 ElemStation=0.250000000000001
 Frame=11 Station=0.250000000000001 OutputCase=ACCSX2 CaseType=Combination Point=1 X2=-0.5 X3=-0.5
 S11=971.740788402639 IsS11Max=Yes IsS11Min=No FrameElem=11 ElemStation=0.250000000000001
 Frame=11 Station=0.250000000000001 OutputCase=ACCSX2 CaseType=Combination Point=2 X2=-0.5 X3=0.5
 S11=971.740788402639 IsS11Max=No IsS11Min=No FrameElem=11 ElemStation=0.250000000000001
 Frame=11 Station=0.250000000000001 OutputCase=ACCSX2 CaseType=Combination Point=3 X2=0.5 X3=-0.5
 S11=-1971.21264754109 IsS11Max=No IsS11Min=Yes FrameElem=11 ElemStation=0.250000000000001
 Frame=11 Station=0.250000000000001 OutputCase=ACCSX2 CaseType=Combination Point=4 X2=0.5 X3=0.5
 S11=-1971.21264754109 IsS11Max=No IsS11Min=No FrameElem=11 ElemStation=0.250000000000001
 Frame=11 Station=0 OutputCase=ENVE CaseType=Combination StepType=Max Point=0 X2=0 X3=0 S11=-
 505.985931229046 IsS11Max=No IsS11Min=No FrameElem=11 ElemStation=0
 Frame=11 Station=0 OutputCase=ENVE CaseType=Combination StepType=Max Point=1 X2=-0.5 X3=-0.5
 S11=1251.28331895166 IsS11Max=Yes IsS11Min=No FrameElem=11 ElemStation=0
 Frame=11 Station=0 OutputCase=ENVE CaseType=Combination StepType=Max Point=2 X2=-0.5 X3=0.5
 S11=1251.28331895166 IsS11Max=No IsS11Min=No FrameElem=11 ElemStation=0
 Frame=11 Station=0 OutputCase=ENVE CaseType=Combination StepType=Max Point=3 X2=0.5 X3=-0.5 S11=-
 2141.06996710603 IsS11Max=No IsS11Min=Yes FrameElem=11 ElemStation=0
 Frame=11 Station=0 OutputCase=ENVE CaseType=Combination StepType=Max Point=4 X2=0.5 X3=0.5 S11=-
 2141.06996710603 IsS11Max=No IsS11Min=No FrameElem=11 ElemStation=0
 Frame=11 Station=0.250000000000001 OutputCase=ENVE CaseType=Combination StepType=Max Point=0 X2=0
 X3=0 S11=-499.735929569227 IsS11Max=No IsS11Min=No FrameElem=11 ElemStation=0.250000000000001
 Frame=11 Station=0.250000000000001 OutputCase=ENVE CaseType=Combination StepType=Max Point=1 X2=-0.5
 X3=-0.5 S11=986.223061755958 IsS11Max=Yes IsS11Min=No FrameElem=11 ElemStation=0.250000000000001

Frame=11 Station=0.250000000000001 OutputCase=ENVE CaseType=Combination StepType=Max Point=2 X2=-0.5
 X3=0.5 S11=986.223061755958 IsS11Max=No IsS11Min=No FrameElem=11 ElemStation=0.250000000000001
 Frame=11 Station=0.250000000000001 OutputCase=ENVE CaseType=Combination StepType=Max Point=3 X2=0.5
 X3=-0.5 S11=-1945.45258322641 IsS11Max=No IsS11Min=Yes FrameElem=11 ElemStation=0.250000000000001
 Frame=11 Station=0.250000000000001 OutputCase=ENVE CaseType=Combination StepType=Max Point=4 X2=0.5
 X3=0.5 S11=-1945.45258322641 IsS11Max=No IsS11Min=No FrameElem=11 ElemStation=0.250000000000001
 Frame=11 Station=0 OutputCase=ENVE CaseType=Combination StepType=Min Point=0 X2=0 X3=0 S11=-
 521.050013092376 IsS11Max=No IsS11Min=No FrameElem=11 ElemStation=0
 Frame=11 Station=0 OutputCase=ENVE CaseType=Combination StepType=Min Point=1 X2=-0.5 X3=-0.5
 S11=1126.0699507659 IsS11Max=Yes IsS11Min=No FrameElem=11 ElemStation=0
 Frame=11 Station=0 OutputCase=ENVE CaseType=Combination StepType=Min Point=2 X2=-0.5 X3=0.5
 S11=1126.0699507659 IsS11Max=No IsS11Min=No FrameElem=11 ElemStation=0
 Frame=11 Station=0 OutputCase=ENVE CaseType=Combination StepType=Min Point=3 X2=0.5 X3=-0.5 S11=-
 2286.25746359576 IsS11Max=No IsS11Min=Yes FrameElem=11 ElemStation=0
 Frame=11 Station=0 OutputCase=ENVE CaseType=Combination StepType=Min Point=4 X2=0.5 X3=0.5 S11=-
 2286.25746359576 IsS11Max=No IsS11Min=No FrameElem=11 ElemStation=0
 Frame=11 Station=0.250000000000001 OutputCase=ENVE CaseType=Combination StepType=Min Point=0 X2=0
 X3=0 S11=-514.800010744809 IsS11Max=No IsS11Min=No FrameElem=11 ElemStation=0.250000000000001
 Frame=11 Station=0.250000000000001 OutputCase=ENVE CaseType=Combination StepType=Min Point=1 X2=-0.5
 X3=-0.5 S11=942.952570095761 IsS11Max=Yes IsS11Min=No FrameElem=11 ElemStation=0.250000000000001
 Frame=11 Station=0.250000000000001 OutputCase=ENVE CaseType=Combination StepType=Min Point=2 X2=-0.5
 X3=0.5 S11=942.952570095761 IsS11Max=No IsS11Min=No FrameElem=11 ElemStation=0.250000000000001
 Frame=11 Station=0.250000000000001 OutputCase=ENVE CaseType=Combination StepType=Min Point=3 X2=0.5
 X3=-0.5 S11=-2012.26268415394 IsS11Max=No IsS11Min=Yes FrameElem=11 ElemStation=0.250000000000001
 Frame=11 Station=0.250000000000001 OutputCase=ENVE CaseType=Combination StepType=Min Point=4 X2=0.5
 X3=0.5 S11=-2012.26268415394 IsS11Max=No IsS11Min=No FrameElem=11 ElemStation=0.250000000000001
 Frame=11 Station=0 OutputCase=FESSUR CaseType=Combination Point=0 X2=0 X3=0 S11=-516.985013008887
 IsS11Max=No IsS11Min=No FrameElem=11 ElemStation=0
 Frame=11 Station=0 OutputCase=FESSUR CaseType=Combination Point=1 X2=-0.5 X3=-0.5
 S11=1234.65343292857 IsS11Max=Yes IsS11Min=No FrameElem=11 ElemStation=0
 Frame=11 Station=0 OutputCase=FESSUR CaseType=Combination Point=2 X2=-0.5 X3=0.5
 S11=1234.65343292857 IsS11Max=No IsS11Min=No FrameElem=11 ElemStation=0
 Frame=11 Station=0 OutputCase=FESSUR CaseType=Combination Point=3 X2=0.5 X3=-0.5 S11=-
 2268.62345894634 IsS11Max=No IsS11Min=Yes FrameElem=11 ElemStation=0
 Frame=11 Station=0 OutputCase=FESSUR CaseType=Combination Point=4 X2=0.5 X3=0.5 S11=-
 2268.62345894634 IsS11Max=No IsS11Min=No FrameElem=11 ElemStation=0
 Frame=11 Station=0.250000000000001 OutputCase=FESSUR CaseType=Combination Point=0 X2=0 X3=0 S11=-
 510.735010677844 IsS11Max=No IsS11Min=No FrameElem=11 ElemStation=0.250000000000001
 Frame=11 Station=0.250000000000001 OutputCase=FESSUR CaseType=Combination Point=1 X2=-0.5 X3=-0.5
 S11=975.09431689975 IsS11Max=Yes IsS11Min=No FrameElem=11 ElemStation=0.250000000000001
 Frame=11 Station=0.250000000000001 OutputCase=FESSUR CaseType=Combination Point=2 X2=-0.5 X3=0.5
 S11=975.09431689975 IsS11Max=No IsS11Min=No FrameElem=11 ElemStation=0.250000000000001
 Frame=11 Station=0.250000000000001 OutputCase=FESSUR CaseType=Combination Point=3 X2=0.5 X3=-0.5
 S11=-1996.56433825544 IsS11Max=No IsS11Min=Yes FrameElem=11 ElemStation=0.250000000000001
 Frame=11 Station=0.250000000000001 OutputCase=FESSUR CaseType=Combination Point=4 X2=0.5 X3=0.5
 S11=-1996.56433825544 IsS11Max=No IsS11Min=No FrameElem=11 ElemStation=0.250000000000001
 Frame=12 Station=0 OutputCase=PERM1 CaseType=Combination Point=0 X2=0 X3=0 S11=-501.249995050805
 IsS11Max=No IsS11Min=No FrameElem=12 ElemStation=0
 Frame=12 Station=0 OutputCase=PERM1 CaseType=Combination Point=1 X2=-0.5 X3=-0.5
 S11=957.434858919867 IsS11Max=Yes IsS11Min=No FrameElem=12 ElemStation=0
 Frame=12 Station=0 OutputCase=PERM1 CaseType=Combination Point=2 X2=-0.5 X3=0.5
 S11=957.434858919867 IsS11Max=No IsS11Min=No FrameElem=12 ElemStation=0
 Frame=12 Station=0 OutputCase=PERM1 CaseType=Combination Point=3 X2=0.5 X3=-0.5 S11=-
 1959.93484902148 IsS11Max=No IsS11Min=Yes FrameElem=12 ElemStation=0
 Frame=12 Station=0 OutputCase=PERM1 CaseType=Combination Point=4 X2=0.5 X3=0.5 S11=-
 1959.93484902148 IsS11Max=No IsS11Min=No FrameElem=12 ElemStation=0
 Frame=12 Station=0.25 OutputCase=PERM1 CaseType=Combination Point=0 X2=0 X3=0 S11=-494.999995050805
 IsS11Max=No IsS11Min=No FrameElem=12 ElemStation=0.25
 Frame=12 Station=0.25 OutputCase=PERM1 CaseType=Combination Point=1 X2=-0.5 X3=-0.5
 S11=738.05025233048 IsS11Max=Yes IsS11Min=No FrameElem=12 ElemStation=0.25
 Frame=12 Station=0.25 OutputCase=PERM1 CaseType=Combination Point=2 X2=-0.5 X3=0.5
 S11=738.05025233048 IsS11Max=No IsS11Min=No FrameElem=12 ElemStation=0.25
 Frame=12 Station=0.25 OutputCase=PERM1 CaseType=Combination Point=3 X2=0.5 X3=-0.5 S11=-
 1728.05024243209 IsS11Max=No IsS11Min=Yes FrameElem=12 ElemStation=0.25
 Frame=12 Station=0.25 OutputCase=PERM1 CaseType=Combination Point=4 X2=0.5 X3=0.5 S11=-
 1728.05024243209 IsS11Max=No IsS11Min=No FrameElem=12 ElemStation=0.25
 Frame=12 Station=0 OutputCase=PERM2 CaseType=Combination Point=0 X2=0 X3=0 S11=-501.249995324815
 IsS11Max=No IsS11Min=No FrameElem=12 ElemStation=0
 Frame=12 Station=0 OutputCase=PERM2 CaseType=Combination Point=1 X2=-0.5 X3=-0.5
 S11=942.952581336271 IsS11Max=Yes IsS11Min=No FrameElem=12 ElemStation=0
 Frame=12 Station=0 OutputCase=PERM2 CaseType=Combination Point=2 X2=-0.5 X3=0.5
 S11=942.952581336271 IsS11Max=No IsS11Min=No FrameElem=12 ElemStation=0
 Frame=12 Station=0 OutputCase=PERM2 CaseType=Combination Point=3 X2=0.5 X3=-0.5 S11=-
 1945.4525719859 IsS11Max=No IsS11Min=Yes FrameElem=12 ElemStation=0
 Frame=12 Station=0 OutputCase=PERM2 CaseType=Combination Point=4 X2=0.5 X3=0.5 S11=-1945.4525719859
 IsS11Max=No IsS11Min=No FrameElem=12 ElemStation=0
 Frame=12 Station=0.25 OutputCase=PERM2 CaseType=Combination Point=0 X2=0 X3=0 S11=-494.999995324815
 IsS11Max=No IsS11Min=No FrameElem=12 ElemStation=0.25
 Frame=12 Station=0.25 OutputCase=PERM2 CaseType=Combination Point=1 X2=-0.5 X3=-0.5
 S11=784.795759722466 IsS11Max=Yes IsS11Min=No FrameElem=12 ElemStation=0.25
 Frame=12 Station=0.25 OutputCase=PERM2 CaseType=Combination Point=2 X2=-0.5 X3=0.5
 S11=784.795759722466 IsS11Max=No IsS11Min=No FrameElem=12 ElemStation=0.25



Frame=12	Station=0.25	OutputCase=PERM2	CaseType=Combination	Point=3	X2=0.5	X3=-0.5	S11=-
1774.7957503721	IsS11Max=No	IsS11Min=Yes	FrameElem=12	ElemStation=0.25			
Frame=12	Station=0.25	OutputCase=PERM2	CaseType=Combination	Point=4	X2=0.5	X3=0.5	S11=-
1774.7957503721	IsS11Max=No	IsS11Min=No	FrameElem=12	ElemStation=0.25			
Frame=12	Station=0	OutputCase=ACC1	CaseType=Combination	Point=0	X2=0	X3=0	S11=-514.799994891334
IsS11Max=No	IsS11Min=No	FrameElem=12	ElemStation=0				
Frame=12	Station=0	OutputCase=ACC1	CaseType=Combination	Point=1	X2=-0.5	X3=-0.5	
S11=982.662678517803	IsS11Max=Yes	IsS11Min=No	FrameElem=12	ElemStation=0			
Frame=12	Station=0	OutputCase=ACC1	CaseType=Combination	Point=2	X2=-0.5	X3=0.5	S11=982.662678517803
IsS11Max=No	IsS11Min=No	FrameElem=12	ElemStation=0				
Frame=12	Station=0	OutputCase=ACC1	CaseType=Combination	Point=3	X2=0.5	X3=-0.5	S11=-
2012.26266830047	IsS11Max=No	IsS11Min=Yes	FrameElem=12	ElemStation=0			
Frame=12	Station=0	OutputCase=ACC1	CaseType=Combination	Point=4	X2=0.5	X3=0.5	S11=-2012.26266830047
IsS11Max=No	IsS11Min=No	FrameElem=12	ElemStation=0				
Frame=12	Station=0.25	OutputCase=ACC1	CaseType=Combination	Point=0	X2=0	X3=0	S11=-508.549994891334
IsS11Max=No	IsS11Min=No	FrameElem=12	ElemStation=0.25				
Frame=12	Station=0.25	OutputCase=ACC1	CaseType=Combination	Point=1	X2=-0.5	X3=-0.5	
S11=757.692124208792	IsS11Max=Yes	IsS11Min=No	FrameElem=12	ElemStation=0.25			
Frame=12	Station=0.25	OutputCase=ACC1	CaseType=Combination	Point=2	X2=-0.5	X3=0.5	
S11=757.692124208792	IsS11Max=No	IsS11Min=No	FrameElem=12	ElemStation=0.25			
Frame=12	Station=0.25	OutputCase=ACC1	CaseType=Combination	Point=3	X2=0.5	X3=-0.5	S11=-
1774.79211399146	IsS11Max=No	IsS11Min=Yes	FrameElem=12	ElemStation=0.25			
Frame=12	Station=0.25	OutputCase=ACC1	CaseType=Combination	Point=4	X2=0.5	X3=0.5	S11=-
1774.79211399146	IsS11Max=No	IsS11Min=No	FrameElem=12	ElemStation=0.25			
Frame=12	Station=0	OutputCase=ACC2	CaseType=Combination	Point=0	X2=0	X3=0	S11=-514.799995165344
IsS11Max=No	IsS11Min=No	FrameElem=12	ElemStation=0				
Frame=12	Station=0	OutputCase=ACC2	CaseType=Combination	Point=1	X2=-0.5	X3=-0.5	
S11=968.180400934208	IsS11Max=Yes	IsS11Min=No	FrameElem=12	ElemStation=0			
Frame=12	Station=0	OutputCase=ACC2	CaseType=Combination	Point=2	X2=-0.5	X3=0.5	S11=968.180400934208
IsS11Max=No	IsS11Min=No	FrameElem=12	ElemStation=0				
Frame=12	Station=0	OutputCase=ACC2	CaseType=Combination	Point=3	X2=0.5	X3=-0.5	S11=-1997.7803912649
IsS11Max=No	IsS11Min=Yes	FrameElem=12	ElemStation=0				
Frame=12	Station=0	OutputCase=ACC2	CaseType=Combination	Point=4	X2=0.5	X3=0.5	S11=-1997.7803912649
IsS11Max=No	IsS11Min=No	FrameElem=12	ElemStation=0				
Frame=12	Station=0.25	OutputCase=ACC2	CaseType=Combination	Point=0	X2=0	X3=0	S11=-508.549995165344
IsS11Max=No	IsS11Min=No	FrameElem=12	ElemStation=0.25				
Frame=12	Station=0.25	OutputCase=ACC2	CaseType=Combination	Point=1	X2=-0.5	X3=-0.5	
S11=804.437631600778	IsS11Max=Yes	IsS11Min=No	FrameElem=12	ElemStation=0.25			
Frame=12	Station=0.25	OutputCase=ACC2	CaseType=Combination	Point=2	X2=-0.5	X3=0.5	
S11=804.437631600778	IsS11Max=No	IsS11Min=No	FrameElem=12	ElemStation=0.25			
Frame=12	Station=0.25	OutputCase=ACC2	CaseType=Combination	Point=3	X2=0.5	X3=-0.5	S11=-
1821.53762193147	IsS11Max=No	IsS11Min=Yes	FrameElem=12	ElemStation=0.25			
Frame=12	Station=0.25	OutputCase=ACC2	CaseType=Combination	Point=4	X2=0.5	X3=0.5	S11=-
1821.53762193147	IsS11Max=No	IsS11Min=No	FrameElem=12	ElemStation=0.25			
Frame=12	Station=0	OutputCase=ACCSX1	CaseType=Combination	Point=0	X2=0	X3=0	S11=-499.735917445348
IsS11Max=No	IsS11Min=No	FrameElem=12	ElemStation=0				
Frame=12	Station=0	OutputCase=ACCSX1	CaseType=Combination	Point=1	X2=-0.5	X3=-0.5	
S11=986.223077836107	IsS11Max=Yes	IsS11Min=No	FrameElem=12	ElemStation=0			
Frame=12	Station=0	OutputCase=ACCSX1	CaseType=Combination	Point=2	X2=-0.5	X3=0.5	
S11=986.223077836107	IsS11Max=No	IsS11Min=No	FrameElem=12	ElemStation=0			
Frame=12	Station=0	OutputCase=ACCSX1	CaseType=Combination	Point=3	X2=0.5	X3=-0.5	S11=-
1985.6949127268	IsS11Max=No	IsS11Min=Yes	FrameElem=12	ElemStation=0			
Frame=12	Station=0	OutputCase=ACCSX1	CaseType=Combination	Point=4	X2=0.5	X3=0.5	S11=-
1985.6949127268	IsS11Max=No	IsS11Min=No	FrameElem=12	ElemStation=0			
Frame=12	Station=0.25	OutputCase=ACCSX1	CaseType=Combination	Point=0	X2=0	X3=0	S11=-
493.485917445348	IsS11Max=No	IsS11Min=No	FrameElem=12	ElemStation=0.25			
Frame=12	Station=0.25	OutputCase=ACCSX1	CaseType=Combination	Point=1	X2=-0.5	X3=-0.5	
S11=757.687043233007	IsS11Max=Yes	IsS11Min=No	FrameElem=12	ElemStation=0.25			
Frame=12	Station=0.25	OutputCase=ACCSX1	CaseType=Combination	Point=2	X2=-0.5	X3=0.5	
S11=757.687043233007	IsS11Max=No	IsS11Min=No	FrameElem=12	ElemStation=0.25			
Frame=12	Station=0.25	OutputCase=ACCSX1	CaseType=Combination	Point=3	X2=0.5	X3=-0.5	S11=-
1744.6588781237	IsS11Max=No	IsS11Min=Yes	FrameElem=12	ElemStation=0.25			
Frame=12	Station=0.25	OutputCase=ACCSX1	CaseType=Combination	Point=4	X2=0.5	X3=0.5	S11=-
1744.6588781237	IsS11Max=No	IsS11Min=No	FrameElem=12	ElemStation=0.25			
Frame=12	Station=0	OutputCase=ACCSX2	CaseType=Combination	Point=0	X2=0	X3=0	S11=-499.735917719358
IsS11Max=No	IsS11Min=No	FrameElem=12	ElemStation=0				
Frame=12	Station=0	OutputCase=ACCSX2	CaseType=Combination	Point=1	X2=-0.5	X3=-0.5	
S11=971.740800252511	IsS11Max=Yes	IsS11Min=No	FrameElem=12	ElemStation=0			
Frame=12	Station=0	OutputCase=ACCSX2	CaseType=Combination	Point=2	X2=-0.5	X3=0.5	
S11=971.740800252511	IsS11Max=No	IsS11Min=No	FrameElem=12	ElemStation=0			
Frame=12	Station=0	OutputCase=ACCSX2	CaseType=Combination	Point=3	X2=0.5	X3=-0.5	S11=-
1971.21263569123	IsS11Max=No	IsS11Min=Yes	FrameElem=12	ElemStation=0			
Frame=12	Station=0	OutputCase=ACCSX2	CaseType=Combination	Point=4	X2=0.5	X3=0.5	S11=-
1971.21263569123	IsS11Max=No	IsS11Min=No	FrameElem=12	ElemStation=0			
Frame=12	Station=0.25	OutputCase=ACCSX2	CaseType=Combination	Point=0	X2=0	X3=0	S11=-
493.485917719358	IsS11Max=No	IsS11Min=No	FrameElem=12	ElemStation=0.25			
Frame=12	Station=0.25	OutputCase=ACCSX2	CaseType=Combination	Point=1	X2=-0.5	X3=-0.5	
S11=804.432550624994	IsS11Max=Yes	IsS11Min=No	FrameElem=12	ElemStation=0.25			
Frame=12	Station=0.25	OutputCase=ACCSX2	CaseType=Combination	Point=2	X2=-0.5	X3=0.5	
S11=804.432550624994	IsS11Max=No	IsS11Min=No	FrameElem=12	ElemStation=0.25			
Frame=12	Station=0.25	OutputCase=ACCSX2	CaseType=Combination	Point=3	X2=0.5	X3=-0.5	S11=-
1791.40438606371	IsS11Max=No	IsS11Min=Yes	FrameElem=12	ElemStation=0.25			



Frame=12 Station=0.25 OutputCase=ACCSX2 CaseType=Combination Point=4 X2=0.5 X3=0.5 S11=-
 1791.40438606371 IsS11Max=No IsS11Min=No FrameElem=12 ElemStation=0.25
 Frame=12 Station=0 OutputCase=ENVE CaseType=Combination StepType=Max Point=0 X2=0 X3=0 S11=-
 499.735917445348 IsS11Max=No IsS11Min=No FrameElem=12 ElemStation=0
 Frame=12 Station=0 OutputCase=ENVE CaseType=Combination StepType=Max Point=1 X2=-0.5 X3=-0.5
 S11=986.223077836107 IsS11Max=Yes IsS11Min=No FrameElem=12 ElemStation=0
 Frame=12 Station=0 OutputCase=ENVE CaseType=Combination StepType=Max Point=2 X2=-0.5 X3=0.5
 S11=986.223077836107 IsS11Max=No IsS11Min=No FrameElem=12 ElemStation=0
 Frame=12 Station=0 OutputCase=ENVE CaseType=Combination StepType=Max Point=3 X2=0.5 X3=-0.5 S11=-
 1945.4525719859 IsS11Max=No IsS11Min=Yes FrameElem=12 ElemStation=0
 Frame=12 Station=0 OutputCase=ENVE CaseType=Combination StepType=Max Point=4 X2=0.5 X3=0.5 S11=-
 1945.4525719859 IsS11Max=No IsS11Min=No FrameElem=12 ElemStation=0
 Frame=12 Station=0.25 OutputCase=ENVE CaseType=Combination StepType=Max Point=0 X2=0 X3=0 S11=-
 493.485917445348 IsS11Max=No IsS11Min=No FrameElem=12 ElemStation=0.25
 Frame=12 Station=0.25 OutputCase=ENVE CaseType=Combination StepType=Max Point=1 X2=-0.5 X3=-0.5
 S11=804.437631600778 IsS11Max=Yes IsS11Min=No FrameElem=12 ElemStation=0.25
 Frame=12 Station=0.25 OutputCase=ENVE CaseType=Combination StepType=Max Point=2 X2=-0.5 X3=0.5
 S11=804.437631600778 IsS11Max=No IsS11Min=No FrameElem=12 ElemStation=0.25
 Frame=12 Station=0.25 OutputCase=ENVE CaseType=Combination StepType=Max Point=3 X2=0.5 X3=-0.5
 S11=-1728.05024243209 IsS11Max=No IsS11Min=Yes FrameElem=12 ElemStation=0.25
 Frame=12 Station=0.25 OutputCase=ENVE CaseType=Combination StepType=Max Point=4 X2=0.5 X3=0.5
 S11=-1728.05024243209 IsS11Max=No IsS11Min=No FrameElem=12 ElemStation=0.25
 Frame=12 Station=0 OutputCase=ENVE CaseType=Combination StepType=Min Point=0 X2=0 X3=0 S11=-
 514.799995165344 IsS11Max=No IsS11Min=No FrameElem=12 ElemStation=0
 Frame=12 Station=0 OutputCase=ENVE CaseType=Combination StepType=Min Point=1 X2=-0.5 X3=-0.5
 S11=942.952581336271 IsS11Max=Yes IsS11Min=No FrameElem=12 ElemStation=0
 Frame=12 Station=0 OutputCase=ENVE CaseType=Combination StepType=Min Point=2 X2=-0.5 X3=0.5
 S11=942.952581336271 IsS11Max=No IsS11Min=No FrameElem=12 ElemStation=0
 Frame=12 Station=0 OutputCase=ENVE CaseType=Combination StepType=Min Point=3 X2=0.5 X3=-0.5 S11=-
 2012.26266830047 IsS11Max=No IsS11Min=Yes FrameElem=12 ElemStation=0
 Frame=12 Station=0 OutputCase=ENVE CaseType=Combination StepType=Min Point=4 X2=0.5 X3=0.5 S11=-
 2012.26266830047 IsS11Max=No IsS11Min=No FrameElem=12 ElemStation=0
 Frame=12 Station=0.25 OutputCase=ENVE CaseType=Combination StepType=Min Point=0 X2=0 X3=0 S11=-
 508.549995165344 IsS11Max=No IsS11Min=No FrameElem=12 ElemStation=0.25
 Frame=12 Station=0.25 OutputCase=ENVE CaseType=Combination StepType=Min Point=1 X2=-0.5 X3=-0.5
 S11=738.05025233048 IsS11Max=Yes IsS11Min=No FrameElem=12 ElemStation=0.25
 Frame=12 Station=0.25 OutputCase=ENVE CaseType=Combination StepType=Min Point=2 X2=-0.5 X3=0.5
 S11=738.05025233048 IsS11Max=No IsS11Min=No FrameElem=12 ElemStation=0.25
 Frame=12 Station=0.25 OutputCase=ENVE CaseType=Combination StepType=Min Point=3 X2=0.5 X3=-0.5
 S11=-1821.53762193147 IsS11Max=No IsS11Min=Yes FrameElem=12 ElemStation=0.25
 Frame=12 Station=0.25 OutputCase=ENVE CaseType=Combination StepType=Min Point=4 X2=0.5 X3=0.5
 S11=-1821.53762193147 IsS11Max=No IsS11Min=No FrameElem=12 ElemStation=0.25
 Frame=12 Station=0 OutputCase=FESSUR CaseType=Combination Point=0 X2=0 X3=0 S11=-510.734994939175
 IsS11Max=No IsS11Min=No FrameElem=12 ElemStation=0
 Frame=12 Station=0 OutputCase=FESSUR CaseType=Combination Point=1 X2=-0.5 X3=-0.5
 S11=975.094332638423 IsS11Max=Yes IsS11Min=No FrameElem=12 ElemStation=0
 Frame=12 Station=0 OutputCase=FESSUR CaseType=Combination Point=2 X2=-0.5 X3=0.5
 S11=975.094332638423 IsS11Max=No IsS11Min=No FrameElem=12 ElemStation=0
 Frame=12 Station=0 OutputCase=FESSUR CaseType=Combination Point=3 X2=0.5 X3=-0.5 S11=-
 1996.56432251677 IsS11Max=No IsS11Min=Yes FrameElem=12 ElemStation=0
 Frame=12 Station=0 OutputCase=FESSUR CaseType=Combination Point=4 X2=0.5 X3=0.5 S11=-
 1996.56432251677 IsS11Max=No IsS11Min=No FrameElem=12 ElemStation=0
 Frame=12 Station=0.25 OutputCase=FESSUR CaseType=Combination Point=0 X2=0 X3=0 S11=-
 504.484994939175 IsS11Max=No IsS11Min=No FrameElem=12 ElemStation=0.25
 Frame=12 Station=0.25 OutputCase=FESSUR CaseType=Combination Point=1 X2=-0.5 X3=-0.5
 S11=751.799562645298 IsS11Max=Yes IsS11Min=No FrameElem=12 ElemStation=0.25
 Frame=12 Station=0.25 OutputCase=FESSUR CaseType=Combination Point=2 X2=-0.5 X3=0.5
 S11=751.799562645298 IsS11Max=No IsS11Min=No FrameElem=12 ElemStation=0.25
 Frame=12 Station=0.25 OutputCase=FESSUR CaseType=Combination Point=3 X2=0.5 X3=-0.5 S11=-
 1760.76955252365 IsS11Max=No IsS11Min=Yes FrameElem=12 ElemStation=0.25
 Frame=12 Station=0.25 OutputCase=FESSUR CaseType=Combination Point=4 X2=0.5 X3=0.5 S11=-
 1760.76955252365 IsS11Max=No IsS11Min=No FrameElem=12 ElemStation=0.25
 Frame=15 Station=0 OutputCase=PERM1 CaseType=Combination Point=0 X2=0 X3=0 S11=-419.999985343839
 IsS11Max=No IsS11Min=No FrameElem=15 ElemStation=0
 Frame=15 Station=0 OutputCase=PERM1 CaseType=Combination Point=1 X2=-0.5 X3=-0.5
 S11=595.761636268962 IsS11Max=Yes IsS11Min=No FrameElem=15 ElemStation=0
 Frame=15 Station=0 OutputCase=PERM1 CaseType=Combination Point=2 X2=-0.5 X3=0.5
 S11=595.761636268962 IsS11Max=No IsS11Min=No FrameElem=15 ElemStation=0
 Frame=15 Station=0 OutputCase=PERM1 CaseType=Combination Point=3 X2=0.5 X3=-0.5 S11=-
 1435.76160695664 IsS11Max=No IsS11Min=Yes FrameElem=15 ElemStation=0
 Frame=15 Station=0 OutputCase=PERM1 CaseType=Combination Point=4 X2=0.5 X3=0.5 S11=-
 1435.76160695664 IsS11Max=No IsS11Min=No FrameElem=15 ElemStation=0
 Frame=15 Station=0.2500000000000002 OutputCase=PERM1 CaseType=Combination Point=0 X2=0 X3=0 S11=-
 413.749983762938 IsS11Max=No IsS11Min=No FrameElem=15 ElemStation=0.2500000000000002
 Frame=15 Station=0.2500000000000002 OutputCase=PERM1 CaseType=Combination Point=1 X2=-0.5 X3=-0.5
 S11=767.181465894929 IsS11Max=Yes IsS11Min=No FrameElem=15 ElemStation=0.2500000000000002
 Frame=15 Station=0.2500000000000002 OutputCase=PERM1 CaseType=Combination Point=2 X2=-0.5 X3=0.5
 S11=767.181465894929 IsS11Max=No IsS11Min=No FrameElem=15 ElemStation=0.2500000000000002
 Frame=15 Station=0.2500000000000002 OutputCase=PERM1 CaseType=Combination Point=3 X2=0.5 X3=-0.5
 S11=-1594.6814334208 IsS11Max=No IsS11Min=Yes FrameElem=15 ElemStation=0.2500000000000002
 Frame=15 Station=0.2500000000000002 OutputCase=PERM1 CaseType=Combination Point=4 X2=0.5 X3=0.5
 S11=-1594.6814334208 IsS11Max=No IsS11Min=No FrameElem=15 ElemStation=0.2500000000000002

```

Frame=15 Station=0 OutputCase=PERM2 CaseType=Combination Point=0 X2=0 X3=0 S11=-419.999988940687
IsS11Max=No IsS11Min=No FrameElem=15 ElemStation=0
Frame=15 Station=0 OutputCase=PERM2 CaseType=Combination Point=1 X2=-0.5 X3=-0.5
S11=630.142544420096 IsS11Max=Yes IsS11Min=No FrameElem=15 ElemStation=0
Frame=15 Station=0 OutputCase=PERM2 CaseType=Combination Point=2 X2=-0.5 X3=0.5
S11=630.142544420096 IsS11Max=No IsS11Min=No FrameElem=15 ElemStation=0
Frame=15 Station=0 OutputCase=PERM2 CaseType=Combination Point=3 X2=0.5 X3=-0.5 S11=-
1470.14252230147 IsS11Max=No IsS11Min=Yes FrameElem=15 ElemStation=0
Frame=15 Station=0 OutputCase=PERM2 CaseType=Combination Point=4 X2=0.5 X3=0.5 S11=-
1470.14252230147 IsS11Max=No IsS11Min=No FrameElem=15 ElemStation=0
Frame=15 Station=0.2500000000000002 OutputCase=PERM2 CaseType=Combination Point=0 X2=0 X3=0 S11=-
413.749987834056 IsS11Max=No IsS11Min=No FrameElem=15 ElemStation=0.2500000000000002
Frame=15 Station=0.2500000000000002 OutputCase=PERM2 CaseType=Combination Point=1 X2=-0.5 X3=-0.5
S11=745.548846047376 IsS11Max=Yes IsS11Min=No FrameElem=15 ElemStation=0.2500000000000002
Frame=15 Station=0.2500000000000002 OutputCase=PERM2 CaseType=Combination Point=2 X2=-0.5 X3=0.5
S11=745.548846047376 IsS11Max=No IsS11Min=No FrameElem=15 ElemStation=0.2500000000000002
Frame=15 Station=0.2500000000000002 OutputCase=PERM2 CaseType=Combination Point=3 X2=0.5 X3=-0.5
S11=-1573.04882171549 IsS11Max=No IsS11Min=Yes FrameElem=15 ElemStation=0.2500000000000002
Frame=15 Station=0.2500000000000002 OutputCase=PERM2 CaseType=Combination Point=4 X2=0.5 X3=0.5
S11=-1573.04882171549 IsS11Max=No IsS11Min=No FrameElem=15 ElemStation=0.2500000000000002
Frame=15 Station=0 OutputCase=ACC1 CaseType=Combination Point=0 X2=0 X3=0 S11=-433.549984851082
IsS11Max=No IsS11Min=No FrameElem=15 ElemStation=0
Frame=15 Station=0 OutputCase=ACC1 CaseType=Combination Point=1 X2=-0.5 X3=-0.5
S11=615.939633906715 IsS11Max=Yes IsS11Min=No FrameElem=15 ElemStation=0
Frame=15 Station=0 OutputCase=ACC1 CaseType=Combination Point=2 X2=-0.5 X3=0.5 S11=615.939633906715
IsS11Max=No IsS11Min=No FrameElem=15 ElemStation=0
Frame=15 Station=0 OutputCase=ACC1 CaseType=Combination Point=3 X2=0.5 X3=-0.5 S11=-
1483.03960360888 IsS11Max=No IsS11Min=Yes FrameElem=15 ElemStation=0
Frame=15 Station=0 OutputCase=ACC1 CaseType=Combination Point=4 X2=0.5 X3=0.5 S11=-1483.03960360888
IsS11Max=No IsS11Min=No FrameElem=15 ElemStation=0
Frame=15 Station=0.2500000000000002 OutputCase=ACC1 CaseType=Combination Point=0 X2=0 X3=0 S11=-
427.299983215106 IsS11Max=No IsS11Min=No FrameElem=15 ElemStation=0.2500000000000002
Frame=15 Station=0.2500000000000002 OutputCase=ACC1 CaseType=Combination Point=1 X2=-0.5 X3=-0.5
S11=793.034767806476 IsS11Max=Yes IsS11Min=No FrameElem=15 ElemStation=0.2500000000000002
Frame=15 Station=0.2500000000000002 OutputCase=ACC1 CaseType=Combination Point=2 X2=-0.5 X3=0.5
S11=793.034767806476 IsS11Max=No IsS11Min=No FrameElem=15 ElemStation=0.2500000000000002
Frame=15 Station=0.2500000000000002 OutputCase=ACC1 CaseType=Combination Point=3 X2=0.5 X3=-0.5
S11=-1647.63473423669 IsS11Max=No IsS11Min=Yes FrameElem=15 ElemStation=0.2500000000000002
Frame=15 Station=0.2500000000000002 OutputCase=ACC1 CaseType=Combination Point=4 X2=0.5 X3=0.5 S11=-
1647.63473423669 IsS11Max=No IsS11Min=No FrameElem=15 ElemStation=0.2500000000000002
Frame=15 Station=0 OutputCase=ACC2 CaseType=Combination Point=0 X2=0 X3=0 S11=-433.54998844793
IsS11Max=No IsS11Min=No FrameElem=15 ElemStation=0
Frame=15 Station=0 OutputCase=ACC2 CaseType=Combination Point=1 X2=-0.5 X3=-0.5
S11=650.320542057849 IsS11Max=Yes IsS11Min=No FrameElem=15 ElemStation=0
Frame=15 Station=0 OutputCase=ACC2 CaseType=Combination Point=2 X2=-0.5 X3=0.5 S11=650.320542057849
IsS11Max=No IsS11Min=No FrameElem=15 ElemStation=0
Frame=15 Station=0 OutputCase=ACC2 CaseType=Combination Point=3 X2=0.5 X3=-0.5 S11=-
1517.42051895371 IsS11Max=No IsS11Min=Yes FrameElem=15 ElemStation=0
Frame=15 Station=0 OutputCase=ACC2 CaseType=Combination Point=4 X2=0.5 X3=0.5 S11=-1517.42051895371
IsS11Max=No IsS11Min=No FrameElem=15 ElemStation=0
Frame=15 Station=0.2500000000000002 OutputCase=ACC2 CaseType=Combination Point=0 X2=0 X3=0 S11=-
427.299987286224 IsS11Max=No IsS11Min=No FrameElem=15 ElemStation=0.2500000000000002
Frame=15 Station=0.2500000000000002 OutputCase=ACC2 CaseType=Combination Point=1 X2=-0.5 X3=-0.5
S11=771.402147958922 IsS11Max=Yes IsS11Min=No FrameElem=15 ElemStation=0.2500000000000002
Frame=15 Station=0.2500000000000002 OutputCase=ACC2 CaseType=Combination Point=2 X2=-0.5 X3=0.5
S11=771.402147958922 IsS11Max=No IsS11Min=No FrameElem=15 ElemStation=0.2500000000000002
Frame=15 Station=0.2500000000000002 OutputCase=ACC2 CaseType=Combination Point=3 X2=0.5 X3=-0.5
S11=-1626.00212253137 IsS11Max=No IsS11Min=Yes FrameElem=15 ElemStation=0.2500000000000002
Frame=15 Station=0.2500000000000002 OutputCase=ACC2 CaseType=Combination Point=4 X2=0.5 X3=0.5 S11=-
1626.00212253137 IsS11Max=No IsS11Min=No FrameElem=15 ElemStation=0.2500000000000002
Frame=15 Station=0 OutputCase=ACCSX1 CaseType=Combination Point=0 X2=0 X3=0 S11=-418.485907631785
IsS11Max=No IsS11Min=No FrameElem=15 ElemStation=0
Frame=15 Station=0 OutputCase=ACCSX1 CaseType=Combination Point=1 X2=-0.5 X3=-0.5
S11=573.148791330101 IsS11Max=Yes IsS11Min=No FrameElem=15 ElemStation=0
Frame=15 Station=0 OutputCase=ACCSX1 CaseType=Combination Point=2 X2=-0.5 X3=0.5
S11=573.148791330101 IsS11Max=No IsS11Min=No FrameElem=15 ElemStation=0
Frame=15 Station=0 OutputCase=ACCSX1 CaseType=Combination Point=3 X2=0.5 X3=-0.5 S11=-
1410.12060659367 IsS11Max=No IsS11Min=Yes FrameElem=15 ElemStation=0
Frame=15 Station=0 OutputCase=ACCSX1 CaseType=Combination Point=4 X2=0.5 X3=0.5 S11=-
1410.12060659367 IsS11Max=No IsS11Min=No FrameElem=15 ElemStation=0
Frame=15 Station=0.2500000000000002 OutputCase=ACCSX1 CaseType=Combination Point=0 X2=0 X3=0 S11=-
412.235905995809 IsS11Max=No IsS11Min=No FrameElem=15 ElemStation=0.2500000000000002
Frame=15 Station=0.2500000000000002 OutputCase=ACCSX1 CaseType=Combination Point=1 X2=-0.5 X3=-0.5
S11=746.678442780842 IsS11Max=Yes IsS11Min=No FrameElem=15 ElemStation=0.2500000000000002
Frame=15 Station=0.2500000000000002 OutputCase=ACCSX1 CaseType=Combination Point=2 X2=-0.5 X3=0.5
S11=746.678442780842 IsS11Max=No IsS11Min=No FrameElem=15 ElemStation=0.2500000000000002
Frame=15 Station=0.2500000000000002 OutputCase=ACCSX1 CaseType=Combination Point=3 X2=0.5 X3=-0.5
S11=-1571.15025477246 IsS11Max=No IsS11Min=Yes FrameElem=15 ElemStation=0.2500000000000002
Frame=15 Station=0.2500000000000002 OutputCase=ACCSX1 CaseType=Combination Point=4 X2=0.5 X3=0.5
S11=-1571.15025477246 IsS11Max=No IsS11Min=No FrameElem=15 ElemStation=0.2500000000000002
Frame=15 Station=0 OutputCase=ACCSX2 CaseType=Combination Point=0 X2=0 X3=0 S11=-418.485911228633
IsS11Max=No IsS11Min=No FrameElem=15 ElemStation=0

```



Frame=15 Station=0 OutputCase=ACCSX2 CaseType=Combination Point=1 X2=-0.5 X3=-0.5
 S11=607.529699481236 IsS11Max=Yes IsS11Min=No FrameElem=15 ElemStation=0
 Frame=15 Station=0 OutputCase=ACCSX2 CaseType=Combination Point=2 X2=-0.5 X3=0.5
 S11=607.529699481236 IsS11Max=No IsS11Min=No FrameElem=15 ElemStation=0
 Frame=15 Station=0 OutputCase=ACCSX2 CaseType=Combination Point=3 X2=0.5 X3=-0.5 S11=-
 1444.5015219385 IsS11Max=No IsS11Min=Yes FrameElem=15 ElemStation=0
 Frame=15 Station=0 OutputCase=ACCSX2 CaseType=Combination Point=4 X2=0.5 X3=0.5 S11=-
 1444.5015219385 IsS11Max=No IsS11Min=No FrameElem=15 ElemStation=0
 Frame=15 Station=0.250000000000002 OutputCase=ACCSX2 CaseType=Combination Point=0 X2=0 X3=0 S11=-
 412.235910066927 IsS11Max=No IsS11Min=No FrameElem=15 ElemStation=0.250000000000002
 Frame=15 Station=0.250000000000002 OutputCase=ACCSX2 CaseType=Combination Point=1 X2=-0.5 X3=-0.5
 S11=725.045822933288 IsS11Max=Yes IsS11Min=No FrameElem=15 ElemStation=0.250000000000002
 Frame=15 Station=0.250000000000002 OutputCase=ACCSX2 CaseType=Combination Point=2 X2=-0.5 X3=0.5
 S11=725.045822933288 IsS11Max=No IsS11Min=No FrameElem=15 ElemStation=0.250000000000002
 Frame=15 Station=0.250000000000002 OutputCase=ACCSX2 CaseType=Combination Point=3 X2=0.5 X3=-0.5
 S11=-1549.51764306714 IsS11Max=No IsS11Min=Yes FrameElem=15 ElemStation=0.250000000000002
 Frame=15 Station=0.250000000000002 OutputCase=ACCSX2 CaseType=Combination Point=4 X2=0.5 X3=0.5
 S11=-1549.51764306714 IsS11Max=No IsS11Min=No FrameElem=15 ElemStation=0.250000000000002
 Frame=15 Station=0 OutputCase=ENVE CaseType=Combination StepType=Max Point=0 X2=0 X3=0 S11=-
 418.485907631785 IsS11Max=No IsS11Min=No FrameElem=15 ElemStation=0
 Frame=15 Station=0 OutputCase=ENVE CaseType=Combination StepType=Max Point=1 X2=-0.5 X3=-0.5
 S11=650.320542057849 IsS11Max=Yes IsS11Min=No FrameElem=15 ElemStation=0
 Frame=15 Station=0 OutputCase=ENVE CaseType=Combination StepType=Max Point=2 X2=-0.5 X3=0.5
 S11=650.320542057849 IsS11Max=No IsS11Min=No FrameElem=15 ElemStation=0
 Frame=15 Station=0 OutputCase=ENVE CaseType=Combination StepType=Max Point=3 X2=0.5 X3=-0.5 S11=-
 1410.12060659367 IsS11Max=No IsS11Min=Yes FrameElem=15 ElemStation=0
 Frame=15 Station=0 OutputCase=ENVE CaseType=Combination StepType=Max Point=4 X2=0.5 X3=0.5 S11=-
 1410.12060659367 IsS11Max=No IsS11Min=No FrameElem=15 ElemStation=0
 Frame=15 Station=0.250000000000002 OutputCase=ENVE CaseType=Combination StepType=Max Point=0 X2=0
 X3=0 S11=-412.235905995809 IsS11Max=No IsS11Min=No FrameElem=15 ElemStation=0.250000000000002
 Frame=15 Station=0.250000000000002 OutputCase=ENVE CaseType=Combination StepType=Max Point=1 X2=-0.5
 X3=-0.5 S11=793.034767806476 IsS11Max=Yes IsS11Min=No FrameElem=15 ElemStation=0.250000000000002
 Frame=15 Station=0.250000000000002 OutputCase=ENVE CaseType=Combination StepType=Max Point=2 X2=-0.5
 X3=0.5 S11=793.034767806476 IsS11Max=No IsS11Min=No FrameElem=15 ElemStation=0.250000000000002
 Frame=15 Station=0.250000000000002 OutputCase=ENVE CaseType=Combination StepType=Max Point=3 X2=0.5
 X3=-0.5 S11=-1549.51764306714 IsS11Max=No IsS11Min=Yes FrameElem=15 ElemStation=0.250000000000002
 Frame=15 Station=0.250000000000002 OutputCase=ENVE CaseType=Combination StepType=Max Point=4 X2=0.5
 X3=0.5 S11=-1549.51764306714 IsS11Max=No IsS11Min=No FrameElem=15 ElemStation=0.250000000000002
 Frame=15 Station=0 OutputCase=ENVE CaseType=Combination StepType=Min Point=0 X2=0 X3=0 S11=-
 433.54998844793 IsS11Max=No IsS11Min=No FrameElem=15 ElemStation=0
 Frame=15 Station=0 OutputCase=ENVE CaseType=Combination StepType=Min Point=1 X2=-0.5 X3=-0.5
 S11=573.148791330101 IsS11Max=Yes IsS11Min=No FrameElem=15 ElemStation=0
 Frame=15 Station=0 OutputCase=ENVE CaseType=Combination StepType=Min Point=2 X2=-0.5 X3=0.5
 S11=573.148791330101 IsS11Max=No IsS11Min=No FrameElem=15 ElemStation=0
 Frame=15 Station=0 OutputCase=ENVE CaseType=Combination StepType=Min Point=3 X2=0.5 X3=-0.5 S11=-
 1517.42051895371 IsS11Max=No IsS11Min=Yes FrameElem=15 ElemStation=0
 Frame=15 Station=0 OutputCase=ENVE CaseType=Combination StepType=Min Point=4 X2=0.5 X3=0.5 S11=-
 1517.42051895371 IsS11Max=No IsS11Min=No FrameElem=15 ElemStation=0
 Frame=15 Station=0.250000000000002 OutputCase=ENVE CaseType=Combination StepType=Min Point=0 X2=0
 X3=0 S11=-427.299987286224 IsS11Max=No IsS11Min=No FrameElem=15 ElemStation=0.250000000000002
 Frame=15 Station=0.250000000000002 OutputCase=ENVE CaseType=Combination StepType=Min Point=1 X2=-0.5
 X3=-0.5 S11=725.045822933288 IsS11Max=Yes IsS11Min=No FrameElem=15 ElemStation=0.250000000000002
 Frame=15 Station=0.250000000000002 OutputCase=ENVE CaseType=Combination StepType=Min Point=2 X2=-0.5
 X3=0.5 S11=725.045822933288 IsS11Max=No IsS11Min=No FrameElem=15 ElemStation=0.250000000000002
 Frame=15 Station=0.250000000000002 OutputCase=ENVE CaseType=Combination StepType=Min Point=3 X2=0.5
 X3=-0.5 S11=-1647.63473423669 IsS11Max=No IsS11Min=Yes FrameElem=15 ElemStation=0.250000000000002
 Frame=15 Station=0.250000000000002 OutputCase=ENVE CaseType=Combination StepType=Min Point=4 X2=0.5
 X3=0.5 S11=-1647.63473423669 IsS11Max=No IsS11Min=No FrameElem=15 ElemStation=0.250000000000002
 Frame=15 Station=0 OutputCase=FESSUR CaseType=Combination Point=0 X2=0 X3=0 S11=-429.484984998909
 IsS11Max=No IsS11Min=No FrameElem=15 ElemStation=0
 Frame=15 Station=0 OutputCase=FESSUR CaseType=Combination Point=1 X2=-0.5 X3=-0.5
 S11=609.886234615389 IsS11Max=Yes IsS11Min=No FrameElem=15 ElemStation=0
 Frame=15 Station=0 OutputCase=FESSUR CaseType=Combination Point=2 X2=-0.5 X3=0.5
 S11=609.886234615389 IsS11Max=No IsS11Min=No FrameElem=15 ElemStation=0
 Frame=15 Station=0 OutputCase=FESSUR CaseType=Combination Point=3 X2=0.5 X3=-0.5 S11=-
 1468.85620461321 IsS11Max=No IsS11Min=Yes FrameElem=15 ElemStation=0
 Frame=15 Station=0 OutputCase=FESSUR CaseType=Combination Point=4 X2=0.5 X3=0.5 S11=-
 1468.85620461321 IsS11Max=No IsS11Min=No FrameElem=15 ElemStation=0
 Frame=15 Station=0.250000000000002 OutputCase=FESSUR CaseType=Combination Point=0 X2=0 X3=0 S11=-
 423.234983379455 IsS11Max=No IsS11Min=No FrameElem=15 ElemStation=0.250000000000002
 Frame=15 Station=0.250000000000002 OutputCase=FESSUR CaseType=Combination Point=1 X2=-0.5 X3=-0.5
 S11=785.278777233012 IsS11Max=Yes IsS11Min=No FrameElem=15 ElemStation=0.250000000000002
 Frame=15 Station=0.250000000000002 OutputCase=FESSUR CaseType=Combination Point=2 X2=-0.5 X3=0.5
 S11=785.278777233012 IsS11Max=No IsS11Min=No FrameElem=15 ElemStation=0.250000000000002
 Frame=15 Station=0.250000000000002 OutputCase=FESSUR CaseType=Combination Point=3 X2=0.5 X3=-0.5
 S11=-1631.74874399192 IsS11Max=No IsS11Min=Yes FrameElem=15 ElemStation=0.250000000000002
 Frame=15 Station=0.250000000000002 OutputCase=FESSUR CaseType=Combination Point=4 X2=0.5 X3=0.5
 S11=-1631.74874399192 IsS11Max=No IsS11Min=No FrameElem=15 ElemStation=0.250000000000002
 Frame=16 Station=0 OutputCase=PERM1 CaseType=Combination Point=0 X2=0 X3=0 S11=-413.750006338093
 IsS11Max=No IsS11Min=No FrameElem=16 ElemStation=0
 Frame=16 Station=0 OutputCase=PERM1 CaseType=Combination Point=1 X2=-0.5 X3=-0.5
 S11=767.181443319762 IsS11Max=Yes IsS11Min=No FrameElem=16 ElemStation=0



Frame=16 Station=0 OutputCase=PERM1 CaseType=Combination Point=2 X2=-0.5 X3=0.5
 S11=767.181443319762 IsS11Max=No IsS11Min=No FrameElem=16 ElemStation=0
 Frame=16 Station=0 OutputCase=PERM1 CaseType=Combination Point=3 X2=0.5 X3=-0.5 S11=-
 1594.68145599595 IsS11Max=No IsS11Min=Yes FrameElem=16 ElemStation=0
 Frame=16 Station=0 OutputCase=PERM1 CaseType=Combination Point=4 X2=0.5 X3=0.5 S11=-
 1594.68145599595 IsS11Max=No IsS11Min=No FrameElem=16 ElemStation=0
 Frame=16 Station=0.2500000000000001 OutputCase=PERM1 CaseType=Combination Point=0 X2=0 X3=0 S11=-
 407.500007868167 IsS11Max=No IsS11Min=No FrameElem=16 ElemStation=0.2500000000000001
 Frame=16 Station=0.2500000000000001 OutputCase=PERM1 CaseType=Combination Point=1 X2=-0.5 X3=-0.5
 S11=963.066854584935 IsS11Max=Yes IsS11Min=No FrameElem=16 ElemStation=0.2500000000000001
 Frame=16 Station=0.2500000000000001 OutputCase=PERM1 CaseType=Combination Point=2 X2=-0.5 X3=0.5
 S11=963.066854584935 IsS11Max=No IsS11Min=No FrameElem=16 ElemStation=0.2500000000000001
 Frame=16 Station=0.2500000000000001 OutputCase=PERM1 CaseType=Combination Point=3 X2=0.5 X3=-0.5
 S11=-1778.06687032127 IsS11Max=No IsS11Min=Yes FrameElem=16 ElemStation=0.2500000000000001
 Frame=16 Station=0.2500000000000001 OutputCase=PERM1 CaseType=Combination Point=4 X2=0.5 X3=0.5
 S11=-1778.06687032127 IsS11Max=No IsS11Min=No FrameElem=16 ElemStation=0.2500000000000001
 Frame=16 Station=0 OutputCase=PERM2 CaseType=Combination Point=0 X2=0 X3=0 S11=-413.750002814994
 IsS11Max=No IsS11Min=No FrameElem=16 ElemStation=0
 Frame=16 Station=0 OutputCase=PERM2 CaseType=Combination Point=1 X2=-0.5 X3=-0.5
 S11=745.548831066426 IsS11Max=Yes IsS11Min=No FrameElem=16 ElemStation=0
 Frame=16 Station=0 OutputCase=PERM2 CaseType=Combination Point=2 X2=-0.5 X3=0.5
 S11=745.548831066426 IsS11Max=No IsS11Min=No FrameElem=16 ElemStation=0
 Frame=16 Station=0 OutputCase=PERM2 CaseType=Combination Point=3 X2=0.5 X3=-0.5 S11=-
 1573.04883669641 IsS11Max=No IsS11Min=Yes FrameElem=16 ElemStation=0
 Frame=16 Station=0 OutputCase=PERM2 CaseType=Combination Point=4 X2=0.5 X3=0.5 S11=-
 1573.04883669641 IsS11Max=No IsS11Min=No FrameElem=16 ElemStation=0
 Frame=16 Station=0.2500000000000001 OutputCase=PERM2 CaseType=Combination Point=0 X2=0 X3=0 S11=-
 407.500003886045 IsS11Max=No IsS11Min=No FrameElem=16 ElemStation=0.2500000000000001
 Frame=16 Station=0.2500000000000001 OutputCase=PERM2 CaseType=Combination Point=1 X2=-0.5 X3=-0.5
 S11=878.081004328703 IsS11Max=Yes IsS11Min=No FrameElem=16 ElemStation=0.2500000000000001
 Frame=16 Station=0.2500000000000001 OutputCase=PERM2 CaseType=Combination Point=2 X2=-0.5 X3=0.5
 S11=878.081004328703 IsS11Max=No IsS11Min=No FrameElem=16 ElemStation=0.2500000000000001
 Frame=16 Station=0.2500000000000001 OutputCase=PERM2 CaseType=Combination Point=3 X2=0.5 X3=-0.5
 S11=-1693.08101210079 IsS11Max=No IsS11Min=Yes FrameElem=16 ElemStation=0.2500000000000001
 Frame=16 Station=0.2500000000000001 OutputCase=PERM2 CaseType=Combination Point=4 X2=0.5 X3=0.5
 S11=-1693.08101210079 IsS11Max=No IsS11Min=No FrameElem=16 ElemStation=0.2500000000000001
 Frame=16 Station=0 OutputCase=ACC1 CaseType=Combination Point=0 X2=0 X3=0 S11=-427.300006566987
 IsS11Max=No IsS11Min=No FrameElem=16 ElemStation=0
 Frame=16 Station=0 OutputCase=ACC1 CaseType=Combination Point=1 X2=-0.5 X3=-0.5 S11=793.03474445458
 IsS11Max=Yes IsS11Min=No FrameElem=16 ElemStation=0
 Frame=16 Station=0 OutputCase=ACC1 CaseType=Combination Point=2 X2=-0.5 X3=0.5 S11=793.03474445458
 IsS11Max=No IsS11Min=No FrameElem=16 ElemStation=0
 Frame=16 Station=0 OutputCase=ACC1 CaseType=Combination Point=3 X2=0.5 X3=-0.5 S11=-
 1647.63475758855 IsS11Max=No IsS11Min=Yes FrameElem=16 ElemStation=0
 Frame=16 Station=0 OutputCase=ACC1 CaseType=Combination Point=4 X2=0.5 X3=0.5 S11=-1647.63475758855
 IsS11Max=No IsS11Min=No FrameElem=16 ElemStation=0
 Frame=16 Station=0.2500000000000001 OutputCase=ACC1 CaseType=Combination Point=0 X2=0 X3=0 S11=-
 421.050008152135 IsS11Max=No IsS11Min=No FrameElem=16 ElemStation=0.2500000000000001
 Frame=16 Station=0.2500000000000001 OutputCase=ACC1 CaseType=Combination Point=1 X2=-0.5 X3=-0.5
 S11=995.461706006715 IsS11Max=Yes IsS11Min=No FrameElem=16 ElemStation=0.2500000000000001
 Frame=16 Station=0.2500000000000001 OutputCase=ACC1 CaseType=Combination Point=2 X2=-0.5 X3=0.5
 S11=995.461706006715 IsS11Max=No IsS11Min=No FrameElem=16 ElemStation=0.2500000000000001
 Frame=16 Station=0.2500000000000001 OutputCase=ACC1 CaseType=Combination Point=3 X2=0.5 X3=-0.5
 S11=-1837.56172231099 IsS11Max=No IsS11Min=Yes FrameElem=16 ElemStation=0.2500000000000001
 Frame=16 Station=0.2500000000000001 OutputCase=ACC1 CaseType=Combination Point=4 X2=0.5 X3=0.5 S11=-
 1837.56172231099 IsS11Max=No IsS11Min=No FrameElem=16 ElemStation=0.2500000000000001
 Frame=16 Station=0 OutputCase=ACC2 CaseType=Combination Point=0 X2=0 X3=0 S11=-427.300003043888
 IsS11Max=No IsS11Min=No FrameElem=16 ElemStation=0
 Frame=16 Station=0 OutputCase=ACC2 CaseType=Combination Point=1 X2=-0.5 X3=-0.5
 S11=771.402132201243 IsS11Max=Yes IsS11Min=No FrameElem=16 ElemStation=0
 Frame=16 Station=0 OutputCase=ACC2 CaseType=Combination Point=2 X2=-0.5 X3=0.5 S11=771.402132201243
 IsS11Max=No IsS11Min=No FrameElem=16 ElemStation=0
 Frame=16 Station=0 OutputCase=ACC2 CaseType=Combination Point=3 X2=0.5 X3=-0.5 S11=-
 1626.00213828902 IsS11Max=No IsS11Min=Yes FrameElem=16 ElemStation=0
 Frame=16 Station=0 OutputCase=ACC2 CaseType=Combination Point=4 X2=0.5 X3=0.5 S11=-1626.00213828902
 IsS11Max=No IsS11Min=No FrameElem=16 ElemStation=0
 Frame=16 Station=0.2500000000000001 OutputCase=ACC2 CaseType=Combination Point=0 X2=0 X3=0 S11=-
 421.050004170014 IsS11Max=No IsS11Min=No FrameElem=16 ElemStation=0.2500000000000001
 Frame=16 Station=0.2500000000000001 OutputCase=ACC2 CaseType=Combination Point=1 X2=-0.5 X3=-0.5
 S11=910.475855750483 IsS11Max=Yes IsS11Min=No FrameElem=16 ElemStation=0.2500000000000001
 Frame=16 Station=0.2500000000000001 OutputCase=ACC2 CaseType=Combination Point=2 X2=-0.5 X3=0.5
 S11=910.475855750483 IsS11Max=No IsS11Min=No FrameElem=16 ElemStation=0.2500000000000001
 Frame=16 Station=0.2500000000000001 OutputCase=ACC2 CaseType=Combination Point=3 X2=0.5 X3=-0.5
 S11=-1752.57586409051 IsS11Max=No IsS11Min=Yes FrameElem=16 ElemStation=0.2500000000000001
 Frame=16 Station=0.2500000000000001 OutputCase=ACC2 CaseType=Combination Point=4 X2=0.5 X3=0.5 S11=-
 1752.57586409051 IsS11Max=No IsS11Min=No FrameElem=16 ElemStation=0.2500000000000001
 Frame=16 Station=0 OutputCase=ACCSX1 CaseType=Combination Point=0 X2=0 X3=0 S11=-412.235928894322
 IsS11Max=No IsS11Min=No FrameElem=16 ElemStation=0
 Frame=16 Station=0 OutputCase=ACCSX1 CaseType=Combination Point=1 X2=-0.5 X3=-0.5
 S11=746.678419882309 IsS11Max=Yes IsS11Min=No FrameElem=16 ElemStation=0
 Frame=16 Station=0 OutputCase=ACCSX1 CaseType=Combination Point=2 X2=-0.5 X3=0.5
 S11=746.678419882309 IsS11Max=No IsS11Min=No FrameElem=16 ElemStation=0



Frame=16 Station=0 OutputCase=ACCSX1 CaseType=Combination Point=3 X2=0.5 X3=-0.5 S11=-
 1571.15027767095 IsS11Max=No IsS11Min=Yes FrameElem=16 ElemStation=0
 Frame=16 Station=0 OutputCase=ACCSX1 CaseType=Combination Point=4 X2=0.5 X3=0.5 S11=-
 1571.15027767095 IsS11Max=No IsS11Min=No FrameElem=16 ElemStation=0
 Frame=16 Station=0.250000000000001 OutputCase=ACCSX1 CaseType=Combination Point=0 X2=0 X3=0 S11=-
 405.98593047947 IsS11Max=No IsS11Min=No FrameElem=16 ElemStation=0.250000000000001
 Frame=16 Station=0.250000000000001 OutputCase=ACCSX1 CaseType=Combination Point=1 X2=-0.5 X3=-0.5
 S11=945.539903295295 IsS11Max=Yes IsS11Min=No FrameElem=16 ElemStation=0.250000000000001
 Frame=16 Station=0.250000000000001 OutputCase=ACCSX1 CaseType=Combination Point=2 X2=-0.5 X3=0.5
 S11=945.539903295295 IsS11Max=No IsS11Min=No FrameElem=16 ElemStation=0.250000000000001
 Frame=16 Station=0.250000000000001 OutputCase=ACCSX1 CaseType=Combination Point=3 X2=0.5 X3=-0.5
 S11=-1757.51176425423 IsS11Max=No IsS11Min=Yes FrameElem=16 ElemStation=0.250000000000001
 Frame=16 Station=0.250000000000001 OutputCase=ACCSX1 CaseType=Combination Point=4 X2=0.5 X3=0.5
 S11=-1757.51176425423 IsS11Max=No IsS11Min=No FrameElem=16 ElemStation=0.250000000000001
 Frame=16 Station=0 OutputCase=ACCSX2 CaseType=Combination Point=0 X2=0 X3=0 S11=-412.235925371222
 IsS11Max=No IsS11Min=No FrameElem=16 ElemStation=0
 Frame=16 Station=0 OutputCase=ACCSX2 CaseType=Combination Point=1 X2=-0.5 X3=-0.5
 S11=725.045807628972 IsS11Max=Yes IsS11Min=No FrameElem=16 ElemStation=0
 Frame=16 Station=0 OutputCase=ACCSX2 CaseType=Combination Point=2 X2=-0.5 X3=0.5
 S11=725.045807628972 IsS11Max=No IsS11Min=No FrameElem=16 ElemStation=0
 Frame=16 Station=0 OutputCase=ACCSX2 CaseType=Combination Point=3 X2=0.5 X3=-0.5 S11=-
 1549.51765837142 IsS11Max=No IsS11Min=Yes FrameElem=16 ElemStation=0
 Frame=16 Station=0 OutputCase=ACCSX2 CaseType=Combination Point=4 X2=0.5 X3=0.5 S11=-
 1549.51765837142 IsS11Max=No IsS11Min=No FrameElem=16 ElemStation=0
 Frame=16 Station=0.250000000000001 OutputCase=ACCSX2 CaseType=Combination Point=0 X2=0 X3=0 S11=-
 405.985926497349 IsS11Max=No IsS11Min=No FrameElem=16 ElemStation=0.250000000000001
 Frame=16 Station=0.250000000000001 OutputCase=ACCSX2 CaseType=Combination Point=1 X2=-0.5 X3=-0.5
 S11=860.554053039063 IsS11Max=Yes IsS11Min=No FrameElem=16 ElemStation=0.250000000000001
 Frame=16 Station=0.250000000000001 OutputCase=ACCSX2 CaseType=Combination Point=2 X2=-0.5 X3=0.5
 S11=860.554053039063 IsS11Max=No IsS11Min=No FrameElem=16 ElemStation=0.250000000000001
 Frame=16 Station=0.250000000000001 OutputCase=ACCSX2 CaseType=Combination Point=3 X2=0.5 X3=-0.5
 S11=-1672.52590603376 IsS11Max=No IsS11Min=Yes FrameElem=16 ElemStation=0.250000000000001
 Frame=16 Station=0.250000000000001 OutputCase=ACCSX2 CaseType=Combination Point=4 X2=0.5 X3=0.5
 S11=-1672.52590603376 IsS11Max=No IsS11Min=No FrameElem=16 ElemStation=0.250000000000001
 Frame=16 Station=0 OutputCase=ENVE CaseType=Combination StepType=Max Point=0 X2=0 X3=0 S11=-
 412.235925371222 IsS11Max=No IsS11Min=No FrameElem=16 ElemStation=0
 Frame=16 Station=0 OutputCase=ENVE CaseType=Combination StepType=Max Point=1 X2=-0.5 X3=-0.5
 S11=793.03474445458 IsS11Max=Yes IsS11Min=No FrameElem=16 ElemStation=0
 Frame=16 Station=0 OutputCase=ENVE CaseType=Combination StepType=Max Point=2 X2=-0.5 X3=0.5
 S11=793.03474445458 IsS11Max=No IsS11Min=No FrameElem=16 ElemStation=0
 Frame=16 Station=0 OutputCase=ENVE CaseType=Combination StepType=Max Point=3 X2=0.5 X3=-0.5 S11=-
 1549.51765837142 IsS11Max=No IsS11Min=Yes FrameElem=16 ElemStation=0
 Frame=16 Station=0 OutputCase=ENVE CaseType=Combination StepType=Max Point=4 X2=0.5 X3=0.5 S11=-
 1549.51765837142 IsS11Max=No IsS11Min=No FrameElem=16 ElemStation=0
 Frame=16 Station=0.250000000000001 OutputCase=ENVE CaseType=Combination StepType=Max Point=0 X2=0
 X3=0 S11=-405.985926497349 IsS11Max=No IsS11Min=No FrameElem=16 ElemStation=0.250000000000001
 Frame=16 Station=0.250000000000001 OutputCase=ENVE CaseType=Combination StepType=Max Point=1 X2=-0.5
 X3=-0.5 S11=995.461706006715 IsS11Max=Yes IsS11Min=No FrameElem=16 ElemStation=0.250000000000001
 Frame=16 Station=0.250000000000001 OutputCase=ENVE CaseType=Combination StepType=Max Point=2 X2=-0.5
 X3=0.5 S11=995.461706006715 IsS11Max=No IsS11Min=No FrameElem=16 ElemStation=0.250000000000001
 Frame=16 Station=0.250000000000001 OutputCase=ENVE CaseType=Combination StepType=Max Point=3 X2=0.5
 X3=-0.5 S11=-1672.52590603376 IsS11Max=No IsS11Min=Yes FrameElem=16 ElemStation=0.250000000000001
 Frame=16 Station=0.250000000000001 OutputCase=ENVE CaseType=Combination StepType=Max Point=4 X2=0.5
 X3=0.5 S11=-1672.52590603376 IsS11Max=No IsS11Min=No FrameElem=16 ElemStation=0.250000000000001
 Frame=16 Station=0 OutputCase=ENVE CaseType=Combination StepType=Min Point=0 X2=0 X3=0 S11=-
 427.300006566987 IsS11Max=No IsS11Min=No FrameElem=16 ElemStation=0
 Frame=16 Station=0 OutputCase=ENVE CaseType=Combination StepType=Min Point=1 X2=-0.5 X3=-0.5
 S11=725.045807628972 IsS11Max=Yes IsS11Min=No FrameElem=16 ElemStation=0
 Frame=16 Station=0 OutputCase=ENVE CaseType=Combination StepType=Min Point=2 X2=-0.5 X3=0.5
 S11=725.045807628972 IsS11Max=No IsS11Min=No FrameElem=16 ElemStation=0
 Frame=16 Station=0 OutputCase=ENVE CaseType=Combination StepType=Min Point=3 X2=0.5 X3=-0.5 S11=-
 1647.63475758855 IsS11Max=No IsS11Min=Yes FrameElem=16 ElemStation=0
 Frame=16 Station=0 OutputCase=ENVE CaseType=Combination StepType=Min Point=4 X2=0.5 X3=0.5 S11=-
 1647.63475758855 IsS11Max=No IsS11Min=No FrameElem=16 ElemStation=0
 Frame=16 Station=0.250000000000001 OutputCase=ENVE CaseType=Combination StepType=Min Point=0 X2=0
 X3=0 S11=-421.050008152135 IsS11Max=No IsS11Min=No FrameElem=16 ElemStation=0.250000000000001
 Frame=16 Station=0.250000000000001 OutputCase=ENVE CaseType=Combination StepType=Min Point=1 X2=-0.5
 X3=-0.5 S11=860.554053039063 IsS11Max=Yes IsS11Min=No FrameElem=16 ElemStation=0.250000000000001
 Frame=16 Station=0.250000000000001 OutputCase=ENVE CaseType=Combination StepType=Min Point=2 X2=-0.5
 X3=0.5 S11=860.554053039063 IsS11Max=No IsS11Min=No FrameElem=16 ElemStation=0.250000000000001
 Frame=16 Station=0.250000000000001 OutputCase=ENVE CaseType=Combination StepType=Min Point=3 X2=0.5
 X3=-0.5 S11=-1837.56172231099 IsS11Max=No IsS11Min=Yes FrameElem=16 ElemStation=0.250000000000001
 Frame=16 Station=0.250000000000001 OutputCase=ENVE CaseType=Combination StepType=Min Point=4 X2=0.5
 X3=0.5 S11=-1837.56172231099 IsS11Max=No IsS11Min=No FrameElem=16 ElemStation=0.250000000000001
 Frame=16 Station=0 OutputCase=FESSUR CaseType=Combination Point=0 X2=0 X3=0 S11=-423.235006498319
 IsS11Max=No IsS11Min=No FrameElem=16 ElemStation=0
 Frame=16 Station=0 OutputCase=FESSUR CaseType=Combination Point=1 X2=-0.5 X3=-0.5
 S11=785.278754114135 IsS11Max=Yes IsS11Min=No FrameElem=16 ElemStation=0
 Frame=16 Station=0 OutputCase=FESSUR CaseType=Combination Point=2 X2=-0.5 X3=0.5
 S11=785.278754114135 IsS11Max=No IsS11Min=No FrameElem=16 ElemStation=0
 Frame=16 Station=0 OutputCase=FESSUR CaseType=Combination Point=3 X2=0.5 X3=-0.5 S11=-
 1631.74876711077 IsS11Max=No IsS11Min=Yes FrameElem=16 ElemStation=0



Frame=16 Station=0 OutputCase=FESSUR CaseType=Combination Point=4 X2=0.5 X3=0.5 S11=-
 1631.74876711077 IsS11Max=No IsS11Min=No FrameElem=16 ElemStation=0
 Frame=16 Station=0.250000000000001 OutputCase=FESSUR CaseType=Combination Point=0 X2=0 X3=0 S11=-
 416.985008066944 IsS11Max=No IsS11Min=No FrameElem=16 ElemStation=0.250000000000001
 Frame=16 Station=0.250000000000001 OutputCase=FESSUR CaseType=Combination Point=1 X2=-0.5 X3=-0.5
 S11=985.743250580181 IsS11Max=Yes IsS11Min=No FrameElem=16 ElemStation=0.250000000000001
 Frame=16 Station=0.250000000000001 OutputCase=FESSUR CaseType=Combination Point=2 X2=-0.5 X3=0.5
 S11=985.743250580181 IsS11Max=No IsS11Min=No FrameElem=16 ElemStation=0.250000000000001
 Frame=16 Station=0.250000000000001 OutputCase=FESSUR CaseType=Combination Point=3 X2=0.5 X3=-0.5
 S11=-1819.71326671407 IsS11Max=No IsS11Min=Yes FrameElem=16 ElemStation=0.250000000000001
 Frame=16 Station=0.250000000000001 OutputCase=FESSUR CaseType=Combination Point=4 X2=0.5 X3=0.5
 S11=-1819.71326671407 IsS11Max=No IsS11Min=No FrameElem=16 ElemStation=0.250000000000001
 Frame=17 Station=0 OutputCase=PERM1 CaseType=Combination Point=0 X2=0 X3=0 S11=-494.999995477887
 IsS11Max=No IsS11Min=No FrameElem=17 ElemStation=0
 Frame=17 Station=0 OutputCase=PERM1 CaseType=Combination Point=1 X2=-0.5 X3=-0.5 S11=-
 1728.0502335039 IsS11Max=No IsS11Min=Yes FrameElem=17 ElemStation=0
 Frame=17 Station=0 OutputCase=PERM1 CaseType=Combination Point=2 X2=-0.5 X3=0.5 S11=-
 1728.0502335039 IsS11Max=No IsS11Min=No FrameElem=17 ElemStation=0
 Frame=17 Station=0 OutputCase=PERM1 CaseType=Combination Point=3 X2=0.5 X3=-0.5
 S11=738.050242548124 IsS11Max=Yes IsS11Min=No FrameElem=17 ElemStation=0
 Frame=17 Station=0 OutputCase=PERM1 CaseType=Combination Point=4 X2=0.5 X3=0.5 S11=738.050242548124
 IsS11Max=No IsS11Min=No FrameElem=17 ElemStation=0
 Frame=17 Station=0.5 OutputCase=PERM1 CaseType=Combination Point=0 X2=0 X3=0 S11=-482.499995838791
 IsS11Max=No IsS11Min=No FrameElem=17 ElemStation=0.5
 Frame=17 Station=0.5 OutputCase=PERM1 CaseType=Combination Point=1 X2=-0.5 X3=-0.5 S11=-
 1368.0573428477 IsS11Max=No IsS11Min=Yes FrameElem=17 ElemStation=0.5
 Frame=17 Station=0.5 OutputCase=PERM1 CaseType=Combination Point=2 X2=-0.5 X3=0.5 S11=-
 1368.0573428477 IsS11Max=No IsS11Min=No FrameElem=17 ElemStation=0.5
 Frame=17 Station=0.5 OutputCase=PERM1 CaseType=Combination Point=3 X2=0.5 X3=-0.5
 S11=403.057351170117 IsS11Max=Yes IsS11Min=No FrameElem=17 ElemStation=0.5
 Frame=17 Station=0.5 OutputCase=PERM1 CaseType=Combination Point=4 X2=0.5 X3=0.5
 S11=403.057351170117 IsS11Max=No IsS11Min=No FrameElem=17 ElemStation=0.5
 Frame=17 Station=0 OutputCase=PERM2 CaseType=Combination Point=0 X2=0 X3=0 S11=-494.999995500358
 IsS11Max=No IsS11Min=No FrameElem=17 ElemStation=0
 Frame=17 Station=0 OutputCase=PERM2 CaseType=Combination Point=1 X2=-0.5 X3=-0.5 S11=-
 1774.79574534765 IsS11Max=No IsS11Min=Yes FrameElem=17 ElemStation=0
 Frame=17 Station=0 OutputCase=PERM2 CaseType=Combination Point=2 X2=-0.5 X3=0.5 S11=-
 1774.79574534765 IsS11Max=No IsS11Min=No FrameElem=17 ElemStation=0
 Frame=17 Station=0 OutputCase=PERM2 CaseType=Combination Point=3 X2=0.5 X3=-0.5
 S11=784.795754346931 IsS11Max=Yes IsS11Min=No FrameElem=17 ElemStation=0
 Frame=17 Station=0 OutputCase=PERM2 CaseType=Combination Point=4 X2=0.5 X3=0.5 S11=784.795754346931
 IsS11Max=No IsS11Min=No FrameElem=17 ElemStation=0
 Frame=17 Station=0.5 OutputCase=PERM2 CaseType=Combination Point=0 X2=0 X3=0 S11=-482.49999575299
 IsS11Max=No IsS11Min=No FrameElem=17 ElemStation=0.5
 Frame=17 Station=0.5 OutputCase=PERM2 CaseType=Combination Point=1 X2=-0.5 X3=-0.5 S11=-
 1506.12552439003 IsS11Max=No IsS11Min=Yes FrameElem=17 ElemStation=0.5
 Frame=17 Station=0.5 OutputCase=PERM2 CaseType=Combination Point=2 X2=-0.5 X3=0.5 S11=-
 1506.12552439003 IsS11Max=No IsS11Min=No FrameElem=17 ElemStation=0.5
 Frame=17 Station=0.5 OutputCase=PERM2 CaseType=Combination Point=3 X2=0.5 X3=-0.5
 S11=541.125532884047 IsS11Max=Yes IsS11Min=No FrameElem=17 ElemStation=0.5
 Frame=17 Station=0.5 OutputCase=PERM2 CaseType=Combination Point=4 X2=0.5 X3=0.5
 S11=541.125532884047 IsS11Max=No IsS11Min=No FrameElem=17 ElemStation=0.5
 Frame=17 Station=0 OutputCase=ACC1 CaseType=Combination Point=0 X2=0 X3=0 S11=-508.549995351594
 IsS11Max=No IsS11Min=No FrameElem=17 ElemStation=0
 Frame=17 Station=0 OutputCase=ACC1 CaseType=Combination Point=1 X2=-0.5 X3=-0.5 S11=-
 1774.79210484734 IsS11Max=No IsS11Min=Yes FrameElem=17 ElemStation=0
 Frame=17 Station=0 OutputCase=ACC1 CaseType=Combination Point=2 X2=-0.5 X3=0.5 S11=-
 1774.79210484734 IsS11Max=No IsS11Min=No FrameElem=17 ElemStation=0
 Frame=17 Station=0 OutputCase=ACC1 CaseType=Combination Point=3 X2=0.5 X3=-0.5 S11=757.692114144152
 IsS11Max=Yes IsS11Min=No FrameElem=17 ElemStation=0
 Frame=17 Station=0 OutputCase=ACC1 CaseType=Combination Point=4 X2=0.5 X3=0.5 S11=757.692114144152
 IsS11Max=No IsS11Min=No FrameElem=17 ElemStation=0
 Frame=17 Station=0.5 OutputCase=ACC1 CaseType=Combination Point=0 X2=0 X3=0 S11=-496.049995721677
 IsS11Max=No IsS11Min=No FrameElem=17 ElemStation=0.5
 Frame=17 Station=0.5 OutputCase=ACC1 CaseType=Combination Point=1 X2=-0.5 X3=-0.5 S11=-
 1406.22606860324 IsS11Max=No IsS11Min=Yes FrameElem=17 ElemStation=0.5
 Frame=17 Station=0.5 OutputCase=ACC1 CaseType=Combination Point=2 X2=-0.5 X3=0.5 S11=-
 1406.22606860324 IsS11Max=No IsS11Min=No FrameElem=17 ElemStation=0.5
 Frame=17 Station=0.5 OutputCase=ACC1 CaseType=Combination Point=3 X2=0.5 X3=-0.5
 S11=414.126077159882 IsS11Max=Yes IsS11Min=No FrameElem=17 ElemStation=0.5
 Frame=17 Station=0.5 OutputCase=ACC1 CaseType=Combination Point=4 X2=0.5 X3=0.5
 S11=414.126077159882 IsS11Max=No IsS11Min=No FrameElem=17 ElemStation=0.5
 Frame=17 Station=0 OutputCase=ACC2 CaseType=Combination Point=0 X2=0 X3=0 S11=-508.549995374065
 IsS11Max=No IsS11Min=No FrameElem=17 ElemStation=0
 Frame=17 Station=0 OutputCase=ACC2 CaseType=Combination Point=1 X2=-0.5 X3=-0.5 S11=-
 1821.53761669109 IsS11Max=No IsS11Min=Yes FrameElem=17 ElemStation=0
 Frame=17 Station=0 OutputCase=ACC2 CaseType=Combination Point=2 X2=-0.5 X3=0.5 S11=-
 1821.53761669109 IsS11Max=No IsS11Min=No FrameElem=17 ElemStation=0
 Frame=17 Station=0 OutputCase=ACC2 CaseType=Combination Point=3 X2=0.5 X3=-0.5 S11=804.437625942959
 IsS11Max=Yes IsS11Min=No FrameElem=17 ElemStation=0
 Frame=17 Station=0 OutputCase=ACC2 CaseType=Combination Point=4 X2=0.5 X3=0.5 S11=804.437625942959
 IsS11Max=No IsS11Min=No FrameElem=17 ElemStation=0



Frame=17	Station=0.5	OutputCase=ACC2	CaseType=Combination	Point=0	X2=0	X3=0	S11=-496.049995635876	
IsS11Max=No	IsS11Min=No	FrameElem=17	ElemStation=0.5					
Frame=17	Station=0.5	OutputCase=ACC2	CaseType=Combination	Point=1	X2=-0.5	X3=-0.5	S11=-	
1544.29425014557	IsS11Max=No	IsS11Min=Yes	FrameElem=17	ElemStation=0.5				
Frame=17	Station=0.5	OutputCase=ACC2	CaseType=Combination	Point=2	X2=-0.5	X3=0.5	S11=-	
1544.29425014557	IsS11Max=No	IsS11Min=No	FrameElem=17	ElemStation=0.5				
Frame=17	Station=0.5	OutputCase=ACC2	CaseType=Combination	Point=3	X2=0.5	X3=-0.5		
S11=552.194258873812	IsS11Max=Yes	IsS11Min=No	FrameElem=17	ElemStation=0.5				
Frame=17	Station=0.5	OutputCase=ACC2	CaseType=Combination	Point=4	X2=0.5	X3=0.5		
S11=552.194258873812	IsS11Max=No	IsS11Min=No	FrameElem=17	ElemStation=0.5				
Frame=17	Station=0	OutputCase=ACCSX1	CaseType=Combination	Point=0	X2=0	X3=0	S11=-496.514073101389	
IsS11Max=No	IsS11Min=No	FrameElem=17	ElemStation=0					
Frame=17	Station=0	OutputCase=ACCSX1	CaseType=Combination	Point=1	X2=-0.5	X3=-0.5	S11=-	
1708.216852588	IsS11Max=No	IsS11Min=Yes	FrameElem=17	ElemStation=0				
Frame=17	Station=0	OutputCase=ACCSX1	CaseType=Combination	Point=2	X2=-0.5	X3=0.5	S11=-	
1708.216852588	IsS11Max=No	IsS11Min=No	FrameElem=17	ElemStation=0				
Frame=17	Station=0	OutputCase=ACCSX1	CaseType=Combination	Point=3	X2=0.5	X3=-0.5		
S11=715.188706385226	IsS11Max=Yes	IsS11Min=No	FrameElem=17	ElemStation=0				
Frame=17	Station=0	OutputCase=ACCSX1	CaseType=Combination	Point=4	X2=0.5	X3=0.5		
S11=715.188706385226	IsS11Max=No	IsS11Min=No	FrameElem=17	ElemStation=0				
Frame=17	Station=0.5	OutputCase=ACCSX1	CaseType=Combination	Point=0	X2=0	X3=0	S11=-484.014073462293	
IsS11Max=No	IsS11Min=No	FrameElem=17	ElemStation=0.5					
Frame=17	Station=0.5	OutputCase=ACCSX1	CaseType=Combination	Point=1	X2=-0.5	X3=-0.5	S11=-	
1355.04235586827	IsS11Max=No	IsS11Min=Yes	FrameElem=17	ElemStation=0.5				
Frame=17	Station=0.5	OutputCase=ACCSX1	CaseType=Combination	Point=2	X2=-0.5	X3=0.5	S11=-	
1355.04235586827	IsS11Max=No	IsS11Min=No	FrameElem=17	ElemStation=0.5				
Frame=17	Station=0.5	OutputCase=ACCSX1	CaseType=Combination	Point=3	X2=0.5	X3=-0.5		
S11=387.014208943688	IsS11Max=Yes	IsS11Min=No	FrameElem=17	ElemStation=0.5				
Frame=17	Station=0.5	OutputCase=ACCSX1	CaseType=Combination	Point=4	X2=0.5	X3=0.5		
S11=387.014208943688	IsS11Max=No	IsS11Min=No	FrameElem=17	ElemStation=0.5				
Frame=17	Station=0	OutputCase=ACCSX2	CaseType=Combination	Point=0	X2=0	X3=0	S11=-496.51407312386	
IsS11Max=No	IsS11Min=No	FrameElem=17	ElemStation=0					
Frame=17	Station=0	OutputCase=ACCSX2	CaseType=Combination	Point=1	X2=-0.5	X3=-0.5	S11=-	
1754.96236443175	IsS11Max=No	IsS11Min=Yes	FrameElem=17	ElemStation=0				
Frame=17	Station=0	OutputCase=ACCSX2	CaseType=Combination	Point=2	X2=-0.5	X3=0.5	S11=-	
1754.96236443175	IsS11Max=No	IsS11Min=No	FrameElem=17	ElemStation=0				
Frame=17	Station=0	OutputCase=ACCSX2	CaseType=Combination	Point=3	X2=0.5	X3=-0.5		
S11=761.934218184032	IsS11Max=Yes	IsS11Min=No	FrameElem=17	ElemStation=0				
Frame=17	Station=0	OutputCase=ACCSX2	CaseType=Combination	Point=4	X2=0.5	X3=0.5		
S11=761.934218184032	IsS11Max=No	IsS11Min=No	FrameElem=17	ElemStation=0				
Frame=17	Station=0.5	OutputCase=ACCSX2	CaseType=Combination	Point=0	X2=0	X3=0	S11=-484.014073376492	
IsS11Max=No	IsS11Min=No	FrameElem=17	ElemStation=0.5					
Frame=17	Station=0.5	OutputCase=ACCSX2	CaseType=Combination	Point=1	X2=-0.5	X3=-0.5	S11=-	
1493.1105374106	IsS11Max=No	IsS11Min=Yes	FrameElem=17	ElemStation=0.5				
Frame=17	Station=0.5	OutputCase=ACCSX2	CaseType=Combination	Point=2	X2=-0.5	X3=0.5	S11=-	
1493.1105374106	IsS11Max=No	IsS11Min=No	FrameElem=17	ElemStation=0.5				
Frame=17	Station=0.5	OutputCase=ACCSX2	CaseType=Combination	Point=3	X2=0.5	X3=-0.5		
S11=525.082390657618	IsS11Max=Yes	IsS11Min=No	FrameElem=17	ElemStation=0.5				
Frame=17	Station=0.5	OutputCase=ACCSX2	CaseType=Combination	Point=4	X2=0.5	X3=0.5		
S11=525.082390657618	IsS11Max=No	IsS11Min=No	FrameElem=17	ElemStation=0.5				
Frame=17	Station=0	OutputCase=ENVE	CaseType=Combination	StepType=Max	Point=0	X2=0	X3=0	S11=-
494.99995477887	IsS11Max=No	IsS11Min=No	FrameElem=17	ElemStation=0				
Frame=17	Station=0	OutputCase=ENVE	CaseType=Combination	StepType=Max	Point=1	X2=-0.5	X3=-0.5	
S11=-1708.216852588	IsS11Max=No	IsS11Min=Yes	FrameElem=17	ElemStation=0				
Frame=17	Station=0	OutputCase=ENVE	CaseType=Combination	StepType=Max	Point=2	X2=-0.5	X3=0.5	S11=-
1708.216852588	IsS11Max=No	IsS11Min=No	FrameElem=17	ElemStation=0				
Frame=17	Station=0	OutputCase=ENVE	CaseType=Combination	StepType=Max	Point=3	X2=0.5	X3=-0.5	
S11=804.437625942959	IsS11Max=Yes	IsS11Min=No	FrameElem=17	ElemStation=0				
Frame=17	Station=0	OutputCase=ENVE	CaseType=Combination	StepType=Max	Point=4	X2=0.5	X3=0.5	
S11=804.437625942959	IsS11Max=No	IsS11Min=No	FrameElem=17	ElemStation=0				
Frame=17	Station=0.5	OutputCase=ENVE	CaseType=Combination	StepType=Max	Point=0	X2=0	X3=0	S11=-
482.49999575299	IsS11Max=No	IsS11Min=No	FrameElem=17	ElemStation=0.5				
Frame=17	Station=0.5	OutputCase=ENVE	CaseType=Combination	StepType=Max	Point=1	X2=-0.5	X3=-0.5	
S11=-1355.04235586827	IsS11Max=No	IsS11Min=Yes	FrameElem=17	ElemStation=0.5				
Frame=17	Station=0.5	OutputCase=ENVE	CaseType=Combination	StepType=Max	Point=2	X2=-0.5	X3=0.5	
S11=-1355.04235586827	IsS11Max=No	IsS11Min=No	FrameElem=17	ElemStation=0.5				
Frame=17	Station=0.5	OutputCase=ENVE	CaseType=Combination	StepType=Max	Point=3	X2=0.5	X3=-0.5	
S11=552.194258873812	IsS11Max=Yes	IsS11Min=No	FrameElem=17	ElemStation=0.5				
Frame=17	Station=0.5	OutputCase=ENVE	CaseType=Combination	StepType=Max	Point=4	X2=0.5	X3=0.5	
S11=552.194258873812	IsS11Max=No	IsS11Min=No	FrameElem=17	ElemStation=0.5				
Frame=17	Station=0	OutputCase=ENVE	CaseType=Combination	StepType=Min	Point=0	X2=0	X3=0	S11=-
508.549995374065	IsS11Max=No	IsS11Min=No	FrameElem=17	ElemStation=0				
Frame=17	Station=0	OutputCase=ENVE	CaseType=Combination	StepType=Min	Point=1	X2=-0.5	X3=-0.5	
S11=-1821.53761669109	IsS11Max=No	IsS11Min=Yes	FrameElem=17	ElemStation=0				
Frame=17	Station=0	OutputCase=ENVE	CaseType=Combination	StepType=Min	Point=2	X2=-0.5	X3=0.5	S11=-
1821.53761669109	IsS11Max=No	IsS11Min=No	FrameElem=17	ElemStation=0				
Frame=17	Station=0	OutputCase=ENVE	CaseType=Combination	StepType=Min	Point=3	X2=0.5	X3=-0.5	
S11=715.188706385226	IsS11Max=Yes	IsS11Min=No	FrameElem=17	ElemStation=0				
Frame=17	Station=0	OutputCase=ENVE	CaseType=Combination	StepType=Min	Point=4	X2=0.5	X3=0.5	
S11=715.188706385226	IsS11Max=No	IsS11Min=No	FrameElem=17	ElemStation=0				
Frame=17	Station=0.5	OutputCase=ENVE	CaseType=Combination	StepType=Min	Point=0	X2=0	X3=0	S11=-
496.049995721677	IsS11Max=No	IsS11Min=No	FrameElem=17	ElemStation=0.5				



Frame=17	Station=0.5	OutputCase=ENVE	CaseType=Combination	StepType=Min	Point=1	X2=-0.5	X3=-0.5	
S11=-1544.29425014557		IsS11Max=No	IsS11Min=Yes	FrameElem=17	ElemStation=0.5			
Frame=17	Station=0.5	OutputCase=ENVE	CaseType=Combination	StepType=Min	Point=2	X2=-0.5	X3=0.5	
S11=-1544.29425014557		IsS11Max=No	IsS11Min=No	FrameElem=17	ElemStation=0.5			
Frame=17	Station=0.5	OutputCase=ENVE	CaseType=Combination	StepType=Min	Point=3	X2=0.5	X3=-0.5	
S11=387.014208943688		IsS11Max=Yes	IsS11Min=No	FrameElem=17	ElemStation=0.5			
Frame=17	Station=0.5	OutputCase=ENVE	CaseType=Combination	StepType=Min	Point=4	X2=0.5	X3=0.5	
S11=387.014208943688		IsS11Max=No	IsS11Min=No	FrameElem=17	ElemStation=0.5			
Frame=17	Station=0	OutputCase=FESSUR	CaseType=Combination	Point=0	X2=0	X3=0	S11=-504.484995389482	
IsS11Max=No	IsS11Min=No	FrameElem=17	ElemStation=0					
Frame=17	Station=0	OutputCase=FESSUR	CaseType=Combination	Point=1	X2=-0.5	X3=-0.5	S11=-	
1760.76954344431		IsS11Max=No	IsS11Min=Yes	FrameElem=17	ElemStation=0			
Frame=17	Station=0	OutputCase=FESSUR	CaseType=Combination	Point=2	X2=-0.5	X3=0.5	S11=-	
1760.76954344431		IsS11Max=No	IsS11Min=No	FrameElem=17	ElemStation=0			
Frame=17	Station=0	OutputCase=FESSUR	CaseType=Combination	Point=3	X2=0.5	X3=-0.5		
S11=751.799552665343		IsS11Max=Yes	IsS11Min=No	FrameElem=17	ElemStation=0			
Frame=17	Station=0	OutputCase=FESSUR	CaseType=Combination	Point=4	X2=0.5	X3=0.5		
S11=751.799552665343		IsS11Max=No	IsS11Min=No	FrameElem=17	ElemStation=0			
Frame=17	Station=0.5	OutputCase=FESSUR	CaseType=Combination	Point=0	X2=0	X3=0	S11=-491.984995756811	
IsS11Max=No	IsS11Min=No	FrameElem=17	ElemStation=0.5					
Frame=17	Station=0.5	OutputCase=FESSUR	CaseType=Combination	Point=1	X2=-0.5	X3=-0.5	S11=-	
1394.77545087657		IsS11Max=No	IsS11Min=Yes	FrameElem=17	ElemStation=0.5			
Frame=17	Station=0.5	OutputCase=FESSUR	CaseType=Combination	Point=2	X2=-0.5	X3=0.5	S11=-	
1394.77545087657		IsS11Max=No	IsS11Min=No	FrameElem=17	ElemStation=0.5			
Frame=17	Station=0.5	OutputCase=FESSUR	CaseType=Combination	Point=3	X2=0.5	X3=-0.5		
S11=410.805459362953		IsS11Max=Yes	IsS11Min=No	FrameElem=17	ElemStation=0.5			
Frame=17	Station=0.5	OutputCase=FESSUR	CaseType=Combination	Point=4	X2=0.5	X3=0.5		
S11=410.805459362953		IsS11Max=No	IsS11Min=No	FrameElem=17	ElemStation=0.5			
Frame=18	Station=0	OutputCase=PERM1	CaseType=Combination	Point=0	X2=0	X3=0	S11=-482.499995838791	
IsS11Max=No	IsS11Min=No	FrameElem=18	ElemStation=0					
Frame=18	Station=0	OutputCase=PERM1	CaseType=Combination	Point=1	X2=-0.5	X3=-0.5	S11=-	
1368.05734284769		IsS11Max=No	IsS11Min=Yes	FrameElem=18	ElemStation=0			
Frame=18	Station=0	OutputCase=PERM1	CaseType=Combination	Point=2	X2=-0.5	X3=0.5	S11=-	
1368.05734284769		IsS11Max=No	IsS11Min=No	FrameElem=18	ElemStation=0			
Frame=18	Station=0	OutputCase=PERM1	CaseType=Combination	Point=3	X2=0.5	X3=-0.5		
S11=403.057351170109		IsS11Max=Yes	IsS11Min=No	FrameElem=18	ElemStation=0			
Frame=18	Station=0	OutputCase=PERM1	CaseType=Combination	Point=4	X2=0.5	X3=0.5	S11=403.057351170109	
IsS11Max=No	IsS11Min=No	FrameElem=18	ElemStation=0					
Frame=18	Station=0.5	OutputCase=PERM1	CaseType=Combination	Point=0	X2=0	X3=0	S11=-469.999996182752	
IsS11Max=No	IsS11Min=No	FrameElem=18	ElemStation=0.5					
Frame=18	Station=0.5	OutputCase=PERM1	CaseType=Combination	Point=1	X2=-0.5	X3=-0.5	S11=-	
1141.10320239634		IsS11Max=No	IsS11Min=Yes	FrameElem=18	ElemStation=0.5			
Frame=18	Station=0.5	OutputCase=PERM1	CaseType=Combination	Point=2	X2=-0.5	X3=0.5	S11=-	
1141.10320239634		IsS11Max=No	IsS11Min=No	FrameElem=18	ElemStation=0.5			
Frame=18	Station=0.5	OutputCase=PERM1	CaseType=Combination	Point=3	X2=0.5	X3=-0.5		
S11=201.103210030837		IsS11Max=Yes	IsS11Min=No	FrameElem=18	ElemStation=0.5			
Frame=18	Station=0.5	OutputCase=PERM1	CaseType=Combination	Point=4	X2=0.5	X3=0.5		
S11=201.103210030837		IsS11Max=No	IsS11Min=No	FrameElem=18	ElemStation=0.5			
Frame=18	Station=0	OutputCase=PERM2	CaseType=Combination	Point=0	X2=0	X3=0	S11=-482.49999575299	
IsS11Max=No	IsS11Min=No	FrameElem=18	ElemStation=0					
Frame=18	Station=0	OutputCase=PERM2	CaseType=Combination	Point=1	X2=-0.5	X3=-0.5	S11=-	
1506.12552439002		IsS11Max=No	IsS11Min=Yes	FrameElem=18	ElemStation=0			
Frame=18	Station=0	OutputCase=PERM2	CaseType=Combination	Point=2	X2=-0.5	X3=0.5	S11=-	
1506.12552439002		IsS11Max=No	IsS11Min=No	FrameElem=18	ElemStation=0			
Frame=18	Station=0	OutputCase=PERM2	CaseType=Combination	Point=3	X2=0.5	X3=-0.5		
S11=541.125532884039		IsS11Max=Yes	IsS11Min=No	FrameElem=18	ElemStation=0			
Frame=18	Station=0.5	OutputCase=PERM2	CaseType=Combination	Point=4	X2=0.5	X3=0.5	S11=541.125532884039	
IsS11Max=No	IsS11Min=No	FrameElem=18	ElemStation=0					
Frame=18	Station=0.5	OutputCase=PERM2	CaseType=Combination	Point=0	X2=0	X3=0	S11=-469.999995993763	
IsS11Max=No	IsS11Min=No	FrameElem=18	ElemStation=0.5					
Frame=18	Station=0.5	OutputCase=PERM2	CaseType=Combination	Point=1	X2=-0.5	X3=-0.5	S11=-	
1330.58242866521		IsS11Max=No	IsS11Min=Yes	FrameElem=18	ElemStation=0.5			
Frame=18	Station=0.5	OutputCase=PERM2	CaseType=Combination	Point=2	X2=-0.5	X3=0.5	S11=-	
1330.58242866521		IsS11Max=No	IsS11Min=No	FrameElem=18	ElemStation=0.5			
Frame=18	Station=0.5	OutputCase=PERM2	CaseType=Combination	Point=3	X2=0.5	X3=-0.5		
S11=390.582436677679		IsS11Max=Yes	IsS11Min=No	FrameElem=18	ElemStation=0.5			
Frame=18	Station=0.5	OutputCase=PERM2	CaseType=Combination	Point=4	X2=0.5	X3=0.5		
S11=390.582436677679		IsS11Max=No	IsS11Min=No	FrameElem=18	ElemStation=0.5			
Frame=18	Station=0	OutputCase=ACCL	CaseType=Combination	Point=0	X2=0	X3=0	S11=-496.049995721678	
IsS11Max=No	IsS11Min=No	FrameElem=18	ElemStation=0					
Frame=18	Station=0	OutputCase=ACCL	CaseType=Combination	Point=1	X2=-0.5	X3=-0.5	S11=-	
1406.22606860323		IsS11Max=No	IsS11Min=Yes	FrameElem=18	ElemStation=0			
Frame=18	Station=0	OutputCase=ACCL	CaseType=Combination	Point=2	X2=-0.5	X3=0.5	S11=-	
1406.22606860323		IsS11Max=No	IsS11Min=No	FrameElem=18	ElemStation=0			
Frame=18	Station=0	OutputCase=ACCL	CaseType=Combination	Point=3	X2=0.5	X3=-0.5	S11=414.126077159874	
IsS11Max=Yes	IsS11Min=No	FrameElem=18	ElemStation=0					
Frame=18	Station=0	OutputCase=ACCL	CaseType=Combination	Point=4	X2=0.5	X3=0.5	S11=414.126077159874	
IsS11Max=No	IsS11Min=No	FrameElem=18	ElemStation=0					
Frame=18	Station=0.5	OutputCase=ACCL	CaseType=Combination	Point=0	X2=0	X3=0	S11=-483.549996074818	
IsS11Max=No	IsS11Min=No	FrameElem=18	ElemStation=0.5					
Frame=18	Station=0.5	OutputCase=ACCL	CaseType=Combination	Point=1	X2=-0.5	X3=-0.5	S11=-	
1174.16378256398		IsS11Max=No	IsS11Min=Yes	FrameElem=18	ElemStation=0.5			

Frame=18	Station=0.5	OutputCase=ACC1	CaseType=Combination	Point=2	X2=-0.5	X3=0.5	S11=-	
1174.16378256398	IsS11Max=No	IsS11Min=No	FrameElem=18	ElemStation=0.5				
Frame=18	Station=0.5	OutputCase=ACC1	CaseType=Combination	Point=3	X2=0.5	X3=-0.5		
S11=207.06379041434	IsS11Max=Yes	IsS11Min=No	FrameElem=18	ElemStation=0.5				
Frame=18	Station=0.5	OutputCase=ACC1	CaseType=Combination	Point=4	X2=0.5	X3=0.5	S11=207.06379041434	
IsS11Max=No	IsS11Min=No	FrameElem=18	ElemStation=0.5					
Frame=18	Station=0	OutputCase=ACC2	CaseType=Combination	Point=0	X2=0	X3=0	S11=-496.049995635878	
IsS11Max=No	IsS11Min=No	FrameElem=18	ElemStation=0					
Frame=18	Station=0	OutputCase=ACC2	CaseType=Combination	Point=1	X2=-0.5	X3=-0.5	S11=-	
1544.29425014556	IsS11Max=No	IsS11Min=Yes	FrameElem=18	ElemStation=0				
Frame=18	Station=0	OutputCase=ACC2	CaseType=Combination	Point=2	X2=-0.5	X3=0.5	S11=-	
1544.29425014556	IsS11Max=No	IsS11Min=No	FrameElem=18	ElemStation=0				
Frame=18	Station=0	OutputCase=ACC2	CaseType=Combination	Point=3	X2=0.5	X3=-0.5	S11=552.194258873804	
IsS11Max=Yes	IsS11Min=No	FrameElem=18	ElemStation=0					
Frame=18	Station=0	OutputCase=ACC2	CaseType=Combination	Point=4	X2=0.5	X3=0.5	S11=552.194258873804	
IsS11Max=No	IsS11Min=No	FrameElem=18	ElemStation=0					
Frame=18	Station=0.5	OutputCase=ACC2	CaseType=Combination	Point=0	X2=0	X3=0	S11=-483.549995885829	
IsS11Max=No	IsS11Min=No	FrameElem=18	ElemStation=0.5					
Frame=18	Station=0.5	OutputCase=ACC2	CaseType=Combination	Point=1	X2=-0.5	X3=-0.5	S11=-	
1363.64300883284	IsS11Max=No	IsS11Min=Yes	FrameElem=18	ElemStation=0.5				
Frame=18	Station=0.5	OutputCase=ACC2	CaseType=Combination	Point=2	X2=-0.5	X3=0.5	S11=-	
1363.64300883284	IsS11Max=No	IsS11Min=No	FrameElem=18	ElemStation=0.5				
Frame=18	Station=0.5	OutputCase=ACC2	CaseType=Combination	Point=3	X2=0.5	X3=-0.5		
S11=396.543017061182	IsS11Max=Yes	IsS11Min=No	FrameElem=18	ElemStation=0.5				
Frame=18	Station=0.5	OutputCase=ACC2	CaseType=Combination	Point=4	X2=0.5	X3=0.5		
S11=396.543017061182	IsS11Max=No	IsS11Min=No	FrameElem=18	ElemStation=0.5				
Frame=18	Station=0	OutputCase=ACCSX1	CaseType=Combination	Point=0	X2=0	X3=0	S11=-484.014073462293	
IsS11Max=No	IsS11Min=No	FrameElem=18	ElemStation=0					
Frame=18	Station=0	OutputCase=ACCSX1	CaseType=Combination	Point=1	X2=-0.5	X3=-0.5	S11=-	
1355.04235586827	IsS11Max=No	IsS11Min=Yes	FrameElem=18	ElemStation=0				
Frame=18	Station=0	OutputCase=ACCSX1	CaseType=Combination	Point=2	X2=-0.5	X3=0.5	S11=-	
1355.04235586827	IsS11Max=No	IsS11Min=No	FrameElem=18	ElemStation=0				
Frame=18	Station=0	OutputCase=ACCSX1	CaseType=Combination	Point=3	X2=0.5	X3=-0.5		
S11=387.01420894368	IsS11Max=Yes	IsS11Min=No	FrameElem=18	ElemStation=0				
Frame=18	Station=0	OutputCase=ACCSX1	CaseType=Combination	Point=4	X2=0.5	X3=0.5	S11=387.01420894368	
IsS11Max=No	IsS11Min=No	FrameElem=18	ElemStation=0					
Frame=18	Station=0.5	OutputCase=ACCSX1	CaseType=Combination	Point=0	X2=0	X3=0	S11=-471.514073806254	
IsS11Max=No	IsS11Min=No	FrameElem=18	ElemStation=0.5					
Frame=18	Station=0.5	OutputCase=ACCSX1	CaseType=Combination	Point=1	X2=-0.5	X3=-0.5	S11=-	
1134.90660935338	IsS11Max=No	IsS11Min=Yes	FrameElem=18	ElemStation=0.5				
Frame=18	Station=0.5	OutputCase=ACCSX1	CaseType=Combination	Point=2	X2=-0.5	X3=0.5	S11=-	
1134.90660935338	IsS11Max=No	IsS11Min=No	FrameElem=18	ElemStation=0.5				
Frame=18	Station=0.5	OutputCase=ACCSX1	CaseType=Combination	Point=3	X2=0.5	X3=-0.5		
S11=191.878461740876	IsS11Max=Yes	IsS11Min=No	FrameElem=18	ElemStation=0.5				
Frame=18	Station=0.5	OutputCase=ACCSX1	CaseType=Combination	Point=4	X2=0.5	X3=0.5		
S11=191.878461740876	IsS11Max=No	IsS11Min=No	FrameElem=18	ElemStation=0.5				
Frame=18	Station=0	OutputCase=ACCSX2	CaseType=Combination	Point=0	X2=0	X3=0	S11=-484.014073376492	
IsS11Max=No	IsS11Min=No	FrameElem=18	ElemStation=0					
Frame=18	Station=0	OutputCase=ACCSX2	CaseType=Combination	Point=1	X2=-0.5	X3=-0.5	S11=-	
1493.11053741059	IsS11Max=No	IsS11Min=Yes	FrameElem=18	ElemStation=0				
Frame=18	Station=0	OutputCase=ACCSX2	CaseType=Combination	Point=2	X2=-0.5	X3=0.5	S11=-	
1493.11053741059	IsS11Max=No	IsS11Min=No	FrameElem=18	ElemStation=0				
Frame=18	Station=0	OutputCase=ACCSX2	CaseType=Combination	Point=3	X2=0.5	X3=-0.5		
S11=525.08239065761	IsS11Max=Yes	IsS11Min=No	FrameElem=18	ElemStation=0				
Frame=18	Station=0	OutputCase=ACCSX2	CaseType=Combination	Point=4	X2=0.5	X3=0.5	S11=525.08239065761	
IsS11Max=No	IsS11Min=No	FrameElem=18	ElemStation=0					
Frame=18	Station=0.5	OutputCase=ACCSX2	CaseType=Combination	Point=0	X2=0	X3=0	S11=-471.514073617265	
IsS11Max=No	IsS11Min=No	FrameElem=18	ElemStation=0.5					
Frame=18	Station=0.5	OutputCase=ACCSX2	CaseType=Combination	Point=1	X2=-0.5	X3=-0.5	S11=-	
1324.38583562225	IsS11Max=No	IsS11Min=Yes	FrameElem=18	ElemStation=0.5				
Frame=18	Station=0.5	OutputCase=ACCSX2	CaseType=Combination	Point=2	X2=-0.5	X3=0.5	S11=-	
1324.38583562225	IsS11Max=No	IsS11Min=No	FrameElem=18	ElemStation=0.5				
Frame=18	Station=0.5	OutputCase=ACCSX2	CaseType=Combination	Point=3	X2=0.5	X3=-0.5		
S11=381.357688387719	IsS11Max=Yes	IsS11Min=No	FrameElem=18	ElemStation=0.5				
Frame=18	Station=0.5	OutputCase=ACCSX2	CaseType=Combination	Point=4	X2=0.5	X3=0.5		
S11=381.357688387719	IsS11Max=No	IsS11Min=No	FrameElem=18	ElemStation=0.5				
Frame=18	Station=0	OutputCase=ENVE	CaseType=Combination	StepType=Max	Point=0	X2=0	X3=0	S11=-
482.49999575299	IsS11Max=No	IsS11Min=No	FrameElem=18	ElemStation=0				
Frame=18	Station=0	OutputCase=ENVE	CaseType=Combination	StepType=Max	Point=1	X2=-0.5	X3=-0.5	
S11=-1355.04235586827	IsS11Max=No	IsS11Min=Yes	FrameElem=18	ElemStation=0				
Frame=18	Station=0	OutputCase=ENVE	CaseType=Combination	StepType=Max	Point=2	X2=-0.5	X3=0.5	S11=-
1355.04235586827	IsS11Max=No	IsS11Min=No	FrameElem=18	ElemStation=0				
Frame=18	Station=0	OutputCase=ENVE	CaseType=Combination	StepType=Max	Point=3	X2=0.5	X3=-0.5	
S11=552.194258873804	IsS11Max=Yes	IsS11Min=No	FrameElem=18	ElemStation=0				
Frame=18	Station=0	OutputCase=ENVE	CaseType=Combination	StepType=Max	Point=4	X2=0.5	X3=0.5	
S11=552.194258873804	IsS11Max=No	IsS11Min=No	FrameElem=18	ElemStation=0				
Frame=18	Station=0.5	OutputCase=ENVE	CaseType=Combination	StepType=Max	Point=0	X2=0	X3=0	S11=-
469.999995993763	IsS11Max=No	IsS11Min=No	FrameElem=18	ElemStation=0.5				
Frame=18	Station=0.5	OutputCase=ENVE	CaseType=Combination	StepType=Max	Point=1	X2=-0.5	X3=-0.5	
S11=-1134.90660935338	IsS11Max=No	IsS11Min=Yes	FrameElem=18	ElemStation=0.5				
Frame=18	Station=0.5	OutputCase=ENVE	CaseType=Combination	StepType=Max	Point=2	X2=-0.5	X3=0.5	
S11=-1134.90660935338	IsS11Max=No	IsS11Min=No	FrameElem=18	ElemStation=0.5				

Frame=18	Station=0.5	OutputCase=ENVE	CaseType=Combination	StepType=Max	Point=3	X2=0.5	X3=-0.5	
S11=396.543017061182	IsS11Max=Yes	IsS11Min=No	FrameElem=18	ElemStation=0.5				
Frame=18	Station=0.5	OutputCase=ENVE	CaseType=Combination	StepType=Max	Point=4	X2=0.5	X3=0.5	
S11=396.543017061182	IsS11Max=No	IsS11Min=No	FrameElem=18	ElemStation=0.5				
Frame=18	Station=0	OutputCase=ENVE	CaseType=Combination	StepType=Min	Point=0	X2=0	X3=0	S11=-
496.049995721678	IsS11Max=No	IsS11Min=No	FrameElem=18	ElemStation=0				
Frame=18	Station=0	OutputCase=ENVE	CaseType=Combination	StepType=Min	Point=1	X2=-0.5	X3=-0.5	
S11=-1544.29425014556	IsS11Max=No	IsS11Min=Yes	FrameElem=18	ElemStation=0				
Frame=18	Station=0	OutputCase=ENVE	CaseType=Combination	StepType=Min	Point=2	X2=-0.5	X3=0.5	S11=-
1544.29425014556	IsS11Max=No	IsS11Min=No	FrameElem=18	ElemStation=0				
Frame=18	Station=0	OutputCase=ENVE	CaseType=Combination	StepType=Min	Point=3	X2=0.5	X3=-0.5	
S11=387.01420894368	IsS11Max=Yes	IsS11Min=No	FrameElem=18	ElemStation=0				
Frame=18	Station=0	OutputCase=ENVE	CaseType=Combination	StepType=Min	Point=4	X2=0.5	X3=0.5	
S11=387.01420894368	IsS11Max=No	IsS11Min=No	FrameElem=18	ElemStation=0				
Frame=18	Station=0.5	OutputCase=ENVE	CaseType=Combination	StepType=Min	Point=0	X2=0	X3=0	S11=-
483.549996074818	IsS11Max=No	IsS11Min=No	FrameElem=18	ElemStation=0.5				
Frame=18	Station=0.5	OutputCase=ENVE	CaseType=Combination	StepType=Min	Point=1	X2=-0.5	X3=-0.5	
S11=-1363.64300883284	IsS11Max=No	IsS11Min=Yes	FrameElem=18	ElemStation=0.5				
Frame=18	Station=0.5	OutputCase=ENVE	CaseType=Combination	StepType=Min	Point=2	X2=-0.5	X3=0.5	
S11=-1363.64300883284	IsS11Max=No	IsS11Min=No	FrameElem=18	ElemStation=0.5				
Frame=18	Station=0.5	OutputCase=ENVE	CaseType=Combination	StepType=Min	Point=3	X2=0.5	X3=-0.5	
S11=191.878461740876	IsS11Max=Yes	IsS11Min=No	FrameElem=18	ElemStation=0.5				
Frame=18	Station=0.5	OutputCase=ENVE	CaseType=Combination	StepType=Min	Point=4	X2=0.5	X3=0.5	
S11=191.878461740876	IsS11Max=No	IsS11Min=No	FrameElem=18	ElemStation=0.5				
Frame=18	Station=0	OutputCase=FESSUR	CaseType=Combination	Point=0	X2=0	X3=0	S11=-491.984995756812	
IsS11Max=No	IsS11Min=No	FrameElem=18	ElemStation=0					
Frame=18	Station=0	OutputCase=FESSUR	CaseType=Combination	Point=1	X2=-0.5	X3=-0.5	S11=-	
1394.77545087657	IsS11Max=No	IsS11Min=Yes	FrameElem=18	ElemStation=0				
Frame=18	Station=0	OutputCase=FESSUR	CaseType=Combination	Point=2	X2=-0.5	X3=0.5	S11=-	
1394.77545087657	IsS11Max=No	IsS11Min=No	FrameElem=18	ElemStation=0				
Frame=18	Station=0	OutputCase=FESSUR	CaseType=Combination	Point=3	X2=0.5	X3=-0.5		
S11=410.805459362944	IsS11Max=Yes	IsS11Min=No	FrameElem=18	ElemStation=0				
Frame=18	Station=0	OutputCase=FESSUR	CaseType=Combination	Point=4	X2=0.5	X3=0.5		
S11=410.805459362944	IsS11Max=No	IsS11Min=No	FrameElem=18	ElemStation=0				
Frame=18	Station=0.5	OutputCase=FESSUR	CaseType=Combination	Point=0	X2=0	X3=0	S11=-479.484996107198	
IsS11Max=No	IsS11Min=No	FrameElem=18	ElemStation=0.5					
Frame=18	Station=0.5	OutputCase=FESSUR	CaseType=Combination	Point=1	X2=-0.5	X3=-0.5	S11=-	
1164.24560851369	IsS11Max=No	IsS11Min=Yes	FrameElem=18	ElemStation=0.5				
Frame=18	Station=0.5	OutputCase=FESSUR	CaseType=Combination	Point=2	X2=-0.5	X3=0.5	S11=-	
1164.24560851369	IsS11Max=No	IsS11Min=No	FrameElem=18	ElemStation=0.5				
Frame=18	Station=0.5	OutputCase=FESSUR	CaseType=Combination	Point=3	X2=0.5	X3=-0.5		
S11=205.275616299289	IsS11Max=Yes	IsS11Min=No	FrameElem=18	ElemStation=0.5				
Frame=18	Station=0.5	OutputCase=FESSUR	CaseType=Combination	Point=4	X2=0.5	X3=0.5		
S11=205.275616299289	IsS11Max=No	IsS11Min=No	FrameElem=18	ElemStation=0.5				
Frame=19	Station=0	OutputCase=PERM1	CaseType=Combination	Point=0	X2=0	X3=0	S11=-469.999996182606	
IsS11Max=No	IsS11Min=No	FrameElem=19	ElemStation=0					
Frame=19	Station=0	OutputCase=PERM1	CaseType=Combination	Point=1	X2=-0.5	X3=-0.5	S11=-	
1141.10320239619	IsS11Max=No	IsS11Min=Yes	FrameElem=19	ElemStation=0				
Frame=19	Station=0	OutputCase=PERM1	CaseType=Combination	Point=2	X2=-0.5	X3=0.5	S11=-	
1141.10320239619	IsS11Max=No	IsS11Min=No	FrameElem=19	ElemStation=0				
Frame=19	Station=0	OutputCase=PERM1	CaseType=Combination	Point=3	X2=0.5	X3=-0.5		
S11=201.103210030981	IsS11Max=Yes	IsS11Min=No	FrameElem=19	ElemStation=0				
Frame=19	Station=0	OutputCase=PERM1	CaseType=Combination	Point=4	X2=0.5	X3=0.5	S11=201.103210030981	
IsS11Max=No	IsS11Min=No	FrameElem=19	ElemStation=0					
Frame=19	Station=0.5	OutputCase=PERM1	CaseType=Combination	Point=0	X2=0	X3=0	S11=-457.499996509625	
IsS11Max=No	IsS11Min=No	FrameElem=19	ElemStation=0.5					
Frame=19	Station=0.5	OutputCase=PERM1	CaseType=Combination	Point=1	X2=-0.5	X3=-0.5	S11=-	
1040.79218711156	IsS11Max=No	IsS11Min=Yes	FrameElem=19	ElemStation=0.5				
Frame=19	Station=0.5	OutputCase=PERM1	CaseType=Combination	Point=2	X2=-0.5	X3=0.5	S11=-	
1040.79218711156	IsS11Max=No	IsS11Min=No	FrameElem=19	ElemStation=0.5				
Frame=19	Station=0.5	OutputCase=PERM1	CaseType=Combination	Point=3	X2=0.5	X3=-0.5		
S11=125.792194092313	IsS11Max=Yes	IsS11Min=No	FrameElem=19	ElemStation=0.5				
Frame=19	Station=0.5	OutputCase=PERM1	CaseType=Combination	Point=4	X2=0.5	X3=0.5		
S11=125.792194092313	IsS11Max=No	IsS11Min=No	FrameElem=19	ElemStation=0.5				
Frame=19	Station=0	OutputCase=PERM2	CaseType=Combination	Point=0	X2=0	X3=0	S11=-469.999995993617	
IsS11Max=No	IsS11Min=No	FrameElem=19	ElemStation=0					
Frame=19	Station=0	OutputCase=PERM2	CaseType=Combination	Point=1	X2=-0.5	X3=-0.5	S11=-	
1330.58242866506	IsS11Max=No	IsS11Min=Yes	FrameElem=19	ElemStation=0				
Frame=19	Station=0	OutputCase=PERM2	CaseType=Combination	Point=2	X2=-0.5	X3=0.5	S11=-	
1330.58242866506	IsS11Max=No	IsS11Min=No	FrameElem=19	ElemStation=0				
Frame=19	Station=0	OutputCase=PERM2	CaseType=Combination	Point=3	X2=0.5	X3=-0.5		
S11=390.582436677824	IsS11Max=Yes	IsS11Min=No	FrameElem=19	ElemStation=0				
Frame=19	Station=0	OutputCase=PERM2	CaseType=Combination	Point=4	X2=0.5	X3=0.5	S11=390.582436677824	
IsS11Max=No	IsS11Min=No	FrameElem=19	ElemStation=0					
Frame=19	Station=0.5	OutputCase=PERM2	CaseType=Combination	Point=0	X2=0	X3=0	S11=-457.49999622253	
IsS11Max=No	IsS11Min=No	FrameElem=19	ElemStation=0.5					
Frame=19	Station=0.5	OutputCase=PERM2	CaseType=Combination	Point=1	X2=-0.5	X3=-0.5	S11=-	
1243.68952064636	IsS11Max=No	IsS11Min=Yes	FrameElem=19	ElemStation=0.5				
Frame=19	Station=0.5	OutputCase=PERM2	CaseType=Combination	Point=2	X2=-0.5	X3=0.5	S11=-	
1243.68952064636	IsS11Max=No	IsS11Min=No	FrameElem=19	ElemStation=0.5				
Frame=19	Station=0.5	OutputCase=PERM2	CaseType=Combination	Point=3	X2=0.5	X3=-0.5		
S11=328.689528201295	IsS11Max=Yes	IsS11Min=No	FrameElem=19	ElemStation=0.5				



Frame=19 Station=0.5 OutputCase=PERM2 CaseType=Combination Point=4 X2=0.5 X3=0.5
 S11=328.689528201295 IsS11Max=No IsS11Min=No FrameElem=19 ElemStation=0.5
 Frame=19 Station=0 OutputCase=ACC1 CaseType=Combination Point=0 X2=0 X3=0 S11=-483.549996074672
 IsS11Max=No IsS11Min=No FrameElem=19 ElemStation=0
 Frame=19 Station=0 OutputCase=ACC1 CaseType=Combination Point=1 X2=-0.5 X3=-0.5 S11=-
 1174.16378256383 IsS11Max=No IsS11Min=Yes FrameElem=19 ElemStation=0
 Frame=19 Station=0 OutputCase=ACC1 CaseType=Combination Point=2 X2=-0.5 X3=0.5 S11=-
 1174.16378256383 IsS11Max=No IsS11Min=No FrameElem=19 ElemStation=0
 Frame=19 Station=0 OutputCase=ACC1 CaseType=Combination Point=3 X2=0.5 X3=-0.5 S11=207.063790414484
 IsS11Max=Yes IsS11Min=No FrameElem=19 ElemStation=0
 Frame=19 Station=0 OutputCase=ACC1 CaseType=Combination Point=4 X2=0.5 X3=0.5 S11=207.063790414484
 IsS11Max=No IsS11Min=No FrameElem=19 ElemStation=0
 Frame=19 Station=0.5 OutputCase=ACC1 CaseType=Combination Point=0 X2=0 X3=0 S11=-471.04999641087
 IsS11Max=No IsS11Min=No FrameElem=19 ElemStation=0.5
 Frame=19 Station=0.5 OutputCase=ACC1 CaseType=Combination Point=1 X2=-0.5 X3=-0.5 S11=-
 1072.20962169129 IsS11Max=No IsS11Min=Yes FrameElem=19 ElemStation=0.5
 Frame=19 Station=0.5 OutputCase=ACC1 CaseType=Combination Point=2 X2=-0.5 X3=0.5 S11=-
 1072.20962169129 IsS11Max=No IsS11Min=No FrameElem=19 ElemStation=0.5
 Frame=19 Station=0.5 OutputCase=ACC1 CaseType=Combination Point=3 X2=0.5 X3=-0.5
 S11=130.109628869555 IsS11Max=Yes IsS11Min=No FrameElem=19 ElemStation=0.5
 Frame=19 Station=0.5 OutputCase=ACC1 CaseType=Combination Point=4 X2=0.5 X3=0.5
 S11=130.109628869555 IsS11Max=No IsS11Min=No FrameElem=19 ElemStation=0.5
 Frame=19 Station=0 OutputCase=ACC2 CaseType=Combination Point=0 X2=0 X3=0 S11=-483.549995885683
 IsS11Max=No IsS11Min=No FrameElem=19 ElemStation=0
 Frame=19 Station=0 OutputCase=ACC2 CaseType=Combination Point=1 X2=-0.5 X3=-0.5 S11=-
 1363.64300883269 IsS11Max=No IsS11Min=Yes FrameElem=19 ElemStation=0
 Frame=19 Station=0 OutputCase=ACC2 CaseType=Combination Point=2 X2=-0.5 X3=0.5 S11=-
 1363.64300883269 IsS11Max=No IsS11Min=No FrameElem=19 ElemStation=0
 Frame=19 Station=0 OutputCase=ACC2 CaseType=Combination Point=3 X2=0.5 X3=-0.5 S11=396.543017061327
 IsS11Max=Yes IsS11Min=No FrameElem=19 ElemStation=0
 Frame=19 Station=0 OutputCase=ACC2 CaseType=Combination Point=4 X2=0.5 X3=0.5 S11=396.543017061327
 IsS11Max=No IsS11Min=No FrameElem=19 ElemStation=0
 Frame=19 Station=0.5 OutputCase=ACC2 CaseType=Combination Point=0 X2=0 X3=0 S11=-471.049996123775
 IsS11Max=No IsS11Min=No FrameElem=19 ElemStation=0.5
 Frame=19 Station=0.5 OutputCase=ACC2 CaseType=Combination Point=1 X2=-0.5 X3=-0.5 S11=-
 1275.10695522609 IsS11Max=No IsS11Min=Yes FrameElem=19 ElemStation=0.5
 Frame=19 Station=0.5 OutputCase=ACC2 CaseType=Combination Point=2 X2=-0.5 X3=0.5 S11=-
 1275.10695522609 IsS11Max=No IsS11Min=No FrameElem=19 ElemStation=0.5
 Frame=19 Station=0.5 OutputCase=ACC2 CaseType=Combination Point=3 X2=0.5 X3=-0.5
 S11=333.006962978537 IsS11Max=Yes IsS11Min=No FrameElem=19 ElemStation=0.5
 Frame=19 Station=0.5 OutputCase=ACC2 CaseType=Combination Point=4 X2=0.5 X3=0.5
 S11=333.006962978537 IsS11Max=No IsS11Min=No FrameElem=19 ElemStation=0.5
 Frame=19 Station=0 OutputCase=ACCSX1 CaseType=Combination Point=0 X2=0 X3=0 S11=-471.514073806106
 IsS11Max=No IsS11Min=No FrameElem=19 ElemStation=0
 Frame=19 Station=0 OutputCase=ACCSX1 CaseType=Combination Point=1 X2=-0.5 X3=-0.5 S11=-
 1134.90660935323 IsS11Max=No IsS11Min=Yes FrameElem=19 ElemStation=0
 Frame=19 Station=0 OutputCase=ACCSX1 CaseType=Combination Point=2 X2=-0.5 X3=0.5 S11=-
 1134.90660935323 IsS11Max=No IsS11Min=No FrameElem=19 ElemStation=0
 Frame=19 Station=0 OutputCase=ACCSX1 CaseType=Combination Point=3 X2=0.5 X3=-0.5
 S11=191.878461741022 IsS11Max=Yes IsS11Min=No FrameElem=19 ElemStation=0
 Frame=19 Station=0 OutputCase=ACCSX1 CaseType=Combination Point=4 X2=0.5 X3=0.5
 S11=191.878461741022 IsS11Max=No IsS11Min=No FrameElem=19 ElemStation=0
 Frame=19 Station=0.5 OutputCase=ACCSX1 CaseType=Combination Point=0 X2=0 X3=0 S11=-459.014074133125
 IsS11Max=No IsS11Min=No FrameElem=19 ElemStation=0.5
 Frame=19 Station=0.5 OutputCase=ACCSX1 CaseType=Combination Point=1 X2=-0.5 X3=-0.5 S11=-
 1041.41398800507 IsS11Max=No IsS11Min=Yes FrameElem=19 ElemStation=0.5
 Frame=19 Station=0.5 OutputCase=ACCSX1 CaseType=Combination Point=2 X2=-0.5 X3=0.5 S11=-
 1041.41398800507 IsS11Max=No IsS11Min=No FrameElem=19 ElemStation=0.5
 Frame=19 Station=0.5 OutputCase=ACCSX1 CaseType=Combination Point=3 X2=0.5 X3=-0.5
 S11=123.385839738825 IsS11Max=Yes IsS11Min=No FrameElem=19 ElemStation=0.5
 Frame=19 Station=0.5 OutputCase=ACCSX1 CaseType=Combination Point=4 X2=0.5 X3=0.5
 S11=123.385839738825 IsS11Max=No IsS11Min=No FrameElem=19 ElemStation=0.5
 Frame=19 Station=0 OutputCase=ACCSX2 CaseType=Combination Point=0 X2=0 X3=0 S11=-471.514073617118
 IsS11Max=No IsS11Min=No FrameElem=19 ElemStation=0
 Frame=19 Station=0 OutputCase=ACCSX2 CaseType=Combination Point=1 X2=-0.5 X3=-0.5 S11=-
 1324.3858356221 IsS11Max=No IsS11Min=Yes FrameElem=19 ElemStation=0
 Frame=19 Station=0 OutputCase=ACCSX2 CaseType=Combination Point=2 X2=-0.5 X3=0.5 S11=-
 1324.3858356221 IsS11Max=No IsS11Min=No FrameElem=19 ElemStation=0
 Frame=19 Station=0 OutputCase=ACCSX2 CaseType=Combination Point=3 X2=0.5 X3=-0.5
 S11=381.357688387864 IsS11Max=Yes IsS11Min=No FrameElem=19 ElemStation=0
 Frame=19 Station=0 OutputCase=ACCSX2 CaseType=Combination Point=4 X2=0.5 X3=0.5
 S11=381.357688387864 IsS11Max=No IsS11Min=No FrameElem=19 ElemStation=0
 Frame=19 Station=0.5 OutputCase=ACCSX2 CaseType=Combination Point=0 X2=0 X3=0 S11=-459.014073846031
 IsS11Max=No IsS11Min=No FrameElem=19 ElemStation=0.5
 Frame=19 Station=0.5 OutputCase=ACCSX2 CaseType=Combination Point=1 X2=-0.5 X3=-0.5 S11=-
 1244.31132153987 IsS11Max=No IsS11Min=Yes FrameElem=19 ElemStation=0.5
 Frame=19 Station=0.5 OutputCase=ACCSX2 CaseType=Combination Point=2 X2=-0.5 X3=0.5 S11=-
 1244.31132153987 IsS11Max=No IsS11Min=No FrameElem=19 ElemStation=0.5
 Frame=19 Station=0.5 OutputCase=ACCSX2 CaseType=Combination Point=3 X2=0.5 X3=-0.5
 S11=326.283173847806 IsS11Max=Yes IsS11Min=No FrameElem=19 ElemStation=0.5
 Frame=19 Station=0.5 OutputCase=ACCSX2 CaseType=Combination Point=4 X2=0.5 X3=0.5
 S11=326.283173847806 IsS11Max=No IsS11Min=No FrameElem=19 ElemStation=0.5

Frame=19	Station=0	OutputCase=ENVE	CaseType=Combination	StepType=Max	Point=0	X2=0	X3=0	S11=-
469.99995993617	IsS11Max=No	IsS11Min=No	FrameElem=19	ElemStation=0				
Frame=19	Station=0	OutputCase=ENVE	CaseType=Combination	StepType=Max	Point=1	X2=-0.5	X3=-0.5	
S11=-1134.90660935323	IsS11Max=No	IsS11Min=Yes	FrameElem=19	ElemStation=0				
Frame=19	Station=0	OutputCase=ENVE	CaseType=Combination	StepType=Max	Point=2	X2=-0.5	X3=0.5	S11=-
1134.90660935323	IsS11Max=No	IsS11Min=No	FrameElem=19	ElemStation=0				
Frame=19	Station=0	OutputCase=ENVE	CaseType=Combination	StepType=Max	Point=3	X2=0.5	X3=-0.5	
S11=396.543017061327	IsS11Max=Yes	IsS11Min=No	FrameElem=19	ElemStation=0				
Frame=19	Station=0	OutputCase=ENVE	CaseType=Combination	StepType=Max	Point=4	X2=0.5	X3=0.5	
S11=396.543017061327	IsS11Max=No	IsS11Min=No	FrameElem=19	ElemStation=0				
Frame=19	Station=0.5	OutputCase=ENVE	CaseType=Combination	StepType=Max	Point=0	X2=0	X3=0	S11=-
457.49999622253	IsS11Max=No	IsS11Min=No	FrameElem=19	ElemStation=0.5				
Frame=19	Station=0.5	OutputCase=ENVE	CaseType=Combination	StepType=Max	Point=1	X2=-0.5	X3=-0.5	
S11=-1040.79218711156	IsS11Max=No	IsS11Min=Yes	FrameElem=19	ElemStation=0.5				
Frame=19	Station=0.5	OutputCase=ENVE	CaseType=Combination	StepType=Max	Point=2	X2=-0.5	X3=0.5	
S11=-1040.79218711156	IsS11Max=No	IsS11Min=No	FrameElem=19	ElemStation=0.5				
Frame=19	Station=0.5	OutputCase=ENVE	CaseType=Combination	StepType=Max	Point=3	X2=0.5	X3=-0.5	
S11=333.006962978537	IsS11Max=Yes	IsS11Min=No	FrameElem=19	ElemStation=0.5				
Frame=19	Station=0.5	OutputCase=ENVE	CaseType=Combination	StepType=Max	Point=4	X2=0.5	X3=0.5	
S11=333.006962978537	IsS11Max=No	IsS11Min=No	FrameElem=19	ElemStation=0.5				
Frame=19	Station=0	OutputCase=ENVE	CaseType=Combination	StepType=Min	Point=0	X2=0	X3=0	S11=-
483.549996074672	IsS11Max=No	IsS11Min=No	FrameElem=19	ElemStation=0				
Frame=19	Station=0	OutputCase=ENVE	CaseType=Combination	StepType=Min	Point=1	X2=-0.5	X3=-0.5	
S11=-1363.64300883269	IsS11Max=No	IsS11Min=Yes	FrameElem=19	ElemStation=0				
Frame=19	Station=0	OutputCase=ENVE	CaseType=Combination	StepType=Min	Point=2	X2=-0.5	X3=0.5	S11=-
1363.64300883269	IsS11Max=No	IsS11Min=No	FrameElem=19	ElemStation=0				
Frame=19	Station=0	OutputCase=ENVE	CaseType=Combination	StepType=Min	Point=3	X2=0.5	X3=-0.5	
S11=191.878461741022	IsS11Max=Yes	IsS11Min=No	FrameElem=19	ElemStation=0				
Frame=19	Station=0	OutputCase=ENVE	CaseType=Combination	StepType=Min	Point=4	X2=0.5	X3=0.5	
S11=191.878461741022	IsS11Max=No	IsS11Min=No	FrameElem=19	ElemStation=0				
Frame=19	Station=0.5	OutputCase=ENVE	CaseType=Combination	StepType=Min	Point=0	X2=0	X3=0	S11=-
471.04999641087	IsS11Max=No	IsS11Min=No	FrameElem=19	ElemStation=0.5				
Frame=19	Station=0.5	OutputCase=ENVE	CaseType=Combination	StepType=Min	Point=1	X2=-0.5	X3=-0.5	
S11=-1275.10695522609	IsS11Max=No	IsS11Min=Yes	FrameElem=19	ElemStation=0.5				
Frame=19	Station=0.5	OutputCase=ENVE	CaseType=Combination	StepType=Min	Point=2	X2=-0.5	X3=0.5	
S11=-1275.10695522609	IsS11Max=No	IsS11Min=No	FrameElem=19	ElemStation=0.5				
Frame=19	Station=0.5	OutputCase=ENVE	CaseType=Combination	StepType=Min	Point=3	X2=0.5	X3=-0.5	
S11=123.385839738825	IsS11Max=Yes	IsS11Min=No	FrameElem=19	ElemStation=0.5				
Frame=19	Station=0.5	OutputCase=ENVE	CaseType=Combination	StepType=Min	Point=4	X2=0.5	X3=0.5	
S11=123.385839738825	IsS11Max=No	IsS11Min=No	FrameElem=19	ElemStation=0.5				
Frame=19	Station=0	OutputCase=FESSUR	CaseType=Combination	Point=0	X2=0	X3=0	S11=-479.484996107052	
IsS11Max=No	IsS11Min=No	FrameElem=19	ElemStation=0					
Frame=19	Station=0	OutputCase=FESSUR	CaseType=Combination	Point=1	X2=-0.5	X3=-0.5	S11=-	
1164.24560851354	IsS11Max=No	IsS11Min=Yes	FrameElem=19	ElemStation=0				
Frame=19	Station=0	OutputCase=FESSUR	CaseType=Combination	Point=2	X2=-0.5	X3=0.5	S11=-	
1164.24560851354	IsS11Max=No	IsS11Min=No	FrameElem=19	ElemStation=0				
Frame=19	Station=0	OutputCase=FESSUR	CaseType=Combination	Point=3	X2=0.5	X3=-0.5		
S11=205.275616299433	IsS11Max=Yes	IsS11Min=No	FrameElem=19	ElemStation=0				
Frame=19	Station=0	OutputCase=FESSUR	CaseType=Combination	Point=4	X2=0.5	X3=0.5		
S11=205.275616299433	IsS11Max=No	IsS11Min=No	FrameElem=19	ElemStation=0				
Frame=19	Station=0.5	OutputCase=FESSUR	CaseType=Combination	Point=0	X2=0	X3=0	S11=-466.984996440496	
IsS11Max=No	IsS11Min=No	FrameElem=19	ElemStation=0.5					
Frame=19	Station=0.5	OutputCase=FESSUR	CaseType=Combination	Point=1	X2=-0.5	X3=-0.5	S11=-	
1062.78439131737	IsS11Max=No	IsS11Min=Yes	FrameElem=19	ElemStation=0.5				
Frame=19	Station=0.5	OutputCase=FESSUR	CaseType=Combination	Point=2	X2=-0.5	X3=0.5	S11=-	
1062.78439131737	IsS11Max=No	IsS11Min=No	FrameElem=19	ElemStation=0.5				
Frame=19	Station=0.5	OutputCase=FESSUR	CaseType=Combination	Point=3	X2=0.5	X3=-0.5		
S11=128.814398436383	IsS11Max=Yes	IsS11Min=No	FrameElem=19	ElemStation=0.5				
Frame=19	Station=0.5	OutputCase=FESSUR	CaseType=Combination	Point=4	X2=0.5	X3=0.5		
S11=128.814398436383	IsS11Max=No	IsS11Min=No	FrameElem=19	ElemStation=0.5				
Frame=20	Station=0	OutputCase=PERM1	CaseType=Combination	Point=0	X2=0	X3=0	S11=-457.499996509712	
IsS11Max=No	IsS11Min=No	FrameElem=20	ElemStation=0					
Frame=20	Station=0	OutputCase=PERM1	CaseType=Combination	Point=1	X2=-0.5	X3=-0.5	S11=-	
1040.79218711165	IsS11Max=No	IsS11Min=Yes	FrameElem=20	ElemStation=0				
Frame=20	Station=0	OutputCase=PERM1	CaseType=Combination	Point=2	X2=-0.5	X3=0.5	S11=-	
1040.79218711165	IsS11Max=No	IsS11Min=No	FrameElem=20	ElemStation=0				
Frame=20	Station=0	OutputCase=PERM1	CaseType=Combination	Point=3	X2=0.5	X3=-0.5		
S11=125.792194092226	IsS11Max=Yes	IsS11Min=No	FrameElem=20	ElemStation=0				
Frame=20	Station=0	OutputCase=PERM1	CaseType=Combination	Point=4	X2=0.5	X3=0.5	S11=125.792194092226	
IsS11Max=No	IsS11Min=No	FrameElem=20	ElemStation=0					
Frame=20	Station=0.5	OutputCase=PERM1	CaseType=Combination	Point=0	X2=0	X3=0	S11=-444.999996819788	
IsS11Max=No	IsS11Min=No	FrameElem=20	ElemStation=0.5					
Frame=20	Station=0.5	OutputCase=PERM1	CaseType=Combination	Point=1	X2=-0.5	X3=-0.5	S11=-	
1060.72867195562	IsS11Max=No	IsS11Min=Yes	FrameElem=20	ElemStation=0.5				
Frame=20	Station=0.5	OutputCase=PERM1	CaseType=Combination	Point=2	X2=-0.5	X3=0.5	S11=-	
1060.72867195562	IsS11Max=No	IsS11Min=No	FrameElem=20	ElemStation=0.5				
Frame=20	Station=0.5	OutputCase=PERM1	CaseType=Combination	Point=3	X2=0.5	X3=-0.5		
S11=170.728678316043	IsS11Max=Yes	IsS11Min=No	FrameElem=20	ElemStation=0.5				
Frame=20	Station=0.5	OutputCase=PERM1	CaseType=Combination	Point=4	X2=0.5	X3=0.5		
S11=170.728678316043	IsS11Max=No	IsS11Min=No	FrameElem=20	ElemStation=0.5				
Frame=20	Station=0	OutputCase=PERM2	CaseType=Combination	Point=0	X2=0	X3=0	S11=-457.499996222618	
IsS11Max=No	IsS11Min=No	FrameElem=20	ElemStation=0					

Frame=20	Station=0	OutputCase=PERM2	CaseType=Combination	Point=1	X2=-0.5	X3=-0.5	S11=-
1243.68952064644	IsS11Max=No	IsS11Min=Yes	FrameElem=20	ElemStation=0			
Frame=20	Station=0	OutputCase=PERM2	CaseType=Combination	Point=2	X2=-0.5	X3=0.5	S11=-
1243.68952064644	IsS11Max=No	IsS11Min=No	FrameElem=20	ElemStation=0			
Frame=20	Station=0	OutputCase=PERM2	CaseType=Combination	Point=3	X2=0.5	X3=-0.5	
S11=328.689528201208	IsS11Max=Yes	IsS11Min=No	FrameElem=20	ElemStation=0			
Frame=20	Station=0	OutputCase=PERM2	CaseType=Combination	Point=4	X2=0.5	X3=0.5	S11=328.689528201208
IsS11Max=No	IsS11Min=No	FrameElem=20	ElemStation=0				
Frame=20	Station=0.5	OutputCase=PERM2	CaseType=Combination	Point=0	X2=0	X3=0	S11=-444.999996439671
IsS11Max=No	IsS11Min=No	FrameElem=20	ElemStation=0.5				
Frame=20	Station=0.5	OutputCase=PERM2	CaseType=Combination	Point=1	X2=-0.5	X3=-0.5	S11=-
1240.96986280717	IsS11Max=No	IsS11Min=Yes	FrameElem=20	ElemStation=0.5			
Frame=20	Station=0.5	OutputCase=PERM2	CaseType=Combination	Point=2	X2=-0.5	X3=0.5	S11=-
1240.96986280717	IsS11Max=No	IsS11Min=No	FrameElem=20	ElemStation=0.5			
Frame=20	Station=0.5	OutputCase=PERM2	CaseType=Combination	Point=3	X2=0.5	X3=-0.5	
S11=350.969869927826	IsS11Max=Yes	IsS11Min=No	FrameElem=20	ElemStation=0.5			
Frame=20	Station=0.5	OutputCase=PERM2	CaseType=Combination	Point=4	X2=0.5	X3=0.5	
S11=350.969869927826	IsS11Max=No	IsS11Min=No	FrameElem=20	ElemStation=0.5			
Frame=20	Station=0	OutputCase=ACC1	CaseType=Combination	Point=0	X2=0	X3=0	S11=-471.049996410956
IsS11Max=No	IsS11Min=No	FrameElem=20	ElemStation=0				
Frame=20	Station=0	OutputCase=ACC1	CaseType=Combination	Point=1	X2=-0.5	X3=-0.5	S11=-
1072.20962169138	IsS11Max=No	IsS11Min=Yes	FrameElem=20	ElemStation=0			
Frame=20	Station=0	OutputCase=ACC1	CaseType=Combination	Point=2	X2=-0.5	X3=0.5	S11=-
1072.20962169138	IsS11Max=No	IsS11Min=No	FrameElem=20	ElemStation=0			
Frame=20	Station=0	OutputCase=ACC1	CaseType=Combination	Point=3	X2=0.5	X3=-0.5	S11=130.109628869467
IsS11Max=Yes	IsS11Min=No	FrameElem=20	ElemStation=0				
Frame=20	Station=0	OutputCase=ACC1	CaseType=Combination	Point=4	X2=0.5	X3=0.5	S11=130.109628869467
IsS11Max=No	IsS11Min=No	FrameElem=20	ElemStation=0				
Frame=20	Station=0.5	OutputCase=ACC1	CaseType=Combination	Point=0	X2=0	X3=0	S11=-458.549996730211
IsS11Max=No	IsS11Min=No	FrameElem=20	ElemStation=0.5				
Frame=20	Station=0.5	OutputCase=ACC1	CaseType=Combination	Point=1	X2=-0.5	X3=-0.5	S11=-
1093.96796094745	IsS11Max=No	IsS11Min=Yes	FrameElem=20	ElemStation=0.5			
Frame=20	Station=0.5	OutputCase=ACC1	CaseType=Combination	Point=2	X2=-0.5	X3=0.5	S11=-
1093.96796094745	IsS11Max=No	IsS11Min=No	FrameElem=20	ElemStation=0.5			
Frame=20	Station=0.5	OutputCase=ACC1	CaseType=Combination	Point=3	X2=0.5	X3=-0.5	
S11=176.867967487025	IsS11Max=Yes	IsS11Min=No	FrameElem=20	ElemStation=0.5			
Frame=20	Station=0.5	OutputCase=ACC1	CaseType=Combination	Point=4	X2=0.5	X3=0.5	
S11=176.867967487025	IsS11Max=No	IsS11Min=No	FrameElem=20	ElemStation=0.5			
Frame=20	Station=0	OutputCase=ACC2	CaseType=Combination	Point=0	X2=0	X3=0	S11=-471.049996123862
IsS11Max=No	IsS11Min=No	FrameElem=20	ElemStation=0				
Frame=20	Station=0	OutputCase=ACC2	CaseType=Combination	Point=1	X2=-0.5	X3=-0.5	S11=-
1275.10695522617	IsS11Max=No	IsS11Min=Yes	FrameElem=20	ElemStation=0			
Frame=20	Station=0	OutputCase=ACC2	CaseType=Combination	Point=2	X2=-0.5	X3=0.5	S11=-
1275.10695522617	IsS11Max=No	IsS11Min=No	FrameElem=20	ElemStation=0			
Frame=20	Station=0	OutputCase=ACC2	CaseType=Combination	Point=3	X2=0.5	X3=-0.5	S11=333.006962978449
IsS11Max=Yes	IsS11Min=No	FrameElem=20	ElemStation=0				
Frame=20	Station=0	OutputCase=ACC2	CaseType=Combination	Point=4	X2=0.5	X3=0.5	S11=333.006962978449
IsS11Max=No	IsS11Min=No	FrameElem=20	ElemStation=0				
Frame=20	Station=0.5	OutputCase=ACC2	CaseType=Combination	Point=0	X2=0	X3=0	S11=-458.549996350094
IsS11Max=No	IsS11Min=No	FrameElem=20	ElemStation=0.5				
Frame=20	Station=0.5	OutputCase=ACC2	CaseType=Combination	Point=1	X2=-0.5	X3=-0.5	S11=-
1274.209151799	IsS11Max=No	IsS11Min=Yes	FrameElem=20	ElemStation=0.5			
Frame=20	Station=0.5	OutputCase=ACC2	CaseType=Combination	Point=2	X2=-0.5	X3=0.5	S11=-
1274.209151799	IsS11Max=No	IsS11Min=No	FrameElem=20	ElemStation=0.5			
Frame=20	Station=0.5	OutputCase=ACC2	CaseType=Combination	Point=3	X2=0.5	X3=-0.5	
S11=357.109159098808	IsS11Max=Yes	IsS11Min=No	FrameElem=20	ElemStation=0.5			
Frame=20	Station=0.5	OutputCase=ACC2	CaseType=Combination	Point=4	X2=0.5	X3=0.5	
S11=357.109159098808	IsS11Max=No	IsS11Min=No	FrameElem=20	ElemStation=0.5			
Frame=20	Station=0	OutputCase=ACCSX1	CaseType=Combination	Point=0	X2=0	X3=0	S11=-459.014074133212
IsS11Max=No	IsS11Min=No	FrameElem=20	ElemStation=0				
Frame=20	Station=0	OutputCase=ACCSX1	CaseType=Combination	Point=1	X2=-0.5	X3=-0.5	S11=-
1041.41398800516	IsS11Max=No	IsS11Min=Yes	FrameElem=20	ElemStation=0			
Frame=20	Station=0	OutputCase=ACCSX1	CaseType=Combination	Point=2	X2=-0.5	X3=0.5	S11=-
1041.41398800516	IsS11Max=No	IsS11Min=No	FrameElem=20	ElemStation=0			
Frame=20	Station=0	OutputCase=ACCSX1	CaseType=Combination	Point=3	X2=0.5	X3=-0.5	
S11=123.385839738737	IsS11Max=Yes	IsS11Min=No	FrameElem=20	ElemStation=0			
Frame=20	Station=0	OutputCase=ACCSX1	CaseType=Combination	Point=4	X2=0.5	X3=0.5	
S11=123.385839738737	IsS11Max=No	IsS11Min=No	FrameElem=20	ElemStation=0			
Frame=20	Station=0.5	OutputCase=ACCSX1	CaseType=Combination	Point=0	X2=0	X3=0	S11=-446.514074443288
IsS11Max=No	IsS11Min=No	FrameElem=20	ElemStation=0.5				
Frame=20	Station=0.5	OutputCase=ACCSX1	CaseType=Combination	Point=1	X2=-0.5	X3=-0.5	S11=-
1068.1688667856	IsS11Max=No	IsS11Min=Yes	FrameElem=20	ElemStation=0.5			
Frame=20	Station=0.5	OutputCase=ACCSX1	CaseType=Combination	Point=2	X2=-0.5	X3=0.5	S11=-
1068.1688667856	IsS11Max=No	IsS11Min=No	FrameElem=20	ElemStation=0.5			
Frame=20	Station=0.5	OutputCase=ACCSX1	CaseType=Combination	Point=3	X2=0.5	X3=-0.5	
S11=175.140717899028	IsS11Max=Yes	IsS11Min=No	FrameElem=20	ElemStation=0.5			
Frame=20	Station=0.5	OutputCase=ACCSX1	CaseType=Combination	Point=4	X2=0.5	X3=0.5	
S11=175.140717899028	IsS11Max=No	IsS11Min=No	FrameElem=20	ElemStation=0.5			
Frame=20	Station=0	OutputCase=ACCSX2	CaseType=Combination	Point=0	X2=0	X3=0	S11=-459.014073846118
IsS11Max=No	IsS11Min=No	FrameElem=20	ElemStation=0				
Frame=20	Station=0	OutputCase=ACCSX2	CaseType=Combination	Point=1	X2=-0.5	X3=-0.5	S11=-
1244.31132153995	IsS11Max=No	IsS11Min=Yes	FrameElem=20	ElemStation=0			



Frame=20	Station=0	OutputCase=ACCSX2	CaseType=Combination	Point=2	X2=-0.5	X3=0.5	S11=-	
1244.31132153995	IsS11Max=No	IsS11Min=No	FrameElem=20	ElemStation=0				
Frame=20	Station=0	OutputCase=ACCSX2	CaseType=Combination	Point=3	X2=0.5	X3=-0.5		
S11=326.283173847718	IsS11Max=Yes	IsS11Min=No	FrameElem=20	ElemStation=0				
Frame=20	Station=0	OutputCase=ACCSX2	CaseType=Combination	Point=4	X2=0.5	X3=0.5		
S11=326.283173847718	IsS11Max=No	IsS11Min=No	FrameElem=20	ElemStation=0				
Frame=20	Station=0.5	OutputCase=ACCSX2	CaseType=Combination	Point=0	X2=0	X3=0	S11=-446.514074063171	
IsS11Max=No	IsS11Min=No	FrameElem=20	ElemStation=0.5					
Frame=20	Station=0.5	OutputCase=ACCSX2	CaseType=Combination	Point=1	X2=-0.5	X3=-0.5	S11=-	
1248.41005763715	IsS11Max=No	IsS11Min=Yes	FrameElem=20	ElemStation=0.5				
Frame=20	Station=0.5	OutputCase=ACCSX2	CaseType=Combination	Point=2	X2=-0.5	X3=0.5	S11=-	
1248.41005763715	IsS11Max=No	IsS11Min=No	FrameElem=20	ElemStation=0.5				
Frame=20	Station=0.5	OutputCase=ACCSX2	CaseType=Combination	Point=3	X2=0.5	X3=-0.5		
S11=355.381909510811	IsS11Max=Yes	IsS11Min=No	FrameElem=20	ElemStation=0.5				
Frame=20	Station=0.5	OutputCase=ACCSX2	CaseType=Combination	Point=4	X2=0.5	X3=0.5		
S11=355.381909510811	IsS11Max=No	IsS11Min=No	FrameElem=20	ElemStation=0.5				
Frame=20	Station=0	OutputCase=ENVE	CaseType=Combination	StepType=Max	Point=0	X2=0	X3=0	S11=-
457.499996222618	IsS11Max=No	IsS11Min=No	FrameElem=20	ElemStation=0				
Frame=20	Station=0	OutputCase=ENVE	CaseType=Combination	StepType=Max	Point=1	X2=-0.5	X3=-0.5	
S11=-1040.79218711165	IsS11Max=No	IsS11Min=Yes	FrameElem=20	ElemStation=0				
Frame=20	Station=0	OutputCase=ENVE	CaseType=Combination	StepType=Max	Point=2	X2=-0.5	X3=0.5	S11=-
1040.79218711165	IsS11Max=No	IsS11Min=No	FrameElem=20	ElemStation=0				
Frame=20	Station=0	OutputCase=ENVE	CaseType=Combination	StepType=Max	Point=3	X2=0.5	X3=-0.5	
S11=333.006962978449	IsS11Max=Yes	IsS11Min=No	FrameElem=20	ElemStation=0				
Frame=20	Station=0	OutputCase=ENVE	CaseType=Combination	StepType=Max	Point=4	X2=0.5	X3=0.5	
S11=333.006962978449	IsS11Max=No	IsS11Min=No	FrameElem=20	ElemStation=0				
Frame=20	Station=0.5	OutputCase=ENVE	CaseType=Combination	StepType=Max	Point=0	X2=0	X3=0	S11=-
444.999996439671	IsS11Max=No	IsS11Min=No	FrameElem=20	ElemStation=0.5				
Frame=20	Station=0.5	OutputCase=ENVE	CaseType=Combination	StepType=Max	Point=1	X2=-0.5	X3=-0.5	
S11=-1060.72867195562	IsS11Max=No	IsS11Min=No	FrameElem=20	ElemStation=0.5				
Frame=20	Station=0.5	OutputCase=ENVE	CaseType=Combination	StepType=Max	Point=2	X2=-0.5	X3=0.5	
S11=-1060.72867195562	IsS11Max=No	IsS11Min=No	FrameElem=20	ElemStation=0.5				
Frame=20	Station=0.5	OutputCase=ENVE	CaseType=Combination	StepType=Max	Point=3	X2=0.5	X3=-0.5	
S11=357.109159098808	IsS11Max=Yes	IsS11Min=No	FrameElem=20	ElemStation=0.5				
Frame=20	Station=0.5	OutputCase=ENVE	CaseType=Combination	StepType=Max	Point=4	X2=0.5	X3=0.5	
S11=357.109159098808	IsS11Max=No	IsS11Min=No	FrameElem=20	ElemStation=0.5				
Frame=20	Station=0	OutputCase=ENVE	CaseType=Combination	StepType=Min	Point=0	X2=0	X3=0	S11=-
471.049996410956	IsS11Max=No	IsS11Min=No	FrameElem=20	ElemStation=0				
Frame=20	Station=0	OutputCase=ENVE	CaseType=Combination	StepType=Min	Point=1	X2=-0.5	X3=-0.5	
S11=-1275.10695522617	IsS11Max=No	IsS11Min=Yes	FrameElem=20	ElemStation=0				
Frame=20	Station=0	OutputCase=ENVE	CaseType=Combination	StepType=Min	Point=2	X2=-0.5	X3=0.5	S11=-
1275.10695522617	IsS11Max=No	IsS11Min=No	FrameElem=20	ElemStation=0				
Frame=20	Station=0	OutputCase=ENVE	CaseType=Combination	StepType=Min	Point=3	X2=0.5	X3=-0.5	
S11=123.385839738737	IsS11Max=Yes	IsS11Min=No	FrameElem=20	ElemStation=0				
Frame=20	Station=0	OutputCase=ENVE	CaseType=Combination	StepType=Min	Point=4	X2=0.5	X3=0.5	
S11=123.385839738737	IsS11Max=No	IsS11Min=No	FrameElem=20	ElemStation=0				
Frame=20	Station=0.5	OutputCase=ENVE	CaseType=Combination	StepType=Min	Point=0	X2=0	X3=0	S11=-
458.549996730211	IsS11Max=No	IsS11Min=No	FrameElem=20	ElemStation=0.5				
Frame=20	Station=0.5	OutputCase=ENVE	CaseType=Combination	StepType=Min	Point=1	X2=-0.5	X3=-0.5	
S11=-1274.209151799	IsS11Max=No	IsS11Min=Yes	FrameElem=20	ElemStation=0.5				
Frame=20	Station=0.5	OutputCase=ENVE	CaseType=Combination	StepType=Min	Point=2	X2=-0.5	X3=0.5	
S11=-1274.209151799	IsS11Max=No	IsS11Min=No	FrameElem=20	ElemStation=0.5				
Frame=20	Station=0.5	OutputCase=ENVE	CaseType=Combination	StepType=Min	Point=3	X2=0.5	X3=-0.5	
S11=170.728678316043	IsS11Max=Yes	IsS11Min=No	FrameElem=20	ElemStation=0.5				
Frame=20	Station=0.5	OutputCase=ENVE	CaseType=Combination	StepType=Min	Point=4	X2=0.5	X3=0.5	
S11=170.728678316043	IsS11Max=No	IsS11Min=No	FrameElem=20	ElemStation=0.5				
Frame=20	Station=0	OutputCase=FESSUR	CaseType=Combination	Point=0	X2=0	X3=0	S11=-466.984996440583	
IsS11Max=No	IsS11Min=No	FrameElem=20	ElemStation=0					
Frame=20	Station=0	OutputCase=FESSUR	CaseType=Combination	Point=1	X2=-0.5	X3=-0.5	S11=-	
1062.78439131746	IsS11Max=No	IsS11Min=Yes	FrameElem=20	ElemStation=0				
Frame=20	Station=0	OutputCase=FESSUR	CaseType=Combination	Point=2	X2=-0.5	X3=0.5	S11=-	
1062.78439131746	IsS11Max=No	IsS11Min=No	FrameElem=20	ElemStation=0				
Frame=20	Station=0	OutputCase=FESSUR	CaseType=Combination	Point=3	X2=0.5	X3=-0.5		
S11=128.814398436295	IsS11Max=Yes	IsS11Min=No	FrameElem=20	ElemStation=0				
Frame=20	Station=0	OutputCase=FESSUR	CaseType=Combination	Point=4	X2=0.5	X3=0.5		
S11=128.814398436295	IsS11Max=No	IsS11Min=No	FrameElem=20	ElemStation=0				
Frame=20	Station=0.5	OutputCase=FESSUR	CaseType=Combination	Point=0	X2=0	X3=0	S11=-454.484996757084	
IsS11Max=No	IsS11Min=No	FrameElem=20	ElemStation=0.5					
Frame=20	Station=0.5	OutputCase=FESSUR	CaseType=Combination	Point=1	X2=-0.5	X3=-0.5	S11=-	
1083.9961742499	IsS11Max=No	IsS11Min=Yes	FrameElem=20	ElemStation=0.5				
Frame=20	Station=0.5	OutputCase=FESSUR	CaseType=Combination	Point=2	X2=-0.5	X3=0.5	S11=-	
1083.9961742499	IsS11Max=No	IsS11Min=No	FrameElem=20	ElemStation=0.5				
Frame=20	Station=0.5	OutputCase=FESSUR	CaseType=Combination	Point=3	X2=0.5	X3=-0.5		
S11=175.026180735731	IsS11Max=Yes	IsS11Min=No	FrameElem=20	ElemStation=0.5				
Frame=20	Station=0.5	OutputCase=FESSUR	CaseType=Combination	Point=4	X2=0.5	X3=0.5		
S11=175.026180735731	IsS11Max=No	IsS11Min=No	FrameElem=20	ElemStation=0.5				
Frame=21	Station=0	OutputCase=PERM1	CaseType=Combination	Point=0	X2=0	X3=0	S11=-444.99999681973	
IsS11Max=No	IsS11Min=No	FrameElem=21	ElemStation=0					
Frame=21	Station=0	OutputCase=PERM1	CaseType=Combination	Point=1	X2=-0.5	X3=-0.5	S11=-	
1060.72867195556	IsS11Max=No	IsS11Min=Yes	FrameElem=21	ElemStation=0				
Frame=21	Station=0	OutputCase=PERM1	CaseType=Combination	Point=2	X2=-0.5	X3=0.5	S11=-	
1060.72867195556	IsS11Max=No	IsS11Min=No	FrameElem=21	ElemStation=0				

Frame=21	Station=0	OutputCase=PERM1	CaseType=Combination	Point=3	X2=0.5	X3=-0.5	
S11=170.728678316099	IsS11Max=Yes	IsS11Min=No	FrameElem=21	ElemStation=0			
Frame=21	Station=0	OutputCase=PERM1	CaseType=Combination	Point=4	X2=0.5	X3=0.5	S11=170.728678316099
IsS11Max=No	IsS11Min=No	FrameElem=21	ElemStation=0				
Frame=21	Station=0.5	OutputCase=PERM1	CaseType=Combination	Point=0	X2=0	X3=0	S11=-432.499997112863
IsS11Max=No	IsS11Min=No	FrameElem=21	ElemStation=0.5				
Frame=21	Station=0.5	OutputCase=PERM1	CaseType=Combination	Point=1	X2=-0.5	X3=-0.5	S11=-
1194.51703189	IsS11Max=No	IsS11Min=Yes	FrameElem=21	ElemStation=0.5			
Frame=21	Station=0.5	OutputCase=PERM1	CaseType=Combination	Point=2	X2=-0.5	X3=0.5	S11=-
1194.51703189	IsS11Max=No	IsS11Min=No	FrameElem=21	ElemStation=0.5			
Frame=21	Station=0.5	OutputCase=PERM1	CaseType=Combination	Point=3	X2=0.5	X3=-0.5	
S11=329.517037664273	IsS11Max=Yes	IsS11Min=No	FrameElem=21	ElemStation=0.5			
Frame=21	Station=0.5	OutputCase=PERM1	CaseType=Combination	Point=4	X2=0.5	X3=0.5	
S11=329.517037664273	IsS11Max=No	IsS11Min=No	FrameElem=21	ElemStation=0.5			
Frame=21	Station=0	OutputCase=PERM2	CaseType=Combination	Point=0	X2=0	X3=0	S11=-444.999996439613
IsS11Max=No	IsS11Min=No	FrameElem=21	ElemStation=0				
Frame=21	Station=0	OutputCase=PERM2	CaseType=Combination	Point=1	X2=-0.5	X3=-0.5	S11=-
1240.96986280711	IsS11Max=No	IsS11Min=Yes	FrameElem=21	ElemStation=0			
Frame=21	Station=0	OutputCase=PERM2	CaseType=Combination	Point=2	X2=-0.5	X3=0.5	S11=-
1240.96986280711	IsS11Max=No	IsS11Min=No	FrameElem=21	ElemStation=0			
Frame=21	Station=0	OutputCase=PERM2	CaseType=Combination	Point=3	X2=0.5	X3=-0.5	
S11=350.969869927882	IsS11Max=Yes	IsS11Min=No	FrameElem=21	ElemStation=0			
Frame=21	Station=0	OutputCase=PERM2	CaseType=Combination	Point=4	X2=0.5	X3=0.5	S11=350.969869927882
IsS11Max=No	IsS11Min=No	FrameElem=21	ElemStation=0				
Frame=21	Station=0.5	OutputCase=PERM2	CaseType=Combination	Point=0	X2=0	X3=0	S11=-432.499996644806
IsS11Max=No	IsS11Min=No	FrameElem=21	ElemStation=0.5				
Frame=21	Station=0.5	OutputCase=PERM2	CaseType=Combination	Point=1	X2=-0.5	X3=-0.5	S11=-
1317.94651762057	IsS11Max=No	IsS11Min=Yes	FrameElem=21	ElemStation=0.5			
Frame=21	Station=0.5	OutputCase=PERM2	CaseType=Combination	Point=2	X2=-0.5	X3=0.5	S11=-
1317.94651762057	IsS11Max=No	IsS11Min=No	FrameElem=21	ElemStation=0.5			
Frame=21	Station=0.5	OutputCase=PERM2	CaseType=Combination	Point=3	X2=0.5	X3=-0.5	
S11=452.946524330956	IsS11Max=Yes	IsS11Min=No	FrameElem=21	ElemStation=0.5			
Frame=21	Station=0.5	OutputCase=PERM2	CaseType=Combination	Point=4	X2=0.5	X3=0.5	
S11=452.946524330956	IsS11Max=No	IsS11Min=No	FrameElem=21	ElemStation=0.5			
Frame=21	Station=0	OutputCase=ACC1	CaseType=Combination	Point=0	X2=0	X3=0	S11=-458.549996730157
IsS11Max=No	IsS11Min=No	FrameElem=21	ElemStation=0				
Frame=21	Station=0	OutputCase=ACC1	CaseType=Combination	Point=1	X2=-0.5	X3=-0.5	S11=-
1093.96796094739	IsS11Max=No	IsS11Min=Yes	FrameElem=21	ElemStation=0			
Frame=21	Station=0	OutputCase=ACC1	CaseType=Combination	Point=2	X2=-0.5	X3=0.5	S11=-
1093.96796094739	IsS11Max=No	IsS11Min=No	FrameElem=21	ElemStation=0			
Frame=21	Station=0	OutputCase=ACC1	CaseType=Combination	Point=3	X2=0.5	X3=-0.5	S11=176.867967487075
IsS11Max=Yes	IsS11Min=No	FrameElem=21	ElemStation=0				
Frame=21	Station=0	OutputCase=ACC1	CaseType=Combination	Point=4	X2=0.5	X3=0.5	S11=176.867967487075
IsS11Max=No	IsS11Min=No	FrameElem=21	ElemStation=0				
Frame=21	Station=0.5	OutputCase=ACC1	CaseType=Combination	Point=0	X2=0	X3=0	S11=-446.049997032469
IsS11Max=No	IsS11Min=No	FrameElem=21	ElemStation=0.5				
Frame=21	Station=0.5	OutputCase=ACC1	CaseType=Combination	Point=1	X2=-0.5	X3=-0.5	S11=-
1233.04317529392	IsS11Max=No	IsS11Min=Yes	FrameElem=21	ElemStation=0.5			
Frame=21	Station=0.5	OutputCase=ACC1	CaseType=Combination	Point=2	X2=-0.5	X3=0.5	S11=-
1233.04317529392	IsS11Max=No	IsS11Min=No	FrameElem=21	ElemStation=0.5			
Frame=21	Station=0.5	OutputCase=ACC1	CaseType=Combination	Point=3	X2=0.5	X3=-0.5	
S11=340.943181228986	IsS11Max=Yes	IsS11Min=No	FrameElem=21	ElemStation=0.5			
Frame=21	Station=0.5	OutputCase=ACC1	CaseType=Combination	Point=4	X2=0.5	X3=0.5	
S11=340.943181228986	IsS11Max=No	IsS11Min=No	FrameElem=21	ElemStation=0.5			
Frame=21	Station=0	OutputCase=ACC2	CaseType=Combination	Point=0	X2=0	X3=0	S11=-458.54999635004
IsS11Max=No	IsS11Min=No	FrameElem=21	ElemStation=0				
Frame=21	Station=0	OutputCase=ACC2	CaseType=Combination	Point=1	X2=-0.5	X3=-0.5	S11=-
1274.20915179894	IsS11Max=No	IsS11Min=Yes	FrameElem=21	ElemStation=0			
Frame=21	Station=0	OutputCase=ACC2	CaseType=Combination	Point=2	X2=-0.5	X3=0.5	S11=-
1274.20915179894	IsS11Max=No	IsS11Min=No	FrameElem=21	ElemStation=0			
Frame=21	Station=0	OutputCase=ACC2	CaseType=Combination	Point=3	X2=0.5	X3=-0.5	S11=357.109159098858
IsS11Max=Yes	IsS11Min=No	FrameElem=21	ElemStation=0				
Frame=21	Station=0	OutputCase=ACC2	CaseType=Combination	Point=4	X2=0.5	X3=0.5	S11=357.109159098858
IsS11Max=No	IsS11Min=No	FrameElem=21	ElemStation=0				
Frame=21	Station=0.5	OutputCase=ACC2	CaseType=Combination	Point=0	X2=0	X3=0	S11=-446.049996564412
IsS11Max=No	IsS11Min=No	FrameElem=21	ElemStation=0.5				
Frame=21	Station=0.5	OutputCase=ACC2	CaseType=Combination	Point=1	X2=-0.5	X3=-0.5	S11=-
1356.47266102449	IsS11Max=No	IsS11Min=Yes	FrameElem=21	ElemStation=0.5			
Frame=21	Station=0.5	OutputCase=ACC2	CaseType=Combination	Point=2	X2=-0.5	X3=0.5	S11=-
1356.47266102449	IsS11Max=No	IsS11Min=No	FrameElem=21	ElemStation=0.5			
Frame=21	Station=0.5	OutputCase=ACC2	CaseType=Combination	Point=3	X2=0.5	X3=-0.5	
S11=464.37266789567	IsS11Max=Yes	IsS11Min=No	FrameElem=21	ElemStation=0.5			
Frame=21	Station=0.5	OutputCase=ACC2	CaseType=Combination	Point=4	X2=0.5	X3=0.5	S11=464.37266789567
IsS11Max=No	IsS11Min=No	FrameElem=21	ElemStation=0.5				
Frame=21	Station=0	OutputCase=ACCSX1	CaseType=Combination	Point=0	X2=0	X3=0	S11=-446.514074443232
IsS11Max=No	IsS11Min=No	FrameElem=21	ElemStation=0				
Frame=21	Station=0	OutputCase=ACCSX1	CaseType=Combination	Point=1	X2=-0.5	X3=-0.5	S11=-
1068.16886678554	IsS11Max=No	IsS11Min=Yes	FrameElem=21	ElemStation=0			
Frame=21	Station=0	OutputCase=ACCSX1	CaseType=Combination	Point=2	X2=-0.5	X3=0.5	S11=-
1068.16886678554	IsS11Max=No	IsS11Min=No	FrameElem=21	ElemStation=0			
Frame=21	Station=0	OutputCase=ACCSX1	CaseType=Combination	Point=3	X2=0.5	X3=-0.5	
S11=175.14071789908	IsS11Max=Yes	IsS11Min=No	FrameElem=21	ElemStation=0			



Frame=21	Station=0	OutputCase=ACCSX1	CaseType=Combination	Point=4	X2=0.5	X3=0.5	S11=175.14071789908	
IsS11Max=No	IsS11Min=No	FrameElem=21	ElemStation=0					
Frame=21	Station=0.5	OutputCase=ACCSX1	CaseType=Combination	Point=0	X2=0	X3=0	S11=-434.014074736365	
IsS11Max=No	IsS11Min=No	FrameElem=21	ElemStation=0.5					
Frame=21	Station=0.5	OutputCase=ACCSX1	CaseType=Combination	Point=1	X2=-0.5	X3=-0.5	S11=-	
1208.77562065646	IsS11Max=No	IsS11Min=Yes	FrameElem=21	ElemStation=0.5				
Frame=21	Station=0.5	OutputCase=ACCSX1	CaseType=Combination	Point=2	X2=-0.5	X3=0.5	S11=-	
1208.77562065646	IsS11Max=No	IsS11Min=No	FrameElem=21	ElemStation=0.5				
Frame=21	Station=0.5	OutputCase=ACCSX1	CaseType=Combination	Point=3	X2=0.5	X3=-0.5		
S11=340.747471183727	IsS11Max=No	IsS11Min=No	FrameElem=21	ElemStation=0.5				
Frame=21	Station=0.5	OutputCase=ACCSX1	CaseType=Combination	Point=4	X2=0.5	X3=0.5		
S11=340.747471183727	IsS11Max=No	IsS11Min=No	FrameElem=21	ElemStation=0.5				
Frame=21	Station=0	OutputCase=ACCSX2	CaseType=Combination	Point=0	X2=0	X3=0	S11=-446.514074063115	
IsS11Max=No	IsS11Min=No	FrameElem=21	ElemStation=0					
Frame=21	Station=0	OutputCase=ACCSX2	CaseType=Combination	Point=1	X2=-0.5	X3=-0.5	S11=-	
1248.41005763709	IsS11Max=No	IsS11Min=Yes	FrameElem=21	ElemStation=0				
Frame=21	Station=0	OutputCase=ACCSX2	CaseType=Combination	Point=2	X2=-0.5	X3=0.5	S11=-	
1248.41005763709	IsS11Max=No	IsS11Min=No	FrameElem=21	ElemStation=0				
Frame=21	Station=0	OutputCase=ACCSX2	CaseType=Combination	Point=3	X2=0.5	X3=-0.5		
S11=355.381909510864	IsS11Max=Yes	IsS11Min=No	FrameElem=21	ElemStation=0				
Frame=21	Station=0	OutputCase=ACCSX2	CaseType=Combination	Point=4	X2=0.5	X3=0.5		
S11=355.381909510864	IsS11Max=No	IsS11Min=No	FrameElem=21	ElemStation=0				
Frame=21	Station=0.5	OutputCase=ACCSX2	CaseType=Combination	Point=0	X2=0	X3=0	S11=-434.014074268308	
IsS11Max=No	IsS11Min=No	FrameElem=21	ElemStation=0.5					
Frame=21	Station=0.5	OutputCase=ACCSX2	CaseType=Combination	Point=1	X2=-0.5	X3=-0.5	S11=-	
1332.20510638703	IsS11Max=No	IsS11Min=Yes	FrameElem=21	ElemStation=0.5				
Frame=21	Station=0.5	OutputCase=ACCSX2	CaseType=Combination	Point=2	X2=-0.5	X3=0.5	S11=-	
1332.20510638703	IsS11Max=No	IsS11Min=No	FrameElem=21	ElemStation=0.5				
Frame=21	Station=0.5	OutputCase=ACCSX2	CaseType=Combination	Point=3	X2=0.5	X3=-0.5		
S11=464.17695785041	IsS11Max=Yes	IsS11Min=No	FrameElem=21	ElemStation=0.5				
Frame=21	Station=0.5	OutputCase=ACCSX2	CaseType=Combination	Point=4	X2=0.5	X3=0.5		
S11=464.17695785041	IsS11Max=No	IsS11Min=No	FrameElem=21	ElemStation=0.5				
Frame=21	Station=0	OutputCase=ENVE	CaseType=Combination	StepType=Max	Point=0	X2=0	X3=0	S11=-
444.99996439613	IsS11Max=No	IsS11Min=No	FrameElem=21	ElemStation=0				
Frame=21	Station=0	OutputCase=ENVE	CaseType=Combination	StepType=Max	Point=1	X2=-0.5	X3=-0.5	
S11=-1060.72867195556	IsS11Max=No	IsS11Min=Yes	FrameElem=21	ElemStation=0				
Frame=21	Station=0	OutputCase=ENVE	CaseType=Combination	StepType=Max	Point=2	X2=-0.5	X3=0.5	S11=-
1060.72867195556	IsS11Max=No	IsS11Min=No	FrameElem=21	ElemStation=0				
Frame=21	Station=0	OutputCase=ENVE	CaseType=Combination	StepType=Max	Point=3	X2=0.5	X3=-0.5	
S11=357.109159098858	IsS11Max=Yes	IsS11Min=No	FrameElem=21	ElemStation=0				
Frame=21	Station=0	OutputCase=ENVE	CaseType=Combination	StepType=Max	Point=4	X2=0.5	X3=0.5	
S11=357.109159098858	IsS11Max=No	IsS11Min=No	FrameElem=21	ElemStation=0				
Frame=21	Station=0.5	OutputCase=ENVE	CaseType=Combination	StepType=Max	Point=0	X2=0	X3=0	S11=-
432.499996644806	IsS11Max=No	IsS11Min=No	FrameElem=21	ElemStation=0.5				
Frame=21	Station=0.5	OutputCase=ENVE	CaseType=Combination	StepType=Max	Point=1	X2=-0.5	X3=-0.5	
S11=-1194.51703189	IsS11Max=No	IsS11Min=Yes	FrameElem=21	ElemStation=0.5				
Frame=21	Station=0.5	OutputCase=ENVE	CaseType=Combination	StepType=Max	Point=2	X2=-0.5	X3=0.5	
S11=-1194.51703189	IsS11Max=No	IsS11Min=No	FrameElem=21	ElemStation=0.5				
Frame=21	Station=0.5	OutputCase=ENVE	CaseType=Combination	StepType=Max	Point=3	X2=0.5	X3=-0.5	
S11=464.37266789567	IsS11Max=Yes	IsS11Min=No	FrameElem=21	ElemStation=0.5				
Frame=21	Station=0.5	OutputCase=ENVE	CaseType=Combination	StepType=Max	Point=4	X2=0.5	X3=0.5	
S11=464.37266789567	IsS11Max=No	IsS11Min=No	FrameElem=21	ElemStation=0.5				
Frame=21	Station=0	OutputCase=ENVE	CaseType=Combination	StepType=Min	Point=0	X2=0	X3=0	S11=-
458.549996730157	IsS11Max=No	IsS11Min=No	FrameElem=21	ElemStation=0				
Frame=21	Station=0	OutputCase=ENVE	CaseType=Combination	StepType=Min	Point=1	X2=-0.5	X3=-0.5	
S11=-1274.20915179894	IsS11Max=No	IsS11Min=Yes	FrameElem=21	ElemStation=0				
Frame=21	Station=0	OutputCase=ENVE	CaseType=Combination	StepType=Min	Point=2	X2=-0.5	X3=0.5	S11=-
1274.20915179894	IsS11Max=No	IsS11Min=No	FrameElem=21	ElemStation=0				
Frame=21	Station=0	OutputCase=ENVE	CaseType=Combination	StepType=Min	Point=3	X2=0.5	X3=-0.5	
S11=170.728678316099	IsS11Max=Yes	IsS11Min=No	FrameElem=21	ElemStation=0				
Frame=21	Station=0	OutputCase=ENVE	CaseType=Combination	StepType=Min	Point=4	X2=0.5	X3=0.5	
S11=170.728678316099	IsS11Max=No	IsS11Min=No	FrameElem=21	ElemStation=0				
Frame=21	Station=0.5	OutputCase=ENVE	CaseType=Combination	StepType=Min	Point=0	X2=0	X3=0	S11=-
446.049997032469	IsS11Max=No	IsS11Min=No	FrameElem=21	ElemStation=0.5				
Frame=21	Station=0.5	OutputCase=ENVE	CaseType=Combination	StepType=Min	Point=1	X2=-0.5	X3=-0.5	
S11=-1356.47266102449	IsS11Max=No	IsS11Min=Yes	FrameElem=21	ElemStation=0.5				
Frame=21	Station=0.5	OutputCase=ENVE	CaseType=Combination	StepType=Min	Point=2	X2=-0.5	X3=0.5	
S11=-1356.47266102449	IsS11Max=No	IsS11Min=No	FrameElem=21	ElemStation=0.5				
Frame=21	Station=0.5	OutputCase=ENVE	CaseType=Combination	StepType=Min	Point=3	X2=0.5	X3=-0.5	
S11=329.517037664273	IsS11Max=Yes	IsS11Min=No	FrameElem=21	ElemStation=0.5				
Frame=21	Station=0.5	OutputCase=ENVE	CaseType=Combination	StepType=Min	Point=4	X2=0.5	X3=0.5	
S11=329.517037664273	IsS11Max=No	IsS11Min=No	FrameElem=21	ElemStation=0.5				
Frame=21	Station=0	OutputCase=FESSUR	CaseType=Combination	Point=0	X2=0	X3=0	S11=-454.484996757029	
IsS11Max=No	IsS11Min=No	FrameElem=21	ElemStation=0					
Frame=21	Station=0	OutputCase=FESSUR	CaseType=Combination	Point=1	X2=-0.5	X3=-0.5	S11=-	
1083.99617424984	IsS11Max=No	IsS11Min=Yes	FrameElem=21	ElemStation=0				
Frame=21	Station=0	OutputCase=FESSUR	CaseType=Combination	Point=2	X2=-0.5	X3=0.5	S11=-	
1083.99617424984	IsS11Max=No	IsS11Min=No	FrameElem=21	ElemStation=0				
Frame=21	Station=0	OutputCase=FESSUR	CaseType=Combination	Point=3	X2=0.5	X3=-0.5		
S11=175.026180735782	IsS11Max=Yes	IsS11Min=No	FrameElem=21	ElemStation=0				
Frame=21	Station=0	OutputCase=FESSUR	CaseType=Combination	Point=4	X2=0.5	X3=0.5		
S11=175.026180735782	IsS11Max=No	IsS11Min=No	FrameElem=21	ElemStation=0				

Frame=21	Station=0.5	OutputCase=FESSUR	CaseType=Combination	Point=0	X2=0	X3=0	S11=-441.984997056587
IsS11Max=No	IsS11Min=No	FrameElem=21	ElemStation=0.5				
Frame=21	Station=0.5	OutputCase=FESSUR	CaseType=Combination	Point=1	X2=-0.5	X3=-0.5	S11=-
1221.48533227275	IsS11Max=No	IsS11Min=Yes	FrameElem=21	ElemStation=0.5			
Frame=21	Station=0.5	OutputCase=FESSUR	CaseType=Combination	Point=2	X2=-0.5	X3=0.5	S11=-
1221.48533227275	IsS11Max=No	IsS11Min=No	FrameElem=21	ElemStation=0.5			
Frame=21	Station=0.5	OutputCase=FESSUR	CaseType=Combination	Point=3	X2=0.5	X3=-0.5	
S11=337.515338159572	IsS11Max=Yes	IsS11Min=No	FrameElem=21	ElemStation=0.5			
Frame=21	Station=0.5	OutputCase=FESSUR	CaseType=Combination	Point=4	X2=0.5	X3=0.5	
S11=337.515338159572	IsS11Max=No	IsS11Min=No	FrameElem=21	ElemStation=0.5			
Frame=22	Station=0	OutputCase=PERM1	CaseType=Combination	Point=0	X2=0	X3=0	S11=-432.49999711266
IsS11Max=No	IsS11Min=No	FrameElem=22	ElemStation=0				
Frame=22	Station=0	OutputCase=PERM1	CaseType=Combination	Point=1	X2=-0.5	X3=-0.5	S11=-
1194.5170318898	IsS11Max=No	IsS11Min=Yes	FrameElem=22	ElemStation=0			
Frame=22	Station=0	OutputCase=PERM1	CaseType=Combination	Point=2	X2=-0.5	X3=0.5	S11=-
1194.5170318898	IsS11Max=No	IsS11Min=No	FrameElem=22	ElemStation=0			
Frame=22	Station=0	OutputCase=PERM1	CaseType=Combination	Point=3	X2=0.5	X3=-0.5	
S11=329.517037664481	IsS11Max=Yes	IsS11Min=No	FrameElem=22	ElemStation=0			
Frame=22	Station=0	OutputCase=PERM1	CaseType=Combination	Point=4	X2=0.5	X3=0.5	S11=329.517037664481
IsS11Max=No	IsS11Min=No	FrameElem=22	ElemStation=0				
Frame=22	Station=0.5	OutputCase=PERM1	CaseType=Combination	Point=0	X2=0	X3=0	S11=-419.999997388851
IsS11Max=No	IsS11Min=No	FrameElem=22	ElemStation=0.5				
Frame=22	Station=0.5	OutputCase=PERM1	CaseType=Combination	Point=1	X2=-0.5	X3=-0.5	S11=-
1435.76164187661	IsS11Max=No	IsS11Min=Yes	FrameElem=22	ElemStation=0.5			
Frame=22	Station=0.5	OutputCase=PERM1	CaseType=Combination	Point=2	X2=-0.5	X3=0.5	S11=-
1435.76164187661	IsS11Max=No	IsS11Min=No	FrameElem=22	ElemStation=0.5			
Frame=22	Station=0.5	OutputCase=PERM1	CaseType=Combination	Point=3	X2=0.5	X3=-0.5	
S11=595.761647098908	IsS11Max=Yes	IsS11Min=No	FrameElem=22	ElemStation=0.5			
Frame=22	Station=0.5	OutputCase=PERM1	CaseType=Combination	Point=4	X2=0.5	X3=0.5	
S11=595.761647098908	IsS11Max=No	IsS11Min=No	FrameElem=22	ElemStation=0.5			
Frame=22	Station=0	OutputCase=PERM2	CaseType=Combination	Point=0	X2=0	X3=0	S11=-432.499996644603
IsS11Max=No	IsS11Min=No	FrameElem=22	ElemStation=0				
Frame=22	Station=0	OutputCase=PERM2	CaseType=Combination	Point=1	X2=-0.5	X3=-0.5	S11=-
1317.94651762037	IsS11Max=No	IsS11Min=Yes	FrameElem=22	ElemStation=0			
Frame=22	Station=0	OutputCase=PERM2	CaseType=Combination	Point=2	X2=-0.5	X3=0.5	S11=-
1317.94651762037	IsS11Max=No	IsS11Min=No	FrameElem=22	ElemStation=0			
Frame=22	Station=0	OutputCase=PERM2	CaseType=Combination	Point=3	X2=0.5	X3=-0.5	
S11=452.946524331165	IsS11Max=Yes	IsS11Min=No	FrameElem=22	ElemStation=0			
Frame=22	Station=0	OutputCase=PERM2	CaseType=Combination	Point=4	X2=0.5	X3=0.5	S11=452.946524331165
IsS11Max=No	IsS11Min=No	FrameElem=22	ElemStation=0				
Frame=22	Station=0.5	OutputCase=PERM2	CaseType=Combination	Point=0	X2=0	X3=0	S11=-419.999996837936
IsS11Max=No	IsS11Min=No	FrameElem=22	ElemStation=0.5				
Frame=22	Station=0.5	OutputCase=PERM2	CaseType=Combination	Point=1	X2=-0.5	X3=-0.5	S11=-
1470.1425475599	IsS11Max=No	IsS11Min=Yes	FrameElem=22	ElemStation=0.5			
Frame=22	Station=0.5	OutputCase=PERM2	CaseType=Combination	Point=2	X2=-0.5	X3=0.5	S11=-
1470.1425475599	IsS11Max=No	IsS11Min=No	FrameElem=22	ElemStation=0.5			
Frame=22	Station=0.5	OutputCase=PERM2	CaseType=Combination	Point=3	X2=0.5	X3=-0.5	
S11=630.142553884027	IsS11Max=Yes	IsS11Min=No	FrameElem=22	ElemStation=0.5			
Frame=22	Station=0.5	OutputCase=PERM2	CaseType=Combination	Point=4	X2=0.5	X3=0.5	
S11=630.142553884027	IsS11Max=No	IsS11Min=No	FrameElem=22	ElemStation=0.5			
Frame=22	Station=0	OutputCase=ACC1	CaseType=Combination	Point=0	X2=0	X3=0	S11=-446.049997032253
IsS11Max=No	IsS11Min=No	FrameElem=22	ElemStation=0				
Frame=22	Station=0	OutputCase=ACC1	CaseType=Combination	Point=1	X2=-0.5	X3=-0.5	S11=-
1233.04317529372	IsS11Max=No	IsS11Min=Yes	FrameElem=22	ElemStation=0			
Frame=22	Station=0	OutputCase=ACC1	CaseType=Combination	Point=2	X2=-0.5	X3=0.5	S11=-
1233.04317529372	IsS11Max=No	IsS11Min=No	FrameElem=22	ElemStation=0			
Frame=22	Station=0	OutputCase=ACC1	CaseType=Combination	Point=3	X2=0.5	X3=-0.5	S11=340.943181229209
IsS11Max=Yes	IsS11Min=No	FrameElem=22	ElemStation=0				
Frame=22	Station=0	OutputCase=ACC1	CaseType=Combination	Point=4	X2=0.5	X3=0.5	S11=340.943181229209
IsS11Max=No	IsS11Min=No	FrameElem=22	ElemStation=0				
Frame=22	Station=0.5	OutputCase=ACC1	CaseType=Combination	Point=0	X2=0	X3=0	S11=-433.549997317623
IsS11Max=No	IsS11Min=No	FrameElem=22	ElemStation=0.5				
Frame=22	Station=0.5	OutputCase=ACC1	CaseType=Combination	Point=1	X2=-0.5	X3=-0.5	S11=-
1483.03963969262	IsS11Max=No	IsS11Min=Yes	FrameElem=22	ElemStation=0.5			
Frame=22	Station=0.5	OutputCase=ACC1	CaseType=Combination	Point=2	X2=-0.5	X3=0.5	S11=-
1483.03963969262	IsS11Max=No	IsS11Min=No	FrameElem=22	ElemStation=0.5			
Frame=22	Station=0.5	OutputCase=ACC1	CaseType=Combination	Point=3	X2=0.5	X3=-0.5	
S11=615.939645057379	IsS11Max=Yes	IsS11Min=No	FrameElem=22	ElemStation=0.5			
Frame=22	Station=0.5	OutputCase=ACC1	CaseType=Combination	Point=4	X2=0.5	X3=0.5	
S11=615.939645057379	IsS11Max=No	IsS11Min=No	FrameElem=22	ElemStation=0.5			
Frame=22	Station=0	OutputCase=ACC2	CaseType=Combination	Point=0	X2=0	X3=0	S11=-446.049996564196
IsS11Max=No	IsS11Min=No	FrameElem=22	ElemStation=0				
Frame=22	Station=0	OutputCase=ACC2	CaseType=Combination	Point=1	X2=-0.5	X3=-0.5	S11=-
1356.47266102428	IsS11Max=No	IsS11Min=Yes	FrameElem=22	ElemStation=0			
Frame=22	Station=0	OutputCase=ACC2	CaseType=Combination	Point=2	X2=-0.5	X3=0.5	S11=-
1356.47266102428	IsS11Max=No	IsS11Min=No	FrameElem=22	ElemStation=0			
Frame=22	Station=0	OutputCase=ACC2	CaseType=Combination	Point=3	X2=0.5	X3=-0.5	S11=464.372667895893
IsS11Max=Yes	IsS11Min=No	FrameElem=22	ElemStation=0				
Frame=22	Station=0	OutputCase=ACC2	CaseType=Combination	Point=4	X2=0.5	X3=0.5	S11=464.372667895893
IsS11Max=No	IsS11Min=No	FrameElem=22	ElemStation=0				
Frame=22	Station=0.5	OutputCase=ACC2	CaseType=Combination	Point=0	X2=0	X3=0	S11=-433.549996766708
IsS11Max=No	IsS11Min=No	FrameElem=22	ElemStation=0.5				



Frame=22	Station=0.5	OutputCase=ACC2	CaseType=Combination	Point=1	X2=-0.5	X3=-0.5	S11=-	
1517.42054537592	IsS11Max=No	IsS11Min=Yes	FrameElem=22	ElemStation=0.5				
Frame=22	Station=0.5	OutputCase=ACC2	CaseType=Combination	Point=2	X2=-0.5	X3=0.5	S11=-	
1517.42054537592	IsS11Max=No	IsS11Min=No	FrameElem=22	ElemStation=0.5				
Frame=22	Station=0.5	OutputCase=ACC2	CaseType=Combination	Point=3	X2=0.5	X3=-0.5		
S11=650.320551842499	IsS11Max=Yes	IsS11Min=No	FrameElem=22	ElemStation=0.5				
Frame=22	Station=0.5	OutputCase=ACC2	CaseType=Combination	Point=4	X2=0.5	X3=0.5		
S11=650.320551842499	IsS11Max=No	IsS11Min=No	FrameElem=22	ElemStation=0.5				
Frame=22	Station=0	OutputCase=ACCSX1	CaseType=Combination	Point=0	X2=0	X3=0	S11=-434.014074736159	
IsS11Max=No	IsS11Min=No	FrameElem=22	ElemStation=0					
Frame=22	Station=0	OutputCase=ACCSX1	CaseType=Combination	Point=1	X2=-0.5	X3=-0.5	S11=-	
1208.77562065626	IsS11Max=No	IsS11Min=Yes	FrameElem=22	ElemStation=0				
Frame=22	Station=0	OutputCase=ACCSX1	CaseType=Combination	Point=2	X2=-0.5	X3=0.5	S11=-	
1208.77562065626	IsS11Max=No	IsS11Min=No	FrameElem=22	ElemStation=0				
Frame=22	Station=0	OutputCase=ACCSX1	CaseType=Combination	Point=3	X2=0.5	X3=-0.5		
S11=340.747471183943	IsS11Max=Yes	IsS11Min=No	FrameElem=22	ElemStation=0				
Frame=22	Station=0	OutputCase=ACCSX1	CaseType=Combination	Point=4	X2=0.5	X3=0.5		
S11=340.747471183943	IsS11Max=No	IsS11Min=No	FrameElem=22	ElemStation=0				
Frame=22	Station=0.5	OutputCase=ACCSX1	CaseType=Combination	Point=0	X2=0	X3=0	S11=-421.514075012349	
IsS11Max=No	IsS11Min=No	FrameElem=22	ElemStation=0.5					
Frame=22	Station=0.5	OutputCase=ACCSX1	CaseType=Combination	Point=1	X2=-0.5	X3=-0.5	S11=-	
1456.83862457955	IsS11Max=No	IsS11Min=Yes	FrameElem=22	ElemStation=0.5				
Frame=22	Station=0.5	OutputCase=ACCSX1	CaseType=Combination	Point=2	X2=-0.5	X3=0.5	S11=-	
1456.83862457955	IsS11Max=No	IsS11Min=No	FrameElem=22	ElemStation=0.5				
Frame=22	Station=0.5	OutputCase=ACCSX1	CaseType=Combination	Point=3	X2=0.5	X3=-0.5		
S11=613.810474554848	IsS11Max=Yes	IsS11Min=No	FrameElem=22	ElemStation=0.5				
Frame=22	Station=0.5	OutputCase=ACCSX1	CaseType=Combination	Point=4	X2=0.5	X3=0.5		
S11=613.810474554848	IsS11Max=No	IsS11Min=No	FrameElem=22	ElemStation=0.5				
Frame=22	Station=0	OutputCase=ACCSX2	CaseType=Combination	Point=0	X2=0	X3=0	S11=-434.014074268101	
IsS11Max=No	IsS11Min=No	FrameElem=22	ElemStation=0					
Frame=22	Station=0	OutputCase=ACCSX2	CaseType=Combination	Point=1	X2=-0.5	X3=-0.5	S11=-	
1332.20510638683	IsS11Max=No	IsS11Min=Yes	FrameElem=22	ElemStation=0				
Frame=22	Station=0	OutputCase=ACCSX2	CaseType=Combination	Point=2	X2=-0.5	X3=0.5	S11=-	
1332.20510638683	IsS11Max=No	IsS11Min=No	FrameElem=22	ElemStation=0				
Frame=22	Station=0	OutputCase=ACCSX2	CaseType=Combination	Point=3	X2=0.5	X3=-0.5		
S11=464.176957850627	IsS11Max=Yes	IsS11Min=No	FrameElem=22	ElemStation=0				
Frame=22	Station=0	OutputCase=ACCSX2	CaseType=Combination	Point=4	X2=0.5	X3=0.5		
S11=464.176957850627	IsS11Max=No	IsS11Min=No	FrameElem=22	ElemStation=0				
Frame=22	Station=0.5	OutputCase=ACCSX2	CaseType=Combination	Point=0	X2=0	X3=0	S11=-421.514074461435	
IsS11Max=No	IsS11Min=No	FrameElem=22	ElemStation=0.5					
Frame=22	Station=0.5	OutputCase=ACCSX2	CaseType=Combination	Point=1	X2=-0.5	X3=-0.5	S11=-	
1491.21953026284	IsS11Max=No	IsS11Min=Yes	FrameElem=22	ElemStation=0.5				
Frame=22	Station=0.5	OutputCase=ACCSX2	CaseType=Combination	Point=2	X2=-0.5	X3=0.5	S11=-	
1491.21953026284	IsS11Max=No	IsS11Min=No	FrameElem=22	ElemStation=0.5				
Frame=22	Station=0.5	OutputCase=ACCSX2	CaseType=Combination	Point=3	X2=0.5	X3=-0.5		
S11=648.191381339967	IsS11Max=Yes	IsS11Min=No	FrameElem=22	ElemStation=0.5				
Frame=22	Station=0.5	OutputCase=ACCSX2	CaseType=Combination	Point=4	X2=0.5	X3=0.5		
S11=648.191381339967	IsS11Max=No	IsS11Min=No	FrameElem=22	ElemStation=0.5				
Frame=22	Station=0	OutputCase=ENVE	CaseType=Combination	StepType=Max	Point=0	X2=0	X3=0	S11=-
432.499996644603	IsS11Max=No	IsS11Min=No	FrameElem=22	ElemStation=0				
Frame=22	Station=0	OutputCase=ENVE	CaseType=Combination	StepType=Max	Point=1	X2=-0.5	X3=-0.5	
S11=-1194.5170318898	IsS11Max=No	IsS11Min=Yes	FrameElem=22	ElemStation=0				
Frame=22	Station=0	OutputCase=ENVE	CaseType=Combination	StepType=Max	Point=2	X2=-0.5	X3=0.5	S11=-
1194.5170318898	IsS11Max=No	IsS11Min=No	FrameElem=22	ElemStation=0				
Frame=22	Station=0	OutputCase=ENVE	CaseType=Combination	StepType=Max	Point=3	X2=0.5	X3=-0.5	
S11=464.372667895893	IsS11Max=Yes	IsS11Min=No	FrameElem=22	ElemStation=0				
Frame=22	Station=0	OutputCase=ENVE	CaseType=Combination	StepType=Max	Point=4	X2=0.5	X3=0.5	
S11=464.372667895893	IsS11Max=No	IsS11Min=No	FrameElem=22	ElemStation=0				
Frame=22	Station=0.5	OutputCase=ENVE	CaseType=Combination	StepType=Max	Point=0	X2=0	X3=0	S11=-
419.999996837936	IsS11Max=No	IsS11Min=No	FrameElem=22	ElemStation=0.5				
Frame=22	Station=0.5	OutputCase=ENVE	CaseType=Combination	StepType=Max	Point=1	X2=-0.5	X3=-0.5	
S11=-1435.76164187661	IsS11Max=No	IsS11Min=Yes	FrameElem=22	ElemStation=0.5				
Frame=22	Station=0.5	OutputCase=ENVE	CaseType=Combination	StepType=Max	Point=2	X2=-0.5	X3=0.5	
S11=-1435.76164187661	IsS11Max=No	IsS11Min=No	FrameElem=22	ElemStation=0.5				
Frame=22	Station=0.5	OutputCase=ENVE	CaseType=Combination	StepType=Max	Point=3	X2=0.5	X3=-0.5	
S11=650.320551842499	IsS11Max=Yes	IsS11Min=No	FrameElem=22	ElemStation=0.5				
Frame=22	Station=0.5	OutputCase=ENVE	CaseType=Combination	StepType=Max	Point=4	X2=0.5	X3=0.5	
S11=650.320551842499	IsS11Max=No	IsS11Min=No	FrameElem=22	ElemStation=0.5				
Frame=22	Station=0	OutputCase=ENVE	CaseType=Combination	StepType=Min	Point=0	X2=0	X3=0	S11=-
446.049997032253	IsS11Max=No	IsS11Min=No	FrameElem=22	ElemStation=0				
Frame=22	Station=0	OutputCase=ENVE	CaseType=Combination	StepType=Min	Point=1	X2=-0.5	X3=-0.5	
S11=-1356.47266102428	IsS11Max=No	IsS11Min=Yes	FrameElem=22	ElemStation=0				
Frame=22	Station=0	OutputCase=ENVE	CaseType=Combination	StepType=Min	Point=2	X2=-0.5	X3=0.5	S11=-
1356.47266102428	IsS11Max=No	IsS11Min=No	FrameElem=22	ElemStation=0				
Frame=22	Station=0	OutputCase=ENVE	CaseType=Combination	StepType=Min	Point=3	X2=0.5	X3=-0.5	
S11=329.517037664481	IsS11Max=Yes	IsS11Min=No	FrameElem=22	ElemStation=0				
Frame=22	Station=0	OutputCase=ENVE	CaseType=Combination	StepType=Min	Point=4	X2=0.5	X3=0.5	
S11=329.517037664481	IsS11Max=No	IsS11Min=No	FrameElem=22	ElemStation=0				
Frame=22	Station=0.5	OutputCase=ENVE	CaseType=Combination	StepType=Min	Point=0	X2=0	X3=0	S11=-
433.549997317623	IsS11Max=No	IsS11Min=No	FrameElem=22	ElemStation=0.5				
Frame=22	Station=0.5	OutputCase=ENVE	CaseType=Combination	StepType=Min	Point=1	X2=-0.5	X3=-0.5	
S11=-1517.42054537592	IsS11Max=No	IsS11Min=Yes	FrameElem=22	ElemStation=0.5				



Frame=22	Station=0.5	OutputCase=ENVE	CaseType=Combination	StepType=Min	Point=2	X2=-0.5	X3=0.5	
S11=-1517.42054537592	IsS11Max=No	IsS11Min=No	FrameElem=22	ElemStation=0.5				
Frame=22	Station=0.5	OutputCase=ENVE	CaseType=Combination	StepType=Min	Point=3	X2=0.5	X3=-0.5	
S11=595.761647098908	IsS11Max=Yes	IsS11Min=No	FrameElem=22	ElemStation=0.5				
Frame=22	Station=0.5	OutputCase=ENVE	CaseType=Combination	StepType=Min	Point=4	X2=0.5	X3=0.5	
S11=595.761647098908	IsS11Max=No	IsS11Min=No	FrameElem=22	ElemStation=0.5				
Frame=22	Station=0	OutputCase=FESSUR	CaseType=Combination	Point=0	X2=0	X3=0	S11=-441.984997056375	
IsS11Max=No	IsS11Min=No	FrameElem=22	ElemStation=0					
Frame=22	Station=0	OutputCase=FESSUR	CaseType=Combination	Point=1	X2=-0.5	X3=-0.5	S11=-	
1221.48533227254	IsS11Max=No	IsS11Min=Yes	FrameElem=22	ElemStation=0				
Frame=22	Station=0	OutputCase=FESSUR	CaseType=Combination	Point=2	X2=-0.5	X3=0.5	S11=-	
1221.48533227254	IsS11Max=No	IsS11Min=No	FrameElem=22	ElemStation=0				
Frame=22	Station=0	OutputCase=FESSUR	CaseType=Combination	Point=3	X2=0.5	X3=-0.5		
S11=337.515338159791	IsS11Max=Yes	IsS11Min=No	FrameElem=22	ElemStation=0				
Frame=22	Station=0	OutputCase=FESSUR	CaseType=Combination	Point=4	X2=0.5	X3=0.5		
S11=337.515338159791	IsS11Max=No	IsS11Min=No	FrameElem=22	ElemStation=0				
Frame=22	Station=0.5	OutputCase=FESSUR	CaseType=Combination	Point=0	X2=0	X3=0	S11=-429.484997338991	
IsS11Max=No	IsS11Min=No	FrameElem=22	ElemStation=0.5					
Frame=22	Station=0.5	OutputCase=FESSUR	CaseType=Combination	Point=1	X2=-0.5	X3=-0.5	S11=-	
1468.85624034782	IsS11Max=No	IsS11Min=Yes	FrameElem=22	ElemStation=0.5				
Frame=22	Station=0.5	OutputCase=FESSUR	CaseType=Combination	Point=2	X2=-0.5	X3=0.5	S11=-	
1468.85624034782	IsS11Max=No	IsS11Min=No	FrameElem=22	ElemStation=0.5				
Frame=22	Station=0.5	OutputCase=FESSUR	CaseType=Combination	Point=3	X2=0.5	X3=-0.5		
S11=609.886245669838	IsS11Max=Yes	IsS11Min=No	FrameElem=22	ElemStation=0.5				
Frame=22	Station=0.5	OutputCase=FESSUR	CaseType=Combination	Point=4	X2=0.5	X3=0.5		
S11=609.886245669838	IsS11Max=No	IsS11Min=No	FrameElem=22	ElemStation=0.5				
Frame=23	Station=0	OutputCase=PERM1	CaseType=Combination	Point=0	X2=0	X3=0	S11=-494.99993948185	
IsS11Max=No	IsS11Min=No	FrameElem=23	ElemStation=0					
Frame=23	Station=0	OutputCase=PERM1	CaseType=Combination	Point=1	X2=-0.5	X3=-0.5		
S11=738.050253433101	IsS11Max=Yes	IsS11Min=No	FrameElem=23	ElemStation=0				
Frame=23	Station=0	OutputCase=PERM1	CaseType=Combination	Point=2	X2=-0.5	X3=0.5		
S11=738.050253433101	IsS11Max=No	IsS11Min=No	FrameElem=23	ElemStation=0				
Frame=23	Station=0	OutputCase=PERM1	CaseType=Combination	Point=3	X2=0.5	X3=-0.5	S11=-	
1728.05024132947	IsS11Max=No	IsS11Min=Yes	FrameElem=23	ElemStation=0				
Frame=23	Station=0	OutputCase=PERM1	CaseType=Combination	Point=4	X2=0.5	X3=0.5	S11=-	
1728.05024132947	IsS11Max=No	IsS11Min=No	FrameElem=23	ElemStation=0				
Frame=23	Station=0.5	OutputCase=PERM1	CaseType=Combination	Point=0	X2=0	X3=0	S11=-482.499994309088	
IsS11Max=No	IsS11Min=No	FrameElem=23	ElemStation=0.5					
Frame=23	Station=0.5	OutputCase=PERM1	CaseType=Combination	Point=1	X2=-0.5	X3=-0.5		
S11=403.057356365717	IsS11Max=Yes	IsS11Min=No	FrameElem=23	ElemStation=0.5				
Frame=23	Station=0.5	OutputCase=PERM1	CaseType=Combination	Point=2	X2=-0.5	X3=0.5		
S11=403.057356365717	IsS11Max=No	IsS11Min=No	FrameElem=23	ElemStation=0.5				
Frame=23	Station=0.5	OutputCase=PERM1	CaseType=Combination	Point=3	X2=0.5	X3=-0.5	S11=-	
1368.05734498389	IsS11Max=No	IsS11Min=Yes	FrameElem=23	ElemStation=0.5				
Frame=23	Station=0.5	OutputCase=PERM1	CaseType=Combination	Point=4	X2=0.5	X3=0.5	S11=-	
1368.05734498389	IsS11Max=No	IsS11Min=No	FrameElem=23	ElemStation=0.5				
Frame=23	Station=0	OutputCase=PERM2	CaseType=Combination	Point=0	X2=0	X3=0	S11=-494.999994518676	
IsS11Max=No	IsS11Min=No	FrameElem=23	ElemStation=0					
Frame=23	Station=0	OutputCase=PERM2	CaseType=Combination	Point=1	X2=-0.5	X3=-0.5		
S11=784.795760528606	IsS11Max=Yes	IsS11Min=No	FrameElem=23	ElemStation=0				
Frame=23	Station=0	OutputCase=PERM2	CaseType=Combination	Point=2	X2=-0.5	X3=0.5		
S11=784.795760528606	IsS11Max=No	IsS11Min=No	FrameElem=23	ElemStation=0				
Frame=23	Station=0	OutputCase=PERM2	CaseType=Combination	Point=3	X2=0.5	X3=-0.5	S11=-	
1774.79574956596	IsS11Max=No	IsS11Min=Yes	FrameElem=23	ElemStation=0				
Frame=23	Station=0	OutputCase=PERM2	CaseType=Combination	Point=4	X2=0.5	X3=0.5	S11=-	
1774.79574956596	IsS11Max=No	IsS11Min=No	FrameElem=23	ElemStation=0				
Frame=23	Station=0.5	OutputCase=PERM2	CaseType=Combination	Point=0	X2=0	X3=0	S11=-482.499994771309	
IsS11Max=No	IsS11Min=No	FrameElem=23	ElemStation=0.5					
Frame=23	Station=0.5	OutputCase=PERM2	CaseType=Combination	Point=1	X2=-0.5	X3=-0.5		
S11=541.125535083157	IsS11Max=Yes	IsS11Min=No	FrameElem=23	ElemStation=0.5				
Frame=23	Station=0.5	OutputCase=PERM2	CaseType=Combination	Point=2	X2=-0.5	X3=0.5		
S11=541.125535083157	IsS11Max=No	IsS11Min=No	FrameElem=23	ElemStation=0.5				
Frame=23	Station=0.5	OutputCase=PERM2	CaseType=Combination	Point=3	X2=0.5	X3=-0.5	S11=-	
1506.12552462577	IsS11Max=No	IsS11Min=Yes	FrameElem=23	ElemStation=0.5				
Frame=23	Station=0.5	OutputCase=PERM2	CaseType=Combination	Point=4	X2=0.5	X3=0.5	S11=-	
1506.12552462577	IsS11Max=No	IsS11Min=No	FrameElem=23	ElemStation=0.5				
Frame=23	Station=0	OutputCase=ACC1	CaseType=Combination	Point=0	X2=0	X3=0	S11=-508.549993761414	
IsS11Max=No	IsS11Min=No	FrameElem=23	ElemStation=0					
Frame=23	Station=0	OutputCase=ACC1	CaseType=Combination	Point=1	X2=-0.5	X3=-0.5		
S11=757.692125338711	IsS11Max=Yes	IsS11Min=No	FrameElem=23	ElemStation=0				
Frame=23	Station=0	OutputCase=ACC1	CaseType=Combination	Point=2	X2=-0.5	X3=0.5	S11=757.692125338711	
IsS11Max=No	IsS11Min=No	FrameElem=23	ElemStation=0					
Frame=23	Station=0	OutputCase=ACC1	CaseType=Combination	Point=3	X2=0.5	X3=-0.5	S11=-	
1774.79211286154	IsS11Max=No	IsS11Min=Yes	FrameElem=23	ElemStation=0				
Frame=23	Station=0	OutputCase=ACC1	CaseType=Combination	Point=4	X2=0.5	X3=0.5	S11=-1774.79211286154	
IsS11Max=No	IsS11Min=No	FrameElem=23	ElemStation=0					
Frame=23	Station=0.5	OutputCase=ACC1	CaseType=Combination	Point=0	X2=0	X3=0	S11=-496.049994131496	
IsS11Max=No	IsS11Min=No	FrameElem=23	ElemStation=0.5					
Frame=23	Station=0.5	OutputCase=ACC1	CaseType=Combination	Point=1	X2=-0.5	X3=-0.5		
S11=414.126082499841	IsS11Max=Yes	IsS11Min=No	FrameElem=23	ElemStation=0.5				
Frame=23	Station=0.5	OutputCase=ACC1	CaseType=Combination	Point=2	X2=-0.5	X3=0.5		
S11=414.126082499841	IsS11Max=No	IsS11Min=No	FrameElem=23	ElemStation=0.5				



Frame=23	Station=0.5	OutputCase=ACC1	CaseType=Combination	Point=3	X2=0.5	X3=-0.5	S11=-	
1406.22607076283	IsS11Max=No	IsS11Min=Yes	FrameElem=23	ElemStation=0.5				
Frame=23	Station=0.5	OutputCase=ACC1	CaseType=Combination	Point=4	X2=0.5	X3=0.5	S11=-	
1406.22607076283	IsS11Max=No	IsS11Min=No	FrameElem=23	ElemStation=0.5				
Frame=23	Station=0	OutputCase=ACC2	CaseType=Combination	Point=0	X2=0	X3=0	S11=-508.549994331905	
IsS11Max=No	IsS11Min=No	FrameElem=23	ElemStation=0					
Frame=23	Station=0	OutputCase=ACC2	CaseType=Combination	Point=1	X2=-0.5	X3=-0.5		
S11=804.437632434216	IsS11Max=Yes	IsS11Min=No	FrameElem=23	ElemStation=0				
Frame=23	Station=0	OutputCase=ACC2	CaseType=Combination	Point=2	X2=-0.5	X3=0.5	S11=804.437632434216	
IsS11Max=No	IsS11Min=No	FrameElem=23	ElemStation=0					
Frame=23	Station=0	OutputCase=ACC2	CaseType=Combination	Point=3	X2=0.5	X3=-0.5	S11=-	
1821.53762109803	IsS11Max=No	IsS11Min=Yes	FrameElem=23	ElemStation=0				
Frame=23	Station=0	OutputCase=ACC2	CaseType=Combination	Point=4	X2=0.5	X3=0.5	S11=-1821.53762109803	
IsS11Max=No	IsS11Min=No	FrameElem=23	ElemStation=0					
Frame=23	Station=0.5	OutputCase=ACC2	CaseType=Combination	Point=0	X2=0	X3=0	S11=-496.049994593717	
IsS11Max=No	IsS11Min=No	FrameElem=23	ElemStation=0.5					
Frame=23	Station=0.5	OutputCase=ACC2	CaseType=Combination	Point=1	X2=-0.5	X3=-0.5		
S11=552.194261217281	IsS11Max=Yes	IsS11Min=No	FrameElem=23	ElemStation=0.5				
Frame=23	Station=0.5	OutputCase=ACC2	CaseType=Combination	Point=2	X2=-0.5	X3=0.5		
S11=552.194261217281	IsS11Max=No	IsS11Min=No	FrameElem=23	ElemStation=0.5				
Frame=23	Station=0.5	OutputCase=ACC2	CaseType=Combination	Point=3	X2=0.5	X3=-0.5	S11=-	
1544.29425040471	IsS11Max=No	IsS11Min=Yes	FrameElem=23	ElemStation=0.5				
Frame=23	Station=0.5	OutputCase=ACC2	CaseType=Combination	Point=4	X2=0.5	X3=0.5	S11=-	
1544.29425040471	IsS11Max=No	IsS11Min=No	FrameElem=23	ElemStation=0.5				
Frame=23	Station=0	OutputCase=ACCSX1	CaseType=Combination	Point=0	X2=0	X3=0	S11=-493.485916296544	
IsS11Max=No	IsS11Min=No	FrameElem=23	ElemStation=0					
Frame=23	Station=0	OutputCase=ACCSX1	CaseType=Combination	Point=1	X2=-0.5	X3=-0.5		
S11=757.687044381811	IsS11Max=Yes	IsS11Min=No	FrameElem=23	ElemStation=0				
Frame=23	Station=0	OutputCase=ACCSX1	CaseType=Combination	Point=2	X2=-0.5	X3=0.5		
S11=757.687044381811	IsS11Max=No	IsS11Min=No	FrameElem=23	ElemStation=0				
Frame=23	Station=0	OutputCase=ACCSX1	CaseType=Combination	Point=3	X2=0.5	X3=-0.5	S11=-	
1744.6588769749	IsS11Max=No	IsS11Min=Yes	FrameElem=23	ElemStation=0				
Frame=23	Station=0	OutputCase=ACCSX1	CaseType=Combination	Point=4	X2=0.5	X3=0.5	S11=-	
1744.6588769749	IsS11Max=No	IsS11Min=No	FrameElem=23	ElemStation=0				
Frame=23	Station=0.5	OutputCase=ACCSX1	CaseType=Combination	Point=0	X2=0	X3=0	S11=-480.985916666627	
IsS11Max=No	IsS11Min=No	FrameElem=23	ElemStation=0.5					
Frame=23	Station=0.5	OutputCase=ACCSX1	CaseType=Combination	Point=1	X2=-0.5	X3=-0.5		
S11=406.99004131392	IsS11Max=Yes	IsS11Min=No	FrameElem=23	ElemStation=0.5				
Frame=23	Station=0.5	OutputCase=ACCSX1	CaseType=Combination	Point=2	X2=-0.5	X3=0.5		
S11=406.99004131392	IsS11Max=No	IsS11Min=No	FrameElem=23	ElemStation=0.5				
Frame=23	Station=0.5	OutputCase=ACCSX1	CaseType=Combination	Point=3	X2=0.5	X3=-0.5	S11=-	
1368.96187464717	IsS11Max=No	IsS11Min=Yes	FrameElem=23	ElemStation=0.5				
Frame=23	Station=0.5	OutputCase=ACCSX1	CaseType=Combination	Point=4	X2=0.5	X3=0.5	S11=-	
1368.96187464717	IsS11Max=No	IsS11Min=No	FrameElem=23	ElemStation=0.5				
Frame=23	Station=0	OutputCase=ACCSX2	CaseType=Combination	Point=0	X2=0	X3=0	S11=-493.485916867036	
IsS11Max=No	IsS11Min=No	FrameElem=23	ElemStation=0					
Frame=23	Station=0	OutputCase=ACCSX2	CaseType=Combination	Point=1	X2=-0.5	X3=-0.5		
S11=804.432551477316	IsS11Max=Yes	IsS11Min=No	FrameElem=23	ElemStation=0				
Frame=23	Station=0	OutputCase=ACCSX2	CaseType=Combination	Point=2	X2=-0.5	X3=0.5		
S11=804.432551477316	IsS11Max=No	IsS11Min=No	FrameElem=23	ElemStation=0				
Frame=23	Station=0	OutputCase=ACCSX2	CaseType=Combination	Point=3	X2=0.5	X3=-0.5	S11=-	
1791.40438521139	IsS11Max=No	IsS11Min=Yes	FrameElem=23	ElemStation=0				
Frame=23	Station=0	OutputCase=ACCSX2	CaseType=Combination	Point=4	X2=0.5	X3=0.5	S11=-	
1791.40438521139	IsS11Max=No	IsS11Min=No	FrameElem=23	ElemStation=0				
Frame=23	Station=0.5	OutputCase=ACCSX2	CaseType=Combination	Point=0	X2=0	X3=0	S11=-480.985917128848	
IsS11Max=No	IsS11Min=No	FrameElem=23	ElemStation=0.5					
Frame=23	Station=0.5	OutputCase=ACCSX2	CaseType=Combination	Point=1	X2=-0.5	X3=-0.5		
S11=545.05822003136	IsS11Max=Yes	IsS11Min=No	FrameElem=23	ElemStation=0.5				
Frame=23	Station=0.5	OutputCase=ACCSX2	CaseType=Combination	Point=2	X2=-0.5	X3=0.5		
S11=545.05822003136	IsS11Max=No	IsS11Min=No	FrameElem=23	ElemStation=0.5				
Frame=23	Station=0.5	OutputCase=ACCSX2	CaseType=Combination	Point=3	X2=0.5	X3=-0.5	S11=-	
1507.03005428906	IsS11Max=No	IsS11Min=Yes	FrameElem=23	ElemStation=0.5				
Frame=23	Station=0.5	OutputCase=ACCSX2	CaseType=Combination	Point=4	X2=0.5	X3=0.5	S11=-	
1507.03005428906	IsS11Max=No	IsS11Min=No	FrameElem=23	ElemStation=0.5				
Frame=23	Station=0	OutputCase=ENVE	CaseType=Combination	StepType=Max	Point=0	X2=0	X3=0	S11=-
493.485916296544	IsS11Max=No	IsS11Min=No	FrameElem=23	ElemStation=0				
Frame=23	Station=0	OutputCase=ENVE	CaseType=Combination	StepType=Max	Point=1	X2=-0.5	X3=-0.5	
S11=804.437632434216	IsS11Max=Yes	IsS11Min=No	FrameElem=23	ElemStation=0				
Frame=23	Station=0	OutputCase=ENVE	CaseType=Combination	StepType=Max	Point=2	X2=-0.5	X3=0.5	
S11=804.437632434216	IsS11Max=No	IsS11Min=No	FrameElem=23	ElemStation=0				
Frame=23	Station=0	OutputCase=ENVE	CaseType=Combination	StepType=Max	Point=3	X2=0.5	X3=-0.5	S11=-
1728.05024132947	IsS11Max=No	IsS11Min=Yes	FrameElem=23	ElemStation=0				
Frame=23	Station=0	OutputCase=ENVE	CaseType=Combination	StepType=Max	Point=4	X2=0.5	X3=0.5	S11=-
1728.05024132947	IsS11Max=No	IsS11Min=No	FrameElem=23	ElemStation=0				
Frame=23	Station=0.5	OutputCase=ENVE	CaseType=Combination	StepType=Max	Point=0	X2=0	X3=0	S11=-
480.985916666627	IsS11Max=No	IsS11Min=No	FrameElem=23	ElemStation=0.5				
Frame=23	Station=0.5	OutputCase=ENVE	CaseType=Combination	StepType=Max	Point=1	X2=-0.5	X3=-0.5	
S11=552.194261217281	IsS11Max=Yes	IsS11Min=No	FrameElem=23	ElemStation=0.5				
Frame=23	Station=0.5	OutputCase=ENVE	CaseType=Combination	StepType=Max	Point=2	X2=-0.5	X3=0.5	
S11=552.194261217281	IsS11Max=No	IsS11Min=No	FrameElem=23	ElemStation=0.5				
Frame=23	Station=0.5	OutputCase=ENVE	CaseType=Combination	StepType=Max	Point=3	X2=0.5	X3=-0.5	
S11=-1368.05734498389	IsS11Max=No	IsS11Min=Yes	FrameElem=23	ElemStation=0.5				

Frame=23	Station=0.5	OutputCase=ENVE	CaseType=Combination	StepType=Max	Point=4	X2=0.5	X3=0.5	
S11=-1368.05734498389	IsS11Max=No	IsS11Min=No	FrameElem=23	ElemStation=0.5				
Frame=23	Station=0	OutputCase=ENVE	CaseType=Combination	StepType=Min	Point=0	X2=0	X3=0	S11=-
508.549994331905	IsS11Max=No	IsS11Min=No	FrameElem=23	ElemStation=0				
Frame=23	Station=0	OutputCase=ENVE	CaseType=Combination	StepType=Min	Point=1	X2=-0.5	X3=-0.5	
S11=738.050253433101	IsS11Max=Yes	IsS11Min=No	FrameElem=23	ElemStation=0				
Frame=23	Station=0	OutputCase=ENVE	CaseType=Combination	StepType=Min	Point=2	X2=-0.5	X3=0.5	
S11=738.050253433101	IsS11Max=No	IsS11Min=No	FrameElem=23	ElemStation=0				
Frame=23	Station=0	OutputCase=ENVE	CaseType=Combination	StepType=Min	Point=3	X2=0.5	X3=-0.5	S11=-
1821.53762109803	IsS11Max=No	IsS11Min=Yes	FrameElem=23	ElemStation=0				
Frame=23	Station=0	OutputCase=ENVE	CaseType=Combination	StepType=Min	Point=4	X2=0.5	X3=0.5	S11=-
1821.53762109803	IsS11Max=No	IsS11Min=No	FrameElem=23	ElemStation=0				
Frame=23	Station=0.5	OutputCase=ENVE	CaseType=Combination	StepType=Min	Point=0	X2=0	X3=0	S11=-
496.049994593717	IsS11Max=No	IsS11Min=No	FrameElem=23	ElemStation=0.5				
Frame=23	Station=0.5	OutputCase=ENVE	CaseType=Combination	StepType=Min	Point=1	X2=-0.5	X3=-0.5	
S11=403.057356365717	IsS11Max=No	IsS11Min=No	FrameElem=23	ElemStation=0.5				
Frame=23	Station=0.5	OutputCase=ENVE	CaseType=Combination	StepType=Min	Point=2	X2=-0.5	X3=0.5	
S11=403.057356365717	IsS11Max=No	IsS11Min=No	FrameElem=23	ElemStation=0.5				
Frame=23	Station=0.5	OutputCase=ENVE	CaseType=Combination	StepType=Min	Point=3	X2=0.5	X3=-0.5	
S11=-1544.29425040471	IsS11Max=No	IsS11Min=Yes	FrameElem=23	ElemStation=0.5				
Frame=23	Station=0.5	OutputCase=ENVE	CaseType=Combination	StepType=Min	Point=4	X2=0.5	X3=0.5	
S11=-1544.29425040471	IsS11Max=No	IsS11Min=No	FrameElem=23	ElemStation=0.5				
Frame=23	Station=0	OutputCase=FESSUR	CaseType=Combination	Point=0	X2=0	X3=0	S11=-504.484993817445	
IsS11Max=No	IsS11Min=No	FrameElem=23	ElemStation=0					
Frame=23	Station=0	OutputCase=FESSUR	CaseType=Combination	Point=1	X2=-0.5	X3=-0.5		
S11=751.799563767028	IsS11Max=Yes	IsS11Min=No	FrameElem=23	ElemStation=0				
Frame=23	Station=0	OutputCase=FESSUR	CaseType=Combination	Point=2	X2=-0.5	X3=0.5		
S11=751.799563767028	IsS11Max=No	IsS11Min=No	FrameElem=23	ElemStation=0				
Frame=23	Station=0	OutputCase=FESSUR	CaseType=Combination	Point=3	X2=0.5	X3=-0.5	S11=-	
1760.76955140192	IsS11Max=No	IsS11Min=Yes	FrameElem=23	ElemStation=0				
Frame=23	Station=0	OutputCase=FESSUR	CaseType=Combination	Point=4	X2=0.5	X3=0.5	S11=-	
1760.76955140192	IsS11Max=No	IsS11Min=No	FrameElem=23	ElemStation=0				
Frame=23	Station=0.5	OutputCase=FESSUR	CaseType=Combination	Point=0	X2=0	X3=0	S11=-491.984994184774	
IsS11Max=No	IsS11Min=No	FrameElem=23	ElemStation=0.5					
Frame=23	Station=0.5	OutputCase=FESSUR	CaseType=Combination	Point=1	X2=-0.5	X3=-0.5		
S11=410.805464659604	IsS11Max=Yes	IsS11Min=No	FrameElem=23	ElemStation=0.5				
Frame=23	Station=0.5	OutputCase=FESSUR	CaseType=Combination	Point=2	X2=-0.5	X3=0.5		
S11=410.805464659604	IsS11Max=No	IsS11Min=No	FrameElem=23	ElemStation=0.5				
Frame=23	Station=0.5	OutputCase=FESSUR	CaseType=Combination	Point=3	X2=0.5	X3=-0.5	S11=-	
1394.77545302915	IsS11Max=No	IsS11Min=Yes	FrameElem=23	ElemStation=0.5				
Frame=23	Station=0.5	OutputCase=FESSUR	CaseType=Combination	Point=4	X2=0.5	X3=0.5	S11=-	
1394.77545302915	IsS11Max=No	IsS11Min=No	FrameElem=23	ElemStation=0.5				
Frame=24	Station=0	OutputCase=PERM1	CaseType=Combination	Point=0	X2=0	X3=0	S11=-482.499994309117	
IsS11Max=No	IsS11Min=No	FrameElem=24	ElemStation=0					
Frame=24	Station=0	OutputCase=PERM1	CaseType=Combination	Point=1	X2=-0.5	X3=-0.5		
S11=403.057356365681	IsS11Max=Yes	IsS11Min=No	FrameElem=24	ElemStation=0				
Frame=24	Station=0	OutputCase=PERM1	CaseType=Combination	Point=2	X2=-0.5	X3=0.5		
S11=403.057356365681	IsS11Max=No	IsS11Min=No	FrameElem=24	ElemStation=0				
Frame=24	Station=0	OutputCase=PERM1	CaseType=Combination	Point=3	X2=0.5	X3=-0.5	S11=-	
1368.05734498391	IsS11Max=No	IsS11Min=Yes	FrameElem=24	ElemStation=0				
Frame=24	Station=0	OutputCase=PERM1	CaseType=Combination	Point=4	X2=0.5	X3=0.5	S11=-	
1368.05734498391	IsS11Max=No	IsS11Min=No	FrameElem=24	ElemStation=0				
Frame=24	Station=0.5	OutputCase=PERM1	CaseType=Combination	Point=0	X2=0	X3=0	S11=-469.999994653078	
IsS11Max=No	IsS11Min=No	FrameElem=24	ElemStation=0.5					
Frame=24	Station=0.5	OutputCase=PERM1	CaseType=Combination	Point=1	X2=-0.5	X3=-0.5		
S11=201.103209613271	IsS11Max=Yes	IsS11Min=No	FrameElem=24	ElemStation=0.5				
Frame=24	Station=0.5	OutputCase=PERM1	CaseType=Combination	Point=2	X2=-0.5	X3=0.5		
S11=201.103209613271	IsS11Max=No	IsS11Min=No	FrameElem=24	ElemStation=0.5				
Frame=24	Station=0.5	OutputCase=PERM1	CaseType=Combination	Point=3	X2=0.5	X3=-0.5	S11=-	
1141.10319891943	IsS11Max=No	IsS11Min=Yes	FrameElem=24	ElemStation=0.5				
Frame=24	Station=0.5	OutputCase=PERM1	CaseType=Combination	Point=4	X2=0.5	X3=0.5	S11=-	
1141.10319891943	IsS11Max=No	IsS11Min=No	FrameElem=24	ElemStation=0.5				
Frame=24	Station=0	OutputCase=PERM2	CaseType=Combination	Point=0	X2=0	X3=0	S11=-482.499994771338	
IsS11Max=No	IsS11Min=No	FrameElem=24	ElemStation=0					
Frame=24	Station=0	OutputCase=PERM2	CaseType=Combination	Point=1	X2=-0.5	X3=-0.5		
S11=541.125535083121	IsS11Max=Yes	IsS11Min=No	FrameElem=24	ElemStation=0				
Frame=24	Station=0	OutputCase=PERM2	CaseType=Combination	Point=2	X2=-0.5	X3=0.5		
S11=541.125535083121	IsS11Max=No	IsS11Min=No	FrameElem=24	ElemStation=0				
Frame=24	Station=0	OutputCase=PERM2	CaseType=Combination	Point=3	X2=0.5	X3=-0.5	S11=-	
1506.1255246258	IsS11Max=No	IsS11Min=Yes	FrameElem=24	ElemStation=0				
Frame=24	Station=0	OutputCase=PERM2	CaseType=Combination	Point=4	X2=0.5	X3=0.5	S11=-1506.1255246258	
IsS11Max=No	IsS11Min=No	FrameElem=24	ElemStation=0					
Frame=24	Station=0.5	OutputCase=PERM2	CaseType=Combination	Point=0	X2=0	X3=0	S11=-469.99999501211	
IsS11Max=No	IsS11Min=No	FrameElem=24	ElemStation=0.5					
Frame=24	Station=0.5	OutputCase=PERM2	CaseType=Combination	Point=1	X2=-0.5	X3=-0.5		
S11=390.582434947564	IsS11Max=Yes	IsS11Min=No	FrameElem=24	ElemStation=0.5				
Frame=24	Station=0.5	OutputCase=PERM2	CaseType=Combination	Point=2	X2=-0.5	X3=0.5		
S11=390.582434947564	IsS11Max=No	IsS11Min=No	FrameElem=24	ElemStation=0.5				
Frame=24	Station=0.5	OutputCase=PERM2	CaseType=Combination	Point=3	X2=0.5	X3=-0.5	S11=-	
1330.58242497178	IsS11Max=No	IsS11Min=Yes	FrameElem=24	ElemStation=0.5				
Frame=24	Station=0.5	OutputCase=PERM2	CaseType=Combination	Point=4	X2=0.5	X3=0.5	S11=-	
1330.58242497178	IsS11Max=No	IsS11Min=No	FrameElem=24	ElemStation=0.5				



Frame=24	Station=0	OutputCase=ACC1	CaseType=Combination	Point=0	X2=0	X3=0	S11=-496.04999413153	
IsS11Max=No	IsS11Min=No	FrameElem=24	ElemStation=0					
Frame=24	Station=0	OutputCase=ACC1	CaseType=Combination	Point=1	X2=-0.5	X3=-0.5		
S11=414.126082499798	IsS11Max=Yes	IsS11Min=No	FrameElem=24	ElemStation=0				
Frame=24	Station=0	OutputCase=ACC1	CaseType=Combination	Point=2	X2=-0.5	X3=0.5	S11=414.126082499798	
IsS11Max=No	IsS11Min=No	FrameElem=24	ElemStation=0					
Frame=24	Station=0	OutputCase=ACC1	CaseType=Combination	Point=3	X2=0.5	X3=-0.5	S11=-	
1406.22607076286	IsS11Max=No	IsS11Min=Yes	FrameElem=24	ElemStation=0				
Frame=24	Station=0	OutputCase=ACC1	CaseType=Combination	Point=4	X2=0.5	X3=0.5	S11=-1406.22607076286	
IsS11Max=No	IsS11Min=No	FrameElem=24	ElemStation=0					
Frame=24	Station=0.5	OutputCase=ACC1	CaseType=Combination	Point=0	X2=0	X3=0	S11=-483.54999448467	
IsS11Max=No	IsS11Min=No	FrameElem=24	ElemStation=0.5					
Frame=24	Station=0.5	OutputCase=ACC1	CaseType=Combination	Point=1	X2=-0.5	X3=-0.5		
S11=207.063789975902	IsS11Max=Yes	IsS11Min=No	FrameElem=24	ElemStation=0.5				
Frame=24	Station=0.5	OutputCase=ACC1	CaseType=Combination	Point=2	X2=-0.5	X3=0.5		
S11=207.063789975902	IsS11Max=No	IsS11Min=No	FrameElem=24	ElemStation=0.5				
Frame=24	Station=0.5	OutputCase=ACC1	CaseType=Combination	Point=3	X2=0.5	X3=-0.5	S11=-	
1174.16377894524	IsS11Max=No	IsS11Min=Yes	FrameElem=24	ElemStation=0.5				
Frame=24	Station=0.5	OutputCase=ACC1	CaseType=Combination	Point=4	X2=0.5	X3=0.5	S11=-	
1174.16377894524	IsS11Max=No	IsS11Min=No	FrameElem=24	ElemStation=0.5				
Frame=24	Station=0	OutputCase=ACC2	CaseType=Combination	Point=0	X2=0	X3=0	S11=-496.049994593751	
IsS11Max=No	IsS11Min=No	FrameElem=24	ElemStation=0					
Frame=24	Station=0	OutputCase=ACC2	CaseType=Combination	Point=1	X2=-0.5	X3=-0.5		
S11=552.194261217238	IsS11Max=Yes	IsS11Min=No	FrameElem=24	ElemStation=0				
Frame=24	Station=0	OutputCase=ACC2	CaseType=Combination	Point=2	X2=-0.5	X3=0.5	S11=552.194261217238	
IsS11Max=No	IsS11Min=No	FrameElem=24	ElemStation=0					
Frame=24	Station=0	OutputCase=ACC2	CaseType=Combination	Point=3	X2=0.5	X3=-0.5	S11=-	
1544.29425040474	IsS11Max=No	IsS11Min=Yes	FrameElem=24	ElemStation=0				
Frame=24	Station=0	OutputCase=ACC2	CaseType=Combination	Point=4	X2=0.5	X3=0.5	S11=-1544.29425040474	
IsS11Max=No	IsS11Min=No	FrameElem=24	ElemStation=0					
Frame=24	Station=0.5	OutputCase=ACC2	CaseType=Combination	Point=0	X2=0	X3=0	S11=-483.549994843703	
IsS11Max=No	IsS11Min=No	FrameElem=24	ElemStation=0.5					
Frame=24	Station=0.5	OutputCase=ACC2	CaseType=Combination	Point=1	X2=-0.5	X3=-0.5		
S11=396.543015310195	IsS11Max=Yes	IsS11Min=No	FrameElem=24	ElemStation=0.5				
Frame=24	Station=0.5	OutputCase=ACC2	CaseType=Combination	Point=2	X2=-0.5	X3=0.5		
S11=396.543015310195	IsS11Max=No	IsS11Min=No	FrameElem=24	ElemStation=0.5				
Frame=24	Station=0.5	OutputCase=ACC2	CaseType=Combination	Point=3	X2=0.5	X3=-0.5	S11=-	
1363.6430049976	IsS11Max=No	IsS11Min=Yes	FrameElem=24	ElemStation=0.5				
Frame=24	Station=0.5	OutputCase=ACC2	CaseType=Combination	Point=4	X2=0.5	X3=0.5	S11=-	
1363.6430049976	IsS11Max=No	IsS11Min=No	FrameElem=24	ElemStation=0.5				
Frame=24	Station=0	OutputCase=ACCSX1	CaseType=Combination	Point=0	X2=0	X3=0	S11=-480.985916666652	
IsS11Max=No	IsS11Min=No	FrameElem=24	ElemStation=0					
Frame=24	Station=0	OutputCase=ACCSX1	CaseType=Combination	Point=1	X2=-0.5	X3=-0.5		
S11=406.990041313889	IsS11Max=Yes	IsS11Min=No	FrameElem=24	ElemStation=0				
Frame=24	Station=0	OutputCase=ACCSX1	CaseType=Combination	Point=2	X2=-0.5	X3=0.5		
S11=406.990041313889	IsS11Max=No	IsS11Min=No	FrameElem=24	ElemStation=0				
Frame=24	Station=0	OutputCase=ACCSX1	CaseType=Combination	Point=3	X2=0.5	X3=-0.5	S11=-	
1368.96187464719	IsS11Max=No	IsS11Min=Yes	FrameElem=24	ElemStation=0				
Frame=24	Station=0	OutputCase=ACCSX1	CaseType=Combination	Point=4	X2=0.5	X3=0.5	S11=-	
1368.96187464719	IsS11Max=No	IsS11Min=No	FrameElem=24	ElemStation=0				
Frame=24	Station=0.5	OutputCase=ACCSX1	CaseType=Combination	Point=0	X2=0	X3=0	S11=-468.485917019792	
IsS11Max=No	IsS11Min=No	FrameElem=24	ElemStation=0.5					
Frame=24	Station=0.5	OutputCase=ACCSX1	CaseType=Combination	Point=1	X2=-0.5	X3=-0.5		
S11=192.796788560973	IsS11Max=Yes	IsS11Min=No	FrameElem=24	ElemStation=0.5				
Frame=24	Station=0.5	OutputCase=ACCSX1	CaseType=Combination	Point=2	X2=-0.5	X3=0.5		
S11=192.796788560973	IsS11Max=No	IsS11Min=No	FrameElem=24	ElemStation=0.5				
Frame=24	Station=0.5	OutputCase=ACCSX1	CaseType=Combination	Point=3	X2=0.5	X3=-0.5	S11=-	
1129.76862260056	IsS11Max=No	IsS11Min=Yes	FrameElem=24	ElemStation=0.5				
Frame=24	Station=0.5	OutputCase=ACCSX1	CaseType=Combination	Point=4	X2=0.5	X3=0.5	S11=-	
1129.76862260056	IsS11Max=No	IsS11Min=No	FrameElem=24	ElemStation=0.5				
Frame=24	Station=0	OutputCase=ACCSX2	CaseType=Combination	Point=0	X2=0	X3=0	S11=-480.985917128872	
IsS11Max=No	IsS11Min=No	FrameElem=24	ElemStation=0					
Frame=24	Station=0	OutputCase=ACCSX2	CaseType=Combination	Point=1	X2=-0.5	X3=-0.5		
S11=545.058220031329	IsS11Max=Yes	IsS11Min=No	FrameElem=24	ElemStation=0				
Frame=24	Station=0	OutputCase=ACCSX2	CaseType=Combination	Point=2	X2=-0.5	X3=0.5		
S11=545.058220031329	IsS11Max=No	IsS11Min=No	FrameElem=24	ElemStation=0				
Frame=24	Station=0	OutputCase=ACCSX2	CaseType=Combination	Point=3	X2=0.5	X3=-0.5	S11=-	
1507.03005428907	IsS11Max=No	IsS11Min=Yes	FrameElem=24	ElemStation=0				
Frame=24	Station=0	OutputCase=ACCSX2	CaseType=Combination	Point=4	X2=0.5	X3=0.5	S11=-	
1507.03005428907	IsS11Max=No	IsS11Min=No	FrameElem=24	ElemStation=0				
Frame=24	Station=0.5	OutputCase=ACCSX2	CaseType=Combination	Point=0	X2=0	X3=0	S11=-468.485917378824	
IsS11Max=No	IsS11Min=No	FrameElem=24	ElemStation=0.5					
Frame=24	Station=0.5	OutputCase=ACCSX2	CaseType=Combination	Point=1	X2=-0.5	X3=-0.5		
S11=382.276013895266	IsS11Max=Yes	IsS11Min=No	FrameElem=24	ElemStation=0.5				
Frame=24	Station=0.5	OutputCase=ACCSX2	CaseType=Combination	Point=2	X2=-0.5	X3=0.5		
S11=382.276013895266	IsS11Max=No	IsS11Min=No	FrameElem=24	ElemStation=0.5				
Frame=24	Station=0.5	OutputCase=ACCSX2	CaseType=Combination	Point=3	X2=0.5	X3=-0.5	S11=-	
1319.24784865291	IsS11Max=No	IsS11Min=Yes	FrameElem=24	ElemStation=0.5				
Frame=24	Station=0.5	OutputCase=ACCSX2	CaseType=Combination	Point=4	X2=0.5	X3=0.5	S11=-	
1319.24784865291	IsS11Max=No	IsS11Min=No	FrameElem=24	ElemStation=0.5				
Frame=24	Station=0	OutputCase=ENVE	CaseType=Combination	StepType=Max	Point=0	X2=0	X3=0	S11=-
480.985916666652	IsS11Max=No	IsS11Min=No	FrameElem=24	ElemStation=0				

Frame=24	Station=0	OutputCase=ENVE	CaseType=Combination	StepType=Max	Point=1	X2=-0.5	X3=-0.5		
S11=552.194261217238	IsS11Max=Yes	IsS11Min=No	FrameElem=24	ElemStation=0					
Frame=24	Station=0	OutputCase=ENVE	CaseType=Combination	StepType=Max	Point=2	X2=-0.5	X3=0.5		
S11=552.194261217238	IsS11Max=No	IsS11Min=No	FrameElem=24	ElemStation=0					
Frame=24	Station=0	OutputCase=ENVE	CaseType=Combination	StepType=Max	Point=3	X2=0.5	X3=-0.5	S11=-	
1368.05734498391	IsS11Max=No	IsS11Min=Yes	FrameElem=24	ElemStation=0					
Frame=24	Station=0	OutputCase=ENVE	CaseType=Combination	StepType=Max	Point=4	X2=0.5	X3=0.5	S11=-	
1368.05734498391	IsS11Max=No	IsS11Min=No	FrameElem=24	ElemStation=0					
Frame=24	Station=0.5	OutputCase=ENVE	CaseType=Combination	StepType=Max	Point=0	X2=0	X3=0	S11=-	
468.485917019792	IsS11Max=No	IsS11Min=No	FrameElem=24	ElemStation=0.5					
Frame=24	Station=0.5	OutputCase=ENVE	CaseType=Combination	StepType=Max	Point=1	X2=-0.5	X3=-0.5		
S11=396.543015310195	IsS11Max=Yes	IsS11Min=No	FrameElem=24	ElemStation=0.5					
Frame=24	Station=0.5	OutputCase=ENVE	CaseType=Combination	StepType=Max	Point=2	X2=-0.5	X3=0.5		
S11=396.543015310195	IsS11Max=No	IsS11Min=No	FrameElem=24	ElemStation=0.5					
Frame=24	Station=0.5	OutputCase=ENVE	CaseType=Combination	StepType=Max	Point=3	X2=0.5	X3=-0.5		
S11=-1129.76862260056	IsS11Max=No	IsS11Min=Yes	FrameElem=24	ElemStation=0.5					
Frame=24	Station=0.5	OutputCase=ENVE	CaseType=Combination	StepType=Max	Point=4	X2=0.5	X3=0.5		
S11=-1129.76862260056	IsS11Max=No	IsS11Min=No	FrameElem=24	ElemStation=0.5					
Frame=24	Station=0	OutputCase=ENVE	CaseType=Combination	StepType=Min	Point=0	X2=0	X3=0	S11=-	
496.049994593751	IsS11Max=No	IsS11Min=No	FrameElem=24	ElemStation=0					
Frame=24	Station=0	OutputCase=ENVE	CaseType=Combination	StepType=Min	Point=1	X2=-0.5	X3=-0.5		
S11=403.057356365681	IsS11Max=Yes	IsS11Min=No	FrameElem=24	ElemStation=0					
Frame=24	Station=0	OutputCase=ENVE	CaseType=Combination	StepType=Min	Point=2	X2=-0.5	X3=0.5		
S11=403.057356365681	IsS11Max=No	IsS11Min=No	FrameElem=24	ElemStation=0					
Frame=24	Station=0	OutputCase=ENVE	CaseType=Combination	StepType=Min	Point=3	X2=0.5	X3=-0.5	S11=-	
1544.29425040474	IsS11Max=No	IsS11Min=Yes	FrameElem=24	ElemStation=0					
Frame=24	Station=0	OutputCase=ENVE	CaseType=Combination	StepType=Min	Point=4	X2=0.5	X3=0.5	S11=-	
1544.29425040474	IsS11Max=No	IsS11Min=No	FrameElem=24	ElemStation=0					
Frame=24	Station=0.5	OutputCase=ENVE	CaseType=Combination	StepType=Min	Point=0	X2=0	X3=0	S11=-	
483.549994843703	IsS11Max=No	IsS11Min=No	FrameElem=24	ElemStation=0.5					
Frame=24	Station=0.5	OutputCase=ENVE	CaseType=Combination	StepType=Min	Point=1	X2=-0.5	X3=-0.5		
S11=192.796788560973	IsS11Max=Yes	IsS11Min=No	FrameElem=24	ElemStation=0.5					
Frame=24	Station=0.5	OutputCase=ENVE	CaseType=Combination	StepType=Min	Point=2	X2=-0.5	X3=0.5		
S11=192.796788560973	IsS11Max=No	IsS11Min=No	FrameElem=24	ElemStation=0.5					
Frame=24	Station=0.5	OutputCase=ENVE	CaseType=Combination	StepType=Min	Point=3	X2=0.5	X3=-0.5		
S11=-1363.6430049976	IsS11Max=No	IsS11Min=Yes	FrameElem=24	ElemStation=0.5					
Frame=24	Station=0.5	OutputCase=ENVE	CaseType=Combination	StepType=Min	Point=4	X2=0.5	X3=0.5		
S11=-1363.6430049976	IsS11Max=No	IsS11Min=No	FrameElem=24	ElemStation=0.5					
Frame=24	Station=0	OutputCase=FESSUR	CaseType=Combination	Point=0	X2=0	X3=0	S11=-491.984994184806		
IsS11Max=No	IsS11Min=No	FrameElem=24	ElemStation=0						
Frame=24	Station=0	OutputCase=FESSUR	CaseType=Combination	Point=1	X2=-0.5	X3=-0.5			
S11=410.805464659563	IsS11Max=Yes	IsS11Min=No	FrameElem=24	ElemStation=0					
Frame=24	Station=0	OutputCase=FESSUR	CaseType=Combination	Point=2	X2=-0.5	X3=0.5			
S11=410.805464659563	IsS11Max=No	IsS11Min=No	FrameElem=24	ElemStation=0					
Frame=24	Station=0	OutputCase=FESSUR	CaseType=Combination	Point=3	X2=0.5	X3=-0.5	S11=-		
1394.77545302918	IsS11Max=No	IsS11Min=Yes	FrameElem=24	ElemStation=0					
Frame=24	Station=0	OutputCase=FESSUR	CaseType=Combination	Point=4	X2=0.5	X3=0.5	S11=-		
1394.77545302918	IsS11Max=No	IsS11Min=No	FrameElem=24	ElemStation=0					
Frame=24	Station=0.5	OutputCase=FESSUR	CaseType=Combination	Point=0	X2=0	X3=0	S11=-479.484994535193		
IsS11Max=No	IsS11Min=No	FrameElem=24	ElemStation=0.5						
Frame=24	Station=0.5	OutputCase=FESSUR	CaseType=Combination	Point=1	X2=-0.5	X3=-0.5			
S11=205.275615867113	IsS11Max=Yes	IsS11Min=No	FrameElem=24	ElemStation=0.5					
Frame=24	Station=0.5	OutputCase=FESSUR	CaseType=Combination	Point=2	X2=-0.5	X3=0.5			
S11=205.275615867113	IsS11Max=No	IsS11Min=No	FrameElem=24	ElemStation=0.5					
Frame=24	Station=0.5	OutputCase=FESSUR	CaseType=Combination	Point=3	X2=0.5	X3=-0.5	S11=-		
1164.2456049375	IsS11Max=No	IsS11Min=Yes	FrameElem=24	ElemStation=0.5					
Frame=24	Station=0.5	OutputCase=FESSUR	CaseType=Combination	Point=4	X2=0.5	X3=0.5	S11=-		
1164.2456049375	IsS11Max=No	IsS11Min=No	FrameElem=24	ElemStation=0.5					
Frame=25	Station=0	OutputCase=PERM1	CaseType=Combination	Point=0	X2=0	X3=0	S11=-469.99999465305		
IsS11Max=No	IsS11Min=No	FrameElem=25	ElemStation=0						
Frame=25	Station=0	OutputCase=PERM1	CaseType=Combination	Point=1	X2=-0.5	X3=-0.5			
S11=201.103209613301	IsS11Max=Yes	IsS11Min=No	FrameElem=25	ElemStation=0					
Frame=25	Station=0	OutputCase=PERM1	CaseType=Combination	Point=2	X2=-0.5	X3=0.5			
S11=201.103209613301	IsS11Max=No	IsS11Min=No	FrameElem=25	ElemStation=0					
Frame=25	Station=0	OutputCase=PERM1	CaseType=Combination	Point=3	X2=0.5	X3=-0.5	S11=-		
1141.1031989194	IsS11Max=No	IsS11Min=Yes	FrameElem=25	ElemStation=0					
Frame=25	Station=0	OutputCase=PERM1	CaseType=Combination	Point=4	X2=0.5	X3=0.5	S11=-1141.1031989194		
IsS11Max=No	IsS11Min=No	FrameElem=25	ElemStation=0						
Frame=25	Station=0.5	OutputCase=PERM1	CaseType=Combination	Point=0	X2=0	X3=0	S11=-457.499994980068		
IsS11Max=No	IsS11Min=No	FrameElem=25	ElemStation=0.5						
Frame=25	Station=0.5	OutputCase=PERM1	CaseType=Combination	Point=1	X2=-0.5	X3=-0.5			
S11=125.792188175859	IsS11Max=Yes	IsS11Min=No	FrameElem=25	ElemStation=0.5					
Frame=25	Station=0.5	OutputCase=PERM1	CaseType=Combination	Point=2	X2=-0.5	X3=0.5			
S11=125.792188175859	IsS11Max=No	IsS11Min=No	FrameElem=25	ElemStation=0.5					
Frame=25	Station=0.5	OutputCase=PERM1	CaseType=Combination	Point=3	X2=0.5	X3=-0.5	S11=-		
1040.792178136	IsS11Max=No	IsS11Min=Yes	FrameElem=25	ElemStation=0.5					
Frame=25	Station=0.5	OutputCase=PERM1	CaseType=Combination	Point=4	X2=0.5	X3=0.5	S11=-		
1040.792178136	IsS11Max=No	IsS11Min=No	FrameElem=25	ElemStation=0.5					
Frame=25	Station=0	OutputCase=PERM2	CaseType=Combination	Point=0	X2=0	X3=0	S11=-469.999995012082		
IsS11Max=No	IsS11Min=No	FrameElem=25	ElemStation=0						
Frame=25	Station=0	OutputCase=PERM2	CaseType=Combination	Point=1	X2=-0.5	X3=-0.5			
S11=390.582434947593	IsS11Max=Yes	IsS11Min=No	FrameElem=25	ElemStation=0					



Frame=25 Station=0 OutputCase=PERM2 CaseType=Combination Point=2 X2=-0.5 X3=0.5
 S11=390.582434947593 IsS11Max=No IsS11Min=No FrameElem=25 ElemStation=0
 Frame=25 Station=0 OutputCase=PERM2 CaseType=Combination Point=3 X2=0.5 X3=-0.5 S11=-
 1330.58242497176 IsS11Max=No IsS11Min=Yes FrameElem=25 ElemStation=0
 Frame=25 Station=0 OutputCase=PERM2 CaseType=Combination Point=4 X2=0.5 X3=0.5 S11=-
 1330.58242497176 IsS11Max=No IsS11Min=No FrameElem=25 ElemStation=0
 Frame=25 Station=0.5 OutputCase=PERM2 CaseType=Combination Point=0 X2=0 X3=0 S11=-457.499995240995
 IsS11Max=No IsS11Min=No FrameElem=25 ElemStation=0.5
 Frame=25 Station=0.5 OutputCase=PERM2 CaseType=Combination Point=1 X2=-0.5 X3=-0.5
 S11=328.689522621922 IsS11Max=Yes IsS11Min=No FrameElem=25 ElemStation=0.5
 Frame=25 Station=0.5 OutputCase=PERM2 CaseType=Combination Point=2 X2=-0.5 X3=0.5
 S11=328.689522621922 IsS11Max=No IsS11Min=No FrameElem=25 ElemStation=0.5
 Frame=25 Station=0.5 OutputCase=PERM2 CaseType=Combination Point=3 X2=0.5 X3=-0.5 S11=-
 1243.68951310391 IsS11Max=No IsS11Min=Yes FrameElem=25 ElemStation=0.5
 Frame=25 Station=0.5 OutputCase=PERM2 CaseType=Combination Point=4 X2=0.5 X3=0.5 S11=-
 1243.68951310391 IsS11Max=No IsS11Min=No FrameElem=25 ElemStation=0.5
 Frame=25 Station=0 OutputCase=ACC1 CaseType=Combination Point=0 X2=0 X3=0 S11=-483.549994484629
 IsS11Max=No IsS11Min=No FrameElem=25 ElemStation=0
 Frame=25 Station=0 OutputCase=ACC1 CaseType=Combination Point=1 X2=-0.5 X3=-0.5
 S11=207.063789975949 IsS11Max=Yes IsS11Min=No FrameElem=25 ElemStation=0
 Frame=25 Station=0 OutputCase=ACC1 CaseType=Combination Point=2 X2=-0.5 X3=0.5 S11=207.063789975949
 IsS11Max=No IsS11Min=No FrameElem=25 ElemStation=0
 Frame=25 Station=0 OutputCase=ACC1 CaseType=Combination Point=3 X2=0.5 X3=-0.5 S11=-
 1174.16377894521 IsS11Max=No IsS11Min=Yes FrameElem=25 ElemStation=0
 Frame=25 Station=0 OutputCase=ACC1 CaseType=Combination Point=4 X2=0.5 X3=0.5 S11=-1174.16377894521
 IsS11Max=No IsS11Min=No FrameElem=25 ElemStation=0
 Frame=25 Station=0.5 OutputCase=ACC1 CaseType=Combination Point=0 X2=0 X3=0 S11=-471.049994820826
 IsS11Max=No IsS11Min=No FrameElem=25 ElemStation=0.5
 Frame=25 Station=0.5 OutputCase=ACC1 CaseType=Combination Point=1 X2=-0.5 X3=-0.5
 S11=130.109622767019 IsS11Max=Yes IsS11Min=No FrameElem=25 ElemStation=0.5
 Frame=25 Station=0.5 OutputCase=ACC1 CaseType=Combination Point=2 X2=-0.5 X3=0.5
 S11=130.109622767019 IsS11Max=No IsS11Min=No FrameElem=25 ElemStation=0.5
 Frame=25 Station=0.5 OutputCase=ACC1 CaseType=Combination Point=3 X2=0.5 X3=-0.5 S11=-
 1072.20961240867 IsS11Max=No IsS11Min=Yes FrameElem=25 ElemStation=0.5
 Frame=25 Station=0.5 OutputCase=ACC1 CaseType=Combination Point=4 X2=0.5 X3=0.5 S11=-
 1072.20961240867 IsS11Max=No IsS11Min=No FrameElem=25 ElemStation=0.5
 Frame=25 Station=0 OutputCase=ACC2 CaseType=Combination Point=0 X2=0 X3=0 S11=-483.549994843661
 IsS11Max=No IsS11Min=No FrameElem=25 ElemStation=0
 Frame=25 Station=0 OutputCase=ACC2 CaseType=Combination Point=1 X2=-0.5 X3=-0.5
 S11=396.543015310241 IsS11Max=Yes IsS11Min=No FrameElem=25 ElemStation=0
 Frame=25 Station=0 OutputCase=ACC2 CaseType=Combination Point=2 X2=-0.5 X3=0.5 S11=396.543015310241
 IsS11Max=No IsS11Min=No FrameElem=25 ElemStation=0
 Frame=25 Station=0 OutputCase=ACC2 CaseType=Combination Point=3 X2=0.5 X3=-0.5 S11=-
 1363.64300499756 IsS11Max=No IsS11Min=Yes FrameElem=25 ElemStation=0
 Frame=25 Station=0 OutputCase=ACC2 CaseType=Combination Point=4 X2=0.5 X3=0.5 S11=-1363.64300499756
 IsS11Max=No IsS11Min=No FrameElem=25 ElemStation=0
 Frame=25 Station=0.5 OutputCase=ACC2 CaseType=Combination Point=0 X2=0 X3=0 S11=-471.049995081753
 IsS11Max=No IsS11Min=No FrameElem=25 ElemStation=0.5
 Frame=25 Station=0.5 OutputCase=ACC2 CaseType=Combination Point=1 X2=-0.5 X3=-0.5
 S11=333.006957213081 IsS11Max=Yes IsS11Min=No FrameElem=25 ElemStation=0.5
 Frame=25 Station=0.5 OutputCase=ACC2 CaseType=Combination Point=2 X2=-0.5 X3=0.5
 S11=333.006957213081 IsS11Max=No IsS11Min=No FrameElem=25 ElemStation=0.5
 Frame=25 Station=0.5 OutputCase=ACC2 CaseType=Combination Point=3 X2=0.5 X3=-0.5 S11=-
 1275.10694737659 IsS11Max=No IsS11Min=Yes FrameElem=25 ElemStation=0.5
 Frame=25 Station=0.5 OutputCase=ACC2 CaseType=Combination Point=4 X2=0.5 X3=0.5 S11=-
 1275.10694737659 IsS11Max=No IsS11Min=No FrameElem=25 ElemStation=0.5
 Frame=25 Station=0 OutputCase=ACCSX1 CaseType=Combination Point=0 X2=0 X3=0 S11=-468.485917019765
 IsS11Max=No IsS11Min=No FrameElem=25 ElemStation=0
 Frame=25 Station=0 OutputCase=ACCSX1 CaseType=Combination Point=1 X2=-0.5 X3=-0.5
 S11=192.796788561004 IsS11Max=Yes IsS11Min=No FrameElem=25 ElemStation=0
 Frame=25 Station=0 OutputCase=ACCSX1 CaseType=Combination Point=2 X2=-0.5 X3=0.5
 S11=192.796788561004 IsS11Max=No IsS11Min=No FrameElem=25 ElemStation=0
 Frame=25 Station=0 OutputCase=ACCSX1 CaseType=Combination Point=3 X2=0.5 X3=-0.5 S11=-
 1129.76862260053 IsS11Max=No IsS11Min=Yes FrameElem=25 ElemStation=0
 Frame=25 Station=0 OutputCase=ACCSX1 CaseType=Combination Point=4 X2=0.5 X3=0.5 S11=-
 1129.76862260053 IsS11Max=No IsS11Min=No FrameElem=25 ElemStation=0
 Frame=25 Station=0.5 OutputCase=ACCSX1 CaseType=Combination Point=0 X2=0 X3=0 S11=-455.985917355963
 IsS11Max=No IsS11Min=No FrameElem=25 ElemStation=0.5
 Frame=25 Station=0.5 OutputCase=ACCSX1 CaseType=Combination Point=1 X2=-0.5 X3=-0.5
 S11=108.711661123054 IsS11Max=Yes IsS11Min=No FrameElem=25 ElemStation=0.5
 Frame=25 Station=0.5 OutputCase=ACCSX1 CaseType=Combination Point=2 X2=-0.5 X3=0.5
 S11=108.711661123054 IsS11Max=No IsS11Min=No FrameElem=25 ElemStation=0.5
 Frame=25 Station=0.5 OutputCase=ACCSX1 CaseType=Combination Point=3 X2=0.5 X3=-0.5 S11=-
 1020.68349583498 IsS11Max=No IsS11Min=Yes FrameElem=25 ElemStation=0.5
 Frame=25 Station=0.5 OutputCase=ACCSX1 CaseType=Combination Point=4 X2=0.5 X3=0.5 S11=-
 1020.68349583498 IsS11Max=No IsS11Min=No FrameElem=25 ElemStation=0.5
 Frame=25 Station=0 OutputCase=ACCSX2 CaseType=Combination Point=0 X2=0 X3=0 S11=-468.485917378797
 IsS11Max=No IsS11Min=No FrameElem=25 ElemStation=0
 Frame=25 Station=0 OutputCase=ACCSX2 CaseType=Combination Point=1 X2=-0.5 X3=-0.5
 S11=382.276013895296 IsS11Max=Yes IsS11Min=No FrameElem=25 ElemStation=0
 Frame=25 Station=0 OutputCase=ACCSX2 CaseType=Combination Point=2 X2=-0.5 X3=0.5
 S11=382.276013895296 IsS11Max=No IsS11Min=No FrameElem=25 ElemStation=0

Frame=25	Station=0	OutputCase=ACCSX2	CaseType=Combination	Point=3	X2=0.5	X3=-0.5	S11=-	
1319.24784865289	IsS11Max=No	IsS11Min=Yes	FrameElem=25	ElemStation=0				
Frame=25	Station=0	OutputCase=ACCSX2	CaseType=Combination	Point=4	X2=0.5	X3=0.5	S11=-	
1319.24784865289	IsS11Max=No	IsS11Min=No	FrameElem=25	ElemStation=0				
Frame=25	Station=0.5	OutputCase=ACCSX2	CaseType=Combination	Point=0	X2=0	X3=0	S11=-455.985917616889	
IsS11Max=No	IsS11Min=No	FrameElem=25	ElemStation=0.5					
Frame=25	Station=0.5	OutputCase=ACCSX2	CaseType=Combination	Point=1	X2=-0.5	X3=-0.5		
S11=311.608995569116	IsS11Max=Yes	IsS11Min=No	FrameElem=25	ElemStation=0.5				
Frame=25	Station=0.5	OutputCase=ACCSX2	CaseType=Combination	Point=2	X2=-0.5	X3=0.5		
S11=311.608995569116	IsS11Max=No	IsS11Min=No	FrameElem=25	ElemStation=0.5				
Frame=25	Station=0.5	OutputCase=ACCSX2	CaseType=Combination	Point=3	X2=0.5	X3=-0.5	S11=-	
1223.58083080289	IsS11Max=No	IsS11Min=Yes	FrameElem=25	ElemStation=0.5				
Frame=25	Station=0.5	OutputCase=ACCSX2	CaseType=Combination	Point=4	X2=0.5	X3=0.5	S11=-	
1223.58083080289	IsS11Max=No	IsS11Min=No	FrameElem=25	ElemStation=0.5				
Frame=25	Station=0	OutputCase=ENVE	CaseType=Combination	StepType=Max	Point=0	X2=0	X3=0	S11=-
468.485917019765	IsS11Max=No	IsS11Min=No	FrameElem=25	ElemStation=0				
Frame=25	Station=0	OutputCase=ENVE	CaseType=Combination	StepType=Max	Point=1	X2=-0.5	X3=-0.5	
S11=396.543015310241	IsS11Max=Yes	IsS11Min=No	FrameElem=25	ElemStation=0				
Frame=25	Station=0	OutputCase=ENVE	CaseType=Combination	StepType=Max	Point=2	X2=-0.5	X3=0.5	
S11=396.543015310241	IsS11Max=No	IsS11Min=No	FrameElem=25	ElemStation=0				
Frame=25	Station=0	OutputCase=ENVE	CaseType=Combination	StepType=Max	Point=3	X2=0.5	X3=-0.5	S11=-
1129.76862260053	IsS11Max=No	IsS11Min=Yes	FrameElem=25	ElemStation=0				
Frame=25	Station=0	OutputCase=ENVE	CaseType=Combination	StepType=Max	Point=4	X2=0.5	X3=0.5	S11=-
1129.76862260053	IsS11Max=No	IsS11Min=No	FrameElem=25	ElemStation=0				
Frame=25	Station=0.5	OutputCase=ENVE	CaseType=Combination	StepType=Max	Point=0	X2=0	X3=0	S11=-
455.985917355963	IsS11Max=No	IsS11Min=No	FrameElem=25	ElemStation=0.5				
Frame=25	Station=0.5	OutputCase=ENVE	CaseType=Combination	StepType=Max	Point=1	X2=-0.5	X3=-0.5	
S11=333.006957213081	IsS11Max=Yes	IsS11Min=No	FrameElem=25	ElemStation=0.5				
Frame=25	Station=0.5	OutputCase=ENVE	CaseType=Combination	StepType=Max	Point=2	X2=-0.5	X3=0.5	
S11=333.006957213081	IsS11Max=No	IsS11Min=No	FrameElem=25	ElemStation=0.5				
Frame=25	Station=0.5	OutputCase=ENVE	CaseType=Combination	StepType=Max	Point=3	X2=0.5	X3=-0.5	
S11=-1020.68349583498	IsS11Max=No	IsS11Min=Yes	FrameElem=25	ElemStation=0.5				
Frame=25	Station=0.5	OutputCase=ENVE	CaseType=Combination	StepType=Max	Point=4	X2=0.5	X3=0.5	
S11=-1020.68349583498	IsS11Max=No	IsS11Min=No	FrameElem=25	ElemStation=0.5				
Frame=25	Station=0	OutputCase=ENVE	CaseType=Combination	StepType=Min	Point=0	X2=0	X3=0	S11=-
483.549994843661	IsS11Max=No	IsS11Min=No	FrameElem=25	ElemStation=0				
Frame=25	Station=0	OutputCase=ENVE	CaseType=Combination	StepType=Min	Point=1	X2=-0.5	X3=-0.5	
S11=192.796788561004	IsS11Max=Yes	IsS11Min=No	FrameElem=25	ElemStation=0				
Frame=25	Station=0	OutputCase=ENVE	CaseType=Combination	StepType=Min	Point=2	X2=-0.5	X3=0.5	
S11=192.796788561004	IsS11Max=No	IsS11Min=No	FrameElem=25	ElemStation=0				
Frame=25	Station=0	OutputCase=ENVE	CaseType=Combination	StepType=Min	Point=3	X2=0.5	X3=-0.5	S11=-
1363.64300499756	IsS11Max=No	IsS11Min=Yes	FrameElem=25	ElemStation=0				
Frame=25	Station=0	OutputCase=ENVE	CaseType=Combination	StepType=Min	Point=4	X2=0.5	X3=0.5	S11=-
1363.64300499756	IsS11Max=No	IsS11Min=No	FrameElem=25	ElemStation=0				
Frame=25	Station=0.5	OutputCase=ENVE	CaseType=Combination	StepType=Min	Point=0	X2=0	X3=0	S11=-
471.049995081753	IsS11Max=No	IsS11Min=No	FrameElem=25	ElemStation=0.5				
Frame=25	Station=0.5	OutputCase=ENVE	CaseType=Combination	StepType=Min	Point=1	X2=-0.5	X3=-0.5	
S11=108.711661123054	IsS11Max=Yes	IsS11Min=No	FrameElem=25	ElemStation=0.5				
Frame=25	Station=0.5	OutputCase=ENVE	CaseType=Combination	StepType=Min	Point=2	X2=-0.5	X3=0.5	
S11=108.711661123054	IsS11Max=No	IsS11Min=No	FrameElem=25	ElemStation=0.5				
Frame=25	Station=0.5	OutputCase=ENVE	CaseType=Combination	StepType=Min	Point=3	X2=0.5	X3=-0.5	
S11=-1275.10694737659	IsS11Max=No	IsS11Min=Yes	FrameElem=25	ElemStation=0.5				
Frame=25	Station=0.5	OutputCase=ENVE	CaseType=Combination	StepType=Min	Point=4	X2=0.5	X3=0.5	
S11=-1275.10694737659	IsS11Max=No	IsS11Min=No	FrameElem=25	ElemStation=0.5				
Frame=25	Station=0	OutputCase=FESSUR	CaseType=Combination	Point=0	X2=0	X3=0	S11=-479.484994535155	
IsS11Max=No	IsS11Min=No	FrameElem=25	ElemStation=0					
Frame=25	Station=0	OutputCase=FESSUR	CaseType=Combination	Point=1	X2=-0.5	X3=-0.5		
S11=205.275615867154	IsS11Max=Yes	IsS11Min=No	FrameElem=25	ElemStation=0				
Frame=25	Station=0	OutputCase=FESSUR	CaseType=Combination	Point=2	X2=-0.5	X3=0.5		
S11=205.275615867154	IsS11Max=No	IsS11Min=No	FrameElem=25	ElemStation=0				
Frame=25	Station=0	OutputCase=FESSUR	CaseType=Combination	Point=3	X2=0.5	X3=-0.5	S11=-	
1164.24560493746	IsS11Max=No	IsS11Min=Yes	FrameElem=25	ElemStation=0				
Frame=25	Station=0	OutputCase=FESSUR	CaseType=Combination	Point=4	X2=0.5	X3=0.5	S11=-	
1164.24560493746	IsS11Max=No	IsS11Min=No	FrameElem=25	ElemStation=0				
Frame=25	Station=0.5	OutputCase=FESSUR	CaseType=Combination	Point=0	X2=0	X3=0	S11=-466.984994868599	
IsS11Max=No	IsS11Min=No	FrameElem=25	ElemStation=0.5					
Frame=25	Station=0.5	OutputCase=FESSUR	CaseType=Combination	Point=1	X2=-0.5	X3=-0.5		
S11=128.814392389671	IsS11Max=Yes	IsS11Min=No	FrameElem=25	ElemStation=0.5				
Frame=25	Station=0.5	OutputCase=FESSUR	CaseType=Combination	Point=2	X2=-0.5	X3=0.5		
S11=128.814392389671	IsS11Max=No	IsS11Min=No	FrameElem=25	ElemStation=0.5				
Frame=25	Station=0.5	OutputCase=FESSUR	CaseType=Combination	Point=3	X2=0.5	X3=-0.5	S11=-	
1062.78438212687	IsS11Max=No	IsS11Min=Yes	FrameElem=25	ElemStation=0.5				
Frame=25	Station=0.5	OutputCase=FESSUR	CaseType=Combination	Point=4	X2=0.5	X3=0.5	S11=-	
1062.78438212687	IsS11Max=No	IsS11Min=No	FrameElem=25	ElemStation=0.5				
Frame=26	Station=0	OutputCase=PERM1	CaseType=Combination	Point=0	X2=0	X3=0	S11=-457.499994979952	
IsS11Max=No	IsS11Min=No	FrameElem=26	ElemStation=0					
Frame=26	Station=0	OutputCase=PERM1	CaseType=Combination	Point=1	X2=-0.5	X3=-0.5		
S11=125.792188175974	IsS11Max=Yes	IsS11Min=No	FrameElem=26	ElemStation=0				
Frame=26	Station=0	OutputCase=PERM1	CaseType=Combination	Point=2	X2=-0.5	X3=0.5		
S11=125.792188175974	IsS11Max=No	IsS11Min=No	FrameElem=26	ElemStation=0				
Frame=26	Station=0	OutputCase=PERM1	CaseType=Combination	Point=3	X2=0.5	X3=-0.5	S11=-	
1040.79217813588	IsS11Max=No	IsS11Min=Yes	FrameElem=26	ElemStation=0				



Frame=26	Station=0	OutputCase=PERM1	CaseType=Combination	Point=4	X2=0.5	X3=0.5	S11=-
1040.79217813588	IsS11Max=No	IsS11Min=No	FrameElem=26	ElemStation=0			
Frame=26	Station=0.5	OutputCase=PERM1	CaseType=Combination	Point=0	X2=0	X3=0	S11=-444.999995290028
IsS11Max=No	IsS11Min=No	FrameElem=26	ElemStation=0.5				
Frame=26	Station=0.5	OutputCase=PERM1	CaseType=Combination	Point=1	X2=-0.5	X3=-0.5	
S11=170.728667053502	IsS11Max=Yes	IsS11Min=No	FrameElem=26	ElemStation=0.5			
Frame=26	Station=0.5	OutputCase=PERM1	CaseType=Combination	Point=2	X2=-0.5	X3=0.5	
S11=170.728667053502	IsS11Max=No	IsS11Min=No	FrameElem=26	ElemStation=0.5			
Frame=26	Station=0.5	OutputCase=PERM1	CaseType=Combination	Point=3	X2=0.5	X3=-0.5	S11=-
1060.72865763356	IsS11Max=No	IsS11Min=Yes	FrameElem=26	ElemStation=0.5			
Frame=26	Station=0.5	OutputCase=PERM1	CaseType=Combination	Point=4	X2=0.5	X3=0.5	S11=-
1060.72865763356	IsS11Max=No	IsS11Min=No	FrameElem=26	ElemStation=0.5			
Frame=26	Station=0	OutputCase=PERM2	CaseType=Combination	Point=0	X2=0	X3=0	S11=-457.499995240878
IsS11Max=No	IsS11Min=No	FrameElem=26	ElemStation=0				
Frame=26	Station=0	OutputCase=PERM2	CaseType=Combination	Point=1	X2=-0.5	X3=-0.5	
S11=328.689522622036	IsS11Max=Yes	IsS11Min=No	FrameElem=26	ElemStation=0			
Frame=26	Station=0	OutputCase=PERM2	CaseType=Combination	Point=2	X2=-0.5	X3=0.5	
S11=328.689522622036	IsS11Max=No	IsS11Min=No	FrameElem=26	ElemStation=0			
Frame=26	Station=0	OutputCase=PERM2	CaseType=Combination	Point=3	X2=0.5	X3=-0.5	S11=-
1243.68951310379	IsS11Max=No	IsS11Min=Yes	FrameElem=26	ElemStation=0			
Frame=26	Station=0	OutputCase=PERM2	CaseType=Combination	Point=4	X2=0.5	X3=0.5	S11=-
1243.68951310379	IsS11Max=No	IsS11Min=No	FrameElem=26	ElemStation=0			
Frame=26	Station=0.5	OutputCase=PERM2	CaseType=Combination	Point=0	X2=0	X3=0	S11=-444.999995457931
IsS11Max=No	IsS11Min=No	FrameElem=26	ElemStation=0.5				
Frame=26	Station=0.5	OutputCase=PERM2	CaseType=Combination	Point=1	X2=-0.5	X3=-0.5	
S11=350.969860606251	IsS11Max=Yes	IsS11Min=No	FrameElem=26	ElemStation=0.5			
Frame=26	Station=0.5	OutputCase=PERM2	CaseType=Combination	Point=2	X2=-0.5	X3=0.5	
S11=350.969860606251	IsS11Max=No	IsS11Min=No	FrameElem=26	ElemStation=0.5			
Frame=26	Station=0.5	OutputCase=PERM2	CaseType=Combination	Point=3	X2=0.5	X3=-0.5	S11=-
1240.96985152211	IsS11Max=No	IsS11Min=Yes	FrameElem=26	ElemStation=0.5			
Frame=26	Station=0.5	OutputCase=PERM2	CaseType=Combination	Point=4	X2=0.5	X3=0.5	S11=-
1240.96985152211	IsS11Max=No	IsS11Min=No	FrameElem=26	ElemStation=0.5			
Frame=26	Station=0	OutputCase=ACC1	CaseType=Combination	Point=0	X2=0	X3=0	S11=-471.049994820715
IsS11Max=No	IsS11Min=No	FrameElem=26	ElemStation=0				
Frame=26	Station=0	OutputCase=ACC1	CaseType=Combination	Point=1	X2=-0.5	X3=-0.5	
S11=130.109622767129	IsS11Max=Yes	IsS11Min=No	FrameElem=26	ElemStation=0			
Frame=26	Station=0	OutputCase=ACC1	CaseType=Combination	Point=2	X2=-0.5	X3=0.5	S11=130.109622767129
IsS11Max=No	IsS11Min=No	FrameElem=26	ElemStation=0				
Frame=26	Station=0	OutputCase=ACC1	CaseType=Combination	Point=3	X2=0.5	X3=-0.5	S11=-
1072.20961240856	IsS11Max=No	IsS11Min=Yes	FrameElem=26	ElemStation=0			
Frame=26	Station=0	OutputCase=ACC1	CaseType=Combination	Point=4	X2=0.5	X3=0.5	S11=-1072.20961240856
IsS11Max=No	IsS11Min=No	FrameElem=26	ElemStation=0				
Frame=26	Station=0.5	OutputCase=ACC1	CaseType=Combination	Point=0	X2=0	X3=0	S11=-458.54999513997
IsS11Max=No	IsS11Min=No	FrameElem=26	ElemStation=0.5				
Frame=26	Station=0.5	OutputCase=ACC1	CaseType=Combination	Point=1	X2=-0.5	X3=-0.5	
S11=176.867955873175	IsS11Max=Yes	IsS11Min=No	FrameElem=26	ElemStation=0.5			
Frame=26	Station=0.5	OutputCase=ACC1	CaseType=Combination	Point=2	X2=-0.5	X3=0.5	
S11=176.867955873175	IsS11Max=No	IsS11Min=No	FrameElem=26	ElemStation=0.5			
Frame=26	Station=0.5	OutputCase=ACC1	CaseType=Combination	Point=3	X2=0.5	X3=-0.5	S11=-
1093.96794615312	IsS11Max=No	IsS11Min=Yes	FrameElem=26	ElemStation=0.5			
Frame=26	Station=0.5	OutputCase=ACC1	CaseType=Combination	Point=4	X2=0.5	X3=0.5	S11=-
1093.96794615312	IsS11Max=No	IsS11Min=No	FrameElem=26	ElemStation=0.5			
Frame=26	Station=0	OutputCase=ACC2	CaseType=Combination	Point=0	X2=0	X3=0	S11=-471.049995081642
IsS11Max=No	IsS11Min=No	FrameElem=26	ElemStation=0				
Frame=26	Station=0	OutputCase=ACC2	CaseType=Combination	Point=1	X2=-0.5	X3=-0.5	
S11=333.006957213192	IsS11Max=Yes	IsS11Min=No	FrameElem=26	ElemStation=0			
Frame=26	Station=0	OutputCase=ACC2	CaseType=Combination	Point=2	X2=-0.5	X3=0.5	S11=333.006957213192
IsS11Max=No	IsS11Min=No	FrameElem=26	ElemStation=0				
Frame=26	Station=0	OutputCase=ACC2	CaseType=Combination	Point=3	X2=0.5	X3=-0.5	S11=-
1275.10694737648	IsS11Max=No	IsS11Min=Yes	FrameElem=26	ElemStation=0			
Frame=26	Station=0	OutputCase=ACC2	CaseType=Combination	Point=4	X2=0.5	X3=0.5	S11=-1275.10694737648
IsS11Max=No	IsS11Min=No	FrameElem=26	ElemStation=0				
Frame=26	Station=0.5	OutputCase=ACC2	CaseType=Combination	Point=0	X2=0	X3=0	S11=-458.549995307874
IsS11Max=No	IsS11Min=No	FrameElem=26	ElemStation=0.5				
Frame=26	Station=0.5	OutputCase=ACC2	CaseType=Combination	Point=1	X2=-0.5	X3=-0.5	
S11=357.109149425925	IsS11Max=Yes	IsS11Min=No	FrameElem=26	ElemStation=0.5			
Frame=26	Station=0.5	OutputCase=ACC2	CaseType=Combination	Point=2	X2=-0.5	X3=0.5	
S11=357.109149425925	IsS11Max=No	IsS11Min=No	FrameElem=26	ElemStation=0.5			
Frame=26	Station=0.5	OutputCase=ACC2	CaseType=Combination	Point=3	X2=0.5	X3=-0.5	S11=-
1274.20914004167	IsS11Max=No	IsS11Min=Yes	FrameElem=26	ElemStation=0.5			
Frame=26	Station=0.5	OutputCase=ACC2	CaseType=Combination	Point=4	X2=0.5	X3=0.5	S11=-
1274.20914004167	IsS11Max=No	IsS11Min=No	FrameElem=26	ElemStation=0.5			
Frame=26	Station=0	OutputCase=ACCSX1	CaseType=Combination	Point=0	X2=0	X3=0	S11=-455.98591735585
IsS11Max=No	IsS11Min=No	FrameElem=26	ElemStation=0				
Frame=26	Station=0	OutputCase=ACCSX1	CaseType=Combination	Point=1	X2=-0.5	X3=-0.5	
S11=108.711661123163	IsS11Max=Yes	IsS11Min=No	FrameElem=26	ElemStation=0			
Frame=26	Station=0	OutputCase=ACCSX1	CaseType=Combination	Point=2	X2=-0.5	X3=0.5	
S11=108.711661123163	IsS11Max=No	IsS11Min=No	FrameElem=26	ElemStation=0			
Frame=26	Station=0	OutputCase=ACCSX1	CaseType=Combination	Point=3	X2=0.5	X3=-0.5	S11=-
1020.68349583486	IsS11Max=No	IsS11Min=Yes	FrameElem=26	ElemStation=0			
Frame=26	Station=0	OutputCase=ACCSX1	CaseType=Combination	Point=4	X2=0.5	X3=0.5	S11=-
1020.68349583486	IsS11Max=No	IsS11Min=No	FrameElem=26	ElemStation=0			

Frame=26	Station=0.5	OutputCase=ACCSX1	CaseType=Combination	Point=0	X2=0	X3=0	S11=-443.485917675105	
IsS11Max=No	IsS11Min=No	FrameElem=26	ElemStation=0.5					
Frame=26	Station=0.5	OutputCase=ACCSX1	CaseType=Combination	Point=1	X2=-0.5	X3=-0.5		
S11=148.339034000182	IsS11Max=Yes	IsS11Min=No	FrameElem=26	ElemStation=0.5				
Frame=26	Station=0.5	OutputCase=ACCSX1	CaseType=Combination	Point=2	X2=-0.5	X3=0.5		
S11=148.339034000182	IsS11Max=No	IsS11Min=No	FrameElem=26	ElemStation=0.5				
Frame=26	Station=0.5	OutputCase=ACCSX1	CaseType=Combination	Point=3	X2=0.5	X3=-0.5	S11=-	
1035.31086935039	IsS11Max=No	IsS11Min=Yes	FrameElem=26	ElemStation=0.5				
Frame=26	Station=0.5	OutputCase=ACCSX1	CaseType=Combination	Point=4	X2=0.5	X3=0.5	S11=-	
1035.31086935039	IsS11Max=No	IsS11Min=No	FrameElem=26	ElemStation=0.5				
Frame=26	Station=0	OutputCase=ACCSX2	CaseType=Combination	Point=0	X2=0	X3=0	S11=-455.985917616776	
IsS11Max=No	IsS11Min=No	FrameElem=26	ElemStation=0					
Frame=26	Station=0	OutputCase=ACCSX2	CaseType=Combination	Point=1	X2=-0.5	X3=-0.5		
S11=311.608995569226	IsS11Max=Yes	IsS11Min=No	FrameElem=26	ElemStation=0				
Frame=26	Station=0	OutputCase=ACCSX2	CaseType=Combination	Point=2	X2=-0.5	X3=0.5		
S11=311.608995569226	IsS11Max=No	IsS11Min=No	FrameElem=26	ElemStation=0				
Frame=26	Station=0	OutputCase=ACCSX2	CaseType=Combination	Point=3	X2=0.5	X3=-0.5	S11=-	
1223.58083080278	IsS11Max=No	IsS11Min=Yes	FrameElem=26	ElemStation=0				
Frame=26	Station=0	OutputCase=ACCSX2	CaseType=Combination	Point=4	X2=0.5	X3=0.5	S11=-	
1223.58083080278	IsS11Max=No	IsS11Min=No	FrameElem=26	ElemStation=0				
Frame=26	Station=0.5	OutputCase=ACCSX2	CaseType=Combination	Point=0	X2=0	X3=0	S11=-443.485917843008	
IsS11Max=No	IsS11Min=No	FrameElem=26	ElemStation=0.5					
Frame=26	Station=0.5	OutputCase=ACCSX2	CaseType=Combination	Point=1	X2=-0.5	X3=-0.5		
S11=328.580227552931	IsS11Max=Yes	IsS11Min=No	FrameElem=26	ElemStation=0.5				
Frame=26	Station=0.5	OutputCase=ACCSX2	CaseType=Combination	Point=2	X2=-0.5	X3=0.5		
S11=328.580227552931	IsS11Max=No	IsS11Min=No	FrameElem=26	ElemStation=0.5				
Frame=26	Station=0.5	OutputCase=ACCSX2	CaseType=Combination	Point=3	X2=0.5	X3=-0.5	S11=-	
1215.55206323895	IsS11Max=No	IsS11Min=Yes	FrameElem=26	ElemStation=0.5				
Frame=26	Station=0.5	OutputCase=ACCSX2	CaseType=Combination	Point=4	X2=0.5	X3=0.5	S11=-	
1215.55206323895	IsS11Max=No	IsS11Min=No	FrameElem=26	ElemStation=0.5				
Frame=26	Station=0	OutputCase=ENVE	CaseType=Combination	StepType=Max	Point=0	X2=0	X3=0	S11=-
455.98591735585	IsS11Max=No	IsS11Min=No	FrameElem=26	ElemStation=0				
Frame=26	Station=0	OutputCase=ENVE	CaseType=Combination	StepType=Max	Point=1	X2=-0.5	X3=-0.5	
S11=333.006957213192	IsS11Max=Yes	IsS11Min=No	FrameElem=26	ElemStation=0				
Frame=26	Station=0	OutputCase=ENVE	CaseType=Combination	StepType=Max	Point=2	X2=-0.5	X3=0.5	
S11=333.006957213192	IsS11Max=No	IsS11Min=No	FrameElem=26	ElemStation=0				
Frame=26	Station=0	OutputCase=ENVE	CaseType=Combination	StepType=Max	Point=3	X2=0.5	X3=-0.5	S11=-
1020.68349583486	IsS11Max=No	IsS11Min=Yes	FrameElem=26	ElemStation=0				
Frame=26	Station=0	OutputCase=ENVE	CaseType=Combination	StepType=Max	Point=4	X2=0.5	X3=0.5	S11=-
1020.68349583486	IsS11Max=No	IsS11Min=No	FrameElem=26	ElemStation=0				
Frame=26	Station=0.5	OutputCase=ENVE	CaseType=Combination	StepType=Max	Point=0	X2=0	X3=0	S11=-
443.485917675105	IsS11Max=No	IsS11Min=No	FrameElem=26	ElemStation=0.5				
Frame=26	Station=0.5	OutputCase=ENVE	CaseType=Combination	StepType=Max	Point=1	X2=-0.5	X3=-0.5	
S11=357.109149425925	IsS11Max=Yes	IsS11Min=No	FrameElem=26	ElemStation=0.5				
Frame=26	Station=0.5	OutputCase=ENVE	CaseType=Combination	StepType=Max	Point=2	X2=-0.5	X3=0.5	
S11=357.109149425925	IsS11Max=No	IsS11Min=No	FrameElem=26	ElemStation=0.5				
Frame=26	Station=0.5	OutputCase=ENVE	CaseType=Combination	StepType=Max	Point=3	X2=0.5	X3=-0.5	
S11=-1035.31086935039	IsS11Max=No	IsS11Min=Yes	FrameElem=26	ElemStation=0.5				
Frame=26	Station=0.5	OutputCase=ENVE	CaseType=Combination	StepType=Max	Point=4	X2=0.5	X3=0.5	
S11=-1035.31086935039	IsS11Max=No	IsS11Min=No	FrameElem=26	ElemStation=0.5				
Frame=26	Station=0	OutputCase=ENVE	CaseType=Combination	StepType=Min	Point=0	X2=0	X3=0	S11=-
471.049995081642	IsS11Max=No	IsS11Min=No	FrameElem=26	ElemStation=0				
Frame=26	Station=0	OutputCase=ENVE	CaseType=Combination	StepType=Min	Point=1	X2=-0.5	X3=-0.5	
S11=108.711661123163	IsS11Max=Yes	IsS11Min=No	FrameElem=26	ElemStation=0				
Frame=26	Station=0	OutputCase=ENVE	CaseType=Combination	StepType=Min	Point=2	X2=-0.5	X3=0.5	
S11=108.711661123163	IsS11Max=No	IsS11Min=No	FrameElem=26	ElemStation=0				
Frame=26	Station=0	OutputCase=ENVE	CaseType=Combination	StepType=Min	Point=3	X2=0.5	X3=-0.5	S11=-
1275.10694737648	IsS11Max=No	IsS11Min=Yes	FrameElem=26	ElemStation=0				
Frame=26	Station=0	OutputCase=ENVE	CaseType=Combination	StepType=Min	Point=4	X2=0.5	X3=0.5	S11=-
1275.10694737648	IsS11Max=No	IsS11Min=No	FrameElem=26	ElemStation=0				
Frame=26	Station=0.5	OutputCase=ENVE	CaseType=Combination	StepType=Min	Point=0	X2=0	X3=0	S11=-
458.549995307874	IsS11Max=No	IsS11Min=No	FrameElem=26	ElemStation=0.5				
Frame=26	Station=0.5	OutputCase=ENVE	CaseType=Combination	StepType=Min	Point=1	X2=-0.5	X3=-0.5	
S11=148.339034000182	IsS11Max=Yes	IsS11Min=No	FrameElem=26	ElemStation=0.5				
Frame=26	Station=0.5	OutputCase=ENVE	CaseType=Combination	StepType=Min	Point=2	X2=-0.5	X3=0.5	
S11=148.339034000182	IsS11Max=No	IsS11Min=No	FrameElem=26	ElemStation=0.5				
Frame=26	Station=0.5	OutputCase=ENVE	CaseType=Combination	StepType=Min	Point=3	X2=0.5	X3=-0.5	
S11=-1274.20914004167	IsS11Max=No	IsS11Min=Yes	FrameElem=26	ElemStation=0.5				
Frame=26	Station=0.5	OutputCase=ENVE	CaseType=Combination	StepType=Min	Point=4	X2=0.5	X3=0.5	
S11=-1274.20914004167	IsS11Max=No	IsS11Min=No	FrameElem=26	ElemStation=0.5				
Frame=26	Station=0	OutputCase=FESSUR	CaseType=Combination	Point=0	X2=0	X3=0	S11=-466.984994868486	
IsS11Max=No	IsS11Min=No	FrameElem=26	ElemStation=0					
Frame=26	Station=0	OutputCase=FESSUR	CaseType=Combination	Point=1	X2=-0.5	X3=-0.5		
S11=128.814392389783	IsS11Max=Yes	IsS11Min=No	FrameElem=26	ElemStation=0				
Frame=26	Station=0	OutputCase=FESSUR	CaseType=Combination	Point=2	X2=-0.5	X3=0.5		
S11=128.814392389783	IsS11Max=No	IsS11Min=No	FrameElem=26	ElemStation=0				
Frame=26	Station=0	OutputCase=FESSUR	CaseType=Combination	Point=3	X2=0.5	X3=-0.5	S11=-	
1062.78438212676	IsS11Max=No	IsS11Min=Yes	FrameElem=26	ElemStation=0				
Frame=26	Station=0	OutputCase=FESSUR	CaseType=Combination	Point=4	X2=0.5	X3=0.5	S11=-	
1062.78438212676	IsS11Max=No	IsS11Min=No	FrameElem=26	ElemStation=0				
Frame=26	Station=0.5	OutputCase=FESSUR	CaseType=Combination	Point=0	X2=0	X3=0	S11=-454.484995184987	
IsS11Max=No	IsS11Min=No	FrameElem=26	ElemStation=0.5					

Frame=26 Station=0.5 OutputCase=FESSUR CaseType=Combination Point=1 X2=-0.5 X3=-0.5
 S11=175.026169227273 IsS11Max=Yes IsS11Min=No FrameElem=26 ElemStation=0.5
 Frame=26 Station=0.5 OutputCase=FESSUR CaseType=Combination Point=2 X2=-0.5 X3=0.5
 S11=175.026169227273 IsS11Max=No IsS11Min=No FrameElem=26 ElemStation=0.5
 Frame=26 Station=0.5 OutputCase=FESSUR CaseType=Combination Point=3 X2=0.5 X3=-0.5 S11=-
 1083.99615959725 IsS11Max=No IsS11Min=Yes FrameElem=26 ElemStation=0.5
 Frame=26 Station=0.5 OutputCase=FESSUR CaseType=Combination Point=4 X2=0.5 X3=0.5 S11=-
 1083.99615959725 IsS11Max=No IsS11Min=No FrameElem=26 ElemStation=0.5
 Frame=27 Station=0 OutputCase=PERM1 CaseType=Combination Point=0 X2=0 X3=0 S11=-444.999995289998
 IsS11Max=No IsS11Min=No FrameElem=27 ElemStation=0
 Frame=27 Station=0 OutputCase=PERM1 CaseType=Combination Point=1 X2=-0.5 X3=-0.5
 S11=170.728667053532 IsS11Max=Yes IsS11Min=No FrameElem=27 ElemStation=0
 Frame=27 Station=0 OutputCase=PERM1 CaseType=Combination Point=2 X2=-0.5 X3=0.5
 S11=170.728667053532 IsS11Max=No IsS11Min=No FrameElem=27 ElemStation=0
 Frame=27 Station=0 OutputCase=PERM1 CaseType=Combination Point=3 X2=0.5 X3=-0.5 S11=-
 1060.72865763353 IsS11Max=No IsS11Min=Yes FrameElem=27 ElemStation=0
 Frame=27 Station=0 OutputCase=PERM1 CaseType=Combination Point=4 X2=0.5 X3=0.5 S11=-
 1060.72865763353 IsS11Max=No IsS11Min=No FrameElem=27 ElemStation=0
 Frame=27 Station=0.5 OutputCase=PERM1 CaseType=Combination Point=0 X2=0 X3=0 S11=-432.499995583131
 IsS11Max=No IsS11Min=No FrameElem=27 ElemStation=0.5
 Frame=27 Station=0.5 OutputCase=PERM1 CaseType=Combination Point=1 X2=-0.5 X3=-0.5
 S11=329.517021246023 IsS11Max=Yes IsS11Min=No FrameElem=27 ElemStation=0.5
 Frame=27 Station=0.5 OutputCase=PERM1 CaseType=Combination Point=2 X2=-0.5 X3=0.5
 S11=329.517021246023 IsS11Max=No IsS11Min=No FrameElem=27 ElemStation=0.5
 Frame=27 Station=0.5 OutputCase=PERM1 CaseType=Combination Point=3 X2=0.5 X3=-0.5 S11=-
 1194.51701241228 IsS11Max=No IsS11Min=Yes FrameElem=27 ElemStation=0.5
 Frame=27 Station=0.5 OutputCase=PERM1 CaseType=Combination Point=4 X2=0.5 X3=0.5 S11=-
 1194.51701241228 IsS11Max=No IsS11Min=No FrameElem=27 ElemStation=0.5
 Frame=27 Station=0 OutputCase=PERM2 CaseType=Combination Point=0 X2=0 X3=0 S11=-444.999995457901
 IsS11Max=No IsS11Min=No FrameElem=27 ElemStation=0
 Frame=27 Station=0 OutputCase=PERM2 CaseType=Combination Point=1 X2=-0.5 X3=-0.5
 S11=350.969860606282 IsS11Max=Yes IsS11Min=No FrameElem=27 ElemStation=0
 Frame=27 Station=0 OutputCase=PERM2 CaseType=Combination Point=2 X2=-0.5 X3=0.5
 S11=350.969860606282 IsS11Max=No IsS11Min=No FrameElem=27 ElemStation=0
 Frame=27 Station=0 OutputCase=PERM2 CaseType=Combination Point=3 X2=0.5 X3=-0.5 S11=-
 1240.96985152208 IsS11Max=No IsS11Min=Yes FrameElem=27 ElemStation=0
 Frame=27 Station=0 OutputCase=PERM2 CaseType=Combination Point=4 X2=0.5 X3=0.5 S11=-
 1240.96985152208 IsS11Max=No IsS11Min=No FrameElem=27 ElemStation=0
 Frame=27 Station=0.5 OutputCase=PERM2 CaseType=Combination Point=0 X2=0 X3=0 S11=-432.499995663095
 IsS11Max=No IsS11Min=No FrameElem=27 ElemStation=0.5
 Frame=27 Station=0.5 OutputCase=PERM2 CaseType=Combination Point=1 X2=-0.5 X3=-0.5
 S11=452.946511400377 IsS11Max=Yes IsS11Min=No FrameElem=27 ElemStation=0.5
 Frame=27 Station=0.5 OutputCase=PERM2 CaseType=Combination Point=2 X2=-0.5 X3=0.5
 S11=452.946511400377 IsS11Max=No IsS11Min=No FrameElem=27 ElemStation=0.5
 Frame=27 Station=0.5 OutputCase=PERM2 CaseType=Combination Point=3 X2=0.5 X3=-0.5 S11=-
 1317.94650272657 IsS11Max=No IsS11Min=Yes FrameElem=27 ElemStation=0.5
 Frame=27 Station=0.5 OutputCase=PERM2 CaseType=Combination Point=4 X2=0.5 X3=0.5 S11=-
 1317.94650272657 IsS11Max=No IsS11Min=No FrameElem=27 ElemStation=0.5
 Frame=27 Station=0 OutputCase=ACC1 CaseType=Combination Point=0 X2=0 X3=0 S11=-458.549995139939
 IsS11Max=No IsS11Min=No FrameElem=27 ElemStation=0
 Frame=27 Station=0 OutputCase=ACC1 CaseType=Combination Point=1 X2=-0.5 X3=-0.5
 S11=176.867955873205 IsS11Max=Yes IsS11Min=No FrameElem=27 ElemStation=0
 Frame=27 Station=0 OutputCase=ACC1 CaseType=Combination Point=2 X2=-0.5 X3=0.5 S11=176.867955873205
 IsS11Max=No IsS11Min=No FrameElem=27 ElemStation=0
 Frame=27 Station=0 OutputCase=ACC1 CaseType=Combination Point=3 X2=0.5 X3=-0.5 S11=-
 1093.96794615308 IsS11Max=No IsS11Min=Yes FrameElem=27 ElemStation=0
 Frame=27 Station=0 OutputCase=ACC1 CaseType=Combination Point=4 X2=0.5 X3=0.5 S11=-1093.96794615308
 IsS11Max=No IsS11Min=No FrameElem=27 ElemStation=0
 Frame=27 Station=0.5 OutputCase=ACC1 CaseType=Combination Point=0 X2=0 X3=0 S11=-446.049995442252
 IsS11Max=No IsS11Min=No FrameElem=27 ElemStation=0.5
 Frame=27 Station=0.5 OutputCase=ACC1 CaseType=Combination Point=1 X2=-0.5 X3=-0.5
 S11=340.943164294208 IsS11Max=Yes IsS11Min=No FrameElem=27 ElemStation=0.5
 Frame=27 Station=0.5 OutputCase=ACC1 CaseType=Combination Point=2 X2=-0.5 X3=0.5
 S11=340.943164294208 IsS11Max=No IsS11Min=No FrameElem=27 ElemStation=0.5
 Frame=27 Station=0.5 OutputCase=ACC1 CaseType=Combination Point=3 X2=0.5 X3=-0.5 S11=-
 1233.04315517871 IsS11Max=No IsS11Min=Yes FrameElem=27 ElemStation=0.5
 Frame=27 Station=0.5 OutputCase=ACC1 CaseType=Combination Point=4 X2=0.5 X3=0.5 S11=-
 1233.04315517871 IsS11Max=No IsS11Min=No FrameElem=27 ElemStation=0.5
 Frame=27 Station=0 OutputCase=ACC2 CaseType=Combination Point=0 X2=0 X3=0 S11=-458.549995307843
 IsS11Max=No IsS11Min=No FrameElem=27 ElemStation=0
 Frame=27 Station=0 OutputCase=ACC2 CaseType=Combination Point=1 X2=-0.5 X3=-0.5
 S11=357.109149425954 IsS11Max=Yes IsS11Min=No FrameElem=27 ElemStation=0
 Frame=27 Station=0 OutputCase=ACC2 CaseType=Combination Point=2 X2=-0.5 X3=0.5 S11=357.109149425954
 IsS11Max=No IsS11Min=No FrameElem=27 ElemStation=0
 Frame=27 Station=0 OutputCase=ACC2 CaseType=Combination Point=3 X2=0.5 X3=-0.5 S11=-
 1274.20914004164 IsS11Max=No IsS11Min=Yes FrameElem=27 ElemStation=0
 Frame=27 Station=0 OutputCase=ACC2 CaseType=Combination Point=4 X2=0.5 X3=0.5 S11=-1274.20914004164
 IsS11Max=No IsS11Min=No FrameElem=27 ElemStation=0
 Frame=27 Station=0.5 OutputCase=ACC2 CaseType=Combination Point=0 X2=0 X3=0 S11=-446.049995522216
 IsS11Max=No IsS11Min=No FrameElem=27 ElemStation=0.5
 Frame=27 Station=0.5 OutputCase=ACC2 CaseType=Combination Point=1 X2=-0.5 X3=-0.5
 S11=464.372654448562 IsS11Max=Yes IsS11Min=No FrameElem=27 ElemStation=0.5



Frame=27 Station=0.5 OutputCase=ACC2 CaseType=Combination Point=2 X2=-0.5 X3=0.5
 S11=464.372654448562 IsS11Max=No IsS11Min=No FrameElem=27 ElemStation=0.5
 Frame=27 Station=0.5 OutputCase=ACC2 CaseType=Combination Point=3 X2=0.5 X3=-0.5 S11=-
 1356.47264549299 IsS11Max=No IsS11Min=Yes FrameElem=27 ElemStation=0.5
 Frame=27 Station=0.5 OutputCase=ACC2 CaseType=Combination Point=4 X2=0.5 X3=0.5 S11=-
 1356.47264549299 IsS11Max=No IsS11Min=No FrameElem=27 ElemStation=0.5
 Frame=27 Station=0 OutputCase=ACCSX1 CaseType=Combination Point=0 X2=0 X3=0 S11=-443.485917675074
 IsS11Max=No IsS11Min=No FrameElem=27 ElemStation=0
 Frame=27 Station=0 OutputCase=ACCSX1 CaseType=Combination Point=1 X2=-0.5 X3=-0.5
 S11=148.339034000213 IsS11Max=Yes IsS11Min=No FrameElem=27 ElemStation=0
 Frame=27 Station=0 OutputCase=ACCSX1 CaseType=Combination Point=2 X2=-0.5 X3=0.5
 S11=148.339034000213 IsS11Max=No IsS11Min=No FrameElem=27 ElemStation=0
 Frame=27 Station=0 OutputCase=ACCSX1 CaseType=Combination Point=3 X2=0.5 X3=-0.5 S11=-
 1035.31086935036 IsS11Max=No IsS11Min=Yes FrameElem=27 ElemStation=0
 Frame=27 Station=0 OutputCase=ACCSX1 CaseType=Combination Point=4 X2=0.5 X3=0.5 S11=-
 1035.31086935036 IsS11Max=No IsS11Min=No FrameElem=27 ElemStation=0
 Frame=27 Station=0.5 OutputCase=ACCSX1 CaseType=Combination Point=0 X2=0 X3=0 S11=-430.985917977386
 IsS11Max=No IsS11Min=No FrameElem=27 ElemStation=0.5
 Frame=27 Station=0.5 OutputCase=ACCSX1 CaseType=Combination Point=1 X2=-0.5 X3=-0.5
 S11=305.283282192192 IsS11Max=Yes IsS11Min=No FrameElem=27 ElemStation=0.5
 Frame=27 Station=0.5 OutputCase=ACCSX1 CaseType=Combination Point=2 X2=-0.5 X3=0.5
 S11=305.283282192192 IsS11Max=No IsS11Min=No FrameElem=27 ElemStation=0.5
 Frame=27 Station=0.5 OutputCase=ACCSX1 CaseType=Combination Point=3 X2=0.5 X3=-0.5 S11=-
 1167.25511814696 IsS11Max=No IsS11Min=Yes FrameElem=27 ElemStation=0.5
 Frame=27 Station=0.5 OutputCase=ACCSX1 CaseType=Combination Point=4 X2=0.5 X3=0.5 S11=-
 1167.25511814696 IsS11Max=No IsS11Min=No FrameElem=27 ElemStation=0.5
 Frame=27 Station=0 OutputCase=ACCSX2 CaseType=Combination Point=0 X2=0 X3=0 S11=-443.485917842978
 IsS11Max=No IsS11Min=No FrameElem=27 ElemStation=0
 Frame=27 Station=0 OutputCase=ACCSX2 CaseType=Combination Point=1 X2=-0.5 X3=-0.5
 S11=328.580227552962 IsS11Max=Yes IsS11Min=No FrameElem=27 ElemStation=0
 Frame=27 Station=0 OutputCase=ACCSX2 CaseType=Combination Point=2 X2=-0.5 X3=0.5
 S11=328.580227552962 IsS11Max=No IsS11Min=No FrameElem=27 ElemStation=0
 Frame=27 Station=0 OutputCase=ACCSX2 CaseType=Combination Point=3 X2=0.5 X3=-0.5 S11=-
 1215.55206323892 IsS11Max=No IsS11Min=Yes FrameElem=27 ElemStation=0
 Frame=27 Station=0 OutputCase=ACCSX2 CaseType=Combination Point=4 X2=0.5 X3=0.5 S11=-
 1215.55206323892 IsS11Max=No IsS11Min=No FrameElem=27 ElemStation=0
 Frame=27 Station=0.5 OutputCase=ACCSX2 CaseType=Combination Point=0 X2=0 X3=0 S11=-430.98591805735
 IsS11Max=No IsS11Min=No FrameElem=27 ElemStation=0.5
 Frame=27 Station=0.5 OutputCase=ACCSX2 CaseType=Combination Point=1 X2=-0.5 X3=-0.5
 S11=428.712772346546 IsS11Max=Yes IsS11Min=No FrameElem=27 ElemStation=0.5
 Frame=27 Station=0.5 OutputCase=ACCSX2 CaseType=Combination Point=2 X2=-0.5 X3=0.5
 S11=428.712772346546 IsS11Max=No IsS11Min=No FrameElem=27 ElemStation=0.5
 Frame=27 Station=0.5 OutputCase=ACCSX2 CaseType=Combination Point=3 X2=0.5 X3=-0.5 S11=-
 1290.68460846125 IsS11Max=No IsS11Min=Yes FrameElem=27 ElemStation=0.5
 Frame=27 Station=0.5 OutputCase=ACCSX2 CaseType=Combination Point=4 X2=0.5 X3=0.5 S11=-
 1290.68460846125 IsS11Max=No IsS11Min=No FrameElem=27 ElemStation=0.5
 Frame=27 Station=0 OutputCase=ENVE CaseType=Combination StepType=Max Point=0 X2=0 X3=0 S11=-
 443.485917675074 IsS11Max=No IsS11Min=No FrameElem=27 ElemStation=0
 Frame=27 Station=0 OutputCase=ENVE CaseType=Combination StepType=Max Point=1 X2=-0.5 X3=-0.5
 S11=357.109149425954 IsS11Max=Yes IsS11Min=No FrameElem=27 ElemStation=0
 Frame=27 Station=0 OutputCase=ENVE CaseType=Combination StepType=Max Point=2 X2=-0.5 X3=0.5
 S11=357.109149425954 IsS11Max=No IsS11Min=No FrameElem=27 ElemStation=0
 Frame=27 Station=0 OutputCase=ENVE CaseType=Combination StepType=Max Point=3 X2=0.5 X3=-0.5 S11=-
 1035.31086935036 IsS11Max=No IsS11Min=Yes FrameElem=27 ElemStation=0
 Frame=27 Station=0 OutputCase=ENVE CaseType=Combination StepType=Max Point=4 X2=0.5 X3=0.5 S11=-
 1035.31086935036 IsS11Max=No IsS11Min=No FrameElem=27 ElemStation=0
 Frame=27 Station=0.5 OutputCase=ENVE CaseType=Combination StepType=Max Point=0 X2=0 X3=0 S11=-
 430.985917977386 IsS11Max=No IsS11Min=No FrameElem=27 ElemStation=0.5
 Frame=27 Station=0.5 OutputCase=ENVE CaseType=Combination StepType=Max Point=1 X2=-0.5 X3=-0.5
 S11=464.372654448562 IsS11Max=Yes IsS11Min=No FrameElem=27 ElemStation=0.5
 Frame=27 Station=0.5 OutputCase=ENVE CaseType=Combination StepType=Max Point=2 X2=-0.5 X3=0.5
 S11=464.372654448562 IsS11Max=No IsS11Min=No FrameElem=27 ElemStation=0.5
 Frame=27 Station=0.5 OutputCase=ENVE CaseType=Combination StepType=Max Point=3 X2=0.5 X3=-0.5
 S11=-1167.25511814696 IsS11Max=No IsS11Min=Yes FrameElem=27 ElemStation=0.5
 Frame=27 Station=0.5 OutputCase=ENVE CaseType=Combination StepType=Max Point=4 X2=0.5 X3=0.5
 S11=-1167.25511814696 IsS11Max=No IsS11Min=No FrameElem=27 ElemStation=0.5
 Frame=27 Station=0 OutputCase=ENVE CaseType=Combination StepType=Min Point=0 X2=0 X3=0 S11=-
 458.549995307843 IsS11Max=No IsS11Min=No FrameElem=27 ElemStation=0
 Frame=27 Station=0 OutputCase=ENVE CaseType=Combination StepType=Min Point=1 X2=-0.5 X3=-0.5
 S11=148.339034000213 IsS11Max=Yes IsS11Min=No FrameElem=27 ElemStation=0
 Frame=27 Station=0 OutputCase=ENVE CaseType=Combination StepType=Min Point=2 X2=-0.5 X3=0.5
 S11=148.339034000213 IsS11Max=No IsS11Min=No FrameElem=27 ElemStation=0
 Frame=27 Station=0 OutputCase=ENVE CaseType=Combination StepType=Min Point=3 X2=0.5 X3=-0.5 S11=-
 1274.20914004164 IsS11Max=No IsS11Min=Yes FrameElem=27 ElemStation=0
 Frame=27 Station=0 OutputCase=ENVE CaseType=Combination StepType=Min Point=4 X2=0.5 X3=0.5 S11=-
 1274.20914004164 IsS11Max=No IsS11Min=No FrameElem=27 ElemStation=0
 Frame=27 Station=0.5 OutputCase=ENVE CaseType=Combination StepType=Min Point=0 X2=0 X3=0 S11=-
 446.049995522216 IsS11Max=No IsS11Min=No FrameElem=27 ElemStation=0.5
 Frame=27 Station=0.5 OutputCase=ENVE CaseType=Combination StepType=Min Point=1 X2=-0.5 X3=-0.5
 S11=305.283282192192 IsS11Max=Yes IsS11Min=No FrameElem=27 ElemStation=0.5
 Frame=27 Station=0.5 OutputCase=ENVE CaseType=Combination StepType=Min Point=2 X2=-0.5 X3=0.5
 S11=305.283282192192 IsS11Max=No IsS11Min=No FrameElem=27 ElemStation=0.5



Frame=27	Station=0.5	OutputCase=ENVE	CaseType=Combination	StepType=Min	Point=3	X2=0.5	X3=-0.5	
S11=-1356.47264549299		IsS11Max=No	IsS11Min=Yes	FrameElem=27	ElemStation=0.5			
Frame=27	Station=0.5	OutputCase=ENVE	CaseType=Combination	StepType=Min	Point=4	X2=0.5	X3=0.5	
S11=-1356.47264549299		IsS11Max=No	IsS11Min=No	FrameElem=27	ElemStation=0.5			
Frame=27	Station=0	OutputCase=FESSUR	CaseType=Combination	Point=0	X2=0	X3=0	S11=-454.484995184957	
IsS11Max=No	IsS11Min=No	FrameElem=27	ElemStation=0					
Frame=27	Station=0	OutputCase=FESSUR	CaseType=Combination	Point=1	X2=-0.5	X3=-0.5		
S11=175.026169227303		IsS11Max=Yes	IsS11Min=No	FrameElem=27	ElemStation=0			
Frame=27	Station=0	OutputCase=FESSUR	CaseType=Combination	Point=2	X2=-0.5	X3=0.5		
S11=175.026169227303		IsS11Max=No	IsS11Min=No	FrameElem=27	ElemStation=0			
Frame=27	Station=0	OutputCase=FESSUR	CaseType=Combination	Point=3	X2=0.5	X3=-0.5	S11=-	
1083.99615959722		IsS11Max=No	IsS11Min=Yes	FrameElem=27	ElemStation=0			
Frame=27	Station=0	OutputCase=FESSUR	CaseType=Combination	Point=4	X2=0.5	X3=0.5	S11=-	
1083.99615959722		IsS11Max=No	IsS11Min=No	FrameElem=27	ElemStation=0			
Frame=27	Station=0.5	OutputCase=FESSUR	CaseType=Combination	Point=0	X2=0	X3=0	S11=-441.984995484515	
IsS11Max=No	IsS11Min=No	FrameElem=27	ElemStation=0.5					
Frame=27	Station=0.5	OutputCase=FESSUR	CaseType=Combination	Point=1	X2=-0.5	X3=-0.5		
S11=337.515321379753		IsS11Max=Yes	IsS11Min=No	FrameElem=27	ElemStation=0.5			
Frame=27	Station=0.5	OutputCase=FESSUR	CaseType=Combination	Point=2	X2=-0.5	X3=0.5		
S11=337.515321379753		IsS11Max=No	IsS11Min=No	FrameElem=27	ElemStation=0.5			
Frame=27	Station=0.5	OutputCase=FESSUR	CaseType=Combination	Point=3	X2=0.5	X3=-0.5	S11=-	
1221.48531234878		IsS11Max=No	IsS11Min=Yes	FrameElem=27	ElemStation=0.5			
Frame=27	Station=0.5	OutputCase=FESSUR	CaseType=Combination	Point=4	X2=0.5	X3=0.5	S11=-	
1221.48531234878		IsS11Max=No	IsS11Min=No	FrameElem=27	ElemStation=0.5			
Frame=28	Station=0	OutputCase=PERM1	CaseType=Combination	Point=0	X2=0	X3=0	S11=-432.49999558316	
IsS11Max=No	IsS11Min=No	FrameElem=28	ElemStation=0					
Frame=28	Station=0	OutputCase=PERM1	CaseType=Combination	Point=1	X2=-0.5	X3=-0.5		
S11=329.517021245995		IsS11Max=Yes	IsS11Min=No	FrameElem=28	ElemStation=0			
Frame=28	Station=0	OutputCase=PERM1	CaseType=Combination	Point=2	X2=-0.5	X3=0.5		
S11=329.517021245995		IsS11Max=No	IsS11Min=No	FrameElem=28	ElemStation=0			
Frame=28	Station=0	OutputCase=PERM1	CaseType=Combination	Point=3	X2=0.5	X3=-0.5	S11=-	
1194.51701241232		IsS11Max=No	IsS11Min=Yes	FrameElem=28	ElemStation=0			
Frame=28	Station=0	OutputCase=PERM1	CaseType=Combination	Point=4	X2=0.5	X3=0.5	S11=-	
1194.51701241232		IsS11Max=No	IsS11Min=No	FrameElem=28	ElemStation=0			
Frame=28	Station=0.5	OutputCase=PERM1	CaseType=Combination	Point=0	X2=0	X3=0	S11=-419.999995859351	
IsS11Max=No	IsS11Min=No	FrameElem=28	ElemStation=0.5					
Frame=28	Station=0.5	OutputCase=PERM1	CaseType=Combination	Point=1	X2=-0.5	X3=-0.5		
S11=595.761625753452		IsS11Max=Yes	IsS11Min=No	FrameElem=28	ElemStation=0.5			
Frame=28	Station=0.5	OutputCase=PERM1	CaseType=Combination	Point=2	X2=-0.5	X3=0.5		
S11=595.761625753452		IsS11Max=No	IsS11Min=No	FrameElem=28	ElemStation=0.5			
Frame=28	Station=0.5	OutputCase=PERM1	CaseType=Combination	Point=3	X2=0.5	X3=-0.5	S11=-	
1435.76161747215		IsS11Max=No	IsS11Min=Yes	FrameElem=28	ElemStation=0.5			
Frame=28	Station=0.5	OutputCase=PERM1	CaseType=Combination	Point=4	X2=0.5	X3=0.5	S11=-	
1435.76161747215		IsS11Max=No	IsS11Min=No	FrameElem=28	ElemStation=0.5			
Frame=28	Station=0	OutputCase=PERM2	CaseType=Combination	Point=0	X2=0	X3=0	S11=-432.499995663124	
IsS11Max=No	IsS11Min=No	FrameElem=28	ElemStation=0					
Frame=28	Station=0	OutputCase=PERM2	CaseType=Combination	Point=1	X2=-0.5	X3=-0.5		
S11=452.946511400349		IsS11Max=Yes	IsS11Min=No	FrameElem=28	ElemStation=0			
Frame=28	Station=0	OutputCase=PERM2	CaseType=Combination	Point=2	X2=-0.5	X3=0.5		
S11=452.946511400349		IsS11Max=No	IsS11Min=No	FrameElem=28	ElemStation=0			
Frame=28	Station=0	OutputCase=PERM2	CaseType=Combination	Point=3	X2=0.5	X3=-0.5	S11=-	
1317.9465027266		IsS11Max=No	IsS11Min=Yes	FrameElem=28	ElemStation=0			
Frame=28	Station=0	OutputCase=PERM2	CaseType=Combination	Point=4	X2=0.5	X3=0.5	S11=-1317.9465027266	
IsS11Max=No	IsS11Min=No	FrameElem=28	ElemStation=0					
Frame=28	Station=0.5	OutputCase=PERM2	CaseType=Combination	Point=0	X2=0	X3=0	S11=-419.999995856458	
IsS11Max=No	IsS11Min=No	FrameElem=28	ElemStation=0.5					
Frame=28	Station=0.5	OutputCase=PERM2	CaseType=Combination	Point=1	X2=-0.5	X3=-0.5		
S11=630.142537504328		IsS11Max=Yes	IsS11Min=No	FrameElem=28	ElemStation=0.5			
Frame=28	Station=0.5	OutputCase=PERM2	CaseType=Combination	Point=2	X2=-0.5	X3=0.5		
S11=630.142537504328		IsS11Max=No	IsS11Min=No	FrameElem=28	ElemStation=0.5			
Frame=28	Station=0.5	OutputCase=PERM2	CaseType=Combination	Point=3	X2=0.5	X3=-0.5	S11=-	
1470.14252921724		IsS11Max=No	IsS11Min=Yes	FrameElem=28	ElemStation=0.5			
Frame=28	Station=0.5	OutputCase=PERM2	CaseType=Combination	Point=4	X2=0.5	X3=0.5	S11=-	
1470.14252921724		IsS11Max=No	IsS11Min=No	FrameElem=28	ElemStation=0.5			
Frame=28	Station=0	OutputCase=ACC1	CaseType=Combination	Point=0	X2=0	X3=0	S11=-446.049995442284	
IsS11Max=No	IsS11Min=No	FrameElem=28	ElemStation=0					
Frame=28	Station=0	OutputCase=ACC1	CaseType=Combination	Point=1	X2=-0.5	X3=-0.5		
S11=340.943164294174		IsS11Max=Yes	IsS11Min=No	FrameElem=28	ElemStation=0			
Frame=28	Station=0	OutputCase=ACC1	CaseType=Combination	Point=2	X2=-0.5	X3=0.5	S11=340.943164294174	
IsS11Max=No	IsS11Min=No	FrameElem=28	ElemStation=0					
Frame=28	Station=0	OutputCase=ACC1	CaseType=Combination	Point=3	X2=0.5	X3=-0.5	S11=-	
1233.04315517874		IsS11Max=No	IsS11Min=Yes	FrameElem=28	ElemStation=0			
Frame=28	Station=0	OutputCase=ACC1	CaseType=Combination	Point=4	X2=0.5	X3=0.5	S11=-1233.04315517874	
IsS11Max=No	IsS11Min=No	FrameElem=28	ElemStation=0					
Frame=28	Station=0.5	OutputCase=ACC1	CaseType=Combination	Point=0	X2=0	X3=0	S11=-433.549995727654	
IsS11Max=No	IsS11Min=No	FrameElem=28	ElemStation=0.5					
Frame=28	Station=0.5	OutputCase=ACC1	CaseType=Combination	Point=1	X2=-0.5	X3=-0.5		
S11=615.939623030146		IsS11Max=Yes	IsS11Min=No	FrameElem=28	ElemStation=0.5			
Frame=28	Station=0.5	OutputCase=ACC1	CaseType=Combination	Point=2	X2=-0.5	X3=0.5		
S11=615.939623030146		IsS11Max=No	IsS11Min=No	FrameElem=28	ElemStation=0.5			
Frame=28	Station=0.5	OutputCase=ACC1	CaseType=Combination	Point=3	X2=0.5	X3=-0.5	S11=-	
1483.03961448545		IsS11Max=No	IsS11Min=Yes	FrameElem=28	ElemStation=0.5			

Frame=28	Station=0.5	OutputCase=ACC1	CaseType=Combination	Point=4	X2=0.5	X3=0.5	S11=-	
1483.03961448545	IsS11Max=No	IsS11Min=No	FrameElem=28	ElemStation=0.5				
Frame=28	Station=0	OutputCase=ACC2	CaseType=Combination	Point=0	X2=0	X3=0	S11=-446.049995522248	
IsS11Max=No	IsS11Min=No	FrameElem=28	ElemStation=0					
Frame=28	Station=0	OutputCase=ACC2	CaseType=Combination	Point=1	X2=-0.5	X3=-0.5		
S11=464.372654448528	IsS11Max=Yes	IsS11Min=No	FrameElem=28	ElemStation=0				
Frame=28	Station=0.5	OutputCase=ACC2	CaseType=Combination	Point=2	X2=-0.5	X3=0.5	S11=464.372654448528	
IsS11Max=No	IsS11Min=No	FrameElem=28	ElemStation=0					
Frame=28	Station=0	OutputCase=ACC2	CaseType=Combination	Point=3	X2=0.5	X3=-0.5	S11=-	
1356.47264549302	IsS11Max=No	IsS11Min=Yes	FrameElem=28	ElemStation=0				
Frame=28	Station=0	OutputCase=ACC2	CaseType=Combination	Point=4	X2=0.5	X3=0.5	S11=-1356.47264549302	
IsS11Max=No	IsS11Min=No	FrameElem=28	ElemStation=0					
Frame=28	Station=0.5	OutputCase=ACC2	CaseType=Combination	Point=0	X2=0	X3=0	S11=-433.549995724761	
IsS11Max=No	IsS11Min=No	FrameElem=28	ElemStation=0.5					
Frame=28	Station=0.5	OutputCase=ACC2	CaseType=Combination	Point=1	X2=-0.5	X3=-0.5		
S11=650.320534781022	IsS11Max=Yes	IsS11Min=No	FrameElem=28	ElemStation=0.5				
Frame=28	Station=0.5	OutputCase=ACC2	CaseType=Combination	Point=2	X2=-0.5	X3=0.5		
S11=650.320534781022	IsS11Max=No	IsS11Min=No	FrameElem=28	ElemStation=0.5				
Frame=28	Station=0.5	OutputCase=ACC2	CaseType=Combination	Point=3	X2=0.5	X3=-0.5	S11=-	
1517.42052623054	IsS11Max=No	IsS11Min=Yes	FrameElem=28	ElemStation=0.5				
Frame=28	Station=0.5	OutputCase=ACC2	CaseType=Combination	Point=4	X2=0.5	X3=0.5	S11=-	
1517.42052623054	IsS11Max=No	IsS11Min=No	FrameElem=28	ElemStation=0.5				
Frame=28	Station=0	OutputCase=ACCSX1	CaseType=Combination	Point=0	X2=0	X3=0	S11=-430.985917977413	
IsS11Max=No	IsS11Min=No	FrameElem=28	ElemStation=0					
Frame=28	Station=0	OutputCase=ACCSX1	CaseType=Combination	Point=1	X2=-0.5	X3=-0.5		
S11=305.283282192163	IsS11Max=Yes	IsS11Min=No	FrameElem=28	ElemStation=0				
Frame=28	Station=0	OutputCase=ACCSX1	CaseType=Combination	Point=2	X2=-0.5	X3=0.5		
S11=305.283282192163	IsS11Max=No	IsS11Min=No	FrameElem=28	ElemStation=0				
Frame=28	Station=0	OutputCase=ACCSX1	CaseType=Combination	Point=3	X2=0.5	X3=-0.5	S11=-	
1167.25511814699	IsS11Max=No	IsS11Min=Yes	FrameElem=28	ElemStation=0				
Frame=28	Station=0	OutputCase=ACCSX1	CaseType=Combination	Point=4	X2=0.5	X3=0.5	S11=-	
1167.25511814699	IsS11Max=No	IsS11Min=No	FrameElem=28	ElemStation=0				
Frame=28	Station=0.5	OutputCase=ACCSX1	CaseType=Combination	Point=0	X2=0	X3=0	S11=-418.485918262783	
IsS11Max=No	IsS11Min=No	FrameElem=28	ElemStation=0.5					
Frame=28	Station=0.5	OutputCase=ACCSX1	CaseType=Combination	Point=1	X2=-0.5	X3=-0.5		
S11=573.148780699111	IsS11Max=Yes	IsS11Min=No	FrameElem=28	ElemStation=0.5				
Frame=28	Station=0.5	OutputCase=ACCSX1	CaseType=Combination	Point=2	X2=-0.5	X3=0.5		
S11=573.148780699111	IsS11Max=No	IsS11Min=No	FrameElem=28	ElemStation=0.5				
Frame=28	Station=0.5	OutputCase=ACCSX1	CaseType=Combination	Point=3	X2=0.5	X3=-0.5	S11=-	
1410.12061722468	IsS11Max=No	IsS11Min=Yes	FrameElem=28	ElemStation=0.5				
Frame=28	Station=0.5	OutputCase=ACCSX1	CaseType=Combination	Point=4	X2=0.5	X3=0.5	S11=-	
1410.12061722468	IsS11Max=No	IsS11Min=No	FrameElem=28	ElemStation=0.5				
Frame=28	Station=0	OutputCase=ACCSX2	CaseType=Combination	Point=0	X2=0	X3=0	S11=-430.985918057377	
IsS11Max=No	IsS11Min=No	FrameElem=28	ElemStation=0					
Frame=28	Station=0	OutputCase=ACCSX2	CaseType=Combination	Point=1	X2=-0.5	X3=-0.5		
S11=428.712772346517	IsS11Max=Yes	IsS11Min=No	FrameElem=28	ElemStation=0				
Frame=28	Station=0	OutputCase=ACCSX2	CaseType=Combination	Point=2	X2=-0.5	X3=0.5		
S11=428.712772346517	IsS11Max=No	IsS11Min=No	FrameElem=28	ElemStation=0				
Frame=28	Station=0	OutputCase=ACCSX2	CaseType=Combination	Point=3	X2=0.5	X3=-0.5	S11=-	
1290.68460846127	IsS11Max=No	IsS11Min=Yes	FrameElem=28	ElemStation=0				
Frame=28	Station=0	OutputCase=ACCSX2	CaseType=Combination	Point=4	X2=0.5	X3=0.5	S11=-	
1290.68460846127	IsS11Max=No	IsS11Min=No	FrameElem=28	ElemStation=0				
Frame=28	Station=0.5	OutputCase=ACCSX2	CaseType=Combination	Point=0	X2=0	X3=0	S11=-418.48591825989	
IsS11Max=No	IsS11Min=No	FrameElem=28	ElemStation=0.5					
Frame=28	Station=0.5	OutputCase=ACCSX2	CaseType=Combination	Point=1	X2=-0.5	X3=-0.5		
S11=607.529692449987	IsS11Max=Yes	IsS11Min=No	FrameElem=28	ElemStation=0.5				
Frame=28	Station=0.5	OutputCase=ACCSX2	CaseType=Combination	Point=2	X2=-0.5	X3=0.5		
S11=607.529692449987	IsS11Max=No	IsS11Min=No	FrameElem=28	ElemStation=0.5				
Frame=28	Station=0.5	OutputCase=ACCSX2	CaseType=Combination	Point=3	X2=0.5	X3=-0.5	S11=-	
1444.50152896977	IsS11Max=No	IsS11Min=Yes	FrameElem=28	ElemStation=0.5				
Frame=28	Station=0.5	OutputCase=ACCSX2	CaseType=Combination	Point=4	X2=0.5	X3=0.5	S11=-	
1444.50152896977	IsS11Max=No	IsS11Min=No	FrameElem=28	ElemStation=0.5				
Frame=28	Station=0	OutputCase=ENVE	CaseType=Combination	StepType=Max	Point=0	X2=0	X3=0	S11=-
430.985917977413	IsS11Max=No	IsS11Min=No	FrameElem=28	ElemStation=0				
Frame=28	Station=0	OutputCase=ENVE	CaseType=Combination	StepType=Max	Point=1	X2=-0.5	X3=-0.5	
S11=464.372654448528	IsS11Max=Yes	IsS11Min=No	FrameElem=28	ElemStation=0				
Frame=28	Station=0	OutputCase=ENVE	CaseType=Combination	StepType=Max	Point=2	X2=-0.5	X3=0.5	
S11=464.372654448528	IsS11Max=No	IsS11Min=No	FrameElem=28	ElemStation=0				
Frame=28	Station=0	OutputCase=ENVE	CaseType=Combination	StepType=Max	Point=3	X2=0.5	X3=-0.5	S11=-
1167.25511814699	IsS11Max=No	IsS11Min=Yes	FrameElem=28	ElemStation=0				
Frame=28	Station=0	OutputCase=ENVE	CaseType=Combination	StepType=Max	Point=4	X2=0.5	X3=0.5	S11=-
1167.25511814699	IsS11Max=No	IsS11Min=No	FrameElem=28	ElemStation=0				
Frame=28	Station=0.5	OutputCase=ENVE	CaseType=Combination	StepType=Max	Point=0	X2=0	X3=0	S11=-
418.48591825989	IsS11Max=No	IsS11Min=No	FrameElem=28	ElemStation=0.5				
Frame=28	Station=0.5	OutputCase=ENVE	CaseType=Combination	StepType=Max	Point=1	X2=-0.5	X3=-0.5	
S11=650.320534781022	IsS11Max=Yes	IsS11Min=No	FrameElem=28	ElemStation=0.5				
Frame=28	Station=0.5	OutputCase=ENVE	CaseType=Combination	StepType=Max	Point=2	X2=-0.5	X3=0.5	
S11=650.320534781022	IsS11Max=No	IsS11Min=No	FrameElem=28	ElemStation=0.5				
Frame=28	Station=0.5	OutputCase=ENVE	CaseType=Combination	StepType=Max	Point=3	X2=0.5	X3=-0.5	
S11=-1410.12061722468	IsS11Max=No	IsS11Min=Yes	FrameElem=28	ElemStation=0.5				
Frame=28	Station=0.5	OutputCase=ENVE	CaseType=Combination	StepType=Max	Point=4	X2=0.5	X3=0.5	
S11=-1410.12061722468	IsS11Max=No	IsS11Min=No	FrameElem=28	ElemStation=0.5				



Frame=28	Station=0	OutputCase=ENVE	CaseType=Combination	StepType=Min	Point=0	X2=0	X3=0	S11=-
446.049995522248	IsS11Max=No	IsS11Min=No	FrameElem=28	ElemStation=0				
Frame=28	Station=0	OutputCase=ENVE	CaseType=Combination	StepType=Min	Point=1	X2=-0.5	X3=-0.5	
S11=305.283282192163	IsS11Max=Yes	IsS11Min=No	FrameElem=28	ElemStation=0				
Frame=28	Station=0	OutputCase=ENVE	CaseType=Combination	StepType=Min	Point=2	X2=-0.5	X3=0.5	
S11=305.283282192163	IsS11Max=No	IsS11Min=No	FrameElem=28	ElemStation=0				
Frame=28	Station=0	OutputCase=ENVE	CaseType=Combination	StepType=Min	Point=3	X2=0.5	X3=-0.5	S11=-
1356.47264549302	IsS11Max=No	IsS11Min=Yes	FrameElem=28	ElemStation=0				
Frame=28	Station=0	OutputCase=ENVE	CaseType=Combination	StepType=Min	Point=4	X2=0.5	X3=0.5	S11=-
1356.47264549302	IsS11Max=No	IsS11Min=No	FrameElem=28	ElemStation=0				
Frame=28	Station=0.5	OutputCase=ENVE	CaseType=Combination	StepType=Min	Point=0	X2=0	X3=0	S11=-
433.549995727654	IsS11Max=No	IsS11Min=No	FrameElem=28	ElemStation=0.5				
Frame=28	Station=0.5	OutputCase=ENVE	CaseType=Combination	StepType=Min	Point=1	X2=-0.5	X3=-0.5	
S11=573.148780699111	IsS11Max=Yes	IsS11Min=No	FrameElem=28	ElemStation=0.5				
Frame=28	Station=0.5	OutputCase=ENVE	CaseType=Combination	StepType=Min	Point=2	X2=-0.5	X3=0.5	
S11=573.148780699111	IsS11Max=No	IsS11Min=No	FrameElem=28	ElemStation=0.5				
Frame=28	Station=0.5	OutputCase=ENVE	CaseType=Combination	StepType=Min	Point=3	X2=0.5	X3=-0.5	
S11=-1517.42052623054	IsS11Max=No	IsS11Min=Yes	FrameElem=28	ElemStation=0.5				
Frame=28	Station=0.5	OutputCase=ENVE	CaseType=Combination	StepType=Min	Point=4	X2=0.5	X3=0.5	
S11=-1517.42052623054	IsS11Max=No	IsS11Min=No	FrameElem=28	ElemStation=0.5				
Frame=28	Station=0	OutputCase=FESSUR	CaseType=Combination	Point=0	X2=0	X3=0	S11=-441.984995484547	
IsS11Max=No	IsS11Min=No	FrameElem=28	ElemStation=0					
Frame=28	Station=0	OutputCase=FESSUR	CaseType=Combination	Point=1	X2=-0.5	X3=-0.5		
S11=337.51532137972	IsS11Max=Yes	IsS11Min=No	FrameElem=28	ElemStation=0				
Frame=28	Station=0	OutputCase=FESSUR	CaseType=Combination	Point=2	X2=-0.5	X3=0.5		
S11=337.51532137972	IsS11Max=No	IsS11Min=No	FrameElem=28	ElemStation=0				
Frame=28	Station=0	OutputCase=FESSUR	CaseType=Combination	Point=3	X2=0.5	X3=-0.5	S11=-	
1221.48531234881	IsS11Max=No	IsS11Min=Yes	FrameElem=28	ElemStation=0				
Frame=28	Station=0	OutputCase=FESSUR	CaseType=Combination	Point=4	X2=0.5	X3=0.5	S11=-	
1221.48531234881	IsS11Max=No	IsS11Min=No	FrameElem=28	ElemStation=0				
Frame=28	Station=0.5	OutputCase=FESSUR	CaseType=Combination	Point=0	X2=0	X3=0	S11=-429.484995767163	
IsS11Max=No	IsS11Min=No	FrameElem=28	ElemStation=0.5					
Frame=28	Station=0.5	OutputCase=FESSUR	CaseType=Combination	Point=1	X2=-0.5	X3=-0.5		
S11=609.886223847138	IsS11Max=Yes	IsS11Min=No	FrameElem=28	ElemStation=0.5				
Frame=28	Station=0.5	OutputCase=FESSUR	CaseType=Combination	Point=2	X2=-0.5	X3=0.5		
S11=609.886223847138	IsS11Max=No	IsS11Min=No	FrameElem=28	ElemStation=0.5				
Frame=28	Station=0.5	OutputCase=FESSUR	CaseType=Combination	Point=3	X2=0.5	X3=-0.5	S11=-	
1468.85621538146	IsS11Max=No	IsS11Min=Yes	FrameElem=28	ElemStation=0.5				
Frame=28	Station=0.5	OutputCase=FESSUR	CaseType=Combination	Point=4	X2=0.5	X3=0.5	S11=-	
1468.85621538146	IsS11Max=No	IsS11Min=No	FrameElem=28	ElemStation=0.5				
Frame=41	Station=0	OutputCase=PERM1	CaseType=Combination	Point=0	X2=0	X3=0	S11=-235.938772273309	
IsS11Max=No	IsS11Min=No	FrameElem=41	ElemStation=0					
Frame=41	Station=0	OutputCase=PERM1	CaseType=Combination	Point=1	X2=-0.5	X3=-0.5		
S11=116.896307096121	IsS11Max=Yes	IsS11Min=No	FrameElem=41	ElemStation=0				
Frame=41	Station=0	OutputCase=PERM1	CaseType=Combination	Point=2	X2=-0.5	X3=0.5		
S11=116.896307096121	IsS11Max=No	IsS11Min=No	FrameElem=41	ElemStation=0				
Frame=41	Station=0	OutputCase=PERM1	CaseType=Combination	Point=3	X2=0.5	X3=-0.5	S11=-	
588.773851642738	IsS11Max=No	IsS11Min=Yes	FrameElem=41	ElemStation=0				
Frame=41	Station=0	OutputCase=PERM1	CaseType=Combination	Point=4	X2=0.5	X3=0.5	S11=-	
588.773851642738	IsS11Max=No	IsS11Min=No	FrameElem=41	ElemStation=0				
Frame=41	Station=0.125	OutputCase=PERM1	CaseType=Combination	Point=0	X2=0	X3=0	S11=-	
235.938772273309	IsS11Max=No	IsS11Min=No	FrameElem=41	ElemStation=0.125				
Frame=41	Station=0.125	OutputCase=PERM1	CaseType=Combination	Point=1	X2=-0.5	X3=-0.5	S11=-	
144.186266431403	IsS11Max=Yes	IsS11Min=No	FrameElem=41	ElemStation=0.125				
Frame=41	Station=0.125	OutputCase=PERM1	CaseType=Combination	Point=2	X2=-0.5	X3=0.5	S11=-	
144.186266431403	IsS11Max=No	IsS11Min=No	FrameElem=41	ElemStation=0.125				
Frame=41	Station=0.125	OutputCase=PERM1	CaseType=Combination	Point=3	X2=0.5	X3=-0.5	S11=-	
327.691278115214	IsS11Max=No	IsS11Min=Yes	FrameElem=41	ElemStation=0.125				
Frame=41	Station=0.125	OutputCase=PERM1	CaseType=Combination	Point=4	X2=0.5	X3=0.5	S11=-	
327.691278115214	IsS11Max=No	IsS11Min=No	FrameElem=41	ElemStation=0.125				
Frame=41	Station=0.25	OutputCase=PERM1	CaseType=Combination	Point=0	X2=0	X3=0	S11=-235.938772273309	
IsS11Max=No	IsS11Min=No	FrameElem=41	ElemStation=0.25					
Frame=41	Station=0.25	OutputCase=PERM1	CaseType=Combination	Point=1	X2=-0.5	X3=-0.5	S11=-	
407.612589958927	IsS11Max=No	IsS11Min=Yes	FrameElem=41	ElemStation=0.25				
Frame=41	Station=0.25	OutputCase=PERM1	CaseType=Combination	Point=2	X2=-0.5	X3=0.5	S11=-	
407.612589958927	IsS11Max=No	IsS11Min=No	FrameElem=41	ElemStation=0.25				
Frame=41	Station=0.25	OutputCase=PERM1	CaseType=Combination	Point=3	X2=0.5	X3=-0.5	S11=-	
64.2649545876898	IsS11Max=Yes	IsS11Min=No	FrameElem=41	ElemStation=0.25				
Frame=41	Station=0.25	OutputCase=PERM1	CaseType=Combination	Point=4	X2=0.5	X3=0.5	S11=-	
64.2649545876898	IsS11Max=No	IsS11Min=No	FrameElem=41	ElemStation=0.25				
Frame=41	Station=0.375	OutputCase=PERM1	CaseType=Combination	Point=0	X2=0	X3=0	S11=-	
235.938772273309	IsS11Max=No	IsS11Min=No	FrameElem=41	ElemStation=0.375				
Frame=41	Station=0.375	OutputCase=PERM1	CaseType=Combination	Point=1	X2=-0.5	X3=-0.5	S11=-	
673.382663486452	IsS11Max=No	IsS11Min=Yes	FrameElem=41	ElemStation=0.375				
Frame=41	Station=0.375	OutputCase=PERM1	CaseType=Combination	Point=2	X2=-0.5	X3=0.5	S11=-	
673.382663486452	IsS11Max=No	IsS11Min=No	FrameElem=41	ElemStation=0.375				
Frame=41	Station=0.375	OutputCase=PERM1	CaseType=Combination	Point=3	X2=0.5	X3=-0.5		
S11=201.505118939835	IsS11Max=Yes	IsS11Min=No	FrameElem=41	ElemStation=0.375				
Frame=41	Station=0.375	OutputCase=PERM1	CaseType=Combination	Point=4	X2=0.5	X3=0.5		
S11=201.505118939835	IsS11Max=No	IsS11Min=No	FrameElem=41	ElemStation=0.375				
Frame=41	Station=0.5	OutputCase=PERM1	CaseType=Combination	Point=0	X2=0	X3=0	S11=-235.938772273309	
IsS11Max=No	IsS11Min=No	FrameElem=41	ElemStation=0.5					

Frame=41	Station=0.5	OutputCase=PERM1	CaseType=Combination	Point=1	X2=-0.5	X3=-0.5	S11=-
941.496487013976	IsS11Max=No	IsS11Min=Yes	FrameElem=41	ElemStation=0.5			
Frame=41	Station=0.5	OutputCase=PERM1	CaseType=Combination	Point=2	X2=-0.5	X3=0.5	S11=-
941.496487013976	IsS11Max=No	IsS11Min=No	FrameElem=41	ElemStation=0.5			
Frame=41	Station=0.5	OutputCase=PERM1	CaseType=Combination	Point=3	X2=0.5	X3=-0.5	
S11=469.618942467359	IsS11Max=Yes	IsS11Min=No	FrameElem=41	ElemStation=0.5			
Frame=41	Station=0.5	OutputCase=PERM1	CaseType=Combination	Point=4	X2=0.5	X3=0.5	
S11=469.618942467359	IsS11Max=No	IsS11Min=No	FrameElem=41	ElemStation=0.5			
Frame=41	Station=0	OutputCase=PERM2	CaseType=Combination	Point=0	X2=0	X3=0	S11=-169.465538592139
IsS11Max=No	IsS11Min=No	FrameElem=41	ElemStation=0				
Frame=41	Station=0	OutputCase=PERM2	CaseType=Combination	Point=1	X2=-0.5	X3=-0.5	
S11=97.1255380494076	IsS11Max=Yes	IsS11Min=No	FrameElem=41	ElemStation=0			
Frame=41	Station=0	OutputCase=PERM2	CaseType=Combination	Point=2	X2=-0.5	X3=0.5	
S11=97.1255380494076	IsS11Max=No	IsS11Min=No	FrameElem=41	ElemStation=0			
Frame=41	Station=0	OutputCase=PERM2	CaseType=Combination	Point=3	X2=0.5	X3=-0.5	S11=-
436.056615233685	IsS11Max=No	IsS11Min=Yes	FrameElem=41	ElemStation=0			
Frame=41	Station=0	OutputCase=PERM2	CaseType=Combination	Point=4	X2=0.5	X3=0.5	S11=-
436.056615233685	IsS11Max=No	IsS11Min=No	FrameElem=41	ElemStation=0			
Frame=41	Station=0.125	OutputCase=PERM2	CaseType=Combination	Point=0	X2=0	X3=0	S11=-
169.465538592139	IsS11Max=No	IsS11Min=No	FrameElem=41	ElemStation=0.125			
Frame=41	Station=0.125	OutputCase=PERM2	CaseType=Combination	Point=1	X2=-0.5	X3=-0.5	S11=-
163.866631276578	IsS11Max=Yes	IsS11Min=No	FrameElem=41	ElemStation=0.125			
Frame=41	Station=0.125	OutputCase=PERM2	CaseType=Combination	Point=2	X2=-0.5	X3=0.5	S11=-
163.866631276578	IsS11Max=No	IsS11Min=No	FrameElem=41	ElemStation=0.125			
Frame=41	Station=0.125	OutputCase=PERM2	CaseType=Combination	Point=3	X2=0.5	X3=-0.5	S11=-
175.064445907699	IsS11Max=No	IsS11Min=Yes	FrameElem=41	ElemStation=0.125			
Frame=41	Station=0.125	OutputCase=PERM2	CaseType=Combination	Point=4	X2=0.5	X3=0.5	S11=-
175.064445907699	IsS11Max=No	IsS11Min=No	FrameElem=41	ElemStation=0.125			
Frame=41	Station=0.25	OutputCase=PERM2	CaseType=Combination	Point=0	X2=0	X3=0	S11=-169.465538592139
IsS11Max=No	IsS11Min=No	FrameElem=41	ElemStation=0.25				
Frame=41	Station=0.25	OutputCase=PERM2	CaseType=Combination	Point=1	X2=-0.5	X3=-0.5	S11=-
427.202550602563	IsS11Max=No	IsS11Min=Yes	FrameElem=41	ElemStation=0.25			
Frame=41	Station=0.25	OutputCase=PERM2	CaseType=Combination	Point=2	X2=-0.5	X3=0.5	S11=-
427.202550602563	IsS11Max=No	IsS11Min=No	FrameElem=41	ElemStation=0.25			
Frame=41	Station=0.25	OutputCase=PERM2	CaseType=Combination	Point=3	X2=0.5	X3=-0.5	
S11=88.271473418286	IsS11Max=Yes	IsS11Min=No	FrameElem=41	ElemStation=0.25			
Frame=41	Station=0.25	OutputCase=PERM2	CaseType=Combination	Point=4	X2=0.5	X3=0.5	
S11=88.271473418286	IsS11Max=No	IsS11Min=No	FrameElem=41	ElemStation=0.25			
Frame=41	Station=0.375	OutputCase=PERM2	CaseType=Combination	Point=0	X2=0	X3=0	S11=-
169.465538592139	IsS11Max=No	IsS11Min=No	FrameElem=41	ElemStation=0.375			
Frame=41	Station=0.375	OutputCase=PERM2	CaseType=Combination	Point=1	X2=-0.5	X3=-0.5	S11=-
692.882219928549	IsS11Max=No	IsS11Min=Yes	FrameElem=41	ElemStation=0.375			
Frame=41	Station=0.375	OutputCase=PERM2	CaseType=Combination	Point=2	X2=-0.5	X3=0.5	S11=-
692.882219928549	IsS11Max=No	IsS11Min=No	FrameElem=41	ElemStation=0.375			
Frame=41	Station=0.375	OutputCase=PERM2	CaseType=Combination	Point=3	X2=0.5	X3=-0.5	
S11=353.951142744271	IsS11Max=Yes	IsS11Min=No	FrameElem=41	ElemStation=0.375			
Frame=41	Station=0.375	OutputCase=PERM2	CaseType=Combination	Point=4	X2=0.5	X3=0.5	
S11=353.951142744271	IsS11Max=No	IsS11Min=No	FrameElem=41	ElemStation=0.375			
Frame=41	Station=0.5	OutputCase=PERM2	CaseType=Combination	Point=0	X2=0	X3=0	S11=-169.465538592139
IsS11Max=No	IsS11Min=No	FrameElem=41	ElemStation=0.5				
Frame=41	Station=0.5	OutputCase=PERM2	CaseType=Combination	Point=1	X2=-0.5	X3=-0.5	S11=-
960.905639254534	IsS11Max=No	IsS11Min=Yes	FrameElem=41	ElemStation=0.5			
Frame=41	Station=0.5	OutputCase=PERM2	CaseType=Combination	Point=2	X2=-0.5	X3=0.5	S11=-
960.905639254534	IsS11Max=No	IsS11Min=No	FrameElem=41	ElemStation=0.5			
Frame=41	Station=0.5	OutputCase=PERM2	CaseType=Combination	Point=3	X2=0.5	X3=-0.5	
S11=621.974562070257	IsS11Max=Yes	IsS11Min=No	FrameElem=41	ElemStation=0.5			
Frame=41	Station=0.5	OutputCase=PERM2	CaseType=Combination	Point=4	X2=0.5	X3=0.5	
S11=621.974562070257	IsS11Max=No	IsS11Min=No	FrameElem=41	ElemStation=0.5			
Frame=41	Station=0	OutputCase=ACCL	CaseType=Combination	Point=0	X2=0	X3=0	S11=-240.528987364651
IsS11Max=No	IsS11Min=No	FrameElem=41	ElemStation=0				
Frame=41	Station=0	OutputCase=ACCL	CaseType=Combination	Point=1	X2=-0.5	X3=-0.5	
S11=121.035543286102	IsS11Max=Yes	IsS11Min=No	FrameElem=41	ElemStation=0			
Frame=41	Station=0	OutputCase=ACCL	CaseType=Combination	Point=2	X2=-0.5	X3=0.5	S11=121.035543286102
IsS11Max=No	IsS11Min=No	FrameElem=41	ElemStation=0				
Frame=41	Station=0	OutputCase=ACCL	CaseType=Combination	Point=3	X2=0.5	X3=-0.5	S11=-
602.093518015403	IsS11Max=No	IsS11Min=Yes	FrameElem=41	ElemStation=0			
Frame=41	Station=0	OutputCase=ACCL	CaseType=Combination	Point=4	X2=0.5	X3=0.5	S11=-602.093518015403
IsS11Max=No	IsS11Min=No	FrameElem=41	ElemStation=0				
Frame=41	Station=0.125	OutputCase=ACCL	CaseType=Combination	Point=0	X2=0	X3=0	S11=-240.528987364651
IsS11Max=No	IsS11Min=No	FrameElem=41	ElemStation=0.125				
Frame=41	Station=0.125	OutputCase=ACCL	CaseType=Combination	Point=1	X2=-0.5	X3=-0.5	S11=-
147.110861021734	IsS11Max=Yes	IsS11Min=No	FrameElem=41	ElemStation=0.125			
Frame=41	Station=0.125	OutputCase=ACCL	CaseType=Combination	Point=2	X2=-0.5	X3=0.5	S11=-
147.110861021734	IsS11Max=No	IsS11Min=No	FrameElem=41	ElemStation=0.125			
Frame=41	Station=0.125	OutputCase=ACCL	CaseType=Combination	Point=3	X2=0.5	X3=-0.5	S11=-
333.947113707567	IsS11Max=No	IsS11Min=Yes	FrameElem=41	ElemStation=0.125			
Frame=41	Station=0.125	OutputCase=ACCL	CaseType=Combination	Point=4	X2=0.5	X3=0.5	S11=-
333.947113707567	IsS11Max=No	IsS11Min=No	FrameElem=41	ElemStation=0.125			
Frame=41	Station=0.25	OutputCase=ACCL	CaseType=Combination	Point=0	X2=0	X3=0	S11=-240.528987364651
IsS11Max=No	IsS11Min=No	FrameElem=41	ElemStation=0.25				
Frame=41	Station=0.25	OutputCase=ACCL	CaseType=Combination	Point=1	X2=-0.5	X3=-0.5	S11=-
417.601015329571	IsS11Max=No	IsS11Min=Yes	FrameElem=41	ElemStation=0.25			

Frame=41 Station=0.25 OutputCase=ACC1	CaseType=Combination Point=2 X2=-0.5 X3=0.5 S11=-
417.601015329571 IsS11Max=No IsS11Min=No	FrameElem=41 ElemStation=0.25
Frame=41 Station=0.25 OutputCase=ACC1	CaseType=Combination Point=3 X2=0.5 X3=-0.5 S11=-
63.4569593997302 IsS11Max=Yes IsS11Min=No	FrameElem=41 ElemStation=0.25
Frame=41 Station=0.25 OutputCase=ACC1	CaseType=Combination Point=4 X2=0.5 X3=0.5 S11=-
63.4569593997302 IsS11Max=No IsS11Min=No	FrameElem=41 ElemStation=0.25
Frame=41 Station=0.375 OutputCase=ACC1	CaseType=Combination Point=0 X2=0 X3=0 S11=-240.528987364651
IsS11Max=No IsS11Min=No FrameElem=41 ElemStation=0.375	
Frame=41 Station=0.375 OutputCase=ACC1	CaseType=Combination Point=1 X2=-0.5 X3=-0.5 S11=-
690.434919637407 IsS11Max=No IsS11Min=Yes	FrameElem=41 ElemStation=0.375
Frame=41 Station=0.375 OutputCase=ACC1	CaseType=Combination Point=2 X2=-0.5 X3=0.5 S11=-
690.434919637407 IsS11Max=No IsS11Min=No	FrameElem=41 ElemStation=0.375
Frame=41 Station=0.375 OutputCase=ACC1	CaseType=Combination Point=3 X2=0.5 X3=-0.5
S11=209.376944908107 IsS11Max=Yes IsS11Min=No	FrameElem=41 ElemStation=0.375
Frame=41 Station=0.375 OutputCase=ACC1	CaseType=Combination Point=4 X2=0.5 X3=0.5
S11=209.376944908107 IsS11Max=No IsS11Min=No	FrameElem=41 ElemStation=0.375
Frame=41 Station=0.5 OutputCase=ACC1	CaseType=Combination Point=0 X2=0 X3=0 S11=-240.528987364651
IsS11Max=No IsS11Min=No FrameElem=41 ElemStation=0.5	
Frame=41 Station=0.5 OutputCase=ACC1	CaseType=Combination Point=1 X2=-0.5 X3=-0.5 S11=-
965.612573945244 IsS11Max=No IsS11Min=Yes	FrameElem=41 ElemStation=0.5
Frame=41 Station=0.5 OutputCase=ACC1	CaseType=Combination Point=2 X2=-0.5 X3=0.5 S11=-
965.612573945244 IsS11Max=No IsS11Min=No	FrameElem=41 ElemStation=0.5
Frame=41 Station=0.5 OutputCase=ACC1	CaseType=Combination Point=3 X2=0.5 X3=-0.5
S11=484.554599215943 IsS11Max=Yes IsS11Min=No	FrameElem=41 ElemStation=0.5
Frame=41 Station=0.5 OutputCase=ACC1	CaseType=Combination Point=4 X2=0.5 X3=0.5
S11=484.554599215943 IsS11Max=No IsS11Min=No	FrameElem=41 ElemStation=0.5
Frame=41 Station=0 OutputCase=ACC2	CaseType=Combination Point=0 X2=0 X3=0 S11=-174.055753683481
IsS11Max=No IsS11Min=No FrameElem=41 ElemStation=0	
Frame=41 Station=0 OutputCase=ACC2	CaseType=Combination Point=1 X2=-0.5 X3=-0.5
S11=101.264774239389 IsS11Max=Yes IsS11Min=No	FrameElem=41 ElemStation=0
Frame=41 Station=0 OutputCase=ACC2	CaseType=Combination Point=2 X2=-0.5 X3=0.5 S11=101.264774239389
IsS11Max=No IsS11Min=No FrameElem=41 ElemStation=0	
Frame=41 Station=0 OutputCase=ACC2	CaseType=Combination Point=3 X2=0.5 X3=-0.5 S11=-449.37628160635
IsS11Max=No IsS11Min=Yes FrameElem=41 ElemStation=0	
Frame=41 Station=0 OutputCase=ACC2	CaseType=Combination Point=4 X2=0.5 X3=0.5 S11=-449.37628160635
IsS11Max=No IsS11Min=No FrameElem=41 ElemStation=0	
Frame=41 Station=0.125 OutputCase=ACC2	CaseType=Combination Point=0 X2=0 X3=0 S11=-174.055753683481
IsS11Max=No IsS11Min=No FrameElem=41 ElemStation=0.125	
Frame=41 Station=0.125 OutputCase=ACC2	CaseType=Combination Point=1 X2=-0.5 X3=-0.5 S11=-
166.791225866909 IsS11Max=Yes IsS11Min=No	FrameElem=41 ElemStation=0.125
Frame=41 Station=0.125 OutputCase=ACC2	CaseType=Combination Point=2 X2=-0.5 X3=0.5 S11=-
166.791225866909 IsS11Max=No IsS11Min=No	FrameElem=41 ElemStation=0.125
Frame=41 Station=0.125 OutputCase=ACC2	CaseType=Combination Point=3 X2=0.5 X3=-0.5 S11=-
181.320281500052 IsS11Max=No IsS11Min=Yes	FrameElem=41 ElemStation=0.125
Frame=41 Station=0.125 OutputCase=ACC2	CaseType=Combination Point=4 X2=0.5 X3=0.5 S11=-
181.320281500052 IsS11Max=No IsS11Min=No	FrameElem=41 ElemStation=0.125
Frame=41 Station=0.25 OutputCase=ACC2	CaseType=Combination Point=0 X2=0 X3=0 S11=-174.055753683481
IsS11Max=No IsS11Min=No FrameElem=41 ElemStation=0.25	
Frame=41 Station=0.25 OutputCase=ACC2	CaseType=Combination Point=1 X2=-0.5 X3=-0.5 S11=-
437.190975973207 IsS11Max=No IsS11Min=Yes	FrameElem=41 ElemStation=0.25
Frame=41 Station=0.25 OutputCase=ACC2	CaseType=Combination Point=2 X2=-0.5 X3=0.5 S11=-
437.190975973207 IsS11Max=No IsS11Min=No	FrameElem=41 ElemStation=0.25
Frame=41 Station=0.25 OutputCase=ACC2	CaseType=Combination Point=3 X2=0.5 X3=-0.5
S11=89.0794686062456 IsS11Max=Yes IsS11Min=No	FrameElem=41 ElemStation=0.25
Frame=41 Station=0.25 OutputCase=ACC2	CaseType=Combination Point=4 X2=0.5 X3=0.5
S11=89.0794686062456 IsS11Max=No IsS11Min=No	FrameElem=41 ElemStation=0.25
Frame=41 Station=0.375 OutputCase=ACC2	CaseType=Combination Point=0 X2=0 X3=0 S11=-174.055753683481
IsS11Max=No IsS11Min=No FrameElem=41 ElemStation=0.375	
Frame=41 Station=0.375 OutputCase=ACC2	CaseType=Combination Point=1 X2=-0.5 X3=-0.5 S11=-
709.934476079505 IsS11Max=No IsS11Min=Yes	FrameElem=41 ElemStation=0.375
Frame=41 Station=0.375 OutputCase=ACC2	CaseType=Combination Point=2 X2=-0.5 X3=0.5 S11=-
709.934476079505 IsS11Max=No IsS11Min=No	FrameElem=41 ElemStation=0.375
Frame=41 Station=0.375 OutputCase=ACC2	CaseType=Combination Point=3 X2=0.5 X3=-0.5
S11=361.822968712543 IsS11Max=Yes IsS11Min=No	FrameElem=41 ElemStation=0.375
Frame=41 Station=0.375 OutputCase=ACC2	CaseType=Combination Point=4 X2=0.5 X3=0.5
S11=361.822968712543 IsS11Max=No IsS11Min=No	FrameElem=41 ElemStation=0.375
Frame=41 Station=0.5 OutputCase=ACC2	CaseType=Combination Point=0 X2=0 X3=0 S11=-174.055753683481
IsS11Max=No IsS11Min=No FrameElem=41 ElemStation=0.5	
Frame=41 Station=0.5 OutputCase=ACC2	CaseType=Combination Point=1 X2=-0.5 X3=-0.5 S11=-
985.021726185802 IsS11Max=No IsS11Min=Yes	FrameElem=41 ElemStation=0.5
Frame=41 Station=0.5 OutputCase=ACC2	CaseType=Combination Point=2 X2=-0.5 X3=0.5 S11=-
985.021726185802 IsS11Max=No IsS11Min=No	FrameElem=41 ElemStation=0.5
Frame=41 Station=0.5 OutputCase=ACC2	CaseType=Combination Point=3 X2=0.5 X3=-0.5
S11=636.910218818841 IsS11Max=Yes IsS11Min=No	FrameElem=41 ElemStation=0.5
Frame=41 Station=0.5 OutputCase=ACC2	CaseType=Combination Point=4 X2=0.5 X3=0.5
S11=636.910218818841 IsS11Max=No IsS11Min=No	FrameElem=41 ElemStation=0.5
Frame=41 Station=0 OutputCase=ACCSX1	CaseType=Combination Point=0 X2=0 X3=0 S11=-233.665974282453
IsS11Max=No IsS11Min=No FrameElem=41 ElemStation=0	
Frame=41 Station=0 OutputCase=ACCSX1	CaseType=Combination Point=1 X2=-0.5 X3=-0.5
S11=157.869907463959 IsS11Max=Yes IsS11Min=No	FrameElem=41 ElemStation=0
Frame=41 Station=0 OutputCase=ACCSX1	CaseType=Combination Point=2 X2=-0.5 X3=0.5
S11=157.869907463959 IsS11Max=No IsS11Min=No	FrameElem=41 ElemStation=0

Frame=41	Station=0	OutputCase=ACCSX1	CaseType=Combination	Point=3	X2=0.5	X3=-0.5	S11=-
625.201856028864	IsS11Max=No	IsS11Min=Yes	FrameElem=41	ElemStation=0			
Frame=41	Station=0	OutputCase=ACCSX1	CaseType=Combination	Point=4	X2=0.5	X3=0.5	S11=-
625.201856028864	IsS11Max=No	IsS11Min=No	FrameElem=41	ElemStation=0			
Frame=41	Station=0.125	OutputCase=ACCSX1	CaseType=Combination	Point=0	X2=0	X3=0	S11=-
233.665974282453	IsS11Max=No	IsS11Min=No	FrameElem=41	ElemStation=0.125			
Frame=41	Station=0.125	OutputCase=ACCSX1	CaseType=Combination	Point=1	X2=-0.5	X3=-0.5	S11=-
104.214311510412	IsS11Max=Yes	IsS11Min=No	FrameElem=41	ElemStation=0.125			
Frame=41	Station=0.125	OutputCase=ACCSX1	CaseType=Combination	Point=2	X2=-0.5	X3=0.5	S11=-
104.214311510412	IsS11Max=No	IsS11Min=No	FrameElem=41	ElemStation=0.125			
Frame=41	Station=0.125	OutputCase=ACCSX1	CaseType=Combination	Point=3	X2=0.5	X3=-0.5	S11=-
363.117637054493	IsS11Max=No	IsS11Min=Yes	FrameElem=41	ElemStation=0.125			
Frame=41	Station=0.125	OutputCase=ACCSX1	CaseType=Combination	Point=4	X2=0.5	X3=0.5	S11=-
363.117637054493	IsS11Max=No	IsS11Min=No	FrameElem=41	ElemStation=0.125			
Frame=41	Station=0.25	OutputCase=ACCSX1	CaseType=Combination	Point=0	X2=0	X3=0	S11=-
233.665974282453	IsS11Max=No	IsS11Min=No	FrameElem=41	ElemStation=0.25			
Frame=41	Station=0.25	OutputCase=ACCSX1	CaseType=Combination	Point=1	X2=-0.5	X3=-0.5	S11=-
368.642280484783	IsS11Max=No	IsS11Min=Yes	FrameElem=41	ElemStation=0.25			
Frame=41	Station=0.25	OutputCase=ACCSX1	CaseType=Combination	Point=2	X2=-0.5	X3=0.5	S11=-
368.642280484783	IsS11Max=No	IsS11Min=No	FrameElem=41	ElemStation=0.25			
Frame=41	Station=0.25	OutputCase=ACCSX1	CaseType=Combination	Point=3	X2=0.5	X3=-0.5	S11=-
98.6896680801225	IsS11Max=Yes	IsS11Min=No	FrameElem=41	ElemStation=0.25			
Frame=41	Station=0.25	OutputCase=ACCSX1	CaseType=Combination	Point=4	X2=0.5	X3=0.5	S11=-
98.6896680801225	IsS11Max=No	IsS11Min=No	FrameElem=41	ElemStation=0.25			
Frame=41	Station=0.375	OutputCase=ACCSX1	CaseType=Combination	Point=0	X2=0	X3=0	S11=-
233.665974282453	IsS11Max=No	IsS11Min=No	FrameElem=41	ElemStation=0.375			
Frame=41	Station=0.375	OutputCase=ACCSX1	CaseType=Combination	Point=1	X2=-0.5	X3=-0.5	S11=-
635.413999459153	IsS11Max=No	IsS11Min=Yes	FrameElem=41	ElemStation=0.375			
Frame=41	Station=0.375	OutputCase=ACCSX1	CaseType=Combination	Point=2	X2=-0.5	X3=0.5	S11=-
635.413999459153	IsS11Max=No	IsS11Min=No	FrameElem=41	ElemStation=0.375			
Frame=41	Station=0.375	OutputCase=ACCSX1	CaseType=Combination	Point=3	X2=0.5	X3=-0.5	
S11=168.082050894248	IsS11Max=Yes	IsS11Min=No	FrameElem=41	ElemStation=0.375			
Frame=41	Station=0.375	OutputCase=ACCSX1	CaseType=Combination	Point=4	X2=0.5	X3=0.5	
S11=168.082050894248	IsS11Max=No	IsS11Min=No	FrameElem=41	ElemStation=0.375			
Frame=41	Station=0.5	OutputCase=ACCSX1	CaseType=Combination	Point=0	X2=0	X3=0	S11=-233.665974282453
IsS11Max=No	IsS11Min=No	FrameElem=41	ElemStation=0.5				
Frame=41	Station=0.5	OutputCase=ACCSX1	CaseType=Combination	Point=1	X2=-0.5	X3=-0.5	S11=-
904.529468433524	IsS11Max=No	IsS11Min=Yes	FrameElem=41	ElemStation=0.5			
Frame=41	Station=0.5	OutputCase=ACCSX1	CaseType=Combination	Point=2	X2=-0.5	X3=0.5	S11=-
904.529468433524	IsS11Max=No	IsS11Min=No	FrameElem=41	ElemStation=0.5			
Frame=41	Station=0.5	OutputCase=ACCSX1	CaseType=Combination	Point=3	X2=0.5	X3=-0.5	
S11=437.197519868619	IsS11Max=Yes	IsS11Min=No	FrameElem=41	ElemStation=0.5			
Frame=41	Station=0.5	OutputCase=ACCSX1	CaseType=Combination	Point=4	X2=0.5	X3=0.5	
S11=437.197519868619	IsS11Max=No	IsS11Min=No	FrameElem=41	ElemStation=0.5			
Frame=41	Station=0.5	OutputCase=ACCSX2	CaseType=Combination	Point=0	X2=0	X3=0	S11=-167.192740601283
IsS11Max=No	IsS11Min=No	FrameElem=41	ElemStation=0				
Frame=41	Station=0	OutputCase=ACCSX2	CaseType=Combination	Point=1	X2=-0.5	X3=-0.5	
S11=138.099138417245	IsS11Max=Yes	IsS11Min=No	FrameElem=41	ElemStation=0			
Frame=41	Station=0	OutputCase=ACCSX2	CaseType=Combination	Point=2	X2=-0.5	X3=0.5	
S11=138.099138417245	IsS11Max=No	IsS11Min=No	FrameElem=41	ElemStation=0			
Frame=41	Station=0	OutputCase=ACCSX2	CaseType=Combination	Point=3	X2=0.5	X3=-0.5	S11=-
472.48461961981	IsS11Max=No	IsS11Min=Yes	FrameElem=41	ElemStation=0			
Frame=41	Station=0	OutputCase=ACCSX2	CaseType=Combination	Point=4	X2=0.5	X3=0.5	S11=-
472.48461961981	IsS11Max=No	IsS11Min=No	FrameElem=41	ElemStation=0			
Frame=41	Station=0.125	OutputCase=ACCSX2	CaseType=Combination	Point=0	X2=0	X3=0	S11=-
167.192740601283	IsS11Max=No	IsS11Min=No	FrameElem=41	ElemStation=0.125			
Frame=41	Station=0.125	OutputCase=ACCSX2	CaseType=Combination	Point=1	X2=-0.5	X3=-0.5	S11=-
123.894676355587	IsS11Max=Yes	IsS11Min=No	FrameElem=41	ElemStation=0.125			
Frame=41	Station=0.125	OutputCase=ACCSX2	CaseType=Combination	Point=2	X2=-0.5	X3=0.5	S11=-
123.894676355587	IsS11Max=No	IsS11Min=No	FrameElem=41	ElemStation=0.125			
Frame=41	Station=0.125	OutputCase=ACCSX2	CaseType=Combination	Point=3	X2=0.5	X3=-0.5	S11=-
210.490804846978	IsS11Max=No	IsS11Min=Yes	FrameElem=41	ElemStation=0.125			
Frame=41	Station=0.125	OutputCase=ACCSX2	CaseType=Combination	Point=4	X2=0.5	X3=0.5	S11=-
210.490804846978	IsS11Max=No	IsS11Min=No	FrameElem=41	ElemStation=0.125			
Frame=41	Station=0.25	OutputCase=ACCSX2	CaseType=Combination	Point=0	X2=0	X3=0	S11=-
167.192740601283	IsS11Max=No	IsS11Min=No	FrameElem=41	ElemStation=0.25			
Frame=41	Station=0.25	OutputCase=ACCSX2	CaseType=Combination	Point=1	X2=-0.5	X3=-0.5	S11=-
388.232241128418	IsS11Max=No	IsS11Min=Yes	FrameElem=41	ElemStation=0.25			
Frame=41	Station=0.25	OutputCase=ACCSX2	CaseType=Combination	Point=2	X2=-0.5	X3=0.5	S11=-
388.232241128418	IsS11Max=No	IsS11Min=No	FrameElem=41	ElemStation=0.25			
Frame=41	Station=0.25	OutputCase=ACCSX2	CaseType=Combination	Point=3	X2=0.5	X3=-0.5	
S11=53.8467599258533	IsS11Max=Yes	IsS11Min=No	FrameElem=41	ElemStation=0.25			
Frame=41	Station=0.25	OutputCase=ACCSX2	CaseType=Combination	Point=4	X2=0.5	X3=0.5	
S11=53.8467599258533	IsS11Max=No	IsS11Min=No	FrameElem=41	ElemStation=0.25			
Frame=41	Station=0.375	OutputCase=ACCSX2	CaseType=Combination	Point=0	X2=0	X3=0	S11=-
167.192740601283	IsS11Max=No	IsS11Min=No	FrameElem=41	ElemStation=0.375			
Frame=41	Station=0.375	OutputCase=ACCSX2	CaseType=Combination	Point=1	X2=-0.5	X3=-0.5	S11=-
654.91355590125	IsS11Max=No	IsS11Min=Yes	FrameElem=41	ElemStation=0.375			
Frame=41	Station=0.375	OutputCase=ACCSX2	CaseType=Combination	Point=2	X2=-0.5	X3=0.5	S11=-
654.91355590125	IsS11Max=No	IsS11Min=No	FrameElem=41	ElemStation=0.375			
Frame=41	Station=0.375	OutputCase=ACCSX2	CaseType=Combination	Point=3	X2=0.5	X3=-0.5	
S11=320.528074698685	IsS11Max=Yes	IsS11Min=No	FrameElem=41	ElemStation=0.375			

Frame=41	Station=0.375	OutputCase=ACCSX2	CaseType=Combination	Point=4	X2=0.5	X3=0.5			
S11=320.528074698685	IsS11Max=No	IsS11Min=No	FrameElem=41	ElemStation=0.375					
Frame=41	Station=0.5	OutputCase=ACCSX2	CaseType=Combination	Point=0	X2=0	X3=0	S11=-167.192740601283		
IsS11Max=No	IsS11Min=No	FrameElem=41	ElemStation=0.5						
Frame=41	Station=0.5	OutputCase=ACCSX2	CaseType=Combination	Point=1	X2=-0.5	X3=-0.5	S11=-		
923.938620674082	IsS11Max=No	IsS11Min=Yes	FrameElem=41	ElemStation=0.5					
Frame=41	Station=0.5	OutputCase=ACCSX2	CaseType=Combination	Point=2	X2=-0.5	X3=0.5	S11=-		
923.938620674082	IsS11Max=No	IsS11Min=No	FrameElem=41	ElemStation=0.5					
Frame=41	Station=0.5	OutputCase=ACCSX2	CaseType=Combination	Point=3	X2=0.5	X3=-0.5			
S11=589.553139471517	IsS11Max=Yes	IsS11Min=No	FrameElem=41	ElemStation=0.5					
Frame=41	Station=0.5	OutputCase=ACCSX2	CaseType=Combination	Point=4	X2=0.5	X3=0.5			
S11=589.553139471517	IsS11Max=No	IsS11Min=No	FrameElem=41	ElemStation=0.5					
Frame=41	Station=0	OutputCase=ENVE	CaseType=Combination	StepType=Max	Point=0	X2=0	X3=0	S11=-	
167.192740601283	IsS11Max=No	IsS11Min=No	FrameElem=41	ElemStation=0					
Frame=41	Station=0	OutputCase=ENVE	CaseType=Combination	StepType=Max	Point=1	X2=-0.5	X3=-0.5		
S11=157.869907463959	IsS11Max=Yes	IsS11Min=No	FrameElem=41	ElemStation=0					
Frame=41	Station=0	OutputCase=ENVE	CaseType=Combination	StepType=Max	Point=2	X2=-0.5	X3=0.5		
S11=157.869907463959	IsS11Max=No	IsS11Min=No	FrameElem=41	ElemStation=0					
Frame=41	Station=0	OutputCase=ENVE	CaseType=Combination	StepType=Max	Point=3	X2=0.5	X3=-0.5	S11=-	
436.056615233685	IsS11Max=No	IsS11Min=Yes	FrameElem=41	ElemStation=0					
Frame=41	Station=0	OutputCase=ENVE	CaseType=Combination	StepType=Max	Point=4	X2=0.5	X3=0.5	S11=-	
436.056615233685	IsS11Max=No	IsS11Min=No	FrameElem=41	ElemStation=0					
Frame=41	Station=0.125	OutputCase=ENVE	CaseType=Combination	StepType=Max	Point=0	X2=0	X3=0	S11=-	
167.192740601283	IsS11Max=No	IsS11Min=No	FrameElem=41	ElemStation=0.125					
Frame=41	Station=0.125	OutputCase=ENVE	CaseType=Combination	StepType=Max	Point=1	X2=-0.5	X3=-0.5		
S11=-104.214311510412	IsS11Max=Yes	IsS11Min=No	FrameElem=41	ElemStation=0.125					
Frame=41	Station=0.125	OutputCase=ENVE	CaseType=Combination	StepType=Max	Point=2	X2=-0.5	X3=0.5		
S11=-104.214311510412	IsS11Max=No	IsS11Min=No	FrameElem=41	ElemStation=0.125					
Frame=41	Station=0.125	OutputCase=ENVE	CaseType=Combination	StepType=Max	Point=3	X2=0.5	X3=-0.5		
S11=-175.064445907699	IsS11Max=No	IsS11Min=Yes	FrameElem=41	ElemStation=0.125					
Frame=41	Station=0.125	OutputCase=ENVE	CaseType=Combination	StepType=Max	Point=4	X2=0.5	X3=0.5		
S11=-175.064445907699	IsS11Max=No	IsS11Min=No	FrameElem=41	ElemStation=0.125					
Frame=41	Station=0.25	OutputCase=ENVE	CaseType=Combination	StepType=Max	Point=0	X2=0	X3=0	S11=-	
167.192740601283	IsS11Max=No	IsS11Min=No	FrameElem=41	ElemStation=0.25					
Frame=41	Station=0.25	OutputCase=ENVE	CaseType=Combination	StepType=Max	Point=1	X2=-0.5	X3=-0.5		
S11=-368.642280484783	IsS11Max=No	IsS11Min=Yes	FrameElem=41	ElemStation=0.25					
Frame=41	Station=0.25	OutputCase=ENVE	CaseType=Combination	StepType=Max	Point=2	X2=-0.5	X3=0.5		
S11=-368.642280484783	IsS11Max=No	IsS11Min=No	FrameElem=41	ElemStation=0.25					
Frame=41	Station=0.25	OutputCase=ENVE	CaseType=Combination	StepType=Max	Point=3	X2=0.5	X3=-0.5		
S11=89.0794686062456	IsS11Max=Yes	IsS11Min=No	FrameElem=41	ElemStation=0.25					
Frame=41	Station=0.25	OutputCase=ENVE	CaseType=Combination	StepType=Max	Point=4	X2=0.5	X3=0.5		
S11=89.0794686062456	IsS11Max=No	IsS11Min=No	FrameElem=41	ElemStation=0.25					
Frame=41	Station=0.375	OutputCase=ENVE	CaseType=Combination	StepType=Max	Point=0	X2=0	X3=0	S11=-	
167.192740601283	IsS11Max=No	IsS11Min=No	FrameElem=41	ElemStation=0.375					
Frame=41	Station=0.375	OutputCase=ENVE	CaseType=Combination	StepType=Max	Point=1	X2=-0.5	X3=-0.5		
S11=-635.413999459153	IsS11Max=No	IsS11Min=Yes	FrameElem=41	ElemStation=0.375					
Frame=41	Station=0.375	OutputCase=ENVE	CaseType=Combination	StepType=Max	Point=2	X2=-0.5	X3=0.5		
S11=-635.413999459153	IsS11Max=No	IsS11Min=No	FrameElem=41	ElemStation=0.375					
Frame=41	Station=0.375	OutputCase=ENVE	CaseType=Combination	StepType=Max	Point=3	X2=0.5	X3=-0.5		
S11=361.822968712543	IsS11Max=Yes	IsS11Min=No	FrameElem=41	ElemStation=0.375					
Frame=41	Station=0.375	OutputCase=ENVE	CaseType=Combination	StepType=Max	Point=4	X2=0.5	X3=0.5		
S11=361.822968712543	IsS11Max=No	IsS11Min=No	FrameElem=41	ElemStation=0.375					
Frame=41	Station=0.5	OutputCase=ENVE	CaseType=Combination	StepType=Max	Point=0	X2=0	X3=0	S11=-	
167.192740601283	IsS11Max=No	IsS11Min=No	FrameElem=41	ElemStation=0.5					
Frame=41	Station=0.5	OutputCase=ENVE	CaseType=Combination	StepType=Max	Point=1	X2=-0.5	X3=-0.5		
S11=-904.529468433524	IsS11Max=No	IsS11Min=Yes	FrameElem=41	ElemStation=0.5					
Frame=41	Station=0.5	OutputCase=ENVE	CaseType=Combination	StepType=Max	Point=2	X2=-0.5	X3=0.5		
S11=-904.529468433524	IsS11Max=No	IsS11Min=No	FrameElem=41	ElemStation=0.5					
Frame=41	Station=0.5	OutputCase=ENVE	CaseType=Combination	StepType=Max	Point=3	X2=0.5	X3=-0.5		
S11=636.910218818841	IsS11Max=Yes	IsS11Min=No	FrameElem=41	ElemStation=0.5					
Frame=41	Station=0.5	OutputCase=ENVE	CaseType=Combination	StepType=Max	Point=4	X2=0.5	X3=0.5		
S11=636.910218818841	IsS11Max=No	IsS11Min=No	FrameElem=41	ElemStation=0.5					
Frame=41	Station=0	OutputCase=ENVE	CaseType=Combination	StepType=Min	Point=0	X2=0	X3=0	S11=-	
240.528987364651	IsS11Max=No	IsS11Min=No	FrameElem=41	ElemStation=0					
Frame=41	Station=0	OutputCase=ENVE	CaseType=Combination	StepType=Min	Point=1	X2=-0.5	X3=-0.5		
S11=97.1255380494076	IsS11Max=Yes	IsS11Min=No	FrameElem=41	ElemStation=0					
Frame=41	Station=0	OutputCase=ENVE	CaseType=Combination	StepType=Min	Point=2	X2=-0.5	X3=0.5		
S11=97.1255380494076	IsS11Max=No	IsS11Min=No	FrameElem=41	ElemStation=0					
Frame=41	Station=0	OutputCase=ENVE	CaseType=Combination	StepType=Min	Point=3	X2=0.5	X3=-0.5	S11=-	
625.201856028864	IsS11Max=No	IsS11Min=Yes	FrameElem=41	ElemStation=0					
Frame=41	Station=0	OutputCase=ENVE	CaseType=Combination	StepType=Min	Point=4	X2=0.5	X3=0.5	S11=-	
625.201856028864	IsS11Max=No	IsS11Min=No	FrameElem=41	ElemStation=0					
Frame=41	Station=0.125	OutputCase=ENVE	CaseType=Combination	StepType=Min	Point=0	X2=0	X3=0	S11=-	
240.528987364651	IsS11Max=No	IsS11Min=No	FrameElem=41	ElemStation=0.125					
Frame=41	Station=0.125	OutputCase=ENVE	CaseType=Combination	StepType=Min	Point=1	X2=-0.5	X3=-0.5		
S11=-166.791225866909	IsS11Max=Yes	IsS11Min=No	FrameElem=41	ElemStation=0.125					
Frame=41	Station=0.125	OutputCase=ENVE	CaseType=Combination	StepType=Min	Point=2	X2=-0.5	X3=0.5		
S11=-166.791225866909	IsS11Max=No	IsS11Min=No	FrameElem=41	ElemStation=0.125					
Frame=41	Station=0.125	OutputCase=ENVE	CaseType=Combination	StepType=Min	Point=3	X2=0.5	X3=-0.5		
S11=-363.117637054493	IsS11Max=No	IsS11Min=Yes	FrameElem=41	ElemStation=0.125					
Frame=41	Station=0.125	OutputCase=ENVE	CaseType=Combination	StepType=Min	Point=4	X2=0.5	X3=0.5		
S11=-363.117637054493	IsS11Max=No	IsS11Min=No	FrameElem=41	ElemStation=0.125					

Frame=41	Station=0.25	OutputCase=ENVE	CaseType=Combination	StepType=Min	Point=0	X2=0	X3=0	S11=-
240.528987364651	IsS11Max=No	IsS11Min=No	FrameElem=41	ElemStation=0.25				
Frame=41	Station=0.25	OutputCase=ENVE	CaseType=Combination	StepType=Min	Point=1	X2=-0.5	X3=-0.5	
S11=-437.190975973207	IsS11Max=No	IsS11Min=Yes	FrameElem=41	ElemStation=0.25				
Frame=41	Station=0.25	OutputCase=ENVE	CaseType=Combination	StepType=Min	Point=2	X2=-0.5	X3=0.5	
S11=-437.190975973207	IsS11Max=No	IsS11Min=No	FrameElem=41	ElemStation=0.25				
Frame=41	Station=0.25	OutputCase=ENVE	CaseType=Combination	StepType=Min	Point=3	X2=0.5	X3=-0.5	
S11=-98.6896680801225	IsS11Max=Yes	IsS11Min=No	FrameElem=41	ElemStation=0.25				
Frame=41	Station=0.25	OutputCase=ENVE	CaseType=Combination	StepType=Min	Point=4	X2=0.5	X3=0.5	
S11=-98.6896680801225	IsS11Max=No	IsS11Min=No	FrameElem=41	ElemStation=0.25				
Frame=41	Station=0.375	OutputCase=ENVE	CaseType=Combination	StepType=Min	Point=0	X2=0	X3=0	S11=-
240.528987364651	IsS11Max=No	IsS11Min=No	FrameElem=41	ElemStation=0.375				
Frame=41	Station=0.375	OutputCase=ENVE	CaseType=Combination	StepType=Min	Point=1	X2=-0.5	X3=-0.5	
S11=-709.934476079505	IsS11Max=No	IsS11Min=Yes	FrameElem=41	ElemStation=0.375				
Frame=41	Station=0.375	OutputCase=ENVE	CaseType=Combination	StepType=Min	Point=2	X2=-0.5	X3=0.5	
S11=-709.934476079505	IsS11Max=No	IsS11Min=No	FrameElem=41	ElemStation=0.375				
Frame=41	Station=0.375	OutputCase=ENVE	CaseType=Combination	StepType=Min	Point=3	X2=0.5	X3=-0.5	
S11=168.082050894248	IsS11Max=Yes	IsS11Min=No	FrameElem=41	ElemStation=0.375				
Frame=41	Station=0.375	OutputCase=ENVE	CaseType=Combination	StepType=Min	Point=4	X2=0.5	X3=0.5	
S11=168.082050894248	IsS11Max=No	IsS11Min=No	FrameElem=41	ElemStation=0.375				
Frame=41	Station=0.5	OutputCase=ENVE	CaseType=Combination	StepType=Min	Point=0	X2=0	X3=0	S11=-
240.528987364651	IsS11Max=No	IsS11Min=No	FrameElem=41	ElemStation=0.5				
Frame=41	Station=0.5	OutputCase=ENVE	CaseType=Combination	StepType=Min	Point=1	X2=-0.5	X3=-0.5	
S11=-985.021726185802	IsS11Max=No	IsS11Min=Yes	FrameElem=41	ElemStation=0.5				
Frame=41	Station=0.5	OutputCase=ENVE	CaseType=Combination	StepType=Min	Point=2	X2=-0.5	X3=0.5	
S11=-985.021726185802	IsS11Max=No	IsS11Min=No	FrameElem=41	ElemStation=0.5				
Frame=41	Station=0.5	OutputCase=ENVE	CaseType=Combination	StepType=Min	Point=3	X2=0.5	X3=-0.5	
S11=437.197519868619	IsS11Max=Yes	IsS11Min=No	FrameElem=41	ElemStation=0.5				
Frame=41	Station=0.5	OutputCase=ENVE	CaseType=Combination	StepType=Min	Point=4	X2=0.5	X3=0.5	
S11=437.197519868619	IsS11Max=No	IsS11Min=No	FrameElem=41	ElemStation=0.5				
Frame=41	Station=0	OutputCase=FESSUR	CaseType=Combination	Point=0	X2=0	X3=0	S11=-239.151922837248	
IsS11Max=No	IsS11Min=No	FrameElem=41	ElemStation=0					
Frame=41	Station=0	OutputCase=FESSUR	CaseType=Combination	Point=1	X2=-0.5	X3=-0.5		
S11=119.793772429108	IsS11Max=Yes	IsS11Min=No	FrameElem=41	ElemStation=0				
Frame=41	Station=0	OutputCase=FESSUR	CaseType=Combination	Point=2	X2=-0.5	X3=0.5		
S11=119.793772429108	IsS11Max=No	IsS11Min=No	FrameElem=41	ElemStation=0				
Frame=41	Station=0	OutputCase=FESSUR	CaseType=Combination	Point=3	X2=0.5	X3=-0.5	S11=-	
598.097618103604	IsS11Max=No	IsS11Min=Yes	FrameElem=41	ElemStation=0				
Frame=41	Station=0	OutputCase=FESSUR	CaseType=Combination	Point=4	X2=0.5	X3=0.5	S11=-	
598.097618103604	IsS11Max=No	IsS11Min=No	FrameElem=41	ElemStation=0				
Frame=41	Station=0.125	OutputCase=FESSUR	CaseType=Combination	Point=0	X2=0	X3=0	S11=-	
239.151922837248	IsS11Max=No	IsS11Min=No	FrameElem=41	ElemStation=0.125				
Frame=41	Station=0.125	OutputCase=FESSUR	CaseType=Combination	Point=1	X2=-0.5	X3=-0.5	S11=-	
146.233482644635	IsS11Max=Yes	IsS11Min=No	FrameElem=41	ElemStation=0.125				
Frame=41	Station=0.125	OutputCase=FESSUR	CaseType=Combination	Point=2	X2=-0.5	X3=0.5	S11=-	
146.233482644635	IsS11Max=No	IsS11Min=No	FrameElem=41	ElemStation=0.125				
Frame=41	Station=0.125	OutputCase=FESSUR	CaseType=Combination	Point=3	X2=0.5	X3=-0.5	S11=-	
332.070363029861	IsS11Max=No	IsS11Min=Yes	FrameElem=41	ElemStation=0.125				
Frame=41	Station=0.125	OutputCase=FESSUR	CaseType=Combination	Point=4	X2=0.5	X3=0.5	S11=-	
332.070363029861	IsS11Max=No	IsS11Min=No	FrameElem=41	ElemStation=0.125				
Frame=41	Station=0.25	OutputCase=FESSUR	CaseType=Combination	Point=0	X2=0	X3=0	S11=-	
239.151922837248	IsS11Max=No	IsS11Min=No	FrameElem=41	ElemStation=0.25				
Frame=41	Station=0.25	OutputCase=FESSUR	CaseType=Combination	Point=1	X2=-0.5	X3=-0.5	S11=-	
414.604487718378	IsS11Max=No	IsS11Min=Yes	FrameElem=41	ElemStation=0.25				
Frame=41	Station=0.25	OutputCase=FESSUR	CaseType=Combination	Point=2	X2=-0.5	X3=0.5	S11=-	
414.604487718378	IsS11Max=No	IsS11Min=No	FrameElem=41	ElemStation=0.25				
Frame=41	Station=0.25	OutputCase=FESSUR	CaseType=Combination	Point=3	X2=0.5	X3=-0.5	S11=-	
63.6993579561181	IsS11Max=Yes	IsS11Min=No	FrameElem=41	ElemStation=0.25				
Frame=41	Station=0.25	OutputCase=FESSUR	CaseType=Combination	Point=4	X2=0.5	X3=0.5	S11=-	
63.6993579561181	IsS11Max=No	IsS11Min=No	FrameElem=41	ElemStation=0.25				
Frame=41	Station=0.375	OutputCase=FESSUR	CaseType=Combination	Point=0	X2=0	X3=0	S11=-	
239.151922837248	IsS11Max=No	IsS11Min=No	FrameElem=41	ElemStation=0.375				
Frame=41	Station=0.375	OutputCase=FESSUR	CaseType=Combination	Point=1	X2=-0.5	X3=-0.5	S11=-	
685.319242792121	IsS11Max=No	IsS11Min=Yes	FrameElem=41	ElemStation=0.375				
Frame=41	Station=0.375	OutputCase=FESSUR	CaseType=Combination	Point=2	X2=-0.5	X3=0.5	S11=-	
685.319242792121	IsS11Max=No	IsS11Min=No	FrameElem=41	ElemStation=0.375				
Frame=41	Station=0.375	OutputCase=FESSUR	CaseType=Combination	Point=3	X2=0.5	X3=-0.5		
S11=207.015397117625	IsS11Max=Yes	IsS11Min=No	FrameElem=41	ElemStation=0.375				
Frame=41	Station=0.375	OutputCase=FESSUR	CaseType=Combination	Point=4	X2=0.5	X3=0.5		
S11=207.015397117625	IsS11Max=No	IsS11Min=No	FrameElem=41	ElemStation=0.375				
Frame=41	Station=0.5	OutputCase=FESSUR	CaseType=Combination	Point=0	X2=0	X3=0	S11=-239.151922837248	
IsS11Max=No	IsS11Min=No	FrameElem=41	ElemStation=0.5					
Frame=41	Station=0.5	OutputCase=FESSUR	CaseType=Combination	Point=1	X2=-0.5	X3=-0.5	S11=-	
958.377747865864	IsS11Max=No	IsS11Min=Yes	FrameElem=41	ElemStation=0.5				
Frame=41	Station=0.5	OutputCase=FESSUR	CaseType=Combination	Point=2	X2=-0.5	X3=0.5	S11=-	
958.377747865864	IsS11Max=No	IsS11Min=No	FrameElem=41	ElemStation=0.5				
Frame=41	Station=0.5	OutputCase=FESSUR	CaseType=Combination	Point=3	X2=0.5	X3=-0.5		
S11=480.073902191368	IsS11Max=Yes	IsS11Min=No	FrameElem=41	ElemStation=0.5				
Frame=41	Station=0.5	OutputCase=FESSUR	CaseType=Combination	Point=4	X2=0.5	X3=0.5		
S11=480.073902191368	IsS11Max=No	IsS11Min=No	FrameElem=41	ElemStation=0.5				
Frame=42	Station=0	OutputCase=PERM1	CaseType=Combination	Point=0	X2=0	X3=0	S11=-235.938772273309	
IsS11Max=No	IsS11Min=No	FrameElem=42	ElemStation=0					

Frame=42	Station=0	OutputCase=PERM1	CaseType=Combination	Point=1	X2=-0.5	X3=-0.5	S11=-
941.496487013998	IsS11Max=No	IsS11Min=Yes	FrameElem=42	ElemStation=0			
Frame=42	Station=0	OutputCase=PERM1	CaseType=Combination	Point=2	X2=-0.5	X3=0.5	S11=-
941.496487013998	IsS11Max=No	IsS11Min=No	FrameElem=42	ElemStation=0			
Frame=42	Station=0	OutputCase=PERM1	CaseType=Combination	Point=3	X2=0.5	X3=-0.5	
S11=469.618942467381	IsS11Max=Yes	IsS11Min=No	FrameElem=42	ElemStation=0			
Frame=42	Station=0	OutputCase=PERM1	CaseType=Combination	Point=4	X2=0.5	X3=0.5	S11=469.618942467381
IsS11Max=No	IsS11Min=No	FrameElem=42	ElemStation=0				
Frame=42	Station=0.125	OutputCase=PERM1	CaseType=Combination	Point=0	X2=0	X3=0	S11=-
235.938772273309	IsS11Max=No	IsS11Min=No	FrameElem=42	ElemStation=0.125			
Frame=42	Station=0.125	OutputCase=PERM1	CaseType=Combination	Point=1	X2=-0.5	X3=-0.5	S11=-
1126.28889045709	IsS11Max=No	IsS11Min=Yes	FrameElem=42	ElemStation=0.125			
Frame=42	Station=0.125	OutputCase=PERM1	CaseType=Combination	Point=2	X2=-0.5	X3=0.5	S11=-
1126.28889045709	IsS11Max=No	IsS11Min=No	FrameElem=42	ElemStation=0.125			
Frame=42	Station=0.125	OutputCase=PERM1	CaseType=Combination	Point=3	X2=0.5	X3=-0.5	
S11=654.411345910472	IsS11Max=Yes	IsS11Min=No	FrameElem=42	ElemStation=0.125			
Frame=42	Station=0.125	OutputCase=PERM1	CaseType=Combination	Point=4	X2=0.5	X3=0.5	
S11=654.411345910472	IsS11Max=No	IsS11Min=No	FrameElem=42	ElemStation=0.125			
Frame=42	Station=0.25	OutputCase=PERM1	CaseType=Combination	Point=0	X2=0	X3=0	S11=-235.938772273309
IsS11Max=No	IsS11Min=No	FrameElem=42	ElemStation=0.25				
Frame=42	Station=0.25	OutputCase=PERM1	CaseType=Combination	Point=1	X2=-0.5	X3=-0.5	S11=-
1313.42504390018	IsS11Max=No	IsS11Min=Yes	FrameElem=42	ElemStation=0.25			
Frame=42	Station=0.25	OutputCase=PERM1	CaseType=Combination	Point=2	X2=-0.5	X3=0.5	S11=-
1313.42504390018	IsS11Max=No	IsS11Min=No	FrameElem=42	ElemStation=0.25			
Frame=42	Station=0.25	OutputCase=PERM1	CaseType=Combination	Point=3	X2=0.5	X3=-0.5	
S11=841.547499353562	IsS11Max=Yes	IsS11Min=No	FrameElem=42	ElemStation=0.25			
Frame=42	Station=0.25	OutputCase=PERM1	CaseType=Combination	Point=4	X2=0.5	X3=0.5	
S11=841.547499353562	IsS11Max=No	IsS11Min=No	FrameElem=42	ElemStation=0.25			
Frame=42	Station=0.375	OutputCase=PERM1	CaseType=Combination	Point=0	X2=0	X3=0	S11=-
235.938772273309	IsS11Max=No	IsS11Min=No	FrameElem=42	ElemStation=0.375			
Frame=42	Station=0.375	OutputCase=PERM1	CaseType=Combination	Point=1	X2=-0.5	X3=-0.5	S11=-
1502.90494734327	IsS11Max=No	IsS11Min=Yes	FrameElem=42	ElemStation=0.375			
Frame=42	Station=0.375	OutputCase=PERM1	CaseType=Combination	Point=2	X2=-0.5	X3=0.5	S11=-
1502.90494734327	IsS11Max=No	IsS11Min=No	FrameElem=42	ElemStation=0.375			
Frame=42	Station=0.375	OutputCase=PERM1	CaseType=Combination	Point=3	X2=0.5	X3=-0.5	
S11=1031.02740279665	IsS11Max=Yes	IsS11Min=No	FrameElem=42	ElemStation=0.375			
Frame=42	Station=0.375	OutputCase=PERM1	CaseType=Combination	Point=4	X2=0.5	X3=0.5	
S11=1031.02740279665	IsS11Max=No	IsS11Min=No	FrameElem=42	ElemStation=0.375			
Frame=42	Station=0.5	OutputCase=PERM1	CaseType=Combination	Point=0	X2=0	X3=0	S11=-235.938772273309
IsS11Max=No	IsS11Min=No	FrameElem=42	ElemStation=0.5				
Frame=42	Station=0.5	OutputCase=PERM1	CaseType=Combination	Point=1	X2=-0.5	X3=-0.5	S11=-
1694.72860078636	IsS11Max=No	IsS11Min=Yes	FrameElem=42	ElemStation=0.5			
Frame=42	Station=0.5	OutputCase=PERM1	CaseType=Combination	Point=2	X2=-0.5	X3=0.5	S11=-
1694.72860078636	IsS11Max=No	IsS11Min=No	FrameElem=42	ElemStation=0.5			
Frame=42	Station=0.5	OutputCase=PERM1	CaseType=Combination	Point=3	X2=0.5	X3=-0.5	
S11=1222.85105623974	IsS11Max=Yes	IsS11Min=No	FrameElem=42	ElemStation=0.5			
Frame=42	Station=0.5	OutputCase=PERM1	CaseType=Combination	Point=4	X2=0.5	X3=0.5	
S11=1222.85105623974	IsS11Max=No	IsS11Min=No	FrameElem=42	ElemStation=0.5			
Frame=42	Station=0	OutputCase=PERM2	CaseType=Combination	Point=0	X2=0	X3=0	S11=-169.465538592139
IsS11Max=No	IsS11Min=No	FrameElem=42	ElemStation=0				
Frame=42	Station=0	OutputCase=PERM2	CaseType=Combination	Point=1	X2=-0.5	X3=-0.5	S11=-
960.905639254556	IsS11Max=No	IsS11Min=Yes	FrameElem=42	ElemStation=0			
Frame=42	Station=0	OutputCase=PERM2	CaseType=Combination	Point=2	X2=-0.5	X3=0.5	S11=-
960.905639254556	IsS11Max=No	IsS11Min=No	FrameElem=42	ElemStation=0			
Frame=42	Station=0	OutputCase=PERM2	CaseType=Combination	Point=3	X2=0.5	X3=-0.5	
S11=621.974562070279	IsS11Max=Yes	IsS11Min=No	FrameElem=42	ElemStation=0			
Frame=42	Station=0	OutputCase=PERM2	CaseType=Combination	Point=4	X2=0.5	X3=0.5	S11=621.974562070279
IsS11Max=No	IsS11Min=No	FrameElem=42	ElemStation=0				
Frame=42	Station=0.125	OutputCase=PERM2	CaseType=Combination	Point=0	X2=0	X3=0	S11=-
169.465538592139	IsS11Max=No	IsS11Min=No	FrameElem=42	ElemStation=0.125			
Frame=42	Station=0.125	OutputCase=PERM2	CaseType=Combination	Point=1	X2=-0.5	X3=-0.5	S11=-
1145.60467402482	IsS11Max=No	IsS11Min=Yes	FrameElem=42	ElemStation=0.125			
Frame=42	Station=0.125	OutputCase=PERM2	CaseType=Combination	Point=2	X2=-0.5	X3=0.5	S11=-
1145.60467402482	IsS11Max=No	IsS11Min=No	FrameElem=42	ElemStation=0.125			
Frame=42	Station=0.125	OutputCase=PERM2	CaseType=Combination	Point=3	X2=0.5	X3=-0.5	
S11=806.673596840543	IsS11Max=Yes	IsS11Min=No	FrameElem=42	ElemStation=0.125			
Frame=42	Station=0.125	OutputCase=PERM2	CaseType=Combination	Point=4	X2=0.5	X3=0.5	
S11=806.673596840543	IsS11Max=No	IsS11Min=No	FrameElem=42	ElemStation=0.125			
Frame=42	Station=0.25	OutputCase=PERM2	CaseType=Combination	Point=0	X2=0	X3=0	S11=-169.465538592139
IsS11Max=No	IsS11Min=No	FrameElem=42	ElemStation=0.25				
Frame=42	Station=0.25	OutputCase=PERM2	CaseType=Combination	Point=1	X2=-0.5	X3=-0.5	S11=-
1332.64745879509	IsS11Max=No	IsS11Min=Yes	FrameElem=42	ElemStation=0.25			
Frame=42	Station=0.25	OutputCase=PERM2	CaseType=Combination	Point=2	X2=-0.5	X3=0.5	S11=-
1332.64745879509	IsS11Max=No	IsS11Min=No	FrameElem=42	ElemStation=0.25			
Frame=42	Station=0.25	OutputCase=PERM2	CaseType=Combination	Point=3	X2=0.5	X3=-0.5	
S11=993.716381610808	IsS11Max=Yes	IsS11Min=No	FrameElem=42	ElemStation=0.25			
Frame=42	Station=0.25	OutputCase=PERM2	CaseType=Combination	Point=4	X2=0.5	X3=0.5	
S11=993.716381610808	IsS11Max=No	IsS11Min=No	FrameElem=42	ElemStation=0.25			
Frame=42	Station=0.375	OutputCase=PERM2	CaseType=Combination	Point=0	X2=0	X3=0	S11=-
169.465538592139	IsS11Max=No	IsS11Min=No	FrameElem=42	ElemStation=0.375			
Frame=42	Station=0.375	OutputCase=PERM2	CaseType=Combination	Point=1	X2=-0.5	X3=-0.5	S11=-
1522.03399356535	IsS11Max=No	IsS11Min=Yes	FrameElem=42	ElemStation=0.375			

Frame=42	Station=0.375	OutputCase=PERM2	CaseType=Combination	Point=2	X2=-0.5	X3=0.5	S11=-
1522.03399356535	IsS11Max=No	IsS11Min=No	FrameElem=42	ElemStation=0.375			
Frame=42	Station=0.375	OutputCase=PERM2	CaseType=Combination	Point=3	X2=0.5	X3=-0.5	
S11=1183.10291638107	IsS11Max=Yes	IsS11Min=No	FrameElem=42	ElemStation=0.375			
Frame=42	Station=0.375	OutputCase=PERM2	CaseType=Combination	Point=4	X2=0.5	X3=0.5	
S11=1183.10291638107	IsS11Max=No	IsS11Min=No	FrameElem=42	ElemStation=0.375			
Frame=42	Station=0.5	OutputCase=PERM2	CaseType=Combination	Point=0	X2=0	X3=0	S11=-169.465538592139
IsS11Max=No	IsS11Min=No	FrameElem=42	ElemStation=0.5				
Frame=42	Station=0.5	OutputCase=PERM2	CaseType=Combination	Point=1	X2=-0.5	X3=-0.5	S11=-
1713.76427833561	IsS11Max=No	IsS11Min=Yes	FrameElem=42	ElemStation=0.5			
Frame=42	Station=0.5	OutputCase=PERM2	CaseType=Combination	Point=2	X2=-0.5	X3=0.5	S11=-
1713.76427833561	IsS11Max=No	IsS11Min=No	FrameElem=42	ElemStation=0.5			
Frame=42	Station=0.5	OutputCase=PERM2	CaseType=Combination	Point=3	X2=0.5	X3=-0.5	
S11=1374.83320115134	IsS11Max=Yes	IsS11Min=No	FrameElem=42	ElemStation=0.5			
Frame=42	Station=0.5	OutputCase=PERM2	CaseType=Combination	Point=4	X2=0.5	X3=0.5	
S11=1374.83320115134	IsS11Max=No	IsS11Min=No	FrameElem=42	ElemStation=0.5			
Frame=42	Station=0	OutputCase=ACC1	CaseType=Combination	Point=0	X2=0	X3=0	S11=-240.528987364651
IsS11Max=No	IsS11Min=No	FrameElem=42	ElemStation=0				
Frame=42	Station=0	OutputCase=ACC1	CaseType=Combination	Point=1	X2=-0.5	X3=-0.5	S11=-
965.612573945267	IsS11Max=No	IsS11Min=Yes	FrameElem=42	ElemStation=0			
Frame=42	Station=0	OutputCase=ACC1	CaseType=Combination	Point=2	X2=-0.5	X3=0.5	S11=-
965.612573945267	IsS11Max=No	IsS11Min=No	FrameElem=42	ElemStation=0			
Frame=42	Station=0	OutputCase=ACC1	CaseType=Combination	Point=3	X2=0.5	X3=-0.5	S11=484.554599215966
IsS11Max=Yes	IsS11Min=No	FrameElem=42	ElemStation=0				
Frame=42	Station=0	OutputCase=ACC1	CaseType=Combination	Point=4	X2=0.5	X3=0.5	S11=484.554599215966
IsS11Max=No	IsS11Min=No	FrameElem=42	ElemStation=0				
Frame=42	Station=0.125	OutputCase=ACC1	CaseType=Combination	Point=0	X2=0	X3=0	S11=-240.528987364651
IsS11Max=No	IsS11Min=No	FrameElem=42	ElemStation=0.125				
Frame=42	Station=0.125	OutputCase=ACC1	CaseType=Combination	Point=1	X2=-0.5	X3=-0.5	S11=-
1155.43187127495	IsS11Max=No	IsS11Min=Yes	FrameElem=42	ElemStation=0.125			
Frame=42	Station=0.125	OutputCase=ACC1	CaseType=Combination	Point=2	X2=-0.5	X3=0.5	S11=-
1155.43187127495	IsS11Max=No	IsS11Min=No	FrameElem=42	ElemStation=0.125			
Frame=42	Station=0.125	OutputCase=ACC1	CaseType=Combination	Point=3	X2=0.5	X3=-0.5	
S11=674.373896545649	IsS11Max=Yes	IsS11Min=No	FrameElem=42	ElemStation=0.125			
Frame=42	Station=0.125	OutputCase=ACC1	CaseType=Combination	Point=4	X2=0.5	X3=0.5	
S11=674.373896545649	IsS11Max=No	IsS11Min=No	FrameElem=42	ElemStation=0.125			
Frame=42	Station=0.25	OutputCase=ACC1	CaseType=Combination	Point=0	X2=0	X3=0	S11=-240.528987364651
IsS11Max=No	IsS11Min=No	FrameElem=42	ElemStation=0.25				
Frame=42	Station=0.25	OutputCase=ACC1	CaseType=Combination	Point=1	X2=-0.5	X3=-0.5	S11=-
1347.59491860463	IsS11Max=No	IsS11Min=Yes	FrameElem=42	ElemStation=0.25			
Frame=42	Station=0.25	OutputCase=ACC1	CaseType=Combination	Point=2	X2=-0.5	X3=0.5	S11=-
1347.59491860463	IsS11Max=No	IsS11Min=No	FrameElem=42	ElemStation=0.25			
Frame=42	Station=0.25	OutputCase=ACC1	CaseType=Combination	Point=3	X2=0.5	X3=-0.5	
S11=866.536943875332	IsS11Max=Yes	IsS11Min=No	FrameElem=42	ElemStation=0.25			
Frame=42	Station=0.25	OutputCase=ACC1	CaseType=Combination	Point=4	X2=0.5	X3=0.5	
S11=866.536943875332	IsS11Max=No	IsS11Min=No	FrameElem=42	ElemStation=0.25			
Frame=42	Station=0.375	OutputCase=ACC1	CaseType=Combination	Point=0	X2=0	X3=0	S11=-240.528987364651
IsS11Max=No	IsS11Min=No	FrameElem=42	ElemStation=0.375				
Frame=42	Station=0.375	OutputCase=ACC1	CaseType=Combination	Point=1	X2=-0.5	X3=-0.5	S11=-
1542.10171593432	IsS11Max=No	IsS11Min=Yes	FrameElem=42	ElemStation=0.375			
Frame=42	Station=0.375	OutputCase=ACC1	CaseType=Combination	Point=2	X2=-0.5	X3=0.5	S11=-
1542.10171593432	IsS11Max=No	IsS11Min=No	FrameElem=42	ElemStation=0.375			
Frame=42	Station=0.375	OutputCase=ACC1	CaseType=Combination	Point=3	X2=0.5	X3=-0.5	
S11=1061.04374120502	IsS11Max=Yes	IsS11Min=No	FrameElem=42	ElemStation=0.375			
Frame=42	Station=0.375	OutputCase=ACC1	CaseType=Combination	Point=4	X2=0.5	X3=0.5	
S11=1061.04374120502	IsS11Max=No	IsS11Min=No	FrameElem=42	ElemStation=0.375			
Frame=42	Station=0.5	OutputCase=ACC1	CaseType=Combination	Point=0	X2=0	X3=0	S11=-240.528987364651
IsS11Max=No	IsS11Min=No	FrameElem=42	ElemStation=0.5				
Frame=42	Station=0.5	OutputCase=ACC1	CaseType=Combination	Point=1	X2=-0.5	X3=-0.5	S11=-
1738.952263264	IsS11Max=No	IsS11Min=Yes	FrameElem=42	ElemStation=0.5			
Frame=42	Station=0.5	OutputCase=ACC1	CaseType=Combination	Point=2	X2=-0.5	X3=0.5	S11=-
1738.952263264	IsS11Max=No	IsS11Min=No	FrameElem=42	ElemStation=0.5			
Frame=42	Station=0.5	OutputCase=ACC1	CaseType=Combination	Point=3	X2=0.5	X3=-0.5	
S11=1257.8942885347	IsS11Max=Yes	IsS11Min=No	FrameElem=42	ElemStation=0.5			
Frame=42	Station=0.5	OutputCase=ACC1	CaseType=Combination	Point=4	X2=0.5	X3=0.5	S11=1257.8942885347
IsS11Max=No	IsS11Min=No	FrameElem=42	ElemStation=0.5				
Frame=42	Station=0	OutputCase=ACC2	CaseType=Combination	Point=0	X2=0	X3=0	S11=-174.055753683481
IsS11Max=No	IsS11Min=No	FrameElem=42	ElemStation=0				
Frame=42	Station=0	OutputCase=ACC2	CaseType=Combination	Point=1	X2=-0.5	X3=-0.5	S11=-
985.021726185825	IsS11Max=No	IsS11Min=Yes	FrameElem=42	ElemStation=0			
Frame=42	Station=0	OutputCase=ACC2	CaseType=Combination	Point=2	X2=-0.5	X3=0.5	S11=-
985.021726185825	IsS11Max=No	IsS11Min=No	FrameElem=42	ElemStation=0			
Frame=42	Station=0	OutputCase=ACC2	CaseType=Combination	Point=3	X2=0.5	X3=-0.5	S11=636.910218818864
IsS11Max=Yes	IsS11Min=No	FrameElem=42	ElemStation=0				
Frame=42	Station=0	OutputCase=ACC2	CaseType=Combination	Point=4	X2=0.5	X3=0.5	S11=636.910218818864
IsS11Max=No	IsS11Min=No	FrameElem=42	ElemStation=0				
Frame=42	Station=0.125	OutputCase=ACC2	CaseType=Combination	Point=0	X2=0	X3=0	S11=-174.055753683481
IsS11Max=No	IsS11Min=No	FrameElem=42	ElemStation=0.125				
Frame=42	Station=0.125	OutputCase=ACC2	CaseType=Combination	Point=1	X2=-0.5	X3=-0.5	S11=-
1174.74765484268	IsS11Max=No	IsS11Min=Yes	FrameElem=42	ElemStation=0.125			
Frame=42	Station=0.125	OutputCase=ACC2	CaseType=Combination	Point=2	X2=-0.5	X3=0.5	S11=-
1174.74765484268	IsS11Max=No	IsS11Min=No	FrameElem=42	ElemStation=0.125			

Frame=42	Station=0.125	OutputCase=ACC2	CaseType=Combination	Point=3	X2=0.5	X3=-0.5	
S11=826.636147475721	IsS11Max=Yes	IsS11Min=No	FrameElem=42	ElemStation=0.125			
Frame=42	Station=0.125	OutputCase=ACC2	CaseType=Combination	Point=4	X2=0.5	X3=0.5	
S11=826.636147475721	IsS11Max=No	IsS11Min=No	FrameElem=42	ElemStation=0.125			
Frame=42	Station=0.25	OutputCase=ACC2	CaseType=Combination	Point=0	X2=0	X3=0	S11=-174.055753683481
IsS11Max=No	IsS11Min=No	FrameElem=42	ElemStation=0.25				
Frame=42	Station=0.25	OutputCase=ACC2	CaseType=Combination	Point=1	X2=-0.5	X3=-0.5	S11=-
1366.81733349954	IsS11Max=No	IsS11Min=Yes	FrameElem=42	ElemStation=0.25			
Frame=42	Station=0.25	OutputCase=ACC2	CaseType=Combination	Point=2	X2=-0.5	X3=0.5	S11=-
1366.81733349954	IsS11Max=No	IsS11Min=No	FrameElem=42	ElemStation=0.25			
Frame=42	Station=0.25	OutputCase=ACC2	CaseType=Combination	Point=3	X2=0.5	X3=-0.5	
S11=1018.70582613258	IsS11Max=Yes	IsS11Min=No	FrameElem=42	ElemStation=0.25			
Frame=42	Station=0.25	OutputCase=ACC2	CaseType=Combination	Point=4	X2=0.5	X3=0.5	
S11=1018.70582613258	IsS11Max=No	IsS11Min=No	FrameElem=42	ElemStation=0.25			
Frame=42	Station=0.375	OutputCase=ACC2	CaseType=Combination	Point=0	X2=0	X3=0	S11=-174.055753683481
IsS11Max=No	IsS11Min=No	FrameElem=42	ElemStation=0.375				
Frame=42	Station=0.375	OutputCase=ACC2	CaseType=Combination	Point=1	X2=-0.5	X3=-0.5	S11=-
1561.2307621564	IsS11Max=No	IsS11Min=Yes	FrameElem=42	ElemStation=0.375			
Frame=42	Station=0.375	OutputCase=ACC2	CaseType=Combination	Point=2	X2=-0.5	X3=0.5	S11=-
1561.2307621564	IsS11Max=No	IsS11Min=No	FrameElem=42	ElemStation=0.375			
Frame=42	Station=0.375	OutputCase=ACC2	CaseType=Combination	Point=3	X2=0.5	X3=-0.5	
S11=1213.11925478943	IsS11Max=Yes	IsS11Min=No	FrameElem=42	ElemStation=0.375			
Frame=42	Station=0.375	OutputCase=ACC2	CaseType=Combination	Point=4	X2=0.5	X3=0.5	
S11=1213.11925478943	IsS11Max=No	IsS11Min=No	FrameElem=42	ElemStation=0.375			
Frame=42	Station=0.5	OutputCase=ACC2	CaseType=Combination	Point=0	X2=0	X3=0	S11=-174.055753683481
IsS11Max=No	IsS11Min=No	FrameElem=42	ElemStation=0.5				
Frame=42	Station=0.5	OutputCase=ACC2	CaseType=Combination	Point=1	X2=-0.5	X3=-0.5	S11=-
1757.98794081325	IsS11Max=No	IsS11Min=Yes	FrameElem=42	ElemStation=0.5			
Frame=42	Station=0.5	OutputCase=ACC2	CaseType=Combination	Point=2	X2=-0.5	X3=0.5	S11=-
1757.98794081325	IsS11Max=No	IsS11Min=No	FrameElem=42	ElemStation=0.5			
Frame=42	Station=0.5	OutputCase=ACC2	CaseType=Combination	Point=3	X2=0.5	X3=-0.5	
S11=1409.87643344629	IsS11Max=Yes	IsS11Min=No	FrameElem=42	ElemStation=0.5			
Frame=42	Station=0.5	OutputCase=ACC2	CaseType=Combination	Point=4	X2=0.5	X3=0.5	
S11=1409.87643344629	IsS11Max=No	IsS11Min=No	FrameElem=42	ElemStation=0.5			
Frame=42	Station=0	OutputCase=ACCSX1	CaseType=Combination	Point=0	X2=0	X3=0	S11=-233.665974282453
IsS11Max=No	IsS11Min=No	FrameElem=42	ElemStation=0				
Frame=42	Station=0	OutputCase=ACCSX1	CaseType=Combination	Point=1	X2=-0.5	X3=-0.5	S11=-
904.529468433546	IsS11Max=No	IsS11Min=Yes	FrameElem=42	ElemStation=0			
Frame=42	Station=0	OutputCase=ACCSX1	CaseType=Combination	Point=2	X2=-0.5	X3=0.5	S11=-
904.529468433546	IsS11Max=No	IsS11Min=No	FrameElem=42	ElemStation=0			
Frame=42	Station=0	OutputCase=ACCSX1	CaseType=Combination	Point=3	X2=0.5	X3=-0.5	
S11=437.197519868641	IsS11Max=Yes	IsS11Min=No	FrameElem=42	ElemStation=0			
Frame=42	Station=0	OutputCase=ACCSX1	CaseType=Combination	Point=4	X2=0.5	X3=0.5	
S11=437.197519868641	IsS11Max=No	IsS11Min=No	FrameElem=42	ElemStation=0			
Frame=42	Station=0.125	OutputCase=ACCSX1	CaseType=Combination	Point=0	X2=0	X3=0	S11=-
233.665974282453	IsS11Max=No	IsS11Min=No	FrameElem=42	ElemStation=0.125			
Frame=42	Station=0.125	OutputCase=ACCSX1	CaseType=Combination	Point=1	X2=-0.5	X3=-0.5	S11=-
1091.30014927963	IsS11Max=No	IsS11Min=Yes	FrameElem=42	ElemStation=0.125			
Frame=42	Station=0.125	OutputCase=ACCSX1	CaseType=Combination	Point=2	X2=-0.5	X3=0.5	S11=-
1091.30014927963	IsS11Max=No	IsS11Min=No	FrameElem=42	ElemStation=0.125			
Frame=42	Station=0.125	OutputCase=ACCSX1	CaseType=Combination	Point=3	X2=0.5	X3=-0.5	
S11=623.968200714727	IsS11Max=Yes	IsS11Min=No	FrameElem=42	ElemStation=0.125			
Frame=42	Station=0.125	OutputCase=ACCSX1	CaseType=Combination	Point=4	X2=0.5	X3=0.5	
S11=623.968200714727	IsS11Max=No	IsS11Min=No	FrameElem=42	ElemStation=0.125			
Frame=42	Station=0.25	OutputCase=ACCSX1	CaseType=Combination	Point=0	X2=0	X3=0	S11=-
233.665974282453	IsS11Max=No	IsS11Min=No	FrameElem=42	ElemStation=0.25			
Frame=42	Station=0.25	OutputCase=ACCSX1	CaseType=Combination	Point=1	X2=-0.5	X3=-0.5	S11=-
1280.41458012572	IsS11Max=No	IsS11Min=Yes	FrameElem=42	ElemStation=0.25			
Frame=42	Station=0.25	OutputCase=ACCSX1	CaseType=Combination	Point=2	X2=-0.5	X3=0.5	S11=-
1280.41458012572	IsS11Max=No	IsS11Min=No	FrameElem=42	ElemStation=0.25			
Frame=42	Station=0.25	OutputCase=ACCSX1	CaseType=Combination	Point=3	X2=0.5	X3=-0.5	
S11=813.082631560813	IsS11Max=Yes	IsS11Min=No	FrameElem=42	ElemStation=0.25			
Frame=42	Station=0.25	OutputCase=ACCSX1	CaseType=Combination	Point=4	X2=0.5	X3=0.5	
S11=813.082631560813	IsS11Max=No	IsS11Min=No	FrameElem=42	ElemStation=0.25			
Frame=42	Station=0.375	OutputCase=ACCSX1	CaseType=Combination	Point=0	X2=0	X3=0	S11=-
233.665974282453	IsS11Max=No	IsS11Min=No	FrameElem=42	ElemStation=0.375			
Frame=42	Station=0.375	OutputCase=ACCSX1	CaseType=Combination	Point=1	X2=-0.5	X3=-0.5	S11=-
1471.8727609718	IsS11Max=No	IsS11Min=Yes	FrameElem=42	ElemStation=0.375			
Frame=42	Station=0.375	OutputCase=ACCSX1	CaseType=Combination	Point=2	X2=-0.5	X3=0.5	S11=-
1471.8727609718	IsS11Max=No	IsS11Min=No	FrameElem=42	ElemStation=0.375			
Frame=42	Station=0.375	OutputCase=ACCSX1	CaseType=Combination	Point=3	X2=0.5	X3=-0.5	
S11=1004.5408124069	IsS11Max=Yes	IsS11Min=No	FrameElem=42	ElemStation=0.375			
Frame=42	Station=0.375	OutputCase=ACCSX1	CaseType=Combination	Point=4	X2=0.5	X3=0.5	
S11=1004.5408124069	IsS11Max=No	IsS11Min=No	FrameElem=42	ElemStation=0.375			
Frame=42	Station=0.5	OutputCase=ACCSX1	CaseType=Combination	Point=0	X2=0	X3=0	S11=-233.665974282453
IsS11Max=No	IsS11Min=No	FrameElem=42	ElemStation=0.5				
Frame=42	Station=0.5	OutputCase=ACCSX1	CaseType=Combination	Point=1	X2=-0.5	X3=-0.5	S11=-
1665.67469181789	IsS11Max=No	IsS11Min=Yes	FrameElem=42	ElemStation=0.5			
Frame=42	Station=0.5	OutputCase=ACCSX1	CaseType=Combination	Point=2	X2=-0.5	X3=0.5	S11=-
1665.67469181789	IsS11Max=No	IsS11Min=No	FrameElem=42	ElemStation=0.5			
Frame=42	Station=0.5	OutputCase=ACCSX1	CaseType=Combination	Point=3	X2=0.5	X3=-0.5	
S11=1198.34274325298	IsS11Max=Yes	IsS11Min=No	FrameElem=42	ElemStation=0.5			

Frame=42 Station=0.5 OutputCase=ACCSX1 CaseType=Combination Point=4 X2=0.5 X3=0.5
S11=1198.34274325298 IsS11Max=No IsS11Min=No FrameElem=42 ElemStation=0.5
Frame=42 Station=0 OutputCase=ACCSX2 CaseType=Combination Point=0 X2=0 X3=0 S11=-167.192740601283
IsS11Max=No IsS11Min=No FrameElem=42 ElemStation=0
Frame=42 Station=0 OutputCase=ACCSX2 CaseType=Combination Point=1 X2=-0.5 X3=-0.5 S11=-
923.938620674104 IsS11Max=No IsS11Min=Yes FrameElem=42 ElemStation=0
Frame=42 Station=0 OutputCase=ACCSX2 CaseType=Combination Point=2 X2=-0.5 X3=0.5 S11=-
923.938620674104 IsS11Max=No IsS11Min=No FrameElem=42 ElemStation=0
Frame=42 Station=0 OutputCase=ACCSX2 CaseType=Combination Point=3 X2=0.5 X3=-0.5
S11=589.553139471539 IsS11Max=Yes IsS11Min=No FrameElem=42 ElemStation=0
Frame=42 Station=0 OutputCase=ACCSX2 CaseType=Combination Point=4 X2=0.5 X3=0.5
S11=589.553139471539 IsS11Max=No IsS11Min=No FrameElem=42 ElemStation=0
Frame=42 Station=0.125 OutputCase=ACCSX2 CaseType=Combination Point=0 X2=0 X3=0 S11=-
167.192740601283 IsS11Max=No IsS11Min=No FrameElem=42 ElemStation=0.125
Frame=42 Station=0.125 OutputCase=ACCSX2 CaseType=Combination Point=1 X2=-0.5 X3=-0.5 S11=-
1110.61593284736 IsS11Max=No IsS11Min=Yes FrameElem=42 ElemStation=0.125
Frame=42 Station=0.125 OutputCase=ACCSX2 CaseType=Combination Point=2 X2=-0.5 X3=0.5 S11=-
1110.61593284736 IsS11Max=No IsS11Min=No FrameElem=42 ElemStation=0.125
Frame=42 Station=0.125 OutputCase=ACCSX2 CaseType=Combination Point=3 X2=0.5 X3=-0.5
S11=776.230451644799 IsS11Max=Yes IsS11Min=No FrameElem=42 ElemStation=0.125
Frame=42 Station=0.125 OutputCase=ACCSX2 CaseType=Combination Point=4 X2=0.5 X3=0.5
S11=776.230451644799 IsS11Max=No IsS11Min=No FrameElem=42 ElemStation=0.125
Frame=42 Station=0.25 OutputCase=ACCSX2 CaseType=Combination Point=0 X2=0 X3=0 S11=-
167.192740601283 IsS11Max=No IsS11Min=No FrameElem=42 ElemStation=0.25
Frame=42 Station=0.25 OutputCase=ACCSX2 CaseType=Combination Point=1 X2=-0.5 X3=-0.5 S11=-
1299.63699502062 IsS11Max=No IsS11Min=Yes FrameElem=42 ElemStation=0.25
Frame=42 Station=0.25 OutputCase=ACCSX2 CaseType=Combination Point=2 X2=-0.5 X3=0.5 S11=-
1299.63699502062 IsS11Max=No IsS11Min=No FrameElem=42 ElemStation=0.25
Frame=42 Station=0.25 OutputCase=ACCSX2 CaseType=Combination Point=3 X2=0.5 X3=-0.5
S11=965.251513818059 IsS11Max=Yes IsS11Min=No FrameElem=42 ElemStation=0.25
Frame=42 Station=0.25 OutputCase=ACCSX2 CaseType=Combination Point=4 X2=0.5 X3=0.5
S11=965.251513818059 IsS11Max=No IsS11Min=No FrameElem=42 ElemStation=0.25
Frame=42 Station=0.375 OutputCase=ACCSX2 CaseType=Combination Point=0 X2=0 X3=0 S11=-
167.192740601283 IsS11Max=No IsS11Min=No FrameElem=42 ElemStation=0.375
Frame=42 Station=0.375 OutputCase=ACCSX2 CaseType=Combination Point=1 X2=-0.5 X3=-0.5 S11=-
1491.00180719388 IsS11Max=No IsS11Min=Yes FrameElem=42 ElemStation=0.375
Frame=42 Station=0.375 OutputCase=ACCSX2 CaseType=Combination Point=2 X2=-0.5 X3=0.5 S11=-
1491.00180719388 IsS11Max=No IsS11Min=No FrameElem=42 ElemStation=0.375
Frame=42 Station=0.375 OutputCase=ACCSX2 CaseType=Combination Point=3 X2=0.5 X3=-0.5
S11=1156.61632599132 IsS11Max=Yes IsS11Min=No FrameElem=42 ElemStation=0.375
Frame=42 Station=0.375 OutputCase=ACCSX2 CaseType=Combination Point=4 X2=0.5 X3=0.5
S11=1156.61632599132 IsS11Max=No IsS11Min=No FrameElem=42 ElemStation=0.375
Frame=42 Station=0.5 OutputCase=ACCSX2 CaseType=Combination Point=0 X2=0 X3=0 S11=-167.192740601283
IsS11Max=No IsS11Min=No FrameElem=42 ElemStation=0.5
Frame=42 Station=0.5 OutputCase=ACCSX2 CaseType=Combination Point=1 X2=-0.5 X3=-0.5 S11=-
1684.71036936714 IsS11Max=No IsS11Min=Yes FrameElem=42 ElemStation=0.5
Frame=42 Station=0.5 OutputCase=ACCSX2 CaseType=Combination Point=2 X2=-0.5 X3=0.5 S11=-
1684.71036936714 IsS11Max=No IsS11Min=No FrameElem=42 ElemStation=0.5
Frame=42 Station=0.5 OutputCase=ACCSX2 CaseType=Combination Point=3 X2=0.5 X3=-0.5
S11=1350.32488816458 IsS11Max=Yes IsS11Min=No FrameElem=42 ElemStation=0.5
Frame=42 Station=0.5 OutputCase=ACCSX2 CaseType=Combination Point=4 X2=0.5 X3=0.5
S11=1350.32488816458 IsS11Max=No IsS11Min=No FrameElem=42 ElemStation=0.5
Frame=42 Station=0 OutputCase=ENVE CaseType=Combination StepType=Max Point=0 X2=0 X3=0 S11=-
167.192740601283 IsS11Max=No IsS11Min=No FrameElem=42 ElemStation=0
Frame=42 Station=0 OutputCase=ENVE CaseType=Combination StepType=Max Point=1 X2=-0.5 X3=-0.5
S11=-904.529468433546 IsS11Max=No IsS11Min=Yes FrameElem=42 ElemStation=0
Frame=42 Station=0 OutputCase=ENVE CaseType=Combination StepType=Max Point=2 X2=-0.5 X3=0.5 S11=-
904.529468433546 IsS11Max=No IsS11Min=No FrameElem=42 ElemStation=0
Frame=42 Station=0 OutputCase=ENVE CaseType=Combination StepType=Max Point=3 X2=0.5 X3=-0.5
S11=636.910218818864 IsS11Max=Yes IsS11Min=No FrameElem=42 ElemStation=0
Frame=42 Station=0 OutputCase=ENVE CaseType=Combination StepType=Max Point=4 X2=0.5 X3=0.5
S11=636.910218818864 IsS11Max=No IsS11Min=No FrameElem=42 ElemStation=0
Frame=42 Station=0.125 OutputCase=ENVE CaseType=Combination StepType=Max Point=0 X2=0 X3=0 S11=-
167.192740601283 IsS11Max=No IsS11Min=No FrameElem=42 ElemStation=0.125
Frame=42 Station=0.125 OutputCase=ENVE CaseType=Combination StepType=Max Point=1 X2=-0.5 X3=-0.5
S11=-1091.30014927963 IsS11Max=No IsS11Min=Yes FrameElem=42 ElemStation=0.125
Frame=42 Station=0.125 OutputCase=ENVE CaseType=Combination StepType=Max Point=2 X2=-0.5 X3=0.5
S11=-1091.30014927963 IsS11Max=No IsS11Min=No FrameElem=42 ElemStation=0.125
Frame=42 Station=0.125 OutputCase=ENVE CaseType=Combination StepType=Max Point=3 X2=0.5 X3=-0.5
S11=826.636147475721 IsS11Max=Yes IsS11Min=No FrameElem=42 ElemStation=0.125
Frame=42 Station=0.125 OutputCase=ENVE CaseType=Combination StepType=Max Point=4 X2=0.5 X3=0.5
S11=826.636147475721 IsS11Max=No IsS11Min=No FrameElem=42 ElemStation=0.125
Frame=42 Station=0.25 OutputCase=ENVE CaseType=Combination StepType=Max Point=0 X2=0 X3=0 S11=-
167.192740601283 IsS11Max=No IsS11Min=No FrameElem=42 ElemStation=0.25
Frame=42 Station=0.25 OutputCase=ENVE CaseType=Combination StepType=Max Point=1 X2=-0.5 X3=-0.5
S11=-1280.41458012572 IsS11Max=No IsS11Min=Yes FrameElem=42 ElemStation=0.25
Frame=42 Station=0.25 OutputCase=ENVE CaseType=Combination StepType=Max Point=2 X2=-0.5 X3=0.5
S11=-1280.41458012572 IsS11Max=No IsS11Min=No FrameElem=42 ElemStation=0.25
Frame=42 Station=0.25 OutputCase=ENVE CaseType=Combination StepType=Max Point=3 X2=0.5 X3=-0.5
S11=1018.70582613258 IsS11Max=Yes IsS11Min=No FrameElem=42 ElemStation=0.25
Frame=42 Station=0.25 OutputCase=ENVE CaseType=Combination StepType=Max Point=4 X2=0.5 X3=0.5
S11=1018.70582613258 IsS11Max=No IsS11Min=No FrameElem=42 ElemStation=0.25

Frame=42	Station=0.375	OutputCase=ENVE	CaseType=Combination	StepType=Max	Point=0	X2=0	X3=0	S11=-
167.192740601283	IsS11Max=No	IsS11Min=No	FrameElem=42	ElemStation=0.375				
Frame=42	Station=0.375	OutputCase=ENVE	CaseType=Combination	StepType=Max	Point=1	X2=-0.5	X3=-0.5	
S11=-1471.8727609718	IsS11Max=No	IsS11Min=Yes	FrameElem=42	ElemStation=0.375				
Frame=42	Station=0.375	OutputCase=ENVE	CaseType=Combination	StepType=Max	Point=2	X2=-0.5	X3=0.5	
S11=-1471.8727609718	IsS11Max=No	IsS11Min=No	FrameElem=42	ElemStation=0.375				
Frame=42	Station=0.375	OutputCase=ENVE	CaseType=Combination	StepType=Max	Point=3	X2=0.5	X3=-0.5	
S11=1213.11925478943	IsS11Max=Yes	IsS11Min=No	FrameElem=42	ElemStation=0.375				
Frame=42	Station=0.375	OutputCase=ENVE	CaseType=Combination	StepType=Max	Point=4	X2=0.5	X3=0.5	
S11=1213.11925478943	IsS11Max=No	IsS11Min=No	FrameElem=42	ElemStation=0.375				
Frame=42	Station=0.5	OutputCase=ENVE	CaseType=Combination	StepType=Max	Point=0	X2=0	X3=0	S11=-
167.192740601283	IsS11Max=No	IsS11Min=No	FrameElem=42	ElemStation=0.5				
Frame=42	Station=0.5	OutputCase=ENVE	CaseType=Combination	StepType=Max	Point=1	X2=-0.5	X3=-0.5	
S11=-1665.67469181789	IsS11Max=No	IsS11Min=Yes	FrameElem=42	ElemStation=0.5				
Frame=42	Station=0.5	OutputCase=ENVE	CaseType=Combination	StepType=Max	Point=2	X2=-0.5	X3=0.5	
S11=-1665.67469181789	IsS11Max=No	IsS11Min=No	FrameElem=42	ElemStation=0.5				
Frame=42	Station=0.5	OutputCase=ENVE	CaseType=Combination	StepType=Max	Point=3	X2=0.5	X3=-0.5	
S11=1409.87643344629	IsS11Max=Yes	IsS11Min=No	FrameElem=42	ElemStation=0.5				
Frame=42	Station=0.5	OutputCase=ENVE	CaseType=Combination	StepType=Max	Point=4	X2=0.5	X3=0.5	
S11=1409.87643344629	IsS11Max=No	IsS11Min=No	FrameElem=42	ElemStation=0.5				
Frame=42	Station=0	OutputCase=ENVE	CaseType=Combination	StepType=Min	Point=0	X2=0	X3=0	S11=-
240.528987364651	IsS11Max=No	IsS11Min=No	FrameElem=42	ElemStation=0				
Frame=42	Station=0	OutputCase=ENVE	CaseType=Combination	StepType=Min	Point=1	X2=-0.5	X3=-0.5	
S11=-985.021726185825	IsS11Max=No	IsS11Min=Yes	FrameElem=42	ElemStation=0				
Frame=42	Station=0	OutputCase=ENVE	CaseType=Combination	StepType=Min	Point=2	X2=-0.5	X3=0.5	S11=-
985.021726185825	IsS11Max=No	IsS11Min=No	FrameElem=42	ElemStation=0				
Frame=42	Station=0	OutputCase=ENVE	CaseType=Combination	StepType=Min	Point=3	X2=0.5	X3=-0.5	
S11=437.197519868641	IsS11Max=Yes	IsS11Min=No	FrameElem=42	ElemStation=0				
Frame=42	Station=0	OutputCase=ENVE	CaseType=Combination	StepType=Min	Point=4	X2=0.5	X3=0.5	
S11=437.197519868641	IsS11Max=No	IsS11Min=No	FrameElem=42	ElemStation=0				
Frame=42	Station=0.125	OutputCase=ENVE	CaseType=Combination	StepType=Min	Point=0	X2=0	X3=0	S11=-
240.528987364651	IsS11Max=No	IsS11Min=No	FrameElem=42	ElemStation=0.125				
Frame=42	Station=0.125	OutputCase=ENVE	CaseType=Combination	StepType=Min	Point=1	X2=-0.5	X3=-0.5	
S11=-1174.74765484268	IsS11Max=No	IsS11Min=Yes	FrameElem=42	ElemStation=0.125				
Frame=42	Station=0.125	OutputCase=ENVE	CaseType=Combination	StepType=Min	Point=2	X2=-0.5	X3=0.5	
S11=-1174.74765484268	IsS11Max=No	IsS11Min=No	FrameElem=42	ElemStation=0.125				
Frame=42	Station=0.125	OutputCase=ENVE	CaseType=Combination	StepType=Min	Point=3	X2=0.5	X3=-0.5	
S11=623.968200714727	IsS11Max=Yes	IsS11Min=No	FrameElem=42	ElemStation=0.125				
Frame=42	Station=0.125	OutputCase=ENVE	CaseType=Combination	StepType=Min	Point=4	X2=0.5	X3=0.5	
S11=623.968200714727	IsS11Max=No	IsS11Min=No	FrameElem=42	ElemStation=0.125				
Frame=42	Station=0.25	OutputCase=ENVE	CaseType=Combination	StepType=Min	Point=0	X2=0	X3=0	S11=-
240.528987364651	IsS11Max=No	IsS11Min=No	FrameElem=42	ElemStation=0.25				
Frame=42	Station=0.25	OutputCase=ENVE	CaseType=Combination	StepType=Min	Point=1	X2=-0.5	X3=-0.5	
S11=-1366.81733349954	IsS11Max=No	IsS11Min=Yes	FrameElem=42	ElemStation=0.25				
Frame=42	Station=0.25	OutputCase=ENVE	CaseType=Combination	StepType=Min	Point=2	X2=-0.5	X3=0.5	
S11=-1366.81733349954	IsS11Max=No	IsS11Min=No	FrameElem=42	ElemStation=0.25				
Frame=42	Station=0.25	OutputCase=ENVE	CaseType=Combination	StepType=Min	Point=3	X2=0.5	X3=-0.5	
S11=813.082631560813	IsS11Max=Yes	IsS11Min=No	FrameElem=42	ElemStation=0.25				
Frame=42	Station=0.25	OutputCase=ENVE	CaseType=Combination	StepType=Min	Point=4	X2=0.5	X3=0.5	
S11=813.082631560813	IsS11Max=No	IsS11Min=No	FrameElem=42	ElemStation=0.25				
Frame=42	Station=0.375	OutputCase=ENVE	CaseType=Combination	StepType=Min	Point=0	X2=0	X3=0	S11=-
240.528987364651	IsS11Max=No	IsS11Min=No	FrameElem=42	ElemStation=0.375				
Frame=42	Station=0.375	OutputCase=ENVE	CaseType=Combination	StepType=Min	Point=1	X2=-0.5	X3=-0.5	
S11=-1561.2307621564	IsS11Max=No	IsS11Min=Yes	FrameElem=42	ElemStation=0.375				
Frame=42	Station=0.375	OutputCase=ENVE	CaseType=Combination	StepType=Min	Point=2	X2=-0.5	X3=0.5	
S11=-1561.2307621564	IsS11Max=No	IsS11Min=No	FrameElem=42	ElemStation=0.375				
Frame=42	Station=0.375	OutputCase=ENVE	CaseType=Combination	StepType=Min	Point=3	X2=0.5	X3=-0.5	
S11=1004.5408124069	IsS11Max=Yes	IsS11Min=No	FrameElem=42	ElemStation=0.375				
Frame=42	Station=0.375	OutputCase=ENVE	CaseType=Combination	StepType=Min	Point=4	X2=0.5	X3=0.5	
S11=1004.5408124069	IsS11Max=No	IsS11Min=No	FrameElem=42	ElemStation=0.375				
Frame=42	Station=0.5	OutputCase=ENVE	CaseType=Combination	StepType=Min	Point=0	X2=0	X3=0	S11=-
240.528987364651	IsS11Max=No	IsS11Min=No	FrameElem=42	ElemStation=0.5				
Frame=42	Station=0.5	OutputCase=ENVE	CaseType=Combination	StepType=Min	Point=1	X2=-0.5	X3=-0.5	
S11=-1757.98794081325	IsS11Max=No	IsS11Min=Yes	FrameElem=42	ElemStation=0.5				
Frame=42	Station=0.5	OutputCase=ENVE	CaseType=Combination	StepType=Min	Point=2	X2=-0.5	X3=0.5	
S11=-1757.98794081325	IsS11Max=No	IsS11Min=No	FrameElem=42	ElemStation=0.5				
Frame=42	Station=0.5	OutputCase=ENVE	CaseType=Combination	StepType=Min	Point=3	X2=0.5	X3=-0.5	
S11=1198.34274325298	IsS11Max=Yes	IsS11Min=No	FrameElem=42	ElemStation=0.5				
Frame=42	Station=0.5	OutputCase=ENVE	CaseType=Combination	StepType=Min	Point=4	X2=0.5	X3=0.5	
S11=1198.34274325298	IsS11Max=No	IsS11Min=No	FrameElem=42	ElemStation=0.5				
Frame=42	Station=0	OutputCase=FESSUR	CaseType=Combination	Point=0	X2=0	X3=0	S11=-239.151922837248	
IsS11Max=No	IsS11Min=No	FrameElem=42	ElemStation=0					
Frame=42	Station=0	OutputCase=FESSUR	CaseType=Combination	Point=1	X2=-0.5	X3=-0.5	S11=-	
958.377747865886	IsS11Max=No	IsS11Min=Yes	FrameElem=42	ElemStation=0				
Frame=42	Station=0	OutputCase=FESSUR	CaseType=Combination	Point=2	X2=-0.5	X3=0.5	S11=-	
958.377747865886	IsS11Max=No	IsS11Min=No	FrameElem=42	ElemStation=0				
Frame=42	Station=0	OutputCase=FESSUR	CaseType=Combination	Point=3	X2=0.5	X3=-0.5		
S11=480.073902191391	IsS11Max=Yes	IsS11Min=No	FrameElem=42	ElemStation=0				
Frame=42	Station=0	OutputCase=FESSUR	CaseType=Combination	Point=4	X2=0.5	X3=0.5		
S11=480.073902191391	IsS11Max=No	IsS11Min=No	FrameElem=42	ElemStation=0				
Frame=42	Station=0.125	OutputCase=FESSUR	CaseType=Combination	Point=0	X2=0	X3=0	S11=-	
239.151922837248	IsS11Max=No	IsS11Min=No	FrameElem=42	ElemStation=0.125				

Frame=42	Station=0.125	OutputCase=FESSUR	CaseType=Combination	Point=1	X2=-0.5	X3=-0.5	S11=-
1146.68897702959	IsS11Max=No	IsS11Min=Yes	FrameElem=42	ElemStation=0.125			
Frame=42	Station=0.125	OutputCase=FESSUR	CaseType=Combination	Point=2	X2=-0.5	X3=0.5	S11=-
1146.68897702959	IsS11Max=No	IsS11Min=No	FrameElem=42	ElemStation=0.125			
Frame=42	Station=0.125	OutputCase=FESSUR	CaseType=Combination	Point=3	X2=0.5	X3=-0.5	
S11=668.385131355096	IsS11Max=Yes	IsS11Min=No	FrameElem=42	ElemStation=0.125			
Frame=42	Station=0.125	OutputCase=FESSUR	CaseType=Combination	Point=4	X2=0.5	X3=0.5	
S11=668.385131355096	IsS11Max=No	IsS11Min=No	FrameElem=42	ElemStation=0.125			
Frame=42	Station=0.25	OutputCase=FESSUR	CaseType=Combination	Point=0	X2=0	X3=0	S11=-
239.151922837248	IsS11Max=No	IsS11Min=No	FrameElem=42	ElemStation=0.25			
Frame=42	Station=0.25	OutputCase=FESSUR	CaseType=Combination	Point=1	X2=-0.5	X3=-0.5	S11=-
1337.3439561933	IsS11Max=No	IsS11Min=Yes	FrameElem=42	ElemStation=0.25			
Frame=42	Station=0.25	OutputCase=FESSUR	CaseType=Combination	Point=2	X2=-0.5	X3=0.5	S11=-
1337.3439561933	IsS11Max=No	IsS11Min=No	FrameElem=42	ElemStation=0.25			
Frame=42	Station=0.25	OutputCase=FESSUR	CaseType=Combination	Point=3	X2=0.5	X3=-0.5	
S11=859.040110518801	IsS11Max=Yes	IsS11Min=No	FrameElem=42	ElemStation=0.25			
Frame=42	Station=0.25	OutputCase=FESSUR	CaseType=Combination	Point=4	X2=0.5	X3=0.5	
S11=859.040110518801	IsS11Max=No	IsS11Min=No	FrameElem=42	ElemStation=0.25			
Frame=42	Station=0.375	OutputCase=FESSUR	CaseType=Combination	Point=0	X2=0	X3=0	S11=-
239.151922837248	IsS11Max=No	IsS11Min=No	FrameElem=42	ElemStation=0.375			
Frame=42	Station=0.375	OutputCase=FESSUR	CaseType=Combination	Point=1	X2=-0.5	X3=-0.5	S11=-
1530.342685357	IsS11Max=No	IsS11Min=Yes	FrameElem=42	ElemStation=0.375			
Frame=42	Station=0.375	OutputCase=FESSUR	CaseType=Combination	Point=2	X2=-0.5	X3=0.5	S11=-
1530.342685357	IsS11Max=No	IsS11Min=No	FrameElem=42	ElemStation=0.375			
Frame=42	Station=0.375	OutputCase=FESSUR	CaseType=Combination	Point=3	X2=0.5	X3=-0.5	
S11=1052.03883968251	IsS11Max=Yes	IsS11Min=No	FrameElem=42	ElemStation=0.375			
Frame=42	Station=0.375	OutputCase=FESSUR	CaseType=Combination	Point=4	X2=0.5	X3=0.5	
S11=1052.03883968251	IsS11Max=No	IsS11Min=No	FrameElem=42	ElemStation=0.375			
Frame=42	Station=0.5	OutputCase=FESSUR	CaseType=Combination	Point=0	X2=0	X3=0	S11=-239.151922837248
IsS11Max=No	IsS11Min=No	FrameElem=42	ElemStation=0.5				
Frame=42	Station=0.5	OutputCase=FESSUR	CaseType=Combination	Point=1	X2=-0.5	X3=-0.5	S11=-
1725.68516452071	IsS11Max=No	IsS11Min=Yes	FrameElem=42	ElemStation=0.5			
Frame=42	Station=0.5	OutputCase=FESSUR	CaseType=Combination	Point=2	X2=-0.5	X3=0.5	S11=-
1725.68516452071	IsS11Max=No	IsS11Min=No	FrameElem=42	ElemStation=0.5			
Frame=42	Station=0.5	OutputCase=FESSUR	CaseType=Combination	Point=3	X2=0.5	X3=-0.5	
S11=1247.38131884621	IsS11Max=Yes	IsS11Min=No	FrameElem=42	ElemStation=0.5			
Frame=42	Station=0.5	OutputCase=FESSUR	CaseType=Combination	Point=4	X2=0.5	X3=0.5	
S11=1247.38131884621	IsS11Max=No	IsS11Min=No	FrameElem=42	ElemStation=0.5			
Frame=43	Station=0	OutputCase=PERM1	CaseType=Combination	Point=0	X2=0	X3=0	S11=-235.938772273309
IsS11Max=No	IsS11Min=No	FrameElem=43	ElemStation=0				
Frame=43	Station=0	OutputCase=PERM1	CaseType=Combination	Point=1	X2=-0.5	X3=-0.5	S11=-
1694.72860078638	IsS11Max=No	IsS11Min=Yes	FrameElem=43	ElemStation=0			
Frame=43	Station=0	OutputCase=PERM1	CaseType=Combination	Point=2	X2=-0.5	X3=0.5	S11=-
1694.72860078638	IsS11Max=No	IsS11Min=No	FrameElem=43	ElemStation=0			
Frame=43	Station=0	OutputCase=PERM1	CaseType=Combination	Point=3	X2=0.5	X3=-0.5	
S11=1222.85105623977	IsS11Max=Yes	IsS11Min=No	FrameElem=43	ElemStation=0			
Frame=43	Station=0	OutputCase=PERM1	CaseType=Combination	Point=4	X2=0.5	X3=0.5	S11=1222.85105623977
IsS11Max=No	IsS11Min=No	FrameElem=43	ElemStation=0				
Frame=43	Station=0.125	OutputCase=PERM1	CaseType=Combination	Point=0	X2=0	X3=0	S11=-
235.938772273309	IsS11Max=No	IsS11Min=No	FrameElem=43	ElemStation=0.125			
Frame=43	Station=0.125	OutputCase=PERM1	CaseType=Combination	Point=1	X2=-0.5	X3=-0.5	S11=-
1803.90126541615	IsS11Max=No	IsS11Min=Yes	FrameElem=43	ElemStation=0.125			
Frame=43	Station=0.125	OutputCase=PERM1	CaseType=Combination	Point=2	X2=-0.5	X3=0.5	S11=-
1803.90126541615	IsS11Max=No	IsS11Min=No	FrameElem=43	ElemStation=0.125			
Frame=43	Station=0.125	OutputCase=PERM1	CaseType=Combination	Point=3	X2=0.5	X3=-0.5	
S11=1332.02372086953	IsS11Max=Yes	IsS11Min=No	FrameElem=43	ElemStation=0.125			
Frame=43	Station=0.125	OutputCase=PERM1	CaseType=Combination	Point=4	X2=0.5	X3=0.5	
S11=1332.02372086953	IsS11Max=No	IsS11Min=No	FrameElem=43	ElemStation=0.125			
Frame=43	Station=0.25	OutputCase=PERM1	CaseType=Combination	Point=0	X2=0	X3=0	S11=-235.938772273309
IsS11Max=No	IsS11Min=No	FrameElem=43	ElemStation=0.25				
Frame=43	Station=0.25	OutputCase=PERM1	CaseType=Combination	Point=1	X2=-0.5	X3=-0.5	S11=-
1915.41768004591	IsS11Max=No	IsS11Min=Yes	FrameElem=43	ElemStation=0.25			
Frame=43	Station=0.25	OutputCase=PERM1	CaseType=Combination	Point=2	X2=-0.5	X3=0.5	S11=-
1915.41768004591	IsS11Max=No	IsS11Min=No	FrameElem=43	ElemStation=0.25			
Frame=43	Station=0.25	OutputCase=PERM1	CaseType=Combination	Point=3	X2=0.5	X3=-0.5	
S11=1443.54013549929	IsS11Max=Yes	IsS11Min=No	FrameElem=43	ElemStation=0.25			
Frame=43	Station=0.25	OutputCase=PERM1	CaseType=Combination	Point=4	X2=0.5	X3=0.5	
S11=1443.54013549929	IsS11Max=No	IsS11Min=No	FrameElem=43	ElemStation=0.25			
Frame=43	Station=0.375	OutputCase=PERM1	CaseType=Combination	Point=0	X2=0	X3=0	S11=-
235.938772273309	IsS11Max=No	IsS11Min=No	FrameElem=43	ElemStation=0.375			
Frame=43	Station=0.375	OutputCase=PERM1	CaseType=Combination	Point=1	X2=-0.5	X3=-0.5	S11=-
2029.27784467567	IsS11Max=No	IsS11Min=Yes	FrameElem=43	ElemStation=0.375			
Frame=43	Station=0.375	OutputCase=PERM1	CaseType=Combination	Point=2	X2=-0.5	X3=0.5	S11=-
2029.27784467567	IsS11Max=No	IsS11Min=No	FrameElem=43	ElemStation=0.375			
Frame=43	Station=0.375	OutputCase=PERM1	CaseType=Combination	Point=3	X2=0.5	X3=-0.5	
S11=1557.40030012906	IsS11Max=Yes	IsS11Min=No	FrameElem=43	ElemStation=0.375			
Frame=43	Station=0.375	OutputCase=PERM1	CaseType=Combination	Point=4	X2=0.5	X3=0.5	
S11=1557.40030012906	IsS11Max=No	IsS11Min=No	FrameElem=43	ElemStation=0.375			
Frame=43	Station=0.5	OutputCase=PERM1	CaseType=Combination	Point=0	X2=0	X3=0	S11=-235.938772273309
IsS11Max=No	IsS11Min=No	FrameElem=43	ElemStation=0.5				
Frame=43	Station=0.5	OutputCase=PERM1	CaseType=Combination	Point=1	X2=-0.5	X3=-0.5	S11=-
2145.48175930544	IsS11Max=No	IsS11Min=Yes	FrameElem=43	ElemStation=0.5			

Frame=43	Station=0.5	OutputCase=PERM1	CaseType=Combination	Point=2	X2=-0.5	X3=0.5	S11=-
2145.48175930544	IsS11Max=No	IsS11Min=No	FrameElem=43	ElemStation=0.5			
Frame=43	Station=0.5	OutputCase=PERM1	CaseType=Combination	Point=3	X2=0.5	X3=-0.5	
S11=1673.60421475882	IsS11Max=Yes	IsS11Min=No	FrameElem=43	ElemStation=0.5			
Frame=43	Station=0.5	OutputCase=PERM1	CaseType=Combination	Point=4	X2=0.5	X3=0.5	
S11=1673.60421475882	IsS11Max=No	IsS11Min=No	FrameElem=43	ElemStation=0.5			
Frame=43	Station=0	OutputCase=PERM2	CaseType=Combination	Point=0	X2=0	X3=0	S11=-169.465538592139
IsS11Max=No	IsS11Min=No	FrameElem=43	ElemStation=0				
Frame=43	Station=0	OutputCase=PERM2	CaseType=Combination	Point=1	X2=-0.5	X3=-0.5	S11=-
1713.76427833564	IsS11Max=No	IsS11Min=Yes	FrameElem=43	ElemStation=0			
Frame=43	Station=0	OutputCase=PERM2	CaseType=Combination	Point=2	X2=-0.5	X3=0.5	S11=-
1713.76427833564	IsS11Max=No	IsS11Min=No	FrameElem=43	ElemStation=0			
Frame=43	Station=0	OutputCase=PERM2	CaseType=Combination	Point=3	X2=0.5	X3=-0.5	
S11=1374.83320115136	IsS11Max=Yes	IsS11Min=No	FrameElem=43	ElemStation=0			
Frame=43	Station=0	OutputCase=PERM2	CaseType=Combination	Point=4	X2=0.5	X3=0.5	S11=1374.83320115136
IsS11Max=No	IsS11Min=No	FrameElem=43	ElemStation=0				
Frame=43	Station=0.125	OutputCase=PERM2	CaseType=Combination	Point=0	X2=0	X3=0	S11=-
169.465538592139	IsS11Max=No	IsS11Min=No	FrameElem=43	ElemStation=0.125			
Frame=43	Station=0.125	OutputCase=PERM2	CaseType=Combination	Point=1	X2=-0.5	X3=-0.5	S11=-
1822.86941862979	IsS11Max=No	IsS11Min=Yes	FrameElem=43	ElemStation=0.125			
Frame=43	Station=0.125	OutputCase=PERM2	CaseType=Combination	Point=2	X2=-0.5	X3=0.5	S11=-
1822.86941862979	IsS11Max=No	IsS11Min=No	FrameElem=43	ElemStation=0.125			
Frame=43	Station=0.125	OutputCase=PERM2	CaseType=Combination	Point=3	X2=0.5	X3=-0.5	
S11=1483.93834144551	IsS11Max=Yes	IsS11Min=No	FrameElem=43	ElemStation=0.125			
Frame=43	Station=0.125	OutputCase=PERM2	CaseType=Combination	Point=4	X2=0.5	X3=0.5	
S11=1483.93834144551	IsS11Max=No	IsS11Min=No	FrameElem=43	ElemStation=0.125			
Frame=43	Station=0.25	OutputCase=PERM2	CaseType=Combination	Point=0	X2=0	X3=0	S11=-169.465538592139
IsS11Max=No	IsS11Min=No	FrameElem=43	ElemStation=0.25				
Frame=43	Station=0.25	OutputCase=PERM2	CaseType=Combination	Point=1	X2=-0.5	X3=-0.5	S11=-
1934.31830892394	IsS11Max=No	IsS11Min=Yes	FrameElem=43	ElemStation=0.25			
Frame=43	Station=0.25	OutputCase=PERM2	CaseType=Combination	Point=2	X2=-0.5	X3=0.5	S11=-
1934.31830892394	IsS11Max=No	IsS11Min=No	FrameElem=43	ElemStation=0.25			
Frame=43	Station=0.25	OutputCase=PERM2	CaseType=Combination	Point=3	X2=0.5	X3=-0.5	
S11=1595.38723173967	IsS11Max=Yes	IsS11Min=No	FrameElem=43	ElemStation=0.25			
Frame=43	Station=0.25	OutputCase=PERM2	CaseType=Combination	Point=4	X2=0.5	X3=0.5	
S11=1595.38723173967	IsS11Max=No	IsS11Min=No	FrameElem=43	ElemStation=0.25			
Frame=43	Station=0.375	OutputCase=PERM2	CaseType=Combination	Point=0	X2=0	X3=0	S11=-
169.465538592139	IsS11Max=No	IsS11Min=No	FrameElem=43	ElemStation=0.375			
Frame=43	Station=0.375	OutputCase=PERM2	CaseType=Combination	Point=1	X2=-0.5	X3=-0.5	S11=-
2048.1109492181	IsS11Max=No	IsS11Min=Yes	FrameElem=43	ElemStation=0.375			
Frame=43	Station=0.375	OutputCase=PERM2	CaseType=Combination	Point=2	X2=-0.5	X3=0.5	S11=-
2048.1109492181	IsS11Max=No	IsS11Min=No	FrameElem=43	ElemStation=0.375			
Frame=43	Station=0.375	OutputCase=PERM2	CaseType=Combination	Point=3	X2=0.5	X3=-0.5	
S11=1709.17987203382	IsS11Max=Yes	IsS11Min=No	FrameElem=43	ElemStation=0.375			
Frame=43	Station=0.375	OutputCase=PERM2	CaseType=Combination	Point=4	X2=0.5	X3=0.5	
S11=1709.17987203382	IsS11Max=No	IsS11Min=No	FrameElem=43	ElemStation=0.375			
Frame=43	Station=0.5	OutputCase=PERM2	CaseType=Combination	Point=0	X2=0	X3=0	S11=-169.465538592139
IsS11Max=No	IsS11Min=No	FrameElem=43	ElemStation=0.5				
Frame=43	Station=0.5	OutputCase=PERM2	CaseType=Combination	Point=1	X2=-0.5	X3=-0.5	S11=-
2164.24733951225	IsS11Max=No	IsS11Min=Yes	FrameElem=43	ElemStation=0.5			
Frame=43	Station=0.5	OutputCase=PERM2	CaseType=Combination	Point=2	X2=-0.5	X3=0.5	S11=-
2164.24733951225	IsS11Max=No	IsS11Min=No	FrameElem=43	ElemStation=0.5			
Frame=43	Station=0.5	OutputCase=PERM2	CaseType=Combination	Point=3	X2=0.5	X3=-0.5	
S11=1825.31626232798	IsS11Max=Yes	IsS11Min=No	FrameElem=43	ElemStation=0.5			
Frame=43	Station=0.5	OutputCase=PERM2	CaseType=Combination	Point=4	X2=0.5	X3=0.5	
S11=1825.31626232798	IsS11Max=No	IsS11Min=No	FrameElem=43	ElemStation=0.5			
Frame=43	Station=0	OutputCase=ACCL	CaseType=Combination	Point=0	X2=0	X3=0	S11=-240.528987364651
IsS11Max=No	IsS11Min=No	FrameElem=43	ElemStation=0				
Frame=43	Station=0	OutputCase=ACCL	CaseType=Combination	Point=1	X2=-0.5	X3=-0.5	S11=-
1738.95226326402	IsS11Max=No	IsS11Min=Yes	FrameElem=43	ElemStation=0			
Frame=43	Station=0	OutputCase=ACCL	CaseType=Combination	Point=2	X2=-0.5	X3=0.5	S11=-
1738.95226326402	IsS11Max=No	IsS11Min=No	FrameElem=43	ElemStation=0			
Frame=43	Station=0	OutputCase=ACCL	CaseType=Combination	Point=3	X2=0.5	X3=-0.5	S11=1257.89428853472
IsS11Max=Yes	IsS11Min=No	FrameElem=43	ElemStation=0				
Frame=43	Station=0	OutputCase=ACCL	CaseType=Combination	Point=4	X2=0.5	X3=0.5	S11=1257.89428853472
IsS11Max=No	IsS11Min=No	FrameElem=43	ElemStation=0				
Frame=43	Station=0.125	OutputCase=ACCL	CaseType=Combination	Point=0	X2=0	X3=0	S11=-240.528987364651
IsS11Max=No	IsS11Min=No	FrameElem=43	ElemStation=0.125				
Frame=43	Station=0.125	OutputCase=ACCL	CaseType=Combination	Point=1	X2=-0.5	X3=-0.5	S11=-
1851.13304378858	IsS11Max=No	IsS11Min=Yes	FrameElem=43	ElemStation=0.125			
Frame=43	Station=0.125	OutputCase=ACCL	CaseType=Combination	Point=2	X2=-0.5	X3=0.5	S11=-
1851.13304378858	IsS11Max=No	IsS11Min=No	FrameElem=43	ElemStation=0.125			
Frame=43	Station=0.125	OutputCase=ACCL	CaseType=Combination	Point=3	X2=0.5	X3=-0.5	
S11=1370.07506905927	IsS11Max=Yes	IsS11Min=No	FrameElem=43	ElemStation=0.125			
Frame=43	Station=0.125	OutputCase=ACCL	CaseType=Combination	Point=4	X2=0.5	X3=0.5	
S11=1370.07506905927	IsS11Max=No	IsS11Min=No	FrameElem=43	ElemStation=0.125			
Frame=43	Station=0.25	OutputCase=ACCL	CaseType=Combination	Point=0	X2=0	X3=0	S11=-240.528987364651
IsS11Max=No	IsS11Min=No	FrameElem=43	ElemStation=0.25				
Frame=43	Station=0.25	OutputCase=ACCL	CaseType=Combination	Point=1	X2=-0.5	X3=-0.5	S11=-
1965.65757431313	IsS11Max=No	IsS11Min=Yes	FrameElem=43	ElemStation=0.25			
Frame=43	Station=0.25	OutputCase=ACCL	CaseType=Combination	Point=2	X2=-0.5	X3=0.5	S11=-
1965.65757431313	IsS11Max=No	IsS11Min=No	FrameElem=43	ElemStation=0.25			

Frame=43 Station=0.25 OutputCase=ACC1 CaseType=Combination Point=3 X2=0.5 X3=-0.5
 S11=1484.59959958383 IsS11Max=Yes IsS11Min=No FrameElem=43 ElemStation=0.25
 Frame=43 Station=0.25 OutputCase=ACC1 CaseType=Combination Point=4 X2=0.5 X3=0.5
 S11=1484.59959958383 IsS11Max=No IsS11Min=No FrameElem=43 ElemStation=0.25
 Frame=43 Station=0.375 OutputCase=ACC1 CaseType=Combination Point=0 X2=0 X3=0 S11=-240.528987364651
 IsS11Max=No IsS11Min=No FrameElem=43 ElemStation=0.375
 Frame=43 Station=0.375 OutputCase=ACC1 CaseType=Combination Point=1 X2=-0.5 X3=-0.5 S11=-
 2082.52585483769 IsS11Max=No IsS11Min=Yes FrameElem=43 ElemStation=0.375
 Frame=43 Station=0.375 OutputCase=ACC1 CaseType=Combination Point=2 X2=-0.5 X3=0.5 S11=-
 2082.52585483769 IsS11Max=No IsS11Min=No FrameElem=43 ElemStation=0.375
 Frame=43 Station=0.375 OutputCase=ACC1 CaseType=Combination Point=3 X2=0.5 X3=-0.5
 S11=1601.46788010838 IsS11Max=Yes IsS11Min=No FrameElem=43 ElemStation=0.375
 Frame=43 Station=0.375 OutputCase=ACC1 CaseType=Combination Point=4 X2=0.5 X3=0.5
 S11=1601.46788010838 IsS11Max=No IsS11Min=No FrameElem=43 ElemStation=0.375
 Frame=43 Station=0.5 OutputCase=ACC1 CaseType=Combination Point=0 X2=0 X3=0 S11=-240.528987364651
 IsS11Max=No IsS11Min=No FrameElem=43 ElemStation=0.5
 Frame=43 Station=0.5 OutputCase=ACC1 CaseType=Combination Point=1 X2=-0.5 X3=-0.5 S11=-
 2201.73788536224 IsS11Max=No IsS11Min=Yes FrameElem=43 ElemStation=0.5
 Frame=43 Station=0.5 OutputCase=ACC1 CaseType=Combination Point=2 X2=-0.5 X3=0.5 S11=-
 2201.73788536224 IsS11Max=No IsS11Min=No FrameElem=43 ElemStation=0.5
 Frame=43 Station=0.5 OutputCase=ACC1 CaseType=Combination Point=3 X2=0.5 X3=-0.5
 S11=1720.67991063294 IsS11Max=Yes IsS11Min=No FrameElem=43 ElemStation=0.5
 Frame=43 Station=0.5 OutputCase=ACC1 CaseType=Combination Point=4 X2=0.5 X3=0.5
 S11=1720.67991063294 IsS11Max=No IsS11Min=No FrameElem=43 ElemStation=0.5
 Frame=43 Station=0 OutputCase=ACC2 CaseType=Combination Point=0 X2=0 X3=0 S11=-174.055753683481
 IsS11Max=No IsS11Min=No FrameElem=43 ElemStation=0
 Frame=43 Station=0 OutputCase=ACC2 CaseType=Combination Point=1 X2=-0.5 X3=-0.5 S11=-
 1757.98794081327 IsS11Max=No IsS11Min=Yes FrameElem=43 ElemStation=0
 Frame=43 Station=0 OutputCase=ACC2 CaseType=Combination Point=2 X2=-0.5 X3=0.5 S11=-
 1757.98794081327 IsS11Max=No IsS11Min=No FrameElem=43 ElemStation=0
 Frame=43 Station=0 OutputCase=ACC2 CaseType=Combination Point=3 X2=0.5 X3=-0.5 S11=1409.87643344631
 IsS11Max=Yes IsS11Min=No FrameElem=43 ElemStation=0
 Frame=43 Station=0 OutputCase=ACC2 CaseType=Combination Point=4 X2=0.5 X3=0.5 S11=1409.87643344631
 IsS11Max=No IsS11Min=No FrameElem=43 ElemStation=0
 Frame=43 Station=0.125 OutputCase=ACC2 CaseType=Combination Point=0 X2=0 X3=0 S11=-174.055753683481
 IsS11Max=No IsS11Min=No FrameElem=43 ElemStation=0.125
 Frame=43 Station=0.125 OutputCase=ACC2 CaseType=Combination Point=1 X2=-0.5 X3=-0.5 S11=-
 1870.10119700222 IsS11Max=No IsS11Min=Yes FrameElem=43 ElemStation=0.125
 Frame=43 Station=0.125 OutputCase=ACC2 CaseType=Combination Point=2 X2=-0.5 X3=0.5 S11=-
 1870.10119700222 IsS11Max=No IsS11Min=No FrameElem=43 ElemStation=0.125
 Frame=43 Station=0.125 OutputCase=ACC2 CaseType=Combination Point=3 X2=0.5 X3=-0.5
 S11=1521.98968963526 IsS11Max=Yes IsS11Min=No FrameElem=43 ElemStation=0.125
 Frame=43 Station=0.125 OutputCase=ACC2 CaseType=Combination Point=4 X2=0.5 X3=0.5
 S11=1521.98968963526 IsS11Max=No IsS11Min=No FrameElem=43 ElemStation=0.125
 Frame=43 Station=0.25 OutputCase=ACC2 CaseType=Combination Point=0 X2=0 X3=0 S11=-174.055753683481
 IsS11Max=No IsS11Min=No FrameElem=43 ElemStation=0.25
 Frame=43 Station=0.25 OutputCase=ACC2 CaseType=Combination Point=1 X2=-0.5 X3=-0.5 S11=-
 1984.55820319116 IsS11Max=No IsS11Min=Yes FrameElem=43 ElemStation=0.25
 Frame=43 Station=0.25 OutputCase=ACC2 CaseType=Combination Point=2 X2=-0.5 X3=0.5 S11=-
 1984.55820319116 IsS11Max=No IsS11Min=No FrameElem=43 ElemStation=0.25
 Frame=43 Station=0.25 OutputCase=ACC2 CaseType=Combination Point=3 X2=0.5 X3=-0.5
 S11=1636.4466958242 IsS11Max=Yes IsS11Min=No FrameElem=43 ElemStation=0.25
 Frame=43 Station=0.25 OutputCase=ACC2 CaseType=Combination Point=4 X2=0.5 X3=0.5
 S11=1636.4466958242 IsS11Max=No IsS11Min=No FrameElem=43 ElemStation=0.25
 Frame=43 Station=0.375 OutputCase=ACC2 CaseType=Combination Point=0 X2=0 X3=0 S11=-174.055753683481
 IsS11Max=No IsS11Min=No FrameElem=43 ElemStation=0.375
 Frame=43 Station=0.375 OutputCase=ACC2 CaseType=Combination Point=1 X2=-0.5 X3=-0.5 S11=-
 2101.35895938011 IsS11Max=No IsS11Min=Yes FrameElem=43 ElemStation=0.375
 Frame=43 Station=0.375 OutputCase=ACC2 CaseType=Combination Point=2 X2=-0.5 X3=0.5 S11=-
 2101.35895938011 IsS11Max=No IsS11Min=No FrameElem=43 ElemStation=0.375
 Frame=43 Station=0.375 OutputCase=ACC2 CaseType=Combination Point=3 X2=0.5 X3=-0.5
 S11=1753.24745201315 IsS11Max=Yes IsS11Min=No FrameElem=43 ElemStation=0.375
 Frame=43 Station=0.375 OutputCase=ACC2 CaseType=Combination Point=4 X2=0.5 X3=0.5
 S11=1753.24745201315 IsS11Max=No IsS11Min=No FrameElem=43 ElemStation=0.375
 Frame=43 Station=0.5 OutputCase=ACC2 CaseType=Combination Point=0 X2=0 X3=0 S11=-174.055753683481
 IsS11Max=No IsS11Min=No FrameElem=43 ElemStation=0.5
 Frame=43 Station=0.5 OutputCase=ACC2 CaseType=Combination Point=1 X2=-0.5 X3=-0.5 S11=-
 2220.50346556905 IsS11Max=No IsS11Min=Yes FrameElem=43 ElemStation=0.5
 Frame=43 Station=0.5 OutputCase=ACC2 CaseType=Combination Point=2 X2=-0.5 X3=0.5 S11=-
 2220.50346556905 IsS11Max=No IsS11Min=No FrameElem=43 ElemStation=0.5
 Frame=43 Station=0.5 OutputCase=ACC2 CaseType=Combination Point=3 X2=0.5 X3=-0.5
 S11=1872.39195820209 IsS11Max=Yes IsS11Min=No FrameElem=43 ElemStation=0.5
 Frame=43 Station=0.5 OutputCase=ACC2 CaseType=Combination Point=4 X2=0.5 X3=0.5
 S11=1872.39195820209 IsS11Max=No IsS11Min=No FrameElem=43 ElemStation=0.5
 Frame=43 Station=0 OutputCase=ACCSX1 CaseType=Combination Point=0 X2=0 X3=0 S11=-233.665974282453
 IsS11Max=No IsS11Min=No FrameElem=43 ElemStation=0
 Frame=43 Station=0 OutputCase=ACCSX1 CaseType=Combination Point=1 X2=-0.5 X3=-0.5 S11=-
 1665.67469181791 IsS11Max=No IsS11Min=Yes FrameElem=43 ElemStation=0
 Frame=43 Station=0 OutputCase=ACCSX1 CaseType=Combination Point=2 X2=-0.5 X3=0.5 S11=-
 1665.67469181791 IsS11Max=No IsS11Min=No FrameElem=43 ElemStation=0
 Frame=43 Station=0 OutputCase=ACCSX1 CaseType=Combination Point=3 X2=0.5 X3=-0.5
 S11=1198.34274325301 IsS11Max=Yes IsS11Min=No FrameElem=43 ElemStation=0

```

Frame=43 Station=0 OutputCase=ACCSX1 CaseType=Combination Point=4 X2=0.5 X3=0.5
S11=1198.34274325301 IsS11Max=No IsS11Min=No FrameElem=43 ElemStation=0
Frame=43 Station=0.125 OutputCase=ACCSX1 CaseType=Combination Point=0 X2=0 X3=0 S11=-
233.665974282453 IsS11Max=No IsS11Min=No FrameElem=43 ElemStation=0.125
Frame=43 Station=0.125 OutputCase=ACCSX1 CaseType=Combination Point=1 X2=-0.5 X3=-0.5 S11=-
1777.4724944036 IsS11Max=No IsS11Min=Yes FrameElem=43 ElemStation=0.125
Frame=43 Station=0.125 OutputCase=ACCSX1 CaseType=Combination Point=2 X2=-0.5 X3=0.5 S11=-
1777.4724944036 IsS11Max=No IsS11Min=No FrameElem=43 ElemStation=0.125
Frame=43 Station=0.125 OutputCase=ACCSX1 CaseType=Combination Point=3 X2=0.5 X3=-0.5
S11=1310.1405458387 IsS11Max=Yes IsS11Min=No FrameElem=43 ElemStation=0.125
Frame=43 Station=0.125 OutputCase=ACCSX1 CaseType=Combination Point=4 X2=0.5 X3=0.5
S11=1310.1405458387 IsS11Max=No IsS11Min=No FrameElem=43 ElemStation=0.125
Frame=43 Station=0.25 OutputCase=ACCSX1 CaseType=Combination Point=0 X2=0 X3=0 S11=-
233.665974282453 IsS11Max=No IsS11Min=No FrameElem=43 ElemStation=0.25
Frame=43 Station=0.25 OutputCase=ACCSX1 CaseType=Combination Point=1 X2=-0.5 X3=-0.5 S11=-
1891.61404698929 IsS11Max=No IsS11Min=Yes FrameElem=43 ElemStation=0.25
Frame=43 Station=0.25 OutputCase=ACCSX1 CaseType=Combination Point=2 X2=-0.5 X3=0.5 S11=-
1891.61404698929 IsS11Max=No IsS11Min=No FrameElem=43 ElemStation=0.25
Frame=43 Station=0.25 OutputCase=ACCSX1 CaseType=Combination Point=3 X2=0.5 X3=-0.5
S11=1424.28209842439 IsS11Max=Yes IsS11Min=No FrameElem=43 ElemStation=0.25
Frame=43 Station=0.25 OutputCase=ACCSX1 CaseType=Combination Point=4 X2=0.5 X3=0.5
S11=1424.28209842439 IsS11Max=No IsS11Min=No FrameElem=43 ElemStation=0.25
Frame=43 Station=0.375 OutputCase=ACCSX1 CaseType=Combination Point=0 X2=0 X3=0 S11=-
233.665974282453 IsS11Max=No IsS11Min=No FrameElem=43 ElemStation=0.375
Frame=43 Station=0.375 OutputCase=ACCSX1 CaseType=Combination Point=1 X2=-0.5 X3=-0.5 S11=-
2008.09934957499 IsS11Max=No IsS11Min=Yes FrameElem=43 ElemStation=0.375
Frame=43 Station=0.375 OutputCase=ACCSX1 CaseType=Combination Point=2 X2=-0.5 X3=0.5 S11=-
2008.09934957499 IsS11Max=No IsS11Min=No FrameElem=43 ElemStation=0.375
Frame=43 Station=0.375 OutputCase=ACCSX1 CaseType=Combination Point=3 X2=0.5 X3=-0.5
S11=1540.76740101008 IsS11Max=Yes IsS11Min=No FrameElem=43 ElemStation=0.375
Frame=43 Station=0.375 OutputCase=ACCSX1 CaseType=Combination Point=4 X2=0.5 X3=0.5
S11=1540.76740101008 IsS11Max=No IsS11Min=No FrameElem=43 ElemStation=0.375
Frame=43 Station=0.5 OutputCase=ACCSX1 CaseType=Combination Point=0 X2=0 X3=0 S11=-233.665974282453
IsS11Max=No IsS11Min=No FrameElem=43 ElemStation=0.5
Frame=43 Station=0.5 OutputCase=ACCSX1 CaseType=Combination Point=1 X2=-0.5 X3=-0.5 S11=-
2126.92840216068 IsS11Max=No IsS11Min=Yes FrameElem=43 ElemStation=0.5
Frame=43 Station=0.5 OutputCase=ACCSX1 CaseType=Combination Point=2 X2=-0.5 X3=0.5 S11=-
2126.92840216068 IsS11Max=No IsS11Min=No FrameElem=43 ElemStation=0.5
Frame=43 Station=0.5 OutputCase=ACCSX1 CaseType=Combination Point=3 X2=0.5 X3=-0.5
S11=1659.59645359577 IsS11Max=Yes IsS11Min=No FrameElem=43 ElemStation=0.5
Frame=43 Station=0.5 OutputCase=ACCSX1 CaseType=Combination Point=4 X2=0.5 X3=0.5
S11=1659.59645359577 IsS11Max=No IsS11Min=No FrameElem=43 ElemStation=0.5
Frame=43 Station=0 OutputCase=ACCSX2 CaseType=Combination Point=0 X2=0 X3=0 S11=-167.192740601283
IsS11Max=No IsS11Min=No FrameElem=43 ElemStation=0
Frame=43 Station=0 OutputCase=ACCSX2 CaseType=Combination Point=1 X2=-0.5 X3=-0.5 S11=-
1684.71036936717 IsS11Max=No IsS11Min=Yes FrameElem=43 ElemStation=0
Frame=43 Station=0 OutputCase=ACCSX2 CaseType=Combination Point=2 X2=-0.5 X3=0.5 S11=-
1684.71036936717 IsS11Max=No IsS11Min=No FrameElem=43 ElemStation=0
Frame=43 Station=0 OutputCase=ACCSX2 CaseType=Combination Point=3 X2=0.5 X3=-0.5
S11=1350.3248881646 IsS11Max=Yes IsS11Min=No FrameElem=43 ElemStation=0
Frame=43 Station=0 OutputCase=ACCSX2 CaseType=Combination Point=4 X2=0.5 X3=0.5 S11=1350.3248881646
IsS11Max=No IsS11Min=No FrameElem=43 ElemStation=0
Frame=43 Station=0.125 OutputCase=ACCSX2 CaseType=Combination Point=0 X2=0 X3=0 S11=-
167.192740601283 IsS11Max=No IsS11Min=No FrameElem=43 ElemStation=0.125
Frame=43 Station=0.125 OutputCase=ACCSX2 CaseType=Combination Point=1 X2=-0.5 X3=-0.5 S11=-
1796.44064761725 IsS11Max=No IsS11Min=Yes FrameElem=43 ElemStation=0.125
Frame=43 Station=0.125 OutputCase=ACCSX2 CaseType=Combination Point=2 X2=-0.5 X3=0.5 S11=-
1796.44064761725 IsS11Max=No IsS11Min=No FrameElem=43 ElemStation=0.125
Frame=43 Station=0.125 OutputCase=ACCSX2 CaseType=Combination Point=3 X2=0.5 X3=-0.5
S11=1462.05516641468 IsS11Max=Yes IsS11Min=No FrameElem=43 ElemStation=0.125
Frame=43 Station=0.125 OutputCase=ACCSX2 CaseType=Combination Point=4 X2=0.5 X3=0.5
S11=1462.05516641468 IsS11Max=No IsS11Min=No FrameElem=43 ElemStation=0.125
Frame=43 Station=0.25 OutputCase=ACCSX2 CaseType=Combination Point=0 X2=0 X3=0 S11=-
167.192740601283 IsS11Max=No IsS11Min=No FrameElem=43 ElemStation=0.25
Frame=43 Station=0.25 OutputCase=ACCSX2 CaseType=Combination Point=1 X2=-0.5 X3=-0.5 S11=-
1910.51467586733 IsS11Max=No IsS11Min=Yes FrameElem=43 ElemStation=0.25
Frame=43 Station=0.25 OutputCase=ACCSX2 CaseType=Combination Point=2 X2=-0.5 X3=0.5 S11=-
1910.51467586733 IsS11Max=No IsS11Min=No FrameElem=43 ElemStation=0.25
Frame=43 Station=0.25 OutputCase=ACCSX2 CaseType=Combination Point=3 X2=0.5 X3=-0.5
S11=1576.12919466476 IsS11Max=Yes IsS11Min=No FrameElem=43 ElemStation=0.25
Frame=43 Station=0.25 OutputCase=ACCSX2 CaseType=Combination Point=4 X2=0.5 X3=0.5
S11=1576.12919466476 IsS11Max=No IsS11Min=No FrameElem=43 ElemStation=0.25
Frame=43 Station=0.375 OutputCase=ACCSX2 CaseType=Combination Point=0 X2=0 X3=0 S11=-
167.192740601283 IsS11Max=No IsS11Min=No FrameElem=43 ElemStation=0.375
Frame=43 Station=0.375 OutputCase=ACCSX2 CaseType=Combination Point=1 X2=-0.5 X3=-0.5 S11=-
2026.93245411741 IsS11Max=No IsS11Min=Yes FrameElem=43 ElemStation=0.375
Frame=43 Station=0.375 OutputCase=ACCSX2 CaseType=Combination Point=2 X2=-0.5 X3=0.5 S11=-
2026.93245411741 IsS11Max=No IsS11Min=No FrameElem=43 ElemStation=0.375
Frame=43 Station=0.375 OutputCase=ACCSX2 CaseType=Combination Point=3 X2=0.5 X3=-0.5
S11=1692.54697291484 IsS11Max=Yes IsS11Min=No FrameElem=43 ElemStation=0.375
Frame=43 Station=0.375 OutputCase=ACCSX2 CaseType=Combination Point=4 X2=0.5 X3=0.5
S11=1692.54697291484 IsS11Max=No IsS11Min=No FrameElem=43 ElemStation=0.375

```

Frame=43	Station=0.5	OutputCase=ACCSX2	CaseType=Combination	Point=0	X2=0	X3=0	S11=-167.192740601283
IsS11Max=No	IsS11Min=No	FrameElem=43	ElemStation=0.5				
Frame=43	Station=0.5	OutputCase=ACCSX2	CaseType=Combination	Point=1	X2=-0.5	X3=-0.5	S11=-
2145.69398236749	IsS11Max=No	IsS11Min=Yes	FrameElem=43	ElemStation=0.5			
Frame=43	Station=0.5	OutputCase=ACCSX2	CaseType=Combination	Point=2	X2=-0.5	X3=0.5	S11=-
2145.69398236749	IsS11Max=No	IsS11Min=No	FrameElem=43	ElemStation=0.5			
Frame=43	Station=0.5	OutputCase=ACCSX2	CaseType=Combination	Point=3	X2=0.5	X3=-0.5	
S11=1811.30850116492	IsS11Max=Yes	IsS11Min=No	FrameElem=43	ElemStation=0.5			
Frame=43	Station=0.5	OutputCase=ACCSX2	CaseType=Combination	Point=4	X2=0.5	X3=0.5	
S11=1811.30850116492	IsS11Max=No	IsS11Min=No	FrameElem=43	ElemStation=0.5			
Frame=43	Station=0	OutputCase=ENVE	CaseType=Combination	StepType=Max	Point=0	X2=0	X3=0
S11=-167.192740601283	IsS11Max=No	IsS11Min=No	FrameElem=43	ElemStation=0			
Frame=43	Station=0	OutputCase=ENVE	CaseType=Combination	StepType=Max	Point=1	X2=-0.5	X3=-0.5
S11=-1665.67469181791	IsS11Max=No	IsS11Min=Yes	FrameElem=43	ElemStation=0			
Frame=43	Station=0	OutputCase=ENVE	CaseType=Combination	StepType=Max	Point=2	X2=-0.5	X3=0.5
S11=-1665.67469181791	IsS11Max=No	IsS11Min=No	FrameElem=43	ElemStation=0			
Frame=43	Station=0	OutputCase=ENVE	CaseType=Combination	StepType=Max	Point=3	X2=0.5	X3=-0.5
S11=1409.87643344631	IsS11Max=Yes	IsS11Min=No	FrameElem=43	ElemStation=0			
Frame=43	Station=0	OutputCase=ENVE	CaseType=Combination	StepType=Max	Point=4	X2=0.5	X3=0.5
S11=1409.87643344631	IsS11Max=No	IsS11Min=No	FrameElem=43	ElemStation=0			
Frame=43	Station=0.125	OutputCase=ENVE	CaseType=Combination	StepType=Max	Point=0	X2=0	X3=0
S11=-167.192740601283	IsS11Max=No	IsS11Min=No	FrameElem=43	ElemStation=0.125			
Frame=43	Station=0.125	OutputCase=ENVE	CaseType=Combination	StepType=Max	Point=1	X2=-0.5	X3=-0.5
S11=-1777.4724944036	IsS11Max=No	IsS11Min=Yes	FrameElem=43	ElemStation=0.125			
Frame=43	Station=0.125	OutputCase=ENVE	CaseType=Combination	StepType=Max	Point=2	X2=-0.5	X3=0.5
S11=-1777.4724944036	IsS11Max=No	IsS11Min=No	FrameElem=43	ElemStation=0.125			
Frame=43	Station=0.125	OutputCase=ENVE	CaseType=Combination	StepType=Max	Point=3	X2=0.5	X3=-0.5
S11=1521.98968963526	IsS11Max=Yes	IsS11Min=No	FrameElem=43	ElemStation=0.125			
Frame=43	Station=0.125	OutputCase=ENVE	CaseType=Combination	StepType=Max	Point=4	X2=0.5	X3=0.5
S11=1521.98968963526	IsS11Max=No	IsS11Min=No	FrameElem=43	ElemStation=0.125			
Frame=43	Station=0.25	OutputCase=ENVE	CaseType=Combination	StepType=Max	Point=0	X2=0	X3=0
S11=-167.192740601283	IsS11Max=No	IsS11Min=No	FrameElem=43	ElemStation=0.25			
Frame=43	Station=0.25	OutputCase=ENVE	CaseType=Combination	StepType=Max	Point=1	X2=-0.5	X3=-0.5
S11=-1891.61404698929	IsS11Max=No	IsS11Min=Yes	FrameElem=43	ElemStation=0.25			
Frame=43	Station=0.25	OutputCase=ENVE	CaseType=Combination	StepType=Max	Point=2	X2=-0.5	X3=0.5
S11=-1891.61404698929	IsS11Max=No	IsS11Min=No	FrameElem=43	ElemStation=0.25			
Frame=43	Station=0.25	OutputCase=ENVE	CaseType=Combination	StepType=Max	Point=3	X2=0.5	X3=-0.5
S11=1636.4466958242	IsS11Max=Yes	IsS11Min=No	FrameElem=43	ElemStation=0.25			
Frame=43	Station=0.25	OutputCase=ENVE	CaseType=Combination	StepType=Max	Point=4	X2=0.5	X3=0.5
S11=1636.4466958242	IsS11Max=No	IsS11Min=No	FrameElem=43	ElemStation=0.25			
Frame=43	Station=0.375	OutputCase=ENVE	CaseType=Combination	StepType=Max	Point=0	X2=0	X3=0
S11=-167.192740601283	IsS11Max=No	IsS11Min=No	FrameElem=43	ElemStation=0.375			
Frame=43	Station=0.375	OutputCase=ENVE	CaseType=Combination	StepType=Max	Point=1	X2=-0.5	X3=-0.5
S11=-2008.09934957499	IsS11Max=No	IsS11Min=Yes	FrameElem=43	ElemStation=0.375			
Frame=43	Station=0.375	OutputCase=ENVE	CaseType=Combination	StepType=Max	Point=2	X2=-0.5	X3=0.5
S11=-2008.09934957499	IsS11Max=No	IsS11Min=No	FrameElem=43	ElemStation=0.375			
Frame=43	Station=0.375	OutputCase=ENVE	CaseType=Combination	StepType=Max	Point=3	X2=0.5	X3=-0.5
S11=1753.24745201315	IsS11Max=Yes	IsS11Min=No	FrameElem=43	ElemStation=0.375			
Frame=43	Station=0.375	OutputCase=ENVE	CaseType=Combination	StepType=Max	Point=4	X2=0.5	X3=0.5
S11=1753.24745201315	IsS11Max=No	IsS11Min=No	FrameElem=43	ElemStation=0.375			
Frame=43	Station=0.5	OutputCase=ENVE	CaseType=Combination	StepType=Max	Point=0	X2=0	X3=0
S11=-167.192740601283	IsS11Max=No	IsS11Min=No	FrameElem=43	ElemStation=0.5			
Frame=43	Station=0.5	OutputCase=ENVE	CaseType=Combination	StepType=Max	Point=1	X2=-0.5	X3=-0.5
S11=-2126.92840216068	IsS11Max=No	IsS11Min=Yes	FrameElem=43	ElemStation=0.5			
Frame=43	Station=0.5	OutputCase=ENVE	CaseType=Combination	StepType=Max	Point=2	X2=-0.5	X3=0.5
S11=-2126.92840216068	IsS11Max=No	IsS11Min=No	FrameElem=43	ElemStation=0.5			
Frame=43	Station=0.5	OutputCase=ENVE	CaseType=Combination	StepType=Max	Point=3	X2=0.5	X3=-0.5
S11=1872.39195820209	IsS11Max=Yes	IsS11Min=No	FrameElem=43	ElemStation=0.5			
Frame=43	Station=0.5	OutputCase=ENVE	CaseType=Combination	StepType=Max	Point=4	X2=0.5	X3=0.5
S11=1872.39195820209	IsS11Max=No	IsS11Min=No	FrameElem=43	ElemStation=0.5			
Frame=43	Station=0	OutputCase=ENVE	CaseType=Combination	StepType=Min	Point=0	X2=0	X3=0
S11=-240.528987364651	IsS11Max=No	IsS11Min=No	FrameElem=43	ElemStation=0			
Frame=43	Station=0	OutputCase=ENVE	CaseType=Combination	StepType=Min	Point=1	X2=-0.5	X3=-0.5
S11=-1757.98794081327	IsS11Max=No	IsS11Min=Yes	FrameElem=43	ElemStation=0			
Frame=43	Station=0	OutputCase=ENVE	CaseType=Combination	StepType=Min	Point=2	X2=-0.5	X3=0.5
S11=-1757.98794081327	IsS11Max=No	IsS11Min=No	FrameElem=43	ElemStation=0			
Frame=43	Station=0	OutputCase=ENVE	CaseType=Combination	StepType=Min	Point=3	X2=0.5	X3=-0.5
S11=1198.34274325301	IsS11Max=Yes	IsS11Min=No	FrameElem=43	ElemStation=0			
Frame=43	Station=0	OutputCase=ENVE	CaseType=Combination	StepType=Min	Point=4	X2=0.5	X3=0.5
S11=1198.34274325301	IsS11Max=No	IsS11Min=No	FrameElem=43	ElemStation=0			
Frame=43	Station=0.125	OutputCase=ENVE	CaseType=Combination	StepType=Min	Point=0	X2=0	X3=0
S11=-240.528987364651	IsS11Max=No	IsS11Min=No	FrameElem=43	ElemStation=0.125			
Frame=43	Station=0.125	OutputCase=ENVE	CaseType=Combination	StepType=Min	Point=1	X2=-0.5	X3=-0.5
S11=-1870.10119700222	IsS11Max=No	IsS11Min=Yes	FrameElem=43	ElemStation=0.125			
Frame=43	Station=0.125	OutputCase=ENVE	CaseType=Combination	StepType=Min	Point=2	X2=-0.5	X3=0.5
S11=-1870.10119700222	IsS11Max=No	IsS11Min=No	FrameElem=43	ElemStation=0.125			
Frame=43	Station=0.125	OutputCase=ENVE	CaseType=Combination	StepType=Min	Point=3	X2=0.5	X3=-0.5
S11=1310.1405458387	IsS11Max=Yes	IsS11Min=No	FrameElem=43	ElemStation=0.125			
Frame=43	Station=0.125	OutputCase=ENVE	CaseType=Combination	StepType=Min	Point=4	X2=0.5	X3=0.5
S11=1310.1405458387	IsS11Max=No	IsS11Min=No	FrameElem=43	ElemStation=0.125			
Frame=43	Station=0.25	OutputCase=ENVE	CaseType=Combination	StepType=Min	Point=0	X2=0	X3=0
S11=-240.528987364651	IsS11Max=No	IsS11Min=No	FrameElem=43	ElemStation=0.25			

Frame=43	Station=0.25	OutputCase=ENVE	CaseType=Combination	StepType=Min	Point=1	X2=-0.5	X3=-0.5	
S11=-1984.55820319116	IsS11Max=No	IsS11Min=Yes	FrameElem=43	ElemStation=0.25				
Frame=43	Station=0.25	OutputCase=ENVE	CaseType=Combination	StepType=Min	Point=2	X2=-0.5	X3=0.5	
S11=-1984.55820319116	IsS11Max=No	IsS11Min=No	FrameElem=43	ElemStation=0.25				
Frame=43	Station=0.25	OutputCase=ENVE	CaseType=Combination	StepType=Min	Point=3	X2=0.5	X3=-0.5	
S11=1424.28209842439	IsS11Max=Yes	IsS11Min=No	FrameElem=43	ElemStation=0.25				
Frame=43	Station=0.25	OutputCase=ENVE	CaseType=Combination	StepType=Min	Point=4	X2=0.5	X3=0.5	
S11=1424.28209842439	IsS11Max=No	IsS11Min=No	FrameElem=43	ElemStation=0.25				
Frame=43	Station=0.375	OutputCase=ENVE	CaseType=Combination	StepType=Min	Point=0	X2=0	X3=0	S11=-
240.528987364651	IsS11Max=No	IsS11Min=No	FrameElem=43	ElemStation=0.375				
Frame=43	Station=0.375	OutputCase=ENVE	CaseType=Combination	StepType=Min	Point=1	X2=-0.5	X3=-0.5	
S11=-2101.35895938011	IsS11Max=No	IsS11Min=Yes	FrameElem=43	ElemStation=0.375				
Frame=43	Station=0.375	OutputCase=ENVE	CaseType=Combination	StepType=Min	Point=2	X2=-0.5	X3=0.5	
S11=-2101.35895938011	IsS11Max=No	IsS11Min=No	FrameElem=43	ElemStation=0.375				
Frame=43	Station=0.375	OutputCase=ENVE	CaseType=Combination	StepType=Min	Point=3	X2=0.5	X3=-0.5	
S11=1540.76740101008	IsS11Max=Yes	IsS11Min=No	FrameElem=43	ElemStation=0.375				
Frame=43	Station=0.375	OutputCase=ENVE	CaseType=Combination	StepType=Min	Point=4	X2=0.5	X3=0.5	
S11=1540.76740101008	IsS11Max=No	IsS11Min=No	FrameElem=43	ElemStation=0.375				
Frame=43	Station=0.5	OutputCase=ENVE	CaseType=Combination	StepType=Min	Point=0	X2=0	X3=0	S11=-
240.528987364651	IsS11Max=No	IsS11Min=No	FrameElem=43	ElemStation=0.5				
Frame=43	Station=0.5	OutputCase=ENVE	CaseType=Combination	StepType=Min	Point=1	X2=-0.5	X3=-0.5	
S11=-2220.50346556905	IsS11Max=No	IsS11Min=Yes	FrameElem=43	ElemStation=0.5				
Frame=43	Station=0.5	OutputCase=ENVE	CaseType=Combination	StepType=Min	Point=2	X2=-0.5	X3=0.5	
S11=-2220.50346556905	IsS11Max=No	IsS11Min=No	FrameElem=43	ElemStation=0.5				
Frame=43	Station=0.5	OutputCase=ENVE	CaseType=Combination	StepType=Min	Point=3	X2=0.5	X3=-0.5	
S11=1659.59645359577	IsS11Max=Yes	IsS11Min=No	FrameElem=43	ElemStation=0.5				
Frame=43	Station=0.5	OutputCase=ENVE	CaseType=Combination	StepType=Min	Point=4	X2=0.5	X3=0.5	
S11=1659.59645359577	IsS11Max=No	IsS11Min=No	FrameElem=43	ElemStation=0.5				
Frame=43	Station=0	OutputCase=FESSUR	CaseType=Combination	Point=0	X2=0	X3=0	S11=-239.151922837248	
IsS11Max=No	IsS11Min=No	FrameElem=43	ElemStation=0					
Frame=43	Station=0	OutputCase=FESSUR	CaseType=Combination	Point=1	X2=-0.5	X3=-0.5	S11=-	
1725.68516452073	IsS11Max=No	IsS11Min=Yes	FrameElem=43	ElemStation=0				
Frame=43	Station=0	OutputCase=FESSUR	CaseType=Combination	Point=2	X2=-0.5	X3=0.5	S11=-	
1725.68516452073	IsS11Max=No	IsS11Min=No	FrameElem=43	ElemStation=0				
Frame=43	Station=0	OutputCase=FESSUR	CaseType=Combination	Point=3	X2=0.5	X3=-0.5		
S11=1247.38131884623	IsS11Max=Yes	IsS11Min=No	FrameElem=43	ElemStation=0				
Frame=43	Station=0	OutputCase=FESSUR	CaseType=Combination	Point=4	X2=0.5	X3=0.5		
S11=1247.38131884623	IsS11Max=No	IsS11Min=No	FrameElem=43	ElemStation=0				
Frame=43	Station=0.125	OutputCase=FESSUR	CaseType=Combination	Point=0	X2=0	X3=0	S11=-	
239.151922837248	IsS11Max=No	IsS11Min=No	FrameElem=43	ElemStation=0.125				
Frame=43	Station=0.125	OutputCase=FESSUR	CaseType=Combination	Point=1	X2=-0.5	X3=-0.5	S11=-	
1836.96351027685	IsS11Max=No	IsS11Min=Yes	FrameElem=43	ElemStation=0.125				
Frame=43	Station=0.125	OutputCase=FESSUR	CaseType=Combination	Point=2	X2=-0.5	X3=0.5	S11=-	
1836.96351027685	IsS11Max=No	IsS11Min=No	FrameElem=43	ElemStation=0.125				
Frame=43	Station=0.125	OutputCase=FESSUR	CaseType=Combination	Point=3	X2=0.5	X3=-0.5		
S11=1358.65966460235	IsS11Max=Yes	IsS11Min=No	FrameElem=43	ElemStation=0.125				
Frame=43	Station=0.125	OutputCase=FESSUR	CaseType=Combination	Point=4	X2=0.5	X3=0.5		
S11=1358.65966460235	IsS11Max=No	IsS11Min=No	FrameElem=43	ElemStation=0.125				
Frame=43	Station=0.25	OutputCase=FESSUR	CaseType=Combination	Point=0	X2=0	X3=0	S11=-	
239.151922837248	IsS11Max=No	IsS11Min=No	FrameElem=43	ElemStation=0.25				
Frame=43	Station=0.25	OutputCase=FESSUR	CaseType=Combination	Point=1	X2=-0.5	X3=-0.5	S11=-	
1950.58560603296	IsS11Max=No	IsS11Min=Yes	FrameElem=43	ElemStation=0.25				
Frame=43	Station=0.25	OutputCase=FESSUR	CaseType=Combination	Point=2	X2=-0.5	X3=0.5	S11=-	
1950.58560603296	IsS11Max=No	IsS11Min=No	FrameElem=43	ElemStation=0.25				
Frame=43	Station=0.25	OutputCase=FESSUR	CaseType=Combination	Point=3	X2=0.5	X3=-0.5		
S11=1472.28176035847	IsS11Max=Yes	IsS11Min=No	FrameElem=43	ElemStation=0.25				
Frame=43	Station=0.25	OutputCase=FESSUR	CaseType=Combination	Point=4	X2=0.5	X3=0.5		
S11=1472.28176035847	IsS11Max=No	IsS11Min=No	FrameElem=43	ElemStation=0.25				
Frame=43	Station=0.375	OutputCase=FESSUR	CaseType=Combination	Point=0	X2=0	X3=0	S11=-	
239.151922837248	IsS11Max=No	IsS11Min=No	FrameElem=43	ElemStation=0.375				
Frame=43	Station=0.375	OutputCase=FESSUR	CaseType=Combination	Point=1	X2=-0.5	X3=-0.5	S11=-	
2066.55145178908	IsS11Max=No	IsS11Min=Yes	FrameElem=43	ElemStation=0.375				
Frame=43	Station=0.375	OutputCase=FESSUR	CaseType=Combination	Point=2	X2=-0.5	X3=0.5	S11=-	
2066.55145178908	IsS11Max=No	IsS11Min=No	FrameElem=43	ElemStation=0.375				
Frame=43	Station=0.375	OutputCase=FESSUR	CaseType=Combination	Point=3	X2=0.5	X3=-0.5		
S11=1588.24760611459	IsS11Max=Yes	IsS11Min=No	FrameElem=43	ElemStation=0.375				
Frame=43	Station=0.375	OutputCase=FESSUR	CaseType=Combination	Point=4	X2=0.5	X3=0.5		
S11=1588.24760611459	IsS11Max=No	IsS11Min=No	FrameElem=43	ElemStation=0.375				
Frame=43	Station=0.5	OutputCase=FESSUR	CaseType=Combination	Point=0	X2=0	X3=0	S11=-239.151922837248	
IsS11Max=No	IsS11Min=No	FrameElem=43	ElemStation=0.5					
Frame=43	Station=0.5	OutputCase=FESSUR	CaseType=Combination	Point=1	X2=-0.5	X3=-0.5	S11=-	
2184.8610475452	IsS11Max=No	IsS11Min=Yes	FrameElem=43	ElemStation=0.5				
Frame=43	Station=0.5	OutputCase=FESSUR	CaseType=Combination	Point=2	X2=-0.5	X3=0.5	S11=-	
2184.8610475452	IsS11Max=No	IsS11Min=No	FrameElem=43	ElemStation=0.5				
Frame=43	Station=0.5	OutputCase=FESSUR	CaseType=Combination	Point=3	X2=0.5	X3=-0.5		
S11=1706.5572018707	IsS11Max=Yes	IsS11Min=No	FrameElem=43	ElemStation=0.5				
Frame=43	Station=0.5	OutputCase=FESSUR	CaseType=Combination	Point=4	X2=0.5	X3=0.5		
S11=1706.5572018707	IsS11Max=No	IsS11Min=No	FrameElem=43	ElemStation=0.5				
Frame=44	Station=0	OutputCase=PERM1	CaseType=Combination	Point=0	X2=0	X3=0	S11=-235.938772273311	
IsS11Max=No	IsS11Min=No	FrameElem=44	ElemStation=0					
Frame=44	Station=0	OutputCase=PERM1	CaseType=Combination	Point=1	X2=-0.5	X3=-0.5	S11=-	
2145.48175930542	IsS11Max=No	IsS11Min=Yes	FrameElem=44	ElemStation=0				

Frame=44	Station=0	OutputCase=PERM1	CaseType=Combination	Point=2	X2=-0.5	X3=0.5	S11=-
2145.48175930542	IsS11Max=No	IsS11Min=No	FrameElem=44	ElemStation=0			
Frame=44	Station=0	OutputCase=PERM1	CaseType=Combination	Point=3	X2=0.5	X3=-0.5	S11=1673.6042147588
IsS11Max=Yes	IsS11Min=No	FrameElem=44	ElemStation=0				
Frame=44	Station=0	OutputCase=PERM1	CaseType=Combination	Point=4	X2=0.5	X3=0.5	S11=1673.6042147588
IsS11Max=No	IsS11Min=No	FrameElem=44	ElemStation=0				
Frame=44	Station=0.125	OutputCase=PERM1	CaseType=Combination	Point=0	X2=0	X3=0	S11=-
235.938772273311	IsS11Max=No	IsS11Min=No	FrameElem=44	ElemStation=0.125			
Frame=44	Station=0.125	OutputCase=PERM1	CaseType=Combination	Point=1	X2=-0.5	X3=-0.5	S11=-
2179.4774540359	IsS11Max=No	IsS11Min=Yes	FrameElem=44	ElemStation=0.125			
Frame=44	Station=0.125	OutputCase=PERM1	CaseType=Combination	Point=2	X2=-0.5	X3=0.5	S11=-
2179.4774540359	IsS11Max=No	IsS11Min=No	FrameElem=44	ElemStation=0.125			
Frame=44	Station=0.125	OutputCase=PERM1	CaseType=Combination	Point=3	X2=0.5	X3=-0.5	S11=-
S11=1707.59990948927	IsS11Max=Yes	IsS11Min=No	FrameElem=44	ElemStation=0.125			
Frame=44	Station=0.125	OutputCase=PERM1	CaseType=Combination	Point=4	X2=0.5	X3=0.5	S11=-
S11=1707.59990948927	IsS11Max=No	IsS11Min=No	FrameElem=44	ElemStation=0.125			
Frame=44	Station=0.25	OutputCase=PERM1	CaseType=Combination	Point=0	X2=0	X3=0	S11=-235.938772273311
IsS11Max=No	IsS11Min=No	FrameElem=44	ElemStation=0.25				
Frame=44	Station=0.25	OutputCase=PERM1	CaseType=Combination	Point=1	X2=-0.5	X3=-0.5	S11=-
2215.81689876637	IsS11Max=No	IsS11Min=Yes	FrameElem=44	ElemStation=0.25			
Frame=44	Station=0.25	OutputCase=PERM1	CaseType=Combination	Point=2	X2=-0.5	X3=0.5	S11=-
2215.81689876637	IsS11Max=No	IsS11Min=No	FrameElem=44	ElemStation=0.25			
Frame=44	Station=0.25	OutputCase=PERM1	CaseType=Combination	Point=3	X2=0.5	X3=-0.5	S11=-
S11=1743.93935421975	IsS11Max=Yes	IsS11Min=No	FrameElem=44	ElemStation=0.25			
Frame=44	Station=0.25	OutputCase=PERM1	CaseType=Combination	Point=4	X2=0.5	X3=0.5	S11=-
S11=1743.93935421975	IsS11Max=No	IsS11Min=No	FrameElem=44	ElemStation=0.25			
Frame=44	Station=0.375	OutputCase=PERM1	CaseType=Combination	Point=0	X2=0	X3=0	S11=-
235.938772273311	IsS11Max=No	IsS11Min=No	FrameElem=44	ElemStation=0.375			
Frame=44	Station=0.375	OutputCase=PERM1	CaseType=Combination	Point=1	X2=-0.5	X3=-0.5	S11=-
2254.50009349685	IsS11Max=No	IsS11Min=Yes	FrameElem=44	ElemStation=0.375			
Frame=44	Station=0.375	OutputCase=PERM1	CaseType=Combination	Point=2	X2=-0.5	X3=0.5	S11=-
2254.50009349685	IsS11Max=No	IsS11Min=No	FrameElem=44	ElemStation=0.375			
Frame=44	Station=0.375	OutputCase=PERM1	CaseType=Combination	Point=3	X2=0.5	X3=-0.5	S11=-
S11=1782.62254895023	IsS11Max=Yes	IsS11Min=No	FrameElem=44	ElemStation=0.375			
Frame=44	Station=0.375	OutputCase=PERM1	CaseType=Combination	Point=4	X2=0.5	X3=0.5	S11=-
S11=1782.62254895023	IsS11Max=No	IsS11Min=No	FrameElem=44	ElemStation=0.375			
Frame=44	Station=0.5	OutputCase=PERM1	CaseType=Combination	Point=0	X2=0	X3=0	S11=-235.938772273311
IsS11Max=No	IsS11Min=No	FrameElem=44	ElemStation=0.5				
Frame=44	Station=0.5	OutputCase=PERM1	CaseType=Combination	Point=1	X2=-0.5	X3=-0.5	S11=-
2295.52703822732	IsS11Max=No	IsS11Min=Yes	FrameElem=44	ElemStation=0.5			
Frame=44	Station=0.5	OutputCase=PERM1	CaseType=Combination	Point=2	X2=-0.5	X3=0.5	S11=-
2295.52703822732	IsS11Max=No	IsS11Min=No	FrameElem=44	ElemStation=0.5			
Frame=44	Station=0.5	OutputCase=PERM1	CaseType=Combination	Point=3	X2=0.5	X3=-0.5	S11=-
S11=1823.6494936807	IsS11Max=Yes	IsS11Min=No	FrameElem=44	ElemStation=0.5			
Frame=44	Station=0.5	OutputCase=PERM1	CaseType=Combination	Point=4	X2=0.5	X3=0.5	S11=-
S11=1823.6494936807	IsS11Max=No	IsS11Min=No	FrameElem=44	ElemStation=0.5			
Frame=44	Station=0	OutputCase=PERM2	CaseType=Combination	Point=0	X2=0	X3=0	S11=-169.465538592141
IsS11Max=No	IsS11Min=No	FrameElem=44	ElemStation=0				
Frame=44	Station=0	OutputCase=PERM2	CaseType=Combination	Point=1	X2=-0.5	X3=-0.5	S11=-
2164.24733951223	IsS11Max=No	IsS11Min=Yes	FrameElem=44	ElemStation=0			
Frame=44	Station=0	OutputCase=PERM2	CaseType=Combination	Point=2	X2=-0.5	X3=0.5	S11=-
2164.24733951223	IsS11Max=No	IsS11Min=No	FrameElem=44	ElemStation=0			
Frame=44	Station=0	OutputCase=PERM2	CaseType=Combination	Point=3	X2=0.5	X3=-0.5	S11=-
S11=1825.31626232795	IsS11Max=Yes	IsS11Min=No	FrameElem=44	ElemStation=0			
Frame=44	Station=0	OutputCase=PERM2	CaseType=Combination	Point=4	X2=0.5	X3=0.5	S11=1825.31626232795
IsS11Max=No	IsS11Min=No	FrameElem=44	ElemStation=0				
Frame=44	Station=0.125	OutputCase=PERM2	CaseType=Combination	Point=0	X2=0	X3=0	S11=-
169.465538592141	IsS11Max=No	IsS11Min=No	FrameElem=44	ElemStation=0.125			
Frame=44	Station=0.125	OutputCase=PERM2	CaseType=Combination	Point=1	X2=-0.5	X3=-0.5	S11=-
2198.21861030127	IsS11Max=No	IsS11Min=Yes	FrameElem=44	ElemStation=0.125			
Frame=44	Station=0.125	OutputCase=PERM2	CaseType=Combination	Point=2	X2=-0.5	X3=0.5	S11=-
2198.21861030127	IsS11Max=No	IsS11Min=No	FrameElem=44	ElemStation=0.125			
Frame=44	Station=0.125	OutputCase=PERM2	CaseType=Combination	Point=3	X2=0.5	X3=-0.5	S11=-
S11=1859.28753311699	IsS11Max=Yes	IsS11Min=No	FrameElem=44	ElemStation=0.125			
Frame=44	Station=0.125	OutputCase=PERM2	CaseType=Combination	Point=4	X2=0.5	X3=0.5	S11=-
S11=1859.28753311699	IsS11Max=No	IsS11Min=No	FrameElem=44	ElemStation=0.125			
Frame=44	Station=0.25	OutputCase=PERM2	CaseType=Combination	Point=0	X2=0	X3=0	S11=-169.465538592141
IsS11Max=No	IsS11Min=No	FrameElem=44	ElemStation=0.25				
Frame=44	Station=0.25	OutputCase=PERM2	CaseType=Combination	Point=1	X2=-0.5	X3=-0.5	S11=-
2234.53363109031	IsS11Max=No	IsS11Min=Yes	FrameElem=44	ElemStation=0.25			
Frame=44	Station=0.25	OutputCase=PERM2	CaseType=Combination	Point=2	X2=-0.5	X3=0.5	S11=-
2234.53363109031	IsS11Max=No	IsS11Min=No	FrameElem=44	ElemStation=0.25			
Frame=44	Station=0.25	OutputCase=PERM2	CaseType=Combination	Point=3	X2=0.5	X3=-0.5	S11=-
S11=1895.60255390603	IsS11Max=Yes	IsS11Min=No	FrameElem=44	ElemStation=0.25			
Frame=44	Station=0.25	OutputCase=PERM2	CaseType=Combination	Point=4	X2=0.5	X3=0.5	S11=-
S11=1895.60255390603	IsS11Max=No	IsS11Min=No	FrameElem=44	ElemStation=0.25			
Frame=44	Station=0.375	OutputCase=PERM2	CaseType=Combination	Point=0	X2=0	X3=0	S11=-
169.465538592141	IsS11Max=No	IsS11Min=No	FrameElem=44	ElemStation=0.375			
Frame=44	Station=0.375	OutputCase=PERM2	CaseType=Combination	Point=1	X2=-0.5	X3=-0.5	S11=-
2273.19240187935	IsS11Max=No	IsS11Min=Yes	FrameElem=44	ElemStation=0.375			
Frame=44	Station=0.375	OutputCase=PERM2	CaseType=Combination	Point=2	X2=-0.5	X3=0.5	S11=-
2273.19240187935	IsS11Max=No	IsS11Min=No	FrameElem=44	ElemStation=0.375			

Frame=44 Station=0.375 OutputCase=PERM2 CaseType=Combination Point=3 X2=0.5 X3=-0.5
 S11=1934.26132469507 IsS11Max=Yes IsS11Min=No FrameElem=44 ElemStation=0.375
 Frame=44 Station=0.375 OutputCase=PERM2 CaseType=Combination Point=4 X2=0.5 X3=0.5
 S11=1934.26132469507 IsS11Max=No IsS11Min=No FrameElem=44 ElemStation=0.375
 Frame=44 Station=0.5 OutputCase=PERM2 CaseType=Combination Point=0 X2=0 X3=0 S11=-169.465538592141
 IsS11Max=No IsS11Min=No FrameElem=44 ElemStation=0.5
 Frame=44 Station=0.5 OutputCase=PERM2 CaseType=Combination Point=1 X2=-0.5 X3=-0.5 S11=-
 2314.19492266839 IsS11Max=No IsS11Min=Yes FrameElem=44 ElemStation=0.5
 Frame=44 Station=0.5 OutputCase=PERM2 CaseType=Combination Point=2 X2=-0.5 X3=0.5 S11=-
 2314.19492266839 IsS11Max=No IsS11Min=No FrameElem=44 ElemStation=0.5
 Frame=44 Station=0.5 OutputCase=PERM2 CaseType=Combination Point=3 X2=0.5 X3=-0.5
 S11=1975.26384548411 IsS11Max=Yes IsS11Min=No FrameElem=44 ElemStation=0.5
 Frame=44 Station=0.5 OutputCase=PERM2 CaseType=Combination Point=4 X2=0.5 X3=0.5
 S11=1975.26384548411 IsS11Max=No IsS11Min=No FrameElem=44 ElemStation=0.5
 Frame=44 Station=0 OutputCase=ACC1 CaseType=Combination Point=0 X2=0 X3=0 S11=-240.528987364653
 IsS11Max=No IsS11Min=No FrameElem=44 ElemStation=0
 Frame=44 Station=0 OutputCase=ACC1 CaseType=Combination Point=1 X2=-0.5 X3=-0.5 S11=-
 2201.73788536222 IsS11Max=No IsS11Min=Yes FrameElem=44 ElemStation=0
 Frame=44 Station=0 OutputCase=ACC1 CaseType=Combination Point=2 X2=-0.5 X3=0.5 S11=-
 2201.73788536222 IsS11Max=No IsS11Min=No FrameElem=44 ElemStation=0
 Frame=44 Station=0 OutputCase=ACC1 CaseType=Combination Point=3 X2=0.5 X3=-0.5 S11=1720.67991063292
 IsS11Max=Yes IsS11Min=No FrameElem=44 ElemStation=0
 Frame=44 Station=0 OutputCase=ACC1 CaseType=Combination Point=4 X2=0.5 X3=0.5 S11=1720.67991063292
 IsS11Max=No IsS11Min=No FrameElem=44 ElemStation=0
 Frame=44 Station=0.125 OutputCase=ACC1 CaseType=Combination Point=0 X2=0 X3=0 S11=-240.528987364653
 IsS11Max=No IsS11Min=No FrameElem=44 ElemStation=0.125
 Frame=44 Station=0.125 OutputCase=ACC1 CaseType=Combination Point=1 X2=-0.5 X3=-0.5 S11=-
 2236.73489467511 IsS11Max=No IsS11Min=Yes FrameElem=44 ElemStation=0.125
 Frame=44 Station=0.125 OutputCase=ACC1 CaseType=Combination Point=2 X2=-0.5 X3=0.5 S11=-
 2236.73489467511 IsS11Max=No IsS11Min=No FrameElem=44 ElemStation=0.125
 Frame=44 Station=0.125 OutputCase=ACC1 CaseType=Combination Point=3 X2=0.5 X3=-0.5
 S11=1755.6769199458 IsS11Max=Yes IsS11Min=No FrameElem=44 ElemStation=0.125
 Frame=44 Station=0.125 OutputCase=ACC1 CaseType=Combination Point=4 X2=0.5 X3=0.5
 S11=1755.6769199458 IsS11Max=No IsS11Min=No FrameElem=44 ElemStation=0.125
 Frame=44 Station=0.25 OutputCase=ACC1 CaseType=Combination Point=0 X2=0 X3=0 S11=-240.528987364653
 IsS11Max=No IsS11Min=No FrameElem=44 ElemStation=0.25
 Frame=44 Station=0.25 OutputCase=ACC1 CaseType=Combination Point=1 X2=-0.5 X3=-0.5 S11=-
 2274.07565398799 IsS11Max=No IsS11Min=Yes FrameElem=44 ElemStation=0.25
 Frame=44 Station=0.25 OutputCase=ACC1 CaseType=Combination Point=2 X2=-0.5 X3=0.5 S11=-
 2274.07565398799 IsS11Max=No IsS11Min=No FrameElem=44 ElemStation=0.25
 Frame=44 Station=0.25 OutputCase=ACC1 CaseType=Combination Point=3 X2=0.5 X3=-0.5
 S11=1793.01767925869 IsS11Max=Yes IsS11Min=No FrameElem=44 ElemStation=0.25
 Frame=44 Station=0.25 OutputCase=ACC1 CaseType=Combination Point=4 X2=0.5 X3=0.5
 S11=1793.01767925869 IsS11Max=No IsS11Min=No FrameElem=44 ElemStation=0.25
 Frame=44 Station=0.375 OutputCase=ACC1 CaseType=Combination Point=0 X2=0 X3=0 S11=-240.528987364653
 IsS11Max=No IsS11Min=No FrameElem=44 ElemStation=0.375
 Frame=44 Station=0.375 OutputCase=ACC1 CaseType=Combination Point=1 X2=-0.5 X3=-0.5 S11=-
 2313.76016330088 IsS11Max=No IsS11Min=Yes FrameElem=44 ElemStation=0.375
 Frame=44 Station=0.375 OutputCase=ACC1 CaseType=Combination Point=2 X2=-0.5 X3=0.5 S11=-
 2313.76016330088 IsS11Max=No IsS11Min=No FrameElem=44 ElemStation=0.375
 Frame=44 Station=0.375 OutputCase=ACC1 CaseType=Combination Point=3 X2=0.5 X3=-0.5
 S11=1832.70218857157 IsS11Max=Yes IsS11Min=No FrameElem=44 ElemStation=0.375
 Frame=44 Station=0.375 OutputCase=ACC1 CaseType=Combination Point=4 X2=0.5 X3=0.5
 S11=1832.70218857157 IsS11Max=No IsS11Min=No FrameElem=44 ElemStation=0.375
 Frame=44 Station=0.5 OutputCase=ACC1 CaseType=Combination Point=0 X2=0 X3=0 S11=-240.528987364653
 IsS11Max=No IsS11Min=No FrameElem=44 ElemStation=0.5
 Frame=44 Station=0.5 OutputCase=ACC1 CaseType=Combination Point=1 X2=-0.5 X3=-0.5 S11=-
 2355.78842261376 IsS11Max=No IsS11Min=Yes FrameElem=44 ElemStation=0.5
 Frame=44 Station=0.5 OutputCase=ACC1 CaseType=Combination Point=2 X2=-0.5 X3=0.5 S11=-
 2355.78842261376 IsS11Max=No IsS11Min=No FrameElem=44 ElemStation=0.5
 Frame=44 Station=0.5 OutputCase=ACC1 CaseType=Combination Point=3 X2=0.5 X3=-0.5
 S11=1874.73044788446 IsS11Max=Yes IsS11Min=No FrameElem=44 ElemStation=0.5
 Frame=44 Station=0.5 OutputCase=ACC1 CaseType=Combination Point=4 X2=0.5 X3=0.5
 S11=1874.73044788446 IsS11Max=No IsS11Min=No FrameElem=44 ElemStation=0.5
 Frame=44 Station=0 OutputCase=ACC2 CaseType=Combination Point=0 X2=0 X3=0 S11=-174.055753683483
 IsS11Max=No IsS11Min=No FrameElem=44 ElemStation=0
 Frame=44 Station=0 OutputCase=ACC2 CaseType=Combination Point=1 X2=-0.5 X3=-0.5 S11=-
 2220.50346556903 IsS11Max=No IsS11Min=Yes FrameElem=44 ElemStation=0
 Frame=44 Station=0 OutputCase=ACC2 CaseType=Combination Point=2 X2=-0.5 X3=0.5 S11=-
 2220.50346556903 IsS11Max=No IsS11Min=No FrameElem=44 ElemStation=0
 Frame=44 Station=0 OutputCase=ACC2 CaseType=Combination Point=3 X2=0.5 X3=-0.5 S11=1872.39195820207
 IsS11Max=Yes IsS11Min=No FrameElem=44 ElemStation=0
 Frame=44 Station=0 OutputCase=ACC2 CaseType=Combination Point=4 X2=0.5 X3=0.5 S11=1872.39195820207
 IsS11Max=No IsS11Min=No FrameElem=44 ElemStation=0
 Frame=44 Station=0.125 OutputCase=ACC2 CaseType=Combination Point=0 X2=0 X3=0 S11=-174.055753683483
 IsS11Max=No IsS11Min=No FrameElem=44 ElemStation=0.125
 Frame=44 Station=0.125 OutputCase=ACC2 CaseType=Combination Point=1 X2=-0.5 X3=-0.5 S11=-
 2255.47605094048 IsS11Max=No IsS11Min=Yes FrameElem=44 ElemStation=0.125
 Frame=44 Station=0.125 OutputCase=ACC2 CaseType=Combination Point=2 X2=-0.5 X3=0.5 S11=-
 2255.47605094048 IsS11Max=No IsS11Min=No FrameElem=44 ElemStation=0.125
 Frame=44 Station=0.125 OutputCase=ACC2 CaseType=Combination Point=3 X2=0.5 X3=-0.5
 S11=1907.36454357352 IsS11Max=Yes IsS11Min=No FrameElem=44 ElemStation=0.125

```

Frame=44 Station=0.125 OutputCase=ACC2 CaseType=Combination Point=4 X2=0.5 X3=0.5
S11=1907.36454357352 IsS11Max=No IsS11Min=No FrameElem=44 ElemStation=0.125
Frame=44 Station=0.25 OutputCase=ACC2 CaseType=Combination Point=0 X2=0 X3=0 S11=-174.055753683483
IsS11Max=No IsS11Min=No FrameElem=44 ElemStation=0.25
Frame=44 Station=0.25 OutputCase=ACC2 CaseType=Combination Point=1 X2=-0.5 X3=-0.5 S11=-
2292.79238631193 IsS11Max=No IsS11Min=Yes FrameElem=44 ElemStation=0.25
Frame=44 Station=0.25 OutputCase=ACC2 CaseType=Combination Point=2 X2=-0.5 X3=0.5 S11=-
2292.79238631193 IsS11Max=No IsS11Min=No FrameElem=44 ElemStation=0.25
Frame=44 Station=0.25 OutputCase=ACC2 CaseType=Combination Point=3 X2=0.5 X3=-0.5
S11=1944.68087894497 IsS11Max=Yes IsS11Min=No FrameElem=44 ElemStation=0.25
Frame=44 Station=0.25 OutputCase=ACC2 CaseType=Combination Point=4 X2=0.5 X3=0.5
S11=1944.68087894497 IsS11Max=No IsS11Min=No FrameElem=44 ElemStation=0.25
Frame=44 Station=0.375 OutputCase=ACC2 CaseType=Combination Point=0 X2=0 X3=0 S11=-174.055753683483
IsS11Max=No IsS11Min=No FrameElem=44 ElemStation=0.375
Frame=44 Station=0.375 OutputCase=ACC2 CaseType=Combination Point=1 X2=-0.5 X3=-0.5 S11=-
2332.45247168338 IsS11Max=No IsS11Min=Yes FrameElem=44 ElemStation=0.375
Frame=44 Station=0.375 OutputCase=ACC2 CaseType=Combination Point=2 X2=-0.5 X3=0.5 S11=-
2332.45247168338 IsS11Max=No IsS11Min=No FrameElem=44 ElemStation=0.375
Frame=44 Station=0.375 OutputCase=ACC2 CaseType=Combination Point=3 X2=0.5 X3=-0.5
S11=1984.34096431641 IsS11Max=Yes IsS11Min=No FrameElem=44 ElemStation=0.375
Frame=44 Station=0.375 OutputCase=ACC2 CaseType=Combination Point=4 X2=0.5 X3=0.5
S11=1984.34096431641 IsS11Max=No IsS11Min=No FrameElem=44 ElemStation=0.375
Frame=44 Station=0.5 OutputCase=ACC2 CaseType=Combination Point=0 X2=0 X3=0 S11=-174.055753683483
IsS11Max=No IsS11Min=No FrameElem=44 ElemStation=0.5
Frame=44 Station=0.5 OutputCase=ACC2 CaseType=Combination Point=1 X2=-0.5 X3=-0.5 S11=-
2374.45630705483 IsS11Max=No IsS11Min=Yes FrameElem=44 ElemStation=0.5
Frame=44 Station=0.5 OutputCase=ACC2 CaseType=Combination Point=2 X2=-0.5 X3=0.5 S11=-
2374.45630705483 IsS11Max=No IsS11Min=No FrameElem=44 ElemStation=0.5
Frame=44 Station=0.5 OutputCase=ACC2 CaseType=Combination Point=3 X2=0.5 X3=-0.5
S11=2026.34479968786 IsS11Max=Yes IsS11Min=No FrameElem=44 ElemStation=0.5
Frame=44 Station=0.5 OutputCase=ACC2 CaseType=Combination Point=4 X2=0.5 X3=0.5
S11=2026.34479968786 IsS11Max=No IsS11Min=No FrameElem=44 ElemStation=0.5
Frame=44 Station=0 OutputCase=ACCSX1 CaseType=Combination Point=0 X2=0 X3=0 S11=-233.665974282455
IsS11Max=No IsS11Min=No FrameElem=44 ElemStation=0
Frame=44 Station=0 OutputCase=ACCSX1 CaseType=Combination Point=1 X2=-0.5 X3=-0.5 S11=-
2126.92840216066 IsS11Max=No IsS11Min=Yes FrameElem=44 ElemStation=0
Frame=44 Station=0 OutputCase=ACCSX1 CaseType=Combination Point=2 X2=-0.5 X3=0.5 S11=-
2126.92840216066 IsS11Max=No IsS11Min=No FrameElem=44 ElemStation=0
Frame=44 Station=0 OutputCase=ACCSX1 CaseType=Combination Point=3 X2=0.5 X3=-0.5
S11=1659.59645359575 IsS11Max=Yes IsS11Min=No FrameElem=44 ElemStation=0
Frame=44 Station=0 OutputCase=ACCSX1 CaseType=Combination Point=4 X2=0.5 X3=0.5
S11=1659.59645359575 IsS11Max=No IsS11Min=No FrameElem=44 ElemStation=0
Frame=44 Station=0.125 OutputCase=ACCSX1 CaseType=Combination Point=0 X2=0 X3=0 S11=-
233.665974282455 IsS11Max=No IsS11Min=No FrameElem=44 ElemStation=0.125
Frame=44 Station=0.125 OutputCase=ACCSX1 CaseType=Combination Point=1 X2=-0.5 X3=-0.5 S11=-
2163.8702091683 IsS11Max=No IsS11Min=Yes FrameElem=44 ElemStation=0.125
Frame=44 Station=0.125 OutputCase=ACCSX1 CaseType=Combination Point=2 X2=-0.5 X3=0.5 S11=-
2163.8702091683 IsS11Max=No IsS11Min=No FrameElem=44 ElemStation=0.125
Frame=44 Station=0.125 OutputCase=ACCSX1 CaseType=Combination Point=3 X2=0.5 X3=-0.5
S11=1696.53826060339 IsS11Max=Yes IsS11Min=No FrameElem=44 ElemStation=0.125
Frame=44 Station=0.125 OutputCase=ACCSX1 CaseType=Combination Point=4 X2=0.5 X3=0.5
S11=1696.53826060339 IsS11Max=No IsS11Min=No FrameElem=44 ElemStation=0.125
Frame=44 Station=0.25 OutputCase=ACCSX1 CaseType=Combination Point=0 X2=0 X3=0 S11=-
233.665974282455 IsS11Max=No IsS11Min=No FrameElem=44 ElemStation=0.25
Frame=44 Station=0.25 OutputCase=ACCSX1 CaseType=Combination Point=1 X2=-0.5 X3=-0.5 S11=-
2203.15576617595 IsS11Max=No IsS11Min=Yes FrameElem=44 ElemStation=0.25
Frame=44 Station=0.25 OutputCase=ACCSX1 CaseType=Combination Point=2 X2=-0.5 X3=0.5 S11=-
2203.15576617595 IsS11Max=No IsS11Min=No FrameElem=44 ElemStation=0.25
Frame=44 Station=0.25 OutputCase=ACCSX1 CaseType=Combination Point=3 X2=0.5 X3=-0.5
S11=1735.82381761104 IsS11Max=Yes IsS11Min=No FrameElem=44 ElemStation=0.25
Frame=44 Station=0.25 OutputCase=ACCSX1 CaseType=Combination Point=4 X2=0.5 X3=0.5
S11=1735.82381761104 IsS11Max=No IsS11Min=No FrameElem=44 ElemStation=0.25
Frame=44 Station=0.375 OutputCase=ACCSX1 CaseType=Combination Point=0 X2=0 X3=0 S11=-
233.665974282455 IsS11Max=No IsS11Min=No FrameElem=44 ElemStation=0.375
Frame=44 Station=0.375 OutputCase=ACCSX1 CaseType=Combination Point=1 X2=-0.5 X3=-0.5 S11=-
2244.78507318359 IsS11Max=No IsS11Min=Yes FrameElem=44 ElemStation=0.375
Frame=44 Station=0.375 OutputCase=ACCSX1 CaseType=Combination Point=2 X2=-0.5 X3=0.5 S11=-
2244.78507318359 IsS11Max=No IsS11Min=No FrameElem=44 ElemStation=0.375
Frame=44 Station=0.375 OutputCase=ACCSX1 CaseType=Combination Point=3 X2=0.5 X3=-0.5
S11=1777.45312461868 IsS11Max=Yes IsS11Min=No FrameElem=44 ElemStation=0.375
Frame=44 Station=0.375 OutputCase=ACCSX1 CaseType=Combination Point=4 X2=0.5 X3=0.5
S11=1777.45312461868 IsS11Max=No IsS11Min=No FrameElem=44 ElemStation=0.375
Frame=44 Station=0.5 OutputCase=ACCSX1 CaseType=Combination Point=0 X2=0 X3=0 S11=-233.665974282455
IsS11Max=No IsS11Min=No FrameElem=44 ElemStation=0.5
Frame=44 Station=0.5 OutputCase=ACCSX1 CaseType=Combination Point=1 X2=-0.5 X3=-0.5 S11=-
2288.75813019124 IsS11Max=No IsS11Min=Yes FrameElem=44 ElemStation=0.5
Frame=44 Station=0.5 OutputCase=ACCSX1 CaseType=Combination Point=2 X2=-0.5 X3=0.5 S11=-
2288.75813019124 IsS11Max=No IsS11Min=No FrameElem=44 ElemStation=0.5
Frame=44 Station=0.5 OutputCase=ACCSX1 CaseType=Combination Point=3 X2=0.5 X3=-0.5
S11=1821.42618162633 IsS11Max=Yes IsS11Min=No FrameElem=44 ElemStation=0.5
Frame=44 Station=0.5 OutputCase=ACCSX1 CaseType=Combination Point=4 X2=0.5 X3=0.5
S11=1821.42618162633 IsS11Max=No IsS11Min=No FrameElem=44 ElemStation=0.5

```

Frame=44	Station=0	OutputCase=ACCSX2	CaseType=Combination	Point=0	X2=0	X3=0	S11=-167.192740601285	
IsS11Max=No	IsS11Min=No	FrameElem=44	ElemStation=0					
Frame=44	Station=0	OutputCase=ACCSX2	CaseType=Combination	Point=1	X2=-0.5	X3=-0.5	S11=-	
2145.69398236747	IsS11Max=No	IsS11Min=Yes	FrameElem=44	ElemStation=0				
Frame=44	Station=0	OutputCase=ACCSX2	CaseType=Combination	Point=2	X2=-0.5	X3=0.5	S11=-	
2145.69398236747	IsS11Max=No	IsS11Min=No	FrameElem=44	ElemStation=0				
Frame=44	Station=0	OutputCase=ACCSX2	CaseType=Combination	Point=3	X2=0.5	X3=-0.5		
S11=1811.3085011649	IsS11Max=Yes	IsS11Min=No	FrameElem=44	ElemStation=0				
Frame=44	Station=0	OutputCase=ACCSX2	CaseType=Combination	Point=4	X2=0.5	X3=0.5	S11=1811.3085011649	
IsS11Max=No	IsS11Min=No	FrameElem=44	ElemStation=0					
Frame=44	Station=0.125	OutputCase=ACCSX2	CaseType=Combination	Point=0	X2=0	X3=0	S11=-	
167.192740601285	IsS11Max=No	IsS11Min=No	FrameElem=44	ElemStation=0.125				
Frame=44	Station=0.125	OutputCase=ACCSX2	CaseType=Combination	Point=1	X2=-0.5	X3=-0.5	S11=-	
2182.61136543368	IsS11Max=No	IsS11Min=Yes	FrameElem=44	ElemStation=0.125				
Frame=44	Station=0.125	OutputCase=ACCSX2	CaseType=Combination	Point=2	X2=-0.5	X3=0.5	S11=-	
2182.61136543368	IsS11Max=No	IsS11Min=No	FrameElem=44	ElemStation=0.125				
Frame=44	Station=0.125	OutputCase=ACCSX2	CaseType=Combination	Point=3	X2=0.5	X3=-0.5		
S11=1848.22588423111	IsS11Max=Yes	IsS11Min=No	FrameElem=44	ElemStation=0.125				
Frame=44	Station=0.125	OutputCase=ACCSX2	CaseType=Combination	Point=4	X2=0.5	X3=0.5		
S11=1848.22588423111	IsS11Max=No	IsS11Min=No	FrameElem=44	ElemStation=0.125				
Frame=44	Station=0.25	OutputCase=ACCSX2	CaseType=Combination	Point=0	X2=0	X3=0	S11=-	
167.192740601285	IsS11Max=No	IsS11Min=No	FrameElem=44	ElemStation=0.25				
Frame=44	Station=0.25	OutputCase=ACCSX2	CaseType=Combination	Point=1	X2=-0.5	X3=-0.5	S11=-	
2221.87249849988	IsS11Max=No	IsS11Min=Yes	FrameElem=44	ElemStation=0.25				
Frame=44	Station=0.25	OutputCase=ACCSX2	CaseType=Combination	Point=2	X2=-0.5	X3=0.5	S11=-	
2221.87249849988	IsS11Max=No	IsS11Min=No	FrameElem=44	ElemStation=0.25				
Frame=44	Station=0.25	OutputCase=ACCSX2	CaseType=Combination	Point=3	X2=0.5	X3=-0.5		
S11=1887.48701729732	IsS11Max=Yes	IsS11Min=No	FrameElem=44	ElemStation=0.25				
Frame=44	Station=0.25	OutputCase=ACCSX2	CaseType=Combination	Point=4	X2=0.5	X3=0.5		
S11=1887.48701729732	IsS11Max=No	IsS11Min=No	FrameElem=44	ElemStation=0.25				
Frame=44	Station=0.375	OutputCase=ACCSX2	CaseType=Combination	Point=0	X2=0	X3=0	S11=-	
167.192740601285	IsS11Max=No	IsS11Min=No	FrameElem=44	ElemStation=0.375				
Frame=44	Station=0.375	OutputCase=ACCSX2	CaseType=Combination	Point=1	X2=-0.5	X3=-0.5	S11=-	
2263.47738156609	IsS11Max=No	IsS11Min=Yes	FrameElem=44	ElemStation=0.375				
Frame=44	Station=0.375	OutputCase=ACCSX2	CaseType=Combination	Point=2	X2=-0.5	X3=0.5	S11=-	
2263.47738156609	IsS11Max=No	IsS11Min=No	FrameElem=44	ElemStation=0.375				
Frame=44	Station=0.375	OutputCase=ACCSX2	CaseType=Combination	Point=3	X2=0.5	X3=-0.5		
S11=1929.09190036352	IsS11Max=Yes	IsS11Min=No	FrameElem=44	ElemStation=0.375				
Frame=44	Station=0.375	OutputCase=ACCSX2	CaseType=Combination	Point=4	X2=0.5	X3=0.5		
S11=1929.09190036352	IsS11Max=No	IsS11Min=No	FrameElem=44	ElemStation=0.375				
Frame=44	Station=0.5	OutputCase=ACCSX2	CaseType=Combination	Point=0	X2=0	X3=0	S11=-167.192740601285	
IsS11Max=No	IsS11Min=No	FrameElem=44	ElemStation=0.5					
Frame=44	Station=0.5	OutputCase=ACCSX2	CaseType=Combination	Point=1	X2=-0.5	X3=-0.5	S11=-	
2307.4260146323	IsS11Max=No	IsS11Min=Yes	FrameElem=44	ElemStation=0.5				
Frame=44	Station=0.5	OutputCase=ACCSX2	CaseType=Combination	Point=2	X2=-0.5	X3=0.5	S11=-	
2307.4260146323	IsS11Max=No	IsS11Min=No	FrameElem=44	ElemStation=0.5				
Frame=44	Station=0.5	OutputCase=ACCSX2	CaseType=Combination	Point=3	X2=0.5	X3=-0.5		
S11=1973.04053342973	IsS11Max=Yes	IsS11Min=No	FrameElem=44	ElemStation=0.5				
Frame=44	Station=0.5	OutputCase=ACCSX2	CaseType=Combination	Point=4	X2=0.5	X3=0.5		
S11=1973.04053342973	IsS11Max=No	IsS11Min=No	FrameElem=44	ElemStation=0.5				
Frame=44	Station=0	OutputCase=ENVE	CaseType=Combination	StepType=Max	Point=0	X2=0	X3=0	S11=-
167.192740601285	IsS11Max=No	IsS11Min=No	FrameElem=44	ElemStation=0				
Frame=44	Station=0	OutputCase=ENVE	CaseType=Combination	StepType=Max	Point=1	X2=-0.5	X3=-0.5	
S11=-2126.92840216066	IsS11Max=No	IsS11Min=Yes	FrameElem=44	ElemStation=0				
Frame=44	Station=0	OutputCase=ENVE	CaseType=Combination	StepType=Max	Point=2	X2=-0.5	X3=0.5	S11=-
2126.92840216066	IsS11Max=No	IsS11Min=No	FrameElem=44	ElemStation=0				
Frame=44	Station=0	OutputCase=ENVE	CaseType=Combination	StepType=Max	Point=3	X2=0.5	X3=-0.5	
S11=1872.39195820207	IsS11Max=Yes	IsS11Min=No	FrameElem=44	ElemStation=0				
Frame=44	Station=0	OutputCase=ENVE	CaseType=Combination	StepType=Max	Point=4	X2=0.5	X3=0.5	
S11=1872.39195820207	IsS11Max=No	IsS11Min=No	FrameElem=44	ElemStation=0				
Frame=44	Station=0.125	OutputCase=ENVE	CaseType=Combination	StepType=Max	Point=0	X2=0	X3=0	S11=-
167.192740601285	IsS11Max=No	IsS11Min=No	FrameElem=44	ElemStation=0.125				
Frame=44	Station=0.125	OutputCase=ENVE	CaseType=Combination	StepType=Max	Point=1	X2=-0.5	X3=-0.5	
S11=-2163.8702091683	IsS11Max=No	IsS11Min=Yes	FrameElem=44	ElemStation=0.125				
Frame=44	Station=0.125	OutputCase=ENVE	CaseType=Combination	StepType=Max	Point=2	X2=-0.5	X3=0.5	
S11=-2163.8702091683	IsS11Max=No	IsS11Min=No	FrameElem=44	ElemStation=0.125				
Frame=44	Station=0.125	OutputCase=ENVE	CaseType=Combination	StepType=Max	Point=3	X2=0.5	X3=-0.5	
S11=1907.36454357352	IsS11Max=Yes	IsS11Min=No	FrameElem=44	ElemStation=0.125				
Frame=44	Station=0.125	OutputCase=ENVE	CaseType=Combination	StepType=Max	Point=4	X2=0.5	X3=0.5	
S11=1907.36454357352	IsS11Max=No	IsS11Min=No	FrameElem=44	ElemStation=0.125				
Frame=44	Station=0.25	OutputCase=ENVE	CaseType=Combination	StepType=Max	Point=0	X2=0	X3=0	S11=-
167.192740601285	IsS11Max=No	IsS11Min=No	FrameElem=44	ElemStation=0.25				
Frame=44	Station=0.25	OutputCase=ENVE	CaseType=Combination	StepType=Max	Point=1	X2=-0.5	X3=-0.5	
S11=-2203.15576617595	IsS11Max=Yes	IsS11Min=Yes	FrameElem=44	ElemStation=0.25				
Frame=44	Station=0.25	OutputCase=ENVE	CaseType=Combination	StepType=Max	Point=2	X2=-0.5	X3=0.5	
S11=-2203.15576617595	IsS11Max=No	IsS11Min=No	FrameElem=44	ElemStation=0.25				
Frame=44	Station=0.25	OutputCase=ENVE	CaseType=Combination	StepType=Max	Point=3	X2=0.5	X3=-0.5	
S11=1944.68087894497	IsS11Max=Yes	IsS11Min=No	FrameElem=44	ElemStation=0.25				
Frame=44	Station=0.25	OutputCase=ENVE	CaseType=Combination	StepType=Max	Point=4	X2=0.5	X3=0.5	
S11=1944.68087894497	IsS11Max=No	IsS11Min=No	FrameElem=44	ElemStation=0.25				
Frame=44	Station=0.375	OutputCase=ENVE	CaseType=Combination	StepType=Max	Point=0	X2=0	X3=0	S11=-
167.192740601285	IsS11Max=No	IsS11Min=No	FrameElem=44	ElemStation=0.375				

Frame=44	Station=0.375	OutputCase=ENVE	CaseType=Combination	StepType=Max	Point=1	X2=-0.5	X3=-0.5	
S11=-2244.78507318359	IsS11Max=No	IsS11Min=Yes	FrameElem=44	ElemStation=0.375				
Frame=44	Station=0.375	OutputCase=ENVE	CaseType=Combination	StepType=Max	Point=2	X2=-0.5	X3=0.5	
S11=-2244.78507318359	IsS11Max=No	IsS11Min=No	FrameElem=44	ElemStation=0.375				
Frame=44	Station=0.375	OutputCase=ENVE	CaseType=Combination	StepType=Max	Point=3	X2=0.5	X3=-0.5	
S11=1984.34096431641	IsS11Max=Yes	IsS11Min=No	FrameElem=44	ElemStation=0.375				
Frame=44	Station=0.375	OutputCase=ENVE	CaseType=Combination	StepType=Max	Point=4	X2=0.5	X3=0.5	
S11=1984.34096431641	IsS11Max=No	IsS11Min=No	FrameElem=44	ElemStation=0.375				
Frame=44	Station=0.5	OutputCase=ENVE	CaseType=Combination	StepType=Max	Point=0	X2=0	X3=0	S11=-
167.192740601285	IsS11Max=No	IsS11Min=No	FrameElem=44	ElemStation=0.5				
Frame=44	Station=0.5	OutputCase=ENVE	CaseType=Combination	StepType=Max	Point=1	X2=-0.5	X3=-0.5	
S11=-2288.75813019124	IsS11Max=No	IsS11Min=Yes	FrameElem=44	ElemStation=0.5				
Frame=44	Station=0.5	OutputCase=ENVE	CaseType=Combination	StepType=Max	Point=2	X2=-0.5	X3=0.5	
S11=-2288.75813019124	IsS11Max=No	IsS11Min=No	FrameElem=44	ElemStation=0.5				
Frame=44	Station=0.5	OutputCase=ENVE	CaseType=Combination	StepType=Max	Point=3	X2=0.5	X3=-0.5	
S11=2026.34479968786	IsS11Max=Yes	IsS11Min=No	FrameElem=44	ElemStation=0.5				
Frame=44	Station=0.5	OutputCase=ENVE	CaseType=Combination	StepType=Max	Point=4	X2=0.5	X3=0.5	
S11=2026.34479968786	IsS11Max=No	IsS11Min=No	FrameElem=44	ElemStation=0.5				
Frame=44	Station=0	OutputCase=ENVE	CaseType=Combination	StepType=Min	Point=0	X2=0	X3=0	S11=-
240.528987364653	IsS11Max=No	IsS11Min=No	FrameElem=44	ElemStation=0				
Frame=44	Station=0	OutputCase=ENVE	CaseType=Combination	StepType=Min	Point=1	X2=-0.5	X3=-0.5	
S11=-2220.50346556903	IsS11Max=No	IsS11Min=Yes	FrameElem=44	ElemStation=0				
Frame=44	Station=0	OutputCase=ENVE	CaseType=Combination	StepType=Min	Point=2	X2=-0.5	X3=0.5	S11=-
2220.50346556903	IsS11Max=No	IsS11Min=No	FrameElem=44	ElemStation=0				
Frame=44	Station=0	OutputCase=ENVE	CaseType=Combination	StepType=Min	Point=3	X2=0.5	X3=-0.5	
S11=1659.59645359575	IsS11Max=Yes	IsS11Min=No	FrameElem=44	ElemStation=0				
Frame=44	Station=0	OutputCase=ENVE	CaseType=Combination	StepType=Min	Point=4	X2=0.5	X3=0.5	
S11=1659.59645359575	IsS11Max=No	IsS11Min=No	FrameElem=44	ElemStation=0				
Frame=44	Station=0.125	OutputCase=ENVE	CaseType=Combination	StepType=Min	Point=0	X2=0	X3=0	S11=-
240.528987364653	IsS11Max=No	IsS11Min=No	FrameElem=44	ElemStation=0.125				
Frame=44	Station=0.125	OutputCase=ENVE	CaseType=Combination	StepType=Min	Point=1	X2=-0.5	X3=-0.5	
S11=-2255.47605094048	IsS11Max=No	IsS11Min=Yes	FrameElem=44	ElemStation=0.125				
Frame=44	Station=0.125	OutputCase=ENVE	CaseType=Combination	StepType=Min	Point=2	X2=-0.5	X3=0.5	
S11=-2255.47605094048	IsS11Max=No	IsS11Min=No	FrameElem=44	ElemStation=0.125				
Frame=44	Station=0.125	OutputCase=ENVE	CaseType=Combination	StepType=Min	Point=3	X2=0.5	X3=-0.5	
S11=1696.53826060339	IsS11Max=Yes	IsS11Min=No	FrameElem=44	ElemStation=0.125				
Frame=44	Station=0.125	OutputCase=ENVE	CaseType=Combination	StepType=Min	Point=4	X2=0.5	X3=0.5	
S11=1696.53826060339	IsS11Max=No	IsS11Min=No	FrameElem=44	ElemStation=0.125				
Frame=44	Station=0.25	OutputCase=ENVE	CaseType=Combination	StepType=Min	Point=0	X2=0	X3=0	S11=-
240.528987364653	IsS11Max=No	IsS11Min=No	FrameElem=44	ElemStation=0.25				
Frame=44	Station=0.25	OutputCase=ENVE	CaseType=Combination	StepType=Min	Point=1	X2=-0.5	X3=-0.5	
S11=-2292.79238631193	IsS11Max=No	IsS11Min=Yes	FrameElem=44	ElemStation=0.25				
Frame=44	Station=0.25	OutputCase=ENVE	CaseType=Combination	StepType=Min	Point=2	X2=-0.5	X3=0.5	
S11=-2292.79238631193	IsS11Max=No	IsS11Min=No	FrameElem=44	ElemStation=0.25				
Frame=44	Station=0.25	OutputCase=ENVE	CaseType=Combination	StepType=Min	Point=3	X2=0.5	X3=-0.5	
S11=1735.82381761104	IsS11Max=Yes	IsS11Min=No	FrameElem=44	ElemStation=0.25				
Frame=44	Station=0.25	OutputCase=ENVE	CaseType=Combination	StepType=Min	Point=4	X2=0.5	X3=0.5	
S11=1735.82381761104	IsS11Max=No	IsS11Min=No	FrameElem=44	ElemStation=0.25				
Frame=44	Station=0.375	OutputCase=ENVE	CaseType=Combination	StepType=Min	Point=0	X2=0	X3=0	S11=-
240.528987364653	IsS11Max=No	IsS11Min=No	FrameElem=44	ElemStation=0.375				
Frame=44	Station=0.375	OutputCase=ENVE	CaseType=Combination	StepType=Min	Point=1	X2=-0.5	X3=-0.5	
S11=-2332.45247168338	IsS11Max=No	IsS11Min=Yes	FrameElem=44	ElemStation=0.375				
Frame=44	Station=0.375	OutputCase=ENVE	CaseType=Combination	StepType=Min	Point=2	X2=-0.5	X3=0.5	
S11=-2332.45247168338	IsS11Max=No	IsS11Min=No	FrameElem=44	ElemStation=0.375				
Frame=44	Station=0.375	OutputCase=ENVE	CaseType=Combination	StepType=Min	Point=3	X2=0.5	X3=-0.5	
S11=1777.45312461868	IsS11Max=Yes	IsS11Min=No	FrameElem=44	ElemStation=0.375				
Frame=44	Station=0.375	OutputCase=ENVE	CaseType=Combination	StepType=Min	Point=4	X2=0.5	X3=0.5	
S11=1777.45312461868	IsS11Max=No	IsS11Min=No	FrameElem=44	ElemStation=0.375				
Frame=44	Station=0.5	OutputCase=ENVE	CaseType=Combination	StepType=Min	Point=0	X2=0	X3=0	S11=-
240.528987364653	IsS11Max=No	IsS11Min=No	FrameElem=44	ElemStation=0.5				
Frame=44	Station=0.5	OutputCase=ENVE	CaseType=Combination	StepType=Min	Point=1	X2=-0.5	X3=-0.5	
S11=-2374.45630705483	IsS11Max=No	IsS11Min=Yes	FrameElem=44	ElemStation=0.5				
Frame=44	Station=0.5	OutputCase=ENVE	CaseType=Combination	StepType=Min	Point=2	X2=-0.5	X3=0.5	
S11=-2374.45630705483	IsS11Max=No	IsS11Min=No	FrameElem=44	ElemStation=0.5				
Frame=44	Station=0.5	OutputCase=ENVE	CaseType=Combination	StepType=Min	Point=3	X2=0.5	X3=-0.5	
S11=1821.42618162633	IsS11Max=Yes	IsS11Min=No	FrameElem=44	ElemStation=0.5				
Frame=44	Station=0.5	OutputCase=ENVE	CaseType=Combination	StepType=Min	Point=4	X2=0.5	X3=0.5	
S11=1821.42618162633	IsS11Max=No	IsS11Min=No	FrameElem=44	ElemStation=0.5				
Frame=44	Station=0	OutputCase=FESSUR	CaseType=Combination	Point=0	X2=0	X3=0	S11=-239.15192283725	
IsS11Max=No	IsS11Min=No	FrameElem=44	ElemStation=0					
Frame=44	Station=0	OutputCase=FESSUR	CaseType=Combination	Point=1	X2=-0.5	X3=-0.5	S11=-	
2184.86104754518	IsS11Max=No	IsS11Min=Yes	FrameElem=44	ElemStation=0				
Frame=44	Station=0	OutputCase=FESSUR	CaseType=Combination	Point=2	X2=-0.5	X3=0.5	S11=-	
2184.86104754518	IsS11Max=No	IsS11Min=No	FrameElem=44	ElemStation=0				
Frame=44	Station=0	OutputCase=FESSUR	CaseType=Combination	Point=3	X2=0.5	X3=-0.5		
S11=1706.55720187068	IsS11Max=Yes	IsS11Min=No	FrameElem=44	ElemStation=0				
Frame=44	Station=0	OutputCase=FESSUR	CaseType=Combination	Point=4	X2=0.5	X3=0.5		
S11=1706.55720187068	IsS11Max=No	IsS11Min=No	FrameElem=44	ElemStation=0				
Frame=44	Station=0.125	OutputCase=FESSUR	CaseType=Combination	Point=0	X2=0	X3=0	S11=-	
239.15192283725	IsS11Max=No	IsS11Min=No	FrameElem=44	ElemStation=0.125				
Frame=44	Station=0.125	OutputCase=FESSUR	CaseType=Combination	Point=1	X2=-0.5	X3=-0.5	S11=-	
2219.55766248334	IsS11Max=No	IsS11Min=Yes	FrameElem=44	ElemStation=0.125				



Frame=44	Station=0.125	OutputCase=FESSUR	CaseType=Combination	Point=2	X2=-0.5	X3=0.5	S11=-
2219.55766248334	IsS11Max=No	IsS11Min=No	FrameElem=44	ElemStation=0.125			
Frame=44	Station=0.125	OutputCase=FESSUR	CaseType=Combination	Point=3	X2=0.5	X3=-0.5	
S11=1741.25381680884	IsS11Max=Yes	IsS11Min=No	FrameElem=44	ElemStation=0.125			
Frame=44	Station=0.125	OutputCase=FESSUR	CaseType=Combination	Point=4	X2=0.5	X3=0.5	
S11=1741.25381680884	IsS11Max=No	IsS11Min=No	FrameElem=44	ElemStation=0.125			
Frame=44	Station=0.25	OutputCase=FESSUR	CaseType=Combination	Point=0	X2=0	X3=0	S11=-239.15192283725
IsS11Max=No	IsS11Min=No	FrameElem=44	ElemStation=0.25				
Frame=44	Station=0.25	OutputCase=FESSUR	CaseType=Combination	Point=1	X2=-0.5	X3=-0.5	S11=-
2256.5980274215	IsS11Max=No	IsS11Min=Yes	FrameElem=44	ElemStation=0.25			
Frame=44	Station=0.25	OutputCase=FESSUR	CaseType=Combination	Point=2	X2=-0.5	X3=0.5	S11=-
2256.5980274215	IsS11Max=No	IsS11Min=No	FrameElem=44	ElemStation=0.25			
Frame=44	Station=0.25	OutputCase=FESSUR	CaseType=Combination	Point=3	X2=0.5	X3=-0.5	
S11=1778.29418174701	IsS11Max=Yes	IsS11Min=No	FrameElem=44	ElemStation=0.25			
Frame=44	Station=0.25	OutputCase=FESSUR	CaseType=Combination	Point=4	X2=0.5	X3=0.5	
S11=1778.29418174701	IsS11Max=No	IsS11Min=No	FrameElem=44	ElemStation=0.25			
Frame=44	Station=0.375	OutputCase=FESSUR	CaseType=Combination	Point=0	X2=0	X3=0	S11=-
239.15192283725	IsS11Max=No	IsS11Min=No	FrameElem=44	ElemStation=0.375			
Frame=44	Station=0.375	OutputCase=FESSUR	CaseType=Combination	Point=1	X2=-0.5	X3=-0.5	S11=-
2295.98214235967	IsS11Max=No	IsS11Min=Yes	FrameElem=44	ElemStation=0.375			
Frame=44	Station=0.375	OutputCase=FESSUR	CaseType=Combination	Point=2	X2=-0.5	X3=0.5	S11=-
2295.98214235967	IsS11Max=No	IsS11Min=No	FrameElem=44	ElemStation=0.375			
Frame=44	Station=0.375	OutputCase=FESSUR	CaseType=Combination	Point=3	X2=0.5	X3=-0.5	
S11=1817.67829668517	IsS11Max=Yes	IsS11Min=No	FrameElem=44	ElemStation=0.375			
Frame=44	Station=0.375	OutputCase=FESSUR	CaseType=Combination	Point=4	X2=0.5	X3=0.5	
S11=1817.67829668517	IsS11Max=No	IsS11Min=No	FrameElem=44	ElemStation=0.375			
Frame=44	Station=0.5	OutputCase=FESSUR	CaseType=Combination	Point=0	X2=0	X3=0	S11=-239.15192283725
IsS11Max=No	IsS11Min=No	FrameElem=44	ElemStation=0.5				
Frame=44	Station=0.5	OutputCase=FESSUR	CaseType=Combination	Point=1	X2=-0.5	X3=-0.5	S11=-
2337.71000729783	IsS11Max=No	IsS11Min=Yes	FrameElem=44	ElemStation=0.5			
Frame=44	Station=0.5	OutputCase=FESSUR	CaseType=Combination	Point=2	X2=-0.5	X3=0.5	S11=-
2337.71000729783	IsS11Max=No	IsS11Min=No	FrameElem=44	ElemStation=0.5			
Frame=44	Station=0.5	OutputCase=FESSUR	CaseType=Combination	Point=3	X2=0.5	X3=-0.5	
S11=1859.40616162333	IsS11Max=Yes	IsS11Min=No	FrameElem=44	ElemStation=0.5			
Frame=44	Station=0.5	OutputCase=FESSUR	CaseType=Combination	Point=4	X2=0.5	X3=0.5	
S11=1859.40616162333	IsS11Max=No	IsS11Min=No	FrameElem=44	ElemStation=0.5			
Frame=45	Station=0	OutputCase=PERM1	CaseType=Combination	Point=0	X2=0	X3=0	S11=-235.93877227331
IsS11Max=No	IsS11Min=No	FrameElem=45	ElemStation=0				
Frame=45	Station=0	OutputCase=PERM1	CaseType=Combination	Point=1	X2=-0.5	X3=-0.5	S11=-
2295.52703822726	IsS11Max=No	IsS11Min=Yes	FrameElem=45	ElemStation=0			
Frame=45	Station=0	OutputCase=PERM1	CaseType=Combination	Point=2	X2=-0.5	X3=0.5	S11=-
2295.52703822726	IsS11Max=No	IsS11Min=No	FrameElem=45	ElemStation=0			
Frame=45	Station=0	OutputCase=PERM1	CaseType=Combination	Point=3	X2=0.5	X3=-0.5	
S11=1823.64949368064	IsS11Max=Yes	IsS11Min=No	FrameElem=45	ElemStation=0			
Frame=45	Station=0	OutputCase=PERM1	CaseType=Combination	Point=4	X2=0.5	X3=0.5	S11=1823.64949368064
IsS11Max=No	IsS11Min=No	FrameElem=45	ElemStation=0				
Frame=45	Station=0.125	OutputCase=PERM1	CaseType=Combination	Point=0	X2=0	X3=0	S11=-235.93877227331
IsS11Max=No	IsS11Min=No	FrameElem=45	ElemStation=0.125				
Frame=45	Station=0.125	OutputCase=PERM1	CaseType=Combination	Point=1	X2=-0.5	X3=-0.5	S11=-
2254.50009514948	IsS11Max=No	IsS11Min=Yes	FrameElem=45	ElemStation=0.125			
Frame=45	Station=0.125	OutputCase=PERM1	CaseType=Combination	Point=2	X2=-0.5	X3=0.5	S11=-
2254.50009514948	IsS11Max=No	IsS11Min=No	FrameElem=45	ElemStation=0.125			
Frame=45	Station=0.125	OutputCase=PERM1	CaseType=Combination	Point=3	X2=0.5	X3=-0.5	
S11=1782.62255060286	IsS11Max=Yes	IsS11Min=No	FrameElem=45	ElemStation=0.125			
Frame=45	Station=0.125	OutputCase=PERM1	CaseType=Combination	Point=4	X2=0.5	X3=0.5	
S11=1782.62255060286	IsS11Max=No	IsS11Min=No	FrameElem=45	ElemStation=0.125			
Frame=45	Station=0.25	OutputCase=PERM1	CaseType=Combination	Point=0	X2=0	X3=0	S11=-235.93877227331
IsS11Max=No	IsS11Min=No	FrameElem=45	ElemStation=0.25				
Frame=45	Station=0.25	OutputCase=PERM1	CaseType=Combination	Point=1	X2=-0.5	X3=-0.5	S11=-
2215.8169020717	IsS11Max=No	IsS11Min=Yes	FrameElem=45	ElemStation=0.25			
Frame=45	Station=0.25	OutputCase=PERM1	CaseType=Combination	Point=2	X2=-0.5	X3=0.5	S11=-
2215.8169020717	IsS11Max=No	IsS11Min=No	FrameElem=45	ElemStation=0.25			
Frame=45	Station=0.25	OutputCase=PERM1	CaseType=Combination	Point=3	X2=0.5	X3=-0.5	
S11=1743.93935752507	IsS11Max=Yes	IsS11Min=No	FrameElem=45	ElemStation=0.25			
Frame=45	Station=0.25	OutputCase=PERM1	CaseType=Combination	Point=4	X2=0.5	X3=0.5	
S11=1743.93935752507	IsS11Max=No	IsS11Min=No	FrameElem=45	ElemStation=0.25			
Frame=45	Station=0.375	OutputCase=PERM1	CaseType=Combination	Point=0	X2=0	X3=0	S11=-235.93877227331
IsS11Max=No	IsS11Min=No	FrameElem=45	ElemStation=0.375				
Frame=45	Station=0.375	OutputCase=PERM1	CaseType=Combination	Point=1	X2=-0.5	X3=-0.5	S11=-
2179.47745899391	IsS11Max=No	IsS11Min=Yes	FrameElem=45	ElemStation=0.375			
Frame=45	Station=0.375	OutputCase=PERM1	CaseType=Combination	Point=2	X2=-0.5	X3=0.5	S11=-
2179.47745899391	IsS11Max=No	IsS11Min=No	FrameElem=45	ElemStation=0.375			
Frame=45	Station=0.375	OutputCase=PERM1	CaseType=Combination	Point=3	X2=0.5	X3=-0.5	
S11=1707.59991444729	IsS11Max=Yes	IsS11Min=No	FrameElem=45	ElemStation=0.375			
Frame=45	Station=0.375	OutputCase=PERM1	CaseType=Combination	Point=4	X2=0.5	X3=0.5	
S11=1707.59991444729	IsS11Max=No	IsS11Min=No	FrameElem=45	ElemStation=0.375			
Frame=45	Station=0.5	OutputCase=PERM1	CaseType=Combination	Point=0	X2=0	X3=0	S11=-235.93877227331
IsS11Max=No	IsS11Min=No	FrameElem=45	ElemStation=0.5				
Frame=45	Station=0.5	OutputCase=PERM1	CaseType=Combination	Point=1	X2=-0.5	X3=-0.5	S11=-
2145.48176591613	IsS11Max=No	IsS11Min=Yes	FrameElem=45	ElemStation=0.5			
Frame=45	Station=0.5	OutputCase=PERM1	CaseType=Combination	Point=2	X2=-0.5	X3=0.5	S11=-
2145.48176591613	IsS11Max=No	IsS11Min=No	FrameElem=45	ElemStation=0.5			

Frame=45 Station=0.5 OutputCase=PERM1 CaseType=Combination Point=3 X2=0.5 X3=-0.5
S11=1673.60422136951 IsS11Max=Yes IsS11Min=No FrameElem=45 ElemStation=0.5
Frame=45 Station=0.5 OutputCase=PERM1 CaseType=Combination Point=4 X2=0.5 X3=0.5
S11=1673.60422136951 IsS11Max=No IsS11Min=No FrameElem=45 ElemStation=0.5
Frame=45 Station=0 OutputCase=PERM2 CaseType=Combination Point=0 X2=0 X3=0 S11=-169.46553859214
IsS11Max=No IsS11Min=No FrameElem=45 ElemStation=0
Frame=45 Station=0 OutputCase=PERM2 CaseType=Combination Point=1 X2=-0.5 X3=-0.5 S11=-
2314.19492266832 IsS11Max=No IsS11Min=Yes FrameElem=45 ElemStation=0
Frame=45 Station=0 OutputCase=PERM2 CaseType=Combination Point=2 X2=-0.5 X3=0.5 S11=-
2314.19492266832 IsS11Max=No IsS11Min=No FrameElem=45 ElemStation=0
Frame=45 Station=0 OutputCase=PERM2 CaseType=Combination Point=3 X2=0.5 X3=-0.5
S11=1975.26384548404 IsS11Max=Yes IsS11Min=No FrameElem=45 ElemStation=0
Frame=45 Station=0 OutputCase=PERM2 CaseType=Combination Point=4 X2=0.5 X3=0.5 S11=1975.26384548404
IsS11Max=No IsS11Min=No FrameElem=45 ElemStation=0
Frame=45 Station=0.125 OutputCase=PERM2 CaseType=Combination Point=0 X2=0 X3=0 S11=-169.46553859214
IsS11Max=No IsS11Min=No FrameElem=45 ElemStation=0.125
Frame=45 Station=0.125 OutputCase=PERM2 CaseType=Combination Point=1 X2=-0.5 X3=-0.5 S11=-
2273.19240290534 IsS11Max=No IsS11Min=Yes FrameElem=45 ElemStation=0.125
Frame=45 Station=0.125 OutputCase=PERM2 CaseType=Combination Point=2 X2=-0.5 X3=0.5 S11=-
2273.19240290534 IsS11Max=No IsS11Min=No FrameElem=45 ElemStation=0.125
Frame=45 Station=0.125 OutputCase=PERM2 CaseType=Combination Point=3 X2=0.5 X3=-0.5
S11=1934.26132572106 IsS11Max=Yes IsS11Min=No FrameElem=45 ElemStation=0.125
Frame=45 Station=0.125 OutputCase=PERM2 CaseType=Combination Point=4 X2=0.5 X3=0.5
S11=1934.26132572106 IsS11Max=No IsS11Min=No FrameElem=45 ElemStation=0.125
Frame=45 Station=0.25 OutputCase=PERM2 CaseType=Combination Point=0 X2=0 X3=0 S11=-169.46553859214
IsS11Max=No IsS11Min=No FrameElem=45 ElemStation=0.25
Frame=45 Station=0.25 OutputCase=PERM2 CaseType=Combination Point=1 X2=-0.5 X3=-0.5 S11=-
2234.53363314236 IsS11Max=No IsS11Min=Yes FrameElem=45 ElemStation=0.25
Frame=45 Station=0.25 OutputCase=PERM2 CaseType=Combination Point=2 X2=-0.5 X3=0.5 S11=-
2234.53363314236 IsS11Max=No IsS11Min=No FrameElem=45 ElemStation=0.25
Frame=45 Station=0.25 OutputCase=PERM2 CaseType=Combination Point=3 X2=0.5 X3=-0.5
S11=1895.60255595808 IsS11Max=Yes IsS11Min=No FrameElem=45 ElemStation=0.25
Frame=45 Station=0.25 OutputCase=PERM2 CaseType=Combination Point=4 X2=0.5 X3=0.5
S11=1895.60255595808 IsS11Max=No IsS11Min=No FrameElem=45 ElemStation=0.25
Frame=45 Station=0.375 OutputCase=PERM2 CaseType=Combination Point=0 X2=0 X3=0 S11=-169.46553859214
IsS11Max=No IsS11Min=No FrameElem=45 ElemStation=0.375
Frame=45 Station=0.375 OutputCase=PERM2 CaseType=Combination Point=1 X2=-0.5 X3=-0.5 S11=-
2198.21861337938 IsS11Max=No IsS11Min=Yes FrameElem=45 ElemStation=0.375
Frame=45 Station=0.375 OutputCase=PERM2 CaseType=Combination Point=2 X2=-0.5 X3=0.5 S11=-
2198.21861337938 IsS11Max=No IsS11Min=No FrameElem=45 ElemStation=0.375
Frame=45 Station=0.375 OutputCase=PERM2 CaseType=Combination Point=3 X2=0.5 X3=-0.5
S11=1859.2875361951 IsS11Max=Yes IsS11Min=No FrameElem=45 ElemStation=0.375
Frame=45 Station=0.375 OutputCase=PERM2 CaseType=Combination Point=4 X2=0.5 X3=0.5
S11=1859.2875361951 IsS11Max=No IsS11Min=No FrameElem=45 ElemStation=0.375
Frame=45 Station=0.5 OutputCase=PERM2 CaseType=Combination Point=0 X2=0 X3=0 S11=-169.46553859214
IsS11Max=No IsS11Min=No FrameElem=45 ElemStation=0.5
Frame=45 Station=0.5 OutputCase=PERM2 CaseType=Combination Point=1 X2=-0.5 X3=-0.5 S11=-
2164.24734361641 IsS11Max=No IsS11Min=Yes FrameElem=45 ElemStation=0.5
Frame=45 Station=0.5 OutputCase=PERM2 CaseType=Combination Point=2 X2=-0.5 X3=0.5 S11=-
2164.24734361641 IsS11Max=No IsS11Min=No FrameElem=45 ElemStation=0.5
Frame=45 Station=0.5 OutputCase=PERM2 CaseType=Combination Point=3 X2=0.5 X3=-0.5
S11=1825.31626643213 IsS11Max=Yes IsS11Min=No FrameElem=45 ElemStation=0.5
Frame=45 Station=0.5 OutputCase=PERM2 CaseType=Combination Point=4 X2=0.5 X3=0.5
S11=1825.31626643213 IsS11Max=No IsS11Min=No FrameElem=45 ElemStation=0.5
Frame=45 Station=0 OutputCase=ACCL CaseType=Combination Point=0 X2=0 X3=0 S11=-240.528987364652
IsS11Max=No IsS11Min=No FrameElem=45 ElemStation=0
Frame=45 Station=0 OutputCase=ACCL CaseType=Combination Point=1 X2=-0.5 X3=-0.5 S11=-
2355.78842261369 IsS11Max=No IsS11Min=Yes FrameElem=45 ElemStation=0
Frame=45 Station=0 OutputCase=ACCL CaseType=Combination Point=2 X2=-0.5 X3=0.5 S11=-
2355.78842261369 IsS11Max=No IsS11Min=No FrameElem=45 ElemStation=0
Frame=45 Station=0 OutputCase=ACCL CaseType=Combination Point=3 X2=0.5 X3=-0.5 S11=1874.73044788439
IsS11Max=Yes IsS11Min=No FrameElem=45 ElemStation=0
Frame=45 Station=0 OutputCase=ACCL CaseType=Combination Point=4 X2=0.5 X3=0.5 S11=1874.73044788439
IsS11Max=No IsS11Min=No FrameElem=45 ElemStation=0
Frame=45 Station=0.125 OutputCase=ACCL CaseType=Combination Point=0 X2=0 X3=0 S11=-240.528987364652
IsS11Max=No IsS11Min=No FrameElem=45 ElemStation=0.125
Frame=45 Station=0.125 OutputCase=ACCL CaseType=Combination Point=1 X2=-0.5 X3=-0.5 S11=-
2313.76016500546 IsS11Max=No IsS11Min=Yes FrameElem=45 ElemStation=0.125
Frame=45 Station=0.125 OutputCase=ACCL CaseType=Combination Point=2 X2=-0.5 X3=0.5 S11=-
2313.76016500546 IsS11Max=No IsS11Min=No FrameElem=45 ElemStation=0.125
Frame=45 Station=0.125 OutputCase=ACCL CaseType=Combination Point=3 X2=0.5 X3=-0.5
S11=1832.70219027616 IsS11Max=Yes IsS11Min=No FrameElem=45 ElemStation=0.125
Frame=45 Station=0.125 OutputCase=ACCL CaseType=Combination Point=4 X2=0.5 X3=0.5
S11=1832.70219027616 IsS11Max=No IsS11Min=No FrameElem=45 ElemStation=0.125
Frame=45 Station=0.25 OutputCase=ACCL CaseType=Combination Point=0 X2=0 X3=0 S11=-240.528987364652
IsS11Max=No IsS11Min=No FrameElem=45 ElemStation=0.25
Frame=45 Station=0.25 OutputCase=ACCL CaseType=Combination Point=1 X2=-0.5 X3=-0.5 S11=-
2274.07565739723 IsS11Max=No IsS11Min=Yes FrameElem=45 ElemStation=0.25
Frame=45 Station=0.25 OutputCase=ACCL CaseType=Combination Point=2 X2=-0.5 X3=0.5 S11=-
2274.07565739723 IsS11Max=No IsS11Min=No FrameElem=45 ElemStation=0.25
Frame=45 Station=0.25 OutputCase=ACCL CaseType=Combination Point=3 X2=0.5 X3=-0.5
S11=1793.01768266792 IsS11Max=Yes IsS11Min=No FrameElem=45 ElemStation=0.25



Frame=45 Station=0.25 OutputCase=ACC1 CaseType=Combination Point=4 X2=0.5 X3=0.5
 S11=1793.01768266792 IsS11Max=No IsS11Min=No FrameElem=45 ElemStation=0.25
 Frame=45 Station=0.375 OutputCase=ACC1 CaseType=Combination Point=0 X2=0 X3=0 S11=-240.528987364652
 IsS11Max=No IsS11Min=No FrameElem=45 ElemStation=0.375
 Frame=45 Station=0.375 OutputCase=ACC1 CaseType=Combination Point=1 X2=-0.5 X3=-0.5 S11=-
 2236.73489978899 IsS11Max=No IsS11Min=Yes FrameElem=45 ElemStation=0.375
 Frame=45 Station=0.375 OutputCase=ACC1 CaseType=Combination Point=2 X2=-0.5 X3=0.5 S11=-
 2236.73489978899 IsS11Max=No IsS11Min=No FrameElem=45 ElemStation=0.375
 Frame=45 Station=0.375 OutputCase=ACC1 CaseType=Combination Point=3 X2=0.5 X3=-0.5
 S11=1755.67692505969 IsS11Max=Yes IsS11Min=No FrameElem=45 ElemStation=0.375
 Frame=45 Station=0.375 OutputCase=ACC1 CaseType=Combination Point=4 X2=0.5 X3=0.5
 S11=1755.67692505969 IsS11Max=No IsS11Min=No FrameElem=45 ElemStation=0.375
 Frame=45 Station=0.5 OutputCase=ACC1 CaseType=Combination Point=0 X2=0 X3=0 S11=-240.528987364652
 IsS11Max=No IsS11Min=No FrameElem=45 ElemStation=0.5
 Frame=45 Station=0.5 OutputCase=ACC1 CaseType=Combination Point=1 X2=-0.5 X3=-0.5 S11=-
 2201.73789218076 IsS11Max=No IsS11Min=Yes FrameElem=45 ElemStation=0.5
 Frame=45 Station=0.5 OutputCase=ACC1 CaseType=Combination Point=2 X2=-0.5 X3=0.5 S11=-
 2201.73789218076 IsS11Max=No IsS11Min=No FrameElem=45 ElemStation=0.5
 Frame=45 Station=0.5 OutputCase=ACC1 CaseType=Combination Point=3 X2=0.5 X3=-0.5
 S11=1720.67991745146 IsS11Max=Yes IsS11Min=No FrameElem=45 ElemStation=0.5
 Frame=45 Station=0.5 OutputCase=ACC1 CaseType=Combination Point=4 X2=0.5 X3=0.5
 S11=1720.67991745146 IsS11Max=No IsS11Min=No FrameElem=45 ElemStation=0.5
 Frame=45 Station=0 OutputCase=ACC2 CaseType=Combination Point=0 X2=0 X3=0 S11=-174.055753683482
 IsS11Max=No IsS11Min=No FrameElem=45 ElemStation=0
 Frame=45 Station=0 OutputCase=ACC2 CaseType=Combination Point=1 X2=-0.5 X3=-0.5 S11=-
 2374.45630705476 IsS11Max=No IsS11Min=Yes FrameElem=45 ElemStation=0
 Frame=45 Station=0 OutputCase=ACC2 CaseType=Combination Point=2 X2=-0.5 X3=0.5 S11=-
 2374.45630705476 IsS11Max=No IsS11Min=No FrameElem=45 ElemStation=0
 Frame=45 Station=0 OutputCase=ACC2 CaseType=Combination Point=3 X2=0.5 X3=-0.5 S11=2026.34479968779
 IsS11Max=Yes IsS11Min=No FrameElem=45 ElemStation=0
 Frame=45 Station=0 OutputCase=ACC2 CaseType=Combination Point=4 X2=0.5 X3=0.5 S11=2026.34479968779
 IsS11Max=No IsS11Min=No FrameElem=45 ElemStation=0
 Frame=45 Station=0.125 OutputCase=ACC2 CaseType=Combination Point=0 X2=0 X3=0 S11=-174.055753683482
 IsS11Max=No IsS11Min=No FrameElem=45 ElemStation=0.125
 Frame=45 Station=0.125 OutputCase=ACC2 CaseType=Combination Point=1 X2=-0.5 X3=-0.5 S11=-
 2332.45247276133 IsS11Max=No IsS11Min=Yes FrameElem=45 ElemStation=0.125
 Frame=45 Station=0.125 OutputCase=ACC2 CaseType=Combination Point=2 X2=-0.5 X3=0.5 S11=-
 2332.45247276133 IsS11Max=No IsS11Min=No FrameElem=45 ElemStation=0.125
 Frame=45 Station=0.125 OutputCase=ACC2 CaseType=Combination Point=3 X2=0.5 X3=-0.5
 S11=1984.34096539436 IsS11Max=Yes IsS11Min=No FrameElem=45 ElemStation=0.125
 Frame=45 Station=0.125 OutputCase=ACC2 CaseType=Combination Point=4 X2=0.5 X3=0.5
 S11=1984.34096539436 IsS11Max=No IsS11Min=No FrameElem=45 ElemStation=0.125
 Frame=45 Station=0.25 OutputCase=ACC2 CaseType=Combination Point=0 X2=0 X3=0 S11=-174.055753683482
 IsS11Max=No IsS11Min=No FrameElem=45 ElemStation=0.25
 Frame=45 Station=0.25 OutputCase=ACC2 CaseType=Combination Point=1 X2=-0.5 X3=-0.5 S11=-
 2292.7923884679 IsS11Max=No IsS11Min=Yes FrameElem=45 ElemStation=0.25
 Frame=45 Station=0.25 OutputCase=ACC2 CaseType=Combination Point=2 X2=-0.5 X3=0.5 S11=-
 2292.7923884679 IsS11Max=No IsS11Min=No FrameElem=45 ElemStation=0.25
 Frame=45 Station=0.25 OutputCase=ACC2 CaseType=Combination Point=3 X2=0.5 X3=-0.5
 S11=1944.68088110093 IsS11Max=Yes IsS11Min=No FrameElem=45 ElemStation=0.25
 Frame=45 Station=0.25 OutputCase=ACC2 CaseType=Combination Point=4 X2=0.5 X3=0.5
 S11=1944.68088110093 IsS11Max=No IsS11Min=No FrameElem=45 ElemStation=0.25
 Frame=45 Station=0.375 OutputCase=ACC2 CaseType=Combination Point=0 X2=0 X3=0 S11=-174.055753683482
 IsS11Max=No IsS11Min=No FrameElem=45 ElemStation=0.375
 Frame=45 Station=0.375 OutputCase=ACC2 CaseType=Combination Point=1 X2=-0.5 X3=-0.5 S11=-
 2255.47605417446 IsS11Max=No IsS11Min=Yes FrameElem=45 ElemStation=0.375
 Frame=45 Station=0.375 OutputCase=ACC2 CaseType=Combination Point=2 X2=-0.5 X3=0.5 S11=-
 2255.47605417446 IsS11Max=No IsS11Min=No FrameElem=45 ElemStation=0.375
 Frame=45 Station=0.375 OutputCase=ACC2 CaseType=Combination Point=3 X2=0.5 X3=-0.5
 S11=1907.3645468075 IsS11Max=Yes IsS11Min=No FrameElem=45 ElemStation=0.375
 Frame=45 Station=0.375 OutputCase=ACC2 CaseType=Combination Point=4 X2=0.5 X3=0.5
 S11=1907.3645468075 IsS11Max=No IsS11Min=No FrameElem=45 ElemStation=0.375
 Frame=45 Station=0.5 OutputCase=ACC2 CaseType=Combination Point=0 X2=0 X3=0 S11=-174.055753683482
 IsS11Max=No IsS11Min=No FrameElem=45 ElemStation=0.5
 Frame=45 Station=0.5 OutputCase=ACC2 CaseType=Combination Point=1 X2=-0.5 X3=-0.5 S11=-
 2220.50346988104 IsS11Max=No IsS11Min=Yes FrameElem=45 ElemStation=0.5
 Frame=45 Station=0.5 OutputCase=ACC2 CaseType=Combination Point=2 X2=-0.5 X3=0.5 S11=-
 2220.50346988104 IsS11Max=No IsS11Min=No FrameElem=45 ElemStation=0.5
 Frame=45 Station=0.5 OutputCase=ACC2 CaseType=Combination Point=3 X2=0.5 X3=-0.5
 S11=1872.39196251407 IsS11Max=Yes IsS11Min=No FrameElem=45 ElemStation=0.5
 Frame=45 Station=0.5 OutputCase=ACC2 CaseType=Combination Point=4 X2=0.5 X3=0.5
 S11=1872.39196251407 IsS11Max=No IsS11Min=No FrameElem=45 ElemStation=0.5
 Frame=45 Station=0 OutputCase=ACCSX1 CaseType=Combination Point=0 X2=0 X3=0 S11=-233.665974282454
 IsS11Max=No IsS11Min=No FrameElem=45 ElemStation=0
 Frame=45 Station=0 OutputCase=ACCSX1 CaseType=Combination Point=1 X2=-0.5 X3=-0.5 S11=-
 2288.75813019117 IsS11Max=No IsS11Min=Yes FrameElem=45 ElemStation=0
 Frame=45 Station=0 OutputCase=ACCSX1 CaseType=Combination Point=2 X2=-0.5 X3=0.5 S11=-
 2288.75813019117 IsS11Max=No IsS11Min=No FrameElem=45 ElemStation=0
 Frame=45 Station=0 OutputCase=ACCSX1 CaseType=Combination Point=3 X2=0.5 X3=-0.5
 S11=1821.42618162626 IsS11Max=Yes IsS11Min=No FrameElem=45 ElemStation=0
 Frame=45 Station=0 OutputCase=ACCSX1 CaseType=Combination Point=4 X2=0.5 X3=0.5
 S11=1821.42618162626 IsS11Max=No IsS11Min=No FrameElem=45 ElemStation=0

Frame=45	Station=0.125	OutputCase=ACCSX1	CaseType=Combination	Point=0	X2=0	X3=0	S11=-
233.665974282454	IsS11Max=No	IsS11Min=No	FrameElem=45	ElemStation=0.125			
Frame=45	Station=0.125	OutputCase=ACCSX1	CaseType=Combination	Point=1	X2=-0.5	X3=-0.5	S11=-
2250.67471987734	IsS11Max=No	IsS11Min=Yes	FrameElem=45	ElemStation=0.125			
Frame=45	Station=0.125	OutputCase=ACCSX1	CaseType=Combination	Point=2	X2=-0.5	X3=0.5	S11=-
2250.67471987734	IsS11Max=No	IsS11Min=No	FrameElem=45	ElemStation=0.125			
Frame=45	Station=0.125	OutputCase=ACCSX1	CaseType=Combination	Point=3	X2=0.5	X3=-0.5	
S11=1783.34277131243	IsS11Max=Yes	IsS11Min=No	FrameElem=45	ElemStation=0.125			
Frame=45	Station=0.125	OutputCase=ACCSX1	CaseType=Combination	Point=4	X2=0.5	X3=0.5	
S11=1783.34277131243	IsS11Max=No	IsS11Min=No	FrameElem=45	ElemStation=0.125			
Frame=45	Station=0.25	OutputCase=ACCSX1	CaseType=Combination	Point=0	X2=0	X3=0	S11=-
233.665974282454	IsS11Max=No	IsS11Min=No	FrameElem=45	ElemStation=0.25			
Frame=45	Station=0.25	OutputCase=ACCSX1	CaseType=Combination	Point=1	X2=-0.5	X3=-0.5	S11=-
2214.93505956351	IsS11Max=No	IsS11Min=Yes	FrameElem=45	ElemStation=0.25			
Frame=45	Station=0.25	OutputCase=ACCSX1	CaseType=Combination	Point=2	X2=-0.5	X3=0.5	S11=-
2214.93505956351	IsS11Max=No	IsS11Min=No	FrameElem=45	ElemStation=0.25			
Frame=45	Station=0.25	OutputCase=ACCSX1	CaseType=Combination	Point=3	X2=0.5	X3=-0.5	
S11=1747.6031109986	IsS11Max=Yes	IsS11Min=No	FrameElem=45	ElemStation=0.25			
Frame=45	Station=0.25	OutputCase=ACCSX1	CaseType=Combination	Point=4	X2=0.5	X3=0.5	
S11=1747.6031109986	IsS11Max=No	IsS11Min=No	FrameElem=45	ElemStation=0.25			
Frame=45	Station=0.375	OutputCase=ACCSX1	CaseType=Combination	Point=0	X2=0	X3=0	S11=-
233.665974282454	IsS11Max=No	IsS11Min=No	FrameElem=45	ElemStation=0.375			
Frame=45	Station=0.375	OutputCase=ACCSX1	CaseType=Combination	Point=1	X2=-0.5	X3=-0.5	S11=-
2181.53914924968	IsS11Max=No	IsS11Min=Yes	FrameElem=45	ElemStation=0.375			
Frame=45	Station=0.375	OutputCase=ACCSX1	CaseType=Combination	Point=2	X2=-0.5	X3=0.5	S11=-
2181.53914924968	IsS11Max=No	IsS11Min=No	FrameElem=45	ElemStation=0.375			
Frame=45	Station=0.375	OutputCase=ACCSX1	CaseType=Combination	Point=3	X2=0.5	X3=-0.5	
S11=1714.20720068477	IsS11Max=Yes	IsS11Min=No	FrameElem=45	ElemStation=0.375			
Frame=45	Station=0.375	OutputCase=ACCSX1	CaseType=Combination	Point=4	X2=0.5	X3=0.5	
S11=1714.20720068477	IsS11Max=No	IsS11Min=No	FrameElem=45	ElemStation=0.375			
Frame=45	Station=0.5	OutputCase=ACCSX1	CaseType=Combination	Point=0	X2=0	X3=0	S11=-233.665974282454
IsS11Max=No	IsS11Min=No	FrameElem=45	ElemStation=0.5				
Frame=45	Station=0.5	OutputCase=ACCSX1	CaseType=Combination	Point=1	X2=-0.5	X3=-0.5	S11=-
2150.48698893585	IsS11Max=No	IsS11Min=Yes	FrameElem=45	ElemStation=0.5			
Frame=45	Station=0.5	OutputCase=ACCSX1	CaseType=Combination	Point=2	X2=-0.5	X3=0.5	S11=-
2150.48698893585	IsS11Max=No	IsS11Min=No	FrameElem=45	ElemStation=0.5			
Frame=45	Station=0.5	OutputCase=ACCSX1	CaseType=Combination	Point=3	X2=0.5	X3=-0.5	
S11=1683.15504037094	IsS11Max=Yes	IsS11Min=No	FrameElem=45	ElemStation=0.5			
Frame=45	Station=0.5	OutputCase=ACCSX1	CaseType=Combination	Point=4	X2=0.5	X3=0.5	
S11=1683.15504037094	IsS11Max=No	IsS11Min=No	FrameElem=45	ElemStation=0.5			
Frame=45	Station=0	OutputCase=ACCSX2	CaseType=Combination	Point=0	X2=0	X3=0	S11=-167.192740601284
IsS11Max=No	IsS11Min=No	FrameElem=45	ElemStation=0				
Frame=45	Station=0	OutputCase=ACCSX2	CaseType=Combination	Point=1	X2=-0.5	X3=-0.5	S11=-
2307.42601463223	IsS11Max=No	IsS11Min=Yes	FrameElem=45	ElemStation=0			
Frame=45	Station=0	OutputCase=ACCSX2	CaseType=Combination	Point=2	X2=-0.5	X3=0.5	S11=-
2307.42601463223	IsS11Max=No	IsS11Min=No	FrameElem=45	ElemStation=0			
Frame=45	Station=0	OutputCase=ACCSX2	CaseType=Combination	Point=3	X2=0.5	X3=-0.5	
S11=1973.04053342966	IsS11Max=Yes	IsS11Min=No	FrameElem=45	ElemStation=0			
Frame=45	Station=0	OutputCase=ACCSX2	CaseType=Combination	Point=4	X2=0.5	X3=0.5	
S11=1973.04053342966	IsS11Max=No	IsS11Min=No	FrameElem=45	ElemStation=0			
Frame=45	Station=0.125	OutputCase=ACCSX2	CaseType=Combination	Point=0	X2=0	X3=0	S11=-
167.192740601284	IsS11Max=No	IsS11Min=No	FrameElem=45	ElemStation=0.125			
Frame=45	Station=0.125	OutputCase=ACCSX2	CaseType=Combination	Point=1	X2=-0.5	X3=-0.5	S11=-
2269.36702763321	IsS11Max=No	IsS11Min=Yes	FrameElem=45	ElemStation=0.125			
Frame=45	Station=0.125	OutputCase=ACCSX2	CaseType=Combination	Point=2	X2=-0.5	X3=0.5	S11=-
2269.36702763321	IsS11Max=No	IsS11Min=No	FrameElem=45	ElemStation=0.125			
Frame=45	Station=0.125	OutputCase=ACCSX2	CaseType=Combination	Point=3	X2=0.5	X3=-0.5	
S11=1934.98154643064	IsS11Max=Yes	IsS11Min=No	FrameElem=45	ElemStation=0.125			
Frame=45	Station=0.125	OutputCase=ACCSX2	CaseType=Combination	Point=4	X2=0.5	X3=0.5	
S11=1934.98154643064	IsS11Max=No	IsS11Min=No	FrameElem=45	ElemStation=0.125			
Frame=45	Station=0.25	OutputCase=ACCSX2	CaseType=Combination	Point=0	X2=0	X3=0	S11=-
167.192740601284	IsS11Max=No	IsS11Min=No	FrameElem=45	ElemStation=0.25			
Frame=45	Station=0.25	OutputCase=ACCSX2	CaseType=Combination	Point=1	X2=-0.5	X3=-0.5	S11=-
2233.65179063418	IsS11Max=No	IsS11Min=Yes	FrameElem=45	ElemStation=0.25			
Frame=45	Station=0.25	OutputCase=ACCSX2	CaseType=Combination	Point=2	X2=-0.5	X3=0.5	S11=-
2233.65179063418	IsS11Max=No	IsS11Min=No	FrameElem=45	ElemStation=0.25			
Frame=45	Station=0.25	OutputCase=ACCSX2	CaseType=Combination	Point=3	X2=0.5	X3=-0.5	
S11=1899.26630943161	IsS11Max=Yes	IsS11Min=No	FrameElem=45	ElemStation=0.25			
Frame=45	Station=0.25	OutputCase=ACCSX2	CaseType=Combination	Point=4	X2=0.5	X3=0.5	
S11=1899.26630943161	IsS11Max=No	IsS11Min=No	FrameElem=45	ElemStation=0.25			
Frame=45	Station=0.375	OutputCase=ACCSX2	CaseType=Combination	Point=0	X2=0	X3=0	S11=-
167.192740601284	IsS11Max=No	IsS11Min=No	FrameElem=45	ElemStation=0.375			
Frame=45	Station=0.375	OutputCase=ACCSX2	CaseType=Combination	Point=1	X2=-0.5	X3=-0.5	S11=-
2200.28030363515	IsS11Max=No	IsS11Min=Yes	FrameElem=45	ElemStation=0.375			
Frame=45	Station=0.375	OutputCase=ACCSX2	CaseType=Combination	Point=2	X2=-0.5	X3=0.5	S11=-
2200.28030363515	IsS11Max=No	IsS11Min=No	FrameElem=45	ElemStation=0.375			
Frame=45	Station=0.375	OutputCase=ACCSX2	CaseType=Combination	Point=3	X2=0.5	X3=-0.5	
S11=1865.89482243258	IsS11Max=Yes	IsS11Min=No	FrameElem=45	ElemStation=0.375			
Frame=45	Station=0.375	OutputCase=ACCSX2	CaseType=Combination	Point=4	X2=0.5	X3=0.5	
S11=1865.89482243258	IsS11Max=No	IsS11Min=No	FrameElem=45	ElemStation=0.375			
Frame=45	Station=0.5	OutputCase=ACCSX2	CaseType=Combination	Point=0	X2=0	X3=0	S11=-167.192740601284
IsS11Max=No	IsS11Min=No	FrameElem=45	ElemStation=0.5				

Frame=45	Station=0.5	OutputCase=ACCSX2	CaseType=Combination	Point=1	X2=-0.5	X3=-0.5	S11=-	
2169.25256663613	IsS11Max=No	IsS11Min=Yes	FrameElem=45	ElemStation=0.5				
Frame=45	Station=0.5	OutputCase=ACCSX2	CaseType=Combination	Point=2	X2=-0.5	X3=0.5	S11=-	
2169.25256663613	IsS11Max=No	IsS11Min=No	FrameElem=45	ElemStation=0.5				
Frame=45	Station=0.5	OutputCase=ACCSX2	CaseType=Combination	Point=3	X2=0.5	X3=-0.5		
S11=1834.86708543356	IsS11Max=Yes	IsS11Min=No	FrameElem=45	ElemStation=0.5				
Frame=45	Station=0.5	OutputCase=ACCSX2	CaseType=Combination	Point=4	X2=0.5	X3=0.5		
S11=1834.86708543356	IsS11Max=No	IsS11Min=No	FrameElem=45	ElemStation=0.5				
Frame=45	Station=0	OutputCase=ENVE	CaseType=Combination	StepType=Max	Point=0	X2=0	X3=0	S11=-
167.192740601284	IsS11Max=No	IsS11Min=No	FrameElem=45	ElemStation=0				
Frame=45	Station=0	OutputCase=ENVE	CaseType=Combination	StepType=Max	Point=1	X2=-0.5	X3=-0.5	
S11=-2288.75813019117	IsS11Max=No	IsS11Min=Yes	FrameElem=45	ElemStation=0				
Frame=45	Station=0	OutputCase=ENVE	CaseType=Combination	StepType=Max	Point=2	X2=-0.5	X3=0.5	S11=-
2288.75813019117	IsS11Max=No	IsS11Min=No	FrameElem=45	ElemStation=0				
Frame=45	Station=0	OutputCase=ENVE	CaseType=Combination	StepType=Max	Point=3	X2=0.5	X3=-0.5	
S11=2026.34479968779	IsS11Max=Yes	IsS11Min=No	FrameElem=45	ElemStation=0				
Frame=45	Station=0	OutputCase=ENVE	CaseType=Combination	StepType=Max	Point=4	X2=0.5	X3=0.5	
S11=2026.34479968779	IsS11Max=No	IsS11Min=No	FrameElem=45	ElemStation=0				
Frame=45	Station=0.125	OutputCase=ENVE	CaseType=Combination	StepType=Max	Point=0	X2=0	X3=0	S11=-
167.192740601284	IsS11Max=No	IsS11Min=No	FrameElem=45	ElemStation=0.125				
Frame=45	Station=0.125	OutputCase=ENVE	CaseType=Combination	StepType=Max	Point=1	X2=-0.5	X3=-0.5	
S11=-2250.67471987734	IsS11Max=No	IsS11Min=Yes	FrameElem=45	ElemStation=0.125				
Frame=45	Station=0.125	OutputCase=ENVE	CaseType=Combination	StepType=Max	Point=2	X2=-0.5	X3=0.5	
S11=-2250.67471987734	IsS11Max=No	IsS11Min=No	FrameElem=45	ElemStation=0.125				
Frame=45	Station=0.125	OutputCase=ENVE	CaseType=Combination	StepType=Max	Point=3	X2=0.5	X3=-0.5	
S11=1984.34096539436	IsS11Max=Yes	IsS11Min=No	FrameElem=45	ElemStation=0.125				
Frame=45	Station=0.125	OutputCase=ENVE	CaseType=Combination	StepType=Max	Point=4	X2=0.5	X3=0.5	
S11=1984.34096539436	IsS11Max=No	IsS11Min=No	FrameElem=45	ElemStation=0.125				
Frame=45	Station=0.25	OutputCase=ENVE	CaseType=Combination	StepType=Max	Point=0	X2=0	X3=0	S11=-
167.192740601284	IsS11Max=No	IsS11Min=No	FrameElem=45	ElemStation=0.25				
Frame=45	Station=0.25	OutputCase=ENVE	CaseType=Combination	StepType=Max	Point=1	X2=-0.5	X3=-0.5	
S11=-2214.93505956351	IsS11Max=No	IsS11Min=Yes	FrameElem=45	ElemStation=0.25				
Frame=45	Station=0.25	OutputCase=ENVE	CaseType=Combination	StepType=Max	Point=2	X2=-0.5	X3=0.5	
S11=-2214.93505956351	IsS11Max=No	IsS11Min=No	FrameElem=45	ElemStation=0.25				
Frame=45	Station=0.25	OutputCase=ENVE	CaseType=Combination	StepType=Max	Point=3	X2=0.5	X3=-0.5	
S11=1944.68088110093	IsS11Max=Yes	IsS11Min=No	FrameElem=45	ElemStation=0.25				
Frame=45	Station=0.25	OutputCase=ENVE	CaseType=Combination	StepType=Max	Point=4	X2=0.5	X3=0.5	
S11=1944.68088110093	IsS11Max=No	IsS11Min=No	FrameElem=45	ElemStation=0.25				
Frame=45	Station=0.375	OutputCase=ENVE	CaseType=Combination	StepType=Max	Point=0	X2=0	X3=0	S11=-
167.192740601284	IsS11Max=No	IsS11Min=No	FrameElem=45	ElemStation=0.375				
Frame=45	Station=0.375	OutputCase=ENVE	CaseType=Combination	StepType=Max	Point=1	X2=-0.5	X3=-0.5	
S11=-2179.47745899391	IsS11Max=No	IsS11Min=Yes	FrameElem=45	ElemStation=0.375				
Frame=45	Station=0.375	OutputCase=ENVE	CaseType=Combination	StepType=Max	Point=2	X2=-0.5	X3=0.5	
S11=-2179.47745899391	IsS11Max=No	IsS11Min=No	FrameElem=45	ElemStation=0.375				
Frame=45	Station=0.375	OutputCase=ENVE	CaseType=Combination	StepType=Max	Point=3	X2=0.5	X3=-0.5	
S11=1907.3645468075	IsS11Max=Yes	IsS11Min=No	FrameElem=45	ElemStation=0.375				
Frame=45	Station=0.375	OutputCase=ENVE	CaseType=Combination	StepType=Max	Point=4	X2=0.5	X3=0.5	
S11=1907.3645468075	IsS11Max=No	IsS11Min=No	FrameElem=45	ElemStation=0.375				
Frame=45	Station=0.5	OutputCase=ENVE	CaseType=Combination	StepType=Max	Point=0	X2=0	X3=0	S11=-
167.192740601284	IsS11Max=No	IsS11Min=No	FrameElem=45	ElemStation=0.5				
Frame=45	Station=0.5	OutputCase=ENVE	CaseType=Combination	StepType=Max	Point=1	X2=-0.5	X3=-0.5	
S11=-2145.48176591613	IsS11Max=No	IsS11Min=Yes	FrameElem=45	ElemStation=0.5				
Frame=45	Station=0.5	OutputCase=ENVE	CaseType=Combination	StepType=Max	Point=2	X2=-0.5	X3=0.5	
S11=-2145.48176591613	IsS11Max=No	IsS11Min=No	FrameElem=45	ElemStation=0.5				
Frame=45	Station=0.5	OutputCase=ENVE	CaseType=Combination	StepType=Max	Point=3	X2=0.5	X3=-0.5	
S11=1872.39196251407	IsS11Max=Yes	IsS11Min=No	FrameElem=45	ElemStation=0.5				
Frame=45	Station=0.5	OutputCase=ENVE	CaseType=Combination	StepType=Max	Point=4	X2=0.5	X3=0.5	
S11=1872.39196251407	IsS11Max=No	IsS11Min=No	FrameElem=45	ElemStation=0.5				
Frame=45	Station=0	OutputCase=ENVE	CaseType=Combination	StepType=Min	Point=0	X2=0	X3=0	S11=-
240.528987364652	IsS11Max=No	IsS11Min=No	FrameElem=45	ElemStation=0				
Frame=45	Station=0	OutputCase=ENVE	CaseType=Combination	StepType=Min	Point=1	X2=-0.5	X3=-0.5	
S11=-2374.45630705476	IsS11Max=No	IsS11Min=Yes	FrameElem=45	ElemStation=0				
Frame=45	Station=0	OutputCase=ENVE	CaseType=Combination	StepType=Min	Point=2	X2=-0.5	X3=0.5	S11=-
2374.45630705476	IsS11Max=No	IsS11Min=No	FrameElem=45	ElemStation=0				
Frame=45	Station=0	OutputCase=ENVE	CaseType=Combination	StepType=Min	Point=3	X2=0.5	X3=-0.5	
S11=1821.42618162626	IsS11Max=Yes	IsS11Min=No	FrameElem=45	ElemStation=0				
Frame=45	Station=0	OutputCase=ENVE	CaseType=Combination	StepType=Min	Point=4	X2=0.5	X3=0.5	
S11=1821.42618162626	IsS11Max=No	IsS11Min=No	FrameElem=45	ElemStation=0				
Frame=45	Station=0.125	OutputCase=ENVE	CaseType=Combination	StepType=Min	Point=0	X2=0	X3=0	S11=-
240.528987364652	IsS11Max=No	IsS11Min=No	FrameElem=45	ElemStation=0.125				
Frame=45	Station=0.125	OutputCase=ENVE	CaseType=Combination	StepType=Min	Point=1	X2=-0.5	X3=-0.5	
S11=-2332.45247276133	IsS11Max=No	IsS11Min=Yes	FrameElem=45	ElemStation=0.125				
Frame=45	Station=0.125	OutputCase=ENVE	CaseType=Combination	StepType=Min	Point=2	X2=-0.5	X3=0.5	
S11=-2332.45247276133	IsS11Max=No	IsS11Min=No	FrameElem=45	ElemStation=0.125				
Frame=45	Station=0.125	OutputCase=ENVE	CaseType=Combination	StepType=Min	Point=3	X2=0.5	X3=-0.5	
S11=1782.62255060286	IsS11Max=Yes	IsS11Min=No	FrameElem=45	ElemStation=0.125				
Frame=45	Station=0.125	OutputCase=ENVE	CaseType=Combination	StepType=Min	Point=4	X2=0.5	X3=0.5	
S11=1782.62255060286	IsS11Max=No	IsS11Min=No	FrameElem=45	ElemStation=0.125				
Frame=45	Station=0.25	OutputCase=ENVE	CaseType=Combination	StepType=Min	Point=0	X2=0	X3=0	S11=-
240.528987364652	IsS11Max=No	IsS11Min=No	FrameElem=45	ElemStation=0.25				
Frame=45	Station=0.25	OutputCase=ENVE	CaseType=Combination	StepType=Min	Point=1	X2=-0.5	X3=-0.5	
S11=-2292.7923884679	IsS11Max=No	IsS11Min=Yes	FrameElem=45	ElemStation=0.25				

Frame=45	Station=0.25	OutputCase=ENVE	CaseType=Combination	StepType=Min	Point=2	X2=-0.5	X3=0.5	
S11=-2292.7923884679	IsS11Max=No	IsS11Min=No	FrameElem=45	ElemStation=0.25				
Frame=45	Station=0.25	OutputCase=ENVE	CaseType=Combination	StepType=Min	Point=3	X2=0.5	X3=-0.5	
S11=1743.93935752507	IsS11Max=Yes	IsS11Min=No	FrameElem=45	ElemStation=0.25				
Frame=45	Station=0.25	OutputCase=ENVE	CaseType=Combination	StepType=Min	Point=4	X2=0.5	X3=0.5	
S11=1743.93935752507	IsS11Max=No	IsS11Min=No	FrameElem=45	ElemStation=0.25				
Frame=45	Station=0.375	OutputCase=ENVE	CaseType=Combination	StepType=Min	Point=0	X2=0	X3=0	S11=-
240.528987364652	IsS11Max=No	IsS11Min=No	FrameElem=45	ElemStation=0.375				
Frame=45	Station=0.375	OutputCase=ENVE	CaseType=Combination	StepType=Min	Point=1	X2=-0.5	X3=-0.5	
S11=-2255.47605417446	IsS11Max=No	IsS11Min=Yes	FrameElem=45	ElemStation=0.375				
Frame=45	Station=0.375	OutputCase=ENVE	CaseType=Combination	StepType=Min	Point=2	X2=-0.5	X3=0.5	
S11=-2255.47605417446	IsS11Max=No	IsS11Min=No	FrameElem=45	ElemStation=0.375				
Frame=45	Station=0.375	OutputCase=ENVE	CaseType=Combination	StepType=Min	Point=3	X2=0.5	X3=-0.5	
S11=1707.59991444729	IsS11Max=Yes	IsS11Min=No	FrameElem=45	ElemStation=0.375				
Frame=45	Station=0.375	OutputCase=ENVE	CaseType=Combination	StepType=Min	Point=4	X2=0.5	X3=0.5	
S11=1707.59991444729	IsS11Max=No	IsS11Min=No	FrameElem=45	ElemStation=0.375				
Frame=45	Station=0.5	OutputCase=ENVE	CaseType=Combination	StepType=Min	Point=0	X2=0	X3=0	S11=-
240.528987364652	IsS11Max=No	IsS11Min=No	FrameElem=45	ElemStation=0.5				
Frame=45	Station=0.5	OutputCase=ENVE	CaseType=Combination	StepType=Min	Point=1	X2=-0.5	X3=-0.5	
S11=-2220.50346988104	IsS11Max=No	IsS11Min=Yes	FrameElem=45	ElemStation=0.5				
Frame=45	Station=0.5	OutputCase=ENVE	CaseType=Combination	StepType=Min	Point=2	X2=-0.5	X3=0.5	
S11=-2220.50346988104	IsS11Max=No	IsS11Min=No	FrameElem=45	ElemStation=0.5				
Frame=45	Station=0.5	OutputCase=ENVE	CaseType=Combination	StepType=Min	Point=3	X2=0.5	X3=-0.5	
S11=1673.60422136951	IsS11Max=Yes	IsS11Min=No	FrameElem=45	ElemStation=0.5				
Frame=45	Station=0.5	OutputCase=ENVE	CaseType=Combination	StepType=Min	Point=4	X2=0.5	X3=0.5	
S11=1673.60422136951	IsS11Max=No	IsS11Min=No	FrameElem=45	ElemStation=0.5				
Frame=45	Station=0	OutputCase=FESSUR	CaseType=Combination	Point=0	X2=0	X3=0	S11=-239.15192283725	
IsS11Max=No	IsS11Min=No	FrameElem=45	ElemStation=0					
Frame=45	Station=0	OutputCase=FESSUR	CaseType=Combination	Point=1	X2=-0.5	X3=-0.5	S11=-	
2337.71000729776	IsS11Max=No	IsS11Min=Yes	FrameElem=45	ElemStation=0				
Frame=45	Station=0	OutputCase=FESSUR	CaseType=Combination	Point=2	X2=-0.5	X3=0.5	S11=-	
2337.71000729776	IsS11Max=No	IsS11Min=No	FrameElem=45	ElemStation=0				
Frame=45	Station=0	OutputCase=FESSUR	CaseType=Combination	Point=3	X2=0.5	X3=-0.5		
S11=1859.40616162326	IsS11Max=Yes	IsS11Min=No	FrameElem=45	ElemStation=0				
Frame=45	Station=0	OutputCase=FESSUR	CaseType=Combination	Point=4	X2=0.5	X3=0.5		
S11=1859.40616162326	IsS11Max=No	IsS11Min=No	FrameElem=45	ElemStation=0				
Frame=45	Station=0.125	OutputCase=FESSUR	CaseType=Combination	Point=0	X2=0	X3=0	S11=-	
239.15192283725	IsS11Max=No	IsS11Min=No	FrameElem=45	ElemStation=0.125				
Frame=45	Station=0.125	OutputCase=FESSUR	CaseType=Combination	Point=1	X2=-0.5	X3=-0.5	S11=-	
2295.98214404866	IsS11Max=No	IsS11Min=Yes	FrameElem=45	ElemStation=0.125				
Frame=45	Station=0.125	OutputCase=FESSUR	CaseType=Combination	Point=2	X2=-0.5	X3=0.5	S11=-	
2295.98214404866	IsS11Max=No	IsS11Min=No	FrameElem=45	ElemStation=0.125				
Frame=45	Station=0.125	OutputCase=FESSUR	CaseType=Combination	Point=3	X2=0.5	X3=-0.5		
S11=1817.67829837417	IsS11Max=Yes	IsS11Min=No	FrameElem=45	ElemStation=0.125				
Frame=45	Station=0.125	OutputCase=FESSUR	CaseType=Combination	Point=4	X2=0.5	X3=0.5		
S11=1817.67829837417	IsS11Max=No	IsS11Min=No	FrameElem=45	ElemStation=0.125				
Frame=45	Station=0.25	OutputCase=FESSUR	CaseType=Combination	Point=0	X2=0	X3=0	S11=-239.15192283725	
IsS11Max=No	IsS11Min=No	FrameElem=45	ElemStation=0.25					
Frame=45	Station=0.25	OutputCase=FESSUR	CaseType=Combination	Point=1	X2=-0.5	X3=-0.5	S11=-	
2256.59803079957	IsS11Max=No	IsS11Min=Yes	FrameElem=45	ElemStation=0.25				
Frame=45	Station=0.25	OutputCase=FESSUR	CaseType=Combination	Point=2	X2=-0.5	X3=0.5	S11=-	
2256.59803079957	IsS11Max=No	IsS11Min=No	FrameElem=45	ElemStation=0.25				
Frame=45	Station=0.25	OutputCase=FESSUR	CaseType=Combination	Point=3	X2=0.5	X3=-0.5		
S11=1778.29418512507	IsS11Max=Yes	IsS11Min=No	FrameElem=45	ElemStation=0.25				
Frame=45	Station=0.25	OutputCase=FESSUR	CaseType=Combination	Point=4	X2=0.5	X3=0.5		
S11=1778.29418512507	IsS11Max=No	IsS11Min=No	FrameElem=45	ElemStation=0.25				
Frame=45	Station=0.375	OutputCase=FESSUR	CaseType=Combination	Point=0	X2=0	X3=0	S11=-	
239.15192283725	IsS11Max=No	IsS11Min=No	FrameElem=45	ElemStation=0.375				
Frame=45	Station=0.375	OutputCase=FESSUR	CaseType=Combination	Point=1	X2=-0.5	X3=-0.5	S11=-	
2219.55766755047	IsS11Max=No	IsS11Min=Yes	FrameElem=45	ElemStation=0.375				
Frame=45	Station=0.375	OutputCase=FESSUR	CaseType=Combination	Point=2	X2=-0.5	X3=0.5	S11=-	
2219.55766755047	IsS11Max=No	IsS11Min=No	FrameElem=45	ElemStation=0.375				
Frame=45	Station=0.375	OutputCase=FESSUR	CaseType=Combination	Point=3	X2=0.5	X3=-0.5		
S11=1741.25382187597	IsS11Max=Yes	IsS11Min=No	FrameElem=45	ElemStation=0.375				
Frame=45	Station=0.375	OutputCase=FESSUR	CaseType=Combination	Point=4	X2=0.5	X3=0.5		
S11=1741.25382187597	IsS11Max=No	IsS11Min=No	FrameElem=45	ElemStation=0.375				
Frame=45	Station=0.5	OutputCase=FESSUR	CaseType=Combination	Point=0	X2=0	X3=0	S11=-239.15192283725	
IsS11Max=No	IsS11Min=No	FrameElem=45	ElemStation=0.5					
Frame=45	Station=0.5	OutputCase=FESSUR	CaseType=Combination	Point=1	X2=-0.5	X3=-0.5	S11=-	
2184.86105430137	IsS11Max=No	IsS11Min=Yes	FrameElem=45	ElemStation=0.5				
Frame=45	Station=0.5	OutputCase=FESSUR	CaseType=Combination	Point=2	X2=-0.5	X3=0.5	S11=-	
2184.86105430137	IsS11Max=No	IsS11Min=No	FrameElem=45	ElemStation=0.5				
Frame=45	Station=0.5	OutputCase=FESSUR	CaseType=Combination	Point=3	X2=0.5	X3=-0.5		
S11=1706.55720862687	IsS11Max=Yes	IsS11Min=No	FrameElem=45	ElemStation=0.5				
Frame=45	Station=0.5	OutputCase=FESSUR	CaseType=Combination	Point=4	X2=0.5	X3=0.5		
S11=1706.55720862687	IsS11Max=No	IsS11Min=No	FrameElem=45	ElemStation=0.5				
Frame=46	Station=0	OutputCase=PERM1	CaseType=Combination	Point=0	X2=0	X3=0	S11=-235.938772273311	
IsS11Max=No	IsS11Min=No	FrameElem=46	ElemStation=0					
Frame=46	Station=0	OutputCase=PERM1	CaseType=Combination	Point=1	X2=-0.5	X3=-0.5	S11=-	
2145.48176591611	IsS11Max=No	IsS11Min=Yes	FrameElem=46	ElemStation=0				
Frame=46	Station=0	OutputCase=PERM1	CaseType=Combination	Point=2	X2=-0.5	X3=0.5	S11=-	
2145.48176591611	IsS11Max=No	IsS11Min=No	FrameElem=46	ElemStation=0				



Frame=46 Station=0 OutputCase=PERM1 CaseType=Combination Point=3 X2=0.5 X3=-0.5
 S11=1673.60422136949 IsS11Max=Yes IsS11Min=No FrameElem=46 ElemStation=0
 Frame=46 Station=0 OutputCase=PERM1 CaseType=Combination Point=4 X2=0.5 X3=0.5 S11=1673.60422136949
 IsS11Max=No IsS11Min=No FrameElem=46 ElemStation=0
 Frame=46 Station=0.125 OutputCase=PERM1 CaseType=Combination Point=0 X2=0 X3=0 S11=-
 235.938772273311 IsS11Max=No IsS11Min=No FrameElem=46 ElemStation=0.125
 Frame=46 Station=0.125 OutputCase=PERM1 CaseType=Combination Point=1 X2=-0.5 X3=-0.5 S11=-
 2029.27785271681 IsS11Max=No IsS11Min=Yes FrameElem=46 ElemStation=0.125
 Frame=46 Station=0.125 OutputCase=PERM1 CaseType=Combination Point=2 X2=-0.5 X3=0.5 S11=-
 2029.27785271681 IsS11Max=No IsS11Min=No FrameElem=46 ElemStation=0.125
 Frame=46 Station=0.125 OutputCase=PERM1 CaseType=Combination Point=3 X2=0.5 X3=-0.5
 S11=1557.40030817018 IsS11Max=Yes IsS11Min=No FrameElem=46 ElemStation=0.125
 Frame=46 Station=0.125 OutputCase=PERM1 CaseType=Combination Point=4 X2=0.5 X3=0.5
 S11=1557.40030817018 IsS11Max=No IsS11Min=No FrameElem=46 ElemStation=0.125
 Frame=46 Station=0.25 OutputCase=PERM1 CaseType=Combination Point=0 X2=0 X3=0 S11=-235.938772273311
 IsS11Max=No IsS11Min=No FrameElem=46 ElemStation=0.25
 Frame=46 Station=0.25 OutputCase=PERM1 CaseType=Combination Point=1 X2=-0.5 X3=-0.5 S11=-
 1915.4176895175 IsS11Max=No IsS11Min=Yes FrameElem=46 ElemStation=0.25
 Frame=46 Station=0.25 OutputCase=PERM1 CaseType=Combination Point=2 X2=-0.5 X3=0.5 S11=-
 1915.4176895175 IsS11Max=No IsS11Min=No FrameElem=46 ElemStation=0.25
 Frame=46 Station=0.25 OutputCase=PERM1 CaseType=Combination Point=3 X2=0.5 X3=-0.5
 S11=1443.54014497088 IsS11Max=Yes IsS11Min=No FrameElem=46 ElemStation=0.25
 Frame=46 Station=0.25 OutputCase=PERM1 CaseType=Combination Point=4 X2=0.5 X3=0.5
 S11=1443.54014497088 IsS11Max=No IsS11Min=No FrameElem=46 ElemStation=0.25
 Frame=46 Station=0.375 OutputCase=PERM1 CaseType=Combination Point=0 X2=0 X3=0 S11=-
 235.938772273311 IsS11Max=No IsS11Min=No FrameElem=46 ElemStation=0.375
 Frame=46 Station=0.375 OutputCase=PERM1 CaseType=Combination Point=1 X2=-0.5 X3=-0.5 S11=-
 1803.9012763182 IsS11Max=No IsS11Min=Yes FrameElem=46 ElemStation=0.375
 Frame=46 Station=0.375 OutputCase=PERM1 CaseType=Combination Point=2 X2=-0.5 X3=0.5 S11=-
 1803.9012763182 IsS11Max=No IsS11Min=No FrameElem=46 ElemStation=0.375
 Frame=46 Station=0.375 OutputCase=PERM1 CaseType=Combination Point=3 X2=0.5 X3=-0.5
 S11=1332.02373177158 IsS11Max=Yes IsS11Min=No FrameElem=46 ElemStation=0.375
 Frame=46 Station=0.375 OutputCase=PERM1 CaseType=Combination Point=4 X2=0.5 X3=0.5
 S11=1332.02373177158 IsS11Max=No IsS11Min=No FrameElem=46 ElemStation=0.375
 Frame=46 Station=0.5 OutputCase=PERM1 CaseType=Combination Point=0 X2=0 X3=0 S11=-235.938772273311
 IsS11Max=No IsS11Min=No FrameElem=46 ElemStation=0.5
 Frame=46 Station=0.5 OutputCase=PERM1 CaseType=Combination Point=1 X2=-0.5 X3=-0.5 S11=-
 1694.72861311889 IsS11Max=No IsS11Min=Yes FrameElem=46 ElemStation=0.5
 Frame=46 Station=0.5 OutputCase=PERM1 CaseType=Combination Point=2 X2=-0.5 X3=0.5 S11=-
 1694.72861311889 IsS11Max=No IsS11Min=No FrameElem=46 ElemStation=0.5
 Frame=46 Station=0.5 OutputCase=PERM1 CaseType=Combination Point=3 X2=0.5 X3=-0.5
 S11=1222.85106857227 IsS11Max=Yes IsS11Min=No FrameElem=46 ElemStation=0.5
 Frame=46 Station=0.5 OutputCase=PERM1 CaseType=Combination Point=4 X2=0.5 X3=0.5
 S11=1222.85106857227 IsS11Max=No IsS11Min=No FrameElem=46 ElemStation=0.5
 Frame=46 Station=0 OutputCase=PERM2 CaseType=Combination Point=0 X2=0 X3=0 S11=-169.465538592141
 IsS11Max=No IsS11Min=No FrameElem=46 ElemStation=0
 Frame=46 Station=0 OutputCase=PERM2 CaseType=Combination Point=1 X2=-0.5 X3=-0.5 S11=-
 2164.24734361638 IsS11Max=No IsS11Min=Yes FrameElem=46 ElemStation=0
 Frame=46 Station=0 OutputCase=PERM2 CaseType=Combination Point=2 X2=-0.5 X3=0.5 S11=-
 2164.24734361638 IsS11Max=No IsS11Min=No FrameElem=46 ElemStation=0
 Frame=46 Station=0 OutputCase=PERM2 CaseType=Combination Point=3 X2=0.5 X3=-0.5 S11=1825.3162664321
 IsS11Max=Yes IsS11Min=No FrameElem=46 ElemStation=0
 Frame=46 Station=0 OutputCase=PERM2 CaseType=Combination Point=4 X2=0.5 X3=0.5 S11=1825.3162664321
 IsS11Max=No IsS11Min=No FrameElem=46 ElemStation=0
 Frame=46 Station=0.125 OutputCase=PERM2 CaseType=Combination Point=0 X2=0 X3=0 S11=-
 169.465538592141 IsS11Max=No IsS11Min=No FrameElem=46 ElemStation=0.125
 Frame=46 Station=0.125 OutputCase=PERM2 CaseType=Combination Point=1 X2=-0.5 X3=-0.5 S11=-
 2048.11095420839 IsS11Max=No IsS11Min=Yes FrameElem=46 ElemStation=0.125
 Frame=46 Station=0.125 OutputCase=PERM2 CaseType=Combination Point=2 X2=-0.5 X3=0.5 S11=-
 2048.11095420839 IsS11Max=No IsS11Min=No FrameElem=46 ElemStation=0.125
 Frame=46 Station=0.125 OutputCase=PERM2 CaseType=Combination Point=3 X2=0.5 X3=-0.5
 S11=1709.17987702411 IsS11Max=Yes IsS11Min=No FrameElem=46 ElemStation=0.125
 Frame=46 Station=0.125 OutputCase=PERM2 CaseType=Combination Point=4 X2=0.5 X3=0.5
 S11=1709.17987702411 IsS11Max=No IsS11Min=No FrameElem=46 ElemStation=0.125
 Frame=46 Station=0.25 OutputCase=PERM2 CaseType=Combination Point=0 X2=0 X3=0 S11=-169.465538592141
 IsS11Max=No IsS11Min=No FrameElem=46 ElemStation=0.25
 Frame=46 Station=0.25 OutputCase=PERM2 CaseType=Combination Point=1 X2=-0.5 X3=-0.5 S11=-
 1934.31831480039 IsS11Max=No IsS11Min=Yes FrameElem=46 ElemStation=0.25
 Frame=46 Station=0.25 OutputCase=PERM2 CaseType=Combination Point=2 X2=-0.5 X3=0.5 S11=-
 1934.31831480039 IsS11Max=No IsS11Min=No FrameElem=46 ElemStation=0.25
 Frame=46 Station=0.25 OutputCase=PERM2 CaseType=Combination Point=3 X2=0.5 X3=-0.5
 S11=1595.38723761611 IsS11Max=Yes IsS11Min=No FrameElem=46 ElemStation=0.25
 Frame=46 Station=0.25 OutputCase=PERM2 CaseType=Combination Point=4 X2=0.5 X3=0.5
 S11=1595.38723761611 IsS11Max=No IsS11Min=No FrameElem=46 ElemStation=0.25
 Frame=46 Station=0.375 OutputCase=PERM2 CaseType=Combination Point=0 X2=0 X3=0 S11=-
 169.465538592141 IsS11Max=No IsS11Min=No FrameElem=46 ElemStation=0.375
 Frame=46 Station=0.375 OutputCase=PERM2 CaseType=Combination Point=1 X2=-0.5 X3=-0.5 S11=-
 1822.8694253924 IsS11Max=No IsS11Min=Yes FrameElem=46 ElemStation=0.375
 Frame=46 Station=0.375 OutputCase=PERM2 CaseType=Combination Point=2 X2=-0.5 X3=0.5 S11=-
 1822.8694253924 IsS11Max=No IsS11Min=No FrameElem=46 ElemStation=0.375
 Frame=46 Station=0.375 OutputCase=PERM2 CaseType=Combination Point=3 X2=0.5 X3=-0.5
 S11=1483.93834820812 IsS11Max=Yes IsS11Min=No FrameElem=46 ElemStation=0.375

Frame=46 Station=0.375 OutputCase=PERM2 CaseType=Combination Point=4 X2=0.5 X3=0.5
S11=1483.93834820812 IsS11Max=No IsS11Min=No FrameElem=46 ElemStation=0.375
Frame=46 Station=0.5 OutputCase=PERM2 CaseType=Combination Point=0 X2=0 X3=0 S11=-169.465538592141
IsS11Max=No IsS11Min=No FrameElem=46 ElemStation=0.5
Frame=46 Station=0.5 OutputCase=PERM2 CaseType=Combination Point=1 X2=-0.5 X3=-0.5 S11=-
1713.7642859844 IsS11Max=No IsS11Min=Yes FrameElem=46 ElemStation=0.5
Frame=46 Station=0.5 OutputCase=PERM2 CaseType=Combination Point=2 X2=-0.5 X3=0.5 S11=-
1713.7642859844 IsS11Max=No IsS11Min=No FrameElem=46 ElemStation=0.5
Frame=46 Station=0.5 OutputCase=PERM2 CaseType=Combination Point=3 X2=0.5 X3=-0.5
S11=1374.83320880012 IsS11Max=Yes IsS11Min=No FrameElem=46 ElemStation=0.5
Frame=46 Station=0.5 OutputCase=PERM2 CaseType=Combination Point=4 X2=0.5 X3=0.5
S11=1374.83320880012 IsS11Max=No IsS11Min=No FrameElem=46 ElemStation=0.5
Frame=46 Station=0 OutputCase=ACC1 CaseType=Combination Point=0 X2=0 X3=0 S11=-240.528987364652
IsS11Max=No IsS11Min=No FrameElem=46 ElemStation=0
Frame=46 Station=0 OutputCase=ACC1 CaseType=Combination Point=1 X2=-0.5 X3=-0.5 S11=-
2201.73789218074 IsS11Max=No IsS11Min=Yes FrameElem=46 ElemStation=0
Frame=46 Station=0 OutputCase=ACC1 CaseType=Combination Point=2 X2=-0.5 X3=0.5 S11=-
2201.73789218074 IsS11Max=No IsS11Min=No FrameElem=46 ElemStation=0
Frame=46 Station=0 OutputCase=ACC1 CaseType=Combination Point=3 X2=0.5 X3=-0.5 S11=1720.67991745143
IsS11Max=Yes IsS11Min=No FrameElem=46 ElemStation=0
Frame=46 Station=0 OutputCase=ACC1 CaseType=Combination Point=4 X2=0.5 X3=0.5 S11=1720.67991745143
IsS11Max=No IsS11Min=No FrameElem=46 ElemStation=0
Frame=46 Station=0.125 OutputCase=ACC1 CaseType=Combination Point=0 X2=0 X3=0 S11=-240.528987364652
IsS11Max=No IsS11Min=No FrameElem=46 ElemStation=0.125
Frame=46 Station=0.125 OutputCase=ACC1 CaseType=Combination Point=1 X2=-0.5 X3=-0.5 S11=-
2082.52586313087 IsS11Max=No IsS11Min=Yes FrameElem=46 ElemStation=0.125
Frame=46 Station=0.125 OutputCase=ACC1 CaseType=Combination Point=2 X2=-0.5 X3=0.5 S11=-
2082.52586313087 IsS11Max=No IsS11Min=No FrameElem=46 ElemStation=0.125
Frame=46 Station=0.125 OutputCase=ACC1 CaseType=Combination Point=3 X2=0.5 X3=-0.5
S11=1601.46788840157 IsS11Max=Yes IsS11Min=No FrameElem=46 ElemStation=0.125
Frame=46 Station=0.125 OutputCase=ACC1 CaseType=Combination Point=4 X2=0.5 X3=0.5
S11=1601.46788840157 IsS11Max=No IsS11Min=No FrameElem=46 ElemStation=0.125
Frame=46 Station=0.25 OutputCase=ACC1 CaseType=Combination Point=0 X2=0 X3=0 S11=-240.528987364652
IsS11Max=No IsS11Min=No FrameElem=46 ElemStation=0.25
Frame=46 Station=0.25 OutputCase=ACC1 CaseType=Combination Point=1 X2=-0.5 X3=-0.5 S11=-
1965.657584081 IsS11Max=No IsS11Min=Yes FrameElem=46 ElemStation=0.25
Frame=46 Station=0.25 OutputCase=ACC1 CaseType=Combination Point=2 X2=-0.5 X3=0.5 S11=-
1965.657584081 IsS11Max=No IsS11Min=No FrameElem=46 ElemStation=0.25
Frame=46 Station=0.25 OutputCase=ACC1 CaseType=Combination Point=3 X2=0.5 X3=-0.5
S11=1484.5996093517 IsS11Max=Yes IsS11Min=No FrameElem=46 ElemStation=0.25
Frame=46 Station=0.25 OutputCase=ACC1 CaseType=Combination Point=4 X2=0.5 X3=0.5
S11=1484.5996093517 IsS11Max=No IsS11Min=No FrameElem=46 ElemStation=0.25
Frame=46 Station=0.375 OutputCase=ACC1 CaseType=Combination Point=0 X2=0 X3=0 S11=-240.528987364652
IsS11Max=No IsS11Min=No FrameElem=46 ElemStation=0.375
Frame=46 Station=0.375 OutputCase=ACC1 CaseType=Combination Point=1 X2=-0.5 X3=-0.5 S11=-
1851.13305503113 IsS11Max=No IsS11Min=Yes FrameElem=46 ElemStation=0.375
Frame=46 Station=0.375 OutputCase=ACC1 CaseType=Combination Point=2 X2=-0.5 X3=0.5 S11=-
1851.13305503113 IsS11Max=No IsS11Min=No FrameElem=46 ElemStation=0.375
Frame=46 Station=0.375 OutputCase=ACC1 CaseType=Combination Point=3 X2=0.5 X3=-0.5
S11=1370.07508030183 IsS11Max=Yes IsS11Min=No FrameElem=46 ElemStation=0.375
Frame=46 Station=0.375 OutputCase=ACC1 CaseType=Combination Point=4 X2=0.5 X3=0.5
S11=1370.07508030183 IsS11Max=No IsS11Min=No FrameElem=46 ElemStation=0.375
Frame=46 Station=0.5 OutputCase=ACC1 CaseType=Combination Point=0 X2=0 X3=0 S11=-240.528987364652
IsS11Max=No IsS11Min=No FrameElem=46 ElemStation=0.5
Frame=46 Station=0.5 OutputCase=ACC1 CaseType=Combination Point=1 X2=-0.5 X3=-0.5 S11=-
1738.95227598127 IsS11Max=No IsS11Min=Yes FrameElem=46 ElemStation=0.5
Frame=46 Station=0.5 OutputCase=ACC1 CaseType=Combination Point=2 X2=-0.5 X3=0.5 S11=-
1738.95227598127 IsS11Max=No IsS11Min=No FrameElem=46 ElemStation=0.5
Frame=46 Station=0.5 OutputCase=ACC1 CaseType=Combination Point=3 X2=0.5 X3=-0.5
S11=1257.89430125196 IsS11Max=Yes IsS11Min=No FrameElem=46 ElemStation=0.5
Frame=46 Station=0.5 OutputCase=ACC1 CaseType=Combination Point=4 X2=0.5 X3=0.5
S11=1257.89430125196 IsS11Max=No IsS11Min=No FrameElem=46 ElemStation=0.5
Frame=46 Station=0 OutputCase=ACC2 CaseType=Combination Point=0 X2=0 X3=0 S11=-174.055753683482
IsS11Max=No IsS11Min=No FrameElem=46 ElemStation=0
Frame=46 Station=0 OutputCase=ACC2 CaseType=Combination Point=1 X2=-0.5 X3=-0.5 S11=-
2220.50346988101 IsS11Max=No IsS11Min=Yes FrameElem=46 ElemStation=0
Frame=46 Station=0 OutputCase=ACC2 CaseType=Combination Point=2 X2=-0.5 X3=0.5 S11=-
2220.50346988101 IsS11Max=No IsS11Min=No FrameElem=46 ElemStation=0
Frame=46 Station=0 OutputCase=ACC2 CaseType=Combination Point=3 X2=0.5 X3=-0.5 S11=1872.39196251405
IsS11Max=Yes IsS11Min=No FrameElem=46 ElemStation=0
Frame=46 Station=0 OutputCase=ACC2 CaseType=Combination Point=4 X2=0.5 X3=0.5 S11=1872.39196251405
IsS11Max=No IsS11Min=No FrameElem=46 ElemStation=0
Frame=46 Station=0.125 OutputCase=ACC2 CaseType=Combination Point=0 X2=0 X3=0 S11=-174.055753683482
IsS11Max=No IsS11Min=No FrameElem=46 ElemStation=0.125
Frame=46 Station=0.125 OutputCase=ACC2 CaseType=Combination Point=1 X2=-0.5 X3=-0.5 S11=-
2101.35896462245 IsS11Max=No IsS11Min=Yes FrameElem=46 ElemStation=0.125
Frame=46 Station=0.125 OutputCase=ACC2 CaseType=Combination Point=2 X2=-0.5 X3=0.5 S11=-
2101.35896462245 IsS11Max=No IsS11Min=No FrameElem=46 ElemStation=0.125
Frame=46 Station=0.125 OutputCase=ACC2 CaseType=Combination Point=3 X2=0.5 X3=-0.5
S11=1753.24745725549 IsS11Max=Yes IsS11Min=No FrameElem=46 ElemStation=0.125
Frame=46 Station=0.125 OutputCase=ACC2 CaseType=Combination Point=4 X2=0.5 X3=0.5
S11=1753.24745725549 IsS11Max=No IsS11Min=No FrameElem=46 ElemStation=0.125



Frame=46	Station=0.25	OutputCase=ACC2	CaseType=Combination	Point=0	X2=0	X3=0	S11=-174.055753683482
IsS11Max=No	IsS11Min=No	FrameElem=46	ElemStation=0.25				
Frame=46	Station=0.25	OutputCase=ACC2	CaseType=Combination	Point=1	X2=-0.5	X3=-0.5	S11=-
1984.55820936389	IsS11Max=No	IsS11Min=Yes	FrameElem=46	ElemStation=0.25			
Frame=46	Station=0.25	OutputCase=ACC2	CaseType=Combination	Point=2	X2=-0.5	X3=0.5	S11=-
1984.55820936389	IsS11Max=No	IsS11Min=No	FrameElem=46	ElemStation=0.25			
Frame=46	Station=0.25	OutputCase=ACC2	CaseType=Combination	Point=3	X2=0.5	X3=-0.5	
S11=1636.44670199693	IsS11Max=Yes	IsS11Min=No	FrameElem=46	ElemStation=0.25			
Frame=46	Station=0.25	OutputCase=ACC2	CaseType=Combination	Point=4	X2=0.5	X3=0.5	
S11=1636.44670199693	IsS11Max=No	IsS11Min=No	FrameElem=46	ElemStation=0.25			
Frame=46	Station=0.375	OutputCase=ACC2	CaseType=Combination	Point=0	X2=0	X3=0	S11=-174.055753683482
IsS11Max=No	IsS11Min=No	FrameElem=46	ElemStation=0.375				
Frame=46	Station=0.375	OutputCase=ACC2	CaseType=Combination	Point=1	X2=-0.5	X3=-0.5	S11=-
1870.10120410534	IsS11Max=No	IsS11Min=Yes	FrameElem=46	ElemStation=0.375			
Frame=46	Station=0.375	OutputCase=ACC2	CaseType=Combination	Point=2	X2=-0.5	X3=0.5	S11=-
1870.10120410534	IsS11Max=No	IsS11Min=No	FrameElem=46	ElemStation=0.375			
Frame=46	Station=0.375	OutputCase=ACC2	CaseType=Combination	Point=3	X2=0.5	X3=-0.5	
S11=1521.98969673837	IsS11Max=Yes	IsS11Min=No	FrameElem=46	ElemStation=0.375			
Frame=46	Station=0.375	OutputCase=ACC2	CaseType=Combination	Point=4	X2=0.5	X3=0.5	
S11=1521.98969673837	IsS11Max=No	IsS11Min=No	FrameElem=46	ElemStation=0.375			
Frame=46	Station=0.5	OutputCase=ACC2	CaseType=Combination	Point=0	X2=0	X3=0	S11=-174.055753683482
IsS11Max=No	IsS11Min=No	FrameElem=46	ElemStation=0.5				
Frame=46	Station=0.5	OutputCase=ACC2	CaseType=Combination	Point=1	X2=-0.5	X3=-0.5	S11=-
1757.98794884678	IsS11Max=No	IsS11Min=Yes	FrameElem=46	ElemStation=0.5			
Frame=46	Station=0.5	OutputCase=ACC2	CaseType=Combination	Point=2	X2=-0.5	X3=0.5	S11=-
1757.98794884678	IsS11Max=No	IsS11Min=No	FrameElem=46	ElemStation=0.5			
Frame=46	Station=0.5	OutputCase=ACC2	CaseType=Combination	Point=3	X2=0.5	X3=-0.5	
S11=1409.87644147981	IsS11Max=Yes	IsS11Min=No	FrameElem=46	ElemStation=0.5			
Frame=46	Station=0.5	OutputCase=ACC2	CaseType=Combination	Point=4	X2=0.5	X3=0.5	
S11=1409.87644147981	IsS11Max=No	IsS11Min=No	FrameElem=46	ElemStation=0.5			
Frame=46	Station=0	OutputCase=ACCSX1	CaseType=Combination	Point=0	X2=0	X3=0	S11=-233.665974282455
IsS11Max=No	IsS11Min=No	FrameElem=46	ElemStation=0				
Frame=46	Station=0	OutputCase=ACCSX1	CaseType=Combination	Point=1	X2=-0.5	X3=-0.5	S11=-
2150.48698893583	IsS11Max=No	IsS11Min=Yes	FrameElem=46	ElemStation=0			
Frame=46	Station=0	OutputCase=ACCSX1	CaseType=Combination	Point=2	X2=-0.5	X3=0.5	S11=-
2150.48698893583	IsS11Max=No	IsS11Min=No	FrameElem=46	ElemStation=0			
Frame=46	Station=0	OutputCase=ACCSX1	CaseType=Combination	Point=3	X2=0.5	X3=-0.5	
S11=1683.15504037092	IsS11Max=Yes	IsS11Min=No	FrameElem=46	ElemStation=0			
Frame=46	Station=0	OutputCase=ACCSX1	CaseType=Combination	Point=4	X2=0.5	X3=0.5	
S11=1683.15504037092	IsS11Max=No	IsS11Min=No	FrameElem=46	ElemStation=0			
Frame=46	Station=0.125	OutputCase=ACCSX1	CaseType=Combination	Point=0	X2=0	X3=0	S11=-
233.665974282455	IsS11Max=No	IsS11Min=No	FrameElem=46	ElemStation=0.125			
Frame=46	Station=0.125	OutputCase=ACCSX1	CaseType=Combination	Point=1	X2=-0.5	X3=-0.5	S11=-
2036.90108210605	IsS11Max=No	IsS11Min=Yes	FrameElem=46	ElemStation=0.125			
Frame=46	Station=0.125	OutputCase=ACCSX1	CaseType=Combination	Point=2	X2=-0.5	X3=0.5	S11=-
2036.90108210605	IsS11Max=No	IsS11Min=No	FrameElem=46	ElemStation=0.125			
Frame=46	Station=0.125	OutputCase=ACCSX1	CaseType=Combination	Point=3	X2=0.5	X3=-0.5	
S11=1569.56913354114	IsS11Max=Yes	IsS11Min=No	FrameElem=46	ElemStation=0.125			
Frame=46	Station=0.125	OutputCase=ACCSX1	CaseType=Combination	Point=4	X2=0.5	X3=0.5	
S11=1569.56913354114	IsS11Max=No	IsS11Min=No	FrameElem=46	ElemStation=0.125			
Frame=46	Station=0.25	OutputCase=ACCSX1	CaseType=Combination	Point=0	X2=0	X3=0	S11=-
233.665974282455	IsS11Max=No	IsS11Min=No	FrameElem=46	ElemStation=0.25			
Frame=46	Station=0.25	OutputCase=ACCSX1	CaseType=Combination	Point=1	X2=-0.5	X3=-0.5	S11=-
1925.65892527628	IsS11Max=No	IsS11Min=Yes	FrameElem=46	ElemStation=0.25			
Frame=46	Station=0.25	OutputCase=ACCSX1	CaseType=Combination	Point=2	X2=-0.5	X3=0.5	S11=-
1925.65892527628	IsS11Max=No	IsS11Min=No	FrameElem=46	ElemStation=0.25			
Frame=46	Station=0.25	OutputCase=ACCSX1	CaseType=Combination	Point=3	X2=0.5	X3=-0.5	
S11=1458.32697671137	IsS11Max=Yes	IsS11Min=No	FrameElem=46	ElemStation=0.25			
Frame=46	Station=0.25	OutputCase=ACCSX1	CaseType=Combination	Point=4	X2=0.5	X3=0.5	
S11=1458.32697671137	IsS11Max=No	IsS11Min=No	FrameElem=46	ElemStation=0.25			
Frame=46	Station=0.375	OutputCase=ACCSX1	CaseType=Combination	Point=0	X2=0	X3=0	S11=-
233.665974282455	IsS11Max=No	IsS11Min=No	FrameElem=46	ElemStation=0.375			
Frame=46	Station=0.375	OutputCase=ACCSX1	CaseType=Combination	Point=1	X2=-0.5	X3=-0.5	S11=-
1816.7605184465	IsS11Max=No	IsS11Min=Yes	FrameElem=46	ElemStation=0.375			
Frame=46	Station=0.375	OutputCase=ACCSX1	CaseType=Combination	Point=2	X2=-0.5	X3=0.5	S11=-
1816.7605184465	IsS11Max=No	IsS11Min=No	FrameElem=46	ElemStation=0.375			
Frame=46	Station=0.375	OutputCase=ACCSX1	CaseType=Combination	Point=3	X2=0.5	X3=-0.5	
S11=1349.4285698816	IsS11Max=Yes	IsS11Min=No	FrameElem=46	ElemStation=0.375			
Frame=46	Station=0.375	OutputCase=ACCSX1	CaseType=Combination	Point=4	X2=0.5	X3=0.5	
S11=1349.4285698816	IsS11Max=No	IsS11Min=No	FrameElem=46	ElemStation=0.375			
Frame=46	Station=0.5	OutputCase=ACCSX1	CaseType=Combination	Point=0	X2=0	X3=0	S11=-233.665974282455
IsS11Max=No	IsS11Min=No	FrameElem=46	ElemStation=0.5				
Frame=46	Station=0.5	OutputCase=ACCSX1	CaseType=Combination	Point=1	X2=-0.5	X3=-0.5	S11=-
1710.20586161673	IsS11Max=No	IsS11Min=Yes	FrameElem=46	ElemStation=0.5			
Frame=46	Station=0.5	OutputCase=ACCSX1	CaseType=Combination	Point=2	X2=-0.5	X3=0.5	S11=-
1710.20586161673	IsS11Max=No	IsS11Min=No	FrameElem=46	ElemStation=0.5			
Frame=46	Station=0.5	OutputCase=ACCSX1	CaseType=Combination	Point=3	X2=0.5	X3=-0.5	
S11=1242.87391305182	IsS11Max=Yes	IsS11Min=No	FrameElem=46	ElemStation=0.5			
Frame=46	Station=0.5	OutputCase=ACCSX1	CaseType=Combination	Point=4	X2=0.5	X3=0.5	
S11=1242.87391305182	IsS11Max=No	IsS11Min=No	FrameElem=46	ElemStation=0.5			
Frame=46	Station=0	OutputCase=ACCSX2	CaseType=Combination	Point=0	X2=0	X3=0	S11=-167.192740601285
IsS11Max=No	IsS11Min=No	FrameElem=46	ElemStation=0				

Frame=46	Station=0	OutputCase=ACCSX2	CaseType=Combination	Point=1	X2=-0.5	X3=-0.5	S11=-	
2169.2525666361	IsS11Max=No	IsS11Min=Yes	FrameElem=46	ElemStation=0				
Frame=46	Station=0	OutputCase=ACCSX2	CaseType=Combination	Point=2	X2=-0.5	X3=0.5	S11=-	
2169.2525666361	IsS11Max=No	IsS11Min=No	FrameElem=46	ElemStation=0				
Frame=46	Station=0	OutputCase=ACCSX2	CaseType=Combination	Point=3	X2=0.5	X3=-0.5		
S11=1834.86708543353	IsS11Max=Yes	IsS11Min=No	FrameElem=46	ElemStation=0				
Frame=46	Station=0	OutputCase=ACCSX2	CaseType=Combination	Point=4	X2=0.5	X3=0.5		
S11=1834.86708543353	IsS11Max=No	IsS11Min=No	FrameElem=46	ElemStation=0				
Frame=46	Station=0.125	OutputCase=ACCSX2	CaseType=Combination	Point=0	X2=0	X3=0	S11=-	
167.192740601285	IsS11Max=No	IsS11Min=No	FrameElem=46	ElemStation=0.125				
Frame=46	Station=0.125	OutputCase=ACCSX2	CaseType=Combination	Point=1	X2=-0.5	X3=-0.5	S11=-	
2055.73418359764	IsS11Max=No	IsS11Min=Yes	FrameElem=46	ElemStation=0.125				
Frame=46	Station=0.125	OutputCase=ACCSX2	CaseType=Combination	Point=2	X2=-0.5	X3=0.5	S11=-	
2055.73418359764	IsS11Max=No	IsS11Min=No	FrameElem=46	ElemStation=0.125				
Frame=46	Station=0.125	OutputCase=ACCSX2	CaseType=Combination	Point=3	X2=0.5	X3=-0.5		
S11=1721.34870239507	IsS11Max=Yes	IsS11Min=No	FrameElem=46	ElemStation=0.125				
Frame=46	Station=0.125	OutputCase=ACCSX2	CaseType=Combination	Point=4	X2=0.5	X3=0.5		
S11=1721.34870239507	IsS11Max=No	IsS11Min=No	FrameElem=46	ElemStation=0.125				
Frame=46	Station=0.25	OutputCase=ACCSX2	CaseType=Combination	Point=0	X2=0	X3=0	S11=-	
167.192740601285	IsS11Max=No	IsS11Min=No	FrameElem=46	ElemStation=0.25				
Frame=46	Station=0.25	OutputCase=ACCSX2	CaseType=Combination	Point=1	X2=-0.5	X3=-0.5	S11=-	
1944.55955055917	IsS11Max=No	IsS11Min=Yes	FrameElem=46	ElemStation=0.25				
Frame=46	Station=0.25	OutputCase=ACCSX2	CaseType=Combination	Point=2	X2=-0.5	X3=0.5	S11=-	
1944.55955055917	IsS11Max=No	IsS11Min=No	FrameElem=46	ElemStation=0.25				
Frame=46	Station=0.25	OutputCase=ACCSX2	CaseType=Combination	Point=3	X2=0.5	X3=-0.5		
S11=1610.1740693566	IsS11Max=Yes	IsS11Min=No	FrameElem=46	ElemStation=0.25				
Frame=46	Station=0.25	OutputCase=ACCSX2	CaseType=Combination	Point=4	X2=0.5	X3=0.5		
S11=1610.1740693566	IsS11Max=No	IsS11Min=No	FrameElem=46	ElemStation=0.25				
Frame=46	Station=0.375	OutputCase=ACCSX2	CaseType=Combination	Point=0	X2=0	X3=0	S11=-	
167.192740601285	IsS11Max=No	IsS11Min=No	FrameElem=46	ElemStation=0.375				
Frame=46	Station=0.375	OutputCase=ACCSX2	CaseType=Combination	Point=1	X2=-0.5	X3=-0.5	S11=-	
1835.72866752071	IsS11Max=No	IsS11Min=Yes	FrameElem=46	ElemStation=0.375				
Frame=46	Station=0.375	OutputCase=ACCSX2	CaseType=Combination	Point=2	X2=-0.5	X3=0.5	S11=-	
1835.72866752071	IsS11Max=No	IsS11Min=No	FrameElem=46	ElemStation=0.375				
Frame=46	Station=0.375	OutputCase=ACCSX2	CaseType=Combination	Point=3	X2=0.5	X3=-0.5		
S11=1501.34318631814	IsS11Max=Yes	IsS11Min=No	FrameElem=46	ElemStation=0.375				
Frame=46	Station=0.375	OutputCase=ACCSX2	CaseType=Combination	Point=4	X2=0.5	X3=0.5		
S11=1501.34318631814	IsS11Max=No	IsS11Min=No	FrameElem=46	ElemStation=0.375				
Frame=46	Station=0.5	OutputCase=ACCSX2	CaseType=Combination	Point=0	X2=0	X3=0	S11=-167.192740601285	
IsS11Max=No	IsS11Min=No	FrameElem=46	ElemStation=0.5					
Frame=46	Station=0.5	OutputCase=ACCSX2	CaseType=Combination	Point=1	X2=-0.5	X3=-0.5	S11=-	
1729.24153448224	IsS11Max=No	IsS11Min=Yes	FrameElem=46	ElemStation=0.5				
Frame=46	Station=0.5	OutputCase=ACCSX2	CaseType=Combination	Point=2	X2=-0.5	X3=0.5	S11=-	
1729.24153448224	IsS11Max=No	IsS11Min=No	FrameElem=46	ElemStation=0.5				
Frame=46	Station=0.5	OutputCase=ACCSX2	CaseType=Combination	Point=3	X2=0.5	X3=-0.5		
S11=1394.85605327967	IsS11Max=Yes	IsS11Min=No	FrameElem=46	ElemStation=0.5				
Frame=46	Station=0.5	OutputCase=ACCSX2	CaseType=Combination	Point=4	X2=0.5	X3=0.5		
S11=1394.85605327967	IsS11Max=No	IsS11Min=No	FrameElem=46	ElemStation=0.5				
Frame=46	Station=0	OutputCase=ENVE	CaseType=Combination	StepType=Max	Point=0	X2=0	X3=0	S11=-
167.192740601285	IsS11Max=No	IsS11Min=No	FrameElem=46	ElemStation=0				
Frame=46	Station=0	OutputCase=ENVE	CaseType=Combination	StepType=Max	Point=1	X2=-0.5	X3=-0.5	
S11=-2145.48176591611	IsS11Max=No	IsS11Min=Yes	FrameElem=46	ElemStation=0				
Frame=46	Station=0	OutputCase=ENVE	CaseType=Combination	StepType=Max	Point=2	X2=-0.5	X3=0.5	S11=-
2145.48176591611	IsS11Max=No	IsS11Min=No	FrameElem=46	ElemStation=0				
Frame=46	Station=0	OutputCase=ENVE	CaseType=Combination	StepType=Max	Point=3	X2=0.5	X3=-0.5	
S11=1872.39196251405	IsS11Max=Yes	IsS11Min=No	FrameElem=46	ElemStation=0				
Frame=46	Station=0	OutputCase=ENVE	CaseType=Combination	StepType=Max	Point=4	X2=0.5	X3=0.5	
S11=1872.39196251405	IsS11Max=No	IsS11Min=No	FrameElem=46	ElemStation=0				
Frame=46	Station=0.125	OutputCase=ENVE	CaseType=Combination	StepType=Max	Point=0	X2=0	X3=0	S11=-
167.192740601285	IsS11Max=No	IsS11Min=No	FrameElem=46	ElemStation=0.125				
Frame=46	Station=0.125	OutputCase=ENVE	CaseType=Combination	StepType=Max	Point=1	X2=-0.5	X3=-0.5	
S11=-2029.27785271681	IsS11Max=No	IsS11Min=Yes	FrameElem=46	ElemStation=0.125				
Frame=46	Station=0.125	OutputCase=ENVE	CaseType=Combination	StepType=Max	Point=2	X2=-0.5	X3=0.5	
S11=-2029.27785271681	IsS11Max=No	IsS11Min=No	FrameElem=46	ElemStation=0.125				
Frame=46	Station=0.125	OutputCase=ENVE	CaseType=Combination	StepType=Max	Point=3	X2=0.5	X3=-0.5	
S11=1753.24745725549	IsS11Max=Yes	IsS11Min=No	FrameElem=46	ElemStation=0.125				
Frame=46	Station=0.125	OutputCase=ENVE	CaseType=Combination	StepType=Max	Point=4	X2=0.5	X3=0.5	
S11=1753.24745725549	IsS11Max=No	IsS11Min=No	FrameElem=46	ElemStation=0.125				
Frame=46	Station=0.25	OutputCase=ENVE	CaseType=Combination	StepType=Max	Point=0	X2=0	X3=0	S11=-
167.192740601285	IsS11Max=No	IsS11Min=No	FrameElem=46	ElemStation=0.25				
Frame=46	Station=0.25	OutputCase=ENVE	CaseType=Combination	StepType=Max	Point=1	X2=-0.5	X3=-0.5	
S11=-1915.4176895175	IsS11Max=No	IsS11Min=Yes	FrameElem=46	ElemStation=0.25				
Frame=46	Station=0.25	OutputCase=ENVE	CaseType=Combination	StepType=Max	Point=2	X2=-0.5	X3=0.5	
S11=-1915.4176895175	IsS11Max=No	IsS11Min=No	FrameElem=46	ElemStation=0.25				
Frame=46	Station=0.25	OutputCase=ENVE	CaseType=Combination	StepType=Max	Point=3	X2=0.5	X3=-0.5	
S11=1636.44670199693	IsS11Max=Yes	IsS11Min=No	FrameElem=46	ElemStation=0.25				
Frame=46	Station=0.25	OutputCase=ENVE	CaseType=Combination	StepType=Max	Point=4	X2=0.5	X3=0.5	
S11=1636.44670199693	IsS11Max=No	IsS11Min=No	FrameElem=46	ElemStation=0.25				
Frame=46	Station=0.375	OutputCase=ENVE	CaseType=Combination	StepType=Max	Point=0	X2=0	X3=0	S11=-
167.192740601285	IsS11Max=No	IsS11Min=No	FrameElem=46	ElemStation=0.375				
Frame=46	Station=0.375	OutputCase=ENVE	CaseType=Combination	StepType=Max	Point=1	X2=-0.5	X3=-0.5	
S11=-1803.9012763182	IsS11Max=No	IsS11Min=Yes	FrameElem=46	ElemStation=0.375				

Frame=46	Station=0.375	OutputCase=ENVE	CaseType=Combination	StepType=Max	Point=2	X2=-0.5	X3=0.5		
S11=-1803.9012763182	IsS11Max=No	IsS11Min=No	FrameElem=46	ElemStation=0.375					
Frame=46	Station=0.375	OutputCase=ENVE	CaseType=Combination	StepType=Max	Point=3	X2=0.5	X3=-0.5		
S11=1521.98969673837	IsS11Max=Yes	IsS11Min=No	FrameElem=46	ElemStation=0.375					
Frame=46	Station=0.375	OutputCase=ENVE	CaseType=Combination	StepType=Max	Point=4	X2=0.5	X3=0.5		
S11=1521.98969673837	IsS11Max=No	IsS11Min=No	FrameElem=46	ElemStation=0.375					
Frame=46	Station=0.5	OutputCase=ENVE	CaseType=Combination	StepType=Max	Point=0	X2=0	X3=0	S11=-	
167.192740601285	IsS11Max=No	IsS11Min=No	FrameElem=46	ElemStation=0.5					
Frame=46	Station=0.5	OutputCase=ENVE	CaseType=Combination	StepType=Max	Point=1	X2=-0.5	X3=-0.5		
S11=-1694.72861311889	IsS11Max=No	IsS11Min=Yes	FrameElem=46	ElemStation=0.5					
Frame=46	Station=0.5	OutputCase=ENVE	CaseType=Combination	StepType=Max	Point=2	X2=-0.5	X3=0.5		
S11=-1694.72861311889	IsS11Max=No	IsS11Min=No	FrameElem=46	ElemStation=0.5					
Frame=46	Station=0.5	OutputCase=ENVE	CaseType=Combination	StepType=Max	Point=3	X2=0.5	X3=-0.5		
S11=1409.87644147981	IsS11Max=Yes	IsS11Min=No	FrameElem=46	ElemStation=0.5					
Frame=46	Station=0.5	OutputCase=ENVE	CaseType=Combination	StepType=Max	Point=4	X2=0.5	X3=0.5		
S11=1409.87644147981	IsS11Max=No	IsS11Min=No	FrameElem=46	ElemStation=0.5					
Frame=46	Station=0	OutputCase=ENVE	CaseType=Combination	StepType=Min	Point=0	X2=0	X3=0	S11=-	
240.528987364652	IsS11Max=No	IsS11Min=No	FrameElem=46	ElemStation=0					
Frame=46	Station=0	OutputCase=ENVE	CaseType=Combination	StepType=Min	Point=1	X2=-0.5	X3=-0.5		
S11=-2220.50346988101	IsS11Max=No	IsS11Min=Yes	FrameElem=46	ElemStation=0					
Frame=46	Station=0	OutputCase=ENVE	CaseType=Combination	StepType=Min	Point=2	X2=-0.5	X3=0.5	S11=-	
2220.50346988101	IsS11Max=No	IsS11Min=No	FrameElem=46	ElemStation=0					
Frame=46	Station=0	OutputCase=ENVE	CaseType=Combination	StepType=Min	Point=3	X2=0.5	X3=-0.5		
S11=1673.60422136949	IsS11Max=Yes	IsS11Min=No	FrameElem=46	ElemStation=0					
Frame=46	Station=0	OutputCase=ENVE	CaseType=Combination	StepType=Min	Point=4	X2=0.5	X3=0.5		
S11=1673.60422136949	IsS11Max=No	IsS11Min=No	FrameElem=46	ElemStation=0					
Frame=46	Station=0.125	OutputCase=ENVE	CaseType=Combination	StepType=Min	Point=0	X2=0	X3=0	S11=-	
240.528987364652	IsS11Max=No	IsS11Min=No	FrameElem=46	ElemStation=0.125					
Frame=46	Station=0.125	OutputCase=ENVE	CaseType=Combination	StepType=Min	Point=1	X2=-0.5	X3=-0.5		
S11=-2101.35896462245	IsS11Max=No	IsS11Min=Yes	FrameElem=46	ElemStation=0.125					
Frame=46	Station=0.125	OutputCase=ENVE	CaseType=Combination	StepType=Min	Point=2	X2=-0.5	X3=0.5		
S11=-2101.35896462245	IsS11Max=No	IsS11Min=No	FrameElem=46	ElemStation=0.125					
Frame=46	Station=0.125	OutputCase=ENVE	CaseType=Combination	StepType=Min	Point=3	X2=0.5	X3=-0.5		
S11=1557.40030817018	IsS11Max=Yes	IsS11Min=No	FrameElem=46	ElemStation=0.125					
Frame=46	Station=0.125	OutputCase=ENVE	CaseType=Combination	StepType=Min	Point=4	X2=0.5	X3=0.5		
S11=1557.40030817018	IsS11Max=No	IsS11Min=No	FrameElem=46	ElemStation=0.125					
Frame=46	Station=0.25	OutputCase=ENVE	CaseType=Combination	StepType=Min	Point=0	X2=0	X3=0	S11=-	
240.528987364652	IsS11Max=No	IsS11Min=No	FrameElem=46	ElemStation=0.25					
Frame=46	Station=0.25	OutputCase=ENVE	CaseType=Combination	StepType=Min	Point=1	X2=-0.5	X3=-0.5		
S11=-1984.55820936389	IsS11Max=No	IsS11Min=Yes	FrameElem=46	ElemStation=0.25					
Frame=46	Station=0.25	OutputCase=ENVE	CaseType=Combination	StepType=Min	Point=2	X2=-0.5	X3=0.5		
S11=-1984.55820936389	IsS11Max=No	IsS11Min=No	FrameElem=46	ElemStation=0.25					
Frame=46	Station=0.25	OutputCase=ENVE	CaseType=Combination	StepType=Min	Point=3	X2=0.5	X3=-0.5		
S11=1443.54014497088	IsS11Max=Yes	IsS11Min=No	FrameElem=46	ElemStation=0.25					
Frame=46	Station=0.25	OutputCase=ENVE	CaseType=Combination	StepType=Min	Point=4	X2=0.5	X3=0.5		
S11=1443.54014497088	IsS11Max=No	IsS11Min=No	FrameElem=46	ElemStation=0.25					
Frame=46	Station=0.375	OutputCase=ENVE	CaseType=Combination	StepType=Min	Point=0	X2=0	X3=0	S11=-	
240.528987364652	IsS11Max=No	IsS11Min=No	FrameElem=46	ElemStation=0.375					
Frame=46	Station=0.375	OutputCase=ENVE	CaseType=Combination	StepType=Min	Point=1	X2=-0.5	X3=-0.5		
S11=-1870.10120410534	IsS11Max=No	IsS11Min=Yes	FrameElem=46	ElemStation=0.375					
Frame=46	Station=0.375	OutputCase=ENVE	CaseType=Combination	StepType=Min	Point=2	X2=-0.5	X3=0.5		
S11=-1870.10120410534	IsS11Max=No	IsS11Min=No	FrameElem=46	ElemStation=0.375					
Frame=46	Station=0.375	OutputCase=ENVE	CaseType=Combination	StepType=Min	Point=3	X2=0.5	X3=-0.5		
S11=1332.02373177158	IsS11Max=Yes	IsS11Min=No	FrameElem=46	ElemStation=0.375					
Frame=46	Station=0.375	OutputCase=ENVE	CaseType=Combination	StepType=Min	Point=4	X2=0.5	X3=0.5		
S11=1332.02373177158	IsS11Max=No	IsS11Min=No	FrameElem=46	ElemStation=0.375					
Frame=46	Station=0.5	OutputCase=ENVE	CaseType=Combination	StepType=Min	Point=0	X2=0	X3=0	S11=-	
240.528987364652	IsS11Max=No	IsS11Min=No	FrameElem=46	ElemStation=0.5					
Frame=46	Station=0.5	OutputCase=ENVE	CaseType=Combination	StepType=Min	Point=1	X2=-0.5	X3=-0.5		
S11=-1757.98794884678	IsS11Max=No	IsS11Min=Yes	FrameElem=46	ElemStation=0.5					
Frame=46	Station=0.5	OutputCase=ENVE	CaseType=Combination	StepType=Min	Point=2	X2=-0.5	X3=0.5		
S11=-1757.98794884678	IsS11Max=No	IsS11Min=No	FrameElem=46	ElemStation=0.5					
Frame=46	Station=0.5	OutputCase=ENVE	CaseType=Combination	StepType=Min	Point=3	X2=0.5	X3=-0.5		
S11=1222.85106857227	IsS11Max=Yes	IsS11Min=No	FrameElem=46	ElemStation=0.5					
Frame=46	Station=0.5	OutputCase=ENVE	CaseType=Combination	StepType=Min	Point=4	X2=0.5	X3=0.5		
S11=1222.85106857227	IsS11Max=No	IsS11Min=No	FrameElem=46	ElemStation=0.5					
Frame=46	Station=0	OutputCase=FESSUR	CaseType=Combination	Point=0	X2=0	X3=0	S11=-239.15192283725		
IsS11Max=No	IsS11Min=No	FrameElem=46	ElemStation=0						
Frame=46	Station=0	OutputCase=FESSUR	CaseType=Combination	Point=1	X2=-0.5	X3=-0.5	S11=-		
2184.86105430135	IsS11Max=No	IsS11Min=Yes	FrameElem=46	ElemStation=0					
Frame=46	Station=0	OutputCase=FESSUR	CaseType=Combination	Point=2	X2=-0.5	X3=0.5	S11=-		
2184.86105430135	IsS11Max=No	IsS11Min=No	FrameElem=46	ElemStation=0					
Frame=46	Station=0	OutputCase=FESSUR	CaseType=Combination	Point=3	X2=0.5	X3=-0.5			
S11=1706.55720862685	IsS11Max=Yes	IsS11Min=No	FrameElem=46	ElemStation=0					
Frame=46	Station=0	OutputCase=FESSUR	CaseType=Combination	Point=4	X2=0.5	X3=0.5			
S11=1706.55720862685	IsS11Max=No	IsS11Min=No	FrameElem=46	ElemStation=0					
Frame=46	Station=0.125	OutputCase=FESSUR	CaseType=Combination	Point=0	X2=0	X3=0	S11=-		
239.15192283725	IsS11Max=No	IsS11Min=No	FrameElem=46	ElemStation=0.125					
Frame=46	Station=0.125	OutputCase=FESSUR	CaseType=Combination	Point=1	X2=-0.5	X3=-0.5	S11=-		
2066.55146000665	IsS11Max=No	IsS11Min=Yes	FrameElem=46	ElemStation=0.125					
Frame=46	Station=0.125	OutputCase=FESSUR	CaseType=Combination	Point=2	X2=-0.5	X3=0.5	S11=-		
2066.55146000665	IsS11Max=No	IsS11Min=No	FrameElem=46	ElemStation=0.125					



Frame=46	Station=0.125	OutputCase=FESSUR	CaseType=Combination	Point=3	X2=0.5	X3=-0.5		
S11=1588.24761433215	IsS11Max=Yes	IsS11Min=No	FrameElem=46	ElemStation=0.125				
Frame=46	Station=0.125	OutputCase=FESSUR	CaseType=Combination	Point=4	X2=0.5	X3=0.5		
S11=1588.24761433215	IsS11Max=No	IsS11Min=No	FrameElem=46	ElemStation=0.125				
Frame=46	Station=0.25	OutputCase=FESSUR	CaseType=Combination	Point=0	X2=0	X3=0	S11=-239.15192283725	
IsS11Max=No	IsS11Min=No	FrameElem=46	ElemStation=0.25					
Frame=46	Station=0.25	OutputCase=FESSUR	CaseType=Combination	Point=1	X2=-0.5	X3=-0.5	S11=-	
1950.58561571195	IsS11Max=No	IsS11Min=Yes	FrameElem=46	ElemStation=0.25				
Frame=46	Station=0.25	OutputCase=FESSUR	CaseType=Combination	Point=2	X2=-0.5	X3=0.5	S11=-	
1950.58561571195	IsS11Max=No	IsS11Min=No	FrameElem=46	ElemStation=0.25				
Frame=46	Station=0.25	OutputCase=FESSUR	CaseType=Combination	Point=3	X2=0.5	X3=-0.5		
S11=1472.28177003745	IsS11Max=Yes	IsS11Min=No	FrameElem=46	ElemStation=0.25				
Frame=46	Station=0.25	OutputCase=FESSUR	CaseType=Combination	Point=4	X2=0.5	X3=0.5		
S11=1472.28177003745	IsS11Max=No	IsS11Min=No	FrameElem=46	ElemStation=0.25				
Frame=46	Station=0.375	OutputCase=FESSUR	CaseType=Combination	Point=0	X2=0	X3=0	S11=-	
239.15192283725	IsS11Max=No	IsS11Min=No	FrameElem=46	ElemStation=0.375				
Frame=46	Station=0.375	OutputCase=FESSUR	CaseType=Combination	Point=1	X2=-0.5	X3=-0.5	S11=-	
1836.96352141725	IsS11Max=No	IsS11Min=Yes	FrameElem=46	ElemStation=0.375				
Frame=46	Station=0.375	OutputCase=FESSUR	CaseType=Combination	Point=2	X2=-0.5	X3=0.5	S11=-	
1836.96352141725	IsS11Max=No	IsS11Min=No	FrameElem=46	ElemStation=0.375				
Frame=46	Station=0.375	OutputCase=FESSUR	CaseType=Combination	Point=3	X2=0.5	X3=-0.5		
S11=1358.65967574275	IsS11Max=Yes	IsS11Min=No	FrameElem=46	ElemStation=0.375				
Frame=46	Station=0.375	OutputCase=FESSUR	CaseType=Combination	Point=4	X2=0.5	X3=0.5		
S11=1358.65967574275	IsS11Max=No	IsS11Min=No	FrameElem=46	ElemStation=0.375				
Frame=46	Station=0.5	OutputCase=FESSUR	CaseType=Combination	Point=0	X2=0	X3=0	S11=-239.15192283725	
IsS11Max=No	IsS11Min=No	FrameElem=46	ElemStation=0.5					
Frame=46	Station=0.5	OutputCase=FESSUR	CaseType=Combination	Point=1	X2=-0.5	X3=-0.5	S11=-	
1725.68517712255	IsS11Max=No	IsS11Min=Yes	FrameElem=46	ElemStation=0.5				
Frame=46	Station=0.5	OutputCase=FESSUR	CaseType=Combination	Point=2	X2=-0.5	X3=0.5	S11=-	
1725.68517712255	IsS11Max=No	IsS11Min=No	FrameElem=46	ElemStation=0.5				
Frame=46	Station=0.5	OutputCase=FESSUR	CaseType=Combination	Point=3	X2=0.5	X3=-0.5		
S11=1247.38133144805	IsS11Max=Yes	IsS11Min=No	FrameElem=46	ElemStation=0.5				
Frame=46	Station=0.5	OutputCase=FESSUR	CaseType=Combination	Point=4	X2=0.5	X3=0.5		
S11=1247.38133144805	IsS11Max=No	IsS11Min=No	FrameElem=46	ElemStation=0.5				
Frame=47	Station=0	OutputCase=PERM1	CaseType=Combination	Point=0	X2=0	X3=0	S11=-235.93877227331	
IsS11Max=No	IsS11Min=No	FrameElem=47	ElemStation=0					
Frame=47	Station=0	OutputCase=PERM1	CaseType=Combination	Point=1	X2=-0.5	X3=-0.5	S11=-	
1694.72861311887	IsS11Max=No	IsS11Min=Yes	FrameElem=47	ElemStation=0				
Frame=47	Station=0	OutputCase=PERM1	CaseType=Combination	Point=2	X2=-0.5	X3=0.5	S11=-	
1694.72861311887	IsS11Max=No	IsS11Min=No	FrameElem=47	ElemStation=0				
Frame=47	Station=0	OutputCase=PERM1	CaseType=Combination	Point=3	X2=0.5	X3=-0.5		
S11=1222.85106857225	IsS11Max=Yes	IsS11Min=No	FrameElem=47	ElemStation=0				
Frame=47	Station=0	OutputCase=PERM1	CaseType=Combination	Point=4	X2=0.5	X3=0.5	S11=1222.85106857225	
IsS11Max=No	IsS11Min=No	FrameElem=47	ElemStation=0					
Frame=47	Station=0.125	OutputCase=PERM1	CaseType=Combination	Point=0	X2=0	X3=0	S11=-235.93877227331	
IsS11Max=No	IsS11Min=No	FrameElem=47	ElemStation=0.125					
Frame=47	Station=0.125	OutputCase=PERM1	CaseType=Combination	Point=1	X2=-0.5	X3=-0.5	S11=-	
1502.90496066082	IsS11Max=No	IsS11Min=Yes	FrameElem=47	ElemStation=0.125				
Frame=47	Station=0.125	OutputCase=PERM1	CaseType=Combination	Point=2	X2=-0.5	X3=0.5	S11=-	
1502.90496066082	IsS11Max=No	IsS11Min=No	FrameElem=47	ElemStation=0.125				
Frame=47	Station=0.125	OutputCase=PERM1	CaseType=Combination	Point=3	X2=0.5	X3=-0.5		
S11=1031.0274161142	IsS11Max=Yes	IsS11Min=No	FrameElem=47	ElemStation=0.125				
Frame=47	Station=0.125	OutputCase=PERM1	CaseType=Combination	Point=4	X2=0.5	X3=0.5		
S11=1031.0274161142	IsS11Max=No	IsS11Min=No	FrameElem=47	ElemStation=0.125				
Frame=47	Station=0.25	OutputCase=PERM1	CaseType=Combination	Point=0	X2=0	X3=0	S11=-235.93877227331	
IsS11Max=No	IsS11Min=No	FrameElem=47	ElemStation=0.25					
Frame=47	Station=0.25	OutputCase=PERM1	CaseType=Combination	Point=1	X2=-0.5	X3=-0.5	S11=-	
1313.42505820278	IsS11Max=No	IsS11Min=Yes	FrameElem=47	ElemStation=0.25				
Frame=47	Station=0.25	OutputCase=PERM1	CaseType=Combination	Point=2	X2=-0.5	X3=0.5	S11=-	
1313.42505820278	IsS11Max=No	IsS11Min=No	FrameElem=47	ElemStation=0.25				
Frame=47	Station=0.25	OutputCase=PERM1	CaseType=Combination	Point=3	X2=0.5	X3=-0.5		
S11=841.547513656155	IsS11Max=Yes	IsS11Min=No	FrameElem=47	ElemStation=0.25				
Frame=47	Station=0.25	OutputCase=PERM1	CaseType=Combination	Point=4	X2=0.5	X3=0.5		
S11=841.547513656155	IsS11Max=No	IsS11Min=No	FrameElem=47	ElemStation=0.25				
Frame=47	Station=0.375	OutputCase=PERM1	CaseType=Combination	Point=0	X2=0	X3=0	S11=-235.93877227331	
IsS11Max=No	IsS11Min=No	FrameElem=47	ElemStation=0.375					
Frame=47	Station=0.375	OutputCase=PERM1	CaseType=Combination	Point=1	X2=-0.5	X3=-0.5	S11=-	
1126.28890574473	IsS11Max=No	IsS11Min=Yes	FrameElem=47	ElemStation=0.375				
Frame=47	Station=0.375	OutputCase=PERM1	CaseType=Combination	Point=2	X2=-0.5	X3=0.5	S11=-	
1126.28890574473	IsS11Max=No	IsS11Min=No	FrameElem=47	ElemStation=0.375				
Frame=47	Station=0.375	OutputCase=PERM1	CaseType=Combination	Point=3	X2=0.5	X3=-0.5		
S11=654.411361198108	IsS11Max=Yes	IsS11Min=No	FrameElem=47	ElemStation=0.375				
Frame=47	Station=0.375	OutputCase=PERM1	CaseType=Combination	Point=4	X2=0.5	X3=0.5		
S11=654.411361198108	IsS11Max=No	IsS11Min=No	FrameElem=47	ElemStation=0.375				
Frame=47	Station=0.5	OutputCase=PERM1	CaseType=Combination	Point=0	X2=0	X3=0	S11=-235.93877227331	
IsS11Max=No	IsS11Min=No	FrameElem=47	ElemStation=0.5					
Frame=47	Station=0.5	OutputCase=PERM1	CaseType=Combination	Point=1	X2=-0.5	X3=-0.5	S11=-	
941.496503286681	IsS11Max=No	IsS11Min=Yes	FrameElem=47	ElemStation=0.5				
Frame=47	Station=0.5	OutputCase=PERM1	CaseType=Combination	Point=2	X2=-0.5	X3=0.5	S11=-	
941.496503286681	IsS11Max=No	IsS11Min=No	FrameElem=47	ElemStation=0.5				
Frame=47	Station=0.5	OutputCase=PERM1	CaseType=Combination	Point=3	X2=0.5	X3=-0.5		
S11=469.61895874006	IsS11Max=Yes	IsS11Min=No	FrameElem=47	ElemStation=0.5				

Frame=47 Station=0.5 OutputCase=PERM1 CaseType=Combination Point=4 X2=0.5 X3=0.5
S11=469.61895874006 IsS11Max=No IsS11Min=No FrameElem=47 ElemStation=0.5
Frame=47 Station=0 OutputCase=PERM2 CaseType=Combination Point=0 X2=0 X3=0 S11=-169.46553859214
IsS11Max=No IsS11Min=No FrameElem=47 ElemStation=0
Frame=47 Station=0 OutputCase=PERM2 CaseType=Combination Point=1 X2=-0.5 X3=-0.5 S11=-
1713.76428598438 IsS11Max=No IsS11Min=Yes FrameElem=47 ElemStation=0
Frame=47 Station=0 OutputCase=PERM2 CaseType=Combination Point=2 X2=-0.5 X3=0.5 S11=-
1713.76428598438 IsS11Max=No IsS11Min=No FrameElem=47 ElemStation=0
Frame=47 Station=0 OutputCase=PERM2 CaseType=Combination Point=3 X2=0.5 X3=-0.5 S11=1374.8332088001
IsS11Max=Yes IsS11Min=No FrameElem=47 ElemStation=0
Frame=47 Station=0 OutputCase=PERM2 CaseType=Combination Point=4 X2=0.5 X3=0.5 S11=1374.8332088001
IsS11Max=No IsS11Min=No FrameElem=47 ElemStation=0
Frame=47 Station=0.125 OutputCase=PERM2 CaseType=Combination Point=0 X2=0 X3=0 S11=-169.46553859214
IsS11Max=No IsS11Min=No FrameElem=47 ElemStation=0.125
Frame=47 Station=0.125 OutputCase=PERM2 CaseType=Combination Point=1 X2=-0.5 X3=-0.5 S11=-
1522.0340018199 IsS11Max=No IsS11Min=Yes FrameElem=47 ElemStation=0.125
Frame=47 Station=0.125 OutputCase=PERM2 CaseType=Combination Point=2 X2=-0.5 X3=0.5 S11=-
1522.0340018199 IsS11Max=No IsS11Min=No FrameElem=47 ElemStation=0.125
Frame=47 Station=0.125 OutputCase=PERM2 CaseType=Combination Point=3 X2=0.5 X3=-0.5
S11=1183.10292463562 IsS11Max=Yes IsS11Min=No FrameElem=47 ElemStation=0.125
Frame=47 Station=0.125 OutputCase=PERM2 CaseType=Combination Point=4 X2=0.5 X3=0.5
S11=1183.10292463562 IsS11Max=No IsS11Min=No FrameElem=47 ElemStation=0.125
Frame=47 Station=0.25 OutputCase=PERM2 CaseType=Combination Point=0 X2=0 X3=0 S11=-169.46553859214
IsS11Max=No IsS11Min=No FrameElem=47 ElemStation=0.25
Frame=47 Station=0.25 OutputCase=PERM2 CaseType=Combination Point=1 X2=-0.5 X3=-0.5 S11=-
1332.64746765542 IsS11Max=No IsS11Min=Yes FrameElem=47 ElemStation=0.25
Frame=47 Station=0.25 OutputCase=PERM2 CaseType=Combination Point=2 X2=-0.5 X3=0.5 S11=-
1332.64746765542 IsS11Max=No IsS11Min=No FrameElem=47 ElemStation=0.25
Frame=47 Station=0.25 OutputCase=PERM2 CaseType=Combination Point=3 X2=0.5 X3=-0.5
S11=993.716390471139 IsS11Max=Yes IsS11Min=No FrameElem=47 ElemStation=0.25
Frame=47 Station=0.25 OutputCase=PERM2 CaseType=Combination Point=4 X2=0.5 X3=0.5
S11=993.716390471139 IsS11Max=No IsS11Min=No FrameElem=47 ElemStation=0.25
Frame=47 Station=0.375 OutputCase=PERM2 CaseType=Combination Point=0 X2=0 X3=0 S11=-169.46553859214
IsS11Max=No IsS11Min=No FrameElem=47 ElemStation=0.375
Frame=47 Station=0.375 OutputCase=PERM2 CaseType=Combination Point=1 X2=-0.5 X3=-0.5 S11=-
1145.60468349094 IsS11Max=No IsS11Min=Yes FrameElem=47 ElemStation=0.375
Frame=47 Station=0.375 OutputCase=PERM2 CaseType=Combination Point=2 X2=-0.5 X3=0.5 S11=-
1145.60468349094 IsS11Max=No IsS11Min=No FrameElem=47 ElemStation=0.375
Frame=47 Station=0.375 OutputCase=PERM2 CaseType=Combination Point=3 X2=0.5 X3=-0.5
S11=806.673606306658 IsS11Max=Yes IsS11Min=No FrameElem=47 ElemStation=0.375
Frame=47 Station=0.375 OutputCase=PERM2 CaseType=Combination Point=4 X2=0.5 X3=0.5
S11=806.673606306658 IsS11Max=No IsS11Min=No FrameElem=47 ElemStation=0.375
Frame=47 Station=0.5 OutputCase=PERM2 CaseType=Combination Point=0 X2=0 X3=0 S11=-169.46553859214
IsS11Max=No IsS11Min=No FrameElem=47 ElemStation=0.5
Frame=47 Station=0.5 OutputCase=PERM2 CaseType=Combination Point=1 X2=-0.5 X3=-0.5 S11=-
960.905649326457 IsS11Max=No IsS11Min=Yes FrameElem=47 ElemStation=0.5
Frame=47 Station=0.5 OutputCase=PERM2 CaseType=Combination Point=2 X2=-0.5 X3=0.5 S11=-
960.905649326457 IsS11Max=No IsS11Min=No FrameElem=47 ElemStation=0.5
Frame=47 Station=0.5 OutputCase=PERM2 CaseType=Combination Point=3 X2=0.5 X3=-0.5
S11=621.974572142176 IsS11Max=Yes IsS11Min=No FrameElem=47 ElemStation=0.5
Frame=47 Station=0.5 OutputCase=PERM2 CaseType=Combination Point=4 X2=0.5 X3=0.5
S11=621.974572142176 IsS11Max=No IsS11Min=No FrameElem=47 ElemStation=0.5
Frame=47 Station=0 OutputCase=ACCL CaseType=Combination Point=0 X2=0 X3=0 S11=-240.528987364652
IsS11Max=No IsS11Min=No FrameElem=47 ElemStation=0
Frame=47 Station=0 OutputCase=ACCL CaseType=Combination Point=1 X2=-0.5 X3=-0.5 S11=-
1738.95227598124 IsS11Max=No IsS11Min=Yes FrameElem=47 ElemStation=0
Frame=47 Station=0 OutputCase=ACCL CaseType=Combination Point=2 X2=-0.5 X3=0.5 S11=-
1738.95227598124 IsS11Max=No IsS11Min=No FrameElem=47 ElemStation=0
Frame=47 Station=0 OutputCase=ACCL CaseType=Combination Point=3 X2=0.5 X3=-0.5 S11=1257.89430125194
IsS11Max=Yes IsS11Min=No FrameElem=47 ElemStation=0
Frame=47 Station=0 OutputCase=ACCL CaseType=Combination Point=4 X2=0.5 X3=0.5 S11=1257.89430125194
IsS11Max=No IsS11Min=No FrameElem=47 ElemStation=0
Frame=47 Station=0.125 OutputCase=ACCL CaseType=Combination Point=0 X2=0 X3=0 S11=-240.528987364652
IsS11Max=No IsS11Min=No FrameElem=47 ElemStation=0.125
Frame=47 Station=0.125 OutputCase=ACCL CaseType=Combination Point=1 X2=-0.5 X3=-0.5 S11=-
1542.10172966534 IsS11Max=No IsS11Min=Yes FrameElem=47 ElemStation=0.125
Frame=47 Station=0.125 OutputCase=ACCL CaseType=Combination Point=2 X2=-0.5 X3=0.5 S11=-
1542.10172966534 IsS11Max=No IsS11Min=No FrameElem=47 ElemStation=0.125
Frame=47 Station=0.125 OutputCase=ACCL CaseType=Combination Point=3 X2=0.5 X3=-0.5
S11=1061.04375493604 IsS11Max=Yes IsS11Min=No FrameElem=47 ElemStation=0.125
Frame=47 Station=0.125 OutputCase=ACCL CaseType=Combination Point=4 X2=0.5 X3=0.5
S11=1061.04375493604 IsS11Max=No IsS11Min=No FrameElem=47 ElemStation=0.125
Frame=47 Station=0.25 OutputCase=ACCL CaseType=Combination Point=0 X2=0 X3=0 S11=-240.528987364652
IsS11Max=No IsS11Min=No FrameElem=47 ElemStation=0.25
Frame=47 Station=0.25 OutputCase=ACCL CaseType=Combination Point=1 X2=-0.5 X3=-0.5 S11=-
1347.59493334944 IsS11Max=No IsS11Min=Yes FrameElem=47 ElemStation=0.25
Frame=47 Station=0.25 OutputCase=ACCL CaseType=Combination Point=2 X2=-0.5 X3=0.5 S11=-
1347.59493334944 IsS11Max=No IsS11Min=No FrameElem=47 ElemStation=0.25
Frame=47 Station=0.25 OutputCase=ACCL CaseType=Combination Point=3 X2=0.5 X3=-0.5
S11=866.536958620137 IsS11Max=Yes IsS11Min=No FrameElem=47 ElemStation=0.25
Frame=47 Station=0.25 OutputCase=ACCL CaseType=Combination Point=4 X2=0.5 X3=0.5
S11=866.536958620137 IsS11Max=No IsS11Min=No FrameElem=47 ElemStation=0.25

Frame=47	Station=0.375	OutputCase=ACC1	CaseType=Combination	Point=0	X2=0	X3=0	S11=-240.528987364652
IsS11Max=No	IsS11Min=No	FrameElem=47	ElemStation=0.375				
Frame=47	Station=0.375	OutputCase=ACC1	CaseType=Combination	Point=1	X2=-0.5	X3=-0.5	S11=-
1155.43188703354	IsS11Max=No	IsS11Min=Yes	FrameElem=47	ElemStation=0.375			
Frame=47	Station=0.375	OutputCase=ACC1	CaseType=Combination	Point=2	X2=-0.5	X3=0.5	S11=-
1155.43188703354	IsS11Max=No	IsS11Min=No	FrameElem=47	ElemStation=0.375			
Frame=47	Station=0.375	OutputCase=ACC1	CaseType=Combination	Point=3	X2=0.5	X3=-0.5	
S11=674.373912304236	IsS11Max=Yes	IsS11Min=No	FrameElem=47	ElemStation=0.375			
Frame=47	Station=0.375	OutputCase=ACC1	CaseType=Combination	Point=4	X2=0.5	X3=0.5	
S11=674.373912304236	IsS11Max=No	IsS11Min=No	FrameElem=47	ElemStation=0.375			
Frame=47	Station=0.5	OutputCase=ACC1	CaseType=Combination	Point=0	X2=0	X3=0	S11=-240.528987364652
IsS11Max=No	IsS11Min=No	FrameElem=47	ElemStation=0.5				
Frame=47	Station=0.5	OutputCase=ACC1	CaseType=Combination	Point=1	X2=-0.5	X3=-0.5	S11=-
965.612590717639	IsS11Max=No	IsS11Min=Yes	FrameElem=47	ElemStation=0.5			
Frame=47	Station=0.5	OutputCase=ACC1	CaseType=Combination	Point=2	X2=-0.5	X3=0.5	S11=-
965.612590717639	IsS11Max=No	IsS11Min=No	FrameElem=47	ElemStation=0.5			
Frame=47	Station=0.5	OutputCase=ACC1	CaseType=Combination	Point=3	X2=0.5	X3=-0.5	
S11=484.554615988335	IsS11Max=Yes	IsS11Min=No	FrameElem=47	ElemStation=0.5			
Frame=47	Station=0.5	OutputCase=ACC1	CaseType=Combination	Point=4	X2=0.5	X3=0.5	
S11=484.554615988335	IsS11Max=No	IsS11Min=No	FrameElem=47	ElemStation=0.5			
Frame=47	Station=0	OutputCase=ACC2	CaseType=Combination	Point=0	X2=0	X3=0	S11=-174.055753683482
IsS11Max=No	IsS11Min=No	FrameElem=47	ElemStation=0				
Frame=47	Station=0	OutputCase=ACC2	CaseType=Combination	Point=1	X2=-0.5	X3=-0.5	S11=-
1757.98794884675	IsS11Max=No	IsS11Min=Yes	FrameElem=47	ElemStation=0			
Frame=47	Station=0	OutputCase=ACC2	CaseType=Combination	Point=2	X2=-0.5	X3=0.5	S11=-
1757.98794884675	IsS11Max=No	IsS11Min=No	FrameElem=47	ElemStation=0			
Frame=47	Station=0	OutputCase=ACC2	CaseType=Combination	Point=3	X2=0.5	X3=-0.5	S11=1409.87644147979
IsS11Max=Yes	IsS11Min=No	FrameElem=47	ElemStation=0				
Frame=47	Station=0	OutputCase=ACC2	CaseType=Combination	Point=4	X2=0.5	X3=0.5	S11=1409.87644147979
IsS11Max=No	IsS11Min=No	FrameElem=47	ElemStation=0				
Frame=47	Station=0.125	OutputCase=ACC2	CaseType=Combination	Point=0	X2=0	X3=0	S11=-174.055753683482
IsS11Max=No	IsS11Min=No	FrameElem=47	ElemStation=0.125				
Frame=47	Station=0.125	OutputCase=ACC2	CaseType=Combination	Point=1	X2=-0.5	X3=-0.5	S11=-
1561.23077082442	IsS11Max=No	IsS11Min=Yes	FrameElem=47	ElemStation=0.125			
Frame=47	Station=0.125	OutputCase=ACC2	CaseType=Combination	Point=2	X2=-0.5	X3=0.5	S11=-
1561.23077082442	IsS11Max=No	IsS11Min=No	FrameElem=47	ElemStation=0.125			
Frame=47	Station=0.125	OutputCase=ACC2	CaseType=Combination	Point=3	X2=0.5	X3=-0.5	
S11=1213.11926345746	IsS11Max=Yes	IsS11Min=No	FrameElem=47	ElemStation=0.125			
Frame=47	Station=0.125	OutputCase=ACC2	CaseType=Combination	Point=4	X2=0.5	X3=0.5	
S11=1213.11926345746	IsS11Max=No	IsS11Min=No	FrameElem=47	ElemStation=0.125			
Frame=47	Station=0.25	OutputCase=ACC2	CaseType=Combination	Point=0	X2=0	X3=0	S11=-174.055753683482
IsS11Max=No	IsS11Min=No	FrameElem=47	ElemStation=0.25				
Frame=47	Station=0.25	OutputCase=ACC2	CaseType=Combination	Point=1	X2=-0.5	X3=-0.5	S11=-
1366.81734280209	IsS11Max=No	IsS11Min=Yes	FrameElem=47	ElemStation=0.25			
Frame=47	Station=0.25	OutputCase=ACC2	CaseType=Combination	Point=2	X2=-0.5	X3=0.5	S11=-
1366.81734280209	IsS11Max=No	IsS11Min=No	FrameElem=47	ElemStation=0.25			
Frame=47	Station=0.25	OutputCase=ACC2	CaseType=Combination	Point=3	X2=0.5	X3=-0.5	
S11=1018.70583543512	IsS11Max=Yes	IsS11Min=No	FrameElem=47	ElemStation=0.25			
Frame=47	Station=0.25	OutputCase=ACC2	CaseType=Combination	Point=4	X2=0.5	X3=0.5	
S11=1018.70583543512	IsS11Max=No	IsS11Min=No	FrameElem=47	ElemStation=0.25			
Frame=47	Station=0.375	OutputCase=ACC2	CaseType=Combination	Point=0	X2=0	X3=0	S11=-174.055753683482
IsS11Max=No	IsS11Min=No	FrameElem=47	ElemStation=0.375				
Frame=47	Station=0.375	OutputCase=ACC2	CaseType=Combination	Point=1	X2=-0.5	X3=-0.5	S11=-
1174.74766477975	IsS11Max=No	IsS11Min=Yes	FrameElem=47	ElemStation=0.375			
Frame=47	Station=0.375	OutputCase=ACC2	CaseType=Combination	Point=2	X2=-0.5	X3=0.5	S11=-
1174.74766477975	IsS11Max=No	IsS11Min=No	FrameElem=47	ElemStation=0.375			
Frame=47	Station=0.375	OutputCase=ACC2	CaseType=Combination	Point=3	X2=0.5	X3=-0.5	
S11=826.636157412786	IsS11Max=Yes	IsS11Min=No	FrameElem=47	ElemStation=0.375			
Frame=47	Station=0.375	OutputCase=ACC2	CaseType=Combination	Point=4	X2=0.5	X3=0.5	
S11=826.636157412786	IsS11Max=No	IsS11Min=No	FrameElem=47	ElemStation=0.375			
Frame=47	Station=0.5	OutputCase=ACC2	CaseType=Combination	Point=0	X2=0	X3=0	S11=-174.055753683482
IsS11Max=No	IsS11Min=No	FrameElem=47	ElemStation=0.5				
Frame=47	Station=0.5	OutputCase=ACC2	CaseType=Combination	Point=1	X2=-0.5	X3=-0.5	S11=-
985.021736757416	IsS11Max=No	IsS11Min=Yes	FrameElem=47	ElemStation=0.5			
Frame=47	Station=0.5	OutputCase=ACC2	CaseType=Combination	Point=2	X2=-0.5	X3=0.5	S11=-
985.021736757416	IsS11Max=No	IsS11Min=No	FrameElem=47	ElemStation=0.5			
Frame=47	Station=0.5	OutputCase=ACC2	CaseType=Combination	Point=3	X2=0.5	X3=-0.5	
S11=636.910229390451	IsS11Max=Yes	IsS11Min=No	FrameElem=47	ElemStation=0.5			
Frame=47	Station=0.5	OutputCase=ACC2	CaseType=Combination	Point=4	X2=0.5	X3=0.5	
S11=636.910229390451	IsS11Max=No	IsS11Min=No	FrameElem=47	ElemStation=0.5			
Frame=47	Station=0	OutputCase=ACCSX1	CaseType=Combination	Point=0	X2=0	X3=0	S11=-233.665974282454
IsS11Max=No	IsS11Min=No	FrameElem=47	ElemStation=0				
Frame=47	Station=0	OutputCase=ACCSX1	CaseType=Combination	Point=1	X2=-0.5	X3=-0.5	S11=-
1710.20586161671	IsS11Max=No	IsS11Min=Yes	FrameElem=47	ElemStation=0			
Frame=47	Station=0	OutputCase=ACCSX1	CaseType=Combination	Point=2	X2=-0.5	X3=0.5	S11=-
1710.20586161671	IsS11Max=No	IsS11Min=No	FrameElem=47	ElemStation=0			
Frame=47	Station=0	OutputCase=ACCSX1	CaseType=Combination	Point=3	X2=0.5	X3=-0.5	
S11=1242.8739130518	IsS11Max=Yes	IsS11Min=No	FrameElem=47	ElemStation=0			
Frame=47	Station=0	OutputCase=ACCSX1	CaseType=Combination	Point=4	X2=0.5	X3=0.5	S11=1242.8739130518
IsS11Max=No	IsS11Min=No	FrameElem=47	ElemStation=0				
Frame=47	Station=0.125	OutputCase=ACCSX1	CaseType=Combination	Point=0	X2=0	X3=0	S11=-
233.665974282454	IsS11Max=No	IsS11Min=No	FrameElem=47	ElemStation=0.125			

Frame=47	Station=0.125	OutputCase=ACCSX1	CaseType=Combination	Point=1	X2=-0.5	X3=-0.5	S11=-
1520.35062540446	IsS11Max=No	IsS11Min=Yes	FrameElem=47	ElemStation=0.125			
Frame=47	Station=0.125	OutputCase=ACCSX1	CaseType=Combination	Point=2	X2=-0.5	X3=0.5	S11=-
1520.35062540446	IsS11Max=No	IsS11Min=No	FrameElem=47	ElemStation=0.125			
Frame=47	Station=0.125	OutputCase=ACCSX1	CaseType=Combination	Point=3	X2=0.5	X3=-0.5	
S11=1053.01867683955	IsS11Max=Yes	IsS11Min=No	FrameElem=47	ElemStation=0.125			
Frame=47	Station=0.125	OutputCase=ACCSX1	CaseType=Combination	Point=4	X2=0.5	X3=0.5	
S11=1053.01867683955	IsS11Max=No	IsS11Min=No	FrameElem=47	ElemStation=0.125			
Frame=47	Station=0.25	OutputCase=ACCSX1	CaseType=Combination	Point=0	X2=0	X3=0	S11=-
233.665974282454	IsS11Max=No	IsS11Min=No	FrameElem=47	ElemStation=0.25			
Frame=47	Station=0.25	OutputCase=ACCSX1	CaseType=Combination	Point=1	X2=-0.5	X3=-0.5	S11=-
1332.8391391922	IsS11Max=No	IsS11Min=Yes	FrameElem=47	ElemStation=0.25			
Frame=47	Station=0.25	OutputCase=ACCSX1	CaseType=Combination	Point=2	X2=-0.5	X3=0.5	S11=-
1332.8391391922	IsS11Max=No	IsS11Min=No	FrameElem=47	ElemStation=0.25			
Frame=47	Station=0.25	OutputCase=ACCSX1	CaseType=Combination	Point=3	X2=0.5	X3=-0.5	
S11=865.507190627294	IsS11Max=Yes	IsS11Min=No	FrameElem=47	ElemStation=0.25			
Frame=47	Station=0.25	OutputCase=ACCSX1	CaseType=Combination	Point=4	X2=0.5	X3=0.5	
S11=865.507190627294	IsS11Max=No	IsS11Min=No	FrameElem=47	ElemStation=0.25			
Frame=47	Station=0.375	OutputCase=ACCSX1	CaseType=Combination	Point=0	X2=0	X3=0	S11=-
233.665974282454	IsS11Max=No	IsS11Min=No	FrameElem=47	ElemStation=0.375			
Frame=47	Station=0.375	OutputCase=ACCSX1	CaseType=Combination	Point=1	X2=-0.5	X3=-0.5	S11=-
1147.67140297995	IsS11Max=No	IsS11Min=Yes	FrameElem=47	ElemStation=0.375			
Frame=47	Station=0.375	OutputCase=ACCSX1	CaseType=Combination	Point=2	X2=-0.5	X3=0.5	S11=-
1147.67140297995	IsS11Max=No	IsS11Min=No	FrameElem=47	ElemStation=0.375			
Frame=47	Station=0.375	OutputCase=ACCSX1	CaseType=Combination	Point=3	X2=0.5	X3=-0.5	
S11=680.33945441504	IsS11Max=Yes	IsS11Min=No	FrameElem=47	ElemStation=0.375			
Frame=47	Station=0.375	OutputCase=ACCSX1	CaseType=Combination	Point=4	X2=0.5	X3=0.5	
S11=680.33945441504	IsS11Max=No	IsS11Min=No	FrameElem=47	ElemStation=0.375			
Frame=47	Station=0.5	OutputCase=ACCSX1	CaseType=Combination	Point=0	X2=0	X3=0	S11=-233.665974282454
IsS11Max=No	IsS11Min=No	FrameElem=47	ElemStation=0.5				
Frame=47	Station=0.5	OutputCase=ACCSX1	CaseType=Combination	Point=1	X2=-0.5	X3=-0.5	S11=-
964.847416767696	IsS11Max=No	IsS11Min=Yes	FrameElem=47	ElemStation=0.5			
Frame=47	Station=0.5	OutputCase=ACCSX1	CaseType=Combination	Point=2	X2=-0.5	X3=0.5	S11=-
964.847416767696	IsS11Max=No	IsS11Min=No	FrameElem=47	ElemStation=0.5			
Frame=47	Station=0.5	OutputCase=ACCSX1	CaseType=Combination	Point=3	X2=0.5	X3=-0.5	
S11=497.515468202787	IsS11Max=Yes	IsS11Min=No	FrameElem=47	ElemStation=0.5			
Frame=47	Station=0.5	OutputCase=ACCSX1	CaseType=Combination	Point=4	X2=0.5	X3=0.5	
S11=497.515468202787	IsS11Max=No	IsS11Min=No	FrameElem=47	ElemStation=0.5			
Frame=47	Station=0	OutputCase=ACCSX2	CaseType=Combination	Point=0	X2=0	X3=0	S11=-167.192740601284
IsS11Max=No	IsS11Min=No	FrameElem=47	ElemStation=0				
Frame=47	Station=0	OutputCase=ACCSX2	CaseType=Combination	Point=1	X2=-0.5	X3=-0.5	S11=-
1729.24153448222	IsS11Max=No	IsS11Min=Yes	FrameElem=47	ElemStation=0			
Frame=47	Station=0	OutputCase=ACCSX2	CaseType=Combination	Point=2	X2=-0.5	X3=0.5	S11=-
1729.24153448222	IsS11Max=No	IsS11Min=No	FrameElem=47	ElemStation=0			
Frame=47	Station=0	OutputCase=ACCSX2	CaseType=Combination	Point=3	X2=0.5	X3=-0.5	
S11=1394.85605327965	IsS11Max=Yes	IsS11Min=No	FrameElem=47	ElemStation=0			
Frame=47	Station=0	OutputCase=ACCSX2	CaseType=Combination	Point=4	X2=0.5	X3=0.5	
S11=1394.85605327965	IsS11Max=No	IsS11Min=No	FrameElem=47	ElemStation=0			
Frame=47	Station=0.125	OutputCase=ACCSX2	CaseType=Combination	Point=0	X2=0	X3=0	S11=-
167.192740601284	IsS11Max=No	IsS11Min=No	FrameElem=47	ElemStation=0.125			
Frame=47	Station=0.125	OutputCase=ACCSX2	CaseType=Combination	Point=1	X2=-0.5	X3=-0.5	S11=-
1539.47966656353	IsS11Max=No	IsS11Min=Yes	FrameElem=47	ElemStation=0.125			
Frame=47	Station=0.125	OutputCase=ACCSX2	CaseType=Combination	Point=2	X2=-0.5	X3=0.5	S11=-
1539.47966656353	IsS11Max=No	IsS11Min=No	FrameElem=47	ElemStation=0.125			
Frame=47	Station=0.125	OutputCase=ACCSX2	CaseType=Combination	Point=3	X2=0.5	X3=-0.5	
S11=1205.09418536096	IsS11Max=Yes	IsS11Min=No	FrameElem=47	ElemStation=0.125			
Frame=47	Station=0.125	OutputCase=ACCSX2	CaseType=Combination	Point=4	X2=0.5	X3=0.5	
S11=1205.09418536096	IsS11Max=No	IsS11Min=No	FrameElem=47	ElemStation=0.125			
Frame=47	Station=0.25	OutputCase=ACCSX2	CaseType=Combination	Point=0	X2=0	X3=0	S11=-
167.192740601284	IsS11Max=No	IsS11Min=No	FrameElem=47	ElemStation=0.25			
Frame=47	Station=0.25	OutputCase=ACCSX2	CaseType=Combination	Point=1	X2=-0.5	X3=-0.5	S11=-
1352.06154864485	IsS11Max=No	IsS11Min=Yes	FrameElem=47	ElemStation=0.25			
Frame=47	Station=0.25	OutputCase=ACCSX2	CaseType=Combination	Point=2	X2=-0.5	X3=0.5	S11=-
1352.06154864485	IsS11Max=No	IsS11Min=No	FrameElem=47	ElemStation=0.25			
Frame=47	Station=0.25	OutputCase=ACCSX2	CaseType=Combination	Point=3	X2=0.5	X3=-0.5	
S11=1017.67606744228	IsS11Max=Yes	IsS11Min=No	FrameElem=47	ElemStation=0.25			
Frame=47	Station=0.25	OutputCase=ACCSX2	CaseType=Combination	Point=4	X2=0.5	X3=0.5	
S11=1017.67606744228	IsS11Max=No	IsS11Min=No	FrameElem=47	ElemStation=0.25			
Frame=47	Station=0.375	OutputCase=ACCSX2	CaseType=Combination	Point=0	X2=0	X3=0	S11=-
167.192740601284	IsS11Max=No	IsS11Min=No	FrameElem=47	ElemStation=0.375			
Frame=47	Station=0.375	OutputCase=ACCSX2	CaseType=Combination	Point=1	X2=-0.5	X3=-0.5	S11=-
1166.98718072616	IsS11Max=No	IsS11Min=Yes	FrameElem=47	ElemStation=0.375			
Frame=47	Station=0.375	OutputCase=ACCSX2	CaseType=Combination	Point=2	X2=-0.5	X3=0.5	S11=-
1166.98718072616	IsS11Max=No	IsS11Min=No	FrameElem=47	ElemStation=0.375			
Frame=47	Station=0.375	OutputCase=ACCSX2	CaseType=Combination	Point=3	X2=0.5	X3=-0.5	
S11=832.60169952359	IsS11Max=Yes	IsS11Min=No	FrameElem=47	ElemStation=0.375			
Frame=47	Station=0.375	OutputCase=ACCSX2	CaseType=Combination	Point=4	X2=0.5	X3=0.5	
S11=832.60169952359	IsS11Max=No	IsS11Min=No	FrameElem=47	ElemStation=0.375			
Frame=47	Station=0.5	OutputCase=ACCSX2	CaseType=Combination	Point=0	X2=0	X3=0	S11=-167.192740601284
IsS11Max=No	IsS11Min=No	FrameElem=47	ElemStation=0.5				
Frame=47	Station=0.5	OutputCase=ACCSX2	CaseType=Combination	Point=1	X2=-0.5	X3=-0.5	S11=-
984.256562807472	IsS11Max=No	IsS11Min=Yes	FrameElem=47	ElemStation=0.5			



Frame=47	Station=0.5	OutputCase=ACCSX2	CaseType=Combination	Point=2	X2=-0.5	X3=0.5	S11=-
984.256562807472		IsS11Max=No	IsS11Min=No	FrameElem=47	ElemStation=0.5		
Frame=47	Station=0.5	OutputCase=ACCSX2	CaseType=Combination	Point=3	X2=0.5	X3=-0.5	
S11=649.871081604903		IsS11Max=Yes	IsS11Min=No	FrameElem=47	ElemStation=0.5		
Frame=47	Station=0.5	OutputCase=ACCSX2	CaseType=Combination	Point=4	X2=0.5	X3=0.5	
S11=649.871081604903		IsS11Max=No	IsS11Min=No	FrameElem=47	ElemStation=0.5		
Frame=47	Station=0	OutputCase=ENVE	CaseType=Combination	StepType=Max	Point=0	X2=0	X3=0
167.192740601284		IsS11Max=No	IsS11Min=No	FrameElem=47	ElemStation=0		
Frame=47	Station=0	OutputCase=ENVE	CaseType=Combination	StepType=Max	Point=1	X2=-0.5	X3=-0.5
S11=-1694.72861311887		IsS11Max=No	IsS11Min=Yes	FrameElem=47	ElemStation=0		
Frame=47	Station=0	OutputCase=ENVE	CaseType=Combination	StepType=Max	Point=2	X2=-0.5	X3=0.5
1694.72861311887		IsS11Max=No	IsS11Min=No	FrameElem=47	ElemStation=0		
Frame=47	Station=0	OutputCase=ENVE	CaseType=Combination	StepType=Max	Point=3	X2=0.5	X3=-0.5
S11=1409.87644147979		IsS11Max=Yes	IsS11Min=No	FrameElem=47	ElemStation=0		
Frame=47	Station=0	OutputCase=ENVE	CaseType=Combination	StepType=Max	Point=4	X2=0.5	X3=0.5
S11=1409.87644147979		IsS11Max=No	IsS11Min=No	FrameElem=47	ElemStation=0		
Frame=47	Station=0.125	OutputCase=ENVE	CaseType=Combination	StepType=Max	Point=0	X2=0	X3=0
167.192740601284		IsS11Max=No	IsS11Min=No	FrameElem=47	ElemStation=0.125		
Frame=47	Station=0.125	OutputCase=ENVE	CaseType=Combination	StepType=Max	Point=1	X2=-0.5	X3=-0.5
S11=-1502.90496066082		IsS11Max=No	IsS11Min=Yes	FrameElem=47	ElemStation=0.125		
Frame=47	Station=0.125	OutputCase=ENVE	CaseType=Combination	StepType=Max	Point=2	X2=-0.5	X3=0.5
S11=-1502.90496066082		IsS11Max=No	IsS11Min=No	FrameElem=47	ElemStation=0.125		
Frame=47	Station=0.125	OutputCase=ENVE	CaseType=Combination	StepType=Max	Point=3	X2=0.5	X3=-0.5
S11=1213.11926345746		IsS11Max=Yes	IsS11Min=No	FrameElem=47	ElemStation=0.125		
Frame=47	Station=0.125	OutputCase=ENVE	CaseType=Combination	StepType=Max	Point=4	X2=0.5	X3=0.5
S11=1213.11926345746		IsS11Max=No	IsS11Min=No	FrameElem=47	ElemStation=0.125		
Frame=47	Station=0.25	OutputCase=ENVE	CaseType=Combination	StepType=Max	Point=0	X2=0	X3=0
167.192740601284		IsS11Max=No	IsS11Min=No	FrameElem=47	ElemStation=0.25		
Frame=47	Station=0.25	OutputCase=ENVE	CaseType=Combination	StepType=Max	Point=1	X2=-0.5	X3=-0.5
S11=-1313.42505820278		IsS11Max=No	IsS11Min=Yes	FrameElem=47	ElemStation=0.25		
Frame=47	Station=0.25	OutputCase=ENVE	CaseType=Combination	StepType=Max	Point=2	X2=-0.5	X3=0.5
S11=-1313.42505820278		IsS11Max=No	IsS11Min=No	FrameElem=47	ElemStation=0.25		
Frame=47	Station=0.25	OutputCase=ENVE	CaseType=Combination	StepType=Max	Point=3	X2=0.5	X3=-0.5
S11=1018.70583543512		IsS11Max=Yes	IsS11Min=No	FrameElem=47	ElemStation=0.25		
Frame=47	Station=0.25	OutputCase=ENVE	CaseType=Combination	StepType=Max	Point=4	X2=0.5	X3=0.5
S11=1018.70583543512		IsS11Max=No	IsS11Min=No	FrameElem=47	ElemStation=0.25		
Frame=47	Station=0.375	OutputCase=ENVE	CaseType=Combination	StepType=Max	Point=0	X2=0	X3=0
167.192740601284		IsS11Max=No	IsS11Min=No	FrameElem=47	ElemStation=0.375		
Frame=47	Station=0.375	OutputCase=ENVE	CaseType=Combination	StepType=Max	Point=1	X2=-0.5	X3=-0.5
S11=-1126.28890574473		IsS11Max=No	IsS11Min=Yes	FrameElem=47	ElemStation=0.375		
Frame=47	Station=0.375	OutputCase=ENVE	CaseType=Combination	StepType=Max	Point=2	X2=-0.5	X3=0.5
S11=-1126.28890574473		IsS11Max=No	IsS11Min=No	FrameElem=47	ElemStation=0.375		
Frame=47	Station=0.375	OutputCase=ENVE	CaseType=Combination	StepType=Max	Point=3	X2=0.5	X3=-0.5
S11=832.60169952359		IsS11Max=Yes	IsS11Min=No	FrameElem=47	ElemStation=0.375		
Frame=47	Station=0.375	OutputCase=ENVE	CaseType=Combination	StepType=Max	Point=4	X2=0.5	X3=0.5
S11=832.60169952359		IsS11Max=No	IsS11Min=No	FrameElem=47	ElemStation=0.375		
Frame=47	Station=0.5	OutputCase=ENVE	CaseType=Combination	StepType=Max	Point=0	X2=0	X3=0
167.192740601284		IsS11Max=No	IsS11Min=No	FrameElem=47	ElemStation=0.5		
Frame=47	Station=0.5	OutputCase=ENVE	CaseType=Combination	StepType=Max	Point=1	X2=-0.5	X3=-0.5
S11=-941.496503286681		IsS11Max=No	IsS11Min=Yes	FrameElem=47	ElemStation=0.5		
Frame=47	Station=0.5	OutputCase=ENVE	CaseType=Combination	StepType=Max	Point=2	X2=-0.5	X3=0.5
S11=-941.496503286681		IsS11Max=No	IsS11Min=No	FrameElem=47	ElemStation=0.5		
Frame=47	Station=0.5	OutputCase=ENVE	CaseType=Combination	StepType=Max	Point=3	X2=0.5	X3=-0.5
S11=649.871081604903		IsS11Max=Yes	IsS11Min=No	FrameElem=47	ElemStation=0.5		
Frame=47	Station=0.5	OutputCase=ENVE	CaseType=Combination	StepType=Max	Point=4	X2=0.5	X3=0.5
S11=649.871081604903		IsS11Max=No	IsS11Min=No	FrameElem=47	ElemStation=0.5		
Frame=47	Station=0	OutputCase=ENVE	CaseType=Combination	StepType=Min	Point=0	X2=0	X3=0
240.528987364652		IsS11Max=No	IsS11Min=No	FrameElem=47	ElemStation=0		
Frame=47	Station=0	OutputCase=ENVE	CaseType=Combination	StepType=Min	Point=1	X2=-0.5	X3=-0.5
S11=-1757.98794884675		IsS11Max=No	IsS11Min=Yes	FrameElem=47	ElemStation=0		
Frame=47	Station=0	OutputCase=ENVE	CaseType=Combination	StepType=Min	Point=2	X2=-0.5	X3=0.5
1757.98794884675		IsS11Max=No	IsS11Min=No	FrameElem=47	ElemStation=0		
Frame=47	Station=0	OutputCase=ENVE	CaseType=Combination	StepType=Min	Point=3	X2=0.5	X3=-0.5
S11=1222.85106857225		IsS11Max=Yes	IsS11Min=No	FrameElem=47	ElemStation=0		
Frame=47	Station=0	OutputCase=ENVE	CaseType=Combination	StepType=Min	Point=4	X2=0.5	X3=0.5
S11=1222.85106857225		IsS11Max=No	IsS11Min=No	FrameElem=47	ElemStation=0		
Frame=47	Station=0.125	OutputCase=ENVE	CaseType=Combination	StepType=Min	Point=0	X2=0	X3=0
240.528987364652		IsS11Max=No	IsS11Min=No	FrameElem=47	ElemStation=0.125		
Frame=47	Station=0.125	OutputCase=ENVE	CaseType=Combination	StepType=Min	Point=1	X2=-0.5	X3=-0.5
S11=-1561.23077082442		IsS11Max=No	IsS11Min=Yes	FrameElem=47	ElemStation=0.125		
Frame=47	Station=0.125	OutputCase=ENVE	CaseType=Combination	StepType=Min	Point=2	X2=-0.5	X3=0.5
S11=-1561.23077082442		IsS11Max=No	IsS11Min=No	FrameElem=47	ElemStation=0.125		
Frame=47	Station=0.125	OutputCase=ENVE	CaseType=Combination	StepType=Min	Point=3	X2=0.5	X3=-0.5
S11=1031.0274161142		IsS11Max=Yes	IsS11Min=No	FrameElem=47	ElemStation=0.125		
Frame=47	Station=0.125	OutputCase=ENVE	CaseType=Combination	StepType=Min	Point=4	X2=0.5	X3=0.5
S11=1031.0274161142		IsS11Max=No	IsS11Min=No	FrameElem=47	ElemStation=0.125		
Frame=47	Station=0.25	OutputCase=ENVE	CaseType=Combination	StepType=Min	Point=0	X2=0	X3=0
240.528987364652		IsS11Max=No	IsS11Min=No	FrameElem=47	ElemStation=0.25		
Frame=47	Station=0.25	OutputCase=ENVE	CaseType=Combination	StepType=Min	Point=1	X2=-0.5	X3=-0.5
S11=-1366.81734280209		IsS11Max=No	IsS11Min=Yes	FrameElem=47	ElemStation=0.25		
Frame=47	Station=0.25	OutputCase=ENVE	CaseType=Combination	StepType=Min	Point=2	X2=-0.5	X3=0.5
S11=-1366.81734280209		IsS11Max=No	IsS11Min=No	FrameElem=47	ElemStation=0.25		

Frame=47	Station=0.25	OutputCase=ENVE	CaseType=Combination	StepType=Min	Point=3	X2=0.5	X3=-0.5		
S11=841.547513656155	IsS11Max=Yes	IsS11Min=No	FrameElem=47	ElemStation=0.25					
Frame=47	Station=0.25	OutputCase=ENVE	CaseType=Combination	StepType=Min	Point=4	X2=0.5	X3=0.5		
S11=841.547513656155	IsS11Max=No	IsS11Min=No	FrameElem=47	ElemStation=0.25					
Frame=47	Station=0.375	OutputCase=ENVE	CaseType=Combination	StepType=Min	Point=0	X2=0	X3=0	S11=-	
240.528987364652	IsS11Max=No	IsS11Min=No	FrameElem=47	ElemStation=0.375					
Frame=47	Station=0.375	OutputCase=ENVE	CaseType=Combination	StepType=Min	Point=1	X2=-0.5	X3=-0.5		
S11=-1174.74766477975	IsS11Max=No	IsS11Min=Yes	FrameElem=47	ElemStation=0.375					
Frame=47	Station=0.375	OutputCase=ENVE	CaseType=Combination	StepType=Min	Point=2	X2=-0.5	X3=0.5		
S11=-1174.74766477975	IsS11Max=No	IsS11Min=No	FrameElem=47	ElemStation=0.375					
Frame=47	Station=0.375	OutputCase=ENVE	CaseType=Combination	StepType=Min	Point=3	X2=0.5	X3=-0.5		
S11=654.411361198108	IsS11Max=Yes	IsS11Min=No	FrameElem=47	ElemStation=0.375					
Frame=47	Station=0.375	OutputCase=ENVE	CaseType=Combination	StepType=Min	Point=4	X2=0.5	X3=0.5		
S11=654.411361198108	IsS11Max=No	IsS11Min=No	FrameElem=47	ElemStation=0.375					
Frame=47	Station=0.5	OutputCase=ENVE	CaseType=Combination	StepType=Min	Point=0	X2=0	X3=0	S11=-	
240.528987364652	IsS11Max=No	IsS11Min=No	FrameElem=47	ElemStation=0.5					
Frame=47	Station=0.5	OutputCase=ENVE	CaseType=Combination	StepType=Min	Point=1	X2=-0.5	X3=-0.5		
S11=-985.021736757416	IsS11Max=No	IsS11Min=Yes	FrameElem=47	ElemStation=0.5					
Frame=47	Station=0.5	OutputCase=ENVE	CaseType=Combination	StepType=Min	Point=2	X2=-0.5	X3=0.5		
S11=-985.021736757416	IsS11Max=No	IsS11Min=No	FrameElem=47	ElemStation=0.5					
Frame=47	Station=0.5	OutputCase=ENVE	CaseType=Combination	StepType=Min	Point=3	X2=0.5	X3=-0.5		
S11=469.61895874006	IsS11Max=Yes	IsS11Min=No	FrameElem=47	ElemStation=0.5					
Frame=47	Station=0.5	OutputCase=ENVE	CaseType=Combination	StepType=Min	Point=4	X2=0.5	X3=0.5		
S11=469.61895874006	IsS11Max=No	IsS11Min=No	FrameElem=47	ElemStation=0.5					
Frame=47	Station=0	OutputCase=FESSUR	CaseType=Combination	Point=0	X2=0	X3=0	S11=-239.15192283725		
IsS11Max=No	IsS11Min=No	FrameElem=47	ElemStation=0						
Frame=47	Station=0	OutputCase=FESSUR	CaseType=Combination	Point=1	X2=-0.5	X3=-0.5	S11=-		
1725.68517712253	IsS11Max=No	IsS11Min=Yes	FrameElem=47	ElemStation=0					
Frame=47	Station=0	OutputCase=FESSUR	CaseType=Combination	Point=2	X2=-0.5	X3=0.5	S11=-		
1725.68517712253	IsS11Max=No	IsS11Min=No	FrameElem=47	ElemStation=0					
Frame=47	Station=0	OutputCase=FESSUR	CaseType=Combination	Point=3	X2=0.5	X3=-0.5			
S11=1247.38133144803	IsS11Max=Yes	IsS11Min=No	FrameElem=47	ElemStation=0					
Frame=47	Station=0	OutputCase=FESSUR	CaseType=Combination	Point=4	X2=0.5	X3=0.5			
S11=1247.38133144803	IsS11Max=No	IsS11Min=No	FrameElem=47	ElemStation=0					
Frame=47	Station=0.125	OutputCase=FESSUR	CaseType=Combination	Point=0	X2=0	X3=0	S11=-		
239.15192283725	IsS11Max=No	IsS11Min=No	FrameElem=47	ElemStation=0.125					
Frame=47	Station=0.125	OutputCase=FESSUR	CaseType=Combination	Point=1	X2=-0.5	X3=-0.5	S11=-		
1530.34269896399	IsS11Max=No	IsS11Min=Yes	FrameElem=47	ElemStation=0.125					
Frame=47	Station=0.125	OutputCase=FESSUR	CaseType=Combination	Point=2	X2=-0.5	X3=0.5	S11=-		
1530.34269896399	IsS11Max=No	IsS11Min=No	FrameElem=47	ElemStation=0.125					
Frame=47	Station=0.125	OutputCase=FESSUR	CaseType=Combination	Point=3	X2=0.5	X3=-0.5			
S11=1052.03885328949	IsS11Max=Yes	IsS11Min=No	FrameElem=47	ElemStation=0.125					
Frame=47	Station=0.125	OutputCase=FESSUR	CaseType=Combination	Point=4	X2=0.5	X3=0.5			
S11=1052.03885328949	IsS11Max=No	IsS11Min=No	FrameElem=47	ElemStation=0.125					
Frame=47	Station=0.25	OutputCase=FESSUR	CaseType=Combination	Point=0	X2=0	X3=0	S11=-239.15192283725		
IsS11Max=No	IsS11Min=No	FrameElem=47	ElemStation=0.25						
Frame=47	Station=0.25	OutputCase=FESSUR	CaseType=Combination	Point=1	X2=-0.5	X3=-0.5	S11=-		
1337.34397080544	IsS11Max=No	IsS11Min=Yes	FrameElem=47	ElemStation=0.25					
Frame=47	Station=0.25	OutputCase=FESSUR	CaseType=Combination	Point=2	X2=-0.5	X3=0.5	S11=-		
1337.34397080544	IsS11Max=No	IsS11Min=No	FrameElem=47	ElemStation=0.25					
Frame=47	Station=0.25	OutputCase=FESSUR	CaseType=Combination	Point=3	X2=0.5	X3=-0.5			
S11=859.040125130942	IsS11Max=Yes	IsS11Min=No	FrameElem=47	ElemStation=0.25					
Frame=47	Station=0.25	OutputCase=FESSUR	CaseType=Combination	Point=4	X2=0.5	X3=0.5			
S11=859.040125130942	IsS11Max=No	IsS11Min=No	FrameElem=47	ElemStation=0.25					
Frame=47	Station=0.375	OutputCase=FESSUR	CaseType=Combination	Point=0	X2=0	X3=0	S11=-		
239.15192283725	IsS11Max=No	IsS11Min=No	FrameElem=47	ElemStation=0.375					
Frame=47	Station=0.375	OutputCase=FESSUR	CaseType=Combination	Point=1	X2=-0.5	X3=-0.5	S11=-		
1146.6889926469	IsS11Max=No	IsS11Min=Yes	FrameElem=47	ElemStation=0.375					
Frame=47	Station=0.375	OutputCase=FESSUR	CaseType=Combination	Point=2	X2=-0.5	X3=0.5	S11=-		
1146.6889926469	IsS11Max=No	IsS11Min=No	FrameElem=47	ElemStation=0.375					
Frame=47	Station=0.375	OutputCase=FESSUR	CaseType=Combination	Point=3	X2=0.5	X3=-0.5			
S11=668.385146972398	IsS11Max=Yes	IsS11Min=No	FrameElem=47	ElemStation=0.375					
Frame=47	Station=0.375	OutputCase=FESSUR	CaseType=Combination	Point=4	X2=0.5	X3=0.5			
S11=668.385146972398	IsS11Max=No	IsS11Min=No	FrameElem=47	ElemStation=0.375					
Frame=47	Station=0.5	OutputCase=FESSUR	CaseType=Combination	Point=0	X2=0	X3=0	S11=-239.15192283725		
IsS11Max=No	IsS11Min=No	FrameElem=47	ElemStation=0.5						
Frame=47	Station=0.5	OutputCase=FESSUR	CaseType=Combination	Point=1	X2=-0.5	X3=-0.5	S11=-		
958.377764488352	IsS11Max=No	IsS11Min=Yes	FrameElem=47	ElemStation=0.5					
Frame=47	Station=0.5	OutputCase=FESSUR	CaseType=Combination	Point=2	X2=-0.5	X3=0.5	S11=-		
958.377764488352	IsS11Max=No	IsS11Min=No	FrameElem=47	ElemStation=0.5					
Frame=47	Station=0.5	OutputCase=FESSUR	CaseType=Combination	Point=3	X2=0.5	X3=-0.5			
S11=480.073918813853	IsS11Max=Yes	IsS11Min=No	FrameElem=47	ElemStation=0.5					
Frame=47	Station=0.5	OutputCase=FESSUR	CaseType=Combination	Point=4	X2=0.5	X3=0.5			
S11=480.073918813853	IsS11Max=No	IsS11Min=No	FrameElem=47	ElemStation=0.5					
Frame=48	Station=0	OutputCase=PERM1	CaseType=Combination	Point=0	X2=0	X3=0	S11=-235.938772273311		
IsS11Max=No	IsS11Min=No	FrameElem=48	ElemStation=0						
Frame=48	Station=0	OutputCase=PERM1	CaseType=Combination	Point=1	X2=-0.5	X3=-0.5	S11=-		
941.49650328666	IsS11Max=No	IsS11Min=Yes	FrameElem=48	ElemStation=0					
Frame=48	Station=0	OutputCase=PERM1	CaseType=Combination	Point=2	X2=-0.5	X3=0.5	S11=-		
941.49650328666	IsS11Max=No	IsS11Min=No	FrameElem=48	ElemStation=0					
Frame=48	Station=0	OutputCase=PERM1	CaseType=Combination	Point=3	X2=0.5	X3=-0.5			
S11=469.618958740038	IsS11Max=Yes	IsS11Min=No	FrameElem=48	ElemStation=0					

Frame=48	Station=0	OutputCase=PERM1	CaseType=Combination	Point=4	X2=0.5	X3=0.5	S11=469.618958740038
IsS11Max=No	IsS11Min=No	FrameElem=48	ElemStation=0				
Frame=48	Station=0.125	OutputCase=PERM1	CaseType=Combination	Point=0	X2=0	X3=0	S11=-
235.938772273311	IsS11Max=No	IsS11Min=No	FrameElem=48	ElemStation=0.125			
Frame=48	Station=0.125	OutputCase=PERM1	CaseType=Combination	Point=1	X2=-0.5	X3=-0.5	S11=-
673.382680073736	IsS11Max=No	IsS11Min=Yes	FrameElem=48	ElemStation=0.125			
Frame=48	Station=0.125	OutputCase=PERM1	CaseType=Combination	Point=2	X2=-0.5	X3=0.5	S11=-
673.382680073736	IsS11Max=No	IsS11Min=No	FrameElem=48	ElemStation=0.125			
Frame=48	Station=0.125	OutputCase=PERM1	CaseType=Combination	Point=3	X2=0.5	X3=-0.5	
S11=201.505135527115	IsS11Max=Yes	IsS11Min=No	FrameElem=48	ElemStation=0.125			
Frame=48	Station=0.125	OutputCase=PERM1	CaseType=Combination	Point=4	X2=0.5	X3=0.5	
S11=201.505135527115	IsS11Max=No	IsS11Min=No	FrameElem=48	ElemStation=0.125			
Frame=48	Station=0.25	OutputCase=PERM1	CaseType=Combination	Point=0	X2=0	X3=0	S11=-235.938772273311
IsS11Max=No	IsS11Min=No	FrameElem=48	ElemStation=0.25				
Frame=48	Station=0.25	OutputCase=PERM1	CaseType=Combination	Point=1	X2=-0.5	X3=-0.5	S11=-
407.612606860813	IsS11Max=No	IsS11Min=Yes	FrameElem=48	ElemStation=0.25			
Frame=48	Station=0.25	OutputCase=PERM1	CaseType=Combination	Point=2	X2=-0.5	X3=0.5	S11=-
407.612606860813	IsS11Max=No	IsS11Min=No	FrameElem=48	ElemStation=0.25			
Frame=48	Station=0.25	OutputCase=PERM1	CaseType=Combination	Point=3	X2=0.5	X3=-0.5	S11=-
64.2649376858085	IsS11Max=Yes	IsS11Min=No	FrameElem=48	ElemStation=0.25			
Frame=48	Station=0.25	OutputCase=PERM1	CaseType=Combination	Point=4	X2=0.5	X3=0.5	S11=-
64.2649376858085	IsS11Max=No	IsS11Min=No	FrameElem=48	ElemStation=0.25			
Frame=48	Station=0.375	OutputCase=PERM1	CaseType=Combination	Point=0	X2=0	X3=0	S11=-
235.938772273311	IsS11Max=No	IsS11Min=No	FrameElem=48	ElemStation=0.375			
Frame=48	Station=0.375	OutputCase=PERM1	CaseType=Combination	Point=1	X2=-0.5	X3=-0.5	S11=-
144.18628364789	IsS11Max=Yes	IsS11Min=No	FrameElem=48	ElemStation=0.375			
Frame=48	Station=0.375	OutputCase=PERM1	CaseType=Combination	Point=2	X2=-0.5	X3=0.5	S11=-
144.18628364789	IsS11Max=No	IsS11Min=No	FrameElem=48	ElemStation=0.375			
Frame=48	Station=0.375	OutputCase=PERM1	CaseType=Combination	Point=3	X2=0.5	X3=-0.5	S11=-
327.691260898732	IsS11Max=No	IsS11Min=Yes	FrameElem=48	ElemStation=0.375			
Frame=48	Station=0.375	OutputCase=PERM1	CaseType=Combination	Point=4	X2=0.5	X3=0.5	S11=-
327.691260898732	IsS11Max=No	IsS11Min=No	FrameElem=48	ElemStation=0.375			
Frame=48	Station=0.5	OutputCase=PERM1	CaseType=Combination	Point=0	X2=0	X3=0	S11=-235.938772273311
IsS11Max=No	IsS11Min=No	FrameElem=48	ElemStation=0.5				
Frame=48	Station=0.5	OutputCase=PERM1	CaseType=Combination	Point=1	X2=-0.5	X3=-0.5	
S11=116.896289565034	IsS11Max=Yes	IsS11Min=No	FrameElem=48	ElemStation=0.5			
Frame=48	Station=0.5	OutputCase=PERM1	CaseType=Combination	Point=2	X2=-0.5	X3=0.5	
S11=116.896289565034	IsS11Max=No	IsS11Min=No	FrameElem=48	ElemStation=0.5			
Frame=48	Station=0.5	OutputCase=PERM1	CaseType=Combination	Point=3	X2=0.5	X3=-0.5	S11=-
588.773834111655	IsS11Max=No	IsS11Min=Yes	FrameElem=48	ElemStation=0.5			
Frame=48	Station=0.5	OutputCase=PERM1	CaseType=Combination	Point=4	X2=0.5	X3=0.5	S11=-
588.773834111655	IsS11Max=No	IsS11Min=No	FrameElem=48	ElemStation=0.5			
Frame=48	Station=0	OutputCase=PERM2	CaseType=Combination	Point=0	X2=0	X3=0	S11=-169.465538592141
IsS11Max=No	IsS11Min=No	FrameElem=48	ElemStation=0				
Frame=48	Station=0	OutputCase=PERM2	CaseType=Combination	Point=1	X2=-0.5	X3=-0.5	S11=-
960.905649326436	IsS11Max=No	IsS11Min=Yes	FrameElem=48	ElemStation=0			
Frame=48	Station=0	OutputCase=PERM2	CaseType=Combination	Point=2	X2=-0.5	X3=0.5	S11=-
960.905649326436	IsS11Max=No	IsS11Min=No	FrameElem=48	ElemStation=0			
Frame=48	Station=0	OutputCase=PERM2	CaseType=Combination	Point=3	X2=0.5	X3=-0.5	
S11=621.974572142154	IsS11Max=Yes	IsS11Min=No	FrameElem=48	ElemStation=0			
Frame=48	Station=0	OutputCase=PERM2	CaseType=Combination	Point=4	X2=0.5	X3=0.5	S11=621.974572142154
IsS11Max=No	IsS11Min=No	FrameElem=48	ElemStation=0				
Frame=48	Station=0.125	OutputCase=PERM2	CaseType=Combination	Point=0	X2=0	X3=0	S11=-
169.465538592141	IsS11Max=No	IsS11Min=No	FrameElem=48	ElemStation=0.125			
Frame=48	Station=0.125	OutputCase=PERM2	CaseType=Combination	Point=1	X2=-0.5	X3=-0.5	S11=-
692.882230184239	IsS11Max=No	IsS11Min=Yes	FrameElem=48	ElemStation=0.125			
Frame=48	Station=0.125	OutputCase=PERM2	CaseType=Combination	Point=2	X2=-0.5	X3=0.5	S11=-
692.882230184239	IsS11Max=No	IsS11Min=No	FrameElem=48	ElemStation=0.125			
Frame=48	Station=0.125	OutputCase=PERM2	CaseType=Combination	Point=3	X2=0.5	X3=-0.5	
S11=353.951152999958	IsS11Max=Yes	IsS11Min=No	FrameElem=48	ElemStation=0.125			
Frame=48	Station=0.125	OutputCase=PERM2	CaseType=Combination	Point=4	X2=0.5	X3=0.5	
S11=353.951152999958	IsS11Max=No	IsS11Min=No	FrameElem=48	ElemStation=0.125			
Frame=48	Station=0	OutputCase=PERM2	CaseType=Combination	Point=0	X2=0	X3=0	S11=-169.465538592141
IsS11Max=No	IsS11Min=No	FrameElem=48	ElemStation=0.25				
Frame=48	Station=0.25	OutputCase=PERM2	CaseType=Combination	Point=1	X2=-0.5	X3=-0.5	S11=-
427.202561042043	IsS11Max=No	IsS11Min=Yes	FrameElem=48	ElemStation=0.25			
Frame=48	Station=0.25	OutputCase=PERM2	CaseType=Combination	Point=2	X2=-0.5	X3=0.5	S11=-
427.202561042043	IsS11Max=No	IsS11Min=No	FrameElem=48	ElemStation=0.25			
Frame=48	Station=0.25	OutputCase=PERM2	CaseType=Combination	Point=3	X2=0.5	X3=-0.5	
S11=88.2714838577611	IsS11Max=Yes	IsS11Min=No	FrameElem=48	ElemStation=0.25			
Frame=48	Station=0.25	OutputCase=PERM2	CaseType=Combination	Point=4	X2=0.5	X3=0.5	
S11=88.2714838577611	IsS11Max=No	IsS11Min=No	FrameElem=48	ElemStation=0.25			
Frame=48	Station=0.375	OutputCase=PERM2	CaseType=Combination	Point=0	X2=0	X3=0	S11=-
169.465538592141	IsS11Max=No	IsS11Min=No	FrameElem=48	ElemStation=0.375			
Frame=48	Station=0.375	OutputCase=PERM2	CaseType=Combination	Point=1	X2=-0.5	X3=-0.5	S11=-
163.866641899846	IsS11Max=Yes	IsS11Min=No	FrameElem=48	ElemStation=0.375			
Frame=48	Station=0.375	OutputCase=PERM2	CaseType=Combination	Point=2	X2=-0.5	X3=0.5	S11=-
163.866641899846	IsS11Max=No	IsS11Min=No	FrameElem=48	ElemStation=0.375			
Frame=48	Station=0.375	OutputCase=PERM2	CaseType=Combination	Point=3	X2=0.5	X3=-0.5	S11=-
175.064435284435	IsS11Max=No	IsS11Min=Yes	FrameElem=48	ElemStation=0.375			
Frame=48	Station=0.375	OutputCase=PERM2	CaseType=Combination	Point=4	X2=0.5	X3=0.5	S11=-
175.064435284435	IsS11Max=No	IsS11Min=No	FrameElem=48	ElemStation=0.375			

Frame=48	Station=0.5	OutputCase=PERM2	CaseType=Combination	Point=0	X2=0	X3=0	S11=-169.465538592141
IsS11Max=No	IsS11Min=No	FrameElem=48	ElemStation=0.5				
Frame=48	Station=0.5	OutputCase=PERM2	CaseType=Combination	Point=1	X2=-0.5	X3=-0.5	
S11=97.1255272423504	IsS11Max=Yes	IsS11Min=No	FrameElem=48	ElemStation=0.5			
Frame=48	Station=0.5	OutputCase=PERM2	CaseType=Combination	Point=2	X2=-0.5	X3=0.5	
S11=97.1255272423504	IsS11Max=No	IsS11Min=No	FrameElem=48	ElemStation=0.5			
Frame=48	Station=0.5	OutputCase=PERM2	CaseType=Combination	Point=3	X2=0.5	X3=-0.5	S11=-
436.056604426632	IsS11Max=No	IsS11Min=Yes	FrameElem=48	ElemStation=0.5			
Frame=48	Station=0.5	OutputCase=PERM2	CaseType=Combination	Point=4	X2=0.5	X3=0.5	S11=-
436.056604426632	IsS11Max=No	IsS11Min=No	FrameElem=48	ElemStation=0.5			
Frame=48	Station=0	OutputCase=ACC1	CaseType=Combination	Point=0	X2=0	X3=0	S11=-240.528987364653
IsS11Max=No	IsS11Min=No	FrameElem=48	ElemStation=0				
Frame=48	Station=0	OutputCase=ACC1	CaseType=Combination	Point=1	X2=-0.5	X3=-0.5	S11=-
965.612590717619	IsS11Max=No	IsS11Min=Yes	FrameElem=48	ElemStation=0			
Frame=48	Station=0	OutputCase=ACC1	CaseType=Combination	Point=2	X2=-0.5	X3=0.5	S11=-
965.612590717619	IsS11Max=No	IsS11Min=No	FrameElem=48	ElemStation=0			
Frame=48	Station=0	OutputCase=ACC1	CaseType=Combination	Point=3	X2=0.5	X3=-0.5	S11=484.554615988314
IsS11Max=Yes	IsS11Min=No	FrameElem=48	ElemStation=0				
Frame=48	Station=0	OutputCase=ACC1	CaseType=Combination	Point=4	X2=0.5	X3=0.5	S11=484.554615988314
IsS11Max=No	IsS11Min=No	FrameElem=48	ElemStation=0				
Frame=48	Station=0.125	OutputCase=ACC1	CaseType=Combination	Point=0	X2=0	X3=0	S11=-240.528987364653
IsS11Max=No	IsS11Min=No	FrameElem=48	ElemStation=0.125				
Frame=48	Station=0.125	OutputCase=ACC1	CaseType=Combination	Point=1	X2=-0.5	X3=-0.5	S11=-
690.434936729812	IsS11Max=No	IsS11Min=Yes	FrameElem=48	ElemStation=0.125			
Frame=48	Station=0.125	OutputCase=ACC1	CaseType=Combination	Point=2	X2=-0.5	X3=0.5	S11=-
690.434936729812	IsS11Max=No	IsS11Min=No	FrameElem=48	ElemStation=0.125			
Frame=48	Station=0.125	OutputCase=ACC1	CaseType=Combination	Point=3	X2=0.5	X3=-0.5	
S11=209.376962000506	IsS11Max=Yes	IsS11Min=No	FrameElem=48	ElemStation=0.125			
Frame=48	Station=0.125	OutputCase=ACC1	CaseType=Combination	Point=4	X2=0.5	X3=0.5	
S11=209.376962000506	IsS11Max=No	IsS11Min=No	FrameElem=48	ElemStation=0.125			
Frame=48	Station=0.25	OutputCase=ACC1	CaseType=Combination	Point=0	X2=0	X3=0	S11=-240.528987364653
IsS11Max=No	IsS11Min=No	FrameElem=48	ElemStation=0.25				
Frame=48	Station=0.25	OutputCase=ACC1	CaseType=Combination	Point=1	X2=-0.5	X3=-0.5	S11=-
417.601032742004	IsS11Max=No	IsS11Min=Yes	FrameElem=48	ElemStation=0.25			
Frame=48	Station=0.25	OutputCase=ACC1	CaseType=Combination	Point=2	X2=-0.5	X3=0.5	S11=-
417.601032742004	IsS11Max=No	IsS11Min=No	FrameElem=48	ElemStation=0.25			
Frame=48	Station=0.25	OutputCase=ACC1	CaseType=Combination	Point=3	X2=0.5	X3=-0.5	S11=-
63.4569419873011	IsS11Max=Yes	IsS11Min=No	FrameElem=48	ElemStation=0.25			
Frame=48	Station=0.25	OutputCase=ACC1	CaseType=Combination	Point=4	X2=0.5	X3=0.5	S11=-
63.4569419873011	IsS11Max=No	IsS11Min=No	FrameElem=48	ElemStation=0.25			
Frame=48	Station=0.375	OutputCase=ACC1	CaseType=Combination	Point=0	X2=0	X3=0	S11=-240.528987364653
IsS11Max=No	IsS11Min=No	FrameElem=48	ElemStation=0.375				
Frame=48	Station=0.375	OutputCase=ACC1	CaseType=Combination	Point=1	X2=-0.5	X3=-0.5	S11=-
147.110878754197	IsS11Max=Yes	IsS11Min=No	FrameElem=48	ElemStation=0.375			
Frame=48	Station=0.375	OutputCase=ACC1	CaseType=Combination	Point=2	X2=-0.5	X3=0.5	S11=-
147.110878754197	IsS11Max=No	IsS11Min=No	FrameElem=48	ElemStation=0.375			
Frame=48	Station=0.375	OutputCase=ACC1	CaseType=Combination	Point=3	X2=0.5	X3=-0.5	S11=-
333.947095975108	IsS11Max=No	IsS11Min=Yes	FrameElem=48	ElemStation=0.375			
Frame=48	Station=0.375	OutputCase=ACC1	CaseType=Combination	Point=4	X2=0.5	X3=0.5	S11=-
333.947095975108	IsS11Max=No	IsS11Min=No	FrameElem=48	ElemStation=0.375			
Frame=48	Station=0.5	OutputCase=ACC1	CaseType=Combination	Point=0	X2=0	X3=0	S11=-240.528987364653
IsS11Max=No	IsS11Min=No	FrameElem=48	ElemStation=0.5				
Frame=48	Station=0.5	OutputCase=ACC1	CaseType=Combination	Point=1	X2=-0.5	X3=-0.5	
S11=121.03552523361	IsS11Max=Yes	IsS11Min=No	FrameElem=48	ElemStation=0.5			
Frame=48	Station=0.5	OutputCase=ACC1	CaseType=Combination	Point=2	X2=-0.5	X3=0.5	
S11=121.03552523361	IsS11Max=No	IsS11Min=No	FrameElem=48	ElemStation=0.5			
Frame=48	Station=0.5	OutputCase=ACC1	CaseType=Combination	Point=3	X2=0.5	X3=-0.5	S11=-
602.093499962916	IsS11Max=No	IsS11Min=Yes	FrameElem=48	ElemStation=0.5			
Frame=48	Station=0.5	OutputCase=ACC1	CaseType=Combination	Point=4	X2=0.5	X3=0.5	S11=-
602.093499962916	IsS11Max=No	IsS11Min=No	FrameElem=48	ElemStation=0.5			
Frame=48	Station=0	OutputCase=ACC2	CaseType=Combination	Point=0	X2=0	X3=0	S11=-174.055753683483
IsS11Max=No	IsS11Min=No	FrameElem=48	ElemStation=0				
Frame=48	Station=0	OutputCase=ACC2	CaseType=Combination	Point=1	X2=-0.5	X3=-0.5	S11=-
985.021736757395	IsS11Max=No	IsS11Min=Yes	FrameElem=48	ElemStation=0			
Frame=48	Station=0	OutputCase=ACC2	CaseType=Combination	Point=2	X2=-0.5	X3=0.5	S11=-
985.021736757395	IsS11Max=No	IsS11Min=No	FrameElem=48	ElemStation=0			
Frame=48	Station=0	OutputCase=ACC2	CaseType=Combination	Point=3	X2=0.5	X3=-0.5	S11=636.91022939043
IsS11Max=Yes	IsS11Min=No	FrameElem=48	ElemStation=0				
Frame=48	Station=0	OutputCase=ACC2	CaseType=Combination	Point=4	X2=0.5	X3=0.5	S11=636.91022939043
IsS11Max=No	IsS11Min=No	FrameElem=48	ElemStation=0				
Frame=48	Station=0.125	OutputCase=ACC2	CaseType=Combination	Point=0	X2=0	X3=0	S11=-174.055753683483
IsS11Max=No	IsS11Min=No	FrameElem=48	ElemStation=0.125				
Frame=48	Station=0.125	OutputCase=ACC2	CaseType=Combination	Point=1	X2=-0.5	X3=-0.5	S11=-
709.934486840314	IsS11Max=No	IsS11Min=Yes	FrameElem=48	ElemStation=0.125			
Frame=48	Station=0.125	OutputCase=ACC2	CaseType=Combination	Point=2	X2=-0.5	X3=0.5	S11=-
709.934486840314	IsS11Max=No	IsS11Min=No	FrameElem=48	ElemStation=0.125			
Frame=48	Station=0.125	OutputCase=ACC2	CaseType=Combination	Point=3	X2=0.5	X3=-0.5	
S11=361.822979473349	IsS11Max=Yes	IsS11Min=No	FrameElem=48	ElemStation=0.125			
Frame=48	Station=0.125	OutputCase=ACC2	CaseType=Combination	Point=4	X2=0.5	X3=0.5	
S11=361.822979473349	IsS11Max=No	IsS11Min=No	FrameElem=48	ElemStation=0.125			
Frame=48	Station=0.25	OutputCase=ACC2	CaseType=Combination	Point=0	X2=0	X3=0	S11=-174.055753683483
IsS11Max=No	IsS11Min=No	FrameElem=48	ElemStation=0.25				

Frame=48	Station=0.25	OutputCase=ACC2	CaseType=Combination	Point=1	X2=-0.5	X3=-0.5	S11=-
437.190986923234	IsS11Max=No	IsS11Min=Yes	FrameElem=48	ElemStation=0.25			
Frame=48	Station=0.25	OutputCase=ACC2	CaseType=Combination	Point=2	X2=-0.5	X3=0.5	S11=-
437.190986923234	IsS11Max=No	IsS11Min=No	FrameElem=48	ElemStation=0.25			
Frame=48	Station=0.25	OutputCase=ACC2	CaseType=Combination	Point=3	X2=0.5	X3=-0.5	
S11=89.0794795562686	IsS11Max=Yes	IsS11Min=No	FrameElem=48	ElemStation=0.25			
Frame=48	Station=0.25	OutputCase=ACC2	CaseType=Combination	Point=4	X2=0.5	X3=0.5	
S11=89.0794795562686	IsS11Max=No	IsS11Min=No	FrameElem=48	ElemStation=0.25			
Frame=48	Station=0.375	OutputCase=ACC2	CaseType=Combination	Point=0	X2=0	X3=0	S11=-174.055753683483
IsS11Max=No	IsS11Min=No	FrameElem=48	ElemStation=0.375				
Frame=48	Station=0.375	OutputCase=ACC2	CaseType=Combination	Point=1	X2=-0.5	X3=-0.5	S11=-
166.791237006153	IsS11Max=Yes	IsS11Min=No	FrameElem=48	ElemStation=0.375			
Frame=48	Station=0.375	OutputCase=ACC2	CaseType=Combination	Point=2	X2=-0.5	X3=0.5	S11=-
166.791237006153	IsS11Max=No	IsS11Min=No	FrameElem=48	ElemStation=0.375			
Frame=48	Station=0.375	OutputCase=ACC2	CaseType=Combination	Point=3	X2=0.5	X3=-0.5	S11=-
181.320270360812	IsS11Max=No	IsS11Min=Yes	FrameElem=48	ElemStation=0.375			
Frame=48	Station=0.375	OutputCase=ACC2	CaseType=Combination	Point=4	X2=0.5	X3=0.5	S11=-
181.320270360812	IsS11Max=No	IsS11Min=No	FrameElem=48	ElemStation=0.375			
Frame=48	Station=0.5	OutputCase=ACC2	CaseType=Combination	Point=0	X2=0	X3=0	S11=-174.055753683483
IsS11Max=No	IsS11Min=No	FrameElem=48	ElemStation=0.5				
Frame=48	Station=0.5	OutputCase=ACC2	CaseType=Combination	Point=1	X2=-0.5	X3=-0.5	
S11=101.264762910927	IsS11Max=Yes	IsS11Min=No	FrameElem=48	ElemStation=0.5			
Frame=48	Station=0.5	OutputCase=ACC2	CaseType=Combination	Point=2	X2=-0.5	X3=0.5	
S11=101.264762910927	IsS11Max=No	IsS11Min=No	FrameElem=48	ElemStation=0.5			
Frame=48	Station=0.5	OutputCase=ACC2	CaseType=Combination	Point=3	X2=0.5	X3=-0.5	S11=-
449.376270277892	IsS11Max=No	IsS11Min=Yes	FrameElem=48	ElemStation=0.5			
Frame=48	Station=0.5	OutputCase=ACC2	CaseType=Combination	Point=4	X2=0.5	X3=0.5	S11=-
449.376270277892	IsS11Max=No	IsS11Min=No	FrameElem=48	ElemStation=0.5			
Frame=48	Station=0	OutputCase=ACCSX1	CaseType=Combination	Point=0	X2=0	X3=0	S11=-233.665974282455
IsS11Max=No	IsS11Min=No	FrameElem=48	ElemStation=0				
Frame=48	Station=0	OutputCase=ACCSX1	CaseType=Combination	Point=1	X2=-0.5	X3=-0.5	S11=-
964.847416767674	IsS11Max=No	IsS11Min=Yes	FrameElem=48	ElemStation=0			
Frame=48	Station=0	OutputCase=ACCSX1	CaseType=Combination	Point=2	X2=-0.5	X3=0.5	S11=-
964.847416767674	IsS11Max=No	IsS11Min=No	FrameElem=48	ElemStation=0			
Frame=48	Station=0	OutputCase=ACCSX1	CaseType=Combination	Point=3	X2=0.5	X3=-0.5	
S11=497.515468202765	IsS11Max=Yes	IsS11Min=No	FrameElem=48	ElemStation=0			
Frame=48	Station=0	OutputCase=ACCSX1	CaseType=Combination	Point=4	X2=0.5	X3=0.5	
S11=497.515468202765	IsS11Max=No	IsS11Min=No	FrameElem=48	ElemStation=0			
Frame=48	Station=0.125	OutputCase=ACCSX1	CaseType=Combination	Point=0	X2=0	X3=0	S11=-
233.665974282455	IsS11Max=No	IsS11Min=No	FrameElem=48	ElemStation=0.125			
Frame=48	Station=0.125	OutputCase=ACCSX1	CaseType=Combination	Point=1	X2=-0.5	X3=-0.5	S11=-
697.725690925336	IsS11Max=No	IsS11Min=Yes	FrameElem=48	ElemStation=0.125			
Frame=48	Station=0.125	OutputCase=ACCSX1	CaseType=Combination	Point=2	X2=-0.5	X3=0.5	S11=-
697.725690925336	IsS11Max=No	IsS11Min=No	FrameElem=48	ElemStation=0.125			
Frame=48	Station=0.125	OutputCase=ACCSX1	CaseType=Combination	Point=3	X2=0.5	X3=-0.5	
S11=230.393742360426	IsS11Max=Yes	IsS11Min=No	FrameElem=48	ElemStation=0.125			
Frame=48	Station=0.125	OutputCase=ACCSX1	CaseType=Combination	Point=4	X2=0.5	X3=0.5	
S11=230.393742360426	IsS11Max=No	IsS11Min=No	FrameElem=48	ElemStation=0.125			
Frame=48	Station=0.25	OutputCase=ACCSX1	CaseType=Combination	Point=0	X2=0	X3=0	S11=-
233.665974282455	IsS11Max=No	IsS11Min=No	FrameElem=48	ElemStation=0.25			
Frame=48	Station=0.25	OutputCase=ACCSX1	CaseType=Combination	Point=1	X2=-0.5	X3=-0.5	S11=-
432.947715082998	IsS11Max=No	IsS11Min=Yes	FrameElem=48	ElemStation=0.25			
Frame=48	Station=0.25	OutputCase=ACCSX1	CaseType=Combination	Point=2	X2=-0.5	X3=0.5	S11=-
432.947715082998	IsS11Max=No	IsS11Min=No	FrameElem=48	ElemStation=0.25			
Frame=48	Station=0.25	OutputCase=ACCSX1	CaseType=Combination	Point=3	X2=0.5	X3=-0.5	S11=-
34.3842334819119	IsS11Max=Yes	IsS11Min=No	FrameElem=48	ElemStation=0.25			
Frame=48	Station=0.25	OutputCase=ACCSX1	CaseType=Combination	Point=4	X2=0.5	X3=0.5	S11=-
34.3842334819119	IsS11Max=No	IsS11Min=No	FrameElem=48	ElemStation=0.25			
Frame=48	Station=0.375	OutputCase=ACCSX1	CaseType=Combination	Point=0	X2=0	X3=0	S11=-
233.665974282455	IsS11Max=No	IsS11Min=No	FrameElem=48	ElemStation=0.375			
Frame=48	Station=0.375	OutputCase=ACCSX1	CaseType=Combination	Point=1	X2=-0.5	X3=-0.5	S11=-
170.513489240659	IsS11Max=Yes	IsS11Min=No	FrameElem=48	ElemStation=0.375			
Frame=48	Station=0.375	OutputCase=ACCSX1	CaseType=Combination	Point=2	X2=-0.5	X3=0.5	S11=-
170.513489240659	IsS11Max=No	IsS11Min=No	FrameElem=48	ElemStation=0.375			
Frame=48	Station=0.375	OutputCase=ACCSX1	CaseType=Combination	Point=3	X2=0.5	X3=-0.5	S11=-
296.81845932425	IsS11Max=No	IsS11Min=Yes	FrameElem=48	ElemStation=0.375			
Frame=48	Station=0.375	OutputCase=ACCSX1	CaseType=Combination	Point=4	X2=0.5	X3=0.5	S11=-
296.81845932425	IsS11Max=No	IsS11Min=No	FrameElem=48	ElemStation=0.375			
Frame=48	Station=0.5	OutputCase=ACCSX1	CaseType=Combination	Point=0	X2=0	X3=0	S11=-233.665974282455
IsS11Max=No	IsS11Min=No	FrameElem=48	ElemStation=0.5				
Frame=48	Station=0.5	OutputCase=ACCSX1	CaseType=Combination	Point=1	X2=-0.5	X3=-0.5	
S11=89.5769866016788	IsS11Max=Yes	IsS11Min=No	FrameElem=48	ElemStation=0.5			
Frame=48	Station=0.5	OutputCase=ACCSX1	CaseType=Combination	Point=2	X2=-0.5	X3=0.5	
S11=89.5769866016788	IsS11Max=No	IsS11Min=No	FrameElem=48	ElemStation=0.5			
Frame=48	Station=0.5	OutputCase=ACCSX1	CaseType=Combination	Point=3	X2=0.5	X3=-0.5	S11=-
556.908935166588	IsS11Max=No	IsS11Min=Yes	FrameElem=48	ElemStation=0.5			
Frame=48	Station=0.5	OutputCase=ACCSX1	CaseType=Combination	Point=4	X2=0.5	X3=0.5	S11=-
556.908935166588	IsS11Max=No	IsS11Min=No	FrameElem=48	ElemStation=0.5			
Frame=48	Station=0	OutputCase=ACCSX2	CaseType=Combination	Point=0	X2=0	X3=0	S11=-167.192740601285
IsS11Max=No	IsS11Min=No	FrameElem=48	ElemStation=0				
Frame=48	Station=0	OutputCase=ACCSX2	CaseType=Combination	Point=1	X2=-0.5	X3=-0.5	S11=-
984.25656280745	IsS11Max=No	IsS11Min=Yes	FrameElem=48	ElemStation=0			

Frame=48	Station=0	OutputCase=ACCSX2	CaseType=Combination	Point=2	X2=-0.5	X3=0.5	S11=-	
984.25656280745	IsS11Max=No	IsS11Min=No	FrameElem=48	ElemStation=0				
Frame=48	Station=0	OutputCase=ACCSX2	CaseType=Combination	Point=3	X2=0.5	X3=-0.5		
S11=649.871081604881	IsS11Max=Yes	IsS11Min=No	FrameElem=48	ElemStation=0				
Frame=48	Station=0	OutputCase=ACCSX2	CaseType=Combination	Point=4	X2=0.5	X3=0.5		
S11=649.871081604881	IsS11Max=No	IsS11Min=No	FrameElem=48	ElemStation=0				
Frame=48	Station=0.125	OutputCase=ACCSX2	CaseType=Combination	Point=0	X2=0	X3=0	S11=-	
167.192740601285	IsS11Max=No	IsS11Min=No	FrameElem=48	ElemStation=0.125				
Frame=48	Station=0.125	OutputCase=ACCSX2	CaseType=Combination	Point=1	X2=-0.5	X3=-0.5	S11=-	
717.225241035839	IsS11Max=No	IsS11Min=Yes	FrameElem=48	ElemStation=0.125				
Frame=48	Station=0.125	OutputCase=ACCSX2	CaseType=Combination	Point=2	X2=-0.5	X3=0.5	S11=-	
717.225241035839	IsS11Max=No	IsS11Min=No	FrameElem=48	ElemStation=0.125				
Frame=48	Station=0.125	OutputCase=ACCSX2	CaseType=Combination	Point=3	X2=0.5	X3=-0.5		
S11=382.839759833269	IsS11Max=Yes	IsS11Min=No	FrameElem=48	ElemStation=0.125				
Frame=48	Station=0.125	OutputCase=ACCSX2	CaseType=Combination	Point=4	X2=0.5	X3=0.5		
S11=382.839759833269	IsS11Max=No	IsS11Min=No	FrameElem=48	ElemStation=0.125				
Frame=48	Station=0.25	OutputCase=ACCSX2	CaseType=Combination	Point=0	X2=0	X3=0	S11=-	
167.192740601285	IsS11Max=No	IsS11Min=No	FrameElem=48	ElemStation=0.25				
Frame=48	Station=0.25	OutputCase=ACCSX2	CaseType=Combination	Point=1	X2=-0.5	X3=-0.5	S11=-	
452.537669264227	IsS11Max=No	IsS11Min=Yes	FrameElem=48	ElemStation=0.25				
Frame=48	Station=0.25	OutputCase=ACCSX2	CaseType=Combination	Point=2	X2=-0.5	X3=0.5	S11=-	
452.537669264227	IsS11Max=No	IsS11Min=No	FrameElem=48	ElemStation=0.25				
Frame=48	Station=0.25	OutputCase=ACCSX2	CaseType=Combination	Point=3	X2=0.5	X3=-0.5		
S11=118.152188061658	IsS11Max=Yes	IsS11Min=No	FrameElem=48	ElemStation=0.25				
Frame=48	Station=0.25	OutputCase=ACCSX2	CaseType=Combination	Point=4	X2=0.5	X3=0.5		
S11=118.152188061658	IsS11Max=No	IsS11Min=No	FrameElem=48	ElemStation=0.25				
Frame=48	Station=0.375	OutputCase=ACCSX2	CaseType=Combination	Point=0	X2=0	X3=0	S11=-	
167.192740601285	IsS11Max=No	IsS11Min=No	FrameElem=48	ElemStation=0.375				
Frame=48	Station=0.375	OutputCase=ACCSX2	CaseType=Combination	Point=1	X2=-0.5	X3=-0.5	S11=-	
190.193847492616	IsS11Max=No	IsS11Min=Yes	FrameElem=48	ElemStation=0.375				
Frame=48	Station=0.375	OutputCase=ACCSX2	CaseType=Combination	Point=2	X2=-0.5	X3=0.5	S11=-	
190.193847492616	IsS11Max=No	IsS11Min=No	FrameElem=48	ElemStation=0.375				
Frame=48	Station=0.375	OutputCase=ACCSX2	CaseType=Combination	Point=3	X2=0.5	X3=-0.5	S11=-	
144.191633709954	IsS11Max=Yes	IsS11Min=No	FrameElem=48	ElemStation=0.375				
Frame=48	Station=0.375	OutputCase=ACCSX2	CaseType=Combination	Point=4	X2=0.5	X3=0.5	S11=-	
144.191633709954	IsS11Max=No	IsS11Min=No	FrameElem=48	ElemStation=0.375				
Frame=48	Station=0.5	OutputCase=ACCSX2	CaseType=Combination	Point=0	X2=0	X3=0	S11=-167.192740601285	
IsS11Max=No	IsS11Min=No	FrameElem=48	ElemStation=0.5					
Frame=48	Station=0.5	OutputCase=ACCSX2	CaseType=Combination	Point=1	X2=-0.5	X3=-0.5		
S11=69.8062242789956	IsS11Max=Yes	IsS11Min=No	FrameElem=48	ElemStation=0.5				
Frame=48	Station=0.5	OutputCase=ACCSX2	CaseType=Combination	Point=2	X2=-0.5	X3=0.5		
S11=69.8062242789956	IsS11Max=No	IsS11Min=No	FrameElem=48	ElemStation=0.5				
Frame=48	Station=0.5	OutputCase=ACCSX2	CaseType=Combination	Point=3	X2=0.5	X3=-0.5	S11=-	
404.191705481565	IsS11Max=No	IsS11Min=Yes	FrameElem=48	ElemStation=0.5				
Frame=48	Station=0.5	OutputCase=ACCSX2	CaseType=Combination	Point=4	X2=0.5	X3=0.5	S11=-	
404.191705481565	IsS11Max=No	IsS11Min=No	FrameElem=48	ElemStation=0.5				
Frame=48	Station=0	OutputCase=ENVE	CaseType=Combination	StepType=Max	Point=0	X2=0	X3=0	S11=-
167.192740601285	IsS11Max=No	IsS11Min=No	FrameElem=48	ElemStation=0				
Frame=48	Station=0	OutputCase=ENVE	CaseType=Combination	StepType=Max	Point=1	X2=-0.5	X3=-0.5	
S11=-941.49650328666	IsS11Max=No	IsS11Min=Yes	FrameElem=48	ElemStation=0				
Frame=48	Station=0	OutputCase=ENVE	CaseType=Combination	StepType=Max	Point=2	X2=-0.5	X3=0.5	S11=-
941.49650328666	IsS11Max=No	IsS11Min=No	FrameElem=48	ElemStation=0				
Frame=48	Station=0	OutputCase=ENVE	CaseType=Combination	StepType=Max	Point=3	X2=0.5	X3=-0.5	
S11=649.871081604881	IsS11Max=Yes	IsS11Min=No	FrameElem=48	ElemStation=0				
Frame=48	Station=0	OutputCase=ENVE	CaseType=Combination	StepType=Max	Point=4	X2=0.5	X3=0.5	
S11=649.871081604881	IsS11Max=No	IsS11Min=No	FrameElem=48	ElemStation=0				
Frame=48	Station=0.125	OutputCase=ENVE	CaseType=Combination	StepType=Max	Point=0	X2=0	X3=0	S11=-
167.192740601285	IsS11Max=No	IsS11Min=No	FrameElem=48	ElemStation=0.125				
Frame=48	Station=0.125	OutputCase=ENVE	CaseType=Combination	StepType=Max	Point=1	X2=-0.5	X3=-0.5	
S11=-673.382680073736	IsS11Max=No	IsS11Min=Yes	FrameElem=48	ElemStation=0.125				
Frame=48	Station=0.125	OutputCase=ENVE	CaseType=Combination	StepType=Max	Point=2	X2=-0.5	X3=0.5	
S11=-673.382680073736	IsS11Max=No	IsS11Min=No	FrameElem=48	ElemStation=0.125				
Frame=48	Station=0.125	OutputCase=ENVE	CaseType=Combination	StepType=Max	Point=3	X2=0.5	X3=-0.5	
S11=382.839759833269	IsS11Max=Yes	IsS11Min=No	FrameElem=48	ElemStation=0.125				
Frame=48	Station=0.125	OutputCase=ENVE	CaseType=Combination	StepType=Max	Point=4	X2=0.5	X3=0.5	
S11=382.839759833269	IsS11Max=No	IsS11Min=No	FrameElem=48	ElemStation=0.125				
Frame=48	Station=0.25	OutputCase=ENVE	CaseType=Combination	StepType=Max	Point=0	X2=0	X3=0	S11=-
167.192740601285	IsS11Max=No	IsS11Min=No	FrameElem=48	ElemStation=0.25				
Frame=48	Station=0.25	OutputCase=ENVE	CaseType=Combination	StepType=Max	Point=1	X2=-0.5	X3=-0.5	
S11=-407.612606860813	IsS11Max=No	IsS11Min=Yes	FrameElem=48	ElemStation=0.25				
Frame=48	Station=0.25	OutputCase=ENVE	CaseType=Combination	StepType=Max	Point=2	X2=-0.5	X3=0.5	
S11=-407.612606860813	IsS11Max=No	IsS11Min=No	FrameElem=48	ElemStation=0.25				
Frame=48	Station=0.25	OutputCase=ENVE	CaseType=Combination	StepType=Max	Point=3	X2=0.5	X3=-0.5	
S11=118.152188061658	IsS11Max=Yes	IsS11Min=No	FrameElem=48	ElemStation=0.25				
Frame=48	Station=0.25	OutputCase=ENVE	CaseType=Combination	StepType=Max	Point=4	X2=0.5	X3=0.5	
S11=118.152188061658	IsS11Max=No	IsS11Min=No	FrameElem=48	ElemStation=0.25				
Frame=48	Station=0.375	OutputCase=ENVE	CaseType=Combination	StepType=Max	Point=0	X2=0	X3=0	S11=-
167.192740601285	IsS11Max=No	IsS11Min=Yes	FrameElem=48	ElemStation=0.375				
Frame=48	Station=0.375	OutputCase=ENVE	CaseType=Combination	StepType=Max	Point=1	X2=-0.5	X3=-0.5	
S11=-144.18628364789	IsS11Max=Yes	IsS11Min=No	FrameElem=48	ElemStation=0.375				
Frame=48	Station=0.375	OutputCase=ENVE	CaseType=Combination	StepType=Max	Point=2	X2=-0.5	X3=0.5	
S11=-144.18628364789	IsS11Max=No	IsS11Min=No	FrameElem=48	ElemStation=0.375				

Frame=48	Station=0.375	OutputCase=ENVE	CaseType=Combination	StepType=Max	Point=3	X2=0.5	X3=-0.5	
S11=-144.191633709954	IsS11Max=No	IsS11Min=No	FrameElem=48	ElemStation=0.375				
Frame=48	Station=0.375	OutputCase=ENVE	CaseType=Combination	StepType=Max	Point=4	X2=0.5	X3=0.5	
S11=-144.191633709954	IsS11Max=No	IsS11Min=No	FrameElem=48	ElemStation=0.375				
Frame=48	Station=0.5	OutputCase=ENVE	CaseType=Combination	StepType=Max	Point=0	X2=0	X3=0	S11=-
167.192740601285	IsS11Max=No	IsS11Min=No	FrameElem=48	ElemStation=0.5				
Frame=48	Station=0.5	OutputCase=ENVE	CaseType=Combination	StepType=Max	Point=1	X2=-0.5	X3=-0.5	
S11=121.03552523361	IsS11Max=Yes	IsS11Min=No	FrameElem=48	ElemStation=0.5				
Frame=48	Station=0.5	OutputCase=ENVE	CaseType=Combination	StepType=Max	Point=2	X2=-0.5	X3=0.5	
S11=121.03552523361	IsS11Max=No	IsS11Min=No	FrameElem=48	ElemStation=0.5				
Frame=48	Station=0.5	OutputCase=ENVE	CaseType=Combination	StepType=Max	Point=3	X2=0.5	X3=-0.5	
S11=-404.191705481565	IsS11Max=No	IsS11Min=Yes	FrameElem=48	ElemStation=0.5				
Frame=48	Station=0.5	OutputCase=ENVE	CaseType=Combination	StepType=Max	Point=4	X2=0.5	X3=0.5	
S11=-404.191705481565	IsS11Max=No	IsS11Min=No	FrameElem=48	ElemStation=0.5				
Frame=48	Station=0	OutputCase=ENVE	CaseType=Combination	StepType=Min	Point=0	X2=0	X3=0	S11=-
240.528987364653	IsS11Max=No	IsS11Min=No	FrameElem=48	ElemStation=0				
Frame=48	Station=0	OutputCase=ENVE	CaseType=Combination	StepType=Min	Point=1	X2=-0.5	X3=-0.5	
S11=-985.021736757395	IsS11Max=No	IsS11Min=Yes	FrameElem=48	ElemStation=0				
Frame=48	Station=0	OutputCase=ENVE	CaseType=Combination	StepType=Min	Point=2	X2=-0.5	X3=0.5	S11=-
985.021736757395	IsS11Max=No	IsS11Min=No	FrameElem=48	ElemStation=0				
Frame=48	Station=0	OutputCase=ENVE	CaseType=Combination	StepType=Min	Point=3	X2=0.5	X3=-0.5	
S11=469.618958740038	IsS11Max=Yes	IsS11Min=No	FrameElem=48	ElemStation=0				
Frame=48	Station=0	OutputCase=ENVE	CaseType=Combination	StepType=Min	Point=4	X2=0.5	X3=0.5	
S11=469.618958740038	IsS11Max=No	IsS11Min=No	FrameElem=48	ElemStation=0				
Frame=48	Station=0.125	OutputCase=ENVE	CaseType=Combination	StepType=Min	Point=0	X2=0	X3=0	S11=-
240.528987364653	IsS11Max=No	IsS11Min=No	FrameElem=48	ElemStation=0.125				
Frame=48	Station=0.125	OutputCase=ENVE	CaseType=Combination	StepType=Min	Point=1	X2=-0.5	X3=-0.5	
S11=-717.225241035839	IsS11Max=No	IsS11Min=Yes	FrameElem=48	ElemStation=0.125				
Frame=48	Station=0.125	OutputCase=ENVE	CaseType=Combination	StepType=Min	Point=2	X2=-0.5	X3=0.5	
S11=-717.225241035839	IsS11Max=No	IsS11Min=No	FrameElem=48	ElemStation=0.125				
Frame=48	Station=0.125	OutputCase=ENVE	CaseType=Combination	StepType=Min	Point=3	X2=0.5	X3=-0.5	
S11=201.505135527115	IsS11Max=Yes	IsS11Min=No	FrameElem=48	ElemStation=0.125				
Frame=48	Station=0.125	OutputCase=ENVE	CaseType=Combination	StepType=Min	Point=4	X2=0.5	X3=0.5	
S11=201.505135527115	IsS11Max=No	IsS11Min=No	FrameElem=48	ElemStation=0.125				
Frame=48	Station=0.25	OutputCase=ENVE	CaseType=Combination	StepType=Min	Point=0	X2=0	X3=0	S11=-
240.528987364653	IsS11Max=No	IsS11Min=No	FrameElem=48	ElemStation=0.25				
Frame=48	Station=0.25	OutputCase=ENVE	CaseType=Combination	StepType=Min	Point=1	X2=-0.5	X3=-0.5	
S11=-452.537669264227	IsS11Max=No	IsS11Min=Yes	FrameElem=48	ElemStation=0.25				
Frame=48	Station=0.25	OutputCase=ENVE	CaseType=Combination	StepType=Min	Point=2	X2=-0.5	X3=0.5	
S11=-452.537669264227	IsS11Max=No	IsS11Min=No	FrameElem=48	ElemStation=0.25				
Frame=48	Station=0.25	OutputCase=ENVE	CaseType=Combination	StepType=Min	Point=3	X2=0.5	X3=-0.5	
S11=-64.2649376858085	IsS11Max=Yes	IsS11Min=No	FrameElem=48	ElemStation=0.25				
Frame=48	Station=0.25	OutputCase=ENVE	CaseType=Combination	StepType=Min	Point=4	X2=0.5	X3=0.5	
S11=-64.2649376858085	IsS11Max=No	IsS11Min=No	FrameElem=48	ElemStation=0.25				
Frame=48	Station=0.375	OutputCase=ENVE	CaseType=Combination	StepType=Min	Point=0	X2=0	X3=0	S11=-
240.528987364653	IsS11Max=No	IsS11Min=No	FrameElem=48	ElemStation=0.375				
Frame=48	Station=0.375	OutputCase=ENVE	CaseType=Combination	StepType=Min	Point=1	X2=-0.5	X3=-0.5	
S11=-190.193847492616	IsS11Max=Yes	IsS11Min=No	FrameElem=48	ElemStation=0.375				
Frame=48	Station=0.375	OutputCase=ENVE	CaseType=Combination	StepType=Min	Point=2	X2=-0.5	X3=0.5	
S11=-190.193847492616	IsS11Max=No	IsS11Min=No	FrameElem=48	ElemStation=0.375				
Frame=48	Station=0.375	OutputCase=ENVE	CaseType=Combination	StepType=Min	Point=3	X2=0.5	X3=-0.5	
S11=-333.947095975108	IsS11Max=No	IsS11Min=Yes	FrameElem=48	ElemStation=0.375				
Frame=48	Station=0.375	OutputCase=ENVE	CaseType=Combination	StepType=Min	Point=4	X2=0.5	X3=0.5	
S11=-333.947095975108	IsS11Max=No	IsS11Min=No	FrameElem=48	ElemStation=0.375				
Frame=48	Station=0.5	OutputCase=ENVE	CaseType=Combination	StepType=Min	Point=0	X2=0	X3=0	S11=-
240.528987364653	IsS11Max=No	IsS11Min=No	FrameElem=48	ElemStation=0.5				
Frame=48	Station=0.5	OutputCase=ENVE	CaseType=Combination	StepType=Min	Point=1	X2=-0.5	X3=-0.5	
S11=69.8062242789956	IsS11Max=Yes	IsS11Min=No	FrameElem=48	ElemStation=0.5				
Frame=48	Station=0.5	OutputCase=ENVE	CaseType=Combination	StepType=Min	Point=2	X2=-0.5	X3=0.5	
S11=69.8062242789956	IsS11Max=No	IsS11Min=No	FrameElem=48	ElemStation=0.5				
Frame=48	Station=0.5	OutputCase=ENVE	CaseType=Combination	StepType=Min	Point=3	X2=0.5	X3=-0.5	
S11=-602.093499962916	IsS11Max=No	IsS11Min=Yes	FrameElem=48	ElemStation=0.5				
Frame=48	Station=0.5	OutputCase=ENVE	CaseType=Combination	StepType=Min	Point=4	X2=0.5	X3=0.5	
S11=-602.093499962916	IsS11Max=No	IsS11Min=No	FrameElem=48	ElemStation=0.5				
Frame=48	Station=0	OutputCase=FESSUR	CaseType=Combination	Point=0	X2=0	X3=0	S11=-239.15192283725	
IsS11Max=No	IsS11Min=No	FrameElem=48	ElemStation=0					
Frame=48	Station=0	OutputCase=FESSUR	CaseType=Combination	Point=1	X2=-0.5	X3=-0.5	S11=-	
958.377764488331	IsS11Max=No	IsS11Min=Yes	FrameElem=48	ElemStation=0				
Frame=48	Station=0	OutputCase=FESSUR	CaseType=Combination	Point=2	X2=-0.5	X3=0.5	S11=-	
958.377764488331	IsS11Max=No	IsS11Min=No	FrameElem=48	ElemStation=0				
Frame=48	Station=0	OutputCase=FESSUR	CaseType=Combination	Point=3	X2=0.5	X3=-0.5		
S11=480.073918813831	IsS11Max=Yes	IsS11Min=No	FrameElem=48	ElemStation=0				
Frame=48	Station=0	OutputCase=FESSUR	CaseType=Combination	Point=4	X2=0.5	X3=0.5		
S11=480.073918813831	IsS11Max=No	IsS11Min=No	FrameElem=48	ElemStation=0				
Frame=48	Station=0.125	OutputCase=FESSUR	CaseType=Combination	Point=0	X2=0	X3=0	S11=-	
239.15192283725	IsS11Max=No	IsS11Min=No	FrameElem=48	ElemStation=0.125				
Frame=48	Station=0.125	OutputCase=FESSUR	CaseType=Combination	Point=1	X2=-0.5	X3=-0.5	S11=-	
685.319259732989	IsS11Max=No	IsS11Min=Yes	FrameElem=48	ElemStation=0.125				
Frame=48	Station=0.125	OutputCase=FESSUR	CaseType=Combination	Point=2	X2=-0.5	X3=0.5	S11=-	
685.319259732989	IsS11Max=No	IsS11Min=No	FrameElem=48	ElemStation=0.125				
Frame=48	Station=0.125	OutputCase=FESSUR	CaseType=Combination	Point=3	X2=0.5	X3=-0.5		
S11=207.015414058489	IsS11Max=Yes	IsS11Min=No	FrameElem=48	ElemStation=0.125				



Frame=48 Station=0.125 OutputCase=FESSUR CaseType=Combination Point=4 X2=0.5 X3=0.5
 S11=207.015414058489 IsS11Max=No IsS11Min=No FrameElem=48 ElemStation=0.125
 Frame=48 Station=0.25 OutputCase=FESSUR CaseType=Combination Point=0 X2=0 X3=0 S11=-239.15192283725
 IsS11Max=No IsS11Min=No FrameElem=48 ElemStation=0.25
 Frame=48 Station=0.25 OutputCase=FESSUR CaseType=Combination Point=1 X2=-0.5 X3=-0.5 S11=-
 414.604504977647 IsS11Max=No IsS11Min=Yes FrameElem=48 ElemStation=0.25
 Frame=48 Station=0.25 OutputCase=FESSUR CaseType=Combination Point=2 X2=-0.5 X3=0.5 S11=-
 414.604504977647 IsS11Max=No IsS11Min=No FrameElem=48 ElemStation=0.25
 Frame=48 Station=0.25 OutputCase=FESSUR CaseType=Combination Point=3 X2=0.5 X3=-0.5 S11=-
 63.6993406968533 IsS11Max=Yes IsS11Min=No FrameElem=48 ElemStation=0.25
 Frame=48 Station=0.25 OutputCase=FESSUR CaseType=Combination Point=4 X2=0.5 X3=0.5 S11=-
 63.6993406968533 IsS11Max=No IsS11Min=No FrameElem=48 ElemStation=0.25
 Frame=48 Station=0.375 OutputCase=FESSUR CaseType=Combination Point=0 X2=0 X3=0 S11=-
 239.15192283725 IsS11Max=No IsS11Min=No FrameElem=48 ElemStation=0.375
 Frame=48 Station=0.375 OutputCase=FESSUR CaseType=Combination Point=1 X2=-0.5 X3=-0.5 S11=-
 146.233500222305 IsS11Max=Yes IsS11Min=No FrameElem=48 ElemStation=0.375
 Frame=48 Station=0.375 OutputCase=FESSUR CaseType=Combination Point=2 X2=-0.5 X3=0.5 S11=-
 146.233500222305 IsS11Max=No IsS11Min=No FrameElem=48 ElemStation=0.375
 Frame=48 Station=0.375 OutputCase=FESSUR CaseType=Combination Point=3 X2=0.5 X3=-0.5 S11=-
 332.070345452195 IsS11Max=No IsS11Min=Yes FrameElem=48 ElemStation=0.375
 Frame=48 Station=0.375 OutputCase=FESSUR CaseType=Combination Point=4 X2=0.5 X3=0.5 S11=-
 332.070345452195 IsS11Max=No IsS11Min=No FrameElem=48 ElemStation=0.375
 Frame=48 Station=0.5 OutputCase=FESSUR CaseType=Combination Point=0 X2=0 X3=0 S11=-239.15192283725
 IsS11Max=No IsS11Min=No FrameElem=48 ElemStation=0.5
 Frame=48 Station=0.5 OutputCase=FESSUR CaseType=Combination Point=1 X2=-0.5 X3=-0.5
 S11=119.793754533037 IsS11Max=Yes IsS11Min=No FrameElem=48 ElemStation=0.5
 Frame=48 Station=0.5 OutputCase=FESSUR CaseType=Combination Point=2 X2=-0.5 X3=0.5
 S11=119.793754533037 IsS11Max=No IsS11Min=No FrameElem=48 ElemStation=0.5
 Frame=48 Station=0.5 OutputCase=FESSUR CaseType=Combination Point=3 X2=0.5 X3=-0.5 S11=-
 598.097600207537 IsS11Max=No IsS11Min=Yes FrameElem=48 ElemStation=0.5
 Frame=48 Station=0.5 OutputCase=FESSUR CaseType=Combination Point=4 X2=0.5 X3=0.5 S11=-
 598.097600207537 IsS11Max=No IsS11Min=No FrameElem=48 ElemStation=0.5
 Frame=74 Station=0 OutputCase=PERM1 CaseType=Combination Point=0 X2=0 X3=0 S11=-164.891225815415
 IsS11Max=No IsS11Min=No FrameElem=74 ElemStation=0
 Frame=74 Station=0 OutputCase=PERM1 CaseType=Combination Point=1 X2=-0.5 X3=-0.5 S11=-
 1535.45808826844 IsS11Max=No IsS11Min=Yes FrameElem=74 ElemStation=0
 Frame=74 Station=0 OutputCase=PERM1 CaseType=Combination Point=2 X2=-0.5 X3=0.5 S11=-
 1535.45808826844 IsS11Max=No IsS11Min=No FrameElem=74 ElemStation=0
 Frame=74 Station=0 OutputCase=PERM1 CaseType=Combination Point=3 X2=0.5 X3=-0.5
 S11=1205.67563663761 IsS11Max=Yes IsS11Min=No FrameElem=74 ElemStation=0
 Frame=74 Station=0 OutputCase=PERM1 CaseType=Combination Point=4 X2=0.5 X3=0.5 S11=1205.67563663761
 IsS11Max=No IsS11Min=No FrameElem=74 ElemStation=0
 Frame=74 Station=6.24999940395355E-02 OutputCase=PERM1 CaseType=Combination Point=0 X2=0 X3=0 S11=-
 164.891225815415 IsS11Max=No IsS11Min=No FrameElem=74 ElemStation=6.24999940395355E-02
 Frame=74 Station=6.24999940395355E-02 OutputCase=PERM1 CaseType=Combination Point=1 X2=-0.5 X3=-0.5
 S11=-1384.55576058353 IsS11Max=No IsS11Min=Yes FrameElem=74 ElemStation=6.24999940395355E-02
 Frame=74 Station=6.24999940395355E-02 OutputCase=PERM1 CaseType=Combination Point=2 X2=-0.5 X3=0.5
 S11=-1384.55576058353 IsS11Max=No IsS11Min=No FrameElem=74 ElemStation=6.24999940395355E-02
 Frame=74 Station=6.24999940395355E-02 OutputCase=PERM1 CaseType=Combination Point=3 X2=0.5 X3=-0.5
 S11=1054.7733089527 IsS11Max=Yes IsS11Min=No FrameElem=74 ElemStation=6.24999940395355E-02
 Frame=74 Station=6.24999940395355E-02 OutputCase=PERM1 CaseType=Combination Point=4 X2=0.5 X3=0.5
 S11=1054.7733089527 IsS11Max=No IsS11Min=No FrameElem=74 ElemStation=6.24999940395355E-02
 Frame=74 Station=0.124999988079071 OutputCase=PERM1 CaseType=Combination Point=0 X2=0 X3=0 S11=-
 164.891225815415 IsS11Max=No IsS11Min=No FrameElem=74 ElemStation=0.124999988079071
 Frame=74 Station=0.124999988079071 OutputCase=PERM1 CaseType=Combination Point=1 X2=-0.5 X3=-0.5
 S11=-1237.47374466996 IsS11Max=No IsS11Min=Yes FrameElem=74 ElemStation=0.124999988079071
 Frame=74 Station=0.124999988079071 OutputCase=PERM1 CaseType=Combination Point=2 X2=-0.5 X3=0.5
 S11=-1237.47374466996 IsS11Max=No IsS11Min=No FrameElem=74 ElemStation=0.124999988079071
 Frame=74 Station=0.124999988079071 OutputCase=PERM1 CaseType=Combination Point=3 X2=0.5 X3=-0.5
 S11=907.691293039128 IsS11Max=Yes IsS11Min=No FrameElem=74 ElemStation=0.124999988079071
 Frame=74 Station=0.124999988079071 OutputCase=PERM1 CaseType=Combination Point=4 X2=0.5 X3=0.5
 S11=907.691293039128 IsS11Max=No IsS11Min=No FrameElem=74 ElemStation=0.124999988079071
 Frame=74 Station=0.187499982118607 OutputCase=PERM1 CaseType=Combination Point=0 X2=0 X3=0 S11=-
 164.891225815415 IsS11Max=No IsS11Min=No FrameElem=74 ElemStation=0.187499982118607
 Frame=74 Station=0.187499982118607 OutputCase=PERM1 CaseType=Combination Point=1 X2=-0.5 X3=-0.5
 S11=-1094.21204052772 IsS11Max=No IsS11Min=Yes FrameElem=74 ElemStation=0.187499982118607
 Frame=74 Station=0.187499982118607 OutputCase=PERM1 CaseType=Combination Point=2 X2=-0.5 X3=0.5
 S11=-1094.21204052772 IsS11Max=No IsS11Min=No FrameElem=74 ElemStation=0.187499982118607
 Frame=74 Station=0.187499982118607 OutputCase=PERM1 CaseType=Combination Point=3 X2=0.5 X3=-0.5
 S11=764.429588896886 IsS11Max=Yes IsS11Min=No FrameElem=74 ElemStation=0.187499982118607
 Frame=74 Station=0.187499982118607 OutputCase=PERM1 CaseType=Combination Point=4 X2=0.5 X3=0.5
 S11=764.429588896886 IsS11Max=No IsS11Min=No FrameElem=74 ElemStation=0.187499982118607
 Frame=74 Station=0.249999976158142 OutputCase=PERM1 CaseType=Combination Point=0 X2=0 X3=0 S11=-
 164.891225815415 IsS11Max=No IsS11Min=No FrameElem=74 ElemStation=0.249999976158142
 Frame=74 Station=0.249999976158142 OutputCase=PERM1 CaseType=Combination Point=1 X2=-0.5 X3=-0.5
 S11=-954.770648156808 IsS11Max=No IsS11Min=Yes FrameElem=74 ElemStation=0.249999976158142
 Frame=74 Station=0.249999976158142 OutputCase=PERM1 CaseType=Combination Point=2 X2=-0.5 X3=0.5
 S11=-954.770648156808 IsS11Max=No IsS11Min=No FrameElem=74 ElemStation=0.249999976158142
 Frame=74 Station=0.249999976158142 OutputCase=PERM1 CaseType=Combination Point=3 X2=0.5 X3=-0.5
 S11=624.988196525978 IsS11Max=Yes IsS11Min=No FrameElem=74 ElemStation=0.249999976158142
 Frame=74 Station=0.249999976158142 OutputCase=PERM1 CaseType=Combination Point=4 X2=0.5 X3=0.5
 S11=624.988196525978 IsS11Max=No IsS11Min=No FrameElem=74 ElemStation=0.249999976158142



Frame=74	Station=0	OutputCase=PERM2	CaseType=Combination	Point=0	X2=0	X3=0	S11=-111.11546006997
IsS11Max=No	IsS11Min=No	FrameElem=74	ElemStation=0				
Frame=74	Station=0	OutputCase=PERM2	CaseType=Combination	Point=1	X2=-0.5	X3=-0.5	S11=-
1396.69646828464	IsS11Max=No	IsS11Min=Yes	FrameElem=74	ElemStation=0			
Frame=74	Station=0	OutputCase=PERM2	CaseType=Combination	Point=2	X2=-0.5	X3=0.5	S11=-
1396.69646828464	IsS11Max=No	IsS11Min=No	FrameElem=74	ElemStation=0			
Frame=74	Station=0	OutputCase=PERM2	CaseType=Combination	Point=3	X2=0.5	X3=-0.5	S11=1174.4655481447
IsS11Max=Yes	IsS11Min=No	FrameElem=74	ElemStation=0				
Frame=74	Station=0	OutputCase=PERM2	CaseType=Combination	Point=4	X2=0.5	X3=0.5	S11=1174.4655481447
IsS11Max=No	IsS11Min=No	FrameElem=74	ElemStation=0				
Frame=74	Station=6.24999940395355E-02	OutputCase=PERM2	CaseType=Combination	Point=0	X2=0	X3=0	S11=-
111.11546006997	IsS11Max=No	IsS11Min=No	FrameElem=74	ElemStation=6.24999940395355E-02			
Frame=74	Station=6.24999940395355E-02	OutputCase=PERM2	CaseType=Combination	Point=1	X2=-0.5	X3=-0.5	
S11=-1245.79414049698	IsS11Max=No	IsS11Min=Yes	FrameElem=74	ElemStation=6.24999940395355E-02			
Frame=74	Station=6.24999940395355E-02	OutputCase=PERM2	CaseType=Combination	Point=2	X2=-0.5	X3=0.5	
S11=-1245.79414049698	IsS11Max=No	IsS11Min=No	FrameElem=74	ElemStation=6.24999940395355E-02			
Frame=74	Station=6.24999940395355E-02	OutputCase=PERM2	CaseType=Combination	Point=3	X2=0.5	X3=-0.5	
S11=1023.56322035704	IsS11Max=Yes	IsS11Min=No	FrameElem=74	ElemStation=6.24999940395355E-02			
Frame=74	Station=6.24999940395355E-02	OutputCase=PERM2	CaseType=Combination	Point=4	X2=0.5	X3=0.5	
S11=1023.56322035704	IsS11Max=No	IsS11Min=No	FrameElem=74	ElemStation=6.24999940395355E-02			
Frame=74	Station=0.124999988079071	OutputCase=PERM2	CaseType=Combination	Point=0	X2=0	X3=0	S11=-
111.11546006997	IsS11Max=No	IsS11Min=No	FrameElem=74	ElemStation=0.124999988079071			
Frame=74	Station=0.124999988079071	OutputCase=PERM2	CaseType=Combination	Point=1	X2=-0.5	X3=-0.5	
S11=-1098.71212448065	IsS11Max=No	IsS11Min=Yes	FrameElem=74	ElemStation=0.124999988079071			
Frame=74	Station=0.124999988079071	OutputCase=PERM2	CaseType=Combination	Point=2	X2=-0.5	X3=0.5	
S11=-1098.71212448065	IsS11Max=No	IsS11Min=No	FrameElem=74	ElemStation=0.124999988079071			
Frame=74	Station=0.124999988079071	OutputCase=PERM2	CaseType=Combination	Point=3	X2=0.5	X3=-0.5	
S11=876.481204340712	IsS11Max=Yes	IsS11Min=No	FrameElem=74	ElemStation=0.124999988079071			
Frame=74	Station=0.124999988079071	OutputCase=PERM2	CaseType=Combination	Point=4	X2=0.5	X3=0.5	
S11=876.481204340712	IsS11Max=No	IsS11Min=No	FrameElem=74	ElemStation=0.124999988079071			
Frame=74	Station=0.187499982118607	OutputCase=PERM2	CaseType=Combination	Point=0	X2=0	X3=0	S11=-
111.11546006997	IsS11Max=No	IsS11Min=No	FrameElem=74	ElemStation=0.187499982118607			
Frame=74	Station=0.187499982118607	OutputCase=PERM2	CaseType=Combination	Point=1	X2=-0.5	X3=-0.5	
S11=-955.450420235656	IsS11Max=No	IsS11Min=Yes	FrameElem=74	ElemStation=0.187499982118607			
Frame=74	Station=0.187499982118607	OutputCase=PERM2	CaseType=Combination	Point=2	X2=-0.5	X3=0.5	
S11=-955.450420235656	IsS11Max=No	IsS11Min=No	FrameElem=74	ElemStation=0.187499982118607			
Frame=74	Station=0.187499982118607	OutputCase=PERM2	CaseType=Combination	Point=3	X2=0.5	X3=-0.5	
S11=733.219500095717	IsS11Max=Yes	IsS11Min=No	FrameElem=74	ElemStation=0.187499982118607			
Frame=74	Station=0.187499982118607	OutputCase=PERM2	CaseType=Combination	Point=4	X2=0.5	X3=0.5	
S11=733.219500095717	IsS11Max=No	IsS11Min=No	FrameElem=74	ElemStation=0.187499982118607			
Frame=74	Station=0.249999976158142	OutputCase=PERM2	CaseType=Combination	Point=0	X2=0	X3=0	S11=-
111.11546006997	IsS11Max=No	IsS11Min=No	FrameElem=74	ElemStation=0.249999976158142			
Frame=74	Station=0.249999976158142	OutputCase=PERM2	CaseType=Combination	Point=1	X2=-0.5	X3=-0.5	
S11=-816.009027761994	IsS11Max=No	IsS11Min=Yes	FrameElem=74	ElemStation=0.249999976158142			
Frame=74	Station=0.249999976158142	OutputCase=PERM2	CaseType=Combination	Point=2	X2=-0.5	X3=0.5	
S11=-816.009027761994	IsS11Max=No	IsS11Min=No	FrameElem=74	ElemStation=0.249999976158142			
Frame=74	Station=0.249999976158142	OutputCase=PERM2	CaseType=Combination	Point=3	X2=0.5	X3=-0.5	
S11=593.778107622054	IsS11Max=Yes	IsS11Min=No	FrameElem=74	ElemStation=0.249999976158142			
Frame=74	Station=0.249999976158142	OutputCase=PERM2	CaseType=Combination	Point=4	X2=0.5	X3=0.5	
S11=593.778107622054	IsS11Max=No	IsS11Min=No	FrameElem=74	ElemStation=0.249999976158142			
Frame=74	Station=0	OutputCase=ACCL	CaseType=Combination	Point=0	X2=0	X3=0	S11=-169.541010668991
IsS11Max=No	IsS11Min=No	FrameElem=74	ElemStation=0				
Frame=74	Station=0	OutputCase=ACCL	CaseType=Combination	Point=1	X2=-0.5	X3=-0.5	S11=-
1586.05272482776	IsS11Max=No	IsS11Min=Yes	FrameElem=74	ElemStation=0			
Frame=74	Station=0	OutputCase=ACCL	CaseType=Combination	Point=2	X2=-0.5	X3=0.5	S11=-
1586.05272482776	IsS11Max=No	IsS11Min=No	FrameElem=74	ElemStation=0			
Frame=74	Station=0	OutputCase=ACCL	CaseType=Combination	Point=3	X2=0.5	X3=-0.5	S11=1246.97070348978
IsS11Max=Yes	IsS11Min=No	FrameElem=74	ElemStation=0				
Frame=74	Station=0	OutputCase=ACCL	CaseType=Combination	Point=4	X2=0.5	X3=0.5	S11=1246.97070348978
IsS11Max=No	IsS11Min=No	FrameElem=74	ElemStation=0				
Frame=74	Station=6.24999940395355E-02	OutputCase=ACCL	CaseType=Combination	Point=0	X2=0	X3=0	S11=-
169.541010668991	IsS11Max=No	IsS11Min=No	FrameElem=74	ElemStation=6.24999940395355E-02			
Frame=74	Station=6.24999940395355E-02	OutputCase=ACCL	CaseType=Combination	Point=1	X2=-0.5	X3=-0.5	
S11=-1430.13266330013	IsS11Max=No	IsS11Min=Yes	FrameElem=74	ElemStation=6.24999940395355E-02			
Frame=74	Station=6.24999940395355E-02	OutputCase=ACCL	CaseType=Combination	Point=2	X2=-0.5	X3=0.5	
S11=-1430.13266330013	IsS11Max=No	IsS11Min=No	FrameElem=74	ElemStation=6.24999940395355E-02			
Frame=74	Station=6.24999940395355E-02	OutputCase=ACCL	CaseType=Combination	Point=3	X2=0.5	X3=-0.5	
S11=1091.05064196215	IsS11Max=Yes	IsS11Min=No	FrameElem=74	ElemStation=6.24999940395355E-02			
Frame=74	Station=6.24999940395355E-02	OutputCase=ACCL	CaseType=Combination	Point=4	X2=0.5	X3=0.5	
S11=1091.05064196215	IsS11Max=No	IsS11Min=No	FrameElem=74	ElemStation=6.24999940395355E-02			
Frame=74	Station=0.124999988079071	OutputCase=ACCL	CaseType=Combination	Point=0	X2=0	X3=0	S11=-
169.541010668991	IsS11Max=No	IsS11Min=No	FrameElem=74	ElemStation=0.124999988079071			
Frame=74	Station=0.124999988079071	OutputCase=ACCL	CaseType=Combination	Point=1	X2=-0.5	X3=-0.5	
S11=-1278.15994476959	IsS11Max=No	IsS11Min=Yes	FrameElem=74	ElemStation=0.124999988079071			
Frame=74	Station=0.124999988079071	OutputCase=ACCL	CaseType=Combination	Point=2	X2=-0.5	X3=0.5	
S11=-1278.15994476959	IsS11Max=No	IsS11Min=No	FrameElem=74	ElemStation=0.124999988079071			
Frame=74	Station=0.124999988079071	OutputCase=ACCL	CaseType=Combination	Point=3	X2=0.5	X3=-0.5	
S11=939.077923431613	IsS11Max=Yes	IsS11Min=No	FrameElem=74	ElemStation=0.124999988079071			
Frame=74	Station=0.124999988079071	OutputCase=ACCL	CaseType=Combination	Point=4	X2=0.5	X3=0.5	
S11=939.077923431613	IsS11Max=No	IsS11Min=No	FrameElem=74	ElemStation=0.124999988079071			
Frame=74	Station=0.187499982118607	OutputCase=ACCL	CaseType=Combination	Point=0	X2=0	X3=0	S11=-
169.541010668991	IsS11Max=No	IsS11Min=No	FrameElem=74	ElemStation=0.187499982118607			

Frame=74 Station=0.187499982118607 OutputCase=ACC1 CaseType=Combination Point=1 X2=-0.5 X3=-0.5
 S11=-1130.13456923617 IsS11Max=No IsS11Min=Yes FrameElem=74 ElemStation=0.187499982118607
 Frame=74 Station=0.187499982118607 OutputCase=ACC1 CaseType=Combination Point=2 X2=-0.5 X3=0.5
 S11=-1130.13456923617 IsS11Max=No IsS11Min=No FrameElem=74 ElemStation=0.187499982118607
 Frame=74 Station=0.187499982118607 OutputCase=ACC1 CaseType=Combination Point=3 X2=0.5 X3=-0.5
 S11=791.052547898185 IsS11Max=Yes IsS11Min=No FrameElem=74 ElemStation=0.187499982118607
 Frame=74 Station=0.187499982118607 OutputCase=ACC1 CaseType=Combination Point=4 X2=0.5 X3=0.5
 S11=791.052547898185 IsS11Max=No IsS11Min=No FrameElem=74 ElemStation=0.187499982118607
 Frame=74 Station=0.249999976158142 OutputCase=ACC1 CaseType=Combination Point=0 X2=0 X3=0 S11=-
 169.541010668991 IsS11Max=No IsS11Min=No FrameElem=74 ElemStation=0.249999976158142
 Frame=74 Station=0.249999976158142 OutputCase=ACC1 CaseType=Combination Point=1 X2=-0.5 X3=-0.5
 S11=-986.056536699842 IsS11Max=No IsS11Min=Yes FrameElem=74 ElemStation=0.249999976158142
 Frame=74 Station=0.249999976158142 OutputCase=ACC1 CaseType=Combination Point=2 X2=-0.5 X3=0.5
 S11=-986.056536699842 IsS11Max=No IsS11Min=No FrameElem=74 ElemStation=0.249999976158142
 Frame=74 Station=0.249999976158142 OutputCase=ACC1 CaseType=Combination Point=3 X2=0.5 X3=-0.5
 S11=646.974515361861 IsS11Max=Yes IsS11Min=No FrameElem=74 ElemStation=0.249999976158142
 Frame=74 Station=0.249999976158142 OutputCase=ACC1 CaseType=Combination Point=4 X2=0.5 X3=0.5
 S11=646.974515361861 IsS11Max=No IsS11Min=No FrameElem=74 ElemStation=0.249999976158142
 Frame=74 Station=0 OutputCase=ACC2 CaseType=Combination Point=0 X2=0 X3=0 S11=-115.765244923546
 IsS11Max=No IsS11Min=No FrameElem=74 ElemStation=0
 Frame=74 Station=0 OutputCase=ACC2 CaseType=Combination Point=1 X2=-0.5 X3=-0.5 S11=-
 1447.29110484396 IsS11Max=No IsS11Min=Yes FrameElem=74 ElemStation=0
 Frame=74 Station=0 OutputCase=ACC2 CaseType=Combination Point=2 X2=-0.5 X3=0.5 S11=-
 1447.29110484396 IsS11Max=No IsS11Min=No FrameElem=74 ElemStation=0
 Frame=74 Station=0 OutputCase=ACC2 CaseType=Combination Point=3 X2=0.5 X3=-0.5 S11=1215.76061499687
 IsS11Max=Yes IsS11Min=No FrameElem=74 ElemStation=0
 Frame=74 Station=0 OutputCase=ACC2 CaseType=Combination Point=4 X2=0.5 X3=0.5 S11=1215.76061499687
 IsS11Max=No IsS11Min=No FrameElem=74 ElemStation=0
 Frame=74 Station=6.24999940395355E-02 OutputCase=ACC2 CaseType=Combination Point=0 X2=0 X3=0 S11=-
 115.765244923546 IsS11Max=No IsS11Min=No FrameElem=74 ElemStation=6.24999940395355E-02
 Frame=74 Station=6.24999940395355E-02 OutputCase=ACC2 CaseType=Combination Point=1 X2=-0.5 X3=-0.5
 S11=-1291.37104321357 IsS11Max=No IsS11Min=Yes FrameElem=74 ElemStation=6.24999940395355E-02
 Frame=74 Station=6.24999940395355E-02 OutputCase=ACC2 CaseType=Combination Point=2 X2=-0.5 X3=0.5
 S11=-1291.37104321357 IsS11Max=No IsS11Min=No FrameElem=74 ElemStation=6.24999940395355E-02
 Frame=74 Station=6.24999940395355E-02 OutputCase=ACC2 CaseType=Combination Point=3 X2=0.5 X3=-0.5
 S11=1059.84055336648 IsS11Max=Yes IsS11Min=No FrameElem=74 ElemStation=6.24999940395355E-02
 Frame=74 Station=6.24999940395355E-02 OutputCase=ACC2 CaseType=Combination Point=4 X2=0.5 X3=0.5
 S11=1059.84055336648 IsS11Max=No IsS11Min=No FrameElem=74 ElemStation=6.24999940395355E-02
 Frame=74 Station=0.124999988079071 OutputCase=ACC2 CaseType=Combination Point=0 X2=0 X3=0 S11=-
 115.765244923546 IsS11Max=No IsS11Min=No FrameElem=74 ElemStation=0.124999988079071
 Frame=74 Station=0.124999988079071 OutputCase=ACC2 CaseType=Combination Point=1 X2=-0.5 X3=-0.5
 S11=-1139.39832458029 IsS11Max=No IsS11Min=Yes FrameElem=74 ElemStation=0.124999988079071
 Frame=74 Station=0.124999988079071 OutputCase=ACC2 CaseType=Combination Point=2 X2=-0.5 X3=0.5
 S11=-1139.39832458029 IsS11Max=No IsS11Min=No FrameElem=74 ElemStation=0.124999988079071
 Frame=74 Station=0.124999988079071 OutputCase=ACC2 CaseType=Combination Point=3 X2=0.5 X3=-0.5
 S11=907.867834733197 IsS11Max=Yes IsS11Min=No FrameElem=74 ElemStation=0.124999988079071
 Frame=74 Station=0.124999988079071 OutputCase=ACC2 CaseType=Combination Point=4 X2=0.5 X3=0.5
 S11=907.867834733197 IsS11Max=No IsS11Min=No FrameElem=74 ElemStation=0.124999988079071
 Frame=74 Station=0.187499982118607 OutputCase=ACC2 CaseType=Combination Point=0 X2=0 X3=0 S11=-
 115.765244923546 IsS11Max=No IsS11Min=No FrameElem=74 ElemStation=0.187499982118607
 Frame=74 Station=0.187499982118607 OutputCase=ACC2 CaseType=Combination Point=1 X2=-0.5 X3=-0.5
 S11=-991.372948944107 IsS11Max=No IsS11Min=Yes FrameElem=74 ElemStation=0.187499982118607
 Frame=74 Station=0.187499982118607 OutputCase=ACC2 CaseType=Combination Point=2 X2=-0.5 X3=0.5
 S11=-991.372948944107 IsS11Max=No IsS11Min=No FrameElem=74 ElemStation=0.187499982118607
 Frame=74 Station=0.187499982118607 OutputCase=ACC2 CaseType=Combination Point=3 X2=0.5 X3=-0.5
 S11=759.842459097016 IsS11Max=Yes IsS11Min=No FrameElem=74 ElemStation=0.187499982118607
 Frame=74 Station=0.187499982118607 OutputCase=ACC2 CaseType=Combination Point=4 X2=0.5 X3=0.5
 S11=759.842459097016 IsS11Max=No IsS11Min=No FrameElem=74 ElemStation=0.187499982118607
 Frame=74 Station=0.249999976158142 OutputCase=ACC2 CaseType=Combination Point=0 X2=0 X3=0 S11=-
 115.765244923546 IsS11Max=No IsS11Min=No FrameElem=74 ElemStation=0.249999976158142
 Frame=74 Station=0.249999976158142 OutputCase=ACC2 CaseType=Combination Point=1 X2=-0.5 X3=-0.5
 S11=-847.294916305029 IsS11Max=No IsS11Min=Yes FrameElem=74 ElemStation=0.249999976158142
 Frame=74 Station=0.249999976158142 OutputCase=ACC2 CaseType=Combination Point=2 X2=-0.5 X3=0.5
 S11=-847.294916305029 IsS11Max=No IsS11Min=No FrameElem=74 ElemStation=0.249999976158142
 Frame=74 Station=0.249999976158142 OutputCase=ACC2 CaseType=Combination Point=3 X2=0.5 X3=-0.5
 S11=615.764426457938 IsS11Max=Yes IsS11Min=No FrameElem=74 ElemStation=0.249999976158142
 Frame=74 Station=0.249999976158142 OutputCase=ACC2 CaseType=Combination Point=4 X2=0.5 X3=0.5
 S11=615.764426457938 IsS11Max=No IsS11Min=No FrameElem=74 ElemStation=0.249999976158142
 Frame=74 Station=0 OutputCase=ACCSX1 CaseType=Combination Point=0 X2=0 X3=0 S11=-167.164023806267
 IsS11Max=No IsS11Min=No FrameElem=74 ElemStation=0
 Frame=74 Station=0 OutputCase=ACCSX1 CaseType=Combination Point=1 X2=-0.5 X3=-0.5 S11=-
 1518.68985758096 IsS11Max=No IsS11Min=Yes FrameElem=74 ElemStation=0
 Frame=74 Station=0 OutputCase=ACCSX1 CaseType=Combination Point=2 X2=-0.5 X3=0.5 S11=-
 1518.68985758096 IsS11Max=No IsS11Min=No FrameElem=74 ElemStation=0
 Frame=74 Station=0 OutputCase=ACCSX1 CaseType=Combination Point=3 X2=0.5 X3=-0.5
 S11=1184.36180996842 IsS11Max=Yes IsS11Min=No FrameElem=74 ElemStation=0
 Frame=74 Station=0 OutputCase=ACCSX1 CaseType=Combination Point=4 X2=0.5 X3=0.5
 S11=1184.36180996842 IsS11Max=No IsS11Min=No FrameElem=74 ElemStation=0
 Frame=74 Station=6.24999940395355E-02 OutputCase=ACCSX1 CaseType=Combination Point=0 X2=0 X3=0
 S11=-167.164023806267 IsS11Max=No IsS11Min=No FrameElem=74 ElemStation=6.24999940395355E-02
 Frame=74 Station=6.24999940395355E-02 OutputCase=ACCSX1 CaseType=Combination Point=1 X2=-0.5 X3=-0.5
 S11=-1368.35530894394 IsS11Max=No IsS11Min=Yes FrameElem=74 ElemStation=6.24999940395355E-02



Frame=74 Station=0.249999976158142 OutputCase=ACCSX2 CaseType=Combination Point=3 X2=0.5 X3=-0.5
 S11=574.735397144447 IsS11Max=Yes IsS11Min=No FrameElem=74 ElemStation=0.249999976158142
 Frame=74 Station=0.249999976158142 OutputCase=ACCSX2 CaseType=Combination Point=4 X2=0.5 X3=0.5
 S11=574.735397144447 IsS11Max=No IsS11Min=No FrameElem=74 ElemStation=0.249999976158142
 Frame=74 Station=0 OutputCase=ENVE CaseType=Combination StepType=Max Point=0 X2=0 X3=0 S11=-
 111.11546006997 IsS11Max=No IsS11Min=No FrameElem=74 ElemStation=0
 Frame=74 Station=0 OutputCase=ENVE CaseType=Combination StepType=Max Point=1 X2=-0.5 X3=-0.5
 S11=-1379.92823759716 IsS11Max=No IsS11Min=Yes FrameElem=74 ElemStation=0
 Frame=74 Station=0 OutputCase=ENVE CaseType=Combination StepType=Max Point=2 X2=-0.5 X3=0.5 S11=-
 1379.92823759716 IsS11Max=No IsS11Min=No FrameElem=74 ElemStation=0
 Frame=74 Station=0 OutputCase=ENVE CaseType=Combination StepType=Max Point=3 X2=0.5 X3=-0.5
 S11=1246.97070348978 IsS11Max=Yes IsS11Min=No FrameElem=74 ElemStation=0
 Frame=74 Station=0 OutputCase=ENVE CaseType=Combination StepType=Max Point=4 X2=0.5 X3=0.5
 S11=1246.97070348978 IsS11Max=No IsS11Min=No FrameElem=74 ElemStation=0
 Frame=74 Station=6.24999940395355E-02 OutputCase=ENVE CaseType=Combination StepType=Max Point=0 X2=0
 X3=0 S11=-111.11546006997 IsS11Max=No IsS11Min=No FrameElem=74 ElemStation=6.24999940395355E-02
 Frame=74 Station=6.24999940395355E-02 OutputCase=ENVE CaseType=Combination StepType=Max Point=1 X2=-
 0.5 X3=-0.5 S11=-1229.59368885739 IsS11Max=No IsS11Min=Yes FrameElem=74 ElemStation=6.24999940395355E-02
 Frame=74 Station=6.24999940395355E-02 OutputCase=ENVE CaseType=Combination StepType=Max Point=2 X2=-
 0.5 X3=0.5 S11=-1229.59368885739 IsS11Max=No IsS11Min=No FrameElem=74 ElemStation=6.24999940395355E-02
 Frame=74 Station=6.24999940395355E-02 OutputCase=ENVE CaseType=Combination StepType=Max Point=3
 X2=0.5 X3=-0.5 S11=1091.05064196215 IsS11Max=Yes IsS11Min=No FrameElem=74 ElemStation=6.24999940395355E-
 02
 Frame=74 Station=6.24999940395355E-02 OutputCase=ENVE CaseType=Combination StepType=Max Point=4
 X2=0.5 X3=0.5 S11=1091.05064196215 IsS11Max=No IsS11Min=No FrameElem=74 ElemStation=6.24999940395355E-02
 Frame=74 Station=0.124999988079071 OutputCase=ENVE CaseType=Combination StepType=Max Point=0 X2=0
 X3=0 S11=-111.11546006997 IsS11Max=No IsS11Min=No FrameElem=74 ElemStation=0.124999988079071
 Frame=74 Station=0.124999988079071 OutputCase=ENVE CaseType=Combination StepType=Max Point=1 X2=-0.5
 X3=-0.5 S11=-1083.07945188896 IsS11Max=No IsS11Min=Yes FrameElem=74 ElemStation=0.124999988079071
 Frame=74 Station=0.124999988079071 OutputCase=ENVE CaseType=Combination StepType=Max Point=2 X2=-0.5
 X3=0.5 S11=-1083.07945188896 IsS11Max=No IsS11Min=No FrameElem=74 ElemStation=0.124999988079071
 Frame=74 Station=0.124999988079071 OutputCase=ENVE CaseType=Combination StepType=Max Point=3 X2=0.5
 X3=-0.5 S11=939.077923431613 IsS11Max=Yes IsS11Min=No FrameElem=74 ElemStation=0.124999988079071
 Frame=74 Station=0.124999988079071 OutputCase=ENVE CaseType=Combination StepType=Max Point=4 X2=0.5
 X3=0.5 S11=939.077923431613 IsS11Max=No IsS11Min=No FrameElem=74 ElemStation=0.124999988079071
 Frame=74 Station=0.187499982118607 OutputCase=ENVE CaseType=Combination StepType=Max Point=0 X2=0
 X3=0 S11=-111.11546006997 IsS11Max=No IsS11Min=No FrameElem=74 ElemStation=0.187499982118607
 Frame=74 Station=0.187499982118607 OutputCase=ENVE CaseType=Combination StepType=Max Point=1 X2=-0.5
 X3=-0.5 S11=-940.385526691858 IsS11Max=No IsS11Min=Yes FrameElem=74 ElemStation=0.187499982118607
 Frame=74 Station=0.187499982118607 OutputCase=ENVE CaseType=Combination StepType=Max Point=2 X2=-0.5
 X3=0.5 S11=-940.385526691858 IsS11Max=No IsS11Min=No FrameElem=74 ElemStation=0.187499982118607
 Frame=74 Station=0.187499982118607 OutputCase=ENVE CaseType=Combination StepType=Max Point=3 X2=0.5
 X3=-0.5 S11=791.052547898185 IsS11Max=Yes IsS11Min=No FrameElem=74 ElemStation=0.187499982118607
 Frame=74 Station=0.187499982118607 OutputCase=ENVE CaseType=Combination StepType=Max Point=4 X2=0.5
 X3=0.5 S11=791.052547898185 IsS11Max=No IsS11Min=No FrameElem=74 ElemStation=0.187499982118607
 Frame=74 Station=0.249999976158142 OutputCase=ENVE CaseType=Combination StepType=Max Point=0 X2=0
 X3=0 S11=-111.11546006997 IsS11Max=No IsS11Min=No FrameElem=74 ElemStation=0.249999976158142
 Frame=74 Station=0.249999976158142 OutputCase=ENVE CaseType=Combination StepType=Max Point=1 X2=-0.5
 X3=-0.5 S11=-801.511913266091 IsS11Max=No IsS11Min=Yes FrameElem=74 ElemStation=0.249999976158142
 Frame=74 Station=0.249999976158142 OutputCase=ENVE CaseType=Combination StepType=Max Point=2 X2=-0.5
 X3=0.5 S11=-801.511913266091 IsS11Max=No IsS11Min=No FrameElem=74 ElemStation=0.249999976158142
 Frame=74 Station=0.249999976158142 OutputCase=ENVE CaseType=Combination StepType=Max Point=3 X2=0.5
 X3=-0.5 S11=646.974515361861 IsS11Max=Yes IsS11Min=No FrameElem=74 ElemStation=0.249999976158142
 Frame=74 Station=0.249999976158142 OutputCase=ENVE CaseType=Combination StepType=Max Point=4 X2=0.5
 X3=0.5 S11=646.974515361861 IsS11Max=No IsS11Min=No FrameElem=74 ElemStation=0.249999976158142
 Frame=74 Station=0 OutputCase=ENVE CaseType=Combination StepType=Min Point=0 X2=0 X3=0 S11=-
 169.541010668991 IsS11Max=No IsS11Min=No FrameElem=74 ElemStation=0
 Frame=74 Station=0 OutputCase=ENVE CaseType=Combination StepType=Min Point=1 X2=-0.5 X3=-0.5
 S11=-1586.05272482776 IsS11Max=No IsS11Min=Yes FrameElem=74 ElemStation=0
 Frame=74 Station=0 OutputCase=ENVE CaseType=Combination StepType=Min Point=2 X2=-0.5 X3=0.5 S11=-
 1586.05272482776 IsS11Max=No IsS11Min=No FrameElem=74 ElemStation=0
 Frame=74 Station=0 OutputCase=ENVE CaseType=Combination StepType=Min Point=3 X2=0.5 X3=-0.5
 S11=1153.15172147551 IsS11Max=Yes IsS11Min=No FrameElem=74 ElemStation=0
 Frame=74 Station=0 OutputCase=ENVE CaseType=Combination StepType=Min Point=4 X2=0.5 X3=0.5
 S11=1153.15172147551 IsS11Max=No IsS11Min=No FrameElem=74 ElemStation=0
 Frame=74 Station=6.24999940395355E-02 OutputCase=ENVE CaseType=Combination StepType=Min Point=0 X2=0
 X3=0 S11=-169.541010668991 IsS11Max=No IsS11Min=No FrameElem=74 ElemStation=6.24999940395355E-02
 Frame=74 Station=6.24999940395355E-02 OutputCase=ENVE CaseType=Combination StepType=Min Point=1 X2=-
 0.5 X3=-0.5 S11=-1430.13266330013 IsS11Max=No IsS11Min=Yes FrameElem=74 ElemStation=6.24999940395355E-02
 Frame=74 Station=6.24999940395355E-02 OutputCase=ENVE CaseType=Combination StepType=Min Point=2 X2=-
 0.5 X3=0.5 S11=-1430.13266330013 IsS11Max=No IsS11Min=No FrameElem=74 ElemStation=6.24999940395355E-02
 Frame=74 Station=6.24999940395355E-02 OutputCase=ENVE CaseType=Combination StepType=Min Point=3
 X2=0.5 X3=-0.5 S11=1002.81717273575 IsS11Max=Yes IsS11Min=No FrameElem=74 ElemStation=6.24999940395355E-
 02
 Frame=74 Station=6.24999940395355E-02 OutputCase=ENVE CaseType=Combination StepType=Min Point=4
 X2=0.5 X3=0.5 S11=1002.81717273575 IsS11Max=No IsS11Min=No FrameElem=74 ElemStation=6.24999940395355E-02
 Frame=74 Station=0.124999988079071 OutputCase=ENVE CaseType=Combination StepType=Min Point=0 X2=0
 X3=0 S11=-169.541010668991 IsS11Max=No IsS11Min=No FrameElem=74 ElemStation=0.124999988079071
 Frame=74 Station=0.124999988079071 OutputCase=ENVE CaseType=Combination StepType=Min Point=1 X2=-0.5
 X3=-0.5 S11=-1278.15994476959 IsS11Max=No IsS11Min=Yes FrameElem=74 ElemStation=0.124999988079071
 Frame=74 Station=0.124999988079071 OutputCase=ENVE CaseType=Combination StepType=Min Point=2 X2=-0.5
 X3=0.5 S11=-1278.15994476959 IsS11Max=No IsS11Min=No FrameElem=74 ElemStation=0.124999988079071



Frame=74 Station=0.124999988079071 OutputCase=ENVE CaseType=Combination StepType=Min Point=3 X2=0.5
 X3=-0.5 S11=856.302935767313 IsS11Max=Yes IsS11Min=No FrameElem=74 ElemStation=0.124999988079071
 Frame=74 Station=0.124999988079071 OutputCase=ENVE CaseType=Combination StepType=Min Point=4 X2=0.5
 X3=0.5 S11=856.302935767313 IsS11Max=No IsS11Min=No FrameElem=74 ElemStation=0.124999988079071
 Frame=74 Station=0.187499982118607 OutputCase=ENVE CaseType=Combination StepType=Min Point=0 X2=0
 X3=0 S11=-169.541010668991 IsS11Max=No IsS11Min=No FrameElem=74 ElemStation=0.187499982118607
 Frame=74 Station=0.187499982118607 OutputCase=ENVE CaseType=Combination StepType=Min Point=1 X2=-0.5
 X3=-0.5 S11=-1130.13456923617 IsS11Max=No IsS11Min=Yes FrameElem=74 ElemStation=0.187499982118607
 Frame=74 Station=0.187499982118607 OutputCase=ENVE CaseType=Combination StepType=Min Point=2 X2=-0.5
 X3=0.5 S11=-1130.13456923617 IsS11Max=No IsS11Min=No FrameElem=74 ElemStation=0.187499982118607
 Frame=74 Station=0.187499982118607 OutputCase=ENVE CaseType=Combination StepType=Min Point=3 X2=0.5
 X3=-0.5 S11=713.609010570213 IsS11Max=Yes IsS11Min=No FrameElem=74 ElemStation=0.187499982118607
 Frame=74 Station=0.187499982118607 OutputCase=ENVE CaseType=Combination StepType=Min Point=4 X2=0.5
 X3=0.5 S11=713.609010570213 IsS11Max=No IsS11Min=No FrameElem=74 ElemStation=0.187499982118607
 Frame=74 Station=0.249999976158142 OutputCase=ENVE CaseType=Combination StepType=Min Point=0 X2=0
 X3=0 S11=-169.541010668991 IsS11Max=No IsS11Min=No FrameElem=74 ElemStation=0.249999976158142
 Frame=74 Station=0.249999976158142 OutputCase=ENVE CaseType=Combination StepType=Min Point=1 X2=-0.5
 X3=-0.5 S11=-986.056536699842 IsS11Max=No IsS11Min=Yes FrameElem=74 ElemStation=0.249999976158142
 Frame=74 Station=0.249999976158142 OutputCase=ENVE CaseType=Combination StepType=Min Point=2 X2=-0.5
 X3=0.5 S11=-986.056536699842 IsS11Max=No IsS11Min=No FrameElem=74 ElemStation=0.249999976158142
 Frame=74 Station=0.249999976158142 OutputCase=ENVE CaseType=Combination StepType=Min Point=3 X2=0.5
 X3=-0.5 S11=574.735397144447 IsS11Max=Yes IsS11Min=No FrameElem=74 ElemStation=0.249999976158142
 Frame=74 Station=0.249999976158142 OutputCase=ENVE CaseType=Combination StepType=Min Point=4 X2=0.5
 X3=0.5 S11=574.735397144447 IsS11Max=No IsS11Min=No FrameElem=74 ElemStation=0.249999976158142
 Frame=74 Station=0 OutputCase=FESSUR CaseType=Combination Point=0 X2=0 X3=0 S11=-168.146075212918
 IsS11Max=No IsS11Min=No FrameElem=74 ElemStation=0
 Frame=74 Station=0 OutputCase=FESSUR CaseType=Combination Point=1 X2=-0.5 X3=-0.5 S11=-
 1570.87433385997 IsS11Max=No IsS11Min=Yes FrameElem=74 ElemStation=0
 Frame=74 Station=0 OutputCase=FESSUR CaseType=Combination Point=2 X2=-0.5 X3=0.5 S11=-
 1570.87433385997 IsS11Max=No IsS11Min=No FrameElem=74 ElemStation=0
 Frame=74 Station=0 OutputCase=FESSUR CaseType=Combination Point=3 X2=0.5 X3=-0.5
 S11=1234.58218343413 IsS11Max=Yes IsS11Min=No FrameElem=74 ElemStation=0
 Frame=74 Station=0 OutputCase=FESSUR CaseType=Combination Point=4 X2=0.5 X3=0.5
 S11=1234.58218343413 IsS11Max=No IsS11Min=No FrameElem=74 ElemStation=0
 Frame=74 Station=6.24999940395355E-02 OutputCase=FESSUR CaseType=Combination Point=0 X2=0 X3=0
 S11=-168.146075212918 IsS11Max=No IsS11Min=No FrameElem=74 ElemStation=6.24999940395355E-02
 Frame=74 Station=6.24999940395355E-02 OutputCase=FESSUR CaseType=Combination Point=1 X2=-0.5 X3=-0.5
 S11=-1416.45959248515 IsS11Max=No IsS11Min=Yes FrameElem=74 ElemStation=6.24999940395355E-02
 Frame=74 Station=6.24999940395355E-02 OutputCase=FESSUR CaseType=Combination Point=2 X2=-0.5 X3=0.5
 S11=-1416.45959248515 IsS11Max=No IsS11Min=No FrameElem=74 ElemStation=6.24999940395355E-02
 Frame=74 Station=6.24999940395355E-02 OutputCase=FESSUR CaseType=Combination Point=3 X2=0.5 X3=-0.5
 S11=1080.16744205931 IsS11Max=Yes IsS11Min=No FrameElem=74 ElemStation=6.24999940395355E-02
 Frame=74 Station=6.24999940395355E-02 OutputCase=FESSUR CaseType=Combination Point=4 X2=0.5 X3=0.5
 S11=1080.16744205931 IsS11Max=No IsS11Min=No FrameElem=74 ElemStation=6.24999940395355E-02
 Frame=74 Station=0.124999988079071 OutputCase=FESSUR CaseType=Combination Point=0 X2=0 X3=0 S11=-
 168.146075212918 IsS11Max=No IsS11Min=No FrameElem=74 ElemStation=0.124999988079071
 Frame=74 Station=0.124999988079071 OutputCase=FESSUR CaseType=Combination Point=1 X2=-0.5 X3=-0.5
 S11=-1265.9540847397 IsS11Max=No IsS11Min=Yes FrameElem=74 ElemStation=0.124999988079071
 Frame=74 Station=0.124999988079071 OutputCase=FESSUR CaseType=Combination Point=2 X2=-0.5 X3=0.5
 S11=-1265.9540847397 IsS11Max=No IsS11Min=No FrameElem=74 ElemStation=0.124999988079071
 Frame=74 Station=0.124999988079071 OutputCase=FESSUR CaseType=Combination Point=3 X2=0.5 X3=-0.5
 S11=929.661934313868 IsS11Max=Yes IsS11Min=No FrameElem=74 ElemStation=0.124999988079071
 Frame=74 Station=0.124999988079071 OutputCase=FESSUR CaseType=Combination Point=4 X2=0.5 X3=0.5
 S11=929.661934313868 IsS11Max=No IsS11Min=No FrameElem=74 ElemStation=0.124999988079071
 Frame=74 Station=0.187499982118607 OutputCase=FESSUR CaseType=Combination Point=0 X2=0 X3=0 S11=-
 168.146075212918 IsS11Max=No IsS11Min=No FrameElem=74 ElemStation=0.187499982118607
 Frame=74 Station=0.187499982118607 OutputCase=FESSUR CaseType=Combination Point=1 X2=-0.5 X3=-0.5
 S11=-1119.35781062363 IsS11Max=No IsS11Min=Yes FrameElem=74 ElemStation=0.187499982118607
 Frame=74 Station=0.187499982118607 OutputCase=FESSUR CaseType=Combination Point=2 X2=-0.5 X3=0.5
 S11=-1119.35781062363 IsS11Max=No IsS11Min=No FrameElem=74 ElemStation=0.187499982118607
 Frame=74 Station=0.187499982118607 OutputCase=FESSUR CaseType=Combination Point=3 X2=0.5 X3=-0.5
 S11=783.065660197795 IsS11Max=Yes IsS11Min=No FrameElem=74 ElemStation=0.187499982118607
 Frame=74 Station=0.187499982118607 OutputCase=FESSUR CaseType=Combination Point=4 X2=0.5 X3=0.5
 S11=783.065660197795 IsS11Max=No IsS11Min=No FrameElem=74 ElemStation=0.187499982118607
 Frame=74 Station=0.249999976158142 OutputCase=FESSUR CaseType=Combination Point=0 X2=0 X3=0 S11=-
 168.146075212918 IsS11Max=No IsS11Min=No FrameElem=74 ElemStation=0.249999976158142
 Frame=74 Station=0.249999976158142 OutputCase=FESSUR CaseType=Combination Point=1 X2=-0.5 X3=-0.5
 S11=-976.670770136932 IsS11Max=No IsS11Min=Yes FrameElem=74 ElemStation=0.249999976158142
 Frame=74 Station=0.249999976158142 OutputCase=FESSUR CaseType=Combination Point=2 X2=-0.5 X3=0.5
 S11=-976.670770136932 IsS11Max=No IsS11Min=No FrameElem=74 ElemStation=0.249999976158142
 Frame=74 Station=0.249999976158142 OutputCase=FESSUR CaseType=Combination Point=3 X2=0.5 X3=-0.5
 S11=640.378619711096 IsS11Max=Yes IsS11Min=No FrameElem=74 ElemStation=0.249999976158142
 Frame=74 Station=0.249999976158142 OutputCase=FESSUR CaseType=Combination Point=4 X2=0.5 X3=0.5
 S11=640.378619711096 IsS11Max=No IsS11Min=No FrameElem=74 ElemStation=0.249999976158142
 Frame=75 Station=0 OutputCase=PERM1 CaseType=Combination Point=0 X2=0 X3=0 S11=-164.891225815413
 IsS11Max=No IsS11Min=No FrameElem=75 ElemStation=0
 Frame=75 Station=0 OutputCase=PERM1 CaseType=Combination Point=1 X2=-0.5 X3=-0.5 S11=-
 954.770648156789 IsS11Max=No IsS11Min=Yes FrameElem=75 ElemStation=0
 Frame=75 Station=0 OutputCase=PERM1 CaseType=Combination Point=2 X2=-0.5 X3=0.5 S11=-
 954.770648156789 IsS11Max=No IsS11Min=No FrameElem=75 ElemStation=0
 Frame=75 Station=0 OutputCase=PERM1 CaseType=Combination Point=3 X2=0.5 X3=-0.5
 S11=624.988196525962 IsS11Max=Yes IsS11Min=No FrameElem=75 ElemStation=0

```

Frame=75 Station=0 OutputCase=PERM1 CaseType=Combination Point=4 X2=0.5 X3=0.5 S11=624.988196525962
IsS11Max=No IsS11Min=No FrameElem=75 ElemStation=0
Frame=75 Station=0.0625 OutputCase=PERM1 CaseType=Combination Point=0 X2=0 X3=0 S11=-
164.891225815413 IsS11Max=No IsS11Min=No FrameElem=75 ElemStation=0.0625
Frame=75 Station=0.0625 OutputCase=PERM1 CaseType=Combination Point=1 X2=-0.5 X3=-0.5 S11=-
819.149554805541 IsS11Max=No IsS11Min=Yes FrameElem=75 ElemStation=0.0625
Frame=75 Station=0.0625 OutputCase=PERM1 CaseType=Combination Point=2 X2=-0.5 X3=0.5 S11=-
819.149554805541 IsS11Max=No IsS11Min=No FrameElem=75 ElemStation=0.0625
Frame=75 Station=0.0625 OutputCase=PERM1 CaseType=Combination Point=3 X2=0.5 X3=-0.5
S11=489.367103174714 IsS11Max=Yes IsS11Min=No FrameElem=75 ElemStation=0.0625
Frame=75 Station=0.0625 OutputCase=PERM1 CaseType=Combination Point=4 X2=0.5 X3=0.5
S11=489.367103174714 IsS11Max=No IsS11Min=No FrameElem=75 ElemStation=0.0625
Frame=75 Station=0.125 OutputCase=PERM1 CaseType=Combination Point=0 X2=0 X3=0 S11=-
164.891225815413 IsS11Max=No IsS11Min=No FrameElem=75 ElemStation=0.125
Frame=75 Station=0.125 OutputCase=PERM1 CaseType=Combination Point=1 X2=-0.5 X3=-0.5 S11=-
687.348773954293 IsS11Max=No IsS11Min=Yes FrameElem=75 ElemStation=0.125
Frame=75 Station=0.125 OutputCase=PERM1 CaseType=Combination Point=2 X2=-0.5 X3=0.5 S11=-
687.348773954293 IsS11Max=No IsS11Min=No FrameElem=75 ElemStation=0.125
Frame=75 Station=0.125 OutputCase=PERM1 CaseType=Combination Point=3 X2=0.5 X3=-0.5
S11=357.566322323466 IsS11Max=Yes IsS11Min=No FrameElem=75 ElemStation=0.125
Frame=75 Station=0.125 OutputCase=PERM1 CaseType=Combination Point=4 X2=0.5 X3=0.5
S11=357.566322323466 IsS11Max=No IsS11Min=No FrameElem=75 ElemStation=0.125
Frame=75 Station=0.1875 OutputCase=PERM1 CaseType=Combination Point=0 X2=0 X3=0 S11=-
164.891225815413 IsS11Max=No IsS11Min=No FrameElem=75 ElemStation=0.1875
Frame=75 Station=0.1875 OutputCase=PERM1 CaseType=Combination Point=1 X2=-0.5 X3=-0.5 S11=-
559.368305603045 IsS11Max=No IsS11Min=Yes FrameElem=75 ElemStation=0.1875
Frame=75 Station=0.1875 OutputCase=PERM1 CaseType=Combination Point=2 X2=-0.5 X3=0.5 S11=-
559.368305603045 IsS11Max=No IsS11Min=No FrameElem=75 ElemStation=0.1875
Frame=75 Station=0.1875 OutputCase=PERM1 CaseType=Combination Point=3 X2=0.5 X3=-0.5
S11=229.585853972218 IsS11Max=Yes IsS11Min=No FrameElem=75 ElemStation=0.1875
Frame=75 Station=0.1875 OutputCase=PERM1 CaseType=Combination Point=4 X2=0.5 X3=0.5
S11=229.585853972218 IsS11Max=No IsS11Min=No FrameElem=75 ElemStation=0.1875
Frame=75 Station=0.25 OutputCase=PERM1 CaseType=Combination Point=0 X2=0 X3=0 S11=-164.891225815413
IsS11Max=No IsS11Min=No FrameElem=75 ElemStation=0.25
Frame=75 Station=0.25 OutputCase=PERM1 CaseType=Combination Point=1 X2=-0.5 X3=-0.5 S11=-
435.208149751797 IsS11Max=No IsS11Min=Yes FrameElem=75 ElemStation=0.25
Frame=75 Station=0.25 OutputCase=PERM1 CaseType=Combination Point=2 X2=-0.5 X3=0.5 S11=-
435.208149751797 IsS11Max=No IsS11Min=No FrameElem=75 ElemStation=0.25
Frame=75 Station=0.25 OutputCase=PERM1 CaseType=Combination Point=3 X2=0.5 X3=-0.5
S11=105.42569812097 IsS11Max=Yes IsS11Min=No FrameElem=75 ElemStation=0.25
Frame=75 Station=0.25 OutputCase=PERM1 CaseType=Combination Point=4 X2=0.5 X3=0.5
S11=105.42569812097 IsS11Max=No IsS11Min=No FrameElem=75 ElemStation=0.25
Frame=75 Station=0 OutputCase=PERM2 CaseType=Combination Point=0 X2=0 X3=0 S11=-111.115460069968
IsS11Max=No IsS11Min=No FrameElem=75 ElemStation=0
Frame=75 Station=0 OutputCase=PERM2 CaseType=Combination Point=1 X2=-0.5 X3=-0.5 S11=-
816.009027761976 IsS11Max=No IsS11Min=Yes FrameElem=75 ElemStation=0
Frame=75 Station=0 OutputCase=PERM2 CaseType=Combination Point=2 X2=-0.5 X3=0.5 S11=-
816.009027761976 IsS11Max=No IsS11Min=No FrameElem=75 ElemStation=0
Frame=75 Station=0 OutputCase=PERM2 CaseType=Combination Point=3 X2=0.5 X3=-0.5
S11=593.778107622039 IsS11Max=Yes IsS11Min=No FrameElem=75 ElemStation=0
Frame=75 Station=0 OutputCase=PERM2 CaseType=Combination Point=4 X2=0.5 X3=0.5
S11=593.778107622039 IsS11Max=No IsS11Min=No FrameElem=75 ElemStation=0
Frame=75 Station=0.0625 OutputCase=PERM2 CaseType=Combination Point=0 X2=0 X3=0 S11=-
111.115460069968 IsS11Max=No IsS11Min=No FrameElem=75 ElemStation=0.0625
Frame=75 Station=0.0625 OutputCase=PERM2 CaseType=Combination Point=1 X2=-0.5 X3=-0.5 S11=-
680.387934307974 IsS11Max=No IsS11Min=Yes FrameElem=75 ElemStation=0.0625
Frame=75 Station=0.0625 OutputCase=PERM2 CaseType=Combination Point=2 X2=-0.5 X3=0.5 S11=-
680.387934307974 IsS11Max=No IsS11Min=No FrameElem=75 ElemStation=0.0625
Frame=75 Station=0.0625 OutputCase=PERM2 CaseType=Combination Point=3 X2=0.5 X3=-0.5
S11=458.157014168037 IsS11Max=Yes IsS11Min=No FrameElem=75 ElemStation=0.0625
Frame=75 Station=0.0625 OutputCase=PERM2 CaseType=Combination Point=4 X2=0.5 X3=0.5
S11=458.157014168037 IsS11Max=No IsS11Min=No FrameElem=75 ElemStation=0.0625
Frame=75 Station=0.125 OutputCase=PERM2 CaseType=Combination Point=0 X2=0 X3=0 S11=-
111.115460069968 IsS11Max=No IsS11Min=No FrameElem=75 ElemStation=0.125
Frame=75 Station=0.125 OutputCase=PERM2 CaseType=Combination Point=1 X2=-0.5 X3=-0.5 S11=-
548.587153353972 IsS11Max=No IsS11Min=Yes FrameElem=75 ElemStation=0.125
Frame=75 Station=0.125 OutputCase=PERM2 CaseType=Combination Point=2 X2=-0.5 X3=0.5 S11=-
548.587153353972 IsS11Max=No IsS11Min=No FrameElem=75 ElemStation=0.125
Frame=75 Station=0.125 OutputCase=PERM2 CaseType=Combination Point=3 X2=0.5 X3=-0.5
S11=326.356233214036 IsS11Max=Yes IsS11Min=No FrameElem=75 ElemStation=0.125
Frame=75 Station=0.125 OutputCase=PERM2 CaseType=Combination Point=4 X2=0.5 X3=0.5
S11=326.356233214036 IsS11Max=No IsS11Min=No FrameElem=75 ElemStation=0.125
Frame=75 Station=0.1875 OutputCase=PERM2 CaseType=Combination Point=0 X2=0 X3=0 S11=-
111.115460069968 IsS11Max=No IsS11Min=No FrameElem=75 ElemStation=0.1875
Frame=75 Station=0.1875 OutputCase=PERM2 CaseType=Combination Point=1 X2=-0.5 X3=-0.5 S11=-
420.60668489997 IsS11Max=No IsS11Min=Yes FrameElem=75 ElemStation=0.1875
Frame=75 Station=0.1875 OutputCase=PERM2 CaseType=Combination Point=2 X2=-0.5 X3=0.5 S11=-
420.60668489997 IsS11Max=No IsS11Min=No FrameElem=75 ElemStation=0.1875
Frame=75 Station=0.1875 OutputCase=PERM2 CaseType=Combination Point=3 X2=0.5 X3=-0.5
S11=198.375764760034 IsS11Max=Yes IsS11Min=No FrameElem=75 ElemStation=0.1875
Frame=75 Station=0.1875 OutputCase=PERM2 CaseType=Combination Point=4 X2=0.5 X3=0.5
S11=198.375764760034 IsS11Max=No IsS11Min=No FrameElem=75 ElemStation=0.1875

```

Frame=75	Station=0.25	OutputCase=PERM2	CaseType=Combination	Point=0	X2=0	X3=0	S11=-111.115460069968
IsS11Max=No	IsS11Min=No	FrameElem=75	ElemStation=0.25				
Frame=75	Station=0.25	OutputCase=PERM2	CaseType=Combination	Point=1	X2=-0.5	X3=-0.5	S11=-
296.446528945969	IsS11Max=No	IsS11Min=Yes	FrameElem=75	ElemStation=0.25			
Frame=75	Station=0.25	OutputCase=PERM2	CaseType=Combination	Point=2	X2=-0.5	X3=0.5	S11=-
296.446528945969	IsS11Max=No	IsS11Min=No	FrameElem=75	ElemStation=0.25			
Frame=75	Station=0.25	OutputCase=PERM2	CaseType=Combination	Point=3	X2=0.5	X3=-0.5	
S11=74.2156088060319	IsS11Max=Yes	IsS11Min=No	FrameElem=75	ElemStation=0.25			
Frame=75	Station=0.25	OutputCase=PERM2	CaseType=Combination	Point=4	X2=0.5	X3=0.5	
S11=74.2156088060319	IsS11Max=No	IsS11Min=No	FrameElem=75	ElemStation=0.25			
Frame=75	Station=0	OutputCase=ACC1	CaseType=Combination	Point=0	X2=0	X3=0	S11=-169.541010668989
IsS11Max=No	IsS11Min=No	FrameElem=75	ElemStation=0				
Frame=75	Station=0	OutputCase=ACC1	CaseType=Combination	Point=1	X2=-0.5	X3=-0.5	S11=-
986.056536699831	IsS11Max=No	IsS11Min=Yes	FrameElem=75	ElemStation=0			
Frame=75	Station=0	OutputCase=ACC1	CaseType=Combination	Point=2	X2=-0.5	X3=0.5	S11=-
986.056536699831	IsS11Max=No	IsS11Min=No	FrameElem=75	ElemStation=0			
Frame=75	Station=0	OutputCase=ACC1	CaseType=Combination	Point=3	X2=0.5	X3=-0.5	S11=646.974515361853
IsS11Max=Yes	IsS11Min=No	FrameElem=75	ElemStation=0				
Frame=75	Station=0	OutputCase=ACC1	CaseType=Combination	Point=4	X2=0.5	X3=0.5	S11=646.974515361853
IsS11Max=No	IsS11Min=No	FrameElem=75	ElemStation=0				
Frame=75	Station=0.0625	OutputCase=ACC1	CaseType=Combination	Point=0	X2=0	X3=0	S11=-
169.541010668989	IsS11Max=No	IsS11Min=No	FrameElem=75	ElemStation=0.0625			
Frame=75	Station=0.0625	OutputCase=ACC1	CaseType=Combination	Point=1	X2=-0.5	X3=-0.5	S11=-
845.925833984928	IsS11Max=No	IsS11Min=Yes	FrameElem=75	ElemStation=0.0625			
Frame=75	Station=0.0625	OutputCase=ACC1	CaseType=Combination	Point=2	X2=-0.5	X3=0.5	S11=-
845.925833984928	IsS11Max=No	IsS11Min=No	FrameElem=75	ElemStation=0.0625			
Frame=75	Station=0.0625	OutputCase=ACC1	CaseType=Combination	Point=3	X2=0.5	X3=-0.5	
S11=506.843812646949	IsS11Max=Yes	IsS11Min=No	FrameElem=75	ElemStation=0.0625			
Frame=75	Station=0.0625	OutputCase=ACC1	CaseType=Combination	Point=4	X2=0.5	X3=0.5	
S11=506.843812646949	IsS11Max=No	IsS11Min=No	FrameElem=75	ElemStation=0.0625			
Frame=75	Station=0.125	OutputCase=ACC1	CaseType=Combination	Point=0	X2=0	X3=0	S11=-169.541010668989
IsS11Max=No	IsS11Min=No	FrameElem=75	ElemStation=0.125				
Frame=75	Station=0.125	OutputCase=ACC1	CaseType=Combination	Point=1	X2=-0.5	X3=-0.5	S11=-
709.742475020024	IsS11Max=No	IsS11Min=Yes	FrameElem=75	ElemStation=0.125			
Frame=75	Station=0.125	OutputCase=ACC1	CaseType=Combination	Point=2	X2=-0.5	X3=0.5	S11=-
709.742475020024	IsS11Max=No	IsS11Min=No	FrameElem=75	ElemStation=0.125			
Frame=75	Station=0.125	OutputCase=ACC1	CaseType=Combination	Point=3	X2=0.5	X3=-0.5	
S11=370.660453682046	IsS11Max=Yes	IsS11Min=No	FrameElem=75	ElemStation=0.125			
Frame=75	Station=0.125	OutputCase=ACC1	CaseType=Combination	Point=4	X2=0.5	X3=0.5	
S11=370.660453682046	IsS11Max=No	IsS11Min=No	FrameElem=75	ElemStation=0.125			
Frame=75	Station=0.1875	OutputCase=ACC1	CaseType=Combination	Point=0	X2=0	X3=0	S11=-
169.541010668989	IsS11Max=No	IsS11Min=No	FrameElem=75	ElemStation=0.1875			
Frame=75	Station=0.1875	OutputCase=ACC1	CaseType=Combination	Point=1	X2=-0.5	X3=-0.5	S11=-
577.50645980512	IsS11Max=No	IsS11Min=Yes	FrameElem=75	ElemStation=0.1875			
Frame=75	Station=0.1875	OutputCase=ACC1	CaseType=Combination	Point=2	X2=-0.5	X3=0.5	S11=-
577.50645980512	IsS11Max=No	IsS11Min=No	FrameElem=75	ElemStation=0.1875			
Frame=75	Station=0.1875	OutputCase=ACC1	CaseType=Combination	Point=3	X2=0.5	X3=-0.5	
S11=238.424438467142	IsS11Max=Yes	IsS11Min=No	FrameElem=75	ElemStation=0.1875			
Frame=75	Station=0.1875	OutputCase=ACC1	CaseType=Combination	Point=4	X2=0.5	X3=0.5	
S11=238.424438467142	IsS11Max=No	IsS11Min=No	FrameElem=75	ElemStation=0.1875			
Frame=75	Station=0.25	OutputCase=ACC1	CaseType=Combination	Point=0	X2=0	X3=0	S11=-169.541010668989
IsS11Max=No	IsS11Min=No	FrameElem=75	ElemStation=0.25				
Frame=75	Station=0.25	OutputCase=ACC1	CaseType=Combination	Point=1	X2=-0.5	X3=-0.5	S11=-
449.217788340217	IsS11Max=No	IsS11Min=Yes	FrameElem=75	ElemStation=0.25			
Frame=75	Station=0.25	OutputCase=ACC1	CaseType=Combination	Point=2	X2=-0.5	X3=0.5	S11=-
449.217788340217	IsS11Max=No	IsS11Min=No	FrameElem=75	ElemStation=0.25			
Frame=75	Station=0.25	OutputCase=ACC1	CaseType=Combination	Point=3	X2=0.5	X3=-0.5	
S11=110.135767002238	IsS11Max=Yes	IsS11Min=No	FrameElem=75	ElemStation=0.25			
Frame=75	Station=0.25	OutputCase=ACC1	CaseType=Combination	Point=4	X2=0.5	X3=0.5	
S11=110.135767002238	IsS11Max=No	IsS11Min=No	FrameElem=75	ElemStation=0.25			
Frame=75	Station=0	OutputCase=ACC2	CaseType=Combination	Point=0	X2=0	X3=0	S11=-115.765244923544
IsS11Max=No	IsS11Min=No	FrameElem=75	ElemStation=0				
Frame=75	Station=0	OutputCase=ACC2	CaseType=Combination	Point=1	X2=-0.5	X3=-0.5	S11=-
847.294916305018	IsS11Max=No	IsS11Min=Yes	FrameElem=75	ElemStation=0			
Frame=75	Station=0	OutputCase=ACC2	CaseType=Combination	Point=2	X2=-0.5	X3=0.5	S11=-
847.294916305018	IsS11Max=No	IsS11Min=No	FrameElem=75	ElemStation=0			
Frame=75	Station=0	OutputCase=ACC2	CaseType=Combination	Point=3	X2=0.5	X3=-0.5	S11=615.76442645793
IsS11Max=Yes	IsS11Min=No	FrameElem=75	ElemStation=0				
Frame=75	Station=0	OutputCase=ACC2	CaseType=Combination	Point=4	X2=0.5	X3=0.5	S11=615.76442645793
IsS11Max=No	IsS11Min=No	FrameElem=75	ElemStation=0				
Frame=75	Station=0.0625	OutputCase=ACC2	CaseType=Combination	Point=0	X2=0	X3=0	S11=-
115.765244923544	IsS11Max=No	IsS11Min=No	FrameElem=75	ElemStation=0.0625			
Frame=75	Station=0.0625	OutputCase=ACC2	CaseType=Combination	Point=1	X2=-0.5	X3=-0.5	S11=-
707.16421348736	IsS11Max=No	IsS11Min=Yes	FrameElem=75	ElemStation=0.0625			
Frame=75	Station=0.0625	OutputCase=ACC2	CaseType=Combination	Point=2	X2=-0.5	X3=0.5	S11=-
707.16421348736	IsS11Max=No	IsS11Min=No	FrameElem=75	ElemStation=0.0625			
Frame=75	Station=0.0625	OutputCase=ACC2	CaseType=Combination	Point=3	X2=0.5	X3=-0.5	
S11=475.633723640272	IsS11Max=Yes	IsS11Min=No	FrameElem=75	ElemStation=0.0625			
Frame=75	Station=0.0625	OutputCase=ACC2	CaseType=Combination	Point=4	X2=0.5	X3=0.5	
S11=475.633723640272	IsS11Max=No	IsS11Min=No	FrameElem=75	ElemStation=0.0625			
Frame=75	Station=0.125	OutputCase=ACC2	CaseType=Combination	Point=0	X2=0	X3=0	S11=-115.765244923544
IsS11Max=No	IsS11Min=No	FrameElem=75	ElemStation=0.125				

Frame=75	Station=0.125	OutputCase=ACC2	CaseType=Combination	Point=1	X2=-0.5	X3=-0.5	S11=-
570.980854419703	IsS11Max=No	IsS11Min=Yes	FrameElem=75	ElemStation=0.125			
Frame=75	Station=0.125	OutputCase=ACC2	CaseType=Combination	Point=2	X2=-0.5	X3=0.5	S11=-
570.980854419703	IsS11Max=No	IsS11Min=No	FrameElem=75	ElemStation=0.125			
Frame=75	Station=0.125	OutputCase=ACC2	CaseType=Combination	Point=3	X2=0.5	X3=-0.5	
S11=339.450364572615	IsS11Max=Yes	IsS11Min=No	FrameElem=75	ElemStation=0.125			
Frame=75	Station=0.125	OutputCase=ACC2	CaseType=Combination	Point=4	X2=0.5	X3=0.5	
S11=339.450364572615	IsS11Max=No	IsS11Min=No	FrameElem=75	ElemStation=0.125			
Frame=75	Station=0.1875	OutputCase=ACC2	CaseType=Combination	Point=0	X2=0	X3=0	S11=-
115.765244923544	IsS11Max=No	IsS11Min=No	FrameElem=75	ElemStation=0.1875			
Frame=75	Station=0.1875	OutputCase=ACC2	CaseType=Combination	Point=1	X2=-0.5	X3=-0.5	S11=-
438.744839102046	IsS11Max=No	IsS11Min=Yes	FrameElem=75	ElemStation=0.1875			
Frame=75	Station=0.1875	OutputCase=ACC2	CaseType=Combination	Point=2	X2=-0.5	X3=0.5	S11=-
438.744839102046	IsS11Max=No	IsS11Min=No	FrameElem=75	ElemStation=0.1875			
Frame=75	Station=0.1875	OutputCase=ACC2	CaseType=Combination	Point=3	X2=0.5	X3=-0.5	
S11=207.214349254958	IsS11Max=Yes	IsS11Min=No	FrameElem=75	ElemStation=0.1875			
Frame=75	Station=0.1875	OutputCase=ACC2	CaseType=Combination	Point=4	X2=0.5	X3=0.5	
S11=207.214349254958	IsS11Max=No	IsS11Min=No	FrameElem=75	ElemStation=0.1875			
Frame=75	Station=0.25	OutputCase=ACC2	CaseType=Combination	Point=0	X2=0	X3=0	S11=-115.765244923544
IsS11Max=No	IsS11Min=No	FrameElem=75	ElemStation=0.25				
Frame=75	Station=0.25	OutputCase=ACC2	CaseType=Combination	Point=1	X2=-0.5	X3=-0.5	S11=-
310.456167534389	IsS11Max=No	IsS11Min=Yes	FrameElem=75	ElemStation=0.25			
Frame=75	Station=0.25	OutputCase=ACC2	CaseType=Combination	Point=2	X2=-0.5	X3=0.5	S11=-
310.456167534389	IsS11Max=No	IsS11Min=No	FrameElem=75	ElemStation=0.25			
Frame=75	Station=0.25	OutputCase=ACC2	CaseType=Combination	Point=3	X2=0.5	X3=-0.5	
S11=78.9256776873005	IsS11Max=Yes	IsS11Min=No	FrameElem=75	ElemStation=0.25			
Frame=75	Station=0.25	OutputCase=ACC2	CaseType=Combination	Point=4	X2=0.5	X3=0.5	
S11=78.9256776873005	IsS11Max=No	IsS11Min=No	FrameElem=75	ElemStation=0.25			
Frame=75	Station=0	OutputCase=ACCSX1	CaseType=Combination	Point=0	X2=0	X3=0	S11=-167.164023806258
IsS11Max=No	IsS11Min=No	FrameElem=75	ElemStation=0				
Frame=75	Station=0	OutputCase=ACCSX1	CaseType=Combination	Point=1	X2=-0.5	X3=-0.5	S11=-
940.273533660881	IsS11Max=No	IsS11Min=Yes	FrameElem=75	ElemStation=0			
Frame=75	Station=0	OutputCase=ACCSX1	CaseType=Combination	Point=2	X2=-0.5	X3=0.5	S11=-
940.273533660881	IsS11Max=No	IsS11Min=No	FrameElem=75	ElemStation=0			
Frame=75	Station=0	OutputCase=ACCSX1	CaseType=Combination	Point=3	X2=0.5	X3=-0.5	
S11=605.945486048365	IsS11Max=Yes	IsS11Min=No	FrameElem=75	ElemStation=0			
Frame=75	Station=0	OutputCase=ACCSX1	CaseType=Combination	Point=4	X2=0.5	X3=0.5	
S11=605.945486048365	IsS11Max=No	IsS11Min=No	FrameElem=75	ElemStation=0			
Frame=75	Station=0.0625	OutputCase=ACCSX1	CaseType=Combination	Point=0	X2=0	X3=0	S11=-
167.164023806258	IsS11Max=No	IsS11Min=No	FrameElem=75	ElemStation=0.0625			
Frame=75	Station=0.0625	OutputCase=ACCSX1	CaseType=Combination	Point=1	X2=-0.5	X3=-0.5	S11=-
805.220219411678	IsS11Max=No	IsS11Min=Yes	FrameElem=75	ElemStation=0.0625			
Frame=75	Station=0.0625	OutputCase=ACCSX1	CaseType=Combination	Point=2	X2=-0.5	X3=0.5	S11=-
805.220219411678	IsS11Max=No	IsS11Min=No	FrameElem=75	ElemStation=0.0625			
Frame=75	Station=0.0625	OutputCase=ACCSX1	CaseType=Combination	Point=3	X2=0.5	X3=-0.5	
S11=470.892171799161	IsS11Max=Yes	IsS11Min=No	FrameElem=75	ElemStation=0.0625			
Frame=75	Station=0.0625	OutputCase=ACCSX1	CaseType=Combination	Point=4	X2=0.5	X3=0.5	
S11=470.892171799161	IsS11Max=No	IsS11Min=No	FrameElem=75	ElemStation=0.0625			
Frame=75	Station=0.125	OutputCase=ACCSX1	CaseType=Combination	Point=0	X2=0	X3=0	S11=-
167.164023806258	IsS11Max=No	IsS11Min=No	FrameElem=75	ElemStation=0.125			
Frame=75	Station=0.125	OutputCase=ACCSX1	CaseType=Combination	Point=1	X2=-0.5	X3=-0.5	S11=-
673.987217662474	IsS11Max=No	IsS11Min=Yes	FrameElem=75	ElemStation=0.125			
Frame=75	Station=0.125	OutputCase=ACCSX1	CaseType=Combination	Point=2	X2=-0.5	X3=0.5	S11=-
673.987217662474	IsS11Max=No	IsS11Min=No	FrameElem=75	ElemStation=0.125			
Frame=75	Station=0.125	OutputCase=ACCSX1	CaseType=Combination	Point=3	X2=0.5	X3=-0.5	
S11=339.659170049958	IsS11Max=Yes	IsS11Min=No	FrameElem=75	ElemStation=0.125			
Frame=75	Station=0.125	OutputCase=ACCSX1	CaseType=Combination	Point=4	X2=0.5	X3=0.5	
S11=339.659170049958	IsS11Max=No	IsS11Min=No	FrameElem=75	ElemStation=0.125			
Frame=75	Station=0.1875	OutputCase=ACCSX1	CaseType=Combination	Point=0	X2=0	X3=0	S11=-
167.164023806258	IsS11Max=No	IsS11Min=No	FrameElem=75	ElemStation=0.1875			
Frame=75	Station=0.1875	OutputCase=ACCSX1	CaseType=Combination	Point=1	X2=-0.5	X3=-0.5	S11=-
546.574528413271	IsS11Max=No	IsS11Min=Yes	FrameElem=75	ElemStation=0.1875			
Frame=75	Station=0.1875	OutputCase=ACCSX1	CaseType=Combination	Point=2	X2=-0.5	X3=0.5	S11=-
546.574528413271	IsS11Max=No	IsS11Min=No	FrameElem=75	ElemStation=0.1875			
Frame=75	Station=0.1875	OutputCase=ACCSX1	CaseType=Combination	Point=3	X2=0.5	X3=-0.5	
S11=212.246480800754	IsS11Max=Yes	IsS11Min=No	FrameElem=75	ElemStation=0.1875			
Frame=75	Station=0.1875	OutputCase=ACCSX1	CaseType=Combination	Point=4	X2=0.5	X3=0.5	
S11=212.246480800754	IsS11Max=No	IsS11Min=No	FrameElem=75	ElemStation=0.1875			
Frame=75	Station=0.25	OutputCase=ACCSX1	CaseType=Combination	Point=0	X2=0	X3=0	S11=-
167.164023806258	IsS11Max=No	IsS11Min=No	FrameElem=75	ElemStation=0.25			
Frame=75	Station=0.25	OutputCase=ACCSX1	CaseType=Combination	Point=1	X2=-0.5	X3=-0.5	S11=-
422.982151664068	IsS11Max=No	IsS11Min=Yes	FrameElem=75	ElemStation=0.25			
Frame=75	Station=0.25	OutputCase=ACCSX1	CaseType=Combination	Point=2	X2=-0.5	X3=0.5	S11=-
422.982151664068	IsS11Max=No	IsS11Min=No	FrameElem=75	ElemStation=0.25			
Frame=75	Station=0.25	OutputCase=ACCSX1	CaseType=Combination	Point=3	X2=0.5	X3=-0.5	
S11=88.6541040515505	IsS11Max=Yes	IsS11Min=No	FrameElem=75	ElemStation=0.25			
Frame=75	Station=0.25	OutputCase=ACCSX1	CaseType=Combination	Point=4	X2=0.5	X3=0.5	
S11=88.6541040515505	IsS11Max=No	IsS11Min=No	FrameElem=75	ElemStation=0.25			
Frame=75	Station=0	OutputCase=ACCSX2	CaseType=Combination	Point=0	X2=0	X3=0	S11=-113.388258060813
IsS11Max=No	IsS11Min=No	FrameElem=75	ElemStation=0				
Frame=75	Station=0	OutputCase=ACCSX2	CaseType=Combination	Point=1	X2=-0.5	X3=-0.5	S11=-
801.511913266068	IsS11Max=No	IsS11Min=Yes	FrameElem=75	ElemStation=0			

Frame=75	Station=0	OutputCase=ACCSX2	CaseType=Combination	Point=2	X2=-0.5	X3=0.5	S11=-	
801.511913266068	IsS11Max=No	IsS11Min=No	FrameElem=75	ElemStation=0				
Frame=75	Station=0	OutputCase=ACCSX2	CaseType=Combination	Point=3	X2=0.5	X3=-0.5		
S11=574.735397144441	IsS11Max=Yes	IsS11Min=No	FrameElem=75	ElemStation=0				
Frame=75	Station=0	OutputCase=ACCSX2	CaseType=Combination	Point=4	X2=0.5	X3=0.5		
S11=574.735397144441	IsS11Max=No	IsS11Min=No	FrameElem=75	ElemStation=0				
Frame=75	Station=0.0625	OutputCase=ACCSX2	CaseType=Combination	Point=0	X2=0	X3=0	S11=-	
113.388258060813	IsS11Max=No	IsS11Min=No	FrameElem=75	ElemStation=0.0625				
Frame=75	Station=0.0625	OutputCase=ACCSX2	CaseType=Combination	Point=1	X2=-0.5	X3=-0.5	S11=-	
666.458598914111	IsS11Max=No	IsS11Min=Yes	FrameElem=75	ElemStation=0.0625				
Frame=75	Station=0.0625	OutputCase=ACCSX2	CaseType=Combination	Point=2	X2=-0.5	X3=0.5	S11=-	
666.458598914111	IsS11Max=No	IsS11Min=No	FrameElem=75	ElemStation=0.0625				
Frame=75	Station=0.0625	OutputCase=ACCSX2	CaseType=Combination	Point=3	X2=0.5	X3=-0.5		
S11=439.682082792484	IsS11Max=Yes	IsS11Min=No	FrameElem=75	ElemStation=0.0625				
Frame=75	Station=0.0625	OutputCase=ACCSX2	CaseType=Combination	Point=4	X2=0.5	X3=0.5		
S11=439.682082792484	IsS11Max=No	IsS11Min=No	FrameElem=75	ElemStation=0.0625				
Frame=75	Station=0.125	OutputCase=ACCSX2	CaseType=Combination	Point=0	X2=0	X3=0	S11=-	
113.388258060813	IsS11Max=No	IsS11Min=No	FrameElem=75	ElemStation=0.125				
Frame=75	Station=0.125	OutputCase=ACCSX2	CaseType=Combination	Point=1	X2=-0.5	X3=-0.5	S11=-	
535.225597062154	IsS11Max=No	IsS11Min=Yes	FrameElem=75	ElemStation=0.125				
Frame=75	Station=0.125	OutputCase=ACCSX2	CaseType=Combination	Point=2	X2=-0.5	X3=0.5	S11=-	
535.225597062154	IsS11Max=No	IsS11Min=No	FrameElem=75	ElemStation=0.125				
Frame=75	Station=0.125	OutputCase=ACCSX2	CaseType=Combination	Point=3	X2=0.5	X3=-0.5		
S11=308.449080940527	IsS11Max=Yes	IsS11Min=No	FrameElem=75	ElemStation=0.125				
Frame=75	Station=0.125	OutputCase=ACCSX2	CaseType=Combination	Point=4	X2=0.5	X3=0.5		
S11=308.449080940527	IsS11Max=No	IsS11Min=No	FrameElem=75	ElemStation=0.125				
Frame=75	Station=0.1875	OutputCase=ACCSX2	CaseType=Combination	Point=0	X2=0	X3=0	S11=-	
113.388258060813	IsS11Max=No	IsS11Min=No	FrameElem=75	ElemStation=0.1875				
Frame=75	Station=0.1875	OutputCase=ACCSX2	CaseType=Combination	Point=1	X2=-0.5	X3=-0.5	S11=-	
407.812907710196	IsS11Max=No	IsS11Min=Yes	FrameElem=75	ElemStation=0.1875				
Frame=75	Station=0.1875	OutputCase=ACCSX2	CaseType=Combination	Point=2	X2=-0.5	X3=0.5	S11=-	
407.812907710196	IsS11Max=No	IsS11Min=No	FrameElem=75	ElemStation=0.1875				
Frame=75	Station=0.1875	OutputCase=ACCSX2	CaseType=Combination	Point=3	X2=0.5	X3=-0.5		
S11=181.03639158857	IsS11Max=Yes	IsS11Min=No	FrameElem=75	ElemStation=0.1875				
Frame=75	Station=0.1875	OutputCase=ACCSX2	CaseType=Combination	Point=4	X2=0.5	X3=0.5		
S11=181.03639158857	IsS11Max=No	IsS11Min=No	FrameElem=75	ElemStation=0.1875				
Frame=75	Station=0.25	OutputCase=ACCSX2	CaseType=Combination	Point=0	X2=0	X3=0	S11=-	
113.388258060813	IsS11Max=No	IsS11Min=No	FrameElem=75	ElemStation=0.25				
Frame=75	Station=0.25	OutputCase=ACCSX2	CaseType=Combination	Point=1	X2=-0.5	X3=-0.5	S11=-	
284.220530858239	IsS11Max=No	IsS11Min=Yes	FrameElem=75	ElemStation=0.25				
Frame=75	Station=0.25	OutputCase=ACCSX2	CaseType=Combination	Point=2	X2=-0.5	X3=0.5	S11=-	
284.220530858239	IsS11Max=No	IsS11Min=No	FrameElem=75	ElemStation=0.25				
Frame=75	Station=0.25	OutputCase=ACCSX2	CaseType=Combination	Point=3	X2=0.5	X3=-0.5		
S11=57.4440147366126	IsS11Max=Yes	IsS11Min=No	FrameElem=75	ElemStation=0.25				
Frame=75	Station=0.25	OutputCase=ACCSX2	CaseType=Combination	Point=4	X2=0.5	X3=0.5		
S11=57.4440147366126	IsS11Max=No	IsS11Min=No	FrameElem=75	ElemStation=0.25				
Frame=75	Station=0	OutputCase=ENVE	CaseType=Combination	StepType=Max	Point=0	X2=0	X3=0	S11=-
111.115460069968	IsS11Max=No	IsS11Min=No	FrameElem=75	ElemStation=0				
Frame=75	Station=0	OutputCase=ENVE	CaseType=Combination	StepType=Max	Point=1	X2=-0.5	X3=-0.5	
S11=-801.511913266068	IsS11Max=No	IsS11Min=Yes	FrameElem=75	ElemStation=0				
Frame=75	Station=0	OutputCase=ENVE	CaseType=Combination	StepType=Max	Point=2	X2=-0.5	X3=0.5	S11=-
801.511913266068	IsS11Max=No	IsS11Min=No	FrameElem=75	ElemStation=0				
Frame=75	Station=0	OutputCase=ENVE	CaseType=Combination	StepType=Max	Point=3	X2=0.5	X3=-0.5	
S11=646.974515361853	IsS11Max=Yes	IsS11Min=No	FrameElem=75	ElemStation=0				
Frame=75	Station=0	OutputCase=ENVE	CaseType=Combination	StepType=Max	Point=4	X2=0.5	X3=0.5	
S11=646.974515361853	IsS11Max=No	IsS11Min=No	FrameElem=75	ElemStation=0				
Frame=75	Station=0.0625	OutputCase=ENVE	CaseType=Combination	StepType=Max	Point=0	X2=0	X3=0	S11=-
111.115460069968	IsS11Max=No	IsS11Min=No	FrameElem=75	ElemStation=0.0625				
Frame=75	Station=0.0625	OutputCase=ENVE	CaseType=Combination	StepType=Max	Point=1	X2=-0.5	X3=-0.5	
S11=-666.458598914111	IsS11Max=No	IsS11Min=Yes	FrameElem=75	ElemStation=0.0625				
Frame=75	Station=0.0625	OutputCase=ENVE	CaseType=Combination	StepType=Max	Point=2	X2=-0.5	X3=0.5	
S11=-666.458598914111	IsS11Max=No	IsS11Min=No	FrameElem=75	ElemStation=0.0625				
Frame=75	Station=0.0625	OutputCase=ENVE	CaseType=Combination	StepType=Max	Point=3	X2=0.5	X3=-0.5	
S11=506.843812646949	IsS11Max=Yes	IsS11Min=No	FrameElem=75	ElemStation=0.0625				
Frame=75	Station=0.0625	OutputCase=ENVE	CaseType=Combination	StepType=Max	Point=4	X2=0.5	X3=0.5	
S11=506.843812646949	IsS11Max=No	IsS11Min=No	FrameElem=75	ElemStation=0.0625				
Frame=75	Station=0.125	OutputCase=ENVE	CaseType=Combination	StepType=Max	Point=0	X2=0	X3=0	S11=-
111.115460069968	IsS11Max=No	IsS11Min=No	FrameElem=75	ElemStation=0.125				
Frame=75	Station=0.125	OutputCase=ENVE	CaseType=Combination	StepType=Max	Point=1	X2=-0.5	X3=-0.5	
S11=-535.225597062154	IsS11Max=No	IsS11Min=Yes	FrameElem=75	ElemStation=0.125				
Frame=75	Station=0.125	OutputCase=ENVE	CaseType=Combination	StepType=Max	Point=2	X2=-0.5	X3=0.5	
S11=-535.225597062154	IsS11Max=No	IsS11Min=No	FrameElem=75	ElemStation=0.125				
Frame=75	Station=0.125	OutputCase=ENVE	CaseType=Combination	StepType=Max	Point=3	X2=0.5	X3=-0.5	
S11=370.660453682046	IsS11Max=Yes	IsS11Min=No	FrameElem=75	ElemStation=0.125				
Frame=75	Station=0.125	OutputCase=ENVE	CaseType=Combination	StepType=Max	Point=4	X2=0.5	X3=0.5	
S11=370.660453682046	IsS11Max=No	IsS11Min=No	FrameElem=75	ElemStation=0.125				
Frame=75	Station=0.1875	OutputCase=ENVE	CaseType=Combination	StepType=Max	Point=0	X2=0	X3=0	S11=-
111.115460069968	IsS11Max=No	IsS11Min=No	FrameElem=75	ElemStation=0.1875				
Frame=75	Station=0.1875	OutputCase=ENVE	CaseType=Combination	StepType=Max	Point=1	X2=-0.5	X3=-0.5	
S11=-407.812907710196	IsS11Max=No	IsS11Min=Yes	FrameElem=75	ElemStation=0.1875				
Frame=75	Station=0.1875	OutputCase=ENVE	CaseType=Combination	StepType=Max	Point=2	X2=-0.5	X3=0.5	
S11=-407.812907710196	IsS11Max=No	IsS11Min=No	FrameElem=75	ElemStation=0.1875				



Frame=75	Station=0.1875	OutputCase=ENVE	CaseType=Combination	StepType=Max	Point=3	X2=0.5	X3=-0.5	
S11=238.424438467142	IsS11Max=Yes	IsS11Min=No	FrameElem=75	ElemStation=0.1875				
Frame=75	Station=0.1875	OutputCase=ENVE	CaseType=Combination	StepType=Max	Point=4	X2=0.5	X3=0.5	
S11=238.424438467142	IsS11Max=No	IsS11Min=No	FrameElem=75	ElemStation=0.1875				
Frame=75	Station=0.25	OutputCase=ENVE	CaseType=Combination	StepType=Max	Point=0	X2=0	X3=0	S11=-
111.115460069968	IsS11Max=No	IsS11Min=No	FrameElem=75	ElemStation=0.25				
Frame=75	Station=0.25	OutputCase=ENVE	CaseType=Combination	StepType=Max	Point=1	X2=-0.5	X3=-0.5	
S11=-284.220530858239	IsS11Max=No	IsS11Min=Yes	FrameElem=75	ElemStation=0.25				
Frame=75	Station=0.25	OutputCase=ENVE	CaseType=Combination	StepType=Max	Point=2	X2=-0.5	X3=0.5	
S11=-284.220530858239	IsS11Max=No	IsS11Min=No	FrameElem=75	ElemStation=0.25				
Frame=75	Station=0.25	OutputCase=ENVE	CaseType=Combination	StepType=Max	Point=3	X2=0.5	X3=-0.5	
S11=110.135767002238	IsS11Max=Yes	IsS11Min=No	FrameElem=75	ElemStation=0.25				
Frame=75	Station=0.25	OutputCase=ENVE	CaseType=Combination	StepType=Max	Point=4	X2=0.5	X3=0.5	
S11=110.135767002238	IsS11Max=No	IsS11Min=No	FrameElem=75	ElemStation=0.25				
Frame=75	Station=0	OutputCase=ENVE	CaseType=Combination	StepType=Min	Point=0	X2=0	X3=0	S11=-
169.541010668989	IsS11Max=No	IsS11Min=No	FrameElem=75	ElemStation=0				
Frame=75	Station=0	OutputCase=ENVE	CaseType=Combination	StepType=Min	Point=1	X2=-0.5	X3=-0.5	
S11=-986.056536699831	IsS11Max=No	IsS11Min=Yes	FrameElem=75	ElemStation=0				
Frame=75	Station=0	OutputCase=ENVE	CaseType=Combination	StepType=Min	Point=2	X2=-0.5	X3=0.5	S11=-
986.056536699831	IsS11Max=No	IsS11Min=No	FrameElem=75	ElemStation=0				
Frame=75	Station=0	OutputCase=ENVE	CaseType=Combination	StepType=Min	Point=3	X2=0.5	X3=-0.5	
S11=574.735397144441	IsS11Max=Yes	IsS11Min=No	FrameElem=75	ElemStation=0				
Frame=75	Station=0	OutputCase=ENVE	CaseType=Combination	StepType=Min	Point=4	X2=0.5	X3=0.5	
S11=574.735397144441	IsS11Max=No	IsS11Min=No	FrameElem=75	ElemStation=0				
Frame=75	Station=0.0625	OutputCase=ENVE	CaseType=Combination	StepType=Min	Point=0	X2=0	X3=0	S11=-
169.541010668989	IsS11Max=No	IsS11Min=No	FrameElem=75	ElemStation=0.0625				
Frame=75	Station=0.0625	OutputCase=ENVE	CaseType=Combination	StepType=Min	Point=1	X2=-0.5	X3=-0.5	
S11=-845.925833984928	IsS11Max=No	IsS11Min=Yes	FrameElem=75	ElemStation=0.0625				
Frame=75	Station=0.0625	OutputCase=ENVE	CaseType=Combination	StepType=Min	Point=2	X2=-0.5	X3=0.5	
S11=-845.925833984928	IsS11Max=No	IsS11Min=No	FrameElem=75	ElemStation=0.0625				
Frame=75	Station=0.0625	OutputCase=ENVE	CaseType=Combination	StepType=Min	Point=3	X2=0.5	X3=-0.5	
S11=439.682082792484	IsS11Max=Yes	IsS11Min=No	FrameElem=75	ElemStation=0.0625				
Frame=75	Station=0.0625	OutputCase=ENVE	CaseType=Combination	StepType=Min	Point=4	X2=0.5	X3=0.5	
S11=439.682082792484	IsS11Max=No	IsS11Min=No	FrameElem=75	ElemStation=0.0625				
Frame=75	Station=0.125	OutputCase=ENVE	CaseType=Combination	StepType=Min	Point=0	X2=0	X3=0	S11=-
169.541010668989	IsS11Max=No	IsS11Min=No	FrameElem=75	ElemStation=0.125				
Frame=75	Station=0.125	OutputCase=ENVE	CaseType=Combination	StepType=Min	Point=1	X2=-0.5	X3=-0.5	
S11=-709.742475020024	IsS11Max=No	IsS11Min=Yes	FrameElem=75	ElemStation=0.125				
Frame=75	Station=0.125	OutputCase=ENVE	CaseType=Combination	StepType=Min	Point=2	X2=-0.5	X3=0.5	
S11=-709.742475020024	IsS11Max=No	IsS11Min=No	FrameElem=75	ElemStation=0.125				
Frame=75	Station=0.125	OutputCase=ENVE	CaseType=Combination	StepType=Min	Point=3	X2=0.5	X3=-0.5	
S11=308.449080940527	IsS11Max=Yes	IsS11Min=No	FrameElem=75	ElemStation=0.125				
Frame=75	Station=0.125	OutputCase=ENVE	CaseType=Combination	StepType=Min	Point=4	X2=0.5	X3=0.5	
S11=308.449080940527	IsS11Max=No	IsS11Min=No	FrameElem=75	ElemStation=0.125				
Frame=75	Station=0.1875	OutputCase=ENVE	CaseType=Combination	StepType=Min	Point=0	X2=0	X3=0	S11=-
169.541010668989	IsS11Max=No	IsS11Min=No	FrameElem=75	ElemStation=0.1875				
Frame=75	Station=0.1875	OutputCase=ENVE	CaseType=Combination	StepType=Min	Point=1	X2=-0.5	X3=-0.5	
S11=-577.50645980512	IsS11Max=No	IsS11Min=Yes	FrameElem=75	ElemStation=0.1875				
Frame=75	Station=0.1875	OutputCase=ENVE	CaseType=Combination	StepType=Min	Point=2	X2=-0.5	X3=0.5	
S11=-577.50645980512	IsS11Max=No	IsS11Min=No	FrameElem=75	ElemStation=0.1875				
Frame=75	Station=0.1875	OutputCase=ENVE	CaseType=Combination	StepType=Min	Point=3	X2=0.5	X3=-0.5	
S11=181.03639158857	IsS11Max=Yes	IsS11Min=No	FrameElem=75	ElemStation=0.1875				
Frame=75	Station=0.1875	OutputCase=ENVE	CaseType=Combination	StepType=Min	Point=4	X2=0.5	X3=0.5	
S11=181.03639158857	IsS11Max=No	IsS11Min=No	FrameElem=75	ElemStation=0.1875				
Frame=75	Station=0.25	OutputCase=ENVE	CaseType=Combination	StepType=Min	Point=0	X2=0	X3=0	S11=-
169.541010668989	IsS11Max=No	IsS11Min=No	FrameElem=75	ElemStation=0.25				
Frame=75	Station=0.25	OutputCase=ENVE	CaseType=Combination	StepType=Min	Point=1	X2=-0.5	X3=-0.5	
S11=-449.217788340217	IsS11Max=No	IsS11Min=Yes	FrameElem=75	ElemStation=0.25				
Frame=75	Station=0.25	OutputCase=ENVE	CaseType=Combination	StepType=Min	Point=2	X2=-0.5	X3=0.5	
S11=-449.217788340217	IsS11Max=No	IsS11Min=No	FrameElem=75	ElemStation=0.25				
Frame=75	Station=0.25	OutputCase=ENVE	CaseType=Combination	StepType=Min	Point=3	X2=0.5	X3=-0.5	
S11=57.4440147366126	IsS11Max=Yes	IsS11Min=No	FrameElem=75	ElemStation=0.25				
Frame=75	Station=0.25	OutputCase=ENVE	CaseType=Combination	StepType=Min	Point=4	X2=0.5	X3=0.5	
S11=57.4440147366126	IsS11Max=No	IsS11Min=No	FrameElem=75	ElemStation=0.25				
Frame=75	Station=0	OutputCase=FESSUR	CaseType=Combination	Point=0	X2=0	X3=0	S11=-168.146075212916	
IsS11Max=No	IsS11Min=No	FrameElem=75	ElemStation=0					
Frame=75	Station=0	OutputCase=FESSUR	CaseType=Combination	Point=1	X2=-0.5	X3=-0.5	S11=-	
976.670770136919	IsS11Max=No	IsS11Min=Yes	FrameElem=75	ElemStation=0				
Frame=75	Station=0	OutputCase=FESSUR	CaseType=Combination	Point=2	X2=-0.5	X3=0.5	S11=-	
976.670770136919	IsS11Max=No	IsS11Min=No	FrameElem=75	ElemStation=0				
Frame=75	Station=0	OutputCase=FESSUR	CaseType=Combination	Point=3	X2=0.5	X3=-0.5		
S11=640.378619711086	IsS11Max=Yes	IsS11Min=No	FrameElem=75	ElemStation=0				
Frame=75	Station=0	OutputCase=FESSUR	CaseType=Combination	Point=4	X2=0.5	X3=0.5		
S11=640.378619711086	IsS11Max=No	IsS11Min=No	FrameElem=75	ElemStation=0				
Frame=75	Station=0.0625	OutputCase=FESSUR	CaseType=Combination	Point=0	X2=0	X3=0	S11=-	
168.146075212916	IsS11Max=No	IsS11Min=No	FrameElem=75	ElemStation=0.0625				
Frame=75	Station=0.0625	OutputCase=FESSUR	CaseType=Combination	Point=1	X2=-0.5	X3=-0.5	S11=-	
837.892950231112	IsS11Max=No	IsS11Min=Yes	FrameElem=75	ElemStation=0.0625				
Frame=75	Station=0.0625	OutputCase=FESSUR	CaseType=Combination	Point=2	X2=-0.5	X3=0.5	S11=-	
837.892950231112	IsS11Max=No	IsS11Min=No	FrameElem=75	ElemStation=0.0625				
Frame=75	Station=0.0625	OutputCase=FESSUR	CaseType=Combination	Point=3	X2=0.5	X3=-0.5		
S11=501.600799805279	IsS11Max=Yes	IsS11Min=No	FrameElem=75	ElemStation=0.0625				

```

Frame=75 Station=0.0625 OutputCase=FESSUR CaseType=Combination Point=4 X2=0.5 X3=0.5
S11=501.600799805279 IsS11Max=No IsS11Min=No FrameElem=75 ElemStation=0.0625
Frame=75 Station=0.125 OutputCase=FESSUR CaseType=Combination Point=0 X2=0 X3=0 S11=-
168.146075212916 IsS11Max=No IsS11Min=No FrameElem=75 ElemStation=0.125
Frame=75 Station=0.125 OutputCase=FESSUR CaseType=Combination Point=1 X2=-0.5 X3=-0.5 S11=-
703.024364700305 IsS11Max=No IsS11Min=Yes FrameElem=75 ElemStation=0.125
Frame=75 Station=0.125 OutputCase=FESSUR CaseType=Combination Point=2 X2=-0.5 X3=0.5 S11=-
703.024364700305 IsS11Max=No IsS11Min=No FrameElem=75 ElemStation=0.125
Frame=75 Station=0.125 OutputCase=FESSUR CaseType=Combination Point=3 X2=0.5 X3=-0.5
S11=366.732214274472 IsS11Max=Yes IsS11Min=No FrameElem=75 ElemStation=0.125
Frame=75 Station=0.125 OutputCase=FESSUR CaseType=Combination Point=4 X2=0.5 X3=0.5
S11=366.732214274472 IsS11Max=No IsS11Min=No FrameElem=75 ElemStation=0.125
Frame=75 Station=0.1875 OutputCase=FESSUR CaseType=Combination Point=0 X2=0 X3=0 S11=-
168.146075212916 IsS11Max=No IsS11Min=No FrameElem=75 ElemStation=0.1875
Frame=75 Station=0.1875 OutputCase=FESSUR CaseType=Combination Point=1 X2=-0.5 X3=-0.5 S11=-
572.065013544498 IsS11Max=No IsS11Min=Yes FrameElem=75 ElemStation=0.1875
Frame=75 Station=0.1875 OutputCase=FESSUR CaseType=Combination Point=2 X2=-0.5 X3=0.5 S11=-
572.065013544498 IsS11Max=No IsS11Min=No FrameElem=75 ElemStation=0.1875
Frame=75 Station=0.1875 OutputCase=FESSUR CaseType=Combination Point=3 X2=0.5 X3=-0.5
S11=235.772863118665 IsS11Max=Yes IsS11Min=No FrameElem=75 ElemStation=0.1875
Frame=75 Station=0.1875 OutputCase=FESSUR CaseType=Combination Point=4 X2=0.5 X3=0.5
S11=235.772863118665 IsS11Max=No IsS11Min=No FrameElem=75 ElemStation=0.1875
Frame=75 Station=0.25 OutputCase=FESSUR CaseType=Combination Point=0 X2=0 X3=0 S11=-
168.146075212916 IsS11Max=No IsS11Min=No FrameElem=75 ElemStation=0.25
Frame=75 Station=0.25 OutputCase=FESSUR CaseType=Combination Point=1 X2=-0.5 X3=-0.5 S11=-
445.014896763691 IsS11Max=No IsS11Min=Yes FrameElem=75 ElemStation=0.25
Frame=75 Station=0.25 OutputCase=FESSUR CaseType=Combination Point=2 X2=-0.5 X3=0.5 S11=-
445.014896763691 IsS11Max=No IsS11Min=No FrameElem=75 ElemStation=0.25
Frame=75 Station=0.25 OutputCase=FESSUR CaseType=Combination Point=3 X2=0.5 X3=-0.5
S11=108.722746337858 IsS11Max=Yes IsS11Min=No FrameElem=75 ElemStation=0.25
Frame=75 Station=0.25 OutputCase=FESSUR CaseType=Combination Point=4 X2=0.5 X3=0.5
S11=108.722746337858 IsS11Max=No IsS11Min=No FrameElem=75 ElemStation=0.25
Frame=77 Station=0 OutputCase=PERM1 CaseType=Combination Point=0 X2=0 X3=0 S11=-164.891225815414
IsS11Max=No IsS11Min=No FrameElem=77 ElemStation=0
Frame=77 Station=0 OutputCase=PERM1 CaseType=Combination Point=1 X2=-0.5 X3=-0.5 S11=-
435.208175269283 IsS11Max=No IsS11Min=Yes FrameElem=77 ElemStation=0
Frame=77 Station=0 OutputCase=PERM1 CaseType=Combination Point=2 X2=-0.5 X3=0.5 S11=-
435.208175269283 IsS11Max=No IsS11Min=No FrameElem=77 ElemStation=0
Frame=77 Station=0 OutputCase=PERM1 CaseType=Combination Point=3 X2=0.5 X3=-0.5
S11=105.425723638454 IsS11Max=Yes IsS11Min=No FrameElem=77 ElemStation=0
Frame=77 Station=0 OutputCase=PERM1 CaseType=Combination Point=4 X2=0.5 X3=0.5 S11=105.425723638454
IsS11Max=No IsS11Min=No FrameElem=77 ElemStation=0
Frame=77 Station=0.0625 OutputCase=PERM1 CaseType=Combination Point=0 X2=0 X3=0 S11=-
164.891225815414 IsS11Max=No IsS11Min=No FrameElem=77 ElemStation=0.0625
Frame=77 Station=0.0625 OutputCase=PERM1 CaseType=Combination Point=1 X2=-0.5 X3=-0.5 S11=-
559.368331917969 IsS11Max=No IsS11Min=Yes FrameElem=77 ElemStation=0.0625
Frame=77 Station=0.0625 OutputCase=PERM1 CaseType=Combination Point=2 X2=-0.5 X3=0.5 S11=-
559.368331917969 IsS11Max=No IsS11Min=No FrameElem=77 ElemStation=0.0625
Frame=77 Station=0.0625 OutputCase=PERM1 CaseType=Combination Point=3 X2=0.5 X3=-0.5
S11=229.58588028714 IsS11Max=Yes IsS11Min=No FrameElem=77 ElemStation=0.0625
Frame=77 Station=0.0625 OutputCase=PERM1 CaseType=Combination Point=4 X2=0.5 X3=0.5
S11=229.58588028714 IsS11Max=No IsS11Min=No FrameElem=77 ElemStation=0.0625
Frame=77 Station=0.125 OutputCase=PERM1 CaseType=Combination Point=0 X2=0 X3=0 S11=-
164.891225815414 IsS11Max=No IsS11Min=No FrameElem=77 ElemStation=0.125
Frame=77 Station=0.125 OutputCase=PERM1 CaseType=Combination Point=1 X2=-0.5 X3=-0.5 S11=-
687.348801066656 IsS11Max=No IsS11Min=Yes FrameElem=77 ElemStation=0.125
Frame=77 Station=0.125 OutputCase=PERM1 CaseType=Combination Point=2 X2=-0.5 X3=0.5 S11=-
687.348801066656 IsS11Max=No IsS11Min=No FrameElem=77 ElemStation=0.125
Frame=77 Station=0.125 OutputCase=PERM1 CaseType=Combination Point=3 X2=0.5 X3=-0.5
S11=357.566349435827 IsS11Max=Yes IsS11Min=No FrameElem=77 ElemStation=0.125
Frame=77 Station=0.125 OutputCase=PERM1 CaseType=Combination Point=4 X2=0.5 X3=0.5
S11=357.566349435827 IsS11Max=No IsS11Min=No FrameElem=77 ElemStation=0.125
Frame=77 Station=0.1875 OutputCase=PERM1 CaseType=Combination Point=0 X2=0 X3=0 S11=-
164.891225815414 IsS11Max=No IsS11Min=No FrameElem=77 ElemStation=0.1875
Frame=77 Station=0.1875 OutputCase=PERM1 CaseType=Combination Point=1 X2=-0.5 X3=-0.5 S11=-
819.149582715342 IsS11Max=No IsS11Min=Yes FrameElem=77 ElemStation=0.1875
Frame=77 Station=0.1875 OutputCase=PERM1 CaseType=Combination Point=2 X2=-0.5 X3=0.5 S11=-
819.149582715342 IsS11Max=No IsS11Min=No FrameElem=77 ElemStation=0.1875
Frame=77 Station=0.1875 OutputCase=PERM1 CaseType=Combination Point=3 X2=0.5 X3=-0.5
S11=489.367131084514 IsS11Max=Yes IsS11Min=No FrameElem=77 ElemStation=0.1875
Frame=77 Station=0.1875 OutputCase=PERM1 CaseType=Combination Point=4 X2=0.5 X3=0.5
S11=489.367131084514 IsS11Max=No IsS11Min=No FrameElem=77 ElemStation=0.1875
Frame=77 Station=0.25 OutputCase=PERM1 CaseType=Combination Point=0 X2=0 X3=0 S11=-164.891225815414
IsS11Max=No IsS11Min=No FrameElem=77 ElemStation=0.25
Frame=77 Station=0.25 OutputCase=PERM1 CaseType=Combination Point=1 X2=-0.5 X3=-0.5 S11=-
954.770676864029 IsS11Max=No IsS11Min=Yes FrameElem=77 ElemStation=0.25
Frame=77 Station=0.25 OutputCase=PERM1 CaseType=Combination Point=2 X2=-0.5 X3=0.5 S11=-
954.770676864029 IsS11Max=No IsS11Min=No FrameElem=77 ElemStation=0.25
Frame=77 Station=0.25 OutputCase=PERM1 CaseType=Combination Point=3 X2=0.5 X3=-0.5
S11=624.9882252332 IsS11Max=Yes IsS11Min=No FrameElem=77 ElemStation=0.25
Frame=77 Station=0.25 OutputCase=PERM1 CaseType=Combination Point=4 X2=0.5 X3=0.5
S11=624.9882252332 IsS11Max=No IsS11Min=No FrameElem=77 ElemStation=0.25

```



Frame=77	Station=0	OutputCase=PERM2	CaseType=Combination	Point=0	X2=0	X3=0	S11=-111.115460069969
IsS11Max=No	IsS11Min=No	FrameElem=77	ElemStation=0				
Frame=77	Station=0	OutputCase=PERM2	CaseType=Combination	Point=1	X2=-0.5	X3=-0.5	S11=-
296.446547887215	IsS11Max=No	IsS11Min=Yes	FrameElem=77	ElemStation=0			
Frame=77	Station=0	OutputCase=PERM2	CaseType=Combination	Point=2	X2=-0.5	X3=0.5	S11=-
296.446547887215	IsS11Max=No	IsS11Min=No	FrameElem=77	ElemStation=0			
Frame=77	Station=0	OutputCase=PERM2	CaseType=Combination	Point=3	X2=0.5	X3=-0.5	
S11=74.2156277472768	IsS11Max=Yes	IsS11Min=No	FrameElem=77	ElemStation=0			
Frame=77	Station=0	OutputCase=PERM2	CaseType=Combination	Point=4	X2=0.5	X3=0.5	S11=74.2156277472768
IsS11Max=No	IsS11Min=No	FrameElem=77	ElemStation=0				
Frame=77	Station=0.0625	OutputCase=PERM2	CaseType=Combination	Point=0	X2=0	X3=0	S11=-
111.115460069969	IsS11Max=No	IsS11Min=No	FrameElem=77	ElemStation=0.0625			
Frame=77	Station=0.0625	OutputCase=PERM2	CaseType=Combination	Point=1	X2=-0.5	X3=-0.5	S11=-
420.606704433148	IsS11Max=No	IsS11Min=Yes	FrameElem=77	ElemStation=0.0625			
Frame=77	Station=0.0625	OutputCase=PERM2	CaseType=Combination	Point=2	X2=-0.5	X3=0.5	S11=-
420.606704433148	IsS11Max=No	IsS11Min=No	FrameElem=77	ElemStation=0.0625			
Frame=77	Station=0.0625	OutputCase=PERM2	CaseType=Combination	Point=3	X2=0.5	X3=-0.5	
S11=198.37578429321	IsS11Max=Yes	IsS11Min=No	FrameElem=77	ElemStation=0.0625			
Frame=77	Station=0.0625	OutputCase=PERM2	CaseType=Combination	Point=4	X2=0.5	X3=0.5	
S11=198.37578429321	IsS11Max=No	IsS11Min=No	FrameElem=77	ElemStation=0.0625			
Frame=77	Station=0.125	OutputCase=PERM2	CaseType=Combination	Point=0	X2=0	X3=0	S11=-
111.115460069969	IsS11Max=No	IsS11Min=No	FrameElem=77	ElemStation=0.125			
Frame=77	Station=0.125	OutputCase=PERM2	CaseType=Combination	Point=1	X2=-0.5	X3=-0.5	S11=-
548.587173479081	IsS11Max=No	IsS11Min=Yes	FrameElem=77	ElemStation=0.125			
Frame=77	Station=0.125	OutputCase=PERM2	CaseType=Combination	Point=2	X2=-0.5	X3=0.5	S11=-
548.587173479081	IsS11Max=No	IsS11Min=No	FrameElem=77	ElemStation=0.125			
Frame=77	Station=0.125	OutputCase=PERM2	CaseType=Combination	Point=3	X2=0.5	X3=-0.5	
S11=326.356253339142	IsS11Max=Yes	IsS11Min=No	FrameElem=77	ElemStation=0.125			
Frame=77	Station=0.125	OutputCase=PERM2	CaseType=Combination	Point=4	X2=0.5	X3=0.5	
S11=326.356253339142	IsS11Max=No	IsS11Min=No	FrameElem=77	ElemStation=0.125			
Frame=77	Station=0.1875	OutputCase=PERM2	CaseType=Combination	Point=0	X2=0	X3=0	S11=-
111.115460069969	IsS11Max=No	IsS11Min=No	FrameElem=77	ElemStation=0.1875			
Frame=77	Station=0.1875	OutputCase=PERM2	CaseType=Combination	Point=1	X2=-0.5	X3=-0.5	S11=-
680.387955025014	IsS11Max=No	IsS11Min=Yes	FrameElem=77	ElemStation=0.1875			
Frame=77	Station=0.1875	OutputCase=PERM2	CaseType=Combination	Point=2	X2=-0.5	X3=0.5	S11=-
680.387955025014	IsS11Max=No	IsS11Min=No	FrameElem=77	ElemStation=0.1875			
Frame=77	Station=0.1875	OutputCase=PERM2	CaseType=Combination	Point=3	X2=0.5	X3=-0.5	
S11=458.157034885075	IsS11Max=Yes	IsS11Min=No	FrameElem=77	ElemStation=0.1875			
Frame=77	Station=0.1875	OutputCase=PERM2	CaseType=Combination	Point=4	X2=0.5	X3=0.5	
S11=458.157034885075	IsS11Max=No	IsS11Min=No	FrameElem=77	ElemStation=0.1875			
Frame=77	Station=0.25	OutputCase=PERM2	CaseType=Combination	Point=0	X2=0	X3=0	S11=-111.115460069969
IsS11Max=No	IsS11Min=No	FrameElem=77	ElemStation=0.25				
Frame=77	Station=0.25	OutputCase=PERM2	CaseType=Combination	Point=1	X2=-0.5	X3=-0.5	S11=-
816.009049070947	IsS11Max=No	IsS11Min=Yes	FrameElem=77	ElemStation=0.25			
Frame=77	Station=0.25	OutputCase=PERM2	CaseType=Combination	Point=2	X2=-0.5	X3=0.5	S11=-
816.009049070947	IsS11Max=No	IsS11Min=No	FrameElem=77	ElemStation=0.25			
Frame=77	Station=0.25	OutputCase=PERM2	CaseType=Combination	Point=3	X2=0.5	X3=-0.5	
S11=593.778128931008	IsS11Max=Yes	IsS11Min=No	FrameElem=77	ElemStation=0.25			
Frame=77	Station=0.25	OutputCase=PERM2	CaseType=Combination	Point=4	X2=0.5	X3=0.5	
S11=593.778128931008	IsS11Max=No	IsS11Min=No	FrameElem=77	ElemStation=0.25			
Frame=77	Station=0	OutputCase=ACCL	CaseType=Combination	Point=0	X2=0	X3=0	S11=-169.541010668997
IsS11Max=No	IsS11Min=No	FrameElem=77	ElemStation=0				
Frame=77	Station=0	OutputCase=ACCL	CaseType=Combination	Point=1	X2=-0.5	X3=-0.5	S11=-
449.217814583684	IsS11Max=No	IsS11Min=Yes	FrameElem=77	ElemStation=0			
Frame=77	Station=0	OutputCase=ACCL	CaseType=Combination	Point=2	X2=-0.5	X3=0.5	S11=-
449.217814583684	IsS11Max=No	IsS11Min=No	FrameElem=77	ElemStation=0			
Frame=77	Station=0	OutputCase=ACCL	CaseType=Combination	Point=3	X2=0.5	X3=-0.5	S11=110.135793245689
IsS11Max=Yes	IsS11Min=No	FrameElem=77	ElemStation=0				
Frame=77	Station=0	OutputCase=ACCL	CaseType=Combination	Point=4	X2=0.5	X3=0.5	S11=110.135793245689
IsS11Max=No	IsS11Min=No	FrameElem=77	ElemStation=0				
Frame=77	Station=0.0625	OutputCase=ACCL	CaseType=Combination	Point=0	X2=0	X3=0	S11=-
169.541010668997	IsS11Max=No	IsS11Min=No	FrameElem=77	ElemStation=0.0625			
Frame=77	Station=0.0625	OutputCase=ACCL	CaseType=Combination	Point=1	X2=-0.5	X3=-0.5	S11=-
577.506486868713	IsS11Max=No	IsS11Min=Yes	FrameElem=77	ElemStation=0.0625			
Frame=77	Station=0.0625	OutputCase=ACCL	CaseType=Combination	Point=2	X2=-0.5	X3=0.5	S11=-
577.506486868713	IsS11Max=No	IsS11Min=No	FrameElem=77	ElemStation=0.0625			
Frame=77	Station=0.0625	OutputCase=ACCL	CaseType=Combination	Point=3	X2=0.5	X3=-0.5	
S11=238.424465530719	IsS11Max=Yes	IsS11Min=No	FrameElem=77	ElemStation=0.0625			
Frame=77	Station=0.0625	OutputCase=ACCL	CaseType=Combination	Point=4	X2=0.5	X3=0.5	
S11=238.424465530719	IsS11Max=No	IsS11Min=No	FrameElem=77	ElemStation=0.0625			
Frame=77	Station=0.125	OutputCase=ACCL	CaseType=Combination	Point=0	X2=0	X3=0	S11=-169.541010668997
IsS11Max=No	IsS11Min=No	FrameElem=77	ElemStation=0.125				
Frame=77	Station=0.125	OutputCase=ACCL	CaseType=Combination	Point=1	X2=-0.5	X3=-0.5	S11=-
709.742502903743	IsS11Max=No	IsS11Min=Yes	FrameElem=77	ElemStation=0.125			
Frame=77	Station=0.125	OutputCase=ACCL	CaseType=Combination	Point=2	X2=-0.5	X3=0.5	S11=-
709.742502903743	IsS11Max=No	IsS11Min=No	FrameElem=77	ElemStation=0.125			
Frame=77	Station=0.125	OutputCase=ACCL	CaseType=Combination	Point=3	X2=0.5	X3=-0.5	
S11=370.660481565748	IsS11Max=Yes	IsS11Min=No	FrameElem=77	ElemStation=0.125			
Frame=77	Station=0.125	OutputCase=ACCL	CaseType=Combination	Point=4	X2=0.5	X3=0.5	
S11=370.660481565748	IsS11Max=No	IsS11Min=No	FrameElem=77	ElemStation=0.125			
Frame=77	Station=0.1875	OutputCase=ACCL	CaseType=Combination	Point=0	X2=0	X3=0	S11=-
169.541010668997	IsS11Max=No	IsS11Min=No	FrameElem=77	ElemStation=0.1875			

Frame=77	Station=0.1875	OutputCase=ACC1	CaseType=Combination	Point=1	X2=-0.5	X3=-0.5	S11=-
845.925862688772	IsS11Max=No	IsS11Min=Yes	FrameElem=77	ElemStation=0.1875			
Frame=77	Station=0.1875	OutputCase=ACC1	CaseType=Combination	Point=2	X2=-0.5	X3=0.5	S11=-
845.925862688772	IsS11Max=No	IsS11Min=No	FrameElem=77	ElemStation=0.1875			
Frame=77	Station=0.1875	OutputCase=ACC1	CaseType=Combination	Point=3	X2=0.5	X3=-0.5	
S11=506.843841350777	IsS11Max=Yes	IsS11Min=No	FrameElem=77	ElemStation=0.1875			
Frame=77	Station=0.1875	OutputCase=ACC1	CaseType=Combination	Point=4	X2=0.5	X3=0.5	
S11=506.843841350777	IsS11Max=No	IsS11Min=No	FrameElem=77	ElemStation=0.1875			
Frame=77	Station=0.25	OutputCase=ACC1	CaseType=Combination	Point=0	X2=0	X3=0	S11=-169.541010668997
IsS11Max=No	IsS11Min=No	FrameElem=77	ElemStation=0.25				
Frame=77	Station=0.25	OutputCase=ACC1	CaseType=Combination	Point=1	X2=-0.5	X3=-0.5	S11=-
986.056566223801	IsS11Max=No	IsS11Min=Yes	FrameElem=77	ElemStation=0.25			
Frame=77	Station=0.25	OutputCase=ACC1	CaseType=Combination	Point=2	X2=-0.5	X3=0.5	S11=-
986.056566223801	IsS11Max=No	IsS11Min=No	FrameElem=77	ElemStation=0.25			
Frame=77	Station=0.25	OutputCase=ACC1	CaseType=Combination	Point=3	X2=0.5	X3=-0.5	
S11=646.974544885807	IsS11Max=Yes	IsS11Min=No	FrameElem=77	ElemStation=0.25			
Frame=77	Station=0.25	OutputCase=ACC1	CaseType=Combination	Point=4	X2=0.5	X3=0.5	
S11=646.974544885807	IsS11Max=No	IsS11Min=No	FrameElem=77	ElemStation=0.25			
Frame=77	Station=0	OutputCase=ACC2	CaseType=Combination	Point=0	X2=0	X3=0	S11=-115.765244923552
IsS11Max=No	IsS11Min=No	FrameElem=77	ElemStation=0				
Frame=77	Station=0	OutputCase=ACC2	CaseType=Combination	Point=1	X2=-0.5	X3=-0.5	S11=-
310.456187201617	IsS11Max=No	IsS11Min=Yes	FrameElem=77	ElemStation=0			
Frame=77	Station=0	OutputCase=ACC2	CaseType=Combination	Point=2	X2=-0.5	X3=0.5	S11=-
310.456187201617	IsS11Max=No	IsS11Min=No	FrameElem=77	ElemStation=0			
Frame=77	Station=0	OutputCase=ACC2	CaseType=Combination	Point=3	X2=0.5	X3=-0.5	S11=78.9256973545123
IsS11Max=Yes	IsS11Min=No	FrameElem=77	ElemStation=0				
Frame=77	Station=0	OutputCase=ACC2	CaseType=Combination	Point=4	X2=0.5	X3=0.5	S11=78.9256973545123
IsS11Max=No	IsS11Min=No	FrameElem=77	ElemStation=0				
Frame=77	Station=0.0625	OutputCase=ACC2	CaseType=Combination	Point=0	X2=0	X3=0	S11=-
115.765244923552	IsS11Max=No	IsS11Min=No	FrameElem=77	ElemStation=0.0625			
Frame=77	Station=0.0625	OutputCase=ACC2	CaseType=Combination	Point=1	X2=-0.5	X3=-0.5	S11=-
438.744859383892	IsS11Max=No	IsS11Min=Yes	FrameElem=77	ElemStation=0.0625			
Frame=77	Station=0.0625	OutputCase=ACC2	CaseType=Combination	Point=2	X2=-0.5	X3=0.5	S11=-
438.744859383892	IsS11Max=No	IsS11Min=No	FrameElem=77	ElemStation=0.0625			
Frame=77	Station=0.0625	OutputCase=ACC2	CaseType=Combination	Point=3	X2=0.5	X3=-0.5	
S11=207.214369536788	IsS11Max=Yes	IsS11Min=No	FrameElem=77	ElemStation=0.0625			
Frame=77	Station=0.0625	OutputCase=ACC2	CaseType=Combination	Point=4	X2=0.5	X3=0.5	
S11=207.214369536788	IsS11Max=No	IsS11Min=No	FrameElem=77	ElemStation=0.0625			
Frame=77	Station=0.125	OutputCase=ACC2	CaseType=Combination	Point=0	X2=0	X3=0	S11=-115.765244923552
IsS11Max=No	IsS11Min=No	FrameElem=77	ElemStation=0.125				
Frame=77	Station=0.125	OutputCase=ACC2	CaseType=Combination	Point=1	X2=-0.5	X3=-0.5	S11=-
570.980875316168	IsS11Max=No	IsS11Min=Yes	FrameElem=77	ElemStation=0.125			
Frame=77	Station=0.125	OutputCase=ACC2	CaseType=Combination	Point=2	X2=-0.5	X3=0.5	S11=-
570.980875316168	IsS11Max=No	IsS11Min=No	FrameElem=77	ElemStation=0.125			
Frame=77	Station=0.125	OutputCase=ACC2	CaseType=Combination	Point=3	X2=0.5	X3=-0.5	
S11=339.450385469063	IsS11Max=Yes	IsS11Min=No	FrameElem=77	ElemStation=0.125			
Frame=77	Station=0.125	OutputCase=ACC2	CaseType=Combination	Point=4	X2=0.5	X3=0.5	
S11=339.450385469063	IsS11Max=No	IsS11Min=No	FrameElem=77	ElemStation=0.125			
Frame=77	Station=0.1875	OutputCase=ACC2	CaseType=Combination	Point=0	X2=0	X3=0	S11=-
115.765244923552	IsS11Max=No	IsS11Min=No	FrameElem=77	ElemStation=0.1875			
Frame=77	Station=0.1875	OutputCase=ACC2	CaseType=Combination	Point=1	X2=-0.5	X3=-0.5	S11=-
707.164234998443	IsS11Max=No	IsS11Min=Yes	FrameElem=77	ElemStation=0.1875			
Frame=77	Station=0.1875	OutputCase=ACC2	CaseType=Combination	Point=2	X2=-0.5	X3=0.5	S11=-
707.164234998443	IsS11Max=No	IsS11Min=No	FrameElem=77	ElemStation=0.1875			
Frame=77	Station=0.1875	OutputCase=ACC2	CaseType=Combination	Point=3	X2=0.5	X3=-0.5	
S11=475.633745151339	IsS11Max=Yes	IsS11Min=No	FrameElem=77	ElemStation=0.1875			
Frame=77	Station=0.1875	OutputCase=ACC2	CaseType=Combination	Point=4	X2=0.5	X3=0.5	
S11=475.633745151339	IsS11Max=No	IsS11Min=No	FrameElem=77	ElemStation=0.1875			
Frame=77	Station=0.25	OutputCase=ACC2	CaseType=Combination	Point=0	X2=0	X3=0	S11=-115.765244923552
IsS11Max=No	IsS11Min=No	FrameElem=77	ElemStation=0.25				
Frame=77	Station=0.25	OutputCase=ACC2	CaseType=Combination	Point=1	X2=-0.5	X3=-0.5	S11=-
847.294938430719	IsS11Max=No	IsS11Min=Yes	FrameElem=77	ElemStation=0.25			
Frame=77	Station=0.25	OutputCase=ACC2	CaseType=Combination	Point=2	X2=-0.5	X3=0.5	S11=-
847.294938430719	IsS11Max=No	IsS11Min=No	FrameElem=77	ElemStation=0.25			
Frame=77	Station=0.25	OutputCase=ACC2	CaseType=Combination	Point=3	X2=0.5	X3=-0.5	
S11=615.764448583614	IsS11Max=Yes	IsS11Min=No	FrameElem=77	ElemStation=0.25			
Frame=77	Station=0.25	OutputCase=ACC2	CaseType=Combination	Point=4	X2=0.5	X3=0.5	
S11=615.764448583614	IsS11Max=No	IsS11Min=No	FrameElem=77	ElemStation=0.25			
Frame=77	Station=0	OutputCase=ACCSX1	CaseType=Combination	Point=0	X2=0	X3=0	S11=-167.164023806274
IsS11Max=No	IsS11Min=No	FrameElem=77	ElemStation=0				
Frame=77	Station=0	OutputCase=ACCSX1	CaseType=Combination	Point=1	X2=-0.5	X3=-0.5	S11=-
459.320039712395	IsS11Max=No	IsS11Min=Yes	FrameElem=77	ElemStation=0			
Frame=77	Station=0	OutputCase=ACCSX1	CaseType=Combination	Point=2	X2=-0.5	X3=0.5	S11=-
459.320039712395	IsS11Max=No	IsS11Min=No	FrameElem=77	ElemStation=0			
Frame=77	Station=0	OutputCase=ACCSX1	CaseType=Combination	Point=3	X2=0.5	X3=-0.5	
S11=124.991992099847	IsS11Max=Yes	IsS11Min=No	FrameElem=77	ElemStation=0			
Frame=77	Station=0	OutputCase=ACCSX1	CaseType=Combination	Point=4	X2=0.5	X3=0.5	
S11=124.991992099847	IsS11Max=No	IsS11Min=No	FrameElem=77	ElemStation=0			
Frame=77	Station=0.0625	OutputCase=ACCSX1	CaseType=Combination	Point=0	X2=0	X3=0	S11=-
167.164023806274	IsS11Max=No	IsS11Min=No	FrameElem=77	ElemStation=0.0625			
Frame=77	Station=0.0625	OutputCase=ACCSX1	CaseType=Combination	Point=1	X2=-0.5	X3=-0.5	S11=-
584.047975463125	IsS11Max=No	IsS11Min=Yes	FrameElem=77	ElemStation=0.0625			

Frame=77	Station=0.0625	OutputCase=ACCSX1	CaseType=Combination	Point=2	X2=-0.5	X3=0.5	S11=-
584.047975463125	IsS11Max=No	IsS11Min=No	FrameElem=77	ElemStation=0.0625			
Frame=77	Station=0.0625	OutputCase=ACCSX1	CaseType=Combination	Point=3	X2=0.5	X3=-0.5	
S11=249.719927850577	IsS11Max=Yes	IsS11Min=No	FrameElem=77	ElemStation=0.0625			
Frame=77	Station=0.0625	OutputCase=ACCSX1	CaseType=Combination	Point=4	X2=0.5	X3=0.5	
S11=249.719927850577	IsS11Max=No	IsS11Min=No	FrameElem=77	ElemStation=0.0625			
Frame=77	Station=0.125	OutputCase=ACCSX1	CaseType=Combination	Point=0	X2=0	X3=0	S11=-
167.164023806274	IsS11Max=No	IsS11Min=No	FrameElem=77	ElemStation=0.125			
Frame=77	Station=0.125	OutputCase=ACCSX1	CaseType=Combination	Point=1	X2=-0.5	X3=-0.5	S11=-
712.596223713855	IsS11Max=No	IsS11Min=Yes	FrameElem=77	ElemStation=0.125			
Frame=77	Station=0.125	OutputCase=ACCSX1	CaseType=Combination	Point=2	X2=-0.5	X3=0.5	S11=-
712.596223713855	IsS11Max=No	IsS11Min=No	FrameElem=77	ElemStation=0.125			
Frame=77	Station=0.125	OutputCase=ACCSX1	CaseType=Combination	Point=3	X2=0.5	X3=-0.5	
S11=378.268176101307	IsS11Max=Yes	IsS11Min=No	FrameElem=77	ElemStation=0.125			
Frame=77	Station=0.125	OutputCase=ACCSX1	CaseType=Combination	Point=4	X2=0.5	X3=0.5	
S11=378.268176101307	IsS11Max=No	IsS11Min=No	FrameElem=77	ElemStation=0.125			
Frame=77	Station=0.1875	OutputCase=ACCSX1	CaseType=Combination	Point=0	X2=0	X3=0	S11=-
167.164023806274	IsS11Max=No	IsS11Min=No	FrameElem=77	ElemStation=0.1875			
Frame=77	Station=0.1875	OutputCase=ACCSX1	CaseType=Combination	Point=1	X2=-0.5	X3=-0.5	S11=-
844.964784464585	IsS11Max=No	IsS11Min=Yes	FrameElem=77	ElemStation=0.1875			
Frame=77	Station=0.1875	OutputCase=ACCSX1	CaseType=Combination	Point=2	X2=-0.5	X3=0.5	S11=-
844.964784464585	IsS11Max=No	IsS11Min=No	FrameElem=77	ElemStation=0.1875			
Frame=77	Station=0.1875	OutputCase=ACCSX1	CaseType=Combination	Point=3	X2=0.5	X3=-0.5	
S11=510.636736852038	IsS11Max=Yes	IsS11Min=No	FrameElem=77	ElemStation=0.1875			
Frame=77	Station=0.1875	OutputCase=ACCSX1	CaseType=Combination	Point=4	X2=0.5	X3=0.5	
S11=510.636736852038	IsS11Max=No	IsS11Min=No	FrameElem=77	ElemStation=0.1875			
Frame=77	Station=0.25	OutputCase=ACCSX1	CaseType=Combination	Point=0	X2=0	X3=0	S11=-
167.164023806274	IsS11Max=No	IsS11Min=No	FrameElem=77	ElemStation=0.25			
Frame=77	Station=0.25	OutputCase=ACCSX1	CaseType=Combination	Point=1	X2=-0.5	X3=-0.5	S11=-
981.153657715315	IsS11Max=No	IsS11Min=Yes	FrameElem=77	ElemStation=0.25			
Frame=77	Station=0.25	OutputCase=ACCSX1	CaseType=Combination	Point=2	X2=-0.5	X3=0.5	S11=-
981.153657715315	IsS11Max=No	IsS11Min=No	FrameElem=77	ElemStation=0.25			
Frame=77	Station=0.25	OutputCase=ACCSX1	CaseType=Combination	Point=3	X2=0.5	X3=-0.5	
S11=646.825610102768	IsS11Max=Yes	IsS11Min=No	FrameElem=77	ElemStation=0.25			
Frame=77	Station=0.25	OutputCase=ACCSX1	CaseType=Combination	Point=4	X2=0.5	X3=0.5	
S11=646.825610102768	IsS11Max=No	IsS11Min=No	FrameElem=77	ElemStation=0.25			
Frame=77	Station=0	OutputCase=ACCSX2	CaseType=Combination	Point=0	X2=0	X3=0	S11=-113.388258060829
IsS11Max=No	IsS11Min=No	FrameElem=77	ElemStation=0				
Frame=77	Station=0	OutputCase=ACCSX2	CaseType=Combination	Point=1	X2=-0.5	X3=-0.5	S11=-
320.558412330327	IsS11Max=No	IsS11Min=Yes	FrameElem=77	ElemStation=0			
Frame=77	Station=0	OutputCase=ACCSX2	CaseType=Combination	Point=2	X2=-0.5	X3=0.5	S11=-
320.558412330327	IsS11Max=No	IsS11Min=No	FrameElem=77	ElemStation=0			
Frame=77	Station=0	OutputCase=ACCSX2	CaseType=Combination	Point=3	X2=0.5	X3=-0.5	
S11=93.7818962086698	IsS11Max=Yes	IsS11Min=No	FrameElem=77	ElemStation=0			
Frame=77	Station=0	OutputCase=ACCSX2	CaseType=Combination	Point=4	X2=0.5	X3=0.5	
S11=93.7818962086698	IsS11Max=No	IsS11Min=No	FrameElem=77	ElemStation=0			
Frame=77	Station=0.0625	OutputCase=ACCSX2	CaseType=Combination	Point=0	X2=0	X3=0	S11=-
113.388258060829	IsS11Max=No	IsS11Min=No	FrameElem=77	ElemStation=0.0625			
Frame=77	Station=0.0625	OutputCase=ACCSX2	CaseType=Combination	Point=1	X2=-0.5	X3=-0.5	S11=-
445.286347978304	IsS11Max=No	IsS11Min=Yes	FrameElem=77	ElemStation=0.0625			
Frame=77	Station=0.0625	OutputCase=ACCSX2	CaseType=Combination	Point=2	X2=-0.5	X3=0.5	S11=-
445.286347978304	IsS11Max=No	IsS11Min=No	FrameElem=77	ElemStation=0.0625			
Frame=77	Station=0.0625	OutputCase=ACCSX2	CaseType=Combination	Point=3	X2=0.5	X3=-0.5	
S11=218.509831856646	IsS11Max=Yes	IsS11Min=No	FrameElem=77	ElemStation=0.0625			
Frame=77	Station=0.0625	OutputCase=ACCSX2	CaseType=Combination	Point=4	X2=0.5	X3=0.5	
S11=218.509831856646	IsS11Max=No	IsS11Min=No	FrameElem=77	ElemStation=0.0625			
Frame=77	Station=0.125	OutputCase=ACCSX2	CaseType=Combination	Point=0	X2=0	X3=0	S11=-
113.388258060829	IsS11Max=No	IsS11Min=No	FrameElem=77	ElemStation=0.125			
Frame=77	Station=0.125	OutputCase=ACCSX2	CaseType=Combination	Point=1	X2=-0.5	X3=-0.5	S11=-
573.83459612628	IsS11Max=No	IsS11Min=Yes	FrameElem=77	ElemStation=0.125			
Frame=77	Station=0.125	OutputCase=ACCSX2	CaseType=Combination	Point=2	X2=-0.5	X3=0.5	S11=-
573.83459612628	IsS11Max=No	IsS11Min=No	FrameElem=77	ElemStation=0.125			
Frame=77	Station=0.125	OutputCase=ACCSX2	CaseType=Combination	Point=3	X2=0.5	X3=-0.5	
S11=347.058080004623	IsS11Max=Yes	IsS11Min=No	FrameElem=77	ElemStation=0.125			
Frame=77	Station=0.125	OutputCase=ACCSX2	CaseType=Combination	Point=4	X2=0.5	X3=0.5	
S11=347.058080004623	IsS11Max=No	IsS11Min=No	FrameElem=77	ElemStation=0.125			
Frame=77	Station=0.1875	OutputCase=ACCSX2	CaseType=Combination	Point=0	X2=0	X3=0	S11=-
113.388258060829	IsS11Max=No	IsS11Min=No	FrameElem=77	ElemStation=0.1875			
Frame=77	Station=0.1875	OutputCase=ACCSX2	CaseType=Combination	Point=1	X2=-0.5	X3=-0.5	S11=-
706.203156774257	IsS11Max=No	IsS11Min=Yes	FrameElem=77	ElemStation=0.1875			
Frame=77	Station=0.1875	OutputCase=ACCSX2	CaseType=Combination	Point=2	X2=-0.5	X3=0.5	S11=-
706.203156774257	IsS11Max=No	IsS11Min=No	FrameElem=77	ElemStation=0.1875			
Frame=77	Station=0.1875	OutputCase=ACCSX2	CaseType=Combination	Point=3	X2=0.5	X3=-0.5	
S11=479.426640652599	IsS11Max=Yes	IsS11Min=No	FrameElem=77	ElemStation=0.1875			
Frame=77	Station=0.1875	OutputCase=ACCSX2	CaseType=Combination	Point=4	X2=0.5	X3=0.5	
S11=479.426640652599	IsS11Max=No	IsS11Min=No	FrameElem=77	ElemStation=0.1875			
Frame=77	Station=0.25	OutputCase=ACCSX2	CaseType=Combination	Point=0	X2=0	X3=0	S11=-
113.388258060829	IsS11Max=No	IsS11Min=No	FrameElem=77	ElemStation=0.25			
Frame=77	Station=0.25	OutputCase=ACCSX2	CaseType=Combination	Point=1	X2=-0.5	X3=-0.5	S11=-
842.392029922233	IsS11Max=No	IsS11Min=Yes	FrameElem=77	ElemStation=0.25			
Frame=77	Station=0.25	OutputCase=ACCSX2	CaseType=Combination	Point=2	X2=-0.5	X3=0.5	S11=-
842.392029922233	IsS11Max=No	IsS11Min=No	FrameElem=77	ElemStation=0.25			

Frame=77 Station=0.25 OutputCase=ACCSX2 CaseType=Combination Point=3 X2=0.5 X3=-0.5
 S11=615.615513800575 IsS11Max=Yes IsS11Min=No FrameElem=77 ElemStation=0.25
 Frame=77 Station=0.25 OutputCase=ACCSX2 CaseType=Combination Point=4 X2=0.5 X3=0.5
 S11=615.615513800575 IsS11Max=No IsS11Min=No FrameElem=77 ElemStation=0.25
 Frame=77 Station=0 OutputCase=ENVE CaseType=Combination StepType=Max Point=0 X2=0 X3=0 S11=-
 111.115460069969 IsS11Max=No IsS11Min=No FrameElem=77 ElemStation=0
 Frame=77 Station=0 OutputCase=ENVE CaseType=Combination StepType=Max Point=1 X2=-0.5 X3=-0.5
 S11=-296.446547887215 IsS11Max=No IsS11Min=Yes FrameElem=77 ElemStation=0
 Frame=77 Station=0 OutputCase=ENVE CaseType=Combination StepType=Max Point=2 X2=-0.5 X3=0.5 S11=-
 296.446547887215 IsS11Max=No IsS11Min=No FrameElem=77 ElemStation=0
 Frame=77 Station=0 OutputCase=ENVE CaseType=Combination StepType=Max Point=3 X2=0.5 X3=-0.5
 S11=124.991992099847 IsS11Max=Yes IsS11Min=No FrameElem=77 ElemStation=0
 Frame=77 Station=0 OutputCase=ENVE CaseType=Combination StepType=Max Point=4 X2=0.5 X3=0.5
 S11=124.991992099847 IsS11Max=No IsS11Min=No FrameElem=77 ElemStation=0
 Frame=77 Station=0.0625 OutputCase=ENVE CaseType=Combination StepType=Max Point=0 X2=0 X3=0 S11=-
 111.115460069969 IsS11Max=No IsS11Min=No FrameElem=77 ElemStation=0.0625
 Frame=77 Station=0.0625 OutputCase=ENVE CaseType=Combination StepType=Max Point=1 X2=-0.5 X3=-0.5
 S11=-420.606704433148 IsS11Max=No IsS11Min=Yes FrameElem=77 ElemStation=0.0625
 Frame=77 Station=0.0625 OutputCase=ENVE CaseType=Combination StepType=Max Point=2 X2=-0.5 X3=0.5
 S11=-420.606704433148 IsS11Max=No IsS11Min=No FrameElem=77 ElemStation=0.0625
 Frame=77 Station=0.0625 OutputCase=ENVE CaseType=Combination StepType=Max Point=3 X2=0.5 X3=-0.5
 S11=249.719927850577 IsS11Max=Yes IsS11Min=No FrameElem=77 ElemStation=0.0625
 Frame=77 Station=0.0625 OutputCase=ENVE CaseType=Combination StepType=Max Point=4 X2=0.5 X3=0.5
 S11=249.719927850577 IsS11Max=No IsS11Min=No FrameElem=77 ElemStation=0.0625
 Frame=77 Station=0.125 OutputCase=ENVE CaseType=Combination StepType=Max Point=0 X2=0 X3=0 S11=-
 111.115460069969 IsS11Max=No IsS11Min=No FrameElem=77 ElemStation=0.125
 Frame=77 Station=0.125 OutputCase=ENVE CaseType=Combination StepType=Max Point=1 X2=-0.5 X3=-0.5
 S11=-548.587173479081 IsS11Max=No IsS11Min=Yes FrameElem=77 ElemStation=0.125
 Frame=77 Station=0.125 OutputCase=ENVE CaseType=Combination StepType=Max Point=2 X2=-0.5 X3=0.5
 S11=-548.587173479081 IsS11Max=No IsS11Min=No FrameElem=77 ElemStation=0.125
 Frame=77 Station=0.125 OutputCase=ENVE CaseType=Combination StepType=Max Point=3 X2=0.5 X3=-0.5
 S11=378.268176101307 IsS11Max=Yes IsS11Min=No FrameElem=77 ElemStation=0.125
 Frame=77 Station=0.125 OutputCase=ENVE CaseType=Combination StepType=Max Point=4 X2=0.5 X3=0.5
 S11=378.268176101307 IsS11Max=No IsS11Min=No FrameElem=77 ElemStation=0.125
 Frame=77 Station=0.1875 OutputCase=ENVE CaseType=Combination StepType=Max Point=0 X2=0 X3=0 S11=-
 111.115460069969 IsS11Max=No IsS11Min=No FrameElem=77 ElemStation=0.1875
 Frame=77 Station=0.1875 OutputCase=ENVE CaseType=Combination StepType=Max Point=1 X2=-0.5 X3=-0.5
 S11=-680.387955025014 IsS11Max=No IsS11Min=Yes FrameElem=77 ElemStation=0.1875
 Frame=77 Station=0.1875 OutputCase=ENVE CaseType=Combination StepType=Max Point=2 X2=-0.5 X3=0.5
 S11=-680.387955025014 IsS11Max=No IsS11Min=No FrameElem=77 ElemStation=0.1875
 Frame=77 Station=0.1875 OutputCase=ENVE CaseType=Combination StepType=Max Point=3 X2=0.5 X3=-0.5
 S11=510.636736852038 IsS11Max=Yes IsS11Min=No FrameElem=77 ElemStation=0.1875
 Frame=77 Station=0.1875 OutputCase=ENVE CaseType=Combination StepType=Max Point=4 X2=0.5 X3=0.5
 S11=510.636736852038 IsS11Max=No IsS11Min=No FrameElem=77 ElemStation=0.1875
 Frame=77 Station=0.25 OutputCase=ENVE CaseType=Combination StepType=Max Point=0 X2=0 X3=0 S11=-
 111.115460069969 IsS11Max=No IsS11Min=No FrameElem=77 ElemStation=0.25
 Frame=77 Station=0.25 OutputCase=ENVE CaseType=Combination StepType=Max Point=1 X2=-0.5 X3=-0.5
 S11=-816.009049070947 IsS11Max=No IsS11Min=Yes FrameElem=77 ElemStation=0.25
 Frame=77 Station=0.25 OutputCase=ENVE CaseType=Combination StepType=Max Point=2 X2=-0.5 X3=0.5
 S11=-816.009049070947 IsS11Max=No IsS11Min=No FrameElem=77 ElemStation=0.25
 Frame=77 Station=0.25 OutputCase=ENVE CaseType=Combination StepType=Max Point=3 X2=0.5 X3=-0.5
 S11=646.974544885807 IsS11Max=Yes IsS11Min=No FrameElem=77 ElemStation=0.25
 Frame=77 Station=0.25 OutputCase=ENVE CaseType=Combination StepType=Max Point=4 X2=0.5 X3=0.5
 S11=646.974544885807 IsS11Max=No IsS11Min=No FrameElem=77 ElemStation=0.25
 Frame=77 Station=0 OutputCase=ENVE CaseType=Combination StepType=Min Point=0 X2=0 X3=0 S11=-
 169.541010668997 IsS11Max=No IsS11Min=No FrameElem=77 ElemStation=0
 Frame=77 Station=0 OutputCase=ENVE CaseType=Combination StepType=Min Point=1 X2=-0.5 X3=-0.5
 S11=-459.320039712395 IsS11Max=No IsS11Min=Yes FrameElem=77 ElemStation=0
 Frame=77 Station=0 OutputCase=ENVE CaseType=Combination StepType=Min Point=2 X2=-0.5 X3=0.5 S11=-
 459.320039712395 IsS11Max=No IsS11Min=No FrameElem=77 ElemStation=0
 Frame=77 Station=0 OutputCase=ENVE CaseType=Combination StepType=Min Point=3 X2=0.5 X3=-0.5
 S11=74.2156277472768 IsS11Max=Yes IsS11Min=No FrameElem=77 ElemStation=0
 Frame=77 Station=0 OutputCase=ENVE CaseType=Combination StepType=Min Point=4 X2=0.5 X3=0.5
 S11=74.2156277472768 IsS11Max=No IsS11Min=No FrameElem=77 ElemStation=0
 Frame=77 Station=0.0625 OutputCase=ENVE CaseType=Combination StepType=Min Point=0 X2=0 X3=0 S11=-
 169.541010668997 IsS11Max=No IsS11Min=No FrameElem=77 ElemStation=0.0625
 Frame=77 Station=0.0625 OutputCase=ENVE CaseType=Combination StepType=Min Point=1 X2=-0.5 X3=-0.5
 S11=-584.047975463125 IsS11Max=No IsS11Min=Yes FrameElem=77 ElemStation=0.0625
 Frame=77 Station=0.0625 OutputCase=ENVE CaseType=Combination StepType=Min Point=2 X2=-0.5 X3=0.5
 S11=-584.047975463125 IsS11Max=No IsS11Min=No FrameElem=77 ElemStation=0.0625
 Frame=77 Station=0.0625 OutputCase=ENVE CaseType=Combination StepType=Min Point=3 X2=0.5 X3=-0.5
 S11=198.37578429321 IsS11Max=Yes IsS11Min=No FrameElem=77 ElemStation=0.0625
 Frame=77 Station=0.0625 OutputCase=ENVE CaseType=Combination StepType=Min Point=4 X2=0.5 X3=0.5
 S11=198.37578429321 IsS11Max=No IsS11Min=No FrameElem=77 ElemStation=0.0625
 Frame=77 Station=0.125 OutputCase=ENVE CaseType=Combination StepType=Min Point=0 X2=0 X3=0 S11=-
 169.541010668997 IsS11Max=No IsS11Min=No FrameElem=77 ElemStation=0.125
 Frame=77 Station=0.125 OutputCase=ENVE CaseType=Combination StepType=Min Point=1 X2=-0.5 X3=-0.5
 S11=-712.596223713855 IsS11Max=No IsS11Min=Yes FrameElem=77 ElemStation=0.125
 Frame=77 Station=0.125 OutputCase=ENVE CaseType=Combination StepType=Min Point=2 X2=-0.5 X3=0.5
 S11=-712.596223713855 IsS11Max=No IsS11Min=No FrameElem=77 ElemStation=0.125
 Frame=77 Station=0.125 OutputCase=ENVE CaseType=Combination StepType=Min Point=3 X2=0.5 X3=-0.5
 S11=326.356253339142 IsS11Max=Yes IsS11Min=No FrameElem=77 ElemStation=0.125

Frame=77	Station=0.125	OutputCase=ENVE	CaseType=Combination	StepType=Min	Point=4	X2=0.5	X3=0.5		
S11=326.356253339142	IsS11Max=No	IsS11Min=No	FrameElem=77	ElemStation=0.125					
Frame=77	Station=0.1875	OutputCase=ENVE	CaseType=Combination	StepType=Min	Point=0	X2=0	X3=0	S11=-	
169.541010668997	IsS11Max=No	IsS11Min=No	FrameElem=77	ElemStation=0.1875					
Frame=77	Station=0.1875	OutputCase=ENVE	CaseType=Combination	StepType=Min	Point=1	X2=-0.5	X3=-0.5		
S11=-845.925862688772	IsS11Max=No	IsS11Min=Yes	FrameElem=77	ElemStation=0.1875					
Frame=77	Station=0.1875	OutputCase=ENVE	CaseType=Combination	StepType=Min	Point=2	X2=-0.5	X3=0.5		
S11=-845.925862688772	IsS11Max=No	IsS11Min=No	FrameElem=77	ElemStation=0.1875					
Frame=77	Station=0.1875	OutputCase=ENVE	CaseType=Combination	StepType=Min	Point=3	X2=0.5	X3=-0.5		
S11=458.157034885075	IsS11Max=Yes	IsS11Min=No	FrameElem=77	ElemStation=0.1875					
Frame=77	Station=0.1875	OutputCase=ENVE	CaseType=Combination	StepType=Min	Point=4	X2=0.5	X3=0.5		
S11=458.157034885075	IsS11Max=No	IsS11Min=No	FrameElem=77	ElemStation=0.1875					
Frame=77	Station=0.25	OutputCase=ENVE	CaseType=Combination	StepType=Min	Point=0	X2=0	X3=0	S11=-	
169.541010668997	IsS11Max=No	IsS11Min=No	FrameElem=77	ElemStation=0.25					
Frame=77	Station=0.25	OutputCase=ENVE	CaseType=Combination	StepType=Min	Point=1	X2=-0.5	X3=-0.5		
S11=-986.056566223801	IsS11Max=No	IsS11Min=Yes	FrameElem=77	ElemStation=0.25					
Frame=77	Station=0.25	OutputCase=ENVE	CaseType=Combination	StepType=Min	Point=2	X2=-0.5	X3=0.5		
S11=-986.056566223801	IsS11Max=No	IsS11Min=No	FrameElem=77	ElemStation=0.25					
Frame=77	Station=0.25	OutputCase=ENVE	CaseType=Combination	StepType=Min	Point=3	X2=0.5	X3=-0.5		
S11=593.778128931008	IsS11Max=Yes	IsS11Min=No	FrameElem=77	ElemStation=0.25					
Frame=77	Station=0.25	OutputCase=ENVE	CaseType=Combination	StepType=Min	Point=4	X2=0.5	X3=0.5		
S11=593.778128931008	IsS11Max=No	IsS11Min=No	FrameElem=77	ElemStation=0.25					
Frame=77	Station=0	OutputCase=FESSUR	CaseType=Combination	Point=0	X2=0	X3=0	S11=-168.146075212922		
IsS11Max=No	IsS11Min=No	FrameElem=77	ElemStation=0						
Frame=77	Station=0	OutputCase=FESSUR	CaseType=Combination	Point=1	X2=-0.5	X3=-0.5	S11=-		
445.014922789364	IsS11Max=No	IsS11Min=Yes	FrameElem=77	ElemStation=0					
Frame=77	Station=0	OutputCase=FESSUR	CaseType=Combination	Point=2	X2=-0.5	X3=0.5	S11=-		
445.014922789364	IsS11Max=No	IsS11Min=No	FrameElem=77	ElemStation=0					
Frame=77	Station=0	OutputCase=FESSUR	CaseType=Combination	Point=3	X2=0.5	X3=-0.5			
S11=108.722772363519	IsS11Max=Yes	IsS11Min=No	FrameElem=77	ElemStation=0					
Frame=77	Station=0	OutputCase=FESSUR	CaseType=Combination	Point=4	X2=0.5	X3=0.5			
S11=108.722772363519	IsS11Max=No	IsS11Min=No	FrameElem=77	ElemStation=0					
Frame=77	Station=0.0625	OutputCase=FESSUR	CaseType=Combination	Point=0	X2=0	X3=0	S11=-		
168.146075212922	IsS11Max=No	IsS11Min=No	FrameElem=77	ElemStation=0.0625					
Frame=77	Station=0.0625	OutputCase=FESSUR	CaseType=Combination	Point=1	X2=-0.5	X3=-0.5	S11=-		
572.06504038349	IsS11Max=No	IsS11Min=Yes	FrameElem=77	ElemStation=0.0625					
Frame=77	Station=0.0625	OutputCase=FESSUR	CaseType=Combination	Point=2	X2=-0.5	X3=0.5	S11=-		
572.06504038349	IsS11Max=No	IsS11Min=No	FrameElem=77	ElemStation=0.0625					
Frame=77	Station=0.0625	OutputCase=FESSUR	CaseType=Combination	Point=3	X2=0.5	X3=-0.5			
S11=235.772889957645	IsS11Max=Yes	IsS11Min=No	FrameElem=77	ElemStation=0.0625					
Frame=77	Station=0.0625	OutputCase=FESSUR	CaseType=Combination	Point=4	X2=0.5	X3=0.5			
S11=235.772889957645	IsS11Max=No	IsS11Min=No	FrameElem=77	ElemStation=0.0625					
Frame=77	Station=0.125	OutputCase=FESSUR	CaseType=Combination	Point=0	X2=0	X3=0	S11=-		
168.146075212922	IsS11Max=No	IsS11Min=No	FrameElem=77	ElemStation=0.125					
Frame=77	Station=0.125	OutputCase=FESSUR	CaseType=Combination	Point=1	X2=-0.5	X3=-0.5	S11=-		
703.024392352617	IsS11Max=No	IsS11Min=Yes	FrameElem=77	ElemStation=0.125					
Frame=77	Station=0.125	OutputCase=FESSUR	CaseType=Combination	Point=2	X2=-0.5	X3=0.5	S11=-		
703.024392352617	IsS11Max=No	IsS11Min=No	FrameElem=77	ElemStation=0.125					
Frame=77	Station=0.125	OutputCase=FESSUR	CaseType=Combination	Point=3	X2=0.5	X3=-0.5			
S11=366.732241926772	IsS11Max=Yes	IsS11Min=No	FrameElem=77	ElemStation=0.125					
Frame=77	Station=0.125	OutputCase=FESSUR	CaseType=Combination	Point=4	X2=0.5	X3=0.5			
S11=366.732241926772	IsS11Max=No	IsS11Min=No	FrameElem=77	ElemStation=0.125					
Frame=77	Station=0.1875	OutputCase=FESSUR	CaseType=Combination	Point=0	X2=0	X3=0	S11=-		
168.146075212922	IsS11Max=No	IsS11Min=No	FrameElem=77	ElemStation=0.1875					
Frame=77	Station=0.1875	OutputCase=FESSUR	CaseType=Combination	Point=1	X2=-0.5	X3=-0.5	S11=-		
837.892978696743	IsS11Max=No	IsS11Min=Yes	FrameElem=77	ElemStation=0.1875					
Frame=77	Station=0.1875	OutputCase=FESSUR	CaseType=Combination	Point=2	X2=-0.5	X3=0.5	S11=-		
837.892978696743	IsS11Max=No	IsS11Min=No	FrameElem=77	ElemStation=0.1875					
Frame=77	Station=0.1875	OutputCase=FESSUR	CaseType=Combination	Point=3	X2=0.5	X3=-0.5			
S11=501.600828270898	IsS11Max=Yes	IsS11Min=No	FrameElem=77	ElemStation=0.1875					
Frame=77	Station=0.1875	OutputCase=FESSUR	CaseType=Combination	Point=4	X2=0.5	X3=0.5			
S11=501.600828270898	IsS11Max=No	IsS11Min=No	FrameElem=77	ElemStation=0.1875					
Frame=77	Station=0.25	OutputCase=FESSUR	CaseType=Combination	Point=0	X2=0	X3=0	S11=-		
168.146075212922	IsS11Max=No	IsS11Min=No	FrameElem=77	ElemStation=0.25					
Frame=77	Station=0.25	OutputCase=FESSUR	CaseType=Combination	Point=1	X2=-0.5	X3=-0.5	S11=-		
976.67079941587	IsS11Max=No	IsS11Min=Yes	FrameElem=77	ElemStation=0.25					
Frame=77	Station=0.25	OutputCase=FESSUR	CaseType=Combination	Point=2	X2=-0.5	X3=0.5	S11=-		
976.67079941587	IsS11Max=No	IsS11Min=No	FrameElem=77	ElemStation=0.25					
Frame=77	Station=0.25	OutputCase=FESSUR	CaseType=Combination	Point=3	X2=0.5	X3=-0.5			
S11=640.378648990025	IsS11Max=Yes	IsS11Min=No	FrameElem=77	ElemStation=0.25					
Frame=77	Station=0.25	OutputCase=FESSUR	CaseType=Combination	Point=4	X2=0.5	X3=0.5			
S11=640.378648990025	IsS11Max=No	IsS11Min=No	FrameElem=77	ElemStation=0.25					
Frame=78	Station=0	OutputCase=PERM1	CaseType=Combination	Point=0	X2=0	X3=0	S11=-164.891260791424		
IsS11Max=No	IsS11Min=No	FrameElem=78	ElemStation=0						
Frame=78	Station=0	OutputCase=PERM1	CaseType=Combination	Point=1	X2=-0.5	X3=-0.5	S11=-		
954.770711840039	IsS11Max=No	IsS11Min=Yes	FrameElem=78	ElemStation=0					
Frame=78	Station=0	OutputCase=PERM1	CaseType=Combination	Point=2	X2=-0.5	X3=0.5	S11=-		
954.770711840039	IsS11Max=No	IsS11Min=No	FrameElem=78	ElemStation=0					
Frame=78	Station=0	OutputCase=PERM1	CaseType=Combination	Point=3	X2=0.5	X3=-0.5			
S11=624.988190257191	IsS11Max=Yes	IsS11Min=No	FrameElem=78	ElemStation=0					
Frame=78	Station=0	OutputCase=PERM1	CaseType=Combination	Point=4	X2=0.5	X3=0.5	S11=624.988190257191		
IsS11Max=No	IsS11Min=No	FrameElem=78	ElemStation=0						

Frame=78 Station=6.24999940395358E-02 OutputCase=PERM1 CaseType=Combination Point=0 X2=0 X3=0 S11=-164.89126176298 IsS11Max=No IsS11Min=No FrameElem=78 ElemStation=6.24999940395358E-02

Frame=78 Station=6.24999940395358E-02 OutputCase=PERM1 CaseType=Combination Point=1 X2=-0.5 X3=-0.5 S11=-1094.21210008292 IsS11Max=No IsS11Min=Yes FrameElem=78 ElemStation=6.24999940395358E-02

Frame=78 Station=6.24999940395358E-02 OutputCase=PERM1 CaseType=Combination Point=2 X2=-0.5 X3=0.5 S11=-1094.21210008292 IsS11Max=No IsS11Min=No FrameElem=78 ElemStation=6.24999940395358E-02

Frame=78 Station=6.24999940395358E-02 OutputCase=PERM1 CaseType=Combination Point=3 X2=0.5 X3=-0.5 S11=764.42957656961 IsS11Max=Yes IsS11Min=No FrameElem=78 ElemStation=6.24999940395358E-02

Frame=78 Station=6.24999940395358E-02 OutputCase=PERM1 CaseType=Combination Point=4 X2=0.5 X3=0.5 S11=764.42957656961 IsS11Max=No IsS11Min=No FrameElem=78 ElemStation=6.24999940395358E-02

Frame=78 Station=0.124999988079072 OutputCase=PERM1 CaseType=Combination Point=0 X2=0 X3=0 S11=-164.891262734535 IsS11Max=No IsS11Min=No FrameElem=78 ElemStation=0.124999988079072

Frame=78 Station=0.124999988079072 OutputCase=PERM1 CaseType=Combination Point=1 X2=-0.5 X3=-0.5 S11=-1237.47380009713 IsS11Max=No IsS11Min=Yes FrameElem=78 ElemStation=0.124999988079072

Frame=78 Station=0.124999988079072 OutputCase=PERM1 CaseType=Combination Point=2 X2=-0.5 X3=0.5 S11=-1237.47380009713 IsS11Max=No IsS11Min=No FrameElem=78 ElemStation=0.124999988079072

Frame=78 Station=0.124999988079072 OutputCase=PERM1 CaseType=Combination Point=3 X2=0.5 X3=-0.5 S11=907.691274628064 IsS11Max=Yes IsS11Min=No FrameElem=78 ElemStation=0.124999988079072

Frame=78 Station=0.124999988079072 OutputCase=PERM1 CaseType=Combination Point=4 X2=0.5 X3=0.5 S11=907.691274628064 IsS11Max=No IsS11Min=No FrameElem=78 ElemStation=0.124999988079072

Frame=78 Station=0.187499982118607 OutputCase=PERM1 CaseType=Combination Point=0 X2=0 X3=0 S11=-164.891263706091 IsS11Max=No IsS11Min=No FrameElem=78 ElemStation=0.187499982118607

Frame=78 Station=0.187499982118607 OutputCase=PERM1 CaseType=Combination Point=1 X2=-0.5 X3=-0.5 S11=-1384.55581188268 IsS11Max=No IsS11Min=Yes FrameElem=78 ElemStation=0.187499982118607

Frame=78 Station=0.187499982118607 OutputCase=PERM1 CaseType=Combination Point=2 X2=-0.5 X3=0.5 S11=-1384.55581188268 IsS11Max=No IsS11Min=No FrameElem=78 ElemStation=0.187499982118607

Frame=78 Station=0.187499982118607 OutputCase=PERM1 CaseType=Combination Point=3 X2=0.5 X3=-0.5 S11=1054.7732844705 IsS11Max=Yes IsS11Min=No FrameElem=78 ElemStation=0.187499982118607

Frame=78 Station=0.187499982118607 OutputCase=PERM1 CaseType=Combination Point=4 X2=0.5 X3=0.5 S11=1054.7732844705 IsS11Max=No IsS11Min=No FrameElem=78 ElemStation=0.187499982118607

Frame=78 Station=0.249999976158143 OutputCase=PERM1 CaseType=Combination Point=0 X2=0 X3=0 S11=-164.891264677647 IsS11Max=No IsS11Min=No FrameElem=78 ElemStation=0.249999976158143

Frame=78 Station=0.249999976158143 OutputCase=PERM1 CaseType=Combination Point=1 X2=-0.5 X3=-0.5 S11=-1535.45813543956 IsS11Max=No IsS11Min=Yes FrameElem=78 ElemStation=0.249999976158143

Frame=78 Station=0.249999976158143 OutputCase=PERM1 CaseType=Combination Point=2 X2=-0.5 X3=0.5 S11=-1535.45813543956 IsS11Max=No IsS11Min=No FrameElem=78 ElemStation=0.249999976158143

Frame=78 Station=0.249999976158143 OutputCase=PERM1 CaseType=Combination Point=3 X2=0.5 X3=-0.5 S11=1205.67560608427 IsS11Max=Yes IsS11Min=No FrameElem=78 ElemStation=0.249999976158143

Frame=78 Station=0.249999976158143 OutputCase=PERM1 CaseType=Combination Point=4 X2=0.5 X3=0.5 S11=1205.67560608427 IsS11Max=No IsS11Min=No FrameElem=78 ElemStation=0.249999976158143

Frame=78 Station=0 OutputCase=PERM2 CaseType=Combination Point=0 X2=0 X3=0 S11=-111.115495045979 IsS11Max=No IsS11Min=No FrameElem=78 ElemStation=0

Frame=78 Station=0 OutputCase=PERM2 CaseType=Combination Point=1 X2=-0.5 X3=-0.5 S11=-816.009084046956 IsS11Max=No IsS11Min=Yes FrameElem=78 ElemStation=0

Frame=78 Station=0 OutputCase=PERM2 CaseType=Combination Point=2 X2=-0.5 X3=0.5 S11=-816.009084046956 IsS11Max=No IsS11Min=No FrameElem=78 ElemStation=0

Frame=78 Station=0 OutputCase=PERM2 CaseType=Combination Point=3 X2=0.5 X3=-0.5 S11=593.778093954999 IsS11Max=Yes IsS11Min=No FrameElem=78 ElemStation=0

Frame=78 Station=0 OutputCase=PERM2 CaseType=Combination Point=4 X2=0.5 X3=0.5 S11=593.778093954999 IsS11Max=No IsS11Min=No FrameElem=78 ElemStation=0

Frame=78 Station=6.24999940395358E-02 OutputCase=PERM2 CaseType=Combination Point=0 X2=0 X3=0 S11=-111.115496017534 IsS11Max=No IsS11Min=No FrameElem=78 ElemStation=6.24999940395358E-02

Frame=78 Station=6.24999940395358E-02 OutputCase=PERM2 CaseType=Combination Point=1 X2=-0.5 X3=-0.5 S11=-955.450474110255 IsS11Max=No IsS11Min=Yes FrameElem=78 ElemStation=6.24999940395358E-02

Frame=78 Station=6.24999940395358E-02 OutputCase=PERM2 CaseType=Combination Point=2 X2=-0.5 X3=0.5 S11=-955.450474110255 IsS11Max=No IsS11Min=No FrameElem=78 ElemStation=6.24999940395358E-02

Frame=78 Station=6.24999940395358E-02 OutputCase=PERM2 CaseType=Combination Point=3 X2=0.5 X3=-0.5 S11=733.219482075186 IsS11Max=Yes IsS11Min=No FrameElem=78 ElemStation=6.24999940395358E-02

Frame=78 Station=6.24999940395358E-02 OutputCase=PERM2 CaseType=Combination Point=4 X2=0.5 X3=0.5 S11=733.219482075186 IsS11Max=No IsS11Min=No FrameElem=78 ElemStation=6.24999940395358E-02

Frame=78 Station=0.124999988079072 OutputCase=PERM2 CaseType=Combination Point=0 X2=0 X3=0 S11=-111.11549698909 IsS11Max=No IsS11Min=No FrameElem=78 ElemStation=0.124999988079072

Frame=78 Station=0.124999988079072 OutputCase=PERM2 CaseType=Combination Point=1 X2=-0.5 X3=-0.5 S11=-1098.71217594489 IsS11Max=No IsS11Min=Yes FrameElem=78 ElemStation=0.124999988079072

Frame=78 Station=0.124999988079072 OutputCase=PERM2 CaseType=Combination Point=2 X2=-0.5 X3=0.5 S11=-1098.71217594489 IsS11Max=No IsS11Min=No FrameElem=78 ElemStation=0.124999988079072

Frame=78 Station=0.124999988079072 OutputCase=PERM2 CaseType=Combination Point=3 X2=0.5 X3=-0.5 S11=876.481181966707 IsS11Max=Yes IsS11Min=No FrameElem=78 ElemStation=0.124999988079072

Frame=78 Station=0.124999988079072 OutputCase=PERM2 CaseType=Combination Point=4 X2=0.5 X3=0.5 S11=876.481181966707 IsS11Max=No IsS11Min=No FrameElem=78 ElemStation=0.124999988079072

Frame=78 Station=0.187499982118607 OutputCase=PERM2 CaseType=Combination Point=0 X2=0 X3=0 S11=-111.115497960646 IsS11Max=No IsS11Min=No FrameElem=78 ElemStation=0.187499982118607

Frame=78 Station=0.187499982118607 OutputCase=PERM2 CaseType=Combination Point=1 X2=-0.5 X3=-0.5 S11=-1245.79418955085 IsS11Max=No IsS11Min=Yes FrameElem=78 ElemStation=0.187499982118607

Frame=78 Station=0.187499982118607 OutputCase=PERM2 CaseType=Combination Point=2 X2=-0.5 X3=0.5 S11=-1245.79418955085 IsS11Max=No IsS11Min=No FrameElem=78 ElemStation=0.187499982118607

Frame=78 Station=0.187499982118607 OutputCase=PERM2 CaseType=Combination Point=3 X2=0.5 X3=-0.5 S11=1023.56319362956 IsS11Max=Yes IsS11Min=No FrameElem=78 ElemStation=0.187499982118607

Frame=78 Station=0.187499982118607 OutputCase=PERM2 CaseType=Combination Point=4 X2=0.5 X3=0.5 S11=1023.56319362956 IsS11Max=No IsS11Min=No FrameElem=78 ElemStation=0.187499982118607

Frame=78 Station=0.249999976158143 OutputCase=PERM2 CaseType=Combination Point=0 X2=0 X3=0 S11=-111.115498932202 IsS11Max=No IsS11Min=No FrameElem=78 ElemStation=0.249999976158143



Frame=78 Station=0.249999976158143 OutputCase=PERM2 CaseType=Combination Point=1 X2=-0.5 X3=-0.5
 S11=-1396.69651492815 IsS11Max=No IsS11Min=Yes FrameElem=78 ElemStation=0.249999976158143
 Frame=78 Station=0.249999976158143 OutputCase=PERM2 CaseType=Combination Point=2 X2=-0.5 X3=0.5
 S11=-1396.69651492815 IsS11Max=No IsS11Min=No FrameElem=78 ElemStation=0.249999976158143
 Frame=78 Station=0.249999976158143 OutputCase=PERM2 CaseType=Combination Point=3 X2=0.5 X3=-0.5
 S11=1174.46551706375 IsS11Max=Yes IsS11Min=No FrameElem=78 ElemStation=0.249999976158143
 Frame=78 Station=0.249999976158143 OutputCase=PERM2 CaseType=Combination Point=4 X2=0.5 X3=0.5
 S11=1174.46551706375 IsS11Max=No IsS11Min=No FrameElem=78 ElemStation=0.249999976158143
 Frame=78 Station=0 OutputCase=ACC1 CaseType=Combination Point=0 X2=0 X3=0 S11=-169.541046808013
 IsS11Max=No IsS11Min=No FrameElem=78 ElemStation=0
 Frame=78 Station=0 OutputCase=ACC1 CaseType=Combination Point=1 X2=-0.5 X3=-0.5 S11=-
 986.056602362818 IsS11Max=No IsS11Min=Yes FrameElem=78 ElemStation=0
 Frame=78 Station=0 OutputCase=ACC1 CaseType=Combination Point=2 X2=-0.5 X3=0.5 S11=-
 986.056602362818 IsS11Max=No IsS11Min=No FrameElem=78 ElemStation=0
 Frame=78 Station=0 OutputCase=ACC1 CaseType=Combination Point=3 X2=0.5 X3=-0.5 S11=646.974508746792
 IsS11Max=Yes IsS11Min=No FrameElem=78 ElemStation=0
 Frame=78 Station=0 OutputCase=ACC1 CaseType=Combination Point=4 X2=0.5 X3=0.5 S11=646.974508746792
 IsS11Max=No IsS11Min=No FrameElem=78 ElemStation=0
 Frame=78 Station=6.24999940395358E-02 OutputCase=ACC1 CaseType=Combination Point=0 X2=0 X3=0 S11=-
 169.541047811874 IsS11Max=No IsS11Min=No FrameElem=78 ElemStation=6.24999940395358E-02
 Frame=78 Station=6.24999940395358E-02 OutputCase=ACC1 CaseType=Combination Point=1 X2=-0.5 X3=-0.5
 S11=-1130.13463065982 IsS11Max=No IsS11Min=Yes FrameElem=78 ElemStation=6.24999940395358E-02
 Frame=78 Station=6.24999940395358E-02 OutputCase=ACC1 CaseType=Combination Point=2 X2=-0.5 X3=0.5
 S11=-1130.13463065982 IsS11Max=No IsS11Min=No FrameElem=78 ElemStation=6.24999940395358E-02
 Frame=78 Station=6.24999940395358E-02 OutputCase=ACC1 CaseType=Combination Point=3 X2=0.5 X3=-0.5
 S11=791.052535036068 IsS11Max=Yes IsS11Min=No FrameElem=78 ElemStation=6.24999940395358E-02
 Frame=78 Station=6.24999940395358E-02 OutputCase=ACC1 CaseType=Combination Point=4 X2=0.5 X3=0.5
 S11=791.052535036068 IsS11Max=No IsS11Min=No FrameElem=78 ElemStation=6.24999940395358E-02
 Frame=78 Station=0.124999988079072 OutputCase=ACC1 CaseType=Combination Point=0 X2=0 X3=0 S11=-
 169.541048815736 IsS11Max=No IsS11Min=No FrameElem=78 ElemStation=0.124999988079072
 Frame=78 Station=0.124999988079072 OutputCase=ACC1 CaseType=Combination Point=1 X2=-0.5 X3=-0.5
 S11=-1278.16000195392 IsS11Max=No IsS11Min=Yes FrameElem=78 ElemStation=0.124999988079072
 Frame=78 Station=0.124999988079072 OutputCase=ACC1 CaseType=Combination Point=2 X2=-0.5 X3=0.5
 S11=-1278.16000195392 IsS11Max=No IsS11Min=No FrameElem=78 ElemStation=0.124999988079072
 Frame=78 Station=0.124999988079072 OutputCase=ACC1 CaseType=Combination Point=3 X2=0.5 X3=-0.5
 S11=939.077904322447 IsS11Max=Yes IsS11Min=No FrameElem=78 ElemStation=0.124999988079072
 Frame=78 Station=0.124999988079072 OutputCase=ACC1 CaseType=Combination Point=4 X2=0.5 X3=0.5
 S11=939.077904322447 IsS11Max=No IsS11Min=No FrameElem=78 ElemStation=0.124999988079072
 Frame=78 Station=0.187499982118607 OutputCase=ACC1 CaseType=Combination Point=0 X2=0 X3=0 S11=-
 169.541049819597 IsS11Max=No IsS11Min=No FrameElem=78 ElemStation=0.187499982118607
 Frame=78 Station=0.187499982118607 OutputCase=ACC1 CaseType=Combination Point=1 X2=-0.5 X3=-0.5
 S11=-1430.13271624512 IsS11Max=No IsS11Min=Yes FrameElem=78 ElemStation=0.187499982118607
 Frame=78 Station=0.187499982118607 OutputCase=ACC1 CaseType=Combination Point=2 X2=-0.5 X3=0.5
 S11=-1430.13271624512 IsS11Max=No IsS11Min=No FrameElem=78 ElemStation=0.187499982118607
 Frame=78 Station=0.187499982118607 OutputCase=ACC1 CaseType=Combination Point=3 X2=0.5 X3=-0.5
 S11=1091.05061660593 IsS11Max=Yes IsS11Min=No FrameElem=78 ElemStation=0.187499982118607
 Frame=78 Station=0.187499982118607 OutputCase=ACC1 CaseType=Combination Point=4 X2=0.5 X3=0.5
 S11=1091.05061660593 IsS11Max=No IsS11Min=No FrameElem=78 ElemStation=0.187499982118607
 Frame=78 Station=0.249999976158143 OutputCase=ACC1 CaseType=Combination Point=0 X2=0 X3=0 S11=-
 169.541050823459 IsS11Max=No IsS11Min=No FrameElem=78 ElemStation=0.249999976158143
 Frame=78 Station=0.249999976158143 OutputCase=ACC1 CaseType=Combination Point=1 X2=-0.5 X3=-0.5
 S11=-1586.05277353343 IsS11Max=No IsS11Min=Yes FrameElem=78 ElemStation=0.249999976158143
 Frame=78 Station=0.249999976158143 OutputCase=ACC1 CaseType=Combination Point=2 X2=-0.5 X3=0.5
 S11=-1586.05277353343 IsS11Max=No IsS11Min=No FrameElem=78 ElemStation=0.249999976158143
 Frame=78 Station=0.249999976158143 OutputCase=ACC1 CaseType=Combination Point=3 X2=0.5 X3=-0.5
 S11=1246.97067188652 IsS11Max=Yes IsS11Min=No FrameElem=78 ElemStation=0.249999976158143
 Frame=78 Station=0.249999976158143 OutputCase=ACC1 CaseType=Combination Point=4 X2=0.5 X3=0.5
 S11=1246.97067188652 IsS11Max=No IsS11Min=No FrameElem=78 ElemStation=0.249999976158143
 Frame=78 Station=0 OutputCase=ACC2 CaseType=Combination Point=0 X2=0 X3=0 S11=-115.765281062568
 IsS11Max=No IsS11Min=No FrameElem=78 ElemStation=0
 Frame=78 Station=0 OutputCase=ACC2 CaseType=Combination Point=1 X2=-0.5 X3=-0.5 S11=-
 847.294974569735 IsS11Max=No IsS11Min=Yes FrameElem=78 ElemStation=0
 Frame=78 Station=0 OutputCase=ACC2 CaseType=Combination Point=2 X2=-0.5 X3=0.5 S11=-
 847.294974569735 IsS11Max=No IsS11Min=No FrameElem=78 ElemStation=0
 Frame=78 Station=0 OutputCase=ACC2 CaseType=Combination Point=3 X2=0.5 X3=-0.5 S11=615.7644124446
 IsS11Max=Yes IsS11Min=No FrameElem=78 ElemStation=0
 Frame=78 Station=0 OutputCase=ACC2 CaseType=Combination Point=4 X2=0.5 X3=0.5 S11=615.7644124446
 IsS11Max=No IsS11Min=No FrameElem=78 ElemStation=0
 Frame=78 Station=6.24999940395358E-02 OutputCase=ACC2 CaseType=Combination Point=0 X2=0 X3=0 S11=-
 115.765282066429 IsS11Max=No IsS11Min=No FrameElem=78 ElemStation=6.24999940395358E-02
 Frame=78 Station=6.24999940395358E-02 OutputCase=ACC2 CaseType=Combination Point=1 X2=-0.5 X3=-0.5
 S11=-991.373004687151 IsS11Max=No IsS11Min=Yes FrameElem=78 ElemStation=6.24999940395358E-02
 Frame=78 Station=6.24999940395358E-02 OutputCase=ACC2 CaseType=Combination Point=2 X2=-0.5 X3=0.5
 S11=-991.373004687151 IsS11Max=No IsS11Min=No FrameElem=78 ElemStation=6.24999940395358E-02
 Frame=78 Station=6.24999940395358E-02 OutputCase=ACC2 CaseType=Combination Point=3 X2=0.5 X3=-0.5
 S11=759.842440554293 IsS11Max=Yes IsS11Min=No FrameElem=78 ElemStation=6.24999940395358E-02
 Frame=78 Station=6.24999940395358E-02 OutputCase=ACC2 CaseType=Combination Point=4 X2=0.5 X3=0.5
 S11=759.842440554293 IsS11Max=No IsS11Min=No FrameElem=78 ElemStation=6.24999940395358E-02
 Frame=78 Station=0.124999988079072 OutputCase=ACC2 CaseType=Combination Point=0 X2=0 X3=0 S11=-
 115.765283070291 IsS11Max=No IsS11Min=No FrameElem=78 ElemStation=0.124999988079072
 Frame=78 Station=0.124999988079072 OutputCase=ACC2 CaseType=Combination Point=1 X2=-0.5 X3=-0.5
 S11=-1139.39837780167 IsS11Max=No IsS11Min=Yes FrameElem=78 ElemStation=0.124999988079072

Frame=78 Station=0.124999988079072 OutputCase=ACC2 CaseType=Combination Point=2 X2=-0.5 X3=0.5
 S11=-1139.39837780167 IsS11Max=No IsS11Min=No FrameElem=78 ElemStation=0.124999988079072
 Frame=78 Station=0.124999988079072 OutputCase=ACC2 CaseType=Combination Point=3 X2=0.5 X3=-0.5
 S11=907.867811661089 IsS11Max=Yes IsS11Min=No FrameElem=78 ElemStation=0.124999988079072
 Frame=78 Station=0.124999988079072 OutputCase=ACC2 CaseType=Combination Point=4 X2=0.5 X3=0.5
 S11=907.867811661089 IsS11Max=No IsS11Min=No FrameElem=78 ElemStation=0.124999988079072
 Frame=78 Station=0.187499982118607 OutputCase=ACC2 CaseType=Combination Point=0 X2=0 X3=0 S11=-
 115.765284074152 IsS11Max=No IsS11Min=No FrameElem=78 ElemStation=0.187499982118607
 Frame=78 Station=0.187499982118607 OutputCase=ACC2 CaseType=Combination Point=1 X2=-0.5 X3=-0.5
 S11=-1291.37109391329 IsS11Max=Yes IsS11Min=No FrameElem=78 ElemStation=0.187499982118607
 Frame=78 Station=0.187499982118607 OutputCase=ACC2 CaseType=Combination Point=2 X2=-0.5 X3=0.5
 S11=-1291.37109391329 IsS11Max=No IsS11Min=No FrameElem=78 ElemStation=0.187499982118607
 Frame=78 Station=0.187499982118607 OutputCase=ACC2 CaseType=Combination Point=3 X2=0.5 X3=-0.5
 S11=1059.84052576499 IsS11Max=Yes IsS11Min=No FrameElem=78 ElemStation=0.187499982118607
 Frame=78 Station=0.187499982118607 OutputCase=ACC2 CaseType=Combination Point=4 X2=0.5 X3=0.5
 S11=1059.84052576499 IsS11Max=No IsS11Min=No FrameElem=78 ElemStation=0.187499982118607
 Frame=78 Station=0.249999976158143 OutputCase=ACC2 CaseType=Combination Point=0 X2=0 X3=0 S11=-
 115.765285078013 IsS11Max=No IsS11Min=No FrameElem=78 ElemStation=0.249999976158143
 Frame=78 Station=0.249999976158143 OutputCase=ACC2 CaseType=Combination Point=1 X2=-0.5 X3=-0.5
 S11=-1447.29115302202 IsS11Max=No IsS11Min=Yes FrameElem=78 ElemStation=0.249999976158143
 Frame=78 Station=0.249999976158143 OutputCase=ACC2 CaseType=Combination Point=2 X2=-0.5 X3=0.5
 S11=-1447.29115302202 IsS11Max=No IsS11Min=No FrameElem=78 ElemStation=0.249999976158143
 Frame=78 Station=0.249999976158143 OutputCase=ACC2 CaseType=Combination Point=3 X2=0.5 X3=-0.5
 S11=1215.76058286599 IsS11Max=Yes IsS11Min=No FrameElem=78 ElemStation=0.249999976158143
 Frame=78 Station=0.249999976158143 OutputCase=ACC2 CaseType=Combination Point=4 X2=0.5 X3=0.5
 S11=1215.76058286599 IsS11Max=No IsS11Min=No FrameElem=78 ElemStation=0.249999976158143
 Frame=78 Station=0 OutputCase=ACCSX1 CaseType=Combination Point=0 X2=0 X3=0 S11=-167.164058926675
 IsS11Max=No IsS11Min=No FrameElem=78 ElemStation=0
 Frame=78 Station=0 OutputCase=ACCSX1 CaseType=Combination Point=1 X2=-0.5 X3=-0.5 S11=-
 981.153692835718 IsS11Max=No IsS11Min=Yes FrameElem=78 ElemStation=0
 Frame=78 Station=0 OutputCase=ACCSX1 CaseType=Combination Point=2 X2=-0.5 X3=0.5 S11=-
 981.153692835718 IsS11Max=No IsS11Min=No FrameElem=78 ElemStation=0
 Frame=78 Station=0 OutputCase=ACCSX1 CaseType=Combination Point=3 X2=0.5 X3=-0.5
 S11=646.825574982368 IsS11Max=Yes IsS11Min=No FrameElem=78 ElemStation=0
 Frame=78 Station=0 OutputCase=ACCSX1 CaseType=Combination Point=4 X2=0.5 X3=0.5
 S11=646.825574982368 IsS11Max=No IsS11Min=No FrameElem=78 ElemStation=0
 Frame=78 Station=6.24999940395358E-02 OutputCase=ACCSX1 CaseType=Combination Point=0 X2=0 X3=0
 S11=-167.1640589823 IsS11Max=No IsS11Min=No FrameElem=78 ElemStation=6.24999940395358E-02
 Frame=78 Station=6.24999940395358E-02 OutputCase=ACCSX1 CaseType=Combination Point=1 X2=-0.5 X3=-0.5
 S11=-1121.16286004521 IsS11Max=No IsS11Min=Yes FrameElem=78 ElemStation=6.24999940395358E-02
 Frame=78 Station=6.24999940395358E-02 OutputCase=ACCSX1 CaseType=Combination Point=2 X2=-0.5 X3=0.5
 S11=-1121.16286004521 IsS11Max=No IsS11Min=No FrameElem=78 ElemStation=6.24999940395358E-02
 Frame=78 Station=6.24999940395358E-02 OutputCase=ACCSX1 CaseType=Combination Point=3 X2=0.5 X3=-0.5
 S11=786.834740248753 IsS11Max=Yes IsS11Min=No FrameElem=78 ElemStation=6.24999940395358E-02
 Frame=78 Station=6.24999940395358E-02 OutputCase=ACCSX1 CaseType=Combination Point=4 X2=0.5 X3=0.5
 S11=786.834740248753 IsS11Max=No IsS11Min=No FrameElem=78 ElemStation=6.24999940395358E-02
 Frame=78 Station=0.124999988079072 OutputCase=ACCSX1 CaseType=Combination Point=0 X2=0 X3=0 S11=-
 167.164060869786 IsS11Max=No IsS11Min=No FrameElem=78 ElemStation=0.124999988079072
 Frame=78 Station=0.124999988079072 OutputCase=ACCSX1 CaseType=Combination Point=1 X2=-0.5 X3=-0.5
 S11=-1264.99233902604 IsS11Max=No IsS11Min=Yes FrameElem=78 ElemStation=0.124999988079072
 Frame=78 Station=0.124999988079072 OutputCase=ACCSX1 CaseType=Combination Point=2 X2=-0.5 X3=0.5
 S11=-1264.99233902604 IsS11Max=No IsS11Min=No FrameElem=78 ElemStation=0.124999988079072
 Frame=78 Station=0.124999988079072 OutputCase=ACCSX1 CaseType=Combination Point=3 X2=0.5 X3=-0.5
 S11=930.664217286471 IsS11Max=Yes IsS11Min=No FrameElem=78 ElemStation=0.124999988079072
 Frame=78 Station=0.124999988079072 OutputCase=ACCSX1 CaseType=Combination Point=4 X2=0.5 X3=0.5
 S11=930.664217286471 IsS11Max=No IsS11Min=No FrameElem=78 ElemStation=0.124999988079072
 Frame=78 Station=0.187499982118607 OutputCase=ACCSX1 CaseType=Combination Point=0 X2=0 X3=0 S11=-
 167.164061841342 IsS11Max=No IsS11Min=No FrameElem=78 ElemStation=0.187499982118607
 Frame=78 Station=0.187499982118607 OutputCase=ACCSX1 CaseType=Combination Point=1 X2=-0.5 X3=-0.5
 S11=-1412.64212977821 IsS11Max=No IsS11Min=Yes FrameElem=78 ElemStation=0.187499982118607
 Frame=78 Station=0.187499982118607 OutputCase=ACCSX1 CaseType=Combination Point=2 X2=-0.5 X3=0.5
 S11=-1412.64212977821 IsS11Max=No IsS11Min=No FrameElem=78 ElemStation=0.187499982118607
 Frame=78 Station=0.187499982118607 OutputCase=ACCSX1 CaseType=Combination Point=3 X2=0.5 X3=-0.5
 S11=1078.31400609552 IsS11Max=Yes IsS11Min=No FrameElem=78 ElemStation=0.187499982118607
 Frame=78 Station=0.187499982118607 OutputCase=ACCSX1 CaseType=Combination Point=4 X2=0.5 X3=0.5
 S11=1078.31400609552 IsS11Max=No IsS11Min=No FrameElem=78 ElemStation=0.187499982118607
 Frame=78 Station=0.249999976158143 OutputCase=ACCSX1 CaseType=Combination Point=0 X2=0 X3=0 S11=-
 167.164062812898 IsS11Max=No IsS11Min=No FrameElem=78 ElemStation=0.249999976158143
 Frame=78 Station=0.249999976158143 OutputCase=ACCSX1 CaseType=Combination Point=1 X2=-0.5 X3=-0.5
 S11=-1564.1122323017 IsS11Max=No IsS11Min=Yes FrameElem=78 ElemStation=0.249999976158143
 Frame=78 Station=0.249999976158143 OutputCase=ACCSX1 CaseType=Combination Point=2 X2=-0.5 X3=0.5
 S11=-1564.1122323017 IsS11Max=No IsS11Min=No FrameElem=78 ElemStation=0.249999976158143
 Frame=78 Station=0.249999976158143 OutputCase=ACCSX1 CaseType=Combination Point=3 X2=0.5 X3=-0.5
 S11=1229.78410667591 IsS11Max=Yes IsS11Min=No FrameElem=78 ElemStation=0.249999976158143
 Frame=78 Station=0.249999976158143 OutputCase=ACCSX1 CaseType=Combination Point=4 X2=0.5 X3=0.5
 S11=1229.78410667591 IsS11Max=No IsS11Min=No FrameElem=78 ElemStation=0.249999976158143
 Frame=78 Station=0 OutputCase=ACCSX2 CaseType=Combination Point=0 X2=0 X3=0 S11=-113.38829318123
 IsS11Max=No IsS11Min=No FrameElem=78 ElemStation=0
 Frame=78 Station=0 OutputCase=ACCSX2 CaseType=Combination Point=1 X2=-0.5 X3=-0.5 S11=-
 842.392065042635 IsS11Max=No IsS11Min=Yes FrameElem=78 ElemStation=0
 Frame=78 Station=0 OutputCase=ACCSX2 CaseType=Combination Point=2 X2=-0.5 X3=0.5 S11=-
 842.392065042635 IsS11Max=No IsS11Min=No FrameElem=78 ElemStation=0



Frame=78 Station=0 OutputCase=ACCSX2 CaseType=Combination Point=3 X2=0.5 X3=-0.5
 S11=615.615478680176 IsS11Max=Yes IsS11Min=No FrameElem=78 ElemStation=0
 Frame=78 Station=0 OutputCase=ACCSX2 CaseType=Combination Point=4 X2=0.5 X3=0.5
 S11=615.615478680176 IsS11Max=No IsS11Min=No FrameElem=78 ElemStation=0
 Frame=78 Station=6.24999940395358E-02 OutputCase=ACCSX2 CaseType=Combination Point=0 X2=0 X3=0
 S11=-113.388294152785 IsS11Max=No IsS11Min=No FrameElem=78 ElemStation=6.24999940395358E-02
 Frame=78 Station=6.24999940395358E-02 OutputCase=ACCSX2 CaseType=Combination Point=1 X2=-0.5 X3=-0.5
 S11=-982.401234072549 IsS11Max=No IsS11Min=Yes FrameElem=78 ElemStation=6.24999940395358E-02
 Frame=78 Station=6.24999940395358E-02 OutputCase=ACCSX2 CaseType=Combination Point=2 X2=-0.5 X3=0.5
 S11=-982.401234072549 IsS11Max=No IsS11Min=No FrameElem=78 ElemStation=6.24999940395358E-02
 Frame=78 Station=6.24999940395358E-02 OutputCase=ACCSX2 CaseType=Combination Point=3 X2=0.5 X3=-0.5
 S11=755.624645766978 IsS11Max=Yes IsS11Min=No FrameElem=78 ElemStation=6.24999940395358E-02
 Frame=78 Station=6.24999940395358E-02 OutputCase=ACCSX2 CaseType=Combination Point=4 X2=0.5 X3=0.5
 S11=755.624645766978 IsS11Max=No IsS11Min=No FrameElem=78 ElemStation=6.24999940395358E-02
 Frame=78 Station=0.124999988079072 OutputCase=ACCSX2 CaseType=Combination Point=0 X2=0 X3=0 S11=-
 113.388295124341 IsS11Max=No IsS11Min=No FrameElem=78 ElemStation=0.124999988079072
 Frame=78 Station=0.124999988079072 OutputCase=ACCSX2 CaseType=Combination Point=1 X2=-0.5 X3=-0.5
 S11=-1126.2307148738 IsS11Max=No IsS11Min=Yes FrameElem=78 ElemStation=0.124999988079072
 Frame=78 Station=0.124999988079072 OutputCase=ACCSX2 CaseType=Combination Point=2 X2=-0.5 X3=0.5
 S11=-1126.2307148738 IsS11Max=No IsS11Min=No FrameElem=78 ElemStation=0.124999988079072
 Frame=78 Station=0.124999988079072 OutputCase=ACCSX2 CaseType=Combination Point=3 X2=0.5 X3=-0.5
 S11=899.454124625113 IsS11Max=Yes IsS11Min=No FrameElem=78 ElemStation=0.124999988079072
 Frame=78 Station=0.124999988079072 OutputCase=ACCSX2 CaseType=Combination Point=4 X2=0.5 X3=0.5
 S11=899.454124625113 IsS11Max=No IsS11Min=No FrameElem=78 ElemStation=0.124999988079072
 Frame=78 Station=0.187499982118607 OutputCase=ACCSX2 CaseType=Combination Point=0 X2=0 X3=0 S11=-
 113.388296095897 IsS11Max=No IsS11Min=No FrameElem=78 ElemStation=0.187499982118607
 Frame=78 Station=0.187499982118607 OutputCase=ACCSX2 CaseType=Combination Point=1 X2=-0.5 X3=-0.5
 S11=-1273.88050744638 IsS11Max=No IsS11Min=Yes FrameElem=78 ElemStation=0.187499982118607
 Frame=78 Station=0.187499982118607 OutputCase=ACCSX2 CaseType=Combination Point=2 X2=-0.5 X3=0.5
 S11=-1273.88050744638 IsS11Max=No IsS11Min=No FrameElem=78 ElemStation=0.187499982118607
 Frame=78 Station=0.187499982118607 OutputCase=ACCSX2 CaseType=Combination Point=3 X2=0.5 X3=-0.5
 S11=1047.10391525458 IsS11Max=Yes IsS11Min=No FrameElem=78 ElemStation=0.187499982118607
 Frame=78 Station=0.187499982118607 OutputCase=ACCSX2 CaseType=Combination Point=4 X2=0.5 X3=0.5
 S11=1047.10391525458 IsS11Max=No IsS11Min=No FrameElem=78 ElemStation=0.187499982118607
 Frame=78 Station=0.249999976158143 OutputCase=ACCSX2 CaseType=Combination Point=0 X2=0 X3=0 S11=-
 113.388297067453 IsS11Max=No IsS11Min=No FrameElem=78 ElemStation=0.249999976158143
 Frame=78 Station=0.249999976158143 OutputCase=ACCSX2 CaseType=Combination Point=1 X2=-0.5 X3=-0.5
 S11=-1425.35061179029 IsS11Max=No IsS11Min=Yes FrameElem=78 ElemStation=0.249999976158143
 Frame=78 Station=0.249999976158143 OutputCase=ACCSX2 CaseType=Combination Point=2 X2=-0.5 X3=0.5
 S11=-1425.35061179029 IsS11Max=No IsS11Min=No FrameElem=78 ElemStation=0.249999976158143
 Frame=78 Station=0.249999976158143 OutputCase=ACCSX2 CaseType=Combination Point=3 X2=0.5 X3=-0.5
 S11=1198.57401765538 IsS11Max=Yes IsS11Min=No FrameElem=78 ElemStation=0.249999976158143
 Frame=78 Station=0.249999976158143 OutputCase=ACCSX2 CaseType=Combination Point=4 X2=0.5 X3=0.5
 S11=1198.57401765538 IsS11Max=No IsS11Min=No FrameElem=78 ElemStation=0.249999976158143
 Frame=78 Station=0 OutputCase=ENVE CaseType=Combination StepType=Max Point=0 X2=0 X3=0 S11=-
 111.115495045979 IsS11Max=No IsS11Min=No FrameElem=78 ElemStation=0
 Frame=78 Station=0 OutputCase=ENVE CaseType=Combination StepType=Max Point=1 X2=-0.5 X3=-0.5
 S11=-816.009084046956 IsS11Max=No IsS11Min=Yes FrameElem=78 ElemStation=0
 Frame=78 Station=0 OutputCase=ENVE CaseType=Combination StepType=Max Point=2 X2=-0.5 X3=0.5 S11=-
 816.009084046956 IsS11Max=No IsS11Min=No FrameElem=78 ElemStation=0
 Frame=78 Station=0 OutputCase=ENVE CaseType=Combination StepType=Max Point=3 X2=0.5 X3=-0.5
 S11=646.974508746792 IsS11Max=Yes IsS11Min=No FrameElem=78 ElemStation=0
 Frame=78 Station=0 OutputCase=ENVE CaseType=Combination StepType=Max Point=4 X2=0.5 X3=0.5
 S11=646.974508746792 IsS11Max=No IsS11Min=No FrameElem=78 ElemStation=0
 Frame=78 Station=6.24999940395358E-02 OutputCase=ENVE CaseType=Combination StepType=Max Point=0 X2=0
 X3=0 S11=-111.115496017534 IsS11Max=No IsS11Min=No FrameElem=78 ElemStation=6.24999940395358E-02
 Frame=78 Station=6.24999940395358E-02 OutputCase=ENVE CaseType=Combination StepType=Max Point=1 X2=-
 0.5 X3=-0.5 S11=-955.450474110255 IsS11Max=No IsS11Min=Yes FrameElem=78 ElemStation=6.24999940395358E-02
 Frame=78 Station=6.24999940395358E-02 OutputCase=ENVE CaseType=Combination StepType=Max Point=2 X2=-
 0.5 X3=0.5 S11=-955.450474110255 IsS11Max=No IsS11Min=No FrameElem=78 ElemStation=6.24999940395358E-02
 Frame=78 Station=6.24999940395358E-02 OutputCase=ENVE CaseType=Combination StepType=Max Point=3
 X2=0.5 X3=-0.5 S11=791.052535036068 IsS11Max=Yes IsS11Min=No FrameElem=78 ElemStation=6.24999940395358E-
 02
 Frame=78 Station=6.24999940395358E-02 OutputCase=ENVE CaseType=Combination StepType=Max Point=4
 X2=0.5 X3=0.5 S11=791.052535036068 IsS11Max=No IsS11Min=No FrameElem=78 ElemStation=6.24999940395358E-02
 Frame=78 Station=0.124999988079072 OutputCase=ENVE CaseType=Combination StepType=Max Point=0 X2=0
 X3=0 S11=-111.11549698909 IsS11Max=No IsS11Min=No FrameElem=78 ElemStation=0.124999988079072
 Frame=78 Station=0.124999988079072 OutputCase=ENVE CaseType=Combination StepType=Max Point=1 X2=-0.5
 X3=-0.5 S11=-1098.71217594489 IsS11Max=No IsS11Min=Yes FrameElem=78 ElemStation=0.124999988079072
 Frame=78 Station=0.124999988079072 OutputCase=ENVE CaseType=Combination StepType=Max Point=2 X2=-0.5
 X3=0.5 S11=-1098.71217594489 IsS11Max=No IsS11Min=No FrameElem=78 ElemStation=0.124999988079072
 Frame=78 Station=0.124999988079072 OutputCase=ENVE CaseType=Combination StepType=Max Point=3 X2=0.5
 X3=-0.5 S11=939.077904322447 IsS11Max=Yes IsS11Min=No FrameElem=78 ElemStation=0.124999988079072
 Frame=78 Station=0.124999988079072 OutputCase=ENVE CaseType=Combination StepType=Max Point=4 X2=0.5
 X3=0.5 S11=939.077904322447 IsS11Max=No IsS11Min=No FrameElem=78 ElemStation=0.124999988079072
 Frame=78 Station=0.187499982118607 OutputCase=ENVE CaseType=Combination StepType=Max Point=0 X2=0
 X3=0 S11=-111.115497960646 IsS11Max=No IsS11Min=No FrameElem=78 ElemStation=0.187499982118607
 Frame=78 Station=0.187499982118607 OutputCase=ENVE CaseType=Combination StepType=Max Point=1 X2=-0.5
 X3=-0.5 S11=-1245.79418955085 IsS11Max=No IsS11Min=Yes FrameElem=78 ElemStation=0.187499982118607
 Frame=78 Station=0.187499982118607 OutputCase=ENVE CaseType=Combination StepType=Max Point=2 X2=-0.5
 X3=0.5 S11=-1245.79418955085 IsS11Max=No IsS11Min=No FrameElem=78 ElemStation=0.187499982118607

Frame=78 Station=0.187499982118607 OutputCase=ENVE CaseType=Combination StepType=Max Point=3 X2=0.5
X3=-0.5 S11=1091.05061660593 IsS11Max=Yes IsS11Min=No FrameElem=78 ElemStation=0.187499982118607
Frame=78 Station=0.187499982118607 OutputCase=ENVE CaseType=Combination StepType=Max Point=4 X2=0.5
X3=0.5 S11=1091.05061660593 IsS11Max=No IsS11Min=No FrameElem=78 ElemStation=0.187499982118607
Frame=78 Station=0.249999976158143 OutputCase=ENVE CaseType=Combination StepType=Max Point=0 X2=0
X3=0 S11=-111.115498932202 IsS11Max=No IsS11Min=No FrameElem=78 ElemStation=0.249999976158143
Frame=78 Station=0.249999976158143 OutputCase=ENVE CaseType=Combination StepType=Max Point=1 X2=-0.5
X3=-0.5 S11=-1396.69651492815 IsS11Max=No IsS11Min=Yes FrameElem=78 ElemStation=0.249999976158143
Frame=78 Station=0.249999976158143 OutputCase=ENVE CaseType=Combination StepType=Max Point=2 X2=-0.5
X3=0.5 S11=-1396.69651492815 IsS11Max=No IsS11Min=No FrameElem=78 ElemStation=0.249999976158143
Frame=78 Station=0.249999976158143 OutputCase=ENVE CaseType=Combination StepType=Max Point=3 X2=0.5
X3=-0.5 S11=1246.97067188652 IsS11Max=Yes IsS11Min=No FrameElem=78 ElemStation=0.249999976158143
Frame=78 Station=0.249999976158143 OutputCase=ENVE CaseType=Combination StepType=Max Point=4 X2=0.5
X3=0.5 S11=1246.97067188652 IsS11Max=No IsS11Min=No FrameElem=78 ElemStation=0.249999976158143
Frame=78 Station=0 OutputCase=ENVE CaseType=Combination StepType=Min Point=0 X2=0 X3=0 S11=-
169.541046808013 IsS11Max=No IsS11Min=No FrameElem=78 ElemStation=0
Frame=78 Station=0 OutputCase=ENVE CaseType=Combination StepType=Min Point=1 X2=-0.5 X3=-0.5
S11=-986.056602362818 IsS11Max=No IsS11Min=Yes FrameElem=78 ElemStation=0
Frame=78 Station=0 OutputCase=ENVE CaseType=Combination StepType=Min Point=2 X2=-0.5 X3=0.5 S11=-
986.056602362818 IsS11Max=No IsS11Min=No FrameElem=78 ElemStation=0
Frame=78 Station=0 OutputCase=ENVE CaseType=Combination StepType=Min Point=3 X2=0.5 X3=-0.5
S11=593.778093954999 IsS11Max=Yes IsS11Min=No FrameElem=78 ElemStation=0
Frame=78 Station=0 OutputCase=ENVE CaseType=Combination StepType=Min Point=4 X2=0.5 X3=0.5
S11=593.778093954999 IsS11Max=No IsS11Min=No FrameElem=78 ElemStation=0
Frame=78 Station=6.24999940395358E-02 OutputCase=ENVE CaseType=Combination StepType=Min Point=0 X2=0
X3=0 S11=-169.541047811874 IsS11Max=No IsS11Min=No FrameElem=78 ElemStation=6.24999940395358E-02
Frame=78 Station=6.24999940395358E-02 OutputCase=ENVE CaseType=Combination StepType=Min Point=1 X2=-
0.5 X3=-0.5 S11=-1130.13463065982 IsS11Max=No IsS11Min=Yes FrameElem=78 ElemStation=6.24999940395358E-02
Frame=78 Station=6.24999940395358E-02 OutputCase=ENVE CaseType=Combination StepType=Min Point=2 X2=-
0.5 X3=0.5 S11=-1130.13463065982 IsS11Max=No IsS11Min=No FrameElem=78 ElemStation=6.24999940395358E-02
Frame=78 Station=6.24999940395358E-02 OutputCase=ENVE CaseType=Combination StepType=Min Point=3
X2=0.5 X3=-0.5 S11=733.219482075186 IsS11Max=Yes IsS11Min=No FrameElem=78 ElemStation=6.24999940395358E-
02
Frame=78 Station=6.24999940395358E-02 OutputCase=ENVE CaseType=Combination StepType=Min Point=4
X2=0.5 X3=0.5 S11=733.219482075186 IsS11Max=No IsS11Min=No FrameElem=78 ElemStation=6.24999940395358E-02
Frame=78 Station=0.124999988079072 OutputCase=ENVE CaseType=Combination StepType=Min Point=0 X2=0
X3=0 S11=-169.541048815736 IsS11Max=No IsS11Min=No FrameElem=78 ElemStation=0.124999988079072
Frame=78 Station=0.124999988079072 OutputCase=ENVE CaseType=Combination StepType=Min Point=1 X2=-0.5
X3=-0.5 S11=-1278.16000195392 IsS11Max=No IsS11Min=Yes FrameElem=78 ElemStation=0.124999988079072
Frame=78 Station=0.124999988079072 OutputCase=ENVE CaseType=Combination StepType=Min Point=2 X2=-0.5
X3=0.5 S11=-1278.16000195392 IsS11Max=No IsS11Min=No FrameElem=78 ElemStation=0.124999988079072
Frame=78 Station=0.124999988079072 OutputCase=ENVE CaseType=Combination StepType=Min Point=3 X2=0.5
X3=-0.5 S11=876.481181966707 IsS11Max=Yes IsS11Min=No FrameElem=78 ElemStation=0.124999988079072
Frame=78 Station=0.124999988079072 OutputCase=ENVE CaseType=Combination StepType=Min Point=4 X2=0.5
X3=0.5 S11=876.481181966707 IsS11Max=No IsS11Min=No FrameElem=78 ElemStation=0.124999988079072
Frame=78 Station=0.187499982118607 OutputCase=ENVE CaseType=Combination StepType=Min Point=0 X2=0
X3=0 S11=-169.541049819597 IsS11Max=No IsS11Min=No FrameElem=78 ElemStation=0.187499982118607
Frame=78 Station=0.187499982118607 OutputCase=ENVE CaseType=Combination StepType=Min Point=1 X2=-0.5
X3=-0.5 S11=-1430.13271624512 IsS11Max=No IsS11Min=Yes FrameElem=78 ElemStation=0.187499982118607
Frame=78 Station=0.187499982118607 OutputCase=ENVE CaseType=Combination StepType=Min Point=2 X2=-0.5
X3=0.5 S11=-1430.13271624512 IsS11Max=No IsS11Min=No FrameElem=78 ElemStation=0.187499982118607
Frame=78 Station=0.187499982118607 OutputCase=ENVE CaseType=Combination StepType=Min Point=3 X2=0.5
X3=-0.5 S11=1023.56319362956 IsS11Max=Yes IsS11Min=No FrameElem=78 ElemStation=0.187499982118607
Frame=78 Station=0.249999976158143 OutputCase=ENVE CaseType=Combination StepType=Min Point=4 X2=0.5
X3=0.5 S11=1023.56319362956 IsS11Max=No IsS11Min=No FrameElem=78 ElemStation=0.187499982118607
Frame=78 Station=0.249999976158143 OutputCase=ENVE CaseType=Combination StepType=Min Point=0 X2=0
X3=0 S11=-169.541050823459 IsS11Max=No IsS11Min=No FrameElem=78 ElemStation=0.249999976158143
Frame=78 Station=0.249999976158143 OutputCase=ENVE CaseType=Combination StepType=Min Point=1 X2=-0.5
X3=-0.5 S11=-1586.05277353343 IsS11Max=No IsS11Min=Yes FrameElem=78 ElemStation=0.249999976158143
Frame=78 Station=0.249999976158143 OutputCase=ENVE CaseType=Combination StepType=Min Point=2 X2=-0.5
X3=0.5 S11=-1586.05277353343 IsS11Max=No IsS11Min=No FrameElem=78 ElemStation=0.249999976158143
Frame=78 Station=0.249999976158143 OutputCase=ENVE CaseType=Combination StepType=Min Point=3 X2=0.5
X3=-0.5 S11=1174.46551706375 IsS11Max=Yes IsS11Min=No FrameElem=78 ElemStation=0.249999976158143
Frame=78 Station=0.249999976158143 OutputCase=ENVE CaseType=Combination StepType=Min Point=4 X2=0.5
X3=0.5 S11=1174.46551706375 IsS11Max=No IsS11Min=No FrameElem=78 ElemStation=0.249999976158143
Frame=78 Station=0 OutputCase=FESSUR CaseType=Combination Point=0 X2=0 X3=0 S11=-168.146111003036
IsS11Max=No IsS11Min=No FrameElem=78 ElemStation=0
Frame=78 Station=0 OutputCase=FESSUR CaseType=Combination Point=1 X2=-0.5 X3=-0.5 S11=-
976.670835205984 IsS11Max=No IsS11Min=Yes FrameElem=78 ElemStation=0
Frame=78 Station=0 OutputCase=FESSUR CaseType=Combination Point=2 X2=-0.5 X3=0.5 S11=-
976.670835205984 IsS11Max=No IsS11Min=No FrameElem=78 ElemStation=0
Frame=78 Station=0 OutputCase=FESSUR CaseType=Combination Point=3 X2=0.5 X3=-0.5
S11=640.378613199912 IsS11Max=Yes IsS11Min=No FrameElem=78 ElemStation=0
Frame=78 Station=0 OutputCase=FESSUR CaseType=Combination Point=4 X2=0.5 X3=0.5
S11=640.378613199912 IsS11Max=No IsS11Min=No FrameElem=78 ElemStation=0
Frame=78 Station=6.24999940395358E-02 OutputCase=FESSUR CaseType=Combination Point=0 X2=0 X3=0
S11=-168.146111997206 IsS11Max=No IsS11Min=No FrameElem=78 ElemStation=6.24999940395358E-02
Frame=78 Station=6.24999940395358E-02 OutputCase=FESSUR CaseType=Combination Point=1 X2=-0.5 X3=-0.5
S11=-1119.35787148675 IsS11Max=No IsS11Min=Yes FrameElem=78 ElemStation=6.24999940395358E-02
Frame=78 Station=6.24999940395358E-02 OutputCase=FESSUR CaseType=Combination Point=2 X2=-0.5 X3=0.5
S11=-1119.35787148675 IsS11Max=No IsS11Min=No FrameElem=78 ElemStation=6.24999940395358E-02

Frame=78 Station=6.24999940395358E-02 OutputCase=FESSUR CaseType=Combination Point=3 X2=0.5 X3=-0.5
 S11=783.065647492336 IsS11Max=Yes IsS11Min=No FrameElem=78 ElemStation=6.24999940395358E-02
 Frame=78 Station=6.24999940395358E-02 OutputCase=FESSUR CaseType=Combination Point=4 X2=0.5 X3=0.5
 S11=783.065647492336 IsS11Max=No IsS11Min=No FrameElem=78 ElemStation=6.24999940395358E-02
 Frame=78 Station=0.124999988079072 OutputCase=FESSUR CaseType=Combination Point=0 X2=0 X3=0 S11=-
 168.146112991376 IsS11Max=No IsS11Min=No FrameElem=78 ElemStation=0.124999988079072
 Frame=78 Station=0.124999988079072 OutputCase=FESSUR CaseType=Combination Point=1 X2=-0.5 X3=-0.5
 S11=-1265.95414139688 IsS11Max=No IsS11Min=Yes FrameElem=78 ElemStation=0.124999988079072
 Frame=78 Station=0.124999988079072 OutputCase=FESSUR CaseType=Combination Point=2 X2=-0.5 X3=0.5
 S11=-1265.95414139688 IsS11Max=No IsS11Min=No FrameElem=78 ElemStation=0.124999988079072
 Frame=78 Station=0.124999988079072 OutputCase=FESSUR CaseType=Combination Point=3 X2=0.5 X3=-0.5
 S11=929.661915414132 IsS11Max=Yes IsS11Min=No FrameElem=78 ElemStation=0.124999988079072
 Frame=78 Station=0.124999988079072 OutputCase=FESSUR CaseType=Combination Point=4 X2=0.5 X3=0.5
 S11=929.661915414132 IsS11Max=No IsS11Min=No FrameElem=78 ElemStation=0.124999988079072
 Frame=78 Station=0.187499982118607 OutputCase=FESSUR CaseType=Combination Point=0 X2=0 X3=0 S11=-
 168.146113985545 IsS11Max=No IsS11Min=No FrameElem=78 ElemStation=0.187499982118607
 Frame=78 Station=0.187499982118607 OutputCase=FESSUR CaseType=Combination Point=1 X2=-0.5 X3=-0.5
 S11=-1416.45964493639 IsS11Max=No IsS11Min=Yes FrameElem=78 ElemStation=0.187499982118607
 Frame=78 Station=0.187499982118607 OutputCase=FESSUR CaseType=Combination Point=2 X2=-0.5 X3=0.5
 S11=-1416.45964493639 IsS11Max=No IsS11Min=No FrameElem=78 ElemStation=0.187499982118607
 Frame=78 Station=0.187499982118607 OutputCase=FESSUR CaseType=Combination Point=3 X2=0.5 X3=-0.5
 S11=1080.1674169653 IsS11Max=Yes IsS11Min=No FrameElem=78 ElemStation=0.187499982118607
 Frame=78 Station=0.187499982118607 OutputCase=FESSUR CaseType=Combination Point=4 X2=0.5 X3=0.5
 S11=1080.1674169653 IsS11Max=No IsS11Min=No FrameElem=78 ElemStation=0.187499982118607
 Frame=78 Station=0.249999976158143 OutputCase=FESSUR CaseType=Combination Point=0 X2=0 X3=0 S11=-
 168.146114979715 IsS11Max=No IsS11Min=No FrameElem=78 ElemStation=0.249999976158143
 Frame=78 Station=0.249999976158143 OutputCase=FESSUR CaseType=Combination Point=1 X2=-0.5 X3=-0.5
 S11=-1570.87438210527 IsS11Max=No IsS11Min=Yes FrameElem=78 ElemStation=0.249999976158143
 Frame=78 Station=0.249999976158143 OutputCase=FESSUR CaseType=Combination Point=2 X2=-0.5 X3=0.5
 S11=-1570.87438210527 IsS11Max=No IsS11Min=No FrameElem=78 ElemStation=0.249999976158143
 Frame=78 Station=0.249999976158143 OutputCase=FESSUR CaseType=Combination Point=3 X2=0.5 X3=-0.5
 S11=1234.58215214584 IsS11Max=Yes IsS11Min=No FrameElem=78 ElemStation=0.249999976158143
 Frame=78 Station=0.249999976158143 OutputCase=FESSUR CaseType=Combination Point=4 X2=0.5 X3=0.5
 S11=1234.58215214584 IsS11Max=No IsS11Min=No FrameElem=78 ElemStation=0.249999976158143
 Frame=112 Station=0 OutputCase=PERM1 CaseType=Combination Point=0 X2=0 X3=0 S11=-164.891225815415
 IsS11Max=No IsS11Min=No FrameElem=112 ElemStation=0
 Frame=112 Station=0 OutputCase=PERM1 CaseType=Combination Point=1 X2=-0.5 X3=-0.5 S11=-
 435.208149751646 IsS11Max=No IsS11Min=Yes FrameElem=112 ElemStation=0
 Frame=112 Station=0 OutputCase=PERM1 CaseType=Combination Point=2 X2=-0.5 X3=0.5 S11=-
 435.208149751646 IsS11Max=No IsS11Min=No FrameElem=112 ElemStation=0
 Frame=112 Station=0 OutputCase=PERM1 CaseType=Combination Point=3 X2=0.5 X3=-0.5
 S11=105.425698120815 IsS11Max=Yes IsS11Min=No FrameElem=112 ElemStation=0
 Frame=112 Station=0 OutputCase=PERM1 CaseType=Combination Point=4 X2=0.5 X3=0.5
 S11=105.425698120815 IsS11Max=No IsS11Min=No FrameElem=112 ElemStation=0
 Frame=112 Station=0.125 OutputCase=PERM1 CaseType=Combination Point=0 X2=0 X3=0 S11=-
 164.891225815415 IsS11Max=No IsS11Min=No FrameElem=112 ElemStation=0.125
 Frame=112 Station=0.125 OutputCase=PERM1 CaseType=Combination Point=1 X2=-0.5 X3=-0.5 S11=-
 198.348775549106 IsS11Max=No IsS11Min=Yes FrameElem=112 ElemStation=0.125
 Frame=112 Station=0.125 OutputCase=PERM1 CaseType=Combination Point=2 X2=-0.5 X3=0.5 S11=-
 198.348775549106 IsS11Max=No IsS11Min=No FrameElem=112 ElemStation=0.125
 Frame=112 Station=0.125 OutputCase=PERM1 CaseType=Combination Point=3 X2=0.5 X3=-0.5 S11=-
 131.433676081725 IsS11Max=Yes IsS11Min=No FrameElem=112 ElemStation=0.125
 Frame=112 Station=0.125 OutputCase=PERM1 CaseType=Combination Point=4 X2=0.5 X3=0.5 S11=-
 131.433676081725 IsS11Max=No IsS11Min=No FrameElem=112 ElemStation=0.125
 Frame=112 Station=0.25 OutputCase=PERM1 CaseType=Combination Point=0 X2=0 X3=0 S11=-
 164.891225815415 IsS11Max=No IsS11Min=No FrameElem=112 ElemStation=0.25
 Frame=112 Station=0.25 OutputCase=PERM1 CaseType=Combination Point=1 X2=-0.5 X3=-0.5
 S11=23.2293486534343 IsS11Max=Yes IsS11Min=No FrameElem=112 ElemStation=0.25
 Frame=112 Station=0.25 OutputCase=PERM1 CaseType=Combination Point=2 X2=-0.5 X3=0.5
 S11=23.2293486534343 IsS11Max=No IsS11Min=No FrameElem=112 ElemStation=0.25
 Frame=112 Station=0.25 OutputCase=PERM1 CaseType=Combination Point=3 X2=0.5 X3=-0.5 S11=-
 353.011800284265 IsS11Max=No IsS11Min=Yes FrameElem=112 ElemStation=0.25
 Frame=112 Station=0.25 OutputCase=PERM1 CaseType=Combination Point=4 X2=0.5 X3=0.5 S11=-
 353.011800284265 IsS11Max=No IsS11Min=No FrameElem=112 ElemStation=0.25
 Frame=112 Station=0.375 OutputCase=PERM1 CaseType=Combination Point=0 X2=0 X3=0 S11=-
 164.891225815415 IsS11Max=No IsS11Min=No FrameElem=112 ElemStation=0.375
 Frame=112 Station=0.375 OutputCase=PERM1 CaseType=Combination Point=1 X2=-0.5 X3=-0.5
 S11=229.526222855974 IsS11Max=Yes IsS11Min=No FrameElem=112 ElemStation=0.375
 Frame=112 Station=0.375 OutputCase=PERM1 CaseType=Combination Point=2 X2=-0.5 X3=0.5
 S11=229.526222855974 IsS11Max=No IsS11Min=No FrameElem=112 ElemStation=0.375
 Frame=112 Station=0.375 OutputCase=PERM1 CaseType=Combination Point=3 X2=0.5 X3=-0.5 S11=-
 559.308674486805 IsS11Max=No IsS11Min=Yes FrameElem=112 ElemStation=0.375
 Frame=112 Station=0.375 OutputCase=PERM1 CaseType=Combination Point=4 X2=0.5 X3=0.5 S11=-
 559.308674486805 IsS11Max=No IsS11Min=No FrameElem=112 ElemStation=0.375
 Frame=112 Station=0.5 OutputCase=PERM1 CaseType=Combination Point=0 X2=0 X3=0 S11=-164.891225815415
 IsS11Max=No IsS11Min=No FrameElem=112 ElemStation=0.5
 Frame=112 Station=0.5 OutputCase=PERM1 CaseType=Combination Point=1 X2=-0.5 X3=-0.5
 S11=420.541847058514 IsS11Max=Yes IsS11Min=No FrameElem=112 ElemStation=0.5
 Frame=112 Station=0.5 OutputCase=PERM1 CaseType=Combination Point=2 X2=-0.5 X3=0.5
 S11=420.541847058514 IsS11Max=No IsS11Min=No FrameElem=112 ElemStation=0.5
 Frame=112 Station=0.5 OutputCase=PERM1 CaseType=Combination Point=3 X2=0.5 X3=-0.5 S11=-
 750.324298689344 IsS11Max=No IsS11Min=Yes FrameElem=112 ElemStation=0.5



Frame=112 Station=0.5 OutputCase=PERM1 CaseType=Combination Point=4 X2=0.5 X3=0.5 S11=-
 750.324298689344 IsS11Max=No IsS11Min=No FrameElem=112 ElemStation=0.5
 Frame=112 Station=0 OutputCase=PERM2 CaseType=Combination Point=0 X2=0 X3=0 S11=-111.11546006997
 IsS11Max=No IsS11Min=No FrameElem=112 ElemStation=0
 Frame=112 Station=0 OutputCase=PERM2 CaseType=Combination Point=1 X2=-0.5 X3=-0.5 S11=-
 296.446528945817 IsS11Max=No IsS11Min=Yes FrameElem=112 ElemStation=0
 Frame=112 Station=0 OutputCase=PERM2 CaseType=Combination Point=2 X2=-0.5 X3=0.5 S11=-
 296.446528945817 IsS11Max=No IsS11Min=No FrameElem=112 ElemStation=0
 Frame=112 Station=0 OutputCase=PERM2 CaseType=Combination Point=3 X2=0.5 X3=-0.5
 S11=74.2156088058775 IsS11Max=Yes IsS11Min=No FrameElem=112 ElemStation=0
 Frame=112 Station=0 OutputCase=PERM2 CaseType=Combination Point=4 X2=0.5 X3=0.5
 S11=74.2156088058775 IsS11Max=No IsS11Min=No FrameElem=112 ElemStation=0
 Frame=112 Station=0.125 OutputCase=PERM2 CaseType=Combination Point=0 X2=0 X3=0 S11=-
 111.11546006997 IsS11Max=No IsS11Min=No FrameElem=112 ElemStation=0.125
 Frame=112 Station=0.125 OutputCase=PERM2 CaseType=Combination Point=1 X2=-0.5 X3=-0.5 S11=-
 59.5871545377699 IsS11Max=Yes IsS11Min=No FrameElem=112 ElemStation=0.125
 Frame=112 Station=0.125 OutputCase=PERM2 CaseType=Combination Point=2 X2=-0.5 X3=0.5 S11=-
 59.5871545377699 IsS11Max=No IsS11Min=No FrameElem=112 ElemStation=0.125
 Frame=112 Station=0.125 OutputCase=PERM2 CaseType=Combination Point=3 X2=0.5 X3=-0.5 S11=-
 162.64376560217 IsS11Max=No IsS11Min=Yes FrameElem=112 ElemStation=0.125
 Frame=112 Station=0.125 OutputCase=PERM2 CaseType=Combination Point=4 X2=0.5 X3=0.5 S11=-
 162.64376560217 IsS11Max=No IsS11Min=No FrameElem=112 ElemStation=0.125
 Frame=112 Station=0.25 OutputCase=PERM2 CaseType=Combination Point=0 X2=0 X3=0 S11=-111.11546006997
 IsS11Max=No IsS11Min=No FrameElem=112 ElemStation=0.25
 Frame=112 Station=0.25 OutputCase=PERM2 CaseType=Combination Point=1 X2=-0.5 X3=-0.5
 S11=161.990969870277 IsS11Max=Yes IsS11Min=No FrameElem=112 ElemStation=0.25
 Frame=112 Station=0.25 OutputCase=PERM2 CaseType=Combination Point=2 X2=-0.5 X3=0.5
 S11=161.990969870277 IsS11Max=No IsS11Min=No FrameElem=112 ElemStation=0.25
 Frame=112 Station=0.25 OutputCase=PERM2 CaseType=Combination Point=3 X2=0.5 X3=-0.5 S11=-
 384.221890010217 IsS11Max=No IsS11Min=Yes FrameElem=112 ElemStation=0.25
 Frame=112 Station=0.25 OutputCase=PERM2 CaseType=Combination Point=4 X2=0.5 X3=0.5 S11=-
 384.221890010217 IsS11Max=No IsS11Min=No FrameElem=112 ElemStation=0.25
 Frame=112 Station=0.375 OutputCase=PERM2 CaseType=Combination Point=0 X2=0 X3=0 S11=-
 111.11546006997 IsS11Max=No IsS11Min=No FrameElem=112 ElemStation=0.375
 Frame=112 Station=0.375 OutputCase=PERM2 CaseType=Combination Point=1 X2=-0.5 X3=-0.5
 S11=368.287844278325 IsS11Max=Yes IsS11Min=No FrameElem=112 ElemStation=0.375
 Frame=112 Station=0.375 OutputCase=PERM2 CaseType=Combination Point=2 X2=-0.5 X3=0.5
 S11=368.287844278325 IsS11Max=No IsS11Min=No FrameElem=112 ElemStation=0.375
 Frame=112 Station=0.375 OutputCase=PERM2 CaseType=Combination Point=3 X2=0.5 X3=-0.5 S11=-
 590.518764418265 IsS11Max=No IsS11Min=Yes FrameElem=112 ElemStation=0.375
 Frame=112 Station=0.375 OutputCase=PERM2 CaseType=Combination Point=4 X2=0.5 X3=0.5 S11=-
 590.518764418265 IsS11Max=No IsS11Min=No FrameElem=112 ElemStation=0.375
 Frame=112 Station=0.5 OutputCase=PERM2 CaseType=Combination Point=0 X2=0 X3=0 S11=-111.11546006997
 IsS11Max=No IsS11Min=No FrameElem=112 ElemStation=0.5
 Frame=112 Station=0.5 OutputCase=PERM2 CaseType=Combination Point=1 X2=-0.5 X3=-0.5
 S11=559.303468686372 IsS11Max=Yes IsS11Min=No FrameElem=112 ElemStation=0.5
 Frame=112 Station=0.5 OutputCase=PERM2 CaseType=Combination Point=2 X2=-0.5 X3=0.5
 S11=559.303468686372 IsS11Max=No IsS11Min=No FrameElem=112 ElemStation=0.5
 Frame=112 Station=0.5 OutputCase=PERM2 CaseType=Combination Point=3 X2=0.5 X3=-0.5 S11=-
 781.534388826312 IsS11Max=No IsS11Min=Yes FrameElem=112 ElemStation=0.5
 Frame=112 Station=0.5 OutputCase=PERM2 CaseType=Combination Point=4 X2=0.5 X3=0.5 S11=-
 781.534388826312 IsS11Max=No IsS11Min=No FrameElem=112 ElemStation=0.5
 Frame=112 Station=0 OutputCase=ACC1 CaseType=Combination Point=0 X2=0 X3=0 S11=-169.541010668994
 IsS11Max=No IsS11Min=No FrameElem=112 ElemStation=0
 Frame=112 Station=0 OutputCase=ACC1 CaseType=Combination Point=1 X2=-0.5 X3=-0.5 S11=-
 449.217788340071 IsS11Max=No IsS11Min=Yes FrameElem=112 ElemStation=0
 Frame=112 Station=0 OutputCase=ACC1 CaseType=Combination Point=2 X2=-0.5 X3=0.5 S11=-
 449.217788340071 IsS11Max=No IsS11Min=No FrameElem=112 ElemStation=0
 Frame=112 Station=0 OutputCase=ACC1 CaseType=Combination Point=3 X2=0.5 X3=-0.5
 S11=110.135767002082 IsS11Max=Yes IsS11Min=No FrameElem=112 ElemStation=0
 Frame=112 Station=0 OutputCase=ACC1 CaseType=Combination Point=4 X2=0.5 X3=0.5 S11=110.135767002082
 IsS11Max=No IsS11Min=No FrameElem=112 ElemStation=0
 Frame=112 Station=0.125 OutputCase=ACC1 CaseType=Combination Point=0 X2=0 X3=0 S11=-
 169.541010668994 IsS11Max=No IsS11Min=No FrameElem=112 ElemStation=0.125
 Frame=112 Station=0.125 OutputCase=ACC1 CaseType=Combination Point=1 X2=-0.5 X3=-0.5 S11=-
 204.482476660218 IsS11Max=No IsS11Min=Yes FrameElem=112 ElemStation=0.125
 Frame=112 Station=0.125 OutputCase=ACC1 CaseType=Combination Point=2 X2=-0.5 X3=0.5 S11=-
 204.482476660218 IsS11Max=No IsS11Min=No FrameElem=112 ElemStation=0.125
 Frame=112 Station=0.125 OutputCase=ACC1 CaseType=Combination Point=3 X2=0.5 X3=-0.5 S11=-
 134.599544677771 IsS11Max=Yes IsS11Min=No FrameElem=112 ElemStation=0.125
 Frame=112 Station=0.125 OutputCase=ACC1 CaseType=Combination Point=4 X2=0.5 X3=0.5 S11=-
 134.599544677771 IsS11Max=No IsS11Min=No FrameElem=112 ElemStation=0.125
 Frame=112 Station=0.25 OutputCase=ACC1 CaseType=Combination Point=0 X2=0 X3=0 S11=-169.541010668994
 IsS11Max=No IsS11Min=No FrameElem=112 ElemStation=0.25
 Frame=112 Station=0.25 OutputCase=ACC1 CaseType=Combination Point=1 X2=-0.5 X3=-0.5
 S11=24.4634600196349 IsS11Max=Yes IsS11Min=No FrameElem=112 ElemStation=0.25
 Frame=112 Station=0.25 OutputCase=ACC1 CaseType=Combination Point=2 X2=-0.5 X3=0.5
 S11=24.4634600196349 IsS11Max=No IsS11Min=No FrameElem=112 ElemStation=0.25
 Frame=112 Station=0.25 OutputCase=ACC1 CaseType=Combination Point=3 X2=0.5 X3=-0.5 S11=-
 363.545481357624 IsS11Max=No IsS11Min=Yes FrameElem=112 ElemStation=0.25
 Frame=112 Station=0.25 OutputCase=ACC1 CaseType=Combination Point=4 X2=0.5 X3=0.5 S11=-
 363.545481357624 IsS11Max=No IsS11Min=No FrameElem=112 ElemStation=0.25

Frame=112 Station=0.375 OutputCase=ACC1 CaseType=Combination Point=0 X2=0 X3=0 S11=-
 169.541010668994 IsS11Max=No IsS11Min=No FrameElem=112 ElemStation=0.375
 Frame=112 Station=0.375 OutputCase=ACC1 CaseType=Combination Point=1 X2=-0.5 X3=-0.5
 S11=237.620021699488 IsS11Max=Yes IsS11Min=No FrameElem=112 ElemStation=0.375
 Frame=112 Station=0.375 OutputCase=ACC1 CaseType=Combination Point=2 X2=-0.5 X3=0.5
 S11=237.620021699488 IsS11Max=No IsS11Min=No FrameElem=112 ElemStation=0.375
 Frame=112 Station=0.375 OutputCase=ACC1 CaseType=Combination Point=3 X2=0.5 X3=-0.5 S11=-
 576.702043037477 IsS11Max=No IsS11Min=Yes FrameElem=112 ElemStation=0.375
 Frame=112 Station=0.375 OutputCase=ACC1 CaseType=Combination Point=4 X2=0.5 X3=0.5 S11=-
 576.702043037477 IsS11Max=No IsS11Min=No FrameElem=112 ElemStation=0.375
 Frame=112 Station=0.5 OutputCase=ACC1 CaseType=Combination Point=0 X2=0 X3=0 S11=-169.541010668994
 IsS11Max=No IsS11Min=No FrameElem=112 ElemStation=0.5
 Frame=112 Station=0.5 OutputCase=ACC1 CaseType=Combination Point=1 X2=-0.5 X3=-0.5
 S11=434.98720837934 IsS11Max=Yes IsS11Min=No FrameElem=112 ElemStation=0.5
 Frame=112 Station=0.5 OutputCase=ACC1 CaseType=Combination Point=2 X2=-0.5 X3=0.5
 S11=434.98720837934 IsS11Max=No IsS11Min=No FrameElem=112 ElemStation=0.5
 Frame=112 Station=0.5 OutputCase=ACC1 CaseType=Combination Point=3 X2=0.5 X3=-0.5 S11=-
 774.069229717329 IsS11Max=No IsS11Min=Yes FrameElem=112 ElemStation=0.5
 Frame=112 Station=0.5 OutputCase=ACC1 CaseType=Combination Point=4 X2=0.5 X3=0.5 S11=-
 774.069229717329 IsS11Max=No IsS11Min=No FrameElem=112 ElemStation=0.5
 Frame=112 Station=0 OutputCase=ACC2 CaseType=Combination Point=0 X2=0 X3=0 S11=-115.765244923549
 IsS11Max=No IsS11Min=No FrameElem=112 ElemStation=0
 Frame=112 Station=0 OutputCase=ACC2 CaseType=Combination Point=1 X2=-0.5 X3=-0.5 S11=-
 310.456167534242 IsS11Max=No IsS11Min=Yes FrameElem=112 ElemStation=0
 Frame=112 Station=0 OutputCase=ACC2 CaseType=Combination Point=2 X2=-0.5 X3=0.5 S11=-
 310.456167534242 IsS11Max=No IsS11Min=No FrameElem=112 ElemStation=0
 Frame=112 Station=0 OutputCase=ACC2 CaseType=Combination Point=3 X2=0.5 X3=-0.5
 S11=78.9256776871438 IsS11Max=Yes IsS11Min=No FrameElem=112 ElemStation=0
 Frame=112 Station=0 OutputCase=ACC2 CaseType=Combination Point=4 X2=0.5 X3=0.5 S11=78.9256776871438
 IsS11Max=No IsS11Min=No FrameElem=112 ElemStation=0
 Frame=112 Station=0.125 OutputCase=ACC2 CaseType=Combination Point=0 X2=0 X3=0 S11=-
 115.765244923549 IsS11Max=No IsS11Min=No FrameElem=112 ElemStation=0.125
 Frame=112 Station=0.125 OutputCase=ACC2 CaseType=Combination Point=1 X2=-0.5 X3=-0.5 S11=-
 65.7208556488822 IsS11Max=Yes IsS11Min=No FrameElem=112 ElemStation=0.125
 Frame=112 Station=0.125 OutputCase=ACC2 CaseType=Combination Point=2 X2=-0.5 X3=0.5 S11=-
 65.7208556488822 IsS11Max=No IsS11Min=No FrameElem=112 ElemStation=0.125
 Frame=112 Station=0.125 OutputCase=ACC2 CaseType=Combination Point=3 X2=0.5 X3=-0.5 S11=-
 165.809634198216 IsS11Max=No IsS11Min=Yes FrameElem=112 ElemStation=0.125
 Frame=112 Station=0.125 OutputCase=ACC2 CaseType=Combination Point=4 X2=0.5 X3=0.5 S11=-
 165.809634198216 IsS11Max=No IsS11Min=No FrameElem=112 ElemStation=0.125
 Frame=112 Station=0.25 OutputCase=ACC2 CaseType=Combination Point=0 X2=0 X3=0 S11=-115.765244923549
 IsS11Max=No IsS11Min=No FrameElem=112 ElemStation=0.25
 Frame=112 Station=0.25 OutputCase=ACC2 CaseType=Combination Point=1 X2=-0.5 X3=-0.5
 S11=163.225081236478 IsS11Max=Yes IsS11Min=No FrameElem=112 ElemStation=0.25
 Frame=112 Station=0.25 OutputCase=ACC2 CaseType=Combination Point=2 X2=-0.5 X3=0.5
 S11=163.225081236478 IsS11Max=No IsS11Min=No FrameElem=112 ElemStation=0.25
 Frame=112 Station=0.25 OutputCase=ACC2 CaseType=Combination Point=3 X2=0.5 X3=-0.5 S11=-
 394.755571083577 IsS11Max=No IsS11Min=Yes FrameElem=112 ElemStation=0.25
 Frame=112 Station=0.25 OutputCase=ACC2 CaseType=Combination Point=4 X2=0.5 X3=0.5 S11=-
 394.755571083577 IsS11Max=No IsS11Min=No FrameElem=112 ElemStation=0.25
 Frame=112 Station=0.375 OutputCase=ACC2 CaseType=Combination Point=0 X2=0 X3=0 S11=-
 115.765244923549 IsS11Max=No IsS11Min=No FrameElem=112 ElemStation=0.375
 Frame=112 Station=0.375 OutputCase=ACC2 CaseType=Combination Point=1 X2=-0.5 X3=-0.5
 S11=376.381643121838 IsS11Max=Yes IsS11Min=No FrameElem=112 ElemStation=0.375
 Frame=112 Station=0.375 OutputCase=ACC2 CaseType=Combination Point=2 X2=-0.5 X3=0.5
 S11=376.381643121838 IsS11Max=No IsS11Min=No FrameElem=112 ElemStation=0.375
 Frame=112 Station=0.375 OutputCase=ACC2 CaseType=Combination Point=3 X2=0.5 X3=-0.5 S11=-
 607.912132968937 IsS11Max=No IsS11Min=Yes FrameElem=112 ElemStation=0.375
 Frame=112 Station=0.375 OutputCase=ACC2 CaseType=Combination Point=4 X2=0.5 X3=0.5 S11=-
 607.912132968937 IsS11Max=No IsS11Min=No FrameElem=112 ElemStation=0.375
 Frame=112 Station=0.5 OutputCase=ACC2 CaseType=Combination Point=0 X2=0 X3=0 S11=-115.765244923549
 IsS11Max=No IsS11Min=No FrameElem=112 ElemStation=0.5
 Frame=112 Station=0.5 OutputCase=ACC2 CaseType=Combination Point=1 X2=-0.5 X3=-0.5
 S11=573.748830007198 IsS11Max=Yes IsS11Min=No FrameElem=112 ElemStation=0.5
 Frame=112 Station=0.5 OutputCase=ACC2 CaseType=Combination Point=2 X2=-0.5 X3=0.5
 S11=573.748830007198 IsS11Max=No IsS11Min=No FrameElem=112 ElemStation=0.5
 Frame=112 Station=0.5 OutputCase=ACC2 CaseType=Combination Point=3 X2=0.5 X3=-0.5 S11=-
 805.279319854297 IsS11Max=No IsS11Min=Yes FrameElem=112 ElemStation=0.5
 Frame=112 Station=0.5 OutputCase=ACC2 CaseType=Combination Point=4 X2=0.5 X3=0.5 S11=-
 805.279319854297 IsS11Max=No IsS11Min=No FrameElem=112 ElemStation=0.5
 Frame=112 Station=0 OutputCase=ACCSX1 CaseType=Combination Point=0 X2=0 X3=0 S11=-167.164023806267
 IsS11Max=No IsS11Min=No FrameElem=112 ElemStation=0
 Frame=112 Station=0 OutputCase=ACCSX1 CaseType=Combination Point=1 X2=-0.5 X3=-0.5 S11=-
 422.982151663924 IsS11Max=No IsS11Min=Yes FrameElem=112 ElemStation=0
 Frame=112 Station=0 OutputCase=ACCSX1 CaseType=Combination Point=2 X2=-0.5 X3=0.5 S11=-
 422.982151663924 IsS11Max=No IsS11Min=No FrameElem=112 ElemStation=0
 Frame=112 Station=0 OutputCase=ACCSX1 CaseType=Combination Point=3 X2=0.5 X3=-0.5
 S11=88.6541040513889 IsS11Max=Yes IsS11Min=No FrameElem=112 ElemStation=0
 Frame=112 Station=0 OutputCase=ACCSX1 CaseType=Combination Point=4 X2=0.5 X3=0.5
 S11=88.6541040513889 IsS11Max=No IsS11Min=No FrameElem=112 ElemStation=0
 Frame=112 Station=0.125 OutputCase=ACCSX1 CaseType=Combination Point=0 X2=0 X3=0 S11=-
 167.164023806267 IsS11Max=No IsS11Min=No FrameElem=112 ElemStation=0.125

Frame=112	Station=0.125	OutputCase=ACCSX1	CaseType=Combination	Point=1	X2=-0.5	X3=-0.5	S11=-
187.258335665472	IsS11Max=No	IsS11Min=Yes	FrameElem=112	ElemStation=0.125			
Frame=112	Station=0.125	OutputCase=ACCSX1	CaseType=Combination	Point=2	X2=-0.5	X3=0.5	S11=-
187.258335665472	IsS11Max=No	IsS11Min=No	FrameElem=112	ElemStation=0.125			
Frame=112	Station=0.125	OutputCase=ACCSX1	CaseType=Combination	Point=3	X2=0.5	X3=-0.5	S11=-
147.069711947063	IsS11Max=Yes	IsS11Min=No	FrameElem=112	ElemStation=0.125			
Frame=112	Station=0.125	OutputCase=ACCSX1	CaseType=Combination	Point=4	X2=0.5	X3=0.5	S11=-
147.069711947063	IsS11Max=No	IsS11Min=No	FrameElem=112	ElemStation=0.125			
Frame=112	Station=0.25	OutputCase=ACCSX1	CaseType=Combination	Point=0	X2=0	X3=0	S11=-
167.164023806267	IsS11Max=No	IsS11Min=No	FrameElem=112	ElemStation=0.25			
Frame=112	Station=0.25	OutputCase=ACCSX1	CaseType=Combination	Point=1	X2=-0.5	X3=-0.5	
S11=33.18423033298	IsS11Max=Yes	IsS11Min=No	FrameElem=112	ElemStation=0.25			
Frame=112	Station=0.25	OutputCase=ACCSX1	CaseType=Combination	Point=2	X2=-0.5	X3=0.5	
S11=33.18423033298	IsS11Max=No	IsS11Min=No	FrameElem=112	ElemStation=0.25			
Frame=112	Station=0.25	OutputCase=ACCSX1	CaseType=Combination	Point=3	X2=0.5	X3=-0.5	S11=-
367.512277945515	IsS11Max=No	IsS11Min=Yes	FrameElem=112	ElemStation=0.25			
Frame=112	Station=0.25	OutputCase=ACCSX1	CaseType=Combination	Point=4	X2=0.5	X3=0.5	S11=-
367.512277945515	IsS11Max=No	IsS11Min=No	FrameElem=112	ElemStation=0.25			
Frame=112	Station=0.375	OutputCase=ACCSX1	CaseType=Combination	Point=0	X2=0	X3=0	S11=-
167.164023806267	IsS11Max=No	IsS11Min=No	FrameElem=112	ElemStation=0.375			
Frame=112	Station=0.375	OutputCase=ACCSX1	CaseType=Combination	Point=1	X2=-0.5	X3=-0.5	
S11=238.345546331432	IsS11Max=Yes	IsS11Min=No	FrameElem=112	ElemStation=0.375			
Frame=112	Station=0.375	OutputCase=ACCSX1	CaseType=Combination	Point=2	X2=-0.5	X3=0.5	
S11=238.345546331432	IsS11Max=No	IsS11Min=No	FrameElem=112	ElemStation=0.375			
Frame=112	Station=0.375	OutputCase=ACCSX1	CaseType=Combination	Point=3	X2=0.5	X3=-0.5	S11=-
572.673593943967	IsS11Max=No	IsS11Min=Yes	FrameElem=112	ElemStation=0.375			
Frame=112	Station=0.375	OutputCase=ACCSX1	CaseType=Combination	Point=4	X2=0.5	X3=0.5	S11=-
572.673593943967	IsS11Max=No	IsS11Min=No	FrameElem=112	ElemStation=0.375			
Frame=112	Station=0.5	OutputCase=ACCSX1	CaseType=Combination	Point=0	X2=0	X3=0	S11=-
167.164023806267	IsS11Max=No	IsS11Min=No	FrameElem=112	ElemStation=0.5			
Frame=112	Station=0.5	OutputCase=ACCSX1	CaseType=Combination	Point=1	X2=-0.5	X3=-0.5	
S11=428.225612329884	IsS11Max=Yes	IsS11Min=No	FrameElem=112	ElemStation=0.5			
Frame=112	Station=0.5	OutputCase=ACCSX1	CaseType=Combination	Point=2	X2=-0.5	X3=0.5	
S11=428.225612329884	IsS11Max=No	IsS11Min=No	FrameElem=112	ElemStation=0.5			
Frame=112	Station=0.5	OutputCase=ACCSX1	CaseType=Combination	Point=3	X2=0.5	X3=-0.5	S11=-
762.553659942418	IsS11Max=No	IsS11Min=Yes	FrameElem=112	ElemStation=0.5			
Frame=112	Station=0.5	OutputCase=ACCSX1	CaseType=Combination	Point=4	X2=0.5	X3=0.5	S11=-
762.553659942418	IsS11Max=No	IsS11Min=No	FrameElem=112	ElemStation=0.5			
Frame=112	Station=0	OutputCase=ACCSX2	CaseType=Combination	Point=0	X2=0	X3=0	S11=-113.388258060822
IsS11Max=No	IsS11Min=No	FrameElem=112	ElemStation=0				
Frame=112	Station=0	OutputCase=ACCSX2	CaseType=Combination	Point=1	X2=-0.5	X3=-0.5	S11=-
284.220530858095	IsS11Max=No	IsS11Min=Yes	FrameElem=112	ElemStation=0			
Frame=112	Station=0	OutputCase=ACCSX2	CaseType=Combination	Point=2	X2=-0.5	X3=0.5	S11=-
284.220530858095	IsS11Max=No	IsS11Min=No	FrameElem=112	ElemStation=0			
Frame=112	Station=0	OutputCase=ACCSX2	CaseType=Combination	Point=3	X2=0.5	X3=-0.5	
S11=57.444014736451	IsS11Max=Yes	IsS11Min=No	FrameElem=112	ElemStation=0			
Frame=112	Station=0	OutputCase=ACCSX2	CaseType=Combination	Point=4	X2=0.5	X3=0.5	
S11=57.444014736451	IsS11Max=No	IsS11Min=No	FrameElem=112	ElemStation=0			
Frame=112	Station=0.125	OutputCase=ACCSX2	CaseType=Combination	Point=0	X2=0	X3=0	S11=-
113.388258060822	IsS11Max=No	IsS11Min=No	FrameElem=112	ElemStation=0.125			
Frame=112	Station=0.125	OutputCase=ACCSX2	CaseType=Combination	Point=1	X2=-0.5	X3=-0.5	S11=-
48.4967146541361	IsS11Max=Yes	IsS11Min=No	FrameElem=112	ElemStation=0.125			
Frame=112	Station=0.125	OutputCase=ACCSX2	CaseType=Combination	Point=2	X2=-0.5	X3=0.5	S11=-
48.4967146541361	IsS11Max=No	IsS11Min=No	FrameElem=112	ElemStation=0.125			
Frame=112	Station=0.125	OutputCase=ACCSX2	CaseType=Combination	Point=3	X2=0.5	X3=-0.5	S11=-
178.279801467508	IsS11Max=No	IsS11Min=Yes	FrameElem=112	ElemStation=0.125			
Frame=112	Station=0.125	OutputCase=ACCSX2	CaseType=Combination	Point=4	X2=0.5	X3=0.5	S11=-
178.279801467508	IsS11Max=No	IsS11Min=No	FrameElem=112	ElemStation=0.125			
Frame=112	Station=0.25	OutputCase=ACCSX2	CaseType=Combination	Point=0	X2=0	X3=0	S11=-
113.388258060822	IsS11Max=No	IsS11Min=No	FrameElem=112	ElemStation=0.25			
Frame=112	Station=0.25	OutputCase=ACCSX2	CaseType=Combination	Point=1	X2=-0.5	X3=-0.5	
S11=171.945851549823	IsS11Max=Yes	IsS11Min=No	FrameElem=112	ElemStation=0.25			
Frame=112	Station=0.25	OutputCase=ACCSX2	CaseType=Combination	Point=2	X2=-0.5	X3=0.5	
S11=171.945851549823	IsS11Max=No	IsS11Min=No	FrameElem=112	ElemStation=0.25			
Frame=112	Station=0.25	OutputCase=ACCSX2	CaseType=Combination	Point=3	X2=0.5	X3=-0.5	S11=-
398.722367671468	IsS11Max=No	IsS11Min=Yes	FrameElem=112	ElemStation=0.25			
Frame=112	Station=0.25	OutputCase=ACCSX2	CaseType=Combination	Point=4	X2=0.5	X3=0.5	S11=-
398.722367671468	IsS11Max=No	IsS11Min=No	FrameElem=112	ElemStation=0.25			
Frame=112	Station=0.375	OutputCase=ACCSX2	CaseType=Combination	Point=0	X2=0	X3=0	S11=-
113.388258060822	IsS11Max=No	IsS11Min=No	FrameElem=112	ElemStation=0.375			
Frame=112	Station=0.375	OutputCase=ACCSX2	CaseType=Combination	Point=1	X2=-0.5	X3=-0.5	
S11=377.107167753782	IsS11Max=Yes	IsS11Min=No	FrameElem=112	ElemStation=0.375			
Frame=112	Station=0.375	OutputCase=ACCSX2	CaseType=Combination	Point=2	X2=-0.5	X3=0.5	
S11=377.107167753782	IsS11Max=No	IsS11Min=No	FrameElem=112	ElemStation=0.375			
Frame=112	Station=0.375	OutputCase=ACCSX2	CaseType=Combination	Point=3	X2=0.5	X3=-0.5	S11=-
603.883683875427	IsS11Max=No	IsS11Min=Yes	FrameElem=112	ElemStation=0.375			
Frame=112	Station=0.375	OutputCase=ACCSX2	CaseType=Combination	Point=4	X2=0.5	X3=0.5	S11=-
603.883683875427	IsS11Max=No	IsS11Min=No	FrameElem=112	ElemStation=0.375			
Frame=112	Station=0.5	OutputCase=ACCSX2	CaseType=Combination	Point=0	X2=0	X3=0	S11=-
113.388258060822	IsS11Max=No	IsS11Min=No	FrameElem=112	ElemStation=0.5			
Frame=112	Station=0.5	OutputCase=ACCSX2	CaseType=Combination	Point=1	X2=-0.5	X3=-0.5	
S11=566.987233957741	IsS11Max=Yes	IsS11Min=No	FrameElem=112	ElemStation=0.5			

Frame=112	Station=0.5	OutputCase=ACCSX2	CaseType=Combination	Point=2	X2=-0.5	X3=0.5			
S11=566.987233957741	IsS11Max=No	IsS11Min=No	FrameElem=112	ElemStation=0.5					
Frame=112	Station=0.5	OutputCase=ACCSX2	CaseType=Combination	Point=3	X2=0.5	X3=-0.5	S11=-		
793.763750079386	IsS11Max=No	IsS11Min=Yes	FrameElem=112	ElemStation=0.5					
Frame=112	Station=0.5	OutputCase=ACCSX2	CaseType=Combination	Point=4	X2=0.5	X3=0.5	S11=-		
793.763750079386	IsS11Max=No	IsS11Min=No	FrameElem=112	ElemStation=0.5					
Frame=112	Station=0	OutputCase=ENVE	CaseType=Combination	StepType=Max	Point=0	X2=0	X3=0	S11=-	
111.11546006997	IsS11Max=No	IsS11Min=No	FrameElem=112	ElemStation=0					
Frame=112	Station=0	OutputCase=ENVE	CaseType=Combination	StepType=Max	Point=1	X2=-0.5	X3=-0.5		
S11=-284.220530858095	IsS11Max=No	IsS11Min=Yes	FrameElem=112	ElemStation=0					
Frame=112	Station=0	OutputCase=ENVE	CaseType=Combination	StepType=Max	Point=2	X2=-0.5	X3=0.5		
S11=-284.220530858095	IsS11Max=No	IsS11Min=No	FrameElem=112	ElemStation=0					
Frame=112	Station=0	OutputCase=ENVE	CaseType=Combination	StepType=Max	Point=3	X2=0.5	X3=-0.5		
S11=110.135767002082	IsS11Max=Yes	IsS11Min=No	FrameElem=112	ElemStation=0					
Frame=112	Station=0	OutputCase=ENVE	CaseType=Combination	StepType=Max	Point=4	X2=0.5	X3=0.5		
S11=110.135767002082	IsS11Max=No	IsS11Min=No	FrameElem=112	ElemStation=0					
Frame=112	Station=0.125	OutputCase=ENVE	CaseType=Combination	StepType=Max	Point=0	X2=0	X3=0	S11=-	
111.11546006997	IsS11Max=No	IsS11Min=No	FrameElem=112	ElemStation=0.125					
Frame=112	Station=0.125	OutputCase=ENVE	CaseType=Combination	StepType=Max	Point=1	X2=-0.5	X3=-0.5		
S11=-48.4967146541361	IsS11Max=Yes	IsS11Min=No	FrameElem=112	ElemStation=0.125					
Frame=112	Station=0.125	OutputCase=ENVE	CaseType=Combination	StepType=Max	Point=2	X2=-0.5	X3=0.5		
S11=-48.4967146541361	IsS11Max=No	IsS11Min=No	FrameElem=112	ElemStation=0.125					
Frame=112	Station=0.125	OutputCase=ENVE	CaseType=Combination	StepType=Max	Point=3	X2=0.5	X3=-0.5		
S11=-131.433676081725	IsS11Max=No	IsS11Min=Yes	FrameElem=112	ElemStation=0.125					
Frame=112	Station=0.125	OutputCase=ENVE	CaseType=Combination	StepType=Max	Point=4	X2=0.5	X3=0.5		
S11=-131.433676081725	IsS11Max=No	IsS11Min=No	FrameElem=112	ElemStation=0.125					
Frame=112	Station=0.25	OutputCase=ENVE	CaseType=Combination	StepType=Max	Point=0	X2=0	X3=0	S11=-	
111.11546006997	IsS11Max=No	IsS11Min=No	FrameElem=112	ElemStation=0.25					
Frame=112	Station=0.25	OutputCase=ENVE	CaseType=Combination	StepType=Max	Point=1	X2=-0.5	X3=-0.5		
S11=171.945851549823	IsS11Max=Yes	IsS11Min=No	FrameElem=112	ElemStation=0.25					
Frame=112	Station=0.25	OutputCase=ENVE	CaseType=Combination	StepType=Max	Point=2	X2=-0.5	X3=0.5		
S11=171.945851549823	IsS11Max=No	IsS11Min=No	FrameElem=112	ElemStation=0.25					
Frame=112	Station=0.25	OutputCase=ENVE	CaseType=Combination	StepType=Max	Point=3	X2=0.5	X3=-0.5		
S11=-353.011800284265	IsS11Max=No	IsS11Min=Yes	FrameElem=112	ElemStation=0.25					
Frame=112	Station=0.25	OutputCase=ENVE	CaseType=Combination	StepType=Max	Point=4	X2=0.5	X3=0.5		
S11=-353.011800284265	IsS11Max=No	IsS11Min=No	FrameElem=112	ElemStation=0.25					
Frame=112	Station=0.375	OutputCase=ENVE	CaseType=Combination	StepType=Max	Point=0	X2=0	X3=0	S11=-	
111.11546006997	IsS11Max=No	IsS11Min=No	FrameElem=112	ElemStation=0.375					
Frame=112	Station=0.375	OutputCase=ENVE	CaseType=Combination	StepType=Max	Point=1	X2=-0.5	X3=-0.5		
S11=377.107167753782	IsS11Max=Yes	IsS11Min=No	FrameElem=112	ElemStation=0.375					
Frame=112	Station=0.375	OutputCase=ENVE	CaseType=Combination	StepType=Max	Point=2	X2=-0.5	X3=0.5		
S11=377.107167753782	IsS11Max=No	IsS11Min=No	FrameElem=112	ElemStation=0.375					
Frame=112	Station=0.375	OutputCase=ENVE	CaseType=Combination	StepType=Max	Point=3	X2=0.5	X3=-0.5		
S11=-559.308674486805	IsS11Max=No	IsS11Min=Yes	FrameElem=112	ElemStation=0.375					
Frame=112	Station=0.375	OutputCase=ENVE	CaseType=Combination	StepType=Max	Point=4	X2=0.5	X3=0.5		
S11=-559.308674486805	IsS11Max=No	IsS11Min=No	FrameElem=112	ElemStation=0.375					
Frame=112	Station=0.5	OutputCase=ENVE	CaseType=Combination	StepType=Max	Point=0	X2=0	X3=0	S11=-	
111.11546006997	IsS11Max=No	IsS11Min=No	FrameElem=112	ElemStation=0.5					
Frame=112	Station=0.5	OutputCase=ENVE	CaseType=Combination	StepType=Max	Point=1	X2=-0.5	X3=-0.5		
S11=573.748830007198	IsS11Max=Yes	IsS11Min=No	FrameElem=112	ElemStation=0.5					
Frame=112	Station=0.5	OutputCase=ENVE	CaseType=Combination	StepType=Max	Point=2	X2=-0.5	X3=0.5		
S11=573.748830007198	IsS11Max=No	IsS11Min=No	FrameElem=112	ElemStation=0.5					
Frame=112	Station=0.5	OutputCase=ENVE	CaseType=Combination	StepType=Max	Point=3	X2=0.5	X3=-0.5		
S11=-750.324298689344	IsS11Max=No	IsS11Min=Yes	FrameElem=112	ElemStation=0.5					
Frame=112	Station=0.5	OutputCase=ENVE	CaseType=Combination	StepType=Max	Point=4	X2=0.5	X3=0.5		
S11=-750.324298689344	IsS11Max=No	IsS11Min=No	FrameElem=112	ElemStation=0.5					
Frame=112	Station=0	OutputCase=ENVE	CaseType=Combination	StepType=Min	Point=0	X2=0	X3=0	S11=-	
169.541010668994	IsS11Max=No	IsS11Min=No	FrameElem=112	ElemStation=0					
Frame=112	Station=0	OutputCase=ENVE	CaseType=Combination	StepType=Min	Point=1	X2=-0.5	X3=-0.5		
S11=-449.217788340071	IsS11Max=No	IsS11Min=Yes	FrameElem=112	ElemStation=0					
Frame=112	Station=0	OutputCase=ENVE	CaseType=Combination	StepType=Min	Point=2	X2=-0.5	X3=0.5		
S11=-449.217788340071	IsS11Max=No	IsS11Min=No	FrameElem=112	ElemStation=0					
Frame=112	Station=0	OutputCase=ENVE	CaseType=Combination	StepType=Min	Point=3	X2=0.5	X3=-0.5		
S11=57.444014736451	IsS11Max=Yes	IsS11Min=No	FrameElem=112	ElemStation=0					
Frame=112	Station=0	OutputCase=ENVE	CaseType=Combination	StepType=Min	Point=4	X2=0.5	X3=0.5		
S11=57.444014736451	IsS11Max=No	IsS11Min=No	FrameElem=112	ElemStation=0					
Frame=112	Station=0.125	OutputCase=ENVE	CaseType=Combination	StepType=Min	Point=0	X2=0	X3=0	S11=-	
169.541010668994	IsS11Max=Yes	IsS11Min=No	FrameElem=112	ElemStation=0.125					
Frame=112	Station=0.125	OutputCase=ENVE	CaseType=Combination	StepType=Min	Point=1	X2=-0.5	X3=-0.5		
S11=-204.482476660218	IsS11Max=No	IsS11Min=Yes	FrameElem=112	ElemStation=0.125					
Frame=112	Station=0.125	OutputCase=ENVE	CaseType=Combination	StepType=Min	Point=2	X2=-0.5	X3=0.5		
S11=-204.482476660218	IsS11Max=No	IsS11Min=No	FrameElem=112	ElemStation=0.125					
Frame=112	Station=0.125	OutputCase=ENVE	CaseType=Combination	StepType=Min	Point=3	X2=0.5	X3=-0.5		
S11=-178.279801467508	IsS11Max=No	IsS11Min=No	FrameElem=112	ElemStation=0.125					
Frame=112	Station=0.125	OutputCase=ENVE	CaseType=Combination	StepType=Min	Point=4	X2=0.5	X3=0.5		
S11=-178.279801467508	IsS11Max=No	IsS11Min=No	FrameElem=112	ElemStation=0.125					
Frame=112	Station=0.25	OutputCase=ENVE	CaseType=Combination	StepType=Min	Point=0	X2=0	X3=0	S11=-	
169.541010668994	IsS11Max=No	IsS11Min=No	FrameElem=112	ElemStation=0.25					
Frame=112	Station=0.25	OutputCase=ENVE	CaseType=Combination	StepType=Min	Point=1	X2=-0.5	X3=-0.5		
S11=23.2293486534343	IsS11Max=Yes	IsS11Min=No	FrameElem=112	ElemStation=0.25					
Frame=112	Station=0.25	OutputCase=ENVE	CaseType=Combination	StepType=Min	Point=2	X2=-0.5	X3=0.5		
S11=23.2293486534343	IsS11Max=No	IsS11Min=No	FrameElem=112	ElemStation=0.25					

Frame=112	Station=0.25	OutputCase=ENVE	CaseType=Combination	StepType=Min	Point=3	X2=0.5	X3=-0.5	
S11=-398.722367671468	IsS11Max=No	IsS11Min=Yes	FrameElem=112	ElemStation=0.25				
Frame=112	Station=0.25	OutputCase=ENVE	CaseType=Combination	StepType=Min	Point=4	X2=0.5	X3=0.5	
S11=-398.722367671468	IsS11Max=No	IsS11Min=No	FrameElem=112	ElemStation=0.25				
Frame=112	Station=0.375	OutputCase=ENVE	CaseType=Combination	StepType=Min	Point=0	X2=0	X3=0	S11=-
169.541010668994	IsS11Max=No	IsS11Min=No	FrameElem=112	ElemStation=0.375				
Frame=112	Station=0.375	OutputCase=ENVE	CaseType=Combination	StepType=Min	Point=1	X2=-0.5	X3=-0.5	
S11=229.526222855974	IsS11Max=Yes	IsS11Min=No	FrameElem=112	ElemStation=0.375				
Frame=112	Station=0.375	OutputCase=ENVE	CaseType=Combination	StepType=Min	Point=2	X2=-0.5	X3=0.5	
S11=229.526222855974	IsS11Max=No	IsS11Min=No	FrameElem=112	ElemStation=0.375				
Frame=112	Station=0.375	OutputCase=ENVE	CaseType=Combination	StepType=Min	Point=3	X2=0.5	X3=-0.5	
S11=-607.912132968937	IsS11Max=No	IsS11Min=Yes	FrameElem=112	ElemStation=0.375				
Frame=112	Station=0.375	OutputCase=ENVE	CaseType=Combination	StepType=Min	Point=4	X2=0.5	X3=0.5	
S11=-607.912132968937	IsS11Max=No	IsS11Min=No	FrameElem=112	ElemStation=0.375				
Frame=112	Station=0.5	OutputCase=ENVE	CaseType=Combination	StepType=Min	Point=0	X2=0	X3=0	S11=-
169.541010668994	IsS11Max=No	IsS11Min=No	FrameElem=112	ElemStation=0.5				
Frame=112	Station=0.5	OutputCase=ENVE	CaseType=Combination	StepType=Min	Point=1	X2=-0.5	X3=-0.5	
S11=420.541847058514	IsS11Max=Yes	IsS11Min=No	FrameElem=112	ElemStation=0.5				
Frame=112	Station=0.5	OutputCase=ENVE	CaseType=Combination	StepType=Min	Point=2	X2=-0.5	X3=0.5	
S11=420.541847058514	IsS11Max=No	IsS11Min=No	FrameElem=112	ElemStation=0.5				
Frame=112	Station=0.5	OutputCase=ENVE	CaseType=Combination	StepType=Min	Point=3	X2=0.5	X3=-0.5	
S11=-805.279319854297	IsS11Max=No	IsS11Min=Yes	FrameElem=112	ElemStation=0.5				
Frame=112	Station=0.5	OutputCase=ENVE	CaseType=Combination	StepType=Min	Point=4	X2=0.5	X3=0.5	
S11=-805.279319854297	IsS11Max=No	IsS11Min=No	FrameElem=112	ElemStation=0.5				
Frame=112	Station=0	OutputCase=FESSUR	CaseType=Combination	Point=0	X2=0	X3=0	S11=-168.146075212921	
IsS11Max=No	IsS11Min=No	FrameElem=112	ElemStation=0					
Frame=112	Station=0	OutputCase=FESSUR	CaseType=Combination	Point=1	X2=-0.5	X3=-0.5	S11=-	
445.014896763543	IsS11Max=No	IsS11Min=Yes	FrameElem=112	ElemStation=0				
Frame=112	Station=0	OutputCase=FESSUR	CaseType=Combination	Point=2	X2=-0.5	X3=0.5	S11=-	
445.014896763543	IsS11Max=No	IsS11Min=No	FrameElem=112	ElemStation=0				
Frame=112	Station=0	OutputCase=FESSUR	CaseType=Combination	Point=3	X2=0.5	X3=-0.5		
S11=108.722746337702	IsS11Max=Yes	IsS11Min=No	FrameElem=112	ElemStation=0				
Frame=112	Station=0	OutputCase=FESSUR	CaseType=Combination	Point=4	X2=0.5	X3=0.5		
S11=108.722746337702	IsS11Max=No	IsS11Min=No	FrameElem=112	ElemStation=0				
Frame=112	Station=0.125	OutputCase=FESSUR	CaseType=Combination	Point=0	X2=0	X3=0	S11=-	
168.146075212921	IsS11Max=No	IsS11Min=No	FrameElem=112	ElemStation=0.125				
Frame=112	Station=0.125	OutputCase=FESSUR	CaseType=Combination	Point=1	X2=-0.5	X3=-0.5	S11=-	
202.642366326884	IsS11Max=No	IsS11Min=Yes	FrameElem=112	ElemStation=0.125				
Frame=112	Station=0.125	OutputCase=FESSUR	CaseType=Combination	Point=2	X2=-0.5	X3=0.5	S11=-	
202.642366326884	IsS11Max=No	IsS11Min=No	FrameElem=112	ElemStation=0.125				
Frame=112	Station=0.125	OutputCase=FESSUR	CaseType=Combination	Point=3	X2=0.5	X3=-0.5	S11=-	
133.649784098957	IsS11Max=Yes	IsS11Min=No	FrameElem=112	ElemStation=0.125				
Frame=112	Station=0.125	OutputCase=FESSUR	CaseType=Combination	Point=4	X2=0.5	X3=0.5	S11=-	
133.649784098957	IsS11Max=No	IsS11Min=No	FrameElem=112	ElemStation=0.125				
Frame=112	Station=0.25	OutputCase=FESSUR	CaseType=Combination	Point=0	X2=0	X3=0	S11=-	
168.146075212921	IsS11Max=No	IsS11Min=No	FrameElem=112	ElemStation=0.25				
Frame=112	Station=0.25	OutputCase=FESSUR	CaseType=Combination	Point=1	X2=-0.5	X3=-0.5		
S11=24.0932266097747	IsS11Max=Yes	IsS11Min=No	FrameElem=112	ElemStation=0.25				
Frame=112	Station=0.25	OutputCase=FESSUR	CaseType=Combination	Point=2	X2=-0.5	X3=0.5		
S11=24.0932266097747	IsS11Max=No	IsS11Min=No	FrameElem=112	ElemStation=0.25				
Frame=112	Station=0.25	OutputCase=FESSUR	CaseType=Combination	Point=3	X2=0.5	X3=-0.5	S11=-	
360.385377035616	IsS11Max=No	IsS11Min=Yes	FrameElem=112	ElemStation=0.25				
Frame=112	Station=0.25	OutputCase=FESSUR	CaseType=Combination	Point=4	X2=0.5	X3=0.5	S11=-	
360.385377035616	IsS11Max=No	IsS11Min=No	FrameElem=112	ElemStation=0.25				
Frame=112	Station=0.375	OutputCase=FESSUR	CaseType=Combination	Point=0	X2=0	X3=0	S11=-	
168.146075212921	IsS11Max=No	IsS11Min=No	FrameElem=112	ElemStation=0.375				
Frame=112	Station=0.375	OutputCase=FESSUR	CaseType=Combination	Point=1	X2=-0.5	X3=-0.5		
S11=235.191882046434	IsS11Max=Yes	IsS11Min=No	FrameElem=112	ElemStation=0.375				
Frame=112	Station=0.375	OutputCase=FESSUR	CaseType=Combination	Point=2	X2=-0.5	X3=0.5		
S11=235.191882046434	IsS11Max=No	IsS11Min=No	FrameElem=112	ElemStation=0.375				
Frame=112	Station=0.375	OutputCase=FESSUR	CaseType=Combination	Point=3	X2=0.5	X3=-0.5	S11=-	
571.484032472275	IsS11Max=No	IsS11Min=Yes	FrameElem=112	ElemStation=0.375				
Frame=112	Station=0.375	OutputCase=FESSUR	CaseType=Combination	Point=4	X2=0.5	X3=0.5	S11=-	
571.484032472275	IsS11Max=No	IsS11Min=No	FrameElem=112	ElemStation=0.375				
Frame=112	Station=0.5	OutputCase=FESSUR	CaseType=Combination	Point=0	X2=0	X3=0	S11=-	
168.146075212921	IsS11Max=No	IsS11Min=No	FrameElem=112	ElemStation=0.5				
Frame=112	Station=0.5	OutputCase=FESSUR	CaseType=Combination	Point=1	X2=-0.5	X3=-0.5		
S11=430.653599983093	IsS11Max=Yes	IsS11Min=No	FrameElem=112	ElemStation=0.5				
Frame=112	Station=0.5	OutputCase=FESSUR	CaseType=Combination	Point=2	X2=-0.5	X3=0.5		
S11=430.653599983093	IsS11Max=No	IsS11Min=No	FrameElem=112	ElemStation=0.5				
Frame=112	Station=0.5	OutputCase=FESSUR	CaseType=Combination	Point=3	X2=0.5	X3=-0.5	S11=-	
766.945750408934	IsS11Max=No	IsS11Min=Yes	FrameElem=112	ElemStation=0.5				
Frame=112	Station=0.5	OutputCase=FESSUR	CaseType=Combination	Point=4	X2=0.5	X3=0.5	S11=-	
766.945750408934	IsS11Max=No	IsS11Min=No	FrameElem=112	ElemStation=0.5				
Frame=113	Station=0	OutputCase=PERM1	CaseType=Combination	Point=0	X2=0	X3=0	S11=-164.891225815415	
IsS11Max=No	IsS11Min=No	FrameElem=113	ElemStation=0					
Frame=113	Station=0	OutputCase=PERM1	CaseType=Combination	Point=1	X2=-0.5	X3=-0.5		
S11=420.541847058514	IsS11Max=Yes	IsS11Min=No	FrameElem=113	ElemStation=0				
Frame=113	Station=0	OutputCase=PERM1	CaseType=Combination	Point=2	X2=-0.5	X3=0.5		
S11=420.541847058514	IsS11Max=No	IsS11Min=No	FrameElem=113	ElemStation=0				
Frame=113	Station=0	OutputCase=PERM1	CaseType=Combination	Point=3	X2=0.5	X3=-0.5	S11=-	
750.324298689344	IsS11Max=No	IsS11Min=Yes	FrameElem=113	ElemStation=0				

Frame=113	Station=0	OutputCase=PERM1	CaseType=Combination	Point=4	X2=0.5	X3=0.5	S11=-
750.324298689344	IsS11Max=No	IsS11Min=No	FrameElem=113	ElemStation=0			
Frame=113	Station=0.125	OutputCase=PERM1	CaseType=Combination	Point=0	X2=0	X3=0	S11=-
164.891225815415	IsS11Max=No	IsS11Min=No	FrameElem=113	ElemStation=0.125			
Frame=113	Station=0.125	OutputCase=PERM1	CaseType=Combination	Point=1	X2=-0.5	X3=-0.5	
S11=596.276221261086	IsS11Max=Yes	IsS11Min=No	FrameElem=113	ElemStation=0.125			
Frame=113	Station=0.125	OutputCase=PERM1	CaseType=Combination	Point=2	X2=-0.5	X3=0.5	
S11=596.276221261086	IsS11Max=No	IsS11Min=No	FrameElem=113	ElemStation=0.125			
Frame=113	Station=0.125	OutputCase=PERM1	CaseType=Combination	Point=3	X2=0.5	X3=-0.5	S11=-
926.058672891916	IsS11Max=No	IsS11Min=Yes	FrameElem=113	ElemStation=0.125			
Frame=113	Station=0.125	OutputCase=PERM1	CaseType=Combination	Point=4	X2=0.5	X3=0.5	S11=-
926.058672891916	IsS11Max=No	IsS11Min=No	FrameElem=113	ElemStation=0.125			
Frame=113	Station=0.25	OutputCase=PERM1	CaseType=Combination	Point=0	X2=0	X3=0	S11=-
164.891225815415	IsS11Max=No	IsS11Min=No	FrameElem=113	ElemStation=0.25			
Frame=113	Station=0.25	OutputCase=PERM1	CaseType=Combination	Point=1	X2=-0.5	X3=-0.5	
S11=756.729345463659	IsS11Max=Yes	IsS11Min=No	FrameElem=113	ElemStation=0.25			
Frame=113	Station=0.25	OutputCase=PERM1	CaseType=Combination	Point=2	X2=-0.5	X3=0.5	
S11=756.729345463659	IsS11Max=No	IsS11Min=No	FrameElem=113	ElemStation=0.25			
Frame=113	Station=0.25	OutputCase=PERM1	CaseType=Combination	Point=3	X2=0.5	X3=-0.5	S11=-
1086.51179709449	IsS11Max=No	IsS11Min=Yes	FrameElem=113	ElemStation=0.25			
Frame=113	Station=0.25	OutputCase=PERM1	CaseType=Combination	Point=4	X2=0.5	X3=0.5	S11=-
1086.51179709449	IsS11Max=No	IsS11Min=No	FrameElem=113	ElemStation=0.25			
Frame=113	Station=0.375	OutputCase=PERM1	CaseType=Combination	Point=0	X2=0	X3=0	S11=-
164.891225815415	IsS11Max=No	IsS11Min=No	FrameElem=113	ElemStation=0.375			
Frame=113	Station=0.375	OutputCase=PERM1	CaseType=Combination	Point=1	X2=-0.5	X3=-0.5	
S11=901.901219666231	IsS11Max=Yes	IsS11Min=No	FrameElem=113	ElemStation=0.375			
Frame=113	Station=0.375	OutputCase=PERM1	CaseType=Combination	Point=2	X2=-0.5	X3=0.5	
S11=901.901219666231	IsS11Max=No	IsS11Min=No	FrameElem=113	ElemStation=0.375			
Frame=113	Station=0.375	OutputCase=PERM1	CaseType=Combination	Point=3	X2=0.5	X3=-0.5	S11=-
1231.68367129706	IsS11Max=No	IsS11Min=Yes	FrameElem=113	ElemStation=0.375			
Frame=113	Station=0.375	OutputCase=PERM1	CaseType=Combination	Point=4	X2=0.5	X3=0.5	S11=-
1231.68367129706	IsS11Max=No	IsS11Min=No	FrameElem=113	ElemStation=0.375			
Frame=113	Station=0.5	OutputCase=PERM1	CaseType=Combination	Point=0	X2=0	X3=0	S11=-164.891225815415
IsS11Max=No	IsS11Min=No	FrameElem=113	ElemStation=0.5				
Frame=113	Station=0.5	OutputCase=PERM1	CaseType=Combination	Point=1	X2=-0.5	X3=-0.5	
S11=1031.7918438688	IsS11Max=Yes	IsS11Min=No	FrameElem=113	ElemStation=0.5			
Frame=113	Station=0.5	OutputCase=PERM1	CaseType=Combination	Point=2	X2=-0.5	X3=0.5	
S11=1031.7918438688	IsS11Max=No	IsS11Min=No	FrameElem=113	ElemStation=0.5			
Frame=113	Station=0.5	OutputCase=PERM1	CaseType=Combination	Point=3	X2=0.5	X3=-0.5	S11=-
1361.57429549963	IsS11Max=No	IsS11Min=Yes	FrameElem=113	ElemStation=0.5			
Frame=113	Station=0.5	OutputCase=PERM1	CaseType=Combination	Point=4	X2=0.5	X3=0.5	S11=-
1361.57429549963	IsS11Max=No	IsS11Min=No	FrameElem=113	ElemStation=0.5			
Frame=113	Station=0	OutputCase=PERM2	CaseType=Combination	Point=0	X2=0	X3=0	S11=-111.11546006997
IsS11Max=No	IsS11Min=No	FrameElem=113	ElemStation=0				
Frame=113	Station=0	OutputCase=PERM2	CaseType=Combination	Point=1	X2=-0.5	X3=-0.5	
S11=559.303468686372	IsS11Max=Yes	IsS11Min=No	FrameElem=113	ElemStation=0			
Frame=113	Station=0	OutputCase=PERM2	CaseType=Combination	Point=2	X2=-0.5	X3=0.5	
S11=559.303468686372	IsS11Max=No	IsS11Min=No	FrameElem=113	ElemStation=0			
Frame=113	Station=0	OutputCase=PERM2	CaseType=Combination	Point=3	X2=0.5	X3=-0.5	S11=-
781.534388826311	IsS11Max=No	IsS11Min=Yes	FrameElem=113	ElemStation=0			
Frame=113	Station=0	OutputCase=PERM2	CaseType=Combination	Point=4	X2=0.5	X3=0.5	S11=-
781.534388826311	IsS11Max=No	IsS11Min=No	FrameElem=113	ElemStation=0			
Frame=113	Station=0.125	OutputCase=PERM2	CaseType=Combination	Point=0	X2=0	X3=0	S11=-
111.11546006997	IsS11Max=No	IsS11Min=No	FrameElem=113	ElemStation=0.125			
Frame=113	Station=0.125	OutputCase=PERM2	CaseType=Combination	Point=1	X2=-0.5	X3=-0.5	
S11=735.037843094452	IsS11Max=Yes	IsS11Min=No	FrameElem=113	ElemStation=0.125			
Frame=113	Station=0.125	OutputCase=PERM2	CaseType=Combination	Point=2	X2=-0.5	X3=0.5	
S11=735.037843094452	IsS11Max=No	IsS11Min=No	FrameElem=113	ElemStation=0.125			
Frame=113	Station=0.125	OutputCase=PERM2	CaseType=Combination	Point=3	X2=0.5	X3=-0.5	S11=-
957.268763234391	IsS11Max=No	IsS11Min=Yes	FrameElem=113	ElemStation=0.125			
Frame=113	Station=0.125	OutputCase=PERM2	CaseType=Combination	Point=4	X2=0.5	X3=0.5	S11=-
957.268763234391	IsS11Max=No	IsS11Min=No	FrameElem=113	ElemStation=0.125			
Frame=113	Station=0.25	OutputCase=PERM2	CaseType=Combination	Point=0	X2=0	X3=0	S11=-111.11546006997
IsS11Max=No	IsS11Min=No	FrameElem=113	ElemStation=0.25				
Frame=113	Station=0.25	OutputCase=PERM2	CaseType=Combination	Point=1	X2=-0.5	X3=-0.5	
S11=895.490967502532	IsS11Max=Yes	IsS11Min=No	FrameElem=113	ElemStation=0.25			
Frame=113	Station=0.25	OutputCase=PERM2	CaseType=Combination	Point=2	X2=-0.5	X3=0.5	
S11=895.490967502532	IsS11Max=No	IsS11Min=No	FrameElem=113	ElemStation=0.25			
Frame=113	Station=0.25	OutputCase=PERM2	CaseType=Combination	Point=3	X2=0.5	X3=-0.5	S11=-
1117.72188764247	IsS11Max=No	IsS11Min=Yes	FrameElem=113	ElemStation=0.25			
Frame=113	Station=0.25	OutputCase=PERM2	CaseType=Combination	Point=4	X2=0.5	X3=0.5	S11=-
1117.72188764247	IsS11Max=No	IsS11Min=No	FrameElem=113	ElemStation=0.25			
Frame=113	Station=0.375	OutputCase=PERM2	CaseType=Combination	Point=0	X2=0	X3=0	S11=-
111.11546006997	IsS11Max=No	IsS11Min=No	FrameElem=113	ElemStation=0.375			
Frame=113	Station=0.375	OutputCase=PERM2	CaseType=Combination	Point=1	X2=-0.5	X3=-0.5	
S11=1040.66284191061	IsS11Max=Yes	IsS11Min=No	FrameElem=113	ElemStation=0.375			
Frame=113	Station=0.375	OutputCase=PERM2	CaseType=Combination	Point=2	X2=-0.5	X3=0.5	
S11=1040.66284191061	IsS11Max=No	IsS11Min=No	FrameElem=113	ElemStation=0.375			
Frame=113	Station=0.375	OutputCase=PERM2	CaseType=Combination	Point=3	X2=0.5	X3=-0.5	S11=-
1262.89376205055	IsS11Max=No	IsS11Min=Yes	FrameElem=113	ElemStation=0.375			
Frame=113	Station=0.375	OutputCase=PERM2	CaseType=Combination	Point=4	X2=0.5	X3=0.5	S11=-
1262.89376205055	IsS11Max=No	IsS11Min=No	FrameElem=113	ElemStation=0.375			

Frame=113	Station=0.5	OutputCase=PERM2	CaseType=Combination	Point=0	X2=0	X3=0	S11=-111.11546006997
IsS11Max=No	IsS11Min=No	FrameElem=113	ElemStation=0.5				
Frame=113	Station=0.5	OutputCase=PERM2	CaseType=Combination	Point=1	X2=-0.5	X3=-0.5	
S11=1170.55346631869	IsS11Max=Yes	IsS11Min=No	FrameElem=113	ElemStation=0.5			
Frame=113	Station=0.5	OutputCase=PERM2	CaseType=Combination	Point=2	X2=-0.5	X3=0.5	
S11=1170.55346631869	IsS11Max=No	IsS11Min=No	FrameElem=113	ElemStation=0.5			
Frame=113	Station=0.5	OutputCase=PERM2	CaseType=Combination	Point=3	X2=0.5	X3=-0.5	S11=-
1392.78438645863	IsS11Max=No	IsS11Min=Yes	FrameElem=113	ElemStation=0.5			
Frame=113	Station=0.5	OutputCase=PERM2	CaseType=Combination	Point=4	X2=0.5	X3=0.5	S11=-
1392.78438645863	IsS11Max=No	IsS11Min=No	FrameElem=113	ElemStation=0.5			
Frame=113	Station=0	OutputCase=ACC1	CaseType=Combination	Point=0	X2=0	X3=0	S11=-169.541010669002
IsS11Max=No	IsS11Min=No	FrameElem=113	ElemStation=0				
Frame=113	Station=0	OutputCase=ACC1	CaseType=Combination	Point=1	X2=-0.5	X3=-0.5	
S11=434.987208379336	IsS11Max=Yes	IsS11Min=No	FrameElem=113	ElemStation=0			
Frame=113	Station=0	OutputCase=ACC1	CaseType=Combination	Point=2	X2=-0.5	X3=0.5	
S11=434.987208379336	IsS11Max=No	IsS11Min=No	FrameElem=113	ElemStation=0			
Frame=113	Station=0	OutputCase=ACC1	CaseType=Combination	Point=3	X2=0.5	X3=-0.5	S11=-
774.06922971734	IsS11Max=No	IsS11Min=Yes	FrameElem=113	ElemStation=0			
Frame=113	Station=0	OutputCase=ACC1	CaseType=Combination	Point=4	X2=0.5	X3=0.5	S11=-774.06922971734
IsS11Max=No	IsS11Min=No	FrameElem=113	ElemStation=0				
Frame=113	Station=0.125	OutputCase=ACC1	CaseType=Combination	Point=0	X2=0	X3=0	S11=-
169.541010669002	IsS11Max=No	IsS11Min=No	FrameElem=113	ElemStation=0.125			
Frame=113	Station=0.125	OutputCase=ACC1	CaseType=Combination	Point=1	X2=-0.5	X3=-0.5	
S11=616.565020059221	IsS11Max=Yes	IsS11Min=No	FrameElem=113	ElemStation=0.125			
Frame=113	Station=0.125	OutputCase=ACC1	CaseType=Combination	Point=2	X2=-0.5	X3=0.5	
S11=616.565020059221	IsS11Max=No	IsS11Min=No	FrameElem=113	ElemStation=0.125			
Frame=113	Station=0.125	OutputCase=ACC1	CaseType=Combination	Point=3	X2=0.5	X3=-0.5	S11=-
955.647041397224	IsS11Max=No	IsS11Min=Yes	FrameElem=113	ElemStation=0.125			
Frame=113	Station=0.125	OutputCase=ACC1	CaseType=Combination	Point=4	X2=0.5	X3=0.5	S11=-
955.647041397224	IsS11Max=No	IsS11Min=No	FrameElem=113	ElemStation=0.125			
Frame=113	Station=0.25	OutputCase=ACC1	CaseType=Combination	Point=0	X2=0	X3=0	S11=-169.541010669002
IsS11Max=No	IsS11Min=No	FrameElem=113	ElemStation=0.25				
Frame=113	Station=0.25	OutputCase=ACC1	CaseType=Combination	Point=1	X2=-0.5	X3=-0.5	
S11=782.353456739105	IsS11Max=Yes	IsS11Min=No	FrameElem=113	ElemStation=0.25			
Frame=113	Station=0.25	OutputCase=ACC1	CaseType=Combination	Point=2	X2=-0.5	X3=0.5	
S11=782.353456739105	IsS11Max=No	IsS11Min=No	FrameElem=113	ElemStation=0.25			
Frame=113	Station=0.25	OutputCase=ACC1	CaseType=Combination	Point=3	X2=0.5	X3=-0.5	S11=-
1121.43547807711	IsS11Max=No	IsS11Min=Yes	FrameElem=113	ElemStation=0.25			
Frame=113	Station=0.25	OutputCase=ACC1	CaseType=Combination	Point=4	X2=0.5	X3=0.5	S11=-
1121.43547807711	IsS11Max=No	IsS11Min=No	FrameElem=113	ElemStation=0.25			
Frame=113	Station=0.375	OutputCase=ACC1	CaseType=Combination	Point=0	X2=0	X3=0	S11=-
169.541010669002	IsS11Max=No	IsS11Min=No	FrameElem=113	ElemStation=0.375			
Frame=113	Station=0.375	OutputCase=ACC1	CaseType=Combination	Point=1	X2=-0.5	X3=-0.5	
S11=932.35251841899	IsS11Max=Yes	IsS11Min=No	FrameElem=113	ElemStation=0.375			
Frame=113	Station=0.375	OutputCase=ACC1	CaseType=Combination	Point=2	X2=-0.5	X3=0.5	
S11=932.35251841899	IsS11Max=No	IsS11Min=No	FrameElem=113	ElemStation=0.375			
Frame=113	Station=0.375	OutputCase=ACC1	CaseType=Combination	Point=3	X2=0.5	X3=-0.5	S11=-
1271.43453975699	IsS11Max=No	IsS11Min=Yes	FrameElem=113	ElemStation=0.375			
Frame=113	Station=0.375	OutputCase=ACC1	CaseType=Combination	Point=4	X2=0.5	X3=0.5	S11=-
1271.43453975699	IsS11Max=No	IsS11Min=No	FrameElem=113	ElemStation=0.375			
Frame=113	Station=0.5	OutputCase=ACC1	CaseType=Combination	Point=0	X2=0	X3=0	S11=-169.541010669002
IsS11Max=No	IsS11Min=No	FrameElem=113	ElemStation=0.5				
Frame=113	Station=0.5	OutputCase=ACC1	CaseType=Combination	Point=1	X2=-0.5	X3=-0.5	
S11=1066.56220509887	IsS11Max=Yes	IsS11Min=No	FrameElem=113	ElemStation=0.5			
Frame=113	Station=0.5	OutputCase=ACC1	CaseType=Combination	Point=2	X2=-0.5	X3=0.5	
S11=1066.56220509887	IsS11Max=No	IsS11Min=No	FrameElem=113	ElemStation=0.5			
Frame=113	Station=0.5	OutputCase=ACC1	CaseType=Combination	Point=3	X2=0.5	X3=-0.5	S11=-
1405.64422643688	IsS11Max=No	IsS11Min=Yes	FrameElem=113	ElemStation=0.5			
Frame=113	Station=0.5	OutputCase=ACC1	CaseType=Combination	Point=4	X2=0.5	X3=0.5	S11=-
1405.64422643688	IsS11Max=No	IsS11Min=No	FrameElem=113	ElemStation=0.5			
Frame=113	Station=0	OutputCase=ACC2	CaseType=Combination	Point=0	X2=0	X3=0	S11=-115.765244923557
IsS11Max=No	IsS11Min=No	FrameElem=113	ElemStation=0				
Frame=113	Station=0	OutputCase=ACC2	CaseType=Combination	Point=1	X2=-0.5	X3=-0.5	
S11=573.748830007195	IsS11Max=Yes	IsS11Min=No	FrameElem=113	ElemStation=0			
Frame=113	Station=0	OutputCase=ACC2	CaseType=Combination	Point=2	X2=-0.5	X3=0.5	
S11=573.748830007195	IsS11Max=No	IsS11Min=No	FrameElem=113	ElemStation=0			
Frame=113	Station=0	OutputCase=ACC2	CaseType=Combination	Point=3	X2=0.5	X3=-0.5	S11=-
805.279319854308	IsS11Max=No	IsS11Min=Yes	FrameElem=113	ElemStation=0			
Frame=113	Station=0	OutputCase=ACC2	CaseType=Combination	Point=4	X2=0.5	X3=0.5	S11=-
805.279319854308	IsS11Max=No	IsS11Min=No	FrameElem=113	ElemStation=0			
Frame=113	Station=0.125	OutputCase=ACC2	CaseType=Combination	Point=0	X2=0	X3=0	S11=-
115.765244923557	IsS11Max=No	IsS11Min=No	FrameElem=113	ElemStation=0.125			
Frame=113	Station=0.125	OutputCase=ACC2	CaseType=Combination	Point=1	X2=-0.5	X3=-0.5	
S11=755.326641892587	IsS11Max=Yes	IsS11Min=No	FrameElem=113	ElemStation=0.125			
Frame=113	Station=0.125	OutputCase=ACC2	CaseType=Combination	Point=2	X2=-0.5	X3=0.5	
S11=755.326641892587	IsS11Max=No	IsS11Min=No	FrameElem=113	ElemStation=0.125			
Frame=113	Station=0.125	OutputCase=ACC2	CaseType=Combination	Point=3	X2=0.5	X3=-0.5	S11=-
986.8571317397	IsS11Max=No	IsS11Min=Yes	FrameElem=113	ElemStation=0.125			
Frame=113	Station=0.125	OutputCase=ACC2	CaseType=Combination	Point=4	X2=0.5	X3=0.5	S11=-
986.8571317397	IsS11Max=No	IsS11Min=No	FrameElem=113	ElemStation=0.125			
Frame=113	Station=0.25	OutputCase=ACC2	CaseType=Combination	Point=0	X2=0	X3=0	S11=-115.765244923557
IsS11Max=No	IsS11Min=No	FrameElem=113	ElemStation=0.25				

Frame=113 Station=0.25 OutputCase=ACC2 CaseType=Combination Point=1 X2=-0.5 X3=-0.5
S11=921.115078777978 IsS11Max=Yes IsS11Min=No FrameElem=113 ElemStation=0.25
Frame=113 Station=0.25 OutputCase=ACC2 CaseType=Combination Point=2 X2=-0.5 X3=0.5
S11=921.115078777978 IsS11Max=No IsS11Min=No FrameElem=113 ElemStation=0.25
Frame=113 Station=0.25 OutputCase=ACC2 CaseType=Combination Point=3 X2=0.5 X3=-0.5 S11=-
1152.64556862509 IsS11Max=No IsS11Min=Yes FrameElem=113 ElemStation=0.25
Frame=113 Station=0.25 OutputCase=ACC2 CaseType=Combination Point=4 X2=0.5 X3=0.5 S11=-
1152.64556862509 IsS11Max=No IsS11Min=No FrameElem=113 ElemStation=0.25
Frame=113 Station=0.375 OutputCase=ACC2 CaseType=Combination Point=0 X2=0 X3=0 S11=-
115.765244923557 IsS11Max=No IsS11Min=No FrameElem=113 ElemStation=0.375
Frame=113 Station=0.375 OutputCase=ACC2 CaseType=Combination Point=1 X2=-0.5 X3=-0.5
S11=1071.11414066337 IsS11Max=Yes IsS11Min=No FrameElem=113 ElemStation=0.375
Frame=113 Station=0.375 OutputCase=ACC2 CaseType=Combination Point=2 X2=-0.5 X3=0.5
S11=1071.11414066337 IsS11Max=No IsS11Min=No FrameElem=113 ElemStation=0.375
Frame=113 Station=0.375 OutputCase=ACC2 CaseType=Combination Point=3 X2=0.5 X3=-0.5 S11=-
1302.64463051048 IsS11Max=No IsS11Min=Yes FrameElem=113 ElemStation=0.375
Frame=113 Station=0.375 OutputCase=ACC2 CaseType=Combination Point=4 X2=0.5 X3=0.5 S11=-
1302.64463051048 IsS11Max=No IsS11Min=No FrameElem=113 ElemStation=0.375
Frame=113 Station=0.5 OutputCase=ACC2 CaseType=Combination Point=0 X2=0 X3=0 S11=-115.765244923557
IsS11Max=No IsS11Min=No FrameElem=113 ElemStation=0.5
Frame=113 Station=0.5 OutputCase=ACC2 CaseType=Combination Point=1 X2=-0.5 X3=-0.5
S11=1205.32382754876 IsS11Max=Yes IsS11Min=No FrameElem=113 ElemStation=0.5
Frame=113 Station=0.5 OutputCase=ACC2 CaseType=Combination Point=2 X2=-0.5 X3=0.5
S11=1205.32382754876 IsS11Max=No IsS11Min=No FrameElem=113 ElemStation=0.5
Frame=113 Station=0.5 OutputCase=ACC2 CaseType=Combination Point=3 X2=0.5 X3=-0.5 S11=-
1436.85431739588 IsS11Max=No IsS11Min=Yes FrameElem=113 ElemStation=0.5
Frame=113 Station=0.5 OutputCase=ACC2 CaseType=Combination Point=4 X2=0.5 X3=0.5 S11=-
1436.85431739588 IsS11Max=No IsS11Min=No FrameElem=113 ElemStation=0.5
Frame=113 Station=0 OutputCase=ACCSX1 CaseType=Combination Point=0 X2=0 X3=0 S11=-167.164023806271
IsS11Max=No IsS11Min=No FrameElem=113 ElemStation=0
Frame=113 Station=0 OutputCase=ACCSX1 CaseType=Combination Point=1 X2=-0.5 X3=-0.5
S11=428.225612329879 IsS11Max=Yes IsS11Min=No FrameElem=113 ElemStation=0
Frame=113 Station=0 OutputCase=ACCSX1 CaseType=Combination Point=2 X2=-0.5 X3=0.5
S11=428.225612329879 IsS11Max=No IsS11Min=No FrameElem=113 ElemStation=0
Frame=113 Station=0 OutputCase=ACCSX1 CaseType=Combination Point=3 X2=0.5 X3=-0.5 S11=-
762.553659942421 IsS11Max=No IsS11Min=Yes FrameElem=113 ElemStation=0
Frame=113 Station=0 OutputCase=ACCSX1 CaseType=Combination Point=4 X2=0.5 X3=0.5 S11=-
762.553659942421 IsS11Max=No IsS11Min=No FrameElem=113 ElemStation=0
Frame=113 Station=0.125 OutputCase=ACCSX1 CaseType=Combination Point=0 X2=0 X3=0 S11=-
167.164023806271 IsS11Max=No IsS11Min=No FrameElem=113 ElemStation=0.125
Frame=113 Station=0.125 OutputCase=ACCSX1 CaseType=Combination Point=1 X2=-0.5 X3=-0.5
S11=602.824428328363 IsS11Max=Yes IsS11Min=No FrameElem=113 ElemStation=0.125
Frame=113 Station=0.125 OutputCase=ACCSX1 CaseType=Combination Point=2 X2=-0.5 X3=0.5
S11=602.824428328363 IsS11Max=No IsS11Min=No FrameElem=113 ElemStation=0.125
Frame=113 Station=0.125 OutputCase=ACCSX1 CaseType=Combination Point=3 X2=0.5 X3=-0.5 S11=-
937.152475940905 IsS11Max=No IsS11Min=Yes FrameElem=113 ElemStation=0.125
Frame=113 Station=0.125 OutputCase=ACCSX1 CaseType=Combination Point=4 X2=0.5 X3=0.5 S11=-
937.152475940905 IsS11Max=No IsS11Min=No FrameElem=113 ElemStation=0.125
Frame=113 Station=0.25 OutputCase=ACCSX1 CaseType=Combination Point=0 X2=0 X3=0 S11=-
167.164023806271 IsS11Max=No IsS11Min=No FrameElem=113 ElemStation=0.25
Frame=113 Station=0.25 OutputCase=ACCSX1 CaseType=Combination Point=1 X2=-0.5 X3=-0.5
S11=762.141994326846 IsS11Max=Yes IsS11Min=No FrameElem=113 ElemStation=0.25
Frame=113 Station=0.25 OutputCase=ACCSX1 CaseType=Combination Point=2 X2=-0.5 X3=0.5
S11=762.141994326846 IsS11Max=No IsS11Min=No FrameElem=113 ElemStation=0.25
Frame=113 Station=0.25 OutputCase=ACCSX1 CaseType=Combination Point=3 X2=0.5 X3=-0.5 S11=-
1096.47004193939 IsS11Max=No IsS11Min=Yes FrameElem=113 ElemStation=0.25
Frame=113 Station=0.25 OutputCase=ACCSX1 CaseType=Combination Point=4 X2=0.5 X3=0.5 S11=-
1096.47004193939 IsS11Max=No IsS11Min=No FrameElem=113 ElemStation=0.25
Frame=113 Station=0.375 OutputCase=ACCSX1 CaseType=Combination Point=0 X2=0 X3=0 S11=-
167.164023806271 IsS11Max=No IsS11Min=No FrameElem=113 ElemStation=0.375
Frame=113 Station=0.375 OutputCase=ACCSX1 CaseType=Combination Point=1 X2=-0.5 X3=-0.5
S11=906.17831032533 IsS11Max=Yes IsS11Min=No FrameElem=113 ElemStation=0.375
Frame=113 Station=0.375 OutputCase=ACCSX1 CaseType=Combination Point=2 X2=-0.5 X3=0.5
S11=906.17831032533 IsS11Max=No IsS11Min=No FrameElem=113 ElemStation=0.375
Frame=113 Station=0.375 OutputCase=ACCSX1 CaseType=Combination Point=3 X2=0.5 X3=-0.5 S11=-
1240.50635793787 IsS11Max=No IsS11Min=Yes FrameElem=113 ElemStation=0.375
Frame=113 Station=0.375 OutputCase=ACCSX1 CaseType=Combination Point=4 X2=0.5 X3=0.5 S11=-
1240.50635793787 IsS11Max=No IsS11Min=No FrameElem=113 ElemStation=0.375
Frame=113 Station=0.5 OutputCase=ACCSX1 CaseType=Combination Point=0 X2=0 X3=0 S11=-
167.164023806271 IsS11Max=No IsS11Min=No FrameElem=113 ElemStation=0.5
Frame=113 Station=0.5 OutputCase=ACCSX1 CaseType=Combination Point=1 X2=-0.5 X3=-0.5
S11=1034.93337632381 IsS11Max=Yes IsS11Min=No FrameElem=113 ElemStation=0.5
Frame=113 Station=0.5 OutputCase=ACCSX1 CaseType=Combination Point=2 X2=-0.5 X3=0.5
S11=1034.93337632381 IsS11Max=No IsS11Min=No FrameElem=113 ElemStation=0.5
Frame=113 Station=0.5 OutputCase=ACCSX1 CaseType=Combination Point=3 X2=0.5 X3=-0.5 S11=-
1369.26142393636 IsS11Max=No IsS11Min=Yes FrameElem=113 ElemStation=0.5
Frame=113 Station=0.5 OutputCase=ACCSX1 CaseType=Combination Point=4 X2=0.5 X3=0.5 S11=-
1369.26142393636 IsS11Max=No IsS11Min=No FrameElem=113 ElemStation=0.5
Frame=113 Station=0 OutputCase=ACCSX2 CaseType=Combination Point=0 X2=0 X3=0 S11=-113.388258060826
IsS11Max=No IsS11Min=No FrameElem=113 ElemStation=0
Frame=113 Station=0 OutputCase=ACCSX2 CaseType=Combination Point=1 X2=-0.5 X3=-0.5
S11=566.987233957737 IsS11Max=Yes IsS11Min=No FrameElem=113 ElemStation=0

Frame=113	Station=0	OutputCase=ACCSX2	CaseType=Combination	Point=2	X2=-0.5	X3=0.5		
S11=566.987233957737	IsS11Max=No	IsS11Min=No	FrameElem=113	ElemStation=0				
Frame=113	Station=0	OutputCase=ACCSX2	CaseType=Combination	Point=3	X2=0.5	X3=-0.5	S11=-	
793.763750079389	IsS11Max=No	IsS11Min=Yes	FrameElem=113	ElemStation=0				
Frame=113	Station=0	OutputCase=ACCSX2	CaseType=Combination	Point=4	X2=0.5	X3=0.5	S11=-	
793.763750079389	IsS11Max=No	IsS11Min=No	FrameElem=113	ElemStation=0				
Frame=113	Station=0.125	OutputCase=ACCSX2	CaseType=Combination	Point=0	X2=0	X3=0	S11=-	
113.388258060826	IsS11Max=No	IsS11Min=No	FrameElem=113	ElemStation=0.125				
Frame=113	Station=0.125	OutputCase=ACCSX2	CaseType=Combination	Point=1	X2=-0.5	X3=-0.5		
S11=741.586050161728	IsS11Max=Yes	IsS11Min=No	FrameElem=113	ElemStation=0.125				
Frame=113	Station=0.125	OutputCase=ACCSX2	CaseType=Combination	Point=2	X2=-0.5	X3=0.5		
S11=741.586050161728	IsS11Max=No	IsS11Min=No	FrameElem=113	ElemStation=0.125				
Frame=113	Station=0.125	OutputCase=ACCSX2	CaseType=Combination	Point=3	X2=0.5	X3=-0.5	S11=-	
968.36256628338	IsS11Max=No	IsS11Min=Yes	FrameElem=113	ElemStation=0.125				
Frame=113	Station=0.125	OutputCase=ACCSX2	CaseType=Combination	Point=4	X2=0.5	X3=0.5	S11=-	
968.36256628338	IsS11Max=No	IsS11Min=No	FrameElem=113	ElemStation=0.125				
Frame=113	Station=0.25	OutputCase=ACCSX2	CaseType=Combination	Point=0	X2=0	X3=0	S11=-	
113.388258060826	IsS11Max=No	IsS11Min=No	FrameElem=113	ElemStation=0.25				
Frame=113	Station=0.25	OutputCase=ACCSX2	CaseType=Combination	Point=1	X2=-0.5	X3=-0.5		
S11=900.903616365719	IsS11Max=Yes	IsS11Min=No	FrameElem=113	ElemStation=0.25				
Frame=113	Station=0.25	OutputCase=ACCSX2	CaseType=Combination	Point=2	X2=-0.5	X3=0.5		
S11=900.903616365719	IsS11Max=No	IsS11Min=No	FrameElem=113	ElemStation=0.25				
Frame=113	Station=0.25	OutputCase=ACCSX2	CaseType=Combination	Point=3	X2=0.5	X3=-0.5	S11=-	
1127.68013248737	IsS11Max=No	IsS11Min=Yes	FrameElem=113	ElemStation=0.25				
Frame=113	Station=0.25	OutputCase=ACCSX2	CaseType=Combination	Point=4	X2=0.5	X3=0.5	S11=-	
1127.68013248737	IsS11Max=No	IsS11Min=No	FrameElem=113	ElemStation=0.25				
Frame=113	Station=0.375	OutputCase=ACCSX2	CaseType=Combination	Point=0	X2=0	X3=0	S11=-	
113.388258060826	IsS11Max=No	IsS11Min=No	FrameElem=113	ElemStation=0.375				
Frame=113	Station=0.375	OutputCase=ACCSX2	CaseType=Combination	Point=1	X2=-0.5	X3=-0.5		
S11=1044.93993256971	IsS11Max=Yes	IsS11Min=No	FrameElem=113	ElemStation=0.375				
Frame=113	Station=0.375	OutputCase=ACCSX2	CaseType=Combination	Point=2	X2=-0.5	X3=0.5		
S11=1044.93993256971	IsS11Max=No	IsS11Min=No	FrameElem=113	ElemStation=0.375				
Frame=113	Station=0.375	OutputCase=ACCSX2	CaseType=Combination	Point=3	X2=0.5	X3=-0.5	S11=-	
1271.71644869136	IsS11Max=No	IsS11Min=Yes	FrameElem=113	ElemStation=0.375				
Frame=113	Station=0.375	OutputCase=ACCSX2	CaseType=Combination	Point=4	X2=0.5	X3=0.5	S11=-	
1271.71644869136	IsS11Max=No	IsS11Min=No	FrameElem=113	ElemStation=0.375				
Frame=113	Station=0.5	OutputCase=ACCSX2	CaseType=Combination	Point=0	X2=0	X3=0	S11=-	
113.388258060826	IsS11Max=No	IsS11Min=No	FrameElem=113	ElemStation=0.5				
Frame=113	Station=0.5	OutputCase=ACCSX2	CaseType=Combination	Point=1	X2=-0.5	X3=-0.5		
S11=1173.6949987737	IsS11Max=Yes	IsS11Min=No	FrameElem=113	ElemStation=0.5				
Frame=113	Station=0.5	OutputCase=ACCSX2	CaseType=Combination	Point=2	X2=-0.5	X3=0.5		
S11=1173.6949987737	IsS11Max=No	IsS11Min=No	FrameElem=113	ElemStation=0.5				
Frame=113	Station=0.5	OutputCase=ACCSX2	CaseType=Combination	Point=3	X2=0.5	X3=-0.5	S11=-	
1400.47151489535	IsS11Max=No	IsS11Min=Yes	FrameElem=113	ElemStation=0.5				
Frame=113	Station=0.5	OutputCase=ACCSX2	CaseType=Combination	Point=4	X2=0.5	X3=0.5	S11=-	
1400.47151489535	IsS11Max=No	IsS11Min=No	FrameElem=113	ElemStation=0.5				
Frame=113	Station=0	OutputCase=ENVE	CaseType=Combination	StepType=Max	Point=0	X2=0	X3=0	S11=-
111.11546006997	IsS11Max=No	IsS11Min=No	FrameElem=113	ElemStation=0				
Frame=113	Station=0	OutputCase=ENVE	CaseType=Combination	StepType=Max	Point=1	X2=-0.5	X3=-0.5	
S11=573.748830007195	IsS11Max=Yes	IsS11Min=No	FrameElem=113	ElemStation=0				
Frame=113	Station=0	OutputCase=ENVE	CaseType=Combination	StepType=Max	Point=2	X2=-0.5	X3=0.5	
S11=573.748830007195	IsS11Max=No	IsS11Min=No	FrameElem=113	ElemStation=0				
Frame=113	Station=0	OutputCase=ENVE	CaseType=Combination	StepType=Max	Point=3	X2=0.5	X3=-0.5	
S11=-750.324298689344	IsS11Max=No	IsS11Min=Yes	FrameElem=113	ElemStation=0				
Frame=113	Station=0	OutputCase=ENVE	CaseType=Combination	StepType=Max	Point=4	X2=0.5	X3=0.5	S11=-
750.324298689344	IsS11Max=No	IsS11Min=No	FrameElem=113	ElemStation=0				
Frame=113	Station=0.125	OutputCase=ENVE	CaseType=Combination	StepType=Max	Point=0	X2=0	X3=0	S11=-
111.11546006997	IsS11Max=No	IsS11Min=No	FrameElem=113	ElemStation=0.125				
Frame=113	Station=0.125	OutputCase=ENVE	CaseType=Combination	StepType=Max	Point=1	X2=-0.5	X3=-0.5	
S11=755.326641892587	IsS11Max=Yes	IsS11Min=No	FrameElem=113	ElemStation=0.125				
Frame=113	Station=0.125	OutputCase=ENVE	CaseType=Combination	StepType=Max	Point=2	X2=-0.5	X3=0.5	
S11=755.326641892587	IsS11Max=No	IsS11Min=No	FrameElem=113	ElemStation=0.125				
Frame=113	Station=0.125	OutputCase=ENVE	CaseType=Combination	StepType=Max	Point=3	X2=0.5	X3=-0.5	
S11=-926.058672891916	IsS11Max=No	IsS11Min=Yes	FrameElem=113	ElemStation=0.125				
Frame=113	Station=0.125	OutputCase=ENVE	CaseType=Combination	StepType=Max	Point=4	X2=0.5	X3=0.5	
S11=-926.058672891916	IsS11Max=No	IsS11Min=No	FrameElem=113	ElemStation=0.125				
Frame=113	Station=0.25	OutputCase=ENVE	CaseType=Combination	StepType=Max	Point=0	X2=0	X3=0	S11=-
111.11546006997	IsS11Max=No	IsS11Min=No	FrameElem=113	ElemStation=0.25				
Frame=113	Station=0.25	OutputCase=ENVE	CaseType=Combination	StepType=Max	Point=1	X2=-0.5	X3=-0.5	
S11=921.115078777978	IsS11Max=Yes	IsS11Min=No	FrameElem=113	ElemStation=0.25				
Frame=113	Station=0.25	OutputCase=ENVE	CaseType=Combination	StepType=Max	Point=2	X2=-0.5	X3=0.5	
S11=921.115078777978	IsS11Max=No	IsS11Min=No	FrameElem=113	ElemStation=0.25				
Frame=113	Station=0.25	OutputCase=ENVE	CaseType=Combination	StepType=Max	Point=3	X2=0.5	X3=-0.5	
S11=-1086.51179709449	IsS11Max=No	IsS11Min=Yes	FrameElem=113	ElemStation=0.25				
Frame=113	Station=0.25	OutputCase=ENVE	CaseType=Combination	StepType=Max	Point=4	X2=0.5	X3=0.5	
S11=-1086.51179709449	IsS11Max=No	IsS11Min=No	FrameElem=113	ElemStation=0.25				
Frame=113	Station=0.375	OutputCase=ENVE	CaseType=Combination	StepType=Max	Point=0	X2=0	X3=0	S11=-
111.11546006997	IsS11Max=No	IsS11Min=No	FrameElem=113	ElemStation=0.375				
Frame=113	Station=0.375	OutputCase=ENVE	CaseType=Combination	StepType=Max	Point=1	X2=-0.5	X3=-0.5	
S11=1071.11414066337	IsS11Max=Yes	IsS11Min=No	FrameElem=113	ElemStation=0.375				
Frame=113	Station=0.375	OutputCase=ENVE	CaseType=Combination	StepType=Max	Point=2	X2=-0.5	X3=0.5	
S11=1071.11414066337	IsS11Max=No	IsS11Min=No	FrameElem=113	ElemStation=0.375				

Frame=113	Station=0.375	OutputCase=ENVE	CaseType=Combination	StepType=Max	Point=3	X2=0.5	X3=-0.5	
S11=-1231.68367129706	IsS11Max=No	IsS11Min=Yes	FrameElem=113	ElemStation=0.375				
Frame=113	Station=0.375	OutputCase=ENVE	CaseType=Combination	StepType=Max	Point=4	X2=0.5	X3=0.5	
S11=-1231.68367129706	IsS11Max=No	IsS11Min=No	FrameElem=113	ElemStation=0.375				
Frame=113	Station=0.5	OutputCase=ENVE	CaseType=Combination	StepType=Max	Point=0	X2=0	X3=0	S11=-
111.11546006997	IsS11Max=No	IsS11Min=No	FrameElem=113	ElemStation=0.5				
Frame=113	Station=0.5	OutputCase=ENVE	CaseType=Combination	StepType=Max	Point=1	X2=-0.5	X3=-0.5	
S11=1205.32382754876	IsS11Max=Yes	IsS11Min=No	FrameElem=113	ElemStation=0.5				
Frame=113	Station=0.5	OutputCase=ENVE	CaseType=Combination	StepType=Max	Point=2	X2=-0.5	X3=0.5	
S11=1205.32382754876	IsS11Max=No	IsS11Min=No	FrameElem=113	ElemStation=0.5				
Frame=113	Station=0.5	OutputCase=ENVE	CaseType=Combination	StepType=Max	Point=3	X2=0.5	X3=-0.5	
S11=-1361.57429549963	IsS11Max=No	IsS11Min=Yes	FrameElem=113	ElemStation=0.5				
Frame=113	Station=0.5	OutputCase=ENVE	CaseType=Combination	StepType=Max	Point=4	X2=0.5	X3=0.5	
S11=-1361.57429549963	IsS11Max=No	IsS11Min=No	FrameElem=113	ElemStation=0.5				
Frame=113	Station=0	OutputCase=ENVE	CaseType=Combination	StepType=Min	Point=0	X2=0	X3=0	S11=-
169.541010669002	IsS11Max=No	IsS11Min=No	FrameElem=113	ElemStation=0				
Frame=113	Station=0	OutputCase=ENVE	CaseType=Combination	StepType=Min	Point=1	X2=-0.5	X3=-0.5	
S11=420.541847058514	IsS11Max=Yes	IsS11Min=No	FrameElem=113	ElemStation=0				
Frame=113	Station=0	OutputCase=ENVE	CaseType=Combination	StepType=Min	Point=2	X2=-0.5	X3=0.5	
S11=420.541847058514	IsS11Max=No	IsS11Min=No	FrameElem=113	ElemStation=0				
Frame=113	Station=0	OutputCase=ENVE	CaseType=Combination	StepType=Min	Point=3	X2=0.5	X3=-0.5	
S11=-805.279319854308	IsS11Max=No	IsS11Min=Yes	FrameElem=113	ElemStation=0				
Frame=113	Station=0	OutputCase=ENVE	CaseType=Combination	StepType=Min	Point=4	X2=0.5	X3=0.5	S11=-
805.279319854308	IsS11Max=No	IsS11Min=No	FrameElem=113	ElemStation=0				
Frame=113	Station=0.125	OutputCase=ENVE	CaseType=Combination	StepType=Min	Point=0	X2=0	X3=0	S11=-
169.541010669002	IsS11Max=No	IsS11Min=No	FrameElem=113	ElemStation=0.125				
Frame=113	Station=0.125	OutputCase=ENVE	CaseType=Combination	StepType=Min	Point=1	X2=-0.5	X3=-0.5	
S11=596.276221261086	IsS11Max=Yes	IsS11Min=No	FrameElem=113	ElemStation=0.125				
Frame=113	Station=0.125	OutputCase=ENVE	CaseType=Combination	StepType=Min	Point=2	X2=-0.5	X3=0.5	
S11=596.276221261086	IsS11Max=No	IsS11Min=No	FrameElem=113	ElemStation=0.125				
Frame=113	Station=0.125	OutputCase=ENVE	CaseType=Combination	StepType=Min	Point=3	X2=0.5	X3=-0.5	
S11=-986.8571317397	IsS11Max=No	IsS11Min=Yes	FrameElem=113	ElemStation=0.125				
Frame=113	Station=0.125	OutputCase=ENVE	CaseType=Combination	StepType=Min	Point=4	X2=0.5	X3=0.5	
S11=-986.8571317397	IsS11Max=No	IsS11Min=No	FrameElem=113	ElemStation=0.125				
Frame=113	Station=0.25	OutputCase=ENVE	CaseType=Combination	StepType=Min	Point=0	X2=0	X3=0	S11=-
169.541010669002	IsS11Max=No	IsS11Min=No	FrameElem=113	ElemStation=0.25				
Frame=113	Station=0.25	OutputCase=ENVE	CaseType=Combination	StepType=Min	Point=1	X2=-0.5	X3=-0.5	
S11=756.729345463659	IsS11Max=Yes	IsS11Min=No	FrameElem=113	ElemStation=0.25				
Frame=113	Station=0.25	OutputCase=ENVE	CaseType=Combination	StepType=Min	Point=2	X2=-0.5	X3=0.5	
S11=756.729345463659	IsS11Max=No	IsS11Min=No	FrameElem=113	ElemStation=0.25				
Frame=113	Station=0.25	OutputCase=ENVE	CaseType=Combination	StepType=Min	Point=3	X2=0.5	X3=-0.5	
S11=-1152.64556862509	IsS11Max=No	IsS11Min=Yes	FrameElem=113	ElemStation=0.25				
Frame=113	Station=0.25	OutputCase=ENVE	CaseType=Combination	StepType=Min	Point=4	X2=0.5	X3=0.5	
S11=-1152.64556862509	IsS11Max=No	IsS11Min=No	FrameElem=113	ElemStation=0.25				
Frame=113	Station=0.375	OutputCase=ENVE	CaseType=Combination	StepType=Min	Point=0	X2=0	X3=0	S11=-
169.541010669002	IsS11Max=No	IsS11Min=No	FrameElem=113	ElemStation=0.375				
Frame=113	Station=0.375	OutputCase=ENVE	CaseType=Combination	StepType=Min	Point=1	X2=-0.5	X3=-0.5	
S11=901.901219666231	IsS11Max=Yes	IsS11Min=No	FrameElem=113	ElemStation=0.375				
Frame=113	Station=0.375	OutputCase=ENVE	CaseType=Combination	StepType=Min	Point=2	X2=-0.5	X3=0.5	
S11=901.901219666231	IsS11Max=No	IsS11Min=No	FrameElem=113	ElemStation=0.375				
Frame=113	Station=0.375	OutputCase=ENVE	CaseType=Combination	StepType=Min	Point=3	X2=0.5	X3=-0.5	
S11=-1302.64463051048	IsS11Max=No	IsS11Min=Yes	FrameElem=113	ElemStation=0.375				
Frame=113	Station=0.375	OutputCase=ENVE	CaseType=Combination	StepType=Min	Point=4	X2=0.5	X3=0.5	
S11=-1302.64463051048	IsS11Max=No	IsS11Min=No	FrameElem=113	ElemStation=0.375				
Frame=113	Station=0.5	OutputCase=ENVE	CaseType=Combination	StepType=Min	Point=0	X2=0	X3=0	S11=-
169.541010669002	IsS11Max=No	IsS11Min=No	FrameElem=113	ElemStation=0.5				
Frame=113	Station=0.5	OutputCase=ENVE	CaseType=Combination	StepType=Min	Point=1	X2=-0.5	X3=-0.5	
S11=1031.7918438688	IsS11Max=Yes	IsS11Min=No	FrameElem=113	ElemStation=0.5				
Frame=113	Station=0.5	OutputCase=ENVE	CaseType=Combination	StepType=Min	Point=2	X2=-0.5	X3=0.5	
S11=1031.7918438688	IsS11Max=No	IsS11Min=No	FrameElem=113	ElemStation=0.5				
Frame=113	Station=0.5	OutputCase=ENVE	CaseType=Combination	StepType=Min	Point=3	X2=0.5	X3=-0.5	
S11=-1436.85431739588	IsS11Max=No	IsS11Min=Yes	FrameElem=113	ElemStation=0.5				
Frame=113	Station=0.5	OutputCase=ENVE	CaseType=Combination	StepType=Min	Point=4	X2=0.5	X3=0.5	
S11=-1436.85431739588	IsS11Max=No	IsS11Min=No	FrameElem=113	ElemStation=0.5				
Frame=113	Station=0	OutputCase=FESSUR	CaseType=Combination	Point=0	X2=0	X3=0	S11=-168.146075212926	
IsS11Max=No	IsS11Min=No	FrameElem=113	ElemStation=0					
Frame=113	Station=0	OutputCase=FESSUR	CaseType=Combination	Point=1	X2=-0.5	X3=-0.5		
S11=430.65359998309	IsS11Max=Yes	IsS11Min=No	FrameElem=113	ElemStation=0				
Frame=113	Station=0	OutputCase=FESSUR	CaseType=Combination	Point=2	X2=-0.5	X3=0.5		
S11=430.65359998309	IsS11Max=No	IsS11Min=No	FrameElem=113	ElemStation=0				
Frame=113	Station=0	OutputCase=FESSUR	CaseType=Combination	Point=3	X2=0.5	X3=-0.5	S11=-	
766.945750408941	IsS11Max=No	IsS11Min=Yes	FrameElem=113	ElemStation=0				
Frame=113	Station=0	OutputCase=FESSUR	CaseType=Combination	Point=4	X2=0.5	X3=0.5	S11=-	
766.945750408941	IsS11Max=No	IsS11Min=No	FrameElem=113	ElemStation=0				
Frame=113	Station=0.125	OutputCase=FESSUR	CaseType=Combination	Point=0	X2=0	X3=0	S11=-	
168.146075212926	IsS11Max=No	IsS11Min=No	FrameElem=113	ElemStation=0.125				
Frame=113	Station=0.125	OutputCase=FESSUR	CaseType=Combination	Point=1	X2=-0.5	X3=-0.5		
S11=610.47838041978	IsS11Max=Yes	IsS11Min=No	FrameElem=113	ElemStation=0.125				
Frame=113	Station=0.125	OutputCase=FESSUR	CaseType=Combination	Point=2	X2=-0.5	X3=0.5		
S11=610.47838041978	IsS11Max=No	IsS11Min=No	FrameElem=113	ElemStation=0.125				
Frame=113	Station=0.125	OutputCase=FESSUR	CaseType=Combination	Point=3	X2=0.5	X3=-0.5	S11=-	
946.770530845632	IsS11Max=No	IsS11Min=Yes	FrameElem=113	ElemStation=0.125				

Frame=113	Station=0.125	OutputCase=FESSUR	CaseType=Combination	Point=4	X2=0.5	X3=0.5	S11=-
946.770530845632	IsS11Max=No	IsS11Min=No	FrameElem=113	ElemStation=0.125			
Frame=113	Station=0.25	OutputCase=FESSUR	CaseType=Combination	Point=0	X2=0	X3=0	S11=-
168.146075212926	IsS11Max=No	IsS11Min=No	FrameElem=113	ElemStation=0.25			
Frame=113	Station=0.25	OutputCase=FESSUR	CaseType=Combination	Point=1	X2=-0.5	X3=-0.5	
S11=774.666223356472	IsS11Max=Yes	IsS11Min=No	FrameElem=113	ElemStation=0.25			
Frame=113	Station=0.25	OutputCase=FESSUR	CaseType=Combination	Point=2	X2=-0.5	X3=0.5	
S11=774.666223356472	IsS11Max=No	IsS11Min=No	FrameElem=113	ElemStation=0.25			
Frame=113	Station=0.25	OutputCase=FESSUR	CaseType=Combination	Point=3	X2=0.5	X3=-0.5	S11=-
1110.95837378232	IsS11Max=No	IsS11Min=Yes	FrameElem=113	ElemStation=0.25			
Frame=113	Station=0.25	OutputCase=FESSUR	CaseType=Combination	Point=4	X2=0.5	X3=0.5	S11=-
1110.95837378232	IsS11Max=No	IsS11Min=No	FrameElem=113	ElemStation=0.25			
Frame=113	Station=0.375	OutputCase=FESSUR	CaseType=Combination	Point=0	X2=0	X3=0	S11=-
168.146075212926	IsS11Max=No	IsS11Min=No	FrameElem=113	ElemStation=0.375			
Frame=113	Station=0.375	OutputCase=FESSUR	CaseType=Combination	Point=1	X2=-0.5	X3=-0.5	
S11=923.217128793162	IsS11Max=Yes	IsS11Min=No	FrameElem=113	ElemStation=0.375			
Frame=113	Station=0.375	OutputCase=FESSUR	CaseType=Combination	Point=2	X2=-0.5	X3=0.5	
S11=923.217128793162	IsS11Max=No	IsS11Min=No	FrameElem=113	ElemStation=0.375			
Frame=113	Station=0.375	OutputCase=FESSUR	CaseType=Combination	Point=3	X2=0.5	X3=-0.5	S11=-
1259.50927921901	IsS11Max=No	IsS11Min=Yes	FrameElem=113	ElemStation=0.375			
Frame=113	Station=0.375	OutputCase=FESSUR	CaseType=Combination	Point=4	X2=0.5	X3=0.5	S11=-
1259.50927921901	IsS11Max=No	IsS11Min=No	FrameElem=113	ElemStation=0.375			
Frame=113	Station=0.5	OutputCase=FESSUR	CaseType=Combination	Point=0	X2=0	X3=0	S11=-
168.146075212926	IsS11Max=No	IsS11Min=No	FrameElem=113	ElemStation=0.5			
Frame=113	Station=0.5	OutputCase=FESSUR	CaseType=Combination	Point=1	X2=-0.5	X3=-0.5	
S11=1056.13109672985	IsS11Max=Yes	IsS11Min=No	FrameElem=113	ElemStation=0.5			
Frame=113	Station=0.5	OutputCase=FESSUR	CaseType=Combination	Point=2	X2=-0.5	X3=0.5	
S11=1056.13109672985	IsS11Max=No	IsS11Min=No	FrameElem=113	ElemStation=0.5			
Frame=113	Station=0.5	OutputCase=FESSUR	CaseType=Combination	Point=3	X2=0.5	X3=-0.5	S11=-
1392.4232471557	IsS11Max=No	IsS11Min=Yes	FrameElem=113	ElemStation=0.5			
Frame=113	Station=0.5	OutputCase=FESSUR	CaseType=Combination	Point=4	X2=0.5	X3=0.5	S11=-
1392.4232471557	IsS11Max=No	IsS11Min=No	FrameElem=113	ElemStation=0.5			
Frame=114	Station=0	OutputCase=PERM1	CaseType=Combination	Point=0	X2=0	X3=0	S11=-164.891225815415
IsS11Max=No	IsS11Min=No	FrameElem=114	ElemStation=0				
Frame=114	Station=0	OutputCase=PERM1	CaseType=Combination	Point=1	X2=-0.5	X3=-0.5	
S11=1031.79184386874	IsS11Max=Yes	IsS11Min=No	FrameElem=114	ElemStation=0			
Frame=114	Station=0	OutputCase=PERM1	CaseType=Combination	Point=2	X2=-0.5	X3=0.5	
S11=1031.79184386874	IsS11Max=No	IsS11Min=No	FrameElem=114	ElemStation=0			
Frame=114	Station=0	OutputCase=PERM1	CaseType=Combination	Point=3	X2=0.5	X3=-0.5	S11=-
1361.57429549957	IsS11Max=No	IsS11Min=Yes	FrameElem=114	ElemStation=0			
Frame=114	Station=0	OutputCase=PERM1	CaseType=Combination	Point=4	X2=0.5	X3=0.5	S11=-
1361.57429549957	IsS11Max=No	IsS11Min=No	FrameElem=114	ElemStation=0			
Frame=114	Station=0.125	OutputCase=PERM1	CaseType=Combination	Point=0	X2=0	X3=0	S11=-
164.891225815415	IsS11Max=No	IsS11Min=No	FrameElem=114	ElemStation=0.125			
Frame=114	Station=0.125	OutputCase=PERM1	CaseType=Combination	Point=1	X2=-0.5	X3=-0.5	
S11=1146.40121807128	IsS11Max=Yes	IsS11Min=No	FrameElem=114	ElemStation=0.125			
Frame=114	Station=0.125	OutputCase=PERM1	CaseType=Combination	Point=2	X2=-0.5	X3=0.5	
S11=1146.40121807128	IsS11Max=No	IsS11Min=No	FrameElem=114	ElemStation=0.125			
Frame=114	Station=0.125	OutputCase=PERM1	CaseType=Combination	Point=3	X2=0.5	X3=-0.5	S11=-
1476.18366970211	IsS11Max=No	IsS11Min=Yes	FrameElem=114	ElemStation=0.125			
Frame=114	Station=0.125	OutputCase=PERM1	CaseType=Combination	Point=4	X2=0.5	X3=0.5	S11=-
1476.18366970211	IsS11Max=No	IsS11Min=No	FrameElem=114	ElemStation=0.125			
Frame=114	Station=0.25	OutputCase=PERM1	CaseType=Combination	Point=0	X2=0	X3=0	S11=-
164.891225815415	IsS11Max=No	IsS11Min=No	FrameElem=114	ElemStation=0.25			
Frame=114	Station=0.25	OutputCase=PERM1	CaseType=Combination	Point=1	X2=-0.5	X3=-0.5	
S11=1245.72934227382	IsS11Max=Yes	IsS11Min=No	FrameElem=114	ElemStation=0.25			
Frame=114	Station=0.25	OutputCase=PERM1	CaseType=Combination	Point=2	X2=-0.5	X3=0.5	
S11=1245.72934227382	IsS11Max=No	IsS11Min=No	FrameElem=114	ElemStation=0.25			
Frame=114	Station=0.25	OutputCase=PERM1	CaseType=Combination	Point=3	X2=0.5	X3=-0.5	S11=-
1575.51179390465	IsS11Max=No	IsS11Min=Yes	FrameElem=114	ElemStation=0.25			
Frame=114	Station=0.25	OutputCase=PERM1	CaseType=Combination	Point=4	X2=0.5	X3=0.5	S11=-
1575.51179390465	IsS11Max=No	IsS11Min=No	FrameElem=114	ElemStation=0.25			
Frame=114	Station=0.375	OutputCase=PERM1	CaseType=Combination	Point=0	X2=0	X3=0	S11=-
164.891225815415	IsS11Max=No	IsS11Min=No	FrameElem=114	ElemStation=0.375			
Frame=114	Station=0.375	OutputCase=PERM1	CaseType=Combination	Point=1	X2=-0.5	X3=-0.5	
S11=1329.77621647636	IsS11Max=Yes	IsS11Min=No	FrameElem=114	ElemStation=0.375			
Frame=114	Station=0.375	OutputCase=PERM1	CaseType=Combination	Point=2	X2=-0.5	X3=0.5	
S11=1329.77621647636	IsS11Max=No	IsS11Min=No	FrameElem=114	ElemStation=0.375			
Frame=114	Station=0.375	OutputCase=PERM1	CaseType=Combination	Point=3	X2=0.5	X3=-0.5	S11=-
1659.55866810719	IsS11Max=No	IsS11Min=Yes	FrameElem=114	ElemStation=0.375			
Frame=114	Station=0.375	OutputCase=PERM1	CaseType=Combination	Point=4	X2=0.5	X3=0.5	S11=-
1659.55866810719	IsS11Max=No	IsS11Min=No	FrameElem=114	ElemStation=0.375			
Frame=114	Station=0.5	OutputCase=PERM1	CaseType=Combination	Point=0	X2=0	X3=0	S11=-164.891225815415
IsS11Max=No	IsS11Min=No	FrameElem=114	ElemStation=0.5				
Frame=114	Station=0.5	OutputCase=PERM1	CaseType=Combination	Point=1	X2=-0.5	X3=-0.5	
S11=1398.5418406789	IsS11Max=Yes	IsS11Min=No	FrameElem=114	ElemStation=0.5			
Frame=114	Station=0.5	OutputCase=PERM1	CaseType=Combination	Point=2	X2=-0.5	X3=0.5	
S11=1398.5418406789	IsS11Max=No	IsS11Min=No	FrameElem=114	ElemStation=0.5			
Frame=114	Station=0.5	OutputCase=PERM1	CaseType=Combination	Point=3	X2=0.5	X3=-0.5	S11=-
1728.32429230973	IsS11Max=No	IsS11Min=Yes	FrameElem=114	ElemStation=0.5			
Frame=114	Station=0.5	OutputCase=PERM1	CaseType=Combination	Point=4	X2=0.5	X3=0.5	S11=-
1728.32429230973	IsS11Max=No	IsS11Min=No	FrameElem=114	ElemStation=0.5			

Frame=114	Station=0	OutputCase=PERM2	CaseType=Combination	Point=0	X2=0	X3=0	S11=-111.11546006997
IsS11Max=No	IsS11Min=No	FrameElem=114	ElemStation=0				
Frame=114	Station=0	OutputCase=PERM2	CaseType=Combination	Point=1	X2=-0.5	X3=-0.5	
S11=1170.55346631863	IsS11Max=Yes	IsS11Min=No	FrameElem=114	ElemStation=0			
Frame=114	Station=0	OutputCase=PERM2	CaseType=Combination	Point=2	X2=-0.5	X3=0.5	
S11=1170.55346631863	IsS11Max=No	IsS11Min=No	FrameElem=114	ElemStation=0			
Frame=114	Station=0	OutputCase=PERM2	CaseType=Combination	Point=3	X2=0.5	X3=-0.5	S11=-
1392.78438645857	IsS11Max=No	IsS11Min=Yes	FrameElem=114	ElemStation=0			
Frame=114	Station=0	OutputCase=PERM2	CaseType=Combination	Point=4	X2=0.5	X3=0.5	S11=-
1392.78438645857	IsS11Max=No	IsS11Min=No	FrameElem=114	ElemStation=0			
Frame=114	Station=0.125	OutputCase=PERM2	CaseType=Combination	Point=0	X2=0	X3=0	S11=-
111.11546006997	IsS11Max=No	IsS11Min=No	FrameElem=114	ElemStation=0.125			
Frame=114	Station=0.125	OutputCase=PERM2	CaseType=Combination	Point=1	X2=-0.5	X3=-0.5	
S11=1285.16284072667	IsS11Max=Yes	IsS11Min=No	FrameElem=114	ElemStation=0.125			
Frame=114	Station=0.125	OutputCase=PERM2	CaseType=Combination	Point=2	X2=-0.5	X3=0.5	
S11=1285.16284072667	IsS11Max=No	IsS11Min=No	FrameElem=114	ElemStation=0.125			
Frame=114	Station=0.125	OutputCase=PERM2	CaseType=Combination	Point=3	X2=0.5	X3=-0.5	S11=-
1507.39376086661	IsS11Max=No	IsS11Min=Yes	FrameElem=114	ElemStation=0.125			
Frame=114	Station=0.125	OutputCase=PERM2	CaseType=Combination	Point=4	X2=0.5	X3=0.5	S11=-
1507.39376086661	IsS11Max=No	IsS11Min=No	FrameElem=114	ElemStation=0.125			
Frame=114	Station=0.25	OutputCase=PERM2	CaseType=Combination	Point=0	X2=0	X3=0	S11=-111.11546006997
IsS11Max=No	IsS11Min=No	FrameElem=114	ElemStation=0.25				
Frame=114	Station=0.25	OutputCase=PERM2	CaseType=Combination	Point=1	X2=-0.5	X3=-0.5	
S11=1384.49096513472	IsS11Max=Yes	IsS11Min=No	FrameElem=114	ElemStation=0.25			
Frame=114	Station=0.25	OutputCase=PERM2	CaseType=Combination	Point=2	X2=-0.5	X3=0.5	
S11=1384.49096513472	IsS11Max=No	IsS11Min=No	FrameElem=114	ElemStation=0.25			
Frame=114	Station=0.25	OutputCase=PERM2	CaseType=Combination	Point=3	X2=0.5	X3=-0.5	S11=-
1606.72188527466	IsS11Max=No	IsS11Min=Yes	FrameElem=114	ElemStation=0.25			
Frame=114	Station=0.25	OutputCase=PERM2	CaseType=Combination	Point=4	X2=0.5	X3=0.5	S11=-
1606.72188527466	IsS11Max=No	IsS11Min=No	FrameElem=114	ElemStation=0.25			
Frame=114	Station=0.375	OutputCase=PERM2	CaseType=Combination	Point=0	X2=0	X3=0	S11=-
111.11546006997	IsS11Max=No	IsS11Min=No	FrameElem=114	ElemStation=0.375			
Frame=114	Station=0.375	OutputCase=PERM2	CaseType=Combination	Point=1	X2=-0.5	X3=-0.5	
S11=1468.53783954277	IsS11Max=Yes	IsS11Min=No	FrameElem=114	ElemStation=0.375			
Frame=114	Station=0.375	OutputCase=PERM2	CaseType=Combination	Point=2	X2=-0.5	X3=0.5	
S11=1468.53783954277	IsS11Max=No	IsS11Min=No	FrameElem=114	ElemStation=0.375			
Frame=114	Station=0.375	OutputCase=PERM2	CaseType=Combination	Point=3	X2=0.5	X3=-0.5	S11=-
1690.76875968271	IsS11Max=No	IsS11Min=Yes	FrameElem=114	ElemStation=0.375			
Frame=114	Station=0.375	OutputCase=PERM2	CaseType=Combination	Point=4	X2=0.5	X3=0.5	S11=-
1690.76875968271	IsS11Max=No	IsS11Min=No	FrameElem=114	ElemStation=0.375			
Frame=114	Station=0.5	OutputCase=PERM2	CaseType=Combination	Point=0	X2=0	X3=0	S11=-111.11546006997
IsS11Max=No	IsS11Min=No	FrameElem=114	ElemStation=0.5				
Frame=114	Station=0.5	OutputCase=PERM2	CaseType=Combination	Point=1	X2=-0.5	X3=-0.5	
S11=1537.30346395082	IsS11Max=Yes	IsS11Min=No	FrameElem=114	ElemStation=0.5			
Frame=114	Station=0.5	OutputCase=PERM2	CaseType=Combination	Point=2	X2=-0.5	X3=0.5	
S11=1537.30346395082	IsS11Max=No	IsS11Min=No	FrameElem=114	ElemStation=0.5			
Frame=114	Station=0.5	OutputCase=PERM2	CaseType=Combination	Point=3	X2=0.5	X3=-0.5	S11=-
1759.53438409075	IsS11Max=No	IsS11Min=Yes	FrameElem=114	ElemStation=0.5			
Frame=114	Station=0.5	OutputCase=PERM2	CaseType=Combination	Point=4	X2=0.5	X3=0.5	S11=-
1759.53438409075	IsS11Max=No	IsS11Min=No	FrameElem=114	ElemStation=0.5			
Frame=114	Station=0	OutputCase=ACC1	CaseType=Combination	Point=0	X2=0	X3=0	S11=-169.541010669005
IsS11Max=No	IsS11Min=No	FrameElem=114	ElemStation=0				
Frame=114	Station=0	OutputCase=ACC1	CaseType=Combination	Point=1	X2=-0.5	X3=-0.5	
S11=1066.56220509881	IsS11Max=Yes	IsS11Min=No	FrameElem=114	ElemStation=0			
Frame=114	Station=0	OutputCase=ACC1	CaseType=Combination	Point=2	X2=-0.5	X3=0.5	
S11=1066.56220509881	IsS11Max=No	IsS11Min=No	FrameElem=114	ElemStation=0			
Frame=114	Station=0	OutputCase=ACC1	CaseType=Combination	Point=3	X2=0.5	X3=-0.5	S11=-
1405.64422643682	IsS11Max=No	IsS11Min=Yes	FrameElem=114	ElemStation=0			
Frame=114	Station=0	OutputCase=ACC1	CaseType=Combination	Point=4	X2=0.5	X3=0.5	S11=-
1405.64422643682	IsS11Max=No	IsS11Min=No	FrameElem=114	ElemStation=0			
Frame=114	Station=0.125	OutputCase=ACC1	CaseType=Combination	Point=0	X2=0	X3=0	S11=-
169.541010669005	IsS11Max=No	IsS11Min=No	FrameElem=114	ElemStation=0.125			
Frame=114	Station=0.125	OutputCase=ACC1	CaseType=Combination	Point=1	X2=-0.5	X3=-0.5	
S11=1184.98251677866	IsS11Max=Yes	IsS11Min=No	FrameElem=114	ElemStation=0.125			
Frame=114	Station=0.125	OutputCase=ACC1	CaseType=Combination	Point=2	X2=-0.5	X3=0.5	
S11=1184.98251677866	IsS11Max=No	IsS11Min=No	FrameElem=114	ElemStation=0.125			
Frame=114	Station=0.125	OutputCase=ACC1	CaseType=Combination	Point=3	X2=0.5	X3=-0.5	S11=-
1524.06453811667	IsS11Max=No	IsS11Min=Yes	FrameElem=114	ElemStation=0.125			
Frame=114	Station=0.125	OutputCase=ACC1	CaseType=Combination	Point=4	X2=0.5	X3=0.5	S11=-
1524.06453811667	IsS11Max=No	IsS11Min=No	FrameElem=114	ElemStation=0.125			
Frame=114	Station=0.25	OutputCase=ACC1	CaseType=Combination	Point=0	X2=0	X3=0	S11=-169.541010669005
IsS11Max=No	IsS11Min=No	FrameElem=114	ElemStation=0.25				
Frame=114	Station=0.25	OutputCase=ACC1	CaseType=Combination	Point=1	X2=-0.5	X3=-0.5	
S11=1287.61345345851	IsS11Max=Yes	IsS11Min=No	FrameElem=114	ElemStation=0.25			
Frame=114	Station=0.25	OutputCase=ACC1	CaseType=Combination	Point=2	X2=-0.5	X3=0.5	
S11=1287.61345345851	IsS11Max=No	IsS11Min=No	FrameElem=114	ElemStation=0.25			
Frame=114	Station=0.25	OutputCase=ACC1	CaseType=Combination	Point=3	X2=0.5	X3=-0.5	S11=-
1626.69547479652	IsS11Max=No	IsS11Min=Yes	FrameElem=114	ElemStation=0.25			
Frame=114	Station=0.25	OutputCase=ACC1	CaseType=Combination	Point=4	X2=0.5	X3=0.5	S11=-
1626.69547479652	IsS11Max=No	IsS11Min=No	FrameElem=114	ElemStation=0.25			
Frame=114	Station=0.375	OutputCase=ACC1	CaseType=Combination	Point=0	X2=0	X3=0	S11=-
169.541010669005	IsS11Max=No	IsS11Min=No	FrameElem=114	ElemStation=0.375			



Frame=114 Station=0.375 OutputCase=ACC1 CaseType=Combination Point=1 X2=-0.5 X3=-0.5
 S11=1374.45501513836 IsS11Max=Yes IsS11Min=No FrameElem=114 ElemStation=0.375
 Frame=114 Station=0.375 OutputCase=ACC1 CaseType=Combination Point=2 X2=-0.5 X3=0.5
 S11=1374.45501513836 IsS11Max=No IsS11Min=No FrameElem=114 ElemStation=0.375
 Frame=114 Station=0.375 OutputCase=ACC1 CaseType=Combination Point=3 X2=0.5 X3=-0.5 S11=-
 1713.53703647638 IsS11Max=No IsS11Min=Yes FrameElem=114 ElemStation=0.375
 Frame=114 Station=0.375 OutputCase=ACC1 CaseType=Combination Point=4 X2=0.5 X3=0.5 S11=-
 1713.53703647638 IsS11Max=No IsS11Min=No FrameElem=114 ElemStation=0.375
 Frame=114 Station=0.5 OutputCase=ACC1 CaseType=Combination Point=0 X2=0 X3=0 S11=-169.541010669005
 IsS11Max=No IsS11Min=No FrameElem=114 ElemStation=0.5
 Frame=114 Station=0.5 OutputCase=ACC1 CaseType=Combination Point=1 X2=-0.5 X3=-0.5
 S11=1445.50720181822 IsS11Max=Yes IsS11Min=No FrameElem=114 ElemStation=0.5
 Frame=114 Station=0.5 OutputCase=ACC1 CaseType=Combination Point=2 X2=-0.5 X3=0.5
 S11=1445.50720181822 IsS11Max=No IsS11Min=No FrameElem=114 ElemStation=0.5
 Frame=114 Station=0.5 OutputCase=ACC1 CaseType=Combination Point=3 X2=0.5 X3=-0.5 S11=-
 1784.58922315623 IsS11Max=No IsS11Min=Yes FrameElem=114 ElemStation=0.5
 Frame=114 Station=0.5 OutputCase=ACC1 CaseType=Combination Point=4 X2=0.5 X3=0.5 S11=-
 1784.58922315623 IsS11Max=No IsS11Min=No FrameElem=114 ElemStation=0.5
 Frame=114 Station=0 OutputCase=ACC2 CaseType=Combination Point=0 X2=0 X3=0 S11=-115.76524492356
 IsS11Max=No IsS11Min=No FrameElem=114 ElemStation=0
 Frame=114 Station=0 OutputCase=ACC2 CaseType=Combination Point=1 X2=-0.5 X3=-0.5
 S11=1205.3238275487 IsS11Max=Yes IsS11Min=No FrameElem=114 ElemStation=0
 Frame=114 Station=0 OutputCase=ACC2 CaseType=Combination Point=2 X2=-0.5 X3=0.5 S11=1205.3238275487
 IsS11Max=No IsS11Min=No FrameElem=114 ElemStation=0
 Frame=114 Station=0 OutputCase=ACC2 CaseType=Combination Point=3 X2=0.5 X3=-0.5 S11=-
 1436.85431739582 IsS11Max=No IsS11Min=Yes FrameElem=114 ElemStation=0
 Frame=114 Station=0 OutputCase=ACC2 CaseType=Combination Point=4 X2=0.5 X3=0.5 S11=-
 1436.85431739582 IsS11Max=No IsS11Min=No FrameElem=114 ElemStation=0
 Frame=114 Station=0.125 OutputCase=ACC2 CaseType=Combination Point=0 X2=0 X3=0 S11=-115.76524492356
 IsS11Max=No IsS11Min=No FrameElem=114 ElemStation=0.125
 Frame=114 Station=0.125 OutputCase=ACC2 CaseType=Combination Point=1 X2=-0.5 X3=-0.5
 S11=1323.74413943406 IsS11Max=Yes IsS11Min=No FrameElem=114 ElemStation=0.125
 Frame=114 Station=0.125 OutputCase=ACC2 CaseType=Combination Point=2 X2=-0.5 X3=0.5
 S11=1323.74413943406 IsS11Max=No IsS11Min=No FrameElem=114 ElemStation=0.125
 Frame=114 Station=0.125 OutputCase=ACC2 CaseType=Combination Point=3 X2=0.5 X3=-0.5 S11=-
 1555.27462928118 IsS11Max=No IsS11Min=Yes FrameElem=114 ElemStation=0.125
 Frame=114 Station=0.125 OutputCase=ACC2 CaseType=Combination Point=4 X2=0.5 X3=0.5 S11=-
 1555.27462928118 IsS11Max=No IsS11Min=No FrameElem=114 ElemStation=0.125
 Frame=114 Station=0.25 OutputCase=ACC2 CaseType=Combination Point=0 X2=0 X3=0 S11=-115.76524492356
 IsS11Max=No IsS11Min=No FrameElem=114 ElemStation=0.25
 Frame=114 Station=0.25 OutputCase=ACC2 CaseType=Combination Point=1 X2=-0.5 X3=-0.5
 S11=1426.37507631942 IsS11Max=Yes IsS11Min=No FrameElem=114 ElemStation=0.25
 Frame=114 Station=0.25 OutputCase=ACC2 CaseType=Combination Point=2 X2=-0.5 X3=0.5
 S11=1426.37507631942 IsS11Max=No IsS11Min=No FrameElem=114 ElemStation=0.25
 Frame=114 Station=0.25 OutputCase=ACC2 CaseType=Combination Point=3 X2=0.5 X3=-0.5 S11=-
 1657.90556616653 IsS11Max=No IsS11Min=Yes FrameElem=114 ElemStation=0.25
 Frame=114 Station=0.25 OutputCase=ACC2 CaseType=Combination Point=4 X2=0.5 X3=0.5 S11=-
 1657.90556616653 IsS11Max=No IsS11Min=No FrameElem=114 ElemStation=0.25
 Frame=114 Station=0.375 OutputCase=ACC2 CaseType=Combination Point=0 X2=0 X3=0 S11=-115.76524492356
 IsS11Max=No IsS11Min=No FrameElem=114 ElemStation=0.375
 Frame=114 Station=0.375 OutputCase=ACC2 CaseType=Combination Point=1 X2=-0.5 X3=-0.5
 S11=1513.21663820477 IsS11Max=Yes IsS11Min=No FrameElem=114 ElemStation=0.375
 Frame=114 Station=0.375 OutputCase=ACC2 CaseType=Combination Point=2 X2=-0.5 X3=0.5
 S11=1513.21663820477 IsS11Max=No IsS11Min=No FrameElem=114 ElemStation=0.375
 Frame=114 Station=0.375 OutputCase=ACC2 CaseType=Combination Point=3 X2=0.5 X3=-0.5 S11=-
 1744.74712805189 IsS11Max=No IsS11Min=Yes FrameElem=114 ElemStation=0.375
 Frame=114 Station=0.375 OutputCase=ACC2 CaseType=Combination Point=4 X2=0.5 X3=0.5 S11=-
 1744.74712805189 IsS11Max=No IsS11Min=No FrameElem=114 ElemStation=0.375
 Frame=114 Station=0.5 OutputCase=ACC2 CaseType=Combination Point=0 X2=0 X3=0 S11=-115.76524492356
 IsS11Max=No IsS11Min=No FrameElem=114 ElemStation=0.5
 Frame=114 Station=0.5 OutputCase=ACC2 CaseType=Combination Point=1 X2=-0.5 X3=-0.5
 S11=1584.26882509013 IsS11Max=Yes IsS11Min=No FrameElem=114 ElemStation=0.5
 Frame=114 Station=0.5 OutputCase=ACC2 CaseType=Combination Point=2 X2=-0.5 X3=0.5
 S11=1584.26882509013 IsS11Max=No IsS11Min=No FrameElem=114 ElemStation=0.5
 Frame=114 Station=0.5 OutputCase=ACC2 CaseType=Combination Point=3 X2=0.5 X3=-0.5 S11=-
 1815.79931493725 IsS11Max=No IsS11Min=Yes FrameElem=114 ElemStation=0.5
 Frame=114 Station=0.5 OutputCase=ACC2 CaseType=Combination Point=4 X2=0.5 X3=0.5 S11=-
 1815.79931493725 IsS11Max=No IsS11Min=No FrameElem=114 ElemStation=0.5
 Frame=114 Station=0 OutputCase=ACCSX1 CaseType=Combination Point=0 X2=0 X3=0 S11=-167.164023806275
 IsS11Max=No IsS11Min=No FrameElem=114 ElemStation=0
 Frame=114 Station=0 OutputCase=ACCSX1 CaseType=Combination Point=1 X2=-0.5 X3=-0.5
 S11=1034.93337632375 IsS11Max=Yes IsS11Min=No FrameElem=114 ElemStation=0
 Frame=114 Station=0 OutputCase=ACCSX1 CaseType=Combination Point=2 X2=-0.5 X3=0.5
 S11=1034.93337632375 IsS11Max=No IsS11Min=No FrameElem=114 ElemStation=0
 Frame=114 Station=0 OutputCase=ACCSX1 CaseType=Combination Point=3 X2=0.5 X3=-0.5 S11=-
 1369.2614239363 IsS11Max=No IsS11Min=Yes FrameElem=114 ElemStation=0
 Frame=114 Station=0 OutputCase=ACCSX1 CaseType=Combination Point=4 X2=0.5 X3=0.5 S11=-
 1369.2614239363 IsS11Max=No IsS11Min=No FrameElem=114 ElemStation=0
 Frame=114 Station=0.125 OutputCase=ACCSX1 CaseType=Combination Point=0 X2=0 X3=0 S11=-
 167.164023806275 IsS11Max=No IsS11Min=No FrameElem=114 ElemStation=0.125
 Frame=114 Station=0.125 OutputCase=ACCSX1 CaseType=Combination Point=1 X2=-0.5 X3=-0.5
 S11=1148.4071923222 IsS11Max=Yes IsS11Min=No FrameElem=114 ElemStation=0.125



Frame=114 Station=0.125 OutputCase=ACCSX1 CaseType=Combination Point=2 X2=-0.5 X3=0.5
 S11=1148.4071923222 IsS11Max=No IsS11Min=No FrameElem=114 ElemStation=0.125
 Frame=114 Station=0.125 OutputCase=ACCSX1 CaseType=Combination Point=3 X2=0.5 X3=-0.5 S11=-
 1482.73523993475 IsS11Max=No IsS11Min=Yes FrameElem=114 ElemStation=0.125
 Frame=114 Station=0.125 OutputCase=ACCSX1 CaseType=Combination Point=4 X2=0.5 X3=0.5 S11=-
 1482.73523993475 IsS11Max=No IsS11Min=No FrameElem=114 ElemStation=0.125
 Frame=114 Station=0.25 OutputCase=ACCSX1 CaseType=Combination Point=0 X2=0 X3=0 S11=-
 167.164023806275 IsS11Max=No IsS11Min=No FrameElem=114 ElemStation=0.25
 Frame=114 Station=0.25 OutputCase=ACCSX1 CaseType=Combination Point=1 X2=-0.5 X3=-0.5
 S11=1246.59975832065 IsS11Max=Yes IsS11Min=No FrameElem=114 ElemStation=0.25
 Frame=114 Station=0.25 OutputCase=ACCSX1 CaseType=Combination Point=2 X2=-0.5 X3=0.5
 S11=1246.59975832065 IsS11Max=No IsS11Min=No FrameElem=114 ElemStation=0.25
 Frame=114 Station=0.25 OutputCase=ACCSX1 CaseType=Combination Point=3 X2=0.5 X3=-0.5 S11=-
 1580.9278059332 IsS11Max=No IsS11Min=Yes FrameElem=114 ElemStation=0.25
 Frame=114 Station=0.25 OutputCase=ACCSX1 CaseType=Combination Point=4 X2=0.5 X3=0.5 S11=-
 1580.9278059332 IsS11Max=No IsS11Min=No FrameElem=114 ElemStation=0.25
 Frame=114 Station=0.375 OutputCase=ACCSX1 CaseType=Combination Point=0 X2=0 X3=0 S11=-
 167.164023806275 IsS11Max=No IsS11Min=No FrameElem=114 ElemStation=0.375
 Frame=114 Station=0.375 OutputCase=ACCSX1 CaseType=Combination Point=1 X2=-0.5 X3=-0.5
 S11=1329.5110743191 IsS11Max=Yes IsS11Min=No FrameElem=114 ElemStation=0.375
 Frame=114 Station=0.375 OutputCase=ACCSX1 CaseType=Combination Point=2 X2=-0.5 X3=0.5
 S11=1329.5110743191 IsS11Max=No IsS11Min=No FrameElem=114 ElemStation=0.375
 Frame=114 Station=0.375 OutputCase=ACCSX1 CaseType=Combination Point=3 X2=0.5 X3=-0.5 S11=-
 1663.83912193165 IsS11Max=No IsS11Min=Yes FrameElem=114 ElemStation=0.375
 Frame=114 Station=0.375 OutputCase=ACCSX1 CaseType=Combination Point=4 X2=0.5 X3=0.5 S11=-
 1663.83912193165 IsS11Max=No IsS11Min=No FrameElem=114 ElemStation=0.375
 Frame=114 Station=0.5 OutputCase=ACCSX1 CaseType=Combination Point=0 X2=0 X3=0 S11=-
 167.164023806275 IsS11Max=No IsS11Min=No FrameElem=114 ElemStation=0.5
 Frame=114 Station=0.5 OutputCase=ACCSX1 CaseType=Combination Point=1 X2=-0.5 X3=-0.5
 S11=1397.14114031755 IsS11Max=Yes IsS11Min=No FrameElem=114 ElemStation=0.5
 Frame=114 Station=0.5 OutputCase=ACCSX1 CaseType=Combination Point=2 X2=-0.5 X3=0.5
 S11=1397.14114031755 IsS11Max=No IsS11Min=No FrameElem=114 ElemStation=0.5
 Frame=114 Station=0.5 OutputCase=ACCSX1 CaseType=Combination Point=3 X2=0.5 X3=-0.5 S11=-
 1731.4691879301 IsS11Max=No IsS11Min=Yes FrameElem=114 ElemStation=0.5
 Frame=114 Station=0.5 OutputCase=ACCSX1 CaseType=Combination Point=4 X2=0.5 X3=0.5 S11=-
 1731.4691879301 IsS11Max=No IsS11Min=No FrameElem=114 ElemStation=0.5
 Frame=114 Station=0 OutputCase=ACCSX2 CaseType=Combination Point=0 X2=0 X3=0 S11=-113.388258060829
 IsS11Max=No IsS11Min=No FrameElem=114 ElemStation=0
 Frame=114 Station=0 OutputCase=ACCSX2 CaseType=Combination Point=1 X2=-0.5 X3=-0.5
 S11=1173.69499877363 IsS11Max=Yes IsS11Min=No FrameElem=114 ElemStation=0
 Frame=114 Station=0 OutputCase=ACCSX2 CaseType=Combination Point=2 X2=-0.5 X3=0.5
 S11=1173.69499877363 IsS11Max=No IsS11Min=No FrameElem=114 ElemStation=0
 Frame=114 Station=0 OutputCase=ACCSX2 CaseType=Combination Point=3 X2=0.5 X3=-0.5 S11=-
 1400.47151489529 IsS11Max=No IsS11Min=Yes FrameElem=114 ElemStation=0
 Frame=114 Station=0 OutputCase=ACCSX2 CaseType=Combination Point=4 X2=0.5 X3=0.5 S11=-
 1400.47151489529 IsS11Max=No IsS11Min=No FrameElem=114 ElemStation=0
 Frame=114 Station=0.125 OutputCase=ACCSX2 CaseType=Combination Point=0 X2=0 X3=0 S11=-
 113.388258060829 IsS11Max=No IsS11Min=No FrameElem=114 ElemStation=0.125
 Frame=114 Station=0.125 OutputCase=ACCSX2 CaseType=Combination Point=1 X2=-0.5 X3=-0.5
 S11=1287.16881497759 IsS11Max=Yes IsS11Min=No FrameElem=114 ElemStation=0.125
 Frame=114 Station=0.125 OutputCase=ACCSX2 CaseType=Combination Point=2 X2=-0.5 X3=0.5
 S11=1287.16881497759 IsS11Max=No IsS11Min=No FrameElem=114 ElemStation=0.125
 Frame=114 Station=0.125 OutputCase=ACCSX2 CaseType=Combination Point=3 X2=0.5 X3=-0.5 S11=-
 1513.94533109925 IsS11Max=No IsS11Min=Yes FrameElem=114 ElemStation=0.125
 Frame=114 Station=0.125 OutputCase=ACCSX2 CaseType=Combination Point=4 X2=0.5 X3=0.5 S11=-
 1513.94533109925 IsS11Max=No IsS11Min=No FrameElem=114 ElemStation=0.125
 Frame=114 Station=0.25 OutputCase=ACCSX2 CaseType=Combination Point=0 X2=0 X3=0 S11=-
 113.388258060829 IsS11Max=No IsS11Min=No FrameElem=114 ElemStation=0.25
 Frame=114 Station=0.25 OutputCase=ACCSX2 CaseType=Combination Point=1 X2=-0.5 X3=-0.5
 S11=1385.36138118155 IsS11Max=Yes IsS11Min=No FrameElem=114 ElemStation=0.25
 Frame=114 Station=0.25 OutputCase=ACCSX2 CaseType=Combination Point=2 X2=-0.5 X3=0.5
 S11=1385.36138118155 IsS11Max=No IsS11Min=No FrameElem=114 ElemStation=0.25
 Frame=114 Station=0.25 OutputCase=ACCSX2 CaseType=Combination Point=3 X2=0.5 X3=-0.5 S11=-
 1612.13789730321 IsS11Max=No IsS11Min=Yes FrameElem=114 ElemStation=0.25
 Frame=114 Station=0.25 OutputCase=ACCSX2 CaseType=Combination Point=4 X2=0.5 X3=0.5 S11=-
 1612.13789730321 IsS11Max=No IsS11Min=No FrameElem=114 ElemStation=0.25
 Frame=114 Station=0.375 OutputCase=ACCSX2 CaseType=Combination Point=0 X2=0 X3=0 S11=-
 113.388258060829 IsS11Max=No IsS11Min=No FrameElem=114 ElemStation=0.375
 Frame=114 Station=0.375 OutputCase=ACCSX2 CaseType=Combination Point=1 X2=-0.5 X3=-0.5
 S11=1468.27269738551 IsS11Max=Yes IsS11Min=No FrameElem=114 ElemStation=0.375
 Frame=114 Station=0.375 OutputCase=ACCSX2 CaseType=Combination Point=2 X2=-0.5 X3=0.5
 S11=1468.27269738551 IsS11Max=No IsS11Min=No FrameElem=114 ElemStation=0.375
 Frame=114 Station=0.375 OutputCase=ACCSX2 CaseType=Combination Point=3 X2=0.5 X3=-0.5 S11=-
 1695.04921350717 IsS11Max=No IsS11Min=Yes FrameElem=114 ElemStation=0.375
 Frame=114 Station=0.375 OutputCase=ACCSX2 CaseType=Combination Point=4 X2=0.5 X3=0.5 S11=-
 1695.04921350717 IsS11Max=No IsS11Min=No FrameElem=114 ElemStation=0.375
 Frame=114 Station=0.5 OutputCase=ACCSX2 CaseType=Combination Point=0 X2=0 X3=0 S11=-
 113.388258060829 IsS11Max=No IsS11Min=No FrameElem=114 ElemStation=0.5
 Frame=114 Station=0.5 OutputCase=ACCSX2 CaseType=Combination Point=1 X2=-0.5 X3=-0.5
 S11=1535.90276358947 IsS11Max=Yes IsS11Min=No FrameElem=114 ElemStation=0.5
 Frame=114 Station=0.5 OutputCase=ACCSX2 CaseType=Combination Point=2 X2=-0.5 X3=0.5
 S11=1535.90276358947 IsS11Max=No IsS11Min=No FrameElem=114 ElemStation=0.5

Frame=114	Station=0.5	OutputCase=ACCSX2	CaseType=Combination	Point=3	X2=0.5	X3=-0.5	S11=-	
1762.67927971113	IsS11Max=No	IsS11Min=Yes	FrameElem=114	ElemStation=0.5				
Frame=114	Station=0.5	OutputCase=ACCSX2	CaseType=Combination	Point=4	X2=0.5	X3=0.5	S11=-	
1762.67927971113	IsS11Max=No	IsS11Min=No	FrameElem=114	ElemStation=0.5				
Frame=114	Station=0	OutputCase=ENVE	CaseType=Combination	StepType=Max	Point=0	X2=0	X3=0	S11=-
111.11546006997	IsS11Max=No	IsS11Min=No	FrameElem=114	ElemStation=0				
Frame=114	Station=0	OutputCase=ENVE	CaseType=Combination	StepType=Max	Point=1	X2=-0.5	X3=-0.5	
S11=1205.3238275487	IsS11Max=Yes	IsS11Min=No	FrameElem=114	ElemStation=0				
Frame=114	Station=0	OutputCase=ENVE	CaseType=Combination	StepType=Max	Point=2	X2=-0.5	X3=0.5	
S11=1205.3238275487	IsS11Max=No	IsS11Min=No	FrameElem=114	ElemStation=0				
Frame=114	Station=0	OutputCase=ENVE	CaseType=Combination	StepType=Max	Point=3	X2=0.5	X3=-0.5	
S11=-1361.57429549957	IsS11Max=No	IsS11Min=Yes	FrameElem=114	ElemStation=0				
Frame=114	Station=0	OutputCase=ENVE	CaseType=Combination	StepType=Max	Point=4	X2=0.5	X3=0.5	S11=-
1361.57429549957	IsS11Max=No	IsS11Min=No	FrameElem=114	ElemStation=0				
Frame=114	Station=0.125	OutputCase=ENVE	CaseType=Combination	StepType=Max	Point=0	X2=0	X3=0	S11=-
111.11546006997	IsS11Max=No	IsS11Min=No	FrameElem=114	ElemStation=0.125				
Frame=114	Station=0.125	OutputCase=ENVE	CaseType=Combination	StepType=Max	Point=1	X2=-0.5	X3=-0.5	
S11=1323.74413943406	IsS11Max=Yes	IsS11Min=No	FrameElem=114	ElemStation=0.125				
Frame=114	Station=0.125	OutputCase=ENVE	CaseType=Combination	StepType=Max	Point=2	X2=-0.5	X3=0.5	
S11=1323.74413943406	IsS11Max=No	IsS11Min=No	FrameElem=114	ElemStation=0.125				
Frame=114	Station=0.125	OutputCase=ENVE	CaseType=Combination	StepType=Max	Point=3	X2=0.5	X3=-0.5	
S11=-1476.18366970211	IsS11Max=No	IsS11Min=Yes	FrameElem=114	ElemStation=0.125				
Frame=114	Station=0.125	OutputCase=ENVE	CaseType=Combination	StepType=Max	Point=4	X2=0.5	X3=0.5	
S11=-1476.18366970211	IsS11Max=No	IsS11Min=No	FrameElem=114	ElemStation=0.125				
Frame=114	Station=0.25	OutputCase=ENVE	CaseType=Combination	StepType=Max	Point=0	X2=0	X3=0	S11=-
111.11546006997	IsS11Max=No	IsS11Min=No	FrameElem=114	ElemStation=0.25				
Frame=114	Station=0.25	OutputCase=ENVE	CaseType=Combination	StepType=Max	Point=1	X2=-0.5	X3=-0.5	
S11=1426.37507631942	IsS11Max=Yes	IsS11Min=No	FrameElem=114	ElemStation=0.25				
Frame=114	Station=0.25	OutputCase=ENVE	CaseType=Combination	StepType=Max	Point=2	X2=-0.5	X3=0.5	
S11=1426.37507631942	IsS11Max=No	IsS11Min=No	FrameElem=114	ElemStation=0.25				
Frame=114	Station=0.25	OutputCase=ENVE	CaseType=Combination	StepType=Max	Point=3	X2=0.5	X3=-0.5	
S11=-1575.51179390465	IsS11Max=No	IsS11Min=Yes	FrameElem=114	ElemStation=0.25				
Frame=114	Station=0.25	OutputCase=ENVE	CaseType=Combination	StepType=Max	Point=4	X2=0.5	X3=0.5	
S11=-1575.51179390465	IsS11Max=No	IsS11Min=No	FrameElem=114	ElemStation=0.25				
Frame=114	Station=0.375	OutputCase=ENVE	CaseType=Combination	StepType=Max	Point=0	X2=0	X3=0	S11=-
111.11546006997	IsS11Max=No	IsS11Min=No	FrameElem=114	ElemStation=0.375				
Frame=114	Station=0.375	OutputCase=ENVE	CaseType=Combination	StepType=Max	Point=1	X2=-0.5	X3=-0.5	
S11=1513.21663820477	IsS11Max=Yes	IsS11Min=No	FrameElem=114	ElemStation=0.375				
Frame=114	Station=0.375	OutputCase=ENVE	CaseType=Combination	StepType=Max	Point=2	X2=-0.5	X3=0.5	
S11=1513.21663820477	IsS11Max=No	IsS11Min=No	FrameElem=114	ElemStation=0.375				
Frame=114	Station=0.375	OutputCase=ENVE	CaseType=Combination	StepType=Max	Point=3	X2=0.5	X3=-0.5	
S11=-1659.55866810719	IsS11Max=No	IsS11Min=Yes	FrameElem=114	ElemStation=0.375				
Frame=114	Station=0.375	OutputCase=ENVE	CaseType=Combination	StepType=Max	Point=4	X2=0.5	X3=0.5	
S11=-1659.55866810719	IsS11Max=No	IsS11Min=No	FrameElem=114	ElemStation=0.375				
Frame=114	Station=0.5	OutputCase=ENVE	CaseType=Combination	StepType=Max	Point=0	X2=0	X3=0	S11=-
111.11546006997	IsS11Max=No	IsS11Min=No	FrameElem=114	ElemStation=0.5				
Frame=114	Station=0.5	OutputCase=ENVE	CaseType=Combination	StepType=Max	Point=1	X2=-0.5	X3=-0.5	
S11=1584.26882509013	IsS11Max=Yes	IsS11Min=No	FrameElem=114	ElemStation=0.5				
Frame=114	Station=0.5	OutputCase=ENVE	CaseType=Combination	StepType=Max	Point=2	X2=-0.5	X3=0.5	
S11=1584.26882509013	IsS11Max=No	IsS11Min=No	FrameElem=114	ElemStation=0.5				
Frame=114	Station=0.5	OutputCase=ENVE	CaseType=Combination	StepType=Max	Point=3	X2=0.5	X3=-0.5	
S11=-1728.32429230973	IsS11Max=No	IsS11Min=Yes	FrameElem=114	ElemStation=0.5				
Frame=114	Station=0.5	OutputCase=ENVE	CaseType=Combination	StepType=Max	Point=4	X2=0.5	X3=0.5	
S11=-1728.32429230973	IsS11Max=No	IsS11Min=No	FrameElem=114	ElemStation=0.5				
Frame=114	Station=0	OutputCase=ENVE	CaseType=Combination	StepType=Min	Point=0	X2=0	X3=0	S11=-
169.541010669005	IsS11Max=No	IsS11Min=No	FrameElem=114	ElemStation=0				
Frame=114	Station=0	OutputCase=ENVE	CaseType=Combination	StepType=Min	Point=1	X2=-0.5	X3=-0.5	
S11=1031.79184386874	IsS11Max=Yes	IsS11Min=No	FrameElem=114	ElemStation=0				
Frame=114	Station=0	OutputCase=ENVE	CaseType=Combination	StepType=Min	Point=2	X2=-0.5	X3=0.5	
S11=1031.79184386874	IsS11Max=No	IsS11Min=No	FrameElem=114	ElemStation=0				
Frame=114	Station=0	OutputCase=ENVE	CaseType=Combination	StepType=Min	Point=3	X2=0.5	X3=-0.5	
S11=-1436.85431739582	IsS11Max=No	IsS11Min=Yes	FrameElem=114	ElemStation=0				
Frame=114	Station=0	OutputCase=ENVE	CaseType=Combination	StepType=Min	Point=4	X2=0.5	X3=0.5	S11=-
1436.85431739582	IsS11Max=No	IsS11Min=No	FrameElem=114	ElemStation=0				
Frame=114	Station=0.125	OutputCase=ENVE	CaseType=Combination	StepType=Min	Point=0	X2=0	X3=0	S11=-
169.541010669005	IsS11Max=No	IsS11Min=No	FrameElem=114	ElemStation=0.125				
Frame=114	Station=0.125	OutputCase=ENVE	CaseType=Combination	StepType=Min	Point=1	X2=-0.5	X3=-0.5	
S11=1146.40121807128	IsS11Max=Yes	IsS11Min=No	FrameElem=114	ElemStation=0.125				
Frame=114	Station=0.125	OutputCase=ENVE	CaseType=Combination	StepType=Min	Point=2	X2=-0.5	X3=0.5	
S11=1146.40121807128	IsS11Max=No	IsS11Min=No	FrameElem=114	ElemStation=0.125				
Frame=114	Station=0.125	OutputCase=ENVE	CaseType=Combination	StepType=Min	Point=3	X2=0.5	X3=-0.5	
S11=-1555.27462928118	IsS11Max=No	IsS11Min=Yes	FrameElem=114	ElemStation=0.125				
Frame=114	Station=0.125	OutputCase=ENVE	CaseType=Combination	StepType=Min	Point=4	X2=0.5	X3=0.5	
S11=-1555.27462928118	IsS11Max=No	IsS11Min=No	FrameElem=114	ElemStation=0.125				
Frame=114	Station=0.25	OutputCase=ENVE	CaseType=Combination	StepType=Min	Point=0	X2=0	X3=0	S11=-
169.541010669005	IsS11Max=No	IsS11Min=No	FrameElem=114	ElemStation=0.25				
Frame=114	Station=0.25	OutputCase=ENVE	CaseType=Combination	StepType=Min	Point=1	X2=-0.5	X3=-0.5	
S11=1245.72934227382	IsS11Max=Yes	IsS11Min=No	FrameElem=114	ElemStation=0.25				
Frame=114	Station=0.25	OutputCase=ENVE	CaseType=Combination	StepType=Min	Point=2	X2=-0.5	X3=0.5	
S11=1245.72934227382	IsS11Max=No	IsS11Min=No	FrameElem=114	ElemStation=0.25				
Frame=114	Station=0.25	OutputCase=ENVE	CaseType=Combination	StepType=Min	Point=3	X2=0.5	X3=-0.5	
S11=-1657.90556616653	IsS11Max=No	IsS11Min=Yes	FrameElem=114	ElemStation=0.25				

Frame=114	Station=0.25	OutputCase=ENVE	CaseType=Combination	StepType=Min	Point=4	X2=0.5	X3=0.5	
S11=-1657.90556616653	IsS11Max=No	IsS11Min=No	FrameElem=114	ElemStation=0.25				
Frame=114	Station=0.375	OutputCase=ENVE	CaseType=Combination	StepType=Min	Point=0	X2=0	X3=0	S11=-
169.541010669005	IsS11Max=No	IsS11Min=No	FrameElem=114	ElemStation=0.375				
Frame=114	Station=0.375	OutputCase=ENVE	CaseType=Combination	StepType=Min	Point=1	X2=-0.5	X3=-0.5	
S11=1329.5110743191	IsS11Max=Yes	IsS11Min=No	FrameElem=114	ElemStation=0.375				
Frame=114	Station=0.375	OutputCase=ENVE	CaseType=Combination	StepType=Min	Point=2	X2=-0.5	X3=0.5	
S11=1329.5110743191	IsS11Max=No	IsS11Min=No	FrameElem=114	ElemStation=0.375				
Frame=114	Station=0.375	OutputCase=ENVE	CaseType=Combination	StepType=Min	Point=3	X2=0.5	X3=-0.5	
S11=-1744.74712805189	IsS11Max=No	IsS11Min=Yes	FrameElem=114	ElemStation=0.375				
Frame=114	Station=0.375	OutputCase=ENVE	CaseType=Combination	StepType=Min	Point=4	X2=0.5	X3=0.5	
S11=-1744.74712805189	IsS11Max=No	IsS11Min=No	FrameElem=114	ElemStation=0.375				
Frame=114	Station=0.5	OutputCase=ENVE	CaseType=Combination	StepType=Min	Point=0	X2=0	X3=0	S11=-
169.541010669005	IsS11Max=No	IsS11Min=No	FrameElem=114	ElemStation=0.5				
Frame=114	Station=0.5	OutputCase=ENVE	CaseType=Combination	StepType=Min	Point=1	X2=-0.5	X3=-0.5	
S11=1397.14114031755	IsS11Max=Yes	IsS11Min=No	FrameElem=114	ElemStation=0.5				
Frame=114	Station=0.5	OutputCase=ENVE	CaseType=Combination	StepType=Min	Point=2	X2=-0.5	X3=0.5	
S11=1397.14114031755	IsS11Max=No	IsS11Min=No	FrameElem=114	ElemStation=0.5				
Frame=114	Station=0.5	OutputCase=ENVE	CaseType=Combination	StepType=Min	Point=3	X2=0.5	X3=-0.5	
S11=-1815.79931493725	IsS11Max=No	IsS11Min=Yes	FrameElem=114	ElemStation=0.5				
Frame=114	Station=0.5	OutputCase=ENVE	CaseType=Combination	StepType=Min	Point=4	X2=0.5	X3=0.5	
S11=-1815.79931493725	IsS11Max=No	IsS11Min=No	FrameElem=114	ElemStation=0.5				
Frame=114	Station=0	OutputCase=FESSUR	CaseType=Combination	Point=0	X2=0	X3=0	S11=-168.146075212928	
IsS11Max=No	IsS11Min=No	FrameElem=114	ElemStation=0					
Frame=114	Station=0	OutputCase=FESSUR	CaseType=Combination	Point=1	X2=-0.5	X3=-0.5		
S11=1056.13109672979	IsS11Max=Yes	IsS11Min=No	FrameElem=114	ElemStation=0				
Frame=114	Station=0	OutputCase=FESSUR	CaseType=Combination	Point=2	X2=-0.5	X3=0.5		
S11=1056.13109672979	IsS11Max=No	IsS11Min=No	FrameElem=114	ElemStation=0				
Frame=114	Station=0	OutputCase=FESSUR	CaseType=Combination	Point=3	X2=0.5	X3=-0.5	S11=-	
1392.42324715564	IsS11Max=No	IsS11Min=Yes	FrameElem=114	ElemStation=0				
Frame=114	Station=0	OutputCase=FESSUR	CaseType=Combination	Point=4	X2=0.5	X3=0.5	S11=-	
1392.42324715564	IsS11Max=No	IsS11Min=No	FrameElem=114	ElemStation=0				
Frame=114	Station=0.125	OutputCase=FESSUR	CaseType=Combination	Point=0	X2=0	X3=0	S11=-	
168.146075212928	IsS11Max=No	IsS11Min=No	FrameElem=114	ElemStation=0.125				
Frame=114	Station=0.125	OutputCase=FESSUR	CaseType=Combination	Point=1	X2=-0.5	X3=-0.5		
S11=1173.40812716645	IsS11Max=Yes	IsS11Min=No	FrameElem=114	ElemStation=0.125				
Frame=114	Station=0.125	OutputCase=FESSUR	CaseType=Combination	Point=2	X2=-0.5	X3=0.5		
S11=1173.40812716645	IsS11Max=No	IsS11Min=No	FrameElem=114	ElemStation=0.125				
Frame=114	Station=0.125	OutputCase=FESSUR	CaseType=Combination	Point=3	X2=0.5	X3=-0.5	S11=-	
1509.7002775923	IsS11Max=No	IsS11Min=Yes	FrameElem=114	ElemStation=0.125				
Frame=114	Station=0.125	OutputCase=FESSUR	CaseType=Combination	Point=4	X2=0.5	X3=0.5	S11=-	
1509.7002775923	IsS11Max=No	IsS11Min=No	FrameElem=114	ElemStation=0.125				
Frame=114	Station=0.25	OutputCase=FESSUR	CaseType=Combination	Point=0	X2=0	X3=0	S11=-	
168.146075212928	IsS11Max=No	IsS11Min=No	FrameElem=114	ElemStation=0.25				
Frame=114	Station=0.25	OutputCase=FESSUR	CaseType=Combination	Point=1	X2=-0.5	X3=-0.5		
S11=1275.0482201031	IsS11Max=Yes	IsS11Min=No	FrameElem=114	ElemStation=0.25				
Frame=114	Station=0.25	OutputCase=FESSUR	CaseType=Combination	Point=2	X2=-0.5	X3=0.5		
S11=1275.0482201031	IsS11Max=No	IsS11Min=No	FrameElem=114	ElemStation=0.25				
Frame=114	Station=0.25	OutputCase=FESSUR	CaseType=Combination	Point=3	X2=0.5	X3=-0.5	S11=-	
1611.34037052896	IsS11Max=No	IsS11Min=Yes	FrameElem=114	ElemStation=0.25				
Frame=114	Station=0.25	OutputCase=FESSUR	CaseType=Combination	Point=4	X2=0.5	X3=0.5	S11=-	
1611.34037052896	IsS11Max=No	IsS11Min=No	FrameElem=114	ElemStation=0.25				
Frame=114	Station=0.375	OutputCase=FESSUR	CaseType=Combination	Point=0	X2=0	X3=0	S11=-	
168.146075212928	IsS11Max=No	IsS11Min=No	FrameElem=114	ElemStation=0.375				
Frame=114	Station=0.375	OutputCase=FESSUR	CaseType=Combination	Point=1	X2=-0.5	X3=-0.5		
S11=1361.05137553976	IsS11Max=Yes	IsS11Min=No	FrameElem=114	ElemStation=0.375				
Frame=114	Station=0.375	OutputCase=FESSUR	CaseType=Combination	Point=2	X2=-0.5	X3=0.5		
S11=1361.05137553976	IsS11Max=No	IsS11Min=No	FrameElem=114	ElemStation=0.375				
Frame=114	Station=0.375	OutputCase=FESSUR	CaseType=Combination	Point=3	X2=0.5	X3=-0.5	S11=-	
1697.34352596562	IsS11Max=No	IsS11Min=Yes	FrameElem=114	ElemStation=0.375				
Frame=114	Station=0.375	OutputCase=FESSUR	CaseType=Combination	Point=4	X2=0.5	X3=0.5	S11=-	
1697.34352596562	IsS11Max=No	IsS11Min=No	FrameElem=114	ElemStation=0.375				
Frame=114	Station=0.5	OutputCase=FESSUR	CaseType=Combination	Point=0	X2=0	X3=0	S11=-	
168.146075212928	IsS11Max=No	IsS11Min=No	FrameElem=114	ElemStation=0.5				
Frame=114	Station=0.5	OutputCase=FESSUR	CaseType=Combination	Point=1	X2=-0.5	X3=-0.5		
S11=1431.41759347642	IsS11Max=Yes	IsS11Min=No	FrameElem=114	ElemStation=0.5				
Frame=114	Station=0.5	OutputCase=FESSUR	CaseType=Combination	Point=2	X2=-0.5	X3=0.5		
S11=1431.41759347642	IsS11Max=No	IsS11Min=No	FrameElem=114	ElemStation=0.5				
Frame=114	Station=0.5	OutputCase=FESSUR	CaseType=Combination	Point=3	X2=0.5	X3=-0.5	S11=-	
1767.70974390228	IsS11Max=No	IsS11Min=Yes	FrameElem=114	ElemStation=0.5				
Frame=114	Station=0.5	OutputCase=FESSUR	CaseType=Combination	Point=4	X2=0.5	X3=0.5	S11=-	
1767.70974390228	IsS11Max=No	IsS11Min=No	FrameElem=114	ElemStation=0.5				
Frame=115	Station=0	OutputCase=PERM1	CaseType=Combination	Point=0	X2=0	X3=0	S11=-164.891225815415	
IsS11Max=No	IsS11Min=No	FrameElem=115	ElemStation=0					
Frame=115	Station=0	OutputCase=PERM1	CaseType=Combination	Point=1	X2=-0.5	X3=-0.5		
S11=1398.54184067894	IsS11Max=Yes	IsS11Min=No	FrameElem=115	ElemStation=0				
Frame=115	Station=0	OutputCase=PERM1	CaseType=Combination	Point=2	X2=-0.5	X3=0.5		
S11=1398.54184067894	IsS11Max=No	IsS11Min=No	FrameElem=115	ElemStation=0				
Frame=115	Station=0	OutputCase=PERM1	CaseType=Combination	Point=3	X2=0.5	X3=-0.5	S11=-	
1728.32429230977	IsS11Max=No	IsS11Min=Yes	FrameElem=115	ElemStation=0				
Frame=115	Station=0	OutputCase=PERM1	CaseType=Combination	Point=4	X2=0.5	X3=0.5	S11=-	
1728.32429230977	IsS11Max=No	IsS11Min=No	FrameElem=115	ElemStation=0				

Frame=115	Station=0.125	OutputCase=PERM1	CaseType=Combination	Point=0	X2=0	X3=0	S11=-
164.891225815415	IsS11Max=No	IsS11Min=No	FrameElem=115	ElemStation=0.125			
Frame=115	Station=0.125	OutputCase=PERM1	CaseType=Combination	Point=1	X2=-0.5	X3=-0.5	
S11=1452.02621488152	IsS11Max=Yes	IsS11Min=No	FrameElem=115	ElemStation=0.125			
Frame=115	Station=0.125	OutputCase=PERM1	CaseType=Combination	Point=2	X2=-0.5	X3=0.5	
S11=1452.02621488152	IsS11Max=No	IsS11Min=No	FrameElem=115	ElemStation=0.125			
Frame=115	Station=0.125	OutputCase=PERM1	CaseType=Combination	Point=3	X2=0.5	X3=-0.5	S11=-
1781.80866651235	IsS11Max=No	IsS11Min=Yes	FrameElem=115	ElemStation=0.125			
Frame=115	Station=0.125	OutputCase=PERM1	CaseType=Combination	Point=4	X2=0.5	X3=0.5	S11=-
1781.80866651235	IsS11Max=No	IsS11Min=No	FrameElem=115	ElemStation=0.125			
Frame=115	Station=0.25	OutputCase=PERM1	CaseType=Combination	Point=0	X2=0	X3=0	S11=-
164.891225815415	IsS11Max=No	IsS11Min=No	FrameElem=115	ElemStation=0.25			
Frame=115	Station=0.25	OutputCase=PERM1	CaseType=Combination	Point=1	X2=-0.5	X3=-0.5	
S11=1490.22933908411	IsS11Max=Yes	IsS11Min=No	FrameElem=115	ElemStation=0.25			
Frame=115	Station=0.25	OutputCase=PERM1	CaseType=Combination	Point=2	X2=-0.5	X3=0.5	
S11=1490.22933908411	IsS11Max=No	IsS11Min=No	FrameElem=115	ElemStation=0.25			
Frame=115	Station=0.25	OutputCase=PERM1	CaseType=Combination	Point=3	X2=0.5	X3=-0.5	S11=-
1820.01179071494	IsS11Max=No	IsS11Min=Yes	FrameElem=115	ElemStation=0.25			
Frame=115	Station=0.25	OutputCase=PERM1	CaseType=Combination	Point=4	X2=0.5	X3=0.5	S11=-
1820.01179071494	IsS11Max=No	IsS11Min=No	FrameElem=115	ElemStation=0.25			
Frame=115	Station=0.375	OutputCase=PERM1	CaseType=Combination	Point=0	X2=0	X3=0	S11=-
164.891225815415	IsS11Max=No	IsS11Min=No	FrameElem=115	ElemStation=0.375			
Frame=115	Station=0.375	OutputCase=PERM1	CaseType=Combination	Point=1	X2=-0.5	X3=-0.5	
S11=1513.15121328669	IsS11Max=Yes	IsS11Min=No	FrameElem=115	ElemStation=0.375			
Frame=115	Station=0.375	OutputCase=PERM1	CaseType=Combination	Point=2	X2=-0.5	X3=0.5	
S11=1513.15121328669	IsS11Max=No	IsS11Min=No	FrameElem=115	ElemStation=0.375			
Frame=115	Station=0.375	OutputCase=PERM1	CaseType=Combination	Point=3	X2=0.5	X3=-0.5	S11=-
1842.93366491752	IsS11Max=No	IsS11Min=Yes	FrameElem=115	ElemStation=0.375			
Frame=115	Station=0.375	OutputCase=PERM1	CaseType=Combination	Point=4	X2=0.5	X3=0.5	S11=-
1842.93366491752	IsS11Max=No	IsS11Min=No	FrameElem=115	ElemStation=0.375			
Frame=115	Station=0.5	OutputCase=PERM1	CaseType=Combination	Point=0	X2=0	X3=0	S11=-164.891225815415
IsS11Max=No	IsS11Min=No	FrameElem=115	ElemStation=0.5				
Frame=115	Station=0.5	OutputCase=PERM1	CaseType=Combination	Point=1	X2=-0.5	X3=-0.5	
S11=1520.79183748927	IsS11Max=Yes	IsS11Min=No	FrameElem=115	ElemStation=0.5			
Frame=115	Station=0.5	OutputCase=PERM1	CaseType=Combination	Point=2	X2=-0.5	X3=0.5	
S11=1520.79183748927	IsS11Max=No	IsS11Min=No	FrameElem=115	ElemStation=0.5			
Frame=115	Station=0.5	OutputCase=PERM1	CaseType=Combination	Point=3	X2=0.5	X3=-0.5	S11=-
1850.57428912011	IsS11Max=No	IsS11Min=Yes	FrameElem=115	ElemStation=0.5			
Frame=115	Station=0.5	OutputCase=PERM1	CaseType=Combination	Point=4	X2=0.5	X3=0.5	S11=-
1850.57428912011	IsS11Max=No	IsS11Min=No	FrameElem=115	ElemStation=0.5			
Frame=115	Station=0	OutputCase=PERM2	CaseType=Combination	Point=0	X2=0	X3=0	S11=-111.11546006997
IsS11Max=No	IsS11Min=No	FrameElem=115	ElemStation=0				
Frame=115	Station=0	OutputCase=PERM2	CaseType=Combination	Point=1	X2=-0.5	X3=-0.5	
S11=1537.30346395086	IsS11Max=Yes	IsS11Min=No	FrameElem=115	ElemStation=0			
Frame=115	Station=0	OutputCase=PERM2	CaseType=Combination	Point=2	X2=-0.5	X3=0.5	
S11=1537.30346395086	IsS11Max=No	IsS11Min=No	FrameElem=115	ElemStation=0			
Frame=115	Station=0	OutputCase=PERM2	CaseType=Combination	Point=3	X2=0.5	X3=-0.5	S11=-
1759.5343840908	IsS11Max=No	IsS11Min=Yes	FrameElem=115	ElemStation=0			
Frame=115	Station=0	OutputCase=PERM2	CaseType=Combination	Point=4	X2=0.5	X3=0.5	S11=-
1759.5343840908	IsS11Max=No	IsS11Min=No	FrameElem=115	ElemStation=0			
Frame=115	Station=0.125	OutputCase=PERM2	CaseType=Combination	Point=0	X2=0	X3=0	S11=-
111.11546006997	IsS11Max=No	IsS11Min=No	FrameElem=115	ElemStation=0.125			
Frame=115	Station=0.125	OutputCase=PERM2	CaseType=Combination	Point=1	X2=-0.5	X3=-0.5	
S11=1590.78783835895	IsS11Max=Yes	IsS11Min=No	FrameElem=115	ElemStation=0.125			
Frame=115	Station=0.125	OutputCase=PERM2	CaseType=Combination	Point=2	X2=-0.5	X3=0.5	
S11=1590.78783835895	IsS11Max=No	IsS11Min=No	FrameElem=115	ElemStation=0.125			
Frame=115	Station=0.125	OutputCase=PERM2	CaseType=Combination	Point=3	X2=0.5	X3=-0.5	S11=-
1813.01875849889	IsS11Max=No	IsS11Min=Yes	FrameElem=115	ElemStation=0.125			
Frame=115	Station=0.125	OutputCase=PERM2	CaseType=Combination	Point=4	X2=0.5	X3=0.5	S11=-
1813.01875849889	IsS11Max=No	IsS11Min=No	FrameElem=115	ElemStation=0.125			
Frame=115	Station=0.25	OutputCase=PERM2	CaseType=Combination	Point=0	X2=0	X3=0	S11=-111.11546006997
IsS11Max=No	IsS11Min=No	FrameElem=115	ElemStation=0.25				
Frame=115	Station=0.25	OutputCase=PERM2	CaseType=Combination	Point=1	X2=-0.5	X3=-0.5	
S11=1628.99096276704	IsS11Max=Yes	IsS11Min=No	FrameElem=115	ElemStation=0.25			
Frame=115	Station=0.25	OutputCase=PERM2	CaseType=Combination	Point=2	X2=-0.5	X3=0.5	
S11=1628.99096276704	IsS11Max=No	IsS11Min=No	FrameElem=115	ElemStation=0.25			
Frame=115	Station=0.25	OutputCase=PERM2	CaseType=Combination	Point=3	X2=0.5	X3=-0.5	S11=-
1851.22188290698	IsS11Max=No	IsS11Min=Yes	FrameElem=115	ElemStation=0.25			
Frame=115	Station=0.25	OutputCase=PERM2	CaseType=Combination	Point=4	X2=0.5	X3=0.5	S11=-
1851.22188290698	IsS11Max=No	IsS11Min=No	FrameElem=115	ElemStation=0.25			
Frame=115	Station=0.375	OutputCase=PERM2	CaseType=Combination	Point=0	X2=0	X3=0	S11=-
111.11546006997	IsS11Max=No	IsS11Min=No	FrameElem=115	ElemStation=0.375			
Frame=115	Station=0.375	OutputCase=PERM2	CaseType=Combination	Point=1	X2=-0.5	X3=-0.5	
S11=1651.91283717513	IsS11Max=Yes	IsS11Min=No	FrameElem=115	ElemStation=0.375			
Frame=115	Station=0.375	OutputCase=PERM2	CaseType=Combination	Point=2	X2=-0.5	X3=0.5	
S11=1651.91283717513	IsS11Max=No	IsS11Min=No	FrameElem=115	ElemStation=0.375			
Frame=115	Station=0.375	OutputCase=PERM2	CaseType=Combination	Point=3	X2=0.5	X3=-0.5	S11=-
1874.14375731507	IsS11Max=No	IsS11Min=Yes	FrameElem=115	ElemStation=0.375			
Frame=115	Station=0.375	OutputCase=PERM2	CaseType=Combination	Point=4	X2=0.5	X3=0.5	S11=-
1874.14375731507	IsS11Max=No	IsS11Min=No	FrameElem=115	ElemStation=0.375			
Frame=115	Station=0.5	OutputCase=PERM2	CaseType=Combination	Point=0	X2=0	X3=0	S11=-111.11546006997
IsS11Max=No	IsS11Min=No	FrameElem=115	ElemStation=0.5				

Frame=115 Station=0.5 OutputCase=PERM2 CaseType=Combination Point=1 X2=-0.5 X3=-0.5
 S11=1659.55346158322 IsS11Max=Yes IsS11Min=No FrameElem=115 ElemStation=0.5
 Frame=115 Station=0.5 OutputCase=PERM2 CaseType=Combination Point=2 X2=-0.5 X3=0.5
 S11=1659.55346158322 IsS11Max=No IsS11Min=No FrameElem=115 ElemStation=0.5
 Frame=115 Station=0.5 OutputCase=PERM2 CaseType=Combination Point=3 X2=0.5 X3=-0.5 S11=-
 1881.78438172316 IsS11Max=No IsS11Min=Yes FrameElem=115 ElemStation=0.5
 Frame=115 Station=0.5 OutputCase=PERM2 CaseType=Combination Point=4 X2=0.5 X3=0.5 S11=-
 1881.78438172316 IsS11Max=No IsS11Min=No FrameElem=115 ElemStation=0.5
 Frame=115 Station=0 OutputCase=ACC1 CaseType=Combination Point=0 X2=0 X3=0 S11=-169.541010668994
 IsS11Max=No IsS11Min=No FrameElem=115 ElemStation=0
 Frame=115 Station=0 OutputCase=ACC1 CaseType=Combination Point=1 X2=-0.5 X3=-0.5
 S11=1445.50720181827 IsS11Max=Yes IsS11Min=No FrameElem=115 ElemStation=0
 Frame=115 Station=0 OutputCase=ACC1 CaseType=Combination Point=2 X2=-0.5 X3=0.5
 S11=1445.50720181827 IsS11Max=No IsS11Min=No FrameElem=115 ElemStation=0
 Frame=115 Station=0 OutputCase=ACC1 CaseType=Combination Point=3 X2=0.5 X3=-0.5 S11=-
 1784.58922315626 IsS11Max=No IsS11Min=Yes FrameElem=115 ElemStation=0
 Frame=115 Station=0 OutputCase=ACC1 CaseType=Combination Point=4 X2=0.5 X3=0.5 S11=-
 1784.58922315626 IsS11Max=No IsS11Min=No FrameElem=115 ElemStation=0
 Frame=115 Station=0.125 OutputCase=ACC1 CaseType=Combination Point=0 X2=0 X3=0 S11=-
 169.541010668994 IsS11Max=No IsS11Min=No FrameElem=115 ElemStation=0.125
 Frame=115 Station=0.125 OutputCase=ACC1 CaseType=Combination Point=1 X2=-0.5 X3=-0.5
 S11=1500.77001349817 IsS11Max=Yes IsS11Min=No FrameElem=115 ElemStation=0.125
 Frame=115 Station=0.125 OutputCase=ACC1 CaseType=Combination Point=2 X2=-0.5 X3=0.5
 S11=1500.77001349817 IsS11Max=No IsS11Min=No FrameElem=115 ElemStation=0.125
 Frame=115 Station=0.125 OutputCase=ACC1 CaseType=Combination Point=3 X2=0.5 X3=-0.5 S11=-
 1839.85203483615 IsS11Max=No IsS11Min=Yes FrameElem=115 ElemStation=0.125
 Frame=115 Station=0.125 OutputCase=ACC1 CaseType=Combination Point=4 X2=0.5 X3=0.5 S11=-
 1839.85203483615 IsS11Max=No IsS11Min=No FrameElem=115 ElemStation=0.125
 Frame=115 Station=0.25 OutputCase=ACC1 CaseType=Combination Point=0 X2=0 X3=0 S11=-169.541010668994
 IsS11Max=No IsS11Min=No FrameElem=115 ElemStation=0.25
 Frame=115 Station=0.25 OutputCase=ACC1 CaseType=Combination Point=1 X2=-0.5 X3=-0.5
 S11=1540.24345017806 IsS11Max=Yes IsS11Min=No FrameElem=115 ElemStation=0.25
 Frame=115 Station=0.25 OutputCase=ACC1 CaseType=Combination Point=2 X2=-0.5 X3=0.5
 S11=1540.24345017806 IsS11Max=No IsS11Min=No FrameElem=115 ElemStation=0.25
 Frame=115 Station=0.25 OutputCase=ACC1 CaseType=Combination Point=3 X2=0.5 X3=-0.5 S11=-
 1879.32547151605 IsS11Max=No IsS11Min=Yes FrameElem=115 ElemStation=0.25
 Frame=115 Station=0.25 OutputCase=ACC1 CaseType=Combination Point=4 X2=0.5 X3=0.5 S11=-
 1879.32547151605 IsS11Max=No IsS11Min=No FrameElem=115 ElemStation=0.25
 Frame=115 Station=0.375 OutputCase=ACC1 CaseType=Combination Point=0 X2=0 X3=0 S11=-
 169.541010668994 IsS11Max=No IsS11Min=No FrameElem=115 ElemStation=0.375
 Frame=115 Station=0.375 OutputCase=ACC1 CaseType=Combination Point=1 X2=-0.5 X3=-0.5
 S11=1563.92751185796 IsS11Max=Yes IsS11Min=No FrameElem=115 ElemStation=0.375
 Frame=115 Station=0.375 OutputCase=ACC1 CaseType=Combination Point=2 X2=-0.5 X3=0.5
 S11=1563.92751185796 IsS11Max=No IsS11Min=No FrameElem=115 ElemStation=0.375
 Frame=115 Station=0.375 OutputCase=ACC1 CaseType=Combination Point=3 X2=0.5 X3=-0.5 S11=-
 1903.00953319595 IsS11Max=No IsS11Min=Yes FrameElem=115 ElemStation=0.375
 Frame=115 Station=0.375 OutputCase=ACC1 CaseType=Combination Point=4 X2=0.5 X3=0.5 S11=-
 1903.00953319595 IsS11Max=No IsS11Min=No FrameElem=115 ElemStation=0.375
 Frame=115 Station=0.5 OutputCase=ACC1 CaseType=Combination Point=0 X2=0 X3=0 S11=-169.541010668994
 IsS11Max=No IsS11Min=No FrameElem=115 ElemStation=0.5
 Frame=115 Station=0.5 OutputCase=ACC1 CaseType=Combination Point=1 X2=-0.5 X3=-0.5
 S11=1571.82219853786 IsS11Max=Yes IsS11Min=No FrameElem=115 ElemStation=0.5
 Frame=115 Station=0.5 OutputCase=ACC1 CaseType=Combination Point=2 X2=-0.5 X3=0.5
 S11=1571.82219853786 IsS11Max=No IsS11Min=No FrameElem=115 ElemStation=0.5
 Frame=115 Station=0.5 OutputCase=ACC1 CaseType=Combination Point=3 X2=0.5 X3=-0.5 S11=-
 1910.90421987585 IsS11Max=No IsS11Min=Yes FrameElem=115 ElemStation=0.5
 Frame=115 Station=0.5 OutputCase=ACC1 CaseType=Combination Point=4 X2=0.5 X3=0.5 S11=-
 1910.90421987585 IsS11Max=No IsS11Min=No FrameElem=115 ElemStation=0.5
 Frame=115 Station=0 OutputCase=ACC2 CaseType=Combination Point=0 X2=0 X3=0 S11=-115.765244923549
 IsS11Max=No IsS11Min=No FrameElem=115 ElemStation=0
 Frame=115 Station=0 OutputCase=ACC2 CaseType=Combination Point=1 X2=-0.5 X3=-0.5
 S11=1584.26882509019 IsS11Max=Yes IsS11Min=No FrameElem=115 ElemStation=0
 Frame=115 Station=0 OutputCase=ACC2 CaseType=Combination Point=2 X2=-0.5 X3=0.5
 S11=1584.26882509019 IsS11Max=No IsS11Min=No FrameElem=115 ElemStation=0
 Frame=115 Station=0 OutputCase=ACC2 CaseType=Combination Point=3 X2=0.5 X3=-0.5 S11=-
 1815.79931493729 IsS11Max=No IsS11Min=Yes FrameElem=115 ElemStation=0
 Frame=115 Station=0 OutputCase=ACC2 CaseType=Combination Point=4 X2=0.5 X3=0.5 S11=-
 1815.79931493729 IsS11Max=No IsS11Min=No FrameElem=115 ElemStation=0
 Frame=115 Station=0.125 OutputCase=ACC2 CaseType=Combination Point=0 X2=0 X3=0 S11=-
 115.765244923549 IsS11Max=No IsS11Min=No FrameElem=115 ElemStation=0.125
 Frame=115 Station=0.125 OutputCase=ACC2 CaseType=Combination Point=1 X2=-0.5 X3=-0.5
 S11=1639.53163697559 IsS11Max=Yes IsS11Min=No FrameElem=115 ElemStation=0.125
 Frame=115 Station=0.125 OutputCase=ACC2 CaseType=Combination Point=2 X2=-0.5 X3=0.5
 S11=1639.53163697559 IsS11Max=No IsS11Min=No FrameElem=115 ElemStation=0.125
 Frame=115 Station=0.125 OutputCase=ACC2 CaseType=Combination Point=3 X2=0.5 X3=-0.5 S11=-
 1871.06212682269 IsS11Max=No IsS11Min=Yes FrameElem=115 ElemStation=0.125
 Frame=115 Station=0.125 OutputCase=ACC2 CaseType=Combination Point=4 X2=0.5 X3=0.5 S11=-
 1871.06212682269 IsS11Max=No IsS11Min=No FrameElem=115 ElemStation=0.125
 Frame=115 Station=0.25 OutputCase=ACC2 CaseType=Combination Point=0 X2=0 X3=0 S11=-115.765244923549
 IsS11Max=No IsS11Min=No FrameElem=115 ElemStation=0.25
 Frame=115 Station=0.25 OutputCase=ACC2 CaseType=Combination Point=1 X2=-0.5 X3=-0.5
 S11=1679.005073861 IsS11Max=Yes IsS11Min=No FrameElem=115 ElemStation=0.25



Frame=115	Station=0.25	OutputCase=ACC2	CaseType=Combination	Point=2	X2=-0.5	X3=0.5	
S11=1679.005073861	IsS11Max=No	IsS11Min=No	FrameElem=115	ElemStation=0.25			
Frame=115	Station=0.25	OutputCase=ACC2	CaseType=Combination	Point=3	X2=0.5	X3=-0.5	S11=-
1910.53556370809	IsS11Max=No	IsS11Min=Yes	FrameElem=115	ElemStation=0.25			
Frame=115	Station=0.25	OutputCase=ACC2	CaseType=Combination	Point=4	X2=0.5	X3=0.5	S11=-
1910.53556370809	IsS11Max=No	IsS11Min=No	FrameElem=115	ElemStation=0.25			
Frame=115	Station=0.375	OutputCase=ACC2	CaseType=Combination	Point=0	X2=0	X3=0	S11=-
115.765244923549	IsS11Max=No	IsS11Min=No	FrameElem=115	ElemStation=0.375			
Frame=115	Station=0.375	OutputCase=ACC2	CaseType=Combination	Point=1	X2=-0.5	X3=-0.5	
S11=1702.6891357464	IsS11Max=Yes	IsS11Min=No	FrameElem=115	ElemStation=0.375			
Frame=115	Station=0.375	OutputCase=ACC2	CaseType=Combination	Point=2	X2=-0.5	X3=0.5	
S11=1702.6891357464	IsS11Max=No	IsS11Min=No	FrameElem=115	ElemStation=0.375			
Frame=115	Station=0.375	OutputCase=ACC2	CaseType=Combination	Point=3	X2=0.5	X3=-0.5	S11=-
1934.2196255935	IsS11Max=No	IsS11Min=Yes	FrameElem=115	ElemStation=0.375			
Frame=115	Station=0.375	OutputCase=ACC2	CaseType=Combination	Point=4	X2=0.5	X3=0.5	S11=-
1934.2196255935	IsS11Max=No	IsS11Min=No	FrameElem=115	ElemStation=0.375			
Frame=115	Station=0.5	OutputCase=ACC2	CaseType=Combination	Point=0	X2=0	X3=0	S11=-115.765244923549
IsS11Max=No	IsS11Min=No	FrameElem=115	ElemStation=0.5				
Frame=115	Station=0.5	OutputCase=ACC2	CaseType=Combination	Point=1	X2=-0.5	X3=-0.5	
S11=1710.5838226318	IsS11Max=Yes	IsS11Min=No	FrameElem=115	ElemStation=0.5			
Frame=115	Station=0.5	OutputCase=ACC2	CaseType=Combination	Point=2	X2=-0.5	X3=0.5	
S11=1710.5838226318	IsS11Max=No	IsS11Min=No	FrameElem=115	ElemStation=0.5			
Frame=115	Station=0.5	OutputCase=ACC2	CaseType=Combination	Point=3	X2=0.5	X3=-0.5	S11=-
1942.1143124789	IsS11Max=No	IsS11Min=Yes	FrameElem=115	ElemStation=0.5			
Frame=115	Station=0.5	OutputCase=ACC2	CaseType=Combination	Point=4	X2=0.5	X3=0.5	S11=-
1942.1143124789	IsS11Max=No	IsS11Min=No	FrameElem=115	ElemStation=0.5			
Frame=115	Station=0	OutputCase=ACCSX1	CaseType=Combination	Point=0	X2=0	X3=0	S11=-167.164023806267
IsS11Max=No	IsS11Min=No	FrameElem=115	ElemStation=0				
Frame=115	Station=0	OutputCase=ACCSX1	CaseType=Combination	Point=1	X2=-0.5	X3=-0.5	
S11=1397.1411403176	IsS11Max=Yes	IsS11Min=No	FrameElem=115	ElemStation=0			
Frame=115	Station=0	OutputCase=ACCSX1	CaseType=Combination	Point=2	X2=-0.5	X3=0.5	
S11=1397.1411403176	IsS11Max=No	IsS11Min=No	FrameElem=115	ElemStation=0			
Frame=115	Station=0	OutputCase=ACCSX1	CaseType=Combination	Point=3	X2=0.5	X3=-0.5	S11=-
1731.46918793014	IsS11Max=No	IsS11Min=Yes	FrameElem=115	ElemStation=0			
Frame=115	Station=0	OutputCase=ACCSX1	CaseType=Combination	Point=4	X2=0.5	X3=0.5	S11=-
1731.46918793014	IsS11Max=No	IsS11Min=No	FrameElem=115	ElemStation=0			
Frame=115	Station=0.125	OutputCase=ACCSX1	CaseType=Combination	Point=0	X2=0	X3=0	S11=-
167.164023806267	IsS11Max=No	IsS11Min=No	FrameElem=115	ElemStation=0.125			
Frame=115	Station=0.125	OutputCase=ACCSX1	CaseType=Combination	Point=1	X2=-0.5	X3=-0.5	
S11=1449.4899563161	IsS11Max=Yes	IsS11Min=No	FrameElem=115	ElemStation=0.125			
Frame=115	Station=0.125	OutputCase=ACCSX1	CaseType=Combination	Point=2	X2=-0.5	X3=0.5	
S11=1449.4899563161	IsS11Max=No	IsS11Min=No	FrameElem=115	ElemStation=0.125			
Frame=115	Station=0.125	OutputCase=ACCSX1	CaseType=Combination	Point=3	X2=0.5	X3=-0.5	S11=-
1783.81800392863	IsS11Max=No	IsS11Min=Yes	FrameElem=115	ElemStation=0.125			
Frame=115	Station=0.125	OutputCase=ACCSX1	CaseType=Combination	Point=4	X2=0.5	X3=0.5	S11=-
1783.81800392863	IsS11Max=No	IsS11Min=No	FrameElem=115	ElemStation=0.125			
Frame=115	Station=0.25	OutputCase=ACCSX1	CaseType=Combination	Point=0	X2=0	X3=0	S11=-
167.164023806267	IsS11Max=No	IsS11Min=No	FrameElem=115	ElemStation=0.25			
Frame=115	Station=0.25	OutputCase=ACCSX1	CaseType=Combination	Point=1	X2=-0.5	X3=-0.5	
S11=1486.55752231459	IsS11Max=Yes	IsS11Min=No	FrameElem=115	ElemStation=0.25			
Frame=115	Station=0.25	OutputCase=ACCSX1	CaseType=Combination	Point=2	X2=-0.5	X3=0.5	
S11=1486.55752231459	IsS11Max=No	IsS11Min=No	FrameElem=115	ElemStation=0.25			
Frame=115	Station=0.25	OutputCase=ACCSX1	CaseType=Combination	Point=3	X2=0.5	X3=-0.5	S11=-
1820.88556992713	IsS11Max=No	IsS11Min=Yes	FrameElem=115	ElemStation=0.25			
Frame=115	Station=0.25	OutputCase=ACCSX1	CaseType=Combination	Point=4	X2=0.5	X3=0.5	S11=-
1820.88556992713	IsS11Max=No	IsS11Min=No	FrameElem=115	ElemStation=0.25			
Frame=115	Station=0.375	OutputCase=ACCSX1	CaseType=Combination	Point=0	X2=0	X3=0	S11=-
167.164023806267	IsS11Max=No	IsS11Min=No	FrameElem=115	ElemStation=0.375			
Frame=115	Station=0.375	OutputCase=ACCSX1	CaseType=Combination	Point=1	X2=-0.5	X3=-0.5	
S11=1508.34383831309	IsS11Max=Yes	IsS11Min=No	FrameElem=115	ElemStation=0.375			
Frame=115	Station=0.375	OutputCase=ACCSX1	CaseType=Combination	Point=2	X2=-0.5	X3=0.5	
S11=1508.34383831309	IsS11Max=No	IsS11Min=No	FrameElem=115	ElemStation=0.375			
Frame=115	Station=0.375	OutputCase=ACCSX1	CaseType=Combination	Point=3	X2=0.5	X3=-0.5	S11=-
1842.67188592562	IsS11Max=No	IsS11Min=Yes	FrameElem=115	ElemStation=0.375			
Frame=115	Station=0.375	OutputCase=ACCSX1	CaseType=Combination	Point=4	X2=0.5	X3=0.5	S11=-
1842.67188592562	IsS11Max=No	IsS11Min=No	FrameElem=115	ElemStation=0.375			
Frame=115	Station=0.5	OutputCase=ACCSX1	CaseType=Combination	Point=0	X2=0	X3=0	S11=-
167.164023806267	IsS11Max=No	IsS11Min=No	FrameElem=115	ElemStation=0.5			
Frame=115	Station=0.5	OutputCase=ACCSX1	CaseType=Combination	Point=1	X2=-0.5	X3=-0.5	
S11=1514.84890431158	IsS11Max=Yes	IsS11Min=No	FrameElem=115	ElemStation=0.5			
Frame=115	Station=0.5	OutputCase=ACCSX1	CaseType=Combination	Point=2	X2=-0.5	X3=0.5	
S11=1514.84890431158	IsS11Max=No	IsS11Min=No	FrameElem=115	ElemStation=0.5			
Frame=115	Station=0.5	OutputCase=ACCSX1	CaseType=Combination	Point=3	X2=0.5	X3=-0.5	S11=-
1849.17695192412	IsS11Max=No	IsS11Min=Yes	FrameElem=115	ElemStation=0.5			
Frame=115	Station=0.5	OutputCase=ACCSX1	CaseType=Combination	Point=4	X2=0.5	X3=0.5	S11=-
1849.17695192412	IsS11Max=No	IsS11Min=No	FrameElem=115	ElemStation=0.5			
Frame=115	Station=0	OutputCase=ACCSX2	CaseType=Combination	Point=0	X2=0	X3=0	S11=-113.388258060822
IsS11Max=No	IsS11Min=No	FrameElem=115	ElemStation=0				
Frame=115	Station=0	OutputCase=ACCSX2	CaseType=Combination	Point=1	X2=-0.5	X3=-0.5	
S11=1535.90276358952	IsS11Max=Yes	IsS11Min=No	FrameElem=115	ElemStation=0			
Frame=115	Station=0	OutputCase=ACCSX2	CaseType=Combination	Point=2	X2=-0.5	X3=0.5	
S11=1535.90276358952	IsS11Max=No	IsS11Min=No	FrameElem=115	ElemStation=0			

Frame=115	Station=0	OutputCase=ACCSX2	CaseType=Combination	Point=3	X2=0.5	X3=-0.5	S11=-	
1762.67927971116	IsS11Max=No	IsS11Min=Yes	FrameElem=115	ElemStation=0				
Frame=115	Station=0	OutputCase=ACCSX2	CaseType=Combination	Point=4	X2=0.5	X3=0.5	S11=-	
1762.67927971116	IsS11Max=No	IsS11Min=No	FrameElem=115	ElemStation=0				
Frame=115	Station=0.125	OutputCase=ACCSX2	CaseType=Combination	Point=0	X2=0	X3=0	S11=-	
113.388258060822	IsS11Max=No	IsS11Min=No	FrameElem=115	ElemStation=0.125				
Frame=115	Station=0.125	OutputCase=ACCSX2	CaseType=Combination	Point=1	X2=-0.5	X3=-0.5		
S11=1588.25157979352	IsS11Max=Yes	IsS11Min=No	FrameElem=115	ElemStation=0.125				
Frame=115	Station=0.125	OutputCase=ACCSX2	CaseType=Combination	Point=2	X2=-0.5	X3=0.5		
S11=1588.25157979352	IsS11Max=No	IsS11Min=No	FrameElem=115	ElemStation=0.125				
Frame=115	Station=0.125	OutputCase=ACCSX2	CaseType=Combination	Point=3	X2=0.5	X3=-0.5	S11=-	
1815.02809591517	IsS11Max=No	IsS11Min=Yes	FrameElem=115	ElemStation=0.125				
Frame=115	Station=0.125	OutputCase=ACCSX2	CaseType=Combination	Point=4	X2=0.5	X3=0.5	S11=-	
1815.02809591517	IsS11Max=No	IsS11Min=No	FrameElem=115	ElemStation=0.125				
Frame=115	Station=0.25	OutputCase=ACCSX2	CaseType=Combination	Point=0	X2=0	X3=0	S11=-	
113.388258060822	IsS11Max=No	IsS11Min=No	FrameElem=115	ElemStation=0.25				
Frame=115	Station=0.25	OutputCase=ACCSX2	CaseType=Combination	Point=1	X2=-0.5	X3=-0.5		
S11=1625.31914599752	IsS11Max=Yes	IsS11Min=No	FrameElem=115	ElemStation=0.25				
Frame=115	Station=0.25	OutputCase=ACCSX2	CaseType=Combination	Point=2	X2=-0.5	X3=0.5		
S11=1625.31914599752	IsS11Max=No	IsS11Min=No	FrameElem=115	ElemStation=0.25				
Frame=115	Station=0.25	OutputCase=ACCSX2	CaseType=Combination	Point=3	X2=0.5	X3=-0.5	S11=-	
1852.09566211917	IsS11Max=No	IsS11Min=Yes	FrameElem=115	ElemStation=0.25				
Frame=115	Station=0.25	OutputCase=ACCSX2	CaseType=Combination	Point=4	X2=0.5	X3=0.5	S11=-	
1852.09566211917	IsS11Max=No	IsS11Min=No	FrameElem=115	ElemStation=0.25				
Frame=115	Station=0.375	OutputCase=ACCSX2	CaseType=Combination	Point=0	X2=0	X3=0	S11=-	
113.388258060822	IsS11Max=No	IsS11Min=No	FrameElem=115	ElemStation=0.375				
Frame=115	Station=0.375	OutputCase=ACCSX2	CaseType=Combination	Point=1	X2=-0.5	X3=-0.5		
S11=1647.10546220153	IsS11Max=Yes	IsS11Min=No	FrameElem=115	ElemStation=0.375				
Frame=115	Station=0.375	OutputCase=ACCSX2	CaseType=Combination	Point=2	X2=-0.5	X3=0.5		
S11=1647.10546220153	IsS11Max=No	IsS11Min=No	FrameElem=115	ElemStation=0.375				
Frame=115	Station=0.375	OutputCase=ACCSX2	CaseType=Combination	Point=3	X2=0.5	X3=-0.5	S11=-	
1873.88197832317	IsS11Max=No	IsS11Min=Yes	FrameElem=115	ElemStation=0.375				
Frame=115	Station=0.375	OutputCase=ACCSX2	CaseType=Combination	Point=4	X2=0.5	X3=0.5	S11=-	
1873.88197832317	IsS11Max=No	IsS11Min=No	FrameElem=115	ElemStation=0.375				
Frame=115	Station=0.5	OutputCase=ACCSX2	CaseType=Combination	Point=0	X2=0	X3=0	S11=-	
113.388258060822	IsS11Max=No	IsS11Min=No	FrameElem=115	ElemStation=0.5				
Frame=115	Station=0.5	OutputCase=ACCSX2	CaseType=Combination	Point=1	X2=-0.5	X3=-0.5		
S11=1653.61052840553	IsS11Max=Yes	IsS11Min=No	FrameElem=115	ElemStation=0.5				
Frame=115	Station=0.5	OutputCase=ACCSX2	CaseType=Combination	Point=2	X2=-0.5	X3=0.5		
S11=1653.61052840553	IsS11Max=No	IsS11Min=No	FrameElem=115	ElemStation=0.5				
Frame=115	Station=0.5	OutputCase=ACCSX2	CaseType=Combination	Point=3	X2=0.5	X3=-0.5	S11=-	
1880.38704452717	IsS11Max=No	IsS11Min=Yes	FrameElem=115	ElemStation=0.5				
Frame=115	Station=0.5	OutputCase=ACCSX2	CaseType=Combination	Point=4	X2=0.5	X3=0.5	S11=-	
1880.38704452717	IsS11Max=No	IsS11Min=No	FrameElem=115	ElemStation=0.5				
Frame=115	Station=0	OutputCase=ENVE	CaseType=Combination	StepType=Max	Point=0	X2=0	X3=0	S11=-
111.11546006997	IsS11Max=No	IsS11Min=No	FrameElem=115	ElemStation=0				
Frame=115	Station=0	OutputCase=ENVE	CaseType=Combination	StepType=Max	Point=1	X2=-0.5	X3=-0.5	
S11=1584.26882509019	IsS11Max=Yes	IsS11Min=No	FrameElem=115	ElemStation=0				
Frame=115	Station=0	OutputCase=ENVE	CaseType=Combination	StepType=Max	Point=2	X2=-0.5	X3=0.5	
S11=1584.26882509019	IsS11Max=No	IsS11Min=No	FrameElem=115	ElemStation=0				
Frame=115	Station=0	OutputCase=ENVE	CaseType=Combination	StepType=Max	Point=3	X2=0.5	X3=-0.5	
S11=-1728.32429230977	IsS11Max=No	IsS11Min=Yes	FrameElem=115	ElemStation=0				
Frame=115	Station=0	OutputCase=ENVE	CaseType=Combination	StepType=Max	Point=4	X2=0.5	X3=0.5	S11=-
1728.32429230977	IsS11Max=No	IsS11Min=No	FrameElem=115	ElemStation=0				
Frame=115	Station=0.125	OutputCase=ENVE	CaseType=Combination	StepType=Max	Point=0	X2=0	X3=0	S11=-
111.11546006997	IsS11Max=No	IsS11Min=No	FrameElem=115	ElemStation=0.125				
Frame=115	Station=0.125	OutputCase=ENVE	CaseType=Combination	StepType=Max	Point=1	X2=-0.5	X3=-0.5	
S11=1639.53163697559	IsS11Max=Yes	IsS11Min=No	FrameElem=115	ElemStation=0.125				
Frame=115	Station=0.125	OutputCase=ENVE	CaseType=Combination	StepType=Max	Point=2	X2=-0.5	X3=0.5	
S11=1639.53163697559	IsS11Max=No	IsS11Min=No	FrameElem=115	ElemStation=0.125				
Frame=115	Station=0.125	OutputCase=ENVE	CaseType=Combination	StepType=Max	Point=3	X2=0.5	X3=-0.5	
S11=-1781.80866651235	IsS11Max=No	IsS11Min=Yes	FrameElem=115	ElemStation=0.125				
Frame=115	Station=0.125	OutputCase=ENVE	CaseType=Combination	StepType=Max	Point=4	X2=0.5	X3=0.5	
S11=-1781.80866651235	IsS11Max=No	IsS11Min=No	FrameElem=115	ElemStation=0.125				
Frame=115	Station=0.25	OutputCase=ENVE	CaseType=Combination	StepType=Max	Point=0	X2=0	X3=0	S11=-
111.11546006997	IsS11Max=No	IsS11Min=No	FrameElem=115	ElemStation=0.25				
Frame=115	Station=0.25	OutputCase=ENVE	CaseType=Combination	StepType=Max	Point=1	X2=-0.5	X3=-0.5	
S11=1679.005073861	IsS11Max=Yes	IsS11Min=No	FrameElem=115	ElemStation=0.25				
Frame=115	Station=0.25	OutputCase=ENVE	CaseType=Combination	StepType=Max	Point=2	X2=-0.5	X3=0.5	
S11=1679.005073861	IsS11Max=No	IsS11Min=No	FrameElem=115	ElemStation=0.25				
Frame=115	Station=0.25	OutputCase=ENVE	CaseType=Combination	StepType=Max	Point=3	X2=0.5	X3=-0.5	
S11=-1820.01179071494	IsS11Max=No	IsS11Min=Yes	FrameElem=115	ElemStation=0.25				
Frame=115	Station=0.25	OutputCase=ENVE	CaseType=Combination	StepType=Max	Point=4	X2=0.5	X3=0.5	
S11=-1820.01179071494	IsS11Max=No	IsS11Min=No	FrameElem=115	ElemStation=0.25				
Frame=115	Station=0.375	OutputCase=ENVE	CaseType=Combination	StepType=Max	Point=0	X2=0	X3=0	S11=-
111.11546006997	IsS11Max=No	IsS11Min=No	FrameElem=115	ElemStation=0.375				
Frame=115	Station=0.375	OutputCase=ENVE	CaseType=Combination	StepType=Max	Point=1	X2=-0.5	X3=-0.5	
S11=1702.6891357464	IsS11Max=Yes	IsS11Min=No	FrameElem=115	ElemStation=0.375				
Frame=115	Station=0.375	OutputCase=ENVE	CaseType=Combination	StepType=Max	Point=2	X2=-0.5	X3=0.5	
S11=1702.6891357464	IsS11Max=No	IsS11Min=No	FrameElem=115	ElemStation=0.375				
Frame=115	Station=0.375	OutputCase=ENVE	CaseType=Combination	StepType=Max	Point=3	X2=0.5	X3=-0.5	
S11=-1842.67188592562	IsS11Max=No	IsS11Min=Yes	FrameElem=115	ElemStation=0.375				

Frame=115	Station=0.375	OutputCase=ENVE	CaseType=Combination	StepType=Max	Point=4	X2=0.5	X3=0.5	
S11=-1842.67188592562	IsS11Max=No	IsS11Min=No	FrameElem=115	ElemStation=0.375				
Frame=115	Station=0.5	OutputCase=ENVE	CaseType=Combination	StepType=Max	Point=0	X2=0	X3=0	S11=-
111.11546006997	IsS11Max=No	IsS11Min=No	FrameElem=115	ElemStation=0.5				
Frame=115	Station=0.5	OutputCase=ENVE	CaseType=Combination	StepType=Max	Point=1	X2=-0.5	X3=-0.5	
S11=1710.5838226318	IsS11Max=Yes	IsS11Min=No	FrameElem=115	ElemStation=0.5				
Frame=115	Station=0.5	OutputCase=ENVE	CaseType=Combination	StepType=Max	Point=2	X2=-0.5	X3=0.5	
S11=1710.5838226318	IsS11Max=No	IsS11Min=No	FrameElem=115	ElemStation=0.5				
Frame=115	Station=0.5	OutputCase=ENVE	CaseType=Combination	StepType=Max	Point=3	X2=0.5	X3=-0.5	
S11=-1849.17695192412	IsS11Max=No	IsS11Min=Yes	FrameElem=115	ElemStation=0.5				
Frame=115	Station=0.5	OutputCase=ENVE	CaseType=Combination	StepType=Max	Point=4	X2=0.5	X3=0.5	
S11=-1849.17695192412	IsS11Max=No	IsS11Min=No	FrameElem=115	ElemStation=0.5				
Frame=115	Station=0	OutputCase=ENVE	CaseType=Combination	StepType=Min	Point=0	X2=0	X3=0	S11=-
169.541010668994	IsS11Max=No	IsS11Min=No	FrameElem=115	ElemStation=0				
Frame=115	Station=0	OutputCase=ENVE	CaseType=Combination	StepType=Min	Point=1	X2=-0.5	X3=-0.5	
S11=1397.1411403176	IsS11Max=Yes	IsS11Min=No	FrameElem=115	ElemStation=0				
Frame=115	Station=0	OutputCase=ENVE	CaseType=Combination	StepType=Min	Point=2	X2=-0.5	X3=0.5	
S11=1397.1411403176	IsS11Max=No	IsS11Min=No	FrameElem=115	ElemStation=0				
Frame=115	Station=0	OutputCase=ENVE	CaseType=Combination	StepType=Min	Point=3	X2=0.5	X3=-0.5	
S11=-1815.79931493729	IsS11Max=No	IsS11Min=Yes	FrameElem=115	ElemStation=0				
Frame=115	Station=0	OutputCase=ENVE	CaseType=Combination	StepType=Min	Point=4	X2=0.5	X3=0.5	S11=-
1815.79931493729	IsS11Max=No	IsS11Min=No	FrameElem=115	ElemStation=0				
Frame=115	Station=0.125	OutputCase=ENVE	CaseType=Combination	StepType=Min	Point=0	X2=0	X3=0	S11=-
169.541010668994	IsS11Max=No	IsS11Min=No	FrameElem=115	ElemStation=0.125				
Frame=115	Station=0.125	OutputCase=ENVE	CaseType=Combination	StepType=Min	Point=1	X2=-0.5	X3=-0.5	
S11=1449.4899563161	IsS11Max=Yes	IsS11Min=No	FrameElem=115	ElemStation=0.125				
Frame=115	Station=0.125	OutputCase=ENVE	CaseType=Combination	StepType=Min	Point=2	X2=-0.5	X3=0.5	
S11=1449.4899563161	IsS11Max=No	IsS11Min=No	FrameElem=115	ElemStation=0.125				
Frame=115	Station=0.125	OutputCase=ENVE	CaseType=Combination	StepType=Min	Point=3	X2=0.5	X3=-0.5	
S11=-1871.06212682269	IsS11Max=No	IsS11Min=Yes	FrameElem=115	ElemStation=0.125				
Frame=115	Station=0.125	OutputCase=ENVE	CaseType=Combination	StepType=Min	Point=4	X2=0.5	X3=0.5	
S11=-1871.06212682269	IsS11Max=No	IsS11Min=No	FrameElem=115	ElemStation=0.125				
Frame=115	Station=0.25	OutputCase=ENVE	CaseType=Combination	StepType=Min	Point=0	X2=0	X3=0	S11=-
169.541010668994	IsS11Max=No	IsS11Min=No	FrameElem=115	ElemStation=0.25				
Frame=115	Station=0.25	OutputCase=ENVE	CaseType=Combination	StepType=Min	Point=1	X2=-0.5	X3=-0.5	
S11=1486.55752231459	IsS11Max=Yes	IsS11Min=No	FrameElem=115	ElemStation=0.25				
Frame=115	Station=0.25	OutputCase=ENVE	CaseType=Combination	StepType=Min	Point=2	X2=-0.5	X3=0.5	
S11=1486.55752231459	IsS11Max=No	IsS11Min=No	FrameElem=115	ElemStation=0.25				
Frame=115	Station=0.25	OutputCase=ENVE	CaseType=Combination	StepType=Min	Point=3	X2=0.5	X3=-0.5	
S11=-1910.53556370809	IsS11Max=No	IsS11Min=Yes	FrameElem=115	ElemStation=0.25				
Frame=115	Station=0.25	OutputCase=ENVE	CaseType=Combination	StepType=Min	Point=4	X2=0.5	X3=0.5	
S11=-1910.53556370809	IsS11Max=No	IsS11Min=No	FrameElem=115	ElemStation=0.25				
Frame=115	Station=0.375	OutputCase=ENVE	CaseType=Combination	StepType=Min	Point=0	X2=0	X3=0	S11=-
169.541010668994	IsS11Max=No	IsS11Min=No	FrameElem=115	ElemStation=0.375				
Frame=115	Station=0.375	OutputCase=ENVE	CaseType=Combination	StepType=Min	Point=1	X2=0.5	X3=-0.5	
S11=1508.34383831309	IsS11Max=Yes	IsS11Min=No	FrameElem=115	ElemStation=0.375				
Frame=115	Station=0.375	OutputCase=ENVE	CaseType=Combination	StepType=Min	Point=2	X2=-0.5	X3=0.5	
S11=1508.34383831309	IsS11Max=No	IsS11Min=No	FrameElem=115	ElemStation=0.375				
Frame=115	Station=0.375	OutputCase=ENVE	CaseType=Combination	StepType=Min	Point=3	X2=0.5	X3=-0.5	
S11=-1934.2196255935	IsS11Max=No	IsS11Min=Yes	FrameElem=115	ElemStation=0.375				
Frame=115	Station=0.375	OutputCase=ENVE	CaseType=Combination	StepType=Min	Point=4	X2=0.5	X3=0.5	
S11=-1934.2196255935	IsS11Max=No	IsS11Min=No	FrameElem=115	ElemStation=0.375				
Frame=115	Station=0.5	OutputCase=ENVE	CaseType=Combination	StepType=Min	Point=0	X2=0	X3=0	S11=-
169.541010668994	IsS11Max=No	IsS11Min=No	FrameElem=115	ElemStation=0.5				
Frame=115	Station=0.5	OutputCase=ENVE	CaseType=Combination	StepType=Min	Point=1	X2=-0.5	X3=-0.5	
S11=1514.84890431158	IsS11Max=Yes	IsS11Min=No	FrameElem=115	ElemStation=0.5				
Frame=115	Station=0.5	OutputCase=ENVE	CaseType=Combination	StepType=Min	Point=2	X2=-0.5	X3=0.5	
S11=1514.84890431158	IsS11Max=No	IsS11Min=No	FrameElem=115	ElemStation=0.5				
Frame=115	Station=0.5	OutputCase=ENVE	CaseType=Combination	StepType=Min	Point=3	X2=0.5	X3=-0.5	
S11=-1942.1143124789	IsS11Max=No	IsS11Min=Yes	FrameElem=115	ElemStation=0.5				
Frame=115	Station=0.5	OutputCase=ENVE	CaseType=Combination	StepType=Min	Point=4	X2=0.5	X3=0.5	
S11=-1942.1143124789	IsS11Max=No	IsS11Min=No	FrameElem=115	ElemStation=0.5				
Frame=115	Station=0	OutputCase=FESSUR	CaseType=Combination	Point=0	X2=0	X3=0	S11=-	168.146075212921
IsS11Max=No	IsS11Min=No	FrameElem=115	ElemStation=0					
Frame=115	Station=0	OutputCase=FESSUR	CaseType=Combination	Point=1	X2=-0.5	X3=-0.5		
S11=1431.41759347647	IsS11Max=Yes	IsS11Min=No	FrameElem=115	ElemStation=0				
Frame=115	Station=0	OutputCase=FESSUR	CaseType=Combination	Point=2	X2=-0.5	X3=0.5		
S11=1431.41759347647	IsS11Max=No	IsS11Min=No	FrameElem=115	ElemStation=0				
Frame=115	Station=0	OutputCase=FESSUR	CaseType=Combination	Point=3	X2=0.5	X3=-0.5	S11=-	
1767.70974390231	IsS11Max=No	IsS11Min=Yes	FrameElem=115	ElemStation=0				
Frame=115	Station=0	OutputCase=FESSUR	CaseType=Combination	Point=4	X2=0.5	X3=0.5	S11=-	
1767.70974390231	IsS11Max=No	IsS11Min=No	FrameElem=115	ElemStation=0				
Frame=115	Station=0.125	OutputCase=FESSUR	CaseType=Combination	Point=0	X2=0	X3=0	S11=-	
168.146075212921	IsS11Max=No	IsS11Min=No	FrameElem=115	ElemStation=0.125				
Frame=115	Station=0.125	OutputCase=FESSUR	CaseType=Combination	Point=1	X2=-0.5	X3=-0.5		
S11=1486.14687391317	IsS11Max=Yes	IsS11Min=No	FrameElem=115	ElemStation=0.125				
Frame=115	Station=0.125	OutputCase=FESSUR	CaseType=Combination	Point=2	X2=-0.5	X3=0.5		
S11=1486.14687391317	IsS11Max=No	IsS11Min=No	FrameElem=115	ElemStation=0.125				
Frame=115	Station=0.125	OutputCase=FESSUR	CaseType=Combination	Point=3	X2=0.5	X3=-0.5	S11=-	
1822.43902433901	IsS11Max=No	IsS11Min=Yes	FrameElem=115	ElemStation=0.125				
Frame=115	Station=0.125	OutputCase=FESSUR	CaseType=Combination	Point=4	X2=0.5	X3=0.5	S11=-	
1822.43902433901	IsS11Max=No	IsS11Min=No	FrameElem=115	ElemStation=0.125				

```

Frame=115 Station=0.25 OutputCase=FESSUR CaseType=Combination Point=0 X2=0 X3=0 S11=-
168.146075212921 Iss11Max=No Iss11Min=No FrameElem=115 ElemStation=0.25
Frame=115 Station=0.25 OutputCase=FESSUR CaseType=Combination Point=1 X2=-0.5 X3=-0.5
S11=1525.23921684988 Iss11Max=Yes Iss11Min=No FrameElem=115 ElemStation=0.25
Frame=115 Station=0.25 OutputCase=FESSUR CaseType=Combination Point=2 X2=-0.5 X3=0.5
S11=1525.23921684988 Iss11Max=No Iss11Min=No FrameElem=115 ElemStation=0.25
Frame=115 Station=0.25 OutputCase=FESSUR CaseType=Combination Point=3 X2=0.5 X3=-0.5 S11=-
1861.53136727572 Iss11Max=No Iss11Min=Yes FrameElem=115 ElemStation=0.25
Frame=115 Station=0.25 OutputCase=FESSUR CaseType=Combination Point=4 X2=0.5 X3=0.5 S11=-
1861.53136727572 Iss11Max=No Iss11Min=No FrameElem=115 ElemStation=0.25
Frame=115 Station=0.375 OutputCase=FESSUR CaseType=Combination Point=0 X2=0 X3=0 S11=-
168.146075212921 Iss11Max=No Iss11Min=No FrameElem=115 ElemStation=0.375
Frame=115 Station=0.375 OutputCase=FESSUR CaseType=Combination Point=1 X2=-0.5 X3=-0.5
S11=1548.69462228658 Iss11Max=Yes Iss11Min=No FrameElem=115 ElemStation=0.375
Frame=115 Station=0.375 OutputCase=FESSUR CaseType=Combination Point=2 X2=-0.5 X3=0.5
S11=1548.69462228658 Iss11Max=No Iss11Min=No FrameElem=115 ElemStation=0.375
Frame=115 Station=0.375 OutputCase=FESSUR CaseType=Combination Point=3 X2=0.5 X3=-0.5 S11=-
1884.98677271242 Iss11Max=No Iss11Min=Yes FrameElem=115 ElemStation=0.375
Frame=115 Station=0.375 OutputCase=FESSUR CaseType=Combination Point=4 X2=0.5 X3=0.5 S11=-
1884.98677271242 Iss11Max=No Iss11Min=No FrameElem=115 ElemStation=0.375
Frame=115 Station=0.5 OutputCase=FESSUR CaseType=Combination Point=0 X2=0 X3=0 S11=-
168.146075212921 Iss11Max=No Iss11Min=No FrameElem=115 ElemStation=0.5
Frame=115 Station=0.5 OutputCase=FESSUR CaseType=Combination Point=1 X2=-0.5 X3=-0.5
S11=1556.51309022328 Iss11Max=Yes Iss11Min=No FrameElem=115 ElemStation=0.5
Frame=115 Station=0.5 OutputCase=FESSUR CaseType=Combination Point=2 X2=-0.5 X3=0.5
S11=1556.51309022328 Iss11Max=No Iss11Min=No FrameElem=115 ElemStation=0.5
Frame=115 Station=0.5 OutputCase=FESSUR CaseType=Combination Point=3 X2=0.5 X3=-0.5 S11=-
1892.80524064912 Iss11Max=No Iss11Min=Yes FrameElem=115 ElemStation=0.5
Frame=115 Station=0.5 OutputCase=FESSUR CaseType=Combination Point=4 X2=0.5 X3=0.5 S11=-
1892.80524064912 Iss11Max=No Iss11Min=No FrameElem=115 ElemStation=0.5
Frame=116 Station=0 OutputCase=PERM1 CaseType=Combination Point=0 X2=0 X3=0 S11=-164.891225815415
Iss11Max=No Iss11Min=No FrameElem=116 ElemStation=0
Frame=116 Station=0 OutputCase=PERM1 CaseType=Combination Point=1 X2=-0.5 X3=-0.5
S11=1520.79183748923 Iss11Max=Yes Iss11Min=No FrameElem=116 ElemStation=0
Frame=116 Station=0 OutputCase=PERM1 CaseType=Combination Point=2 X2=-0.5 X3=0.5
S11=1520.79183748923 Iss11Max=No Iss11Min=No FrameElem=116 ElemStation=0
Frame=116 Station=0 OutputCase=PERM1 CaseType=Combination Point=3 X2=0.5 X3=-0.5 S11=-
1850.57428912006 Iss11Max=No Iss11Min=Yes FrameElem=116 ElemStation=0
Frame=116 Station=0 OutputCase=PERM1 CaseType=Combination Point=4 X2=0.5 X3=0.5 S11=-
1850.57428912006 Iss11Max=No Iss11Min=No FrameElem=116 ElemStation=0
Frame=116 Station=0.125 OutputCase=PERM1 CaseType=Combination Point=0 X2=0 X3=0 S11=-
164.891225815415 Iss11Max=No Iss11Min=No FrameElem=116 ElemStation=0.125
Frame=116 Station=0.125 OutputCase=PERM1 CaseType=Combination Point=1 X2=-0.5 X3=-0.5
S11=1513.1512116918 Iss11Max=Yes Iss11Min=No FrameElem=116 ElemStation=0.125
Frame=116 Station=0.125 OutputCase=PERM1 CaseType=Combination Point=2 X2=-0.5 X3=0.5
S11=1513.1512116918 Iss11Max=No Iss11Min=No FrameElem=116 ElemStation=0.125
Frame=116 Station=0.125 OutputCase=PERM1 CaseType=Combination Point=3 X2=0.5 X3=-0.5 S11=-
1842.93366332263 Iss11Max=No Iss11Min=Yes FrameElem=116 ElemStation=0.125
Frame=116 Station=0.125 OutputCase=PERM1 CaseType=Combination Point=4 X2=0.5 X3=0.5 S11=-
1842.93366332263 Iss11Max=No Iss11Min=No FrameElem=116 ElemStation=0.125
Frame=116 Station=0.25 OutputCase=PERM1 CaseType=Combination Point=0 X2=0 X3=0 S11=-
164.891225815415 Iss11Max=No Iss11Min=No FrameElem=116 ElemStation=0.25
Frame=116 Station=0.25 OutputCase=PERM1 CaseType=Combination Point=1 X2=-0.5 X3=-0.5
S11=1490.22933589438 Iss11Max=Yes Iss11Min=No FrameElem=116 ElemStation=0.25
Frame=116 Station=0.25 OutputCase=PERM1 CaseType=Combination Point=2 X2=-0.5 X3=0.5
S11=1490.22933589438 Iss11Max=No Iss11Min=No FrameElem=116 ElemStation=0.25
Frame=116 Station=0.25 OutputCase=PERM1 CaseType=Combination Point=3 X2=0.5 X3=-0.5 S11=-
1820.01178752521 Iss11Max=No Iss11Min=Yes FrameElem=116 ElemStation=0.25
Frame=116 Station=0.25 OutputCase=PERM1 CaseType=Combination Point=4 X2=0.5 X3=0.5 S11=-
1820.01178752521 Iss11Max=No Iss11Min=No FrameElem=116 ElemStation=0.25
Frame=116 Station=0.375 OutputCase=PERM1 CaseType=Combination Point=0 X2=0 X3=0 S11=-
164.891225815415 Iss11Max=No Iss11Min=No FrameElem=116 ElemStation=0.375
Frame=116 Station=0.375 OutputCase=PERM1 CaseType=Combination Point=1 X2=-0.5 X3=-0.5
S11=1452.02621009695 Iss11Max=Yes Iss11Min=No FrameElem=116 ElemStation=0.375
Frame=116 Station=0.375 OutputCase=PERM1 CaseType=Combination Point=2 X2=-0.5 X3=0.5
S11=1452.02621009695 Iss11Max=No Iss11Min=No FrameElem=116 ElemStation=0.375
Frame=116 Station=0.375 OutputCase=PERM1 CaseType=Combination Point=3 X2=0.5 X3=-0.5 S11=-
1781.80866172778 Iss11Max=No Iss11Min=Yes FrameElem=116 ElemStation=0.375
Frame=116 Station=0.375 OutputCase=PERM1 CaseType=Combination Point=4 X2=0.5 X3=0.5 S11=-
1781.80866172778 Iss11Max=No Iss11Min=No FrameElem=116 ElemStation=0.375
Frame=116 Station=0.5 OutputCase=PERM1 CaseType=Combination Point=0 X2=0 X3=0 S11=-164.891225815415
Iss11Max=No Iss11Min=No FrameElem=116 ElemStation=0.5
Frame=116 Station=0.5 OutputCase=PERM1 CaseType=Combination Point=1 X2=-0.5 X3=-0.5
S11=1398.54183429952 Iss11Max=Yes Iss11Min=No FrameElem=116 ElemStation=0.5
Frame=116 Station=0.5 OutputCase=PERM1 CaseType=Combination Point=2 X2=-0.5 X3=0.5
S11=1398.54183429952 Iss11Max=No Iss11Min=No FrameElem=116 ElemStation=0.5
Frame=116 Station=0.5 OutputCase=PERM1 CaseType=Combination Point=3 X2=0.5 X3=-0.5 S11=-
1728.32428593035 Iss11Max=No Iss11Min=Yes FrameElem=116 ElemStation=0.5
Frame=116 Station=0.5 OutputCase=PERM1 CaseType=Combination Point=4 X2=0.5 X3=0.5 S11=-
1728.32428593035 Iss11Max=No Iss11Min=No FrameElem=116 ElemStation=0.5
Frame=116 Station=0 OutputCase=PERM2 CaseType=Combination Point=0 X2=0 X3=0 S11=-111.11546006997
Iss11Max=No Iss11Min=No FrameElem=116 ElemStation=0

```



```

Frame=116 Station=0 OutputCase=PERM2 CaseType=Combination Point=1 X2=-0.5 X3=-0.5
S11=1659.55346158318 IsS11Max=Yes IsS11Min=No FrameElem=116 ElemStation=0
Frame=116 Station=0 OutputCase=PERM2 CaseType=Combination Point=2 X2=-0.5 X3=0.5
S11=1659.55346158318 IsS11Max=No IsS11Min=No FrameElem=116 ElemStation=0
Frame=116 Station=0 OutputCase=PERM2 CaseType=Combination Point=3 X2=0.5 X3=-0.5 S11=-
1881.78438172312 IsS11Max=No IsS11Min=Yes FrameElem=116 ElemStation=0
Frame=116 Station=0 OutputCase=PERM2 CaseType=Combination Point=4 X2=0.5 X3=0.5 S11=-
1881.78438172312 IsS11Max=No IsS11Min=No FrameElem=116 ElemStation=0
Frame=116 Station=0.125 OutputCase=PERM2 CaseType=Combination Point=0 X2=0 X3=0 S11=-
111.11546006997 IsS11Max=No IsS11Min=No FrameElem=116 ElemStation=0.125
Frame=116 Station=0.125 OutputCase=PERM2 CaseType=Combination Point=1 X2=-0.5 X3=-0.5
S11=1651.91283599126 IsS11Max=Yes IsS11Min=No FrameElem=116 ElemStation=0.125
Frame=116 Station=0.125 OutputCase=PERM2 CaseType=Combination Point=2 X2=-0.5 X3=0.5
S11=1651.91283599126 IsS11Max=No IsS11Min=No FrameElem=116 ElemStation=0.125
Frame=116 Station=0.125 OutputCase=PERM2 CaseType=Combination Point=3 X2=0.5 X3=-0.5 S11=-
1874.1437561312 IsS11Max=No IsS11Min=Yes FrameElem=116 ElemStation=0.125
Frame=116 Station=0.125 OutputCase=PERM2 CaseType=Combination Point=4 X2=0.5 X3=0.5 S11=-
1874.1437561312 IsS11Max=No IsS11Min=No FrameElem=116 ElemStation=0.125
Frame=116 Station=0.25 OutputCase=PERM2 CaseType=Combination Point=0 X2=0 X3=0 S11=-111.11546006997
IsS11Max=No IsS11Min=No FrameElem=116 ElemStation=0.25
Frame=116 Station=0.25 OutputCase=PERM2 CaseType=Combination Point=1 X2=-0.5 X3=-0.5
S11=1628.99096039934 IsS11Max=Yes IsS11Min=No FrameElem=116 ElemStation=0.25
Frame=116 Station=0.25 OutputCase=PERM2 CaseType=Combination Point=2 X2=-0.5 X3=0.5
S11=1628.99096039934 IsS11Max=No IsS11Min=No FrameElem=116 ElemStation=0.25
Frame=116 Station=0.25 OutputCase=PERM2 CaseType=Combination Point=3 X2=0.5 X3=-0.5 S11=-
1851.22188053928 IsS11Max=No IsS11Min=Yes FrameElem=116 ElemStation=0.25
Frame=116 Station=0.25 OutputCase=PERM2 CaseType=Combination Point=4 X2=0.5 X3=0.5 S11=-
1851.22188053928 IsS11Max=No IsS11Min=No FrameElem=116 ElemStation=0.25
Frame=116 Station=0.375 OutputCase=PERM2 CaseType=Combination Point=0 X2=0 X3=0 S11=-
111.11546006997 IsS11Max=No IsS11Min=No FrameElem=116 ElemStation=0.375
Frame=116 Station=0.375 OutputCase=PERM2 CaseType=Combination Point=1 X2=-0.5 X3=-0.5
S11=1590.78783480742 IsS11Max=Yes IsS11Min=No FrameElem=116 ElemStation=0.375
Frame=116 Station=0.375 OutputCase=PERM2 CaseType=Combination Point=2 X2=-0.5 X3=0.5
S11=1590.78783480742 IsS11Max=No IsS11Min=No FrameElem=116 ElemStation=0.375
Frame=116 Station=0.375 OutputCase=PERM2 CaseType=Combination Point=3 X2=0.5 X3=-0.5 S11=-
1813.01875494736 IsS11Max=No IsS11Min=Yes FrameElem=116 ElemStation=0.375
Frame=116 Station=0.375 OutputCase=PERM2 CaseType=Combination Point=4 X2=0.5 X3=0.5 S11=-
1813.01875494736 IsS11Max=No IsS11Min=No FrameElem=116 ElemStation=0.375
Frame=116 Station=0.5 OutputCase=PERM2 CaseType=Combination Point=0 X2=0 X3=0 S11=-111.11546006997
IsS11Max=No IsS11Min=No FrameElem=116 ElemStation=0.5
Frame=116 Station=0.5 OutputCase=PERM2 CaseType=Combination Point=1 X2=-0.5 X3=-0.5
S11=1537.3034592155 IsS11Max=Yes IsS11Min=No FrameElem=116 ElemStation=0.5
Frame=116 Station=0.5 OutputCase=PERM2 CaseType=Combination Point=2 X2=-0.5 X3=0.5
S11=1537.3034592155 IsS11Max=No IsS11Min=No FrameElem=116 ElemStation=0.5
Frame=116 Station=0.5 OutputCase=PERM2 CaseType=Combination Point=3 X2=0.5 X3=-0.5 S11=-
1759.53437935544 IsS11Max=No IsS11Min=Yes FrameElem=116 ElemStation=0.5
Frame=116 Station=0.5 OutputCase=PERM2 CaseType=Combination Point=4 X2=0.5 X3=0.5 S11=-
1759.53437935544 IsS11Max=No IsS11Min=No FrameElem=116 ElemStation=0.5
Frame=116 Station=0 OutputCase=ACC1 CaseType=Combination Point=0 X2=0 X3=0 S11=-169.541010668998
IsS11Max=No IsS11Min=No FrameElem=116 ElemStation=0
Frame=116 Station=0 OutputCase=ACC1 CaseType=Combination Point=1 X2=-0.5 X3=-0.5
S11=1571.82219853781 IsS11Max=Yes IsS11Min=No FrameElem=116 ElemStation=0
Frame=116 Station=0 OutputCase=ACC1 CaseType=Combination Point=2 X2=-0.5 X3=0.5
S11=1571.82219853781 IsS11Max=No IsS11Min=No FrameElem=116 ElemStation=0
Frame=116 Station=0 OutputCase=ACC1 CaseType=Combination Point=3 X2=0.5 X3=-0.5 S11=-
1910.90421987581 IsS11Max=No IsS11Min=Yes FrameElem=116 ElemStation=0
Frame=116 Station=0 OutputCase=ACC1 CaseType=Combination Point=4 X2=0.5 X3=0.5 S11=-
1910.90421987581 IsS11Max=No IsS11Min=No FrameElem=116 ElemStation=0
Frame=116 Station=0.125 OutputCase=ACC1 CaseType=Combination Point=0 X2=0 X3=0 S11=-
169.541010668998 IsS11Max=No IsS11Min=No FrameElem=116 ElemStation=0.125
Frame=116 Station=0.125 OutputCase=ACC1 CaseType=Combination Point=1 X2=-0.5 X3=-0.5
S11=1563.9275102177 IsS11Max=Yes IsS11Min=No FrameElem=116 ElemStation=0.125
Frame=116 Station=0.125 OutputCase=ACC1 CaseType=Combination Point=2 X2=-0.5 X3=0.5
S11=1563.9275102177 IsS11Max=No IsS11Min=No FrameElem=116 ElemStation=0.125
Frame=116 Station=0.125 OutputCase=ACC1 CaseType=Combination Point=3 X2=0.5 X3=-0.5 S11=-
1903.00953155569 IsS11Max=No IsS11Min=Yes FrameElem=116 ElemStation=0.125
Frame=116 Station=0.125 OutputCase=ACC1 CaseType=Combination Point=4 X2=0.5 X3=0.5 S11=-
1903.00953155569 IsS11Max=No IsS11Min=No FrameElem=116 ElemStation=0.125
Frame=116 Station=0.25 OutputCase=ACC1 CaseType=Combination Point=0 X2=0 X3=0 S11=-169.541010668998
IsS11Max=No IsS11Min=No FrameElem=116 ElemStation=0.25
Frame=116 Station=0.25 OutputCase=ACC1 CaseType=Combination Point=1 X2=-0.5 X3=-0.5
S11=1540.24344689758 IsS11Max=Yes IsS11Min=No FrameElem=116 ElemStation=0.25
Frame=116 Station=0.25 OutputCase=ACC1 CaseType=Combination Point=2 X2=-0.5 X3=0.5
S11=1540.24344689758 IsS11Max=No IsS11Min=No FrameElem=116 ElemStation=0.25
Frame=116 Station=0.25 OutputCase=ACC1 CaseType=Combination Point=3 X2=0.5 X3=-0.5 S11=-
1879.32546823558 IsS11Max=No IsS11Min=Yes FrameElem=116 ElemStation=0.25
Frame=116 Station=0.25 OutputCase=ACC1 CaseType=Combination Point=4 X2=0.5 X3=0.5 S11=-
1879.32546823558 IsS11Max=No IsS11Min=No FrameElem=116 ElemStation=0.25
Frame=116 Station=0.375 OutputCase=ACC1 CaseType=Combination Point=0 X2=0 X3=0 S11=-
169.541010668998 IsS11Max=No IsS11Min=No FrameElem=116 ElemStation=0.375
Frame=116 Station=0.375 OutputCase=ACC1 CaseType=Combination Point=1 X2=-0.5 X3=-0.5
S11=1500.77000857747 IsS11Max=Yes IsS11Min=No FrameElem=116 ElemStation=0.375

```

Frame=116 Station=0.375 OutputCase=ACC1 CaseType=Combination Point=2 X2=-0.5 X3=0.5
 S11=1500.77000857747 IsS11Max=No IsS11Min=No FrameElem=116 ElemStation=0.375
 Frame=116 Station=0.375 OutputCase=ACC1 CaseType=Combination Point=3 X2=0.5 X3=-0.5 S11=-
 1839.85202991546 IsS11Max=No IsS11Min=Yes FrameElem=116 ElemStation=0.375
 Frame=116 Station=0.375 OutputCase=ACC1 CaseType=Combination Point=4 X2=0.5 X3=0.5 S11=-
 1839.85202991546 IsS11Max=No IsS11Min=No FrameElem=116 ElemStation=0.375
 Frame=116 Station=0.5 OutputCase=ACC1 CaseType=Combination Point=0 X2=0 X3=0 S11=-169.541010668998
 IsS11Max=No IsS11Min=No FrameElem=116 ElemStation=0.5
 Frame=116 Station=0.5 OutputCase=ACC1 CaseType=Combination Point=1 X2=-0.5 X3=-0.5
 S11=1445.50719525735 IsS11Max=Yes IsS11Min=No FrameElem=116 ElemStation=0.5
 Frame=116 Station=0.5 OutputCase=ACC1 CaseType=Combination Point=2 X2=-0.5 X3=0.5
 S11=1445.50719525735 IsS11Max=No IsS11Min=No FrameElem=116 ElemStation=0.5
 Frame=116 Station=0.5 OutputCase=ACC1 CaseType=Combination Point=3 X2=0.5 X3=-0.5 S11=-
 1784.58921659535 IsS11Max=No IsS11Min=Yes FrameElem=116 ElemStation=0.5
 Frame=116 Station=0.5 OutputCase=ACC1 CaseType=Combination Point=4 X2=0.5 X3=0.5 S11=-
 1784.58921659535 IsS11Max=No IsS11Min=No FrameElem=116 ElemStation=0.5
 Frame=116 Station=0 OutputCase=ACC2 CaseType=Combination Point=0 X2=0 X3=0 S11=-115.765244923553
 IsS11Max=No IsS11Min=No FrameElem=116 ElemStation=0
 Frame=116 Station=0 OutputCase=ACC2 CaseType=Combination Point=1 X2=-0.5 X3=-0.5
 S11=1710.58382263176 IsS11Max=Yes IsS11Min=No FrameElem=116 ElemStation=0
 Frame=116 Station=0 OutputCase=ACC2 CaseType=Combination Point=2 X2=-0.5 X3=0.5
 S11=1710.58382263176 IsS11Max=No IsS11Min=No FrameElem=116 ElemStation=0
 Frame=116 Station=0 OutputCase=ACC2 CaseType=Combination Point=3 X2=0.5 X3=-0.5 S11=-
 1942.11431247887 IsS11Max=No IsS11Min=Yes FrameElem=116 ElemStation=0
 Frame=116 Station=0 OutputCase=ACC2 CaseType=Combination Point=4 X2=0.5 X3=0.5 S11=-
 1942.11431247887 IsS11Max=No IsS11Min=No FrameElem=116 ElemStation=0
 Frame=116 Station=0.125 OutputCase=ACC2 CaseType=Combination Point=0 X2=0 X3=0 S11=-
 115.765244923553 IsS11Max=No IsS11Min=No FrameElem=116 ElemStation=0.125
 Frame=116 Station=0.125 OutputCase=ACC2 CaseType=Combination Point=1 X2=-0.5 X3=-0.5
 S11=1702.68913451715 IsS11Max=Yes IsS11Min=No FrameElem=116 ElemStation=0.125
 Frame=116 Station=0.125 OutputCase=ACC2 CaseType=Combination Point=2 X2=-0.5 X3=0.5
 S11=1702.68913451715 IsS11Max=No IsS11Min=No FrameElem=116 ElemStation=0.125
 Frame=116 Station=0.125 OutputCase=ACC2 CaseType=Combination Point=3 X2=0.5 X3=-0.5 S11=-
 1934.21962436426 IsS11Max=No IsS11Min=Yes FrameElem=116 ElemStation=0.125
 Frame=116 Station=0.125 OutputCase=ACC2 CaseType=Combination Point=4 X2=0.5 X3=0.5 S11=-
 1934.21962436426 IsS11Max=No IsS11Min=No FrameElem=116 ElemStation=0.125
 Frame=116 Station=0.25 OutputCase=ACC2 CaseType=Combination Point=0 X2=0 X3=0 S11=-115.765244923553
 IsS11Max=No IsS11Min=No FrameElem=116 ElemStation=0.25
 Frame=116 Station=0.25 OutputCase=ACC2 CaseType=Combination Point=1 X2=-0.5 X3=-0.5
 S11=1679.00507140254 IsS11Max=Yes IsS11Min=No FrameElem=116 ElemStation=0.25
 Frame=116 Station=0.25 OutputCase=ACC2 CaseType=Combination Point=2 X2=-0.5 X3=0.5
 S11=1679.00507140254 IsS11Max=No IsS11Min=No FrameElem=116 ElemStation=0.25
 Frame=116 Station=0.25 OutputCase=ACC2 CaseType=Combination Point=3 X2=0.5 X3=-0.5 S11=-
 1910.53556124965 IsS11Max=No IsS11Min=Yes FrameElem=116 ElemStation=0.25
 Frame=116 Station=0.25 OutputCase=ACC2 CaseType=Combination Point=4 X2=0.5 X3=0.5 S11=-
 1910.53556124965 IsS11Max=No IsS11Min=No FrameElem=116 ElemStation=0.25
 Frame=116 Station=0.375 OutputCase=ACC2 CaseType=Combination Point=0 X2=0 X3=0 S11=-
 115.765244923553 IsS11Max=No IsS11Min=No FrameElem=116 ElemStation=0.375
 Frame=116 Station=0.375 OutputCase=ACC2 CaseType=Combination Point=1 X2=-0.5 X3=-0.5
 S11=1639.53163328794 IsS11Max=Yes IsS11Min=No FrameElem=116 ElemStation=0.375
 Frame=116 Station=0.375 OutputCase=ACC2 CaseType=Combination Point=2 X2=-0.5 X3=0.5
 S11=1639.53163328794 IsS11Max=No IsS11Min=No FrameElem=116 ElemStation=0.375
 Frame=116 Station=0.375 OutputCase=ACC2 CaseType=Combination Point=3 X2=0.5 X3=-0.5 S11=-
 1871.06212313504 IsS11Max=No IsS11Min=Yes FrameElem=116 ElemStation=0.375
 Frame=116 Station=0.375 OutputCase=ACC2 CaseType=Combination Point=4 X2=0.5 X3=0.5 S11=-
 1871.06212313504 IsS11Max=No IsS11Min=No FrameElem=116 ElemStation=0.375
 Frame=116 Station=0.5 OutputCase=ACC2 CaseType=Combination Point=0 X2=0 X3=0 S11=-115.765244923553
 IsS11Max=No IsS11Min=No FrameElem=116 ElemStation=0.5
 Frame=116 Station=0.5 OutputCase=ACC2 CaseType=Combination Point=1 X2=-0.5 X3=-0.5
 S11=1584.26882017333 IsS11Max=Yes IsS11Min=No FrameElem=116 ElemStation=0.5
 Frame=116 Station=0.5 OutputCase=ACC2 CaseType=Combination Point=2 X2=-0.5 X3=0.5
 S11=1584.26882017333 IsS11Max=No IsS11Min=No FrameElem=116 ElemStation=0.5
 Frame=116 Station=0.5 OutputCase=ACC2 CaseType=Combination Point=3 X2=0.5 X3=-0.5 S11=-
 1815.79931002044 IsS11Max=No IsS11Min=Yes FrameElem=116 ElemStation=0.5
 Frame=116 Station=0.5 OutputCase=ACC2 CaseType=Combination Point=4 X2=0.5 X3=0.5 S11=-
 1815.79931002044 IsS11Max=No IsS11Min=No FrameElem=116 ElemStation=0.5
 Frame=116 Station=0 OutputCase=ACCSX1 CaseType=Combination Point=0 X2=0 X3=0 S11=-167.164023806267
 IsS11Max=No IsS11Min=No FrameElem=116 ElemStation=0
 Frame=116 Station=0 OutputCase=ACCSX1 CaseType=Combination Point=1 X2=-0.5 X3=-0.5
 S11=1514.84890431154 IsS11Max=Yes IsS11Min=No FrameElem=116 ElemStation=0
 Frame=116 Station=0 OutputCase=ACCSX1 CaseType=Combination Point=2 X2=-0.5 X3=0.5
 S11=1514.84890431154 IsS11Max=No IsS11Min=No FrameElem=116 ElemStation=0
 Frame=116 Station=0 OutputCase=ACCSX1 CaseType=Combination Point=3 X2=0.5 X3=-0.5 S11=-
 1849.17695192407 IsS11Max=No IsS11Min=Yes FrameElem=116 ElemStation=0
 Frame=116 Station=0 OutputCase=ACCSX1 CaseType=Combination Point=4 X2=0.5 X3=0.5 S11=-
 1849.17695192407 IsS11Max=No IsS11Min=No FrameElem=116 ElemStation=0
 Frame=116 Station=0.125 OutputCase=ACCSX1 CaseType=Combination Point=0 X2=0 X3=0 S11=-
 167.164023806267 IsS11Max=No IsS11Min=No FrameElem=116 ElemStation=0.125
 Frame=116 Station=0.125 OutputCase=ACCSX1 CaseType=Combination Point=1 X2=-0.5 X3=-0.5
 S11=1506.07272031002 IsS11Max=Yes IsS11Min=No FrameElem=116 ElemStation=0.125
 Frame=116 Station=0.125 OutputCase=ACCSX1 CaseType=Combination Point=2 X2=-0.5 X3=0.5
 S11=1506.07272031002 IsS11Max=No IsS11Min=No FrameElem=116 ElemStation=0.125

Frame=116	Station=0.125	OutputCase=ACCSX1	CaseType=Combination	Point=3	X2=0.5	X3=-0.5	S11=-
1840.40076792256	IsS11Max=No	IsS11Min=Yes	FrameElem=116	ElemStation=0.125			
Frame=116	Station=0.125	OutputCase=ACCSX1	CaseType=Combination	Point=4	X2=0.5	X3=0.5	S11=-
1840.40076792256	IsS11Max=No	IsS11Min=No	FrameElem=116	ElemStation=0.125			
Frame=116	Station=0.25	OutputCase=ACCSX1	CaseType=Combination	Point=0	X2=0	X3=0	S11=-
167.164023806267	IsS11Max=No	IsS11Min=No	FrameElem=116	ElemStation=0.25			
Frame=116	Station=0.25	OutputCase=ACCSX1	CaseType=Combination	Point=1	X2=-0.5	X3=-0.5	
S11=1482.0152863085	IsS11Max=Yes	IsS11Min=No	FrameElem=116	ElemStation=0.25			
Frame=116	Station=0.25	OutputCase=ACCSX1	CaseType=Combination	Point=2	X2=-0.5	X3=0.5	
S11=1482.0152863085	IsS11Max=No	IsS11Min=No	FrameElem=116	ElemStation=0.25			
Frame=116	Station=0.25	OutputCase=ACCSX1	CaseType=Combination	Point=3	X2=0.5	X3=-0.5	S11=-
1816.34333392104	IsS11Max=No	IsS11Min=Yes	FrameElem=116	ElemStation=0.25			
Frame=116	Station=0.25	OutputCase=ACCSX1	CaseType=Combination	Point=4	X2=0.5	X3=0.5	S11=-
1816.34333392104	IsS11Max=No	IsS11Min=No	FrameElem=116	ElemStation=0.25			
Frame=116	Station=0.375	OutputCase=ACCSX1	CaseType=Combination	Point=0	X2=0	X3=0	S11=-
167.164023806267	IsS11Max=No	IsS11Min=No	FrameElem=116	ElemStation=0.375			
Frame=116	Station=0.375	OutputCase=ACCSX1	CaseType=Combination	Point=1	X2=-0.5	X3=-0.5	
S11=1442.67660230699	IsS11Max=Yes	IsS11Min=No	FrameElem=116	ElemStation=0.375			
Frame=116	Station=0.375	OutputCase=ACCSX1	CaseType=Combination	Point=2	X2=-0.5	X3=0.5	
S11=1442.67660230699	IsS11Max=No	IsS11Min=No	FrameElem=116	ElemStation=0.375			
Frame=116	Station=0.375	OutputCase=ACCSX1	CaseType=Combination	Point=3	X2=0.5	X3=-0.5	S11=-
1777.00464991952	IsS11Max=No	IsS11Min=Yes	FrameElem=116	ElemStation=0.375			
Frame=116	Station=0.375	OutputCase=ACCSX1	CaseType=Combination	Point=4	X2=0.5	X3=0.5	S11=-
1777.00464991952	IsS11Max=No	IsS11Min=No	FrameElem=116	ElemStation=0.375			
Frame=116	Station=0.5	OutputCase=ACCSX1	CaseType=Combination	Point=0	X2=0	X3=0	S11=-
167.164023806267	IsS11Max=No	IsS11Min=No	FrameElem=116	ElemStation=0.5			
Frame=116	Station=0.5	OutputCase=ACCSX1	CaseType=Combination	Point=1	X2=-0.5	X3=-0.5	
S11=1388.05666830547	IsS11Max=Yes	IsS11Min=No	FrameElem=116	ElemStation=0.5			
Frame=116	Station=0.5	OutputCase=ACCSX1	CaseType=Combination	Point=2	X2=-0.5	X3=0.5	
S11=1388.05666830547	IsS11Max=No	IsS11Min=No	FrameElem=116	ElemStation=0.5			
Frame=116	Station=0.5	OutputCase=ACCSX1	CaseType=Combination	Point=3	X2=0.5	X3=-0.5	S11=-
1722.38471591801	IsS11Max=No	IsS11Min=Yes	FrameElem=116	ElemStation=0.5			
Frame=116	Station=0.5	OutputCase=ACCSX1	CaseType=Combination	Point=4	X2=0.5	X3=0.5	S11=-
1722.38471591801	IsS11Max=No	IsS11Min=No	FrameElem=116	ElemStation=0.5			
Frame=116	Station=0	OutputCase=ACCSX2	CaseType=Combination	Point=0	X2=0	X3=0	S11=-113.388258060822
IsS11Max=No	IsS11Min=No	FrameElem=116	ElemStation=0				
Frame=116	Station=0	OutputCase=ACCSX2	CaseType=Combination	Point=1	X2=-0.5	X3=-0.5	
S11=1653.61052840548	IsS11Max=Yes	IsS11Min=No	FrameElem=116	ElemStation=0			
Frame=116	Station=0	OutputCase=ACCSX2	CaseType=Combination	Point=2	X2=-0.5	X3=0.5	
S11=1653.61052840548	IsS11Max=No	IsS11Min=No	FrameElem=116	ElemStation=0			
Frame=116	Station=0	OutputCase=ACCSX2	CaseType=Combination	Point=3	X2=0.5	X3=-0.5	S11=-
1880.38704452713	IsS11Max=No	IsS11Min=Yes	FrameElem=116	ElemStation=0			
Frame=116	Station=0	OutputCase=ACCSX2	CaseType=Combination	Point=4	X2=0.5	X3=0.5	S11=-
1880.38704452713	IsS11Max=No	IsS11Min=No	FrameElem=116	ElemStation=0			
Frame=116	Station=0.125	OutputCase=ACCSX2	CaseType=Combination	Point=0	X2=0	X3=0	S11=-
113.388258060822	IsS11Max=No	IsS11Min=No	FrameElem=116	ElemStation=0.125			
Frame=116	Station=0.125	OutputCase=ACCSX2	CaseType=Combination	Point=1	X2=-0.5	X3=-0.5	
S11=1644.83434460948	IsS11Max=Yes	IsS11Min=No	FrameElem=116	ElemStation=0.125			
Frame=116	Station=0.125	OutputCase=ACCSX2	CaseType=Combination	Point=2	X2=-0.5	X3=0.5	
S11=1644.83434460948	IsS11Max=No	IsS11Min=No	FrameElem=116	ElemStation=0.125			
Frame=116	Station=0.125	OutputCase=ACCSX2	CaseType=Combination	Point=3	X2=0.5	X3=-0.5	S11=-
1871.61086073112	IsS11Max=No	IsS11Min=Yes	FrameElem=116	ElemStation=0.125			
Frame=116	Station=0.125	OutputCase=ACCSX2	CaseType=Combination	Point=4	X2=0.5	X3=0.5	S11=-
1871.61086073112	IsS11Max=No	IsS11Min=No	FrameElem=116	ElemStation=0.125			
Frame=116	Station=0.25	OutputCase=ACCSX2	CaseType=Combination	Point=0	X2=0	X3=0	S11=-
113.388258060822	IsS11Max=No	IsS11Min=No	FrameElem=116	ElemStation=0.25			
Frame=116	Station=0.25	OutputCase=ACCSX2	CaseType=Combination	Point=1	X2=-0.5	X3=-0.5	
S11=1620.77691081347	IsS11Max=Yes	IsS11Min=No	FrameElem=116	ElemStation=0.25			
Frame=116	Station=0.25	OutputCase=ACCSX2	CaseType=Combination	Point=2	X2=-0.5	X3=0.5	
S11=1620.77691081347	IsS11Max=No	IsS11Min=No	FrameElem=116	ElemStation=0.25			
Frame=116	Station=0.25	OutputCase=ACCSX2	CaseType=Combination	Point=3	X2=0.5	X3=-0.5	S11=-
1847.55342693511	IsS11Max=No	IsS11Min=Yes	FrameElem=116	ElemStation=0.25			
Frame=116	Station=0.25	OutputCase=ACCSX2	CaseType=Combination	Point=4	X2=0.5	X3=0.5	S11=-
1847.55342693511	IsS11Max=No	IsS11Min=No	FrameElem=116	ElemStation=0.25			
Frame=116	Station=0.375	OutputCase=ACCSX2	CaseType=Combination	Point=0	X2=0	X3=0	S11=-
113.388258060822	IsS11Max=No	IsS11Min=No	FrameElem=116	ElemStation=0.375			
Frame=116	Station=0.375	OutputCase=ACCSX2	CaseType=Combination	Point=1	X2=-0.5	X3=-0.5	
S11=1581.43822701746	IsS11Max=Yes	IsS11Min=No	FrameElem=116	ElemStation=0.375			
Frame=116	Station=0.375	OutputCase=ACCSX2	CaseType=Combination	Point=2	X2=-0.5	X3=0.5	
S11=1581.43822701746	IsS11Max=No	IsS11Min=No	FrameElem=116	ElemStation=0.375			
Frame=116	Station=0.375	OutputCase=ACCSX2	CaseType=Combination	Point=3	X2=0.5	X3=-0.5	S11=-
1808.2147431391	IsS11Max=No	IsS11Min=Yes	FrameElem=116	ElemStation=0.375			
Frame=116	Station=0.375	OutputCase=ACCSX2	CaseType=Combination	Point=4	X2=0.5	X3=0.5	S11=-
1808.2147431391	IsS11Max=No	IsS11Min=No	FrameElem=116	ElemStation=0.375			
Frame=116	Station=0.5	OutputCase=ACCSX2	CaseType=Combination	Point=0	X2=0	X3=0	S11=-
113.388258060822	IsS11Max=No	IsS11Min=No	FrameElem=116	ElemStation=0.5			
Frame=116	Station=0.5	OutputCase=ACCSX2	CaseType=Combination	Point=1	X2=-0.5	X3=-0.5	
S11=1526.81829322145	IsS11Max=Yes	IsS11Min=No	FrameElem=116	ElemStation=0.5			
Frame=116	Station=0.5	OutputCase=ACCSX2	CaseType=Combination	Point=2	X2=-0.5	X3=0.5	
S11=1526.81829322145	IsS11Max=No	IsS11Min=No	FrameElem=116	ElemStation=0.5			
Frame=116	Station=0.5	OutputCase=ACCSX2	CaseType=Combination	Point=3	X2=0.5	X3=-0.5	S11=-
1753.59480934309	IsS11Max=No	IsS11Min=Yes	FrameElem=116	ElemStation=0.5			

Frame=116	Station=0.5	OutputCase=ACCSX2	CaseType=Combination	Point=4	X2=0.5	X3=0.5	S11=-
1753.59480934309	IsS11Max=No	IsS11Min=No	FrameElem=116	ElemStation=0.5			
Frame=116	Station=0	OutputCase=ENVE	CaseType=Combination	StepType=Max	Point=0	X2=0	X3=0
111.11546006997	IsS11Max=No	IsS11Min=No	FrameElem=116	ElemStation=0			
Frame=116	Station=0	OutputCase=ENVE	CaseType=Combination	StepType=Max	Point=1	X2=-0.5	X3=-0.5
S11=1710.58382263176	IsS11Max=Yes	IsS11Min=No	FrameElem=116	ElemStation=0			
Frame=116	Station=0	OutputCase=ENVE	CaseType=Combination	StepType=Max	Point=2	X2=-0.5	X3=0.5
S11=1710.58382263176	IsS11Max=No	IsS11Min=No	FrameElem=116	ElemStation=0			
Frame=116	Station=0	OutputCase=ENVE	CaseType=Combination	StepType=Max	Point=3	X2=0.5	X3=-0.5
S11=-1849.17695192407	IsS11Max=No	IsS11Min=Yes	FrameElem=116	ElemStation=0			
Frame=116	Station=0	OutputCase=ENVE	CaseType=Combination	StepType=Max	Point=4	X2=0.5	X3=0.5
1849.17695192407	IsS11Max=No	IsS11Min=No	FrameElem=116	ElemStation=0			
Frame=116	Station=0.125	OutputCase=ENVE	CaseType=Combination	StepType=Max	Point=0	X2=0	X3=0
111.11546006997	IsS11Max=No	IsS11Min=No	FrameElem=116	ElemStation=0.125			
Frame=116	Station=0.125	OutputCase=ENVE	CaseType=Combination	StepType=Max	Point=1	X2=-0.5	X3=-0.5
S11=1702.68913451715	IsS11Max=Yes	IsS11Min=No	FrameElem=116	ElemStation=0.125			
Frame=116	Station=0.125	OutputCase=ENVE	CaseType=Combination	StepType=Max	Point=2	X2=-0.5	X3=0.5
S11=1702.68913451715	IsS11Max=No	IsS11Min=No	FrameElem=116	ElemStation=0.125			
Frame=116	Station=0.125	OutputCase=ENVE	CaseType=Combination	StepType=Max	Point=3	X2=0.5	X3=-0.5
S11=-1840.40076792256	IsS11Max=No	IsS11Min=Yes	FrameElem=116	ElemStation=0.125			
Frame=116	Station=0.125	OutputCase=ENVE	CaseType=Combination	StepType=Max	Point=4	X2=0.5	X3=0.5
S11=-1840.40076792256	IsS11Max=No	IsS11Min=No	FrameElem=116	ElemStation=0.125			
Frame=116	Station=0.25	OutputCase=ENVE	CaseType=Combination	StepType=Max	Point=0	X2=0	X3=0
111.11546006997	IsS11Max=No	IsS11Min=No	FrameElem=116	ElemStation=0.25			
Frame=116	Station=0.25	OutputCase=ENVE	CaseType=Combination	StepType=Max	Point=1	X2=-0.5	X3=-0.5
S11=1679.00507140254	IsS11Max=Yes	IsS11Min=No	FrameElem=116	ElemStation=0.25			
Frame=116	Station=0.25	OutputCase=ENVE	CaseType=Combination	StepType=Max	Point=2	X2=-0.5	X3=0.5
S11=1679.00507140254	IsS11Max=No	IsS11Min=No	FrameElem=116	ElemStation=0.25			
Frame=116	Station=0.25	OutputCase=ENVE	CaseType=Combination	StepType=Max	Point=3	X2=0.5	X3=-0.5
S11=-1816.34333392104	IsS11Max=No	IsS11Min=Yes	FrameElem=116	ElemStation=0.25			
Frame=116	Station=0.25	OutputCase=ENVE	CaseType=Combination	StepType=Max	Point=4	X2=0.5	X3=0.5
S11=-1816.34333392104	IsS11Max=No	IsS11Min=No	FrameElem=116	ElemStation=0.25			
Frame=116	Station=0.375	OutputCase=ENVE	CaseType=Combination	StepType=Max	Point=0	X2=0	X3=0
111.11546006997	IsS11Max=No	IsS11Min=No	FrameElem=116	ElemStation=0.375			
Frame=116	Station=0.375	OutputCase=ENVE	CaseType=Combination	StepType=Max	Point=1	X2=-0.5	X3=-0.5
S11=1639.53163328794	IsS11Max=Yes	IsS11Min=No	FrameElem=116	ElemStation=0.375			
Frame=116	Station=0.375	OutputCase=ENVE	CaseType=Combination	StepType=Max	Point=2	X2=-0.5	X3=0.5
S11=1639.53163328794	IsS11Max=No	IsS11Min=No	FrameElem=116	ElemStation=0.375			
Frame=116	Station=0.375	OutputCase=ENVE	CaseType=Combination	StepType=Max	Point=3	X2=0.5	X3=-0.5
S11=-1777.00464991952	IsS11Max=No	IsS11Min=Yes	FrameElem=116	ElemStation=0.375			
Frame=116	Station=0.375	OutputCase=ENVE	CaseType=Combination	StepType=Max	Point=4	X2=0.5	X3=0.5
S11=-1777.00464991952	IsS11Max=No	IsS11Min=No	FrameElem=116	ElemStation=0.375			
Frame=116	Station=0.5	OutputCase=ENVE	CaseType=Combination	StepType=Max	Point=0	X2=0	X3=0
111.11546006997	IsS11Max=No	IsS11Min=No	FrameElem=116	ElemStation=0.5			
Frame=116	Station=0.5	OutputCase=ENVE	CaseType=Combination	StepType=Max	Point=1	X2=-0.5	X3=-0.5
S11=1584.26882017333	IsS11Max=Yes	IsS11Min=No	FrameElem=116	ElemStation=0.5			
Frame=116	Station=0.5	OutputCase=ENVE	CaseType=Combination	StepType=Max	Point=2	X2=-0.5	X3=0.5
S11=1584.26882017333	IsS11Max=No	IsS11Min=No	FrameElem=116	ElemStation=0.5			
Frame=116	Station=0.5	OutputCase=ENVE	CaseType=Combination	StepType=Max	Point=3	X2=0.5	X3=-0.5
S11=-1722.38471591801	IsS11Max=No	IsS11Min=Yes	FrameElem=116	ElemStation=0.5			
Frame=116	Station=0.5	OutputCase=ENVE	CaseType=Combination	StepType=Max	Point=4	X2=0.5	X3=0.5
S11=-1722.38471591801	IsS11Max=No	IsS11Min=No	FrameElem=116	ElemStation=0.5			
Frame=116	Station=0	OutputCase=ENVE	CaseType=Combination	StepType=Min	Point=0	X2=0	X3=0
169.541010668998	IsS11Max=No	IsS11Min=No	FrameElem=116	ElemStation=0			
Frame=116	Station=0	OutputCase=ENVE	CaseType=Combination	StepType=Min	Point=1	X2=-0.5	X3=-0.5
S11=1514.84890431154	IsS11Max=Yes	IsS11Min=No	FrameElem=116	ElemStation=0			
Frame=116	Station=0	OutputCase=ENVE	CaseType=Combination	StepType=Min	Point=2	X2=-0.5	X3=0.5
S11=1514.84890431154	IsS11Max=No	IsS11Min=No	FrameElem=116	ElemStation=0			
Frame=116	Station=0	OutputCase=ENVE	CaseType=Combination	StepType=Min	Point=3	X2=0.5	X3=-0.5
S11=-1942.11431247887	IsS11Max=No	IsS11Min=Yes	FrameElem=116	ElemStation=0			
Frame=116	Station=0	OutputCase=ENVE	CaseType=Combination	StepType=Min	Point=4	X2=0.5	X3=0.5
1942.11431247887	IsS11Max=No	IsS11Min=No	FrameElem=116	ElemStation=0			
Frame=116	Station=0.125	OutputCase=ENVE	CaseType=Combination	StepType=Min	Point=0	X2=0	X3=0
169.541010668998	IsS11Max=No	IsS11Min=No	FrameElem=116	ElemStation=0.125			
Frame=116	Station=0.125	OutputCase=ENVE	CaseType=Combination	StepType=Min	Point=1	X2=-0.5	X3=-0.5
S11=1506.07272031002	IsS11Max=Yes	IsS11Min=No	FrameElem=116	ElemStation=0.125			
Frame=116	Station=0.125	OutputCase=ENVE	CaseType=Combination	StepType=Min	Point=2	X2=-0.5	X3=0.5
S11=1506.07272031002	IsS11Max=No	IsS11Min=No	FrameElem=116	ElemStation=0.125			
Frame=116	Station=0.125	OutputCase=ENVE	CaseType=Combination	StepType=Min	Point=3	X2=0.5	X3=-0.5
S11=-1934.21962436426	IsS11Max=No	IsS11Min=Yes	FrameElem=116	ElemStation=0.125			
Frame=116	Station=0.125	OutputCase=ENVE	CaseType=Combination	StepType=Min	Point=4	X2=0.5	X3=0.5
S11=-1934.21962436426	IsS11Max=No	IsS11Min=No	FrameElem=116	ElemStation=0.125			
Frame=116	Station=0.25	OutputCase=ENVE	CaseType=Combination	StepType=Min	Point=0	X2=0	X3=0
169.541010668998	IsS11Max=No	IsS11Min=No	FrameElem=116	ElemStation=0.25			
Frame=116	Station=0.25	OutputCase=ENVE	CaseType=Combination	StepType=Min	Point=1	X2=-0.5	X3=-0.5
S11=1482.0152863085	IsS11Max=Yes	IsS11Min=No	FrameElem=116	ElemStation=0.25			
Frame=116	Station=0.25	OutputCase=ENVE	CaseType=Combination	StepType=Min	Point=2	X2=-0.5	X3=0.5
S11=1482.0152863085	IsS11Max=No	IsS11Min=No	FrameElem=116	ElemStation=0.25			
Frame=116	Station=0.25	OutputCase=ENVE	CaseType=Combination	StepType=Min	Point=3	X2=0.5	X3=-0.5
S11=-1910.53556124965	IsS11Max=No	IsS11Min=Yes	FrameElem=116	ElemStation=0.25			
Frame=116	Station=0.25	OutputCase=ENVE	CaseType=Combination	StepType=Min	Point=4	X2=0.5	X3=0.5
S11=-1910.53556124965	IsS11Max=No	IsS11Min=No	FrameElem=116	ElemStation=0.25			



Frame=116	Station=0.375	OutputCase=ENVE	CaseType=Combination	StepType=Min	Point=0	X2=0	X3=0	S11=-
169.541010668998	Iss11Max=No	Iss11Min=No	FrameElem=116	ElemStation=0.375				
Frame=116	Station=0.375	OutputCase=ENVE	CaseType=Combination	StepType=Min	Point=1	X2=-0.5	X3=-0.5	
S11=1442.67660230699	Iss11Max=Yes	Iss11Min=No	FrameElem=116	ElemStation=0.375				
Frame=116	Station=0.375	OutputCase=ENVE	CaseType=Combination	StepType=Min	Point=2	X2=-0.5	X3=0.5	
S11=1442.67660230699	Iss11Max=No	Iss11Min=No	FrameElem=116	ElemStation=0.375				
Frame=116	Station=0.375	OutputCase=ENVE	CaseType=Combination	StepType=Min	Point=3	X2=0.5	X3=-0.5	
S11=-1871.06212313504	Iss11Max=No	Iss11Min=Yes	FrameElem=116	ElemStation=0.375				
Frame=116	Station=0.375	OutputCase=ENVE	CaseType=Combination	StepType=Min	Point=4	X2=0.5	X3=0.5	
S11=-1871.06212313504	Iss11Max=No	Iss11Min=No	FrameElem=116	ElemStation=0.375				
Frame=116	Station=0.5	OutputCase=ENVE	CaseType=Combination	StepType=Min	Point=0	X2=0	X3=0	S11=-
169.541010668998	Iss11Max=No	Iss11Min=No	FrameElem=116	ElemStation=0.5				
Frame=116	Station=0.5	OutputCase=ENVE	CaseType=Combination	StepType=Min	Point=1	X2=-0.5	X3=-0.5	
S11=1388.05666830547	Iss11Max=Yes	Iss11Min=No	FrameElem=116	ElemStation=0.5				
Frame=116	Station=0.5	OutputCase=ENVE	CaseType=Combination	StepType=Min	Point=2	X2=-0.5	X3=0.5	
S11=1388.05666830547	Iss11Max=No	Iss11Min=No	FrameElem=116	ElemStation=0.5				
Frame=116	Station=0.5	OutputCase=ENVE	CaseType=Combination	StepType=Min	Point=3	X2=0.5	X3=-0.5	
S11=-1815.79931002044	Iss11Max=No	Iss11Min=Yes	FrameElem=116	ElemStation=0.5				
Frame=116	Station=0.5	OutputCase=ENVE	CaseType=Combination	StepType=Min	Point=4	X2=0.5	X3=0.5	
S11=-1815.79931002044	Iss11Max=No	Iss11Min=No	FrameElem=116	ElemStation=0.5				
Frame=116	Station=0	OutputCase=FESSUR	CaseType=Combination	Point=0	X2=0	X3=0	S11=-168.146075212923	
Iss11Max=No	Iss11Min=No	FrameElem=116	ElemStation=0					
Frame=116	Station=0	OutputCase=FESSUR	CaseType=Combination	Point=1	X2=-0.5	X3=-0.5		
S11=1556.51309022324	Iss11Max=Yes	Iss11Min=No	FrameElem=116	ElemStation=0				
Frame=116	Station=0	OutputCase=FESSUR	CaseType=Combination	Point=2	X2=-0.5	X3=0.5		
S11=1556.51309022324	Iss11Max=No	Iss11Min=No	FrameElem=116	ElemStation=0				
Frame=116	Station=0	OutputCase=FESSUR	CaseType=Combination	Point=3	X2=0.5	X3=-0.5	S11=-	
1892.80524064908	Iss11Max=No	Iss11Min=Yes	FrameElem=116	ElemStation=0				
Frame=116	Station=0	OutputCase=FESSUR	CaseType=Combination	Point=4	X2=0.5	X3=0.5	S11=-	
1892.80524064908	Iss11Max=No	Iss11Min=No	FrameElem=116	ElemStation=0				
Frame=116	Station=0.125	OutputCase=FESSUR	CaseType=Combination	Point=0	X2=0	X3=0	S11=-	
168.146075212923	Iss11Max=No	Iss11Min=No	FrameElem=116	ElemStation=0.125				
Frame=116	Station=0.125	OutputCase=FESSUR	CaseType=Combination	Point=1	X2=-0.5	X3=-0.5		
S11=1548.69462065993	Iss11Max=Yes	Iss11Min=No	FrameElem=116	ElemStation=0.125				
Frame=116	Station=0.125	OutputCase=FESSUR	CaseType=Combination	Point=2	X2=-0.5	X3=0.5		
S11=1548.69462065993	Iss11Max=No	Iss11Min=No	FrameElem=116	ElemStation=0.125				
Frame=116	Station=0.125	OutputCase=FESSUR	CaseType=Combination	Point=3	X2=0.5	X3=-0.5	S11=-	
1884.98677108578	Iss11Max=No	Iss11Min=Yes	FrameElem=116	ElemStation=0.125				
Frame=116	Station=0.125	OutputCase=FESSUR	CaseType=Combination	Point=4	X2=0.5	X3=0.5	S11=-	
1884.98677108578	Iss11Max=No	Iss11Min=No	FrameElem=116	ElemStation=0.125				
Frame=116	Station=0.25	OutputCase=FESSUR	CaseType=Combination	Point=0	X2=0	X3=0	S11=-	
168.146075212923	Iss11Max=No	Iss11Min=No	FrameElem=116	ElemStation=0.25				
Frame=116	Station=0.25	OutputCase=FESSUR	CaseType=Combination	Point=1	X2=-0.5	X3=-0.5		
S11=1525.23921359662	Iss11Max=Yes	Iss11Min=No	FrameElem=116	ElemStation=0.25				
Frame=116	Station=0.25	OutputCase=FESSUR	CaseType=Combination	Point=2	X2=-0.5	X3=0.5		
S11=1525.23921359662	Iss11Max=No	Iss11Min=No	FrameElem=116	ElemStation=0.25				
Frame=116	Station=0.25	OutputCase=FESSUR	CaseType=Combination	Point=3	X2=0.5	X3=-0.5	S11=-	
1861.53136402247	Iss11Max=No	Iss11Min=Yes	FrameElem=116	ElemStation=0.25				
Frame=116	Station=0.25	OutputCase=FESSUR	CaseType=Combination	Point=4	X2=0.5	X3=0.5	S11=-	
1861.53136402247	Iss11Max=No	Iss11Min=No	FrameElem=116	ElemStation=0.25				
Frame=116	Station=0.375	OutputCase=FESSUR	CaseType=Combination	Point=0	X2=0	X3=0	S11=-	
168.146075212923	Iss11Max=No	Iss11Min=No	FrameElem=116	ElemStation=0.375				
Frame=116	Station=0.375	OutputCase=FESSUR	CaseType=Combination	Point=1	X2=-0.5	X3=-0.5		
S11=1486.14686903331	Iss11Max=Yes	Iss11Min=No	FrameElem=116	ElemStation=0.375				
Frame=116	Station=0.375	OutputCase=FESSUR	CaseType=Combination	Point=2	X2=-0.5	X3=0.5		
S11=1486.14686903331	Iss11Max=No	Iss11Min=No	FrameElem=116	ElemStation=0.375				
Frame=116	Station=0.375	OutputCase=FESSUR	CaseType=Combination	Point=3	X2=0.5	X3=-0.5	S11=-	
1822.43901945916	Iss11Max=No	Iss11Min=Yes	FrameElem=116	ElemStation=0.375				
Frame=116	Station=0.375	OutputCase=FESSUR	CaseType=Combination	Point=4	X2=0.5	X3=0.5	S11=-	
1822.43901945916	Iss11Max=No	Iss11Min=No	FrameElem=116	ElemStation=0.375				
Frame=116	Station=0.5	OutputCase=FESSUR	CaseType=Combination	Point=0	X2=0	X3=0	S11=-	
168.146075212923	Iss11Max=No	Iss11Min=No	FrameElem=116	ElemStation=0.5				
Frame=116	Station=0.5	OutputCase=FESSUR	CaseType=Combination	Point=1	X2=-0.5	X3=-0.5		
S11=1431.41758697	Iss11Max=Yes	Iss11Min=No	FrameElem=116	ElemStation=0.5				
Frame=116	Station=0.5	OutputCase=FESSUR	CaseType=Combination	Point=2	X2=-0.5	X3=0.5		
S11=1431.41758697	Iss11Max=No	Iss11Min=No	FrameElem=116	ElemStation=0.5				
Frame=116	Station=0.5	OutputCase=FESSUR	CaseType=Combination	Point=3	X2=0.5	X3=-0.5	S11=-	
1767.70973739585	Iss11Max=No	Iss11Min=Yes	FrameElem=116	ElemStation=0.5				
Frame=116	Station=0.5	OutputCase=FESSUR	CaseType=Combination	Point=4	X2=0.5	X3=0.5	S11=-	
1767.70973739585	Iss11Max=No	Iss11Min=No	FrameElem=116	ElemStation=0.5				
Frame=117	Station=0	OutputCase=PERM1	CaseType=Combination	Point=0	X2=0	X3=0	S11=-164.891225815414	
Iss11Max=No	Iss11Min=No	FrameElem=117	ElemStation=0					
Frame=117	Station=0	OutputCase=PERM1	CaseType=Combination	Point=1	X2=-0.5	X3=-0.5		
S11=1398.54183429937	Iss11Max=Yes	Iss11Min=No	FrameElem=117	ElemStation=0				
Frame=117	Station=0	OutputCase=PERM1	CaseType=Combination	Point=2	X2=-0.5	X3=0.5		
S11=1398.54183429937	Iss11Max=No	Iss11Min=No	FrameElem=117	ElemStation=0				
Frame=117	Station=0	OutputCase=PERM1	CaseType=Combination	Point=3	X2=0.5	X3=-0.5	S11=-	
1728.3242859302	Iss11Max=No	Iss11Min=Yes	FrameElem=117	ElemStation=0				
Frame=117	Station=0	OutputCase=PERM1	CaseType=Combination	Point=4	X2=0.5	X3=0.5	S11=-	
1728.3242859302	Iss11Max=No	Iss11Min=No	FrameElem=117	ElemStation=0				
Frame=117	Station=0.125	OutputCase=PERM1	CaseType=Combination	Point=0	X2=0	X3=0	S11=-	
164.891225815414	Iss11Max=No	Iss11Min=No	FrameElem=117	ElemStation=0.125				

```

Frame=117 Station=0.125 OutputCase=PERM1 CaseType=Combination Point=1 X2=-0.5 X3=-0.5
S11=1329.77620850196 IsS11Max=Yes IsS11Min=No FrameElem=117 ElemStation=0.125
Frame=117 Station=0.125 OutputCase=PERM1 CaseType=Combination Point=2 X2=-0.5 X3=0.5
S11=1329.77620850196 IsS11Max=No IsS11Min=No FrameElem=117 ElemStation=0.125
Frame=117 Station=0.125 OutputCase=PERM1 CaseType=Combination Point=3 X2=0.5 X3=-0.5 S11=-
1659.55866013279 IsS11Max=No IsS11Min=Yes FrameElem=117 ElemStation=0.125
Frame=117 Station=0.125 OutputCase=PERM1 CaseType=Combination Point=4 X2=0.5 X3=0.5 S11=-
1659.55866013279 IsS11Max=No IsS11Min=No FrameElem=117 ElemStation=0.125
Frame=117 Station=0.25 OutputCase=PERM1 CaseType=Combination Point=0 X2=0 X3=0 S11=-
164.891225815414 IsS11Max=No IsS11Min=No FrameElem=117 ElemStation=0.25
Frame=117 Station=0.25 OutputCase=PERM1 CaseType=Combination Point=1 X2=-0.5 X3=-0.5
S11=1245.72933270456 IsS11Max=Yes IsS11Min=No FrameElem=117 ElemStation=0.25
Frame=117 Station=0.25 OutputCase=PERM1 CaseType=Combination Point=2 X2=-0.5 X3=0.5
S11=1245.72933270456 IsS11Max=No IsS11Min=No FrameElem=117 ElemStation=0.25
Frame=117 Station=0.25 OutputCase=PERM1 CaseType=Combination Point=3 X2=0.5 X3=-0.5 S11=-
1575.51178433539 IsS11Max=No IsS11Min=Yes FrameElem=117 ElemStation=0.25
Frame=117 Station=0.25 OutputCase=PERM1 CaseType=Combination Point=4 X2=0.5 X3=0.5 S11=-
1575.51178433539 IsS11Max=No IsS11Min=No FrameElem=117 ElemStation=0.25
Frame=117 Station=0.375 OutputCase=PERM1 CaseType=Combination Point=0 X2=0 X3=0 S11=-
164.891225815414 IsS11Max=No IsS11Min=No FrameElem=117 ElemStation=0.375
Frame=117 Station=0.375 OutputCase=PERM1 CaseType=Combination Point=1 X2=-0.5 X3=-0.5
S11=1146.40120690715 IsS11Max=Yes IsS11Min=No FrameElem=117 ElemStation=0.375
Frame=117 Station=0.375 OutputCase=PERM1 CaseType=Combination Point=2 X2=-0.5 X3=0.5
S11=1146.40120690715 IsS11Max=No IsS11Min=No FrameElem=117 ElemStation=0.375
Frame=117 Station=0.375 OutputCase=PERM1 CaseType=Combination Point=3 X2=0.5 X3=-0.5 S11=-
1476.18365853798 IsS11Max=No IsS11Min=Yes FrameElem=117 ElemStation=0.375
Frame=117 Station=0.375 OutputCase=PERM1 CaseType=Combination Point=4 X2=0.5 X3=0.5 S11=-
1476.18365853798 IsS11Max=No IsS11Min=No FrameElem=117 ElemStation=0.375
Frame=117 Station=0.5 OutputCase=PERM1 CaseType=Combination Point=0 X2=0 X3=0 S11=-164.891225815414
IsS11Max=No IsS11Min=No FrameElem=117 ElemStation=0.5
Frame=117 Station=0.5 OutputCase=PERM1 CaseType=Combination Point=1 X2=-0.5 X3=-0.5
S11=1031.79183110975 IsS11Max=Yes IsS11Min=No FrameElem=117 ElemStation=0.5
Frame=117 Station=0.5 OutputCase=PERM1 CaseType=Combination Point=2 X2=-0.5 X3=0.5
S11=1031.79183110975 IsS11Max=No IsS11Min=No FrameElem=117 ElemStation=0.5
Frame=117 Station=0.5 OutputCase=PERM1 CaseType=Combination Point=3 X2=0.5 X3=-0.5 S11=-
1361.57428274058 IsS11Max=No IsS11Min=Yes FrameElem=117 ElemStation=0.5
Frame=117 Station=0.5 OutputCase=PERM1 CaseType=Combination Point=4 X2=0.5 X3=0.5 S11=-
1361.57428274058 IsS11Max=No IsS11Min=No FrameElem=117 ElemStation=0.5
Frame=117 Station=0 OutputCase=PERM2 CaseType=Combination Point=0 X2=0 X3=0 S11=-111.115460069969
IsS11Max=No IsS11Min=No FrameElem=117 ElemStation=0
Frame=117 Station=0 OutputCase=PERM2 CaseType=Combination Point=1 X2=-0.5 X3=-0.5
S11=1537.30345921535 IsS11Max=Yes IsS11Min=No FrameElem=117 ElemStation=0
Frame=117 Station=0 OutputCase=PERM2 CaseType=Combination Point=2 X2=-0.5 X3=0.5
S11=1537.30345921535 IsS11Max=No IsS11Min=No FrameElem=117 ElemStation=0
Frame=117 Station=0 OutputCase=PERM2 CaseType=Combination Point=3 X2=0.5 X3=-0.5 S11=-
1759.53437935529 IsS11Max=No IsS11Min=Yes FrameElem=117 ElemStation=0
Frame=117 Station=0 OutputCase=PERM2 CaseType=Combination Point=4 X2=0.5 X3=0.5 S11=-
1759.53437935529 IsS11Max=No IsS11Min=No FrameElem=117 ElemStation=0
Frame=117 Station=0.125 OutputCase=PERM2 CaseType=Combination Point=0 X2=0 X3=0 S11=-
111.115460069969 IsS11Max=No IsS11Min=No FrameElem=117 ElemStation=0.125
Frame=117 Station=0.125 OutputCase=PERM2 CaseType=Combination Point=1 X2=-0.5 X3=-0.5
S11=1468.53783362345 IsS11Max=Yes IsS11Min=No FrameElem=117 ElemStation=0.125
Frame=117 Station=0.125 OutputCase=PERM2 CaseType=Combination Point=2 X2=-0.5 X3=0.5
S11=1468.53783362345 IsS11Max=No IsS11Min=No FrameElem=117 ElemStation=0.125
Frame=117 Station=0.125 OutputCase=PERM2 CaseType=Combination Point=3 X2=0.5 X3=-0.5 S11=-
1690.76875376339 IsS11Max=No IsS11Min=Yes FrameElem=117 ElemStation=0.125
Frame=117 Station=0.125 OutputCase=PERM2 CaseType=Combination Point=4 X2=0.5 X3=0.5 S11=-
1690.76875376339 IsS11Max=No IsS11Min=No FrameElem=117 ElemStation=0.125
Frame=117 Station=0.25 OutputCase=PERM2 CaseType=Combination Point=0 X2=0 X3=0 S11=-
111.115460069969 IsS11Max=No IsS11Min=No FrameElem=117 ElemStation=0.25
Frame=117 Station=0.25 OutputCase=PERM2 CaseType=Combination Point=1 X2=-0.5 X3=-0.5
S11=1384.49095803155 IsS11Max=Yes IsS11Min=No FrameElem=117 ElemStation=0.25
Frame=117 Station=0.25 OutputCase=PERM2 CaseType=Combination Point=2 X2=-0.5 X3=0.5
S11=1384.49095803155 IsS11Max=No IsS11Min=No FrameElem=117 ElemStation=0.25
Frame=117 Station=0.25 OutputCase=PERM2 CaseType=Combination Point=3 X2=0.5 X3=-0.5 S11=-
1606.72187817149 IsS11Max=No IsS11Min=Yes FrameElem=117 ElemStation=0.25
Frame=117 Station=0.25 OutputCase=PERM2 CaseType=Combination Point=4 X2=0.5 X3=0.5 S11=-
1606.72187817149 IsS11Max=No IsS11Min=No FrameElem=117 ElemStation=0.25
Frame=117 Station=0.375 OutputCase=PERM2 CaseType=Combination Point=0 X2=0 X3=0 S11=-
111.115460069969 IsS11Max=No IsS11Min=No FrameElem=117 ElemStation=0.375
Frame=117 Station=0.375 OutputCase=PERM2 CaseType=Combination Point=1 X2=-0.5 X3=-0.5
S11=1285.16283243965 IsS11Max=Yes IsS11Min=No FrameElem=117 ElemStation=0.375
Frame=117 Station=0.375 OutputCase=PERM2 CaseType=Combination Point=2 X2=-0.5 X3=0.5
S11=1285.16283243965 IsS11Max=No IsS11Min=No FrameElem=117 ElemStation=0.375
Frame=117 Station=0.375 OutputCase=PERM2 CaseType=Combination Point=3 X2=0.5 X3=-0.5 S11=-
1507.39375257959 IsS11Max=No IsS11Min=Yes FrameElem=117 ElemStation=0.375
Frame=117 Station=0.375 OutputCase=PERM2 CaseType=Combination Point=4 X2=0.5 X3=0.5 S11=-
1507.39375257959 IsS11Max=No IsS11Min=No FrameElem=117 ElemStation=0.375
Frame=117 Station=0.5 OutputCase=PERM2 CaseType=Combination Point=0 X2=0 X3=0 S11=-111.115460069969
IsS11Max=No IsS11Min=No FrameElem=117 ElemStation=0.5
Frame=117 Station=0.5 OutputCase=PERM2 CaseType=Combination Point=1 X2=-0.5 X3=-0.5
S11=1170.55345684775 IsS11Max=Yes IsS11Min=No FrameElem=117 ElemStation=0.5

```



Frame=117 Station=0.5 OutputCase=PERM2 CaseType=Combination Point=2 X2=-0.5 X3=0.5
 S11=1170.55345684775 IsS11Max=No IsS11Min=No FrameElem=117 ElemStation=0.5
 Frame=117 Station=0.5 OutputCase=PERM2 CaseType=Combination Point=3 X2=0.5 X3=-0.5 S11=-
 1392.78437698769 IsS11Max=No IsS11Min=Yes FrameElem=117 ElemStation=0.5
 Frame=117 Station=0.5 OutputCase=PERM2 CaseType=Combination Point=4 X2=0.5 X3=0.5 S11=-
 1392.78437698769 IsS11Max=No IsS11Min=No FrameElem=117 ElemStation=0.5
 Frame=117 Station=0 OutputCase=ACC1 CaseType=Combination Point=0 X2=0 X3=0 S11=-169.541010668997
 IsS11Max=No IsS11Min=No FrameElem=117 ElemStation=0
 Frame=117 Station=0 OutputCase=ACC1 CaseType=Combination Point=1 X2=-0.5 X3=-0.5
 S11=1445.5071952572 IsS11Max=Yes IsS11Min=No FrameElem=117 ElemStation=0
 Frame=117 Station=0 OutputCase=ACC1 CaseType=Combination Point=2 X2=-0.5 X3=0.5 S11=1445.5071952572
 IsS11Max=No IsS11Min=No FrameElem=117 ElemStation=0
 Frame=117 Station=0 OutputCase=ACC1 CaseType=Combination Point=3 X2=0.5 X3=-0.5 S11=-
 1784.5892165952 IsS11Max=No IsS11Min=Yes FrameElem=117 ElemStation=0
 Frame=117 Station=0 OutputCase=ACC1 CaseType=Combination Point=4 X2=0.5 X3=0.5 S11=-1784.5892165952
 IsS11Max=No IsS11Min=No FrameElem=117 ElemStation=0
 Frame=117 Station=0.125 OutputCase=ACC1 CaseType=Combination Point=0 X2=0 X3=0 S11=-
 169.541010668997 IsS11Max=No IsS11Min=No FrameElem=117 ElemStation=0.125
 Frame=117 Station=0.125 OutputCase=ACC1 CaseType=Combination Point=1 X2=-0.5 X3=-0.5
 S11=1374.45500693711 IsS11Max=Yes IsS11Min=No FrameElem=117 ElemStation=0.125
 Frame=117 Station=0.125 OutputCase=ACC1 CaseType=Combination Point=2 X2=-0.5 X3=0.5
 S11=1374.45500693711 IsS11Max=No IsS11Min=No FrameElem=117 ElemStation=0.125
 Frame=117 Station=0.125 OutputCase=ACC1 CaseType=Combination Point=3 X2=0.5 X3=-0.5 S11=-
 1713.5370282751 IsS11Max=No IsS11Min=Yes FrameElem=117 ElemStation=0.125
 Frame=117 Station=0.125 OutputCase=ACC1 CaseType=Combination Point=4 X2=0.5 X3=0.5 S11=-
 1713.5370282751 IsS11Max=No IsS11Min=No FrameElem=117 ElemStation=0.125
 Frame=117 Station=0.25 OutputCase=ACC1 CaseType=Combination Point=0 X2=0 X3=0 S11=-169.541010668997
 IsS11Max=No IsS11Min=No FrameElem=117 ElemStation=0.25
 Frame=117 Station=0.25 OutputCase=ACC1 CaseType=Combination Point=1 X2=-0.5 X3=-0.5
 S11=1287.61344361702 IsS11Max=Yes IsS11Min=No FrameElem=117 ElemStation=0.25
 Frame=117 Station=0.25 OutputCase=ACC1 CaseType=Combination Point=2 X2=-0.5 X3=0.5
 S11=1287.61344361702 IsS11Max=No IsS11Min=No FrameElem=117 ElemStation=0.25
 Frame=117 Station=0.25 OutputCase=ACC1 CaseType=Combination Point=3 X2=0.5 X3=-0.5 S11=-
 1626.69546495501 IsS11Max=No IsS11Min=Yes FrameElem=117 ElemStation=0.25
 Frame=117 Station=0.25 OutputCase=ACC1 CaseType=Combination Point=4 X2=0.5 X3=0.5 S11=-
 1626.69546495501 IsS11Max=No IsS11Min=No FrameElem=117 ElemStation=0.25
 Frame=117 Station=0.375 OutputCase=ACC1 CaseType=Combination Point=0 X2=0 X3=0 S11=-
 169.541010668997 IsS11Max=No IsS11Min=No FrameElem=117 ElemStation=0.375
 Frame=117 Station=0.375 OutputCase=ACC1 CaseType=Combination Point=1 X2=-0.5 X3=-0.5
 S11=1184.98250529692 IsS11Max=Yes IsS11Min=No FrameElem=117 ElemStation=0.375
 Frame=117 Station=0.375 OutputCase=ACC1 CaseType=Combination Point=2 X2=-0.5 X3=0.5
 S11=1184.98250529692 IsS11Max=No IsS11Min=No FrameElem=117 ElemStation=0.375
 Frame=117 Station=0.375 OutputCase=ACC1 CaseType=Combination Point=3 X2=0.5 X3=-0.5 S11=-
 1524.06452663492 IsS11Max=No IsS11Min=Yes FrameElem=117 ElemStation=0.375
 Frame=117 Station=0.375 OutputCase=ACC1 CaseType=Combination Point=4 X2=0.5 X3=0.5 S11=-
 1524.06452663492 IsS11Max=No IsS11Min=No FrameElem=117 ElemStation=0.375
 Frame=117 Station=0.5 OutputCase=ACC1 CaseType=Combination Point=0 X2=0 X3=0 S11=-169.541010668997
 IsS11Max=No IsS11Min=No FrameElem=117 ElemStation=0.5
 Frame=117 Station=0.5 OutputCase=ACC1 CaseType=Combination Point=1 X2=-0.5 X3=-0.5
 S11=1066.56219197683 IsS11Max=Yes IsS11Min=No FrameElem=117 ElemStation=0.5
 Frame=117 Station=0.5 OutputCase=ACC1 CaseType=Combination Point=2 X2=-0.5 X3=0.5
 S11=1066.56219197683 IsS11Max=No IsS11Min=No FrameElem=117 ElemStation=0.5
 Frame=117 Station=0.5 OutputCase=ACC1 CaseType=Combination Point=3 X2=0.5 X3=-0.5 S11=-
 1405.64421331482 IsS11Max=No IsS11Min=Yes FrameElem=117 ElemStation=0.5
 Frame=117 Station=0.5 OutputCase=ACC1 CaseType=Combination Point=4 X2=0.5 X3=0.5 S11=-
 1405.64421331482 IsS11Max=No IsS11Min=No FrameElem=117 ElemStation=0.5
 Frame=117 Station=0 OutputCase=ACC2 CaseType=Combination Point=0 X2=0 X3=0 S11=-115.765244923552
 IsS11Max=No IsS11Min=No FrameElem=117 ElemStation=0
 Frame=117 Station=0 OutputCase=ACC2 CaseType=Combination Point=1 X2=-0.5 X3=-0.5
 S11=1584.26882017318 IsS11Max=Yes IsS11Min=No FrameElem=117 ElemStation=0
 Frame=117 Station=0 OutputCase=ACC2 CaseType=Combination Point=2 X2=-0.5 X3=0.5
 S11=1584.26882017318 IsS11Max=No IsS11Min=No FrameElem=117 ElemStation=0
 Frame=117 Station=0 OutputCase=ACC2 CaseType=Combination Point=3 X2=0.5 X3=-0.5 S11=-
 1815.79931002028 IsS11Max=No IsS11Min=Yes FrameElem=117 ElemStation=0
 Frame=117 Station=0 OutputCase=ACC2 CaseType=Combination Point=4 X2=0.5 X3=0.5 S11=-
 1815.79931002028 IsS11Max=No IsS11Min=No FrameElem=117 ElemStation=0
 Frame=117 Station=0.125 OutputCase=ACC2 CaseType=Combination Point=0 X2=0 X3=0 S11=-
 115.765244923552 IsS11Max=No IsS11Min=No FrameElem=117 ElemStation=0.125
 Frame=117 Station=0.125 OutputCase=ACC2 CaseType=Combination Point=1 X2=-0.5 X3=-0.5
 S11=1513.21663205859 IsS11Max=Yes IsS11Min=No FrameElem=117 ElemStation=0.125
 Frame=117 Station=0.125 OutputCase=ACC2 CaseType=Combination Point=2 X2=-0.5 X3=0.5
 S11=1513.21663205859 IsS11Max=No IsS11Min=No FrameElem=117 ElemStation=0.125
 Frame=117 Station=0.125 OutputCase=ACC2 CaseType=Combination Point=3 X2=0.5 X3=-0.5 S11=-
 1744.7471219057 IsS11Max=No IsS11Min=Yes FrameElem=117 ElemStation=0.125
 Frame=117 Station=0.125 OutputCase=ACC2 CaseType=Combination Point=4 X2=0.5 X3=0.5 S11=-
 1744.7471219057 IsS11Max=No IsS11Min=No FrameElem=117 ElemStation=0.125
 Frame=117 Station=0.25 OutputCase=ACC2 CaseType=Combination Point=0 X2=0 X3=0 S11=-115.765244923552
 IsS11Max=No IsS11Min=No FrameElem=117 ElemStation=0.25
 Frame=117 Station=0.25 OutputCase=ACC2 CaseType=Combination Point=1 X2=-0.5 X3=-0.5
 S11=1426.37506894401 IsS11Max=Yes IsS11Min=No FrameElem=117 ElemStation=0.25
 Frame=117 Station=0.25 OutputCase=ACC2 CaseType=Combination Point=2 X2=-0.5 X3=0.5
 S11=1426.37506894401 IsS11Max=No IsS11Min=No FrameElem=117 ElemStation=0.25



Frame=117	Station=0.25	OutputCase=ACC2	CaseType=Combination	Point=3	X2=0.5	X3=-0.5	S11=-
1657.90555879111	IsS11Max=No	IsS11Min=Yes	FrameElem=117	ElemStation=0.25			
Frame=117	Station=0.25	OutputCase=ACC2	CaseType=Combination	Point=4	X2=0.5	X3=0.5	S11=-
1657.90555879111	IsS11Max=No	IsS11Min=No	FrameElem=117	ElemStation=0.25			
Frame=117	Station=0.375	OutputCase=ACC2	CaseType=Combination	Point=0	X2=0	X3=0	S11=-
115.765244923552	IsS11Max=No	IsS11Min=No	FrameElem=117	ElemStation=0.375			
Frame=117	Station=0.375	OutputCase=ACC2	CaseType=Combination	Point=1	X2=-0.5	X3=-0.5	
S11=1323.74413082942	IsS11Max=Yes	IsS11Min=No	FrameElem=117	ElemStation=0.375			
Frame=117	Station=0.375	OutputCase=ACC2	CaseType=Combination	Point=2	X2=-0.5	X3=0.5	
S11=1323.74413082942	IsS11Max=No	IsS11Min=No	FrameElem=117	ElemStation=0.375			
Frame=117	Station=0.375	OutputCase=ACC2	CaseType=Combination	Point=3	X2=0.5	X3=-0.5	S11=-
1555.27462067653	IsS11Max=No	IsS11Min=Yes	FrameElem=117	ElemStation=0.375			
Frame=117	Station=0.375	OutputCase=ACC2	CaseType=Combination	Point=4	X2=0.5	X3=0.5	S11=-
1555.27462067653	IsS11Max=No	IsS11Min=No	FrameElem=117	ElemStation=0.375			
Frame=117	Station=0.5	OutputCase=ACC2	CaseType=Combination	Point=0	X2=0	X3=0	S11=-115.765244923552
IsS11Max=No	IsS11Min=No	FrameElem=117	ElemStation=0.5				
Frame=117	Station=0.5	OutputCase=ACC2	CaseType=Combination	Point=1	X2=-0.5	X3=-0.5	
S11=1205.32381771484	IsS11Max=Yes	IsS11Min=No	FrameElem=117	ElemStation=0.5			
Frame=117	Station=0.5	OutputCase=ACC2	CaseType=Combination	Point=2	X2=-0.5	X3=0.5	
S11=1205.32381771484	IsS11Max=No	IsS11Min=No	FrameElem=117	ElemStation=0.5			
Frame=117	Station=0.5	OutputCase=ACC2	CaseType=Combination	Point=3	X2=0.5	X3=-0.5	S11=-
1436.85430756194	IsS11Max=No	IsS11Min=Yes	FrameElem=117	ElemStation=0.5			
Frame=117	Station=0.5	OutputCase=ACC2	CaseType=Combination	Point=4	X2=0.5	X3=0.5	S11=-
1436.85430756194	IsS11Max=No	IsS11Min=No	FrameElem=117	ElemStation=0.5			
Frame=117	Station=0	OutputCase=ACCSX1	CaseType=Combination	Point=0	X2=0	X3=0	S11=-167.16402380627
IsS11Max=No	IsS11Min=No	FrameElem=117	ElemStation=0				
Frame=117	Station=0	OutputCase=ACCSX1	CaseType=Combination	Point=1	X2=-0.5	X3=-0.5	
S11=1388.05666830532	IsS11Max=Yes	IsS11Min=No	FrameElem=117	ElemStation=0			
Frame=117	Station=0	OutputCase=ACCSX1	CaseType=Combination	Point=2	X2=-0.5	X3=0.5	
S11=1388.05666830532	IsS11Max=No	IsS11Min=No	FrameElem=117	ElemStation=0			
Frame=117	Station=0	OutputCase=ACCSX1	CaseType=Combination	Point=3	X2=0.5	X3=-0.5	S11=-
1722.38471591786	IsS11Max=No	IsS11Min=Yes	FrameElem=117	ElemStation=0			
Frame=117	Station=0	OutputCase=ACCSX1	CaseType=Combination	Point=4	X2=0.5	X3=0.5	S11=-
1722.38471591786	IsS11Max=No	IsS11Min=No	FrameElem=117	ElemStation=0			
Frame=117	Station=0.125	OutputCase=ACCSX1	CaseType=Combination	Point=0	X2=0	X3=0	S11=-
167.16402380627	IsS11Max=No	IsS11Min=No	FrameElem=117	ElemStation=0.125			
Frame=117	Station=0.125	OutputCase=ACCSX1	CaseType=Combination	Point=1	X2=-0.5	X3=-0.5	
S11=1318.15548430382	IsS11Max=Yes	IsS11Min=No	FrameElem=117	ElemStation=0.125			
Frame=117	Station=0.125	OutputCase=ACCSX1	CaseType=Combination	Point=2	X2=-0.5	X3=0.5	
S11=1318.15548430382	IsS11Max=No	IsS11Min=No	FrameElem=117	ElemStation=0.125			
Frame=117	Station=0.125	OutputCase=ACCSX1	CaseType=Combination	Point=3	X2=0.5	X3=-0.5	S11=-
1652.48353191637	IsS11Max=No	IsS11Min=Yes	FrameElem=117	ElemStation=0.125			
Frame=117	Station=0.125	OutputCase=ACCSX1	CaseType=Combination	Point=4	X2=0.5	X3=0.5	S11=-
1652.48353191637	IsS11Max=No	IsS11Min=No	FrameElem=117	ElemStation=0.125			
Frame=117	Station=0.25	OutputCase=ACCSX1	CaseType=Combination	Point=0	X2=0	X3=0	S11=-
167.16402380627	IsS11Max=No	IsS11Min=No	FrameElem=117	ElemStation=0.25			
Frame=117	Station=0.25	OutputCase=ACCSX1	CaseType=Combination	Point=1	X2=-0.5	X3=-0.5	
S11=1232.97305030233	IsS11Max=Yes	IsS11Min=No	FrameElem=117	ElemStation=0.25			
Frame=117	Station=0.25	OutputCase=ACCSX1	CaseType=Combination	Point=2	X2=-0.5	X3=0.5	
S11=1232.97305030233	IsS11Max=No	IsS11Min=No	FrameElem=117	ElemStation=0.25			
Frame=117	Station=0.25	OutputCase=ACCSX1	CaseType=Combination	Point=3	X2=0.5	X3=-0.5	S11=-
1567.30109791487	IsS11Max=No	IsS11Min=Yes	FrameElem=117	ElemStation=0.25			
Frame=117	Station=0.25	OutputCase=ACCSX1	CaseType=Combination	Point=4	X2=0.5	X3=0.5	S11=-
1567.30109791487	IsS11Max=No	IsS11Min=No	FrameElem=117	ElemStation=0.25			
Frame=117	Station=0.375	OutputCase=ACCSX1	CaseType=Combination	Point=0	X2=0	X3=0	S11=-
167.16402380627	IsS11Max=No	IsS11Min=No	FrameElem=117	ElemStation=0.375			
Frame=117	Station=0.375	OutputCase=ACCSX1	CaseType=Combination	Point=1	X2=-0.5	X3=-0.5	
S11=1132.50936630084	IsS11Max=Yes	IsS11Min=No	FrameElem=117	ElemStation=0.375			
Frame=117	Station=0.375	OutputCase=ACCSX1	CaseType=Combination	Point=2	X2=-0.5	X3=0.5	
S11=1132.50936630084	IsS11Max=No	IsS11Min=No	FrameElem=117	ElemStation=0.375			
Frame=117	Station=0.375	OutputCase=ACCSX1	CaseType=Combination	Point=3	X2=0.5	X3=-0.5	S11=-
1466.83741391338	IsS11Max=No	IsS11Min=Yes	FrameElem=117	ElemStation=0.375			
Frame=117	Station=0.375	OutputCase=ACCSX1	CaseType=Combination	Point=4	X2=0.5	X3=0.5	S11=-
1466.83741391338	IsS11Max=No	IsS11Min=No	FrameElem=117	ElemStation=0.375			
Frame=117	Station=0.5	OutputCase=ACCSX1	CaseType=Combination	Point=0	X2=0	X3=0	S11=-167.16402380627
IsS11Max=No	IsS11Min=No	FrameElem=117	ElemStation=0.5				
Frame=117	Station=0.5	OutputCase=ACCSX1	CaseType=Combination	Point=1	X2=-0.5	X3=-0.5	
S11=1016.76443229934	IsS11Max=Yes	IsS11Min=No	FrameElem=117	ElemStation=0.5			
Frame=117	Station=0.5	OutputCase=ACCSX1	CaseType=Combination	Point=2	X2=-0.5	X3=0.5	
S11=1016.76443229934	IsS11Max=No	IsS11Min=No	FrameElem=117	ElemStation=0.5			
Frame=117	Station=0.5	OutputCase=ACCSX1	CaseType=Combination	Point=3	X2=0.5	X3=-0.5	S11=-
1351.09247991188	IsS11Max=No	IsS11Min=Yes	FrameElem=117	ElemStation=0.5			
Frame=117	Station=0.5	OutputCase=ACCSX1	CaseType=Combination	Point=4	X2=0.5	X3=0.5	S11=-
1351.09247991188	IsS11Max=No	IsS11Min=No	FrameElem=117	ElemStation=0.5			
Frame=117	Station=0	OutputCase=ACCSX2	CaseType=Combination	Point=0	X2=0	X3=0	S11=-113.388258060825
IsS11Max=No	IsS11Min=No	FrameElem=117	ElemStation=0				
Frame=117	Station=0	OutputCase=ACCSX2	CaseType=Combination	Point=1	X2=-0.5	X3=-0.5	
S11=1526.8182932213	IsS11Max=Yes	IsS11Min=No	FrameElem=117	ElemStation=0			
Frame=117	Station=0	OutputCase=ACCSX2	CaseType=Combination	Point=2	X2=-0.5	X3=0.5	
S11=1526.8182932213	IsS11Max=No	IsS11Min=No	FrameElem=117	ElemStation=0			
Frame=117	Station=0	OutputCase=ACCSX2	CaseType=Combination	Point=3	X2=0.5	X3=-0.5	S11=-
1753.59480934295	IsS11Max=No	IsS11Min=Yes	FrameElem=117	ElemStation=0			

Frame=117	Station=0	OutputCase=ACCSX2	CaseType=Combination	Point=4	X2=0.5	X3=0.5	S11=-	
1753.59480934295	IsS11Max=No	IsS11Min=No	FrameElem=117	ElemStation=0				
Frame=117	Station=0.125	OutputCase=ACCSX2	CaseType=Combination	Point=0	X2=0	X3=0	S11=-	
113.388258060825	IsS11Max=No	IsS11Min=No	FrameElem=117	ElemStation=0.125				
Frame=117	Station=0.125	OutputCase=ACCSX2	CaseType=Combination	Point=1	X2=-0.5	X3=-0.5		
S11=1456.91710942531	IsS11Max=Yes	IsS11Min=No	FrameElem=117	ElemStation=0.125				
Frame=117	Station=0.125	OutputCase=ACCSX2	CaseType=Combination	Point=2	X2=-0.5	X3=0.5		
S11=1456.91710942531	IsS11Max=No	IsS11Min=No	FrameElem=117	ElemStation=0.125				
Frame=117	Station=0.125	OutputCase=ACCSX2	CaseType=Combination	Point=3	X2=0.5	X3=-0.5	S11=-	
1683.69362554696	IsS11Max=No	IsS11Min=Yes	FrameElem=117	ElemStation=0.125				
Frame=117	Station=0.125	OutputCase=ACCSX2	CaseType=Combination	Point=4	X2=0.5	X3=0.5	S11=-	
1683.69362554696	IsS11Max=No	IsS11Min=No	FrameElem=117	ElemStation=0.125				
Frame=117	Station=0.25	OutputCase=ACCSX2	CaseType=Combination	Point=0	X2=0	X3=0	S11=-	
113.388258060825	IsS11Max=No	IsS11Min=No	FrameElem=117	ElemStation=0.25				
Frame=117	Station=0.25	OutputCase=ACCSX2	CaseType=Combination	Point=1	X2=-0.5	X3=-0.5		
S11=1371.73467562932	IsS11Max=Yes	IsS11Min=No	FrameElem=117	ElemStation=0.25				
Frame=117	Station=0.25	OutputCase=ACCSX2	CaseType=Combination	Point=2	X2=-0.5	X3=0.5		
S11=1371.73467562932	IsS11Max=No	IsS11Min=No	FrameElem=117	ElemStation=0.25				
Frame=117	Station=0.25	OutputCase=ACCSX2	CaseType=Combination	Point=3	X2=0.5	X3=-0.5	S11=-	
1598.51119175097	IsS11Max=No	IsS11Min=Yes	FrameElem=117	ElemStation=0.25				
Frame=117	Station=0.25	OutputCase=ACCSX2	CaseType=Combination	Point=4	X2=0.5	X3=0.5	S11=-	
1598.51119175097	IsS11Max=No	IsS11Min=No	FrameElem=117	ElemStation=0.25				
Frame=117	Station=0.375	OutputCase=ACCSX2	CaseType=Combination	Point=0	X2=0	X3=0	S11=-	
113.388258060825	IsS11Max=No	IsS11Min=No	FrameElem=117	ElemStation=0.375				
Frame=117	Station=0.375	OutputCase=ACCSX2	CaseType=Combination	Point=1	X2=-0.5	X3=-0.5		
S11=1271.27099183334	IsS11Max=Yes	IsS11Min=No	FrameElem=117	ElemStation=0.375				
Frame=117	Station=0.375	OutputCase=ACCSX2	CaseType=Combination	Point=2	X2=-0.5	X3=0.5		
S11=1271.27099183334	IsS11Max=No	IsS11Min=No	FrameElem=117	ElemStation=0.375				
Frame=117	Station=0.375	OutputCase=ACCSX2	CaseType=Combination	Point=3	X2=0.5	X3=-0.5	S11=-	
1498.04750795499	IsS11Max=No	IsS11Min=Yes	FrameElem=117	ElemStation=0.375				
Frame=117	Station=0.375	OutputCase=ACCSX2	CaseType=Combination	Point=4	X2=0.5	X3=0.5	S11=-	
1498.04750795499	IsS11Max=No	IsS11Min=No	FrameElem=117	ElemStation=0.375				
Frame=117	Station=0.5	OutputCase=ACCSX2	CaseType=Combination	Point=0	X2=0	X3=0	S11=-	
113.388258060825	IsS11Max=No	IsS11Min=No	FrameElem=117	ElemStation=0.5				
Frame=117	Station=0.5	OutputCase=ACCSX2	CaseType=Combination	Point=1	X2=-0.5	X3=-0.5		
S11=1155.52605803735	IsS11Max=Yes	IsS11Min=No	FrameElem=117	ElemStation=0.5				
Frame=117	Station=0.5	OutputCase=ACCSX2	CaseType=Combination	Point=2	X2=-0.5	X3=0.5		
S11=1155.52605803735	IsS11Max=No	IsS11Min=No	FrameElem=117	ElemStation=0.5				
Frame=117	Station=0.5	OutputCase=ACCSX2	CaseType=Combination	Point=3	X2=0.5	X3=-0.5	S11=-	
1382.302574159	IsS11Max=No	IsS11Min=Yes	FrameElem=117	ElemStation=0.5				
Frame=117	Station=0.5	OutputCase=ACCSX2	CaseType=Combination	Point=4	X2=0.5	X3=0.5	S11=-	
1382.302574159	IsS11Max=No	IsS11Min=No	FrameElem=117	ElemStation=0.5				
Frame=117	Station=0	OutputCase=ENVE	CaseType=Combination	StepType=Max	Point=0	X2=0	X3=0	S11=-
111.115460069969	IsS11Max=No	IsS11Min=No	FrameElem=117	ElemStation=0				
Frame=117	Station=0	OutputCase=ENVE	CaseType=Combination	StepType=Max	Point=1	X2=-0.5	X3=-0.5	
S11=1584.26882017318	IsS11Max=Yes	IsS11Min=No	FrameElem=117	ElemStation=0				
Frame=117	Station=0	OutputCase=ENVE	CaseType=Combination	StepType=Max	Point=2	X2=-0.5	X3=0.5	
S11=1584.26882017318	IsS11Max=No	IsS11Min=No	FrameElem=117	ElemStation=0				
Frame=117	Station=0	OutputCase=ENVE	CaseType=Combination	StepType=Max	Point=3	X2=0.5	X3=-0.5	
S11=-1722.38471591786	IsS11Max=No	IsS11Min=Yes	FrameElem=117	ElemStation=0				
Frame=117	Station=0	OutputCase=ENVE	CaseType=Combination	StepType=Max	Point=4	X2=0.5	X3=0.5	S11=-
1722.38471591786	IsS11Max=No	IsS11Min=No	FrameElem=117	ElemStation=0				
Frame=117	Station=0.125	OutputCase=ENVE	CaseType=Combination	StepType=Max	Point=0	X2=0	X3=0	S11=-
111.115460069969	IsS11Max=No	IsS11Min=No	FrameElem=117	ElemStation=0.125				
Frame=117	Station=0.125	OutputCase=ENVE	CaseType=Combination	StepType=Max	Point=1	X2=-0.5	X3=-0.5	
S11=1513.21663205859	IsS11Max=Yes	IsS11Min=No	FrameElem=117	ElemStation=0.125				
Frame=117	Station=0.125	OutputCase=ENVE	CaseType=Combination	StepType=Max	Point=2	X2=-0.5	X3=0.5	
S11=1513.21663205859	IsS11Max=No	IsS11Min=No	FrameElem=117	ElemStation=0.125				
Frame=117	Station=0.125	OutputCase=ENVE	CaseType=Combination	StepType=Max	Point=3	X2=0.5	X3=-0.5	
S11=-1652.48353191637	IsS11Max=No	IsS11Min=Yes	FrameElem=117	ElemStation=0.125				
Frame=117	Station=0.125	OutputCase=ENVE	CaseType=Combination	StepType=Max	Point=4	X2=0.5	X3=0.5	
S11=-1652.48353191637	IsS11Max=No	IsS11Min=No	FrameElem=117	ElemStation=0.125				
Frame=117	Station=0.25	OutputCase=ENVE	CaseType=Combination	StepType=Max	Point=0	X2=0	X3=0	S11=-
111.115460069969	IsS11Max=No	IsS11Min=No	FrameElem=117	ElemStation=0.25				
Frame=117	Station=0.25	OutputCase=ENVE	CaseType=Combination	StepType=Max	Point=1	X2=-0.5	X3=-0.5	
S11=1426.37506894401	IsS11Max=Yes	IsS11Min=No	FrameElem=117	ElemStation=0.25				
Frame=117	Station=0.25	OutputCase=ENVE	CaseType=Combination	StepType=Max	Point=2	X2=-0.5	X3=0.5	
S11=1426.37506894401	IsS11Max=No	IsS11Min=No	FrameElem=117	ElemStation=0.25				
Frame=117	Station=0.25	OutputCase=ENVE	CaseType=Combination	StepType=Max	Point=3	X2=0.5	X3=-0.5	
S11=-1567.30109791487	IsS11Max=No	IsS11Min=Yes	FrameElem=117	ElemStation=0.25				
Frame=117	Station=0.25	OutputCase=ENVE	CaseType=Combination	StepType=Max	Point=4	X2=0.5	X3=0.5	
S11=-1567.30109791487	IsS11Max=No	IsS11Min=No	FrameElem=117	ElemStation=0.25				
Frame=117	Station=0.375	OutputCase=ENVE	CaseType=Combination	StepType=Max	Point=0	X2=0	X3=0	S11=-
111.115460069969	IsS11Max=No	IsS11Min=No	FrameElem=117	ElemStation=0.375				
Frame=117	Station=0.375	OutputCase=ENVE	CaseType=Combination	StepType=Max	Point=1	X2=-0.5	X3=-0.5	
S11=1323.74413082942	IsS11Max=Yes	IsS11Min=No	FrameElem=117	ElemStation=0.375				
Frame=117	Station=0.375	OutputCase=ENVE	CaseType=Combination	StepType=Max	Point=2	X2=-0.5	X3=0.5	
S11=1323.74413082942	IsS11Max=No	IsS11Min=No	FrameElem=117	ElemStation=0.375				
Frame=117	Station=0.375	OutputCase=ENVE	CaseType=Combination	StepType=Max	Point=3	X2=0.5	X3=-0.5	
S11=-1466.83741391338	IsS11Max=No	IsS11Min=Yes	FrameElem=117	ElemStation=0.375				
Frame=117	Station=0.375	OutputCase=ENVE	CaseType=Combination	StepType=Max	Point=4	X2=0.5	X3=0.5	
S11=-1466.83741391338	IsS11Max=No	IsS11Min=No	FrameElem=117	ElemStation=0.375				

Frame=117	Station=0.5	OutputCase=ENVE	CaseType=Combination	StepType=Max	Point=0	X2=0	X3=0	S11=-
111.115460069969		IsS11Max=No	IsS11Min=No	FrameElem=117	ElemStation=0.5			
Frame=117	Station=0.5	OutputCase=ENVE	CaseType=Combination	StepType=Max	Point=1	X2=-0.5	X3=-0.5	
S11=1205.32381771484		IsS11Max=Yes	IsS11Min=No	FrameElem=117	ElemStation=0.5			
Frame=117	Station=0.5	OutputCase=ENVE	CaseType=Combination	StepType=Max	Point=2	X2=-0.5	X3=0.5	
S11=1205.32381771484		IsS11Max=No	IsS11Min=No	FrameElem=117	ElemStation=0.5			
Frame=117	Station=0.5	OutputCase=ENVE	CaseType=Combination	StepType=Max	Point=3	X2=0.5	X3=-0.5	
S11=-1351.09247991188		IsS11Max=No	IsS11Min=Yes	FrameElem=117	ElemStation=0.5			
Frame=117	Station=0.5	OutputCase=ENVE	CaseType=Combination	StepType=Max	Point=4	X2=0.5	X3=0.5	
S11=-1351.09247991188		IsS11Max=No	IsS11Min=No	FrameElem=117	ElemStation=0.5			
Frame=117	Station=0	OutputCase=ENVE	CaseType=Combination	StepType=Min	Point=0	X2=0	X3=0	S11=-
169.541010668997		IsS11Max=No	IsS11Min=No	FrameElem=117	ElemStation=0			
Frame=117	Station=0	OutputCase=ENVE	CaseType=Combination	StepType=Min	Point=1	X2=-0.5	X3=-0.5	
S11=1388.05666830532		IsS11Max=Yes	IsS11Min=No	FrameElem=117	ElemStation=0			
Frame=117	Station=0	OutputCase=ENVE	CaseType=Combination	StepType=Min	Point=2	X2=-0.5	X3=0.5	
S11=1388.05666830532		IsS11Max=No	IsS11Min=No	FrameElem=117	ElemStation=0			
Frame=117	Station=0	OutputCase=ENVE	CaseType=Combination	StepType=Min	Point=3	X2=0.5	X3=-0.5	
S11=-1815.79931002028		IsS11Max=No	IsS11Min=Yes	FrameElem=117	ElemStation=0			
Frame=117	Station=0	OutputCase=ENVE	CaseType=Combination	StepType=Min	Point=4	X2=0.5	X3=0.5	S11=-
1815.79931002028		IsS11Max=No	IsS11Min=No	FrameElem=117	ElemStation=0			
Frame=117	Station=0.125	OutputCase=ENVE	CaseType=Combination	StepType=Min	Point=0	X2=0	X3=0	S11=-
169.541010668997		IsS11Max=No	IsS11Min=No	FrameElem=117	ElemStation=0.125			
Frame=117	Station=0.125	OutputCase=ENVE	CaseType=Combination	StepType=Min	Point=1	X2=-0.5	X3=-0.5	
S11=1318.15548430382		IsS11Max=Yes	IsS11Min=No	FrameElem=117	ElemStation=0.125			
Frame=117	Station=0.125	OutputCase=ENVE	CaseType=Combination	StepType=Min	Point=2	X2=-0.5	X3=0.5	
S11=1318.15548430382		IsS11Max=No	IsS11Min=No	FrameElem=117	ElemStation=0.125			
Frame=117	Station=0.125	OutputCase=ENVE	CaseType=Combination	StepType=Min	Point=3	X2=0.5	X3=-0.5	
S11=-1744.7471219057		IsS11Max=No	IsS11Min=Yes	FrameElem=117	ElemStation=0.125			
Frame=117	Station=0.125	OutputCase=ENVE	CaseType=Combination	StepType=Min	Point=4	X2=0.5	X3=0.5	
S11=-1744.7471219057		IsS11Max=No	IsS11Min=No	FrameElem=117	ElemStation=0.125			
Frame=117	Station=0.25	OutputCase=ENVE	CaseType=Combination	StepType=Min	Point=0	X2=0	X3=0	S11=-
169.541010668997		IsS11Max=No	IsS11Min=No	FrameElem=117	ElemStation=0.25			
Frame=117	Station=0.25	OutputCase=ENVE	CaseType=Combination	StepType=Min	Point=1	X2=-0.5	X3=-0.5	
S11=1232.97305030233		IsS11Max=Yes	IsS11Min=No	FrameElem=117	ElemStation=0.25			
Frame=117	Station=0.25	OutputCase=ENVE	CaseType=Combination	StepType=Min	Point=2	X2=-0.5	X3=0.5	
S11=1232.97305030233		IsS11Max=No	IsS11Min=No	FrameElem=117	ElemStation=0.25			
Frame=117	Station=0.25	OutputCase=ENVE	CaseType=Combination	StepType=Min	Point=3	X2=0.5	X3=-0.5	
S11=-1657.90555879111		IsS11Max=No	IsS11Min=Yes	FrameElem=117	ElemStation=0.25			
Frame=117	Station=0.25	OutputCase=ENVE	CaseType=Combination	StepType=Min	Point=4	X2=0.5	X3=0.5	
S11=-1657.90555879111		IsS11Max=No	IsS11Min=No	FrameElem=117	ElemStation=0.25			
Frame=117	Station=0.375	OutputCase=ENVE	CaseType=Combination	StepType=Min	Point=0	X2=0	X3=0	S11=-
169.541010668997		IsS11Max=No	IsS11Min=No	FrameElem=117	ElemStation=0.375			
Frame=117	Station=0.375	OutputCase=ENVE	CaseType=Combination	StepType=Min	Point=1	X2=-0.5	X3=-0.5	
S11=1132.50936630084		IsS11Max=Yes	IsS11Min=No	FrameElem=117	ElemStation=0.375			
Frame=117	Station=0.375	OutputCase=ENVE	CaseType=Combination	StepType=Min	Point=2	X2=-0.5	X3=0.5	
S11=1132.50936630084		IsS11Max=No	IsS11Min=No	FrameElem=117	ElemStation=0.375			
Frame=117	Station=0.375	OutputCase=ENVE	CaseType=Combination	StepType=Min	Point=3	X2=0.5	X3=-0.5	
S11=-1555.27462067653		IsS11Max=No	IsS11Min=Yes	FrameElem=117	ElemStation=0.375			
Frame=117	Station=0.375	OutputCase=ENVE	CaseType=Combination	StepType=Min	Point=4	X2=0.5	X3=0.5	
S11=-1555.27462067653		IsS11Max=No	IsS11Min=No	FrameElem=117	ElemStation=0.375			
Frame=117	Station=0.5	OutputCase=ENVE	CaseType=Combination	StepType=Min	Point=0	X2=0	X3=0	S11=-
169.541010668997		IsS11Max=No	IsS11Min=No	FrameElem=117	ElemStation=0.5			
Frame=117	Station=0.5	OutputCase=ENVE	CaseType=Combination	StepType=Min	Point=1	X2=-0.5	X3=-0.5	
S11=1016.76443229934		IsS11Max=Yes	IsS11Min=No	FrameElem=117	ElemStation=0.5			
Frame=117	Station=0.5	OutputCase=ENVE	CaseType=Combination	StepType=Min	Point=2	X2=-0.5	X3=0.5	
S11=1016.76443229934		IsS11Max=No	IsS11Min=No	FrameElem=117	ElemStation=0.5			
Frame=117	Station=0.5	OutputCase=ENVE	CaseType=Combination	StepType=Min	Point=3	X2=0.5	X3=-0.5	
S11=-1436.85430756194		IsS11Max=No	IsS11Min=Yes	FrameElem=117	ElemStation=0.5			
Frame=117	Station=0.5	OutputCase=ENVE	CaseType=Combination	StepType=Min	Point=4	X2=0.5	X3=0.5	
S11=-1436.85430756194		IsS11Max=No	IsS11Min=No	FrameElem=117	ElemStation=0.5			
Frame=117	Station=0	OutputCase=FESSUR	CaseType=Combination	Point=0	X2=0	X3=0	S11=-168.146075212922	
IsS11Max=No	IsS11Min=No	FrameElem=117	ElemStation=0					
Frame=117	Station=0	OutputCase=FESSUR	CaseType=Combination	Point=1	X2=-0.5	X3=-0.5		
S11=1431.41758696985		IsS11Max=Yes	IsS11Min=No	FrameElem=117	ElemStation=0			
Frame=117	Station=0	OutputCase=FESSUR	CaseType=Combination	Point=2	X2=-0.5	X3=0.5		
S11=1431.41758696985		IsS11Max=No	IsS11Min=No	FrameElem=117	ElemStation=0			
Frame=117	Station=0	OutputCase=FESSUR	CaseType=Combination	Point=3	X2=0.5	X3=-0.5	S11=-	
1767.7097373957		IsS11Max=No	IsS11Min=Yes	FrameElem=117	ElemStation=0			
Frame=117	Station=0	OutputCase=FESSUR	CaseType=Combination	Point=4	X2=0.5	X3=0.5	S11=-	
1767.7097373957		IsS11Max=No	IsS11Min=No	FrameElem=117	ElemStation=0			
Frame=117	Station=0.125	OutputCase=FESSUR	CaseType=Combination	Point=0	X2=0	X3=0	S11=-	
168.146075212922		IsS11Max=No	IsS11Min=No	FrameElem=117	ElemStation=0.125			
Frame=117	Station=0.125	OutputCase=FESSUR	CaseType=Combination	Point=1	X2=-0.5	X3=-0.5		
S11=1361.05136740656		IsS11Max=Yes	IsS11Min=No	FrameElem=117	ElemStation=0.125			
Frame=117	Station=0.125	OutputCase=FESSUR	CaseType=Combination	Point=2	X2=-0.5	X3=0.5		
S11=1361.05136740656		IsS11Max=No	IsS11Min=No	FrameElem=117	ElemStation=0.125			
Frame=117	Station=0.125	OutputCase=FESSUR	CaseType=Combination	Point=3	X2=0.5	X3=-0.5	S11=-	
1697.34351783241		IsS11Max=No	IsS11Min=Yes	FrameElem=117	ElemStation=0.125			
Frame=117	Station=0.125	OutputCase=FESSUR	CaseType=Combination	Point=4	X2=0.5	X3=0.5	S11=-	
1697.34351783241		IsS11Max=No	IsS11Min=No	FrameElem=117	ElemStation=0.125			
Frame=117	Station=0.25	OutputCase=FESSUR	CaseType=Combination	Point=0	X2=0	X3=0	S11=-	
168.146075212922		IsS11Max=No	IsS11Min=No	FrameElem=117	ElemStation=0.25			

Frame=117	Station=0.25	OutputCase=FESSUR	CaseType=Combination	Point=1	X2=-0.5	X3=-0.5	
S11=1275.04821034328	IsS11Max=Yes	IsS11Min=No	FrameElem=117	ElemStation=0.25			
Frame=117	Station=0.25	OutputCase=FESSUR	CaseType=Combination	Point=2	X2=-0.5	X3=0.5	
S11=1275.04821034328	IsS11Max=No	IsS11Min=No	FrameElem=117	ElemStation=0.25			
Frame=117	Station=0.25	OutputCase=FESSUR	CaseType=Combination	Point=3	X2=0.5	X3=-0.5	S11=-
1611.34036076912	IsS11Max=No	IsS11Min=Yes	FrameElem=117	ElemStation=0.25			
Frame=117	Station=0.25	OutputCase=FESSUR	CaseType=Combination	Point=4	X2=0.5	X3=0.5	S11=-
1611.34036076912	IsS11Max=No	IsS11Min=No	FrameElem=117	ElemStation=0.25			
Frame=117	Station=0.375	OutputCase=FESSUR	CaseType=Combination	Point=0	X2=0	X3=0	S11=-
168.146075212922	IsS11Max=No	IsS11Min=No	FrameElem=117	ElemStation=0.375			
Frame=117	Station=0.375	OutputCase=FESSUR	CaseType=Combination	Point=1	X2=-0.5	X3=-0.5	
S11=1173.40811577999	IsS11Max=Yes	IsS11Min=No	FrameElem=117	ElemStation=0.375			
Frame=117	Station=0.375	OutputCase=FESSUR	CaseType=Combination	Point=2	X2=-0.5	X3=0.5	
S11=1173.40811577999	IsS11Max=No	IsS11Min=No	FrameElem=117	ElemStation=0.375			
Frame=117	Station=0.375	OutputCase=FESSUR	CaseType=Combination	Point=3	X2=0.5	X3=-0.5	S11=-
1509.70026620584	IsS11Max=No	IsS11Min=Yes	FrameElem=117	ElemStation=0.375			
Frame=117	Station=0.375	OutputCase=FESSUR	CaseType=Combination	Point=4	X2=0.5	X3=0.5	S11=-
1509.70026620584	IsS11Max=No	IsS11Min=No	FrameElem=117	ElemStation=0.375			
Frame=117	Station=0.5	OutputCase=FESSUR	CaseType=Combination	Point=0	X2=0	X3=0	S11=-
168.146075212922	IsS11Max=No	IsS11Min=No	FrameElem=117	ElemStation=0.5			
Frame=117	Station=0.5	OutputCase=FESSUR	CaseType=Combination	Point=1	X2=-0.5	X3=-0.5	
S11=1056.13108371671	IsS11Max=Yes	IsS11Min=No	FrameElem=117	ElemStation=0.5			
Frame=117	Station=0.5	OutputCase=FESSUR	CaseType=Combination	Point=2	X2=-0.5	X3=0.5	
S11=1056.13108371671	IsS11Max=No	IsS11Min=No	FrameElem=117	ElemStation=0.5			
Frame=117	Station=0.5	OutputCase=FESSUR	CaseType=Combination	Point=3	X2=0.5	X3=-0.5	S11=-
1392.42323414255	IsS11Max=No	IsS11Min=Yes	FrameElem=117	ElemStation=0.5			
Frame=117	Station=0.5	OutputCase=FESSUR	CaseType=Combination	Point=4	X2=0.5	X3=0.5	S11=-
1392.42323414255	IsS11Max=No	IsS11Min=No	FrameElem=117	ElemStation=0.5			
Frame=118	Station=0	OutputCase=PERM1	CaseType=Combination	Point=0	X2=0	X3=0	S11=-164.891225815415
IsS11Max=No	IsS11Min=No	FrameElem=118	ElemStation=0				
Frame=118	Station=0	OutputCase=PERM1	CaseType=Combination	Point=1	X2=-0.5	X3=-0.5	
S11=1031.79183110977	IsS11Max=Yes	IsS11Min=No	FrameElem=118	ElemStation=0			
Frame=118	Station=0	OutputCase=PERM1	CaseType=Combination	Point=2	X2=-0.5	X3=0.5	
S11=1031.79183110977	IsS11Max=No	IsS11Min=No	FrameElem=118	ElemStation=0			
Frame=118	Station=0	OutputCase=PERM1	CaseType=Combination	Point=3	X2=0.5	X3=-0.5	S11=-
1361.5742827406	IsS11Max=No	IsS11Min=Yes	FrameElem=118	ElemStation=0			
Frame=118	Station=0	OutputCase=PERM1	CaseType=Combination	Point=4	X2=0.5	X3=0.5	S11=-
1361.5742827406	IsS11Max=No	IsS11Min=No	FrameElem=118	ElemStation=0			
Frame=118	Station=0.125	OutputCase=PERM1	CaseType=Combination	Point=0	X2=0	X3=0	S11=-
164.891225815415	IsS11Max=No	IsS11Min=No	FrameElem=118	ElemStation=0.125			
Frame=118	Station=0.125	OutputCase=PERM1	CaseType=Combination	Point=1	X2=-0.5	X3=-0.5	
S11=901.901205312406	IsS11Max=Yes	IsS11Min=No	FrameElem=118	ElemStation=0.125			
Frame=118	Station=0.125	OutputCase=PERM1	CaseType=Combination	Point=2	X2=-0.5	X3=0.5	
S11=901.901205312406	IsS11Max=No	IsS11Min=No	FrameElem=118	ElemStation=0.125			
Frame=118	Station=0.125	OutputCase=PERM1	CaseType=Combination	Point=3	X2=0.5	X3=-0.5	S11=-
1231.68365694324	IsS11Max=No	IsS11Min=Yes	FrameElem=118	ElemStation=0.125			
Frame=118	Station=0.125	OutputCase=PERM1	CaseType=Combination	Point=4	X2=0.5	X3=0.5	S11=-
1231.68365694324	IsS11Max=No	IsS11Min=No	FrameElem=118	ElemStation=0.125			
Frame=118	Station=0.25	OutputCase=PERM1	CaseType=Combination	Point=0	X2=0	X3=0	S11=-
164.891225815415	IsS11Max=No	IsS11Min=No	FrameElem=118	ElemStation=0.25			
Frame=118	Station=0.25	OutputCase=PERM1	CaseType=Combination	Point=1	X2=-0.5	X3=-0.5	
S11=756.729329515044	IsS11Max=Yes	IsS11Min=No	FrameElem=118	ElemStation=0.25			
Frame=118	Station=0.25	OutputCase=PERM1	CaseType=Combination	Point=2	X2=-0.5	X3=0.5	
S11=756.729329515044	IsS11Max=No	IsS11Min=No	FrameElem=118	ElemStation=0.25			
Frame=118	Station=0.25	OutputCase=PERM1	CaseType=Combination	Point=3	X2=0.5	X3=-0.5	S11=-
1086.51178114587	IsS11Max=No	IsS11Min=Yes	FrameElem=118	ElemStation=0.25			
Frame=118	Station=0.25	OutputCase=PERM1	CaseType=Combination	Point=4	X2=0.5	X3=0.5	S11=-
1086.51178114587	IsS11Max=No	IsS11Min=No	FrameElem=118	ElemStation=0.25			
Frame=118	Station=0.375	OutputCase=PERM1	CaseType=Combination	Point=0	X2=0	X3=0	S11=-
164.891225815415	IsS11Max=No	IsS11Min=No	FrameElem=118	ElemStation=0.375			
Frame=118	Station=0.375	OutputCase=PERM1	CaseType=Combination	Point=1	X2=-0.5	X3=-0.5	
S11=596.276203717681	IsS11Max=Yes	IsS11Min=No	FrameElem=118	ElemStation=0.375			
Frame=118	Station=0.375	OutputCase=PERM1	CaseType=Combination	Point=2	X2=-0.5	X3=0.5	
S11=596.276203717681	IsS11Max=No	IsS11Min=No	FrameElem=118	ElemStation=0.375			
Frame=118	Station=0.375	OutputCase=PERM1	CaseType=Combination	Point=3	X2=0.5	X3=-0.5	S11=-
926.058655348511	IsS11Max=No	IsS11Min=Yes	FrameElem=118	ElemStation=0.375			
Frame=118	Station=0.375	OutputCase=PERM1	CaseType=Combination	Point=4	X2=0.5	X3=0.5	S11=-
926.058655348511	IsS11Max=No	IsS11Min=No	FrameElem=118	ElemStation=0.375			
Frame=118	Station=0.5	OutputCase=PERM1	CaseType=Combination	Point=0	X2=0	X3=0	S11=-164.891225815415
IsS11Max=No	IsS11Min=No	FrameElem=118	ElemStation=0.5				
Frame=118	Station=0.5	OutputCase=PERM1	CaseType=Combination	Point=1	X2=-0.5	X3=-0.5	
S11=420.541827920319	IsS11Max=Yes	IsS11Min=No	FrameElem=118	ElemStation=0.5			
Frame=118	Station=0.5	OutputCase=PERM1	CaseType=Combination	Point=2	X2=-0.5	X3=0.5	
S11=420.541827920319	IsS11Max=No	IsS11Min=No	FrameElem=118	ElemStation=0.5			
Frame=118	Station=0.5	OutputCase=PERM1	CaseType=Combination	Point=3	X2=0.5	X3=-0.5	S11=-
750.324279551148	IsS11Max=No	IsS11Min=Yes	FrameElem=118	ElemStation=0.5			
Frame=118	Station=0.5	OutputCase=PERM1	CaseType=Combination	Point=4	X2=0.5	X3=0.5	S11=-
750.324279551148	IsS11Max=No	IsS11Min=No	FrameElem=118	ElemStation=0.5			
Frame=118	Station=0	OutputCase=PERM2	CaseType=Combination	Point=0	X2=0	X3=0	S11=-111.115460069969
IsS11Max=No	IsS11Min=No	FrameElem=118	ElemStation=0				
Frame=118	Station=0	OutputCase=PERM2	CaseType=Combination	Point=1	X2=-0.5	X3=-0.5	
S11=1170.55345684778	IsS11Max=Yes	IsS11Min=No	FrameElem=118	ElemStation=0			

Frame=118 Station=0 OutputCase=PERM2 CaseType=Combination Point=2 X2=-0.5 X3=0.5
 S11=1170.55345684778 Iss11Max=No Iss11Min=No FrameElem=118 ElemStation=0
 Frame=118 Station=0 OutputCase=PERM2 CaseType=Combination Point=3 X2=0.5 X3=-0.5 S11=-
 1392.78437698771 Iss11Max=No Iss11Min=Yes FrameElem=118 ElemStation=0
 Frame=118 Station=0 OutputCase=PERM2 CaseType=Combination Point=4 X2=0.5 X3=0.5 S11=-
 1392.78437698771 Iss11Max=No Iss11Min=No FrameElem=118 ElemStation=0
 Frame=118 Station=0.125 OutputCase=PERM2 CaseType=Combination Point=0 X2=0 X3=0 S11=-
 111.115460069969 Iss11Max=No Iss11Min=No FrameElem=118 ElemStation=0.125
 Frame=118 Station=0.125 OutputCase=PERM2 CaseType=Combination Point=1 X2=-0.5 X3=-0.5
 S11=1040.66283125592 Iss11Max=Yes Iss11Min=No FrameElem=118 ElemStation=0.125
 Frame=118 Station=0.125 OutputCase=PERM2 CaseType=Combination Point=2 X2=-0.5 X3=0.5
 S11=1040.66283125592 Iss11Max=No Iss11Min=No FrameElem=118 ElemStation=0.125
 Frame=118 Station=0.125 OutputCase=PERM2 CaseType=Combination Point=3 X2=0.5 X3=-0.5 S11=-
 1262.89375139586 Iss11Max=No Iss11Min=Yes FrameElem=118 ElemStation=0.125
 Frame=118 Station=0.125 OutputCase=PERM2 CaseType=Combination Point=4 X2=0.5 X3=0.5 S11=-
 1262.89375139586 Iss11Max=No Iss11Min=No FrameElem=118 ElemStation=0.125
 Frame=118 Station=0.25 OutputCase=PERM2 CaseType=Combination Point=0 X2=0 X3=0 S11=-
 111.115460069969 Iss11Max=No Iss11Min=No FrameElem=118 ElemStation=0.25
 Frame=118 Station=0.25 OutputCase=PERM2 CaseType=Combination Point=1 X2=-0.5 X3=-0.5
 S11=895.490955664066 Iss11Max=Yes Iss11Min=No FrameElem=118 ElemStation=0.25
 Frame=118 Station=0.25 OutputCase=PERM2 CaseType=Combination Point=2 X2=-0.5 X3=0.5
 S11=895.490955664066 Iss11Max=No Iss11Min=No FrameElem=118 ElemStation=0.25
 Frame=118 Station=0.25 OutputCase=PERM2 CaseType=Combination Point=3 X2=0.5 X3=-0.5 S11=-
 1117.721875804 Iss11Max=No Iss11Min=Yes FrameElem=118 ElemStation=0.25
 Frame=118 Station=0.25 OutputCase=PERM2 CaseType=Combination Point=4 X2=0.5 X3=0.5 S11=-
 1117.721875804 Iss11Max=No Iss11Min=No FrameElem=118 ElemStation=0.25
 Frame=118 Station=0.375 OutputCase=PERM2 CaseType=Combination Point=0 X2=0 X3=0 S11=-
 111.115460069969 Iss11Max=No Iss11Min=No FrameElem=118 ElemStation=0.375
 Frame=118 Station=0.375 OutputCase=PERM2 CaseType=Combination Point=1 X2=-0.5 X3=-0.5
 S11=735.037830072211 Iss11Max=Yes Iss11Min=No FrameElem=118 ElemStation=0.375
 Frame=118 Station=0.375 OutputCase=PERM2 CaseType=Combination Point=2 X2=-0.5 X3=0.5
 S11=735.037830072211 Iss11Max=No Iss11Min=No FrameElem=118 ElemStation=0.375
 Frame=118 Station=0.375 OutputCase=PERM2 CaseType=Combination Point=3 X2=0.5 X3=-0.5 S11=-
 957.26875021215 Iss11Max=No Iss11Min=Yes FrameElem=118 ElemStation=0.375
 Frame=118 Station=0.375 OutputCase=PERM2 CaseType=Combination Point=4 X2=0.5 X3=0.5 S11=-
 957.26875021215 Iss11Max=No Iss11Min=No FrameElem=118 ElemStation=0.375
 Frame=118 Station=0.5 OutputCase=PERM2 CaseType=Combination Point=0 X2=0 X3=0 S11=-111.115460069969
 Iss11Max=No Iss11Min=No FrameElem=118 ElemStation=0.5
 Frame=118 Station=0.5 OutputCase=PERM2 CaseType=Combination Point=1 X2=-0.5 X3=-0.5
 S11=559.303454480356 Iss11Max=Yes Iss11Min=No FrameElem=118 ElemStation=0.5
 Frame=118 Station=0.5 OutputCase=PERM2 CaseType=Combination Point=2 X2=-0.5 X3=0.5
 S11=559.303454480356 Iss11Max=No Iss11Min=No FrameElem=118 ElemStation=0.5
 Frame=118 Station=0.5 OutputCase=PERM2 CaseType=Combination Point=3 X2=0.5 X3=-0.5 S11=-
 781.534374620295 Iss11Max=No Iss11Min=Yes FrameElem=118 ElemStation=0.5
 Frame=118 Station=0.5 OutputCase=PERM2 CaseType=Combination Point=4 X2=0.5 X3=0.5 S11=-
 781.534374620295 Iss11Max=No Iss11Min=No FrameElem=118 ElemStation=0.5
 Frame=118 Station=0 OutputCase=ACC1 CaseType=Combination Point=0 X2=0 X3=0 S11=-169.541010668998
 Iss11Max=No Iss11Min=No FrameElem=118 ElemStation=0
 Frame=118 Station=0 OutputCase=ACC1 CaseType=Combination Point=1 X2=-0.5 X3=-0.5
 S11=1066.56219197685 Iss11Max=Yes Iss11Min=No FrameElem=118 ElemStation=0
 Frame=118 Station=0 OutputCase=ACC1 CaseType=Combination Point=2 X2=-0.5 X3=0.5
 S11=1066.56219197685 Iss11Max=No Iss11Min=No FrameElem=118 ElemStation=0
 Frame=118 Station=0 OutputCase=ACC1 CaseType=Combination Point=3 X2=0.5 X3=-0.5 S11=-
 1405.64421331485 Iss11Max=No Iss11Min=Yes FrameElem=118 ElemStation=0
 Frame=118 Station=0 OutputCase=ACC1 CaseType=Combination Point=4 X2=0.5 X3=0.5 S11=-
 1405.64421331485 Iss11Max=No Iss11Min=No FrameElem=118 ElemStation=0
 Frame=118 Station=0.125 OutputCase=ACC1 CaseType=Combination Point=0 X2=0 X3=0 S11=-
 169.541010668998 Iss11Max=No Iss11Min=No FrameElem=118 ElemStation=0.125
 Frame=118 Station=0.125 OutputCase=ACC1 CaseType=Combination Point=1 X2=-0.5 X3=-0.5
 S11=932.352503656805 Iss11Max=Yes Iss11Min=No FrameElem=118 ElemStation=0.125
 Frame=118 Station=0.125 OutputCase=ACC1 CaseType=Combination Point=2 X2=-0.5 X3=0.5
 S11=932.352503656805 Iss11Max=No Iss11Min=No FrameElem=118 ElemStation=0.125
 Frame=118 Station=0.125 OutputCase=ACC1 CaseType=Combination Point=3 X2=0.5 X3=-0.5 S11=-
 1271.4345249948 Iss11Max=No Iss11Min=Yes FrameElem=118 ElemStation=0.125
 Frame=118 Station=0.125 OutputCase=ACC1 CaseType=Combination Point=4 X2=0.5 X3=0.5 S11=-
 1271.4345249948 Iss11Max=No Iss11Min=No FrameElem=118 ElemStation=0.125
 Frame=118 Station=0.25 OutputCase=ACC1 CaseType=Combination Point=0 X2=0 X3=0 S11=-169.541010668998
 Iss11Max=No Iss11Min=No FrameElem=118 ElemStation=0.25
 Frame=118 Station=0.25 OutputCase=ACC1 CaseType=Combination Point=1 X2=-0.5 X3=-0.5
 S11=782.353440336756 Iss11Max=Yes Iss11Min=No FrameElem=118 ElemStation=0.25
 Frame=118 Station=0.25 OutputCase=ACC1 CaseType=Combination Point=2 X2=-0.5 X3=0.5
 S11=782.353440336756 Iss11Max=No Iss11Min=No FrameElem=118 ElemStation=0.25
 Frame=118 Station=0.25 OutputCase=ACC1 CaseType=Combination Point=3 X2=0.5 X3=-0.5 S11=-
 1121.43546167475 Iss11Max=No Iss11Min=Yes FrameElem=118 ElemStation=0.25
 Frame=118 Station=0.25 OutputCase=ACC1 CaseType=Combination Point=4 X2=0.5 X3=0.5 S11=-
 1121.43546167475 Iss11Max=No Iss11Min=No FrameElem=118 ElemStation=0.25
 Frame=118 Station=0.375 OutputCase=ACC1 CaseType=Combination Point=0 X2=0 X3=0 S11=-
 169.541010668998 Iss11Max=No Iss11Min=No FrameElem=118 ElemStation=0.375
 Frame=118 Station=0.375 OutputCase=ACC1 CaseType=Combination Point=1 X2=-0.5 X3=-0.5
 S11=616.565002016707 Iss11Max=Yes Iss11Min=No FrameElem=118 ElemStation=0.375
 Frame=118 Station=0.375 OutputCase=ACC1 CaseType=Combination Point=2 X2=-0.5 X3=0.5
 S11=616.565002016707 Iss11Max=No Iss11Min=No FrameElem=118 ElemStation=0.375



Frame=118	Station=0.375	OutputCase=ACC1	CaseType=Combination	Point=3	X2=0.5	X3=-0.5	S11=-
955.647023354702	IsS11Max=No	IsS11Min=Yes	FrameElem=118	ElemStation=0.375			
Frame=118	Station=0.375	OutputCase=ACC1	CaseType=Combination	Point=4	X2=0.5	X3=0.5	S11=-
955.647023354702	IsS11Max=No	IsS11Min=No	FrameElem=118	ElemStation=0.375			
Frame=118	Station=0.5	OutputCase=ACC1	CaseType=Combination	Point=0	X2=0	X3=0	S11=-169.541010668998
IsS11Max=No	IsS11Min=No	FrameElem=118	ElemStation=0.5				
Frame=118	Station=0.5	OutputCase=ACC1	CaseType=Combination	Point=1	X2=-0.5	X3=-0.5	
S11=434.987188696658	IsS11Max=Yes	IsS11Min=No	FrameElem=118	ElemStation=0.5			
Frame=118	Station=0.5	OutputCase=ACC1	CaseType=Combination	Point=2	X2=-0.5	X3=0.5	
S11=434.987188696658	IsS11Max=No	IsS11Min=No	FrameElem=118	ElemStation=0.5			
Frame=118	Station=0.5	OutputCase=ACC1	CaseType=Combination	Point=3	X2=0.5	X3=-0.5	S11=-
774.069210034653	IsS11Max=No	IsS11Min=Yes	FrameElem=118	ElemStation=0.5			
Frame=118	Station=0.5	OutputCase=ACC1	CaseType=Combination	Point=4	X2=0.5	X3=0.5	S11=-
774.069210034653	IsS11Max=No	IsS11Min=No	FrameElem=118	ElemStation=0.5			
Frame=118	Station=0	OutputCase=ACC2	CaseType=Combination	Point=0	X2=0	X3=0	S11=-115.765244923552
IsS11Max=No	IsS11Min=No	FrameElem=118	ElemStation=0				
Frame=118	Station=0	OutputCase=ACC2	CaseType=Combination	Point=1	X2=-0.5	X3=-0.5	
S11=1205.32381771486	IsS11Max=Yes	IsS11Min=No	FrameElem=118	ElemStation=0			
Frame=118	Station=0	OutputCase=ACC2	CaseType=Combination	Point=2	X2=-0.5	X3=0.5	
S11=1205.32381771486	IsS11Max=No	IsS11Min=No	FrameElem=118	ElemStation=0			
Frame=118	Station=0	OutputCase=ACC2	CaseType=Combination	Point=3	X2=0.5	X3=-0.5	S11=-
1436.85430756197	IsS11Max=No	IsS11Min=Yes	FrameElem=118	ElemStation=0			
Frame=118	Station=0	OutputCase=ACC2	CaseType=Combination	Point=4	X2=0.5	X3=0.5	S11=-
1436.85430756197	IsS11Max=No	IsS11Min=No	FrameElem=118	ElemStation=0			
Frame=118	Station=0.125	OutputCase=ACC2	CaseType=Combination	Point=0	X2=0	X3=0	S11=-
115.765244923552	IsS11Max=No	IsS11Min=No	FrameElem=118	ElemStation=0.125			
Frame=118	Station=0.125	OutputCase=ACC2	CaseType=Combination	Point=1	X2=-0.5	X3=-0.5	
S11=1071.11412960032	IsS11Max=Yes	IsS11Min=No	FrameElem=118	ElemStation=0.125			
Frame=118	Station=0.125	OutputCase=ACC2	CaseType=Combination	Point=2	X2=-0.5	X3=0.5	
S11=1071.11412960032	IsS11Max=No	IsS11Min=No	FrameElem=118	ElemStation=0.125			
Frame=118	Station=0.125	OutputCase=ACC2	CaseType=Combination	Point=3	X2=0.5	X3=-0.5	S11=-
1302.64461944742	IsS11Max=No	IsS11Min=Yes	FrameElem=118	ElemStation=0.125			
Frame=118	Station=0.125	OutputCase=ACC2	CaseType=Combination	Point=4	X2=0.5	X3=0.5	S11=-
1302.64461944742	IsS11Max=No	IsS11Min=No	FrameElem=118	ElemStation=0.125			
Frame=118	Station=0.25	OutputCase=ACC2	CaseType=Combination	Point=0	X2=0	X3=0	S11=-115.765244923552
IsS11Max=No	IsS11Min=No	FrameElem=118	ElemStation=0.25				
Frame=118	Station=0.25	OutputCase=ACC2	CaseType=Combination	Point=1	X2=-0.5	X3=-0.5	
S11=921.115066485778	IsS11Max=Yes	IsS11Min=No	FrameElem=118	ElemStation=0.25			
Frame=118	Station=0.25	OutputCase=ACC2	CaseType=Combination	Point=2	X2=-0.5	X3=0.5	
S11=921.115066485778	IsS11Max=No	IsS11Min=No	FrameElem=118	ElemStation=0.25			
Frame=118	Station=0.25	OutputCase=ACC2	CaseType=Combination	Point=3	X2=0.5	X3=-0.5	S11=-
1152.64555633288	IsS11Max=No	IsS11Min=Yes	FrameElem=118	ElemStation=0.25			
Frame=118	Station=0.25	OutputCase=ACC2	CaseType=Combination	Point=4	X2=0.5	X3=0.5	S11=-
1152.64555633288	IsS11Max=No	IsS11Min=No	FrameElem=118	ElemStation=0.25			
Frame=118	Station=0.375	OutputCase=ACC2	CaseType=Combination	Point=0	X2=0	X3=0	S11=-
115.765244923552	IsS11Max=No	IsS11Min=No	FrameElem=118	ElemStation=0.375			
Frame=118	Station=0.375	OutputCase=ACC2	CaseType=Combination	Point=1	X2=-0.5	X3=-0.5	
S11=755.326628371236	IsS11Max=Yes	IsS11Min=No	FrameElem=118	ElemStation=0.375			
Frame=118	Station=0.375	OutputCase=ACC2	CaseType=Combination	Point=2	X2=-0.5	X3=0.5	
S11=755.326628371236	IsS11Max=No	IsS11Min=No	FrameElem=118	ElemStation=0.375			
Frame=118	Station=0.375	OutputCase=ACC2	CaseType=Combination	Point=3	X2=0.5	X3=-0.5	S11=-
986.857118218341	IsS11Max=No	IsS11Min=Yes	FrameElem=118	ElemStation=0.375			
Frame=118	Station=0.375	OutputCase=ACC2	CaseType=Combination	Point=4	X2=0.5	X3=0.5	S11=-
986.857118218341	IsS11Max=No	IsS11Min=No	FrameElem=118	ElemStation=0.375			
Frame=118	Station=0.5	OutputCase=ACC2	CaseType=Combination	Point=0	X2=0	X3=0	S11=-115.765244923552
IsS11Max=No	IsS11Min=No	FrameElem=118	ElemStation=0.5				
Frame=118	Station=0.5	OutputCase=ACC2	CaseType=Combination	Point=1	X2=-0.5	X3=-0.5	
S11=573.748815256695	IsS11Max=Yes	IsS11Min=No	FrameElem=118	ElemStation=0.5			
Frame=118	Station=0.5	OutputCase=ACC2	CaseType=Combination	Point=2	X2=-0.5	X3=0.5	
S11=573.748815256695	IsS11Max=No	IsS11Min=No	FrameElem=118	ElemStation=0.5			
Frame=118	Station=0.5	OutputCase=ACC2	CaseType=Combination	Point=3	X2=0.5	X3=-0.5	S11=-
805.2793051038	IsS11Max=No	IsS11Min=Yes	FrameElem=118	ElemStation=0.5			
Frame=118	Station=0.5	OutputCase=ACC2	CaseType=Combination	Point=4	X2=0.5	X3=0.5	S11=-
805.2793051038	IsS11Max=No	IsS11Min=No	FrameElem=118	ElemStation=0.5			
Frame=118	Station=0	OutputCase=ACCSX1	CaseType=Combination	Point=0	X2=0	X3=0	S11=-167.16402380627
IsS11Max=No	IsS11Min=No	FrameElem=118	ElemStation=0				
Frame=118	Station=0	OutputCase=ACCSX1	CaseType=Combination	Point=1	X2=-0.5	X3=-0.5	
S11=1016.76443229936	IsS11Max=Yes	IsS11Min=No	FrameElem=118	ElemStation=0			
Frame=118	Station=0	OutputCase=ACCSX1	CaseType=Combination	Point=2	X2=-0.5	X3=0.5	
S11=1016.76443229936	IsS11Max=No	IsS11Min=No	FrameElem=118	ElemStation=0			
Frame=118	Station=0	OutputCase=ACCSX1	CaseType=Combination	Point=3	X2=0.5	X3=-0.5	S11=-
1351.09247991191	IsS11Max=No	IsS11Min=Yes	FrameElem=118	ElemStation=0			
Frame=118	Station=0	OutputCase=ACCSX1	CaseType=Combination	Point=4	X2=0.5	X3=0.5	S11=-
1351.09247991191	IsS11Max=No	IsS11Min=No	FrameElem=118	ElemStation=0			
Frame=118	Station=0.125	OutputCase=ACCSX1	CaseType=Combination	Point=0	X2=0	X3=0	S11=-
167.16402380627	IsS11Max=No	IsS11Min=No	FrameElem=118	ElemStation=0.125			
Frame=118	Station=0.125	OutputCase=ACCSX1	CaseType=Combination	Point=1	X2=-0.5	X3=-0.5	
S11=885.738248297914	IsS11Max=Yes	IsS11Min=No	FrameElem=118	ElemStation=0.125			
Frame=118	Station=0.125	OutputCase=ACCSX1	CaseType=Combination	Point=2	X2=-0.5	X3=0.5	
S11=885.738248297914	IsS11Max=No	IsS11Min=No	FrameElem=118	ElemStation=0.125			
Frame=118	Station=0.125	OutputCase=ACCSX1	CaseType=Combination	Point=3	X2=0.5	X3=-0.5	S11=-
1220.06629591045	IsS11Max=No	IsS11Min=Yes	FrameElem=118	ElemStation=0.125			

Frame=118	Station=0.125	OutputCase=ACCSX1	CaseType=Combination	Point=4	X2=0.5	X3=0.5	S11=-
1220.06629591045	IsS11Max=No	IsS11Min=No	FrameElem=118	ElemStation=0.125			
Frame=118	Station=0.25	OutputCase=ACCSX1	CaseType=Combination	Point=0	X2=0	X3=0	S11=-
167.16402380627	IsS11Max=No	IsS11Min=No	FrameElem=118	ElemStation=0.25			
Frame=118	Station=0.25	OutputCase=ACCSX1	CaseType=Combination	Point=1	X2=-0.5	X3=-0.5	
S11=739.430814296463	IsS11Max=Yes	IsS11Min=No	FrameElem=118	ElemStation=0.25			
Frame=118	Station=0.25	OutputCase=ACCSX1	CaseType=Combination	Point=2	X2=-0.5	X3=0.5	
S11=739.430814296463	IsS11Max=No	IsS11Min=No	FrameElem=118	ElemStation=0.25			
Frame=118	Station=0.25	OutputCase=ACCSX1	CaseType=Combination	Point=3	X2=0.5	X3=-0.5	S11=-
1073.758861909	IsS11Max=No	IsS11Min=Yes	FrameElem=118	ElemStation=0.25			
Frame=118	Station=0.25	OutputCase=ACCSX1	CaseType=Combination	Point=4	X2=0.5	X3=0.5	S11=-
1073.758861909	IsS11Max=No	IsS11Min=No	FrameElem=118	ElemStation=0.25			
Frame=118	Station=0.375	OutputCase=ACCSX1	CaseType=Combination	Point=0	X2=0	X3=0	S11=-
167.16402380627	IsS11Max=No	IsS11Min=No	FrameElem=118	ElemStation=0.375			
Frame=118	Station=0.375	OutputCase=ACCSX1	CaseType=Combination	Point=1	X2=-0.5	X3=-0.5	
S11=577.842130295012	IsS11Max=Yes	IsS11Min=No	FrameElem=118	ElemStation=0.375			
Frame=118	Station=0.375	OutputCase=ACCSX1	CaseType=Combination	Point=2	X2=-0.5	X3=0.5	
S11=577.842130295012	IsS11Max=No	IsS11Min=No	FrameElem=118	ElemStation=0.375			
Frame=118	Station=0.375	OutputCase=ACCSX1	CaseType=Combination	Point=3	X2=0.5	X3=-0.5	S11=-
912.170177907553	IsS11Max=No	IsS11Min=Yes	FrameElem=118	ElemStation=0.375			
Frame=118	Station=0.375	OutputCase=ACCSX1	CaseType=Combination	Point=4	X2=0.5	X3=0.5	S11=-
912.170177907553	IsS11Max=No	IsS11Min=No	FrameElem=118	ElemStation=0.375			
Frame=118	Station=0.5	OutputCase=ACCSX1	CaseType=Combination	Point=0	X2=0	X3=0	S11=-167.16402380627
IsS11Max=No	IsS11Min=No	FrameElem=118	ElemStation=0.5				
Frame=118	Station=0.5	OutputCase=ACCSX1	CaseType=Combination	Point=1	X2=-0.5	X3=-0.5	
S11=400.972196293561	IsS11Max=Yes	IsS11Min=No	FrameElem=118	ElemStation=0.5			
Frame=118	Station=0.5	OutputCase=ACCSX1	CaseType=Combination	Point=2	X2=-0.5	X3=0.5	
S11=400.972196293561	IsS11Max=No	IsS11Min=No	FrameElem=118	ElemStation=0.5			
Frame=118	Station=0.5	OutputCase=ACCSX1	CaseType=Combination	Point=3	X2=0.5	X3=-0.5	S11=-
735.300243906102	IsS11Max=No	IsS11Min=Yes	FrameElem=118	ElemStation=0.5			
Frame=118	Station=0.5	OutputCase=ACCSX1	CaseType=Combination	Point=4	X2=0.5	X3=0.5	S11=-
735.300243906102	IsS11Max=No	IsS11Min=No	FrameElem=118	ElemStation=0.5			
Frame=118	Station=0	OutputCase=ACCSX2	CaseType=Combination	Point=0	X2=0	X3=0	S11=-113.388258060825
IsS11Max=No	IsS11Min=No	FrameElem=118	ElemStation=0				
Frame=118	Station=0	OutputCase=ACCSX2	CaseType=Combination	Point=1	X2=-0.5	X3=-0.5	
S11=1155.52605803737	IsS11Max=Yes	IsS11Min=No	FrameElem=118	ElemStation=0			
Frame=118	Station=0	OutputCase=ACCSX2	CaseType=Combination	Point=2	X2=-0.5	X3=0.5	
S11=1155.52605803737	IsS11Max=No	IsS11Min=No	FrameElem=118	ElemStation=0			
Frame=118	Station=0	OutputCase=ACCSX2	CaseType=Combination	Point=3	X2=0.5	X3=-0.5	S11=-
1382.30257415902	IsS11Max=No	IsS11Min=Yes	FrameElem=118	ElemStation=0			
Frame=118	Station=0	OutputCase=ACCSX2	CaseType=Combination	Point=4	X2=0.5	X3=0.5	S11=-
1382.30257415902	IsS11Max=No	IsS11Min=No	FrameElem=118	ElemStation=0			
Frame=118	Station=0.125	OutputCase=ACCSX2	CaseType=Combination	Point=0	X2=0	X3=0	S11=-
113.388258060825	IsS11Max=No	IsS11Min=No	FrameElem=118	ElemStation=0.125			
Frame=118	Station=0.125	OutputCase=ACCSX2	CaseType=Combination	Point=1	X2=-0.5	X3=-0.5	
S11=1024.49987424143	IsS11Max=Yes	IsS11Min=No	FrameElem=118	ElemStation=0.125			
Frame=118	Station=0.125	OutputCase=ACCSX2	CaseType=Combination	Point=2	X2=-0.5	X3=0.5	
S11=1024.49987424143	IsS11Max=No	IsS11Min=No	FrameElem=118	ElemStation=0.125			
Frame=118	Station=0.125	OutputCase=ACCSX2	CaseType=Combination	Point=3	X2=0.5	X3=-0.5	S11=-
1251.27639036308	IsS11Max=No	IsS11Min=Yes	FrameElem=118	ElemStation=0.125			
Frame=118	Station=0.125	OutputCase=ACCSX2	CaseType=Combination	Point=4	X2=0.5	X3=0.5	S11=-
1251.27639036308	IsS11Max=No	IsS11Min=No	FrameElem=118	ElemStation=0.125			
Frame=118	Station=0.25	OutputCase=ACCSX2	CaseType=Combination	Point=0	X2=0	X3=0	S11=-
113.388258060825	IsS11Max=No	IsS11Min=No	FrameElem=118	ElemStation=0.25			
Frame=118	Station=0.25	OutputCase=ACCSX2	CaseType=Combination	Point=1	X2=-0.5	X3=-0.5	
S11=878.192440445485	IsS11Max=Yes	IsS11Min=No	FrameElem=118	ElemStation=0.25			
Frame=118	Station=0.25	OutputCase=ACCSX2	CaseType=Combination	Point=2	X2=-0.5	X3=0.5	
S11=878.192440445485	IsS11Max=No	IsS11Min=No	FrameElem=118	ElemStation=0.25			
Frame=118	Station=0.25	OutputCase=ACCSX2	CaseType=Combination	Point=3	X2=0.5	X3=-0.5	S11=-
1104.96895656714	IsS11Max=No	IsS11Min=Yes	FrameElem=118	ElemStation=0.25			
Frame=118	Station=0.25	OutputCase=ACCSX2	CaseType=Combination	Point=4	X2=0.5	X3=0.5	S11=-
1104.96895656714	IsS11Max=No	IsS11Min=No	FrameElem=118	ElemStation=0.25			
Frame=118	Station=0.375	OutputCase=ACCSX2	CaseType=Combination	Point=0	X2=0	X3=0	S11=-
113.388258060825	IsS11Max=No	IsS11Min=No	FrameElem=118	ElemStation=0.375			
Frame=118	Station=0.375	OutputCase=ACCSX2	CaseType=Combination	Point=1	X2=-0.5	X3=-0.5	
S11=716.603756649542	IsS11Max=Yes	IsS11Min=No	FrameElem=118	ElemStation=0.375			
Frame=118	Station=0.375	OutputCase=ACCSX2	CaseType=Combination	Point=2	X2=-0.5	X3=0.5	
S11=716.603756649542	IsS11Max=No	IsS11Min=No	FrameElem=118	ElemStation=0.375			
Frame=118	Station=0.375	OutputCase=ACCSX2	CaseType=Combination	Point=3	X2=0.5	X3=-0.5	S11=-
943.380272771192	IsS11Max=No	IsS11Min=Yes	FrameElem=118	ElemStation=0.375			
Frame=118	Station=0.375	OutputCase=ACCSX2	CaseType=Combination	Point=4	X2=0.5	X3=0.5	S11=-
943.380272771192	IsS11Max=No	IsS11Min=No	FrameElem=118	ElemStation=0.375			
Frame=118	Station=0.5	OutputCase=ACCSX2	CaseType=Combination	Point=0	X2=0	X3=0	S11=-
113.388258060825	IsS11Max=No	IsS11Min=No	FrameElem=118	ElemStation=0.5			
Frame=118	Station=0.5	OutputCase=ACCSX2	CaseType=Combination	Point=1	X2=-0.5	X3=-0.5	
S11=539.733822853598	IsS11Max=Yes	IsS11Min=No	FrameElem=118	ElemStation=0.5			
Frame=118	Station=0.5	OutputCase=ACCSX2	CaseType=Combination	Point=2	X2=-0.5	X3=0.5	
S11=539.733822853598	IsS11Max=No	IsS11Min=No	FrameElem=118	ElemStation=0.5			
Frame=118	Station=0.5	OutputCase=ACCSX2	CaseType=Combination	Point=3	X2=0.5	X3=-0.5	S11=-
766.510338975249	IsS11Max=No	IsS11Min=Yes	FrameElem=118	ElemStation=0.5			
Frame=118	Station=0.5	OutputCase=ACCSX2	CaseType=Combination	Point=4	X2=0.5	X3=0.5	S11=-
766.510338975249	IsS11Max=No	IsS11Min=No	FrameElem=118	ElemStation=0.5			

Frame=118	Station=0	OutputCase=ENVE	CaseType=Combination	StepType=Max	Point=0	X2=0	X3=0	S11=-
111.115460069969	IsS11Max=No	IsS11Min=No	FrameElem=118	ElemStation=0				
Frame=118	Station=0	OutputCase=ENVE	CaseType=Combination	StepType=Max	Point=1	X2=-0.5	X3=-0.5	
S11=1205.32381771486	IsS11Max=Yes	IsS11Min=No	FrameElem=118	ElemStation=0				
Frame=118	Station=0	OutputCase=ENVE	CaseType=Combination	StepType=Max	Point=2	X2=-0.5	X3=0.5	
S11=1205.32381771486	IsS11Max=No	IsS11Min=No	FrameElem=118	ElemStation=0				
Frame=118	Station=0	OutputCase=ENVE	CaseType=Combination	StepType=Max	Point=3	X2=0.5	X3=-0.5	
S11=-1351.09247991191	IsS11Max=No	IsS11Min=Yes	FrameElem=118	ElemStation=0				
Frame=118	Station=0	OutputCase=ENVE	CaseType=Combination	StepType=Max	Point=4	X2=0.5	X3=0.5	S11=-
1351.09247991191	IsS11Max=No	IsS11Min=No	FrameElem=118	ElemStation=0				
Frame=118	Station=0.125	OutputCase=ENVE	CaseType=Combination	StepType=Max	Point=0	X2=0	X3=0	S11=-
111.115460069969	IsS11Max=No	IsS11Min=No	FrameElem=118	ElemStation=0.125				
Frame=118	Station=0.125	OutputCase=ENVE	CaseType=Combination	StepType=Max	Point=1	X2=-0.5	X3=-0.5	
S11=1071.11412960032	IsS11Max=Yes	IsS11Min=No	FrameElem=118	ElemStation=0.125				
Frame=118	Station=0.125	OutputCase=ENVE	CaseType=Combination	StepType=Max	Point=2	X2=-0.5	X3=0.5	
S11=1071.11412960032	IsS11Max=No	IsS11Min=No	FrameElem=118	ElemStation=0.125				
Frame=118	Station=0.125	OutputCase=ENVE	CaseType=Combination	StepType=Max	Point=3	X2=0.5	X3=-0.5	
S11=-1220.06629591045	IsS11Max=No	IsS11Min=Yes	FrameElem=118	ElemStation=0.125				
Frame=118	Station=0.125	OutputCase=ENVE	CaseType=Combination	StepType=Max	Point=4	X2=0.5	X3=0.5	
S11=-1220.06629591045	IsS11Max=No	IsS11Min=No	FrameElem=118	ElemStation=0.125				
Frame=118	Station=0.25	OutputCase=ENVE	CaseType=Combination	StepType=Max	Point=0	X2=0	X3=0	S11=-
111.115460069969	IsS11Max=No	IsS11Min=No	FrameElem=118	ElemStation=0.25				
Frame=118	Station=0.25	OutputCase=ENVE	CaseType=Combination	StepType=Max	Point=1	X2=-0.5	X3=-0.5	
S11=921.115066485778	IsS11Max=Yes	IsS11Min=No	FrameElem=118	ElemStation=0.25				
Frame=118	Station=0.25	OutputCase=ENVE	CaseType=Combination	StepType=Max	Point=2	X2=-0.5	X3=0.5	
S11=921.115066485778	IsS11Max=No	IsS11Min=No	FrameElem=118	ElemStation=0.25				
Frame=118	Station=0.25	OutputCase=ENVE	CaseType=Combination	StepType=Max	Point=3	X2=0.5	X3=-0.5	
S11=-1073.758861909	IsS11Max=No	IsS11Min=Yes	FrameElem=118	ElemStation=0.25				
Frame=118	Station=0.25	OutputCase=ENVE	CaseType=Combination	StepType=Max	Point=4	X2=0.5	X3=0.5	
S11=-1073.758861909	IsS11Max=No	IsS11Min=No	FrameElem=118	ElemStation=0.25				
Frame=118	Station=0.375	OutputCase=ENVE	CaseType=Combination	StepType=Max	Point=0	X2=0	X3=0	S11=-
111.115460069969	IsS11Max=No	IsS11Min=No	FrameElem=118	ElemStation=0.375				
Frame=118	Station=0.375	OutputCase=ENVE	CaseType=Combination	StepType=Max	Point=1	X2=-0.5	X3=-0.5	
S11=755.326628371236	IsS11Max=Yes	IsS11Min=No	FrameElem=118	ElemStation=0.375				
Frame=118	Station=0.375	OutputCase=ENVE	CaseType=Combination	StepType=Max	Point=2	X2=-0.5	X3=0.5	
S11=755.326628371236	IsS11Max=No	IsS11Min=No	FrameElem=118	ElemStation=0.375				
Frame=118	Station=0.375	OutputCase=ENVE	CaseType=Combination	StepType=Max	Point=3	X2=0.5	X3=-0.5	
S11=-912.170177907553	IsS11Max=No	IsS11Min=Yes	FrameElem=118	ElemStation=0.375				
Frame=118	Station=0.375	OutputCase=ENVE	CaseType=Combination	StepType=Max	Point=4	X2=0.5	X3=0.5	
S11=-912.170177907553	IsS11Max=No	IsS11Min=No	FrameElem=118	ElemStation=0.375				
Frame=118	Station=0.5	OutputCase=ENVE	CaseType=Combination	StepType=Max	Point=0	X2=0	X3=0	S11=-
111.115460069969	IsS11Max=No	IsS11Min=No	FrameElem=118	ElemStation=0.5				
Frame=118	Station=0.5	OutputCase=ENVE	CaseType=Combination	StepType=Max	Point=1	X2=-0.5	X3=-0.5	
S11=573.748815256695	IsS11Max=Yes	IsS11Min=No	FrameElem=118	ElemStation=0.5				
Frame=118	Station=0.5	OutputCase=ENVE	CaseType=Combination	StepType=Max	Point=2	X2=-0.5	X3=0.5	
S11=573.748815256695	IsS11Max=No	IsS11Min=No	FrameElem=118	ElemStation=0.5				
Frame=118	Station=0.5	OutputCase=ENVE	CaseType=Combination	StepType=Max	Point=3	X2=0.5	X3=-0.5	
S11=-735.300243906102	IsS11Max=No	IsS11Min=Yes	FrameElem=118	ElemStation=0.5				
Frame=118	Station=0.5	OutputCase=ENVE	CaseType=Combination	StepType=Max	Point=4	X2=0.5	X3=0.5	
S11=-735.300243906102	IsS11Max=No	IsS11Min=No	FrameElem=118	ElemStation=0.5				
Frame=118	Station=0	OutputCase=ENVE	CaseType=Combination	StepType=Min	Point=0	X2=0	X3=0	S11=-
169.541010668998	IsS11Max=No	IsS11Min=No	FrameElem=118	ElemStation=0				
Frame=118	Station=0	OutputCase=ENVE	CaseType=Combination	StepType=Min	Point=1	X2=-0.5	X3=-0.5	
S11=1016.76443229936	IsS11Max=Yes	IsS11Min=No	FrameElem=118	ElemStation=0				
Frame=118	Station=0	OutputCase=ENVE	CaseType=Combination	StepType=Min	Point=2	X2=-0.5	X3=0.5	
S11=1016.76443229936	IsS11Max=No	IsS11Min=No	FrameElem=118	ElemStation=0				
Frame=118	Station=0	OutputCase=ENVE	CaseType=Combination	StepType=Min	Point=3	X2=0.5	X3=-0.5	
S11=-1436.85430756197	IsS11Max=No	IsS11Min=Yes	FrameElem=118	ElemStation=0				
Frame=118	Station=0	OutputCase=ENVE	CaseType=Combination	StepType=Min	Point=4	X2=0.5	X3=0.5	S11=-
1436.85430756197	IsS11Max=No	IsS11Min=No	FrameElem=118	ElemStation=0				
Frame=118	Station=0.125	OutputCase=ENVE	CaseType=Combination	StepType=Min	Point=0	X2=0	X3=0	S11=-
169.541010668998	IsS11Max=No	IsS11Min=No	FrameElem=118	ElemStation=0.125				
Frame=118	Station=0.125	OutputCase=ENVE	CaseType=Combination	StepType=Min	Point=1	X2=-0.5	X3=-0.5	
S11=885.738248297914	IsS11Max=Yes	IsS11Min=No	FrameElem=118	ElemStation=0.125				
Frame=118	Station=0.125	OutputCase=ENVE	CaseType=Combination	StepType=Min	Point=2	X2=-0.5	X3=0.5	
S11=885.738248297914	IsS11Max=No	IsS11Min=No	FrameElem=118	ElemStation=0.125				
Frame=118	Station=0.125	OutputCase=ENVE	CaseType=Combination	StepType=Min	Point=3	X2=0.5	X3=-0.5	
S11=-1302.64461944742	IsS11Max=No	IsS11Min=Yes	FrameElem=118	ElemStation=0.125				
Frame=118	Station=0.125	OutputCase=ENVE	CaseType=Combination	StepType=Min	Point=4	X2=0.5	X3=0.5	
S11=-1302.64461944742	IsS11Max=No	IsS11Min=No	FrameElem=118	ElemStation=0.125				
Frame=118	Station=0.25	OutputCase=ENVE	CaseType=Combination	StepType=Min	Point=0	X2=0	X3=0	S11=-
169.541010668998	IsS11Max=No	IsS11Min=No	FrameElem=118	ElemStation=0.25				
Frame=118	Station=0.25	OutputCase=ENVE	CaseType=Combination	StepType=Min	Point=1	X2=-0.5	X3=-0.5	
S11=739.430814296463	IsS11Max=Yes	IsS11Min=No	FrameElem=118	ElemStation=0.25				
Frame=118	Station=0.25	OutputCase=ENVE	CaseType=Combination	StepType=Min	Point=2	X2=-0.5	X3=0.5	
S11=739.430814296463	IsS11Max=No	IsS11Min=No	FrameElem=118	ElemStation=0.25				
Frame=118	Station=0.25	OutputCase=ENVE	CaseType=Combination	StepType=Min	Point=3	X2=0.5	X3=-0.5	
S11=-1152.64555633288	IsS11Max=No	IsS11Min=Yes	FrameElem=118	ElemStation=0.25				
Frame=118	Station=0.25	OutputCase=ENVE	CaseType=Combination	StepType=Min	Point=4	X2=0.5	X3=0.5	
S11=-1152.64555633288	IsS11Max=No	IsS11Min=No	FrameElem=118	ElemStation=0.25				
Frame=118	Station=0.375	OutputCase=ENVE	CaseType=Combination	StepType=Min	Point=0	X2=0	X3=0	S11=-
169.541010668998	IsS11Max=No	IsS11Min=No	FrameElem=118	ElemStation=0.375				

Frame=118	Station=0.375	OutputCase=ENVE	CaseType=Combination	StepType=Min	Point=1	X2=-0.5	X3=-0.5	
S11=577.842130295012	IsS11Max=Yes	IsS11Min=No	FrameElem=118	ElemStation=0.375				
Frame=118	Station=0.375	OutputCase=ENVE	CaseType=Combination	StepType=Min	Point=2	X2=-0.5	X3=0.5	
S11=577.842130295012	IsS11Max=No	IsS11Min=No	FrameElem=118	ElemStation=0.375				
Frame=118	Station=0.375	OutputCase=ENVE	CaseType=Combination	StepType=Min	Point=3	X2=0.5	X3=-0.5	
S11=-986.857118218341	IsS11Max=No	IsS11Min=Yes	FrameElem=118	ElemStation=0.375				
Frame=118	Station=0.375	OutputCase=ENVE	CaseType=Combination	StepType=Min	Point=4	X2=0.5	X3=0.5	
S11=-986.857118218341	IsS11Max=No	IsS11Min=No	FrameElem=118	ElemStation=0.375				
Frame=118	Station=0.5	OutputCase=ENVE	CaseType=Combination	StepType=Min	Point=0	X2=0	X3=0	S11=-
S11=169.541010668998	IsS11Max=No	IsS11Min=No	FrameElem=118	ElemStation=0.5				
Frame=118	Station=0.5	OutputCase=ENVE	CaseType=Combination	StepType=Min	Point=1	X2=-0.5	X3=-0.5	
S11=400.972196293561	IsS11Max=Yes	IsS11Min=No	FrameElem=118	ElemStation=0.5				
Frame=118	Station=0.5	OutputCase=ENVE	CaseType=Combination	StepType=Min	Point=2	X2=-0.5	X3=0.5	
S11=400.972196293561	IsS11Max=No	IsS11Min=No	FrameElem=118	ElemStation=0.5				
Frame=118	Station=0.5	OutputCase=ENVE	CaseType=Combination	StepType=Min	Point=3	X2=0.5	X3=-0.5	
S11=-805.2793051038	IsS11Max=No	IsS11Min=Yes	FrameElem=118	ElemStation=0.5				
Frame=118	Station=0.5	OutputCase=ENVE	CaseType=Combination	StepType=Min	Point=4	X2=0.5	X3=0.5	
S11=-805.2793051038	IsS11Max=No	IsS11Min=No	FrameElem=118	ElemStation=0.5				
Frame=118	Station=0	OutputCase=FESSUR	CaseType=Combination	Point=0	X2=0	X3=0	S11=-168.146075212923	
IsS11Max=No	IsS11Min=No	FrameElem=118	ElemStation=0					
Frame=118	Station=0	OutputCase=FESSUR	CaseType=Combination	Point=1	X2=-0.5	X3=-0.5		
S11=1056.13108371673	IsS11Max=Yes	IsS11Min=No	FrameElem=118	ElemStation=0				
Frame=118	Station=0	OutputCase=FESSUR	CaseType=Combination	Point=2	X2=-0.5	X3=0.5		
S11=1056.13108371673	IsS11Max=No	IsS11Min=No	FrameElem=118	ElemStation=0				
Frame=118	Station=0	OutputCase=FESSUR	CaseType=Combination	Point=3	X2=0.5	X3=-0.5	S11=-	
S11=1392.42323414257	IsS11Max=No	IsS11Min=Yes	FrameElem=118	ElemStation=0				
Frame=118	Station=0	OutputCase=FESSUR	CaseType=Combination	Point=4	X2=0.5	X3=0.5	S11=-	
S11=1392.42323414257	IsS11Max=No	IsS11Min=No	FrameElem=118	ElemStation=0				
Frame=118	Station=0.125	OutputCase=FESSUR	CaseType=Combination	Point=0	X2=0	X3=0	S11=-	
S11=168.146075212923	IsS11Max=No	IsS11Min=No	FrameElem=118	ElemStation=0.125				
Frame=118	Station=0.125	OutputCase=FESSUR	CaseType=Combination	Point=1	X2=-0.5	X3=-0.5		
S11=923.217114153485	IsS11Max=Yes	IsS11Min=No	FrameElem=118	ElemStation=0.125				
Frame=118	Station=0.125	OutputCase=FESSUR	CaseType=Combination	Point=2	X2=-0.5	X3=0.5		
S11=923.217114153485	IsS11Max=No	IsS11Min=No	FrameElem=118	ElemStation=0.125				
Frame=118	Station=0.125	OutputCase=FESSUR	CaseType=Combination	Point=3	X2=0.5	X3=-0.5	S11=-	
S11=1259.50926457933	IsS11Max=No	IsS11Min=Yes	FrameElem=118	ElemStation=0.125				
Frame=118	Station=0.125	OutputCase=FESSUR	CaseType=Combination	Point=4	X2=0.5	X3=0.5	S11=-	
S11=1259.50926457933	IsS11Max=No	IsS11Min=No	FrameElem=118	ElemStation=0.125				
Frame=118	Station=0.25	OutputCase=FESSUR	CaseType=Combination	Point=0	X2=0	X3=0	S11=-	
S11=168.146075212923	IsS11Max=No	IsS11Min=No	FrameElem=118	ElemStation=0.25				
Frame=118	Station=0.25	OutputCase=FESSUR	CaseType=Combination	Point=1	X2=-0.5	X3=-0.5		
S11=774.666207090242	IsS11Max=Yes	IsS11Min=No	FrameElem=118	ElemStation=0.25				
Frame=118	Station=0.25	OutputCase=FESSUR	CaseType=Combination	Point=2	X2=-0.5	X3=0.5		
S11=774.666207090242	IsS11Max=No	IsS11Min=No	FrameElem=118	ElemStation=0.25				
Frame=118	Station=0.25	OutputCase=FESSUR	CaseType=Combination	Point=3	X2=0.5	X3=-0.5	S11=-	
S11=1110.95835751609	IsS11Max=No	IsS11Min=Yes	FrameElem=118	ElemStation=0.25				
Frame=118	Station=0.25	OutputCase=FESSUR	CaseType=Combination	Point=4	X2=0.5	X3=0.5	S11=-	
S11=1110.95835751609	IsS11Max=No	IsS11Min=No	FrameElem=118	ElemStation=0.25				
Frame=118	Station=0.375	OutputCase=FESSUR	CaseType=Combination	Point=0	X2=0	X3=0	S11=-	
S11=168.146075212923	IsS11Max=No	IsS11Min=No	FrameElem=118	ElemStation=0.375				
Frame=118	Station=0.375	OutputCase=FESSUR	CaseType=Combination	Point=1	X2=-0.5	X3=-0.5		
S11=610.478362526999	IsS11Max=Yes	IsS11Min=No	FrameElem=118	ElemStation=0.375				
Frame=118	Station=0.375	OutputCase=FESSUR	CaseType=Combination	Point=2	X2=-0.5	X3=0.5		
S11=610.478362526999	IsS11Max=No	IsS11Min=No	FrameElem=118	ElemStation=0.375				
Frame=118	Station=0.375	OutputCase=FESSUR	CaseType=Combination	Point=3	X2=0.5	X3=-0.5	S11=-	
S11=946.770512952845	IsS11Max=No	IsS11Min=Yes	FrameElem=118	ElemStation=0.375				
Frame=118	Station=0.375	OutputCase=FESSUR	CaseType=Combination	Point=4	X2=0.5	X3=0.5	S11=-	
S11=946.770512952845	IsS11Max=No	IsS11Min=No	FrameElem=118	ElemStation=0.375				
Frame=118	Station=0.5	OutputCase=FESSUR	CaseType=Combination	Point=0	X2=0	X3=0	S11=-	
S11=168.146075212923	IsS11Max=No	IsS11Min=No	FrameElem=118	ElemStation=0.5				
Frame=118	Station=0.5	OutputCase=FESSUR	CaseType=Combination	Point=1	X2=-0.5	X3=-0.5		
S11=430.653580463756	IsS11Max=Yes	IsS11Min=No	FrameElem=118	ElemStation=0.5				
Frame=118	Station=0.5	OutputCase=FESSUR	CaseType=Combination	Point=2	X2=-0.5	X3=0.5		
S11=430.653580463756	IsS11Max=No	IsS11Min=No	FrameElem=118	ElemStation=0.5				
Frame=118	Station=0.5	OutputCase=FESSUR	CaseType=Combination	Point=3	X2=0.5	X3=-0.5	S11=-	
S11=766.945730889602	IsS11Max=No	IsS11Min=Yes	FrameElem=118	ElemStation=0.5				
Frame=118	Station=0.5	OutputCase=FESSUR	CaseType=Combination	Point=4	X2=0.5	X3=0.5	S11=-	
S11=766.945730889602	IsS11Max=No	IsS11Min=No	FrameElem=118	ElemStation=0.5				
Frame=119	Station=0	OutputCase=PERM1	CaseType=Combination	Point=0	X2=0	X3=0	S11=-164.891225815415	
IsS11Max=No	IsS11Min=No	FrameElem=119	ElemStation=0					
Frame=119	Station=0	OutputCase=PERM1	CaseType=Combination	Point=1	X2=-0.5	X3=-0.5		
S11=420.541827920189	IsS11Max=Yes	IsS11Min=No	FrameElem=119	ElemStation=0				
Frame=119	Station=0	OutputCase=PERM1	CaseType=Combination	Point=2	X2=-0.5	X3=0.5		
S11=420.541827920189	IsS11Max=No	IsS11Min=No	FrameElem=119	ElemStation=0				
Frame=119	Station=0	OutputCase=PERM1	CaseType=Combination	Point=3	X2=0.5	X3=-0.5	S11=-	
S11=750.324279551018	IsS11Max=No	IsS11Min=Yes	FrameElem=119	ElemStation=0				
Frame=119	Station=0	OutputCase=PERM1	CaseType=Combination	Point=4	X2=0.5	X3=0.5	S11=-	
S11=750.324279551018	IsS11Max=No	IsS11Min=No	FrameElem=119	ElemStation=0				
Frame=119	Station=0.125	OutputCase=PERM1	CaseType=Combination	Point=0	X2=0	X3=0	S11=-	
S11=164.891225815415	IsS11Max=No	IsS11Min=No	FrameElem=119	ElemStation=0.125				
Frame=119	Station=0.125	OutputCase=PERM1	CaseType=Combination	Point=1	X2=-0.5	X3=-0.5		
S11=229.526202122826	IsS11Max=Yes	IsS11Min=No	FrameElem=119	ElemStation=0.125				

Frame=119 Station=0.125 OutputCase=PERM1 CaseType=Combination Point=2 X2=-0.5 X3=0.5
S11=229.526202122826 IsS11Max=No IsS11Min=No FrameElem=119 ElemStation=0.125
Frame=119 Station=0.125 OutputCase=PERM1 CaseType=Combination Point=3 X2=0.5 X3=-0.5 S11=-
559.308653753656 IsS11Max=No IsS11Min=Yes FrameElem=119 ElemStation=0.125
Frame=119 Station=0.125 OutputCase=PERM1 CaseType=Combination Point=4 X2=0.5 X3=0.5 S11=-
559.308653753656 IsS11Max=No IsS11Min=No FrameElem=119 ElemStation=0.125
Frame=119 Station=0.25 OutputCase=PERM1 CaseType=Combination Point=0 X2=0 X3=0 S11=-
164.891225815415 IsS11Max=No IsS11Min=No FrameElem=119 ElemStation=0.25
Frame=119 Station=0.25 OutputCase=PERM1 CaseType=Combination Point=1 X2=-0.5 X3=-0.5
S11=23.2293263254639 IsS11Max=Yes IsS11Min=No FrameElem=119 ElemStation=0.25
Frame=119 Station=0.25 OutputCase=PERM1 CaseType=Combination Point=2 X2=-0.5 X3=0.5
S11=23.2293263254639 IsS11Max=No IsS11Min=No FrameElem=119 ElemStation=0.25
Frame=119 Station=0.25 OutputCase=PERM1 CaseType=Combination Point=3 X2=0.5 X3=-0.5 S11=-
353.011777956293 IsS11Max=No IsS11Min=Yes FrameElem=119 ElemStation=0.25
Frame=119 Station=0.25 OutputCase=PERM1 CaseType=Combination Point=4 X2=0.5 X3=0.5 S11=-
353.011777956293 IsS11Max=No IsS11Min=No FrameElem=119 ElemStation=0.25
Frame=119 Station=0.375 OutputCase=PERM1 CaseType=Combination Point=0 X2=0 X3=0 S11=-
164.891225815415 IsS11Max=No IsS11Min=No FrameElem=119 ElemStation=0.375
Frame=119 Station=0.375 OutputCase=PERM1 CaseType=Combination Point=1 X2=-0.5 X3=-0.5 S11=-
198.348799471899 IsS11Max=No IsS11Min=Yes FrameElem=119 ElemStation=0.375
Frame=119 Station=0.375 OutputCase=PERM1 CaseType=Combination Point=2 X2=-0.5 X3=0.5 S11=-
198.348799471899 IsS11Max=No IsS11Min=No FrameElem=119 ElemStation=0.375
Frame=119 Station=0.375 OutputCase=PERM1 CaseType=Combination Point=3 X2=0.5 X3=-0.5 S11=-
131.433652158931 IsS11Max=Yes IsS11Min=No FrameElem=119 ElemStation=0.375
Frame=119 Station=0.375 OutputCase=PERM1 CaseType=Combination Point=4 X2=0.5 X3=0.5 S11=-
131.433652158931 IsS11Max=No IsS11Min=No FrameElem=119 ElemStation=0.375
Frame=119 Station=0.5 OutputCase=PERM1 CaseType=Combination Point=0 X2=0 X3=0 S11=-164.891225815415
IsS11Max=No IsS11Min=No FrameElem=119 ElemStation=0.5
Frame=119 Station=0.5 OutputCase=PERM1 CaseType=Combination Point=1 X2=-0.5 X3=-0.5 S11=-
435.208175269261 IsS11Max=No IsS11Min=Yes FrameElem=119 ElemStation=0.5
Frame=119 Station=0.5 OutputCase=PERM1 CaseType=Combination Point=2 X2=-0.5 X3=0.5 S11=-
435.208175269261 IsS11Max=No IsS11Min=No FrameElem=119 ElemStation=0.5
Frame=119 Station=0.5 OutputCase=PERM1 CaseType=Combination Point=3 X2=0.5 X3=-0.5
S11=105.425723638431 IsS11Max=Yes IsS11Min=No FrameElem=119 ElemStation=0.5
Frame=119 Station=0.5 OutputCase=PERM1 CaseType=Combination Point=4 X2=0.5 X3=0.5
S11=105.425723638431 IsS11Max=No IsS11Min=No FrameElem=119 ElemStation=0.5
Frame=119 Station=0 OutputCase=PERM2 CaseType=Combination Point=0 X2=0 X3=0 S11=-111.11546006997
IsS11Max=No IsS11Min=No FrameElem=119 ElemStation=0
Frame=119 Station=0 OutputCase=PERM2 CaseType=Combination Point=1 X2=-0.5 X3=-0.5
S11=559.303454480226 IsS11Max=Yes IsS11Min=No FrameElem=119 ElemStation=0
Frame=119 Station=0 OutputCase=PERM2 CaseType=Combination Point=2 X2=-0.5 X3=0.5
S11=559.303454480226 IsS11Max=No IsS11Min=No FrameElem=119 ElemStation=0
Frame=119 Station=0 OutputCase=PERM2 CaseType=Combination Point=3 X2=0.5 X3=-0.5 S11=-
781.534374620165 IsS11Max=No IsS11Min=Yes FrameElem=119 ElemStation=0
Frame=119 Station=0 OutputCase=PERM2 CaseType=Combination Point=4 X2=0.5 X3=0.5 S11=-
781.534374620165 IsS11Max=No IsS11Min=No FrameElem=119 ElemStation=0
Frame=119 Station=0.125 OutputCase=PERM2 CaseType=Combination Point=0 X2=0 X3=0 S11=-
111.11546006997 IsS11Max=No IsS11Min=No FrameElem=119 ElemStation=0.125
Frame=119 Station=0.125 OutputCase=PERM2 CaseType=Combination Point=1 X2=-0.5 X3=-0.5
S11=368.287828888371 IsS11Max=Yes IsS11Min=No FrameElem=119 ElemStation=0.125
Frame=119 Station=0.125 OutputCase=PERM2 CaseType=Combination Point=2 X2=-0.5 X3=0.5
S11=368.287828888371 IsS11Max=No IsS11Min=No FrameElem=119 ElemStation=0.125
Frame=119 Station=0.125 OutputCase=PERM2 CaseType=Combination Point=3 X2=0.5 X3=-0.5 S11=-
590.51874902831 IsS11Max=No IsS11Min=Yes FrameElem=119 ElemStation=0.125
Frame=119 Station=0.125 OutputCase=PERM2 CaseType=Combination Point=4 X2=0.5 X3=0.5 S11=-
590.51874902831 IsS11Max=No IsS11Min=No FrameElem=119 ElemStation=0.125
Frame=119 Station=0.25 OutputCase=PERM2 CaseType=Combination Point=0 X2=0 X3=0 S11=-111.11546006997
IsS11Max=No IsS11Min=No FrameElem=119 ElemStation=0.25
Frame=119 Station=0.25 OutputCase=PERM2 CaseType=Combination Point=1 X2=-0.5 X3=-0.5
S11=161.990953296516 IsS11Max=Yes IsS11Min=No FrameElem=119 ElemStation=0.25
Frame=119 Station=0.25 OutputCase=PERM2 CaseType=Combination Point=2 X2=-0.5 X3=0.5
S11=161.990953296516 IsS11Max=No IsS11Min=No FrameElem=119 ElemStation=0.25
Frame=119 Station=0.25 OutputCase=PERM2 CaseType=Combination Point=3 X2=0.5 X3=-0.5 S11=-
384.221873436455 IsS11Max=No IsS11Min=Yes FrameElem=119 ElemStation=0.25
Frame=119 Station=0.25 OutputCase=PERM2 CaseType=Combination Point=4 X2=0.5 X3=0.5 S11=-
384.221873436455 IsS11Max=No IsS11Min=No FrameElem=119 ElemStation=0.25
Frame=119 Station=0.375 OutputCase=PERM2 CaseType=Combination Point=0 X2=0 X3=0 S11=-
111.11546006997 IsS11Max=No IsS11Min=No FrameElem=119 ElemStation=0.375
Frame=119 Station=0.375 OutputCase=PERM2 CaseType=Combination Point=1 X2=-0.5 X3=-0.5 S11=-
59.5871722953387 IsS11Max=Yes IsS11Min=No FrameElem=119 ElemStation=0.375
Frame=119 Station=0.375 OutputCase=PERM2 CaseType=Combination Point=2 X2=-0.5 X3=0.5 S11=-
59.5871722953387 IsS11Max=No IsS11Min=No FrameElem=119 ElemStation=0.375
Frame=119 Station=0.375 OutputCase=PERM2 CaseType=Combination Point=3 X2=0.5 X3=-0.5 S11=-
162.6437478446 IsS11Max=No IsS11Min=Yes FrameElem=119 ElemStation=0.375
Frame=119 Station=0.375 OutputCase=PERM2 CaseType=Combination Point=4 X2=0.5 X3=0.5 S11=-
162.6437478446 IsS11Max=No IsS11Min=No FrameElem=119 ElemStation=0.375
Frame=119 Station=0.5 OutputCase=PERM2 CaseType=Combination Point=0 X2=0 X3=0 S11=-111.11546006997
IsS11Max=No IsS11Min=No FrameElem=119 ElemStation=0.5
Frame=119 Station=0.5 OutputCase=PERM2 CaseType=Combination Point=1 X2=-0.5 X3=-0.5 S11=-
296.446547887194 IsS11Max=No IsS11Min=Yes FrameElem=119 ElemStation=0.5
Frame=119 Station=0.5 OutputCase=PERM2 CaseType=Combination Point=2 X2=-0.5 X3=0.5 S11=-
296.446547887194 IsS11Max=No IsS11Min=No FrameElem=119 ElemStation=0.5



Frame=119	Station=0.5	OutputCase=PERM2	CaseType=Combination	Point=3	X2=0.5	X3=-0.5	
S11=74.2156277472545	IsS11Max=Yes	IsS11Min=No	FrameElem=119	ElemStation=0.5			
Frame=119	Station=0.5	OutputCase=PERM2	CaseType=Combination	Point=4	X2=0.5	X3=0.5	
S11=74.2156277472545	IsS11Max=No	IsS11Min=No	FrameElem=119	ElemStation=0.5			
Frame=119	Station=0	OutputCase=ACC1	CaseType=Combination	Point=0	X2=0	X3=0	S11=-169.541010669005
IsS11Max=No	IsS11Min=No	FrameElem=119	ElemStation=0				
Frame=119	Station=0	OutputCase=ACC1	CaseType=Combination	Point=1	X2=-0.5	X3=-0.5	
S11=434.987188696519	IsS11Max=Yes	IsS11Min=No	FrameElem=119	ElemStation=0			
Frame=119	Station=0	OutputCase=ACC1	CaseType=Combination	Point=2	X2=-0.5	X3=0.5	
S11=434.987188696519	IsS11Max=No	IsS11Min=No	FrameElem=119	ElemStation=0			
Frame=119	Station=0	OutputCase=ACC1	CaseType=Combination	Point=3	X2=0.5	X3=-0.5	S11=-
774.069210034529	IsS11Max=No	IsS11Min=Yes	FrameElem=119	ElemStation=0			
Frame=119	Station=0	OutputCase=ACC1	CaseType=Combination	Point=4	X2=0.5	X3=0.5	S11=-
774.069210034529	IsS11Max=No	IsS11Min=No	FrameElem=119	ElemStation=0			
Frame=119	Station=0.125	OutputCase=ACC1	CaseType=Combination	Point=0	X2=0	X3=0	S11=-
169.541010669005	IsS11Max=No	IsS11Min=No	FrameElem=119	ElemStation=0.125			
Frame=119	Station=0.125	OutputCase=ACC1	CaseType=Combination	Point=1	X2=-0.5	X3=-0.5	
S11=237.620000376471	IsS11Max=Yes	IsS11Min=No	FrameElem=119	ElemStation=0.125			
Frame=119	Station=0.125	OutputCase=ACC1	CaseType=Combination	Point=2	X2=-0.5	X3=0.5	
S11=237.620000376471	IsS11Max=No	IsS11Min=No	FrameElem=119	ElemStation=0.125			
Frame=119	Station=0.125	OutputCase=ACC1	CaseType=Combination	Point=3	X2=0.5	X3=-0.5	S11=-
576.702021714481	IsS11Max=No	IsS11Min=Yes	FrameElem=119	ElemStation=0.125			
Frame=119	Station=0.125	OutputCase=ACC1	CaseType=Combination	Point=4	X2=0.5	X3=0.5	S11=-
576.702021714481	IsS11Max=No	IsS11Min=No	FrameElem=119	ElemStation=0.125			
Frame=119	Station=0.25	OutputCase=ACC1	CaseType=Combination	Point=0	X2=0	X3=0	S11=-169.541010669005
IsS11Max=No	IsS11Min=No	FrameElem=119	ElemStation=0.25				
Frame=119	Station=0.25	OutputCase=ACC1	CaseType=Combination	Point=1	X2=-0.5	X3=-0.5	
S11=24.4634370564233	IsS11Max=Yes	IsS11Min=No	FrameElem=119	ElemStation=0.25			
Frame=119	Station=0.25	OutputCase=ACC1	CaseType=Combination	Point=2	X2=-0.5	X3=0.5	
S11=24.4634370564233	IsS11Max=No	IsS11Min=No	FrameElem=119	ElemStation=0.25			
Frame=119	Station=0.25	OutputCase=ACC1	CaseType=Combination	Point=3	X2=0.5	X3=-0.5	S11=-
363.545458394433	IsS11Max=No	IsS11Min=Yes	FrameElem=119	ElemStation=0.25			
Frame=119	Station=0.25	OutputCase=ACC1	CaseType=Combination	Point=4	X2=0.5	X3=0.5	S11=-
363.545458394433	IsS11Max=No	IsS11Min=No	FrameElem=119	ElemStation=0.25			
Frame=119	Station=0.375	OutputCase=ACC1	CaseType=Combination	Point=0	X2=0	X3=0	S11=-
169.541010669005	IsS11Max=No	IsS11Min=No	FrameElem=119	ElemStation=0.375			
Frame=119	Station=0.375	OutputCase=ACC1	CaseType=Combination	Point=1	X2=-0.5	X3=-0.5	S11=-
204.482501263625	IsS11Max=No	IsS11Min=Yes	FrameElem=119	ElemStation=0.375			
Frame=119	Station=0.375	OutputCase=ACC1	CaseType=Combination	Point=2	X2=-0.5	X3=0.5	S11=-
204.482501263625	IsS11Max=No	IsS11Min=No	FrameElem=119	ElemStation=0.375			
Frame=119	Station=0.375	OutputCase=ACC1	CaseType=Combination	Point=3	X2=0.5	X3=-0.5	S11=-
134.599520074386	IsS11Max=Yes	IsS11Min=No	FrameElem=119	ElemStation=0.375			
Frame=119	Station=0.375	OutputCase=ACC1	CaseType=Combination	Point=4	X2=0.5	X3=0.5	S11=-
134.599520074386	IsS11Max=No	IsS11Min=No	FrameElem=119	ElemStation=0.375			
Frame=119	Station=0.5	OutputCase=ACC1	CaseType=Combination	Point=0	X2=0	X3=0	S11=-169.541010669005
IsS11Max=No	IsS11Min=No	FrameElem=119	ElemStation=0.5				
Frame=119	Station=0.5	OutputCase=ACC1	CaseType=Combination	Point=1	X2=-0.5	X3=-0.5	S11=-
449.217814583672	IsS11Max=No	IsS11Min=Yes	FrameElem=119	ElemStation=0.5			
Frame=119	Station=0.5	OutputCase=ACC1	CaseType=Combination	Point=2	X2=-0.5	X3=0.5	S11=-
449.217814583672	IsS11Max=No	IsS11Min=No	FrameElem=119	ElemStation=0.5			
Frame=119	Station=0.5	OutputCase=ACC1	CaseType=Combination	Point=3	X2=0.5	X3=-0.5	
S11=110.135793245662	IsS11Max=Yes	IsS11Min=No	FrameElem=119	ElemStation=0.5			
Frame=119	Station=0.5	OutputCase=ACC1	CaseType=Combination	Point=4	X2=0.5	X3=0.5	
S11=110.135793245662	IsS11Max=No	IsS11Min=No	FrameElem=119	ElemStation=0.5			
Frame=119	Station=0	OutputCase=ACC2	CaseType=Combination	Point=0	X2=0	X3=0	S11=-115.76524492356
IsS11Max=No	IsS11Min=No	FrameElem=119	ElemStation=0				
Frame=119	Station=0	OutputCase=ACC2	CaseType=Combination	Point=1	X2=-0.5	X3=-0.5	
S11=573.748815256556	IsS11Max=Yes	IsS11Min=No	FrameElem=119	ElemStation=0			
Frame=119	Station=0	OutputCase=ACC2	CaseType=Combination	Point=2	X2=-0.5	X3=0.5	
S11=573.748815256556	IsS11Max=No	IsS11Min=No	FrameElem=119	ElemStation=0			
Frame=119	Station=0	OutputCase=ACC2	CaseType=Combination	Point=3	X2=0.5	X3=-0.5	S11=-
805.279305103676	IsS11Max=No	IsS11Min=Yes	FrameElem=119	ElemStation=0			
Frame=119	Station=0	OutputCase=ACC2	CaseType=Combination	Point=4	X2=0.5	X3=0.5	S11=-
805.279305103676	IsS11Max=No	IsS11Min=No	FrameElem=119	ElemStation=0			
Frame=119	Station=0.125	OutputCase=ACC2	CaseType=Combination	Point=0	X2=0	X3=0	S11=-115.76524492356
IsS11Max=No	IsS11Min=No	FrameElem=119	ElemStation=0.125				
Frame=119	Station=0.125	OutputCase=ACC2	CaseType=Combination	Point=1	X2=-0.5	X3=-0.5	
S11=376.381627142016	IsS11Max=Yes	IsS11Min=No	FrameElem=119	ElemStation=0.125			
Frame=119	Station=0.125	OutputCase=ACC2	CaseType=Combination	Point=2	X2=-0.5	X3=0.5	
S11=376.381627142016	IsS11Max=No	IsS11Min=No	FrameElem=119	ElemStation=0.125			
Frame=119	Station=0.125	OutputCase=ACC2	CaseType=Combination	Point=3	X2=0.5	X3=-0.5	S11=-
607.912116989135	IsS11Max=No	IsS11Min=Yes	FrameElem=119	ElemStation=0.125			
Frame=119	Station=0.125	OutputCase=ACC2	CaseType=Combination	Point=4	X2=0.5	X3=0.5	S11=-
607.912116989135	IsS11Max=No	IsS11Min=No	FrameElem=119	ElemStation=0.125			
Frame=119	Station=0.25	OutputCase=ACC2	CaseType=Combination	Point=0	X2=0	X3=0	S11=-115.76524492356
IsS11Max=No	IsS11Min=No	FrameElem=119	ElemStation=0.25				
Frame=119	Station=0.25	OutputCase=ACC2	CaseType=Combination	Point=1	X2=-0.5	X3=-0.5	
S11=163.225064027475	IsS11Max=Yes	IsS11Min=No	FrameElem=119	ElemStation=0.25			
Frame=119	Station=0.25	OutputCase=ACC2	CaseType=Combination	Point=2	X2=-0.5	X3=0.5	
S11=163.225064027475	IsS11Max=No	IsS11Min=No	FrameElem=119	ElemStation=0.25			
Frame=119	Station=0.25	OutputCase=ACC2	CaseType=Combination	Point=3	X2=0.5	X3=-0.5	S11=-
394.755553874595	IsS11Max=No	IsS11Min=Yes	FrameElem=119	ElemStation=0.25			



Frame=119	Station=0.25	OutputCase=ACC2	CaseType=Combination	Point=4	X2=0.5	X3=0.5	S11=-
394.755553874595	Iss11Max=No	Iss11Min=No	FrameElem=119	ElemStation=0.25			
Frame=119	Station=0.375	OutputCase=ACC2	CaseType=Combination	Point=0	X2=0	X3=0	S11=-115.76524492356
Iss11Max=No	Iss11Min=No	FrameElem=119	ElemStation=0.375				
Frame=119	Station=0.375	OutputCase=ACC2	CaseType=Combination	Point=1	X2=-0.5	X3=-0.5	S11=-
65.7208740870648	Iss11Max=Yes	Iss11Min=No	FrameElem=119	ElemStation=0.375			
Frame=119	Station=0.375	OutputCase=ACC2	CaseType=Combination	Point=2	X2=-0.5	X3=0.5	S11=-
65.7208740870648	Iss11Max=No	Iss11Min=No	FrameElem=119	ElemStation=0.375			
Frame=119	Station=0.375	OutputCase=ACC2	CaseType=Combination	Point=3	X2=0.5	X3=-0.5	S11=-
165.809615760055	Iss11Max=No	Iss11Min=Yes	FrameElem=119	ElemStation=0.375			
Frame=119	Station=0.375	OutputCase=ACC2	CaseType=Combination	Point=4	X2=0.5	X3=0.5	S11=-
165.809615760055	Iss11Max=No	Iss11Min=No	FrameElem=119	ElemStation=0.375			
Frame=119	Station=0.5	OutputCase=ACC2	CaseType=Combination	Point=0	X2=0	X3=0	S11=-115.76524492356
Iss11Max=No	Iss11Min=No	FrameElem=119	ElemStation=0.5				
Frame=119	Station=0.5	OutputCase=ACC2	CaseType=Combination	Point=1	X2=-0.5	X3=-0.5	S11=-
310.456187201605	Iss11Max=No	Iss11Min=Yes	FrameElem=119	ElemStation=0.5			
Frame=119	Station=0.5	OutputCase=ACC2	CaseType=Combination	Point=2	X2=-0.5	X3=0.5	S11=-
310.456187201605	Iss11Max=No	Iss11Min=No	FrameElem=119	ElemStation=0.5			
Frame=119	Station=0.5	OutputCase=ACC2	CaseType=Combination	Point=3	X2=0.5	X3=-0.5	S11=-
S11=78.9256973544854	Iss11Max=Yes	Iss11Min=No	FrameElem=119	ElemStation=0.5			
Frame=119	Station=0.5	OutputCase=ACC2	CaseType=Combination	Point=4	X2=0.5	X3=0.5	S11=-
S11=78.9256973544854	Iss11Max=No	Iss11Min=No	FrameElem=119	ElemStation=0.5			
Frame=119	Station=0	OutputCase=ACCSX1	CaseType=Combination	Point=0	X2=0	X3=0	S11=-167.164023806274
Iss11Max=No	Iss11Min=No	FrameElem=119	ElemStation=0				
Frame=119	Station=0	OutputCase=ACCSX1	CaseType=Combination	Point=1	X2=-0.5	X3=-0.5	S11=-
S11=400.972196293427	Iss11Max=Yes	Iss11Min=No	FrameElem=119	ElemStation=0			
Frame=119	Station=0	OutputCase=ACCSX1	CaseType=Combination	Point=2	X2=-0.5	X3=0.5	S11=-
S11=400.972196293427	Iss11Max=No	Iss11Min=No	FrameElem=119	ElemStation=0			
Frame=119	Station=0	OutputCase=ACCSX1	CaseType=Combination	Point=3	X2=0.5	X3=-0.5	S11=-
735.300243905975	Iss11Max=No	Iss11Min=Yes	FrameElem=119	ElemStation=0			
Frame=119	Station=0	OutputCase=ACCSX1	CaseType=Combination	Point=4	X2=0.5	X3=0.5	S11=-
735.300243905975	Iss11Max=No	Iss11Min=No	FrameElem=119	ElemStation=0			
Frame=119	Station=0.125	OutputCase=ACCSX1	CaseType=Combination	Point=0	X2=0	X3=0	S11=-
167.164023806274	Iss11Max=No	Iss11Min=No	FrameElem=119	ElemStation=0.125			
Frame=119	Station=0.125	OutputCase=ACCSX1	CaseType=Combination	Point=1	X2=-0.5	X3=-0.5	S11=-
S11=208.821012291977	Iss11Max=Yes	Iss11Min=No	FrameElem=119	ElemStation=0.125			
Frame=119	Station=0.125	OutputCase=ACCSX1	CaseType=Combination	Point=2	X2=-0.5	X3=0.5	S11=-
S11=208.821012291977	Iss11Max=No	Iss11Min=No	FrameElem=119	ElemStation=0.125			
Frame=119	Station=0.125	OutputCase=ACCSX1	CaseType=Combination	Point=3	X2=0.5	X3=-0.5	S11=-
543.149059904525	Iss11Max=No	Iss11Min=Yes	FrameElem=119	ElemStation=0.125			
Frame=119	Station=0.125	OutputCase=ACCSX1	CaseType=Combination	Point=4	X2=0.5	X3=0.5	S11=-
543.149059904525	Iss11Max=No	Iss11Min=No	FrameElem=119	ElemStation=0.125			
Frame=119	Station=0.25	OutputCase=ACCSX1	CaseType=Combination	Point=0	X2=0	X3=0	S11=-
167.164023806274	Iss11Max=No	Iss11Min=No	FrameElem=119	ElemStation=0.25			
Frame=119	Station=0.25	OutputCase=ACCSX1	CaseType=Combination	Point=1	X2=-0.5	X3=-0.5	S11=-
S11=1.38857829052677	Iss11Max=Yes	Iss11Min=No	FrameElem=119	ElemStation=0.25			
Frame=119	Station=0.25	OutputCase=ACCSX1	CaseType=Combination	Point=2	X2=-0.5	X3=0.5	S11=-
S11=1.38857829052677	Iss11Max=No	Iss11Min=No	FrameElem=119	ElemStation=0.25			
Frame=119	Station=0.25	OutputCase=ACCSX1	CaseType=Combination	Point=3	X2=0.5	X3=-0.5	S11=-
335.716625903075	Iss11Max=No	Iss11Min=Yes	FrameElem=119	ElemStation=0.25			
Frame=119	Station=0.25	OutputCase=ACCSX1	CaseType=Combination	Point=4	X2=0.5	X3=0.5	S11=-
335.716625903075	Iss11Max=No	Iss11Min=No	FrameElem=119	ElemStation=0.25			
Frame=119	Station=0.375	OutputCase=ACCSX1	CaseType=Combination	Point=0	X2=0	X3=0	S11=-
167.164023806274	Iss11Max=No	Iss11Min=No	FrameElem=119	ElemStation=0.375			
Frame=119	Station=0.375	OutputCase=ACCSX1	CaseType=Combination	Point=1	X2=-0.5	X3=-0.5	S11=-
221.325105710923	Iss11Max=No	Iss11Min=Yes	FrameElem=119	ElemStation=0.375			
Frame=119	Station=0.375	OutputCase=ACCSX1	CaseType=Combination	Point=2	X2=-0.5	X3=0.5	S11=-
221.325105710923	Iss11Max=No	Iss11Min=No	FrameElem=119	ElemStation=0.375			
Frame=119	Station=0.375	OutputCase=ACCSX1	CaseType=Combination	Point=3	X2=0.5	X3=-0.5	S11=-
113.002941901625	Iss11Max=Yes	Iss11Min=No	FrameElem=119	ElemStation=0.375			
Frame=119	Station=0.375	OutputCase=ACCSX1	CaseType=Combination	Point=4	X2=0.5	X3=0.5	S11=-
113.002941901625	Iss11Max=No	Iss11Min=No	FrameElem=119	ElemStation=0.375			
Frame=119	Station=0.5	OutputCase=ACCSX1	CaseType=Combination	Point=0	X2=0	X3=0	S11=-
167.164023806274	Iss11Max=No	Iss11Min=No	FrameElem=119	ElemStation=0.5			
Frame=119	Station=0.5	OutputCase=ACCSX1	CaseType=Combination	Point=1	X2=-0.5	X3=-0.5	S11=-
459.320039712373	Iss11Max=No	Iss11Min=Yes	FrameElem=119	ElemStation=0.5			
Frame=119	Station=0.5	OutputCase=ACCSX1	CaseType=Combination	Point=2	X2=-0.5	X3=0.5	S11=-
459.320039712373	Iss11Max=No	Iss11Min=No	FrameElem=119	ElemStation=0.5			
Frame=119	Station=0.5	OutputCase=ACCSX1	CaseType=Combination	Point=3	X2=0.5	X3=-0.5	S11=-
S11=124.991992099825	Iss11Max=Yes	Iss11Min=No	FrameElem=119	ElemStation=0.5			
Frame=119	Station=0.5	OutputCase=ACCSX1	CaseType=Combination	Point=4	X2=0.5	X3=0.5	S11=-
S11=124.991992099825	Iss11Max=No	Iss11Min=No	FrameElem=119	ElemStation=0.5			
Frame=119	Station=0	OutputCase=ACCSX2	CaseType=Combination	Point=0	X2=0	X3=0	S11=-113.388258060829
Iss11Max=No	Iss11Min=No	FrameElem=119	ElemStation=0				
Frame=119	Station=0	OutputCase=ACCSX2	CaseType=Combination	Point=1	X2=-0.5	X3=-0.5	S11=-
S11=539.733822853464	Iss11Max=Yes	Iss11Min=No	FrameElem=119	ElemStation=0			
Frame=119	Station=0	OutputCase=ACCSX2	CaseType=Combination	Point=2	X2=-0.5	X3=0.5	S11=-
S11=539.733822853464	Iss11Max=No	Iss11Min=No	FrameElem=119	ElemStation=0			
Frame=119	Station=0	OutputCase=ACCSX2	CaseType=Combination	Point=3	X2=0.5	X3=-0.5	S11=-
766.510338975122	Iss11Max=No	Iss11Min=Yes	FrameElem=119	ElemStation=0			
Frame=119	Station=0	OutputCase=ACCSX2	CaseType=Combination	Point=4	X2=0.5	X3=0.5	S11=-
766.510338975122	Iss11Max=No	Iss11Min=No	FrameElem=119	ElemStation=0			

Frame=119	Station=0.125	OutputCase=ACCSX2	CaseType=Combination	Point=0	X2=0	X3=0	S11=-	
113.388258060829	IsS11Max=No	IsS11Min=No	FrameElem=119	ElemStation=0.125				
Frame=119	Station=0.125	OutputCase=ACCSX2	CaseType=Combination	Point=1	X2=-0.5	X3=-0.5		
S11=347.582639057521	IsS11Max=Yes	IsS11Min=No	FrameElem=119	ElemStation=0.125				
Frame=119	Station=0.125	OutputCase=ACCSX2	CaseType=Combination	Point=2	X2=-0.5	X3=0.5		
S11=347.582639057521	IsS11Max=No	IsS11Min=No	FrameElem=119	ElemStation=0.125				
Frame=119	Station=0.125	OutputCase=ACCSX2	CaseType=Combination	Point=3	X2=0.5	X3=-0.5	S11=-	
574.35915517918	IsS11Max=No	IsS11Min=Yes	FrameElem=119	ElemStation=0.125				
Frame=119	Station=0.125	OutputCase=ACCSX2	CaseType=Combination	Point=4	X2=0.5	X3=0.5	S11=-	
574.35915517918	IsS11Max=No	IsS11Min=No	FrameElem=119	ElemStation=0.125				
Frame=119	Station=0.25	OutputCase=ACCSX2	CaseType=Combination	Point=0	X2=0	X3=0	S11=-	
113.388258060829	IsS11Max=No	IsS11Min=No	FrameElem=119	ElemStation=0.25				
Frame=119	Station=0.25	OutputCase=ACCSX2	CaseType=Combination	Point=1	X2=-0.5	X3=-0.5		
S11=140.150205261579	IsS11Max=Yes	IsS11Min=No	FrameElem=119	ElemStation=0.25				
Frame=119	Station=0.25	OutputCase=ACCSX2	CaseType=Combination	Point=2	X2=-0.5	X3=0.5		
S11=140.150205261579	IsS11Max=No	IsS11Min=No	FrameElem=119	ElemStation=0.25				
Frame=119	Station=0.25	OutputCase=ACCSX2	CaseType=Combination	Point=3	X2=0.5	X3=-0.5	S11=-	
366.926721383237	IsS11Max=No	IsS11Min=Yes	FrameElem=119	ElemStation=0.25				
Frame=119	Station=0.25	OutputCase=ACCSX2	CaseType=Combination	Point=4	X2=0.5	X3=0.5	S11=-	
366.926721383237	IsS11Max=No	IsS11Min=No	FrameElem=119	ElemStation=0.25				
Frame=119	Station=0.375	OutputCase=ACCSX2	CaseType=Combination	Point=0	X2=0	X3=0	S11=-	
113.388258060829	IsS11Max=No	IsS11Min=No	FrameElem=119	ElemStation=0.375				
Frame=119	Station=0.375	OutputCase=ACCSX2	CaseType=Combination	Point=1	X2=-0.5	X3=-0.5	S11=-	
82.5634785343634	IsS11Max=Yes	IsS11Min=No	FrameElem=119	ElemStation=0.375				
Frame=119	Station=0.375	OutputCase=ACCSX2	CaseType=Combination	Point=2	X2=-0.5	X3=0.5	S11=-	
82.5634785343634	IsS11Max=No	IsS11Min=No	FrameElem=119	ElemStation=0.375				
Frame=119	Station=0.375	OutputCase=ACCSX2	CaseType=Combination	Point=3	X2=0.5	X3=-0.5	S11=-	
144.213037587295	IsS11Max=No	IsS11Min=Yes	FrameElem=119	ElemStation=0.375				
Frame=119	Station=0.375	OutputCase=ACCSX2	CaseType=Combination	Point=4	X2=0.5	X3=0.5	S11=-	
144.213037587295	IsS11Max=No	IsS11Min=No	FrameElem=119	ElemStation=0.375				
Frame=119	Station=0.5	OutputCase=ACCSX2	CaseType=Combination	Point=0	X2=0	X3=0	S11=-	
113.388258060829	IsS11Max=No	IsS11Min=No	FrameElem=119	ElemStation=0.5				
Frame=119	Station=0.5	OutputCase=ACCSX2	CaseType=Combination	Point=1	X2=-0.5	X3=-0.5	S11=-	
320.558412330306	IsS11Max=No	IsS11Min=Yes	FrameElem=119	ElemStation=0.5				
Frame=119	Station=0.5	OutputCase=ACCSX2	CaseType=Combination	Point=2	X2=-0.5	X3=0.5	S11=-	
320.558412330306	IsS11Max=No	IsS11Min=No	FrameElem=119	ElemStation=0.5				
Frame=119	Station=0.5	OutputCase=ACCSX2	CaseType=Combination	Point=3	X2=0.5	X3=-0.5		
S11=93.7818962086476	IsS11Max=Yes	IsS11Min=No	FrameElem=119	ElemStation=0.5				
Frame=119	Station=0.5	OutputCase=ACCSX2	CaseType=Combination	Point=4	X2=0.5	X3=0.5		
S11=93.7818962086476	IsS11Max=No	IsS11Min=No	FrameElem=119	ElemStation=0.5				
Frame=119	Station=0	OutputCase=ENVE	CaseType=Combination	StepType=Max	Point=0	X2=0	X3=0	S11=-
111.11546006997	IsS11Max=No	IsS11Min=No	FrameElem=119	ElemStation=0				
Frame=119	Station=0	OutputCase=ENVE	CaseType=Combination	StepType=Max	Point=1	X2=-0.5	X3=-0.5	
S11=573.748815256556	IsS11Max=Yes	IsS11Min=No	FrameElem=119	ElemStation=0				
Frame=119	Station=0	OutputCase=ENVE	CaseType=Combination	StepType=Max	Point=2	X2=-0.5	X3=0.5	
S11=573.748815256556	IsS11Max=No	IsS11Min=No	FrameElem=119	ElemStation=0				
Frame=119	Station=0	OutputCase=ENVE	CaseType=Combination	StepType=Max	Point=3	X2=0.5	X3=-0.5	
S11=-735.300243905975	IsS11Max=No	IsS11Min=Yes	FrameElem=119	ElemStation=0				
Frame=119	Station=0	OutputCase=ENVE	CaseType=Combination	StepType=Max	Point=4	X2=0.5	X3=0.5	S11=-
735.300243905975	IsS11Max=No	IsS11Min=No	FrameElem=119	ElemStation=0				
Frame=119	Station=0.125	OutputCase=ENVE	CaseType=Combination	StepType=Max	Point=0	X2=0	X3=0	S11=-
111.11546006997	IsS11Max=No	IsS11Min=No	FrameElem=119	ElemStation=0.125				
Frame=119	Station=0.125	OutputCase=ENVE	CaseType=Combination	StepType=Max	Point=1	X2=-0.5	X3=-0.5	
S11=376.381627142016	IsS11Max=Yes	IsS11Min=No	FrameElem=119	ElemStation=0.125				
Frame=119	Station=0.125	OutputCase=ENVE	CaseType=Combination	StepType=Max	Point=2	X2=-0.5	X3=0.5	
S11=376.381627142016	IsS11Max=No	IsS11Min=No	FrameElem=119	ElemStation=0.125				
Frame=119	Station=0.125	OutputCase=ENVE	CaseType=Combination	StepType=Max	Point=3	X2=0.5	X3=-0.5	
S11=-543.149059904525	IsS11Max=No	IsS11Min=Yes	FrameElem=119	ElemStation=0.125				
Frame=119	Station=0.125	OutputCase=ENVE	CaseType=Combination	StepType=Max	Point=4	X2=0.5	X3=0.5	
S11=-543.149059904525	IsS11Max=No	IsS11Min=No	FrameElem=119	ElemStation=0.125				
Frame=119	Station=0.25	OutputCase=ENVE	CaseType=Combination	StepType=Max	Point=0	X2=0	X3=0	S11=-
111.11546006997	IsS11Max=No	IsS11Min=No	FrameElem=119	ElemStation=0.25				
Frame=119	Station=0.25	OutputCase=ENVE	CaseType=Combination	StepType=Max	Point=1	X2=-0.5	X3=-0.5	
S11=163.225064027475	IsS11Max=Yes	IsS11Min=No	FrameElem=119	ElemStation=0.25				
Frame=119	Station=0.25	OutputCase=ENVE	CaseType=Combination	StepType=Max	Point=2	X2=-0.5	X3=0.5	
S11=163.225064027475	IsS11Max=No	IsS11Min=No	FrameElem=119	ElemStation=0.25				
Frame=119	Station=0.25	OutputCase=ENVE	CaseType=Combination	StepType=Max	Point=3	X2=0.5	X3=-0.5	
S11=-335.716625903075	IsS11Max=No	IsS11Min=Yes	FrameElem=119	ElemStation=0.25				
Frame=119	Station=0.25	OutputCase=ENVE	CaseType=Combination	StepType=Max	Point=4	X2=0.5	X3=0.5	
S11=-335.716625903075	IsS11Max=No	IsS11Min=No	FrameElem=119	ElemStation=0.25				
Frame=119	Station=0.375	OutputCase=ENVE	CaseType=Combination	StepType=Max	Point=0	X2=0	X3=0	S11=-
111.11546006997	IsS11Max=No	IsS11Min=No	FrameElem=119	ElemStation=0.375				
Frame=119	Station=0.375	OutputCase=ENVE	CaseType=Combination	StepType=Max	Point=1	X2=-0.5	X3=-0.5	
S11=-59.5871722953387	IsS11Max=Yes	IsS11Min=No	FrameElem=119	ElemStation=0.375				
Frame=119	Station=0.375	OutputCase=ENVE	CaseType=Combination	StepType=Max	Point=2	X2=-0.5	X3=0.5	
S11=-59.5871722953387	IsS11Max=No	IsS11Min=No	FrameElem=119	ElemStation=0.375				
Frame=119	Station=0.375	OutputCase=ENVE	CaseType=Combination	StepType=Max	Point=3	X2=0.5	X3=-0.5	
S11=-113.002941901625	IsS11Max=No	IsS11Min=Yes	FrameElem=119	ElemStation=0.375				
Frame=119	Station=0.375	OutputCase=ENVE	CaseType=Combination	StepType=Max	Point=4	X2=0.5	X3=0.5	
S11=-113.002941901625	IsS11Max=No	IsS11Min=No	FrameElem=119	ElemStation=0.375				
Frame=119	Station=0.5	OutputCase=ENVE	CaseType=Combination	StepType=Max	Point=0	X2=0	X3=0	S11=-
111.11546006997	IsS11Max=No	IsS11Min=No	FrameElem=119	ElemStation=0.5				

Frame=119	Station=0.5	OutputCase=ENVE	CaseType=Combination	StepType=Max	Point=1	X2=-0.5	X3=-0.5	
S11=-296.446547887194	IsS11Max=No	IsS11Min=Yes	FrameElem=119	ElemStation=0.5				
Frame=119	Station=0.5	OutputCase=ENVE	CaseType=Combination	StepType=Max	Point=2	X2=-0.5	X3=0.5	
S11=-296.446547887194	IsS11Max=No	IsS11Min=No	FrameElem=119	ElemStation=0.5				
Frame=119	Station=0.5	OutputCase=ENVE	CaseType=Combination	StepType=Max	Point=3	X2=0.5	X3=-0.5	
S11=124.991992099825	IsS11Max=Yes	IsS11Min=No	FrameElem=119	ElemStation=0.5				
Frame=119	Station=0.5	OutputCase=ENVE	CaseType=Combination	StepType=Max	Point=4	X2=0.5	X3=0.5	
S11=124.991992099825	IsS11Max=No	IsS11Min=No	FrameElem=119	ElemStation=0.5				
Frame=119	Station=0	OutputCase=ENVE	CaseType=Combination	StepType=Min	Point=0	X2=0	X3=0	S11=-
169.541010669005	IsS11Max=No	IsS11Min=No	FrameElem=119	ElemStation=0				
Frame=119	Station=0	OutputCase=ENVE	CaseType=Combination	StepType=Min	Point=1	X2=-0.5	X3=-0.5	
S11=400.972196293427	IsS11Max=Yes	IsS11Min=No	FrameElem=119	ElemStation=0				
Frame=119	Station=0	OutputCase=ENVE	CaseType=Combination	StepType=Min	Point=2	X2=-0.5	X3=0.5	
S11=400.972196293427	IsS11Max=No	IsS11Min=No	FrameElem=119	ElemStation=0				
Frame=119	Station=0	OutputCase=ENVE	CaseType=Combination	StepType=Min	Point=3	X2=0.5	X3=-0.5	
S11=-805.279305103676	IsS11Max=No	IsS11Min=Yes	FrameElem=119	ElemStation=0				
Frame=119	Station=0	OutputCase=ENVE	CaseType=Combination	StepType=Min	Point=4	X2=0.5	X3=0.5	S11=-
805.279305103676	IsS11Max=No	IsS11Min=No	FrameElem=119	ElemStation=0				
Frame=119	Station=0.125	OutputCase=ENVE	CaseType=Combination	StepType=Min	Point=0	X2=0	X3=0	S11=-
169.541010669005	IsS11Max=No	IsS11Min=No	FrameElem=119	ElemStation=0.125				
Frame=119	Station=0.125	OutputCase=ENVE	CaseType=Combination	StepType=Min	Point=1	X2=-0.5	X3=-0.5	
S11=208.821012291977	IsS11Max=Yes	IsS11Min=No	FrameElem=119	ElemStation=0.125				
Frame=119	Station=0.125	OutputCase=ENVE	CaseType=Combination	StepType=Min	Point=2	X2=-0.5	X3=0.5	
S11=208.821012291977	IsS11Max=No	IsS11Min=No	FrameElem=119	ElemStation=0.125				
Frame=119	Station=0.125	OutputCase=ENVE	CaseType=Combination	StepType=Min	Point=3	X2=0.5	X3=-0.5	
S11=-607.912116989135	IsS11Max=No	IsS11Min=Yes	FrameElem=119	ElemStation=0.125				
Frame=119	Station=0.125	OutputCase=ENVE	CaseType=Combination	StepType=Min	Point=4	X2=0.5	X3=0.5	
S11=-607.912116989135	IsS11Max=No	IsS11Min=No	FrameElem=119	ElemStation=0.125				
Frame=119	Station=0.25	OutputCase=ENVE	CaseType=Combination	StepType=Min	Point=0	X2=0	X3=0	S11=-
169.541010669005	IsS11Max=No	IsS11Min=No	FrameElem=119	ElemStation=0.25				
Frame=119	Station=0.25	OutputCase=ENVE	CaseType=Combination	StepType=Min	Point=1	X2=-0.5	X3=-0.5	
S11=1.38857829052677	IsS11Max=Yes	IsS11Min=No	FrameElem=119	ElemStation=0.25				
Frame=119	Station=0.25	OutputCase=ENVE	CaseType=Combination	StepType=Min	Point=2	X2=-0.5	X3=0.5	
S11=1.38857829052677	IsS11Max=No	IsS11Min=No	FrameElem=119	ElemStation=0.25				
Frame=119	Station=0.25	OutputCase=ENVE	CaseType=Combination	StepType=Min	Point=3	X2=0.5	X3=-0.5	
S11=-394.75553874595	IsS11Max=No	IsS11Min=Yes	FrameElem=119	ElemStation=0.25				
Frame=119	Station=0.25	OutputCase=ENVE	CaseType=Combination	StepType=Min	Point=4	X2=0.5	X3=0.5	
S11=-394.75553874595	IsS11Max=No	IsS11Min=No	FrameElem=119	ElemStation=0.25				
Frame=119	Station=0.375	OutputCase=ENVE	CaseType=Combination	StepType=Min	Point=0	X2=0	X3=0	S11=-
169.541010669005	IsS11Max=No	IsS11Min=No	FrameElem=119	ElemStation=0.375				
Frame=119	Station=0.375	OutputCase=ENVE	CaseType=Combination	StepType=Min	Point=1	X2=-0.5	X3=-0.5	
S11=-221.325105710923	IsS11Max=No	IsS11Min=Yes	FrameElem=119	ElemStation=0.375				
Frame=119	Station=0.375	OutputCase=ENVE	CaseType=Combination	StepType=Min	Point=2	X2=-0.5	X3=0.5	
S11=-221.325105710923	IsS11Max=No	IsS11Min=No	FrameElem=119	ElemStation=0.375				
Frame=119	Station=0.375	OutputCase=ENVE	CaseType=Combination	StepType=Min	Point=3	X2=0.5	X3=-0.5	
S11=-165.809615760055	IsS11Max=Yes	IsS11Min=No	FrameElem=119	ElemStation=0.375				
Frame=119	Station=0.375	OutputCase=ENVE	CaseType=Combination	StepType=Min	Point=4	X2=0.5	X3=0.5	
S11=-165.809615760055	IsS11Max=No	IsS11Min=No	FrameElem=119	ElemStation=0.375				
Frame=119	Station=0.5	OutputCase=ENVE	CaseType=Combination	StepType=Min	Point=0	X2=0	X3=0	S11=-
169.541010669005	IsS11Max=No	IsS11Min=No	FrameElem=119	ElemStation=0.5				
Frame=119	Station=0.5	OutputCase=ENVE	CaseType=Combination	StepType=Min	Point=1	X2=-0.5	X3=-0.5	
S11=-459.320039712373	IsS11Max=No	IsS11Min=Yes	FrameElem=119	ElemStation=0.5				
Frame=119	Station=0.5	OutputCase=ENVE	CaseType=Combination	StepType=Min	Point=2	X2=-0.5	X3=0.5	
S11=-459.320039712373	IsS11Max=No	IsS11Min=No	FrameElem=119	ElemStation=0.5				
Frame=119	Station=0.5	OutputCase=ENVE	CaseType=Combination	StepType=Min	Point=3	X2=0.5	X3=-0.5	
S11=74.2156277472545	IsS11Max=Yes	IsS11Min=No	FrameElem=119	ElemStation=0.5				
Frame=119	Station=0.5	OutputCase=ENVE	CaseType=Combination	StepType=Min	Point=4	X2=0.5	X3=0.5	
S11=74.2156277472545	IsS11Max=No	IsS11Min=No	FrameElem=119	ElemStation=0.5				
Frame=119	Station=0	OutputCase=FESSUR	CaseType=Combination	Point=0	X2=0	X3=0	S11=-168.146075212928	
IsS11Max=No	IsS11Min=No	FrameElem=119	ElemStation=0					
Frame=119	Station=0	OutputCase=FESSUR	CaseType=Combination	Point=1	X2=-0.5	X3=-0.5		
S11=430.65358046362	IsS11Max=Yes	IsS11Min=No	FrameElem=119	ElemStation=0				
Frame=119	Station=0	OutputCase=FESSUR	CaseType=Combination	Point=2	X2=-0.5	X3=0.5		
S11=430.65358046362	IsS11Max=No	IsS11Min=No	FrameElem=119	ElemStation=0				
Frame=119	Station=0	OutputCase=FESSUR	CaseType=Combination	Point=3	X2=0.5	X3=-0.5	S11=-	
766.945730889476	IsS11Max=No	IsS11Min=Yes	FrameElem=119	ElemStation=0				
Frame=119	Station=0	OutputCase=FESSUR	CaseType=Combination	Point=4	X2=0.5	X3=0.5	S11=-	
766.945730889476	IsS11Max=No	IsS11Min=No	FrameElem=119	ElemStation=0				
Frame=119	Station=0.125	OutputCase=FESSUR	CaseType=Combination	Point=0	X2=0	X3=0	S11=-	
168.146075212928	IsS11Max=No	IsS11Min=No	FrameElem=119	ElemStation=0.125				
Frame=119	Station=0.125	OutputCase=FESSUR	CaseType=Combination	Point=1	X2=-0.5	X3=-0.5		
S11=235.191860900378	IsS11Max=Yes	IsS11Min=No	FrameElem=119	ElemStation=0.125				
Frame=119	Station=0.125	OutputCase=FESSUR	CaseType=Combination	Point=2	X2=-0.5	X3=0.5		
S11=235.191860900378	IsS11Max=No	IsS11Min=No	FrameElem=119	ElemStation=0.125				
Frame=119	Station=0.125	OutputCase=FESSUR	CaseType=Combination	Point=3	X2=0.5	X3=-0.5	S11=-	
571.484011326234	IsS11Max=No	IsS11Min=Yes	FrameElem=119	ElemStation=0.125				
Frame=119	Station=0.125	OutputCase=FESSUR	CaseType=Combination	Point=4	X2=0.5	X3=0.5	S11=-	
571.484011326234	IsS11Max=No	IsS11Min=No	FrameElem=119	ElemStation=0.125				
Frame=119	Station=0.25	OutputCase=FESSUR	CaseType=Combination	Point=0	X2=0	X3=0	S11=-	
168.146075212928	IsS11Max=No	IsS11Min=No	FrameElem=119	ElemStation=0.25				
Frame=119	Station=0.25	OutputCase=FESSUR	CaseType=Combination	Point=1	X2=-0.5	X3=-0.5		
S11=24.0932038371355	IsS11Max=Yes	IsS11Min=No	FrameElem=119	ElemStation=0.25				

Frame=119	Station=0.25	OutputCase=FESSUR	CaseType=Combination	Point=2	X2=-0.5	X3=0.5		
S11=24.0932038371355	IsS11Max=No	IsS11Min=No	FrameElem=119	ElemStation=0.25				
Frame=119	Station=0.25	OutputCase=FESSUR	CaseType=Combination	Point=3	X2=0.5	X3=-0.5	S11=-	
360.385354262991	IsS11Max=No	IsS11Min=Yes	FrameElem=119	ElemStation=0.25				
Frame=119	Station=0.25	OutputCase=FESSUR	CaseType=Combination	Point=4	X2=0.5	X3=0.5	S11=-	
360.385354262991	IsS11Max=No	IsS11Min=No	FrameElem=119	ElemStation=0.25				
Frame=119	Station=0.375	OutputCase=FESSUR	CaseType=Combination	Point=0	X2=0	X3=0	S11=-	
168.146075212928	IsS11Max=No	IsS11Min=No	FrameElem=119	ElemStation=0.375				
Frame=119	Station=0.375	OutputCase=FESSUR	CaseType=Combination	Point=1	X2=-0.5	X3=-0.5	S11=-	
202.642390726107	IsS11Max=No	IsS11Min=Yes	FrameElem=119	ElemStation=0.375				
Frame=119	Station=0.375	OutputCase=FESSUR	CaseType=Combination	Point=2	X2=-0.5	X3=0.5	S11=-	
202.642390726107	IsS11Max=No	IsS11Min=No	FrameElem=119	ElemStation=0.375				
Frame=119	Station=0.375	OutputCase=FESSUR	CaseType=Combination	Point=3	X2=0.5	X3=-0.5	S11=-	
133.649759699749	IsS11Max=Yes	IsS11Min=No	FrameElem=119	ElemStation=0.375				
Frame=119	Station=0.375	OutputCase=FESSUR	CaseType=Combination	Point=4	X2=0.5	X3=0.5	S11=-	
133.649759699749	IsS11Max=No	IsS11Min=No	FrameElem=119	ElemStation=0.375				
Frame=119	Station=0.5	OutputCase=FESSUR	CaseType=Combination	Point=0	X2=0	X3=0	S11=-	
168.146075212928	IsS11Max=No	IsS11Min=No	FrameElem=119	ElemStation=0.5				
Frame=119	Station=0.5	OutputCase=FESSUR	CaseType=Combination	Point=1	X2=-0.5	X3=-0.5	S11=-	
445.014922789349	IsS11Max=No	IsS11Min=Yes	FrameElem=119	ElemStation=0.5				
Frame=119	Station=0.5	OutputCase=FESSUR	CaseType=Combination	Point=2	X2=-0.5	X3=0.5	S11=-	
445.014922789349	IsS11Max=No	IsS11Min=No	FrameElem=119	ElemStation=0.5				
Frame=119	Station=0.5	OutputCase=FESSUR	CaseType=Combination	Point=3	X2=0.5	X3=-0.5		
S11=108.722772363493	IsS11Max=Yes	IsS11Min=No	FrameElem=119	ElemStation=0.5				
Frame=119	Station=0.5	OutputCase=FESSUR	CaseType=Combination	Point=4	X2=0.5	X3=0.5		
S11=108.722772363493	IsS11Max=No	IsS11Min=No	FrameElem=119	ElemStation=0.5				

TABLE: "ELEMENT JOINT FORCES - FRAMES"

Frame=1	Joint=1	OutputCase=PERM1	CaseType=Combination	F1=235.938772273309	F2=0	F3=-478.419007365005	
M1=0	M2=286.662905880613	M3=0	FrameElem=1				
Frame=1	Joint=30	OutputCase=PERM1	CaseType=Combination	F1=-235.938772273309	F2=0	F3=484.669006768959	
M1=0	M2=-166.276915594765	M3=0	FrameElem=1				
Frame=1	Joint=1	OutputCase=PERM2	CaseType=Combination	F1=169.465538592139	F2=0	F3=-478.387175608924	
M1=0	M2=272.261659822668	M3=0	FrameElem=1				
Frame=1	Joint=30	OutputCase=PERM2	CaseType=Combination	F1=-169.465538592139	F2=0	F3=484.637175012878	
M1=0	M2=-151.883627475082	M3=0	FrameElem=1				
Frame=1	Joint=1	OutputCase=ACC1	CaseType=Combination	F1=240.528987364651	F2=0	F3=-491.275710552204	
M1=0	M2=294.20124175057	M3=0	FrameElem=1				
Frame=1	Joint=30	OutputCase=ACC1	CaseType=Combination	F1=-240.528987364651	F2=0	F3=497.525709956158	
M1=0	M2=-170.60107597445	M3=0	FrameElem=1				
Frame=1	Joint=1	OutputCase=ACC2	CaseType=Combination	F1=174.055753683481	F2=0	F3=-491.243878796123	
M1=0	M2=279.799995692625	M3=0	FrameElem=1				
Frame=1	Joint=30	OutputCase=ACC2	CaseType=Combination	F1=-174.055753683481	F2=0	F3=497.493878200077	
M1=0	M2=-156.207787854767	M3=0	FrameElem=1				
Frame=1	Joint=1	OutputCase=ACCSX1	CaseType=Combination	F1=233.665974282453	F2=0	F3=-477.455651111257	
M1=0	M2=292.87820913746	M3=0	FrameElem=1				
Frame=1	Joint=30	OutputCase=ACCSX1	CaseType=Combination	F1=-233.665974282453	F2=0	F3=483.70565051521	
M1=0	M2=-172.733057892082	M3=0	FrameElem=1				
Frame=1	Joint=1	OutputCase=ACCSX2	CaseType=Combination	F1=167.192740601283	F2=0	F3=-477.423819355176	
M1=0	M2=278.476963079516	M3=0	FrameElem=1				
Frame=1	Joint=30	OutputCase=ACCSX2	CaseType=Combination	F1=-167.192740601283	F2=0	F3=483.673818759129	
M1=0	M2=-158.339769772398	M3=0	FrameElem=1				
Frame=1	Joint=1	OutputCase=ENVE	CaseType=Combination	StepType=Max	F1=240.528987364651	F2=0	F3=-
477.423819355176	M1=0	M2=294.20124175057	M3=0	FrameElem=1			
Frame=1	Joint=30	OutputCase=ENVE	CaseType=Combination	StepType=Max	F1=-167.192740601283	F2=0	
F3=497.525709956158	M1=0	M2=-151.883627475082	M3=0	FrameElem=1			
Frame=1	Joint=1	OutputCase=ENVE	CaseType=Combination	StepType=Min	F1=167.192740601283	F2=0	F3=-
491.275710552204	M1=0	M2=272.261659822668	M3=0	FrameElem=1			
Frame=1	Joint=30	OutputCase=ENVE	CaseType=Combination	StepType=Min	F1=-240.528987364651	F2=0	
F3=483.673818759129	M1=0	M2=-172.733057892082	M3=0	FrameElem=1			
Frame=1	Joint=1	OutputCase=FESSUR	CaseType=Combination	F1=239.151922837248	F2=0	F3=-487.418699596045	
M1=0	M2=291.939740989582	M3=0	FrameElem=1				
Frame=1	Joint=30	OutputCase=FESSUR	CaseType=Combination	F1=-239.151922837248	F2=0	F3=493.668698999998	
M1=0	M2=-169.303827860545	M3=0	FrameElem=1				
Frame=2	Joint=30	OutputCase=PERM1	CaseType=Combination	F1=235.938772273309	F2=0	F3=-426.759276132758	
M1=0	M2=166.276915594759	M3=0	FrameElem=2				
Frame=2	Joint=31	OutputCase=PERM1	CaseType=Combination	F1=-235.938772273309	F2=0	F3=433.009276132758	
M1=0	M2=-58.8058465615692	M3=0	FrameElem=2				
Frame=2	Joint=30	OutputCase=PERM2	CaseType=Combination	F1=169.465538592139	F2=0	F3=-426.682125472614	
M1=0	M2=151.883627475075	M3=0	FrameElem=2				
Frame=2	Joint=31	OutputCase=PERM2	CaseType=Combination	F1=-169.465538592139	F2=0	F3=432.932125472614	
M1=0	M2=-44.4318461069218	M3=0	FrameElem=2				
Frame=2	Joint=30	OutputCase=ACC1	CaseType=Combination	F1=240.528987364651	F2=0	F3=-438.236283463952	
M1=0	M2=170.601075974444	M3=0	FrameElem=2				
Frame=2	Joint=31	OutputCase=ACC1	CaseType=Combination	F1=-240.528987364651	F2=0	F3=444.486283463952	
M1=0	M2=-60.2607551084564	M3=0	FrameElem=2				
Frame=2	Joint=30	OutputCase=ACC2	CaseType=Combination	F1=174.055753683481	F2=0	F3=-438.159132803807	
M1=0	M2=156.207787854761	M3=0	FrameElem=2				
Frame=2	Joint=31	OutputCase=ACC2	CaseType=Combination	F1=-174.055753683481	F2=0	F3=444.409132803807	
M1=0	M2=-45.8867546538091	M3=0	FrameElem=2				
Frame=2	Joint=30	OutputCase=ACCSX1	CaseType=Combination	F1=233.665974282453	F2=0	F3=-426.783310404037	
M1=0	M2=172.733057892076	M3=0	FrameElem=2				



Frame=2 Joint=31 OutputCase=ACCSX1 CaseType=Combination F1=-233.665974282453 F2=0 F3=433.033310404037
 M1=0 M2=-65.2559802910663 M3=0 FrameElem=2
 Frame=2 Joint=30 OutputCase=ACCSX2 CaseType=Combination F1=167.192740601283 F2=0 F3=-426.706159743893
 M1=0 M2=158.339769772392 M3=0 FrameElem=2
 Frame=2 Joint=31 OutputCase=ACCSX2 CaseType=Combination F1=-167.192740601283 F2=0 F3=432.956159743893
 M1=0 M2=-50.881979836419 M3=0 FrameElem=2
 Frame=2 Joint=30 OutputCase=ENVE CaseType=Combination StepType=Max F1=240.528987364651 F2=0 F3=-
 426.682125472614 M1=0 M2=172.733057892076 M3=0 FrameElem=2
 Frame=2 Joint=31 OutputCase=ENVE CaseType=Combination StepType=Max F1=-167.192740601283 F2=0
 F3=444.486283463952 M1=0 M2=-44.4318461069218 M3=0 FrameElem=2
 Frame=2 Joint=30 OutputCase=ENVE CaseType=Combination StepType=Min F1=167.192740601283 F2=0 F3=-
 438.236283463952 M1=0 M2=151.883627475075 M3=0 FrameElem=2
 Frame=2 Joint=31 OutputCase=ENVE CaseType=Combination StepType=Min F1=-240.528987364651 F2=0
 F3=432.932125472614 M1=0 M2=-65.2559802910663 M3=0 FrameElem=2
 Frame=2 Joint=30 OutputCase=FESSUR CaseType=Combination F1=239.151922837248 F2=0 F3=-434.793181264594
 M1=0 M2=169.303827860539 M3=0 FrameElem=2
 Frame=2 Joint=31 OutputCase=FESSUR CaseType=Combination F1=-239.151922837248 F2=0 F3=441.043181264594
 M1=0 M2=-59.8242825443902 M3=0 FrameElem=2
 Frame=3 Joint=15 OutputCase=PERM1 CaseType=Combination F1=186.258772273307 F2=0 F3=507.49999658074
 M1=0 M2=286.662903366804 M3=0 FrameElem=3
 Frame=3 Joint=28 OutputCase=PERM1 CaseType=Combination F1=-162.220256649896 F2=0 F3=-501.24999658074
 M1=0 M2=-243.114140292332 M3=0 FrameElem=3
 Frame=3 Joint=15 OutputCase=PERM2 CaseType=Combination F1=134.689538592137 F2=0 F3=507.499996306729
 M1=0 M2=272.261658287781 M3=0 FrameElem=3
 Frame=3 Joint=28 OutputCase=PERM2 CaseType=Combination F1=-117.862577655749 F2=0 F3=-501.249996306729
 M1=0 M2=-240.700428243016 M3=0 FrameElem=3
 Frame=3 Joint=15 OutputCase=ACC1 CaseType=Combination F1=190.848987364649 F2=0 F3=521.049996481763
 M1=0 M2=294.201239167707 M3=0 FrameElem=3
 Frame=3 Joint=28 OutputCase=ACC1 CaseType=Combination F1=-166.232971741238 F2=0 F3=-514.799996481763
 M1=0 M2=-249.577110143456 M3=0 FrameElem=3
 Frame=3 Joint=15 OutputCase=ACC2 CaseType=Combination F1=139.279753683479 F2=0 F3=521.049996207752
 M1=0 M2=279.799994088684 M3=0 FrameElem=3
 Frame=3 Joint=28 OutputCase=ACC2 CaseType=Combination F1=-121.875292747091 F2=0 F3=-514.799996207752
 M1=0 M2=-247.16339809414 M3=0 FrameElem=3
 Frame=3 Joint=15 OutputCase=ACCSX1 CaseType=Combination F1=183.985974282451 F2=0 F3=509.014074186187
 M1=0 M2=281.968594578711 M3=0 FrameElem=3
 Frame=3 Joint=28 OutputCase=ACCSX1 CaseType=Combination F1=-159.94745865904 F2=0 F3=-502.764074186187
 M1=0 M2=-238.988031038052 M3=0 FrameElem=3
 Frame=3 Joint=15 OutputCase=ACCSX2 CaseType=Combination F1=132.416740601281 F2=0 F3=509.014073912176
 M1=0 M2=267.567349499688 M3=0 FrameElem=3
 Frame=3 Joint=28 OutputCase=ACCSX2 CaseType=Combination F1=-115.589779664893 F2=0 F3=-
 502.764073912176 M1=0 M2=-236.574318988736 M3=0 FrameElem=3
 Frame=3 Joint=15 OutputCase=ENVE CaseType=Combination StepType=Max F1=190.848987364649 F2=0
 F3=521.049996481763 M1=0 M2=294.201239167707 M3=0 FrameElem=3
 Frame=3 Joint=28 OutputCase=ENVE CaseType=Combination StepType=Max F1=-115.589779664893 F2=0 F3=-
 501.249996306729 M1=0 M2=-236.574318988736 M3=0 FrameElem=3
 Frame=3 Joint=15 OutputCase=ENVE CaseType=Combination StepType=Min F1=132.416740601281 F2=0
 F3=507.499996306729 M1=0 M2=267.567349499688 M3=0 FrameElem=3
 Frame=3 Joint=28 OutputCase=ENVE CaseType=Combination StepType=Min F1=-166.232971741238 F2=0 F3=-
 514.799996481763 M1=0 M2=-249.577110143456 M3=0 FrameElem=3
 Frame=3 Joint=15 OutputCase=FESSUR CaseType=Combination F1=189.471922837247 F2=0 F3=516.984996511456
 M1=0 M2=291.939738427436 M3=0 FrameElem=3
 Frame=3 Joint=28 OutputCase=FESSUR CaseType=Combination F1=-165.029157213835 F2=0 F3=-
 510.734996511456 M1=0 M2=-247.638219188119 M3=0 FrameElem=3
 Frame=4 Joint=32 OutputCase=PERM1 CaseType=Combination F1=235.938772273311 F2=0 F3=433.009276611264
 M1=0 M2=58.8058436397301 M3=0 FrameElem=4
 Frame=4 Joint=33 OutputCase=PERM1 CaseType=Combination F1=-235.938772273311 F2=0 F3=-426.759276611264
 M1=0 M2=-166.276912792542 M3=0 FrameElem=4
 Frame=4 Joint=32 OutputCase=PERM2 CaseType=Combination F1=169.465538592141 F2=0 F3=432.932125792741
 M1=0 M2=44.4318443057546 M3=0 FrameElem=4
 Frame=4 Joint=33 OutputCase=PERM2 CaseType=Combination F1=-169.465538592141 F2=0 F3=-426.682125792741
 M1=0 M2=-151.883625753936 M3=0 FrameElem=4
 Frame=4 Joint=32 OutputCase=ACC1 CaseType=Combination F1=240.528987364653 F2=0 F3=444.486283966422
 M1=0 M2=60.2607520997159 M3=0 FrameElem=4
 Frame=4 Joint=33 OutputCase=ACC1 CaseType=Combination F1=-240.528987364653 F2=0 F3=-438.236283966422
 M1=0 M2=-170.601073091318 M3=0 FrameElem=4
 Frame=4 Joint=32 OutputCase=ACC2 CaseType=Combination F1=174.055753683483 F2=0 F3=444.409133147899
 M1=0 M2=45.8867527657404 M3=0 FrameElem=4
 Frame=4 Joint=33 OutputCase=ACC2 CaseType=Combination F1=-174.055753683483 F2=0 F3=-438.159133147899
 M1=0 M2=-156.207786052712 M3=0 FrameElem=4
 Frame=4 Joint=32 OutputCase=ACCSX1 CaseType=Combination F1=233.665974282455 F2=0 F3=432.99339065237
 M1=0 M2=53.873826814028 M3=0 FrameElem=4
 Frame=4 Joint=33 OutputCase=ACCSX1 CaseType=Combination F1=-233.665974282455 F2=0 F3=-426.74339065237
 M1=0 M2=-161.340924477117 M3=0 FrameElem=4
 Frame=4 Joint=32 OutputCase=ACCSX2 CaseType=Combination F1=167.192740601285 F2=0 F3=432.916239833847
 M1=0 M2=39.4998274800525 M3=0 FrameElem=4
 Frame=4 Joint=33 OutputCase=ACCSX2 CaseType=Combination F1=-167.192740601285 F2=0 F3=-
 426.666239833847 M1=0 M2=-146.947637438511 M3=0 FrameElem=4
 Frame=4 Joint=32 OutputCase=ENVE CaseType=Combination StepType=Max F1=240.528987364653 F2=0
 F3=444.486283966422 M1=0 M2=60.2607520997159 M3=0 FrameElem=4
 Frame=4 Joint=33 OutputCase=ENVE CaseType=Combination StepType=Max F1=-167.192740601285 F2=0 F3=-
 426.666239833847 M1=0 M2=-146.947637438511 M3=0 FrameElem=4



Frame=4 Joint=32 OutputCase=ENVE CaseType=Combination StepType=Min F1=167.192740601285 F2=0
 F3=432.916239833847 M1=0 M2=39.4998274800525 M3=0 FrameElem=4
 Frame=4 Joint=33 OutputCase=ENVE CaseType=Combination StepType=Min F1=-240.528987364653 F2=0 F3=-
 438.236283966422 M1=0 M2=-170.601073091318 M3=0 FrameElem=4
 Frame=4 Joint=32 OutputCase=FESSUR CaseType=Combination F1=239.15192283725 F2=0 F3=441.043181759874
 M1=0 M2=59.8242795617202 M3=0 FrameElem=4
 Frame=4 Joint=33 OutputCase=FESSUR CaseType=Combination F1=-239.15192283725 F2=0 F3=-434.793181759874
 M1=0 M2=-169.303825001685 M3=0 FrameElem=4
 Frame=5 Joint=33 OutputCase=PERM1 CaseType=Combination F1=235.938772273306 F2=0 F3=484.669007922372
 M1=0 M2=166.27691279259 M3=0 FrameElem=5
 Frame=5 Joint=15 OutputCase=PERM1 CaseType=Combination F1=-235.938772273306 F2=0 F3=-478.419008518419
 M1=0 M2=-286.662903366787 M3=0 FrameElem=5
 Frame=5 Joint=33 OutputCase=PERM2 CaseType=Combination F1=169.465538592137 F2=0 F3=484.63717575767
 M1=0 M2=151.883625753984 M3=0 FrameElem=5
 Frame=5 Joint=15 OutputCase=PERM2 CaseType=Combination F1=-169.465538592137 F2=0 F3=-478.387176353716
 M1=0 M2=-272.261658287764 M3=0 FrameElem=5
 Frame=5 Joint=33 OutputCase=ACC1 CaseType=Combination F1=240.528987364648 F2=0 F3=497.525711156991
 M1=0 M2=170.601073091366 M3=0 FrameElem=5
 Frame=5 Joint=15 OutputCase=ACC1 CaseType=Combination F1=-240.528987364648 F2=0 F3=-491.275711753037
 M1=0 M2=-294.20123916769 M3=0 FrameElem=5
 Frame=5 Joint=33 OutputCase=ACC2 CaseType=Combination F1=174.055753683479 F2=0 F3=497.493878992288
 M1=0 M2=156.20778605276 M3=0 FrameElem=5
 Frame=5 Joint=15 OutputCase=ACC2 CaseType=Combination F1=-174.055753683479 F2=0 F3=-491.243879588334
 M1=0 M2=-279.799994088666 M3=0 FrameElem=5
 Frame=5 Joint=33 OutputCase=ACCSX1 CaseType=Combination F1=233.66597428245 F2=0 F3=485.635726123895
 M1=0 M2=161.340924477165 M3=0 FrameElem=5
 Frame=5 Joint=15 OutputCase=ACCSX1 CaseType=Combination F1=-233.66597428245 F2=0 F3=-479.385726719942
 M1=0 M2=-281.968594578694 M3=0 FrameElem=5
 Frame=5 Joint=33 OutputCase=ACCSX2 CaseType=Combination F1=167.192740601281 F2=0 F3=485.603893959192
 M1=0 M2=146.947637438559 M3=0 FrameElem=5
 Frame=5 Joint=15 OutputCase=ACCSX2 CaseType=Combination F1=-167.192740601281 F2=0 F3=-
 479.35389455239 M1=0 M2=-267.567349499671 M3=0 FrameElem=5
 Frame=5 Joint=33 OutputCase=ENVE CaseType=Combination StepType=Max F1=240.528987364648 F2=0
 F3=497.525711156991 M1=0 M2=170.601073091366 M3=0 FrameElem=5
 Frame=5 Joint=15 OutputCase=ENVE CaseType=Combination StepType=Max F1=-167.192740601281 F2=0 F3=-
 478.387176353716 M1=0 M2=-267.567349499671 M3=0 FrameElem=5
 Frame=5 Joint=33 OutputCase=ENVE CaseType=Combination StepType=Min F1=167.192740601281 F2=0
 F3=484.63717575767 M1=0 M2=146.947637438559 M3=0 FrameElem=5
 Frame=5 Joint=15 OutputCase=ENVE CaseType=Combination StepType=Min F1=-240.528987364648 F2=0 F3=-
 491.275711753037 M1=0 M2=-294.20123916769 M3=0 FrameElem=5
 Frame=5 Joint=33 OutputCase=FESSUR CaseType=Combination F1=239.151922837246 F2=0 F3=493.668700186605
 M1=0 M2=169.303825001733 M3=0 FrameElem=5
 Frame=5 Joint=15 OutputCase=FESSUR CaseType=Combination F1=-239.151922837246 F2=0 F3=-
 487.418700782652 M1=0 M2=-291.939738427419 M3=0 FrameElem=5
 Frame=6 Joint=28 OutputCase=PERM1 CaseType=Combination F1=162.220256649895 F2=0 F3=501.24999658045
 M1=0 M2=243.114140292338 M3=0 FrameElem=6
 Frame=6 Joint=29 OutputCase=PERM1 CaseType=Combination F1=-138.714709779661 F2=0 F3=-494.99999658045
 M1=0 M2=-205.508373004335 M3=0 FrameElem=6
 Frame=6 Joint=28 OutputCase=PERM2 CaseType=Combination F1=117.862577655749 F2=0 F3=501.249996306439
 M1=0 M2=240.700428243023 M3=0 FrameElem=6
 Frame=6 Joint=29 OutputCase=PERM2 CaseType=Combination F1=-101.408694846584 F2=0 F3=-494.999996306439
 M1=0 M2=-213.299291641215 M3=0 FrameElem=6
 Frame=6 Joint=28 OutputCase=ACC1 CaseType=Combination F1=166.232971741238 F2=0 F3=514.799996481456
 M1=0 M2=249.577110143463 M3=0 FrameElem=6
 Frame=6 Joint=29 OutputCase=ACC1 CaseType=Combination F1=-142.149924871003 F2=0 F3=-508.549996481456
 M1=0 M2=-211.040351582624 M3=0 FrameElem=6
 Frame=6 Joint=28 OutputCase=ACC2 CaseType=Combination F1=121.875292747091 F2=0 F3=514.799996207445
 M1=0 M2=247.163398094147 M3=0 FrameElem=6
 Frame=6 Joint=29 OutputCase=ACC2 CaseType=Combination F1=-104.843909937927 F2=0 F3=-508.549996207445
 M1=0 M2=-218.831270219504 M3=0 FrameElem=6
 Frame=6 Joint=28 OutputCase=ACCSX1 CaseType=Combination F1=159.94745865904 F2=0 F3=502.76407418589
 M1=0 M2=238.988031038058 M3=0 FrameElem=6
 Frame=6 Joint=29 OutputCase=ACCSX1 CaseType=Combination F1=-136.441911788805 F2=0 F3=-496.51407418589
 M1=0 M2=-201.950463247769 M3=0 FrameElem=6
 Frame=6 Joint=28 OutputCase=ACCSX2 CaseType=Combination F1=115.589779664893 F2=0 F3=502.764073911878
 M1=0 M2=236.574318988743 M3=0 FrameElem=6
 Frame=6 Joint=29 OutputCase=ACCSX2 CaseType=Combination F1=-99.1358968557287 F2=0 F3=-
 496.514073911878 M1=0 M2=-209.741381884649 M3=0 FrameElem=6
 Frame=6 Joint=28 OutputCase=ENVE CaseType=Combination StepType=Max F1=166.232971741238 F2=0
 F3=514.799996481456 M1=0 M2=249.577110143463 M3=0 FrameElem=6
 Frame=6 Joint=29 OutputCase=ENVE CaseType=Combination StepType=Max F1=-99.1358968557287 F2=0 F3=-
 494.999996306439 M1=0 M2=-201.950463247769 M3=0 FrameElem=6
 Frame=6 Joint=28 OutputCase=ENVE CaseType=Combination StepType=Min F1=115.589779664893 F2=0
 F3=501.249996306439 M1=0 M2=236.574318988743 M3=0 FrameElem=6
 Frame=6 Joint=29 OutputCase=ENVE CaseType=Combination StepType=Min F1=-142.149924871003 F2=0 F3=-
 508.549996481456 M1=0 M2=-218.831270219504 M3=0 FrameElem=6
 Frame=6 Joint=28 OutputCase=FESSUR CaseType=Combination F1=165.029157213835 F2=0 F3=510.734996511154
 M1=0 M2=247.638219188126 M3=0 FrameElem=6
 Frame=6 Joint=29 OutputCase=FESSUR CaseType=Combination F1=-141.1193603436 F2=0 F3=-504.484996511154
 M1=0 M2=-209.380758009137 M3=0 FrameElem=6
 Frame=9 Joint=35 OutputCase=PERM1 CaseType=Combination F1=-101.78028991538 F2=0 F3=419.999996580126
 M1=0 M2=169.293607414626 M3=0 FrameElem=9



Frame=9 Joint=23 OutputCase=PERM1 CaseType=Combination F1=118.357242994317 F2=0 F3=-413.749996580126
 M1=0 M2=-196.821912483104 M3=0 FrameElem=9
 Frame=9 Joint=23 OutputCase=PERM2 CaseType=Combination F1=-66.9378049399462 F2=0 F3=419.999996306115
 M1=0 M2=175.02375845366 M3=0 FrameElem=9
 Frame=9 Joint=23 OutputCase=PERM2 CaseType=Combination F1=78.5416720952024 F2=0 F3=-413.749996306115
 M1=0 M2=-193.216475483112 M3=0 FrameElem=9
 Frame=9 Joint=23 OutputCase=ACC1 CaseType=Combination F1=-105.275074824035 F2=0 F3=433.549996481123
 M1=0 M2=174.914940395832 M3=0 FrameElem=9
 Frame=9 Joint=23 OutputCase=ACC1 CaseType=Combination F1=122.429527902972 F2=0 F3=-427.299996481123
 M1=0 M2=-203.389129514532 M3=0 FrameElem=9
 Frame=9 Joint=35 OutputCase=ACC2 CaseType=Combination F1=-70.4325898486014 F2=0 F3=433.549996207112
 M1=0 M2=180.645091434866 M3=0 FrameElem=9
 Frame=9 Joint=35 OutputCase=ACC2 CaseType=Combination F1=82.6139570038576 F2=0 F3=-427.299996207112
 M1=0 M2=-199.78369251454 M3=0 FrameElem=9
 Frame=9 Joint=35 OutputCase=ACCSX1 CaseType=Combination F1=-104.053087906234 F2=0 F3=421.514074185558
 M1=0 M2=172.554091594532 M3=0 FrameElem=9
 Frame=9 Joint=23 OutputCase=ACCSX1 CaseType=Combination F1=120.630040985172 F2=0 F3=-415.264074185558
 M1=0 M2=-200.650596196822 M3=0 FrameElem=9
 Frame=9 Joint=35 OutputCase=ACCSX2 CaseType=Combination F1=-69.2106029308007 F2=0 F3=421.514073911547
 M1=0 M2=178.284242633566 M3=0 FrameElem=9
 Frame=9 Joint=23 OutputCase=ACCSX2 CaseType=Combination F1=80.8144700860569 F2=0 F3=-415.264073911547
 M1=0 M2=-197.04515919683 M3=0 FrameElem=9
 Frame=9 Joint=35 OutputCase=ENVE CaseType=Combination StepType=Max F1=-66.9378049399462 F2=0
 F3=433.549996481123 M1=0 M2=180.645091434866 M3=0 FrameElem=9
 Frame=9 Joint=23 OutputCase=ENVE CaseType=Combination StepType=Max F1=122.429527902972 F2=0 F3=-
 413.749996306115 M1=0 M2=-193.216475483112 M3=0 FrameElem=9
 Frame=9 Joint=35 OutputCase=ENVE CaseType=Combination StepType=Min F1=-105.275074824035 F2=0
 F3=419.999996306115 M1=0 M2=169.293607414626 M3=0 FrameElem=9
 Frame=9 Joint=23 OutputCase=ENVE CaseType=Combination StepType=Min F1=78.5416720952024 F2=0 F3=-
 427.299996481123 M1=0 M2=-203.389129514532 M3=0 FrameElem=9
 Frame=9 Joint=35 OutputCase=FESSUR CaseType=Combination F1=-104.226639351439 F2=0 F3=429.484996510824
 M1=0 M2=173.22854050147 M3=0 FrameElem=9
 Frame=9 Joint=23 OutputCase=FESSUR CaseType=Combination F1=121.207842430376 F2=0 F3=-423.234996510824
 M1=0 M2=-201.418964405103 M3=0 FrameElem=9
 Frame=10 Joint=23 OutputCase=PERM1 CaseType=Combination F1=-118.357242994317 F2=0 F3=413.749996580369
 M1=0 M2=196.821912483104 M3=0 FrameElem=10
 Frame=10 Joint=21 OutputCase=PERM1 CaseType=Combination F1=134.401225815418 F2=0 F3=-407.499997176416
 M1=0 M2=-228.427811793656 M3=0 FrameElem=10
 Frame=10 Joint=23 OutputCase=PERM2 CaseType=Combination F1=-78.5416720952023 F2=0 F3=413.749996306359
 M1=0 M2=193.216475483112 M3=0 FrameElem=10
 Frame=10 Joint=21 OutputCase=PERM2 CaseType=Combination F1=89.772460069973 F2=0 F3=-407.499996902405
 M1=0 M2=-214.263502665995 M3=0 FrameElem=10
 Frame=10 Joint=23 OutputCase=ACC1 CaseType=Combination F1=-122.429527902977 F2=0 F3=427.299996481388
 M1=0 M2=203.389129514533 M3=0 FrameElem=10
 Frame=10 Joint=21 OutputCase=ACC1 CaseType=Combination F1=139.051010669003 F2=0 F3=-421.049997077435
 M1=0 M2=-236.085287118332 M3=0 FrameElem=10
 Frame=10 Joint=23 OutputCase=ACC2 CaseType=Combination F1=-82.6139570038622 F2=0 F3=427.299996207378
 M1=0 M2=199.783692514541 M3=0 FrameElem=10
 Frame=10 Joint=21 OutputCase=ACC2 CaseType=Combination F1=94.4222449235582 F2=0 F3=-421.049996803424
 M1=0 M2=-221.920977990671 M3=0 FrameElem=10
 Frame=10 Joint=23 OutputCase=ACCSX1 CaseType=Combination F1=-120.630040985172 F2=0
 F3=415.264074185813 M1=0 M2=200.650596196824 M3=0 FrameElem=10
 Frame=10 Joint=21 OutputCase=ACCSX1 CaseType=Combination F1=136.674023806273 F2=0 F3=-
 409.014074781859 M1=0 M2=-232.824694914803 M3=0 FrameElem=10
 Frame=10 Joint=23 OutputCase=ACCSX2 CaseType=Combination F1=-80.8144700860573 F2=0
 F3=415.264073911802 M1=0 M2=197.045159196832 M3=0 FrameElem=10
 Frame=10 Joint=21 OutputCase=ACCSX2 CaseType=Combination F1=92.0452580608279 F2=0 F3=-
 409.014074507849 M1=0 M2=-218.660385787142 M3=0 FrameElem=10
 Frame=10 Joint=23 OutputCase=ENVE CaseType=Combination StepType=Max F1=-78.5416720952023 F2=0
 F3=427.299996481388 M1=0 M2=203.389129514533 M3=0 FrameElem=10
 Frame=10 Joint=21 OutputCase=ENVE CaseType=Combination StepType=Max F1=139.051010669003 F2=0 F3=-
 407.499996902405 M1=0 M2=-214.263502665995 M3=0 FrameElem=10
 Frame=10 Joint=23 OutputCase=ENVE CaseType=Combination StepType=Min F1=-122.429527902977 F2=0
 F3=413.749996306359 M1=0 M2=193.216475483112 M3=0 FrameElem=10
 Frame=10 Joint=21 OutputCase=ENVE CaseType=Combination StepType=Min F1=89.772460069973 F2=0 F3=-
 421.049997077435 M1=0 M2=-236.085287118332 M3=0 FrameElem=10
 Frame=10 Joint=23 OutputCase=FESSUR CaseType=Combination F1=-121.207842430379 F2=0
 F3=423.234996511083 M1=0 M2=201.418964405104 M3=0 FrameElem=10
 Frame=10 Joint=21 OutputCase=FESSUR CaseType=Combination F1=137.656075212928 F2=0 F3=-
 416.984997107129 M1=0 M2=-233.788044520929 M3=0 FrameElem=10
 Frame=11 Joint=1 OutputCase=PERM1 CaseType=Combination F1=-186.258774184591 F2=0 F3=507.499995050855
 M1=0 M2=-286.662905880606 M3=0 FrameElem=11
 Frame=11 Joint=26 OutputCase=PERM1 CaseType=Combination F1=162.220258559591 F2=0 F3=-501.249995050855
 M1=0 M2=243.114142328445 M3=0 FrameElem=11
 Frame=11 Joint=1 OutputCase=PERM2 CaseType=Combination F1=-134.689539930037 F2=0 F3=507.499995324866
 M1=0 M2=-272.261659822661 M3=0 FrameElem=11
 Frame=11 Joint=26 OutputCase=PERM2 CaseType=Combination F1=117.862578992536 F2=0 F3=-501.249995324866
 M1=0 M2=240.700429443514 M3=0 FrameElem=11
 Frame=11 Joint=1 OutputCase=ACC1 CaseType=Combination F1=-190.848989331008 F2=0 F3=521.049994891394
 M1=0 M2=-294.201241750564 M3=0 FrameElem=11
 Frame=11 Joint=26 OutputCase=ACC1 CaseType=Combination F1=166.232973706008 F2=0 F3=-514.799994891394
 M1=0 M2=249.577112234856 M3=0 FrameElem=11

Frame=11 Joint=1 OutputCase=ACC2 CaseType=Combination F1=-139.279755076453 F2=0 F3=521.049995165404
M1=0 M2=-279.799995692619 M3=0 FrameElem=11

Frame=11 Joint=26 OutputCase=ACC2 CaseType=Combination F1=121.875294138953 F2=0 F3=-514.799995165404
M1=0 M2=247.163399349925 M3=0 FrameElem=11

Frame=11 Joint=1 OutputCase=ACCSX1 CaseType=Combination F1=-193.225976193734 F2=0 F3=505.985917445391
M1=0 M2=-292.878209137454 M3=0 FrameElem=11

Frame=11 Joint=26 OutputCase=ACCSX1 CaseType=Combination F1=168.609960568734 F2=0 F3=-
499.735917445391 M1=0 M2=247.659832546909 M3=0 FrameElem=11

Frame=11 Joint=1 OutputCase=ACCSX2 CaseType=Combination F1=-141.656741939179 F2=0 F3=505.985917719401
M1=0 M2=-278.476963079509 M3=0 FrameElem=11

Frame=11 Joint=26 OutputCase=ACCSX2 CaseType=Combination F1=124.252281001679 F2=0 F3=-
499.735917719401 M1=0 M2=245.246119661978 M3=0 FrameElem=11

Frame=11 Joint=1 OutputCase=ENVE CaseType=Combination StepType=Max F1=-134.689539930037 F2=0
F3=521.049995165404 M1=0 M2=-272.261659822661 M3=0 FrameElem=11

Frame=11 Joint=26 OutputCase=ENVE CaseType=Combination StepType=Max F1=168.609960568734 F2=0 F3=-
499.735917445391 M1=0 M2=249.577112234856 M3=0 FrameElem=11

Frame=11 Joint=1 OutputCase=ENVE CaseType=Combination StepType=Min F1=-193.225976193734 F2=0
F3=505.985917445391 M1=0 M2=-294.201241750564 M3=0 FrameElem=11

Frame=11 Joint=26 OutputCase=ENVE CaseType=Combination StepType=Min F1=117.862578992536 F2=0 F3=-
514.799995165404 M1=0 M2=240.700429443514 M3=0 FrameElem=11

Frame=11 Joint=1 OutputCase=FESSUR CaseType=Combination F1=-189.471924787083 F2=0 F3=516.984994939232
M1=0 M2=-291.939740989576 M3=0 FrameElem=11

Frame=11 Joint=26 OutputCase=FESSUR CaseType=Combination F1=165.029159162083 F2=0 F3=-
510.734994939232 M1=0 M2=247.638221262933 M3=0 FrameElem=11

Frame=12 Joint=26 OutputCase=PERM1 CaseType=Combination F1=-162.220258559592 F2=0 F3=501.249995050805
M1=0 M2=-243.114142328445 M3=0 FrameElem=12

Frame=12 Joint=27 OutputCase=PERM1 CaseType=Combination F1=138.714711684592 F2=0 F3=-494.999995050805
M1=0 M2=205.508374563548 M3=0 FrameElem=12

Frame=12 Joint=26 OutputCase=PERM2 CaseType=Combination F1=-117.862578992537 F2=0 F3=501.249995324815
M1=0 M2=-240.700429443514 M3=0 FrameElem=12

Frame=12 Joint=27 OutputCase=PERM2 CaseType=Combination F1=101.408696180037 F2=0 F3=-494.999995324815
M1=0 M2=213.29929250788 M3=0 FrameElem=12

Frame=12 Joint=26 OutputCase=ACC1 CaseType=Combination F1=-166.232973706008 F2=0 F3=514.799994891334
M1=0 M2=-249.577112234856 M3=0 FrameElem=12

Frame=12 Joint=27 OutputCase=ACC1 CaseType=Combination F1=142.149926831008 F2=0 F3=-508.549994891334
M1=0 M2=211.040353183354 M3=0 FrameElem=12

Frame=12 Joint=26 OutputCase=ACC2 CaseType=Combination F1=-121.875294138953 F2=0 F3=514.799995165344
M1=0 M2=-247.163399349925 M3=0 FrameElem=12

Frame=12 Joint=27 OutputCase=ACC2 CaseType=Combination F1=104.843911326453 F2=0 F3=-508.549995165344
M1=0 M2=218.831271127687 M3=0 FrameElem=12

Frame=12 Joint=26 OutputCase=ACCSX1 CaseType=Combination F1=-168.609960568733 F2=0
F3=499.735917445348 M1=0 M2=-247.659832546909 M3=0 FrameElem=12

Frame=12 Joint=27 OutputCase=ACCSX1 CaseType=Combination F1=144.526913693733 F2=0 F3=-
493.485917445348 M1=0 M2=208.528826779726 M3=0 FrameElem=12

Frame=12 Joint=26 OutputCase=ACCSX2 CaseType=Combination F1=-124.252281001678 F2=0
F3=499.735917719358 M1=0 M2=-245.246119661978 M3=0 FrameElem=12

Frame=12 Joint=27 OutputCase=ACCSX2 CaseType=Combination F1=107.220898189178 F2=0 F3=-
493.485917719358 M1=0 M2=216.319744724059 M3=0 FrameElem=12

Frame=12 Joint=26 OutputCase=ENVE CaseType=Combination StepType=Max F1=-117.862578992537 F2=0
F3=514.799995165344 M1=0 M2=-240.700429443514 M3=0 FrameElem=12

Frame=12 Joint=27 OutputCase=ENVE CaseType=Combination StepType=Max F1=144.526913693733 F2=0 F3=-
493.485917445348 M1=0 M2=218.831271127687 M3=0 FrameElem=12

Frame=12 Joint=26 OutputCase=ENVE CaseType=Combination StepType=Min F1=-168.609960568733 F2=0
F3=499.735917445348 M1=0 M2=-249.577112234856 M3=0 FrameElem=12

Frame=12 Joint=27 OutputCase=ENVE CaseType=Combination StepType=Min F1=101.408696180037 F2=0 F3=-
508.549995165344 M1=0 M2=205.508374563548 M3=0 FrameElem=12

Frame=12 Joint=26 OutputCase=FESSUR CaseType=Combination F1=-165.029159162083 F2=0
F3=510.734994939175 M1=0 M2=-247.638221262933 M3=0 FrameElem=12

Frame=12 Joint=27 OutputCase=FESSUR CaseType=Combination F1=141.119362287083 F2=0 F3=-
504.484994939175 M1=0 M2=209.380759597412 M3=0 FrameElem=12

Frame=15 Joint=34 OutputCase=PERM1 CaseType=Combination F1=101.780288315413 F2=0 F3=419.999995050473
M1=0 M2=-169.293603602134 M3=0 FrameElem=15

Frame=15 Joint=22 OutputCase=PERM1 CaseType=Combination F1=-118.357241440413 F2=0 F3=-
413.749995050473 M1=0 M2=196.821908276311 M3=0 FrameElem=15

Frame=15 Joint=34 OutputCase=PERM2 CaseType=Combination F1=66.937803819968 F2=0 F3=419.999995324483
M1=0 M2=-175.023755560131 M3=0 FrameElem=15

Frame=15 Joint=22 OutputCase=PERM2 CaseType=Combination F1=-78.541671007468 F2=0 F3=-413.749995324483
M1=0 M2=193.216472313572 M3=0 FrameElem=15

Frame=15 Joint=34 OutputCase=ACC1 CaseType=Combination F1=105.275073168999 F2=0 F3=433.549994890998
M1=0 M2=-174.914936459633 M3=0 FrameElem=15

Frame=15 Joint=22 OutputCase=ACC1 CaseType=Combination F1=-122.429526293999 F2=0 F3=-427.299994890998
M1=0 M2=203.389125170264 M3=0 FrameElem=15

Frame=15 Joint=34 OutputCase=ACC2 CaseType=Combination F1=70.4325886735542 F2=0 F3=433.549995165008
M1=0 M2=-180.64508841763 M3=0 FrameElem=15

Frame=15 Joint=22 OutputCase=ACC2 CaseType=Combination F1=-82.6139558610543 F2=0 F3=-427.299995165008
M1=0 M2=199.783689207525 M3=0 FrameElem=15

Frame=15 Joint=34 OutputCase=ACCSX1 CaseType=Combination F1=102.898086306271 F2=0 F3=418.485917445018
M1=0 M2=-165.272449826982 M3=0 FrameElem=15

Frame=15 Joint=22 OutputCase=ACCSX1 CaseType=Combination F1=-120.052539431271 F2=0 F3=-
412.235917445018 M1=0 M2=193.152391462775 M3=0 FrameElem=15

Frame=15 Joint=34 OutputCase=ACCSX2 CaseType=Combination F1=68.0556018108255 F2=0 F3=418.485917719028
M1=0 M2=-171.002601784979 M3=0 FrameElem=15

Frame=15 Joint=22 OutputCase=ACCSX2 CaseType=Combination F1=-80.2369689983256 F2=0 F3=-
 412.235917719028 M1=0 M2=189.546955500036 M3=0 FrameElem=15
 Frame=15 Joint=34 OutputCase=ENVE CaseType=Combination StepType=Max F1=105.275073168999 F2=0
 F3=433.549995165008 M1=0 M2=-165.272449826982 M3=0 FrameElem=15
 Frame=15 Joint=22 OutputCase=ENVE CaseType=Combination StepType=Max F1=-78.541671007468 F2=0 F3=-
 412.235917445018 M1=0 M2=203.389125170264 M3=0 FrameElem=15
 Frame=15 Joint=34 OutputCase=ENVE CaseType=Combination StepType=Min F1=66.937803819968 F2=0
 F3=418.485917445018 M1=0 M2=-180.64508841763 M3=0 FrameElem=15
 Frame=15 Joint=22 OutputCase=ENVE CaseType=Combination StepType=Min F1=-122.429526293999 F2=0 F3=-
 427.299995165008 M1=0 M2=189.546955500036 M3=0 FrameElem=15
 Frame=15 Joint=34 OutputCase=FESSUR CaseType=Combination F1=104.226637712923 F2=0 F3=429.48499493884
 M1=0 M2=-173.228536602383 M3=0 FrameElem=15
 Frame=15 Joint=22 OutputCase=FESSUR CaseType=Combination F1=-121.207840837924 F2=0 F3=-
 423.23499493884 M1=0 M2=201.418960102078 M3=0 FrameElem=15
 Frame=16 Joint=22 OutputCase=PERM1 CaseType=Combination F1=118.357241440415 F2=0 F3=413.749995050452
 M1=0 M2=-196.821908276309 M3=0 FrameElem=16
 Frame=16 Joint=20 OutputCase=PERM1 CaseType=Combination F1=-134.401225815415 F2=0 F3=-
 407.499995050452 M1=0 M2=228.42781040885 M3=0 FrameElem=16
 Frame=16 Joint=22 OutputCase=PERM2 CaseType=Combination F1=78.54167100747 F2=0 F3=413.749995324461
 M1=0 M2=-193.21647231357 M3=0 FrameElem=16
 Frame=16 Joint=20 OutputCase=PERM2 CaseType=Combination F1=-89.77246006997 F2=0 F3=-407.499995324461
 M1=0 M2=214.263501369124 M3=0 FrameElem=16
 Frame=16 Joint=22 OutputCase=ACCL CaseType=Combination F1=122.429526294004 F2=0 F3=427.299994890978
 M1=0 M2=-203.389125170261 M3=0 FrameElem=16
 Frame=16 Joint=20 OutputCase=ACCL CaseType=Combination F1=-139.051010669004 F2=0 F3=-421.049994890978
 M1=0 M2=236.085285693141 M3=0 FrameElem=16
 Frame=16 Joint=22 OutputCase=ACC2 CaseType=Combination F1=82.6139558610585 F2=0 F3=427.299995164987
 M1=0 M2=-199.783689207522 M3=0 FrameElem=16
 Frame=16 Joint=20 OutputCase=ACC2 CaseType=Combination F1=-94.4222449235586 F2=0 F3=-421.049995164987
 M1=0 M2=221.920976653416 M3=0 FrameElem=16
 Frame=16 Joint=22 OutputCase=ACCSX1 CaseType=Combination F1=120.05253943128 F2=0 F3=412.235917445001
 M1=0 M2=-193.152391462772 M3=0 FrameElem=16
 Frame=16 Joint=20 OutputCase=ACCSX1 CaseType=Combination F1=-136.67402380628 F2=0 F3=-
 405.985917445001 M1=0 M2=225.254305629127 M3=0 FrameElem=16
 Frame=16 Joint=22 OutputCase=ACCSX2 CaseType=Combination F1=80.2369689983349 F2=0 F3=412.23591771901
 M1=0 M2=-189.546955500033 M3=0 FrameElem=16
 Frame=16 Joint=20 OutputCase=ACCSX2 CaseType=Combination F1=-92.045258060835 F2=0 F3=-405.98591771901
 M1=0 M2=211.089996589401 M3=0 FrameElem=16
 Frame=16 Joint=22 OutputCase=ENVE CaseType=Combination StepType=Max F1=122.429526294004 F2=0
 F3=427.299995164987 M1=0 M2=-189.546955500033 M3=0 FrameElem=16
 Frame=16 Joint=20 OutputCase=ENVE CaseType=Combination StepType=Max F1=-89.77246006997 F2=0 F3=-
 405.985917445001 M1=0 M2=236.085285693141 M3=0 FrameElem=16
 Frame=16 Joint=22 OutputCase=ENVE CaseType=Combination StepType=Min F1=78.54167100747 F2=0
 F3=412.235917445001 M1=0 M2=-203.389125170261 M3=0 FrameElem=16
 Frame=16 Joint=20 OutputCase=ENVE CaseType=Combination StepType=Min F1=-139.051010669004 F2=0 F3=-
 421.049995164987 M1=0 M2=211.089996589401 M3=0 FrameElem=16
 Frame=16 Joint=22 OutputCase=FESSUR CaseType=Combination F1=121.207840837927 F2=0 F3=423.23499493882
 M1=0 M2=-201.418960102075 M3=0 FrameElem=16
 Frame=16 Joint=20 OutputCase=FESSUR CaseType=Combination F1=-137.656075212927 F2=0 F3=-
 416.98499493882 M1=0 M2=233.788043107854 M3=0 FrameElem=16
 Frame=17 Joint=29 OutputCase=PERM1 CaseType=Combination F1=138.71470977966 F2=0 F3=494.99996580292
 M1=0 M2=205.508373004335 M3=0 FrameElem=17
 Frame=17 Joint=2 OutputCase=PERM1 CaseType=Combination F1=-93.3025222987209 F2=0 F3=-482.499996580292
 M1=0 M2=-147.592891168151 M3=0 FrameElem=17
 Frame=17 Joint=29 OutputCase=PERM2 CaseType=Combination F1=101.408694846585 F2=0 F3=494.99996306281
 M1=0 M2=213.299291641215 M3=0 FrameElem=17
 Frame=17 Joint=2 OutputCase=PERM2 CaseType=Combination F1=-69.6201636099268 F2=0 F3=-482.499996306281
 M1=0 M2=-170.60425477284 M3=0 FrameElem=17
 Frame=17 Joint=29 OutputCase=ACCL CaseType=Combination F1=142.149924871002 F2=0 F3=508.549996481299
 M1=0 M2=211.040351582624 M3=0 FrameElem=17
 Frame=17 Joint=2 OutputCase=ACCL CaseType=Combination F1=-95.5827373900628 F2=0 F3=-496.049996481299
 M1=0 M2=-151.696012146927 M3=0 FrameElem=17
 Frame=17 Joint=29 OutputCase=ACC2 CaseType=Combination F1=104.843909937926 F2=0 F3=508.549996207288
 M1=0 M2=218.831270219504 M3=0 FrameElem=17
 Frame=17 Joint=2 OutputCase=ACC2 CaseType=Combination F1=-71.9003787012688 F2=0 F3=-496.049996207288
 M1=0 M2=-174.707375751615 M3=0 FrameElem=17
 Frame=17 Joint=29 OutputCase=ACCSX1 CaseType=Combination F1=136.441911788805 F2=0 F3=496.51407418573
 M1=0 M2=201.950463247769 M3=0 FrameElem=17
 Frame=17 Joint=2 OutputCase=ACCSX1 CaseType=Combination F1=-91.029724307865 F2=0 F3=-484.01407418573
 M1=0 M2=-145.171380400997 M3=0 FrameElem=17
 Frame=17 Joint=29 OutputCase=ACCSX2 CaseType=Combination F1=99.1358968557287 F2=0 F3=496.514073911719
 M1=0 M2=209.741381884649 M3=0 FrameElem=17
 Frame=17 Joint=2 OutputCase=ACCSX2 CaseType=Combination F1=-67.347365619071 F2=0 F3=-484.014073911719
 M1=0 M2=-168.182744005685 M3=0 FrameElem=17
 Frame=17 Joint=29 OutputCase=ENVE CaseType=Combination StepType=Max F1=142.149924871002 F2=0
 F3=508.549996481299 M1=0 M2=218.831270219504 M3=0 FrameElem=17
 Frame=17 Joint=2 OutputCase=ENVE CaseType=Combination StepType=Max F1=-67.347365619071 F2=0 F3=-
 482.499996306281 M1=0 M2=-145.171380400997 M3=0 FrameElem=17
 Frame=17 Joint=29 OutputCase=ENVE CaseType=Combination StepType=Min F1=99.1358968557287 F2=0
 F3=494.99996306281 M1=0 M2=201.950463247769 M3=0 FrameElem=17
 Frame=17 Joint=2 OutputCase=ENVE CaseType=Combination StepType=Min F1=-95.5827373900628 F2=0 F3=-
 496.049996481299 M1=0 M2=-174.707375751615 M3=0 FrameElem=17

Frame=17 Joint=29 OutputCase=FESSUR CaseType=Combination F1=141.1193603436 F2=0 F3=504.484996510997
M1=0 M2=209.380758009137 M3=0 FrameElem=17
Frame=17 Joint=2 OutputCase=FESSUR CaseType=Combination F1=-94.8986728626602 F2=0 F3=-
491.984996510997 M1=0 M2=-150.465075853294 M3=0 FrameElem=17
Frame=18 Joint=2 OutputCase=PERM1 CaseType=Combination F1=93.3025222987171 F2=0 F3=482.499996580334
M1=0 M2=147.59289116815 M3=0 FrameElem=18
Frame=18 Joint=3 OutputCase=PERM1 CaseType=Combination F1=-50.0222098304845 F2=0 F3=-469.999996580334
M1=0 M2=-111.850534368931 M3=0 FrameElem=18
Frame=18 Joint=2 OutputCase=PERM2 CaseType=Combination F1=69.6201636099231 F2=0 F3=482.499996306323
M1=0 M2=170.604254772838 M3=0 FrameElem=18
Frame=18 Joint=3 OutputCase=PERM2 CaseType=Combination F1=-39.3239448821602 F2=0 F3=-469.999996306323
M1=0 M2=-143.43040544524 M3=0 FrameElem=18
Frame=18 Joint=2 OutputCase=ACC1 CaseType=Combination F1=95.5827373900586 F2=0 F3=496.049996481341
M1=0 M2=151.696012146925 M3=0 FrameElem=18
Frame=18 Joint=3 OutputCase=ACC1 CaseType=Combination F1=-51.147424921826 F2=0 F3=-483.549996481341
M1=0 M2=-115.102297748193 M3=0 FrameElem=18
Frame=18 Joint=2 OutputCase=ACC2 CaseType=Combination F1=71.9003787012646 F2=0 F3=496.04999620733
M1=0 M2=174.707375751614 M3=0 FrameElem=18
Frame=18 Joint=3 OutputCase=ACC2 CaseType=Combination F1=-40.4491599735018 F2=0 F3=-483.54999620733
M1=0 M2=-146.682168824502 M3=0 FrameElem=18
Frame=18 Joint=2 OutputCase=ACCSX1 CaseType=Combination F1=91.0297243078612 F2=0 F3=484.014074185774
M1=0 M2=145.171380400995 M3=0 FrameElem=18
Frame=18 Joint=3 OutputCase=ACCSX1 CaseType=Combination F1=-47.7494118396286 F2=0 F3=-
471.514074185774 M1=0 M2=-110.565422591188 M3=0 FrameElem=18
Frame=18 Joint=2 OutputCase=ACCSX2 CaseType=Combination F1=67.3473656190672 F2=0 F3=484.014073911763
M1=0 M2=168.182744005684 M3=0 FrameElem=18
Frame=18 Joint=3 OutputCase=ACCSX2 CaseType=Combination F1=-37.0511468913044 F2=0 F3=-
471.514073911763 M1=0 M2=-142.145293667497 M3=0 FrameElem=18
Frame=18 Joint=2 OutputCase=ENVE CaseType=Combination StepType=Max F1=95.5827373900586 F2=0
F3=496.049996481341 M1=0 M2=174.707375751614 M3=0 FrameElem=18
Frame=18 Joint=3 OutputCase=ENVE CaseType=Combination StepType=Max F1=-37.0511468913044 F2=0 F3=-
469.999996306323 M1=0 M2=-110.565422591188 M3=0 FrameElem=18
Frame=18 Joint=2 OutputCase=ENVE CaseType=Combination StepType=Min F1=67.3473656190672 F2=0
F3=482.499996306323 M1=0 M2=145.171380400995 M3=0 FrameElem=18
Frame=18 Joint=3 OutputCase=ENVE CaseType=Combination StepType=Min F1=-51.147424921826 F2=0 F3=-
483.549996481341 M1=0 M2=-146.682168824502 M3=0 FrameElem=18
Frame=18 Joint=2 OutputCase=FESSUR CaseType=Combination F1=94.8986728626562 F2=0 F3=491.984996511039
M1=0 M2=150.465075853293 M3=0 FrameElem=18
Frame=18 Joint=3 OutputCase=FESSUR CaseType=Combination F1=-50.8098603944236 F2=0 F3=-
479.484996511039 M1=0 M2=-114.126768734414 M3=0 FrameElem=18
Frame=19 Joint=3 OutputCase=PERM1 CaseType=Combination F1=50.0222098304839 F2=0 F3=469.999996580269
M1=0 M2=111.850534368931 M3=0 FrameElem=19
Frame=19 Joint=4 OutputCase=PERM1 CaseType=Combination F1=-8.87377237495828 F2=0 F3=-457.499996580269
M1=0 M2=-97.2153651003228 M3=0 FrameElem=19
Frame=19 Joint=3 OutputCase=PERM2 CaseType=Combination F1=39.3239448821597 F2=0 F3=469.999996306258
M1=0 M2=143.43040544524 M3=0 FrameElem=19
Frame=19 Joint=4 OutputCase=PERM2 CaseType=Combination F1=-10.5200386632917 F2=0 F3=-457.499996306258
M1=0 M2=-131.031587403971 M3=0 FrameElem=19
Frame=19 Joint=3 OutputCase=ACC1 CaseType=Combination F1=51.1474249218253 F2=0 F3=483.549996481276
M1=0 M2=115.102297748193 M3=0 FrameElem=19
Frame=19 Joint=4 OutputCase=ACC1 CaseType=Combination F1=-8.84398746629968 F2=0 F3=-471.049996481276
M1=0 M2=-100.193270880071 M3=0 FrameElem=19
Frame=19 Joint=3 OutputCase=ACC2 CaseType=Combination F1=40.4491599735011 F2=0 F3=483.549996207265
M1=0 M2=146.682168824502 M3=0 FrameElem=19
Frame=19 Joint=4 OutputCase=ACC2 CaseType=Combination F1=-10.4902537546331 F2=0 F3=-471.049996207265
M1=0 M2=-134.009493183718 M3=0 FrameElem=19
Frame=19 Joint=3 OutputCase=ACCSX1 CaseType=Combination F1=47.7494118396273 F2=0 F3=471.514074185708
M1=0 M2=110.565422591188 M3=0 FrameElem=19
Frame=19 Joint=4 OutputCase=ACCSX1 CaseType=Combination F1=-6.60097438410169 F2=0 F3=-
459.014074185708 M1=0 M2=-97.0666523119915 M3=0 FrameElem=19
Frame=19 Joint=3 OutputCase=ACCSX2 CaseType=Combination F1=37.0511468913031 F2=0 F3=471.514073911697
M1=0 M2=142.145293667497 M3=0 FrameElem=19
Frame=19 Joint=4 OutputCase=ACCSX2 CaseType=Combination F1=-8.24724067243513 F2=0 F3=-
459.014073911697 M1=0 M2=-130.882874615639 M3=0 FrameElem=19
Frame=19 Joint=3 OutputCase=ENVE CaseType=Combination StepType=Max F1=51.1474249218253 F2=0
F3=483.549996481276 M1=0 M2=146.682168824502 M3=0 FrameElem=19
Frame=19 Joint=4 OutputCase=ENVE CaseType=Combination StepType=Max F1=-6.60097438410169 F2=0 F3=-
457.499996306258 M1=0 M2=-97.0666523119915 M3=0 FrameElem=19
Frame=19 Joint=3 OutputCase=ENVE CaseType=Combination StepType=Min F1=37.0511468913031 F2=0
F3=469.999996306258 M1=0 M2=110.565422591188 M3=0 FrameElem=19
Frame=19 Joint=4 OutputCase=ENVE CaseType=Combination StepType=Min F1=-10.5200386632917 F2=0 F3=-
471.049996481276 M1=0 M2=-134.009493183718 M3=0 FrameElem=19
Frame=19 Joint=3 OutputCase=FESSUR CaseType=Combination F1=50.8098603944229 F2=0 F3=479.484996510974
M1=0 M2=114.126768734414 M3=0 FrameElem=19
Frame=19 Joint=4 OutputCase=FESSUR CaseType=Combination F1=-8.85292293889726 F2=0 F3=-
466.984996510974 M1=0 M2=-99.2998991461462 M3=0 FrameElem=19
Frame=20 Joint=4 OutputCase=PERM1 CaseType=Combination F1=8.87377237495855 F2=0 F3=457.499996580271
M1=0 M2=97.2153651003229 M3=0 FrameElem=20
Frame=20 Joint=5 OutputCase=PERM1 CaseType=Combination F1=30.1427900678601 F2=0 F3=-444.999996580271
M1=0 M2=-102.621445855972 M3=0 FrameElem=20
Frame=20 Joint=4 OutputCase=PERM2 CaseType=Combination F1=10.5200386632917 F2=0 F3=457.49999630626
M1=0 M2=131.031587403971 M3=0 FrameElem=20

Frame=20	Joint=5	OutputCase=PERM2	CaseType=Combination	F1=16.7915550466813	F2=0	F3=-444.99999630626	
M1=0	M2=-132.661644394583	M3=0	FrameElem=20				
Frame=20	Joint=4	OutputCase=ACC1	CaseType=Combination	F1=8.84398746629939	F2=0	F3=471.049996481281	
M1=0	M2=100.193270880071	M3=0	FrameElem=20				
Frame=20	Joint=5	OutputCase=ACC1	CaseType=Combination	F1=31.3275749765193	F2=0	F3=-458.549996481281	
M1=0	M2=-105.902994036206	M3=0	FrameElem=20				
Frame=20	Joint=4	OutputCase=ACC2	CaseType=Combination	F1=10.4902537546326	F2=0	F3=471.04999620727	
M1=0	M2=134.009493183719	M3=0	FrameElem=20				
Frame=20	Joint=5	OutputCase=ACC2	CaseType=Combination	F1=17.9763399553405	F2=0	F3=-458.54999620727	
M1=0	M2=-135.943192574817	M3=0	FrameElem=20				
Frame=20	Joint=4	OutputCase=ACCSX1	CaseType=Combination	F1=6.60097438410071	F2=0	F3=459.014074185709	
M1=0	M2=97.0666523119914	M3=0	FrameElem=20				
Frame=20	Joint=5	OutputCase=ACCSX1	CaseType=Combination	F1=32.4155880587179	F2=0	F3=-446.514074185709	
M1=0	M2=-103.609132057052	M3=0	FrameElem=20				
Frame=20	Joint=4	OutputCase=ACCSX2	CaseType=Combination	F1=8.24724067243389	F2=0	F3=459.014073911698	
M1=0	M2=130.882874615639	M3=0	FrameElem=20				
Frame=20	Joint=5	OutputCase=ACCSX2	CaseType=Combination	F1=19.0643530375392	F2=0	F3=-446.514073911698	
M1=0	M2=-133.649330595663	M3=0	FrameElem=20				
Frame=20	Joint=4	OutputCase=ENVE	CaseType=Combination	StepType=Max	F1=10.5200386632917	F2=0	
F3=471.049996481281	M1=0	M2=134.009493183719	M3=0	FrameElem=20			
Frame=20	Joint=5	OutputCase=ENVE	CaseType=Combination	StepType=Max	F1=32.4155880587179	F2=0	F3=-
444.99999630626	M1=0	M2=-102.621445855972	M3=0	FrameElem=20			
Frame=20	Joint=4	OutputCase=ENVE	CaseType=Combination	StepType=Min	F1=6.60097438410071	F2=0	
F3=457.49999630626	M1=0	M2=97.0666523119914	M3=0	FrameElem=20			
Frame=20	Joint=5	OutputCase=ENVE	CaseType=Combination	StepType=Min	F1=16.7915550466813	F2=0	F3=-
458.549996481281	M1=0	M2=-135.943192574817	M3=0	FrameElem=20			
Frame=20	Joint=4	OutputCase=FESSUR	CaseType=Combination	F1=8.85292293889714	F2=0	F3=466.984996510978	
M1=0	M2=99.2998991461463	M3=0	FrameElem=20				
Frame=20	Joint=5	OutputCase=FESSUR	CaseType=Combination	F1=30.9721395039215	F2=0	F3=-454.484996510978	
M1=0	M2=-104.918529582135	M3=0	FrameElem=20				
Frame=21	Joint=5	OutputCase=PERM1	CaseType=Combination	F1=-30.1427900678595	F2=0	F3=444.999996580135	
M1=0	M2=102.621445855971	M3=0	FrameElem=21				
Frame=21	Joint=6	OutputCase=PERM1	CaseType=Combination	F1=67.0274774979711	F2=0	F3=-432.499996580135	
M1=0	M2=-127.002839129523	M3=0	FrameElem=21				
Frame=21	Joint=5	OutputCase=PERM2	CaseType=Combination	F1=-16.7915550466806	F2=0	F3=444.999996306124	
M1=0	M2=132.661644394582	M3=0	FrameElem=21				
Frame=21	Joint=6	OutputCase=PERM2	CaseType=Combination	F1=42.6108362477588	F2=0	F3=-432.499996306124	
M1=0	M2=-147.574420162627	M3=0	FrameElem=21				
Frame=21	Joint=5	OutputCase=ACC1	CaseType=Combination	F1=-31.3275749765167	F2=0	F3=458.549996481148	
M1=0	M2=105.902994036205	M3=0	FrameElem=21				
Frame=21	Joint=6	OutputCase=ACC1	CaseType=Combination	F1=69.3672624066284	F2=0	F3=-446.049996481148	
M1=0	M2=-131.165529710243	M3=0	FrameElem=21				
Frame=21	Joint=5	OutputCase=ACC2	CaseType=Combination	F1=-17.9763399553379	F2=0	F3=458.549996207137	
M1=0	M2=135.943192574817	M3=0	FrameElem=21				
Frame=21	Joint=6	OutputCase=ACC2	CaseType=Combination	F1=44.9506211564161	F2=0	F3=-446.049996207137	
M1=0	M2=-151.737110743347	M3=0	FrameElem=21				
Frame=21	Joint=5	OutputCase=ACCSX1	CaseType=Combination	F1=-32.4155880587164	F2=0	F3=446.514074185574	
M1=0	M2=103.609132057052	M3=0	FrameElem=21				
Frame=21	Joint=6	OutputCase=ACCSX1	CaseType=Combination	F1=69.3002754888281	F2=0	F3=-434.014074185574	
M1=0	M2=-129.126924320016	M3=0	FrameElem=21				
Frame=21	Joint=5	OutputCase=ACCSX2	CaseType=Combination	F1=-19.0643530375376	F2=0	F3=446.514073911563	
M1=0	M2=133.649330595663	M3=0	FrameElem=21				
Frame=21	Joint=6	OutputCase=ACCSX2	CaseType=Combination	F1=44.8836342386157	F2=0	F3=-434.014073911563	
M1=0	M2=-149.698505353121	M3=0	FrameElem=21				
Frame=21	Joint=5	OutputCase=ENVE	CaseType=Combination	StepType=Max	F1=-16.7915550466806	F2=0	
F3=458.549996481148	M1=0	M2=135.943192574817	M3=0	FrameElem=21			
Frame=21	Joint=6	OutputCase=ENVE	CaseType=Combination	StepType=Max	F1=69.3672624066284	F2=0	F3=-
432.499996306124	M1=0	M2=-127.002839129523	M3=0	FrameElem=21			
Frame=21	Joint=5	OutputCase=ENVE	CaseType=Combination	StepType=Min	F1=-32.4155880587164	F2=0	
F3=444.999996306124	M1=0	M2=102.621445855971	M3=0	FrameElem=21			
Frame=21	Joint=6	OutputCase=ENVE	CaseType=Combination	StepType=Min	F1=42.6108362477588	F2=0	F3=-
446.049996481148	M1=0	M2=-151.737110743347	M3=0	FrameElem=21			
Frame=21	Joint=5	OutputCase=FESSUR	CaseType=Combination	F1=-30.9721395039195	F2=0	F3=454.484996510844	
M1=0	M2=104.918529582135	M3=0	FrameElem=21				
Frame=21	Joint=6	OutputCase=FESSUR	CaseType=Combination	F1=68.6653269340312	F2=0	F3=-441.984996510844	
M1=0	M2=-129.916722536027	M3=0	FrameElem=21				
Frame=22	Joint=6	OutputCase=PERM1	CaseType=Combination	F1=-67.0274774979755	F2=0	F3=432.499996580124	
M1=0	M2=127.002839129524	M3=0	FrameElem=22				
Frame=22	Joint=35	OutputCase=PERM1	CaseType=Combination	F1=101.78028991538	F2=0	F3=-419.999996580124	
M1=0	M2=-169.293607414626	M3=0	FrameElem=22				
Frame=22	Joint=6	OutputCase=PERM2	CaseType=Combination	F1=-42.6108362477632	F2=0	F3=432.499996306113	
M1=0	M2=147.574420162628	M3=0	FrameElem=22				
Frame=22	Joint=35	OutputCase=PERM2	CaseType=Combination	F1=66.9378049399465	F2=0	F3=-419.999996306113	
M1=0	M2=-175.023758453661	M3=0	FrameElem=22				
Frame=22	Joint=6	OutputCase=ACC1	CaseType=Combination	F1=-69.3672624066331	F2=0	F3=446.049996481117	
M1=0	M2=131.165529710244	M3=0	FrameElem=22				
Frame=22	Joint=35	OutputCase=ACC1	CaseType=Combination	F1=105.275074824038	F2=0	F3=-433.549996481117	
M1=0	M2=-174.914940395833	M3=0	FrameElem=22				
Frame=22	Joint=6	OutputCase=ACC2	CaseType=Combination	F1=-44.9506211564208	F2=0	F3=446.049996207105	
M1=0	M2=151.737110743348	M3=0	FrameElem=22				
Frame=22	Joint=35	OutputCase=ACC2	CaseType=Combination	F1=70.4325898486041	F2=0	F3=-433.549996207105	
M1=0	M2=-180.645091434867	M3=0	FrameElem=22				



Frame=22 Joint=6 OutputCase=ACCSX1 CaseType=Combination F1=-69.300275488833 F2=0 F3=434.014074185557
 M1=0 M2=129.126924320017 M3=0 FrameElem=22
 Frame=22 Joint=35 OutputCase=ACCSX1 CaseType=Combination F1=104.053087906238 F2=0 F3=-
 421.514074185557 M1=0 M2=-172.554091594533 M3=0 FrameElem=22
 Frame=22 Joint=6 OutputCase=ACCSX2 CaseType=Combination F1=-44.8836342386207 F2=0 F3=434.014073911546
 M1=0 M2=149.698505353122 M3=0 FrameElem=22
 Frame=22 Joint=35 OutputCase=ACCSX2 CaseType=Combination F1=69.210602930804 F2=0 F3=-421.514073911546
 M1=0 M2=-178.284242633567 M3=0 FrameElem=22
 Frame=22 Joint=6 OutputCase=ENVE CaseType=Combination StepType=Max F1=-42.6108362477632 F2=0
 F3=446.049996481117 M1=0 M2=151.737110743348 M3=0 FrameElem=22
 Frame=22 Joint=35 OutputCase=ENVE CaseType=Combination StepType=Max F1=105.275074824038 F2=0 F3=-
 419.999996306113 M1=0 M2=-169.293607414626 M3=0 FrameElem=22
 Frame=22 Joint=6 OutputCase=ENVE CaseType=Combination StepType=Min F1=-69.3672624066331 F2=0
 F3=432.499996306113 M1=0 M2=127.002839129524 M3=0 FrameElem=22
 Frame=22 Joint=35 OutputCase=ENVE CaseType=Combination StepType=Min F1=66.9378049399465 F2=0 F3=-
 433.549996481117 M1=0 M2=-180.645091434867 M3=0 FrameElem=22
 Frame=22 Joint=6 OutputCase=FESSUR CaseType=Combination F1=-68.6653269340359 F2=0 F3=441.984996510819
 M1=0 M2=129.916722536028 M3=0 FrameElem=22
 Frame=22 Joint=35 OutputCase=FESSUR CaseType=Combination F1=104.226639351441 F2=0 F3=-
 429.484996510819 M1=0 M2=-173.228540501471 M3=0 FrameElem=22
 Frame=23 Joint=27 OutputCase=PERM1 CaseType=Combination F1=-138.714711684591 F2=0 F3=494.999995050618
 M1=0 M2=-205.508374563548 M3=0 FrameElem=23
 Frame=23 Joint=7 OutputCase=PERM1 CaseType=Combination F1=93.3025241845915 F2=0 F3=-482.499995050618
 M1=0 M2=147.592891779134 M3=0 FrameElem=23
 Frame=23 Joint=27 OutputCase=PERM2 CaseType=Combination F1=-101.408696180037 F2=0 F3=494.999995324628
 M1=0 M2=-213.29929250788 M3=0 FrameElem=23
 Frame=23 Joint=7 OutputCase=PERM2 CaseType=Combination F1=69.6201649300368 F2=0 F3=-482.499995324628
 M1=0 M2=170.604254975744 M3=0 FrameElem=23
 Frame=23 Joint=27 OutputCase=ACC1 CaseType=Combination F1=-142.149926831008 F2=0 F3=508.549994891151
 M1=0 M2=-211.040353183354 M3=0 FrameElem=23
 Frame=23 Joint=7 OutputCase=ACC1 CaseType=Combination F1=95.5827393310077 F2=0 F3=-496.049994891151
 M1=0 M2=151.69601277189 M3=0 FrameElem=23
 Frame=23 Joint=27 OutputCase=ACC2 CaseType=Combination F1=-104.843911326453 F2=0 F3=508.549995165161
 M1=0 M2=-218.831271127687 M3=0 FrameElem=23
 Frame=23 Joint=7 OutputCase=ACC2 CaseType=Combination F1=71.900380076453 F2=0 F3=-496.049995165161
 M1=0 M2=174.7073759685 M3=0 FrameElem=23
 Frame=23 Joint=27 OutputCase=ACCSX1 CaseType=Combination F1=-144.526913693733 F2=0 F3=493.48591744517
 M1=0 M2=-208.528826779726 M3=0 FrameElem=23
 Frame=23 Joint=7 OutputCase=ACCSX1 CaseType=Combination F1=97.959726193733 F2=0 F3=-480.98591744517
 M1=0 M2=147.995992996758 M3=0 FrameElem=23
 Frame=23 Joint=27 OutputCase=ACCSX2 CaseType=Combination F1=-107.220898189178 F2=0 F3=493.48591771918
 M1=0 M2=-216.319744724059 M3=0 FrameElem=23
 Frame=23 Joint=7 OutputCase=ACCSX2 CaseType=Combination F1=74.2773669391784 F2=0 F3=-480.98591771918
 M1=0 M2=171.007356193368 M3=0 FrameElem=23
 Frame=23 Joint=27 OutputCase=ENVE CaseType=Combination StepType=Max F1=-101.408696180037 F2=0
 F3=508.549995165161 M1=0 M2=-205.508374563548 M3=0 FrameElem=23
 Frame=23 Joint=7 OutputCase=ENVE CaseType=Combination StepType=Max F1=97.959726193733 F2=0 F3=-
 480.98591744517 M1=0 M2=174.7073759685 M3=0 FrameElem=23
 Frame=23 Joint=27 OutputCase=ENVE CaseType=Combination StepType=Min F1=-144.526913693733 F2=0
 F3=493.48591744517 M1=0 M2=-218.831271127687 M3=0 FrameElem=23
 Frame=23 Joint=7 OutputCase=ENVE CaseType=Combination StepType=Min F1=69.6201649300368 F2=0 F3=-
 496.049995165161 M1=0 M2=147.592891779134 M3=0 FrameElem=23
 Frame=23 Joint=27 OutputCase=FESSUR CaseType=Combination F1=-141.119362287083 F2=0
 F3=504.484994938991 M1=0 M2=-209.380759597412 M3=0 FrameElem=23
 Frame=23 Joint=7 OutputCase=FESSUR CaseType=Combination F1=94.8986747870828 F2=0 F3=-491.984994938991
 M1=0 M2=150.465076474063 M3=0 FrameElem=23
 Frame=24 Joint=7 OutputCase=PERM1 CaseType=Combination F1=-93.3025241845876 F2=0 F3=482.499995050573
 M1=0 M2=-147.592891779133 M3=0 FrameElem=24
 Frame=24 Joint=8 OutputCase=PERM1 CaseType=Combination F1=50.0222116845876 F2=0 F3=-469.999995050573
 M1=0 M2=111.850534044392 M3=0 FrameElem=24
 Frame=24 Joint=7 OutputCase=PERM2 CaseType=Combination F1=-69.620164930033 F2=0 F3=482.499995324583
 M1=0 M2=-170.604254975743 M3=0 FrameElem=24
 Frame=24 Joint=8 OutputCase=PERM2 CaseType=Combination F1=39.323946180033 F2=0 F3=-469.999995324583
 M1=0 M2=143.430404993279 M3=0 FrameElem=24
 Frame=24 Joint=7 OutputCase=ACC1 CaseType=Combination F1=-95.5827393310031 F2=0 F3=496.049994891106
 M1=0 M2=-151.696012771888 M3=0 FrameElem=24
 Frame=24 Joint=8 OutputCase=ACC1 CaseType=Combination F1=51.1474268310031 F2=0 F3=-483.549994891106
 M1=0 M2=115.102297410096 M3=0 FrameElem=24
 Frame=24 Joint=7 OutputCase=ACC2 CaseType=Combination F1=-71.9003800764484 F2=0 F3=496.049995165116
 M1=0 M2=-174.707375968498 M3=0 FrameElem=24
 Frame=24 Joint=8 OutputCase=ACC2 CaseType=Combination F1=40.4491613264484 F2=0 F3=-483.549995165116
 M1=0 M2=146.682168358983 M3=0 FrameElem=24
 Frame=24 Joint=7 OutputCase=ACCSX1 CaseType=Combination F1=-97.9597261937289 F2=0 F3=480.98591744512
 M1=0 M2=-147.995992996757 M3=0 FrameElem=24
 Frame=24 Joint=8 OutputCase=ACCSX1 CaseType=Combination F1=53.5244136937289 F2=0 F3=-468.48591744512
 M1=0 M2=110.213784263461 M3=0 FrameElem=24
 Frame=24 Joint=7 OutputCase=ACCSX2 CaseType=Combination F1=-74.2773669391743 F2=0 F3=480.98591771913
 M1=0 M2=-171.007356193367 M3=0 FrameElem=24
 Frame=24 Joint=8 OutputCase=ACCSX2 CaseType=Combination F1=42.8261481891743 F2=0 F3=-468.48591771913
 M1=0 M2=141.793655212349 M3=0 FrameElem=24
 Frame=24 Joint=7 OutputCase=ENVE CaseType=Combination StepType=Max F1=-69.620164930033 F2=0
 F3=496.049995165116 M1=0 M2=-147.592891779133 M3=0 FrameElem=24



Frame=24 Joint=8 OutputCase=ENVE CaseType=Combination StepType=Max F1=53.5244136937289 F2=0 F3=-
 468.48591744512 M1=0 M2=146.682168358983 M3=0 FrameElem=24
 Frame=24 Joint=7 OutputCase=ENVE CaseType=Combination StepType=Min F1=-97.9597261937289 F2=0
 F3=480.98591744512 M1=0 M2=-174.707375968498 M3=0 FrameElem=24
 Frame=24 Joint=8 OutputCase=ENVE CaseType=Combination StepType=Min F1=39.323946180033 F2=0 F3=-
 483.549995165116 M1=0 M2=110.213784263461 M3=0 FrameElem=24
 Frame=24 Joint=7 OutputCase=FESSUR CaseType=Combination F1=-94.8986747870784 F2=0 F3=491.984994938946
 M1=0 M2=-150.465076474061 M3=0 FrameElem=24
 Frame=24 Joint=8 OutputCase=FESSUR CaseType=Combination F1=50.8098622870784 F2=0 F3=-479.484994938946
 M1=0 M2=114.126768400385 M3=0 FrameElem=24
 Frame=25 Joint=8 OutputCase=PERM1 CaseType=Combination F1=-50.0222116845873 F2=0 F3=469.999995050567
 M1=0 M2=-111.850534044392 M3=0 FrameElem=25
 Frame=25 Joint=9 OutputCase=PERM1 CaseType=Combination F1=8.87377418458732 F2=0 F3=-457.499995050567
 M1=0 M2=97.2153638593211 M3=0 FrameElem=25
 Frame=25 Joint=8 OutputCase=PERM2 CaseType=Combination F1=-39.3239461800325 F2=0 F3=469.999995324577
 M1=0 M2=-143.430404993279 M3=0 FrameElem=25
 Frame=25 Joint=9 OutputCase=PERM2 CaseType=Combination F1=10.5200399300325 F2=0 F3=-457.499995324577
 M1=0 M2=131.031586310486 M3=0 FrameElem=25
 Frame=25 Joint=8 OutputCase=ACC1 CaseType=Combination F1=-51.1474268310043 F2=0 F3=483.549994891092
 M1=0 M2=-115.102297410096 M3=0 FrameElem=25
 Frame=25 Joint=9 OutputCase=ACC1 CaseType=Combination F1=8.84398933100428 F2=0 F3=-471.049994891092
 M1=0 M2=100.193269597974 M3=0 FrameElem=25
 Frame=25 Joint=8 OutputCase=ACC2 CaseType=Combination F1=-40.4491613264494 F2=0 F3=483.549995165102
 M1=0 M2=-146.682168358983 M3=0 FrameElem=25
 Frame=25 Joint=9 OutputCase=ACC2 CaseType=Combination F1=10.4902550764494 F2=0 F3=-471.049995165102
 M1=0 M2=134.009492049139 M3=0 FrameElem=25
 Frame=25 Joint=8 OutputCase=ACCSX1 CaseType=Combination F1=-53.5244136937299 F2=0 F3=468.485917445115
 M1=0 M2=-110.213784263461 M3=0 FrameElem=25
 Frame=25 Joint=9 OutputCase=ACCSX1 CaseType=Combination F1=11.2209761937299 F2=0 F3=-455.985917445115
 M1=0 M2=94.1162630798357 M3=0 FrameElem=25
 Frame=25 Joint=8 OutputCase=ACCSX2 CaseType=Combination F1=-42.8261481891751 F2=0 F3=468.485917719125
 M1=0 M2=-141.793655212348 M3=0 FrameElem=25
 Frame=25 Joint=9 OutputCase=ACCSX2 CaseType=Combination F1=12.8672419391751 F2=0 F3=-455.985917719125
 M1=0 M2=127.932485531 M3=0 FrameElem=25
 Frame=25 Joint=8 OutputCase=ENVE CaseType=Combination StepType=Max F1=-39.3239461800325 F2=0
 F3=483.549995165102 M1=0 M2=-110.213784263461 M3=0 FrameElem=25
 Frame=25 Joint=9 OutputCase=ENVE CaseType=Combination StepType=Max F1=12.8672419391751 F2=0 F3=-
 455.985917445115 M1=0 M2=134.009492049139 M3=0 FrameElem=25
 Frame=25 Joint=8 OutputCase=ENVE CaseType=Combination StepType=Min F1=-53.5244136937299 F2=0
 F3=468.485917445115 M1=0 M2=-146.682168358983 M3=0 FrameElem=25
 Frame=25 Joint=9 OutputCase=ENVE CaseType=Combination StepType=Min F1=8.84398933100428 F2=0 F3=-
 471.049995165102 M1=0 M2=94.1162630798357 M3=0 FrameElem=25
 Frame=25 Joint=8 OutputCase=FESSUR CaseType=Combination F1=-50.8098622870792 F2=0 F3=479.484994938935
 M1=0 M2=-114.126768400385 M3=0 FrameElem=25
 Frame=25 Joint=9 OutputCase=FESSUR CaseType=Combination F1=8.85292478707919 F2=0 F3=-466.984994938935
 M1=0 M2=99.2998978763784 M3=0 FrameElem=25
 Frame=26 Joint=9 OutputCase=PERM1 CaseType=Combination F1=-8.87377418458613 F2=0 F3=457.499995050482
 M1=0 M2=-97.215363859321 M3=0 FrameElem=26
 Frame=26 Joint=10 OutputCase=PERM1 CaseType=Combination F1=-30.1427883154139 F2=0 F3=-
 444.999995050482 M1=0 M2=102.621443723922 M3=0 FrameElem=26
 Frame=26 Joint=9 OutputCase=PERM2 CaseType=Combination F1=-10.5200399300314 F2=0 F3=457.499995324491
 M1=0 M2=-131.031586310486 M3=0 FrameElem=26
 Frame=26 Joint=10 OutputCase=PERM2 CaseType=Combination F1=-16.7915538199686 F2=0 F3=-
 444.999995324491 M1=0 M2=132.661642677364 M3=0 FrameElem=26
 Frame=26 Joint=9 OutputCase=ACC1 CaseType=Combination F1=-8.84398933100212 F2=0 F3=471.049994891007
 M1=0 M2=-100.193269597974 M3=0 FrameElem=26
 Frame=26 Joint=10 OutputCase=ACC1 CaseType=Combination F1=-31.3275731689979 F2=0 F3=-458.549994891007
 M1=0 M2=105.902991835524 M3=0 FrameElem=26
 Frame=26 Joint=9 OutputCase=ACC2 CaseType=Combination F1=-10.4902550764473 F2=0 F3=471.049995165017
 M1=0 M2=-134.009492049139 M3=0 FrameElem=26
 Frame=26 Joint=10 OutputCase=ACC2 CaseType=Combination F1=-17.9763386735526 F2=0 F3=-458.549995165017
 M1=0 M2=135.943190788966 M3=0 FrameElem=26
 Frame=26 Joint=9 OutputCase=ACCSX1 CaseType=Combination F1=-11.2209761937288 F2=0 F3=455.985917445033
 M1=0 M2=-94.1162630798354 M3=0 FrameElem=26
 Frame=26 Joint=10 OutputCase=ACCSX1 CaseType=Combination F1=-28.9505863062712 F2=0 F3=-
 443.485917445033 M1=0 M2=98.6374919458811 M3=0 FrameElem=26
 Frame=26 Joint=9 OutputCase=ACCSX2 CaseType=Combination F1=-12.867241939174 F2=0 F3=455.985917719042
 M1=0 M2=-127.932485531 M3=0 FrameElem=26
 Frame=26 Joint=10 OutputCase=ACCSX2 CaseType=Combination F1=-15.599351810826 F2=0 F3=-
 443.485917719042 M1=0 M2=128.677690899323 M3=0 FrameElem=26
 Frame=26 Joint=9 OutputCase=ENVE CaseType=Combination StepType=Max F1=-8.84398933100212 F2=0
 F3=471.049995165017 M1=0 M2=-94.1162630798354 M3=0 FrameElem=26
 Frame=26 Joint=10 OutputCase=ENVE CaseType=Combination StepType=Max F1=-15.599351810826 F2=0 F3=-
 443.485917445033 M1=0 M2=135.943190788966 M3=0 FrameElem=26
 Frame=26 Joint=9 OutputCase=ENVE CaseType=Combination StepType=Min F1=-12.867241939174 F2=0
 F3=455.985917445033 M1=0 M2=-134.009492049139 M3=0 FrameElem=26
 Frame=26 Joint=10 OutputCase=ENVE CaseType=Combination StepType=Min F1=-31.3275731689979 F2=0 F3=-
 458.549995165017 M1=0 M2=98.6374919458811 M3=0 FrameElem=26
 Frame=26 Joint=9 OutputCase=FESSUR CaseType=Combination F1=-8.85292478707732 F2=0 F3=466.984994938849
 M1=0 M2=-99.299897876378 M3=0 FrameElem=26
 Frame=26 Joint=10 OutputCase=FESSUR CaseType=Combination F1=-30.9721377129227 F2=0 F3=-
 454.484994938849 M1=0 M2=104.918527402043 M3=0 FrameElem=26



Frame=27 Joint=10 OutputCase=PERM1 CaseType=Combination F1=30.1427883154125 F2=0 F3=444.999995050462
 M1=0 M2=-102.621443723922 M3=0 FrameElem=27
 Frame=27 Joint=11 OutputCase=PERM1 CaseType=Combination F1=-67.0274758154125 F2=0 F3=-
 432.499995050462 M1=0 M2=127.002836138192 M3=0 FrameElem=27
 Frame=27 Joint=10 OutputCase=PERM2 CaseType=Combination F1=16.7915538199675 F2=0 F3=444.999995324472
 M1=0 M2=-132.661642677364 M3=0 FrameElem=27
 Frame=27 Joint=11 OutputCase=PERM2 CaseType=Combination F1=-42.6108350699675 F2=0 F3=-
 432.499995324472 M1=0 M2=147.574417843912 M3=0 FrameElem=27
 Frame=27 Joint=10 OutputCase=ACC1 CaseType=Combination F1=31.3275731689962 F2=0 F3=458.549994890991
 M1=0 M2=-105.902991835524 M3=0 FrameElem=27
 Frame=27 Joint=11 OutputCase=ACC1 CaseType=Combination F1=-69.3672606689962 F2=0 F3=-446.049994890991
 M1=0 M2=131.165526622743 M3=0 FrameElem=27
 Frame=27 Joint=10 OutputCase=ACC2 CaseType=Combination F1=17.9763386735512 F2=0 F3=458.549995165001
 M1=0 M2=-135.943190788966 M3=0 FrameElem=27
 Frame=27 Joint=11 OutputCase=ACC2 CaseType=Combination F1=-44.9506199235512 F2=0 F3=-446.049995165001
 M1=0 M2=151.737108328462 M3=0 FrameElem=27
 Frame=27 Joint=10 OutputCase=ACCSX1 CaseType=Combination F1=28.9505863062697 F2=0 F3=443.485917445013
 M1=0 M2=-98.6374919458811 M3=0 FrameElem=27
 Frame=27 Joint=11 OutputCase=ACCSX1 CaseType=Combination F1=-66.9902738062697 F2=0 F3=-
 430.985917445013 M1=0 M2=122.711533361596 M3=0 FrameElem=27
 Frame=27 Joint=10 OutputCase=ACCSX2 CaseType=Combination F1=15.5993518108247 F2=0 F3=443.485917719023
 M1=0 M2=-128.677690899323 M3=0 FrameElem=27
 Frame=27 Joint=11 OutputCase=ACCSX2 CaseType=Combination F1=-42.5736330608247 F2=0 F3=-
 430.985917719023 M1=0 M2=143.283115067316 M3=0 FrameElem=27
 Frame=27 Joint=10 OutputCase=ENVE CaseType=Combination StepType=Max F1=31.3275731689962 F2=0
 F3=458.549995165001 M1=0 M2=-98.6374919458811 M3=0 FrameElem=27
 Frame=27 Joint=11 OutputCase=ENVE CaseType=Combination StepType=Max F1=-42.5736330608247 F2=0 F3=-
 430.985917445013 M1=0 M2=151.737108328462 M3=0 FrameElem=27
 Frame=27 Joint=10 OutputCase=ENVE CaseType=Combination StepType=Min F1=15.5993518108247 F2=0
 F3=443.485917445013 M1=0 M2=-135.943190788966 M3=0 FrameElem=27
 Frame=27 Joint=11 OutputCase=ENVE CaseType=Combination StepType=Min F1=-69.3672606689962 F2=0 F3=-
 446.049995165001 M1=0 M2=122.711533361596 M3=0 FrameElem=27
 Frame=27 Joint=10 OutputCase=FESSUR CaseType=Combination F1=30.9721377129211 F2=0 F3=454.484994938832
 M1=0 M2=-104.918527402043 M3=0 FrameElem=27
 Frame=27 Joint=11 OutputCase=FESSUR CaseType=Combination F1=-68.6653252129211 F2=0 F3=-
 441.984994938832 M1=0 M2=129.916719477378 M3=0 FrameElem=27
 Frame=28 Joint=11 OutputCase=PERM1 CaseType=Combination F1=67.0274758154132 F2=0 F3=432.499995050451
 M1=0 M2=-127.002836138193 M3=0 FrameElem=28
 Frame=28 Joint=34 OutputCase=PERM1 CaseType=Combination F1=-101.780288315413 F2=0 F3=-
 419.999995050451 M1=0 M2=169.293603602134 M3=0 FrameElem=28
 Frame=28 Joint=11 OutputCase=PERM2 CaseType=Combination F1=42.6108350699682 F2=0 F3=432.499995324461
 M1=0 M2=-147.574417843912 M3=0 FrameElem=28
 Frame=28 Joint=34 OutputCase=PERM2 CaseType=Combination F1=-66.9378038199682 F2=0 F3=-
 419.999995324461 M1=0 M2=175.023755560131 M3=0 FrameElem=28
 Frame=28 Joint=11 OutputCase=ACC1 CaseType=Combination F1=69.3672606689961 F2=0 F3=446.049994890981
 M1=0 M2=-131.165526622743 M3=0 FrameElem=28
 Frame=28 Joint=34 OutputCase=ACC1 CaseType=Combination F1=-105.275073168996 F2=0 F3=-433.549994890981
 M1=0 M2=174.914936459633 M3=0 FrameElem=28
 Frame=28 Joint=11 OutputCase=ACC2 CaseType=Combination F1=44.9506199235511 F2=0 F3=446.04999516499
 M1=0 M2=-151.737108328463 M3=0 FrameElem=28
 Frame=28 Joint=34 OutputCase=ACC2 CaseType=Combination F1=-70.4325886735511 F2=0 F3=-433.54999516499
 M1=0 M2=180.645088417631 M3=0 FrameElem=28
 Frame=28 Joint=11 OutputCase=ACCSX1 CaseType=Combination F1=66.9902738062694 F2=0 F3=430.985917445
 M1=0 M2=-122.711533361596 M3=0 FrameElem=28
 Frame=28 Joint=34 OutputCase=ACCSX1 CaseType=Combination F1=-102.898086306269 F2=0 F3=-418.485917445
 M1=0 M2=165.272449826982 M3=0 FrameElem=28
 Frame=28 Joint=11 OutputCase=ACCSX2 CaseType=Combination F1=42.5736330608243 F2=0 F3=430.98591771901
 M1=0 M2=-143.283115067316 M3=0 FrameElem=28
 Frame=28 Joint=34 OutputCase=ACCSX2 CaseType=Combination F1=-68.0556018108243 F2=0 F3=-
 418.48591771901 M1=0 M2=171.002601784979 M3=0 FrameElem=28
 Frame=28 Joint=11 OutputCase=ENVE CaseType=Combination StepType=Max F1=69.3672606689961 F2=0
 F3=446.04999516499 M1=0 M2=-122.711533361596 M3=0 FrameElem=28
 Frame=28 Joint=34 OutputCase=ENVE CaseType=Combination StepType=Max F1=-66.9378038199682 F2=0 F3=-
 418.485917445 M1=0 M2=180.645088417631 M3=0 FrameElem=28
 Frame=28 Joint=11 OutputCase=ENVE CaseType=Combination StepType=Min F1=42.5736330608243 F2=0
 F3=430.985917445 M1=0 M2=-151.737108328463 M3=0 FrameElem=28
 Frame=28 Joint=34 OutputCase=ENVE CaseType=Combination StepType=Min F1=-105.275073168996 F2=0 F3=-
 433.54999516499 M1=0 M2=165.272449826982 M3=0 FrameElem=28
 Frame=28 Joint=11 OutputCase=FESSUR CaseType=Combination F1=68.6653252129212 F2=0 F3=441.984994938822
 M1=0 M2=-129.916719477378 M3=0 FrameElem=28
 Frame=28 Joint=34 OutputCase=FESSUR CaseType=Combination F1=-104.226637712921 F2=0 F3=-
 429.484994938822 M1=0 M2=173.228536602384 M3=0 FrameElem=28
 Frame=41 Joint=31 OutputCase=PERM1 CaseType=Combination F1=235.938772273309 F2=0 F3=-346.547598036701
 M1=0 M2=58.8058465615669 M3=0 FrameElem=41
 Frame=41 Joint=19 OutputCase=PERM1 CaseType=Combination F1=-235.938772273309 F2=0 F3=359.047598036701
 M1=0 M2=117.59295245678 M3=0 FrameElem=41
 Frame=41 Joint=31 OutputCase=PERM2 CaseType=Combination F1=169.465538592139 F2=0 F3=-346.427059101316
 M1=0 M2=44.4318461069196 M3=0 FrameElem=41
 Frame=41 Joint=19 OutputCase=PERM2 CaseType=Combination F1=-169.465538592139 F2=0 F3=358.927059101316
 M1=0 M2=131.906683443735 M3=0 FrameElem=41
 Frame=41 Joint=31 OutputCase=ACC1 CaseType=Combination F1=240.528987364651 F2=0 F3=-355.966039077118
 M1=0 M2=60.2607551084541 M3=0 FrameElem=41



Frame=41 Joint=19 OutputCase=ACC1 CaseType=Combination F1=-240.528987364651 F2=0 F3=368.466039077118
 M1=0 M2=120.847264430101 M3=0 FrameElem=41
 Frame=41 Joint=31 OutputCase=ACC2 CaseType=Combination F1=174.055753683481 F2=0 F3=-355.845500141732
 M1=0 M2=45.8867546538068 M3=0 FrameElem=41
 Frame=41 Joint=19 OutputCase=ACC2 CaseType=Combination F1=-174.055753683481 F2=0 F3=368.345500141732
 M1=0 M2=135.160995417056 M3=0 FrameElem=41
 Frame=41 Joint=31 OutputCase=ACCSX1 CaseType=Combination F1=233.665974282453 F2=0 F3=-
 347.883125299163 M1=0 M2=65.2559802910638 M3=0 FrameElem=41
 Frame=41 Joint=19 OutputCase=ACCSX1 CaseType=Combination F1=-233.665974282453 F2=0
 F3=360.383125299163 M1=0 M2=111.810582358514 M3=0 FrameElem=41
 Frame=41 Joint=31 OutputCase=ACCSX2 CaseType=Combination F1=167.192740601283 F2=0 F3=-
 347.762586363777 M1=0 M2=50.8819798364165 M3=0 FrameElem=41
 Frame=41 Joint=19 OutputCase=ACCSX2 CaseType=Combination F1=-167.192740601283 F2=0
 F3=360.262586363777 M1=0 M2=126.124313345469 M3=0 FrameElem=41
 Frame=41 Joint=31 OutputCase=ENVE CaseType=Combination StepType=Max F1=240.528987364651 F2=0 F3=-
 346.427059101316 M1=0 M2=65.2559802910638 M3=0 FrameElem=41
 Frame=41 Joint=19 OutputCase=ENVE CaseType=Combination StepType=Max F1=-167.192740601283 F2=0
 F3=368.466039077118 M1=0 M2=135.160995417056 M3=0 FrameElem=41
 Frame=41 Joint=31 OutputCase=ENVE CaseType=Combination StepType=Min F1=167.192740601283 F2=0 F3=-
 355.966039077118 M1=0 M2=44.4318461069196 M3=0 FrameElem=41
 Frame=41 Joint=19 OutputCase=ENVE CaseType=Combination StepType=Min F1=-240.528987364651 F2=0
 F3=358.927059101316 M1=0 M2=111.810582358514 M3=0 FrameElem=41
 Frame=41 Joint=31 OutputCase=FESSUR CaseType=Combination F1=239.151922837248 F2=0 F3=-
 353.140506764993 M1=0 M2=59.824282544388 M3=0 FrameElem=41
 Frame=41 Joint=19 OutputCase=FESSUR CaseType=Combination F1=-239.151922837248 F2=0
 F3=365.640506764993 M1=0 M2=119.870970838105 M3=0 FrameElem=41
 Frame=42 Joint=19 OutputCase=PERM1 CaseType=Combination F1=235.938772273309 F2=0 F3=-244.82737125746
 M1=0 M2=-117.592952456783 M3=0 FrameElem=42
 Frame=42 Joint=36 OutputCase=PERM1 CaseType=Combination F1=-235.938772273309 F2=0 F3=257.32737125746
 M1=0 M2=243.131638085517 M3=0 FrameElem=42
 Frame=42 Joint=19 OutputCase=PERM2 CaseType=Combination F1=169.465538592139 F2=0 F3=-244.702879693692
 M1=0 M2=-131.906683443738 M3=0 FrameElem=42
 Frame=42 Joint=36 OutputCase=PERM2 CaseType=Combination F1=-169.465538592139 F2=0 F3=257.202879693692
 M1=0 M2=257.383123290588 M3=0 FrameElem=42
 Frame=42 Joint=19 OutputCase=ACC1 CaseType=Combination F1=240.528987364651 F2=0 F3=-251.529896439583
 M1=0 M2=-120.847264430105 M3=0 FrameElem=42
 Frame=42 Joint=36 OutputCase=ACC1 CaseType=Combination F1=-240.528987364651 F2=0 F3=264.029896439583
 M1=0 M2=249.7372126499 M3=0 FrameElem=42
 Frame=42 Joint=19 OutputCase=ACC2 CaseType=Combination F1=174.055753683481 F2=0 F3=-251.405404875815
 M1=0 M2=-135.160995417059 M3=0 FrameElem=42
 Frame=42 Joint=36 OutputCase=ACC2 CaseType=Combination F1=-174.055753683481 F2=0 F3=263.905404875815
 M1=0 M2=263.98869785497 M3=0 FrameElem=42
 Frame=42 Joint=19 OutputCase=ACCSX1 CaseType=Combination F1=233.665974282453 F2=0 F3=-
 247.465074461454 M1=0 M2=-111.810582358517 M3=0 FrameElem=42
 Frame=42 Joint=36 OutputCase=ACCSX1 CaseType=Combination F1=-233.665974282453 F2=0
 F3=259.965074461454 M1=0 M2=238.668119589248 M3=0 FrameElem=42
 Frame=42 Joint=19 OutputCase=ACCSX2 CaseType=Combination F1=167.192740601283 F2=0 F3=-
 247.340582897685 M1=0 M2=-126.124313345472 M3=0 FrameElem=42
 Frame=42 Joint=36 OutputCase=ACCSX2 CaseType=Combination F1=-167.192740601283 F2=0
 F3=259.840582897685 M1=0 M2=252.919604794318 M3=0 FrameElem=42
 Frame=42 Joint=19 OutputCase=ENVE CaseType=Combination StepType=Max F1=240.528987364651 F2=0 F3=-
 244.702879693692 M1=0 M2=-111.810582358517 M3=0 FrameElem=42
 Frame=42 Joint=36 OutputCase=ENVE CaseType=Combination StepType=Max F1=-167.192740601283 F2=0
 F3=264.029896439583 M1=0 M2=263.98869785497 M3=0 FrameElem=42
 Frame=42 Joint=19 OutputCase=ENVE CaseType=Combination StepType=Min F1=167.192740601283 F2=0 F3=-
 251.529896439583 M1=0 M2=-135.160995417059 M3=0 FrameElem=42
 Frame=42 Joint=36 OutputCase=ENVE CaseType=Combination StepType=Min F1=-240.528987364651 F2=0
 F3=257.202879693692 M1=0 M2=238.668119589248 M3=0 FrameElem=42
 Frame=42 Joint=19 OutputCase=FESSUR CaseType=Combination F1=239.151922837248 F2=0 F3=-
 249.519138884946 M1=0 M2=-119.870970838108 M3=0 FrameElem=42
 Frame=42 Joint=36 OutputCase=FESSUR CaseType=Combination F1=-239.151922837248 F2=0
 F3=262.019138884946 M1=0 M2=247.755540280585 M3=0 FrameElem=42
 Frame=43 Joint=36 OutputCase=PERM1 CaseType=Combination F1=235.938772273309 F2=0 F3=-144.001052839679
 M1=0 M2=-243.131638085516 M3=0 FrameElem=43
 Frame=43 Joint=37 OutputCase=PERM1 CaseType=Combination F1=-235.938772273309 F2=0 F3=156.501052839679
 M1=0 M2=318.257164505359 M3=0 FrameElem=43
 Frame=43 Joint=36 OutputCase=PERM2 CaseType=Combination F1=169.465538592139 F2=0 F3=-143.9110203922
 M1=0 M2=-257.383123290586 M3=0 FrameElem=43
 Frame=43 Joint=37 OutputCase=PERM2 CaseType=Combination F1=-169.465538592139 F2=0 F3=156.4110203922
 M1=0 M2=332.463633486669 M3=0 FrameElem=43
 Frame=43 Joint=36 OutputCase=ACC1 CaseType=Combination F1=240.528987364651 F2=0 F3=-148.011874032734
 M1=0 M2=-249.737212649898 M3=0 FrameElem=43
 Frame=43 Joint=37 OutputCase=ACC1 CaseType=Combination F1=-240.528987364651 F2=0 F3=160.511874032734
 M1=0 M2=326.868149666269 M3=0 FrameElem=43
 Frame=43 Joint=36 OutputCase=ACC2 CaseType=Combination F1=174.055753683481 F2=0 F3=-147.921841585254
 M1=0 M2=-263.988697854969 M3=0 FrameElem=43
 Frame=43 Joint=37 OutputCase=ACC2 CaseType=Combination F1=-174.055753683481 F2=0 F3=160.421841585254
 M1=0 M2=341.074618647599 M3=0 FrameElem=43
 Frame=43 Joint=36 OutputCase=ACCSX1 CaseType=Combination F1=233.665974282453 F2=0 F3=-
 147.501236780915 M1=0 M2=-238.668119589247 M3=0 FrameElem=43
 Frame=43 Joint=37 OutputCase=ACCSX1 CaseType=Combination F1=-233.665974282453 F2=0
 F3=160.001236780915 M1=0 M2=315.543737979708 M3=0 FrameElem=43



Frame=43 Joint=36 OutputCase=ACCSX2 CaseType=Combination F1=167.192740601283 F2=0 F3=-
 147.411204333435 M1=0 M2=-252.919604794317 M3=0 FrameElem=43
 Frame=43 Joint=37 OutputCase=ACCSX2 CaseType=Combination F1=-167.192740601283 F2=0
 F3=159.911204333435 M1=0 M2=329.750206961038 M3=0 FrameElem=43
 Frame=43 Joint=36 OutputCase=ENVE CaseType=Combination StepType=Max F1=240.528987364651 F2=0 F3=-
 143.9110203922 M1=0 M2=-238.668119589247 M3=0 FrameElem=43
 Frame=43 Joint=37 OutputCase=ENVE CaseType=Combination StepType=Max F1=-167.192740601283 F2=0
 F3=160.511874032734 M1=0 M2=341.074618647599 M3=0 FrameElem=43
 Frame=43 Joint=36 OutputCase=ENVE CaseType=Combination StepType=Min F1=167.192740601283 F2=0 F3=-
 148.011874032734 M1=0 M2=-263.988697854969 M3=0 FrameElem=43
 Frame=43 Joint=37 OutputCase=ENVE CaseType=Combination StepType=Min F1=-240.528987364651 F2=0
 F3=156.4110203922 M1=0 M2=315.543737979708 M3=0 FrameElem=43
 Frame=43 Joint=36 OutputCase=FESSUR CaseType=Combination F1=239.151922837248 F2=0 F3=-
 146.808627674817 M1=0 M2=-247.755540280584 M3=0 FrameElem=43
 Frame=43 Joint=37 OutputCase=FESSUR CaseType=Combination F1=-239.151922837248 F2=0
 F3=159.308627674817 M1=0 M2=324.284854117996 M3=0 FrameElem=43
 Frame=44 Joint=37 OutputCase=PERM1 CaseType=Combination F1=235.938772273311 F2=0 F3=-43.7650929739583
 M1=0 M2=-318.257164505354 M3=0 FrameElem=44
 Frame=44 Joint=38 OutputCase=PERM1 CaseType=Combination F1=-235.938772273311 F2=0 F3=56.2650929739583
 M1=0 M2=343.264710992333 M3=0 FrameElem=44
 Frame=44 Joint=37 OutputCase=PERM2 CaseType=Combination F1=169.465538592141 F2=0 F3=-43.7325277187084
 M1=0 M2=-332.463633486684 M3=0 FrameElem=44
 Frame=44 Joint=38 OutputCase=PERM2 CaseType=Combination F1=-169.465538592141 F2=0 F3=56.2325277187084
 M1=0 M2=357.454897346038 M3=0 FrameElem=44
 Frame=44 Joint=37 OutputCase=ACC1 CaseType=Combination F1=240.528987364653 F2=0 F3=-45.1001790838367
 M1=0 M2=-326.868149666263 M3=0 FrameElem=44
 Frame=44 Joint=38 OutputCase=ACC1 CaseType=Combination F1=-240.528987364653 F2=0 F3=57.6001790838367
 M1=0 M2=352.543239208182 M3=0 FrameElem=44
 Frame=44 Joint=37 OutputCase=ACC2 CaseType=Combination F1=174.055753683483 F2=0 F3=-45.0676138285868
 M1=0 M2=-341.074618647594 M3=0 FrameElem=44
 Frame=44 Joint=38 OutputCase=ACC2 CaseType=Combination F1=-174.055753683483 F2=0 F3=57.5676138285868
 M1=0 M2=366.733425561887 M3=0 FrameElem=44
 Frame=44 Joint=37 OutputCase=ACCSX1 CaseType=Combination F1=233.665974282455 F2=0 F3=-47.693242676849
 M1=0 M2=-315.543737979703 M3=0 FrameElem=44
 Frame=44 Joint=38 OutputCase=ACCSX1 CaseType=Combination F1=-233.665974282455 F2=0 F3=60.193242676849
 M1=0 M2=342.515359318127 M3=0 FrameElem=44
 Frame=44 Joint=37 OutputCase=ACCSX2 CaseType=Combination F1=167.192740601285 F2=0 F3=-
 47.6606774215991 M1=0 M2=-329.750206961033 M3=0 FrameElem=44
 Frame=44 Joint=38 OutputCase=ACCSX2 CaseType=Combination F1=-167.192740601285 F2=0
 F3=60.1606774215991 M1=0 M2=356.705545671833 M3=0 FrameElem=44
 Frame=44 Joint=37 OutputCase=ENVE CaseType=Combination StepType=Max F1=240.528987364653 F2=0 F3=-
 43.7325277187084 M1=0 M2=-315.543737979703 M3=0 FrameElem=44
 Frame=44 Joint=38 OutputCase=ENVE CaseType=Combination StepType=Max F1=-167.192740601285 F2=0
 F3=60.193242676849 M1=0 M2=366.733425561887 M3=0 FrameElem=44
 Frame=44 Joint=37 OutputCase=ENVE CaseType=Combination StepType=Min F1=167.192740601285 F2=0 F3=-
 47.693242676849 M1=0 M2=-341.074618647594 M3=0 FrameElem=44
 Frame=44 Joint=38 OutputCase=ENVE CaseType=Combination StepType=Min F1=-240.528987364653 F2=0
 F3=56.2325277187084 M1=0 M2=342.515359318127 M3=0 FrameElem=44
 Frame=44 Joint=37 OutputCase=FESSUR CaseType=Combination F1=239.15192283725 F2=0 F3=-44.6996532508732
 M1=0 M2=-324.28485411799 M3=0 FrameElem=44
 Frame=44 Joint=38 OutputCase=FESSUR CaseType=Combination F1=-239.15192283725 F2=0 F3=57.1996532508732
 M1=0 M2=349.759680743427 M3=0 FrameElem=44
 Frame=45 Joint=38 OutputCase=PERM1 CaseType=Combination F1=235.93877227331 F2=0 F3=56.2650907703733
 M1=0 M2=-343.264710992324 M3=0 FrameElem=45
 Frame=45 Joint=41 OutputCase=PERM1 CaseType=Combination F1=-235.93877227331 F2=0 F3=-43.7650907703733
 M1=0 M2=318.257165607134 M3=0 FrameElem=45
 Frame=45 Joint=38 OutputCase=PERM2 CaseType=Combination F1=169.46553859214 F2=0 F3=56.2325263506364
 M1=0 M2=-357.45489734603 M3=0 FrameElem=45
 Frame=45 Joint=41 OutputCase=PERM2 CaseType=Combination F1=-169.46553859214 F2=0 F3=-43.7325263506364
 M1=0 M2=332.463634170708 M3=0 FrameElem=45
 Frame=45 Joint=38 OutputCase=ACC1 CaseType=Combination F1=240.528987364652 F2=0 F3=57.6001768109756
 M1=0 M2=-352.543239208173 M3=0 FrameElem=45
 Frame=45 Joint=41 OutputCase=ACC1 CaseType=Combination F1=-240.528987364652 F2=0 F3=-45.1001768109756
 M1=0 M2=326.868150802681 M3=0 FrameElem=45
 Frame=45 Joint=38 OutputCase=ACC2 CaseType=Combination F1=174.055753683482 F2=0 F3=57.5676123912388
 M1=0 M2=-366.733425561879 M3=0 FrameElem=45
 Frame=45 Joint=41 OutputCase=ACC2 CaseType=Combination F1=-174.055753683482 F2=0 F3=-45.0676123912388
 M1=0 M2=341.074619366255 M3=0 FrameElem=45
 Frame=45 Joint=38 OutputCase=ACCSX1 CaseType=Combination F1=233.665974282454 F2=0 F3=52.340380418437
 M1=0 M2=-342.515359318119 M3=0 FrameElem=45
 Frame=45 Joint=41 OutputCase=ACCSX1 CaseType=Combination F1=-233.665974282454 F2=0 F3=-
 39.840380418437 M1=0 M2=319.470169108896 M3=0 FrameElem=45
 Frame=45 Joint=38 OutputCase=ACCSX2 CaseType=Combination F1=167.192740601284 F2=0 F3=52.3078159987001
 M1=0 M2=-356.705545671824 M3=0 FrameElem=45
 Frame=45 Joint=41 OutputCase=ACCSX2 CaseType=Combination F1=-167.192740601284 F2=0 F3=-
 39.8078159987001 M1=0 M2=333.67663767247 M3=0 FrameElem=45
 Frame=45 Joint=38 OutputCase=ENVE CaseType=Combination StepType=Max F1=240.528987364652 F2=0
 F3=57.6001768109756 M1=0 M2=-342.515359318119 M3=0 FrameElem=45
 Frame=45 Joint=41 OutputCase=ENVE CaseType=Combination StepType=Max F1=-167.192740601284 F2=0 F3=-
 39.8078159987001 M1=0 M2=341.074619366255 M3=0 FrameElem=45
 Frame=45 Joint=38 OutputCase=ENVE CaseType=Combination StepType=Min F1=167.192740601284 F2=0
 F3=52.3078159987001 M1=0 M2=-366.733425561879 M3=0 FrameElem=45

Frame=45	Joint=41	OutputCase=ENVE	CaseType=Combination	StepType=Min	F1=-240.528987364652	F2=0	F3=-
45.1001768109756	M1=0	M2=318.257165607134	M3=0	FrameElem=45			
Frame=45	Joint=38	OutputCase=PESSUR	CaseType=Combination		F1=239.15192283725	F2=0	F3=57.1996509987949
M1=0	M2=-349.759680743418	M3=0	FrameElem=45				
Frame=45	Joint=41	OutputCase=PESSUR	CaseType=Combination		F1=-239.15192283725	F2=0	F3=-
44.6996509987949	M1=0	M2=324.284855244017	M3=0	FrameElem=45			
Frame=46	Joint=41	OutputCase=PERM1	CaseType=Combination		F1=235.938772273311	F2=0	F3=156.501050932407
M1=0	M2=-318.257165607135	M3=0	FrameElem=46				
Frame=46	Joint=42	OutputCase=PERM1	CaseType=Combination		F1=-235.938772273311	F2=0	F3=-
144.001050932407	M1=0	M2=243.131640140932	M3=0	FrameElem=46			
Frame=46	Joint=41	OutputCase=PERM2	CaseType=Combination		F1=169.465538592141	F2=0	F3=156.411019210661
M1=0	M2=-332.463634170709	M3=0	FrameElem=46				
Frame=46	Joint=42	OutputCase=PERM2	CaseType=Combination		F1=-169.465538592141	F2=0	F3=-
143.911019210661	M1=0	M2=257.383124565379	M3=0	FrameElem=46			
Frame=46	Joint=41	OutputCase=ACC1	CaseType=Combination		F1=240.528987364652	F2=0	F3=160.511872066492
M1=0	M2=-326.868150802683	M3=0	FrameElem=46				
Frame=46	Joint=42	OutputCase=ACC1	CaseType=Combination		F1=-240.528987364652	F2=0	F3=-148.011872066492
M1=0	M2=249.737214769437	M3=0	FrameElem=46				
Frame=46	Joint=41	OutputCase=ACC2	CaseType=Combination		F1=174.055753683482	F2=0	F3=160.421840344746
M1=0	M2=-341.074619366257	M3=0	FrameElem=46				
Frame=46	Joint=42	OutputCase=ACC2	CaseType=Combination		F1=-174.055753683482	F2=0	F3=-147.921840344746
M1=0	M2=263.988699193884	M3=0	FrameElem=46				
Frame=46	Joint=41	OutputCase=ACCSX1	CaseType=Combination		F1=233.665974282455	F2=0	F3=153.010375773034
M1=0	M2=-319.470169108898	M3=0	FrameElem=46				
Frame=46	Joint=42	OutputCase=ACCSX1	CaseType=Combination		F1=-233.665974282455	F2=0	F3=-
140.510375773034	M1=0	M2=246.089981222238	M3=0	FrameElem=46			
Frame=46	Joint=41	OutputCase=ACCSX2	CaseType=Combination		F1=167.192740601285	F2=0	F3=152.920344051288
M1=0	M2=-333.676637672472	M3=0	FrameElem=46				
Frame=46	Joint=42	OutputCase=ACCSX2	CaseType=Combination		F1=-167.192740601285	F2=0	F3=-
140.420344051288	M1=0	M2=260.341465646827	M3=0	FrameElem=46			
Frame=46	Joint=41	OutputCase=ENVE	CaseType=Combination	StepType=Max	F1=240.528987364652	F2=0	F3=-
F3=160.511872066492	M1=0	M2=-318.257165607135	M3=0	FrameElem=46			
Frame=46	Joint=42	OutputCase=ENVE	CaseType=Combination	StepType=Max	F1=-167.192740601285	F2=0	F3=-
140.420344051288	M1=0	M2=263.988699193884	M3=0	FrameElem=46			
Frame=46	Joint=41	OutputCase=ENVE	CaseType=Combination	StepType=Min	F1=167.192740601285	F2=0	F3=-
F3=152.920344051288	M1=0	M2=-341.074619366257	M3=0	FrameElem=46			
Frame=46	Joint=42	OutputCase=ENVE	CaseType=Combination	StepType=Min	F1=-240.528987364652	F2=0	F3=-
148.011872066492	M1=0	M2=243.131640140932	M3=0	FrameElem=46			
Frame=46	Joint=41	OutputCase=PESSUR	CaseType=Combination		F1=239.15192283725	F2=0	F3=159.308625726266
M1=0	M2=-324.284855244019	M3=0	FrameElem=46				
Frame=46	Joint=42	OutputCase=PESSUR	CaseType=Combination		F1=-239.15192283725	F2=0	F3=-
146.808625726266	M1=0	M2=247.755542380885	M3=0	FrameElem=46			
Frame=47	Joint=42	OutputCase=PERM1	CaseType=Combination		F1=235.93877227331	F2=0	F3=257.327369944072
M1=0	M2=-243.131640140931	M3=0	FrameElem=47				
Frame=47	Joint=43	OutputCase=PERM1	CaseType=Combination		F1=-235.93877227331	F2=0	F3=-244.827369944072
M1=0	M2=117.592955168895	M3=0	FrameElem=47				
Frame=47	Joint=42	OutputCase=PERM2	CaseType=Combination		F1=169.46553859214	F2=0	F3=257.202878885984
M1=0	M2=-257.383124565378	M3=0	FrameElem=47				
Frame=47	Joint=43	OutputCase=PERM2	CaseType=Combination		F1=-169.46553859214	F2=0	F3=-244.702878885984
M1=0	M2=131.906685122386	M3=0	FrameElem=47				
Frame=47	Joint=42	OutputCase=ACC1	CaseType=Combination		F1=240.528987364652	F2=0	F3=264.029895087877
M1=0	M2=-249.737214769436	M3=0	FrameElem=47				
Frame=47	Joint=43	OutputCase=ACC1	CaseType=Combination		F1=-240.528987364652	F2=0	F3=-251.529895087877
M1=0	M2=120.847267225498	M3=0	FrameElem=47				
Frame=47	Joint=42	OutputCase=ACC2	CaseType=Combination		F1=174.055753683482	F2=0	F3=263.905404029789
M1=0	M2=-263.988699193883	M3=0	FrameElem=47				
Frame=47	Joint=43	OutputCase=ACC2	CaseType=Combination		F1=-174.055753683482	F2=0	F3=-251.405404029789
M1=0	M2=135.160997178989	M3=0	FrameElem=47				
Frame=47	Joint=42	OutputCase=ACCSX1	CaseType=Combination		F1=233.665974282454	F2=0	F3=254.70281494968
M1=0	M2=-246.08998122238	M3=0	FrameElem=47				
Frame=47	Joint=43	OutputCase=ACCSX1	CaseType=Combination		F1=-233.665974282454	F2=0	F3=-
242.20281494968	M1=0	M2=121.86357374754	M3=0	FrameElem=47			
Frame=47	Joint=42	OutputCase=ACCSX2	CaseType=Combination		F1=167.192740601284	F2=0	F3=254.578323891592
M1=0	M2=-260.341465646827	M3=0	FrameElem=47				
Frame=47	Joint=43	OutputCase=ACCSX2	CaseType=Combination		F1=-167.192740601284	F2=0	F3=-
242.078323891592	M1=0	M2=136.177303701031	M3=0	FrameElem=47			
Frame=47	Joint=42	OutputCase=ENVE	CaseType=Combination	StepType=Max	F1=240.528987364652	F2=0	F3=-
F3=264.029895087877	M1=0	M2=-243.131640140931	M3=0	FrameElem=47			
Frame=47	Joint=43	OutputCase=ENVE	CaseType=Combination	StepType=Max	F1=-167.192740601284	F2=0	F3=-
242.078323891592	M1=0	M2=136.177303701031	M3=0	FrameElem=47			
Frame=47	Joint=42	OutputCase=ENVE	CaseType=Combination	StepType=Min	F1=167.192740601284	F2=0	F3=-
F3=254.578323891592	M1=0	M2=-263.988699193883	M3=0	FrameElem=47			
Frame=47	Joint=43	OutputCase=ENVE	CaseType=Combination	StepType=Min	F1=-240.528987364652	F2=0	F3=-
251.529895087877	M1=0	M2=117.592955168895	M3=0	FrameElem=47			
Frame=47	Joint=42	OutputCase=PESSUR	CaseType=Combination		F1=239.15192283725	F2=0	F3=262.019137544736
M1=0	M2=-247.755542380885	M3=0	FrameElem=47				
Frame=47	Joint=43	OutputCase=PESSUR	CaseType=Combination		F1=-239.15192283725	F2=0	F3=-
249.519137544736	M1=0	M2=119.870973608517	M3=0	FrameElem=47			
Frame=48	Joint=43	OutputCase=PERM1	CaseType=Combination		F1=235.938772273311	F2=0	F3=359.047597617233
M1=0	M2=-117.592955168891	M3=0	FrameElem=48				
Frame=48	Joint=32	OutputCase=PERM1	CaseType=Combination		F1=-235.938772273311	F2=0	F3=-
346.547597617233	M1=0	M2=-58.8058436397287	M3=0	FrameElem=48			



Frame=48 Joint=43 OutputCase=PERM2 CaseType=Combination F1=169.465538592141 F2=0 F3=358.927058856264
 M1=0 M2=-131.906685122382 M3=0 FrameElem=48
 Frame=48 Joint=32 OutputCase=PERM2 CaseType=Combination F1=-169.465538592141 F2=0 F3=-
 346.427058856264 M1=0 M2=-44.4318443057531 M3=0 FrameElem=48
 Frame=48 Joint=43 OutputCase=ACC1 CaseType=Combination F1=240.528987364653 F2=0 F3=368.466038650411
 M1=0 M2=-120.847267225494 M3=0 FrameElem=48
 Frame=48 Joint=32 OutputCase=ACC1 CaseType=Combination F1=-240.528987364653 F2=0 F3=-355.966038650411
 M1=0 M2=-60.2607520997145 M3=0 FrameElem=48
 Frame=48 Joint=43 OutputCase=ACC2 CaseType=Combination F1=174.055753683483 F2=0 F3=368.345499889442
 M1=0 M2=-135.160997178985 M3=0 FrameElem=48
 Frame=48 Joint=32 OutputCase=ACC2 CaseType=Combination F1=-174.055753683483 F2=0 F3=-355.845499889442
 M1=0 M2=-45.8867527657389 M3=0 FrameElem=48
 Frame=48 Joint=43 OutputCase=ACCSX1 CaseType=Combination F1=233.665974282455 F2=0 F3=357.724801123119
 M1=0 M2=-121.863573747536 M3=0 FrameElem=48
 Frame=48 Joint=32 OutputCase=ACCSX1 CaseType=Combination F1=-233.665974282455 F2=0 F3=-
 345.224801123119 M1=0 M2=-53.8738268140266 M3=0 FrameElem=48
 Frame=48 Joint=43 OutputCase=ACCSX2 CaseType=Combination F1=167.192740601285 F2=0 F3=357.60426236215
 M1=0 M2=-136.177303701027 M3=0 FrameElem=48
 Frame=48 Joint=32 OutputCase=ACCSX2 CaseType=Combination F1=-167.192740601285 F2=0 F3=-
 345.10426236215 M1=0 M2=-39.4998274800511 M3=0 FrameElem=48
 Frame=48 Joint=43 OutputCase=ENVE CaseType=Combination StepType=Max F1=240.528987364653 F2=0
 F3=368.466038650411 M1=0 M2=-117.592955168891 M3=0 FrameElem=48
 Frame=48 Joint=32 OutputCase=ENVE CaseType=Combination StepType=Max F1=-167.192740601285 F2=0 F3=-
 345.10426236215 M1=0 M2=-39.4998274800511 M3=0 FrameElem=48
 Frame=48 Joint=43 OutputCase=ENVE CaseType=Combination StepType=Min F1=167.192740601285 F2=0
 F3=357.60426236215 M1=0 M2=-136.177303701027 M3=0 FrameElem=48
 Frame=48 Joint=32 OutputCase=ENVE CaseType=Combination StepType=Min F1=-240.528987364653 F2=0 F3=-
 355.966038650411 M1=0 M2=-60.2607520997145 M3=0 FrameElem=48
 Frame=48 Joint=43 OutputCase=FESSUR CaseType=Combination F1=239.15192283725 F2=0 F3=365.640506340457
 M1=0 M2=-119.870973608513 M3=0 FrameElem=48
 Frame=48 Joint=32 OutputCase=FESSUR CaseType=Combination F1=-239.15192283725 F2=0 F3=-
 353.140506340457 M1=0 M2=-59.8242795617187 M3=0 FrameElem=48
 Frame=74 Joint=20 OutputCase=PERM1 CaseType=Combination F1=164.891225815415 F2=0 F3=407.499995050427
 M1=0 M2=-228.427810408842 M3=0 FrameElem=74
 Frame=74 Joint=39 OutputCase=PERM1 CaseType=Combination F1=-164.891225815415 F2=0 F3=-366.74999893665
 M1=0 M2=-131.646570390242 M3=0 FrameElem=74
 Frame=74 Joint=20 OutputCase=PERM2 CaseType=Combination F1=111.11546006997 F2=0 F3=407.499995324437
 M1=0 M2=-214.263501369116 M3=0 FrameElem=74
 Frame=74 Joint=39 OutputCase=PERM2 CaseType=Combination F1=-111.11546006997 F2=0 F3=-366.74999921066
 M1=0 M2=117.482261282014 M3=0 FrameElem=74
 Frame=74 Joint=20 OutputCase=ACC1 CaseType=Combination F1=169.541010668991 F2=0 F3=421.049994890956
 M1=0 M2=-236.085285693133 M3=0 FrameElem=74
 Frame=74 Joint=39 OutputCase=ACC1 CaseType=Combination F1=-169.541010668991 F2=0 F3=-378.944998906402
 M1=0 M2=136.085921005152 M3=0 FrameElem=74
 Frame=74 Joint=20 OutputCase=ACC2 CaseType=Combination F1=115.765244923546 F2=0 F3=421.049995164966
 M1=0 M2=-221.920976653407 M3=0 FrameElem=74
 Frame=74 Joint=39 OutputCase=ACC2 CaseType=Combination F1=-115.765244923546 F2=0 F3=-378.944999180412
 M1=0 M2=121.921611896924 M3=0 FrameElem=74
 Frame=74 Joint=20 OutputCase=ACCSX1 CaseType=Combination F1=167.164023806267 F2=0 F3=405.985917444978
 M1=0 M2=-225.254305629119 M3=0 FrameElem=74
 Frame=74 Joint=39 OutputCase=ACCSX1 CaseType=Combination F1=-167.164023806267 F2=0 F3=-
 365.235921331201 M1=0 M2=128.851584975782 M3=0 FrameElem=74
 Frame=74 Joint=20 OutputCase=ACCSX2 CaseType=Combination F1=113.388258060822 F2=0 F3=405.985917718988
 M1=0 M2=-211.089996589393 M3=0 FrameElem=74
 Frame=74 Joint=39 OutputCase=ACCSX2 CaseType=Combination F1=-113.388258060822 F2=0 F3=-
 365.235921605211 M1=0 M2=114.687275867554 M3=0 FrameElem=74
 Frame=74 Joint=20 OutputCase=ENVE CaseType=Combination StepType=Max F1=169.541010668991 F2=0
 F3=421.049995164966 M1=0 M2=-211.089996589393 M3=0 FrameElem=74
 Frame=74 Joint=39 OutputCase=ENVE CaseType=Combination StepType=Max F1=-111.11546006997 F2=0 F3=-
 365.235921331201 M1=0 M2=136.085921005152 M3=0 FrameElem=74
 Frame=74 Joint=20 OutputCase=ENVE CaseType=Combination StepType=Min F1=111.11546006997 F2=0
 F3=405.985917444978 M1=0 M2=-236.085285693133 M3=0 FrameElem=74
 Frame=74 Joint=39 OutputCase=ENVE CaseType=Combination StepType=Min F1=-169.541010668991 F2=0 F3=-
 378.944999180412 M1=0 M2=114.687275867554 M3=0 FrameElem=74
 Frame=74 Joint=20 OutputCase=FESSUR CaseType=Combination F1=168.146075212918 F2=0 F3=416.984994938797
 M1=0 M2=-233.788043107846 M3=0 FrameElem=74
 Frame=74 Joint=39 OutputCase=FESSUR CaseType=Combination F1=-168.146075212918 F2=0 F3=-
 375.286498915476 M1=0 M2=134.754115820679 M3=0 FrameElem=74
 Frame=75 Joint=39 OutputCase=PERM1 CaseType=Combination F1=164.891225815413 F2=0 F3=366.749998936683
 M1=0 M2=-131.646570390231 M3=0 FrameElem=75
 Frame=75 Joint=40 OutputCase=PERM1 CaseType=Combination F1=-164.891225815413 F2=0 F3=-
 325.999998936683 M1=0 M2=45.0528206560529 M3=0 FrameElem=75
 Frame=75 Joint=39 OutputCase=PERM2 CaseType=Combination F1=111.115460069968 F2=0 F3=366.749999210693
 M1=0 M2=-117.482261282003 M3=0 FrameElem=75
 Frame=75 Joint=40 OutputCase=PERM2 CaseType=Combination F1=-111.115460069968 F2=0 F3=-
 325.999999210693 M1=0 M2=30.8885114793224 M3=0 FrameElem=75
 Frame=75 Joint=39 OutputCase=ACC1 CaseType=Combination F1=169.541010668989 F2=0 F3=378.944998906432
 M1=0 M2=-136.085921005142 M3=0 FrameElem=75
 Frame=75 Joint=40 OutputCase=ACC1 CaseType=Combination F1=-169.541010668989 F2=0 F3=-336.839998906432
 M1=0 M2=46.6127962785264 M3=0 FrameElem=75
 Frame=75 Joint=39 OutputCase=ACC2 CaseType=Combination F1=115.765244923544 F2=0 F3=378.944999180442
 M1=0 M2=-121.921611896914 M3=0 FrameElem=75



Frame=75 Joint=40 OutputCase=ACC2 CaseType=Combination F1=-115.765244923544 F2=0 F3=-336.839999180442
 M1=0 M2=32.4484871017959 M3=0 FrameElem=75
 Frame=75 Joint=39 OutputCase=ACCSX1 CaseType=Combination F1=167.164023806258 F2=0 F3=365.235921331231
 M1=0 M2=-128.851584975772 M3=0 FrameElem=75
 Frame=75 Joint=40 OutputCase=ACCSX1 CaseType=Combination F1=-167.164023806258 F2=0 F3=-
 324.485921331231 M1=0 M2=42.6363546429571 M3=0 FrameElem=75
 Frame=75 Joint=39 OutputCase=ACCSX2 CaseType=Combination F1=113.388258060813 F2=0 F3=365.235921605241
 M1=0 M2=-114.687275867544 M3=0 FrameElem=75
 Frame=75 Joint=40 OutputCase=ACCSX2 CaseType=Combination F1=-113.388258060813 F2=0 F3=-
 324.485921605241 M1=0 M2=28.4720454662266 M3=0 FrameElem=75
 Frame=75 Joint=39 OutputCase=ENVE CaseType=Combination StepType=Max F1=169.541010668989 F2=0
 F3=378.944999180442 M1=0 M2=-114.687275867544 M3=0 FrameElem=75
 Frame=75 Joint=40 OutputCase=ENVE CaseType=Combination StepType=Max F1=-111.115460069968 F2=0 F3=-
 324.485921331231 M1=0 M2=46.6127962785264 M3=0 FrameElem=75
 Frame=75 Joint=39 OutputCase=ENVE CaseType=Combination StepType=Min F1=111.115460069968 F2=0
 F3=365.235921331231 M1=0 M2=-136.085921005142 M3=0 FrameElem=75
 Frame=75 Joint=40 OutputCase=ENVE CaseType=Combination StepType=Min F1=-169.541010668989 F2=0 F3=-
 336.839999180442 M1=0 M2=28.4720454662266 M3=0 FrameElem=75
 Frame=75 Joint=39 OutputCase=FESSUR CaseType=Combination F1=168.146075212916 F2=0 F3=375.286498915508
 M1=0 M2=-134.754115820669 M3=0 FrameElem=75
 Frame=75 Joint=40 OutputCase=FESSUR CaseType=Combination F1=-168.146075212916 F2=0 F3=-
 333.587988915508 M1=0 M2=46.1448035917844 M3=0 FrameElem=75
 Frame=77 Joint=24 OutputCase=PERM1 CaseType=Combination F1=164.891225815414 F2=0 F3=-326.000001063145
 M1=0 M2=-45.0528249089822 M3=0 FrameElem=77
 Frame=77 Joint=25 OutputCase=PERM1 CaseType=Combination F1=-164.891225815414 F2=0 F3=366.750001063145
 M1=0 M2=131.646575174758 M3=0 FrameElem=77
 Frame=77 Joint=24 OutputCase=PERM2 CaseType=Combination F1=111.115460069969 F2=0 F3=-326.00000789135
 M1=0 M2=-30.8885146362118 M3=0 FrameElem=77
 Frame=77 Joint=25 OutputCase=PERM2 CaseType=Combination F1=-111.115460069969 F2=0 F3=366.75000789135
 M1=0 M2=117.482264833485 M3=0 FrameElem=77
 Frame=77 Joint=24 OutputCase=ACC1 CaseType=Combination F1=169.541010668997 F2=0 F3=-336.840001093391
 M1=0 M2=-46.612800652452 M3=0 FrameElem=77
 Frame=77 Joint=25 OutputCase=ACC1 CaseType=Combination F1=-169.541010668997 F2=0 F3=378.945001093391
 M1=0 M2=136.085925925789 M3=0 FrameElem=77
 Frame=77 Joint=24 OutputCase=ACC2 CaseType=Combination F1=115.765244923552 F2=0 F3=-336.840000819381
 M1=0 M2=-32.4484903796816 M3=0 FrameElem=77
 Frame=77 Joint=25 OutputCase=ACC2 CaseType=Combination F1=-115.765244923552 F2=0 F3=378.945000819381
 M1=0 M2=121.921615584516 M3=0 FrameElem=77
 Frame=77 Joint=24 OutputCase=ACCSX1 CaseType=Combination F1=167.164023806274 F2=0 F3=-
 327.514078668594 M1=0 M2=-48.692669317691 M3=0 FrameElem=77
 Frame=77 Joint=25 OutputCase=ACCSX1 CaseType=Combination F1=-167.164023806274 F2=0
 F3=368.264078668594 M1=0 M2=135.664938984829 M3=0 FrameElem=77
 Frame=77 Joint=24 OutputCase=ACCSX2 CaseType=Combination F1=113.388258060829 F2=0 F3=-
 327.514078394584 M1=0 M2=-34.5283590449207 M3=0 FrameElem=77
 Frame=77 Joint=25 OutputCase=ACCSX2 CaseType=Combination F1=-113.388258060829 F2=0
 F3=368.264078394584 M1=0 M2=121.500628643556 M3=0 FrameElem=77
 Frame=77 Joint=24 OutputCase=ENVE CaseType=Combination StepType=Max F1=169.541010668997 F2=0 F3=-
 326.000000789135 M1=0 M2=-30.8885146362118 M3=0 FrameElem=77
 Frame=77 Joint=25 OutputCase=ENVE CaseType=Combination StepType=Max F1=-111.115460069969 F2=0
 F3=378.945001093391 M1=0 M2=136.085925925789 M3=0 FrameElem=77
 Frame=77 Joint=24 OutputCase=ENVE CaseType=Combination StepType=Min F1=111.115460069969 F2=0 F3=-
 336.840001093391 M1=0 M2=-48.692669317691 M3=0 FrameElem=77
 Frame=77 Joint=25 OutputCase=ENVE CaseType=Combination StepType=Min F1=-169.541010668997 F2=0
 F3=366.750000789135 M1=0 M2=117.482264833485 M3=0 FrameElem=77
 Frame=77 Joint=24 OutputCase=FESSUR CaseType=Combination F1=168.146075212922 F2=0 F3=-
 333.588001084317 M1=0 M2=-46.144807929411 M3=0 FrameElem=77
 Frame=77 Joint=25 OutputCase=FESSUR CaseType=Combination F1=-168.146075212922 F2=0
 F3=375.286501084317 M1=0 M2=134.75412070048 M3=0 FrameElem=77
 Frame=78 Joint=25 OutputCase=PERM1 CaseType=Combination F1=164.891225815415 F2=0 F3=-366.750001063131
 M1=0 M2=-131.646575174773 M3=0 FrameElem=78
 Frame=78 Joint=21 OutputCase=PERM1 CaseType=Combination F1=-164.891225815415 F2=0 F3=407.499997176908
 M1=0 M2=228.42781179365 M3=0 FrameElem=78
 Frame=78 Joint=25 OutputCase=PERM2 CaseType=Combination F1=111.115460069969 F2=0 F3=-366.7500078912
 M1=0 M2=-117.4822648335 M3=0 FrameElem=78
 Frame=78 Joint=21 OutputCase=PERM2 CaseType=Combination F1=-111.115460069969 F2=0 F3=407.499996902898
 M1=0 M2=214.263502665989 M3=0 FrameElem=78
 Frame=78 Joint=25 OutputCase=ACC1 CaseType=Combination F1=169.541010669003 F2=0 F3=-378.945001093378
 M1=0 M2=-136.085925925805 M3=0 FrameElem=78
 Frame=78 Joint=21 OutputCase=ACC1 CaseType=Combination F1=-169.541010669003 F2=0 F3=421.049997077932
 M1=0 M2=236.085287118327 M3=0 FrameElem=78
 Frame=78 Joint=25 OutputCase=ACC2 CaseType=Combination F1=115.765244923558 F2=0 F3=-378.945000819367
 M1=0 M2=-121.921615584532 M3=0 FrameElem=78
 Frame=78 Joint=21 OutputCase=ACC2 CaseType=Combination F1=-115.765244923558 F2=0 F3=421.049996803922
 M1=0 M2=221.920977990666 M3=0 FrameElem=78
 Frame=78 Joint=25 OutputCase=ACCSX1 CaseType=Combination F1=167.164023806276 F2=0 F3=-
 368.264078668582 M1=0 M2=-135.664938984845 M3=0 FrameElem=78
 Frame=78 Joint=21 OutputCase=ACCSX1 CaseType=Combination F1=-167.164023806276 F2=0 F3=409.01407478236
 M1=0 M2=232.824694914798 M3=0 FrameElem=78
 Frame=78 Joint=25 OutputCase=ACCSX2 CaseType=Combination F1=113.388258060831 F2=0 F3=-
 368.264078394572 M1=0 M2=-121.500628643572 M3=0 FrameElem=78
 Frame=78 Joint=21 OutputCase=ACCSX2 CaseType=Combination F1=-113.388258060831 F2=0
 F3=409.014074508349 M1=0 M2=218.660385787137 M3=0 FrameElem=78



Frame=78	Joint=25	OutputCase=ENVE	CaseType=Combination	StepType=Max	F1=169.541010669003	F2=0	F3=-
366.75000078912	M1=0	M2=-117.4822648335	M3=0	FrameElem=78			
Frame=78	Joint=21	OutputCase=ENVE	CaseType=Combination	StepType=Max	F1=-111.115460069969	F2=0	
F3=421.049997077932	M1=0	M2=236.085287118327	M3=0	FrameElem=78			
Frame=78	Joint=25	OutputCase=ENVE	CaseType=Combination	StepType=Min	F1=111.115460069969	F2=0	F3=-
378.945001093378	M1=0	M2=-136.085925925805	M3=0	FrameElem=78			
Frame=78	Joint=21	OutputCase=ENVE	CaseType=Combination	StepType=Min	F1=-169.541010669003	F2=0	
F3=407.499996902898	M1=0	M2=214.263502665989	M3=0	FrameElem=78			
Frame=78	Joint=25	OutputCase=FESSUR	CaseType=Combination		F1=168.146075212927	F2=0	F3=-
375.286501084304	M1=0	M2=-134.754120700495	M3=0	FrameElem=78			
Frame=78	Joint=21	OutputCase=FESSUR	CaseType=Combination		F1=-168.146075212927	F2=0	
F3=416.984997107625	M1=0	M2=233.788044520924	M3=0	FrameElem=78			
Frame=112	Joint=40	OutputCase=PERM1	CaseType=Combination		F1=164.891225815415	F2=0	F3=325.999998936731
M1=0	M2=-45.0528206560411	M3=0	FrameElem=112				
Frame=112	Joint=85	OutputCase=PERM1	CaseType=Combination		F1=-164.891225815415	F2=0	F3=-
244.499998936731	M1=0	M2=-97.5721788123243	M3=0	FrameElem=112			
Frame=112	Joint=40	OutputCase=PERM2	CaseType=Combination		F1=111.11546006997	F2=0	F3=325.999999210741
M1=0	M2=-30.8885114793106	M3=0	FrameElem=112				
Frame=112	Joint=85	OutputCase=PERM2	CaseType=Combination		F1=-111.11546006997	F2=0	F3=-
244.499999210741	M1=0	M2=-111.73648812606	M3=0	FrameElem=112			
Frame=112	Joint=40	OutputCase=ACC1	CaseType=Combination		F1=169.541010668994	F2=0	F3=336.839998906482
M1=0	M2=-46.6127962785153	M3=0	FrameElem=112				
Frame=112	Joint=85	OutputCase=ACC1	CaseType=Combination		F1=-169.541010668994	F2=0	F3=-
252.629998906482	M1=0	M2=-100.754703174726	M3=0	FrameElem=112			
Frame=112	Joint=40	OutputCase=ACC2	CaseType=Combination		F1=115.765244923549	F2=0	F3=336.839999180492
M1=0	M2=-32.4484871017848	M3=0	FrameElem=112				
Frame=112	Joint=85	OutputCase=ACC2	CaseType=Combination		F1=-115.765244923549	F2=0	F3=-
252.629999180492	M1=0	M2=-114.919012488461	M3=0	FrameElem=112			
Frame=112	Joint=40	OutputCase=ACCSX1	CaseType=Combination		F1=167.164023806267	F2=0	F3=324.48592133128
M1=0	M2=-42.6363546429454	M3=0	FrameElem=112				
Frame=112	Joint=85	OutputCase=ACCSX1	CaseType=Combination		F1=-167.164023806267	F2=0	F3=-
242.98592133128	M1=0	M2=-99.2316060226944	M3=0	FrameElem=112			
Frame=112	Joint=40	OutputCase=ACCSX2	CaseType=Combination		F1=113.388258060822	F2=0	F3=324.48592160529
M1=0	M2=-28.4720454662149	M3=0	FrameElem=112				
Frame=112	Joint=85	OutputCase=ACCSX2	CaseType=Combination		F1=-113.388258060822	F2=0	F3=-
242.98592160529	M1=0	M2=-113.39591533643	M3=0	FrameElem=112			
Frame=112	Joint=40	OutputCase=ENVE	CaseType=Combination	StepType=Max	F1=169.541010668994	F2=0	
F3=336.839999180492	M1=0	M2=-28.4720454662149	M3=0	FrameElem=112			
Frame=112	Joint=85	OutputCase=ENVE	CaseType=Combination	StepType=Max	F1=-111.11546006997	F2=0	F3=-
242.98592133128	M1=0	M2=-97.5721788123243	M3=0	FrameElem=112			
Frame=112	Joint=40	OutputCase=ENVE	CaseType=Combination	StepType=Min	F1=111.11546006997	F2=0	
F3=324.48592133128	M1=0	M2=-46.6127962785153	M3=0	FrameElem=112			
Frame=112	Joint=85	OutputCase=ENVE	CaseType=Combination	StepType=Min	F1=-169.541010668994	F2=0	F3=-
252.629999180492	M1=0	M2=-114.919012488461	M3=0	FrameElem=112			
Frame=112	Joint=40	OutputCase=FESSUR	CaseType=Combination		F1=168.146075212921	F2=0	
F3=333.587998915557	M1=0	M2=-46.1448035917731	M3=0	FrameElem=112			
Frame=112	Joint=85	OutputCase=FESSUR	CaseType=Combination		F1=-168.146075212921	F2=0	F3=-
250.190998915557	M1=0	M2=-99.7999458660053	M3=0	FrameElem=112			
Frame=113	Joint=85	OutputCase=PERM1	CaseType=Combination		F1=164.891225815415	F2=0	F3=244.499998936758
M1=0	M2=97.5721788123161	M3=0	FrameElem=113				
Frame=113	Joint=86	OutputCase=PERM1	CaseType=Combination		F1=-164.891225815415	F2=0	F3=-
162.999998936758	M1=0	M2=-199.447178280702	M3=0	FrameElem=113			
Frame=113	Joint=85	OutputCase=PERM2	CaseType=Combination		F1=111.11546006997	F2=0	F3=244.499999210768
M1=0	M2=111.736488126052	M3=0	FrameElem=113				
Frame=113	Joint=86	OutputCase=PERM2	CaseType=Combination		F1=-111.11546006997	F2=0	F3=-
162.999999210768	M1=0	M2=-213.611487731443	M3=0	FrameElem=113			
Frame=113	Joint=85	OutputCase=ACC1	CaseType=Combination		F1=169.541010669002	F2=0	F3=252.629998906507
M1=0	M2=100.754703174718	M3=0	FrameElem=113				
Frame=113	Joint=86	OutputCase=ACC1	CaseType=Combination		F1=-169.541010669002	F2=0	F3=-
168.419998906507	M1=0	M2=-206.017202627979	M3=0	FrameElem=113			
Frame=113	Joint=85	OutputCase=ACC2	CaseType=Combination		F1=115.765244923557	F2=0	F3=252.629999180517
M1=0	M2=114.919012488453	M3=0	FrameElem=113				
Frame=113	Joint=86	OutputCase=ACC2	CaseType=Combination		F1=-115.765244923557	F2=0	F3=-
168.419999180517	M1=0	M2=-220.181512078719	M3=0	FrameElem=113			
Frame=113	Joint=85	OutputCase=ACCSX1	CaseType=Combination		F1=167.164023806271	F2=0	
F3=242.985921331306	M1=0	M2=99.2316060226863	M3=0	FrameElem=113			
Frame=113	Joint=86	OutputCase=ACCSX1	CaseType=Combination		F1=-167.164023806271	F2=0	F3=-
161.485921331306	M1=0	M2=-200.349566688347	M3=0	FrameElem=113			
Frame=113	Joint=85	OutputCase=ACCSX2	CaseType=Combination		F1=113.388258060826	F2=0	
F3=242.985921605316	M1=0	M2=113.395915336422	M3=0	FrameElem=113			
Frame=113	Joint=86	OutputCase=ACCSX2	CaseType=Combination		F1=-113.388258060826	F2=0	F3=-
161.485921605316	M1=0	M2=-214.513876139087	M3=0	FrameElem=113			
Frame=113	Joint=85	OutputCase=ENVE	CaseType=Combination	StepType=Max	F1=169.541010669002	F2=0	
F3=252.629999180517	M1=0	M2=114.919012488453	M3=0	FrameElem=113			
Frame=113	Joint=86	OutputCase=ENVE	CaseType=Combination	StepType=Max	F1=-111.11546006997	F2=0	F3=-
161.485921331306	M1=0	M2=-199.447178280702	M3=0	FrameElem=113			
Frame=113	Joint=85	OutputCase=ENVE	CaseType=Combination	StepType=Min	F1=111.11546006997	F2=0	
F3=242.985921331306	M1=0	M2=97.5721788123161	M3=0	FrameElem=113			
Frame=113	Joint=86	OutputCase=ENVE	CaseType=Combination	StepType=Min	F1=-169.541010669002	F2=0	F3=-
168.419999180517	M1=0	M2=-220.181512078719	M3=0	FrameElem=113			
Frame=113	Joint=85	OutputCase=FESSUR	CaseType=Combination		F1=168.146075212926	F2=0	
F3=250.190998915583	M1=0	M2=99.7999458659972	M3=0	FrameElem=113			



Frame=113 Joint=86 OutputCase=FESSUR CaseType=Combination F1=-168.146075212926 F2=0 F3=-
 166.793998915583 M1=0 M2=-204.046195323796 M3=0 FrameElem=113
 Frame=114 Joint=86 OutputCase=PERM1 CaseType=Combination F1=164.891225815415 F2=0 F3=162.999998936728
 M1=0 M2=199.447178280693 M3=0 FrameElem=114
 Frame=114 Joint=87 OutputCase=PERM1 CaseType=Combination F1=-164.891225815415 F2=0 F3=-
 81.499998936728 M1=0 M2=-260.572177749046 M3=0 FrameElem=114
 Frame=114 Joint=86 OutputCase=PERM2 CaseType=Combination F1=111.11546006997 F2=0 F3=162.999999210738
 M1=0 M2=213.611487731433 M3=0 FrameElem=114
 Frame=114 Joint=87 OutputCase=PERM2 CaseType=Combination F1=-111.11546006997 F2=0 F3=-81.499999210738
 M1=0 M2=-274.736487336791 M3=0 FrameElem=114
 Frame=114 Joint=86 OutputCase=ACC1 CaseType=Combination F1=169.541010669005 F2=0 F3=168.419998906478
 M1=0 M2=206.017202627969 M3=0 FrameElem=114
 Frame=114 Joint=87 OutputCase=ACC1 CaseType=Combination F1=-169.541010669005 F2=0 F3=-
 84.2099989064782 M1=0 M2=-269.174702081198 M3=0 FrameElem=114
 Frame=114 Joint=86 OutputCase=ACC2 CaseType=Combination F1=115.76524492356 F2=0 F3=168.419999180488
 M1=0 M2=220.18151207871 M3=0 FrameElem=114
 Frame=114 Joint=87 OutputCase=ACC2 CaseType=Combination F1=-115.76524492356 F2=0 F3=-84.2099991804882
 M1=0 M2=-283.339011668943 M3=0 FrameElem=114
 Frame=114 Joint=86 OutputCase=ACCSX1 CaseType=Combination F1=167.164023806275 F2=0
 F3=161.485921331277 M1=0 M2=200.349566688337 M3=0 FrameElem=114
 Frame=114 Joint=87 OutputCase=ACCSX1 CaseType=Combination F1=-167.164023806275 F2=0 F3=-
 79.9859213312765 M1=0 M2=-260.717527353965 M3=0 FrameElem=114
 Frame=114 Joint=86 OutputCase=ACCSX2 CaseType=Combination F1=113.388258060829 F2=0
 F3=161.485921605287 M1=0 M2=214.513876139078 M3=0 FrameElem=114
 Frame=114 Joint=87 OutputCase=ACCSX2 CaseType=Combination F1=-113.388258060829 F2=0 F3=-
 79.9859216052865 M1=0 M2=-274.88183694171 M3=0 FrameElem=114
 Frame=114 Joint=86 OutputCase=ENVE CaseType=Combination StepType=Max F1=169.541010669005 F2=0
 F3=168.419999180488 M1=0 M2=220.18151207871 M3=0 FrameElem=114
 Frame=114 Joint=87 OutputCase=ENVE CaseType=Combination StepType=Max F1=-111.11546006997 F2=0 F3=-
 79.9859213312765 M1=0 M2=-260.572177749046 M3=0 FrameElem=114
 Frame=114 Joint=86 OutputCase=ENVE CaseType=Combination StepType=Min F1=111.11546006997 F2=0
 F3=161.485921331277 M1=0 M2=199.447178280693 M3=0 FrameElem=114
 Frame=114 Joint=87 OutputCase=ENVE CaseType=Combination StepType=Min F1=-169.541010669005 F2=0 F3=-
 84.2099991804882 M1=0 M2=-283.339011668943 M3=0 FrameElem=114
 Frame=114 Joint=86 OutputCase=FESSUR CaseType=Combination F1=168.146075212928 F2=0
 F3=166.793998915553 M1=0 M2=204.046195323786 M3=0 FrameElem=114
 Frame=114 Joint=87 OutputCase=FESSUR CaseType=Combination F1=-168.146075212928 F2=0 F3=-
 83.3969989155531 M1=0 M2=-266.593944781552 M3=0 FrameElem=114
 Frame=115 Joint=87 OutputCase=PERM1 CaseType=Combination F1=164.891225815415 F2=0 F3=81.4999989367637
 M1=0 M2=260.572177749058 M3=0 FrameElem=115
 Frame=115 Joint=88 OutputCase=PERM1 CaseType=Combination F1=-164.891225815415 F2=0
 F3=1.06323630887382E-06 M1=0 M2=-280.947177217443 M3=0 FrameElem=115
 Frame=115 Joint=87 OutputCase=PERM2 CaseType=Combination F1=111.11546006997 F2=0 F3=81.4999992107736
 M1=0 M2=274.736487336803 M3=0 FrameElem=115
 Frame=115 Joint=88 OutputCase=PERM2 CaseType=Combination F1=-111.11546006997 F2=0
 F3=7.89226414869148E-07 M1=0 M2=-295.111486942193 M3=0 FrameElem=115
 Frame=115 Joint=87 OutputCase=ACC1 CaseType=Combination F1=169.541010668994 F2=0 F3=84.2099989065157
 M1=0 M2=269.174702081209 M3=0 FrameElem=115
 Frame=115 Joint=88 OutputCase=ACC1 CaseType=Combination F1=-169.541010668994 F2=0
 F3=1.09348434262913E-06 M1=0 M2=-290.22720153447 M3=0 FrameElem=115
 Frame=115 Joint=87 OutputCase=ACC2 CaseType=Combination F1=115.765244923549 F2=0 F3=84.2099991805256
 M1=0 M2=283.339011668954 M3=0 FrameElem=115
 Frame=115 Joint=88 OutputCase=ACC2 CaseType=Combination F1=-115.765244923549 F2=0
 F3=8.19474448743307E-07 M1=0 M2=-304.391511259221 M3=0 FrameElem=115
 Frame=115 Joint=87 OutputCase=ACCSX1 CaseType=Combination F1=167.164023806267 F2=0
 F3=79.9859213313121 M1=0 M2=260.717527353976 M3=0 FrameElem=115
 Frame=115 Joint=88 OutputCase=ACCSX1 CaseType=Combination F1=-167.164023806267 F2=0
 F3=1.51407866868788 M1=0 M2=-280.335488019636 M3=0 FrameElem=115
 Frame=115 Joint=87 OutputCase=ACCSX2 CaseType=Combination F1=113.388258060822 F2=0 F3=79.985921605322
 M1=0 M2=274.881836941722 M3=0 FrameElem=115
 Frame=115 Joint=88 OutputCase=ACCSX2 CaseType=Combination F1=-113.388258060822 F2=0
 F3=1.51407839467799 M1=0 M2=-294.499797744387 M3=0 FrameElem=115
 Frame=115 Joint=87 OutputCase=ENVE CaseType=Combination StepType=Max F1=169.541010668994 F2=0
 F3=84.2099991805256 M1=0 M2=283.339011668954 M3=0 FrameElem=115
 Frame=115 Joint=88 OutputCase=ENVE CaseType=Combination StepType=Max F1=-111.11546006997 F2=0
 F3=1.51407866868788 M1=0 M2=-280.335488019636 M3=0 FrameElem=115
 Frame=115 Joint=87 OutputCase=ENVE CaseType=Combination StepType=Min F1=111.11546006997 F2=0
 F3=79.9859213313121 M1=0 M2=260.572177749058 M3=0 FrameElem=115
 Frame=115 Joint=88 OutputCase=ENVE CaseType=Combination StepType=Min F1=-169.541010668994 F2=0
 F3=7.89226414869148E-07 M1=0 M2=-304.391511259221 M3=0 FrameElem=115
 Frame=115 Joint=87 OutputCase=FESSUR CaseType=Combination F1=168.146075212921 F2=0
 F3=83.3969989155901 M1=0 M2=266.593944781563 M3=0 FrameElem=115
 Frame=115 Joint=88 OutputCase=FESSUR CaseType=Combination F1=-168.146075212921 F2=0
 F3=1.08440993251691E-06 M1=0 M2=-287.443194239362 M3=0 FrameElem=115
 Frame=116 Joint=88 OutputCase=PERM1 CaseType=Combination F1=164.891225815415 F2=0 F3=-
 1.06324073545494E-06 M1=0 M2=280.947177217439 M3=0 FrameElem=116
 Frame=116 Joint=89 OutputCase=PERM1 CaseType=Combination F1=-164.891225815415 F2=0
 F3=81.5000010632407 M1=0 M2=-260.572176685811 M3=0 FrameElem=116
 Frame=116 Joint=88 OutputCase=PERM2 CaseType=Combination F1=111.11546006997 F2=0 F3=-
 7.89230706921273E-07 M1=0 M2=295.111486942189 M3=0 FrameElem=116
 Frame=116 Joint=89 OutputCase=PERM2 CaseType=Combination F1=-111.11546006997 F2=0 F3=81.5000007892307
 M1=0 M2=-274.736486547566 M3=0 FrameElem=116



Frame=116 Joint=88 OutputCase=ACC1 CaseType=Combination F1=169.541010668998 F2=0 F3=-
 1.09348981514046E-06 M1=0 M2=290.227201534466 M3=0 FrameElem=116
 Frame=116 Joint=89 OutputCase=ACC1 CaseType=Combination F1=-169.541010668998 F2=0 F3=84.2100010934898
 M1=0 M2=-269.174700987714 M3=0 FrameElem=116
 Frame=116 Joint=88 OutputCase=ACC2 CaseType=Combination F1=115.765244923553 F2=0 F3=-
 8.19479786695609E-07 M1=0 M2=304.391511259216 M3=0 FrameElem=116
 Frame=116 Joint=89 OutputCase=ACC2 CaseType=Combination F1=-115.765244923553 F2=0 F3=84.2100008194798
 M1=0 M2=-283.339010849469 M3=0 FrameElem=116
 Frame=116 Joint=88 OutputCase=ACCSX1 CaseType=Combination F1=167.164023806267 F2=0 F3=-
 1.5140786686922 M1=0 M2=280.335488019632 M3=0 FrameElem=116
 Frame=116 Joint=89 OutputCase=ACCSX1 CaseType=Combination F1=-167.164023806267 F2=0
 F3=83.0140786686922 M1=0 M2=-259.203448685278 M3=0 FrameElem=116
 Frame=116 Joint=88 OutputCase=ACCSX2 CaseType=Combination F1=113.388258060822 F2=0 F3=-
 1.51407839468217 M1=0 M2=294.499797744382 M3=0 FrameElem=116
 Frame=116 Joint=89 OutputCase=ACCSX2 CaseType=Combination F1=-113.388258060822 F2=0
 F3=83.0140783946822 M1=0 M2=-273.367758547034 M3=0 FrameElem=116
 Frame=116 Joint=88 OutputCase=ENVE CaseType=Combination StepType=Max F1=169.541010668998 F2=0 F3=-
 7.89230706921273E-07 M1=0 M2=304.391511259216 M3=0 FrameElem=116
 Frame=116 Joint=89 OutputCase=ENVE CaseType=Combination StepType=Max F1=-111.11546006997 F2=0
 F3=84.2100010934898 M1=0 M2=-259.203448685278 M3=0 FrameElem=116
 Frame=116 Joint=88 OutputCase=ENVE CaseType=Combination StepType=Min F1=111.11546006997 F2=0 F3=-
 1.5140786686922 M1=0 M2=280.335488019632 M3=0 FrameElem=116
 Frame=116 Joint=89 OutputCase=ENVE CaseType=Combination StepType=Min F1=-169.541010668998 F2=0
 F3=81.5000007892307 M1=0 M2=-283.339010849469 M3=0 FrameElem=116
 Frame=116 Joint=88 OutputCase=FESSUR CaseType=Combination F1=168.146075212923 F2=0 F3=-
 1.08441509127921E-06 M1=0 M2=287.443194239358 M3=0 FrameElem=116
 Frame=116 Joint=89 OutputCase=FESSUR CaseType=Combination F1=-168.146075212923 F2=0
 F3=83.3970010844151 M1=0 M2=-266.593943697143 M3=0 FrameElem=116
 Frame=117 Joint=89 OutputCase=PERM1 CaseType=Combination F1=164.891225815414 F2=0 F3=-
 81.5000010632166 M1=0 M2=260.5721766858 M3=0 FrameElem=117
 Frame=117 Joint=90 OutputCase=PERM1 CaseType=Combination F1=-164.891225815414 F2=0
 F3=163.000001063217 M1=0 M2=-199.447176154192 M3=0 FrameElem=117
 Frame=117 Joint=89 OutputCase=PERM2 CaseType=Combination F1=111.115460069969 F2=0 F3=-
 81.5000007892066 M1=0 M2=274.736486547556 M3=0 FrameElem=117
 Frame=117 Joint=90 OutputCase=PERM2 CaseType=Combination F1=-111.115460069969 F2=0
 F3=163.000000789207 M1=0 M2=-213.611486152952 M3=0 FrameElem=117
 Frame=117 Joint=89 OutputCase=ACC1 CaseType=Combination F1=169.541010668997 F2=0 F3=-84.2100010934651
 M1=0 M2=269.174700987702 M3=0 FrameElem=117
 Frame=117 Joint=90 OutputCase=ACC1 CaseType=Combination F1=-169.541010668997 F2=0 F3=168.420001093465
 M1=0 M2=-206.01720044097 M3=0 FrameElem=117
 Frame=117 Joint=89 OutputCase=ACC2 CaseType=Combination F1=115.765244923552 F2=0 F3=-84.210000819455
 M1=0 M2=283.339010849458 M3=0 FrameElem=117
 Frame=117 Joint=90 OutputCase=ACC2 CaseType=Combination F1=-115.765244923552 F2=0 F3=168.420000819455
 M1=0 M2=-220.18151043973 M3=0 FrameElem=117
 Frame=117 Joint=89 OutputCase=ACCSX1 CaseType=Combination F1=167.16402380627 F2=0 F3=-
 83.0140786686675 M1=0 M2=259.203448685268 M3=0 FrameElem=117
 Frame=117 Joint=90 OutputCase=ACCSX1 CaseType=Combination F1=-167.16402380627 F2=0
 F3=164.514078668668 M1=0 M2=-197.321409350934 M3=0 FrameElem=117
 Frame=117 Joint=89 OutputCase=ACCSX2 CaseType=Combination F1=113.388258060825 F2=0 F3=-
 83.0140783946575 M1=0 M2=273.367758547023 M3=0 FrameElem=117
 Frame=117 Joint=90 OutputCase=ACCSX2 CaseType=Combination F1=-113.388258060825 F2=0
 F3=164.514078394657 M1=0 M2=-211.485719349694 M3=0 FrameElem=117
 Frame=117 Joint=89 OutputCase=ENVE CaseType=Combination StepType=Max F1=169.541010668997 F2=0 F3=-
 81.5000007892066 M1=0 M2=283.339010849458 M3=0 FrameElem=117
 Frame=117 Joint=90 OutputCase=ENVE CaseType=Combination StepType=Max F1=-111.115460069969 F2=0
 F3=168.420001093465 M1=0 M2=-197.321409350934 M3=0 FrameElem=117
 Frame=117 Joint=89 OutputCase=ENVE CaseType=Combination StepType=Min F1=111.115460069969 F2=0 F3=-
 84.2100010934651 M1=0 M2=259.203448685268 M3=0 FrameElem=117
 Frame=117 Joint=90 OutputCase=ENVE CaseType=Combination StepType=Min F1=-169.541010668997 F2=0
 F3=163.000000789207 M1=0 M2=-220.18151043973 M3=0 FrameElem=117
 Frame=117 Joint=89 OutputCase=FESSUR CaseType=Combination F1=168.146075212922 F2=0 F3=-
 83.3970010843905 M1=0 M2=266.593943697132 M3=0 FrameElem=117
 Frame=117 Joint=90 OutputCase=FESSUR CaseType=Combination F1=-168.146075212922 F2=0
 F3=166.794001084391 M1=0 M2=-204.046193154936 M3=0 FrameElem=117
 Frame=118 Joint=90 OutputCase=PERM1 CaseType=Combination F1=164.891225815415 F2=0 F3=-
 163.000001063161 M1=0 M2=199.447176154193 M3=0 FrameElem=118
 Frame=118 Joint=91 OutputCase=PERM1 CaseType=Combination F1=-164.891225815415 F2=0
 F3=244.500001063161 M1=0 M2=-97.5721756226157 M3=0 FrameElem=118
 Frame=118 Joint=90 OutputCase=PERM2 CaseType=Combination F1=111.115460069969 F2=0 F3=-
 163.000000789151 M1=0 M2=213.611486152953 M3=0 FrameElem=118
 Frame=118 Joint=91 OutputCase=PERM2 CaseType=Combination F1=-111.115460069969 F2=0
 F3=244.500000789151 M1=0 M2=-111.736485758381 M3=0 FrameElem=118
 Frame=118 Joint=90 OutputCase=ACC1 CaseType=Combination F1=169.541010668998 F2=0 F3=-168.420001093409
 M1=0 M2=206.017200440971 M3=0 FrameElem=118
 Frame=118 Joint=91 OutputCase=ACC1 CaseType=Combination F1=-169.541010668998 F2=0 F3=252.630001093409
 M1=0 M2=-100.75469989427 M3=0 FrameElem=118
 Frame=118 Joint=90 OutputCase=ACC2 CaseType=Combination F1=115.765244923552 F2=0 F3=-168.420000819399
 M1=0 M2=220.181510439731 M3=0 FrameElem=118
 Frame=118 Joint=91 OutputCase=ACC2 CaseType=Combination F1=-115.765244923552 F2=0 F3=252.630000819399
 M1=0 M2=-114.919010030035 M3=0 FrameElem=118
 Frame=118 Joint=90 OutputCase=ACCSX1 CaseType=Combination F1=167.16402380627 F2=0 F3=-
 164.514078668612 M1=0 M2=197.321409350935 M3=0 FrameElem=118



Frame=118 Joint=91 OutputCase=ACCSX1 CaseType=Combination F1=-167.16402380627 F2=0
 F3=246.014078668612 M1=0 M2=-94.6893700166322 M3=0 FrameElem=118
 Frame=118 Joint=90 OutputCase=ACCSX2 CaseType=Combination F1=113.388258060825 F2=0 F3=-
 164.514078394602 M1=0 M2=211.485719349695 M3=0 FrameElem=118
 Frame=118 Joint=91 OutputCase=ACCSX2 CaseType=Combination F1=-113.388258060825 F2=0
 F3=246.014078394602 M1=0 M2=-108.853680152398 M3=0 FrameElem=118
 Frame=118 Joint=90 OutputCase=ENVE CaseType=Combination StepType=Max F1=169.541010668998 F2=0 F3=-
 163.000000789151 M1=0 M2=220.181510439731 M3=0 FrameElem=118
 Frame=118 Joint=91 OutputCase=ENVE CaseType=Combination StepType=Max F1=-111.115460069969 F2=0
 F3=252.630001093409 M1=0 M2=-94.6893700166322 M3=0 FrameElem=118
 Frame=118 Joint=90 OutputCase=ENVE CaseType=Combination StepType=Min F1=111.115460069969 F2=0 F3=-
 168.420001093409 M1=0 M2=197.321409350935 M3=0 FrameElem=118
 Frame=118 Joint=91 OutputCase=ENVE CaseType=Combination StepType=Min F1=-169.541010668998 F2=0
 F3=244.500000789151 M1=0 M2=-114.919010030035 M3=0 FrameElem=118
 Frame=118 Joint=90 OutputCase=FESSUR CaseType=Combination F1=168.146075212923 F2=0 F3=-
 166.794001084335 M1=0 M2=204.046193154937 M3=0 FrameElem=118
 Frame=118 Joint=91 OutputCase=FESSUR CaseType=Combination F1=-168.146075212923 F2=0
 F3=250.191001084335 M1=0 M2=-99.7999426127735 M3=0 FrameElem=118
 Frame=119 Joint=91 OutputCase=PERM1 CaseType=Combination F1=164.891225815415 F2=0 F3=-
 244.500001063151 M1=0 M2=97.5721756225989 M3=0 FrameElem=119
 Frame=119 Joint=24 OutputCase=PERM1 CaseType=Combination F1=-164.891225815415 F2=0
 F3=326.000001063151 M1=0 M2=45.0528249089877 M3=0 FrameElem=119
 Frame=119 Joint=91 OutputCase=PERM2 CaseType=Combination F1=111.11546006997 F2=0 F3=-244.500000789141
 M1=0 M2=111.736485758364 M3=0 FrameElem=119
 Frame=119 Joint=24 OutputCase=PERM2 CaseType=Combination F1=-111.11546006997 F2=0 F3=326.000000789141
 M1=0 M2=30.8885146362174 M3=0 FrameElem=119
 Frame=119 Joint=91 OutputCase=ACC1 CaseType=Combination F1=169.541010669005 F2=0 F3=-252.630001093398
 M1=0 M2=100.754699894252 M3=0 FrameElem=119
 Frame=119 Joint=24 OutputCase=ACC1 CaseType=Combination F1=-169.541010669005 F2=0 F3=336.840001093398
 M1=0 M2=46.6128006524575 M3=0 FrameElem=119
 Frame=119 Joint=91 OutputCase=ACC2 CaseType=Combination F1=115.76524492356 F2=0 F3=-252.630000819388
 M1=0 M2=114.919010030017 M3=0 FrameElem=119
 Frame=119 Joint=24 OutputCase=ACC2 CaseType=Combination F1=-115.76524492356 F2=0 F3=336.840000819388
 M1=0 M2=32.4484903796872 M3=0 FrameElem=119
 Frame=119 Joint=91 OutputCase=ACCSX1 CaseType=Combination F1=167.164023806274 F2=0 F3=-
 246.014078668601 M1=0 M2=94.689370016615 M3=0 FrameElem=119
 Frame=119 Joint=24 OutputCase=ACCSX1 CaseType=Combination F1=-167.164023806274 F2=0
 F3=327.514078668601 M1=0 M2=48.6926693176964 M3=0 FrameElem=119
 Frame=119 Joint=91 OutputCase=ACCSX2 CaseType=Combination F1=113.388258060829 F2=0 F3=-
 246.014078394591 M1=0 M2=108.85368015238 M3=0 FrameElem=119
 Frame=119 Joint=24 OutputCase=ACCSX2 CaseType=Combination F1=-113.388258060829 F2=0
 F3=327.514078394591 M1=0 M2=34.5283590449261 M3=0 FrameElem=119
 Frame=119 Joint=91 OutputCase=ENVE CaseType=Combination StepType=Max F1=169.541010669005 F2=0 F3=-
 244.500000789141 M1=0 M2=114.919010030017 M3=0 FrameElem=119
 Frame=119 Joint=24 OutputCase=ENVE CaseType=Combination StepType=Max F1=-111.11546006997 F2=0
 F3=336.840001093398 M1=0 M2=48.6926693176964 M3=0 FrameElem=119
 Frame=119 Joint=91 OutputCase=ENVE CaseType=Combination StepType=Min F1=111.11546006997 F2=0 F3=-
 252.630001093398 M1=0 M2=94.689370016615 M3=0 FrameElem=119
 Frame=119 Joint=24 OutputCase=ENVE CaseType=Combination StepType=Min F1=-169.541010669005 F2=0
 F3=326.000000789141 M1=0 M2=30.8885146362174 M3=0 FrameElem=119
 Frame=119 Joint=91 OutputCase=FESSUR CaseType=Combination F1=168.146075212928 F2=0 F3=-
 250.191001084324 M1=0 M2=99.7999426127561 M3=0 FrameElem=119
 Frame=119 Joint=24 OutputCase=FESSUR CaseType=Combination F1=-168.146075212928 F2=0
 F3=333.588001084324 M1=0 M2=46.1448079294166 M3=0 FrameElem=119

TABLE: "OBJECTS AND ELEMENTS - JOINTS"

JointElem	JointObject	GlobalX	GlobalY	GlobalZ
JointElem=1	JointObject=1	GlobalX=-2.49999997615814	GlobalY=0	GlobalZ=0
JointElem=15	JointObject=15	GlobalX=2.49999997615814	GlobalY=0	GlobalZ=0
JointElem=35	JointObject=35	GlobalX=2.49999997615814	GlobalY=0	GlobalZ=3.5
JointElem=40	JointObject=40	GlobalX=-2	GlobalY=0	GlobalZ=4
JointElem=39	JointObject=39	GlobalX=-2.25	GlobalY=0	GlobalZ=4
JointElem=34	JointObject=34	GlobalX=-2.49999997615814	GlobalY=0	GlobalZ=3.5
JointElem=20	JointObject=20	GlobalX=-2.49999997615814	GlobalY=0	GlobalZ=4
JointElem=21	JointObject=21	GlobalX=2.49999997615814	GlobalY=0	GlobalZ=3.99999997615814
JointElem=22	JointObject=22	GlobalX=-2.5	GlobalY=0	GlobalZ=3.75
JointElem=23	JointObject=23	GlobalX=2.5	GlobalY=0	GlobalZ=3.75
JointElem=24	JointObject=24	GlobalX=2	GlobalY=0	GlobalZ=4
JointElem=25	JointObject=25	GlobalX=2.25	GlobalY=0	GlobalZ=4
JointElem=26	JointObject=26	GlobalX=-2.5	GlobalY=0	GlobalZ=0.25
JointElem=27	JointObject=27	GlobalX=-2.5	GlobalY=0	GlobalZ=0.5
JointElem=28	JointObject=28	GlobalX=2.5	GlobalY=0	GlobalZ=0.25
JointElem=29	JointObject=29	GlobalX=2.5	GlobalY=0	GlobalZ=0.5
JointElem=30	JointObject=30	GlobalX=-2.25	GlobalY=0	GlobalZ=0
JointElem=31	JointObject=31	GlobalX=-2	GlobalY=0	GlobalZ=0
JointElem=32	JointObject=32	GlobalX=2	GlobalY=0	GlobalZ=0
JointElem=33	JointObject=33	GlobalX=2.25	GlobalY=0	GlobalZ=0
JointElem=19	JointObject=19	GlobalX=-1.5	GlobalY=0	GlobalZ=0
JointElem=36	JointObject=36	GlobalX=-1	GlobalY=0	GlobalZ=0
JointElem=37	JointObject=37	GlobalX=-0.5	GlobalY=0	GlobalZ=0
JointElem=38	JointObject=38	GlobalX=0	GlobalY=0	GlobalZ=0
JointElem=41	JointObject=41	GlobalX=0.5	GlobalY=0	GlobalZ=0
JointElem=42	JointObject=42	GlobalX=1	GlobalY=0	GlobalZ=0



JointElem=43	JointObject=43	GlobalX=1.5	GlobalY=0	GlobalZ=0
JointElem=85	JointObject=85	GlobalX=-1.5	GlobalY=0	GlobalZ=4
JointElem=86	JointObject=86	GlobalX=-1	GlobalY=0	GlobalZ=4
JointElem=87	JointObject=87	GlobalX=-0.5	GlobalY=0	GlobalZ=4
JointElem=88	JointObject=88	GlobalX=0	GlobalY=0	GlobalZ=4
JointElem=89	JointObject=89	GlobalX=0.5	GlobalY=0	GlobalZ=4
JointElem=90	JointObject=90	GlobalX=1	GlobalY=0	GlobalZ=4
JointElem=91	JointObject=91	GlobalX=1.5	GlobalY=0	GlobalZ=4
JointElem=2	JointObject=2	GlobalX=2.49999999602636	GlobalY=0	GlobalZ=1
JointElem=3	JointObject=3	GlobalX=2.49999999205271	GlobalY=0	GlobalZ=1.5
JointElem=4	JointObject=4	GlobalX=2.49999998807907	GlobalY=0	GlobalZ=2
JointElem=5	JointObject=5	GlobalX=2.49999998410543	GlobalY=0	GlobalZ=2.5
JointElem=6	JointObject=6	GlobalX=2.49999998013179	GlobalY=0	GlobalZ=3
JointElem=7	JointObject=7	GlobalX=-2.49999999602636	GlobalY=0	GlobalZ=1
JointElem=8	JointObject=8	GlobalX=-2.49999999205271	GlobalY=0	GlobalZ=1.5
JointElem=9	JointObject=9	GlobalX=-2.49999998807907	GlobalY=0	GlobalZ=2
JointElem=10	JointObject=10	GlobalX=-2.49999998410543	GlobalY=0	GlobalZ=2.5
JointElem=11	JointObject=11	GlobalX=-2.49999998013179	GlobalY=0	GlobalZ=3

TABLE: "OBJECTS AND ELEMENTS - FRAMES"

FrameElem=1	FrameObject=1	ElemJtI=1	ElemJtJ=30
FrameElem=2	FrameObject=2	ElemJtI=30	ElemJtJ=31
FrameElem=4	FrameObject=4	ElemJtI=32	ElemJtJ=33
FrameElem=5	FrameObject=5	ElemJtI=33	ElemJtJ=15
FrameElem=41	FrameObject=41	ElemJtI=31	ElemJtJ=19
FrameElem=42	FrameObject=42	ElemJtI=19	ElemJtJ=36
FrameElem=43	FrameObject=43	ElemJtI=36	ElemJtJ=37
FrameElem=44	FrameObject=44	ElemJtI=37	ElemJtJ=38
FrameElem=45	FrameObject=45	ElemJtI=38	ElemJtJ=41
FrameElem=46	FrameObject=46	ElemJtI=41	ElemJtJ=42
FrameElem=47	FrameObject=47	ElemJtI=42	ElemJtJ=43
FrameElem=48	FrameObject=48	ElemJtI=43	ElemJtJ=32
FrameElem=74	FrameObject=74	ElemJtI=20	ElemJtJ=39
FrameElem=75	FrameObject=75	ElemJtI=39	ElemJtJ=40
FrameElem=77	FrameObject=77	ElemJtI=24	ElemJtJ=25
FrameElem=78	FrameObject=78	ElemJtI=25	ElemJtJ=21
FrameElem=112	FrameObject=112	ElemJtI=40	ElemJtJ=85
FrameElem=113	FrameObject=113	ElemJtI=85	ElemJtJ=86
FrameElem=114	FrameObject=114	ElemJtI=86	ElemJtJ=87
FrameElem=115	FrameObject=115	ElemJtI=87	ElemJtJ=88
FrameElem=116	FrameObject=116	ElemJtI=88	ElemJtJ=89
FrameElem=117	FrameObject=117	ElemJtI=89	ElemJtJ=90
FrameElem=118	FrameObject=118	ElemJtI=90	ElemJtJ=91
FrameElem=119	FrameObject=119	ElemJtI=91	ElemJtJ=24
FrameElem=3	FrameObject=3	ElemJtI=15	ElemJtJ=28
FrameElem=6	FrameObject=6	ElemJtI=28	ElemJtJ=29
FrameElem=9	FrameObject=9	ElemJtI=35	ElemJtJ=23
FrameElem=10	FrameObject=10	ElemJtI=23	ElemJtJ=21
FrameElem=11	FrameObject=11	ElemJtI=1	ElemJtJ=26
FrameElem=12	FrameObject=12	ElemJtI=26	ElemJtJ=27
FrameElem=15	FrameObject=15	ElemJtI=34	ElemJtJ=22
FrameElem=16	FrameObject=16	ElemJtI=22	ElemJtJ=20
FrameElem=17	FrameObject=17	ElemJtI=29	ElemJtJ=2
FrameElem=18	FrameObject=18	ElemJtI=2	ElemJtJ=3
FrameElem=19	FrameObject=19	ElemJtI=3	ElemJtJ=4
FrameElem=20	FrameObject=20	ElemJtI=4	ElemJtJ=5
FrameElem=21	FrameObject=21	ElemJtI=5	ElemJtJ=6
FrameElem=22	FrameObject=22	ElemJtI=6	ElemJtJ=35
FrameElem=23	FrameObject=23	ElemJtI=27	ElemJtJ=7
FrameElem=24	FrameObject=24	ElemJtI=7	ElemJtJ=8
FrameElem=25	FrameObject=25	ElemJtI=8	ElemJtJ=9
FrameElem=26	FrameObject=26	ElemJtI=9	ElemJtJ=10
FrameElem=27	FrameObject=27	ElemJtI=10	ElemJtJ=11
FrameElem=28	FrameObject=28	ElemJtI=11	ElemJtJ=34

TABLE: "BASE REACTIONS"

OutputCase=PERM1 CaseType=Combination GlobalFX=-1.91128271032071E-06 GlobalFY=0 GlobalFZ=1139.99999043935
 GlobalMX=0 GlobalMY=-6.33854850842774E-06 GlobalMZ=0 GlobalX=0 GlobalY=0 GlobalZ=0 _
 XCentroidFX=-2.49999999012507 YCentroidFX=0 ZCentroidFX=0 XCentroidFY=0 YCentroidFY=0
 ZCentroidFY=0 XCentroidFZ=5.56013031718089E-09 YCentroidFZ=0 ZCentroidFZ=0
 OutputCase=PERM2 CaseType=Combination GlobalFX=-1.33789783793858E-06 GlobalFY=0 GlobalFZ=1139.99999043935
 GlobalMX=0 GlobalMY=-3.98957512591502E-06 GlobalMZ=0 GlobalX=0 GlobalY=0 GlobalZ=0 _
 XCentroidFX=-2.49999998907948 YCentroidFX=0 ZCentroidFX=0 XCentroidFY=0 YCentroidFY=0
 ZCentroidFY=0 XCentroidFZ=3.49962733278399E-09 YCentroidFZ=0 ZCentroidFZ=0
 OutputCase=ACC1 CaseType=Combination GlobalFX=-1.96635745730589E-06 GlobalFY=0 GlobalFZ=1167.0999901809
 GlobalMX=0 GlobalMY=-6.55881760991406E-06 GlobalMZ=0 GlobalX=0 GlobalY=0 GlobalZ=0 _
 XCentroidFX=-2.4999999322469 YCentroidFX=0 ZCentroidFX=0 XCentroidFY=0 YCentroidFY=0
 ZCentroidFY=0 XCentroidFZ=5.61975637485649E-09 YCentroidFZ=0 ZCentroidFZ=0
 OutputCase=ACC2 CaseType=Combination GlobalFX=-1.39297258527904E-06 GlobalFY=0 GlobalFZ=1167.0999901809
 GlobalMX=0 GlobalMY=-4.20984422788706E-06 GlobalMZ=0 GlobalX=0 GlobalY=0 GlobalZ=0 _
 XCentroidFX=-2.4999999234864 YCentroidFX=0 ZCentroidFX=0 XCentroidFY=0 YCentroidFY=0
 ZCentroidFY=0 XCentroidFZ=3.60709816065934E-09 YCentroidFZ=0 ZCentroidFZ=0



```

OutputCase=ACCSX1 CaseType=Combination GlobalFX=-9.24000191128112 GlobalFY=0 GlobalFZ=1139.99999043934
GlobalMX=0 GlobalMY=-18.4800063385549 GlobalMZ=0 GlobalX=0 GlobalY=0 GlobalZ=0 XCentroidFX=-
2.49999997615815 _
YCentroidFX=0 ZCentroidFX=0 XCentroidFY=0 YCentroidFY=0 ZCentroidFY=0
XCentroidFZ=1.62105320118757E-02 YCentroidFZ=0 ZCentroidFZ=0
OutputCase=ACCSX2 CaseType=Combination GlobalFX=-9.24000133789625 GlobalFY=0 GlobalFZ=1139.99999043934
GlobalMX=0 GlobalMY=-18.4800039895816 GlobalMZ=0 GlobalX=0 GlobalY=0 GlobalZ=0 XCentroidFX=-
2.49999997615814 _
YCentroidFX=0 ZCentroidFX=0 XCentroidFY=0 YCentroidFY=0 ZCentroidFY=0
XCentroidFZ=1.62105299513728E-02 YCentroidFZ=0 ZCentroidFZ=0
OutputCase=ENVE CaseType=Combination StepType=Max GlobalFX=-1.33789783793858E-06 GlobalFY=0
GlobalFZ=1167.0999901809 GlobalMX=0 GlobalMY=-3.98957512591502E-06 GlobalMZ=0 GlobalX=0 GlobalY=0
GlobalZ=0 XCentroidFX=0 _
YCentroidFX=0 ZCentroidFX=0 XCentroidFY=0 YCentroidFY=0 ZCentroidFY=0 XCentroidFZ=0
YCentroidFZ=0 ZCentroidFZ=0
OutputCase=ENVE CaseType=Combination StepType=Min GlobalFX=-9.24000191128112 GlobalFY=0
GlobalFZ=1139.99999043934 GlobalMX=0 GlobalMY=-18.4800063385549 GlobalMZ=0 GlobalX=0 GlobalY=0 GlobalZ=0
XCentroidFX=0 _
YCentroidFX=0 ZCentroidFX=0 XCentroidFY=0 YCentroidFY=0 ZCentroidFY=0 XCentroidFZ=0
YCentroidFZ=0 ZCentroidFZ=0
OutputCase=FESSUR CaseType=Combination GlobalFX=-1.94983503387647E-06 GlobalFY=0
GlobalFZ=1158.96999025843 GlobalMX=0 GlobalMY=-6.49273687969298E-06 GlobalMZ=0 GlobalX=0 GlobalY=0
GlobalZ=0 _
XCentroidFX=-2.4999999111746 YCentroidFX=0 ZCentroidFX=0 XCentroidFY=0 YCentroidFY=0
ZCentroidFY=0 XCentroidFZ=5.60216134521757E-09 YCentroidFZ=0 ZCentroidFZ=0

```

END TABLE DATA