

| | | | | | |
|---|------------|------------|--------------|-----------|---|
| REVISIONE | DATA | ELABORATO | VERIFICATO | APPROVATO | DESCRIZIONE |
| B | 18.10.2023 | 112 | 013 | 063 | Revisione come da commenti Tema 11.9.2023 |
| A | 21.4.2023 | 100 | 013 | 093 | Embalone per autorizzazione |
| COMMITTENTE | | | | | |
| GRUPPO VISCONTI 2014 150 kV R.E. S.p.A. | | | | | SE 380/150/36 kV CASTELLUCCIO DEI SAURI |
| INGEGNERIA & COORDINAZIONE BRULLI Trasmissione | | | | | TITOLO SEZIONI REPARTO AT |
| SCALA | FORMATO | FOLIO / DI | N. DOCUMENTO | | |
| 1:200 | A0+++ | 1 / 5 | 7 0 4 5 3 B | | |

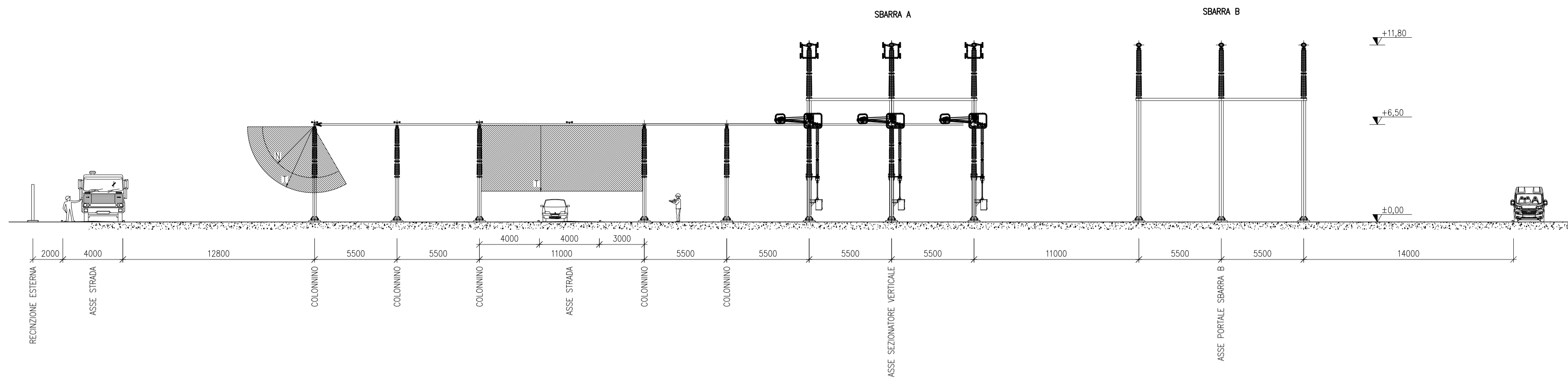

SEZIONE PARALLELO SBARRE 380 kV (SBARRA A)



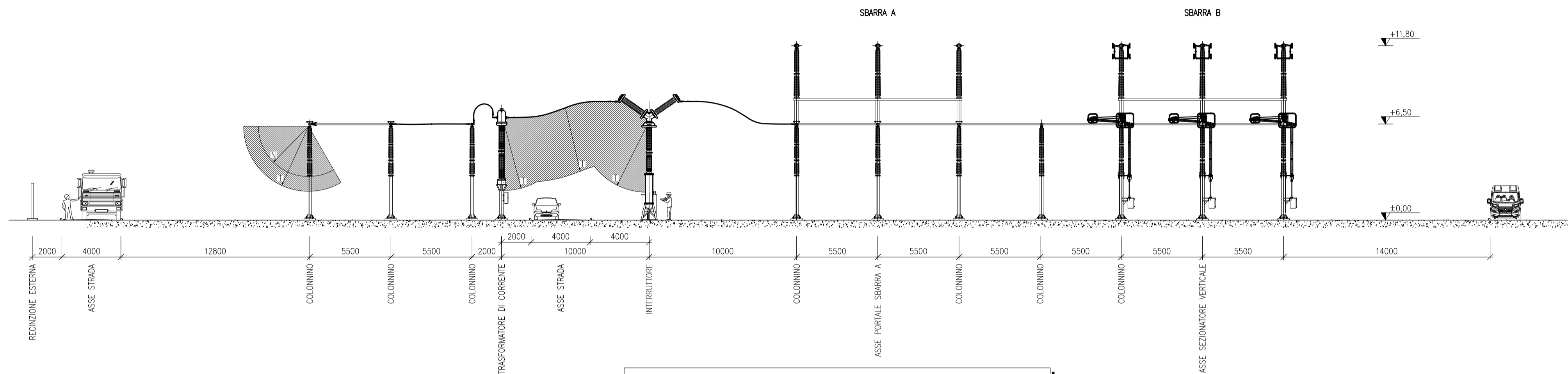

SEZIONE PARALLELO SBARRE 380 kV (SBARRA B)

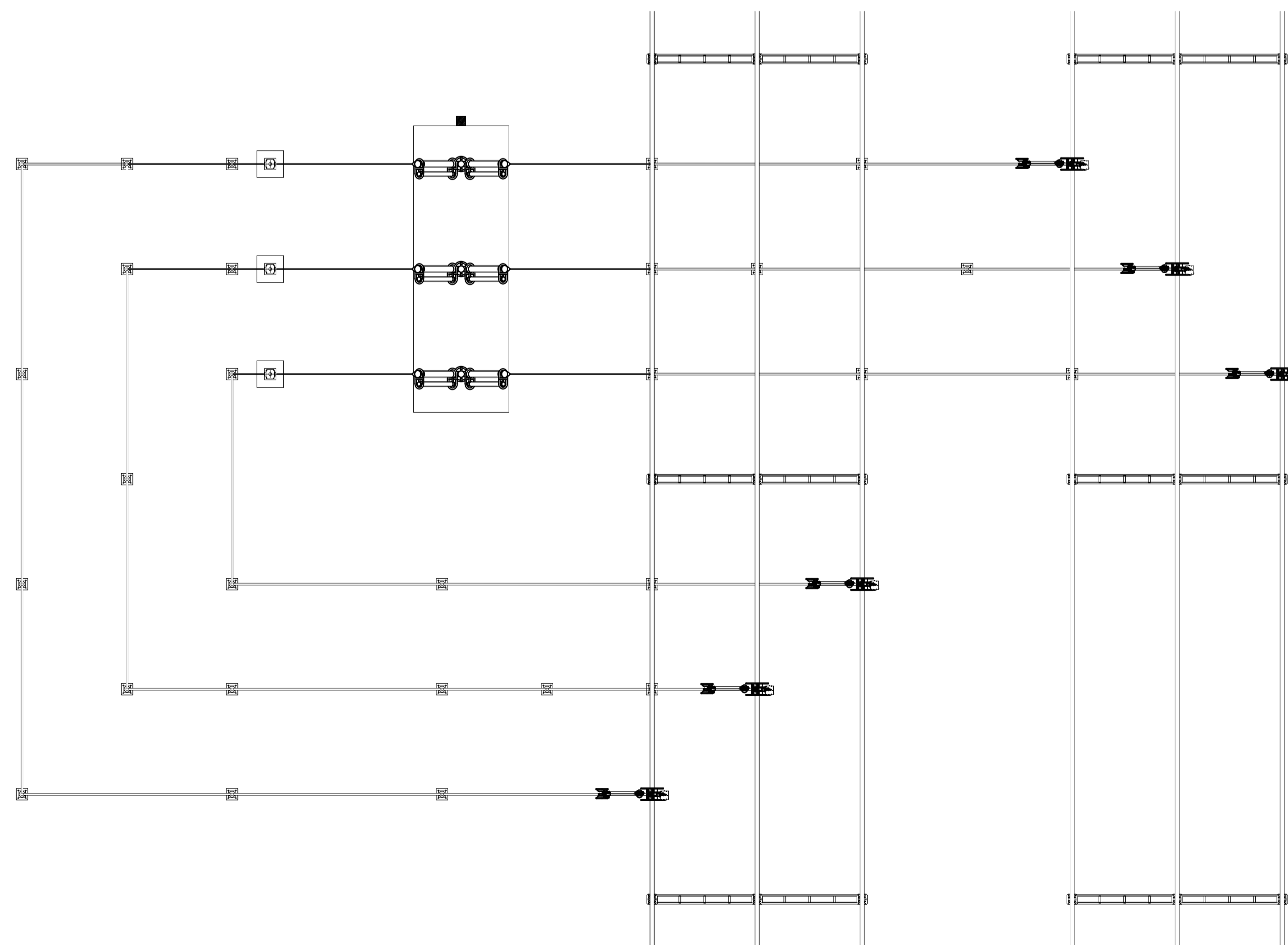

PIANTA PARALLELO SBARRE 380 kV

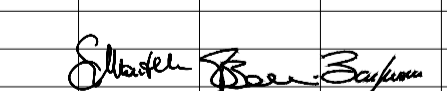

Giulio Baccin

| | | | |  | |
|---|------------|-------------|------------|---|--|
| B | 18.10.2023 | 112 | 013 | 093 | Revisione come da commenti Terni 11.9.2023 |
| A | 21.4.2023 | 100 | 013 | 093 | Emissione per autorizzazione |
| REVISIONE | DATA | ELABORATO | VERIFICATO | APPROVATO | DESCRIZIONE |
| COMMITTENTE | | | | IMPIANTO | |
|  | | | | SE 380/150/36 kV CASTELLUCCIO DEI SAURI | |
|  | | | | TITOLO | |
| | | | | SEZIONI REPARTO AT | |
| SCALA | FORMATO | FOGLIO / DI | | N. DOCUMENTO | |
| 1:200 | A1 | 2 / 5 | | 7 0 4 5 3 B | |

SEZIONE CONGIUNTURE SBARRE 150 kV

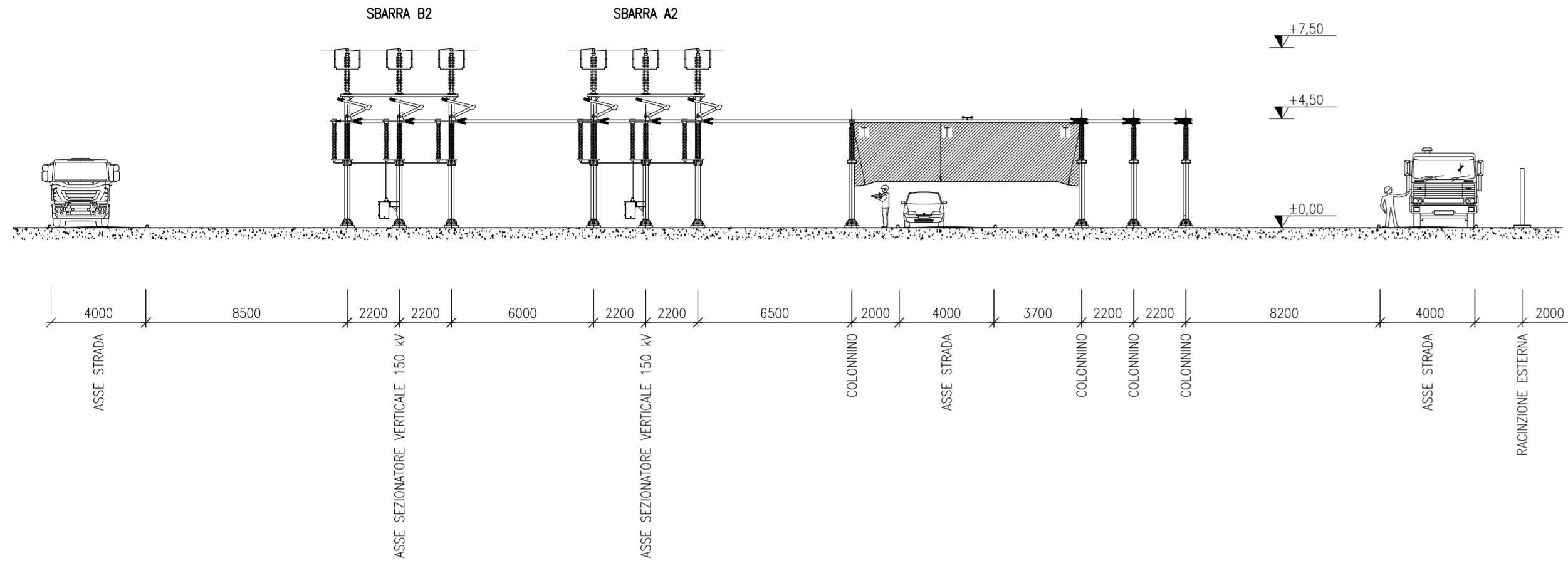

SEZIONE PARALLELO SBARRE 150 kV SBARRA A1

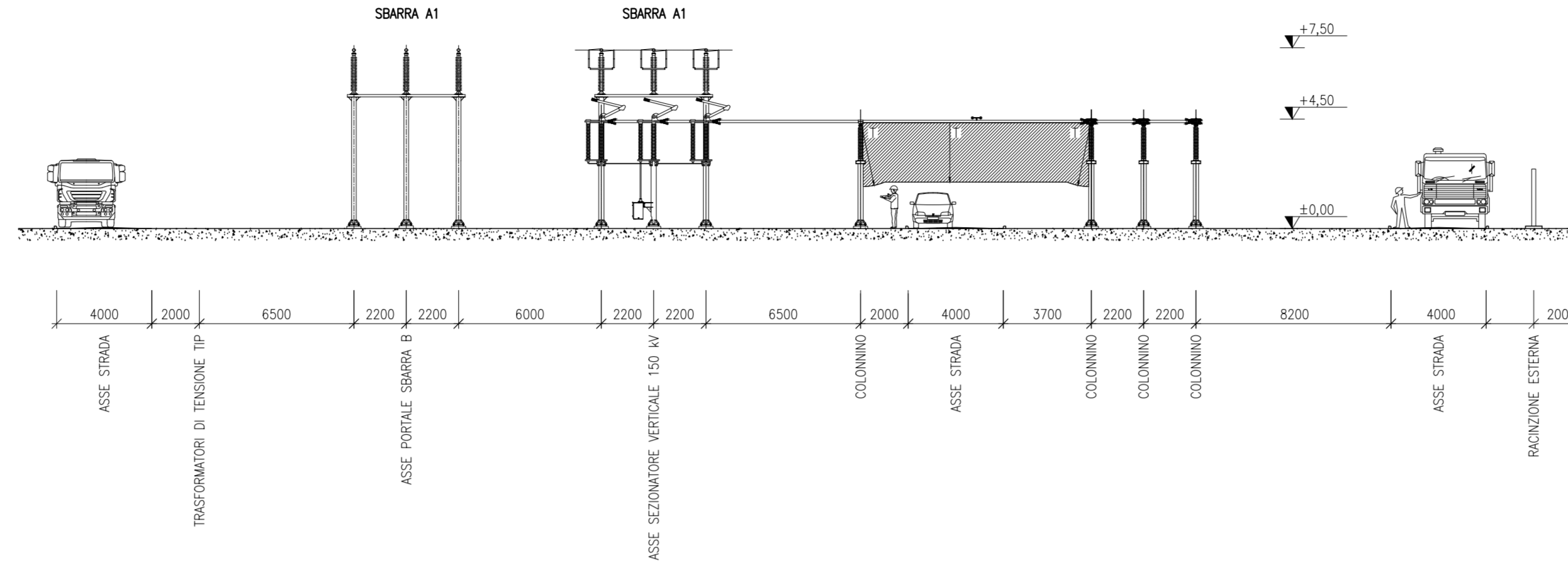

TIP 150 kV

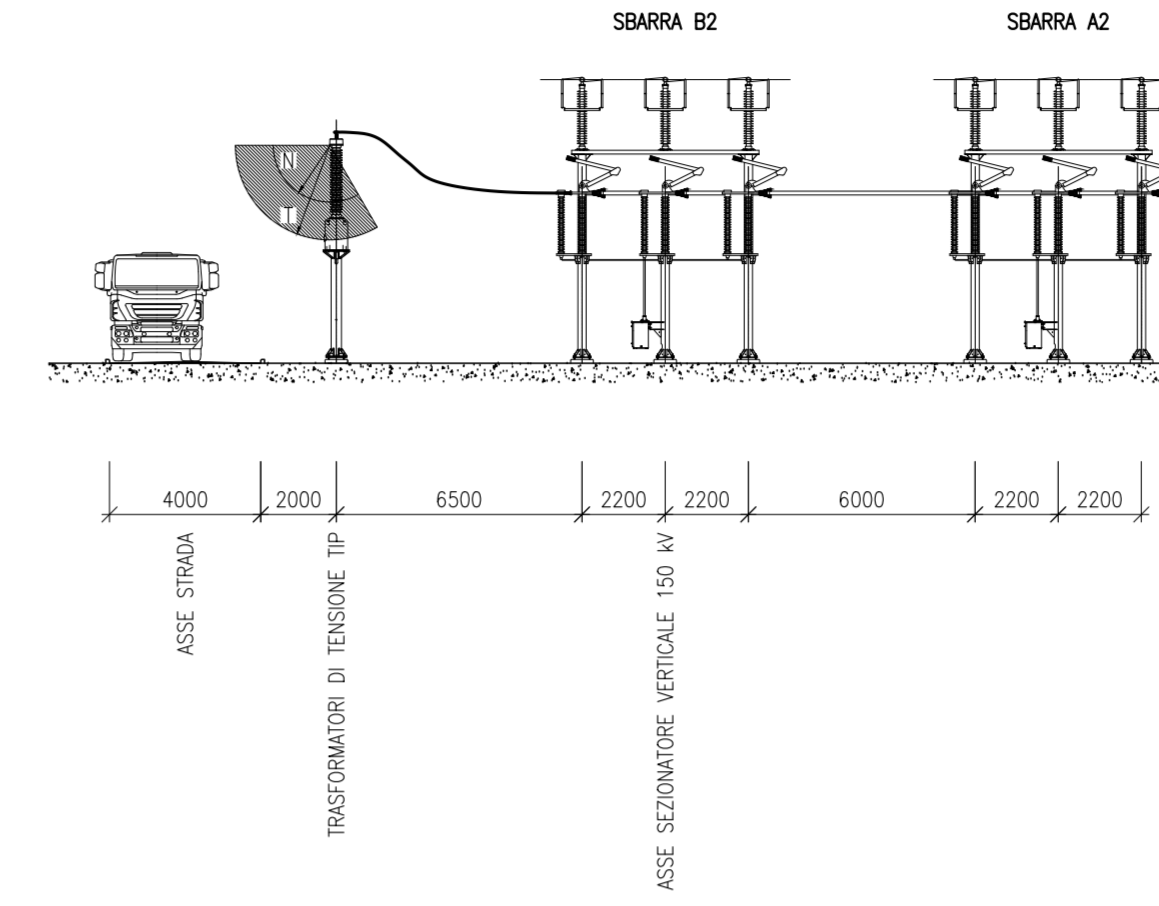

SEZIONE CONGIUNTURE SBARRE 150 kV

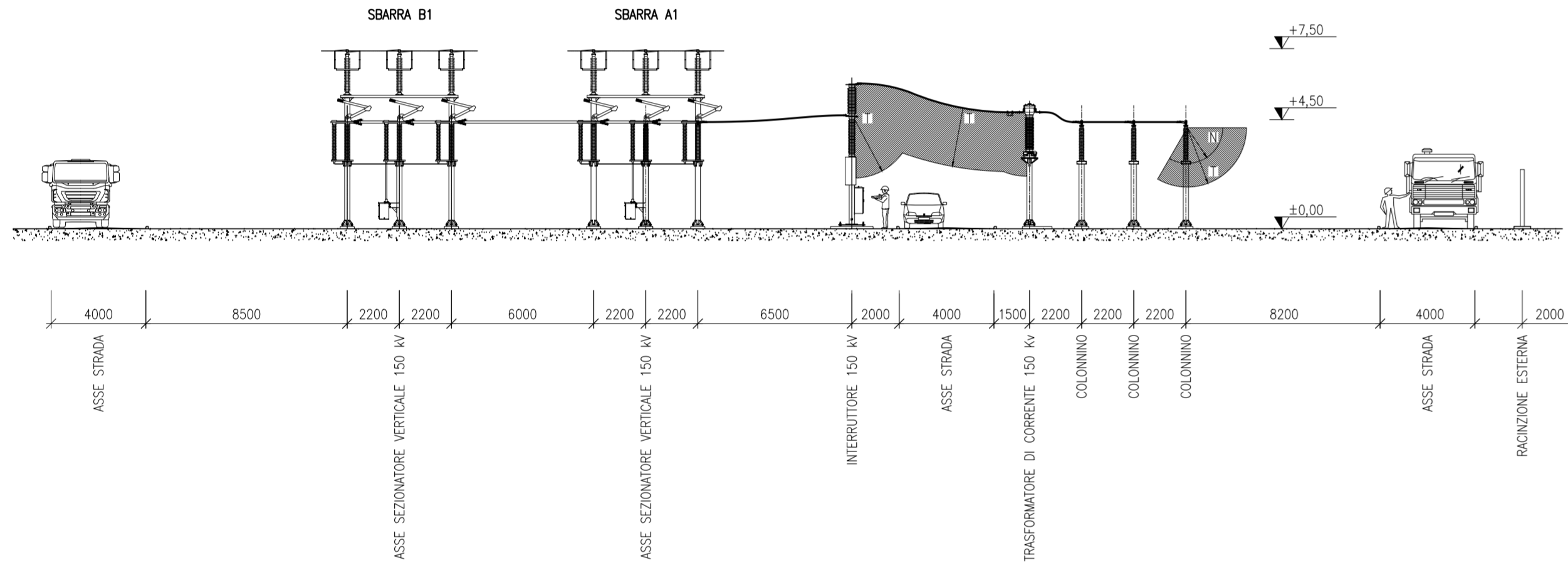

SEZIONE PARALLELO SBARRE 150 kV

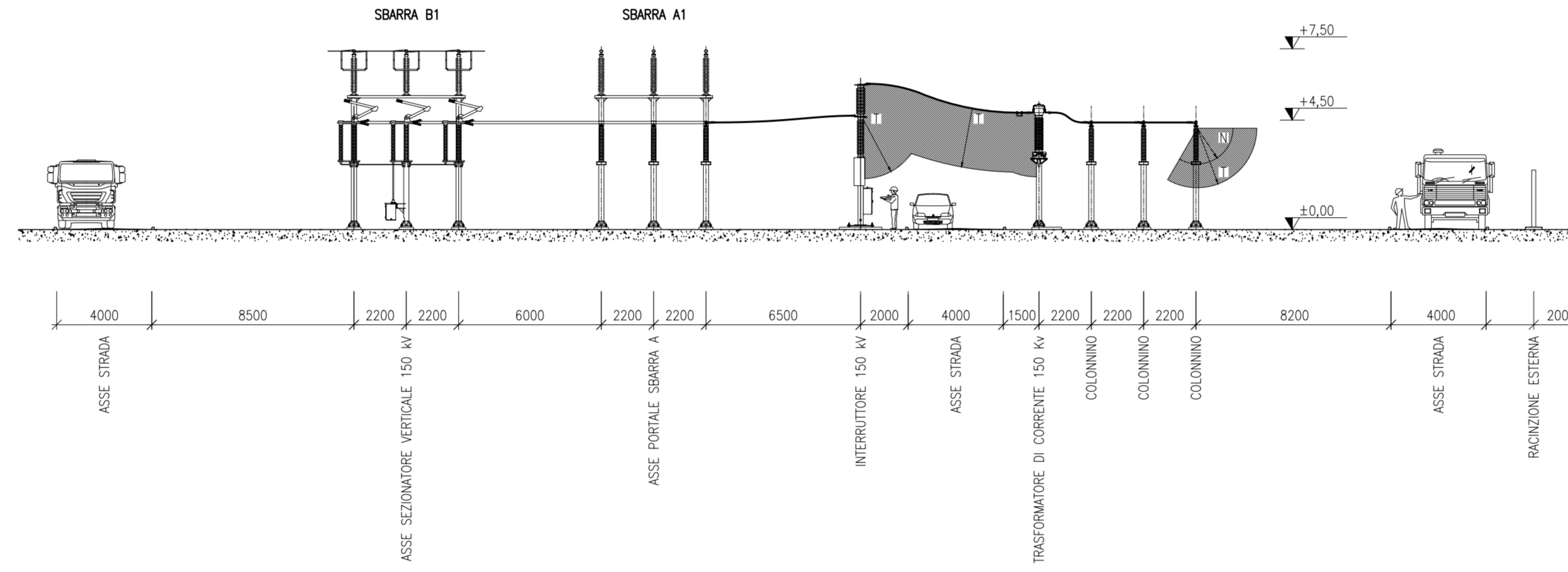

PIANTA CONGIUNTURE SBARRE

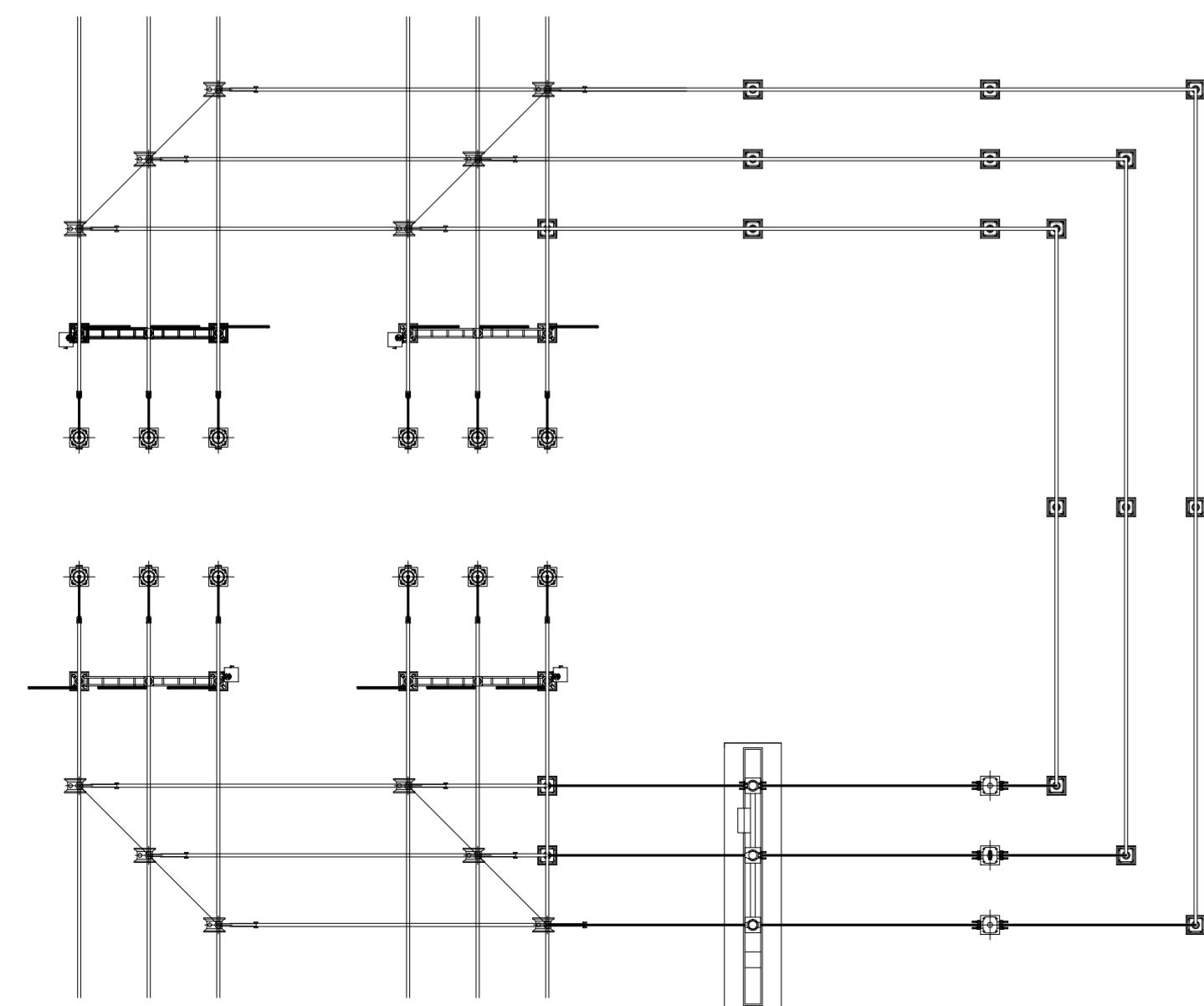

PIANTA PARALLELO SBARRE 150 kV

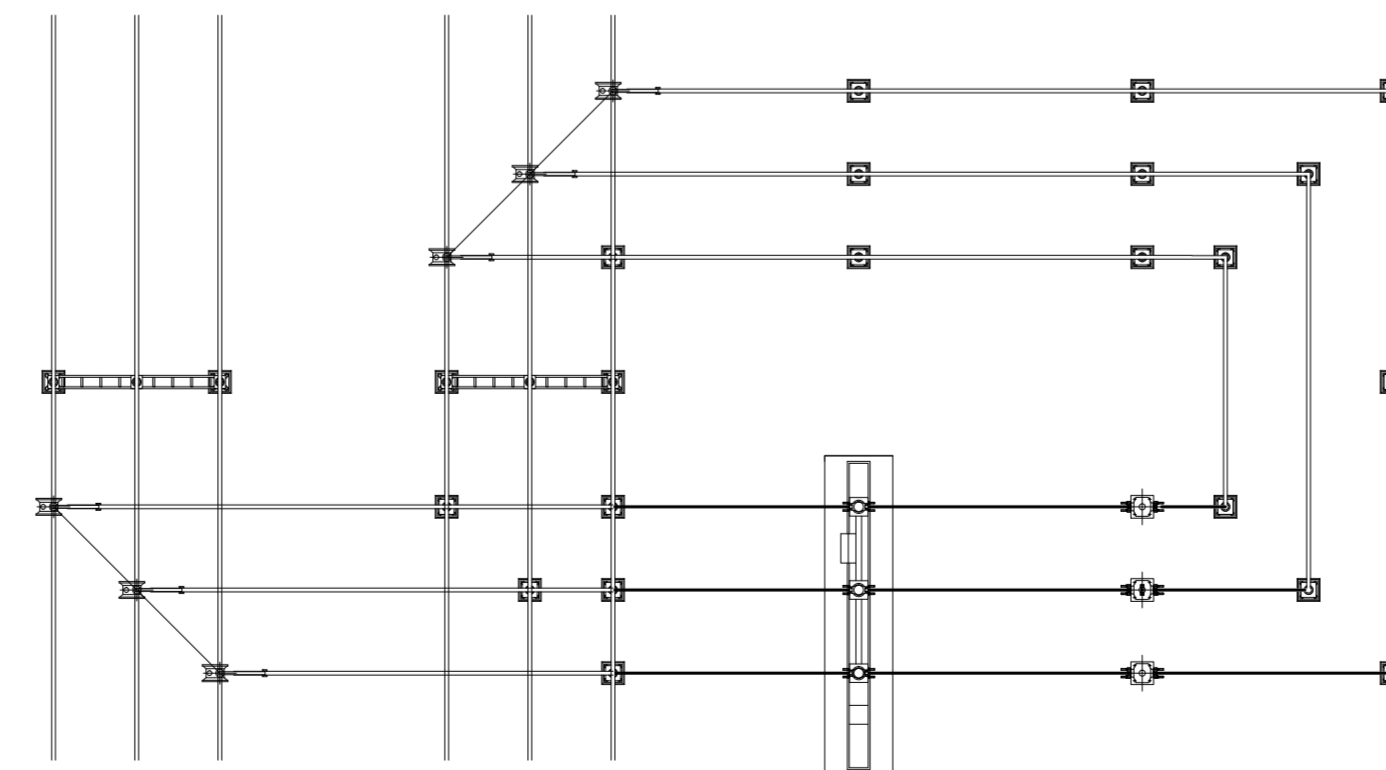

TIP 150 kV

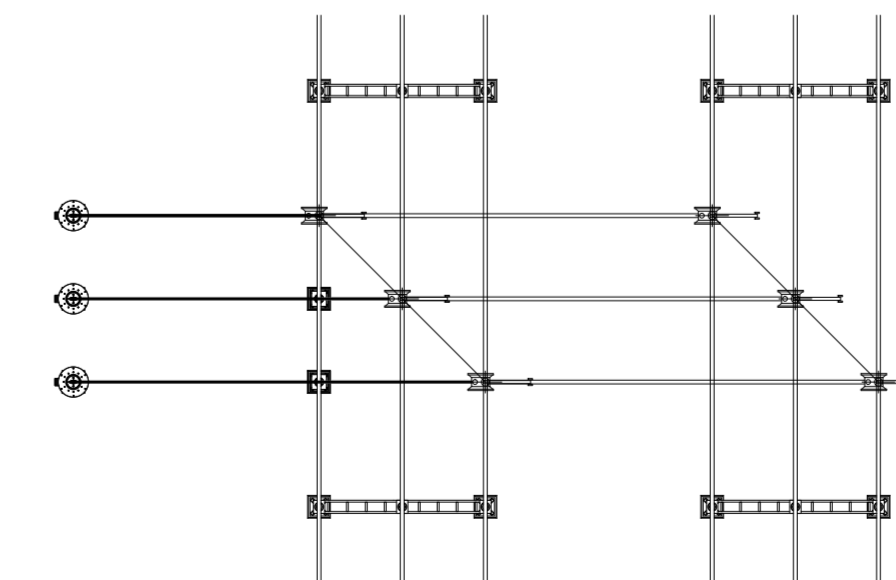

Luca Baccin



| | | | | | |
|---|------------|------------|--------------|-----------|---|
|  | | | | | |
| B | 18.10.2023 | 112 | 013 | 093 | Revisione come da commenti Tema 11.9.2023 |
| A | 21.4.2023 | 100 | 013 | 093 | Emissione per autorizzazione |
| REVISIONE | DATA | ELABORATO | VERIFICATO | APPROVATO | DESCRIZIONE |
| COMMITENTE: GRUPPO ISCONTI <small>JOIN THE REVOLUTION</small> | | | | | SE 380/150/36 kV CASTELLUCCIO DEI SAURI |
| INGEGNERIA & COSTRUZIONI BRULLI Trasmissione | | | | | TITOLO: SEZIONI REPARTO AT |
| SCALA | FORMATO | FOLIO / DI | N. DOCUMENTO | | |
| 1:200 | A1 | 3 / 5 | 7 0 4 5 3 B | | |

SEZIONE SBARRA 380 KV

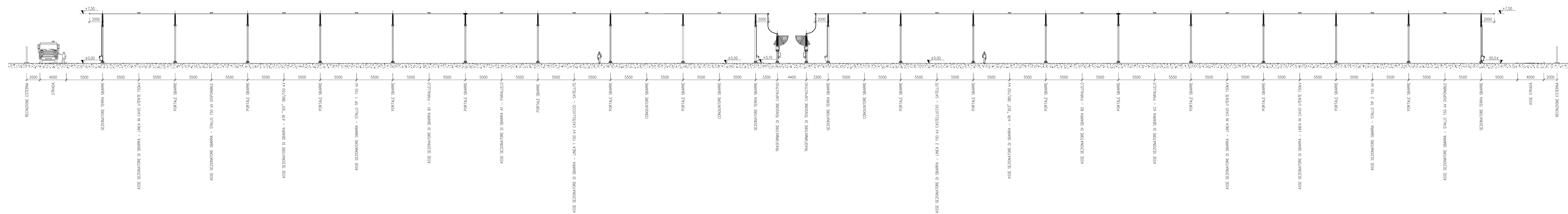

SEZIONE SBARRA 150 KV



| | | | |
|---|-----------------|---|---------------|
|  | | SE 380/150/36 KV CASTELLUCCIO DEI SAURI | |
|  | | SEZIONI REPARTO AT | |
| DATA: 21/4/2021 | VERIFICATO: 012 | APPROVATO: 002 | SECCIONAZIONE |
| 1/200 | A0+ | 4/5 | 7 0 4 5 3 B |

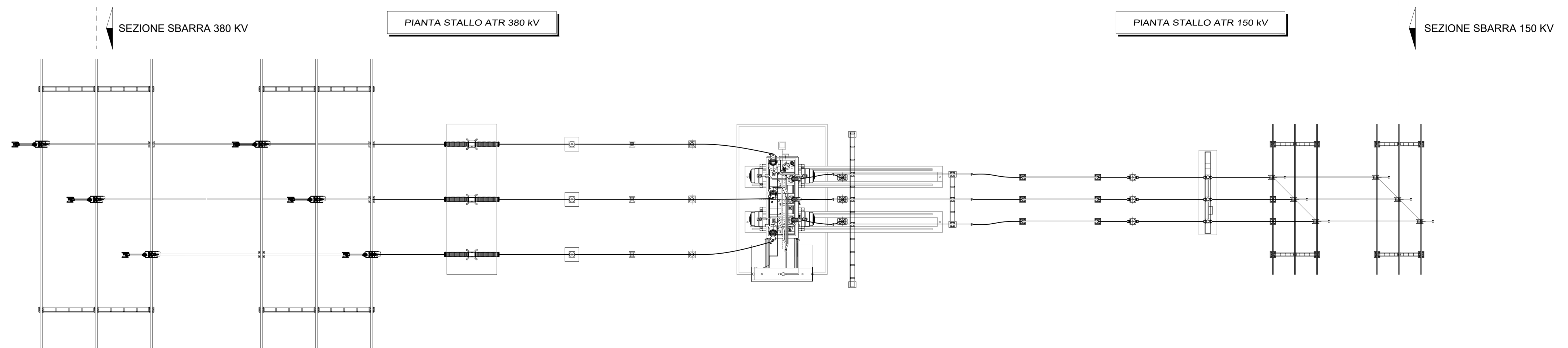
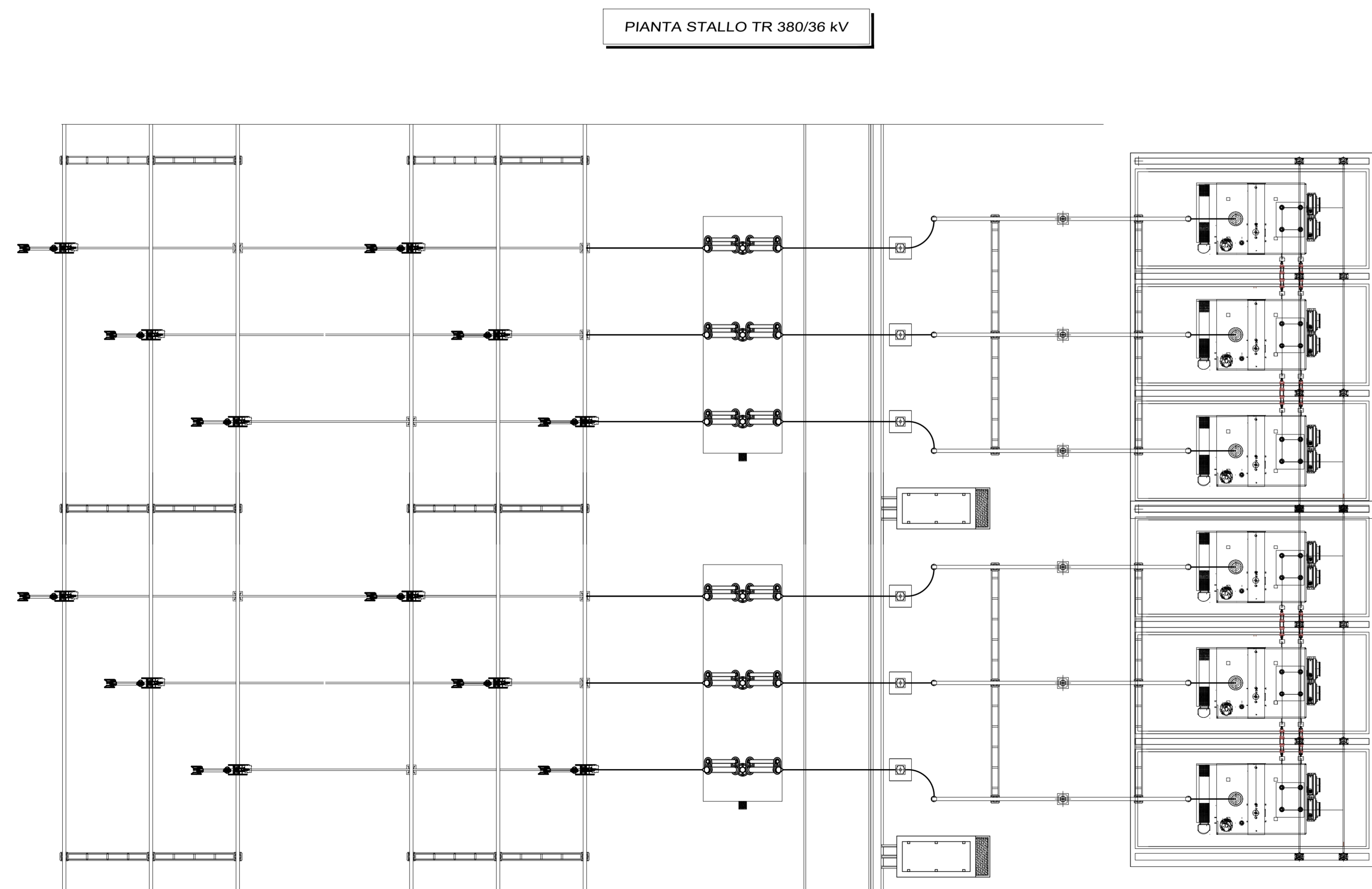
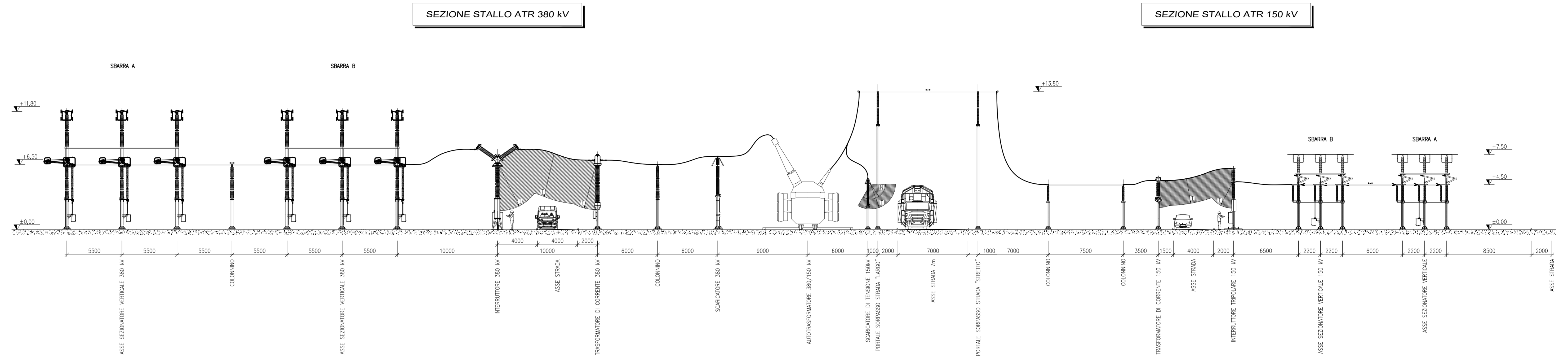
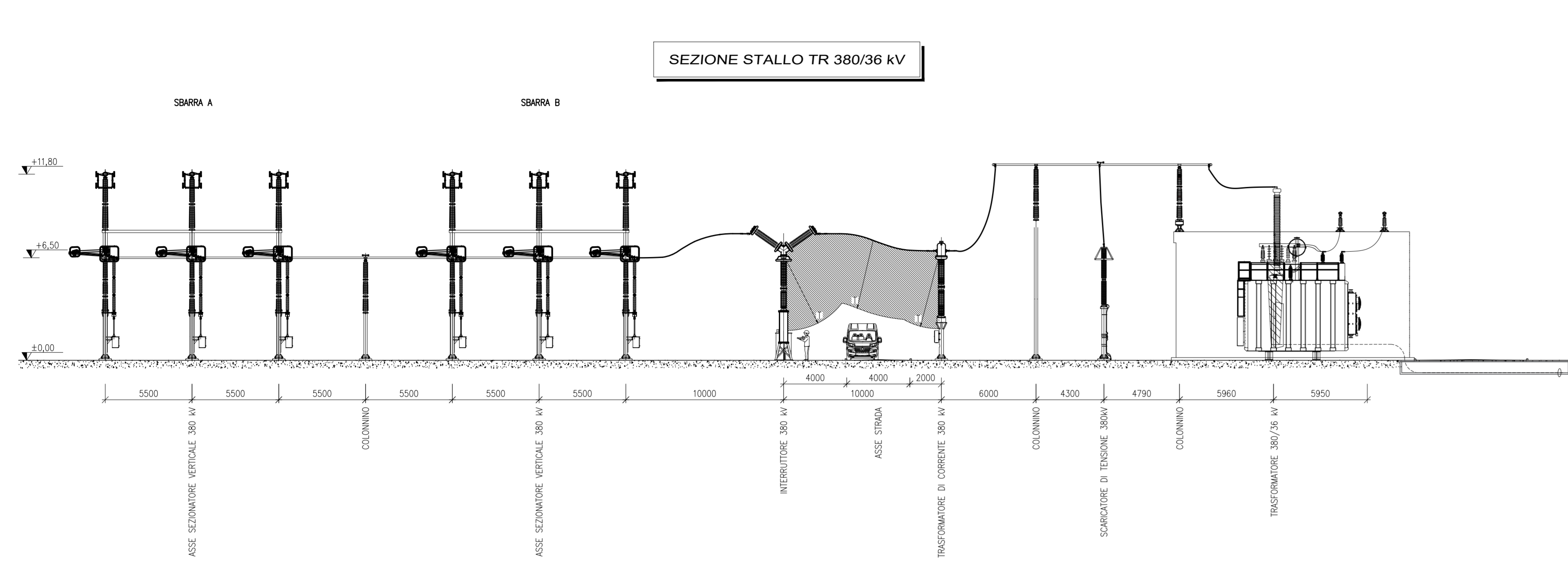

| | | | | | |
|---|------------|-----------|--------------|-----------|--|
|  | | | | | |
| B | 18.10.2023 | 112 | 093 | 093 | Revisione come da commenti Terzo 11.9.2023 |
| A | 21.4.2023 | 100 | 013 | 093 | Emissione per autorizzazione |
| REVISIONE | DATA | ELABORATO | VERIFICATO | APPROVATO | DESCRIZIONE |
| COMMITTEE | | | | | REPARTO |
|  | | | | | SE 380/150/36 kV CASTELLUCCIO DEI SAURI |
|  | | | | | SEZIONI REPARTO AT |
| SCALA | FORMATO | FUSO / DI | N. DOCUMENTO | | |
| 1:200 | A1+++ | 5 / 5 | 7 0 4 5 3 B | | |

