

SEZIONE SU VIADOTTO
(SCALE 1 : 20)

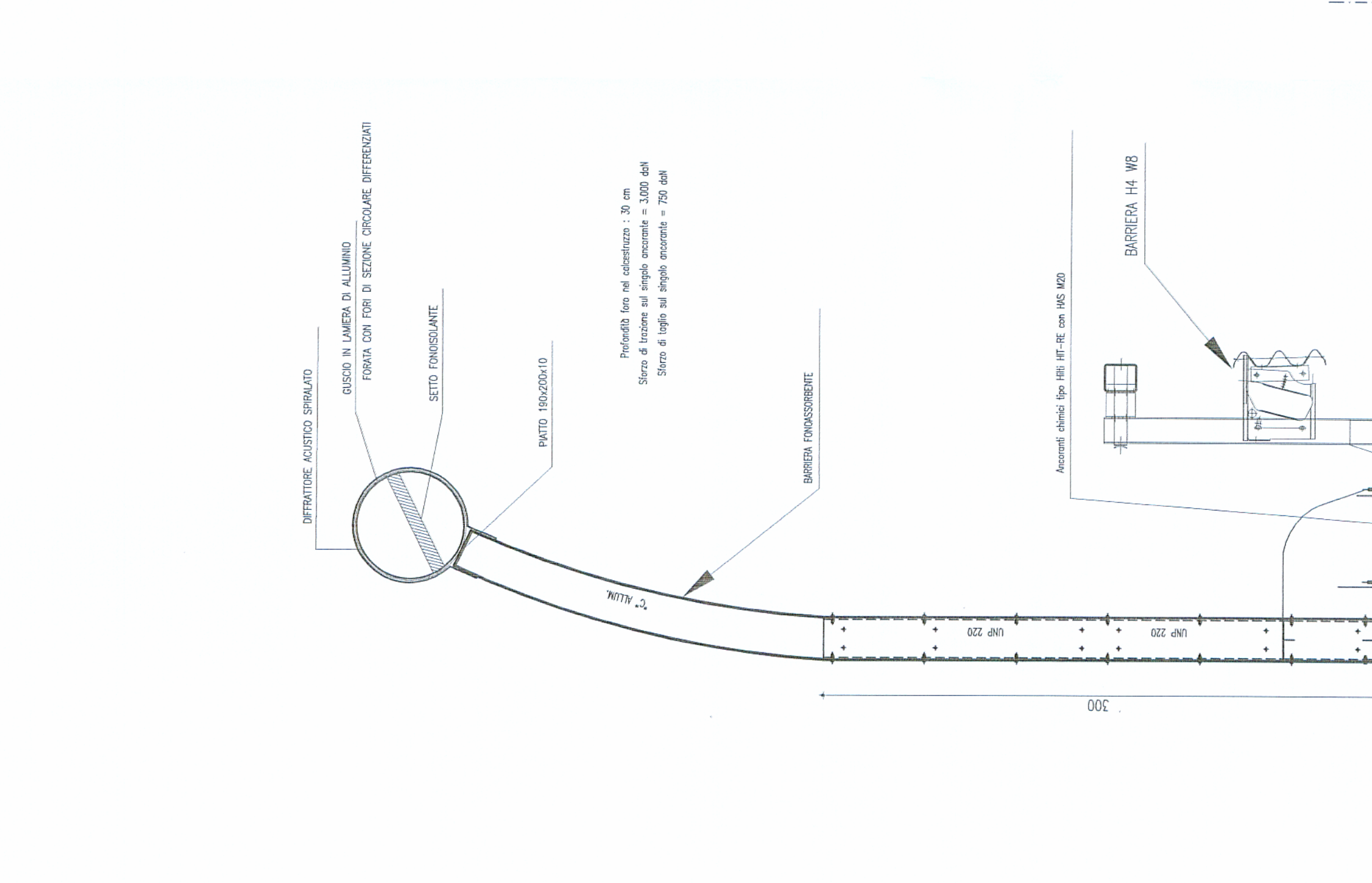

SEZIONE IN RILEVATO
(SCALE 1 : 20)

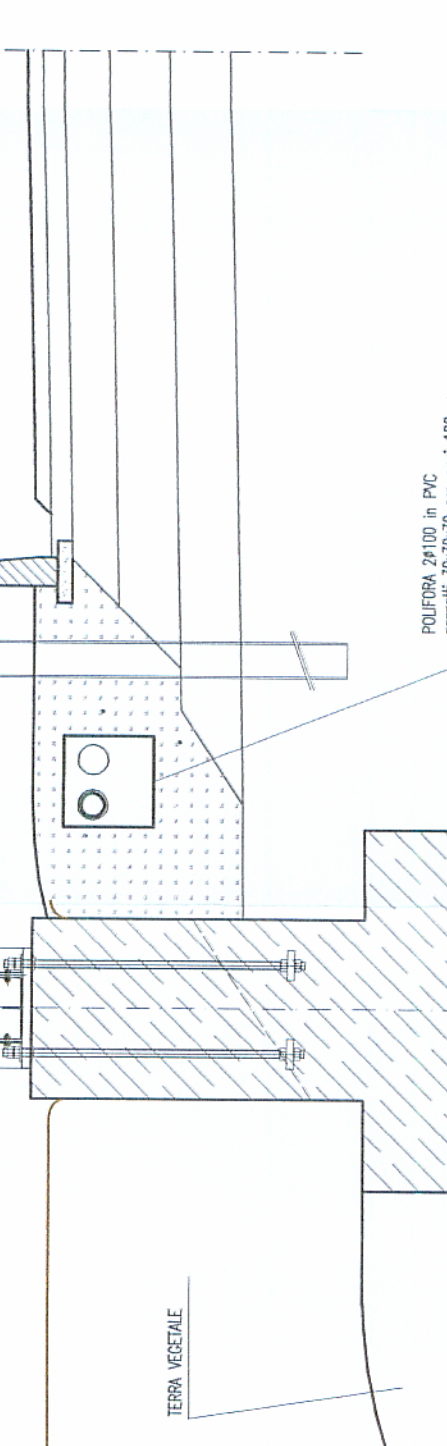
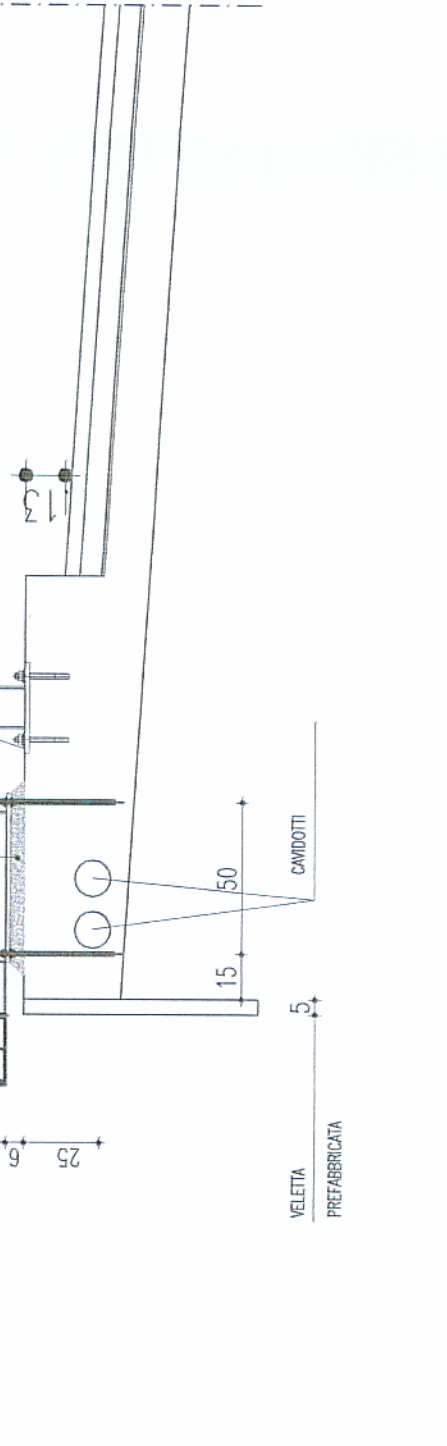
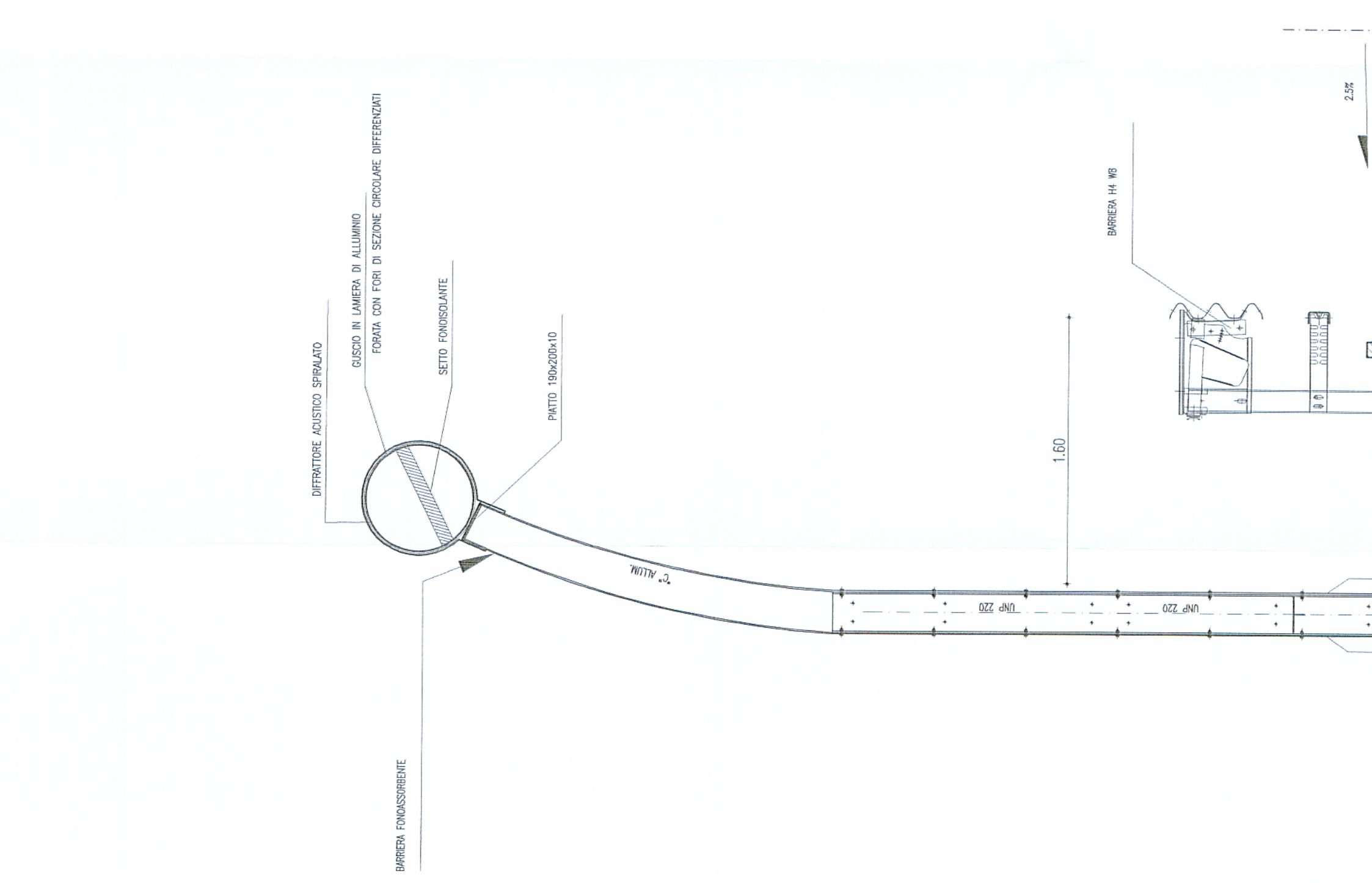

SEZIONE SU VIADOTTO
(SCALE 1 : 20)

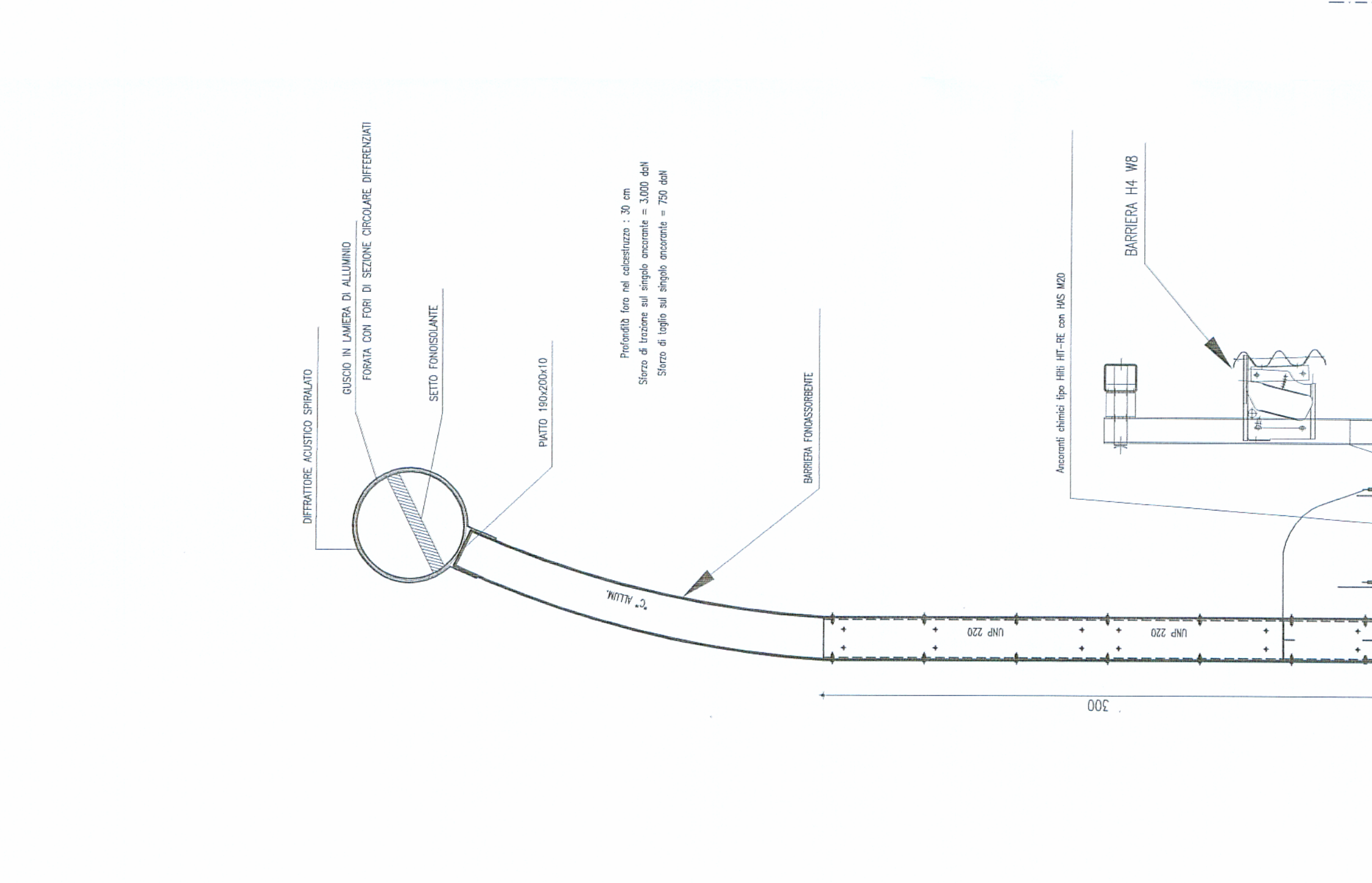

SEZIONE IN RILEVATO
(SCALE 1 : 20)

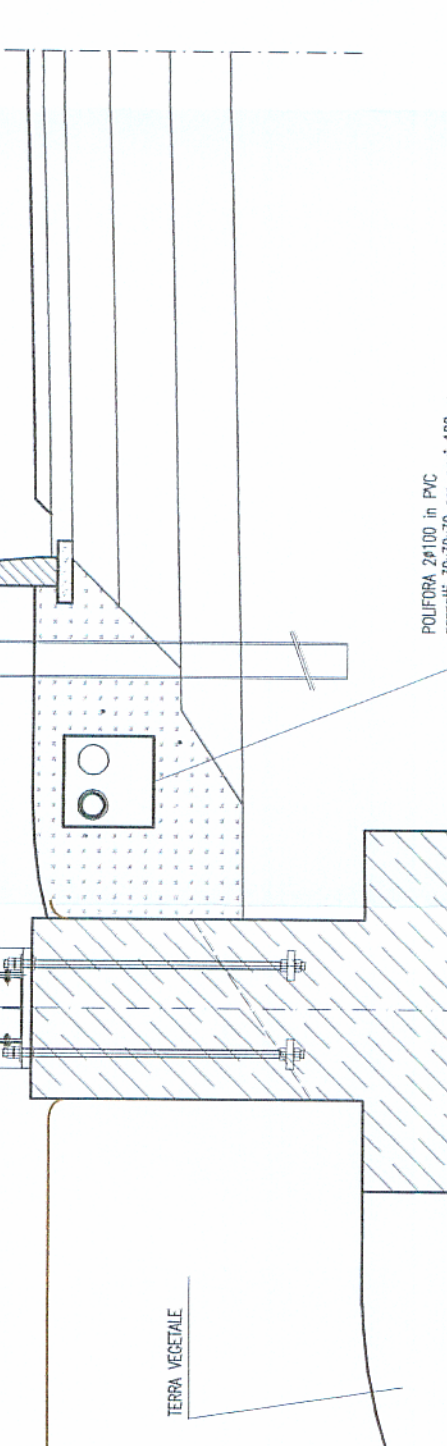
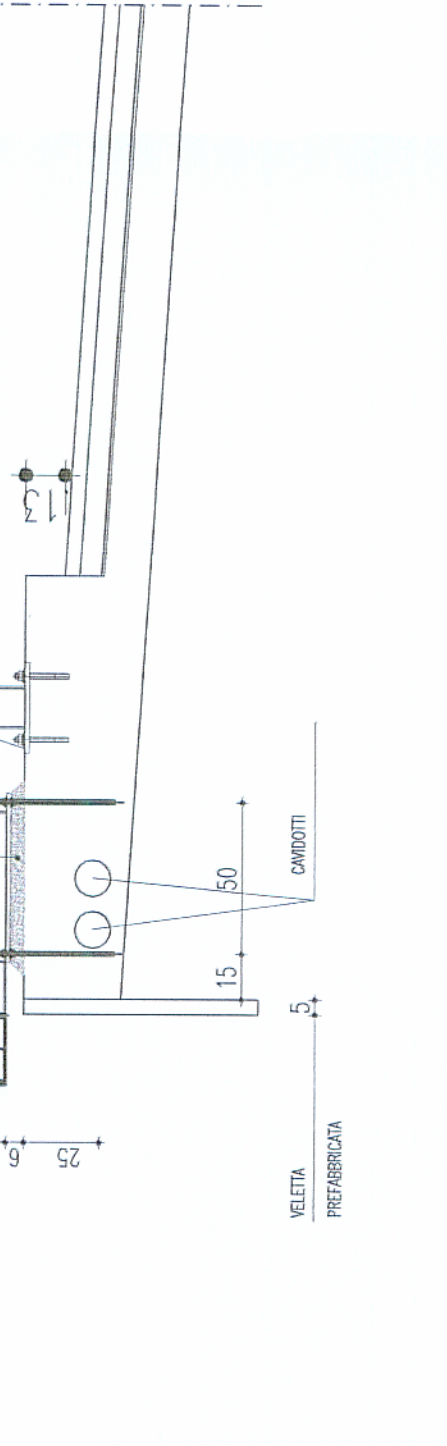
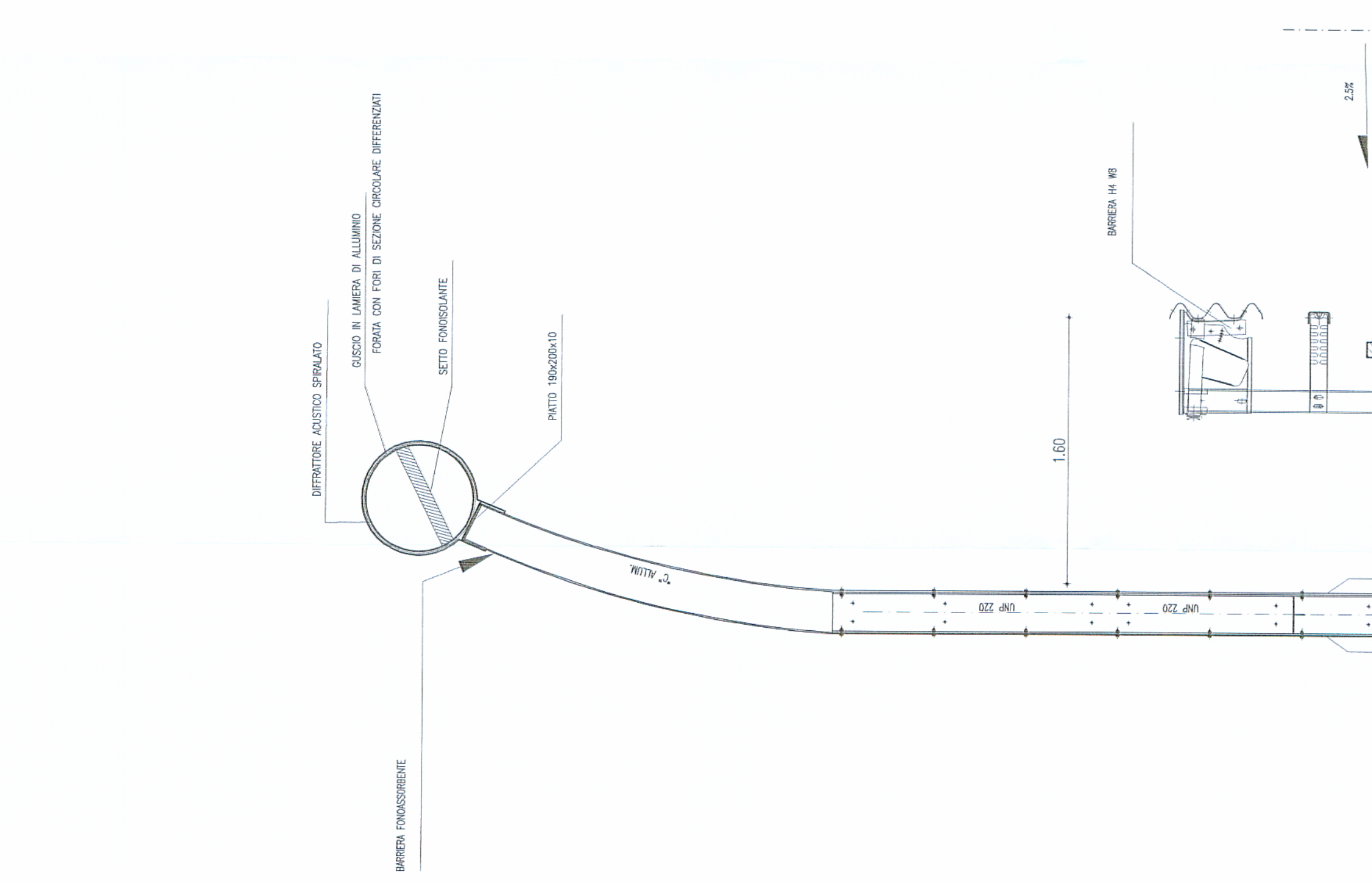

SEZIONE PROSPETTO
(SCALE 1 : 20)

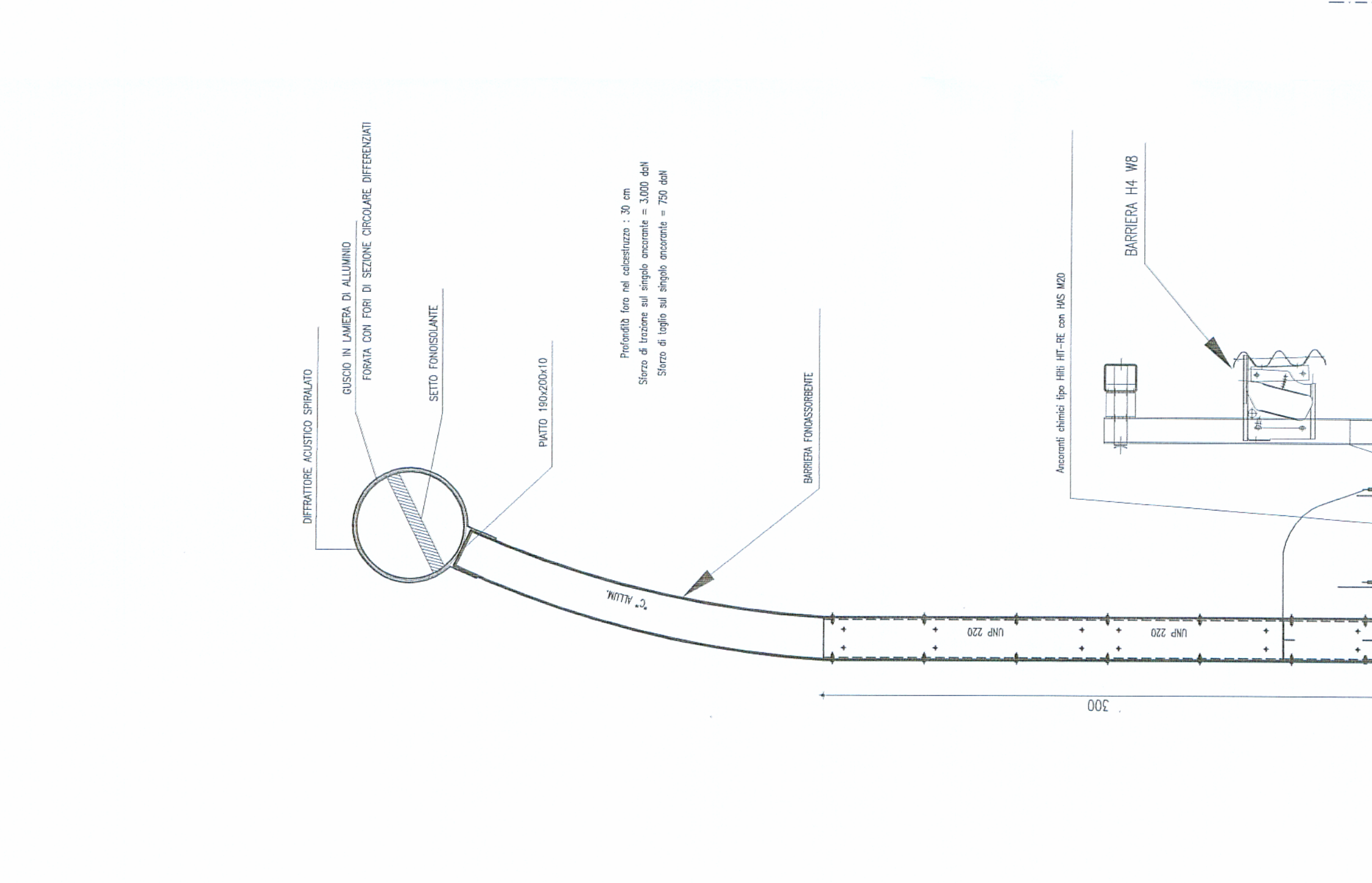

PROSPETTO
(SCALE 1 : 20)

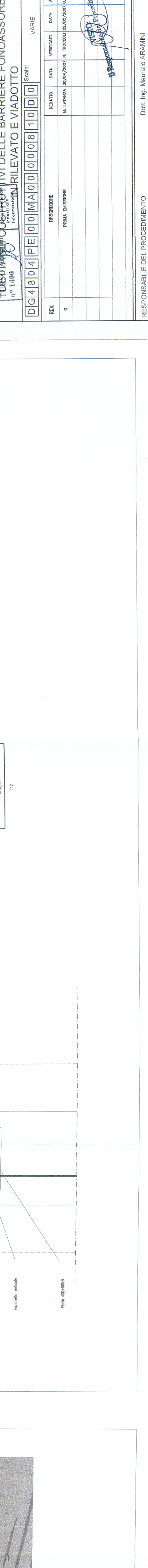
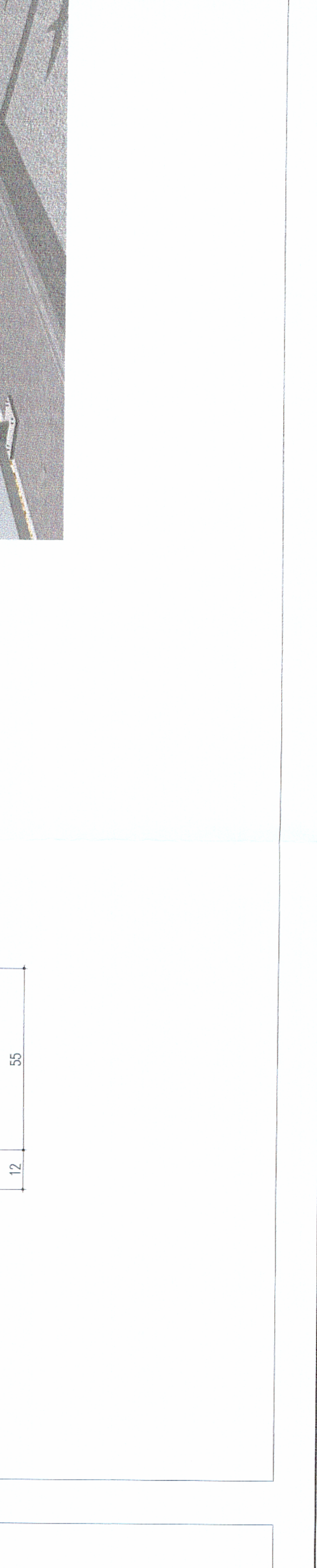
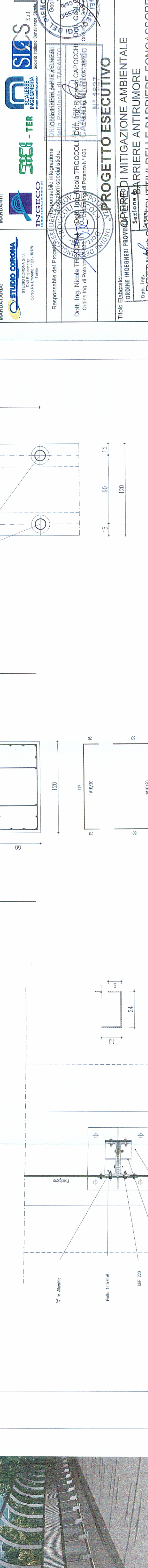
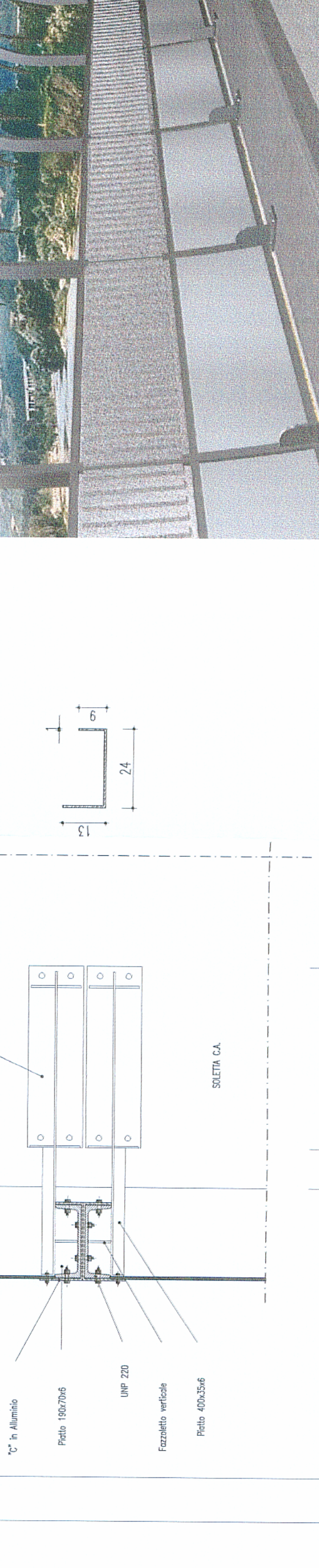
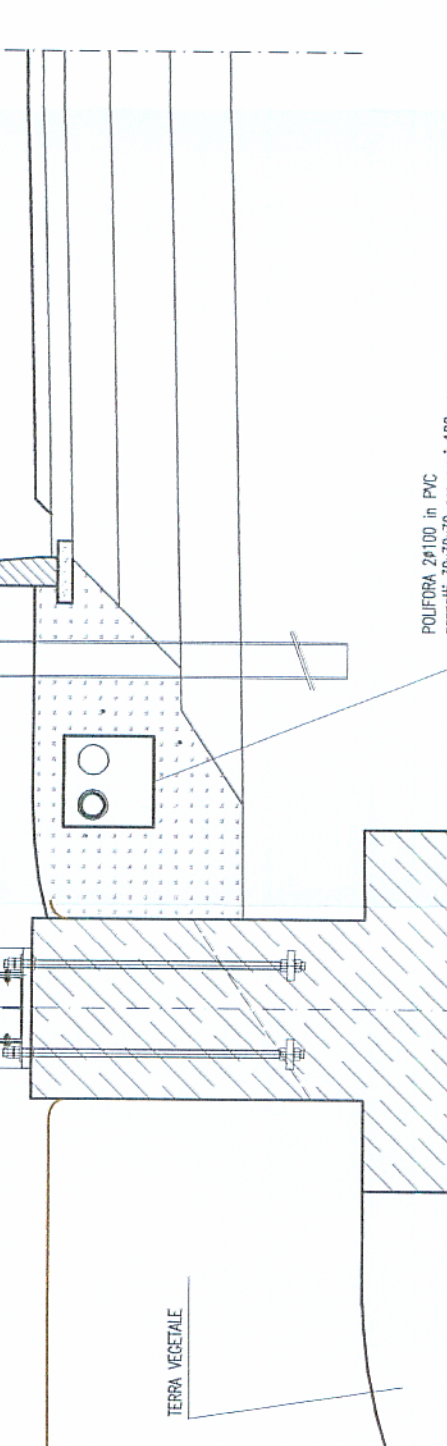
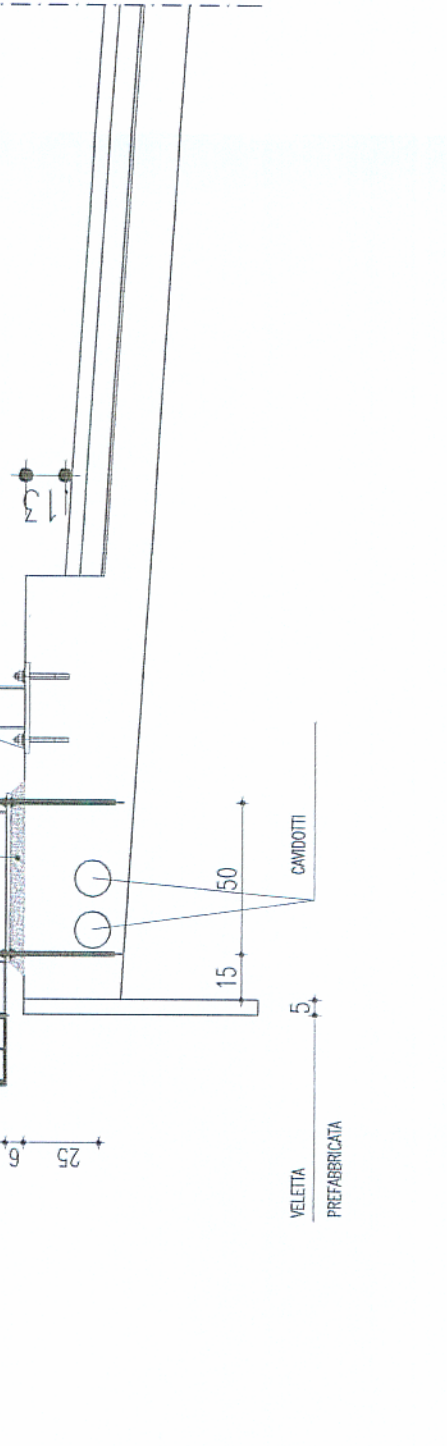
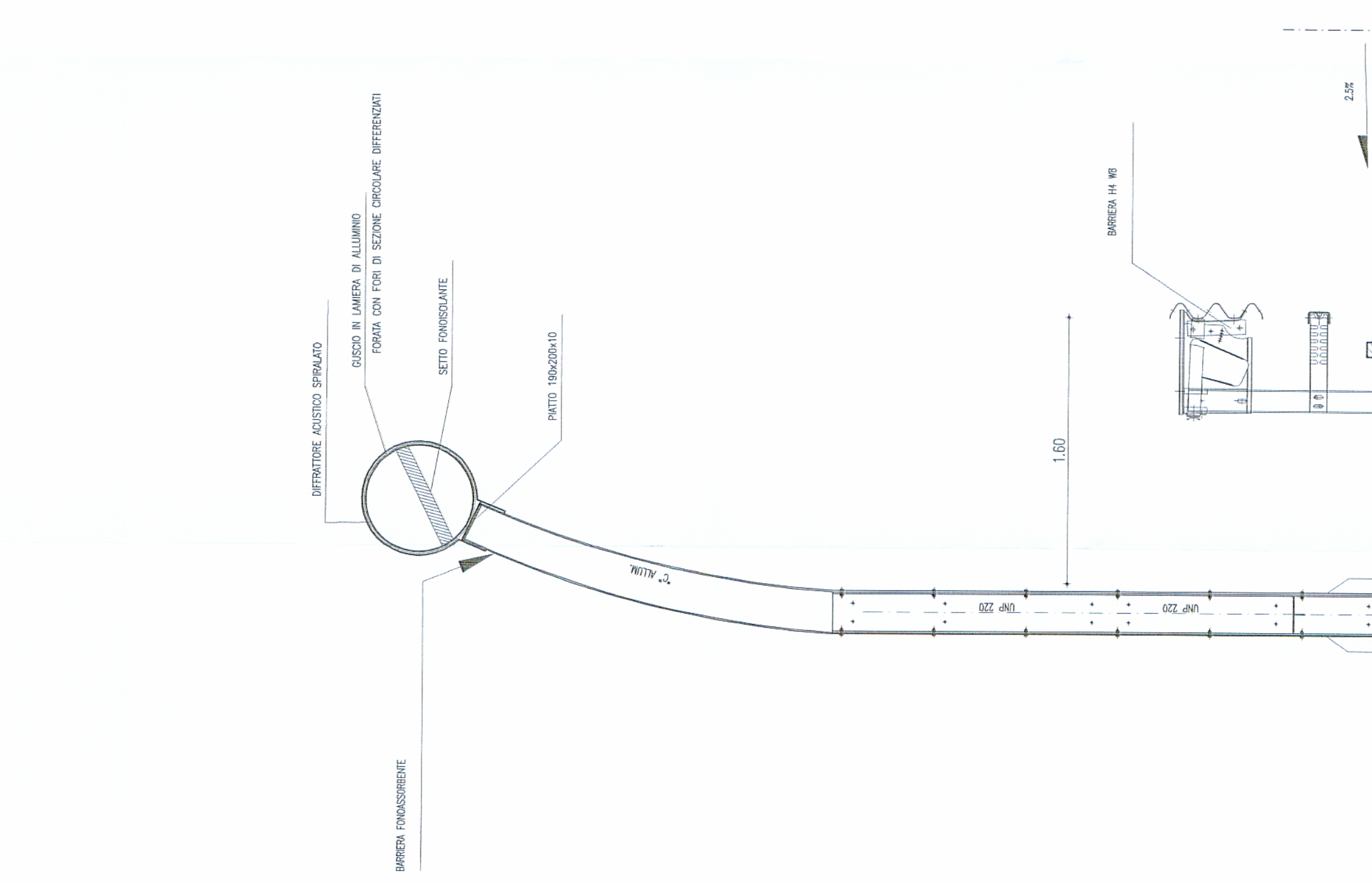

MACROLOTTO N°2
AUTOSTRADA SALERNO-REGGIO CALABRIA
LAVORI DI AMMODERNAMENTO ED ADEGUAMENTO AL TIPO 1/A DELLE NORIE C.N.R. RM DEL
TRATTO DAL KM. 108+400 AL KM. 139+000 COMPOSTO DA SEGUENTI LOTTI UNIFICATI:
1-2-3-4-5
CODICE UNICO PROGETTO: F11 B0400210000

CONTRAENTE GENERALE:
S&S S.p.A.
Via S. S. 20/A
10148 Torino

CONSORCIO STABILE TRA LE IMPRESE:
S&S S.p.A.
S&S S.p.A.
S&S S.p.A.

MANDATARI:
S&S S.p.A.
S&S S.p.A.
S&S S.p.A.

PROGETTO ESECUTIVO
Dati: Ing. Nicola...
Dati: Ing. Nicola...

PROGETTO ESECUTIVO
Dati: Ing. Nicola...
Dati: Ing. Nicola...

PROGETTO ESECUTIVO
Dati: Ing. Nicola...
Dati: Ing. Nicola...

REVISIONE	DATA	VERBALE	DATA	PROSPETTO	PIANTA
0					

RESPONSABILE DEL PROCEDIMENTO: **Dott. Ing. Massimo FERRARI**