

CONCEDENTE

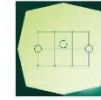

CONCESSIONARIA



SOCIETÀ DI PROGETTO
BREBEMI SPA

CUP E3 1 B05000390007

COLLEGAMENTO AUTOSTRADALE
DI CONNESSIONE TRA LE CITTA' DI
BRESCIA E MILANO

PROCEDURA AUTORIZZATIVA D. LGS 163/2006
DELIBERA G.I.P.E. DI APPROVAZIONE DEL PROGETTO DEFINITIVO N° 42/2009

INTERCONNESSIONE A35-A4
PROGETTO DEFINITIVO

INTERCONNESSIONE A35-A4

11 - INTERCONNESSIONE A35-A4

00000 - GENERALE

TIPOLOGICO B - TOMBINI IDRAULICI PREFABBRICATI

RELAZIONE DI CALCOLO

PROGETTAZIONE:



CONSORZIO B.B.M.

VERIFICA:

PER IL CONSORZIO
IL PROGETTISTA RESPONSABILE INTEGRAZIONE
PRESTAZIONI SPECIALISTICHE
IMPRESA PIZZAROTTI E C. S. P.A.
DOTT. ING. PIETRO MAZZOLI
ORDINE DEGLI INGEGNERI DI PARMA N. 821

PER IL CONSORZIO
IL DIRETTORE TECNICO
IMPRESA PIZZAROTTI E C. S. P.A.
DOTT. ING. SABINO DEL BALZO
ORDINE DEGLI INGEGNERI DI POTENZA N. 631

APPROVATO SDP

I.D.	IDENTIFICAZIONE ELABORATO											PROGR.		DATA:
	EMIT.	TIPO	FASE	M.A.	LOTTO	OPERA	PROG. OPERA	TRATTO	PARTI	PROGR.	PARTI. DOC.	STATO	REV.	MARZO 2015
60235	04	RC	D	I	11	00	000	00	00	003	00	A	00	SCALA:

ELABORAZIONE PROGETTUALE

IL PROGETTISTA
IMPRESA PIZZAROTTI E C. S. P.A.
DOTT. ING. PIETRO MAZZOLI
ORDINE DEGLI INGEGNERI DI PARMA N. 821

REVISIONE

N.	REV.	DESCRIZIONE	DATA	REDATTO	DATA	CONTROLLATO	DATA	APPROVATO
A	00	EMISSIONE	04/03/15	PIACENTINI	04/03/15	MAZZOLI	04/03/15	MAZZOLI

IL CONCEDENTE



IL CONCESSIONARIO



SOCIETÀ DI PROGETTO
BREBEMI SPA

Società di Progetto
Brebemi SpA

IL PRESENTE DOCUMENTO NON POTRA' ESSERE COPIATO, RIPRODOTTO O ALTRIMENTI PUBBLICATO, IN TUTTO O IN PARTE, SENZA IL CONSENSO SCRITTO DELLA SdP BREBEMI S.P.A. OGNI UTILIZZO NON AUTORIZZATO SARA' PERSEGUITO A NORMA DI LEGGE. THIS DOCUMENT MAY NOT BE COPIED, REPRODUCED OR PUBLISHED, EITHER IN PART OR IN ITS ENTIRETY, WITHOUT THE WRITTEN PERMISSION OF SdP BREBEMI S.P.A. UNAUTHORIZED USE WILL BE PROSECUTED BY LAW

INDICE

1	PREMESSA	4
2	NORMATIVA DI RIFERIMENTO	5
3	CRITERI DI CALCOLO.....	6
3.1	CRITERI E DEFINIZIONE DELL'AZIONE SISMICA	6
3.2	COMBINAZIONI DI CARICO.....	8
3.2.1	<i>Combinazioni per la verifica allo SLU</i>	<i>8</i>
3.2.2	<i>Combinazioni per la verifica allo SLE.....</i>	<i>9</i>
3.2.3	<i>Combinazioni per la condizione sismica.....</i>	<i>9</i>
4	CARATTERISTICHE DEI MATERIALI.....	11
4.1	CALCESTRUZZO PER MAGRONE	11
4.2	CALCESTRUZZO.....	11
4.3	ACCIAIO PER CEMENTO ARMATO	11
4.4	DURABILITÀ E PRESCRIZIONI SUI MATERIALI	12
4.5	COPRIFERRO MINIMO E COPRIFERRO NOMINALE.....	13
5	PARAMETRI GEOTECNICI PER IL CALCOLO DELLE STRUTTURE	14
6	SCHEMA STATICO E ANALISI DEI CARICHI.....	15
6.1	PROGRAMMI DI CALCOLO UTILIZZATO.....	15
6.2	MODELLAZIONE ADOTTATA.....	15
7	CONDIZIONI DI CARICO ELEMENTARI	17
	PESO PROPRIO E CARICHI PERMANENTI PORTATI.....	17
7.1	SPINTE DEL TERRENO	17
7.2	CARICHI DA TRAFFICO VEICOLARE SULLA SOLETTA SUPERIORE	18
7.3	SPINTA DEL SOVRACCARICO SUL RILEVATO.....	19
7.4	FRENATURA	21
7.5	AZIONI TERMICHE	22
7.6	RITIRO	22
7.7	AZIONE SISMICA	23
7.8	RIASSUNTO CONDIZIONI DI CARICO E COMBINAZIONI DI CARICO.....	23
7.9	SCHEMI DI CARICO.....	32
8	VERIFICA STATICHE	41
8.1	RIASSUNTO CONDIZIONI DI CARICO E VALORI DI CALCOLO	44
8.2	MASSIME SOLLECITAZIONI	47

APPROVATO S.P.

Società di Progetto
Brebemi SpA

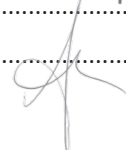

8.3	VERIFICHE DI RESISTENZA E FESSURAZIONE	51
8.3.1	<i>Soletta superiore – sezione di incastro</i>	51
8.3.2	<i>Soletta superiore – sezione di mezzeria</i>	57
8.3.3	<i>Soletta inferiore – sezione di incastro</i>	61
8.3.4	<i>Soletta inferiore – sezione di mezzeria</i>	67
8.3.5	<i>Piedritti – sezione di incastro inferiore</i>	71
8.3.6	<i>Piedritti – sezione di incastro superiore</i>	77
8.3.7	<i>Piedritti – sezione di mezzeria</i>	82
8.4	ARMATURA DI RIPARTIZIONE DELLO SCATOLARE	87
8.5	VERIFICA ARMATURA LONGITUDINALE A RITIRO	87
9	VERIFICHE GEOTECNICHE	90
9.1	VERIFICHE GEOTECNICHE TOMBINO	90
10	ALLEGATI.....	92
10.1	TABULATI DI INPUT	92
10.2	TABULATI DI OUTPUT	216

APPROVATO SDP

Società di Progetto
Brebemi SpA



	Doc. N. 60235-00000-A00.doc	CODIFICA DOCUMENTO 04RCDII100000000000300A00	REV. 00	FOGLIO 4 di 628
--	--------------------------------	---	------------	--------------------

1 PREMESSA

La presente relazione tipologica riguarda i tombini scatolari prefabbricati di dimensione 1.50x1.50, previsti per la risoluzione delle interferenze idrauliche nell'ambito del Progetto Definitivo dell'interconnessione A35-A4.

La struttura è costituita da uno scatolare prefabbricato di larghezza 1.5 m ed altezza utile pari a 1.50 m, realizzato in conci della lunghezza di 2 metri giuntati tra di loro. I giunti strutturali sono del tipo maschio-femmina e lavorano come chiave di taglio. Sui giunti strutturali tra un concio e il successivo è sempre previsto l'inserimento di una guarnizione butilica (sul giunto lato femmina). Sia i piedritti che le solette dello scatolare hanno spessore 16 cm.. la soletta inferiore presenta uno sbalzo di lunghezza pari a 20cm mentre la soletta superiore culmina longitudinalmente con un cordolo, da entrambi gli imbocchi, di spessore 25cm ed altezza 30cm. Il manufatto appoggia su uno strato di calcestruzzo magro di spessore 20 cm.

APPROVATO SDP

Società di Progetto
Brebemi SpA



	Doc. N. 60235-00000-A00.doc	CODIFICA DOCUMENTO 04RCDII100000000000300A00	REV. 00	FOGLIO 5 di 628
--	--------------------------------	---	------------	--------------------

2 NORMATIVA DI RIFERIMENTO

I calcoli e le disposizioni esecutive sono conformi alle norme attualmente in vigore.

- D. M. Min. II. TT. del 14 gennaio 2008 – Norme tecniche per le costruzioni
- CIRCOLARE 2 febbraio 2009, n.617 “Istruzione per l’applicazione delle «Nuove norme tecniche per le costruzioni» di cui al decreto ministeriale 14 gennaio 2008
- UNI EN 1991-1-5:2004 Parte 1-5: Azioni sulle strutture - Azioni in generale - Azioni termiche
- UNI EN 1991-2:2005 Parte 2: Azioni sulle strutture - Carichi da traffico sui ponti
- UNI EN 1992-1-1:2005 Parte 1-1: Progettazione delle strutture in calcestruzzo - Regole generali e regole per gli edifici
- UNI EN 1992-2:2006 Parte 2: Progettazione delle strutture in calcestruzzo- Ponti di calcestruzzo, Progettazione e dettagli costruttivi
- UNI EN 1997-1:2005 Parte 1: Progettazione geotecnica - Regole generali
- UNI EN 1998-1:2005 Parte 1: Progettazione delle strutture per la resistenza sismica - Regole generali, azioni sismiche e regole per gli edifici
- UNI EN 1998-2:2009 Parte 2: Progettazione delle strutture per la resistenza sismica - Ponti
- UNI EN 1998-5:2005 Parte 5: Progettazione delle strutture per la resistenza sismica - Fondazioni, strutture di contenimento ed aspetti geotecnici
- UNI EN 197-1 giugno 2001 – “Cemento: composizione, specificazioni e criteri di conformità per cementi comuni
- UNI EN 11104 marzo 2004 – “Calcestruzzo: specificazione, prestazione, produzione e conformità”, Istruzioni complementari per l’applicazione delle EN 206-1
- UNI EN 206-1 ottobre 2006 – “Calcestruzzo: specificazione, prestazione, produzione e conformità”
- Linee guida sul calcestruzzo strutturale - Presidenza del Consiglio Superiore dei Lavori Pubblici - Servizio Tecnico Centrale

Società di Progetto
Brebemi SpA



	Doc. N. 60235-00000-A00.doc	CODIFICA DOCUMENTO 04RCDII100000000000300A00	REV. 00	FOGLIO 6 di 628
--	--------------------------------	---	------------	--------------------

3 CRITERI DI CALCOLO

In ottemperanza al D.M. del 14.01.2008 (Norme tecniche per le costruzioni), i calcoli sono condotti con il metodo semiprobabilistico agli stati limite.

3.1 Criteri e definizione dell'azione sismica

L'effetto dell'azione sismica di progetto sull'opera nel suo complesso, includendo il volume significativo di terreno, la struttura di fondazione, gli elementi strutturali e non, nonché gli impianti, deve rispettare gli stati limite ultimi e di esercizio definiti al § 3.2.1, i cui requisiti di sicurezza sono indicati nel § 7.1 della norma.

Il rispetto degli stati limite si considera conseguito quando:

- nei confronti degli stati limite di esercizio siano rispettate le verifiche relative al solo Stato Limite di Danno;
- nei confronti degli stati limite ultimi siano rispettate le indicazioni progettuali e costruttive riportate nel § 7 e siano soddisfatte le verifiche relative al solo Stato Limite di salvaguardia della Vita.

Per Stato Limite di Danno (SLD) s'intende che l'opera, nel suo complesso, a seguito del terremoto, includendo gli elementi strutturali, quelli non strutturali, le apparecchiature rilevanti alla sua funzione, subisce danni tali da non provocare rischi agli utenti e non compromette significativamente la capacità di resistenza e di rigidezza nei confronti delle azioni verticali e orizzontali. Lo stato limite di esercizio comporta la verifica delle tensioni di lavoro, in conformità al § 4.1.2.2.5 (NT).

Per Stato Limite di salvaguardia della Vita (SLV) si intende che l'opera a seguito del terremoto subisce rotture e crolli dei componenti non strutturali e impiantistici e significativi danni di componenti strutturali, cui si associa una perdita significativa di rigidezza nei confronti delle azioni orizzontali (creazione di cerniere plastiche secondo il criterio della gerarchia delle resistenze), mantenendo ancora un margine di sicurezza (resistenza e rigidezza) nei confronti delle azioni verticali.

Gli stati limite, sia di esercizio sia ultimi, sono individuati riferendosi alle prestazioni che l'opera a realizzarsi deve assolvere durante un evento sismico; per la funzione che l'opera deve espletare nella sua vita utile, è significativo calcolare lo Stato Limite di Danno (SLD) per l'esercizio e lo Stato Limite di Salvaguardia della Vita (SLV) per lo stato limite ultimo.

In merito alle opere scatolari di cui trattasi, nel rispetto del punto § 7.9.2., assimilando l'opera scatolare alla categoria delle spalle da ponte, rientrando tra le opere che si muovono con il terreno (§ 7.9.2.1), si può ritenere che la struttura debba mantenere sotto l'azione sismica un comportamento elastico; queste categorie di opere che si muovono con il terreno ~~non subiscono le~~ amplificazioni dell'accelerazione del suolo.

A riguardo del calcolo allo SLV, dovendo la struttura mantenere durante l'evento sismico un comportamento elastico, vengono eseguite le verifiche alle tensioni di esercizio (§ 4.1.2.2.5),

Società di Progetto
Brebemi SpA

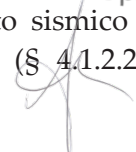

assumendo come limite delle tensioni di esercizio quelle adottate per la combinazione caratteristica (rara) (EC2 § 7.2). Tale combinazione, in accordo al punto § 7.10.6.1. (NTC) e alla Circ. 617 § 7.10.6.1. (nella quale si afferma che il sostanziale mantenimento in campo elastico della struttura nelle verifiche allo SLU, fornisce ampie garanzie rispetto alla sicurezza nei confronti dello SLD), consente di ritenere soddisfatte anche le verifiche nei confronti dello SLD.

Per la definizione dell'azione sismica, occorre definire il periodo di riferimento P_{VR} in funzione dello stato limite considerato.

La vita nominale (V_N) dell'opera è stata assunta pari a 50 anni.
La classe d'uso assunta è la IV.

Il periodo di riferimento (V_R) per l'azione sismica, data la vita nominale e la classe d'uso vale:
 $V_R = V_N \cdot C_u = 100$ anni

Coordinate geografiche	Latitudine [DEG sessadecimale] Longitudine [DEG sessadecimale]	N E	45.5437 10.1266	Descrizione suolo di fondazione	Depositi di terreni a grana grossa mediamente addensati o terreni a grana fina mediamente consistenti con spessori superiori a 30 m, caratterizzati da un graduale miglioramento delle proprietà meccaniche con la profondità e da valori di V_s , 30 compresi tra 180 m/s e 360 m/s (ovvero $15 < NSPT_{30} < 50$ nei terreni a grana grossa e $70 < cu_{30} < 250$ kPa nei terreni a grana fina).																																																																					
Suolo e topografia	Cat. suolo di fondazione (A,...E) Categoria topografica (T1,...T4) Coeff. di amplificazione topografica	C T1 S_T	1.0																																																																							
Varie	Vita nominale dell'opera (10, 50, 100)	V_N [anni]	50	<table border="1"> <thead> <tr> <th rowspan="2">DATI SPETTRALI</th> <th colspan="2">Stati limite d'esercizio</th> <th colspan="2">Stati limite ultimi</th> </tr> <tr> <th>SLO</th> <th>SLD</th> <th>SLV</th> <th>SLC</th> </tr> </thead> <tbody> <tr> <td>Probabilità di superamento</td> <td>P_{VR}</td> <td>81%</td> <td>63%</td> <td>10%</td> </tr> <tr> <td>Periodo di ritorno</td> <td>T_R [anni]</td> <td>60</td> <td>101</td> <td>949</td> </tr> <tr> <td>Accelerazione</td> <td>a_g [m/s^2]</td> <td>0.579</td> <td>0.747</td> <td>1.808</td> </tr> <tr> <td></td> <td>a_g/g</td> <td>0.059</td> <td>0.076</td> <td>0.184</td> </tr> <tr> <td>Fattore di amplificazione</td> <td>F_0</td> <td>2.419</td> <td>2.414</td> <td>2.454</td> </tr> <tr> <td>Periodo in. velocità costante</td> <td>T_C^* [s]</td> <td>0.239</td> <td>0.252</td> <td>0.289</td> </tr> <tr> <td>Coefficiente di sottosuolo</td> <td>C_C</td> <td>1.68</td> <td>1.65</td> <td>1.58</td> </tr> <tr> <td>Coeff. di amplif. stratigrafica</td> <td>S_S</td> <td>1.50</td> <td>1.50</td> <td>1.43</td> </tr> <tr> <td>Coefficiente di sito</td> <td>S</td> <td>1.50</td> <td>1.50</td> <td>1.43</td> </tr> <tr> <td>Periodi</td> <td>T_B [s]</td> <td>0.134</td> <td>0.139</td> <td>0.152</td> </tr> <tr> <td></td> <td>T_C [s]</td> <td>0.402</td> <td>0.417</td> <td>0.457</td> </tr> <tr> <td></td> <td>T_D [s]</td> <td>1.836</td> <td>1.905</td> <td>2.337</td> </tr> </tbody> </table>		DATI SPETTRALI	Stati limite d'esercizio		Stati limite ultimi		SLO	SLD	SLV	SLC	Probabilità di superamento	P_{VR}	81%	63%	10%	Periodo di ritorno	T_R [anni]	60	101	949	Accelerazione	a_g [m/s^2]	0.579	0.747	1.808		a_g/g	0.059	0.076	0.184	Fattore di amplificazione	F_0	2.419	2.414	2.454	Periodo in. velocità costante	T_C^* [s]	0.239	0.252	0.289	Coefficiente di sottosuolo	C_C	1.68	1.65	1.58	Coeff. di amplif. stratigrafica	S_S	1.50	1.50	1.43	Coefficiente di sito	S	1.50	1.50	1.43	Periodi	T_B [s]	0.134	0.139	0.152		T_C [s]	0.402	0.417	0.457		T_D [s]	1.836	1.905	2.337
	DATI SPETTRALI	Stati limite d'esercizio					Stati limite ultimi																																																																			
		SLO	SLD	SLV	SLC																																																																					
Probabilità di superamento	P_{VR}	81%	63%	10%																																																																						
Periodo di ritorno	T_R [anni]	60	101	949																																																																						
Accelerazione	a_g [m/s^2]	0.579	0.747	1.808																																																																						
	a_g/g	0.059	0.076	0.184																																																																						
Fattore di amplificazione	F_0	2.419	2.414	2.454																																																																						
Periodo in. velocità costante	T_C^* [s]	0.239	0.252	0.289																																																																						
Coefficiente di sottosuolo	C_C	1.68	1.65	1.58																																																																						
Coeff. di amplif. stratigrafica	S_S	1.50	1.50	1.43																																																																						
Coefficiente di sito	S	1.50	1.50	1.43																																																																						
Periodi	T_B [s]	0.134	0.139	0.152																																																																						
	T_C [s]	0.402	0.417	0.457																																																																						
	T_D [s]	1.836	1.905	2.337																																																																						
Struttura	Descrizione	Ponte integrale																																																																								
	Massimo fattore di struttura	q_0	1																																																																							
	Coefficiente riduttivo per regolarità	K_R	1																																																																							
	Fattore di struttura	q	1.0																																																																							
	Coeff. di smorz. viscoso equivalente	ξ	5%																																																																							
	Fattore di smorzamento viscoso	η	1.00																																																																							
Inverso fattore di struttura	$1/q$	1.00																																																																								

Il calcolo viene eseguito con il metodo pseudostatico (NT par. 7.11.6). In queste condizioni l'azione sismica è rappresentata da una forza statica equivalente pari al prodotto delle forze di gravità per un opportuno coefficiente sismico.

Nelle verifiche allo Stato Limite Ultimo i valori dei coefficienti sismici orizzontali k_h e verticale k_v possono essere valutati mediante le espressioni:

$$k_h = \beta_m \cdot \frac{a_{max}}{g} \quad k_v = \pm 0.5 \cdot k_h$$

dove

a_{max} = accelerazione orizzontale massima attesa al sito;

g = accelerazione di gravità;

L'accelerazione massima è valutata con la relazione

$$a_{max}(SLV) = S \cdot a_g = 1,43 \cdot 0,184g = 0,263 g$$

Essendo lo scatolare una struttura che non ammette spostamenti relativi rispetto al terreno, il coefficiente β_m , assume il valore:

$$\beta_m = 1,00$$

Pertanto, i due coefficienti sismici valgono:

Prova in corso
Brebemi SpA



	Doc. N. 60235-00000-A00.doc	CODIFICA DOCUMENTO 04RCDII100000000000300A00	REV. 00	FOGLIO 8 di 628
--	--------------------------------	---	------------	--------------------

$$(SLV) \quad k_h = \beta_m \cdot \frac{a_{max}}{g} = 0,263 \quad k_v = \pm 0,5^* \quad k_h = 0,125$$

Le spinte delle terre, considerando lo scatolare una struttura rigida e priva di spostamenti (NT par. 7.11.6.2.1 e EC8-5 par.7.3.2.1), sono calcolate in regime di spinta a riposo, condizione che comporta il calcolo delle spinte in condizione sismica non con la formula di cui sopra (k_h ; k_v), ma con l'incremento dinamico di spinta del terreno calcolato secondo la formula di wood:

$$\Delta P_d = S \cdot a_g / g \cdot \gamma \cdot h_{tot}^2$$

Il punto di applicazione della spinta che interessa lo scatolare è posto $h_{scat}/2$, con "h_{tot}" altezza dal piano campagna alla fondazione dello scatolare e h_{scat} l'altezza dello scatolare.

Essendo "ΔP_d" la risultante globale, ed il diagramma di spinta di tipo rettangolare, è immediato ricavare la quota parte della spinta che agisce sul piedritto dello scatolare.

L'azione sismica è rappresentata da un insieme di forze statiche orizzontali e verticali, date dal prodotto delle forze di gravità per i coefficienti sismici in precedenza definiti, dove la componente verticale è considerata agente verso l'alto o verso il basso, in modo da produrre gli effetti più sfavorevoli.

3.2 Combinazioni di carico

Le combinazioni di carico, considerate ai fini delle verifiche, sono stabilite in modo da garantire la sicurezza in conformità a quanto prescritto al cap. 2 delle NT.

3.2.1 Combinazioni per la verifica allo SLU

Gli stati limite ultimi delle opere interrate si riferiscono allo sviluppo di meccanismi di collasso, determinati dalla mobilitazione della resistenza del terreno, e al raggiungimento della resistenza degli elementi strutturali che compongono l'opera.

Le verifiche agli stati limite ultimi sono eseguiti in riferimento ai seguenti stati limite:

- SLU di tipo geotecnico (GEO) e di equilibrio di corpo rigido (EQU)
 - collasso per carico limite dell'insieme fondazione-terreno;
- SLU di tipo strutturale (STR)
 - raggiungimento della resistenza negli elementi strutturali.

Trattandosi di opere interrate, le verifiche saranno condotte secondo l'approccio progettuale "Approccio 1", utilizzando i coefficienti parziali riportati nelle Tabelle 6.2.I e 5.1.V per i parametri geotecnici e le azioni.

1. combinazione 1 → (A1+M1+R1) → STR
2. combinazione 2 → (A2+M2+R2) → GEO (carico limite)

Tabella 6.2.II - Coefficienti parziali per i parametri del terreno

PARAMETRO	GRANDEZZA ALLA QUALE APPLICARE IL COEFF. PARZIALE	COEFFICIENTE PARZIALE γ_M	Società di Progetto Brebemi SpA

APPROVATO SDR



Tangente dell'angolo di resistenza al taglio	$\tan \varphi'_k$	$\gamma_{\varphi'}$	1	1,25
Coesione efficace	c'_k	$\gamma_{c'}$	1	1,25
Resistenza non drenata	c'_{uk}	γ_{cu}	1	1,4
Peso dell'unità di volume	γ	γ_{γ}	1	1

Tabella 6.2.I/5.1.V - Coefficienti parziali per le azioni o per l'effetto delle azioni

CARICHI	EFFETTO	SIMBOLO γ_F	EQU	(A1) STR	(A2) GEO
Permanente	favorevole	γ_{G1}	0,9	1,0	1,0
	sfavorevole		1,1	1,35	1,0
Permanente non strutturali	favorevole	γ_{G2}	0,0(0,9)	0,0	0,0
	sfavorevole		1,5 (1,1)	1,35	1,0
Variabili da traffico	favorevole	γ_Q	0,0	0,0	0,0
	sfavorevole		1,35	1,35	1,15
Variabili	favorevole	γ_{Qi}	0,0	0,0	0,0
	sfavorevole		1,5	1,5	1,30

Tabella 6.5.I - Coefficienti parziali γ_R per la resistenza del sistema

VERIFICA	COEFF. PARZIALE (R1)	COEFF. PARZIALE (R2)
Capacità portante della fondazione	$\gamma_R=1$	$\gamma_R=1,8$
Scorrimento	$\gamma_R=1$	$\gamma_R=1,1$

Ai fini delle verifiche degli stati limite ultimi si definiscono le seguenti combinazioni:

$$\text{STR}) \Rightarrow \gamma_{G1} \cdot G_1 + \gamma_{G2} \cdot G_2 + \gamma_{Q1} \cdot Q_{k1} + \sum_i \psi_{0i} \cdot Q_{ki} \Rightarrow (\Phi_d' = \Phi_k')$$

$$\text{GEO}) \Rightarrow \gamma_{G1} \cdot G_1 + \gamma_{G2} \cdot G_2 + \gamma_{Q1} \cdot Q_{k1} + \sum_i \psi_{0i} \cdot Q_{ki} \Rightarrow (\text{spinte } \Phi_d' = \tan^{-1}(\tan \Phi_k' / \gamma_{\Phi}))$$

3.2.2 Combinazioni per la verifica allo SLE

Ai fini delle verifiche degli stati limite di esercizio (fessurazione/ stato tensionale) si definiscono le seguenti combinazioni:

$$\text{Frequente}) \Rightarrow G_1 + G_2 + \psi_{11} \cdot Q_{k1} + \sum_i \psi_{2i} \cdot Q_{ki} \Rightarrow (\Phi_d' = \Phi_k')$$

$$\text{Quasi permanente}) \Rightarrow G_1 + G_2 + \psi_{21} \cdot Q_{k1} + \sum_i \psi_{2i} \cdot Q_{ki} \Rightarrow (\Phi_d' = \Phi_k')$$

$$\text{Rara}) \Rightarrow G_1 + G_2 + Q_{k1} + \sum_i \psi_{0i} \cdot Q_{ki} \Rightarrow (\Phi_d' = \Phi_k')$$

3.2.3 Combinazioni per la condizione sismica

Società di Progetto
Brebemi SpA



	Doc. N. 60235-00000-A00.doc	CODIFICA DOCUMENTO 04RCDII100000000000300A00	REV. 00	FOGLIO 10 di 628
--	--------------------------------	---	------------	---------------------

Per la condizione sismica, le combinazioni per gli stati limite ultimi da prendere in considerazione sono le seguenti (approccio 1):

$$\text{STR}) \Rightarrow E+G_1+G_2+\sum_i \psi_{2i} \cdot Q_{ki} \Rightarrow (\Phi_d' = \Phi_k')$$

$$\text{GEO}) \Rightarrow E+G_1+G_2+\sum_i \psi_{2i} \cdot Q_{ki} \Rightarrow (\text{spinte } \Phi_d' = \tan^{-1}(\tan \Phi_k' / \gamma_\phi))$$

Le verifiche agli stati limite ultimi § 7.11.1(NTC) devono essere effettuate ponendo pari all'unità i coefficienti parziali sulle azioni e impiegando i parametri geotecnici e le resistenze di progetto, con i valori dei coefficienti parziali indicati nel Cap. 6.

Gli effetti dell'azione sismica saranno valutati tenendo conto delle masse associate ai seguenti carichi gravitazionali:

$$G_1+G_2+\sum_i \psi_{2i} \cdot Q_{ki}$$

I valori del coefficiente ψ_{2i} sono quelli riportati nella tabella 5.1.VI e § 2.5.I della norma; la stessa propone nel caso di ponti, e più in generale per opere stradali, di assumere per i carichi dovuti al transito dei mezzi $\psi_{2i} = 0 \div 0.2$ (condizione cautelativa).

Data la natura dell'opera in progetto, così come previsto dalla norma, si può assumere $\psi_{2i} = 0$.

APPROVATO SDP

Società di Progetto
Brebemi SpA



4 CARATTERISTICHE DEI MATERIALI

Per la realizzazione dell'opera è previsto l'impiego dei sottoelencati materiali.

4.1 Calcestruzzo per magrone

Per il magrone di sottofondazione si prevede l'utilizzo di calcestruzzo di classe Rck 15.

4.2 Calcestruzzo

1) Per la realizzazione del tombino scatolare, si prevede l'utilizzo di calcestruzzo in classe Rck ≥ 50

N/mm² che presenta le seguenti caratteristiche:

Resistenza a compressione (cilindrica)	→	$f_{ck} = 40.00 \text{ N/mm}^2$	
Resistenza di calcolo a compressione N/mm ²	→	$f_{cd} = \alpha_{cc} * f_{ck} / \gamma_c = 0.85 * f_{ck} / 1.5 = 23.52$	
Resistenza di calcolo a compressione elastica N/mm ²	→	$\sigma_c = 0.60 * f_{ck}$	= 24.00
Resistenza a trazione media N/mm ²	→	$f_{ctm} = 0.30 * f_{ck}^{2/3}$	= 3.60
Resistenza a trazione N/mm ²	→	$f_{ctk} = 0.7 * f_{ctm}$	= 2.52
Resistenza a trazione di calcolo N/mm ²	→	$f_{ctd} = f_{ctk} / \gamma_c$	= 1.68
Resistenza a compressione (comb. Rara) N/mm ²	→	$\sigma_c = 0.60 * f_{ck}$	= 24.00
Resistenza a compressione (comb. Quasi permanente)	→	$\sigma_c = 0.45 * f_{ck}$	= 18.00
		N/mm ²	

4.3 Acciaio per cemento armato

Per le armature metalliche si adottano tondini in acciaio del tipo B450C controllato in stabilimento che presentano le seguenti caratteristiche:

Proprietà	Requisito
Limite di snervamento f_y	$\geq 450 \text{ MPa}$
Limite di rottura f_t	$\geq 540 \text{ MPa}$
Allungamento totale al carico massimo A_{gt}	$\geq 7.5\%$
Rapporto f_t/f_y	$1,15 \leq R_m/R_e \leq 1,35$
Rapporto $f_y \text{ misurato} / f_y \text{ nom}$	$\leq 1,25$

Tensione di snervamento caratteristica	→	$f_{yk} \geq 450 \text{ N/mm}^2$
Tensione caratteristica a rottura	→	$f_{tk} \geq 540 \text{ N/mm}^2$
Tensione in condizione di esercizio (comb. Rara)	→	$\sigma_c = 0,80 * f_{yk} = 360,00 \text{ N/mm}^2$
Fattore di sicurezza acciaio	→	$\gamma_s = 1,15$
Resistenza a trazione di calcolo	→	$f_{yd} = f_{yk} / \gamma_s = 391,30 \text{ N/mm}^2$

APPROVATO SDR

Società di Progetto

4.4 Durabilità e prescrizioni sui materiali

Per garantire la durabilità delle strutture in calcestruzzo armato ordinario, esposte all'azione dell'ambiente, si devono adottare i provvedimenti atti a limitare gli effetti di degrado indotti dall'attacco chimico, fisico e derivante dalla corrosione delle armature e dai cicli di gelo e disgelo. Al fine di ottenere la prestazione richiesta in funzione delle condizioni ambientali, nonché per la definizione della relativa classe, si fa riferimento alle indicazioni contenute nelle Linee Guida sul calcestruzzo strutturale edite dal Servizio Tecnico Centrale del Consiglio Superiore dei Lavori Pubblici ovvero alle norme UNI EN 206-1:2006 ed UNI 11104:2004.

Per le opere della presente relazione si adotta quanto segue:

Fondazione CLASSE DI ESPOSIZIONE XC2
Elevazione CLASSE DI ESPOSIZIONE XC4-XD1-XF1

Condizioni ambientali	Classe di esposizione
Ordinarie	X0, XC1, XC2, XC3, XF1
Aggressive	XC4, XD1, XS1, XA1, XA2, XF2, XF3
Molto aggressive	XD2, XD3, XS2, XS3, XA3, XF4

Tabella 4.1.III: Descrizione delle condizioni ambientali

Le fondazioni dei muri si trovano in condizioni ambientali *Ordinarie*, le elevazioni in condizioni *Aggressive*.

Nella tabella 4.1.IV sono indicati i criteri di scelta dello stato limite di fessurazione con riferimento alle condizioni ambientale e al tipo di armatura.

Gruppi di esigenze	Condizioni ambientali	Combinazione di azioni	Armatura			
			Sensibile		Poco sensibile	
			Stato limite	w_a	Stato limite	w_a
a	Ordinarie	frequente	ap. fessure	$\leq w_2$	ap. fessure	$\leq w_3$
		quasi permanente	ap. fessure	$\leq w_2$	ap. fessure	$\leq w_2$
b	Aggressive	frequente	ap. fessure	$\leq w_2$	ap. fessure	$\leq w_2$
		quasi permanente	decompressione	-	ap. fessure	$\leq w_1$
c	Molto aggressive	frequente	formazione fessure	-	ap. fessure	$\leq w_1$
		quasi permanente	decompressione	-	ap. fessure	$\leq w_1$

Tabella 4.1.IV: Criteri di scelta dello stato limite di fessurazione

In grigio chiaro sono indicate gli stati limite di fessurazione da utilizzare per le verifiche delle fondazioni in grigio scuro sono indicati quelli per le elevazioni.

	Doc. N. 60235-00000-A00.doc	CODIFICA DOCUMENTO 04RCDII100000000000300A00	REV. 00	FOGLIO 13 di 628
--	--------------------------------	---	------------	---------------------

4.5 Copriferro minimo e copriferro nominale

Ai fini di preservare le armature dai fenomeni di aggressione ambientale, dovrà essere previsto un idoneo copriferro; il suo valore, misurato tra la parete interna del cassero e la generatrice dell'armatura metallica più vicina, individua il cosiddetto "copriferro nominale".

Il copriferro nominale c_{nom} è somma di due contributi, il copriferro minimo c_{min} e la tolleranza di posizionamento h . Vale pertanto: $c_{nom} = c_{min} + h$.

La tolleranza di posizionamento delle armature h , per le strutture gettate in opera, può essere assunta pari ad almeno 5 mm. Considerata la Classe di esposizione ambientale dell'opera, si adotta un copriferro minimo pari a 35mm, pertanto $c_{nom}=40$ mm, valore valido per tutte le parti di struttura.

APPROVATO SDP

Società di Progetto
Brebemi SpA



5 PARAMETRI GEOTECNICI PER IL CALCOLO DELLE STRUTTURE

I parametri necessari a definire le caratteristiche del terreno ai fini del calcolo delle strutture sono ricavati dalla Relazione Geotecnica Generale, rif. 00429-00010-A-00 e dalle tavole del profilo geotecnico longitudinale.

- I parametri geotecnici necessari al calcolo sono::

Carratterizzazione materiali da rilevato/reinterri																
Parametri in condizioni drenate					Spinta a riposo			Spinta attiva			Spinta Passiva			Peso di volume		Permeabilità
ϕ_k	ϕ'_{dM1}	ϕ'_{dM2}	E'_{25}	E_{UR}	K_{0k}	K_{0M1}	K_{0M2}	K_{Ak}	K_{AM1}	K_{AM2}	K_{Pk}	K_{PM1}	K_{PM2}	naturale γ_n	sommerso γ'	k
(°)	(°)	(°)	(Mpa)	(Mpa)	(-)	(-)	(-)	(-)	(-)	(-)	(-)	(-)	(-)	(kN/m ³)	(kN/m ³)	(m/s)
38	38	32	40	120	0.380	0.380	0.470	0.238	0.238	0.307	4.200	4.200	3.250	20	11	$1 \times E^{-3} \pm E^{-5}$

I coefficienti di spinta sono calcolati secondo la teoria di Caquot - Kerisel ipotizzando angolo d'attrito tra terreno e struttura di sostegno $\delta = 0$ ed ipotizzando che il terreno a monte/valle del sostegno (rispettivamente per il calcolo di K_A e K_P) sia orizzontale ($\beta = 0$). Nel caso in cui tali ipotesi iniziali non siano rappresentative del problema in oggetto, i valori delle spinte dovranno essere calcolati nuovamente utilizzando la stessa teoria.

LEGENDA PARAMETRI	
ϕ_k	Angolo di resistenza al taglio caratteristico;
ϕ'_{dM1}	Angolo di resistenza al taglio di progetto secondo coefficienti parziali M1 come da NTC2008;
ϕ'_{dM2}	Angolo di resistenza al taglio di progetto secondo coefficienti parziali M2 come da NTC2008;
E'_{25}	Modulo elastico secante corrispondente alla mobilitazione del 25% della resistenza del terreno;
E_{UR}	Modulo elastico secante in ricarica;
K_{0k}	Valore caratteristico del coefficiente di spinta a riposo;
K_{0M1}	Valore di progetto del coefficiente di spinta a riposo secondo coefficienti parziali M1 come da NTC2008;
K_{0M2}	Valore di progetto del coefficiente di spinta a riposo secondo coefficienti parziali M2 come da NTC2008;
K_{Ak}	Valore caratteristico del coefficiente di spinta attiva;
K_{AM1}	Valore di progetto del coefficiente di spinta attiva secondo coefficienti parziali M1 come da NTC2008;
K_{AM2}	Valore di progetto del coefficiente di spinta attiva secondo coefficienti parziali M2 come da NTC2008;
K_{Pk}	Valore caratteristico del coefficiente di spinta passiva;
K_{PM1}	Valore di progetto del coefficiente di spinta passiva secondo coefficienti parziali M1 come da NTC2008;
K_{PM2}	Valore di progetto del coefficiente di spinta passiva secondo coefficienti parziali M2 come da NTC2008;
γ_n	Peso di volume naturale;
γ'	Peso di volume sommerso;
k	Permeabilità;

	Doc. N. 60235-00000-A00.doc	CODIFICA DOCUMENTO 04RCDII100000000000300A00	REV. 00	FOGLIO 15 di 628
--	--------------------------------	---	------------	---------------------

6 SCHEMA STATICO E ANALISI DEI CARICHI

6.1 Programmi di calcolo utilizzato

Il programma di calcolo utilizzato per le analisi dello scatolare è SAP2000, che opera secondo il metodo degli spostamenti attraverso un solutore di equazione a blocchi. SAP2000 è prodotto da CSI Computers & Structures, INC. con sede a Berkeley (CA). Il software è distribuito in Italia da CSI Italia Srl. La versione del software utilizzata è la 14 con licenza n° 2A0C/80-0x2EE61.

Le verifiche vengono eseguite tramite opportuni fogli di calcolo precedentemente elaborati ed ampiamente testati, in grado di fornire i domini di resistenza di sezioni rettangolari comunque armate e di eseguirle necessarie elaborazioni per le verifiche a taglio e a fessurazione.

6.2 Modellazione adottata

Per la mesh del calcolo (si rimanda alle Figg. 1 e 2) si è assunto lo schema statico di telaio chiuso. La mesh è composta da 54 aste e da 54 nodi; l'output dell'indagine elettronica viene raccolto nell'allegato.

Il suolo viene modellato facendo ricorso all'usuale artificio delle molle elastiche alla Winkler.

La costante di sottofondo del terreno di fondazione adottata nelle successive calcolazioni:

$$K_s = 1000 \text{ kN/m}^3$$

Agli effetti delle caratteristiche geometriche delle varie aste si è modellata una striscia di struttura di larghezza pari a $D=100\text{cm}$ ed altezza pari allo spessore dell'elemento rappresentato:

- 100 x 25 cm per la soletta superiore
- 100 x 25 cm per la soletta di fondazione
- 100 x 25 cm per i piedritti

Per le aste del reticolo si è assunto:

$E_c = 32588 \text{ N/mm}^2$; modulo elastico del calcestruzzo (C28/35) per la fondazione

$E_c = 33643 \text{ N/mm}^2$; modulo elastico del calcestruzzo (C32/40) per l'elevazione

Lo schema statico della struttura e la relativa numerazione dei nodi e delle aste sono riportati nelle Figg.1 e 2.

Società di Progetto
Brebemi SpA







Figura 1 – Numerazione dei nodi

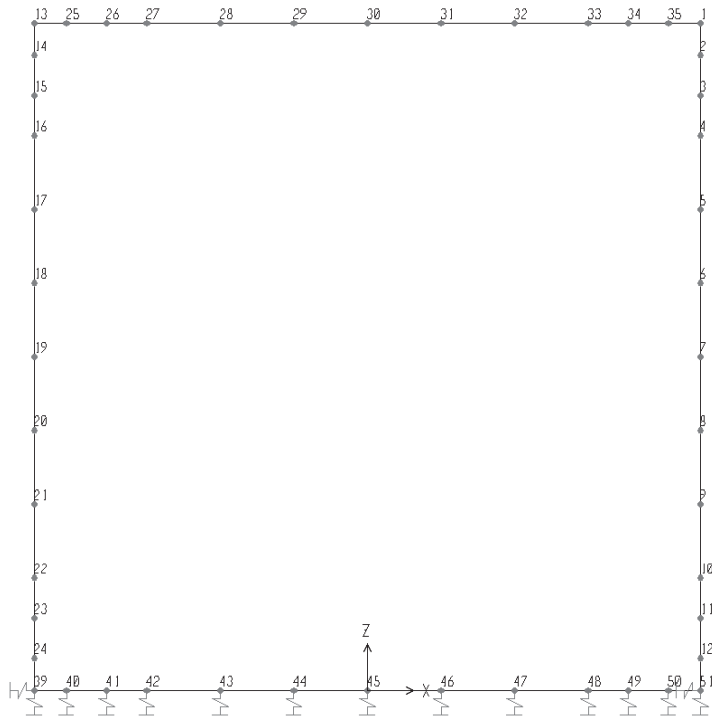

Figura 2 – Numerazione delle aste

APPROVATO SDP

Società di Progetto
Brebemi SpA

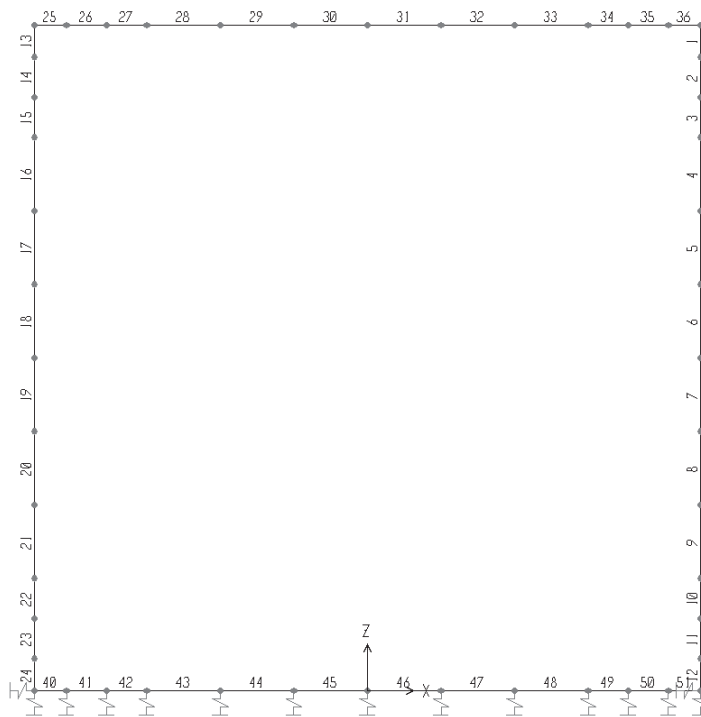

7 CONDIZIONI DI CARICO ELEMENTARI

Nel seguente paragrafo si descrivono i carichi elementari da assumere per le verifiche di resistenza in esercizio ed in presenza dell'evento sismico.

Tali Combinazioni Elementari saranno opportunamente combinate secondo quanto previsto dalla normativa vigente.

Nei successivi paragrafi si riporta la metodologia adottata per l'analisi dei carichi condotta con un apposito foglio di calcolo di cui nel successivo capitolo si riportano i tabulati

Peso proprio e carichi permanenti portati

Il peso specifico del c.a. è $\gamma_c = 25 \text{ kN/m}^3$

Soletta superiore

- peso proprio 4.00 kN/m²
- peso sovrastruttura stradale 3.00 kN/m²

Soletta inferiore

- peso proprio 4.00kN/m²

Piedritti

- peso proprio 4.00 kN/m²

7.1 Spinte del terreno

Il rinterro a ridosso dello scatolare verrà realizzato tramite materiale arido di buone caratteristiche meccaniche. Per tale materiale, conformemente a quanto riportato nella relazione geotecnica del presente lotto, si ha:

$\gamma_t = 19,00 \text{ kN/m}^3$	peso specifico del terreno
$\gamma' = 11,00 \text{ kN/m}^3$	peso specifico del terreno sommerso
$\phi = 35^\circ$	angolo d'attrito
$c = 0$	coesione

Si applicano, di conseguenza, i valori delle spinte secondo la profondità con

$$p_h = K \gamma_t z$$

e con il consueto diagramma trapezoidale delle pressioni orizzontali.

Le pressioni del terreno relative alla spinta a riposo, in corrispondenza dei nodi caratteristici del piedritto di destra, risultano essere le seguenti:

$P_{\min} = K_0 * H r * \gamma_t$	kN/m ²	[ST1S]
$P_{\max} = K_0 * \gamma_t * (H + S_{psolinf} / 2 + S_{psolsup} / 2)$	kN/m ²	[ST2S]
In caso di presenza di falda:		
$P'_{\max} = K_0 * \gamma' * (H + S_{psolinf} / 2 + S_{psolsup} / 2)$	kN/m ²	[ST2S]
$P''_{\max} = \gamma_w * (H + S_{psolinf} / 2 + S_{psolsup} / 2)$	kN/m ²	[SW2S]

Le pressioni del terreno relative alla spinta attiva, in corrispondenza dei nodi caratteristici del piedritto, risultano essere le seguenti:

$$P_{\min} = -K_a * H_r * \gamma_t \quad \text{kN/m}^2 \quad [\text{ST1D}]$$

$$P_{\max} = -K_a * \gamma_t * (H + S_{psolinf} / 2 + S_{psolsup} / 2) \quad \text{kN/m}^2 \quad [\text{ST2D}]$$

In caso di presenza di falda:

$$P_{\max} = -K_a * \gamma' * (H + S_{psolinf} / 2 + S_{psolsup} / 2) \quad \text{kN/m}^2 \quad [\text{ST2D}]$$

$$P'_{\max} = -\gamma_w * (H + S_{psolinf} / 2 + S_{psolsup} / 2) \quad \text{kN/m}^2 \quad [\text{SW2D}]$$

$$P''_{\max} = -\gamma_w * (H + S_{psolinf} / 2 + S_{psolsup} / 2) \quad \text{kN/m}^2 \quad [\text{SW2D}]$$

Sempre in presenza di falda agisce sulla soletta inferiore la spinta di archimede, verso l'alto, pari a:

$$V''_{\max} = \gamma_w [(H + S_{psolsup} / 2) + S_{psolinf} * (B + S_{ppie} + 2 * S_{balzo})] \quad \text{kN/m}^2 \quad [\text{SA}]$$

Tali spinte vengono considerate nelle seguenti condizioni elementari:

- agenti su entrambi i piedritti (spinta attiva)
- agenti sul piedritto sinistro (spinta a riposo) e sul piedritto destro (spinta attiva).
- agenti su entrambi i piedritti (spinta a riposo)

Le condizioni sopra descritte servono a mettere in conto possibili situazioni (anche temporanee) di disomogeneità nei costipamenti o altre condizioni che possano generare situazioni di spinte asimmetriche sull'opera.

Naturalmente queste spinte saranno opportunamente combinate, utilizzando i valori dei coefficienti parziali delle azioni da assumere nell'analisi per la determinazione degli effetti delle azioni nelle verifiche agli stati limite ultimi.

7.2 Carichi da traffico veicolare sulla soletta superiore

Con riferimento alle norme vigenti (vedi paragrafo 5.1.3 del D.M. 14-01-2008) come azioni variabili da traffico gravante sulla soletta superiore si assume lo schema di carico 1. Il carico di normativa applicato è il $Q_{1,k}$, ossia il mezzo convenzionale da 600kN a due assi da 300 kN ognuno (carico tandem), con interasse di 1,20m lungo il senso di marcia e di larghezza 2,40m (comprese le dimensioni delle impronte) e ove possibile, il carico ripartito $q_{1,k}$ da 9kN/m².

Tale carico viene posizionato ortogonalmente all'asse del sottopasso e considerato ripartito, sia in direzione longitudinale che trasversale, con un angolo di diffusione di 30° attraverso il rilevato stradale, e 45° sino al piano medio della soletta superiore.



Figura 3 – Diffusione impronta di carico

Società di Progetto
Brebemi SpA

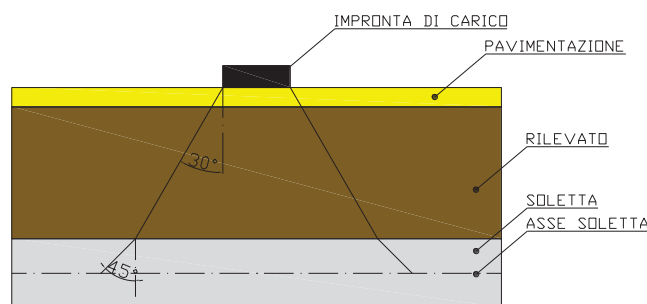

In direzione trasversale, quale base collaborante viene considerato un valore pari alla larghezza di ingombro dello schema di carico uguale a 2,40m aumentata dello spessore di diffusione del carico. Limitando la diffusione del carico lato seconda colonna di carico a 0,30m (come in Fig.4) la

In direzione longitudinale si individuano due ingombri, il primo vale se la lunghezza della soletta superiore è minore della lunghezza di diffusione longitudinale del carico, mentre se la lunghezza della soletta superiore è maggiore della lunghezza di diffusione longitudinale del carico:

larghezza di diffusione trasversale diventa: $B_T = 2,40 + 0,3 + (H_r \cdot \text{tg}30^\circ + S_{psolsup}/2)$

Ingombro longitudinale 1: $LL_1 = 1,60 + 2 * (H_r \cdot \text{tg}30^\circ + S_{psolsup}/2)$

Ingombro longitudinale 2: $LL_2 = 1,60 + 2 * (H_r + S_{psolsup}/2) * \text{tg}30^\circ$

Se $B+2S_{ppie} \geq LL_1$ $L_L = LL_1$ altrimenti $L_L = LL_2$.

Carico medio uniforme: $Q_{1k,dis} = 600 / (B_T * L_L)$ kN/m² [QM01]

Carico ripartito: $q_{1k,dis} = 9$ kN/m² kN/m² [QM02]



Figura 4 – Diffusione trasversale del carico mobile

APPROVATO SDP

7.3 Spinta del sovraccarico sul rilevato

In accordo con quanto riportato nella circolare n°617 2 febbraio 2009 al §5.1.3.3.7.1, il sovraccarico da considerare sul terrapieno adiacente la parete dello scatolare, è quello generato dallo schema di carico 1, dove il carico tandem è sostituito da un carico uniformemente distribuito.

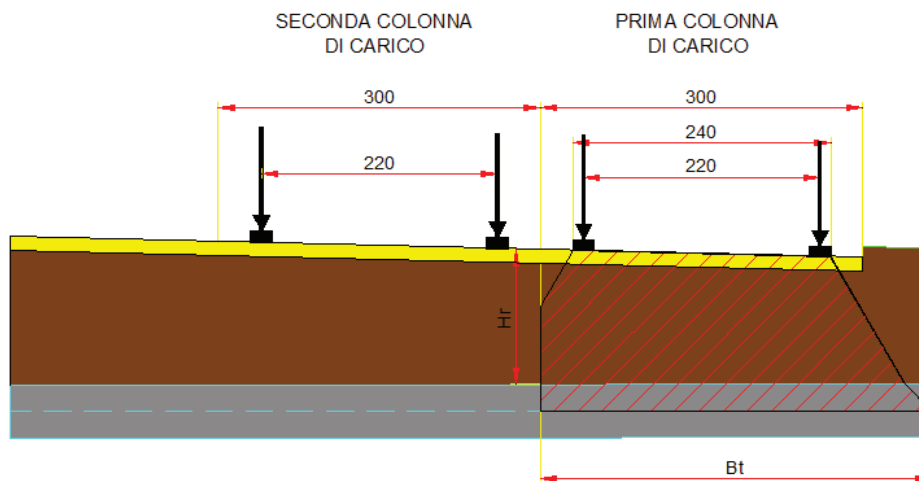
Il carico tandem trasformato in carico uniformemente distribuito assume il valore $2 * Q_{1k} / (3 * 2,2) = 90,91 \text{ kN/m}^2$.

Il carico uniformemente distribuito $q_{ik} = 9 \text{ kN/m}^2$ viene sommato al carico tandem distribuito.

Mettendo in conto il ricoprimento con rilevato della struttura, il quale contribuisce a diffondere il carico fino al piano di estradosso soletta, il carico distribuito da utilizzare per il calcolo delle spinte agenti sulle pareti dello scatolare risulta $(2 * Q_{1k}) / ((3 + H_r \cdot \text{tg}30^\circ) * (2,2 + 2 * H_r \cdot \text{tg}30^\circ))$. Schema di carico utilizzato a ridosso del rilevato (direzione asse corsia)

Società di Progetto
Brebemi SpA



Figura 5 – Spinta del sovraccarico sul rilevato

Utilizzando due colonne di carico, e la ripartizione trasversale del carico di superficie distribuito, si ottiene quanto riportato nell'immagine seguente:

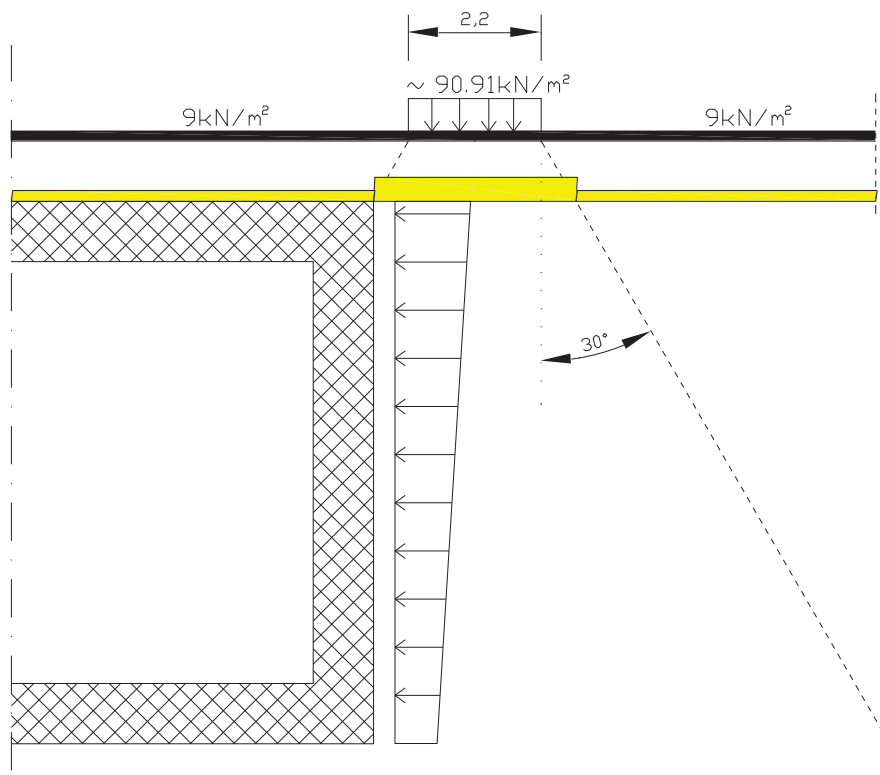
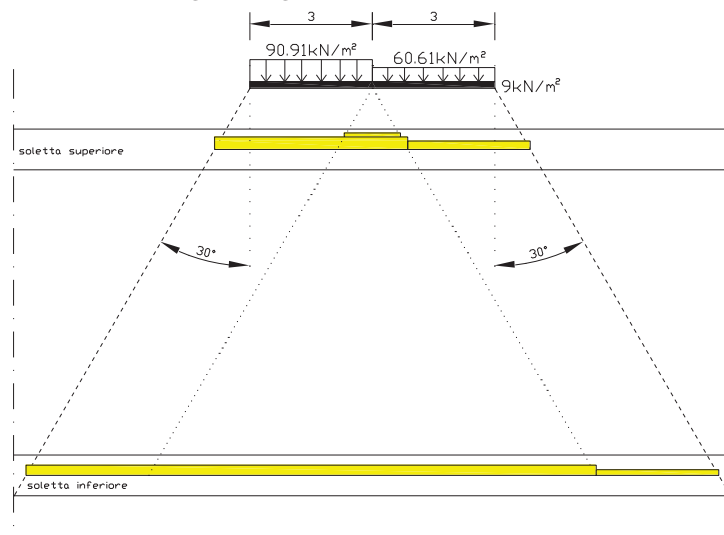

APPROVATO SDP

Per il calcolo delle azioni agenti sulle pareti dello scatolare, si considera il carico distribuito dovuto alla colonna di carico 1, limitando la diffusione del carico sul lato della seconda colonna di carico come schema seguente:

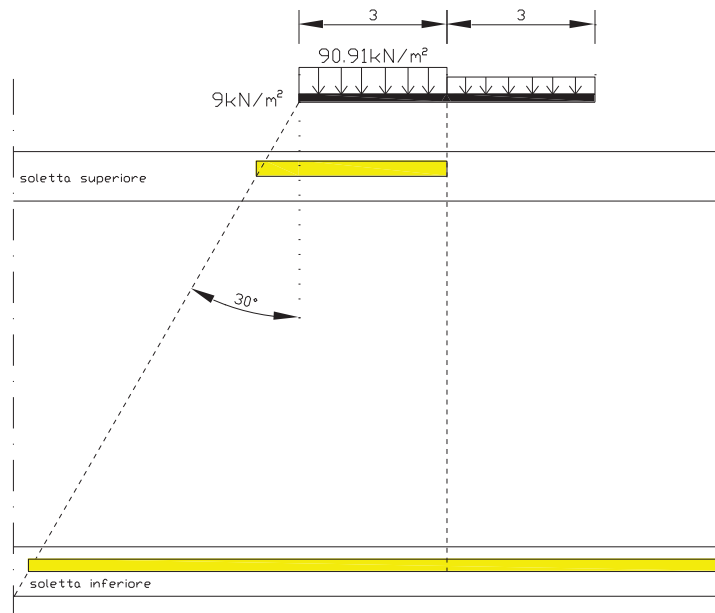

Tale distribuzione di carico fornisce alle pareti una spinta variabile lungo l'altezza, con intensità nei nodi superiore e inferiore pari a (asse solette):

$$\sigma_{1v,sup} = (2 \cdot Q_{1.k}) / ((3 + (H_r + S_{psolsup}/2) \cdot \text{tg}30^\circ) \cdot (2,2 + 2 \cdot (H_r + S_{psolsup}/2) \cdot \text{tg}30^\circ)) \quad \text{kN/m}^2$$

$$\sigma_{2v,sup} = (q_{1k} \cdot 3) / (3 + (H_r + S_{psolsup}) \cdot \text{tg}30^\circ) \quad \text{kN/m}^2$$

$$q'_{acc,sup} = (\sigma_{1v,sup} + \sigma_{2v,sup}) \cdot K_0 \quad \text{kN/m}^2$$

[SQMS/D]

$$\sigma_{1v,inf} = (2 \cdot Q_{1.k}) / ((3 + (H_r + S_{psolsup}/2 + S_{psolinf}/2 + H) \cdot \text{tg}30^\circ) \cdot (2,2 + 2 \cdot \text{tg}30^\circ \cdot (H_r + S_{psolsup}/2 + S_{psolinf}/2 + H))) \quad \text{kN/m}^2$$

$$\sigma_{2v,inf} = (q_{1k} \cdot 3) / (3 + (H_r + S_{psolsup}/2 + S_{psolinf}/2 + H) \cdot \text{tg}30^\circ) \quad \text{kN/m}^2$$

$$q'_{acc,inf} = (\sigma_{1v,inf} + \sigma_{2v,inf}) \cdot 0,384 \quad \text{kN/m}^2$$

[SQMS/D]

7.4 Frenatura

In accordo con il § 5.1.3.5 del D.M. 14-01-2008 e § 4.4.1 di UNI EN 1991-2:2005 il carico frenante di normativa (q_3) è funzione del carico verticale totale agente sulla corsia convenzionale n.1, il quale viene ripartito sulla larghezza collaborante (L) e sulla larghezza dello scatolare (CDC 13-14):

$$\text{Carico frenante} \quad q_3 = 0,60 \cdot (2 \cdot Q_{1.k}) + 0,10 \cdot q_{1k} \cdot w_l \cdot L \quad \text{kN}$$

L'azione di cui sopra, viene distribuita sulla soletta superiore dello scatolare; il valore della frenatura equivalente da applicare alla soletta, si ottiene distribuendo il valore del carico frenante,

	Doc. N. 60235-00000-A00.doc	CODIFICA DOCUMENTO 04RCDII100000000000300A00	REV. 00	FOGLIO 22 di 628
--	--------------------------------	---	------------	---------------------

alla lunghezza dello scatolare e alla larghezza di diffusione del carico (L_L), con la seguente relazione:

$$q_{3,dis} = q_3 / (L * L_L) \quad \text{kN/m}^2 \quad [\text{FA01}]$$

7.5 Azioni termiche

In accordo con il § 3.5 del D.M. 14-01-2008 sono stati considerati gli effetti dovuti alle variazioni termiche. In particolare, è stata considerata una variazione termica uniforme di $\pm 10^\circ\text{C}$ (denominata TC01 e TC02) sulla soletta superiore ed un salto termico di 5°C (denominato TV01 e TV02), analizzando i due casi di intradosso più caldo dell'estradosso e viceversa, con andamento lineare nello spessore della soletta superiore.

Per il coefficiente di dilatazione termica si assume:

$$\alpha = 10 * 10^{-6} = 0.00001 \text{ } ^\circ\text{C}^{-1}$$

7.6 Ritiro

I fenomeni da ritiro sulla soletta superiore sono tenuti in conto tramite l'applicazione di una variazione uniforme $\Delta T'$ tale da generare 1/3 della deformazione totale da ritiro. In particolare la riduzione ad 1/3 degli effetti del ritiro deriva dal fatto che le deformazioni da ritiro si sviluppano in tempi molto lunghi (in contemporanea al fluage che riduce le sollecitazioni coattive derivanti da deformazioni imposte).

$$\Delta T_{rit} = \varepsilon_{cs} / 3 \times \alpha t \text{ (da assumersi con il segno - : raffreddamento)}$$

Il valore della deformazione totale da ritiro viene calcolato utilizzando le formule di cui al par 11.2.10.6 delle NTC.

$$\varepsilon_{cs} = \varepsilon_{cd} + \varepsilon_{ca}$$

dove:

ε_{cs} = deformazione totale per ritiro ,

ε_{cd} = deformazione per ritiro da essiccamento ,

ε_{ca} = deformazione per ritiro autogeno ,

Il termine ε_{cd} (valutato a tempo infinito) è funzione dell'umidità relativa (U) , della resistenza del calcestruzzo (f_{ck}) e dello spessore fittizio del manufatto (h_0) , secondo i parametri k_h e ε_{c0} ricavabili dalle tabelle 11.2.Va e 11.2.Vb delle NTC. Nel caso in esame risulta:

$$f_{ck} = 28 \text{ MPa}$$

$$\text{Umidità relativa} = U = 70 \%$$

$$A_c = \text{area trasversale passo uomo}$$

$$u = \text{perimetro della sezione esposta all'aria}$$

$$h_0 = \text{spessore fittizio} = 2A_c/u$$

si deduce dalla tabella 11.2.Va ε_{c0}

si deduce dalla tabella 11.2.Vb k_h

$$\text{si calcola quindi } \varepsilon_{cd,\infty} = k_h \times \varepsilon_{c0}$$

Il termine ε_{ca} è funzione della resistenza a compressione del calcestruzzo secondo la formula seguente:

$$\varepsilon_{ca,\infty} = -2.5 (f_{ck} - 10) \times 10^{-6}$$

Risulta quindi una variazione termica uniforme :

$$\Delta T_{rit} = (\varepsilon_{cd} + \varepsilon_{ca}) / 3 \times \alpha t \text{ [} ^\circ\text{C]}]$$

Società di Progetto
Brebemi SpA

[RIT]



7.7 Azione sismica

Stato limite di salvaguardia della vita (SLV)

La risultante delle forze inerziali orizzontali indotte dal sisma viene valutata con la seguente espressione:

$$F_h = P^* k_h$$

$$k_h = \beta_m \cdot \frac{a_{max}}{g}$$

$$(SLV) \quad k_h = \beta_m \cdot \frac{a_{max}}{g} \quad ; \quad k_v = 0.5 k_h$$

P = peso proprio;

k = coefficienti sismici;

Si può ritenere che la struttura debba mantenere sotto l'azione sismica un comportamento elastico, assimilando l'opera scatolare alla categoria delle spalle da ponte e rientrando così tra le opere che si muovono con il terreno; queste categorie di opere non subiscono le amplificazioni dell'accelerazione del suolo.

Per tener conto dell'incremento di spinta del terreno dovuta al sisma si fa riferimento al metodo di Wood, in cui l'incremento di spinta sismica ΔP_d per la condizione a riposo viene valutato:

$$\Delta P_d = S \cdot a_g / g \cdot \gamma \cdot h_{tot}^2$$

Ai fini delle azioni orizzontali :

- Spinta inerziale sulla soletta superiore:

$$(S_{psol\sup} * \gamma_c + H_r * \gamma_t) * k_h \quad \text{kN/m}^2 \quad [IS01]$$

$$(S_{psol\sup} * \gamma_c + H_r * \gamma_t) * k_v \quad \text{kN/m}^2 \quad [IS02]$$

- Spinta inerziale sui piedritti:

$$(S_{ppie} * \gamma_c) * k_h \quad \text{kN/m}^2 \quad [IS01]$$

$$(S_{ppie} * \gamma_c) * k_v \quad \text{kN/m}^2 \quad [IS02]$$

- Sovrappinta sismica :

$$S \cdot a_g / g \cdot \gamma \cdot h_{tot} \quad \text{kN/m}^2 \quad [SSTS]$$

7.8 Riassunto condizioni di carico e Combinazioni di carico

Al fine di determinare le combinazioni come da norma (§3.2 (NT)), si definisce la classificazione delle azioni e le combinazioni allo SLU e SLE.

Classificazione delle azioni agenti sulla struttura.

condizione per sap2000	n°	condizioni per combinazioni di carico	n°
PPST	1	PPST	1
PPNS	2	PPNS	2
ST1S	4	SK0S = ST1S + ST2S	4
ST2S	5	SKAS = ST2S + ST3S	5
ST3S	6	SK0D = ST1D + ST2D	6
ST4S	7	SKAD = ST2D + ST3D	7

Società di Progetto
Brebemi SpA



ST1D	8	SK0SG = ST1SG + ST2SG	4
ST2D	9	SKASG = ST2SG + ST3SG	5
ST3D	10	SK0DG = ST1DG + ST2DG	6
ST4D	11	SKADG = ST2DG + ST3DG	7
ST1SG	12	SWS = SW1S + SW2S	8
ST2SG	13	SWD = SW1D + SW2D	9
ST3SG	14	SA	10
ST4SG	15	QM01	11
ST1DG	16	QM02	12
ST2DG	17	SQMS	13
ST3DG	18	SQMD	14
ST4DG	19	SQMSG	15
SW1S	20	SQMDG	16
SW2S	21	FA01	17
SW1D	22	TC01	18
SW2D	23	TC02	19
SA	24	TV01	20
QM01	25	TV02	21
QM02	26	RIT	22
SQMS	27	IS01	23
SQMD	28	SSTS	24
SQMSG	29	IS02	23
SQMDG	30		
FA01	31		
TC01	32		
TC02	33		
TV01	34		
TV02	35		
RIT	36		
IS01	37		
SSTS	38		
IS02	39		

Per un esame più dettagliato dei risultati del calcolo elettronico si rimanda agli output allegati.
Le convenzioni adottate per le sollecitazioni di segno positivo sono le seguenti:

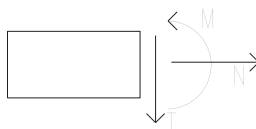

Nelle verifiche di seguito riportate le combinazioni di calcolo considerate sono riportate nella tabella seguente. Si fa notare che le voci riportate in prima riga sono le condizioni di carico descritte nei paragrafi precedenti, e le relative etichette sono desumibili affianco a ciascuna descrizione della condizione.

		PPST	PPNS	SK0S	SKAS	SW2S	SK0D	SKAD	SWD	SA	QM01	QM02	SQMS	SQMD	FA01	TC01	TC02	TV01	TV02	RIT	
SLU STR	1	1.35	1.35	1.35		1.35	1.35		1.35	1.35											
	2	1.35	1.35		1.00	1.00		1.00	1.00	1.35											
	3	1.35	1.35		1.00	1.00		1.00	1.00	1.35	1.35	1.35									
	4	1.35	1.35	1.35		1.35		1.00	1.00	1.35	1.35	1.35	1.35								
	5	1.35	1.35	1.35		1.35	1.35		1.35	1.35	1.35	1.35	1.35	1.35							
	6	1.00	1.00	1.35		1.35		1.00	1.00	1.00				1.35							
	7	1.00	1.00	1.35		1.35	1.35		1.35	1.00				1.35	1.35						
	8	1.35	1.35	1.35		1.35		1.00	1.00	1.35	1.01	1.01	1.01		1.35						

Società di Progetto
Brepem SpA

		PPST	PPNS	SK0S	SKAS	SW2S	SK0D	SKAD	SWD	SA	QM01	QM02	SQMS	SQMD	FA01	TC01	TC02	TV01	TV02	RIT
	46	1.00	1.00	1.00		1.00	1.00		1.00	1.00	0.75	0.75	0.75	0.75						0.50
	47	1.00	1.00	1.00		1.00		1.00	1.00	1.00			0.75							0.50
	48	1.00	1.00	1.00		1.00	1.00		1.00	1.00			0.75	0.75						0.50
	49	1.00	1.00		1.00	1.00		1.00	1.00	1.00							0.50			0.60
	50	1.00	1.00		1.00	1.00		1.00	1.00	1.00								0.50		0.60
	51	1.00	1.00		1.00	1.00		1.00	1.00	1.00									0.50	0.60
		PPST	PPNS	SK0S	SKAS	SW2S	SK0D	SKAD	SWD	SA	QM01	QM02	SQMS	SQMD	FA01	TC01	TC02	TV01	TV02	RIT
SLE QUASI PERMANENTE	1	1.00	1.00		1.00	1.00	1.00		1.00	1.00										
	2	1.00	1.00		1.00	1.00	1.00		1.00	1.00						0.5				
	3	1.00	1.00		1.00	1.00	1.00		1.00	1.00							0.5			
	4	1.00	1.00		1.00	1.00	1.00		1.00	1.00									0.50	
	5	1.00	1.00		1.00	1.00	1.00		1.00	1.00										0.50
	6	1.00	1.00		1.00	1.00	1.00		1.00	1.00										0.50
	7	1.00	1.00		1.00	1.00	1.00		1.00	1.00							0.50		0.50	
	8	1.00	1.00		1.00	1.00	1.00		1.00	1.00							0.50			0.50
	9	1.00	1.00		1.00	1.00	1.00		1.00	1.00							0.50			0.50
	10	1.00	1.00	1.00		1.00		1.00		1.00	1.00									
	11	1.00	1.00	1.00		1.00		1.00		1.00	1.00						0.5			
	12	1.00	1.00	1.00		1.00		1.00		1.00	1.00							0.5		
	13	1.00	1.00	1.00		1.00		1.00		1.00	1.00								0.50	
	14	1.00	1.00	1.00		1.00		1.00		1.00	1.00									0.50
	15	1.00	1.00	1.00		1.00		1.00		1.00	1.00									0.50
	16	1.00	1.00	1.00		1.00		1.00		1.00	1.00						0.50		0.50	
	17	1.00	1.00	1.00		1.00		1.00		1.00	1.00						0.50			0.50
	18	1.00	1.00	1.00		1.00		1.00		1.00	1.00						0.50			0.50
		PPST	PPNS	SK0S	SKAS	SW2S	SK0D	SKAD	SWD	SA	QM01	QM02	SQMS	SQMD	FA01	TC01	TC02	TV01	TV02	RIT
SLU GEO	1	1.00	1.00	1.00		1.00	1.00		1.00	1.00										
	2	1.00	1.00		1.00	1.00		1.00		1.00	1.15	1.15								
	3	1.00	1.00	1.00		1.00		1.00		1.00	1.15	1.15	1.15							
	4	1.00	1.00	1.00		1.00	1.00		1.00	1.00	1.15	1.15	1.15	1.15						
	5	1.00	1.00	1.00		1.00		1.00		1.00	1.00	0.86	0.86	0.86		1.15				
	6	1.00	1.00		1.00	1.00		1.00		1.00	1.00	1.15	1.15					0.60		
	7	1.00	1.00	1.00		1.00		1.00		1.00	1.00	1.15	1.15	1.15				0.60		
	8	1.00	1.00	1.00		1.00	1.00		1.00	1.00	1.15	1.15	1.15	1.15				0.60		
	9	1.00	1.00	1.00		1.00		1.00		1.00	1.00	0.86	0.86	0.86		1.15		0.60		
	10	1.00	1.00		1.00	1.00		1.00		1.00	1.00	0.86	0.86					1.00		
	11	1.00	1.00	1.00		1.00		1.00		1.00	1.00	0.86	0.86	0.86				1.00		
	12	1.00	1.00	1.00		1.00	1.00		1.00		1.00	0.86	0.86	0.86	0.86			1.00		
	13	1.00	1.00		1.00	1.00		1.00		1.00	1.00	1.15	1.15						0.60	
	14	1.00	1.00	1.00		1.00		1.00		1.00	1.00	1.15	1.15	1.15					0.60	
	15	1.00	1.00	1.00		1.00	1.00		1.00		1.00	1.15	1.15	1.15	1.15				0.60	
	16	1.00	1.00	1.00		1.00		1.00		1.00	1.00	0.86	0.86	0.86		1.15			0.60	
	17	1.00	1.00		1.00	1.00		1.00		1.00	1.00	0.86	0.86					1.00		
	18	1.00	1.00	1.00		1.00		1.00		1.00	1.00	0.86	0.86	0.86				1.00		
	19	1.00	1.00	1.00		1.00	1.00		1.00		1.00	0.86	0.86	0.86	0.86			1.00		
	20	1.00	1.00		1.00	1.00		1.00		1.00	1.00	1.15	1.15							0.60
	21	1.00	1.00	1.00		1.00		1.00		1.00	1.00	1.15	1.15	1.15						0.60
	22	1.00	1.00	1.00		1.00	1.00		1.00		1.00	1.15	1.15	1.15	1.15					0.60
	23	1.00	1.00	1.00		1.00		1.00		1.00	1.00	0.86	0.86	0.86		1.15				0.60
	24	1.00	1.00		1.00	1.00		1.00		1.00	1.00	0.86	0.86							1.00
	25	1.00	1.00	1.00		1.00		1.00		1.00	1.00	0.86	0.86	0.86						1.00
	26	1.00	1.00	1.00		1.00	1.00		1.00		1.00	0.86	0.86	0.86	0.86					1.00

		PPS T	PPN S	SK0 S	SKA S	SW2 S	SK0 D	SKA D	SW D	SA	QM0 1	QM0 2	SQM S	SQM D	FA0 1	TC0 1	TC0 2	TV0 1	TV0 2	RIT	SST S	ISO 1	ISO2	
SIS	1	1.00	1.00		1.00	1.00	1.00		1.00	1.00											1.00	1.00	0.30	
	2	1.00	1.00		1.00	1.00	1.00		1.00	1.00							0.5					1.00	1.00	0.30
	3	1.00	1.00		1.00	1.00	1.00		1.00	1.00								0.5				1.00	1.00	0.30
	4	1.00	1.00		1.00	1.00	1.00		1.00	1.00									0.50			1.00	1.00	0.30
	5	1.00	1.00		1.00	1.00	1.00		1.00	1.00										0.50		1.00	1.00	0.30
	6	1.00	1.00		1.00	1.00	1.00		1.00	1.00											0.50	1.00	1.00	0.30
	7	1.00	1.00		1.00	1.00	1.00		1.00	1.00							0.50		0.50			1.00	1.00	0.30
	8	1.00	1.00		1.00	1.00	1.00		1.00	1.00							0.50			0.50		1.00	1.00	0.30
	9	1.00	1.00		1.00	1.00	1.00		1.00	1.00							0.50				0.5	1.00	1.00	0.30
	10	1.00	1.00		1.00	1.00	1.00		1.00	1.00												1.00	1.00	0.30
	11	1.00	1.00		1.00	1.00	1.00		1.00	1.00												1.00	1.00	0.30
	12	1.00	1.00		1.00	1.00	1.00		1.00	1.00								0.5				1.00	1.00	0.30

Società di Progetto
Brebem SpA

13	1.00	1.00		1.00	1.00	1.00		1.00	1.00							0.50			1.00	1.00	-	0.30	
14	1.00	1.00		1.00	1.00	1.00		1.00	1.00								0.50		1.00	1.00	-	0.30	
15	1.00	1.00		1.00	1.00	1.00		1.00	1.00									0.50	1.00	1.00	-	0.30	
16	1.00	1.00		1.00	1.00	1.00		1.00	1.00					0.50		0.50			1.00	1.00	-	0.30	
17	1.00	1.00		1.00	1.00	1.00		1.00	1.00					0.50		0.50			1.00	1.00	-	0.30	
18	1.00	1.00		1.00	1.00	1.00		1.00	1.00					0.50				0.50	1.00	1.00	-	0.30	
19	1.00	1.00		1.00	1.00	1.00		1.00	1.00										1.00	0.30	1.00		
20	1.00	1.00		1.00	1.00	1.00		1.00	1.00					0.5					1.00	0.30	1.00		
21	1.00	1.00		1.00	1.00	1.00		1.00	1.00							0.5			1.00	0.30	1.00		
22	1.00	1.00		1.00	1.00	1.00		1.00	1.00							0.50			1.00	0.30	1.00		
23	1.00	1.00		1.00	1.00	1.00		1.00	1.00									0.50	1.00	0.30	1.00		
24	1.00	1.00		1.00	1.00	1.00		1.00	1.00										0.50	1.00	0.30	1.00	
25	1.00	1.00		1.00	1.00	1.00		1.00	1.00					0.50		0.50			1.00	0.30	1.00		
26	1.00	1.00		1.00	1.00	1.00		1.00	1.00					0.50		0.50			1.00	0.30	1.00		
27	1.00	1.00		1.00	1.00	1.00		1.00	1.00					0.50				0.50	1.00	0.30	1.00		
28	1.00	1.00		1.00	1.00	1.00		1.00	1.00										1.00	0.30	-	1.00	
29	1.00	1.00		1.00	1.00	1.00		1.00	1.00					0.5					1.00	0.30	-	1.00	
30	1.00	1.00		1.00	1.00	1.00		1.00	1.00							0.5			1.00	0.30	-	1.00	
31	1.00	1.00		1.00	1.00	1.00		1.00	1.00							0.50			1.00	0.30	-	1.00	
32	1.00	1.00		1.00	1.00	1.00		1.00	1.00									0.50	1.00	0.30	-	1.00	
33	1.00	1.00		1.00	1.00	1.00		1.00	1.00										0.50	1.00	0.30	-	1.00
34	1.00	1.00		1.00	1.00	1.00		1.00	1.00					0.50		0.50			1.00	0.30	-	1.00	
35	1.00	1.00		1.00	1.00	1.00		1.00	1.00					0.50		0.50			1.00	0.30	-	1.00	
36	1.00	1.00		1.00	1.00	1.00		1.00	1.00					0.50				0.50	1.00	0.30	-	1.00	

APPROVATO SDP



7.9 Schemi di carico

Si riportano di seguito la modellazione dei carichi così come inserita nel programma ad elementi finiti Sap2000:



Figura 6 – PESO PROPRIO DELLA STRUTTURA E CARICHI PERMANENTI PORTATI



Figura 7 – SPINTA DELLE TERRE ST1S: spinta a riposo

APPROVATO SDP

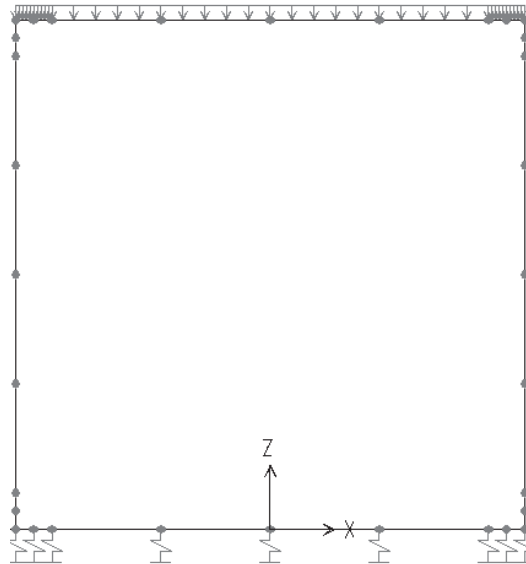

Figura 8 – SPINTA DELLE TERRE ST2S: spinta a riposo

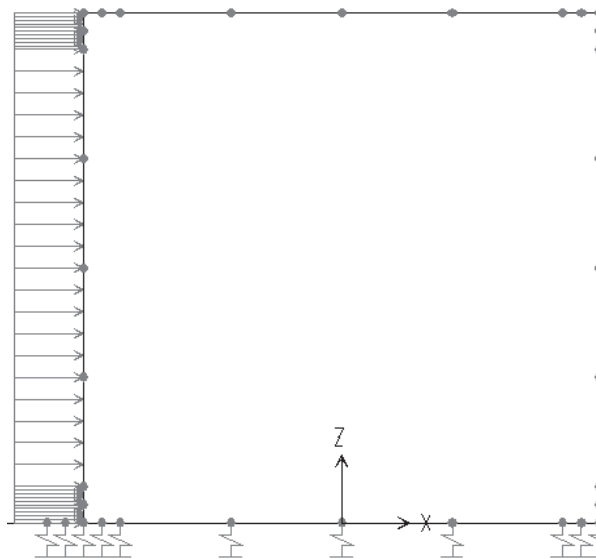

Figura 9 – SPINTA DELL'ACQUA SW2S

APPROVATO SDP

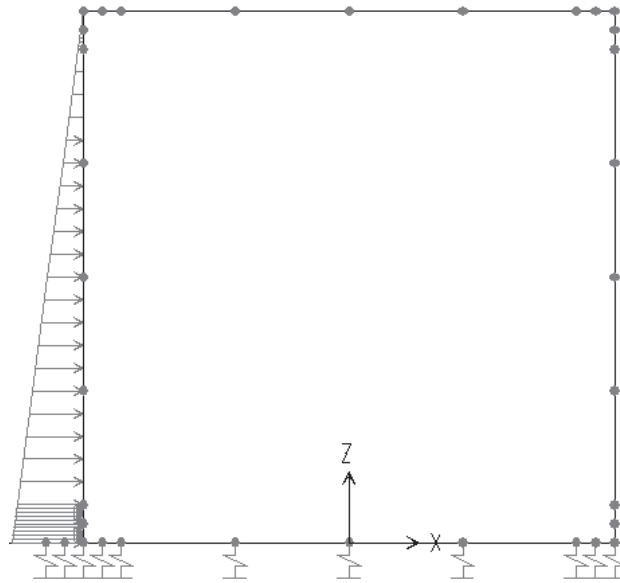
Società di Progetto
Brebemi SpA



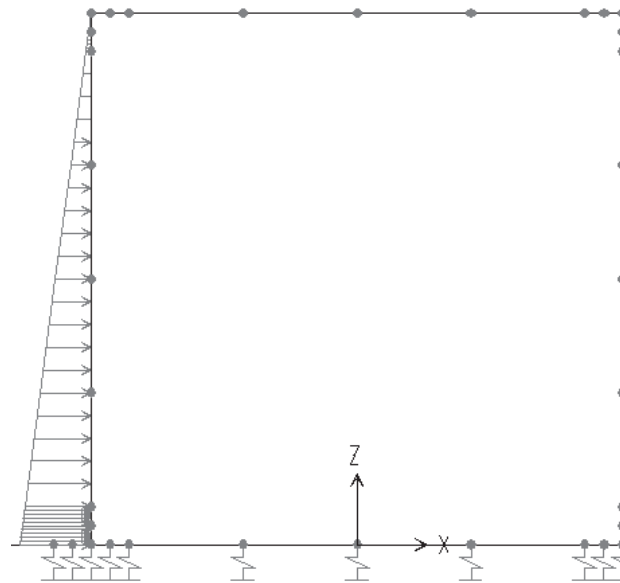

Figura 10 – SPINTA DELLE TERRE ST3S: spinta attiva



Figura 11 – SPINTA DELLE TERRE ST4S: spinta attiva

APPROVATO SDP

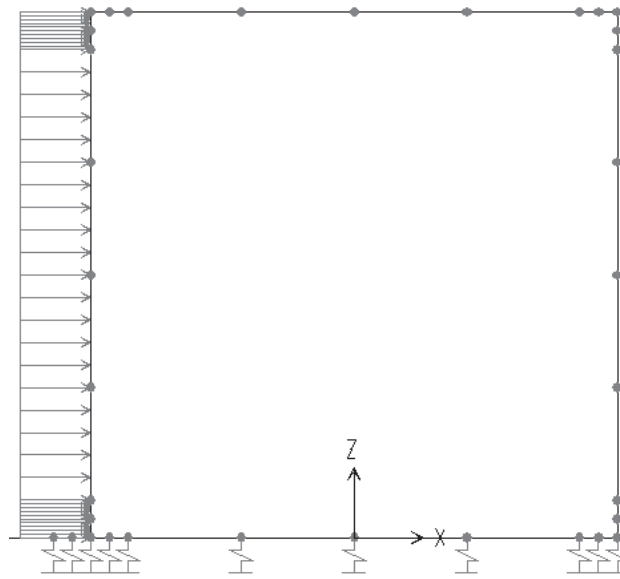

Figura 12 – SPINTA DELLE TERRE ST1D: spinta a riposo

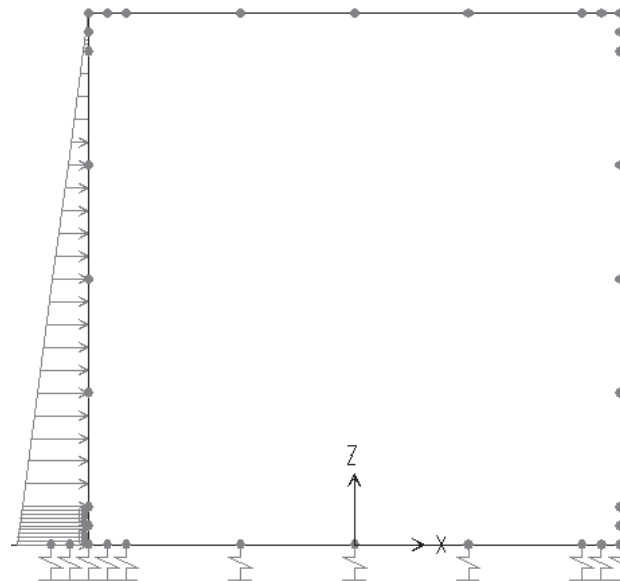

Figura 13 – SPINTA DELLE TERRE ST2D: spinta a riposo

APPROVATO SDP

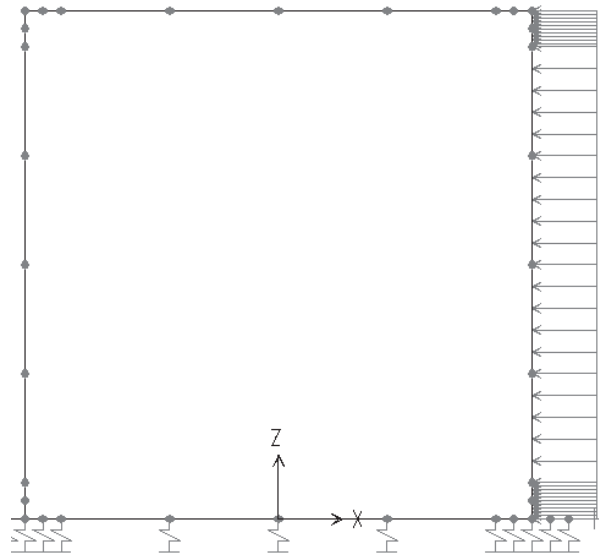

Figura 14 – SPINTA DELL'ACQUA SW2D

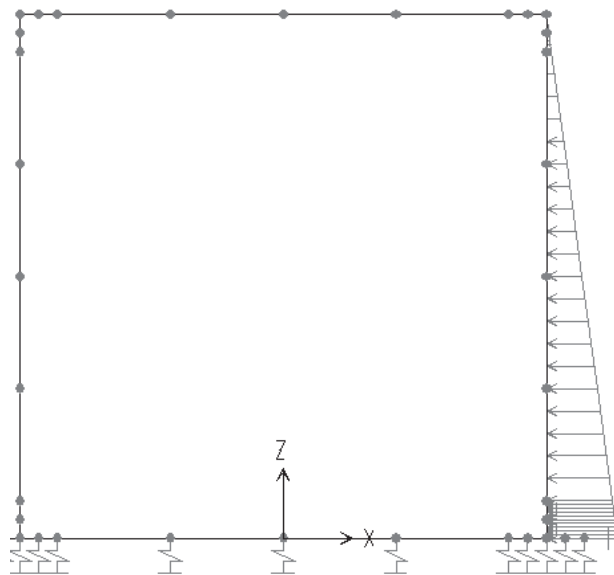

Figura 15 – SPINTA DELLE TERRE ST3D: spinta attiva

APPROVATO SDP

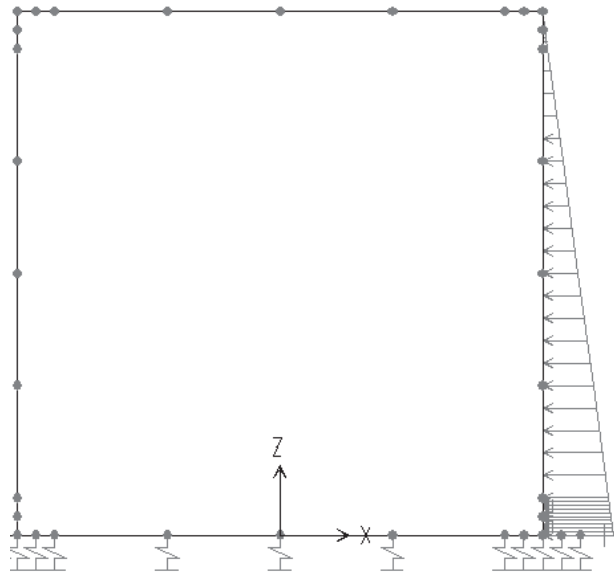
Società di Progetto
Brebemi SpA



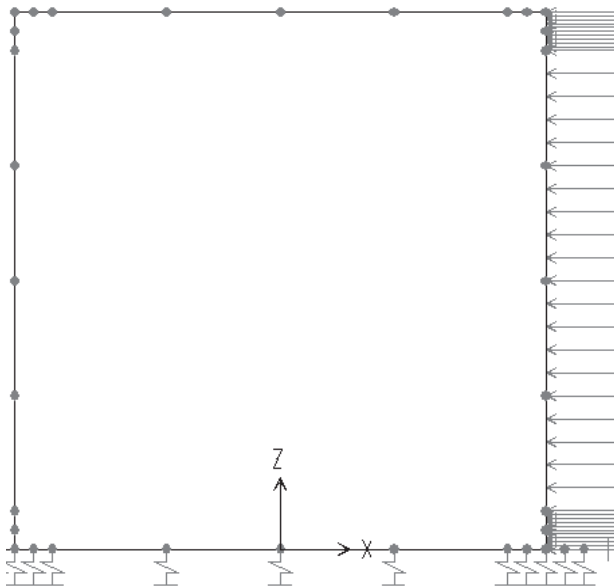

Figura 16 – SPINTA DELLE TERRE ST4D: spinta attiva



Figura 17 – SPINTA DI ARCHIMEDE SA

APPROVATO SDP

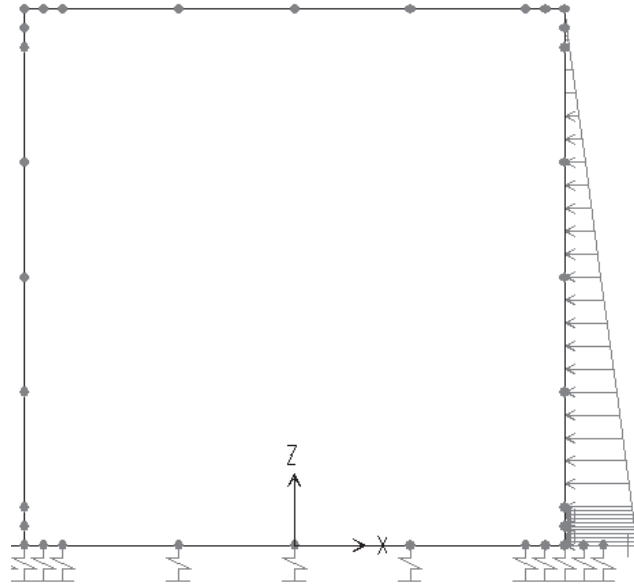
Società di Progetto
Brebemi SpA



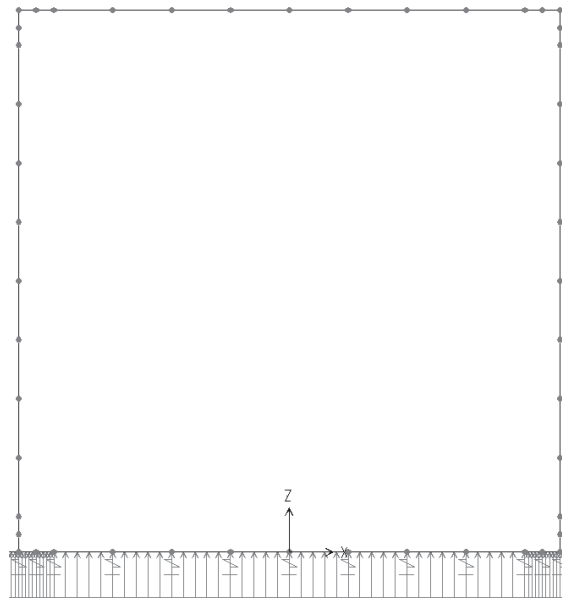

Figura 18 – AZIONE VERTICALE DA TRAFFICO QM01 (Q1K)



Figura 19 – AZIONE VERTICALE DA TRAFFICO QM02 (q1K)

APPROVATO SDP

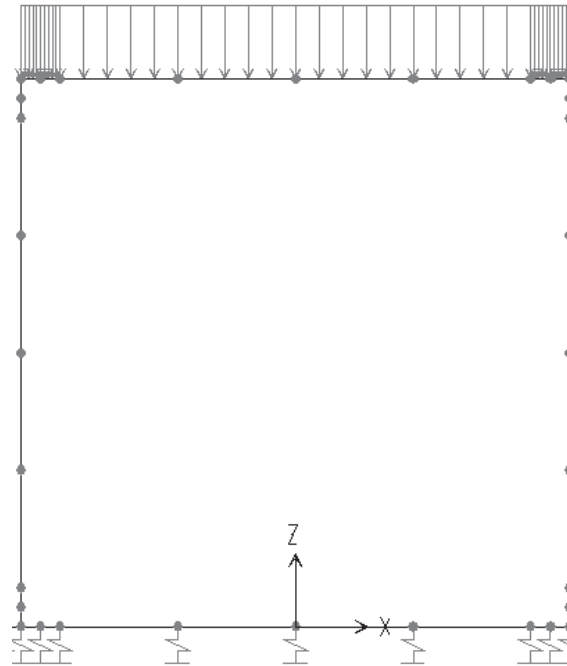
Società di Progetto
Brebemi SpA



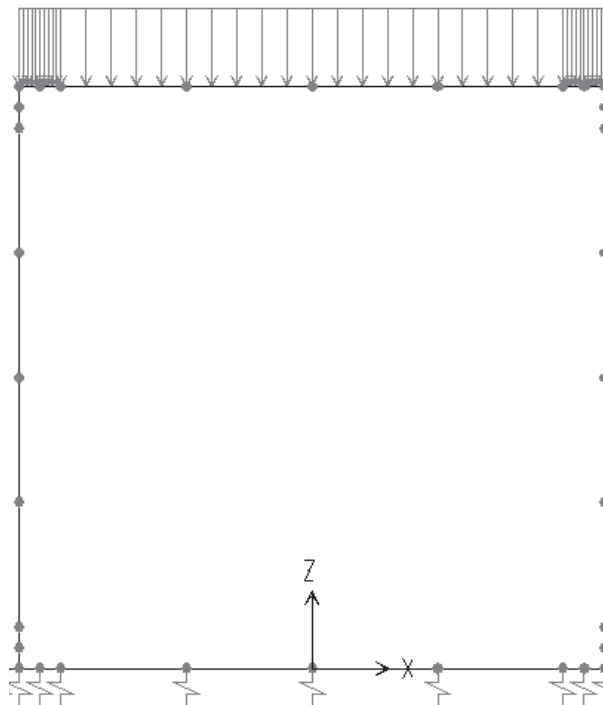

Figura 20 – SPINTA DOVUTA DALL’AZIONE VERTICALE DA TRAFFICO SUL PIEDR. DX
SQMD



Figura 21 – SPINTA DOVUTA DALL’AZIONE VERTICALE DA TRAFFICO SUL PIEDR. SX
SQMS

APPROVATO SDP

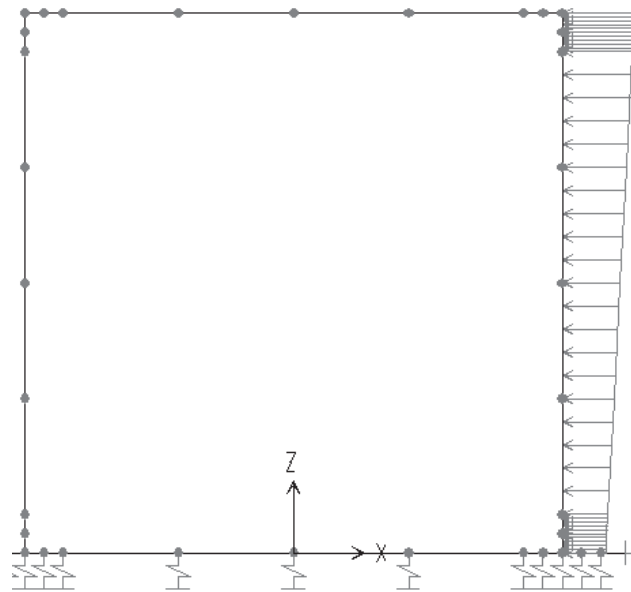

Figura 22 – AZIONE FRENANTE O CENTRIFUGA FA01

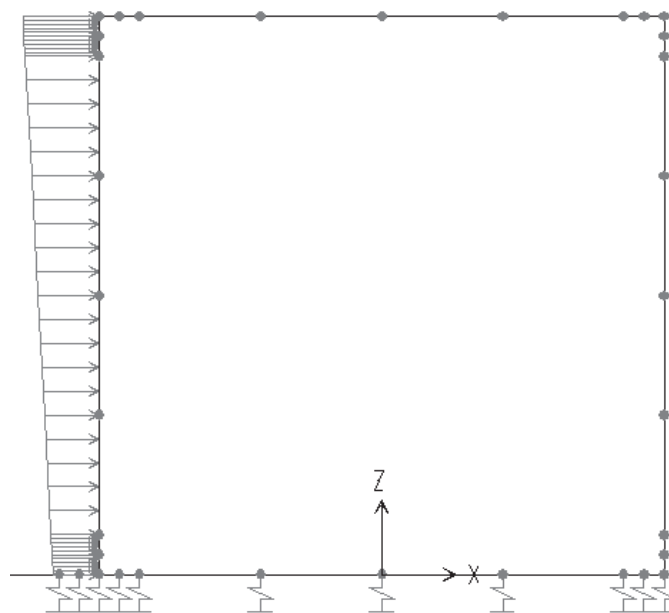

Figura 23 – AZIONI INERZIALI PER SISMA ORIZZONTALE IS01

APPROVATO SDP

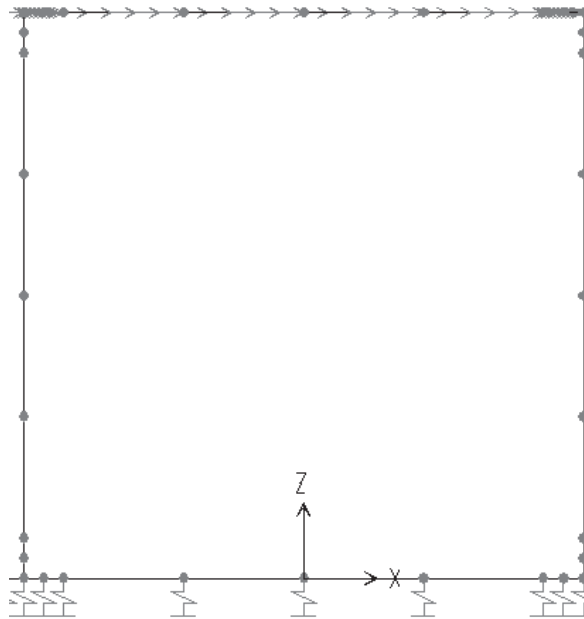
Società di Progetto
Brebemi SpA



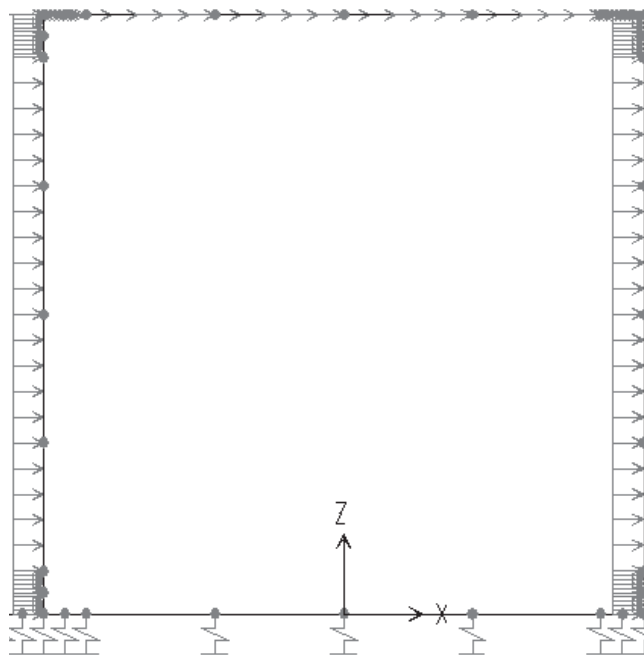

Figura 24 – AZIONI INERZIALI PER SISMA VERTICALE IS02



Figura 25 – SOVRASPINTA SISMICA SST

APPROVATO SDP

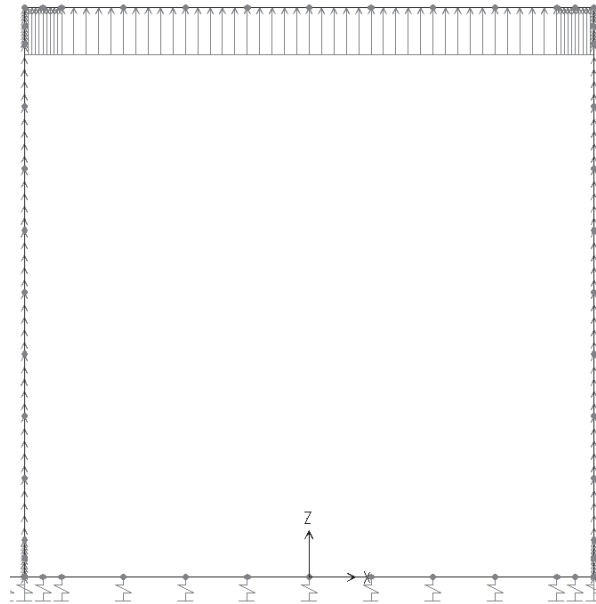
8 VERIFICA STATICHE

Di seguito si riportano le verifiche delle sezioni per le aste più significative e per le Combinazioni di carico risultate più critiche.

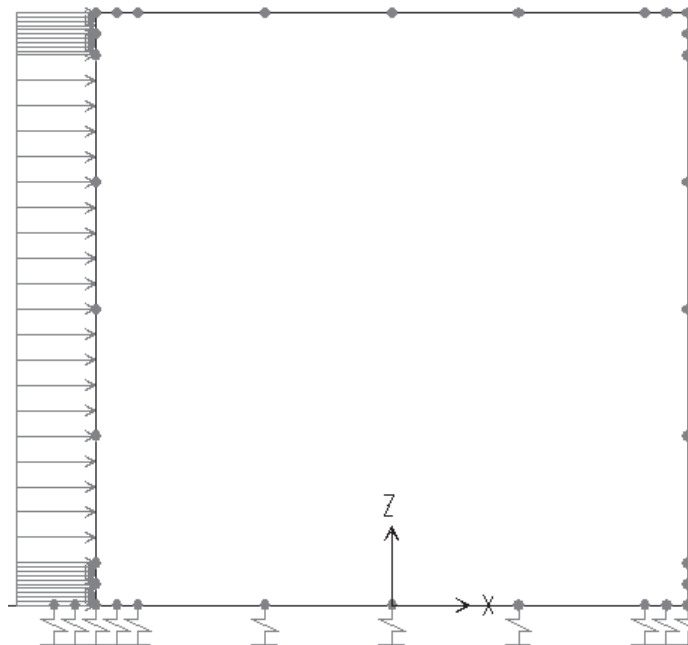
Società di Progetto
Brebemi SpA



	Doc. N. 60235-00000-A00.doc	CODIFICA DOCUMENTO 04RCDII100000000000300A00	REV. 00	FOGLIO 42 di 628
--	--------------------------------	---	------------	---------------------

Le verifiche a flessione allo SLU e allo SLE sono effettuate nella sezione di attacco piedritto-soletta, considerata di spessore di 16 cm. (A)

Le verifiche a taglio sono eseguite nelle sezioni dove termina la rastremazione del manufatto prefabbricato e la sezione corrente è pari a 16 cm e nelle sezioni dei nodi di estremità dove lo spessore del manufatto prefabbricato è pari a 36 cm. (C-B)



Figura 26 – Sezioni di riferimento per le verifiche

I calcoli di verifica sono effettuati con il metodo degli Stati Limite, applicando il D. M.14.01.2008 .

Le verifiche a fessurazione sono state condotte considerando:

Verifica di formazione delle fessure: la verifica si esegue per la sezione interamente reagente e per le sollecitazioni di esercizio si determina la massima trazione nel calcestruzzo σ_{ct} , confrontandola con la resistenza caratteristica a trazione per flessione f_{ctk} : se risulta $\sigma_{ct} < f_{ctk}$ la verifica è soddisfatta, altrimenti si procede alla verifica di apertura delle fessure.

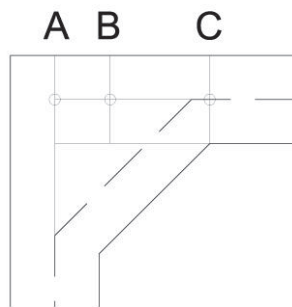
Verifica di apertura delle fessure: l'apertura convenzionale delle fessure è calcolata, come richiesto dal D. M. Min. II. TT. del 14 gennaio 2008, e valutata con le sollecitazioni relative alle Combinazioni FR o QP della normativa vigente sui ponti stradali". La massima apertura ammissibile risulta rispettivamente le strutture in ambiente aggressivo ed armature poco sensibili:

b.1) combinazione di carico Frequante:

$$w_k \leq w_2 = 0,30 \text{ mm}$$

b.2) combinazione di carico quasi permanente:

$$w_k \leq w_1 = 0,20 \text{ mm}$$

La massima apertura ammissibile risulta rispettivamente le strutture in ambiente ordinario ed armature poco sensibili:

b.1) combinazione di carico Frequante:

$$w_k \leq w_3 = 0,40 \text{ mm}$$

b.2) combinazione di carico quasi permanente:

$$w_k \leq w_2 = 0,30 \text{ mm}$$

Verifica delle tensioni di esercizio: le verifiche si eseguono per la condizione di carico Quasi Permanente e Rara, verificando rispettivamente che le tensioni di lavoro siano inferiori ai seguenti limiti:

Sezione di Progetto
Broburni SpA



per la condizione QP si verifica che le massime tensioni presenti nel calcestruzzo siano inferiori a $\sigma_c < 0.45 f_{ck}$;

per la condizione rara si verifica che le massime tensioni presenti nel calcestruzzo siano inferiori a $\sigma_c < 0.60 f_{ck}$, mentre quelle dell'acciaio $\sigma_s < 0.80 f_{yk}$

A favore di sicurezza si trascura il contributo dello sforzo normale nelle verifiche delle sezioni delle solette orizzontali.

TOMBINO 1,50X1,50

Il tombino scatolare presenta sezione corrente di forma rettangolare ed è realizzato da una soletta di fondazione su cui si innestano i piedritti, costituiti da setti continui in cemento armato prefabbricato a spessore costante e sui quali si realizzerà la soletta di copertura, costituita da una piastra in calcestruzzo armato prefabbricato, anch'essa a spessore costante .

La geometria è quella riportata nella figura:



Figura 27 – sezione trasversale

APPROVATO SDP

$$L_n = 1,50 \text{ m}$$

$$L = 1,82 \text{ m}$$

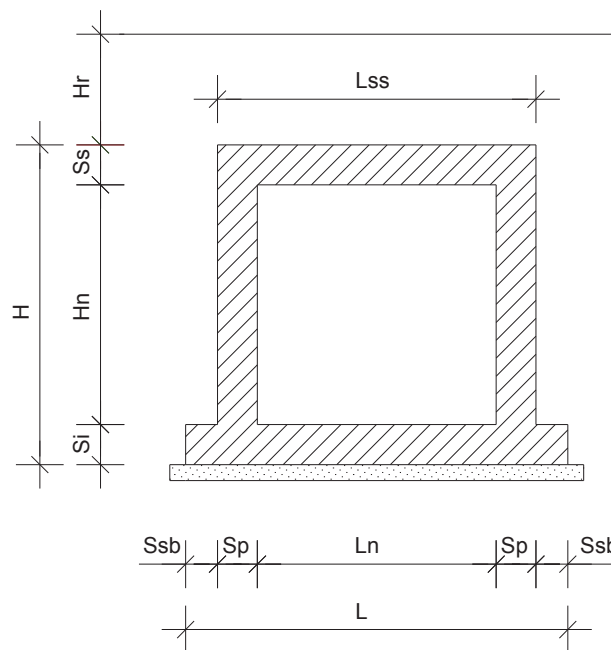
$$L_{ss} = 1,82 \text{ m}$$

$$S_s = 0,16 \text{ m}$$

$$S_i = 0,16 \text{ m}$$

$$S_p = 0,16 \text{ m}$$

$$H_n = 1,50 \text{ m}$$

$$H = 1,82 \text{ m}$$

$$S_{sb} = 0,00 \text{ m}$$

In favore di sicurezza, per la determinazione dei carichi agenti sulla struttura e per la ripartizione dei carichi da traffico, si assume un ricoprimento pari a:

$$H_{ric} = 0,50 \text{ m}$$

Società di Progetto
Brebemi SpA

8.1 Riassunto condizioni di carico e valori di calcolo

Nel seguito viene riportata la tabella riassuntiva per il calcolo delle condizioni precedentemente illustrate per l'analisi con assenza di falda.

Caratteristiche geometriche

B	=	1,50	m	Larghezza interna sezione trasversale di calcolo
H	=	1,50	m	Altezza interna sezione trasversale di calcolo
L _{tomb}	=	2,00	m	Lunghezza totale assunta per lo scatolare
S _p solsup	=	0,16	m	Spessore soletta superiore
S _p solinf	=	0,16	m	Spessore soletta inferiore
S _p pie	=	0,16	m	Spessore piedritti sezione trasversale di calcolo
H _{ric} pavimentato	=	0,00	m	Spessore pavimentazione
H _{ric} rilevato	=	0,50	m	Spessore rilevato
H _{ric} totale	=	0,50	m	Ricoprimento da estradosso pavimentazione
γ _{cls}	=	25,00	kN/m ³	Peso specifico del c.a.
L _{cons}	=	1,00		Lunghezza tombino considerata per l'analisi dei carichi
Presenza falda	=	0,00		Se 1 falda presente se 0 falda assente
H _{falda}	=	0,00		quota falda rispetto al P.C.

Caratteristiche geotecniche

γ'	=	20,00	kN/m ³	Peso specifico rilevato secco
γ _{sat}	=	20,00	kN/m ³	Peso specifico terreno da rilevato saturo
γ _w	=	0,00	kN/m ³	Peso specifico acqua
γ _{pav}	=	20,00	kN/m ³	Peso specifico pavimentazione
γ _{medio ric}	=	20,00	kN/m ⁴	Peso specifico pavimentazione medio del ricoprimento
φ _{ril}	=	38,00	°	Angolo di resistenza al taglio di progetto secondo coeff parziale M del rilevato
γ _{φM1}	=	1,00		Coefficiente parziale M1 come da NTC2008
K _{0M1}	=	0,380		Coefficiente di spinta a riposo di progetto secondo coeff parziale M
K _{AM1}	=	0,238		Coefficiente di spinta attiva di progetto secondo coeff parziale M
K _{PM1}	=	4,200		Coefficiente di spinta passiva di progetto secondo coeff parziale M1
c _{ril}	=	0,00	kN/m ³	Coesione rilevato
γ _{terra}	=	20,00	kN/m ³	Peso specifico terreno di fondazione
φ _{terra}	=	35,00	°	Angolo di attrito terreno di fondazione
K _S	=	1000,00	kN/m ³	Costante di sottofondo
γ _{φM2}	=	1,25		Coefficiente parziale M2 come da NTC2008
φ' _{ril}	=	32	°	Angolo di resistenza al taglio di progetto secondo coeff parziale M del terreno di fondazione
K _{0M2}	=	0,470		Coefficiente di spinta a riposo di progetto secondo coeff parziale M
K _{AM2}	=	0,307		Coefficiente di spinta attiva di progetto secondo coeff parziale M
K _{PM2}	=	3,250		Coefficiente di spinta passiva di progetto secondo coeff parziale M2
α	=	30	°	Angolo di diffusione carichi nel terreno

ANALISI DEI CARICHI

Peso proprio

Progetto
Brebemi SpA



PPST = Automatico dal programma

Carichi permanenti

PPNS_{sol}sup = 10,00 kN/m Peso ricoprimento soletta superiore
 H riempimento = 0,00 m altezza di riempimento
 PPAQ = 0,00 kN/m Peso riempimento con acqua su soletta inferiore

Spinta della terra con ϕ_{ri}

ST1S.q = 4,41 kN/m Spinta a riposo (M1) costante sul piedritto sx
 ST2S.q = 12,62 kN/m Spinta a riposo (M1) lineare sul piedritto sx
 ST3S.q = 2,77 kN/m Spinta attiva (M1) costante sul piedritto sx
 ST4S.q = 7,91 kN/m Spinta attiva (M1) lineare sul piedritto sx
 ST1D.q = -4,41 kN/m Spinta a riposo (M1) costante sul piedritto dx
 ST2D.q = -12,62 kN/m Spinta a riposo (M1) lineare sul piedritto dx
 ST3D.q = -2,77 kN/m Spinta attiva (M1) costante sul piedritto dx
 ST4D.q = -7,91 kN/m Spinta attiva (M1) lineare sul piedritto dx

Spinta della terra con ϕ'_{ri}

ST1SG.q = 5,46 kN/m Spinta a riposo (M2) costante sul piedritto sx
 ST2SG.q = 15,61 kN/m Spinta a riposo (M2) lineare sul piedritto sx
 ST3SG.q = 3,57 kN/m Spinta attiva (M2) costante sul piedritto sx
 ST4SG.q = 10,20 kN/m Spinta attiva (M2) lineare sul piedritto sx
 ST1DG.q = -5,46 kN/m Spinta a riposo (M2) costante sul piedritto dx
 ST2DG.q = -15,61 kN/m Spinta a riposo (M2) lineare sul piedritto dx
 ST3DG.q = -3,57 kN/m Spinta attiva (M2) costante sul piedritto dx
 ST4DG.q = -10,20 kN/m Spinta attiva (M2) lineare sul piedritto dx

Azioni della falda

Spinta idrostatica

SW1S = 0,00 kN/m Spinta costante sul piedritto sx
 SW2S = 0,00 kN/m Spinta lineare sul piedritto sx
 SW1D = 0,00 kN/m Spinta costante sul piedritto dx
 SW2D = 0,00 kN/m Spinta lineare sul piedritto dx

Spinta di Archimede

SA = 0,00 kN/m Spinta costante sulla soletta inferiore

Carichi accidentali

Carichi su soletta superiore

Q_{ik 1°} = 300,00 kN Carico tandem come da NTC2008 prima corsia
 Q_{ik 2°} = 200,00 kN Carico tandem come da NTC2008 seconda corsia
 b = 0,40 m Larghezza impronta di carico come da NTC2008
 l = 0,40 m Lunghezza impronta di carico come da NTC2008
 it = 2,00 m Interasse trasversale delle impronte come da NTC2008
 il = 1,20 m Interasse longitudinale delle impronte come da NTC2008
 B_{T1} = 3,14 m Larghezza di diffusione trasversale del carico tandem singola colonna di carico
 B_{T2} = 3,07 m Larghezza di diffusione trasversale del carico tandem due colonne di carico
 B_T = 3,07 m Larghezza di diffusione trasversale di calcolo
 L_{l1} = 2,34 m Larghezza di diffusione longitudinale del carico tandem se >B+2S
 L_{l2} = 2,27 m Larghezza di diffusione longitudinale del carico tandem se <B+2S
 L_l = 2,27 m Larghezza di diffusione longitudinale di calcolo

APPROVATO SDP



QM01.q _{1c}	=	86,10 kN/m ²	Carico medio uniforme di calcolo
QM01.q _{1c}	=	87,00 kN/m	Carico tandem medio uniforme di calcolo assunto
q _{ik 1°}	=	9,00 kN/m ²	Carico distribuito come da NTC2008 prima corsia
q _{ik 2°}	=	2,50 kN/m ²	Carico distribuito come da NTC2008 seconda corsia
QM02.q _{ik}	=	9,00 kN/m	Carico distribuito di calcolo assunto
<u>Spinta della terra con ϕ_{rit} - carico in avvicinamento</u>			
n° corsie	=	2	
b	=	3,00 m	Larghezza di ripartizione del carico come da Circolare 2/2/09 n.6
l	=	2,20 m	lunghezza di ripartizione del carico come da Circolare 2/2/09 n.6
q _{1c'}	=	90,91 kN/m ²	Carico tandem trasformato in carico distribuito
q _{1csup}	=	62,69 kN/m ²	Carico Qik distribuito sull'asse della soletta sup
q _{1cinf}	=	36,95 kN/m ²	Carico Qik distribuito sull'asse della soletta inf
q _{1dsup}	=	8,10 kN/m ²	Carico qik distribuito sull'asse della soletta sup
q _{1dinf}	=	6,29 kN/m ²	Carico qik distribuito sull'asse della soletta inf
SQMS.P _{sup}	=	26,91 kN/m	Spinta a riposo (M1) sul piedritto sx in asse soletta superiore
SQMS.P _{inf}	=	16,44 kN/m	Spinta a riposo (M1) sul piedritto sx in asse soletta inferiore
SQMD.P _{sup}	=	-26,91 kN/m	Spinta a riposo (M1) sul piedritto dx in asse soletta superiore
SQMD.P _{inf}	=	-16,44 kN/m	Spinta a riposo (M1) sul piedritto dx in asse soletta inferiore
<u>Spinta della terra con ϕ'_{rit} - carico in avvicinamento</u>			
SQMSG.P _{sup}	=	33,28 kN/m	Spinta a riposo (M2) sul piedritto sx in asse soletta superiore
SQMSG.P _{inf}	=	20,33 kN/m	Spinta a riposo (M2) sul piedritto sx in asse soletta inferiore
SQMDG.P _{sup}	=	-33,28 kN/m	Spinta a riposo (M2) sul piedritto dx in asse soletta superiore
SQMDG.P _{inf}	=	-20,33 kN/m	Spinta a riposo (M2) sul piedritto dx in asse soletta inferiore
Azione frenante o accelerazione			
Q ₃	=	364,91 kN	Carico frenante
Q _{3-app}	=	370,00 kN	Carico frenante approssimato per eccesso alla decina superiore
n°	=	1	Numero carreggiate
B'	=	3,58 m	Larghezza di diffusione trasversale nel terreno azione di frenatura di calcolo
L'	=	2,78 m	Larghezza di diffusione longitudinale nel terreno azione di frenatura di calcolo
f1	=	37,25 kN/m ²	Azione frenante di calcolo da ripartire in senso longitudinale
Lt	=	7,22 m	Larghezza di ripartizione trasversale alla strada
Lt-app	=	8,00 m	Larghezza di ripartizione trasversale alla strada approssimata al concio superiore L = 2 m
f2	=	16,65 KN/m	Azione frenante di calcolo in direzione da sinistra a destra
FA02.q3	=	16,70 kN/m	Azione frenante di calcolo in direzione da sinistra a destra assunta
Azioni termiche			
TC01	=	10,00 °C	Carico termico uniforme sulla soletta superiore
TC02	=	-10,00 °C	Carico termico uniforme sulla soletta superiore
TV01	=	5,00 °C	Carico termico a farfalla sulla soletta superiore e piedritti estradosso più caldo
TV02	=	-5,00 °C	Carico termico a farfalla sulla soletta superiore e piedritti estradosso più freddo
Ritiro			
fck	=	40,00	Resistenza caratteristica cilindrica della soletta superiore
U	=	0,70	Umidità
Ac	=	1,13	Area sezione trasversale tombino
u	=	3,64	Perimetro esposto all'aria

	Doc. N. 60235-00000-A00.doc	CODIFICA DOCUMENTO 04RCDII100000000000300A00	REV. 00	FOGLIO 47 di 628
--	--------------------------------	---	------------	---------------------

ho	=	0,62	2Ac/u
eco	=	-0,00030	
kh	=	0,75	
ecd	=	-0,000225	Deformazione per ritiro da essiccamento a tempo infinito
eca	=	-0,000075	Deformazione per ritiro autogeno a tempo infinito
ecs	=	-0,000300	Deformazione per ritiro totale a tempo infinito
Dtrit	=	-10,00 °C	Variazione terica equivalente al ritiro
Azione sismica			
Cs	=	B	Categoria di sottosuolo
Ct	=	T1	Categoria topografica
Clu	=	4	Classe d'uso
Cu	=	2	Coefficiente d'uso
VN	=	50 anni	Vita nominale
VR	=	100 anni	Periodo di riferimento
T _R	=	949	Periodo di ritorno
SL	=	SLV	Stato limite ultimo di salvaguardia della vita
a _g	=	0,185 g	Accelerazione del suolo
F ₀	=	2,484	Fattore di amplificazione dello spettro in accelerazione orizzontale
T _c *	=	0,288 s	Periodo di inizio del tratto a velocità costante dello spettro in accelerazione orizzontale
Ss	=	1,20	Coeff di amplificazione sismografica
a _{max}	=	0,222 g	Accelerazione massima attesa in sito
β _m	=	1,00	Coeff riduttivo dell'accelerazione massima come da NTC2008
k _h	=	0,222	Coeff sismico orizzontale come da NTC2008
k _v	=	0,111	Coeff sismico verticale come da NTC2008
IS01.pie	=	0,89 kN/m	Inerzia dei piedritti per sisma da sinistra a destra
IS01.sol+ric	=	3,11 kN/m	Inerzia della soletta superiore e del ricoprimento per sisma da sinistra a destra
SSTS.qv	=	10,31 kN/m	Sovraspinta sull'asse del piedritto sx
IS02.pie	=	0,45 kN/m	Inerzia dei piedritti per sisma verticale
IS02.sol+ric	=	1,56 kN/m	Inerzia della soletta superiore e del ricoprimento per sisma verticale

8.2 Massime sollecitazioni

Nel seguito vengono riportati i diagrammi delle sollecitazioni massime nelle combinazioni più sfavorevoli, effettuati gli Involuppi del momento flettente e del taglio in combinazioni RARA, FRE, QPE, SIS, per l'analisi con assenza di falda. Si omettono i diagrammi di involucro delle azioni normali in quanto nelle singole verifiche sono considerate le azioni normali (riferite alla singola combinazione) corrispondenti alle azioni flettenti di involucro.

Sezione STRU
Brenem SpA

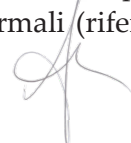

Per quanto riguarda le combinazioni STRU si mostrano i diagrammi delle azioni flettenti e taglianti, per quanto riguarda le combinazioni RARA, FRE, QPE, SIS si mostrano i diagrammi delle sole azioni flettenti.

Le unità di misura delle sollecitazioni sono M[KNm] e V[KN].



Figura 28 – Azioni flettenti – INVSTRU

APPROVATO SDP



Figura 29 – Azioni taglianti – INVSTRU

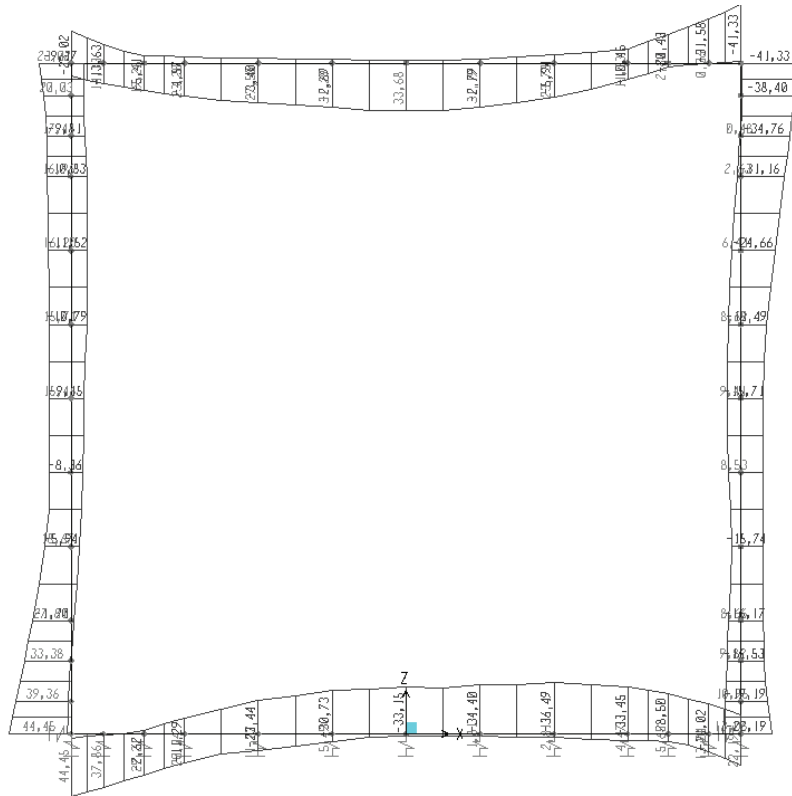

Figura 30 – Azioni flettenti – INVRARA

APPROVATO SDP

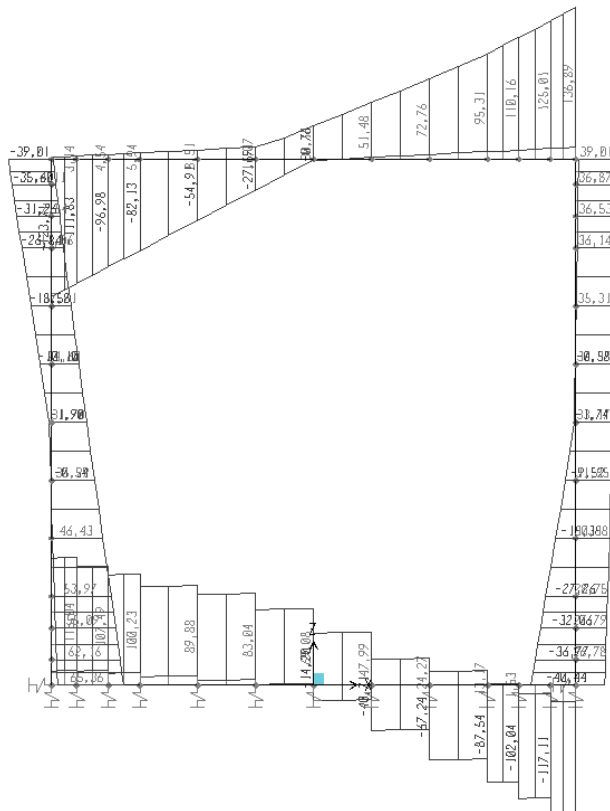
Società di Progetto
Brebemi SpA



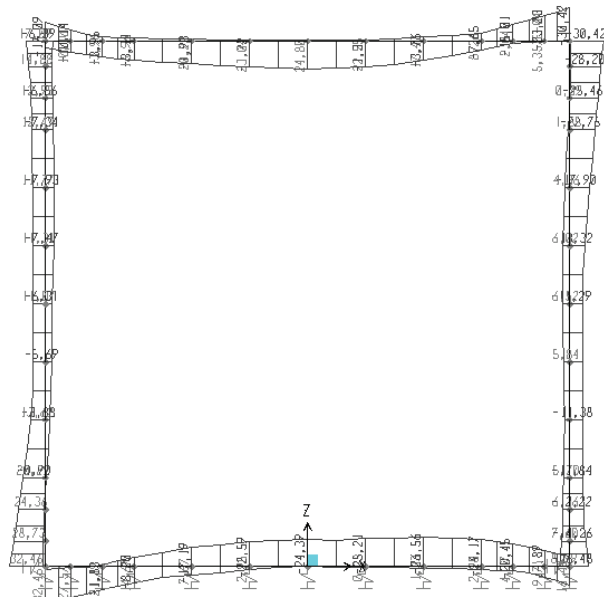

Figura 31 – Azioni flettenti – INVFREQUENTE



Figura 32 – Azioni flettenti – INVQUASIPERMANENTE

APPROVATO SDP

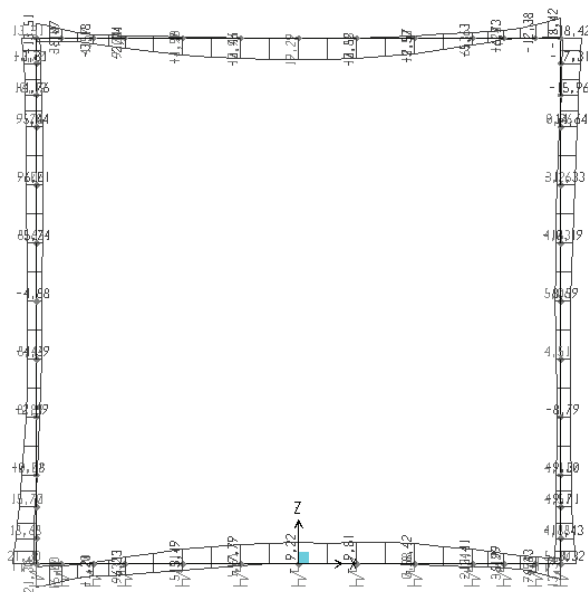

Figura 33 – Azioni flettenti – INVSISMICA

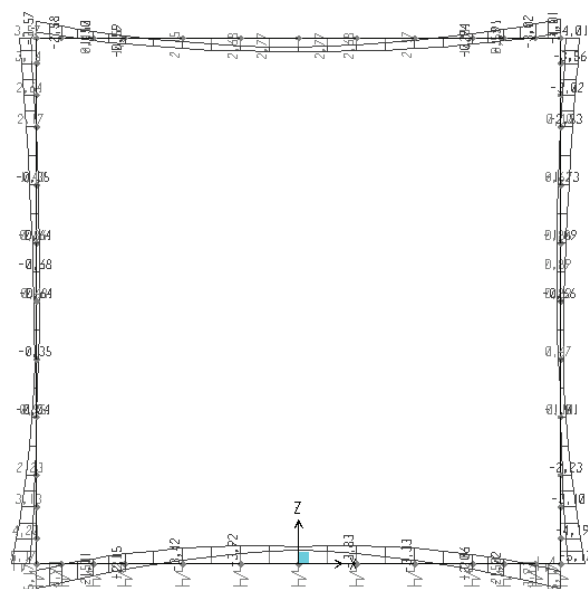
Le verifiche strutturali vengono effettuate sugli elementi 30-31-45-46-1-24-18-36-40 per quanto riguarda le sollecitazioni di flessione e 34-42-22-3 per quanto riguarda le sollecitazioni di taglio.

8.3 Verifiche di resistenza e fessurazione

Si riportano di seguito le verifiche di resistenza e fessurazione per le sezioni scelte quali caratteristiche della struttura e per le massime sollecitazioni.

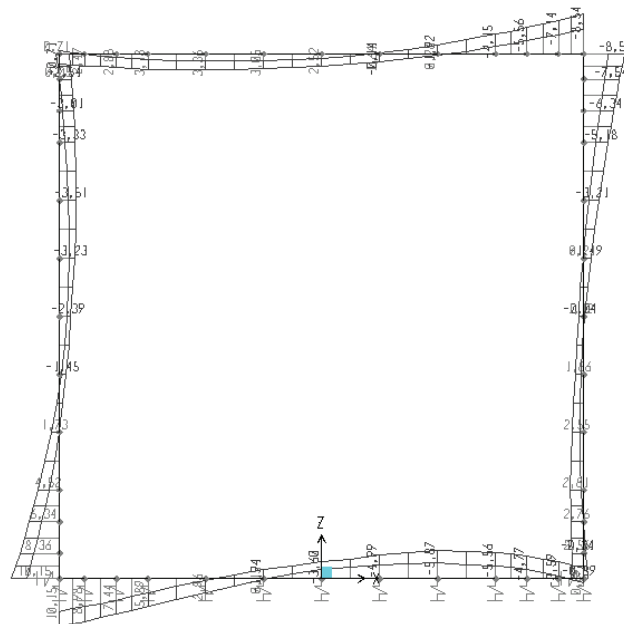
8.3.1 Soletta superiore – sezione di incastro

La sezione di verifica ha dimensioni 100 cm di larghezza e 16 di altezza. L'armatura è costituita da $\phi 12/20 + \phi 12/20$ al lembo superiore e $\phi 12/20$ al lembo inferiore. La sezione è armata a taglio da un sistema di ferri piegati $\phi 12/20$ e da un sistema di staffe $\phi 10/20$ per ogni estremo della soletta.

Calcestruzzo

Classe	=	C40/50	
Rck	\geq	50	MPa Valore caratteristico resistenza cubica
Fck	=	41,5	MPa Valore caratteristico resistenza cilindrica
fcm	=	49,5	MPa Valore medio resistenza cilindrica
fctm	=	3,60	MPa Valore medio resistenza a trazione semplice
fcfm	=	4,32	MPa Valore medio resistenza a trazione per flessione
ν	=	0,2	Coefficiente di Poisson
Ecm	=	35547	MPa Modulo elastico
γ_c	=	1,5	Coefficiente parziale di sicurezza
α_{cc}	=	0,85	Coefficiente risuttivo per resistenze di lunga durata
fcd	=	23,52	MPa Resistenza di calcolo a compressione

Società di Progetto
Brebemi SpA



f_{ctd}	=	1,68	MPa	Resistenza di calcolo a trazione
ϵ_{cu}	=	0,0035		Deformazione a rottura per il calcestruzzo
ϵ_{c0}	=	0,002		Def. limite del tratto a parabola del legame costitutivo del calcestruzzo

Valori per studio alle tensioni ammissibili:

n	=	15		Coefficiente di omogeneizzazione
-----	---	----	--	----------------------------------

Acciaio per c.a.

Tipo	=	B 450 C		
$f_{yk\ nom}$	=	450	MPa	Valore nominale della tensione caratteristica di snervamento
$f_{tk\ nom}$	=	540	MPa	Valore nominale della tensione caratteristica di rottura
γ_s	=	1,15		Coefficiente parziale di sicurezza
E_s	=	210000	MPa	Modulo elastico
f_{yd}	=	391,3	MPa	Resistenza di calcolo
ϵ_{su}	=	0,01		Deformazione a rottura per l'acciaio

Caratteristiche geometriche

Sezione di cls				
B	=	100	cm	base
H	=	16	cm	altezza
A_{cls}	=	1600	cmq	area di cls

Sistema di armatura per sollecitazioni M_X-V_Y

Armatura longitudinale inferiore (per sollecitazione $M_{X\ positiva}$)

$d1$	=	12	mm	diametro ferri prima fila
$c1$	=	3,00	cm	copriferro ferri prima fila
$i1$	=	20,00	cm	interasse ferri prima fila
$As1$	=	5,65	cmq	area acciaio ferri prima fila
$d2$	=	12	mm	diametro ferri seconda fila
$c2$	=	3,00	cm	copriferro ferri seconda fila
$i2$	=	20,00	cm	interasse ferri seconda fila
$As2$	=	5,65	cmq	area acciaio ferri seconda fila
$d3$	=	0	mm	diametro ferri terza fila
$c3$	=	0,00	cm	copriferro ferri terza fila
$i3$	=	0,00	cm	interasse ferri terza fila
$As3$	=	0,00	cmq	area acciaio ferri terza fila
As	=	11,31	cmq	area acciaio in zona tesa

Armatura longitudinale superiore (per sollecitazione $M_{X\ positiva}$)

$d1$	=	12	mm	diametro ferri prima fila
$c1$	=	3,00	cm	copriferro ferri prima fila
$i1$	=	20,00	cm	interasse ferri prima fila
$As'1$	=	5,65	cmq	area acciaio ferri prima fila
$d2$	=	0	mm	diametro ferri seconda fila
$c2$	=	0,00	cm	copriferro ferri seconda fila
$i2$	=	0,00	cm	interasse ferri seconda fila
$As'2$	=	0,00	cmq	area acciaio ferri seconda fila
$d3$	=	0	mm	diametro ferri terza fila
$c3$	=	0,00	cm	copriferro ferri terza fila
$i3$	=	0,00	cm	interasse ferri terza fila
$As'3$	=	0,00	cmq	area acciaio ferri terza fila
As'	=	5,65	cmq	area di acciaio in zona compressa

Armatura trasversale, staffe e/o ferri piegati (per sollecitazione V_Y)

θ	=	45	°	Inclinazione della biella di cls (standard: 45°)
----------	---	----	---	--

As_w 1° ordine:

APPROVATO SDP

Società di Progetto
Brebemi SpA



	Doc. N. 60235-00000-A00.doc	CODIFICA DOCUMENTO 04RCDII100000000000300A00	REV. 00	FOGLIO 53 di 628

α	=	45	°	staffe: 90°; ferri piegati: angolo minore di 90°
n° bracci	=	5		
$\varphi 1$	=	12	mm	Diametro staffe primo ordine
s	=	470	mm	Passo delle staffe
Asw 2° ordine:				
α	=	45	°	staffe: 90°; ferri piegati: angolo minore di 90°
n° bracci	=	10		
$\varphi 2$	=	10	mm	Diametro staffe secondo ordine
s	=	470	mm	Passo delle staffe

Verifica a taglio della sezione maggiormente sollecitata (V_Y):

Nella verifica a taglio NON si considera l'effetto positivo della compressione sulla sezione.

Nella verifica a taglio NON si considera l'effetto positivo dovuto ai meccanismi secondari di resistenza a taglio.

Nella sezione sono previste armature trasversali resistenti a sollecitazioni di taglio.

$V_{Sd Y}$ = 96 kN Massima azione di taglio agente sulla sezione

$V_{Rd Y}$ = 190 kN Risorsa resistente a taglio della sezione

SF = 1,98 [-] Coefficiente di sicurezza per sollecitazione V_Y

La verifica a taglio per sollecitazione V_Y è soddisfatta.

Combinazioni di carico e verifica a pressoflessione retta

							N+MX
n°	COMB	N [kN]	MX [kNm]	VY [kN]	MY [kNm]	VX [kN]	SF
0	0		42,0	96,0			1,28

APPROVATO SDP

Società di Progetto
Brebemi SpA



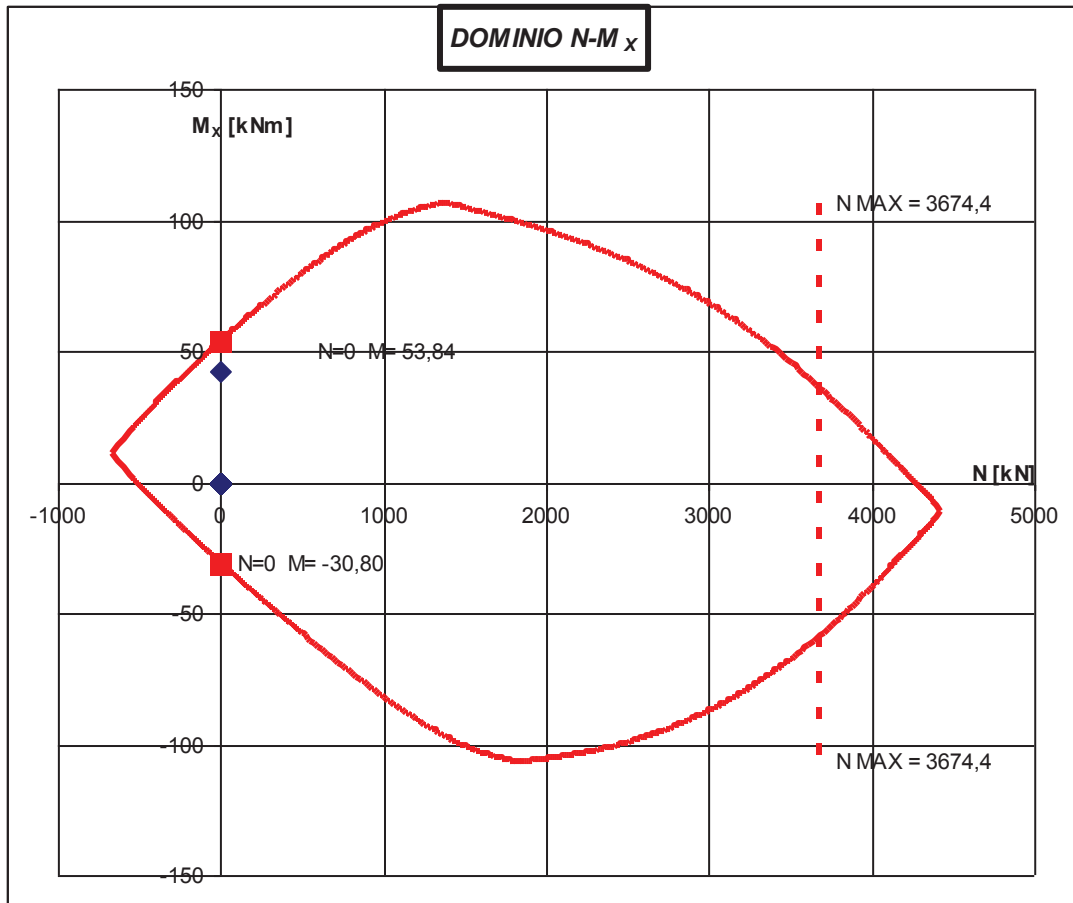

Caratteristiche dei materiali

Rck	=	50	MPa	resistenza caratteristica a 28 giorni del calcestruzzo
Ec	=	35547	MPa	modulo elastico del calcestruzzo
Acciaio B 450 C saldabile				
		21000		
Es	=	0	MPa	modulo elastico dell'acciaio
n	=	15		coefficiente di omogeneizzazione

Tensioni ammissibili

sigma c amm	=	14,75	MPa	tensione ammissibile del cls a compressione
tau c0	=	0,87	MPa	tensione ammissibile del cls a taglio senza l'ausilio di armatura
tau c1	=	2,40	MPa	tensione ammissibile del cls a taglio con l'ausilio di armatura
fctm	=	3,60	MPa	tensione media ammissibile nel cls a trazione
fcfm	=	4,32	MPa	tensione ammissibile nel cls a trazione per flessione
sigma s amm	=	255	MPa	tensione ammissibile dall'acciaio
tau b	=	2,60	MPa	tensione tangenziale di aderenza delle

APPROVATO SDP

Società di Progetto
Brebemi SpA

barre

Caratteristiche geometriche

Sezione di cls

 B = 100 cm base
 H = 16 cm altezza

 area di
 A cls = 1600 cmq cls

Armatura in zona tesa

 d1 = 12 mm diametro ferri prima fila
 c1 = 3,00 cm copriferro ferri prima fila
 i1 = 20,00 cm interasse ferri prima fila
 As1 = 5,65 cmq area acciaio ferri prima fila
 d2 = 12 mm diametro ferri seconda fila
 c2 = 3,00 cm copriferro ferri seconda fila
 i2 = 20,00 cm interasse ferri seconda fila
 As2 = 5,65 cmq area acciaio ferri seconda fila
 d3 = 0 mm diametro ferri terza fila
 c3 = 0,00 cm copriferro ferri terza fila
 i3 = 0,00 cm interasse ferri terza fila
 As3 = 0,00 cmq area acciaio ferri terza fila
 As = 11,31 cmq area acciaio in zona tesa

Armatura in zona compressa

 d1 = 12 mm diametro ferri prima fila
 c1 = 3,00 cm copriferro ferri prima fila
 i1 = 20,00 cm interasse ferri prima fila
 As'1 = 5,65 cmq area acciaio ferri prima fila
 d2 = 0 mm diametro ferri seconda fila
 c2 = 0,00 cm copriferro ferri seconda fila
 i2 = 0,00 cm interasse ferri seconda fila
 As'2 = 0,00 cmq area acciaio ferri seconda fila
 d3 = 0 mm diametro ferri terza fila
 c3 = 0,00 cm copriferro ferri terza fila
 i3 = 0,00 cm interasse ferri terza fila
 As'3 = 0,00 cmq area acciaio ferri terza fila
 area di acciaio in zona compressa
 As' = 5,65 cmq compressa

Sezione ideale interamente reagente omogeneizzata a cls

 Ai = 1854 cmq area
 S*i sup = 15209 cmc momento statico superiore
 posizione del baricentro rispetto alla fibra superiore
 ygi sup = 8,20 cm
 Ji = 38985 cm⁴ momento d'inerzia
 Wi sup = 4754 cmc momento resistente superiore
 Wi inf = 4999 cmc momento resistente inferiore

Caratteristiche di esposizione

 Classe = XC4 classe di esposizione del sito
 Condizioni ambientali: Aggressive

APPROVATO SDP

 Società di Progetto
Brebemi SpA



Armature poco sensibili alla corrosione.

La verifica alla fessurazione è effettuata considerando i risultati delle combinazioni Frequente e Quasi permanente.

La verifica alle tensioni è effettuata considerando i risultati delle combinazioni Rara e Quasi Permanente.

wd - Frequente	≤	0,3	mm	apertura limite delle fessure per le combinazioni Frequente
wd - Q.P.	≤	0,2	mm	apertura limite delle fessure per le combinazioni Quasi Permanente
σc Rara	≤	24,9	MPa	tensione limite nel calcestruzzo per le combinazioni Rara
σc Q.P.	≤	18,7	MPa	tensione limite nel calcestruzzo per le combinazioni Quasi Permanente
σs	≤	360,0	MPa	tensione limite per l'acciaio di armatura
c'	=	3,0	cm	copriferro minimo da normativa per armatura in zona tesa
beta	=	1,7		
beta 1	=	1,0		
beta 2	=	0,5		1,0 carichi di breve durata - 0,5 carichi di lunga durata o ciclici
k 2	=	0,4		0,4 barre ad aderenza migliorata
k 3	=	0,125		0,125 asse neutro all'interno della sezione
num s	=	10,0		numero di ferri in zona tesa
s	=	10,00	cm	passo dell'armatura in zona tesa
d max	=	12	mm	diametro massimo dell'armatura in zona tesa
d min	=	12	mm	diametro minimo dell'armatura in zona tesa
c	=	3,00	cm	copriferro armatura in zona tesa
dist	=	0,00	cm	distanza fra le file di barre in zona tesa

COMBO	[kN]		Verifica tensioni in esercizio					Verifica fessurazione		
	N	M _x	[MPa]	[MPa]	[MPa]	[MPa]	[MPa]	[kNm]	Mf > M ?	[mm]
INVSIS	0,0	9,0	3,21	74,9	74,9	-12,4	-12,4	18,00	SI	-
INVRAR	0,0	31,0	11,05	258,1	258,1	-42,7	-42,7	18,00	NO	-
INVFRE	0,0	19,0	-	-	-	-	-	18,00	NO	0,05 2
INVQPE	0,0	5,0	1,78	41,6	41,6	-6,9	-6,9	18,00	SI	OK

Viene svolta di seguito la verifica a taglio riguardante la sezione di altezza 36 cm.

A favore di sicurezza si considera la sezione non armata a taglio.

Verifica a taglio della sezione maggiormente sollecitata (V_y):

Nella verifica a taglio NON si considera l'effetto positivo della compressione sulla sezione.

Nella verifica a taglio si considera l'effetto positivo dovuto ai meccanismi secondari di resistenza a taglio.

Società di Progetto
Brebemi SpA

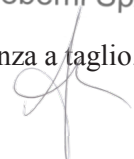

Nella sezione non sono previste armature per far fronte a sollecitazioni taglianti.

$V_{Sd Y}$	=	126	kN	Massima azione di taglio agente sulla sezione
$V_{Rd Y}$	=	163	kN	Risorsa resistente a taglio della sezione
SF	=	1,30	[-]	Coefficiente di sicurezza per sollecitazione V_Y

La verifica a taglio per sollecitazione V_Y è soddisfatta.

8.3.2 Soletta superiore – sezione di mezzeria

La sezione di verifica ha dimensioni 100 cm di larghezza e 16 di altezza

L'armatura è costituita da $\phi 12/20 + \phi 12/20$ al lembo inferiore e $\phi 12/20$ al lembo superiore.

Calcestruzzo

Classe	=	C40/50		
Rck	≥	50	MPa	Valore caratteristico resistenza cubica
fck	=	41,5	MPa	Valore caratteristico resistenza cilindrica
fcm	=	49,5	MPa	Valore medio resistenza cilindrica
fctm	=	3,60	MPa	Valore medio resistenza a trazione semplice
fctm	=	4,32	MPa	Valore medio resistenza a trazione per flessione
ν	=	0,2		Coefficiente di Poisson
Ecm	=	35547	MPa	Modulo elastico
γ_c	=	1,5		Coefficiente parziale di sicurezza
α_{cc}	=	0,85		Coefficiente risuttivo per resistenze di lunga durata
fcd	=	23,52	MPa	Resistenza di calcolo a compressione
fctd	=	1,68	MPa	Resistenza di calcolo a trazione
ϵ_{cu}	=	0,0035		Deformazione a rottura per il calcestruzzo
ϵ_{c0}	=	0,002		Def. limite del tratto a parabola del legame costitutivo del calcestruzzo

Valori per studio alle tensioni ammissibili:

n	=	15		Coefficiente di omogeneizzazione
---	---	----	--	----------------------------------

Acciaio per c.a.

Tipo	=	B 450 C		
fyk nom	=	450	MPa	Valore nominale della tensione caratteristica di snervamento
ftk nom	=	540	MPa	Valore nominale della tensione caratteristica di rottura
γ_s	=	1,15		Coefficiente parziale di sicurezza
Es	=	210000	MPa	Modulo elastico
fyd	=	391,3	MPa	Resistenza di calcolo
ϵ_{su}	=	0,01		Deformazione a rottura per l'acciaio

Caratteristiche geometriche

Sezione di cls				
B	=	100	cm	base
H	=	16	cm	altezza
A cls	=	1600	cmq	area di cls

Sistema di armatura per sollecitazioni M_X-V_Y

Armatura longitudinale inferiore (per sollecitazione M_X positiva)

d1	=	12	mm	diametro ferri prima fila
c1	=	3,00	cm	copriferro ferri prima fila
i1	=	20,00	cm	interasse ferri prima fila

Società di Progetto
Brebemi SpA



As1	=	5,65	cmq	area acciaio ferri prima fila
d2	=	12	mm	diametro ferri seconda fila
c2	=	3,00	cm	copriferro ferri seconda fila
i2	=	20,00	cm	interasse ferri seconda fila
As2	=	5,65	cmq	area acciaio ferri seconda fila
d3	=	0	mm	diametro ferri terza fila
c3	=	0,00	cm	copriferro ferri terza fila
i3	=	0,00	cm	interasse ferri terza fila
As3	=	0,00	cmq	area acciaio ferri terza fila
As	=	11,31	cmq	area acciaio in zona tesa
Armatura longitudinale superiore (per sollecitazione M_X positiva)				
d1	=	12	mm	diametro ferri prima fila
c1	=	3,00	cm	copriferro ferri prima fila
i1	=	20,00	cm	interasse ferri prima fila
As'1	=	5,65	cmq	area acciaio ferri prima fila
d2	=	0	mm	diametro ferri seconda fila
c2	=	0,00	cm	copriferro ferri seconda fila
i2	=	0,00	cm	interasse ferri seconda fila
As'2	=	0,00	cmq	area acciaio ferri seconda fila
d3	=	0	mm	diametro ferri terza fila
c3	=	0,00	cm	copriferro ferri terza fila
i3	=	0,00	cm	interasse ferri terza fila
As'3	=	0,00	cmq	area acciaio ferri terza fila
As'	=	5,65	cmq	area di acciaio in zona compressa
Armatura trasversale, staffe e/o ferri piegati (per sollecitazione V_Y)				
θ	=	45	°	Inclinazione della biella di cls (standard: 45°)
Asw 1° ordine:				
α	=	0	°	staffe: 90°; ferri piegati: angolo minore di 90°
n° bracci	=	0		
$\varphi 1$	=	0	mm	Diametro staffe primo ordine
s	=	0	mm	Passo delle staffe
Asw 2° ordine:				
α	=	0	°	staffe: 90°; ferri piegati: angolo minore di 90°
n° bracci	=	0		
$\varphi 2$	=	0	mm	Diametro staffe secondo ordine
s	=	0	mm	Passo delle staffe

Verifica a taglio della sezione maggiormente sollecitata

(V_Y):

Nella verifica a taglio NON si considera l'effetto positivo della compressione sulla sezione.

Nella verifica a taglio si considera l'effetto positivo dovuto ai meccanismi secondari di resistenza a taglio.

Nella sezione non sono previste armature per far fronte a sollecitazioni taglianti.

$$V_{sd Y} = 31 \text{ kN} \quad \text{Massima azione di taglio agente sulla sezione}$$

$$V_{rd Y} = 105 \text{ kN} \quad \text{Risorsa resistente a taglio della sezione}$$

$$SF = 3,37 \quad [-] \quad \text{Coefficiente di sicurezza per sollecitazione } V_Y$$

La verifica a taglio per sollecitazione V_Y è soddisfatta.

Combinazioni di carico e verifica a pressoflessione retta

							N+MX
n°	COMB	N [kN]	MX [kNm]	VY [kN]	MY [kNm]	VX [kN]	SF

Società di Progetto
Brebemi SpA

0 | 0 | 34,0 | 31,0 | 1,58

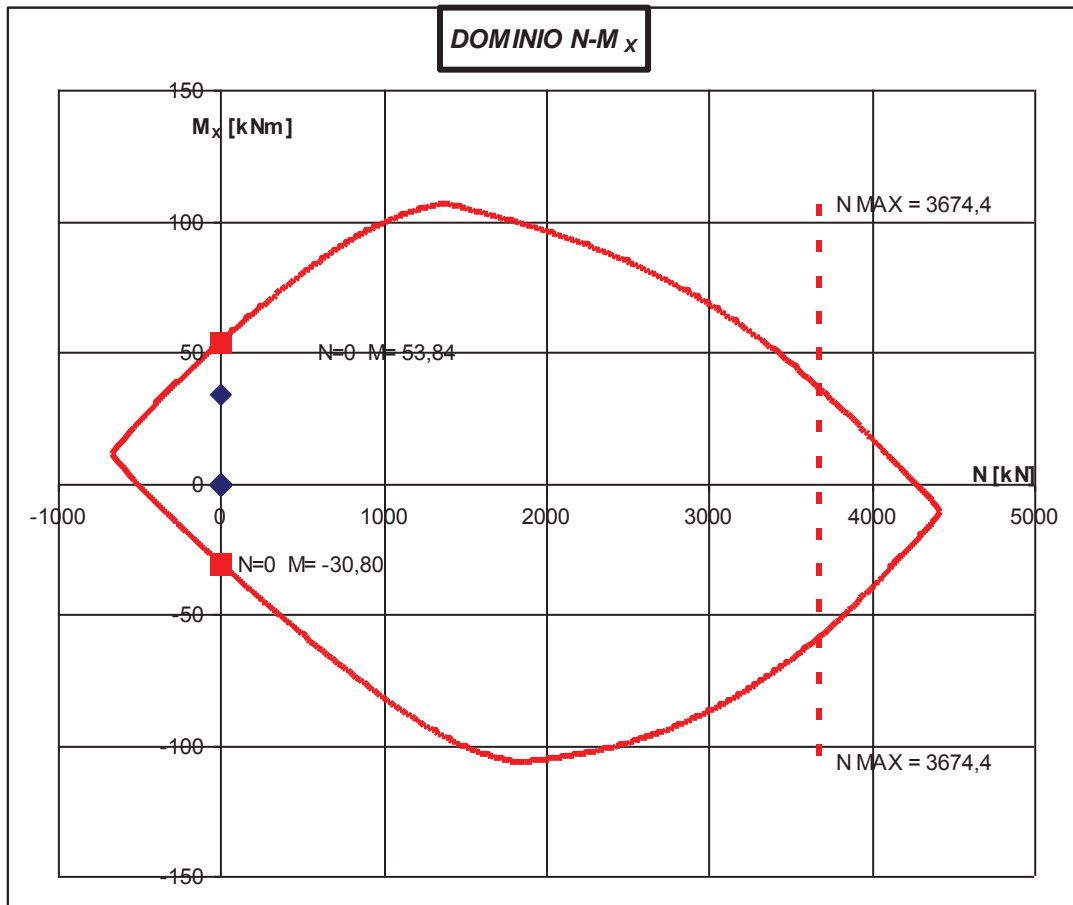

Caratteristiche dei materiali

Rck	=	50	MPa	resistenza caratteristica a 28 giorni del calcestruzzo
Ec	=	35547	MPa	modulo elastico del calcestruzzo
Acciaio B 450 C saldabile				
		21000		
Es	=	0	MPa	modulo elastico dell'acciaio
n	=	15		coefficiente di omogeneizzazione

Tensioni ammissibili

sigma c amm	=	14,75	MPa	tensione ammissibile del cls a compressione
tau c0	=	0,87	MPa	tensione ammissibile del cls a taglio senza l'ausilio di armatura
tau c1	=	2,40	MPa	tensione ammissibile del cls a taglio con l'ausilio di armatura
fctm	=	3,60	MPa	tensione media ammissibile nel cls a trazione
fcfm	=	4,32	MPa	tensione ammissibile nel cls a trazione per flessione
sigma s amm	=	255	MPa	tensione ammissibile

APPROVATO SDP

Società di Progetto
Brebemi SpA

tau b	=	2,60	MPa	dall'acciaio tensione tangenziale di aderenza delle barre
Caratteristiche geometriche				
Sezione di cls				
B	=	100	cm	base
H	=	16	cm	altezza
A cls	=	1600	cmq	area di cls
Armatura in zona tesa				
d1	=	12	mm	diametro ferri prima fila
c1	=	3,00	cm	copriferro ferri prima fila
i1	=	20,00	cm	interasse ferri prima fila
As1	=	5,65	cmq	area acciaio ferri prima fila
d2	=	12	mm	diametro ferri seconda fila
c2	=	3,00	cm	copriferro ferri seconda fila
i2	=	20,00	cm	interasse ferri seconda fila
As2	=	5,65	cmq	area acciaio ferri seconda fila
d3	=	0	mm	diametro ferri terza fila
c3	=	0,00	cm	copriferro ferri terza fila
i3	=	0,00	cm	interasse ferri terza fila
As3	=	0,00	cmq	area acciaio ferri terza fila
As	=	11,31	cmq	area acciaio in zona tesa
Armatura in zona compressa				
d1	=	12	mm	diametro ferri prima fila
c1	=	3,00	cm	copriferro ferri prima fila
i1	=	20,00	cm	interasse ferri prima fila
As'1	=	5,65	cmq	area acciaio ferri prima fila
d2	=	0	mm	diametro ferri seconda fila
c2	=	0,00	cm	copriferro ferri seconda fila
i2	=	0,00	cm	interasse ferri seconda fila
As'2	=	0,00	cmq	area acciaio ferri seconda fila
d3	=	0	mm	diametro ferri terza fila
c3	=	0,00	cm	copriferro ferri terza fila
i3	=	0,00	cm	interasse ferri terza fila
As'3	=	0,00	cmq	area acciaio ferri terza fila
As'	=	5,65	cmq	area di acciaio in zona compressa
Sezione ideale interamente reagente omogeneizzata a cls				
Ai	=	1854	cmq	area
S*i sup	=	15209	cmc	momento statico superiore
ysi sup	=	8,20	cm	posizione del baricentro rispetto alla fibra superiore
Ji	=	38985	cm ⁴	momento d'inerzia
Wi sup	=	4754	cmc	momento resistente superiore
Wi inf	=	4999	cmc	momento resistente inferiore

Caratteristiche di esposizione

APPROVATO SDP

 Società di Progetto
Brebemi SpA



Classe = XC4 classe di esposizione del sito

Condizioni ambientali: Aggressive

Armature poco sensibili alla corrosione.

La verifica alla fessurazione è effettuata considerando i risultati delle combinazioni Frequente e Quasi permanente.

La verifica alle tensioni è effettuata considerando i risultati delle combinazioni Rara e Quasi Permanente.

wd - Frequente	≤	0,3	mm	apertura limite delle fessure per le combinazioni Frequente
wd - Q.P.	≤	0,2	mm	apertura limite delle fessure per le combinazioni Quasi Permanente
σc Rara	≤	24,9	MPa	tensione limite nel calcestruzzo per le combinazioni Rara
σc Q.P.	≤	18,7	MPa	tensione limite nel calcestruzzo per le combinazioni Quasi Permanente
σs	≤	360,0	MPa	tensione limite per l'acciaio di armatura
c'	=	3,0	cm	copriferro minimo da normativa per armatura in zona tesa
beta	=	1,7		
beta 1	=	1,0		
beta 2	=	0,5		1,0 carichi di breve durata - 0,5 carichi di lunga durata o ciclici
k 2	=	0,4		0,4 barre ad aderenza migliorata
k 3	=	0,125		0,125 asse neutro all'interno della sezione
num s	=	10,0		numero di ferri in zona tesa
s	=	10,00	cm	passo dell'armatura in zona tesa
d max	=	12	mm	diametro massimo dell'armatura in zona tesa
d min	=	12	mm	diametro minimo dell'armatura in zona tesa
c	=	3,00	cm	copriferro armatura in zona tesa
dist	=	0,00	cm	distanza fra le file di barre in zona tesa

APPROVATO SDP

	Verifica tensioni in esercizio						Verifica fessurazione			
	[kN]	[kNm]	[MPa]	[MPa]	[MPa]	[MPa]	[MPa]	[kNm]	Mf > M ?	[mm]
COMBO	N	M _x	σ _c max	σ _s max	σ _s min	σ _s ' max	σ _s ' min	M f	Mf > M ?	wk'
INVSIS	0,0	4,0	1,43	33,3	33,3	-5,5	-5,5	18,00	SI	-
INVRAR	0,0	25,0	8,91	208,1	208,1	-34,4	-34,4	18,00	NO	-
INVFRE	0,0	20,0	-	-	-	-	-	18,00	NO	0,05 7
INVQPE	0,0	3,0	1,07	25,0	25,0	-4,1	-4,1	18,00	SI	OK

8.3.3 Soletta inferiore – sezione di incastro

La sezione di verifica ha dimensioni 100 cm di larghezza e 16 di altezza. L'armatura è costituita da φ12/20 + φ12/20 al lembo inferiore e φ12/20 al lembo superiore. La sezione è armata a taglio da un sistema di ferri piegati φ12/20 e da un sistema di staffe φ10/20 per ogni estremo della soletta.

Società di Progetto
Bresbim SPA

Calcestruzzo

Classe	=	C40/50	
Rck	≥	50	MPa Valore caratteristico resistenza cubica
fck	=	41,5	MPa Valore caratteristico resistenza cilindrica
fcm	=	49,5	MPa Valore medio resistenza cilindrica
fctm	=	3,60	MPa Valore medio resistenza a trazione semplice
fcfm	=	4,32	MPa Valore medio resistenza a trazione per flessione
ν	=	0,2	Coefficiente di Poisson
Ecm	=	35547	MPa Modulo elastico
γ_c	=	1,5	Coefficiente parziale di sicurezza
α_{cc}	=	0,85	Coefficiente risuttivo per resistenze di lunga durata
fcd	=	23,52	MPa Resistenza di calcolo a compressione
fctd	=	1,68	MPa Resistenza di calcolo a trazione
ϵ_{cu}	=	0,0035	Deformazione a rottura per il calcestruzzo
ϵ_{c0}	=	0,002	Def. limite del tratto a parabola del legame costitutivo del calcestruzzo

Valori per studio alle tensioni ammissibili:

n	=	15	Coefficiente di omogeneizzazione
---	---	----	----------------------------------

Acciaio per c.a.

Tipo	=	B 450 C	
fyk nom	=	450	MPa Valore nominale della tensione caratteristica di snervamento
ftk nom	=	540	MPa Valore nominale della tensione caratteristica di rottura
γ_s	=	1,15	Coefficiente parziale di sicurezza
Es	=	210000	MPa Modulo elastico
fyd	=	391,3	MPa Resistenza di calcolo
ϵ_{su}	=	0,01	Deformazione a rottura per l'acciaio

Caratteristiche geometriche

Sezione di cls			
B	=	100	cm base
H	=	16	cm altezza
A cls	=	1600	cmq area di cls

Sistema di armatura per sollecitazioni M_X-V_Y

Armatura longitudinale inferiore (per sollecitazione $M_{X \text{ positiva}}$)

d1	=	12	mm diametro ferri prima fila
c1	=	3,00	cm copriferro ferri prima fila
i1	=	20,00	cm interasse ferri prima fila
As1	=	5,65	cmq area acciaio ferri prima fila
d2	=	12	mm diametro ferri seconda fila
c2	=	3,00	cm copriferro ferri seconda fila
i2	=	20,00	cm interasse ferri seconda fila
As2	=	5,65	cmq area acciaio ferri seconda fila
d3	=	0	mm diametro ferri terza fila
c3	=	0,00	cm copriferro ferri terza fila
i3	=	0,00	cm interasse ferri terza fila
As3	=	0,00	cmq area acciaio ferri terza fila
As	=	11,31	cmq area acciaio in zona tesa

Armatura longitudinale superiore (per sollecitazione $M_{X \text{ positiva}}$)

d1	=	12	mm diametro ferri prima fila
c1	=	3,00	cm copriferro ferri prima fila
i1	=	20,00	cm interasse ferri prima fila

APPROVATO SDP

Società di Progetto
Brebemi SpA



As'1	=	5,65	cmq	area acciaio ferri prima fila
d2	=	0	mm	diametro ferri seconda fila
c2	=	0,00	cm	copriferro ferri seconda fila
i2	=	0,00	cm	interasse ferri seconda fila
As'2	=	0,00	cmq	area acciaio ferri seconda fila
d3	=	0	mm	diametro ferri terza fila
c3	=	0,00	cm	copriferro ferri terza fila
i3	=	0,00	cm	interasse ferri terza fila
As'3	=	0,00	cmq	area acciaio ferri terza fila
As'	=	5,65	cmq	area di acciaio in zona compressa
Armatura trasversale, staffe e/o ferri piegati (per sollecitazione V_Y)				
θ	=	45	°	Inclinazione della biella di cls (standard: 45°)
Asw 1° ordine:				
α	=	45	°	staffe: 90°; ferri piegati: angolo minore di 90°
n° bracci	=	5		
$\varphi 1$	=	12	mm	Diametro staffe primo ordine
s	=	470	mm	Passo delle staffe
Asw 2° ordine:				
α	=	90	°	staffe: 90°; ferri piegati: angolo minore di 90°
n° bracci	=	10		
$\varphi 2$	=	10	mm	Diametro staffe secondo ordine
s	=	470	mm	Passo delle staffe

Verifica a taglio della sezione maggiormente sollecitata (V_Y):

Nella verifica a taglio NON si considera l'effetto positivo della compressione sulla sezione.

Nella verifica a taglio NON si considera l'effetto positivo dovuto ai meccanismi secondari di resistenza a taglio.

Nella sezione sono previste armature trasversali resistenti a sollecitazioni di taglio.

$V_{Sd Y}$ = 101 kN Massima azione di taglio agente sulla sezione

$V_{Rd Y}$ = 158 kN Risorsa resistente a taglio della sezione

SF = 1,56 [-] Coefficiente di sicurezza per sollecitazione V_Y

La verifica a taglio per sollecitazione V_Y è soddisfatta.

Combinazioni di carico e verifica a pressoflessione retta

							N+MX
n°	COMB	N [kN]	MX [kNm]	VY [kN]	MY [kNm]	VX [kN]	SF
0	0		45,0	101,0			1,20

APPROVATO SDP

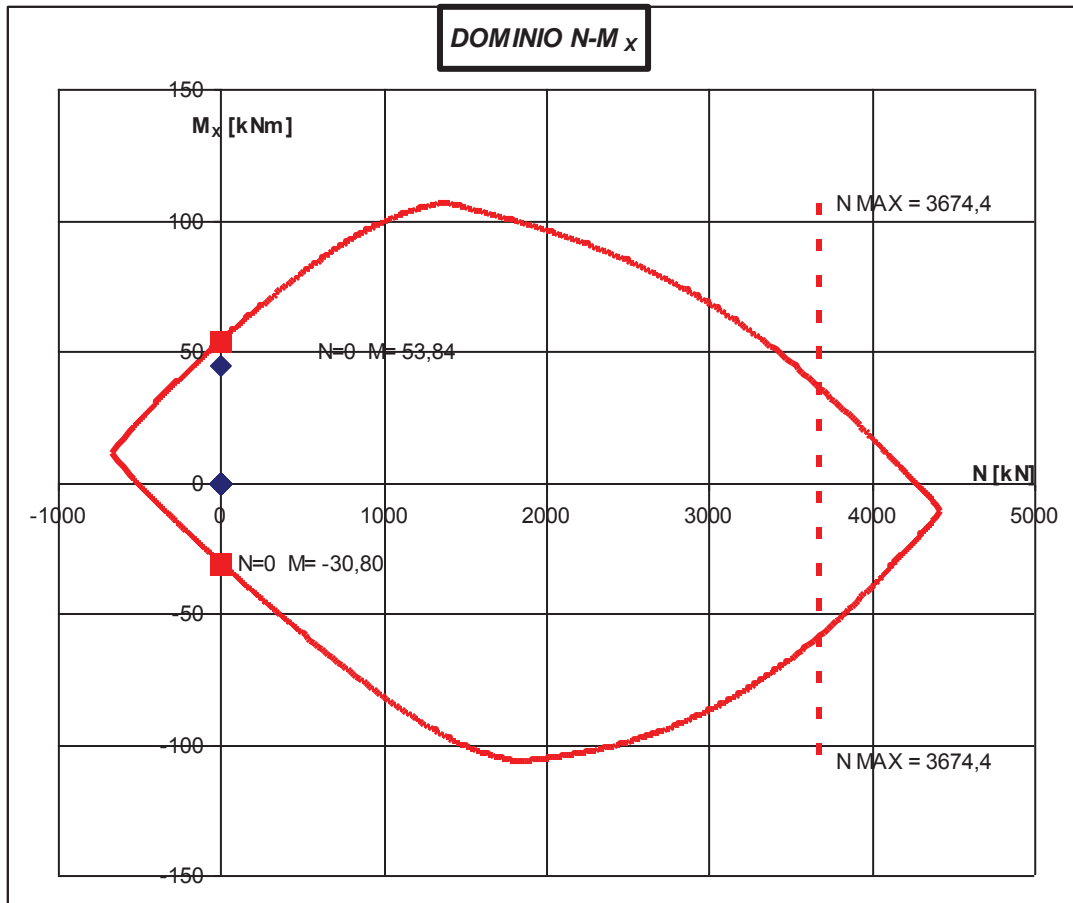

Caratteristiche dei materiali

Rck	=	50	MPa	resistenza caratteristica a 28 giorni del calcestruzzo
Ec	=	35547	MPa	modulo elastico del calcestruzzo
Acciaio B 450 C saldabile				
		21000		
Es	=	0	MPa	modulo elastico dell'acciaio
n	=	15		coefficiente di omogeneizzazione

Tensioni ammissibili

sigma c amm	=	14,75	MPa	tensione ammissibile del cls a compressione
tau c0	=	0,87	MPa	tensione ammissibile del cls a taglio senza l'ausilio di armatura
tau c1	=	2,40	MPa	tensione ammissibile del cls a taglio con l'ausilio di armatura
fctm	=	3,60	MPa	tensione media ammissibile nel cls a trazione
fcfm	=	4,32	MPa	tensione ammissibile nel cls a trazione per flessione
sigma s amm	=	255	MPa	tensione ammissibile dall'acciaio
tau b	=	2,60	MPa	tensione tangenziale di aderenza delle

APPROVATO SDP

Società di Progetto
Brebemi SpA

barre

**Caratteristiche
geometriche**

Sezione di cls

B	=	100	cm	base
H	=	16	cm	altezza
A cls	=	1600	cmq	area di cls

 Armatura in zona
tesa

d1	=	12	mm	diametro ferri prima fila
c1	=	3,00	cm	copriferro ferri prima fila
i1	=	20,00	cm	interasse ferri prima fila
As1	=	5,65	cmq	area acciaio ferri prima fila
d2	=	12	mm	diametro ferri seconda fila
c2	=	3,00	cm	copriferro ferri seconda fila
i2	=	20,00	cm	interasse ferri seconda fila
As2	=	5,65	cmq	area acciaio ferri seconda fila
d3	=	0	mm	diametro ferri terza fila
c3	=	0,00	cm	copriferro ferri terza fila
i3	=	0,00	cm	interasse ferri terza fila
As3	=	0,00	cmq	area acciaio ferri terza fila
As	=	11,31	cmq	area acciaio in zona tesa

Armatura in zona compressa

d1	=	12	mm	diametro ferri prima fila
c1	=	3,00	cm	copriferro ferri prima fila
i1	=	20,00	cm	interasse ferri prima fila
As'1	=	5,65	cmq	area acciaio ferri prima fila
d2	=	0	mm	diametro ferri seconda fila
c2	=	0,00	cm	copriferro ferri seconda fila
i2	=	0,00	cm	interasse ferri seconda fila
As'2	=	0,00	cmq	area acciaio ferri seconda fila
d3	=	0	mm	diametro ferri terza fila
c3	=	0,00	cm	copriferro ferri terza fila
i3	=	0,00	cm	interasse ferri terza fila
As'3	=	0,00	cmq	area acciaio ferri terza fila
As'	=	5,65	cmq	area di acciaio in zona compressa

 Sezione ideale interamente reagente
omogeneizzata a cls

Ai	=	1854	cmq	area
S*i sup	=	15209	cmc	momento statico superiore
ygi sup	=	8,20	cm	posizione del baricentro rispetto alla fibra superiore
Ji	=	38985	cm ⁴	momento d'inerzia
Wi sup	=	4754	cmc	momento resistente superiore
Wi inf	=	4999	cmc	momento resistente inferiore

**Caratteristiche di
esposizione**

Classe	=	XC4	classe di esposizione del sito
Condizioni ambientali:	Aggressive		

APPROVATO SDP

 Società di Progetto
Brebemi SpA



Armature poco sensibili alla corrosione.

La verifica alla fessurazione è effettuata considerando i risultati delle combinazioni Frequente e Quasi permanente.

La verifica alle tensioni è effettuata considerando i risultati delle combinazioni Rara e Quasi Permanente.

wd - Frequente	≤	0,3	mm	apertura limite delle fessure per le combinazioni Frequente
wd - Q.P.	≤	0,2	mm	apertura limite delle fessure per le combinazioni Quasi Permanente
σc Rara	≤	24,9	MPa	tensione limite nel calcestruzzo per le combinazioni Rara
σc Q.P.	≤	18,7	MPa	tensione limite nel calcestruzzo per le combinazioni Quasi Permanente
σs	≤	360,0	MPa	tensione limite per l'acciaio di armatura
c'	=	3,0	cm	copriferro minimo da normativa per armatura in zona tesa
beta	=	1,7		
beta 1	=	1,0		
beta 2	=	0,5		1,0 carichi di breve durata - 0,5 carichi di lunga durata o ciclici
k 2	=	0,4		0,4 barre ad aderenza migliorata
k 3	=	0,125		0,125 asse neutro all'interno della sezione
num s	=	10,0		numero di ferri in zona tesa
s	=	10,00	cm	passo dell'armatura in zona tesa
d max	=	12	mm	diametro massimo dell'armatura in zona tesa
d min	=	12	mm	diametro minimo dell'armatura in zona tesa
c	=	3,00	cm	copriferro armatura in zona tesa
dist	=	0,00	cm	distanza fra le file di barre in zona tesa

COMBO	[kN]		Verifica tensioni in esercizio					Verifica fessurazione		
	N	M _x	[MPa]	[MPa]	[MPa]	[MPa]	[MPa]	[kNm]	Mf > M ?	[mm]
INVSIS	0,0	11,0	3,92	91,6	91,6	-15,1	-15,1	18,00	SI	-
INVRAR	0,0	33,0	11,76	274,8	274,8	-45,4	-45,4	18,00	NO	-
INVFRE	0,0	22,0	-	-	-	-	-	18,00	NO	0,07 7
INVQPE	0,0	6,0	2,14	50,0	50,0	-8,3	-8,3	18,00	SI	OK

Viene svolta di seguito la verifica a taglio riguardante la sezione di altezza 36 cm.

A favore di sicurezza si considera la sezione non armata a taglio.

Verifica a taglio della sezione maggiormente sollecitata (V_y):

Nella verifica a taglio NON si considera l'effetto positivo della compressione sulla sezione.

Nella verifica a taglio si considera l'effetto positivo dovuto ai meccanismi secondari di resistenza a taglio.

Società di Progetto
Brebemi SpA

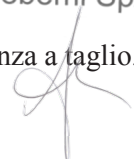

Nella sezione non sono previste armature per far fronte a sollecitazioni taglianti.

V_{SdY}	=	118	kN	Massima azione di taglio agente sulla sezione
V_{RdY}	=	163	kN	Risorsa resistente a taglio della sezione
SF	=	1,38	[-]	Coefficiente di sicurezza per sollecitazione V_Y

La verifica a taglio per sollecitazione V_Y è soddisfatta.

8.3.4 Soletta inferiore – sezione di mezzzeria

La sezione di verifica ha dimensioni 100 cm di larghezza e 16 di altezza. L'armatura è costituita da $\phi 12/20 + \phi 12/20$ al lembo superiore e $\phi 12/20$ al lembo inferiore.

Calcestruzzo

Classe	=	C40/50		
Rck	≥	50	MPa	Valore caratteristico resistenza cubica
fck	=	41,5	MPa	Valore caratteristico resistenza cilindrica
fcm	=	49,5	MPa	Valore medio resistenza cilindrica
fctm	=	3,60	MPa	Valore medio resistenza a trazione semplice
fctm	=	4,32	MPa	Valore medio resistenza a trazione per flessione
ν	=	0,2		Coefficiente di Poisson
Ecm	=	35547	MPa	Modulo elastico
γ_c	=	1,5		Coefficiente parziale di sicurezza
α_{cc}	=	0,85		Coefficiente risuttivo per resistenze di lunga durata
fcd	=	23,52	MPa	Resistenza di calcolo a compressione
fctd	=	1,68	MPa	Resistenza di calcolo a trazione
ϵ_{cu}	=	0,0035		Deformazione a rottura per il calcestruzzo
ϵ_{c0}	=	0,002		Def. limite del tratto a parabola del legame costitutivo del calcestruzzo

Valori per studio alle tensioni ammissibili:

n	=	15		Coefficiente di omogeneizzazione
---	---	----	--	----------------------------------

Acciaio per c.a.

Tipo	=	B 450 C		
f _{yk} nom	=	450	MPa	Valore nominale della tensione caratteristica di snervamento
f _{tk} nom	=	540	MPa	Valore nominale della tensione caratteristica di rottura
γ_s	=	1,15		Coefficiente parziale di sicurezza
E _s	=	210000	MPa	Modulo elastico
f _{yd}	=	391,3	MPa	Resistenza di calcolo
ϵ_{su}	=	0,01		Deformazione a rottura per l'acciaio

Caratteristiche geometriche

Sezione di cls				
B	=	100	cm	base
H	=	16	cm	altezza
A cls	=	1600	cmq	area di cls

Sistema di armatura per sollecitazioni M_X-V_Y

Armatura longitudinale inferiore (per sollecitazione M_X positiva)

d _l	=	12	mm	diametro ferri prima fila
c _l	=	3,00	cm	copriferro ferri prima fila
i _l	=	20,00	cm	interasse ferri prima fila

Società di Progetto
Brebemi SpA



As1	=	5,65	cmq	area acciaio ferri prima fila
d2	=	12	mm	diametro ferri seconda fila
c2	=	3,00	cm	copriferro ferri seconda fila
i2	=	20,00	cm	interasse ferri seconda fila
As2	=	5,65	cmq	area acciaio ferri seconda fila
d3	=	0	mm	diametro ferri terza fila
c3	=	0,00	cm	copriferro ferri terza fila
i3	=	0,00	cm	interasse ferri terza fila
As3	=	0,00	cmq	area acciaio ferri terza fila
As	=	11,31	cmq	area acciaio in zona tesa
Armatura longitudinale superiore (per sollecitazione M_X positiva)				
d1	=	12	mm	diametro ferri prima fila
c1	=	3,00	cm	copriferro ferri prima fila
i1	=	20,00	cm	interasse ferri prima fila
As'1	=	5,65	cmq	area acciaio ferri prima fila
d2	=	0	mm	diametro ferri seconda fila
c2	=	0,00	cm	copriferro ferri seconda fila
i2	=	0,00	cm	interasse ferri seconda fila
As'2	=	0,00	cmq	area acciaio ferri seconda fila
d3	=	0	mm	diametro ferri terza fila
c3	=	0,00	cm	copriferro ferri terza fila
i3	=	0,00	cm	interasse ferri terza fila
As'3	=	0,00	cmq	area acciaio ferri terza fila
As'	=	5,65	cmq	area di acciaio in zona compressa
Armatura trasversale, staffe e/o ferri piegati (per sollecitazione V_Y)				
θ	=	45	°	Inclinazione della biella di cls (standard: 45°)
Asw 1° ordine:				
α	=	0	°	staffe: 90°; ferri piegati: angolo minore di 90°
n° bracci	=	0		
$\varphi 1$	=	0	mm	Diametro staffe primo ordine
s	=	0	mm	Passo delle staffe
Asw 2° ordine:				
α	=	0	°	staffe: 90°; ferri piegati: angolo minore di 90°
n° bracci	=	0		
$\varphi 2$	=	0	mm	Diametro staffe secondo ordine
s	=	0	mm	Passo delle staffe

Verifica a taglio della sezione maggiormente sollecitata

(V_Y):

Nella verifica a taglio NON si considera l'effetto positivo della compressione sulla sezione.

Nella verifica a taglio si considera l'effetto positivo dovuto ai meccanismi secondari di resistenza a taglio.

Nella sezione non sono previste armature per far fronte a sollecitazioni taglianti.

$$V_{Sd Y} = 70 \text{ kN} \quad \text{Massima azione di taglio agente sulla sezione}$$

$$V_{Rd Y} = 105 \text{ kN} \quad \text{Risorsa resistente a taglio della sezione}$$

$$SF = 1,49 \quad [-] \quad \text{Coefficiente di sicurezza per sollecitazione } V_Y$$

La verifica a taglio per sollecitazione V_Y è soddisfatta.

Combinazioni di carico e verifica a pressoflessione retta

							N+MX
n°	COMB	N [kN]	MX [kNm]	VY [kN]	MY [kNm]	VX [kN]	SF

Società di Progetto
Brebemi SpA



0 | 0 | 37,0 | 70,0 | 1,46

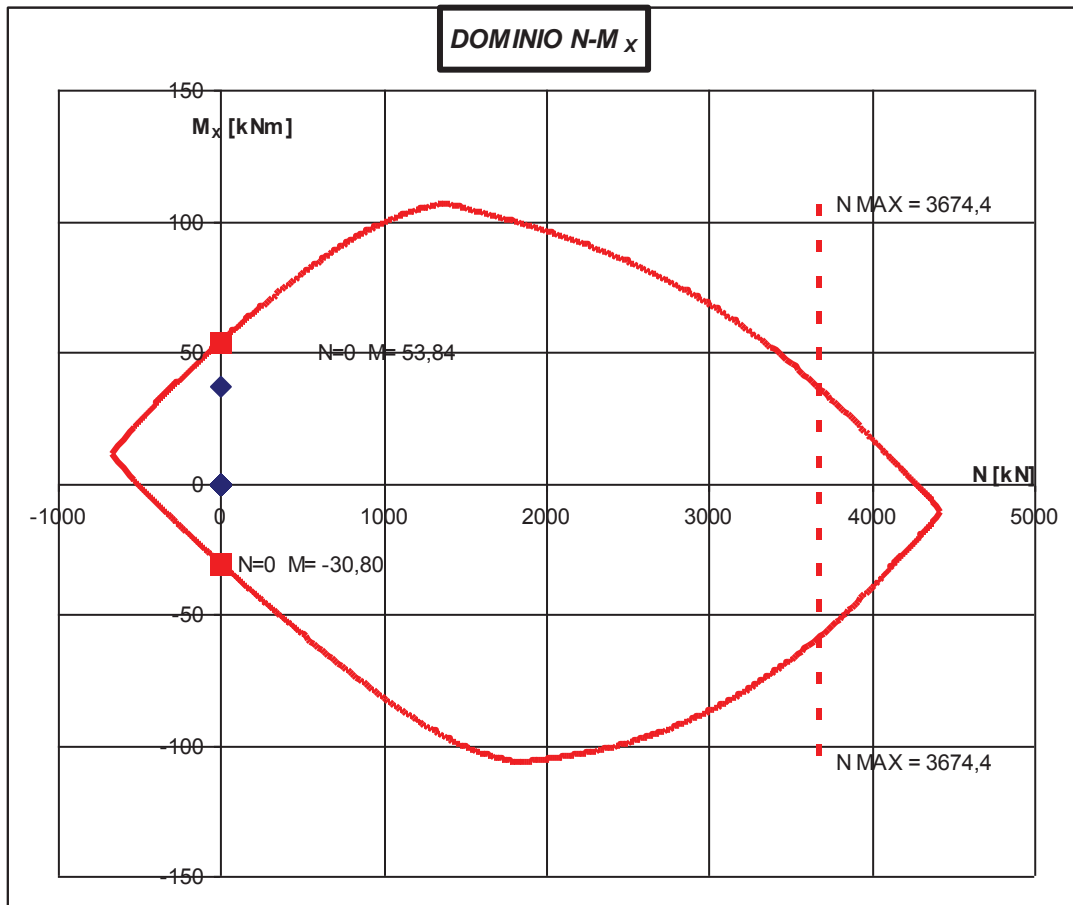

Caratteristiche dei materiali

Rck	=	50	MPa	resistenza caratteristica a 28 giorni del calcestruzzo
Ec	=	35547	MPa	modulo elastico del calcestruzzo
Acciaio B 450 C saldabile				
		21000		
Es	=	0	MPa	modulo elastico dell'acciaio
n	=	15		coefficiente di omogeneizzazione

Tensioni ammissibili

sigma c amm	=	14,75	MPa	tensione ammissibile del cls a compressione
tau c0	=	0,87	MPa	tensione ammissibile del cls a taglio senza l'ausilio di armatura
tau c1	=	2,40	MPa	tensione ammissibile del cls a taglio con l'ausilio di armatura
fctm	=	3,60	MPa	tensione media ammissibile nel cls a trazione
fcfm	=	4,32	MPa	tensione ammissibile nel cls a trazione per flessione
sigma s amm	=	255	MPa	tensione ammissibile

APPROVATO SDP

Società di Progetto
Brebemi SpA

tau b	=	2,60	MPa	dall'acciaio tensione tangenziale di aderenza delle barre
Caratteristiche geometriche				
Sezione di cls				
B	=	100	cm	base
H	=	16	cm	altezza
A cls	=	1600	cmq	area di cls
Armatura in zona tesa				
d1	=	12	mm	diametro ferri prima fila
c1	=	3,00	cm	copriferro ferri prima fila
i1	=	20,00	cm	interasse ferri prima fila
As1	=	5,65	cmq	area acciaio ferri prima fila
d2	=	12	mm	diametro ferri seconda fila
c2	=	3,00	cm	copriferro ferri seconda fila
i2	=	20,00	cm	interasse ferri seconda fila
As2	=	5,65	cmq	area acciaio ferri seconda fila
d3	=	0	mm	diametro ferri terza fila
c3	=	0,00	cm	copriferro ferri terza fila
i3	=	0,00	cm	interasse ferri terza fila
As3	=	0,00	cmq	area acciaio ferri terza fila
As	=	11,31	cmq	area acciaio in zona tesa
Armatura in zona compressa				
d1	=	12	mm	diametro ferri prima fila
c1	=	3,00	cm	copriferro ferri prima fila
i1	=	20,00	cm	interasse ferri prima fila
As'1	=	5,65	cmq	area acciaio ferri prima fila
d2	=	0	mm	diametro ferri seconda fila
c2	=	0,00	cm	copriferro ferri seconda fila
i2	=	0,00	cm	interasse ferri seconda fila
As'2	=	0,00	cmq	area acciaio ferri seconda fila
d3	=	0	mm	diametro ferri terza fila
c3	=	0,00	cm	copriferro ferri terza fila
i3	=	0,00	cm	interasse ferri terza fila
As'3	=	0,00	cmq	area acciaio ferri terza fila
As'	=	5,65	cmq	area di acciaio in zona compressa
Sezione ideale interamente reagente omogeneizzata a cls				
Ai	=	1854	cmq	area
S*i sup	=	15209	cmc	momento statico superiore
ysi sup	=	8,20	cm	posizione del baricentro rispetto alla fibra superiore
Ji	=	38985	cm ⁴	momento d'inerzia
Wi sup	=	4754	cmc	momento resistente superiore
Wi inf	=	4999	cmc	momento resistente inferiore

Caratteristiche di esposizione

APPROVATO SDP

 Società di Progetto
Brebemi SpA



Classe = XC4 classe di esposizione del sito

Condizioni ambientali: Aggressive

Armature poco sensibili alla corrosione.

La verifica alla fessurazione è effettuata considerando i risultati delle combinazioni Frequente e Quasi permanente.

La verifica alle tensioni è effettuata considerando i risultati delle combinazioni Rara e Quasi Permanente.

wd - Frequente	≤	0,3	mm	apertura limite delle fessure per le combinazioni Frequente
wd - Q.P.	≤	0,2	mm	apertura limite delle fessure per le combinazioni Quasi Permanente
σc Rara	≤	24,9	MPa	tensione limite nel calcestruzzo per le combinazioni Rara
σc Q.P.	≤	18,7	MPa	tensione limite nel calcestruzzo per le combinazioni Quasi Permanente
σs	≤	360,0	MPa	tensione limite per l'acciaio di armatura
c'	=	3,0	cm	copriferro minimo da normativa per armatura in zona tesa
beta	=	1,7		
beta 1	=	1,0		
beta 2	=	0,5		1,0 carichi di breve durata - 0,5 carichi di lunga durata o ciclici
k 2	=	0,4		0,4 barre ad aderenza migliorata
k 3	=	0,125		0,125 asse neutro all'interno della sezione
num s	=	10,0		numero di ferri in zona tesa
s	=	10,00	cm	passo dell'armatura in zona tesa
d max	=	12	mm	diametro massimo dell'armatura in zona tesa
d min	=	12	mm	diametro minimo dell'armatura in zona tesa
c	=	3,00	cm	copriferro armatura in zona tesa
dist	=	0,00	cm	distanza fra le file di barre in zona tesa

APPROVATO SDP

	Verifica tensioni in esercizio						Verifica fessurazione			
	[kN]	[kNm]	[MPa]	[MPa]	[MPa]	[MPa]	[MPa]	[kNm]	Mf > M ?	[mm]
COMBO	N	M _x	σ _c max	σ _s max	σ _s min	σ _s ' max	σ _s ' min	M f	Mf > M ?	wk'
INVSIS	0,0	6,0	2,14	50,0	50,0	-8,3	-8,3	18,00	SI	-
INVRAR	0,0	27,0	9,62	224,8	224,8	-37,2	-37,2	18,00	NO	-
INVFRE	0,0	20,0	-	-	-	-	-	18,00	NO	0,05 7
INVQPE	0,0	4,0	1,43	33,3	33,3	-5,5	-5,5	18,00	SI	OK

8.3.5 Piedritti – sezione di incastro inferiore

La sezione di verifica ha dimensioni 100 cm di larghezza e 16 di altezza

L'armatura è costituita da φ12/20 + φ12/20 al lembo contro terra e φ12/20 al lembo interno

 Società di Progetto
Brenemi SpA

Calcestruzzo

Classe	=	C40/50	
Rck	≥	50	MPa Valore caratteristico resistenza cubica
fck	=	41,5	MPa Valore caratteristico resistenza cilindrica
fcm	=	49,5	MPa Valore medio resistenza cilindrica
fctm	=	3,60	MPa Valore medio resistenza a trazione semplice
fefm	=	4,32	MPa Valore medio resistenza a trazione per flessione
ν	=	0,2	Coefficiente di Poisson
Ecm	=	35547	MPa Modulo elastico
γ_c	=	1,5	Coefficiente parziale di sicurezza
α_{cc}	=	0,85	Coefficiente risuttivo per resistenze di lunga durata
fcd	=	23,52	MPa Resistenza di calcolo a compressione
fctd	=	1,68	MPa Resistenza di calcolo a trazione
ϵ_{cu}	=	0,0035	Deformazione a rottura per il calcestruzzo
ϵ_{c0}	=	0,002	Def. limite del tratto a parabola del legame costitutivo del calcestruzzo

Valori per studio alle tensioni ammissibili:

n	=	15	Coefficiente di omogeneizzazione
---	---	----	----------------------------------

Acciaio per c.a.

Tipo	=	B 450 C	
f _{yk} nom	=	450	MPa Valore nominale della tensione caratteristica di snervamento
f _{tk} nom	=	540	MPa Valore nominale della tensione caratteristica di rottura
γ_s	=	1,15	Coefficiente parziale di sicurezza
E _s	=	210000	MPa Modulo elastico
f _{yd}	=	391,3	MPa Resistenza di calcolo
ϵ_{su}	=	0,01	Deformazione a rottura per l'acciaio

Caratteristiche geometriche

Sezione di cls			
B	=	100	cm base
H	=	16	cm altezza
A cls	=	1600	cmq area di cls

Sistema di armatura per sollecitazioni M_X-V_Y

Armatura longitudinale inferiore (per sollecitazione M_X positiva)

d1	=	12	mm diametro ferri prima fila
c1	=	3,00	cm copriferro ferri prima fila
i1	=	20,00	cm interasse ferri prima fila
As1	=	5,65	cmq area acciaio ferri prima fila
d2	=	12	mm diametro ferri seconda fila
c2	=	3,00	cm copriferro ferri seconda fila
i2	=	20,00	cm interasse ferri seconda fila
As2	=	5,65	cmq area acciaio ferri seconda fila
d3	=	0	mm diametro ferri terza fila
c3	=	0,00	cm copriferro ferri terza fila
i3	=	0,00	cm interasse ferri terza fila
As3	=	0,00	cmq area acciaio ferri terza fila
As	=	11,31	cmq area acciaio in zona tesa

Armatura longitudinale superiore (per sollecitazione M_X positiva)

d1	=	12	mm diametro ferri prima fila
c1	=	3,00	cm copriferro ferri prima fila
i1	=	20,00	cm interasse ferri prima fila
As'1	=	5,65	cmq area acciaio ferri prima fila

APPROVATO SDP

Società di Progetto
Brebemi SpA



d2	=	0	mm	diametro ferri seconda fila
c2	=	0,00	cm	copriferro ferri seconda fila
i2	=	0,00	cm	interasse ferri seconda fila
As'2	=	0,00	cmq	area acciaio ferri seconda fila
d3	=	0	mm	diametro ferri terza fila
c3	=	0,00	cm	copriferro ferri terza fila
i3	=	0,00	cm	interasse ferri terza fila
As'3	=	0,00	cmq	area acciaio ferri terza fila
As'	=	5,65	cmq	area di acciaio in zona compressa
Armatura trasversale, staffe e/o ferri piegati (per sollecitazione V_Y)				
θ	=	45	°	Inclinazione della biella di cls (standard: 45°)
Asw 1° ordine:				
α	=	0	°	staffe: 90°; ferri piegati: angolo minore di 90°
n° bracci	=	0		
$\varphi 1$	=	0	mm	Diametro staffe primo ordine
s	=	0	mm	Passo delle staffe
Asw 2° ordine:				
α	=	0	°	staffe: 90°; ferri piegati: angolo minore di 90°
n° bracci	=	0		
$\varphi 2$	=	0	mm	Diametro staffe secondo ordine
s	=	0	mm	Passo delle staffe

Verifica a taglio della sezione maggiormente sollecitata

(V_Y):

Nella verifica a taglio NON si considera l'effetto positivo della compressione sulla sezione.

Nella verifica a taglio si considera l'effetto positivo dovuto ai meccanismi secondari di resistenza a taglio.

Nella sezione non sono previste armature per far fronte a sollecitazioni taglienti.

$V_{sd Y}$ = 54 kN Massima azione di taglio agente sulla sezione

$V_{rd Y}$ = 105 kN Risorsa resistente a taglio della sezione

SF = 1,94 [-] Coefficiente di sicurezza per sollecitazione V_Y

La verifica a taglio per sollecitazione V_Y è soddisfatta.

Combinazioni di carico e verifica a pressoflessione retta

							N+MX
n°	COMB	N [kN]	MX [kNm]	VY [kN]	MY [kNm]	VX [kN]	SF
0	0	76,0	45,0	54,0			1,29

APPROVATO SDP

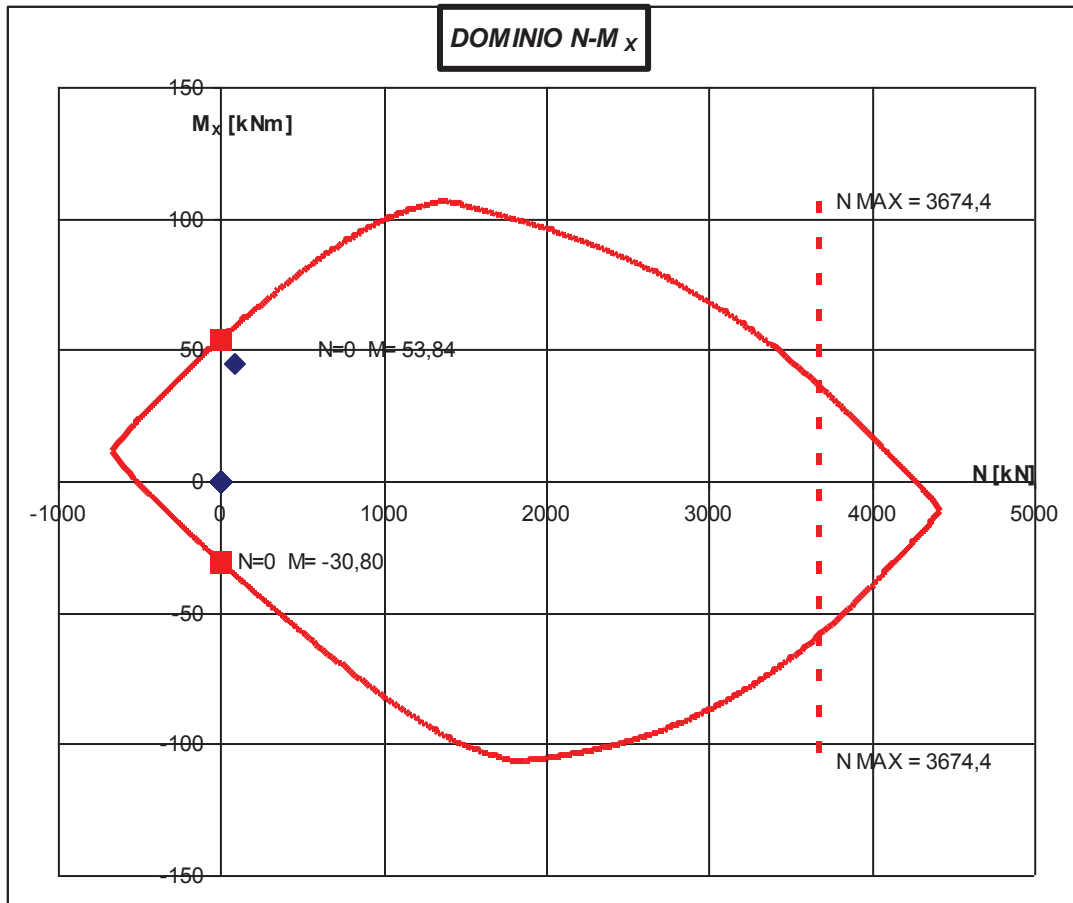

Caratteristiche dei materiali

Rck	=	50	MPa	resistenza caratteristica a 28 giorni del calcestruzzo
Ec	=	35547	MPa	modulo elastico del calcestruzzo
Acciaio B 450 C saldabile				
		21000		
Es	=	0	MPa	modulo elastico dell'acciaio
n	=	15		coefficiente di omogeneizzazione

Tensioni ammissibili

sigma c amm	=	14,75	MPa	tensione ammissibile del cls a compressione
tau c0	=	0,87	MPa	tensione ammissibile del cls a taglio senza l'ausilio di armatura
tau c1	=	2,40	MPa	tensione ammissibile del cls a taglio con l'ausilio di armatura
fctm	=	3,60	MPa	tensione media ammissibile nel cls a trazione
fcfm	=	4,32	MPa	tensione ammissibile nel cls a trazione per flessione
sigma s amm	=	255	MPa	tensione ammissibile dall'acciaio
tau b	=	2,60	MPa	tensione tangenziale di aderenza delle

APPROVATO SDP

Società di Progetto
Brebemi SpA

barre

**Caratteristiche
geometriche**

Sezione di cls

B	=	100	cm	base
H	=	16	cm	altezza
A cls	=	1600	cmq	area di cls

 Armatura in zona
tesa

d1	=	12	mm	diametro ferri prima fila
c1	=	3,00	cm	copriferro ferri prima fila
i1	=	20,00	cm	interasse ferri prima fila
As1	=	5,65	cmq	area acciaio ferri prima fila
d2	=	12	mm	diametro ferri seconda fila
c2	=	3,00	cm	copriferro ferri seconda fila
i2	=	20,00	cm	interasse ferri seconda fila
As2	=	5,65	cmq	area acciaio ferri seconda fila
d3	=	0	mm	diametro ferri terza fila
c3	=	0,00	cm	copriferro ferri terza fila
i3	=	0,00	cm	interasse ferri terza fila
As3	=	0,00	cmq	area acciaio ferri terza fila
As	=	11,31	cmq	area acciaio in zona tesa

Armatura in zona compressa

d1	=	12	mm	diametro ferri prima fila
c1	=	3,00	cm	copriferro ferri prima fila
i1	=	20,00	cm	interasse ferri prima fila
As'1	=	5,65	cmq	area acciaio ferri prima fila
d2	=	0	mm	diametro ferri seconda fila
c2	=	0,00	cm	copriferro ferri seconda fila
i2	=	0,00	cm	interasse ferri seconda fila
As'2	=	0,00	cmq	area acciaio ferri seconda fila
d3	=	0	mm	diametro ferri terza fila
c3	=	0,00	cm	copriferro ferri terza fila
i3	=	0,00	cm	interasse ferri terza fila
As'3	=	0,00	cmq	area acciaio ferri terza fila
As'	=	5,65	cmq	area di acciaio in zona compressa

 Sezione ideale interamente reagente
omogeneizzata a cls

Ai	=	1854	cmq	area
S*i sup	=	15209	cmc	momento statico superiore
ygi sup	=	8,20	cm	posizione del baricentro rispetto alla fibra superiore
Ji	=	38985	cm ⁴	momento d'inerzia
Wi sup	=	4754	cmc	momento resistente superiore
Wi inf	=	4999	cmc	momento resistente inferiore

**Caratteristiche di
esposizione**

Classe	=	XC4	classe di esposizione del sito
Condizioni ambientali:	Aggressive		

APPROVATO SDP

 Società di Progetto
Brebemi SpA



Armature poco sensibili alla corrosione.

La verifica alla fessurazione è effettuata considerando i risultati delle combinazioni Frequente e Quasi permanente.

La verifica alle tensioni è effettuata considerando i risultati delle combinazioni Rara e Quasi Permanente.

wd - Frequente	≤	0,3	mm	apertura limite delle fessure per le combinazioni Frequente
wd - Q.P.	≤	0,2	mm	apertura limite delle fessure per le combinazioni Quasi Permanente
σc Rara	≤	24,9	MPa	tensione limite nel calcestruzzo per le combinazioni Rara
σc Q.P.	≤	18,7	MPa	tensione limite nel calcestruzzo per le combinazioni Quasi Permanente
σs	≤	360,0	MPa	tensione limite per l'acciaio di armatura
c'	=	3,0	cm	copriferro minimo da normativa per armatura in zona tesa
beta	=	1,7		
beta 1	=	1,0		
beta 2	=	0,5		1,0 carichi di breve durata - 0,5 carichi di lunga durata o ciclici
k 2	=	0,4		0,4 barre ad aderenza migliorata
k 3	=	0,125		0,125 asse neutro all'interno della sezione
num s	=	10,0		numero di ferri in zona tesa
s	=	10,00	cm	passo dell'armatura in zona tesa
d max	=	12	mm	diametro massimo dell'armatura in zona tesa
d min	=	12	mm	diametro minimo dell'armatura in zona tesa
c	=	3,00	cm	copriferro armatura in zona tesa
dist	=	0,00	cm	distanza fra le file di barre in zona tesa

COMBO	[kN]		Verifica tensioni in esercizio					Verifica fessurazione		
	N	M _x	[MPa]	[MPa]	[MPa]	[MPa]	[MPa]	[kNm]	M _f > M ?	[mm]
INVRARA	56,0	33,0	11,87	248,9	248,9	-54,1	-54,1	18,86	NO	-
INVFRE	71,0	22,0	-	-	-	-	-	19,71	NO	0,051
INVQPE	18,0	6,0	2,17	41,7	41,7	-11,0	-11,0	19,58	SI	OK
INSIS	0,0	11,0	3,95	85,1	85,1	0,0	-17,3	18,64	SI	-

Viene svolta di seguito la verifica a taglio riguardante la sezione di altezza 36 cm.

Verifica a taglio della sezione maggiormente sollecitata (V_y):

Nella verifica a taglio NON si considera l'effetto positivo della compressione sulla sezione.

Società di Progetto
Brebemi SpA



Nella verifica a taglio si considera l'effetto positivo dovuto ai meccanismi secondari di resistenza a taglio. Nella sezione non sono previste armature per far fronte a sollecitazioni taglianti.

V_{SdY}	=	63	kN	Massima azione di taglio agente sulla sezione
V_{RdY}	=	163	kN	Risorsa resistente a taglio della sezione
SF	=	2,59	[-]	Coefficiente di sicurezza per sollecitazione V_Y

La verifica a taglio per sollecitazione V_Y è soddisfatta.

8.3.6 Piedritti – sezione di incastro superiore

La sezione di verifica ha dimensioni 100 cm di larghezza e 16 di altezza

L'armatura è costituita da $\phi 12/20 + \phi 12/20$ al lembo contro terra e $\phi 12/20$ al lembo interno.

Calcestruzzo

Classe	=	C40/50		
Rck	≥	50	MPa	Valore caratteristico resistenza cubica
fck	=	41,5	MPa	Valore caratteristico resistenza cilindrica
fcm	=	49,5	MPa	Valore medio resistenza cilindrica
fctm	=	3,60	MPa	Valore medio resistenza a trazione semplice
fctm	=	4,32	MPa	Valore medio resistenza a trazione per flessione
ν	=	0,2		Coefficiente di Poisson
Ecm	=	35547	MPa	Modulo elastico
γ_c	=	1,5		Coefficiente parziale di sicurezza
α_{cc}	=	0,85		Coefficiente risuttivo per resistenze di lunga durata
fcd	=	23,52	MPa	Resistenza di calcolo a compressione
fctd	=	1,68	MPa	Resistenza di calcolo a trazione
ϵ_{cu}	=	0,0035		Deformazione a rottura per il calcestruzzo
ϵ_{c0}	=	0,002		Def. limite del tratto a parabola del legame costitutivo del calcestruzzo

Valori per studio alle tensioni ammissibili:

n	=	15		Coefficiente di omogeneizzazione
---	---	----	--	----------------------------------

Acciaio per c.a.

Tipo	=	B 450 C		
f _{yk} nom	=	450	MPa	Valore nominale della tensione caratteristica di snervamento
f _{tk} nom	=	540	MPa	Valore nominale della tensione caratteristica di rottura
γ_s	=	1,15		Coefficiente parziale di sicurezza
E _s	=	210000	MPa	Modulo elastico
f _{yd}	=	391,3	MPa	Resistenza di calcolo
ϵ_{su}	=	0,01		Deformazione a rottura per l'acciaio

Caratteristiche geometriche

Sezione di cls				
B	=	100	cm	base
H	=	16	cm	altezza
A cls	=	1600	cmq	area di cls

Sistema di armatura per sollecitazioni M_X-V_Y

Armatura longitudinale inferiore (per sollecitazione M_X positiva)

d _l	=	12	mm	diametro ferri prima fila
c _l	=	3,00	cm	copriferro ferri prima fila

Società di Progetto
Brebemi SpA



i1	=	20,00	cm	interasse ferri prima fila
As1	=	5,65	cmq	area acciaio ferri prima fila
d2	=	12	mm	diametro ferri seconda fila
c2	=	3,00	cm	copriferro ferri seconda fila
i2	=	20,00	cm	interasse ferri seconda fila
As2	=	5,65	cmq	area acciaio ferri seconda fila
d3	=	0	mm	diametro ferri terza fila
c3	=	0,00	cm	copriferro ferri terza fila
i3	=	0,00	cm	interasse ferri terza fila
As3	=	0,00	cmq	area acciaio ferri terza fila
As	=	11,31	cmq	area acciaio in zona tesa

Armatura longitudinale superiore (per sollecitazione M_X positiva)

d1	=	12	mm	diametro ferri prima fila
c1	=	3,00	cm	copriferro ferri prima fila
i1	=	20,00	cm	interasse ferri prima fila
As'1	=	5,65	cmq	area acciaio ferri prima fila
d2	=	0	mm	diametro ferri seconda fila
c2	=	0,00	cm	copriferro ferri seconda fila
i2	=	0,00	cm	interasse ferri seconda fila
As'2	=	0,00	cmq	area acciaio ferri seconda fila
d3	=	0	mm	diametro ferri terza fila
c3	=	0,00	cm	copriferro ferri terza fila
i3	=	0,00	cm	interasse ferri terza fila
As'3	=	0,00	cmq	area acciaio ferri terza fila
As'	=	5,65	cmq	area di acciaio in zona compressa

Armatura trasversale, staffe e/o ferri piegati (per sollecitazione V_Y)

θ	=	45	°	Inclinazione della biella di cls (standard: 45°)
Asw 1° ordine:				
α	=	0	°	staffe: 90°; ferri piegati: angolo minore di 90°
n° bracci	=	0		
$\varphi 1$	=	0	mm	Diametro staffe primo ordine
s	=	0	mm	Passo delle staffe
Asw 2° ordine:				
α	=	0	°	staffe: 90°; ferri piegati: angolo minore di 90°
n° bracci	=	0		
$\varphi 2$	=	0	mm	Diametro staffe secondo ordine
s	=	0	mm	Passo delle staffe

Verifica a taglio della sezione maggiormente sollecitata

(V_Y):

Nella verifica a taglio NON si considera l'effetto positivo della compressione sulla sezione.

Nella verifica a taglio si considera l'effetto positivo dovuto ai meccanismi secondari di resistenza a taglio.

Nella sezione non sono previste armature per far fronte a sollecitazioni taglianti.

$V_{sd Y}$	=	36	kN	Massima azione di taglio agente sulla sezione
$V_{rd Y}$	=	105	kN	Risorsa resistente a taglio della sezione
SF	=	2,91	[-]	Coefficiente di sicurezza per sollecitazione V_Y

La verifica a taglio per sollecitazione V_Y è soddisfatta.

Combinazioni di carico e verifica a pressoflessione retta

n°	COMB	N	MX [kNm]	VY [kN]	MY [kNm]	VX	N+MX SF

Società di Progetto
Brebemi SpA

		[kN]				[kN]
0	0	127,0	42,0	36,0		1,45

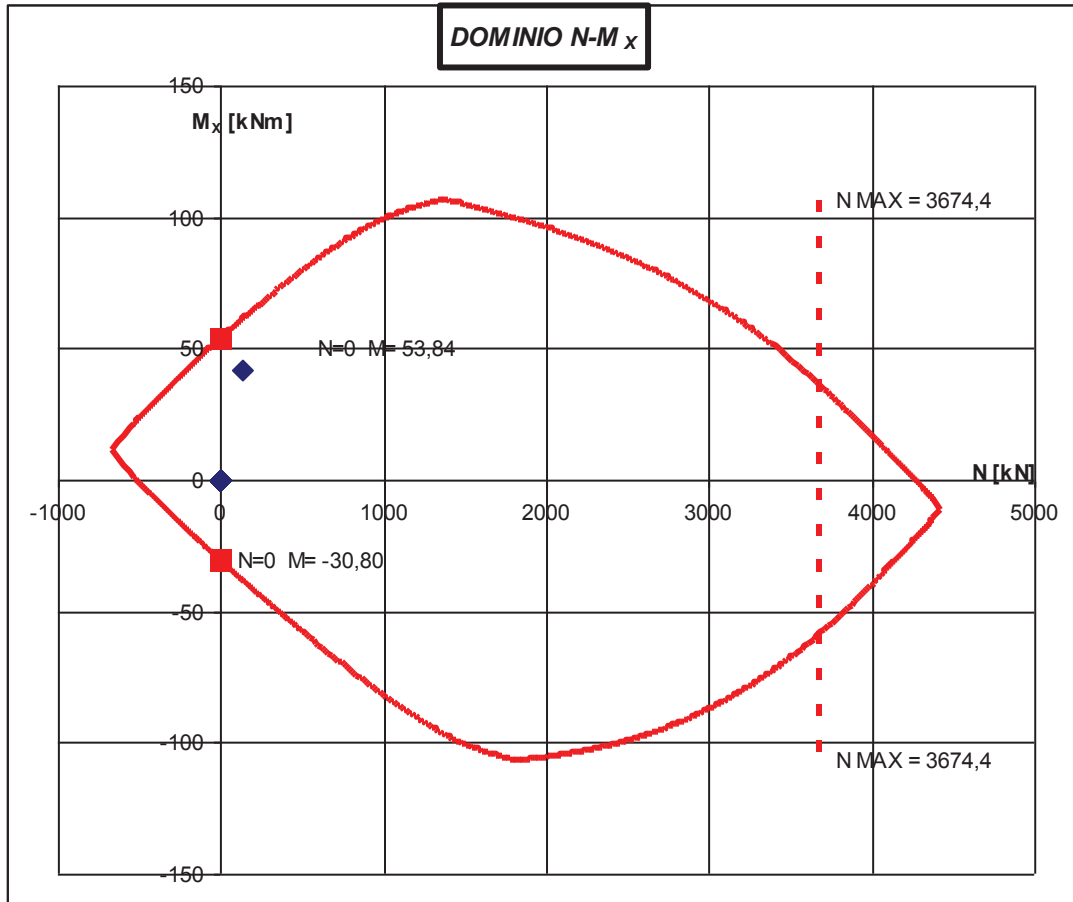

Caratteristiche dei materiali

Rck	=	50	MPa	resistenza caratteristica a 28 giorni del calcestruzzo
Ec	=	35547	MPa	modulo elastico del calcestruzzo
Acciaio B 450 C saldabile				
		21000		
Es	=	0	MPa	modulo elastico dell'acciaio
n	=	15		coefficiente di omogeneizzazione

Tensioni ammissibili

sigma c amm	=	14,75	MPa	tensione ammissibile del cls a compressione
tau c0	=	0,87	MPa	tensione ammissibile del cls a taglio senza l'ausilio di armatura
tau c1	=	2,40	MPa	tensione ammissibile del cls a taglio con l'ausilio di armatura
fctm	=	3,60	MPa	tensione media ammissibile nel cls a trazione
fcfm	=	4,32	MPa	tensione ammissibile nel cls a trazione per flessione

APPROVATO SDP

Società di Progetto
Brebemi SpA

sigma s amm	=	255	MPa	tensione ammissibile dall'acciaio
tau b	=	2,60	MPa	tensione tangenziale di aderenza delle barre
Caratteristiche geometriche				
Sezione di cls				
B	=	100	cm	base
H	=	16	cm	altezza
A cls	=	1600	cmq	area di cls
Armatura in zona tesa				
d1	=	12	mm	diametro ferri prima fila
c1	=	3,00	cm	copriferro ferri prima fila
i1	=	20,00	cm	interasse ferri prima fila
As1	=	5,65	cmq	area acciaio ferri prima fila
d2	=	12	mm	diametro ferri seconda fila
c2	=	3,00	cm	copriferro ferri seconda fila
i2	=	20,00	cm	interasse ferri seconda fila
As2	=	5,65	cmq	area acciaio ferri seconda fila
d3	=	0	mm	diametro ferri terza fila
c3	=	0,00	cm	copriferro ferri terza fila
i3	=	0,00	cm	interasse ferri terza fila
As3	=	0,00	cmq	area acciaio ferri terza fila
As	=	11,31	cmq	area acciaio in zona tesa
Armatura in zona compressa				
d1	=	12	mm	diametro ferri prima fila
c1	=	3,00	cm	copriferro ferri prima fila
i1	=	20,00	cm	interasse ferri prima fila
As'1	=	5,65	cmq	area acciaio ferri prima fila
d2	=	0	mm	diametro ferri seconda fila
c2	=	0,00	cm	copriferro ferri seconda fila
i2	=	0,00	cm	interasse ferri seconda fila
As'2	=	0,00	cmq	area acciaio ferri seconda fila
d3	=	0	mm	diametro ferri terza fila
c3	=	0,00	cm	copriferro ferri terza fila
i3	=	0,00	cm	interasse ferri terza fila
As'3	=	0,00	cmq	area acciaio ferri terza fila
As'	=	5,65	cmq	area di acciaio in zona compressa
Sezione ideale interamente reagente omogeneizzata a cls				
Ai	=	1854	cmq	area
S*i sup	=	15209	cmc	momento statico superiore
ysi sup	=	8,20	cm	posizione del baricentro rispetto alla fibra superiore
Ji	=	38985	cm ⁴	momento d'inerzia
Wi sup	=	4754	cmc	momento resistente superiore
Wi inf	=	4999	cmc	momento resistente inferiore

**Caratteristiche di
esposizione**

APPROVATO SDP

 Società di Progetto
Brebemi SpA



Classe = XC4 classe di esposizione del sito

Condizioni ambientali: Aggressive

Armature poco sensibili alla corrosione.

La verifica alla fessurazione è effettuata considerando i risultati delle combinazioni Frequente e Quasi permanente.

La verifica alle tensioni è effettuata considerando i risultati delle combinazioni Rara e Quasi Permanente.

wd - Frequente	≤	0,3	mm	apertura limite delle fessure per le combinazioni Frequente
wd - Q.P.	≤	0,2	mm	apertura limite delle fessure per le combinazioni Quasi Permanente
σc Rara	≤	24,9	MPa	tensione limite nel calcestruzzo per le combinazioni Rara
σc Q.P.	≤	18,7	MPa	tensione limite nel calcestruzzo per le combinazioni Quasi Permanente
σs	≤	360,0	MPa	tensione limite per l'acciaio di armatura
c'	=	3,0	cm	copriferro minimo da normativa per armatura in zona tesa
beta	=	1,7		
beta 1	=	1,0		
beta 2	=	0,5		1,0 carichi di breve durata - 0,5 carichi di lunga durata o ciclici
k 2	=	0,4		0,4 barre ad aderenza migliorata
k 3	=	0,125		0,125 asse neutro all'interno della sezione
num s	=	10,0		numero di ferri in zona tesa
s	=	10,00	cm	passo dell'armatura in zona tesa
d max	=	12	mm	diametro massimo dell'armatura in zona tesa
d min	=	12	mm	diametro minimo dell'armatura in zona tesa
c	=	3,00	cm	copriferro armatura in zona tesa
dist	=	0,00	cm	distanza fra le file di barre in zona tesa

	Verifica tensioni in esercizio						Verifica fessurazione			
	[kN]	[kNm]	[MPa]	[MPa]	[MPa]	[MPa]	[MPa]	[kNm]		[mm]
COMBO	N	M _x	σ _c max	σ _s max	σ _s min	σ _s ' max	σ _s ' min	M _f	M _f > M ?	wk'
INVSIS	18,0	9,0	3,24	66,7	66,7	-15,2	-15,2	19,02	SI	-
INVRARA	94,0	31,0	11,22	215,2	215,2	-56,9	-56,9	19,60	NO	-
INVFRE	79,0	19,0	-	-	-	-	-	20,27	SI	OK
INVQPE	13,0	5,0	1,81	35,7	35,7	-8,9	-8,9	19,35	SI	OK

Società di Progetto
Brebemi SpA

Viene svolta di seguito la verifica a taglio riguardante la sezione di altezza 36 cm.



Verifica a taglio della sezione maggiormente

sollecitata (V_Y):

Nella verifica a taglio NON si considera l'effetto positivo della compressione sulla sezione.

Nella verifica a taglio si considera l'effetto positivo dovuto ai meccanismi secondari di resistenza a taglio.

Nella sezione non sono previste armature per far fronte a sollecitazioni taglianti.

$V_{Sd Y}$	=	37	kN	Massima azione di taglio agente sulla sezione
$V_{Rd Y}$	=	163	kN	Risorsa resistente a taglio della sezione
SF	=	4,41	[-]	Coefficiente di sicurezza per sollecitazione V_Y

La verifica a taglio per sollecitazione V_Y è soddisfatta.

8.3.7 Piedritti – sezione di mezzeria

La sezione di verifica ha dimensioni 100 cm di larghezza e 16 di altezza

L'armatura è costituita da $\phi 12/20$ al lembo contro terra e $\phi 12/20$ al lembo interno.

Calcestruzzo

Classe	=	C40/50		
R_{ck}	\geq	50	MPa	Valore caratteristico resistenza cubica
f_{ck}	=	41,5	MPa	Valore caratteristico resistenza cilindrica
f_{cm}	=	49,5	MPa	Valore medio resistenza cilindrica
f_{ctm}	=	3,60	MPa	Valore medio resistenza a trazione semplice
f_{ctm}	=	4,32	MPa	Valore medio resistenza a trazione per flessione
ν	=	0,2		Coefficiente di Poisson
E_{cm}	=	35547	MPa	Modulo elastico
γ_c	=	1,5		Coefficiente parziale di sicurezza
α_{cc}	=	0,85		Coefficiente risuttivo per resistenze di lunga durata
f_{cd}	=	23,52	MPa	Resistenza di calcolo a compressione
f_{ctd}	=	1,68	MPa	Resistenza di calcolo a trazione
ϵ_{cu}	=	0,0035		Deformazione a rottura per il calcestruzzo
ϵ_{c0}	=	0,002		Def. limite del tratto a parabola del legame costitutivo del calcestruzzo

Valori per studio alle tensioni ammissibili:

n	=	15		Coefficiente di omogeneizzazione
-----	---	----	--	----------------------------------

Acciaio per c.a.

Tipo	=	B 450 C		
$f_{yk \text{ nom}}$	=	450	MPa	Valore nominale della tensione caratteristica di snervamento
$f_{tk \text{ nom}}$	=	540	MPa	Valore nominale della tensione caratteristica di rottura
γ_s	=	1,15		Coefficiente parziale di sicurezza
E_s	=	210000	MPa	Modulo elastico
f_{yd}	=	391,3	MPa	Resistenza di calcolo
ϵ_{su}	=	0,01		Deformazione a rottura per l'acciaio

Caratteristiche geometriche

Sezione di cls				
B	=	100	cm	base
H	=	16	cm	altezza
A cls	=	1600	cmq	area di cls

Sistema di armatura per sollecitazioni M_X-V_Y

Società di Progetto
Brebemi SpA



Armatura longitudinale inferiore (per sollecitazione M_X positiva)

d1	=	12	mm	diametro ferri prima fila
c1	=	3,00	cm	copriferro ferri prima fila
i1	=	20,00	cm	interasse ferri prima fila
As1	=	5,65	cmq	area acciaio ferri prima fila
d2	=	0	mm	diametro ferri seconda fila
c2	=	0,00	cm	copriferro ferri seconda fila
i2	=	0,00	cm	interasse ferri seconda fila
As2	=	0,00	cmq	area acciaio ferri seconda fila
d3	=	0	mm	diametro ferri terza fila
c3	=	0,00	cm	copriferro ferri terza fila
i3	=	0,00	cm	interasse ferri terza fila
As3	=	0,00	cmq	area acciaio ferri terza fila
As	=	5,65	cmq	area acciaio in zona tesa

Armatura longitudinale superiore (per sollecitazione M_X positiva)

d1	=	12	mm	diametro ferri prima fila
c1	=	3,00	cm	copriferro ferri prima fila
i1	=	20,00	cm	interasse ferri prima fila
As'1	=	5,65	cmq	area acciaio ferri prima fila
d2	=	0	mm	diametro ferri seconda fila
c2	=	0,00	cm	copriferro ferri seconda fila
i2	=	0,00	cm	interasse ferri seconda fila
As'2	=	0,00	cmq	area acciaio ferri seconda fila
d3	=	0	mm	diametro ferri terza fila
c3	=	0,00	cm	copriferro ferri terza fila
i3	=	0,00	cm	interasse ferri terza fila
As'3	=	0,00	cmq	area acciaio ferri terza fila
As'	=	5,65	cmq	area di acciaio in zona compressa

Armatura trasversale, staffe e/o ferri piegati (per sollecitazione V_Y)

θ	=	45	°	Inclinazione della biella di cls (standard: 45°)
Asw 1° ordine:				
α	=	0	°	staffe: 90°; ferri piegati: angolo minore di 90°
n° bracci	=	0		
$\phi 1$	=	0	mm	Diametro staffe primo ordine
s	=	0	mm	Passo delle staffe
Asw 2° ordine:				
α	=	0	°	staffe: 90°; ferri piegati: angolo minore di 90°
n° bracci	=	0		
$\phi 2$	=	0	mm	Diametro staffe secondo ordine
s	=	0	mm	Passo delle staffe

Verifica a taglio della sezione maggiormente sollecitata
(V_Y):

Nella verifica a taglio NON si considera l'effetto positivo della compressione sulla sezione.

Nella verifica a taglio si considera l'effetto positivo dovuto ai meccanismi secondari di resistenza a taglio.

Nella sezione non sono previste armature per far fronte a sollecitazioni taglianti.

$V_{sd Y}$	=	57	kN	Massima azione di taglio agente sulla sezione
$V_{Rd Y}$	=	83	kN	Risorsa resistente a taglio della sezione
SF	=	1,46	[-]	Coefficiente di sicurezza per sollecitazione V_Y

La verifica a taglio per sollecitazione V_Y è soddisfatta.

APPROVATO SDP

Società di Progetto
Brebemi SpA



**Combinazioni di carico e verifica a pressoflessione
retta**

n°	COMB	N [kN]	MX [kNm]	VY [kN]	MY [kNm]	VX [kN]	N+MX
							SF
0	0		12,0	57,0			2,50

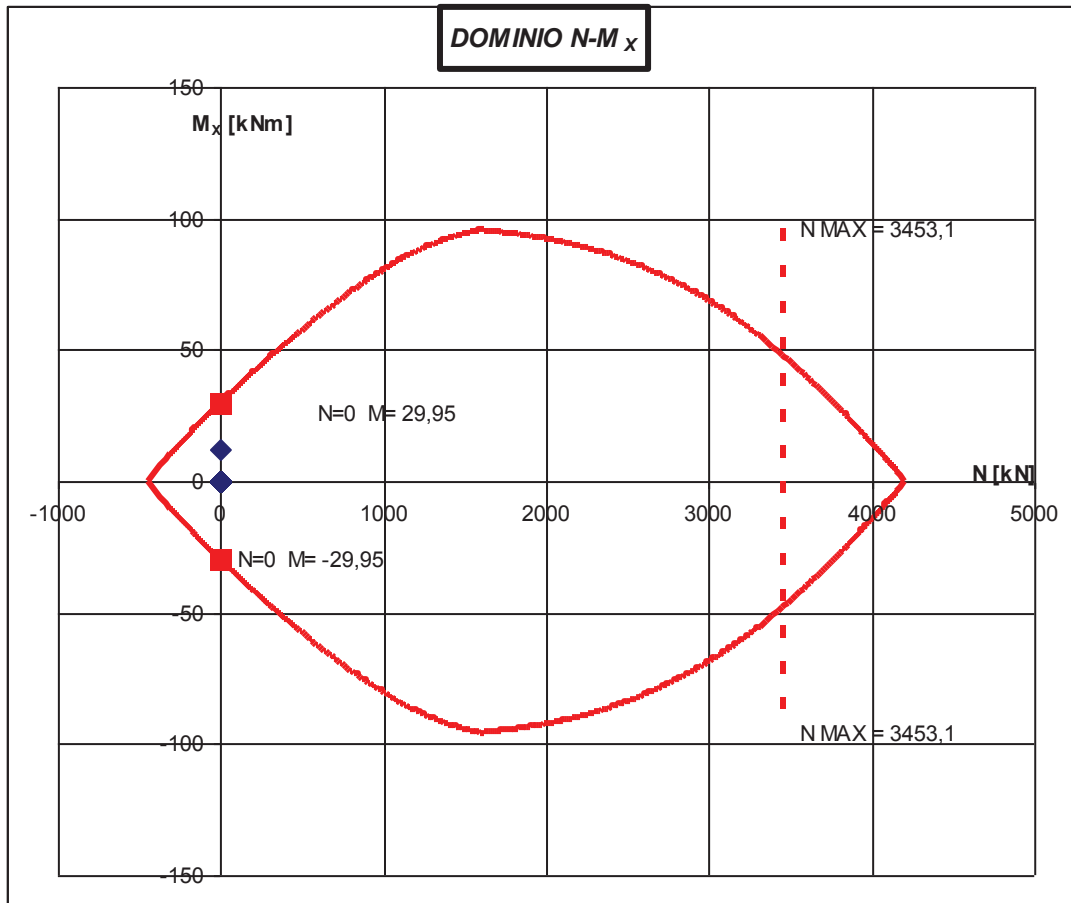

APPROVATO SDP

Caratteristiche dei materiali

Rck	=	50	MPa	resistenza caratteristica a 28 giorni del calcestruzzo
Ec	=	35547	MPa	modulo elastico del calcestruzzo
Acciaio B 450 C saldabile				
Es	=	21000	MPa	modulo elastico dell'acciaio
n	=	0	MPa	coefficiente di omogeneizzazione
n	=	15		

Tensioni ammissibili

sigma c amm	=	14,75	MPa	tensione ammissibile del cls a compressione
tau c0	=	0,87	MPa	tensione ammissibile del cls a taglio senza l'ausilio di armatura
tau c1	=	2,40	MPa	tensione ammissibile del cls a taglio con l'ausilio di armatura

Società di Progetto
Brebemi SpA

fctm	=	3,60	MPa	tensione media ammissibile nel cls a trazione
fcfm	=	4,32	MPa	tensione ammissibile nel cls a trazione per flessione
sigma s amm	=	255	MPa	tensione ammissibile dall'acciaio
tau b	=	2,60	MPa	tensione tangenziale di aderenza delle barre

Caratteristiche geometriche

Sezione di cls

B	=	100	cm	base
H	=	16	cm	altezza
A cls	=	1600	cmq	area di cls

Armatura in zona tesa

d1	=	12	mm	diametro ferri prima fila
c1	=	3,00	cm	copriferro ferri prima fila
i1	=	20,00	cm	interasse ferri prima fila
As1	=	5,65	cmq	area acciaio ferri prima fila
d2	=	0	mm	diametro ferri seconda fila
c2	=	0,00	cm	copriferro ferri seconda fila
i2	=	0,00	cm	interasse ferri seconda fila
As2	=	0,00	cmq	area acciaio ferri seconda fila
d3	=	0	mm	diametro ferri terza fila
c3	=	0,00	cm	copriferro ferri terza fila
i3	=	0,00	cm	interasse ferri terza fila
As3	=	0,00	cmq	area acciaio ferri terza fila
As	=	5,65	cmq	area acciaio in zona tesa

Armatura in zona compressa

d1	=	12	mm	diametro ferri prima fila
c1	=	3,00	cm	copriferro ferri prima fila
i1	=	20,00	cm	interasse ferri prima fila
As'1	=	5,65	cmq	area acciaio ferri prima fila
d2	=	0	mm	diametro ferri seconda fila
c2	=	0,00	cm	copriferro ferri seconda fila
i2	=	0,00	cm	interasse ferri seconda fila
As'2	=	0,00	cmq	area acciaio ferri seconda fila
d3	=	0	mm	diametro ferri terza fila
c3	=	0,00	cm	copriferro ferri terza fila
i3	=	0,00	cm	interasse ferri terza fila
As'3	=	0,00	cmq	area acciaio ferri terza fila
As'	=	5,65	cmq	area di acciaio in zona compressa

Sezione ideale interamente reagente omogeneizzata a cls

Ai	=	1770	cmq	area
S*i sup	=	14157	cmc	momento statico superiore
ygi sup	=	8,00	cm	posizione del baricentro rispetto alla fibra superiore
Ji	=	37418	cm ⁴	momento d'inerzia
Wi sup	=	4677	cmc	momento resistente superiore

APPROVATO SDP

Società di Progetto
Brebemi SpA



Wi inf = 4677 cmc momento resistente inferiore

Caratteristiche di esposizione

Classe = XC4 classe di esposizione del sito

Condizioni ambientali: Aggressive
Armature poco sensibili alla corrosione.

La verifica alla fessurazione è effettuata considerando i risultati delle combinazioni Frequente e Quasi permanente.

La verifica alle tensioni è effettuata considerando i risultati delle combinazioni Rara e Quasi Permanente.

wd - Frequente	≤	0,3	mm	apertura limite delle fessure per le combinazioni Frequente
wd - Q.P.	≤	0,2	mm	apertura limite delle fessure per le combinazioni Quasi Permanente
σc Rara	≤	24,9	MPa	tensione limite nel calcestruzzo per le combinazioni Rara
σc Q.P.	≤	18,7	MPa	tensione limite nel calcestruzzo per le combinazioni Quasi Permanente
σs	≤	360,0	MPa	tensione limite per l'acciaio di armatura
c'	=	3,0	cm	copriferro minimo da normativa per armatura in zona tesa
beta	=	1,7		
beta 1	=	1,0		
beta 2	=	0,5		1,0 carichi di breve durata - 0,5 carichi di lunga durata o ciclici
k 2	=	0,4		0,4 barre ad aderenza migliorata
k 3	=	0,125		0,125 asse neutro all'interno della sezione
num s	=	5,0		numero di ferri in zona tesa
s	=	16,80	cm	passo dell'armatura in zona tesa
d max	=	12	mm	diametro massimo dell'armatura in zona tesa
d min	=	12	mm	diametro minimo dell'armatura in zona tesa
c	=	3,00	cm	copriferro armatura in zona tesa
dist	=	0,00	cm	distanza fra le file di barre in zona tesa

APPROVATO SDP

	[kN]		Verifica tensioni in esercizio					Verifica fessurazione		
	[kNm]	[kNm]	[MPa]	[MPa]	[MPa]	[MPa]	[MPa]	[kNm]		[mm]
COMBO	N	M _x	σc max	σs max	σs min	σs' max	σs' min	M f	Mf > M ?	wk'
INVRARA	0,0	9,0	4,20	143,5	143,5	-3,0	-3,0	16,84	SI	-
INVFRE	0,0	7,0	-	-	-	-	-	16,84	SI	OK
INVQPE	0,0	2,0	0,93	31,9	31,9	-0,7	-0,7	16,84	SI	OK
INVSIS	0,0	4,0	1,87	63,8	63,8	-1,4	-1,4	16,84	SI	-

Società di Progetto
Brebemi SpA

8.4 Armatura di ripartizione dello scatolare

Così come previsto dal D.M. 14 gennaio 2008, si prevede un'armatura longitudinale in misura non inferiore al 20%. L'armatura per l'opera in oggetto risulta essere una rete elettrosaldata $\Phi 6/20/20$ situata al lembo interno ed esterno del manufatto ed integrata, nel senso longitudinale del manufatto, da ferri longitudinali $\Phi 10/40$ in mezzeria della soletta inferiore e superiore e in prossimità degli spigoli sui 4 lati.

8.5 Verifica armatura longitudinale a ritiro

Viene verificata l'armatura longitudinale dello scatolare, ai fini della verifica si prenderà in considerazione la sola soletta superiore poiché presenta maggiori criticità geometriche e di esposizione all'aria rispetto gli altri elementi dello scatolare.

Nel seguito viene eseguita la verifica a fessurazione della soletta superiore:

Calcolo armatura longitudinale antiritiro

Si considera una sezione avente le seguenti caratteristiche geometriche :

Altezza soletta superiore	H =	160	mm
Larghezza unitaria soletta superiore	B =	1000	mm
R _{ck} calcestruzzo	R _{ck} =	50	N/mm ²
	f _{ck} =	41,5	N/mm ²

Ritiro secondo paragrafo 11.2.10.6 delle N.T.C. 2008

Considerando:

$h_0 = 2 A_c / u =$	160	mm
A _c = area della sezione in c.a. =	160000	mm ²
u = perimetro della sezione esposta all'aria =	2000	mm

La deformazione totale da ritiro si può esprimere come:

$$\epsilon_{cs} = \epsilon_{cd} + \epsilon_{ca}$$

dove:

ϵ_{cd} = deformazione per ritiro da essiccamento.

ϵ_{ca} = deformazione per ritiro autogeno.

Il valore medio a tempo infinito della deformazione per ritiro per essiccamento vale:

$$\epsilon_{cd,infinito} = k_h \times \epsilon_{c0}$$

Per un umidità relativa pari al 90% si ottiene un valore $\epsilon_{c0} =$

Società di Progetto
Brebemi SpA

-0,30 ‰



Per spessori di soletta pari a 160 mm si ha un valore di $k_h = 0,94$

quindi

$$\varepsilon_{cd,infinito} = k_h \times \varepsilon_{c0} = -0,2820 \quad \text{‰}$$

Lo sviluppo nel tempo della deformazione ε_{cd} può essere valutato come:

$$\varepsilon_{cd,t} = \beta_{ds} (t - t_s) \times \varepsilon_{cd,infinito}$$

dove la funzione di sviluppo temporale assume la forma:

$$\beta_{ds} = (t - t_s) / [(t - t_s) + 0,04 \times h_o^{3/2}] = 0,9980$$

$t =$ età del calcestruzzo nel momento considerato = 40000 gg
(> 100 anni)

$t_s =$ età del calcestruzzo a partire dalla quale si considera l'effetto del ritiro = 28 gg
(termine di maturazione)

quindi si ha:

$$\varepsilon_{cd,t} = -0,2814 \quad \text{‰}$$

Il valore medio della deformazione per ritiro autogeno vale:

$$\varepsilon_{ca,infinito} = -2,5 (f_{ck} - 10) \times 10^{-6} = -7,88E-05$$

Quindi

$$\varepsilon_{cs} = \varepsilon_{cd} + \varepsilon_{ca} = -0,36018 \quad \text{‰} = \varepsilon_{free}$$

Si valuta ora la deformazione per ritiro contrastato considerando quanto riportato al punto b dell'Annex M dell' Eurocodice 2 -

Progettazione delle strutture di calcestruzzo - Parte 3 : Strutture di contenimento liquidi.

La deformazione totale da ritiro si può esprimere come:

$$\varepsilon_{cs}^* = R_{ax} \times \varepsilon_{free} = -0,18009 \quad \text{‰}$$

$$\text{avendo assunto } R_{ax} = 0,5$$

Da cui si ottiene:

$$R_{ax} \times \varepsilon_{free} = (\varepsilon_{sm} - \varepsilon_{cm})$$

APPROVATO SDP

Società di Progetto
Brebemi SpA



$$W_k = S_{R,max} \times (\varepsilon_{sm} - \varepsilon_{cm}) = S_{R,max} \times R_{ax} \times \varepsilon_{free}$$

$$S_{R,max} = 1,3 (h - X) \quad \text{per } i > 5 (c + \phi/2)$$

$$S_{R,max} = k_3 c + (k_1 k_2 k_4 \phi) / \rho_{p,eff} \quad \text{per } i \leq 5 (c + \phi/2)$$

Essendo:

$\phi =$	6	mm
$c =$	30	mm
$i =$	200	mm
$k_1 =$	0,8	per barre ad aderenza migliorata
$k_2 =$	1	per trazione pura
$k_3 =$	3,4	
$k_4 =$	0,425	
$h_{eff} =$	26,67	mm
$A_s =$	283	mm ²
$A_{c,eff} =$	26667	mm ²
$\rho_{p,eff} =$	0,01	

si ha:

$5 (c + \phi/2) =$	165	mm	
$S_{R,max} =$	173,33	mm	per $i > 5 (c + f/2)$
$w_k =$	0,031	mm	
$w_k =$	<	$w_1 =$	0,2 mm 'Verificato'

APPROVATO SDP

Società di Progetto
Brebemi SpA



9 VERIFICHE GEOTECNICHE

9.1 Verifiche geotecniche tombino

La verifica di capacità portante viene effettuata secondo l'Approccio I combinazione 2 (GEO) sia in condizioni statiche che in condizioni sismiche.

Si fa notare che, essendo lo scatolare una struttura rigida, le azioni orizzontali comportano dal lato sfavorevole una rapida diminuzione di spinta (da regime di K_0 a regime di K_a) che avviene per piccoli spostamenti, mentre dal lato resistente la spinta aumenta tendendo a K_p per cui, in definitiva, la struttura risulta autoequilibrata in direzione orizzontale. Ciò è particolarmente significativo nel caso in esame, considerando che per il terreno di rinterro il rapporto tra K_p e K_a è molto elevato (circa 20).

Poiché le verifiche di capacità portante sono eseguite allo stato limite ultimo (a cui corrispondono per definizione "grandi" spostamenti) si ritiene di poter considerare l'azione resistente massima in regime di spinta passiva.

Si tratta quindi di verificare che, per la combinazione di carico più gravosa, la massima spinta agente sia inferiore a quella resistente assicurando così l'equilibrio della struttura.

Nel caso in esame:

<u>Azione resistente massima:</u>	152,14	KN
<u>Azione agente massima in condizioni statiche (combinazione GEO):</u>	74,28	KN
<u>Azione agente massima in condizioni sismiche (combinazione GEO):</u>	39,62	KN

Dai calcoli sopra riportati si evince che la resistenza massima del terreno è largamente maggiore rispetto alle azioni agenti, per cui si ritiene la struttura equilibrata.

Ne consegue che per le verifiche di capacità portante si può ritenere nulla la risultante delle forze orizzontali e considerare unicamente l'azione verticale, che risulta massima per il caso statico per il quale si considerano agenti i carichi accidentali da traffico:

$$N_{\max}(\text{GEO}) = 245,94 \text{ KN}$$

Per il caso sismico si trascura secondo normativa la componente verticale della spinta.

Per il dimensionamento geotecnico si fa riferimento alla seguente geometria:

WBS	IDA11
Progressiva	KM 3+400.03
Profondità di posa	Q=134.73m
Quota piano campagna	Q=135.75m
Quota falda di progetto	non interessa l'opera Q<117.05m circa sul livello del mare
Larghezza fondazione	B= 1.82m
Lunghezza del rilevato autostradale	m 16 circa

Altezza del rilevato autostradale in prossimità dello scatolare H_{ril}: 62cm (media)

La verifica di capacità portante viene effettuata con riferimento alla formulazione riportata al §9.3.2 della relazione metodologica di P.E. considerando il solo caso SLU-GEO (approccio 1 combinazione 2) che, dalle relazioni di calcolo delle opere, risulta essere il più gravoso in termini di verifica di capacità portante delle fondazioni.

Si riportano di seguito i tabulati di calcolo della verifica di capacità portante per lo scatolare in esame.

Brebemi SpA

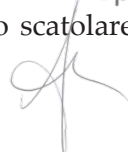

VERIFICA CAPACITA' PORTANTE DI FONDAZIONE
GEO
Caratteristiche
geotecniche
Terreno sopra il piano di posa della fondazione

gamma t	KN/mc	20,00	peso specifica terreno in sito
fi t	°	38,00	angolo di attrito interno
cu d	KN/mq	0,00	coesione in condizioni drenate
cu nd	KN/mq	0,00	coesione in condizioni non drenate
beta	°	0,00	inclinazione del terreno

Terreno sotto il piano di posa della fondazione

gamma t	KN/mc	20,00	peso specifica terreno in sito
fi t'	°	32,01	angolo di attrito interno ridotto
cu d'	KN/mq	0,00	coesione in condizioni drenate ridotta
cu nd'	KN/mq	0,00	coesione in condizioni non drenate ridotta

Geometria fondazione

B	m	1,82	larghezza fondazione
L	m	1,00	lunghezza fondazione
H	m	1,82	altezza fondazione
b	m	0,00	larghezza sopralzo
l	m	0,00	lunghezza sopralzo
h	m	0,00	altezza sopralzo
PP	KN	0,00	peso fondazione
ric	m	0,62	ricoprimento ciabatta anteriore
D	m	2,44	affondamento anteriore fondazione
d	m	0,00	distanza dei carichi da estradosso fondazione

sollecitazioni baricentro dell'estradosso della fondazione

N	KN	214,60	azione verticale
Tx	KN	0,00	taglio in direzione di x
My	KNm	0,00	momento trasversale attorno a y
Ty	KN	0,00	taglio in direzione di y
Mx	KNm	0,00	momento trasversale attorno a x

sollecitazioni baricentro dell'intradosso della fondazione

N	KN	214,60	azione verticale
Tx	KN	0,00	taglio in direzione di x
My	KNm	0,00	momento trasversale attorno a y
Ty	KN	0,00	taglio in direzione di y
Mx	KNm	0,00	momento trasversale attorno a x
q'	KN/mq	48,80	sovraccarico stabilizzante terreno ai bordi

Parametri per il calcolo della capacità portante

B eq	m	1,82	larghezza equivalente
L eq	m	1,00	lunghezza equivalente
p	KN/mq	117,91	pressione di servizio

APPROVATO SDP

 Società di Progetto
Brebemi SpA



*fattori di capacità
portante*

Nq		23,19
Nc		35,51
Ng		20,81

fattori di forma

sq		1,00
sc		1,00
sg		1,00

fattori correttivi per affondamento piano di posa

dq		1,26
dc		1,13
dg		1,00

fattori correttivi per inclinazione del carico

iq		1,00
ic		1,00
ig		1,00

fattori correttivi per inclinazione del terreno

gq		1,00
gc		1,00
gg		1,00

CAPACITÀ PORTANTE LIMITE

q lim q	KN/mq	1422,53
q lim c	KN/mq	0,00
q lim g	KN/mq	378,71
q lim	KN/mq	1801,25
q amm	KN/mq	1000,69
F.S. ≥ 1		8,49

capacità portante limite
capacità portante ammissibile
verifica soddisfatta

Coefficiente parziali per le resistenza alla capacità portante

γ_R (R2)		1,80
-----------------	--	------

coefficiente di sicurezza minimo assunto

APPROVATO SDP

10 ALLEGATI

10.1 Tabulati di input

TABLE: "PROGRAM CONTROL"
ProgramName=SAP2000 Version=14.0.0 ProgLevel=Advanced LicenseOS=Yes
LicenseSC=Yes LicenseBR=Yes LicenseHT=No CurrUnits="KN, m, C"

Società di Progetto
Brebemi SpA
SteelCode=AISC-ASD89 ConcCode="ACI 318-99" AlumCode="AA-ASD 2000"
ColdCode=AISI-ASD96 _
BridgeCode="AASHTO LRFD 2007" RegenHinge=Yes





Doc. N.
60235-00000-A00.doc

CODIFICA DOCUMENTO
04RCDII100000000000300A00

REV.
00

FOGLIO
93 di 628

TABLE: "ACTIVE DEGREES OF FREEDOM"

UX=Yes UY=Yes UZ=Yes RX=Yes RY=Yes RZ=Yes

TABLE: "ANALYSIS OPTIONS"

Solver=Advanced SolverProc=Auto Force32Bit=No StiffCase=None
GeomMod=No

TABLE: "COORDINATE SYSTEMS"

Name=X-GLOBAL Type=Cartesian X=0 Y=0 Z=0 AboutZ=0 AboutY=0
AboutX=0

TABLE: "GRID LINES"

CoordSys=GLOBAL AxisDir=X XRYZCoord=-0,83 LineType=Primary
LineColor=Gray8Dark Visible=Yes BubbleLoc=End AllVisible=Yes
BubbleSize=2,4384
CoordSys=GLOBAL AxisDir=X XRYZCoord=0 LineType=Primary
LineColor=Gray8Dark Visible=Yes BubbleLoc=End
CoordSys=GLOBAL AxisDir=X XRYZCoord=0,83 LineType=Primary
LineColor=Gray8Dark Visible=Yes BubbleLoc=End
CoordSys=GLOBAL AxisDir=Y XRYZCoord=0 LineType=Primary
LineColor=Gray8Dark Visible=Yes BubbleLoc=End
CoordSys=GLOBAL AxisDir=Z XRYZCoord=0 LineType=Primary
LineColor=Gray8Dark Visible=Yes BubbleLoc=End
CoordSys=GLOBAL AxisDir=Z XRYZCoord=1,66 LineType=Primary
LineColor=Gray8Dark Visible=Yes BubbleLoc=End

TABLE: "MATERIAL PROPERTIES 01 - GENERAL"

Material=A615Gr60 Type=Rebar SymType=Uniaxial TempDepend=No
Color=Yellow Notes="ASTM A615 Grade 60 added 06/11/2012 13.02.24"
Material=C40/50 Type=Concrete SymType=Isotropic TempDepend=No
Color=Blue Notes="ASTM A36 added 06/11/2012 13.01.44"

TABLE: "MATERIAL PROPERTIES 02 - BASIC MECHANICAL PROPERTIES"

Material=A615Gr60 UnitWeight=76,9728639422648 UnitMass=7,84904737995992
E1=199947978,795958 A1=0,0000117
Material=C40/50 UnitWeight=25 UnitMass=2,54929048055605 E1=35547000
G12=14811250 U12=0,2 A1=0,0000117

TABLE: "MATERIAL PROPERTIES 03B - CONCRETE DATA"

Material=C40/50 Fc=20684,2736685473 LtWtConc=No SSCurveOpt=Mander
SSHysType=Takeda Sfc=0,002 SCap=0,005 FinalSlope=-0,1 FAngle=0
DAngle=0

TABLE: "FRAME SECTION PROPERTIES 01 - GENERAL"

SectionName="Sp piedr" Material=C40/50 Shape=Rectangular t3=0,16 t2=1
Area=0,16 TorsConst=1,2277152495261E-03 I33=3,41333333333333E-04
I22=1,33333333333333E-02 AS2=0,133333333333333 AS3=0,133333333333333
S33=4,26666666666667E-03 S22=2,66666666666667E-02 Z33=0,0064 Z22=0,04
R33=4,61880215351701E-02 R22=0,288675134594813 ConcCol=Yes ConcBeam=No
Color=Blue TotalWt=13,28 TotalMass=1,35418310327137 FromFile=No
AMod=1 A2Mod=1 A3Mod=1 JMod=1 I2Mod=1 I3Mod=1 MMod=1
WMod=1 Notes="Added 30/11/2011 10.17.22"
SectionName="Sp solin" Material=C40/50 Shape=Rectangular t3=0,16 t2=1
Area=0,16 TorsConst=1,2277152495261E-03 I33=3,41333333333333E-04
I22=1,33333333333333E-02 AS2=0,133333333333333 AS3=0,133333333333333
S33=4,26666666666667E-03 S22=2,66666666666667E-02 Z33=0,0064 Z22=0,04
R33=4,61880215351701E-02 R22=0,288675134594813 ConcCol=Yes ConcBeam=No
Color=White TotalWt=6,64 TotalMass=0,677091551635687 FromFile=No
AMod=1 A2Mod=1 A3Mod=1 JMod=1 I2Mod=1 I3Mod=1 MMod=1
WMod=1 Notes="Added 30/11/2011 10.17.04"
SectionName="Sp sopsup" Material=C40/50 Shape=Rectangular t3=0,16 t2=1
Area=0,16 TorsConst=1,2277152495261E-03 I33=3,41333333333333E-04
I22=1,33333333333333E-02 AS2=0,133333333333333 AS3=0,133333333333333
S33=4,26666666666667E-03 S22=2,66666666666667E-02 Z33=0,0064 Z22=0,04
R33=4,61880215351701E-02 R22=0,288675134594813 ConcCol=Yes ConcBeam=No
Color=Gray8Dark TotalWt=6,64 TotalMass=0,677091551635687 FromFile=No
AMod=1 A2Mod=1 A3Mod=1 JMod=1 I2Mod=1 I3Mod=1 MMod=1
WMod=1 Notes="Added 30/11/2011 10.15.09"

TABLE: "LOAD PATTERN DEFINITIONS"

LoadPat=DEAD DesignType=DEAD SelfWtMult=1
LoadPat=PPST DesignType=DEAD SelfWtMult=1
LoadPat=PPNS DesignType=DEAD SelfWtMult=0
LoadPat=PPAQ DesignType=DEAD SelfWtMult=0
LoadPat=ST1S DesignType=DEAD SelfWtMult=0
LoadPat=ST2S DesignType=DEAD SelfWtMult=0
LoadPat=ST3S DesignType=DEAD SelfWtMult=0
LoadPat=ST4S DesignType=DEAD SelfWtMult=0
LoadPat=ST1D DesignType=DEAD SelfWtMult=0
LoadPat=ST2D DesignType=DEAD SelfWtMult=0
LoadPat=ST3D DesignType=DEAD SelfWtMult=0
LoadPat=ST4D DesignType=DEAD SelfWtMult=0
LoadPat=ST1SG DesignType=DEAD SelfWtMult=0
LoadPat=ST2SG DesignType=DEAD SelfWtMult=0

LoadPat=ST3SG DesignType=DEAD SelfWtMult=0
LoadPat=ST4SG DesignType=DEAD SelfWtMult=0
LoadPat=ST1DG DesignType=DEAD SelfWtMult=0
LoadPat=ST2DG DesignType=DEAD SelfWtMult=0
LoadPat=ST3DG DesignType=DEAD SelfWtMult=0
LoadPat=ST4DG DesignType=DEAD SelfWtMult=0
LoadPat=SW1S DesignType=DEAD SelfWtMult=0
LoadPat=SW2S DesignType=DEAD SelfWtMult=0
LoadPat=SW1D DesignType=DEAD SelfWtMult=0
LoadPat=SW2D DesignType=DEAD SelfWtMult=0
LoadPat=SA DesignType=DEAD SelfWtMult=0
LoadPat=QM01 DesignType=LIVE SelfWtMult=0
LoadPat=QM02 DesignType=LIVE SelfWtMult=0
LoadPat=SQMS DesignType=LIVE SelfWtMult=0
LoadPat=SQMD DesignType=LIVE SelfWtMult=0
LoadPat=SQMSG DesignType=LIVE SelfWtMult=0
LoadPat=SQMDG DesignType=LIVE SelfWtMult=0
LoadPat=FA01 DesignType=LIVE SelfWtMult=0
LoadPat=TC01 DesignType=LIVE SelfWtMult=0
LoadPat=TC02 DesignType=LIVE SelfWtMult=0
LoadPat=TV01 DesignType=LIVE SelfWtMult=0
LoadPat=TV02 DesignType=LIVE SelfWtMult=0
LoadPat=RIT DesignType=LIVE SelfWtMult=0
LoadPat=IS01 DesignType=LIVE SelfWtMult=0
LoadPat=SSTS DesignType=LIVE SelfWtMult=0
LoadPat=IS02 DesignType=LIVE SelfWtMult=0

TABLE: "AUTO WAVE 3 - WAVE CHARACTERISTICS - GENERAL"

WaveChar=Default WaveType="From Theory" KinFactor=1 SWaterDepth=45
WaveHeight=18 WavePeriod=12 WaveTheory=Linear

TABLE: "COMBINATION DEFINITIONS"

ComboName=SK05 ComboType="Linear Add" AutoDesign=No
CaseType="Linear Static" CaseName=ST1S ScaleFactor=1 SteelDesign=No
ConcDesign=No AlumDesign=No ColdDesign=No
ComboName=SK05 CaseType="Linear Static" CaseName=ST2S ScaleFactor=1
ComboName=SKAS ComboType="Linear Add" AutoDesign=No
CaseType="Linear Static" CaseName=ST3S ScaleFactor=1 SteelDesign=No
ConcDesign=No AlumDesign=No ColdDesign=No
ComboName=SKAS CaseType="Linear Static" CaseName=ST4S ScaleFactor=1
ComboName=SK0D ComboType="Linear Add" AutoDesign=No
CaseType="Linear Static" CaseName=ST1D ScaleFactor=1 SteelDesign=No
ConcDesign=No AlumDesign=No ColdDesign=No
ComboName=SK0D CaseType="Linear Static" CaseName=ST2D ScaleFactor=1
ComboName=SKAD ComboType="Linear Add" AutoDesign=No
CaseType="Linear Static" CaseName=ST3D ScaleFactor=1 SteelDesign=No
ConcDesign=No AlumDesign=No ColdDesign=No
ComboName=SKAD CaseType="Linear Static" CaseName=ST4D ScaleFactor=1
ComboName=SWS ComboType="Linear Add" AutoDesign=No
CaseType="Linear Static" CaseName=SW1S ScaleFactor=1 SteelDesign=No
ConcDesign=No AlumDesign=No ColdDesign=No
ComboName=SWS CaseType="Linear Static" CaseName=SW2S ScaleFactor=1
ComboName=SWD ComboType="Linear Add" AutoDesign=No
CaseType="Linear Static" CaseName=SW1D ScaleFactor=1 SteelDesign=No
ConcDesign=No AlumDesign=No ColdDesign=No
ComboName=SWD CaseType="Linear Static" CaseName=SW2D ScaleFactor=1
ComboName=SK0SG ComboType="Linear Add" AutoDesign=No
CaseType="Linear Static" CaseName=ST1SG ScaleFactor=1 SteelDesign=No
ConcDesign=No AlumDesign=No ColdDesign=No
ComboName=SK0SG CaseType="Linear Static" CaseName=ST2SG
ScaleFactor=1
ComboName=SKASG ComboType="Linear Add" AutoDesign=No
CaseType="Linear Static" CaseName=ST3SG ScaleFactor=1 SteelDesign=No
ConcDesign=No AlumDesign=No ColdDesign=No
ComboName=SKASG CaseType="Linear Static" CaseName=ST4SG
ScaleFactor=1
ComboName=SK0DG ComboType="Linear Add" AutoDesign=No
CaseType="Linear Static" CaseName=ST1DG ScaleFactor=1 SteelDesign=No
ConcDesign=No AlumDesign=No ColdDesign=No
ComboName=SK0DG CaseType="Linear Static" CaseName=ST2DG
ScaleFactor=1
ComboName=STR001 ComboType="Linear Add" AutoDesign=No
CaseType="Linear Static" CaseName=PPST ScaleFactor=1,35 SteelDesign=No
ConcDesign=No AlumDesign=No ColdDesign=No
ComboName=STR001 CaseType="Linear Static" CaseName=PPNS
ScaleFactor=1,35
ComboName=STR001 CaseType="Linear Static" CaseName=PPAQ
ScaleFactor=0

Società di Progetto
Brebemì SpA

ComboName=STR005 ScaleFactor=1,35	CaseType="Linear Static"	CaseName=PPNS	ComboName=STR007 CaseType="Linear Static"	ComboType="Linear Add"	AutoDesign=No
ComboName=STR005 ScaleFactor=0	CaseType="Linear Static"	CaseName=PPAQ	ComboName=STR007 ScaleFactor=1	CaseName=PPST	SteelDesign=No
ComboName=STR005 ScaleFactor=1,35	CaseType="Response Combo"	CaseName=SK05	ComboName=STR007 ScaleFactor=0	CaseType="Linear Static"	CaseName=PPNS
ComboName=STR005 ScaleFactor=0	CaseType="Response Combo"	CaseName=SKAS	ComboName=STR007 ScaleFactor=1,35	CaseType="Linear Static"	CaseName=PPAQ
ComboName=STR005 ScaleFactor=1,35	CaseType="Response Combo"	CaseName=SWS	ComboName=STR007 ScaleFactor=0	CaseType="Response Combo"	CaseName=SK05
ComboName=STR005 ScaleFactor=1,35	CaseType="Response Combo"	CaseName=SK0D	ComboName=STR007 ScaleFactor=1,35	CaseType="Response Combo"	CaseName=SKAS
ComboName=STR005 ScaleFactor=0	CaseType="Response Combo"	CaseName=SKAD	ComboName=STR007 ScaleFactor=0	CaseType="Response Combo"	CaseName=SWS
ComboName=STR005 ScaleFactor=1,35	CaseType="Response Combo"	CaseName=SWD	ComboName=STR007 ScaleFactor=1,35	CaseType="Response Combo"	CaseName=SKAD
ComboName=STR005 ScaleFactor=1,35	CaseType="Linear Static"	CaseName=SA	ComboName=STR007 ScaleFactor=0	CaseType="Response Combo"	CaseName=SWD
ComboName=STR005 ScaleFactor=1,35	CaseType="Linear Static"	CaseName=QM01	ComboName=STR007 ScaleFactor=1,35	CaseType="Linear Static"	CaseName=SA
ComboName=STR005 ScaleFactor=1,35	CaseType="Linear Static"	CaseName=QM02	ComboName=STR007 ScaleFactor=0	CaseType="Linear Static"	CaseName=QM01
ComboName=STR005 ScaleFactor=1,35	CaseType="Linear Static"	CaseName=SQMS	ComboName=STR007 ScaleFactor=0	CaseType="Linear Static"	CaseName=QM02
ComboName=STR005 ScaleFactor=1,35	CaseType="Linear Static"	CaseName=SQMD	ComboName=STR007 ScaleFactor=1,35	CaseType="Linear Static"	CaseName=SQMS
ComboName=STR005 ScaleFactor=0	CaseType="Linear Static"	CaseName=FA01	ComboName=STR007 ScaleFactor=1,35	CaseType="Linear Static"	CaseName=SQMD
ComboName=STR005 ScaleFactor=0	CaseType="Linear Static"	CaseName=TC01	ComboName=STR007 ScaleFactor=0	CaseType="Linear Static"	CaseName=FA01
ComboName=STR005 ScaleFactor=0	CaseType="Linear Static"	CaseName=TC02	ComboName=STR007 ScaleFactor=0	CaseType="Linear Static"	CaseName=TC01
ComboName=STR005 ScaleFactor=0	CaseType="Linear Static"	CaseName=TV01	ComboName=STR007 ScaleFactor=0	CaseType="Linear Static"	CaseName=TC02
ComboName=STR005 ScaleFactor=0	CaseType="Linear Static"	CaseName=TV02	ComboName=STR007 ScaleFactor=0	CaseType="Linear Static"	CaseName=TV01
ComboName=STR005 ScaleFactor=0	CaseType="Linear Static"	CaseName=RIT	ComboName=STR007 ScaleFactor=0	CaseType="Linear Static"	CaseName=TV02
ComboName=STR005 ScaleFactor=0	CaseType="Linear Static"	CaseName=SSTS	ComboName=STR007 ScaleFactor=0	CaseType="Linear Static"	CaseName=RIT
ComboName=STR005 ScaleFactor=0	CaseType="Linear Static"	CaseName=IS01	ComboName=STR007 ScaleFactor=0	CaseType="Linear Static"	CaseName=SSTS
ComboName=STR006 CaseType="Linear Static"	CaseType="Linear Add"	AutoDesign=No	ComboName=STR007 ScaleFactor=0	CaseType="Linear Static"	CaseName=IS01
ComboName=STR006 ScaleFactor=1	CaseName=PPST	SteelDesign=No	ComboName=STR007 ScaleFactor=0	CaseType="Linear Add"	AutoDesign=No
ComboName=STR006 ScaleFactor=0	CaseType="Linear Static"	CaseName=PPNS	ComboName=STR007 ScaleFactor=1,35	CaseName=PPST	SteelDesign=No
ComboName=STR006 ScaleFactor=0	CaseType="Linear Static"	CaseName=PPAQ	ComboName=STR008 ScaleFactor=1,35	CaseType="Linear Static"	CaseName=PPNS
ComboName=STR006 ScaleFactor=1,35	CaseType="Response Combo"	CaseName=SK05	ComboName=STR008 ScaleFactor=0	CaseType="Linear Static"	CaseName=PPAQ
ComboName=STR006 ScaleFactor=0	CaseType="Response Combo"	CaseName=SKAS	ComboName=STR008 ScaleFactor=1,35	CaseType="Response Combo"	CaseName=SK05
ComboName=STR006 ScaleFactor=1,35	CaseType="Response Combo"	CaseName=SWS	ComboName=STR008 ScaleFactor=0	CaseType="Response Combo"	CaseName=SKAS
ComboName=STR006 ScaleFactor=0	CaseType="Response Combo"	CaseName=SK0D	ComboName=STR008 ScaleFactor=1,35	CaseType="Response Combo"	CaseName=SWS
ComboName=STR006 ScaleFactor=1	CaseType="Response Combo"	CaseName=SKAD	ComboName=STR008 ScaleFactor=0	CaseType="Response Combo"	CaseName=SK0D
ComboName=STR006 ScaleFactor=1	CaseType="Response Combo"	CaseName=SWD	ComboName=STR008 ScaleFactor=1	CaseType="Response Combo"	CaseName=SKAD
ComboName=STR006 ScaleFactor=0	CaseType="Linear Static"	CaseName=SA	ComboName=STR008 ScaleFactor=1,35	CaseType="Response Combo"	CaseName=SWD
ComboName=STR006 ScaleFactor=0	CaseType="Linear Static"	CaseName=QM01	ComboName=STR008 ScaleFactor=1,0125	CaseType="Linear Static"	CaseName=SA
ComboName=STR006 ScaleFactor=0	CaseType="Linear Static"	CaseName=QM02	ComboName=STR008 ScaleFactor=1,0125	CaseType="Linear Static"	CaseName=QM01
ComboName=STR006 ScaleFactor=1,35	CaseType="Linear Static"	CaseName=SQMS	ComboName=STR008 ScaleFactor=1,0125	CaseType="Linear Static"	CaseName=QM02
ComboName=STR006 ScaleFactor=0	CaseType="Linear Static"	CaseName=SQMD	ComboName=STR008 ScaleFactor=0	CaseType="Linear Static"	CaseName=SQMS
ComboName=STR006 ScaleFactor=0	CaseType="Linear Static"	CaseName=FA01	ComboName=STR008 ScaleFactor=1,35	CaseType="Linear Static"	CaseName=SQMD
ComboName=STR006 ScaleFactor=0	CaseType="Linear Static"	CaseName=TC01	ComboName=STR008 ScaleFactor=0	CaseType="Linear Static"	CaseName=FA01
ComboName=STR006 ScaleFactor=0	CaseType="Linear Static"	CaseName=TC02	ComboName=STR008 ScaleFactor=0	CaseType="Linear Static"	CaseName=TC01
ComboName=STR006 ScaleFactor=0	CaseType="Linear Static"	CaseName=TV01	ComboName=STR008 ScaleFactor=0	CaseType="Linear Static"	CaseName=TC02
ComboName=STR006 ScaleFactor=0	CaseType="Linear Static"	CaseName=TV02	ComboName=STR008 ScaleFactor=0	CaseType="Linear Static"	CaseName=TV01
ComboName=STR006 ScaleFactor=0	CaseType="Linear Static"	CaseName=RIT	ComboName=STR008 ScaleFactor=0	CaseType="Linear Static"	CaseName=TV02
ComboName=STR006 ScaleFactor=0	CaseType="Linear Static"	CaseName=SSTS	ComboName=STR008 ScaleFactor=0	CaseType="Linear Static"	CaseName=RIT
ComboName=STR006 ScaleFactor=0	CaseType="Linear Static"	CaseName=IS01	ComboName=STR008 ScaleFactor=0	CaseType="Linear Static"	CaseName=SSTS

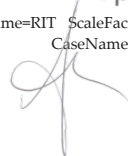

ComboName=STR008	CaseType="Linear Static"	CaseName=IS01	ScaleFactor=0	ComboName=STR010	CaseType="Linear Static"	CaseName=SSTS	
ComboName=STR009	ComboType="Linear Add"	AutoDesign=No		ScaleFactor=0			
CaseType="Linear Static"	CaseName=PPST	ScaleFactor=1,35	SteelDesign=No	ComboName=STR010	CaseType="Linear Static"	CaseName=IS01	ScaleFactor=0
ConcDesign=No	AlumDesign=No	ColdDesign=No		ComboName=STR011	ComboType="Linear Add"	AutoDesign=No	
ComboName=STR009	CaseType="Linear Static"	CaseName=PPNS		CaseType="Linear Static"	CaseName=PPST	ScaleFactor=1,35	SteelDesign=No
ScaleFactor=1,35				ConcDesign=No	AlumDesign=No	ColdDesign=No	
ComboName=STR009	CaseType="Linear Static"	CaseName=PPAQ		ComboName=STR011	CaseType="Linear Static"	CaseName=PPNS	
ScaleFactor=0				ScaleFactor=1,35			
ComboName=STR009	CaseType="Response Combo"	CaseName=SK05		ComboName=STR011	CaseType="Linear Static"	CaseName=PPAQ	
ScaleFactor=1,35				ScaleFactor=0			
ComboName=STR009	CaseType="Response Combo"	CaseName=SKAS		ComboName=STR011	CaseType="Response Combo"	CaseName=SK05	
ScaleFactor=0				ScaleFactor=0			
ComboName=STR009	CaseType="Response Combo"	CaseName=SWS		ComboName=STR011	CaseType="Response Combo"	CaseName=SKAS	
ScaleFactor=1,35				ScaleFactor=1			
ComboName=STR009	CaseType="Response Combo"	CaseName=SK0D		ComboName=STR011	CaseType="Response Combo"	CaseName=SWS	
ScaleFactor=1,35				ScaleFactor=1			
ComboName=STR009	CaseType="Response Combo"	CaseName=SKAD		ComboName=STR011	CaseType="Response Combo"	CaseName=SK0D	
ScaleFactor=0				ScaleFactor=0			
ComboName=STR009	CaseType="Response Combo"	CaseName=SWD		ComboName=STR011	CaseType="Response Combo"	CaseName=SKAD	
ScaleFactor=1,35				ScaleFactor=1			
ComboName=STR009	CaseType="Linear Static"	CaseName=SA		ComboName=STR011	CaseType="Response Combo"	CaseName=SWD	
ScaleFactor=1,35				ScaleFactor=1			
ComboName=STR009	CaseType="Linear Static"	CaseName=QM01		ComboName=STR011	CaseType="Linear Static"	CaseName=SA	
ScaleFactor=0				ScaleFactor=1,35			
ComboName=STR009	CaseType="Linear Static"	CaseName=QM02		ComboName=STR011	CaseType="Linear Static"	CaseName=QM01	
ScaleFactor=0				ScaleFactor=1,35			
ComboName=STR009	CaseType="Linear Static"	CaseName=SQMS		ComboName=STR011	CaseType="Linear Static"	CaseName=QM02	
ScaleFactor=0				ScaleFactor=1,35			
ComboName=STR009	CaseType="Linear Static"	CaseName=SQMD		ComboName=STR011	CaseType="Linear Static"	CaseName=SQMS	
ScaleFactor=0				ScaleFactor=0			
ComboName=STR009	CaseType="Linear Static"	CaseName=FA01		ComboName=STR011	CaseType="Linear Static"	CaseName=SQMD	
ScaleFactor=0				ScaleFactor=0			
ComboName=STR009	CaseType="Linear Static"	CaseName=TC01		ComboName=STR011	CaseType="Linear Static"	CaseName=FA01	
ScaleFactor=1,2				ScaleFactor=0			
ComboName=STR009	CaseType="Linear Static"	CaseName=TC02		ComboName=STR011	CaseType="Linear Static"	CaseName=TC01	
ScaleFactor=0				ScaleFactor=0,72			
ComboName=STR009	CaseType="Linear Static"	CaseName=TV01		ComboName=STR011	CaseType="Linear Static"	CaseName=TC02	
ScaleFactor=0				ScaleFactor=0			
ComboName=STR009	CaseType="Linear Static"	CaseName=TV02		ComboName=STR011	CaseType="Linear Static"	CaseName=TV01	
ScaleFactor=0				ScaleFactor=0			
ComboName=STR009	CaseType="Linear Static"	CaseName=RIT	ScaleFactor=0	ComboName=STR011	CaseType="Linear Static"	CaseName=TV02	
ScaleFactor=0				ScaleFactor=0			
ComboName=STR009	CaseType="Linear Static"	CaseName=SSTS		ComboName=STR011	CaseType="Linear Static"	CaseName=RIT	ScaleFactor=0
ScaleFactor=0				ComboName=STR011	CaseType="Linear Static"	CaseName=SSTS	
ComboName=STR009	CaseType="Linear Static"	CaseName=IS01	ScaleFactor=0	ScaleFactor=0			
ComboName=STR010	ComboType="Linear Add"	AutoDesign=No		ComboName=STR011	CaseType="Linear Static"	CaseName=IS01	ScaleFactor=0
CaseType="Linear Static"	CaseName=PPST	ScaleFactor=1,35	SteelDesign=No	ComboName=STR012	ComboType="Linear Add"	AutoDesign=No	
ConcDesign=No	AlumDesign=No	ColdDesign=No		CaseType="Linear Static"	CaseName=PPST	ScaleFactor=1,35	SteelDesign=No
ComboName=STR010	CaseType="Linear Static"	CaseName=PPNS		ConcDesign=No	AlumDesign=No	ColdDesign=No	
ScaleFactor=1,35				ComboName=STR012	CaseType="Linear Static"	CaseName=PPNS	
ComboName=STR010	CaseType="Linear Static"	CaseName=PPAQ		ScaleFactor=1,35			
ScaleFactor=0				ComboName=STR012	CaseType="Linear Static"	CaseName=PPAQ	
ComboName=STR010	CaseType="Response Combo"	CaseName=SK05		ScaleFactor=0			
ScaleFactor=0				ComboName=STR012	CaseType="Linear Static"	CaseName=PPAQ	
ComboName=STR010	CaseType="Response Combo"	CaseName=SKAS		ScaleFactor=0			
ScaleFactor=1				ComboName=STR012	CaseType="Response Combo"	CaseName=SK05	
ComboName=STR010	CaseType="Response Combo"	CaseName=SWS		ScaleFactor=1,35			
ScaleFactor=1				ComboName=STR012	CaseType="Response Combo"	CaseName=SKAS	
ComboName=STR010	CaseType="Response Combo"	CaseName=SK0D		ScaleFactor=0			
ScaleFactor=0				ComboName=STR012	CaseType="Response Combo"	CaseName=SWS	
ComboName=STR010	CaseType="Response Combo"	CaseName=SKAD		ScaleFactor=1,35			
ScaleFactor=1				ComboName=STR012	CaseType="Response Combo"	CaseName=SK0D	
ComboName=STR010	CaseType="Response Combo"	CaseName=SWD		ScaleFactor=0			
ScaleFactor=1				ComboName=STR012	CaseType="Response Combo"	CaseName=SKAD	
ComboName=STR010	CaseType="Linear Static"	CaseName=SA		ScaleFactor=1			
ScaleFactor=1,35				ComboName=STR012	CaseType="Response Combo"	CaseName=SWD	
ComboName=STR010	CaseType="Linear Static"	CaseName=QM01		ScaleFactor=1			
ScaleFactor=0				ComboName=STR012	CaseType="Linear Static"	CaseName=SA	
ComboName=STR010	CaseType="Linear Static"	CaseName=QM02		ScaleFactor=1,35			
ScaleFactor=0				ComboName=STR012	CaseType="Linear Static"	CaseName=QM01	
ComboName=STR010	CaseType="Linear Static"	CaseName=SQMS		ScaleFactor=1,35			
ScaleFactor=0				ComboName=STR012	CaseType="Linear Static"	CaseName=QM02	
ComboName=STR010	CaseType="Linear Static"	CaseName=SQMD		ScaleFactor=1,35			
ScaleFactor=0				ComboName=STR012	CaseType="Linear Static"	CaseName=SQMS	
ComboName=STR010	CaseType="Linear Static"	CaseName=FA01		ScaleFactor=1,35			
ScaleFactor=0				ComboName=STR012	CaseType="Linear Static"	CaseName=SQMD	
ComboName=STR010	CaseType="Linear Static"	CaseName=TC01		ScaleFactor=0			
ScaleFactor=1,2				ComboName=STR012	CaseType="Linear Static"	CaseName=FA01	
ComboName=STR010	CaseType="Linear Static"	CaseName=TC02		ScaleFactor=0			
ScaleFactor=0				ComboName=STR012	CaseType="Linear Static"	CaseName=TC01	
ComboName=STR010	CaseType="Linear Static"	CaseName=TV01		ScaleFactor=0,72			
ScaleFactor=0				ComboName=STR012	CaseType="Linear Static"	CaseName=TC02	
ComboName=STR010	CaseType="Linear Static"	CaseName=TV02		ScaleFactor=0			
ScaleFactor=0				ComboName=STR012	CaseType="Linear Static"	CaseName=TV01	
ComboName=STR010	CaseType="Linear Static"	CaseName=RIT	ScaleFactor=0	ScaleFactor=0			
ScaleFactor=0				ComboName=STR012	CaseType="Linear Static"	CaseName=TV02	
ComboName=STR010	CaseType="Linear Static"	CaseName=RIT	ScaleFactor=0	ScaleFactor=0			

ComboName=STR012	CaseType="Linear	Static"	CaseName=TV02	ComboName=STR014	CaseType="Linear	Static"	CaseName=TV01
ScaleFactor=0				ScaleFactor=0			
ComboName=STR012	CaseType="Linear Static"	CaseName=RIT	ScaleFactor=0	ComboName=STR014	CaseType="Linear	Static"	CaseName=TV02
ComboName=STR012	CaseType="Linear	Static"	CaseName=SSTS	ScaleFactor=0			
ScaleFactor=0				ComboName=STR014	CaseType="Linear Static"	CaseName=RIT	ScaleFactor=0
ComboName=STR012	CaseType="Linear Static"	CaseName=IS01	ScaleFactor=0	ComboName=STR014	CaseType="Linear	Static"	CaseName=SSTS
ComboName=STR013	ComboType="Linear	Add"	AutoDesign=No	ScaleFactor=0			
CaseType="Linear Static"	CaseName=PPST	ScaleFactor=1,35	SteelDesign=No	ComboName=STR014	CaseType="Linear Static"	CaseName=IS01	ScaleFactor=0
ConcDesign=No	AlumDesign=No	ColdDesign=No		ComboName=STR015	ComboType="Linear	Add"	AutoDesign=No
ComboName=STR013	CaseType="Linear	Static"	CaseName=PPNS	CaseType="Linear Static"	CaseName=PPST	ScaleFactor=1	SteelDesign=No
ScaleFactor=1,35				ConcDesign=No	AlumDesign=No	ColdDesign=No	
ComboName=STR013	CaseType="Linear	Static"	CaseName=PPAQ	ComboName=STR015	CaseType="Linear	Static"	CaseName=PPNS
ScaleFactor=0				ScaleFactor=1			
ComboName=STR013	CaseType="Response	Combo"	CaseName=SK05	ComboName=STR015	CaseType="Linear	Static"	CaseName=PPAQ
ScaleFactor=1,35				ScaleFactor=0			
ComboName=STR013	CaseType="Response	Combo"	CaseName=SKAS	ComboName=STR015	CaseType="Response	Combo"	CaseName=SK05
ScaleFactor=0				ScaleFactor=1,35			
ComboName=STR013	CaseType="Response	Combo"	CaseName=SWS	ComboName=STR015	CaseType="Response	Combo"	CaseName=SKAS
ScaleFactor=1,35				ScaleFactor=0			
ComboName=STR013	CaseType="Response	Combo"	CaseName=SK0D	ComboName=STR015	CaseType="Response	Combo"	CaseName=SWS
ScaleFactor=1,35				ScaleFactor=1,35			
ComboName=STR013	CaseType="Response	Combo"	CaseName=SKAD	ComboName=STR015	CaseType="Response	Combo"	CaseName=SK0D
ScaleFactor=0				ScaleFactor=1,35			
ComboName=STR013	CaseType="Response	Combo"	CaseName=SWD	ComboName=STR015	CaseType="Response	Combo"	CaseName=SKAD
ScaleFactor=1,35				ScaleFactor=0			
ComboName=STR013	CaseType="Linear	Static"	CaseName=SA	ComboName=STR015	CaseType="Response	Combo"	CaseName=SWD
ScaleFactor=1,35				ScaleFactor=1,35			
ComboName=STR013	CaseType="Linear	Static"	CaseName=QM01	ComboName=STR015	CaseType="Linear Static"	CaseName=SA	ScaleFactor=1
ScaleFactor=1,35				ComboName=STR015	CaseType="Linear	Static"	CaseName=QM01
ComboName=STR013	CaseType="Linear	Static"	CaseName=QM02	ScaleFactor=0			
ScaleFactor=1,35				ComboName=STR015	CaseType="Linear	Static"	CaseName=QM02
ScaleFactor=1,35				ScaleFactor=0			
ComboName=STR013	CaseType="Linear	Static"	CaseName=SQMS	ComboName=STR015	CaseType="Linear	Static"	CaseName=SQMS
ScaleFactor=1,35				ScaleFactor=1,35			
ComboName=STR013	CaseType="Linear	Static"	CaseName=SQMD	ComboName=STR015	CaseType="Linear	Static"	CaseName=SQMD
ScaleFactor=1,35				ScaleFactor=1,35			
ComboName=STR013	CaseType="Linear	Static"	CaseName=FA01	ComboName=STR015	CaseType="Linear	Static"	CaseName=FA01
ScaleFactor=0				ScaleFactor=0			
ComboName=STR013	CaseType="Linear	Static"	CaseName=TC01	ComboName=STR015	CaseType="Linear	Static"	CaseName=TC01
ScaleFactor=0,72				ScaleFactor=0,72			
ComboName=STR013	CaseType="Linear	Static"	CaseName=TC02	ComboName=STR015	CaseType="Linear	Static"	CaseName=TC02
ScaleFactor=0				ScaleFactor=0			
ComboName=STR013	CaseType="Linear	Static"	CaseName=TV01	ComboName=STR015	CaseType="Linear	Static"	CaseName=TV01
ScaleFactor=0				ScaleFactor=0			
ComboName=STR013	CaseType="Linear	Static"	CaseName=TV02	ComboName=STR015	CaseType="Linear	Static"	CaseName=TV02
ScaleFactor=0				ScaleFactor=0			
ComboName=STR013	CaseType="Linear Static"	CaseName=RIT	ScaleFactor=0	ComboName=STR015	CaseType="Linear Static"	CaseName=RIT	ScaleFactor=0
ScaleFactor=0				ComboName=STR015	CaseType="Linear	Static"	CaseName=SSTS
ComboName=STR013	CaseType="Linear	Static"	CaseName=SSTS	ScaleFactor=0			
ScaleFactor=0				ComboName=STR015	CaseType="Linear Static"	CaseName=IS01	ScaleFactor=0
ComboName=STR013	CaseType="Linear Static"	CaseName=IS01	ScaleFactor=0	ComboName=STR016	ComboType="Linear	Add"	AutoDesign=No
ScaleFactor=0				CaseType="Linear Static"	CaseName=PPST	ScaleFactor=1,35	SteelDesign=No
ComboName=STR014	ComboType="Linear	Add"	AutoDesign=No	ConcDesign=No	AlumDesign=No	ColdDesign=No	
CaseType="Linear Static"	CaseName=PPST	ScaleFactor=1	SteelDesign=No	ComboName=STR016	CaseType="Linear	Static"	CaseName=PPNS
ConcDesign=No	AlumDesign=No	ColdDesign=No		ScaleFactor=1,35			
ComboName=STR014	CaseType="Linear	Static"	CaseName=PPNS	ComboName=STR016	CaseType="Linear	Static"	CaseName=PPAQ
ScaleFactor=1				ScaleFactor=0			
ComboName=STR014	CaseType="Linear	Static"	CaseName=PPAQ	ComboName=STR016	CaseType="Response	Combo"	CaseName=SK05
ScaleFactor=0				ScaleFactor=1,35			
ComboName=STR014	CaseType="Response	Combo"	CaseName=SK05	ComboName=STR016	CaseType="Response	Combo"	CaseName=SKAS
ScaleFactor=1,35				ScaleFactor=0			
ComboName=STR014	CaseType="Response	Combo"	CaseName=SKAS	ComboName=STR016	CaseType="Response	Combo"	CaseName=SWS
ScaleFactor=0				ScaleFactor=1,35			
ComboName=STR014	CaseType="Response	Combo"	CaseName=SWS	ComboName=STR016	CaseType="Response	Combo"	CaseName=SK0D
ScaleFactor=1,35				ScaleFactor=0			
ComboName=STR014	CaseType="Response	Combo"	CaseName=SK0D	ComboName=STR016	CaseType="Response	Combo"	CaseName=SKAD
ScaleFactor=0				ScaleFactor=1			
ComboName=STR014	CaseType="Response	Combo"	CaseName=SKAD	ComboName=STR016	CaseType="Response	Combo"	CaseName=SWD
ScaleFactor=1				ScaleFactor=1			
ComboName=STR014	CaseType="Response	Combo"	CaseName=SWD	ComboName=STR016	CaseType="Response	Combo"	CaseName=SWD
ScaleFactor=1				ScaleFactor=1			
ComboName=STR014	CaseType="Linear Static"	CaseName=SA	ScaleFactor=1	ComboName=STR016	CaseType="Linear	Static"	CaseName=SA
ScaleFactor=0				ScaleFactor=1,35			
ComboName=STR014	CaseType="Linear	Static"	CaseName=QM01	ComboName=STR016	CaseType="Linear	Static"	CaseName=QM01
ScaleFactor=0				ScaleFactor=1,0125			
ComboName=STR014	CaseType="Linear	Static"	CaseName=QM02	ComboName=STR016	CaseType="Linear	Static"	CaseName=QM02
ScaleFactor=0				ScaleFactor=1,0125			
ComboName=STR014	CaseType="Linear	Static"	CaseName=SQMS	ComboName=STR016	CaseType="Linear	Static"	CaseName=SQMS
ScaleFactor=1,35				ScaleFactor=1,0125			
ComboName=STR014	CaseType="Linear	Static"	CaseName=SQMD	ComboName=STR016	CaseType="Linear	Static"	CaseName=SQMD
ScaleFactor=0				ScaleFactor=0			
ComboName=STR014	CaseType="Linear	Static"	CaseName=FA01	ComboName=STR016	CaseType="Linear	Static"	CaseName=FA01
ScaleFactor=0				ScaleFactor=1,35			
ComboName=STR014	CaseType="Linear	Static"	CaseName=TC01	ComboName=STR016	CaseType="Linear	Static"	CaseName=TC01
ScaleFactor=0,72				ScaleFactor=0,72			
ComboName=STR014	CaseType="Linear	Static"	CaseName=TC02	ComboName=STR016	CaseType="Linear	Static"	CaseName=TC02
ScaleFactor=0				ScaleFactor=0,72			

ComboName=STR028 ScaleFactor=0	CaseType="Linear Static"	CaseName=QM02	ComboName=STR030 ScaleFactor=0	CaseType="Linear Static"	CaseName=QM01
ComboName=STR028 ScaleFactor=1,0125	CaseType="Linear Static"	CaseName=SQMS	ComboName=STR030 ScaleFactor=0	CaseType="Linear Static"	CaseName=QM02
ComboName=STR028 ScaleFactor=1,0125	CaseType="Linear Static"	CaseName=SQMD	ComboName=STR030 ScaleFactor=0	CaseType="Linear Static"	CaseName=SQMS
ComboName=STR028 ScaleFactor=0	CaseType="Linear Static"	CaseName=FA01	ComboName=STR030 ScaleFactor=0	CaseType="Linear Static"	CaseName=SQMD
ComboName=STR028 ScaleFactor=1,2	CaseType="Linear Static"	CaseName=TC01	ComboName=STR030 ScaleFactor=0	CaseType="Linear Static"	CaseName=FA01
ComboName=STR028 ScaleFactor=0	CaseType="Linear Static"	CaseName=TC02	ComboName=STR030 ScaleFactor=1,2	CaseType="Linear Static"	CaseName=TC01
ComboName=STR028 ScaleFactor=0,72	CaseType="Linear Static"	CaseName=TV01	ComboName=STR030 ScaleFactor=0	CaseType="Linear Static"	CaseName=TC02
ComboName=STR028 ScaleFactor=0	CaseType="Linear Static"	CaseName=TV02	ComboName=STR030 ScaleFactor=0	CaseType="Linear Static"	CaseName=TV01
ComboName=STR028 ScaleFactor=0	CaseType="Linear Static"	CaseName=RIT	ComboName=STR030 ScaleFactor=0,72	CaseType="Linear Static"	CaseName=TV02
ComboName=STR028 ScaleFactor=0	CaseType="Linear Static"	CaseName=SSTS	ComboName=STR030 ScaleFactor=0	CaseType="Linear Static"	CaseName=RIT
ComboName=STR028 ScaleFactor=0	CaseType="Linear Static"	CaseName=IS01	ComboName=STR030 ScaleFactor=0	CaseType="Linear Static"	CaseName=SSTS
ComboName=STR029 CaseType="Linear Static"	ComboType="Linear Add"	AutoDesign=No	ComboName=STR030 CaseType="Linear Static"	CaseName=IS01	ScaleFactor=0
ConcDesign=No AlumDesign=No ColdDesign=No	CaseName=PPST	ScaleFactor=1,35	ComboName=STR031 CaseType="Linear Static"	ComboType="Linear Add"	AutoDesign=No
ComboName=STR029 ScaleFactor=1,35	CaseType="Linear Static"	CaseName=PPNS	ConcDesign=No AlumDesign=No ColdDesign=No	CaseName=PPST	ScaleFactor=1,35
ComboName=STR029 ScaleFactor=0	CaseType="Linear Static"	CaseName=PPAQ	ComboName=STR031 ScaleFactor=1,35	CaseType="Linear Static"	CaseName=PPNS
ComboName=STR029 ScaleFactor=1,35	CaseType="Response Combo"	CaseName=SK05	ComboName=STR031 ScaleFactor=0	CaseType="Linear Static"	CaseName=PPAQ
ComboName=STR029 ScaleFactor=0	CaseType="Response Combo"	CaseName=SKAS	ComboName=STR031 ScaleFactor=1	CaseType="Response Combo"	CaseName=SK05
ComboName=STR029 ScaleFactor=1,35	CaseType="Response Combo"	CaseName=SWS	ComboName=STR031 ScaleFactor=0	CaseType="Response Combo"	CaseName=SKAS
ComboName=STR029 ScaleFactor=1,35	CaseType="Response Combo"	CaseName=SK0D	ComboName=STR031 ScaleFactor=1	CaseType="Response Combo"	CaseName=SWS
ComboName=STR029 ScaleFactor=0	CaseType="Response Combo"	CaseName=SKAD	ComboName=STR031 ScaleFactor=0	CaseType="Response Combo"	CaseName=SK0D
ComboName=STR029 ScaleFactor=1,35	CaseType="Response Combo"	CaseName=SWD	ComboName=STR031 ScaleFactor=1	CaseType="Response Combo"	CaseName=SKAD
ComboName=STR029 ScaleFactor=1,35	CaseType="Linear Static"	CaseName=SA	ComboName=STR031 ScaleFactor=1	CaseType="Response Combo"	CaseName=SWD
ComboName=STR029 ScaleFactor=0	CaseType="Linear Static"	CaseName=QM01	ComboName=STR031 ScaleFactor=1,35	CaseType="Linear Static"	CaseName=SA
ComboName=STR029 ScaleFactor=0	CaseType="Linear Static"	CaseName=QM02	ComboName=STR031 ScaleFactor=1,0125	CaseType="Linear Static"	CaseName=QM01
ComboName=STR029 ScaleFactor=0	CaseType="Linear Static"	CaseName=SQMS	ComboName=STR031 ScaleFactor=1,0125	CaseType="Linear Static"	CaseName=QM02
ComboName=STR029 ScaleFactor=0	CaseType="Linear Static"	CaseName=SQMD	ComboName=STR031 ScaleFactor=0	CaseType="Linear Static"	CaseName=SQMS
ComboName=STR029 ScaleFactor=0	CaseType="Linear Static"	CaseName=FA01	ComboName=STR031 ScaleFactor=0	CaseType="Linear Static"	CaseName=SQMD
ComboName=STR029 ScaleFactor=1,2	CaseType="Linear Static"	CaseName=TC01	ComboName=STR031 ScaleFactor=0	CaseType="Linear Static"	CaseName=FA01
ComboName=STR029 ScaleFactor=0	CaseType="Linear Static"	CaseName=TC02	ComboName=STR031 ScaleFactor=1,2	CaseType="Linear Static"	CaseName=TC01
ComboName=STR029 ScaleFactor=0	CaseType="Linear Static"	CaseName=TV01	ComboName=STR031 ScaleFactor=0	CaseType="Linear Static"	CaseName=TC02
ComboName=STR029 ScaleFactor=0,72	CaseType="Linear Static"	CaseName=TV02	ComboName=STR031 ScaleFactor=0	CaseType="Linear Static"	CaseName=TV01
ComboName=STR029 ScaleFactor=0	CaseType="Linear Static"	CaseName=RIT	ComboName=STR031 ScaleFactor=0,72	CaseType="Linear Static"	CaseName=TV02
ComboName=STR029 ScaleFactor=0	CaseType="Linear Static"	CaseName=SSTS	ComboName=STR031 ScaleFactor=0	CaseType="Linear Static"	CaseName=RIT
ComboName=STR029 ScaleFactor=0	CaseType="Linear Static"	CaseName=IS01	ComboName=STR031 ScaleFactor=0	CaseType="Linear Static"	CaseName=SSTS
ComboName=STR030 CaseType="Linear Static"	ComboType="Linear Add"	AutoDesign=No	ComboName=STR031 CaseType="Linear Static"	CaseName=IS01	ScaleFactor=0
ConcDesign=No AlumDesign=No ColdDesign=No	CaseName=PPST	ScaleFactor=1,35	ComboName=STR032 CaseType="Linear Static"	ComboType="Linear Add"	AutoDesign=No
ComboName=STR030 ScaleFactor=1,35	CaseType="Linear Static"	CaseName=PPNS	ConcDesign=No AlumDesign=No ColdDesign=No	CaseName=PPST	ScaleFactor=1,35
ComboName=STR030 ScaleFactor=0	CaseType="Linear Static"	CaseName=PPAQ	ComboName=STR032 ScaleFactor=1,35	CaseType="Linear Static"	CaseName=PPNS
ComboName=STR030 ScaleFactor=0	CaseType="Response Combo"	CaseName=SK05	ComboName=STR032 ScaleFactor=0	CaseType="Linear Static"	CaseName=PPAQ
ComboName=STR030 ScaleFactor=1	CaseType="Response Combo"	CaseName=SKAS	ComboName=STR032 ScaleFactor=1,35	CaseType="Response Combo"	CaseName=SK05
ComboName=STR030 ScaleFactor=1	CaseType="Response Combo"	CaseName=SWS	ComboName=STR032 ScaleFactor=0	CaseType="Response Combo"	CaseName=SKAS
ComboName=STR030 ScaleFactor=0	CaseType="Response Combo"	CaseName=SK0D	ComboName=STR032 ScaleFactor=1,35	CaseType="Response Combo"	CaseName=SWS
ComboName=STR030 ScaleFactor=0	CaseType="Response Combo"	CaseName=SKAD	ComboName=STR032 ScaleFactor=0	CaseType="Response Combo"	CaseName=SK0D
ComboName=STR030 ScaleFactor=1	CaseType="Response Combo"	CaseName=SWD	ComboName=STR032 ScaleFactor=1	CaseType="Response Combo"	CaseName=SKAD
ComboName=STR030 ScaleFactor=1,35	CaseType="Linear Static"	CaseName=SA	ComboName=STR032 ScaleFactor=1	CaseType="Response Combo"	CaseName=SWD



ComboName=STR036 ScaleFactor=1,35	CaseType="Response Combo"	CaseName=SWD	ComboName=STR038 ScaleFactor=0	CaseType="Response Combo"	CaseName=SK0D
ComboName=STR036 ScaleFactor=1,35	CaseType="Linear Static"	CaseName=SA	ComboName=STR038 ScaleFactor=1	CaseType="Response Combo"	CaseName=SKAD
ComboName=STR036 ScaleFactor=0	CaseType="Linear Static"	CaseName=QM01	ComboName=STR038 ScaleFactor=1	CaseType="Response Combo"	CaseName=SWD
ComboName=STR036 ScaleFactor=0	CaseType="Linear Static"	CaseName=QM02	ComboName=STR038 ScaleFactor=1,35	CaseType="Linear Static"	CaseName=SA
ComboName=STR036 ScaleFactor=0	CaseType="Linear Static"	CaseName=SQMS	ComboName=STR038 ScaleFactor=1,0125	CaseType="Linear Static"	CaseName=QM01
ComboName=STR036 ScaleFactor=0	CaseType="Linear Static"	CaseName=SQMD	ComboName=STR038 ScaleFactor=1,0125	CaseType="Linear Static"	CaseName=QM02
ComboName=STR036 ScaleFactor=0	CaseType="Linear Static"	CaseName=FA01	ComboName=STR038 ScaleFactor=0	CaseType="Linear Static"	CaseName=SQMS
ComboName=STR036 ScaleFactor=1,2	CaseType="Linear Static"	CaseName=TC01	ComboName=STR038 ScaleFactor=0	CaseType="Linear Static"	CaseName=SQMD
ComboName=STR036 ScaleFactor=0	CaseType="Linear Static"	CaseName=TC02	ComboName=STR038 ScaleFactor=0	CaseType="Linear Static"	CaseName=FA01
ComboName=STR036 ScaleFactor=0	CaseType="Linear Static"	CaseName=TV01	ComboName=STR038 ScaleFactor=1,2	CaseType="Linear Static"	CaseName=TC01
ComboName=STR036 ScaleFactor=0	CaseType="Linear Static"	CaseName=TV02	ComboName=STR038 ScaleFactor=0	CaseType="Linear Static"	CaseName=TC02
ComboName=STR036 ScaleFactor=0,72	CaseType="Linear Static"	CaseName=RIT	ComboName=STR038 ScaleFactor=0	CaseType="Linear Static"	CaseName=TV01
ComboName=STR036 ScaleFactor=0	CaseType="Linear Static"	CaseName=SSTS	ComboName=STR038 ScaleFactor=0	CaseType="Linear Static"	CaseName=TV02
ComboName=STR036 ScaleFactor=0	CaseType="Linear Static"	CaseName=IS01	ComboName=STR038 ScaleFactor=0,72	CaseType="Linear Static"	CaseName=RIT
ComboName=STR037 CaseType="Linear Static" ScaleFactor=1,35	ComboType="Linear Add" AutoDesign=No	CaseName=PPST ScaleFactor=1,35 SteelDesign=No ConcDesign=No AlumDesign=No ColdDesign=No	ComboName=STR038 ScaleFactor=0	CaseType="Linear Static"	CaseName=SSTS
ComboName=STR037 ScaleFactor=1,35	CaseType="Linear Static"	CaseName=PPNS	ComboName=STR038 ScaleFactor=0	CaseType="Linear Static"	CaseName=IS01 ScaleFactor=0 AutoDesign=No
ComboName=STR037 ScaleFactor=0	CaseType="Linear Static"	CaseName=PPAQ	ComboName=STR039 CaseType="Linear Static" ScaleFactor=1,35	CaseName=PPST ScaleFactor=1,35 SteelDesign=No ConcDesign=No AlumDesign=No ColdDesign=No	CaseName=PPNS
ComboName=STR037 ScaleFactor=0	CaseType="Response Combo"	CaseName=SK0S	ComboName=STR039 ScaleFactor=1,35	CaseType="Linear Static"	CaseName=PPAQ
ComboName=STR037 ScaleFactor=1	CaseType="Response Combo"	CaseName=SKAS	ComboName=STR039 ScaleFactor=0	CaseType="Linear Static"	CaseName=PPAQ
ComboName=STR037 ScaleFactor=1	CaseType="Response Combo"	CaseName=SWS	ComboName=STR039 ScaleFactor=1,35	CaseType="Response Combo"	CaseName=SK0S
ComboName=STR037 ScaleFactor=0	CaseType="Response Combo"	CaseName=SK0D	ComboName=STR039 ScaleFactor=0	CaseType="Response Combo"	CaseName=SKAS
ComboName=STR037 ScaleFactor=1	CaseType="Response Combo"	CaseName=SKAD	ComboName=STR039 ScaleFactor=1,35	CaseType="Response Combo"	CaseName=SWS
ComboName=STR037 ScaleFactor=1	CaseType="Response Combo"	CaseName=SWD	ComboName=STR039 ScaleFactor=0	CaseType="Response Combo"	CaseName=SK0D
ComboName=STR037 ScaleFactor=1,35	CaseType="Linear Static"	CaseName=SA	ComboName=STR039 ScaleFactor=1	CaseType="Response Combo"	CaseName=SKAD
ComboName=STR037 ScaleFactor=0	CaseType="Linear Static"	CaseName=QM01	ComboName=STR039 ScaleFactor=1	CaseType="Response Combo"	CaseName=SWD
ComboName=STR037 ScaleFactor=0	CaseType="Linear Static"	CaseName=QM02	ComboName=STR039 ScaleFactor=1,35	CaseType="Linear Static"	CaseName=SA
ComboName=STR037 ScaleFactor=0	CaseType="Linear Static"	CaseName=SQMS	ComboName=STR039 ScaleFactor=1,0125	CaseType="Linear Static"	CaseName=QM01
ComboName=STR037 ScaleFactor=0	CaseType="Linear Static"	CaseName=SQMD	ComboName=STR039 ScaleFactor=1,0125	CaseType="Linear Static"	CaseName=QM02
ComboName=STR037 ScaleFactor=0	CaseType="Linear Static"	CaseName=FA01	ComboName=STR039 ScaleFactor=1,0125	CaseType="Linear Static"	CaseName=SQMS
ComboName=STR037 ScaleFactor=1,2	CaseType="Linear Static"	CaseName=TC01	ComboName=STR039 ScaleFactor=0	CaseType="Linear Static"	CaseName=SQMD
ComboName=STR037 ScaleFactor=0	CaseType="Linear Static"	CaseName=TC02	ComboName=STR039 ScaleFactor=1,2	CaseType="Linear Static"	CaseName=FA01
ComboName=STR037 ScaleFactor=0	CaseType="Linear Static"	CaseName=TV01	ComboName=STR039 ScaleFactor=0	CaseType="Linear Static"	CaseName=TC01
ComboName=STR037 ScaleFactor=0	CaseType="Linear Static"	CaseName=TV02	ComboName=STR039 ScaleFactor=0	CaseType="Linear Static"	CaseName=TC02
ComboName=STR037 ScaleFactor=0,72	CaseType="Linear Static"	CaseName=RIT	ComboName=STR039 ScaleFactor=0	CaseType="Linear Static"	CaseName=TV01
ComboName=STR037 ScaleFactor=0	CaseType="Linear Static"	CaseName=SSTS	ComboName=STR039 ScaleFactor=0	CaseType="Linear Static"	CaseName=TV02
ComboName=STR037 ScaleFactor=0	CaseType="Linear Static"	CaseName=IS01	ComboName=STR039 ScaleFactor=0	CaseType="Linear Static"	CaseName=RIT
ComboName=STR038 CaseType="Linear Static" ScaleFactor=1,35	ComboType="Linear Add" AutoDesign=No	CaseName=PPST ScaleFactor=1,35 SteelDesign=No ConcDesign=No AlumDesign=No ColdDesign=No	ComboName=STR039 ScaleFactor=0,72	CaseType="Linear Static"	CaseName=SSTS
ComboName=STR038 ScaleFactor=0	CaseType="Linear Static"	CaseName=PPNS	ComboName=STR039 ScaleFactor=0	CaseType="Linear Static"	CaseName=IS01 ScaleFactor=0 AutoDesign=No
ComboName=STR038 ScaleFactor=0	CaseType="Linear Static"	CaseName=PPAQ	ComboName=STR040 CaseType="Linear Static" ScaleFactor=1,35	CaseName=PPST ScaleFactor=1,35 SteelDesign=No ConcDesign=No AlumDesign=No ColdDesign=No	CaseName=PPNS
ComboName=STR038 ScaleFactor=1	CaseType="Response Combo"	CaseName=SK0S	ComboName=STR040 ScaleFactor=0	CaseType="Linear Static"	CaseName=PPAQ
ComboName=STR038 ScaleFactor=1	CaseType="Response Combo"	CaseName=SKAS	ComboName=STR040 ScaleFactor=0	CaseType="Linear Static"	CaseName=PPAQ
ComboName=STR038 ScaleFactor=1	CaseType="Response Combo"	CaseName=SWS	ComboName=STR040 ScaleFactor=1,35	CaseType="Response Combo"	CaseName=SK0S

APPROVATO SDP

Società di Progetto
Brebemi SpA

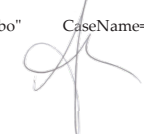

ComboName=STR044 ScaleFactor=1,35	CaseType="Linear Static"	CaseName=PPNS	ComboName=STR046 CaseType="Linear Static"	ComboType="Linear Add"	AutoDesign=No
ComboName=STR044 ScaleFactor=0	CaseType="Linear Static"	CaseName=PPAQ	ComboName=STR046 ScaleFactor=1,35	CaseName=PPST ScaleFactor=1,35	SteelDesign=No
ComboName=STR044 ScaleFactor=0	CaseType="Response Combo"	CaseName=SK05	ComboName=STR046 ScaleFactor=0	ConcDesign=No AlumDesign=No ColdDesign=No	CaseName=PPNS
ComboName=STR044 ScaleFactor=1	CaseType="Response Combo"	CaseName=SKAS	ComboName=STR046 ScaleFactor=1,35	CaseType="Linear Static"	CaseName=PPAQ
ComboName=STR044 ScaleFactor=1	CaseType="Response Combo"	CaseName=SWS	ComboName=STR046 ScaleFactor=0	CaseType="Response Combo"	CaseName=SK05
ComboName=STR044 ScaleFactor=0	CaseType="Response Combo"	CaseName=SK0D	ComboName=STR046 ScaleFactor=1,35	CaseType="Response Combo"	CaseName=SKAS
ComboName=STR044 ScaleFactor=1	CaseType="Response Combo"	CaseName=SKAD	ComboName=STR046 ScaleFactor=0	CaseType="Response Combo"	CaseName=SWS
ComboName=STR044 ScaleFactor=1	CaseType="Response Combo"	CaseName=SWD	ComboName=STR046 ScaleFactor=1,35	CaseType="Response Combo"	CaseName=SK0D
ComboName=STR044 ScaleFactor=1,35	CaseType="Linear Static"	CaseName=SA	ComboName=STR046 ScaleFactor=0	CaseType="Response Combo"	CaseName=SKAD
ComboName=STR044 ScaleFactor=0	CaseType="Linear Static"	CaseName=QM01	ComboName=STR046 ScaleFactor=1	CaseType="Response Combo"	CaseName=SWD
ComboName=STR044 ScaleFactor=0	CaseType="Linear Static"	CaseName=QM02	ComboName=STR046 ScaleFactor=1,35	CaseType="Linear Static"	CaseName=SA
ComboName=STR044 ScaleFactor=0	CaseType="Linear Static"	CaseName=SQMS	ComboName=STR046 ScaleFactor=1,35	CaseType="Linear Static"	CaseName=QM01
ComboName=STR044 ScaleFactor=0	CaseType="Linear Static"	CaseName=SQMD	ComboName=STR046 ScaleFactor=1,35	CaseType="Linear Static"	CaseName=QM02
ComboName=STR044 ScaleFactor=0	CaseType="Linear Static"	CaseName=FA01	ComboName=STR046 ScaleFactor=0	CaseType="Linear Static"	CaseName=SQMS
ComboName=STR044 ScaleFactor=0	CaseType="Linear Static"	CaseName=TC01	ComboName=STR046 ScaleFactor=0	CaseType="Linear Static"	CaseName=SQMD
ComboName=STR044 ScaleFactor=1,2	CaseType="Linear Static"	CaseName=TC02	ComboName=STR046 ScaleFactor=0	CaseType="Linear Static"	CaseName=FA01
ComboName=STR044 ScaleFactor=0	CaseType="Linear Static"	CaseName=TV01	ComboName=STR046 ScaleFactor=0,72	CaseType="Linear Static"	CaseName=TC01
ComboName=STR044 ScaleFactor=0	CaseType="Linear Static"	CaseName=TV02	ComboName=STR046 ScaleFactor=0	CaseType="Linear Static"	CaseName=TC02
ComboName=STR044 ScaleFactor=0	CaseType="Linear Static"	CaseName=RIT ScaleFactor=0	ComboName=STR046 ScaleFactor=0	CaseType="Linear Static"	CaseName=TV01
ComboName=STR044 ScaleFactor=0	CaseType="Linear Static"	CaseName=SSTS	ComboName=STR046 ScaleFactor=0	CaseType="Linear Static"	CaseName=TV02
ComboName=STR044 ScaleFactor=0	CaseType="Linear Static"	CaseName=IS01 ScaleFactor=0	ComboName=STR046 ScaleFactor=0	CaseType="Linear Static"	CaseName=RIT ScaleFactor=0
ComboName=STR045 CaseType="Linear Static"	ComboType="Linear Add"	AutoDesign=No	ComboName=STR046 ScaleFactor=0	CaseType="Linear Static"	CaseName=SSTS
ComboName=STR045 ScaleFactor=1,35	CaseName=PPST ScaleFactor=1,35	SteelDesign=No	ComboName=STR046 ScaleFactor=0	CaseType="Linear Static"	CaseName=IS01 ScaleFactor=0
ComboName=STR045 ScaleFactor=0	ConcDesign=No AlumDesign=No ColdDesign=No	CaseName=PPNS	ComboName=STR047 ScaleFactor=1,35	ComboType="Linear Add"	AutoDesign=No
ComboName=STR045 ScaleFactor=0	CaseType="Linear Static"	CaseName=PPAQ	ComboName=STR047 ScaleFactor=0	CaseName=PPST ScaleFactor=1,35	SteelDesign=No
ComboName=STR045 ScaleFactor=1	CaseType="Response Combo"	CaseName=SK05	ComboName=STR047 ScaleFactor=1,35	ConcDesign=No AlumDesign=No ColdDesign=No	CaseName=PPNS
ComboName=STR045 ScaleFactor=1	CaseType="Response Combo"	CaseName=SKAS	ComboName=STR047 ScaleFactor=0	CaseType="Linear Static"	CaseName=PPAQ
ComboName=STR045 ScaleFactor=1	CaseType="Response Combo"	CaseName=SWS	ComboName=STR047 ScaleFactor=1,35	CaseType="Response Combo"	CaseName=SK05
ComboName=STR045 ScaleFactor=0	CaseType="Response Combo"	CaseName=SK0D	ComboName=STR047 ScaleFactor=1,35	CaseType="Response Combo"	CaseName=SKAS
ComboName=STR045 ScaleFactor=1	CaseType="Response Combo"	CaseName=SKAD	ComboName=STR047 ScaleFactor=0	CaseType="Response Combo"	CaseName=SWS
ComboName=STR045 ScaleFactor=1	CaseType="Response Combo"	CaseName=SWD	ComboName=STR047 ScaleFactor=1,35	CaseType="Response Combo"	CaseName=SK0D
ComboName=STR045 ScaleFactor=1,35	CaseType="Linear Static"	CaseName=SA	ComboName=STR047 ScaleFactor=0	CaseType="Response Combo"	CaseName=SKAD
ComboName=STR045 ScaleFactor=1,35	CaseType="Linear Static"	CaseName=QM01	ComboName=STR047 ScaleFactor=1,35	CaseType="Response Combo"	CaseName=SKAD
ComboName=STR045 ScaleFactor=0	CaseType="Linear Static"	CaseName=QM02	ComboName=STR047 ScaleFactor=1,35	CaseType="Response Combo"	CaseName=SWD
ComboName=STR045 ScaleFactor=0	CaseType="Linear Static"	CaseName=SQMS	ComboName=STR047 ScaleFactor=1,35	CaseType="Linear Static"	CaseName=SA
ComboName=STR045 ScaleFactor=0	CaseType="Linear Static"	CaseName=SQMD	ComboName=STR047 ScaleFactor=1,35	CaseType="Linear Static"	CaseName=QM01
ComboName=STR045 ScaleFactor=0	CaseType="Linear Static"	CaseName=FA01	ComboName=STR047 ScaleFactor=1,35	CaseType="Linear Static"	CaseName=QM02
ComboName=STR045 ScaleFactor=0	CaseType="Linear Static"	CaseName=TC01	ComboName=STR047 ScaleFactor=0	CaseType="Linear Static"	CaseName=SQMS
ComboName=STR045 ScaleFactor=0,72	CaseType="Linear Static"	CaseName=TC02	ComboName=STR047 ScaleFactor=0	CaseType="Linear Static"	CaseName=SQMD
ComboName=STR045 ScaleFactor=0	CaseType="Linear Static"	CaseName=TV01	ComboName=STR047 ScaleFactor=0	CaseType="Linear Static"	CaseName=FA01
ComboName=STR045 ScaleFactor=0	CaseType="Linear Static"	CaseName=TV02	ComboName=STR047 ScaleFactor=0,72	CaseType="Linear Static"	CaseName=TC01
ComboName=STR045 ScaleFactor=0	CaseType="Linear Static"	CaseName=RIT ScaleFactor=0	ComboName=STR047 ScaleFactor=0	CaseType="Linear Static"	CaseName=TC02
ComboName=STR045 ScaleFactor=0	CaseType="Linear Static"	CaseName=SSTS	ComboName=STR047 ScaleFactor=0	CaseType="Linear Static"	CaseName=IS01 ScaleFactor=0
ComboName=STR045 ScaleFactor=0	CaseType="Linear Static"	CaseName=IS01 ScaleFactor=0	ComboName=STR047 ScaleFactor=0	CaseType="Linear Static"	CaseName=RIT ScaleFactor=0

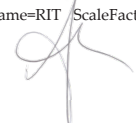

ComboName=STR059 ScaleFactor=0	CaseType="Linear Static"	CaseName=TC01	ComboName=STR061 ScaleFactor=0	CaseType="Linear Static"	CaseName=FA01
ComboName=STR059 ScaleFactor=1,2	CaseType="Linear Static"	CaseName=TC02	ComboName=STR061 ScaleFactor=0	CaseType="Linear Static"	CaseName=TC01
ComboName=STR059 ScaleFactor=0,72	CaseType="Linear Static"	CaseName=TV01	ComboName=STR061 ScaleFactor=1,2	CaseType="Linear Static"	CaseName=TC02
ComboName=STR059 ScaleFactor=0	CaseType="Linear Static"	CaseName=TV02	ComboName=STR061 ScaleFactor=0,72	CaseType="Linear Static"	CaseName=TV01
ComboName=STR059	CaseType="Linear Static"	CaseName=RIT	ComboName=STR061	CaseType="Linear Static"	CaseName=TV02
ComboName=STR059 ScaleFactor=0	CaseType="Linear Static"	CaseName=SSTS	ComboName=STR061	CaseType="Linear Static"	CaseName=RIT
ComboName=STR059	CaseType="Linear Static"	CaseName=IS01	ComboName=STR061	CaseType="Linear Static"	CaseName=SSTS
ComboName=STR060 CaseType="Linear Static"	ComboType="Linear Add"	AutoDesign=No	ComboName=STR061	CaseType="Linear Static"	CaseName=IS01
CaseType="Linear Static"	CaseName=PPST	ScaleFactor=1,35	SteelDesign=No	ComboName=STR062	ComboType="Linear Add"
ConcDesign=No	AlumDesign=No	ColdDesign=No	CaseType="Linear Static"	CaseName=PPST	ScaleFactor=1
ComboName=STR060 ScaleFactor=1,35	CaseType="Linear Static"	CaseName=PPNS	ConcDesign=No	AlumDesign=No	ColdDesign=No
ComboName=STR060 ScaleFactor=0	CaseType="Linear Static"	CaseName=PPAQ	ComboName=STR062	CaseType="Linear Static"	CaseName=PPNS
ComboName=STR060 ScaleFactor=1,35	CaseType="Response Combo"	CaseName=SK05	ComboName=STR062	CaseType="Linear Static"	CaseName=PPAQ
ComboName=STR060 ScaleFactor=0	CaseType="Response Combo"	CaseName=SKAS	ComboName=STR062	CaseType="Response Combo"	CaseName=SK05
ComboName=STR060 ScaleFactor=1,35	CaseType="Response Combo"	CaseName=SWS	ComboName=STR062	CaseType="Response Combo"	CaseName=SKAS
ComboName=STR060 ScaleFactor=1,35	CaseType="Response Combo"	CaseName=SK0D	ComboName=STR062	CaseType="Response Combo"	CaseName=SWS
ComboName=STR060 ScaleFactor=0	CaseType="Response Combo"	CaseName=SKAD	ComboName=STR062	CaseType="Response Combo"	CaseName=SK0D
ComboName=STR060 ScaleFactor=1,35	CaseType="Response Combo"	CaseName=SWD	ComboName=STR062	CaseType="Response Combo"	CaseName=SKAD
ComboName=STR060 ScaleFactor=1,35	CaseType="Linear Static"	CaseName=SA	ComboName=STR062	CaseType="Response Combo"	CaseName=SWD
ComboName=STR060 ScaleFactor=1,0125	CaseType="Linear Static"	CaseName=QM01	ComboName=STR062	CaseType="Linear Static"	CaseName=SA
ComboName=STR060 ScaleFactor=1,0125	CaseType="Linear Static"	CaseName=QM02	ComboName=STR062	CaseType="Linear Static"	CaseName=QM01
ComboName=STR060 ScaleFactor=1,0125	CaseType="Linear Static"	CaseName=SQMS	ComboName=STR062	CaseType="Linear Static"	CaseName=QM02
ComboName=STR060 ScaleFactor=1,0125	CaseType="Linear Static"	CaseName=SQMD	ComboName=STR062	CaseType="Linear Static"	CaseName=SQMS
ComboName=STR060 ScaleFactor=0	CaseType="Linear Static"	CaseName=FA01	ComboName=STR062	CaseType="Linear Static"	CaseName=SQMD
ComboName=STR060 ScaleFactor=0	CaseType="Linear Static"	CaseName=TC01	ComboName=STR062	CaseType="Linear Static"	CaseName=FA01
ComboName=STR060 ScaleFactor=1,2	CaseType="Linear Static"	CaseName=TC02	ComboName=STR062	CaseType="Linear Static"	CaseName=TC01
ComboName=STR060 ScaleFactor=0,72	CaseType="Linear Static"	CaseName=TV01	ComboName=STR062	CaseType="Linear Static"	CaseName=TC02
ComboName=STR060 ScaleFactor=0	CaseType="Linear Static"	CaseName=TV02	ComboName=STR062	CaseType="Linear Static"	CaseName=TV01
ComboName=STR060	CaseType="Linear Static"	CaseName=RIT	ComboName=STR062	CaseType="Linear Static"	CaseName=TV02
ComboName=STR060 ScaleFactor=0	CaseType="Linear Static"	CaseName=SSTS	ComboName=STR062	CaseType="Linear Static"	CaseName=RIT
ComboName=STR060	CaseType="Linear Static"	CaseName=IS01	ComboName=STR062	CaseType="Linear Static"	CaseName=SSTS
ComboName=STR061 CaseType="Linear Static"	ComboType="Linear Add"	AutoDesign=No	ComboName=STR062	CaseType="Linear Static"	CaseName=IS01
CaseType="Linear Static"	CaseName=PPST	ScaleFactor=1	SteelDesign=No	ComboName=STR063	ComboType="Linear Add"
ConcDesign=No	AlumDesign=No	ColdDesign=No	CaseType="Linear Static"	CaseName=PPST	ScaleFactor=1,35
ComboName=STR061 ScaleFactor=1	CaseType="Linear Static"	CaseName=PPNS	ConcDesign=No	AlumDesign=No	ColdDesign=No
ComboName=STR061 ScaleFactor=0	CaseType="Linear Static"	CaseName=PPAQ	ComboName=STR063	CaseType="Linear Static"	CaseName=PPNS
ComboName=STR061 ScaleFactor=1,35	CaseType="Response Combo"	CaseName=SK05	ComboName=STR063	CaseType="Linear Static"	CaseName=PPAQ
ComboName=STR061 ScaleFactor=0	CaseType="Response Combo"	CaseName=SKAS	ComboName=STR063	CaseType="Response Combo"	CaseName=SK05
ComboName=STR061 ScaleFactor=1,35	CaseType="Response Combo"	CaseName=SWS	ComboName=STR063	CaseType="Response Combo"	CaseName=SKAS
ComboName=STR061 ScaleFactor=0	CaseType="Response Combo"	CaseName=SK0D	ComboName=STR063	CaseType="Response Combo"	CaseName=SWS
ComboName=STR061 ScaleFactor=1	CaseType="Response Combo"	CaseName=SKAD	ComboName=STR063	CaseType="Response Combo"	CaseName=SK0D
ComboName=STR061 ScaleFactor=1	CaseType="Response Combo"	CaseName=SWD	ComboName=STR063	CaseType="Response Combo"	CaseName=SKAD
ComboName=STR061	CaseType="Linear Static"	CaseName=SA	ComboName=STR063	CaseType="Response Combo"	CaseName=SWD
ComboName=STR061 ScaleFactor=0	CaseType="Linear Static"	CaseName=QM01	ComboName=STR063	CaseType="Linear Static"	CaseName=SA
ComboName=STR061 ScaleFactor=0	CaseType="Linear Static"	CaseName=QM02	ComboName=STR063	CaseType="Linear Static"	CaseName=QM01
ComboName=STR061 ScaleFactor=1,0125	CaseType="Linear Static"	CaseName=SQMS	ComboName=STR063	CaseType="Linear Static"	CaseName=QM02
ComboName=STR061 ScaleFactor=0	CaseType="Linear Static"	CaseName=SQMD	ComboName=STR063	CaseType="Linear Static"	CaseName=SQMS

APPROVATO SDR

Società di Progetto
Brebemi SpA



ComboName=STR067 ScaleFactor=1,0125	CaseType="Linear Static"	CaseName=QM02	ComboName=STR069 ScaleFactor=0	CaseType="Linear Static"	CaseName=QM02
ComboName=STR067 ScaleFactor=1,0125	CaseType="Linear Static"	CaseName=SQMS	ComboName=STR069 ScaleFactor=1,0125	CaseType="Linear Static"	CaseName=SQMS
ComboName=STR067 ScaleFactor=1,0125	CaseType="Linear Static"	CaseName=SQMD	ComboName=STR069 ScaleFactor=1,0125	CaseType="Linear Static"	CaseName=SQMD
ComboName=STR067 ScaleFactor=0	CaseType="Linear Static"	CaseName=FA01	ComboName=STR069 ScaleFactor=0	CaseType="Linear Static"	CaseName=FA01
ComboName=STR067 ScaleFactor=0	CaseType="Linear Static"	CaseName=TC01	ComboName=STR069 ScaleFactor=0	CaseType="Linear Static"	CaseName=TC01
ComboName=STR067 ScaleFactor=1,2	CaseType="Linear Static"	CaseName=TC02	ComboName=STR069 ScaleFactor=1,2	CaseType="Linear Static"	CaseName=TC02
ComboName=STR067 ScaleFactor=0	CaseType="Linear Static"	CaseName=TV01	ComboName=STR069 ScaleFactor=0	CaseType="Linear Static"	CaseName=TV01
ComboName=STR067 ScaleFactor=0,72	CaseType="Linear Static"	CaseName=TV02	ComboName=STR069 ScaleFactor=0,72	CaseType="Linear Static"	CaseName=TV02
ComboName=STR067 ScaleFactor=0	CaseType="Linear Static"	CaseName=RIT	ComboName=STR069 ScaleFactor=0	CaseType="Linear Static"	CaseName=RIT
ComboName=STR067 ScaleFactor=0	CaseType="Linear Static"	CaseName=SSTS	ComboName=STR069 ScaleFactor=0	CaseType="Linear Static"	CaseName=SSTS
ComboName=STR067 ScaleFactor=0	CaseType="Linear Static"	CaseName=IS01	ComboName=STR069 ScaleFactor=0	CaseType="Linear Static"	CaseName=IS01
ComboName=STR068 CaseType="Linear Static"	ComboType="Linear Add"	AutoDesign=No	ComboName=STR070 CaseType="Linear Static"	ComboType="Linear Add"	AutoDesign=No
ConcDesign=No AlumDesign=No ColdDesign=No	CaseName=PPST	ScaleFactor=1	SteelDesign=No	CaseName=PPST	ScaleFactor=1,35
ComboName=STR068 ScaleFactor=1	CaseType="Linear Static"	CaseName=PPNS	ComboName=STR070 ScaleFactor=1,35	CaseType="Linear Static"	CaseName=PPNS
ComboName=STR068 ScaleFactor=0	CaseType="Linear Static"	CaseName=PPAQ	ComboName=STR070 ScaleFactor=0	CaseType="Linear Static"	CaseName=PPAQ
ComboName=STR068 ScaleFactor=1,35	CaseType="Response Combo"	CaseName=SK05	ComboName=STR070 ScaleFactor=1,35	CaseType="Response Combo"	CaseName=SK05
ComboName=STR068 ScaleFactor=0	CaseType="Response Combo"	CaseName=SKAS	ComboName=STR070 ScaleFactor=0	CaseType="Response Combo"	CaseName=SKAS
ComboName=STR068 ScaleFactor=1,35	CaseType="Response Combo"	CaseName=SWS	ComboName=STR070 ScaleFactor=1,35	CaseType="Response Combo"	CaseName=SWS
ComboName=STR068 ScaleFactor=0	CaseType="Response Combo"	CaseName=SK0D	ComboName=STR070 ScaleFactor=0	CaseType="Response Combo"	CaseName=SK0D
ComboName=STR068 ScaleFactor=1	CaseType="Response Combo"	CaseName=SKAD	ComboName=STR070 ScaleFactor=1,35	CaseType="Response Combo"	CaseName=SKAD
ComboName=STR068 ScaleFactor=1	CaseType="Response Combo"	CaseName=SWD	ComboName=STR070 ScaleFactor=0	CaseType="Response Combo"	CaseName=SWD
ComboName=STR068 ScaleFactor=0	CaseType="Linear Static"	CaseName=SA	ComboName=STR070 ScaleFactor=1,35	CaseType="Linear Static"	CaseName=SA
ComboName=STR068 ScaleFactor=0	CaseType="Linear Static"	CaseName=QM01	ComboName=STR070 ScaleFactor=0	CaseType="Linear Static"	CaseName=QM01
ComboName=STR068 ScaleFactor=0	CaseType="Linear Static"	CaseName=QM02	ComboName=STR070 ScaleFactor=0	CaseType="Linear Static"	CaseName=QM02
ComboName=STR068 ScaleFactor=1,0125	CaseType="Linear Static"	CaseName=SQMS	ComboName=STR070 ScaleFactor=0	CaseType="Linear Static"	CaseName=SQMS
ComboName=STR068 ScaleFactor=0	CaseType="Linear Static"	CaseName=SQMD	ComboName=STR070 ScaleFactor=0	CaseType="Linear Static"	CaseName=SQMD
ComboName=STR068 ScaleFactor=0	CaseType="Linear Static"	CaseName=FA01	ComboName=STR070 ScaleFactor=0	CaseType="Linear Static"	CaseName=FA01
ComboName=STR068 ScaleFactor=0	CaseType="Linear Static"	CaseName=TC01	ComboName=STR070 ScaleFactor=0	CaseType="Linear Static"	CaseName=TC01
ComboName=STR068 ScaleFactor=1,2	CaseType="Linear Static"	CaseName=TC02	ComboName=STR070 ScaleFactor=0	CaseType="Linear Static"	CaseName=TC02
ComboName=STR068 ScaleFactor=0	CaseType="Linear Static"	CaseName=TV01	ComboName=STR070 ScaleFactor=1,2	CaseType="Linear Static"	CaseName=TV01
ComboName=STR068 ScaleFactor=0,72	CaseType="Linear Static"	CaseName=TV02	ComboName=STR070 ScaleFactor=0	CaseType="Linear Static"	CaseName=TV02
ComboName=STR068 ScaleFactor=0	CaseType="Linear Static"	CaseName=RIT	ComboName=STR070 ScaleFactor=0	CaseType="Linear Static"	CaseName=RIT
ComboName=STR068 ScaleFactor=0	CaseType="Linear Static"	CaseName=SSTS	ComboName=STR070 ScaleFactor=0,72	CaseType="Linear Static"	CaseName=SSTS
ComboName=STR068 ScaleFactor=0	CaseType="Linear Static"	CaseName=IS01	ComboName=STR070 ScaleFactor=0	CaseType="Linear Static"	CaseName=IS01
ComboName=STR069 CaseType="Linear Static"	ComboType="Linear Add"	AutoDesign=No	ComboName=STR071 CaseType="Linear Static"	ComboType="Linear Add"	AutoDesign=No
ConcDesign=No AlumDesign=No ColdDesign=No	CaseName=PPST	ScaleFactor=1	SteelDesign=No	CaseName=PPST	ScaleFactor=1,35
ComboName=STR069 ScaleFactor=1	CaseType="Linear Static"	CaseName=PPNS	ConcDesign=No AlumDesign=No ColdDesign=No	CaseType="Linear Static"	CaseName=PPNS
ComboName=STR069 ScaleFactor=0	CaseType="Linear Static"	CaseName=PPAQ	ComboName=STR071 ScaleFactor=1,35	CaseType="Linear Static"	CaseName=PPNS
ComboName=STR069 ScaleFactor=1,35	CaseType="Response Combo"	CaseName=SK05	ComboName=STR071 ScaleFactor=0	CaseType="Linear Static"	CaseName=PPAQ
ComboName=STR069 ScaleFactor=0	CaseType="Response Combo"	CaseName=SKAS	ComboName=STR071 ScaleFactor=0	CaseType="Response Combo"	CaseName=SK05
ComboName=STR069 ScaleFactor=1,35	CaseType="Response Combo"	CaseName=SWS	ComboName=STR071 ScaleFactor=1	CaseType="Response Combo"	CaseName=SKAS
ComboName=STR069 ScaleFactor=1,35	CaseType="Response Combo"	CaseName=SK0D	ComboName=STR071 ScaleFactor=1	CaseType="Response Combo"	CaseName=SWS
ComboName=STR069 ScaleFactor=0	CaseType="Response Combo"	CaseName=SKAD	ComboName=STR071 ScaleFactor=0	CaseType="Response Combo"	CaseName=SK0D
ComboName=STR069 ScaleFactor=1,35	CaseType="Response Combo"	CaseName=SWD	ComboName=STR071 ScaleFactor=1	CaseType="Response Combo"	CaseName=SKAD
ComboName=STR069 ScaleFactor=0	CaseType="Linear Static"	CaseName=SA	ComboName=STR071 ScaleFactor=1	CaseType="Response Combo"	CaseName=SWD
ComboName=STR069 ScaleFactor=0	CaseType="Linear Static"	CaseName=QM01	ComboName=STR071 ScaleFactor=1	CaseType="Response Combo"	CaseName=SA

ComboName=STR071 ScaleFactor=1,35	CaseType="Linear Static"	CaseName=SA	ComboName=STR073 ScaleFactor=1	CaseType="Response Combo"	CaseName=SKAD
ComboName=STR071 ScaleFactor=0	CaseType="Linear Static"	CaseName=QM01	ComboName=STR073 ScaleFactor=1	CaseType="Response Combo"	CaseName=SWD
ComboName=STR071 ScaleFactor=0	CaseType="Linear Static"	CaseName=QM02	ComboName=STR073 ScaleFactor=1,35	CaseType="Linear Static"	CaseName=SA
ComboName=STR071 ScaleFactor=0	CaseType="Linear Static"	CaseName=SQMS	ComboName=STR073 ScaleFactor=1,0125	CaseType="Linear Static"	CaseName=QM01
ComboName=STR071 ScaleFactor=0	CaseType="Linear Static"	CaseName=SQMD	ComboName=STR073 ScaleFactor=1,0125	CaseType="Linear Static"	CaseName=QM02
ComboName=STR071 ScaleFactor=0	CaseType="Linear Static"	CaseName=FA01	ComboName=STR073 ScaleFactor=1,0125	CaseType="Linear Static"	CaseName=SQMS
ComboName=STR071 ScaleFactor=0	CaseType="Linear Static"	CaseName=TC01	ComboName=STR073 ScaleFactor=0	CaseType="Linear Static"	CaseName=SQMD
ComboName=STR071 ScaleFactor=1,2	CaseType="Linear Static"	CaseName=TC02	ComboName=STR073 ScaleFactor=0	CaseType="Linear Static"	CaseName=FA01
ComboName=STR071 ScaleFactor=0	CaseType="Linear Static"	CaseName=TV01	ComboName=STR073 ScaleFactor=0	CaseType="Linear Static"	CaseName=TC01
ComboName=STR071 ScaleFactor=0	CaseType="Linear Static"	CaseName=TV02	ComboName=STR073 ScaleFactor=1,2	CaseType="Linear Static"	CaseName=TC02
ComboName=STR071 ScaleFactor=0,72	CaseType="Linear Static"	CaseName=RIT	ComboName=STR073 ScaleFactor=0	CaseType="Linear Static"	CaseName=TV01
ComboName=STR071 ScaleFactor=0	CaseType="Linear Static"	CaseName=SSTS	ComboName=STR073 ScaleFactor=0	CaseType="Linear Static"	CaseName=TV02
ComboName=STR071 ScaleFactor=0	CaseType="Linear Static"	CaseName=IS01	ComboName=STR073 ScaleFactor=0,72	CaseType="Linear Static"	CaseName=RIT
ComboName=STR072 CaseType="Linear Static"	CaseType="Linear Add"	CaseName=PPST	ComboName=STR073 ScaleFactor=0	CaseType="Linear Static"	CaseName=SSTS
ConcDesign=No AlumDesign=No ColdDesign=No	ScaleFactor=1,35	SteelDesign=No	ComboName=STR073 ScaleFactor=0	CaseType="Linear Static"	CaseName=IS01
ComboName=STR072 ScaleFactor=1,35	CaseType="Linear Static"	CaseName=PPNS	ComboName=STR074 ScaleFactor=1,35	CaseType="Linear Add"	CaseName=IS01
ComboName=STR072 ScaleFactor=0	CaseType="Linear Static"	CaseName=PPAQ	CaseType="Linear Static"	CaseName=PPST	CaseName=IS01
ComboName=STR072 ScaleFactor=0	CaseType="Response Combo"	CaseName=SK0S	ConcDesign=No AlumDesign=No ColdDesign=No	ScaleFactor=1,35	SteelDesign=No
ComboName=STR072 ScaleFactor=1	CaseType="Response Combo"	CaseName=SKAS	ComboName=STR074 ScaleFactor=1,35	CaseType="Linear Static"	CaseName=PPNS
ComboName=STR072 ScaleFactor=1	CaseType="Response Combo"	CaseName=SWS	ComboName=STR074 ScaleFactor=0	CaseType="Linear Static"	CaseName=PPAQ
ComboName=STR072 ScaleFactor=0	CaseType="Response Combo"	CaseName=SK0D	ComboName=STR074 ScaleFactor=1,35	CaseType="Response Combo"	CaseName=SK0S
ComboName=STR072 ScaleFactor=1	CaseType="Response Combo"	CaseName=SKAD	ComboName=STR074 ScaleFactor=1,35	CaseType="Response Combo"	CaseName=SKAS
ComboName=STR072 ScaleFactor=1	CaseType="Response Combo"	CaseName=SWD	ComboName=STR074 ScaleFactor=0	CaseType="Response Combo"	CaseName=SWS
ComboName=STR072 ScaleFactor=1,35	CaseType="Linear Static"	CaseName=SA	ComboName=STR074 ScaleFactor=0	CaseType="Response Combo"	CaseName=SK0D
ComboName=STR072 ScaleFactor=1,0125	CaseType="Linear Static"	CaseName=QM01	ComboName=STR074 ScaleFactor=1,35	CaseType="Response Combo"	CaseName=SKAD
ComboName=STR072 ScaleFactor=1,0125	CaseType="Linear Static"	CaseName=QM02	ComboName=STR074 ScaleFactor=0	CaseType="Response Combo"	CaseName=SWD
ComboName=STR072 ScaleFactor=0	CaseType="Linear Static"	CaseName=SQMS	ComboName=STR074 ScaleFactor=1,35	CaseType="Linear Static"	CaseName=SA
ComboName=STR072 ScaleFactor=0	CaseType="Linear Static"	CaseName=SQMD	ComboName=STR074 ScaleFactor=1,0125	CaseType="Linear Static"	CaseName=QM01
ComboName=STR072 ScaleFactor=0	CaseType="Linear Static"	CaseName=FA01	ComboName=STR074 ScaleFactor=1,0125	CaseType="Linear Static"	CaseName=QM02
ComboName=STR072 ScaleFactor=0	CaseType="Linear Static"	CaseName=TC01	ComboName=STR074 ScaleFactor=1,0125	CaseType="Linear Static"	CaseName=SQMS
ComboName=STR072 ScaleFactor=1,2	CaseType="Linear Static"	CaseName=TC02	ComboName=STR074 ScaleFactor=0	CaseType="Linear Static"	CaseName=SQMD
ComboName=STR072 ScaleFactor=0	CaseType="Linear Static"	CaseName=TV01	ComboName=STR074 ScaleFactor=1,2	CaseType="Linear Static"	CaseName=FA01
ComboName=STR072 ScaleFactor=0	CaseType="Linear Static"	CaseName=TV02	ComboName=STR074 ScaleFactor=0	CaseType="Linear Static"	CaseName=TC01
ComboName=STR072 ScaleFactor=0,72	CaseType="Linear Static"	CaseName=RIT	ComboName=STR074 ScaleFactor=0	CaseType="Linear Static"	CaseName=TC02
ComboName=STR072 ScaleFactor=0	CaseType="Linear Static"	CaseName=SSTS	ComboName=STR074 ScaleFactor=0,72	CaseType="Linear Static"	CaseName=TV01
ComboName=STR072 ScaleFactor=0	CaseType="Linear Static"	CaseName=IS01	ComboName=STR074 ScaleFactor=0	CaseType="Linear Static"	CaseName=TV02
ComboName=STR073 CaseType="Linear Static"	CaseType="Linear Add"	CaseName=PPST	ComboName=STR074 ScaleFactor=0,72	CaseType="Linear Static"	CaseName=RIT
ConcDesign=No AlumDesign=No ColdDesign=No	ScaleFactor=1,35	SteelDesign=No	ComboName=STR074 ScaleFactor=0	CaseType="Linear Static"	CaseName=SSTS
ComboName=STR073 ScaleFactor=1,35	CaseType="Linear Static"	CaseName=PPNS	ComboName=STR075 ScaleFactor=1	CaseType="Linear Static"	CaseName=IS01
ComboName=STR073 ScaleFactor=0	CaseType="Linear Static"	CaseName=PPAQ	CaseType="Linear Add"	CaseName=IS01	CaseName=IS01
ComboName=STR073 ScaleFactor=0	CaseType="Response Combo"	CaseName=SK0S	ConcDesign=No AlumDesign=No ColdDesign=No	CaseName=PPST	CaseName=IS01
ComboName=STR073 ScaleFactor=0	CaseType="Response Combo"	CaseName=SKAS	ComboName=STR075 ScaleFactor=1	CaseType="Linear Static"	CaseName=PPNS
ComboName=STR073 ScaleFactor=1,35	CaseType="Response Combo"	CaseName=SWS	CaseType="Linear Static"	CaseName=PPAQ	CaseName=PPNS
ComboName=STR073 ScaleFactor=0	CaseType="Response Combo"	CaseName=SK0D	CaseType="Linear Static"	CaseName=SK0S	CaseName=PPNS
ComboName=STR073 ScaleFactor=1,35	CaseType="Response Combo"	CaseName=SKAD	CaseType="Response Combo"	CaseName=SKAS	CaseName=SK0S
ComboName=STR073 ScaleFactor=0	CaseType="Response Combo"	CaseName=SWD	CaseType="Response Combo"	CaseName=SWS	CaseName=SK0D
ComboName=STR073 ScaleFactor=0	CaseType="Response Combo"	CaseName=SA	CaseType="Response Combo"	CaseName=SK0D	CaseName=SKAS

Società di Progetto
Brebemi SpA



ComboName=STR075 ScaleFactor=1,35	CaseType="Response Combo"	CaseName=SWS	ComboName=STR077 ScaleFactor=0	CaseType="Response Combo"	CaseName=SKAS
ComboName=STR075 ScaleFactor=0	CaseType="Response Combo"	CaseName=SK0D	ComboName=STR077 ScaleFactor=1,35	CaseType="Response Combo"	CaseName=SWS
ComboName=STR075 ScaleFactor=1	CaseType="Response Combo"	CaseName=SKAD	ComboName=STR077 ScaleFactor=1,35	CaseType="Response Combo"	CaseName=SK0D
ComboName=STR075 ScaleFactor=1	CaseType="Response Combo"	CaseName=SWD	ComboName=STR077 ScaleFactor=0	CaseType="Response Combo"	CaseName=SKAD
ComboName=STR075 ScaleFactor=0	CaseType="Linear Static"	CaseName=SA	ComboName=STR077 ScaleFactor=1,35	CaseType="Response Combo"	CaseName=SWD
ComboName=STR075 ScaleFactor=0	CaseType="Linear Static"	CaseName=QM01	ComboName=STR077 ScaleFactor=1,35	CaseType="Linear Static"	CaseName=SA
ComboName=STR075 ScaleFactor=1,0125	CaseType="Linear Static"	CaseName=QM02	ComboName=STR077 ScaleFactor=0	CaseType="Linear Static"	CaseName=QM01
ComboName=STR075 ScaleFactor=0	CaseType="Linear Static"	CaseName=SQMS	ComboName=STR077 ScaleFactor=0	CaseType="Linear Static"	CaseName=QM02
ComboName=STR075 ScaleFactor=0	CaseType="Linear Static"	CaseName=SQMD	ComboName=STR077 ScaleFactor=0	CaseType="Linear Static"	CaseName=SQMS
ComboName=STR075 ScaleFactor=0	CaseType="Linear Static"	CaseName=FA01	ComboName=STR077 ScaleFactor=0	CaseType="Linear Static"	CaseName=SQMD
ComboName=STR075 ScaleFactor=1,2	CaseType="Linear Static"	CaseName=TC01	ComboName=STR077 ScaleFactor=0	CaseType="Linear Static"	CaseName=FA01
ComboName=STR075 ScaleFactor=0	CaseType="Linear Static"	CaseName=TC02	ComboName=STR077 ScaleFactor=0	CaseType="Linear Static"	CaseName=TC01
ComboName=STR075 ScaleFactor=0	CaseType="Linear Static"	CaseName=IV01	ComboName=STR077 ScaleFactor=0	CaseType="Linear Static"	CaseName=TC02
ComboName=STR075 ScaleFactor=0	CaseType="Linear Static"	CaseName=IV02	ComboName=STR077 ScaleFactor=1,2	CaseType="Linear Static"	CaseName=TV01
ComboName=STR075 ScaleFactor=0,72	CaseType="Linear Static"	CaseName=RIT	ComboName=STR077 ScaleFactor=0	CaseType="Linear Static"	CaseName=TV02
ComboName=STR075 ScaleFactor=0	CaseType="Linear Static"	CaseName=SSTS	ComboName=STR077 ScaleFactor=0	CaseType="Linear Static"	CaseName=RIT
ComboName=STR075 ScaleFactor=0	CaseType="Linear Add"	CaseName=IS01	ComboName=STR077 ScaleFactor=0	CaseType="Linear Static"	CaseName=SSTS
CaseType="Linear Static"	CaseName=PPST	ScaleFactor=1	ComboName=STR077 ScaleFactor=0	CaseType="Linear Static"	CaseName=IS01
ConcDesign=No AlumDesign=No ColdDesign=No	CaseName=PPNS	CaseName=IS01	ComboName=STR078 ScaleFactor=1,35	CaseType="Linear Add"	AutoDesign=No
ScaleFactor=1	CaseName=PPAQ	CaseName=PPST	ComboName=STR078 ScaleFactor=0	CaseName=PPST	ScaleFactor=1,35
ComboName=STR076 ScaleFactor=1,35	CaseType="Response Combo"	CaseName=SK05	ComboName=STR078 ScaleFactor=0	CaseType="Linear Static"	CaseName=PPNS
ComboName=STR076 ScaleFactor=0	CaseType="Response Combo"	CaseName=SKAS	ComboName=STR078 ScaleFactor=1	CaseType="Response Combo"	CaseName=PPAQ
ComboName=STR076 ScaleFactor=1,35	CaseType="Response Combo"	CaseName=SWS	ComboName=STR078 ScaleFactor=1	CaseType="Response Combo"	CaseName=SK05
ComboName=STR076 ScaleFactor=1,35	CaseType="Response Combo"	CaseName=SK0D	ComboName=STR078 ScaleFactor=0	CaseType="Response Combo"	CaseName=SKAS
ComboName=STR076 ScaleFactor=0	CaseType="Response Combo"	CaseName=SKAD	ComboName=STR078 ScaleFactor=0	CaseType="Response Combo"	CaseName=SWS
ComboName=STR076 ScaleFactor=1,35	CaseType="Response Combo"	CaseName=SWD	ComboName=STR078 ScaleFactor=0	CaseType="Response Combo"	CaseName=SK0D
ComboName=STR076 ScaleFactor=0	CaseType="Linear Static"	CaseName=SA	ComboName=STR078 ScaleFactor=1	CaseType="Response Combo"	CaseName=SKAD
ComboName=STR076 ScaleFactor=0	CaseType="Linear Static"	CaseName=QM01	ComboName=STR078 ScaleFactor=0	CaseType="Response Combo"	CaseName=SWD
ComboName=STR076 ScaleFactor=0	CaseType="Linear Static"	CaseName=QM02	ComboName=STR078 ScaleFactor=1,35	CaseType="Linear Static"	CaseName=SA
ComboName=STR076 ScaleFactor=1,0125	CaseType="Linear Static"	CaseName=SQMS	ComboName=STR078 ScaleFactor=0	CaseType="Linear Static"	CaseName=QM01
ComboName=STR076 ScaleFactor=1,0125	CaseType="Linear Static"	CaseName=SQMD	ComboName=STR078 ScaleFactor=0	CaseType="Linear Static"	CaseName=QM02
ComboName=STR076 ScaleFactor=0	CaseType="Linear Static"	CaseName=FA01	ComboName=STR078 ScaleFactor=0	CaseType="Linear Static"	CaseName=SQMS
ComboName=STR076 ScaleFactor=0	CaseType="Linear Static"	CaseName=TC01	ComboName=STR078 ScaleFactor=0	CaseType="Linear Static"	CaseName=SQMD
ComboName=STR076 ScaleFactor=1,2	CaseType="Linear Static"	CaseName=TC02	ComboName=STR078 ScaleFactor=0	CaseType="Linear Static"	CaseName=FA01
ComboName=STR076 ScaleFactor=0	CaseType="Linear Static"	CaseName=IV01	ComboName=STR078 ScaleFactor=0	CaseType="Linear Static"	CaseName=TC01
ComboName=STR076 ScaleFactor=0	CaseType="Linear Static"	CaseName=IV02	ComboName=STR078 ScaleFactor=1,2	CaseType="Linear Static"	CaseName=TC02
ComboName=STR076 ScaleFactor=0,72	CaseType="Linear Static"	CaseName=RIT	ComboName=STR078 ScaleFactor=0	CaseType="Linear Static"	CaseName=TV01
ComboName=STR076 ScaleFactor=0	CaseType="Linear Static"	CaseName=SSTS	ComboName=STR078 ScaleFactor=0	CaseType="Linear Static"	CaseName=TV02
ComboName=STR076 ScaleFactor=0	CaseType="Linear Static"	CaseName=IS01	ComboName=STR078 ScaleFactor=0	CaseType="Linear Static"	CaseName=RIT
ComboName=STR077 ScaleFactor=1,35	CaseType="Linear Add"	CaseName=IS01	ComboName=STR078 ScaleFactor=0	CaseType="Linear Static"	CaseName=SSTS
CaseType="Linear Static"	CaseName=PPST	ScaleFactor=1,35	ComboName=STR078 ScaleFactor=0	CaseType="Linear Static"	CaseName=IS01
ConcDesign=No AlumDesign=No ColdDesign=No	CaseName=PPNS	CaseName=IS01	ComboName=STR079 ScaleFactor=1,35	CaseType="Linear Add"	AutoDesign=No
ScaleFactor=1,35	CaseName=PPAQ	CaseName=PPST	ComboName=STR079 ScaleFactor=0	CaseName=PPST	ScaleFactor=1,35
ComboName=STR077 ScaleFactor=1,35	CaseType="Response Combo"	CaseName=SK05	ComboName=STR079 ScaleFactor=0	CaseType="Linear Static"	CaseName=PPNS
ScaleFactor=1,35	CaseType="Response Combo"	CaseName=SKAS	ComboName=STR079 ScaleFactor=0	CaseType="Linear Static"	CaseName=PPAQ

APPROVATO SDP

Società di Progetto
Brebemi SpA



ComboName=STR083 ScaleFactor=1	CaseType="Linear Static"	CaseName=PPNS	ComboName=STR085 CaseType="Linear Static"	ComboType="Linear Add"	AutoDesign=No
ComboName=STR083 ScaleFactor=0	CaseType="Linear Static"	CaseName=PPAQ	ConcDesign=No AlumDesign=No ColdDesign=No	CaseName=PPST ScaleFactor=1,35	SteelDesign=No
ComboName=STR083 ScaleFactor=1,35	CaseType="Response Combo"	CaseName=SK05	ComboName=STR085 ScaleFactor=1,35	CaseType="Linear Static"	CaseName=PPNS
ComboName=STR083 ScaleFactor=0	CaseType="Response Combo"	CaseName=SKAS	ComboName=STR085 ScaleFactor=0	CaseType="Linear Static"	CaseName=PPAQ
ComboName=STR083 ScaleFactor=1,35	CaseType="Response Combo"	CaseName=SWS	ComboName=STR085 ScaleFactor=0	CaseType="Response Combo"	CaseName=SK05
ComboName=STR083 ScaleFactor=1,35	CaseType="Response Combo"	CaseName=SK0D	ComboName=STR085 ScaleFactor=1	CaseType="Response Combo"	CaseName=SKAS
ComboName=STR083 ScaleFactor=0	CaseType="Response Combo"	CaseName=SKAD	ComboName=STR085 ScaleFactor=1	CaseType="Response Combo"	CaseName=SWS
ComboName=STR083 ScaleFactor=1,35	CaseType="Response Combo"	CaseName=SWD	ComboName=STR085 ScaleFactor=0	CaseType="Response Combo"	CaseName=SK0D
ComboName=STR083 ScaleFactor=0	CaseType="Linear Static"	CaseName=SA ScaleFactor=1	ComboName=STR085 ScaleFactor=1	CaseType="Response Combo"	CaseName=SKAD
ComboName=STR083 ScaleFactor=0	CaseType="Linear Static"	CaseName=QM01	ComboName=STR085 ScaleFactor=1	CaseType="Response Combo"	CaseName=SWD
ComboName=STR083 ScaleFactor=0	CaseType="Linear Static"	CaseName=QM02	ComboName=STR085 ScaleFactor=1,35	CaseType="Linear Static"	CaseName=SA
ComboName=STR083 ScaleFactor=1,35	CaseType="Linear Static"	CaseName=SQMS	ComboName=STR085 ScaleFactor=1,0125	CaseType="Linear Static"	CaseName=QM01
ComboName=STR083 ScaleFactor=1,35	CaseType="Linear Static"	CaseName=SQMD	ComboName=STR085 ScaleFactor=1,0125	CaseType="Linear Static"	CaseName=QM02
ComboName=STR083 ScaleFactor=0	CaseType="Linear Static"	CaseName=FA01	ComboName=STR085 ScaleFactor=0	CaseType="Linear Static"	CaseName=SQMS
ComboName=STR083 ScaleFactor=0	CaseType="Linear Static"	CaseName=TC01	ComboName=STR085 ScaleFactor=0	CaseType="Linear Static"	CaseName=SQMD
ComboName=STR083 ScaleFactor=0	CaseType="Linear Static"	CaseName=TC02	ComboName=STR085 ScaleFactor=0	CaseType="Linear Static"	CaseName=FA01
ComboName=STR083 ScaleFactor=0,72	CaseType="Linear Static"	CaseName=TV01	ComboName=STR085 ScaleFactor=0	CaseType="Linear Static"	CaseName=TC01
ComboName=STR083 ScaleFactor=0	CaseType="Linear Static"	CaseName=TV02	ComboName=STR085 ScaleFactor=0	CaseType="Linear Static"	CaseName=TC02
ComboName=STR083 ScaleFactor=0	CaseType="Linear Static"	CaseName=RIT ScaleFactor=0	ComboName=STR085 ScaleFactor=1,2	CaseType="Linear Static"	CaseName=TV01
ComboName=STR083 ScaleFactor=0	CaseType="Linear Static"	CaseName=SSTS	ComboName=STR085 ScaleFactor=0	CaseType="Linear Static"	CaseName=TV02
ComboName=STR083 ScaleFactor=0	CaseType="Linear Static"	CaseName=IS01 ScaleFactor=0	ComboName=STR085 ScaleFactor=0	CaseType="Linear Static"	CaseName=RIT ScaleFactor=0
ComboName=STR084 CaseType="Linear Static"	ComboType="Linear Add"	AutoDesign=No	ComboName=STR085 ScaleFactor=0	CaseType="Linear Static"	CaseName=SSTS
CaseName=PPST ScaleFactor=1,35	CaseName=PPNS	SteelDesign=No	ComboName=STR085 ScaleFactor=0	CaseType="Linear Static"	CaseName=IS01 ScaleFactor=0
ConcDesign=No AlumDesign=No ColdDesign=No	CaseName=PPAQ	AutoDesign=No	ComboName=STR086 ScaleFactor=1,35	ComboType="Linear Add"	AutoDesign=No
ComboName=STR084 ScaleFactor=1,35	CaseType="Linear Static"	CaseName=SK05	CaseType="Linear Static"	CaseName=PPST ScaleFactor=1,35	SteelDesign=No
ComboName=STR084 ScaleFactor=0	CaseType="Linear Static"	CaseName=SKAS	ConcDesign=No AlumDesign=No ColdDesign=No	CaseName=PPNS	SteelDesign=No
ComboName=STR084 ScaleFactor=0	CaseType="Response Combo"	CaseName=SKAS	ComboName=STR086 ScaleFactor=1,35	CaseType="Linear Static"	CaseName=PPNS
ComboName=STR084 ScaleFactor=1,35	CaseType="Response Combo"	CaseName=SWS	ComboName=STR086 ScaleFactor=0	CaseType="Linear Static"	CaseName=PPAQ
ComboName=STR084 ScaleFactor=0	CaseType="Response Combo"	CaseName=SK0D	ComboName=STR086 ScaleFactor=1,35	CaseType="Linear Static"	CaseName=SK05
ComboName=STR084 ScaleFactor=1	CaseType="Response Combo"	CaseName=SKAD	ComboName=STR086 ScaleFactor=0	CaseType="Response Combo"	CaseName=SKAS
ComboName=STR084 ScaleFactor=1	CaseType="Response Combo"	CaseName=SWD	ComboName=STR086 ScaleFactor=0	CaseType="Response Combo"	CaseName=SWS
ComboName=STR084 ScaleFactor=1,35	CaseType="Linear Static"	CaseName=SA	ComboName=STR086 ScaleFactor=1	CaseType="Response Combo"	CaseName=SK0D
ComboName=STR084 ScaleFactor=1,0125	CaseType="Linear Static"	CaseName=QM01	ComboName=STR086 ScaleFactor=1	CaseType="Response Combo"	CaseName=SKAD
ComboName=STR084 ScaleFactor=1,0125	CaseType="Linear Static"	CaseName=QM02	ComboName=STR086 ScaleFactor=1,35	CaseType="Response Combo"	CaseName=SKAD
ComboName=STR084 ScaleFactor=1,0125	CaseType="Linear Static"	CaseName=SQMS	ComboName=STR086 ScaleFactor=0	CaseType="Response Combo"	CaseName=SWD
ComboName=STR084 ScaleFactor=0	CaseType="Linear Static"	CaseName=SQMD	ComboName=STR086 ScaleFactor=1,0125	CaseType="Response Combo"	CaseName=SWD
ComboName=STR084 ScaleFactor=1,35	CaseType="Linear Static"	CaseName=FA01	ComboName=STR086 ScaleFactor=1,0125	CaseType="Response Combo"	CaseName=SA
ComboName=STR084 ScaleFactor=0	CaseType="Linear Static"	CaseName=TC01	ComboName=STR086 ScaleFactor=0	CaseType="Linear Static"	CaseName=QM01
ComboName=STR084 ScaleFactor=0	CaseType="Linear Static"	CaseName=TC02	ComboName=STR086 ScaleFactor=1,0125	CaseType="Linear Static"	CaseName=QM02
ComboName=STR084 ScaleFactor=0,72	CaseType="Linear Static"	CaseName=TV01	ComboName=STR086 ScaleFactor=0	CaseType="Linear Static"	CaseName=SQMS
ComboName=STR084 ScaleFactor=0	CaseType="Linear Static"	CaseName=TV02	ComboName=STR086 ScaleFactor=0	CaseType="Linear Static"	CaseName=SQMD
ComboName=STR084 ScaleFactor=0	CaseType="Linear Static"	CaseName=RIT ScaleFactor=0	ComboName=STR086 ScaleFactor=0	CaseType="Linear Static"	CaseName=FA01
ComboName=STR084 ScaleFactor=0	CaseType="Linear Static"	CaseName=SSTS	ComboName=STR086 ScaleFactor=0	CaseType="Linear Static"	CaseName=TC01
ComboName=STR084 ScaleFactor=0	CaseType="Linear Static"	CaseName=IS01 ScaleFactor=0	ComboName=STR086 ScaleFactor=0	CaseType="Linear Static"	CaseName=TC02
			ComboName=STR086 ScaleFactor=1,2	CaseType="Linear Static"	CaseName=TC02
			ComboName=STR086 ScaleFactor=0	CaseType="Linear Static"	CaseName=TV01
			ComboName=STR086 ScaleFactor=0	CaseType="Linear Static"	CaseName=TV02
			ComboName=STR086 ScaleFactor=0	CaseType="Linear Static"	CaseName=RIT ScaleFactor=0



ComboName=STR090 ScaleFactor=0	CaseType="Linear Static"	CaseName=TV02	ComboName=STR092 ScaleFactor=1,2	CaseType="Linear Static"	CaseName=TV01
ComboName=STR090 ScaleFactor=0	CaseType="Linear Static"	CaseName=RIT ScaleFactor=0	ComboName=STR092 ScaleFactor=0	CaseType="Linear Static"	CaseName=TV02
ComboName=STR090 ScaleFactor=0	CaseType="Linear Static"	CaseName=IS01 ScaleFactor=0	ComboName=STR092 ScaleFactor=0	CaseType="Linear Static"	CaseName=RIT ScaleFactor=0
ComboName=STR091 CaseType="Linear Static"	ComboType="Linear Add"	AutoDesign=No	ComboName=STR092 ScaleFactor=0	CaseType="Linear Static"	CaseName=SSTS
CaseType="Linear Static"	CaseName=PPST ScaleFactor=1,35	SteelDesign=No	ComboName=STR092 ScaleFactor=0	CaseType="Linear Static"	CaseName=IS01 ScaleFactor=0
ConcDesign=No AlumDesign=No ColdDesign=No	CaseType="Linear Static"	CaseName=PPNS	ComboName=STR093 ScaleFactor=0	ComboType="Linear Add"	AutoDesign=No
ComboName=STR091 ScaleFactor=1,35	CaseType="Linear Static"	CaseName=PPAQ	ComboName=STR093 ScaleFactor=0	CaseName=PPST ScaleFactor=1,35	SteelDesign=No
ComboName=STR091 ScaleFactor=0	CaseType="Response Combo"	CaseName=SK05	ComboName=STR093 ScaleFactor=0	ConcDesign=No AlumDesign=No ColdDesign=No	CaseName=PPNS
ComboName=STR091 ScaleFactor=1	CaseType="Response Combo"	CaseName=SKAS	ComboName=STR093 ScaleFactor=1,35	CaseType="Linear Static"	CaseName=PPAQ
ComboName=STR091 ScaleFactor=1	CaseType="Response Combo"	CaseName=SWS	ComboName=STR093 ScaleFactor=1,35	CaseType="Response Combo"	CaseName=SK05
ComboName=STR091 ScaleFactor=0	CaseType="Response Combo"	CaseName=SK0D	ComboName=STR093 ScaleFactor=0	CaseType="Response Combo"	CaseName=SKAS
ComboName=STR091 ScaleFactor=1	CaseType="Response Combo"	CaseName=SKAD	ComboName=STR093 ScaleFactor=0	CaseType="Response Combo"	CaseName=SWS
ComboName=STR091 ScaleFactor=1	CaseType="Response Combo"	CaseName=SWD	ComboName=STR093 ScaleFactor=1	CaseType="Response Combo"	CaseName=SK0D
ComboName=STR091 ScaleFactor=1,35	CaseType="Linear Static"	CaseName=SA	ComboName=STR093 ScaleFactor=1	CaseType="Response Combo"	CaseName=SKAD
ComboName=STR091 ScaleFactor=0	CaseType="Linear Static"	CaseName=QM01	ComboName=STR093 ScaleFactor=1,35	CaseType="Response Combo"	CaseName=SWD
ComboName=STR091 ScaleFactor=0	CaseType="Linear Static"	CaseName=QM02	ComboName=STR093 ScaleFactor=1,0125	CaseType="Linear Static"	CaseName=SA
ComboName=STR091 ScaleFactor=0	CaseType="Linear Static"	CaseName=SQMS	ComboName=STR093 ScaleFactor=1,0125	CaseType="Linear Static"	CaseName=QM01
ComboName=STR091 ScaleFactor=0	CaseType="Linear Static"	CaseName=SQMD	ComboName=STR093 ScaleFactor=0	CaseType="Linear Static"	CaseName=QM02
ComboName=STR091 ScaleFactor=0,72	CaseType="Linear Static"	CaseName=FA01	ComboName=STR093 ScaleFactor=0	CaseType="Linear Static"	CaseName=SQMS
ComboName=STR091 ScaleFactor=0	CaseType="Linear Static"	CaseName=TC01	ComboName=STR093 ScaleFactor=0,72	CaseType="Linear Static"	CaseName=SQMD
ComboName=STR091 ScaleFactor=0	CaseType="Linear Static"	CaseName=TC02	ComboName=STR093 ScaleFactor=0	CaseType="Linear Static"	CaseName=FA01
ComboName=STR091 ScaleFactor=1,2	CaseType="Linear Static"	CaseName=TV01	ComboName=STR093 ScaleFactor=0	CaseType="Linear Static"	CaseName=TC01
ComboName=STR091 ScaleFactor=0	CaseType="Linear Static"	CaseName=TV02	ComboName=STR093 ScaleFactor=1,2	CaseType="Linear Static"	CaseName=TC02
ComboName=STR091 ScaleFactor=0	CaseType="Linear Static"	CaseName=RIT ScaleFactor=0	ComboName=STR093 ScaleFactor=0	CaseType="Linear Static"	CaseName=TV01
ComboName=STR091 ScaleFactor=0	CaseType="Linear Static"	CaseName=SSTS	ComboName=STR093 ScaleFactor=0	CaseType="Linear Static"	CaseName=TV02
ComboName=STR091 ScaleFactor=0	CaseType="Linear Static"	CaseName=IS01 ScaleFactor=0	ComboName=STR093 ScaleFactor=0	CaseType="Linear Static"	CaseName=RIT ScaleFactor=0
ComboName=STR092 CaseType="Linear Static"	ComboType="Linear Add"	AutoDesign=No	ComboName=STR093 ScaleFactor=0	CaseType="Linear Static"	CaseName=SSTS
CaseType="Linear Static"	CaseName=PPST ScaleFactor=1,35	SteelDesign=No	ComboName=STR093 ScaleFactor=0	CaseType="Linear Static"	CaseName=IS01 ScaleFactor=0
ConcDesign=No AlumDesign=No ColdDesign=No	CaseType="Linear Static"	CaseName=PPNS	ComboName=STR093 ScaleFactor=0	ComboType="Linear Add"	AutoDesign=No
ComboName=STR092 ScaleFactor=1,35	CaseType="Linear Static"	CaseName=PPAQ	ComboName=STR094 ScaleFactor=0	CaseName=PPST ScaleFactor=1,35	SteelDesign=No
ComboName=STR092 ScaleFactor=0	CaseType="Response Combo"	CaseName=SK05	ComboName=STR094 ScaleFactor=0	ConcDesign=No AlumDesign=No ColdDesign=No	CaseName=PPNS
ComboName=STR092 ScaleFactor=1	CaseType="Response Combo"	CaseName=SKAS	ComboName=STR094 ScaleFactor=1,35	CaseType="Linear Static"	CaseName=PPAQ
ComboName=STR092 ScaleFactor=1	CaseType="Response Combo"	CaseName=SWS	ComboName=STR094 ScaleFactor=0	CaseType="Linear Static"	CaseName=SK05
ComboName=STR092 ScaleFactor=0	CaseType="Response Combo"	CaseName=SK0D	ComboName=STR094 ScaleFactor=1,35	CaseType="Response Combo"	CaseName=SKAS
ComboName=STR092 ScaleFactor=1	CaseType="Response Combo"	CaseName=SKAD	ComboName=STR094 ScaleFactor=0	CaseType="Response Combo"	CaseName=SWS
ComboName=STR092 ScaleFactor=1	CaseType="Response Combo"	CaseName=SWD	ComboName=STR094 ScaleFactor=1,35	CaseType="Response Combo"	CaseName=SK0D
ComboName=STR092 ScaleFactor=1,35	CaseType="Linear Static"	CaseName=SA	ComboName=STR094 ScaleFactor=0	CaseType="Response Combo"	CaseName=SKAD
ComboName=STR092 ScaleFactor=1,0125	CaseType="Linear Static"	CaseName=QM01	ComboName=STR094 ScaleFactor=1,35	CaseType="Response Combo"	CaseName=SWD
ComboName=STR092 ScaleFactor=1,0125	CaseType="Linear Static"	CaseName=QM02	ComboName=STR094 ScaleFactor=1,0125	CaseType="Response Combo"	CaseName=SA
ComboName=STR092 ScaleFactor=0	CaseType="Linear Static"	CaseName=SQMS	ComboName=STR094 ScaleFactor=1,0125	CaseType="Linear Static"	CaseName=QM01
ComboName=STR092 ScaleFactor=0	CaseType="Linear Static"	CaseName=SQMD	ComboName=STR094 ScaleFactor=0	CaseType="Linear Static"	CaseName=QM02
ComboName=STR092 ScaleFactor=0	CaseType="Linear Static"	CaseName=FA01	ComboName=STR094 ScaleFactor=1,0125	CaseType="Linear Static"	CaseName=SQMS
ComboName=STR092 ScaleFactor=0,72	CaseType="Linear Static"	CaseName=TC01	ComboName=STR094 ScaleFactor=0	CaseType="Linear Static"	CaseName=SQMD
ComboName=STR092 ScaleFactor=0	CaseType="Linear Static"	CaseName=TC02	ComboName=STR094 ScaleFactor=0,72	CaseType="Linear Static"	CaseName=FA01

ComboName=STR094 ScaleFactor=0	CaseType="Linear Static"	CaseName=TC02	ComboName=STR096 ScaleFactor=0	CaseType="Linear Static"	CaseName=TC02
ComboName=STR094 ScaleFactor=1,2	CaseType="Linear Static"	CaseName=TV01	ComboName=STR096 ScaleFactor=1,2	CaseType="Linear Static"	CaseName=TV01
ComboName=STR094 ScaleFactor=0	CaseType="Linear Static"	CaseName=TV02	ComboName=STR096 ScaleFactor=0	CaseType="Linear Static"	CaseName=TV02
ComboName=STR094 ScaleFactor=0	CaseType="Linear Static"	CaseName=RIT	ComboName=STR096 ScaleFactor=0	CaseType="Linear Static"	CaseName=RIT
ComboName=STR094 ScaleFactor=0	CaseType="Linear Static"	CaseName=SSTS	ComboName=STR096 ScaleFactor=0	CaseType="Linear Static"	CaseName=SSTS
ComboName=STR094 ScaleFactor=0	CaseType="Linear Static"	CaseName=IS01	ComboName=STR096 ScaleFactor=0	CaseType="Linear Static"	CaseName=IS01
ComboName=STR095 CaseType="Linear Static"	ComboType="Linear Add"	AutoDesign=No	ComboName=STR097 CaseType="Linear Static"	ComboType="Linear Add"	AutoDesign=No
ConcDesign=No AlumDesign=No ColdDesign=No	CaseName=PPST	ScaleFactor=1	SteelDesign=No	CaseName=PPST	ScaleFactor=1,35
ComboName=STR095 ScaleFactor=1	CaseType="Linear Static"	CaseName=PPNS	ComboName=STR097 ScaleFactor=1,35	CaseType="Linear Static"	CaseName=PPNS
ComboName=STR095 ScaleFactor=0	CaseType="Linear Static"	CaseName=PPAQ	ComboName=STR097 ScaleFactor=0	CaseType="Linear Static"	CaseName=PPAQ
ComboName=STR095 ScaleFactor=1,35	CaseType="Response Combo"	CaseName=SK05	ComboName=STR097 ScaleFactor=1,35	CaseType="Response Combo"	CaseName=SK05
ComboName=STR095 ScaleFactor=0	CaseType="Response Combo"	CaseName=SKAS	ComboName=STR097 ScaleFactor=0	CaseType="Response Combo"	CaseName=SKAS
ComboName=STR095 ScaleFactor=1,35	CaseType="Response Combo"	CaseName=SWS	ComboName=STR097 ScaleFactor=1,35	CaseType="Response Combo"	CaseName=SWS
ComboName=STR095 ScaleFactor=0	CaseType="Response Combo"	CaseName=SK0D	ComboName=STR097 ScaleFactor=0	CaseType="Response Combo"	CaseName=SK0D
ComboName=STR095 ScaleFactor=1	CaseType="Response Combo"	CaseName=SKAD	ComboName=STR097 ScaleFactor=1	CaseType="Response Combo"	CaseName=SKAD
ComboName=STR095 ScaleFactor=1	CaseType="Response Combo"	CaseName=SWD	ComboName=STR097 ScaleFactor=1,35	CaseType="Response Combo"	CaseName=SWD
ComboName=STR095 ScaleFactor=0	CaseType="Linear Static"	CaseName=SA	ComboName=STR097 ScaleFactor=1,35	CaseType="Linear Static"	CaseName=SA
ComboName=STR095 ScaleFactor=0	CaseType="Linear Static"	CaseName=QM01	ComboName=STR097 ScaleFactor=0	CaseType="Linear Static"	CaseName=QM01
ComboName=STR095 ScaleFactor=0	CaseType="Linear Static"	CaseName=QM02	ComboName=STR097 ScaleFactor=0	CaseType="Linear Static"	CaseName=QM02
ComboName=STR095 ScaleFactor=1,0125	CaseType="Linear Static"	CaseName=SQMS	ComboName=STR097 ScaleFactor=0	CaseType="Linear Static"	CaseName=SQMS
ComboName=STR095 ScaleFactor=0	CaseType="Linear Static"	CaseName=SQMD	ComboName=STR097 ScaleFactor=0	CaseType="Linear Static"	CaseName=SQMD
ComboName=STR095 ScaleFactor=0	CaseType="Linear Static"	CaseName=FA01	ComboName=STR097 ScaleFactor=0	CaseType="Linear Static"	CaseName=FA01
ComboName=STR095 ScaleFactor=0,72	CaseType="Linear Static"	CaseName=TC01	ComboName=STR097 ScaleFactor=0	CaseType="Linear Static"	CaseName=TC01
ComboName=STR095 ScaleFactor=0	CaseType="Linear Static"	CaseName=TC02	ComboName=STR097 ScaleFactor=0,72	CaseType="Linear Static"	CaseName=TC02
ComboName=STR095 ScaleFactor=1,2	CaseType="Linear Static"	CaseName=TV01	ComboName=STR097 ScaleFactor=1,2	CaseType="Linear Static"	CaseName=TV01
ComboName=STR095 ScaleFactor=0	CaseType="Linear Static"	CaseName=TV02	ComboName=STR097 ScaleFactor=0	CaseType="Linear Static"	CaseName=TV02
ComboName=STR095 ScaleFactor=0	CaseType="Linear Static"	CaseName=RIT	ComboName=STR097 ScaleFactor=0	CaseType="Linear Static"	CaseName=RIT
ComboName=STR095 ScaleFactor=0	CaseType="Linear Static"	CaseName=SSTS	ComboName=STR097 ScaleFactor=0	CaseType="Linear Static"	CaseName=SSTS
ComboName=STR095 ScaleFactor=0	CaseType="Linear Static"	CaseName=IS01	ComboName=STR097 ScaleFactor=0	CaseType="Linear Static"	CaseName=IS01
ComboName=STR096 CaseType="Linear Static"	ComboType="Linear Add"	AutoDesign=No	ComboName=STR098 CaseType="Linear Static"	ComboType="Linear Add"	AutoDesign=No
ConcDesign=No AlumDesign=No ColdDesign=No	CaseName=PPST	ScaleFactor=1	SteelDesign=No	CaseName=PPST	ScaleFactor=1,35
ComboName=STR096 ScaleFactor=1	CaseType="Linear Static"	CaseName=PPNS	ComboName=STR098 ScaleFactor=1,35	CaseType="Linear Static"	CaseName=PPNS
ComboName=STR096 ScaleFactor=0	CaseType="Linear Static"	CaseName=PPAQ	ComboName=STR098 ScaleFactor=0	CaseType="Linear Static"	CaseName=PPAQ
ComboName=STR096 ScaleFactor=1,35	CaseType="Response Combo"	CaseName=SK05	ComboName=STR098 ScaleFactor=0	CaseType="Response Combo"	CaseName=SK05
ComboName=STR096 ScaleFactor=0	CaseType="Response Combo"	CaseName=SKAS	ComboName=STR098 ScaleFactor=1	CaseType="Response Combo"	CaseName=SKAS
ComboName=STR096 ScaleFactor=1,35	CaseType="Response Combo"	CaseName=SWS	ComboName=STR098 ScaleFactor=1	CaseType="Response Combo"	CaseName=SWS
ComboName=STR096 ScaleFactor=1,35	CaseType="Response Combo"	CaseName=SK0D	ComboName=STR098 ScaleFactor=0	CaseType="Response Combo"	CaseName=SK0D
ComboName=STR096 ScaleFactor=0	CaseType="Response Combo"	CaseName=SKAD	ComboName=STR098 ScaleFactor=1	CaseType="Response Combo"	CaseName=SKAD
ComboName=STR096 ScaleFactor=1,35	CaseType="Response Combo"	CaseName=SWD	ComboName=STR098 ScaleFactor=0	CaseType="Response Combo"	CaseName=SWD
ComboName=STR096 ScaleFactor=0	CaseType="Linear Static"	CaseName=SA	ComboName=STR098 ScaleFactor=1	CaseType="Linear Static"	CaseName=SA
ComboName=STR096 ScaleFactor=0	CaseType="Linear Static"	CaseName=QM01	ComboName=STR098 ScaleFactor=1,35	CaseType="Linear Static"	CaseName=QM01
ComboName=STR096 ScaleFactor=0	CaseType="Linear Static"	CaseName=QM02	ComboName=STR098 ScaleFactor=0	CaseType="Linear Static"	CaseName=QM02
ComboName=STR096 ScaleFactor=1,0125	CaseType="Linear Static"	CaseName=SQMS	ComboName=STR098 ScaleFactor=0	CaseType="Linear Static"	CaseName=SQMS
ComboName=STR096 ScaleFactor=1,0125	CaseType="Linear Static"	CaseName=SQMD	ComboName=STR098 ScaleFactor=0	CaseType="Linear Static"	CaseName=SQMD
ComboName=STR096 ScaleFactor=0	CaseType="Linear Static"	CaseName=FA01	ComboName=STR098 ScaleFactor=0	CaseType="Linear Static"	CaseName=FA01
ComboName=STR096 ScaleFactor=0,72	CaseType="Linear Static"	CaseName=TC01	ComboName=STR098 ScaleFactor=0	CaseType="Linear Static"	CaseName=TC01

ComboName=STR098 ScaleFactor=0	CaseType="Linear Static"	CaseName=TC01	ComboName=STR100 ScaleFactor=0	CaseType="Linear Static"	CaseName=FA01
ComboName=STR098 ScaleFactor=0,72	CaseType="Linear Static"	CaseName=TC02	ComboName=STR100 ScaleFactor=0	CaseType="Linear Static"	CaseName=TC01
ComboName=STR098 ScaleFactor=1,2	CaseType="Linear Static"	CaseName=TV01	ComboName=STR100 ScaleFactor=0,72	CaseType="Linear Static"	CaseName=TC02
ComboName=STR098 ScaleFactor=0	CaseType="Linear Static"	CaseName=TV02	ComboName=STR100 ScaleFactor=1,2	CaseType="Linear Static"	CaseName=TV01
ComboName=STR098 ScaleFactor=0	CaseType="Linear Static"	CaseName=RIT	ComboName=STR100 ScaleFactor=0	CaseType="Linear Static"	CaseName=TV02
ComboName=STR098 ScaleFactor=0	CaseType="Linear Static"	CaseName=SSTS	ComboName=STR100 ScaleFactor=0	CaseType="Linear Static"	CaseName=RIT
ComboName=STR098 ScaleFactor=0	CaseType="Linear Static"	CaseName=IS01	ComboName=STR100 ScaleFactor=0	CaseType="Linear Static"	CaseName=SSTS
ComboName=STR099 CaseType="Linear Static"	ComboType="Linear Add"	AutoDesign=No	ComboName=STR100 ScaleFactor=0	CaseType="Linear Static"	CaseName=IS01
CaseType="Linear Static"	CaseName=PPST	ScaleFactor=1,35	SteelDesign=No	ComboName=STR101 CaseType="Linear Add"	AutoDesign=No
ConcDesign=No	AlumDesign=No	ColdDesign=No	ComboName=STR101 CaseType="Linear Static"	CaseName=PPST	ScaleFactor=1,35
ScaleFactor=1,35	CaseType="Linear Static"	CaseName=PPNS	ConcDesign=No	AlumDesign=No	ColdDesign=No
ComboName=STR099 ScaleFactor=0	CaseType="Linear Static"	CaseName=PPAQ	ComboName=STR101 ScaleFactor=1,35	CaseType="Linear Static"	CaseName=PPNS
ComboName=STR099 ScaleFactor=0	CaseType="Response Combo"	CaseName=SK05	ComboName=STR101 ScaleFactor=0	CaseType="Linear Static"	CaseName=PPAQ
ComboName=STR099 ScaleFactor=1	CaseType="Response Combo"	CaseName=SKAS	ComboName=STR101 ScaleFactor=1,35	CaseType="Response Combo"	CaseName=SK05
ComboName=STR099 ScaleFactor=1	CaseType="Response Combo"	CaseName=SWS	ComboName=STR101 ScaleFactor=0	CaseType="Response Combo"	CaseName=SKAS
ComboName=STR099 ScaleFactor=0	CaseType="Response Combo"	CaseName=SK0D	ComboName=STR101 ScaleFactor=1,35	CaseType="Response Combo"	CaseName=SWS
ComboName=STR099 ScaleFactor=1	CaseType="Response Combo"	CaseName=SKAD	ComboName=STR101 ScaleFactor=1,35	CaseType="Response Combo"	CaseName=SK0D
ComboName=STR099 ScaleFactor=1	CaseType="Response Combo"	CaseName=SWD	ComboName=STR101 ScaleFactor=0	CaseType="Response Combo"	CaseName=SKAD
ComboName=STR099 ScaleFactor=1,35	CaseType="Linear Static"	CaseName=SA	ComboName=STR101 ScaleFactor=1,35	CaseType="Response Combo"	CaseName=SWD
ComboName=STR099 ScaleFactor=1,0125	CaseType="Linear Static"	CaseName=QM01	ComboName=STR101 ScaleFactor=1,35	CaseType="Linear Static"	CaseName=SA
ComboName=STR099 ScaleFactor=1,0125	CaseType="Linear Static"	CaseName=QM02	ComboName=STR101 ScaleFactor=1,0125	CaseType="Linear Static"	CaseName=QM01
ComboName=STR099 ScaleFactor=0	CaseType="Linear Static"	CaseName=SQMS	ComboName=STR101 ScaleFactor=1,0125	CaseType="Linear Static"	CaseName=QM02
ComboName=STR099 ScaleFactor=0	CaseType="Linear Static"	CaseName=SQMD	ComboName=STR101 ScaleFactor=1,0125	CaseType="Linear Static"	CaseName=SQMS
ComboName=STR099 ScaleFactor=0	CaseType="Linear Static"	CaseName=FA01	ComboName=STR101 ScaleFactor=1,0125	CaseType="Linear Static"	CaseName=SQMD
ComboName=STR099 ScaleFactor=0	CaseType="Linear Static"	CaseName=TC01	ComboName=STR101 ScaleFactor=0	CaseType="Linear Static"	CaseName=FA01
ComboName=STR099 ScaleFactor=0,72	CaseType="Linear Static"	CaseName=TC02	ComboName=STR101 ScaleFactor=0	CaseType="Linear Static"	CaseName=TC01
ComboName=STR099 ScaleFactor=1,2	CaseType="Linear Static"	CaseName=TV01	ComboName=STR101 ScaleFactor=0,72	CaseType="Linear Static"	CaseName=TC02
ComboName=STR099 ScaleFactor=0	CaseType="Linear Static"	CaseName=TV02	ComboName=STR101 ScaleFactor=1,2	CaseType="Linear Static"	CaseName=TV01
ComboName=STR099 ScaleFactor=0	CaseType="Linear Static"	CaseName=RIT	ComboName=STR101 ScaleFactor=0	CaseType="Linear Static"	CaseName=TV02
ComboName=STR099 ScaleFactor=0	CaseType="Linear Static"	CaseName=SSTS	ComboName=STR101 ScaleFactor=0	CaseType="Linear Static"	CaseName=RIT
ComboName=STR099 ScaleFactor=0	CaseType="Linear Static"	CaseName=IS01	ComboName=STR101 ScaleFactor=0	CaseType="Linear Static"	CaseName=SSTS
ComboName=STR100 CaseType="Linear Static"	ComboType="Linear Add"	AutoDesign=No	ComboName=STR101 ScaleFactor=0	CaseType="Linear Static"	CaseName=IS01
CaseType="Linear Static"	CaseName=PPST	ScaleFactor=1,35	SteelDesign=No	ComboName=STR102 CaseType="Linear Add"	AutoDesign=No
ConcDesign=No	AlumDesign=No	ColdDesign=No	ComboName=STR102 CaseType="Linear Static"	CaseName=PPST	ScaleFactor=1
ScaleFactor=1,35	CaseType="Linear Static"	CaseName=PPNS	ConcDesign=No	AlumDesign=No	ColdDesign=No
ComboName=STR100 ScaleFactor=0	CaseType="Linear Static"	CaseName=PPAQ	ComboName=STR102 ScaleFactor=1	CaseType="Linear Static"	CaseName=PPNS
ComboName=STR100 ScaleFactor=1,35	CaseType="Response Combo"	CaseName=SK05	ComboName=STR102 ScaleFactor=0	CaseType="Linear Static"	CaseName=PPAQ
ComboName=STR100 ScaleFactor=0	CaseType="Response Combo"	CaseName=SKAS	ComboName=STR102 ScaleFactor=1,35	CaseType="Response Combo"	CaseName=SK05
ComboName=STR100 ScaleFactor=1,35	CaseType="Response Combo"	CaseName=SWS	ComboName=STR102 ScaleFactor=0	CaseType="Response Combo"	CaseName=SKAS
ComboName=STR100 ScaleFactor=0	CaseType="Response Combo"	CaseName=SK0D	ComboName=STR102 ScaleFactor=1,35	CaseType="Response Combo"	CaseName=SWS
ComboName=STR100 ScaleFactor=1	CaseType="Response Combo"	CaseName=SKAD	ComboName=STR102 ScaleFactor=0	CaseType="Response Combo"	CaseName=SK0D
ComboName=STR100 ScaleFactor=1	CaseType="Response Combo"	CaseName=SWD	ComboName=STR102 ScaleFactor=1	CaseType="Response Combo"	CaseName=SKAD
ComboName=STR100 ScaleFactor=1,35	CaseType="Linear Static"	CaseName=SA	ComboName=STR102 ScaleFactor=1	CaseType="Response Combo"	CaseName=SWD
ComboName=STR100 ScaleFactor=1,0125	CaseType="Linear Static"	CaseName=QM01	ComboName=STR102 ScaleFactor=0	CaseType="Linear Static"	CaseName=SA
ComboName=STR100 ScaleFactor=1,0125	CaseType="Linear Static"	CaseName=QM02	ComboName=STR102 ScaleFactor=0	CaseType="Linear Static"	CaseName=QM01
ComboName=STR100 ScaleFactor=1,0125	CaseType="Linear Static"	CaseName=SQMS	ComboName=STR102 ScaleFactor=0	CaseType="Linear Static"	CaseName=QM02
ComboName=STR100 ScaleFactor=1,0125	CaseType="Linear Static"	CaseName=SQMD	ComboName=STR102 ScaleFactor=0	CaseType="Linear Static"	CaseName=SQMS

APPROVATO SDP

Società di Progetto
Brebemi SpA



ComboName=STR106 ScaleFactor=1,0125	CaseType="Linear Static"	CaseName=QM01	ComboName=STR108 ScaleFactor=1,35	CaseType="Response Combo"	CaseName=SWD
ComboName=STR106 ScaleFactor=1,0125	CaseType="Linear Static"	CaseName=QM02	ComboName=STR108 ScaleFactor=1,35	CaseType="Linear Static"	CaseName=SA
ComboName=STR106 ScaleFactor=0	CaseType="Linear Static"	CaseName=SQMS	ComboName=STR108 ScaleFactor=1,0125	CaseType="Linear Static"	CaseName=QM01
ComboName=STR106 ScaleFactor=0	CaseType="Linear Static"	CaseName=SQMD	ComboName=STR108 ScaleFactor=1,0125	CaseType="Linear Static"	CaseName=QM02
ComboName=STR106 ScaleFactor=0	CaseType="Linear Static"	CaseName=FA01	ComboName=STR108 ScaleFactor=1,0125	CaseType="Linear Static"	CaseName=SQMS
ComboName=STR106 ScaleFactor=0	CaseType="Linear Static"	CaseName=TC01	ComboName=STR108 ScaleFactor=1,0125	CaseType="Linear Static"	CaseName=SQMD
ComboName=STR106 ScaleFactor=0	CaseType="Linear Static"	CaseName=TC02	ComboName=STR108 ScaleFactor=0	CaseType="Linear Static"	CaseName=FA01
ComboName=STR106 ScaleFactor=1,2	CaseType="Linear Static"	CaseName=TV01	ComboName=STR108 ScaleFactor=0	CaseType="Linear Static"	CaseName=TC01
ComboName=STR106 ScaleFactor=0	CaseType="Linear Static"	CaseName=TV02	ComboName=STR108 ScaleFactor=0	CaseType="Linear Static"	CaseName=TC02
ComboName=STR106 ScaleFactor=0,72	CaseType="Linear Static"	CaseName=RIT	ComboName=STR108 ScaleFactor=1,2	CaseType="Linear Static"	CaseName=TV01
ComboName=STR106 ScaleFactor=0	CaseType="Linear Static"	CaseName=SSTS	ComboName=STR108 ScaleFactor=0	CaseType="Linear Static"	CaseName=TV02
ComboName=STR106 ScaleFactor=0	CaseType="Linear Static"	CaseName=IS01	ComboName=STR108 ScaleFactor=0,72	CaseType="Linear Static"	CaseName=RIT
ComboName=STR107 CaseType="Linear Static" CaseName=PPST ScaleFactor=1,35 SteelDesign=No ConcDesign=No AlumDesign=No ColdDesign=No	ComboType="Linear Add"	AutoDesign=No	ComboName=STR108 ScaleFactor=0	CaseType="Linear Static"	CaseName=SSTS
ComboName=STR107 ScaleFactor=1,35	CaseType="Linear Static"	CaseName=PPNS	ComboName=STR108 ScaleFactor=0	CaseType="Linear Static"	CaseName=IS01 ScaleFactor=0 AutoDesign=No SteelDesign=No
ComboName=STR107 ScaleFactor=0	CaseType="Linear Static"	CaseName=PPAQ	ComboName=STR109 CaseType="Linear Static" CaseName=PPST ScaleFactor=1 ConcDesign=No AlumDesign=No ColdDesign=No	CaseName=PPST ScaleFactor=1 SteelDesign=No	CaseName=PPNS
ComboName=STR107 ScaleFactor=1,35	CaseType="Response Combo"	CaseName=SK05	ComboName=STR109 ScaleFactor=1	CaseType="Linear Static"	CaseName=PPAQ
ComboName=STR107 ScaleFactor=0	CaseType="Response Combo"	CaseName=SKAS	ComboName=STR109 ScaleFactor=0	CaseType="Linear Static"	CaseName=SK05
ComboName=STR107 ScaleFactor=1,35	CaseType="Response Combo"	CaseName=SWS	ComboName=STR109 ScaleFactor=1,35	CaseType="Response Combo"	CaseName=SKAS
ComboName=STR107 ScaleFactor=0	CaseType="Response Combo"	CaseName=SK0D	ComboName=STR109 ScaleFactor=0	CaseType="Response Combo"	CaseName=SWS
ComboName=STR107 ScaleFactor=1	CaseType="Response Combo"	CaseName=SKAD	ComboName=STR109 ScaleFactor=1,35	CaseType="Response Combo"	CaseName=SK0D
ComboName=STR107 ScaleFactor=1	CaseType="Response Combo"	CaseName=SWD	ComboName=STR109 ScaleFactor=0	CaseType="Response Combo"	CaseName=SKAD
ComboName=STR107 ScaleFactor=1,35	CaseType="Linear Static"	CaseName=SA	ComboName=STR109 ScaleFactor=1	CaseType="Response Combo"	CaseName=SWD
ComboName=STR107 ScaleFactor=1,0125	CaseType="Linear Static"	CaseName=QM01	ComboName=STR109 ScaleFactor=1	CaseType="Response Combo"	CaseName=SA ScaleFactor=1 CaseName=QM01
ComboName=STR107 ScaleFactor=1,0125	CaseType="Linear Static"	CaseName=QM02	ComboName=STR109 ScaleFactor=0	CaseType="Linear Static"	CaseName=QM01
ComboName=STR107 ScaleFactor=1,0125	CaseType="Linear Static"	CaseName=SQMS	ComboName=STR109 ScaleFactor=0	CaseType="Linear Static"	CaseName=QM02
ComboName=STR107 ScaleFactor=0	CaseType="Linear Static"	CaseName=SQMD	ComboName=STR109 ScaleFactor=1,0125	CaseType="Linear Static"	CaseName=SQMS
ComboName=STR107 ScaleFactor=0	CaseType="Linear Static"	CaseName=FA01	ComboName=STR109 ScaleFactor=0	CaseType="Linear Static"	CaseName=SQMD
ComboName=STR107 ScaleFactor=0	CaseType="Linear Static"	CaseName=TC01	ComboName=STR109 ScaleFactor=0	CaseType="Linear Static"	CaseName=FA01
ComboName=STR107 ScaleFactor=0	CaseType="Linear Static"	CaseName=TC02	ComboName=STR109 ScaleFactor=0	CaseType="Linear Static"	CaseName=TC01
ComboName=STR107 ScaleFactor=1,2	CaseType="Linear Static"	CaseName=TV01	ComboName=STR109 ScaleFactor=0	CaseType="Linear Static"	CaseName=TC02
ComboName=STR107 ScaleFactor=0	CaseType="Linear Static"	CaseName=TV02	ComboName=STR109 ScaleFactor=0	CaseType="Linear Static"	CaseName=TV01
ComboName=STR107 ScaleFactor=0,72	CaseType="Linear Static"	CaseName=RIT	ComboName=STR109 ScaleFactor=1,2	CaseType="Linear Static"	CaseName=TV02
ComboName=STR107 ScaleFactor=0	CaseType="Linear Static"	CaseName=SSTS	ComboName=STR109 ScaleFactor=0	CaseType="Linear Static"	CaseName=RIT
ComboName=STR107 ScaleFactor=0	CaseType="Linear Static"	CaseName=IS01	ComboName=STR109 ScaleFactor=0,72	CaseType="Linear Static"	CaseName=SSTS
ComboName=STR108 CaseType="Linear Static" CaseName=PPST ScaleFactor=1,35 SteelDesign=No ConcDesign=No AlumDesign=No ColdDesign=No	ComboType="Linear Add"	AutoDesign=No	ComboName=STR109 ScaleFactor=0	CaseType="Linear Static"	CaseName=IS01 ScaleFactor=0 AutoDesign=No SteelDesign=No
ComboName=STR108 ScaleFactor=1,35	CaseType="Linear Static"	CaseName=PPNS	ComboName=STR109 ScaleFactor=1	CaseType="Linear Static"	CaseName=PPNS
ComboName=STR108 ScaleFactor=0	CaseType="Linear Static"	CaseName=PPAQ	ComboName=STR110 CaseType="Linear Static" CaseName=PPST ScaleFactor=1 ConcDesign=No AlumDesign=No ColdDesign=No	CaseName=PPST ScaleFactor=1 SteelDesign=No	CaseName=PPAQ
ComboName=STR108 ScaleFactor=1,35	CaseType="Response Combo"	CaseName=SK05	ComboName=STR110 ScaleFactor=1	CaseType="Linear Static"	CaseName=PPAQ
ComboName=STR108 ScaleFactor=0	CaseType="Response Combo"	CaseName=SKAS	ComboName=STR110 ScaleFactor=0	CaseType="Linear Static"	CaseName=SK05
ComboName=STR108 ScaleFactor=1,35	CaseType="Response Combo"	CaseName=SWS	ComboName=STR110 ScaleFactor=1,35	CaseType="Response Combo"	CaseName=SKAS
ComboName=STR108 ScaleFactor=1,35	CaseType="Response Combo"	CaseName=SK0D	ComboName=STR110 ScaleFactor=0	CaseType="Response Combo"	CaseName=SKAS
ComboName=STR108 ScaleFactor=1,35	CaseType="Response Combo"	CaseName=SKAD	ComboName=STR110 ScaleFactor=0	CaseType="Response Combo"	CaseName=SWS

ComboName=STR110 ScaleFactor=1,35	CaseType="Response	Combo"	CaseName=SK0D	ComboName=STR112 ScaleFactor=1	CaseType="Response	Combo"	CaseName=SWS
ComboName=STR110 ScaleFactor=0	CaseType="Response	Combo"	CaseName=SKAD	ComboName=STR112 ScaleFactor=0	CaseType="Response	Combo"	CaseName=SK0D
ComboName=STR110 ScaleFactor=1,35	CaseType="Response	Combo"	CaseName=SWD	ComboName=STR112 ScaleFactor=1	CaseType="Response	Combo"	CaseName=SKAD
ComboName=STR110 ScaleFactor=0	CaseType="Linear Static"	CaseName=SA	ScaleFactor=1	ComboName=STR112 ScaleFactor=1	CaseType="Response	Combo"	CaseName=SWD
ComboName=STR110 ScaleFactor=0	CaseType="Linear	Static"	CaseName=QM01	ComboName=STR112 ScaleFactor=1,35	CaseType="Linear	Static"	CaseName=SA
ComboName=STR110 ScaleFactor=0	CaseType="Linear	Static"	CaseName=QM02	ComboName=STR112 ScaleFactor=0	CaseType="Linear	Static"	CaseName=QM01
ComboName=STR110 ScaleFactor=1,0125	CaseType="Linear	Static"	CaseName=SQMS	ComboName=STR112 ScaleFactor=0	CaseType="Linear	Static"	CaseName=QM02
ComboName=STR110 ScaleFactor=1,0125	CaseType="Linear	Static"	CaseName=SQMD	ComboName=STR112 ScaleFactor=0	CaseType="Linear	Static"	CaseName=SQMS
ComboName=STR110 ScaleFactor=0	CaseType="Linear	Static"	CaseName=FA01	ComboName=STR112 ScaleFactor=0	CaseType="Linear	Static"	CaseName=SQMD
ComboName=STR110 ScaleFactor=0	CaseType="Linear	Static"	CaseName=TC01	ComboName=STR112 ScaleFactor=0	CaseType="Linear	Static"	CaseName=FA01
ComboName=STR110 ScaleFactor=0	CaseType="Linear	Static"	CaseName=TC02	ComboName=STR112 ScaleFactor=0	CaseType="Linear	Static"	CaseName=TC01
ComboName=STR110 ScaleFactor=1,2	CaseType="Linear	Static"	CaseName=TV01	ComboName=STR112 ScaleFactor=0	CaseType="Linear	Static"	CaseName=TC02
ComboName=STR110 ScaleFactor=0	CaseType="Linear	Static"	CaseName=TV02	ComboName=STR112 ScaleFactor=0	CaseType="Linear	Static"	CaseName=TV01
ComboName=STR110 ScaleFactor=0,72	CaseType="Linear	Static"	CaseName=RIT	ComboName=STR112 ScaleFactor=0	CaseType="Linear	Static"	CaseName=TV02
ComboName=STR110 ScaleFactor=0	CaseType="Linear	Static"	CaseName=SSTS	ComboName=STR112 ScaleFactor=1,2	CaseType="Linear Static"	CaseName=RIT	ScaleFactor=0
ComboName=STR110 ScaleFactor=0	CaseType="Linear Static"	CaseName=IS01	ScaleFactor=0	ComboName=STR112 ScaleFactor=0	CaseType="Linear	Static"	CaseName=SSTS
ComboName=STR111 CaseType="Linear Static"	CaseName=PPST	ScaleFactor=1,35	SteelDesign=No	ComboName=STR112 ScaleFactor=0	CaseType="Linear Static"	CaseName=IS01	ScaleFactor=0
ConcDesign=No AlumDesign=No ColdDesign=No	CaseName=PPNS	CaseName=PPNS		ComboName=STR112 ScaleFactor=0	CaseType="Linear Add"	AutoDesign=No	
ComboName=STR111 ScaleFactor=1,35	CaseType="Linear	Static"	CaseName=PPAQ	ComboName=STR113 ScaleFactor=0	CaseType="Linear Static"	CaseName=PPST	ScaleFactor=1,35
ComboName=STR111 ScaleFactor=0	CaseType="Linear	Static"	CaseName=SK05	ComboName=STR113 ScaleFactor=0	CaseType="Linear	Static"	CaseName=PPNS
ComboName=STR111 ScaleFactor=0	CaseType="Response	Combo"	CaseName=SKAS	ComboName=STR113 ScaleFactor=1,35	CaseType="Linear	Static"	CaseName=PPAQ
ComboName=STR111 ScaleFactor=1,35	CaseType="Response	Combo"	CaseName=SWS	ComboName=STR113 ScaleFactor=0	CaseType="Response	Combo"	CaseName=SK05
ComboName=STR111 ScaleFactor=0	CaseType="Response	Combo"	CaseName=SK0D	ComboName=STR113 ScaleFactor=1	CaseType="Response	Combo"	CaseName=SKAS
ComboName=STR111 ScaleFactor=0	CaseType="Response	Combo"	CaseName=SKAD	ComboName=STR113 ScaleFactor=1	CaseType="Response	Combo"	CaseName=SWS
ComboName=STR111 ScaleFactor=1,35	CaseType="Response	Combo"	CaseName=SWD	ComboName=STR113 ScaleFactor=0	CaseType="Response	Combo"	CaseName=SK0D
ComboName=STR111 ScaleFactor=0	CaseType="Linear	Static"	CaseName=SA	ComboName=STR113 ScaleFactor=0	CaseType="Response	Combo"	CaseName=SKAD
ComboName=STR111 ScaleFactor=0	CaseType="Linear	Static"	CaseName=QM01	ComboName=STR113 ScaleFactor=1	CaseType="Response	Combo"	CaseName=SWD
ComboName=STR111 ScaleFactor=0	CaseType="Linear	Static"	CaseName=QM02	ComboName=STR113 ScaleFactor=1	CaseType="Response	Combo"	CaseName=SA
ComboName=STR111 ScaleFactor=0	CaseType="Linear	Static"	CaseName=SQMS	ComboName=STR113 ScaleFactor=1,35	CaseType="Linear	Static"	CaseName=QM01
ComboName=STR111 ScaleFactor=0	CaseType="Linear	Static"	CaseName=SQMD	ComboName=STR113 ScaleFactor=1,35	CaseType="Linear	Static"	CaseName=QM02
ComboName=STR111 ScaleFactor=0	CaseType="Linear	Static"	CaseName=FA01	ComboName=STR113 ScaleFactor=0	CaseType="Linear	Static"	CaseName=SQMS
ComboName=STR111 ScaleFactor=0	CaseType="Linear	Static"	CaseName=TC01	ComboName=STR113 ScaleFactor=0	CaseType="Linear	Static"	CaseName=SQMD
ComboName=STR111 ScaleFactor=0	CaseType="Linear	Static"	CaseName=TC02	ComboName=STR113 ScaleFactor=0	CaseType="Linear	Static"	CaseName=FA01
ComboName=STR111 ScaleFactor=0	CaseType="Linear	Static"	CaseName=TV01	ComboName=STR113 ScaleFactor=0	CaseType="Linear	Static"	CaseName=TC01
ComboName=STR111 ScaleFactor=0	CaseType="Linear	Static"	CaseName=TV02	ComboName=STR113 ScaleFactor=0,72	CaseType="Linear	Static"	CaseName=TC02
ComboName=STR111 ScaleFactor=0	CaseType="Linear Static"	CaseName=RIT	ScaleFactor=0	ComboName=STR113 ScaleFactor=0	CaseType="Linear	Static"	CaseName=TV01
ComboName=STR111 ScaleFactor=0	CaseType="Linear	Static"	CaseName=SSTS	ComboName=STR113 ScaleFactor=0	CaseType="Linear	Static"	CaseName=TV02
ComboName=STR111 ScaleFactor=0	CaseType="Linear Static"	CaseName=IS01	ScaleFactor=0	ComboName=STR113 ScaleFactor=0,72	CaseType="Linear Static"	CaseName=RIT	ScaleFactor=0
ComboName=STR112 CaseType="Linear Static"	CaseName=PPST	ScaleFactor=1,35	SteelDesign=No	ComboName=STR113 ScaleFactor=0	CaseType="Linear	Static"	CaseName=SSTS
ConcDesign=No AlumDesign=No ColdDesign=No	CaseName=PPNS	CaseName=PPNS		ComboName=STR113 ScaleFactor=0	CaseType="Linear Static"	CaseName=IS01	ScaleFactor=0
ComboName=STR112 ScaleFactor=1,35	CaseType="Linear	Static"	CaseName=PPAQ	ComboName=STR114 ScaleFactor=0	CaseType="Linear Add"	AutoDesign=No	
ComboName=STR112 ScaleFactor=0	CaseType="Linear	Static"	CaseName=SK05	ComboName=STR114 ScaleFactor=0	CaseType="Linear Static"	CaseName=PPST	ScaleFactor=1,35
ComboName=STR112 ScaleFactor=0	CaseType="Response	Combo"	CaseName=SKAS	ComboName=STR114 ScaleFactor=0	CaseType="Linear	Static"	CaseName=PPNS
ComboName=STR112 ScaleFactor=0	CaseType="Response	Combo"	CaseName=SWS	ComboName=STR114 ScaleFactor=1,35	CaseType="Linear	Static"	CaseName=PPAQ
ComboName=STR112 ScaleFactor=0	CaseType="Response	Combo"	CaseName=SK0D	ComboName=STR114 ScaleFactor=0	CaseType="Linear	Static"	CaseName=SK05
ComboName=STR112 ScaleFactor=1	CaseType="Response	Combo"	CaseName=SKAD	ComboName=STR114 ScaleFactor=1,35	CaseType="Response	Combo"	CaseName=SKAS

APPROVATO SGP

Società di Progetto
Brebemi SpA

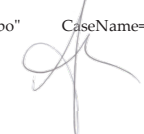

ComboName=STR114 ScaleFactor=0	CaseType="Response Combo"	CaseName=SKAS	ComboName=STR116 ScaleFactor=1,35	CaseType="Response Combo"	CaseName=SK05
ComboName=STR114 ScaleFactor=1,35	CaseType="Response Combo"	CaseName=SWS	ComboName=STR116 ScaleFactor=0	CaseType="Response Combo"	CaseName=SKAS
ComboName=STR114 ScaleFactor=0	CaseType="Response Combo"	CaseName=SK0D	ComboName=STR116 ScaleFactor=1,35	CaseType="Response Combo"	CaseName=SWS
ComboName=STR114 ScaleFactor=1	CaseType="Response Combo"	CaseName=SKAD	ComboName=STR116 ScaleFactor=0	CaseType="Response Combo"	CaseName=SK0D
ComboName=STR114 ScaleFactor=1	CaseType="Response Combo"	CaseName=SWD	ComboName=STR116 ScaleFactor=1	CaseType="Response Combo"	CaseName=SKAD
ComboName=STR114 ScaleFactor=1,35	CaseType="Linear Static"	CaseName=SA	ComboName=STR116 ScaleFactor=1	CaseType="Response Combo"	CaseName=SWD
ComboName=STR114 ScaleFactor=1,35	CaseType="Linear Static"	CaseName=QM01	ComboName=STR116 ScaleFactor=0	CaseType="Linear Static"	CaseName=SA ScaleFactor=1
ComboName=STR114 ScaleFactor=1,35	CaseType="Linear Static"	CaseName=QM02	ComboName=STR116 ScaleFactor=0	CaseType="Linear Static"	CaseName=QM01
ComboName=STR114 ScaleFactor=1,35	CaseType="Linear Static"	CaseName=SQMS	ComboName=STR116 ScaleFactor=0	CaseType="Linear Static"	CaseName=QM02
ComboName=STR114 ScaleFactor=0	CaseType="Linear Static"	CaseName=SQMD	ComboName=STR116 ScaleFactor=0	CaseType="Linear Static"	CaseName=SQMS
ComboName=STR114 ScaleFactor=0	CaseType="Linear Static"	CaseName=FA01	ComboName=STR116 ScaleFactor=0	CaseType="Linear Static"	CaseName=SQMD
ComboName=STR114 ScaleFactor=0	CaseType="Linear Static"	CaseName=TC01	ComboName=STR116 ScaleFactor=0	CaseType="Linear Static"	CaseName=FA01
ComboName=STR114 ScaleFactor=0	CaseType="Linear Static"	CaseName=TC02	ComboName=STR116 ScaleFactor=0	CaseType="Linear Static"	CaseName=TC01
ComboName=STR114 ScaleFactor=0	CaseType="Linear Static"	CaseName=TV01	ComboName=STR116 ScaleFactor=0	CaseType="Linear Static"	CaseName=TC02
ComboName=STR114 ScaleFactor=0,72	CaseType="Linear Static"	CaseName=TV02	ComboName=STR116 ScaleFactor=0,72	CaseType="Linear Static"	CaseName=TV01
ComboName=STR114 ScaleFactor=0	CaseType="Linear Static"	CaseName=RIT ScaleFactor=0	ComboName=STR116 ScaleFactor=0	CaseType="Linear Static"	CaseName=TV02
ComboName=STR114 ScaleFactor=0	CaseType="Linear Static"	CaseName=SSTS	ComboName=STR116 ScaleFactor=0	CaseType="Linear Static"	CaseName=RIT ScaleFactor=0
ComboName=STR114 ScaleFactor=0	CaseType="Linear Static"	CaseName=IS01 ScaleFactor=0	ComboName=STR116 ScaleFactor=0	CaseType="Linear Static"	CaseName=SSTS
ComboName=STR115 CaseType="Linear Static"	ComboType="Linear Add"	AutoDesign=No	ComboName=STR117 ScaleFactor=0	CaseType="Linear Static"	CaseName=IS01 ScaleFactor=0
CaseType="Linear Static"	CaseName=PPST ScaleFactor=1,35	SteelDesign=No	ComboName=STR117 ScaleFactor=1,35	ComboType="Linear Add"	AutoDesign=No
ConcDesign=No AlumDesign=No ColdDesign=No	CaseName=PPNS	CaseName=PPNS	ComboName=STR117 ScaleFactor=0	CaseType="Linear Static"	CaseName=PPST ScaleFactor=1 SteelDesign=No
ComboName=STR115 ScaleFactor=1,35	CaseType="Linear Static"	CaseName=PPAQ	ComboName=STR117 ScaleFactor=1,35	CaseType="Linear Static"	ConcDesign=No AlumDesign=No ColdDesign=No
ComboName=STR115 ScaleFactor=0	CaseType="Linear Static"	CaseName=PPAQ	ComboName=STR117 ScaleFactor=0	CaseType="Linear Static"	CaseName=PPNS
ComboName=STR115 ScaleFactor=1,35	CaseType="Response Combo"	CaseName=SK05	ComboName=STR117 ScaleFactor=0	CaseType="Linear Static"	CaseName=PPAQ
ComboName=STR115 ScaleFactor=0	CaseType="Response Combo"	CaseName=SKAS	ComboName=STR117 ScaleFactor=1,35	CaseType="Response Combo"	CaseName=SK05
ComboName=STR115 ScaleFactor=1,35	CaseType="Response Combo"	CaseName=SWS	ComboName=STR117 ScaleFactor=0	CaseType="Response Combo"	CaseName=SKAS
ComboName=STR115 ScaleFactor=1,35	CaseType="Response Combo"	CaseName=SK0D	ComboName=STR117 ScaleFactor=1,35	CaseType="Response Combo"	CaseName=SWS
ComboName=STR115 ScaleFactor=0	CaseType="Response Combo"	CaseName=SKAD	ComboName=STR117 ScaleFactor=0	CaseType="Response Combo"	CaseName=SK0D
ComboName=STR115 ScaleFactor=1,35	CaseType="Response Combo"	CaseName=SWD	ComboName=STR117 ScaleFactor=1,35	CaseType="Response Combo"	CaseName=SKAD
ComboName=STR115 ScaleFactor=1,35	CaseType="Linear Static"	CaseName=SA	ComboName=STR117 ScaleFactor=0	CaseType="Response Combo"	CaseName=SKAD
ComboName=STR115 ScaleFactor=1,35	CaseType="Linear Static"	CaseName=QM01	ComboName=STR117 ScaleFactor=1,35	CaseType="Response Combo"	CaseName=SWD
ComboName=STR115 ScaleFactor=1,35	CaseType="Linear Static"	CaseName=QM02	ComboName=STR117 ScaleFactor=0	CaseType="Linear Static"	CaseName=SA ScaleFactor=1
ComboName=STR115 ScaleFactor=1,35	CaseType="Linear Static"	CaseName=SQMS	ComboName=STR117 ScaleFactor=0	CaseType="Linear Static"	CaseName=QM01
ComboName=STR115 ScaleFactor=1,35	CaseType="Linear Static"	CaseName=SQMD	ComboName=STR117 ScaleFactor=1,35	CaseType="Linear Static"	CaseName=QM02
ComboName=STR115 ScaleFactor=0	CaseType="Linear Static"	CaseName=FA01	ComboName=STR117 ScaleFactor=1,35	CaseType="Linear Static"	CaseName=SQMS
ComboName=STR115 ScaleFactor=0	CaseType="Linear Static"	CaseName=TC01	ComboName=STR117 ScaleFactor=0	CaseType="Linear Static"	CaseName=SQMD
ComboName=STR115 ScaleFactor=0	CaseType="Linear Static"	CaseName=TC02	ComboName=STR117 ScaleFactor=1,35	CaseType="Linear Static"	CaseName=FA01
ComboName=STR115 ScaleFactor=0	CaseType="Linear Static"	CaseName=TV01	ComboName=STR117 ScaleFactor=0	CaseType="Linear Static"	CaseName=TC01
ComboName=STR115 ScaleFactor=0,72	CaseType="Linear Static"	CaseName=TV02	ComboName=STR117 ScaleFactor=0	CaseType="Linear Static"	CaseName=TC02
ComboName=STR115 ScaleFactor=0	CaseType="Linear Static"	CaseName=RIT ScaleFactor=0	ComboName=STR117 ScaleFactor=0,72	CaseType="Linear Static"	CaseName=TV01
ComboName=STR115 ScaleFactor=0	CaseType="Linear Static"	CaseName=SSTS	ComboName=STR117 ScaleFactor=0	CaseType="Linear Static"	CaseName=TV02
ComboName=STR115 ScaleFactor=0	CaseType="Linear Static"	CaseName=IS01 ScaleFactor=0	ComboName=STR117 ScaleFactor=0	CaseType="Linear Static"	CaseName=RIT ScaleFactor=0
ComboName=STR116 CaseType="Linear Static"	ComboType="Linear Add"	AutoDesign=No	ComboName=STR118 ScaleFactor=1,35	CaseType="Linear Static"	CaseName=SSTS
CaseType="Linear Static"	CaseName=PPST ScaleFactor=1	SteelDesign=No	ComboName=STR118 ScaleFactor=0	CaseType="Linear Static"	CaseName=IS01 ScaleFactor=0
ConcDesign=No AlumDesign=No ColdDesign=No	CaseName=PPNS	CaseName=PPNS	ComboName=STR118 ScaleFactor=1,35	ComboType="Linear Add"	AutoDesign=No
ComboName=STR116 ScaleFactor=1	CaseType="Linear Static"	CaseName=PPAQ	ComboName=STR118 ScaleFactor=0	CaseType="Linear Static"	CaseName=PPST ScaleFactor=1 SteelDesign=No
ComboName=STR116 ScaleFactor=0	CaseType="Linear Static"	CaseName=PPAQ	ComboName=STR118 ScaleFactor=0	CaseType="Linear Static"	ConcDesign=No AlumDesign=No ColdDesign=No

Società di Progetto
Brebemi SpA



ComboName=STR122 ScaleFactor=1	CaseType="Linear Static"	CaseName=PPNS	ComboName=STR124 ScaleFactor=1,35	CaseType="Linear Static"	CaseName=PPNS
ComboName=STR122 ScaleFactor=0	CaseType="Linear Static"	CaseName=PPAQ	ComboName=STR124 ScaleFactor=0	CaseType="Linear Static"	CaseName=PPAQ
ComboName=STR122 ScaleFactor=1,35	CaseType="Response Combo"	CaseName=SK05	ComboName=STR124 ScaleFactor=1,35	CaseType="Response Combo"	CaseName=SK05
ComboName=STR122 ScaleFactor=0	CaseType="Response Combo"	CaseName=SKAS	ComboName=STR124 ScaleFactor=0	CaseType="Response Combo"	CaseName=SKAS
ComboName=STR122 ScaleFactor=1,35	CaseType="Response Combo"	CaseName=SWS	ComboName=STR124 ScaleFactor=1,35	CaseType="Response Combo"	CaseName=SWS
ComboName=STR122 ScaleFactor=0	CaseType="Response Combo"	CaseName=SK0D	ComboName=STR124 ScaleFactor=1,35	CaseType="Response Combo"	CaseName=SK0D
ComboName=STR122 ScaleFactor=1	CaseType="Response Combo"	CaseName=SKAD	ComboName=STR124 ScaleFactor=0	CaseType="Response Combo"	CaseName=SKAD
ComboName=STR122 ScaleFactor=1	CaseType="Response Combo"	CaseName=SWD	ComboName=STR124 ScaleFactor=1,35	CaseType="Response Combo"	CaseName=SWD
ComboName=STR122 ScaleFactor=0	CaseType="Linear Static"	CaseName=SA	ComboName=STR124 ScaleFactor=1,35	CaseType="Linear Static"	CaseName=SA
ComboName=STR122 ScaleFactor=0	CaseType="Linear Static"	CaseName=QM01	ComboName=STR124 ScaleFactor=0	CaseType="Linear Static"	CaseName=QM01
ComboName=STR122 ScaleFactor=0	CaseType="Linear Static"	CaseName=QM02	ComboName=STR124 ScaleFactor=0	CaseType="Linear Static"	CaseName=QM02
ComboName=STR122 ScaleFactor=1,0125	CaseType="Linear Static"	CaseName=SQMS	ComboName=STR124 ScaleFactor=0	CaseType="Linear Static"	CaseName=SQMS
ComboName=STR122 ScaleFactor=0	CaseType="Linear Static"	CaseName=SQMD	ComboName=STR124 ScaleFactor=0	CaseType="Linear Static"	CaseName=SQMD
ComboName=STR122 ScaleFactor=0	CaseType="Linear Static"	CaseName=FA01	ComboName=STR124 ScaleFactor=0	CaseType="Linear Static"	CaseName=FA01
ComboName=STR122 ScaleFactor=0	CaseType="Linear Static"	CaseName=TC01	ComboName=STR124 ScaleFactor=0,72	CaseType="Linear Static"	CaseName=TC01
ComboName=STR122 ScaleFactor=0	CaseType="Linear Static"	CaseName=TC02	ComboName=STR124 ScaleFactor=0	CaseType="Linear Static"	CaseName=TC02
ComboName=STR122 ScaleFactor=0	CaseType="Linear Static"	CaseName=TV01	ComboName=STR124 ScaleFactor=0	CaseType="Linear Static"	CaseName=TV01
ComboName=STR122 ScaleFactor=1,2	CaseType="Linear Static"	CaseName=TV02	ComboName=STR124 ScaleFactor=1,2	CaseType="Linear Static"	CaseName=TV02
ComboName=STR122 ScaleFactor=0	CaseType="Linear Static"	CaseName=RIT	ComboName=STR124 ScaleFactor=0	CaseType="Linear Static"	CaseName=RIT
ComboName=STR122 ScaleFactor=0	CaseType="Linear Static"	CaseName=SSTS	ComboName=STR124 ScaleFactor=0	CaseType="Linear Static"	CaseName=SSTS
ComboName=STR122 CaseType="Linear Static"	CaseName=IS01	ScaleFactor=0	ComboName=STR124 CaseType="Linear Static"	CaseName=IS01	ScaleFactor=0
ComboName=STR123 CaseType="Linear Static"	ComboType="Linear Add"	AutoDesign=No	ComboName=STR125 CaseType="Linear Add"	ComboType="Linear Add"	AutoDesign=No
ConcDesign=No AlumDesign=No ColdDesign=No	CaseName=PPST	ScaleFactor=1 SteelDesign=No	CaseType="Linear Static"	CaseName=PPST	ScaleFactor=1,35 SteelDesign=No
ConcDesign=No AlumDesign=No ColdDesign=No	CaseType="Linear Static"	CaseName=PPNS	ConcDesign=No AlumDesign=No ColdDesign=No	CaseType="Linear Static"	CaseName=PPNS
ScaleFactor=1	CaseType="Linear Static"	CaseName=PPAQ	ComboName=STR125 ScaleFactor=1,35	CaseType="Linear Static"	CaseName=PPAQ
ScaleFactor=0	CaseType="Linear Static"	CaseName=SK05	ComboName=STR125 ScaleFactor=0	CaseType="Linear Static"	CaseName=SK05
ScaleFactor=1,35	CaseType="Response Combo"	CaseName=SKAS	ComboName=STR125 ScaleFactor=0	CaseType="Response Combo"	CaseName=SKAS
ScaleFactor=0	CaseType="Response Combo"	CaseName=SWS	ComboName=STR125 ScaleFactor=1	CaseType="Response Combo"	CaseName=SWS
ScaleFactor=1,35	CaseType="Response Combo"	CaseName=SK0D	ComboName=STR125 ScaleFactor=1	CaseType="Response Combo"	CaseName=SK0D
ScaleFactor=1,35	CaseType="Response Combo"	CaseName=SKAD	ComboName=STR125 ScaleFactor=0	CaseType="Response Combo"	CaseName=SKAD
ScaleFactor=0	CaseType="Response Combo"	CaseName=SWD	ComboName=STR125 ScaleFactor=1	CaseType="Response Combo"	CaseName=SWD
ScaleFactor=1,35	CaseType="Response Combo"	CaseName=SA	ComboName=STR125 ScaleFactor=1	CaseType="Response Combo"	CaseName=SA
ScaleFactor=0	CaseType="Linear Static"	CaseName=QM01	ComboName=STR125 ScaleFactor=1,35	CaseType="Linear Static"	CaseName=QM01
ScaleFactor=0	CaseType="Linear Static"	CaseName=QM02	ComboName=STR125 ScaleFactor=0	CaseType="Linear Static"	CaseName=QM02
ScaleFactor=1,0125	CaseType="Linear Static"	CaseName=SQMS	ComboName=STR125 ScaleFactor=0	CaseType="Linear Static"	CaseName=SQMS
ScaleFactor=1,0125	CaseType="Linear Static"	CaseName=SQMD	ComboName=STR125 ScaleFactor=0	CaseType="Linear Static"	CaseName=SQMD
ScaleFactor=0	CaseType="Linear Static"	CaseName=FA01	ComboName=STR125 ScaleFactor=0	CaseType="Linear Static"	CaseName=FA01
ScaleFactor=0	CaseType="Linear Static"	CaseName=TC01	ComboName=STR125 ScaleFactor=0,72	CaseType="Linear Static"	CaseName=TC01
ScaleFactor=0	CaseType="Linear Static"	CaseName=TC02	ComboName=STR125 ScaleFactor=0	CaseType="Linear Static"	CaseName=TC02
ScaleFactor=0	CaseType="Linear Static"	CaseName=TV01	ComboName=STR125 ScaleFactor=0	CaseType="Linear Static"	CaseName=TV01
ScaleFactor=1,2	CaseType="Linear Static"	CaseName=TV02	ComboName=STR125 ScaleFactor=0	CaseType="Linear Static"	CaseName=TV01
ScaleFactor=0	CaseType="Linear Static"	CaseName=RIT	ComboName=STR125 ScaleFactor=1,2	CaseType="Linear Static"	CaseName=TV02
ScaleFactor=0	CaseType="Linear Static"	CaseName=SSTS	ComboName=STR125 ScaleFactor=0	CaseType="Linear Static"	CaseName=RIT
ScaleFactor=0	CaseType="Linear Static"	CaseName=IS01	ComboName=STR125 ScaleFactor=0	CaseType="Linear Static"	CaseName=SSTS
CaseType="Linear Static"	CaseName=IS01	ScaleFactor=0	ComboName=STR125 ScaleFactor=0	CaseType="Linear Static"	CaseName=IS01
CaseType="Linear Static"	CaseName=PPST	ScaleFactor=1,35 SteelDesign=No	CaseType="Linear Static"	CaseName=PPST	ScaleFactor=1,35 SteelDesign=No
ConcDesign=No AlumDesign=No ColdDesign=No	CaseType="Linear Static"	CaseName=IS01	ConcDesign=No AlumDesign=No ColdDesign=No	CaseType="Linear Static"	CaseName=IS01

ComboName=STR126 CaseType="Linear Static" ConcDesign=No AlumDesign=No ScaleFactor=1,35	ComboType="Linear Add" CaseName=PPST ScaleFactor=1,35	AutoDesign=No SteelDesign=No	ComboName=STR127 CaseType="Linear Static" ScaleFactor=0	CaseType="Linear Static"	CaseName=SSTS
ComboName=STR126 ScaleFactor=1,35	CaseType="Linear Static"	CaseName=PPNS	ComboName=STR127 CaseType="Linear Static" ScaleFactor=1,35	CaseName=IS01 ScaleFactor=0	AutoDesign=No SteelDesign=No
ComboName=STR126 ScaleFactor=0	CaseType="Linear Static"	CaseName=PPAQ	ComboName=STR128 ScaleFactor=1,35	CaseType="Linear Add" CaseName=PPST ScaleFactor=1,35	ConcDesign=No AlumDesign=No ColdDesign=No
ComboName=STR126 ScaleFactor=0	CaseType="Response Combo"	CaseName=SK05	ComboName=STR128 ScaleFactor=0	CaseType="Linear Static"	CaseName=PPNS
ComboName=STR126 ScaleFactor=1	CaseType="Response Combo"	CaseName=SKAS	ComboName=STR128 ScaleFactor=1,35	CaseType="Response Combo"	CaseName=PPAQ
ComboName=STR126 ScaleFactor=1	CaseType="Response Combo"	CaseName=SWS	ComboName=STR128 ScaleFactor=0	CaseType="Response Combo"	CaseName=SK05
ComboName=STR126 ScaleFactor=0	CaseType="Response Combo"	CaseName=SK0D	ComboName=STR128 ScaleFactor=1,35	CaseType="Response Combo"	CaseName=SKAS
ComboName=STR126 ScaleFactor=1	CaseType="Response Combo"	CaseName=SKAD	ComboName=STR128 ScaleFactor=0	CaseType="Response Combo"	CaseName=SWS
ComboName=STR126 ScaleFactor=1	CaseType="Response Combo"	CaseName=SWD	ComboName=STR128 ScaleFactor=1,35	CaseType="Response Combo"	CaseName=SK0D
ComboName=STR126 ScaleFactor=1,35	CaseType="Linear Static"	CaseName=SA	ComboName=STR128 ScaleFactor=0	CaseType="Response Combo"	CaseName=SKAD
ComboName=STR126 ScaleFactor=1,0125	CaseType="Linear Static"	CaseName=QM01	ComboName=STR128 ScaleFactor=1,35	CaseType="Response Combo"	CaseName=SWD
ComboName=STR126 ScaleFactor=1,0125	CaseType="Linear Static"	CaseName=QM02	ComboName=STR128 ScaleFactor=1,0125	CaseType="Linear Static"	CaseName=SA
ComboName=STR126 ScaleFactor=0	CaseType="Linear Static"	CaseName=SQMS	ComboName=STR128 ScaleFactor=1,0125	CaseType="Linear Static"	CaseName=QM01
ComboName=STR126 ScaleFactor=0	CaseType="Linear Static"	CaseName=SQMD	ComboName=STR128 ScaleFactor=0	CaseType="Linear Static"	CaseName=QM02
ComboName=STR126 ScaleFactor=0	CaseType="Linear Static"	CaseName=FA01	ComboName=STR128 ScaleFactor=1,0125	CaseType="Linear Static"	CaseName=SQMS
ComboName=STR126 ScaleFactor=0,72	CaseType="Linear Static"	CaseName=TC01	ComboName=STR128 ScaleFactor=0	CaseType="Linear Static"	CaseName=SQMD
ComboName=STR126 ScaleFactor=0	CaseType="Linear Static"	CaseName=TC02	ComboName=STR128 ScaleFactor=0,72	CaseType="Linear Static"	CaseName=FA01
ComboName=STR126 ScaleFactor=0	CaseType="Linear Static"	CaseName=TV01	ComboName=STR128 ScaleFactor=0	CaseType="Linear Static"	CaseName=TC01
ComboName=STR126 ScaleFactor=1,2	CaseType="Linear Static"	CaseName=TV02	ComboName=STR128 ScaleFactor=0	CaseType="Linear Static"	CaseName=TC02
ComboName=STR126 ScaleFactor=0	CaseType="Linear Static"	CaseName=RIT	ComboName=STR128 ScaleFactor=0	CaseType="Linear Static"	CaseName=TV01
ComboName=STR126 ScaleFactor=0	CaseType="Linear Static"	CaseName=SSTS	ComboName=STR128 ScaleFactor=1,2	CaseType="Linear Static"	CaseName=TV02
ComboName=STR126 ScaleFactor=0	CaseType="Linear Static"	CaseName=IS01	ComboName=STR128 ScaleFactor=0	CaseType="Linear Static"	CaseName=RIT
ComboName=STR127 CaseType="Linear Static" ConcDesign=No AlumDesign=No ScaleFactor=1,35	ComboType="Linear Add" CaseName=PPST ScaleFactor=1,35	AutoDesign=No SteelDesign=No	ComboName=STR128 ScaleFactor=0	CaseType="Linear Static"	CaseName=SSTS
ComboName=STR127 ScaleFactor=1,35	CaseType="Linear Static"	CaseName=PPNS	ComboName=STR129 ScaleFactor=1	CaseType="Linear Add" CaseName=PPST ScaleFactor=1	AutoDesign=No SteelDesign=No
ComboName=STR127 ScaleFactor=0	CaseType="Linear Static"	CaseName=PPAQ	ComboName=STR129 ScaleFactor=0	CaseType="Linear Static"	ConcDesign=No AlumDesign=No ColdDesign=No
ComboName=STR127 ScaleFactor=1,35	CaseType="Response Combo"	CaseName=SK05	ComboName=STR129 ScaleFactor=0	CaseType="Linear Static"	CaseName=PPNS
ComboName=STR127 ScaleFactor=0	CaseType="Response Combo"	CaseName=SKAS	ComboName=STR129 ScaleFactor=1,35	CaseType="Linear Static"	CaseName=PPAQ
ComboName=STR127 ScaleFactor=1,35	CaseType="Response Combo"	CaseName=SWS	ComboName=STR129 ScaleFactor=0	CaseType="Response Combo"	CaseName=SK05
ComboName=STR127 ScaleFactor=0	CaseType="Response Combo"	CaseName=SK0D	ComboName=STR129 ScaleFactor=1,35	CaseType="Response Combo"	CaseName=SKAS
ComboName=STR127 ScaleFactor=1	CaseType="Response Combo"	CaseName=SKAD	ComboName=STR129 ScaleFactor=0	CaseType="Response Combo"	CaseName=SWS
ComboName=STR127 ScaleFactor=1	CaseType="Response Combo"	CaseName=SWD	ComboName=STR129 ScaleFactor=1	CaseType="Response Combo"	CaseName=SK0D
ComboName=STR127 ScaleFactor=1,35	CaseType="Linear Static"	CaseName=SA	ComboName=STR129 ScaleFactor=0	CaseType="Response Combo"	CaseName=SKAD
ComboName=STR127 ScaleFactor=1,0125	CaseType="Linear Static"	CaseName=QM01	ComboName=STR129 ScaleFactor=0,72	CaseType="Response Combo"	CaseName=SKAD
ComboName=STR127 ScaleFactor=1,0125	CaseType="Linear Static"	CaseName=QM02	ComboName=STR129 ScaleFactor=0	CaseType="Response Combo"	CaseName=SA
ComboName=STR127 ScaleFactor=1,0125	CaseType="Linear Static"	CaseName=SQMS	ComboName=STR129 ScaleFactor=0	CaseType="Linear Static"	CaseName=QM01
ComboName=STR127 ScaleFactor=0	CaseType="Linear Static"	CaseName=SQMD	ComboName=STR129 ScaleFactor=1,0125	CaseType="Linear Static"	CaseName=QM02
ComboName=STR127 ScaleFactor=0	CaseType="Linear Static"	CaseName=FA01	ComboName=STR129 ScaleFactor=0	CaseType="Linear Static"	CaseName=SQMS
ComboName=STR127 ScaleFactor=0,72	CaseType="Linear Static"	CaseName=TC01	ComboName=STR129 ScaleFactor=0	CaseType="Linear Static"	CaseName=SQMD
ComboName=STR127 ScaleFactor=0	CaseType="Linear Static"	CaseName=TC02	ComboName=STR129 ScaleFactor=0	CaseType="Linear Static"	CaseName=FA01
ComboName=STR127 ScaleFactor=0	CaseType="Linear Static"	CaseName=TV01	ComboName=STR129 ScaleFactor=0,72	CaseType="Linear Static"	CaseName=TC01
ComboName=STR127 ScaleFactor=1,2	CaseType="Linear Static"	CaseName=TV02	ComboName=STR129 ScaleFactor=0	CaseType="Linear Static"	CaseName=TC02
ComboName=STR127 ScaleFactor=0	CaseType="Linear Static"	CaseName=RIT	ComboName=STR129 ScaleFactor=0	CaseType="Linear Static"	CaseName=TV01
ComboName=STR127 ScaleFactor=0	CaseType="Linear Static"	CaseName=SSTS	ComboName=STR129 ScaleFactor=0	CaseType="Linear Static"	CaseName=TV02



ComboName=STR129	CaseType="Linear Static"	CaseName=RIT	ScaleFactor=0	ComboName=STR131	CaseType="Linear Static"	CaseName=TV02	
ComboName=STR129	CaseType="Linear Static"	CaseName=SSTS		ScaleFactor=1,2			
ComboName=STR129	CaseType="Linear Static"	CaseName=IS01	ScaleFactor=0	ComboName=STR131	CaseType="Linear Static"	CaseName=RIT	ScaleFactor=0
ComboName=STR130	ComboType="Linear Add"	AutoDesign=No		ComboName=STR131	CaseType="Linear Static"	CaseName=SSTS	
CaseType="Linear Static"	CaseName=PPST	ScaleFactor=1	SteelDesign=No	ScaleFactor=0			
ConcDesign=No AlumDesign=No ColdDesign=No				ComboName=STR131	CaseType="Linear Static"	CaseName=IS01	ScaleFactor=0
ComboName=STR130	CaseType="Linear Static"	CaseName=PPNS		ComboName=STR132	ComboType="Linear Add"	AutoDesign=No	
ScaleFactor=1				CaseType="Linear Static"	CaseName=PPST	ScaleFactor=1,35	SteelDesign=No
ComboName=STR130	CaseType="Linear Static"	CaseName=PPAQ		ConcDesign=No AlumDesign=No ColdDesign=No			
ScaleFactor=0				ComboName=STR132	CaseType="Linear Static"	CaseName=PPNS	
ComboName=STR130	CaseType="Response Combo"	CaseName=SK05		ScaleFactor=1,35			
ScaleFactor=1,35				ComboName=STR132	CaseType="Linear Static"	CaseName=PPAQ	
ComboName=STR130	CaseType="Response Combo"	CaseName=SKAS		ScaleFactor=0			
ScaleFactor=0				ComboName=STR132	CaseType="Response Combo"	CaseName=SK05	
ComboName=STR130	CaseType="Response Combo"	CaseName=SWS		ScaleFactor=0			
ScaleFactor=1,35				ComboName=STR132	CaseType="Response Combo"	CaseName=SKAS	
ComboName=STR130	CaseType="Response Combo"	CaseName=SK0D		ScaleFactor=1			
ScaleFactor=1,35				ComboName=STR132	CaseType="Response Combo"	CaseName=SWS	
ComboName=STR130	CaseType="Response Combo"	CaseName=SKAD		ScaleFactor=0			
ScaleFactor=0				ComboName=STR132	CaseType="Response Combo"	CaseName=SK0D	
ComboName=STR130	CaseType="Response Combo"	CaseName=SWD		ScaleFactor=0			
ScaleFactor=1,35				ComboName=STR132	CaseType="Response Combo"	CaseName=SKAD	
ComboName=STR130	CaseType="Linear Static"	CaseName=SA	ScaleFactor=1	ScaleFactor=1			
ComboName=STR130	CaseType="Linear Static"	CaseName=QM01		ComboName=STR132	CaseType="Response Combo"	CaseName=SWD	
ScaleFactor=0				ScaleFactor=1			
ComboName=STR130	CaseType="Linear Static"	CaseName=QM02		ComboName=STR132	CaseType="Linear Static"	CaseName=SA	
ScaleFactor=0				ScaleFactor=1,35			
ComboName=STR130	CaseType="Linear Static"	CaseName=SQMS		ComboName=STR132	CaseType="Linear Static"	CaseName=QM01	
ScaleFactor=1,0125				ScaleFactor=0			
ComboName=STR130	CaseType="Linear Static"	CaseName=SQMD		ComboName=STR132	CaseType="Linear Static"	CaseName=QM02	
ScaleFactor=1,0125				ScaleFactor=0			
ComboName=STR130	CaseType="Linear Static"	CaseName=FA01		ComboName=STR132	CaseType="Linear Static"	CaseName=SQMS	
ScaleFactor=0				ScaleFactor=0			
ComboName=STR130	CaseType="Linear Static"	CaseName=TC01		ComboName=STR132	CaseType="Linear Static"	CaseName=SQMD	
ScaleFactor=0,72				ScaleFactor=0			
ComboName=STR130	CaseType="Linear Static"	CaseName=TC02		ComboName=STR132	CaseType="Linear Static"	CaseName=FA01	
ScaleFactor=0				ScaleFactor=0			
ComboName=STR130	CaseType="Linear Static"	CaseName=TV01		ComboName=STR132	CaseType="Linear Static"	CaseName=TC01	
ScaleFactor=0				ScaleFactor=0			
ComboName=STR130	CaseType="Linear Static"	CaseName=TV02		ComboName=STR132	CaseType="Linear Static"	CaseName=TC02	
ScaleFactor=1,2				ScaleFactor=0,72			
ComboName=STR130	CaseType="Linear Static"	CaseName=RIT	ScaleFactor=0	ComboName=STR132	CaseType="Linear Static"	CaseName=TV01	
ComboName=STR130	CaseType="Linear Static"	CaseName=SSTS		ScaleFactor=0			
ScaleFactor=0				ComboName=STR132	CaseType="Linear Static"	CaseName=TV02	
ComboName=STR130	CaseType="Linear Static"	CaseName=IS01	ScaleFactor=0	ScaleFactor=1,2			
ComboName=STR131	ComboType="Linear Add"	AutoDesign=No		ComboName=STR132	CaseType="Linear Static"	CaseName=RIT	ScaleFactor=0
CaseType="Linear Static"	CaseName=PPST	ScaleFactor=1,35	SteelDesign=No	ComboName=STR132	CaseType="Linear Static"	CaseName=SSTS	
ConcDesign=No AlumDesign=No ColdDesign=No				ScaleFactor=0			
ComboName=STR131	CaseType="Linear Static"	CaseName=PPNS		ComboName=STR132	CaseType="Linear Static"	CaseName=IS01	ScaleFactor=0
ScaleFactor=1,35				ComboName=STR133	ComboType="Linear Add"	AutoDesign=No	
ComboName=STR131	CaseType="Linear Static"	CaseName=PPAQ		CaseType="Linear Static"	CaseName=PPST	ScaleFactor=1,35	SteelDesign=No
ScaleFactor=0				ConcDesign=No AlumDesign=No ColdDesign=No			
ComboName=STR131	CaseType="Response Combo"	CaseName=SK05		ComboName=STR133	CaseType="Linear Static"	CaseName=PPNS	
ScaleFactor=1,35				ScaleFactor=1,35			
ComboName=STR131	CaseType="Response Combo"	CaseName=SKAS		ComboName=STR133	CaseType="Linear Static"	CaseName=PPAQ	
ScaleFactor=0				ScaleFactor=0			
ComboName=STR131	CaseType="Response Combo"	CaseName=SWS		ComboName=STR133	CaseType="Response Combo"	CaseName=SK05	
ScaleFactor=1,35				ScaleFactor=0			
ComboName=STR131	CaseType="Response Combo"	CaseName=SK0D		ComboName=STR133	CaseType="Response Combo"	CaseName=SKAS	
ScaleFactor=1,35				ScaleFactor=1			
ComboName=STR131	CaseType="Response Combo"	CaseName=SKAD		ComboName=STR133	CaseType="Response Combo"	CaseName=SWS	
ScaleFactor=0				ScaleFactor=1			
ComboName=STR131	CaseType="Response Combo"	CaseName=SWD		ScaleFactor=0			
ScaleFactor=1,35				ComboName=STR133	CaseType="Response Combo"	CaseName=SK0D	
ComboName=STR131	CaseType="Linear Static"	CaseName=SA		ScaleFactor=0			
ScaleFactor=1,35				ComboName=STR133	CaseType="Response Combo"	CaseName=SKAD	
ComboName=STR131	CaseType="Linear Static"	CaseName=QM01		ScaleFactor=1			
ScaleFactor=0				ComboName=STR133	CaseType="Response Combo"	CaseName=SWD	
ComboName=STR131	CaseType="Linear Static"	CaseName=QM02		ScaleFactor=1			
ScaleFactor=0				ScaleFactor=1,35			
ComboName=STR131	CaseType="Linear Static"	CaseName=SQMS		ComboName=STR133	CaseType="Linear Static"	CaseName=QM01	
ScaleFactor=0				ScaleFactor=1,0125			
ComboName=STR131	CaseType="Linear Static"	CaseName=SQMD		ComboName=STR133	CaseType="Linear Static"	CaseName=QM02	
ScaleFactor=0				ScaleFactor=1,0125			
ComboName=STR131	CaseType="Linear Static"	CaseName=FA01		ComboName=STR133	CaseType="Linear Static"	CaseName=SQMS	
ScaleFactor=0				ScaleFactor=0			
ComboName=STR131	CaseType="Linear Static"	CaseName=TC01		ComboName=STR133	CaseType="Linear Static"	CaseName=SQMD	
ScaleFactor=0				ScaleFactor=0			
ComboName=STR131	CaseType="Linear Static"	CaseName=TC02		ComboName=STR133	CaseType="Linear Static"	CaseName=FA01	
ScaleFactor=0,72				ScaleFactor=0			
ComboName=STR131	CaseType="Linear Static"	CaseName=TV01		ComboName=STR133	CaseType="Linear Static"	CaseName=TC01	
ScaleFactor=0				ScaleFactor=0			
ComboName=STR131	CaseType="Linear Static"	CaseName=TV02		ComboName=STR133	CaseType="Linear Static"	CaseName=TC02	
ScaleFactor=0				ScaleFactor=0,72			

APPROVATO SGP

Società di Progetto
Brebemi SpA



ComboName=STR137 ScaleFactor=0,72	CaseType="Linear Static"	CaseName=TC02	ComboName=STR139 ScaleFactor=0	CaseType="Linear Static"	CaseName=FA01
ComboName=STR137 ScaleFactor=0	CaseType="Linear Static"	CaseName=TV01	ComboName=STR139 ScaleFactor=0	CaseType="Linear Static"	CaseName=TC01
ComboName=STR137 ScaleFactor=1,2	CaseType="Linear Static"	CaseName=TV02	ComboName=STR139 ScaleFactor=0	CaseType="Linear Static"	CaseName=TC02
ComboName=STR137 ScaleFactor=0	CaseType="Linear Static"	CaseName=RIT	ComboName=STR139 ScaleFactor=0	CaseType="Linear Static"	CaseName=TV01
ComboName=STR137 ScaleFactor=0	CaseType="Linear Static"	CaseName=SSTS	ComboName=STR139 ScaleFactor=0	CaseType="Linear Static"	CaseName=TV02
ComboName=STR137 ScaleFactor=0	CaseType="Linear Static"	CaseName=IS01	ComboName=STR139 ScaleFactor=1,2	CaseType="Linear Static"	CaseName=RIT
ComboName=STR138 CaseType="Linear Static"	ComboType="Linear Add"	AutoDesign=No	ComboName=STR139 ScaleFactor=0,72	CaseType="Linear Static"	CaseName=SSTS
ConcDesign=No AlumDesign=No ColdDesign=No	CaseName=PPST	ScaleFactor=1,35	SteelDesign=No	ComboName=STR139 ScaleFactor=0	CaseType="Linear Static"
ComboName=STR138 ScaleFactor=1,35	CaseType="Linear Static"	CaseName=PPNS	ComboName=STR139 ScaleFactor=0	CaseType="Linear Static"	CaseName=IS01
ComboName=STR138 ScaleFactor=0	CaseType="Linear Static"	CaseName=PPAQ	ComboName=STR140 CaseType="Linear Add"	AutoDesign=No	CaseName=IS01
ComboName=STR138 ScaleFactor=0	CaseType="Response Combo"	CaseName=SK05	CaseType="Linear Static"	CaseName=PPST	ScaleFactor=1,35
ComboName=STR138 ScaleFactor=1,35	CaseType="Response Combo"	CaseName=SKAS	ConcDesign=No AlumDesign=No ColdDesign=No	CaseType="Linear Static"	CaseName=PPNS
ComboName=STR138 ScaleFactor=0	CaseType="Response Combo"	CaseName=SWS	ComboName=STR140 ScaleFactor=1,35	CaseType="Linear Static"	CaseName=PPAQ
ComboName=STR138 ScaleFactor=1,35	CaseType="Response Combo"	CaseName=SK0D	ComboName=STR140 ScaleFactor=0	CaseType="Response Combo"	CaseName=SK05
ComboName=STR138 ScaleFactor=1,35	CaseType="Response Combo"	CaseName=SKAD	ComboName=STR140 ScaleFactor=0	CaseType="Response Combo"	CaseName=SKAS
ComboName=STR138 ScaleFactor=1,35	CaseType="Response Combo"	CaseName=SWD	ComboName=STR140 ScaleFactor=1	CaseType="Response Combo"	CaseName=SWS
ComboName=STR138 ScaleFactor=1,35	CaseType="Linear Static"	CaseName=SA	ComboName=STR140 ScaleFactor=0	CaseType="Response Combo"	CaseName=SK0D
ComboName=STR138 ScaleFactor=0	CaseType="Linear Static"	CaseName=QM01	ComboName=STR140 ScaleFactor=0	CaseType="Response Combo"	CaseName=SKAD
ComboName=STR138 ScaleFactor=0	CaseType="Linear Static"	CaseName=QM02	ComboName=STR140 ScaleFactor=1	CaseType="Response Combo"	CaseName=SWD
ComboName=STR138 ScaleFactor=0	CaseType="Linear Static"	CaseName=SQMS	ComboName=STR140 ScaleFactor=1	CaseType="Response Combo"	CaseName=SA
ComboName=STR138 ScaleFactor=0	CaseType="Linear Static"	CaseName=SQMD	ComboName=STR140 ScaleFactor=1,35	CaseType="Linear Static"	CaseName=QM01
ComboName=STR138 ScaleFactor=0	CaseType="Linear Static"	CaseName=FA01	ComboName=STR140 ScaleFactor=1,0125	CaseType="Linear Static"	CaseName=QM02
ComboName=STR138 ScaleFactor=0	CaseType="Linear Static"	CaseName=TC01	ComboName=STR140 ScaleFactor=1,0125	CaseType="Linear Static"	CaseName=SQMS
ComboName=STR138 ScaleFactor=0	CaseType="Linear Static"	CaseName=TC02	ComboName=STR140 ScaleFactor=0	CaseType="Linear Static"	CaseName=SQMD
ComboName=STR138 ScaleFactor=0	CaseType="Linear Static"	CaseName=TV01	ComboName=STR140 ScaleFactor=0	CaseType="Linear Static"	CaseName=FA01
ComboName=STR138 ScaleFactor=0	CaseType="Linear Static"	CaseName=TV02	ComboName=STR140 ScaleFactor=0	CaseType="Linear Static"	CaseName=TC01
ComboName=STR138 ScaleFactor=1,2	CaseType="Linear Static"	CaseName=RIT	ComboName=STR140 ScaleFactor=0	CaseType="Linear Static"	CaseName=TC02
ComboName=STR138 ScaleFactor=0,72	CaseType="Linear Static"	CaseName=SSTS	ComboName=STR140 ScaleFactor=0	CaseType="Linear Static"	CaseName=TV01
ComboName=STR138 ScaleFactor=0	CaseType="Linear Static"	CaseName=IS01	ComboName=STR140 ScaleFactor=0	CaseType="Linear Static"	CaseName=TV02
ComboName=STR139 CaseType="Linear Static"	ComboType="Linear Add"	AutoDesign=No	ComboName=STR140 ScaleFactor=1,2	CaseType="Linear Static"	CaseName=RIT
ConcDesign=No AlumDesign=No ColdDesign=No	CaseName=PPST	ScaleFactor=1,35	SteelDesign=No	ComboName=STR140 ScaleFactor=0,72	CaseType="Linear Static"
ComboName=STR139 ScaleFactor=1,35	CaseType="Linear Static"	CaseName=PPNS	ComboName=STR140 ScaleFactor=0	CaseType="Linear Static"	CaseName=SSTS
ComboName=STR139 ScaleFactor=0	CaseType="Linear Static"	CaseName=PPAQ	ComboName=STR140 ScaleFactor=0	CaseType="Linear Static"	CaseName=IS01
ComboName=STR139 ScaleFactor=0	CaseType="Response Combo"	CaseName=SK05	CaseType="Linear Static"	CaseName=IS01	ScaleFactor=0
ComboName=STR139 ScaleFactor=0	CaseType="Response Combo"	CaseName=SKAS	CaseType="Linear Static"	CaseName=PPST	ScaleFactor=1,35
ComboName=STR139 ScaleFactor=1	CaseType="Response Combo"	CaseName=SWS	ConcDesign=No AlumDesign=No ColdDesign=No	CaseType="Linear Static"	CaseName=PPNS
ComboName=STR139 ScaleFactor=1	CaseType="Response Combo"	CaseName=SK0D	ComboName=STR141 ScaleFactor=1,35	CaseType="Linear Static"	CaseName=PPAQ
ComboName=STR139 ScaleFactor=0	CaseType="Response Combo"	CaseName=SKAD	ComboName=STR141 ScaleFactor=0	CaseType="Response Combo"	CaseName=SK05
ComboName=STR139 ScaleFactor=1	CaseType="Response Combo"	CaseName=SWD	ComboName=STR141 ScaleFactor=1,35	CaseType="Response Combo"	CaseName=SKAS
ComboName=STR139 ScaleFactor=1,35	CaseType="Linear Static"	CaseName=SA	ComboName=STR141 ScaleFactor=0	CaseType="Response Combo"	CaseName=SWS
ComboName=STR139 ScaleFactor=0	CaseType="Linear Static"	CaseName=QM01	ComboName=STR141 ScaleFactor=1,35	CaseType="Response Combo"	CaseName=SK0D
ComboName=STR139 ScaleFactor=0	CaseType="Linear Static"	CaseName=QM02	ComboName=STR141 ScaleFactor=0	CaseType="Response Combo"	CaseName=SKAD
ComboName=STR139 ScaleFactor=0	CaseType="Linear Static"	CaseName=SQMS	ComboName=STR141 ScaleFactor=1	CaseType="Response Combo"	CaseName=SWD
ComboName=STR139 ScaleFactor=0	CaseType="Linear Static"	CaseName=SQMD	ComboName=STR141 ScaleFactor=1	CaseType="Response Combo"	CaseName=SA
ComboName=STR139 ScaleFactor=0	CaseType="Linear Static"	CaseName=FA01	ComboName=STR141 ScaleFactor=1,35	CaseType="Linear Static"	CaseName=QM01
ComboName=STR139 ScaleFactor=0	CaseType="Linear Static"	CaseName=TC01	ComboName=STR141 ScaleFactor=1,0125	CaseType="Linear Static"	CaseName=QM02
ComboName=STR139 ScaleFactor=0	CaseType="Linear Static"	CaseName=TC02	ComboName=STR141 ScaleFactor=1,0125	CaseType="Linear Static"	CaseName=QM02

APPROVATO SDP

Società di Progetto
Brebemi SpA



ComboName=STR141 ScaleFactor=1,0125	CaseType="Linear Static"	CaseName=SQMS	ComboName=STR143 ScaleFactor=0	CaseType="Linear Static"	CaseName=QM01
ComboName=STR141 ScaleFactor=0	CaseType="Linear Static"	CaseName=SQMD	ComboName=STR143 ScaleFactor=0	CaseType="Linear Static"	CaseName=QM02
ComboName=STR141 ScaleFactor=0	CaseType="Linear Static"	CaseName=FA01	ComboName=STR143 ScaleFactor=1,0125	CaseType="Linear Static"	CaseName=SQMS
ComboName=STR141 ScaleFactor=0	CaseType="Linear Static"	CaseName=TC01	ComboName=STR143 ScaleFactor=0	CaseType="Linear Static"	CaseName=SQMD
ComboName=STR141 ScaleFactor=0	CaseType="Linear Static"	CaseName=TC02	ComboName=STR143 ScaleFactor=0	CaseType="Linear Static"	CaseName=FA01
ComboName=STR141 ScaleFactor=0	CaseType="Linear Static"	CaseName=TV01	ComboName=STR143 ScaleFactor=0	CaseType="Linear Static"	CaseName=TC01
ComboName=STR141 ScaleFactor=1,2	CaseType="Linear Static"	CaseName=TV02	ComboName=STR143 ScaleFactor=0	CaseType="Linear Static"	CaseName=TC02
ComboName=STR141 ScaleFactor=0,72	CaseType="Linear Static"	CaseName=RIT	ComboName=STR143 ScaleFactor=0	CaseType="Linear Static"	CaseName=TV01
ComboName=STR141 ScaleFactor=0	CaseType="Linear Static"	CaseName=SSTS	ComboName=STR143 ScaleFactor=1,2	CaseType="Linear Static"	CaseName=TV02
ComboName=STR141 ScaleFactor=0	CaseType="Linear Static"	CaseName=IS01	ComboName=STR143 ScaleFactor=0,72	CaseType="Linear Static"	CaseName=RIT
ComboName=STR142 CaseType="Linear Static"	CaseType="Linear Add"	AutoDesign=No	ComboName=STR143 ScaleFactor=0	CaseType="Linear Static"	CaseName=SSTS
CaseType="Linear Static"	CaseName=PPST	ScaleFactor=1,35	SteelDesign=No	ComboName=STR143 ScaleFactor=0	CaseName=IS01
ConcDesign=No AlumDesign=No ColdDesign=No	CaseType="Linear Static"	CaseName=PPNS	ComboName=STR143 ScaleFactor=0	CaseType="Linear Add"	AutoDesign=No
ComboName=STR142 ScaleFactor=1,35	CaseType="Linear Static"	CaseName=PPAQ	CaseType="Linear Static"	CaseName=PPST	ScaleFactor=1
ComboName=STR142 ScaleFactor=0	CaseType="Linear Static"	CaseName=SK05	ConcDesign=No AlumDesign=No ColdDesign=No	CaseType="Linear Static"	CaseName=PPNS
ComboName=STR142 ScaleFactor=1,35	CaseType="Response Combo"	CaseName=SKAS	ComboName=STR144 ScaleFactor=1	CaseType="Linear Static"	CaseName=IS01
ComboName=STR142 ScaleFactor=1,35	CaseType="Response Combo"	CaseName=SWS	ComboName=STR144 ScaleFactor=0	CaseType="Linear Add"	AutoDesign=No
ComboName=STR142 ScaleFactor=1,35	CaseType="Response Combo"	CaseName=SK0D	ComboName=STR144 ScaleFactor=1,35	CaseType="Linear Static"	CaseName=PPST
ComboName=STR142 ScaleFactor=1,35	CaseType="Response Combo"	CaseName=SKAD	ComboName=STR144 ScaleFactor=0	CaseType="Linear Static"	CaseName=PPAQ
ComboName=STR142 ScaleFactor=1,35	CaseType="Response Combo"	CaseName=SWD	ComboName=STR144 ScaleFactor=1,35	CaseType="Response Combo"	CaseName=SK05
ComboName=STR142 ScaleFactor=1,35	CaseType="Linear Static"	CaseName=SA	ComboName=STR144 ScaleFactor=0	CaseType="Response Combo"	CaseName=SKAS
ComboName=STR142 ScaleFactor=1,0125	CaseType="Linear Static"	CaseName=QM01	ComboName=STR144 ScaleFactor=1,35	CaseType="Response Combo"	CaseName=SWS
ComboName=STR142 ScaleFactor=1,0125	CaseType="Linear Static"	CaseName=QM02	ComboName=STR144 ScaleFactor=1,35	CaseType="Response Combo"	CaseName=SK0D
ComboName=STR142 ScaleFactor=1,0125	CaseType="Linear Static"	CaseName=SQMS	ComboName=STR144 ScaleFactor=0	CaseType="Response Combo"	CaseName=SKAD
ComboName=STR142 ScaleFactor=1,0125	CaseType="Linear Static"	CaseName=SQMD	ComboName=STR144 ScaleFactor=1,35	CaseType="Response Combo"	CaseName=SWD
ComboName=STR142 ScaleFactor=0	CaseType="Linear Static"	CaseName=FA01	ComboName=STR144 ScaleFactor=1,35	CaseType="Response Combo"	CaseName=SK0D
ComboName=STR142 ScaleFactor=0	CaseType="Linear Static"	CaseName=TC01	ComboName=STR144 ScaleFactor=0	CaseType="Response Combo"	CaseName=SKAD
ComboName=STR142 ScaleFactor=0	CaseType="Linear Static"	CaseName=TC02	ComboName=STR144 ScaleFactor=1,35	CaseType="Response Combo"	CaseName=SWD
ComboName=STR142 ScaleFactor=0	CaseType="Linear Static"	CaseName=TV01	ComboName=STR144 ScaleFactor=1,35	CaseType="Response Combo"	CaseName=SK0D
ComboName=STR142 ScaleFactor=1,2	CaseType="Linear Static"	CaseName=TV02	ComboName=STR144 ScaleFactor=0	CaseType="Response Combo"	CaseName=SKAD
ComboName=STR142 ScaleFactor=0,72	CaseType="Linear Static"	CaseName=RIT	ComboName=STR144 ScaleFactor=1,35	CaseType="Response Combo"	CaseName=SWD
ComboName=STR142 ScaleFactor=0	CaseType="Linear Static"	CaseName=SSTS	ComboName=STR144 ScaleFactor=1,35	CaseType="Response Combo"	CaseName=SK0D
ComboName=STR142 ScaleFactor=0	CaseType="Linear Static"	CaseName=IS01	ComboName=STR144 ScaleFactor=0	CaseType="Response Combo"	CaseName=SKAD
ComboName=STR143 CaseType="Linear Static"	CaseType="Linear Add"	AutoDesign=No	ComboName=STR144 ScaleFactor=1,2	CaseType="Response Combo"	CaseName=RIT
CaseType="Linear Static"	CaseName=PPST	ScaleFactor=1	SteelDesign=No	CaseType="Linear Static"	CaseName=SSTS
ConcDesign=No AlumDesign=No ColdDesign=No	CaseType="Linear Static"	CaseName=PPNS	ComboName=STR144 ScaleFactor=0,72	CaseType="Linear Static"	CaseName=SSTS
ScaleFactor=1	CaseType="Linear Static"	CaseName=PPAQ	ComboName=STR144 ScaleFactor=0	CaseType="Linear Static"	CaseName=IS01
ComboName=STR143 ScaleFactor=0	CaseType="Linear Static"	CaseName=SK05	CaseType="Linear Static"	CaseType="Linear Add"	AutoDesign=No
ComboName=STR143 ScaleFactor=1,35	CaseType="Response Combo"	CaseName=SKAS	CaseType="Linear Static"	CaseName=PPST	ScaleFactor=1,35
ComboName=STR143 ScaleFactor=0	CaseType="Response Combo"	CaseName=SWS	ConcDesign=No AlumDesign=No ColdDesign=No	CaseType="Linear Static"	CaseName=PPNS
ComboName=STR143 ScaleFactor=1,35	CaseType="Response Combo"	CaseName=SK0D	ComboName=STR145 ScaleFactor=1,35	CaseType="Linear Static"	CaseName=PPAQ
ComboName=STR143 ScaleFactor=0	CaseType="Response Combo"	CaseName=SKAD	ComboName=STR145 ScaleFactor=0	CaseType="Linear Static"	CaseName=PPAQ
ComboName=STR143 ScaleFactor=1	CaseType="Response Combo"	CaseName=SWD	ComboName=STR145 ScaleFactor=1,35	CaseType="Response Combo"	CaseName=SK05
ComboName=STR143 ScaleFactor=1	CaseType="Response Combo"	CaseName=SA	ComboName=STR145 ScaleFactor=0	CaseType="Response Combo"	CaseName=SKAS
ComboName=STR143 ScaleFactor=1	CaseType="Response Combo"	CaseName=SA	CaseType="Response Combo"	CaseType="Response Combo"	CaseName=SK0D
CaseType="Linear Static"	CaseName=SA	ScaleFactor=1	CaseType="Response Combo"	CaseType="Response Combo"	CaseName=SKAD

APPROVATO SDR

Società di Progetto
Brebem SpA

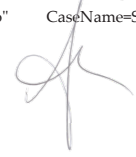

ComboName=STR145 ScaleFactor=1,35	CaseType="Response Combo"	CaseName=SWD	ComboName=STR147 ScaleFactor=0	CaseType="Response Combo"	CaseName=SK0D
ComboName=STR145 ScaleFactor=1,35	CaseType="Linear Static"	CaseName=SA	ComboName=STR147 ScaleFactor=1	CaseType="Response Combo"	CaseName=SKAD
ComboName=STR145 ScaleFactor=0	CaseType="Linear Static"	CaseName=QM01	ComboName=STR147 ScaleFactor=1	CaseType="Response Combo"	CaseName=SWD
ComboName=STR145 ScaleFactor=0	CaseType="Linear Static"	CaseName=QM02	ComboName=STR147 ScaleFactor=1,35	CaseType="Linear Static"	CaseName=SA
ComboName=STR145 ScaleFactor=0	CaseType="Linear Static"	CaseName=SQMS	ComboName=STR147 ScaleFactor=1,35	CaseType="Linear Static"	CaseName=QM01
ComboName=STR145 ScaleFactor=0	CaseType="Linear Static"	CaseName=SQMD	ComboName=STR147 ScaleFactor=1,35	CaseType="Linear Static"	CaseName=QM02
ComboName=STR145 ScaleFactor=0	CaseType="Linear Static"	CaseName=FA01	ComboName=STR147 ScaleFactor=0	CaseType="Linear Static"	CaseName=SQMS
ComboName=STR145 ScaleFactor=0	CaseType="Linear Static"	CaseName=TC01	ComboName=STR147 ScaleFactor=0	CaseType="Linear Static"	CaseName=SQMD
ComboName=STR145 ScaleFactor=0	CaseType="Linear Static"	CaseName=TC02	ComboName=STR147 ScaleFactor=0	CaseType="Linear Static"	CaseName=FA01
ComboName=STR145 ScaleFactor=0	CaseType="Linear Static"	CaseName=TV01	ComboName=STR147 ScaleFactor=0	CaseType="Linear Static"	CaseName=TC01
ComboName=STR145 ScaleFactor=0	CaseType="Linear Static"	CaseName=TV02	ComboName=STR147 ScaleFactor=0	CaseType="Linear Static"	CaseName=TC02
ComboName=STR145 ScaleFactor=1,2	CaseType="Linear Static"	CaseName=RIT	ComboName=STR147 ScaleFactor=0	CaseType="Linear Static"	CaseName=TV01
ComboName=STR145 ScaleFactor=0	CaseType="Linear Static"	CaseName=SSTS	ComboName=STR147 ScaleFactor=0	CaseType="Linear Static"	CaseName=TV02
ComboName=STR145 ScaleFactor=0	CaseType="Linear Static"	CaseName=IS01	ComboName=STR147 ScaleFactor=0,72	CaseType="Linear Static"	CaseName=RIT
ComboName=STR146 CaseType="Linear Static"	ComboType="Linear Add"	CaseName=PPST ScaleFactor=1,35 SteelDesign=No ConcDesign=No AlumDesign=No ColdDesign=No	ComboName=STR147 ScaleFactor=0	CaseType="Linear Static"	CaseName=SSTS
ComboName=STR146 ScaleFactor=1,35	CaseType="Linear Static"	CaseName=PPNS	ComboName=STR147 ScaleFactor=0	CaseType="Linear Static"	CaseName=IS01 ScaleFactor=0 AutoDesign=No
ComboName=STR146 ScaleFactor=0	CaseType="Linear Static"	CaseName=PPAQ	ComboName=STR148 CaseType="Linear Static"	CaseName=PPST ScaleFactor=1,35 SteelDesign=No ConcDesign=No AlumDesign=No ColdDesign=No	CaseName=PPNS
ComboName=STR146 ScaleFactor=0	CaseType="Response Combo"	CaseName=SK0S	ComboName=STR148 ScaleFactor=1,35	CaseType="Linear Static"	CaseName=PPAQ
ComboName=STR146 ScaleFactor=1	CaseType="Response Combo"	CaseName=SKAS	ComboName=STR148 ScaleFactor=0	CaseType="Linear Static"	CaseName=PPAQ
ComboName=STR146 ScaleFactor=1	CaseType="Response Combo"	CaseName=SWS	ComboName=STR148 ScaleFactor=1,35	CaseType="Response Combo"	CaseName=SK0S
ComboName=STR146 ScaleFactor=0	CaseType="Response Combo"	CaseName=SK0D	ComboName=STR148 ScaleFactor=0	CaseType="Response Combo"	CaseName=SKAS
ComboName=STR146 ScaleFactor=1	CaseType="Response Combo"	CaseName=SKAD	ComboName=STR148 ScaleFactor=1,35	CaseType="Response Combo"	CaseName=SWS
ComboName=STR146 ScaleFactor=1	CaseType="Response Combo"	CaseName=SWD	ComboName=STR148 ScaleFactor=0	CaseType="Response Combo"	CaseName=SK0D
ComboName=STR146 ScaleFactor=1,35	CaseType="Linear Static"	CaseName=SA	ComboName=STR148 ScaleFactor=1	CaseType="Response Combo"	CaseName=SKAD
ComboName=STR146 ScaleFactor=0	CaseType="Linear Static"	CaseName=QM01	ComboName=STR148 ScaleFactor=1	CaseType="Response Combo"	CaseName=SWD
ComboName=STR146 ScaleFactor=0	CaseType="Linear Static"	CaseName=QM02	ComboName=STR148 ScaleFactor=1,35	CaseType="Response Combo"	CaseName=SK0D
ComboName=STR146 ScaleFactor=0	CaseType="Linear Static"	CaseName=SQMS	ComboName=STR148 ScaleFactor=0	CaseType="Response Combo"	CaseName=SKAD
ComboName=STR146 ScaleFactor=0	CaseType="Linear Static"	CaseName=SQMD	ComboName=STR148 ScaleFactor=1,35	CaseType="Response Combo"	CaseName=SWD
ComboName=STR146 ScaleFactor=0	CaseType="Linear Static"	CaseName=FA01	ComboName=STR148 ScaleFactor=1,35	CaseType="Response Combo"	CaseName=SK0D
ComboName=STR146 ScaleFactor=0	CaseType="Linear Static"	CaseName=TC01	ComboName=STR148 ScaleFactor=0	CaseType="Response Combo"	CaseName=SKAD
ComboName=STR146 ScaleFactor=0	CaseType="Linear Static"	CaseName=TC02	ComboName=STR148 ScaleFactor=0	CaseType="Response Combo"	CaseName=SWD
ComboName=STR146 ScaleFactor=0	CaseType="Linear Static"	CaseName=TV01	ComboName=STR148 ScaleFactor=0	CaseType="Response Combo"	CaseName=SKAD
ComboName=STR146 ScaleFactor=0	CaseType="Linear Static"	CaseName=TV02	ComboName=STR148 ScaleFactor=0	CaseType="Response Combo"	CaseName=SWD
ComboName=STR146 ScaleFactor=1,2	CaseType="Linear Static"	CaseName=RIT	ComboName=STR148 ScaleFactor=0	CaseType="Response Combo"	CaseName=SKAD
ComboName=STR146 ScaleFactor=0	CaseType="Linear Static"	CaseName=SSTS	ComboName=STR148 ScaleFactor=0	CaseType="Response Combo"	CaseName=SWD
ComboName=STR146 ScaleFactor=0	CaseType="Linear Static"	CaseName=IS01	ComboName=STR148 ScaleFactor=0	CaseType="Response Combo"	CaseName=SKAD
ComboName=STR147 CaseType="Linear Static"	ComboType="Linear Add"	CaseName=PPST ScaleFactor=1,35 SteelDesign=No ConcDesign=No AlumDesign=No ColdDesign=No	ComboName=STR148 ScaleFactor=0,72	CaseType="Response Combo"	CaseName=SWD
ComboName=STR147 ScaleFactor=1,35	CaseType="Linear Static"	CaseName=PPNS	ComboName=STR148 ScaleFactor=0	CaseType="Response Combo"	CaseName=SKAD
ComboName=STR147 ScaleFactor=0	CaseType="Linear Static"	CaseName=PPAQ	ComboName=STR148 ScaleFactor=0	CaseType="Response Combo"	CaseName=SWD
ComboName=STR147 ScaleFactor=0	CaseType="Response Combo"	CaseName=SK0S	ComboName=STR148 ScaleFactor=0	CaseType="Response Combo"	CaseName=SKAD
ComboName=STR147 ScaleFactor=1	CaseType="Response Combo"	CaseName=SKAS	ComboName=STR148 ScaleFactor=0	CaseType="Response Combo"	CaseName=SWD
ComboName=STR147 ScaleFactor=1	CaseType="Response Combo"	CaseName=SWS	ComboName=STR148 ScaleFactor=0	CaseType="Response Combo"	CaseName=SKAD

APPROVATO SDP

Società di Progetto
Brebemi SpA

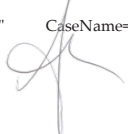

ComboName=STR149 ScaleFactor=0	CaseType="Response Combo"	CaseName=SKAS	ComboName=STR151 ScaleFactor=0	CaseType="Linear Static"	CaseName=PPAQ
ComboName=STR149 ScaleFactor=1,35	CaseType="Response Combo"	CaseName=SWS	ComboName=STR151 ScaleFactor=1,35	CaseType="Response Combo"	CaseName=SK05
ComboName=STR149 ScaleFactor=1,35	CaseType="Response Combo"	CaseName=SK0D	ComboName=STR151 ScaleFactor=0	CaseType="Response Combo"	CaseName=SKAS
ComboName=STR149 ScaleFactor=0	CaseType="Response Combo"	CaseName=SKAD	ComboName=STR151 ScaleFactor=1,35	CaseType="Response Combo"	CaseName=SWS
ComboName=STR149 ScaleFactor=1,35	CaseType="Response Combo"	CaseName=SWD	ComboName=STR151 ScaleFactor=1,35	CaseType="Response Combo"	CaseName=SK0D
ComboName=STR149 ScaleFactor=1,35	CaseType="Linear Static"	CaseName=SA	ComboName=STR151 ScaleFactor=0	CaseType="Response Combo"	CaseName=SKAD
ComboName=STR149 ScaleFactor=1,35	CaseType="Linear Static"	CaseName=QM01	ComboName=STR151 ScaleFactor=1,35	CaseType="Response Combo"	CaseName=SWD
ComboName=STR149 ScaleFactor=1,35	CaseType="Linear Static"	CaseName=QM02	ComboName=STR151 ScaleFactor=0	CaseType="Linear Static"	CaseName=SA ScaleFactor=1
ComboName=STR149 ScaleFactor=1,35	CaseType="Linear Static"	CaseName=SQMS	ComboName=STR151 ScaleFactor=0	CaseType="Linear Static"	CaseName=QM01
ComboName=STR149 ScaleFactor=1,35	CaseType="Linear Static"	CaseName=SQMD	ComboName=STR151 ScaleFactor=0	CaseType="Linear Static"	CaseName=QM02
ComboName=STR149 ScaleFactor=0	CaseType="Linear Static"	CaseName=FA01	ComboName=STR151 ScaleFactor=1,35	CaseType="Linear Static"	CaseName=SQMS
ComboName=STR149 ScaleFactor=0	CaseType="Linear Static"	CaseName=TC01	ComboName=STR151 ScaleFactor=1,35	CaseType="Linear Static"	CaseName=SQMD
ComboName=STR149 ScaleFactor=0	CaseType="Linear Static"	CaseName=TC02	ComboName=STR151 ScaleFactor=0	CaseType="Linear Static"	CaseName=FA01
ComboName=STR149 ScaleFactor=0	CaseType="Linear Static"	CaseName=TV01	ComboName=STR151 ScaleFactor=0	CaseType="Linear Static"	CaseName=TC01
ComboName=STR149 ScaleFactor=0	CaseType="Linear Static"	CaseName=TV02	ComboName=STR151 ScaleFactor=0	CaseType="Linear Static"	CaseName=TC02
ComboName=STR149 ScaleFactor=0,72	CaseType="Linear Static"	CaseName=RIT	ComboName=STR151 ScaleFactor=0	CaseType="Linear Static"	CaseName=TV01
ComboName=STR149 ScaleFactor=0	CaseType="Linear Static"	CaseName=SSTS	ComboName=STR151 ScaleFactor=0	CaseType="Linear Static"	CaseName=TV02
ComboName=STR149 ScaleFactor=0	CaseType="Linear Static"	CaseName=IS01 ScaleFactor=0	ComboName=STR151 ScaleFactor=0,72	CaseType="Linear Static"	CaseName=RIT
ComboName=STR150 CaseType="Linear Static"	CaseType="Linear Add"	AutoDesign=No	ComboName=STR151 ScaleFactor=0	CaseType="Linear Static"	CaseName=SSTS
CaseType="Linear Static"	CaseName=PPST ScaleFactor=1	SteelDesign=No	ComboName=STR151 ScaleFactor=0	CaseType="Linear Static"	CaseName=IS01 ScaleFactor=0
ConcDesign=No AlumDesign=No ColdDesign=No	CaseType="Linear Static"	CaseName=PPNS	ComboName=STR151 ScaleFactor=0	CaseType="Linear Add"	AutoDesign=No
ComboName=STR150 ScaleFactor=1	CaseType="Linear Static"	CaseName=PPAQ	CaseType="Linear Static"	CaseName=PPST ScaleFactor=1,35	SteelDesign=No
ComboName=STR150 ScaleFactor=0	CaseType="Response Combo"	CaseName=SK05	ConcDesign=No AlumDesign=No ColdDesign=No	CaseType="Linear Static"	CaseName=PPNS
ComboName=STR150 ScaleFactor=1,35	CaseType="Response Combo"	CaseName=SKAS	ComboName=STR152 ScaleFactor=1,35	CaseType="Linear Static"	CaseName=PPAQ
ComboName=STR150 ScaleFactor=0	CaseType="Response Combo"	CaseName=SWS	ComboName=STR152 ScaleFactor=0	CaseType="Linear Static"	CaseName=SK05
ComboName=STR150 ScaleFactor=1,35	CaseType="Response Combo"	CaseName=SK0D	ComboName=STR152 ScaleFactor=1,35	CaseType="Response Combo"	CaseName=SKAS
ComboName=STR150 ScaleFactor=0	CaseType="Response Combo"	CaseName=SKAD	ComboName=STR152 ScaleFactor=0	CaseType="Response Combo"	CaseName=SWS
ComboName=STR150 ScaleFactor=1	CaseType="Response Combo"	CaseName=SKAD	ComboName=STR152 ScaleFactor=1,35	CaseType="Response Combo"	CaseName=SK0D
ComboName=STR150 ScaleFactor=1	CaseType="Response Combo"	CaseName=SWD	ComboName=STR152 ScaleFactor=0	CaseType="Response Combo"	CaseName=SKAD
ComboName=STR150 ScaleFactor=0	CaseType="Linear Static"	CaseName=SA ScaleFactor=1	ComboName=STR152 ScaleFactor=1	CaseType="Response Combo"	CaseName=SKAD
ComboName=STR150 ScaleFactor=0	CaseType="Linear Static"	CaseName=QM01	ComboName=STR152 ScaleFactor=1	CaseType="Response Combo"	CaseName=SWD
ComboName=STR150 ScaleFactor=0	CaseType="Linear Static"	CaseName=QM02	ComboName=STR152 ScaleFactor=1,35	CaseType="Linear Static"	CaseName=SA
ComboName=STR150 ScaleFactor=1,35	CaseType="Linear Static"	CaseName=SQMS	ComboName=STR152 ScaleFactor=1,0125	CaseType="Linear Static"	CaseName=QM01
ComboName=STR150 ScaleFactor=0	CaseType="Linear Static"	CaseName=SQMD	ComboName=STR152 ScaleFactor=1,0125	CaseType="Linear Static"	CaseName=QM02
ComboName=STR150 ScaleFactor=0	CaseType="Linear Static"	CaseName=FA01	ComboName=STR152 ScaleFactor=1,0125	CaseType="Linear Static"	CaseName=SQMS
ComboName=STR150 ScaleFactor=0	CaseType="Linear Static"	CaseName=TC01	ComboName=STR152 ScaleFactor=0	CaseType="Linear Static"	CaseName=SQMD
ComboName=STR150 ScaleFactor=0	CaseType="Linear Static"	CaseName=TC02	ComboName=STR152 ScaleFactor=1,35	CaseType="Linear Static"	CaseName=FA01
ComboName=STR150 ScaleFactor=0	CaseType="Linear Static"	CaseName=TV01	ComboName=STR152 ScaleFactor=0	CaseType="Linear Static"	CaseName=TC01
ComboName=STR150 ScaleFactor=0	CaseType="Linear Static"	CaseName=TV02	ComboName=STR152 ScaleFactor=0	CaseType="Linear Static"	CaseName=TC02
ComboName=STR150 ScaleFactor=0,72	CaseType="Linear Static"	CaseName=RIT	ComboName=STR152 ScaleFactor=0	CaseType="Linear Static"	CaseName=TV01
ComboName=STR150 ScaleFactor=0	CaseType="Linear Static"	CaseName=SSTS	ComboName=STR152 ScaleFactor=0	CaseType="Linear Static"	CaseName=TV02
ComboName=STR150 ScaleFactor=0	CaseType="Linear Static"	CaseName=IS01 ScaleFactor=0	ComboName=STR152 ScaleFactor=0,72	CaseType="Linear Static"	CaseName=RIT
ComboName=STR151 CaseType="Linear Static"	CaseType="Linear Add"	AutoDesign=No	ComboName=STR152 ScaleFactor=0	CaseType="Linear Static"	CaseName=SSTS
CaseType="Linear Static"	CaseName=PPST ScaleFactor=1	SteelDesign=No	ComboName=STR152 ScaleFactor=0	CaseType="Linear Static"	CaseName=IS01 ScaleFactor=0
ConcDesign=No AlumDesign=No ColdDesign=No	CaseType="Linear Static"	CaseName=PPNS	ComboName=STR152 ScaleFactor=0	CaseType="Linear Static"	CaseName=IS01 ScaleFactor=0
ComboName=STR151 ScaleFactor=1	CaseType="Linear Static"	CaseName=PPNS	ComboName=STR152 ScaleFactor=0	CaseType="Linear Static"	CaseName=IS01 ScaleFactor=0

ComboName=STR153 CaseType="Linear Static" ConcDesign=No AlumDesign=No ColdDesign=No ScaleFactor=1,35	ComboType="Linear Add" CaseName=PPST ScaleFactor=1,35	AutoDesign=No SteelDesign=No	ComboName=STR154 ScaleFactor=1,2	CaseType="Linear Static"	CaseName=RIT
ComboName=STR153 ScaleFactor=1,35	CaseType="Linear Static"	CaseName=PPNS	ComboName=STR154 ScaleFactor=0	CaseType="Linear Static"	CaseName=SSTS
ComboName=STR153 ScaleFactor=0	CaseType="Linear Static"	CaseName=PPAQ	ComboName=STR154 CaseType="Linear Static"	CaseName=IS01	ScaleFactor=0
ComboName=STR153 ScaleFactor=0	CaseType="Response Combo"	CaseName=SK05	ComboName=STR155 CaseType="Linear Static"	CaseName=PPST	ScaleFactor=1,35
ComboName=STR153 ScaleFactor=1	CaseType="Response Combo"	CaseName=SKAS	ConcDesign=No AlumDesign=No ColdDesign=No	CaseType="Linear Static"	CaseName=PPNS
ComboName=STR153 ScaleFactor=1	CaseType="Response Combo"	CaseName=SWS	ComboName=STR155 ScaleFactor=1,35	CaseType="Linear Static"	CaseName=PPAQ
ComboName=STR153 ScaleFactor=0	CaseType="Response Combo"	CaseName=SK0D	ComboName=STR155 ScaleFactor=0	CaseType="Response Combo"	CaseName=SK05
ComboName=STR153 ScaleFactor=1	CaseType="Response Combo"	CaseName=SKAD	ComboName=STR155 ScaleFactor=1,35	CaseType="Response Combo"	CaseName=SKAS
ComboName=STR153 ScaleFactor=1	CaseType="Response Combo"	CaseName=SWD	ComboName=STR155 ScaleFactor=1,35	CaseType="Response Combo"	CaseName=SWS
ComboName=STR153 ScaleFactor=1,35	CaseType="Linear Static"	CaseName=SA	ComboName=STR155 ScaleFactor=0	CaseType="Response Combo"	CaseName=SK0D
ComboName=STR153 ScaleFactor=1,0125	CaseType="Linear Static"	CaseName=QM01	ComboName=STR155 ScaleFactor=1,35	CaseType="Response Combo"	CaseName=SKAD
ComboName=STR153 ScaleFactor=1,0125	CaseType="Linear Static"	CaseName=QM02	ComboName=STR155 ScaleFactor=1,35	CaseType="Response Combo"	CaseName=SWD
ComboName=STR153 ScaleFactor=0	CaseType="Linear Static"	CaseName=SQMS	ComboName=STR155 ScaleFactor=1,35	CaseType="Response Combo"	CaseName=SA
ComboName=STR153 ScaleFactor=0	CaseType="Linear Static"	CaseName=SQMD	ComboName=STR155 ScaleFactor=1,0125	CaseType="Linear Static"	CaseName=QM01
ComboName=STR153 ScaleFactor=0	CaseType="Linear Static"	CaseName=FA01	ComboName=STR155 ScaleFactor=1,0125	CaseType="Linear Static"	CaseName=QM02
ComboName=STR153 ScaleFactor=0	CaseType="Linear Static"	CaseName=TC01	ComboName=STR155 ScaleFactor=1,0125	CaseType="Linear Static"	CaseName=SQMS
ComboName=STR153 ScaleFactor=0	CaseType="Linear Static"	CaseName=TC02	ComboName=STR155 ScaleFactor=1,0125	CaseType="Linear Static"	CaseName=SQMD
ComboName=STR153 ScaleFactor=0	CaseType="Linear Static"	CaseName=TV01	ComboName=STR155 ScaleFactor=0	CaseType="Linear Static"	CaseName=FA01
ComboName=STR153 ScaleFactor=0	CaseType="Linear Static"	CaseName=TV02	ComboName=STR155 ScaleFactor=0	CaseType="Linear Static"	CaseName=TC01
ComboName=STR153 ScaleFactor=1,2	CaseType="Linear Static"	CaseName=RIT	ComboName=STR155 ScaleFactor=0	CaseType="Linear Static"	CaseName=TC02
ComboName=STR153 ScaleFactor=0	CaseType="Linear Static"	CaseName=SSTS	ComboName=STR155 ScaleFactor=0	CaseType="Linear Static"	CaseName=TV01
ComboName=STR153 ScaleFactor=0	CaseType="Linear Static"	CaseName=IS01	ScaleFactor=0	CaseType="Linear Static"	CaseName=TV02
ComboName=STR154 CaseType="Linear Static"	ComboType="Linear Add"	AutoDesign=No	ComboName=STR155 ScaleFactor=1,2	CaseType="Linear Static"	CaseName=RIT
CaseType="Linear Static"	CaseName=PPST	ScaleFactor=1,35	SteelDesign=No	CaseType="Linear Static"	CaseName=SSTS
ConcDesign=No AlumDesign=No ColdDesign=No	CaseType="Linear Static"	CaseName=PPNS	ComboName=STR155 ScaleFactor=0	CaseType="Linear Static"	CaseName=IS01
ScaleFactor=1,35	CaseType="Linear Static"	CaseName=PPAQ	CaseType="Linear Static"	CaseName=IS01	ScaleFactor=0
ComboName=STR154 ScaleFactor=0	CaseType="Linear Static"	CaseName=PPAQ	ComboName=STR156 CaseType="Linear Add"	AutoDesign=No	ScaleFactor=0
ComboName=STR154 ScaleFactor=1,35	CaseType="Response Combo"	CaseName=SK05	CaseType="Linear Static"	CaseName=PPST	ScaleFactor=1
ComboName=STR154 ScaleFactor=0	CaseType="Response Combo"	CaseName=SKAS	ConcDesign=No AlumDesign=No ColdDesign=No	CaseType="Linear Static"	SteelDesign=No
ComboName=STR154 ScaleFactor=1,35	CaseType="Response Combo"	CaseName=SKAS	ComboName=STR156 CaseType="Linear Static"	CaseName=PPNS	ScaleFactor=1,35
ComboName=STR154 ScaleFactor=0	CaseType="Response Combo"	CaseName=SWS	ScaleFactor=1	CaseName=PPAQ	ScaleFactor=1
ComboName=STR154 ScaleFactor=1,35	CaseType="Response Combo"	CaseName=SK0D	ComboName=STR156 ScaleFactor=0	CaseType="Linear Static"	CaseName=SK05
ComboName=STR154 ScaleFactor=0	CaseType="Response Combo"	CaseName=SK0D	ComboName=STR156 ScaleFactor=1,35	CaseType="Response Combo"	CaseName=SKAS
ComboName=STR154 ScaleFactor=1	CaseType="Response Combo"	CaseName=SKAD	ComboName=STR156 ScaleFactor=0	CaseType="Response Combo"	CaseName=SKAS
ComboName=STR154 ScaleFactor=1	CaseType="Response Combo"	CaseName=SWD	ComboName=STR156 ScaleFactor=1,35	CaseType="Response Combo"	CaseName=SWS
ComboName=STR154 ScaleFactor=1,35	CaseType="Linear Static"	CaseName=SA	ComboName=STR156 ScaleFactor=0	CaseType="Response Combo"	CaseName=SK0D
ComboName=STR154 ScaleFactor=1,0125	CaseType="Linear Static"	CaseName=QM01	ComboName=STR156 ScaleFactor=1	CaseType="Response Combo"	CaseName=SKAD
ComboName=STR154 ScaleFactor=1,0125	CaseType="Linear Static"	CaseName=QM02	ComboName=STR156 ScaleFactor=1	CaseType="Response Combo"	CaseName=SWD
ComboName=STR154 ScaleFactor=1,0125	CaseType="Linear Static"	CaseName=SQMS	ComboName=STR156 ScaleFactor=1	CaseType="Response Combo"	CaseName=SWD
ComboName=STR154 ScaleFactor=0	CaseType="Linear Static"	CaseName=SQMD	CaseType="Linear Static"	CaseName=SA	ScaleFactor=1
ComboName=STR154 ScaleFactor=0	CaseType="Linear Static"	CaseName=FA01	CaseType="Linear Static"	CaseName=QM01	ScaleFactor=0
ComboName=STR154 ScaleFactor=0	CaseType="Linear Static"	CaseName=TC01	CaseType="Linear Static"	CaseName=QM02	ScaleFactor=0
ComboName=STR154 ScaleFactor=0	CaseType="Linear Static"	CaseName=TC02	CaseType="Linear Static"	CaseName=SQMS	ScaleFactor=0
ComboName=STR154 ScaleFactor=0	CaseType="Linear Static"	CaseName=TV01	CaseType="Linear Static"	CaseName=SQMD	ScaleFactor=0
ComboName=STR154 ScaleFactor=0	CaseType="Linear Static"	CaseName=TV02	CaseType="Linear Static"	CaseName=FA01	ScaleFactor=0
ComboName=STR154 ScaleFactor=0	CaseType="Linear Static"	CaseName=TC01	CaseType="Linear Static"	CaseName=TC01	ScaleFactor=0
ComboName=STR154 ScaleFactor=0	CaseType="Linear Static"	CaseName=TC02	CaseType="Linear Static"	CaseName=TC02	ScaleFactor=0
ComboName=STR154 ScaleFactor=0	CaseType="Linear Static"	CaseName=TV01	CaseType="Linear Static"	CaseName=TV01	ScaleFactor=0
ComboName=STR154 ScaleFactor=0	CaseType="Linear Static"	CaseName=TV02	CaseType="Linear Static"	CaseName=TV02	ScaleFactor=0

APPROVATO SDR

Società di Progetto
Brebemi SpA



ComboName=STR156 ScaleFactor=0	CaseType="Linear Static"	CaseName=TV01	ComboName=STR158 ScaleFactor=0,72	CaseType="Linear Static"	CaseName=TC01
ComboName=STR156 ScaleFactor=0	CaseType="Linear Static"	CaseName=TV02	ComboName=STR158 ScaleFactor=0	CaseType="Linear Static"	CaseName=TC02
ComboName=STR156 ScaleFactor=1,2	CaseType="Linear Static"	CaseName=RIT	ComboName=STR158 ScaleFactor=0	CaseType="Linear Static"	CaseName=TV01
ComboName=STR156 ScaleFactor=0	CaseType="Linear Static"	CaseName=SSTS	ComboName=STR158 ScaleFactor=0	CaseType="Linear Static"	CaseName=TV02
ComboName=STR156 CaseType="Linear Static"	CaseName=IS01 ScaleFactor=0	ComboName=STR157 CaseType="Linear Add"	AutoDesign=No	CaseName=STR158 CaseType="Linear Static"	CaseName=RIT
CaseType="Linear Static"	CaseName=PPST ScaleFactor=1	SteelDesign=No	ConcDesign=No AlumDesign=No ColdDesign=No	ComboName=STR158 CaseType="Linear Static"	CaseName=SSTS
ComboName=STR157 ScaleFactor=1	CaseType="Linear Static"	CaseName=PPNS	ComboName=STR158 CaseType="Linear Static"	CaseName=IS01 ScaleFactor=0	AutoDesign=No
ComboName=STR157 ScaleFactor=0	CaseType="Linear Static"	CaseName=PPAQ	ComboName=STR159 CaseType="Linear Add"	AutoDesign=No	CaseName=PPST ScaleFactor=1,35
ComboName=STR157 ScaleFactor=1,35	CaseType="Response Combo"	CaseName=SK05	ConcDesign=No AlumDesign=No ColdDesign=No	CaseName=STR159 CaseType="Linear Static"	CaseName=PPNS
ComboName=STR157 ScaleFactor=0	CaseType="Response Combo"	CaseName=SKAS	ComboName=STR159 ScaleFactor=1,35	CaseType="Linear Static"	CaseName=PPAQ
ComboName=STR157 ScaleFactor=1,35	CaseType="Response Combo"	CaseName=SWS	ComboName=STR159 ScaleFactor=0	CaseType="Response Combo"	CaseName=SK05
ComboName=STR157 ScaleFactor=1,35	CaseType="Response Combo"	CaseName=SK0D	ComboName=STR159 ScaleFactor=1	CaseType="Response Combo"	CaseName=SKAS
ComboName=STR157 ScaleFactor=0	CaseType="Response Combo"	CaseName=SKAD	ComboName=STR159 ScaleFactor=1	CaseType="Response Combo"	CaseName=SWS
ComboName=STR157 ScaleFactor=1,35	CaseType="Response Combo"	CaseName=SWD	ComboName=STR159 ScaleFactor=0	CaseType="Response Combo"	CaseName=SK0D
ComboName=STR157 ScaleFactor=0	CaseType="Linear Static"	CaseName=SA ScaleFactor=1	ComboName=STR159 ScaleFactor=1	CaseType="Response Combo"	CaseName=SKAD
ComboName=STR157 ScaleFactor=0	CaseType="Linear Static"	CaseName=QM01	ComboName=STR159 ScaleFactor=1	CaseType="Response Combo"	CaseName=SWD
ComboName=STR157 ScaleFactor=0	CaseType="Linear Static"	CaseName=QM02	ComboName=STR159 ScaleFactor=1	CaseType="Response Combo"	CaseName=SWD
ComboName=STR157 ScaleFactor=1,0125	CaseType="Linear Static"	CaseName=SQMS	ComboName=STR159 ScaleFactor=1,35	CaseType="Linear Static"	CaseName=SA
ComboName=STR157 ScaleFactor=1,0125	CaseType="Linear Static"	CaseName=SQMD	ComboName=STR159 ScaleFactor=0	CaseType="Linear Static"	CaseName=QM01
ComboName=STR157 ScaleFactor=0	CaseType="Linear Static"	CaseName=FA01	ComboName=STR159 ScaleFactor=0	CaseType="Linear Static"	CaseName=QM02
ComboName=STR157 ScaleFactor=0	CaseType="Linear Static"	CaseName=TC01	ComboName=STR159 ScaleFactor=0	CaseType="Linear Static"	CaseName=SQMS
ComboName=STR157 ScaleFactor=0	CaseType="Linear Static"	CaseName=TC02	ComboName=STR159 ScaleFactor=0	CaseType="Linear Static"	CaseName=SQMD
ComboName=STR157 ScaleFactor=0	CaseType="Linear Static"	CaseName=TV01	ComboName=STR159 ScaleFactor=0	CaseType="Linear Static"	CaseName=FA01
ComboName=STR157 ScaleFactor=0	CaseType="Linear Static"	CaseName=TV02	ComboName=STR159 ScaleFactor=0,72	CaseType="Linear Static"	CaseName=TC01
ComboName=STR157 ScaleFactor=1,2	CaseType="Linear Static"	CaseName=RIT	ComboName=STR159 ScaleFactor=0	CaseType="Linear Static"	CaseName=TC02
ComboName=STR157 ScaleFactor=0	CaseType="Linear Static"	CaseName=SSTS	ComboName=STR159 ScaleFactor=0	CaseType="Linear Static"	CaseName=TV01
ComboName=STR157 CaseType="Linear Static"	CaseName=IS01 ScaleFactor=0	ComboName=STR158 CaseType="Linear Add"	AutoDesign=No	ComboName=STR159 CaseType="Linear Static"	CaseName=TV02
CaseType="Linear Static"	CaseName=PPST ScaleFactor=1,35	SteelDesign=No	ConcDesign=No AlumDesign=No ColdDesign=No	ComboName=STR159 CaseType="Linear Static"	CaseName=RIT
ComboName=STR158 ScaleFactor=1,35	CaseType="Linear Static"	CaseName=PPNS	ComboName=STR159 ScaleFactor=0	CaseType="Linear Static"	CaseName=SSTS
ComboName=STR158 ScaleFactor=0	CaseType="Linear Static"	CaseName=PPAQ	ComboName=STR159 CaseType="Linear Static"	CaseName=IS01 ScaleFactor=0	AutoDesign=No
ComboName=STR158 ScaleFactor=1,35	CaseType="Response Combo"	CaseName=SK05	CaseType="Linear Static"	CaseName=STR160 CaseType="Linear Add"	AutoDesign=No
ComboName=STR158 ScaleFactor=0	CaseType="Response Combo"	CaseName=SKAS	CaseType="Linear Static"	CaseName=STR160 CaseType="Linear Add"	AutoDesign=No
ComboName=STR158 ScaleFactor=1,35	CaseType="Response Combo"	CaseName=SWS	ConcDesign=No AlumDesign=No ColdDesign=No	CaseName=STR160 CaseType="Linear Static"	CaseName=PPNS
ComboName=STR158 ScaleFactor=1,35	CaseType="Response Combo"	CaseName=SK0D	ComboName=STR160 ScaleFactor=1,35	CaseType="Linear Static"	CaseName=PPAQ
ComboName=STR158 ScaleFactor=0	CaseType="Response Combo"	CaseName=SKAD	ComboName=STR160 ScaleFactor=0	CaseType="Linear Static"	CaseName=PPAQ
ComboName=STR158 ScaleFactor=1,35	CaseType="Response Combo"	CaseName=SWD	ComboName=STR160 ScaleFactor=1	CaseType="Response Combo"	CaseName=SK05
ComboName=STR158 ScaleFactor=1,35	CaseType="Response Combo"	CaseName=SA	ComboName=STR160 ScaleFactor=1	CaseType="Response Combo"	CaseName=SKAS
ComboName=STR158 ScaleFactor=0	CaseType="Linear Static"	CaseName=QM01	ComboName=STR160 ScaleFactor=0	CaseType="Response Combo"	CaseName=SKAD
ComboName=STR158 ScaleFactor=0	CaseType="Linear Static"	CaseName=QM02	ComboName=STR160 ScaleFactor=1	CaseType="Response Combo"	CaseName=SWD
ComboName=STR158 ScaleFactor=0	CaseType="Linear Static"	CaseName=SQMS	ComboName=STR160 ScaleFactor=1	CaseType="Response Combo"	CaseName=SK0D
ComboName=STR158 ScaleFactor=0	CaseType="Linear Static"	CaseName=SQMD	ComboName=STR160 ScaleFactor=0	CaseType="Response Combo"	CaseName=SKAD
ComboName=STR158 ScaleFactor=0	CaseType="Linear Static"	CaseName=FA01	ComboName=STR160 ScaleFactor=1,0125	CaseType="Response Combo"	CaseName=SKAD
ComboName=STR158 ScaleFactor=0	CaseType="Linear Static"	CaseName=FA01	ComboName=STR160 ScaleFactor=1,0125	CaseType="Response Combo"	CaseName=SKAD
ComboName=STR158 ScaleFactor=0	CaseType="Linear Static"	CaseName=FA01	ComboName=STR160 ScaleFactor=0	CaseType="Linear Static"	CaseName=SQMS



ComboName=STR164 ScaleFactor=0	CaseType="Linear Static"	CaseName=QM01	ComboName=STR166 ScaleFactor=1	CaseType="Response Combo"	CaseName=SWD
ComboName=STR164 ScaleFactor=0	CaseType="Linear Static"	CaseName=QM02	ComboName=STR166 ScaleFactor=1,35	CaseType="Linear Static"	CaseName=SA
ComboName=STR164 ScaleFactor=1,0125	CaseType="Linear Static"	CaseName=SQMS	ComboName=STR166 ScaleFactor=0	CaseType="Linear Static"	CaseName=QM01
ComboName=STR164 ScaleFactor=1,0125	CaseType="Linear Static"	CaseName=SQMD	ComboName=STR166 ScaleFactor=0	CaseType="Linear Static"	CaseName=QM02
ComboName=STR164 ScaleFactor=0	CaseType="Linear Static"	CaseName=FA01	ComboName=STR166 ScaleFactor=0	CaseType="Linear Static"	CaseName=SQMS
ComboName=STR164 ScaleFactor=0,72	CaseType="Linear Static"	CaseName=TC01	ComboName=STR166 ScaleFactor=0	CaseType="Linear Static"	CaseName=SQMD
ComboName=STR164 ScaleFactor=0	CaseType="Linear Static"	CaseName=TC02	ComboName=STR166 ScaleFactor=0	CaseType="Linear Static"	CaseName=FA01
ComboName=STR164 ScaleFactor=0	CaseType="Linear Static"	CaseName=TV01	ComboName=STR166 ScaleFactor=0	CaseType="Linear Static"	CaseName=TC01
ComboName=STR164 ScaleFactor=0	CaseType="Linear Static"	CaseName=TV02	ComboName=STR166 ScaleFactor=0,72	CaseType="Linear Static"	CaseName=TC02
ComboName=STR164 ScaleFactor=1,2	CaseType="Linear Static"	CaseName=RIT	ComboName=STR166 ScaleFactor=0	CaseType="Linear Static"	CaseName=TV01
ComboName=STR164 ScaleFactor=0	CaseType="Linear Static"	CaseName=SSTS	ComboName=STR166 ScaleFactor=0	CaseType="Linear Static"	CaseName=TV02
ComboName=STR164 ScaleFactor=0	CaseType="Linear Static"	CaseName=IS01	ComboName=STR166 ScaleFactor=1,2	CaseType="Linear Static"	CaseName=RIT
ComboName=STR165 CaseType="Linear Static"	ComboType="Linear Add"	AutoDesign=No	ComboName=STR166 ScaleFactor=0	CaseType="Linear Static"	CaseName=SSTS
CaseType="Linear Static"	CaseName=PPST	ScaleFactor=1,35	SteelDesign=No	CaseType="Linear Static"	CaseName=IS01
ConcDesign=No	AlumDesign=No	ColdDesign=No	ComboName=STR166 ScaleFactor=0	CaseType="Linear Static"	CaseName=IS01
ComboName=STR165 ScaleFactor=1,35	CaseType="Linear Static"	CaseName=PPNS	ComboName=STR166 ScaleFactor=0	CaseType="Linear Static"	CaseName=IS01
ComboName=STR165 ScaleFactor=0	CaseType="Linear Static"	CaseName=PPAQ	ComboName=STR167 ScaleFactor=1,35	CaseType="Linear Add"	AutoDesign=No
ComboName=STR165 ScaleFactor=0	CaseType="Linear Static"	CaseName=SK05	CaseType="Linear Static"	CaseName=PPST	ScaleFactor=1,35
ComboName=STR165 ScaleFactor=0	CaseType="Linear Static"	CaseName=SKAS	ConcDesign=No	AlumDesign=No	ColdDesign=No
ComboName=STR165 ScaleFactor=0	CaseType="Response Combo"	CaseName=SK05	ComboName=STR167 ScaleFactor=1,35	CaseType="Linear Static"	CaseName=PPNS
ComboName=STR165 ScaleFactor=0	CaseType="Response Combo"	CaseName=SKAS	ComboName=STR167 ScaleFactor=0	CaseType="Linear Static"	CaseName=PPAQ
ComboName=STR165 ScaleFactor=0	CaseType="Response Combo"	CaseName=SWS	ComboName=STR167 ScaleFactor=0	CaseType="Response Combo"	CaseName=SK05
ComboName=STR165 ScaleFactor=0	CaseType="Response Combo"	CaseName=SK0D	ComboName=STR167 ScaleFactor=1	CaseType="Response Combo"	CaseName=SKAS
ComboName=STR165 ScaleFactor=0	CaseType="Response Combo"	CaseName=SKAD	ComboName=STR167 ScaleFactor=1	CaseType="Response Combo"	CaseName=SWS
ComboName=STR165 ScaleFactor=0	CaseType="Response Combo"	CaseName=SWD	ComboName=STR167 ScaleFactor=0	CaseType="Response Combo"	CaseName=SK0D
ComboName=STR165 ScaleFactor=1,35	CaseType="Linear Static"	CaseName=SA	ComboName=STR167 ScaleFactor=0	CaseType="Response Combo"	CaseName=SKAD
ComboName=STR165 ScaleFactor=1,35	CaseType="Linear Static"	CaseName=QM01	ComboName=STR167 ScaleFactor=1	CaseType="Response Combo"	CaseName=SWD
ComboName=STR165 ScaleFactor=0	CaseType="Linear Static"	CaseName=QM02	ComboName=STR167 ScaleFactor=1	CaseType="Linear Static"	CaseName=SA
ComboName=STR165 ScaleFactor=0	CaseType="Linear Static"	CaseName=SQMS	ComboName=STR167 ScaleFactor=1,35	CaseType="Linear Static"	CaseName=QM01
ComboName=STR165 ScaleFactor=0	CaseType="Linear Static"	CaseName=SQMD	ComboName=STR167 ScaleFactor=1,0125	CaseType="Linear Static"	CaseName=QM02
ComboName=STR165 ScaleFactor=0	CaseType="Linear Static"	CaseName=FA01	ComboName=STR167 ScaleFactor=1,0125	CaseType="Linear Static"	CaseName=SQMS
ComboName=STR165 ScaleFactor=0	CaseType="Linear Static"	CaseName=TC01	ComboName=STR167 ScaleFactor=0	CaseType="Linear Static"	CaseName=SQMD
ComboName=STR165 ScaleFactor=0	CaseType="Linear Static"	CaseName=TC02	ComboName=STR167 ScaleFactor=0	CaseType="Linear Static"	CaseName=FA01
ComboName=STR165 ScaleFactor=0,72	CaseType="Linear Static"	CaseName=TV01	ComboName=STR167 ScaleFactor=0	CaseType="Linear Static"	CaseName=TC01
ComboName=STR165 ScaleFactor=0	CaseType="Linear Static"	CaseName=TV02	ComboName=STR167 ScaleFactor=0,72	CaseType="Linear Static"	CaseName=TC02
ComboName=STR165 ScaleFactor=0	CaseType="Linear Static"	CaseName=RIT	ComboName=STR167 ScaleFactor=0	CaseType="Linear Static"	CaseName=TV01
ComboName=STR165 ScaleFactor=0	CaseType="Linear Static"	CaseName=SSTS	ComboName=STR167 ScaleFactor=0	CaseType="Linear Static"	CaseName=TV02
ComboName=STR165 ScaleFactor=0	CaseType="Linear Static"	CaseName=IS01	ComboName=STR167 ScaleFactor=0	CaseType="Linear Static"	CaseName=RIT
ComboName=STR166 CaseType="Linear Static"	ComboType="Linear Add"	AutoDesign=No	ComboName=STR167 ScaleFactor=1,2	CaseType="Linear Static"	CaseName=SSTS
CaseType="Linear Static"	CaseName=PPST	ScaleFactor=1,35	SteelDesign=No	CaseType="Linear Static"	CaseName=IS01
ConcDesign=No	AlumDesign=No	ColdDesign=No	ComboName=STR167 ScaleFactor=0	CaseType="Linear Static"	CaseName=IS01
ComboName=STR166 ScaleFactor=1,35	CaseType="Linear Static"	CaseName=PPNS	ComboName=STR167 ScaleFactor=0	CaseType="Linear Static"	CaseName=IS01
ComboName=STR166 ScaleFactor=0	CaseType="Linear Static"	CaseName=PPAQ	ComboName=STR168 ScaleFactor=1,35	CaseType="Linear Add"	AutoDesign=No
ComboName=STR166 ScaleFactor=0	CaseType="Linear Static"	CaseName=SK05	CaseType="Linear Static"	CaseName=PPST	ScaleFactor=1,35
ComboName=STR166 ScaleFactor=0	CaseType="Response Combo"	CaseName=SK05	ConcDesign=No	AlumDesign=No	ColdDesign=No
ComboName=STR166 ScaleFactor=0	CaseType="Response Combo"	CaseName=SKAS	ComboName=STR168 ScaleFactor=1,35	CaseType="Linear Static"	CaseName=PPNS
ComboName=STR166 ScaleFactor=1	CaseType="Response Combo"	CaseName=SKAS	ComboName=STR168 ScaleFactor=0	CaseType="Linear Static"	CaseName=PPAQ
ComboName=STR166 ScaleFactor=1	CaseType="Response Combo"	CaseName=SWS	ComboName=STR168 ScaleFactor=1,35	CaseType="Response Combo"	CaseName=SK05
ComboName=STR166 ScaleFactor=0	CaseType="Response Combo"	CaseName=SK0D	ComboName=STR168 ScaleFactor=0	CaseType="Response Combo"	CaseName=SKAS
ComboName=STR166 ScaleFactor=0	CaseType="Response Combo"	CaseName=SKAD	ComboName=STR168 ScaleFactor=0	CaseType="Response Combo"	CaseName=SWS
ComboName=STR166 ScaleFactor=1	CaseType="Response Combo"	CaseName=SKAD	ComboName=STR168 ScaleFactor=1,35	CaseType="Response Combo"	CaseName=SWS

Società di Progetto
Brebemi SpA



ComboName=STR168 ScaleFactor=0	CaseType="Response Combo"	CaseName=SK0D	ComboName=STR170 ScaleFactor=0	CaseType="Response Combo"	CaseName=SKAS
ComboName=STR168 ScaleFactor=1	CaseType="Response Combo"	CaseName=SKAD	ComboName=STR170 ScaleFactor=1,35	CaseType="Response Combo"	CaseName=SWS
ComboName=STR168 ScaleFactor=1	CaseType="Response Combo"	CaseName=SWD	ComboName=STR170 ScaleFactor=0	CaseType="Response Combo"	CaseName=SK0D
ComboName=STR168 ScaleFactor=1,35	CaseType="Linear Static"	CaseName=SA	ComboName=STR170 ScaleFactor=1	CaseType="Response Combo"	CaseName=SKAD
ComboName=STR168 ScaleFactor=1,0125	CaseType="Linear Static"	CaseName=QM01	ComboName=STR170 ScaleFactor=1	CaseType="Response Combo"	CaseName=SWD
ComboName=STR168 ScaleFactor=1,0125	CaseType="Linear Static"	CaseName=QM02	ComboName=STR170 ScaleFactor=0	CaseType="Linear Static"	CaseName=SA ScaleFactor=1
ComboName=STR168 ScaleFactor=1,0125	CaseType="Linear Static"	CaseName=SQMS	ComboName=STR170 ScaleFactor=0	CaseType="Linear Static"	CaseName=QM01
ComboName=STR168 ScaleFactor=0	CaseType="Linear Static"	CaseName=SQMD	ComboName=STR170 ScaleFactor=1,0125	CaseType="Linear Static"	CaseName=QM02
ComboName=STR168 ScaleFactor=0	CaseType="Linear Static"	CaseName=FA01	ComboName=STR170 ScaleFactor=0	CaseType="Linear Static"	CaseName=SQMS
ComboName=STR168 ScaleFactor=0	CaseType="Linear Static"	CaseName=TC01	ComboName=STR170 ScaleFactor=1,0125	CaseType="Linear Static"	CaseName=SQMD
ComboName=STR168 ScaleFactor=0,72	CaseType="Linear Static"	CaseName=TC02	ComboName=STR170 ScaleFactor=0	CaseType="Linear Static"	CaseName=FA01
ComboName=STR168 ScaleFactor=0	CaseType="Linear Static"	CaseName=TV01	ComboName=STR170 ScaleFactor=0	CaseType="Linear Static"	CaseName=TC01
ComboName=STR168 ScaleFactor=0	CaseType="Linear Static"	CaseName=TV02	ComboName=STR170 ScaleFactor=0,72	CaseType="Linear Static"	CaseName=TC02
ComboName=STR168 ScaleFactor=1,2	CaseType="Linear Static"	CaseName=RIT	ComboName=STR170 ScaleFactor=0	CaseType="Linear Static"	CaseName=TV01
ComboName=STR168 ScaleFactor=0	CaseType="Linear Static"	CaseName=SSTS	ComboName=STR170 ScaleFactor=0	CaseType="Linear Static"	CaseName=TV02
ComboName=STR168 ScaleFactor=0	CaseType="Linear Static"	CaseName=IS01 ScaleFactor=0	ComboName=STR170 ScaleFactor=1,2	CaseType="Linear Static"	CaseName=RIT
ComboName=STR169 CaseType="Linear Static"	CaseType="Linear Add"	AutoDesign=No	ComboName=STR170 ScaleFactor=0	CaseType="Linear Static"	CaseName=SSTS
CaseType="Linear Static"	CaseName=PPST ScaleFactor=1,35	SteelDesign=No	ComboName=STR170 ScaleFactor=0	CaseType="Linear Static"	CaseName=IS01 ScaleFactor=0
ConcDesign=No AlumDesign=No ColdDesign=No	CaseType="Linear Static"	CaseName=PPNS	ComboName=STR171 ScaleFactor=0	CaseType="Linear Add"	AutoDesign=No
ComboName=STR169 ScaleFactor=1,35	CaseType="Linear Static"	CaseName=PPAQ	CaseType="Linear Static"	CaseName=PPST ScaleFactor=1	SteelDesign=No
ComboName=STR169 ScaleFactor=0	CaseType="Linear Static"	CaseName=SK0S	ConcDesign=No AlumDesign=No ColdDesign=No	CaseType="Linear Static"	CaseName=PPNS
ComboName=STR169 ScaleFactor=1,35	CaseType="Response Combo"	CaseName=SKAS	ComboName=STR171 ScaleFactor=1	CaseType="Linear Static"	CaseName=PPAQ
ComboName=STR169 ScaleFactor=0	CaseType="Response Combo"	CaseName=SWS	ComboName=STR171 ScaleFactor=0	CaseType="Linear Static"	CaseName=SK0S
ComboName=STR169 ScaleFactor=1,35	CaseType="Response Combo"	CaseName=SK0D	ComboName=STR171 ScaleFactor=1,35	CaseType="Response Combo"	CaseName=SKAS
ComboName=STR169 ScaleFactor=1,35	CaseType="Response Combo"	CaseName=SKAD	ComboName=STR171 ScaleFactor=0	CaseType="Response Combo"	CaseName=SWS
ComboName=STR169 ScaleFactor=0	CaseType="Response Combo"	CaseName=SWD	ComboName=STR171 ScaleFactor=1,35	CaseType="Response Combo"	CaseName=SK0D
ComboName=STR169 ScaleFactor=1,35	CaseType="Linear Static"	CaseName=SA	ComboName=STR171 ScaleFactor=0	CaseType="Response Combo"	CaseName=SKAD
ComboName=STR169 ScaleFactor=1,0125	CaseType="Linear Static"	CaseName=QM01	ComboName=STR171 ScaleFactor=0	CaseType="Response Combo"	CaseName=SKAD
ComboName=STR169 ScaleFactor=1,0125	CaseType="Linear Static"	CaseName=QM02	ComboName=STR171 ScaleFactor=1,35	CaseType="Response Combo"	CaseName=SWD
ComboName=STR169 ScaleFactor=1,0125	CaseType="Linear Static"	CaseName=SQMS	ComboName=STR171 ScaleFactor=0	CaseType="Response Combo"	CaseName=SA ScaleFactor=1
ComboName=STR169 ScaleFactor=1,0125	CaseType="Linear Static"	CaseName=SQMD	ComboName=STR171 ScaleFactor=0,72	CaseType="Linear Static"	CaseName=QM01
ComboName=STR169 ScaleFactor=0	CaseType="Linear Static"	CaseName=FA01	ComboName=STR171 ScaleFactor=1,0125	CaseType="Linear Static"	CaseName=QM02
ComboName=STR169 ScaleFactor=0	CaseType="Linear Static"	CaseName=TC01	ComboName=STR171 ScaleFactor=0	CaseType="Linear Static"	CaseName=SQMS
ComboName=STR169 ScaleFactor=0,72	CaseType="Linear Static"	CaseName=TC02	ComboName=STR171 ScaleFactor=1,0125	CaseType="Linear Static"	CaseName=SQMD
ComboName=STR169 ScaleFactor=0	CaseType="Linear Static"	CaseName=TV01	ComboName=STR171 ScaleFactor=0	CaseType="Linear Static"	CaseName=FA01
ComboName=STR169 ScaleFactor=0	CaseType="Linear Static"	CaseName=TV02	ComboName=STR171 ScaleFactor=0	CaseType="Linear Static"	CaseName=TC01
ComboName=STR169 ScaleFactor=0	CaseType="Linear Static"	CaseName=RIT	ComboName=STR171 ScaleFactor=0,72	CaseType="Linear Static"	CaseName=TC02
ComboName=STR169 ScaleFactor=1,2	CaseType="Linear Static"	CaseName=SSTS	ComboName=STR171 ScaleFactor=0	CaseType="Linear Static"	CaseName=TV01
ComboName=STR169 ScaleFactor=0	CaseType="Linear Static"	CaseName=IS01 ScaleFactor=0	ComboName=STR171 ScaleFactor=0	CaseType="Linear Static"	CaseName=TV02
ComboName=STR170 CaseType="Linear Static"	CaseType="Linear Add"	AutoDesign=No	ComboName=STR171 ScaleFactor=1,2	CaseType="Linear Static"	CaseName=RIT
CaseType="Linear Static"	CaseName=PPST ScaleFactor=1	SteelDesign=No	ComboName=STR171 ScaleFactor=0	CaseType="Linear Static"	CaseName=SSTS
ConcDesign=No AlumDesign=No ColdDesign=No	CaseType="Linear Static"	CaseName=PPNS	ComboName=STR171 ScaleFactor=0	CaseType="Linear Static"	CaseName=IS01 ScaleFactor=0
ComboName=STR170 ScaleFactor=1	CaseType="Linear Static"	CaseName=PPAQ	CaseType="Linear Static"	CaseName=IS01 ScaleFactor=0	AutoDesign=No
ComboName=STR170 ScaleFactor=0	CaseType="Linear Static"	CaseName=SK0S	CaseType="Linear Add"	AutoDesign=No	SteelDesign=No
ComboName=STR170 ScaleFactor=1,35	CaseType="Response Combo"	CaseName=SK0D	CaseType="Linear Static"	CaseName=PPST ScaleFactor=1,35	SteelDesign=No
ComboName=STR170 ScaleFactor=0	CaseType="Response Combo"	CaseName=SKAD	ConcDesign=No AlumDesign=No ColdDesign=No	CaseType="Linear Static"	CaseName=PPNS
ComboName=STR170 ScaleFactor=0	CaseType="Response Combo"	CaseName=SKAS	ComboName=STR172 ScaleFactor=1,35	CaseType="Linear Static"	CaseName=PPAQ
ComboName=STR170 ScaleFactor=1,35	CaseType="Response Combo"	CaseName=SWS	ComboName=STR172 ScaleFactor=0	CaseType="Linear Static"	CaseName=PPAQ
ComboName=STR170 ScaleFactor=0	CaseType="Response Combo"	CaseName=SK0D	CaseType="Linear Static"	CaseName=PPAQ	CaseName=PPAQ

APPROVATO SDP

Società di Progetto
Brebemi SpA



ComboName=STR172 ScaleFactor=1,35	CaseType="Response Combo"	CaseName=SK05	ComboName=STR174 ScaleFactor=1,35	CaseType="Linear Static"	CaseName=PPNS
ComboName=STR172 ScaleFactor=0	CaseType="Response Combo"	CaseName=SKAS	ComboName=STR174 ScaleFactor=0	CaseType="Linear Static"	CaseName=PPAQ
ComboName=STR172 ScaleFactor=1,35	CaseType="Response Combo"	CaseName=SWS	ComboName=STR174 ScaleFactor=0	CaseType="Response Combo"	CaseName=SK05
ComboName=STR172 ScaleFactor=1,35	CaseType="Response Combo"	CaseName=SK0D	ComboName=STR174 ScaleFactor=1	CaseType="Response Combo"	CaseName=SKAS
ComboName=STR172 ScaleFactor=0	CaseType="Response Combo"	CaseName=SKAD	ComboName=STR174 ScaleFactor=1	CaseType="Response Combo"	CaseName=SWS
ComboName=STR172 ScaleFactor=1,35	CaseType="Response Combo"	CaseName=SWD	ComboName=STR174 ScaleFactor=0	CaseType="Response Combo"	CaseName=SK0D
ComboName=STR172 ScaleFactor=1,35	CaseType="Linear Static"	CaseName=SA	ComboName=STR174 ScaleFactor=1	CaseType="Response Combo"	CaseName=SKAD
ComboName=STR172 ScaleFactor=0	CaseType="Linear Static"	CaseName=QM01	ComboName=STR174 ScaleFactor=1	CaseType="Response Combo"	CaseName=SWD
ComboName=STR172 ScaleFactor=0	CaseType="Linear Static"	CaseName=QM02	ComboName=STR174 ScaleFactor=1,35	CaseType="Linear Static"	CaseName=SA
ComboName=STR172 ScaleFactor=0	CaseType="Linear Static"	CaseName=SQMS	ComboName=STR174 ScaleFactor=1,0125	CaseType="Linear Static"	CaseName=QM01
ComboName=STR172 ScaleFactor=0	CaseType="Linear Static"	CaseName=SQMD	ComboName=STR174 ScaleFactor=1,0125	CaseType="Linear Static"	CaseName=QM02
ComboName=STR172 ScaleFactor=0	CaseType="Linear Static"	CaseName=FA01	ComboName=STR174 ScaleFactor=0	CaseType="Linear Static"	CaseName=SQMS
ComboName=STR172 ScaleFactor=0	CaseType="Linear Static"	CaseName=TC01	ComboName=STR174 ScaleFactor=0	CaseType="Linear Static"	CaseName=SQMD
ComboName=STR172 ScaleFactor=0	CaseType="Linear Static"	CaseName=TC02	ComboName=STR174 ScaleFactor=0	CaseType="Linear Static"	CaseName=FA01
ComboName=STR172 ScaleFactor=0,72	CaseType="Linear Static"	CaseName=TV01	ComboName=STR174 ScaleFactor=0	CaseType="Linear Static"	CaseName=TC01
ComboName=STR172 ScaleFactor=0	CaseType="Linear Static"	CaseName=TV02	ComboName=STR174 ScaleFactor=0	CaseType="Linear Static"	CaseName=TC02
ComboName=STR172 ScaleFactor=1,2	CaseType="Linear Static"	CaseName=RIT	ComboName=STR174 ScaleFactor=0,72	CaseType="Linear Static"	CaseName=TV01
ComboName=STR172 ScaleFactor=0	CaseType="Linear Static"	CaseName=SSTS	ComboName=STR174 ScaleFactor=0	CaseType="Linear Static"	CaseName=TV02
ComboName=STR172 ScaleFactor=1,35	CaseType="Linear Static"	CaseName=IS01	ComboName=STR174 ScaleFactor=1,2	CaseType="Linear Static"	CaseName=RIT
ComboName=STR173 CaseType="Linear Static"	CaseType="Linear Add"	CaseName=IS01	ComboName=STR174 ScaleFactor=0	CaseType="Linear Static"	CaseName=SSTS
CaseType="Linear Static"	CaseName=PPST	ScaleFactor=1,35	ComboName=STR174 ScaleFactor=0	CaseType="Linear Static"	CaseName=IS01
ConcDesign=No AlumDesign=No ColdDesign=No	CaseType="Linear Static"	CaseName=PPNS	ComboName=STR174 ScaleFactor=0	CaseType="Linear Add"	AutoDesign=No
ComboName=STR173 ScaleFactor=1,35	CaseType="Linear Static"	CaseName=PPAQ	ComboName=STR175 ScaleFactor=1,35	CaseName=PPST	ScaleFactor=1,35
ComboName=STR173 ScaleFactor=0	CaseType="Linear Static"	CaseName=SK05	ComboName=STR175 ScaleFactor=0	CaseType="Linear Static"	SteelDesign=No
ComboName=STR173 ScaleFactor=1	CaseType="Response Combo"	CaseName=SKAS	ComboName=STR175 ScaleFactor=1,35	CaseType="Linear Static"	CaseName=PPNS
ComboName=STR173 ScaleFactor=1	CaseType="Response Combo"	CaseName=SWS	ComboName=STR175 ScaleFactor=0	CaseType="Linear Static"	CaseName=PPAQ
ComboName=STR173 ScaleFactor=0	CaseType="Response Combo"	CaseName=SK0D	ComboName=STR175 ScaleFactor=1,0125	CaseType="Response Combo"	CaseName=SK05
ComboName=STR173 ScaleFactor=1	CaseType="Response Combo"	CaseName=SKAD	ComboName=STR175 ScaleFactor=1,0125	CaseType="Response Combo"	CaseName=SKAS
ComboName=STR173 ScaleFactor=1	CaseType="Response Combo"	CaseName=SWD	ComboName=STR175 ScaleFactor=0	CaseType="Response Combo"	CaseName=SWS
ComboName=STR173 ScaleFactor=1,35	CaseType="Linear Static"	CaseName=SA	ComboName=STR175 ScaleFactor=1,35	CaseType="Response Combo"	CaseName=SK0D
ComboName=STR173 ScaleFactor=0	CaseType="Linear Static"	CaseName=QM01	ComboName=STR175 ScaleFactor=1	CaseType="Response Combo"	CaseName=SKAD
ComboName=STR173 ScaleFactor=0	CaseType="Linear Static"	CaseName=QM02	ComboName=STR175 ScaleFactor=1	CaseType="Response Combo"	CaseName=SWD
ComboName=STR173 ScaleFactor=0	CaseType="Linear Static"	CaseName=SQMS	ComboName=STR175 ScaleFactor=1,35	CaseType="Linear Static"	CaseName=SA
ComboName=STR173 ScaleFactor=0	CaseType="Linear Static"	CaseName=SQMD	ComboName=STR175 ScaleFactor=1,0125	CaseType="Linear Static"	CaseName=QM01
ComboName=STR173 ScaleFactor=0	CaseType="Linear Static"	CaseName=FA01	ComboName=STR175 ScaleFactor=1,0125	CaseType="Linear Static"	CaseName=QM02
ComboName=STR173 ScaleFactor=0	CaseType="Linear Static"	CaseName=TC01	ComboName=STR175 ScaleFactor=0	CaseType="Linear Static"	CaseName=SQMS
ComboName=STR173 ScaleFactor=0	CaseType="Linear Static"	CaseName=TC02	ComboName=STR175 ScaleFactor=0	CaseType="Linear Static"	CaseName=SQMD
ComboName=STR173 ScaleFactor=0,72	CaseType="Linear Static"	CaseName=TV01	ComboName=STR175 ScaleFactor=0	CaseType="Linear Static"	CaseName=FA01
ComboName=STR173 ScaleFactor=0	CaseType="Linear Static"	CaseName=TV02	ComboName=STR175 ScaleFactor=0	CaseType="Linear Static"	CaseName=TC01
ComboName=STR173 ScaleFactor=1,2	CaseType="Linear Static"	CaseName=RIT	ComboName=STR175 ScaleFactor=0	CaseType="Linear Static"	CaseName=TC02
ComboName=STR173 ScaleFactor=0	CaseType="Linear Static"	CaseName=SSTS	ComboName=STR175 ScaleFactor=0,72	CaseType="Linear Static"	CaseName=TV01
ComboName=STR173 ScaleFactor=0	CaseType="Linear Static"	CaseName=IS01	ComboName=STR175 ScaleFactor=0	CaseType="Linear Static"	CaseName=TV02
ComboName=STR174 CaseType="Linear Static"	CaseType="Linear Add"	CaseName=IS01	ComboName=STR175 ScaleFactor=1,2	CaseType="Linear Static"	CaseName=RIT
CaseType="Linear Static"	CaseName=PPST	ScaleFactor=1,35	ComboName=STR175 ScaleFactor=0	CaseType="Linear Static"	CaseName=SSTS
ConcDesign=No AlumDesign=No ColdDesign=No	CaseType="Linear Static"	CaseName=SSTS	ComboName=STR175 ScaleFactor=0	CaseType="Linear Static"	CaseName=SSTS



ComboName=STR175	CaseType="Linear Static"	CaseName=IS01	ScaleFactor=0	ComboName=STR177	CaseType="Linear Static"	CaseName=RIT	
ComboName=STR176	ComboType="Linear Add"	AutoDesign=No		ScaleFactor=1,2			
CaseType="Linear Static"	CaseName=PPST	ScaleFactor=1,35	SteelDesign=No	ComboName=STR177	CaseType="Linear Static"	CaseName=SSTS	
ConcDesign=No	AlumDesign=No	ColdDesign=No		ScaleFactor=0			
ComboName=STR176	CaseType="Linear Static"	CaseName=PPNS		ComboName=STR177	CaseType="Linear Static"	CaseName=IS01	ScaleFactor=0
ScaleFactor=1,35				ComboName=STR178	ComboType="Linear Add"	AutoDesign=No	
ComboName=STR176	CaseType="Linear Static"	CaseName=PPAQ		CaseType="Linear Static"	CaseName=PPST	ScaleFactor=1	SteelDesign=No
ScaleFactor=0				ConcDesign=No	AlumDesign=No	ColdDesign=No	
ComboName=STR176	CaseType="Response Combo"	CaseName=SK05		ComboName=STR178	CaseType="Linear Static"	CaseName=PPNS	
ScaleFactor=1,35				ScaleFactor=1			
ComboName=STR176	CaseType="Response Combo"	CaseName=SKAS		ComboName=STR178	CaseType="Linear Static"	CaseName=PPAQ	
ScaleFactor=0				ScaleFactor=0			
ComboName=STR176	CaseType="Response Combo"	CaseName=SWS		ComboName=STR178	CaseType="Response Combo"	CaseName=SK05	
ScaleFactor=1,35				ScaleFactor=1,35			
ComboName=STR176	CaseType="Response Combo"	CaseName=SK0D		ComboName=STR178	CaseType="Response Combo"	CaseName=SKAS	
ScaleFactor=1,35				ScaleFactor=0			
ComboName=STR176	CaseType="Response Combo"	CaseName=SKAD		ComboName=STR178	CaseType="Response Combo"	CaseName=SWS	
ScaleFactor=0				ScaleFactor=1,35			
ComboName=STR176	CaseType="Response Combo"	CaseName=SWD		ComboName=STR178	CaseType="Response Combo"	CaseName=SK0D	
ScaleFactor=1,35				ScaleFactor=1,35			
ComboName=STR176	CaseType="Linear Static"	CaseName=SA		ComboName=STR178	CaseType="Response Combo"	CaseName=SKAD	
ScaleFactor=1,35				ScaleFactor=0			
ComboName=STR176	CaseType="Linear Static"	CaseName=QM01		ComboName=STR178	CaseType="Response Combo"	CaseName=SWD	
ScaleFactor=1,0125				ScaleFactor=1,35			
ComboName=STR176	CaseType="Linear Static"	CaseName=QM02		ComboName=STR178	CaseType="Linear Static"	CaseName=SA	ScaleFactor=1
ScaleFactor=1,0125				ComboName=STR178	CaseType="Linear Static"	CaseName=QM01	
ComboName=STR176	CaseType="Linear Static"	CaseName=SQMS		ScaleFactor=0			
ScaleFactor=1,0125				ComboName=STR178	CaseType="Linear Static"	CaseName=QM02	
ComboName=STR176	CaseType="Linear Static"	CaseName=SQMD		ScaleFactor=0			
ScaleFactor=1,0125				ComboName=STR178	CaseType="Linear Static"	CaseName=SQMS	
ComboName=STR176	CaseType="Linear Static"	CaseName=FA01		ScaleFactor=1,0125			
ScaleFactor=0				ComboName=STR178	CaseType="Linear Static"	CaseName=SQMD	
ComboName=STR176	CaseType="Linear Static"	CaseName=TC01		ScaleFactor=1,0125			
ScaleFactor=0				ComboName=STR178	CaseType="Linear Static"	CaseName=FA01	
ComboName=STR176	CaseType="Linear Static"	CaseName=TC02		ScaleFactor=0			
ScaleFactor=0				ComboName=STR178	CaseType="Linear Static"	CaseName=TC01	
ComboName=STR176	CaseType="Linear Static"	CaseName=TV01		ScaleFactor=0			
ScaleFactor=0,72				ComboName=STR178	CaseType="Linear Static"	CaseName=TC02	
ComboName=STR176	CaseType="Linear Static"	CaseName=TV02		ScaleFactor=0			
ScaleFactor=0				ComboName=STR178	CaseType="Linear Static"	CaseName=TV01	
ComboName=STR176	CaseType="Linear Static"	CaseName=RIT		ScaleFactor=0,72			
ScaleFactor=1,2				ComboName=STR178	CaseType="Linear Static"	CaseName=TV02	
ComboName=STR176	CaseType="Linear Static"	CaseName=SSTS		ScaleFactor=0			
ScaleFactor=0				ComboName=STR178	CaseType="Linear Static"	CaseName=RIT	
ComboName=STR176	CaseType="Linear Static"	CaseName=IS01	ScaleFactor=0	ScaleFactor=1,2			
ComboName=STR177	ComboType="Linear Add"	AutoDesign=No		ComboName=STR178	CaseType="Linear Static"	CaseName=SSTS	
CaseType="Linear Static"	CaseName=PPST	ScaleFactor=1	SteelDesign=No	ScaleFactor=0			
ConcDesign=No	AlumDesign=No	ColdDesign=No		ComboName=STR178	CaseType="Linear Static"	CaseName=IS01	ScaleFactor=0
ComboName=STR177	CaseType="Linear Static"	CaseName=PPNS		ComboName=STR179	ComboType="Linear Add"	AutoDesign=No	
ScaleFactor=1				CaseType="Linear Static"	CaseName=PPST	ScaleFactor=1,35	SteelDesign=No
ComboName=STR177	CaseType="Linear Static"	CaseName=PPAQ		ConcDesign=No	AlumDesign=No	ColdDesign=No	
ScaleFactor=0				ComboName=STR179	CaseType="Linear Static"	CaseName=PPNS	
ComboName=STR177	CaseType="Response Combo"	CaseName=SK05		ScaleFactor=1,35			
ScaleFactor=1,35				ComboName=STR179	CaseType="Linear Static"	CaseName=PPAQ	
ComboName=STR177	CaseType="Response Combo"	CaseName=SKAS		ScaleFactor=0			
ScaleFactor=0				ComboName=STR179	CaseType="Response Combo"	CaseName=SK05	
ComboName=STR177	CaseType="Response Combo"	CaseName=SWS		ScaleFactor=1,35			
ScaleFactor=1,35				ComboName=STR179	CaseType="Response Combo"	CaseName=SKAS	
ComboName=STR177	CaseType="Response Combo"	CaseName=SK0D		ScaleFactor=0			
ScaleFactor=0				ComboName=STR179	CaseType="Response Combo"	CaseName=SWS	
ComboName=STR177	CaseType="Response Combo"	CaseName=SKAD		ScaleFactor=1,35			
ScaleFactor=1				ComboName=STR179	CaseType="Response Combo"	CaseName=SK0D	
ComboName=STR177	CaseType="Response Combo"	CaseName=SWD		ScaleFactor=1,35			
ScaleFactor=1				ComboName=STR179	CaseType="Response Combo"	CaseName=SKAD	
ComboName=STR177	CaseType="Linear Static"	CaseName=SA	ScaleFactor=1	ScaleFactor=0			
ComboName=STR177	CaseType="Linear Static"	CaseName=QM01		ComboName=STR179	CaseType="Response Combo"	CaseName=SWD	
ScaleFactor=0				ScaleFactor=1,35			
ComboName=STR177	CaseType="Linear Static"	CaseName=QM02		ComboName=STR179	CaseType="Linear Static"	CaseName=SA	
ScaleFactor=0				ScaleFactor=1,35			
ComboName=STR177	CaseType="Linear Static"	CaseName=SQMS		ComboName=STR179	CaseType="Linear Static"	CaseName=QM01	
ScaleFactor=1,0125				ScaleFactor=0			
ComboName=STR177	CaseType="Linear Static"	CaseName=SQMD		ComboName=STR179	CaseType="Linear Static"	CaseName=QM02	
ScaleFactor=0				ScaleFactor=0			
ComboName=STR177	CaseType="Linear Static"	CaseName=FA01		ComboName=STR179	CaseType="Linear Static"	CaseName=SQMS	
ScaleFactor=0				ScaleFactor=0			
ComboName=STR177	CaseType="Linear Static"	CaseName=TC01		ComboName=STR179	CaseType="Linear Static"	CaseName=SQMD	
ScaleFactor=0				ScaleFactor=0			
ComboName=STR177	CaseType="Linear Static"	CaseName=TC02		ComboName=STR179	CaseType="Linear Static"	CaseName=FA01	
ScaleFactor=0				ScaleFactor=0			
ComboName=STR177	CaseType="Linear Static"	CaseName=TV01		ComboName=STR179	CaseType="Linear Static"	CaseName=TC01	
ScaleFactor=0,72				ScaleFactor=0			
ComboName=STR177	CaseType="Linear Static"	CaseName=TV02		ComboName=STR179	CaseType="Linear Static"	CaseName=TC02	
ScaleFactor=0				ScaleFactor=0			
ComboName=STR177	CaseType="Linear Static"	CaseName=RIT		ComboName=STR179	CaseType="Linear Static"	CaseName=RIT	
ScaleFactor=0				ScaleFactor=0			

APPROVATO SDR

Società di Progetto
Brebemi SpA



ComboName=STR179 ScaleFactor=0,72	CaseType="Linear Static"	CaseName=TV01	ComboName=STR181 ScaleFactor=0	CaseType="Linear Static"	CaseName=TC01
ComboName=STR179 ScaleFactor=0	CaseType="Linear Static"	CaseName=TV02	ComboName=STR181 ScaleFactor=0	CaseType="Linear Static"	CaseName=TC02
ComboName=STR179 ScaleFactor=1,2	CaseType="Linear Static"	CaseName=RIT	ComboName=STR181 ScaleFactor=0	CaseType="Linear Static"	CaseName=TV01
ComboName=STR179 ScaleFactor=0	CaseType="Linear Static"	CaseName=SSTS	ComboName=STR181 ScaleFactor=0,72	CaseType="Linear Static"	CaseName=TV02
ComboName=STR179 ScaleFactor=0	CaseType="Linear Static"	CaseName=IS01	ComboName=STR181 ScaleFactor=1,2	CaseType="Linear Static"	CaseName=RIT
ComboName=STR180 CaseType="Linear Static"	ComboType="Linear Add"	AutoDesign=No	ComboName=STR181 ScaleFactor=0	CaseType="Linear Static"	CaseName=SSTS
CaseName=PPST ScaleFactor=1,35	SteelDesign=No	ConcDesign=No	ComboName=STR181 ScaleFactor=0	CaseType="Linear Static"	CaseName=IS01
AlumDesign=No	ColdDesign=No	CaseName=PPNS	ComboName=STR181 ScaleFactor=0	CaseType="Linear Static"	CaseName=IS01
CaseName=STR180 ScaleFactor=1,35	CaseType="Linear Static"	CaseName=PPAQ	ComboName=STR182 ScaleFactor=0	CaseType="Linear Add"	AutoDesign=No
CaseName=STR180 ScaleFactor=0	CaseType="Linear Static"	CaseName=SK05	CaseType="Linear Static"	CaseName=PPST ScaleFactor=1,35	SteelDesign=No
CaseName=STR180 ScaleFactor=1,35	CaseType="Response Combo"	CaseName=SKAS	ComboName=STR182 ScaleFactor=1,35	CaseType="Linear Static"	CaseName=PPNS
CaseName=STR180 ScaleFactor=0	CaseType="Response Combo"	CaseName=SK0D	ComboName=STR182 ScaleFactor=0	CaseType="Linear Static"	CaseName=PPAQ
CaseName=STR180 ScaleFactor=1,35	CaseType="Response Combo"	CaseName=SKAD	ComboName=STR182 ScaleFactor=0	CaseType="Response Combo"	CaseName=SK05
CaseName=STR180 ScaleFactor=0	CaseType="Response Combo"	CaseName=SWD	ComboName=STR182 ScaleFactor=1	CaseType="Response Combo"	CaseName=SKAS
CaseName=STR180 ScaleFactor=1,35	CaseType="Linear Static"	CaseName=SA	ComboName=STR182 ScaleFactor=0	CaseType="Response Combo"	CaseName=SK0D
CaseName=STR180 ScaleFactor=0	CaseType="Linear Static"	CaseName=QM01	ComboName=STR182 ScaleFactor=1	CaseType="Response Combo"	CaseName=SKAD
CaseName=STR180 ScaleFactor=0	CaseType="Linear Static"	CaseName=QM02	ComboName=STR182 ScaleFactor=0	CaseType="Response Combo"	CaseName=SWS
CaseName=STR180 ScaleFactor=0	CaseType="Linear Static"	CaseName=SQMS	ComboName=STR182 ScaleFactor=1	CaseType="Response Combo"	CaseName=SK0D
CaseName=STR180 ScaleFactor=0	CaseType="Linear Static"	CaseName=SQMD	ComboName=STR182 ScaleFactor=0	CaseType="Response Combo"	CaseName=SKAD
CaseName=STR180 ScaleFactor=0	CaseType="Linear Static"	CaseName=FA01	ComboName=STR182 ScaleFactor=1,0125	CaseType="Response Combo"	CaseName=SWD
CaseName=STR180 ScaleFactor=0	CaseType="Linear Static"	CaseName=TC01	ComboName=STR182 ScaleFactor=1,35	CaseType="Linear Static"	CaseName=SA
CaseName=STR180 ScaleFactor=0	CaseType="Linear Static"	CaseName=TC02	ComboName=STR182 ScaleFactor=1,0125	CaseType="Linear Static"	CaseName=QM01
CaseName=STR180 ScaleFactor=0	CaseType="Linear Static"	CaseName=TV01	ComboName=STR182 ScaleFactor=0	CaseType="Linear Static"	CaseName=QM02
CaseName=STR180 ScaleFactor=0,72	CaseType="Linear Static"	CaseName=TV02	ComboName=STR182 ScaleFactor=0	CaseType="Linear Static"	CaseName=SQMS
CaseName=STR180 ScaleFactor=1,2	CaseType="Linear Static"	CaseName=RIT	ComboName=STR182 ScaleFactor=0	CaseType="Linear Static"	CaseName=SQMD
CaseName=STR180 ScaleFactor=0	CaseType="Linear Static"	CaseName=SSTS	ComboName=STR182 ScaleFactor=0	CaseType="Linear Static"	CaseName=FA01
CaseName=STR180 ScaleFactor=0	CaseType="Linear Static"	CaseName=IS01	ComboName=STR182 ScaleFactor=0	CaseType="Linear Static"	CaseName=TC01
CaseName=STR181 CaseType="Linear Static"	ComboType="Linear Add"	AutoDesign=No	ComboName=STR182 ScaleFactor=0,72	CaseType="Linear Static"	CaseName=TC02
CaseName=PPST ScaleFactor=1,35	SteelDesign=No	ConcDesign=No	ComboName=STR182 ScaleFactor=0	CaseType="Linear Static"	CaseName=TV01
AlumDesign=No	ColdDesign=No	CaseName=PPNS	ComboName=STR182 ScaleFactor=0	CaseType="Linear Static"	CaseName=TV02
CaseName=STR181 ScaleFactor=1,35	CaseType="Linear Static"	CaseName=PPAQ	ComboName=STR182 ScaleFactor=1,2	CaseType="Linear Static"	CaseName=RIT
CaseName=STR181 ScaleFactor=0	CaseType="Linear Static"	CaseName=SK05	ComboName=STR182 ScaleFactor=0	CaseType="Linear Static"	CaseName=SSTS
CaseName=STR181 ScaleFactor=0	CaseType="Response Combo"	CaseName=SKAS	ComboName=STR182 ScaleFactor=0	CaseType="Linear Static"	CaseName=IS01
CaseName=STR181 ScaleFactor=1	CaseType="Response Combo"	CaseName=SWS	CaseType="Linear Static"	CaseName=IS01	ScaleFactor=0
CaseName=STR181 ScaleFactor=0	CaseType="Response Combo"	CaseName=SK0D	CaseType="Linear Static"	CaseName=IS01	ScaleFactor=0
CaseName=STR181 ScaleFactor=1	CaseType="Response Combo"	CaseName=SKAD	CaseType="Linear Static"	CaseName=IS01	ScaleFactor=0
CaseName=STR181 ScaleFactor=0	CaseType="Response Combo"	CaseName=SWD	CaseType="Linear Static"	CaseName=IS01	ScaleFactor=0
CaseName=STR181 ScaleFactor=1,35	CaseType="Linear Static"	CaseName=SA	CaseType="Linear Static"	CaseName=IS01	ScaleFactor=0
CaseName=STR181 ScaleFactor=0	CaseType="Linear Static"	CaseName=QM01	CaseType="Linear Static"	CaseName=IS01	ScaleFactor=0
CaseName=STR181 ScaleFactor=0	CaseType="Linear Static"	CaseName=QM02	CaseType="Linear Static"	CaseName=IS01	ScaleFactor=0
CaseName=STR181 ScaleFactor=0	CaseType="Linear Static"	CaseName=SQMS	CaseType="Linear Static"	CaseName=IS01	ScaleFactor=0
CaseName=STR181 ScaleFactor=0	CaseType="Linear Static"	CaseName=SQMD	CaseType="Linear Static"	CaseName=IS01	ScaleFactor=0
CaseName=STR181 ScaleFactor=0	CaseType="Linear Static"	CaseName=FA01	CaseType="Linear Static"	CaseName=IS01	ScaleFactor=0



ComboName=RAR013 ScaleFactor=0	CaseType="Linear Static"	CaseName=TV02	ComboName=RAR015 ScaleFactor=0	CaseType="Linear Static"	CaseName=TV01
ComboName=RAR013 ScaleFactor=0	CaseType="Linear Static"	CaseName=RIT	ComboName=RAR015 ScaleFactor=0	CaseType="Linear Static"	CaseName=TV02
ComboName=RAR013 ScaleFactor=0	CaseType="Linear Static"	CaseName=SSTS	ComboName=RAR015 ScaleFactor=0	CaseType="Linear Static"	CaseName=RIT
ComboName=RAR013 ScaleFactor=0	CaseType="Linear Static"	CaseName=IS01	ComboName=RAR015 ScaleFactor=0	CaseType="Linear Static"	CaseName=SSTS
ComboName=RAR014 CaseType="Linear Static"	ComboType="Linear Add"	AutoDesign=No	ComboName=RAR015 ScaleFactor=0	CaseType="Linear Static"	CaseName=IS01
ConcDesign=No AlumDesign=No ColdDesign=No	CaseName=PPST	ScaleFactor=1	ComboName=RAR016 CaseType="Linear Static"	ComboType="Linear Add"	AutoDesign=No
ComboName=RAR014 ScaleFactor=1	CaseType="Linear Static"	CaseName=PPNS	ConcDesign=No AlumDesign=No ColdDesign=No	CaseName=PPST	ScaleFactor=1
ComboName=RAR014 ScaleFactor=0	CaseType="Linear Static"	CaseName=PPAQ	ComboName=RAR016 ScaleFactor=1	CaseType="Linear Static"	CaseName=PPNS
ComboName=RAR014 ScaleFactor=1	CaseType="Response Combo"	CaseName=SK05	ComboName=RAR016 ScaleFactor=0	CaseType="Linear Static"	CaseName=PPAQ
ComboName=RAR014 ScaleFactor=0	CaseType="Response Combo"	CaseName=SKAS	ComboName=RAR016 ScaleFactor=1	CaseType="Response Combo"	CaseName=SK05
ComboName=RAR014 ScaleFactor=1	CaseType="Response Combo"	CaseName=SWS	ComboName=RAR016 ScaleFactor=0	CaseType="Response Combo"	CaseName=SKAS
ComboName=RAR014 ScaleFactor=0	CaseType="Response Combo"	CaseName=SK0D	ComboName=RAR016 ScaleFactor=1	CaseType="Response Combo"	CaseName=SWS
ComboName=RAR014 ScaleFactor=1	CaseType="Response Combo"	CaseName=SKAD	ComboName=RAR016 ScaleFactor=0	CaseType="Response Combo"	CaseName=SK0D
ComboName=RAR014 ScaleFactor=1	CaseType="Response Combo"	CaseName=SWD	ComboName=RAR016 ScaleFactor=1	CaseType="Response Combo"	CaseName=SKAD
ComboName=RAR014 ScaleFactor=0,75	CaseType="Linear Static"	CaseName=SA	ComboName=RAR016 ScaleFactor=1	CaseType="Response Combo"	CaseName=SWD
ComboName=RAR014 ScaleFactor=0,75	CaseType="Linear Static"	CaseName=QM01	ComboName=RAR016 ScaleFactor=0,75	CaseType="Linear Static"	CaseName=SA
ComboName=RAR014 ScaleFactor=0,75	CaseType="Linear Static"	CaseName=QM02	ComboName=RAR016 ScaleFactor=0,75	CaseType="Linear Static"	CaseName=QM01
ComboName=RAR014 ScaleFactor=0	CaseType="Linear Static"	CaseName=SQMS	ComboName=RAR016 ScaleFactor=0,75	CaseType="Linear Static"	CaseName=QM02
ComboName=RAR014 ScaleFactor=1	CaseType="Linear Static"	CaseName=SQMD	ComboName=RAR016 ScaleFactor=0	CaseType="Linear Static"	CaseName=SQMS
ComboName=RAR014 ScaleFactor=0,6	CaseType="Linear Static"	CaseName=FA01	ComboName=RAR016 ScaleFactor=0	CaseType="Linear Static"	CaseName=SQMD
ComboName=RAR014 ScaleFactor=0	CaseType="Linear Static"	CaseName=TC01	ComboName=RAR016 ScaleFactor=1	CaseType="Linear Static"	CaseName=FA01
ComboName=RAR014 ScaleFactor=0	CaseType="Linear Static"	CaseName=TC02	ComboName=RAR016 ScaleFactor=0	CaseType="Linear Static"	CaseName=TC01
ComboName=RAR014 ScaleFactor=0	CaseType="Linear Static"	CaseName=TV01	ComboName=RAR016 ScaleFactor=0	CaseType="Linear Static"	CaseName=TC02
ComboName=RAR014 ScaleFactor=0	CaseType="Linear Static"	CaseName=TV02	ComboName=RAR016 ScaleFactor=0	CaseType="Linear Static"	CaseName=TV01
ComboName=RAR014 ScaleFactor=0	CaseType="Linear Static"	CaseName=RIT	ComboName=RAR016 ScaleFactor=0	CaseType="Linear Static"	CaseName=TV02
ComboName=RAR014 ScaleFactor=0	CaseType="Linear Static"	CaseName=SSTS	ComboName=RAR016 ScaleFactor=0	CaseType="Linear Static"	CaseName=RIT
ComboName=RAR015 CaseType="Linear Static"	ComboType="Linear Add"	AutoDesign=No	ComboName=RAR016 ScaleFactor=0	CaseType="Linear Static"	CaseName=SSTS
ConcDesign=No AlumDesign=No ColdDesign=No	CaseName=PPST	ScaleFactor=1	ComboName=RAR017 CaseType="Linear Static"	CaseType="Linear Static"	CaseName=IS01
ComboName=RAR015 ScaleFactor=1	CaseType="Linear Static"	CaseName=PPNS	ConcDesign=No AlumDesign=No ColdDesign=No	CaseName=PPST	ScaleFactor=1
ComboName=RAR015 ScaleFactor=0	CaseType="Linear Static"	CaseName=PPAQ	ComboName=RAR017 ScaleFactor=1	CaseType="Linear Static"	CaseName=PPNS
ComboName=RAR015 ScaleFactor=0	CaseType="Response Combo"	CaseName=SK05	ComboName=RAR017 ScaleFactor=0	CaseType="Linear Static"	CaseName=PPAQ
ComboName=RAR015 ScaleFactor=1	CaseType="Response Combo"	CaseName=SKAS	ComboName=RAR017 ScaleFactor=1	CaseType="Response Combo"	CaseName=SK05
ComboName=RAR015 ScaleFactor=1	CaseType="Response Combo"	CaseName=SWS	ComboName=RAR017 ScaleFactor=0	CaseType="Response Combo"	CaseName=SKAS
ComboName=RAR015 ScaleFactor=0	CaseType="Response Combo"	CaseName=SK0D	ComboName=RAR017 ScaleFactor=1	CaseType="Response Combo"	CaseName=SWS
ComboName=RAR015 ScaleFactor=1	CaseType="Response Combo"	CaseName=SKAD	ComboName=RAR017 ScaleFactor=0	CaseType="Response Combo"	CaseName=SK0D
ComboName=RAR015 ScaleFactor=1	CaseType="Response Combo"	CaseName=SWD	ComboName=RAR017 ScaleFactor=1	CaseType="Response Combo"	CaseName=SKAD
ComboName=RAR015 ScaleFactor=0,75	CaseType="Linear Static"	CaseName=SA	ComboName=RAR017 ScaleFactor=0	CaseType="Response Combo"	CaseName=SWD
ComboName=RAR015 ScaleFactor=0,75	CaseType="Linear Static"	CaseName=QM01	ComboName=RAR017 ScaleFactor=0,75	CaseType="Linear Static"	CaseName=SA
ComboName=RAR015 ScaleFactor=0	CaseType="Linear Static"	CaseName=QM02	ComboName=RAR017 ScaleFactor=0,75	CaseType="Linear Static"	CaseName=QM01
ComboName=RAR015 ScaleFactor=0	CaseType="Linear Static"	CaseName=SQMS	ComboName=RAR017 ScaleFactor=0,75	CaseType="Linear Static"	CaseName=QM02
ComboName=RAR015 ScaleFactor=0	CaseType="Linear Static"	CaseName=SQMD	ComboName=RAR017 ScaleFactor=0	CaseType="Linear Static"	CaseName=SQMS
ComboName=RAR015 ScaleFactor=0	CaseType="Linear Static"	CaseName=FA01	ComboName=RAR017 ScaleFactor=0	CaseType="Linear Static"	CaseName=SQMD
ComboName=RAR015 ScaleFactor=1	CaseType="Linear Static"	CaseName=TC01	ComboName=RAR017 ScaleFactor=0	CaseType="Linear Static"	CaseName=FA01
ComboName=RAR015 ScaleFactor=0	CaseType="Linear Static"	CaseName=TC02	ComboName=RAR017 ScaleFactor=1	CaseType="Linear Static"	CaseName=TC01



ComboName=RAR017 ScaleFactor=0	CaseType="Linear Static"	CaseName=TC02	ComboName=RAR019 ScaleFactor=1	CaseType="Linear Static"	CaseName=TC01
ComboName=RAR017 ScaleFactor=0	CaseType="Linear Static"	CaseName=TV01	ComboName=RAR019 ScaleFactor=0	CaseType="Linear Static"	CaseName=TC02
ComboName=RAR017 ScaleFactor=0	CaseType="Linear Static"	CaseName=TV02	ComboName=RAR019 ScaleFactor=0	CaseType="Linear Static"	CaseName=TV01
ComboName=RAR017 ScaleFactor=0	CaseType="Linear Static"	CaseName=RIT ScaleFactor=0	ComboName=RAR019 ScaleFactor=0	CaseType="Linear Static"	CaseName=TV02
ComboName=RAR017 ScaleFactor=0	CaseType="Linear Static"	CaseName=SSTS	ComboName=RAR019 ScaleFactor=0	CaseType="Linear Static"	CaseName=RIT ScaleFactor=0
ComboName=RAR017 ScaleFactor=0	CaseType="Linear Static"	CaseName=IS01	ComboName=RAR019 ScaleFactor=0	CaseType="Linear Static"	CaseName=SSTS
ComboName=RAR018 CaseType="Linear Static" ConcDesign=No AlumDesign=No ColdDesign=No	ComboType="Linear Add"	AutoDesign=No SteelDesign=No	ComboName=RAR019 ScaleFactor=0	CaseType="Linear Static"	CaseName=IS01
ComboName=RAR018 ScaleFactor=1	CaseType="Linear Static"	CaseName=PPNS	ComboName=RAR020 ScaleFactor=1	ComboType="Linear Add"	AutoDesign=No SteelDesign=No
ComboName=RAR018 ScaleFactor=0	CaseType="Linear Static"	CaseName=PPAQ	ComboName=RAR020 ScaleFactor=0	CaseType="Linear Static"	CaseName=PPNS
ComboName=RAR018 ScaleFactor=1	CaseType="Response Combo"	CaseName=SK05	ComboName=RAR020 ScaleFactor=0	CaseType="Linear Static"	CaseName=PPAQ
ComboName=RAR018 ScaleFactor=0	CaseType="Response Combo"	CaseName=SKAS	ComboName=RAR020 ScaleFactor=1	CaseType="Response Combo"	CaseName=SK05
ComboName=RAR018 ScaleFactor=1	CaseType="Response Combo"	CaseName=SWS	ComboName=RAR020 ScaleFactor=0	CaseType="Response Combo"	CaseName=SKAS
ComboName=RAR018 ScaleFactor=0	CaseType="Response Combo"	CaseName=SK0D	ComboName=RAR020 ScaleFactor=1	CaseType="Response Combo"	CaseName=SWS
ComboName=RAR018 ScaleFactor=1	CaseType="Response Combo"	CaseName=SKAD	ComboName=RAR020 ScaleFactor=0	CaseType="Response Combo"	CaseName=SK0D
ComboName=RAR018 ScaleFactor=0	CaseType="Response Combo"	CaseName=SWD	ComboName=RAR020 ScaleFactor=1	CaseType="Response Combo"	CaseName=SKAD
ComboName=RAR018 ScaleFactor=0	CaseType="Linear Static"	CaseName=SA ScaleFactor=1	ComboName=RAR020 ScaleFactor=0	CaseType="Response Combo"	CaseName=SWD
ComboName=RAR018 ScaleFactor=0	CaseType="Linear Static"	CaseName=QM01	ComboName=RAR020 ScaleFactor=0	CaseType="Linear Static"	CaseName=SA ScaleFactor=1
ComboName=RAR018 ScaleFactor=0	CaseType="Linear Static"	CaseName=QM02	ComboName=RAR020 ScaleFactor=0	CaseType="Linear Static"	CaseName=QM01
ComboName=RAR018 ScaleFactor=0,75	CaseType="Linear Static"	CaseName=SQMS	ComboName=RAR020 ScaleFactor=0	CaseType="Linear Static"	CaseName=QM02
ComboName=RAR018 ScaleFactor=0	CaseType="Linear Static"	CaseName=SQMD	ComboName=RAR020 ScaleFactor=0	CaseType="Linear Static"	CaseName=SQMS
ComboName=RAR018 ScaleFactor=0	CaseType="Linear Static"	CaseName=FA01	ComboName=RAR020 ScaleFactor=0	CaseType="Linear Static"	CaseName=SQMD
ComboName=RAR018 ScaleFactor=1	CaseType="Linear Static"	CaseName=TC01	ComboName=RAR020 ScaleFactor=0	CaseType="Linear Static"	CaseName=FA01
ComboName=RAR018 ScaleFactor=0	CaseType="Linear Static"	CaseName=TC02	ComboName=RAR020 ScaleFactor=1	CaseType="Linear Static"	CaseName=TC01
ComboName=RAR018 ScaleFactor=0	CaseType="Linear Static"	CaseName=TV01	ComboName=RAR020 ScaleFactor=0	CaseType="Linear Static"	CaseName=TC02
ComboName=RAR018 ScaleFactor=0	CaseType="Linear Static"	CaseName=TV02	ComboName=RAR020 ScaleFactor=0,6	CaseType="Linear Static"	CaseName=TV01
ComboName=RAR018 ScaleFactor=0	CaseType="Linear Static"	CaseName=RIT ScaleFactor=0	ComboName=RAR020 ScaleFactor=0	CaseType="Linear Static"	CaseName=TV02
ComboName=RAR018 ScaleFactor=0	CaseType="Linear Static"	CaseName=SSTS	ComboName=RAR020 ScaleFactor=0	CaseType="Linear Static"	CaseName=RIT ScaleFactor=0
ComboName=RAR018 ScaleFactor=0	CaseType="Linear Static"	CaseName=IS01	ComboName=RAR020 ScaleFactor=0	CaseType="Linear Static"	CaseName=SSTS
ComboName=RAR019 CaseType="Linear Static" ConcDesign=No AlumDesign=No ColdDesign=No	ComboType="Linear Add"	AutoDesign=No SteelDesign=No	ComboName=RAR020 ScaleFactor=0	CaseType="Linear Static"	CaseName=IS01
ComboName=RAR019 ScaleFactor=1	CaseType="Linear Static"	CaseName=PPNS	ComboName=RAR021 ScaleFactor=1	ComboType="Linear Add"	AutoDesign=No SteelDesign=No
ComboName=RAR019 ScaleFactor=0	CaseType="Linear Static"	CaseName=PPAQ	ComboName=RAR021 ScaleFactor=0	CaseType="Linear Static"	CaseName=PPNS
ComboName=RAR019 ScaleFactor=1	CaseType="Response Combo"	CaseName=SK05	ComboName=RAR021 ScaleFactor=0	CaseType="Linear Static"	CaseName=PPAQ
ComboName=RAR019 ScaleFactor=0	CaseType="Response Combo"	CaseName=SKAS	ComboName=RAR021 ScaleFactor=1	CaseType="Response Combo"	CaseName=SK05
ComboName=RAR019 ScaleFactor=1	CaseType="Response Combo"	CaseName=SWS	ComboName=RAR021 ScaleFactor=0	CaseType="Response Combo"	CaseName=SKAS
ComboName=RAR019 ScaleFactor=1	CaseType="Response Combo"	CaseName=SK0D	ComboName=RAR021 ScaleFactor=1	CaseType="Response Combo"	CaseName=SWS
ComboName=RAR019 ScaleFactor=0	CaseType="Response Combo"	CaseName=SKAD	ComboName=RAR021 ScaleFactor=0	CaseType="Response Combo"	CaseName=SK0D
ComboName=RAR019 ScaleFactor=1	CaseType="Response Combo"	CaseName=SWD	ComboName=RAR021 ScaleFactor=1	CaseType="Response Combo"	CaseName=SKAD
ComboName=RAR019 ScaleFactor=0	CaseType="Linear Static"	CaseName=SA ScaleFactor=1	ComboName=RAR021 ScaleFactor=0	CaseType="Response Combo"	CaseName=SWD
ComboName=RAR019 ScaleFactor=0	CaseType="Linear Static"	CaseName=QM01	ComboName=RAR021 ScaleFactor=0,75	CaseType="Linear Static"	CaseName=SA ScaleFactor=1
ComboName=RAR019 ScaleFactor=0	CaseType="Linear Static"	CaseName=QM02	ComboName=RAR021 ScaleFactor=0,75	CaseType="Linear Static"	CaseName=QM01
ComboName=RAR019 ScaleFactor=0,75	CaseType="Linear Static"	CaseName=SQMS	ComboName=RAR021 ScaleFactor=0	CaseType="Linear Static"	CaseName=QM02
ComboName=RAR019 ScaleFactor=0,75	CaseType="Linear Static"	CaseName=SQMD	ComboName=RAR021 ScaleFactor=0	CaseType="Linear Static"	CaseName=SQMS
ComboName=RAR019 ScaleFactor=0	CaseType="Linear Static"	CaseName=FA01	ComboName=RAR021 ScaleFactor=0	CaseType="Linear Static"	CaseName=SQMD

ComboName=RAR021 ScaleFactor=0	CaseType="Linear Static"	CaseName=FA01	ComboName=RAR023 ScaleFactor=0,75	CaseType="Linear Static"	CaseName=SQMD
ComboName=RAR021 ScaleFactor=1	CaseType="Linear Static"	CaseName=TC01	ComboName=RAR023 ScaleFactor=0	CaseType="Linear Static"	CaseName=FA01
ComboName=RAR021 ScaleFactor=0	CaseType="Linear Static"	CaseName=TC02	ComboName=RAR023 ScaleFactor=1	CaseType="Linear Static"	CaseName=TC01
ComboName=RAR021 ScaleFactor=0,6	CaseType="Linear Static"	CaseName=TV01	ComboName=RAR023 ScaleFactor=0	CaseType="Linear Static"	CaseName=TC02
ComboName=RAR021 ScaleFactor=0	CaseType="Linear Static"	CaseName=TV02	ComboName=RAR023 ScaleFactor=0,6	CaseType="Linear Static"	CaseName=TV01
ComboName=RAR021 ScaleFactor=0	CaseType="Linear Static"	CaseName=RIT	ComboName=RAR023 ScaleFactor=0	CaseType="Linear Static"	CaseName=TV02
ComboName=RAR021 ScaleFactor=0	CaseType="Linear Static"	CaseName=SSTS	ComboName=RAR023 ScaleFactor=0	CaseType="Linear Static"	CaseName=RIT
ComboName=RAR021 ScaleFactor=0	CaseType="Linear Static"	CaseName=IS01	ComboName=RAR023 ScaleFactor=0	CaseType="Linear Static"	CaseName=SSTS
ComboName=RAR022 CaseType="Linear Static" ScaleFactor=1 ConcDesign=No AlumDesign=No ColdDesign=No	ComboType="Linear Add" CaseName=PPST ScaleFactor=1 SteelDesign=No	AutoDesign=No SteelDesign=No	ComboName=RAR023 ScaleFactor=0	CaseType="Linear Static"	CaseName=IS01
ComboName=RAR022 ScaleFactor=1	CaseType="Linear Static"	CaseName=PPNS	ComboName=RAR024 CaseType="Linear Static" ScaleFactor=1 ConcDesign=No AlumDesign=No ColdDesign=No	ComboType="Linear Add" CaseName=PPST ScaleFactor=1 SteelDesign=No	AutoDesign=No SteelDesign=No
ComboName=RAR022 ScaleFactor=0	CaseType="Linear Static"	CaseName=PPAQ	ComboName=RAR024 ScaleFactor=1	CaseType="Linear Static"	CaseName=PPNS
ComboName=RAR022 ScaleFactor=1	CaseType="Response Combo"	CaseName=SK05	ComboName=RAR024 ScaleFactor=0	CaseType="Linear Static"	CaseName=PPAQ
ComboName=RAR022 ScaleFactor=0	CaseType="Response Combo"	CaseName=SKAS	ComboName=RAR024 ScaleFactor=1	CaseType="Response Combo"	CaseName=SK05
ComboName=RAR022 ScaleFactor=1	CaseType="Response Combo"	CaseName=SWS	ComboName=RAR024 ScaleFactor=0	CaseType="Response Combo"	CaseName=SKAS
ComboName=RAR022 ScaleFactor=0	CaseType="Response Combo"	CaseName=SK0D	ComboName=RAR024 ScaleFactor=1	CaseType="Response Combo"	CaseName=SWS
ComboName=RAR022 ScaleFactor=1	CaseType="Response Combo"	CaseName=SKAD	ComboName=RAR024 ScaleFactor=0	CaseType="Response Combo"	CaseName=SK0D
ComboName=RAR022 ScaleFactor=1	CaseType="Response Combo"	CaseName=SWD	ComboName=RAR024 ScaleFactor=1	CaseType="Response Combo"	CaseName=SKAD
ComboName=RAR022 ScaleFactor=0,75	CaseType="Linear Static"	CaseName=SA	ComboName=RAR024 ScaleFactor=1	CaseType="Response Combo"	CaseName=SWD
ComboName=RAR022 ScaleFactor=0,75	CaseType="Linear Static"	CaseName=QM01	ComboName=RAR024 ScaleFactor=0	CaseType="Linear Static"	CaseName=SA
ComboName=RAR022 ScaleFactor=0,75	CaseType="Linear Static"	CaseName=QM02	ComboName=RAR024 ScaleFactor=0	CaseType="Linear Static"	CaseName=QM01
ComboName=RAR022 ScaleFactor=0	CaseType="Linear Static"	CaseName=SQMS	ComboName=RAR024 ScaleFactor=0,75	CaseType="Linear Static"	CaseName=QM02
ComboName=RAR022 ScaleFactor=0	CaseType="Linear Static"	CaseName=SQMD	ComboName=RAR024 ScaleFactor=0	CaseType="Linear Static"	CaseName=SQMS
ComboName=RAR022 ScaleFactor=1	CaseType="Linear Static"	CaseName=FA01	ComboName=RAR024 ScaleFactor=0	CaseType="Linear Static"	CaseName=SQMD
ComboName=RAR022 ScaleFactor=0	CaseType="Linear Static"	CaseName=TC01	ComboName=RAR024 ScaleFactor=1	CaseType="Linear Static"	CaseName=FA01
ComboName=RAR022 ScaleFactor=0	CaseType="Linear Static"	CaseName=TC02	ComboName=RAR024 ScaleFactor=0	CaseType="Linear Static"	CaseName=TC01
ComboName=RAR022 ScaleFactor=0,6	CaseType="Linear Static"	CaseName=TV01	ComboName=RAR024 ScaleFactor=1	CaseType="Linear Static"	CaseName=TC02
ComboName=RAR022 ScaleFactor=0	CaseType="Linear Static"	CaseName=TV02	ComboName=RAR024 ScaleFactor=0	CaseType="Linear Static"	CaseName=TV01
ComboName=RAR022 ScaleFactor=0	CaseType="Linear Static"	CaseName=RIT	ComboName=RAR024 ScaleFactor=0,6	CaseType="Linear Static"	CaseName=TV02
ComboName=RAR022 ScaleFactor=0	CaseType="Linear Static"	CaseName=SSTS	ComboName=RAR024 ScaleFactor=0	CaseType="Linear Static"	CaseName=RIT
ComboName=RAR022 ScaleFactor=0	CaseType="Linear Static"	CaseName=IS01	ComboName=RAR024 ScaleFactor=0	CaseType="Linear Static"	CaseName=SSTS
ComboName=RAR023 CaseType="Linear Static" ScaleFactor=1 ConcDesign=No AlumDesign=No ColdDesign=No	ComboType="Linear Add" CaseName=PPST ScaleFactor=1 SteelDesign=No	AutoDesign=No SteelDesign=No	ComboName=RAR024 ScaleFactor=0	CaseType="Linear Static"	CaseName=IS01
ComboName=RAR023 ScaleFactor=1	CaseType="Linear Static"	CaseName=PPNS	ComboName=RAR025 CaseType="Linear Static" ScaleFactor=1 ConcDesign=No AlumDesign=No ColdDesign=No	ComboType="Linear Add" CaseName=PPST ScaleFactor=1 SteelDesign=No	AutoDesign=No SteelDesign=No
ComboName=RAR023 ScaleFactor=0	CaseType="Linear Static"	CaseName=PPAQ	ComboName=RAR025 ScaleFactor=1	CaseType="Linear Static"	CaseName=PPNS
ComboName=RAR023 ScaleFactor=1	CaseType="Response Combo"	CaseName=SK05	ComboName=RAR025 ScaleFactor=0	CaseType="Linear Static"	CaseName=PPAQ
ComboName=RAR023 ScaleFactor=0	CaseType="Response Combo"	CaseName=SKAS	ComboName=RAR025 ScaleFactor=1	CaseType="Response Combo"	CaseName=SK05
ComboName=RAR023 ScaleFactor=1	CaseType="Response Combo"	CaseName=SWS	ComboName=RAR025 ScaleFactor=0	CaseType="Response Combo"	CaseName=SKAS
ComboName=RAR023 ScaleFactor=0	CaseType="Response Combo"	CaseName=SK0D	ComboName=RAR025 ScaleFactor=1	CaseType="Response Combo"	CaseName=SWS
ComboName=RAR023 ScaleFactor=0	CaseType="Response Combo"	CaseName=SKAD	ComboName=RAR025 ScaleFactor=0	CaseType="Response Combo"	CaseName=SK0D
ComboName=RAR023 ScaleFactor=1	CaseType="Response Combo"	CaseName=SWD	ComboName=RAR025 ScaleFactor=1	CaseType="Response Combo"	CaseName=SKAD
ComboName=RAR023 ScaleFactor=0,75	CaseType="Linear Static"	CaseName=SA	ComboName=RAR025 ScaleFactor=0	CaseType="Response Combo"	CaseName=SWD
ComboName=RAR023 ScaleFactor=0,75	CaseType="Linear Static"	CaseName=QM01	ComboName=RAR025 ScaleFactor=1	CaseType="Response Combo"	CaseName=SA
ComboName=RAR023 ScaleFactor=0,75	CaseType="Linear Static"	CaseName=QM02	ComboName=RAR025 ScaleFactor=0	CaseType="Linear Static"	CaseName=QM01
ComboName=RAR023 ScaleFactor=0,75	CaseType="Linear Static"	CaseName=SQMS	ComboName=RAR025 ScaleFactor=0	CaseType="Linear Static"	CaseName=QM02
ComboName=RAR023 ScaleFactor=0,75	CaseType="Linear Static"	CaseName=SQMD	ComboName=RAR025 ScaleFactor=0	CaseType="Linear Static"	CaseName=SQMS

APPROVATO SDP

Società di Progetto
Brebem SpA



ComboName=RAR029 ScaleFactor=0,75	CaseType="Linear Static"	CaseName=QM01	ComboName=RAR031 ScaleFactor=1	CaseType="Response Combo"	CaseName=SWD
ComboName=RAR029 ScaleFactor=0,75	CaseType="Linear Static"	CaseName=QM02	ComboName=RAR031 ComboName=RAR031 ScaleFactor=0	CaseType="Linear Static" CaseType="Linear Static"	CaseName=SA ScaleFactor=1 CaseName=QM01
ComboName=RAR029 ScaleFactor=0,75	CaseType="Linear Static"	CaseName=SQMS	ComboName=RAR031 ScaleFactor=0	CaseType="Linear Static"	CaseName=QM02
ComboName=RAR029 ScaleFactor=0,75	CaseType="Linear Static"	CaseName=SQMD	ComboName=RAR031 ScaleFactor=0,75	CaseType="Linear Static"	CaseName=SQMS
ComboName=RAR029 ScaleFactor=0	CaseType="Linear Static"	CaseName=FA01	ComboName=RAR031 ScaleFactor=0,75	CaseType="Linear Static"	CaseName=SQMD
ComboName=RAR029 ScaleFactor=1	CaseType="Linear Static"	CaseName=TC01	ComboName=RAR031 ScaleFactor=0	CaseType="Linear Static"	CaseName=FA01
ComboName=RAR029 ScaleFactor=0	CaseType="Linear Static"	CaseName=TC02	ComboName=RAR031 ScaleFactor=1	CaseType="Linear Static"	CaseName=TC01
ComboName=RAR029 ScaleFactor=0	CaseType="Linear Static"	CaseName=TV01	ComboName=RAR031 ScaleFactor=0	CaseType="Linear Static"	CaseName=TC02
ComboName=RAR029 ScaleFactor=0,6	CaseType="Linear Static"	CaseName=TV02	ComboName=RAR031 ScaleFactor=0	CaseType="Linear Static"	CaseName=TV01
ComboName=RAR029	CaseType="Linear Static"	CaseName=RIT ScaleFactor=0	ComboName=RAR031 ScaleFactor=0,6	CaseType="Linear Static"	CaseName=TV02
ComboName=RAR029 ScaleFactor=0	CaseType="Linear Static"	CaseName=SSTS	ComboName=RAR031 ScaleFactor=0	CaseType="Linear Static"	CaseName=TV02
ComboName=RAR029 ScaleFactor=0	CaseType="Linear Static"	CaseName=IS01	ComboName=RAR031 ScaleFactor=0	CaseType="Linear Static"	CaseName=RIT ScaleFactor=0 CaseName=SSTS
ComboName=RAR030 CaseType="Linear Static" ConcDesign=No AlumDesign=No ColdDesign=No	ComboType="Linear Add" CaseName=PPST ScaleFactor=1	AutoDesign=No SteelDesign=No	ComboName=RAR031 ScaleFactor=0	CaseType="Linear Static"	CaseName=IS01
ComboName=RAR030 ScaleFactor=1	CaseType="Linear Static"	CaseName=PPNS	ComboName=RAR032 CaseType="Linear Static" ConcDesign=No AlumDesign=No ColdDesign=No	ComboType="Linear Add" CaseName=PPST ScaleFactor=1	AutoDesign=No SteelDesign=No
ComboName=RAR030 ScaleFactor=0	CaseType="Linear Static"	CaseName=PPAQ	ComboName=RAR032 ScaleFactor=1	CaseType="Linear Static"	CaseName=PPNS
ComboName=RAR030 ScaleFactor=1	CaseType="Response Combo"	CaseName=SK05	ComboName=RAR032 ScaleFactor=0	CaseType="Linear Static"	CaseName=PPAQ
ComboName=RAR030 ScaleFactor=0	CaseType="Response Combo"	CaseName=SKAS	ComboName=RAR032 ScaleFactor=1	CaseType="Response Combo"	CaseName=SK05
ComboName=RAR030 ScaleFactor=1	CaseType="Response Combo"	CaseName=SWS	ComboName=RAR032 ScaleFactor=0	CaseType="Response Combo"	CaseName=SKAS
ComboName=RAR030 ScaleFactor=0	CaseType="Response Combo"	CaseName=SK0D	ComboName=RAR032 ScaleFactor=1	CaseType="Response Combo"	CaseName=SWS
ComboName=RAR030 ScaleFactor=1	CaseType="Response Combo"	CaseName=SKAD	ComboName=RAR032 ScaleFactor=0	CaseType="Response Combo"	CaseName=SK0D
ComboName=RAR030 ScaleFactor=1	CaseType="Response Combo"	CaseName=SWD	ComboName=RAR032 ScaleFactor=1	CaseType="Response Combo"	CaseName=SKAD
ComboName=RAR030	CaseType="Linear Static"	CaseName=SA ScaleFactor=1	ComboName=RAR032 ScaleFactor=1	CaseType="Response Combo"	CaseName=SWD
ComboName=RAR030	CaseType="Linear Static"	CaseName=QM01	ComboName=RAR032 ScaleFactor=1	CaseType="Response Combo"	CaseName=SWD
ComboName=RAR030 ScaleFactor=0	CaseType="Linear Static"	CaseName=QM02	ComboName=RAR032 ScaleFactor=0	CaseType="Linear Static"	CaseName=SA ScaleFactor=1 CaseName=QM01
ComboName=RAR030 ScaleFactor=0,75	CaseType="Linear Static"	CaseName=SQMS	ComboName=RAR032 ScaleFactor=0	CaseType="Linear Static"	CaseName=QM02
ComboName=RAR030 ScaleFactor=0	CaseType="Linear Static"	CaseName=SQMD	ComboName=RAR032 ScaleFactor=0	CaseType="Linear Static"	CaseName=SQMS
ComboName=RAR030 ScaleFactor=0	CaseType="Linear Static"	CaseName=FA01	ComboName=RAR032 ScaleFactor=0	CaseType="Linear Static"	CaseName=SQMD
ComboName=RAR030 ScaleFactor=1	CaseType="Linear Static"	CaseName=TC01	ComboName=RAR032 ScaleFactor=0	CaseType="Linear Static"	CaseName=FA01
ComboName=RAR030 ScaleFactor=0	CaseType="Linear Static"	CaseName=TC02	ComboName=RAR032 ScaleFactor=1	CaseType="Linear Static"	CaseName=TC01
ComboName=RAR030 ScaleFactor=0	CaseType="Linear Static"	CaseName=TV01	ComboName=RAR032 ScaleFactor=0	CaseType="Linear Static"	CaseName=TC02
ComboName=RAR030 ScaleFactor=0,6	CaseType="Linear Static"	CaseName=TV02	ComboName=RAR032 ScaleFactor=0	CaseType="Linear Static"	CaseName=TV01
ComboName=RAR030	CaseType="Linear Static"	CaseName=RIT ScaleFactor=0	ComboName=RAR032 ScaleFactor=0,6	CaseType="Linear Static"	CaseName=TV02
ComboName=RAR030 ScaleFactor=0	CaseType="Linear Static"	CaseName=SSTS	ComboName=RAR032 ScaleFactor=0	CaseType="Linear Static"	CaseName=RIT
ComboName=RAR030 ScaleFactor=0	CaseType="Linear Static"	CaseName=IS01	ComboName=RAR032 ScaleFactor=0,6	CaseType="Linear Static"	CaseName=SSTS
ComboName=RAR031 CaseType="Linear Static" ConcDesign=No AlumDesign=No ColdDesign=No	ComboType="Linear Add" CaseName=PPST ScaleFactor=1	AutoDesign=No SteelDesign=No	ComboName=RAR032 ScaleFactor=0	CaseType="Linear Static"	CaseName=IS01
ComboName=RAR031 ScaleFactor=1	CaseType="Linear Static"	CaseName=PPNS	ComboName=RAR033 CaseType="Linear Static" ConcDesign=No AlumDesign=No ColdDesign=No	ComboType="Linear Add" CaseName=PPST ScaleFactor=1	AutoDesign=No SteelDesign=No
ComboName=RAR031 ScaleFactor=0	CaseType="Linear Static"	CaseName=PPAQ	ComboName=RAR033 ScaleFactor=1	CaseType="Linear Static"	CaseName=PPNS
ComboName=RAR031 ScaleFactor=1	CaseType="Response Combo"	CaseName=SK05	ComboName=RAR033 ScaleFactor=0	CaseType="Linear Static"	CaseName=PPAQ
ComboName=RAR031 ScaleFactor=0	CaseType="Response Combo"	CaseName=SKAS	ComboName=RAR033 ScaleFactor=0	CaseType="Response Combo"	CaseName=SK05
ComboName=RAR031 ScaleFactor=1	CaseType="Response Combo"	CaseName=SWS	ComboName=RAR033 ScaleFactor=1	CaseType="Response Combo"	CaseName=SKAS
ComboName=RAR031 ScaleFactor=0	CaseType="Response Combo"	CaseName=SK0D	ComboName=RAR033 ScaleFactor=1	CaseType="Response Combo"	CaseName=SWS
ComboName=RAR031 ScaleFactor=0	CaseType="Response Combo"	CaseName=SKAD	ComboName=RAR033 ScaleFactor=1	CaseType="Response Combo"	CaseName=SWS

APPROVATO SGP

Società di Progetto
Brebem SpA



ComboName=RAR037 ScaleFactor=0	CaseType="Linear Static"	CaseName=PPAQ	ComboName=RAR039 CaseType="Linear Add"	AutoDesign=No
ComboName=RAR037 ScaleFactor=1	CaseType="Response Combo"	CaseName=SK05	CaseType="Linear Static"	CaseName=PPST ScaleFactor=1
ComboName=RAR037 ScaleFactor=0	CaseType="Response Combo"	CaseName=SKAS	ConcDesign=No AlumDesign=No ColdDesign=No	CaseName=PPNS
ComboName=RAR037 ScaleFactor=1	CaseType="Response Combo"	CaseName=SWS	ComboName=RAR039 ScaleFactor=1	CaseType="Linear Static"
ComboName=RAR037 ScaleFactor=1	CaseType="Response Combo"	CaseName=SK0D	ComboName=RAR039 ScaleFactor=0	CaseType="Response Combo"
ComboName=RAR037 ScaleFactor=0	CaseType="Response Combo"	CaseName=SKAD	ComboName=RAR039 ScaleFactor=1	CaseType="Response Combo"
ComboName=RAR037 ScaleFactor=1	CaseType="Response Combo"	CaseName=SWD	ComboName=RAR039 ScaleFactor=0	CaseType="Response Combo"
ComboName=RAR037 ScaleFactor=0	CaseType="Linear Static"	CaseName=SA ScaleFactor=1	ComboName=RAR039 ScaleFactor=1	CaseType="Response Combo"
ComboName=RAR037 ScaleFactor=0	CaseType="Linear Static"	CaseName=QM01	ComboName=RAR039 ScaleFactor=0	CaseType="Response Combo"
ComboName=RAR037 ScaleFactor=0	CaseType="Linear Static"	CaseName=QM02	ComboName=RAR039 ScaleFactor=1	CaseType="Response Combo"
ComboName=RAR037 ScaleFactor=0,75	CaseType="Linear Static"	CaseName=SQMS	ComboName=RAR039 ScaleFactor=1	CaseType="Linear Static"
ComboName=RAR037 ScaleFactor=0,75	CaseType="Linear Static"	CaseName=SQMD	ComboName=RAR039 ScaleFactor=0	CaseType="Linear Static"
ComboName=RAR037 ScaleFactor=0	CaseType="Linear Static"	CaseName=FA01	ComboName=RAR039 ScaleFactor=0	CaseType="Linear Static"
ComboName=RAR037 ScaleFactor=1	CaseType="Linear Static"	CaseName=TC01	ComboName=RAR039 ScaleFactor=0	CaseType="Linear Static"
ComboName=RAR037 ScaleFactor=0	CaseType="Linear Static"	CaseName=TC02	ComboName=RAR039 ScaleFactor=0	CaseType="Linear Static"
ComboName=RAR037 ScaleFactor=0	CaseType="Linear Static"	CaseName=TV01	ComboName=RAR039 ScaleFactor=0	CaseType="Linear Static"
ComboName=RAR037 ScaleFactor=0	CaseType="Linear Static"	CaseName=TV02	ComboName=RAR039 ScaleFactor=0,6	CaseType="Linear Static"
ComboName=RAR037 ScaleFactor=0,6	CaseType="Linear Static"	CaseName=RIT	ComboName=RAR039 ScaleFactor=0	CaseType="Linear Static"
ComboName=RAR037 ScaleFactor=0	CaseType="Linear Static"	CaseName=SSTS	ComboName=RAR039 ScaleFactor=0	CaseType="Linear Static"
ComboName=RAR037 ScaleFactor=0	CaseType="Linear Static"	CaseName=IS01	ComboName=RAR039 ScaleFactor=0	CaseType="Linear Static"
ComboName=RAR038 CaseType="Linear Static"	CaseType="Linear Add"	AutoDesign=No	ComboName=RAR039 ScaleFactor=0	CaseType="Linear Static"
ConcDesign=No AlumDesign=No ColdDesign=No	CaseName=PPST ScaleFactor=1	SteelDesign=No	ComboName=RAR039 ScaleFactor=0	CaseType="Linear Static"
ComboName=RAR038 ScaleFactor=1	CaseType="Linear Static"	CaseName=PPNS	ComboName=RAR039 ScaleFactor=0	CaseType="Linear Static"
ComboName=RAR038 ScaleFactor=0	CaseType="Linear Static"	CaseName=PPAQ	ComboName=RAR040 CaseType="Linear Add"	AutoDesign=No
ComboName=RAR038 ScaleFactor=0	CaseType="Response Combo"	CaseName=SK05	CaseType="Linear Static"	CaseName=PPST ScaleFactor=1
ComboName=RAR038 ScaleFactor=1	CaseType="Response Combo"	CaseName=SKAS	ConcDesign=No AlumDesign=No ColdDesign=No	CaseName=PPNS
ComboName=RAR038 ScaleFactor=1	CaseType="Response Combo"	CaseName=SWS	ComboName=RAR040 ScaleFactor=1	CaseType="Linear Static"
ComboName=RAR038 ScaleFactor=0	CaseType="Response Combo"	CaseName=SK0D	ComboName=RAR040 ScaleFactor=0	CaseType="Response Combo"
ComboName=RAR038 ScaleFactor=1	CaseType="Response Combo"	CaseName=SKAD	ComboName=RAR040 ScaleFactor=1	CaseType="Response Combo"
ComboName=RAR038 ScaleFactor=1	CaseType="Response Combo"	CaseName=SWD	ComboName=RAR040 ScaleFactor=0	CaseType="Response Combo"
ComboName=RAR038 ScaleFactor=0	CaseType="Linear Static"	CaseName=SA ScaleFactor=1	ComboName=RAR040 ScaleFactor=1	CaseType="Response Combo"
ComboName=RAR038 ScaleFactor=0	CaseType="Linear Static"	CaseName=QM01	ComboName=RAR040 ScaleFactor=0	CaseType="Response Combo"
ComboName=RAR038 ScaleFactor=0	CaseType="Linear Static"	CaseName=QM02	ComboName=RAR040 ScaleFactor=1	CaseType="Response Combo"
ComboName=RAR038 ScaleFactor=0	CaseType="Linear Static"	CaseName=SQMS	ComboName=RAR040 ScaleFactor=1	CaseType="Linear Static"
ComboName=RAR038 ScaleFactor=0	CaseType="Linear Static"	CaseName=SQMD	ComboName=RAR040 ScaleFactor=0	CaseType="Linear Static"
ComboName=RAR038 ScaleFactor=0	CaseType="Linear Static"	CaseName=FA01	ComboName=RAR040 ScaleFactor=0	CaseType="Linear Static"
ComboName=RAR038 ScaleFactor=0	CaseType="Linear Static"	CaseName=TC01	ComboName=RAR040 ScaleFactor=0	CaseType="Linear Static"
ComboName=RAR038 ScaleFactor=1	CaseType="Linear Static"	CaseName=TC02	ComboName=RAR040 ScaleFactor=0,6	CaseType="Linear Static"
ComboName=RAR038 ScaleFactor=0	CaseType="Linear Static"	CaseName=TV01	ComboName=RAR040 ScaleFactor=0	CaseType="Linear Static"
ComboName=RAR038 ScaleFactor=0	CaseType="Linear Static"	CaseName=TV02	ComboName=RAR040 ScaleFactor=0	CaseType="Linear Static"
ComboName=RAR038 ScaleFactor=0	CaseType="Linear Static"	CaseName=RIT ScaleFactor=0	ComboName=RAR040 ScaleFactor=0	CaseType="Linear Static"
ComboName=RAR038 ScaleFactor=0	CaseType="Linear Static"	CaseName=SSTS	ComboName=RAR040 ScaleFactor=0	CaseType="Linear Static"
ComboName=RAR038 ScaleFactor=0	CaseType="Linear Static"	CaseName=IS01	ComboName=RAR040 ScaleFactor=0	CaseType="Linear Static"
ComboName=RAR040 ScaleFactor=0	CaseType="Linear Static"	CaseName=RIT ScaleFactor=0	ComboName=RAR040 ScaleFactor=0	CaseType="Linear Static"
ComboName=RAR040 ScaleFactor=0	CaseType="Linear Static"	CaseName=SSTS	ComboName=RAR040 ScaleFactor=0	CaseType="Linear Static"

APPROVATO SGP

Società di Progetto
Brebemi SpA

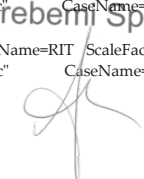

ComboName=RAR056 ScaleFactor=0	CaseType="Linear Static"	CaseName=SQMS	ComboName=RAR058 ScaleFactor=0,75	CaseType="Linear Static"	CaseName=QM02
ComboName=RAR056 ScaleFactor=0	CaseType="Linear Static"	CaseName=SQMD	ComboName=RAR058 ScaleFactor=0,75	CaseType="Linear Static"	CaseName=SQMS
ComboName=RAR056 ScaleFactor=0	CaseType="Linear Static"	CaseName=FA01	ComboName=RAR058 ScaleFactor=0	CaseType="Linear Static"	CaseName=SQMD
ComboName=RAR056 ScaleFactor=0	CaseType="Linear Static"	CaseName=TC01	ComboName=RAR058 ScaleFactor=0	CaseType="Linear Static"	CaseName=FA01
ComboName=RAR056 ScaleFactor=1	CaseType="Linear Static"	CaseName=TC02	ComboName=RAR058 ScaleFactor=0	CaseType="Linear Static"	CaseName=TC01
ComboName=RAR056 ScaleFactor=0	CaseType="Linear Static"	CaseName=TV01	ComboName=RAR058 ScaleFactor=1	CaseType="Linear Static"	CaseName=TC02
ComboName=RAR056 ScaleFactor=0,6	CaseType="Linear Static"	CaseName=TV02	ComboName=RAR058 ScaleFactor=0	CaseType="Linear Static"	CaseName=TV01
ComboName=RAR056 ScaleFactor=0	CaseType="Linear Static"	CaseName=RIT	ComboName=RAR058 ScaleFactor=0,6	CaseType="Linear Static"	CaseName=TV02
ComboName=RAR056 ScaleFactor=0	CaseType="Linear Static"	CaseName=SSTS	ComboName=RAR058 ScaleFactor=0	CaseType="Linear Static"	CaseName=RIT
ComboName=RAR056 ScaleFactor=0	CaseType="Linear Static"	CaseName=IS01	ComboName=RAR058 ScaleFactor=0	CaseType="Linear Static"	CaseName=SSTS
ComboName=RAR057 CaseType="Linear Static"	ComboType="Linear Add"	AutoDesign=No	ComboName=RAR058 ScaleFactor=0	CaseType="Linear Static"	CaseName=IS01
ConcDesign=No AlumDesign=No ColdDesign=No	CaseName=PPST	ScaleFactor=1	ComboName=RAR059 CaseType="Linear Static"	ComboType="Linear Add"	AutoDesign=No
ComboName=RAR057 ScaleFactor=1	CaseType="Linear Static"	CaseName=PPNS	ConcDesign=No AlumDesign=No ColdDesign=No	CaseName=PPST	ScaleFactor=1
ComboName=RAR057 ScaleFactor=0	CaseType="Linear Static"	CaseName=PPAQ	ComboName=RAR059 ScaleFactor=1	CaseType="Linear Static"	CaseName=PPNS
ComboName=RAR057 ScaleFactor=0	CaseType="Response Combo"	CaseName=SK05	ComboName=RAR059 ScaleFactor=0	CaseType="Linear Static"	CaseName=PPAQ
ComboName=RAR057 ScaleFactor=1	CaseType="Response Combo"	CaseName=SKAS	ComboName=RAR059 ScaleFactor=1	CaseType="Response Combo"	CaseName=SK05
ComboName=RAR057 ScaleFactor=1	CaseType="Response Combo"	CaseName=SWS	ComboName=RAR059 ScaleFactor=0	CaseType="Response Combo"	CaseName=SKAS
ComboName=RAR057 ScaleFactor=0	CaseType="Response Combo"	CaseName=SK0D	ComboName=RAR059 ScaleFactor=1	CaseType="Response Combo"	CaseName=SWS
ComboName=RAR057 ScaleFactor=1	CaseType="Response Combo"	CaseName=SKAD	ComboName=RAR059 ScaleFactor=1	CaseType="Response Combo"	CaseName=SK0D
ComboName=RAR057 ScaleFactor=1	CaseType="Response Combo"	CaseName=SWD	ComboName=RAR059 ScaleFactor=0	CaseType="Response Combo"	CaseName=SKAD
ComboName=RAR057 ScaleFactor=0,75	CaseType="Linear Static"	CaseName=SA	ComboName=RAR059 ScaleFactor=1	CaseType="Response Combo"	CaseName=SWD
ComboName=RAR057 ScaleFactor=0,75	CaseType="Linear Static"	CaseName=QM01	ComboName=RAR059 ScaleFactor=0,75	CaseType="Linear Static"	CaseName=SA
ComboName=RAR057 ScaleFactor=0	CaseType="Linear Static"	CaseName=QM02	ComboName=RAR059 ScaleFactor=0,75	CaseType="Linear Static"	CaseName=QM01
ComboName=RAR057 ScaleFactor=0	CaseType="Linear Static"	CaseName=SQMS	ComboName=RAR059 ScaleFactor=0,75	CaseType="Linear Static"	CaseName=QM02
ComboName=RAR057 ScaleFactor=0	CaseType="Linear Static"	CaseName=SQMD	ComboName=RAR059 ScaleFactor=0,75	CaseType="Linear Static"	CaseName=SQMS
ComboName=RAR057 ScaleFactor=0	CaseType="Linear Static"	CaseName=FA01	ComboName=RAR059 ScaleFactor=0,75	CaseType="Linear Static"	CaseName=SQMD
ComboName=RAR057 ScaleFactor=0	CaseType="Linear Static"	CaseName=TC01	ComboName=RAR059 ScaleFactor=0	CaseType="Linear Static"	CaseName=FA01
ComboName=RAR057 ScaleFactor=1	CaseType="Linear Static"	CaseName=TC02	ComboName=RAR059 ScaleFactor=0	CaseType="Linear Static"	CaseName=TC01
ComboName=RAR057 ScaleFactor=0	CaseType="Linear Static"	CaseName=TV01	ComboName=RAR059 ScaleFactor=1	CaseType="Linear Static"	CaseName=TC02
ComboName=RAR057 ScaleFactor=0,6	CaseType="Linear Static"	CaseName=TV02	ComboName=RAR059 ScaleFactor=0	CaseType="Linear Static"	CaseName=TV01
ComboName=RAR057 ScaleFactor=0	CaseType="Linear Static"	CaseName=RIT	ComboName=RAR059 ScaleFactor=0	CaseType="Linear Static"	CaseName=TV02
ComboName=RAR057 ScaleFactor=0	CaseType="Linear Static"	CaseName=SSTS	ComboName=RAR059 ScaleFactor=0,6	CaseType="Linear Static"	CaseName=RIT
ComboName=RAR057 ScaleFactor=0	CaseType="Linear Static"	CaseName=IS01	ComboName=RAR059 ScaleFactor=0	CaseType="Linear Static"	CaseName=SSTS
ComboName=RAR058 CaseType="Linear Static"	ComboType="Linear Add"	AutoDesign=No	ComboName=RAR059 ScaleFactor=0	CaseType="Linear Static"	CaseName=IS01
ConcDesign=No AlumDesign=No ColdDesign=No	CaseName=PPST	ScaleFactor=1	ComboName=RAR060 CaseType="Linear Static"	ComboType="Linear Add"	AutoDesign=No
ComboName=RAR058 ScaleFactor=1	CaseType="Linear Static"	CaseName=PPNS	ConcDesign=No AlumDesign=No ColdDesign=No	CaseName=PPST	ScaleFactor=1
ComboName=RAR058 ScaleFactor=0	CaseType="Linear Static"	CaseName=PPAQ	ComboName=RAR060 ScaleFactor=1	CaseType="Linear Static"	CaseName=PPNS
ComboName=RAR058 ScaleFactor=1	CaseType="Response Combo"	CaseName=SK05	ComboName=RAR060 ScaleFactor=0	CaseType="Linear Static"	CaseName=PPAQ
ComboName=RAR058 ScaleFactor=0	CaseType="Response Combo"	CaseName=SKAS	ComboName=RAR060 ScaleFactor=1	CaseType="Response Combo"	CaseName=SK05
ComboName=RAR058 ScaleFactor=1	CaseType="Response Combo"	CaseName=SWS	ComboName=RAR060 ScaleFactor=0	CaseType="Response Combo"	CaseName=SKAS
ComboName=RAR058 ScaleFactor=0	CaseType="Response Combo"	CaseName=SK0D	ComboName=RAR060 ScaleFactor=1	CaseType="Response Combo"	CaseName=SWS
ComboName=RAR058 ScaleFactor=1	CaseType="Response Combo"	CaseName=SKAD	ComboName=RAR060 ScaleFactor=0	CaseType="Response Combo"	CaseName=SK0D
ComboName=RAR058 ScaleFactor=1	CaseType="Response Combo"	CaseName=SWD	ComboName=RAR060 ScaleFactor=1	CaseType="Response Combo"	CaseName=SKAD
ComboName=RAR058 ScaleFactor=0,75	CaseType="Linear Static"	CaseName=SA	ComboName=RAR060 ScaleFactor=1	CaseType="Response Combo"	CaseName=SWD
ComboName=RAR058 ScaleFactor=0,75	CaseType="Linear Static"	CaseName=QM01	ComboName=RAR060 ScaleFactor=0	CaseType="Response Combo"	CaseName=SA
			ComboName=RAR060 ScaleFactor=1	CaseType="Linear Static"	CaseName=SA

APPROVATO SGP

Società di Progetto
Brebem SpA

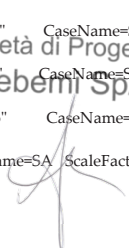

ComboName=RAR060 ScaleFactor=0	CaseType="Linear Static"	CaseName=QM01	ComboName=RAR062 ScaleFactor=1	CaseType="Response Combo"	CaseName=SWD
ComboName=RAR060 ScaleFactor=0	CaseType="Linear Static"	CaseName=QM02	ComboName=RAR062 ScaleFactor=0	CaseType="Linear Static"	CaseName=SA ScaleFactor=1 CaseName=QM01
ComboName=RAR060 ScaleFactor=0,75	CaseType="Linear Static"	CaseName=SQMS	ComboName=RAR062 ScaleFactor=0	CaseType="Linear Static"	CaseName=QM02
ComboName=RAR060 ScaleFactor=0	CaseType="Linear Static"	CaseName=SQMD	ComboName=RAR062 ScaleFactor=0	CaseType="Linear Static"	CaseName=SQMS
ComboName=RAR060 ScaleFactor=0	CaseType="Linear Static"	CaseName=FA01	ComboName=RAR062 ScaleFactor=0	CaseType="Linear Static"	CaseName=SQMD
ComboName=RAR060 ScaleFactor=0	CaseType="Linear Static"	CaseName=TC01	ComboName=RAR062 ScaleFactor=0	CaseType="Linear Static"	CaseName=FA01
ComboName=RAR060 ScaleFactor=1	CaseType="Linear Static"	CaseName=TC02	ComboName=RAR062 ScaleFactor=0	CaseType="Linear Static"	CaseName=TC01
ComboName=RAR060 ScaleFactor=0	CaseType="Linear Static"	CaseName=TV01	ComboName=RAR062 ScaleFactor=0	CaseType="Linear Static"	CaseName=TC02
ComboName=RAR060 ScaleFactor=0,6	CaseType="Linear Static"	CaseName=TV02	ComboName=RAR062 ScaleFactor=1	CaseType="Linear Static"	CaseName=TV01
ComboName=RAR060 ScaleFactor=0	CaseType="Linear Static"	CaseName=RIT ScaleFactor=0	ComboName=RAR062 ScaleFactor=0	CaseType="Linear Static"	CaseName=TV02
ComboName=RAR060 ScaleFactor=0	CaseType="Linear Static"	CaseName=SSTS	ComboName=RAR062 ScaleFactor=0,6	CaseType="Linear Static"	CaseName=RIT
ComboName=RAR061 CaseType="Linear Static"	ComboType="Linear Add"	AutoDesign=No	ComboName=RAR062 ScaleFactor=0	CaseType="Linear Static"	CaseName=SSTS
ConcDesign=No AlumDesign=No ColdDesign=No	CaseName=PPST ScaleFactor=1	SteelDesign=No	ComboName=RAR062 ScaleFactor=0	CaseType="Linear Static"	CaseName=IS01
ComboName=RAR061 ScaleFactor=1	CaseType="Linear Static"	CaseName=PPNS	ComboName=RAR063 CaseType="Linear Static"	CaseName=PPST ScaleFactor=1	AutoDesign=No SteelDesign=No
ComboName=RAR061 ScaleFactor=0	CaseType="Linear Static"	CaseName=PPAQ	ConcDesign=No AlumDesign=No ColdDesign=No	ComboName=RAR063 ScaleFactor=1	CaseName=PPNS
ComboName=RAR061 ScaleFactor=1	CaseType="Response Combo"	CaseName=SK05	ComboName=RAR063 ScaleFactor=0	CaseType="Linear Static"	CaseName=PPAQ
ComboName=RAR061 ScaleFactor=0	CaseType="Response Combo"	CaseName=SKAS	ComboName=RAR063 ScaleFactor=0	CaseType="Response Combo"	CaseName=SK05
ComboName=RAR061 ScaleFactor=1	CaseType="Response Combo"	CaseName=SK0D	ComboName=RAR063 ScaleFactor=1	CaseType="Response Combo"	CaseName=SKAS
ComboName=RAR061 ScaleFactor=0	CaseType="Response Combo"	CaseName=SKAD	ComboName=RAR063 ScaleFactor=1	CaseType="Response Combo"	CaseName=SWS
ComboName=RAR061 ScaleFactor=1	CaseType="Response Combo"	CaseName=SWD	ComboName=RAR063 ScaleFactor=0	CaseType="Response Combo"	CaseName=SK0D
ComboName=RAR061 ScaleFactor=0	CaseType="Linear Static"	CaseName=SA ScaleFactor=1	ComboName=RAR063 ScaleFactor=1	CaseType="Response Combo"	CaseName=SKAD
ComboName=RAR061 ScaleFactor=0	CaseType="Linear Static"	CaseName=QM01	ComboName=RAR063 ScaleFactor=1	CaseType="Response Combo"	CaseName=SWD
ComboName=RAR061 ScaleFactor=0	CaseType="Linear Static"	CaseName=QM02	ComboName=RAR063 ScaleFactor=0,75	CaseType="Linear Static"	CaseName=SA ScaleFactor=1 CaseName=QM01
ComboName=RAR061 ScaleFactor=0,75	CaseType="Linear Static"	CaseName=SQMS	ComboName=RAR063 ScaleFactor=0,75	CaseType="Linear Static"	CaseName=QM02
ComboName=RAR061 ScaleFactor=0,75	CaseType="Linear Static"	CaseName=SQMD	ComboName=RAR063 ScaleFactor=0	CaseType="Linear Static"	CaseName=SQMS
ComboName=RAR061 ScaleFactor=0	CaseType="Linear Static"	CaseName=FA01	ComboName=RAR063 ScaleFactor=0	CaseType="Linear Static"	CaseName=SQMD
ComboName=RAR061 ScaleFactor=0	CaseType="Linear Static"	CaseName=TC01	ComboName=RAR063 ScaleFactor=0	CaseType="Linear Static"	CaseName=FA01
ComboName=RAR061 ScaleFactor=1	CaseType="Linear Static"	CaseName=TC02	ComboName=RAR063 ScaleFactor=0	CaseType="Linear Static"	CaseName=TC01
ComboName=RAR061 ScaleFactor=0	CaseType="Linear Static"	CaseName=TV01	ComboName=RAR063 ScaleFactor=1	CaseType="Linear Static"	CaseName=TC02
ComboName=RAR061 ScaleFactor=0,6	CaseType="Linear Static"	CaseName=TV02	ComboName=RAR063 ScaleFactor=0	CaseType="Linear Static"	CaseName=TV01
ComboName=RAR061 ScaleFactor=0	CaseType="Linear Static"	CaseName=RIT ScaleFactor=0	ComboName=RAR063 ScaleFactor=0	CaseType="Linear Static"	CaseName=TV02
ComboName=RAR061 ScaleFactor=0	CaseType="Linear Static"	CaseName=SSTS	ComboName=RAR063 ScaleFactor=0,6	CaseType="Linear Static"	CaseName=RIT
ComboName=RAR062 CaseType="Linear Static"	ComboType="Linear Add"	AutoDesign=No	ComboName=RAR063 ScaleFactor=0	CaseType="Linear Static"	CaseName=SSTS
ConcDesign=No AlumDesign=No ColdDesign=No	CaseName=PPST ScaleFactor=1	SteelDesign=No	ComboName=RAR064 CaseType="Linear Static"	CaseName=PPST ScaleFactor=1	AutoDesign=No SteelDesign=No
ComboName=RAR062 ScaleFactor=1	CaseType="Linear Static"	CaseName=PPNS	ConcDesign=No AlumDesign=No ColdDesign=No	CaseType="Linear Static"	CaseName=PPNS
ComboName=RAR062 ScaleFactor=0	CaseType="Linear Static"	CaseName=PPAQ	ComboName=RAR064 ScaleFactor=1	CaseType="Linear Static"	CaseName=PPAQ
ComboName=RAR062 ScaleFactor=0	CaseType="Response Combo"	CaseName=SK05	ComboName=RAR064 ScaleFactor=0	CaseType="Response Combo"	CaseName=SK05
ComboName=RAR062 ScaleFactor=1	CaseType="Response Combo"	CaseName=SKAS	ComboName=RAR064 ScaleFactor=1	CaseType="Response Combo"	CaseName=SKAS
ComboName=RAR062 ScaleFactor=0	CaseType="Response Combo"	CaseName=SK0D	ComboName=RAR064 ScaleFactor=0	CaseType="Response Combo"	CaseName=SWS
ComboName=RAR062 ScaleFactor=0	CaseType="Response Combo"	CaseName=SKAD	ComboName=RAR064 ScaleFactor=1	CaseType="Response Combo"	CaseName=SWD

Società di Progetto
Brebemi SpA



ComboName=RAR068 ScaleFactor=0	CaseType="Linear Static"	CaseName=PPAQ	ComboName=RAR070 ScaleFactor=1	CaseType="Linear Static"	CaseName=PPNS
ComboName=RAR068 ScaleFactor=0	CaseType="Response Combo"	CaseName=SK05	ComboName=RAR070 ScaleFactor=0	CaseType="Linear Static"	CaseName=PPAQ
ComboName=RAR068 ScaleFactor=1	CaseType="Response Combo"	CaseName=SKAS	ComboName=RAR070 ScaleFactor=1	CaseType="Response Combo"	CaseName=SK05
ComboName=RAR068 ScaleFactor=1	CaseType="Response Combo"	CaseName=SWS	ComboName=RAR070 ScaleFactor=0	CaseType="Response Combo"	CaseName=SKAS
ComboName=RAR068 ScaleFactor=0	CaseType="Response Combo"	CaseName=SK0D	ComboName=RAR070 ScaleFactor=1	CaseType="Response Combo"	CaseName=SWS
ComboName=RAR068 ScaleFactor=1	CaseType="Response Combo"	CaseName=SKAD	ComboName=RAR070 ScaleFactor=0	CaseType="Response Combo"	CaseName=SK0D
ComboName=RAR068 ScaleFactor=1	CaseType="Response Combo"	CaseName=SWD	ComboName=RAR070 ScaleFactor=1	CaseType="Response Combo"	CaseName=SKAD
ComboName=RAR068 ScaleFactor=0	CaseType="Linear Static"	CaseName=SA	ComboName=RAR070 ScaleFactor=1	CaseType="Response Combo"	CaseName=SWD
ComboName=RAR068 ScaleFactor=0	CaseType="Linear Static"	CaseName=QM01	ComboName=RAR070 ScaleFactor=1	CaseType="Linear Static"	CaseName=SA
ComboName=RAR068 ScaleFactor=0	CaseType="Linear Static"	CaseName=QM02	ComboName=RAR070 ScaleFactor=1	CaseType="Linear Static"	CaseName=QM01
ComboName=RAR068 ScaleFactor=0	CaseType="Linear Static"	CaseName=SQM5	ComboName=RAR070 ScaleFactor=1	CaseType="Linear Static"	CaseName=QM02
ComboName=RAR068 ScaleFactor=0	CaseType="Linear Static"	CaseName=SQMD	ComboName=RAR070 ScaleFactor=1	CaseType="Linear Static"	CaseName=SQM5
ComboName=RAR068 ScaleFactor=0	CaseType="Linear Static"	CaseName=FA01	ComboName=RAR070 ScaleFactor=0	CaseType="Linear Static"	CaseName=SQMD
ComboName=RAR068 ScaleFactor=0	CaseType="Linear Static"	CaseName=TC01	ComboName=RAR070 ScaleFactor=0	CaseType="Linear Static"	CaseName=FA01
ComboName=RAR068 ScaleFactor=0	CaseType="Linear Static"	CaseName=TC02	ComboName=RAR070 ScaleFactor=0	CaseType="Linear Static"	CaseName=TC01
ComboName=RAR068 ScaleFactor=1	CaseType="Linear Static"	CaseName=TV01	ComboName=RAR070 ScaleFactor=0	CaseType="Linear Static"	CaseName=TC02
ComboName=RAR068 ScaleFactor=0	CaseType="Linear Static"	CaseName=TV02	ComboName=RAR070 ScaleFactor=0,6	CaseType="Linear Static"	CaseName=TV01
ComboName=RAR068 ScaleFactor=0	CaseType="Linear Static"	CaseName=RIT	ComboName=RAR070 ScaleFactor=0	CaseType="Linear Static"	CaseName=TV02
ComboName=RAR068 ScaleFactor=0	CaseType="Linear Static"	CaseName=SSTS	ComboName=RAR070 ScaleFactor=0	CaseType="Linear Static"	CaseName=RIT
ComboName=RAR068 ScaleFactor=0	CaseType="Linear Static"	CaseName=IS01	ComboName=RAR070 ScaleFactor=0	CaseType="Linear Static"	CaseName=SSTS
ComboName=RAR069 CaseType="Linear Static"	ComboType="Linear Add"	AutoDesign=No	ComboName=RAR070 ScaleFactor=0	CaseType="Linear Static"	CaseName=IS01
ConcDesign=No AlumDesign=No ColdDesign=No	CaseName=PPST	ScaleFactor=1	SteelDesign=No	ComboName=RAR071 CaseType="Linear Static"	CaseName=PPNS
ComboName=RAR069 ScaleFactor=1	CaseType="Linear Static"	CaseName=PPNS	ComboName=RAR071 ScaleFactor=1	CaseType="Linear Static"	CaseName=PPAQ
ComboName=RAR069 ScaleFactor=0	CaseType="Linear Static"	CaseName=PPAQ	ComboName=RAR071 ScaleFactor=0	CaseType="Response Combo"	CaseName=SK05
ComboName=RAR069 ScaleFactor=0	CaseType="Response Combo"	CaseName=SK05	ComboName=RAR071 ScaleFactor=1	CaseType="Response Combo"	CaseName=SKAS
ComboName=RAR069 ScaleFactor=1	CaseType="Response Combo"	CaseName=SKAS	ComboName=RAR071 ScaleFactor=0	CaseType="Response Combo"	CaseName=SWS
ComboName=RAR069 ScaleFactor=0	CaseType="Response Combo"	CaseName=SK0D	ComboName=RAR071 ScaleFactor=1	CaseType="Response Combo"	CaseName=SK0D
ComboName=RAR069 ScaleFactor=1	CaseType="Response Combo"	CaseName=SKAD	ComboName=RAR071 ScaleFactor=0	CaseType="Response Combo"	CaseName=SKAD
ComboName=RAR069 ScaleFactor=1	CaseType="Response Combo"	CaseName=SWD	ComboName=RAR071 ScaleFactor=0	CaseType="Response Combo"	CaseName=SWD
ComboName=RAR069 ScaleFactor=1	CaseType="Linear Static"	CaseName=SA	ComboName=RAR071 ScaleFactor=1	CaseType="Linear Static"	CaseName=SA
ComboName=RAR069 ScaleFactor=1	CaseType="Linear Static"	CaseName=QM01	ComboName=RAR071 ScaleFactor=1	CaseType="Linear Static"	CaseName=QM01
ComboName=RAR069 ScaleFactor=1	CaseType="Linear Static"	CaseName=QM02	ComboName=RAR071 ScaleFactor=1	CaseType="Linear Static"	CaseName=QM02
ComboName=RAR069 ScaleFactor=0	CaseType="Linear Static"	CaseName=SQM5	ComboName=RAR071 ScaleFactor=1	CaseType="Linear Static"	CaseName=SQM5
ComboName=RAR069 ScaleFactor=0	CaseType="Linear Static"	CaseName=SQMD	ComboName=RAR071 ScaleFactor=1	CaseType="Linear Static"	CaseName=SQMD
ComboName=RAR069 ScaleFactor=0	CaseType="Linear Static"	CaseName=FA01	ComboName=RAR071 ScaleFactor=0	CaseType="Linear Static"	CaseName=FA01
ComboName=RAR069 ScaleFactor=0	CaseType="Linear Static"	CaseName=TC01	ComboName=RAR071 ScaleFactor=0	CaseType="Linear Static"	CaseName=TC01
ComboName=RAR069 ScaleFactor=0	CaseType="Linear Static"	CaseName=TC02	ComboName=RAR071 ScaleFactor=0	CaseType="Linear Static"	CaseName=TC02
ComboName=RAR069 ScaleFactor=0,6	CaseType="Linear Static"	CaseName=TV01	ComboName=RAR071 ScaleFactor=0,6	CaseType="Linear Static"	CaseName=TV01
ComboName=RAR069 ScaleFactor=0	CaseType="Linear Static"	CaseName=TV02	ComboName=RAR071 ScaleFactor=0	CaseType="Linear Static"	CaseName=TV02
ComboName=RAR069 ScaleFactor=0	CaseType="Linear Static"	CaseName=RIT	ComboName=RAR071 ScaleFactor=0	CaseType="Linear Static"	CaseName=RIT
ComboName=RAR069 ScaleFactor=0	CaseType="Linear Static"	CaseName=SSTS	ComboName=RAR071 ScaleFactor=0	CaseType="Linear Static"	CaseName=SSTS
ComboName=RAR069 ScaleFactor=0	CaseType="Linear Static"	CaseName=IS01	ComboName=RAR071 ScaleFactor=0	CaseType="Linear Static"	CaseName=IS01
ComboName=RAR070 CaseType="Linear Static"	ComboType="Linear Add"	AutoDesign=No	ComboName=RAR071 ScaleFactor=0	CaseType="Linear Static"	CaseName=IS01
ConcDesign=No AlumDesign=No ColdDesign=No	CaseName=PPST	ScaleFactor=1	SteelDesign=No		

ComboName=RAR072 CaseType="Linear Static" ConcDesign=No AlumDesign=No ColdDesign=No ScaleFactor=1	ComboType="Linear Add" CaseName=PPST ScaleFactor=1	AutoDesign=No SteelDesign=No	ComboName=RAR073 CaseType="Linear Static" ScaleFactor=0	CaseType="Linear Static"	CaseName=IS01
ComboName=RAR072 ScaleFactor=0	CaseType="Linear Static"	CaseName=PPNS	ComboName=RAR074 CaseType="Linear Static" ConcDesign=No AlumDesign=No ColdDesign=No ScaleFactor=1	ComboType="Linear Add" CaseName=PPST ScaleFactor=1	AutoDesign=No SteelDesign=No
ComboName=RAR072 ScaleFactor=1	CaseType="Response Combo"	CaseName=SK05	ComboName=RAR074 ScaleFactor=0	CaseType="Linear Static"	CaseName=PPAQ
ComboName=RAR072 ScaleFactor=0	CaseType="Response Combo"	CaseName=SKAS	ComboName=RAR074 ScaleFactor=1	CaseType="Response Combo"	CaseName=SK05
ComboName=RAR072 ScaleFactor=1	CaseType="Response Combo"	CaseName=SWS	ComboName=RAR074 ScaleFactor=0	CaseType="Response Combo"	CaseName=SKAS
ComboName=RAR072 ScaleFactor=0	CaseType="Response Combo"	CaseName=SK0D	ComboName=RAR074 ScaleFactor=1	CaseType="Response Combo"	CaseName=SWS
ComboName=RAR072 ScaleFactor=1	CaseType="Response Combo"	CaseName=SKAD	ComboName=RAR074 ScaleFactor=0	CaseType="Response Combo"	CaseName=SK0D
ComboName=RAR072 ScaleFactor=1	CaseType="Response Combo"	CaseName=SWD	ComboName=RAR074 ScaleFactor=1	CaseType="Response Combo"	CaseName=SKAD
ComboName=RAR072 ScaleFactor=0	CaseType="Linear Static"	CaseName=SA	ComboName=RAR074 ScaleFactor=1	CaseType="Response Combo"	CaseName=SWD
ComboName=RAR072 ScaleFactor=0	CaseType="Linear Static"	CaseName=QM01	ComboName=RAR074 ScaleFactor=0,75	CaseType="Linear Static"	CaseName=SA ScaleFactor=1
ComboName=RAR072 ScaleFactor=0	CaseType="Linear Static"	CaseName=QM02	ComboName=RAR074 ScaleFactor=0,75	CaseType="Linear Static"	CaseName=QM01
ComboName=RAR072 ScaleFactor=1	CaseType="Linear Static"	CaseName=SQMS	ComboName=RAR074 ScaleFactor=0,75	CaseType="Linear Static"	CaseName=QM02
ComboName=RAR072 ScaleFactor=0	CaseType="Linear Static"	CaseName=SQMD	ComboName=RAR074 ScaleFactor=0	CaseType="Linear Static"	CaseName=SQMS
ComboName=RAR072 ScaleFactor=0	CaseType="Linear Static"	CaseName=FA01	ComboName=RAR074 ScaleFactor=1	CaseType="Linear Static"	CaseName=SQMD
ComboName=RAR072 ScaleFactor=0	CaseType="Linear Static"	CaseName=TC01	ComboName=RAR074 ScaleFactor=0	CaseType="Linear Static"	CaseName=FA01
ComboName=RAR072 ScaleFactor=0	CaseType="Linear Static"	CaseName=TC02	ComboName=RAR074 ScaleFactor=0	CaseType="Linear Static"	CaseName=TC01
ComboName=RAR072 ScaleFactor=0,6	CaseType="Linear Static"	CaseName=TV01	ComboName=RAR074 ScaleFactor=0,6	CaseType="Linear Static"	CaseName=TC02
ComboName=RAR072 ScaleFactor=0	CaseType="Linear Static"	CaseName=TV02	ComboName=RAR074 ScaleFactor=0	CaseType="Linear Static"	CaseName=TV01
ComboName=RAR072 ScaleFactor=0	CaseType="Linear Static"	CaseName=RIT	ComboName=RAR074 ScaleFactor=0	CaseType="Linear Static"	CaseName=TV02
ComboName=RAR072 ScaleFactor=0	CaseType="Linear Static"	CaseName=SSTS	ComboName=RAR074 ScaleFactor=0	CaseType="Linear Static"	CaseName=RIT ScaleFactor=0
ComboName=RAR072 ScaleFactor=0	CaseType="Linear Static"	CaseName=IS01	ComboName=RAR074 ScaleFactor=0	CaseType="Linear Static"	CaseName=SSTS
ComboName=RAR073 CaseType="Linear Static" ConcDesign=No AlumDesign=No ColdDesign=No ScaleFactor=1	ComboType="Linear Add" CaseName=PPST ScaleFactor=1	AutoDesign=No SteelDesign=No	ComboName=RAR074 ScaleFactor=0	CaseType="Linear Static"	CaseName=IS01
ComboName=RAR073 ScaleFactor=0	CaseType="Linear Static"	CaseName=PPNS	ComboName=RAR075 CaseType="Linear Static" ConcDesign=No AlumDesign=No ColdDesign=No ScaleFactor=1	ComboType="Linear Add" CaseName=PPST ScaleFactor=1	AutoDesign=No SteelDesign=No
ComboName=RAR073 ScaleFactor=1	CaseType="Response Combo"	CaseName=SK05	ComboName=RAR075 ScaleFactor=0	CaseType="Linear Static"	CaseName=PPAQ
ComboName=RAR073 ScaleFactor=0	CaseType="Response Combo"	CaseName=SKAS	ComboName=RAR075 ScaleFactor=0	CaseType="Response Combo"	CaseName=SK05
ComboName=RAR073 ScaleFactor=1	CaseType="Response Combo"	CaseName=SWS	ComboName=RAR075 ScaleFactor=1	CaseType="Response Combo"	CaseName=SKAS
ComboName=RAR073 ScaleFactor=0	CaseType="Response Combo"	CaseName=SK0D	ComboName=RAR075 ScaleFactor=0	CaseType="Response Combo"	CaseName=SWS
ComboName=RAR073 ScaleFactor=1	CaseType="Response Combo"	CaseName=SKAD	ComboName=RAR075 ScaleFactor=1	CaseType="Response Combo"	CaseName=SK0D
ComboName=RAR073 ScaleFactor=0	CaseType="Response Combo"	CaseName=SWD	ComboName=RAR075 ScaleFactor=0	CaseType="Response Combo"	CaseName=SKAD
ComboName=RAR073 ScaleFactor=1	CaseType="Response Combo"	CaseName=SWD	ComboName=RAR075 ScaleFactor=1	CaseType="Response Combo"	CaseName=SKAD
ComboName=RAR073 ScaleFactor=0	CaseType="Linear Static"	CaseName=SA	ComboName=RAR075 ScaleFactor=0,75	CaseType="Response Combo"	CaseName=SWD
ComboName=RAR073 ScaleFactor=0	CaseType="Linear Static"	CaseName=QM01	ComboName=RAR075 ScaleFactor=0,75	CaseType="Linear Static"	CaseName=SA ScaleFactor=1
ComboName=RAR073 ScaleFactor=0	CaseType="Linear Static"	CaseName=QM02	ComboName=RAR075 ScaleFactor=0,75	CaseType="Linear Static"	CaseName=QM01
ComboName=RAR073 ScaleFactor=1	CaseType="Linear Static"	CaseName=SQMS	ComboName=RAR075 ScaleFactor=0	CaseType="Linear Static"	CaseName=QM02
ComboName=RAR073 ScaleFactor=0	CaseType="Linear Static"	CaseName=SQMD	ComboName=RAR075 ScaleFactor=0	CaseType="Linear Static"	CaseName=SQMS
ComboName=RAR073 ScaleFactor=0	CaseType="Linear Static"	CaseName=FA01	ComboName=RAR075 ScaleFactor=0	CaseType="Linear Static"	CaseName=SQMD
ComboName=RAR073 ScaleFactor=0	CaseType="Linear Static"	CaseName=TC01	ComboName=RAR075 ScaleFactor=0	CaseType="Linear Static"	CaseName=FA01
ComboName=RAR073 ScaleFactor=0	CaseType="Linear Static"	CaseName=TC02	ComboName=RAR075 ScaleFactor=0	CaseType="Linear Static"	CaseName=TC01
ComboName=RAR073 ScaleFactor=0,6	CaseType="Linear Static"	CaseName=TV01	ComboName=RAR075 ScaleFactor=0	CaseType="Linear Static"	CaseName=TC02
ComboName=RAR073 ScaleFactor=0	CaseType="Linear Static"	CaseName=TV02	ComboName=RAR075 ScaleFactor=1	CaseType="Linear Static"	CaseName=TV01
ComboName=RAR073 ScaleFactor=0	CaseType="Linear Static"	CaseName=RIT	ComboName=RAR075 ScaleFactor=0	CaseType="Linear Static"	CaseName=TV02
ComboName=RAR073 ScaleFactor=0	CaseType="Linear Static"	CaseName=SSTS	ComboName=RAR075 ScaleFactor=0	CaseType="Linear Static"	CaseName=RIT ScaleFactor=0

APPROVATO SDR

Società di Progetto
Brebemi SpA

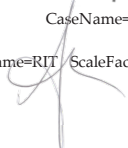

ComboName=RAR075 ScaleFactor=0	CaseType="Linear Static"	CaseName=SSTS	ComboName=RAR077 ScaleFactor=0	CaseType="Linear Static"	CaseName=TV02
ComboName=RAR075 ScaleFactor=0	CaseType="Linear Static"	CaseName=IS01	ComboName=RAR077 ScaleFactor=0	CaseType="Linear Static"	CaseName=RIT ScaleFactor=0
ComboName=RAR076 CaseType="Linear Static"	ComboType="Linear Add"	AutoDesign=No	ComboName=RAR077 ScaleFactor=0	CaseType="Linear Static"	CaseName=SSTS
ConcDesign=No AlumDesign=No ColdDesign=No	ScaleFactor=1	SteelDesign=No	ComboName=RAR077 ScaleFactor=0	CaseType="Linear Static"	CaseName=IS01
ComboName=RAR076 ScaleFactor=1	CaseType="Linear Static"	CaseName=PPNS	ComboName=RAR078 ScaleFactor=0	ComboType="Linear Add"	AutoDesign=No
ComboName=RAR076 ScaleFactor=0	CaseType="Linear Static"	CaseName=PPAQ	CaseType="Linear Static"	CaseName=PPST ScaleFactor=1	SteelDesign=No
ComboName=RAR076 ScaleFactor=1	CaseType="Response Combo"	CaseName=SK05	ConcDesign=No AlumDesign=No ColdDesign=No	CaseType="Linear Static"	CaseName=PPNS
ComboName=RAR076 ScaleFactor=0	CaseType="Response Combo"	CaseName=SKAS	ComboName=RAR078 ScaleFactor=1	CaseType="Linear Static"	CaseName=PPAQ
ComboName=RAR076 ScaleFactor=0	CaseType="Response Combo"	CaseName=SWS	ComboName=RAR078 ScaleFactor=0	CaseType="Response Combo"	CaseName=SK05
ComboName=RAR076 ScaleFactor=1	CaseType="Response Combo"	CaseName=SK0D	ComboName=RAR078 ScaleFactor=1	CaseType="Response Combo"	CaseName=SKAS
ComboName=RAR076 ScaleFactor=0	CaseType="Response Combo"	CaseName=SKAD	ComboName=RAR078 ScaleFactor=0	CaseType="Response Combo"	CaseName=SWS
ComboName=RAR076 ScaleFactor=1	CaseType="Response Combo"	CaseName=SWD	ComboName=RAR078 ScaleFactor=1	CaseType="Response Combo"	CaseName=SK0D
ComboName=RAR076 ScaleFactor=0,75	CaseType="Linear Static"	CaseName=SA ScaleFactor=1	ComboName=RAR078 ScaleFactor=0	CaseType="Response Combo"	CaseName=SKAD
ComboName=RAR076 ScaleFactor=0,75	CaseType="Linear Static"	CaseName=QM01	ComboName=RAR078 ScaleFactor=1	CaseType="Response Combo"	CaseName=SWD
ComboName=RAR076 ScaleFactor=0,75	CaseType="Linear Static"	CaseName=QM02	ComboName=RAR078 ScaleFactor=0	CaseType="Response Combo"	CaseName=SKAD
ComboName=RAR076 ScaleFactor=0,75	CaseType="Linear Static"	CaseName=SQMS	ComboName=RAR078 ScaleFactor=0	CaseType="Linear Static"	CaseName=SA ScaleFactor=1
ComboName=RAR076 ScaleFactor=0	CaseType="Linear Static"	CaseName=SQMD	ComboName=RAR078 ScaleFactor=0	CaseType="Linear Static"	CaseName=QM01
ComboName=RAR076 ScaleFactor=0	CaseType="Linear Static"	CaseName=FA01	ComboName=RAR078 ScaleFactor=0,75	CaseType="Linear Static"	CaseName=QM02
ComboName=RAR076 ScaleFactor=0	CaseType="Linear Static"	CaseName=TC01	ComboName=RAR078 ScaleFactor=0	CaseType="Linear Static"	CaseName=SQMS
ComboName=RAR076 ScaleFactor=0	CaseType="Linear Static"	CaseName=TC02	ComboName=RAR078 ScaleFactor=0	CaseType="Linear Static"	CaseName=SQMD
ComboName=RAR076 ScaleFactor=1	CaseType="Linear Static"	CaseName=TV01	ComboName=RAR078 ScaleFactor=0	CaseType="Linear Static"	CaseName=FA01
ComboName=RAR076 ScaleFactor=0	CaseType="Linear Static"	CaseName=TV02	ComboName=RAR078 ScaleFactor=0	CaseType="Linear Static"	CaseName=TC01
ComboName=RAR076 ScaleFactor=0	CaseType="Linear Static"	CaseName=RIT ScaleFactor=0	ComboName=RAR078 ScaleFactor=0	CaseType="Linear Static"	CaseName=TC02
ComboName=RAR076 ScaleFactor=0	CaseType="Linear Static"	CaseName=SSTS	ComboName=RAR078 ScaleFactor=1	CaseType="Linear Static"	CaseName=TV01
ComboName=RAR076 ScaleFactor=0	CaseType="Linear Static"	CaseName=IS01	ComboName=RAR078 ScaleFactor=0	CaseType="Linear Static"	CaseName=TV02
ComboName=RAR077 CaseType="Linear Static"	ComboType="Linear Add"	AutoDesign=No	ComboName=RAR078 ScaleFactor=0	CaseType="Linear Static"	CaseName=RIT ScaleFactor=0
ConcDesign=No AlumDesign=No ColdDesign=No	ScaleFactor=1	SteelDesign=No	ComboName=RAR078 ScaleFactor=0	CaseType="Linear Static"	CaseName=SSTS
ComboName=RAR077 ScaleFactor=1	CaseType="Linear Static"	CaseName=PPNS	ComboName=RAR078 ScaleFactor=0	CaseType="Linear Static"	CaseName=IS01
ComboName=RAR077 ScaleFactor=0	CaseType="Linear Static"	CaseName=PPAQ	ComboName=RAR079 CaseType="Linear Static"	ComboType="Linear Add"	AutoDesign=No
ComboName=RAR077 ScaleFactor=1	CaseType="Response Combo"	CaseName=SK05	CaseType="Linear Static"	CaseName=PPST ScaleFactor=1	SteelDesign=No
ComboName=RAR077 ScaleFactor=0	CaseType="Response Combo"	CaseName=SKAS	ConcDesign=No AlumDesign=No ColdDesign=No	CaseType="Linear Static"	CaseName=PPNS
ComboName=RAR077 ScaleFactor=1	CaseType="Response Combo"	CaseName=SWS	ComboName=RAR079 ScaleFactor=1	CaseType="Linear Static"	CaseName=PPAQ
ComboName=RAR077 ScaleFactor=1	CaseType="Response Combo"	CaseName=SK0D	ComboName=RAR079 ScaleFactor=0	CaseType="Linear Static"	CaseName=PPAQ
ComboName=RAR077 ScaleFactor=0	CaseType="Response Combo"	CaseName=SKAD	ComboName=RAR079 ScaleFactor=1	CaseType="Response Combo"	CaseName=SK05
ComboName=RAR077 ScaleFactor=1	CaseType="Response Combo"	CaseName=SWD	ComboName=RAR079 ScaleFactor=0	CaseType="Response Combo"	CaseName=SKAS
ComboName=RAR077 ScaleFactor=0,75	CaseType="Linear Static"	CaseName=SA ScaleFactor=1	ComboName=RAR079 ScaleFactor=1	CaseType="Response Combo"	CaseName=SWS
ComboName=RAR077 ScaleFactor=0,75	CaseType="Linear Static"	CaseName=QM01	ComboName=RAR079 ScaleFactor=0	CaseType="Response Combo"	CaseName=SKAD
ComboName=RAR077 ScaleFactor=0,75	CaseType="Linear Static"	CaseName=QM02	ComboName=RAR079 ScaleFactor=1	CaseType="Response Combo"	CaseName=SWD
ComboName=RAR077 ScaleFactor=0,75	CaseType="Linear Static"	CaseName=SQMS	ComboName=RAR079 ScaleFactor=0	CaseType="Response Combo"	CaseName=SKAD
ComboName=RAR077 ScaleFactor=0,75	CaseType="Linear Static"	CaseName=SQMD	ComboName=RAR079 ScaleFactor=0	CaseType="Linear Static"	CaseName=SA ScaleFactor=1
ComboName=RAR077 ScaleFactor=0	CaseType="Linear Static"	CaseName=FA01	ComboName=RAR079 ScaleFactor=0,75	CaseType="Linear Static"	CaseName=QM01
ComboName=RAR077 ScaleFactor=0	CaseType="Linear Static"	CaseName=TC01	ComboName=RAR079 ScaleFactor=0,75	CaseType="Linear Static"	CaseName=QM02
ComboName=RAR077 ScaleFactor=0	CaseType="Linear Static"	CaseName=TC02	ComboName=RAR079 ScaleFactor=0	CaseType="Linear Static"	CaseName=SQMS
ComboName=RAR077 ScaleFactor=0	CaseType="Linear Static"	CaseName=TV01	ComboName=RAR079 ScaleFactor=0	CaseType="Linear Static"	CaseName=SQMD
ComboName=RAR077 ScaleFactor=1	CaseType="Linear Static"	CaseName=TV02	ComboName=RAR079 ScaleFactor=0	CaseType="Linear Static"	CaseName=FA01
			ComboName=RAR079 ScaleFactor=0	CaseType="Linear Static"	CaseName=TC01
			ComboName=RAR079 ScaleFactor=0	CaseType="Linear Static"	CaseName=TC02

ComboName=RAR083 ScaleFactor=0,6	CaseType="Linear Static"	CaseName=TC01	ComboName=RAR085 ScaleFactor=0	CaseType="Linear Static"	CaseName=FA01
ComboName=RAR083 ScaleFactor=0	CaseType="Linear Static"	CaseName=TC02	ComboName=RAR085 ScaleFactor=0,6	CaseType="Linear Static"	CaseName=TC01
ComboName=RAR083 ScaleFactor=1	CaseType="Linear Static"	CaseName=TV01	ComboName=RAR085 ScaleFactor=0	CaseType="Linear Static"	CaseName=TC02
ComboName=RAR083 ScaleFactor=0	CaseType="Linear Static"	CaseName=TV02	ComboName=RAR085 ScaleFactor=1	CaseType="Linear Static"	CaseName=TV01
ComboName=RAR083 ScaleFactor=0	CaseType="Linear Static"	CaseName=RIT	ComboName=RAR085 ScaleFactor=0	CaseType="Linear Static"	CaseName=TV02
ComboName=RAR083 ScaleFactor=0	CaseType="Linear Static"	CaseName=SSTS	ComboName=RAR085 ScaleFactor=0	CaseType="Linear Static"	CaseName=RIT
ComboName=RAR083 ScaleFactor=0	CaseType="Linear Static"	CaseName=IS01	ComboName=RAR085 ScaleFactor=0	CaseType="Linear Static"	CaseName=SSTS
ComboName=RAR084 CaseType="Linear Static"	ComboType="Linear Add"	AutoDesign=No	ComboName=RAR085 ScaleFactor=0	CaseType="Linear Static"	CaseName=IS01
ConcDesign=No AlumDesign=No	CaseName=PPST	ScaleFactor=1	ComboName=RAR086 CaseType="Linear Static"	ComboType="Linear Add"	AutoDesign=No
ComboName=RAR084 ScaleFactor=1	CaseType="Linear Static"	CaseName=PPNS	ConcDesign=No AlumDesign=No	CaseName=PPST	ScaleFactor=1
ComboName=RAR084 ScaleFactor=0	CaseType="Linear Static"	CaseName=PPAQ	CaseType="Linear Static"	CaseName=PPNS	SteelDesign=No
ComboName=RAR084 ScaleFactor=1	CaseType="Response Combo"	CaseName=SK05	ComboName=RAR086 ScaleFactor=1	CaseType="Linear Static"	CaseName=PPAQ
ComboName=RAR084 ScaleFactor=0	CaseType="Response Combo"	CaseName=SKAS	ComboName=RAR086 ScaleFactor=0	CaseType="Response Combo"	CaseName=SK05
ComboName=RAR084 ScaleFactor=1	CaseType="Response Combo"	CaseName=SWS	ComboName=RAR086 ScaleFactor=1	CaseType="Response Combo"	CaseName=SKAS
ComboName=RAR084 ScaleFactor=0	CaseType="Response Combo"	CaseName=SK0D	ComboName=RAR086 ScaleFactor=0	CaseType="Response Combo"	CaseName=SWS
ComboName=RAR084 ScaleFactor=1	CaseType="Response Combo"	CaseName=SKAD	ComboName=RAR086 ScaleFactor=1	CaseType="Response Combo"	CaseName=SK0D
ComboName=RAR084 ScaleFactor=1	CaseType="Response Combo"	CaseName=SWD	ComboName=RAR086 ScaleFactor=0	CaseType="Response Combo"	CaseName=SKAD
ComboName=RAR084 ScaleFactor=0	CaseType="Linear Static"	CaseName=SA	ComboName=RAR086 ScaleFactor=1	CaseType="Response Combo"	CaseName=SWD
ComboName=RAR084 ScaleFactor=0	CaseType="Linear Static"	CaseName=QM01	ComboName=RAR086 ScaleFactor=0	CaseType="Linear Static"	CaseName=SA
ComboName=RAR084 ScaleFactor=0	CaseType="Linear Static"	CaseName=QM02	ComboName=RAR086 ScaleFactor=0	CaseType="Linear Static"	CaseName=QM01
ComboName=RAR084 ScaleFactor=0,75	CaseType="Linear Static"	CaseName=SQM5	ComboName=RAR086 ScaleFactor=0	CaseType="Linear Static"	CaseName=QM02
ComboName=RAR084 ScaleFactor=0	CaseType="Linear Static"	CaseName=SQMD	ComboName=RAR086 ScaleFactor=0	CaseType="Linear Static"	CaseName=SQM5
ComboName=RAR084 ScaleFactor=0	CaseType="Linear Static"	CaseName=FA01	ComboName=RAR086 ScaleFactor=0	CaseType="Linear Static"	CaseName=SQMD
ComboName=RAR084 ScaleFactor=0,6	CaseType="Linear Static"	CaseName=TC01	ComboName=RAR086 ScaleFactor=0	CaseType="Linear Static"	CaseName=FA01
ComboName=RAR084 ScaleFactor=0	CaseType="Linear Static"	CaseName=TC02	ComboName=RAR086 ScaleFactor=0,6	CaseType="Linear Static"	CaseName=TC01
ComboName=RAR084 ScaleFactor=1	CaseType="Linear Static"	CaseName=TV01	ComboName=RAR086 ScaleFactor=1	CaseType="Linear Static"	CaseName=TC02
ComboName=RAR084 ScaleFactor=0	CaseType="Linear Static"	CaseName=TV02	ComboName=RAR086 ScaleFactor=0	CaseType="Linear Static"	CaseName=TV01
ComboName=RAR084 ScaleFactor=0	CaseType="Linear Static"	CaseName=RIT	ComboName=RAR086 ScaleFactor=0	CaseType="Linear Static"	CaseName=TV02
ComboName=RAR084 ScaleFactor=0	CaseType="Linear Static"	CaseName=SSTS	ComboName=RAR086 ScaleFactor=0	CaseType="Linear Static"	CaseName=RIT
ComboName=RAR084 ScaleFactor=0	CaseType="Linear Static"	CaseName=IS01	ComboName=RAR086 ScaleFactor=0	CaseType="Linear Static"	CaseName=SSTS
ComboName=RAR085 CaseType="Linear Static"	ComboType="Linear Add"	AutoDesign=No	ComboName=RAR087 CaseType="Linear Static"	CaseType="Linear Static"	CaseName=IS01
ConcDesign=No AlumDesign=No	CaseName=PPST	ScaleFactor=1	CaseType="Linear Static"	CaseName=PPST	ScaleFactor=1
ComboName=RAR085 ScaleFactor=1	CaseType="Linear Static"	CaseName=PPNS	ConcDesign=No AlumDesign=No	CaseName=PPST	SteelDesign=No
ComboName=RAR085 ScaleFactor=0	CaseType="Linear Static"	CaseName=PPAQ	CaseType="Linear Static"	CaseName=PPNS	CaseName=PPAQ
ComboName=RAR085 ScaleFactor=1	CaseType="Response Combo"	CaseName=SK05	ComboName=RAR087 ScaleFactor=0	CaseType="Linear Static"	CaseName=PPAQ
ComboName=RAR085 ScaleFactor=0	CaseType="Response Combo"	CaseName=SKAS	ComboName=RAR087 ScaleFactor=0	CaseType="Response Combo"	CaseName=SK05
ComboName=RAR085 ScaleFactor=1	CaseType="Response Combo"	CaseName=SWS	ComboName=RAR087 ScaleFactor=1	CaseType="Response Combo"	CaseName=SKAS
ComboName=RAR085 ScaleFactor=0	CaseType="Response Combo"	CaseName=SK0D	ComboName=RAR087 ScaleFactor=0	CaseType="Response Combo"	CaseName=SWS
ComboName=RAR085 ScaleFactor=1	CaseType="Response Combo"	CaseName=SKAD	ComboName=RAR087 ScaleFactor=1	CaseType="Response Combo"	CaseName=SK0D
ComboName=RAR085 ScaleFactor=1	CaseType="Response Combo"	CaseName=SWD	ComboName=RAR087 ScaleFactor=0	CaseType="Response Combo"	CaseName=SKAD
ComboName=RAR085 ScaleFactor=0	CaseType="Linear Static"	CaseName=SA	ComboName=RAR087 ScaleFactor=1	CaseType="Response Combo"	CaseName=SWD
ComboName=RAR085 ScaleFactor=0	CaseType="Linear Static"	CaseName=QM01	ComboName=RAR087 ScaleFactor=0	CaseType="Linear Static"	CaseName=SA
ComboName=RAR085 ScaleFactor=0	CaseType="Linear Static"	CaseName=QM02	ComboName=RAR087 ScaleFactor=0,75	CaseType="Linear Static"	CaseName=QM01
ComboName=RAR085 ScaleFactor=0,75	CaseType="Linear Static"	CaseName=SQM5	ComboName=RAR087 ScaleFactor=0,75	CaseType="Linear Static"	CaseName=QM02
ComboName=RAR085 ScaleFactor=0,75	CaseType="Linear Static"	CaseName=SQMD	ComboName=RAR087 ScaleFactor=0	CaseType="Linear Static"	CaseName=SQM5

APPROVATO SGP

Società di Progetto
Brebemi SpA

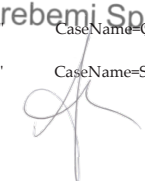

ComboName=RAR095 ScaleFactor=0	CaseType="Response	Combo"	CaseName=SKAD	ComboName=RAR097 ScaleFactor=1	CaseType="Response	Combo"	CaseName=SWS
ComboName=RAR095 ScaleFactor=1	CaseType="Response	Combo"	CaseName=SWD	ComboName=RAR097 ScaleFactor=1	CaseType="Response	Combo"	CaseName=SK0D
ComboName=RAR095 ScaleFactor=0,75	CaseType="Linear Static"	CaseName=SA	ScaleFactor=1	ComboName=RAR097 ScaleFactor=0	CaseType="Response	Combo"	CaseName=SKAD
ComboName=RAR095 ScaleFactor=0,75	CaseType="Linear Static"	CaseName=QM01		ComboName=RAR097 ScaleFactor=1	CaseType="Response	Combo"	CaseName=SWD
ComboName=RAR095 ScaleFactor=0,75	CaseType="Linear Static"	CaseName=QM02		ComboName=RAR097 ScaleFactor=0	CaseType="Linear Static"	CaseName=SA	ScaleFactor=1
ComboName=RAR095 ScaleFactor=0,75	CaseType="Linear Static"	CaseName=SQMS		ComboName=RAR097 ScaleFactor=0	CaseType="Linear Static"	CaseName=QM01	
ComboName=RAR095 ScaleFactor=0	CaseType="Linear Static"	CaseName=SQMD		ComboName=RAR097 ScaleFactor=0,75	CaseType="Linear Static"	CaseName=QM02	
ComboName=RAR095 ScaleFactor=0	CaseType="Linear Static"	CaseName=FA01		ComboName=RAR097 ScaleFactor=0,75	CaseType="Linear Static"	CaseName=SQMS	
ComboName=RAR095 ScaleFactor=0	CaseType="Linear Static"	CaseName=TC01		ComboName=RAR097 ScaleFactor=0,75	CaseType="Linear Static"	CaseName=SQMD	
ComboName=RAR095 ScaleFactor=0	CaseType="Linear Static"	CaseName=TC02		ComboName=RAR097 ScaleFactor=0	CaseType="Linear Static"	CaseName=FA01	
ComboName=RAR095 ScaleFactor=1	CaseType="Linear Static"	CaseName=TV01		ComboName=RAR097 ScaleFactor=0	CaseType="Linear Static"	CaseName=TC01	
ComboName=RAR095 ScaleFactor=0	CaseType="Linear Static"	CaseName=TV02		ComboName=RAR097 ScaleFactor=0	CaseType="Linear Static"	CaseName=TC02	
ComboName=RAR095 ScaleFactor=0,6	CaseType="Linear Static"	CaseName=RIT		ComboName=RAR097 ScaleFactor=1	CaseType="Linear Static"	CaseName=TV01	
ComboName=RAR095 ScaleFactor=0	CaseType="Linear Static"	CaseName=SSTS		ComboName=RAR097 ScaleFactor=0	CaseType="Linear Static"	CaseName=TV02	
ComboName=RAR095 ScaleFactor=0	CaseType="Linear Static"	CaseName=IS01		ComboName=RAR097 ScaleFactor=0,6	CaseType="Linear Static"	CaseName=RIT	
ComboName=RAR096 CaseType="Linear Static"	ComboType="Linear Add"	AutoDesign=No	SteelDesign=No	ComboName=RAR097 ScaleFactor=0	CaseType="Linear Static"	CaseName=SSTS	
ConcDesign=No AlumDesign=No ColdDesign=No	CaseName=PPST	ScaleFactor=1		ComboName=RAR097 ScaleFactor=0	CaseType="Linear Static"	CaseName=IS01	
ComboName=RAR096 ScaleFactor=1	CaseType="Linear Static"	CaseName=PPNS		ComboName=RAR097 ScaleFactor=0	ComboType="Linear Add"	AutoDesign=No	SteelDesign=No
ComboName=RAR096 ScaleFactor=0	CaseType="Linear Static"	CaseName=PPAQ		ComboName=RAR097 ScaleFactor=0	CaseName=PPST	ScaleFactor=1	
ComboName=RAR096 ScaleFactor=1	CaseType="Response Combo"	CaseName=SK0S		ConcDesign=No AlumDesign=No ColdDesign=No	CaseType="Linear Static"	CaseName=PPNS	
ComboName=RAR096 ScaleFactor=0	CaseType="Response Combo"	CaseName=SKAS		ComboName=RAR098 ScaleFactor=1	CaseType="Linear Static"	CaseName=PPAQ	
ComboName=RAR096 ScaleFactor=1	CaseType="Response Combo"	CaseName=SWS		ComboName=RAR098 ScaleFactor=0	CaseType="Response Combo"	CaseName=SK0S	
ComboName=RAR096 ScaleFactor=0	CaseType="Response Combo"	CaseName=SK0D		ComboName=RAR098 ScaleFactor=1	CaseType="Response Combo"	CaseName=SKAS	
ComboName=RAR096 ScaleFactor=1	CaseType="Response Combo"	CaseName=SKAD		ComboName=RAR098 ScaleFactor=1	CaseType="Response Combo"	CaseName=SWS	
ComboName=RAR096 ScaleFactor=1	CaseType="Response Combo"	CaseName=SWD		ComboName=RAR098 ScaleFactor=0	CaseType="Response Combo"	CaseName=SK0D	
ComboName=RAR096 ScaleFactor=0	CaseType="Linear Static"	CaseName=SA	ScaleFactor=1	ComboName=RAR098 ScaleFactor=1	CaseType="Response Combo"	CaseName=SKAD	
ComboName=RAR096 ScaleFactor=0	CaseType="Linear Static"	CaseName=QM01		ComboName=RAR098 ScaleFactor=1	CaseType="Response Combo"	CaseName=SKAD	
ComboName=RAR096 ScaleFactor=0	CaseType="Linear Static"	CaseName=QM02		ComboName=RAR098 ScaleFactor=1	CaseType="Response Combo"	CaseName=SWD	
ComboName=RAR096 ScaleFactor=0,75	CaseType="Linear Static"	CaseName=SQMS		ComboName=RAR098 ScaleFactor=0	CaseType="Linear Static"	CaseName=SA	ScaleFactor=1
ComboName=RAR096 ScaleFactor=0	CaseType="Linear Static"	CaseName=SQMD		ComboName=RAR098 ScaleFactor=0	CaseType="Linear Static"	CaseName=QM01	
ComboName=RAR096 ScaleFactor=0	CaseType="Linear Static"	CaseName=FA01		ComboName=RAR098 ScaleFactor=0	CaseType="Linear Static"	CaseName=QM02	
ComboName=RAR096 ScaleFactor=0	CaseType="Linear Static"	CaseName=TC01		ComboName=RAR098 ScaleFactor=0	CaseType="Linear Static"	CaseName=SQMS	
ComboName=RAR096 ScaleFactor=0	CaseType="Linear Static"	CaseName=TC02		ComboName=RAR098 ScaleFactor=0	CaseType="Linear Static"	CaseName=SQMD	
ComboName=RAR096 ScaleFactor=1	CaseType="Linear Static"	CaseName=TV01		ComboName=RAR098 ScaleFactor=0	CaseType="Linear Static"	CaseName=FA01	
ComboName=RAR096 ScaleFactor=0	CaseType="Linear Static"	CaseName=TV02		ComboName=RAR098 ScaleFactor=0	CaseType="Linear Static"	CaseName=TC01	
ComboName=RAR096 ScaleFactor=0,6	CaseType="Linear Static"	CaseName=RIT		ComboName=RAR098 ScaleFactor=0	CaseType="Linear Static"	CaseName=TC02	
ComboName=RAR096 ScaleFactor=0	CaseType="Linear Static"	CaseName=SSTS		ComboName=RAR098 ScaleFactor=1	CaseType="Linear Static"	CaseName=TV01	
ComboName=RAR096 ScaleFactor=0	CaseType="Linear Static"	CaseName=IS01		ComboName=RAR098 ScaleFactor=0	CaseType="Linear Static"	CaseName=TV02	
ComboName=RAR097 CaseType="Linear Static"	ComboType="Linear Add"	AutoDesign=No	SteelDesign=No	ComboName=RAR098 ScaleFactor=0	CaseType="Linear Static"	CaseName=RIT	ScaleFactor=0
ConcDesign=No AlumDesign=No ColdDesign=No	CaseName=PPST	ScaleFactor=1		ComboName=RAR098 ScaleFactor=0	CaseType="Linear Static"	CaseName=SSTS	
ComboName=RAR097 ScaleFactor=1	CaseType="Linear Static"	CaseName=PPNS		ComboName=RAR098 ScaleFactor=0	CaseType="Linear Static"	CaseName=IS01	
ComboName=RAR097 ScaleFactor=0	CaseType="Linear Static"	CaseName=PPAQ		ComboName=RAR099 ScaleFactor=1	ComboType="Linear Add"	AutoDesign=No	SteelDesign=No
ComboName=RAR097 ScaleFactor=1	CaseType="Response Combo"	CaseName=SK0S		ConcDesign=No AlumDesign=No ColdDesign=No	CaseName=PPST	ScaleFactor=1	
ComboName=RAR097 ScaleFactor=0	CaseType="Response Combo"	CaseName=SKAS		ComboName=RAR099 ScaleFactor=1	CaseType="Linear Static"	CaseName=PPNS	
ComboName=RAR097 ScaleFactor=0	CaseType="Response Combo"	CaseName=SKAD		ComboName=RAR099 ScaleFactor=0	CaseType="Linear Static"	CaseName=PPAQ	

APPROVATO SDP

Società di Progetto
Brebemi SpA



ComboName=RAR099 ScaleFactor=0	CaseType="Response Combo"	CaseName=SK05	ComboName=RAR101 ScaleFactor=0	CaseType="Linear Static"	CaseName=PPAQ
ComboName=RAR099 ScaleFactor=1	CaseType="Response Combo"	CaseName=SKAS	ComboName=RAR101 ScaleFactor=1	CaseType="Response Combo"	CaseName=SK05
ComboName=RAR099 ScaleFactor=1	CaseType="Response Combo"	CaseName=SWS	ComboName=RAR101 ScaleFactor=0	CaseType="Response Combo"	CaseName=SKAS
ComboName=RAR099 ScaleFactor=0	CaseType="Response Combo"	CaseName=SK0D	ComboName=RAR101 ScaleFactor=1	CaseType="Response Combo"	CaseName=SWS
ComboName=RAR099 ScaleFactor=1	CaseType="Response Combo"	CaseName=SKAD	ComboName=RAR101 ScaleFactor=1	CaseType="Response Combo"	CaseName=SK0D
ComboName=RAR099 ScaleFactor=1	CaseType="Response Combo"	CaseName=SWD	ComboName=RAR101 ScaleFactor=0	CaseType="Response Combo"	CaseName=SKAD
ComboName=RAR099	CaseType="Linear Static"	CaseName=SA ScaleFactor=1	ComboName=RAR101	CaseType="Response Combo"	CaseName=SWD
ComboName=RAR099	CaseType="Linear Static"	CaseName=QM01	ComboName=RAR101 ScaleFactor=1	CaseType="Linear Static"	CaseName=SA ScaleFactor=1
ComboName=RAR099	CaseType="Linear Static"	CaseName=QM02	ComboName=RAR101	CaseType="Linear Static"	CaseName=QM01
ComboName=RAR099	CaseType="Linear Static"	CaseName=SQMS	ComboName=RAR101 ScaleFactor=1	CaseType="Linear Static"	CaseName=QM02
ComboName=RAR099	CaseType="Linear Static"	CaseName=SQMD	ComboName=RAR101 ScaleFactor=1	CaseType="Linear Static"	CaseName=SQMS
ComboName=RAR099	CaseType="Linear Static"	CaseName=FA01	ComboName=RAR101 ScaleFactor=1	CaseType="Linear Static"	CaseName=SQMD
ComboName=RAR099	CaseType="Linear Static"	CaseName=TC01	ComboName=RAR101 ScaleFactor=0	CaseType="Linear Static"	CaseName=FA01
ComboName=RAR099	CaseType="Linear Static"	CaseName=TC02	ComboName=RAR101 ScaleFactor=0	CaseType="Linear Static"	CaseName=TC01
ComboName=RAR099	CaseType="Linear Static"	CaseName=TV01	ComboName=RAR101 ScaleFactor=0	CaseType="Linear Static"	CaseName=TC02
ComboName=RAR099 ScaleFactor=0,6	CaseType="Linear Static"	CaseName=TV02	ComboName=RAR101 ScaleFactor=0	CaseType="Linear Static"	CaseName=TV01
ComboName=RAR099	CaseType="Linear Static"	CaseName=RIT ScaleFactor=0	ComboName=RAR101	CaseType="Linear Static"	CaseName=TV02
ComboName=RAR099	CaseType="Linear Static"	CaseName=SSTS	ComboName=RAR101 ScaleFactor=0,6	CaseType="Linear Static"	CaseName=RIT ScaleFactor=0
ComboName=RAR099	CaseType="Linear Static"	CaseName=IS01	ComboName=RAR101 ScaleFactor=0	CaseType="Linear Static"	CaseName=SSTS
ComboName=RAR100 CaseType="Linear Static"	ComboType="Linear Add"	AutoDesign=No SteelDesign=No	ComboName=RAR101 ScaleFactor=0	CaseType="Linear Static"	CaseName=IS01
ConcDesign=No AlumDesign=No ColdDesign=No	CaseName=PPST ScaleFactor=1	CaseName=PPNS	ComboName=RAR102	ComboType="Linear Add"	AutoDesign=No SteelDesign=No
ComboName=RAR100	CaseType="Linear Static"	CaseName=PPAQ	CaseType="Linear Static"	CaseName=PPST ScaleFactor=1	CaseName=PPNS
ComboName=RAR100	CaseType="Response Combo"	CaseName=SK05	ComboName=RAR102 ScaleFactor=1	CaseType="Linear Static"	CaseName=PPAQ
ComboName=RAR100	CaseType="Response Combo"	CaseName=SKAS	ComboName=RAR102 ScaleFactor=0	CaseType="Response Combo"	CaseName=SK05
ComboName=RAR100	CaseType="Response Combo"	CaseName=SWS	ComboName=RAR102 ScaleFactor=1	CaseType="Response Combo"	CaseName=SKAS
ComboName=RAR100	CaseType="Response Combo"	CaseName=SK0D	ComboName=RAR102 ScaleFactor=0	CaseType="Response Combo"	CaseName=SWS
ComboName=RAR100	CaseType="Response Combo"	CaseName=SKAD	ComboName=RAR102 ScaleFactor=1	CaseType="Response Combo"	CaseName=SK0D
ComboName=RAR100	CaseType="Response Combo"	CaseName=SWD	ComboName=RAR102 ScaleFactor=0	CaseType="Response Combo"	CaseName=SKAD
ComboName=RAR100	CaseType="Response Combo"	CaseName=SWD	ComboName=RAR102 ScaleFactor=1	CaseType="Response Combo"	CaseName=SKAD
ComboName=RAR100	CaseType="Linear Static"	CaseName=SA ScaleFactor=1	ComboName=RAR102 ScaleFactor=1	CaseType="Response Combo"	CaseName=SWD
ComboName=RAR100	CaseType="Linear Static"	CaseName=QM01	ComboName=RAR102	CaseType="Response Combo"	CaseName=SWD
ComboName=RAR100	CaseType="Linear Static"	CaseName=QM02	ComboName=RAR102 ScaleFactor=1	CaseType="Linear Static"	CaseName=SA ScaleFactor=1
ComboName=RAR100	CaseType="Linear Static"	CaseName=SQMS	ComboName=RAR102	CaseType="Linear Static"	CaseName=QM01
ComboName=RAR100	CaseType="Linear Static"	CaseName=SQMD	ComboName=RAR102 ScaleFactor=0	CaseType="Linear Static"	CaseName=QM02
ComboName=RAR100	CaseType="Linear Static"	CaseName=FA01	ComboName=RAR102 ScaleFactor=0	CaseType="Linear Static"	CaseName=SQMS
ComboName=RAR100	CaseType="Linear Static"	CaseName=TC01	ComboName=RAR102 ScaleFactor=1	CaseType="Linear Static"	CaseName=SQMD
ComboName=RAR100	CaseType="Linear Static"	CaseName=TC02	ComboName=RAR102 ScaleFactor=0	CaseType="Linear Static"	CaseName=FA01
ComboName=RAR100	CaseType="Linear Static"	CaseName=TV01	ComboName=RAR102 ScaleFactor=0	CaseType="Linear Static"	CaseName=TC01
ComboName=RAR100	CaseType="Linear Static"	CaseName=TV02	ComboName=RAR102 ScaleFactor=0	CaseType="Linear Static"	CaseName=TC02
ComboName=RAR100 ScaleFactor=0,6	CaseType="Linear Static"	CaseName=RIT ScaleFactor=0	ComboName=RAR102 ScaleFactor=0	CaseType="Linear Static"	CaseName=TV01
ComboName=RAR100	CaseType="Linear Static"	CaseName=SSTS	ComboName=RAR102 ScaleFactor=0,6	CaseType="Linear Static"	CaseName=TV02
ComboName=RAR100	CaseType="Linear Static"	CaseName=IS01	ComboName=RAR102	CaseType="Linear Static"	CaseName=RIT ScaleFactor=0
ComboName=RAR101 CaseType="Linear Static"	ComboType="Linear Add"	AutoDesign=No SteelDesign=No	ComboName=RAR102 ScaleFactor=0	CaseType="Linear Static"	CaseName=SSTS
ConcDesign=No AlumDesign=No ColdDesign=No	CaseName=PPST ScaleFactor=1	CaseName=PPNS	ComboName=RAR102	CaseType="Linear Static"	CaseName=SSTS
ComboName=RAR101	CaseType="Linear Static"	CaseName=PPAQ	ComboName=RAR102 ScaleFactor=0	CaseType="Linear Static"	CaseName=IS01

APPROVATO SGP

Società di Progetto
Brebemi SpA



ComboName=RAR106 ScaleFactor=0	CaseType="Linear Static"	CaseName=IS01	ComboName=RAR108 ScaleFactor=0	CaseType="Linear Static"	CaseName=SSTS
ComboName=RAR107 CaseType="Linear Static" ConcDesign=No AlumDesign=No ColdDesign=No	ComboType="Linear Add" CaseName=PPST ScaleFactor=1	AutoDesign=No SteelDesign=No	ComboName=RAR108 ScaleFactor=0	CaseType="Linear Static"	CaseName=IS01
ComboName=RAR107 ScaleFactor=1	CaseType="Linear Static"	CaseName=PPNS	ComboName=RAR109 CaseType="Linear Static" ConcDesign=No AlumDesign=No ColdDesign=No	ComboType="Linear Add" CaseName=PPST ScaleFactor=1	AutoDesign=No SteelDesign=No
ComboName=RAR107 ScaleFactor=0	CaseType="Linear Static"	CaseName=PPAQ	ComboName=RAR109 ScaleFactor=1	CaseType="Linear Static"	CaseName=PPNS
ComboName=RAR107 ScaleFactor=1	CaseType="Response Combo"	CaseName=SK05	ComboName=RAR109 ScaleFactor=0	CaseType="Linear Static"	CaseName=PPAQ
ComboName=RAR107 ScaleFactor=0	CaseType="Response Combo"	CaseName=SKAS	ComboName=RAR109 ScaleFactor=1	CaseType="Response Combo"	CaseName=SK05
ComboName=RAR107 ScaleFactor=1	CaseType="Response Combo"	CaseName=SWS	ComboName=RAR109 ScaleFactor=0	CaseType="Response Combo"	CaseName=SKAS
ComboName=RAR107 ScaleFactor=1	CaseType="Response Combo"	CaseName=SK0D	ComboName=RAR109 ScaleFactor=1	CaseType="Response Combo"	CaseName=SWS
ComboName=RAR107 ScaleFactor=0	CaseType="Response Combo"	CaseName=SKAD	ComboName=RAR109 ScaleFactor=1	CaseType="Response Combo"	CaseName=SK0D
ComboName=RAR107 ScaleFactor=1	CaseType="Response Combo"	CaseName=SWD	ComboName=RAR109 ScaleFactor=0	CaseType="Response Combo"	CaseName=SKAD
ComboName=RAR107	CaseType="Linear Static"	CaseName=SA ScaleFactor=1	ComboName=RAR109 ScaleFactor=1	CaseType="Response Combo"	CaseName=SWD
ComboName=RAR107 ScaleFactor=0,75	CaseType="Linear Static"	CaseName=QM01	ComboName=RAR109 ScaleFactor=0	CaseType="Linear Static"	CaseName=SA ScaleFactor=1
ComboName=RAR107 ScaleFactor=0,75	CaseType="Linear Static"	CaseName=QM02	ComboName=RAR109 ScaleFactor=0	CaseType="Linear Static"	CaseName=QM01
ComboName=RAR107 ScaleFactor=0,75	CaseType="Linear Static"	CaseName=SQMS	ComboName=RAR109 ScaleFactor=0,75	CaseType="Linear Static"	CaseName=QM02
ComboName=RAR107 ScaleFactor=0,75	CaseType="Linear Static"	CaseName=SQMD	ComboName=RAR109 ScaleFactor=0,75	CaseType="Linear Static"	CaseName=SQMS
ComboName=RAR107 ScaleFactor=0	CaseType="Linear Static"	CaseName=FA01	ComboName=RAR109 ScaleFactor=0	CaseType="Linear Static"	CaseName=SQMD
ComboName=RAR107 ScaleFactor=0	CaseType="Linear Static"	CaseName=TC01	ComboName=RAR109 ScaleFactor=0	CaseType="Linear Static"	CaseName=FA01
ComboName=RAR107 ScaleFactor=0	CaseType="Linear Static"	CaseName=TC02	ComboName=RAR109 ScaleFactor=0	CaseType="Linear Static"	CaseName=TC01
ComboName=RAR107 ScaleFactor=0	CaseType="Linear Static"	CaseName=TV01	ComboName=RAR109 ScaleFactor=0	CaseType="Linear Static"	CaseName=TC02
ComboName=RAR107 ScaleFactor=1	CaseType="Linear Static"	CaseName=TV02	ComboName=RAR109 ScaleFactor=0	CaseType="Linear Static"	CaseName=TV01
ComboName=RAR107	CaseType="Linear Static"	CaseName=RIT ScaleFactor=0	ComboName=RAR109 ScaleFactor=1	CaseType="Linear Static"	CaseName=TV02
ComboName=RAR107 ScaleFactor=0	CaseType="Linear Static"	CaseName=SSTS	ComboName=RAR109 ScaleFactor=0	CaseType="Linear Static"	CaseName=RIT ScaleFactor=0
ComboName=RAR107 ScaleFactor=0	CaseType="Linear Static"	CaseName=IS01	ComboName=RAR109 ScaleFactor=0	CaseType="Linear Static"	CaseName=SSTS
ComboName=RAR108 CaseType="Linear Static" ConcDesign=No AlumDesign=No ColdDesign=No	ComboType="Linear Add" CaseName=PPST ScaleFactor=1	AutoDesign=No SteelDesign=No	ComboName=RAR109 ScaleFactor=0	CaseType="Linear Static"	CaseName=IS01
ComboName=RAR108 ScaleFactor=1	CaseType="Linear Static"	CaseName=PPNS	ComboName=RAR110 CaseType="Linear Static" ConcDesign=No AlumDesign=No ColdDesign=No	ComboType="Linear Add" CaseName=PPST ScaleFactor=1	AutoDesign=No SteelDesign=No
ComboName=RAR108 ScaleFactor=0	CaseType="Linear Static"	CaseName=PPAQ	ComboName=RAR110 ScaleFactor=1	CaseType="Linear Static"	CaseName=PPNS
ComboName=RAR108 ScaleFactor=1	CaseType="Response Combo"	CaseName=SK05	ComboName=RAR110 ScaleFactor=0	CaseType="Linear Static"	CaseName=PPAQ
ComboName=RAR108 ScaleFactor=0	CaseType="Response Combo"	CaseName=SKAS	ComboName=RAR110 ScaleFactor=0	CaseType="Response Combo"	CaseName=SK05
ComboName=RAR108 ScaleFactor=1	CaseType="Response Combo"	CaseName=SWS	ComboName=RAR110 ScaleFactor=1	CaseType="Response Combo"	CaseName=SKAS
ComboName=RAR108 ScaleFactor=0	CaseType="Response Combo"	CaseName=SK0D	ComboName=RAR110 ScaleFactor=0	CaseType="Response Combo"	CaseName=SWS
ComboName=RAR108 ScaleFactor=1	CaseType="Response Combo"	CaseName=SKAD	ComboName=RAR110 ScaleFactor=0	CaseType="Response Combo"	CaseName=SK0D
ComboName=RAR108 ScaleFactor=1	CaseType="Response Combo"	CaseName=SWD	ComboName=RAR110 ScaleFactor=1	CaseType="Response Combo"	CaseName=SKAD
ComboName=RAR108	CaseType="Linear Static"	CaseName=SA ScaleFactor=1	ComboName=RAR110 ScaleFactor=1	CaseType="Response Combo"	CaseName=SWD
ComboName=RAR108 ScaleFactor=0	CaseType="Linear Static"	CaseName=QM01	ComboName=RAR110 ScaleFactor=0	CaseType="Linear Static"	CaseName=SA ScaleFactor=1
ComboName=RAR108 ScaleFactor=0	CaseType="Linear Static"	CaseName=QM02	ComboName=RAR110 ScaleFactor=0	CaseType="Linear Static"	CaseName=QM01
ComboName=RAR108 ScaleFactor=0,75	CaseType="Linear Static"	CaseName=SQMS	ComboName=RAR110 ScaleFactor=0	CaseType="Linear Static"	CaseName=QM02
ComboName=RAR108 ScaleFactor=0	CaseType="Linear Static"	CaseName=SQMD	ComboName=RAR110 ScaleFactor=0	CaseType="Linear Static"	CaseName=SQMS
ComboName=RAR108 ScaleFactor=0	CaseType="Linear Static"	CaseName=FA01	ComboName=RAR110 ScaleFactor=0	CaseType="Linear Static"	CaseName=SQMD
ComboName=RAR108 ScaleFactor=0	CaseType="Linear Static"	CaseName=TC01	ComboName=RAR110 ScaleFactor=0,6	CaseType="Linear Static"	CaseName=FA01
ComboName=RAR108 ScaleFactor=0	CaseType="Linear Static"	CaseName=TC02	ComboName=RAR110 ScaleFactor=0	CaseType="Linear Static"	CaseName=TC01
ComboName=RAR108 ScaleFactor=0	CaseType="Linear Static"	CaseName=TV01	ComboName=RAR110 ScaleFactor=0	CaseType="Linear Static"	CaseName=TC02
ComboName=RAR108 ScaleFactor=1	CaseType="Linear Static"	CaseName=TV02	ComboName=RAR110 ScaleFactor=0	CaseType="Linear Static"	CaseName=TV01
ComboName=RAR108	CaseType="Linear Static"	CaseName=RIT ScaleFactor=0	ComboName=RAR110 ScaleFactor=0	CaseType="Linear Static"	CaseName=TV02

APPROVATO SGP

Società di Progetto
Brebemi SpA



ComboName=RAR122 ScaleFactor=0	CaseType="Linear Static"	CaseName=SQMS	ComboName=RAR124 ScaleFactor=0,75	CaseType="Linear Static"	CaseName=QM01
ComboName=RAR122 ScaleFactor=0	CaseType="Linear Static"	CaseName=SQMD	ComboName=RAR124 ScaleFactor=0,75	CaseType="Linear Static"	CaseName=QM02
ComboName=RAR122 ScaleFactor=0	CaseType="Linear Static"	CaseName=FA01	ComboName=RAR124 ScaleFactor=0,75	CaseType="Linear Static"	CaseName=SQMS
ComboName=RAR122 ScaleFactor=0	CaseType="Linear Static"	CaseName=TC01	ComboName=RAR124 ScaleFactor=0	CaseType="Linear Static"	CaseName=SQMD
ComboName=RAR122 ScaleFactor=0	CaseType="Linear Static"	CaseName=TC02	ComboName=RAR124 ScaleFactor=0	CaseType="Linear Static"	CaseName=FA01
ComboName=RAR122 ScaleFactor=0	CaseType="Linear Static"	CaseName=TV01	ComboName=RAR124 ScaleFactor=0	CaseType="Linear Static"	CaseName=TC01
ComboName=RAR122 ScaleFactor=1	CaseType="Linear Static"	CaseName=TV02	ComboName=RAR124 ScaleFactor=0	CaseType="Linear Static"	CaseName=TC02
ComboName=RAR122 ScaleFactor=0,6	CaseType="Linear Static"	CaseName=RIT	ComboName=RAR124 ScaleFactor=0	CaseType="Linear Static"	CaseName=TV01
ComboName=RAR122 ScaleFactor=0	CaseType="Linear Static"	CaseName=SSTS	ComboName=RAR124 ScaleFactor=1	CaseType="Linear Static"	CaseName=TV02
ComboName=RAR122 ScaleFactor=0	CaseType="Linear Static"	CaseName=IS01	ComboName=RAR124 ScaleFactor=0,6	CaseType="Linear Static"	CaseName=RIT
ComboName=RAR123 CaseType="Linear Static" ConcDesign=No AlumDesign=No ColdDesign=No	ComboType="Linear Add" CaseName=PPST ScaleFactor=1	AutoDesign=No SteelDesign=No	ComboName=RAR124 ScaleFactor=0	CaseType="Linear Static"	CaseName=SSTS
ComboName=RAR123 ScaleFactor=1	CaseType="Linear Static"	CaseName=PPNS	ComboName=RAR124 ScaleFactor=0	CaseType="Linear Static"	CaseName=IS01
ComboName=RAR123 ScaleFactor=0	CaseType="Linear Static"	CaseName=PPAQ	ComboName=RAR125 CaseType="Linear Static" ConcDesign=No AlumDesign=No ColdDesign=No	ComboType="Linear Add" CaseName=PPST ScaleFactor=1	AutoDesign=No SteelDesign=No
ComboName=RAR123 ScaleFactor=0	CaseType="Response Combo"	CaseName=SK05	ComboName=RAR125 ScaleFactor=1	CaseType="Linear Static"	CaseName=PPNS
ComboName=RAR123 ScaleFactor=1	CaseType="Response Combo"	CaseName=SKAS	ComboName=RAR125 ScaleFactor=0	CaseType="Linear Static"	CaseName=PPAQ
ComboName=RAR123 ScaleFactor=1	CaseType="Response Combo"	CaseName=SWS	ComboName=RAR125 ScaleFactor=1	CaseType="Response Combo"	CaseName=SK05
ComboName=RAR123 ScaleFactor=0	CaseType="Response Combo"	CaseName=SK0D	ComboName=RAR125 ScaleFactor=0	CaseType="Response Combo"	CaseName=SKAS
ComboName=RAR123 ScaleFactor=1	CaseType="Response Combo"	CaseName=SKAD	ComboName=RAR125 ScaleFactor=1	CaseType="Response Combo"	CaseName=SWS
ComboName=RAR123 ScaleFactor=1	CaseType="Response Combo"	CaseName=SWD	ComboName=RAR125 ScaleFactor=1	CaseType="Response Combo"	CaseName=SK0D
ComboName=RAR123 ScaleFactor=0,75	CaseType="Linear Static"	CaseName=SA ScaleFactor=1	ComboName=RAR125 ScaleFactor=0	CaseType="Response Combo"	CaseName=SKAD
ComboName=RAR123 ScaleFactor=0,75	CaseType="Linear Static"	CaseName=QM01	ComboName=RAR125 ScaleFactor=1	CaseType="Response Combo"	CaseName=SWD
ComboName=RAR123 ScaleFactor=0	CaseType="Linear Static"	CaseName=QM02	ComboName=RAR125 ScaleFactor=0,75	CaseType="Linear Static"	CaseName=SA ScaleFactor=1
ComboName=RAR123 ScaleFactor=0	CaseType="Linear Static"	CaseName=SQMS	ComboName=RAR125 ScaleFactor=0,75	CaseType="Linear Static"	CaseName=QM01
ComboName=RAR123 ScaleFactor=0	CaseType="Linear Static"	CaseName=SQMD	ComboName=RAR125 ScaleFactor=0,75	CaseType="Linear Static"	CaseName=QM02
ComboName=RAR123 ScaleFactor=0	CaseType="Linear Static"	CaseName=FA01	ComboName=RAR125 ScaleFactor=0,75	CaseType="Linear Static"	CaseName=SQMS
ComboName=RAR123 ScaleFactor=0	CaseType="Linear Static"	CaseName=TC01	ComboName=RAR125 ScaleFactor=0,75	CaseType="Linear Static"	CaseName=SQMD
ComboName=RAR123 ScaleFactor=0	CaseType="Linear Static"	CaseName=TC02	ComboName=RAR125 ScaleFactor=0	CaseType="Linear Static"	CaseName=FA01
ComboName=RAR123 ScaleFactor=0	CaseType="Linear Static"	CaseName=TV01	ComboName=RAR125 ScaleFactor=0	CaseType="Linear Static"	CaseName=TC01
ComboName=RAR123 ScaleFactor=1	CaseType="Linear Static"	CaseName=TV02	ComboName=RAR125 ScaleFactor=0	CaseType="Linear Static"	CaseName=TC02
ComboName=RAR123 ScaleFactor=0,6	CaseType="Linear Static"	CaseName=RIT	ComboName=RAR125 ScaleFactor=0	CaseType="Linear Static"	CaseName=TV01
ComboName=RAR123 ScaleFactor=0	CaseType="Linear Static"	CaseName=SSTS	ComboName=RAR125 ScaleFactor=1	CaseType="Linear Static"	CaseName=TV02
ComboName=RAR123 ScaleFactor=0	CaseType="Linear Static"	CaseName=IS01	ComboName=RAR125 ScaleFactor=0,6	CaseType="Linear Static"	CaseName=RIT
ComboName=RAR124 CaseType="Linear Static" ConcDesign=No AlumDesign=No ColdDesign=No	ComboType="Linear Add" CaseName=PPST ScaleFactor=1	AutoDesign=No SteelDesign=No	ComboName=RAR125 ScaleFactor=0	CaseType="Linear Static"	CaseName=SSTS
ComboName=RAR124 ScaleFactor=1	CaseType="Linear Static"	CaseName=PPNS	ComboName=RAR125 ScaleFactor=0	CaseType="Linear Static"	CaseName=IS01
ComboName=RAR124 ScaleFactor=0	CaseType="Linear Static"	CaseName=PPAQ	ComboName=RAR126 CaseType="Linear Static" ConcDesign=No AlumDesign=No ColdDesign=No	ComboType="Linear Add" CaseName=PPST ScaleFactor=1	AutoDesign=No SteelDesign=No
ComboName=RAR124 ScaleFactor=1	CaseType="Response Combo"	CaseName=SK05	ComboName=RAR126 ScaleFactor=1	CaseType="Linear Static"	CaseName=PPNS
ComboName=RAR124 ScaleFactor=0	CaseType="Response Combo"	CaseName=SKAS	ComboName=RAR126 ScaleFactor=0	CaseType="Linear Static"	CaseName=PPAQ
ComboName=RAR124 ScaleFactor=1	CaseType="Response Combo"	CaseName=SWS	ComboName=RAR126 ScaleFactor=1	CaseType="Response Combo"	CaseName=SK05
ComboName=RAR124 ScaleFactor=0	CaseType="Response Combo"	CaseName=SK0D	ComboName=RAR126 ScaleFactor=0	CaseType="Response Combo"	CaseName=SKAS
ComboName=RAR124 ScaleFactor=1	CaseType="Response Combo"	CaseName=SKAD	ComboName=RAR126 ScaleFactor=1	CaseType="Response Combo"	CaseName=SWS
ComboName=RAR124 ScaleFactor=1	CaseType="Response Combo"	CaseName=SWD	ComboName=RAR126 ScaleFactor=0	CaseType="Response Combo"	CaseName=SK0D
ComboName=RAR124 ScaleFactor=1	CaseType="Linear Static"	CaseName=SA ScaleFactor=1			

APPROVED SDP

Società di Progetto
Brebem SpA

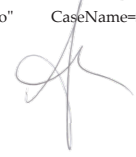

ComboName=RAR126 ScaleFactor=1	CaseType="Response	Combo"	CaseName=SKAD	ComboName=RAR128 ScaleFactor=1	CaseType="Response	Combo"	CaseName=SWS
ComboName=RAR126 ScaleFactor=1	CaseType="Response	Combo"	CaseName=SWD	ComboName=RAR128 ScaleFactor=0	CaseType="Response	Combo"	CaseName=SK0D
ComboName=RAR126 ScaleFactor=0	CaseType="Linear Static"	CaseName=SA	ScaleFactor=1	ComboName=RAR128 ScaleFactor=1	CaseType="Response	Combo"	CaseName=SKAD
ComboName=RAR126 ScaleFactor=0	CaseType="Linear	Static"	CaseName=QM01	ComboName=RAR128 ScaleFactor=1	CaseType="Response	Combo"	CaseName=SWD
ComboName=RAR126 ScaleFactor=0	CaseType="Linear	Static"	CaseName=QM02	ComboName=RAR128 ScaleFactor=0	CaseType="Linear Static"	CaseName=SA	ScaleFactor=1
ComboName=RAR126 ScaleFactor=0,75	CaseType="Linear	Static"	CaseName=SQMS	ComboName=RAR128 ScaleFactor=0	CaseType="Linear	Static"	CaseName=QM01
ComboName=RAR126 ScaleFactor=0	CaseType="Linear	Static"	CaseName=SQMD	ComboName=RAR128 ScaleFactor=0	CaseType="Linear	Static"	CaseName=QM02
ComboName=RAR126 ScaleFactor=0	CaseType="Linear	Static"	CaseName=FA01	ComboName=RAR128 ScaleFactor=0	CaseType="Linear	Static"	CaseName=SQMS
ComboName=RAR126 ScaleFactor=0	CaseType="Linear	Static"	CaseName=TC01	ComboName=RAR128 ScaleFactor=0	CaseType="Linear	Static"	CaseName=SQMD
ComboName=RAR126 ScaleFactor=0	CaseType="Linear	Static"	CaseName=TC02	ComboName=RAR128 ScaleFactor=0	CaseType="Linear	Static"	CaseName=FA01
ComboName=RAR126 ScaleFactor=0	CaseType="Linear	Static"	CaseName=TV01	ComboName=RAR128 ScaleFactor=0	CaseType="Linear	Static"	CaseName=TC01
ComboName=RAR126 ScaleFactor=1	CaseType="Linear	Static"	CaseName=TV02	ComboName=RAR128 ScaleFactor=0	CaseType="Linear	Static"	CaseName=TC02
ComboName=RAR126 ScaleFactor=0,6	CaseType="Linear	Static"	CaseName=RIT	ComboName=RAR128 ScaleFactor=0	CaseType="Linear	Static"	CaseName=TV01
ComboName=RAR126 ScaleFactor=0	CaseType="Linear	Static"	CaseName=SSTS	ComboName=RAR128 ScaleFactor=0	CaseType="Linear	Static"	CaseName=TV02
ComboName=RAR126 ScaleFactor=0	CaseType="Linear	Static"	CaseName=IS01	ComboName=RAR128 ScaleFactor=0	CaseType="Linear Static"	CaseName=RIT	ScaleFactor=1
ComboName=RAR127 CaseType="Linear Static"	ComboType="Linear Add"	AutoDesign=No	SteelDesign=No	ComboName=RAR128 ScaleFactor=0	CaseType="Linear	Static"	CaseName=SSTS
ConcDesign=No AlumDesign=No ColdDesign=No	CaseName=PPST	ScaleFactor=1		ComboName=RAR128 ScaleFactor=0	CaseType="Linear	Static"	CaseName=IS01
ComboName=RAR127 ScaleFactor=1	CaseType="Linear	Static"	CaseName=PPNS	ComboName=RAR129 ScaleFactor=0	ComboType="Linear Add"	AutoDesign=No	SteelDesign=No
ComboName=RAR127 ScaleFactor=0	CaseType="Linear	Static"	CaseName=PPAQ	ComboName=RAR129 ScaleFactor=1	CaseName=PPST	ScaleFactor=1	
ComboName=RAR127 ScaleFactor=1	CaseType="Response	Combo"	CaseName=SK0S	ComboName=RAR129 ScaleFactor=0	CaseType="Linear	Static"	CaseName=PPNS
ComboName=RAR127 ScaleFactor=0	CaseType="Response	Combo"	CaseName=SKAS	ComboName=RAR129 ScaleFactor=0	CaseType="Linear	Static"	CaseName=PPAQ
ComboName=RAR127 ScaleFactor=1	CaseType="Response	Combo"	CaseName=SWS	ComboName=RAR129 ScaleFactor=1	CaseType="Response	Combo"	CaseName=SK0S
ComboName=RAR127 ScaleFactor=1	CaseType="Response	Combo"	CaseName=SK0D	ComboName=RAR129 ScaleFactor=0	CaseType="Response	Combo"	CaseName=SKAS
ComboName=RAR127 ScaleFactor=0	CaseType="Response	Combo"	CaseName=SKAD	ComboName=RAR129 ScaleFactor=1	CaseType="Response	Combo"	CaseName=SWS
ComboName=RAR127 ScaleFactor=1	CaseType="Response	Combo"	CaseName=SWD	ComboName=RAR129 ScaleFactor=0	CaseType="Response	Combo"	CaseName=SK0D
ComboName=RAR127 ScaleFactor=0	CaseType="Linear Static"	CaseName=SA	ScaleFactor=1	ComboName=RAR129 ScaleFactor=1	CaseType="Response	Combo"	CaseName=SKAD
ComboName=RAR127 ScaleFactor=0	CaseType="Linear	Static"	CaseName=QM01	ComboName=RAR129 ScaleFactor=1	CaseType="Response	Combo"	CaseName=SWD
ComboName=RAR127 ScaleFactor=0	CaseType="Linear	Static"	CaseName=QM02	ComboName=RAR129 ScaleFactor=0	CaseType="Linear Static"	CaseName=SA	ScaleFactor=1
ComboName=RAR127 ScaleFactor=0,75	CaseType="Linear	Static"	CaseName=SQMS	ComboName=RAR129 ScaleFactor=1	CaseType="Linear	Static"	CaseName=QM01
ComboName=RAR127 ScaleFactor=0,75	CaseType="Linear	Static"	CaseName=SQMD	ComboName=RAR129 ScaleFactor=0	CaseType="Linear	Static"	CaseName=QM02
ComboName=RAR127 ScaleFactor=0	CaseType="Linear	Static"	CaseName=FA01	ComboName=RAR129 ScaleFactor=0	CaseType="Linear	Static"	CaseName=SQMS
ComboName=RAR127 ScaleFactor=0	CaseType="Linear	Static"	CaseName=TC01	ComboName=RAR129 ScaleFactor=0	CaseType="Linear	Static"	CaseName=SQMD
ComboName=RAR127 ScaleFactor=0	CaseType="Linear	Static"	CaseName=TC02	ComboName=RAR129 ScaleFactor=0	CaseType="Linear	Static"	CaseName=FA01
ComboName=RAR127 ScaleFactor=0	CaseType="Linear	Static"	CaseName=TV01	ComboName=RAR129 ScaleFactor=0	CaseType="Linear	Static"	CaseName=TC01
ComboName=RAR127 ScaleFactor=1	CaseType="Linear	Static"	CaseName=TV02	ComboName=RAR129 ScaleFactor=0	CaseType="Linear	Static"	CaseName=TC02
ComboName=RAR127 ScaleFactor=0,6	CaseType="Linear	Static"	CaseName=RIT	ComboName=RAR129 ScaleFactor=0,6	CaseType="Linear	Static"	CaseName=TV01
ComboName=RAR127 ScaleFactor=0	CaseType="Linear	Static"	CaseName=SSTS	ComboName=RAR129 ScaleFactor=0	CaseType="Linear	Static"	CaseName=TV02
ComboName=RAR127 ScaleFactor=0	CaseType="Linear	Static"	CaseName=IS01	ComboName=RAR129 ScaleFactor=0	CaseType="Linear	Static"	CaseName=RIT
ComboName=RAR128 CaseType="Linear Static"	ComboType="Linear Add"	AutoDesign=No	SteelDesign=No	ComboName=RAR129 ScaleFactor=0	CaseType="Linear	Static"	CaseName=IS01
ConcDesign=No AlumDesign=No ColdDesign=No	CaseName=PPST	ScaleFactor=1		ComboName=RAR129 ScaleFactor=0	CaseType="Linear	Static"	CaseName=IS01
ComboName=RAR128 ScaleFactor=1	CaseType="Linear	Static"	CaseName=PPNS	ComboName=RAR130 ScaleFactor=0	ComboType="Linear Add"	AutoDesign=No	SteelDesign=No
ComboName=RAR128 ScaleFactor=0	CaseType="Linear	Static"	CaseName=PPAQ	ComboName=RAR130 ScaleFactor=1	CaseName=PPST	ScaleFactor=1	
ComboName=RAR128 ScaleFactor=0	CaseType="Response	Combo"	CaseName=SK0S	ComboName=RAR130 ScaleFactor=0	CaseType="Linear	Static"	CaseName=PPNS
ComboName=RAR128 ScaleFactor=1	CaseType="Response	Combo"	CaseName=SKAS	ComboName=RAR130 ScaleFactor=0	CaseType="Linear	Static"	CaseName=PPAQ

APPROVATO SGP

Società di Progetto
Brebemi SpA



ComboName=RAR130 ScaleFactor=1	CaseType="Response Combo"	CaseName=SK05	ComboName=RAR132 ScaleFactor=1	CaseType="Linear Static"	CaseName=PPNS
ComboName=RAR130 ScaleFactor=0	CaseType="Response Combo"	CaseName=SKAS	ComboName=RAR132 ScaleFactor=0	CaseType="Linear Static"	CaseName=PPAQ
ComboName=RAR130 ScaleFactor=1	CaseType="Response Combo"	CaseName=SWS	ComboName=RAR132 ScaleFactor=1	CaseType="Response Combo"	CaseName=SK05
ComboName=RAR130 ScaleFactor=0	CaseType="Response Combo"	CaseName=SK0D	ComboName=RAR132 ScaleFactor=0	CaseType="Response Combo"	CaseName=SKAS
ComboName=RAR130 ScaleFactor=1	CaseType="Response Combo"	CaseName=SKAD	ComboName=RAR132 ScaleFactor=1	CaseType="Response Combo"	CaseName=SWS
ComboName=RAR130 ScaleFactor=1	CaseType="Response Combo"	CaseName=SWD	ComboName=RAR132 ScaleFactor=0	CaseType="Response Combo"	CaseName=SK0D
ComboName=RAR130 ScaleFactor=1	CaseType="Linear Static"	CaseName=SA	ComboName=RAR132 ScaleFactor=1	CaseType="Response Combo"	CaseName=SKAD
ComboName=RAR130 ScaleFactor=1	CaseType="Linear Static"	CaseName=QM01	ComboName=RAR132 ScaleFactor=1	CaseType="Response Combo"	CaseName=SWD
ComboName=RAR130 ScaleFactor=1	CaseType="Linear Static"	CaseName=QM02	ComboName=RAR132 ScaleFactor=1	CaseType="Response Combo"	CaseName=SWD
ComboName=RAR130 ScaleFactor=1	CaseType="Linear Static"	CaseName=SQMS	ComboName=RAR132 ScaleFactor=0	CaseType="Linear Static"	CaseName=SA
ComboName=RAR130 ScaleFactor=0	CaseType="Linear Static"	CaseName=SQMD	ComboName=RAR132 ScaleFactor=0	CaseType="Linear Static"	CaseName=QM01
ComboName=RAR130 ScaleFactor=0	CaseType="Linear Static"	CaseName=FA01	ComboName=RAR132 ScaleFactor=1	CaseType="Linear Static"	CaseName=QM02
ComboName=RAR130 ScaleFactor=0	CaseType="Linear Static"	CaseName=TC01	ComboName=RAR132 ScaleFactor=0	CaseType="Linear Static"	CaseName=SQMS
ComboName=RAR130 ScaleFactor=0	CaseType="Linear Static"	CaseName=TC02	ComboName=RAR132 ScaleFactor=0	CaseType="Linear Static"	CaseName=SQMD
ComboName=RAR130 ScaleFactor=0	CaseType="Linear Static"	CaseName=TV01	ComboName=RAR132 ScaleFactor=0	CaseType="Linear Static"	CaseName=FA01
ComboName=RAR130 ScaleFactor=0	CaseType="Linear Static"	CaseName=TV02	ComboName=RAR132 ScaleFactor=0	CaseType="Linear Static"	CaseName=TC01
ComboName=RAR130 ScaleFactor=0,6	CaseType="Linear Static"	CaseName=RIT	ComboName=RAR132 ScaleFactor=0	CaseType="Linear Static"	CaseName=TC02
ComboName=RAR130 ScaleFactor=0	CaseType="Linear Static"	CaseName=SSTS	ComboName=RAR132 ScaleFactor=0	CaseType="Linear Static"	CaseName=TV01
ComboName=RAR130 ScaleFactor=0	CaseType="Linear Static"	CaseName=IS01	ComboName=RAR132 ScaleFactor=0,6	CaseType="Linear Static"	CaseName=TV02
ComboName=RAR131 CaseType="Linear Static"	ComboType="Linear Add"	AutoDesign=No	ComboName=RAR132 ScaleFactor=0	CaseType="Linear Static"	CaseName=RIT
CaseName=PPST	ScaleFactor=1	SteelDesign=No	ComboName=RAR132 ScaleFactor=0	CaseType="Linear Static"	CaseName=SSTS
ConcDesign=No	AlumDesign=No	ColdDesign=No	ComboName=RAR132 ScaleFactor=0	CaseType="Linear Static"	CaseName=IS01
ComboName=RAR131	CaseType="Linear Static"	CaseName=PPNS	ComboName=RAR132 ScaleFactor=0	CaseType="Linear Static"	CaseName=IS01
ScaleFactor=1	CaseType="Linear Static"	CaseName=PPAQ	ComboName=RAR133 CaseType="Linear Static"	ComboType="Linear Add"	AutoDesign=No
ScaleFactor=0	CaseType="Linear Static"	CaseName=PPAQ	ConcDesign=No	AlumDesign=No	ColdDesign=No
ScaleFactor=1	CaseType="Response Combo"	CaseName=SK05	ComboName=RAR133 ScaleFactor=1	CaseType="Linear Static"	CaseName=PPNS
ScaleFactor=0	CaseType="Response Combo"	CaseName=SKAS	ComboName=RAR133 ScaleFactor=0	CaseType="Linear Static"	CaseName=PPAQ
ScaleFactor=1	CaseType="Response Combo"	CaseName=SWS	ComboName=RAR133 ScaleFactor=1	CaseType="Response Combo"	CaseName=SK05
ScaleFactor=1	CaseType="Response Combo"	CaseName=SK0D	ComboName=RAR133 ScaleFactor=0	CaseType="Response Combo"	CaseName=SKAS
ScaleFactor=0	CaseType="Response Combo"	CaseName=SKAD	ComboName=RAR133 ScaleFactor=1	CaseType="Response Combo"	CaseName=SWS
ScaleFactor=1	CaseType="Response Combo"	CaseName=SWD	ComboName=RAR133 ScaleFactor=1	CaseType="Response Combo"	CaseName=SK0D
ScaleFactor=1	CaseType="Linear Static"	CaseName=SA	ComboName=RAR133 ScaleFactor=0	CaseType="Response Combo"	CaseName=SKAD
ScaleFactor=1	CaseType="Linear Static"	CaseName=QM01	ComboName=RAR133 ScaleFactor=1	CaseType="Response Combo"	CaseName=SWD
ScaleFactor=1	CaseType="Linear Static"	CaseName=QM02	ComboName=RAR133 ScaleFactor=0	CaseType="Response Combo"	CaseName=SWD
ScaleFactor=1	CaseType="Linear Static"	CaseName=SQMS	ComboName=RAR133 ScaleFactor=0	CaseType="Linear Static"	CaseName=SA
ScaleFactor=0	CaseType="Linear Static"	CaseName=SQMD	ComboName=RAR133 ScaleFactor=1	CaseType="Linear Static"	CaseName=QM01
ScaleFactor=0	CaseType="Linear Static"	CaseName=FA01	ComboName=RAR133 ScaleFactor=0	CaseType="Linear Static"	CaseName=QM02
ScaleFactor=0	CaseType="Linear Static"	CaseName=TC01	ComboName=RAR133 ScaleFactor=1	CaseType="Linear Static"	CaseName=SQMS
ScaleFactor=0	CaseType="Linear Static"	CaseName=TC02	ComboName=RAR133 ScaleFactor=0	CaseType="Linear Static"	CaseName=SQMD
ScaleFactor=0	CaseType="Linear Static"	CaseName=TV01	ComboName=RAR133 ScaleFactor=0	CaseType="Linear Static"	CaseName=FA01
ScaleFactor=0	CaseType="Linear Static"	CaseName=TV02	ComboName=RAR133 ScaleFactor=0	CaseType="Linear Static"	CaseName=TC01
ScaleFactor=0,6	CaseType="Linear Static"	CaseName=RIT	ComboName=RAR133 ScaleFactor=0	CaseType="Linear Static"	CaseName=TC02
ScaleFactor=0	CaseType="Linear Static"	CaseName=SSTS	ComboName=RAR133 ScaleFactor=0,6	CaseType="Linear Static"	CaseName=TV01
ScaleFactor=0	CaseType="Linear Static"	CaseName=IS01	ComboName=RAR133 ScaleFactor=0	CaseType="Linear Static"	CaseName=TV02
ScaleFactor=0	CaseType="Linear Static"	CaseName=IS01	ComboName=RAR132 CaseType="Linear Add"	AutoDesign=No	SteelDesign=No
CaseType="Linear Static"	CaseName=PPST	ScaleFactor=1	CaseType="Linear Static"	CaseName=SSTS	
ConcDesign=No	AlumDesign=No	ColdDesign=No	CaseType="Linear Static"	CaseName=SSTS	

ComboName=RAR161 ScaleFactor=1	CaseType="Response Combo"	CaseName=SWS	ComboName=RAR163 ScaleFactor=0	CaseType="Response Combo"	CaseName=SKAS
ComboName=RAR161 ScaleFactor=1	CaseType="Response Combo"	CaseName=SK0D	ComboName=RAR163 ScaleFactor=1	CaseType="Response Combo"	CaseName=SWS
ComboName=RAR161 ScaleFactor=0	CaseType="Response Combo"	CaseName=SKAD	ComboName=RAR163 ScaleFactor=1	CaseType="Response Combo"	CaseName=SK0D
ComboName=RAR161 ScaleFactor=1	CaseType="Response Combo"	CaseName=SWD	ComboName=RAR163 ScaleFactor=0	CaseType="Response Combo"	CaseName=SKAD
ComboName=RAR161 ScaleFactor=0,75	CaseType="Linear Static"	CaseName=SA	ComboName=RAR163 ScaleFactor=1	CaseType="Response Combo"	CaseName=SWD
ComboName=RAR161 ScaleFactor=0,75	CaseType="Linear Static"	CaseName=QM01	ComboName=RAR163 ScaleFactor=0	CaseType="Linear Static"	CaseName=SA
ComboName=RAR161 ScaleFactor=0,75	CaseType="Linear Static"	CaseName=QM02	ComboName=RAR163 ScaleFactor=0	CaseType="Linear Static"	CaseName=QM01
ComboName=RAR161 ScaleFactor=0,75	CaseType="Linear Static"	CaseName=SQMS	ComboName=RAR163 ScaleFactor=0,75	CaseType="Linear Static"	CaseName=QM02
ComboName=RAR161 ScaleFactor=0	CaseType="Linear Static"	CaseName=SQMD	ComboName=RAR163 ScaleFactor=0,75	CaseType="Linear Static"	CaseName=SQMS
ComboName=RAR161 ScaleFactor=0	CaseType="Linear Static"	CaseName=FA01	ComboName=RAR163 ScaleFactor=0	CaseType="Linear Static"	CaseName=SQMD
ComboName=RAR161 ScaleFactor=0	CaseType="Linear Static"	CaseName=TC01	ComboName=RAR163 ScaleFactor=0	CaseType="Linear Static"	CaseName=FA01
ComboName=RAR161 ScaleFactor=0	CaseType="Linear Static"	CaseName=TC02	ComboName=RAR163 ScaleFactor=0	CaseType="Linear Static"	CaseName=TC01
ComboName=RAR161 ScaleFactor=0,6	CaseType="Linear Static"	CaseName=TV01	ComboName=RAR163 ScaleFactor=0	CaseType="Linear Static"	CaseName=TC02
ComboName=RAR161 ScaleFactor=0	CaseType="Linear Static"	CaseName=TV02	ComboName=RAR163 ScaleFactor=0,6	CaseType="Linear Static"	CaseName=TV01
ComboName=RAR161 ScaleFactor=0	CaseType="Linear Static"	CaseName=RIT	ComboName=RAR163 ScaleFactor=0	CaseType="Linear Static"	CaseName=TV02
ComboName=RAR161 ScaleFactor=0	CaseType="Linear Static"	CaseName=SSTS	ComboName=RAR163 ScaleFactor=0	CaseType="Linear Static"	CaseName=RIT
ComboName=RAR161 ScaleFactor=0	CaseType="Linear Static"	CaseName=IS01	ComboName=RAR163 ScaleFactor=0	CaseType="Linear Static"	CaseName=SSTS
ComboName=RAR162 CaseType="Linear Static"	ComboType="Linear Add"	AutoDesign=No	ComboName=RAR163 ScaleFactor=0	CaseType="Linear Static"	CaseName=IS01
ConcDesign=No AlumDesign=No ColdDesign=No	CaseName=PPST	ScaleFactor=1	ComboName=INVRAR	ComboType="Envelope"	AutoDesign=No
ScaleFactor=1	CaseType="Linear Static"	CaseName=PPNS	CaseType="Response Combo"	CaseName=RAR001	ScaleFactor=1
ComboName=RAR162 ScaleFactor=0	CaseType="Linear Static"	CaseName=PPAQ	ComboName=INVRAR ScaleFactor=1	ConcDesign=No AlumDesign=No ColdDesign=No	CaseName=RAR002
ComboName=RAR162 ScaleFactor=1	CaseType="Response Combo"	CaseName=SK05	ComboName=INVRAR ScaleFactor=1	CaseType="Response Combo"	CaseName=RAR003
ComboName=RAR162 ScaleFactor=0	CaseType="Response Combo"	CaseName=SKAS	ComboName=INVRAR ScaleFactor=1	CaseType="Response Combo"	CaseName=RAR004
ComboName=RAR162 ScaleFactor=1	CaseType="Response Combo"	CaseName=SWS	ComboName=INVRAR ScaleFactor=1	CaseType="Response Combo"	CaseName=RAR005
ComboName=RAR162 ScaleFactor=0	CaseType="Response Combo"	CaseName=SK0D	ComboName=INVRAR ScaleFactor=1	CaseType="Response Combo"	CaseName=RAR006
ComboName=RAR162 ScaleFactor=1	CaseType="Response Combo"	CaseName=SKAD	ComboName=INVRAR ScaleFactor=1	CaseType="Response Combo"	CaseName=RAR007
ComboName=RAR162 ScaleFactor=1	CaseType="Response Combo"	CaseName=SWD	ComboName=INVRAR ScaleFactor=1	CaseType="Response Combo"	CaseName=RAR008
ComboName=RAR162 ScaleFactor=0	CaseType="Linear Static"	CaseName=SA	ComboName=INVRAR ScaleFactor=1	CaseType="Response Combo"	CaseName=RAR009
ComboName=RAR162 ScaleFactor=0	CaseType="Linear Static"	CaseName=QM01	ComboName=INVRAR ScaleFactor=1	CaseType="Response Combo"	CaseName=RAR010
ComboName=RAR162 ScaleFactor=0	CaseType="Linear Static"	CaseName=QM02	ComboName=INVRAR ScaleFactor=1	CaseType="Response Combo"	CaseName=RAR011
ComboName=RAR162 ScaleFactor=0,75	CaseType="Linear Static"	CaseName=SQMS	ComboName=INVRAR ScaleFactor=1	CaseType="Response Combo"	CaseName=RAR012
ComboName=RAR162 ScaleFactor=0	CaseType="Linear Static"	CaseName=SQMD	ComboName=INVRAR ScaleFactor=1	CaseType="Response Combo"	CaseName=RAR013
ComboName=RAR162 ScaleFactor=0	CaseType="Linear Static"	CaseName=FA01	ComboName=INVRAR ScaleFactor=1	CaseType="Response Combo"	CaseName=RAR014
ComboName=RAR162 ScaleFactor=0	CaseType="Linear Static"	CaseName=TC01	ComboName=INVRAR ScaleFactor=1	CaseType="Response Combo"	CaseName=RAR015
ComboName=RAR162 ScaleFactor=0	CaseType="Linear Static"	CaseName=TC02	ComboName=INVRAR ScaleFactor=1	CaseType="Response Combo"	CaseName=RAR016
ComboName=RAR162 ScaleFactor=0,6	CaseType="Linear Static"	CaseName=TV01	ComboName=INVRAR ScaleFactor=1	CaseType="Response Combo"	CaseName=RAR017
ComboName=RAR162 ScaleFactor=0	CaseType="Linear Static"	CaseName=TV02	ComboName=INVRAR ScaleFactor=1	CaseType="Response Combo"	CaseName=RAR018
ComboName=RAR162 ScaleFactor=0	CaseType="Linear Static"	CaseName=RIT	ComboName=INVRAR ScaleFactor=1	CaseType="Response Combo"	CaseName=RAR019
ComboName=RAR162 ScaleFactor=0	CaseType="Linear Static"	CaseName=SSTS	ComboName=INVRAR ScaleFactor=1	CaseType="Response Combo"	CaseName=RAR020
ComboName=RAR162 ScaleFactor=0	CaseType="Linear Static"	CaseName=IS01	ComboName=INVRAR ScaleFactor=1	CaseType="Response Combo"	CaseName=RAR021
ComboName=RAR163 ScaleFactor=1	ComboType="Linear Add"	AutoDesign=No	ComboName=INVRAR ScaleFactor=1	CaseType="Response Combo"	CaseName=RAR022
CaseType="Linear Static"	CaseName=PPST	ScaleFactor=1	ComboName=INVRAR ScaleFactor=1	CaseType="Response Combo"	CaseName=RAR023
ConcDesign=No AlumDesign=No ColdDesign=No	CaseType="Linear Static"	CaseName=PPNS	ComboName=INVRAR ScaleFactor=1	CaseType="Response Combo"	CaseName=RAR024
ScaleFactor=1	CaseType="Linear Static"	CaseName=PPAQ	ComboName=INVRAR ScaleFactor=1	CaseType="Response Combo"	
ComboName=RAR163 ScaleFactor=0	CaseType="Linear Static"	CaseName=PPAQ	ComboName=INVRAR ScaleFactor=1	CaseType="Response Combo"	
ComboName=RAR163 ScaleFactor=1	CaseType="Response Combo"	CaseName=SK05	ComboName=INVRAR ScaleFactor=1	CaseType="Response Combo"	



ComboName=FRE47	CaseType="Linear Static"	CaseName=TV02	ScaleFactor=0	ComboName=FRE50	CaseType="Response Combo"	CaseName=SK05
ComboName=FRE47	CaseType="Linear Static"	CaseName=RIT	ScaleFactor=0,5	ScaleFactor=0		
ComboName=FRE47	CaseType="Linear Static"	CaseName=SSTS	ScaleFactor=0	ComboName=FRE50	CaseType="Response Combo"	CaseName=SKAS
ComboName=FRE47	CaseType="Linear Static"	CaseName=IS01	ScaleFactor=0	ScaleFactor=1		
ComboName=FRE48	ComboType="Linear Add"	AutoDesign=No		ComboName=FRE50	CaseType="Response Combo"	CaseName=SWS
CaseType="Linear Static"	CaseName=PPST	ScaleFactor=1	SteelDesign=No	ScaleFactor=1		
ConcDesign=No	AlumDesign=No	ColdDesign=No		ComboName=FRE50	CaseType="Response Combo"	CaseName=SK0D
ComboName=FRE48	CaseType="Linear Static"	CaseName=PPNS		ScaleFactor=0		
ScaleFactor=1				ComboName=FRE50	CaseType="Response Combo"	CaseName=SKAD
ComboName=FRE48	CaseType="Linear Static"	CaseName=PPAQ		ScaleFactor=1		
ScaleFactor=0				ComboName=FRE50	CaseType="Response Combo"	CaseName=SWD
ComboName=FRE48	CaseType="Response Combo"	CaseName=SK05		ScaleFactor=1		
ScaleFactor=1				ComboName=FRE50	CaseType="Linear Static"	CaseName=SA
ComboName=FRE48	CaseType="Response Combo"	CaseName=SKAS		ComboName=FRE50	CaseType="Linear Static"	ScaleFactor=1
ScaleFactor=0				CaseName=QM01		
ComboName=FRE48	CaseType="Response Combo"	CaseName=SWS		ScaleFactor=0		
ScaleFactor=1				ComboName=FRE50	CaseType="Linear Static"	CaseName=QM02
ComboName=FRE48	CaseType="Response Combo"	CaseName=SK0D		ScaleFactor=0		
ScaleFactor=1				ComboName=FRE50	CaseType="Linear Static"	CaseName=SQMS
ComboName=FRE48	CaseType="Response Combo"	CaseName=SKAD		ScaleFactor=0		
ScaleFactor=0				ComboName=FRE50	CaseType="Linear Static"	CaseName=SQMD
ComboName=FRE48	CaseType="Response Combo"	CaseName=SWD		ScaleFactor=0		
ScaleFactor=1				ComboName=FRE50	CaseType="Linear Static"	CaseName=FA01
ComboName=FRE48	CaseType="Linear Static"	CaseName=SA	ScaleFactor=1	ComboName=FRE50	CaseType="Linear Static"	CaseName=TC01
ScaleFactor=0	CaseType="Linear Static"	CaseName=QM01		ComboName=FRE50	CaseType="Linear Static"	ScaleFactor=0
ComboName=FRE48	CaseType="Linear Static"	CaseName=QM02		ComboName=FRE50	CaseType="Linear Static"	CaseName=TC02
ScaleFactor=0				ScaleFactor=0,5		CaseName=TV01
ComboName=FRE48	CaseType="Linear Static"	CaseName=SQMS		ComboName=FRE50	CaseType="Linear Static"	CaseName=TV02
ScaleFactor=0,75				ComboName=FRE50	CaseType="Linear Static"	ScaleFactor=0
ComboName=FRE48	CaseType="Linear Static"	CaseName=SQMD		ComboName=FRE50	CaseType="Linear Static"	CaseName=RIT
ScaleFactor=0,75				ScaleFactor=0		ScaleFactor=0,6
ComboName=FRE48	CaseType="Linear Static"	CaseName=FA01	ScaleFactor=0	ComboName=FRE50	CaseType="Linear Static"	CaseName=SSTS
ComboName=FRE48	CaseType="Linear Static"	CaseName=TC01	ScaleFactor=0	ComboName=FRE50	CaseType="Linear Static"	ScaleFactor=0
ComboName=FRE48	CaseType="Linear Static"	CaseName=TC02	ScaleFactor=0	ComboName=FRE50	CaseType="Linear Static"	CaseName=IS01
ComboName=FRE48	CaseType="Linear Static"	CaseName=TV01	ScaleFactor=0	ComboName=FRE51	ComboType="Linear Add"	AutoDesign=No
ComboName=FRE48	CaseType="Linear Static"	CaseName=TV02	ScaleFactor=0	CaseType="Linear Static"	CaseName=PPST	ScaleFactor=1
ComboName=FRE48	CaseType="Linear Static"	CaseName=RIT	ScaleFactor=0,5	ConcDesign=No	AlumDesign=No	ColdDesign=No
ComboName=FRE48	CaseType="Linear Static"	CaseName=SSTS	ScaleFactor=0	CaseName=PPNS		
ComboName=FRE48	CaseType="Linear Static"	CaseName=IS01	ScaleFactor=0	ScaleFactor=1		
ComboName=FRE49	ComboType="Linear Add"	AutoDesign=No		ComboName=FRE51	CaseType="Linear Static"	CaseName=PPAQ
CaseType="Linear Static"	CaseName=PPST	ScaleFactor=1	SteelDesign=No	ScaleFactor=0		
ConcDesign=No	AlumDesign=No	ColdDesign=No		ComboName=FRE51	CaseType="Response Combo"	CaseName=SK05
ComboName=FRE49	CaseType="Linear Static"	CaseName=PPNS		ScaleFactor=1		
ScaleFactor=1				ComboName=FRE51	CaseType="Response Combo"	CaseName=SKAS
ComboName=FRE49	CaseType="Linear Static"	CaseName=PPAQ		ScaleFactor=0		
ScaleFactor=0				ComboName=FRE51	CaseType="Response Combo"	CaseName=SWS
ComboName=FRE49	CaseType="Response Combo"	CaseName=SK05		ScaleFactor=1		
ScaleFactor=0				ComboName=FRE51	CaseType="Response Combo"	CaseName=SK0D
ComboName=FRE49	CaseType="Response Combo"	CaseName=SKAS		ScaleFactor=0		
ScaleFactor=1				ComboName=FRE51	CaseType="Response Combo"	CaseName=SKAD
ComboName=FRE49	CaseType="Response Combo"	CaseName=SWS		ScaleFactor=1		
ScaleFactor=1				ComboName=FRE51	CaseType="Response Combo"	CaseName=SWD
ComboName=FRE49	CaseType="Response Combo"	CaseName=SK0D		ScaleFactor=0		
ScaleFactor=0				ComboName=FRE51	CaseType="Response Combo"	CaseName=SKAD
ComboName=FRE49	CaseType="Response Combo"	CaseName=SKAD		ScaleFactor=1		
ScaleFactor=1				ComboName=FRE51	CaseType="Response Combo"	CaseName=SWD
ComboName=FRE49	CaseType="Response Combo"	CaseName=SWD		ScaleFactor=1		
ScaleFactor=1				ComboName=FRE51	CaseType="Response Combo"	CaseName=SKAD
ComboName=FRE49	CaseType="Linear Static"	CaseName=SA	ScaleFactor=1	ScaleFactor=0		
ScaleFactor=0	CaseType="Linear Static"	CaseName=QM01		ComboName=FRE51	CaseType="Response Combo"	CaseName=SKAD
ComboName=FRE49	CaseType="Linear Static"	CaseName=QM02		ScaleFactor=1		
ScaleFactor=0				ComboName=FRE51	CaseType="Response Combo"	CaseName=SKAD
ComboName=FRE49	CaseType="Linear Static"	CaseName=SQMS		ScaleFactor=0		
ScaleFactor=0				ComboName=FRE51	CaseType="Response Combo"	CaseName=SKAD
ComboName=FRE49	CaseType="Linear Static"	CaseName=SQMD		ScaleFactor=1		
ScaleFactor=0				ComboName=FRE51	CaseType="Response Combo"	CaseName=SKAD
ComboName=FRE49	CaseType="Linear Static"	CaseName=FA01	ScaleFactor=0	ScaleFactor=0		
ComboName=FRE49	CaseType="Linear Static"	CaseName=TC01	ScaleFactor=0	ComboName=FRE51	CaseType="Response Combo"	CaseName=SKAD
ComboName=FRE49	CaseType="Linear Static"	CaseName=TC02	ScaleFactor=0	ScaleFactor=1		
ScaleFactor=0,5				ComboName=FRE51	CaseType="Response Combo"	CaseName=SKAD
ComboName=FRE49	CaseType="Linear Static"	CaseName=TV01	ScaleFactor=0	ScaleFactor=0		
ScaleFactor=0				ComboName=FRE51	CaseType="Response Combo"	CaseName=SKAD
ComboName=FRE49	CaseType="Linear Static"	CaseName=TV02	ScaleFactor=0	ScaleFactor=1		
ScaleFactor=0				ComboName=FRE51	CaseType="Response Combo"	CaseName=SKAD
ComboName=FRE49	CaseType="Linear Static"	CaseName=RIT	ScaleFactor=0,6	ScaleFactor=0		
ScaleFactor=0				ComboName=FRE51	CaseType="Response Combo"	CaseName=SKAD
ComboName=FRE49	CaseType="Linear Static"	CaseName=SSTS	ScaleFactor=0	ScaleFactor=1		
ScaleFactor=0				ComboName=FRE51	CaseType="Response Combo"	CaseName=SKAD
ComboName=FRE49	CaseType="Linear Static"	CaseName=IS01	ScaleFactor=0	ScaleFactor=1		
ScaleFactor=0				ComboName=FRE51	CaseType="Response Combo"	CaseName=SKAD
ComboName=FRE50	ComboType="Linear Add"	AutoDesign=No		ScaleFactor=1		
CaseType="Linear Static"	CaseName=PPST	ScaleFactor=1	SteelDesign=No	ComboName=INVFRE	CaseType="Response Combo"	CaseName=SKAD
ConcDesign=No	AlumDesign=No	ColdDesign=No		ScaleFactor=1		
ComboName=FRE50	CaseType="Linear Static"	CaseName=PPNS		ScaleFactor=1		
ScaleFactor=1				ComboName=INVFRE	CaseType="Response Combo"	CaseName=SKAD
ComboName=FRE50	CaseType="Linear Static"	CaseName=PPAQ		ScaleFactor=1		
ScaleFactor=0				ComboName=INVFRE	CaseType="Response Combo"	CaseName=SKAD

Società di Progetto
Brebemi SpA



ComboName=QPE12 CaseType="Response Combo" CaseName=SKAS
ScaleFactor=0
ComboName=QPE12 CaseType="Response Combo" CaseName=SWS
ScaleFactor=1
ComboName=QPE12 CaseType="Response Combo" CaseName=SK0D
ScaleFactor=0
ComboName=QPE12 CaseType="Response Combo" CaseName=SKAD
ScaleFactor=1
ComboName=QPE12 CaseType="Response Combo" CaseName=SWD
ScaleFactor=1
ComboName=QPE12 CaseType="Linear Static" CaseName=SA ScaleFactor=1
ComboName=QPE12 CaseType="Linear Static" CaseName=QM01
ScaleFactor=0
ComboName=QPE12 CaseType="Linear Static" CaseName=QM02
ScaleFactor=0
ComboName=QPE12 CaseType="Linear Static" CaseName=SQMS
ScaleFactor=0
ComboName=QPE12 CaseType="Linear Static" CaseName=SQMD
ScaleFactor=0
ComboName=QPE12 CaseType="Linear Static" CaseName=FA01 ScaleFactor=0
ComboName=QPE12 CaseType="Linear Static" CaseName=TC01 ScaleFactor=0
ComboName=QPE12 CaseType="Linear Static" CaseName=TC02
ScaleFactor=0,5
ComboName=QPE12 CaseType="Linear Static" CaseName=TV01 ScaleFactor=0
ComboName=QPE12 CaseType="Linear Static" CaseName=TV02 ScaleFactor=0
ComboName=QPE12 CaseType="Linear Static" CaseName=RIT ScaleFactor=0
ComboName=QPE12 CaseType="Linear Static" CaseName=SSTS ScaleFactor=0
ComboName=QPE12 CaseType="Linear Static" CaseName=IS01 ScaleFactor=0
ComboName=QPE13 ComboType="Linear Add" AutoDesign=No
CaseType="Linear Static" CaseName=PPST ScaleFactor=1 SteelDesign=No
ConcDesign=No AlumDesign=No ColdDesign=No

APPROVATO SDP

Società di Progetto
Brebemi SpA



ComboName=QPE17 CaseType="Response Combo" CaseName=SWS ScaleFactor=1
 ComboName=QPE17 CaseType="Response Combo" CaseName=SK0D ScaleFactor=0
 ComboName=QPE17 CaseType="Response Combo" CaseName=SKAD ScaleFactor=1
 ComboName=QPE17 CaseType="Response Combo" CaseName=SWD ScaleFactor=1
 ComboName=QPE17 CaseType="Linear Static" CaseName=SA ScaleFactor=1
 ComboName=QPE17 CaseType="Linear Static" CaseName=QM01 ScaleFactor=0
 ComboName=QPE17 CaseType="Linear Static" CaseName=QM02 ScaleFactor=0
 ComboName=QPE17 CaseType="Linear Static" CaseName=SQMS ScaleFactor=0
 ComboName=QPE17 CaseType="Linear Static" CaseName=SQMD ScaleFactor=0
 ComboName=QPE17 CaseType="Linear Static" CaseName=FA01 ScaleFactor=0
 ComboName=QPE17 CaseType="Linear Static" CaseName=TC01 ScaleFactor=0,5
 ComboName=QPE17 CaseType="Linear Static" CaseName=TC02 ScaleFactor=0
 ComboName=QPE17 CaseType="Linear Static" CaseName=TV01 ScaleFactor=0
 ComboName=QPE17 CaseType="Linear Static" CaseName=TV02 ScaleFactor=0,5
 ComboName=QPE17 CaseType="Linear Static" CaseName=RIT ScaleFactor=0
 ComboName=QPE17 CaseType="Linear Static" CaseName=SSTS ScaleFactor=0
 ComboName=QPE17 CaseType="Linear Static" CaseName=IS01 ScaleFactor=0
 ComboName=QPE18 ComboType="Linear Add" AutoDesign=No CaseType="Linear Static" CaseName=PPST ScaleFactor=1 SteelDesign=No ConcDesign=No
 AlumDesign=No ColdDesign=No
 ComboName=QPE18 CaseType="Linear Static" CaseName=PPNS ScaleFactor=1
 ComboName=QPE18 CaseType="Linear Static" CaseName=PPAQ ScaleFactor=0
 ComboName=QPE18 CaseType="Response Combo" CaseName=SK05 ScaleFactor=1
 ComboName=QPE18 CaseType="Response Combo" CaseName=SKAS ScaleFactor=0
 ComboName=QPE18 CaseType="Response Combo" CaseName=SWS ScaleFactor=1
 ComboName=QPE18 CaseType="Response Combo" CaseName=SK0D ScaleFactor=0
 ComboName=QPE18 CaseType="Response Combo" CaseName=SKAD ScaleFactor=1
 ComboName=QPE18 CaseType="Response Combo" CaseName=SWD ScaleFactor=1
 ComboName=QPE18 CaseType="Linear Static" CaseName=SA ScaleFactor=1
 ComboName=QPE18 CaseType="Linear Static" CaseName=QM01 ScaleFactor=0
 ComboName=QPE18 CaseType="Linear Static" CaseName=QM02 ScaleFactor=0
 ComboName=QPE18 CaseType="Linear Static" CaseName=SQMS ScaleFactor=0
 ComboName=QPE18 CaseType="Linear Static" CaseName=SQMD ScaleFactor=0
 ComboName=QPE18 CaseType="Linear Static" CaseName=FA01 ScaleFactor=0
 ComboName=QPE18 CaseType="Linear Static" CaseName=TC01 ScaleFactor=0,5
 ComboName=QPE18 CaseType="Linear Static" CaseName=TC02 ScaleFactor=0
 ComboName=QPE18 CaseType="Linear Static" CaseName=TV01 ScaleFactor=0
 ComboName=QPE18 CaseType="Linear Static" CaseName=TV02 ScaleFactor=0
 ComboName=QPE18 CaseType="Linear Static" CaseName=RIT ScaleFactor=0,5
 ComboName=QPE18 CaseType="Linear Static" CaseName=SSTS ScaleFactor=0
 ComboName=QPE18 CaseType="Linear Static" CaseName=IS01 ScaleFactor=0
 ComboName=INVQPE ComboType="Envelope" AutoDesign=No CaseType="Response Combo" CaseName=QPE01 ScaleFactor=1 SteelDesign=No ConcDesign=No
 AlumDesign=No ColdDesign=No
 ComboName=INVQPE CaseType="Response Combo" CaseName=QPE02 ScaleFactor=1
 ComboName=INVQPE CaseType="Response Combo" CaseName=QPE03 ScaleFactor=1
 ComboName=INVQPE CaseType="Response Combo" CaseName=QPE04 ScaleFactor=1
 ComboName=INVQPE CaseType="Response Combo" CaseName=QPE05 ScaleFactor=1
 ComboName=INVQPE CaseType="Response Combo" CaseName=QPE06 ScaleFactor=1
 ComboName=INVQPE CaseType="Response Combo" CaseName=QPE07 ScaleFactor=1
 ComboName=INVQPE CaseType="Response Combo" CaseName=QPE08 ScaleFactor=1
 ComboName=INVQPE CaseType="Response Combo" CaseName=QPE09 ScaleFactor=1
 ComboName=INVQPE CaseType="Response Combo" CaseName=QPE10 ScaleFactor=1
 ComboName=INVQPE CaseType="Response Combo" CaseName=QPE11 ScaleFactor=1
 ComboName=INVQPE CaseType="Response Combo" CaseName=QPE12 ScaleFactor=1
 ComboName=INVQPE CaseType="Response Combo" CaseName=QPE13 ScaleFactor=1
 ComboName=INVQPE CaseType="Response Combo" CaseName=QPE14 ScaleFactor=1
 ComboName=INVQPE CaseType="Response Combo" CaseName=QPE15 ScaleFactor=1
 ComboName=INVQPE CaseType="Response Combo" CaseName=QPE16 ScaleFactor=1
 ComboName=INVQPE CaseType="Response Combo" CaseName=QPE17 ScaleFactor=1
 ComboName=INVQPE CaseType="Response Combo" CaseName=QPE18 ScaleFactor=1

TABLE: "FUNCTION - RESPONSE SPECTRUM - USER"

Name=UNIFRS Period=0 Accel=1 FuncDamp=0,05
 Name=UNIFRS Period=1 Accel=1

TABLE: "FUNCTION - TIME HISTORY - USER"

Name=RAMPTH Time=0 Value=0
 Name=RAMPTH Time=1 Value=1
 Name=RAMPTH Time=4 Value=1
 Name=UNIFTH Time=0 Value=1
 Name=UNIFTH Time=1 Value=1

TABLE: "FUNCTION - POWER SPECTRAL DENSITY - USER"

Name=UNIFPSD Frequency=0 Value=1
 Name=UNIFPSD Frequency=1 Value=1

TABLE: "FUNCTION - STEADY STATE - USER"

Name=UNIFSS Frequency=0 Value=1
 Name=UNIFSS Frequency=1 Value=1

TABLE: "LOAD CASE DEFINITIONS"

Case=DEAD Type=LinStatic InitialCond=Zero DesTypeOpt="Prog Det" DesignType=DEAD AutoType=None RunCase=Yes CaseStatus=Finished
 Case=MODAL Type=LinModal InitialCond=Zero DesTypeOpt="Prog Det" DesignType=OTHER AutoType=None RunCase=Yes CaseStatus=Finished
 Case=PPST Type=LinStatic InitialCond=Zero DesTypeOpt="Prog Det" DesignType=DEAD AutoType=None RunCase=Yes CaseStatus=Finished
 Case=PPNS Type=LinStatic InitialCond=Zero DesTypeOpt="Prog Det" DesignType=DEAD AutoType=None RunCase=Yes CaseStatus=Finished
 Case=PPAQ Type=LinStatic InitialCond=Zero DesTypeOpt="Prog Det" DesignType=DEAD AutoType=None RunCase=Yes CaseStatus=Finished
 Case=ST15 Type=LinStatic InitialCond=Zero DesTypeOpt="Prog Det" DesignType=DEAD AutoType=None RunCase=Yes CaseStatus=Finished
 Case=ST25 Type=LinStatic InitialCond=Zero DesTypeOpt="Prog Det" DesignType=DEAD AutoType=None RunCase=Yes CaseStatus=Finished
 Case=ST35 Type=LinStatic InitialCond=Zero DesTypeOpt="Prog Det" DesignType=DEAD AutoType=None RunCase=Yes CaseStatus=Finished

APPROVATO SDP

Società di Progetto
Brebemi SpA





Doc. N.
60235-00000-A00.doc

CODIFICA DOCUMENTO
04RCDII10000000000300A00

REV.
00

FOGLIO
213 di 628

Case=ST45	Type=LinStatic	InitialCond=Zero	DesTypeOpt="Prog Det"	DesignType=DEAD	AutoType=None	RunCase=Yes	CaseStatus=Finished
Case=ST1D	Type=LinStatic	InitialCond=Zero	DesTypeOpt="Prog Det"	DesignType=DEAD	AutoType=None	RunCase=Yes	CaseStatus=Finished
Case=ST2D	Type=LinStatic	InitialCond=Zero	DesTypeOpt="Prog Det"	DesignType=DEAD	AutoType=None	RunCase=Yes	CaseStatus=Finished
Case=ST3D	Type=LinStatic	InitialCond=Zero	DesTypeOpt="Prog Det"	DesignType=DEAD	AutoType=None	RunCase=Yes	CaseStatus=Finished
Case=ST4D	Type=LinStatic	InitialCond=Zero	DesTypeOpt="Prog Det"	DesignType=DEAD	AutoType=None	RunCase=Yes	CaseStatus=Finished
Case=ST15G	Type=LinStatic	InitialCond=Zero	DesTypeOpt="Prog Det"	DesignType=DEAD	AutoType=None	RunCase=Yes	CaseStatus=Finished
Case=ST25G	Type=LinStatic	InitialCond=Zero	DesTypeOpt="Prog Det"	DesignType=DEAD	AutoType=None	RunCase=Yes	CaseStatus=Finished
Case=ST35G	Type=LinStatic	InitialCond=Zero	DesTypeOpt="Prog Det"	DesignType=DEAD	AutoType=None	RunCase=Yes	CaseStatus=Finished
Case=ST45G	Type=LinStatic	InitialCond=Zero	DesTypeOpt="Prog Det"	DesignType=DEAD	AutoType=None	RunCase=Yes	CaseStatus=Finished
Case=ST1DG	Type=LinStatic	InitialCond=Zero	DesTypeOpt="Prog Det"	DesignType=DEAD	AutoType=None	RunCase=Yes	CaseStatus=Finished
Case=ST2DG	Type=LinStatic	InitialCond=Zero	DesTypeOpt="Prog Det"	DesignType=DEAD	AutoType=None	RunCase=Yes	CaseStatus=Finished
Case=ST3DG	Type=LinStatic	InitialCond=Zero	DesTypeOpt="Prog Det"	DesignType=DEAD	AutoType=None	RunCase=Yes	CaseStatus=Finished
Case=ST4DG	Type=LinStatic	InitialCond=Zero	DesTypeOpt="Prog Det"	DesignType=DEAD	AutoType=None	RunCase=Yes	CaseStatus=Finished
Case=SW15	Type=LinStatic	InitialCond=Zero	DesTypeOpt="Prog Det"	DesignType=DEAD	AutoType=None	RunCase=Yes	CaseStatus=Finished
Case=SW25	Type=LinStatic	InitialCond=Zero	DesTypeOpt="Prog Det"	DesignType=DEAD	AutoType=None	RunCase=Yes	CaseStatus=Finished
Case=SW1D	Type=LinStatic	InitialCond=Zero	DesTypeOpt="Prog Det"	DesignType=DEAD	AutoType=None	RunCase=Yes	CaseStatus=Finished
Case=SW2D	Type=LinStatic	InitialCond=Zero	DesTypeOpt="Prog Det"	DesignType=DEAD	AutoType=None	RunCase=Yes	CaseStatus=Finished
Case=SA	Type=LinStatic	InitialCond=Zero	DesTypeOpt="Prog Det"	DesignType=DEAD	AutoType=None	RunCase=Yes	CaseStatus=Finished
Case=QM01	Type=LinStatic	InitialCond=Zero	DesTypeOpt="Prog Det"	DesignType=LIVE	AutoType=None	RunCase=Yes	CaseStatus=Finished
Case=QM02	Type=LinStatic	InitialCond=Zero	DesTypeOpt="Prog Det"	DesignType=LIVE	AutoType=None	RunCase=Yes	CaseStatus=Finished
Case=SQM5	Type=LinStatic	InitialCond=Zero	DesTypeOpt="Prog Det"	DesignType=LIVE	AutoType=None	RunCase=Yes	CaseStatus=Finished
Case=SQMD	Type=LinStatic	InitialCond=Zero	DesTypeOpt="Prog Det"	DesignType=LIVE	AutoType=None	RunCase=Yes	CaseStatus=Finished
Case=SQMSG	Type=LinStatic	InitialCond=Zero	DesTypeOpt="Prog Det"	DesignType=LIVE	AutoType=None	RunCase=Yes	CaseStatus=Finished
Case=SQMDG	Type=LinStatic	InitialCond=Zero	DesTypeOpt="Prog Det"	DesignType=LIVE	AutoType=None	RunCase=Yes	CaseStatus=Finished
Case=FA01	Type=LinStatic	InitialCond=Zero	DesTypeOpt="Prog Det"	DesignType=LIVE	AutoType=None	RunCase=Yes	CaseStatus=Finished
Case=TC01	Type=LinStatic	InitialCond=Zero	DesTypeOpt="Prog Det"	DesignType=LIVE	AutoType=None	RunCase=Yes	CaseStatus=Finished
Case=TC02	Type=LinStatic	InitialCond=Zero	DesTypeOpt="Prog Det"	DesignType=LIVE	AutoType=None	RunCase=Yes	CaseStatus=Finished
Case=TV01	Type=LinStatic	InitialCond=Zero	DesTypeOpt="Prog Det"	DesignType=LIVE	AutoType=None	RunCase=Yes	CaseStatus=Finished
Case=TV02	Type=LinStatic	InitialCond=Zero	DesTypeOpt="Prog Det"	DesignType=LIVE	AutoType=None	RunCase=Yes	CaseStatus=Finished
Case=RIT	Type=LinStatic	InitialCond=Zero	DesTypeOpt="Prog Det"	DesignType=LIVE	AutoType=None	RunCase=Yes	CaseStatus=Finished
Case=IS01	Type=LinStatic	InitialCond=Zero	DesTypeOpt="Prog Det"	DesignType=LIVE	AutoType=None	RunCase=Yes	CaseStatus=Finished
Case=SSTS	Type=LinStatic	InitialCond=Zero	DesTypeOpt="Prog Det"	DesignType=LIVE	AutoType=None	RunCase=Yes	CaseStatus=Finished
Case=IS02	Type=LinStatic	InitialCond=Zero	DesTypeOpt="Prog Det"	DesignType=LIVE	AutoType=None	RunCase=Yes	CaseStatus=Finished

TABLE: "CASE - STATIC 1 - LOAD ASSIGNMENTS"

Case=DEAD	LoadType="Load pattern"	LoadName=DEAD	LoadSF=1
Case=PPST	LoadType="Load pattern"	LoadName=PPST	LoadSF=1
Case=PPNS	LoadType="Load pattern"	LoadName=PPNS	LoadSF=1
Case=PPAQ	LoadType="Load pattern"	LoadName=PPAQ	LoadSF=1
Case=ST15	LoadType="Load pattern"	LoadName=ST15	LoadSF=1
Case=ST25	LoadType="Load pattern"	LoadName=ST25	LoadSF=1
Case=ST35	LoadType="Load pattern"	LoadName=ST35	LoadSF=1
Case=ST45	LoadType="Load pattern"	LoadName=ST45	LoadSF=1
Case=ST1D	LoadType="Load pattern"	LoadName=ST1D	LoadSF=1
Case=ST2D	LoadType="Load pattern"	LoadName=ST2D	LoadSF=1
Case=ST3D	LoadType="Load pattern"	LoadName=ST3D	LoadSF=1
Case=ST4D	LoadType="Load pattern"	LoadName=ST4D	LoadSF=1
Case=ST15G	LoadType="Load pattern"	LoadName=ST15G	LoadSF=1
Case=ST25G	LoadType="Load pattern"	LoadName=ST25G	LoadSF=1
Case=ST35G	LoadType="Load pattern"	LoadName=ST35G	LoadSF=1
Case=ST45G	LoadType="Load pattern"	LoadName=ST45G	LoadSF=1
Case=ST1DG	LoadType="Load pattern"	LoadName=ST1DG	LoadSF=1
Case=ST2DG	LoadType="Load pattern"	LoadName=ST2DG	LoadSF=1
Case=ST3DG	LoadType="Load pattern"	LoadName=ST3DG	LoadSF=1
Case=ST4DG	LoadType="Load pattern"	LoadName=ST4DG	LoadSF=1
Case=SW15	LoadType="Load pattern"	LoadName=SW15	LoadSF=1
Case=SW25	LoadType="Load pattern"	LoadName=SW25	LoadSF=1
Case=SW1D	LoadType="Load pattern"	LoadName=SW1D	LoadSF=1
Case=SW2D	LoadType="Load pattern"	LoadName=SW2D	LoadSF=1
Case=SA	LoadType="Load pattern"	LoadName=SA	LoadSF=1
Case=QM01	LoadType="Load pattern"	LoadName=QM01	LoadSF=1
Case=QM02	LoadType="Load pattern"	LoadName=QM02	LoadSF=1
Case=SQM5	LoadType="Load pattern"	LoadName=SQM5	LoadSF=1
Case=SQMD	LoadType="Load pattern"	LoadName=SQMD	LoadSF=1
Case=SQMSG	LoadType="Load pattern"	LoadName=SQMSG	LoadSF=1
Case=SQMDG	LoadType="Load pattern"	LoadName=SQMDG	LoadSF=1
Case=FA01	LoadType="Load pattern"	LoadName=FA01	LoadSF=1
Case=TC01	LoadType="Load pattern"	LoadName=TC01	LoadSF=1
Case=TC02	LoadType="Load pattern"	LoadName=TC02	LoadSF=1
Case=TV01	LoadType="Load pattern"	LoadName=TV01	LoadSF=1
Case=TV02	LoadType="Load pattern"	LoadName=TV02	LoadSF=1
Case=RIT	LoadType="Load pattern"	LoadName=RIT	LoadSF=1
Case=IS01	LoadType="Load pattern"	LoadName=IS01	LoadSF=1
Case=SSTS	LoadType="Load pattern"	LoadName=SSTS	LoadSF=1
Case=IS02	LoadType="Load pattern"	LoadName=IS02	LoadSF=1

TABLE: "CASE - MODAL 1 - GENERAL"

Case=MODAL ModeType=Eigen MaxNumModes=12 MinNumModes=1 EigenShift=0 EigenCutoff=0 EigenTol=0,00000001 AutoShift=Yes

TABLE: "JOINT COORDINATES"

Joint=1	CoordSys=GLOBAL	CoordType=Cartesian	XorR=0,83	Y=0	Z=1,66	SpecialJt=No	GlobalX=0,83	GlobalY=0	GlobalZ=1,66
Joint=30	CoordSys=GLOBAL	CoordType=Cartesian	XorR=0	Y=0	Z=1,66	SpecialJt=No	GlobalX=0	GlobalY=0	GlobalZ=1,66
Joint=39	CoordSys=GLOBAL	CoordType=Cartesian	XorR=-0,83	Y=0	Z=0	SpecialJt=No	GlobalX=-0,83	GlobalY=0	GlobalZ=0
Joint=45	CoordSys=GLOBAL	CoordType=Cartesian	XorR=0	Y=0	Z=0	SpecialJt=No	GlobalX=0	GlobalY=0	GlobalZ=0

TABLE: "CONNECTIVITY - FRAME"

Frame=1	JointI=2	JointJ=1	IsCurved=No	Length=7,99999999999998E-02	CentroidX=0,83	CentroidY=0	CentroidZ=1,62
Frame=3	JointI=4	JointJ=3	IsCurved=No	Length=0,1	CentroidX=0,83	CentroidY=0	CentroidZ=1,43

APPROVATO SDP

Società di Progetto
Brebemi SpA



Frame=18	JointI=19	JointJ=18	IsCurved=No	Length=0,1833	CentroidX=-0,83	CentroidY=0	CentroidZ=0,92175
Frame=22	JointI=23	JointJ=22	IsCurved=No	Length=0,1	CentroidX=-0,83	CentroidY=0	CentroidZ=0,23
Frame=24	JointI=39	JointJ=24	IsCurved=No	Length=0,08	CentroidX=-0,83	CentroidY=0	CentroidZ=0,04
Frame=30	JointI=29	JointJ=30	IsCurved=No	Length=0,1834	CentroidX=-0,0917	CentroidY=0	CentroidZ=1,66
Frame=31	JointI=30	JointJ=31	IsCurved=No	Length=0,1834	CentroidX=0,0917	CentroidY=0	CentroidZ=1,66
Frame=34	JointI=33	JointJ=34	IsCurved=No	Length=0,1	CentroidX=0,6	CentroidY=0	CentroidZ=1,66
Frame=36	JointI=35	JointJ=1	IsCurved=No	Length=0,08	CentroidX=0,79	CentroidY=0	CentroidZ=1,66
Frame=40	JointI=39	JointJ=40	IsCurved=No	Length=0,08	CentroidX=-0,79	CentroidY=0	CentroidZ=0
Frame=42	JointI=41	JointJ=42	IsCurved=No	Length=0,1	CentroidX=-0,6	CentroidY=0	CentroidZ=0
Frame=45	JointI=44	JointJ=45	IsCurved=No	Length=0,1834	CentroidX=-0,0917	CentroidY=0	CentroidZ=0
Frame=46	JointI=45	JointJ=46	IsCurved=No	Length=0,1834	CentroidX=0,0917	CentroidY=0	CentroidZ=0

TABLE: "JOINT SPRING ASSIGNMENTS 1 - UNCOUPLED"

Joint=39	CoordSys=Local	U1=40	U2=0	U3=120	R1=0	R2=0	R3=0
Joint=45	CoordSys=Local	U1=0	U2=0	U3=183,3	R1=0	R2=0	R3=0

TABLE: "FRAME SECTION ASSIGNMENTS"

Frame=1	SectionType=Rectangular	AutoSelect=N.A.	AnalSect="Sp piedr"	DesignSect="Sp piedr"	MatProp=Default
Frame=3	SectionType=Rectangular	AutoSelect=N.A.	AnalSect="Sp piedr"	DesignSect="Sp piedr"	MatProp=Default
Frame=18	SectionType=Rectangular	AutoSelect=N.A.	AnalSect="Sp piedr"	DesignSect="Sp piedr"	MatProp=Default
Frame=22	SectionType=Rectangular	AutoSelect=N.A.	AnalSect="Sp piedr"	DesignSect="Sp piedr"	MatProp=Default
Frame=24	SectionType=Rectangular	AutoSelect=N.A.	AnalSect="Sp piedr"	DesignSect="Sp piedr"	MatProp=Default
Frame=30	SectionType=Rectangular	AutoSelect=N.A.	AnalSect="Sp solsup"	DesignSect="Sp solsup"	MatProp=Default
Frame=31	SectionType=Rectangular	AutoSelect=N.A.	AnalSect="Sp solsup"	DesignSect="Sp solsup"	MatProp=Default
Frame=34	SectionType=Rectangular	AutoSelect=N.A.	AnalSect="Sp solsup"	DesignSect="Sp solsup"	MatProp=Default
Frame=36	SectionType=Rectangular	AutoSelect=N.A.	AnalSect="Sp solsup"	DesignSect="Sp solsup"	MatProp=Default
Frame=40	SectionType=Rectangular	AutoSelect=N.A.	AnalSect="Sp solinf"	DesignSect="Sp solinf"	MatProp=Default
Frame=42	SectionType=Rectangular	AutoSelect=N.A.	AnalSect="Sp solinf"	DesignSect="Sp solinf"	MatProp=Default
Frame=45	SectionType=Rectangular	AutoSelect=N.A.	AnalSect="Sp solinf"	DesignSect="Sp solinf"	MatProp=Default
Frame=46	SectionType=Rectangular	AutoSelect=N.A.	AnalSect="Sp solinf"	DesignSect="Sp solinf"	MatProp=Default

TABLE: "FRAME OUTPUT STATION ASSIGNMENTS"

Frame=1	StationType=MinNumSta	MinNumSta=3	AddAtElmInt=No	AddAtPtLoad=No
Frame=3	StationType=MinNumSta	MinNumSta=3	AddAtElmInt=No	AddAtPtLoad=No
Frame=18	StationType=MinNumSta	MinNumSta=3	AddAtElmInt=No	AddAtPtLoad=No
Frame=22	StationType=MinNumSta	MinNumSta=3	AddAtElmInt=No	AddAtPtLoad=No
Frame=24	StationType=MinNumSta	MinNumSta=3	AddAtElmInt=No	AddAtPtLoad=No
Frame=30	StationType=MinNumSta	MinNumSta=3	AddAtElmInt=No	AddAtPtLoad=No
Frame=31	StationType=MinNumSta	MinNumSta=3	AddAtElmInt=No	AddAtPtLoad=No
Frame=34	StationType=MinNumSta	MinNumSta=3	AddAtElmInt=No	AddAtPtLoad=No
Frame=36	StationType=MinNumSta	MinNumSta=3	AddAtElmInt=No	AddAtPtLoad=No
Frame=40	StationType=MinNumSta	MinNumSta=3	AddAtElmInt=No	AddAtPtLoad=No
Frame=42	StationType=MinNumSta	MinNumSta=3	AddAtElmInt=No	AddAtPtLoad=No
Frame=45	StationType=MinNumSta	MinNumSta=3	AddAtElmInt=No	AddAtPtLoad=No
Frame=46	StationType=MinNumSta	MinNumSta=3	AddAtElmInt=No	AddAtPtLoad=No

TABLE: "FRAME AUTO MESH ASSIGNMENTS"

Frame=1	AutoMesh=Yes	AtJoints=Yes	AtFrames=No	NumSegments=0	MaxLength=0	MaxDegrees=0
Frame=3	AutoMesh=Yes	AtJoints=Yes	AtFrames=No	NumSegments=0	MaxLength=0	MaxDegrees=0
Frame=18	AutoMesh=Yes	AtJoints=Yes	AtFrames=No	NumSegments=0	MaxLength=0	MaxDegrees=0
Frame=22	AutoMesh=Yes	AtJoints=Yes	AtFrames=No	NumSegments=0	MaxLength=0	MaxDegrees=0
Frame=24	AutoMesh=Yes	AtJoints=Yes	AtFrames=No	NumSegments=0	MaxLength=0	MaxDegrees=0
Frame=30	AutoMesh=Yes	AtJoints=Yes	AtFrames=No	NumSegments=0	MaxLength=0	MaxDegrees=0
Frame=31	AutoMesh=Yes	AtJoints=Yes	AtFrames=No	NumSegments=0	MaxLength=0	MaxDegrees=0
Frame=34	AutoMesh=Yes	AtJoints=Yes	AtFrames=No	NumSegments=0	MaxLength=0	MaxDegrees=0
Frame=36	AutoMesh=Yes	AtJoints=Yes	AtFrames=No	NumSegments=0	MaxLength=0	MaxDegrees=0
Frame=40	AutoMesh=Yes	AtJoints=Yes	AtFrames=No	NumSegments=0	MaxLength=0	MaxDegrees=0
Frame=42	AutoMesh=Yes	AtJoints=Yes	AtFrames=No	NumSegments=0	MaxLength=0	MaxDegrees=0
Frame=45	AutoMesh=Yes	AtJoints=Yes	AtFrames=No	NumSegments=0	MaxLength=0	MaxDegrees=0
Frame=46	AutoMesh=Yes	AtJoints=Yes	AtFrames=No	NumSegments=0	MaxLength=0	MaxDegrees=0

TABLE: "FRAME LOADS - DISTRIBUTED"

Frame=40	LoadPat=SA	CoordSys=GLOBAL	Type=Force	Dir=Z	DistType=RelDist	RelDistA=0	RelDistB=1	AbsDistA=0	AbsDistB=0,08	FOverLA=0	FOverLB=0
Frame=42	LoadPat=SA	CoordSys=GLOBAL	Type=Force	Dir=Z	DistType=RelDist	RelDistA=0	RelDistB=1	AbsDistA=0	AbsDistB=0,1	FOverLA=0	FOverLB=0
Frame=45	LoadPat=SA	CoordSys=GLOBAL	Type=Force	Dir=Z	DistType=RelDist	RelDistA=0	RelDistB=1	AbsDistA=0	AbsDistB=0,1834	FOverLA=0	FOverLB=0
Frame=46	LoadPat=SA	CoordSys=GLOBAL	Type=Force	Dir=Z	DistType=RelDist	RelDistA=0	RelDistB=1	AbsDistA=0	AbsDistB=0,1834	FOverLA=0	FOverLB=0
Frame=30	LoadPat=PPNS	CoordSys=GLOBAL	Type=Force	Dir=Z	DistType=RelDist	RelDistA=0	RelDistB=1	AbsDistA=0	AbsDistB=0,1834	FOverLA=10	FOverLB=10
Frame=30	LoadPat=QM01	CoordSys=GLOBAL	Type=Force	Dir=Z	DistType=RelDist	RelDistA=0	RelDistB=1	AbsDistA=0	AbsDistB=0,1834	FOverLA=87	FOverLB=87
Frame=30	LoadPat=QM02	CoordSys=GLOBAL	Type=Force	Dir=Z	DistType=RelDist	RelDistA=0	RelDistB=1	AbsDistA=0	AbsDistB=0,1834	FOverLA=9	FOverLB=9
Frame=30	LoadPat=FA01	CoordSys=GLOBAL	Type=Force	Dir=X	DistType=RelDist	RelDistA=0	RelDistB=1	AbsDistA=0	AbsDistB=0,1834	FOverLA=16,7	FOverLB=16,7
Frame=30	LoadPat=IS01	CoordSys=GLOBAL	Type=Force	Dir=X	DistType=RelDist	RelDistA=0	RelDistB=1	AbsDistA=0	AbsDistB=0,1834	FOverLA=3,11	FOverLB=3,11
Frame=30	LoadPat=IS02	CoordSys=GLOBAL	Type=Force	Dir=Z	DistType=RelDist	RelDistA=0	RelDistB=1	AbsDistA=0	AbsDistB=0,1834	FOverLA=1,56	FOverLB=1,56
Frame=31	LoadPat=PPNS	CoordSys=GLOBAL	Type=Force	Dir=Z	DistType=RelDist	RelDistA=0	RelDistB=1	AbsDistA=0	AbsDistB=0,1834	FOverLA=10	FOverLB=10
Frame=31	LoadPat=QM01	CoordSys=GLOBAL	Type=Force	Dir=Z	DistType=RelDist	RelDistA=0	RelDistB=1	AbsDistA=0	AbsDistB=0,1834	FOverLA=87	FOverLB=87
Frame=31	LoadPat=QM02	CoordSys=GLOBAL	Type=Force	Dir=Z	DistType=RelDist	RelDistA=0	RelDistB=1	AbsDistA=0	AbsDistB=0,1834	FOverLA=9	FOverLB=9
Frame=31	LoadPat=FA01	CoordSys=GLOBAL	Type=Force	Dir=X	DistType=RelDist	RelDistA=0	RelDistB=1	AbsDistA=0	AbsDistB=0,1834	FOverLA=16,7	FOverLB=16,7
Frame=31	LoadPat=IS01	CoordSys=GLOBAL	Type=Force	Dir=X	DistType=RelDist	RelDistA=0	RelDistB=1	AbsDistA=0	AbsDistB=0,1834	FOverLA=3,11	FOverLB=3,11
Frame=31	LoadPat=IS02	CoordSys=GLOBAL	Type=Force	Dir=Z	DistType=RelDist	RelDistA=0	RelDistB=1	AbsDistA=0	AbsDistB=0,1834	FOverLA=1,56	FOverLB=1,56
Frame=34	LoadPat=PPNS	CoordSys=GLOBAL	Type=Force	Dir=Z	DistType=RelDist	RelDistA=0	RelDistB=1	AbsDistA=0	AbsDistB=0,1	FOverLA=10	FOverLB=10
Frame=34	LoadPat=QM01	CoordSys=GLOBAL	Type=Force	Dir=Z	DistType=RelDist	RelDistA=0	RelDistB=1	AbsDistA=0	AbsDistB=0,1	FOverLA=87	FOverLB=87
Frame=34	LoadPat=QM02	CoordSys=GLOBAL	Type=Force	Dir=Z	DistType=RelDist	RelDistA=0	RelDistB=1	AbsDistA=0	AbsDistB=0,1	FOverLA=9	FOverLB=9
Frame=34	LoadPat=FA01	CoordSys=GLOBAL	Type=Force	Dir=X	DistType=RelDist	RelDistA=0	RelDistB=1	AbsDistA=0	AbsDistB=0,1	FOverLA=16,7	FOverLB=16,7
Frame=34	LoadPat=IS01	CoordSys=GLOBAL	Type=Force	Dir=X	DistType=RelDist	RelDistA=0	RelDistB=1	AbsDistA=0	AbsDistB=0,1	FOverLA=3,11	FOverLB=3,11
Frame=34	LoadPat=IS02	CoordSys=GLOBAL	Type=Force	Dir=Z	DistType=RelDist	RelDistA=0	RelDistB=1	AbsDistA=0	AbsDistB=0,1	FOverLA=1,56	FOverLB=1,56
Frame=36	LoadPat=PPNS	CoordSys=GLOBAL	Type=Force	Dir=Z	DistType=RelDist	RelDistA=0	RelDistB=1	AbsDistA=0	AbsDistB=0,08	FOverLA=10	FOverLB=10
Frame=36	LoadPat=QM01	CoordSys=GLOBAL	Type=Force	Dir=Z	DistType=RelDist	RelDistA=0	RelDistB=1	AbsDistA=0	AbsDistB=0,08	FOverLA=87	FOverLB=87
Frame=36	LoadPat=QM02	CoordSys=GLOBAL	Type=Force	Dir=Z	DistType=RelDist	RelDistA=0	RelDistB=1	AbsDistA=0	AbsDistB=0,08	FOverLA=9	FOverLB=9
Frame=36	LoadPat=FA01	CoordSys=GLOBAL	Type=Force	Dir=X	DistType=RelDist	RelDistA=0	RelDistB=1	AbsDistA=0	AbsDistB=0,08	FOverLA=16,7	FOverLB=16,7

APPROVATO SDP

Roberto di Podetto
Brebioni SpA

Frame=24 LoadPat=ST2SG CoordSys=GLOBAL Type=Force Dir=X DistType=RelDist RelDistA=0 RelDistB=1 AbsDistA=0 AbsDistB=0,08 FOverLA=15,61 FOverLB=14,86

Frame=24 LoadPat=ST3SG CoordSys=GLOBAL Type=Force Dir=X DistType=RelDist RelDistA=0 RelDistB=1 AbsDistA=0 AbsDistB=0,08 FOverLA=3,57 FOverLB=3,57

Frame=24 LoadPat=ST4SG CoordSys=GLOBAL Type=Force Dir=X DistType=RelDist RelDistA=0 RelDistB=1 AbsDistA=0 AbsDistB=0,08 FOverLA=10,2 FOverLB=9,7

Frame=24 LoadPat=SW1S CoordSys=GLOBAL Type=Force Dir=X DistType=RelDist RelDistA=0 RelDistB=1 AbsDistA=0 AbsDistB=0,08 FOverLA=0 FOverLB=0

Frame=24 LoadPat=SW2S CoordSys=GLOBAL Type=Force Dir=X DistType=RelDist RelDistA=0 RelDistB=1 AbsDistA=0 AbsDistB=0,08 FOverLA=0 FOverLB=0

Frame=24 LoadPat=SQMS CoordSys=GLOBAL Type=Force Dir=X DistType=RelDist RelDistA=0 RelDistB=1 AbsDistA=0 AbsDistB=0,08 FOverLA=16,44 FOverLB=18,06

Frame=24 LoadPat=SQMSG CoordSys=GLOBAL Type=Force Dir=X DistType=RelDist RelDistA=0 RelDistB=1 AbsDistA=0 AbsDistB=0,08 FOverLA=20,33 FOverLB=21,1

Frame=24 LoadPat=IS01 CoordSys=GLOBAL Type=Force Dir=X DistType=RelDist RelDistA=0 RelDistB=1 AbsDistA=0 AbsDistB=0,08 FOverLA=0,89 FOverLB=0,89

Frame=24 LoadPat=IS02 CoordSys=GLOBAL Type=Force Dir=Z DistType=RelDist RelDistA=0 RelDistB=1 AbsDistA=0 AbsDistB=0,08 FOverLA=0,45 FOverLB=0,45

Frame=24 LoadPat=SSTS CoordSys=GLOBAL Type=Force Dir=X DistType=RelDist RelDistA=0 RelDistB=1 AbsDistA=0 AbsDistB=0,08 FOverLA=10,31 FOverLB=10,31

TABLE: "FRAME LOADS - TEMPERATURE"

Frame=30 LoadPat=TC01 Type=Temperature Temp=10 JtPattern=None

Frame=30 LoadPat=TC02 Type=Temperature Temp=-10 JtPattern=None

Frame=30 LoadPat=TV01 Type=Gradient2 TempGrad2=5 JtPattern=None

Frame=30 LoadPat=TV02 Type=Gradient2 TempGrad2=-5 JtPattern=None

Frame=30 LoadPat=RIT Type=Temperature Temp=-10 JtPattern=None

Frame=31 LoadPat=TC01 Type=Temperature Temp=10 JtPattern=None

Frame=31 LoadPat=TC02 Type=Temperature Temp=-10 JtPattern=None

Frame=31 LoadPat=TV01 Type=Gradient2 TempGrad2=5 JtPattern=None

Frame=31 LoadPat=TV02 Type=Gradient2 TempGrad2=-5 JtPattern=None

Frame=31 LoadPat=RIT Type=Temperature Temp=-10 JtPattern=None

Frame=34 LoadPat=TC01 Type=Temperature Temp=10 JtPattern=None

Frame=34 LoadPat=TC02 Type=Temperature Temp=-10 JtPattern=None

Frame=34 LoadPat=TV01 Type=Gradient2 TempGrad2=5 JtPattern=None

Frame=34 LoadPat=TV02 Type=Gradient2 TempGrad2=-5 JtPattern=None

Frame=34 LoadPat=RIT Type=Temperature Temp=-10 JtPattern=None

Frame=36 LoadPat=TC01 Type=Temperature Temp=10 JtPattern=None

Frame=36 LoadPat=TC02 Type=Temperature Temp=-10 JtPattern=None

Frame=36 LoadPat=TV01 Type=Gradient2 TempGrad2=5 JtPattern=None

Frame=36 LoadPat=TV02 Type=Gradient2 TempGrad2=-5 JtPattern=None

Frame=36 LoadPat=RIT Type=Temperature Temp=-10 JtPattern=None

Frame=1 LoadPat=TV01 Type=Gradient2 TempGrad2=5 JtPattern=None

Frame=1 LoadPat=TV02 Type=Gradient2 TempGrad2=-5 JtPattern=None

Frame=3 LoadPat=TV01 Type=Gradient2 TempGrad2=5 JtPattern=None

Frame=3 LoadPat=TV02 Type=Gradient2 TempGrad2=-5 JtPattern=None

Frame=18 LoadPat=TV01 Type=Gradient2 TempGrad2=5 JtPattern=None

Frame=18 LoadPat=TV02 Type=Gradient2 TempGrad2=-5 JtPattern=None

Frame=22 LoadPat=TV01 Type=Gradient2 TempGrad2=5 JtPattern=None

Frame=22 LoadPat=TV02 Type=Gradient2 TempGrad2=-5 JtPattern=None

Frame=24 LoadPat=TV01 Type=Gradient2 TempGrad2=5 JtPattern=None

Frame=24 LoadPat=TV02 Type=Gradient2 TempGrad2=-5 JtPattern=None

END TABLE DATA

10.2 Tabulati di output

File E:\Lavoro_LIMA2\BEM01C_Lavoro-PAC Costruttivo_Lima 2\BEM01C_Tombino prefabbricato IDA08 1,50x1,50_Lima2\output tombino IDA08.s2k was saved on 11/9/12 at 14.50.04

TABLE: "PROGRAM CONTROL"

ProgramName=SAP2000 Version=14.0.0 ProgLevel=Advanced LicenseOS=Yes LicenseSC=Yes LicenseBR=Yes LicenseHT=No CurrUnits="KN, m, C" SteelCode=AISC-ASD89 ConcCode="ACI 318-99" AlumCode="AA-ASD 2000" ColdCode=AISI-ASD96
BridgeCode="AASHTO LRFD 2007" RegenHinge=Yes

TABLE: "ELEMENT FORCES - FRAMES"

Frame=1 Station=0 OutputCase=STR001 CaseType=Combination P=-16,119000000396 V2=8,27676720782447 V3=0 T=0 M2=0 M3=-2,85002453963063 FrameElem=1-1 ElemStation=0

Frame=1 Station=3,999999999999999E-02 OutputCase=STR001 CaseType=Combination P=-15,9030000000396 V2=8,53961220782447 V3=0 T=0 M2=0 M3=-3,18640702794361 FrameElem=1-1 ElemStation=3,999999999999999E-02

Frame=1 Station=7,999999999999998E-02 OutputCase=STR001 CaseType=Combination P=-15,6870000000396 V2=8,78598720782447 V3=0 T=0 M2=0 M3=-3,53297391626559 FrameElem=1-1 ElemStation=7,999999999999998E-02

Frame=1 Station=0 OutputCase=STR002 CaseType=Combination P=-16,1190000002971 V2=3,44018409771643 V3=0 T=0 M2=0 M3=-2,40788149672046 FrameElem=1-1 ElemStation=0

Frame=1 Station=3,999999999999999E-02 OutputCase=STR002 CaseType=Combination P=-15,90300000002971 V2=3,56268409771643 V3=0 T=0 M2=0 M3=-2,54796486062911 FrameElem=1-1 ElemStation=3,999999999999999E-02

Frame=1 Station=7,999999999999998E-02 OutputCase=STR002 CaseType=Combination P=-15,68700000002971 V2=3,67738409771643 V3=0 T=0 M2=0 M3=-2,69279222453777 FrameElem=1-1 ElemStation=7,999999999999998E-02

Frame=1 Station=0 OutputCase=STR003 CaseType=Combination P=-123,6869999998952 V2=4,73637719347669 V3=0 T=0 M2=0 M3=-17,536576210569 FrameElem=1-1 ElemStation=0

Frame=1 Station=3,999999999999999E-02 OutputCase=STR003 CaseType=Combination P=-123,4709999998952 V2=4,85887719347669 V3=0 T=0 M2=0 M3=-17,7285072983081 FrameElem=1-1 ElemStation=3,999999999999999E-02

Frame=1 Station=7,999999999999998E-02 OutputCase=STR003 CaseType=Combination P=-123,2549999998952 V2=4,97357719347669 V3=0 T=0 M2=0 M3=-17,9251823860472 FrameElem=1-1 ElemStation=7,999999999999998E-02

Frame=1 Station=0 OutputCase=STR004 CaseType=Combination P=-136,868781584414 V2=21,4772805860505 V3=0 T=0 M2=0 M3=-29,45609041249 FrameElem=1-1 ElemStation=0

Frame=1 Station=3,999999999999999E-02 OutputCase=STR004 CaseType=Combination P=-136,652781584414 V2=21,5997805860505 V3=0 T=0 M2=0 M3=-30,317657655933 FrameElem=1-1 ElemStation=3,999999999999999E-02

Frame=1 Station=7,999999999999998E-02 OutputCase=STR004 CaseType=Combination P=-136,436781584414 V2=21,7144805860505 V3=0 T=0 M2=0 M3=-31,1839688593751 FrameElem=1-1 ElemStation=7,999999999999998E-02

APPROVATO SDR

Società di Progetto
Brehemi SpA

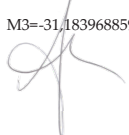



Doc. N.
60235-0000-A00.doc

CODIFICA DOCUMENTO
04RCDII10000000000300A00

REV.
00

FOGLIO
217 di 628

Frame=1 Station=0 OutputCase=STR005 CaseType=Combination P=-123,687000000308 V2=35,0436639591592 V3=0 T=0 M2=0 M3=-19,6206471852978 FrameElem=1-1
ElemStation=0
Frame=1 Station=3,999999999999999E-02 OutputCase=STR005 CaseType=Combination P=-123,471000000308 V2=36,7568139591592 V3=0 T=0 M2=0 M3=-21,0567053436642
FrameElem=1-1 ElemStation=3,999999999999999E-02
Frame=1 Station=7,999999999999998E-02 OutputCase=STR005 CaseType=Combination P=-123,255000000308 V2=38,4553839591592 V3=0 T=0 M2=0 M3=-22,5609979020306
FrameElem=1-1 ElemStation=7,999999999999998E-02
Frame=1 Station=0 OutputCase=STR006 CaseType=Combination P=-25,1217815856973 V2=20,3781685055253 V3=0 T=0 M2=0 M3=-13,802570585039 FrameElem=1-1
ElemStation=0
Frame=1 Station=3,999999999999999E-02 OutputCase=STR006 CaseType=Combination P=-24,9617815856973 V2=20,5006685055253 V3=0 T=0 M2=0 M3=-14,62017332526
FrameElem=1-1 ElemStation=3,999999999999999E-02
Frame=1 Station=7,999999999999998E-02 OutputCase=STR006 CaseType=Combination P=-24,8017815856973 V2=20,6153685055253 V3=0 T=0 M2=0 M3=-15,442520065481
FrameElem=1-1 ElemStation=7,999999999999998E-02
Frame=1 Station=0 OutputCase=STR007 CaseType=Combination P=-11,9400000015914 V2=33,944551878634 V3=0 T=0 M2=0 M3=-3,96712735784584 FrameElem=1-1
ElemStation=0
Frame=1 Station=3,999999999999999E-02 OutputCase=STR007 CaseType=Combination P=-11,7800000015914 V2=35,657701878634 V3=0 T=0 M2=0 M3=-5,35922103299119
FrameElem=1-1 ElemStation=3,999999999999999E-02
Frame=1 Station=7,999999999999998E-02 OutputCase=STR007 CaseType=Combination P=-11,6200000015914 V2=37,356271878634 V3=0 T=0 M2=0 M3=-6,81954910813655
FrameElem=1-1 ElemStation=7,999999999999998E-02
Frame=1 Station=0 OutputCase=STR008 CaseType=Combination P=-126,52082502344 V2=36,3189318576606 V3=0 T=0 M2=0 M3=-37,717625961863 FrameElem=1-1
ElemStation=0
Frame=1 Station=3,999999999999999E-02 OutputCase=STR008 CaseType=Combination P=-126,30482502344 V2=36,4414318576606 V3=0 T=0 M2=0 M3=-39,1729958704928
FrameElem=1-1 ElemStation=3,999999999999999E-02
Frame=1 Station=7,999999999999998E-02 OutputCase=STR008 CaseType=Combination P=-126,08882502344 V2=36,5561318576606 V3=0 T=0 M2=0 M3=-40,6329731447992
FrameElem=1-1 ElemStation=7,999999999999998E-02
Frame=1 Station=0 OutputCase=STR009 CaseType=Combination P=-16,1190000003963 V2=9,19622941372445 V3=0 T=0 M2=0 M3=-3,53937759218843 FrameElem=1-1
ElemStation=0
Frame=1 Station=3,999999999999999E-02 OutputCase=STR009 CaseType=Combination P=-15,9030000003963 V2=9,45907441372445 V3=0 T=0 M2=0 M3=-3,91253856873741
FrameElem=1-1 ElemStation=3,999999999999999E-02
Frame=1 Station=7,999999999999998E-02 OutputCase=STR009 CaseType=Combination P=-15,6870000003963 V2=9,70544941372445 V3=0 T=0 M2=0 M3=-4,29588394528639
FrameElem=1-1 ElemStation=7,999999999999998E-02
Frame=1 Station=0 OutputCase=STR010 CaseType=Combination P=-16,1190000002974 V2=4,35964630361641 V3=0 T=0 M2=0 M3=-3,09723454927826 FrameElem=1-1
ElemStation=0
Frame=1 Station=3,999999999999999E-02 OutputCase=STR010 CaseType=Combination P=-15,9030000002974 V2=4,48214630361641 V3=0 T=0 M2=0 M3=-3,27409640142291
FrameElem=1-1 ElemStation=3,999999999999999E-02
Frame=1 Station=7,999999999999998E-02 OutputCase=STR010 CaseType=Combination P=-15,6870000002974 V2=4,59684630361641 V3=0 T=0 M2=0 M3=-3,45570225356757
FrameElem=1-1 ElemStation=7,999999999999998E-02
Frame=1 Station=0 OutputCase=STR011 CaseType=Combination P=-123,686999998952 V2=5,28805451701668 V3=0 T=0 M2=0 M3=-17,9501880421037 FrameElem=1-1
ElemStation=0
Frame=1 Station=3,999999999999999E-02 OutputCase=STR011 CaseType=Combination P=-123,470999998952 V2=5,41055451701668 V3=0 T=0 M2=0 M3=-18,1641862227844
FrameElem=1-1 ElemStation=3,999999999999999E-02
Frame=1 Station=7,999999999999998E-02 OutputCase=STR011 CaseType=Combination P=-123,254999998952 V2=5,52525451701668 V3=0 T=0 M2=0 M3=-18,382928403465
FrameElem=1-1 ElemStation=7,999999999999998E-02
Frame=1 Station=0 OutputCase=STR012 CaseType=Combination P=-136,868781584414 V2=22,0289579095905 V3=0 T=0 M2=0 M3=-29,8697022440257 FrameElem=1-1
ElemStation=0
Frame=1 Station=3,999999999999999E-02 OutputCase=STR012 CaseType=Combination P=-136,652781584414 V2=22,1514579095905 V3=0 T=0 M2=0 M3=-30,7533365604093
FrameElem=1-1 ElemStation=3,999999999999999E-02
Frame=1 Station=7,999999999999998E-02 OutputCase=STR012 CaseType=Combination P=-136,436781584414 V2=22,2661579095905 V3=0 T=0 M2=0 M3=-31,6417148767929
FrameElem=1-1 ElemStation=7,999999999999998E-02
Frame=1 Station=0 OutputCase=STR013 CaseType=Combination P=-123,687000000308 V2=35,5953412826992 V3=0 T=0 M2=0 M3=-20,0342590168325 FrameElem=1-1
ElemStation=0
Frame=1 Station=3,999999999999999E-02 OutputCase=STR013 CaseType=Combination P=-123,471000000308 V2=37,3084912826992 V3=0 T=0 M2=0 M3=-21,4923842681405
FrameElem=1-1 ElemStation=3,999999999999999E-02
Frame=1 Station=7,999999999999998E-02 OutputCase=STR013 CaseType=Combination P=-123,255000000308 V2=39,0070612826992 V3=0 T=0 M2=0 M3=-23,0187439194485
FrameElem=1-1 ElemStation=7,999999999999998E-02
Frame=1 Station=0 OutputCase=STR014 CaseType=Combination P=-25,1217815856975 V2=20,9298458290653 V3=0 T=0 M2=0 M3=-14,2161824165737 FrameElem=1-1
ElemStation=0
Frame=1 Station=3,999999999999999E-02 OutputCase=STR014 CaseType=Combination P=-24,9617815856975 V2=21,0523458290653 V3=0 T=0 M2=0 M3=-15,0558522497363
FrameElem=1-1 ElemStation=3,999999999999999E-02
Frame=1 Station=7,999999999999998E-02 OutputCase=STR014 CaseType=Combination P=-24,8017815856975 V2=21,1670458290653 V3=0 T=0 M2=0 M3=-15,9002660828989
FrameElem=1-1 ElemStation=7,999999999999998E-02
Frame=1 Station=0 OutputCase=STR015 CaseType=Combination P=-11,9400000015916 V2=34,496229202174 V3=0 T=0 M2=0 M3=-4,38073918938052 FrameElem=1-1
ElemStation=0
Frame=1 Station=3,999999999999999E-02 OutputCase=STR015 CaseType=Combination P=-11,7800000015916 V2=36,209379202174 V3=0 T=0 M2=0 M3=-5,79489995746747
FrameElem=1-1 ElemStation=3,999999999999999E-02
Frame=1 Station=7,999999999999998E-02 OutputCase=STR015 CaseType=Combination P=-11,6200000015916 V2=37,907949202174 V3=0 T=0 M2=0 M3=-7,27729512555443
FrameElem=1-1 ElemStation=7,999999999999998E-02
Frame=1 Station=0 OutputCase=STR016 CaseType=Combination P=-126,52082502344 V2=36,8706091812006 V3=0 T=0 M2=0 M3=-38,131374427721 FrameElem=1-1
ElemStation=0
Frame=1 Station=3,999999999999999E-02 OutputCase=STR016 CaseType=Combination P=-126,30482502344 V2=36,9931091812006 V3=0 T=0 M2=0 M3=-39,608674794969
FrameElem=1-1 ElemStation=3,999999999999999E-02
Frame=1 Station=7,999999999999998E-02 OutputCase=STR016 CaseType=Combination P=-126,08882502344 V2=37,1078091812006 V3=0 T=0 M2=0 M3=-41,0907191622171
FrameElem=1-1 ElemStation=7,999999999999998E-02
Frame=1 Station=0 OutputCase=STR017 CaseType=Combination P=-96,7949999992884 V2=5,33179112543661 V3=0 T=0 M2=0 M3=-14,4437555846647 FrameElem=1-1
ElemStation=0
Frame=1 Station=3,999999999999999E-02 OutputCase=STR017 CaseType=Combination P=-96,5789999992884 V2=5,45429112543661 V3=0 T=0 M2=0 M3=-14,6595032296821
FrameElem=1-1 ElemStation=3,999999999999999E-02
Frame=1 Station=7,999999999999998E-02 OutputCase=STR017 CaseType=Combination P=-96,3629999992884 V2=5,56899112543661 V3=0 T=0 M2=0 M3=-14,8799948746996
FrameElem=1-1 ElemStation=7,999999999999998E-02
Frame=1 Station=0 OutputCase=STR018 CaseType=Combination P=-107,150912233306 V2=18,5260440591148 V3=0 T=0 M2=0 M3=-23,8270760337376 FrameElem=1-1
ElemStation=0
Frame=1 Station=3,999999999999999E-02 OutputCase=STR018 CaseType=Combination P=-106,934912233306 V2=18,6485440591148 V3=0 T=0 M2=0 M3=-24,5705937961022
FrameElem=1-1 ElemStation=3,999999999999999E-02
Frame=1 Station=7,999999999999998E-02 OutputCase=STR018 CaseType=Combination P=-106,718912233306 V2=18,7632440591148 V3=0 T=0 M2=0 M3=-25,318853584668
FrameElem=1-1 ElemStation=7,999999999999998E-02
Frame=1 Station=0 OutputCase=STR019 CaseType=Combination P=-96,7950000003303 V2=29,271401972255 V3=0 T=0 M2=0 M3=-16,1173445764388 FrameElem=1-1
ElemStation=0
Frame=1 Station=3,999999999999999E-02 OutputCase=STR019 CaseType=Combination P=-96,5790000003303 V2=30,6219757272255 V3=0 T=0 M2=0 M3=-17,3152623055279
FrameElem=1-1 ElemStation=3,999999999999999E-02

Società di Progetto
Brebemi SpA



Doc. N.
60235-0000-A00.doc

CODIFICA DOCUMENTO
04RCDII10000000000300A00

REV.
00

FOGLIO
218 di 628

Frame=1 Station=7,999999999999999E-02 OutputCase=STR019 CaseType=Combination P=-96,3630000003303 V2=31,9574969772255 V3=0 T=0 M2=0 M3=-18,5669019346169
FrameElem=1-1 ElemStation=7,999999999999999E-02
Frame=1 Station=0 OutputCase=STR020 CaseType=Combination P=-22,2959122342526 V2=17,7509802525297 V3=0 T=0 M2=0 M3=-11,9557298847477 FrameElem=1-1
ElemStation=0
Frame=1 Station=3,999999999999999E-02 OutputCase=STR020 CaseType=Combination P=-22,1359122342526 V2=17,8734802525297 V3=0 T=0 M2=0 M3=-12,6682450948489
FrameElem=1-1 ElemStation=3,999999999999999E-02
Frame=1 Station=7,999999999999999E-02 OutputCase=STR020 CaseType=Combination P=-21,9759122342526 V2=17,9881802525297 V3=0 T=0 M2=0 M3=-13,3855043049501
FrameElem=1-1 ElemStation=7,999999999999999E-02
Frame=1 Station=0 OutputCase=STR021 CaseType=Combination P=-11,9400000012774 V2=28,4963381706404 V3=0 T=0 M2=0 M3=-4,24599842744898 FrameElem=1-1
ElemStation=0
Frame=1 Station=3,999999999999999E-02 OutputCase=STR021 CaseType=Combination P=-11,7800000012773 V2=29,8469119206404 V3=0 T=0 M2=0 M3=-5,41291360427459
FrameElem=1-1 ElemStation=3,999999999999999E-02
Frame=1 Station=7,999999999999999E-02 OutputCase=STR021 CaseType=Combination P=-11,6200000012774 V2=31,1824331706404 V3=0 T=0 M2=0 M3=-6,6335506811002
FrameElem=1-1 ElemStation=7,999999999999999E-02
Frame=1 Station=0 OutputCase=STR022 CaseType=Combination P=-15,6613185631464 V2=8,96735640501561 V3=0 T=0 M2=0 M3=-2,86010264800973 FrameElem=1-1
ElemStation=0
Frame=1 Station=3,999999999999999E-02 OutputCase=STR022 CaseType=Combination P=-15,4453185631464 V2=9,23020140501561 V3=0 T=0 M2=0 M3=-3,22410870421036
FrameElem=1-1 ElemStation=3,999999999999999E-02
Frame=1 Station=7,999999999999999E-02 OutputCase=STR022 CaseType=Combination P=-15,2293185631464 V2=9,47657640501561 V3=0 T=0 M2=0 M3=-3,59829916041098
FrameElem=1-1 ElemStation=7,999999999999999E-02
Frame=1 Station=0 OutputCase=STR023 CaseType=Combination P=-15,6613185630475 V2=4,13077329490757 V3=0 T=0 M2=0 M3=-2,41795960509956 FrameElem=1-1
ElemStation=0
Frame=1 Station=3,999999999999999E-02 OutputCase=STR023 CaseType=Combination P=-15,4453185630475 V2=4,25327329490757 V3=0 T=0 M2=0 M3=-2,58566653689586
FrameElem=1-1 ElemStation=3,999999999999999E-02
Frame=1 Station=7,999999999999999E-02 OutputCase=STR023 CaseType=Combination P=-15,2293185630475 V2=4,36797329490757 V3=0 T=0 M2=0 M3=-2,75811746869216
FrameElem=1-1 ElemStation=7,999999999999999E-02
Frame=1 Station=0 OutputCase=STR024 CaseType=Combination P=-96,3373185620385 V2=5,10291811672777 V3=0 T=0 M2=0 M3=-13,764480640486 FrameElem=1-1
ElemStation=0
Frame=1 Station=3,999999999999999E-02 OutputCase=STR024 CaseType=Combination P=-96,1213185620385 V2=5,22541811672776 V3=0 T=0 M2=0 M3=-13,9710733651551
FrameElem=1-1 ElemStation=3,999999999999999E-02
Frame=1 Station=7,999999999999999E-02 OutputCase=STR024 CaseType=Combination P=-95,9053185620385 V2=5,34011811672776 V3=0 T=0 M2=0 M3=-14,1824100898242
FrameElem=1-1 ElemStation=7,999999999999999E-02
Frame=1 Station=0 OutputCase=STR025 CaseType=Combination P=-106,693230796056 V2=18,297171050406 V3=0 T=0 M2=0 M3=-23,1478010895589 FrameElem=1-1
ElemStation=0
Frame=1 Station=3,999999999999999E-02 OutputCase=STR025 CaseType=Combination P=-106,477230796056 V2=18,419671050406 V3=0 T=0 M2=0 M3=-23,8821639315751
FrameElem=1-1 ElemStation=3,999999999999999E-02
Frame=1 Station=7,999999999999999E-02 OutputCase=STR025 CaseType=Combination P=-106,261230796056 V2=18,534371050406 V3=0 T=0 M2=0 M3=-24,62120770735914
FrameElem=1-1 ElemStation=7,999999999999999E-02
Frame=1 Station=0 OutputCase=STR026 CaseType=Combination P=-96,3373185630804 V2=29,0425289685167 V3=0 T=0 M2=0 M3=-15,4380696322601 FrameElem=1-1
ElemStation=0
Frame=1 Station=3,999999999999999E-02 OutputCase=STR026 CaseType=Combination P=-96,1213185630804 V2=30,3931027185167 V3=0 T=0 M2=0 M3=-16,6268324410008
FrameElem=1-1 ElemStation=3,999999999999999E-02
Frame=1 Station=7,999999999999999E-02 OutputCase=STR026 CaseType=Combination P=-95,9053185630804 V2=31,7286239685167 V3=0 T=0 M2=0 M3=-17,8693171497415
FrameElem=1-1 ElemStation=7,999999999999999E-02
Frame=1 Station=0 OutputCase=STR027 CaseType=Combination P=-21,8382307970027 V2=17,5221072438208 V3=0 T=0 M2=0 M3=-11,276454940569 FrameElem=1-1
ElemStation=0
Frame=1 Station=3,999999999999999E-02 OutputCase=STR027 CaseType=Combination P=-21,6782307970027 V2=17,6446072438208 V3=0 T=0 M2=0 M3=-11,9798152303219
FrameElem=1-1 ElemStation=3,999999999999999E-02
Frame=1 Station=7,999999999999999E-02 OutputCase=STR027 CaseType=Combination P=-21,5182307970027 V2=17,7593072438208 V3=0 T=0 M2=0 M3=-12,6879195200747
FrameElem=1-1 ElemStation=7,999999999999999E-02
Frame=1 Station=0 OutputCase=STR028 CaseType=Combination P=-11,4823185640275 V2=28,2674651619315 V3=0 T=0 M2=0 M3=-3,56672348327028 FrameElem=1-1
ElemStation=0
Frame=1 Station=3,999999999999999E-02 OutputCase=STR028 CaseType=Combination P=-11,3223185640275 V2=29,6180389119315 V3=0 T=0 M2=0 M3=-4,72448373974753
FrameElem=1-1 ElemStation=3,999999999999999E-02
Frame=1 Station=7,999999999999999E-02 OutputCase=STR028 CaseType=Combination P=-11,1623185640275 V2=30,9535601619315 V3=0 T=0 M2=0 M3=-5,93596589622479
FrameElem=1-1 ElemStation=7,999999999999999E-02
Frame=1 Station=0 OutputCase=STR029 CaseType=Combination P=-16,5766814376462 V2=9,42510242243329 V3=0 T=0 M2=0 M3=-4,21865253636713 FrameElem=1-1
ElemStation=0
Frame=1 Station=3,999999999999999E-02 OutputCase=STR029 CaseType=Combination P=-16,3606814376462 V2=9,68794742243329 V3=0 T=0 M2=0 M3=-4,60096843326446
FrameElem=1-1 ElemStation=3,999999999999999E-02
Frame=1 Station=7,999999999999999E-02 OutputCase=STR029 CaseType=Combination P=-16,1446814376462 V2=9,93432242243329 V3=0 T=0 M2=0 M3=-4,99346873016179
FrameElem=1-1 ElemStation=7,999999999999999E-02
Frame=1 Station=0 OutputCase=STR030 CaseType=Combination P=-16,5766814375473 V2=4,58851931232525 V3=0 T=0 M2=0 M3=-3,77650949345696 FrameElem=1-1
ElemStation=0
Frame=1 Station=3,999999999999999E-02 OutputCase=STR030 CaseType=Combination P=-16,3606814375473 V2=4,71101931232525 V3=0 T=0 M2=0 M3=-3,96252626594997
FrameElem=1-1 ElemStation=3,999999999999999E-02
Frame=1 Station=7,999999999999999E-02 OutputCase=STR030 CaseType=Combination P=-16,1446814375473 V2=4,82571931232525 V3=0 T=0 M2=0 M3=-4,15328703844298
FrameElem=1-1 ElemStation=7,999999999999999E-02
Frame=1 Station=0 OutputCase=STR031 CaseType=Combination P=-97,2526814365383 V2=5,56066413414545 V3=0 T=0 M2=0 M3=-15,1230305288434 FrameElem=1-1
ElemStation=0
Frame=1 Station=3,999999999999999E-02 OutputCase=STR031 CaseType=Combination P=-97,0366814365383 V2=5,68316413414545 V3=0 T=0 M2=0 M3=-15,3479330942092
FrameElem=1-1 ElemStation=3,999999999999999E-02
Frame=1 Station=7,999999999999999E-02 OutputCase=STR031 CaseType=Combination P=-96,8206814365383 V2=5,79786413414545 V3=0 T=0 M2=0 M3=-15,57759659575
FrameElem=1-1 ElemStation=7,999999999999999E-02
Frame=1 Station=0 OutputCase=STR032 CaseType=Combination P=-107,608593670555 V2=18,7549170678237 V3=0 T=0 M2=0 M3=-24,5063509779163 FrameElem=1-1
ElemStation=0
Frame=1 Station=3,999999999999999E-02 OutputCase=STR032 CaseType=Combination P=-107,392593670555 V2=18,8774170678237 V3=0 T=0 M2=0 M3=-25,2590236606293
FrameElem=1-1 ElemStation=3,999999999999999E-02
Frame=1 Station=7,999999999999999E-02 OutputCase=STR032 CaseType=Combination P=-107,176593670555 V2=18,9921170678237 V3=0 T=0 M2=0 M3=-26,0164403433422
FrameElem=1-1 ElemStation=7,999999999999999E-02
Frame=1 Station=0 OutputCase=STR033 CaseType=Combination P=-97,2526814375802 V2=29,5002749859344 V3=0 T=0 M2=0 M3=-16,7966195206175 FrameElem=1-1
ElemStation=0
Frame=1 Station=3,999999999999999E-02 OutputCase=STR033 CaseType=Combination P=-97,0366814375802 V2=30,8508487359343 V3=0 T=0 M2=0 M3=-18,0036921700549
FrameElem=1-1 ElemStation=3,999999999999999E-02
Frame=1 Station=7,999999999999999E-02 OutputCase=STR033 CaseType=Combination P=-96,8206814375802 V2=32,1863699859343 V3=0 T=0 M2=0 M3=-19,2644867194923
FrameElem=1-1 ElemStation=7,999999999999999E-02
Frame=1 Station=0 OutputCase=STR034 CaseType=Combination P=-22,7535936715025 V2=17,9798532612385 V3=0 T=0 M2=0 M3=-12,6350048289264 FrameElem=1-1
ElemStation=0

Società di Progetto
Brebemi SpA



Doc. N.
60235-0000-A00.doc

CODIFICA DOCUMENTO
04RCDII1000000000300A00

REV.
00

FOGLIO
219 di 628

Frame=1 Station=3,9999999999999999E-02 OutputCase=STR034 CaseType=Combination P=-22,5935936715025 V2=18,1023532612385 V3=0 T=0 M2=0 M3=-13,356674959376
FrameElem=1-1 ElemStation=3,9999999999999999E-02
Frame=1 Station=7,9999999999999998E-02 OutputCase=STR034 CaseType=Combination P=-22,4335936715025 V2=18,2170532612385 V3=0 T=0 M2=0 M3=-14,0830890898255
FrameElem=1-1 ElemStation=7,9999999999999998E-02
Frame=1 Station=0 OutputCase=STR035 CaseType=Combination P=-12,3976814385272 V2=28,7252111793492 V3=0 T=0 M2=0 M3=-4,92527337162768 FrameElem=1-1
ElemStation=0
Frame=1 Station=3,9999999999999999E-02 OutputCase=STR035 CaseType=Combination P=-12,2376814385272 V2=30,0757849293492 V3=0 T=0 M2=0 M3=-6,10134346880164
FrameElem=1-1 ElemStation=3,9999999999999999E-02
Frame=1 Station=7,9999999999999998E-02 OutputCase=STR035 CaseType=Combination P=-12,0776814385272 V2=31,4113061793492 V3=0 T=0 M2=0 M3=-7,33113546597561
FrameElem=1-1 ElemStation=7,9999999999999998E-02
Frame=1 Station=0 OutputCase=STR036 CaseType=Combination P=-16,1190000003962 V2=8,64455209018446 V3=0 T=0 M2=0 M3=-3,12576576065375 FrameElem=1-1
ElemStation=0
Frame=1 Station=3,9999999999999999E-02 OutputCase=STR036 CaseType=Combination P=-15,9030000003962 V2=8,90739709018446 V3=0 T=0 M2=0 M3=-3,47685964426113
FrameElem=1-1 ElemStation=3,9999999999999999E-02
Frame=1 Station=7,9999999999999998E-02 OutputCase=STR036 CaseType=Combination P=-15,6870000003962 V2=9,15377209018446 V3=0 T=0 M2=0 M3=-3,83813792786851
FrameElem=1-1 ElemStation=7,9999999999999998E-02
Frame=1 Station=0 OutputCase=STR037 CaseType=Combination P=-16,1190000002972 V2=3,80796898007642 V3=0 T=0 M2=0 M3=-2,68362271774358 FrameElem=1-1
ElemStation=0
Frame=1 Station=3,9999999999999999E-02 OutputCase=STR037 CaseType=Combination P=-15,9030000002972 V2=3,93046898007642 V3=0 T=0 M2=0 M3=-2,83841747694663
FrameElem=1-1 ElemStation=3,9999999999999999E-02
Frame=1 Station=7,9999999999999998E-02 OutputCase=STR037 CaseType=Combination P=-15,6870000002972 V2=4,04516898007642 V3=0 T=0 M2=0 M3=-2,99795623614969
FrameElem=1-1 ElemStation=7,9999999999999998E-02
Frame=1 Station=0 OutputCase=STR038 CaseType=Combination P=-96,7949999992882 V2=4,78011380189662 V3=0 T=0 M2=0 M3=-14,03014375313 FrameElem=1-1
ElemStation=0
Frame=1 Station=3,9999999999999999E-02 OutputCase=STR038 CaseType=Combination P=-96,5789999992882 V2=4,90261380189662 V3=0 T=0 M2=0 M3=-14,2238243052059
FrameElem=1-1 ElemStation=3,9999999999999999E-02
Frame=1 Station=7,9999999999999998E-02 OutputCase=STR038 CaseType=Combination P=-96,3629999992882 V2=5,01731380189662 V3=0 T=0 M2=0 M3=-14,4222488572817
FrameElem=1-1 ElemStation=7,9999999999999998E-02
Frame=1 Station=0 OutputCase=STR039 CaseType=Combination P=-107,150912233305 V2=17,9743667355748 V3=0 T=0 M2=0 M3=-23,4134642022029 FrameElem=1-1
ElemStation=0
Frame=1 Station=3,9999999999999999E-02 OutputCase=STR039 CaseType=Combination P=-106,934912233305 V2=18,0968667355748 V3=0 T=0 M2=0 M3=-24,1349148716259
FrameElem=1-1 ElemStation=3,9999999999999999E-02
Frame=1 Station=7,9999999999999998E-02 OutputCase=STR039 CaseType=Combination P=-106,718912233305 V2=18,2115667355748 V3=0 T=0 M2=0 M3=-24,8611095410489
FrameElem=1-1 ElemStation=7,9999999999999998E-02
Frame=1 Station=0 OutputCase=STR040 CaseType=Combination P=-96,7950000003301 V2=28,7197246536855 V3=0 T=0 M2=0 M3=-15,7037327449042 FrameElem=1-1
ElemStation=0
Frame=1 Station=3,9999999999999999E-02 OutputCase=STR040 CaseType=Combination P=-96,5790000003301 V2=30,0702984036855 V3=0 T=0 M2=0 M3=-16,8795833810516
FrameElem=1-1 ElemStation=3,9999999999999999E-02
Frame=1 Station=7,9999999999999998E-02 OutputCase=STR040 CaseType=Combination P=-96,3630000003301 V2=31,4058196536855 V3=0 T=0 M2=0 M3=-18,109155917199
FrameElem=1-1 ElemStation=7,9999999999999998E-02
Frame=1 Station=0 OutputCase=STR041 CaseType=Combination P=-22,2959122342524 V2=17,1993029289897 V3=0 T=0 M2=0 M3=-11,5421180532131 FrameElem=1-1
ElemStation=0
Frame=1 Station=3,9999999999999999E-02 OutputCase=STR041 CaseType=Combination P=-22,1359122342524 V2=17,3218029289897 V3=0 T=0 M2=0 M3=-12,2325661703726
FrameElem=1-1 ElemStation=3,9999999999999999E-02
Frame=1 Station=7,9999999999999998E-02 OutputCase=STR041 CaseType=Combination P=-21,9759122342524 V2=17,4365029289897 V3=0 T=0 M2=0 M3=-12,9277582875322
FrameElem=1-1 ElemStation=7,9999999999999998E-02
Frame=1 Station=0 OutputCase=STR042 CaseType=Combination P=-11,9400000012772 V2=27,9446608471004 V3=0 T=0 M2=0 M3=-3,8323865959143 FrameElem=1-1
ElemStation=0
Frame=1 Station=3,9999999999999999E-02 OutputCase=STR042 CaseType=Combination P=-11,7800000012772 V2=29,2952345971004 V3=0 T=0 M2=0 M3=-4,97723467979831
FrameElem=1-1 ElemStation=3,9999999999999999E-02
Frame=1 Station=7,9999999999999998E-02 OutputCase=STR042 CaseType=Combination P=-11,6200000012772 V2=30,6307558471004 V3=0 T=0 M2=0 M3=-6,17580466368232
FrameElem=1-1 ElemStation=7,9999999999999998E-02
Frame=1 Station=0 OutputCase=STR043 CaseType=Combination P=-16,1190000003958 V2=7,35730500192449 V3=0 T=0 M2=0 M3=-2,16067148707283 FrameElem=1-1
ElemStation=0
Frame=1 Station=3,9999999999999999E-02 OutputCase=STR043 CaseType=Combination P=-15,9030000003958 V2=7,62015000192449 V3=0 T=0 M2=0 M3=-2,46027548714981
FrameElem=1-1 ElemStation=3,9999999999999999E-02
Frame=1 Station=7,9999999999999998E-02 OutputCase=STR043 CaseType=Combination P=-15,6870000003958 V2=7,86652500192449 V3=0 T=0 M2=0 M3=-2,77006388722679
FrameElem=1-1 ElemStation=7,9999999999999998E-02
Frame=1 Station=0 OutputCase=STR044 CaseType=Combination P=-16,1190000002968 V2=2,52072189181645 V3=0 T=0 M2=0 M3=-1,71852844416266 FrameElem=1-1
ElemStation=0
Frame=1 Station=3,9999999999999999E-02 OutputCase=STR044 CaseType=Combination P=-15,9030000002968 V2=2,64322189181645 V3=0 T=0 M2=0 M3=-1,8218331983531
FrameElem=1-1 ElemStation=3,9999999999999999E-02
Frame=1 Station=7,9999999999999998E-02 OutputCase=STR044 CaseType=Combination P=-15,6870000002968 V2=2,75792189181645 V3=0 T=0 M2=0 M3=-1,92988219550797
FrameElem=1-1 ElemStation=7,9999999999999998E-02
Frame=1 Station=0 OutputCase=STR045 CaseType=Combination P=-123,68699998952 V2=4,18469986993671 V3=0 T=0 M2=0 M3=-17,1229643790343 FrameElem=1-1
ElemStation=0
Frame=1 Station=3,9999999999999999E-02 OutputCase=STR045 CaseType=Combination P=-123,47099998952 V2=4,30719986993671 V3=0 T=0 M2=0 M3=-17,2928283738318
FrameElem=1-1 ElemStation=3,9999999999999999E-02
Frame=1 Station=7,9999999999999998E-02 OutputCase=STR045 CaseType=Combination P=-123,25499998952 V2=4,42189986993671 V3=0 T=0 M2=0 M3=-17,4674363686293
FrameElem=1-1 ElemStation=7,9999999999999998E-02
Frame=1 Station=0 OutputCase=STR046 CaseType=Combination P=-136,868781584414 V2=20,9256032625105 V3=0 T=0 M2=0 M3=-29,0424785809563 FrameElem=1-1
ElemStation=0
Frame=1 Station=3,9999999999999999E-02 OutputCase=STR046 CaseType=Combination P=-136,652781584414 V2=21,0481032625105 V3=0 T=0 M2=0 M3=-29,8819787114568
FrameElem=1-1 ElemStation=3,9999999999999999E-02
Frame=1 Station=7,9999999999999998E-02 OutputCase=STR046 CaseType=Combination P=-136,436781584414 V2=21,1628032625105 V3=0 T=0 M2=0 M3=-30,7262228419572
FrameElem=1-1 ElemStation=7,9999999999999998E-02
Frame=1 Station=0 OutputCase=STR047 CaseType=Combination P=-123,687000000308 V2=34,4919866356192 V3=0 T=0 M2=0 M3=-19,207033537632 FrameElem=1-1
ElemStation=0
Frame=1 Station=3,9999999999999999E-02 OutputCase=STR047 CaseType=Combination P=-123,471000000308 V2=36,2051366356192 V3=0 T=0 M2=0 M3=-20,6210264191879
FrameElem=1-1 ElemStation=3,9999999999999999E-02
Frame=1 Station=7,9999999999999998E-02 OutputCase=STR047 CaseType=Combination P=-123,255000000308 V2=37,9037066356192 V3=0 T=0 M2=0 M3=-22,1032518846127
FrameElem=1-1 ElemStation=7,9999999999999998E-02
Frame=1 Station=0 OutputCase=STR048 CaseType=Combination P=-25,1217815856972 V2=19,8264911819853 V3=0 T=0 M2=0 M3=-13,3889587535043 FrameElem=1-1
ElemStation=0
Frame=1 Station=3,9999999999999999E-02 OutputCase=STR048 CaseType=Combination P=-24,9617815856972 V2=19,9489911819853 V3=0 T=0 M2=0 M3=-14,1844944007837
FrameElem=1-1 ElemStation=3,9999999999999999E-02
Frame=1 Station=7,9999999999999998E-02 OutputCase=STR048 CaseType=Combination P=-24,8017815856972 V2=20,0636911819853 V3=0 T=0 M2=0 M3=-14,9847740480632
FrameElem=1-1 ElemStation=7,9999999999999998E-02

Società di Progetto
Brebemi SpA



Doc. N.
60235-0000-A00.doc

CODIFICA DOCUMENTO
04RCDII10000000000300A00

REV.
00

FOGLIO
220 di 628

Frame=1 Station=0 OutputCase=STR049 CaseType=Combination P=-11,940000015912 V2=33,392874555094 V3=0 T=0 M2=0 M3=-3,55351552631116 FrameElem=1-1 ElemStation=0

Frame=1 Station=3,9999999999999999E-02 OutputCase=STR049 CaseType=Combination P=-11,780000015912 V2=35,106204555094 V3=0 T=0 M2=0 M3=-4,92354210851491 FrameElem=1-1 ElemStation=3,9999999999999999E-02

Frame=1 Station=7,9999999999999998E-02 OutputCase=STR049 CaseType=Combination P=-11,620000015912 V2=36,804594555094 V3=0 T=0 M2=0 M3=-6,36180309071867 FrameElem=1-1 ElemStation=7,9999999999999998E-02

Frame=1 Station=0 OutputCase=STR050 CaseType=Combination P=-126,52082502344 V2=35,7672545341206 V3=0 T=0 M2=0 M3=-37,3041507646517 FrameElem=1-1 ElemStation=0

Frame=1 Station=3,9999999999999999E-02 OutputCase=STR050 CaseType=Combination P=-126,30482502344 V2=35,8897545341206 V3=0 T=0 M2=0 M3=-38,7373169460165 FrameElem=1-1 ElemStation=3,9999999999999999E-02

Frame=1 Station=7,9999999999999998E-02 OutputCase=STR050 CaseType=Combination P=-126,08882502344 V2=36,0044545341206 V3=0 T=0 M2=0 M3=-40,1752271273813 FrameElem=1-1 ElemStation=7,9999999999999998E-02

Frame=1 Station=0 OutputCase=STR051 CaseType=Combination P=-96,794999992879 V2=3,49286671363665 V3=0 T=0 M2=0 M3=-13,0650494795491 FrameElem=1-1 ElemStation=0

Frame=1 Station=3,9999999999999999E-02 OutputCase=STR051 CaseType=Combination P=-96,578999992879 V2=3,61536671363665 V3=0 T=0 M2=0 M3=-13,2072401480945 FrameElem=1-1 ElemStation=3,9999999999999999E-02

Frame=1 Station=7,9999999999999998E-02 OutputCase=STR051 CaseType=Combination P=-96,362999992879 V2=3,73006671363665 V3=0 T=0 M2=0 M3=-13,35417481664 FrameElem=1-1 ElemStation=7,9999999999999998E-02

Frame=1 Station=0 OutputCase=STR052 CaseType=Combination P=-107,150912233305 V2=16,6871196473149 V3=0 T=0 M2=0 M3=-22,448369928622 FrameElem=1-1 ElemStation=0

Frame=1 Station=3,9999999999999999E-02 OutputCase=STR052 CaseType=Combination P=-106,934912233305 V2=16,8096196473149 V3=0 T=0 M2=0 M3=-23,1183307145146 FrameElem=1-1 ElemStation=3,9999999999999999E-02

Frame=1 Station=7,9999999999999998E-02 OutputCase=STR052 CaseType=Combination P=-106,718912233305 V2=16,9243196473149 V3=0 T=0 M2=0 M3=-23,7930355004072 FrameElem=1-1 ElemStation=7,9999999999999998E-02

Frame=1 Station=0 OutputCase=STR053 CaseType=Combination P=-96,795000003298 V2=27,4324775654255 V3=0 T=0 M2=0 M3=-14,7386384713232 FrameElem=1-1 ElemStation=0

Frame=1 Station=3,9999999999999999E-02 OutputCase=STR053 CaseType=Combination P=-96,579000003298 V2=28,7830513154255 V3=0 T=0 M2=0 M3=-15,8629992239403 FrameElem=1-1 ElemStation=3,9999999999999999E-02

Frame=1 Station=7,9999999999999998E-02 OutputCase=STR053 CaseType=Combination P=-96,363000003298 V2=30,1185725654255 V3=0 T=0 M2=0 M3=-17,0410818765573 FrameElem=1-1 ElemStation=7,9999999999999998E-02

Frame=1 Station=0 OutputCase=STR054 CaseType=Combination P=-22,295912234252 V2=15,9120558407297 V3=0 T=0 M2=0 M3=-10,5770237796321 FrameElem=1-1 ElemStation=0

Frame=1 Station=3,9999999999999999E-02 OutputCase=STR054 CaseType=Combination P=-22,135912234252 V2=16,034558407297 V3=0 T=0 M2=0 M3=-11,2159820132613 FrameElem=1-1 ElemStation=3,9999999999999999E-02

Frame=1 Station=7,9999999999999998E-02 OutputCase=STR054 CaseType=Combination P=-21,975912234252 V2=16,1492558407297 V3=0 T=0 M2=0 M3=-11,8596842468905 FrameElem=1-1 ElemStation=7,9999999999999998E-02

Frame=1 Station=0 OutputCase=STR055 CaseType=Combination P=-11,940000012768 V2=26,6574137588404 V3=0 T=0 M2=0 M3=-2,8672923233338 FrameElem=1-1 ElemStation=0

Frame=1 Station=3,9999999999999999E-02 OutputCase=STR055 CaseType=Combination P=-11,780000012768 V2=28,0079875088404 V3=0 T=0 M2=0 M3=-3,96065052268699 FrameElem=1-1 ElemStation=3,9999999999999999E-02

Frame=1 Station=7,9999999999999998E-02 OutputCase=STR055 CaseType=Combination P=-11,620000012768 V2=29,3435087588404 V3=0 T=0 M2=0 M3=-5,1077306230406 FrameElem=1-1 ElemStation=7,9999999999999998E-02

Frame=1 Station=0 OutputCase=STR056 CaseType=Combination P=-15,6613185631459 V2=7,12843199321565 V3=0 T=0 M2=0 M3=-1,48139654289413 FrameElem=1-1 ElemStation=0

Frame=1 Station=3,9999999999999999E-02 OutputCase=STR056 CaseType=Combination P=-15,4453185631459 V2=7,39127699321564 V3=0 T=0 M2=0 M3=-1,77184562262276 FrameElem=1-1 ElemStation=3,9999999999999999E-02

Frame=1 Station=7,9999999999999998E-02 OutputCase=STR056 CaseType=Combination P=-15,2293185631459 V2=7,63765199321564 V3=0 T=0 M2=0 M3=-2,07247910235138 FrameElem=1-1 ElemStation=7,9999999999999998E-02

Frame=1 Station=0 OutputCase=STR057 CaseType=Combination P=-15,6613185630469 V2=2,2918488831076 V3=0 T=0 M2=0 M3=-1,03925349998396 FrameElem=1-1 ElemStation=0

Frame=1 Station=3,9999999999999999E-02 OutputCase=STR057 CaseType=Combination P=-15,4453185630469 V2=2,4143488831076 V3=0 T=0 M2=0 M3=-1,13340345530826 FrameElem=1-1 ElemStation=3,9999999999999999E-02

Frame=1 Station=7,9999999999999998E-02 OutputCase=STR057 CaseType=Combination P=-15,2293185630469 V2=2,5290488831076 V3=0 T=0 M2=0 M3=-1,23229741063257 FrameElem=1-1 ElemStation=7,9999999999999998E-02

Frame=1 Station=0 OutputCase=STR058 CaseType=Combination P=-96,337318562038 V2=3,2639937049278 V3=0 T=0 M2=0 M3=-12,3857745353704 FrameElem=1-1 ElemStation=0

Frame=1 Station=3,9999999999999999E-02 OutputCase=STR058 CaseType=Combination P=-96,121318562038 V2=3,3864937049278 V3=0 T=0 M2=0 M3=-12,5188102835675 FrameElem=1-1 ElemStation=3,9999999999999999E-02

Frame=1 Station=7,9999999999999998E-02 OutputCase=STR058 CaseType=Combination P=-95,905318562038 V2=3,5011937049278 V3=0 T=0 M2=0 M3=-12,6565900317646 FrameElem=1-1 ElemStation=7,9999999999999998E-02

Frame=1 Station=0 OutputCase=STR059 CaseType=Combination P=-106,693230796055 V2=16,458246638606 V3=0 T=0 M2=0 M3=-21,7690949844433 FrameElem=1-1 ElemStation=0

Frame=1 Station=3,9999999999999999E-02 OutputCase=STR059 CaseType=Combination P=-106,477230796055 V2=16,580746638606 V3=0 T=0 M2=0 M3=-22,4299008499876 FrameElem=1-1 ElemStation=3,9999999999999999E-02

Frame=1 Station=7,9999999999999998E-02 OutputCase=STR059 CaseType=Combination P=-106,261230796055 V2=16,695446638606 V3=0 T=0 M2=0 M3=-23,0954507155318 FrameElem=1-1 ElemStation=7,9999999999999998E-02

Frame=1 Station=0 OutputCase=STR060 CaseType=Combination P=-96,3373185630799 V2=27,2036045567167 V3=0 T=0 M2=0 M3=-14,0593635271445 FrameElem=1-1 ElemStation=0

Frame=1 Station=3,9999999999999999E-02 OutputCase=STR060 CaseType=Combination P=-96,1213185630799 V2=28,5541783067167 V3=0 T=0 M2=0 M3=-15,1745693594132 FrameElem=1-1 ElemStation=3,9999999999999999E-02

Frame=1 Station=7,9999999999999998E-02 OutputCase=STR060 CaseType=Combination P=-95,9053185630799 V2=29,8896995567167 V3=0 T=0 M2=0 M3=-16,3434970916819 FrameElem=1-1 ElemStation=7,9999999999999998E-02

Frame=1 Station=0 OutputCase=STR061 CaseType=Combination P=-21,8382307970022 V2=15,6831828320209 V3=0 T=0 M2=0 M3=-9,89774883545344 FrameElem=1-1 ElemStation=0

Frame=1 Station=3,9999999999999999E-02 OutputCase=STR061 CaseType=Combination P=-21,6782307970022 V2=15,8056828320209 V3=0 T=0 M2=0 M3=-10,5275521487343 FrameElem=1-1 ElemStation=3,9999999999999999E-02

Frame=1 Station=7,9999999999999998E-02 OutputCase=STR061 CaseType=Combination P=-21,5182307970022 V2=15,9203828320209 V3=0 T=0 M2=0 M3=-11,1620994620151 FrameElem=1-1 ElemStation=7,9999999999999998E-02

Frame=1 Station=0 OutputCase=STR062 CaseType=Combination P=-11,4823185640269 V2=26,4285407501316 V3=0 T=0 M2=0 M3=-2,18801737815468 FrameElem=1-1 ElemStation=0

Frame=1 Station=3,9999999999999999E-02 OutputCase=STR062 CaseType=Combination P=-11,3223185640269 V2=27,7791145001316 V3=0 T=0 M2=0 M3=-3,27222065815994 FrameElem=1-1 ElemStation=3,9999999999999999E-02

Frame=1 Station=7,9999999999999998E-02 OutputCase=STR062 CaseType=Combination P=-11,1623185640269 V2=29,1146357501316 V3=0 T=0 M2=0 M3=-4,4101458381652 FrameElem=1-1 ElemStation=7,9999999999999998E-02

Frame=1 Station=0 OutputCase=STR063 CaseType=Combination P=-16,5766814376457 V2=7,58617801063333 V3=0 T=0 M2=0 M3=-2,83994643125153 FrameElem=1-1 ElemStation=0

Frame=1 Station=3,9999999999999999E-02 OutputCase=STR063 CaseType=Combination P=-16,3606814376457 V2=7,84902301063333 V3=0 T=0 M2=0 M3=-3,14870535167686 FrameElem=1-1 ElemStation=3,9999999999999999E-02

Società di Progetto
Brebemi SpA



Doc. N.
60235-0000-A00.doc

CODIFICA DOCUMENTO
04RCDII10000000000300A00

REV.
00

FOGLIO
221 di 628

Frame=1 Station=7,999999999999E-02 OutputCase=STR063 CaseType=Combination P=-16,1446814376457 V2=8,09539801063333 V3=0 T=0 M2=0 M3=-3,4676486721022
FrameElem=1-1 ElemStation=7,999999999999E-02
Frame=1 Station=0 OutputCase=STR064 CaseType=Combination P=-16,5766814375467 V2=2,74959490052529 V3=0 T=0 M2=0 M3=-2,39780338834136 FrameElem=1-1
ElemStation=0
Frame=1 Station=3,999999999999E-02 OutputCase=STR064 CaseType=Combination P=-16,3606814375467 V2=2,87209490052529 V3=0 T=0 M2=0 M3=-2,51026318436237
FrameElem=1-1 ElemStation=3,999999999999E-02
Frame=1 Station=7,999999999999E-02 OutputCase=STR064 CaseType=Combination P=-16,1446814375467 V2=2,98679490052529 V3=0 T=0 M2=0 M3=-2,62746698038338
FrameElem=1-1 ElemStation=7,999999999999E-02
Frame=1 Station=0 OutputCase=STR065 CaseType=Combination P=-97,2526814365377 V2=3,72173972234549 V3=0 T=0 M2=0 M3=-13,7443244237278 FrameElem=1-1
ElemStation=0
Frame=1 Station=3,999999999999E-02 OutputCase=STR065 CaseType=Combination P=-97,0366814365377 V2=3,84423972234549 V3=0 T=0 M2=0 M3=-13,8956700126216
FrameElem=1-1 ElemStation=3,999999999999E-02
Frame=1 Station=7,999999999999E-02 OutputCase=STR065 CaseType=Combination P=-96,8206814365377 V2=3,95893972234549 V3=0 T=0 M2=0 M3=-14,0517596015154
FrameElem=1-1 ElemStation=7,999999999999E-02
Frame=1 Station=0 OutputCase=STR066 CaseType=Combination P=-107,608593670555 V2=16,9159926560237 V3=0 T=0 M2=0 M3=-23,1276448728007 FrameElem=1-1
ElemStation=0
Frame=1 Station=3,999999999999E-02 OutputCase=STR066 CaseType=Combination P=-107,392593670555 V2=17,0384926560237 V3=0 T=0 M2=0 M3=-23,8067605790417
FrameElem=1-1 ElemStation=3,999999999999E-02
Frame=1 Station=7,999999999999E-02 OutputCase=STR066 CaseType=Combination P=-107,176593670555 V2=17,1531926560237 V3=0 T=0 M2=0 M3=-24,4906202852826
FrameElem=1-1 ElemStation=7,999999999999E-02
Frame=1 Station=0 OutputCase=STR067 CaseType=Combination P=-97,2526814375797 V2=27,6613505741344 V3=0 T=0 M2=0 M3=-15,4179134155019 FrameElem=1-1
ElemStation=0
Frame=1 Station=3,999999999999E-02 OutputCase=STR067 CaseType=Combination P=-97,0366814375797 V2=29,0119243241344 V3=0 T=0 M2=0 M3=-16,5514290884673
FrameElem=1-1 ElemStation=3,999999999999E-02
Frame=1 Station=7,999999999999E-02 OutputCase=STR067 CaseType=Combination P=-96,8206814375797 V2=30,3474455741344 V3=0 T=0 M2=0 M3=-17,7386666614327
FrameElem=1-1 ElemStation=7,999999999999E-02
Frame=1 Station=0 OutputCase=STR068 CaseType=Combination P=-22,7535936715019 V2=16,1409288494386 V3=0 T=0 M2=0 M3=-11,2562987238108 FrameElem=1-1
ElemStation=0
Frame=1 Station=3,999999999999E-02 OutputCase=STR068 CaseType=Combination P=-22,5935936715019 V2=16,2634288494386 V3=0 T=0 M2=0 M3=-11,9044118777884
FrameElem=1-1 ElemStation=3,999999999999E-02
Frame=1 Station=7,999999999999E-02 OutputCase=STR068 CaseType=Combination P=-22,4335936715019 V2=16,3781288494386 V3=0 T=0 M2=0 M3=-12,5572690317659
FrameElem=1-1 ElemStation=7,999999999999E-02
Frame=1 Station=0 OutputCase=STR069 CaseType=Combination P=-12,3976814385267 V2=26,886286765492 V3=0 T=0 M2=0 M3=-3,54656726651208 FrameElem=1-1
ElemStation=0
Frame=1 Station=3,999999999999E-02 OutputCase=STR069 CaseType=Combination P=-12,2376814385267 V2=28,2368605175492 V3=0 T=0 M2=0 M3=-4,64908038721404
FrameElem=1-1 ElemStation=3,999999999999E-02
Frame=1 Station=7,999999999999E-02 OutputCase=STR069 CaseType=Combination P=-12,0776814385267 V2=29,5723817675492 V3=0 T=0 M2=0 M3=-5,80531540791601
FrameElem=1-1 ElemStation=7,999999999999E-02
Frame=1 Station=0 OutputCase=STR070 CaseType=Combination P=-16,1190000003956 V2=6,8056276783845 V3=0 T=0 M2=0 M3=-1,74705965553815 FrameElem=1-1
ElemStation=0
Frame=1 Station=3,999999999999E-02 OutputCase=STR070 CaseType=Combination P=-15,9030000003956 V2=7,0684726783845 V3=0 T=0 M2=0 M3=-2,02459656267353
FrameElem=1-1 ElemStation=3,999999999999E-02
Frame=1 Station=7,999999999999E-02 OutputCase=STR070 CaseType=Combination P=-15,6870000003956 V2=7,3148476783845 V3=0 T=0 M2=0 M3=-2,31231786980891
FrameElem=1-1 ElemStation=7,999999999999E-02
Frame=1 Station=0 OutputCase=STR071 CaseType=Combination P=-16,1190000002967 V2=1,96904456827646 V3=0 T=0 M2=0 M3=-1,30491661262798 FrameElem=1-1
ElemStation=0
Frame=1 Station=3,999999999999E-02 OutputCase=STR071 CaseType=Combination P=-15,9030000002967 V2=2,09154456827646 V3=0 T=0 M2=0 M3=-1,38615439535904
FrameElem=1-1 ElemStation=3,999999999999E-02
Frame=1 Station=7,999999999999E-02 OutputCase=STR071 CaseType=Combination P=-15,6870000002967 V2=2,20624456827646 V3=0 T=0 M2=0 M3=-1,47213617809009
FrameElem=1-1 ElemStation=7,999999999999E-02
Frame=1 Station=0 OutputCase=STR072 CaseType=Combination P=-96,7949999992877 V2=2,94118939009666 V3=0 T=0 M2=0 M3=-12,6514376480144 FrameElem=1-1
ElemStation=0
Frame=1 Station=3,999999999999E-02 OutputCase=STR072 CaseType=Combination P=-96,5789999992877 V2=3,06368939009666 V3=0 T=0 M2=0 M3=-12,7715612236183
FrameElem=1-1 ElemStation=3,999999999999E-02
Frame=1 Station=7,999999999999E-02 OutputCase=STR072 CaseType=Combination P=-96,3629999992877 V2=3,17838939009666 V3=0 T=0 M2=0 M3=-12,8964287992221
FrameElem=1-1 ElemStation=7,999999999999E-02
Frame=1 Station=0 OutputCase=STR073 CaseType=Combination P=-107,150912233305 V2=16,1354423237749 V3=0 T=0 M2=0 M3=-22,0347580970873 FrameElem=1-1
ElemStation=0
Frame=1 Station=3,999999999999E-02 OutputCase=STR073 CaseType=Combination P=-106,934912233305 V2=16,2579423237749 V3=0 T=0 M2=0 M3=-22,6826517900383
FrameElem=1-1 ElemStation=3,999999999999E-02
Frame=1 Station=7,999999999999E-02 OutputCase=STR073 CaseType=Combination P=-106,718912233305 V2=16,3726423237749 V3=0 T=0 M2=0 M3=-23,3352894829893
FrameElem=1-1 ElemStation=7,999999999999E-02
Frame=1 Station=0 OutputCase=STR074 CaseType=Combination P=-96,7950000003296 V2=26,8808002418856 V3=0 T=0 M2=0 M3=-14,3250266397886 FrameElem=1-1
ElemStation=0
Frame=1 Station=3,999999999999E-02 OutputCase=STR074 CaseType=Combination P=-96,5790000003296 V2=28,2313739918856 V3=0 T=0 M2=0 M3=-15,427320299464
FrameElem=1-1 ElemStation=3,999999999999E-02
Frame=1 Station=7,999999999999E-02 OutputCase=STR074 CaseType=Combination P=-96,3630000003296 V2=29,5668952418855 V3=0 T=0 M2=0 M3=-16,5833358591394
FrameElem=1-1 ElemStation=7,999999999999E-02
Frame=1 Station=0 OutputCase=STR075 CaseType=Combination P=-22,2959122342519 V2=15,3603785171897 V3=0 T=0 M2=0 M3=-10,1634119480975 FrameElem=1-1
ElemStation=0
Frame=1 Station=3,999999999999E-02 OutputCase=STR075 CaseType=Combination P=-22,1359122342519 V2=15,4828785171897 V3=0 T=0 M2=0 M3=-10,7803030887851
FrameElem=1-1 ElemStation=3,999999999999E-02
Frame=1 Station=7,999999999999E-02 OutputCase=STR075 CaseType=Combination P=-21,9759122342519 V2=15,5975785171897 V3=0 T=0 M2=0 M3=-11,4019382294726
FrameElem=1-1 ElemStation=7,999999999999E-02
Frame=1 Station=0 OutputCase=STR076 CaseType=Combination P=-11,940000012766 V2=26,1057364353004 V3=0 T=0 M2=0 M3=-2,4536804907987 FrameElem=1-1
ElemStation=0
Frame=1 Station=3,999999999999E-02 OutputCase=STR076 CaseType=Combination P=-11,780000012766 V2=27,4563101853004 V3=0 T=0 M2=0 M3=-3,52497159821071
FrameElem=1-1 ElemStation=3,999999999999E-02
Frame=1 Station=7,999999999999E-02 OutputCase=STR076 CaseType=Combination P=-11,620000012766 V2=28,7918314353004 V3=0 T=0 M2=0 M3=-4,64998460562272
FrameElem=1-1 ElemStation=7,999999999999E-02
Frame=1 Station=0 OutputCase=STR077 CaseType=Combination P=-15,3561976049796 V2=7,89531219330973 V3=0 T=0 M2=0 M3=-1,71789963266613 FrameElem=1-1
ElemStation=0
Frame=1 Station=3,999999999999E-02 OutputCase=STR077 CaseType=Combination P=-15,1401976049796 V2=8,15815719330973 V3=0 T=0 M2=0 M3=-2,03902392039852
FrameElem=1-1 ElemStation=3,999999999999E-02
Frame=1 Station=7,999999999999E-02 OutputCase=STR077 CaseType=Combination P=-14,9241976049796 V2=8,40453219330973 V3=0 T=0 M2=0 M3=-2,37033260813091
FrameElem=1-1 ElemStation=7,999999999999E-02
Frame=1 Station=0 OutputCase=STR078 CaseType=Combination P=-15,3561976048806 V2=3,05872908320169 V3=0 T=0 M2=0 M3=-1,27575658975596 FrameElem=1-1
ElemStation=0

Società di Progetto
Brebemi SpA



Doc. N.
60235-0000-A00.doc

CODIFICA DOCUMENTO
04RCDII10000000000300A00

REV.
00

FOGLIO
222 di 628

Frame=1 Station=3,9999999999999999E-02 OutputCase=STR078 CaseType=Combination P=-15,1401976048806 V2=3,18122908320169 V3=0 T=0 M2=0 M3=-1,40058175308403
FrameElem=1-1 ElemStation=3,9999999999999999E-02
Frame=1 Station=7,9999999999999998E-02 OutputCase=STR078 CaseType=Combination P=-14,9241976048806 V2=3,29592908320169 V3=0 T=0 M2=0 M3=-1,53015091641209
FrameElem=1-1 ElemStation=7,9999999999999998E-02
Frame=1 Station=0 OutputCase=STR079 CaseType=Combination P=-123,229318561702 V2=4,50750418476785 V3=0 T=0 M2=0 M3=-16,8573012663903 FrameElem=1-1
ElemStation=0
Frame=1 Station=3,9999999999999999E-02 OutputCase=STR079 CaseType=Combination P=-123,013318561702 V2=4,63000418476785 V3=0 T=0 M2=0 M3=-17,040077433781
FrameElem=1-1 ElemStation=3,9999999999999999E-02
Frame=1 Station=7,9999999999999998E-02 OutputCase=STR079 CaseType=Combination P=-122,797318561702 V2=4,74470418476785 V3=0 T=0 M2=0 M3=-17,2275976011718
FrameElem=1-1 ElemStation=7,9999999999999998E-02
Frame=1 Station=0 OutputCase=STR080 CaseType=Combination P=-136,411100147164 V2=21,2484075773417 V3=0 T=0 M2=0 M3=-28,7768154683123 FrameElem=1-1
ElemStation=0
Frame=1 Station=3,9999999999999999E-02 OutputCase=STR080 CaseType=Combination P=-136,195100147164 V2=21,3709075773417 V3=0 T=0 M2=0 M3=-29,629227771406
FrameElem=1-1 ElemStation=3,9999999999999999E-02
Frame=1 Station=7,9999999999999998E-02 OutputCase=STR080 CaseType=Combination P=-135,979100147164 V2=21,4856075773417 V3=0 T=0 M2=0 M3=-30,4863840744997
FrameElem=1-1 ElemStation=7,9999999999999998E-02
Frame=1 Station=0 OutputCase=STR081 CaseType=Combination P=-123,229318563058 V2=34,8147909504504 V3=0 T=0 M2=0 M3=-18,9413722411191 FrameElem=1-1
ElemStation=0
Frame=1 Station=3,9999999999999999E-02 OutputCase=STR081 CaseType=Combination P=-123,013318563058 V2=36,5279409504504 V3=0 T=0 M2=0 M3=-20,3682754791372
FrameElem=1-1 ElemStation=3,9999999999999999E-02
Frame=1 Station=7,9999999999999998E-02 OutputCase=STR081 CaseType=Combination P=-122,797318563058 V2=38,2265109504504 V3=0 T=0 M2=0 M3=-21,8634131171552
FrameElem=1-1 ElemStation=7,9999999999999998E-02
Frame=1 Station=0 OutputCase=STR082 CaseType=Combination P=-24,6641001484474 V2=20,1492954968165 V3=0 T=0 M2=0 M3=-13,1232956408603 FrameElem=1-1
ElemStation=0
Frame=1 Station=3,9999999999999999E-02 OutputCase=STR082 CaseType=Combination P=-24,5041001484474 V2=20,2717954968165 V3=0 T=0 M2=0 M3=-13,931743460733
FrameElem=1-1 ElemStation=3,9999999999999999E-02
Frame=1 Station=7,9999999999999998E-02 OutputCase=STR082 CaseType=Combination P=-24,3441001484474 V2=20,3864954968165 V3=0 T=0 M2=0 M3=-14,7449352806056
FrameElem=1-1 ElemStation=7,9999999999999998E-02
Frame=1 Station=0 OutputCase=STR083 CaseType=Combination P=-11,4823185643415 V2=33,7156788699252 V3=0 T=0 M2=0 M3=-3,28785241366714 FrameElem=1-1
ElemStation=0
Frame=1 Station=3,9999999999999999E-02 OutputCase=STR083 CaseType=Combination P=-11,3223185643415 V2=35,4288288699252 V3=0 T=0 M2=0 M3=-4,67079116846414
FrameElem=1-1 ElemStation=3,9999999999999999E-02
Frame=1 Station=7,9999999999999998E-02 OutputCase=STR083 CaseType=Combination P=-11,1623185643415 V2=37,1273988699251 V3=0 T=0 M2=0 M3=-6,12196432326114
FrameElem=1-1 ElemStation=7,9999999999999998E-02
Frame=1 Station=0 OutputCase=STR084 CaseType=Combination P=-126,06314358619 V2=36,0900588489518 V3=0 T=0 M2=0 M3=-37,0384876520076 FrameElem=1-1
ElemStation=0
Frame=1 Station=3,9999999999999999E-02 OutputCase=STR084 CaseType=Combination P=-125,84714358619 V2=36,2125588489518 V3=0 T=0 M2=0 M3=-38,4845660059657
FrameElem=1-1 ElemStation=3,9999999999999999E-02
Frame=1 Station=7,9999999999999998E-02 OutputCase=STR084 CaseType=Combination P=-125,63114358619 V2=36,3272588489518 V3=0 T=0 M2=0 M3=-39,9353883599238
FrameElem=1-1 ElemStation=7,9999999999999998E-02
Frame=1 Station=0 OutputCase=STR085 CaseType=Combination P=-96,0321976038717 V2=4,03087390502189 V3=0 T=0 M2=0 M3=-12,6222776251424 FrameElem=1-1
ElemStation=0
Frame=1 Station=3,9999999999999999E-02 OutputCase=STR085 CaseType=Combination P=-95,8161976038717 V2=4,15337390502189 V3=0 T=0 M2=0 M3=-12,7859885813433
FrameElem=1-1 ElemStation=3,9999999999999999E-02
Frame=1 Station=7,9999999999999998E-02 OutputCase=STR085 CaseType=Combination P=-95,6001976038716 V2=4,26807390502189 V3=0 T=0 M2=0 M3=-12,9544435375441
FrameElem=1-1 ElemStation=7,9999999999999998E-02
Frame=1 Station=0 OutputCase=STR086 CaseType=Combination P=-106,388109837889 V2=17,2251268387001 V3=0 T=0 M2=0 M3=-22,0055980742153 FrameElem=1-1
ElemStation=0
Frame=1 Station=3,9999999999999999E-02 OutputCase=STR086 CaseType=Combination P=-106,172109837889 V2=17,3476268387001 V3=0 T=0 M2=0 M3=-22,6970791477633
FrameElem=1-1 ElemStation=3,9999999999999999E-02
Frame=1 Station=7,9999999999999998E-02 OutputCase=STR086 CaseType=Combination P=-105,956109837889 V2=17,4623268387001 V3=0 T=0 M2=0 M3=-23,3933042213113
FrameElem=1-1 ElemStation=7,9999999999999998E-02
Frame=1 Station=0 OutputCase=STR087 CaseType=Combination P=-96,0321976049136 V2=27,9704847568108 V3=0 T=0 M2=0 M3=-14,2958666169165 FrameElem=1-1
ElemStation=0
Frame=1 Station=3,9999999999999999E-02 OutputCase=STR087 CaseType=Combination P=-95,8161976049136 V2=29,3210585068108 V3=0 T=0 M2=0 M3=-15,441747657189
FrameElem=1-1 ElemStation=3,9999999999999999E-02
Frame=1 Station=7,9999999999999998E-02 OutputCase=STR087 CaseType=Combination P=-95,6001976049136 V2=30,6565797568108 V3=0 T=0 M2=0 M3=-16,6413505974614
FrameElem=1-1 ElemStation=7,9999999999999998E-02
Frame=1 Station=0 OutputCase=STR088 CaseType=Combination P=-21,5331098388358 V2=16,450063032115 V3=0 T=0 M2=0 M3=-10,1342519252254 FrameElem=1-1
ElemStation=0
Frame=1 Station=3,9999999999999999E-02 OutputCase=STR088 CaseType=Combination P=-21,3731098388358 V2=16,572563032115 V3=0 T=0 M2=0 M3=-10,79473044651
FrameElem=1-1 ElemStation=3,9999999999999999E-02
Frame=1 Station=7,9999999999999998E-02 OutputCase=STR088 CaseType=Combination P=-21,2131098388358 V2=16,687263032115 V3=0 T=0 M2=0 M3=-11,4599529677946
FrameElem=1-1 ElemStation=7,9999999999999998E-02
Frame=1 Station=0 OutputCase=STR089 CaseType=Combination P=-11,1771976058606 V2=27,1954209502256 V3=0 T=0 M2=0 M3=-2,42452046792668 FrameElem=1-1
ElemStation=0
Frame=1 Station=3,9999999999999999E-02 OutputCase=STR089 CaseType=Combination P=-11,0171976058606 V2=28,5459947002256 V3=0 T=0 M2=0 M3=-3,5393989559357
FrameElem=1-1 ElemStation=3,9999999999999999E-02
Frame=1 Station=7,9999999999999998E-02 OutputCase=STR089 CaseType=Combination P=-10,8571976058606 V2=29,8815159502256 V3=0 T=0 M2=0 M3=-4,70799934394472
FrameElem=1-1 ElemStation=7,9999999999999998E-02
Frame=1 Station=0 OutputCase=STR090 CaseType=Combination P=-15,3561976049797 V2=8,44698951684972 V3=0 T=0 M2=0 M3=-2,13151146420081 FrameElem=1-1
ElemStation=0
Frame=1 Station=3,9999999999999999E-02 OutputCase=STR090 CaseType=Combination P=-15,1401976049797 V2=8,70983451684972 V3=0 T=0 M2=0 M3=-2,4747028448748
FrameElem=1-1 ElemStation=3,9999999999999999E-02
Frame=1 Station=7,9999999999999998E-02 OutputCase=STR090 CaseType=Combination P=-14,9241976049797 V2=8,95620951684972 V3=0 T=0 M2=0 M3=-2,82807862554879
FrameElem=1-1 ElemStation=7,9999999999999998E-02
Frame=1 Station=0 OutputCase=STR091 CaseType=Combination P=-15,3561976048808 V2=3,61040640674168 V3=0 T=0 M2=0 M3=-1,68936842129064 FrameElem=1-1
ElemStation=0
Frame=1 Station=3,9999999999999999E-02 OutputCase=STR091 CaseType=Combination P=-15,1401976048808 V2=3,73290640674168 V3=0 T=0 M2=0 M3=-1,83626067756031
FrameElem=1-1 ElemStation=3,9999999999999999E-02
Frame=1 Station=7,9999999999999998E-02 OutputCase=STR091 CaseType=Combination P=-14,9241976048808 V2=3,84760640674168 V3=0 T=0 M2=0 M3=-1,98789693382997
FrameElem=1-1 ElemStation=7,9999999999999998E-02
Frame=1 Station=0 OutputCase=STR092 CaseType=Combination P=-96,0321976038718 V2=4,58255122856188 V3=0 T=0 M2=0 M3=-13,0358894566771 FrameElem=1-1
ElemStation=0
Frame=1 Station=3,9999999999999999E-02 OutputCase=STR092 CaseType=Combination P=-95,8161976038718 V2=4,70505122856188 V3=0 T=0 M2=0 M3=-13,2216675058195
FrameElem=1-1 ElemStation=3,9999999999999999E-02
Frame=1 Station=7,9999999999999998E-02 OutputCase=STR092 CaseType=Combination P=-95,6001976038718 V2=4,81975122856188 V3=0 T=0 M2=0 M3=-13,412189554962
FrameElem=1-1 ElemStation=7,9999999999999998E-02

Società di Progetto
Brebemi SpA



Doc. N.
60235-0000-A00.doc

CODIFICA DOCUMENTO
04RCDII10000000000300A00

REV.
00

FOGLIO
223 di 628

Frame=1 Station=0 OutputCase=STR093 CaseType=Combination P=-106,388109837889 V2=17,7768041622401 V3=0 T=0 M2=0 M3=-22,41920990575 FrameElem=1-1 ElemStation=0

Frame=1 Station=3,9999999999999999E-02 OutputCase=STR093 CaseType=Combination P=-106,172109837889 V2=17,8993041622401 V3=0 T=0 M2=0 M3=-23,1327580722396 FrameElem=1-1 ElemStation=3,9999999999999999E-02

Frame=1 Station=7,9999999999999998E-02 OutputCase=STR093 CaseType=Combination P=-105,956109837889 V2=18,0140041622401 V3=0 T=0 M2=0 M3=-23,8510502387292 FrameElem=1-1 ElemStation=7,9999999999999998E-02

Frame=1 Station=0 OutputCase=STR094 CaseType=Combination P=-96,0321976049137 V2=28,5221620803508 V3=0 T=0 M2=0 M3=-14,7094784484512 FrameElem=1-1 ElemStation=0

Frame=1 Station=3,9999999999999999E-02 OutputCase=STR094 CaseType=Combination P=-95,8161976049137 V2=29,8727358303508 V3=0 T=0 M2=0 M3=-15,8774265816652 FrameElem=1-1 ElemStation=3,9999999999999999E-02

Frame=1 Station=7,9999999999999998E-02 OutputCase=STR094 CaseType=Combination P=-95,6001976049137 V2=31,2082570803508 V3=0 T=0 M2=0 M3=-17,0990966148793 FrameElem=1-1 ElemStation=7,9999999999999998E-02

Frame=1 Station=0 OutputCase=STR095 CaseType=Combination P=-21,533109838836 V2=17,001740355655 V3=0 T=0 M2=0 M3=-10,5478637567601 FrameElem=1-1 ElemStation=0

Frame=1 Station=3,9999999999999999E-02 OutputCase=STR095 CaseType=Combination P=-21,373109838836 V2=17,124240355655 V3=0 T=0 M2=0 M3=-11,2304093709863 FrameElem=1-1 ElemStation=3,9999999999999999E-02

Frame=1 Station=7,9999999999999998E-02 OutputCase=STR095 CaseType=Combination P=-21,213109838836 V2=17,238940355655 V3=0 T=0 M2=0 M3=-11,9176989852125 FrameElem=1-1 ElemStation=7,9999999999999998E-02

Frame=1 Station=0 OutputCase=STR096 CaseType=Combination P=-11,1771976058608 V2=27,7470982737656 V3=0 T=0 M2=0 M3=-2,83813229946136 FrameElem=1-1 ElemStation=0

Frame=1 Station=3,9999999999999999E-02 OutputCase=STR096 CaseType=Combination P=-11,0171976058608 V2=29,0976720237656 V3=0 T=0 M2=0 M3=-3,97507788041198 FrameElem=1-1 ElemStation=3,9999999999999999E-02

Frame=1 Station=7,9999999999999998E-02 OutputCase=STR096 CaseType=Combination P=-10,8571976058608 V2=30,4331932737656 V3=0 T=0 M2=0 M3=-5,1657453613626 FrameElem=1-1 ElemStation=7,9999999999999998E-02

Frame=1 Station=0 OutputCase=STR097 CaseType=Combination P=-15,3561976049794 V2=7,34363486976974 V3=0 T=0 M2=0 M3=-1,30428780113145 FrameElem=1-1 ElemStation=0

Frame=1 Station=3,9999999999999999E-02 OutputCase=STR097 CaseType=Combination P=-15,1401976049794 V2=7,60647986976974 V3=0 T=0 M2=0 M3=-1,60334499592224 FrameElem=1-1 ElemStation=3,9999999999999999E-02

Frame=1 Station=7,9999999999999998E-02 OutputCase=STR097 CaseType=Combination P=-14,9241976049794 V2=7,85285486976974 V3=0 T=0 M2=0 M3=-1,91258659071303 FrameElem=1-1 ElemStation=7,9999999999999998E-02

Frame=1 Station=0 OutputCase=STR098 CaseType=Combination P=-15,3561976048804 V2=2,5070517596617 V3=0 T=0 M2=0 M3=-0,862144758221278 FrameElem=1-1 ElemStation=0

Frame=1 Station=3,9999999999999999E-02 OutputCase=STR098 CaseType=Combination P=-15,1401976048805 V2=2,6295517596617 V3=0 T=0 M2=0 M3=-0,964902828607746 FrameElem=1-1 ElemStation=3,9999999999999999E-02

Frame=1 Station=7,9999999999999998E-02 OutputCase=STR098 CaseType=Combination P=-14,9241976048805 V2=2,7442517596617 V3=0 T=0 M2=0 M3=-1,07240489899421 FrameElem=1-1 ElemStation=7,9999999999999998E-02

Frame=1 Station=0 OutputCase=STR099 CaseType=Combination P=-96,0321976038715 V2=3,4791965814819 V3=0 T=0 M2=0 M3=-12,2086657936077 FrameElem=1-1 ElemStation=0

Frame=1 Station=3,9999999999999999E-02 OutputCase=STR099 CaseType=Combination P=-95,8161976038715 V2=3,6016965814819 V3=0 T=0 M2=0 M3=-12,350309656867 FrameElem=1-1 ElemStation=3,9999999999999999E-02

Frame=1 Station=7,9999999999999998E-02 OutputCase=STR099 CaseType=Combination P=-95,6001976038715 V2=3,7163965814819 V3=0 T=0 M2=0 M3=-12,4966975201263 FrameElem=1-1 ElemStation=7,9999999999999998E-02

Frame=1 Station=0 OutputCase=STR100 CaseType=Combination P=-106,388109837889 V2=16,6734495151601 V3=0 T=0 M2=0 M3=-21,5919862426806 FrameElem=1-1 ElemStation=0

Frame=1 Station=3,9999999999999999E-02 OutputCase=STR100 CaseType=Combination P=-106,172109837889 V2=16,7959495151601 V3=0 T=0 M2=0 M3=-22,261400223287 FrameElem=1-1 ElemStation=3,9999999999999999E-02

Frame=1 Station=7,9999999999999998E-02 OutputCase=STR100 CaseType=Combination P=-105,956109837889 V2=16,9106495151601 V3=0 T=0 M2=0 M3=-22,9355582038934 FrameElem=1-1 ElemStation=7,9999999999999998E-02

Frame=1 Station=0 OutputCase=STR101 CaseType=Combination P=-96,0321976049134 V2=27,4188074332708 V3=0 T=0 M2=0 M3=-13,8822547853819 FrameElem=1-1 ElemStation=0

Frame=1 Station=3,9999999999999999E-02 OutputCase=STR101 CaseType=Combination P=-95,8161976049134 V2=28,7693811832708 V3=0 T=0 M2=0 M3=-15,0060687327127 FrameElem=1-1 ElemStation=3,9999999999999999E-02

Frame=1 Station=7,9999999999999998E-02 OutputCase=STR101 CaseType=Combination P=-95,6001976049134 V2=30,1049024332708 V3=0 T=0 M2=0 M3=-16,1836045800435 FrameElem=1-1 ElemStation=7,9999999999999998E-02

Frame=1 Station=0 OutputCase=STR102 CaseType=Combination P=-21,5331098388357 V2=15,898385708575 V3=0 T=0 M2=0 M3=-9,72064009369076 FrameElem=1-1 ElemStation=0

Frame=1 Station=3,9999999999999999E-02 OutputCase=STR102 CaseType=Combination P=-21,3731098388357 V2=16,020885708575 V3=0 T=0 M2=0 M3=-10,3590515220338 FrameElem=1-1 ElemStation=3,9999999999999999E-02

Frame=1 Station=7,9999999999999998E-02 OutputCase=STR102 CaseType=Combination P=-21,2131098388357 V2=16,13558708575 V3=0 T=0 M2=0 M3=-11,0022069503768 FrameElem=1-1 ElemStation=7,9999999999999998E-02

Frame=1 Station=0 OutputCase=STR103 CaseType=Combination P=-11,1771976058604 V2=26,6437436266857 V3=0 T=0 M2=0 M3=-2,010908636392 FrameElem=1-1 ElemStation=0

Frame=1 Station=3,9999999999999999E-02 OutputCase=STR103 CaseType=Combination P=-11,0171976058604 V2=27,9943173766857 V3=0 T=0 M2=0 M3=-3,10372003145942 FrameElem=1-1 ElemStation=3,9999999999999999E-02

Frame=1 Station=7,9999999999999998E-02 OutputCase=STR103 CaseType=Combination P=-10,8571976058604 V2=29,3298386266857 V3=0 T=0 M2=0 M3=-4,2502533262685 FrameElem=1-1 ElemStation=7,9999999999999998E-02

Frame=1 Station=0 OutputCase=STR104 CaseType=Combination P=-15,3561976049794 V2=7,34363486976974 V3=0 T=0 M2=0 M3=-1,30428780113145 FrameElem=1-1 ElemStation=0

Frame=1 Station=3,9999999999999999E-02 OutputCase=STR104 CaseType=Combination P=-15,1401976049794 V2=7,60647986976974 V3=0 T=0 M2=0 M3=-1,60334499592224 FrameElem=1-1 ElemStation=3,9999999999999999E-02

Frame=1 Station=7,9999999999999998E-02 OutputCase=STR104 CaseType=Combination P=-14,9241976049794 V2=7,85285486976974 V3=0 T=0 M2=0 M3=-1,91258659071303 FrameElem=1-1 ElemStation=7,9999999999999998E-02

Frame=1 Station=0 OutputCase=STR105 CaseType=Combination P=-15,3561976048804 V2=2,5070517596617 V3=0 T=0 M2=0 M3=-0,862144758221278 FrameElem=1-1 ElemStation=0

Frame=1 Station=3,9999999999999999E-02 OutputCase=STR105 CaseType=Combination P=-15,1401976048805 V2=2,6295517596617 V3=0 T=0 M2=0 M3=-0,964902828607746 FrameElem=1-1 ElemStation=3,9999999999999999E-02

Frame=1 Station=7,9999999999999998E-02 OutputCase=STR105 CaseType=Combination P=-14,9241976048805 V2=2,7442517596617 V3=0 T=0 M2=0 M3=-1,07240489899421 FrameElem=1-1 ElemStation=7,9999999999999998E-02

Frame=1 Station=0 OutputCase=STR106 CaseType=Combination P=-96,0321976038715 V2=3,4791965814819 V3=0 T=0 M2=0 M3=-12,2086657936077 FrameElem=1-1 ElemStation=0

Frame=1 Station=3,9999999999999999E-02 OutputCase=STR106 CaseType=Combination P=-95,8161976038715 V2=3,6016965814819 V3=0 T=0 M2=0 M3=-12,350309656867 FrameElem=1-1 ElemStation=3,9999999999999999E-02

Frame=1 Station=7,9999999999999998E-02 OutputCase=STR106 CaseType=Combination P=-95,6001976038715 V2=3,7163965814819 V3=0 T=0 M2=0 M3=-12,4966975201263 FrameElem=1-1 ElemStation=7,9999999999999998E-02

Frame=1 Station=0 OutputCase=STR107 CaseType=Combination P=-106,388109837889 V2=16,6734495151601 V3=0 T=0 M2=0 M3=-21,5919862426806 FrameElem=1-1 ElemStation=0

Frame=1 Station=3,9999999999999999E-02 OutputCase=STR107 CaseType=Combination P=-106,172109837889 V2=16,7959495151601 V3=0 T=0 M2=0 M3=-22,261400223287 FrameElem=1-1 ElemStation=3,9999999999999999E-02

Società di Progetto
Brebemi SpA



Doc. N.
60235-0000-A00.doc

CODIFICA DOCUMENTO
04RCDII10000000000300A00

REV.
00

FOGLIO
224 di 628

Frame=1 Station=7,999999999999999E-02 OutputCase=STR107 CaseType=Combination P=-105,956109837889 V2=16,9106495151601 V3=0 T=0 M2=0 M3=-22,935582038934
FrameElem=1-1 ElemStation=7,999999999999999E-02
Frame=1 Station=0 OutputCase=STR108 CaseType=Combination P=-96,0321976049134 V2=27,4188074332708 V3=0 T=0 M2=0 M3=-13,8822547853819 FrameElem=1-1
ElemStation=0
Frame=1 Station=3,999999999999999E-02 OutputCase=STR108 CaseType=Combination P=-95,8161976049134 V2=28,7693811832708 V3=0 T=0 M2=0 M3=-15,0060687327127
FrameElem=1-1 ElemStation=3,999999999999999E-02
Frame=1 Station=7,999999999999999E-02 OutputCase=STR108 CaseType=Combination P=-95,6001976049134 V2=30,1049024332708 V3=0 T=0 M2=0 M3=-16,1836045800435
FrameElem=1-1 ElemStation=7,999999999999999E-02
Frame=1 Station=0 OutputCase=STR109 CaseType=Combination P=-21,5331098388357 V2=15,898385708575 V3=0 T=0 M2=0 M3=-9,72064009369076 FrameElem=1-1
ElemStation=0
Frame=1 Station=3,999999999999999E-02 OutputCase=STR109 CaseType=Combination P=-21,3731098388357 V2=16,020885708575 V3=0 T=0 M2=0 M3=-10,3590515220338
FrameElem=1-1 ElemStation=3,999999999999999E-02
Frame=1 Station=7,999999999999999E-02 OutputCase=STR109 CaseType=Combination P=-21,2131098388357 V2=16,135585708575 V3=0 T=0 M2=0 M3=-11,0022069503768
FrameElem=1-1 ElemStation=7,999999999999999E-02
Frame=1 Station=0 OutputCase=STR110 CaseType=Combination P=-11,1771976058604 V2=26,6437436266857 V3=0 T=0 M2=0 M3=-2,010908636392 FrameElem=1-1
ElemStation=0
Frame=1 Station=3,999999999999999E-02 OutputCase=STR110 CaseType=Combination P=-11,0171976058604 V2=27,9943173766857 V3=0 T=0 M2=0 M3=-3,10372003145942
FrameElem=1-1 ElemStation=3,999999999999999E-02
Frame=1 Station=7,999999999999999E-02 OutputCase=STR110 CaseType=Combination P=-10,8571976058604 V2=29,3298386266857 V3=0 T=0 M2=0 M3=-4,25025332652685
FrameElem=1-1 ElemStation=7,999999999999999E-02
Frame=1 Station=0 OutputCase=STR111 CaseType=Combination P=-16,8818023958125 V2=8,6582222233921 V3=0 T=0 M2=0 M3=-3,98214944659513 FrameElem=1-1
ElemStation=0
Frame=1 Station=3,999999999999999E-02 OutputCase=STR111 CaseType=Combination P=-16,6658023958125 V2=8,92106722233921 V3=0 T=0 M2=0 M3=-4,3337901354887
FrameElem=1-1 ElemStation=3,999999999999999E-02
Frame=1 Station=7,999999999999999E-02 OutputCase=STR111 CaseType=Combination P=-16,4498023958125 V2=9,16744222233921 V3=0 T=0 M2=0 M3=-4,69561522438227
FrameElem=1-1 ElemStation=7,999999999999999E-02
Frame=1 Station=0 OutputCase=STR112 CaseType=Combination P=-16,8818023957136 V2=3,82163911223117 V3=0 T=0 M2=0 M3=-3,54000640368496 FrameElem=1-1
ElemStation=0
Frame=1 Station=3,999999999999999E-02 OutputCase=STR112 CaseType=Combination P=-16,6658023957136 V2=3,94413911223117 V3=0 T=0 M2=0 M3=-3,6953479681742
FrameElem=1-1 ElemStation=3,999999999999999E-02
Frame=1 Station=7,999999999999999E-02 OutputCase=STR112 CaseType=Combination P=-16,4498023957136 V2=4,05883911223117 V3=0 T=0 M2=0 M3=-3,85543353266345
FrameElem=1-1 ElemStation=7,999999999999999E-02
Frame=1 Station=0 OutputCase=STR113 CaseType=Combination P=-124,144681436202 V2=4,96525020218554 V3=0 T=0 M2=0 M3=-18,2158511547477 FrameElem=1-1
ElemStation=0
Frame=1 Station=3,999999999999999E-02 OutputCase=STR113 CaseType=Combination P=-123,928681436202 V2=5,08775020218554 V3=0 T=0 M2=0 M3=-18,4169371628351
FrameElem=1-1 ElemStation=3,999999999999999E-02
Frame=1 Station=7,999999999999999E-02 OutputCase=STR113 CaseType=Combination P=-123,712681436202 V2=5,20245020218554 V3=0 T=0 M2=0 M3=-18,6227671709226
FrameElem=1-1 ElemStation=7,999999999999999E-02
Frame=1 Station=0 OutputCase=STR114 CaseType=Combination P=-137,326463021664 V2=21,7061535947594 V3=0 T=0 M2=0 M3=-30,1353653566697 FrameElem=1-1
ElemStation=0
Frame=1 Station=3,999999999999999E-02 OutputCase=STR114 CaseType=Combination P=-137,110463021664 V2=21,8286535947594 V3=0 T=0 M2=0 M3=-31,0060875004601
FrameElem=1-1 ElemStation=3,999999999999999E-02
Frame=1 Station=7,999999999999999E-02 OutputCase=STR114 CaseType=Combination P=-136,894463021664 V2=21,9433535947594 V3=0 T=0 M2=0 M3=-31,8815536442505
FrameElem=1-1 ElemStation=7,999999999999999E-02
Frame=1 Station=0 OutputCase=STR115 CaseType=Combination P=-124,144681437558 V2=35,2725369678681 V3=0 T=0 M2=0 M3=-20,2999221294765 FrameElem=1-1
ElemStation=0
Frame=1 Station=3,999999999999999E-02 OutputCase=STR115 CaseType=Combination P=-123,928681437558 V2=36,985686967868 V3=0 T=0 M2=0 M3=-21,7451352081913
FrameElem=1-1 ElemStation=3,999999999999999E-02
Frame=1 Station=7,999999999999999E-02 OutputCase=STR115 CaseType=Combination P=-123,712681437558 V2=38,6842569678681 V3=0 T=0 M2=0 M3=-23,258582686906
FrameElem=1-1 ElemStation=7,999999999999999E-02
Frame=1 Station=0 OutputCase=STR116 CaseType=Combination P=-25,5794630229472 V2=20,6070415142342 V3=0 T=0 M2=0 M3=-14,4818455292177 FrameElem=1-1
ElemStation=0
Frame=1 Station=3,999999999999999E-02 OutputCase=STR116 CaseType=Combination P=-25,4194630229472 V2=20,7295415142342 V3=0 T=0 M2=0 M3=-15,3086031897871
FrameElem=1-1 ElemStation=3,999999999999999E-02
Frame=1 Station=7,999999999999999E-02 OutputCase=STR116 CaseType=Combination P=-25,2594630229472 V2=20,8442415142342 V3=0 T=0 M2=0 M3=-16,1401048503564
FrameElem=1-1 ElemStation=7,999999999999999E-02
Frame=1 Station=0 OutputCase=STR117 CaseType=Combination P=-12,3976814388413 V2=34,1734248873428 V3=0 T=0 M2=0 M3=-4,64640230202454 FrameElem=1-1
ElemStation=0
Frame=1 Station=3,999999999999999E-02 OutputCase=STR117 CaseType=Combination P=-12,2376814388413 V2=35,8865748873428 V3=0 T=0 M2=0 M3=-6,04765089751825
FrameElem=1-1 ElemStation=3,999999999999999E-02
Frame=1 Station=7,999999999999999E-02 OutputCase=STR117 CaseType=Combination P=-12,0776814388413 V2=37,5851448873428 V3=0 T=0 M2=0 M3=-7,51713389301196
FrameElem=1-1 ElemStation=7,999999999999999E-02
Frame=1 Station=0 OutputCase=STR118 CaseType=Combination P=-126,97850646069 V2=36,5478048663695 V3=0 T=0 M2=0 M3=-38,397037540365 FrameElem=1-1
ElemStation=0
Frame=1 Station=3,999999999999999E-02 OutputCase=STR118 CaseType=Combination P=-126,76250646069 V2=36,6703048663694 V3=0 T=0 M2=0 M3=-39,8614257350198
FrameElem=1-1 ElemStation=3,999999999999999E-02
Frame=1 Station=7,999999999999999E-02 OutputCase=STR118 CaseType=Combination P=-126,54650646069 V2=36,7850048663695 V3=0 T=0 M2=0 M3=-41,3305579296746
FrameElem=1-1 ElemStation=7,999999999999999E-02
Frame=1 Station=0 OutputCase=STR119 CaseType=Combination P=-97,5578023947046 V2=4,79378393405137 V3=0 T=0 M2=0 M3=-14,8865274390714 FrameElem=1-1
ElemStation=0
Frame=1 Station=3,999999999999999E-02 OutputCase=STR119 CaseType=Combination P=-97,3418023947046 V2=4,91628393405137 V3=0 T=0 M2=0 M3=-15,0807547964334
FrameElem=1-1 ElemStation=3,999999999999999E-02
Frame=1 Station=7,999999999999999E-02 OutputCase=STR119 CaseType=Combination P=-97,1258023947046 V2=5,03098393405137 V3=0 T=0 M2=0 M3=-15,2797261537955
FrameElem=1-1 ElemStation=7,999999999999999E-02
Frame=1 Station=0 OutputCase=STR120 CaseType=Combination P=-107,913714628722 V2=17,9880368677296 V3=0 T=0 M2=0 M3=-24,2698478881443 FrameElem=1-1
ElemStation=0
Frame=1 Station=3,999999999999999E-02 OutputCase=STR120 CaseType=Combination P=-107,697714628722 V2=18,1105368677296 V3=0 T=0 M2=0 M3=-24,9918453628535
FrameElem=1-1 ElemStation=3,999999999999999E-02
Frame=1 Station=7,999999999999999E-02 OutputCase=STR120 CaseType=Combination P=-107,481714628722 V2=18,2252368677296 V3=0 T=0 M2=0 M3=-25,7185868375627
FrameElem=1-1 ElemStation=7,999999999999999E-02
Frame=1 Station=0 OutputCase=STR121 CaseType=Combination P=-97,5578023957465 V2=28,7333947858403 V3=0 T=0 M2=0 M3=-16,5601164308455 FrameElem=1-1
ElemStation=0
Frame=1 Station=3,999999999999999E-02 OutputCase=STR121 CaseType=Combination P=-97,3418023957465 V2=30,0839685358403 V3=0 T=0 M2=0 M3=-17,365138722791
FrameElem=1-1 ElemStation=3,999999999999999E-02
Frame=1 Station=7,999999999999999E-02 OutputCase=STR121 CaseType=Combination P=-97,1258023957465 V2=31,4194897858403 V3=0 T=0 M2=0 M3=-18,9666332137128
FrameElem=1-1 ElemStation=7,999999999999999E-02
Frame=1 Station=0 OutputCase=STR122 CaseType=Combination P=-23,0587146296688 V2=17,2129730611444 V3=0 T=0 M2=0 M3=-12,3985017391544 FrameElem=1-1
ElemStation=0

Società di Progetto
Brebemi SpA



Doc. N.
60235-0000-A00.doc

CODIFICA DOCUMENTO
04RCDII10000000000300A00

REV.
00

FOGLIO
225 di 628

Frame=1 Station=3,999999999999999E-02 OutputCase=STR122 CaseType=Combination P=-22,8987146296688 V2=17,3354730611444 V3=0 T=0 M2=0 M3=-13,0894966616002
FrameElem=1-1 ElemStation=3,999999999999999E-02
Frame=1 Station=7,999999999999998E-02 OutputCase=STR122 CaseType=Combination P=-22,7387146296688 V2=17,4501730611444 V3=0 T=0 M2=0 M3=-13,785235584046
FrameElem=1-1 ElemStation=7,999999999999998E-02
Frame=1 Station=0 OutputCase=STR123 CaseType=Combination P=-12,7028023966936 V2=27,9583309792551 V3=0 T=0 M2=0 M3=-4,68877028185567 FrameElem=1-1
ElemStation=0
Frame=1 Station=3,999999999999999E-02 OutputCase=STR123 CaseType=Combination P=-12,5428023966936 V2=29,3089047292551 V3=0 T=0 M2=0 M3=-5,83416517102588
FrameElem=1-1 ElemStation=3,999999999999999E-02
Frame=1 Station=7,999999999999998E-02 OutputCase=STR123 CaseType=Combination P=-12,3828023966936 V2=30,6444259792551 V3=0 T=0 M2=0 M3=-7,03328196019608
FrameElem=1-1 ElemStation=7,999999999999998E-02
Frame=1 Station=0 OutputCase=STR124 CaseType=Combination P=-16,8818023958127 V2=9,2098995458792 V3=0 T=0 M2=0 M3=-4,39576127812981 FrameElem=1-1
ElemStation=0
Frame=1 Station=3,999999999999999E-02 OutputCase=STR124 CaseType=Combination P=-16,6658023958127 V2=9,4727445458792 V3=0 T=0 M2=0 M3=-4,76946905996498
FrameElem=1-1 ElemStation=3,999999999999999E-02
Frame=1 Station=7,999999999999998E-02 OutputCase=STR124 CaseType=Combination P=-16,4498023958127 V2=9,7191195458792 V3=0 T=0 M2=0 M3=-5,15336124180015
FrameElem=1-1 ElemStation=7,999999999999998E-02
Frame=1 Station=0 OutputCase=STR125 CaseType=Combination P=-16,8818023957137 V2=4,37331643577116 V3=0 T=0 M2=0 M3=-3,95361823521964 FrameElem=1-1
ElemStation=0
Frame=1 Station=3,999999999999999E-02 OutputCase=STR125 CaseType=Combination P=-16,6658023957137 V2=4,49581643577116 V3=0 T=0 M2=0 M3=-4,13102689265048
FrameElem=1-1 ElemStation=3,999999999999999E-02
Frame=1 Station=7,999999999999998E-02 OutputCase=STR125 CaseType=Combination P=-16,4498023957137 V2=4,61051643577116 V3=0 T=0 M2=0 M3=-4,31317955008133
FrameElem=1-1 ElemStation=7,999999999999998E-02
Frame=1 Station=0 OutputCase=STR126 CaseType=Combination P=-97,5578023947048 V2=5,34546125759136 V3=0 T=0 M2=0 M3=-15,3001392706061 FrameElem=1-1
ElemStation=0
Frame=1 Station=3,999999999999999E-02 OutputCase=STR126 CaseType=Combination P=-97,3418023947048 V2=5,46796125759136 V3=0 T=0 M2=0 M3=-15,5164337209097
FrameElem=1-1 ElemStation=3,999999999999999E-02
Frame=1 Station=7,999999999999998E-02 OutputCase=STR126 CaseType=Combination P=-97,1258023947048 V2=5,58266125759136 V3=0 T=0 M2=0 M3=-15,7374721712134
FrameElem=1-1 ElemStation=7,999999999999998E-02
Frame=1 Station=0 OutputCase=STR127 CaseType=Combination P=-107,913714628722 V2=18,5397141912696 V3=0 T=0 M2=0 M3=-24,683459719679 FrameElem=1-1
ElemStation=0
Frame=1 Station=3,999999999999999E-02 OutputCase=STR127 CaseType=Combination P=-107,697714628722 V2=18,6622141912696 V3=0 T=0 M2=0 M3=-25,4275242873298
FrameElem=1-1 ElemStation=3,999999999999999E-02
Frame=1 Station=7,999999999999998E-02 OutputCase=STR127 CaseType=Combination P=-107,481714628722 V2=18,7769141912696 V3=0 T=0 M2=0 M3=-26,1763328549805
FrameElem=1-1 ElemStation=7,999999999999998E-02
Frame=1 Station=0 OutputCase=STR128 CaseType=Combination P=-97,5578023957467 V2=29,2850721093802 V3=0 T=0 M2=0 M3=-16,9737282623802 FrameElem=1-1
ElemStation=0
Frame=1 Station=3,999999999999999E-02 OutputCase=STR128 CaseType=Combination P=-97,3418023957467 V2=30,6356458593802 V3=0 T=0 M2=0 M3=-18,1721927967554
FrameElem=1-1 ElemStation=3,999999999999999E-02
Frame=1 Station=7,999999999999998E-02 OutputCase=STR128 CaseType=Combination P=-97,1258023957467 V2=31,9711671093802 V3=0 T=0 M2=0 M3=-19,4243792311306
FrameElem=1-1 ElemStation=7,999999999999998E-02
Frame=1 Station=0 OutputCase=STR129 CaseType=Combination P=-23,058714629669 V2=17,7646503846844 V3=0 T=0 M2=0 M3=-12,8121135706891 FrameElem=1-1
ElemStation=0
Frame=1 Station=3,999999999999999E-02 OutputCase=STR129 CaseType=Combination P=-22,898714629669 V2=17,8871503846844 V3=0 T=0 M2=0 M3=-13,5251755860765
FrameElem=1-1 ElemStation=3,999999999999999E-02
Frame=1 Station=7,999999999999998E-02 OutputCase=STR129 CaseType=Combination P=-22,738714629669 V2=18,0018503846844 V3=0 T=0 M2=0 M3=-14,2429816014639
FrameElem=1-1 ElemStation=7,999999999999998E-02
Frame=1 Station=0 OutputCase=STR130 CaseType=Combination P=-12,7028023966937 V2=28,5100083027951 V3=0 T=0 M2=0 M3=-5,10238211339035 FrameElem=1-1
ElemStation=0
Frame=1 Station=3,999999999999999E-02 OutputCase=STR130 CaseType=Combination P=-12,5428023966937 V2=29,8605820527951 V3=0 T=0 M2=0 M3=-6,26984409550216
FrameElem=1-1 ElemStation=3,999999999999999E-02
Frame=1 Station=7,999999999999998E-02 OutputCase=STR130 CaseType=Combination P=-12,3828023966937 V2=31,1961033027951 V3=0 T=0 M2=0 M3=-7,49102797761396
FrameElem=1-1 ElemStation=7,999999999999998E-02
Frame=1 Station=0 OutputCase=STR131 CaseType=Combination P=-16,8818023958124 V2=8,10654489879922 V3=0 T=0 M2=0 M3=-3,56853761506045 FrameElem=1-1
ElemStation=0
Frame=1 Station=3,999999999999999E-02 OutputCase=STR131 CaseType=Combination P=-16,6658023958124 V2=8,36938989879922 V3=0 T=0 M2=0 M3=-3,89811121101242
FrameElem=1-1 ElemStation=3,999999999999999E-02
Frame=1 Station=7,999999999999998E-02 OutputCase=STR131 CaseType=Combination P=-16,4498023958124 V2=8,61576489879922 V3=0 T=0 M2=0 M3=-4,23786920696439
FrameElem=1-1 ElemStation=7,999999999999998E-02
Frame=1 Station=0 OutputCase=STR132 CaseType=Combination P=-16,8818023957134 V2=3,26996178869118 V3=0 T=0 M2=0 M3=-3,12639457215028 FrameElem=1-1
ElemStation=0
Frame=1 Station=3,999999999999999E-02 OutputCase=STR132 CaseType=Combination P=-16,6658023957134 V2=3,39246178869118 V3=0 T=0 M2=0 M3=-3,25966904369792
FrameElem=1-1 ElemStation=3,999999999999999E-02
Frame=1 Station=7,999999999999998E-02 OutputCase=STR132 CaseType=Combination P=-16,4498023957134 V2=3,50716178869118 V3=0 T=0 M2=0 M3=-3,39768751524557
FrameElem=1-1 ElemStation=7,999999999999998E-02
Frame=1 Station=0 OutputCase=STR133 CaseType=Combination P=-97,5578023947044 V2=4,24210661051138 V3=0 T=0 M2=0 M3=-14,4729156075367 FrameElem=1-1
ElemStation=0
Frame=1 Station=3,999999999999999E-02 OutputCase=STR133 CaseType=Combination P=-97,3418023947044 V2=4,36460661051138 V3=0 T=0 M2=0 M3=-14,6450758719572
FrameElem=1-1 ElemStation=3,999999999999999E-02
Frame=1 Station=7,999999999999998E-02 OutputCase=STR133 CaseType=Combination P=-97,1258023947044 V2=4,47930661051138 V3=0 T=0 M2=0 M3=-14,8219801363776
FrameElem=1-1 ElemStation=7,999999999999998E-02
Frame=1 Station=0 OutputCase=STR134 CaseType=Combination P=-107,913714628722 V2=17,4363595441896 V3=0 T=0 M2=0 M3=-23,8562360566096 FrameElem=1-1
ElemStation=0
Frame=1 Station=3,999999999999999E-02 OutputCase=STR134 CaseType=Combination P=-107,697714628722 V2=17,5588595441896 V3=0 T=0 M2=0 M3=-24,5561664383772
FrameElem=1-1 ElemStation=3,999999999999999E-02
Frame=1 Station=7,999999999999998E-02 OutputCase=STR134 CaseType=Combination P=-107,481714628722 V2=17,6735595441896 V3=0 T=0 M2=0 M3=-25,2608408201448
FrameElem=1-1 ElemStation=7,999999999999998E-02
Frame=1 Station=0 OutputCase=STR135 CaseType=Combination P=-97,5578023957463 V2=28,181714623003 V3=0 T=0 M2=0 M3=-16,1465045993109 FrameElem=1-1
ElemStation=0
Frame=1 Station=3,999999999999999E-02 OutputCase=STR135 CaseType=Combination P=-97,3418023957463 V2=29,5322912123003 V3=0 T=0 M2=0 M3=-17,3008349478029
FrameElem=1-1 ElemStation=3,999999999999999E-02
Frame=1 Station=7,999999999999998E-02 OutputCase=STR135 CaseType=Combination P=-97,1258023957463 V2=30,8678124623003 V3=0 T=0 M2=0 M3=-18,5088871962949
FrameElem=1-1 ElemStation=7,999999999999998E-02
Frame=1 Station=0 OutputCase=STR136 CaseType=Combination P=-23,0587146296686 V2=16,6612957376045 V3=0 T=0 M2=0 M3=-11,9848899076198 FrameElem=1-1
ElemStation=0
Frame=1 Station=3,999999999999999E-02 OutputCase=STR136 CaseType=Combination P=-22,8987146296686 V2=16,7837957376045 V3=0 T=0 M2=0 M3=-12,6538177371239
FrameElem=1-1 ElemStation=3,999999999999999E-02
Frame=1 Station=7,999999999999998E-02 OutputCase=STR136 CaseType=Combination P=-22,7387146296686 V2=16,8984957376045 V3=0 T=0 M2=0 M3=-13,3274895666281
FrameElem=1-1 ElemStation=7,999999999999998E-02

Società di Progetto
Brebemi SpA



Doc. N.
60235-0000-A00.doc

CODIFICA DOCUMENTO
04RCDII10000000000300A00

REV.
00

FOGLIO
226 di 628

Frame=1 Station=0 OutputCase=STR137 CaseType=Combination P=-12,7028023966934 V2=27,4066536557151 V3=0 T=0 M2=0 M3=-4,27515845032099 FrameElem=1-1 ElemStation=0
Frame=1 Station=3,999999999999999E-02 OutputCase=STR137 CaseType=Combination P=-12,5428023966934 V2=28,7572274057151 V3=0 T=0 M2=0 M3=-5,3984862465496 FrameElem=1-1 ElemStation=3,999999999999999E-02
Frame=1 Station=7,999999999999998E-02 OutputCase=STR137 CaseType=Combination P=-12,3828023966934 V2=30,0927486557151 V3=0 T=0 M2=0 M3=-6,5755359427782 FrameElem=1-1 ElemStation=7,999999999999998E-02
Frame=1 Station=0 OutputCase=STR138 CaseType=Combination P=-16,8818023958124 V2=8,10654489879922 V3=0 T=0 M2=0 M3=-3,56853761506045 FrameElem=1-1 ElemStation=0
Frame=1 Station=3,999999999999999E-02 OutputCase=STR138 CaseType=Combination P=-16,6658023958124 V2=8,36938989879922 V3=0 T=0 M2=0 M3=-3,89811121101242 FrameElem=1-1 ElemStation=3,999999999999999E-02
Frame=1 Station=7,999999999999998E-02 OutputCase=STR138 CaseType=Combination P=-16,4498023958124 V2=8,61576489879922 V3=0 T=0 M2=0 M3=-4,23786920696439 FrameElem=1-1 ElemStation=7,999999999999998E-02
Frame=1 Station=0 OutputCase=STR139 CaseType=Combination P=-16,8818023957134 V2=3,26996178869118 V3=0 T=0 M2=0 M3=-3,12639457215028 FrameElem=1-1 ElemStation=0
Frame=1 Station=3,999999999999999E-02 OutputCase=STR139 CaseType=Combination P=-16,6658023957134 V2=3,39246178869118 V3=0 T=0 M2=0 M3=-3,25966904369792 FrameElem=1-1 ElemStation=3,999999999999999E-02
Frame=1 Station=7,999999999999998E-02 OutputCase=STR139 CaseType=Combination P=-16,4498023957134 V2=3,50716178869118 V3=0 T=0 M2=0 M3=-3,39768751524557 FrameElem=1-1 ElemStation=7,999999999999998E-02
Frame=1 Station=0 OutputCase=STR140 CaseType=Combination P=-97,5578023947044 V2=4,24210661051138 V3=0 T=0 M2=0 M3=-14,4729156075367 FrameElem=1-1 ElemStation=0
Frame=1 Station=3,999999999999999E-02 OutputCase=STR140 CaseType=Combination P=-97,3418023947044 V2=4,36460661051138 V3=0 T=0 M2=0 M3=-14,6450758719572 FrameElem=1-1 ElemStation=3,999999999999999E-02
Frame=1 Station=7,999999999999998E-02 OutputCase=STR140 CaseType=Combination P=-97,1258023947044 V2=4,47930661051138 V3=0 T=0 M2=0 M3=-14,8219801363776 FrameElem=1-1 ElemStation=7,999999999999998E-02
Frame=1 Station=0 OutputCase=STR141 CaseType=Combination P=-107,913714628722 V2=17,4363595441896 V3=0 T=0 M2=0 M3=-23,8562360566096 FrameElem=1-1 ElemStation=0
Frame=1 Station=3,999999999999999E-02 OutputCase=STR141 CaseType=Combination P=-107,697714628722 V2=17,5588595441896 V3=0 T=0 M2=0 M3=-24,5561664383772 FrameElem=1-1 ElemStation=3,999999999999999E-02
Frame=1 Station=7,999999999999998E-02 OutputCase=STR141 CaseType=Combination P=-107,481714628722 V2=17,6735595441896 V3=0 T=0 M2=0 M3=-25,2608408201448 FrameElem=1-1 ElemStation=7,999999999999998E-02
Frame=1 Station=0 OutputCase=STR142 CaseType=Combination P=-97,5578023957463 V2=28,1817174623003 V3=0 T=0 M2=0 M3=-16,1465045993109 FrameElem=1-1 ElemStation=0
Frame=1 Station=3,999999999999999E-02 OutputCase=STR142 CaseType=Combination P=-97,3418023957463 V2=29,5322912123003 V3=0 T=0 M2=0 M3=-17,3008349478029 FrameElem=1-1 ElemStation=3,999999999999999E-02
Frame=1 Station=7,999999999999998E-02 OutputCase=STR142 CaseType=Combination P=-97,1258023957463 V2=30,8678124623003 V3=0 T=0 M2=0 M3=-18,5088871962949 FrameElem=1-1 ElemStation=7,999999999999998E-02
Frame=1 Station=0 OutputCase=STR143 CaseType=Combination P=-23,0587146296686 V2=16,6612957376045 V3=0 T=0 M2=0 M3=-11,9848899076198 FrameElem=1-1 ElemStation=0
Frame=1 Station=3,999999999999999E-02 OutputCase=STR143 CaseType=Combination P=-22,8987146296686 V2=16,7837957376045 V3=0 T=0 M2=0 M3=-12,6538177371239 FrameElem=1-1 ElemStation=3,999999999999999E-02
Frame=1 Station=7,999999999999998E-02 OutputCase=STR143 CaseType=Combination P=-22,7387146296686 V2=16,8984957376045 V3=0 T=0 M2=0 M3=-13,3274895666281 FrameElem=1-1 ElemStation=7,999999999999998E-02
Frame=1 Station=0 OutputCase=STR144 CaseType=Combination P=-12,7028023966934 V2=27,4066536557151 V3=0 T=0 M2=0 M3=-4,275158450321 FrameElem=1-1 ElemStation=0
Frame=1 Station=3,999999999999999E-02 OutputCase=STR144 CaseType=Combination P=-12,5428023966934 V2=28,7572274057151 V3=0 T=0 M2=0 M3=-5,3984862465496 FrameElem=1-1 ElemStation=3,999999999999999E-02
Frame=1 Station=7,999999999999998E-02 OutputCase=STR144 CaseType=Combination P=-12,3828023966934 V2=30,0927486557151 V3=0 T=0 M2=0 M3=-6,5755359427782 FrameElem=1-1 ElemStation=7,999999999999998E-02
Frame=1 Station=0 OutputCase=STR145 CaseType=Combination P=-16,1190000003958 V2=7,35730500192449 V3=0 T=0 M2=0 M3=-2,16067148707283 FrameElem=1-1 ElemStation=0
Frame=1 Station=3,999999999999999E-02 OutputCase=STR145 CaseType=Combination P=-15,9030000003958 V2=7,62015000192449 V3=0 T=0 M2=0 M3=-2,46027548714981 FrameElem=1-1 ElemStation=3,999999999999999E-02
Frame=1 Station=7,999999999999998E-02 OutputCase=STR145 CaseType=Combination P=-15,6870000003958 V2=7,86652500192449 V3=0 T=0 M2=0 M3=-2,77006388722679 FrameElem=1-1 ElemStation=7,999999999999998E-02
Frame=1 Station=0 OutputCase=STR146 CaseType=Combination P=-16,1190000002968 V2=2,52072189181645 V3=0 T=0 M2=0 M3=-1,71852844416266 FrameElem=1-1 ElemStation=0
Frame=1 Station=3,999999999999999E-02 OutputCase=STR146 CaseType=Combination P=-15,9030000002968 V2=2,64322189181645 V3=0 T=0 M2=0 M3=-1,82183331983531 FrameElem=1-1 ElemStation=3,999999999999999E-02
Frame=1 Station=7,999999999999998E-02 OutputCase=STR146 CaseType=Combination P=-15,6870000002968 V2=2,75792189181645 V3=0 T=0 M2=0 M3=-1,92988219550797 FrameElem=1-1 ElemStation=7,999999999999998E-02
Frame=1 Station=0 OutputCase=STR147 CaseType=Combination P=-123,686999998952 V2=4,18469986993671 V3=0 T=0 M2=0 M3=-17,1229643790343 FrameElem=1-1 ElemStation=0
Frame=1 Station=3,999999999999999E-02 OutputCase=STR147 CaseType=Combination P=-123,470999998952 V2=4,30719986993671 V3=0 T=0 M2=0 M3=-17,2928283738318 FrameElem=1-1 ElemStation=3,999999999999999E-02
Frame=1 Station=7,999999999999998E-02 OutputCase=STR147 CaseType=Combination P=-123,254999998952 V2=4,42189986993671 V3=0 T=0 M2=0 M3=-17,4674363686293 FrameElem=1-1 ElemStation=7,999999999999998E-02
Frame=1 Station=0 OutputCase=STR148 CaseType=Combination P=-136,868781584414 V2=20,9256032625105 V3=0 T=0 M2=0 M3=-29,0424785809563 FrameElem=1-1 ElemStation=0
Frame=1 Station=3,999999999999999E-02 OutputCase=STR148 CaseType=Combination P=-136,652781584414 V2=21,0481032625105 V3=0 T=0 M2=0 M3=-29,8819787114568 FrameElem=1-1 ElemStation=3,999999999999999E-02
Frame=1 Station=7,999999999999998E-02 OutputCase=STR148 CaseType=Combination P=-136,436781584414 V2=21,1628032625105 V3=0 T=0 M2=0 M3=-30,726228419572 FrameElem=1-1 ElemStation=7,999999999999998E-02
Frame=1 Station=0 OutputCase=STR149 CaseType=Combination P=-123,687000000308 V2=34,4919866356192 V3=0 T=0 M2=0 M3=-19,2070353537632 FrameElem=1-1 ElemStation=0
Frame=1 Station=3,999999999999999E-02 OutputCase=STR149 CaseType=Combination P=-123,471000000308 V2=36,2051366356192 V3=0 T=0 M2=0 M3=-20,6210264191879 FrameElem=1-1 ElemStation=3,999999999999999E-02
Frame=1 Station=7,999999999999998E-02 OutputCase=STR149 CaseType=Combination P=-123,255000000308 V2=37,9037066356192 V3=0 T=0 M2=0 M3=-22,1032518846127 FrameElem=1-1 ElemStation=7,999999999999998E-02
Frame=1 Station=0 OutputCase=STR150 CaseType=Combination P=-25,1217815856972 V2=19,8264911819853 V3=0 T=0 M2=0 M3=-13,3889587535043 FrameElem=1-1 ElemStation=0
Frame=1 Station=3,999999999999999E-02 OutputCase=STR150 CaseType=Combination P=-24,9617815856972 V2=19,9489911819853 V3=0 T=0 M2=0 M3=-14,184494007837 FrameElem=1-1 ElemStation=3,999999999999999E-02
Frame=1 Station=7,999999999999998E-02 OutputCase=STR150 CaseType=Combination P=-24,8017815856972 V2=20,0636911819853 V3=0 T=0 M2=0 M3=-14,9847740480632 FrameElem=1-1 ElemStation=7,999999999999998E-02
Frame=1 Station=0 OutputCase=STR151 CaseType=Combination P=-11,9400000015912 V2=33,392874555094 V3=0 T=0 M2=0 M3=-3,55351552631116 FrameElem=1-1 ElemStation=0
Frame=1 Station=3,999999999999999E-02 OutputCase=STR151 CaseType=Combination P=-11,7800000015912 V2=35,106024555094 V3=0 T=0 M2=0 M3=-4,92354210851491 FrameElem=1-1 ElemStation=3,999999999999999E-02

Società di Progetto
Brebemi SpA



Doc. N.
60235-0000-A00.doc

CODIFICA DOCUMENTO
04RCDII10000000000300A00

REV.
00

FOGLIO
227 di 628

Frame=1 Station=7,999999999999E-02 OutputCase=STR151 CaseType=Combination P=-11,620000015912 V2=36,804594555094 V3=0 T=0 M2=0 M3=-6,36180309071867
FrameElem=1-1 ElemStation=7,999999999999E-02
Frame=1 Station=0 OutputCase=STR152 CaseType=Combination P=-126,52082502344 V2=35,7672545341206 V3=0 T=0 M2=0 M3=-37,3041507646517 FrameElem=1-1
ElemStation=0
Frame=1 Station=3,999999999999E-02 OutputCase=STR152 CaseType=Combination P=-126,30482502344 V2=35,8897545341206 V3=0 T=0 M2=0 M3=-38,7373169460165
FrameElem=1-1 ElemStation=3,999999999999E-02
Frame=1 Station=7,999999999999E-02 OutputCase=STR152 CaseType=Combination P=-126,08882502344 V2=36,0044545341206 V3=0 T=0 M2=0 M3=-40,1752271273813
FrameElem=1-1 ElemStation=7,999999999999E-02
Frame=1 Station=0 OutputCase=STR153 CaseType=Combination P=-96,7949999992879 V2=3,49286671363665 V3=0 T=0 M2=0 M3=-13,0650494795491 FrameElem=1-1
ElemStation=0
Frame=1 Station=3,999999999999E-02 OutputCase=STR153 CaseType=Combination P=-96,5789999992879 V2=3,61536671363665 V3=0 T=0 M2=0 M3=-13,2072401480945
FrameElem=1-1 ElemStation=3,999999999999E-02
Frame=1 Station=7,999999999999E-02 OutputCase=STR153 CaseType=Combination P=-96,3629999992879 V2=3,73006671363665 V3=0 T=0 M2=0 M3=-13,35417481664
FrameElem=1-1 ElemStation=7,999999999999E-02
Frame=1 Station=0 OutputCase=STR154 CaseType=Combination P=-107,150912233305 V2=16,6871196473149 V3=0 T=0 M2=0 M3=-22,448369928622 FrameElem=1-1
ElemStation=0
Frame=1 Station=3,999999999999E-02 OutputCase=STR154 CaseType=Combination P=-106,934912233305 V2=16,8096196473149 V3=0 T=0 M2=0 M3=-23,1183307145146
FrameElem=1-1 ElemStation=3,999999999999E-02
Frame=1 Station=7,999999999999E-02 OutputCase=STR154 CaseType=Combination P=-106,718912233305 V2=16,9243196473149 V3=0 T=0 M2=0 M3=-23,7930355004072
FrameElem=1-1 ElemStation=7,999999999999E-02
Frame=1 Station=0 OutputCase=STR155 CaseType=Combination P=-96,7950000003298 V2=27,4324775654255 V3=0 T=0 M2=0 M3=-14,7386384713232 FrameElem=1-1
ElemStation=0
Frame=1 Station=3,999999999999E-02 OutputCase=STR155 CaseType=Combination P=-96,5790000003298 V2=28,7830513154255 V3=0 T=0 M2=0 M3=-15,8629992239403
FrameElem=1-1 ElemStation=3,999999999999E-02
Frame=1 Station=7,999999999999E-02 OutputCase=STR155 CaseType=Combination P=-96,3630000003298 V2=30,1185725654255 V3=0 T=0 M2=0 M3=-17,0410818765573
FrameElem=1-1 ElemStation=7,999999999999E-02
Frame=1 Station=0 OutputCase=STR156 CaseType=Combination P=-22,295912234252 V2=15,9120558407297 V3=0 T=0 M2=0 M3=-10,5770237796321 FrameElem=1-1
ElemStation=0
Frame=1 Station=3,999999999999E-02 OutputCase=STR156 CaseType=Combination P=-22,135912234252 V2=16,0345558407297 V3=0 T=0 M2=0 M3=-11,2159820132613
FrameElem=1-1 ElemStation=3,999999999999E-02
Frame=1 Station=7,999999999999E-02 OutputCase=STR156 CaseType=Combination P=-21,975912234252 V2=16,1492558407297 V3=0 T=0 M2=0 M3=-11,8596842468905
FrameElem=1-1 ElemStation=7,999999999999E-02
Frame=1 Station=0 OutputCase=STR157 CaseType=Combination P=-11,940000012768 V2=26,6574137588404 V3=0 T=0 M2=0 M3=-2,8672923223338 FrameElem=1-1
ElemStation=0
Frame=1 Station=3,999999999999E-02 OutputCase=STR157 CaseType=Combination P=-11,780000012768 V2=28,0079875088404 V3=0 T=0 M2=0 M3=-3,96065052268699
FrameElem=1-1 ElemStation=3,999999999999E-02
Frame=1 Station=7,999999999999E-02 OutputCase=STR157 CaseType=Combination P=-11,620000012768 V2=29,3435087588404 V3=0 T=0 M2=0 M3=-5,1077306230406
FrameElem=1-1 ElemStation=7,999999999999E-02
Frame=1 Station=0 OutputCase=STR158 CaseType=Combination P=-16,1190000003959 V2=7,90898232546448 V3=0 T=0 M2=0 M3=-2,57428331860751 FrameElem=1-1
ElemStation=0
Frame=1 Station=3,999999999999E-02 OutputCase=STR158 CaseType=Combination P=-15,9030000003959 V2=8,17182732546448 V3=0 T=0 M2=0 M3=-2,89595441162609
FrameElem=1-1 ElemStation=3,999999999999E-02
Frame=1 Station=7,999999999999E-02 OutputCase=STR158 CaseType=Combination P=-15,6870000003959 V2=8,41820232546448 V3=0 T=0 M2=0 M3=-3,22780990464467
FrameElem=1-1 ElemStation=7,999999999999E-02
Frame=1 Station=0 OutputCase=STR159 CaseType=Combination P=-16,119000000297 V2=3,07239921535644 V3=0 T=0 M2=0 M3=-2,13214027569734 FrameElem=1-1
ElemStation=0
Frame=1 Station=3,999999999999E-02 OutputCase=STR159 CaseType=Combination P=-15,903000000297 V2=3,19489921535644 V3=0 T=0 M2=0 M3=-2,25751224431159
FrameElem=1-1 ElemStation=3,999999999999E-02
Frame=1 Station=7,999999999999E-02 OutputCase=STR159 CaseType=Combination P=-15,687000000297 V2=3,30959921535644 V3=0 T=0 M2=0 M3=-2,38762821292585
FrameElem=1-1 ElemStation=7,999999999999E-02
Frame=1 Station=0 OutputCase=STR160 CaseType=Combination P=-96,794999999288 V2=4,04454403717664 V3=0 T=0 M2=0 M3=-13,4786613110838 FrameElem=1-1
ElemStation=0
Frame=1 Station=3,999999999999E-02 OutputCase=STR160 CaseType=Combination P=-96,578999999288 V2=4,16704403717663 V3=0 T=0 M2=0 M3=-13,6429190725708
FrameElem=1-1 ElemStation=3,999999999999E-02
Frame=1 Station=7,999999999999E-02 OutputCase=STR160 CaseType=Combination P=-96,362999999288 V2=4,28174403717663 V3=0 T=0 M2=0 M3=-13,8119208340579
FrameElem=1-1 ElemStation=7,999999999999E-02
Frame=1 Station=0 OutputCase=STR161 CaseType=Combination P=-107,150912233305 V2=17,2387969708549 V3=0 T=0 M2=0 M3=-22,8619817601567 FrameElem=1-1
ElemStation=0
Frame=1 Station=3,999999999999E-02 OutputCase=STR161 CaseType=Combination P=-106,934912233305 V2=17,3612969708548 V3=0 T=0 M2=0 M3=-23,5540096389909
FrameElem=1-1 ElemStation=3,999999999999E-02
Frame=1 Station=7,999999999999E-02 OutputCase=STR161 CaseType=Combination P=-106,718912233305 V2=17,4759969708549 V3=0 T=0 M2=0 M3=-24,2507815178251
FrameElem=1-1 ElemStation=7,999999999999E-02
Frame=1 Station=0 OutputCase=STR162 CaseType=Combination P=-96,7950000003299 V2=27,9841548889655 V3=0 T=0 M2=0 M3=-15,1522503028579 FrameElem=1-1
ElemStation=0
Frame=1 Station=3,999999999999E-02 OutputCase=STR162 CaseType=Combination P=-96,5790000003299 V2=29,3347286389655 V3=0 T=0 M2=0 M3=-16,2986781484165
FrameElem=1-1 ElemStation=3,999999999999E-02
Frame=1 Station=7,999999999999E-02 OutputCase=STR162 CaseType=Combination P=-96,3630000003299 V2=30,6702498889655 V3=0 T=0 M2=0 M3=-17,4988278939752
FrameElem=1-1 ElemStation=7,999999999999E-02
Frame=1 Station=0 OutputCase=STR163 CaseType=Combination P=-22,295912234252 V2=16,4637331642697 V3=0 T=0 M2=0 M3=-10,9906356111668 FrameElem=1-1
ElemStation=0
Frame=1 Station=3,999999999999E-02 OutputCase=STR163 CaseType=Combination P=-22,135912234252 V2=16,5862331642697 V3=0 T=0 M2=0 M3=-11,6516609377376
FrameElem=1-1 ElemStation=3,999999999999E-02
Frame=1 Station=7,999999999999E-02 OutputCase=STR163 CaseType=Combination P=-21,975912234252 V2=16,7009331642697 V3=0 T=0 M2=0 M3=-12,3174302643084
FrameElem=1-1 ElemStation=7,999999999999E-02
Frame=1 Station=0 OutputCase=STR164 CaseType=Combination P=-11,94000001277 V2=27,2090910823804 V3=0 T=0 M2=0 M3=-3,28090415386806 FrameElem=1-1
ElemStation=0
Frame=1 Station=3,999999999999E-02 OutputCase=STR164 CaseType=Combination P=-11,78000001277 V2=28,5596648323804 V3=0 T=0 M2=0 M3=-4,39632944716327
FrameElem=1-1 ElemStation=3,999999999999E-02
Frame=1 Station=7,999999999999E-02 OutputCase=STR164 CaseType=Combination P=-11,62000001277 V2=29,8951860823804 V3=0 T=0 M2=0 M3=-5,56547664045848
FrameElem=1-1 ElemStation=7,999999999999E-02
Frame=1 Station=0 OutputCase=STR165 CaseType=Combination P=-16,1190000003956 V2=6,8056276783845 V3=0 T=0 M2=0 M3=-1,74705965553815 FrameElem=1-1
ElemStation=0
Frame=1 Station=3,999999999999E-02 OutputCase=STR165 CaseType=Combination P=-15,9030000003956 V2=7,0684726783845 V3=0 T=0 M2=0 M3=-2,02459638267353
FrameElem=1-1 ElemStation=3,999999999999E-02
Frame=1 Station=7,999999999999E-02 OutputCase=STR165 CaseType=Combination P=-15,6870000003956 V2=7,3148476783845 V3=0 T=0 M2=0 M3=-2,31231786980891
FrameElem=1-1 ElemStation=7,999999999999E-02
Frame=1 Station=0 OutputCase=STR166 CaseType=Combination P=-16,1190000002967 V2=1,96904456827646 V3=0 T=0 M2=0 M3=-1,30491661262798 FrameElem=1-1
ElemStation=0

Società di Progetto
Brebemi SpA



Doc. N.
60235-0000-A00.doc

CODIFICA DOCUMENTO
04RCDII10000000000300A00

REV.
00

FOGLIO
228 di 628

Frame=1 Station=3,9999999999999999E-02 OutputCase=STR166 CaseType=Combination P=-15,9030000002967 V2=2,09154456827646 V3=0 T=0 M2=0 M3=-1,38615439535904
FrameElem=1-1 ElemStation=3,9999999999999999E-02
Frame=1 Station=7,9999999999999998E-02 OutputCase=STR166 CaseType=Combination P=-15,6870000002967 V2=2,20624456827646 V3=0 T=0 M2=0 M3=-1,47213617809009
FrameElem=1-1 ElemStation=7,9999999999999998E-02
Frame=1 Station=0 OutputCase=STR167 CaseType=Combination P=-96,7949999992877 V2=2,94118939009666 V3=0 T=0 M2=0 M3=-12,6514376480144 FrameElem=1-1
ElemStation=0
Frame=1 Station=3,9999999999999999E-02 OutputCase=STR167 CaseType=Combination P=-96,5789999992877 V2=3,06368939009666 V3=0 T=0 M2=0 M3=-12,7715612236183
FrameElem=1-1 ElemStation=3,9999999999999999E-02
Frame=1 Station=7,9999999999999998E-02 OutputCase=STR167 CaseType=Combination P=-96,3629999992877 V2=3,17838939009666 V3=0 T=0 M2=0 M3=-12,8964287992221
FrameElem=1-1 ElemStation=7,9999999999999998E-02
Frame=1 Station=0 OutputCase=STR168 CaseType=Combination P=-107,150912233305 V2=16,1354423237749 V3=0 T=0 M2=0 M3=-22,0347580970873 FrameElem=1-1
ElemStation=0
Frame=1 Station=3,9999999999999999E-02 OutputCase=STR168 CaseType=Combination P=-106,934912233305 V2=16,2579423237749 V3=0 T=0 M2=0 M3=-22,6826517900383
FrameElem=1-1 ElemStation=3,9999999999999999E-02
Frame=1 Station=7,9999999999999998E-02 OutputCase=STR168 CaseType=Combination P=-106,718912233305 V2=16,3726423237749 V3=0 T=0 M2=0 M3=-23,3352894829893
FrameElem=1-1 ElemStation=7,9999999999999998E-02
Frame=1 Station=0 OutputCase=STR169 CaseType=Combination P=-96,795000003296 V2=26,8808002418856 V3=0 T=0 M2=0 M3=-14,3250266397886 FrameElem=1-1
ElemStation=0
Frame=1 Station=3,9999999999999999E-02 OutputCase=STR169 CaseType=Combination P=-96,579000003296 V2=28,2313739918856 V3=0 T=0 M2=0 M3=-15,427320299464
FrameElem=1-1 ElemStation=3,9999999999999999E-02
Frame=1 Station=7,9999999999999998E-02 OutputCase=STR169 CaseType=Combination P=-96,363000003296 V2=29,5668952418855 V3=0 T=0 M2=0 M3=-16,5833358591394
FrameElem=1-1 ElemStation=7,9999999999999998E-02
Frame=1 Station=0 OutputCase=STR170 CaseType=Combination P=-22,2959122342519 V2=15,3603785171897 V3=0 T=0 M2=0 M3=-10,1634119480975 FrameElem=1-1
ElemStation=0
Frame=1 Station=3,9999999999999999E-02 OutputCase=STR170 CaseType=Combination P=-22,1359122342519 V2=15,4828785171897 V3=0 T=0 M2=0 M3=-10,7803303887851
FrameElem=1-1 ElemStation=3,9999999999999999E-02
Frame=1 Station=7,9999999999999998E-02 OutputCase=STR170 CaseType=Combination P=-21,9759122342519 V2=15,5975785171897 V3=0 T=0 M2=0 M3=-11,4019382294726
FrameElem=1-1 ElemStation=7,9999999999999998E-02
Frame=1 Station=0 OutputCase=STR171 CaseType=Combination P=-11,940000012766 V2=26,1057364353004 V3=0 T=0 M2=0 M3=-2,4536804907987 FrameElem=1-1
ElemStation=0
Frame=1 Station=3,9999999999999999E-02 OutputCase=STR171 CaseType=Combination P=-11,780000012766 V2=27,4563101853004 V3=0 T=0 M2=0 M3=-3,52497159821071
FrameElem=1-1 ElemStation=3,9999999999999999E-02
Frame=1 Station=7,9999999999999998E-02 OutputCase=STR171 CaseType=Combination P=-11,620000012766 V2=28,7918314353004 V3=0 T=0 M2=0 M3=-4,64998460562272
FrameElem=1-1 ElemStation=7,9999999999999998E-02
Frame=1 Station=0 OutputCase=STR172 CaseType=Combination P=-15,6613185631459 V2=7,12843199321565 V3=0 T=0 M2=0 M3=-1,48139654289413 FrameElem=1-1
ElemStation=0
Frame=1 Station=3,9999999999999999E-02 OutputCase=STR172 CaseType=Combination P=-15,4453185631459 V2=7,39127699321564 V3=0 T=0 M2=0 M3=-1,77184562262276
FrameElem=1-1 ElemStation=3,9999999999999999E-02
Frame=1 Station=7,9999999999999998E-02 OutputCase=STR172 CaseType=Combination P=-15,2293185631459 V2=7,63765199321564 V3=0 T=0 M2=0 M3=-2,07247910235138
FrameElem=1-1 ElemStation=7,9999999999999998E-02
Frame=1 Station=0 OutputCase=STR173 CaseType=Combination P=-15,6613185630469 V2=2,2918488831076 V3=0 T=0 M2=0 M3=-1,03925349998396 FrameElem=1-1
ElemStation=0
Frame=1 Station=3,9999999999999999E-02 OutputCase=STR173 CaseType=Combination P=-15,4453185630469 V2=2,4143488831076 V3=0 T=0 M2=0 M3=-1,13340345530826
FrameElem=1-1 ElemStation=3,9999999999999999E-02
Frame=1 Station=7,9999999999999998E-02 OutputCase=STR173 CaseType=Combination P=-15,2293185630469 V2=2,5290488831076 V3=0 T=0 M2=0 M3=-1,23229741063257
FrameElem=1-1 ElemStation=7,9999999999999998E-02
Frame=1 Station=0 OutputCase=STR174 CaseType=Combination P=-96,337318562038 V2=3,2639937049278 V3=0 T=0 M2=0 M3=-12,3857745353704 FrameElem=1-1
ElemStation=0
Frame=1 Station=3,9999999999999999E-02 OutputCase=STR174 CaseType=Combination P=-96,121318562038 V2=3,3864937049278 V3=0 T=0 M2=0 M3=-12,5188102835675
FrameElem=1-1 ElemStation=3,9999999999999999E-02
Frame=1 Station=7,9999999999999998E-02 OutputCase=STR174 CaseType=Combination P=-95,905318562038 V2=3,5011937049278 V3=0 T=0 M2=0 M3=-12,6565900317646
FrameElem=1-1 ElemStation=7,9999999999999998E-02
Frame=1 Station=0 OutputCase=STR175 CaseType=Combination P=-106,693230796055 V2=16,458246638606 V3=0 T=0 M2=0 M3=-21,7690949844433 FrameElem=1-1
ElemStation=0
Frame=1 Station=3,9999999999999999E-02 OutputCase=STR175 CaseType=Combination P=-106,477230796055 V2=16,580746638606 V3=0 T=0 M2=0 M3=-22,4299008499876
FrameElem=1-1 ElemStation=3,9999999999999999E-02
Frame=1 Station=7,9999999999999998E-02 OutputCase=STR175 CaseType=Combination P=-106,261230796055 V2=16,695446638606 V3=0 T=0 M2=0 M3=-23,0954507155318
FrameElem=1-1 ElemStation=7,9999999999999998E-02
Frame=1 Station=0 OutputCase=STR176 CaseType=Combination P=-96,3373185630799 V2=27,2036045567167 V3=0 T=0 M2=0 M3=-14,0593635271445 FrameElem=1-1
ElemStation=0
Frame=1 Station=3,9999999999999999E-02 OutputCase=STR176 CaseType=Combination P=-96,1213185630799 V2=28,5541783067167 V3=0 T=0 M2=0 M3=-15,1745693594132
FrameElem=1-1 ElemStation=3,9999999999999999E-02
Frame=1 Station=7,9999999999999998E-02 OutputCase=STR176 CaseType=Combination P=-95,9053185630799 V2=29,8896995567167 V3=0 T=0 M2=0 M3=-16,3434970916819
FrameElem=1-1 ElemStation=7,9999999999999998E-02
Frame=1 Station=0 OutputCase=STR177 CaseType=Combination P=-21,8382307970022 V2=15,6831828320209 V3=0 T=0 M2=0 M3=-9,89774883545344 FrameElem=1-1
ElemStation=0
Frame=1 Station=3,9999999999999999E-02 OutputCase=STR177 CaseType=Combination P=-21,6782307970022 V2=15,8056828320209 V3=0 T=0 M2=0 M3=-10,5275521487343
FrameElem=1-1 ElemStation=3,9999999999999999E-02
Frame=1 Station=7,9999999999999998E-02 OutputCase=STR177 CaseType=Combination P=-21,5182307970022 V2=15,9203828320209 V3=0 T=0 M2=0 M3=-11,1620994620151
FrameElem=1-1 ElemStation=7,9999999999999998E-02
Frame=1 Station=0 OutputCase=STR178 CaseType=Combination P=-11,4823185640269 V2=26,4285407501316 V3=0 T=0 M2=0 M3=-2,18801737815468 FrameElem=1-1
ElemStation=0
Frame=1 Station=3,9999999999999999E-02 OutputCase=STR178 CaseType=Combination P=-11,3223185640269 V2=27,7791145001316 V3=0 T=0 M2=0 M3=-3,27222065815994
FrameElem=1-1 ElemStation=3,9999999999999999E-02
Frame=1 Station=7,9999999999999998E-02 OutputCase=STR178 CaseType=Combination P=-11,1623185640269 V2=29,1146357501316 V3=0 T=0 M2=0 M3=-4,4101458381652
FrameElem=1-1 ElemStation=7,9999999999999998E-02
Frame=1 Station=0 OutputCase=STR179 CaseType=Combination P=-15,6613185631459 V2=7,12843199321565 V3=0 T=0 M2=0 M3=-1,48139654289413 FrameElem=1-1
ElemStation=0
Frame=1 Station=3,9999999999999999E-02 OutputCase=STR179 CaseType=Combination P=-15,4453185631459 V2=7,39127699321564 V3=0 T=0 M2=0 M3=-1,77184562262276
FrameElem=1-1 ElemStation=3,9999999999999999E-02
Frame=1 Station=7,9999999999999998E-02 OutputCase=STR179 CaseType=Combination P=-15,2293185631459 V2=7,63765199321564 V3=0 T=0 M2=0 M3=-2,07247910235138
FrameElem=1-1 ElemStation=7,9999999999999998E-02
Frame=1 Station=0 OutputCase=STR180 CaseType=Combination P=-16,5766814376457 V2=7,58617801063333 V3=0 T=0 M2=0 M3=-2,83994643125153 FrameElem=1-1
ElemStation=0
Frame=1 Station=3,9999999999999999E-02 OutputCase=STR180 CaseType=Combination P=-16,3606814376457 V2=7,84902301063333 V3=0 T=0 M2=0 M3=-3,14870535167686
FrameElem=1-1 ElemStation=3,9999999999999999E-02
Frame=1 Station=7,9999999999999998E-02 OutputCase=STR180 CaseType=Combination P=-16,1446814376457 V2=8,09539801063333 V3=0 T=0 M2=0 M3=-3,4676486721022
FrameElem=1-1 ElemStation=7,9999999999999998E-02

Società di Progetto
Brebemi SpA



Doc. N.
60235-0000-A00.doc

CODIFICA DOCUMENTO
04RCDII10000000000300A00

REV.
00

FOGLIO
229 di 628

Frame=1 Station=0 OutputCase=STR181 CaseType=Combination P=-16,5766814375467 V2=2,74959490052529 V3=0 T=0 M2=0 M3=-2,39780338834136 FrameElem=1-1 ElemStation=0

Frame=1 Station=3,999999999999999E-02 OutputCase=STR181 CaseType=Combination P=-16,3606814375467 V2=2,87209490052529 V3=0 T=0 M2=0 M3=-2,51026318436237

FrameElem=1-1 ElemStation=3,999999999999999E-02

Frame=1 Station=7,999999999999998E-02 OutputCase=STR181 CaseType=Combination P=-16,1446814375467 V2=2,98679490052529 V3=0 T=0 M2=0 M3=-2,62746698038338

FrameElem=1-1 ElemStation=7,999999999999998E-02

Frame=1 Station=0 OutputCase=STR182 CaseType=Combination P=-97,2526814365377 V2=3,72173972234549 V3=0 T=0 M2=0 M3=-13,7443244237278 FrameElem=1-1 ElemStation=0

Frame=1 Station=3,999999999999999E-02 OutputCase=STR182 CaseType=Combination P=-97,0366814365377 V2=3,84423972234549 V3=0 T=0 M2=0 M3=-13,8956700126216

FrameElem=1-1 ElemStation=3,999999999999999E-02

Frame=1 Station=7,999999999999998E-02 OutputCase=STR182 CaseType=Combination P=-96,8206814365377 V2=3,95893972234549 V3=0 T=0 M2=0 M3=-14,0517596015154

FrameElem=1-1 ElemStation=7,999999999999998E-02

Frame=1 Station=0 OutputCase=STR183 CaseType=Combination P=-107,608593670555 V2=16,9159926560237 V3=0 T=0 M2=0 M3=-23,1276448728007 FrameElem=1-1 ElemStation=0

Frame=1 Station=3,999999999999999E-02 OutputCase=STR183 CaseType=Combination P=-107,392593670555 V2=17,0384926560237 V3=0 T=0 M2=0 M3=-23,8067605790417

FrameElem=1-1 ElemStation=3,999999999999999E-02

Frame=1 Station=7,999999999999998E-02 OutputCase=STR183 CaseType=Combination P=-107,176593670555 V2=17,1531926560237 V3=0 T=0 M2=0 M3=-24,4906202852826

FrameElem=1-1 ElemStation=7,999999999999998E-02

Frame=1 Station=0 OutputCase=STR184 CaseType=Combination P=-97,2526814375797 V2=27,6613505741344 V3=0 T=0 M2=0 M3=-15,4179134155019 FrameElem=1-1 ElemStation=0

Frame=1 Station=3,999999999999999E-02 OutputCase=STR184 CaseType=Combination P=-97,0366814375797 V2=29,0119243241344 V3=0 T=0 M2=0 M3=-16,5514290884673

FrameElem=1-1 ElemStation=3,999999999999999E-02

Frame=1 Station=7,999999999999998E-02 OutputCase=STR184 CaseType=Combination P=-96,8206814375797 V2=30,3474455741344 V3=0 T=0 M2=0 M3=-17,7386666614327

FrameElem=1-1 ElemStation=7,999999999999998E-02

Frame=1 Station=0 OutputCase=STR185 CaseType=Combination P=-22,7535936715019 V2=16,1409288494386 V3=0 T=0 M2=0 M3=-11,2562987238108 FrameElem=1-1 ElemStation=0

Frame=1 Station=3,999999999999999E-02 OutputCase=STR185 CaseType=Combination P=-22,5935936715019 V2=16,2634288494386 V3=0 T=0 M2=0 M3=-11,9044118777884

FrameElem=1-1 ElemStation=3,999999999999999E-02

Frame=1 Station=7,999999999999998E-02 OutputCase=STR185 CaseType=Combination P=-22,4335936715019 V2=16,3781288494386 V3=0 T=0 M2=0 M3=-12,5572690317659

FrameElem=1-1 ElemStation=7,999999999999998E-02

Frame=1 Station=0 OutputCase=STR186 CaseType=Combination P=-12,3976814385267 V2=26,8862867675492 V3=0 T=0 M2=0 M3=-3,54656726651207 FrameElem=1-1 ElemStation=0

Frame=1 Station=3,999999999999999E-02 OutputCase=STR186 CaseType=Combination P=-12,2376814385267 V2=28,2368605175492 V3=0 T=0 M2=0 M3=-4,64908038721404

FrameElem=1-1 ElemStation=3,999999999999999E-02

Frame=1 Station=7,999999999999998E-02 OutputCase=STR186 CaseType=Combination P=-12,0776814385267 V2=29,5723817675492 V3=0 T=0 M2=0 M3=-5,80531540791601

FrameElem=1-1 ElemStation=7,999999999999998E-02

Frame=1 Station=0 OutputCase=STR187 CaseType=Combination P=-16,5766814376457 V2=7,58617801063333 V3=0 T=0 M2=0 M3=-2,83994643125153 FrameElem=1-1 ElemStation=0

Frame=1 Station=3,999999999999999E-02 OutputCase=STR187 CaseType=Combination P=-16,3606814376457 V2=7,84902301063333 V3=0 T=0 M2=0 M3=-3,14870535167686

FrameElem=1-1 ElemStation=3,999999999999999E-02

Frame=1 Station=7,999999999999998E-02 OutputCase=STR187 CaseType=Combination P=-16,1446814376457 V2=8,09539801063333 V3=0 T=0 M2=0 M3=-3,4676486721022

FrameElem=1-1 ElemStation=7,999999999999998E-02

Frame=1 Station=0 OutputCase=INVSTR CaseType=Combination StepType=Max P=-11,1771976058604 V2=36,8706091812006 V3=0 T=0 M2=0 M3=-0,862144758221278

FrameElem=1-1 ElemStation=0

Frame=1 Station=3,999999999999999E-02 OutputCase=INVSTR CaseType=Combination StepType=Max P=-11,0171976058604 V2=37,3084912826992 V3=0 T=0 M2=0 M3=-0,964902828607746

FrameElem=1-1 ElemStation=3,999999999999999E-02

Frame=1 Station=7,999999999999998E-02 OutputCase=INVSTR CaseType=Combination StepType=Max P=-10,8571976058604 V2=39,0070612826992 V3=0 T=0 M2=0 M3=-1,07240489899421

FrameElem=1-1 ElemStation=7,999999999999998E-02

Frame=1 Station=0 OutputCase=INVSTR CaseType=Combination StepType=Min P=-137,326463021664 V2=1,96904456827646 V3=0 T=0 M2=0 M3=-38,397037540365

FrameElem=1-1 ElemStation=0

Frame=1 Station=3,999999999999999E-02 OutputCase=INVSTR CaseType=Combination StepType=Min P=-137,110463021664 V2=2,09154456827646 V3=0 T=0 M2=0 M3=-39,8614257350198

FrameElem=1-1 ElemStation=3,999999999999999E-02

Frame=1 Station=7,999999999999998E-02 OutputCase=INVSTR CaseType=Combination StepType=Min P=-136,894463021664 V2=2,20624456827646 V3=0 T=0 M2=0 M3=-41,330579296746

FrameElem=1-1 ElemStation=7,999999999999998E-02

Frame=1 Station=0 OutputCase=SIS01 CaseType=Combination P=-17,1950802776089 V2=11,765298852182 V3=0 T=0 M2=0 M3=-6,68326430641782

FrameElem=1-1 ElemStation=0

Frame=1 Station=3,999999999999999E-02 OutputCase=SIS01 CaseType=Combination P=-17,0404802776089 V2=11,924398852182 V3=0 T=0 M2=0 M3=-7,15709892717177

FrameElem=1-1 ElemStation=3,999999999999999E-02

Frame=1 Station=7,999999999999998E-02 OutputCase=SIS01 CaseType=Combination P=-16,8858802776089 V2=12,071298852182 V3=0 T=0 M2=0 M3=-7,63705354792571

FrameElem=1-1 ElemStation=7,999999999999998E-02

Frame=1 Station=0 OutputCase=SIS02 CaseType=Combination P=-17,1950802776091 V2=12,1484081046403 V3=0 T=0 M2=0 M3=-6,97049474498357

FrameElem=1-1 ElemStation=0

Frame=1 Station=3,999999999999999E-02 OutputCase=SIS02 CaseType=Combination P=-17,0404802776091 V2=12,3075081046403 V3=0 T=0 M2=0 M3=-7,45965373583585

FrameElem=1-1 ElemStation=3,999999999999999E-02

Frame=1 Station=7,999999999999998E-02 OutputCase=SIS02 CaseType=Combination P=-16,8858802776091 V2=12,4544081046403 V3=0 T=0 M2=0 M3=-7,95493272668813

FrameElem=1-1 ElemStation=7,999999999999998E-02

Frame=1 Station=0 OutputCase=SIS03 CaseType=Combination P=-17,1950802776088 V2=11,3821895997237 V3=0 T=0 M2=0 M3=-6,39603386785207

FrameElem=1-1 ElemStation=0

Frame=1 Station=3,999999999999999E-02 OutputCase=SIS03 CaseType=Combination P=-17,0404802776088 V2=11,5412895997237 V3=0 T=0 M2=0 M3=-6,85454411850768

FrameElem=1-1 ElemStation=3,999999999999999E-02

Frame=1 Station=7,999999999999998E-02 OutputCase=SIS03 CaseType=Combination P=-16,8858802776088 V2=11,6881895997237 V3=0 T=0 M2=0 M3=-7,3191743691633

FrameElem=1-1 ElemStation=7,999999999999998E-02

Frame=1 Station=0 OutputCase=SIS04 CaseType=Combination P=-16,8772459461854 V2=11,6063592628009 V3=0 T=0 M2=0 M3=-6,21154559518261

FrameElem=1-1 ElemStation=0

Frame=1 Station=3,999999999999999E-02 OutputCase=SIS04 CaseType=Combination P=-16,7226459461854 V2=11,7654592628009 V3=0 T=0 M2=0 M3=-6,67902263236131

FrameElem=1-1 ElemStation=3,999999999999999E-02

Frame=1 Station=7,999999999999998E-02 OutputCase=SIS04 CaseType=Combination P=-16,5680459461854 V2=11,9123592628009 V3=0 T=0 M2=0 M3=-7,15261966954001

FrameElem=1-1 ElemStation=7,999999999999998E-02

Frame=1 Station=0 OutputCase=SIS05 CaseType=Combination P=-17,5129146090325 V2=11,9242384415632 V3=0 T=0 M2=0 M3=-7,15498301765303

FrameElem=1-1 ElemStation=0

Frame=1 Station=3,999999999999999E-02 OutputCase=SIS05 CaseType=Combination P=-17,3583146090325 V2=12,0833384415632 V3=0 T=0 M2=0 M3=-7,63517522198222

FrameElem=1-1 ElemStation=3,999999999999999E-02

Frame=1 Station=7,999999999999998E-02 OutputCase=SIS05 CaseType=Combination P=-17,2037146090325 V2=12,2302384415631 V3=0 T=0 M2=0 M3=-8,12148742631141

FrameElem=1-1 ElemStation=7,999999999999998E-02

Frame=1 Station=0 OutputCase=SIS06 CaseType=Combination P=-17,1950802776088 V2=11,3821895997237 V3=0 T=0 M2=0 M3=-6,39603386785207

FrameElem=1-1 ElemStation=0

Frame=1 Station=3,999999999999999E-02 OutputCase=SIS06 CaseType=Combination P=-17,0404802776088 V2=11,5412895997237 V3=0 T=0 M2=0 M3=-6,85454411850768

FrameElem=1-1 ElemStation=3,999999999999999E-02

APPROVATO S.D.P.
Società di Progetto
Brebemi SpA



Doc. N.
60235-0000-A00.doc

CODIFICA DOCUMENTO
04RCDII10000000000300A00

REV.
00

FOGLIO
230 di 628

Frame=1 Station=7,999999999999999E-02 OutputCase=SIS06 CaseType=Combination P=-16,8858802776088 V2=11,6881895997237 V3=0 T=0 M2=0 M3=-7,3191743691633
FrameElem=1-1 ElemStation=7,999999999999999E-02
Frame=1 Station=0 OutputCase=SIS07 CaseType=Combination P=-16,8772459461855 V2=11,9894685152592 V3=0 T=0 M2=0 M3=-6,49877603374836 FrameElem=1-1
ElemStation=0
Frame=1 Station=3,999999999999999E-02 OutputCase=SIS07 CaseType=Combination P=-16,7226459461855 V2=12,1485685152592 V3=0 T=0 M2=0 M3=-6,9815774410254
FrameElem=1-1 ElemStation=3,999999999999999E-02
Frame=1 Station=7,999999999999999E-02 OutputCase=SIS07 CaseType=Combination P=-16,5680459461855 V2=12,2954685152592 V3=0 T=0 M2=0 M3=-7,47049884830243
FrameElem=1-1 ElemStation=7,999999999999999E-02
Frame=1 Station=0 OutputCase=SIS08 CaseType=Combination P=-17,5129146090326 V2=12,3073476940215 V3=0 T=0 M2=0 M3=-7,44221345621878 FrameElem=1-1
ElemStation=0
Frame=1 Station=3,999999999999999E-02 OutputCase=SIS08 CaseType=Combination P=-17,3583146090326 V2=12,4664476940215 V3=0 T=0 M2=0 M3=-7,9377300306463
FrameElem=1-1 ElemStation=3,999999999999999E-02
Frame=1 Station=7,999999999999999E-02 OutputCase=SIS08 CaseType=Combination P=-17,2037146090326 V2=12,6133476940215 V3=0 T=0 M2=0 M3=-8,43936660507383
FrameElem=1-1 ElemStation=7,999999999999999E-02
Frame=1 Station=0 OutputCase=SIS09 CaseType=Combination P=-17,1950802776089 V2=11,765298852182 V3=0 T=0 M2=0 M3=-6,68326430641782 FrameElem=1-1
ElemStation=0
Frame=1 Station=3,999999999999999E-02 OutputCase=SIS09 CaseType=Combination P=-17,0404802776089 V2=11,924398852182 V3=0 T=0 M2=0 M3=-7,15709892717177
FrameElem=1-1 ElemStation=3,999999999999999E-02
Frame=1 Station=7,999999999999999E-02 OutputCase=SIS09 CaseType=Combination P=-16,8858802776089 V2=12,071298852182 V3=0 T=0 M2=0 M3=-7,63705354792571
FrameElem=1-1 ElemStation=7,999999999999999E-02
Frame=1 Station=0 OutputCase=SIS10 CaseType=Combination P=-17,9935602776415 V2=11,7245277809512 V3=0 T=0 M2=0 M3=-6,78291769423164 FrameElem=1-1
ElemStation=0
Frame=1 Station=3,999999999999999E-02 OutputCase=SIS10 CaseType=Combination P=-17,8281602776415 V2=11,8836277809512 V3=0 T=0 M2=0 M3=-7,25512147213635
FrameElem=1-1 ElemStation=3,999999999999999E-02
Frame=1 Station=7,999999999999999E-02 OutputCase=SIS10 CaseType=Combination P=-17,6627602776415 V2=12,0305277809512 V3=0 T=0 M2=0 M3=-7,73344525004106
FrameElem=1-1 ElemStation=7,999999999999999E-02
Frame=1 Station=0 OutputCase=SIS10 CaseType=Combination P=-17,9935602776416 V2=12,1076370334095 V3=0 T=0 M2=0 M3=-7,07014813279739 FrameElem=1-1
ElemStation=0
Frame=1 Station=3,999999999999999E-02 OutputCase=SIS11 CaseType=Combination P=-17,8281602776416 V2=12,2667370334095 V3=0 T=0 M2=0 M3=-7,55767628080043
FrameElem=1-1 ElemStation=3,999999999999999E-02
Frame=1 Station=7,999999999999999E-02 OutputCase=SIS11 CaseType=Combination P=-17,6627602776416 V2=12,4136370334095 V3=0 T=0 M2=0 M3=-8,05132442880348
FrameElem=1-1 ElemStation=7,999999999999999E-02
Frame=1 Station=0 OutputCase=SIS12 CaseType=Combination P=-17,9935602776414 V2=11,3414185284928 V3=0 T=0 M2=0 M3=-6,49568725566589 FrameElem=1-1
ElemStation=0
Frame=1 Station=3,999999999999999E-02 OutputCase=SIS12 CaseType=Combination P=-17,8281602776414 V2=11,5005185284928 V3=0 T=0 M2=0 M3=-6,95256666347227
FrameElem=1-1 ElemStation=3,999999999999999E-02
Frame=1 Station=7,999999999999999E-02 OutputCase=SIS12 CaseType=Combination P=-17,6627602776414 V2=11,6474185284928 V3=0 T=0 M2=0 M3=-7,41556607127865
FrameElem=1-1 ElemStation=7,999999999999999E-02
Frame=1 Station=0 OutputCase=SIS13 CaseType=Combination P=-17,67525946218 V2=11,56558819157 V3=0 T=0 M2=0 M3=-6,31119898299643 FrameElem=1-1
ElemStation=0
Frame=1 Station=3,999999999999999E-02 OutputCase=SIS13 CaseType=Combination P=-17,510325946218 V2=11,72468819157 V3=0 T=0 M2=0 M3=-6,7770451773259
FrameElem=1-1 ElemStation=3,999999999999999E-02
Frame=1 Station=7,999999999999999E-02 OutputCase=SIS13 CaseType=Combination P=-17,344925946218 V2=11,87158819157 V3=0 T=0 M2=0 M3=-7,24901137165536
FrameElem=1-1 ElemStation=7,999999999999999E-02
Frame=1 Station=0 OutputCase=SIS14 CaseType=Combination P=-18,3113946090651 V2=11,8834673703323 V3=0 T=0 M2=0 M3=-7,25463640546685 FrameElem=1-1
ElemStation=0
Frame=1 Station=3,999999999999999E-02 OutputCase=SIS14 CaseType=Combination P=-18,1459946090651 V2=12,0425673703323 V3=0 T=0 M2=0 M3=-7,7331977669468
FrameElem=1-1 ElemStation=3,999999999999999E-02
Frame=1 Station=7,999999999999999E-02 OutputCase=SIS14 CaseType=Combination P=-17,9805946090651 V2=12,1894673703323 V3=0 T=0 M2=0 M3=-8,21787912842676
FrameElem=1-1 ElemStation=7,999999999999999E-02
Frame=1 Station=0 OutputCase=SIS15 CaseType=Combination P=-17,9935602776414 V2=11,3414185284928 V3=0 T=0 M2=0 M3=-6,49568725566589 FrameElem=1-1
ElemStation=0
Frame=1 Station=3,999999999999999E-02 OutputCase=SIS15 CaseType=Combination P=-17,8281602776414 V2=11,5005185284928 V3=0 T=0 M2=0 M3=-6,95256666347227
FrameElem=1-1 ElemStation=3,999999999999999E-02
Frame=1 Station=7,999999999999999E-02 OutputCase=SIS15 CaseType=Combination P=-17,6627602776414 V2=11,6474185284928 V3=0 T=0 M2=0 M3=-7,41556607127865
FrameElem=1-1 ElemStation=7,999999999999999E-02
Frame=1 Station=0 OutputCase=SIS16 CaseType=Combination P=-17,675259462181 V2=11,9486974440284 V3=0 T=0 M2=0 M3=-6,59842942156218 FrameElem=1-1
ElemStation=0
Frame=1 Station=3,999999999999999E-02 OutputCase=SIS16 CaseType=Combination P=-17,5103259462181 V2=12,1077974440283 V3=0 T=0 M2=0 M3=-7,0795998598998
FrameElem=1-1 ElemStation=3,999999999999999E-02
Frame=1 Station=7,999999999999999E-02 OutputCase=SIS16 CaseType=Combination P=-17,3449259462181 V2=12,2546974440283 V3=0 T=0 M2=0 M3=-7,56689055041778
FrameElem=1-1 ElemStation=7,999999999999999E-02
Frame=1 Station=0 OutputCase=SIS17 CaseType=Combination P=-18,3113946090652 V2=12,2665766227906 V3=0 T=0 M2=0 M3=-7,5418668440326 FrameElem=1-1
ElemStation=0
Frame=1 Station=3,999999999999999E-02 OutputCase=SIS17 CaseType=Combination P=-18,1459946090652 V2=12,4256766227906 V3=0 T=0 M2=0 M3=-8,03575257561089
FrameElem=1-1 ElemStation=3,999999999999999E-02
Frame=1 Station=7,999999999999999E-02 OutputCase=SIS17 CaseType=Combination P=-17,9805946090652 V2=12,5725766227906 V3=0 T=0 M2=0 M3=-8,53575830718918
FrameElem=1-1 ElemStation=7,999999999999999E-02
Frame=1 Station=0 OutputCase=SIS18 CaseType=Combination P=-17,9935602776415 V2=11,7245277809512 V3=0 T=0 M2=0 M3=-6,78291769423164 FrameElem=1-1
ElemStation=0
Frame=1 Station=3,999999999999999E-02 OutputCase=SIS18 CaseType=Combination P=-17,8281602776415 V2=11,8836277809512 V3=0 T=0 M2=0 M3=-7,25512147213635
FrameElem=1-1 ElemStation=3,999999999999999E-02
Frame=1 Station=7,999999999999999E-02 OutputCase=SIS18 CaseType=Combination P=-17,6627602776415 V2=12,0305277809512 V3=0 T=0 M2=0 M3=-7,73344525004106
FrameElem=1-1 ElemStation=7,999999999999999E-02
Frame=1 Station=0 OutputCase=SIS19 CaseType=Combination P=-13,985973376059 V2=9,95611510075178 V3=0 T=0 M2=0 M3=-4,82318449253499 FrameElem=1-1
ElemStation=0
Frame=1 Station=3,999999999999999E-02 OutputCase=SIS19 CaseType=Combination P=-13,843973376059 V2=10,1401351007518 V3=0 T=0 M2=0 M3=-5,22515016323173
FrameElem=1-1 ElemStation=3,999999999999999E-02
Frame=1 Station=7,999999999999999E-02 OutputCase=SIS19 CaseType=Combination P=-13,701973376059 V2=10,3119551007518 V3=0 T=0 M2=0 M3=-5,63423263392846
FrameElem=1-1 ElemStation=7,999999999999999E-02
Frame=1 Station=0 OutputCase=SIS20 CaseType=Combination P=-13,9859733760591 V2=10,3392243532101 V3=0 T=0 M2=0 M3=-5,11041493110074 FrameElem=1-1
ElemStation=0
Frame=1 Station=3,999999999999999E-02 OutputCase=SIS20 CaseType=Combination P=-13,8439733760591 V2=10,5232443532101 V3=0 T=0 M2=0 M3=-5,52770497189581
FrameElem=1-1 ElemStation=3,999999999999999E-02
Frame=1 Station=7,999999999999999E-02 OutputCase=SIS20 CaseType=Combination P=-13,7019733760591 V2=10,6950643532101 V3=0 T=0 M2=0 M3=-5,95211181269088
FrameElem=1-1 ElemStation=7,999999999999999E-02
Frame=1 Station=0 OutputCase=SIS21 CaseType=Combination P=-13,9859733760589 V2=9,57300584829346 V3=0 T=0 M2=0 M3=-4,53595405369624 FrameElem=1-1
ElemStation=0

Società di Progetto
Brebemi SpA



Doc. N.
60235-0000-A00.doc

CODIFICA DOCUMENTO
04RCDII10000000000300A00

REV.
00

FOGLIO
231 di 628

Frame=1 Station=3,999999999999999E-02 OutputCase=SIS21 CaseType=Combination P=-13,8439733760589 V2=9,75702584829346 V3=0 T=0 M2=0 M3=-4,92259535456764
FrameElem=1-1 ElemStation=3,999999999999999E-02
Frame=1 Station=7,999999999999999E-02 OutputCase=SIS21 CaseType=Combination P=-13,7019733760589 V2=9,92884584829346 V3=0 T=0 M2=0 M3=-5,31635345516605
FrameElem=1-1 ElemStation=7,999999999999999E-02
Frame=1 Station=0 OutputCase=SIS22 CaseType=Combination P=-13,6681390446354 V2=9,79717551137064 V3=0 T=0 M2=0 M3=-4,35146578129978 FrameElem=1-1
ElemStation=0
Frame=1 Station=3,999999999999999E-02 OutputCase=SIS22 CaseType=Combination P=-13,5261390446354 V2=9,98119551137064 V3=0 T=0 M2=0 M3=-4,74707386842127
FrameElem=1-1 ElemStation=3,999999999999999E-02
Frame=1 Station=7,999999999999999E-02 OutputCase=SIS22 CaseType=Combination P=-13,3841390446354 V2=10,1530155113706 V3=0 T=0 M2=0 M3=-5,14979875554276
FrameElem=1-1 ElemStation=7,999999999999999E-02
Frame=1 Station=0 OutputCase=SIS23 CaseType=Combination P=-14,3038077074825 V2=10,1150546901329 V3=0 T=0 M2=0 M3=-5,2949032037702 FrameElem=1-1
ElemStation=0
Frame=1 Station=3,999999999999999E-02 OutputCase=SIS23 CaseType=Combination P=-14,1618077074825 V2=10,2990746901329 V3=0 T=0 M2=0 M3=-5,70322645804218
FrameElem=1-1 ElemStation=3,999999999999999E-02
Frame=1 Station=7,999999999999999E-02 OutputCase=SIS23 CaseType=Combination P=-14,0198077074825 V2=10,4708946901329 V3=0 T=0 M2=0 M3=-6,11866651231416
FrameElem=1-1 ElemStation=7,999999999999999E-02
Frame=1 Station=0 OutputCase=SIS24 CaseType=Combination P=-13,9859733760589 V2=9,57300584829346 V3=0 T=0 M2=0 M3=-4,53595405396924 FrameElem=1-1
ElemStation=0
Frame=1 Station=3,999999999999999E-02 OutputCase=SIS24 CaseType=Combination P=-13,8439733760589 V2=9,75702584829346 V3=0 T=0 M2=0 M3=-4,92259535456764
FrameElem=1-1 ElemStation=3,999999999999999E-02
Frame=1 Station=7,999999999999999E-02 OutputCase=SIS24 CaseType=Combination P=-13,7019733760589 V2=9,92884584829346 V3=0 T=0 M2=0 M3=-5,31635345516605
FrameElem=1-1 ElemStation=7,999999999999999E-02
Frame=1 Station=0 OutputCase=SIS25 CaseType=Combination P=-13,6681390446356 V2=10,180284763829 V3=0 T=0 M2=0 M3=-4,63869621986553 FrameElem=1-1
ElemStation=0
Frame=1 Station=3,999999999999999E-02 OutputCase=SIS25 CaseType=Combination P=-13,5261390446356 V2=10,364304763829 V3=0 T=0 M2=0 M3=-5,04962867708536
FrameElem=1-1 ElemStation=3,999999999999999E-02
Frame=1 Station=7,999999999999999E-02 OutputCase=SIS25 CaseType=Combination P=-13,3841390446356 V2=10,536124763829 V3=0 T=0 M2=0 M3=-5,46767793430518
FrameElem=1-1 ElemStation=7,999999999999999E-02
Frame=1 Station=0 OutputCase=SIS26 CaseType=Combination P=-14,3038077074826 V2=10,4981639425913 V3=0 T=0 M2=0 M3=-5,58213364233595 FrameElem=1-1
ElemStation=0
Frame=1 Station=3,999999999999999E-02 OutputCase=SIS26 CaseType=Combination P=-14,1618077074826 V2=10,6821839425912 V3=0 T=0 M2=0 M3=-6,00578126670626
FrameElem=1-1 ElemStation=3,999999999999999E-02
Frame=1 Station=7,999999999999999E-02 OutputCase=SIS26 CaseType=Combination P=-14,0198077074826 V2=10,8540039425913 V3=0 T=0 M2=0 M3=-6,43654569107658
FrameElem=1-1 ElemStation=7,999999999999999E-02
Frame=1 Station=0 OutputCase=SIS27 CaseType=Combination P=-13,985973376059 V2=9,95611510075178 V3=0 T=0 M2=0 M3=-4,82318449253499 FrameElem=1-1
ElemStation=0
Frame=1 Station=3,999999999999999E-02 OutputCase=SIS27 CaseType=Combination P=-13,843973376059 V2=10,1401351007518 V3=0 T=0 M2=0 M3=-5,22515016323173
FrameElem=1-1 ElemStation=3,999999999999999E-02
Frame=1 Station=7,999999999999999E-02 OutputCase=SIS27 CaseType=Combination P=-13,701973376059 V2=10,3119551007518 V3=0 T=0 M2=0 M3=-5,63423263392846
FrameElem=1-1 ElemStation=7,999999999999999E-02
Frame=1 Station=0 OutputCase=SIS28 CaseType=Combination P=-16,6475733761676 V2=9,82021152998231 V3=0 T=0 M2=0 M3=-5,15536245191438 FrameElem=1-1
ElemStation=0
Frame=1 Station=3,999999999999999E-02 OutputCase=SIS28 CaseType=Combination P=-16,4695733761676 V2=10,0042315299823 V3=0 T=0 M2=0 M3=-5,55189197978034
FrameElem=1-1 ElemStation=3,999999999999999E-02
Frame=1 Station=7,999999999999999E-02 OutputCase=SIS28 CaseType=Combination P=-16,2915733761676 V2=10,1760515299823 V3=0 T=0 M2=0 M3=-5,9555383076463
FrameElem=1-1 ElemStation=7,999999999999999E-02
Frame=1 Station=0 OutputCase=SIS29 CaseType=Combination P=-16,6475733761677 V2=10,2033207824406 V3=0 T=0 M2=0 M3=-5,44259289048013 FrameElem=1-1
ElemStation=0
Frame=1 Station=3,999999999999999E-02 OutputCase=SIS29 CaseType=Combination P=-16,4695733761677 V2=10,3873407824406 V3=0 T=0 M2=0 M3=-5,85444678844442
FrameElem=1-1 ElemStation=3,999999999999999E-02
Frame=1 Station=7,999999999999999E-02 OutputCase=SIS29 CaseType=Combination P=-16,2915733761677 V2=10,5591607824406 V3=0 T=0 M2=0 M3=-6,27341748640871
FrameElem=1-1 ElemStation=7,999999999999999E-02
Frame=1 Station=0 OutputCase=SIS30 CaseType=Combination P=-16,6475733761675 V2=9,43710227752398 V3=0 T=0 M2=0 M3=-4,86813201334863 FrameElem=1-1
ElemStation=0
Frame=1 Station=3,999999999999999E-02 OutputCase=SIS30 CaseType=Combination P=-16,4695733761675 V2=9,62112227752398 V3=0 T=0 M2=0 M3=-5,24933717111626
FrameElem=1-1 ElemStation=3,999999999999999E-02
Frame=1 Station=7,999999999999999E-02 OutputCase=SIS30 CaseType=Combination P=-16,2915733761675 V2=9,79294227752398 V3=0 T=0 M2=0 M3=-5,63765912888388
FrameElem=1-1 ElemStation=7,999999999999999E-02
Frame=1 Station=0 OutputCase=SIS31 CaseType=Combination P=-16,329739044744 V2=9,66127194060116 V3=0 T=0 M2=0 M3=-4,68364374067917 FrameElem=1-1
ElemStation=0
Frame=1 Station=3,999999999999999E-02 OutputCase=SIS31 CaseType=Combination P=-16,151739044744 V2=9,84529194060116 V3=0 T=0 M2=0 M3=-5,07381568496989
FrameElem=1-1 ElemStation=3,999999999999999E-02
Frame=1 Station=7,999999999999999E-02 OutputCase=SIS31 CaseType=Combination P=-15,973739044744 V2=10,0171119406012 V3=0 T=0 M2=0 M3=-5,4711044292606
FrameElem=1-1 ElemStation=7,999999999999999E-02
Frame=1 Station=0 OutputCase=SIS32 CaseType=Combination P=-16,9654077075911 V2=9,97915111936345 V3=0 T=0 M2=0 M3=-5,62708116314959 FrameElem=1-1
ElemStation=0
Frame=1 Station=3,999999999999999E-02 OutputCase=SIS32 CaseType=Combination P=-16,7874077075911 V2=10,1631711193634 V3=0 T=0 M2=0 M3=-6,02996827459079
FrameElem=1-1 ElemStation=3,999999999999999E-02
Frame=1 Station=7,999999999999999E-02 OutputCase=SIS32 CaseType=Combination P=-16,6094077075911 V2=10,334911193634 V3=0 T=0 M2=0 M3=-6,439972186032
FrameElem=1-1 ElemStation=7,999999999999999E-02
Frame=1 Station=0 OutputCase=SIS33 CaseType=Combination P=-16,6475733761675 V2=9,43710227752398 V3=0 T=0 M2=0 M3=-4,86813201334863 FrameElem=1-1
ElemStation=0
Frame=1 Station=3,999999999999999E-02 OutputCase=SIS33 CaseType=Combination P=-16,4695733761675 V2=9,62112227752398 V3=0 T=0 M2=0 M3=-5,24933717111626
FrameElem=1-1 ElemStation=3,999999999999999E-02
Frame=1 Station=7,999999999999999E-02 OutputCase=SIS33 CaseType=Combination P=-16,2915733761675 V2=9,79294227752398 V3=0 T=0 M2=0 M3=-5,63765912888388
FrameElem=1-1 ElemStation=7,999999999999999E-02
Frame=1 Station=0 OutputCase=SIS34 CaseType=Combination P=-16,3297390447441 V2=10,0443811930595 V3=0 T=0 M2=0 M3=-4,97087417924492 FrameElem=1-1
ElemStation=0
Frame=1 Station=3,999999999999999E-02 OutputCase=SIS34 CaseType=Combination P=-16,1517390447441 V2=10,2284011930595 V3=0 T=0 M2=0 M3=-5,37637049363397
FrameElem=1-1 ElemStation=3,999999999999999E-02
Frame=1 Station=7,999999999999999E-02 OutputCase=SIS34 CaseType=Combination P=-15,9737390447441 V2=10,4002211930595 V3=0 T=0 M2=0 M3=-5,78898360802301
FrameElem=1-1 ElemStation=7,999999999999999E-02
Frame=1 Station=0 OutputCase=SIS35 CaseType=Combination P=-16,9654077075912 V2=10,3622603718218 V3=0 T=0 M2=0 M3=-5,91431160171534 FrameElem=1-1
ElemStation=0
Frame=1 Station=3,999999999999999E-02 OutputCase=SIS35 CaseType=Combination P=-16,7874077075912 V2=10,5462803718218 V3=0 T=0 M2=0 M3=-6,3325208325488
FrameElem=1-1 ElemStation=3,999999999999999E-02
Frame=1 Station=7,999999999999999E-02 OutputCase=SIS35 CaseType=Combination P=-16,6094077075912 V2=10,7181003718218 V3=0 T=0 M2=0 M3=-6,75785136479441
FrameElem=1-1 ElemStation=7,999999999999999E-02

Società di Progetto
Brebemi SpA



Doc. N.
60235-00000-A00.doc

CODIFICA DOCUMENTO
04RCDII10000000000300A00

REV.
00

FOGLIO
232 di 628

Frame=1 Station=0 OutputCase=SIS36 CaseType=Combination P=-16,6475733761676 V2=9,82021152998231 V3=0 T=0 M2=0 M3=-5,15536245191438 FrameElem=1-1 ElemStation=0
Frame=1 Station=3,999999999999999E-02 OutputCase=SIS36 CaseType=Combination P=-16,4695733761676 V2=10,0042315299823 V3=0 T=0 M2=0 M3=-5,55189197978034 FrameElem=1-1 ElemStation=3,999999999999999E-02
Frame=1 Station=7,999999999999998E-02 OutputCase=SIS36 CaseType=Combination P=-16,2915733761676 V2=10,1760515299823 V3=0 T=0 M2=0 M3=-5,9555383076463 FrameElem=1-1 ElemStation=7,999999999999998E-02
Frame=1 Station=0 OutputCase=INVSIS CaseType=Combination StepType=Max P=-13,6681390446354 V2=12,3073476940215 V3=0 T=0 M2=0 M3=-4,35146578129978 FrameElem=1-1 ElemStation=0
Frame=1 Station=3,999999999999999E-02 OutputCase=INVSIS CaseType=Combination StepType=Max P=-13,5261390446354 V2=12,4664476940215 V3=0 T=0 M2=0 M3=-4,74707386842127 FrameElem=1-1 ElemStation=3,999999999999999E-02
Frame=1 Station=7,999999999999998E-02 OutputCase=INVSIS CaseType=Combination StepType=Max P=-13,3841390446354 V2=12,6133476940215 V3=0 T=0 M2=0 M3=-5,14979875554276 FrameElem=1-1 ElemStation=7,999999999999998E-02
Frame=1 Station=0 OutputCase=INVSIS CaseType=Combination StepType=Min P=-18,3113946090652 V2=9,43710227752398 V3=0 T=0 M2=0 M3=-7,5418668440326 FrameElem=1-1 ElemStation=0
Frame=1 Station=3,999999999999999E-02 OutputCase=INVSIS CaseType=Combination StepType=Min P=-18,1459946090652 V2=9,62112227752398 V3=0 T=0 M2=0 M3=-8,03575257561089 FrameElem=1-1 ElemStation=3,999999999999999E-02
Frame=1 Station=7,999999999999998E-02 OutputCase=INVSIS CaseType=Combination StepType=Min P=-17,9805946090652 V2=9,79294227752398 V3=0 T=0 M2=0 M3=-8,53575830718918 FrameElem=1-1 ElemStation=7,999999999999998E-02
Frame=1 Station=0 OutputCase=RAR001 CaseType=Combination P=-11,9400000002934 V2=6,13093887246257 V3=0 T=0 M2=0 M3=-2,11112928861528 FrameElem=1-1 ElemStation=0
Frame=1 Station=3,999999999999999E-02 OutputCase=RAR001 CaseType=Combination P=-11,7800000002934 V2=6,32563867246257 V3=0 T=0 M2=0 M3=-2,36030150218045 FrameElem=1-1 ElemStation=3,999999999999999E-02
Frame=1 Station=7,999999999999998E-02 OutputCase=RAR001 CaseType=Combination P=-11,6200000002934 V2=6,50813867246257 V3=0 T=0 M2=0 M3=-2,61701771574562 FrameElem=1-1 ElemStation=7,999999999999998E-02
Frame=1 Station=0 OutputCase=RAR002 CaseType=Combination P=-91,6199999992386 V2=4,59740814684798 V3=0 T=0 M2=0 M3=-13,0894969118937 FrameElem=1-1 ElemStation=0
Frame=1 Station=3,999999999999999E-02 OutputCase=RAR002 CaseType=Combination P=-91,4599999992386 V2=4,71990814684798 V3=0 T=0 M2=0 M3=-13,2758692377677 FrameElem=1-1 ElemStation=3,999999999999999E-02
Frame=1 Station=7,999999999999998E-02 OutputCase=RAR002 CaseType=Combination P=-91,2999999992387 V2=4,83460814684798 V3=0 T=0 M2=0 M3=-13,4669855636416 FrameElem=1-1 ElemStation=7,999999999999998E-02
Frame=1 Station=0 OutputCase=RAR003 CaseType=Combination P=-100,961144092958 V2=16,4228388797669 V3=0 T=0 M2=0 M3=-21,5190444176744 FrameElem=1-1 ElemStation=0
Frame=1 Station=3,999999999999999E-02 OutputCase=RAR003 CaseType=Combination P=-100,801144092958 V2=16,5453388797669 V3=0 T=0 M2=0 M3=-22,1784339728651 FrameElem=1-1 ElemStation=3,999999999999999E-02
Frame=1 Station=7,999999999999998E-02 OutputCase=RAR003 CaseType=Combination P=-100,641144092958 V2=16,6600388797669 V3=0 T=0 M2=0 M3=-22,8425675280557 FrameElem=1-1 ElemStation=7,999999999999998E-02
Frame=1 Station=0 OutputCase=RAR004 CaseType=Combination P=-91,6200000002282 V2=25,9582695993772 V3=0 T=0 M2=0 M3=-14,5338127298503 FrameElem=1-1 ElemStation=0
Frame=1 Station=3,999999999999999E-02 OutputCase=RAR004 CaseType=Combination P=-91,4600000002282 V2=27,2272695993772 V3=0 T=0 M2=0 M3=-15,5975595138253 FrameElem=1-1 ElemStation=3,999999999999999E-02
Frame=1 Station=7,999999999999998E-02 OutputCase=RAR004 CaseType=Combination P=-91,3000000002282 V2=28,4854695993772 V3=0 T=0 M2=0 M3=-16,7118502978004 FrameElem=1-1 ElemStation=7,999999999999998E-02
Frame=1 Station=0 OutputCase=RAR005 CaseType=Combination P=-21,2811440939549 V2=15,4626958458704 V3=0 T=0 M2=0 M3=-10,312603888977 FrameElem=1-1 ElemStation=0
Frame=1 Station=3,999999999999999E-02 OutputCase=RAR005 CaseType=Combination P=-21,1211440939549 V2=15,5851958458704 V3=0 T=0 M2=0 M3=-10,9335877227325 FrameElem=1-1 ElemStation=3,999999999999999E-02
Frame=1 Station=7,999999999999998E-02 OutputCase=RAR005 CaseType=Combination P=-20,9611440939549 V2=15,6998958458704 V3=0 T=0 M2=0 M3=-11,5593155565673 FrameElem=1-1 ElemStation=7,999999999999998E-02
Frame=1 Station=0 OutputCase=RAR006 CaseType=Combination P=-11,9400000012247 V2=24,998126564807 V3=0 T=0 M2=0 M3=-3,32737220107354 FrameElem=1-1 ElemStation=0
Frame=1 Station=3,999999999999999E-02 OutputCase=RAR006 CaseType=Combination P=-11,7800000012247 V2=26,267126564807 V3=0 T=0 M2=0 M3=-4,35271326369277 FrameElem=1-1 ElemStation=3,999999999999999E-02
Frame=1 Station=7,999999999999998E-02 OutputCase=RAR006 CaseType=Combination P=-11,6200000012247 V2=27,525326564807 V3=0 T=0 M2=0 M3=-5,42859832631199 FrameElem=1-1 ElemStation=7,999999999999998E-02
Frame=1 Station=0 OutputCase=RAR007 CaseType=Combination P=-93,2959910848294 V2=27,4166546365151 V3=0 T=0 M2=0 M3=-27,638801590782 FrameElem=1-1 ElemStation=0
Frame=1 Station=3,999999999999999E-02 OutputCase=RAR007 CaseType=Combination P=-93,1359910848294 V2=27,5391546365151 V3=0 T=0 M2=0 M3=-28,7379437762426 FrameElem=1-1 ElemStation=3,999999999999999E-02
Frame=1 Station=7,999999999999998E-02 OutputCase=RAR007 CaseType=Combination P=-92,9759910848294 V2=27,6538546365151 V3=0 T=0 M2=0 M3=-29,8418299617032 FrameElem=1-1 ElemStation=7,999999999999998E-02
Frame=1 Station=0 OutputCase=RAR008 CaseType=Combination P=-11,9400000002354 V2=4,40348361786814 V3=0 T=0 M2=0 M3=-2,45751726024852 FrameElem=1-1 ElemStation=0
Frame=1 Station=3,999999999999999E-02 OutputCase=RAR008 CaseType=Combination P=-11,7800000002354 V2=4,52598361786814 V3=0 T=0 M2=0 M3=-2,63613260496324 FrameElem=1-1 ElemStation=3,999999999999999E-02
Frame=1 Station=7,999999999999998E-02 OutputCase=RAR008 CaseType=Combination P=-11,6200000002354 V2=4,64068361786814 V3=0 T=0 M2=0 M3=-2,81949194967797 FrameElem=1-1 ElemStation=7,999999999999998E-02
Frame=1 Station=0 OutputCase=RAR009 CaseType=Combination P=-91,6199999992388 V2=5,05713924979797 V3=0 T=0 M2=0 M3=-13,4341734381726 FrameElem=1-1 ElemStation=0
Frame=1 Station=3,999999999999999E-02 OutputCase=RAR009 CaseType=Combination P=-91,4599999992388 V2=5,17963924979797 V3=0 T=0 M2=0 M3=-13,6389350081646 FrameElem=1-1 ElemStation=3,999999999999999E-02
Frame=1 Station=7,999999999999998E-02 OutputCase=RAR009 CaseType=Combination P=-91,2999999992388 V2=5,29433924979797 V3=0 T=0 M2=0 M3=-13,8484405781565 FrameElem=1-1 ElemStation=7,999999999999998E-02
Frame=1 Station=0 OutputCase=RAR010 CaseType=Combination P=-100,961144092959 V2=16,8825699827169 V3=0 T=0 M2=0 M3=-21,8637209439533 FrameElem=1-1 ElemStation=0
Frame=1 Station=3,999999999999999E-02 OutputCase=RAR010 CaseType=Combination P=-100,801144092959 V2=17,0050699827169 V3=0 T=0 M2=0 M3=-22,541499743262 FrameElem=1-1 ElemStation=3,999999999999999E-02
Frame=1 Station=7,999999999999998E-02 OutputCase=RAR010 CaseType=Combination P=-100,641144092959 V2=17,1197699827169 V3=0 T=0 M2=0 M3=-23,2240225425706 FrameElem=1-1 ElemStation=7,999999999999998E-02
Frame=1 Station=0 OutputCase=RAR011 CaseType=Combination P=-91,6200000002283 V2=26,4180007023272 V3=0 T=0 M2=0 M3=-14,8784892561292 FrameElem=1-1 ElemStation=0
Frame=1 Station=3,999999999999999E-02 OutputCase=RAR011 CaseType=Combination P=-91,4600000002283 V2=27,6870007023272 V3=0 T=0 M2=0 M3=-15,9606252842222 FrameElem=1-1 ElemStation=3,999999999999999E-02
Frame=1 Station=7,999999999999998E-02 OutputCase=RAR011 CaseType=Combination P=-91,3000000002283 V2=28,9452007023272 V3=0 T=0 M2=0 M3=-17,0933038123153 FrameElem=1-1 ElemStation=7,999999999999998E-02
Frame=1 Station=0 OutputCase=RAR012 CaseType=Combination P=-21,2811440939551 V2=15,9224269488204 V3=0 T=0 M2=0 M3=-10,6572804151766 FrameElem=1-1 ElemStation=0
Frame=1 Station=3,999999999999999E-02 OutputCase=RAR012 CaseType=Combination P=-21,1211440939551 V2=16,0449269488204 V3=0 T=0 M2=0 M3=-11,2966534931294 FrameElem=1-1 ElemStation=3,999999999999999E-02

APPROVATO SDP
Società di Progetto
Brebemi SpA



Doc. N.
60235-0000-A00.doc

CODIFICA DOCUMENTO
04RCDII10000000000300A00

REV.
00

FOGLIO
233 di 628

Frame=1 Station=7,999999999999999E-02 OutputCase=RAR012 CaseType=Combination P=-20,9611440939551 V2=16,1596269488204 V3=0 T=0 M2=0 M3=-11,9407705710822
FrameElem=1-1 ElemStation=7,999999999999999E-02
Frame=1 Station=0 OutputCase=RAR013 CaseType=Combination P=-11,940000012248 V2=25,4578576684307 V3=0 T=0 M2=0 M3=-3,67204872735244 FrameElem=1-1
ElemStation=0
Frame=1 Station=3,999999999999999E-02 OutputCase=RAR013 CaseType=Combination P=-11,7800000012248 V2=26,7268576684307 V3=0 T=0 M2=0 M3=-4,71577903408966
FrameElem=1-1 ElemStation=3,999999999999999E-02
Frame=1 Station=7,999999999999999E-02 OutputCase=RAR013 CaseType=Combination P=-11,6200000012248 V2=27,9850576684307 V3=0 T=0 M2=0 M3=-5,8100533082689
FrameElem=1-1 ElemStation=7,999999999999999E-02
Frame=1 Station=0 OutputCase=RAR014 CaseType=Combination P=-93,2959910848296 V2=27,8763857394651 V3=0 T=0 M2=0 M3=-27,9834781170609 FrameElem=1-1
ElemStation=0
Frame=1 Station=3,999999999999999E-02 OutputCase=RAR014 CaseType=Combination P=-93,1359910848296 V2=27,9988857394651 V3=0 T=0 M2=0 M3=-29,1010095466395
FrameElem=1-1 ElemStation=3,999999999999999E-02
Frame=1 Station=7,999999999999999E-02 OutputCase=RAR014 CaseType=Combination P=-92,9759910848296 V2=28,1135857394651 V3=0 T=0 M2=0 M3=-30,2232849762181
FrameElem=1-1 ElemStation=7,999999999999999E-02
Frame=1 Station=0 OutputCase=RAR015 CaseType=Combination P=-71,699999999488 V2=5,12359089329051 V3=0 T=0 M2=0 M3=-10,8623476568311 FrameElem=1-1
ElemStation=0
Frame=1 Station=3,999999999999999E-02 OutputCase=RAR015 CaseType=Combination P=-71,539999999488 V2=5,24609089329051 V3=0 T=0 M2=0 M3=-11,0697672925627
FrameElem=1-1 ElemStation=3,999999999999999E-02
Frame=1 Station=7,999999999999999E-02 OutputCase=RAR015 CaseType=Combination P=-71,379999999488 V2=5,36079089329051 V3=0 T=0 M2=0 M3=-11,2819309282943
FrameElem=1-1 ElemStation=7,999999999999999E-02
Frame=1 Station=0 OutputCase=RAR016 CaseType=Combination P=-78,9479075365819 V2=14,3218731381386 V3=0 T=0 M2=0 M3=-17,4132331234642 FrameElem=1-1
ElemStation=0
Frame=1 Station=3,999999999999999E-02 OutputCase=RAR016 CaseType=Combination P=-78,7879075365819 V2=14,4443731381386 V3=0 T=0 M2=0 M3=-17,9885840489898
FrameElem=1-1 ElemStation=3,999999999999999E-02
Frame=1 Station=7,999999999999999E-02 OutputCase=RAR016 CaseType=Combination P=-78,6279075365819 V2=14,5590731381386 V3=0 T=0 M2=0 M3=-18,5686789745153
FrameElem=1-1 ElemStation=7,999999999999999E-02
Frame=1 Station=0 OutputCase=RAR017 CaseType=Combination P=-71,700000002447 V2=21,7676553725652 V3=0 T=0 M2=0 M3=-12,002602746673 FrameElem=1-1
ElemStation=0
Frame=1 Station=3,999999999999999E-02 OutputCase=RAR017 CaseType=Combination P=-71,540000002447 V2=22,7680803725652 V3=0 T=0 M2=0 M3=-12,8933546282423
FrameElem=1-1 ElemStation=3,999999999999999E-02
Frame=1 Station=7,999999999999999E-02 OutputCase=RAR017 CaseType=Combination P=-71,380000002447 V2=23,7573553725652 V3=0 T=0 M2=0 M3=-13,8239005098116
FrameElem=1-1 ElemStation=7,999999999999999E-02
Frame=1 Station=0 OutputCase=RAR018 CaseType=Combination P=-19,1879075373292 V2=13,6017658627162 V3=0 T=0 M2=0 M3=-9,00840272688171 FrameElem=1-1
ElemStation=0
Frame=1 Station=3,999999999999999E-02 OutputCase=RAR018 CaseType=Combination P=-19,0279075373292 V2=13,7242658627162 V3=0 T=0 M2=0 M3=-9,55494936139035
FrameElem=1-1 ElemStation=3,999999999999999E-02
Frame=1 Station=7,999999999999999E-02 OutputCase=RAR018 CaseType=Combination P=-18,8679075373292 V2=13,8389658627162 V3=0 T=0 M2=0 M3=-10,106239995899
FrameElem=1-1 ElemStation=7,999999999999999E-02
Frame=1 Station=0 OutputCase=RAR019 CaseType=Combination P=-11,940000009921 V2=21,0475480971428 V3=0 T=0 M2=0 M3=-3,5977235009047 FrameElem=1-1
ElemStation=0
Frame=1 Station=3,999999999999999E-02 OutputCase=RAR019 CaseType=Combination P=-11,780000009921 V2=22,0479730971428 V3=0 T=0 M2=0 M3=-4,45971994064285
FrameElem=1-1 ElemStation=3,999999999999999E-02
Frame=1 Station=7,999999999999999E-02 OutputCase=RAR019 CaseType=Combination P=-11,620000009921 V2=23,0372480971428 V3=0 T=0 M2=0 M3=-5,36146153119523
FrameElem=1-1 ElemStation=7,999999999999999E-02
Frame=1 Station=0 OutputCase=RAR020 CaseType=Combination P=-11,5585988025271 V2=4,21275611061077 V3=0 T=0 M2=0 M3=-1,89145480676627 FrameElem=1-1
ElemStation=0
Frame=1 Station=3,999999999999999E-02 OutputCase=RAR020 CaseType=Combination P=-11,3985988025271 V2=4,33525611061077 V3=0 T=0 M2=0 M3=-2,0624410511907
FrameElem=1-1 ElemStation=3,999999999999999E-02
Frame=1 Station=7,999999999999999E-02 OutputCase=RAR020 CaseType=Combination P=-11,2385988025271 V2=4,44995611061077 V3=0 T=0 M2=0 M3=-2,23817129561513
FrameElem=1-1 ElemStation=7,999999999999999E-02
Frame=1 Station=0 OutputCase=RAR021 CaseType=Combination P=-71,3185988017798 V2=4,93286338603314 V3=0 T=0 M2=0 M3=-10,2962852033488 FrameElem=1-1
ElemStation=0
Frame=1 Station=3,999999999999999E-02 OutputCase=RAR021 CaseType=Combination P=-71,1585988017798 V2=5,05536338603314 V3=0 T=0 M2=0 M3=-10,4960757387901
FrameElem=1-1 ElemStation=3,999999999999999E-02
Frame=1 Station=7,999999999999999E-02 OutputCase=RAR021 CaseType=Combination P=-70,9985988017798 V2=5,17006338603314 V3=0 T=0 M2=0 M3=-10,7006102742315
FrameElem=1-1 ElemStation=7,999999999999999E-02
Frame=1 Station=0 OutputCase=RAR022 CaseType=Combination P=-78,5665063388736 V2=14,1311456308812 V3=0 T=0 M2=0 M3=-16,847170669982 FrameElem=1-1
ElemStation=0
Frame=1 Station=3,999999999999999E-02 OutputCase=RAR022 CaseType=Combination P=-78,4065063388736 V2=14,2536456308812 V3=0 T=0 M2=0 M3=-17,4148924952172
FrameElem=1-1 ElemStation=3,999999999999999E-02
Frame=1 Station=7,999999999999999E-02 OutputCase=RAR022 CaseType=Combination P=-78,2465063388736 V2=14,3683456308812 V3=0 T=0 M2=0 M3=-17,9873583204525
FrameElem=1-1 ElemStation=7,999999999999999E-02
Frame=1 Station=0 OutputCase=RAR023 CaseType=Combination P=-71,3185988025365 V2=21,5769278653078 V3=0 T=0 M2=0 M3=-11,4365402931908 FrameElem=1-1
ElemStation=0
Frame=1 Station=3,999999999999999E-02 OutputCase=RAR023 CaseType=Combination P=-71,1585988025365 V2=22,5773528653078 V3=0 T=0 M2=0 M3=-12,3196630744697
FrameElem=1-1 ElemStation=3,999999999999999E-02
Frame=1 Station=7,999999999999999E-02 OutputCase=RAR023 CaseType=Combination P=-70,9985988025365 V2=23,5666278653078 V3=0 T=0 M2=0 M3=-13,242598557487
FrameElem=1-1 ElemStation=7,999999999999999E-02
Frame=1 Station=0 OutputCase=RAR024 CaseType=Combination P=-18,806506339621 V2=13,4110383554589 V3=0 T=0 M2=0 M3=-8,44234027339946 FrameElem=1-1
ElemStation=0
Frame=1 Station=3,999999999999999E-02 OutputCase=RAR024 CaseType=Combination P=-18,646506339621 V2=13,5335383554589 V3=0 T=0 M2=0 M3=-8,98125780761781
FrameElem=1-1 ElemStation=3,999999999999999E-02
Frame=1 Station=7,999999999999999E-02 OutputCase=RAR024 CaseType=Combination P=-18,486506339621 V2=13,6482383554589 V3=0 T=0 M2=0 M3=-9,52491934183616
FrameElem=1-1 ElemStation=7,999999999999999E-02
Frame=1 Station=0 OutputCase=RAR025 CaseType=Combination P=-11,5585988032838 V2=20,8568205898854 V3=0 T=0 M2=0 M3=-3,03170989660823 FrameElem=1-1
ElemStation=0
Frame=1 Station=3,999999999999999E-02 OutputCase=RAR025 CaseType=Combination P=-11,3985988032838 V2=21,8572455898854 V3=0 T=0 M2=0 M3=-3,88602838687031
FrameElem=1-1 ElemStation=3,999999999999999E-02
Frame=1 Station=7,999999999999999E-02 OutputCase=RAR025 CaseType=Combination P=-11,2385988032838 V2=22,8465205898854 V3=0 T=0 M2=0 M3=-4,78014087713239
FrameElem=1-1 ElemStation=7,999999999999999E-02
Frame=1 Station=0 OutputCase=RAR026 CaseType=Combination P=-12,3214011979436 V2=4,59421112512551 V3=0 T=0 M2=0 M3=-3,02357971373077 FrameElem=1-1
ElemStation=0
Frame=1 Station=3,999999999999999E-02 OutputCase=RAR026 CaseType=Combination P=-12,1614011979436 V2=4,71671112512551 V3=0 T=0 M2=0 M3=-3,20982418873579
FrameElem=1-1 ElemStation=3,999999999999999E-02
Frame=1 Station=7,999999999999999E-02 OutputCase=RAR026 CaseType=Combination P=-12,0014011979436 V2=4,83141112512551 V3=0 T=0 M2=0 M3=-3,40081260374081
FrameElem=1-1 ElemStation=7,999999999999999E-02
Frame=1 Station=0 OutputCase=RAR027 CaseType=Combination P=-72,0814011971962 V2=5,31431840054788 V3=0 T=0 M2=0 M3=-11,4284101103133 FrameElem=1-1
ElemStation=0

Società di Progetto
Brebemi SpA



Doc. N.
60235-0000-A00.doc

CODIFICA DOCUMENTO
04RCDII10000000000300A00

REV.
00

FOGLIO
234 di 628

Frame=1 Station=3,999999999999999E-02 OutputCase=RAR027 CaseType=Combination P=-71,9214011971962 V2=5,43681840054788 V3=0 T=0 M2=0 M3=-11,6434588463352
FrameElem=1-1 ElemStation=3,999999999999999E-02
Frame=1 Station=7,999999999999998E-02 OutputCase=RAR027 CaseType=Combination P=-71,7614011971963 V2=5,55151840054788 V3=0 T=0 M2=0 M3=-11,8632515823571
FrameElem=1-1 ElemStation=7,999999999999998E-02
Frame=1 Station=0 OutputCase=RAR028 CaseType=Combination P=-79,3293087342901 V2=14,512600645396 V3=0 T=0 M2=0 M3=-17,9792955769465 FrameElem=1-1
ElemStation=0
Frame=1 Station=3,999999999999999E-02 OutputCase=RAR028 CaseType=Combination P=-79,1693087342901 V2=14,635100645396 V3=0 T=0 M2=0 M3=-18,5622756027623
FrameElem=1-1 ElemStation=3,999999999999999E-02
Frame=1 Station=7,999999999999998E-02 OutputCase=RAR028 CaseType=Combination P=-79,0093087342901 V2=14,749800645396 V3=0 T=0 M2=0 M3=-19,1499996285782
FrameElem=1-1 ElemStation=7,999999999999998E-02
Frame=1 Station=0 OutputCase=RAR029 CaseType=Combination P=-72,0814011979529 V2=21,9583828798226 V3=0 T=0 M2=0 M3=-12,5686652001553 FrameElem=1-1
ElemStation=0
Frame=1 Station=3,999999999999999E-02 OutputCase=RAR029 CaseType=Combination P=-71,9214011979529 V2=22,9588078798226 V3=0 T=0 M2=0 M3=-13,4670461820148
FrameElem=1-1 ElemStation=3,999999999999999E-02
Frame=1 Station=7,999999999999998E-02 OutputCase=RAR029 CaseType=Combination P=-71,7614011979529 V2=23,9480828798226 V3=0 T=0 M2=0 M3=-14,4052211638744
FrameElem=1-1 ElemStation=7,999999999999998E-02
Frame=1 Station=0 OutputCase=RAR030 CaseType=Combination P=-19,5693087350375 V2=13,7924933699736 V3=0 T=0 M2=0 M3=-9,57446518036396 FrameElem=1-1
ElemStation=0
Frame=1 Station=3,999999999999999E-02 OutputCase=RAR030 CaseType=Combination P=-19,4093087350375 V2=13,9149933699736 V3=0 T=0 M2=0 M3=-10,1286409151629
FrameElem=1-1 ElemStation=3,999999999999999E-02
Frame=1 Station=7,999999999999998E-02 OutputCase=RAR030 CaseType=Combination P=-19,2493087350375 V2=14,0296933699736 V3=0 T=0 M2=0 M3=-10,6875606499618
FrameElem=1-1 ElemStation=7,999999999999998E-02
Frame=1 Station=0 OutputCase=RAR031 CaseType=Combination P=-12,3214011987003 V2=21,2382756044002 V3=0 T=0 M2=0 M3=-4,16383480357272 FrameElem=1-1
ElemStation=0
Frame=1 Station=3,999999999999999E-02 OutputCase=RAR031 CaseType=Combination P=-12,1614011987003 V2=22,2387006044002 V3=0 T=0 M2=0 M3=-5,0334114944154
FrameElem=1-1 ElemStation=3,999999999999999E-02
Frame=1 Station=7,999999999999998E-02 OutputCase=RAR031 CaseType=Combination P=-12,0014011987003 V2=23,2279756044002 V3=0 T=0 M2=0 M3=-5,94278218525807
FrameElem=1-1 ElemStation=7,999999999999998E-02
Frame=1 Station=0 OutputCase=RAR032 CaseType=Combination P=-11,940000002352 V2=3,94375251491815 V3=0 T=0 M2=0 M3=-2,11284073396962 FrameElem=1-1
ElemStation=0
Frame=1 Station=3,999999999999999E-02 OutputCase=RAR032 CaseType=Combination P=-11,7800000002352 V2=4,06625251491815 V3=0 T=0 M2=0 M3=-2,27306683456634
FrameElem=1-1 ElemStation=3,999999999999999E-02
Frame=1 Station=7,999999999999998E-02 OutputCase=RAR032 CaseType=Combination P=-11,6200000002352 V2=4,18095251491815 V3=0 T=0 M2=0 M3=-2,43803693516307
FrameElem=1-1 ElemStation=7,999999999999998E-02
Frame=1 Station=0 OutputCase=RAR033 CaseType=Combination P=-71,6999999994879 V2=4,66385979034052 V3=0 T=0 M2=0 M3=-10,5176711305522 FrameElem=1-1
ElemStation=0
Frame=1 Station=3,999999999999999E-02 OutputCase=RAR033 CaseType=Combination P=-71,5399999994879 V2=4,78635979034052 V3=0 T=0 M2=0 M3=-10,7067015221658
FrameElem=1-1 ElemStation=3,999999999999999E-02
Frame=1 Station=7,999999999999998E-02 OutputCase=RAR033 CaseType=Combination P=-71,3799999994879 V2=4,90105979034052 V3=0 T=0 M2=0 M3=-10,9004759137794
FrameElem=1-1 ElemStation=7,999999999999998E-02
Frame=1 Station=0 OutputCase=RAR034 CaseType=Combination P=-78,9479075365817 V2=13,8621420351886 V3=0 T=0 M2=0 M3=-17,0685565971853 FrameElem=1-1
ElemStation=0
Frame=1 Station=3,999999999999999E-02 OutputCase=RAR034 CaseType=Combination P=-78,7879075365817 V2=13,9846420351886 V3=0 T=0 M2=0 M3=-17,6255182785929
FrameElem=1-1 ElemStation=3,999999999999999E-02
Frame=1 Station=7,999999999999998E-02 OutputCase=RAR034 CaseType=Combination P=-78,6279075365817 V2=14,0993420351886 V3=0 T=0 M2=0 M3=-18,1872239600004
FrameElem=1-1 ElemStation=7,999999999999998E-02
Frame=1 Station=0 OutputCase=RAR035 CaseType=Combination P=-71,7000000002446 V2=21,3079242696152 V3=0 T=0 M2=0 M3=-11,6579262203941 FrameElem=1-1
ElemStation=0
Frame=1 Station=3,999999999999999E-02 OutputCase=RAR035 CaseType=Combination P=-71,5400000002446 V2=22,3083492696152 V3=0 T=0 M2=0 M3=-12,5302888578454
FrameElem=1-1 ElemStation=3,999999999999999E-02
Frame=1 Station=7,999999999999998E-02 OutputCase=RAR035 CaseType=Combination P=-71,3800000002446 V2=23,2976242696152 V3=0 T=0 M2=0 M3=-13,4424454952967
FrameElem=1-1 ElemStation=7,999999999999998E-02
Frame=1 Station=0 OutputCase=RAR036 CaseType=Combination P=-19,1879075373291 V2=13,1420347597662 V3=0 T=0 M2=0 M3=-8,66372620060281 FrameElem=1-1
ElemStation=0
Frame=1 Station=3,999999999999999E-02 OutputCase=RAR036 CaseType=Combination P=-19,0279075373291 V2=13,2645347597662 V3=0 T=0 M2=0 M3=-9,19188359099346
FrameElem=1-1 ElemStation=3,999999999999999E-02
Frame=1 Station=7,999999999999998E-02 OutputCase=RAR036 CaseType=Combination P=-18,8679075373291 V2=13,3792347597662 V3=0 T=0 M2=0 M3=-9,7247849813841
FrameElem=1-1 ElemStation=7,999999999999998E-02
Frame=1 Station=0 OutputCase=RAR037 CaseType=Combination P=-11,9400000009919 V2=20,5878169941928 V3=0 T=0 M2=0 M3=-3,25309582381157 FrameElem=1-1
ElemStation=0
Frame=1 Station=3,999999999999999E-02 OutputCase=RAR037 CaseType=Combination P=-11,7800000009919 V2=21,5882419941928 V3=0 T=0 M2=0 M3=-4,09665417024595
FrameElem=1-1 ElemStation=3,999999999999999E-02
Frame=1 Station=7,999999999999998E-02 OutputCase=RAR037 CaseType=Combination P=-11,6200000009919 V2=22,5775169941928 V3=0 T=0 M2=0 M3=-4,9800651668033
FrameElem=1-1 ElemStation=7,999999999999998E-02
Frame=1 Station=0 OutputCase=RAR038 CaseType=Combination P=-11,9400000002349 V2=2,87104660803484 V3=0 T=0 M2=0 M3=-1,30859550598552 FrameElem=1-1
ElemStation=0
Frame=1 Station=3,999999999999999E-02 OutputCase=RAR038 CaseType=Combination P=-11,7800000002349 V2=2,99354660803484 V3=0 T=0 M2=0 M3=-1,42591337030691
FrameElem=1-1 ElemStation=3,999999999999999E-02
Frame=1 Station=7,999999999999998E-02 OutputCase=RAR038 CaseType=Combination P=-11,6200000002349 V2=3,10824660803484 V3=0 T=0 M2=0 M3=-1,5479752346283
FrameElem=1-1 ElemStation=7,999999999999998E-02
Frame=1 Station=0 OutputCase=RAR039 CaseType=Combination P=-91,6199999992385 V2=4,13767704389799 V3=0 T=0 M2=0 M3=-12,7448203856148 FrameElem=1-1
ElemStation=0
Frame=1 Station=3,999999999999999E-02 OutputCase=RAR039 CaseType=Combination P=-91,4599999992385 V2=4,26017704389799 V3=0 T=0 M2=0 M3=-12,9128034673708
FrameElem=1-1 ElemStation=3,999999999999999E-02
Frame=1 Station=7,999999999999998E-02 OutputCase=RAR039 CaseType=Combination P=-91,2999999992385 V2=4,37487704389799 V3=0 T=0 M2=0 M3=-13,0855305491267
FrameElem=1-1 ElemStation=7,999999999999998E-02
Frame=1 Station=0 OutputCase=RAR040 CaseType=Combination P=-100,961144092958 V2=15,9631077678169 V3=0 T=0 M2=0 M3=-21,1743678913955 FrameElem=1-1
ElemStation=0
Frame=1 Station=3,999999999999999E-02 OutputCase=RAR040 CaseType=Combination P=-100,801144092958 V2=16,0856077678169 V3=0 T=0 M2=0 M3=-21,8153682024682
FrameElem=1-1 ElemStation=3,999999999999999E-02
Frame=1 Station=7,999999999999998E-02 OutputCase=RAR040 CaseType=Combination P=-100,641144092958 V2=16,2003077678169 V3=0 T=0 M2=0 M3=-22,4611125135408
FrameElem=1-1 ElemStation=7,999999999999998E-02
Frame=1 Station=0 OutputCase=RAR041 CaseType=Combination P=-91,620000000228 V2=25,4985384964272 V3=0 T=0 M2=0 M3=-14,1891362035714 FrameElem=1-1
ElemStation=0
Frame=1 Station=3,999999999999999E-02 OutputCase=RAR041 CaseType=Combination P=-91,460000000228 V2=26,7675384964272 V3=0 T=0 M2=0 M3=-15,2344937434284
FrameElem=1-1 ElemStation=3,999999999999999E-02
Frame=1 Station=7,999999999999998E-02 OutputCase=RAR041 CaseType=Combination P=-91,300000000228 V2=28,0257384964272 V3=0 T=0 M2=0 M3=-16,3303952832855
FrameElem=1-1 ElemStation=7,999999999999998E-02

Società di Progetto
Brebemi SpA



Doc. N.
60235-0000-A00.doc

CODIFICA DOCUMENTO
04RCDII10000000000300A00

REV.
00

FOGLIO
235 di 628

Frame=1 Station=0 OutputCase=RAR042 CaseType=Combination P=-21,2811440939548 V2=15,0029647429204 V3=0 T=0 M2=0 M3=-9,96792736261876 FrameElem=1-1 ElemStation=0

Frame=1 Station=3,999999999999999E-02 OutputCase=RAR042 CaseType=Combination P=-21,1211440939548 V2=15,1254647429204 V3=0 T=0 M2=0 M3=-10,5705219523356 FrameElem=1-1 ElemStation=3,999999999999999E-02

Frame=1 Station=7,999999999999998E-02 OutputCase=RAR042 CaseType=Combination P=-20,9611440939548 V2=15,2401647429204 V3=0 T=0 M2=0 M3=-11,1778605420524 FrameElem=1-1 ElemStation=7,999999999999998E-02

Frame=1 Station=0 OutputCase=RAR043 CaseType=Combination P=-11,9400000012246 V2=24,5383954625307 V3=0 T=0 M2=0 M3=-2,98269567479464 FrameElem=1-1 ElemStation=0

Frame=1 Station=3,999999999999999E-02 OutputCase=RAR043 CaseType=Combination P=-11,7800000012246 V2=25,8073954625307 V3=0 T=0 M2=0 M3=-3,98964749329587 FrameElem=1-1 ElemStation=3,999999999999999E-02

Frame=1 Station=7,999999999999998E-02 OutputCase=RAR043 CaseType=Combination P=-11,6200000012246 V2=27,0655954625307 V3=0 T=0 M2=0 M3=-5,04714331179709 FrameElem=1-1 ElemStation=7,999999999999998E-02

Frame=1 Station=0 OutputCase=RAR044 CaseType=Combination P=-93,2959910848293 V2=26,9569235335651 V3=0 T=0 M2=0 M3=-27,2941250645031 FrameElem=1-1 ElemStation=0

Frame=1 Station=3,999999999999999E-02 OutputCase=RAR044 CaseType=Combination P=-93,1359910848293 V2=27,0794235335651 V3=0 T=0 M2=0 M3=-28,3748780058457 FrameElem=1-1 ElemStation=3,999999999999999E-02

Frame=1 Station=7,999999999999998E-02 OutputCase=RAR044 CaseType=Combination P=-92,9759910848293 V2=27,1941235335651 V3=0 T=0 M2=0 M3=-29,4603749471883 FrameElem=1-1 ElemStation=7,999999999999998E-02

Frame=1 Station=0 OutputCase=RAR045 CaseType=Combination P=-71,699999994875 V2=3,59115388345721 V3=0 T=0 M2=0 M3=-9,71342590256805 FrameElem=1-1 ElemStation=0

Frame=1 Station=3,999999999999999E-02 OutputCase=RAR045 CaseType=Combination P=-71,539999994875 V2=3,71365388345721 V3=0 T=0 M2=0 M3=-9,85954805790634 FrameElem=1-1 ElemStation=3,999999999999999E-02

Frame=1 Station=7,999999999999998E-02 OutputCase=RAR045 CaseType=Combination P=-71,379999994876 V2=3,82835388345721 V3=0 T=0 M2=0 M3=-10,0104142132446 FrameElem=1-1 ElemStation=7,999999999999998E-02

Frame=1 Station=0 OutputCase=RAR046 CaseType=Combination P=-78,9479075365814 V2=12,7894361283053 V3=0 T=0 M2=0 M3=-16,2643113692012 FrameElem=1-1 ElemStation=0

Frame=1 Station=3,999999999999999E-02 OutputCase=RAR046 CaseType=Combination P=-78,7879075365814 V2=12,9119361283053 V3=0 T=0 M2=0 M3=-16,7783648143335 FrameElem=1-1 ElemStation=3,999999999999999E-02

Frame=1 Station=7,999999999999998E-02 OutputCase=RAR046 CaseType=Combination P=-78,6279075365814 V2=13,0266361283053 V3=0 T=0 M2=0 M3=-17,2971622594657 FrameElem=1-1 ElemStation=7,999999999999998E-02

Frame=1 Station=0 OutputCase=RAR047 CaseType=Combination P=-71,7000000002442 V2=20,2352183627319 V3=0 T=0 M2=0 M3=-10,85368099241 FrameElem=1-1 ElemStation=0

Frame=1 Station=3,999999999999999E-02 OutputCase=RAR047 CaseType=Combination P=-71,5400000002442 V2=21,2356433627319 V3=0 T=0 M2=0 M3=-11,683135393586 FrameElem=1-1 ElemStation=3,999999999999999E-02

Frame=1 Station=7,999999999999998E-02 OutputCase=RAR047 CaseType=Combination P=-71,3800000002443 V2=22,2249183627319 V3=0 T=0 M2=0 M3=-12,5523837947619 FrameElem=1-1 ElemStation=7,999999999999998E-02

Frame=1 Station=0 OutputCase=RAR048 CaseType=Combination P=-19,1879075373288 V2=12,0693288528829 V3=0 T=0 M2=0 M3=-7,85948097261871 FrameElem=1-1 ElemStation=0

Frame=1 Station=3,999999999999999E-02 OutputCase=RAR048 CaseType=Combination P=-19,0279075373288 V2=12,1918288528829 V3=0 T=0 M2=0 M3=-8,34473012673402 FrameElem=1-1 ElemStation=3,999999999999999E-02

Frame=1 Station=7,999999999999998E-02 OutputCase=RAR048 CaseType=Combination P=-18,8679075373288 V2=12,3065288528829 V3=0 T=0 M2=0 M3=-8,83472328084934 FrameElem=1-1 ElemStation=7,999999999999998E-02

Frame=1 Station=0 OutputCase=RAR049 CaseType=Combination P=-11,9400000009916 V2=19,5151110873095 V3=0 T=0 M2=0 M3=-2,44885059582747 FrameElem=1-1 ElemStation=0

Frame=1 Station=3,999999999999999E-02 OutputCase=RAR049 CaseType=Combination P=-11,7800000009916 V2=20,5155360873095 V3=0 T=0 M2=0 M3=-3,24950070598652 FrameElem=1-1 ElemStation=3,999999999999999E-02

Frame=1 Station=7,999999999999998E-02 OutputCase=RAR049 CaseType=Combination P=-11,6200000009916 V2=21,5048110873095 V3=0 T=0 M2=0 M3=-4,08994481614556 FrameElem=1-1 ElemStation=7,999999999999998E-02

Frame=1 Station=0 OutputCase=RAR050 CaseType=Combination P=-11,5585988025267 V2=2,68031910077747 V3=0 T=0 M2=0 M3=-0,742533052503268 FrameElem=1-1 ElemStation=0

Frame=1 Station=3,999999999999999E-02 OutputCase=RAR050 CaseType=Combination P=-11,3985988025267 V2=2,80281910077747 V3=0 T=0 M2=0 M3=-0,852221816534366 FrameElem=1-1 ElemStation=3,999999999999999E-02

Frame=1 Station=7,999999999999998E-02 OutputCase=RAR050 CaseType=Combination P=-11,2385988025267 V2=2,91751910077747 V3=0 T=0 M2=0 M3=-0,966654580565465 FrameElem=1-1 ElemStation=7,999999999999998E-02

Frame=1 Station=0 OutputCase=RAR051 CaseType=Combination P=-71,3185988017793 V2=3,40042637619984 V3=0 T=0 M2=0 M3=-9,1473634490858 FrameElem=1-1 ElemStation=0

Frame=1 Station=3,999999999999999E-02 OutputCase=RAR051 CaseType=Combination P=-71,1585988017793 V2=3,52292637619984 V3=0 T=0 M2=0 M3=-9,2858565041338 FrameElem=1-1 ElemStation=3,999999999999999E-02

Frame=1 Station=7,999999999999998E-02 OutputCase=RAR051 CaseType=Combination P=-70,9985988017793 V2=3,6372637619984 V3=0 T=0 M2=0 M3=-9,42909355918179 FrameElem=1-1 ElemStation=7,999999999999998E-02

Frame=1 Station=0 OutputCase=RAR052 CaseType=Combination P=-78,5665063388732 V2=12,5987086210479 V3=0 T=0 M2=0 M3=-15,698248915719 FrameElem=1-1 ElemStation=0

Frame=1 Station=3,999999999999999E-02 OutputCase=RAR052 CaseType=Combination P=-78,4065063388732 V2=12,7212086210479 V3=0 T=0 M2=0 M3=-16,2046732605609 FrameElem=1-1 ElemStation=3,999999999999999E-02

Frame=1 Station=7,999999999999998E-02 OutputCase=RAR052 CaseType=Combination P=-78,2465063388732 V2=12,8359086210479 V3=0 T=0 M2=0 M3=-16,7158416054028 FrameElem=1-1 ElemStation=7,999999999999998E-02

Frame=1 Station=0 OutputCase=RAR053 CaseType=Combination P=-71,318598802536 V2=20,0444908554745 V3=0 T=0 M2=0 M3=-10,2876185389278 FrameElem=1-1 ElemStation=0

Frame=1 Station=3,999999999999999E-02 OutputCase=RAR053 CaseType=Combination P=-71,158598802536 V2=21,0449158554745 V3=0 T=0 M2=0 M3=-11,1094438398134 FrameElem=1-1 ElemStation=3,999999999999999E-02

Frame=1 Station=7,999999999999998E-02 OutputCase=RAR053 CaseType=Combination P=-70,998598802536 V2=22,0341908554745 V3=0 T=0 M2=0 M3=-11,971063140699 FrameElem=1-1 ElemStation=7,999999999999998E-02

Frame=1 Station=0 OutputCase=RAR054 CaseType=Combination P=-18,8065063396205 V2=11,8786013456256 V3=0 T=0 M2=0 M3=-7,29341851913646 FrameElem=1-1 ElemStation=0

Frame=1 Station=3,999999999999999E-02 OutputCase=RAR054 CaseType=Combination P=-18,6465063396205 V2=12,0011013456256 V3=0 T=0 M2=0 M3=-7,77103857296148 FrameElem=1-1 ElemStation=3,999999999999999E-02

Frame=1 Station=7,999999999999998E-02 OutputCase=RAR054 CaseType=Combination P=-18,4865063396205 V2=12,1158013456256 V3=0 T=0 M2=0 M3=-8,2534026267865 FrameElem=1-1 ElemStation=7,999999999999998E-02

Frame=1 Station=0 OutputCase=RAR055 CaseType=Combination P=-11,5585988032834 V2=19,3243835800521 V3=0 T=0 M2=0 M3=-1,88278814234523 FrameElem=1-1 ElemStation=0

Frame=1 Station=3,999999999999999E-02 OutputCase=RAR055 CaseType=Combination P=-11,3985988032834 V2=20,3248085800521 V3=0 T=0 M2=0 M3=-2,67580915221398 FrameElem=1-1 ElemStation=3,999999999999999E-02

Frame=1 Station=7,999999999999998E-02 OutputCase=RAR055 CaseType=Combination P=-11,2385988032834 V2=21,3140835800521 V3=0 T=0 M2=0 M3=-3,50862418208273 FrameElem=1-1 ElemStation=7,999999999999998E-02

Frame=1 Station=0 OutputCase=RAR056 CaseType=Combination P=-12,3214011979432 V2=3,06177411529221 V3=0 T=0 M2=0 M3=-1,87465795946777 FrameElem=1-1 ElemStation=0

Frame=1 Station=3,999999999999999E-02 OutputCase=RAR056 CaseType=Combination P=-12,1614011979432 V2=3,18427411529221 V3=0 T=0 M2=0 M3=-1,99960492407945 FrameElem=1-1 ElemStation=3,999999999999999E-02

Società di Progetto
Brebemi SpA



Doc. N.
60235-0000-A00.doc

CODIFICA DOCUMENTO
04RCDII10000000000300A00

REV.
00

FOGLIO
236 di 628

Frame=1 Station=7,999999999999999E-02 OutputCase=RAR056 CaseType=Combination P=-12,0014011979432 V2=3,29897411529221 V3=0 T=0 M2=0 M3=-2,12929588869114
FrameElem=1-1 ElemStation=7,999999999999999E-02
Frame=1 Station=0 OutputCase=RAR057 CaseType=Combination P=-72,0814011971958 V2=3,78188139071458 V3=0 T=0 M2=0 M3=-10,2794883560503 FrameElem=1-1
ElemStation=0
Frame=1 Station=3,999999999999999E-02 OutputCase=RAR057 CaseType=Combination P=-71,9214011971958 V2=3,90438139071458 V3=0 T=0 M2=0 M3=-10,4332396116789
FrameElem=1-1 ElemStation=3,999999999999999E-02
Frame=1 Station=7,999999999999999E-02 OutputCase=RAR057 CaseType=Combination P=-71,7614011971958 V2=4,01908139071458 V3=0 T=0 M2=0 M3=-10,5917348673075
FrameElem=1-1 ElemStation=7,999999999999999E-02
Frame=1 Station=0 OutputCase=RAR058 CaseType=Combination P=-79,3293087342896 V2=12,9801636355627 V3=0 T=0 M2=0 M3=-16,8303738226835 FrameElem=1-1
ElemStation=0
Frame=1 Station=3,999999999999999E-02 OutputCase=RAR058 CaseType=Combination P=-79,1693087342896 V2=13,1026636355627 V3=0 T=0 M2=0 M3=-17,352056368106
FrameElem=1-1 ElemStation=3,999999999999999E-02
Frame=1 Station=7,999999999999999E-02 OutputCase=RAR058 CaseType=Combination P=-79,0093087342896 V2=13,2173636355627 V3=0 T=0 M2=0 M3=-17,8784829135285
FrameElem=1-1 ElemStation=7,999999999999999E-02
Frame=1 Station=0 OutputCase=RAR059 CaseType=Combination P=-72,0814011979525 V2=20,4259458699893 V3=0 T=0 M2=0 M3=-11,419744458923 FrameElem=1-1
ElemStation=0
Frame=1 Station=3,999999999999999E-02 OutputCase=RAR059 CaseType=Combination P=-71,9214011979525 V2=21,4263708699893 V3=0 T=0 M2=0 M3=-12,2568269473585
FrameElem=1-1 ElemStation=3,999999999999999E-02
Frame=1 Station=7,999999999999999E-02 OutputCase=RAR059 CaseType=Combination P=-71,7614011979525 V2=22,4156458699893 V3=0 T=0 M2=0 M3=-13,1337044488247
FrameElem=1-1 ElemStation=7,999999999999999E-02
Frame=1 Station=0 OutputCase=RAR060 CaseType=Combination P=-19,569308735037 V2=12,2600563601403 V3=0 T=0 M2=0 M3=-8,42554342610096 FrameElem=1-1
ElemStation=0
Frame=1 Station=3,999999999999999E-02 OutputCase=RAR060 CaseType=Combination P=-19,409308735037 V2=12,3825563601403 V3=0 T=0 M2=0 M3=-8,91842168050657
FrameElem=1-1 ElemStation=3,999999999999999E-02
Frame=1 Station=7,999999999999999E-02 OutputCase=RAR060 CaseType=Combination P=-19,249308735037 V2=12,4972563601403 V3=0 T=0 M2=0 M3=-9,41604393491218
FrameElem=1-1 ElemStation=7,999999999999999E-02
Frame=1 Station=0 OutputCase=RAR061 CaseType=Combination P=-12,3214011986999 V2=19,7058385945669 V3=0 T=0 M2=0 M3=-3,01491304930972 FrameElem=1-1
ElemStation=0
Frame=1 Station=3,999999999999999E-02 OutputCase=RAR061 CaseType=Combination P=-12,1614011986999 V2=20,7062635945669 V3=0 T=0 M2=0 M3=-3,82319225975906
FrameElem=1-1 ElemStation=3,999999999999999E-02
Frame=1 Station=7,999999999999999E-02 OutputCase=RAR061 CaseType=Combination P=-12,0014011986999 V2=21,6955385945669 V3=0 T=0 M2=0 M3=-4,6712654702084
FrameElem=1-1 ElemStation=7,999999999999999E-02
Frame=1 Station=0 OutputCase=RAR062 CaseType=Combination P=-11,940000002348 V2=2,41131550508485 V3=0 T=0 M2=0 M3=-0,963918979706617 FrameElem=1-1
ElemStation=0
Frame=1 Station=3,999999999999999E-02 OutputCase=RAR062 CaseType=Combination P=-11,780000002348 V2=2,53381550508485 V3=0 T=0 M2=0 M3=-1,06284759991001
FrameElem=1-1 ElemStation=3,999999999999999E-02
Frame=1 Station=7,999999999999999E-02 OutputCase=RAR062 CaseType=Combination P=-11,620000002348 V2=2,64851550508485 V3=0 T=0 M2=0 M3=-1,1665202201134
FrameElem=1-1 ElemStation=7,999999999999999E-02
Frame=1 Station=0 OutputCase=RAR063 CaseType=Combination P=-71,699999994874 V2=3,13142278050722 V3=0 T=0 M2=0 M3=-9,36874937628915 FrameElem=1-1
ElemStation=0
Frame=1 Station=3,999999999999999E-02 OutputCase=RAR063 CaseType=Combination P=-71,539999994874 V2=3,25392278050722 V3=0 T=0 M2=0 M3=-9,49648228750944
FrameElem=1-1 ElemStation=3,999999999999999E-02
Frame=1 Station=7,999999999999999E-02 OutputCase=RAR063 CaseType=Combination P=-71,379999994874 V2=3,36862278050722 V3=0 T=0 M2=0 M3=-9,62895919872973
FrameElem=1-1 ElemStation=7,999999999999999E-02
Frame=1 Station=0 OutputCase=RAR064 CaseType=Combination P=-78,9479075365813 V2=12,3297050253553 V3=0 T=0 M2=0 M3=-15,9196348429223 FrameElem=1-1
ElemStation=0
Frame=1 Station=3,999999999999999E-02 OutputCase=RAR064 CaseType=Combination P=-78,7879075365813 V2=12,4522050253553 V3=0 T=0 M2=0 M3=-16,4152990439366
FrameElem=1-1 ElemStation=3,999999999999999E-02
Frame=1 Station=7,999999999999999E-02 OutputCase=RAR064 CaseType=Combination P=-78,6279075365813 V2=12,5669050253553 V3=0 T=0 M2=0 M3=-16,9157072449508
FrameElem=1-1 ElemStation=7,999999999999999E-02
Frame=1 Station=0 OutputCase=RAR065 CaseType=Combination P=-71,700000002441 V2=19,7754872597819 V3=0 T=0 M2=0 M3=-10,5090044661311 FrameElem=1-1
ElemStation=0
Frame=1 Station=3,999999999999999E-02 OutputCase=RAR065 CaseType=Combination P=-71,540000002441 V2=20,7759122597819 V3=0 T=0 M2=0 M3=-11,3200696231891
FrameElem=1-1 ElemStation=3,999999999999999E-02
Frame=1 Station=7,999999999999999E-02 OutputCase=RAR065 CaseType=Combination P=-71,380000002441 V2=21,7651872597819 V3=0 T=0 M2=0 M3=-12,170928780247
FrameElem=1-1 ElemStation=7,999999999999999E-02
Frame=1 Station=0 OutputCase=RAR066 CaseType=Combination P=-19,1879075373286 V2=11,6095977499329 V3=0 T=0 M2=0 M3=-7,51480444633981 FrameElem=1-1
ElemStation=0
Frame=1 Station=3,999999999999999E-02 OutputCase=RAR066 CaseType=Combination P=-19,0279075373286 V2=11,7320977499329 V3=0 T=0 M2=0 M3=-7,98166435633712
FrameElem=1-1 ElemStation=3,999999999999999E-02
Frame=1 Station=7,999999999999999E-02 OutputCase=RAR066 CaseType=Combination P=-18,8679075373286 V2=11,8467977499329 V3=0 T=0 M2=0 M3=-8,45326826633444
FrameElem=1-1 ElemStation=7,999999999999999E-02
Frame=1 Station=0 OutputCase=RAR067 CaseType=Combination P=-11,940000009915 V2=19,053799843595 V3=0 T=0 M2=0 M3=-2,10417406954857 FrameElem=1-1
ElemStation=0
Frame=1 Station=3,999999999999999E-02 OutputCase=RAR067 CaseType=Combination P=-11,780000009915 V2=20,0558049843595 V3=0 T=0 M2=0 M3=-2,88643493558962
FrameElem=1-1 ElemStation=3,999999999999999E-02
Frame=1 Station=7,999999999999999E-02 OutputCase=RAR067 CaseType=Combination P=-11,620000009915 V2=21,0450799843595 V3=0 T=0 M2=0 M3=-3,70848980163067
FrameElem=1-1 ElemStation=7,999999999999999E-02
Frame=1 Station=0 OutputCase=RAR068 CaseType=Combination P=-11,3043313373881 V2=3,31938593418921 V3=0 T=0 M2=0 M3=-0,939618960646601 FrameElem=1-1
ElemStation=0
Frame=1 Station=3,999999999999999E-02 OutputCase=RAR068 CaseType=Combination P=-11,1443313373881 V2=3,44188593418921 V3=0 T=0 M2=0 M3=-1,07487039801417
FrameElem=1-1 ElemStation=3,999999999999999E-02
Frame=1 Station=7,999999999999999E-02 OutputCase=RAR068 CaseType=Combination P=-10,9843313373881 V2=3,5658593418921 V3=0 T=0 M2=0 M3=-1,21486583538174
FrameElem=1-1 ElemStation=7,999999999999999E-02
Frame=1 Station=0 OutputCase=RAR069 CaseType=Combination P=-91,2385988015304 V2=4,40668063959061 V3=0 T=0 M2=0 M3=-12,5234344584115 FrameElem=1-1
ElemStation=0
Frame=1 Station=3,999999999999999E-02 OutputCase=RAR069 CaseType=Combination P=-91,0785988015304 V2=4,52918063959061 V3=0 T=0 M2=0 M3=-12,7021776839951
FrameElem=1-1 ElemStation=3,999999999999999E-02
Frame=1 Station=7,999999999999999E-02 OutputCase=RAR069 CaseType=Combination P=-90,9185988015304 V2=4,64388063959061 V3=0 T=0 M2=0 M3=-12,8856649095787
FrameElem=1-1 ElemStation=7,999999999999999E-02
Frame=1 Station=0 OutputCase=RAR070 CaseType=Combination P=-100,57974289525 V2=16,2321113725095 V3=0 T=0 M2=0 M3=-20,9529819641921 FrameElem=1-1
ElemStation=0
Frame=1 Station=3,999999999999999E-02 OutputCase=RAR070 CaseType=Combination P=-100,41974289525 V2=16,3546113725095 V3=0 T=0 M2=0 M3=-21,6047424190925
FrameElem=1-1 ElemStation=3,999999999999999E-02
Frame=1 Station=7,999999999999999E-02 OutputCase=RAR070 CaseType=Combination P=-100,25974289525 V2=16,4693113725095 V3=0 T=0 M2=0 M3=-22,2612468739929
FrameElem=1-1 ElemStation=7,999999999999999E-02
Frame=1 Station=0 OutputCase=RAR071 CaseType=Combination P=-91,2385988025199 V2=25,765420921198 V3=0 T=0 M2=0 M3=-13,967750276368 FrameElem=1-1
ElemStation=0

Società di Progetto
Brebemi SpA



Doc. N.
60235-0000-A00.doc

CODIFICA DOCUMENTO
04RCDII10000000000300A00

REV.
00

FOGLIO
237 di 628

Frame=1 Station=3,999999999999999E-02 OutputCase=RAR071 CaseType=Combination P=-91,0785988025199 V2=27,0365420921198 V3=0 T=0 M2=0 M3=-15,0238679600528
FrameElem=1-1 ElemStation=3,999999999999999E-02
Frame=1 Station=7,999999999999998E-02 OutputCase=RAR071 CaseType=Combination P=-90,9185988025199 V2=28,2947420921198 V3=0 T=0 M2=0 M3=-16,1305296437376
FrameElem=1-1 ElemStation=7,999999999999998E-02
Frame=1 Station=0 OutputCase=RAR072 CaseType=Combination P=-20,8997428962467 V2=15,271968338613 V3=0 T=0 M2=0 M3=-9,74654143541541 FrameElem=1-1
ElemStation=0
Frame=1 Station=3,999999999999999E-02 OutputCase=RAR072 CaseType=Combination P=-20,7397428962467 V2=15,394468338613 V3=0 T=0 M2=0 M3=-10,3598961689599
FrameElem=1-1 ElemStation=3,999999999999999E-02
Frame=1 Station=7,999999999999998E-02 OutputCase=RAR072 CaseType=Combination P=-20,5797428962467 V2=15,509168338613 V3=0 T=0 M2=0 M3=-10,9779949025045
FrameElem=1-1 ElemStation=7,999999999999998E-02
Frame=1 Station=0 OutputCase=RAR073 CaseType=Combination P=-11,5585988035164 V2=24,8073990582233 V3=0 T=0 M2=0 M3=-2,76130974759129 FrameElem=1-1
ElemStation=0
Frame=1 Station=3,999999999999999E-02 OutputCase=RAR073 CaseType=Combination P=-11,3985988035164 V2=26,0763990582233 V3=0 T=0 M2=0 M3=-3,77902170992022
FrameElem=1-1 ElemStation=3,999999999999999E-02
Frame=1 Station=7,999999999999998E-02 OutputCase=RAR073 CaseType=Combination P=-11,2385988035164 V2=27,3345990582233 V3=0 T=0 M2=0 M3=-4,84727767224915
FrameElem=1-1 ElemStation=7,999999999999998E-02
Frame=1 Station=0 OutputCase=RAR074 CaseType=Combination P=-92,9145898871212 V2=27,2259271292577 V3=0 T=0 M2=0 M3=-27,0727391372998 FrameElem=1-1
ElemStation=0
Frame=1 Station=3,999999999999999E-02 OutputCase=RAR074 CaseType=Combination P=-92,7545898871212 V2=27,3484271292577 V3=0 T=0 M2=0 M3=-28,164252224701
FrameElem=1-1 ElemStation=3,999999999999999E-02
Frame=1 Station=7,999999999999998E-02 OutputCase=RAR074 CaseType=Combination P=-92,5945898871212 V2=27,4631271292577 V3=0 T=0 M2=0 M3=-29,2605093076404
FrameElem=1-1 ElemStation=7,999999999999998E-02
Frame=1 Station=0 OutputCase=RAR075 CaseType=Combination P=-71,0643313366407 V2=4,03949320961158 V3=0 T=0 M2=0 M3=-9,34444935722914 FrameElem=1-1
ElemStation=0
Frame=1 Station=3,999999999999999E-02 OutputCase=RAR075 CaseType=Combination P=-70,9043313366407 V2=4,16199320961158 V3=0 T=0 M2=0 M3=-9,5085050856136
FrameElem=1-1 ElemStation=3,999999999999999E-02
Frame=1 Station=7,999999999999998E-02 OutputCase=RAR075 CaseType=Combination P=-70,7443313366407 V2=4,27669320961158 V3=0 T=0 M2=0 M3=-9,67730481399806
FrameElem=1-1 ElemStation=7,999999999999998E-02
Frame=1 Station=0 OutputCase=RAR076 CaseType=Combination P=-78,3122388737346 V2=13,2377754544597 V3=0 T=0 M2=0 M3=-15,8953348238623 FrameElem=1-1
ElemStation=0
Frame=1 Station=3,999999999999999E-02 OutputCase=RAR076 CaseType=Combination P=-78,1522388737346 V2=13,3602754544597 V3=0 T=0 M2=0 M3=-16,4273218420407
FrameElem=1-1 ElemStation=3,999999999999999E-02
Frame=1 Station=7,999999999999998E-02 OutputCase=RAR076 CaseType=Combination P=-77,9922388737346 V2=13,4749754544597 V3=0 T=0 M2=0 M3=-16,9640528602191
FrameElem=1-1 ElemStation=7,999999999999998E-02
Frame=1 Station=0 OutputCase=RAR077 CaseType=Combination P=-71,0643313373974 V2=20,6835576888863 V3=0 T=0 M2=0 M3=-10,4847044470711 FrameElem=1-1
ElemStation=0
Frame=1 Station=3,999999999999999E-02 OutputCase=RAR077 CaseType=Combination P=-70,9043313373974 V2=21,6839826888863 V3=0 T=0 M2=0 M3=-11,3320924212932
FrameElem=1-1 ElemStation=3,999999999999999E-02
Frame=1 Station=7,999999999999998E-02 OutputCase=RAR077 CaseType=Combination P=-70,7443313373974 V2=22,6732576888862 V3=0 T=0 M2=0 M3=-12,2192743955153
FrameElem=1-1 ElemStation=7,999999999999998E-02
Frame=1 Station=0 OutputCase=RAR078 CaseType=Combination P=-18,5522388744819 V2=12,5176681790373 V3=0 T=0 M2=0 M3=-7,49050442727979 FrameElem=1-1
ElemStation=0
Frame=1 Station=3,999999999999999E-02 OutputCase=RAR078 CaseType=Combination P=-18,3922388744819 V2=12,6401681790373 V3=0 T=0 M2=0 M3=-7,99368715444128
FrameElem=1-1 ElemStation=3,999999999999999E-02
Frame=1 Station=7,999999999999998E-02 OutputCase=RAR078 CaseType=Combination P=-18,2322388744819 V2=12,7548681790373 V3=0 T=0 M2=0 M3=-8,50161388160277
FrameElem=1-1 ElemStation=7,999999999999998E-02
Frame=1 Station=0 OutputCase=RAR079 CaseType=Combination P=-11,3043313381448 V2=19,9634504134639 V3=0 T=0 M2=0 M3=-2,09787405048856 FrameElem=1-1
ElemStation=0
Frame=1 Station=3,999999999999999E-02 OutputCase=RAR079 CaseType=Combination P=-11,1443313381448 V2=20,9638754134639 V3=0 T=0 M2=0 M3=-2,89845773369378
FrameElem=1-1 ElemStation=3,999999999999999E-02
Frame=1 Station=7,999999999999998E-02 OutputCase=RAR079 CaseType=Combination P=-10,9843313381448 V2=21,9531504134639 V3=0 T=0 M2=0 M3=-3,756835416899
FrameElem=1-1 ElemStation=7,999999999999998E-02
Frame=1 Station=0 OutputCase=RAR080 CaseType=Combination P=-11,3043313373882 V2=3,7791170371392 V3=0 T=0 M2=0 M3=-1,2842954869255 FrameElem=1-1
ElemStation=0
Frame=1 Station=3,999999999999999E-02 OutputCase=RAR080 CaseType=Combination P=-11,1443313373882 V2=3,9016170371392 V3=0 T=0 M2=0 M3=-1,43793616841107
FrameElem=1-1 ElemStation=3,999999999999999E-02
Frame=1 Station=7,999999999999998E-02 OutputCase=RAR080 CaseType=Combination P=-10,9843313373882 V2=4,0163170371392 V3=0 T=0 M2=0 M3=-1,59632084989664
FrameElem=1-1 ElemStation=7,999999999999998E-02
Frame=1 Station=0 OutputCase=RAR081 CaseType=Combination P=-71,0643313366408 V2=4,49922431256157 V3=0 T=0 M2=0 M3=-9,68912588350804 FrameElem=1-1
ElemStation=0
Frame=1 Station=3,999999999999999E-02 OutputCase=RAR081 CaseType=Combination P=-70,9043313366409 V2=4,62172431256157 V3=0 T=0 M2=0 M3=-9,8715708560105
FrameElem=1-1 ElemStation=3,999999999999999E-02
Frame=1 Station=7,999999999999998E-02 OutputCase=RAR081 CaseType=Combination P=-70,7443313366409 V2=4,73642431256157 V3=0 T=0 M2=0 M3=-10,058759828513
FrameElem=1-1 ElemStation=7,999999999999998E-02
Frame=1 Station=0 OutputCase=RAR082 CaseType=Combination P=-78,3122388737347 V2=13,6975065574097 V3=0 T=0 M2=0 M3=-16,2400113501412 FrameElem=1-1
ElemStation=0
Frame=1 Station=3,999999999999999E-02 OutputCase=RAR082 CaseType=Combination P=-78,1522388737347 V2=13,8200665574097 V3=0 T=0 M2=0 M3=-16,7903876124376
FrameElem=1-1 ElemStation=3,999999999999999E-02
Frame=1 Station=7,999999999999998E-02 OutputCase=RAR082 CaseType=Combination P=-77,9922388737347 V2=13,9347065574097 V3=0 T=0 M2=0 M3=-17,345507874734
FrameElem=1-1 ElemStation=7,999999999999998E-02
Frame=1 Station=0 OutputCase=RAR083 CaseType=Combination P=-71,0643313373975 V2=21,1432887918362 V3=0 T=0 M2=0 M3=-10,82938097335 FrameElem=1-1
ElemStation=0
Frame=1 Station=3,999999999999999E-02 OutputCase=RAR083 CaseType=Combination P=-70,9043313373976 V2=22,1437137918362 V3=0 T=0 M2=0 M3=-11,6951581916901
FrameElem=1-1 ElemStation=3,999999999999999E-02
Frame=1 Station=7,999999999999998E-02 OutputCase=RAR083 CaseType=Combination P=-70,7443313373976 V2=23,1329887918362 V3=0 T=0 M2=0 M3=-12,6007294100302
FrameElem=1-1 ElemStation=7,999999999999998E-02
Frame=1 Station=0 OutputCase=RAR084 CaseType=Combination P=-18,5522388744821 V2=12,9773992819873 V3=0 T=0 M2=0 M3=-7,83518095355869 FrameElem=1-1
ElemStation=0
Frame=1 Station=3,999999999999999E-02 OutputCase=RAR084 CaseType=Combination P=-18,3922388744821 V2=13,098992819873 V3=0 T=0 M2=0 M3=-8,35675292483818
FrameElem=1-1 ElemStation=3,999999999999999E-02
Frame=1 Station=7,999999999999998E-02 OutputCase=RAR084 CaseType=Combination P=-18,2322388744821 V2=13,214592819873 V3=0 T=0 M2=0 M3=-8,8830688911767
FrameElem=1-1 ElemStation=7,999999999999998E-02
Frame=1 Station=0 OutputCase=RAR085 CaseType=Combination P=-11,3043313381449 V2=20,4231815614139 V3=0 T=0 M2=0 M3=-2,42455057676746 FrameElem=1-1
ElemStation=0
Frame=1 Station=3,999999999999999E-02 OutputCase=RAR085 CaseType=Combination P=-11,1443313381449 V2=21,4236065164139 V3=0 T=0 M2=0 M3=-3,26152350409068
FrameElem=1-1 ElemStation=3,999999999999999E-02
Frame=1 Station=7,999999999999998E-02 OutputCase=RAR085 CaseType=Combination P=-10,9843313381449 V2=22,4128815614139 V3=0 T=0 M2=0 M3=-4,1382904314139
FrameElem=1-1 ElemStation=7,999999999999998E-02

APPROVATO S.D.P.
Società di Progetto
Brebemi SpA



Doc. N.
60235-0000-A00.doc

CODIFICA DOCUMENTO
04RCDII10000000000300A00

REV.
00

FOGLIO
238 di 628

Frame=1 Station=0 OutputCase=RAR086 CaseType=Combination P=-11,304331337388 V2=2,85965483123922 V3=0 T=0 M2=0 M3=-0,594942434367701 FrameElem=1-1 ElemStation=0
Frame=1 Station=3,999999999999999E-02 OutputCase=RAR086 CaseType=Combination P=-11,144331337388 V2=2,98215483123922 V3=0 T=0 M2=0 M3=-0,711804627617269 FrameElem=1-1 ElemStation=3,999999999999999E-02
Frame=1 Station=7,999999999999998E-02 OutputCase=RAR086 CaseType=Combination P=-10,984331337388 V2=3,09685483123922 V3=0 T=0 M2=0 M3=-0,833410820866838 FrameElem=1-1 ElemStation=7,999999999999998E-02
Frame=1 Station=0 OutputCase=RAR087 CaseType=Combination P=-71,0643313366406 V2=3,57976210666159 V3=0 T=0 M2=0 M3=-8,99977283095024 FrameElem=1-1 ElemStation=0
Frame=1 Station=3,999999999999999E-02 OutputCase=RAR087 CaseType=Combination P=-70,9043313366406 V2=3,70226210666159 V3=0 T=0 M2=0 M3=-9,1454393152167 FrameElem=1-1 ElemStation=3,999999999999999E-02
Frame=1 Station=7,999999999999998E-02 OutputCase=RAR087 CaseType=Combination P=-70,7443313366406 V2=3,81696210666159 V3=0 T=0 M2=0 M3=-9,29584979948316 FrameElem=1-1 ElemStation=7,999999999999998E-02
Frame=1 Station=0 OutputCase=RAR088 CaseType=Combination P=-78,3122388737344 V2=12,7780443515097 V3=0 T=0 M2=0 M3=-15,5506582975834 FrameElem=1-1 ElemStation=0
Frame=1 Station=3,999999999999999E-02 OutputCase=RAR088 CaseType=Combination P=-78,1522388737344 V2=12,9005443515097 V3=0 T=0 M2=0 M3=-16,0642560716438 FrameElem=1-1 ElemStation=3,999999999999999E-02
Frame=1 Station=7,999999999999998E-02 OutputCase=RAR088 CaseType=Combination P=-77,9922388737344 V2=13,0152443515097 V3=0 T=0 M2=0 M3=-16,5825978457042 FrameElem=1-1 ElemStation=7,999999999999998E-02
Frame=1 Station=0 OutputCase=RAR089 CaseType=Combination P=-71,0643313373973 V2=20,2238265859363 V3=0 T=0 M2=0 M3=-10,1400279207922 FrameElem=1-1 ElemStation=0
Frame=1 Station=3,999999999999999E-02 OutputCase=RAR089 CaseType=Combination P=-70,9043313373973 V2=21,2242515859363 V3=0 T=0 M2=0 M3=-10,9690266508963 FrameElem=1-1 ElemStation=3,999999999999999E-02
Frame=1 Station=7,999999999999998E-02 OutputCase=RAR089 CaseType=Combination P=-70,7443313373973 V2=22,2135265859363 V3=0 T=0 M2=0 M3=-11,8378193810004 FrameElem=1-1 ElemStation=7,999999999999998E-02
Frame=1 Station=0 OutputCase=RAR090 CaseType=Combination P=-18,5522388744818 V2=12,0579370760873 V3=0 T=0 M2=0 M3=-7,14582790100089 FrameElem=1-1 ElemStation=0
Frame=1 Station=3,999999999999999E-02 OutputCase=RAR090 CaseType=Combination P=-18,3922388744818 V2=12,1804370760873 V3=0 T=0 M2=0 M3=-7,63062138404438 FrameElem=1-1 ElemStation=3,999999999999999E-02
Frame=1 Station=7,999999999999998E-02 OutputCase=RAR090 CaseType=Combination P=-18,2322388744818 V2=12,2951370760873 V3=0 T=0 M2=0 M3=-8,12015886708787 FrameElem=1-1 ElemStation=7,999999999999998E-02
Frame=1 Station=0 OutputCase=RAR091 CaseType=Combination P=-11,3043313381447 V2=19,5037193105139 V3=0 T=0 M2=0 M3=-1,73519752420966 FrameElem=1-1 ElemStation=0
Frame=1 Station=3,999999999999999E-02 OutputCase=RAR091 CaseType=Combination P=-11,1443313381447 V2=20,5041443105139 V3=0 T=0 M2=0 M3=-2,53539196329688 FrameElem=1-1 ElemStation=3,999999999999999E-02
Frame=1 Station=7,999999999999998E-02 OutputCase=RAR091 CaseType=Combination P=-10,9843313381447 V2=21,4934193105139 V3=0 T=0 M2=0 M3=-3,3753804023841 FrameElem=1-1 ElemStation=7,999999999999998E-02
Frame=1 Station=0 OutputCase=RAR092 CaseType=Combination P=-11,304331337388 V2=2,85965483123922 V3=0 T=0 M2=0 M3=-0,594942434367701 FrameElem=1-1 ElemStation=0
Frame=1 Station=3,999999999999999E-02 OutputCase=RAR092 CaseType=Combination P=-11,144331337388 V2=2,98215483123922 V3=0 T=0 M2=0 M3=-0,711804627617269 FrameElem=1-1 ElemStation=3,999999999999999E-02
Frame=1 Station=7,999999999999998E-02 OutputCase=RAR092 CaseType=Combination P=-10,984331337388 V2=3,09685483123922 V3=0 T=0 M2=0 M3=-0,833410820866838 FrameElem=1-1 ElemStation=7,999999999999998E-02
Frame=1 Station=0 OutputCase=RAR093 CaseType=Combination P=-71,0643313366406 V2=3,57976210666159 V3=0 T=0 M2=0 M3=-8,99977283095024 FrameElem=1-1 ElemStation=0
Frame=1 Station=3,999999999999999E-02 OutputCase=RAR093 CaseType=Combination P=-70,9043313366406 V2=3,70226210666159 V3=0 T=0 M2=0 M3=-9,1454393152167 FrameElem=1-1 ElemStation=3,999999999999999E-02
Frame=1 Station=7,999999999999998E-02 OutputCase=RAR093 CaseType=Combination P=-70,7443313366406 V2=3,81696210666159 V3=0 T=0 M2=0 M3=-9,29584979948316 FrameElem=1-1 ElemStation=7,999999999999998E-02
Frame=1 Station=0 OutputCase=RAR094 CaseType=Combination P=-78,3122388737344 V2=12,7780443515097 V3=0 T=0 M2=0 M3=-15,5506582975834 FrameElem=1-1 ElemStation=0
Frame=1 Station=3,999999999999999E-02 OutputCase=RAR094 CaseType=Combination P=-78,1522388737344 V2=12,9005443515097 V3=0 T=0 M2=0 M3=-16,0642560716438 FrameElem=1-1 ElemStation=3,999999999999999E-02
Frame=1 Station=7,999999999999998E-02 OutputCase=RAR094 CaseType=Combination P=-77,9922388737344 V2=13,0152443515097 V3=0 T=0 M2=0 M3=-16,5825978457042 FrameElem=1-1 ElemStation=7,999999999999998E-02
Frame=1 Station=0 OutputCase=RAR095 CaseType=Combination P=-71,0643313373973 V2=20,2238265859363 V3=0 T=0 M2=0 M3=-10,1400279207922 FrameElem=1-1 ElemStation=0
Frame=1 Station=3,999999999999999E-02 OutputCase=RAR095 CaseType=Combination P=-70,9043313373973 V2=21,2242515859363 V3=0 T=0 M2=0 M3=-10,9690266508963 FrameElem=1-1 ElemStation=3,999999999999999E-02
Frame=1 Station=7,999999999999998E-02 OutputCase=RAR095 CaseType=Combination P=-70,7443313373973 V2=22,2135265859363 V3=0 T=0 M2=0 M3=-11,8378193810004 FrameElem=1-1 ElemStation=7,999999999999998E-02
Frame=1 Station=0 OutputCase=RAR096 CaseType=Combination P=-18,5522388744818 V2=12,0579370760873 V3=0 T=0 M2=0 M3=-7,14582790100089 FrameElem=1-1 ElemStation=0
Frame=1 Station=3,999999999999999E-02 OutputCase=RAR096 CaseType=Combination P=-18,3922388744818 V2=12,1804370760873 V3=0 T=0 M2=0 M3=-7,63062138404438 FrameElem=1-1 ElemStation=3,999999999999999E-02
Frame=1 Station=7,999999999999998E-02 OutputCase=RAR096 CaseType=Combination P=-18,2322388744818 V2=12,2951370760873 V3=0 T=0 M2=0 M3=-8,12015886708787 FrameElem=1-1 ElemStation=7,999999999999998E-02
Frame=1 Station=0 OutputCase=RAR097 CaseType=Combination P=-11,3043313381447 V2=19,5037193105139 V3=0 T=0 M2=0 M3=-1,73519752420966 FrameElem=1-1 ElemStation=0
Frame=1 Station=3,999999999999999E-02 OutputCase=RAR097 CaseType=Combination P=-11,1443313381447 V2=20,5041443105139 V3=0 T=0 M2=0 M3=-2,53539196329688 FrameElem=1-1 ElemStation=3,999999999999999E-02
Frame=1 Station=7,999999999999998E-02 OutputCase=RAR097 CaseType=Combination P=-10,9843313381447 V2=21,4934193105139 V3=0 T=0 M2=0 M3=-3,3753804023841 FrameElem=1-1 ElemStation=7,999999999999998E-02
Frame=1 Station=0 OutputCase=RAR098 CaseType=Combination P=-12,575668630822 V2=3,95514429171377 V3=0 T=0 M2=0 M3=-2,82649380558743 FrameElem=1-1 ElemStation=0
Frame=1 Station=3,999999999999999E-02 OutputCase=RAR098 CaseType=Combination P=-12,415668630822 V2=4,07764429171377 V3=0 T=0 M2=0 M3=-2,9871755725598 FrameElem=1-1 ElemStation=3,999999999999999E-02
Frame=1 Station=7,999999999999998E-02 OutputCase=RAR098 CaseType=Combination P=-12,255668630822 V2=4,19234429171377 V3=0 T=0 M2=0 M3=-3,15260134892453 FrameElem=1-1 ElemStation=7,999999999999998E-02
Frame=1 Station=0 OutputCase=RAR099 CaseType=Combination P=-92,0014011969469 V2=4,78813565410535 V3=0 T=0 M2=0 M3=-13,65559365376 FrameElem=1-1 ElemStation=0
Frame=1 Station=3,999999999999999E-02 OutputCase=RAR099 CaseType=Combination P=-91,8414011969469 V2=4,91063565410535 V3=0 T=0 M2=0 M3=-13,8495607915402 FrameElem=1-1 ElemStation=3,999999999999999E-02
Frame=1 Station=7,999999999999998E-02 OutputCase=RAR099 CaseType=Combination P=-91,6814011969469 V2=5,02533565410535 V3=0 T=0 M2=0 M3=-14,0483062177044 FrameElem=1-1 ElemStation=7,999999999999998E-02
Frame=1 Station=0 OutputCase=RAR100 CaseType=Combination P=-101,342545290667 V2=16,6135663870243 V3=0 T=0 M2=0 M3=-22,0851068711566 FrameElem=1-1 ElemStation=0
Frame=1 Station=3,999999999999999E-02 OutputCase=RAR100 CaseType=Combination P=-101,182545290667 V2=16,7360663870243 V3=0 T=0 M2=0 M3=-22,7521255266376 FrameElem=1-1 ElemStation=3,999999999999999E-02

Società di Progetto
Brebemi SpA



Doc. N.
60235-0000-A00.doc

CODIFICA DOCUMENTO
04RCDII10000000000300A00

REV.
00

FOGLIO
239 di 628

Frame=1 Station=7,999999999999999E-02 OutputCase=RAR100 CaseType=Combination P=-101,022545290667 V2=16,8507663870243 V3=0 T=0 M2=0 M3=-23,4238881821186
FrameElem=1-1 ElemStation=7,999999999999999E-02
Frame=1 Station=0 OutputCase=RAR101 CaseType=Combination P=-92,0014011979364 V2=26,1489971066346 V3=0 T=0 M2=0 M3=-15,0998751833325 FrameElem=1-1
ElemStation=0
Frame=1 Station=3,999999999999999E-02 OutputCase=RAR101 CaseType=Combination P=-91,8414011979364 V2=27,4179971066346 V3=0 T=0 M2=0 M3=-16,1712510675979
FrameElem=1-1 ElemStation=3,999999999999999E-02
Frame=1 Station=7,999999999999999E-02 OutputCase=RAR101 CaseType=Combination P=-91,6814011979364 V2=28,6761971066346 V3=0 T=0 M2=0 M3=-17,2931709518633
FrameElem=1-1 ElemStation=7,999999999999999E-02
Frame=1 Station=0 OutputCase=RAR102 CaseType=Combination P=-21,6625452916632 V2=15,6534233531278 V3=0 T=0 M2=0 M3=-10,8786663423799 FrameElem=1-1
ElemStation=0
Frame=1 Station=3,999999999999999E-02 OutputCase=RAR102 CaseType=Combination P=-21,5025452916632 V2=15,7759233531278 V3=0 T=0 M2=0 M3=-11,507279276505
FrameElem=1-1 ElemStation=3,999999999999999E-02
Frame=1 Station=7,999999999999999E-02 OutputCase=RAR102 CaseType=Combination P=-21,3425452916632 V2=15,8906233531278 V3=0 T=0 M2=0 M3=-12,1406362106301
FrameElem=1-1 ElemStation=7,999999999999999E-02
Frame=1 Station=0 OutputCase=RAR103 CaseType=Combination P=-12,3214011989329 V2=25,1888540727381 V3=0 T=0 M2=0 M3=-3,89343465455579 FrameElem=1-1
ElemStation=0
Frame=1 Station=3,999999999999999E-02 OutputCase=RAR103 CaseType=Combination P=-12,1614011989329 V2=26,4578540727381 V3=0 T=0 M2=0 M3=-4,92640481746531
FrameElem=1-1 ElemStation=3,999999999999999E-02
Frame=1 Station=7,999999999999999E-02 OutputCase=RAR103 CaseType=Combination P=-12,0014011989329 V2=27,7160540727381 V3=0 T=0 M2=0 M3=-6,00991898037483
FrameElem=1-1 ElemStation=7,999999999999999E-02
Frame=1 Station=0 OutputCase=RAR104 CaseType=Combination P=-93,6773922825377 V2=27,6073821437725 V3=0 T=0 M2=0 M3=-28,2048640442643 FrameElem=1-1
ElemStation=0
Frame=1 Station=3,999999999999999E-02 OutputCase=RAR104 CaseType=Combination P=-93,5173922825377 V2=27,7298821437725 V3=0 T=0 M2=0 M3=-29,3116353300152
FrameElem=1-1 ElemStation=3,999999999999999E-02
Frame=1 Station=7,999999999999999E-02 OutputCase=RAR104 CaseType=Combination P=-93,3573922825377 V2=27,8445821437725 V3=0 T=0 M2=0 M3=-30,4231506157661
FrameElem=1-1 ElemStation=7,999999999999999E-02
Frame=1 Station=0 OutputCase=RAR105 CaseType=Combination P=-72,3356686623348 V2=4,67525156713614 V3=0 T=0 M2=0 M3=-11,23132420217 FrameElem=1-1
ElemStation=0
Frame=1 Station=3,999999999999999E-02 OutputCase=RAR105 CaseType=Combination P=-72,1756686623348 V2=4,79775156713614 V3=0 T=0 M2=0 M3=-11,4208102648554
FrameElem=1-1 ElemStation=3,999999999999999E-02
Frame=1 Station=7,999999999999999E-02 OutputCase=RAR105 CaseType=Combination P=-72,0156686623348 V2=4,91245156713614 V3=0 T=0 M2=0 M3=-11,6150403275409
FrameElem=1-1 ElemStation=7,999999999999999E-02
Frame=1 Station=0 OutputCase=RAR106 CaseType=Combination P=-79,5835761994287 V2=13,8735338119842 V3=0 T=0 M2=0 M3=-17,7822096688032 FrameElem=1-1
ElemStation=0
Frame=1 Station=3,999999999999999E-02 OutputCase=RAR106 CaseType=Combination P=-79,4235761994287 V2=13,9960338119842 V3=0 T=0 M2=0 M3=-18,3396270212825
FrameElem=1-1 ElemStation=3,999999999999999E-02
Frame=1 Station=7,999999999999999E-02 OutputCase=RAR106 CaseType=Combination P=-79,2635761994287 V2=14,1107338119842 V3=0 T=0 M2=0 M3=-18,9017883737619
FrameElem=1-1 ElemStation=7,999999999999999E-02
Frame=1 Station=0 OutputCase=RAR107 CaseType=Combination P=-72,3356686630915 V2=21,3193160464108 V3=0 T=0 M2=0 M3=-12,3715792920119 FrameElem=1-1
ElemStation=0
Frame=1 Station=3,999999999999999E-02 OutputCase=RAR107 CaseType=Combination P=-72,1756686630915 V2=22,3197410464108 V3=0 T=0 M2=0 M3=-13,244397600535
FrameElem=1-1 ElemStation=3,999999999999999E-02
Frame=1 Station=7,999999999999999E-02 OutputCase=RAR107 CaseType=Combination P=-72,0156686630915 V2=23,3090160464108 V3=0 T=0 M2=0 M3=-14,1570099090581
FrameElem=1-1 ElemStation=7,999999999999999E-02
Frame=1 Station=0 OutputCase=RAR108 CaseType=Combination P=-19,8235762001761 V2=13,1534265365619 V3=0 T=0 M2=0 M3=-9,37737927222062 FrameElem=1-1
ElemStation=0
Frame=1 Station=3,999999999999999E-02 OutputCase=RAR108 CaseType=Combination P=-19,6635762001761 V2=13,2759265365619 V3=0 T=0 M2=0 M3=-9,9059923368309
FrameElem=1-1 ElemStation=3,999999999999999E-02
Frame=1 Station=7,999999999999999E-02 OutputCase=RAR108 CaseType=Combination P=-19,5035762001761 V2=13,3906265365619 V3=0 T=0 M2=0 M3=-10,4393493951456
FrameElem=1-1 ElemStation=7,999999999999999E-02
Frame=1 Station=0 OutputCase=RAR109 CaseType=Combination P=-12,5756686638389 V2=20,5992087709884 V3=0 T=0 M2=0 M3=-3,96674889542939 FrameElem=1-1
ElemStation=0
Frame=1 Station=3,999999999999999E-02 OutputCase=RAR109 CaseType=Combination P=-12,4156686638389 V2=21,5996337709884 V3=0 T=0 M2=0 M3=-4,81076291293559
FrameElem=1-1 ElemStation=3,999999999999999E-02
Frame=1 Station=7,999999999999999E-02 OutputCase=RAR109 CaseType=Combination P=-12,2556686638389 V2=22,5889087709884 V3=0 T=0 M2=0 M3=-5,6945709304418
FrameElem=1-1 ElemStation=7,999999999999999E-02
Frame=1 Station=0 OutputCase=RAR110 CaseType=Combination P=-12,5756686630824 V2=4,41487539466376 V3=0 T=0 M2=0 M3=-3,17117033186633 FrameElem=1-1
ElemStation=0
Frame=1 Station=3,999999999999999E-02 OutputCase=RAR110 CaseType=Combination P=-12,4156686630824 V2=4,53737539466376 V3=0 T=0 M2=0 M3=-3,35024134765288
FrameElem=1-1 ElemStation=3,999999999999999E-02
Frame=1 Station=7,999999999999999E-02 OutputCase=RAR110 CaseType=Combination P=-12,2556686630824 V2=4,65207539466376 V3=0 T=0 M2=0 M3=-3,53405636343943
FrameElem=1-1 ElemStation=7,999999999999999E-02
Frame=1 Station=0 OutputCase=RAR111 CaseType=Combination P=-72,335668662335 V2=5,13498267008613 V3=0 T=0 M2=0 M3=-11,5760007284489 FrameElem=1-1
ElemStation=0
Frame=1 Station=3,999999999999999E-02 OutputCase=RAR111 CaseType=Combination P=-72,175668662335 V2=5,25748267008613 V3=0 T=0 M2=0 M3=-11,7838760352523
FrameElem=1-1 ElemStation=3,999999999999999E-02
Frame=1 Station=7,999999999999999E-02 OutputCase=RAR111 CaseType=Combination P=-72,015668662335 V2=5,37218267008613 V3=0 T=0 M2=0 M3=-11,9964953420558
FrameElem=1-1 ElemStation=7,999999999999999E-02
Frame=1 Station=0 OutputCase=RAR112 CaseType=Combination P=-79,5835761994288 V2=14,3332649149342 V3=0 T=0 M2=0 M3=-18,1268861950821 FrameElem=1-1
ElemStation=0
Frame=1 Station=3,999999999999999E-02 OutputCase=RAR112 CaseType=Combination P=-79,4235761994288 V2=14,4557649149342 V3=0 T=0 M2=0 M3=-18,702629716794
FrameElem=1-1 ElemStation=3,999999999999999E-02
Frame=1 Station=7,999999999999999E-02 OutputCase=RAR112 CaseType=Combination P=-79,2635761994288 V2=14,5704649149342 V3=0 T=0 M2=0 M3=-19,2832433882768
FrameElem=1-1 ElemStation=7,999999999999999E-02
Frame=1 Station=0 OutputCase=RAR113 CaseType=Combination P=-72,3356686630917 V2=21,7790471493608 V3=0 T=0 M2=0 M3=-12,7162558182908 FrameElem=1-1
ElemStation=0
Frame=1 Station=3,999999999999999E-02 OutputCase=RAR113 CaseType=Combination P=-72,1756686630917 V2=22,7794721493608 V3=0 T=0 M2=0 M3=-13,6074633709319
FrameElem=1-1 ElemStation=3,999999999999999E-02
Frame=1 Station=7,999999999999999E-02 OutputCase=RAR113 CaseType=Combination P=-72,0156686630917 V2=23,7687471493608 V3=0 T=0 M2=0 M3=-14,538464923573
FrameElem=1-1 ElemStation=7,999999999999999E-02
Frame=1 Station=0 OutputCase=RAR114 CaseType=Combination P=-19,8235762001762 V2=13,6131576395119 V3=0 T=0 M2=0 M3=-9,72205579849952 FrameElem=1-1
ElemStation=0
Frame=1 Station=3,999999999999999E-02 OutputCase=RAR114 CaseType=Combination P=-19,6635762001762 V2=13,7356576395118 V3=0 T=0 M2=0 M3=-10,26908810408
FrameElem=1-1 ElemStation=3,999999999999999E-02
Frame=1 Station=7,999999999999999E-02 OutputCase=RAR114 CaseType=Combination P=-19,5035762001762 V2=13,8503576395119 V3=0 T=0 M2=0 M3=-10,8208044096605
FrameElem=1-1 ElemStation=7,999999999999999E-02
Frame=1 Station=0 OutputCase=RAR115 CaseType=Combination P=-12,5756686638391 V2=21,0589398739384 V3=0 T=0 M2=0 M3=-4,31142542170829 FrameElem=1-1
ElemStation=0

Società di Progetto
Brebemi SpA



Doc. N.
60235-0000-A00.doc

CODIFICA DOCUMENTO
04RCDII10000000000300A00

REV.
00

FOGLIO
240 di 628

Frame=1 Station=3,9999999999999999E-02 OutputCase=RAR115 CaseType=Combination P=-12,4156686638391 V2=22,0593648739384 V3=0 T=0 M2=0 M3=-5,17382868333249
FrameElem=1-1 ElemStation=3,9999999999999999E-02
Frame=1 Station=7,9999999999999998E-02 OutputCase=RAR115 CaseType=Combination P=-12,2556686638391 V2=23,0486398739384 V3=0 T=0 M2=0 M3=-6,07620594495669
FrameElem=1-1 ElemStation=7,9999999999999998E-02
Frame=1 Station=0 OutputCase=RAR116 CaseType=Combination P=-12,5756686630821 V2=3,49541318876378 V3=0 T=0 M2=0 M3=-2,48181727930853 FrameElem=1-1
ElemStation=0
Frame=1 Station=3,9999999999999999E-02 OutputCase=RAR116 CaseType=Combination P=-12,4156686630821 V2=3,61791318876378 V3=0 T=0 M2=0 M3=-2,62410980685908
FrameElem=1-1 ElemStation=3,9999999999999999E-02
Frame=1 Station=7,9999999999999998E-02 OutputCase=RAR116 CaseType=Combination P=-12,2556686630821 V2=3,73261318876378 V3=0 T=0 M2=0 M3=-2,77114633440964
FrameElem=1-1 ElemStation=7,9999999999999998E-02
Frame=1 Station=0 OutputCase=RAR117 CaseType=Combination P=-72,3356686623347 V2=4,21552046418615 V3=0 T=0 M2=0 M3=-10,8866476758911 FrameElem=1-1
ElemStation=0
Frame=1 Station=3,9999999999999999E-02 OutputCase=RAR117 CaseType=Combination P=-72,1756686623347 V2=4,33802046418615 V3=0 T=0 M2=0 M3=-11,0577444944585
FrameElem=1-1 ElemStation=3,9999999999999999E-02
Frame=1 Station=7,9999999999999998E-02 OutputCase=RAR117 CaseType=Combination P=-72,0156686623347 V2=4,45272046418615 V3=0 T=0 M2=0 M3=-11,233585313026
FrameElem=1-1 ElemStation=7,9999999999999998E-02
Frame=1 Station=0 OutputCase=RAR118 CaseType=Combination P=-79,5835761994285 V2=13,4138027090342 V3=0 T=0 M2=0 M3=-17,4375331425243 FrameElem=1-1
ElemStation=0
Frame=1 Station=3,9999999999999999E-02 OutputCase=RAR118 CaseType=Combination P=-79,4235761994286 V2=13,5363027090342 V3=0 T=0 M2=0 M3=-17,9765612508856
FrameElem=1-1 ElemStation=3,9999999999999999E-02
Frame=1 Station=7,9999999999999998E-02 OutputCase=RAR118 CaseType=Combination P=-79,2635761994286 V2=13,6510027090342 V3=0 T=0 M2=0 M3=-18,520333359247
FrameElem=1-1 ElemStation=7,9999999999999998E-02
Frame=1 Station=0 OutputCase=RAR119 CaseType=Combination P=-72,3356686630914 V2=20,8595849434608 V3=0 T=0 M2=0 M3=-12,026902765733 FrameElem=1-1
ElemStation=0
Frame=1 Station=3,9999999999999999E-02 OutputCase=RAR119 CaseType=Combination P=-72,1756686630914 V2=21,8600099434608 V3=0 T=0 M2=0 M3=-12,8813318301381
FrameElem=1-1 ElemStation=3,9999999999999999E-02
Frame=1 Station=7,9999999999999998E-02 OutputCase=RAR119 CaseType=Combination P=-72,0156686630914 V2=22,8492849434608 V3=0 T=0 M2=0 M3=-13,7755548945432
FrameElem=1-1 ElemStation=7,9999999999999998E-02
Frame=1 Station=0 OutputCase=RAR120 CaseType=Combination P=-19,8235762001759 V2=12,6936954336119 V3=0 T=0 M2=0 M3=-9,03270274594172 FrameElem=1-1
ElemStation=0
Frame=1 Station=3,9999999999999999E-02 OutputCase=RAR120 CaseType=Combination P=-19,6635762001759 V2=12,8161954336119 V3=0 T=0 M2=0 M3=-9,5429265632862
FrameElem=1-1 ElemStation=3,9999999999999999E-02
Frame=1 Station=7,9999999999999998E-02 OutputCase=RAR120 CaseType=Combination P=-19,5035762001759 V2=12,9308954336119 V3=0 T=0 M2=0 M3=-10,0578943806307
FrameElem=1-1 ElemStation=7,9999999999999998E-02
Frame=1 Station=0 OutputCase=RAR121 CaseType=Combination P=-12,5756686638388 V2=20,1394776680385 V3=0 T=0 M2=0 M3=-3,62207236915049 FrameElem=1-1
ElemStation=0
Frame=1 Station=3,9999999999999999E-02 OutputCase=RAR121 CaseType=Combination P=-12,4156686638388 V2=21,1399026680385 V3=0 T=0 M2=0 M3=-4,44769714253869
FrameElem=1-1 ElemStation=3,9999999999999999E-02
Frame=1 Station=7,9999999999999998E-02 OutputCase=RAR121 CaseType=Combination P=-12,2556686638388 V2=22,1291776680385 V3=0 T=0 M2=0 M3=-5,3131159159269
FrameElem=1-1 ElemStation=7,9999999999999998E-02
Frame=1 Station=0 OutputCase=RAR122 CaseType=Combination P=-12,5756686630821 V2=3,49541318876378 V3=0 T=0 M2=0 M3=-2,48181727930853 FrameElem=1-1
ElemStation=0
Frame=1 Station=3,9999999999999999E-02 OutputCase=RAR122 CaseType=Combination P=-12,4156686630821 V2=3,61791318876378 V3=0 T=0 M2=0 M3=-2,62410980685908
FrameElem=1-1 ElemStation=3,9999999999999999E-02
Frame=1 Station=7,9999999999999998E-02 OutputCase=RAR122 CaseType=Combination P=-12,2556686630821 V2=3,73261318876378 V3=0 T=0 M2=0 M3=-2,77114633440963
FrameElem=1-1 ElemStation=7,9999999999999998E-02
Frame=1 Station=0 OutputCase=RAR123 CaseType=Combination P=-72,3356686623347 V2=4,21552046418615 V3=0 T=0 M2=0 M3=-10,8866476758911 FrameElem=1-1
ElemStation=0
Frame=1 Station=3,9999999999999999E-02 OutputCase=RAR123 CaseType=Combination P=-72,1756686623347 V2=4,33802046418615 V3=0 T=0 M2=0 M3=-11,0577444944585
FrameElem=1-1 ElemStation=3,9999999999999999E-02
Frame=1 Station=7,9999999999999998E-02 OutputCase=RAR123 CaseType=Combination P=-72,0156686623347 V2=4,45272046418615 V3=0 T=0 M2=0 M3=-11,233585313026
FrameElem=1-1 ElemStation=7,9999999999999998E-02
Frame=1 Station=0 OutputCase=RAR124 CaseType=Combination P=-79,5835761994285 V2=13,4138027090342 V3=0 T=0 M2=0 M3=-17,4375331425243 FrameElem=1-1
ElemStation=0
Frame=1 Station=3,9999999999999999E-02 OutputCase=RAR124 CaseType=Combination P=-79,4235761994286 V2=13,5363027090342 V3=0 T=0 M2=0 M3=-17,9765612508856
FrameElem=1-1 ElemStation=3,9999999999999999E-02
Frame=1 Station=7,9999999999999998E-02 OutputCase=RAR124 CaseType=Combination P=-79,2635761994286 V2=13,6510027090342 V3=0 T=0 M2=0 M3=-18,520333359247
FrameElem=1-1 ElemStation=7,9999999999999998E-02
Frame=1 Station=0 OutputCase=RAR125 CaseType=Combination P=-72,3356686630914 V2=20,8595849434608 V3=0 T=0 M2=0 M3=-12,026902765733 FrameElem=1-1
ElemStation=0
Frame=1 Station=3,9999999999999999E-02 OutputCase=RAR125 CaseType=Combination P=-72,1756686630914 V2=21,8600099434608 V3=0 T=0 M2=0 M3=-12,8813318301381
FrameElem=1-1 ElemStation=3,9999999999999999E-02
Frame=1 Station=7,9999999999999998E-02 OutputCase=RAR125 CaseType=Combination P=-72,0156686630914 V2=22,8492849434608 V3=0 T=0 M2=0 M3=-13,7755548945432
FrameElem=1-1 ElemStation=7,9999999999999998E-02
Frame=1 Station=0 OutputCase=RAR126 CaseType=Combination P=-19,8235762001759 V2=12,6936954336119 V3=0 T=0 M2=0 M3=-9,03270274594172 FrameElem=1-1
ElemStation=0
Frame=1 Station=3,9999999999999999E-02 OutputCase=RAR126 CaseType=Combination P=-19,6635762001759 V2=12,8161954336119 V3=0 T=0 M2=0 M3=-9,5429265632862
FrameElem=1-1 ElemStation=3,9999999999999999E-02
Frame=1 Station=7,9999999999999998E-02 OutputCase=RAR126 CaseType=Combination P=-19,5035762001759 V2=12,9308954336119 V3=0 T=0 M2=0 M3=-10,0578943806307
FrameElem=1-1 ElemStation=7,9999999999999998E-02
Frame=1 Station=0 OutputCase=RAR127 CaseType=Combination P=-12,5756686638388 V2=20,1394776680385 V3=0 T=0 M2=0 M3=-3,62207236915049 FrameElem=1-1
ElemStation=0
Frame=1 Station=3,9999999999999999E-02 OutputCase=RAR127 CaseType=Combination P=-12,4156686638388 V2=21,1399026680385 V3=0 T=0 M2=0 M3=-4,44769714253869
FrameElem=1-1 ElemStation=3,9999999999999999E-02
Frame=1 Station=7,9999999999999998E-02 OutputCase=RAR127 CaseType=Combination P=-12,2556686638388 V2=22,1291776680385 V3=0 T=0 M2=0 M3=-5,3131159159269
FrameElem=1-1 ElemStation=7,9999999999999998E-02
Frame=1 Station=0 OutputCase=RAR128 CaseType=Combination P=-11,940000002349 V2=2,87104660803484 V3=0 T=0 M2=0 M3=-1,30859550598552 FrameElem=1-1
ElemStation=0
Frame=1 Station=3,9999999999999999E-02 OutputCase=RAR128 CaseType=Combination P=-11,7800000002349 V2=2,99354660803484 V3=0 T=0 M2=0 M3=-1,42591337030691
FrameElem=1-1 ElemStation=3,9999999999999999E-02
Frame=1 Station=7,9999999999999998E-02 OutputCase=RAR128 CaseType=Combination P=-11,620000002349 V2=3,10824660803484 V3=0 T=0 M2=0 M3=-1,5479752346283
FrameElem=1-1 ElemStation=7,9999999999999998E-02
Frame=1 Station=0 OutputCase=RAR129 CaseType=Combination P=-91,6199999992385 V2=4,13767704389799 V3=0 T=0 M2=0 M3=-12,7448203856148 FrameElem=1-1
ElemStation=0
Frame=1 Station=3,9999999999999999E-02 OutputCase=RAR129 CaseType=Combination P=-91,4599999992385 V2=4,26017704389799 V3=0 T=0 M2=0 M3=-12,9128034673708
FrameElem=1-1 ElemStation=3,9999999999999999E-02
Frame=1 Station=7,9999999999999998E-02 OutputCase=RAR129 CaseType=Combination P=-91,2999999992385 V2=4,37487704389799 V3=0 T=0 M2=0 M3=-13,0855305491267
FrameElem=1-1 ElemStation=7,9999999999999998E-02

Società di Progetto
Brebemi SpA

APPROVATO SDP

12/01/2018



Doc. N.
60235-0000-A00.doc

CODIFICA DOCUMENTO
04RCDII10000000000300A00

REV.
00

FOGLIO
241 di 628

Frame=1 Station=0 OutputCase=RAR130 CaseType=Combination P=-100,961144092958 V2=15,9631077768169 V3=0 T=0 M2=0 M3=-21,1743678913955 FrameElem=1-1 ElemStation=0

Frame=1 Station=3,999999999999999E-02 OutputCase=RAR130 CaseType=Combination P=-100,801144092958 V2=16,0856077768169 V3=0 T=0 M2=0 M3=-21,8153682024682 FrameElem=1-1 ElemStation=3,999999999999999E-02

Frame=1 Station=7,999999999999998E-02 OutputCase=RAR130 CaseType=Combination P=-100,641144092958 V2=16,2003077768169 V3=0 T=0 M2=0 M3=-22,4611125135408 FrameElem=1-1 ElemStation=7,999999999999998E-02

Frame=1 Station=0 OutputCase=RAR131 CaseType=Combination P=-91,620000000228 V2=25,4985384964272 V3=0 T=0 M2=0 M3=-14,1891362035714 FrameElem=1-1 ElemStation=0

Frame=1 Station=3,999999999999999E-02 OutputCase=RAR131 CaseType=Combination P=-91,460000000228 V2=26,7675384964272 V3=0 T=0 M2=0 M3=-15,2344937434284 FrameElem=1-1 ElemStation=3,999999999999999E-02

Frame=1 Station=7,999999999999998E-02 OutputCase=RAR131 CaseType=Combination P=-91,300000000228 V2=28,0257384964272 V3=0 T=0 M2=0 M3=-16,3303952832855 FrameElem=1-1 ElemStation=7,999999999999998E-02

Frame=1 Station=0 OutputCase=RAR132 CaseType=Combination P=-21,2811440939548 V2=15,0029647429204 V3=0 T=0 M2=0 M3=-9,96792736261876 FrameElem=1-1 ElemStation=0

Frame=1 Station=3,999999999999999E-02 OutputCase=RAR132 CaseType=Combination P=-21,1211440939548 V2=15,1254647429204 V3=0 T=0 M2=0 M3=-10,5705219523356 FrameElem=1-1 ElemStation=3,999999999999999E-02

Frame=1 Station=7,999999999999998E-02 OutputCase=RAR132 CaseType=Combination P=-20,9611440939548 V2=15,2401647429204 V3=0 T=0 M2=0 M3=-11,1778605420524 FrameElem=1-1 ElemStation=7,999999999999998E-02

Frame=1 Station=0 OutputCase=RAR133 CaseType=Combination P=-11,9400000012246 V2=24,5383954625307 V3=0 T=0 M2=0 M3=-2,98269567479464 FrameElem=1-1 ElemStation=0

Frame=1 Station=3,999999999999999E-02 OutputCase=RAR133 CaseType=Combination P=-11,7800000012246 V2=25,8073954625307 V3=0 T=0 M2=0 M3=-3,98964749329587 FrameElem=1-1 ElemStation=3,999999999999999E-02

Frame=1 Station=7,999999999999998E-02 OutputCase=RAR133 CaseType=Combination P=-11,6200000012246 V2=27,0655954625307 V3=0 T=0 M2=0 M3=-5,04714331179709 FrameElem=1-1 ElemStation=7,999999999999998E-02

Frame=1 Station=0 OutputCase=RAR134 CaseType=Combination P=-93,2959910848293 V2=26,9569235335651 V3=0 T=0 M2=0 M3=-27,2941250645031 FrameElem=1-1 ElemStation=0

Frame=1 Station=3,999999999999999E-02 OutputCase=RAR134 CaseType=Combination P=-93,1359910848293 V2=27,0794235335651 V3=0 T=0 M2=0 M3=-28,3748780058457 FrameElem=1-1 ElemStation=3,999999999999999E-02

Frame=1 Station=7,999999999999998E-02 OutputCase=RAR134 CaseType=Combination P=-92,9759910848293 V2=27,1941235335651 V3=0 T=0 M2=0 M3=-29,4603749471883 FrameElem=1-1 ElemStation=7,999999999999998E-02

Frame=1 Station=0 OutputCase=RAR135 CaseType=Combination P=-71,699999994875 V2=3,59115388345721 V3=0 T=0 M2=0 M3=-9,71342590256805 FrameElem=1-1 ElemStation=0

Frame=1 Station=3,999999999999999E-02 OutputCase=RAR135 CaseType=Combination P=-71,539999994875 V2=3,71365388345721 V3=0 T=0 M2=0 M3=-9,85954805790634 FrameElem=1-1 ElemStation=3,999999999999999E-02

Frame=1 Station=7,999999999999998E-02 OutputCase=RAR135 CaseType=Combination P=-71,379999994876 V2=3,82835388345721 V3=0 T=0 M2=0 M3=-10,0104142132446 FrameElem=1-1 ElemStation=7,999999999999998E-02

Frame=1 Station=0 OutputCase=RAR136 CaseType=Combination P=-78,9479075365814 V2=12,7894361283053 V3=0 T=0 M2=0 M3=-16,2643113692012 FrameElem=1-1 ElemStation=0

Frame=1 Station=3,999999999999999E-02 OutputCase=RAR136 CaseType=Combination P=-78,7879075365814 V2=12,9119361283053 V3=0 T=0 M2=0 M3=-16,7783648143335 FrameElem=1-1 ElemStation=3,999999999999999E-02

Frame=1 Station=7,999999999999998E-02 OutputCase=RAR136 CaseType=Combination P=-78,6279075365814 V2=13,0266361283053 V3=0 T=0 M2=0 M3=-17,2971622594657 FrameElem=1-1 ElemStation=7,999999999999998E-02

Frame=1 Station=0 OutputCase=RAR137 CaseType=Combination P=-71,7000000002442 V2=20,2352183627319 V3=0 T=0 M2=0 M3=-10,85368099241 FrameElem=1-1 ElemStation=0

Frame=1 Station=3,999999999999999E-02 OutputCase=RAR137 CaseType=Combination P=-71,5400000002442 V2=21,2356433627319 V3=0 T=0 M2=0 M3=-11,683135393586 FrameElem=1-1 ElemStation=3,999999999999999E-02

Frame=1 Station=7,999999999999998E-02 OutputCase=RAR137 CaseType=Combination P=-71,3800000002443 V2=22,2249183627319 V3=0 T=0 M2=0 M3=-12,5523837947619 FrameElem=1-1 ElemStation=7,999999999999998E-02

Frame=1 Station=0 OutputCase=RAR138 CaseType=Combination P=-19,1879075373288 V2=12,0693288528829 V3=0 T=0 M2=0 M3=-7,85948097261871 FrameElem=1-1 ElemStation=0

Frame=1 Station=3,999999999999999E-02 OutputCase=RAR138 CaseType=Combination P=-19,0279075373288 V2=12,1918288528829 V3=0 T=0 M2=0 M3=-8,34473012673402 FrameElem=1-1 ElemStation=3,999999999999999E-02

Frame=1 Station=7,999999999999998E-02 OutputCase=RAR138 CaseType=Combination P=-18,8679075373288 V2=12,3065288528829 V3=0 T=0 M2=0 M3=-8,83472328084934 FrameElem=1-1 ElemStation=7,999999999999998E-02

Frame=1 Station=0 OutputCase=RAR139 CaseType=Combination P=-11,9400000009916 V2=19,5151110873095 V3=0 T=0 M2=0 M3=-2,44885059582747 FrameElem=1-1 ElemStation=0

Frame=1 Station=3,999999999999999E-02 OutputCase=RAR139 CaseType=Combination P=-11,7800000009916 V2=20,5155360873095 V3=0 T=0 M2=0 M3=-3,24950070598652 FrameElem=1-1 ElemStation=3,999999999999999E-02

Frame=1 Station=7,999999999999998E-02 OutputCase=RAR139 CaseType=Combination P=-11,6200000009916 V2=21,5048110873095 V3=0 T=0 M2=0 M3=-4,0899448164556 FrameElem=1-1 ElemStation=7,999999999999998E-02

Frame=1 Station=0 OutputCase=RAR140 CaseType=Combination P=-11,9400000002351 V2=3,33077771098483 V3=0 T=0 M2=0 M3=-1,65327203226442 FrameElem=1-1 ElemStation=0

Frame=1 Station=3,999999999999999E-02 OutputCase=RAR140 CaseType=Combination P=-11,7800000002351 V2=3,45327771098483 V3=0 T=0 M2=0 M3=-1,78897914070381 FrameElem=1-1 ElemStation=3,999999999999999E-02

Frame=1 Station=7,999999999999998E-02 OutputCase=RAR140 CaseType=Combination P=-11,6200000002351 V2=3,56797771098483 V3=0 T=0 M2=0 M3=-1,9294302491432 FrameElem=1-1 ElemStation=7,999999999999998E-02

Frame=1 Station=0 OutputCase=RAR141 CaseType=Combination P=-71,699999994877 V2=4,0508849864072 V3=0 T=0 M2=0 M3=-10,058102428847 FrameElem=1-1 ElemStation=0

Frame=1 Station=3,999999999999999E-02 OutputCase=RAR141 CaseType=Combination P=-71,539999994877 V2=4,1733849864072 V3=0 T=0 M2=0 M3=-10,2226138283032 FrameElem=1-1 ElemStation=3,999999999999999E-02

Frame=1 Station=7,999999999999998E-02 OutputCase=RAR141 CaseType=Combination P=-71,379999994877 V2=4,2880849864072 V3=0 T=0 M2=0 M3=-10,3918692277595 FrameElem=1-1 ElemStation=7,999999999999998E-02

Frame=1 Station=0 OutputCase=RAR142 CaseType=Combination P=-78,9479075365815 V2=13,2491672312553 V3=0 T=0 M2=0 M3=-16,6089878954801 FrameElem=1-1 ElemStation=0

Frame=1 Station=3,999999999999999E-02 OutputCase=RAR142 CaseType=Combination P=-78,7879075365815 V2=13,3716672312553 V3=0 T=0 M2=0 M3=-17,1414305847304 FrameElem=1-1 ElemStation=3,999999999999999E-02

Frame=1 Station=7,999999999999998E-02 OutputCase=RAR142 CaseType=Combination P=-78,6279075365815 V2=13,4863672312553 V3=0 T=0 M2=0 M3=-17,6786172739806 FrameElem=1-1 ElemStation=7,999999999999998E-02

Frame=1 Station=0 OutputCase=RAR143 CaseType=Combination P=-71,7000000002444 V2=20,6949494656819 V3=0 T=0 M2=0 M3=-11,1983575186889 FrameElem=1-1 ElemStation=0

Frame=1 Station=3,999999999999999E-02 OutputCase=RAR143 CaseType=Combination P=-71,5400000002444 V2=21,6953744656819 V3=0 T=0 M2=0 M3=-12,0462011639829 FrameElem=1-1 ElemStation=3,999999999999999E-02

Frame=1 Station=7,999999999999998E-02 OutputCase=RAR143 CaseType=Combination P=-71,3800000002444 V2=22,6846494656819 V3=0 T=0 M2=0 M3=-12,9338388092768 FrameElem=1-1 ElemStation=7,999999999999998E-02

Frame=1 Station=0 OutputCase=RAR144 CaseType=Combination P=-19,1879075373289 V2=12,5290599558329 V3=0 T=0 M2=0 M3=-8,20415749889761 FrameElem=1-1 ElemStation=0

Frame=1 Station=3,999999999999999E-02 OutputCase=RAR144 CaseType=Combination P=-19,0279075373289 V2=12,6515599558329 V3=0 T=0 M2=0 M3=-8,70779589713092 FrameElem=1-1 ElemStation=3,999999999999999E-02

Società di Progetto
Brebemi SpA



Doc. N.
60235-0000-A00.doc

CODIFICA DOCUMENTO
04RCDII10000000000300A00

REV.
00

FOGLIO
242 di 628

Frame=1 Station=7,999999999999999E-02 OutputCase=RAR144 CaseType=Combination P=-18,8679075373289 V2=12,7662599558329 V3=0 T=0 M2=0 M3=-9,21617829536424
FrameElem=1-1 ElemStation=1 ElemStation=3,999999999999999E-02
Frame=1 Station=0 OutputCase=RAR145 CaseType=Combination P=-11,9400000009918 V2=19,9748421902595 V3=0 T=0 M2=0 M3=-2,79352712210637 FrameElem=1-1
ElemStation=0
Frame=1 Station=3,999999999999999E-02 OutputCase=RAR145 CaseType=Combination P=-11,7800000009918 V2=20,9752671902595 V3=0 T=0 M2=0 M3=-3,61256647638342
FrameElem=1-1 ElemStation=3,999999999999999E-02
Frame=1 Station=7,999999999999999E-02 OutputCase=RAR145 CaseType=Combination P=-11,6200000009918 V2=21,9645421902595 V3=0 T=0 M2=0 M3=-4,47139983066046
FrameElem=1-1 ElemStation=7,999999999999999E-02
Frame=1 Station=0 OutputCase=RAR146 CaseType=Combination P=-11,9400000002348 V2=2,41131550508485 V3=0 T=0 M2=0 M3=-0,963918979706617 FrameElem=1-1
ElemStation=0
Frame=1 Station=3,999999999999999E-02 OutputCase=RAR146 CaseType=Combination P=-11,7800000002348 V2=2,53381550508485 V3=0 T=0 M2=0 M3=-1,06284759991001
FrameElem=1-1 ElemStation=3,999999999999999E-02
Frame=1 Station=7,999999999999999E-02 OutputCase=RAR146 CaseType=Combination P=-11,6200000002348 V2=2,64851550508485 V3=0 T=0 M2=0 M3=-1,1665202201134
FrameElem=1-1 ElemStation=7,999999999999999E-02
Frame=1 Station=0 OutputCase=RAR147 CaseType=Combination P=-71,6999999994874 V2=3,13142278050722 V3=0 T=0 M2=0 M3=-9,36874937628915 FrameElem=1-1
ElemStation=0
Frame=1 Station=3,999999999999999E-02 OutputCase=RAR147 CaseType=Combination P=-71,5399999994874 V2=3,25392278050722 V3=0 T=0 M2=0 M3=-9,49648228750944
FrameElem=1-1 ElemStation=3,999999999999999E-02
Frame=1 Station=7,999999999999999E-02 OutputCase=RAR147 CaseType=Combination P=-71,3799999994874 V2=3,36862278050722 V3=0 T=0 M2=0 M3=-9,62895919872973
FrameElem=1-1 ElemStation=7,999999999999999E-02
Frame=1 Station=0 OutputCase=RAR148 CaseType=Combination P=-78,9479075365813 V2=12,3297050253553 V3=0 T=0 M2=0 M3=-15,9196348429223 FrameElem=1-1
ElemStation=0
Frame=1 Station=3,999999999999999E-02 OutputCase=RAR148 CaseType=Combination P=-78,7879075365813 V2=12,4522050253553 V3=0 T=0 M2=0 M3=-16,4152990439366
FrameElem=1-1 ElemStation=3,999999999999999E-02
Frame=1 Station=7,999999999999999E-02 OutputCase=RAR148 CaseType=Combination P=-78,6279075365813 V2=12,5669050253553 V3=0 T=0 M2=0 M3=-16,9157072449508
FrameElem=1-1 ElemStation=7,999999999999999E-02
Frame=1 Station=0 OutputCase=RAR149 CaseType=Combination P=-71,7000000002441 V2=19,7754872597819 V3=0 T=0 M2=0 M3=-10,5090044661311 FrameElem=1-1
ElemStation=0
Frame=1 Station=3,999999999999999E-02 OutputCase=RAR149 CaseType=Combination P=-71,5400000002441 V2=20,7759122597819 V3=0 T=0 M2=0 M3=-11,3200696231891
FrameElem=1-1 ElemStation=3,999999999999999E-02
Frame=1 Station=7,999999999999999E-02 OutputCase=RAR149 CaseType=Combination P=-71,3800000002441 V2=21,7651872597819 V3=0 T=0 M2=0 M3=-12,170928780247
FrameElem=1-1 ElemStation=7,999999999999999E-02
Frame=1 Station=0 OutputCase=RAR150 CaseType=Combination P=-19,1879075373286 V2=11,6095977499329 V3=0 T=0 M2=0 M3=-7,51480444633981 FrameElem=1-1
ElemStation=0
Frame=1 Station=3,999999999999999E-02 OutputCase=RAR150 CaseType=Combination P=-19,0279075373286 V2=11,7320977499329 V3=0 T=0 M2=0 M3=-7,98166435633712
FrameElem=1-1 ElemStation=3,999999999999999E-02
Frame=1 Station=7,999999999999999E-02 OutputCase=RAR150 CaseType=Combination P=-18,8679075373286 V2=11,8467977499329 V3=0 T=0 M2=0 M3=-8,45326826633444
FrameElem=1-1 ElemStation=7,999999999999999E-02
Frame=1 Station=0 OutputCase=RAR151 CaseType=Combination P=-11,9400000009915 V2=19,0553799843595 V3=0 T=0 M2=0 M3=-2,10417406954857 FrameElem=1-1
ElemStation=0
Frame=1 Station=3,999999999999999E-02 OutputCase=RAR151 CaseType=Combination P=-11,7800000009915 V2=20,0558049843595 V3=0 T=0 M2=0 M3=-2,88643493558962
FrameElem=1-1 ElemStation=3,999999999999999E-02
Frame=1 Station=7,999999999999999E-02 OutputCase=RAR151 CaseType=Combination P=-11,6200000009915 V2=21,0450799843595 V3=0 T=0 M2=0 M3=-3,70848980163067
FrameElem=1-1 ElemStation=7,999999999999999E-02
Frame=1 Station=0 OutputCase=RAR152 CaseType=Combination P=-11,5585988025267 V2=2,68031910077747 V3=0 T=0 M2=0 M3=-0,742533052503267 FrameElem=1-1
ElemStation=0
Frame=1 Station=3,999999999999999E-02 OutputCase=RAR152 CaseType=Combination P=-11,3985988025267 V2=2,80281910077747 V3=0 T=0 M2=0 M3=-0,852221816534366
FrameElem=1-1 ElemStation=3,999999999999999E-02
Frame=1 Station=7,999999999999999E-02 OutputCase=RAR152 CaseType=Combination P=-11,2385988025267 V2=2,91751910077747 V3=0 T=0 M2=0 M3=-0,966654580565465
FrameElem=1-1 ElemStation=7,999999999999999E-02
Frame=1 Station=0 OutputCase=RAR153 CaseType=Combination P=-71,3185988017793 V2=3,40042637619984 V3=0 T=0 M2=0 M3=-9,1473634490858 FrameElem=1-1
ElemStation=0
Frame=1 Station=3,999999999999999E-02 OutputCase=RAR153 CaseType=Combination P=-71,1585988017793 V2=3,52292637619984 V3=0 T=0 M2=0 M3=-9,2858565041338
FrameElem=1-1 ElemStation=3,999999999999999E-02
Frame=1 Station=7,999999999999999E-02 OutputCase=RAR153 CaseType=Combination P=-70,9985988017793 V2=3,63762637619984 V3=0 T=0 M2=0 M3=-9,42909355918179
FrameElem=1-1 ElemStation=7,999999999999999E-02
Frame=1 Station=0 OutputCase=RAR154 CaseType=Combination P=-78,5665063388732 V2=12,5987086210479 V3=0 T=0 M2=0 M3=-15,6982489157179 FrameElem=1-1
ElemStation=0
Frame=1 Station=3,999999999999999E-02 OutputCase=RAR154 CaseType=Combination P=-78,4065063388732 V2=12,7212086210479 V3=0 T=0 M2=0 M3=-16,2046732605609
FrameElem=1-1 ElemStation=3,999999999999999E-02
Frame=1 Station=7,999999999999999E-02 OutputCase=RAR154 CaseType=Combination P=-78,2465063388732 V2=12,8359086210479 V3=0 T=0 M2=0 M3=-16,7158416054028
FrameElem=1-1 ElemStation=7,999999999999999E-02
Frame=1 Station=0 OutputCase=RAR155 CaseType=Combination P=-71,318598802536 V2=20,0444908554745 V3=0 T=0 M2=0 M3=-10,2876185389278 FrameElem=1-1
ElemStation=0
Frame=1 Station=3,999999999999999E-02 OutputCase=RAR155 CaseType=Combination P=-71,158598802536 V2=21,0449158554745 V3=0 T=0 M2=0 M3=-11,1094438398134
FrameElem=1-1 ElemStation=3,999999999999999E-02
Frame=1 Station=7,999999999999999E-02 OutputCase=RAR155 CaseType=Combination P=-70,998598802536 V2=22,0341908554745 V3=0 T=0 M2=0 M3=-11,971063140699
FrameElem=1-1 ElemStation=7,999999999999999E-02
Frame=1 Station=0 OutputCase=RAR156 CaseType=Combination P=-18,8065063396205 V2=11,8786013456256 V3=0 T=0 M2=0 M3=-7,29341851913646 FrameElem=1-1
ElemStation=0
Frame=1 Station=3,999999999999999E-02 OutputCase=RAR156 CaseType=Combination P=-18,6465063396205 V2=12,0011013456256 V3=0 T=0 M2=0 M3=-7,77103857296148
FrameElem=1-1 ElemStation=3,999999999999999E-02
Frame=1 Station=7,999999999999999E-02 OutputCase=RAR156 CaseType=Combination P=-18,4865063396205 V2=12,1158013456256 V3=0 T=0 M2=0 M3=-8,2534026267865
FrameElem=1-1 ElemStation=7,999999999999999E-02
Frame=1 Station=0 OutputCase=RAR157 CaseType=Combination P=-11,5585988032834 V2=19,3243835800521 V3=0 T=0 M2=0 M3=-1,88278814234523 FrameElem=1-1
ElemStation=0
Frame=1 Station=3,999999999999999E-02 OutputCase=RAR157 CaseType=Combination P=-11,3985988032834 V2=20,3248085800521 V3=0 T=0 M2=0 M3=-2,67580915221398
FrameElem=1-1 ElemStation=3,999999999999999E-02
Frame=1 Station=7,999999999999999E-02 OutputCase=RAR157 CaseType=Combination P=-11,2385988032834 V2=21,3140835800521 V3=0 T=0 M2=0 M3=-3,50862416208273
FrameElem=1-1 ElemStation=7,999999999999999E-02
Frame=1 Station=0 OutputCase=RAR158 CaseType=Combination P=-12,3214011979432 V2=3,06177411529221 V3=0 T=0 M2=0 M3=-1,87465795946777 FrameElem=1-1
ElemStation=0
Frame=1 Station=3,999999999999999E-02 OutputCase=RAR158 CaseType=Combination P=-12,1614011979432 V2=3,18427411529221 V3=0 T=0 M2=0 M3=-1,99960492407945
FrameElem=1-1 ElemStation=3,999999999999999E-02
Frame=1 Station=7,999999999999999E-02 OutputCase=RAR158 CaseType=Combination P=-12,0014011979432 V2=3,29897411529221 V3=0 T=0 M2=0 M3=-2,12929588869114
FrameElem=1-1 ElemStation=7,999999999999999E-02
Frame=1 Station=0 OutputCase=RAR159 CaseType=Combination P=-72,0814011971958 V2=3,78188139071458 V3=0 T=0 M2=0 M3=-10,2794883560503 FrameElem=1-1
ElemStation=0

Società di Progetto
Brebemi SpA



Doc. N.
60235-0000-A00.doc

CODIFICA DOCUMENTO
04RCDII10000000000300A00

REV.
00

FOGLIO
243 di 628

Frame=1 Station=3,999999999999999E-02 OutputCase=RAR159 CaseType=Combination P=-71,9214011971958 V2=3,90438139071458 V3=0 T=0 M2=0 M3=-10,4332396116789
FrameElem=1-1 ElemStation=3,999999999999999E-02
Frame=1 Station=7,999999999999998E-02 OutputCase=RAR159 CaseType=Combination P=-71,7614011971958 V2=4,01908139071458 V3=0 T=0 M2=0 M3=-10,5917348673075
FrameElem=1-1 ElemStation=7,999999999999998E-02
Frame=1 Station=0 OutputCase=RAR160 CaseType=Combination P=-79,3293087342896 V2=12,9801636355627 V3=0 T=0 M2=0 M3=-16,8303738226835 FrameElem=1-1
ElemStation=0
Frame=1 Station=3,999999999999999E-02 OutputCase=RAR160 CaseType=Combination P=-79,1693087342896 V2=13,1026636355627 V3=0 T=0 M2=0 M3=-17,352056368106
FrameElem=1-1 ElemStation=3,999999999999999E-02
Frame=1 Station=7,999999999999998E-02 OutputCase=RAR160 CaseType=Combination P=-79,0093087342896 V2=13,2173636355627 V3=0 T=0 M2=0 M3=-17,8784829135285
FrameElem=1-1 ElemStation=7,999999999999998E-02
Frame=1 Station=0 OutputCase=RAR161 CaseType=Combination P=-72,0814011979525 V2=20,4259458699893 V3=0 T=0 M2=0 M3=-11,4197434458923 FrameElem=1-1
ElemStation=0
Frame=1 Station=3,999999999999999E-02 OutputCase=RAR161 CaseType=Combination P=-71,9214011979525 V2=21,4263708699893 V3=0 T=0 M2=0 M3=-12,2568269473585
FrameElem=1-1 ElemStation=3,999999999999999E-02
Frame=1 Station=7,999999999999998E-02 OutputCase=RAR161 CaseType=Combination P=-71,7614011979525 V2=22,4156458699893 V3=0 T=0 M2=0 M3=-13,1337044488247
FrameElem=1-1 ElemStation=7,999999999999998E-02
Frame=1 Station=0 OutputCase=RAR162 CaseType=Combination P=-19,569308735037 V2=12,2600563601403 V3=0 T=0 M2=0 M3=-8,42554342610096 FrameElem=1-1
ElemStation=0
Frame=1 Station=3,999999999999999E-02 OutputCase=RAR162 CaseType=Combination P=-19,409308735037 V2=12,3825563601403 V3=0 T=0 M2=0 M3=-8,91842168050657
FrameElem=1-1 ElemStation=3,999999999999999E-02
Frame=1 Station=7,999999999999998E-02 OutputCase=RAR162 CaseType=Combination P=-19,249308735037 V2=12,4972563601403 V3=0 T=0 M2=0 M3=-9,41604393491218
FrameElem=1-1 ElemStation=7,999999999999998E-02
Frame=1 Station=0 OutputCase=RAR163 CaseType=Combination P=-12,3214011986999 V2=19,7058385945669 V3=0 T=0 M2=0 M3=-3,01491304930972 FrameElem=1-1
ElemStation=0
Frame=1 Station=3,999999999999999E-02 OutputCase=RAR163 CaseType=Combination P=-12,1614011986999 V2=20,7062635945669 V3=0 T=0 M2=0 M3=-3,82319225975906
FrameElem=1-1 ElemStation=3,999999999999999E-02
Frame=1 Station=7,999999999999998E-02 OutputCase=RAR163 CaseType=Combination P=-12,0014011986999 V2=21,6955385945669 V3=0 T=0 M2=0 M3=-4,6712654702084
FrameElem=1-1 ElemStation=7,999999999999998E-02
Frame=1 Station=0 OutputCase=INVRAR CaseType=Combination StepType=Max P=-11,304331337388 V2=27,8763857394651 V3=0 T=0 M2=0 M3=-0,594942434367701
FrameElem=1-1 ElemStation=0
Frame=1 Station=3,999999999999999E-02 OutputCase=INVRAR CaseType=Combination StepType=Max P=-11,144331337388 V2=27,9988857394651 V3=0 T=0 M2=0 M3=-
0,711804627617269 FrameElem=1-1 ElemStation=3,999999999999999E-02
Frame=1 Station=7,999999999999998E-02 OutputCase=INVRAR CaseType=Combination StepType=Max P=-10,984331337388 V2=28,9452007023272 V3=0 T=0 M2=0 M3=-
0,833410820866838 FrameElem=1-1 ElemStation=7,999999999999998E-02
Frame=1 Station=0 OutputCase=INVRAR CaseType=Combination StepType=Min P=-101,342545290667 V2=2,41131550508485 V3=0 T=0 M2=0 M3=-28,2048640442643
FrameElem=1-1 ElemStation=0
Frame=1 Station=3,999999999999999E-02 OutputCase=INVRAR CaseType=Combination StepType=Min P=-101,182545290667 V2=2,53381550508485 V3=0 T=0 M2=0 M3=-
29,3116353300152 FrameElem=1-1 ElemStation=3,999999999999999E-02
Frame=1 Station=7,999999999999998E-02 OutputCase=INVRAR CaseType=Combination StepType=Min P=-101,022545290667 V2=2,64851550508485 V3=0 T=0 M2=0 M3=-
30,4231506157661 FrameElem=1-1 ElemStation=7,999999999999998E-02
Frame=1 Station=0 OutputCase=FRE01 CaseType=Combination P=-11,940000002934 V2=6,13093867246257 V3=0 T=0 M2=0 M3=-2,11112928861528 FrameElem=1-1
ElemStation=0
Frame=1 Station=3,999999999999999E-02 OutputCase=FRE01 CaseType=Combination P=-11,7800000002934 V2=6,32563867246257 V3=0 T=0 M2=0 M3=-2,36030150218045
FrameElem=1-1 ElemStation=3,999999999999999E-02
Frame=1 Station=7,999999999999998E-02 OutputCase=FRE01 CaseType=Combination P=-11,6200000002934 V2=6,50813867246257 V3=0 T=0 M2=0 M3=-2,61701771574562
FrameElem=1-1 ElemStation=7,999999999999998E-02
Frame=1 Station=0 OutputCase=FRE02 CaseType=Combination P=-71,6999999994878 V2=4,35737238837386 V3=0 T=0 M2=0 M3=-10,2878867796996 FrameElem=1-1
ElemStation=0
Frame=1 Station=3,999999999999999E-02 OutputCase=FRE02 CaseType=Combination P=-71,5399999994878 V2=4,47987238837386 V3=0 T=0 M2=0 M3=-10,4646576752345
FrameElem=1-1 ElemStation=3,999999999999999E-02
Frame=1 Station=7,999999999999998E-02 OutputCase=FRE02 CaseType=Combination P=-71,3799999994878 V2=4,59457238837386 V3=0 T=0 M2=0 M3=-10,6461725707695
FrameElem=1-1 ElemStation=7,999999999999998E-02
Frame=1 Station=0 OutputCase=FRE03 CaseType=Combination P=-78,9479075365816 V2=13,5556546332219 V3=0 T=0 M2=0 M3=-16,8387722463327 FrameElem=1-1
ElemStation=0
Frame=1 Station=3,999999999999999E-02 OutputCase=FRE03 CaseType=Combination P=-78,7879075365816 V2=13,6781546332219 V3=0 T=0 M2=0 M3=-17,3834744316616
FrameElem=1-1 ElemStation=3,999999999999999E-02
Frame=1 Station=7,999999999999998E-02 OutputCase=FRE03 CaseType=Combination P=-78,6279075365816 V2=13,7928546332219 V3=0 T=0 M2=0 M3=-17,9329206169905
FrameElem=1-1 ElemStation=7,999999999999998E-02
Frame=1 Station=0 OutputCase=FRE04 CaseType=Combination P=-71,7000000002445 V2=21,0014368676485 V3=0 T=0 M2=0 M3=-11,4281418695415 FrameElem=1-1
ElemStation=0
Frame=1 Station=3,999999999999999E-02 OutputCase=FRE04 CaseType=Combination P=-71,5400000002445 V2=22,0018618676485 V3=0 T=0 M2=0 M3=-12,2882450109141
FrameElem=1-1 ElemStation=3,999999999999999E-02
Frame=1 Station=7,999999999999998E-02 OutputCase=FRE04 CaseType=Combination P=-71,3800000002445 V2=22,9911368676485 V3=0 T=0 M2=0 M3=-13,1881421522867
FrameElem=1-1 ElemStation=7,999999999999998E-02
Frame=1 Station=0 OutputCase=FRE05 CaseType=Combination P=-19,187907537329 V2=12,8355473577996 V3=0 T=0 M2=0 M3=-8,43394184975021 FrameElem=1-1
ElemStation=0
Frame=1 Station=3,999999999999999E-02 OutputCase=FRE05 CaseType=Combination P=-19,027907537329 V2=12,9580473577996 V3=0 T=0 M2=0 M3=-8,94983974406219
FrameElem=1-1 ElemStation=3,999999999999999E-02
Frame=1 Station=7,999999999999998E-02 OutputCase=FRE05 CaseType=Combination P=-18,867907537329 V2=13,0727473577996 V3=0 T=0 M2=0 M3=-9,47048163837417
FrameElem=1-1 ElemStation=7,999999999999998E-02
Frame=1 Station=0 OutputCase=FRE06 CaseType=Combination P=-11,9400000009919 V2=20,2813295922262 V3=0 T=0 M2=0 M3=-3,02331147295897 FrameElem=1-1
ElemStation=0
Frame=1 Station=3,999999999999999E-02 OutputCase=FRE06 CaseType=Combination P=-11,7800000009919 V2=21,2817545922262 V3=0 T=0 M2=0 M3=-3,85461032331469
FrameElem=1-1 ElemStation=3,999999999999999E-02
Frame=1 Station=7,999999999999998E-02 OutputCase=FRE06 CaseType=Combination P=-11,6200000009919 V2=22,2710295922262 V3=0 T=0 M2=0 M3=-4,7257031736704
FrameElem=1-1 ElemStation=7,999999999999998E-02
Frame=1 Station=0 OutputCase=FRE07 CaseType=Combination P=-11,9400000002353 V2=4,09699621590148 V3=0 T=0 M2=0 M3=-2,22773290939592 FrameElem=1-1
ElemStation=0
Frame=1 Station=3,999999999999999E-02 OutputCase=FRE07 CaseType=Combination P=-11,7800000002353 V2=4,21949621590148 V3=0 T=0 M2=0 M3=-2,39408875803198
FrameElem=1-1 ElemStation=3,999999999999999E-02
Frame=1 Station=7,999999999999998E-02 OutputCase=FRE07 CaseType=Combination P=-11,6200000002353 V2=4,33419621590148 V3=0 T=0 M2=0 M3=-2,56518860666803
FrameElem=1-1 ElemStation=7,999999999999998E-02
Frame=1 Station=0 OutputCase=FRE08 CaseType=Combination P=-71,6999999994879 V2=4,74048164083218 V3=0 T=0 M2=0 M3=-10,5751172182653 FrameElem=1-1
ElemStation=0
Frame=1 Station=3,999999999999999E-02 OutputCase=FRE08 CaseType=Combination P=-71,5399999994879 V2=4,86298164083218 V3=0 T=0 M2=0 M3=-10,7672124838986
FrameElem=1-1 ElemStation=3,999999999999999E-02
Frame=1 Station=7,999999999999998E-02 OutputCase=FRE08 CaseType=Combination P=-71,3799999994879 V2=4,97768164083218 V3=0 T=0 M2=0 M3=-10,9640517495319
FrameElem=1-1 ElemStation=7,999999999999998E-02

Società di Progetto
Brebemi SpA



Doc. N.
60235-0000-A00.doc

CODIFICA DOCUMENTO
04RCDII10000000000300A00

REV.
00

FOGLIO
244 di 628

Frame=1 Station=0 OutputCase=FRE09 CaseType=Combination P=-78,9479075365817 V2=13,9387638856803 V3=0 T=0 M2=0 M3=-17,1260026848985 FrameElem=1-1 ElemStation=0
Frame=1 Station=3,999999999999999E-02 OutputCase=FRE09 CaseType=Combination P=-78,7879075365817 V2=14,0612638856803 V3=0 T=0 M2=0 M3=-17,6860292403257
FrameElem=1-1 ElemStation=3,999999999999999E-02
Frame=1 Station=7,999999999999998E-02 OutputCase=FRE09 CaseType=Combination P=-78,6279075365817 V2=14,1759638856803 V3=0 T=0 M2=0 M3=-18,2507997957529
FrameElem=1-1 ElemStation=7,999999999999998E-02
Frame=1 Station=0 OutputCase=FRE10 CaseType=Combination P=-71,7000000002446 V2=21,3845461201069 V3=0 T=0 M2=0 M3=-11,7153723081073 FrameElem=1-1 ElemStation=0
Frame=1 Station=3,999999999999999E-02 OutputCase=FRE10 CaseType=Combination P=-71,5400000002446 V2=22,3849711201069 V3=0 T=0 M2=0 M3=-12,5907998195782
FrameElem=1-1 ElemStation=3,999999999999999E-02
Frame=1 Station=7,999999999999998E-02 OutputCase=FRE10 CaseType=Combination P=-71,3800000002446 V2=23,3742461201069 V3=0 T=0 M2=0 M3=-13,5060213310491
FrameElem=1-1 ElemStation=7,999999999999998E-02
Frame=1 Station=0 OutputCase=FRE11 CaseType=Combination P=-19,1879075373291 V2=13,2186566102579 V3=0 T=0 M2=0 M3=-8,72117228831596 FrameElem=1-1 ElemStation=0
Frame=1 Station=3,999999999999999E-02 OutputCase=FRE11 CaseType=Combination P=-19,0279075373291 V2=13,3411566102579 V3=0 T=0 M2=0 M3=-9,25239455272627
FrameElem=1-1 ElemStation=3,999999999999999E-02
Frame=1 Station=7,999999999999998E-02 OutputCase=FRE11 CaseType=Combination P=-18,8679075373291 V2=13,4558566102579 V3=0 T=0 M2=0 M3=-9,78836081713659
FrameElem=1-1 ElemStation=7,999999999999998E-02
Frame=1 Station=0 OutputCase=FRE12 CaseType=Combination P=-11,9400000000992 V2=20,6644388446845 V3=0 T=0 M2=0 M3=-3,31054191152472 FrameElem=1-1 ElemStation=0
Frame=1 Station=3,999999999999999E-02 OutputCase=FRE12 CaseType=Combination P=-11,7800000000992 V2=21,6648638446845 V3=0 T=0 M2=0 M3=-4,15716513197877
FrameElem=1-1 ElemStation=3,999999999999999E-02
Frame=1 Station=7,999999999999998E-02 OutputCase=FRE12 CaseType=Combination P=-11,6200000000992 V2=22,6541388446845 V3=0 T=0 M2=0 M3=-5,04358235243281
FrameElem=1-1 ElemStation=7,999999999999998E-02
Frame=1 Station=0 OutputCase=FRE13 CaseType=Combination P=-11,6221656688118 V2=3,93805662652034 V3=0 T=0 M2=0 M3=-1,75601419816071 FrameElem=1-1 ElemStation=0
Frame=1 Station=3,999999999999999E-02 OutputCase=FRE13 CaseType=Combination P=-11,4621656688118 V2=4,06055662652034 V3=0 T=0 M2=0 M3=-1,91601246322152
FrameElem=1-1 ElemStation=3,999999999999999E-02
Frame=1 Station=7,999999999999998E-02 OutputCase=FRE13 CaseType=Combination P=-11,3021656688118 V2=4,17525662652034 V3=0 T=0 M2=0 M3=-2,08075472828234
FrameElem=1-1 ElemStation=7,999999999999998E-02
Frame=1 Station=0 OutputCase=FRE14 CaseType=Combination P=-12,2578343316588 V2=4,259593580528262 V3=0 T=0 M2=0 M3=-2,69945162063113 FrameElem=1-1 ElemStation=0
Frame=1 Station=3,999999999999999E-02 OutputCase=FRE14 CaseType=Combination P=-12,0978343316588 V2=4,37843580528262 V3=0 T=0 M2=0 M3=-2,87216505284243
FrameElem=1-1 ElemStation=3,999999999999999E-02
Frame=1 Station=7,999999999999998E-02 OutputCase=FRE14 CaseType=Combination P=-11,9378343316588 V2=4,49313580528262 V3=0 T=0 M2=0 M3=-3,04962248505373
FrameElem=1-1 ElemStation=7,999999999999998E-02
Frame=1 Station=0 OutputCase=FRE15 CaseType=Combination P=-11,9400000002352 V2=3,71388696344315 V3=0 T=0 M2=0 M3=-1,94050247083017 FrameElem=1-1 ElemStation=0
Frame=1 Station=3,999999999999999E-02 OutputCase=FRE15 CaseType=Combination P=-11,7800000002352 V2=3,83638696344315 V3=0 T=0 M2=0 M3=-2,09153394936789
FrameElem=1-1 ElemStation=3,999999999999999E-02
Frame=1 Station=7,999999999999998E-02 OutputCase=FRE15 CaseType=Combination P=-11,6200000002352 V2=3,95108696344315 V3=0 T=0 M2=0 M3=-2,24730942790562
FrameElem=1-1 ElemStation=7,999999999999998E-02
Frame=1 Station=0 OutputCase=FRE16 CaseType=Combination P=-11,9400000002352 V2=3,1775340100015 V3=0 T=0 M2=0 M3=-1,53837985683812 FrameElem=1-1 ElemStation=0
Frame=1 Station=3,999999999999999E-02 OutputCase=FRE16 CaseType=Combination P=-11,7800000002352 V2=3,3000340100015 V3=0 T=0 M2=0 M3=-1,66795721723818
FrameElem=1-1 ElemStation=3,999999999999999E-02
Frame=1 Station=7,999999999999998E-02 OutputCase=FRE16 CaseType=Combination P=-11,6200000002352 V2=3,4147340100015 V3=0 T=0 M2=0 M3=-1,80227857763824
FrameElem=1-1 ElemStation=7,999999999999998E-02
Frame=1 Station=0 OutputCase=FRE17 CaseType=Combination P=-71,6999999994877 V2=3,97426313591553 V3=0 T=0 M2=0 M3=-10,0006563411338 FrameElem=1-1 ElemStation=0
Frame=1 Station=3,999999999999999E-02 OutputCase=FRE17 CaseType=Combination P=-71,5399999994877 V2=4,09676313591553 V3=0 T=0 M2=0 M3=-10,1621028665704
FrameElem=1-1 ElemStation=3,999999999999999E-02
Frame=1 Station=7,999999999999998E-02 OutputCase=FRE17 CaseType=Combination P=-71,3799999994877 V2=4,21146313591553 V3=0 T=0 M2=0 M3=-10,328293392007
FrameElem=1-1 ElemStation=7,999999999999998E-02
Frame=1 Station=0 OutputCase=FRE18 CaseType=Combination P=-78,9479075365815 V2=13,1725453807636 V3=0 T=0 M2=0 M3=-16,551541807767 FrameElem=1-1 ElemStation=0
Frame=1 Station=3,999999999999999E-02 OutputCase=FRE18 CaseType=Combination P=-78,7879075365815 V2=13,2950453807636 V3=0 T=0 M2=0 M3=-17,0809196229975
FrameElem=1-1 ElemStation=3,999999999999999E-02
Frame=1 Station=7,999999999999998E-02 OutputCase=FRE18 CaseType=Combination P=-78,6279075365815 V2=13,4097453807636 V3=0 T=0 M2=0 M3=-17,6150414382281
FrameElem=1-1 ElemStation=7,999999999999998E-02
Frame=1 Station=0 OutputCase=FRE19 CaseType=Combination P=-71,7000000002444 V2=20,6183276151902 V3=0 T=0 M2=0 M3=-11,1409114309758 FrameElem=1-1 ElemStation=0
Frame=1 Station=3,999999999999999E-02 OutputCase=FRE19 CaseType=Combination P=-71,5400000002444 V2=21,6187526151902 V3=0 T=0 M2=0 M3=-11,98569020225
FrameElem=1-1 ElemStation=3,999999999999999E-02
Frame=1 Station=7,999999999999998E-02 OutputCase=FRE19 CaseType=Combination P=-71,3800000002444 V2=22,6080276151902 V3=0 T=0 M2=0 M3=-12,8702629735243
FrameElem=1-1 ElemStation=7,999999999999998E-02
Frame=1 Station=0 OutputCase=FRE20 CaseType=Combination P=-19,1879075373289 V2=12,4524381053413 V3=0 T=0 M2=0 M3=-8,14671141118446 FrameElem=1-1 ElemStation=0
Frame=1 Station=3,999999999999999E-02 OutputCase=FRE20 CaseType=Combination P=-19,0279075373289 V2=12,5749381053412 V3=0 T=0 M2=0 M3=-8,6472849353981
FrameElem=1-1 ElemStation=3,999999999999999E-02
Frame=1 Station=7,999999999999998E-02 OutputCase=FRE20 CaseType=Combination P=-18,8679075373289 V2=12,6896381053413 V3=0 T=0 M2=0 M3=-9,15260245961175
FrameElem=1-1 ElemStation=7,999999999999998E-02
Frame=1 Station=0 OutputCase=FRE21 CaseType=Combination P=-11,9400000009917 V2=19,8982203397678 V3=0 T=0 M2=0 M3=-2,73608103439322 FrameElem=1-1 ElemStation=0
Frame=1 Station=3,999999999999999E-02 OutputCase=FRE21 CaseType=Combination P=-11,7800000009917 V2=20,8986453397678 V3=0 T=0 M2=0 M3=-3,5520555146506
FrameElem=1-1 ElemStation=3,999999999999999E-02
Frame=1 Station=7,999999999999998E-02 OutputCase=FRE21 CaseType=Combination P=-11,6200000009917 V2=21,8879203397678 V3=0 T=0 M2=0 M3=-4,40782399490798
FrameElem=1-1 ElemStation=7,999999999999998E-02
Frame=1 Station=0 OutputCase=FRE22 CaseType=Combination P=-11,6221656688115 V2=3,01859442062036 V3=0 T=0 M2=0 M3=-1,06666114560291 FrameElem=1-1 ElemStation=0
Frame=1 Station=3,999999999999999E-02 OutputCase=FRE22 CaseType=Combination P=-11,4621656688115 V2=3,14109442062036 V3=0 T=0 M2=0 M3=-1,18988092242772
FrameElem=1-1 ElemStation=3,999999999999999E-02
Frame=1 Station=7,999999999999998E-02 OutputCase=FRE22 CaseType=Combination P=-11,3021656688115 V2=3,25579442062036 V3=0 T=0 M2=0 M3=-1,31784469925254
FrameElem=1-1 ElemStation=7,999999999999998E-02
Frame=1 Station=0 OutputCase=FRE23 CaseType=Combination P=-12,2578343316586 V2=3,33647359938264 V3=0 T=0 M2=0 M3=-2,01009856807333 FrameElem=1-1 ElemStation=0
Frame=1 Station=3,999999999999999E-02 OutputCase=FRE23 CaseType=Combination P=-12,0978343316586 V2=3,45897359938264 V3=0 T=0 M2=0 M3=-2,14603351204863
FrameElem=1-1 ElemStation=3,999999999999999E-02

Società di Progetto
Brebemi SpA

APPROVATO SDP



Doc. N.
60235-0000-A00.doc

CODIFICA DOCUMENTO
04RCDII10000000000300A00

REV.
00

FOGLIO
245 di 628

Frame=1 Station=7,999999999999999E-02 OutputCase=FRE23 CaseType=Combination P=-11,9378343316586 V2=3,57367359938264 V3=0 T=0 M2=0 M3=-2,28671245602394
FrameElem=1-1 ElemStation=7,999999999999999E-02
Frame=1 Station=0 OutputCase=FRE24 CaseType=Combination P=-11,940000002349 V2=2,79442475754317 V3=0 T=0 M2=0 M3=-1,25114941827237 FrameElem=1-1
ElemStation=0
Frame=1 Station=3,999999999999999E-02 OutputCase=FRE24 CaseType=Combination P=-11,7800000002349 V2=2,91692475754317 V3=0 T=0 M2=0 M3=-1,36540240857409
FrameElem=1-1 ElemStation=3,999999999999999E-02
Frame=1 Station=7,999999999999999E-02 OutputCase=FRE24 CaseType=Combination P=-11,6200000002349 V2=3,03162475754317 V3=0 T=0 M2=0 M3=-1,48439939887582
FrameElem=1-1 ElemStation=7,999999999999999E-02
Frame=1 Station=0 OutputCase=FRE25 CaseType=Combination P=-11,5585988025269 V2=3,44653760569412 V3=0 T=0 M2=0 M3=-1,31699392963477 FrameElem=1-1
ElemStation=0
Frame=1 Station=3,999999999999999E-02 OutputCase=FRE25 CaseType=Combination P=-11,3985988025269 V2=3,56903760569412 V3=0 T=0 M2=0 M3=-1,45733143386253
FrameElem=1-1 ElemStation=3,999999999999999E-02
Frame=1 Station=7,999999999999999E-02 OutputCase=FRE25 CaseType=Combination P=-11,2385988025269 V2=3,68373760569412 V3=0 T=0 M2=0 M3=-1,6024129380903
FrameElem=1-1 ElemStation=7,999999999999999E-02
Frame=1 Station=0 OutputCase=FRE26 CaseType=Combination P=-71,3821656680642 V2=4,19843279899272 V3=0 T=0 M2=0 M3=-9,81616806846434 FrameElem=1-1
ElemStation=0
Frame=1 Station=3,999999999999999E-02 OutputCase=FRE26 CaseType=Combination P=-71,2221656680643 V2=4,32093279899272 V3=0 T=0 M2=0 M3=-9,98658138042405
FrameElem=1-1 ElemStation=3,999999999999999E-02
Frame=1 Station=7,999999999999999E-02 OutputCase=FRE26 CaseType=Combination P=-71,0621656680643 V2=4,43563279899272 V3=0 T=0 M2=0 M3=-10,1617386923838
FrameElem=1-1 ElemStation=7,999999999999999E-02
Frame=1 Station=0 OutputCase=FRE27 CaseType=Combination P=-78,6300732051581 V2=13,3967150438408 V3=0 T=0 M2=0 M3=-16,3670535350975 FrameElem=1-1
ElemStation=0
Frame=1 Station=3,999999999999999E-02 OutputCase=FRE27 CaseType=Combination P=-78,4700732051581 V2=13,5192150438408 V3=0 T=0 M2=0 M3=-16,9053981368512
FrameElem=1-1 ElemStation=3,999999999999999E-02
Frame=1 Station=7,999999999999999E-02 OutputCase=FRE27 CaseType=Combination P=-78,3100732051581 V2=13,6339150438408 V3=0 T=0 M2=0 M3=-17,4484867386048
FrameElem=1-1 ElemStation=7,999999999999999E-02
Frame=1 Station=0 OutputCase=FRE28 CaseType=Combination P=-71,3821656688209 V2=20,842972782674 V3=0 T=0 M2=0 M3=-10,9564231583063 FrameElem=1-1
ElemStation=0
Frame=1 Station=3,999999999999999E-02 OutputCase=FRE28 CaseType=Combination P=-71,2221656688209 V2=21,8429222782674 V3=0 T=0 M2=0 M3=-11,8101687161037
FrameElem=1-1 ElemStation=3,999999999999999E-02
Frame=1 Station=7,999999999999999E-02 OutputCase=FRE28 CaseType=Combination P=-71,062165668821 V2=22,8321972782674 V3=0 T=0 M2=0 M3=-12,703708273901
FrameElem=1-1 ElemStation=7,999999999999999E-02
Frame=1 Station=0 OutputCase=FRE29 CaseType=Combination P=-18,8700732059055 V2=12,6766077684184 V3=0 T=0 M2=0 M3=-7,962223138515 FrameElem=1-1
ElemStation=0
Frame=1 Station=3,999999999999999E-02 OutputCase=FRE29 CaseType=Combination P=-18,7100732059055 V2=12,7991077684184 V3=0 T=0 M2=0 M3=-8,47176344925174
FrameElem=1-1 ElemStation=3,999999999999999E-02
Frame=1 Station=7,999999999999999E-02 OutputCase=FRE29 CaseType=Combination P=-18,5500732059055 V2=12,9138077684184 V3=0 T=0 M2=0 M3=-8,9860475998847
FrameElem=1-1 ElemStation=7,999999999999999E-02
Frame=1 Station=0 OutputCase=FRE30 CaseType=Combination P=-11,6221656695683 V2=20,122390002845 V3=0 T=0 M2=0 M3=-2,55159276172377 FrameElem=1-1
ElemStation=0
Frame=1 Station=3,999999999999999E-02 OutputCase=FRE30 CaseType=Combination P=-11,4621656695683 V2=21,122815002845 V3=0 T=0 M2=0 M3=-3,36753402850423
FrameElem=1-1 ElemStation=3,999999999999999E-02
Frame=1 Station=7,999999999999999E-02 OutputCase=FRE30 CaseType=Combination P=-11,3021656695683 V2=22,112090002845 V3=0 T=0 M2=0 M3=-4,2412692952847
FrameElem=1-1 ElemStation=7,999999999999999E-02
Frame=1 Station=0 OutputCase=FRE31 CaseType=Combination P=-11,558598802527 V2=3,82964685815245 V3=0 T=0 M2=0 M3=-1,60422436820052 FrameElem=1-1
ElemStation=0
Frame=1 Station=3,999999999999999E-02 OutputCase=FRE31 CaseType=Combination P=-11,398598802527 V2=3,95214685815244 V3=0 T=0 M2=0 M3=-1,75988624252661
FrameElem=1-1 ElemStation=3,999999999999999E-02
Frame=1 Station=7,999999999999999E-02 OutputCase=FRE31 CaseType=Combination P=-11,238598802527 V2=4,06684685815245 V3=0 T=0 M2=0 M3=-1,92029211685271
FrameElem=1-1 ElemStation=7,999999999999999E-02
Frame=1 Station=0 OutputCase=FRE32 CaseType=Combination P=-11,5585988025268 V2=3,06342835323579 V3=0 T=0 M2=0 M3=-1,02976349106902 FrameElem=1-1
ElemStation=0
Frame=1 Station=3,999999999999999E-02 OutputCase=FRE32 CaseType=Combination P=-11,3985988025268 V2=3,18592835323579 V3=0 T=0 M2=0 M3=-1,15477662519845
FrameElem=1-1 ElemStation=3,999999999999999E-02
Frame=1 Station=7,999999999999999E-02 OutputCase=FRE32 CaseType=Combination P=-11,2385988025268 V2=3,30062835323579 V3=0 T=0 M2=0 M3=-1,28453375932788
FrameElem=1-1 ElemStation=7,999999999999999E-02
Frame=1 Station=0 OutputCase=FRE33 CaseType=Combination P=-11,5585988025268 V2=3,06342835323579 V3=0 T=0 M2=0 M3=-1,02976349106902 FrameElem=1-1
ElemStation=0
Frame=1 Station=3,999999999999999E-02 OutputCase=FRE33 CaseType=Combination P=-11,3985988025268 V2=3,18592835323579 V3=0 T=0 M2=0 M3=-1,15477662519845
FrameElem=1-1 ElemStation=3,999999999999999E-02
Frame=1 Station=7,999999999999999E-02 OutputCase=FRE33 CaseType=Combination P=-11,2385988025268 V2=3,30062835323579 V3=0 T=0 M2=0 M3=-1,28453375932788
FrameElem=1-1 ElemStation=7,999999999999999E-02
Frame=1 Station=0 OutputCase=FRE34 CaseType=Combination P=-12,3214011979434 V2=3,82799262020886 V3=0 T=0 M2=0 M3=-2,44911883659927 FrameElem=1-1
ElemStation=0
Frame=1 Station=3,999999999999999E-02 OutputCase=FRE34 CaseType=Combination P=-12,1614011979434 V2=3,95049262020886 V3=0 T=0 M2=0 M3=-2,60471454140762
FrameElem=1-1 ElemStation=3,999999999999999E-02
Frame=1 Station=7,999999999999999E-02 OutputCase=FRE34 CaseType=Combination P=-12,0014011979434 V2=4,06519262020886 V3=0 T=0 M2=0 M3=-2,76505424621597
FrameElem=1-1 ElemStation=7,999999999999999E-02
Frame=1 Station=0 OutputCase=FRE35 CaseType=Combination P=-72,0178343309113 V2=4,516311977755 V3=0 T=0 M2=0 M3=-10,7596054909348 FrameElem=1-1
ElemStation=0
Frame=1 Station=3,999999999999999E-02 OutputCase=FRE35 CaseType=Combination P=-71,8578343309113 V2=4,638811977755 V3=0 T=0 M2=0 M3=-10,942733970045
FrameElem=1-1 ElemStation=3,999999999999999E-02
Frame=1 Station=7,999999999999999E-02 OutputCase=FRE35 CaseType=Combination P=-71,6978343309113 V2=4,753511977755 V3=0 T=0 M2=0 M3=-11,1306064491552
FrameElem=1-1 ElemStation=7,999999999999999E-02
Frame=1 Station=0 OutputCase=FRE36 CaseType=Combination P=-79,2657418680052 V2=13,7145942226031 V3=0 T=0 M2=0 M3=-17,310490957568 FrameElem=1-1
ElemStation=0
Frame=1 Station=3,999999999999999E-02 OutputCase=FRE36 CaseType=Combination P=-79,1057418680052 V2=13,8370942226031 V3=0 T=0 M2=0 M3=-17,8615507264721
FrameElem=1-1 ElemStation=3,999999999999999E-02
Frame=1 Station=7,999999999999999E-02 OutputCase=FRE36 CaseType=Combination P=-78,9457418680052 V2=13,9517942226031 V3=0 T=0 M2=0 M3=-18,4173544953762
FrameElem=1-1 ElemStation=7,999999999999999E-02
Frame=1 Station=0 OutputCase=FRE37 CaseType=Combination P=-72,017834331668 V2=21,1603764570297 V3=0 T=0 M2=0 M3=-11,89986605807767 FrameElem=1-1
ElemStation=0
Frame=1 Station=3,999999999999999E-02 OutputCase=FRE37 CaseType=Combination P=-71,857834331668 V2=22,1608014570297 V3=0 T=0 M2=0 M3=-12,7663213057246
FrameElem=1-1 ElemStation=3,999999999999999E-02
Frame=1 Station=7,999999999999999E-02 OutputCase=FRE37 CaseType=Combination P=-71,697834331668 V2=23,1500764570297 V3=0 T=0 M2=0 M3=-13,6725760306724
FrameElem=1-1 ElemStation=7,999999999999999E-02
Frame=1 Station=0 OutputCase=FRE38 CaseType=Combination P=-19,5057418687525 V2=12,9944869471807 V3=0 T=0 M2=0 M3=-8,90566056098542 FrameElem=1-1
ElemStation=0

Società di Progetto
Brebemi SpA



Doc. N.
60235-0000-A00.doc

CODIFICA DOCUMENTO
04RCDII10000000000300A00

REV.
00

FOGLIO
246 di 628

Frame=1 Station=3,999999999999999E-02 OutputCase=FRE38 CaseType=Combination P=-19,3457418687525 V2=13,1169869471807 V3=0 T=0 M2=0 M3=-9,42791603887264
FrameElem=1-1 ElemStation=3,999999999999999E-02
Frame=1 Station=7,999999999999998E-02 OutputCase=FRE38 CaseType=Combination P=-19,1857418687525 V2=13,2316869471807 V3=0 T=0 M2=0 M3=-9,95491551675987
FrameElem=1-1 ElemStation=7,999999999999998E-02
Frame=1 Station=0 OutputCase=FRE39 CaseType=Combination P=-12,257834324154 V2=20,4402691816073 V3=0 T=0 M2=0 M3=-3,49503018419418 FrameElem=1-1
ElemStation=0
Frame=1 Station=3,999999999999999E-02 OutputCase=FRE39 CaseType=Combination P=-12,097834324154 V2=21,4406941816073 V3=0 T=0 M2=0 M3=-4,33268661812514
FrameElem=1-1 ElemStation=3,999999999999999E-02
Frame=1 Station=7,999999999999998E-02 OutputCase=FRE39 CaseType=Combination P=-11,937834324154 V2=22,4299691816073 V3=0 T=0 M2=0 M3=-5,2101370520561
FrameElem=1-1 ElemStation=7,999999999999998E-02
Frame=1 Station=0 OutputCase=FRE40 CaseType=Combination P=-12,3214011979435 V2=4,21110187266718 V3=0 T=0 M2=0 M3=-2,73634927516502 FrameElem=1-1
ElemStation=0
Frame=1 Station=3,999999999999999E-02 OutputCase=FRE40 CaseType=Combination P=-12,1614011979435 V2=4,33360187266718 V3=0 T=0 M2=0 M3=-2,9072693500717
FrameElem=1-1 ElemStation=3,999999999999999E-02
Frame=1 Station=7,999999999999998E-02 OutputCase=FRE40 CaseType=Combination P=-12,0014011979435 V2=4,44830187266718 V3=0 T=0 M2=0 M3=-3,08293342497839
FrameElem=1-1 ElemStation=7,999999999999998E-02
Frame=1 Station=0 OutputCase=FRE41 CaseType=Combination P=-12,3214011979433 V2=3,44488336775053 V3=0 T=0 M2=0 M3=-2,16188839803352 FrameElem=1-1
ElemStation=0
Frame=1 Station=3,999999999999999E-02 OutputCase=FRE41 CaseType=Combination P=-12,1614011979433 V2=3,56738336775053 V3=0 T=0 M2=0 M3=-2,30215973274354
FrameElem=1-1 ElemStation=3,999999999999999E-02
Frame=1 Station=7,999999999999998E-02 OutputCase=FRE41 CaseType=Combination P=-12,0014011979433 V2=3,68208336775053 V3=0 T=0 M2=0 M3=-2,44717506745356
FrameElem=1-1 ElemStation=7,999999999999998E-02
Frame=1 Station=0 OutputCase=FRE42 CaseType=Combination P=-12,3214011979433 V2=3,44488336775053 V3=0 T=0 M2=0 M3=-2,16188839803352 FrameElem=1-1
ElemStation=0
Frame=1 Station=3,999999999999999E-02 OutputCase=FRE42 CaseType=Combination P=-12,1614011979433 V2=3,56738336775053 V3=0 T=0 M2=0 M3=-2,30215973274354
FrameElem=1-1 ElemStation=3,999999999999999E-02
Frame=1 Station=7,999999999999998E-02 OutputCase=FRE42 CaseType=Combination P=-12,0014011979433 V2=3,68208336775053 V3=0 T=0 M2=0 M3=-2,44717506745356
FrameElem=1-1 ElemStation=7,999999999999998E-02
Frame=1 Station=0 OutputCase=FRE43 CaseType=Combination P=-11,94000000235 V2=3,1775340100015 V3=0 T=0 M2=0 M3=-1,53837985683812 FrameElem=1-1
ElemStation=0
Frame=1 Station=3,999999999999999E-02 OutputCase=FRE43 CaseType=Combination P=-11,78000000235 V2=3,3000340100015 V3=0 T=0 M2=0 M3=-1,66795721723818
FrameElem=1-1 ElemStation=3,999999999999999E-02
Frame=1 Station=7,999999999999998E-02 OutputCase=FRE43 CaseType=Combination P=-11,62000000235 V2=3,4147340100015 V3=0 T=0 M2=0 M3=-1,80227857763824
FrameElem=1-1 ElemStation=7,999999999999998E-02
Frame=1 Station=0 OutputCase=FRE44 CaseType=Combination P=-71,6999999994877 V2=3,97426313591553 V3=0 T=0 M2=0 M3=-10,0006563411338 FrameElem=1-1
ElemStation=0
Frame=1 Station=3,999999999999999E-02 OutputCase=FRE44 CaseType=Combination P=-71,5399999994877 V2=4,09676313591553 V3=0 T=0 M2=0 M3=-10,1621028665704
FrameElem=1-1 ElemStation=3,999999999999999E-02
Frame=1 Station=7,999999999999998E-02 OutputCase=FRE44 CaseType=Combination P=-71,3799999994877 V2=4,21146313591553 V3=0 T=0 M2=0 M3=-10,328293392007
FrameElem=1-1 ElemStation=7,999999999999998E-02
Frame=1 Station=0 OutputCase=FRE45 CaseType=Combination P=-78,9479075365815 V2=13,1725453807636 V3=0 T=0 M2=0 M3=-16,551541807767 FrameElem=1-1
ElemStation=0
Frame=1 Station=3,999999999999999E-02 OutputCase=FRE45 CaseType=Combination P=-78,7879075365815 V2=13,2950453807636 V3=0 T=0 M2=0 M3=-17,0809196229975
FrameElem=1-1 ElemStation=3,999999999999999E-02
Frame=1 Station=7,999999999999998E-02 OutputCase=FRE45 CaseType=Combination P=-78,6279075365815 V2=13,4097453807636 V3=0 T=0 M2=0 M3=-17,6150414382281
FrameElem=1-1 ElemStation=7,999999999999998E-02
Frame=1 Station=0 OutputCase=FRE46 CaseType=Combination P=-71,700000002444 V2=20,6183276151902 V3=0 T=0 M2=0 M3=-11,1409114309758 FrameElem=1-1
ElemStation=0
Frame=1 Station=3,999999999999999E-02 OutputCase=FRE46 CaseType=Combination P=-71,540000002444 V2=21,6187526151902 V3=0 T=0 M2=0 M3=-11,98569020225
FrameElem=1-1 ElemStation=3,999999999999999E-02
Frame=1 Station=7,999999999999998E-02 OutputCase=FRE46 CaseType=Combination P=-71,380000002444 V2=22,6080276151902 V3=0 T=0 M2=0 M3=-12,8702629735243
FrameElem=1-1 ElemStation=7,999999999999998E-02
Frame=1 Station=0 OutputCase=FRE47 CaseType=Combination P=-19,1879075373289 V2=12,4524381053413 V3=0 T=0 M2=0 M3=-8,14671141118446 FrameElem=1-1
ElemStation=0
Frame=1 Station=3,999999999999999E-02 OutputCase=FRE47 CaseType=Combination P=-19,0279075373289 V2=12,5749381053412 V3=0 T=0 M2=0 M3=-8,6472849353981
FrameElem=1-1 ElemStation=3,999999999999999E-02
Frame=1 Station=7,999999999999998E-02 OutputCase=FRE47 CaseType=Combination P=-18,8679075373289 V2=12,6896381053413 V3=0 T=0 M2=0 M3=-9,15260245961175
FrameElem=1-1 ElemStation=7,999999999999998E-02
Frame=1 Station=0 OutputCase=FRE48 CaseType=Combination P=-11,940000009917 V2=19,8982203397678 V3=0 T=0 M2=0 M3=-2,73608103439322 FrameElem=1-1
ElemStation=0
Frame=1 Station=3,999999999999999E-02 OutputCase=FRE48 CaseType=Combination P=-11,780000009917 V2=20,8986453397678 V3=0 T=0 M2=0 M3=-3,5520555146506
FrameElem=1-1 ElemStation=3,999999999999999E-02
Frame=1 Station=7,999999999999998E-02 OutputCase=FRE48 CaseType=Combination P=-11,620000009917 V2=21,8879203397678 V3=0 T=0 M2=0 M3=-4,40782399490798
FrameElem=1-1 ElemStation=7,999999999999998E-02
Frame=1 Station=0 OutputCase=FRE49 CaseType=Combination P=-11,940000002349 V2=2,79442475754317 V3=0 T=0 M2=0 M3=-1,25114941827237 FrameElem=1-1
ElemStation=0
Frame=1 Station=3,999999999999999E-02 OutputCase=FRE49 CaseType=Combination P=-11,780000002349 V2=2,91692475754317 V3=0 T=0 M2=0 M3=-1,36540240857409
FrameElem=1-1 ElemStation=3,999999999999999E-02
Frame=1 Station=7,999999999999998E-02 OutputCase=FRE49 CaseType=Combination P=-11,620000002349 V2=3,03162475754317 V3=0 T=0 M2=0 M3=-1,48439939887582
FrameElem=1-1 ElemStation=7,999999999999998E-02
Frame=1 Station=0 OutputCase=FRE50 CaseType=Combination P=-11,6221656688115 V2=3,01859442062036 V3=0 T=0 M2=0 M3=-1,06666114560291 FrameElem=1-1
ElemStation=0
Frame=1 Station=3,999999999999999E-02 OutputCase=FRE50 CaseType=Combination P=-11,4621656688115 V2=3,14109442062036 V3=0 T=0 M2=0 M3=-1,18988092242772
FrameElem=1-1 ElemStation=3,999999999999999E-02
Frame=1 Station=7,999999999999998E-02 OutputCase=FRE50 CaseType=Combination P=-11,3021656688115 V2=3,25579442062036 V3=0 T=0 M2=0 M3=-1,31784469925254
FrameElem=1-1 ElemStation=7,999999999999998E-02
Frame=1 Station=0 OutputCase=FRE51 CaseType=Combination P=-12,2578343316586 V2=3,33647359938264 V3=0 T=0 M2=0 M3=-2,01009856807332 FrameElem=1-1
ElemStation=0
Frame=1 Station=3,999999999999999E-02 OutputCase=FRE51 CaseType=Combination P=-12,0978343316586 V2=3,45897359938264 V3=0 T=0 M2=0 M3=-2,14603351204863
FrameElem=1-1 ElemStation=3,999999999999999E-02
Frame=1 Station=7,999999999999998E-02 OutputCase=FRE51 CaseType=Combination P=-11,9378343316586 V2=3,57367359938264 V3=0 T=0 M2=0 M3=-2,28671245602394
FrameElem=1-1 ElemStation=7,999999999999998E-02
Frame=1 Station=0 OutputCase=INVFRE CaseType=Combination StepType=Max P=-11,5585988025268 V2=21,3845461201069 V3=0 T=0 M2=0 M3=-1,02976349106902
FrameElem=1-1 ElemStation=0
Frame=1 Station=3,999999999999999E-02 OutputCase=INVFRE CaseType=Combination StepType=Max P=-11,3985988025268 V2=22,3849711201069 V3=0 T=0 M2=0 M3=-
1,15477662519845 FrameElem=1-1 ElemStation=3,999999999999999E-02
Frame=1 Station=7,999999999999998E-02 OutputCase=INVFRE CaseType=Combination StepType=Max P=-11,2385988025268 V2=23,3742461201069 V3=0 T=0 M2=0 M3=-
1,28453375932788 FrameElem=1-1 ElemStation=7,999999999999998E-02

APPROVATO SDP
Società di Progetto
Brebemi SpA



Doc. N.
60235-0000-A00.doc

CODIFICA DOCUMENTO
04RCDII10000000000300A00

REV.
00

FOGLIO
247 di 628

Frame=1 Station=0 OutputCase=INVFRE CaseType=Combination StepType=Min P=-79,2657418680052 V2=2,79442475754317 V3=0 T=0 M2=0 M3=-17,310490957568
FrameElem=1-1 ElemStation=0
Frame=1 Station=3,9999999999999999E-02 OutputCase=INVFRE CaseType=Combination StepType=Min P=-79,1057418680052 V2=2,91692475754317 V3=0 T=0 M2=0 M3=-17,8615507264721 FrameElem=1-1 ElemStation=3,9999999999999999E-02
Frame=1 Station=7,9999999999999998E-02 OutputCase=INVFRE CaseType=Combination StepType=Min P=-78,9457418680052 V2=3,03162475754317 V3=0 T=0 M2=0 M3=-18,4173544953762 FrameElem=1-1 ElemStation=7,9999999999999998E-02
Frame=1 Station=0 OutputCase=QPE01 CaseType=Combination P=-10,9718021330773 V2=4,81410189182693 V3=0 T=0 M2=0 M3=-1,19622993942446 FrameElem=1-1 ElemStation=0
Frame=1 Station=3,9999999999999999E-02 OutputCase=QPE01 CaseType=Combination P=-10,8118021330773 V2=5,00880189182693 V3=0 T=0 M2=0 M3=-1,39272868176421
FrameElem=1-1 ElemStation=3,9999999999999999E-02
Frame=1 Station=7,9999999999999998E-02 OutputCase=QPE01 CaseType=Combination P=-10,6518021330773 V2=5,19130189182693 V3=0 T=0 M2=0 M3=-1,59677142410395
FrameElem=1-1 ElemStation=7,9999999999999998E-02
Frame=1 Station=0 OutputCase=QPE02 CaseType=Combination P=-10,9718021330774 V2=5,19721114428526 V3=0 T=0 M2=0 M3=-1,48346037799021 FrameElem=1-1 ElemStation=0
Frame=1 Station=3,9999999999999999E-02 OutputCase=QPE02 CaseType=Combination P=-10,8118021330774 V2=5,39191114428525 V3=0 T=0 M2=0 M3=-1,69528349042829
FrameElem=1-1 ElemStation=3,9999999999999999E-02
Frame=1 Station=7,9999999999999998E-02 OutputCase=QPE02 CaseType=Combination P=-10,6518021330774 V2=5,57441114428525 V3=0 T=0 M2=0 M3=-1,9146506286637
FrameElem=1-1 ElemStation=7,9999999999999998E-02
Frame=1 Station=0 OutputCase=QPE03 CaseType=Combination P=-10,9718021330772 V2=4,4309926393686 V3=0 T=0 M2=0 M3=-0,908999500858714 FrameElem=1-1 ElemStation=0
Frame=1 Station=3,9999999999999999E-02 OutputCase=QPE03 CaseType=Combination P=-10,8118021330772 V2=4,6256926393686 V3=0 T=0 M2=0 M3=-1,09017387310012
FrameElem=1-1 ElemStation=3,9999999999999999E-02
Frame=1 Station=7,9999999999999998E-02 OutputCase=QPE03 CaseType=Combination P=-10,6518021330772 V2=4,8081926393686 V3=0 T=0 M2=0 M3=-1,27889224534154
FrameElem=1-1 ElemStation=7,9999999999999998E-02
Frame=1 Station=0 OutputCase=QPE04 CaseType=Combination P=-10,6539678016538 V2=4,65516230244579 V3=0 T=0 M2=0 M3=-0,724511228189256 FrameElem=1-1 ElemStation=0
Frame=1 Station=3,9999999999999999E-02 OutputCase=QPE04 CaseType=Combination P=-10,4939678016538 V2=4,84986230244579 V3=0 T=0 M2=0 M3=-0,914652386953754
FrameElem=1-1 ElemStation=3,9999999999999999E-02
Frame=1 Station=7,9999999999999998E-02 OutputCase=QPE04 CaseType=Combination P=-10,3339678016538 V2=5,03236230244579 V3=0 T=0 M2=0 M3=-1,11233754571825
FrameElem=1-1 ElemStation=7,9999999999999998E-02
Frame=1 Station=0 OutputCase=QPE05 CaseType=Combination P=-11,2896364645008 V2=4,97304148120807 V3=0 T=0 M2=0 M3=-1,66794865065967 FrameElem=1-1 ElemStation=0
Frame=1 Station=3,9999999999999999E-02 OutputCase=QPE05 CaseType=Combination P=-11,1296364645008 V2=5,16774148120807 V3=0 T=0 M2=0 M3=-1,87080497657466
FrameElem=1-1 ElemStation=3,9999999999999999E-02
Frame=1 Station=7,9999999999999998E-02 OutputCase=QPE05 CaseType=Combination P=-10,9696364645008 V2=5,35024148120807 V3=0 T=0 M2=0 M3=-2,08120530248965
FrameElem=1-1 ElemStation=7,9999999999999998E-02
Frame=1 Station=0 OutputCase=QPE06 CaseType=Combination P=-10,9718021330772 V2=4,4309926393686 V3=0 T=0 M2=0 M3=-0,908999500858714 FrameElem=1-1 ElemStation=0
Frame=1 Station=3,9999999999999999E-02 OutputCase=QPE06 CaseType=Combination P=-10,8118021330772 V2=4,6256926393686 V3=0 T=0 M2=0 M3=-1,09017387310012
FrameElem=1-1 ElemStation=3,9999999999999999E-02
Frame=1 Station=7,9999999999999998E-02 OutputCase=QPE06 CaseType=Combination P=-10,6518021330772 V2=4,8081926393686 V3=0 T=0 M2=0 M3=-1,27889224534154
FrameElem=1-1 ElemStation=7,9999999999999998E-02
Frame=1 Station=0 OutputCase=QPE07 CaseType=Combination P=-10,6539678016539 V2=5,03827155490411 V3=0 T=0 M2=0 M3=-1,01174166675501 FrameElem=1-1 ElemStation=0
Frame=1 Station=3,9999999999999999E-02 OutputCase=QPE07 CaseType=Combination P=-10,4939678016539 V2=5,23297155490411 V3=0 T=0 M2=0 M3=-1,21720719561784
FrameElem=1-1 ElemStation=3,9999999999999999E-02
Frame=1 Station=7,9999999999999998E-02 OutputCase=QPE07 CaseType=Combination P=-10,3339678016539 V2=5,41547155490411 V3=0 T=0 M2=0 M3=-1,43021672448067
FrameElem=1-1 ElemStation=7,9999999999999998E-02
Frame=1 Station=0 OutputCase=QPE08 CaseType=Combination P=-11,2896364645009 V2=5,3561507336664 V3=0 T=0 M2=0 M3=-1,95517908922542 FrameElem=1-1 ElemStation=0
Frame=1 Station=3,9999999999999999E-02 OutputCase=QPE08 CaseType=Combination P=-11,1296364645009 V2=5,5508507336664 V3=0 T=0 M2=0 M3=-2,17335978523874
FrameElem=1-1 ElemStation=3,9999999999999999E-02
Frame=1 Station=7,9999999999999998E-02 OutputCase=QPE08 CaseType=Combination P=-10,9696364645009 V2=5,7333507336664 V3=0 T=0 M2=0 M3=-2,39908448125207
FrameElem=1-1 ElemStation=7,9999999999999998E-02
Frame=1 Station=0 OutputCase=QPE09 CaseType=Combination P=-10,9718021330773 V2=4,81410189182693 V3=0 T=0 M2=0 M3=-1,19622993942446 FrameElem=1-1 ElemStation=0
Frame=1 Station=3,9999999999999999E-02 OutputCase=QPE09 CaseType=Combination P=-10,8118021330773 V2=5,00880189182693 V3=0 T=0 M2=0 M3=-1,39272868176421
FrameElem=1-1 ElemStation=3,9999999999999999E-02
Frame=1 Station=7,9999999999999998E-02 OutputCase=QPE09 CaseType=Combination P=-10,6518021330773 V2=5,19130189182693 V3=0 T=0 M2=0 M3=-1,59677142410395
FrameElem=1-1 ElemStation=7,9999999999999998E-02
Frame=1 Station=0 OutputCase=QPE10 CaseType=Combination P=-12,9081978674512 V2=4,95410189358713 V3=0 T=0 M2=0 M3=-2,79795573230784 FrameElem=1-1 ElemStation=0
Frame=1 Station=3,9999999999999999E-02 OutputCase=QPE10 CaseType=Combination P=-12,7481978674512 V2=5,07660189358713 V3=0 T=0 M2=0 M3=-2,99859580805132
FrameElem=1-1 ElemStation=3,9999999999999999E-02
Frame=1 Station=7,9999999999999998E-02 OutputCase=QPE10 CaseType=Combination P=-12,5881978674512 V2=5,19130189358713 V3=0 T=0 M2=0 M3=-3,2039798837948
FrameElem=1-1 ElemStation=7,9999999999999998E-02
Frame=1 Station=0 OutputCase=QPE11 CaseType=Combination P=-12,9081978674513 V2=5,33721114604545 V3=0 T=0 M2=0 M3=-3,08518617087359 FrameElem=1-1 ElemStation=0
Frame=1 Station=3,9999999999999999E-02 OutputCase=QPE11 CaseType=Combination P=-12,7481978674513 V2=5,45971114604545 V3=0 T=0 M2=0 M3=-3,3011506167154
FrameElem=1-1 ElemStation=3,9999999999999999E-02
Frame=1 Station=7,9999999999999998E-02 OutputCase=QPE11 CaseType=Combination P=-12,5881978674513 V2=5,57441114604545 V3=0 T=0 M2=0 M3=-3,52185906255722
FrameElem=1-1 ElemStation=7,9999999999999998E-02
Frame=1 Station=0 OutputCase=QPE12 CaseType=Combination P=-12,9081978674511 V2=4,5709926411288 V3=0 T=0 M2=0 M3=-2,51072529374209 FrameElem=1-1 ElemStation=0
Frame=1 Station=3,9999999999999999E-02 OutputCase=QPE12 CaseType=Combination P=-12,7481978674511 V2=4,6934926411288 V3=0 T=0 M2=0 M3=-2,69604099938724
FrameElem=1-1 ElemStation=3,9999999999999999E-02
Frame=1 Station=7,9999999999999998E-02 OutputCase=QPE12 CaseType=Combination P=-12,5881978674511 V2=4,8081926411288 V3=0 T=0 M2=0 M3=-2,88610070503239
FrameElem=1-1 ElemStation=7,9999999999999998E-02
Frame=1 Station=0 OutputCase=QPE13 CaseType=Combination P=-12,5903635360277 V2=4,79516230420599 V3=0 T=0 M2=0 M3=-2,32623702107263 FrameElem=1-1 ElemStation=0
Frame=1 Station=3,9999999999999999E-02 OutputCase=QPE13 CaseType=Combination P=-12,4303635360277 V2=4,91766230420599 V3=0 T=0 M2=0 M3=-2,52051951324087
FrameElem=1-1 ElemStation=3,9999999999999999E-02
Frame=1 Station=7,9999999999999998E-02 OutputCase=QPE13 CaseType=Combination P=-12,2703635360277 V2=5,03236230420599 V3=0 T=0 M2=0 M3=-2,71954600540911
FrameElem=1-1 ElemStation=7,9999999999999998E-02
Frame=1 Station=0 OutputCase=QPE14 CaseType=Combination P=-13,2260321988748 V2=5,11304148296827 V3=0 T=0 M2=0 M3=-3,26967444354304 FrameElem=1-1 ElemStation=0
Frame=1 Station=3,9999999999999999E-02 OutputCase=QPE14 CaseType=Combination P=-13,0660321988748 V2=5,23554148296827 V3=0 T=0 M2=0 M3=-3,47667210286177
FrameElem=1-1 ElemStation=3,9999999999999999E-02

Società di Progetto
Brebemi SpA



Doc. N.
60235-0000-A00.doc

CODIFICA DOCUMENTO
04RCDII10000000000300A00

REV.
00

FOGLIO
248 di 628

Frame=1 Station=7,999999999999999E-02 OutputCase=QPE14 CaseType=Combination P=-12,9060321988748 V2=5,35024148296827 V3=0 T=0 M2=0 M3=-3,6884137621805
FrameElem=1-1 ElemStation=7,999999999999999E-02
Frame=1 Station=0 OutputCase=QPE15 CaseType=Combination P=-12,9081978674511 V2=4,5709926411288 V3=0 T=0 M2=0 M3=-2,51072529374209 FrameElem=1-1
ElemStation=0
Frame=1 Station=3,999999999999999E-02 OutputCase=QPE15 CaseType=Combination P=-12,7481978674511 V2=4,6934926411288 V3=0 T=0 M2=0 M3=-2,69604099938724
FrameElem=1-1 ElemStation=3,999999999999999E-02
Frame=1 Station=7,999999999999999E-02 OutputCase=QPE15 CaseType=Combination P=-12,5881978674511 V2=4,8081926411288 V3=0 T=0 M2=0 M3=-2,88610070503239
FrameElem=1-1 ElemStation=7,999999999999999E-02
Frame=1 Station=0 OutputCase=QPE16 CaseType=Combination P=-12,5903635360278 V2=5,17827155666431 V3=0 T=0 M2=0 M3=-2,61346745963838 FrameElem=1-1
ElemStation=0
Frame=1 Station=3,999999999999999E-02 OutputCase=QPE16 CaseType=Combination P=-12,4303635360278 V2=5,30077155666431 V3=0 T=0 M2=0 M3=-2,82307432190495
FrameElem=1-1 ElemStation=3,999999999999999E-02
Frame=1 Station=7,999999999999999E-02 OutputCase=QPE16 CaseType=Combination P=-12,2703635360278 V2=5,41547155666431 V3=0 T=0 M2=0 M3=-3,03742518417152
FrameElem=1-1 ElemStation=7,999999999999999E-02
Frame=1 Station=0 OutputCase=QPE17 CaseType=Combination P=-13,2260321988749 V2=5,4961507354266 V3=0 T=0 M2=0 M3=-3,55690488210879 FrameElem=1-1
ElemStation=0
Frame=1 Station=3,999999999999999E-02 OutputCase=QPE17 CaseType=Combination P=-13,0660321988749 V2=5,6186507354266 V3=0 T=0 M2=0 M3=-3,77922691152586
FrameElem=1-1 ElemStation=3,999999999999999E-02
Frame=1 Station=7,999999999999999E-02 OutputCase=QPE17 CaseType=Combination P=-12,9060321988749 V2=5,7333507354266 V3=0 T=0 M2=0 M3=-4,00629294094292
FrameElem=1-1 ElemStation=7,999999999999999E-02
Frame=1 Station=0 OutputCase=QPE18 CaseType=Combination P=-12,9081978674512 V2=4,95410189358713 V3=0 T=0 M2=0 M3=-2,79795573230784 FrameElem=1-1
ElemStation=0
Frame=1 Station=3,999999999999999E-02 OutputCase=QPE18 CaseType=Combination P=-12,7481978674512 V2=5,07660189358713 V3=0 T=0 M2=0 M3=-2,99859580805132
FrameElem=1-1 ElemStation=3,999999999999999E-02
Frame=1 Station=7,999999999999999E-02 OutputCase=QPE18 CaseType=Combination P=-12,5881978674512 V2=5,19130189358713 V3=0 T=0 M2=0 M3=-3,2039798837948
FrameElem=1-1 ElemStation=7,999999999999999E-02
Frame=1 Station=0 OutputCase=INVQPE CaseType=Combination StepType=Max P=-10,6539678016538 V2=5,4961507354266 V3=0 T=0 M2=0 M3=-0,724511228189256
FrameElem=1-1 ElemStation=0
Frame=1 Station=3,999999999999999E-02 OutputCase=INVQPE CaseType=Combination StepType=Max P=-10,4939678016538 V2=5,6186507354266 V3=0 T=0 M2=0 M3=-
0,914652386953754 FrameElem=1-1 ElemStation=3,999999999999999E-02
Frame=1 Station=7,999999999999999E-02 OutputCase=INVQPE CaseType=Combination StepType=Max P=-10,3339678016538 V2=5,7333507354266 V3=0 T=0 M2=0 M3=-
1,11233754571825 FrameElem=1-1 ElemStation=7,999999999999999E-02
Frame=1 Station=0 OutputCase=INVQPE CaseType=Combination StepType=Min P=-13,2260321988749 V2=4,4309926393686 V3=0 T=0 M2=0 M3=-3,55690488210879
FrameElem=1-1 ElemStation=0
Frame=1 Station=3,999999999999999E-02 OutputCase=INVQPE CaseType=Combination StepType=Min P=-13,0660321988749 V2=4,6256926393686 V3=0 T=0 M2=0 M3=-
3,77922691152586 FrameElem=1-1 ElemStation=3,999999999999999E-02
Frame=1 Station=7,999999999999999E-02 OutputCase=INVQPE CaseType=Combination StepType=Min P=-12,9060321988749 V2=4,8081926393686 V3=0 T=0 M2=0 M3=-
4,00629294094292 FrameElem=1-1 ElemStation=7,999999999999999E-02
Frame=3 Station=0 OutputCase=STR001 CaseType=Combination P=-17,1989999996731 V2=6,71616720755581 V3=0 T=0 M2=0 M3=-1,34389109785246 FrameElem=3-1
ElemStation=0
Frame=3 Station=0,05 OutputCase=STR001 CaseType=Combination P=-16,9289999996731 V2=7,14479220755581 V3=0 T=0 M2=0 M3=-1,69052195823025 FrameElem=3-1
ElemStation=0,05
Frame=3 Station=0,1 OutputCase=STR001 CaseType=Combination P=-16,6589999996731 V2=7,54776720755581 V3=0 T=0 M2=0 M3=-2,05794281860804 FrameElem=3-1
ElemStation=0,1
Frame=3 Station=0 OutputCase=STR002 CaseType=Combination P=-17,1989999995567 V2=2,71368409923041 V3=0 T=0 M2=0 M3=-1,78932801006216 FrameElem=3-1
ElemStation=0
Frame=3 Station=0,05 OutputCase=STR002 CaseType=Combination P=-16,9289999995567 V2=2,91318409923041 V3=0 T=0 M2=0 M3=-1,93004971502368 FrameElem=3-1
ElemStation=0,05
Frame=3 Station=0,1 OutputCase=STR002 CaseType=Combination P=-16,6589999995567 V2=3,10068409923041 V3=0 T=0 M2=0 M3=-2,0804464199852 FrameElem=3-1
ElemStation=0,1
Frame=3 Station=0 OutputCase=STR003 CaseType=Combination P=-124,76699999939 V2=4,00987719501488 V3=0 T=0 M2=0 M3=-16,6587841047556 FrameElem=3-1
ElemStation=0
Frame=3 Station=0,05 OutputCase=STR003 CaseType=Combination P=-124,49699999939 V2=4,20937719501488 V3=0 T=0 M2=0 M3=-16,8643154645064 FrameElem=3-1
ElemStation=0,05
Frame=3 Station=0,1 OutputCase=STR003 CaseType=Combination P=-124,22699999939 V2=4,39687719501488 V3=0 T=0 M2=0 M3=-17,0795218242571 FrameElem=3-1
ElemStation=0,1
Frame=3 Station=0 OutputCase=STR004 CaseType=Combination P=-137,948781582728 V2=20,7507805902779 V3=0 T=0 M2=0 M3=-25,2301176277222 FrameElem=3-1
ElemStation=0
Frame=3 Station=0,05 OutputCase=STR004 CaseType=Combination P=-137,678781582728 V2=20,9502805902779 V3=0 T=0 M2=0 M3=-26,2726941572361 FrameElem=3-1
ElemStation=0,05
Frame=3 Station=0,1 OutputCase=STR004 CaseType=Combination P=-137,408781582728 V2=21,1377805902779 V3=0 T=0 M2=0 M3=-27,32494568675 FrameElem=3-1
ElemStation=0,1
Frame=3 Station=0 OutputCase=STR005 CaseType=Combination P=-124,767000000135 V2=26,2909389455372 V3=0 T=0 M2=0 M3=-13,4823718952022 FrameElem=3-1
ElemStation=0
Frame=3 Station=0,05 OutputCase=STR005 CaseType=Combination P=-124,497000000135 V2=28,5054451955372 V3=0 T=0 M2=0 M3=-14,8523504049791 FrameElem=3-1
ElemStation=0,05
Frame=3 Station=0,1 OutputCase=STR005 CaseType=Combination P=-124,227000000135 V2=30,7034139455372 V3=0 T=0 M2=0 M3=-16,3326407897559 FrameElem=3-1
ElemStation=0,1
Frame=3 Station=0 OutputCase=STR006 CaseType=Combination P=-25,921781582979 V2=19,651668509731 V3=0 T=0 M2=0 M3=-9,79642021637781 FrameElem=3-1
ElemStation=0
Frame=3 Station=0,05 OutputCase=STR006 CaseType=Combination P=-25,721781582979 V2=19,851168509731 V3=0 T=0 M2=0 M3=-10,7840411418644 FrameElem=3-1
ElemStation=0,05
Frame=3 Station=0,1 OutputCase=STR006 CaseType=Combination P=-25,521781582979 V2=20,038668509731 V3=0 T=0 M2=0 M3=-11,7813370673509 FrameElem=3-1
ElemStation=0,1
Frame=3 Station=0 OutputCase=STR007 CaseType=Combination P=-12,7400000003865 V2=25,1918268649903 V3=0 T=0 M2=0 M3=1,95132551614217 FrameElem=3-1
ElemStation=0
Frame=3 Station=0,05 OutputCase=STR007 CaseType=Combination P=-12,5400000003865 V2=27,4063331149903 V3=0 T=0 M2=0 M3=0,636302610392649 FrameElem=3-1
ElemStation=0,05
Frame=3 Station=0,1 OutputCase=STR007 CaseType=Combination P=-12,3400000003865 V2=29,6043018649903 V3=0 T=0 M2=0 M3=-0,789032170356869 FrameElem=3-1
ElemStation=0,1
Frame=3 Station=0 OutputCase=STR008 CaseType=Combination P=-127,600825019416 V2=35,592431868797 V3=0 T=0 M2=0 M3=-30,5234595557054 FrameElem=3-1
ElemStation=0
Frame=3 Station=0,05 OutputCase=STR008 CaseType=Combination P=-127,330825019416 V2=35,791931868797 V3=0 T=0 M2=0 M3=-32,3081186491453 FrameElem=3-1
ElemStation=0,05
Frame=3 Station=0,1 OutputCase=STR008 CaseType=Combination P=-127,060825019416 V2=35,979431868797 V3=0 T=0 M2=0 M3=-34,1024527425851 FrameElem=3-1
ElemStation=0,1
Frame=3 Station=0 OutputCase=STR009 CaseType=Combination P=-17,1989999996734 V2=7,63562941345715 V3=0 T=0 M2=0 M3=-1,84935170923002 FrameElem=3-1
ElemStation=0

Società di Progetto
Brebemi SpA



Doc. N.
60235-0000-A00.doc

CODIFICA DOCUMENTO
04RCDII10000000000300A00

REV.
00

FOGLIO
249 di 628

Frame=3 ElemStation=0,05	Station=0,05	OutputCase=STR009	CaseType=Combination	P=-16,9289999996734	V2=8,06425441345715	V3=0	T=0	M2=0	M3=-2,24195567990287	FrameElem=3-1
Frame=3 ElemStation=0,1	Station=0,1	OutputCase=STR009	CaseType=Combination	P=-16,6589999996734	V2=8,46722941345716	V3=0	T=0	M2=0	M3=-2,65534965057573	FrameElem=3-1
Frame=3 ElemStation=0	Station=0	OutputCase=STR010	CaseType=Combination	P=-17,198999999557	V2=3,63314630513176	V3=0	T=0	M2=0	M3=-2,29478862143971	FrameElem=3-1
Frame=3 ElemStation=0,05	Station=0,05	OutputCase=STR010	CaseType=Combination	P=-16,928999999557	V2=3,83264630513176	V3=0	T=0	M2=0	M3=-2,4814834366963	FrameElem=3-1
Frame=3 ElemStation=0,1	Station=0,1	OutputCase=STR010	CaseType=Combination	P=-16,658999999557	V2=4,02014630513176	V3=0	T=0	M2=0	M3=-2,67785325195289	FrameElem=3-1
Frame=3 ElemStation=0	Station=0	OutputCase=STR011	CaseType=Combination	P=-124,76699999939	V2=4,56155451855569	V3=0	T=0	M2=0	M3=-16,9620604715821	FrameElem=3-1
Frame=3 ElemStation=0,05	Station=0,05	OutputCase=STR011	CaseType=Combination	P=-124,49699999939	V2=4,76105451855569	V3=0	T=0	M2=0	M3=-17,1951756975099	FrameElem=3-1
Frame=3 ElemStation=0,1	Station=0,1	OutputCase=STR011	CaseType=Combination	P=-124,22699999939	V2=4,94855451855569	V3=0	T=0	M2=0	M3=-17,4379659234377	FrameElem=3-1
Frame=3 ElemStation=0	Station=0	OutputCase=STR012	CaseType=Combination	P=-137,948781582728	V2=21,3024579138187	V3=0	T=0	M2=0	M3=-25,5333939945487	FrameElem=3-1
Frame=3 ElemStation=0,05	Station=0,05	OutputCase=STR012	CaseType=Combination	P=-137,678781582728	V2=21,5019579138187	V3=0	T=0	M2=0	M3=-26,6035543902397	FrameElem=3-1
Frame=3 ElemStation=0,1	Station=0,1	OutputCase=STR012	CaseType=Combination	P=-137,408781582728	V2=21,6894579138187	V3=0	T=0	M2=0	M3=-27,6833897859306	FrameElem=3-1
Frame=3 ElemStation=0	Station=0	OutputCase=STR013	CaseType=Combination	P=-124,767000000135	V2=26,842616269078	V3=0	T=0	M2=0	M3=-13,7856482620288	FrameElem=3-1
Frame=3 ElemStation=0,05	Station=0,05	OutputCase=STR013	CaseType=Combination	P=-124,497000000135	V2=29,057122519078	V3=0	T=0	M2=0	M3=-15,1832106379827	FrameElem=3-1
Frame=3 ElemStation=0,1	Station=0,1	OutputCase=STR013	CaseType=Combination	P=-124,227000000135	V2=31,255091269078	V3=0	T=0	M2=0	M3=-16,6910848889366	FrameElem=3-1
Frame=3 ElemStation=0	Station=0	OutputCase=STR014	CaseType=Combination	P=-25,9217815829792	V2=20,2033458332718	V3=0	T=0	M2=0	M3=-10,099665832043	FrameElem=3-1
Frame=3 ElemStation=0,05	Station=0,05	OutputCase=STR014	CaseType=Combination	P=-25,7217815829792	V2=20,4028458332718	V3=0	T=0	M2=0	M3=-11,1149013748679	FrameElem=3-1
Frame=3 ElemStation=0,1	Station=0,1	OutputCase=STR014	CaseType=Combination	P=-25,5217815829792	V2=20,5903458332718	V3=0	T=0	M2=0	M3=-12,1397811665315	FrameElem=3-1
Frame=3 ElemStation=0	Station=0	OutputCase=STR015	CaseType=Combination	P=-12,7400000003867	V2=25,7435041885311	V3=0	T=0	M2=0	M3=1,64804914931563	FrameElem=3-1
Frame=3 ElemStation=0,05	Station=0,05	OutputCase=STR015	CaseType=Combination	P=-12,5400000003867	V2=27,9580104385311	V3=0	T=0	M2=0	M3=0,305442377389076	FrameElem=3-1
Frame=3 ElemStation=0,1	Station=0,1	OutputCase=STR015	CaseType=Combination	P=-12,3400000003867	V2=30,1559791885311	V3=0	T=0	M2=0	M3=-1,14747626953748	FrameElem=3-1
Frame=3 ElemStation=0	Station=0	OutputCase=STR016	CaseType=Combination	P=-127,600825019416	V2=36,1441091923378	V3=0	T=0	M2=0	M3=-30,8267359225319	FrameElem=3-1
Frame=3 ElemStation=0,05	Station=0,05	OutputCase=STR016	CaseType=Combination	P=-127,330825019416	V2=36,3436091923378	V3=0	T=0	M2=0	M3=-32,6389788821488	FrameElem=3-1
Frame=3 ElemStation=0,1	Station=0,1	OutputCase=STR016	CaseType=Combination	P=-127,060825019416	V2=36,5311091923378	V3=0	T=0	M2=0	M3=-34,4608968417657	FrameElem=3-1
Frame=3 ElemStation=0	Station=0	OutputCase=STR017	CaseType=Combination	P=-97,874999999432	V2=4,60529112697011	V3=0	T=0	M2=0	M3=-13,4468806924598	FrameElem=3-1
Frame=3 ElemStation=0,05	Station=0,05	OutputCase=STR017	CaseType=Combination	P=-97,604999999432	V2=4,80479112697011	V3=0	T=0	M2=0	M3=-13,6821827488083	FrameElem=3-1
Frame=3 ElemStation=0,1	Station=0,1	OutputCase=STR017	CaseType=Combination	P=-97,334999999432	V2=4,99229112697011	V3=0	T=0	M2=0	M3=-13,9271598051568	FrameElem=3-1
Frame=3 ElemStation=0	Station=0	OutputCase=STR018	CaseType=Combination	P=-108,230912231796	V2=17,7995440627089	V3=0	T=0	M2=0	M3=-20,1913505544429	FrameElem=3-1
Frame=3 ElemStation=0,05	Station=0,05	OutputCase=STR018	CaseType=Combination	P=-107,960912231796	V2=17,9990440627089	V3=0	T=0	M2=0	M3=-21,0863652575783	FrameElem=3-1
Frame=3 ElemStation=0,1	Station=0,1	OutputCase=STR018	CaseType=Combination	P=-107,690912231796	V2=18,1865440627089	V3=0	T=0	M2=0	M3=-21,9910549607138	FrameElem=3-1
Frame=3 ElemStation=0	Station=0	OutputCase=STR019	CaseType=Combination	P=-97,8750000000199	V2=22,3167082169432	V3=0	T=0	M2=0	M3=-10,9532123072423	FrameElem=3-1
Frame=3 ElemStation=0,05	Station=0,05	OutputCase=STR019	CaseType=Combination	P=-97,6050000000199	V2=24,0847441544432	V3=0	T=0	M2=0	M3=-12,1133270149645	FrameElem=3-1
Frame=3 ElemStation=0,1	Station=0,1	OutputCase=STR019	CaseType=Combination	P=-97,3350000000199	V2=25,8339644669432	V3=0	T=0	M2=0	M3=-13,3613731289367	FrameElem=3-1
Frame=3 ElemStation=0	Station=0	OutputCase=STR020	CaseType=Combination	P=-23,0959122320058	V2=17,0244802561081	V3=0	T=0	M2=0	M3=-8,47501716677186	FrameElem=3-1
Frame=3 ElemStation=0,05	Station=0,05	OutputCase=STR020	CaseType=Combination	P=-22,8959122320058	V2=17,2239802561081	V3=0	T=0	M2=0	M3=-9,33127867957726	FrameElem=3-1
Frame=3 ElemStation=0,1	Station=0,1	OutputCase=STR020	CaseType=Combination	P=-22,6959122320058	V2=17,4114802561081	V3=0	T=0	M2=0	M3=-10,1972151923827	FrameElem=3-1
Frame=3 ElemStation=0	Station=0	OutputCase=STR021	CaseType=Combination	P=-12,7400000002296	V2=21,5416444103424	V3=0	T=0	M2=0	M3=0,763121080428688	FrameElem=3-1
Frame=3 ElemStation=0,05	Station=0,05	OutputCase=STR021	CaseType=Combination	P=-12,5400000002296	V2=23,3096803478424	V3=0	T=0	M2=0	M3=0,358240436963434	FrameElem=3-1
Frame=3 ElemStation=0,1	Station=0,1	OutputCase=STR021	CaseType=Combination	P=-12,3400000002296	V2=25,0589006603424	V3=0	T=0	M2=0	M3=-1,56753336060555	FrameElem=3-1
Frame=3 ElemStation=0	Station=0	OutputCase=STR022	CaseType=Combination	P=-16,7413185624235	V2=7,40675640474832	V3=0	T=0	M2=0	M3=-1,21585136679309	FrameElem=3-1
Frame=3 ElemStation=0,05	Station=0,05	OutputCase=STR022	CaseType=Combination	P=-16,4713185624235	V2=7,83538140474832	V3=0	T=0	M2=0	M3=-1,5970116870305	FrameElem=3-1
Frame=3 ElemStation=0,1	Station=0,1	OutputCase=STR022	CaseType=Combination	P=-16,2013185624235	V2=8,23835640474832	V3=0	T=0	M2=0	M3=-1,99896200726792	FrameElem=3-1
Frame=3 ElemStation=0	Station=0	OutputCase=STR023	CaseType=Combination	P=-16,7413185623071	V2=3,40427329642292	V3=0	T=0	M2=0	M3=-1,66128827900278	FrameElem=3-1
Frame=3 ElemStation=0,05	Station=0,05	OutputCase=STR023	CaseType=Combination	P=-16,4713185623071	V2=3,6037329642292	V3=0	T=0	M2=0	M3=-1,83653944382393	FrameElem=3-1
Frame=3 ElemStation=0,1	Station=0,1	OutputCase=STR023	CaseType=Combination	P=-16,2013185623071	V2=3,79127329642292	V3=0	T=0	M2=0	M3=-2,02146560864508	FrameElem=3-1

Società di Progetto
Brebemi SpA

	Doc. N. 60235-0000-A00.doc	CODIFICA DOCUMENTO 04RCDII10000000000300A00	REV. 00	FOGLIO 250 di 628
--	-------------------------------	--	------------	----------------------

Frame=3 ElemStation=0	Station=0	OutputCase=STR024	CaseType=Combination	P=-97,4173185621821	V2=4,37641811826127	V3=0	T=0	M2=0	M3=-12,8133803500229	FrameElem=3-1
Frame=3 ElemStation=0,05	Station=0,05	OutputCase=STR024	CaseType=Combination	P=-97,1473185621821	V2=4,57591811826127	V3=0	T=0	M2=0	M3=-13,0372387559359	FrameElem=3-1
Frame=3 ElemStation=0,1	Station=0,1	OutputCase=STR024	CaseType=Combination	P=-96,8773185621821	V2=4,76341811826127	V3=0	T=0	M2=0	M3=-13,270772161849	FrameElem=3-1
Frame=3 ElemStation=0	Station=0	OutputCase=STR025	CaseType=Combination	P=-107,773230794546	V2=17,570671054	V3=0	T=0	M2=0	M3=-19,557850212006	FrameElem=3-1
Frame=3 ElemStation=0,05	Station=0,05	OutputCase=STR025	CaseType=Combination	P=-107,503230794546	V2=17,770171054	V3=0	T=0	M2=0	M3=-20,441421264706	FrameElem=3-1
Frame=3 ElemStation=0,1	Station=0,1	OutputCase=STR025	CaseType=Combination	P=-107,233230794546	V2=17,957671054	V3=0	T=0	M2=0	M3=-21,334667317406	FrameElem=3-1
Frame=3 ElemStation=0	Station=0	OutputCase=STR026	CaseType=Combination	P=-97,41731856277	V2=22,0878352082344	V3=0	T=0	M2=0	M3=-10,3197119648054	FrameElem=3-1
Frame=3 ElemStation=0,05	Station=0,05	OutputCase=STR026	CaseType=Combination	P=-97,14731856277	V2=23,8558711457344	V3=0	T=0	M2=0	M3=-11,4683830220921	FrameElem=3-1
Frame=3 ElemStation=0,1	Station=0,1	OutputCase=STR026	CaseType=Combination	P=-96,87731856277	V2=25,6050914582344	V3=0	T=0	M2=0	M3=-12,7049854856288	FrameElem=3-1
Frame=3 ElemStation=0	Station=0	OutputCase=STR027	CaseType=Combination	P=-22,6382307947559	V2=16,7956072473993	V3=0	T=0	M2=0	M3=-7,84151682433493	FrameElem=3-1
Frame=3 ElemStation=0,05	Station=0,05	OutputCase=STR027	CaseType=Combination	P=-22,4382307947559	V2=16,9951072473993	V3=0	T=0	M2=0	M3=-8,68633468670489	FrameElem=3-1
Frame=3 ElemStation=0,1	Station=0,1	OutputCase=STR027	CaseType=Combination	P=-22,2382307947559	V2=17,1826072473993	V3=0	T=0	M2=0	M3=-9,54082754907486	FrameElem=3-1
Frame=3 ElemStation=0	Station=0	OutputCase=STR028	CaseType=Combination	P=-12,2823185629797	V2=21,3127714016336	V3=0	T=0	M2=0	M3=-1,39662142286562	FrameElem=3-1
Frame=3 ElemStation=0,05	Station=0,05	OutputCase=STR028	CaseType=Combination	P=-12,0823185629797	V2=23,0808073391336	V3=0	T=0	M2=0	M3=0,286703555908939	FrameElem=3-1
Frame=3 ElemStation=0,1	Station=0,1	OutputCase=STR028	CaseType=Combination	P=-11,8823185629797	V2=24,8300276516336	V3=0	T=0	M2=0	M3=-0,91114571729774	FrameElem=3-1
Frame=3 ElemStation=0	Station=0	OutputCase=STR029	CaseType=Combination	P=-17,6566814369233	V2=7,86450242216599	V3=0	T=0	M2=0	M3=-2,48285205166695	FrameElem=3-1
Frame=3 ElemStation=0,05	Station=0,05	OutputCase=STR029	CaseType=Combination	P=-17,3866814369233	V2=8,29317242216599	V3=0	T=0	M2=0	M3=-2,88689967277525	FrameElem=3-1
Frame=3 ElemStation=0,1	Station=0,1	OutputCase=STR029	CaseType=Combination	P=-17,1166814369233	V2=8,69610242216599	V3=0	T=0	M2=0	M3=-3,31173729388355	FrameElem=3-1
Frame=3 ElemStation=0	Station=0	OutputCase=STR030	CaseType=Combination	P=-17,6566814368068	V2=3,8620193138406	V3=0	T=0	M2=0	M3=-2,92828896387665	FrameElem=3-1
Frame=3 ElemStation=0,05	Station=0,05	OutputCase=STR030	CaseType=Combination	P=-17,3866814368069	V2=4,0615193138406	V3=0	T=0	M2=0	M3=-3,12642742956868	FrameElem=3-1
Frame=3 ElemStation=0,1	Station=0,1	OutputCase=STR030	CaseType=Combination	P=-17,1166814368069	V2=4,2490193138406	V3=0	T=0	M2=0	M3=-3,33424089526071	FrameElem=3-1
Frame=3 ElemStation=0	Station=0	OutputCase=STR031	CaseType=Combination	P=-98,3326814366819	V2=4,83416413567895	V3=0	T=0	M2=0	M3=-14,0803810348967	FrameElem=3-1
Frame=3 ElemStation=0,05	Station=0,05	OutputCase=STR031	CaseType=Combination	P=-98,0626814366819	V2=5,03366413567895	V3=0	T=0	M2=0	M3=-14,3271267416807	FrameElem=3-1
Frame=3 ElemStation=0,1	Station=0,1	OutputCase=STR031	CaseType=Combination	P=-97,7926814366819	V2=5,22116413567895	V3=0	T=0	M2=0	M3=-14,5835474484646	FrameElem=3-1
Frame=3 ElemStation=0	Station=0	OutputCase=STR032	CaseType=Combination	P=-108,688593669046	V2=18,0284170714177	V3=0	T=0	M2=0	M3=-20,8248508968798	FrameElem=3-1
Frame=3 ElemStation=0,05	Station=0,05	OutputCase=STR032	CaseType=Combination	P=-108,418593669046	V2=18,2279170714177	V3=0	T=0	M2=0	M3=-21,7313092504507	FrameElem=3-1
Frame=3 ElemStation=0,1	Station=0,1	OutputCase=STR032	CaseType=Combination	P=-108,148593669046	V2=18,4154170714177	V3=0	T=0	M2=0	M3=-22,6474426040216	FrameElem=3-1
Frame=3 ElemStation=0	Station=0	OutputCase=STR033	CaseType=Combination	P=-98,3326814372698	V2=22,5455812256521	V3=0	T=0	M2=0	M3=-11,5867126496793	FrameElem=3-1
Frame=3 ElemStation=0,05	Station=0,05	OutputCase=STR033	CaseType=Combination	P=-98,0626814372698	V2=24,3136171631521	V3=0	T=0	M2=0	M3=-12,7582710078369	FrameElem=3-1
Frame=3 ElemStation=0,1	Station=0,1	OutputCase=STR033	CaseType=Combination	P=-97,7926814372698	V2=26,0628374756521	V3=0	T=0	M2=0	M3=-14,0177607722445	FrameElem=3-1
Frame=3 ElemStation=0	Station=0	OutputCase=STR034	CaseType=Combination	P=-23,5535936692557	V2=17,2533532648169	V3=0	T=0	M2=0	M3=-9,10851750920879	FrameElem=3-1
Frame=3 ElemStation=0,05	Station=0,05	OutputCase=STR034	CaseType=Combination	P=-23,3535936692557	V2=17,4528532648169	V3=0	T=0	M2=0	M3=-9,97622267244964	FrameElem=3-1
Frame=3 ElemStation=0,1	Station=0,1	OutputCase=STR034	CaseType=Combination	P=-23,1535936692557	V2=17,6403532648169	V3=0	T=0	M2=0	M3=-10,8536028356905	FrameElem=3-1
Frame=3 ElemStation=0	Station=0	OutputCase=STR035	CaseType=Combination	P=-13,1976814374795	V2=21,7705174190513	V3=0	T=0	M2=0	M3=0,129620737991757	FrameElem=3-1
Frame=3 ElemStation=0,05	Station=0,05	OutputCase=STR035	CaseType=Combination	P=-12,9976814374795	V2=23,5385533565513	V3=0	T=0	M2=0	M3=-1,00318442983581	FrameElem=3-1
Frame=3 ElemStation=0,1	Station=0,1	OutputCase=STR035	CaseType=Combination	P=-12,7976814374795	V2=25,2877736690513	V3=0	T=0	M2=0	M3=-2,22392100391337	FrameElem=3-1
Frame=3 ElemStation=0	Station=0	OutputCase=STR036	CaseType=Combination	P=-17,1989999996732	V2=7,08395208991635	V3=0	T=0	M2=0	M3=-1,54607534240348	FrameElem=3-1
Frame=3 ElemStation=0,05	Station=0,05	OutputCase=STR036	CaseType=Combination	P=-16,9289999996732	V2=7,51257708991635	V3=0	T=0	M2=0	M3=-1,9110954468993	FrameElem=3-1
Frame=3 ElemStation=0,1	Station=0,1	OutputCase=STR036	CaseType=Combination	P=-16,6589999996732	V2=7,91555208991635	V3=0	T=0	M2=0	M3=-2,29690555139512	FrameElem=3-1
Frame=3 ElemStation=0	Station=0	OutputCase=STR037	CaseType=Combination	P=-17,1989999995568	V2=3,08146898159095	V3=0	T=0	M2=0	M3=-1,99151225461318	FrameElem=3-1
Frame=3 ElemStation=0,05	Station=0,05	OutputCase=STR037	CaseType=Combination	P=-16,9289999995568	V2=3,28096898159095	V3=0	T=0	M2=0	M3=-2,15062320369273	FrameElem=3-1
Frame=3 ElemStation=0,1	Station=0,1	OutputCase=STR037	CaseType=Combination	P=-16,6589999995568	V2=3,46846898159095	V3=0	T=0	M2=0	M3=-2,31940915277228	FrameElem=3-1
Frame=3 ElemStation=0	Station=0	OutputCase=STR038	CaseType=Combination	P=-97,8749999994319	V2=4,0536138034293	V3=0	T=0	M2=0	M3=-13,1436043256333	FrameElem=3-1
Frame=3 ElemStation=0,05	Station=0,05	OutputCase=STR038	CaseType=Combination	P=-97,6049999994319	V2=4,2531138034293	V3=0	T=0	M2=0	M3=-13,3513225158047	FrameElem=3-1

Società di Progetto
Brebemi SpA

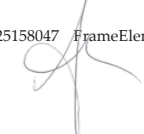



Doc. N.
60235-0000-A00.doc

CODIFICA DOCUMENTO
04RCDII10000000000300A00

REV.
00

FOGLIO
251 di 628

Frame=3 Station=0,1 OutputCase=STR038 CaseType=Combination P=-97,3349999994318 V2=4,4406138034293 V3=0 T=0 M2=0 M3=-13,5687157059762 ElemStation=0,1	FrameElem=3-1
Frame=3 Station=0 OutputCase=STR039 CaseType=Combination P=-108,230912231796 V2=17,2478667391681 V3=0 T=0 M2=0 M3=-19,8880741876164 ElemStation=0	FrameElem=3-1
Frame=3 Station=0,05 OutputCase=STR039 CaseType=Combination P=-107,960912231796 V2=17,4473667391681 V3=0 T=0 M2=0 M3=-20,755505245748 ElemStation=0,05	FrameElem=3-1
Frame=3 Station=0,1 OutputCase=STR039 CaseType=Combination P=-107,690912231796 V2=17,6348667391681 V3=0 T=0 M2=0 M3=-21,6326108615332 ElemStation=0,1	FrameElem=3-1
Frame=3 Station=0 OutputCase=STR040 CaseType=Combination P=-97,875000000197 V2=21,7650308934024 V3=0 T=0 M2=0 M3=-10,6499359404158 ElemStation=0	FrameElem=3-1
Frame=3 Station=0,05 OutputCase=STR040 CaseType=Combination P=-97,605000000197 V2=23,5330668309024 V3=0 T=0 M2=0 M3=-11,7824667819609 ElemStation=0,05	FrameElem=3-1
Frame=3 Station=0,1 OutputCase=STR040 CaseType=Combination P=-97,335000000197 V2=25,2822871434024 V3=0 T=0 M2=0 M3=-13,002929029756 ElemStation=0,1	FrameElem=3-1
Frame=3 Station=0 OutputCase=STR041 CaseType=Combination P=-23,0959122320056 V2=16,4728029325673 V3=0 T=0 M2=0 M3=-8,17174079994533 ElemStation=0	FrameElem=3-1
Frame=3 Station=0,05 OutputCase=STR041 CaseType=Combination P=-22,8959122320056 V2=16,6723029325673 V3=0 T=0 M2=0 M3=-9,00041844657369 ElemStation=0,05	FrameElem=3-1
Frame=3 Station=0,1 OutputCase=STR041 CaseType=Combination P=-22,6959122320056 V2=16,8598029325673 V3=0 T=0 M2=0 M3=-9,83877109320206 ElemStation=0,1	FrameElem=3-1
Frame=3 Station=0 OutputCase=STR042 CaseType=Combination P=-12,7400000002294 V2=20,9899670868016 V3=0 T=0 M2=0 M3=-1,06639744725522 ElemStation=0	FrameElem=3-1
Frame=3 Station=0,05 OutputCase=STR042 CaseType=Combination P=-12,5400000002295 V2=22,7580030243016 V3=0 T=0 M2=0 M3=-2,73802039598602E-02 ElemStation=0,05	FrameElem=3-1
Frame=3 Station=0,1 OutputCase=STR042 CaseType=Combination P=-12,3400000002294 V2=24,5072233368016 V3=0 T=0 M2=0 M3=-1,20908926142494 ElemStation=0,1	FrameElem=3-1
Frame=3 Station=0 OutputCase=STR043 CaseType=Combination P=-17,1989999996728 V2=5,79670500165446 V3=0 T=0 M2=0 M3=-0,838430486474907 ElemStation=0	FrameElem=3-1
Frame=3 Station=0,05 OutputCase=STR043 CaseType=Combination P=-16,9289999996728 V2=6,22533000165446 V3=0 T=0 M2=0 M3=-1,13908823655763 ElemStation=0,05	FrameElem=3-1
Frame=3 Station=0,1 OutputCase=STR043 CaseType=Combination P=-16,6589999996728 V2=6,62830500165447 V3=0 T=0 M2=0 M3=-1,46053598664035 ElemStation=0,1	FrameElem=3-1
Frame=3 Station=0 OutputCase=STR044 CaseType=Combination P=-17,1989999995564 V2=1,79422189332907 V3=0 T=0 M2=0 M3=-1,2838673986846 ElemStation=0	FrameElem=3-1
Frame=3 Station=0,05 OutputCase=STR044 CaseType=Combination P=-16,9289999995564 V2=1,99372189332907 V3=0 T=0 M2=0 M3=-1,37861599335106 ElemStation=0,05	FrameElem=3-1
Frame=3 Station=0,1 OutputCase=STR044 CaseType=Combination P=-16,6589999995564 V2=2,18122189332907 V3=0 T=0 M2=0 M3=-1,48303598801751 ElemStation=0,1	FrameElem=3-1
Frame=3 Station=0 OutputCase=STR045 CaseType=Combination P=-124,76699999939 V2=3,45819987147407 V3=0 T=0 M2=0 M3=-16,3555077379291 ElemStation=0	FrameElem=3-1
Frame=3 Station=0,05 OutputCase=STR045 CaseType=Combination P=-124,49699999939 V2=3,65769987147407 V3=0 T=0 M2=0 M3=-16,5334552315028 ElemStation=0,05	FrameElem=3-1
Frame=3 Station=0,1 OutputCase=STR045 CaseType=Combination P=-124,22699999939 V2=3,84519987147407 V3=0 T=0 M2=0 M3=-16,7210777250765 ElemStation=0,1	FrameElem=3-1
Frame=3 Station=0 OutputCase=STR046 CaseType=Combination P=-137,948781582728 V2=20,1991032667371 V3=0 T=0 M2=0 M3=-24,9268412608957 ElemStation=0	FrameElem=3-1
Frame=3 Station=0,05 OutputCase=STR046 CaseType=Combination P=-137,678781582728 V2=20,3986032667371 V3=0 T=0 M2=0 M3=-25,9418339242325 ElemStation=0,05	FrameElem=3-1
Frame=3 Station=0,1 OutputCase=STR046 CaseType=Combination P=-137,408781582728 V2=20,5861032667371 V3=0 T=0 M2=0 M3=-26,9665015875694 ElemStation=0,1	FrameElem=3-1
Frame=3 Station=0 OutputCase=STR047 CaseType=Combination P=-124,767000000135 V2=25,7392616219964 V3=0 T=0 M2=0 M3=-13,1790955283757 ElemStation=0	FrameElem=3-1
Frame=3 Station=0,05 OutputCase=STR047 CaseType=Combination P=-124,497000000135 V2=27,9537678719964 V3=0 T=0 M2=0 M3=-14,5214901719755 ElemStation=0,05	FrameElem=3-1
Frame=3 Station=0,1 OutputCase=STR047 CaseType=Combination P=-124,227000000135 V2=30,1517366219964 V3=0 T=0 M2=0 M3=-15,9741966905753 ElemStation=0,1	FrameElem=3-1
Frame=3 Station=0 OutputCase=STR048 CaseType=Combination P=-25,9217815829789 V2=19,0999911861902 V3=0 T=0 M2=0 M3=-9,49314384955128 ElemStation=0	FrameElem=3-1
Frame=3 Station=0,05 OutputCase=STR048 CaseType=Combination P=-25,7217815829789 V2=19,2994911861902 V3=0 T=0 M2=0 M3=-10,4531809088608 ElemStation=0,05	FrameElem=3-1
Frame=3 Station=0,1 OutputCase=STR048 CaseType=Combination P=-25,5217815829789 V2=19,4869911861902 V3=0 T=0 M2=0 M3=-11,4228929681703 ElemStation=0,1	FrameElem=3-1
Frame=3 Station=0 OutputCase=STR049 CaseType=Combination P=-12,7400000003863 V2=24,6401495414495 V3=0 T=0 M2=0 M3=2,2546018829687 ElemStation=0	FrameElem=3-1
Frame=3 Station=0,05 OutputCase=STR049 CaseType=Combination P=-12,5400000003863 V2=26,8546557914495 V3=0 T=0 M2=0 M3=0,967162843396222 ElemStation=0,05	FrameElem=3-1
Frame=3 Station=0,1 OutputCase=STR049 CaseType=Combination P=-12,3400000003863 V2=29,0526245414495 V3=0 T=0 M2=0 M3=-0,430588071176255 ElemStation=0,1	FrameElem=3-1
Frame=3 Station=0 OutputCase=STR050 CaseType=Combination P=-127,600825019416 V2=35,0407545452562 V3=0 T=0 M2=0 M3=-30,2201831888789 ElemStation=0	FrameElem=3-1
Frame=3 Station=0,05 OutputCase=STR050 CaseType=Combination P=-127,330825019416 V2=35,2402545452562 V3=0 T=0 M2=0 M3=-31,9772584161417 ElemStation=0,05	FrameElem=3-1
Frame=3 Station=0,1 OutputCase=STR050 CaseType=Combination P=-127,060825019416 V2=35,4277545452562 V3=0 T=0 M2=0 M3=-33,7440086434045 ElemStation=0,1	FrameElem=3-1
Frame=3 Station=0 OutputCase=STR051 CaseType=Combination P=-97,8749999994315 V2=2,76636671516742 V3=0 T=0 M2=0 M3=-12,4359594697047 ElemStation=0	FrameElem=3-1
Frame=3 Station=0,05 OutputCase=STR051 CaseType=Combination P=-97,6049999994315 V2=2,96586671516742 V3=0 T=0 M2=0 M3=-12,5793153054631 ElemStation=0,05	FrameElem=3-1
Frame=3 Station=0,1 OutputCase=STR051 CaseType=Combination P=-97,3349999994315 V2=3,15336671516742 V3=0 T=0 M2=0 M3=-12,7323464112214 ElemStation=0,1	FrameElem=3-1
Frame=3 Station=0 OutputCase=STR052 CaseType=Combination P=-108,230912231796 V2=15,9606196509062 V3=0 T=0 M2=0 M3=-19,1804293316878 ElemStation=0	FrameElem=3-1
Frame=3 Station=0,05 OutputCase=STR052 CaseType=Combination P=-107,960912231796 V2=16,1601196509062 V3=0 T=0 M2=0 M3=-19,9834978142331 ElemStation=0,05	FrameElem=3-1
Frame=3 Station=0,1 OutputCase=STR052 CaseType=Combination P=-107,690912231796 V2=16,3476196509062 V3=0 T=0 M2=0 M3=-20,7962412967784 ElemStation=0,1	FrameElem=3-1
Frame=3 Station=0 OutputCase=STR053 CaseType=Combination P=-97,875000000194 V2=20,4777838051405 V3=0 T=0 M2=0 M3=-9,94229108448723 ElemStation=0	FrameElem=3-1

Società di Progetto
Brebemi SpA



Doc. N.
60235-00000-A00.doc

CODIFICA DOCUMENTO
04RCDII10000000000300A00

REV.
00

FOGLIO
252 di 628

Frame=3 Station=0,05 OutputCase=STR053 CaseType=Combination P=-97,6050000000194 V2=22,2458197426405 V3=0 T=0 M2=0 M3=-11,0104595716193 FrameElem=3-1 ElemStation=0,05
Frame=3 Station=0,1 OutputCase=STR053 CaseType=Combination P=-97,3350000000194 V2=23,9950400551405 V3=0 T=0 M2=0 M3=-12,1665594650013 FrameElem=3-1 ElemStation=0,1
Frame=3 Station=0 OutputCase=STR054 CaseType=Combination P=-23,0959122320052 V2=15,1855558443054 V3=0 T=0 M2=0 M3=-7,46409594401675 FrameElem=3-1 ElemStation=0
Frame=3 Station=0,05 OutputCase=STR054 CaseType=Combination P=-22,8959122320052 V2=15,3850558443054 V3=0 T=0 M2=0 M3=-8,22841123623202 FrameElem=3-1 ElemStation=0,05
Frame=3 Station=0,1 OutputCase=STR054 CaseType=Combination P=-22,6959122320052 V2=15,5725558443054 V3=0 T=0 M2=0 M3=-9,00240152844729 FrameElem=3-1 ElemStation=0,1
Frame=3 Station=0 OutputCase=STR055 CaseType=Combination P=-12,7400000002291 V2=19,7027199985397 V3=0 T=0 M2=0 M3=1,7740423031838 FrameElem=3-1 ElemStation=0
Frame=3 Station=0,05 OutputCase=STR055 CaseType=Combination P=-12,5400000002291 V2=21,4707559360397 V3=0 T=0 M2=0 M3=0,744627006381811 FrameElem=3-1 ElemStation=0,05
Frame=3 Station=0,1 OutputCase=STR055 CaseType=Combination P=-12,3400000002291 V2=23,2199762485397 V3=0 T=0 M2=0 M3=-0,372719696670176 FrameElem=3-1 ElemStation=0,1
Frame=3 Station=0 OutputCase=STR056 CaseType=Combination P=-16,7413185624229 V2=5,56783199294563 V3=0 T=0 M2=0 M3=-0,204930144037976 FrameElem=3-1 ElemStation=0
Frame=3 Station=0,05 OutputCase=STR056 CaseType=Combination P=-16,4713185624229 V2=5,99645699294563 V3=0 T=0 M2=0 M3=-0,494144243685257 FrameElem=3-1 ElemStation=0,05
Frame=3 Station=0,1 OutputCase=STR056 CaseType=Combination P=-16,2013185624229 V2=6,39943199294563 V3=0 T=0 M2=0 M3=-0,8041483433232539 FrameElem=3-1 ElemStation=0,1
Frame=3 Station=0 OutputCase=STR057 CaseType=Combination P=-16,7413185623065 V2=1,56534888462023 V3=0 T=0 M2=0 M3=-0,650367056247674 FrameElem=3-1 ElemStation=0
Frame=3 Station=0,05 OutputCase=STR057 CaseType=Combination P=-16,4713185623065 V2=1,76484888462023 V3=0 T=0 M2=0 M3=-0,733672000478685 FrameElem=3-1 ElemStation=0,05
Frame=3 Station=0,1 OutputCase=STR057 CaseType=Combination P=-16,2013185623065 V2=1,95234888462023 V3=0 T=0 M2=0 M3=-0,826651944709697 FrameElem=3-1 ElemStation=0,1
Frame=3 Station=0 OutputCase=STR058 CaseType=Combination P=-97,4173185621816 V2=2,53749370645858 V3=0 T=0 M2=0 M3=-11,8024591272678 FrameElem=3-1 ElemStation=0
Frame=3 Station=0,05 OutputCase=STR058 CaseType=Combination P=-97,1473185621816 V2=2,73699370645858 V3=0 T=0 M2=0 M3=-11,9343713125907 FrameElem=3-1 ElemStation=0,05
Frame=3 Station=0,1 OutputCase=STR058 CaseType=Combination P=-96,8773185621816 V2=2,92449370645858 V3=0 T=0 M2=0 M3=-12,0759584979136 FrameElem=3-1 ElemStation=0,1
Frame=3 Station=0 OutputCase=STR059 CaseType=Combination P=-107,773230794546 V2=15,7317466421973 V3=0 T=0 M2=0 M3=-18,5469289892508 FrameElem=3-1 ElemStation=0
Frame=3 Station=0,05 OutputCase=STR059 CaseType=Combination P=-107,503230794546 V2=15,9312466421973 V3=0 T=0 M2=0 M3=-19,3385538213607 FrameElem=3-1 ElemStation=0,05
Frame=3 Station=0,1 OutputCase=STR059 CaseType=Combination P=-107,233230794546 V2=16,1187466421973 V3=0 T=0 M2=0 M3=-20,1398536534706 FrameElem=3-1 ElemStation=0,1
Frame=3 Station=0 OutputCase=STR060 CaseType=Combination P=-97,4173185627695 V2=20,2489107964317 V3=0 T=0 M2=0 M3=-9,3087907420503 FrameElem=3-1 ElemStation=0
Frame=3 Station=0,05 OutputCase=STR060 CaseType=Combination P=-97,1473185627695 V2=22,0169467339317 V3=0 T=0 M2=0 M3=-10,3655155787469 FrameElem=3-1 ElemStation=0,05
Frame=3 Station=0,1 OutputCase=STR060 CaseType=Combination P=-96,8773185627695 V2=23,7661670464317 V3=0 T=0 M2=0 M3=-11,5101718216935 FrameElem=3-1 ElemStation=0,1
Frame=3 Station=0 OutputCase=STR061 CaseType=Combination P=-22,6382307947553 V2=14,9566828355966 V3=0 T=0 M2=0 M3=-6,83059560157982 FrameElem=3-1 ElemStation=0
Frame=3 Station=0,05 OutputCase=STR061 CaseType=Combination P=-22,4382307947553 V2=15,1561828355966 V3=0 T=0 M2=0 M3=-7,58346724335965 FrameElem=3-1 ElemStation=0,05
Frame=3 Station=0,1 OutputCase=STR061 CaseType=Combination P=-22,2382307947553 V2=15,3436828355966 V3=0 T=0 M2=0 M3=-8,34601388513948 FrameElem=3-1 ElemStation=0,1
Frame=3 Station=0 OutputCase=STR062 CaseType=Combination P=-12,2823185629792 V2=19,4738469898309 V3=0 T=0 M2=0 M3=2,40754264562073 FrameElem=3-1 ElemStation=0
Frame=3 Station=0,05 OutputCase=STR062 CaseType=Combination P=-12,0823185629792 V2=21,2418829273309 V3=0 T=0 M2=0 M3=1,38957099925418 FrameElem=3-1 ElemStation=0,05
Frame=3 Station=0,1 OutputCase=STR062 CaseType=Combination P=-11,8823185629792 V2=22,9911032398309 V3=0 T=0 M2=0 M3=0,283667946637639 FrameElem=3-1 ElemStation=0,1
Frame=3 Station=0 OutputCase=STR063 CaseType=Combination P=-17,6566814369227 V2=6,0255780103633 V3=0 T=0 M2=0 M3=-1,47193082891184 FrameElem=3-1 ElemStation=0
Frame=3 Station=0,05 OutputCase=STR063 CaseType=Combination P=-17,3866814369227 V2=6,4542030103633 V3=0 T=0 M2=0 M3=-1,78403222943 FrameElem=3-1 ElemStation=0,05
Frame=3 Station=0,1 OutputCase=STR063 CaseType=Combination P=-17,1166814369227 V2=6,8571780103633 V3=0 T=0 M2=0 M3=-2,11692362994817 FrameElem=3-1 ElemStation=0,1
Frame=3 Station=0 OutputCase=STR064 CaseType=Combination P=-17,6566814368063 V2=2,02309490203791 V3=0 T=0 M2=0 M3=-1,91736774112154 FrameElem=3-1 ElemStation=0
Frame=3 Station=0,05 OutputCase=STR064 CaseType=Combination P=-17,3866814368063 V2=2,22259490203791 V3=0 T=0 M2=0 M3=-2,02355998622343 FrameElem=3-1 ElemStation=0,05
Frame=3 Station=0,1 OutputCase=STR064 CaseType=Combination P=-17,1166814368063 V2=2,41009490203791 V3=0 T=0 M2=0 M3=-2,13942723132533 FrameElem=3-1 ElemStation=0,1
Frame=3 Station=0 OutputCase=STR065 CaseType=Combination P=-98,3326814366814 V2=2,99523972387626 V3=0 T=0 M2=0 M3=-13,0694598121416 FrameElem=3-1 ElemStation=0
Frame=3 Station=0,05 OutputCase=STR065 CaseType=Combination P=-98,0626814366814 V2=3,19473972387626 V3=0 T=0 M2=0 M3=-13,2242592983354 FrameElem=3-1 ElemStation=0,05
Frame=3 Station=0,1 OutputCase=STR065 CaseType=Combination P=-97,7926814366814 V2=3,38223972387626 V3=0 T=0 M2=0 M3=-13,3887337845292 FrameElem=3-1 ElemStation=0,1
Frame=3 Station=0 OutputCase=STR066 CaseType=Combination P=-108,688593669045 V2=16,189492659615 V3=0 T=0 M2=0 M3=-19,8139296741247 FrameElem=3-1 ElemStation=0
Frame=3 Station=0,05 OutputCase=STR066 CaseType=Combination P=-108,418593669045 V2=16,388992659615 V3=0 T=0 M2=0 M3=-20,6284418071055 FrameElem=3-1 ElemStation=0,05
Frame=3 Station=0,1 OutputCase=STR066 CaseType=Combination P=-108,148593669045 V2=16,576492659615 V3=0 T=0 M2=0 M3=-21,4526289400862 FrameElem=3-1 ElemStation=0,1
Frame=3 Station=0 OutputCase=STR067 CaseType=Combination P=-98,3326814372693 V2=20,7066568138494 V3=0 T=0 M2=0 M3=-10,5757914269242 FrameElem=3-1 ElemStation=0
Frame=3 Station=0,05 OutputCase=STR067 CaseType=Combination P=-98,0626814372693 V2=22,4746927513494 V3=0 T=0 M2=0 M3=-11,6554035644916 FrameElem=3-1 ElemStation=0,05
Frame=3 Station=0,1 OutputCase=STR067 CaseType=Combination P=-97,7926814372693 V2=24,2239130638494 V3=0 T=0 M2=0 M3=-12,8229471083091 FrameElem=3-1 ElemStation=0,1

Società di Progetto
Brebemi SpA



Doc. N.
60235-00000-A00.doc

CODIFICA DOCUMENTO
04RCDII10000000000300A00

REV.
00

FOGLIO
253 di 628

Frame=3 ElemStation=0	Station=0	OutputCase=STR068	CaseType=Combination	P=-23,5535936692551	V2=15,4144288530142	V3=0	T=0	M2=0	M3=-8,09759628645368	FrameElem=3-1
Frame=3 ElemStation=0,05	Station=0,05	OutputCase=STR068	CaseType=Combination	P=-23,3535936692551	V2=15,6139288530142	V3=0	T=0	M2=0	M3=-8,8735522910439	FrameElem=3-1
Frame=3 ElemStation=0,1	Station=0,1	OutputCase=STR068	CaseType=Combination	P=-23,1535936692551	V2=15,8014288530142	V3=0	T=0	M2=0	M3=-9,65878917175511	FrameElem=3-1
Frame=3 ElemStation=0	Station=0	OutputCase=STR069	CaseType=Combination	P=-13,1976814374789	V2=19,9315930072486	V3=0	T=0	M2=0	M3=1,14054196074687	FrameElem=3-1
Frame=3 ElemStation=0,05	Station=0,05	OutputCase=STR069	CaseType=Combination	P=-12,997681437479	V2=21,6996289447486	V3=0	T=0	M2=0	M3=9,96830135094378E-02	FrameElem=3-1
Frame=3 ElemStation=0,1	Station=0,1	OutputCase=STR069	CaseType=Combination	P=-12,7976814374789	V2=23,4488492572486	V3=0	T=0	M2=0	M3=-1,02910733997799	FrameElem=3-1
Frame=3 ElemStation=0	Station=0	OutputCase=STR070	CaseType=Combination	P=-17,1989999996727	V2=5,24502767811366	V3=0	T=0	M2=0	M3=-0,535154119648374	FrameElem=3-1
Frame=3 ElemStation=0,05	Station=0,05	OutputCase=STR070	CaseType=Combination	P=-16,9289999996727	V2=5,67365267811366	V3=0	T=0	M2=0	M3=-0,808228003554057	FrameElem=3-1
Frame=3 ElemStation=0,1	Station=0,1	OutputCase=STR070	CaseType=Combination	P=-16,6589999996727	V2=6,07662767811366	V3=0	T=0	M2=0	M3=-1,10209188745974	FrameElem=3-1
Frame=3 ElemStation=0	Station=0	OutputCase=STR071	CaseType=Combination	P=-17,1989999995563	V2=1,24254456978826	V3=0	T=0	M2=0	M3=-0,980591031858072	FrameElem=3-1
Frame=3 ElemStation=0,05	Station=0,05	OutputCase=STR071	CaseType=Combination	P=-16,9289999995563	V2=1,44204456978826	V3=0	T=0	M2=0	M3=-1,04775576034748	FrameElem=3-1
Frame=3 ElemStation=0,1	Station=0,1	OutputCase=STR071	CaseType=Combination	P=-16,6589999995563	V2=1,62954456978826	V3=0	T=0	M2=0	M3=-1,1245954888369	FrameElem=3-1
Frame=3 ElemStation=0	Station=0	OutputCase=STR072	CaseType=Combination	P=-97,8749999994313	V2=2,21468939162661	V3=0	T=0	M2=0	M3=-12,1326381028782	FrameElem=3-1
Frame=3 ElemStation=0,05	Station=0,05	OutputCase=STR072	CaseType=Combination	P=-97,6049999994313	V2=2,41418939162661	V3=0	T=0	M2=0	M3=-12,2484550724595	FrameElem=3-1
Frame=3 ElemStation=0,1	Station=0,1	OutputCase=STR072	CaseType=Combination	P=-97,3349999994313	V2=2,60168939162661	V3=0	T=0	M2=0	M3=-12,3739020420408	FrameElem=3-1
Frame=3 ElemStation=0	Station=0	OutputCase=STR073	CaseType=Combination	P=-108,230912231795	V2=15,4089423273654	V3=0	T=0	M2=0	M3=-18,8771529648612	FrameElem=3-1
Frame=3 ElemStation=0,05	Station=0,05	OutputCase=STR073	CaseType=Combination	P=-107,960912231795	V2=15,6084423273654	V3=0	T=0	M2=0	M3=-19,6526375812295	FrameElem=3-1
Frame=3 ElemStation=0,1	Station=0,1	OutputCase=STR073	CaseType=Combination	P=-107,690912231795	V2=15,7959423273654	V3=0	T=0	M2=0	M3=-20,4377971975978	FrameElem=3-1
Frame=3 ElemStation=0	Station=0	OutputCase=STR074	CaseType=Combination	P=-97,8750000000192	V2=19,9261064815997	V3=0	T=0	M2=0	M3=-9,6390147176607	FrameElem=3-1
Frame=3 ElemStation=0,05	Station=0,05	OutputCase=STR074	CaseType=Combination	P=-97,6050000000192	V2=21,6941424190997	V3=0	T=0	M2=0	M3=-10,6795993386157	FrameElem=3-1
Frame=3 ElemStation=0,1	Station=0,1	OutputCase=STR074	CaseType=Combination	P=-97,3350000000192	V2=23,4433627315997	V3=0	T=0	M2=0	M3=-11,8081153658207	FrameElem=3-1
Frame=3 ElemStation=0	Station=0	OutputCase=STR075	CaseType=Combination	P=-23,0959122320051	V2=14,6338785207646	V3=0	T=0	M2=0	M3=-7,16081957719022	FrameElem=3-1
Frame=3 ElemStation=0,05	Station=0,05	OutputCase=STR075	CaseType=Combination	P=-22,8959122320051	V2=14,8333785207646	V3=0	T=0	M2=0	M3=-7,89755100322845	FrameElem=3-1
Frame=3 ElemStation=0,1	Station=0,1	OutputCase=STR075	CaseType=Combination	P=-22,6959122320051	V2=15,0208785207646	V3=0	T=0	M2=0	M3=-8,64395742926668	FrameElem=3-1
Frame=3 ElemStation=0	Station=0	OutputCase=STR076	CaseType=Combination	P=-12,7400000002289	V2=19,1510426749989	V3=0	T=0	M2=0	M3=2,07731867001033	FrameElem=3-1
Frame=3 ElemStation=0,05	Station=0,05	OutputCase=STR076	CaseType=Combination	P=-12,5400000002289	V2=20,9190786124989	V3=0	T=0	M2=0	M3=1,07548723938538	FrameElem=3-1
Frame=3 1 ElemStation=0,1	Station=0,1	OutputCase=STR076	CaseType=Combination	P=-12,3400000002289	V2=22,6682989249989	V3=0	T=0	M2=0	M3=-1,42755974895625E-02	FrameElem=3-1
Frame=3 ElemStation=0	Station=0	OutputCase=STR077	CaseType=Combination	P=-16,4361976042566	V2=6,33471219304108	V3=0	T=0	M2=0	M3=-0,28805719379091	FrameElem=3-1
Frame=3 ElemStation=0,05	Station=0,05	OutputCase=STR077	CaseType=Combination	P=-16,1661976042566	V2=6,76333719304108	V3=0	T=0	M2=0	M3=-0,615615303442964	FrameElem=3-1
Frame=3 ElemStation=0,1	Station=0,1	OutputCase=STR077	CaseType=Combination	P=-15,8961976042566	V2=7,16631219304108	V3=0	T=0	M2=0	M3=-0,963963413095018	FrameElem=3-1
Frame=3 ElemStation=0	Station=0	OutputCase=STR078	CaseType=Combination	P=-16,4361976041402	V2=2,33222908471568	V3=0	T=0	M2=0	M3=-0,733494106000608	FrameElem=3-1
Frame=3 ElemStation=0,05	Station=0,05	OutputCase=STR078	CaseType=Combination	P=-16,1661976041402	V2=2,53172908471568	V3=0	T=0	M2=0	M3=-0,855143060236392	FrameElem=3-1
Frame=3 ElemStation=0,1	Station=0,1	OutputCase=STR078	CaseType=Combination	P=-15,8961976041402	V2=2,71922908471568	V3=0	T=0	M2=0	M3=-0,986467014472176	FrameElem=3-1
Frame=3 ElemStation=0	Station=0	OutputCase=STR079	CaseType=Combination	P=-124,30931856214	V2=3,78100418630604	V3=0	T=0	M2=0	M3=-16,0252837623187	FrameElem=3-1
Frame=3 ElemStation=0,05	Station=0,05	OutputCase=STR079	CaseType=Combination	P=-124,03931856214	V2=3,98050418630604	V3=0	T=0	M2=0	M3=-16,219371471634	FrameElem=3-1
Frame=3 ElemStation=0,1	Station=0,1	OutputCase=STR079	CaseType=Combination	P=-123,76931856214	V2=4,16800418630604	V3=0	T=0	M2=0	M3=-16,4231341809493	FrameElem=3-1
Frame=3 ElemStation=0	Station=0	OutputCase=STR080	CaseType=Combination	P=-137,491100145478	V2=20,5219075815691	V3=0	T=0	M2=0	M3=-24,5966172852853	FrameElem=3-1
Frame=3 ElemStation=0,05	Station=0,05	OutputCase=STR080	CaseType=Combination	P=-137,221100145478	V2=20,7214075815691	V3=0	T=0	M2=0	M3=-25,6277501643637	FrameElem=3-1
Frame=3 ElemStation=0,1	Station=0,1	OutputCase=STR080	CaseType=Combination	P=-136,951100145478	V2=20,9089075815691	V3=0	T=0	M2=0	M3=-26,6685580434422	FrameElem=3-1
Frame=3 ElemStation=0	Station=0	OutputCase=STR081	CaseType=Combination	P=-124,309318562885	V2=26,062059368284	V3=0	T=0	M2=0	M3=-12,8488715527653	FrameElem=3-1
Frame=3 ElemStation=0,05	Station=0,05	OutputCase=STR081	CaseType=Combination	P=-124,039318562885	V2=28,2765721868284	V3=0	T=0	M2=0	M3=-14,2074064121067	FrameElem=3-1
Frame=3 ElemStation=0,1	Station=0,1	OutputCase=STR081	CaseType=Combination	P=-123,769318562885	V2=30,4745409368284	V3=0	T=0	M2=0	M3=-15,6762531464481	FrameElem=3-1
Frame=3 ElemStation=0	Station=0	OutputCase=STR082	CaseType=Combination	P=-25,4641001457291	V2=19,4227955010222	V3=0	T=0	M2=0	M3=-9,16291987394088	FrameElem=3-1
Frame=3 ElemStation=0,05	Station=0,05	OutputCase=STR082	CaseType=Combination	P=-25,2641001457291	V2=19,6222955010222	V3=0	T=0	M2=0	M3=-10,139097148992	FrameElem=3-1

Società di Progetto
Brebemi SpA

	Doc. N. 60235-0000-A00.doc	CODIFICA DOCUMENTO 04RCDII10000000000300A00	REV. 00	FOGLIO 254 di 628
--	-------------------------------	--	------------	----------------------

Frame=3 ElemStation=0,1	Station=0,1	OutputCase=STR082	CaseType=Combination	P=-25,0641001457291	V2=19,8097955010222	V3=0	T=0	M2=0	M3=-11,1249494240431	FrameElem=3-1
Frame=3 ElemStation=0	Station=0	OutputCase=STR083	CaseType=Combination	P=-12,2823185631366	V2=24,9629538562815	V3=0	T=0	M2=0	M3=2,5848258585791	FrameElem=3-1
Frame=3 ElemStation=0,05	Station=0,05	OutputCase=STR083	CaseType=Combination	P=-12,0823185631366	V2=27,1774601062815	V3=0	T=0	M2=0	M3=1,28124660326502	FrameElem=3-1
Frame=3 ElemStation=0,1	Station=0,1	OutputCase=STR083	CaseType=Combination	P=-11,8823185631366	V2=29,3754288562815	V3=0	T=0	M2=0	M3=-0,132644527049054	FrameElem=3-1
Frame=3 ElemStation=0	Station=0	OutputCase=STR084	CaseType=Combination	P=-127,143143582166	V2=35,3635588600882	V3=0	T=0	M2=0	M3=-29,8899592132685	FrameElem=3-1
Frame=3 ElemStation=0,05	Station=0,05	OutputCase=STR084	CaseType=Combination	P=-126,873143582166	V2=35,5630588600882	V3=0	T=0	M2=0	M3=-31,6631746562729	FrameElem=3-1
Frame=3 ElemStation=0,1	Station=0,1	OutputCase=STR084	CaseType=Combination	P=-126,603143582166	V2=35,7505588600882	V3=0	T=0	M2=0	M3=-33,4460650992773	FrameElem=3-1
Frame=3 ElemStation=0	Station=0	OutputCase=STR085	CaseType=Combination	P=-97,1121976040153	V2=3,30437390655403	V3=0	T=0	M2=0	M3=-11,8855861770207	FrameElem=3-1
Frame=3 ElemStation=0,05	Station=0,05	OutputCase=STR085	CaseType=Combination	P=-96,8421976040153	V2=3,50387390655403	V3=0	T=0	M2=0	M3=-12,0558423723484	FrameElem=3-1
Frame=3 ElemStation=0,1	Station=0,1	OutputCase=STR085	CaseType=Combination	P=-96,5721976040153	V2=3,69137390655403	V3=0	T=0	M2=0	M3=-12,2357735676761	FrameElem=3-1
Frame=3 ElemStation=0	Station=0	OutputCase=STR086	CaseType=Combination	P=-107,468109836379	V2=16,4986268422928	V3=0	T=0	M2=0	M3=-18,6300560390038	FrameElem=3-1
Frame=3 ElemStation=0,05	Station=0,05	OutputCase=STR086	CaseType=Combination	P=-107,198109836379	V2=16,6981268422928	V3=0	T=0	M2=0	M3=-19,4600248811184	FrameElem=3-1
Frame=3 ElemStation=0,1	Station=0,1	OutputCase=STR086	CaseType=Combination	P=-106,928109836379	V2=16,8856268422928	V3=0	T=0	M2=0	M3=-20,2996687232331	FrameElem=3-1
Frame=3 ElemStation=0	Station=0	OutputCase=STR087	CaseType=Combination	P=-97,1121976046032	V2=21,0157909965271	V3=0	T=0	M2=0	M3=-9,39191779180323	FrameElem=3-1
Frame=3 ElemStation=0,05	Station=0,05	OutputCase=STR087	CaseType=Combination	P=-96,8421976046032	V2=22,7838269340271	V3=0	T=0	M2=0	M3=-10,4869866385046	FrameElem=3-1
Frame=3 ElemStation=0,1	Station=0,1	OutputCase=STR087	CaseType=Combination	P=-96,5721976046032	V2=24,5330472465271	V3=0	T=0	M2=0	M3=-11,6699868914559	FrameElem=3-1
Frame=3 ElemStation=0	Station=0	OutputCase=STR088	CaseType=Combination	P=-22,333109836589	V2=15,723563035692	V3=0	T=0	M2=0	M3=-6,91372265133275	FrameElem=3-1
Frame=3 ElemStation=0,05	Station=0,05	OutputCase=STR088	CaseType=Combination	P=-22,133109836589	V2=15,923063035692	V3=0	T=0	M2=0	M3=-7,70493830311736	FrameElem=3-1
Frame=3 ElemStation=0,1	Station=0,1	OutputCase=STR088	CaseType=Combination	P=-21,933109836589	V2=16,110563035692	V3=0	T=0	M2=0	M3=-8,50582895490196	FrameElem=3-1
Frame=3 ElemStation=0	Station=0	OutputCase=STR089	CaseType=Combination	P=-11,9771976048129	V2=20,2407271899264	V3=0	T=0	M2=0	M3=2,32441559586779	FrameElem=3-1
Frame=3 ElemStation=0,05	Station=0,05	OutputCase=STR089	CaseType=Combination	P=-11,7771976048129	V2=22,0087631274264	V3=0	T=0	M2=0	M3=1,26809993949648	FrameElem=3-1
Frame=3 ElemStation=0,1	Station=0,1	OutputCase=STR089	CaseType=Combination	P=-11,5771976048129	V2=23,7579834399264	V3=0	T=0	M2=0	M3=0,123852876875159	FrameElem=3-1
Frame=3 ElemStation=0	Station=0	OutputCase=STR090	CaseType=Combination	P=-16,4361976042568	V2=6,88638951658189	V3=0	T=0	M2=0	M3=-0,591333560617443	FrameElem=3-1
Frame=3 ElemStation=0,05	Station=0,05	OutputCase=STR090	CaseType=Combination	P=-16,1661976042568	V2=7,31501451658189	V3=0	T=0	M2=0	M3=-0,946475536446537	FrameElem=3-1
Frame=3 ElemStation=0,1	Station=0,1	OutputCase=STR090	CaseType=Combination	P=-15,8961976042568	V2=7,71798951658189	V3=0	T=0	M2=0	M3=-1,32240751227563	FrameElem=3-1
Frame=3 ElemStation=0	Station=0	OutputCase=STR091	CaseType=Combination	P=-16,4361976041404	V2=2,88390640825649	V3=0	T=0	M2=0	M3=-1,03677047282714	FrameElem=3-1
Frame=3 ElemStation=0,05	Station=0,05	OutputCase=STR091	CaseType=Combination	P=-16,1661976041404	V2=3,08340640825649	V3=0	T=0	M2=0	M3=-1,18600329323997	FrameElem=3-1
Frame=3 ElemStation=0,1	Station=0,1	OutputCase=STR091	CaseType=Combination	P=-15,8961976041404	V2=3,27090640825649	V3=0	T=0	M2=0	M3=-1,34491111365279	FrameElem=3-1
Frame=3 ElemStation=0	Station=0	OutputCase=STR092	CaseType=Combination	P=-97,1121976040154	V2=3,85605123009484	V3=0	T=0	M2=0	M3=-12,1888625438472	FrameElem=3-1
Frame=3 ElemStation=0,05	Station=0,05	OutputCase=STR092	CaseType=Combination	P=-96,8421976040155	V2=4,05555123009484	V3=0	T=0	M2=0	M3=-12,3867026053352	FrameElem=3-1
Frame=3 ElemStation=0,1	Station=0,1	OutputCase=STR092	CaseType=Combination	P=-96,5721976040154	V2=4,24305123009484	V3=0	T=0	M2=0	M3=-12,5942176668567	FrameElem=3-1
Frame=3 ElemStation=0	Station=0	OutputCase=STR093	CaseType=Combination	P=-107,468109836379	V2=17,0503041658336	V3=0	T=0	M2=0	M3=-18,9333324058303	FrameElem=3-1
Frame=3 ElemStation=0,05	Station=0,05	OutputCase=STR093	CaseType=Combination	P=-107,198109836379	V2=17,2498041658336	V3=0	T=0	M2=0	M3=-19,790885114122	FrameElem=3-1
Frame=3 ElemStation=0,1	Station=0,1	OutputCase=STR093	CaseType=Combination	P=-106,928109836379	V2=17,4373041658336	V3=0	T=0	M2=0	M3=-20,6581128224137	FrameElem=3-1
Frame=3 ElemStation=0	Station=0	OutputCase=STR094	CaseType=Combination	P=-97,1121976046033	V2=21,567468320068	V3=0	T=0	M2=0	M3=-9,69519415862976	FrameElem=3-1
Frame=3 ElemStation=0,05	Station=0,05	OutputCase=STR094	CaseType=Combination	P=-96,8421976046033	V2=23,335504257568	V3=0	T=0	M2=0	M3=-10,8178468715082	FrameElem=3-1
Frame=3 ElemStation=0,1	Station=0,1	OutputCase=STR094	CaseType=Combination	P=-96,5721976046033	V2=25,084724570068	V3=0	T=0	M2=0	M3=-12,0284309906366	FrameElem=3-1
Frame=3 ElemStation=0	Station=0	OutputCase=STR095	CaseType=Combination	P=-22,3331098365892	V2=16,2752403592328	V3=0	T=0	M2=0	M3=-7,21699901815929	FrameElem=3-1
Frame=3 ElemStation=0,05	Station=0,05	OutputCase=STR095	CaseType=Combination	P=-22,1331098365892	V2=16,4747403592328	V3=0	T=0	M2=0	M3=-8,03579853612093	FrameElem=3-1
Frame=3 ElemStation=0,1	Station=0,1	OutputCase=STR095	CaseType=Combination	P=-21,9331098365892	V2=16,6622403592328	V3=0	T=0	M2=0	M3=-8,86427305408257	FrameElem=3-1
Frame=3 ElemStation=0	Station=0	OutputCase=STR096	CaseType=Combination	P=-11,977197604813	V2=20,7924045134672	V3=0	T=0	M2=0	M3=2,02113922904126	FrameElem=3-1
Frame=3 ElemStation=0,05	Station=0,05	OutputCase=STR096	CaseType=Combination	P=-11,777197604813	V2=22,5604404509672	V3=0	T=0	M2=0	M3=0,937239706492904	FrameElem=3-1
Frame=3 ElemStation=0,1	Station=0,1	OutputCase=STR096	CaseType=Combination	P=-11,577197604813	V2=24,3096607634672	V3=0	T=0	M2=0	M3=-0,234591222305454	FrameElem=3-1
Frame=3 ElemStation=0	Station=0	OutputCase=STR097	CaseType=Combination	P=-16,4361976042565	V2=5,78303486950027	V3=0	T=0	M2=0	M3=1,52191730356233E-02	FrameElem=3-1

Società di Progetto
Brebemi SpA

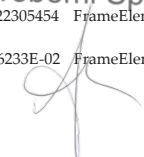



Doc. N.
60235-00000-A00.doc

CODIFICA DOCUMENTO
04RCDII10000000000300A00

REV.
00

FOGLIO
255 di 628

Frame=3 ElemStation=0,05	Station=0,05	OutputCase=STR097	CaseType=Combination	P=-16,1661976042565	V2=6,21165986950027	V3=0	T=0	M2=0	M3=-0,284755070439391	FrameElem=3-1
Frame=3 ElemStation=0,1	Station=0,1	OutputCase=STR097	CaseType=Combination	P=-15,8961976042565	V2=6,61463486950027	V3=0	T=0	M2=0	M3=-0,605519313914405	FrameElem=3-1
Frame=3 ElemStation=0	Station=0	OutputCase=STR098	CaseType=Combination	P=-16,4361976041401	V2=1,78055176117488	V3=0	T=0	M2=0	M3=-0,430217739174075	FrameElem=3-1
Frame=3 ElemStation=0,05	Station=0,05	OutputCase=STR098	CaseType=Combination	P=-16,1661976041401	V2=1,98005176117488	V3=0	T=0	M2=0	M3=-0,524282827232819	FrameElem=3-1
Frame=3 ElemStation=0,1	Station=0,1	OutputCase=STR098	CaseType=Combination	P=-15,8961976041401	V2=2,16755176117488	V3=0	T=0	M2=0	M3=-0,628022915291562	FrameElem=3-1
Frame=3 ElemStation=0	Station=0	OutputCase=STR099	CaseType=Combination	P=-97,1121976040151	V2=2,75269658301323	V3=0	T=0	M2=0	M3=-11,5823098101942	FrameElem=3-1
Frame=3 ElemStation=0,05	Station=0,05	OutputCase=STR099	CaseType=Combination	P=-96,8421976040151	V2=2,95219658301323	V3=0	T=0	M2=0	M3=-11,7249821393448	FrameElem=3-1
Frame=3 ElemStation=0,1	Station=0,1	OutputCase=STR099	CaseType=Combination	P=-96,5721976040151	V2=3,13969658301323	V3=0	T=0	M2=0	M3=-11,8773294684955	FrameElem=3-1
Frame=3 ElemStation=0	Station=0	OutputCase=STR100	CaseType=Combination	P=-107,468109836379	V2=15,946949518752	V3=0	T=0	M2=0	M3=-18,3267796721772	FrameElem=3-1
Frame=3 ElemStation=0,05	Station=0,05	OutputCase=STR100	CaseType=Combination	P=-107,198109836379	V2=16,146449518752	V3=0	T=0	M2=0	M3=-19,1291646481149	FrameElem=3-1
Frame=3 ElemStation=0,1	Station=0,1	OutputCase=STR100	CaseType=Combination	P=-106,928109836379	V2=16,333949518752	V3=0	T=0	M2=0	M3=-19,9412246240524	FrameElem=3-1
Frame=3 ElemStation=0	Station=0	OutputCase=STR101	CaseType=Combination	P=-97,112197604603	V2=20,4641136729863	V3=0	T=0	M2=0	M3=-9,0886414249767	FrameElem=3-1
Frame=3 ElemStation=0,05	Station=0,05	OutputCase=STR101	CaseType=Combination	P=-96,842197604603	V2=22,2321496104863	V3=0	T=0	M2=0	M3=-10,156126405501	FrameElem=3-1
Frame=3 ElemStation=0,1	Station=0,1	OutputCase=STR101	CaseType=Combination	P=-96,572197604603	V2=23,9813699229863	V3=0	T=0	M2=0	M3=-11,3115427922753	FrameElem=3-1
Frame=3 ElemStation=0	Station=0	OutputCase=STR102	CaseType=Combination	P=-22,3331098365889	V2=15,1718857121512	V3=0	T=0	M2=0	M3=-6,61044628450622	FrameElem=3-1
Frame=3 ElemStation=0,05	Station=0,05	OutputCase=STR102	CaseType=Combination	P=-22,1331098365889	V2=15,3713857121512	V3=0	T=0	M2=0	M3=-7,37407807011378	FrameElem=3-1
Frame=3 ElemStation=0,1	Station=0,1	OutputCase=STR102	CaseType=Combination	P=-21,9331098365889	V2=15,5588857121512	V3=0	T=0	M2=0	M3=-8,14738485572134	FrameElem=3-1
Frame=3 ElemStation=0	Station=0	OutputCase=STR103	CaseType=Combination	P=-11,9771976048127	V2=19,6890498663855	V3=0	T=0	M2=0	M3=2,62769196269433	FrameElem=3-1
Frame=3 ElemStation=0,05	Station=0,05	OutputCase=STR103	CaseType=Combination	P=-11,7771976048127	V2=21,4570858038856	V3=0	T=0	M2=0	M3=1,59896017250005	FrameElem=3-1
Frame=3 ElemStation=0,1	Station=0,1	OutputCase=STR103	CaseType=Combination	P=-11,5771976048127	V2=23,2063061163856	V3=0	T=0	M2=0	M3=0,482296976055773	FrameElem=3-1
Frame=3 ElemStation=0	Station=0	OutputCase=STR104	CaseType=Combination	P=-16,4361976042565	V2=5,78303486950027	V3=0	T=0	M2=0	M3=1,52191730356231E-02	FrameElem=3-1
Frame=3 ElemStation=0,05	Station=0,05	OutputCase=STR104	CaseType=Combination	P=-16,1661976042565	V2=6,21165986950027	V3=0	T=0	M2=0	M3=-0,284755070439391	FrameElem=3-1
Frame=3 ElemStation=0,1	Station=0,1	OutputCase=STR104	CaseType=Combination	P=-15,8961976042565	V2=6,61463486950027	V3=0	T=0	M2=0	M3=-0,605519313914405	FrameElem=3-1
Frame=3 ElemStation=0	Station=0	OutputCase=STR105	CaseType=Combination	P=-16,4361976041401	V2=1,78055176117488	V3=0	T=0	M2=0	M3=-0,430217739174075	FrameElem=3-1
Frame=3 ElemStation=0,05	Station=0,05	OutputCase=STR105	CaseType=Combination	P=-16,1661976041401	V2=1,98005176117488	V3=0	T=0	M2=0	M3=-0,524282827232819	FrameElem=3-1
Frame=3 ElemStation=0,1	Station=0,1	OutputCase=STR105	CaseType=Combination	P=-15,8961976041401	V2=2,16755176117488	V3=0	T=0	M2=0	M3=-0,628022915291562	FrameElem=3-1
Frame=3 ElemStation=0	Station=0	OutputCase=STR106	CaseType=Combination	P=-97,1121976040151	V2=2,75269658301323	V3=0	T=0	M2=0	M3=-11,5823098101942	FrameElem=3-1
Frame=3 ElemStation=0,05	Station=0,05	OutputCase=STR106	CaseType=Combination	P=-96,8421976040151	V2=2,95219658301323	V3=0	T=0	M2=0	M3=-11,7249821393448	FrameElem=3-1
Frame=3 ElemStation=0,1	Station=0,1	OutputCase=STR106	CaseType=Combination	P=-96,5721976040151	V2=3,13969658301323	V3=0	T=0	M2=0	M3=-11,8773294684955	FrameElem=3-1
Frame=3 ElemStation=0	Station=0	OutputCase=STR107	CaseType=Combination	P=-107,468109836379	V2=15,946949518752	V3=0	T=0	M2=0	M3=-18,3267796721772	FrameElem=3-1
Frame=3 ElemStation=0,05	Station=0,05	OutputCase=STR107	CaseType=Combination	P=-107,198109836379	V2=16,146449518752	V3=0	T=0	M2=0	M3=-19,1291646481149	FrameElem=3-1
Frame=3 ElemStation=0,1	Station=0,1	OutputCase=STR107	CaseType=Combination	P=-106,928109836379	V2=16,333949518752	V3=0	T=0	M2=0	M3=-19,9412246240524	FrameElem=3-1
Frame=3 ElemStation=0	Station=0	OutputCase=STR108	CaseType=Combination	P=-97,112197604603	V2=20,4641136729863	V3=0	T=0	M2=0	M3=-9,0886414249767	FrameElem=3-1
Frame=3 ElemStation=0,05	Station=0,05	OutputCase=STR108	CaseType=Combination	P=-96,842197604603	V2=22,2321496104863	V3=0	T=0	M2=0	M3=-10,156126405501	FrameElem=3-1
Frame=3 ElemStation=0,1	Station=0,1	OutputCase=STR108	CaseType=Combination	P=-96,572197604603	V2=23,9813699229863	V3=0	T=0	M2=0	M3=-11,3115427922753	FrameElem=3-1
Frame=3 ElemStation=0	Station=0	OutputCase=STR109	CaseType=Combination	P=-22,3331098365889	V2=15,1718857121512	V3=0	T=0	M2=0	M3=-6,61044628450622	FrameElem=3-1
Frame=3 ElemStation=0,05	Station=0,05	OutputCase=STR109	CaseType=Combination	P=-22,1331098365889	V2=15,3713857121512	V3=0	T=0	M2=0	M3=-7,37407807011378	FrameElem=3-1
Frame=3 ElemStation=0,1	Station=0,1	OutputCase=STR109	CaseType=Combination	P=-21,9331098365889	V2=15,5588857121512	V3=0	T=0	M2=0	M3=-8,14738485572134	FrameElem=3-1
Frame=3 ElemStation=0	Station=0	OutputCase=STR110	CaseType=Combination	P=-11,9771976048127	V2=19,6890498663855	V3=0	T=0	M2=0	M3=2,62769196269433	FrameElem=3-1
Frame=3 ElemStation=0,05	Station=0,05	OutputCase=STR110	CaseType=Combination	P=-11,7771976048127	V2=21,4570858038856	V3=0	T=0	M2=0	M3=1,59896017250005	FrameElem=3-1
Frame=3 ElemStation=0,1	Station=0,1	OutputCase=STR110	CaseType=Combination	P=-11,5771976048127	V2=23,2063061163856	V3=0	T=0	M2=0	M3=0,482296976055773	FrameElem=3-1
Frame=3 ElemStation=0	Station=0	OutputCase=STR111	CaseType=Combination	P=-17,9618023950896	V2=7,09762222207054	V3=0	T=0	M2=0	M3=-2,39972500191401	FrameElem=3-1
Frame=3 ElemStation=0,05	Station=0,05	OutputCase=STR111	CaseType=Combination	P=-17,6918023950896	V2=7,52624722207054	V3=0	T=0	M2=0	M3=-2,76542861301754	FrameElem=3-1
Frame=3 ElemStation=0,1	Station=0,1	OutputCase=STR111	CaseType=Combination	P=-17,4218023950896	V2=7,9292222207054	V3=0	T=0	M2=0	M3=-3,15192222412107	FrameElem=3-1

Società di Progetto
Brebemi SpA



Doc. N.
60235-0000-A00.doc

CODIFICA DOCUMENTO
04RCDII10000000000300A00

REV.
00

FOGLIO
256 di 628

Frame=3 ElemStation=0	Station=0	OutputCase=STR112	CaseType=Combination	P=-17,9618023949732	V2=3,09513911374514	V3=0	T=0	M2=0	M3=-2,84516191412371	FrameElem=3-1
Frame=3 ElemStation=0,05	Station=0,05	OutputCase=STR112	CaseType=Combination	P=-17,6918023949732	V2=3,29463911374514	V3=0	T=0	M2=0	M3=-3,00495636981097	FrameElem=3-1
Frame=3 ElemStation=0,1	Station=0,1	OutputCase=STR112	CaseType=Combination	P=-17,4218023949732	V2=3,48213911374514	V3=0	T=0	M2=0	M3=-3,17442582549823	FrameElem=3-1
Frame=3 ElemStation=0	Station=0	OutputCase=STR113	CaseType=Combination	P=-125,22468143664	V2=4,23875020372372	V3=0	T=0	M2=0	M3=-17,2922844471925	FrameElem=3-1
Frame=3 ElemStation=0,05	Station=0,05	OutputCase=STR113	CaseType=Combination	P=-124,95468143664	V2=4,43825020372372	V3=0	T=0	M2=0	M3=-17,5092594573787	FrameElem=3-1
Frame=3 ElemStation=0,1	Station=0,1	OutputCase=STR113	CaseType=Combination	P=-124,68468143664	V2=4,62575020372372	V3=0	T=0	M2=0	M3=-17,7359094675649	FrameElem=3-1
Frame=3 ElemStation=0	Station=0	OutputCase=STR114	CaseType=Combination	P=-138,406463019978	V2=20,9796535989867	V3=0	T=0	M2=0	M3=-25,8636179701591	FrameElem=3-1
Frame=3 ElemStation=0,05	Station=0,05	OutputCase=STR114	CaseType=Combination	P=-138,136463019978	V2=21,1791535989867	V3=0	T=0	M2=0	M3=-26,9176381501085	FrameElem=3-1
Frame=3 ElemStation=0,1	Station=0,1	OutputCase=STR114	CaseType=Combination	P=-137,866463019978	V2=21,3666535989867	V3=0	T=0	M2=0	M3=-27,9813333300578	FrameElem=3-1
Frame=3 ElemStation=0	Station=0	OutputCase=STR115	CaseType=Combination	P=-125,224681437385	V2=26,5198119542461	V3=0	T=0	M2=0	M3=-14,1158722376392	FrameElem=3-1
Frame=3 ElemStation=0,05	Station=0,05	OutputCase=STR115	CaseType=Combination	P=-124,954681437385	V2=28,7343182042461	V3=0	T=0	M2=0	M3=-15,4972943978515	FrameElem=3-1
Frame=3 ElemStation=0,1	Station=0,1	OutputCase=STR115	CaseType=Combination	P=-124,684681437385	V2=30,9322869542461	V3=0	T=0	M2=0	M3=-16,9890284330638	FrameElem=3-1
Frame=3 ElemStation=0	Station=0	OutputCase=STR116	CaseType=Combination	P=-26,3794630202289	V2=19,8805415184398	V3=0	T=0	M2=0	M3=-10,4299205588147	FrameElem=3-1
Frame=3 ElemStation=0,05	Station=0,05	OutputCase=STR116	CaseType=Combination	P=-26,1794630202289	V2=20,0800415184398	V3=0	T=0	M2=0	M3=-11,4289851347367	FrameElem=3-1
Frame=3 ElemStation=0,1	Station=0,1	OutputCase=STR116	CaseType=Combination	P=-25,9794630202289	V2=20,2675415184398	V3=0	T=0	M2=0	M3=-12,4377247106587	FrameElem=3-1
Frame=3 ElemStation=0	Station=0	OutputCase=STR117	CaseType=Combination	P=-13,1976814376364	V2=25,4206998736992	V3=0	T=0	M2=0	M3=-1,31782517370524	FrameElem=3-1
Frame=3 FrameElem=3-1 ElemStation=0,05	Station=0,05	OutputCase=STR117	CaseType=Combination	P=-12,9976814376364	V2=27,6352061236992	V3=0	T=0	M2=0	M3=-8,64138247972401E-03	
Frame=3 ElemStation=0,1	Station=0,1	OutputCase=STR117	CaseType=Combination	P=-12,7976814376364	V2=29,8331748736992	V3=0	T=0	M2=0	M3=-1,44541981366468	FrameElem=3-1
Frame=3 ElemStation=0	Station=0	OutputCase=STR118	CaseType=Combination	P=-128,058506456666	V2=35,8213048775058	V3=0	T=0	M2=0	M3=-31,1569598981423	FrameElem=3-1
Frame=3 ElemStation=0,05	Station=0,05	OutputCase=STR118	CaseType=Combination	P=-127,788506456666	V2=36,0208048775058	V3=0	T=0	M2=0	M3=-32,9530626420176	FrameElem=3-1
Frame=3 ElemStation=0,1	Station=0,1	OutputCase=STR118	CaseType=Combination	P=-127,518506456666	V2=36,2083048775058	V3=0	T=0	M2=0	M3=-34,7588403858929	FrameElem=3-1
Frame=3 ElemStation=0	Station=0	OutputCase=STR119	CaseType=Combination	P=-98,6378023948482	V2=4,06728393558349	V3=0	T=0	M2=0	M3=-13,9972539851438	FrameElem=3-1
Frame=3 ElemStation=0,05	Station=0,05	OutputCase=STR119	CaseType=Combination	P=-98,3678023948482	V2=4,26678393558349	V3=0	T=0	M2=0	M3=-14,205655681923	FrameElem=3-1
Frame=3 ElemStation=0,1	Station=0,1	OutputCase=STR119	CaseType=Combination	P=-98,0978023948482	V2=4,45428393558349	V3=0	T=0	M2=0	M3=-14,4237323787021	FrameElem=3-1
Frame=3 ElemStation=0	Station=0	OutputCase=STR120	CaseType=Combination	P=-108,993714627212	V2=17,2615368713223	V3=0	T=0	M2=0	M3=-20,7417238471269	FrameElem=3-1
Frame=3 ElemStation=0,05	Station=0,05	OutputCase=STR120	CaseType=Combination	P=-108,723714627212	V2=17,4610368713223	V3=0	T=0	M2=0	M3=-21,609838190693	FrameElem=3-1
Frame=3 ElemStation=0,1	Station=0,1	OutputCase=STR120	CaseType=Combination	P=-108,453714627212	V2=17,6485368713223	V3=0	T=0	M2=0	M3=-22,4876275342591	FrameElem=3-1
Frame=3 ElemStation=0	Station=0	OutputCase=STR121	CaseType=Combination	P=-98,6378023954361	V2=21,7787010255566	V3=0	T=0	M2=0	M3=-11,5035855999263	FrameElem=3-1
Frame=3 ElemStation=0,05	Station=0,05	OutputCase=STR121	CaseType=Combination	P=-98,3678023954361	V2=23,5467369630566	V3=0	T=0	M2=0	M3=-12,6367999480792	FrameElem=3-1
Frame=3 ElemStation=0,1	Station=0,1	OutputCase=STR121	CaseType=Combination	P=-98,0978023954361	V2=25,2959572755566	V3=0	T=0	M2=0	M3=-13,857945702482	FrameElem=3-1
Frame=3 ElemStation=0	Station=0	OutputCase=STR122	CaseType=Combination	P=-23,858714627422	V2=16,4864730647215	V3=0	T=0	M2=0	M3=-9,02539045945586	FrameElem=3-1
Frame=3 ElemStation=0,05	Station=0,05	OutputCase=STR122	CaseType=Combination	P=-23,658714627422	V2=16,6859730647215	V3=0	T=0	M2=0	M3=-9,85475161269193	FrameElem=3-1
Frame=3 ElemStation=0,1	Station=0,1	OutputCase=STR122	CaseType=Combination	P=-23,458714627422	V2=16,8734730647215	V3=0	T=0	M2=0	M3=-10,693787765928	FrameElem=3-1
Frame=3 ElemStation=0	Station=0	OutputCase=STR123	CaseType=Combination	P=-13,5028023956458	V2=21,0036372189558	V3=0	T=0	M2=0	M3=0,212747787744691	FrameElem=3-1
Frame=3 ElemStation=0,05	Station=0,05	OutputCase=STR123	CaseType=Combination	P=-13,3028023956458	V2=22,7716731564558	V3=0	T=0	M2=0	M3=-0,8817133700781	FrameElem=3-1
Frame=3 ElemStation=0,1	Station=0,1	OutputCase=STR123	CaseType=Combination	P=-13,1028023956458	V2=24,5208934689558	V3=0	T=0	M2=0	M3=-2,06410593415089	FrameElem=3-1
Frame=3 ElemStation=0	Station=0	OutputCase=STR124	CaseType=Combination	P=-17,9618023950897	V2=7,64929954561135	V3=0	T=0	M2=0	M3=-2,70300136874055	FrameElem=3-1
Frame=3 ElemStation=0,05	Station=0,05	OutputCase=STR124	CaseType=Combination	P=-17,6918023950897	V2=8,07792454561135	V3=0	T=0	M2=0	M3=-3,09628884602111	FrameElem=3-1
Frame=3 ElemStation=0,1	Station=0,1	OutputCase=STR124	CaseType=Combination	P=-17,4218023950897	V2=8,48089954561135	V3=0	T=0	M2=0	M3=-3,51036632330168	FrameElem=3-1
Frame=3 ElemStation=0	Station=0	OutputCase=STR125	CaseType=Combination	P=-17,9618023949733	V2=3,64681643728595	V3=0	T=0	M2=0	M3=-3,14843828095024	FrameElem=3-1
Frame=3 ElemStation=0,05	Station=0,05	OutputCase=STR125	CaseType=Combination	P=-17,6918023949733	V2=3,84631643728595	V3=0	T=0	M2=0	M3=-3,33581660281454	FrameElem=3-1
Frame=3 ElemStation=0,1	Station=0,1	OutputCase=STR125	CaseType=Combination	P=-17,4218023949733	V2=4,03381643728595	V3=0	T=0	M2=0	M3=-3,53286992467884	FrameElem=3-1
Frame=3 ElemStation=0	Station=0	OutputCase=STR126	CaseType=Combination	P=-98,6378023948484	V2=4,6189612591243	V3=0	T=0	M2=0	M3=-14,3005303519703	FrameElem=3-1
Frame=3 ElemStation=0,05	Station=0,05	OutputCase=STR126	CaseType=Combination	P=-98,3678023948484	V2=4,8184612591243	V3=0	T=0	M2=0	M3=-14,5365159149265	FrameElem=3-1

Società di Progetto
Brebemi SpA



Doc. N.
60235-0000-A00.doc

CODIFICA DOCUMENTO
04RCDII10000000000300A00

REV.
00

FOGLIO
257 di 628

Frame=3 Station=0,1 OutputCase=STR126 CaseType=Combination P=-98,0978023948484 V2=5,0059612591243 V3=0 T=0 M2=0 M3=-14,7821764778828 FrameElem=3-1 ElemStation=0,1
Frame=3 Station=0 OutputCase=STR127 CaseType=Combination P=-108,993714627212 V2=17,8132141948631 V3=0 T=0 M2=0 M3=-21,0450002139534 FrameElem=3-1 ElemStation=0
Frame=3 Station=0,05 OutputCase=STR127 CaseType=Combination P=-108,723714627212 V2=18,0127141948631 V3=0 T=0 M2=0 M3=-21,9406984236966 FrameElem=3-1 ElemStation=0,05
Frame=3 Station=0,1 OutputCase=STR127 CaseType=Combination P=-108,453714627212 V2=18,2002141948631 V3=0 T=0 M2=0 M3=-22,8460716334397 FrameElem=3-1 ElemStation=0,1
Frame=3 Station=0 OutputCase=STR128 CaseType=Combination P=-98,6378023954363 V2=22,3303783490974 V3=0 T=0 M2=0 M3=-11,8068619667529 FrameElem=3-1 ElemStation=0
Frame=3 Station=0,05 OutputCase=STR128 CaseType=Combination P=-98,3678023954363 V2=24,0984142865974 V3=0 T=0 M2=0 M3=-12,9676601810827 FrameElem=3-1 ElemStation=0,05
Frame=3 Station=0,1 OutputCase=STR128 CaseType=Combination P=-98,0978023954363 V2=25,8476345990974 V3=0 T=0 M2=0 M3=-14,2163898016626 FrameElem=3-1 ElemStation=0,1
Frame=3 Station=0 OutputCase=STR129 CaseType=Combination P=-23,8587146274221 V2=17,0381503882623 V3=0 T=0 M2=0 M3=-9,32866682628239 FrameElem=3-1 ElemStation=0
Frame=3 Station=0,05 OutputCase=STR129 CaseType=Combination P=-23,6587146274221 V2=17,2376503882623 V3=0 T=0 M2=0 M3=-10,1856118456955 FrameElem=3-1 ElemStation=0,05
Frame=3 Station=0,1 OutputCase=STR129 CaseType=Combination P=-23,4587146274221 V2=17,4251503882623 V3=0 T=0 M2=0 M3=-11,0522318651086 FrameElem=3-1 ElemStation=0,1
Frame=3 Station=0 OutputCase=STR130 CaseType=Combination P=-13,502802395646 V2=21,5553145424966 V3=0 T=0 M2=0 M3=-9,05285790818419E-02 FrameElem=3-1 ElemStation=0
Frame=3 Station=0,05 OutputCase=STR130 CaseType=Combination P=-13,302802395646 V2=23,3233504799966 V3=0 T=0 M2=0 M3=-1,21257360308167 FrameElem=3-1 ElemStation=0,05
Frame=3 Station=0,1 OutputCase=STR130 CaseType=Combination P=-13,102802395646 V2=25,0725707924966 V3=0 T=0 M2=0 M3=-2,4225500333315 FrameElem=3-1 ElemStation=0,1
Frame=3 Station=0 OutputCase=STR131 CaseType=Combination P=-17,9618023950894 V2=6,54594489852973 V3=0 T=0 M2=0 M3=-2,09644863508748 FrameElem=3-1 ElemStation=0
Frame=3 Station=0,05 OutputCase=STR131 CaseType=Combination P=-17,6918023950894 V2=6,97456989852973 V3=0 T=0 M2=0 M3=-2,43456838001397 FrameElem=3-1 ElemStation=0,05
Frame=3 Station=0,1 OutputCase=STR131 CaseType=Combination P=-17,4218023950894 V2=7,37754489852973 V3=0 T=0 M2=0 M3=-2,79347812494045 FrameElem=3-1 ElemStation=0,1
Frame=3 Station=0 OutputCase=STR132 CaseType=Combination P=-17,961802394973 V2=2,54346179020434 V3=0 T=0 M2=0 M3=-2,54188554729718 FrameElem=3-1 ElemStation=0
Frame=3 Station=0,05 OutputCase=STR132 CaseType=Combination P=-17,691802394973 V2=2,74296179020434 V3=0 T=0 M2=0 M3=-2,6740961368074 FrameElem=3-1 ElemStation=0,05
Frame=3 Station=0,1 OutputCase=STR132 CaseType=Combination P=-17,421802394973 V2=2,93046179020434 V3=0 T=0 M2=0 M3=-2,81598172631761 FrameElem=3-1 ElemStation=0,1
Frame=3 Station=0 OutputCase=STR133 CaseType=Combination P=-98,6378023948481 V2=3,51560661204269 V3=0 T=0 M2=0 M3=-13,6939776183173 FrameElem=3-1 ElemStation=0
Frame=3 Station=0,05 OutputCase=STR133 CaseType=Combination P=-98,3678023948481 V2=3,71510661204269 V3=0 T=0 M2=0 M3=-13,8747954489194 FrameElem=3-1 ElemStation=0,05
Frame=3 Station=0,1 OutputCase=STR133 CaseType=Combination P=-98,097802394848 V2=3,90260661204269 V3=0 T=0 M2=0 M3=-14,0652882795215 FrameElem=3-1 ElemStation=0,1
Frame=3 Station=0 OutputCase=STR134 CaseType=Combination P=-108,993714627212 V2=16,7098595477815 V3=0 T=0 M2=0 M3=-20,4384474803004 FrameElem=3-1 ElemStation=0
Frame=3 Station=0,05 OutputCase=STR134 CaseType=Combination P=-108,723714627212 V2=16,9093595477815 V3=0 T=0 M2=0 M3=-21,2789779576894 FrameElem=3-1 ElemStation=0,05
Frame=3 Station=0,1 OutputCase=STR134 CaseType=Combination P=-108,453714627212 V2=17,0968595477815 V3=0 T=0 M2=0 M3=-22,1291834350785 FrameElem=3-1 ElemStation=0,1
Frame=3 Station=0 OutputCase=STR135 CaseType=Combination P=-98,6378023954359 V2=21,2270237020158 V3=0 T=0 M2=0 M3=-11,2003092330998 FrameElem=3-1 ElemStation=0
Frame=3 Station=0,05 OutputCase=STR135 CaseType=Combination P=-98,3678023954359 V2=22,9950596395158 V3=0 T=0 M2=0 M3=-12,3059397150756 FrameElem=3-1 ElemStation=0,05
Frame=3 Station=0,1 OutputCase=STR135 CaseType=Combination P=-98,0978023954359 V2=24,7442799520158 V3=0 T=0 M2=0 M3=-13,4995016033014 FrameElem=3-1 ElemStation=0,1
Frame=3 Station=0 OutputCase=STR136 CaseType=Combination P=-23,8587146274218 V2=15,9347957411807 V3=0 T=0 M2=0 M3=-8,72211409262933 FrameElem=3-1 ElemStation=0
Frame=3 Station=0,05 OutputCase=STR136 CaseType=Combination P=-23,6587146274218 V2=16,1342957411807 V3=0 T=0 M2=0 M3=-9,52389137968836 FrameElem=3-1 ElemStation=0,05
Frame=3 Station=0,1 OutputCase=STR136 CaseType=Combination P=-23,4587146274218 V2=16,3217957411807 V3=0 T=0 M2=0 M3=-10,3353436667474 FrameElem=3-1 ElemStation=0,1
Frame=3 Station=0 OutputCase=STR137 CaseType=Combination P=-13,5028023956456 V2=20,451959895415 V3=0 T=0 M2=0 M3=0,516024154571224 FrameElem=3-1 ElemStation=0
Frame=3 Station=0,05 OutputCase=STR137 CaseType=Combination P=-13,3028023956457 V2=22,219995832915 V3=0 T=0 M2=0 M3=0,550853137074526 FrameElem=3-1 ElemStation=0,05
Frame=3 Station=0,1 OutputCase=STR137 CaseType=Combination P=-13,1028023956457 V2=23,969216145415 V3=0 T=0 M2=0 M3=-1,70566183497028 FrameElem=3-1 ElemStation=0,1
Frame=3 Station=0 OutputCase=STR138 CaseType=Combination P=-17,9618023950894 V2=6,54594489852973 V3=0 T=0 M2=0 M3=-2,09644863508748 FrameElem=3-1 ElemStation=0
Frame=3 Station=0,05 OutputCase=STR138 CaseType=Combination P=-17,6918023950894 V2=6,97456989852973 V3=0 T=0 M2=0 M3=-2,43456838001397 FrameElem=3-1 ElemStation=0,05
Frame=3 Station=0,1 OutputCase=STR138 CaseType=Combination P=-17,4218023950894 V2=7,37754489852973 V3=0 T=0 M2=0 M3=-2,79347812494045 FrameElem=3-1 ElemStation=0,1
Frame=3 Station=0 OutputCase=STR139 CaseType=Combination P=-17,961802394973 V2=2,54346179020434 V3=0 T=0 M2=0 M3=-2,54188554729718 FrameElem=3-1 ElemStation=0
Frame=3 Station=0,05 OutputCase=STR139 CaseType=Combination P=-17,691802394973 V2=2,74296179020434 V3=0 T=0 M2=0 M3=-2,6740961368074 FrameElem=3-1 ElemStation=0,05
Frame=3 Station=0,1 OutputCase=STR139 CaseType=Combination P=-17,421802394973 V2=2,93046179020434 V3=0 T=0 M2=0 M3=-2,81598172631761 FrameElem=3-1 ElemStation=0,1
Frame=3 Station=0 OutputCase=STR140 CaseType=Combination P=-98,6378023948481 V2=3,51560661204269 V3=0 T=0 M2=0 M3=-13,6939776183173 FrameElem=3-1 ElemStation=0
Frame=3 Station=0,05 OutputCase=STR140 CaseType=Combination P=-98,3678023948481 V2=3,71510661204269 V3=0 T=0 M2=0 M3=-13,8747954489194 FrameElem=3-1 ElemStation=0,05
Frame=3 Station=0,1 OutputCase=STR140 CaseType=Combination P=-98,097802394848 V2=3,90260661204269 V3=0 T=0 M2=0 M3=-14,0652882795215 FrameElem=3-1 ElemStation=0,1
Frame=3 Station=0 OutputCase=STR141 CaseType=Combination P=-108,993714627212 V2=16,7098595477815 V3=0 T=0 M2=0 M3=-20,4384474803004 FrameElem=3-1 ElemStation=0

Società di Progetto
Brebemi SpA



Doc. N.
60235-0000-A00.doc

CODIFICA DOCUMENTO
04RCDII10000000000300A00

REV.
00

FOGLIO
258 di 628

Frame=3 ElemStation=0,05	Station=0,05	OutputCase=STR141	CaseType=Combination	P=-108,723714627212	V2=16,9093595477815	V3=0	T=0	M2=0	M3=-21,2789779576894	FrameElem=3-1
Frame=3 ElemStation=0,1	Station=0,1	OutputCase=STR141	CaseType=Combination	P=-108,453714627212	V2=17,0968595477815	V3=0	T=0	M2=0	M3=-22,1291834350785	FrameElem=3-1
Frame=3 ElemStation=0	Station=0	OutputCase=STR142	CaseType=Combination	P=-98,6378023954359	V2=21,2270237020158	V3=0	T=0	M2=0	M3=-11,2003092330998	FrameElem=3-1
Frame=3 ElemStation=0,05	Station=0,05	OutputCase=STR142	CaseType=Combination	P=-98,3678023954359	V2=22,9950596395158	V3=0	T=0	M2=0	M3=-12,3059397150756	FrameElem=3-1
Frame=3 ElemStation=0,1	Station=0,1	OutputCase=STR142	CaseType=Combination	P=-98,0978023954359	V2=24,7442799520158	V3=0	T=0	M2=0	M3=-13,4995016033014	FrameElem=3-1
Frame=3 ElemStation=0	Station=0	OutputCase=STR143	CaseType=Combination	P=-23,8587146274218	V2=15,9347957411807	V3=0	T=0	M2=0	M3=-8,72211409262933	FrameElem=3-1
Frame=3 ElemStation=0,05	Station=0,05	OutputCase=STR143	CaseType=Combination	P=-23,6587146274218	V2=16,1342957411807	V3=0	T=0	M2=0	M3=-9,52389137968836	FrameElem=3-1
Frame=3 ElemStation=0,1	Station=0,1	OutputCase=STR143	CaseType=Combination	P=-23,4587146274218	V2=16,3217957411807	V3=0	T=0	M2=0	M3=-10,3353436667474	FrameElem=3-1
Frame=3 ElemStation=0	Station=0	OutputCase=STR144	CaseType=Combination	P=-13,5028023956456	V2=20,451959895415	V3=0	T=0	M2=0	M3=0,516024154571224	FrameElem=3-1
Frame=3 ElemStation=0,05	Station=0,05	OutputCase=STR144	CaseType=Combination	P=-13,3028023956457	V2=22,219995832915	V3=0	T=0	M2=0	M3=-0,550853137074526	FrameElem=3-1
Frame=3 ElemStation=0,1	Station=0,1	OutputCase=STR144	CaseType=Combination	P=-13,1028023956457	V2=23,969216145415	V3=0	T=0	M2=0	M3=-1,70566183497028	FrameElem=3-1
Frame=3 ElemStation=0	Station=0	OutputCase=STR145	CaseType=Combination	P=-17,1989999996728	V2=5,79670500165446	V3=0	T=0	M2=0	M3=-0,838430486474907	FrameElem=3-1
Frame=3 ElemStation=0,05	Station=0,05	OutputCase=STR145	CaseType=Combination	P=-16,9289999996728	V2=6,22533000165446	V3=0	T=0	M2=0	M3=-1,13908823655763	FrameElem=3-1
Frame=3 ElemStation=0,1	Station=0,1	OutputCase=STR145	CaseType=Combination	P=-16,6589999996728	V2=6,62830500165447	V3=0	T=0	M2=0	M3=-1,46053598664035	FrameElem=3-1
Frame=3 ElemStation=0	Station=0	OutputCase=STR146	CaseType=Combination	P=-17,1989999995564	V2=1,79422189332907	V3=0	T=0	M2=0	M3=-1,2838673986846	FrameElem=3-1
Frame=3 ElemStation=0,05	Station=0,05	OutputCase=STR146	CaseType=Combination	P=-16,9289999995564	V2=1,99372189332907	V3=0	T=0	M2=0	M3=-1,37861599335106	FrameElem=3-1
Frame=3 ElemStation=0,1	Station=0,1	OutputCase=STR146	CaseType=Combination	P=-16,6589999995564	V2=2,18122189332907	V3=0	T=0	M2=0	M3=-1,48303958801751	FrameElem=3-1
Frame=3 ElemStation=0	Station=0	OutputCase=STR147	CaseType=Combination	P=-124,76699999939	V2=3,45819987147407	V3=0	T=0	M2=0	M3=-16,3555077379291	FrameElem=3-1
Frame=3 ElemStation=0,05	Station=0,05	OutputCase=STR147	CaseType=Combination	P=-124,49699999939	V2=3,65769987147407	V3=0	T=0	M2=0	M3=-16,5334552315028	FrameElem=3-1
Frame=3 ElemStation=0,1	Station=0,1	OutputCase=STR147	CaseType=Combination	P=-124,22699999939	V2=3,84519987147407	V3=0	T=0	M2=0	M3=-16,7210777250765	FrameElem=3-1
Frame=3 ElemStation=0	Station=0	OutputCase=STR148	CaseType=Combination	P=-137,948781582728	V2=20,1991032667371	V3=0	T=0	M2=0	M3=-24,9268412608957	FrameElem=3-1
Frame=3 ElemStation=0,05	Station=0,05	OutputCase=STR148	CaseType=Combination	P=-137,678781582728	V2=20,3986032667371	V3=0	T=0	M2=0	M3=-25,9418339242325	FrameElem=3-1
Frame=3 ElemStation=0,1	Station=0,1	OutputCase=STR148	CaseType=Combination	P=-137,408781582728	V2=20,5861032667371	V3=0	T=0	M2=0	M3=-26,9665015875694	FrameElem=3-1
Frame=3 ElemStation=0	Station=0	OutputCase=STR149	CaseType=Combination	P=-124,767000000135	V2=25,7392616219964	V3=0	T=0	M2=0	M3=-13,1790955283757	FrameElem=3-1
Frame=3 ElemStation=0,05	Station=0,05	OutputCase=STR149	CaseType=Combination	P=-124,497000000135	V2=27,9537678719964	V3=0	T=0	M2=0	M3=-14,5214901719755	FrameElem=3-1
Frame=3 ElemStation=0,1	Station=0,1	OutputCase=STR149	CaseType=Combination	P=-124,227000000135	V2=30,1517366219964	V3=0	T=0	M2=0	M3=-15,9741966905753	FrameElem=3-1
Frame=3 ElemStation=0	Station=0	OutputCase=STR150	CaseType=Combination	P=-25,9217815829789	V2=19,0999911861902	V3=0	T=0	M2=0	M3=-9,49314384955128	FrameElem=3-1
Frame=3 ElemStation=0,05	Station=0,05	OutputCase=STR150	CaseType=Combination	P=-25,7217815829789	V2=19,2994911861902	V3=0	T=0	M2=0	M3=-10,4531809088608	FrameElem=3-1
Frame=3 ElemStation=0,1	Station=0,1	OutputCase=STR150	CaseType=Combination	P=-25,5217815829789	V2=19,4869911861902	V3=0	T=0	M2=0	M3=-11,4228929681703	FrameElem=3-1
Frame=3 ElemStation=0	Station=0	OutputCase=STR151	CaseType=Combination	P=-12,7400000003863	V2=24,6401495414495	V3=0	T=0	M2=0	M3=2,2546018829687	FrameElem=3-1
Frame=3 ElemStation=0,05	Station=0,05	OutputCase=STR151	CaseType=Combination	P=-12,5400000003863	V2=26,8546557914495	V3=0	T=0	M2=0	M3=0,967162843396222	FrameElem=3-1
Frame=3 ElemStation=0,1	Station=0,1	OutputCase=STR151	CaseType=Combination	P=-12,3400000003863	V2=29,0526245414495	V3=0	T=0	M2=0	M3=-0,430588071176255	FrameElem=3-1
Frame=3 ElemStation=0	Station=0	OutputCase=STR152	CaseType=Combination	P=-127,600825019416	V2=35,0407545452562	V3=0	T=0	M2=0	M3=-30,2201831888789	FrameElem=3-1
Frame=3 ElemStation=0,05	Station=0,05	OutputCase=STR152	CaseType=Combination	P=-127,330825019416	V2=35,2402545452562	V3=0	T=0	M2=0	M3=-31,9772584161417	FrameElem=3-1
Frame=3 ElemStation=0,1	Station=0,1	OutputCase=STR152	CaseType=Combination	P=-127,060825019416	V2=35,4277545452562	V3=0	T=0	M2=0	M3=-33,7440086434045	FrameElem=3-1
Frame=3 ElemStation=0	Station=0	OutputCase=STR153	CaseType=Combination	P=-97,8749999994315	V2=2,76636671516742	V3=0	T=0	M2=0	M3=-12,4359594697047	FrameElem=3-1
Frame=3 ElemStation=0,05	Station=0,05	OutputCase=STR153	CaseType=Combination	P=-97,6049999994315	V2=2,96586671516742	V3=0	T=0	M2=0	M3=-12,5793153054631	FrameElem=3-1
Frame=3 ElemStation=0,1	Station=0,1	OutputCase=STR153	CaseType=Combination	P=-97,3349999994315	V2=3,15336671516742	V3=0	T=0	M2=0	M3=-12,7323461412214	FrameElem=3-1
Frame=3 ElemStation=0	Station=0	OutputCase=STR154	CaseType=Combination	P=-108,230912231796	V2=15,9606196509062	V3=0	T=0	M2=0	M3=-19,1804293316878	FrameElem=3-1
Frame=3 ElemStation=0,05	Station=0,05	OutputCase=STR154	CaseType=Combination	P=-107,960912231796	V2=16,1601196509062	V3=0	T=0	M2=0	M3=-19,9834978142331	FrameElem=3-1
Frame=3 ElemStation=0,1	Station=0,1	OutputCase=STR154	CaseType=Combination	P=-107,690912231796	V2=16,3476196509062	V3=0	T=0	M2=0	M3=-20,7962412967784	FrameElem=3-1
Frame=3 ElemStation=0	Station=0	OutputCase=STR155	CaseType=Combination	P=-97,8750000000194	V2=20,4777838051405	V3=0	T=0	M2=0	M3=-9,94229108448723	FrameElem=3-1
Frame=3 ElemStation=0,05	Station=0,05	OutputCase=STR155	CaseType=Combination	P=-97,6050000000194	V2=22,2458197426405	V3=0	T=0	M2=0	M3=-11,0104595716193	FrameElem=3-1
Frame=3 ElemStation=0,1	Station=0,1	OutputCase=STR155	CaseType=Combination	P=-97,3350000000194	V2=23,9950400551405	V3=0	T=0	M2=0	M3=-12,1665594650013	FrameElem=3-1

Società di Progetto
Brebemi SpA



Doc. N.
60235-0000-A00.doc

CODIFICA DOCUMENTO
04RCDII10000000000300A00

REV.
00

FOGLIO
259 di 628

Frame=3 ElemStation=0	Station=0	OutputCase=STR156	CaseType=Combination	P=-23,0959122320052	V2=15,1855558443054	V3=0	T=0	M2=0	M3=-7,46409594401675	FrameElem=3-1
Frame=3 ElemStation=0,05	Station=0,05	OutputCase=STR156	CaseType=Combination	P=-22,8959122320052	V2=15,3850558443054	V3=0	T=0	M2=0	M3=-8,22841123623202	FrameElem=3-1
Frame=3 ElemStation=0,1	Station=0,1	OutputCase=STR156	CaseType=Combination	P=-22,6959122320052	V2=15,5725558443054	V3=0	T=0	M2=0	M3=-9,00240152844729	FrameElem=3-1
Frame=3 ElemStation=0	Station=0	OutputCase=STR157	CaseType=Combination	P=-12,740000002291	V2=19,702719985397	V3=0	T=0	M2=0	M3=1,7740423031838	FrameElem=3-1
Frame=3 ElemStation=0,05	Station=0,05	OutputCase=STR157	CaseType=Combination	P=-12,540000002291	V2=21,4707559360397	V3=0	T=0	M2=0	M3=0,744627006381811	FrameElem=3-1
Frame=3 ElemStation=0,1	Station=0,1	OutputCase=STR157	CaseType=Combination	P=-12,340000002291	V2=23,2199762485397	V3=0	T=0	M2=0	M3=0,372719696670176	FrameElem=3-1
Frame=3 ElemStation=0	Station=0	OutputCase=STR158	CaseType=Combination	P=-17,19899999673	V2=6,34838232519527	V3=0	T=0	M2=0	M3=-1,14170685330144	FrameElem=3-1
Frame=3 ElemStation=0,05	Station=0,05	OutputCase=STR158	CaseType=Combination	P=-16,92899999673	V2=6,77700732519527	V3=0	T=0	M2=0	M3=-1,4699484695612	FrameElem=3-1
Frame=3 ElemStation=0,1	Station=0,1	OutputCase=STR158	CaseType=Combination	P=-16,65899999673	V2=7,17998232519527	V3=0	T=0	M2=0	M3=-1,81898008582097	FrameElem=3-1
Frame=3 ElemStation=0	Station=0	OutputCase=STR159	CaseType=Combination	P=-17,198999995566	V2=2,34589921686987	V3=0	T=0	M2=0	M3=-1,58714376551114	FrameElem=3-1
Frame=3 ElemStation=0,05	Station=0,05	OutputCase=STR159	CaseType=Combination	P=-16,928999995566	V2=2,54539921686987	V3=0	T=0	M2=0	M3=-1,70947622635463	FrameElem=3-1
Frame=3 ElemStation=0,1	Station=0,1	OutputCase=STR159	CaseType=Combination	P=-16,658999995566	V2=2,73289921686988	V3=0	T=0	M2=0	M3=-1,84148368719813	FrameElem=3-1
Frame=3 ElemStation=0	Station=0	OutputCase=STR160	CaseType=Combination	P=-97,874999994317	V2=3,31804403870823	V3=0	T=0	M2=0	M3=-12,7392358365312	FrameElem=3-1
Frame=3 ElemStation=0,05	Station=0,05	OutputCase=STR160	CaseType=Combination	P=-97,604999994317	V2=3,51754403870822	V3=0	T=0	M2=0	M3=-12,9101755384666	FrameElem=3-1
Frame=3 ElemStation=0,1	Station=0,1	OutputCase=STR160	CaseType=Combination	P=-97,334999994316	V2=3,70504403870823	V3=0	T=0	M2=0	M3=-13,090790240402	FrameElem=3-1
Frame=3 ElemStation=0	Station=0	OutputCase=STR161	CaseType=Combination	P=-108,230912231796	V2=16,512296974447	V3=0	T=0	M2=0	M3=-19,4837056985143	FrameElem=3-1
Frame=3 ElemStation=0,05	Station=0,05	OutputCase=STR161	CaseType=Combination	P=-107,960912231796	V2=16,711796974447	V3=0	T=0	M2=0	M3=-20,3143580472367	FrameElem=3-1
Frame=3 ElemStation=0,1	Station=0,1	OutputCase=STR161	CaseType=Combination	P=-107,690912231796	V2=16,899296974447	V3=0	T=0	M2=0	M3=-21,154685395959	FrameElem=3-1
Frame=3 ElemStation=0	Station=0	OutputCase=STR162	CaseType=Combination	P=-97,875000000195	V2=21,0294611286813	V3=0	T=0	M2=0	M3=-10,2455674513138	FrameElem=3-1
Frame=3 ElemStation=0,05	Station=0,05	OutputCase=STR162	CaseType=Combination	P=-97,605000000195	V2=22,7974970661813	V3=0	T=0	M2=0	M3=-11,3413198046228	FrameElem=3-1
Frame=3 ElemStation=0,1	Station=0,1	OutputCase=STR162	CaseType=Combination	P=-97,335000000195	V2=24,5467173786813	V3=0	T=0	M2=0	M3=-12,5250035641819	FrameElem=3-1
Frame=3 ElemStation=0	Station=0	OutputCase=STR163	CaseType=Combination	P=-23,0959122320054	V2=15,7373231678462	V3=0	T=0	M2=0	M3=-7,76737231084328	FrameElem=3-1
Frame=3 ElemStation=0,05	Station=0,05	OutputCase=STR163	CaseType=Combination	P=-22,8959122320054	V2=15,9367331678462	V3=0	T=0	M2=0	M3=-8,5592714692356	FrameElem=3-1
Frame=3 ElemStation=0,1	Station=0,1	OutputCase=STR163	CaseType=Combination	P=-22,6959122320054	V2=16,1242331678462	V3=0	T=0	M2=0	M3=-9,36084562762791	FrameElem=3-1
Frame=3 ElemStation=0	Station=0	OutputCase=STR164	CaseType=Combination	P=-12,740000002292	V2=20,2543973220806	V3=0	T=0	M2=0	M3=1,47076593635726	FrameElem=3-1
Frame=3 ElemStation=0,05	Station=0,05	OutputCase=STR164	CaseType=Combination	P=-12,540000002292	V2=22,0224332595806	V3=0	T=0	M2=0	M3=0,413766773378237	FrameElem=3-1
Frame=3 ElemStation=0,1	Station=0,1	OutputCase=STR164	CaseType=Combination	P=-12,340000002292	V2=23,7716535720806	V3=0	T=0	M2=0	M3=-0,73116379585079	FrameElem=3-1
Frame=3 ElemStation=0	Station=0	OutputCase=STR165	CaseType=Combination	P=-17,198999996727	V2=5,24502767811366	V3=0	T=0	M2=0	M3=-0,535154119648374	FrameElem=3-1
Frame=3 ElemStation=0,05	Station=0,05	OutputCase=STR165	CaseType=Combination	P=-16,928999996727	V2=5,67365267811366	V3=0	T=0	M2=0	M3=-0,808228003554057	FrameElem=3-1
Frame=3 ElemStation=0,1	Station=0,1	OutputCase=STR165	CaseType=Combination	P=-16,658999996727	V2=6,0766267811366	V3=0	T=0	M2=0	M3=-1,10209188745974	FrameElem=3-1
Frame=3 ElemStation=0	Station=0	OutputCase=STR166	CaseType=Combination	P=-17,198999995563	V2=1,24254456978826	V3=0	T=0	M2=0	M3=-0,980591031858072	FrameElem=3-1
Frame=3 ElemStation=0,05	Station=0,05	OutputCase=STR166	CaseType=Combination	P=-16,928999995563	V2=1,44204456978826	V3=0	T=0	M2=0	M3=-1,04775576034748	FrameElem=3-1
Frame=3 ElemStation=0,1	Station=0,1	OutputCase=STR166	CaseType=Combination	P=-16,658999995563	V2=1,62954456978826	V3=0	T=0	M2=0	M3=-1,124594888369	FrameElem=3-1
Frame=3 ElemStation=0	Station=0	OutputCase=STR167	CaseType=Combination	P=-97,874999994313	V2=2,21468939162661	V3=0	T=0	M2=0	M3=-12,1326831028782	FrameElem=3-1
Frame=3 ElemStation=0,05	Station=0,05	OutputCase=STR167	CaseType=Combination	P=-97,604999994313	V2=2,41418939162661	V3=0	T=0	M2=0	M3=-12,2484550724595	FrameElem=3-1
Frame=3 ElemStation=0,1	Station=0,1	OutputCase=STR167	CaseType=Combination	P=-97,334999994313	V2=2,60168939162661	V3=0	T=0	M2=0	M3=-12,3739020420408	FrameElem=3-1
Frame=3 ElemStation=0	Station=0	OutputCase=STR168	CaseType=Combination	P=-108,230912231795	V2=15,4089423273654	V3=0	T=0	M2=0	M3=-18,8771529648612	FrameElem=3-1
Frame=3 ElemStation=0,05	Station=0,05	OutputCase=STR168	CaseType=Combination	P=-107,960912231795	V2=15,6084423273654	V3=0	T=0	M2=0	M3=-19,6526375812295	FrameElem=3-1
Frame=3 ElemStation=0,1	Station=0,1	OutputCase=STR168	CaseType=Combination	P=-107,690912231795	V2=15,7959423273654	V3=0	T=0	M2=0	M3=-20,4377971975978	FrameElem=3-1
Frame=3 ElemStation=0	Station=0	OutputCase=STR169	CaseType=Combination	P=-97,875000000192	V2=19,9261064815997	V3=0	T=0	M2=0	M3=-9,6390147176607	FrameElem=3-1
Frame=3 ElemStation=0,05	Station=0,05	OutputCase=STR169	CaseType=Combination	P=-97,605000000192	V2=21,6941424190997	V3=0	T=0	M2=0	M3=-10,6795993386157	FrameElem=3-1
Frame=3 ElemStation=0,1	Station=0,1	OutputCase=STR169	CaseType=Combination	P=-97,335000000192	V2=23,4433627315997	V3=0	T=0	M2=0	M3=-11,8081153658207	FrameElem=3-1
Frame=3 ElemStation=0	Station=0	OutputCase=STR170	CaseType=Combination	P=-23,0959122320051	V2=14,6338785207646	V3=0	T=0	M2=0	M3=-7,16081957719022	FrameElem=3-1
Frame=3 ElemStation=0,05	Station=0,05	OutputCase=STR170	CaseType=Combination	P=-22,8959122320051	V2=14,8333785207646	V3=0	T=0	M2=0	M3=-7,89755100322845	FrameElem=3-1

Società di Progetto
Brebemi SpA



Doc. N.
60235-0000-A00.doc

CODIFICA DOCUMENTO
04RCDII10000000000300A00

REV.
00

FOGLIO
260 di 628

Frame=3 ElemStation=0,1	Station=0,1	OutputCase=STR170	CaseType=Combination	P=-22,6959122320051	V2=15,0208785207646	V3=0	T=0	M2=0	M3=-8,64395742926668	FrameElem=3-1
Frame=3 ElemStation=0	Station=0	OutputCase=STR171	CaseType=Combination	P=-12,7400000002289	V2=19,1510426749989	V3=0	T=0	M2=0	M3=2,07731867001033	FrameElem=3-1
Frame=3 ElemStation=0,05	Station=0,05	OutputCase=STR171	CaseType=Combination	P=-12,5400000002289	V2=20,9190786124989	V3=0	T=0	M2=0	M3=1,07548723938538	FrameElem=3-1
Frame=3 ElemStation=0,1	Station=0,1	OutputCase=STR171	CaseType=Combination	P=-12,3400000002289	V2=22,6682989249989	V3=0	T=0	M2=0	M3=-1,42755974895624E-02	FrameElem=3-1
Frame=3 ElemStation=0	Station=0	OutputCase=STR172	CaseType=Combination	P=-16,7413185624229	V2=5,56783199294563	V3=0	T=0	M2=0	M3=-0,204930144037976	FrameElem=3-1
Frame=3 ElemStation=0,05	Station=0,05	OutputCase=STR172	CaseType=Combination	P=-16,471318562423	V2=5,99645699294563	V3=0	T=0	M2=0	M3=-0,494144243685257	FrameElem=3-1
Frame=3 ElemStation=0,1	Station=0,1	OutputCase=STR172	CaseType=Combination	P=-16,2013185624229	V2=6,39943199294563	V3=0	T=0	M2=0	M3=-0,804148343332539	FrameElem=3-1
Frame=3 ElemStation=0	Station=0	OutputCase=STR173	CaseType=Combination	P=-16,7413185623065	V2=1,56534888462023	V3=0	T=0	M2=0	M3=-0,650367056247674	FrameElem=3-1
Frame=3 ElemStation=0,05	Station=0,05	OutputCase=STR173	CaseType=Combination	P=-16,4713185623065	V2=1,76484888462023	V3=0	T=0	M2=0	M3=-0,733672000478685	FrameElem=3-1
Frame=3 ElemStation=0,1	Station=0,1	OutputCase=STR173	CaseType=Combination	P=-16,2013185623065	V2=1,95234888462023	V3=0	T=0	M2=0	M3=-0,826651944709697	FrameElem=3-1
Frame=3 ElemStation=0	Station=0	OutputCase=STR174	CaseType=Combination	P=-97,4173185621816	V2=2,53749370645858	V3=0	T=0	M2=0	M3=-11,8024591272678	FrameElem=3-1
Frame=3 ElemStation=0,05	Station=0,05	OutputCase=STR174	CaseType=Combination	P=-97,1473185621816	V2=2,73699370645858	V3=0	T=0	M2=0	M3=-11,9343713125907	FrameElem=3-1
Frame=3 ElemStation=0,1	Station=0,1	OutputCase=STR174	CaseType=Combination	P=-96,8773185621816	V2=2,92449370645858	V3=0	T=0	M2=0	M3=-12,0759584979136	FrameElem=3-1
Frame=3 ElemStation=0	Station=0	OutputCase=STR175	CaseType=Combination	P=-107,773230794546	V2=15,7317466421973	V3=0	T=0	M2=0	M3=-18,5469289892508	FrameElem=3-1
Frame=3 ElemStation=0,05	Station=0,05	OutputCase=STR175	CaseType=Combination	P=-107,503230794546	V2=15,9312466421973	V3=0	T=0	M2=0	M3=-19,3385538213607	FrameElem=3-1
Frame=3 ElemStation=0,1	Station=0,1	OutputCase=STR175	CaseType=Combination	P=-107,233230794546	V2=16,1187466421973	V3=0	T=0	M2=0	M3=-20,1398536534706	FrameElem=3-1
Frame=3 ElemStation=0	Station=0	OutputCase=STR176	CaseType=Combination	P=-97,4173185627695	V2=20,2489107964317	V3=0	T=0	M2=0	M3=-9,3087907420503	FrameElem=3-1
Frame=3 ElemStation=0,05	Station=0,05	OutputCase=STR176	CaseType=Combination	P=-97,1473185627695	V2=22,0169467339317	V3=0	T=0	M2=0	M3=-10,3655155787469	FrameElem=3-1
Frame=3 ElemStation=0,1	Station=0,1	OutputCase=STR176	CaseType=Combination	P=-96,8773185627695	V2=23,7661670464317	V3=0	T=0	M2=0	M3=-11,5101718216935	FrameElem=3-1
Frame=3 ElemStation=0	Station=0	OutputCase=STR177	CaseType=Combination	P=-22,6382307947553	V2=14,9566828355966	V3=0	T=0	M2=0	M3=-6,83059560157982	FrameElem=3-1
Frame=3 ElemStation=0,05	Station=0,05	OutputCase=STR177	CaseType=Combination	P=-22,4382307947553	V2=15,1561828355966	V3=0	T=0	M2=0	M3=-7,58346724335965	FrameElem=3-1
Frame=3 ElemStation=0,1	Station=0,1	OutputCase=STR177	CaseType=Combination	P=-22,2382307947553	V2=15,3436828355966	V3=0	T=0	M2=0	M3=-8,34601388513948	FrameElem=3-1
Frame=3 ElemStation=0	Station=0	OutputCase=STR178	CaseType=Combination	P=-12,2823185629792	V2=19,4738469898309	V3=0	T=0	M2=0	M3=2,40754264562073	FrameElem=3-1
Frame=3 ElemStation=0,05	Station=0,05	OutputCase=STR178	CaseType=Combination	P=-12,0823185629792	V2=21,2418829273309	V3=0	T=0	M2=0	M3=1,38957099925418	FrameElem=3-1
Frame=3 ElemStation=0,1	Station=0,1	OutputCase=STR178	CaseType=Combination	P=-11,8823185629792	V2=22,9911032398309	V3=0	T=0	M2=0	M3=0,283667946637639	FrameElem=3-1
Frame=3 ElemStation=0	Station=0	OutputCase=STR179	CaseType=Combination	P=-16,7413185624229	V2=5,56783199294563	V3=0	T=0	M2=0	M3=-0,204930144037976	FrameElem=3-1
Frame=3 ElemStation=0,05	Station=0,05	OutputCase=STR179	CaseType=Combination	P=-16,471318562423	V2=5,99645699294563	V3=0	T=0	M2=0	M3=-0,494144243685257	FrameElem=3-1
Frame=3 ElemStation=0,1	Station=0,1	OutputCase=STR179	CaseType=Combination	P=-16,2013185624229	V2=6,39943199294563	V3=0	T=0	M2=0	M3=-0,804148343332539	FrameElem=3-1
Frame=3 ElemStation=0	Station=0	OutputCase=STR180	CaseType=Combination	P=-17,6566814369227	V2=6,0255780103633	V3=0	T=0	M2=0	M3=-1,47193082891184	FrameElem=3-1
Frame=3 ElemStation=0,05	Station=0,05	OutputCase=STR180	CaseType=Combination	P=-17,3866814369227	V2=6,4542030103633	V3=0	T=0	M2=0	M3=-1,78403222943	FrameElem=3-1
Frame=3 ElemStation=0,1	Station=0,1	OutputCase=STR180	CaseType=Combination	P=-17,1166814369227	V2=6,8571780103633	V3=0	T=0	M2=0	M3=-2,11692362994817	FrameElem=3-1
Frame=3 ElemStation=0	Station=0	OutputCase=STR181	CaseType=Combination	P=-17,6566814368063	V2=2,02309490203791	V3=0	T=0	M2=0	M3=-1,91736774112154	FrameElem=3-1
Frame=3 ElemStation=0,05	Station=0,05	OutputCase=STR181	CaseType=Combination	P=-17,3866814368063	V2=2,22259490203791	V3=0	T=0	M2=0	M3=-2,0235998622343	FrameElem=3-1
Frame=3 ElemStation=0,1	Station=0,1	OutputCase=STR181	CaseType=Combination	P=-17,1166814368063	V2=2,41009490203791	V3=0	T=0	M2=0	M3=-2,13942723132533	FrameElem=3-1
Frame=3 ElemStation=0	Station=0	OutputCase=STR182	CaseType=Combination	P=-98,3326814366814	V2=2,99523972387626	V3=0	T=0	M2=0	M3=-13,0694598121416	FrameElem=3-1
Frame=3 ElemStation=0,05	Station=0,05	OutputCase=STR182	CaseType=Combination	P=-98,0626814366814	V2=3,19473972387626	V3=0	T=0	M2=0	M3=-13,2242592983354	FrameElem=3-1
Frame=3 ElemStation=0,1	Station=0,1	OutputCase=STR182	CaseType=Combination	P=-97,7926814366814	V2=3,38223972387626	V3=0	T=0	M2=0	M3=-13,3887337845292	FrameElem=3-1
Frame=3 ElemStation=0	Station=0	OutputCase=STR183	CaseType=Combination	P=-108,688593669045	V2=16,18942659615	V3=0	T=0	M2=0	M3=-19,8139296741247	FrameElem=3-1
Frame=3 ElemStation=0,05	Station=0,05	OutputCase=STR183	CaseType=Combination	P=-108,418593669045	V2=16,388992659615	V3=0	T=0	M2=0	M3=-20,6284418071055	FrameElem=3-1
Frame=3 ElemStation=0,1	Station=0,1	OutputCase=STR183	CaseType=Combination	P=-108,148593669045	V2=16,576492659615	V3=0	T=0	M2=0	M3=-21,4526289400862	FrameElem=3-1
Frame=3 ElemStation=0	Station=0	OutputCase=STR184	CaseType=Combination	P=-98,3326814372693	V2=20,7066568138494	V3=0	T=0	M2=0	M3=-10,5757914269242	FrameElem=3-1
Frame=3 ElemStation=0,05	Station=0,05	OutputCase=STR184	CaseType=Combination	P=-98,0626814372693	V2=22,4746927513494	V3=0	T=0	M2=0	M3=-11,6554035644916	FrameElem=3-1
Frame=3 ElemStation=0,1	Station=0,1	OutputCase=STR184	CaseType=Combination	P=-97,7926814372693	V2=24,2239130638494	V3=0	T=0	M2=0	M3=-12,8229471083091	FrameElem=3-1
Frame=3 ElemStation=0	Station=0	OutputCase=STR185	CaseType=Combination	P=-23,5535936692551	V2=15,4144288530142	V3=0	T=0	M2=0	M3=-8,09759628645368	FrameElem=3-1

Società di Progetto
Brebemi SpA

	Doc. N. 60235-00000-A00.doc	CODIFICA DOCUMENTO 04RCDII10000000000300A00	REV. 00	FOGLIO 261 di 628
--	--------------------------------	--	------------	----------------------

Frame=3 ElemStation=0,05	Station=0,05	OutputCase=STR185	CaseType=Combination	P=-23,3535936692551	V2=15,6139288530142	V3=0	T=0	M2=0	M3=-8,87335522910439	FrameElem=3-1
Frame=3 ElemStation=0,1	Station=0,1	OutputCase=STR185	CaseType=Combination	P=-23,1535936692551	V2=15,8014288530142	V3=0	T=0	M2=0	M3=-9,65878917175511	FrameElem=3-1
Frame=3 ElemStation=0	Station=0	OutputCase=STR186	CaseType=Combination	P=-13,1976814374789	V2=19,9315930072486	V3=0	T=0	M2=0	M3=1,14054196074687	FrameElem=3-1
Frame=3 ElemStation=0,05	Station=0,05	OutputCase=STR186	CaseType=Combination	P=-12,997681437479	V2=21,6996289447486	V3=0	T=0	M2=0	M3=9,96830135094378E-02	FrameElem=3-1
Frame=3 ElemStation=0,1	Station=0,1	OutputCase=STR186	CaseType=Combination	P=-12,7976814374789	V2=23,4488492572486	V3=0	T=0	M2=0	M3=-1,02910733997799	FrameElem=3-1
Frame=3 ElemStation=0	Station=0	OutputCase=STR187	CaseType=Combination	P=-17,6566814369227	V2=6,0255780103633	V3=0	T=0	M2=0	M3=-1,47193082891184	FrameElem=3-1
Frame=3 ElemStation=0,05	Station=0,05	OutputCase=STR187	CaseType=Combination	P=-17,3866814369227	V2=6,4542030103633	V3=0	T=0	M2=0	M3=-1,78403222943	FrameElem=3-1
Frame=3 ElemStation=0,1	Station=0,1	OutputCase=STR187	CaseType=Combination	P=-17,1166814369227	V2=6,8571780103633	V3=0	T=0	M2=0	M3=-2,11692362994817	FrameElem=3-1
Frame=3 FrameElem=3-1 ElemStation=0	Station=0	OutputCase=INVSTR	CaseType=Combination	StepType=Max	P=-11,9771976048127	V2=36,1441091923378	V3=0	T=0	M2=0	M3=2,62769196269433
Frame=3 FrameElem=3-1 ElemStation=0,05	Station=0,05	OutputCase=INVSTR	CaseType=Combination	StepType=Max	P=-11,7771976048127	V2=36,3436091923378	V3=0	T=0	M2=0	M3=1,59896017250005
Frame=3 FrameElem=3-1 ElemStation=0,1	Station=0,1	OutputCase=INVSTR	CaseType=Combination	StepType=Max	P=-11,5771976048127	V2=36,5311091923378	V3=0	T=0	M2=0	M3=0,482296976055773
Frame=3 FrameElem=3-1 ElemStation=0	Station=0	OutputCase=INVSTR	CaseType=Combination	StepType=Min	P=-138,406463019978	V2=1,24254456978826	V3=0	T=0	M2=0	M3=-31,1569598981423
Frame=3 FrameElem=3-1 ElemStation=0,05	Station=0,05	OutputCase=INVSTR	CaseType=Combination	StepType=Min	P=-138,136463019978	V2=1,44204456978826	V3=0	T=0	M2=0	M3=-32,9530626420176
Frame=3 FrameElem=3-1 ElemStation=0,1	Station=0,1	OutputCase=INVSTR	CaseType=Combination	StepType=Min	P=-137,866463019978	V2=1,62954456978826	V3=0	T=0	M2=0	M3=-34,7588403858929
Frame=3 ElemStation=0	Station=0	OutputCase=SIS01	CaseType=Combination	P=-17,968080276635	V2=10,7872988525214	V3=0	T=0	M2=0	M3=-4,4229378690375	FrameElem=3-1
Frame=3 ElemStation=0,05	Station=0,05	OutputCase=SIS01	CaseType=Combination	P=-17,774830276635	V2=11,0602988525214	V3=0	T=0	M2=0	M3=-4,96920697833024	FrameElem=3-1
Frame=3 ElemStation=0,1	Station=0,1	OutputCase=SIS01	CaseType=Combination	P=-17,581580276635	V2=11,3142988525214	V3=0	T=0	M2=0	M3=-5,52865108762297	FrameElem=3-1
Frame=3 ElemStation=0	Station=0	OutputCase=SIS02	CaseType=Combination	P=-17,9680802766351	V2=11,1704081049803	V3=0	T=0	M2=0	M3=-4,63354645711148	FrameElem=3-1
Frame=3 ElemStation=0,05	Station=0,05	OutputCase=SIS02	CaseType=Combination	P=-17,7748302766351	V2=11,4434081049803	V3=0	T=0	M2=0	M3=-5,19897102902716	FrameElem=3-1
Frame=3 ElemStation=0,1	Station=0,1	OutputCase=SIS02	CaseType=Combination	P=-17,5815802766351	V2=11,6974081049803	V3=0	T=0	M2=0	M3=-5,77757060094284	FrameElem=3-1
Frame=3 ElemStation=0	Station=0	OutputCase=SIS03	CaseType=Combination	P=-17,9680802766349	V2=10,4041896000625	V3=0	T=0	M2=0	M3=-4,21232928096352	FrameElem=3-1
Frame=3 ElemStation=0,05	Station=0,05	OutputCase=SIS03	CaseType=Combination	P=-17,7748302766349	V2=10,6771896000625	V3=0	T=0	M2=0	M3=-4,73944292763331	FrameElem=3-1
Frame=3 ElemStation=0,1	Station=0,1	OutputCase=SIS03	CaseType=Combination	P=-17,5815802766349	V2=10,9311896000625	V3=0	T=0	M2=0	M3=-5,2797315743031	FrameElem=3-1
Frame=3 ElemStation=0	Station=0	OutputCase=SIS04	CaseType=Combination	P=-17,6502459452115	V2=10,6283592631402	V3=0	T=0	M2=0	M3=-3,98300707567852	FrameElem=3-1
Frame=3 ElemStation=0,05	Station=0,05	OutputCase=SIS04	CaseType=Combination	P=-17,4569959452115	V2=10,9013592631402	V3=0	T=0	M2=0	M3=-4,5213292055022	FrameElem=3-1
Frame=3 ElemStation=0,1	Station=0,1	OutputCase=SIS04	CaseType=Combination	P=-17,2637459452115	V2=11,1553592631402	V3=0	T=0	M2=0	M3=-5,07282633532588	FrameElem=3-1
Frame=3 ElemStation=0	Station=0	OutputCase=SIS05	CaseType=Combination	P=-18,2859146080585	V2=10,9462384419025	V3=0	T=0	M2=0	M3=-4,86286866239648	FrameElem=3-1
Frame=3 ElemStation=0,05	Station=0,05	OutputCase=SIS05	CaseType=Combination	P=-18,0926646080585	V2=11,2192384419025	V3=0	T=0	M2=0	M3=-5,41708475115827	FrameElem=3-1
Frame=3 ElemStation=0,1	Station=0,1	OutputCase=SIS05	CaseType=Combination	P=-17,8994146080585	V2=11,4732384419025	V3=0	T=0	M2=0	M3=-5,98447583992006	FrameElem=3-1
Frame=3 ElemStation=0	Station=0	OutputCase=SIS06	CaseType=Combination	P=-17,9680802766349	V2=10,4041896000625	V3=0	T=0	M2=0	M3=-4,21232928096352	FrameElem=3-1
Frame=3 ElemStation=0,05	Station=0,05	OutputCase=SIS06	CaseType=Combination	P=-17,7748302766349	V2=10,6771896000625	V3=0	T=0	M2=0	M3=-4,73944292763331	FrameElem=3-1
Frame=3 ElemStation=0,1	Station=0,1	OutputCase=SIS06	CaseType=Combination	P=-17,5815802766349	V2=10,9311896000625	V3=0	T=0	M2=0	M3=-5,2797315743031	FrameElem=3-1
Frame=3 ElemStation=0	Station=0	OutputCase=SIS07	CaseType=Combination	P=-17,6502459452116	V2=11,0114685155991	V3=0	T=0	M2=0	M3=-4,1936156637525	FrameElem=3-1
Frame=3 ElemStation=0,05	Station=0,05	OutputCase=SIS07	CaseType=Combination	P=-17,4569959452116	V2=11,2844685155991	V3=0	T=0	M2=0	M3=-4,75109325619912	FrameElem=3-1
Frame=3 ElemStation=0,1	Station=0,1	OutputCase=SIS07	CaseType=Combination	P=-17,2637459452116	V2=11,5384685155991	V3=0	T=0	M2=0	M3=-5,32174584864575	FrameElem=3-1
Frame=3 ElemStation=0	Station=0	OutputCase=SIS08	CaseType=Combination	P=-18,2859146080587	V2=11,3293476943614	V3=0	T=0	M2=0	M3=-5,07347725047046	FrameElem=3-1
Frame=3 ElemStation=0,05	Station=0,05	OutputCase=SIS08	CaseType=Combination	P=-18,0926646080587	V2=11,6023476943614	V3=0	T=0	M2=0	M3=-5,6468488018552	FrameElem=3-1
Frame=3 ElemStation=0,1	Station=0,1	OutputCase=SIS08	CaseType=Combination	P=-17,8994146080587	V2=11,8563476943614	V3=0	T=0	M2=0	M3=-6,23339535323993	FrameElem=3-1
Frame=3 ElemStation=0	Station=0	OutputCase=SIS09	CaseType=Combination	P=-17,968080276635	V2=10,7872988525214	V3=0	T=0	M2=0	M3=-4,4229378690375	FrameElem=3-1
Frame=3 ElemStation=0,05	Station=0,05	OutputCase=SIS09	CaseType=Combination	P=-17,774830276635	V2=11,0602988525214	V3=0	T=0	M2=0	M3=-4,96920697833024	FrameElem=3-1
Frame=3 ElemStation=0,1	Station=0,1	OutputCase=SIS09	CaseType=Combination	P=-17,581580276635	V2=11,3142988525214	V3=0	T=0	M2=0	M3=-5,52865108762297	FrameElem=3-1
Frame=3 ElemStation=0	Station=0	OutputCase=SIS10	CaseType=Combination	P=-18,8205602766131	V2=10,7465277812904	V3=0	T=0	M2=0	M3=-4,5307454710974	FrameElem=3-1
Frame=3 ElemStation=0,05	Station=0,05	OutputCase=SIS10	CaseType=Combination	P=-18,6138102766131	V2=11,0195277812904	V3=0	T=0	M2=0	M3=-5,07497602682858	FrameElem=3-1
Frame=3 ElemStation=0,1	Station=0,1	OutputCase=SIS10	CaseType=Combination	P=-18,4070602766131	V2=11,2735277812904	V3=0	T=0	M2=0	M3=-5,63238158255977	FrameElem=3-1

Società di Progetto
Brebemi SpA

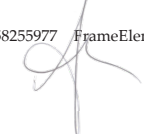

Frame=3 ElemStation=0	Station=0	OutputCase=SIS11	CaseType=Combination	P=-18,8205602766132	V2=11,1296370337493	V3=0	T=0	M2=0	M3=-4,74135405917138	FrameElem=3-1
Frame=3 ElemStation=0,05	Station=0,05	OutputCase=SIS11	CaseType=Combination	P=-18,6138102766132	V2=11,4026370337493	V3=0	T=0	M2=0	M3=-5,30474007752551	FrameElem=3-1
Frame=3 ElemStation=0,1	Station=0,1	OutputCase=SIS11	CaseType=Combination	P=-18,4070602766132	V2=11,6566370337493	V3=0	T=0	M2=0	M3=-5,88130109587964	FrameElem=3-1
Frame=3 ElemStation=0	Station=0	OutputCase=SIS12	CaseType=Combination	P=-18,8205602766132	V2=10,3634185288315	V3=0	T=0	M2=0	M3=-4,32013688302341	FrameElem=3-1
Frame=3 ElemStation=0,05	Station=0,05	OutputCase=SIS12	CaseType=Combination	P=-18,6138102766132	V2=10,6364185288315	V3=0	T=0	M2=0	M3=-4,84521197613166	FrameElem=3-1
Frame=3 ElemStation=0,1	Station=0,1	OutputCase=SIS12	CaseType=Combination	P=-18,4070602766132	V2=10,8904185288315	V3=0	T=0	M2=0	M3=-5,3834620692399	FrameElem=3-1
Frame=3 ElemStation=0	Station=0	OutputCase=SIS13	CaseType=Combination	P=-18,5027259451896	V2=10,5875881919093	V3=0	T=0	M2=0	M3=-4,09081467773842	FrameElem=3-1
Frame=3 ElemStation=0,05	Station=0,05	OutputCase=SIS13	CaseType=Combination	P=-18,2959759451896	V2=10,8605881919093	V3=0	T=0	M2=0	M3=-4,62709825400055	FrameElem=3-1
Frame=3 ElemStation=0,1	Station=0,1	OutputCase=SIS13	CaseType=Combination	P=-18,0892259451896	V2=11,1145881919093	V3=0	T=0	M2=0	M3=-5,17655683026268	FrameElem=3-1
Frame=3 ElemStation=0	Station=0	OutputCase=SIS14	CaseType=Combination	P=-19,1383946080366	V2=10,9054673706715	V3=0	T=0	M2=0	M3=-4,97067626445638	FrameElem=3-1
Frame=3 ElemStation=0,05	Station=0,05	OutputCase=SIS14	CaseType=Combination	P=-18,9316446080366	V2=11,1784673706715	V3=0	T=0	M2=0	M3=-5,52285379965662	FrameElem=3-1
Frame=3 ElemStation=0,1	Station=0,1	OutputCase=SIS14	CaseType=Combination	P=-18,7248946080366	V2=11,4324673706715	V3=0	T=0	M2=0	M3=-6,08820633485686	FrameElem=3-1
Frame=3 ElemStation=0	Station=0	OutputCase=SIS15	CaseType=Combination	P=-18,8205602766132	V2=10,3634185288315	V3=0	T=0	M2=0	M3=-4,32013688302341	FrameElem=3-1
Frame=3 ElemStation=0,05	Station=0,05	OutputCase=SIS15	CaseType=Combination	P=-18,6138102766132	V2=10,6364185288315	V3=0	T=0	M2=0	M3=-4,84521197613166	FrameElem=3-1
Frame=3 ElemStation=0,1	Station=0,1	OutputCase=SIS15	CaseType=Combination	P=-18,4070602766132	V2=10,8904185288315	V3=0	T=0	M2=0	M3=-5,3834620692399	FrameElem=3-1
Frame=3 ElemStation=0	Station=0	OutputCase=SIS16	CaseType=Combination	P=-18,5027259451897	V2=10,9706974443682	V3=0	T=0	M2=0	M3=-4,3014232658124	FrameElem=3-1
Frame=3 ElemStation=0,05	Station=0,05	OutputCase=SIS16	CaseType=Combination	P=-18,2959759451897	V2=11,2436974443682	V3=0	T=0	M2=0	M3=-4,85686230469747	FrameElem=3-1
Frame=3 ElemStation=0,1	Station=0,1	OutputCase=SIS16	CaseType=Combination	P=-18,0892259451897	V2=11,4976974443682	V3=0	T=0	M2=0	M3=-5,42547634358255	FrameElem=3-1
Frame=3 ElemStation=0	Station=0	OutputCase=SIS17	CaseType=Combination	P=-19,1383946080368	V2=11,2885766231304	V3=0	T=0	M2=0	M3=-5,18128485253036	FrameElem=3-1
Frame=3 ElemStation=0,05	Station=0,05	OutputCase=SIS17	CaseType=Combination	P=-18,9316446080367	V2=11,5615766231304	V3=0	T=0	M2=0	M3=-5,75261785035354	FrameElem=3-1
Frame=3 ElemStation=0,1	Station=0,1	OutputCase=SIS17	CaseType=Combination	P=-18,7248946080367	V2=11,8155766231304	V3=0	T=0	M2=0	M3=-6,33712584817673	FrameElem=3-1
Frame=3 ElemStation=0	Station=0	OutputCase=SIS18	CaseType=Combination	P=-18,8205602766131	V2=10,7465277812904	V3=0	T=0	M2=0	M3=-4,5307454710974	FrameElem=3-1
Frame=3 ElemStation=0,05	Station=0,05	OutputCase=SIS18	CaseType=Combination	P=-18,6138102766131	V2=11,0195277812904	V3=0	T=0	M2=0	M3=-5,07497602682858	FrameElem=3-1
Frame=3 ElemStation=0,1	Station=0,1	OutputCase=SIS18	CaseType=Combination	P=-18,4070602766131	V2=11,2735277812904	V3=0	T=0	M2=0	M3=-5,63238158255977	FrameElem=3-1
Frame=3 ElemStation=0	Station=0	OutputCase=SIS19	CaseType=Combination	P=-14,6959733753931	V2=8,85351510087747	V3=0	T=0	M2=0	M3=-2,93715480552332	FrameElem=3-1
Frame=3 ElemStation=0,05	Station=0,05	OutputCase=SIS19	CaseType=Combination	P=-14,5184733753931	V2=9,15766510087747	V3=0	T=0	M2=0	M3=-3,38751347723386	FrameElem=3-1
Frame=3 ElemStation=0,1	Station=0,1	OutputCase=SIS19	CaseType=Combination	P=-14,3409733753931	V2=9,44281510087747	V3=0	T=0	M2=0	M3=-3,8526046489444	FrameElem=3-1
Frame=3 ElemStation=0	Station=0	OutputCase=SIS20	CaseType=Combination	P=-14,6959733753932	V2=9,2366243533637	V3=0	T=0	M2=0	M3=-3,1477633935973	FrameElem=3-1
Frame=3 ElemStation=0,05	Station=0,05	OutputCase=SIS20	CaseType=Combination	P=-14,5184733753932	V2=9,5407743533637	V3=0	T=0	M2=0	M3=-3,61727752793079	FrameElem=3-1
Frame=3 ElemStation=0,1	Station=0,1	OutputCase=SIS20	CaseType=Combination	P=-14,3409733753932	V2=9,8259243533637	V3=0	T=0	M2=0	M3=-4,10152416226427	FrameElem=3-1
Frame=3 ElemStation=0	Station=0	OutputCase=SIS21	CaseType=Combination	P=-14,695973375393	V2=8,47040584841858	V3=0	T=0	M2=0	M3=-2,72654621744934	FrameElem=3-1
Frame=3 ElemStation=0,05	Station=0,05	OutputCase=SIS21	CaseType=Combination	P=-14,518473375393	V2=8,77455584841858	V3=0	T=0	M2=0	M3=-3,15774942653693	FrameElem=3-1
Frame=3 ElemStation=0,1	Station=0,1	OutputCase=SIS21	CaseType=Combination	P=-14,340973375393	V2=9,05970584841858	V3=0	T=0	M2=0	M3=-3,60368513562453	FrameElem=3-1
Frame=3 ElemStation=0	Station=0	OutputCase=SIS22	CaseType=Combination	P=-14,3781390439695	V2=8,69457551149634	V3=0	T=0	M2=0	M3=-2,49722401216434	FrameElem=3-1
Frame=3 ElemStation=0,05	Station=0,05	OutputCase=SIS22	CaseType=Combination	P=-14,2006390439695	V2=8,99872551149633	V3=0	T=0	M2=0	M3=-2,93963570440582	FrameElem=3-1
Frame=3 ElemStation=0,1	Station=0,1	OutputCase=SIS22	CaseType=Combination	P=-14,0231390439695	V2=9,28387551149634	V3=0	T=0	M2=0	M3=-3,39677989664731	FrameElem=3-1
Frame=3 ElemStation=0	Station=0	OutputCase=SIS23	CaseType=Combination	P=-15,0138077068166	V2=9,01245469025861	V3=0	T=0	M2=0	M3=-3,3770855988823	FrameElem=3-1
Frame=3 ElemStation=0,05	Station=0,05	OutputCase=SIS23	CaseType=Combination	P=-14,8363077068166	V2=9,31660469025861	V3=0	T=0	M2=0	M3=-3,8353912500619	FrameElem=3-1
Frame=3 ElemStation=0,1	Station=0,1	OutputCase=SIS23	CaseType=Combination	P=-14,6588077068166	V2=9,60175469025861	V3=0	T=0	M2=0	M3=-4,30842940124149	FrameElem=3-1
Frame=3 ElemStation=0	Station=0	OutputCase=SIS24	CaseType=Combination	P=-14,695973375393	V2=8,47040584841858	V3=0	T=0	M2=0	M3=-2,72654621744934	FrameElem=3-1
Frame=3 ElemStation=0,05	Station=0,05	OutputCase=SIS24	CaseType=Combination	P=-14,518473375393	V2=8,77455584841858	V3=0	T=0	M2=0	M3=-3,15774942653693	FrameElem=3-1
Frame=3 ElemStation=0,1	Station=0,1	OutputCase=SIS24	CaseType=Combination	P=-14,340973375393	V2=9,05970584841858	V3=0	T=0	M2=0	M3=-3,60368513562453	FrameElem=3-1
Frame=3 ElemStation=0	Station=0	OutputCase=SIS25	CaseType=Combination	P=-14,3781390439697	V2=9,07768476395523	V3=0	T=0	M2=0	M3=-2,70783260023832	FrameElem=3-1
Frame=3 ElemStation=0,05	Station=0,05	OutputCase=SIS25	CaseType=Combination	P=-14,2006390439697	V2=9,38183476395523	V3=0	T=0	M2=0	M3=-3,16939975510275	FrameElem=3-1



	Doc. N. 60235-0000-A00.doc	CODIFICA DOCUMENTO 04RCDII10000000000300A00	REV. 00	FOGLIO 263 di 628
--	-------------------------------	--	------------	----------------------

Frame=3 ElemStation=0,1	Station=0,1	OutputCase=SIS25	CaseType=Combination	P=-14,0231390439697	V2=9,66698476395523	V3=0	T=0	M2=0	M3=-3,64569940996718	FrameElem=3-1
Frame=3 ElemStation=0	Station=0	OutputCase=SIS26	CaseType=Combination	P=-15,0138077068167	V2=9,39556394271751	V3=0	T=0	M2=0	M3=-3,58769418695628	FrameElem=3-1
Frame=3 ElemStation=0,05	Station=0,05	OutputCase=SIS26	CaseType=Combination	P=-14,8363077068167	V2=9,6997139427175	V3=0	T=0	M2=0	M3=-4,06515530075882	FrameElem=3-1
Frame=3 ElemStation=0,1	Station=0,1	OutputCase=SIS26	CaseType=Combination	P=-14,6588077068167	V2=9,9848639427175	V3=0	T=0	M2=0	M3=-4,55734891456136	FrameElem=3-1
Frame=3 ElemStation=0	Station=0	OutputCase=SIS27	CaseType=Combination	P=-14,6959733753931	V2=8,85351510087747	V3=0	T=0	M2=0	M3=-2,93715480552332	FrameElem=3-1
Frame=3 ElemStation=0,05	Station=0,05	OutputCase=SIS27	CaseType=Combination	P=-14,5184733753931	V2=9,15766510087747	V3=0	T=0	M2=0	M3=-3,38751347723386	FrameElem=3-1
Frame=3 ElemStation=0,1	Station=0,1	OutputCase=SIS27	CaseType=Combination	P=-14,3409733753931	V2=9,44281510087747	V3=0	T=0	M2=0	M3=-3,8526046489444	FrameElem=3-1
Frame=3 ElemStation=0	Station=0	OutputCase=SIS28	CaseType=Combination	P=-17,5375733753201	V2=8,71761153010755	V3=0	T=0	M2=0	M3=-3,29651347905631	FrameElem=3-1
Frame=3 ElemStation=0,05	Station=0,05	OutputCase=SIS28	CaseType=Combination	P=-17,3150733753201	V2=9,02176153010755	V3=0	T=0	M2=0	M3=-3,74007697222835	FrameElem=3-1
Frame=3 ElemStation=0,1	Station=0,1	OutputCase=SIS28	CaseType=Combination	P=-17,0925733753201	V2=9,30691153010755	V3=0	T=0	M2=0	M3=-4,1983729654004	FrameElem=3-1
Frame=3 ElemStation=0	Station=0	OutputCase=SIS29	CaseType=Combination	P=-17,5375733753202	V2=9,10072078256644	V3=0	T=0	M2=0	M3=-3,50712206713029	FrameElem=3-1
Frame=3 ElemStation=0,05	Station=0,05	OutputCase=SIS29	CaseType=Combination	P=-17,3150733753202	V2=9,40487078256644	V3=0	T=0	M2=0	M3=-3,96984102292528	FrameElem=3-1
Frame=3 ElemStation=0,1	Station=0,1	OutputCase=SIS29	CaseType=Combination	P=-17,0925733753202	V2=9,69002078256644	V3=0	T=0	M2=0	M3=-4,44729247872027	FrameElem=3-1
Frame=3 ElemStation=0	Station=0	OutputCase=SIS30	CaseType=Combination	P=-17,5375733753199	V2=8,33450227764865	V3=0	T=0	M2=0	M3=-3,08590489098233	FrameElem=3-1
Frame=3 ElemStation=0,05	Station=0,05	OutputCase=SIS30	CaseType=Combination	P=-17,3150733753199	V2=8,63865227764865	V3=0	T=0	M2=0	M3=-3,51031292153143	FrameElem=3-1
Frame=3 ElemStation=0,1	Station=0,1	OutputCase=SIS30	CaseType=Combination	P=-17,0925733753199	V2=8,92380227764865	V3=0	T=0	M2=0	M3=-3,94945345208053	FrameElem=3-1
Frame=3 ElemStation=0	Station=0	OutputCase=SIS31	CaseType=Combination	P=-17,2197390438965	V2=8,55867194072641	V3=0	T=0	M2=0	M3=-2,85658268569733	FrameElem=3-1
Frame=3 ElemStation=0,05	Station=0,05	OutputCase=SIS31	CaseType=Combination	P=-16,9972390438965	V2=8,86282194072641	V3=0	T=0	M2=0	M3=-3,29219919940032	FrameElem=3-1
Frame=3 ElemStation=0,1	Station=0,1	OutputCase=SIS31	CaseType=Combination	P=-16,7747390438965	V2=9,14797194072641	V3=0	T=0	M2=0	M3=-3,7425482131033	FrameElem=3-1
Frame=3 ElemStation=0	Station=0	OutputCase=SIS32	CaseType=Combination	P=-17,8554077067436	V2=8,87655111948868	V3=0	T=0	M2=0	M3=-3,73644427241529	FrameElem=3-1
Frame=3 ElemStation=0,05	Station=0,05	OutputCase=SIS32	CaseType=Combination	P=-17,6329077067436	V2=9,18070111948868	V3=0	T=0	M2=0	M3=-4,18795474505639	FrameElem=3-1
Frame=3 ElemStation=0,1	Station=0,1	OutputCase=SIS32	CaseType=Combination	P=-17,4104077067436	V2=9,46585111948868	V3=0	T=0	M2=0	M3=-4,65419771769749	FrameElem=3-1
Frame=3 ElemStation=0	Station=0	OutputCase=SIS33	CaseType=Combination	P=-17,5375733753199	V2=8,33450227764865	V3=0	T=0	M2=0	M3=-3,08590489098233	FrameElem=3-1
Frame=3 ElemStation=0,05	Station=0,05	OutputCase=SIS33	CaseType=Combination	P=-17,3150733753199	V2=8,63865227764865	V3=0	T=0	M2=0	M3=-3,51031292153143	FrameElem=3-1
Frame=3 ElemStation=0,1	Station=0,1	OutputCase=SIS33	CaseType=Combination	P=-17,0925733753199	V2=8,92380227764865	V3=0	T=0	M2=0	M3=-3,94945345208053	FrameElem=3-1
Frame=3 ElemStation=0	Station=0	OutputCase=SIS34	CaseType=Combination	P=-17,2197390438966	V2=8,9417811931853	V3=0	T=0	M2=0	M3=-3,06719127377131	FrameElem=3-1
Frame=3 ElemStation=0,05	Station=0,05	OutputCase=SIS34	CaseType=Combination	P=-16,9972390438966	V2=9,2459311931853	V3=0	T=0	M2=0	M3=-3,52196325009724	FrameElem=3-1
Frame=3 ElemStation=0,1	Station=0,1	OutputCase=SIS34	CaseType=Combination	P=-16,7747390438966	V2=9,5310811931853	V3=0	T=0	M2=0	M3=-3,99146772642317	FrameElem=3-1
Frame=3 ElemStation=0	Station=0	OutputCase=SIS35	CaseType=Combination	P=-17,8554077067437	V2=9,25966037194758	V3=0	T=0	M2=0	M3=-3,94705286048927	FrameElem=3-1
Frame=3 ElemStation=0,05	Station=0,05	OutputCase=SIS35	CaseType=Combination	P=-17,6329077067437	V2=9,56381037194758	V3=0	T=0	M2=0	M3=-4,41771879575331	FrameElem=3-1
Frame=3 ElemStation=0,1	Station=0,1	OutputCase=SIS35	CaseType=Combination	P=-17,4104077067437	V2=9,84896037194758	V3=0	T=0	M2=0	M3=-4,90311723101736	FrameElem=3-1
Frame=3 ElemStation=0	Station=0	OutputCase=SIS36	CaseType=Combination	P=-17,5375733753201	V2=8,71761153010755	V3=0	T=0	M2=0	M3=-3,29651347905631	FrameElem=3-1
Frame=3 ElemStation=0,05	Station=0,05	OutputCase=SIS36	CaseType=Combination	P=-17,3150733753201	V2=9,02176153010755	V3=0	T=0	M2=0	M3=-3,74007697222835	FrameElem=3-1
Frame=3 ElemStation=0,1	Station=0,1	OutputCase=SIS36	CaseType=Combination	P=-17,0925733753201	V2=9,30691153010755	V3=0	T=0	M2=0	M3=-4,1983729654004	FrameElem=3-1
Frame=3 FrameElem=3-1 ElemStation=0	Station=0	OutputCase=INVSIS	CaseType=Combination	StepType=Max	P=-14,3781390439695	V2=11,3293476943614	V3=0	T=0	M2=0	M3=-2,49722401216434
Frame=3 FrameElem=3-1 ElemStation=0,05	Station=0,05	OutputCase=INVSIS	CaseType=Combination	StepType=Max	P=-14,2006390439695	V2=11,6023476943614	V3=0	T=0	M2=0	M3=-2,93963570440582
Frame=3 FrameElem=3-1 ElemStation=0,1	Station=0,1	OutputCase=INVSIS	CaseType=Combination	StepType=Max	P=-14,0231390439695	V2=11,8563476943614	V3=0	T=0	M2=0	M3=-3,39677989664731
Frame=3 FrameElem=3-1 ElemStation=0	Station=0	OutputCase=INVSIS	CaseType=Combination	StepType=Min	P=-19,1383946080368	V2=8,33450227764865	V3=0	T=0	M2=0	M3=-5,18128485253036
Frame=3 FrameElem=3-1 ElemStation=0,05	Station=0,05	OutputCase=INVSIS	CaseType=Combination	StepType=Min	P=-18,9316446080367	V2=8,63865227764865	V3=0	T=0	M2=0	M3=-5,75261785035354
Frame=3 FrameElem=3-1 ElemStation=0,1	Station=0,1	OutputCase=INVSIS	CaseType=Combination	StepType=Min	P=-18,7248946080367	V2=8,92380227764865	V3=0	T=0	M2=0	M3=-6,33712584817673
Frame=3 ElemStation=0	Station=0	OutputCase=RAR001	CaseType=Combination	P=-12,7399999997579	V2=4,97493867226356	V3=0	T=0	M2=0	M3=-0,99547488729812	FrameElem=3-1
Frame=3 ElemStation=0,05	Station=0,05	OutputCase=RAR001	CaseType=Combination	P=-12,5399999997579	V2=5,29243867226356	V3=0	T=0	M2=0	M3=-1,25223848757796	FrameElem=3-1
Frame=3 ElemStation=0,1	Station=0,1	OutputCase=RAR001	CaseType=Combination	P=-12,3399999997579	V2=5,59093867226356	V3=0	T=0	M2=0	M3=-1,52440208785781	FrameElem=3-1
Frame=3 ElemStation=0	Station=0	OutputCase=RAR002	CaseType=Combination	P=-92,419999999518	V2=3,8709081483824	V3=0	T=0	M2=0	M3=-12,2394986154064	FrameElem=3-1

Società di Progetto
Brebemi SpA

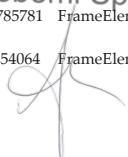



Doc. N.
60235-00000-A00.doc

CODIFICA DOCUMENTO
04RCDII10000000000300A00

REV.
00

FOGLIO
264 di 628

Frame=3 ElemStation=0,05	Station=0,05	OutputCase=RAR002	CaseType=Combination	P=-,92,219999999518	V2=4,0704081483824	V3=0	T=0	M2=0	M3=-12,4380815228255	FrameElem=3-1
Frame=3 ElemStation=0,1	Station=0,1	OutputCase=RAR002	CaseType=Combination	P=-,92,019999999518	V2=4,2579081483824	V3=0	T=0	M2=0	M3=-12,6463394302446	FrameElem=3-1
Frame=3 ElemStation=0	Station=0	OutputCase=RAR003	CaseType=Combination	P=-,101,761144091724	V2=15,6963388829311	V3=0	T=0	M2=0	M3=-18,3039599743602	FrameElem=3-1
Frame=3 ElemStation=0,05	Station=0,05	OutputCase=RAR003	CaseType=Combination	P=-,101,561144091724	V2=15,8958388829311	V3=0	T=0	M2=0	M3=-19,0938144185068	FrameElem=3-1
Frame=3 ElemStation=0,1	Station=0,1	OutputCase=RAR003	CaseType=Combination	P=-,101,361144091724	V2=16,0833388829311	V3=0	T=0	M2=0	M3=-19,8933438626533	FrameElem=3-1
Frame=3 ElemStation=0	Station=0	OutputCase=RAR004	CaseType=Combination	P=-,92,420000001001	V2=19,4747695892868	V3=0	T=0	M2=0	M3=-,98694214459424	FrameElem=3-1
Frame=3 ElemStation=0,05	Station=0,05	OutputCase=RAR004	CaseType=Combination	P=-,92,220000001001	V2=21,1151445892868	V3=0	T=0	M2=0	M3=-11,0017410407252	FrameElem=3-1
Frame=3 ElemStation=0,1	Station=0,1	OutputCase=RAR004	CaseType=Combination	P=-,92,020000001001	V2=22,7432695892868	V3=0	T=0	M2=0	M3=-12,0982524368563	FrameElem=3-1
Frame=3 ElemStation=0	Station=0	OutputCase=RAR005	CaseType=Combination	P=-,22,0811440918478	V2=14,7361958490167	V3=0	T=0	M2=0	M3=-,728954805236507	FrameElem=3-1
Frame=3 ElemStation=0,05	Station=0,05	OutputCase=RAR005	CaseType=Combination	P=-,21,8811440918478	V2=14,9356958490167	V3=0	T=0	M2=0	M3=-,8,0313953448159	FrameElem=3-1
Frame=3 ElemStation=0,1	Station=0,1	OutputCase=RAR005	CaseType=Combination	P=-,21,6811440918478	V2=15,1231958490167	V3=0	T=0	M2=0	M3=-,8,78291763726674	FrameElem=3-1
Frame=3 ElemStation=0	Station=0	OutputCase=RAR006	CaseType=Combination	P=-,12,740000002235	V2=18,514626553724	V3=0	T=0	M2=0	M3=1,02746977740091	FrameElem=3-1
Frame=3 FrameElem=3-1 ElemStation=0,05	Station=0,05	OutputCase=RAR006	CaseType=Combination	P=-,12,540000002235	V2=20,1550015553724	V3=0	T=0	M2=0	M3=6,06780329656189E-02	
Frame=3 ElemStation=0,1	Station=0,1	OutputCase=RAR006	CaseType=Combination	P=-,12,340000002235	V2=21,7831265553724	V3=0	T=0	M2=0	M3=-,0,98782621146967	FrameElem=3-1
Frame=3 ElemStation=0	Station=0	OutputCase=RAR007	CaseType=Combination	P=-,94,0959910818638	V2=26,6901546447971	V3=0	T=0	M2=0	M3=-22,2249539950885	FrameElem=3-1
Frame=3 ElemStation=0,05	Station=0,05	OutputCase=RAR007	CaseType=Combination	P=-,93,8959910818638	V2=26,8896546447971	V3=0	T=0	M2=0	M3=-23,5644992273284	FrameElem=3-1
Frame=3 ElemStation=0,1	Station=0,1	OutputCase=RAR007	CaseType=Combination	P=-,93,6959910818638	V2=27,0771546447971	V3=0	T=0	M2=0	M3=-24,9137194595682	FrameElem=3-1
Frame=3 ElemStation=0	Station=0	OutputCase=RAR008	CaseType=Combination	P=-,12,7399999996417	V2=3,67698361938577	V3=0	T=0	M2=0	M3=-1,64630386955918	FrameElem=3-1
Frame=3 ElemStation=0,05	Station=0,05	OutputCase=RAR008	CaseType=Combination	P=-,12,5399999996417	V2=3,87648361938577	V3=0	T=0	M2=0	M3=-,1,83519055052847	FrameElem=3-1
Frame=3 ElemStation=0,1	Station=0,1	OutputCase=RAR008	CaseType=Combination	P=-,12,3399999996417	V2=4,06398361938577	V3=0	T=0	M2=0	M3=-,2,03375223149776	FrameElem=3-1
Frame=3 ElemStation=0	Station=0	OutputCase=RAR009	CaseType=Combination	P=-,92,4199999995182	V2=4,33063925133307	V3=0	T=0	M2=0	M3=-12,4922289210951	FrameElem=3-1
Frame=3 ElemStation=0,05	Station=0,05	OutputCase=RAR009	CaseType=Combination	P=-,92,2199999995182	V2=4,53013925133307	V3=0	T=0	M2=0	M3=-12,7137983836618	FrameElem=3-1
Frame=3 ElemStation=0,1	Station=0,1	OutputCase=RAR009	CaseType=Combination	P=-,92,0199999995182	V2=4,71763925133307	V3=0	T=0	M2=0	M3=-12,9450428462284	FrameElem=3-1
Frame=3 ElemStation=0	Station=0	OutputCase=RAR010	CaseType=Combination	P=-,101,761144091725	V2=16,1560699858818	V3=0	T=0	M2=0	M3=-18,556690280049	FrameElem=3-1
Frame=3 ElemStation=0,05	Station=0,05	OutputCase=RAR010	CaseType=Combination	P=-,101,561144091725	V2=16,3555699858818	V3=0	T=0	M2=0	M3=-19,3695312793431	FrameElem=3-1
Frame=3 ElemStation=0,1	Station=0,1	OutputCase=RAR010	CaseType=Combination	P=-,101,361144091725	V2=16,5430699858818	V3=0	T=0	M2=0	M3=-20,1920472786372	FrameElem=3-1
Frame=3 ElemStation=0	Station=0	OutputCase=RAR011	CaseType=Combination	P=-,92,420000001003	V2=19,9345006922375	V3=0	T=0	M2=0	M3=-10,239672450283	FrameElem=3-1
Frame=3 ElemStation=0,05	Station=0,05	OutputCase=RAR011	CaseType=Combination	P=-,92,220000001003	V2=21,5748756922375	V3=0	T=0	M2=0	M3=-11,2774579015616	FrameElem=3-1
Frame=3 ElemStation=0,1	Station=0,1	OutputCase=RAR011	CaseType=Combination	P=-,92,020000001003	V2=23,2030006922375	V3=0	T=0	M2=0	M3=-12,3969558528401	FrameElem=3-1
Frame=3 ElemStation=0	Station=0	OutputCase=RAR012	CaseType=Combination	P=-,22,081144091848	V2=15,1959269519674	V3=0	T=0	M2=0	M3=-,7,54227835805384	FrameElem=3-1
Frame=3 ElemStation=0,05	Station=0,05	OutputCase=RAR012	CaseType=Combination	P=-,21,881144091848	V2=15,3954269519674	V3=0	T=0	M2=0	M3=-,8,30711220565221	FrameElem=3-1
Frame=3 ElemStation=0,1	Station=0,1	OutputCase=RAR012	CaseType=Combination	P=-,21,681144091848	V2=15,5829269519674	V3=0	T=0	M2=0	M3=-,9,08162105325058	FrameElem=3-1
Frame=3 ElemStation=0	Station=0	OutputCase=RAR013	CaseType=Combination	P=-,12,740000002237	V2=18,9743576583231	V3=0	T=0	M2=0	M3=0,774739471712129	FrameElem=3-1
Frame=3 ElemStation=0,05	Station=0,05	OutputCase=RAR013	CaseType=Combination	P=-,12,540000002237	V2=20,6147326583231	V3=0	T=0	M2=0	M3=0,215038827870692	FrameElem=3-1
Frame=3 ElemStation=0,1	Station=0,1	OutputCase=RAR013	CaseType=Combination	P=-,12,340000002237	V2=22,2428576583231	V3=0	T=0	M2=0	M3=-,1,28652962745351	FrameElem=3-1
Frame=3 ElemStation=0	Station=0	OutputCase=RAR014	CaseType=Combination	P=-,94,0959910818639	V2=27,1498857477478	V3=0	T=0	M2=0	M3=-22,4776843007773	FrameElem=3-1
Frame=3 ElemStation=0,05	Station=0,05	OutputCase=RAR014	CaseType=Combination	P=-,93,8959910818639	V2=27,3493857477478	V3=0	T=0	M2=0	M3=-23,8402160881647	FrameElem=3-1
Frame=3 ElemStation=0,1	Station=0,1	OutputCase=RAR014	CaseType=Combination	P=-,93,6959910818639	V2=27,5368857477478	V3=0	T=0	M2=0	M3=-25,2124228755521	FrameElem=3-1
Frame=3 ElemStation=0	Station=0	OutputCase=RAR015	CaseType=Combination	P=-,72,4999999995491	V2=4,39709089482158	V3=0	T=0	M2=0	M3=-,9,90711281105554	FrameElem=3-1
Frame=3 ElemStation=0,05	Station=0,05	OutputCase=RAR015	CaseType=Combination	P=-,72,2999999995491	V2=4,59659089482158	V3=0	T=0	M2=0	M3=-,10,1320048557966	FrameElem=3-1
Frame=3 ElemStation=0,1	Station=0,1	OutputCase=RAR015	CaseType=Combination	P=-,72,0999999995491	V2=4,78409089482158	V3=0	T=0	M2=0	M3=-,10,3665719005377	FrameElem=3-1
Frame=3 ElemStation=0	Station=0	OutputCase=RAR016	CaseType=Combination	P=-,79,7479075354788	V2=13,5953731408338	V3=0	T=0	M2=0	M3=-14,6183418285401	FrameElem=3-1
Frame=3 ElemStation=0,05	Station=0,05	OutputCase=RAR016	CaseType=Combination	P=-,79,5479075354788	V2=13,7948731408338	V3=0	T=0	M2=0	M3=-15,3031479855818	FrameElem=3-1
Frame=3 ElemStation=0,1	Station=0,1	OutputCase=RAR016	CaseType=Combination	P=-,79,3479075354788	V2=13,9823731408338	V3=0	T=0	M2=0	M3=-15,9976291426235	FrameElem=3-1

Società di Progetto
Brebemi SpA



Doc. N.
60235-00000-A00.doc

CODIFICA DOCUMENTO
04RCDII10000000000300A00

REV.
00

FOGLIO
265 di 628

Frame=3 ElemStation=0	Station=0	OutputCase=RAR017	CaseType=Combination	P=-72,5000000000148	V2=16,6160303649488	V3=0	T=0	M2=0	M3=-8,16029250641817	FrameElem=3-1
Frame=3 ElemStation=0,05	Station=0,05	OutputCase=RAR017	CaseType=Combination	P=-72,3000000000148	V2=17,9256866149488	V3=0	T=0	M2=0	M3=-9,02389350383228	FrameElem=3-1
Frame=3 ElemStation=0,1	Station=0,1	OutputCase=RAR017	CaseType=Combination	P=-72,1000000000148	V2=19,2214053649488	V3=0	T=0	M2=0	M3=-9,95262887624639	FrameElem=3-1
Frame=3 ElemStation=0	Station=0	OutputCase=RAR018	CaseType=Combination	P=-19,9879075355714	V2=12,875265865398	V3=0	T=0	M2=0	M3=-6,35753288704376	FrameElem=3-1
Frame=3 ElemStation=0,05	Station=0,05	OutputCase=RAR018	CaseType=Combination	P=-19,7879075355714	V2=13,074765865398	V3=0	T=0	M2=0	M3=-7,00633368031366	FrameElem=3-1
Frame=3 ElemStation=0,1	Station=0,1	OutputCase=RAR018	CaseType=Combination	P=-19,5879075355714	V2=13,262265865398	V3=0	T=0	M2=0	M3=-7,66480947358357	FrameElem=3-1
Frame=3 ElemStation=0	Station=0	OutputCase=RAR019	CaseType=Combination	P=-12,7400000001073	V2=15,895923089513	V3=0	T=0	M2=0	M3=0,100516435078188	FrameElem=3-1
Frame=3 ElemStation=0,05	Station=0,05	OutputCase=RAR019	CaseType=Combination	P=-12,5400000001073	V2=17,205579339513	V3=0	T=0	M2=0	M3=0,727079198564128	FrameElem=3-1
Frame=3 ElemStation=0,1	Station=0,1	OutputCase=RAR019	CaseType=Combination	P=-12,3400000001073	V2=18,501298089513	V3=0	T=0	M2=0	M3=-1,61980920720645	FrameElem=3-1
Frame=3 ElemStation=0	Station=0	OutputCase=RAR020	CaseType=Combination	P=-12,3585988019334	V2=3,4862561121284	V3=0	T=0	M2=0	M3=-1,1183869175284	FrameElem=3-1
Frame=3 ElemStation=0,05	Station=0,05	OutputCase=RAR020	CaseType=Combination	P=-12,1585988019334	V2=3,6857561121284	V3=0	T=0	M2=0	M3=-1,29773722313482	FrameElem=3-1
Frame=3 ElemStation=0,1	Station=0,1	OutputCase=RAR020	CaseType=Combination	P=-11,9585988019334	V2=3,8732561121284	V3=0	T=0	M2=0	M3=-1,48676252874125	FrameElem=3-1
Frame=3 ElemStation=0	Station=0	OutputCase=RAR021	CaseType=Combination	P=-72,1185988018409	V2=4,20636338756422	V3=0	T=0	M2=0	M3=-9,37919585902477	FrameElem=3-1
Frame=3 ElemStation=0,05	Station=0,05	OutputCase=RAR021	CaseType=Combination	P=-71,9185988018409	V2=4,40586338756422	V3=0	T=0	M2=0	M3=-9,59455152840297	FrameElem=3-1
Frame=3 ElemStation=0,1	Station=0,1	OutputCase=RAR021	CaseType=Combination	P=-71,7185988018409	V2=4,59336338756422	V3=0	T=0	M2=0	M3=-9,81958219778119	FrameElem=3-1
Frame=3 ElemStation=0	Station=0	OutputCase=RAR022	CaseType=Combination	P=-79,3665063377706	V2=13,4046456335765	V3=0	T=0	M2=0	M3=-14,0904248765093	FrameElem=3-1
Frame=3 ElemStation=0,05	Station=0,05	OutputCase=RAR022	CaseType=Combination	P=-79,1665063377706	V2=13,6041456335765	V3=0	T=0	M2=0	M3=-14,7656946581882	FrameElem=3-1
Frame=3 ElemStation=0,1	Station=0,1	OutputCase=RAR022	CaseType=Combination	P=-78,9665063377706	V2=13,7916456335765	V3=0	T=0	M2=0	M3=-15,450639439867	FrameElem=3-1
Frame=3 ElemStation=0	Station=0	OutputCase=RAR023	CaseType=Combination	P=-72,1185988023065	V2=16,4253028576914	V3=0	T=0	M2=0	M3=-7,6323755543874	FrameElem=3-1
Frame=3 ElemStation=0,05	Station=0,05	OutputCase=RAR023	CaseType=Combination	P=-71,9185988023065	V2=17,7349591076914	V3=0	T=0	M2=0	M3=-8,48644017643863	FrameElem=3-1
Frame=3 ElemStation=0,1	Station=0,1	OutputCase=RAR023	CaseType=Combination	P=-71,7185988023065	V2=19,0306778576914	V3=0	T=0	M2=0	M3=-9,40563917348988	FrameElem=3-1
Frame=3 ElemStation=0	Station=0	OutputCase=RAR024	CaseType=Combination	P=-19,6065063378631	V2=12,6845383581406	V3=0	T=0	M2=0	M3=-5,82961593501299	FrameElem=3-1
Frame=3 ElemStation=0,05	Station=0,05	OutputCase=RAR024	CaseType=Combination	P=-19,4065063378631	V2=12,8840383581406	V3=0	T=0	M2=0	M3=-6,46888035292002	FrameElem=3-1
Frame=3 ElemStation=0,1	Station=0,1	OutputCase=RAR024	CaseType=Combination	P=-19,2065063378631	V2=13,0715383581406	V3=0	T=0	M2=0	M3=-7,11781977082705	FrameElem=3-1
Frame=3 ElemStation=0	Station=0	OutputCase=RAR025	CaseType=Combination	P=-12,3585988023991	V2=15,7051955822556	V3=0	T=0	M2=0	M3=0,628433387108963	FrameElem=3-1
Frame=3 ElemStation=0,05	Station=0,05	OutputCase=RAR025	CaseType=Combination	P=-12,1585988023991	V2=17,0148518322556	V3=0	T=0	M2=0	M3=0,189625871170484	FrameElem=3-1
Frame=3 ElemStation=0,1	Station=0,1	OutputCase=RAR025	CaseType=Combination	P=-11,9585988023991	V2=18,3105705822556	V3=0	T=0	M2=0	M3=-1,07281950444993	FrameElem=3-1
Frame=3 ElemStation=0	Station=0	OutputCase=RAR026	CaseType=Combination	P=-13,1214011973499	V2=3,86771112664313	V3=0	T=0	M2=0	M3=-2,17422082158996	FrameElem=3-1
Frame=3 ElemStation=0,05	Station=0,05	OutputCase=RAR026	CaseType=Combination	P=-12,9214011973499	V2=4,06721112664313	V3=0	T=0	M2=0	M3=-2,37264387792211	FrameElem=3-1
Frame=3 ElemStation=0,1	Station=0,1	OutputCase=RAR026	CaseType=Combination	P=-12,7214011973499	V2=4,25471112664313	V3=0	T=0	M2=0	M3=-2,58074193425427	FrameElem=3-1
Frame=3 ElemStation=0	Station=0	OutputCase=RAR027	CaseType=Combination	P=-72,8814011972574	V2=4,58781840207895	V3=0	T=0	M2=0	M3=-10,4350297630863	FrameElem=3-1
Frame=3 ElemStation=0,05	Station=0,05	OutputCase=RAR027	CaseType=Combination	P=-72,6814011972574	V2=4,78731840207895	V3=0	T=0	M2=0	M3=-10,6694581831903	FrameElem=3-1
Frame=3 ElemStation=0,1	Station=0,1	OutputCase=RAR027	CaseType=Combination	P=-72,4814011972574	V2=4,97481840207895	V3=0	T=0	M2=0	M3=-10,9135616032942	FrameElem=3-1
Frame=3 ElemStation=0	Station=0	OutputCase=RAR028	CaseType=Combination	P=-80,1293087331871	V2=13,7861006480912	V3=0	T=0	M2=0	M3=-15,1462587805709	FrameElem=3-1
Frame=3 ElemStation=0,05	Station=0,05	OutputCase=RAR028	CaseType=Combination	P=-79,9293087331871	V2=13,9856006480912	V3=0	T=0	M2=0	M3=-15,8406013129755	FrameElem=3-1
Frame=3 ElemStation=0,1	Station=0,1	OutputCase=RAR028	CaseType=Combination	P=-79,7293087331871	V2=14,1731006480912	V3=0	T=0	M2=0	M3=-16,54461884538	FrameElem=3-1
Frame=3 ElemStation=0	Station=0	OutputCase=RAR029	CaseType=Combination	P=-72,881401197723	V2=16,8067578722062	V3=0	T=0	M2=0	M3=-8,68820945844895	FrameElem=3-1
Frame=3 ElemStation=0,05	Station=0,05	OutputCase=RAR029	CaseType=Combination	P=-72,681401197723	V2=18,1164141222062	V3=0	T=0	M2=0	M3=-9,56134683122592	FrameElem=3-1
Frame=3 ElemStation=0,1	Station=0,1	OutputCase=RAR029	CaseType=Combination	P=-72,481401197723	V2=19,4121328722062	V3=0	T=0	M2=0	M3=-10,4996185790029	FrameElem=3-1
Frame=3 ElemStation=0	Station=0	OutputCase=RAR030	CaseType=Combination	P=-20,3693087332796	V2=13,0659933726554	V3=0	T=0	M2=0	M3=-6,88544983907454	FrameElem=3-1
Frame=3 ElemStation=0,05	Station=0,05	OutputCase=RAR030	CaseType=Combination	P=-20,1693087332796	V2=13,2654933726554	V3=0	T=0	M2=0	M3=-7,54378700770731	FrameElem=3-1
Frame=3 ElemStation=0,1	Station=0,1	OutputCase=RAR030	CaseType=Combination	P=-19,9693087332796	V2=13,4529933726554	V3=0	T=0	M2=0	M3=-8,21179917634008	FrameElem=3-1
Frame=3 ElemStation=0	Station=0	OutputCase=RAR031	CaseType=Combination	P=-13,1214011978156	V2=16,0866505967704	V3=0	T=0	M2=0	M3=0,427400516952588	FrameElem=3-1
Frame=3 ElemStation=0,05	Station=0,05	OutputCase=RAR031	CaseType=Combination	P=-12,9214011978156	V2=17,3963068467704	V3=0	T=0	M2=0	M3=-1,26453252595777	FrameElem=3-1

Società di Progetto
Brebemi SpA



Doc. N.
60235-00000-A00.doc

CODIFICA DOCUMENTO
04RCDII10000000000300A00

REV.
00

FOGLIO
266 di 628

Frame=3 ElemStation=0,1	Station=0,1	OutputCase=RAR031	CaseType=Combination	P=-12,7214011978156	V2=18,6920255967704	V3=0	T=0	M2=0	M3=-2,16679890996296	FrameElem=3-1
Frame=3 ElemStation=0	Station=0	OutputCase=RAR032	CaseType=Combination	P=-12,7399999996415	V2=3,21725251643509	V3=0	T=0	M2=0	M3=-1,3935735638704	FrameElem=3-1
Frame=3 ElemStation=0,05	Station=0,05	OutputCase=RAR032	CaseType=Combination	P=-12,5399999996415	V2=3,41675251643509	V3=0	T=0	M2=0	M3=-1,55947368969216	FrameElem=3-1
Frame=3 ElemStation=0,1	Station=0,1	OutputCase=RAR032	CaseType=Combination	P=-12,3399999996415	V2=3,60425251643509	V3=0	T=0	M2=0	M3=-1,73504881551391	FrameElem=3-1
Frame=3 ElemStation=0	Station=0	OutputCase=RAR033	CaseType=Combination	P=-72,499999999549	V2=3,93735979187091	V3=0	T=0	M2=0	M3=-9,65438250536676	FrameElem=3-1
Frame=3 ElemStation=0,05	Station=0,05	OutputCase=RAR033	CaseType=Combination	P=-72,299999999549	V2=4,13685979187091	V3=0	T=0	M2=0	M3=-9,85628799496031	FrameElem=3-1
Frame=3 ElemStation=0,1	Station=0,1	OutputCase=RAR033	CaseType=Combination	P=-72,099999999549	V2=4,32435979187091	V3=0	T=0	M2=0	M3=-10,0678684845539	FrameElem=3-1
Frame=3 ElemStation=0	Station=0	OutputCase=RAR034	CaseType=Combination	P=-79,7479075354787	V2=13,1356420378831	V3=0	T=0	M2=0	M3=-14,3656115228513	FrameElem=3-1
Frame=3 ElemStation=0,05	Station=0,05	OutputCase=RAR034	CaseType=Combination	P=-79,5479075354787	V2=13,3351420378831	V3=0	T=0	M2=0	M3=-15,0274311247455	FrameElem=3-1
Frame=3 ElemStation=0,1	Station=0,1	OutputCase=RAR034	CaseType=Combination	P=-79,3479075354787	V2=13,5226420378831	V3=0	T=0	M2=0	M3=-15,6989257266397	FrameElem=3-1
Frame=3 ElemStation=0	Station=0	OutputCase=RAR035	CaseType=Combination	P=-72,500000000146	V2=16,1562992619981	V3=0	T=0	M2=0	M3=-7,9075622007294	FrameElem=3-1
Frame=3 ElemStation=0,05	Station=0,05	OutputCase=RAR035	CaseType=Combination	P=-72,300000000146	V2=17,4659555119981	V3=0	T=0	M2=0	M3=-8,74817664299597	FrameElem=3-1
Frame=3 ElemStation=0,1	Station=0,1	OutputCase=RAR035	CaseType=Combination	P=-72,100000000146	V2=18,7616742619981	V3=0	T=0	M2=0	M3=-9,65392546026254	FrameElem=3-1
Frame=3 ElemStation=0	Station=0	OutputCase=RAR036	CaseType=Combination	P=-19,9879075355712	V2=12,4155347624473	V3=0	T=0	M2=0	M3=-6,10480258135499	FrameElem=3-1
Frame=3 ElemStation=0,05	Station=0,05	OutputCase=RAR036	CaseType=Combination	P=-19,7879075355712	V2=12,6150347624473	V3=0	T=0	M2=0	M3=-6,73061681947735	FrameElem=3-1
Frame=3 ElemStation=0,1	Station=0,1	OutputCase=RAR036	CaseType=Combination	P=-19,5879075355712	V2=12,8025347624473	V3=0	T=0	M2=0	M3=-7,36610605759972	FrameElem=3-1
Frame=3 ElemStation=0	Station=0	OutputCase=RAR037	CaseType=Combination	P=-12,7400000001072	V2=15,4361919865623	V3=0	T=0	M2=0	M3=-0,353246740766965	FrameElem=3-1
Frame=3 ElemStation=0,05	Station=0,05	OutputCase=RAR037	CaseType=Combination	P=-12,5400000001072	V2=16,7458482365623	V3=0	T=0	M2=0	M3=-0,451362337727817	FrameElem=3-1
Frame=3 ElemStation=0,1	Station=0,1	OutputCase=RAR037	CaseType=Combination	P=-12,3400000001072	V2=18,0415669865623	V3=0	T=0	M2=0	M3=-1,3211057912226	FrameElem=3-1
Frame=3 ElemStation=0	Station=0	OutputCase=RAR038	CaseType=Combination	P=-12,7399999996412	V2=2,14454660955019	V3=0	T=0	M2=0	M3=-0,803869517263256	FrameElem=3-1
Frame=3 ElemStation=0,05	Station=0,05	OutputCase=RAR038	CaseType=Combination	P=-12,5399999996412	V2=2,34404660955019	V3=0	T=0	M2=0	M3=-0,916134347740765	FrameElem=3-1
Frame=3 ElemStation=0,1	Station=0,1	OutputCase=RAR038	CaseType=Combination	P=-12,3399999996412	V2=2,53154660955019	V3=0	T=0	M2=0	M3=-1,03807417821827	FrameElem=3-1
Frame=3 ElemStation=0	Station=0	OutputCase=RAR039	CaseType=Combination	P=-92,4199999995179	V2=3,41117704543173	V3=0	T=0	M2=0	M3=-11,9867683097176	FrameElem=3-1
Frame=3 ElemStation=0,05	Station=0,05	OutputCase=RAR039	CaseType=Combination	P=-92,2199999995179	V2=3,61067704543173	V3=0	T=0	M2=0	M3=-12,1623646619892	FrameElem=3-1
Frame=3 ElemStation=0,1	Station=0,1	OutputCase=RAR039	CaseType=Combination	P=-92,0199999995179	V2=3,79817704543173	V3=0	T=0	M2=0	M3=-12,3476360142608	FrameElem=3-1
Frame=3 ElemStation=0	Station=0	OutputCase=RAR040	CaseType=Combination	P=-101,761144091724	V2=15,2366077799804	V3=0	T=0	M2=0	M3=-18,0512296686714	FrameElem=3-1
Frame=3 ElemStation=0,05	Station=0,05	OutputCase=RAR040	CaseType=Combination	P=-101,561144091724	V2=15,4361077799804	V3=0	T=0	M2=0	M3=-18,8180975576705	FrameElem=3-1
Frame=3 ElemStation=0,1	Station=0,1	OutputCase=RAR040	CaseType=Combination	P=-101,361144091724	V2=15,6236077799804	V3=0	T=0	M2=0	M3=-19,5946404466695	FrameElem=3-1
Frame=3 ElemStation=0	Station=0	OutputCase=RAR041	CaseType=Combination	P=-92,4200000001	V2=19,0150384863362	V3=0	T=0	M2=0	M3=-9,73421183890546	FrameElem=3-1
Frame=3 ElemStation=0,05	Station=0,05	OutputCase=RAR041	CaseType=Combination	P=-92,2200000001	V2=20,6554134863362	V3=0	T=0	M2=0	M3=-10,7260241798889	FrameElem=3-1
Frame=3 ElemStation=0,1	Station=0,1	OutputCase=RAR041	CaseType=Combination	P=-92,0200000001	V2=22,2835384863362	V3=0	T=0	M2=0	M3=-11,7995490208724	FrameElem=3-1
Frame=3 ElemStation=0	Station=0	OutputCase=RAR042	CaseType=Combination	P=-22,0811440918477	V2=14,276464746066	V3=0	T=0	M2=0	M3=-7,03681774667629	FrameElem=3-1
Frame=3 ElemStation=0,05	Station=0,05	OutputCase=RAR042	CaseType=Combination	P=-21,8811440918477	V2=14,475964746066	V3=0	T=0	M2=0	M3=-7,75567848397959	FrameElem=3-1
Frame=3 ElemStation=0,1	Station=0,1	OutputCase=RAR042	CaseType=Combination	P=-21,6811440918477	V2=14,663464746066	V3=0	T=0	M2=0	M3=-8,48421422128289	FrameElem=3-1
Frame=3 ElemStation=0	Station=0	OutputCase=RAR043	CaseType=Combination	P=-12,7400000002234	V2=18,0548954524217	V3=0	T=0	M2=0	M3=-1,2802008308968	FrameElem=3-1
Frame=3 ElemStation=0,05	Station=0,05	OutputCase=RAR043	CaseType=Combination	P=-12,5400000002234	V2=19,6952704524217	V3=0	T=0	M2=0	M3=-0,33639489380193	FrameElem=3-1
Frame=3 ElemStation=0,1	Station=0,1	OutputCase=RAR043	CaseType=Combination	P=-12,3400000002234	V2=21,3233954524217	V3=0	T=0	M2=0	M3=-0,689122795485826	FrameElem=3-1
Frame=3 ElemStation=0	Station=0	OutputCase=RAR044	CaseType=Combination	P=-94,0959910818636	V2=26,2304235418465	V3=0	T=0	M2=0	M3=-21,9722236893997	FrameElem=3-1
Frame=3 ElemStation=0,05	Station=0,05	OutputCase=RAR044	CaseType=Combination	P=-93,8959910818636	V2=26,4299235418465	V3=0	T=0	M2=0	M3=-23,2887823664921	FrameElem=3-1
Frame=3 ElemStation=0,1	Station=0,1	OutputCase=RAR044	CaseType=Combination	P=-93,6959910818636	V2=26,6174235418465	V3=0	T=0	M2=0	M3=-24,6150160435844	FrameElem=3-1
Frame=3 ElemStation=0	Station=0	OutputCase=RAR045	CaseType=Combination	P=-72,4999999995487	V2=2,86465388498601	V3=0	T=0	M2=0	M3=-9,06467845875962	FrameElem=3-1
Frame=3 ElemStation=0,05	Station=0,05	OutputCase=RAR045	CaseType=Combination	P=-72,2999999995487	V2=3,06415388498601	V3=0	T=0	M2=0	M3=-9,21294865300891	FrameElem=3-1
Frame=3 ElemStation=0,1	Station=0,1	OutputCase=RAR045	CaseType=Combination	P=-72,0999999995487	V2=3,25165388498601	V3=0	T=0	M2=0	M3=-9,37089384725822	FrameElem=3-1
Frame=3 ElemStation=0	Station=0	OutputCase=RAR046	CaseType=Combination	P=-79,7479075354784	V2=12,0629361309982	V3=0	T=0	M2=0	M3=-13,7759074762442	FrameElem=3-1

Società di Progetto
Brebemi SpA

	Doc. N. 60235-00000-A00.doc	CODIFICA DOCUMENTO 04RCDII10000000000300A00	REV. 00	FOGLIO 267 di 628
--	--------------------------------	--	------------	----------------------

Frame=3 ElemStation=0,05	Station=0,05	OutputCase=RAR046	CaseType=Combination	P=-79,5479075354784	V2=12,2624361309982	V3=0	T=0	M2=0	M3=-14,3840917827941	FrameElem=3-1
Frame=3 ElemStation=0,1	Station=0,1	OutputCase=RAR046	CaseType=Combination	P=-79,3479075354784	V2=12,4499361309982	V3=0	T=0	M2=0	M3=-15,001951089344	FrameElem=3-1
Frame=3 ElemStation=0	Station=0	OutputCase=RAR047	CaseType=Combination	P=-72,500000000143	V2=15,0835933551132	V3=0	T=0	M2=0	M3=-7,31785815412225	FrameElem=3-1
Frame=3 ElemStation=0,05	Station=0,05	OutputCase=RAR047	CaseType=Combination	P=-72,300000000143	V2=16,3932496051132	V3=0	T=0	M2=0	M3=-8,10483730104457	FrameElem=3-1
Frame=3 ElemStation=0,1	Station=0,1	OutputCase=RAR047	CaseType=Combination	P=-72,100000000143	V2=17,6889683551132	V3=0	T=0	M2=0	M3=-8,9569508229669	FrameElem=3-1
Frame=3 ElemStation=0	Station=0	OutputCase=RAR048	CaseType=Combination	P=-19,9879075355709	V2=11,3428288555624	V3=0	T=0	M2=0	M3=-5,51509853474784	FrameElem=3-1
Frame=3 ElemStation=0,05	Station=0,05	OutputCase=RAR048	CaseType=Combination	P=-19,7879075355709	V2=11,5423288555624	V3=0	T=0	M2=0	M3=-6,0827277752596	FrameElem=3-1
Frame=3 ElemStation=0,1	Station=0,1	OutputCase=RAR048	CaseType=Combination	P=-19,5879075355709	V2=11,7298288555624	V3=0	T=0	M2=0	M3=-6,66913142030408	FrameElem=3-1
Frame=3 ElemStation=0	Station=0	OutputCase=RAR049	CaseType=Combination	P=-12,7400000001069	V2=14,3634860796774	V3=0	T=0	M2=0	M3=0,942950787374112	FrameElem=3-1
Frame=3 ElemStation=0,05	Station=0,05	OutputCase=RAR049	CaseType=Combination	P=-12,5400000001069	V2=15,6731423296774	V3=0	T=0	M2=0	M3=0,191977004223575	FrameElem=3-1
Frame=3 ElemStation=0,1	Station=0,1	OutputCase=RAR049	CaseType=Combination	P=-12,3400000001069	V2=16,9688610796774	V3=0	T=0	M2=0	M3=0,624131153926965	FrameElem=3-1
Frame=3 ElemStation=0	Station=0	OutputCase=RAR050	CaseType=Combination	P=-12,358598801933	V2=1,95381910229282	V3=0	T=0	M2=0	M3=-0,27595256523248	FrameElem=3-1
Frame=3 ElemStation=0,05	Station=0,05	OutputCase=RAR050	CaseType=Combination	P=-12,158598801933	V2=2,15331910229282	V3=0	T=0	M2=0	M3=-0,378681020347121	FrameElem=3-1
Frame=3 ElemStation=0,1	Station=0,1	OutputCase=RAR050	CaseType=Combination	P=-11,958598801933	V2=2,34081910229283	V3=0	T=0	M2=0	M3=-0,491084475461762	FrameElem=3-1
Frame=3 ElemStation=0	Station=0	OutputCase=RAR051	CaseType=Combination	P=-72,1185988018404	V2=2,67392637772864	V3=0	T=0	M2=0	M3=-8,53676150672884	FrameElem=3-1
Frame=3 ElemStation=0,05	Station=0,05	OutputCase=RAR051	CaseType=Combination	P=-71,9185988018404	V2=2,87342637772864	V3=0	T=0	M2=0	M3=-8,67549532561527	FrameElem=3-1
Frame=3 ElemStation=0,1	Station=0,1	OutputCase=RAR051	CaseType=Combination	P=-71,7185988018404	V2=3,06092637772864	V3=0	T=0	M2=0	M3=-8,8239041445017	FrameElem=3-1
Frame=3 ElemStation=0	Station=0	OutputCase=RAR052	CaseType=Combination	P=-79,3665063377701	V2=11,8722086237409	V3=0	T=0	M2=0	M3=-13,2479905242134	FrameElem=3-1
Frame=3 ElemStation=0,05	Station=0,05	OutputCase=RAR052	CaseType=Combination	P=-79,1665063377701	V2=12,0717086237409	V3=0	T=0	M2=0	M3=-13,8466384554005	FrameElem=3-1
Frame=3 ElemStation=0,1	Station=0,1	OutputCase=RAR052	CaseType=Combination	P=-78,9665063377701	V2=12,2592086237409	V3=0	T=0	M2=0	M3=-14,4549613865875	FrameElem=3-1
Frame=3 ElemStation=0	Station=0	OutputCase=RAR053	CaseType=Combination	P=-72,1185988023061	V2=14,8928658478559	V3=0	T=0	M2=0	M3=-6,78994120209147	FrameElem=3-1
Frame=3 ElemStation=0,05	Station=0,05	OutputCase=RAR053	CaseType=Combination	P=-71,9185988023061	V2=16,2025220978559	V3=0	T=0	M2=0	M3=-7,56738397365093	FrameElem=3-1
Frame=3 ElemStation=0,1	Station=0,1	OutputCase=RAR053	CaseType=Combination	P=-71,7185988023061	V2=17,4982408478559	V3=0	T=0	M2=0	M3=-8,40996112021039	FrameElem=3-1
Frame=3 ElemStation=0	Station=0	OutputCase=RAR054	CaseType=Combination	P=-19,6065063378627	V2=11,1521013483051	V3=0	T=0	M2=0	M3=-4,98718158271706	FrameElem=3-1
Frame=3 ElemStation=0,05	Station=0,05	OutputCase=RAR054	CaseType=Combination	P=-19,4065063378627	V2=11,3516013483051	V3=0	T=0	M2=0	M3=-5,54982415013232	FrameElem=3-1
Frame=3 ElemStation=0,1	Station=0,1	OutputCase=RAR054	CaseType=Combination	P=-19,2065063378627	V2=11,5391013483051	V3=0	T=0	M2=0	M3=-6,12214171754757	FrameElem=3-1
Frame=3 ElemStation=0	Station=0	OutputCase=RAR055	CaseType=Combination	P=-12,3585988023986	V2=14,17275857242	V3=0	T=0	M2=0	M3=1,47086773940489	FrameElem=3-1
Frame=3 ElemStation=0,05	Station=0,05	OutputCase=RAR055	CaseType=Combination	P=-12,1585988023986	V2=15,48241482242	V3=0	T=0	M2=0	M3=0,72943033161722	FrameElem=3-1
Frame=3 ElemStation=0,1	Station=0,1	OutputCase=RAR055	CaseType=Combination	P=-11,9585988023986	V2=16,7781335724201	V3=0	T=0	M2=0	M3=0,077141451170452	FrameElem=3-1
Frame=3 ElemStation=0	Station=0	OutputCase=RAR056	CaseType=Combination	P=-13,1214011973495	V2=2,33527411680756	V3=0	T=0	M2=0	M3=-1,33178646929403	FrameElem=3-1
Frame=3 ElemStation=0,05	Station=0,05	OutputCase=RAR056	CaseType=Combination	P=-12,9214011973495	V2=2,53477411680756	V3=0	T=0	M2=0	M3=-1,45358767513441	FrameElem=3-1
Frame=3 ElemStation=0,1	Station=0,1	OutputCase=RAR056	CaseType=Combination	P=-12,7214011973495	V2=2,72227411680756	V3=0	T=0	M2=0	M3=-1,58506388097479	FrameElem=3-1
Frame=3 ElemStation=0	Station=0	OutputCase=RAR057	CaseType=Combination	P=-72,8814011972569	V2=3,05538139224337	V3=0	T=0	M2=0	M3=-9,59259541079039	FrameElem=3-1
Frame=3 ElemStation=0,05	Station=0,05	OutputCase=RAR057	CaseType=Combination	P=-72,6814011972569	V2=3,25488139224337	V3=0	T=0	M2=0	M3=-9,75040198040256	FrameElem=3-1
Frame=3 ElemStation=0,1	Station=0,1	OutputCase=RAR057	CaseType=Combination	P=-72,4814011972569	V2=3,44238139224337	V3=0	T=0	M2=0	M3=-9,91788355001473	FrameElem=3-1
Frame=3 ElemStation=0	Station=0	OutputCase=RAR058	CaseType=Combination	P=-80,1293087331866	V2=12,2536636382556	V3=0	T=0	M2=0	M3=-14,303824428275	FrameElem=3-1
Frame=3 ElemStation=0,05	Station=0,05	OutputCase=RAR058	CaseType=Combination	P=-79,9293087331866	V2=12,4531636382556	V3=0	T=0	M2=0	M3=-14,9215451101878	FrameElem=3-1
Frame=3 ElemStation=0,1	Station=0,1	OutputCase=RAR058	CaseType=Combination	P=-79,7293087331866	V2=12,6406636382556	V3=0	T=0	M2=0	M3=-15,5489407921005	FrameElem=3-1
Frame=3 ElemStation=0	Station=0	OutputCase=RAR059	CaseType=Combination	P=-72,8814011977226	V2=15,2743208623706	V3=0	T=0	M2=0	M3=-7,84577510615302	FrameElem=3-1
Frame=3 ElemStation=0,05	Station=0,05	OutputCase=RAR059	CaseType=Combination	P=-72,6814011977226	V2=16,5839771123706	V3=0	T=0	M2=0	M3=-8,64229062843822	FrameElem=3-1
Frame=3 ElemStation=0,1	Station=0,1	OutputCase=RAR059	CaseType=Combination	P=-72,4814011977226	V2=17,8796958623706	V3=0	T=0	M2=0	M3=-9,50394052572342	FrameElem=3-1
Frame=3 ElemStation=0	Station=0	OutputCase=RAR060	CaseType=Combination	P=-20,3693087332791	V2=11,5335563628198	V3=0	T=0	M2=0	M3=-6,04301548677861	FrameElem=3-1
Frame=3 ElemStation=0,05	Station=0,05	OutputCase=RAR060	CaseType=Combination	P=-20,1693087332791	V2=11,7330563628198	V3=0	T=0	M2=0	M3=-6,6247308049196	FrameElem=3-1
Frame=3 ElemStation=0,1	Station=0,1	OutputCase=RAR060	CaseType=Combination	P=-19,9693087332791	V2=11,9205563628198	V3=0	T=0	M2=0	M3=-7,2161211230606	FrameElem=3-1

Società di Progetto
Brebemi SpA

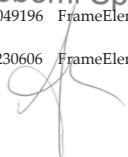



Doc. N.
60235-00000-A00.doc

CODIFICA DOCUMENTO
04RCDII10000000000300A00

REV.
00

FOGLIO
268 di 628

Frame=3 ElemStation=0	Station=0	OutputCase=RAR061	CaseType=Combination	P=-13,1214011978151	V2=14,5542135869348	V3=0	T=0	M2=0	M3=0,415033835343336	FrameElem=3-1
Frame=3 ElemStation=0,05	Station=0,05	OutputCase=RAR061	CaseType=Combination	P=-12,9214011978151	V2=15,8638698369348	V3=0	T=0	M2=0	M3=-0,345476323170069	FrameElem=3-1
Frame=3 ElemStation=0,1	Station=0,1	OutputCase=RAR061	CaseType=Combination	P=-12,7214011978151	V2=17,1595885869348	V3=0	T=0	M2=0	M3=-1,17112085668348	FrameElem=3-1
Frame=3 ElemStation=0	Station=0	OutputCase=RAR062	CaseType=Combination	P=-12,7399999996411	V2=1,68481550659952	V3=0	T=0	M2=0	M3=-0,551139211574478	FrameElem=3-1
Frame=3 ElemStation=0,05	Station=0,05	OutputCase=RAR062	CaseType=Combination	P=-12,5399999996411	V2=1,88431550659952	V3=0	T=0	M2=0	M3=-0,640417486904454	FrameElem=3-1
Frame=3 ElemStation=0,1	Station=0,1	OutputCase=RAR062	CaseType=Combination	P=-12,3399999996411	V2=2,07181550659952	V3=0	T=0	M2=0	M3=-0,73937076223443	FrameElem=3-1
Frame=3 ElemStation=0	Station=0	OutputCase=RAR063	CaseType=Combination	P=-72,4999999995485	V2=2,40492278203533	V3=0	T=0	M2=0	M3=-8,81194815307084	FrameElem=3-1
Frame=3 ElemStation=0,05	Station=0,05	OutputCase=RAR063	CaseType=Combination	P=-72,2999999995485	V2=2,60442278203533	V3=0	T=0	M2=0	M3=-8,9372317921726	FrameElem=3-1
Frame=3 ElemStation=0,1	Station=0,1	OutputCase=RAR063	CaseType=Combination	P=-72,0999999995485	V2=2,79192278203533	V3=0	T=0	M2=0	M3=-9,07219043127437	FrameElem=3-1
Frame=3 ElemStation=0	Station=0	OutputCase=RAR064	CaseType=Combination	P=-79,7479075354782	V2=11,6032050280476	V3=0	T=0	M2=0	M3=-13,5231771705554	FrameElem=3-1
Frame=3 ElemStation=0,05	Station=0,05	OutputCase=RAR064	CaseType=Combination	P=-79,5479075354782	V2=11,8027050280476	V3=0	T=0	M2=0	M3=-14,1083749219578	FrameElem=3-1
Frame=3 ElemStation=0,1	Station=0,1	OutputCase=RAR064	CaseType=Combination	P=-79,3479075354782	V2=11,9902050280476	V3=0	T=0	M2=0	M3=-14,7032476733602	FrameElem=3-1
Frame=3 ElemStation=0	Station=0	OutputCase=RAR065	CaseType=Combination	P=-72,500000000142	V2=14,6238622521626	V3=0	T=0	M2=0	M3=-7,06512784843347	FrameElem=3-1
Frame=3 ElemStation=0,05	Station=0,05	OutputCase=RAR065	CaseType=Combination	P=-72,300000000142	V2=15,9335185021626	V3=0	T=0	M2=0	M3=-7,82912044020826	FrameElem=3-1
Frame=3 ElemStation=0,1	Station=0,1	OutputCase=RAR065	CaseType=Combination	P=-72,100000000142	V2=17,2292372521626	V3=0	T=0	M2=0	M3=-8,65824740698306	FrameElem=3-1
Frame=3 ElemStation=0	Station=0	OutputCase=RAR066	CaseType=Combination	P=-19,9879075355708	V2=10,8830977526118	V3=0	T=0	M2=0	M3=-5,26236822905906	FrameElem=3-1
Frame=3 ElemStation=0,05	Station=0,05	OutputCase=RAR066	CaseType=Combination	P=-19,7879075355708	V2=11,0825977526118	V3=0	T=0	M2=0	M3=-5,18156061668965	FrameElem=3-1
Frame=3 ElemStation=0,1	Station=0,1	OutputCase=RAR066	CaseType=Combination	P=-19,5879075355708	V2=11,2700977526118	V3=0	T=0	M2=0	M3=-6,37042800432024	FrameElem=3-1
Frame=3 ElemStation=0	Station=0	OutputCase=RAR067	CaseType=Combination	P=-12,7400000001067	V2=13,9037549767267	V3=0	T=0	M2=0	M3=1,19568109306289	FrameElem=3-1
Frame=3 ElemStation=0,05	Station=0,05	OutputCase=RAR067	CaseType=Combination	P=-12,5400000001067	V2=15,2134112267267	V3=0	T=0	M2=0	M3=0,467693865059887	FrameElem=3-1
Frame=3 ElemStation=0,1	Station=0,1	OutputCase=RAR067	CaseType=Combination	P=-12,3400000001067	V2=16,5091299767267	V3=0	T=0	M2=0	M3=-0,32542773794312	FrameElem=3-1
Frame=3 ElemStation=0	Station=0	OutputCase=RAR068	CaseType=Combination	P=-12,1043313367944	V2=2,5928859357057	V3=0	T=0	M2=0	M3=-0,345225106693258	FrameElem=3-1
Frame=3 ElemStation=0,05	Station=0,05	OutputCase=RAR068	CaseType=Combination	P=-11,9043313367944	V2=2,7923859357057	V3=0	T=0	M2=0	M3=-0,479906903478543	FrameElem=3-1
Frame=3 ElemStation=0,1	Station=0,1	OutputCase=RAR068	CaseType=Combination	P=-11,7043313367944	V2=2,9798859357057	V3=0	T=0	M2=0	M3=-0,624263700263829	FrameElem=3-1
Frame=3 ElemStation=0	Station=0	OutputCase=RAR069	CaseType=Combination	P=-92,0385988018098	V2=3,68018064112503	V3=0	T=0	M2=0	M3=-11,7115816633756	FrameElem=3-1
Frame=3 ElemStation=0,05	Station=0,05	OutputCase=RAR069	CaseType=Combination	P=-91,8385988018098	V2=3,87968064112503	V3=0	T=0	M2=0	M3=-11,9006281954318	FrameElem=3-1
Frame=3 ElemStation=0,1	Station=0,1	OutputCase=RAR069	CaseType=Combination	P=-91,6385988018098	V2=4,06718064112503	V3=0	T=0	M2=0	M3=-12,0993497274881	FrameElem=3-1
Frame=3 ElemStation=0	Station=0	OutputCase=RAR070	CaseType=Combination	P=-101,379742894016	V2=15,5056113756737	V3=0	T=0	M2=0	M3=-17,7760430223294	FrameElem=3-1
Frame=3 ElemStation=0,05	Station=0,05	OutputCase=RAR070	CaseType=Combination	P=-101,179742894016	V2=15,7051113756737	V3=0	T=0	M2=0	M3=-18,5563610911131	FrameElem=3-1
Frame=3 ElemStation=0,1	Station=0,1	OutputCase=RAR070	CaseType=Combination	P=-100,979742894016	V2=15,8926113756737	V3=0	T=0	M2=0	M3=-19,3463541598968	FrameElem=3-1
Frame=3 ElemStation=0	Station=0	OutputCase=RAR071	CaseType=Combination	P=-92,0385988023919	V2=19,2840420820295	V3=0	T=0	M2=0	M3=-9,45902519256347	FrameElem=3-1
Frame=3 ElemStation=0,05	Station=0,05	OutputCase=RAR071	CaseType=Combination	P=-91,8385988023919	V2=20,9244170820295	V3=0	T=0	M2=0	M3=-10,4642877133316	FrameElem=3-1
Frame=3 ElemStation=0,1	Station=0,1	OutputCase=RAR071	CaseType=Combination	P=-91,6385988023919	V2=22,5525420820295	V3=0	T=0	M2=0	M3=-11,5512627340997	FrameElem=3-1
Frame=3 ElemStation=0	Station=0	OutputCase=RAR072	CaseType=Combination	P=-21,6997428941396	V2=14,5454683417593	V3=0	T=0	M2=0	M3=-6,76163110033429	FrameElem=3-1
Frame=3 ElemStation=0,05	Station=0,05	OutputCase=RAR072	CaseType=Combination	P=-21,4997428941396	V2=14,7449683417593	V3=0	T=0	M2=0	M3=-7,49394201742226	FrameElem=3-1
Frame=3 ElemStation=0,1	Station=0,1	OutputCase=RAR072	CaseType=Combination	P=-21,2997428941396	V2=14,9324683417593	V3=0	T=0	M2=0	M3=-8,23592793451023	FrameElem=3-1
Frame=3 ElemStation=0	Station=0	OutputCase=RAR073	CaseType=Combination	P=-12,3585988025153	V2=18,3238990481151	V3=0	T=0	M2=0	M3=1,55538672943168	FrameElem=3-1
Frame=3 ElemStation=0,05	Station=0,05	OutputCase=RAR073	CaseType=Combination	P=-12,1585988025153	V2=19,9642740481151	V3=0	T=0	M2=0	M3=0,598131360359263	FrameElem=3-1
Frame=3 ElemStation=0,1	Station=0,1	OutputCase=RAR073	CaseType=Combination	P=-11,9585988025153	V2=21,5923990481151	V3=0	T=0	M2=0	M3=-0,440836508713158	FrameElem=3-1
Frame=3 ElemStation=0	Station=0	OutputCase=RAR074	CaseType=Combination	P=-93,7145898841555	V2=26,4994271375398	V3=0	T=0	M2=0	M3=-21,6970370430577	FrameElem=3-1
Frame=3 ElemStation=0,05	Station=0,05	OutputCase=RAR074	CaseType=Combination	P=-93,5145898841555	V2=26,6989271375398	V3=0	T=0	M2=0	M3=-23,0270458999347	FrameElem=3-1
Frame=3 ElemStation=0,1	Station=0,1	OutputCase=RAR074	CaseType=Combination	P=-93,3145898841555	V2=26,8864271375398	V3=0	T=0	M2=0	M3=-24,3667297568117	FrameElem=3-1
Frame=3 ElemStation=0	Station=0	OutputCase=RAR075	CaseType=Combination	P=-71,8643313367018	V2=3,31299321114152	V3=0	T=0	M2=0	M3=-8,60603404818962	FrameElem=3-1
Frame=3 ElemStation=0,05	Station=0,05	OutputCase=RAR075	CaseType=Combination	P=-71,6643313367018	V2=3,51249321114152	V3=0	T=0	M2=0	M3=-8,77672120874669	FrameElem=3-1

Società di Progetto
Brebemi SpA



Doc. N.
60235-0000-A00.doc

CODIFICA DOCUMENTO
04RCDII10000000000300A00

REV.
00

FOGLIO
269 di 628

Frame=3 ElemStation=0,1	Station=0,1	OutputCase=RAR075	CaseType=Combination	P=-71,4643313367018	V2=3,69999321114152	V3=0	T=0	M2=0	M3=-8,95708336930377	FrameElem=3-1
Frame=3 ElemStation=0	Station=0	OutputCase=RAR076	CaseType=Combination	P=-79,1122388726315	V2=12,5112754571538	V3=0	T=0	M2=0	M3=-13,3172630656742	FrameElem=3-1
Frame=3 ElemStation=0,05	Station=0,05	OutputCase=RAR076	CaseType=Combination	P=-78,9122388726315	V2=12,7107754571538	V3=0	T=0	M2=0	M3=-13,9478643385319	FrameElem=3-1
Frame=3 ElemStation=0,1	Station=0,1	OutputCase=RAR076	CaseType=Combination	P=-78,7122388726315	V2=12,8982754571538	V3=0	T=0	M2=0	M3=-14,5881406113896	FrameElem=3-1
Frame=3 ElemStation=0	Station=0	OutputCase=RAR077	CaseType=Combination	P=-71,8643313371675	V2=15,5319326812687	V3=0	T=0	M2=0	M3=-6,85921374355225	FrameElem=3-1
Frame=3 ElemStation=0,05	Station=0,05	OutputCase=RAR077	CaseType=Combination	P=-71,6643313371675	V2=16,8415889312687	V3=0	T=0	M2=0	M3=-7,66860985678235	FrameElem=3-1
Frame=3 ElemStation=0,1	Station=0,1	OutputCase=RAR077	CaseType=Combination	P=-71,4643313371675	V2=18,1373076812687	V3=0	T=0	M2=0	M3=-8,54314034501246	FrameElem=3-1
Frame=3 ElemStation=0	Station=0	OutputCase=RAR078	CaseType=Combination	P=-19,3522388727241	V2=11,7911681817179	V3=0	T=0	M2=0	M3=-5,05645412417784	FrameElem=3-1
Frame=3 ElemStation=0,05	Station=0,05	OutputCase=RAR078	CaseType=Combination	P=-19,1522388727241	V2=11,9906681817179	V3=0	T=0	M2=0	M3=-5,65105003326374	FrameElem=3-1
Frame=3 ElemStation=0,1	Station=0,1	OutputCase=RAR078	CaseType=Combination	P=-18,9522388727241	V2=12,1781681817179	V3=0	T=0	M2=0	M3=-6,25532094234964	FrameElem=3-1
Frame=3 ElemStation=0	Station=0	OutputCase=RAR079	CaseType=Combination	P=-12,10433133726	V2=14,8118254058329	V3=0	T=0	M2=0	M3=1,40159519794411	FrameElem=3-1
Frame=3 ElemStation=0,05	Station=0,05	OutputCase=RAR079	CaseType=Combination	P=-11,90433133726	V2=16,1214816558329	V3=0	T=0	M2=0	M3=0,628204448485797	FrameElem=3-1
Frame=3 ElemStation=0,1	Station=0,1	OutputCase=RAR079	CaseType=Combination	P=-11,70433133726	V2=17,4172004058329	V3=0	T=0	M2=0	M3=-0,210320675972518	FrameElem=3-1
Frame=3 ElemStation=0	Station=0	OutputCase=RAR080	CaseType=Combination	P=-12,1043313367945	V2=3,05261703865637	V3=0	T=0	M2=0	M3=-0,597955412382036	FrameElem=3-1
Frame=3 ElemStation=0,05	Station=0,05	OutputCase=RAR080	CaseType=Combination	P=-11,9043313367945	V2=3,25211703865637	V3=0	T=0	M2=0	M3=-0,755623764314854	FrameElem=3-1
Frame=3 ElemStation=0,1	Station=0,1	OutputCase=RAR080	CaseType=Combination	P=-11,7043313367945	V2=3,43961703865638	V3=0	T=0	M2=0	M3=-0,922967116247673	FrameElem=3-1
Frame=3 ElemStation=0	Station=0	OutputCase=RAR081	CaseType=Combination	P=-71,864331336702	V2=3,77272431409219	V3=0	T=0	M2=0	M3=-8,8587643538784	FrameElem=3-1
Frame=3 ElemStation=0,05	Station=0,05	OutputCase=RAR081	CaseType=Combination	P=-71,664331336702	V2=3,97222431409219	V3=0	T=0	M2=0	M3=-9,052438069583	FrameElem=3-1
Frame=3 ElemStation=0,1	Station=0,1	OutputCase=RAR081	CaseType=Combination	P=-71,464331336702	V2=4,15972431409219	V3=0	T=0	M2=0	M3=-9,25578678528762	FrameElem=3-1
Frame=3 ElemStation=0	Station=0	OutputCase=RAR082	CaseType=Combination	P=-79,1122388726317	V2=12,9710065601044	V3=0	T=0	M2=0	M3=-13,569993371363	FrameElem=3-1
Frame=3 ElemStation=0,05	Station=0,05	OutputCase=RAR082	CaseType=Combination	P=-78,9122388726317	V2=13,1705065601044	V3=0	T=0	M2=0	M3=-14,2235811993682	FrameElem=3-1
Frame=3 ElemStation=0,1	Station=0,1	OutputCase=RAR082	CaseType=Combination	P=-78,7122388726317	V2=13,3580065601044	V3=0	T=0	M2=0	M3=-14,8868440273734	FrameElem=3-1
Frame=3 ElemStation=0	Station=0	OutputCase=RAR083	CaseType=Combination	P=-71,8643313371676	V2=15,9916637842194	V3=0	T=0	M2=0	M3=-7,11194404924103	FrameElem=3-1
Frame=3 ElemStation=0,05	Station=0,05	OutputCase=RAR083	CaseType=Combination	P=-71,6643313371676	V2=17,3013200342194	V3=0	T=0	M2=0	M3=-7,94432671761866	FrameElem=3-1
Frame=3 ElemStation=0,1	Station=0,1	OutputCase=RAR083	CaseType=Combination	P=-71,4643313371676	V2=18,5970387842194	V3=0	T=0	M2=0	M3=-8,8418437609963	FrameElem=3-1
Frame=3 ElemStation=0	Station=0	OutputCase=RAR084	CaseType=Combination	P=-19,3522388727242	V2=12,2508992846686	V3=0	T=0	M2=0	M3=-5,30918442986662	FrameElem=3-1
Frame=3 ElemStation=0,05	Station=0,05	OutputCase=RAR084	CaseType=Combination	P=-19,1522388727242	V2=12,4503992846686	V3=0	T=0	M2=0	M3=-5,92676689410005	FrameElem=3-1
Frame=3 ElemStation=0,1	Station=0,1	OutputCase=RAR084	CaseType=Combination	P=-18,9522388727242	V2=12,6378992846686	V3=0	T=0	M2=0	M3=-6,55402435833348	FrameElem=3-1
Frame=3 ElemStation=0	Station=0	OutputCase=RAR085	CaseType=Combination	P=-12,1043313372602	V2=15,2715565087836	V3=0	T=0	M2=0	M3=1,14886489225533	FrameElem=3-1
Frame=3 ElemStation=0,05	Station=0,05	OutputCase=RAR085	CaseType=Combination	P=-11,9043313372602	V2=16,5812127587836	V3=0	T=0	M2=0	M3=0,352487587649486	FrameElem=3-1
Frame=3 ElemStation=0,1	Station=0,1	OutputCase=RAR085	CaseType=Combination	P=-11,7043313372602	V2=17,8769315087836	V3=0	T=0	M2=0	M3=-0,509024091956363	FrameElem=3-1
Frame=3 ElemStation=0	Station=0	OutputCase=RAR086	CaseType=Combination	P=-12,1043313367942	V2=2,13315483275503	V3=0	T=0	M2=0	M3=-9,24948010044807E-02	FrameElem=3-1
Frame=3 ElemStation=0,05	Station=0,05	OutputCase=RAR086	CaseType=Combination	P=-11,9043313367942	V2=2,33265483275503	V3=0	T=0	M2=0	M3=-0,204190042642232	FrameElem=3-1
Frame=3 ElemStation=0,1	Station=0,1	OutputCase=RAR086	CaseType=Combination	P=-11,7043313367942	V2=2,52015483275503	V3=0	T=0	M2=0	M3=-0,325560284279984	FrameElem=3-1
Frame=3 ElemStation=0	Station=0	OutputCase=RAR087	CaseType=Combination	P=-71,8643313367017	V2=2,85326210819084	V3=0	T=0	M2=0	M3=-8,35330374250084	FrameElem=3-1
Frame=3 ElemStation=0,05	Station=0,05	OutputCase=RAR087	CaseType=Combination	P=-71,6643313367017	V2=3,05276210819084	V3=0	T=0	M2=0	M3=-8,50100434791038	FrameElem=3-1
Frame=3 ElemStation=0,1	Station=0,1	OutputCase=RAR087	CaseType=Combination	P=-71,4643313367017	V2=3,24026210819085	V3=0	T=0	M2=0	M3=-8,65837995331993	FrameElem=3-1
Frame=3 ElemStation=0	Station=0	OutputCase=RAR088	CaseType=Combination	P=-79,1122388726314	V2=12,0515443542031	V3=0	T=0	M2=0	M3=-13,0645327599854	FrameElem=3-1
Frame=3 ElemStation=0,05	Station=0,05	OutputCase=RAR088	CaseType=Combination	P=-78,9122388726314	V2=12,2510443542031	V3=0	T=0	M2=0	M3=-13,6721474776956	FrameElem=3-1
Frame=3 ElemStation=0,1	Station=0,1	OutputCase=RAR088	CaseType=Combination	P=-78,7122388726314	V2=12,4385443542031	V3=0	T=0	M2=0	M3=-14,2894371954057	FrameElem=3-1
Frame=3 ElemStation=0	Station=0	OutputCase=RAR089	CaseType=Combination	P=-71,8643313371673	V2=15,0722015783181	V3=0	T=0	M2=0	M3=-6,60648343786347	FrameElem=3-1
Frame=3 ElemStation=0,05	Station=0,05	OutputCase=RAR089	CaseType=Combination	P=-71,6643313371673	V2=16,3818578283181	V3=0	T=0	M2=0	M3=-7,39289299594604	FrameElem=3-1
Frame=3 ElemStation=0,1	Station=0,1	OutputCase=RAR089	CaseType=Combination	P=-71,4643313371673	V2=17,6775765783181	V3=0	T=0	M2=0	M3=-8,24443692902861	FrameElem=3-1
Frame=3 ElemStation=0	Station=0	OutputCase=RAR090	CaseType=Combination	P=-19,3522388727239	V2=11,3314370787673	V3=0	T=0	M2=0	M3=-4,80372381848906	FrameElem=3-1

Società di Progetto
Brebemi SpA

	Doc. N. 60235-00000-A00.doc	CODIFICA DOCUMENTO 04RCDII10000000000300A00	REV. 00	FOGLIO 270 di 628
--	--------------------------------	--	------------	----------------------

Frame=3 ElemStation=0,05	Station=0,05	OutputCase=RAR090	CaseType=Combination	P=-19,1522388727239	V2=11,5309370787673	V3=0	T=0	M2=0	M3=-5,37533317242743	FrameElem=3-1
Frame=3 ElemStation=0,1	Station=0,1	OutputCase=RAR090	CaseType=Combination	P=-18,9522388727239	V2=11,7184370787673	V3=0	T=0	M2=0	M3=-5,95661752636579	FrameElem=3-1
Frame=3 ElemStation=0	Station=0	OutputCase=RAR091	CaseType=Combination	P=-12,1043313372599	V2=14,3520943028823	V3=0	T=0	M2=0	M3=1,65432550363289	FrameElem=3-1
Frame=3 ElemStation=0,05	Station=0,05	OutputCase=RAR091	CaseType=Combination	P=-11,9043313372599	V2=15,6617505528823	V3=0	T=0	M2=0	M3=0,903921309322108	FrameElem=3-1
Frame=3 1 ElemStation=0,1	Station=0,1	OutputCase=RAR091	CaseType=Combination	P=-11,7043313372599	V2=16,9574693028823	V3=0	T=0	M2=0	M3=8,83827400113264E-02	FrameElem=3-1
Frame=3 ElemStation=0	Station=0	OutputCase=RAR092	CaseType=Combination	P=-12,1043313367942	V2=2,13315483275503	V3=0	T=0	M2=0	M3=-9,24948010044807E-02	FrameElem=3-1
Frame=3 ElemStation=0,05	Station=0,05	OutputCase=RAR092	CaseType=Combination	P=-11,9043313367942	V2=2,33265483275503	V3=0	T=0	M2=0	M3=-0,204190042642232	FrameElem=3-1
Frame=3 ElemStation=0,1	Station=0,1	OutputCase=RAR092	CaseType=Combination	P=-11,7043313367942	V2=2,52015483275503	V3=0	T=0	M2=0	M3=-0,325560284279984	FrameElem=3-1
Frame=3 ElemStation=0	Station=0	OutputCase=RAR093	CaseType=Combination	P=-71,8643313367017	V2=2,85326210819084	V3=0	T=0	M2=0	M3=-8,35330374250084	FrameElem=3-1
Frame=3 ElemStation=0,05	Station=0,05	OutputCase=RAR093	CaseType=Combination	P=-71,6643313367017	V2=3,05276210819084	V3=0	T=0	M2=0	M3=-8,50100434791038	FrameElem=3-1
Frame=3 ElemStation=0,1	Station=0,1	OutputCase=RAR093	CaseType=Combination	P=-71,4643313367017	V2=3,24026210819085	V3=0	T=0	M2=0	M3=-8,65837995331993	FrameElem=3-1
Frame=3 ElemStation=0	Station=0	OutputCase=RAR094	CaseType=Combination	P=-79,1122388726314	V2=12,0515443542031	V3=0	T=0	M2=0	M3=-13,0645327599854	FrameElem=3-1
Frame=3 ElemStation=0,05	Station=0,05	OutputCase=RAR094	CaseType=Combination	P=-78,9122388726314	V2=12,2510443542031	V3=0	T=0	M2=0	M3=-13,6721474776956	FrameElem=3-1
Frame=3 ElemStation=0,1	Station=0,1	OutputCase=RAR094	CaseType=Combination	P=-78,7122388726314	V2=12,4385443542031	V3=0	T=0	M2=0	M3=-14,2894371954057	FrameElem=3-1
Frame=3 ElemStation=0	Station=0	OutputCase=RAR095	CaseType=Combination	P=-71,8643313371673	V2=15,0722015783181	V3=0	T=0	M2=0	M3=-6,60648343786347	FrameElem=3-1
Frame=3 ElemStation=0,05	Station=0,05	OutputCase=RAR095	CaseType=Combination	P=-71,6643313371673	V2=16,3818578283181	V3=0	T=0	M2=0	M3=-7,39289299594604	FrameElem=3-1
Frame=3 ElemStation=0,1	Station=0,1	OutputCase=RAR095	CaseType=Combination	P=-71,4643313371673	V2=17,6775765783181	V3=0	T=0	M2=0	M3=-8,24443692902861	FrameElem=3-1
Frame=3 ElemStation=0	Station=0	OutputCase=RAR096	CaseType=Combination	P=-19,3522388727239	V2=11,3314370787673	V3=0	T=0	M2=0	M3=-4,80372381848906	FrameElem=3-1
Frame=3 ElemStation=0,05	Station=0,05	OutputCase=RAR096	CaseType=Combination	P=-19,1522388727239	V2=11,5309370787673	V3=0	T=0	M2=0	M3=-5,37533317242743	FrameElem=3-1
Frame=3 ElemStation=0,1	Station=0,1	OutputCase=RAR096	CaseType=Combination	P=-18,9522388727239	V2=11,7184370787673	V3=0	T=0	M2=0	M3=-5,95661752636579	FrameElem=3-1
Frame=3 ElemStation=0	Station=0	OutputCase=RAR097	CaseType=Combination	P=-12,1043313372599	V2=14,3520943028823	V3=0	T=0	M2=0	M3=1,65432550363289	FrameElem=3-1
Frame=3 ElemStation=0,05	Station=0,05	OutputCase=RAR097	CaseType=Combination	P=-11,9043313372599	V2=15,6617505528823	V3=0	T=0	M2=0	M3=0,903921309322108	FrameElem=3-1
Frame=3 1 ElemStation=0,1	Station=0,1	OutputCase=RAR097	CaseType=Combination	P=-11,7043313372599	V2=16,9574693028823	V3=0	T=0	M2=0	M3=8,83827400113265E-02	FrameElem=3-1
Frame=3 ElemStation=0	Station=0	OutputCase=RAR098	CaseType=Combination	P=-13,3756686624885	V2=3,22864429323025	V3=0	T=0	M2=0	M3=-2,10494828012918	FrameElem=3-1
Frame=3 ElemStation=0,05	Station=0,05	OutputCase=RAR098	CaseType=Combination	P=-13,1756686624885	V2=3,42814429323025	V3=0	T=0	M2=0	M3=-2,27141799479069	FrameElem=3-1
Frame=3 ElemStation=0,1	Station=0,1	OutputCase=RAR098	CaseType=Combination	P=-12,9756686624885	V2=3,61564429323025	V3=0	T=0	M2=0	M3=-2,4475627094522	FrameElem=3-1
Frame=3 ElemStation=0	Station=0	OutputCase=RAR099	CaseType=Combination	P=-92,8014011972263	V2=4,0616356563976	V3=0	T=0	M2=0	M3=-12,7674155674371	FrameElem=3-1
Frame=3 ElemStation=0,05	Station=0,05	OutputCase=RAR099	CaseType=Combination	P=-92,6014011972263	V2=4,2611356563976	V3=0	T=0	M2=0	M3=-12,9755348502191	FrameElem=3-1
Frame=3 ElemStation=0,1	Station=0,1	OutputCase=RAR099	CaseType=Combination	P=-92,4014011972263	V2=4,4486356563976	V3=0	T=0	M2=0	M3=-13,1933291330011	FrameElem=3-1
Frame=3 ElemStation=0	Station=0	OutputCase=RAR100	CaseType=Combination	P=-102,142545289433	V2=15,8870663901885	V3=0	T=0	M2=0	M3=-18,831876926391	FrameElem=3-1
Frame=3 ElemStation=0,05	Station=0,05	OutputCase=RAR100	CaseType=Combination	P=-101,942545289433	V2=16,0865663901885	V3=0	T=0	M2=0	M3=-19,6312677459004	FrameElem=3-1
Frame=3 ElemStation=0,1	Station=0,1	OutputCase=RAR100	CaseType=Combination	P=-101,742545289433	V2=16,2740663901885	V3=0	T=0	M2=0	M3=-20,4403335654098	FrameElem=3-1
Frame=3 ElemStation=0	Station=0	OutputCase=RAR101	CaseType=Combination	P=-92,8014011978084	V2=19,6654970965442	V3=0	T=0	M2=0	M3=-10,514859096625	FrameElem=3-1
Frame=3 ElemStation=0,05	Station=0,05	OutputCase=RAR101	CaseType=Combination	P=-92,6014011978084	V2=21,3058720965442	V3=0	T=0	M2=0	M3=-11,5391943681189	FrameElem=3-1
Frame=3 ElemStation=0,1	Station=0,1	OutputCase=RAR101	CaseType=Combination	P=-92,4014011978084	V2=22,9339970965442	V3=0	T=0	M2=0	M3=-12,6452421396128	FrameElem=3-1
Frame=3 ElemStation=0	Station=0	OutputCase=RAR102	CaseType=Combination	P=-22,4625452895561	V2=14,9269233562741	V3=0	T=0	M2=0	M3=-7,81746500439584	FrameElem=3-1
Frame=3 ElemStation=0,05	Station=0,05	OutputCase=RAR102	CaseType=Combination	P=-22,2625452895561	V2=15,1264233562741	V3=0	T=0	M2=0	M3=-8,56884867220955	FrameElem=3-1
Frame=3 ElemStation=0,1	Station=0,1	OutputCase=RAR102	CaseType=Combination	P=-22,0625452895561	V2=15,3139233562741	V3=0	T=0	M2=0	M3=-9,32990734002325	FrameElem=3-1
Frame=3 ElemStation=0	Station=0	OutputCase=RAR103	CaseType=Combination	P=-13,1214011979318	V2=18,7053540626298	V3=0	T=0	M2=0	M3=0,49955282537013	FrameElem=3-1
Frame=3 ElemStation=0,05	Station=0,05	OutputCase=RAR103	CaseType=Combination	P=-12,9214011979318	V2=20,3457290626298	V3=0	T=0	M2=0	M3=-0,476775294428025	FrameElem=3-1
Frame=3 ElemStation=0,1	Station=0,1	OutputCase=RAR103	CaseType=Combination	P=-12,7214011979318	V2=21,9738540626298	V3=0	T=0	M2=0	M3=-1,53481591422618	FrameElem=3-1
Frame=3 ElemStation=0	Station=0	OutputCase=RAR104	CaseType=Combination	P=-94,477392279572	V2=26,8808821520545	V3=0	T=0	M2=0	M3=-22,7528709471193	FrameElem=3-1
Frame=3 ElemStation=0,05	Station=0,05	OutputCase=RAR104	CaseType=Combination	P=-94,277392279572	V2=27,0803821520545	V3=0	T=0	M2=0	M3=-24,101952554722	FrameElem=3-1
Frame=3 ElemStation=0,1	Station=0,1	OutputCase=RAR104	CaseType=Combination	P=-94,077392279572	V2=27,2678821520545	V3=0	T=0	M2=0	M3=-25,4607091623247	FrameElem=3-1

Società di Progetto
Brebemi SpA

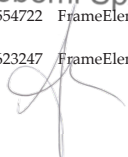



Doc. N.
60235-0000-A00.doc

CODIFICA DOCUMENTO
04RCDII10000000000300A00

REV.
00

FOGLIO
271 di 628

Frame=3 ElemStation=0	Station=0	OutputCase=RAR105	CaseType=Combination	P=-73,135668662396	V2=3,94875156866607	V3=0	T=0	M2=0	M3=-10,3657572216255	FrameElem=3-1
Frame=3 ElemStation=0,05	Station=0,05	OutputCase=RAR105	CaseType=Combination	P=-72,935668662396	V2=4,14825156866607	V3=0	T=0	M2=0	M3=-10,5682323000588	FrameElem=3-1
Frame=3 ElemStation=0,1	Station=0,1	OutputCase=RAR105	CaseType=Combination	P=-72,735668662396	V2=4,33575156866607	V3=0	T=0	M2=0	M3=-10,7803823784921	FrameElem=3-1
Frame=3 ElemStation=0	Station=0	OutputCase=RAR106	CaseType=Combination	P=-80,3835761983257	V2=13,1470338146783	V3=0	T=0	M2=0	M3=-15,0769862391101	FrameElem=3-1
Frame=3 ElemStation=0,05	Station=0,05	OutputCase=RAR106	CaseType=Combination	P=-80,1835761983257	V2=13,3465338146783	V3=0	T=0	M2=0	M3=-15,739375429844	FrameElem=3-1
Frame=3 ElemStation=0,1	Station=0,1	OutputCase=RAR106	CaseType=Combination	P=-79,9835761983257	V2=13,5340338146783	V3=0	T=0	M2=0	M3=-16,411439620578	FrameElem=3-1
Frame=3 ElemStation=0	Station=0	OutputCase=RAR107	CaseType=Combination	P=-73,1356686628616	V2=16,1676910387933	V3=0	T=0	M2=0	M3=-8,61893691698817	FrameElem=3-1
Frame=3 ElemStation=0,05	Station=0,05	OutputCase=RAR107	CaseType=Combination	P=-72,9356686628616	V2=17,4773472887933	V3=0	T=0	M2=0	M3=-9,4601209480945	FrameElem=3-1
Frame=3 ElemStation=0,1	Station=0,1	OutputCase=RAR107	CaseType=Combination	P=-72,7356686628616	V2=18,7730660387933	V3=0	T=0	M2=0	M3=-10,3664393542008	FrameElem=3-1
Frame=3 ElemStation=0	Station=0	OutputCase=RAR108	CaseType=Combination	P=-20,6235761984182	V2=12,4269265392425	V3=0	T=0	M2=0	M3=-6,81617279761376	FrameElem=3-1
Frame=3 ElemStation=0,05	Station=0,05	OutputCase=RAR108	CaseType=Combination	P=-20,4235761984182	V2=12,6264265392425	V3=0	T=0	M2=0	M3=-7,44256112457589	FrameElem=3-1
Frame=3 ElemStation=0,1	Station=0,1	OutputCase=RAR108	CaseType=Combination	P=-20,2235761984182	V2=12,8139265392425	V3=0	T=0	M2=0	M3=-8,07861995153801	FrameElem=3-1
Frame=3 ElemStation=0	Station=0	OutputCase=RAR109	CaseType=Combination	P=-13,3756686629542	V2=15,4475837633575	V3=0	T=0	M2=0	M3=-0,35812797549181	FrameElem=3-1
Frame=3 ElemStation=0,05	Station=0,05	OutputCase=RAR109	CaseType=Combination	P=-13,1756686629542	V2=16,7572400133575	V3=0	T=0	M2=0	M3=-1,16330664282635	FrameElem=3-1
Frame=3 ElemStation=0,1	Station=0,1	OutputCase=RAR109	CaseType=Combination	P=-12,9756686629542	V2=18,0529587633575	V3=0	T=0	M2=0	M3=-2,03361968516089	FrameElem=3-1
Frame=3 ElemStation=0	Station=0	OutputCase=RAR110	CaseType=Combination	P=-13,3756686624886	V2=3,68837539618093	V3=0	T=0	M2=0	M3=-2,35767858581796	FrameElem=3-1
Frame=3 ElemStation=0,05	Station=0,05	OutputCase=RAR110	CaseType=Combination	P=-13,1756686624886	V2=3,88787539618093	V3=0	T=0	M2=0	M3=-2,547134855627	FrameElem=3-1
Frame=3 ElemStation=0,1	Station=0,1	OutputCase=RAR110	CaseType=Combination	P=-12,9756686624886	V2=4,07537539618093	V3=0	T=0	M2=0	M3=-2,74626612543605	FrameElem=3-1
Frame=3 ElemStation=0	Station=0	OutputCase=RAR111	CaseType=Combination	P=-73,1356686623961	V2=4,40848267161674	V3=0	T=0	M2=0	M3=-10,6184875273143	FrameElem=3-1
Frame=3 ElemStation=0,05	Station=0,05	OutputCase=RAR111	CaseType=Combination	P=-72,9356686623961	V2=4,60798267161674	V3=0	T=0	M2=0	M3=-10,8439491608952	FrameElem=3-1
Frame=3 ElemStation=0,1	Station=0,1	OutputCase=RAR111	CaseType=Combination	P=-72,7356686623961	V2=4,79548267161674	V3=0	T=0	M2=0	M3=-11,079085794476	FrameElem=3-1
Frame=3 ElemStation=0	Station=0	OutputCase=RAR112	CaseType=Combination	P=-80,3835761983258	V2=13,606764917629	V3=0	T=0	M2=0	M3=-15,3297165447989	FrameElem=3-1
Frame=3 ElemStation=0,05	Station=0,05	OutputCase=RAR112	CaseType=Combination	P=-80,1835761983258	V2=13,806264917629	V3=0	T=0	M2=0	M3=-16,0150922906803	FrameElem=3-1
Frame=3 ElemStation=0,1	Station=0,1	OutputCase=RAR112	CaseType=Combination	P=-79,9835761983258	V2=13,993764917629	V3=0	T=0	M2=0	M3=-16,7101430365618	FrameElem=3-1
Frame=3 ElemStation=0	Station=0	OutputCase=RAR113	CaseType=Combination	P=-73,1356686628618	V2=16,627422141744	V3=0	T=0	M2=0	M3=-8,87166722267695	FrameElem=3-1
Frame=3 ElemStation=0,05	Station=0,05	OutputCase=RAR113	CaseType=Combination	P=-72,9356686628618	V2=17,937078391744	V3=0	T=0	M2=0	M3=-9,73583780893081	FrameElem=3-1
Frame=3 ElemStation=0,1	Station=0,1	OutputCase=RAR113	CaseType=Combination	P=-72,7356686628618	V2=19,232797141744	V3=0	T=0	M2=0	M3=-10,6651427701847	FrameElem=3-1
Frame=3 ElemStation=0	Station=0	OutputCase=RAR114	CaseType=Combination	P=-20,6235761984183	V2=12,8866576421932	V3=0	T=0	M2=0	M3=-7,06890760330254	FrameElem=3-1
Frame=3 ElemStation=0,05	Station=0,05	OutputCase=RAR114	CaseType=Combination	P=-20,4235761984183	V2=13,0861576421932	V3=0	T=0	M2=0	M3=-7,7182779854122	FrameElem=3-1
Frame=3 ElemStation=0,1	Station=0,1	OutputCase=RAR114	CaseType=Combination	P=-20,2235761984183	V2=13,2736576421932	V3=0	T=0	M2=0	M3=-8,37732336752186	FrameElem=3-1
Frame=3 ElemStation=0	Station=0	OutputCase=RAR115	CaseType=Combination	P=-13,3756686629543	V2=15,9073148663082	V3=0	T=0	M2=0	M3=-0,610858281180587	FrameElem=3-1
Frame=3 ElemStation=0,05	Station=0,05	OutputCase=RAR115	CaseType=Combination	P=-13,1756686629543	V2=17,2169711163082	V3=0	T=0	M2=0	M3=-1,43902350366266	FrameElem=3-1
Frame=3 ElemStation=0,1	Station=0,1	OutputCase=RAR115	CaseType=Combination	P=-12,9756686629543	V2=18,5126898663082	V3=0	T=0	M2=0	M3=-2,33232310114474	FrameElem=3-1
Frame=3 ElemStation=0	Station=0	OutputCase=RAR116	CaseType=Combination	P=-13,3756686624884	V2=2,76891319027958	V3=0	T=0	M2=0	M3=-1,8522179744404	FrameElem=3-1
Frame=3 ElemStation=0,05	Station=0,05	OutputCase=RAR116	CaseType=Combination	P=-13,1756686624884	V2=2,96841319027958	V3=0	T=0	M2=0	M3=-1,99570113395438	FrameElem=3-1
Frame=3 ElemStation=0,1	Station=0,1	OutputCase=RAR116	CaseType=Combination	P=-12,9756686624884	V2=3,15591319027958	V3=0	T=0	M2=0	M3=-2,14885929346836	FrameElem=3-1
Frame=3 ElemStation=0	Station=0	OutputCase=RAR117	CaseType=Combination	P=-73,1356686623958	V2=3,4890204657154	V3=0	T=0	M2=0	M3=-10,1130269159368	FrameElem=3-1
Frame=3 ElemStation=0,05	Station=0,05	OutputCase=RAR117	CaseType=Combination	P=-72,9356686623958	V2=3,6885204657154	V3=0	T=0	M2=0	M3=-10,2925154392225	FrameElem=3-1
Frame=3 ElemStation=0,1	Station=0,1	OutputCase=RAR117	CaseType=Combination	P=-72,7356686623958	V2=3,8760204657154	V3=0	T=0	M2=0	M3=-10,4816789625083	FrameElem=3-1
Frame=3 ElemStation=0	Station=0	OutputCase=RAR118	CaseType=Combination	P=-80,3835761983255	V2=12,6873027117276	V3=0	T=0	M2=0	M3=-14,8242559334213	FrameElem=3-1
Frame=3 ElemStation=0,05	Station=0,05	OutputCase=RAR118	CaseType=Combination	P=-80,1835761983255	V2=12,8868027117276	V3=0	T=0	M2=0	M3=-15,4636585690077	FrameElem=3-1
Frame=3 ElemStation=0,1	Station=0,1	OutputCase=RAR118	CaseType=Combination	P=-79,9835761983255	V2=13,0743027117276	V3=0	T=0	M2=0	M3=-16,1127362045941	FrameElem=3-1
Frame=3 ElemStation=0	Station=0	OutputCase=RAR119	CaseType=Combination	P=-73,1356686628615	V2=15,7079599358426	V3=0	T=0	M2=0	M3=-8,36620661129939	FrameElem=3-1
Frame=3 ElemStation=0,05	Station=0,05	OutputCase=RAR119	CaseType=Combination	P=-72,9356686628615	V2=17,0176161858426	V3=0	T=0	M2=0	M3=-9,18440408725819	FrameElem=3-1

Società di Progetto
Brebemi SpA



Doc. N.
60235-0000-A00.doc

CODIFICA DOCUMENTO
04RCDII10000000000300A00

REV.
00

FOGLIO
272 di 628

Frame=3 ElemStation=0,1	Station=0,1 OutputCase=RAR119	CaseType=Combination	P=-72,7356686628615	V2=18,3133349358426	V3=0	T=0	M2=0	M3=-10,067735938217	FrameElem=3-1
Frame=3 ElemStation=0	Station=0 OutputCase=RAR120	CaseType=Combination	P=-20,6235761984181	V2=11,9671954362918	V3=0	T=0	M2=0	M3=-6,56344699192498	FrameElem=3-1
Frame=3 ElemStation=0,05	Station=0,05 OutputCase=RAR120	CaseType=Combination	P=-20,4235761984181	V2=12,1666954362918	V3=0	T=0	M2=0	M3=-7,16684426373958	FrameElem=3-1
Frame=3 ElemStation=0,1	Station=0,1 OutputCase=RAR120	CaseType=Combination	P=-20,2235761984181	V2=12,3541954362918	V3=0	T=0	M2=0	M3=-7,77991653555417	FrameElem=3-1
Frame=3 ElemStation=0	Station=0 OutputCase=RAR121	CaseType=Combination	P=-13,375668662954	V2=14,9878526604068	V3=0	T=0	M2=0	M3=-0,105397669803032	FrameElem=3-1
Frame=3 ElemStation=0,05	Station=0,05 OutputCase=RAR121	CaseType=Combination	P=-13,175668662954	V2=16,2975089104068	V3=0	T=0	M2=0	M3=-0,887589781990039	FrameElem=3-1
Frame=3 ElemStation=0,1	Station=0,1 OutputCase=RAR121	CaseType=Combination	P=-12,975668662954	V2=17,5932276604068	V3=0	T=0	M2=0	M3=-1,73491626917705	FrameElem=3-1
Frame=3 ElemStation=0	Station=0 OutputCase=RAR122	CaseType=Combination	P=-13,3756686624884	V2=2,76891319027958	V3=0	T=0	M2=0	M3=-1,8522179744404	FrameElem=3-1
Frame=3 ElemStation=0,05	Station=0,05 OutputCase=RAR122	CaseType=Combination	P=-13,1756686624884	V2=2,96841319027958	V3=0	T=0	M2=0	M3=-1,99570113395438	FrameElem=3-1
Frame=3 ElemStation=0,1	Station=0,1 OutputCase=RAR122	CaseType=Combination	P=-12,9756686624884	V2=3,15591319027958	V3=0	T=0	M2=0	M3=-2,14885923946836	FrameElem=3-1
Frame=3 ElemStation=0	Station=0 OutputCase=RAR123	CaseType=Combination	P=-73,1356686623958	V2=3,4890204657154	V3=0	T=0	M2=0	M3=-10,1130269159368	FrameElem=3-1
Frame=3 ElemStation=0,05	Station=0,05 OutputCase=RAR123	CaseType=Combination	P=-72,9356686623958	V2=3,6885204657154	V3=0	T=0	M2=0	M3=-10,2925154392225	FrameElem=3-1
Frame=3 ElemStation=0,1	Station=0,1 OutputCase=RAR123	CaseType=Combination	P=-72,7356686623958	V2=3,8760204657154	V3=0	T=0	M2=0	M3=-10,4816789625083	FrameElem=3-1
Frame=3 ElemStation=0	Station=0 OutputCase=RAR124	CaseType=Combination	P=-80,3835761983255	V2=12,6873027117276	V3=0	T=0	M2=0	M3=-14,8242559334213	FrameElem=3-1
Frame=3 ElemStation=0,05	Station=0,05 OutputCase=RAR124	CaseType=Combination	P=-80,1835761983255	V2=12,8868027117276	V3=0	T=0	M2=0	M3=-15,4636585690077	FrameElem=3-1
Frame=3 ElemStation=0,1	Station=0,1 OutputCase=RAR124	CaseType=Combination	P=-79,9835761983255	V2=13,0743027117276	V3=0	T=0	M2=0	M3=-16,1127362045941	FrameElem=3-1
Frame=3 ElemStation=0	Station=0 OutputCase=RAR125	CaseType=Combination	P=-73,1356686628615	V2=15,7079599358426	V3=0	T=0	M2=0	M3=-8,36620661129939	FrameElem=3-1
Frame=3 ElemStation=0,05	Station=0,05 OutputCase=RAR125	CaseType=Combination	P=-72,9356686628615	V2=17,0176161858426	V3=0	T=0	M2=0	M3=-9,18440408725819	FrameElem=3-1
Frame=3 ElemStation=0,1	Station=0,1 OutputCase=RAR125	CaseType=Combination	P=-72,7356686628615	V2=18,3133349358426	V3=0	T=0	M2=0	M3=-10,067735938217	FrameElem=3-1
Frame=3 ElemStation=0	Station=0 OutputCase=RAR126	CaseType=Combination	P=-20,6235761984181	V2=11,9671954362918	V3=0	T=0	M2=0	M3=-6,56344699192498	FrameElem=3-1
Frame=3 ElemStation=0,05	Station=0,05 OutputCase=RAR126	CaseType=Combination	P=-20,4235761984181	V2=12,1666954362918	V3=0	T=0	M2=0	M3=-7,16684426373958	FrameElem=3-1
Frame=3 ElemStation=0,1	Station=0,1 OutputCase=RAR126	CaseType=Combination	P=-20,2235761984181	V2=12,3541954362918	V3=0	T=0	M2=0	M3=-7,77991653555417	FrameElem=3-1
Frame=3 ElemStation=0	Station=0 OutputCase=RAR127	CaseType=Combination	P=-13,375668662954	V2=14,9878526604068	V3=0	T=0	M2=0	M3=-0,105397669803032	FrameElem=3-1
Frame=3 ElemStation=0,05	Station=0,05 OutputCase=RAR127	CaseType=Combination	P=-13,175668662954	V2=16,2975089104068	V3=0	T=0	M2=0	M3=-0,887589781990039	FrameElem=3-1
Frame=3 ElemStation=0,1	Station=0,1 OutputCase=RAR127	CaseType=Combination	P=-12,975668662954	V2=17,5932276604068	V3=0	T=0	M2=0	M3=-1,73491626917705	FrameElem=3-1
Frame=3 ElemStation=0	Station=0 OutputCase=RAR128	CaseType=Combination	P=-12,7399999996412	V2=2,14454660955019	V3=0	T=0	M2=0	M3=-0,803869517263256	FrameElem=3-1
Frame=3 ElemStation=0,05	Station=0,05 OutputCase=RAR128	CaseType=Combination	P=-12,5399999996412	V2=2,34404660955019	V3=0	T=0	M2=0	M3=-0,916134347740765	FrameElem=3-1
Frame=3 ElemStation=0,1	Station=0,1 OutputCase=RAR128	CaseType=Combination	P=-12,3399999996412	V2=2,53154660955019	V3=0	T=0	M2=0	M3=-1,03807417821827	FrameElem=3-1
Frame=3 ElemStation=0	Station=0 OutputCase=RAR129	CaseType=Combination	P=-92,4199999995179	V2=3,41117704543173	V3=0	T=0	M2=0	M3=-11,9867683097176	FrameElem=3-1
Frame=3 ElemStation=0,05	Station=0,05 OutputCase=RAR129	CaseType=Combination	P=-92,2199999995179	V2=3,61067704543173	V3=0	T=0	M2=0	M3=-12,1623646619892	FrameElem=3-1
Frame=3 ElemStation=0,1	Station=0,1 OutputCase=RAR129	CaseType=Combination	P=-92,0199999995179	V2=3,79817704543173	V3=0	T=0	M2=0	M3=-12,3476360142608	FrameElem=3-1
Frame=3 ElemStation=0	Station=0 OutputCase=RAR130	CaseType=Combination	P=-101,761144091724	V2=15,2366077799804	V3=0	T=0	M2=0	M3=-18,0512296686714	FrameElem=3-1
Frame=3 ElemStation=0,05	Station=0,05 OutputCase=RAR130	CaseType=Combination	P=-101,561144091724	V2=15,4361077799804	V3=0	T=0	M2=0	M3=-18,8180975576705	FrameElem=3-1
Frame=3 ElemStation=0,1	Station=0,1 OutputCase=RAR130	CaseType=Combination	P=-101,361144091724	V2=15,6236077799804	V3=0	T=0	M2=0	M3=-19,5946404466695	FrameElem=3-1
Frame=3 ElemStation=0	Station=0 OutputCase=RAR131	CaseType=Combination	P=-92,4200000001	V2=19,0150384863362	V3=0	T=0	M2=0	M3=-9,73421183890546	FrameElem=3-1
Frame=3 ElemStation=0,05	Station=0,05 OutputCase=RAR131	CaseType=Combination	P=-92,2200000001	V2=20,6554134863362	V3=0	T=0	M2=0	M3=-10,7260241798889	FrameElem=3-1
Frame=3 ElemStation=0,1	Station=0,1 OutputCase=RAR131	CaseType=Combination	P=-92,0200000001	V2=22,2835384863362	V3=0	T=0	M2=0	M3=-11,7995490208724	FrameElem=3-1
Frame=3 ElemStation=0	Station=0 OutputCase=RAR132	CaseType=Combination	P=-22,0811440918477	V2=14,276464746066	V3=0	T=0	M2=0	M3=-7,03681774667629	FrameElem=3-1
Frame=3 ElemStation=0,05	Station=0,05 OutputCase=RAR132	CaseType=Combination	P=-21,8811440918477	V2=14,475964746066	V3=0	T=0	M2=0	M3=-7,75567848397959	FrameElem=3-1
Frame=3 ElemStation=0,1	Station=0,1 OutputCase=RAR132	CaseType=Combination	P=-21,6811440918477	V2=14,663464746066	V3=0	T=0	M2=0	M3=-8,48421422128289	FrameElem=3-1
Frame=3 ElemStation=0	Station=0 OutputCase=RAR133	CaseType=Combination	P=-12,7400000002234	V2=18,0548954524217	V3=0	T=0	M2=0	M3=1,2802008308968	FrameElem=3-1
Frame=3 ElemStation=0,05	Station=0,05 OutputCase=RAR133	CaseType=Combination	P=-12,5400000002234	V2=19,6952704524217	V3=0	T=0	M2=0	M3=0,33639489380193	FrameElem=3-1
Frame=3 ElemStation=0,1	Station=0,1 OutputCase=RAR133	CaseType=Combination	P=-12,3400000002234	V2=21,3233954524217	V3=0	T=0	M2=0	M3=0,689122795485826	FrameElem=3-1
Frame=3 ElemStation=0	Station=0 OutputCase=RAR134	CaseType=Combination	P=-94,0959910818636	V2=26,2304235418465	V3=0	T=0	M2=0	M3=-21,9722236893997	FrameElem=3-1

Società di Progetto
Brebemi SpA



Doc. N.
60235-0000-A00.doc

CODIFICA DOCUMENTO
04RCDII10000000000300A00

REV.
00

FOGLIO
273 di 628

Frame=3 Station=0,05 OutputCase=RAR134 CaseType=Combination P=-93,8959910818636 V2=26,4299235418465 V3=0 T=0 M2=0 M3=-23,2887823664921	FrameElem=3-1
ElemStation=0,05	
Frame=3 Station=0,1 OutputCase=RAR134 CaseType=Combination P=-93,6959910818636 V2=26,6174235418465 V3=0 T=0 M2=0 M3=-24,6150160435844	FrameElem=3-1
ElemStation=0,1	
Frame=3 Station=0 OutputCase=RAR135 CaseType=Combination P=-72,4999999995487 V2=2,86465388498601 V3=0 T=0 M2=0 M3=-9,06467845875962	FrameElem=3-1
ElemStation=0	
Frame=3 Station=0,05 OutputCase=RAR135 CaseType=Combination P=-72,2999999995487 V2=3,06415388498601 V3=0 T=0 M2=0 M3=-9,21294865300891	FrameElem=3-1
ElemStation=0,05	
Frame=3 Station=0,1 OutputCase=RAR135 CaseType=Combination P=-72,0999999995487 V2=3,25165388498601 V3=0 T=0 M2=0 M3=-9,37089384725822	FrameElem=3-1
ElemStation=0,1	
Frame=3 Station=0 OutputCase=RAR136 CaseType=Combination P=-79,7479075354784 V2=12,0629361309982 V3=0 T=0 M2=0 M3=-13,7759074762442	FrameElem=3-1
ElemStation=0	
Frame=3 Station=0,05 OutputCase=RAR136 CaseType=Combination P=-79,5479075354784 V2=12,2624361309982 V3=0 T=0 M2=0 M3=-14,3840917827941	FrameElem=3-1
ElemStation=0,05	
Frame=3 Station=0,1 OutputCase=RAR136 CaseType=Combination P=-79,3479075354784 V2=12,4499361309982 V3=0 T=0 M2=0 M3=-15,001951089344	FrameElem=3-1
ElemStation=0,1	
Frame=3 Station=0 OutputCase=RAR137 CaseType=Combination P=-72,500000000143 V2=15,0835933551132 V3=0 T=0 M2=0 M3=-7,31785815412225	FrameElem=3-1
ElemStation=0	
Frame=3 Station=0,05 OutputCase=RAR137 CaseType=Combination P=-72,300000000143 V2=16,3932496051132 V3=0 T=0 M2=0 M3=-8,10483730104457	FrameElem=3-1
ElemStation=0,05	
Frame=3 Station=0,1 OutputCase=RAR137 CaseType=Combination P=-72,100000000143 V2=17,6889683551132 V3=0 T=0 M2=0 M3=-8,9569508229669	FrameElem=3-1
ElemStation=0,1	
Frame=3 Station=0 OutputCase=RAR138 CaseType=Combination P=-19,9879075355709 V2=11,342828855624 V3=0 T=0 M2=0 M3=-5,51509853474784	FrameElem=3-1
ElemStation=0	
Frame=3 Station=0,05 OutputCase=RAR138 CaseType=Combination P=-19,7879075355709 V2=11,542328855624 V3=0 T=0 M2=0 M3=-6,0872747752596	FrameElem=3-1
ElemStation=0,05	
Frame=3 Station=0,1 OutputCase=RAR138 CaseType=Combination P=-19,5879075355709 V2=11,729828855624 V3=0 T=0 M2=0 M3=-6,66913142030408	FrameElem=3-1
ElemStation=0,1	
Frame=3 Station=0 OutputCase=RAR139 CaseType=Combination P=-12,7400000001069 V2=14,3634860796774 V3=0 T=0 M2=0 M3=-0,942950787374112	FrameElem=3-1
ElemStation=0	
Frame=3 Station=0,05 OutputCase=RAR139 CaseType=Combination P=-12,5400000001069 V2=15,6731423296774 V3=0 T=0 M2=0 M3=-0,191977004223575	FrameElem=3-1
ElemStation=0,05	
Frame=3 Station=0,1 OutputCase=RAR139 CaseType=Combination P=-12,3400000001069 V2=16,9688610796774 V3=0 T=0 M2=0 M3=-0,624131153926965	FrameElem=3-1
ElemStation=0,1	
Frame=3 Station=0 OutputCase=RAR140 CaseType=Combination P=-12,7399999996414 V2=2,60427771250086 V3=0 T=0 M2=0 M3=-1,05659982295203	FrameElem=3-1
ElemStation=0	
Frame=3 Station=0,05 OutputCase=RAR140 CaseType=Combination P=-12,5399999996414 V2=2,80377771250086 V3=0 T=0 M2=0 M3=-1,19185120857708	FrameElem=3-1
ElemStation=0,05	
Frame=3 Station=0,1 OutputCase=RAR140 CaseType=Combination P=-12,3399999996413 V2=2,99127771250086 V3=0 T=0 M2=0 M3=-1,33677759420212	FrameElem=3-1
ElemStation=0,1	
Frame=3 Station=0 OutputCase=RAR141 CaseType=Combination P=-72,4999999995488 V2=3,32438498793668 V3=0 T=0 M2=0 M3=-9,31740876444839	FrameElem=3-1
ElemStation=0	
Frame=3 Station=0,05 OutputCase=RAR141 CaseType=Combination P=-72,2999999995488 V2=3,52388498793668 V3=0 T=0 M2=0 M3=-9,48866551384523	FrameElem=3-1
ElemStation=0,05	
Frame=3 Station=0,1 OutputCase=RAR141 CaseType=Combination P=-72,0999999995488 V2=3,71138498793668 V3=0 T=0 M2=0 M3=-9,66959726324206	FrameElem=3-1
ElemStation=0,1	
Frame=3 Station=0 OutputCase=RAR142 CaseType=Combination P=-79,7479075354785 V2=12,5226672339489 V3=0 T=0 M2=0 M3=-14,028637781933	FrameElem=3-1
ElemStation=0	
Frame=3 Station=0,05 OutputCase=RAR142 CaseType=Combination P=-79,5479075354785 V2=12,7221672339489 V3=0 T=0 M2=0 M3=-14,6598086436304	FrameElem=3-1
ElemStation=0,05	
Frame=3 Station=0,1 OutputCase=RAR142 CaseType=Combination P=-79,3479075354785 V2=12,9096672339489 V3=0 T=0 M2=0 M3=-15,3006545053279	FrameElem=3-1
ElemStation=0,1	
Frame=3 Station=0 OutputCase=RAR143 CaseType=Combination P=-72,500000000145 V2=15,5433244580639 V3=0 T=0 M2=0 M3=-7,57058845981103	FrameElem=3-1
ElemStation=0	
Frame=3 Station=0,05 OutputCase=RAR143 CaseType=Combination P=-72,300000000145 V2=16,8529807080639 V3=0 T=0 M2=0 M3=-8,38055416188089	FrameElem=3-1
ElemStation=0,05	
Frame=3 Station=0,1 OutputCase=RAR143 CaseType=Combination P=-72,100000000145 V2=18,1486994580639 V3=0 T=0 M2=0 M3=-9,25565423895075	FrameElem=3-1
ElemStation=0,1	
Frame=3 Station=0 OutputCase=RAR144 CaseType=Combination P=-19,987907535571 V2=11,8025599585131 V3=0 T=0 M2=0 M3=-5,76782884043662	FrameElem=3-1
ElemStation=0	
Frame=3 Station=0,05 OutputCase=RAR144 CaseType=Combination P=-19,787907535571 V2=12,0020599585131 V3=0 T=0 M2=0 M3=-6,36299433836227	FrameElem=3-1
ElemStation=0,05	
Frame=3 Station=0,1 OutputCase=RAR144 CaseType=Combination P=-19,587907535571 V2=12,1895599585131 V3=0 T=0 M2=0 M3=-6,96783483628793	FrameElem=3-1
ElemStation=0,1	
Frame=3 Station=0 OutputCase=RAR145 CaseType=Combination P=-12,740000000107 V2=14,8232171826281 V3=0 T=0 M2=0 M3=-0,690220481685335	FrameElem=3-1
ElemStation=0	
Frame=3 Station=0,05 OutputCase=RAR145 CaseType=Combination P=-12,540000000107 V2=16,1328734326281 V3=0 T=0 M2=0 M3=-8,37398566127356E-02	FrameElem=3-1
ElemStation=0,05	
Frame=3 Station=0,1 OutputCase=RAR145 CaseType=Combination P=-12,340000000107 V2=17,4285921826281 V3=0 T=0 M2=0 M3=-0,922834569910809	FrameElem=3-1
ElemStation=0,1	
Frame=3 Station=0 OutputCase=RAR146 CaseType=Combination P=-12,7399999996411 V2=1,68481550659952 V3=0 T=0 M2=0 M3=-0,551139211574478	FrameElem=3-1
ElemStation=0	
Frame=3 Station=0,05 OutputCase=RAR146 CaseType=Combination P=-12,5399999996411 V2=1,88431550659952 V3=0 T=0 M2=0 M3=-0,640417486904454	FrameElem=3-1
ElemStation=0,05	
Frame=3 Station=0,1 OutputCase=RAR146 CaseType=Combination P=-12,3399999996411 V2=2,07181550659952 V3=0 T=0 M2=0 M3=-0,73937076223443	FrameElem=3-1
ElemStation=0,1	
Frame=3 Station=0 OutputCase=RAR147 CaseType=Combination P=-72,4999999995485 V2=2,40492278203533 V3=0 T=0 M2=0 M3=-8,81194815307084	FrameElem=3-1
ElemStation=0	
Frame=3 Station=0,05 OutputCase=RAR147 CaseType=Combination P=-72,2999999995485 V2=2,60442278203533 V3=0 T=0 M2=0 M3=-8,9372317921726	FrameElem=3-1
ElemStation=0,05	
Frame=3 Station=0,1 OutputCase=RAR147 CaseType=Combination P=-72,0999999995485 V2=2,79192278203533 V3=0 T=0 M2=0 M3=-9,07219043127437	FrameElem=3-1
ElemStation=0,1	
Frame=3 Station=0 OutputCase=RAR148 CaseType=Combination P=-79,7479075354782 V2=11,6032050280476 V3=0 T=0 M2=0 M3=-13,5231271705554	FrameElem=3-1
ElemStation=0	
Frame=3 Station=0,05 OutputCase=RAR148 CaseType=Combination P=-79,5479075354782 V2=11,8027050280476 V3=0 T=0 M2=0 M3=-14,1083749219578	FrameElem=3-1
ElemStation=0,05	
Frame=3 Station=0,1 OutputCase=RAR148 CaseType=Combination P=-79,3479075354782 V2=11,9902050280476 V3=0 T=0 M2=0 M3=-14,7032476733602	FrameElem=3-1
ElemStation=0,1	

Società di Progetto
Brebemi SpA



Doc. N.
60235-0000-A00.doc

CODIFICA DOCUMENTO
04RCDII10000000000300A00

REV.
00

FOGLIO
274 di 628

Frame=3 ElemStation=0	Station=0	OutputCase=RAR149	CaseType=Combination	P=-72,5000000000142	V2=14,6238622521626	V3=0	T=0	M2=0	M3=-7,06512784843347	FrameElem=3-1
Frame=3 ElemStation=0,05	Station=0,05	OutputCase=RAR149	CaseType=Combination	P=-72,3000000000142	V2=15,9335185021626	V3=0	T=0	M2=0	M3=-7,82912044020826	FrameElem=3-1
Frame=3 ElemStation=0,1	Station=0,1	OutputCase=RAR149	CaseType=Combination	P=-72,1000000000142	V2=17,2292372521626	V3=0	T=0	M2=0	M3=-8,65824740698306	FrameElem=3-1
Frame=3 ElemStation=0	Station=0	OutputCase=RAR150	CaseType=Combination	P=-19,9879075355708	V2=10,8830977526118	V3=0	T=0	M2=0	M3=-5,26236822905906	FrameElem=3-1
Frame=3 ElemStation=0,05	Station=0,05	OutputCase=RAR150	CaseType=Combination	P=-19,7879075355708	V2=11,0825977526118	V3=0	T=0	M2=0	M3=-8,1156061668965	FrameElem=3-1
Frame=3 ElemStation=0,1	Station=0,1	OutputCase=RAR150	CaseType=Combination	P=-19,5879075355708	V2=11,2700977526118	V3=0	T=0	M2=0	M3=-6,37042800432024	FrameElem=3-1
Frame=3 ElemStation=0	Station=0	OutputCase=RAR151	CaseType=Combination	P=-12,7400000001067	V2=13,9037549767267	V3=0	T=0	M2=0	M3=1,19568109306289	FrameElem=3-1
Frame=3 ElemStation=0,05	Station=0,05	OutputCase=RAR151	CaseType=Combination	P=-12,5400000001067	V2=15,2134112267267	V3=0	T=0	M2=0	M3=0,467693865059887	FrameElem=3-1
Frame=3 ElemStation=0,1	Station=0,1	OutputCase=RAR151	CaseType=Combination	P=-12,3400000001067	V2=16,5091299767267	V3=0	T=0	M2=0	M3=-0,32542773794312	FrameElem=3-1
Frame=3 ElemStation=0	Station=0	OutputCase=RAR152	CaseType=Combination	P=-12,358598801933	V2=1,95381910229282	V3=0	T=0	M2=0	M3=-0,27595256523248	FrameElem=3-1
Frame=3 ElemStation=0,05	Station=0,05	OutputCase=RAR152	CaseType=Combination	P=-12,158598801933	V2=2,15331910229282	V3=0	T=0	M2=0	M3=-0,378681020347121	FrameElem=3-1
Frame=3 ElemStation=0,1	Station=0,1	OutputCase=RAR152	CaseType=Combination	P=-11,958598801933	V2=2,34081910229283	V3=0	T=0	M2=0	M3=-0,491084475461762	FrameElem=3-1
Frame=3 ElemStation=0	Station=0	OutputCase=RAR153	CaseType=Combination	P=-72,1185988018404	V2=2,67392637772864	V3=0	T=0	M2=0	M3=-8,53676150672884	FrameElem=3-1
Frame=3 ElemStation=0,05	Station=0,05	OutputCase=RAR153	CaseType=Combination	P=-71,9185988018404	V2=2,87342637772864	V3=0	T=0	M2=0	M3=-8,67549532561527	FrameElem=3-1
Frame=3 ElemStation=0,1	Station=0,1	OutputCase=RAR153	CaseType=Combination	P=-71,7185988018404	V2=3,06092637772864	V3=0	T=0	M2=0	M3=-8,8239041445017	FrameElem=3-1
Frame=3 ElemStation=0	Station=0	OutputCase=RAR154	CaseType=Combination	P=-79,3665063377701	V2=11,8722086237409	V3=0	T=0	M2=0	M3=-13,2479905242134	FrameElem=3-1
Frame=3 ElemStation=0,05	Station=0,05	OutputCase=RAR154	CaseType=Combination	P=-79,1665063377701	V2=12,0717086237409	V3=0	T=0	M2=0	M3=-13,8466384554005	FrameElem=3-1
Frame=3 ElemStation=0,1	Station=0,1	OutputCase=RAR154	CaseType=Combination	P=-78,9665063377701	V2=12,2592086237409	V3=0	T=0	M2=0	M3=-14,4549613865875	FrameElem=3-1
Frame=3 ElemStation=0	Station=0	OutputCase=RAR155	CaseType=Combination	P=-72,1185988023061	V2=14,8928658478559	V3=0	T=0	M2=0	M3=-6,78994120209147	FrameElem=3-1
Frame=3 ElemStation=0,05	Station=0,05	OutputCase=RAR155	CaseType=Combination	P=-71,9185988023061	V2=16,205220978559	V3=0	T=0	M2=0	M3=-7,56738397365093	FrameElem=3-1
Frame=3 ElemStation=0,1	Station=0,1	OutputCase=RAR155	CaseType=Combination	P=-71,7185988023061	V2=17,4982408478559	V3=0	T=0	M2=0	M3=-8,40996112021039	FrameElem=3-1
Frame=3 ElemStation=0	Station=0	OutputCase=RAR156	CaseType=Combination	P=-19,6065063378627	V2=11,1521013483051	V3=0	T=0	M2=0	M3=-4,98718158271706	FrameElem=3-1
Frame=3 ElemStation=0,05	Station=0,05	OutputCase=RAR156	CaseType=Combination	P=-19,4065063378627	V2=11,3516013483051	V3=0	T=0	M2=0	M3=-5,54982415013232	FrameElem=3-1
Frame=3 ElemStation=0,1	Station=0,1	OutputCase=RAR156	CaseType=Combination	P=-19,2065063378627	V2=11,5391013483051	V3=0	T=0	M2=0	M3=-6,12214171754757	FrameElem=3-1
Frame=3 ElemStation=0	Station=0	OutputCase=RAR157	CaseType=Combination	P=-12,3585988023986	V2=14,17275857242	V3=0	T=0	M2=0	M3=1,47086773940489	FrameElem=3-1
Frame=3 ElemStation=0,05	Station=0,05	OutputCase=RAR157	CaseType=Combination	P=-12,1585988023986	V2=15,4824148224201	V3=0	T=0	M2=0	M3=0,72943033161722	FrameElem=3-1
Frame=3 ElemStation=0,1	Station=0,1	OutputCase=RAR157	CaseType=Combination	P=-11,9585988023986	V2=16,7781335724201	V3=0	T=0	M2=0	M3=-0,077141451170452	FrameElem=3-1
Frame=3 ElemStation=0	Station=0	OutputCase=RAR158	CaseType=Combination	P=-13,1214011973495	V2=2,33527411680756	V3=0	T=0	M2=0	M3=-1,33178646929403	FrameElem=3-1
Frame=3 ElemStation=0,05	Station=0,05	OutputCase=RAR158	CaseType=Combination	P=-12,9214011973495	V2=2,53477411680756	V3=0	T=0	M2=0	M3=-1,45358767513441	FrameElem=3-1
Frame=3 ElemStation=0,1	Station=0,1	OutputCase=RAR158	CaseType=Combination	P=-12,7214011973495	V2=2,72227411680756	V3=0	T=0	M2=0	M3=-1,58506388097479	FrameElem=3-1
Frame=3 ElemStation=0	Station=0	OutputCase=RAR159	CaseType=Combination	P=-72,8814011972569	V2=3,05538139224337	V3=0	T=0	M2=0	M3=-9,59259541079039	FrameElem=3-1
Frame=3 ElemStation=0,05	Station=0,05	OutputCase=RAR159	CaseType=Combination	P=-72,6814011972569	V2=3,25488139224337	V3=0	T=0	M2=0	M3=-9,75040198040256	FrameElem=3-1
Frame=3 ElemStation=0,1	Station=0,1	OutputCase=RAR159	CaseType=Combination	P=-72,4814011972569	V2=3,44238139224337	V3=0	T=0	M2=0	M3=-9,91788355001473	FrameElem=3-1
Frame=3 ElemStation=0	Station=0	OutputCase=RAR160	CaseType=Combination	P=-80,1293087331866	V2=12,2536636382556	V3=0	T=0	M2=0	M3=-14,303824428275	FrameElem=3-1
Frame=3 ElemStation=0,05	Station=0,05	OutputCase=RAR160	CaseType=Combination	P=-79,9293087331866	V2=12,4531636382556	V3=0	T=0	M2=0	M3=-14,9215451101878	FrameElem=3-1
Frame=3 ElemStation=0,1	Station=0,1	OutputCase=RAR160	CaseType=Combination	P=-79,7293087331866	V2=12,6406636382556	V3=0	T=0	M2=0	M3=-15,5489407921005	FrameElem=3-1
Frame=3 ElemStation=0	Station=0	OutputCase=RAR161	CaseType=Combination	P=-72,8814011977226	V2=15,2743208623706	V3=0	T=0	M2=0	M3=-7,84577510615302	FrameElem=3-1
Frame=3 ElemStation=0,05	Station=0,05	OutputCase=RAR161	CaseType=Combination	P=-72,6814011977226	V2=16,5839771123706	V3=0	T=0	M2=0	M3=-8,64229062843822	FrameElem=3-1
Frame=3 ElemStation=0,1	Station=0,1	OutputCase=RAR161	CaseType=Combination	P=-72,4814011977226	V2=17,8796958623706	V3=0	T=0	M2=0	M3=-9,50394052572342	FrameElem=3-1
Frame=3 ElemStation=0	Station=0	OutputCase=RAR162	CaseType=Combination	P=-20,3693087332791	V2=11,5335563628198	V3=0	T=0	M2=0	M3=-6,04301548677861	FrameElem=3-1
Frame=3 ElemStation=0,05	Station=0,05	OutputCase=RAR162	CaseType=Combination	P=-20,1693087332791	V2=11,7330563628198	V3=0	T=0	M2=0	M3=-6,6247308049196	FrameElem=3-1
Frame=3 ElemStation=0,1	Station=0,1	OutputCase=RAR162	CaseType=Combination	P=-19,9693087332791	V2=11,9205563628198	V3=0	T=0	M2=0	M3=-7,2161211230606	FrameElem=3-1
Frame=3 ElemStation=0	Station=0	OutputCase=RAR163	CaseType=Combination	P=-13,1214011978151	V2=14,5542135869348	V3=0	T=0	M2=0	M3=0,415033835343336	FrameElem=3-1
Frame=3 ElemStation=0,05	Station=0,05	OutputCase=RAR163	CaseType=Combination	P=-12,9214011978151	V2=15,8638698369348	V3=0	T=0	M2=0	M3=-0,345476323170069	FrameElem=3-1

Società di Progetto
Brebemi SpA

Frame=3 Station=0,1 OutputCase=RAR163 CaseType=Combination P=-12,7214011978151 V2=17,1595885869348 V3=0 T=0 M2=0 M3=-1,17112085668348 FrameElem=3-1 ElemStation=0,1
Frame=3 Station=0 OutputCase=INVRAR CaseType=Combination StepType=Max P=-12,1043313367942 V2=27,1498857477478 V3=0 T=0 M2=0 M3=1,65432550363289 FrameElem=3-1 ElemStation=0
Frame=3 Station=0,05 OutputCase=INVRAR CaseType=Combination StepType=Max P=-11,9043313367942 V2=27,3493857477478 V3=0 T=0 M2=0 M3=0,903921309322108 FrameElem=3-1 ElemStation=0,05
Frame=3 Station=0,1 OutputCase=INVRAR CaseType=Combination StepType=Max P=-11,7043313367942 V2=27,5368857477478 V3=0 T=0 M2=0 M3=8,83827400113265E-02 FrameElem=3-1 ElemStation=0,1
Frame=3 Station=0 OutputCase=INVRAR CaseType=Combination StepType=Min P=-102,142545289433 V2=1,68481550659952 V3=0 T=0 M2=0 M3=-22,7528709471193 FrameElem=3-1 ElemStation=0
Frame=3 Station=0,05 OutputCase=INVRAR CaseType=Combination StepType=Min P=-101,942545289433 V2=1,88431550659952 V3=0 T=0 M2=0 M3=-24,101952554722 FrameElem=3-1 ElemStation=0,05
Frame=3 Station=0,1 OutputCase=INVRAR CaseType=Combination StepType=Min P=-101,742545289433 V2=2,07181550659952 V3=0 T=0 M2=0 M3=-25,4607091623247 FrameElem=3-1 ElemStation=0,1
Frame=3 Station=0 OutputCase=FRE01 CaseType=Combination P=-12,7399999997579 V2=4,97493867226356 V3=0 T=0 M2=0 M3=-0,99547488729812 FrameElem=3-1 ElemStation=0
Frame=3 Station=0,05 OutputCase=FRE01 CaseType=Combination P=-12,5399999997579 V2=5,29243867226356 V3=0 T=0 M2=0 M3=-1,25223848757796 FrameElem=3-1 ElemStation=0,05
Frame=3 Station=0,1 OutputCase=FRE01 CaseType=Combination P=-12,3399999997579 V2=5,59093867226356 V3=0 T=0 M2=0 M3=-1,52440208785781 FrameElem=3-1 ElemStation=0,1
Frame=3 Station=0 OutputCase=FRE02 CaseType=Combination P=-72,4999999995489 V2=3,63087238990379 V3=0 T=0 M2=0 M3=-9,48589563490758 FrameElem=3-1 ElemStation=0
Frame=3 Station=0,05 OutputCase=FRE02 CaseType=Combination P=-72,2999999995489 V2=3,83037238990379 V3=0 T=0 M2=0 M3=-9,67247675440277 FrameElem=3-1 ElemStation=0,05
Frame=3 Station=0,1 OutputCase=FRE02 CaseType=Combination P=-72,0999999995489 V2=4,01787238990379 V3=0 T=0 M2=0 M3=-9,86873287389796 FrameElem=3-1 ElemStation=0,1
Frame=3 Station=0 OutputCase=FRE03 CaseType=Combination P=-79,7479075354786 V2=12,829154635916 V3=0 T=0 M2=0 M3=-14,1971246523922 FrameElem=3-1 ElemStation=0
Frame=3 Station=0,05 OutputCase=FRE03 CaseType=Combination P=-79,5479075354786 V2=13,028654635916 V3=0 T=0 M2=0 M3=-14,843619884188 FrameElem=3-1 ElemStation=0,05
Frame=3 Station=0,1 OutputCase=FRE03 CaseType=Combination P=-79,3479075354786 V2=13,216154635916 V3=0 T=0 M2=0 M3=-15,4997901159838 FrameElem=3-1 ElemStation=0,1
Frame=3 Station=0 OutputCase=FRE04 CaseType=Combination P=-72,500000000146 V2=15,849811860031 V3=0 T=0 M2=0 M3=-7,73907533027021 FrameElem=3-1 ElemStation=0
Frame=3 Station=0,05 OutputCase=FRE04 CaseType=Combination P=-72,300000000145 V2=17,159468110031 V3=0 T=0 M2=0 M3=-8,56436540243843 FrameElem=3-1 ElemStation=0,05
Frame=3 Station=0,1 OutputCase=FRE04 CaseType=Combination P=-72,100000000145 V2=18,455186860031 V3=0 T=0 M2=0 M3=-9,45478984960665 FrameElem=3-1 ElemStation=0,1
Frame=3 Station=0 OutputCase=FRE05 CaseType=Combination P=-19,9879075355711 V2=12,1090473604802 V3=0 T=0 M2=0 M3=-5,9363157108958 FrameElem=3-1 ElemStation=0
Frame=3 Station=0,05 OutputCase=FRE05 CaseType=Combination P=-19,7879075355711 V2=12,3085473604802 V3=0 T=0 M2=0 M3=-6,54680557891981 FrameElem=3-1 ElemStation=0,05
Frame=3 Station=0,1 OutputCase=FRE05 CaseType=Combination P=-19,5879075355711 V2=12,4960473604802 V3=0 T=0 M2=0 M3=-7,16697044694382 FrameElem=3-1 ElemStation=0,1
Frame=3 Station=0 OutputCase=FRE06 CaseType=Combination P=-12,7400000001071 V2=15,1297045845952 V3=0 T=0 M2=0 M3=0,52173361122615 FrameElem=3-1 ElemStation=0
Frame=3 Station=0,05 OutputCase=FRE06 CaseType=Combination P=-12,5400000001071 V2=16,4393608345952 V3=0 T=0 M2=0 M3=0,267551097170276 FrameElem=3-1 ElemStation=0,05
Frame=3 Station=0,1 OutputCase=FRE06 CaseType=Combination P=-12,3400000001071 V2=17,7350795845952 V3=0 T=0 M2=0 M3=-1,12197018056671 FrameElem=3-1 ElemStation=0,1
Frame=3 Station=0 OutputCase=FRE07 CaseType=Combination P=-12,7399999996416 V2=3,37049621741865 V3=0 T=0 M2=0 M3=-1,4778169991 FrameElem=3-1 ElemStation=0
Frame=3 Station=0,05 OutputCase=FRE07 CaseType=Combination P=-12,5399999996416 V2=3,56999621741865 V3=0 T=0 M2=0 M3=-1,65137930997093 FrameElem=3-1 ElemStation=0,05
Frame=3 Station=0,1 OutputCase=FRE07 CaseType=Combination P=-12,3399999996416 V2=3,75749621741865 V3=0 T=0 M2=0 M3=-1,83461662084186 FrameElem=3-1 ElemStation=0,1
Frame=3 Station=0 OutputCase=FRE08 CaseType=Combination P=-72,499999999549 V2=4,01398164236269 V3=0 T=0 M2=0 M3=-9,69650422298156 FrameElem=3-1 ElemStation=0
Frame=3 Station=0,05 OutputCase=FRE08 CaseType=Combination P=-72,299999999549 V2=4,21348164236269 V3=0 T=0 M2=0 M3=-9,90224080509969 FrameElem=3-1 ElemStation=0,05
Frame=3 Station=0,1 OutputCase=FRE08 CaseType=Combination P=-72,099999999549 V2=4,40098164236269 V3=0 T=0 M2=0 M3=-10,1176523872178 FrameElem=3-1 ElemStation=0,1
Frame=3 Station=0 OutputCase=FRE09 CaseType=Combination P=-79,7479075354787 V2=13,2122638883749 V3=0 T=0 M2=0 M3=-14,4077332404661 FrameElem=3-1 ElemStation=0
Frame=3 Station=0,05 OutputCase=FRE09 CaseType=Combination P=-79,5479075354787 V2=13,4117638883749 V3=0 T=0 M2=0 M3=-15,0733839348849 FrameElem=3-1 ElemStation=0,05
Frame=3 Station=0,1 OutputCase=FRE09 CaseType=Combination P=-79,3479075354787 V2=13,5992638883749 V3=0 T=0 M2=0 M3=-15,7487096293036 FrameElem=3-1 ElemStation=0,1
Frame=3 Station=0 OutputCase=FRE10 CaseType=Combination P=-72,500000000147 V2=16,2329211124899 V3=0 T=0 M2=0 M3=-7,94968391834419 FrameElem=3-1 ElemStation=0
Frame=3 Station=0,05 OutputCase=FRE10 CaseType=Combination P=-72,300000000147 V2=17,5425773624899 V3=0 T=0 M2=0 M3=-8,79412945313535 FrameElem=3-1 ElemStation=0,05
Frame=3 Station=0,1 OutputCase=FRE10 CaseType=Combination P=-72,100000000147 V2=18,8382961124899 V3=0 T=0 M2=0 M3=-9,70370936292652 FrameElem=3-1 ElemStation=0,1
Frame=3 Station=0 OutputCase=FRE11 CaseType=Combination P=-19,9879075355713 V2=12,4921566129391 V3=0 T=0 M2=0 M3=-6,14692429896978 FrameElem=3-1 ElemStation=0
Frame=3 Station=0,05 OutputCase=FRE11 CaseType=Combination P=-19,7879075355713 V2=12,6916566129391 V3=0 T=0 M2=0 M3=-6,77656962961674 FrameElem=3-1 ElemStation=0,05
Frame=3 Station=0,1 OutputCase=FRE11 CaseType=Combination P=-19,5879075355713 V2=12,8791566129391 V3=0 T=0 M2=0 M3=-7,4158899602637 FrameElem=3-1 ElemStation=0,1
Frame=3 Station=0 OutputCase=FRE12 CaseType=Combination P=-12,7400000001072 V2=15,5128138370541 V3=0 T=0 M2=0 M3=0,311125023152169 FrameElem=3-1 ElemStation=0
Frame=3 Station=0,05 OutputCase=FRE12 CaseType=Combination P=-12,5400000001072 V2=16,8224700870541 V3=0 T=0 M2=0 M3=0,0497315147867202 FrameElem=3-1 ElemStation=0,05
Frame=3 Station=0,1 OutputCase=FRE12 CaseType=Combination P=-12,3400000001072 V2=18,1181888370541 V3=0 T=0 M2=0 M3=-1,37088969388658 FrameElem=3-1 ElemStation=0,1
Frame=3 Station=0 OutputCase=FRE13 CaseType=Combination P=-12,422165668218 V2=3,21155662803751 V3=0 T=0 M2=0 M3=-1,03788620574102 FrameElem=3-1 ElemStation=0





Doc. N.
60235-00000-A00.doc

CODIFICA DOCUMENTO
04RCDII10000000000300A00

REV.
00

FOGLIO
276 di 628

Frame=3 ElemStation=0,05	Station=0,05	OutputCase=FRE13	CaseType=Combination	P=-12,222165668218	V2=3,41105662803751	V3=0	T=0	M2=0	M3=-1,20350153714289	FrameElem=3-1
Frame=3 ElemStation=0,1	Station=0,1	OutputCase=FRE13	CaseType=Combination	P=-12,022165668218	V2=3,59855662803751	V3=0	T=0	M2=0	M3=-1,37879186854477	FrameElem=3-1
Frame=3 ElemStation=0	Station=0	OutputCase=FRE14	CaseType=Combination	P=-13,0578343310651	V2=3,52943580679979	V3=0	T=0	M2=0	M3=-1,91774779245898	FrameElem=3-1
Frame=3 ElemStation=0,05	Station=0,05	OutputCase=FRE14	CaseType=Combination	P=-12,8578343310651	V2=3,72893580679979	V3=0	T=0	M2=0	M3=-2,09925708279896	FrameElem=3-1
Frame=3 ElemStation=0,1	Station=0,1	OutputCase=FRE14	CaseType=Combination	P=-12,6578343310651	V2=3,91643580679979	V3=0	T=0	M2=0	M3=-2,29044137313895	FrameElem=3-1
Frame=3 ElemStation=0	Station=0	OutputCase=FRE15	CaseType=Combination	P=-12,7399999996415	V2=2,98738696495976	V3=0	T=0	M2=0	M3=-1,26720841102601	FrameElem=3-1
Frame=3 ElemStation=0,05	Station=0,05	OutputCase=FRE15	CaseType=Combination	P=-12,5399999996415	V2=3,18688696495976	V3=0	T=0	M2=0	M3=-1,421615259274	FrameElem=3-1
Frame=3 ElemStation=0,1	Station=0,1	OutputCase=FRE15	CaseType=Combination	P=-12,3399999996415	V2=3,37438696495976	V3=0	T=0	M2=0	M3=-1,58569710752199	FrameElem=3-1
Frame=3 ElemStation=0	Station=0	OutputCase=FRE16	CaseType=Combination	P=-12,7399999996413	V2=2,45103401151731	V3=0	T=0	M2=0	M3=-0,97235638772244	FrameElem=3-1
Frame=3 ElemStation=0,05	Station=0,05	OutputCase=FRE16	CaseType=Combination	P=-12,5399999996413	V2=2,65053401151731	V3=0	T=0	M2=0	M3=-1,09994558829831	FrameElem=3-1
Frame=3 ElemStation=0,1	Station=0,1	OutputCase=FRE16	CaseType=Combination	P=-12,3399999996413	V2=2,83803401151731	V3=0	T=0	M2=0	M3=-1,23720978887417	FrameElem=3-1
Frame=3 ElemStation=0	Station=0	OutputCase=FRE17	CaseType=Combination	P=-72,4999999995488	V2=3,2477631374449	V3=0	T=0	M2=0	M3=-9,2752870468336	FrameElem=3-1
Frame=3 ElemStation=0,05	Station=0,05	OutputCase=FRE17	CaseType=Combination	P=-72,2999999995488	V2=3,4472631374449	V3=0	T=0	M2=0	M3=-9,44271270370584	FrameElem=3-1
Frame=3 ElemStation=0,1	Station=0,1	OutputCase=FRE17	CaseType=Combination	P=-72,0999999995488	V2=3,6347631374449	V3=0	T=0	M2=0	M3=-9,61981336057809	FrameElem=3-1
Frame=3 ElemStation=0	Station=0	OutputCase=FRE18	CaseType=Combination	P=-79,7479075354785	V2=12,4460453834571	V3=0	T=0	M2=0	M3=-13,9865160643182	FrameElem=3-1
Frame=3 ElemStation=0,05	Station=0,05	OutputCase=FRE18	CaseType=Combination	P=-79,5479075354785	V2=12,6455453834571	V3=0	T=0	M2=0	M3=-14,613855833491	FrameElem=3-1
Frame=3 ElemStation=0,1	Station=0,1	OutputCase=FRE18	CaseType=Combination	P=-79,3479075354785	V2=12,8330453834571	V3=0	T=0	M2=0	M3=-15,2508706026639	FrameElem=3-1
Frame=3 ElemStation=0	Station=0	OutputCase=FRE19	CaseType=Combination	P=-72,500000000144	V2=15,4667026075721	V3=0	T=0	M2=0	M3=-7,52846674219623	FrameElem=3-1
Frame=3 ElemStation=0,05	Station=0,05	OutputCase=FRE19	CaseType=Combination	P=-72,300000000144	V2=16,7763588575721	V3=0	T=0	M2=0	M3=-8,3346013517415	FrameElem=3-1
Frame=3 ElemStation=0,1	Station=0,1	OutputCase=FRE19	CaseType=Combination	P=-72,100000000144	V2=18,0270776075721	V3=0	T=0	M2=0	M3=-9,20587033628678	FrameElem=3-1
Frame=3 ElemStation=0	Station=0	OutputCase=FRE20	CaseType=Combination	P=-19,9879075355571	V2=11,7259381080213	V3=0	T=0	M2=0	M3=-5,72570712282182	FrameElem=3-1
Frame=3 ElemStation=0,05	Station=0,05	OutputCase=FRE20	CaseType=Combination	P=-19,7879075355571	V2=11,9254381080213	V3=0	T=0	M2=0	M3=-6,31704152822289	FrameElem=3-1
Frame=3 ElemStation=0,1	Station=0,1	OutputCase=FRE20	CaseType=Combination	P=-19,5879075355571	V2=12,1129381080213	V3=0	T=0	M2=0	M3=-6,91805093362395	FrameElem=3-1
Frame=3 ElemStation=0	Station=0	OutputCase=FRE21	CaseType=Combination	P=-12,740000000107	V2=14,7465953321363	V3=0	T=0	M2=0	M3=-0,732342199300131	FrameElem=3-1
Frame=3 ElemStation=0,05	Station=0,05	OutputCase=FRE21	CaseType=Combination	P=-12,540000000107	V2=16,0562515821363	V3=0	T=0	M2=0	M3=-3,77870464733505E-02	FrameElem=3-1
Frame=3 ElemStation=0,1	Station=0,1	OutputCase=FRE21	CaseType=Combination	P=-12,340000000107	V2=17,3519703321363	V3=0	T=0	M2=0	M3=-0,873050667246835	FrameElem=3-1
Frame=3 ElemStation=0	Station=0	OutputCase=FRE22	CaseType=Combination	P=-12,4221656682178	V2=2,29209442213617	V3=0	T=0	M2=0	M3=-0,53242559436461	FrameElem=3-1
Frame=3 ElemStation=0,05	Station=0,05	OutputCase=FRE22	CaseType=Combination	P=-12,2221656682178	V2=2,49159442213617	V3=0	T=0	M2=0	M3=-0,652067815470269	FrameElem=3-1
Frame=3 ElemStation=0,1	Station=0,1	OutputCase=FRE22	CaseType=Combination	P=-12,0221656682178	V2=2,67909442213617	V3=0	T=0	M2=0	M3=-0,781385036577078	FrameElem=3-1
Frame=3 ElemStation=0	Station=0	OutputCase=FRE23	CaseType=Combination	P=-13,0578343310648	V2=2,60997360089844	V3=0	T=0	M2=0	M3=-1,41228718108142	FrameElem=3-1
Frame=3 ElemStation=0,05	Station=0,05	OutputCase=FRE23	CaseType=Combination	P=-12,8578343310648	V2=2,80947360089844	V3=0	T=0	M2=0	M3=-1,54782336112634	FrameElem=3-1
Frame=3 ElemStation=0,1	Station=0,1	OutputCase=FRE23	CaseType=Combination	P=-12,6578343310648	V2=2,99697360089844	V3=0	T=0	M2=0	M3=-1,69303454117127	FrameElem=3-1
Frame=3 ElemStation=0	Station=0	OutputCase=FRE24	CaseType=Combination	P=-12,7399999996412	V2=2,06792475905841	V3=0	T=0	M2=0	M3=-0,761747799648459	FrameElem=3-1
Frame=3 ElemStation=0,05	Station=0,05	OutputCase=FRE24	CaseType=Combination	P=-12,5399999996412	V2=2,26742475905841	V3=0	T=0	M2=0	M3=-0,87018153760138	FrameElem=3-1
Frame=3 ElemStation=0,1	Station=0,1	OutputCase=FRE24	CaseType=Combination	P=-12,3399999996412	V2=2,45492475905841	V3=0	T=0	M2=0	M3=-0,988290275554301	FrameElem=3-1
Frame=3 ElemStation=0	Station=0	OutputCase=FRE25	CaseType=Combination	P=-12,3585988019332	V2=2,72003760721061	V3=0	T=0	M2=0	M3=-0,697169741380442	FrameElem=3-1
Frame=3 ElemStation=0,05	Station=0,05	OutputCase=FRE25	CaseType=Combination	P=-12,1585988019332	V2=2,91953760721061	V3=0	T=0	M2=0	M3=-0,838209121740973	FrameElem=3-1
Frame=3 ElemStation=0,1	Station=0,1	OutputCase=FRE25	CaseType=Combination	P=-11,9585988019332	V2=3,10703760721061	V3=0	T=0	M2=0	M3=-0,988923502101504	FrameElem=3-1
Frame=3 ElemStation=0	Station=0	OutputCase=FRE26	CaseType=Combination	P=-72,1821656681254	V2=3,47193280052266	V3=0	T=0	M2=0	M3=-9,0459648415486	FrameElem=3-1
Frame=3 ElemStation=0,05	Station=0,05	OutputCase=FRE26	CaseType=Combination	P=-71,9821656681254	V2=3,67143280052266	V3=0	T=0	M2=0	M3=-9,22459898157473	FrameElem=3-1
Frame=3 ElemStation=0,1	Station=0,1	OutputCase=FRE26	CaseType=Combination	P=-71,7821656681254	V2=3,85893280052266	V3=0	T=0	M2=0	M3=-9,41290812160086	FrameElem=3-1
Frame=3 ElemStation=0	Station=0	OutputCase=FRE27	CaseType=Combination	P=-79,4300732040551	V2=12,6702150465349	V3=0	T=0	M2=0	M3=-13,7571938590332	FrameElem=3-1
Frame=3 ElemStation=0,05	Station=0,05	OutputCase=FRE27	CaseType=Combination	P=-79,2300732040551	V2=12,8697150465349	V3=0	T=0	M2=0	M3=-14,3957421113599	FrameElem=3-1
Frame=3 ElemStation=0,1	Station=0,1	OutputCase=FRE27	CaseType=Combination	P=-79,0300732040551	V2=13,0572150465349	V3=0	T=0	M2=0	M3=-15,0439653636867	FrameElem=3-1

Società di Progetto
Brebemi SpA



Doc. N.
60235-0000-A00.doc

CODIFICA DOCUMENTO
04RCDII10000000000300A00

REV.
00

FOGLIO
277 di 628

Frame=3 ElemStation=0	Station=0	OutputCase=FRE28	CaseType=Combination	P=-72,182165668591	V2=15,6908722706499	V3=0	T=0	M2=0	M3=-7,29914453691123	FrameElem=3-1
Frame=3 ElemStation=0,05	Station=0,05	OutputCase=FRE28	CaseType=Combination	P=-71,982165668591	V2=17,0005285206499	V3=0	T=0	M2=0	M3=-8,11648762961039	FrameElem=3-1
Frame=3 ElemStation=0,1	Station=0,1	OutputCase=FRE28	CaseType=Combination	P=-71,782165668591	V2=18,2962472706499	V3=0	T=0	M2=0	M3=-8,99896509730955	FrameElem=3-1
Frame=3 ElemStation=0	Station=0	OutputCase=FRE29	CaseType=Combination	P=-19,6700732041476	V2=11,9501077710991	V3=0	T=0	M2=0	M3=-5,49638491753682	FrameElem=3-1
Frame=3 ElemStation=0,05	Station=0,05	OutputCase=FRE29	CaseType=Combination	P=-19,4700732041476	V2=12,1496077710991	V3=0	T=0	M2=0	M3=-6,09892780609178	FrameElem=3-1
Frame=3 ElemStation=0,1	Station=0,1	OutputCase=FRE29	CaseType=Combination	P=-19,2700732041476	V2=12,3371077710991	V3=0	T=0	M2=0	M3=-6,71114569464673	FrameElem=3-1
Frame=3 ElemStation=0	Station=0	OutputCase=FRE30	CaseType=Combination	P=-12,4221656686836	V2=14,9707649952141	V3=0	T=0	M2=0	M3=0,96166440458513	FrameElem=3-1
Frame=3 ElemStation=0,05	Station=0,05	OutputCase=FRE30	CaseType=Combination	P=-12,2221656686836	V2=16,2804212452141	V3=0	T=0	M2=0	M3=0,18032667565776	FrameElem=3-1
Frame=3 ElemStation=0,1	Station=0,1	OutputCase=FRE30	CaseType=Combination	P=-12,0221656686836	V2=17,5761399952141	V3=0	T=0	M2=0	M3=-0,666145428269612	FrameElem=3-1
Frame=3 ElemStation=0	Station=0	OutputCase=FRE31	CaseType=Combination	P=-12,3585988019333	V2=3,10314685966951	V3=0	T=0	M2=0	M3=-0,907778329454423	FrameElem=3-1
Frame=3 ElemStation=0,05	Station=0,05	OutputCase=FRE31	CaseType=Combination	P=-12,1585988019333	V2=3,30264685966951	V3=0	T=0	M2=0	M3=-1,0679731724379	FrameElem=3-1
Frame=3 ElemStation=0,1	Station=0,1	OutputCase=FRE31	CaseType=Combination	P=-11,9585988019333	V2=3,49014685966951	V3=0	T=0	M2=0	M3=-1,23784301542137	FrameElem=3-1
Frame=3 ElemStation=0	Station=0	OutputCase=FRE32	CaseType=Combination	P=-12,3585988019331	V2=2,33692835475172	V3=0	T=0	M2=0	M3=-0,486561153306461	FrameElem=3-1
Frame=3 ElemStation=0,05	Station=0,05	OutputCase=FRE32	CaseType=Combination	P=-12,1585988019331	V2=2,53642835475172	V3=0	T=0	M2=0	M3=-0,608445071044047	FrameElem=3-1
Frame=3 ElemStation=0,1	Station=0,1	OutputCase=FRE32	CaseType=Combination	P=-11,9585988019331	V2=2,72392835475172	V3=0	T=0	M2=0	M3=-0,740003988781633	FrameElem=3-1
Frame=3 ElemStation=0	Station=0	OutputCase=FRE33	CaseType=Combination	P=-12,3585988019331	V2=2,33692835475172	V3=0	T=0	M2=0	M3=-0,486561153306461	FrameElem=3-1
Frame=3 ElemStation=0,05	Station=0,05	OutputCase=FRE33	CaseType=Combination	P=-12,1585988019331	V2=2,53642835475172	V3=0	T=0	M2=0	M3=-0,608445071044047	FrameElem=3-1
Frame=3 ElemStation=0,1	Station=0,1	OutputCase=FRE33	CaseType=Combination	P=-11,9585988019331	V2=2,72392835475172	V3=0	T=0	M2=0	M3=-0,740003988781633	FrameElem=3-1
Frame=3 ElemStation=0	Station=0	OutputCase=FRE34	CaseType=Combination	P=-13,1214011973497	V2=3,10149262172534	V3=0	T=0	M2=0	M3=-1,75300364544199	FrameElem=3-1
Frame=3 ElemStation=0,05	Station=0,05	OutputCase=FRE34	CaseType=Combination	P=-12,9214011973497	V2=3,30099262172534	V3=0	T=0	M2=0	M3=-1,91311577652826	FrameElem=3-1
Frame=3 ElemStation=0,1	Station=0,1	OutputCase=FRE34	CaseType=Combination	P=-12,7214011973497	V2=3,48849262172534	V3=0	T=0	M2=0	M3=-2,08290290761453	FrameElem=3-1
Frame=3 ElemStation=0	Station=0	OutputCase=FRE35	CaseType=Combination	P=-72,817834309724	V2=3,78981197928493	V3=0	T=0	M2=0	M3=-9,92582642826656	FrameElem=3-1
Frame=3 ElemStation=0,05	Station=0,05	OutputCase=FRE35	CaseType=Combination	P=-72,617834309724	V2=3,98931197928493	V3=0	T=0	M2=0	M3=-10,1203545272308	FrameElem=3-1
Frame=3 ElemStation=0,1	Station=0,1	OutputCase=FRE35	CaseType=Combination	P=-72,417834309724	V2=4,17681197928493	V3=0	T=0	M2=0	M3=-10,3245576261951	FrameElem=3-1
Frame=3 ElemStation=0	Station=0	OutputCase=FRE36	CaseType=Combination	P=-80,0657418669021	V2=12,9880942252972	V3=0	T=0	M2=0	M3=-14,6370554457511	FrameElem=3-1
Frame=3 ElemStation=0,05	Station=0,05	OutputCase=FRE36	CaseType=Combination	P=-79,8657418669021	V2=13,1875942252972	V3=0	T=0	M2=0	M3=-15,291497657016	FrameElem=3-1
Frame=3 ElemStation=0,1	Station=0,1	OutputCase=FRE36	CaseType=Combination	P=-79,6657418669021	V2=13,3750942252972	V3=0	T=0	M2=0	M3=-15,9556148682809	FrameElem=3-1
Frame=3 ElemStation=0	Station=0	OutputCase=FRE37	CaseType=Combination	P=-72,8178343314381	V2=16,0087514494122	V3=0	T=0	M2=0	M3=-8,17900612362919	FrameElem=3-1
Frame=3 ElemStation=0,05	Station=0,05	OutputCase=FRE37	CaseType=Combination	P=-72,6178343314381	V2=17,3184076994122	V3=0	T=0	M2=0	M3=-9,01224317526646	FrameElem=3-1
Frame=3 ElemStation=0,1	Station=0,1	OutputCase=FRE37	CaseType=Combination	P=-72,4178343314381	V2=18,6141264494122	V3=0	T=0	M2=0	M3=-9,91061460190374	FrameElem=3-1
Frame=3 ElemStation=0	Station=0	OutputCase=FRE38	CaseType=Combination	P=-20,3057418669947	V2=12,2679869498614	V3=0	T=0	M2=0	M3=-6,37624650425478	FrameElem=3-1
Frame=3 ElemStation=0,05	Station=0,05	OutputCase=FRE38	CaseType=Combination	P=-20,1057418669947	V2=12,4674869498614	V3=0	T=0	M2=0	M3=-6,99468335174785	FrameElem=3-1
Frame=3 ElemStation=0,1	Station=0,1	OutputCase=FRE38	CaseType=Combination	P=-19,9057418669947	V2=12,6549869498614	V3=0	T=0	M2=0	M3=-7,62279519924092	FrameElem=3-1
Frame=3 ElemStation=0	Station=0	OutputCase=FRE39	CaseType=Combination	P=-13,0578343315306	V2=15,2886441739763	V3=0	T=0	M2=0	M3=0,08180281786717	FrameElem=3-1
Frame=3 ElemStation=0,05	Station=0,05	OutputCase=FRE39	CaseType=Combination	P=-12,8578343315306	V2=16,5983004239763	V3=0	T=0	M2=0	M3=-0,715428869998313	FrameElem=3-1
Frame=3 ElemStation=0,1	Station=0,1	OutputCase=FRE39	CaseType=Combination	P=-12,6578343315306	V2=17,8940191739763	V3=0	T=0	M2=0	M3=-1,5777949328638	FrameElem=3-1
Frame=3 ElemStation=0	Station=0	OutputCase=FRE40	CaseType=Combination	P=-13,1214011973498	V2=3,48460187418424	V3=0	T=0	M2=0	M3=-1,96361223351597	FrameElem=3-1
Frame=3 ElemStation=0,05	Station=0,05	OutputCase=FRE40	CaseType=Combination	P=-12,9214011973498	V2=3,68410187418424	V3=0	T=0	M2=0	M3=-2,14287982722519	FrameElem=3-1
Frame=3 ElemStation=0,1	Station=0,1	OutputCase=FRE40	CaseType=Combination	P=-12,7214011973498	V2=3,87160187418424	V3=0	T=0	M2=0	M3=-2,3318224209344	FrameElem=3-1
Frame=3 ElemStation=0	Station=0	OutputCase=FRE41	CaseType=Combination	P=-13,1214011973496	V2=2,71838336926645	V3=0	T=0	M2=0	M3=-1,54239505736801	FrameElem=3-1
Frame=3 ElemStation=0,05	Station=0,05	OutputCase=FRE41	CaseType=Combination	P=-12,9214011973496	V2=2,91788336926645	V3=0	T=0	M2=0	M3=-1,68335172583134	FrameElem=3-1
Frame=3 ElemStation=0,1	Station=0,1	OutputCase=FRE41	CaseType=Combination	P=-12,7214011973496	V2=3,10538336926645	V3=0	T=0	M2=0	M3=-1,83398339429466	FrameElem=3-1
Frame=3 ElemStation=0	Station=0	OutputCase=FRE42	CaseType=Combination	P=-13,1214011973496	V2=2,71838336926645	V3=0	T=0	M2=0	M3=-1,54239505736801	FrameElem=3-1
Frame=3 ElemStation=0,05	Station=0,05	OutputCase=FRE42	CaseType=Combination	P=-12,9214011973496	V2=2,91788336926645	V3=0	T=0	M2=0	M3=-1,68335172583134	FrameElem=3-1

Società di Progetto
Brebemi SpA



Doc. N.
60235-0000-A00.doc

CODIFICA DOCUMENTO
04RCDII10000000000300A00

REV.
00

FOGLIO
278 di 628

Frame=3 ElemStation=0,1	Station=0,1	OutputCase=FRE42	CaseType=Combination	P=-12,7214011973496	V2=3,10538336926645	V3=0	T=0	M2=0	M3=-1,83398339429466	FrameElem=3-1
Frame=3 ElemStation=0	Station=0	OutputCase=FRE43	CaseType=Combination	P=-12,7399999996413	V2=2,45103401151731	V3=0	T=0	M2=0	M3=-0,97235638772244	FrameElem=3-1
Frame=3 ElemStation=0,05	Station=0,05	OutputCase=FRE43	CaseType=Combination	P=-12,5399999996413	V2=2,65053401151731	V3=0	T=0	M2=0	M3=-1,09994558829831	FrameElem=3-1
Frame=3 ElemStation=0,1	Station=0,1	OutputCase=FRE43	CaseType=Combination	P=-12,3399999996413	V2=2,83803401151731	V3=0	T=0	M2=0	M3=-1,23720978887417	FrameElem=3-1
Frame=3 ElemStation=0	Station=0	OutputCase=FRE44	CaseType=Combination	P=-72,4999999995488	V2=3,2477631374449	V3=0	T=0	M2=0	M3=-9,2752870468336	FrameElem=3-1
Frame=3 ElemStation=0,05	Station=0,05	OutputCase=FRE44	CaseType=Combination	P=-72,2999999995488	V2=3,4472631374449	V3=0	T=0	M2=0	M3=-9,44271270370584	FrameElem=3-1
Frame=3 ElemStation=0,1	Station=0,1	OutputCase=FRE44	CaseType=Combination	P=-72,0999999995488	V2=3,6347631374449	V3=0	T=0	M2=0	M3=-9,61981336057809	FrameElem=3-1
Frame=3 ElemStation=0	Station=0	OutputCase=FRE45	CaseType=Combination	P=-79,7479075354785	V2=12,4460453834571	V3=0	T=0	M2=0	M3=-13,9865160643182	FrameElem=3-1
Frame=3 ElemStation=0,05	Station=0,05	OutputCase=FRE45	CaseType=Combination	P=-79,5479075354785	V2=12,6455453834571	V3=0	T=0	M2=0	M3=-14,613855833491	FrameElem=3-1
Frame=3 ElemStation=0,1	Station=0,1	OutputCase=FRE45	CaseType=Combination	P=-79,3479075354785	V2=12,8330453834571	V3=0	T=0	M2=0	M3=-15,2508706026639	FrameElem=3-1
Frame=3 ElemStation=0	Station=0	OutputCase=FRE46	CaseType=Combination	P=-72,500000000144	V2=15,4667026075721	V3=0	T=0	M2=0	M3=-7,52846674219623	FrameElem=3-1
Frame=3 ElemStation=0,05	Station=0,05	OutputCase=FRE46	CaseType=Combination	P=-72,300000000144	V2=16,7763588575721	V3=0	T=0	M2=0	M3=-8,3346013517415	FrameElem=3-1
Frame=3 ElemStation=0,1	Station=0,1	OutputCase=FRE46	CaseType=Combination	P=-72,100000000144	V2=18,0720776075721	V3=0	T=0	M2=0	M3=-9,20587033628678	FrameElem=3-1
Frame=3 ElemStation=0	Station=0	OutputCase=FRE47	CaseType=Combination	P=-19,9879075355571	V2=11,7259381080213	V3=0	T=0	M2=0	M3=-5,72570712282182	FrameElem=3-1
Frame=3 ElemStation=0,05	Station=0,05	OutputCase=FRE47	CaseType=Combination	P=-19,7879075355571	V2=11,9254381080213	V3=0	T=0	M2=0	M3=-6,31704152822289	FrameElem=3-1
Frame=3 ElemStation=0,1	Station=0,1	OutputCase=FRE47	CaseType=Combination	P=-19,5879075355571	V2=12,1129381080213	V3=0	T=0	M2=0	M3=-6,91805093362395	FrameElem=3-1
Frame=3 ElemStation=0	Station=0	OutputCase=FRE48	CaseType=Combination	P=-12,740000000107	V2=14,7465953321363	V3=0	T=0	M2=0	M3=-0,732342199300131	FrameElem=3-1
Frame=3 ElemStation=0,05	Station=0,05	OutputCase=FRE48	CaseType=Combination	P=-12,540000000107	V2=16,0562515821363	V3=0	T=0	M2=0	M3=-3,77870464733505E-02	FrameElem=3-1
Frame=3 ElemStation=0,1	Station=0,1	OutputCase=FRE48	CaseType=Combination	P=-12,340000000107	V2=17,3519703321363	V3=0	T=0	M2=0	M3=-0,873050667246835	FrameElem=3-1
Frame=3 ElemStation=0	Station=0	OutputCase=FRE49	CaseType=Combination	P=-12,7399999996412	V2=2,06792475905841	V3=0	T=0	M2=0	M3=-0,761747799648459	FrameElem=3-1
Frame=3 ElemStation=0,05	Station=0,05	OutputCase=FRE49	CaseType=Combination	P=-12,5399999996412	V2=2,26742475905841	V3=0	T=0	M2=0	M3=-0,87018153760138	FrameElem=3-1
Frame=3 ElemStation=0,1	Station=0,1	OutputCase=FRE49	CaseType=Combination	P=-12,3399999996412	V2=2,45492475905841	V3=0	T=0	M2=0	M3=-0,988290275554301	FrameElem=3-1
Frame=3 ElemStation=0	Station=0	OutputCase=FRE50	CaseType=Combination	P=-12,4221656682178	V2=2,29209442213617	V3=0	T=0	M2=0	M3=-0,532425594363461	FrameElem=3-1
Frame=3 ElemStation=0,05	Station=0,05	OutputCase=FRE50	CaseType=Combination	P=-12,2221656682178	V2=2,49159442213617	V3=0	T=0	M2=0	M3=-0,652067815470269	FrameElem=3-1
Frame=3 ElemStation=0,1	Station=0,1	OutputCase=FRE50	CaseType=Combination	P=-12,0221656682178	V2=2,67909442213617	V3=0	T=0	M2=0	M3=-0,781385036577078	FrameElem=3-1
Frame=3 ElemStation=0	Station=0	OutputCase=FRE51	CaseType=Combination	P=-13,0578343310648	V2=2,60997360089844	V3=0	T=0	M2=0	M3=-1,41228718108142	FrameElem=3-1
Frame=3 ElemStation=0,05	Station=0,05	OutputCase=FRE51	CaseType=Combination	P=-12,8578343310648	V2=2,80947360089844	V3=0	T=0	M2=0	M3=-1,54782336112634	FrameElem=3-1
Frame=3 ElemStation=0,1	Station=0,1	OutputCase=FRE51	CaseType=Combination	P=-12,6578343310648	V2=2,99697360089844	V3=0	T=0	M2=0	M3=-1,69303454117127	FrameElem=3-1
Frame=3 FrameElem=3-1	Station=0	OutputCase=INVFRE	CaseType=Combination	StepType=Max	P=-12,3585988019331	V2=16,2329211124899	V3=0	T=0	M2=0	M3=0,96166440458513
Frame=3 FrameElem=3-1	Station=0,05	OutputCase=INVFRE	CaseType=Combination	StepType=Max	P=-12,1585988019331	V2=17,5425773624899	V3=0	T=0	M2=0	M3=0,18032667565776
Frame=3 FrameElem=3-1	Station=0,1	OutputCase=INVFRE	CaseType=Combination	StepType=Max	P=-11,9585988019331	V2=18,8382961124899	V3=0	T=0	M2=0	M3=0,666145428269612
Frame=3 FrameElem=3-1	Station=0	OutputCase=INVFRE	CaseType=Combination	StepType=Min	P=-80,0657418669021	V2=2,06792475905841	V3=0	T=0	M2=0	M3=-14,6370554457511
Frame=3 FrameElem=3-1	Station=0,05	OutputCase=INVFRE	CaseType=Combination	StepType=Min	P=-79,8657418669021	V2=2,26742475905841	V3=0	T=0	M2=0	M3=-15,291497657016
Frame=3 FrameElem=3-1	Station=0,1	OutputCase=INVFRE	CaseType=Combination	StepType=Min	P=-79,6657418669021	V2=2,45492475905841	V3=0	T=0	M2=0	M3=-15,9556148682809
Frame=3 ElemStation=0	Station=0	OutputCase=QPE01	CaseType=Combination	P=-11,7718021326582	V2=3,65810189186075	V3=0	T=0	M2=0	M3=-0,343942894221332	FrameElem=3-1
Frame=3 ElemStation=0,05	Station=0,05	OutputCase=QPE01	CaseType=Combination	P=-11,5718021326582	V2=3,97560189186075	V3=0	T=0	M2=0	M3=-0,534864655481036	FrameElem=3-1
Frame=3 ElemStation=0,1	Station=0,1	OutputCase=QPE01	CaseType=Combination	P=-11,3718021326582	V2=4,27410189186075	V3=0	T=0	M2=0	M3=-0,741186416740741	FrameElem=3-1
Frame=3 ElemStation=0	Station=0	OutputCase=QPE02	CaseType=Combination	P=-11,7718021326583	V2=4,04121114431965	V3=0	T=0	M2=0	M3=-0,554551482295313	FrameElem=3-1
Frame=3 ElemStation=0,05	Station=0,05	OutputCase=QPE02	CaseType=Combination	P=-11,5718021326583	V2=4,35871114431965	V3=0	T=0	M2=0	M3=-0,764628706177962	FrameElem=3-1
Frame=3 ElemStation=0,1	Station=0,1	OutputCase=QPE02	CaseType=Combination	P=-11,3718021326583	V2=4,65721114431965	V3=0	T=0	M2=0	M3=-0,990105930060612	FrameElem=3-1
Frame=3 ElemStation=0	Station=0	OutputCase=QPE03	CaseType=Combination	P=-11,7718021326581	V2=3,27499263940186	V3=0	T=0	M2=0	M3=-0,133334306147351	FrameElem=3-1
Frame=3 ElemStation=0,05	Station=0,05	OutputCase=QPE03	CaseType=Combination	P=-11,5718021326581	V2=3,59249263940186	V3=0	T=0	M2=0	M3=-0,30510060478411	FrameElem=3-1
Frame=3 ElemStation=0,1	Station=0,1	OutputCase=QPE03	CaseType=Combination	P=-11,3718021326581	V2=3,89099263940186	V3=0	T=0	M2=0	M3=-0,492266903420871	FrameElem=3-1
Frame=3 ElemStation=0	Station=0	OutputCase=QPE04	CaseType=Combination	P=-11,4539678012347	V2=3,49916230247961	V3=0	T=0	M2=0	M3=9,59878991376476E-02	FrameElem=3-1

Società di Progetto
Brebemi SpA



Doc. N.
60235-00000-A00.doc

CODIFICA DOCUMENTO
04RCDII10000000000300A00

REV.
00

FOGLIO
279 di 628

Frame=3 Station=0,05 OutputCase=QPE04 CaseType=Combination P=-11,2539678012347 V2=3,81666230247961 V3=0 T=0 M2=0 M3=-8,69868826529995E-02 FrameElem=3-1 ElemStation=0,05
Frame=3 Station=0,1 OutputCase=QPE04 CaseType=Combination P=-11,0539678012347 V2=4,11516230247962 V3=0 T=0 M2=0 M3=-0,285361664443648 FrameElem=3-1 ElemStation=0,1
Frame=3 Station=0 OutputCase=QPE05 CaseType=Combination P=-12,0896364640817 V2=3,81704148124189 V3=0 T=0 M2=0 M3=-0,783873687580312 FrameElem=3-1 ElemStation=0
Frame=3 Station=0,05 OutputCase=QPE05 CaseType=Combination P=-11,8896364640817 V2=4,13454148124189 V3=0 T=0 M2=0 M3=-0,982742428309073 FrameElem=3-1 ElemStation=0,05
Frame=3 Station=0,1 OutputCase=QPE05 CaseType=Combination P=-11,6896364640817 V2=4,43304148124189 V3=0 T=0 M2=0 M3=-1,19701116903784 FrameElem=3-1 ElemStation=0,1
Frame=3 Station=0 OutputCase=QPE06 CaseType=Combination P=-11,7718021326581 V2=3,27499263940186 V3=0 T=0 M2=0 M3=-0,133334306147351 FrameElem=3-1 ElemStation=0
Frame=3 Station=0,05 OutputCase=QPE06 CaseType=Combination P=-11,5718021326581 V2=3,59249263940186 V3=0 T=0 M2=0 M3=-0,30510064078411 FrameElem=3-1 ElemStation=0,05
Frame=3 Station=0,1 OutputCase=QPE06 CaseType=Combination P=-11,3718021326581 V2=3,89099263940186 V3=0 T=0 M2=0 M3=-0,492266903420871 FrameElem=3-1 ElemStation=0,1
Frame=3 Station=0 OutputCase=QPE07 CaseType=Combination P=-11,4539678012348 V2=3,88227155493851 V3=0 T=0 M2=0 M3=-0,114620688936334 FrameElem=3-1 ElemStation=0
Frame=3 Station=0,05 OutputCase=QPE07 CaseType=Combination P=-11,2539678012348 V2=4,19977155493851 V3=0 T=0 M2=0 M3=-0,316750933349925 FrameElem=3-1 ElemStation=0,05
Frame=3 Station=0,1 OutputCase=QPE07 CaseType=Combination P=-11,0539678012348 V2=4,49827155493851 V3=0 T=0 M2=0 M3=-0,534281177763518 FrameElem=3-1 ElemStation=0,1
Frame=3 Station=0 OutputCase=QPE08 CaseType=Combination P=-12,0896364640818 V2=4,20015073370078 V3=0 T=0 M2=0 M3=-0,994482275654293 FrameElem=3-1 ElemStation=0
Frame=3 Station=0,05 OutputCase=QPE08 CaseType=Combination P=-11,8896364640818 V2=4,51765073370078 V3=0 T=0 M2=0 M3=-1,212506479006 FrameElem=3-1 ElemStation=0,05
Frame=3 Station=0,1 OutputCase=QPE08 CaseType=Combination P=-11,6896364640818 V2=4,81615073370078 V3=0 T=0 M2=0 M3=-1,44593068235771 FrameElem=3-1 ElemStation=0,1
Frame=3 Station=0 OutputCase=QPE09 CaseType=Combination P=-11,7718021326582 V2=3,65810189186075 V3=0 T=0 M2=0 M3=-0,343942894221332 FrameElem=3-1 ElemStation=0
Frame=3 Station=0,05 OutputCase=QPE09 CaseType=Combination P=-11,5718021326582 V2=3,97560189186075 V3=0 T=0 M2=0 M3=-0,534864655481036 FrameElem=3-1 ElemStation=0,05
Frame=3 Station=0,1 OutputCase=QPE09 CaseType=Combination P=-11,3718021326582 V2=4,27410189186075 V3=0 T=0 M2=0 M3=-0,741186416740741 FrameElem=3-1 ElemStation=0,1
Frame=3 Station=0 OutputCase=QPE10 CaseType=Combination P=-13,7081978667411 V2=4,22760189487079 V3=0 T=0 M2=0 M3=-1,87661868648801 FrameElem=3-1 ElemStation=0
Frame=3 Station=0,05 OutputCase=QPE10 CaseType=Combination P=-13,5081978667411 V2=4,42710189487079 V3=0 T=0 M2=0 M3=-2,09303628123154 FrameElem=3-1 ElemStation=0,05
Frame=3 Station=0,1 OutputCase=QPE10 CaseType=Combination P=-13,3081978667411 V2=4,61460189487079 V3=0 T=0 M2=0 M3=-2,31912887597508 FrameElem=3-1 ElemStation=0,1
Frame=3 Station=0 OutputCase=QPE11 CaseType=Combination P=-13,7081978667412 V2=4,61071114732968 V3=0 T=0 M2=0 M3=-2,08722727456199 FrameElem=3-1 ElemStation=0
Frame=3 Station=0,05 OutputCase=QPE11 CaseType=Combination P=-13,5081978667412 V2=4,81021114732968 V3=0 T=0 M2=0 M3=-2,32280033192847 FrameElem=3-1 ElemStation=0,05
Frame=3 Station=0,1 OutputCase=QPE11 CaseType=Combination P=-13,3081978667412 V2=4,99771114732968 V3=0 T=0 M2=0 M3=-2,56804838929496 FrameElem=3-1 ElemStation=0,1
Frame=3 Station=0 OutputCase=QPE12 CaseType=Combination P=-13,708197866741 V2=3,84449264241189 V3=0 T=0 M2=0 M3=-1,66601009841402 FrameElem=3-1 ElemStation=0
Frame=3 Station=0,05 OutputCase=QPE12 CaseType=Combination P=-13,508197866741 V2=4,04399264241189 V3=0 T=0 M2=0 M3=-1,86327223053462 FrameElem=3-1 ElemStation=0,05
Frame=3 Station=0,1 OutputCase=QPE12 CaseType=Combination P=-13,308197866741 V2=4,23149264241189 V3=0 T=0 M2=0 M3=-2,07020936265521 FrameElem=3-1 ElemStation=0,1
Frame=3 Station=0 OutputCase=QPE13 CaseType=Combination P=-13,3903635353176 V2=4,06866230548965 V3=0 T=0 M2=0 M3=-1,43668789312903 FrameElem=3-1 ElemStation=0
Frame=3 Station=0,05 OutputCase=QPE13 CaseType=Combination P=-13,1903635353176 V2=4,26816230548965 V3=0 T=0 M2=0 M3=-1,64515850840351 FrameElem=3-1 ElemStation=0,05
Frame=3 Station=0,1 OutputCase=QPE13 CaseType=Combination P=-12,9903635353176 V2=4,45566230548965 V3=0 T=0 M2=0 M3=-1,86330412367799 FrameElem=3-1 ElemStation=0,1
Frame=3 Station=0 OutputCase=QPE14 CaseType=Combination P=-14,0260321981646 V2=4,38654148425193 V3=0 T=0 M2=0 M3=-2,31654947984699 FrameElem=3-1 ElemStation=0
Frame=3 Station=0,05 OutputCase=QPE14 CaseType=Combination P=-13,8260321981646 V2=4,58604148425193 V3=0 T=0 M2=0 M3=-2,54091405405958 FrameElem=3-1 ElemStation=0,05
Frame=3 Station=0,1 OutputCase=QPE14 CaseType=Combination P=-13,6260321981646 V2=4,77354148425193 V3=0 T=0 M2=0 M3=-2,77495362827218 FrameElem=3-1 ElemStation=0,1
Frame=3 Station=0 OutputCase=QPE15 CaseType=Combination P=-13,708197866741 V2=3,84449264241189 V3=0 T=0 M2=0 M3=-1,66601009841402 FrameElem=3-1 ElemStation=0
Frame=3 Station=0,05 OutputCase=QPE15 CaseType=Combination P=-13,508197866741 V2=4,04399264241189 V3=0 T=0 M2=0 M3=-1,86327223053462 FrameElem=3-1 ElemStation=0,05
Frame=3 Station=0,1 OutputCase=QPE15 CaseType=Combination P=-13,308197866741 V2=4,23149264241189 V3=0 T=0 M2=0 M3=-2,07020936265521 FrameElem=3-1 ElemStation=0,1
Frame=3 Station=0 OutputCase=QPE16 CaseType=Combination P=-13,3903635353177 V2=4,45177155794854 V3=0 T=0 M2=0 M3=-1,64729648120301 FrameElem=3-1 ElemStation=0
Frame=3 Station=0,05 OutputCase=QPE16 CaseType=Combination P=-13,1903635353177 V2=4,65127155794854 V3=0 T=0 M2=0 M3=-1,87492255910043 FrameElem=3-1 ElemStation=0,05
Frame=3 Station=0,1 OutputCase=QPE16 CaseType=Combination P=-12,9903635353177 V2=4,83877155794854 V3=0 T=0 M2=0 M3=-2,11222363699786 FrameElem=3-1 ElemStation=0,1
Frame=3 Station=0 OutputCase=QPE17 CaseType=Combination P=-14,0260321981647 V2=4,76965073671082 V3=0 T=0 M2=0 M3=-2,52715806792097 FrameElem=3-1 ElemStation=0
Frame=3 Station=0,05 OutputCase=QPE17 CaseType=Combination P=-13,8260321981647 V2=4,96915073671082 V3=0 T=0 M2=0 M3=-2,77067810475651 FrameElem=3-1 ElemStation=0,05
Frame=3 Station=0,1 OutputCase=QPE17 CaseType=Combination P=-13,6260321981647 V2=5,15665073671082 V3=0 T=0 M2=0 M3=-3,02387314159205 FrameElem=3-1 ElemStation=0,1
Frame=3 Station=0 OutputCase=QPE18 CaseType=Combination P=-13,7081978667411 V2=4,22760189487079 V3=0 T=0 M2=0 M3=-1,87661868648801 FrameElem=3-1 ElemStation=0
Frame=3 Station=0,05 OutputCase=QPE18 CaseType=Combination P=-13,5081978667411 V2=4,42710189487079 V3=0 T=0 M2=0 M3=-2,09303628123154 FrameElem=3-1 ElemStation=0,05
Frame=3 Station=0,1 OutputCase=QPE18 CaseType=Combination P=-13,3081978667411 V2=4,61460189487079 V3=0 T=0 M2=0 M3=-2,31912887597508 FrameElem=3-1 ElemStation=0,1

Società di Progetto
Brebemi SpA



Doc. N.
60235-00000-A00.doc

CODIFICA DOCUMENTO
04RCDII10000000000300A00

REV.
00

FOGLIO
280 di 628

Frame=3 Station=0 OutputCase=INVQPE CaseType=Combination StepType=Max P=-11,4539678012347 V2=4,76965073671082 V3=0 T=0 M2=0 M3=9,5987891376476E-02
FrameElem=3-1 ElemStation=0
Frame=3 Station=0,05 OutputCase=INVQPE CaseType=Combination StepType=Max P=-11,2539678012347 V2=4,96915073671082 V3=0 T=0 M2=0 M3=-8,69868826529995E-02 FrameElem=3-1 ElemStation=0,05
Frame=3 Station=0,1 OutputCase=INVQPE CaseType=Combination StepType=Max P=-11,0539678012347 V2=5,15665073671082 V3=0 T=0 M2=0 M3=-0,285361664443648
FrameElem=3-1 ElemStation=0,1
Frame=3 Station=0 OutputCase=INVQPE CaseType=Combination StepType=Min P=-14,0260321981647 V2=3,27499263940186 V3=0 T=0 M2=0 M3=-2,52715806792097
FrameElem=3-1 ElemStation=0
Frame=3 Station=0,05 OutputCase=INVQPE CaseType=Combination StepType=Min P=-13,8260321981647 V2=3,59249263940186 V3=0 T=0 M2=0 M3=-2,77067810475651
FrameElem=3-1 ElemStation=0,05
Frame=3 Station=0,1 OutputCase=INVQPE CaseType=Combination StepType=Min P=-13,6260321981647 V2=3,89099263940186 V3=0 T=0 M2=0 M3=-3,02387314159205
FrameElem=3-1 ElemStation=0,1
Frame=18 Station=0 OutputCase=STR001 CaseType=Combination P=-20,1684599986416 V2=-0,307082709059666 V3=0 T=0 M2=0 M3=-0,729274771476578 FrameElem=18-1 ElemStation=0
Frame=18 Station=9,16500000000001E-02 OutputCase=STR001 CaseType=Combination P=-19,6735499986416 V2=-1,59044620280967 V3=0 T=0 M2=0 M3=-0,641663755787197 FrameElem=18-1 ElemStation=9,16500000000001E-02
Frame=18 Station=0,1833 OutputCase=STR001 CaseType=Combination P=-19,1786399986416 V2=-2,78781908405967 V3=0 T=0 M2=0 M3=-0,440372995713441
FrameElem=18-1 ElemStation=0,1833
Frame=18 Station=0 OutputCase=STR002 CaseType=Combination P=-20,1684599987493 V2=0,264940900686582 V3=0 T=0 M2=0 M3=1,05008024684159 FrameElem=18-1 ElemStation=0
Frame=18 Station=9,16500000000001E-02 OutputCase=STR002 CaseType=Combination P=-19,6735499987493 V2=-0,331700599313418 V3=0 T=0 M2=0 M3=1,05344749985616 FrameElem=18-1 ElemStation=9,16500000000001E-02
Frame=18 Station=0,1833 OutputCase=STR002 CaseType=Combination P=-19,1786399987493 V2=0,888016099313418 V3=0 T=0 M2=0 M3=1,10964900739574
FrameElem=18-1 ElemStation=0,1833
Frame=18 Station=0 OutputCase=STR003 CaseType=Combination P=-127,736459994457 V2=-1,03125219515306 V3=0 T=0 M2=0 M3=15,2067597581459 FrameElem=18-1 ElemStation=0
Frame=18 Station=9,16500000000001E-02 OutputCase=STR003 CaseType=Combination P=-127,241549994457 V2=-1,62789369515306 V3=0 T=0 M2=0 M3=15,3289231083942
FrameElem=18-1 ElemStation=9,16500000000001E-02
Frame=18 Station=0,1833 OutputCase=STR003 CaseType=Combination P=-126,746639994457 V2=-2,18420919515306 V3=0 T=0 M2=0 M3=15,5039207131674
FrameElem=18-1 ElemStation=0,1833
Frame=18 Station=0 OutputCase=STR004 CaseType=Combination P=-114,5546784135 V2=15,8388474368175 V3=0 T=0 M2=0 M3=6,56205497490805 FrameElem=18-1 ElemStation=0
Frame=18 Station=9,16500000000001E-02 OutputCase=STR004 CaseType=Combination P=-114,0597684135 V2=11,4981774180675 V3=0 T=0 M2=0 M3=5,3096145762341
FrameElem=18-1 ElemStation=9,16500000000001E-02
Frame=18 Station=0,1833 OutputCase=STR004 CaseType=Combination P=-113,5648584135 V2=7,19400701181745 V3=0 T=0 M2=0 M3=4,45332399101441 FrameElem=18-1 ElemStation=0,1833
Frame=18 Station=0 OutputCase=STR005 CaseType=Combination P=-127,736459994035 V2=-0,902055950511853 V3=0 T=0 M2=0 M3=5,92756572713037 FrameElem=18-1 ElemStation=0
Frame=18 Station=9,16500000000001E-02 OutputCase=STR005 CaseType=Combination P=-127,241549994035 V2=-5,24272596926186 V3=0 T=0 M2=0 M3=6,20942912439447
FrameElem=18-1 ElemStation=9,16500000000001E-02
Frame=18 Station=0,1833 OutputCase=STR005 CaseType=Combination P=-126,746639994035 V2=-9,54689637551186 V3=0 T=0 M2=0 M3=6,8874423341342 FrameElem=18-1 ElemStation=0,1833
Frame=18 Station=0 OutputCase=STR006 CaseType=Combination P=-1,75781841812422 V2=16,9379595174231 V3=0 T=0 M2=0 M3=-8,26724070332519 FrameElem=18-1 ElemStation=0
Frame=18 Station=9,16500000000001E-02 OutputCase=STR006 CaseType=Combination P=-1,39121841812422 V2=12,5972894986731 V3=0 T=0 M2=0 M3=-9,62041472369733
FrameElem=18-1 ElemStation=9,16500000000001E-02
Frame=18 Station=0,1833 OutputCase=STR006 CaseType=Combination P=-1,02461841812422 V2=8,29311909242306 V3=0 T=0 M2=0 M3=-10,5774389315938
FrameElem=18-1 ElemStation=0,1833
Frame=18 Station=0 OutputCase=STR007 CaseType=Combination P=-14,939599986591 V2=0,197056130093756 V3=0 T=0 M2=0 M3=-8,90172995110287 FrameElem=18-1 ElemStation=0
Frame=18 Station=9,16500000000001E-02 OutputCase=STR007 CaseType=Combination P=-14,572999986591 V2=-4,14361388865625 V3=0 T=0 M2=0 M3=-8,72060017602627
FrameElem=18-1 ElemStation=9,16500000000001E-02
Frame=18 Station=0,1833 OutputCase=STR007 CaseType=Combination P=-14,206399986591 V2=-8,44778429490625 V3=0 T=0 M2=0 M3=-8,14332058847405
FrameElem=18-1 ElemStation=0,1833
Frame=18 Station=0 OutputCase=STR008 CaseType=Combination P=-71,1186349792628 V2=31,1532902952452 V3=0 T=0 M2=0 M3=4,22675707971904 FrameElem=18-1 ElemStation=0
Frame=18 Station=9,16500000000001E-02 OutputCase=STR008 CaseType=Combination P=-70,6237249792628 V2=27,5769469077452 V3=0 T=0 M2=0 M3=1,53581722256059
FrameElem=18-1 ElemStation=9,16500000000001E-02
Frame=18 Station=0,1833 OutputCase=STR008 CaseType=Combination P=-70,1288149792628 V2=24,0494758827452 V3=0 T=0 M2=0 M3=-0,829590339145041
FrameElem=18-1 ElemStation=0,1833
Frame=18 Station=0 OutputCase=STR009 CaseType=Combination P=-20,1684599986409 V2=-1,22654491495937 V3=0 T=0 M2=0 M3=-0,729426427123475 FrameElem=18-1 ElemStation=0
Frame=18 Station=9,16500000000001E-02 OutputCase=STR009 CaseType=Combination P=-19,6735499986409 V2=-2,50990840870937 V3=0 T=0 M2=0 M3=-0,557546700263386 FrameElem=18-1 ElemStation=9,16500000000001E-02
Frame=18 Station=0,1833 OutputCase=STR009 CaseType=Combination P=-19,1786399986409 V2=-3,70728128995938 V3=0 T=0 M2=0 M3=-0,271987229018921
FrameElem=18-1 ElemStation=0,1833
Frame=18 Station=0 OutputCase=STR010 CaseType=Combination P=-20,1684599987486 V2=-0,654521305213126 V3=0 T=0 M2=0 M3=1,04992859119469 FrameElem=18-1 ElemStation=0
Frame=18 Station=9,16500000000001E-02 OutputCase=STR010 CaseType=Combination P=-19,6735499987486 V2=-1,25116280521313 V3=0 T=0 M2=0 M3=1,13756455537997
FrameElem=18-1 ElemStation=9,16500000000001E-02
Frame=18 Station=0,1833 OutputCase=STR010 CaseType=Combination P=-19,1786399987486 V2=-1,80747830521313 V3=0 T=0 M2=0 M3=1,27803477409026
FrameElem=18-1 ElemStation=0,1833
Frame=18 Station=0 OutputCase=STR011 CaseType=Combination P=-127,736459994457 V2=-1,58292951869289 V3=0 T=0 M2=0 M3=15,2066687647577 FrameElem=18-1 ElemStation=0
Frame=18 Station=9,16500000000001E-02 OutputCase=STR011 CaseType=Combination P=-127,241549994457 V2=-2,17957101869289 V3=0 T=0 M2=0 M3=15,3793933417084
FrameElem=18-1 ElemStation=9,16500000000001E-02
Frame=18 Station=0,1833 OutputCase=STR011 CaseType=Combination P=-126,746639994457 V2=-2,73588651869289 V3=0 T=0 M2=0 M3=15,6049521731841
FrameElem=18-1 ElemStation=0,1833
Frame=18 Station=0 OutputCase=STR012 CaseType=Combination P=-114,5546784135 V2=15,2871701132776 V3=0 T=0 M2=0 M3=6,56196398151991 FrameElem=18-1 ElemStation=0
Frame=18 Station=9,16500000000001E-02 OutputCase=STR012 CaseType=Combination P=-114,0597684135 V2=10,9465000945276 V3=0 T=0 M2=0 M3=5,3600848100377
FrameElem=18-1 ElemStation=9,16500000000001E-02
Frame=18 Station=0,1833 OutputCase=STR012 CaseType=Combination P=-113,5648584135 V2=6,64232968827763 V3=0 T=0 M2=0 M3=4,55435545103112 FrameElem=18-1 ElemStation=0,1833
Frame=18 Station=0 OutputCase=STR013 CaseType=Combination P=-127,736459994035 V2=-1,45373327405168 V3=0 T=0 M2=0 M3=5,9274747374223 FrameElem=18-1 ElemStation=0
Frame=18 Station=9,16500000000001E-02 OutputCase=STR013 CaseType=Combination P=-127,241549994035 V2=-5,79440329280168 V3=0 T=0 M2=0 M3=6,25989935770876
FrameElem=18-1 ElemStation=9,16500000000001E-02

Società di Progetto
Brebemi SpA



Doc. N.
60235-0000-A00.doc

CODIFICA DOCUMENTO
04RCDII10000000000300A00

REV.
00

FOGLIO
281 di 628

Frame=18 Station=0,1833 OutputCase=STR013 CaseType=Combination P=-126,746639994035 V2=-10,0985736990517 V3=0 T=0 M2=0 M3=6,98847379415091
FrameElem=18-1 ElemStation=0,1833
Frame=18 Station=0 OutputCase=STR014 CaseType=Combination P=-1,75781841812377 V2=16,3862821938832 V3=0 T=0 M2=0 M3=-8,26733169671333 FrameElem=18-1
ElemStation=0
Frame=18 Station=9,16500000000001E-02 OutputCase=STR014 CaseType=Combination P=-1,39121841812377 V2=12,0456121751332 V3=0 T=0 M2=0 M3=-9,56994449038304
FrameElem=18-1 ElemStation=9,16500000000001E-02
Frame=18 Station=0,1833 OutputCase=STR014 CaseType=Combination P=-1,02461841812377 V2=7,74144176888323 V3=0 T=0 M2=0 M3=-10,4764074715771
FrameElem=18-1 ElemStation=0,1833
Frame=18 Station=0 OutputCase=STR015 CaseType=Combination P=-14,9395999986587 V2=-0,354621193446069 V3=0 T=0 M2=0 M3=-8,901820944491 FrameElem=18-1
ElemStation=0
Frame=18 Station=9,16500000000001E-02 OutputCase=STR015 CaseType=Combination P=-14,5729999986587 V2=-4,69529121219607 V3=0 T=0 M2=0 M3=-8,67012994271198
FrameElem=18-1 ElemStation=9,16500000000001E-02
Frame=18 Station=0,1833 OutputCase=STR015 CaseType=Combination P=-14,2063999986587 V2=-8,99946161844608 V3=0 T=0 M2=0 M3=-8,04228912845734
FrameElem=18-1 ElemStation=0,1833
Frame=18 Station=0 OutputCase=STR016 CaseType=Combination P=-71,1186349792623 V2=30,6016129717054 V3=0 T=0 M2=0 M3=4,2266660863309 FrameElem=18-1
ElemStation=0
Frame=18 Station=9,16500000000001E-02 OutputCase=STR016 CaseType=Combination P=-70,6237249792623 V2=27,0252695842054 V3=0 T=0 M2=0 M3=1,58628745587488
FrameElem=18-1 ElemStation=9,16500000000001E-02
Frame=18 Station=0,1833 OutputCase=STR016 CaseType=Combination P=-70,1288149792623 V2=23,4977985592054 V3=0 T=0 M2=0 M3=-0,728558879128329
FrameElem=18-1 ElemStation=0,1833
Frame=18 Station=0 OutputCase=STR017 CaseType=Combination P=-100,84445999553 V2=-1,62666612709286 V3=0 T=0 M2=0 M3=11,6674382246729 FrameElem=18-1
ElemStation=0
Frame=18 Station=9,16500000000001E-02 OutputCase=STR017 CaseType=Combination P=-100,34954999553 V2=-2,22330762709286 V3=0 T=0 M2=0 M3=11,8441712617835
FrameElem=18-1 ElemStation=9,16500000000001E-02
Frame=18 Station=0,1833 OutputCase=STR017 CaseType=Combination P=-99,8546399955295 V2=-2,77962312709286 V3=0 T=0 M2=0 M3=12,073738553419 FrameElem=18-1
ElemStation=0,1833
Frame=18 Station=0 OutputCase=STR018 CaseType=Combination P=-90,4885477649961 V2=11,5214780836425 V3=0 T=0 M2=0 M3=4,7742537692768 FrameElem=18-1
ElemStation=0
Frame=18 Station=9,16500000000001E-02 OutputCase=STR018 CaseType=Combination P=-89,9936377649961 V2=7,94513469614248 V3=0 T=0 M2=0 M3=3,88256950131174
FrameElem=18-1 ElemStation=9,16500000000001E-02
Frame=18 Station=0,1833 OutputCase=STR018 CaseType=Combination P=-89,4987277649961 V2=4,41766367114247 V3=0 T=0 M2=0 M3=3,3164175287995 FrameElem=18-1
ElemStation=0,1833
Frame=18 Station=0 OutputCase=STR019 CaseType=Combination P=-100,844459995186 V2=-1,67277484604851 V3=0 T=0 M2=0 M3=4,26320394683174 FrameElem=18-1
ElemStation=0
Frame=18 Station=9,16500000000001E-02 OutputCase=STR019 CaseType=Combination P=-100,349549995186 V2=-5,24911823354852 V3=0 T=0 M2=0 M3=4,58077295987287
FrameElem=18-1 ElemStation=9,16500000000001E-02
Frame=18 Station=0,1833 OutputCase=STR019 CaseType=Combination P=-99,8546399951861 V2=-8,77658925854852 V3=0 T=0 M2=0 M3=5,22387426836681
FrameElem=18-1 ElemStation=0,1833
Frame=18 Station=0 OutputCase=STR020 CaseType=Combination P=-4,58368776854693 V2=12,2965418902882 V3=0 T=0 M2=0 M3=-6,51587203113037 FrameElem=18-1
ElemStation=0
Frame=18 Station=9,16500000000001E-02 OutputCase=STR020 CaseType=Combination P=-4,21708776854693 V2=8,72019850278817 V3=0 T=0 M2=0 M3=-7,4785908969745
FrameElem=18-1 ElemStation=9,16500000000001E-02
Frame=18 Station=0,1833 OutputCase=STR020 CaseType=Combination P=-3,85048776854693 V2=5,19272747778817 V3=0 T=0 M2=0 M3=-8,11577746736582
FrameElem=18-1 ElemStation=0,1833
Frame=18 Station=0 OutputCase=STR021 CaseType=Combination P=-14,9395999987369 V2=-0,897711039402815 V3=0 T=0 M2=0 M3=-7,02692185357543 FrameElem=18-1
ElemStation=0
Frame=18 Station=9,16500000000001E-02 OutputCase=STR021 CaseType=Combination P=-14,5729999987369 V2=-4,47405442690282 V3=0 T=0 M2=0 M3=-6,78038743841338
FrameElem=18-1 ElemStation=9,16500000000001E-02
Frame=18 Station=0,1833 OutputCase=STR021 CaseType=Combination P=-14,2063999987369 V2=-8,00152545190282 V3=0 T=0 M2=0 M3=-6,20832072779852
FrameElem=18-1 ElemStation=0,1833
Frame=18 Station=0 OutputCase=STR022 CaseType=Combination P=-20,6261414358909 V2=-0,997671906250489 V3=0 T=0 M2=0 M3=-0,477318316236556 FrameElem=18-1
ElemStation=0
Frame=18 Station=9,16500000000001E-02 OutputCase=STR022 CaseType=Combination P=-20,1312314358909 V2=-2,28103540000049 V3=0 T=0 M2=0 M3=-
0,326414800624636 FrameElem=18-1 ElemStation=9,16500000000001E-02
Frame=18 Station=0,1833 OutputCase=STR022 CaseType=Combination P=-19,6363214358909 V2=-3,47840828125049 V3=0 T=0 M2=0 M3=-6,18315406283408E-02
FrameElem=18-1 ElemStation=0,1833
Frame=18 Station=0 OutputCase=STR023 CaseType=Combination P=-20,6261414359986 V2=-0,425648296504241 V3=0 T=0 M2=0 M3=1,30203670208161 FrameElem=18-1
ElemStation=0
Frame=18 Station=9,16500000000001E-02 OutputCase=STR023 CaseType=Combination P=-20,1312314359986 V2=-1,02228979650424 V3=0 T=0 M2=0 M3=1,36869645501872
FrameElem=18-1 ElemStation=9,16500000000001E-02
Frame=18 Station=0,1833 OutputCase=STR023 CaseType=Combination P=-19,6363214359986 V2=-1,57860529650424 V3=0 T=0 M2=0 M3=1,48819046248084
FrameElem=18-1 ElemStation=0,1833
Frame=18 Station=0 OutputCase=STR024 CaseType=Combination P=-101,30214143278 V2=-1,39779311838397 V3=0 T=0 M2=0 M3=11,9195463355598 FrameElem=18-1
ElemStation=0
Frame=18 Station=9,16500000000001E-02 OutputCase=STR024 CaseType=Combination P=-100,807231432378 V2=-1,99443461838397 V3=0 T=0 M2=0 M3=12,0753031614222
FrameElem=18-1 ElemStation=9,16500000000001E-02
Frame=18 Station=0,1833 OutputCase=STR024 CaseType=Combination P=-100,312321432378 V2=-2,55075011838397 V3=0 T=0 M2=0 M3=12,2838942418096 FrameElem=18-1
ElemStation=0,1833
Frame=18 Station=0 OutputCase=STR025 CaseType=Combination P=-90,9462292022461 V2=11,7503510923514 V3=0 T=0 M2=0 M3=5,02636188016371 FrameElem=18-1
ElemStation=0
Frame=18 Station=9,16500000000001E-02 OutputCase=STR025 CaseType=Combination P=-90,4513192022461 V2=8,17400770485136 V3=0 T=0 M2=0 M3=4,11370140095049
FrameElem=18-1 ElemStation=9,16500000000001E-02
Frame=18 Station=0,1833 OutputCase=STR025 CaseType=Combination P=-89,9564092022461 V2=4,64653667985136 V3=0 T=0 M2=0 M3=3,52657321719008 FrameElem=18-1
ElemStation=0,1833
Frame=18 Station=0 OutputCase=STR026 CaseType=Combination P=-101,302141432436 V2=-1,44390183733963 V3=0 T=0 M2=0 M3=4,51531205771866 FrameElem=18-1
ElemStation=0
Frame=18 Station=9,16500000000001E-02 OutputCase=STR026 CaseType=Combination P=-100,807231432436 V2=-5,02024522483963 V3=0 T=0 M2=0 M3=4,81190485951162
FrameElem=18-1 ElemStation=9,16500000000001E-02
Frame=18 Station=0,1833 OutputCase=STR026 CaseType=Combination P=-100,312321432436 V2=-8,54771624983964 V3=0 T=0 M2=0 M3=5,43402995675739
FrameElem=18-1 ElemStation=0,1833
Frame=18 Station=0 OutputCase=STR027 CaseType=Combination P=-5,04136920579693 V2=12,5254148989971 V3=0 T=0 M2=0 M3=-6,26376392024345 FrameElem=18-1
ElemStation=0
Frame=18 Station=9,16500000000001E-02 OutputCase=STR027 CaseType=Combination P=-4,67476920579693 V2=8,94907151149706 V3=0 T=0 M2=0 M3=-7,24745899733575
FrameElem=18-1 ElemStation=9,16500000000001E-02
Frame=18 Station=0,1833 OutputCase=STR027 CaseType=Combination P=-4,30816920579693 V2=5,42160048649705 V3=0 T=0 M2=0 M3=-7,90562177897524
FrameElem=18-1 ElemStation=0,1833
Frame=18 Station=0 OutputCase=STR028 CaseType=Combination P=-15,3972814359869 V2=-0,668838030693931 V3=0 T=0 M2=0 M3=-6,77481374268851 FrameElem=18-1
ElemStation=0

Società di Progetto
Brebemi SpA



Doc. N.
60235-0000-A00.doc

CODIFICA DOCUMENTO
04RCDII10000000000300A00

REV.
00

FOGLIO
282 di 628

Frame=18 Station=9,16500000000001E-02 OutputCase=STR028 CaseType=Combination P=-15,0306814359869 V2=-4,24518141819393 V3=0 T=0 M2=0 M3=-6,54925553877463
FrameElem=18-1 ElemStation=9,16500000000001E-02
Frame=18 Station=0,1833 OutputCase=STR028 CaseType=Combination P=-14,6640814359869 V2=-7,77265244319394 V3=0 T=0 M2=0 M3=-5,99816503940794
FrameElem=18-1 ElemStation=0,1833
Frame=18 Station=0 OutputCase=STR029 CaseType=Combination P=-19,7107785613909 V2=-1,45541792366826 V3=0 T=0 M2=0 M3=-0,981534538010394 FrameElem=18-1
ElemStation=0
Frame=18 Station=9,16500000000001E-02 OutputCase=STR029 CaseType=Combination P=-19,2158685613909 V2=-2,73878141741826 V3=0 T=0 M2=0 M3=-
0,788678599902135 FrameElem=18-1 ElemStation=9,16500000000001E-02
Frame=18 Station=0,1833 OutputCase=STR029 CaseType=Combination P=-18,7209585613909 V2=-3,93615429866826 V3=0 T=0 M2=0 M3=-0,482142917409502
FrameElem=18-1 ElemStation=0,1833
Frame=18 Station=0 OutputCase=STR030 CaseType=Combination P=-19,7107785614986 V2=-0,88339431392201 V3=0 T=0 M2=0 M3=-0,797820480307772 FrameElem=18-1
ElemStation=0
Frame=18 Station=9,16500000000001E-02 OutputCase=STR030 CaseType=Combination P=-19,2158685614986 V2=-1,48003581392201 V3=0 T=0 M2=0
M3=0,906432655741224 FrameElem=18-1 ElemStation=9,16500000000001E-02
Frame=18 Station=0,1833 OutputCase=STR030 CaseType=Combination P=-18,7209585614986 V2=-2,03635131392201 V3=0 T=0 M2=0 M3=1,06787908569968
FrameElem=18-1 ElemStation=0,1833
Frame=18 Station=0 OutputCase=STR031 CaseType=Combination P=-100,38677855828 V2=-1,85553913580174 V3=0 T=0 M2=0 M3=11,415330113786 FrameElem=18-1
ElemStation=0
Frame=18 Station=9,16500000000001E-02 OutputCase=STR031 CaseType=Combination P=-99,8918685582795 V2=-2,45218063580174 V3=0 T=0 M2=0 M3=11,6130393621447
FrameElem=18-1 ElemStation=9,16500000000001E-02
Frame=18 Station=0,1833 OutputCase=STR031 CaseType=Combination P=-99,3969585582795 V2=-3,00849613580174 V3=0 T=0 M2=0 M3=11,8635828650284
FrameElem=18-1 ElemStation=0,1833
Frame=18 Station=0 OutputCase=STR032 CaseType=Combination P=-90,0308663277461 V2=11,2926050749336 V3=0 T=0 M2=0 M3=4,52214565838988 FrameElem=18-1
ElemStation=0
Frame=18 Station=9,16500000000001E-02 OutputCase=STR032 CaseType=Combination P=-89,5359563277461 V2=7,71626168743359 V3=0 T=0 M2=0 M3=3,65143761067299
FrameElem=18-1 ElemStation=9,16500000000001E-02
Frame=18 Station=0,1833 OutputCase=STR032 CaseType=Combination P=-89,0410463277461 V2=4,18879066243359 V3=0 T=0 M2=0 M3=3,10626184040892 FrameElem=18-1
ElemStation=0,1833
Frame=18 Station=0 OutputCase=STR033 CaseType=Combination P=-100,386778557936 V2=-1,9016478547574 V3=0 T=0 M2=0 M3=4,01109583594482 FrameElem=18-1
ElemStation=0
Frame=18 Station=9,16500000000001E-02 OutputCase=STR033 CaseType=Combination P=-99,8918685579361 V2=-5,4779912422574 V3=0 T=0 M2=0 M3=4,34964106023412
FrameElem=18-1 ElemStation=9,16500000000001E-02
Frame=18 Station=0,1833 OutputCase=STR033 CaseType=Combination P=-99,3969585579361 V2=-9,00546226275741 V3=0 T=0 M2=0 M3=5,01371857997623
FrameElem=18-1 ElemStation=0,1833
Frame=18 Station=0 OutputCase=STR034 CaseType=Combination P=-4,12600633129693 V2=12,0676688815793 V3=0 T=0 M2=0 M3=-6,76798014201729 FrameElem=18-1
ElemStation=0
Frame=18 Station=9,16500000000001E-02 OutputCase=STR034 CaseType=Combination P=-3,75940633129693 V2=8,49132549407929 V3=0 T=0 M2=0 M3=-7,70972279661325
FrameElem=18-1 ElemStation=9,16500000000001E-02
Frame=18 Station=0,1833 OutputCase=STR034 CaseType=Combination P=-3,39280633129693 V2=4,96385446907929 V3=0 T=0 M2=0 M3=-8,3259331557564 FrameElem=18-1
ElemStation=0,1833
Frame=18 Station=0 OutputCase=STR035 CaseType=Combination P=-14,4819185614869 V2=-1,1265840481117 V3=0 T=0 M2=0 M3=-7,27902996446235 FrameElem=18-1
ElemStation=0
Frame=18 Station=9,16500000000001E-02 OutputCase=STR035 CaseType=Combination P=-14,1153185614869 V2=-4,7029274356117 V3=0 T=0 M2=0 M3=-7,01151933805213
FrameElem=18-1 ElemStation=9,16500000000001E-02
Frame=18 Station=0,1833 OutputCase=STR035 CaseType=Combination P=-13,7487185614869 V2=-8,23039846061171 V3=0 T=0 M2=0 M3=-6,4184764161891
FrameElem=18-1 ElemStation=0,1833
Frame=18 Station=0 OutputCase=STR036 CaseType=Combination P=-20,1684599986413 V2=-0,674867591419549 V3=0 T=0 M2=0 M3=-0,729335433735337 FrameElem=18-1
ElemStation=0
Frame=18 Station=9,16500000000001E-02 OutputCase=STR036 CaseType=Combination P=-19,6735499986413 V2=-1,95823108516955 V3=0 T=0 M2=0 M3=-
0,608016933577673 FrameElem=18-1 ElemStation=9,16500000000001E-02
Frame=18 Station=0,1833 OutputCase=STR036 CaseType=Combination P=-19,1786399986413 V2=-3,15560396641955 V3=0 T=0 M2=0 M3=-0,373018689035633
FrameElem=18-1 ElemStation=0,1833
Frame=18 Station=0 OutputCase=STR037 CaseType=Combination P=-20,168459998749 V2=-0,102843981673301 V3=0 T=0 M2=0 M3=1,05001958458283 FrameElem=18-1
ElemStation=0
Frame=18 Station=9,16500000000001E-02 OutputCase=STR037 CaseType=Combination P=-19,673549998749 V2=-0,699485481673301 V3=0 T=0 M2=0 M3=1,08709432206569
FrameElem=18-1 ElemStation=9,16500000000001E-02
Frame=18 Station=0,1833 OutputCase=STR037 CaseType=Combination P=-19,178639998749 V2=-1,2558009816733 V3=0 T=0 M2=0 M3=1,17700331407355 FrameElem=18-1
ElemStation=0,1833
Frame=18 Station=0 OutputCase=STR038 CaseType=Combination P=-100,84445999553 V2=-1,07498880355303 V3=0 T=0 M2=0 M3=11,667529218061 FrameElem=18-1
ElemStation=0
Frame=18 Station=9,16500000000001E-02 OutputCase=STR038 CaseType=Combination P=-100,34954999553 V2=-1,67163030355303 V3=0 T=0 M2=0 M3=11,7937010284692
FrameElem=18-1 ElemStation=9,16500000000001E-02
Frame=18 Station=0,1833 OutputCase=STR038 CaseType=Combination P=-99,85463999553 V2=-2,22794580355303 V3=0 T=0 M2=0 M3=11,9727070934023 FrameElem=18-1
ElemStation=0,1833
Frame=18 Station=0 OutputCase=STR039 CaseType=Combination P=-90,4885477649965 V2=12,0731554071823 V3=0 T=0 M2=0 M3=4,77434476266493 FrameElem=18-1
ElemStation=0
Frame=18 Station=9,16500000000001E-02 OutputCase=STR039 CaseType=Combination P=-89,9936377649965 V2=8,4968120196823 V3=0 T=0 M2=0 M3=3,83209926799746
FrameElem=18-1 ElemStation=9,16500000000001E-02
Frame=18 Station=0,1833 OutputCase=STR039 CaseType=Combination P=-89,4987277649965 V2=4,9693409946823 V3=0 T=0 M2=0 M3=3,21538606878279 FrameElem=18-1
ElemStation=0,1833
Frame=18 Station=0 OutputCase=STR040 CaseType=Combination P=-100,844459995187 V2=-1,12109752250869 V3=0 T=0 M2=0 M3=4,26329494021988 FrameElem=18-1
ElemStation=0
Frame=18 Station=9,16500000000001E-02 OutputCase=STR040 CaseType=Combination P=-100,349549995187 V2=-4,69744091000869 V3=0 T=0 M2=0 M3=4,53030272655858
FrameElem=18-1 ElemStation=9,16500000000001E-02
Frame=18 Station=0,1833 OutputCase=STR040 CaseType=Combination P=-99,8546399951865 V2=-8,2249119350087 V3=0 T=0 M2=0 M3=5,12284280835009 FrameElem=18-1
ElemStation=0,1833
Frame=18 Station=0 OutputCase=STR041 CaseType=Combination P=-4,58368776854738 V2=12,848219213828 V3=0 T=0 M2=0 M3=-6,51578103774223 FrameElem=18-1
ElemStation=0
Frame=18 Station=9,16500000000001E-02 OutputCase=STR041 CaseType=Combination P=-4,21708776854738 V2=9,271875826328 V3=0 T=0 M2=0 M3=-7,52906113028879
FrameElem=18-1 ElemStation=9,16500000000001E-02
Frame=18 Station=0,1833 OutputCase=STR041 CaseType=Combination P=-3,85048776854738 V2=5,744404801328 V3=0 T=0 M2=0 M3=-8,21680892738253 FrameElem=18-1
ElemStation=0,1833
Frame=18 Station=0 OutputCase=STR042 CaseType=Combination P=-14,9395999987374 V2=-0,34603371586299 V3=0 T=0 M2=0 M3=-7,02683086018729 FrameElem=18-1
ElemStation=0
Frame=18 Station=9,16500000000001E-02 OutputCase=STR042 CaseType=Combination P=-14,5729999987374 V2=-3,92237710336299 V3=0 T=0 M2=0 M3=-6,83085767172766
FrameElem=18-1 ElemStation=9,16500000000001E-02
Frame=18 Station=0,1833 OutputCase=STR042 CaseType=Combination P=-14,2063999987374 V2=-7,449848128363 V3=0 T=0 M2=0 M3=-6,30935218781523 FrameElem=18-1
ElemStation=0,1833

APPROVATO S.D.P.
Società di Progetto
Brebemi SpA



Doc. N.
60235-0000-A00.doc

CODIFICA DOCUMENTO
04RCDII10000000000300A00

REV.
00

FOGLIO
283 di 628

Frame=18 Station=0 OutputCase=STR043 CaseType=Combination P=-20,1684599986424 V2=0,612379496840043 V3=0 T=0 M2=0 M3=-0,729123115829681 FrameElem=18-1 ElemStation=0
Frame=18 Station=9,1650000000001E-02 OutputCase=STR043 CaseType=Combination P=-19,6735499986424 V2=-0,670983996909958 V3=0 T=0 M2=0 M3=-0,725780811311008 FrameElem=18-1 ElemStation=9,1650000000001E-02
Frame=18 Station=0,1833 OutputCase=STR043 CaseType=Combination P=-19,1786399986424 V2=-1,86835687815996 V3=0 T=0 M2=0 M3=-0,60875876240796 FrameElem=18-1 ElemStation=0,1833
Frame=18 Station=0 OutputCase=STR044 CaseType=Combination P=-20,1684599987501 V2=1,18440310658629 V3=0 T=0 M2=0 M3=1,05023190248848 FrameElem=18-1 ElemStation=0
Frame=18 Station=9,1650000000001E-02 OutputCase=STR044 CaseType=Combination P=-19,6735499987501 V2=0,58776160658629 V3=0 T=0 M2=0 M3=0,969330444332351 FrameElem=18-1 ElemStation=9,1650000000001E-02
Frame=18 Station=0,1833 OutputCase=STR044 CaseType=Combination P=-19,1786399987501 V2=0,03144610658629 V3=0 T=0 M2=0 M3=0,941263240701218 FrameElem=18-1 ElemStation=0,1833
Frame=18 Station=0 OutputCase=STR045 CaseType=Combination P=-127,736459994458 V2=-0,479574871613235 V3=0 T=0 M2=0 M3=15,206850751534 FrameElem=18-1 ElemStation=0
Frame=18 Station=9,1650000000001E-02 OutputCase=STR045 CaseType=Combination P=-127,241549994458 V2=-1,07621637161324 V3=0 T=0 M2=0 M3=15,27845287507999 FrameElem=18-1 ElemStation=9,1650000000001E-02
Frame=18 Station=0,1833 OutputCase=STR045 CaseType=Combination P=-126,746639994458 V2=-1,63253187161324 V3=0 T=0 M2=0 M3=15,4028892531507 FrameElem=18-1 ElemStation=0,1833
Frame=18 Station=0 OutputCase=STR046 CaseType=Combination P=-114,554678413501 V2=16,3905247603573 V3=0 T=0 M2=0 M3=6,56214596829618 FrameElem=18-1 ElemStation=0
Frame=18 Station=9,1650000000001E-02 OutputCase=STR046 CaseType=Combination P=-114,059768413501 V2=12,0498547416073 V3=0 T=0 M2=0 M3=5,25914434340913 FrameElem=18-1 ElemStation=9,1650000000001E-02
Frame=18 Station=0,1833 OutputCase=STR046 CaseType=Combination P=-113,564858413501 V2=7,74568433535728 V3=0 T=0 M2=0 M3=4,35229253099769 FrameElem=18-1 ElemStation=0,1833
Frame=18 Station=0 OutputCase=STR047 CaseType=Combination P=-127,736459994036 V2=-0,350378626972028 V3=0 T=0 M2=0 M3=5,92765672051851 FrameElem=18-1 ElemStation=0
Frame=18 Station=9,1650000000001E-02 OutputCase=STR047 CaseType=Combination P=-127,241549994036 V2=-4,69104864572203 V3=0 T=0 M2=0 M3=6,15895889108018 FrameElem=18-1 ElemStation=9,1650000000001E-02
Frame=18 Station=0,1833 OutputCase=STR047 CaseType=Combination P=-126,746639994036 V2=-8,99521905197203 V3=0 T=0 M2=0 M3=6,78641087411748 FrameElem=18-1 ElemStation=0,1833
Frame=18 Station=0 OutputCase=STR048 CaseType=Combination P=-1,75781841812467 V2=17,4896368409629 V3=0 T=0 M2=0 M3=-8,26714970993705 FrameElem=18-1 ElemStation=0
Frame=18 Station=9,1650000000001E-02 OutputCase=STR048 CaseType=Combination P=-1,39121841812467 V2=13,1489668222129 V3=0 T=0 M2=0 M3=-9,67088495701161 FrameElem=18-1 ElemStation=9,1650000000001E-02
Frame=18 Station=0,1833 OutputCase=STR048 CaseType=Combination P=-1,02461841812467 V2=8,84479641596288 V3=0 T=0 M2=0 M3=-10,6784703916106 FrameElem=18-1 ElemStation=0,1833
Frame=18 Station=0 OutputCase=STR049 CaseType=Combination P=-14,9395999986596 V2=0,748733453633581 V3=0 T=0 M2=0 M3=-8,90163895771473 FrameElem=18-1 ElemStation=0
Frame=18 Station=9,1650000000001E-02 OutputCase=STR049 CaseType=Combination P=-14,5729999986596 V2=-3,59193656511642 V3=0 T=0 M2=0 M3=-8,77107040934056 FrameElem=18-1 ElemStation=9,1650000000001E-02
Frame=18 Station=0,1833 OutputCase=STR049 CaseType=Combination P=-14,2063999986596 V2=-7,89610697136643 V3=0 T=0 M2=0 M3=-8,24435204849076 FrameElem=18-1 ElemStation=0,1833
Frame=18 Station=0 OutputCase=STR050 CaseType=Combination P=-71,1186349792632 V2=31,7049676187851 V3=0 T=0 M2=0 M3=4,22684807310718 FrameElem=18-1 ElemStation=0
Frame=18 Station=9,1650000000001E-02 OutputCase=STR050 CaseType=Combination P=-70,6237249792632 V2=28,1286242312851 V3=0 T=0 M2=0 M3=1,48534698924631 FrameElem=18-1 ElemStation=9,1650000000001E-02
Frame=18 Station=0,1833 OutputCase=STR050 CaseType=Combination P=-70,1288149792632 V2=24,6011532062851 V3=0 T=0 M2=0 M3=-0,930621799161752 FrameElem=18-1 ElemStation=0,1833
Frame=18 Station=0 OutputCase=STR051 CaseType=Combination P=-100,844459995531 V2=0,212258284706559 V3=0 T=0 M2=0 M3=11,6677415359667 FrameElem=18-1 ElemStation=0
Frame=18 Station=9,1650000000001E-02 OutputCase=STR051 CaseType=Combination P=-100,349549995531 V2=-0,384383215293442 V3=0 T=0 M2=0 M3=11,6759371507358 FrameElem=18-1 ElemStation=9,1650000000001E-02
Frame=18 Station=0,1833 OutputCase=STR051 CaseType=Combination P=-99,854639995531 V2=-0,940698715293442 V3=0 T=0 M2=0 M3=11,73696702003 FrameElem=18-1 ElemStation=0,1833
Frame=18 Station=0 OutputCase=STR052 CaseType=Combination P=-90,4885477649976 V2=13,3604024954419 V3=0 T=0 M2=0 M3=4,77455708057059 FrameElem=18-1 ElemStation=0
Frame=18 Station=9,1650000000001E-02 OutputCase=STR052 CaseType=Combination P=-89,9936377649976 V2=9,78405910794189 V3=0 T=0 M2=0 M3=3,71433539026412 FrameElem=18-1 ElemStation=9,1650000000001E-02
Frame=18 Station=0,1833 OutputCase=STR052 CaseType=Combination P=-89,4987277649976 V2=6,25658808294189 V3=0 T=0 M2=0 M3=2,97964599541046 FrameElem=18-1 ElemStation=0,1833
Frame=18 Station=0 OutputCase=STR053 CaseType=Combination P=-100,844459995188 V2=0,166149565750902 V3=0 T=0 M2=0 M3=4,26350725812553 FrameElem=18-1 ElemStation=0
Frame=18 Station=9,1650000000001E-02 OutputCase=STR053 CaseType=Combination P=-100,349549995188 V2=-3,4101938217491 V3=0 T=0 M2=0 M3=4,41253884882524 FrameElem=18-1 ElemStation=9,1650000000001E-02
Frame=18 Station=0,1833 OutputCase=STR053 CaseType=Combination P=-99,8546399951876 V2=6,9376648467491 V3=0 T=0 M2=0 M3=4,88710273497777 FrameElem=18-1 ElemStation=0,1833
Frame=18 Station=0 OutputCase=STR054 CaseType=Combination P=-4,58368776854843 V2=14,1354663020876 V3=0 T=0 M2=0 M3=-6,51556871983658 FrameElem=18-1 ElemStation=0
Frame=18 Station=9,1650000000001E-02 OutputCase=STR054 CaseType=Combination P=-4,21708776854843 V2=10,5591229145876 V3=0 T=0 M2=0 M3=-7,64682500802212 FrameElem=18-1 ElemStation=9,1650000000001E-02
Frame=18 Station=0,1833 OutputCase=STR054 CaseType=Combination P=-3,85048776854843 V2=7,03165188958759 V3=0 T=0 M2=0 M3=-8,45254900075486 FrameElem=18-1 ElemStation=0,1833
Frame=18 Station=0 OutputCase=STR055 CaseType=Combination P=-14,9395999987384 V2=0,941213372396601 V3=0 T=0 M2=0 M3=-7,02661854228163 FrameElem=18-1 ElemStation=0
Frame=18 Station=9,1650000000001E-02 OutputCase=STR055 CaseType=Combination P=-14,5729999987384 V2=-2,6351300151034 V3=0 T=0 M2=0 M3=-6,948621549461 FrameElem=18-1 ElemStation=9,1650000000001E-02
Frame=18 Station=0,1833 OutputCase=STR055 CaseType=Combination P=-14,2063999987384 V2=-6,1626010401034 V3=0 T=0 M2=0 M3=-6,54509226118755 FrameElem=18-1 ElemStation=0,1833
Frame=18 Station=0 OutputCase=STR056 CaseType=Combination P=-20,6261414358924 V2=0,841252505548927 V3=0 T=0 M2=0 M3=-0,477015004942762 FrameElem=18-1 ElemStation=0
Frame=18 Station=9,1650000000001E-02 OutputCase=STR056 CaseType=Combination P=-20,1312314358924 V2=-0,442110988201073 V3=0 T=0 M2=0 M3=-0,494648911672258 FrameElem=18-1 ElemStation=9,1650000000001E-02
Frame=18 Station=0,1833 OutputCase=STR056 CaseType=Combination P=-19,6363214358924 V2=-1,63948386945107 V3=0 T=0 M2=0 M3=-0,39860307401738 FrameElem=18-1 ElemStation=0,1833
Frame=18 Station=0 OutputCase=STR057 CaseType=Combination P=-20,6261414360001 V2=1,41327611529518 V3=0 T=0 M2=0 M3=1,3023400133754 FrameElem=18-1 ElemStation=0
Frame=18 Station=9,1650000000001E-02 OutputCase=STR057 CaseType=Combination P=-20,1312314360001 V2=0,816634615295175 V3=0 T=0 M2=0 M3=1,2004623439711 FrameElem=18-1 ElemStation=9,1650000000001E-02

Società di Progetto
Brebemi SpA



Doc. N.
60235-00000-A00.doc

CODIFICA DOCUMENTO
04RCDII10000000000300A00

REV.
00

FOGLIO
284 di 628

Frame=18 Station=0,1833 OutputCase=STR057 CaseType=Combination P=-19,6363214360001 V2=0,260319115295174 V3=0 T=0 M2=0 M3=1,1514189290918 FrameElem=18-1 ElemStation=0,1833
Frame=18 Station=0 OutputCase=STR058 CaseType=Combination P=-101,302141432781 V2=0,441131293415444 V3=0 T=0 M2=0 M3=11,9198496468536 FrameElem=18-1 ElemStation=0
Frame=18 Station=9,16500000000001E-02 OutputCase=STR058 CaseType=Combination P=-100,807231432781 V2=0,155510206584557 V3=0 T=0 M2=0 M3=11,9070690503746 FrameElem=18-1 ElemStation=9,16500000000001E-02
Frame=18 Station=0,1833 OutputCase=STR058 CaseType=Combination P=-100,312321432781 V2=-0,711825706584557 V3=0 T=0 M2=0 M3=11,9471227084206 FrameElem=18-1 ElemStation=0,1833
Frame=18 Station=0 OutputCase=STR059 CaseType=Combination P=-90,9462292022476 V2=13,5892755041508 V3=0 T=0 M2=0 M3=5,02666519145751 FrameElem=18-1 ElemStation=0
Frame=18 Station=9,16500000000001E-02 OutputCase=STR059 CaseType=Combination P=-90,4513192022476 V2=10,0129321166508 V3=0 T=0 M2=0 M3=3,94546728990287 FrameElem=18-1 ElemStation=9,16500000000001E-02
Frame=18 Station=0,1833 OutputCase=STR059 CaseType=Combination P=-89,9564092022476 V2=6,48546109165077 V3=0 T=0 M2=0 M3=3,18980168380104 FrameElem=18-1 ElemStation=0,1833
Frame=18 Station=0 OutputCase=STR060 CaseType=Combination P=-101,302141432438 V2=0,395022574459787 V3=0 T=0 M2=0 M3=4,51561536901245 FrameElem=18-1 ElemStation=0
Frame=18 Station=9,16500000000001E-02 OutputCase=STR060 CaseType=Combination P=-100,807231432438 V2=-3,18132081304022 V3=0 T=0 M2=0 M3=4,64367074846399 FrameElem=18-1 ElemStation=9,16500000000001E-02
Frame=18 Station=0,1833 OutputCase=STR060 CaseType=Combination P=-100,312321432438 V2=-6,70879183804022 V3=0 T=0 M2=0 M3=5,09725842336835 FrameElem=18-1 ElemStation=0,1833
Frame=18 Station=0 OutputCase=STR061 CaseType=Combination P=-5,04136920579843 V2=14,3643393107965 V3=0 T=0 M2=0 M3=-6,26346060894966 FrameElem=18-1 ElemStation=0
Frame=18 Station=9,16500000000001E-02 OutputCase=STR061 CaseType=Combination P=-4,67476920579843 V2=10,7879959232965 V3=0 T=0 M2=0 M3=-7,41569310838337 FrameElem=18-1 ElemStation=9,16500000000001E-02
Frame=18 Station=0,1833 OutputCase=STR061 CaseType=Combination P=-4,30816920579843 V2=7,26052489829647 V3=0 T=0 M2=0 M3=-8,24239331236428 FrameElem=18-1 ElemStation=0,1833
Frame=18 Station=0 OutputCase=STR062 CaseType=Combination P=-15,3972814359884 V2=1,17008638110549 V3=0 T=0 M2=0 M3=-6,77451043139471 FrameElem=18-1 ElemStation=0
Frame=18 Station=9,16500000000001E-02 OutputCase=STR062 CaseType=Combination P=-15,0306814359884 V2=-2,40625700639452 V3=0 T=0 M2=0 M3=-6,71748964982225 FrameElem=18-1 ElemStation=9,16500000000001E-02
Frame=18 Station=0,1833 OutputCase=STR062 CaseType=Combination P=-14,6640814359884 V2=-5,93372803139452 V3=0 T=0 M2=0 M3=-6,33493657279697 FrameElem=18-1 ElemStation=0,1833
Frame=18 Station=0 OutputCase=STR063 CaseType=Combination P=-19,7107785613924 V2=0,383506488131158 V3=0 T=0 M2=0 M3=-0,9812312267166 FrameElem=18-1 ElemStation=0
Frame=18 Station=9,16500000000001E-02 OutputCase=STR063 CaseType=Combination P=-19,2158685613924 V2=-0,899857005618842 V3=0 T=0 M2=0 M3=-0,956912710949758 FrameElem=18-1 ElemStation=9,16500000000001E-02
Frame=18 Station=0,1833 OutputCase=STR063 CaseType=Combination P=-18,7209585613924 V2=-2,09722988686884 V3=0 T=0 M2=0 M3=-0,818914450798541 FrameElem=18-1 ElemStation=0,1833
Frame=18 Station=0 OutputCase=STR064 CaseType=Combination P=-19,7107785615001 V2=0,955530097877406 V3=0 T=0 M2=0 M3=0,798123791601566 FrameElem=18-1 ElemStation=0
Frame=18 Station=9,16500000000001E-02 OutputCase=STR064 CaseType=Combination P=-19,2158685615001 V2=0,358888597877406 V3=0 T=0 M2=0 M3=0,738198544693601 FrameElem=18-1 ElemStation=9,16500000000001E-02
Frame=18 Station=0,1833 OutputCase=STR064 CaseType=Combination P=-18,7209585615001 V2=-0,197426902122595 V3=0 T=0 M2=0 M3=0,731107552310637 FrameElem=18-1 ElemStation=0,1833
Frame=18 Station=0 OutputCase=STR065 CaseType=Combination P=-100,386778558281 V2=-1,66147240023255E-02 V3=0 T=0 M2=0 M3=11,4156334250798 FrameElem=18-1 ElemStation=0
Frame=18 Station=9,16500000000001E-02 OutputCase=STR065 CaseType=Combination P=-99,891868558281 V2=-0,613256224002326 V3=0 T=0 M2=0 M3=11,4448052510971 FrameElem=18-1 ElemStation=9,16500000000001E-02
Frame=18 Station=0,1833 OutputCase=STR065 CaseType=Combination P=-99,396958558281 V2=-1,16957172400233 V3=0 T=0 M2=0 M3=11,5268113316394 FrameElem=18-1 ElemStation=0,1833
Frame=18 Station=0 OutputCase=STR066 CaseType=Combination P=-90,0308663277476 V2=13,131529486733 V3=0 T=0 M2=0 M3=4,52244896968367 FrameElem=18-1 ElemStation=0
Frame=18 Station=9,16500000000001E-02 OutputCase=STR066 CaseType=Combination P=-89,5359563277476 V2=9,55518609923301 V3=0 T=0 M2=0 M3=3,48320349062537 FrameElem=18-1 ElemStation=9,16500000000001E-02
Frame=18 Station=0,1833 OutputCase=STR066 CaseType=Combination P=-89,0410463277476 V2=6,027715074233 V3=0 T=0 M2=0 M3=2,76949030701988 FrameElem=18-1 ElemStation=0,1833
Frame=18 Station=0 OutputCase=STR067 CaseType=Combination P=-100,386778557938 V2=-6,27234429579824E-02 V3=0 T=0 M2=0 M3=4,01139914723861 FrameElem=18-1 ElemStation=0
Frame=18 Station=9,16500000000001E-02 OutputCase=STR067 CaseType=Combination P=-99,8918685579376 V2=-3,63906683045799 V3=0 T=0 M2=0 M3=4,18140694918649 FrameElem=18-1 ElemStation=9,16500000000001E-02
Frame=18 Station=0,1833 OutputCase=STR067 CaseType=Combination P=-99,3969585579376 V2=-7,16653785545799 V3=0 T=0 M2=0 M3=4,67694704658719 FrameElem=18-1 ElemStation=0,1833
Frame=18 Station=0 OutputCase=STR068 CaseType=Combination P=-4,12600633129843 V2=13,9065932933787 V3=0 T=0 M2=0 M3=-6,7676768307235 FrameElem=18-1 ElemStation=0
Frame=18 Station=9,16500000000001E-02 OutputCase=STR068 CaseType=Combination P=-3,75940633129843 V2=10,3302499058787 V3=0 T=0 M2=0 M3=-7,87795690766087 FrameElem=18-1 ElemStation=9,16500000000001E-02
Frame=18 Station=0,1833 OutputCase=STR068 CaseType=Combination P=-3,39280633129843 V2=6,8027788808787 V3=0 T=0 M2=0 M3=-8,66270468914544 FrameElem=18-1 ElemStation=0,1833
Frame=18 Station=0 OutputCase=STR069 CaseType=Combination P=-14,4819185614884 V2=0,712340363687717 V3=0 T=0 M2=0 M3=-7,27872665316855 FrameElem=18-1 ElemStation=0
Frame=18 Station=9,16500000000001E-02 OutputCase=STR069 CaseType=Combination P=-14,1153185614884 V2=-2,86400302381229 V3=0 T=0 M2=0 M3=-7,17975344909975 FrameElem=18-1 ElemStation=9,16500000000001E-02
Frame=18 Station=0,1833 OutputCase=STR069 CaseType=Combination P=-13,7487185614884 V2=-6,39147404881229 V3=0 T=0 M2=0 M3=-6,75524794957814 FrameElem=18-1 ElemStation=0,1833
Frame=18 Station=0 OutputCase=STR070 CaseType=Combination P=-20,1684599986428 V2=1,16405682037987 V3=0 T=0 M2=0 M3=0,729032122441543 FrameElem=18-1 ElemStation=0
Frame=18 Station=9,16500000000001E-02 OutputCase=STR070 CaseType=Combination P=-19,6735499986428 V2=-0,119306673370133 V3=0 T=0 M2=0 M3=-0,776251044625295 FrameElem=18-1 ElemStation=9,16500000000001E-02
Frame=18 Station=0,1833 OutputCase=STR070 CaseType=Combination P=-19,1786399986428 V2=-1,31667955462013 V3=0 T=0 M2=0 M3=-0,709790222424672 FrameElem=18-1 ElemStation=0,1833
Frame=18 Station=0 OutputCase=STR071 CaseType=Combination P=-20,1684599987505 V2=1,73608043012612 V3=0 T=0 M2=0 M3=1,05032289587662 FrameElem=18-1 ElemStation=0
Frame=18 Station=9,16500000000001E-02 OutputCase=STR071 CaseType=Combination P=-19,6735499987505 V2=1,13943893012612 V3=0 T=0 M2=0 M3=0,91886021018064 FrameElem=18-1 ElemStation=9,16500000000001E-02
Frame=18 Station=0,1833 OutputCase=STR071 CaseType=Combination P=-19,1786399987505 V2=0,583123430126115 V3=0 T=0 M2=0 M3=0,840231780684506 FrameElem=18-1 ElemStation=0,1833
Frame=18 Station=0 OutputCase=STR072 CaseType=Combination P=-100,844459995531 V2=0,763935608246384 V3=0 T=0 M2=0 M3=11,6678325293548 FrameElem=18-1 ElemStation=0

Società di Progetto
Brebemi SpA



Doc. N.
60235-0000-A00.doc

CODIFICA DOCUMENTO
04RCDII10000000000300A00

REV.
00

FOGLIO
285 di 628

Frame=18 Station=9,1650000000001E-02 OutputCase=STR072 CaseType=Combination P=-100,349549995531 V2=0,167294108246383 V3=0 T=0 M2=0 M3=11,6254669174216
FrameElem=18-1 ElemStation=9,1650000000001E-02
Frame=18 Station=0,1833 OutputCase=STR072 CaseType=Combination P=-99,8546399955315 V2=-0,389021391753617 V3=0 T=0 M2=0 M3=11,6359355600133
FrameElem=18-1 ElemStation=0,1833
Frame=18 Station=0 OutputCase=STR073 CaseType=Combination P=-90,488547764998 V2=13,9120798189817 V3=0 T=0 M2=0 M3=4,77464807395873 FrameElem=18-1
ElemStation=0
Frame=18 Station=9,1650000000001E-02 OutputCase=STR073 CaseType=Combination P=-89,993637764998 V2=10,3357364314817 V3=0 T=0 M2=0 M3=3,66386515694983
FrameElem=18-1 ElemStation=9,1650000000001E-02
Frame=18 Station=0,1833 OutputCase=STR073 CaseType=Combination P=-89,498727764998 V2=6,80826540648171 V3=0 T=0 M2=0 M3=2,87861453539375 FrameElem=18-1
ElemStation=0,1833
Frame=18 Station=0 OutputCase=STR074 CaseType=Combination P=-100,844459995188 V2=0,717826889290727 V3=0 T=0 M2=0 M3=4,26359825151367 FrameElem=18-1
ElemStation=0
Frame=18 Station=9,1650000000001E-02 OutputCase=STR074 CaseType=Combination P=-100,349549995188 V2=-2,85851649820928 V3=0 T=0 M2=0 M3=4,36206861551096
FrameElem=18-1 ElemStation=9,1650000000001E-02
Frame=18 Station=0,1833 OutputCase=STR074 CaseType=Combination P=-99,854639995188 V2=-6,38598752320928 V3=0 T=0 M2=0 M3=4,78607127496106 FrameElem=18-1
ElemStation=0,1833
Frame=18 Station=0 OutputCase=STR075 CaseType=Combination P=-4,58368776854888 V2=14,6871436256274 V3=0 T=0 M2=0 M3=-6,51547772644844 FrameElem=18-1
ElemStation=0
Frame=18 Station=9,1650000000001E-02 OutputCase=STR075 CaseType=Combination P=-4,21708776854888 V2=11,1108002381274 V3=0 T=0 M2=0 M3=-7,69729524133641
FrameElem=18-1 ElemStation=9,1650000000001E-02
Frame=18 Station=0,1833 OutputCase=STR075 CaseType=Combination P=-3,85048776854888 V2=7,58332921312741 V3=0 T=0 M2=0 M3=-8,55358046077157
FrameElem=18-1 ElemStation=0,1833
Frame=18 Station=0 OutputCase=STR076 CaseType=Combination P=-14,9395999987389 V2=1,49289069593643 V3=0 T=0 M2=0 M3=-7,02652754889349 FrameElem=18-1
ElemStation=0
Frame=18 Station=9,1650000000001E-02 OutputCase=STR076 CaseType=Combination P=-14,5729999987389 V2=-2,08345269156358 V3=0 T=0 M2=0 M3=-6,99909178277529
FrameElem=18-1 ElemStation=9,1650000000001E-02
Frame=18 Station=0,1833 OutputCase=STR076 CaseType=Combination P=-14,2063999987389 V2=-5,61092371656358 V3=0 T=0 M2=0 M3=-6,64612372120427
FrameElem=18-1 ElemStation=0,1833
Frame=18 Station=0 OutputCase=STR077 CaseType=Combination P=-20,9312623940583 V2=0,074372305455142 V3=0 T=0 M2=0 M3=-0,309094586665046 FrameElem=18-1
ElemStation=0
Frame=18 Station=9,1650000000001E-02 OutputCase=STR077 CaseType=Combination P=-20,4363523940583 V2=-1,20899118829486 V3=0 T=0 M2=0 M3=-
0,256443923055947 FrameElem=18-1 ElemStation=9,1650000000001E-02
Frame=18 Station=0,1833 OutputCase=STR077 CaseType=Combination P=-19,9414423940583 V2=-2,40636406954486 V3=0 T=0 M2=0 M3=-9,01135150624734E-02
FrameElem=18-1 ElemStation=0,1833
Frame=18 Station=0 OutputCase=STR078 CaseType=Combination P=-20,931262394166 V2=0,64639591520139 V3=0 T=0 M2=0 M3=1,47026043165312 FrameElem=18-1
ElemStation=0
Frame=18 Station=9,1650000000001E-02 OutputCase=STR078 CaseType=Combination P=-20,436352394166 V2=4,97544152013894E-02 V3=0 T=0 M2=0
M3=1,43866733258741 FrameElem=18-1 ElemStation=9,1650000000001E-02
Frame=18 Station=0,1833 OutputCase=STR078 CaseType=Combination P=-19,941442394166 V2=-0,506561084798611 V3=0 T=0 M2=0 M3=1,4599084880467 FrameElem=18-1
ElemStation=0,1833
Frame=18 Station=0 OutputCase=STR079 CaseType=Combination P=-128,194141431707 V2=-0,802379186444176 V3=0 T=0 M2=0 M3=15,4588678690328 FrameElem=18-1
ElemStation=0
Frame=18 Station=9,1650000000001E-02 OutputCase=STR079 CaseType=Combination P=-127,699231431707 V2=-1,39902068644418 V3=0 T=0 M2=0 M3=15,5600550080329
FrameElem=18-1 ElemStation=9,1650000000001E-02
Frame=18 Station=0,1833 OutputCase=STR079 CaseType=Combination P=-127,204321431707 V2=-1,95533618644418 V3=0 T=0 M2=0 M3=15,714076401558 FrameElem=18-1
ElemStation=0,1833
Frame=18 Station=0 OutputCase=STR080 CaseType=Combination P=-115,01235985075 V2=16,0677204455263 V3=0 T=0 M2=0 M3=6,81416308579497 FrameElem=18-1
ElemStation=0
Frame=18 Station=9,1650000000001E-02 OutputCase=STR080 CaseType=Combination P=-114,51744985075 V2=11,7270504267763 V3=0 T=0 M2=0 M3=5,54074647636216
FrameElem=18-1 ElemStation=9,1650000000001E-02
Frame=18 Station=0,1833 OutputCase=STR080 CaseType=Combination P=-114,02253985075 V2=7,42288002052633 V3=0 T=0 M2=0 M3=4,66347967940499 FrameElem=18-1
ElemStation=0,1833
Frame=18 Station=0 OutputCase=STR081 CaseType=Combination P=-128,194141431285 V2=-0,673182941802969 V3=0 T=0 M2=0 M3=6,17967383801729 FrameElem=18-1
ElemStation=0
Frame=18 Station=9,1650000000001E-02 OutputCase=STR081 CaseType=Combination P=-127,699231431285 V2=-5,01385296055297 V3=0 T=0 M2=0 M3=6,44056102403322
FrameElem=18-1 ElemStation=9,1650000000001E-02
Frame=18 Station=0,1833 OutputCase=STR081 CaseType=Combination P=-127,204321431285 V2=-9,31802336680298 V3=0 T=0 M2=0 M3=7,09759802252478
FrameElem=18-1 ElemStation=0,1833
Frame=18 Station=0 OutputCase=STR082 CaseType=Combination P=-2,21549985537422 V2=17,166832526132 V3=0 T=0 M2=0 M3=-8,01513259243827 FrameElem=18-1
ElemStation=0
Frame=18 Station=9,1650000000001E-02 OutputCase=STR082 CaseType=Combination P=-1,84889895537422 V2=12,8261625073819 V3=0 T=0 M2=0 M3=-9,38928282405858
FrameElem=18-1 ElemStation=9,1650000000001E-02
Frame=18 Station=0,1833 OutputCase=STR082 CaseType=Combination P=-1,48229985537422 V2=8,52199210113194 V3=0 T=0 M2=0 M3=-10,3672832432033
FrameElem=18-1 ElemStation=0,1833
Frame=18 Station=0 OutputCase=STR083 CaseType=Combination P=-15,3972814359091 V2=0,425929138802641 V3=0 T=0 M2=0 M3=-8,64962184021595 FrameElem=18-1
ElemStation=0
Frame=18 Station=9,1650000000001E-02 OutputCase=STR083 CaseType=Combination P=-15,0306814359091 V2=-3,91474087994736 V3=0 T=0 M2=0 M3=-8,48946827638752
FrameElem=18-1 ElemStation=9,1650000000001E-02
Frame=18 Station=0,1833 OutputCase=STR083 CaseType=Combination P=-14,6640814359091 V2=-8,21891128619737 V3=0 T=0 M2=0 M3=-7,93316490008347
FrameElem=18-1 ElemStation=0,1833
Frame=18 Station=0 OutputCase=STR084 CaseType=Combination P=-71,5763164165128 V2=31,3821633039541 V3=0 T=0 M2=0 M3=4,47886519060596 FrameElem=18-1
ElemStation=0
Frame=18 Station=9,1650000000001E-02 OutputCase=STR084 CaseType=Combination P=-71,0814064165128 V2=27,8058199164541 V3=0 T=0 M2=0 M3=1,76694912219934
FrameElem=18-1 ElemStation=9,1650000000001E-02
Frame=18 Station=0,1833 OutputCase=STR084 CaseType=Combination P=-70,5864964165128 V2=24,2783488914541 V3=0 T=0 M2=0 M3=-0,61943465075446
FrameElem=18-1 ElemStation=0,1833
Frame=18 Station=0 OutputCase=STR085 CaseType=Combination P=-101,607262390947 V2=-0,325748906678342 V3=0 T=0 M2=0 M3=12,0877700651313 FrameElem=18-1
ElemStation=0
Frame=18 Station=9,1650000000001E-02 OutputCase=STR085 CaseType=Combination P=-101,112352390947 V2=-0,922390406678342 V3=0 T=0 M2=0
M3=12,1452740389909 FrameElem=18-1 ElemStation=9,1650000000001E-02
Frame=18 Station=0,1833 OutputCase=STR085 CaseType=Combination P=-100,617442390947 V2=-1,47870590667834 V3=0 T=0 M2=0 M3=12,2556122673755
FrameElem=18-1 ElemStation=0,1833
Frame=18 Station=0 OutputCase=STR086 CaseType=Combination P=-91,2513501604135 V2=12,822395304057 V3=0 T=0 M2=0 M3=5,19458560973522 FrameElem=18-1
ElemStation=0
Frame=18 Station=9,1650000000001E-02 OutputCase=STR086 CaseType=Combination P=-90,7564401604135 V2=9,24605191655699 V3=0 T=0 M2=0 M3=4,18367227851918
FrameElem=18-1 ElemStation=9,1650000000001E-02
Frame=18 Station=0,1833 OutputCase=STR086 CaseType=Combination P=-90,2615301604135 V2=5,71858089155699 V3=0 T=0 M2=0 M3=3,49829124275595 FrameElem=18-1
ElemStation=0,1833

APPROVATO S.D.P.
Società di Progetto
Brebemi SpA



Doc. N.
60235-00000-A00.doc

CODIFICA DOCUMENTO
04RCDII10000000000300A00

REV.
00

FOGLIO
286 di 628

Frame=18 Station=0 OutputCase=STR087 CaseType=Combination P=-101,607262390604 V2=-0,371857625633999 V3=0 T=0 M2=0 M3=4,68353578729017 FrameElem=18-1 ElemStation=0
Frame=18 Station=9,1650000000001E-02 OutputCase=STR087 CaseType=Combination P=-101,112352390604 V2=-3,948201013134 V3=0 T=0 M2=0 M3=4,8818757370803
FrameElem=18-1 ElemStation=9,1650000000001E-02
Frame=18 Station=0,1833 OutputCase=STR087 CaseType=Combination P=-100,617442390604 V2=-7,475672038134 V3=0 T=0 M2=0 M3=5,40574798232325 FrameElem=18-1 ElemStation=0,1833
Frame=18 Station=0 OutputCase=STR088 CaseType=Combination P=-5,34649016396435 V2=13,5974591107027 V3=0 T=0 M2=0 M3=-6,09554019067194 FrameElem=18-1 ElemStation=0
Frame=18 Station=9,1650000000001E-02 OutputCase=STR088 CaseType=Combination P=-4,97989016396435 V2=10,0211157232027 V3=0 T=0 M2=0 M3=-7,17748811976706
FrameElem=18-1 ElemStation=9,1650000000001E-02
Frame=18 Station=0,1833 OutputCase=STR088 CaseType=Combination P=-4,61329016396435 V2=6,49364469820269 V3=0 T=0 M2=0 M3=-7,93390375340937
FrameElem=18-1 ElemStation=0,1833
Frame=18 Station=0 OutputCase=STR089 CaseType=Combination P=-15,7024023941544 V2=0,4032061810117 V3=0 T=0 M2=0 M3=-6,606590013117 FrameElem=18-1 ElemStation=0
Frame=18 Station=9,1650000000001E-02 OutputCase=STR089 CaseType=Combination P=-15,3358023941544 V2=-3,1731372064883 V3=0 T=0 M2=0 M3=-6,47928466120594
FrameElem=18-1 ElemStation=9,1650000000001E-02
Frame=18 Station=0,1833 OutputCase=STR089 CaseType=Combination P=-14,9692023941544 V2=-6,7006082314883 V3=0 T=0 M2=0 M3=-6,02644701384207
FrameElem=18-1 ElemStation=0,1833
Frame=18 Station=0 OutputCase=STR090 CaseType=Combination P=-20,9312623940578 V2=-0,477305018084683 V3=0 T=0 M2=0 M3=-0,309185580053185 FrameElem=18-1 ElemStation=0
Frame=18 Station=9,1650000000001E-02 OutputCase=STR090 CaseType=Combination P=-20,4363523940578 V2=-1,76066851183468 V3=0 T=0 M2=0 M3=-0,205973689741661 FrameElem=18-1 ElemStation=9,1650000000001E-02
Frame=18 Station=0,1833 OutputCase=STR090 CaseType=Combination P=-19,9414423940578 V2=-2,95804139308468 V3=0 T=0 M2=0 M3=1,09179449542383E-02
FrameElem=18-1 ElemStation=0,1833
Frame=18 Station=0 OutputCase=STR091 CaseType=Combination P=-20,9312623941655 V2=9,47185916615649E-02 V3=0 T=0 M2=0 M3=1,47016943826498 FrameElem=18-1 ElemStation=0
Frame=18 Station=9,1650000000001E-02 OutputCase=STR091 CaseType=Combination P=-20,4363523941655 V2=-0,501922908338436 V3=0 T=0 M2=0 M3=1,4891375659017
FrameElem=18-1 ElemStation=9,1650000000001E-02
Frame=18 Station=0,1833 OutputCase=STR091 CaseType=Combination P=-19,9414423941655 V2=-1,05823840833844 V3=0 T=0 M2=0 M3=1,56093994806342
FrameElem=18-1 ElemStation=0,1833
Frame=18 Station=0 OutputCase=STR092 CaseType=Combination P=-101,607262390946 V2=-0,877426230218167 V3=0 T=0 M2=0 M3=12,0876790717432 FrameElem=18-1 ElemStation=0
Frame=18 Station=9,1650000000001E-02 OutputCase=STR092 CaseType=Combination P=-101,112352390946 V2=-1,47406773021817 V3=0 T=0 M2=0 M3=12,1957442723052
FrameElem=18-1 ElemStation=9,1650000000001E-02
Frame=18 Station=0,1833 OutputCase=STR092 CaseType=Combination P=-100,617442390946 V2=-2,03038323021817 V3=0 T=0 M2=0 M3=12,3566437273922
FrameElem=18-1 ElemStation=0,1833
Frame=18 Station=0 OutputCase=STR093 CaseType=Combination P=-91,251350160413 V2=12,2707179805172 V3=0 T=0 M2=0 M3=5,19449461634709 FrameElem=18-1 ElemStation=0
Frame=18 Station=9,1650000000001E-02 OutputCase=STR093 CaseType=Combination P=-90,7564401604131 V2=8,69437459301717 V3=0 T=0 M2=0 M3=4,23414251183347
FrameElem=18-1 ElemStation=9,1650000000001E-02
Frame=18 Station=0,1833 OutputCase=STR093 CaseType=Combination P=-90,261530160413 V2=5,16690356801716 V3=0 T=0 M2=0 M3=3,59932270277266 FrameElem=18-1 ElemStation=0,1833
Frame=18 Station=0 OutputCase=STR094 CaseType=Combination P=-101,607262390603 V2=-0,923534949173824 V3=0 T=0 M2=0 M3=4,68344479390203 FrameElem=18-1 ElemStation=0
Frame=18 Station=9,1650000000001E-02 OutputCase=STR094 CaseType=Combination P=-101,112352390603 V2=-4,49987833667383 V3=0 T=0 M2=0 M3=4,93234597039459
FrameElem=18-1 ElemStation=9,1650000000001E-02
Frame=18 Station=0,1833 OutputCase=STR094 CaseType=Combination P=-100,617442390603 V2=-8,02734936167383 V3=0 T=0 M2=0 M3=5,50677944233997
FrameElem=18-1 ElemStation=0,1833
Frame=18 Station=0 OutputCase=STR095 CaseType=Combination P=-5,3464901639639 V2=13,0457817871629 V3=0 T=0 M2=0 M3=-6,09563118406008 FrameElem=18-1 ElemStation=0
Frame=18 Station=9,1650000000001E-02 OutputCase=STR095 CaseType=Combination P=-4,9798901639639 V2=9,46943839966286 V3=0 T=0 M2=0 M3=-7,12701788645278
FrameElem=18-1 ElemStation=9,1650000000001E-02
Frame=18 Station=0,1833 OutputCase=STR095 CaseType=Combination P=-4,6132901639639 V2=5,94196737466286 V3=0 T=0 M2=0 M3=-7,83287229339266 FrameElem=18-1 ElemStation=0,1833
Frame=18 Station=0 OutputCase=STR096 CaseType=Combination P=-15,7024023941539 V2=-0,148471142528125 V3=0 T=0 M2=0 M3=-6,60668100650514 FrameElem=18-1 ElemStation=0
Frame=18 Station=9,1650000000001E-02 OutputCase=STR096 CaseType=Combination P=-15,3358023941539 V2=-3,72481453002813 V3=0 T=0 M2=0 M3=-6,42881442789165
FrameElem=18-1 ElemStation=9,1650000000001E-02
Frame=18 Station=0,1833 OutputCase=STR096 CaseType=Combination P=-14,9692023941539 V2=-7,2522855502813 V3=0 T=0 M2=0 M3=-5,9254155382536
FrameElem=18-1 ElemStation=0,1833
Frame=18 Station=0 OutputCase=STR097 CaseType=Combination P=-20,9312623940587 V2=0,626049628994967 V3=0 T=0 M2=0 M3=-0,309003593276908 FrameElem=18-1 ElemStation=0
Frame=18 Station=9,1650000000001E-02 OutputCase=STR097 CaseType=Combination P=-20,4363523940588 V2=-0,657313864755034 V3=0 T=0 M2=0 M3=-0,306914156370234 FrameElem=18-1 ElemStation=9,1650000000001E-02
Frame=18 Station=0,1833 OutputCase=STR097 CaseType=Combination P=-19,9414423940588 V2=-1,85468674600503 V3=0 T=0 M2=0 M3=-0,191144975079185
FrameElem=18-1 ElemStation=0,1833
Frame=18 Station=0 OutputCase=STR098 CaseType=Combination P=-20,9312623941664 V2=1,19807323874121 V3=0 T=0 M2=0 M3=1,47035142504126 FrameElem=18-1 ElemStation=0
Frame=18 Station=9,1650000000001E-02 OutputCase=STR098 CaseType=Combination P=-20,4363523941664 V2=0,601431738741214 V3=0 T=0 M2=0 M3=1,38819709927312
FrameElem=18-1 ElemStation=9,1650000000001E-02
Frame=18 Station=0,1833 OutputCase=STR098 CaseType=Combination P=-19,9414423941664 V2=4,51162387412142E-02 V3=0 T=0 M2=0 M3=1,35887702802999
FrameElem=18-1 ElemStation=0,1833
Frame=18 Station=0 OutputCase=STR099 CaseType=Combination P=-101,607262390947 V2=0,225928416861483 V3=0 T=0 M2=0 M3=12,0878610585195 FrameElem=18-1 ElemStation=0
Frame=18 Station=9,1650000000001E-02 OutputCase=STR099 CaseType=Combination P=-101,112352390947 V2=-0,370713083138517 V3=0 T=0 M2=0 M3=12,0948038056766 FrameElem=18-1 ElemStation=9,1650000000001E-02
Frame=18 Station=0,1833 OutputCase=STR099 CaseType=Combination P=-100,617442390947 V2=-0,927028583138517 V3=0 T=0 M2=0 M3=12,1545808073588
FrameElem=18-1 ElemStation=0,1833
Frame=18 Station=0 OutputCase=STR100 CaseType=Combination P=-91,2513501604139 V2=13,3740726275968 V3=0 T=0 M2=0 M3=5,19467660312336 FrameElem=18-1 ElemStation=0
Frame=18 Station=9,1650000000001E-02 OutputCase=STR100 CaseType=Combination P=-90,756440160414 V2=9,79772924009682 V3=0 T=0 M2=0 M3=4,13320204520489
FrameElem=18-1 ElemStation=9,1650000000001E-02
Frame=18 Station=0,1833 OutputCase=STR100 CaseType=Combination P=-90,261530160414 V2=6,27025821509681 V3=0 T=0 M2=0 M3=3,39725978273924 FrameElem=18-1 ElemStation=0,1833
Frame=18 Station=0 OutputCase=STR101 CaseType=Combination P=-101,607262390604 V2=0,179819697905826 V3=0 T=0 M2=0 M3=4,6836267806783 FrameElem=18-1 ElemStation=0
Frame=18 Station=9,1650000000001E-02 OutputCase=STR101 CaseType=Combination P=-101,112352390604 V2=-3,39652368959418 V3=0 T=0 M2=0 M3=4,83140550376602
FrameElem=18-1 ElemStation=9,1650000000001E-02

Società di Progetto
Brebemi SpA



Doc. N.
60235-0000-A00.doc

CODIFICA DOCUMENTO
04RCDII10000000000300A00

REV.
00

FOGLIO
287 di 628

Frame=18 Station=0,1833 OutputCase=STR101 CaseType=Combination P=-100,617442390604 V2=-6,92399471459418 V3=0 T=0 M2=0 M3=5,30471652230654
FrameElem=18-1 ElemStation=0,1833
Frame=18 Station=0 OutputCase=STR102 CaseType=Combination P=-5,3464901639648 V2=14,1491364342425 V3=0 T=0 M2=0 M3=-6,0954491972838 FrameElem=18-1
ElemStation=0
Frame=18 Station=9,1650000000001E-02 OutputCase=STR102 CaseType=Combination P=-4,9798901639648 V2=10,5727930467425 V3=0 T=0 M2=0 M3=-7,22795835308135
FrameElem=18-1 ElemStation=9,1650000000001E-02
Frame=18 Station=0,1833 OutputCase=STR102 CaseType=Combination P=-4,6132901639648 V2=7,04532202174251 V3=0 T=0 M2=0 M3=-8,03493521342608 FrameElem=18-1
ElemStation=0,1833
Frame=18 Station=0 OutputCase=STR103 CaseType=Combination P=-15,7024023941548 V2=0,954883504551525 V3=0 T=0 M2=0 M3=-6,60649901972886 FrameElem=18-1
ElemStation=0
Frame=18 Station=9,1650000000001E-02 OutputCase=STR103 CaseType=Combination P=-15,3358023941548 V2=-2,62145988294848 V3=0 T=0 M2=0 M3=-6,52975489452023
FrameElem=18-1 ElemStation=9,1650000000001E-02
Frame=18 Station=0,1833 OutputCase=STR103 CaseType=Combination P=-14,9692023941548 V2=-6,14893090794848 V3=0 T=0 M2=0 M3=-6,12747847385878
FrameElem=18-1 ElemStation=0,1833
Frame=18 Station=0 OutputCase=STR104 CaseType=Combination P=-20,9312623940587 V2=0,626049628994967 V3=0 T=0 M2=0 M3=-0,309003593276908 FrameElem=18-1
ElemStation=0
Frame=18 Station=9,1650000000001E-02 OutputCase=STR104 CaseType=Combination P=-20,4363523940588 V2=-0,657313864755034 V3=0 T=0 M2=0 M3=-
0,306914156370234 FrameElem=18-1 ElemStation=9,1650000000001E-02
Frame=18 Station=0,1833 OutputCase=STR104 CaseType=Combination P=-19,9414423940588 V2=-1,85468674600503 V3=0 T=0 M2=0 M3=-0,191144975079185
FrameElem=18-1 ElemStation=0,1833
Frame=18 Station=0 OutputCase=STR105 CaseType=Combination P=-20,9312623941664 V2=1,19807323874121 V3=0 T=0 M2=0 M3=1,47035142504126 FrameElem=18-1
ElemStation=0
Frame=18 Station=9,1650000000001E-02 OutputCase=STR105 CaseType=Combination P=-20,4363523941664 V2=0,601431738741214 V3=0 T=0 M2=0 M3=1,38819709927312
FrameElem=18-1 ElemStation=9,1650000000001E-02
Frame=18 Station=0,1833 OutputCase=STR105 CaseType=Combination P=-19,9414423941664 V2=4,51162387412142E-02 V3=0 T=0 M2=0 M3=1,35887702802999
FrameElem=18-1 ElemStation=0,1833
Frame=18 Station=0 OutputCase=STR106 CaseType=Combination P=-101,607262390947 V2=0,225928416861483 V3=0 T=0 M2=0 M3=12,0878610585195 FrameElem=18-1
ElemStation=0
Frame=18 Station=9,1650000000001E-02 OutputCase=STR106 CaseType=Combination P=-101,112352390947 V2=-0,370713083138517 V3=0 T=0 M2=0
M3=12,0948038056766 FrameElem=18-1 ElemStation=9,1650000000001E-02
Frame=18 Station=0,1833 OutputCase=STR106 CaseType=Combination P=-100,617442390947 V2=-0,927028583138518 V3=0 T=0 M2=0 M3=12,1545808073588
FrameElem=18-1 ElemStation=0,1833
Frame=18 Station=0 OutputCase=STR107 CaseType=Combination P=-91,2513501604139 V2=13,3740726275968 V3=0 T=0 M2=0 M3=5,19467660312336 FrameElem=18-1
ElemStation=0
Frame=18 Station=9,1650000000001E-02 OutputCase=STR107 CaseType=Combination P=-90,756440160414 V2=9,79772924009682 V3=0 T=0 M2=0 M3=4,13320204520489
FrameElem=18-1 ElemStation=9,1650000000001E-02
Frame=18 Station=0,1833 OutputCase=STR107 CaseType=Combination P=-90,261530160414 V2=6,27025821509681 V3=0 T=0 M2=0 M3=3,39725978273924 FrameElem=18-1
ElemStation=0,1833
Frame=18 Station=0 OutputCase=STR108 CaseType=Combination P=-101,607262390604 V2=0,179819697905826 V3=0 T=0 M2=0 M3=4,6836267806783 FrameElem=18-1
ElemStation=0
Frame=18 Station=9,1650000000001E-02 OutputCase=STR108 CaseType=Combination P=-101,112352390604 V2=-3,39652368959418 V3=0 T=0 M2=0 M3=4,83140550376602
FrameElem=18-1 ElemStation=9,1650000000001E-02
Frame=18 Station=0,1833 OutputCase=STR108 CaseType=Combination P=-100,617442390604 V2=-6,92399471459418 V3=0 T=0 M2=0 M3=5,30471652230654
FrameElem=18-1 ElemStation=0,1833
Frame=18 Station=0 OutputCase=STR109 CaseType=Combination P=-5,3464901639648 V2=14,1491364342425 V3=0 T=0 M2=0 M3=-6,0954491972838 FrameElem=18-1
ElemStation=0
Frame=18 Station=9,1650000000001E-02 OutputCase=STR109 CaseType=Combination P=-4,9798901639648 V2=10,5727930467425 V3=0 T=0 M2=0 M3=-7,22795835308135
FrameElem=18-1 ElemStation=9,1650000000001E-02
Frame=18 Station=0,1833 OutputCase=STR109 CaseType=Combination P=-4,6132901639648 V2=7,04532202174251 V3=0 T=0 M2=0 M3=-8,03493521342608 FrameElem=18-1
ElemStation=0,1833
Frame=18 Station=0 OutputCase=STR110 CaseType=Combination P=-15,7024023941548 V2=0,954883504551525 V3=0 T=0 M2=0 M3=-6,60649901972886 FrameElem=18-1
ElemStation=0
Frame=18 Station=9,1650000000001E-02 OutputCase=STR110 CaseType=Combination P=-15,3358023941548 V2=-2,62145988294848 V3=0 T=0 M2=0 M3=-6,52975489452023
FrameElem=18-1 ElemStation=9,1650000000001E-02
Frame=18 Station=0,1833 OutputCase=STR110 CaseType=Combination P=-14,9692023941548 V2=-6,14893090794848 V3=0 T=0 M2=0 M3=-6,12747847385878
FrameElem=18-1 ElemStation=0,1833
Frame=18 Station=0 OutputCase=STR111 CaseType=Combination P=-19,405657603225 V2=-0,688537723574473 V3=0 T=0 M2=0 M3=-1,14945495628811 FrameElem=18-1
ElemStation=0
Frame=18 Station=9,1650000000001E-02 OutputCase=STR111 CaseType=Combination P=-18,910747603225 V2=-1,97190121732447 V3=0 T=0 M2=0 M3=-1,02688358851845
FrameElem=18-1 ElemStation=9,1650000000001E-02
Frame=18 Station=0,1833 OutputCase=STR111 CaseType=Combination P=-18,415837603225 V2=-3,16927409857447 V3=0 T=0 M2=0 M3=-0,790632476364408
FrameElem=18-1 ElemStation=0,1833
Frame=18 Station=0 OutputCase=STR112 CaseType=Combination P=-19,4056576033326 V2=-0,116514113828225 V3=0 T=0 M2=0 M3=0,629900062030056 FrameElem=18-1
ElemStation=0
Frame=18 Station=9,1650000000001E-02 OutputCase=STR112 CaseType=Combination P=-18,9107476033326 V2=-0,713155613828226 V3=0 T=0 M2=0
M3=0,668227667124913 FrameElem=18-1 ElemStation=9,1650000000001E-02
Frame=18 Station=0,1833 OutputCase=STR112 CaseType=Combination P=-18,4158376033326 V2=-1,26947111382823 V3=0 T=0 M2=0 M3=0,75938952674477
FrameElem=18-1 ElemStation=0,1833
Frame=18 Station=0 OutputCase=STR113 CaseType=Combination P=-127,278778557207 V2=-1,26012520386194 V3=0 T=0 M2=0 M3=14,954651647259 FrameElem=18-1
ElemStation=0
Frame=18 Station=9,1650000000001E-02 OutputCase=STR113 CaseType=Combination P=-126,783868557207 V2=-1,85676670386195 V3=0 T=0 M2=0 M3=15,0977912087554
FrameElem=18-1 ElemStation=9,1650000000001E-02
Frame=18 Station=0,1833 OutputCase=STR113 CaseType=Combination P=-126,288958557207 V2=-2,41308220386194 V3=0 T=0 M2=0 M3=15,2937650247769
FrameElem=18-1 ElemStation=0,1833
Frame=18 Station=0 OutputCase=STR114 CaseType=Combination P=-114,09699697625 V2=15,6099744281086 V3=0 T=0 M2=0 M3=6,30994686402113 FrameElem=18-1
ElemStation=0
Frame=18 Station=9,1650000000001E-02 OutputCase=STR114 CaseType=Combination P=-113,60208697625 V2=11,2693044093586 V3=0 T=0 M2=0 M3=5,07848267708466
FrameElem=18-1 ElemStation=9,1650000000001E-02
Frame=18 Station=0,1833 OutputCase=STR114 CaseType=Combination P=-113,10717697625 V2=6,96513400310857 V3=0 T=0 M2=0 M3=4,24316830262383 FrameElem=18-1
ElemStation=0,1833
Frame=18 Station=0 OutputCase=STR115 CaseType=Combination P=-127,278778556785 V2=-1,13092895922074 V3=0 T=0 M2=0 M3=5,67545761624345 FrameElem=18-1
ElemStation=0
Frame=18 Station=9,1650000000001E-02 OutputCase=STR115 CaseType=Combination P=-126,783868556785 V2=-5,47159897797074 V3=0 T=0 M2=0 M3=5,97829722475572
FrameElem=18-1 ElemStation=9,1650000000001E-02
Frame=18 Station=0,1833 OutputCase=STR115 CaseType=Combination P=-126,288958556785 V2=-9,77576938422074 V3=0 T=0 M2=0 M3=6,6772864574362
FrameElem=18-1 ElemStation=0,1833
Frame=18 Station=0 OutputCase=STR116 CaseType=Combination P=-1,30013698087422 V2=16,7090865087142 V3=0 T=0 M2=0 M3=-8,51934881421211 FrameElem=18-1
ElemStation=0

Società di Progetto
Brebemi SpA



Doc. N.
60235-0000-A00.doc

CODIFICA DOCUMENTO
04RCDII10000000000300A00

REV.
00

FOGLIO
288 di 628

Frame=18 Station=9,1650000000001E-02 OutputCase=STR116 CaseType=Combination P=-0,933536980874223 V2=12,3684164899642 V3=0 T=0 M2=0 M3=-9,85154662333608 FrameElem=18-1 ElemStation=9,1650000000001E-02
Frame=18 Station=0,1833 OutputCase=STR116 CaseType=Combination P=-0,566936980874223 V2=8,06424608371417 V3=0 T=0 M2=0 M3=-10,7875946199844
FrameElem=18-1 ElemStation=0,1833
Frame=18 Station=0 OutputCase=STR117 CaseType=Combination P=-14,4819185614091 V2=-3,18168786151284E-02 V3=0 T=0 M2=0 M3=-9,15383806198978
FrameElem=18-1 ElemStation=0
Frame=18 Station=9,1650000000001E-02 OutputCase=STR117 CaseType=Combination P=-14,1153185614091 V2=-4,37248689736513 V3=0 T=0 M2=0 M3=-8,95173207566502
FrameElem=18-1 ElemStation=9,1650000000001E-02
Frame=18 Station=0,1833 OutputCase=STR117 CaseType=Combination P=-13,7487185614091 V2=-8,67665730361514 V3=0 T=0 M2=0 M3=-8,35347627686463
FrameElem=18-1 ElemStation=0,1833
Frame=18 Station=0 OutputCase=STR118 CaseType=Combination P=-70,6609535420128 V2=30,9244172865364 V3=0 T=0 M2=0 M3=3,97464896883212 FrameElem=18-1
ElemStation=0
Frame=18 Station=9,1650000000001E-02 OutputCase=STR118 CaseType=Combination P=-70,1660435420128 V2=27,3480738990363 V3=0 T=0 M2=0 M3=1,30468532292184
FrameElem=18-1 ElemStation=9,1650000000001E-02
Frame=18 Station=0,1833 OutputCase=STR118 CaseType=Combination P=-69,6711335420128 V2=23,8206028740363 V3=0 T=0 M2=0 M3=-1,03974602753562
FrameElem=18-1 ElemStation=0,1833
Frame=18 Station=0 OutputCase=STR119 CaseType=Combination P=-100,081657600114 V2=-1,08865893570796 V3=0 T=0 M2=0 M3=11,2474096955083 FrameElem=18-1
ElemStation=0
Frame=18 Station=9,1650000000001E-02 OutputCase=STR119 CaseType=Combination P=-99,5867476001136 V2=-1,68530043570796 V3=0 T=0 M2=0 M3=11,3748343735284
FrameElem=18-1 ElemStation=9,1650000000001E-02
Frame=18 Station=0,1833 OutputCase=STR119 CaseType=Combination P=-99,0918376001136 V2=-2,24161593570796 V3=0 T=0 M2=0 M3=11,5550933060735
FrameElem=18-1 ElemStation=0,1833
Frame=18 Station=0 OutputCase=STR120 CaseType=Combination P=-89,7257453695802 V2=12,0594852750274 V3=0 T=0 M2=0 M3=4,35422524011216 FrameElem=18-1
ElemStation=0
Frame=18 Station=9,1650000000001E-02 OutputCase=STR120 CaseType=Combination P=-89,2308353695802 V2=8,48314188752738 V3=0 T=0 M2=0 M3=3,41323261305668
FrameElem=18-1 ElemStation=9,1650000000001E-02
Frame=18 Station=0,1833 OutputCase=STR120 CaseType=Combination P=-88,7359253695802 V2=4,95567086252737 V3=0 T=0 M2=0 M3=2,79777228145402 FrameElem=18-1
ElemStation=0,1833
Frame=18 Station=0 OutputCase=STR121 CaseType=Combination P=-100,08165759977 V2=-1,13476765466361 V3=0 T=0 M2=0 M3=3,8431754176671 FrameElem=18-1
ElemStation=0
Frame=18 Station=9,1650000000001E-02 OutputCase=STR121 CaseType=Combination P=-99,5867475997702 V2=-4,71111104216362 V3=0 T=0 M2=0 M3=4,1114360716178
FrameElem=18-1 ElemStation=9,1650000000001E-02
Frame=18 Station=0,1833 OutputCase=STR121 CaseType=Combination P=-99,0918375997702 V2=-8,23858206716362 V3=0 T=0 M2=0 M3=4,70522902102132
FrameElem=18-1 ElemStation=0,1833
Frame=18 Station=0 OutputCase=STR122 CaseType=Combination P=-3,82088537313101 V2=12,8345490816731 V3=0 T=0 M2=0 M3=-6,93590056029501 FrameElem=18-1
ElemStation=0
Frame=18 Station=9,1650000000001E-02 OutputCase=STR122 CaseType=Combination P=-3,45428537313101 V2=9,25820569417307 V3=0 T=0 M2=0 M3=-7,94792778522956
FrameElem=18-1 ElemStation=9,1650000000001E-02
Frame=18 Station=0,1833 OutputCase=STR122 CaseType=Combination P=-3,08768537313101 V2=5,73073466917307 V3=0 T=0 M2=0 M3=-8,63442271471131
FrameElem=18-1 ElemStation=0,1833
Frame=18 Station=0 OutputCase=STR123 CaseType=Combination P=-14,176797603321 V2=-0,359703848017915 V3=0 T=0 M2=0 M3=-7,44695038274006 FrameElem=18-1
ElemStation=0
Frame=18 Station=9,1650000000001E-02 OutputCase=STR123 CaseType=Combination P=-13,810197603321 V2=-3,93604723551792 V3=0 T=0 M2=0 M3=-7,2497243266844
FrameElem=18-1 ElemStation=9,1650000000001E-02
Frame=18 Station=0,1833 OutputCase=STR123 CaseType=Combination P=-13,443597603321 V2=-7,46351826051792 V3=0 T=0 M2=0 M3=-6,726965975144 FrameElem=18-1
ElemStation=0,1833
Frame=18 Station=0 OutputCase=STR124 CaseType=Combination P=-19,4056576032245 V2=-1,2402150471143 V3=0 T=0 M2=0 M3=-1,1495459467625 FrameElem=18-1
ElemStation=0
Frame=18 Station=9,1650000000001E-02 OutputCase=STR124 CaseType=Combination P=-18,9107476032245 V2=-2,5235785408643 V3=0 T=0 M2=0 M3=-0,97641335520416
FrameElem=18-1 ElemStation=9,1650000000001E-02
Frame=18 Station=0,1833 OutputCase=STR124 CaseType=Combination P=-18,4158376032245 V2=-3,7209514221143 V3=0 T=0 M2=0 M3=-0,689601016347696
FrameElem=18-1 ElemStation=0,1833
Frame=18 Station=0 OutputCase=STR125 CaseType=Combination P=-19,4056576033322 V2=-0,66819143736805 V3=0 T=0 M2=0 M3=0,629809068641918 FrameElem=18-1
ElemStation=0
Frame=18 Station=9,1650000000001E-02 OutputCase=STR125 CaseType=Combination P=-18,9107476033322 V2=-1,26483293736805 V3=0 T=0 M2=0 M3=0,7186979004392
FrameElem=18-1 ElemStation=9,1650000000001E-02
Frame=18 Station=0,1833 OutputCase=STR125 CaseType=Combination P=-18,4158376033322 V2=-1,82114843736805 V3=0 T=0 M2=0 M3=0,860420986761482
FrameElem=18-1 ElemStation=0,1833
Frame=18 Station=0 OutputCase=STR126 CaseType=Combination P=-100,081657600113 V2=-1,64033625924778 V3=0 T=0 M2=0 M3=11,2473187021201 FrameElem=18-1
ElemStation=0
Frame=18 Station=9,1650000000001E-02 OutputCase=STR126 CaseType=Combination P=-99,5867476001131 V2=-2,23697775924778 V3=0 T=0 M2=0 M3=11,4253046068427
FrameElem=18-1 ElemStation=9,1650000000001E-02
Frame=18 Station=0,1833 OutputCase=STR126 CaseType=Combination P=-99,0918376001131 V2=-2,79329325924778 V3=0 T=0 M2=0 M3=11,6561247660903
FrameElem=18-1 ElemStation=0,1833
Frame=18 Station=0 OutputCase=STR127 CaseType=Combination P=-89,7257453695797 V2=11,5078079514876 V3=0 T=0 M2=0 M3=4,35413424672402 FrameElem=18-1
ElemStation=0
Frame=18 Station=9,1650000000001E-02 OutputCase=STR127 CaseType=Combination P=-89,2308353695797 V2=7,93146456398755 V3=0 T=0 M2=0 M3=3,46370284637097
FrameElem=18-1 ElemStation=9,1650000000001E-02
Frame=18 Station=0,1833 OutputCase=STR127 CaseType=Combination P=-88,7359253695797 V2=4,40399353898755 V3=0 T=0 M2=0 M3=2,89880374147073 FrameElem=18-1
ElemStation=0,1833
Frame=18 Station=0 OutputCase=STR128 CaseType=Combination P=-100,08165759977 V2=-1,68644497820344 V3=0 T=0 M2=0 M3=3,84308442427897 FrameElem=18-1
ElemStation=0
Frame=18 Station=9,1650000000001E-02 OutputCase=STR128 CaseType=Combination P=-99,5867475997697 V2=-5,26278836570344 V3=0 T=0 M2=0 M3=4,16190630493209
FrameElem=18-1 ElemStation=9,1650000000001E-02
Frame=18 Station=0,1833 OutputCase=STR128 CaseType=Combination P=-99,0918375997697 V2=-8,79025939070345 V3=0 T=0 M2=0 M3=4,80626048103803
FrameElem=18-1 ElemStation=0,1833
Frame=18 Station=0 OutputCase=STR129 CaseType=Combination P=-3,82088537313056 V2=12,2828717581333 V3=0 T=0 M2=0 M3=-6,93599155368314 FrameElem=18-1
ElemStation=0
Frame=18 Station=9,1650000000001E-02 OutputCase=STR129 CaseType=Combination P=-3,45428537313056 V2=8,70652837063325 V3=0 T=0 M2=0 M3=-7,89745755191528
FrameElem=18-1 ElemStation=9,1650000000001E-02
Frame=18 Station=0,1833 OutputCase=STR129 CaseType=Combination P=-3,08768537313056 V2=5,17905734563325 V3=0 T=0 M2=0 M3=-8,5339125469459
FrameElem=18-1 ElemStation=0,1833
Frame=18 Station=0 OutputCase=STR130 CaseType=Combination P=-14,1767976033206 V2=-0,91138117155774 V3=0 T=0 M2=0 M3=-7,4470413761282 FrameElem=18-1
ElemStation=0
Frame=18 Station=9,1650000000001E-02 OutputCase=STR130 CaseType=Combination P=-13,8101976033206 V2=-4,48772455905774 V3=0 T=0 M2=0 M3=-7,19925409335415
FrameElem=18-1 ElemStation=9,1650000000001E-02
Frame=18 Station=0,1833 OutputCase=STR130 CaseType=Combination P=-13,4435976033206 V2=-8,01519558405774 V3=0 T=0 M2=0 M3=-6,62593451512729
FrameElem=18-1 ElemStation=0,1833

Società di Progetto
Brebemi SpA



Doc. N.
60235-00000-A00.doc

CODIFICA DOCUMENTO
04RCDII10000000000300A00

REV.
00

FOGLIO
289 di 628

Frame=18 Station=0 OutputCase=STR131 CaseType=Combination P=-19,4056576032254 V2=-0,136860400034648 V3=0 T=0 M2=0 M3=-1,14936396289997 FrameElem=18-1 ElemStation=0

Frame=18 Station=9,16500000000001E-02 OutputCase=STR131 CaseType=Combination P=-18,9107476032254 V2=-1,42022389378465 V3=0 T=0 M2=0 M3=-1,07735382183273 FrameElem=18-1 ElemStation=9,16500000000001E-02

Frame=18 Station=0,1833 OutputCase=STR131 CaseType=Combination P=-18,4158376032254 V2=-2,61759677503465 V3=0 T=0 M2=0 M3=-0,89166393638112 FrameElem=18-1 ElemStation=0,1833

Frame=18 Station=0 OutputCase=STR132 CaseType=Combination P=-19,4056576033331 V2=0,4351632097116 V3=0 T=0 M2=0 M3=0,629991055418194 FrameElem=18-1 ElemStation=0

Frame=18 Station=9,16500000000001E-02 OutputCase=STR132 CaseType=Combination P=-18,9107476033331 V2=0,161478290288401 V3=0 T=0 M2=0 M3=0,617757433810626 FrameElem=18-1 ElemStation=9,16500000000001E-02

Frame=18 Station=0,1833 OutputCase=STR132 CaseType=Combination P=-18,4158376033331 V2=-0,717793790288401 V3=0 T=0 M2=0 M3=0,658358066728058 FrameElem=18-1 ElemStation=0,1833

Frame=18 Station=0 OutputCase=STR133 CaseType=Combination P=-100,081657600114 V2=-0,536981612168132 V3=0 T=0 M2=0 M3=11,2475006888964 FrameElem=18-1 ElemStation=0

Frame=18 Station=9,16500000000001E-02 OutputCase=STR133 CaseType=Combination P=-99,5867476001141 V2=-1,13362311216813 V3=0 T=0 M2=0 M3=11,3243641402141 FrameElem=18-1 ElemStation=9,16500000000001E-02

Frame=18 Station=0,1833 OutputCase=STR133 CaseType=Combination P=-99,091837600114 V2=-1,68993861216813 V3=0 T=0 M2=0 M3=11,4540618460568 FrameElem=18-1 ElemStation=0,1833

Frame=18 Station=0 OutputCase=STR134 CaseType=Combination P=-89,7257453695806 V2=12,6111625985672 V3=0 T=0 M2=0 M3=4,3543162335003 FrameElem=18-1 ElemStation=0

Frame=18 Station=9,16500000000001E-02 OutputCase=STR134 CaseType=Combination P=-89,2308353695806 V2=9,0348192110672 V3=0 T=0 M2=0 M3=3,36276237974239 FrameElem=18-1 ElemStation=9,16500000000001E-02

Frame=18 Station=0,1833 OutputCase=STR134 CaseType=Combination P=-88,7359253695806 V2=5,5073481860672 V3=0 T=0 M2=0 M3=2,6967408214373 FrameElem=18-1 ElemStation=0,1833

Frame=18 Station=0 OutputCase=STR135 CaseType=Combination P=-100,081657599771 V2=-0,583090331123789 V3=0 T=0 M2=0 M3=3,84326641105524 FrameElem=18-1 ElemStation=0

Frame=18 Station=9,16500000000001E-02 OutputCase=STR135 CaseType=Combination P=-99,5867475997706 V2=-4,15943371862379 V3=0 T=0 M2=0 M3=4,06096583830352 FrameElem=18-1 ElemStation=9,16500000000001E-02

Frame=18 Station=0,1833 OutputCase=STR135 CaseType=Combination P=-99,0918375997706 V2=-7,68690474362379 V3=0 T=0 M2=0 M3=4,60419756100461 FrameElem=18-1 ElemStation=0,1833

Frame=18 Station=0 OutputCase=STR136 CaseType=Combination P=-3,82088537313146 V2=13,3862264052129 V3=0 T=0 M2=0 M3=-6,93580956690687 FrameElem=18-1 ElemStation=0

Frame=18 Station=9,16500000000001E-02 OutputCase=STR136 CaseType=Combination P=-3,45428537313146 V2=9,8098830177129 V3=0 T=0 M2=0 M3=-7,99839801854385 FrameElem=18-1 ElemStation=9,16500000000001E-02

Frame=18 Station=0,1833 OutputCase=STR136 CaseType=Combination P=-3,08768537313146 V2=6,2824119927129 V3=0 T=0 M2=0 M3=-8,73545417472802 FrameElem=18-1 ElemStation=0,1833

Frame=18 Station=0 OutputCase=STR137 CaseType=Combination P=-14,1767976033215 V2=0,19197347552191 V3=0 T=0 M2=0 M3=-7,44685938935192 FrameElem=18-1 ElemStation=0

Frame=18 Station=9,16500000000001E-02 OutputCase=STR137 CaseType=Combination P=-13,8101976033215 V2=-3,38436991197809 V3=0 T=0 M2=0 M3=-7,30019455998272 FrameElem=18-1 ElemStation=9,16500000000001E-02

Frame=18 Station=0,1833 OutputCase=STR137 CaseType=Combination P=-13,4435976033215 V2=-6,9118409369781 V3=0 T=0 M2=0 M3=-6,82799743516071 FrameElem=18-1 ElemStation=0,1833

Frame=18 Station=0 OutputCase=STR138 CaseType=Combination P=-19,4056576032254 V2=-0,136860400034648 V3=0 T=0 M2=0 M3=-1,14936396289997 FrameElem=18-1 ElemStation=0

Frame=18 Station=9,16500000000001E-02 OutputCase=STR138 CaseType=Combination P=-18,9107476032254 V2=-1,42022389378465 V3=0 T=0 M2=0 M3=-1,07735382183273 FrameElem=18-1 ElemStation=9,16500000000001E-02

Frame=18 Station=0,1833 OutputCase=STR138 CaseType=Combination P=-18,4158376032254 V2=-2,61759677503465 V3=0 T=0 M2=0 M3=-0,89166393638112 FrameElem=18-1 ElemStation=0,1833

Frame=18 Station=0 OutputCase=STR139 CaseType=Combination P=-19,4056576033331 V2=0,4351632097116 V3=0 T=0 M2=0 M3=0,629991055418194 FrameElem=18-1 ElemStation=0

Frame=18 Station=9,16500000000001E-02 OutputCase=STR139 CaseType=Combination P=-18,9107476033331 V2=0,161478290288401 V3=0 T=0 M2=0 M3=0,617757433810626 FrameElem=18-1 ElemStation=9,16500000000001E-02

Frame=18 Station=0,1833 OutputCase=STR139 CaseType=Combination P=-18,4158376033331 V2=-0,717793790288401 V3=0 T=0 M2=0 M3=0,658358066728058 FrameElem=18-1 ElemStation=0,1833

Frame=18 Station=0 OutputCase=STR140 CaseType=Combination P=-100,081657600114 V2=-0,536981612168132 V3=0 T=0 M2=0 M3=11,2475006888964 FrameElem=18-1 ElemStation=0

Frame=18 Station=9,16500000000001E-02 OutputCase=STR140 CaseType=Combination P=-99,5867476001141 V2=-1,13362311216813 V3=0 T=0 M2=0 M3=11,3243641402141 FrameElem=18-1 ElemStation=9,16500000000001E-02

Frame=18 Station=0,1833 OutputCase=STR140 CaseType=Combination P=-99,091837600114 V2=-1,68993861216813 V3=0 T=0 M2=0 M3=11,4540618460568 FrameElem=18-1 ElemStation=0,1833

Frame=18 Station=0 OutputCase=STR141 CaseType=Combination P=-89,7257453695806 V2=12,6111625985672 V3=0 T=0 M2=0 M3=4,3543162335003 FrameElem=18-1 ElemStation=0

Frame=18 Station=9,16500000000001E-02 OutputCase=STR141 CaseType=Combination P=-89,2308353695806 V2=9,0348192110672 V3=0 T=0 M2=0 M3=3,36276237974239 FrameElem=18-1 ElemStation=9,16500000000001E-02

Frame=18 Station=0,1833 OutputCase=STR141 CaseType=Combination P=-88,7359253695806 V2=5,5073481860672 V3=0 T=0 M2=0 M3=2,6967408214373 FrameElem=18-1 ElemStation=0,1833

Frame=18 Station=0 OutputCase=STR142 CaseType=Combination P=-100,081657599771 V2=-0,583090331123789 V3=0 T=0 M2=0 M3=3,84326641105524 FrameElem=18-1 ElemStation=0

Frame=18 Station=9,16500000000001E-02 OutputCase=STR142 CaseType=Combination P=-99,5867475997706 V2=-4,15943371862379 V3=0 T=0 M2=0 M3=4,06096583830352 FrameElem=18-1 ElemStation=9,16500000000001E-02

Frame=18 Station=0,1833 OutputCase=STR142 CaseType=Combination P=-99,0918375997706 V2=-7,68690474362379 V3=0 T=0 M2=0 M3=4,60419756100461 FrameElem=18-1 ElemStation=0,1833

Frame=18 Station=0 OutputCase=STR143 CaseType=Combination P=-3,82088537313146 V2=13,3862264052129 V3=0 T=0 M2=0 M3=-6,93580956690687 FrameElem=18-1 ElemStation=0

Frame=18 Station=9,16500000000001E-02 OutputCase=STR143 CaseType=Combination P=-3,45428537313146 V2=9,8098830177129 V3=0 T=0 M2=0 M3=-7,99839801854385 FrameElem=18-1 ElemStation=9,16500000000001E-02

Frame=18 Station=0,1833 OutputCase=STR143 CaseType=Combination P=-3,08768537313146 V2=6,2824119927129 V3=0 T=0 M2=0 M3=-8,73545417472802 FrameElem=18-1 ElemStation=0,1833

Frame=18 Station=0 OutputCase=STR144 CaseType=Combination P=-14,1767976033215 V2=0,19197347552191 V3=0 T=0 M2=0 M3=-7,44685938935192 FrameElem=18-1 ElemStation=0

Frame=18 Station=9,16500000000001E-02 OutputCase=STR144 CaseType=Combination P=-13,8101976033215 V2=-3,38436991197809 V3=0 T=0 M2=0 M3=-7,30019455998272 FrameElem=18-1 ElemStation=9,16500000000001E-02

Frame=18 Station=0,1833 OutputCase=STR144 CaseType=Combination P=-13,4435976033215 V2=-6,9118409369781 V3=0 T=0 M2=0 M3=-6,82799743516071 FrameElem=18-1 ElemStation=0,1833

Frame=18 Station=0 OutputCase=STR145 CaseType=Combination P=-20,1684599986424 V2=0,612379496840043 V3=0 T=0 M2=0 M3=-0,729123115829681 FrameElem=18-1 ElemStation=0

Frame=18 Station=9,16500000000001E-02 OutputCase=STR145 CaseType=Combination P=-19,6735499986424 V2=-0,67083996909958 V3=0 T=0 M2=0 M3=-0,725780811311008 FrameElem=18-1 ElemStation=9,16500000000001E-02

Società di Progetto
Brebemi SpA



Doc. N.
60235-0000-A00.doc

CODIFICA DOCUMENTO
04RCDII10000000000300A00

REV.
00

FOGLIO
290 di 628

Frame=18 Station=0,1833 OutputCase=STR145 CaseType=Combination P=-19,1786399986424 V2=-1,86835687815996 V3=0 T=0 M2=0 M3=-0,60875876240796
FrameElem=18-1 ElemStation=0,1833
Frame=18 Station=0 OutputCase=STR146 CaseType=Combination P=-20,1684599987501 V2=1,18440310658629 V3=0 T=0 M2=0 M3=1,05023190248848 FrameElem=18-1
ElemStation=0
Frame=18 Station=9,16500000000001E-02 OutputCase=STR146 CaseType=Combination P=-19,6735499987501 V2=0,58776160658629 V3=0 T=0 M2=0 M3=0,969330444332351
FrameElem=18-1 ElemStation=9,16500000000001E-02
Frame=18 Station=0,1833 OutputCase=STR146 CaseType=Combination P=-19,1786399987501 V2=0,03144610658629 V3=0 T=0 M2=0 M3=0,941263240701218
FrameElem=18-1 ElemStation=0,1833
Frame=18 Station=0 OutputCase=STR147 CaseType=Combination P=-127,736459994458 V2=-0,479574871613235 V3=0 T=0 M2=0 M3=15,206850751534 FrameElem=18-1
ElemStation=0
Frame=18 Station=9,16500000000001E-02 OutputCase=STR147 CaseType=Combination P=-127,241549994458 V2=-1,07621637161324 V3=0 T=0 M2=0 M3=15,2784528750799
FrameElem=18-1 ElemStation=9,16500000000001E-02
Frame=18 Station=0,1833 OutputCase=STR147 CaseType=Combination P=-126,746639994458 V2=-1,63253187161324 V3=0 T=0 M2=0 M3=15,4028892531507
FrameElem=18-1 ElemStation=0,1833
Frame=18 Station=0 OutputCase=STR148 CaseType=Combination P=-114,554678413501 V2=16,3905247603573 V3=0 T=0 M2=0 M3=6,56214596829618 FrameElem=18-1
ElemStation=0
Frame=18 Station=9,16500000000001E-02 OutputCase=STR148 CaseType=Combination P=-114,059768413501 V2=12,0498547416073 V3=0 T=0 M2=0 M3=5,25914434340913
FrameElem=18-1 ElemStation=9,16500000000001E-02
Frame=18 Station=0,1833 OutputCase=STR148 CaseType=Combination P=-113,564858413501 V2=7,74568433535728 V3=0 T=0 M2=0 M3=4,35229253099769 FrameElem=18-1
ElemStation=0,1833
Frame=18 Station=0 OutputCase=STR149 CaseType=Combination P=-127,736459994036 V2=-0,350378626972028 V3=0 T=0 M2=0 M3=5,92765672051851 FrameElem=18-1
ElemStation=0
Frame=18 Station=9,16500000000001E-02 OutputCase=STR149 CaseType=Combination P=-127,241549994036 V2=-4,69104864572203 V3=0 T=0 M2=0 M3=6,15895889108018
FrameElem=18-1 ElemStation=9,16500000000001E-02
Frame=18 Station=0,1833 OutputCase=STR149 CaseType=Combination P=-126,746639994036 V2=-8,99521905197203 V3=0 T=0 M2=0 M3=6,78641087411748
FrameElem=18-1 ElemStation=0,1833
Frame=18 Station=0 OutputCase=STR150 CaseType=Combination P=-1,75781841812467 V2=17,4896368409629 V3=0 T=0 M2=0 M3=-8,26714970993705 FrameElem=18-1
ElemStation=0
Frame=18 Station=9,16500000000001E-02 OutputCase=STR150 CaseType=Combination P=-1,39121841812467 V2=13,1489668222129 V3=0 T=0 M2=0 M3=-9,67088495701161
FrameElem=18-1 ElemStation=9,16500000000001E-02
Frame=18 Station=0,1833 OutputCase=STR150 CaseType=Combination P=-1,02461841812467 V2=8,84479641596288 V3=0 T=0 M2=0 M3=-10,6784703916106
FrameElem=18-1 ElemStation=0,1833
Frame=18 Station=0 OutputCase=STR151 CaseType=Combination P=-14,9395999986596 V2=0,748733453633581 V3=0 T=0 M2=0 M3=-8,90163895771473 FrameElem=18-1
ElemStation=0
Frame=18 Station=9,16500000000001E-02 OutputCase=STR151 CaseType=Combination P=-14,5729999986596 V2=-3,59193656511642 V3=0 T=0 M2=0 M3=-8,77107040934056
FrameElem=18-1 ElemStation=9,16500000000001E-02
Frame=18 Station=0,1833 OutputCase=STR151 CaseType=Combination P=-14,2063999986596 V2=-7,89610697136643 V3=0 T=0 M2=0 M3=-8,24435204849076
FrameElem=18-1 ElemStation=0,1833
Frame=18 Station=0 OutputCase=STR152 CaseType=Combination P=-71,1186349792632 V2=31,7049676187851 V3=0 T=0 M2=0 M3=4,22684807310718 FrameElem=18-1
ElemStation=0
Frame=18 Station=9,16500000000001E-02 OutputCase=STR152 CaseType=Combination P=-70,6237249792632 V2=28,1286242312851 V3=0 T=0 M2=0 M3=1,48534698924631
FrameElem=18-1 ElemStation=9,16500000000001E-02
Frame=18 Station=0,1833 OutputCase=STR152 CaseType=Combination P=-70,1288149792632 V2=24,6011532062851 V3=0 T=0 M2=0 M3=-0,930621799161752
FrameElem=18-1 ElemStation=0,1833
Frame=18 Station=0 OutputCase=STR153 CaseType=Combination P=-100,844459995531 V2=0,212258284706559 V3=0 T=0 M2=0 M3=11,6677415359667 FrameElem=18-1
ElemStation=0
Frame=18 Station=9,16500000000001E-02 OutputCase=STR153 CaseType=Combination P=-100,349549995531 V2=-0,384383215293442 V3=0 T=0 M2=0
M3=11,6759371507358 FrameElem=18-1 ElemStation=9,16500000000001E-02
Frame=18 Station=0,1833 OutputCase=STR153 CaseType=Combination P=-99,854639995531 V2=-0,940698715293442 V3=0 T=0 M2=0 M3=11,73696702003 FrameElem=18-1
ElemStation=0,1833
Frame=18 Station=0 OutputCase=STR154 CaseType=Combination P=-90,4885477649976 V2=13,3604024954419 V3=0 T=0 M2=0 M3=4,77455708057059 FrameElem=18-1
ElemStation=0
Frame=18 Station=9,16500000000001E-02 OutputCase=STR154 CaseType=Combination P=-89,9936377649976 V2=9,78405910794189 V3=0 T=0 M2=0 M3=3,71433539026412
FrameElem=18-1 ElemStation=9,16500000000001E-02
Frame=18 Station=0,1833 OutputCase=STR154 CaseType=Combination P=-89,4987277649976 V2=6,25658808294189 V3=0 T=0 M2=0 M3=2,97964599541046 FrameElem=18-1
ElemStation=0,1833
Frame=18 Station=0 OutputCase=STR155 CaseType=Combination P=-100,844459995188 V2=0,166149565750902 V3=0 T=0 M2=0 M3=4,26350725812553 FrameElem=18-1
ElemStation=0
Frame=18 Station=9,16500000000001E-02 OutputCase=STR155 CaseType=Combination P=-100,349549995188 V2=-3,4101938217491 V3=0 T=0 M2=0 M3=4,41253884882524
FrameElem=18-1 ElemStation=9,16500000000001E-02
Frame=18 Station=0,1833 OutputCase=STR155 CaseType=Combination P=-99,8546399951876 V2=-6,9376648467491 V3=0 T=0 M2=0 M3=4,88710273497777 FrameElem=18-1
ElemStation=0,1833
Frame=18 Station=0 OutputCase=STR156 CaseType=Combination P=-4,58368776854843 V2=14,1354663020876 V3=0 T=0 M2=0 M3=-6,51556871983658 FrameElem=18-1
ElemStation=0
Frame=18 Station=9,16500000000001E-02 OutputCase=STR156 CaseType=Combination P=-4,21708776854843 V2=10,5591229145876 V3=0 T=0 M2=0 M3=-7,64682500802212
FrameElem=18-1 ElemStation=9,16500000000001E-02
Frame=18 Station=0,1833 OutputCase=STR156 CaseType=Combination P=-3,85048776854843 V2=7,03165188958759 V3=0 T=0 M2=0 M3=-8,45254900075486
FrameElem=18-1 ElemStation=0,1833
Frame=18 Station=0 OutputCase=STR157 CaseType=Combination P=-14,9395999987384 V2=0,941213372396601 V3=0 T=0 M2=0 M3=-7,02661854228163 FrameElem=18-1
ElemStation=0
Frame=18 Station=9,16500000000001E-02 OutputCase=STR157 CaseType=Combination P=-14,5729999987384 V2=-2,6351300151034 V3=0 T=0 M2=0 M3=-6,948621549461
FrameElem=18-1 ElemStation=9,16500000000001E-02
Frame=18 Station=0,1833 OutputCase=STR157 CaseType=Combination P=-14,2063999987384 V2=-6,1626010401034 V3=0 T=0 M2=0 M3=-6,54509226118755
FrameElem=18-1 ElemStation=0,1833
Frame=18 Station=0 OutputCase=STR158 CaseType=Combination P=-20,1684599986419 V2=6,07021733002178E-02 V3=0 T=0 M2=0 M3=-0,729214109217819
FrameElem=18-1 ElemStation=0
Frame=18 Station=9,16500000000001E-02 OutputCase=STR158 CaseType=Combination P=-19,6735499986419 V2=-1,22266132044978 V3=0 T=0 M2=0 M3=-
0,675310577996721 FrameElem=18-1 ElemStation=9,16500000000001E-02
Frame=18 Station=0,1833 OutputCase=STR158 CaseType=Combination P=-19,1786399986419 V2=-2,42003420169978 V3=0 T=0 M2=0 M3=-0,507727302391249
FrameElem=18-1 ElemStation=0,1833
Frame=18 Station=0 OutputCase=STR159 CaseType=Combination P=-20,1684599987496 V2=0,632725783046466 V3=0 T=0 M2=0 M3=1,05014090910035 FrameElem=18-1
ElemStation=0
Frame=18 Station=9,16500000000001E-02 OutputCase=STR159 CaseType=Combination P=-19,6735499987496 V2=3,60842830464652E-02 V3=0 T=0 M2=0
M3=1,01980067764664 FrameElem=18-1 ElemStation=9,16500000000001E-02
Frame=18 Station=0,1833 OutputCase=STR159 CaseType=Combination P=-19,1786399987496 V2=-0,520231216953535 V3=0 T=0 M2=0 M3=1,04229470071793
FrameElem=18-1 ElemStation=0,1833
Frame=18 Station=0 OutputCase=STR160 CaseType=Combination P=-100,844459995531 V2=-0,339419038833266 V3=0 T=0 M2=0 M3=11,6676505425786 FrameElem=18-1
ElemStation=0

Società di Progetto
Brebemi SpA



Doc. N.
60235-0000-A00.doc

CODIFICA DOCUMENTO
04RCDII10000000000300A00

REV.
00

FOGLIO
291 di 628

Frame=18 Station=9,1650000000001E-02 OutputCase=STR160 CaseType=Combination P=-100,349549995531 V2=-0,936060538833267 V3=0 T=0 M2=0 M3=11,7264073840501 FrameElem=18-1 ElemStation=9,1650000000001E-02
Frame=18 Station=0,1833 OutputCase=STR160 CaseType=Combination P=-99,8546399955306 V2=-1,49237603883327 V3=0 T=0 M2=0 M3=11,8379984800467
FrameElem=18-1 ElemStation=0,1833
Frame=18 Station=0 OutputCase=STR161 CaseType=Combination P=-90,4885477649971 V2=12,8087251719021 V3=0 T=0 M2=0 M3=4,77446608718245 FrameElem=18-1 ElemStation=0
Frame=18 Station=9,1650000000001E-02 OutputCase=STR161 CaseType=Combination P=-89,9936377649971 V2=9,23238178440207 V3=0 T=0 M2=0 M3=3,76480562357841
FrameElem=18-1 ElemStation=9,1650000000001E-02
Frame=18 Station=0,1833 OutputCase=STR161 CaseType=Combination P=-89,4987277649971 V2=5,70491075940206 V3=0 T=0 M2=0 M3=3,08067745542718 FrameElem=18-1 ElemStation=0,1833
Frame=18 Station=0 OutputCase=STR162 CaseType=Combination P=-100,844459995187 V2=-0,385527757788923 V3=0 T=0 M2=0 M3=4,26341626473739 FrameElem=18-1 ElemStation=0
Frame=18 Station=9,1650000000001E-02 OutputCase=STR162 CaseType=Combination P=-100,349549995187 V2=-3,96187114528893 V3=0 T=0 M2=0 M3=4,4630098213953
FrameElem=18-1 ElemStation=9,1650000000001E-02
Frame=18 Station=0,1833 OutputCase=STR162 CaseType=Combination P=-99,8546399951871 V2=-7,48934217028893 V3=0 T=0 M2=0 M3=4,98813419499448
FrameElem=18-1 ElemStation=0,1833
Frame=18 Station=0 OutputCase=STR163 CaseType=Combination P=-4,58368776854798 V2=13,5837889785478 V3=0 T=0 M2=0 M3=6,51565971322471 FrameElem=18-1 ElemStation=0
Frame=18 Station=9,1650000000001E-02 OutputCase=STR163 CaseType=Combination P=-4,21708776854798 V2=10,0074455910478 V3=0 T=0 M2=0 M3=-7,59635477470784
FrameElem=18-1 ElemStation=9,1650000000001E-02
Frame=18 Station=0,1833 OutputCase=STR163 CaseType=Combination P=-3,85048776854798 V2=6,47997456604776 V3=0 T=0 M2=0 M3=-8,35151754073815
FrameElem=18-1 ElemStation=0,1833
Frame=18 Station=0 OutputCase=STR164 CaseType=Combination P=-14,93959998738 V2=0,389536048856776 V3=0 T=0 M2=0 M3=7,02670953566977 FrameElem=18-1 ElemStation=0
Frame=18 Station=9,1650000000001E-02 OutputCase=STR164 CaseType=Combination P=-14,572999998738 V2=-3,18680733864323 V3=0 T=0 M2=0 M3=6,89815131614671
FrameElem=18-1 ElemStation=9,1650000000001E-02
Frame=18 Station=0,1833 OutputCase=STR164 CaseType=Combination P=-14,206399998738 V2=-6,71427836364323 V3=0 T=0 M2=0 M3=-6,44406080117084
FrameElem=18-1 ElemStation=0,1833
Frame=18 Station=0 OutputCase=STR165 CaseType=Combination P=-20,1684599986428 V2=1,16405682037987 V3=0 T=0 M2=0 M3=-0,729032122441543 FrameElem=18-1 ElemStation=0
Frame=18 Station=9,1650000000001E-02 OutputCase=STR165 CaseType=Combination P=-19,6735499986428 V2=-0,119306673370133 V3=0 T=0 M2=0 M3=-0,776251044625295 FrameElem=18-1 ElemStation=9,1650000000001E-02
Frame=18 Station=0,1833 OutputCase=STR165 CaseType=Combination P=-19,1786399986428 V2=-1,31667955462013 V3=0 T=0 M2=0 M3=-0,709790222424672
FrameElem=18-1 ElemStation=0,1833
Frame=18 Station=0 OutputCase=STR166 CaseType=Combination P=-20,1684599987505 V2=1,73608043012612 V3=0 T=0 M2=0 M3=1,05032289587662 FrameElem=18-1 ElemStation=0
Frame=18 Station=9,1650000000001E-02 OutputCase=STR166 CaseType=Combination P=-19,6735499987505 V2=1,13943893012612 V3=0 T=0 M2=0 M3=0,918860211018064
FrameElem=18-1 ElemStation=9,1650000000001E-02
Frame=18 Station=0,1833 OutputCase=STR166 CaseType=Combination P=-19,1786399987505 V2=0,583123430126115 V3=0 T=0 M2=0 M3=0,840231780684506
FrameElem=18-1 ElemStation=0,1833
Frame=18 Station=0 OutputCase=STR167 CaseType=Combination P=-100,844459995531 V2=0,763935608246384 V3=0 T=0 M2=0 M3=11,6678325293548 FrameElem=18-1 ElemStation=0
Frame=18 Station=9,1650000000001E-02 OutputCase=STR167 CaseType=Combination P=-100,349549995531 V2=0,167294108246383 V3=0 T=0 M2=0 M3=11,6254669174216
FrameElem=18-1 ElemStation=9,1650000000001E-02
Frame=18 Station=0,1833 OutputCase=STR167 CaseType=Combination P=-99,8546399955315 V2=-0,389021391753617 V3=0 T=0 M2=0 M3=11,6359355600133
FrameElem=18-1 ElemStation=0,1833
Frame=18 Station=0 OutputCase=STR168 CaseType=Combination P=-90,488547764998 V2=13,9120798189817 V3=0 T=0 M2=0 M3=4,77464807395873 FrameElem=18-1 ElemStation=0
Frame=18 Station=9,1650000000001E-02 OutputCase=STR168 CaseType=Combination P=-89,993637764998 V2=10,3357364314817 V3=0 T=0 M2=0 M3=3,66386515694983
FrameElem=18-1 ElemStation=9,1650000000001E-02
Frame=18 Station=0,1833 OutputCase=STR168 CaseType=Combination P=-89,498727764998 V2=6,80826540648171 V3=0 T=0 M2=0 M3=2,87861453539375 FrameElem=18-1 ElemStation=0,1833
Frame=18 Station=0 OutputCase=STR169 CaseType=Combination P=-100,844459995188 V2=0,717826889290727 V3=0 T=0 M2=0 M3=4,26359825151367 FrameElem=18-1 ElemStation=0
Frame=18 Station=9,1650000000001E-02 OutputCase=STR169 CaseType=Combination P=-100,349549995188 V2=-2,85851649820928 V3=0 T=0 M2=0 M3=4,36206861551096
FrameElem=18-1 ElemStation=9,1650000000001E-02
Frame=18 Station=0,1833 OutputCase=STR169 CaseType=Combination P=-99,854639995188 V2=-6,38598752320928 V3=0 T=0 M2=0 M3=4,78607127496106 FrameElem=18-1 ElemStation=0,1833
Frame=18 Station=0 OutputCase=STR170 CaseType=Combination P=-4,58368776854888 V2=14,6871436256274 V3=0 T=0 M2=0 M3=-6,51547726444844 FrameElem=18-1 ElemStation=0
Frame=18 Station=9,1650000000001E-02 OutputCase=STR170 CaseType=Combination P=-4,21708776854888 V2=11,1108002381274 V3=0 T=0 M2=0 M3=-7,69729524133641
FrameElem=18-1 ElemStation=9,1650000000001E-02
Frame=18 Station=0,1833 OutputCase=STR170 CaseType=Combination P=-3,85048776854888 V2=7,58332921312741 V3=0 T=0 M2=0 M3=-8,55358046077157
FrameElem=18-1 ElemStation=0,1833
Frame=18 Station=0 OutputCase=STR171 CaseType=Combination P=-14,939599987389 V2=1,49289069593643 V3=0 T=0 M2=0 M3=7,02652754889349 FrameElem=18-1 ElemStation=0
Frame=18 Station=9,1650000000001E-02 OutputCase=STR171 CaseType=Combination P=-14,5729999987389 V2=-2,08345269156358 V3=0 T=0 M2=0 M3=-6,99909178277529
FrameElem=18-1 ElemStation=9,1650000000001E-02
Frame=18 Station=0,1833 OutputCase=STR171 CaseType=Combination P=-14,2063999987389 V2=-5,61092371656358 V3=0 T=0 M2=0 M3=-6,64612372120427
FrameElem=18-1 ElemStation=0,1833
Frame=18 Station=0 OutputCase=STR172 CaseType=Combination P=-20,6261414358924 V2=0,841252505548927 V3=0 T=0 M2=0 M3=-0,477015004942762 FrameElem=18-1 ElemStation=0
Frame=18 Station=9,1650000000001E-02 OutputCase=STR172 CaseType=Combination P=-20,1312314358924 V2=-0,442110988201073 V3=0 T=0 M2=0 M3=-0,494648911672258 FrameElem=18-1 ElemStation=9,1650000000001E-02
Frame=18 Station=0,1833 OutputCase=STR172 CaseType=Combination P=-19,6363214358924 V2=-1,63948386945107 V3=0 T=0 M2=0 M3=-0,39860307401738
FrameElem=18-1 ElemStation=0,1833
Frame=18 Station=0 OutputCase=STR173 CaseType=Combination P=-20,6261414360001 V2=1,41327611529518 V3=0 T=0 M2=0 M3=1,3023400133754 FrameElem=18-1 ElemStation=0
Frame=18 Station=9,1650000000001E-02 OutputCase=STR173 CaseType=Combination P=-20,1312314360001 V2=0,816634615295175 V3=0 T=0 M2=0 M3=1,2004623439711
FrameElem=18-1 ElemStation=9,1650000000001E-02
Frame=18 Station=0,1833 OutputCase=STR173 CaseType=Combination P=-19,6363214360001 V2=0,260319115295174 V3=0 T=0 M2=0 M3=1,1514189290918 FrameElem=18-1 ElemStation=0,1833
Frame=18 Station=0 OutputCase=STR174 CaseType=Combination P=-101,302141432781 V2=0,441131293415444 V3=0 T=0 M2=0 M3=11,9198496468536 FrameElem=18-1 ElemStation=0
Frame=18 Station=9,1650000000001E-02 OutputCase=STR174 CaseType=Combination P=-100,807231432781 V2=-0,155510206584557 V3=0 T=0 M2=0 M3=11,9070690503746 FrameElem=18-1 ElemStation=9,1650000000001E-02
Frame=18 Station=0,1833 OutputCase=STR174 CaseType=Combination P=-100,312321432781 V2=-0,711825706584557 V3=0 T=0 M2=0 M3=11,9471227084206
FrameElem=18-1 ElemStation=0,1833

Società di Progetto
Brebemi SpA



Doc. N.
60235-00000-A00.doc

CODIFICA DOCUMENTO
04RCDII10000000000300A00

REV.
00

FOGLIO
292 di 628

Frame=18 Station=0 OutputCase=STR175 CaseType=Combination P=-90,9462292022476 V2=13,5892755041508 V3=0 T=0 M2=0 M3=5,02666519145751 FrameElem=18-1 ElemStation=0
Frame=18 Station=9,1650000000001E-02 OutputCase=STR175 CaseType=Combination P=-90,4513192022476 V2=10,0129321166508 V3=0 T=0 M2=0 M3=3,94564728990287 FrameElem=18-1 ElemStation=9,1650000000001E-02
Frame=18 Station=0,1833 OutputCase=STR175 CaseType=Combination P=-89,9564092022476 V2=6,48546109165077 V3=0 T=0 M2=0 M3=3,18980168380104 FrameElem=18-1 ElemStation=0,1833
Frame=18 Station=0 OutputCase=STR176 CaseType=Combination P=-101,30214432438 V2=0,395022574459787 V3=0 T=0 M2=0 M3=4,51561536901245 FrameElem=18-1 ElemStation=0
Frame=18 Station=9,1650000000001E-02 OutputCase=STR176 CaseType=Combination P=-100,807231432438 V2=-3,18132081304022 V3=0 T=0 M2=0 M3=4,64367074846399 FrameElem=18-1 ElemStation=9,1650000000001E-02
Frame=18 Station=0,1833 OutputCase=STR176 CaseType=Combination P=-100,312321432438 V2=-6,70879183804022 V3=0 T=0 M2=0 M3=5,09725842336835 FrameElem=18-1 ElemStation=0,1833
Frame=18 Station=0 OutputCase=STR177 CaseType=Combination P=-5,04136920579843 V2=14,3643393107965 V3=0 T=0 M2=0 M3=-6,26346060894966 FrameElem=18-1 ElemStation=0
Frame=18 Station=9,1650000000001E-02 OutputCase=STR177 CaseType=Combination P=-4,67476920579843 V2=10,7879959232965 V3=0 T=0 M2=0 M3=-7,41569310838337 FrameElem=18-1 ElemStation=9,1650000000001E-02
Frame=18 Station=0,1833 OutputCase=STR177 CaseType=Combination P=-4,30816920579843 V2=7,26052489829647 V3=0 T=0 M2=0 M3=-8,24239331236428 FrameElem=18-1 ElemStation=0,1833
Frame=18 Station=0 OutputCase=STR178 CaseType=Combination P=-15,3972814359884 V2=1,17008638110549 V3=0 T=0 M2=0 M3=-6,77451043139471 FrameElem=18-1 ElemStation=0
Frame=18 Station=9,1650000000001E-02 OutputCase=STR178 CaseType=Combination P=-15,0306814359884 V2=-2,40625700639452 V3=0 T=0 M2=0 M3=-6,71748964982225 FrameElem=18-1 ElemStation=9,1650000000001E-02
Frame=18 Station=0,1833 OutputCase=STR178 CaseType=Combination P=-14,6640814359884 V2=-5,93372803139452 V3=0 T=0 M2=0 M3=-6,33493657279697 FrameElem=18-1 ElemStation=0,1833
Frame=18 Station=0 OutputCase=STR179 CaseType=Combination P=-20,6261414358924 V2=0,841252505548927 V3=0 T=0 M2=0 M3=-0,477015004942762 FrameElem=18-1 ElemStation=0
Frame=18 Station=9,1650000000001E-02 OutputCase=STR179 CaseType=Combination P=-20,1312314358924 V2=-0,442110988201073 V3=0 T=0 M2=0 M3=-0,494648911672258 FrameElem=18-1 ElemStation=9,1650000000001E-02
Frame=18 Station=0,1833 OutputCase=STR179 CaseType=Combination P=-19,6363214358924 V2=-1,63948386945107 V3=0 T=0 M2=0 M3=-0,39860307401738 FrameElem=18-1 ElemStation=0,1833
Frame=18 Station=0 OutputCase=STR180 CaseType=Combination P=-19,7107785613924 V2=0,383506488131158 V3=0 T=0 M2=0 M3=-0,9812312267166 FrameElem=18-1 ElemStation=0
Frame=18 Station=9,1650000000001E-02 OutputCase=STR180 CaseType=Combination P=-19,2158685613924 V2=-0,899857005618842 V3=0 T=0 M2=0 M3=-0,956912710949758 FrameElem=18-1 ElemStation=9,1650000000001E-02
Frame=18 Station=0,1833 OutputCase=STR180 CaseType=Combination P=-18,7209585613924 V2=-2,09722988686884 V3=0 T=0 M2=0 M3=-0,818914450798541 FrameElem=18-1 ElemStation=0,1833
Frame=18 Station=0 OutputCase=STR181 CaseType=Combination P=-19,7107785615001 V2=0,955530097877406 V3=0 T=0 M2=0 M3=0,798123791601566 FrameElem=18-1 ElemStation=0
Frame=18 Station=9,1650000000001E-02 OutputCase=STR181 CaseType=Combination P=-19,2158685615001 V2=0,358888597877406 V3=0 T=0 M2=0 M3=0,738198544693601 FrameElem=18-1 ElemStation=9,1650000000001E-02
Frame=18 Station=0,1833 OutputCase=STR181 CaseType=Combination P=-18,7209585615001 V2=-0,197426902122595 V3=0 T=0 M2=0 M3=0,731107552310637 FrameElem=18-1 ElemStation=0,1833
Frame=18 Station=0 OutputCase=STR182 CaseType=Combination P=-100,386778558281 V2=-1,66147240023254E-02 V3=0 T=0 M2=0 M3=11,4156334250798 FrameElem=18-1 ElemStation=0
Frame=18 Station=9,1650000000001E-02 OutputCase=STR182 CaseType=Combination P=-99,891868558281 V2=-0,613256224002326 V3=0 T=0 M2=0 M3=11,4448052510971 FrameElem=18-1 ElemStation=9,1650000000001E-02
Frame=18 Station=0,1833 OutputCase=STR182 CaseType=Combination P=-99,396958558281 V2=-1,16957172400233 V3=0 T=0 M2=0 M3=11,5268113316394 FrameElem=18-1 ElemStation=0,1833
Frame=18 Station=0 OutputCase=STR183 CaseType=Combination P=-90,0308663277476 V2=13,131529486733 V3=0 T=0 M2=0 M3=4,52244896968367 FrameElem=18-1 ElemStation=0
Frame=18 Station=9,1650000000001E-02 OutputCase=STR183 CaseType=Combination P=-89,5359563277476 V2=9,55518609923301 V3=0 T=0 M2=0 M3=3,48320349062537 FrameElem=18-1 ElemStation=9,1650000000001E-02
Frame=18 Station=0,1833 OutputCase=STR183 CaseType=Combination P=-89,0410463277476 V2=6,027715074233 V3=0 T=0 M2=0 M3=2,76949030701988 FrameElem=18-1 ElemStation=0,1833
Frame=18 Station=0 OutputCase=STR184 CaseType=Combination P=-100,386778557938 V2=-6,27234429579824E-02 V3=0 T=0 M2=0 M3=4,01139914723861 FrameElem=18-1 ElemStation=0
Frame=18 Station=9,1650000000001E-02 OutputCase=STR184 CaseType=Combination P=-99,8918685579376 V2=-3,63906683045799 V3=0 T=0 M2=0 M3=4,18140694918649 FrameElem=18-1 ElemStation=9,1650000000001E-02
Frame=18 Station=0,1833 OutputCase=STR184 CaseType=Combination P=-99,3969585579376 V2=-7,16653785545799 V3=0 T=0 M2=0 M3=4,67694704658719 FrameElem=18-1 ElemStation=0,1833
Frame=18 Station=0 OutputCase=STR185 CaseType=Combination P=-4,12600633129843 V2=13,9065932933787 V3=0 T=0 M2=0 M3=-6,7676768307235 FrameElem=18-1 ElemStation=0
Frame=18 Station=9,1650000000001E-02 OutputCase=STR185 CaseType=Combination P=-3,75940633129843 V2=10,3302499058787 V3=0 T=0 M2=0 M3=-7,87795690766087 FrameElem=18-1 ElemStation=9,1650000000001E-02
Frame=18 Station=0,1833 OutputCase=STR185 CaseType=Combination P=-3,39280633129843 V2=6,8027788808787 V3=0 T=0 M2=0 M3=-8,66270468914544 FrameElem=18-1 ElemStation=0,1833
Frame=18 Station=0 OutputCase=STR186 CaseType=Combination P=-14,4819185614884 V2=0,712340363687717 V3=0 T=0 M2=0 M3=-7,27872665316855 FrameElem=18-1 ElemStation=0
Frame=18 Station=9,1650000000001E-02 OutputCase=STR186 CaseType=Combination P=-14,1153185614884 V2=-2,86400302381229 V3=0 T=0 M2=0 M3=-7,17975344909975 FrameElem=18-1 ElemStation=9,1650000000001E-02
Frame=18 Station=0,1833 OutputCase=STR186 CaseType=Combination P=-13,7487185614884 V2=-6,39147404881229 V3=0 T=0 M2=0 M3=-6,75524794957814 FrameElem=18-1 ElemStation=0,1833
Frame=18 Station=0 OutputCase=STR187 CaseType=Combination P=-19,7107785613924 V2=0,383506488131158 V3=0 T=0 M2=0 M3=-0,9812312267166 FrameElem=18-1 ElemStation=0
Frame=18 Station=9,1650000000001E-02 OutputCase=STR187 CaseType=Combination P=-19,2158685613924 V2=-0,899857005618842 V3=0 T=0 M2=0 M3=-0,956912710949758 FrameElem=18-1 ElemStation=9,1650000000001E-02
Frame=18 Station=0,1833 OutputCase=STR187 CaseType=Combination P=-18,7209585613924 V2=-2,09722988686884 V3=0 T=0 M2=0 M3=-0,818914450798541 FrameElem=18-1 ElemStation=0,1833
Frame=18 Station=0 OutputCase=INVSTR CaseType=Combination StepType=Max P=-1,30013698087422 V2=31,7049676187851 V3=0 T=0 M2=0 M3=15,4588678690328 FrameElem=18-1 ElemStation=0
Frame=18 Station=9,1650000000001E-02 OutputCase=INVSTR CaseType=Combination StepType=Max P=-0,933536980874223 V2=28,1286242312851 V3=0 T=0 M2=0 M3=15,5600550080329 FrameElem=18-1 ElemStation=9,1650000000001E-02
Frame=18 Station=0,1833 OutputCase=INVSTR CaseType=Combination StepType=Max P=-0,566936980874223 V2=24,6011532062851 V3=0 T=0 M2=0 M3=15,714076401558 FrameElem=18-1 ElemStation=0,1833
Frame=18 Station=0 OutputCase=INVSTR CaseType=Combination StepType=Min P=-128,194141431707 V2=-1,9016478547574 V3=0 T=0 M2=0 M3=-9,15383806198978 FrameElem=18-1 ElemStation=0
Frame=18 Station=9,1650000000001E-02 OutputCase=INVSTR CaseType=Combination StepType=Min P=-127,699231431707 V2=-5,79440329280168 V3=0 T=0 M2=0 M3=-9,85154662333608 FrameElem=18-1 ElemStation=9,1650000000001E-02

Società di Progetto
Brebemi SpA



Doc. N.
60235-0000-A00.doc

CODIFICA DOCUMENTO
04RCDII10000000000300A00

REV.
00

FOGLIO
293 di 628

Frame=18 Station=0,1833 OutputCase=INVSTR CaseType=Combination StepType=Min P=-127,204321431707 V2=-10,0985736990517 V3=0 T=0 M2=0 M3=-10,7875946199844 FrameElem=18-1 ElemStation=0,1833
Frame=18 Station=0 OutputCase=SIS01 CaseType=Combination P=-8,78480322337709 V2=6,32850615358922 V3=0 T=0 M2=0 M3=-2,21658774210735 FrameElem=18-1 ElemStation=0
Frame=18 Station=9,1650000000001E-02 OutputCase=SIS01 CaseType=Combination P=-8,43057597337709 V2=4,70538465358922 V3=0 T=0 M2=0 M3=-2,72190779852131 FrameElem=18-1 ElemStation=9,1650000000001E-02
Frame=18 Station=0,1833 OutputCase=SIS01 CaseType=Combination P=-8,07634872337709 V2=3,12258915358922 V3=0 T=0 M2=0 M3=-3,08031670841026 FrameElem=18-1 ElemStation=0,1833
Frame=18 Station=0 OutputCase=SIS02 CaseType=Combination P=-8,78480322337678 V2=5,94539690113101 V3=0 T=0 M2=0 M3=-2,21665093196023 FrameElem=18-1 ElemStation=0
Frame=18 Station=9,1650000000001E-02 OutputCase=SIS02 CaseType=Combination P=-8,43057597337678 V2=4,32227540113101 V3=0 T=0 M2=0 M3=-2,68685902538638 FrameElem=18-1 ElemStation=9,1650000000001E-02
Frame=18 Station=0,1833 OutputCase=SIS02 CaseType=Combination P=-8,07634872337678 V2=2,73947990113101 V3=0 T=0 M2=0 M3=-3,01015597228754 FrameElem=18-1 ElemStation=0,1833
Frame=18 Station=0 OutputCase=SIS03 CaseType=Combination P=-8,78480322337741 V2=6,71161540604744 V3=0 T=0 M2=0 M3=-2,21652455225448 FrameElem=18-1 ElemStation=0
Frame=18 Station=9,1650000000001E-02 OutputCase=SIS03 CaseType=Combination P=-8,43057597337741 V2=5,08849390604744 V3=0 T=0 M2=0 M3=-2,75695657165623 FrameElem=18-1 ElemStation=9,1650000000001E-02
Frame=18 Station=0,1833 OutputCase=SIS03 CaseType=Combination P=-8,07634872337741 V2=3,50569840604743 V3=0 T=0 M2=0 M3=-3,15047744453297 FrameElem=18-1 ElemStation=0,1833
Frame=18 Station=0 OutputCase=SIS04 CaseType=Combination P=-9,1026375548007 V2=6,48744574297039 V3=0 T=0 M2=0 M3=-2,04151266510255 FrameElem=18-1 ElemStation=0
Frame=18 Station=9,1650000000001E-02 OutputCase=SIS04 CaseType=Combination P=-8,74841030480071 V2=4,86432424297039 V3=0 T=0 M2=0 M3=-2,56139953488329 FrameElem=18-1 ElemStation=9,1650000000001E-02
Frame=18 Station=0,1833 OutputCase=SIS04 CaseType=Combination P=-8,39418305480071 V2=3,28152874297039 V3=0 T=0 M2=0 M3=-2,93437525813902 FrameElem=18-1 ElemStation=0,1833
Frame=18 Station=0 OutputCase=SIS05 CaseType=Combination P=-8,46696889195348 V2=6,16956656420806 V3=0 T=0 M2=0 M3=-2,39166281911216 FrameElem=18-1 ElemStation=0
Frame=18 Station=9,1650000000001E-02 OutputCase=SIS05 CaseType=Combination P=-8,11274164195348 V2=4,54644506420805 V3=0 T=0 M2=0 M3=-2,88241606215933 FrameElem=18-1 ElemStation=9,1650000000001E-02
Frame=18 Station=0,1833 OutputCase=SIS05 CaseType=Combination P=-7,75851439195348 V2=2,96364956420805 V3=0 T=0 M2=0 M3=-3,2262581586815 FrameElem=18-1 ElemStation=0,1833
Frame=18 Station=0 OutputCase=SIS06 CaseType=Combination P=-8,78480322337741 V2=6,71161540604744 V3=0 T=0 M2=0 M3=-2,21652455225448 FrameElem=18-1 ElemStation=0
Frame=18 Station=9,1650000000001E-02 OutputCase=SIS06 CaseType=Combination P=-8,43057597337741 V2=5,08849390604744 V3=0 T=0 M2=0 M3=-2,75695657165623 FrameElem=18-1 ElemStation=9,1650000000001E-02
Frame=18 Station=0,1833 OutputCase=SIS06 CaseType=Combination P=-8,07634872337741 V2=3,50569840604743 V3=0 T=0 M2=0 M3=-3,15047744453297 FrameElem=18-1 ElemStation=0,1833
Frame=18 Station=0 OutputCase=SIS07 CaseType=Combination P=-9,10263755480039 V2=6,10433649051218 V3=0 T=0 M2=0 M3=-2,04157585495542 FrameElem=18-1 ElemStation=0
Frame=18 Station=9,1650000000001E-02 OutputCase=SIS07 CaseType=Combination P=-8,74841030480039 V2=4,48121499051218 V3=0 T=0 M2=0 M3=-2,52635076174836 FrameElem=18-1 ElemStation=9,1650000000001E-02
Frame=18 Station=0,1833 OutputCase=SIS07 CaseType=Combination P=-8,39418305480039 V2=2,89841949051218 V3=0 T=0 M2=0 M3=-2,86421452201631 FrameElem=18-1 ElemStation=0,1833
Frame=18 Station=0 OutputCase=SIS08 CaseType=Combination P=-8,46696889195317 V2=5,78645731174984 V3=0 T=0 M2=0 M3=-2,39172600896503 FrameElem=18-1 ElemStation=0
Frame=18 Station=9,1650000000001E-02 OutputCase=SIS08 CaseType=Combination P=-8,11274164195317 V2=4,16333581174984 V3=0 T=0 M2=0 M3=-2,84736728902441 FrameElem=18-1 ElemStation=9,1650000000001E-02
Frame=18 Station=0,1833 OutputCase=SIS08 CaseType=Combination P=-7,75851439195317 V2=2,58054031174984 V3=0 T=0 M2=0 M3=-3,15609742255878 FrameElem=18-1 ElemStation=0,1833
Frame=18 Station=0 OutputCase=SIS09 CaseType=Combination P=-8,78480322337709 V2=6,32850615358922 V3=0 T=0 M2=0 M3=-2,21658774210735 FrameElem=18-1 ElemStation=0
Frame=18 Station=9,1650000000001E-02 OutputCase=SIS09 CaseType=Combination P=-8,43057597337709 V2=4,70538465358922 V3=0 T=0 M2=0 M3=-2,72190779852131 FrameElem=18-1 ElemStation=9,1650000000001E-02
Frame=18 Station=0,1833 OutputCase=SIS09 CaseType=Combination P=-8,07634872337709 V2=3,12258915358922 V3=0 T=0 M2=0 M3=-3,08031670841026 FrameElem=18-1 ElemStation=0,1833
Frame=18 Station=0 OutputCase=SIS10 CaseType=Combination P=-9,78575622332282 V2=6,36927722481953 V3=0 T=0 M2=0 M3=-2,08636012797777 FrameElem=18-1 ElemStation=0
Frame=18 Station=9,1650000000001E-02 OutputCase=SIS10 CaseType=Combination P=-9,40678347332282 V2=4,74615572481953 V3=0 T=0 M2=0 M3=-2,59541685306998 FrameElem=18-1 ElemStation=9,1650000000001E-02
Frame=18 Station=0,1833 OutputCase=SIS10 CaseType=Combination P=-9,02781072332282 V2=3,16336022481953 V3=0 T=0 M2=0 M3=-2,95756243163719 FrameElem=18-1 ElemStation=0,1833
Frame=18 Station=0 OutputCase=SIS11 CaseType=Combination P=-9,78575622332251 V2=5,98616797236132 V3=0 T=0 M2=0 M3=-2,08642331783064 FrameElem=18-1 ElemStation=0
Frame=18 Station=9,1650000000001E-02 OutputCase=SIS11 CaseType=Combination P=-9,40678347332251 V2=4,36304647236132 V3=0 T=0 M2=0 M3=-2,56036807993506 FrameElem=18-1 ElemStation=9,1650000000001E-02
Frame=18 Station=0,1833 OutputCase=SIS11 CaseType=Combination P=-9,02781072332251 V2=2,78025097236132 V3=0 T=0 M2=0 M3=-2,88740169551448 FrameElem=18-1 ElemStation=0,1833
Frame=18 Station=0 OutputCase=SIS12 CaseType=Combination P=-9,78575622332314 V2=6,75238647727774 V3=0 T=0 M2=0 M3=-2,0862969381249 FrameElem=18-1 ElemStation=0
Frame=18 Station=9,1650000000001E-02 OutputCase=SIS12 CaseType=Combination P=-9,40678347332314 V2=5,12926497727774 V3=0 T=0 M2=0 M3=-2,6304656262049 FrameElem=18-1 ElemStation=9,1650000000001E-02
Frame=18 Station=0,1833 OutputCase=SIS12 CaseType=Combination P=-9,02781072332314 V2=3,54646947727774 V3=0 T=0 M2=0 M3=-3,02772316775991 FrameElem=18-1 ElemStation=0,1833
Frame=18 Station=0 OutputCase=SIS13 CaseType=Combination P=-10,1035905547464 V2=6,5282168142007 V3=0 T=0 M2=0 M3=-1,91128505097297 FrameElem=18-1 ElemStation=0
Frame=18 Station=9,1650000000001E-02 OutputCase=SIS13 CaseType=Combination P=-9,72461780474644 V2=4,9050953142007 V3=0 T=0 M2=0 M3=-2,43490858943196 FrameElem=18-1 ElemStation=9,1650000000001E-02
Frame=18 Station=0,1833 OutputCase=SIS13 CaseType=Combination P=-9,34564505474643 V2=3,3222998142007 V3=0 T=0 M2=0 M3=-2,81162098136596 FrameElem=18-1 ElemStation=0,1833
Frame=18 Station=0 OutputCase=SIS14 CaseType=Combination P=-9,46792189189921 V2=6,21033763543836 V3=0 T=0 M2=0 M3=-2,26143520498258 FrameElem=18-1 ElemStation=0
Frame=18 Station=9,1650000000001E-02 OutputCase=SIS14 CaseType=Combination P=-9,08894914189921 V2=4,58721613543836 V3=0 T=0 M2=0 M3=-2,755923116708 FrameElem=18-1 ElemStation=9,1650000000001E-02
Frame=18 Station=0,1833 OutputCase=SIS14 CaseType=Combination P=-8,70997639189921 V2=3,00442063543836 V3=0 T=0 M2=0 M3=-3,10350388190843 FrameElem=18-1 ElemStation=0,1833
Frame=18 Station=0 OutputCase=SIS15 CaseType=Combination P=-9,78575622332314 V2=6,75238647727774 V3=0 T=0 M2=0 M3=-2,0862969381249 FrameElem=18-1 ElemStation=0

Società di Progetto
Brebemi SpA



Doc. N.
60235-0000-A00.doc

CODIFICA DOCUMENTO
04RCDII10000000000300A00

REV.
00

FOGLIO
294 di 628

Frame=18 Station=9,1650000000001E-02 OutputCase=SIS15 CaseType=Combination P=-9,40678347332314 V2=5,12926497727774 V3=0 T=0 M2=0 M3=-2,6304656262049
FrameElem=18-1 ElemStation=9,1650000000001E-02
Frame=18 Station=0,1833 OutputCase=SIS15 CaseType=Combination P=-9,02781072332314 V2=3,54646947727774 V3=0 T=0 M2=0 M3=-3,02772316775991 FrameElem=18-1
ElemStation=0,1833
Frame=18 Station=0 OutputCase=SIS16 CaseType=Combination P=-10,1035905547461 V2=6,14510756174249 V3=0 T=0 M2=0 M3=-1,91134824082584 FrameElem=18-1
ElemStation=0
Frame=18 Station=9,1650000000001E-02 OutputCase=SIS16 CaseType=Combination P=-9,72461780474612 V2=4,52198606174249 V3=0 T=0 M2=0 M3=-2,39985981629704
FrameElem=18-1 ElemStation=9,1650000000001E-02
Frame=18 Station=0,1833 OutputCase=SIS16 CaseType=Combination P=-9,34564505474612 V2=2,93919056174249 V3=0 T=0 M2=0 M3=-2,74146024524324 FrameElem=18-1
ElemStation=0,1833
Frame=18 Station=0 OutputCase=SIS17 CaseType=Combination P=-9,4679218918989 V2=5,8272283298015 V3=0 T=0 M2=0 M3=-2,26149839483545 FrameElem=18-1
ElemStation=0
Frame=18 Station=9,1650000000001E-02 OutputCase=SIS17 CaseType=Combination P=-9,0889491418989 V2=4,20410688298015 V3=0 T=0 M2=0 M3=-2,72087634357308
FrameElem=18-1 ElemStation=9,1650000000001E-02
Frame=18 Station=0,1833 OutputCase=SIS17 CaseType=Combination P=-8,7099763918989 V2=2,62131138298015 V3=0 T=0 M2=0 M3=-3,03334314578571 FrameElem=18-1
ElemStation=0,1833
Frame=18 Station=0 OutputCase=SIS18 CaseType=Combination P=-9,7857562232282 V2=6,36927722481953 V3=0 T=0 M2=0 M3=-2,08636012797777 FrameElem=18-1
ElemStation=0
Frame=18 Station=9,1650000000001E-02 OutputCase=SIS18 CaseType=Combination P=-9,40678347332282 V2=4,74615572481953 V3=0 T=0 M2=0 M3=-2,59541685306998
FrameElem=18-1 ElemStation=9,1650000000001E-02
Frame=18 Station=0,1833 OutputCase=SIS18 CaseType=Combination P=-9,02781072332282 V2=3,16336022481953 V3=0 T=0 M2=0 M3=-2,95756243163719 FrameElem=18-1
ElemStation=0,1833
Frame=18 Station=0 OutputCase=SIS19 CaseType=Combination P=-9,89457162430044 V2=3,95700220302692 V3=0 T=0 M2=0 M3=-2,19225128427214 FrameElem=18-1
ElemStation=0
Frame=18 Station=9,1650000000001E-02 OutputCase=SIS19 CaseType=Combination P=-9,56921412430044 V2=2,39097865302692 V3=0 T=0 M2=0 M3=-2,48283951717581
FrameElem=18-1 ElemStation=9,1650000000001E-02
Frame=18 Station=0,1833 OutputCase=SIS19 CaseType=Combination P=-9,24385662430044 V2=0,865281103026916 V3=0 T=0 M2=0 M3=-2,63174963067197 FrameElem=18-1
ElemStation=0,1833
Frame=18 Station=0 OutputCase=SIS20 CaseType=Combination P=-9,89457162430013 V2=3,57389295056871 V3=0 T=0 M2=0 M3=-2,19231447412501 FrameElem=18-1
ElemStation=0
Frame=18 Station=9,1650000000001E-02 OutputCase=SIS20 CaseType=Combination P=-9,56921412430013 V2=2,00786940056871 V3=0 T=0 M2=0 M3=-2,44779074404089
FrameElem=18-1 ElemStation=9,1650000000001E-02
Frame=18 Station=0,1833 OutputCase=SIS20 CaseType=Combination P=-9,24385662430013 V2=0,482171850568704 V3=0 T=0 M2=0 M3=-2,56158889454926 FrameElem=18-1
ElemStation=0,1833
Frame=18 Station=0 OutputCase=SIS21 CaseType=Combination P=-9,89457162430076 V2=4,34011145548513 V3=0 T=0 M2=0 M3=-2,19218809441927 FrameElem=18-1
ElemStation=0
Frame=18 Station=9,1650000000001E-02 OutputCase=SIS21 CaseType=Combination P=-9,56921412430076 V2=2,77408790548513 V3=0 T=0 M2=0 M3=-2,51788829031073
FrameElem=18-1 ElemStation=9,1650000000001E-02
Frame=18 Station=0,1833 OutputCase=SIS21 CaseType=Combination P=-9,24385662430076 V2=1,24839035548513 V3=0 T=0 M2=0 M3=-2,70191036679469 FrameElem=18-1
ElemStation=0,1833
Frame=18 Station=0 OutputCase=SIS22 CaseType=Combination P=-10,2124059557241 V2=4,11594179240809 V3=0 T=0 M2=0 M3=-2,01717620726733 FrameElem=18-1
ElemStation=0
Frame=18 Station=9,1650000000001E-02 OutputCase=SIS22 CaseType=Combination P=-9,88704845572406 V2=2,54991824240809 V3=0 T=0 M2=0 M3=-2,32233125353779
FrameElem=18-1 ElemStation=9,1650000000001E-02
Frame=18 Station=0,1833 OutputCase=SIS22 CaseType=Combination P=-9,56169095572406 V2=1,02422069240809 V3=0 T=0 M2=0 M3=-2,48580818040074 FrameElem=18-1
ElemStation=0,1833
Frame=18 Station=0 OutputCase=SIS23 CaseType=Combination P=-9,57673729287683 V2=3,79806261364575 V3=0 T=0 M2=0 M3=-2,36732636127694 FrameElem=18-1
ElemStation=0
Frame=18 Station=9,1650000000001E-02 OutputCase=SIS23 CaseType=Combination P=-9,25137979287683 V2=2,23203906364575 V3=0 T=0 M2=0 M3=-2,64334778081383
FrameElem=18-1 ElemStation=9,1650000000001E-02
Frame=18 Station=0,1833 OutputCase=SIS23 CaseType=Combination P=-8,92602229287683 V2=0,706341513645746 V3=0 T=0 M2=0 M3=-2,77769108094321 FrameElem=18-1
ElemStation=0,1833
Frame=18 Station=0 OutputCase=SIS24 CaseType=Combination P=-9,89457162430076 V2=4,34011145548513 V3=0 T=0 M2=0 M3=-2,19218809441927 FrameElem=18-1
ElemStation=0
Frame=18 Station=9,1650000000001E-02 OutputCase=SIS24 CaseType=Combination P=-9,56921412430076 V2=2,77408790548513 V3=0 T=0 M2=0 M3=-2,51788829031073
FrameElem=18-1 ElemStation=9,1650000000001E-02
Frame=18 Station=0,1833 OutputCase=SIS24 CaseType=Combination P=-9,24385662430076 V2=1,24839035548513 V3=0 T=0 M2=0 M3=-2,70191036679469 FrameElem=18-1
ElemStation=0,1833
Frame=18 Station=0 OutputCase=SIS25 CaseType=Combination P=-10,2124059557237 V2=3,73283253994988 V3=0 T=0 M2=0 M3=-2,01723939712021 FrameElem=18-1
ElemStation=0
Frame=18 Station=9,1650000000001E-02 OutputCase=SIS25 CaseType=Combination P=-9,88704845572374 V2=2,16680898994988 V3=0 T=0 M2=0 M3=-2,28728248040287
FrameElem=18-1 ElemStation=9,1650000000001E-02
Frame=18 Station=0,1833 OutputCase=SIS25 CaseType=Combination P=-9,56169095572374 V2=0,641111439949874 V3=0 T=0 M2=0 M3=-2,41564744427802 FrameElem=18-1
ElemStation=0,1833
Frame=18 Station=0 OutputCase=SIS26 CaseType=Combination P=-9,57673729287652 V2=3,41495336118754 V3=0 T=0 M2=0 M3=-2,36738955112982 FrameElem=18-1
ElemStation=0
Frame=18 Station=9,1650000000001E-02 OutputCase=SIS26 CaseType=Combination P=-9,25137979287652 V2=1,84892981118754 V3=0 T=0 M2=0 M3=-2,60829900767891
FrameElem=18-1 ElemStation=9,1650000000001E-02
Frame=18 Station=0,1833 OutputCase=SIS26 CaseType=Combination P=-8,92602229287652 V2=0,323232261187535 V3=0 T=0 M2=0 M3=-2,70753034482049 FrameElem=18-1
ElemStation=0,1833
Frame=18 Station=0 OutputCase=SIS27 CaseType=Combination P=-9,89457162430044 V2=3,95700220302692 V3=0 T=0 M2=0 M3=-2,19225128427214 FrameElem=18-1
ElemStation=0
Frame=18 Station=9,1650000000001E-02 OutputCase=SIS27 CaseType=Combination P=-9,56921412430044 V2=2,39097865302692 V3=0 T=0 M2=0 M3=-2,48283951717581
FrameElem=18-1 ElemStation=9,1650000000001E-02
Frame=18 Station=0,1833 OutputCase=SIS27 CaseType=Combination P=-9,24385662430044 V2=0,865281103026916 V3=0 T=0 M2=0 M3=-2,63174963067197 FrameElem=18-1
ElemStation=0,1833
Frame=18 Station=0 OutputCase=SIS28 CaseType=Combination P=-13,2310816241195 V2=4,09290577379461 V3=0 T=0 M2=0 M3=-1,75815923717353 FrameElem=18-1
ElemStation=0
Frame=18 Station=9,1650000000001E-02 OutputCase=SIS28 CaseType=Combination P=-12,8232391241195 V2=2,5268822379461 V3=0 T=0 M2=0 M3=-2,06120303233806
FrameElem=18-1 ElemStation=9,1650000000001E-02
Frame=18 Station=0,1833 OutputCase=SIS28 CaseType=Combination P=-12,4153966241195 V2=1,00118467379461 V3=0 T=0 M2=0 M3=-2,22256870809508 FrameElem=18-1
ElemStation=0,1833
Frame=18 Station=0 OutputCase=SIS29 CaseType=Combination P=-13,2310816241192 V2=3,7097965213364 V3=0 T=0 M2=0 M3=-1,7582224270264 FrameElem=18-1
ElemStation=0
Frame=18 Station=9,1650000000001E-02 OutputCase=SIS29 CaseType=Combination P=-12,8232391241192 V2=2,1437729713364 V3=0 T=0 M2=0 M3=-2,02615425920314
FrameElem=18-1 ElemStation=9,1650000000001E-02
Frame=18 Station=0,1833 OutputCase=SIS29 CaseType=Combination P=-12,4153966241192 V2=0,6180754213364 V3=0 T=0 M2=0 M3=-2,15240797197237 FrameElem=18-1
ElemStation=0,1833

Società di Progetto
Brebemi SpA



Doc. N.
60235-0000-A00.doc

CODIFICA DOCUMENTO
04RCDII10000000000300A00

REV.
00

FOGLIO
295 di 628

Frame=18 Station=0 OutputCase=SIS30 CaseType=Combination P=-13,2310816241199 V2=4,47601502625283 V3=0 T=0 M2=0 M3=-1,75809604732066 FrameElem=18-1 ElemStation=0

Frame=18 Station=9,1650000000001E-02 OutputCase=SIS30 CaseType=Combination P=-12,8232391241199 V2=2,90999147625282 V3=0 T=0 M2=0 M3=-2,09625180547298 FrameElem=18-1 ElemStation=9,1650000000001E-02

Frame=18 Station=0,1833 OutputCase=SIS30 CaseType=Combination P=-12,4153966241199 V2=1,38429392625282 V3=0 T=0 M2=0 M3=-2,2927294442178 FrameElem=18-1 ElemStation=0,1833

Frame=18 Station=0 OutputCase=SIS31 CaseType=Combination P=-13,5489159555432 V2=4,25184536317578 V3=0 T=0 M2=0 M3=-1,58308416016873 FrameElem=18-1 ElemStation=0

Frame=18 Station=9,1650000000001E-02 OutputCase=SIS31 CaseType=Combination P=-13,1410734555432 V2=2,68582181317578 V3=0 T=0 M2=0 M3=-1,90069476870004 FrameElem=18-1 ElemStation=9,1650000000001E-02

Frame=18 Station=0,1833 OutputCase=SIS31 CaseType=Combination P=-12,7332309555432 V2=1,16012426317578 V3=0 T=0 M2=0 M3=-2,07662725782385 FrameElem=18-1 ElemStation=0,1833

Frame=18 Station=0 OutputCase=SIS32 CaseType=Combination P=-12,9132472926959 V2=3,93396618441344 V3=0 T=0 M2=0 M3=-1,93323431417834 FrameElem=18-1 ElemStation=0

Frame=18 Station=9,1650000000001E-02 OutputCase=SIS32 CaseType=Combination P=-12,5054047926959 V2=2,36794263441344 V3=0 T=0 M2=0 M3=-2,22171129597608 FrameElem=18-1 ElemStation=9,1650000000001E-02

Frame=18 Station=0,1833 OutputCase=SIS32 CaseType=Combination P=-12,0975622926959 V2=0,842245084413442 V3=0 T=0 M2=0 M3=-2,36851015836632 FrameElem=18-1 ElemStation=0,1833

Frame=18 Station=0 OutputCase=SIS33 CaseType=Combination P=-13,2310816241199 V2=4,47601502625283 V3=0 T=0 M2=0 M3=-1,75809604732066 FrameElem=18-1 ElemStation=0

Frame=18 Station=9,1650000000001E-02 OutputCase=SIS33 CaseType=Combination P=-12,8232391241199 V2=2,90999147625282 V3=0 T=0 M2=0 M3=-2,09625180547298 FrameElem=18-1 ElemStation=9,1650000000001E-02

Frame=18 Station=0,1833 OutputCase=SIS33 CaseType=Combination P=-12,4153966241199 V2=1,38429392625282 V3=0 T=0 M2=0 M3=-2,2927294442178 FrameElem=18-1 ElemStation=0,1833

Frame=18 Station=0 OutputCase=SIS34 CaseType=Combination P=-13,5489159555428 V2=3,86873611071757 V3=0 T=0 M2=0 M3=-1,5831473500216 FrameElem=18-1 ElemStation=0

Frame=18 Station=9,1650000000001E-02 OutputCase=SIS34 CaseType=Combination P=-13,1410734555428 V2=2,30271256071757 V3=0 T=0 M2=0 M3=-1,86564599556512 FrameElem=18-1 ElemStation=9,1650000000001E-02

Frame=18 Station=0,1833 OutputCase=SIS34 CaseType=Combination P=-12,7332309555428 V2=0,77701501071757 V3=0 T=0 M2=0 M3=-2,00646652170113 FrameElem=18-1 ElemStation=0,1833

Frame=18 Station=0 OutputCase=SIS35 CaseType=Combination P=-12,9132472926956 V2=3,55085693195523 V3=0 T=0 M2=0 M3=-1,93329750403121 FrameElem=18-1 ElemStation=0

Frame=18 Station=9,1650000000001E-02 OutputCase=SIS35 CaseType=Combination P=-12,5054047926956 V2=1,98483338195523 V3=0 T=0 M2=0 M3=-2,18666252284116 FrameElem=18-1 ElemStation=9,1650000000001E-02

Frame=18 Station=0,1833 OutputCase=SIS35 CaseType=Combination P=-12,0975622926956 V2=0,45913583195523 V3=0 T=0 M2=0 M3=-2,2983494222436 FrameElem=18-1 ElemStation=0,1833

Frame=18 Station=0 OutputCase=SIS36 CaseType=Combination P=-13,2310816241195 V2=4,09290577379461 V3=0 T=0 M2=0 M3=-1,75815923717353 FrameElem=18-1 ElemStation=0

Frame=18 Station=9,1650000000001E-02 OutputCase=SIS36 CaseType=Combination P=-12,8232391241195 V2=2,52688222379461 V3=0 T=0 M2=0 M3=-2,06120303233806 FrameElem=18-1 ElemStation=9,1650000000001E-02

Frame=18 Station=0,1833 OutputCase=SIS36 CaseType=Combination P=-12,4153966241195 V2=1,00118467379461 V3=0 T=0 M2=0 M3=-2,22256870809508 FrameElem=18-1 ElemStation=0,1833

Frame=18 Station=0 OutputCase=INVSIS CaseType=Combination StepType=Max P=-8,46696889195317 V2=6,75238647727774 V3=0 T=0 M2=0 M3=-1,58308416016873 FrameElem=18-1 ElemStation=0

Frame=18 Station=9,1650000000001E-02 OutputCase=INVSIS CaseType=Combination StepType=Max P=-8,11274164195317 V2=5,12926497727774 V3=0 T=0 M2=0 M3=-1,86564599556512 FrameElem=18-1 ElemStation=9,1650000000001E-02

Frame=18 Station=0,1833 OutputCase=INVSIS CaseType=Combination StepType=Max P=-7,75851439195317 V2=3,54646947727774 V3=0 T=0 M2=0 M3=-2,00646652170113 FrameElem=18-1 ElemStation=0,1833

Frame=18 Station=0 OutputCase=INVSIS CaseType=Combination StepType=Min P=-13,5489159555432 V2=3,41495336118754 V3=0 T=0 M2=0 M3=-2,39172600896503 FrameElem=18-1 ElemStation=0

Frame=18 Station=9,1650000000001E-02 OutputCase=INVSIS CaseType=Combination StepType=Min P=-13,1410734555432 V2=1,84892981118754 V3=0 T=0 M2=0 M3=-2,88241606215933 FrameElem=18-1 ElemStation=9,1650000000001E-02

Frame=18 Station=0,1833 OutputCase=INVSIS CaseType=Combination StepType=Min P=-12,7332309555432 V2=0,323232261187535 V3=0 T=0 M2=0 M3=-3,2262581586815 FrameElem=18-1 ElemStation=0,1833

Frame=18 Station=0 OutputCase=RAR001 CaseType=Combination P=-14,939599989938 V2=-0,22746867337753 V3=0 T=0 M2=0 M3=-0,540203534427095 FrameElem=18-1 ElemStation=0

Frame=18 Station=9,1650000000001E-02 OutputCase=RAR001 CaseType=Combination P=-14,572999989938 V2=-1,17810829837753 V3=0 T=0 M2=0 M3=-0,475306485768294 FrameElem=18-1 ElemStation=9,1650000000001E-02

Frame=18 Station=0,1833 OutputCase=RAR001 CaseType=Combination P=-14,206399989938 V2=-2,06505117337753 V3=0 T=0 M2=0 M3=-0,326202219046993 FrameElem=18-1 ElemStation=0,1833

Frame=18 Station=0 OutputCase=RAR002 CaseType=Combination P=-94,6195999959018 V2=-0,892283148502742 V3=0 T=0 M2=0 M3=10,8638933475454 FrameElem=18-1 ElemStation=0

Frame=18 Station=9,1650000000001E-02 OutputCase=RAR002 CaseType=Combination P=-94,2529999959018 V2=-1,48892464850274 V3=0 T=0 M2=0 M3=10,9733201846682 FrameElem=18-1 ElemStation=9,1650000000001E-02

Frame=18 Station=0,1833 OutputCase=RAR002 CaseType=Combination P=-93,8863999959018 V2=-2,04524014850274 V3=0 T=0 M2=0 M3=11,135581276316 FrameElem=18-1 ElemStation=0,1833

Frame=18 Station=0 OutputCase=RAR003 CaseType=Combination P=-85,2784559053835 V2=11,1572411360472 V3=0 T=0 M2=0 M3=4,82913242503905 FrameElem=18-1 ElemStation=0

Frame=18 Station=9,1650000000001E-02 OutputCase=RAR003 CaseType=Combination P=-84,9118559053834 V2=7,94193001104724 V3=0 T=0 M2=0 M3=3,95411940040157 FrameElem=18-1 ElemStation=9,1650000000001E-02

Frame=18 Station=0,1833 OutputCase=RAR003 CaseType=Combination P=-84,5452559053835 V2=4,75365563604724 V3=0 T=0 M2=0 M3=3,37255068130159 FrameElem=18-1 ElemStation=0,1833

Frame=18 Station=0 OutputCase=RAR004 CaseType=Combination P=-94,6195999955817 V2=-0,668189592971743 V3=0 T=0 M2=0 M3=4,39078942750398 FrameElem=18-1 ElemStation=0

Frame=18 Station=9,1650000000001E-02 OutputCase=RAR004 CaseType=Combination P=-94,2529999955817 V2=-3,88350071797175 V3=0 T=0 M2=0 M3=4,59957712918109 FrameElem=18-1 ElemStation=9,1650000000001E-02

Frame=18 Station=0,1833 OutputCase=RAR004 CaseType=Combination P=-93,8863999955817 V2=-7,07177509297175 V3=0 T=0 M2=0 M3=5,1018091363957 FrameElem=18-1 ElemStation=0,1833

Frame=18 Station=0 OutputCase=RAR005 CaseType=Combination P=-5,59845590856276 V2=12,1173841700025 V3=0 T=0 M2=0 M3=-5,65729684259375 FrameElem=18-1 ElemStation=0

Frame=18 Station=9,1650000000001E-02 OutputCase=RAR005 CaseType=Combination P=-5,23185590856276 V2=8,90207304500253 V3=0 T=0 M2=0 M3=-6,62030697629324 FrameElem=18-1 ElemStation=9,1650000000001E-02

Frame=18 Station=0,1833 OutputCase=RAR005 CaseType=Combination P=-4,86525590856276 V2=5,71379867000253 V3=0 T=0 M2=0 M3=-7,28987280445522 FrameElem=18-1 ElemStation=0,1833

Frame=18 Station=0 OutputCase=RAR006 CaseType=Combination P=-14,939599989761 V2=0,291953440983548 V3=0 T=0 M2=0 M3=-6,09563984012883 FrameElem=18-1 ElemStation=0

Frame=18 Station=9,1650000000001E-02 OutputCase=RAR006 CaseType=Combination P=-14,572999989761 V2=-2,92335768401646 V3=0 T=0 M2=0 M3=-5,97484924751372 FrameElem=18-1 ElemStation=9,1650000000001E-02

APPROVATO S.D.P.

Società di Progetto
Brebemi SpA



Doc. N.
60235-00000-A00.doc

CODIFICA DOCUMENTO
04RCDII10000000000300A00

REV.
00

FOGLIO
296 di 628

Frame=18 Station=0,1833 OutputCase=RAR006 CaseType=Combination P=-14,206399998761 V2=-6,11163205901646 V3=0 T=0 M2=0 M3=-5,56061434936111
FrameElem=18-1 ElemStation=0,1833
Frame=18 Station=0 OutputCase=RAR007 CaseType=Combination P=-53,1036089170593 V2=22,5012728830308 V3=0 T=0 M2=0 M3=3,09928213230646 FrameElem=18-1
ElemStation=0
Frame=18 Station=9,1650000000001E-02 OutputCase=RAR007 CaseType=Combination P=-52,7370089170593 V2=19,8521296330308 V3=0 T=0 M2=0 M3=1,15871395287356
FrameElem=18-1 ElemStation=9,1650000000001E-02
Frame=18 Station=0,1833 OutputCase=RAR007 CaseType=Combination P=-52,3704089170593 V2=17,2391881330308 V3=0 T=0 M2=0 M3=-0,540719192890592
FrameElem=18-1 ElemStation=0,1833
Frame=18 Station=0 OutputCase=RAR008 CaseType=Combination P=-14,9395999990805 V2=-0,698358619463875 V3=0 T=0 M2=0 M3=0,37733770026892 FrameElem=18-1
ElemStation=0
Frame=18 Station=9,1650000000001E-02 OutputCase=RAR008 CaseType=Combination P=-14,5729999990805 V2=-1,29500011946388 V3=0 T=0 M2=0
M3=0,468991354243256 FrameElem=18-1 ElemStation=9,1650000000001E-02
Frame=18 Station=0,1833 OutputCase=RAR008 CaseType=Combination P=-14,2063999990805 V2=-1,85131561946388 V3=0 T=0 M2=0 M3=0,613479262804621
FrameElem=18-1 ElemStation=0,1833
Frame=18 Station=0 OutputCase=RAR009 CaseType=Combination P=-94,61959999959014 V2=-1,3520142514526 V3=0 T=0 M2=0 M3=10,863817519722 FrameElem=18-1
ElemStation=0
Frame=18 Station=9,1650000000001E-02 OutputCase=RAR009 CaseType=Combination P=-94,25299999959014 V2=-1,9486557514526 V3=0 T=0 M2=0 M3=11,0153787124301
FrameElem=18-1 ElemStation=9,1650000000001E-02
Frame=18 Station=0,1833 OutputCase=RAR009 CaseType=Combination P=-93,88639999959014 V2=-2,5049712514526 V3=0 T=0 M2=0 M3=11,2197741596633
FrameElem=18-1 ElemStation=0,1833
Frame=18 Station=0 OutputCase=RAR010 CaseType=Combination P=-85,2784559053831 V2=10,6975100330974 V3=0 T=0 M2=0 M3=4,82905659721561 FrameElem=18-1
ElemStation=0
Frame=18 Station=9,1650000000001E-02 OutputCase=RAR010 CaseType=Combination P=-84,9118559053831 V2=7,48219890809739 V3=0 T=0 M2=0 M3=3,99617792816348
FrameElem=18-1 ElemStation=9,1650000000001E-02
Frame=18 Station=0,1833 OutputCase=RAR010 CaseType=Combination P=-84,5452559053831 V2=4,29392453309739 V3=0 T=0 M2=0 M3=3,4567435644885
FrameElem=18-1 ElemStation=0,1833
Frame=18 Station=0 OutputCase=RAR011 CaseType=Combination P=-94,61959999955813 V2=-1,1279206959216 V3=0 T=0 M2=0 M3=4,39071359968053 FrameElem=18-1
ElemStation=0
Frame=18 Station=9,1650000000001E-02 OutputCase=RAR011 CaseType=Combination P=-94,25299999955813 V2=-4,3432318209216 V3=0 T=0 M2=0 M3=4,64163565694299
FrameElem=18-1 ElemStation=9,1650000000001E-02
Frame=18 Station=0,1833 OutputCase=RAR011 CaseType=Combination P=-93,88639999955813 V2=-7,5315061959216 V3=0 T=0 M2=0 M3=5,18600201974296
FrameElem=18-1 ElemStation=0,1833
Frame=18 Station=0 OutputCase=RAR012 CaseType=Combination P=-5,59845590856238 V2=11,6576530670527 V3=0 T=0 M2=0 M3=-5,6573726704172 FrameElem=18-1
ElemStation=0
Frame=18 Station=9,1650000000001E-02 OutputCase=RAR012 CaseType=Combination P=-5,23185590856238 V2=8,44234194205268 V3=0 T=0 M2=0 M3=-6,57824844853133
FrameElem=18-1 ElemStation=9,1650000000001E-02
Frame=18 Station=0,1833 OutputCase=RAR012 CaseType=Combination P=-4,86525590856238 V2=5,25406756705268 V3=0 T=0 M2=0 M3=-7,20567992110796
FrameElem=18-1 ElemStation=0,1833
Frame=18 Station=0 OutputCase=RAR013 CaseType=Combination P=-14,9395999987606 V2=-0,167777661966306 V3=0 T=0 M2=0 M3=-6,09571566795228 FrameElem=18-1
ElemStation=0
Frame=18 Station=9,1650000000001E-02 OutputCase=RAR013 CaseType=Combination P=-14,5729999987606 V2=-3,38308878696631 V3=0 T=0 M2=0 M3=-
5,93279071975181 FrameElem=18-1 ElemStation=9,1650000000001E-02
Frame=18 Station=0,1833 OutputCase=RAR013 CaseType=Combination P=-14,2063999987606 V2=-6,57136316196631 V3=0 T=0 M2=0 M3=-5,47624146601385
FrameElem=18-1 ElemStation=0,1833
Frame=18 Station=0 OutputCase=RAR014 CaseType=Combination P=-53,1036089170589 V2=22,0415417800809 V3=0 T=0 M2=0 M3=3,09920630448301 FrameElem=18-1
ElemStation=0
Frame=18 Station=9,1650000000001E-02 OutputCase=RAR014 CaseType=Combination P=-52,7370089170589 V2=19,3923985300809 V3=0 T=0 M2=0 M3=1,20077248063546
FrameElem=18-1 ElemStation=9,1650000000001E-02
Frame=18 Station=0,1833 OutputCase=RAR014 CaseType=Combination P=-52,3704089170589 V2=16,7794570300809 V3=0 T=0 M2=0 M3=-0,456526309543332
FrameElem=18-1 ElemStation=0,1833
Frame=18 Station=0 OutputCase=RAR015 CaseType=Combination P=-74,699599996696 V2=-1,41846589493034 V3=0 T=0 M2=0 M3=8,2421596509315 FrameElem=18-1
ElemStation=0
Frame=18 Station=9,1650000000001E-02 OutputCase=RAR015 CaseType=Combination P=-74,332999996696 V2=-2,01510739493034 V3=0 T=0 M2=0 M3=8,39981113676436
FrameElem=18-1 ElemStation=9,1650000000001E-02
Frame=18 Station=0,1833 OutputCase=RAR015 CaseType=Combination P=-73,966399996696 V2=-2,57142289493034 V3=0 T=0 M2=0 M3=8,61029687712223
FrameElem=18-1 ElemStation=0,1833
Frame=18 Station=0 OutputCase=RAR016 CaseType=Combination P=-67,4516924620469 V2=7,87405437388988 V3=0 T=0 M2=0 M3=3,50482119349304 FrameElem=18-1
ElemStation=0
Frame=18 Station=9,1650000000001E-02 OutputCase=RAR016 CaseType=Combination P=-67,0850924620469 V2=5,22491112388988 V3=0 T=0 M2=0 M3=2,90483759042291
FrameElem=18-1 ElemStation=9,1650000000001E-02
Frame=18 Station=0,1833 OutputCase=RAR016 CaseType=Combination P=-66,7184924620469 V2=2,61196962388988 V3=0 T=0 M2=0 M3=2,54598902102153
FrameElem=18-1 ElemStation=0,1833
Frame=18 Station=0 OutputCase=RAR017 CaseType=Combination P=-74,6995999964341 V2=-1,32422786798961 V3=0 T=0 M2=0 M3=3,15791480731546 FrameElem=18-1
ElemStation=0
Frame=18 Station=9,1650000000001E-02 OutputCase=RAR017 CaseType=Combination P=-74,3329999964341 V2=-3,97337111798961 V3=0 T=0 M2=0 M3=3,40095377171359
FrameElem=18-1 ElemStation=9,1650000000001E-02
Frame=18 Station=0,1833 OutputCase=RAR017 CaseType=Combination P=-73,9663999964341 V2=-6,58631261798962 V3=0 T=0 M2=0 M3=3,88512776978046
FrameElem=18-1 ElemStation=0,1833
Frame=18 Station=0 OutputCase=RAR018 CaseType=Combination P=-7,69169246443136 V2=8,59416164935635 V3=0 T=0 M2=0 M3=4,36000075723156 FrameElem=18-1
ElemStation=0
Frame=18 Station=9,1650000000001E-02 OutputCase=RAR018 CaseType=Combination P=-7,32509246443136 V2=5,94501839935635 V3=0 T=0 M2=0 M3=-5,0259821920982
FrameElem=18-1 ElemStation=9,1650000000001E-02
Frame=18 Station=0,1833 OutputCase=RAR018 CaseType=Combination P=-6,95849246443136 V2=3,33207689935635 V3=0 T=0 M2=0 M3=-5,45082859329608
FrameElem=18-1 ElemStation=0,1833
Frame=18 Station=0 OutputCase=RAR019 CaseType=Combination P=-14,9395999988186 V2=-0,604120592523145 V3=0 T=0 M2=0 M3=-4,70690714340914 FrameElem=18-1
ElemStation=0
Frame=18 Station=9,1650000000001E-02 OutputCase=RAR019 CaseType=Combination P=-14,5729999988186 V2=-3,25326384252315 V3=0 T=0 M2=0 M3=-
4,52986601080752 FrameElem=18-1 ElemStation=9,1650000000001E-02
Frame=18 Station=0,1833 OutputCase=RAR019 CaseType=Combination P=-14,2063999988186 V2=-5,86620534252315 V3=0 T=0 M2=0 M3=-4,11168984453715
FrameElem=18-1 ElemStation=0,1833
Frame=18 Station=0 OutputCase=RAR020 CaseType=Combination P=-15,3210011967888 V2=-0,507631112206471 V3=0 T=0 M2=0 M3=0,587427792612658 FrameElem=18-1
ElemStation=0
Frame=18 Station=9,1650000000001E-02 OutputCase=RAR020 CaseType=Combination P=-14,9544011967888 V2=-1,10427261220647 V3=0 T=0 M2=0
M3=0,661601270608881 FrameElem=18-1 ElemStation=9,1650000000001E-02
Frame=18 Station=0,1833 OutputCase=RAR020 CaseType=Combination P=-14,5878011967888 V2=-1,66058811220647 V3=0 T=0 M2=0 M3=0,788609003130104
FrameElem=18-1 ElemStation=0,1833
Frame=18 Station=0 OutputCase=RAR021 CaseType=Combination P=-75,0810011944043 V2=-1,22773838767294 V3=0 T=0 M2=0 M3=8,45224974333726 FrameElem=18-1
ElemStation=0

Società di Progetto
Brebemi SpA



Doc. N.
60235-0000-A00.doc

CODIFICA DOCUMENTO
04RCDII10000000000300A00

REV.
00

FOGLIO
297 di 628

Frame=18 Station=9,16500000000001E-02 OutputCase=RAR021 CaseType=Combination P=-74,7144011944043 V2=-1,82437988767294 V3=0 T=0 M2=0 M3=8,59242105312999
FrameElem=18-1 ElemStation=9,16500000000001E-02
Frame=18 Station=0,1833 OutputCase=RAR021 CaseType=Combination P=-74,3478011944043 V2=-2,38069538767294 V3=0 T=0 M2=0 M3=8,78542661744771
FrameElem=18-1 ElemStation=0,1833
Frame=18 Station=0 OutputCase=RAR022 CaseType=Combination P=-67,8330936597552 V2=8,06478188114729 V3=0 T=0 M2=0 M3=3,71491128589881 FrameElem=18-1
ElemStation=0
Frame=18 Station=9,16500000000001E-02 OutputCase=RAR022 CaseType=Combination P=-67,4664936597552 V2=5,41563863114729 V3=0 T=0 M2=0 M3=3,09744750678853
FrameElem=18-1 ElemStation=9,16500000000001E-02
Frame=18 Station=0,1833 OutputCase=RAR022 CaseType=Combination P=-67,0998936597552 V2=2,80269713114728 V3=0 T=0 M2=0 M3=2,72111876134701
FrameElem=18-1 ElemStation=0,1833
Frame=18 Station=0 OutputCase=RAR023 CaseType=Combination P=-75,0810011941424 V2=-1,13350036073221 V3=0 T=0 M2=0 M3=3,36800489972123 FrameElem=18-1
ElemStation=0
Frame=18 Station=9,16500000000001E-02 OutputCase=RAR023 CaseType=Combination P=-74,7144011941424 V2=-3,78264361073221 V3=0 T=0 M2=0 M3=3,59356368807921
FrameElem=18-1 ElemStation=9,16500000000001E-02
Frame=18 Station=0,1833 OutputCase=RAR023 CaseType=Combination P=-74,3478011941424 V2=-6,39558511073221 V3=0 T=0 M2=0 M3=4,06025751010594
FrameElem=18-1 ElemStation=0,1833
Frame=18 Station=0 OutputCase=RAR024 CaseType=Combination P=-8,07309366213969 V2=8,78488915661375 V3=0 T=0 M2=0 M3=-4,1499106648258 FrameElem=18-1
ElemStation=0
Frame=18 Station=9,16500000000001E-02 OutputCase=RAR024 CaseType=Combination P=-7,70649366213969 V2=6,13574590661375 V3=0 T=0 M2=0 M3=-4,83337227573257
FrameElem=18-1 ElemStation=9,16500000000001E-02
Frame=18 Station=0,1833 OutputCase=RAR024 CaseType=Combination P=-7,33989366213969 V2=3,52280440661375 V3=0 T=0 M2=0 M3=-5,2756988529706
FrameElem=18-1 ElemStation=0,1833
Frame=18 Station=0 OutputCase=RAR025 CaseType=Combination P=-15,3210011965269 V2=-0,413393085265741 V3=0 T=0 M2=0 M3=-4,49681705100338 FrameElem=18-1
ElemStation=0
Frame=18 Station=9,16500000000001E-02 OutputCase=RAR025 CaseType=Combination P=-14,9544011965269 V2=-3,06253633526574 V3=0 T=0 M2=0 M3=-4,3372560944419
FrameElem=18-1 ElemStation=9,16500000000001E-02
Frame=18 Station=0,1833 OutputCase=RAR025 CaseType=Combination P=-14,5878011965269 V2=-5,67547783526575 V3=0 T=0 M2=0 M3=-3,93656010421167
FrameElem=18-1 ElemStation=0,1833
Frame=18 Station=0 OutputCase=RAR026 CaseType=Combination P=-14,5581988013722 V2=-0,889086126721278 V3=0 T=0 M2=0 M3=0,167247607801126 FrameElem=18-1
ElemStation=0
Frame=18 Station=9,16500000000001E-02 OutputCase=RAR026 CaseType=Combination P=-14,1915988013722 V2=-1,48572762672128 V3=0 T=0 M2=0
M3=0,276381437877632 FrameElem=18-1 ElemStation=9,16500000000001E-02
Frame=18 Station=0,1833 OutputCase=RAR026 CaseType=Combination P=-13,8249988013722 V2=-2,04204312672128 V3=0 T=0 M2=0 M3=0,438349522479137
FrameElem=18-1 ElemStation=0,1833
Frame=18 Station=0 OutputCase=RAR027 CaseType=Combination P=-74,3181987989877 V2=-1,60919340218775 V3=0 T=0 M2=0 M3=8,03206955852573 FrameElem=18-1
ElemStation=0
Frame=18 Station=9,16500000000001E-02 OutputCase=RAR027 CaseType=Combination P=-73,9515987989877 V2=-2,20583490218775 V3=0 T=0 M2=0 M3=8,20720122039874
FrameElem=18-1 ElemStation=9,16500000000001E-02
Frame=18 Station=0,1833 OutputCase=RAR027 CaseType=Combination P=-73,5849987989877 V2=-2,76215040218775 V3=0 T=0 M2=0 M3=8,43516713679675
FrameElem=18-1 ElemStation=0,1833
Frame=18 Station=0 OutputCase=RAR028 CaseType=Combination P=-67,0702912643386 V2=7,68332686663248 V3=0 T=0 M2=0 M3=3,29473110108728 FrameElem=18-1
ElemStation=0
Frame=18 Station=9,16500000000001E-02 OutputCase=RAR028 CaseType=Combination P=-66,7036912643385 V2=5,03418361663248 V3=0 T=0 M2=0 M3=2,71222767405728
FrameElem=18-1 ElemStation=9,16500000000001E-02
Frame=18 Station=0,1833 OutputCase=RAR028 CaseType=Combination P=-66,3370912643386 V2=2,42124211663248 V3=0 T=0 M2=0 M3=2,37085928069604
FrameElem=18-1 ElemStation=0,1833
Frame=18 Station=0 OutputCase=RAR029 CaseType=Combination P=-74,3181987987257 V2=-1,51495537524702 V3=0 T=0 M2=0 M3=2,9478247149097 FrameElem=18-1
ElemStation=0
Frame=18 Station=9,16500000000001E-02 OutputCase=RAR029 CaseType=Combination P=-73,9515987987257 V2=-4,16409862524702 V3=0 T=0 M2=0 M3=3,20834385534796
FrameElem=18-1 ElemStation=9,16500000000001E-02
Frame=18 Station=0,1833 OutputCase=RAR029 CaseType=Combination P=-73,5849987987257 V2=-6,77704012524702 V3=0 T=0 M2=0 M3=3,70999802945498
FrameElem=18-1 ElemStation=0,1833
Frame=18 Station=0 OutputCase=RAR030 CaseType=Combination P=-7,31029126672302 V2=8,40343414209895 V3=0 T=0 M2=0 M3=4,57009084963733 FrameElem=18-1
ElemStation=0
Frame=18 Station=9,16500000000001E-02 OutputCase=RAR030 CaseType=Combination P=-6,94369126672302 V2=5,75429089209895 V3=0 T=0 M2=0 M3=-5,21859210846382
FrameElem=18-1 ElemStation=9,16500000000001E-02
Frame=18 Station=0,1833 OutputCase=RAR030 CaseType=Combination P=-6,57709126672302 V2=3,14134939209894 V3=0 T=0 M2=0 M3=-5,62595833362157
FrameElem=18-1 ElemStation=0,1833
Frame=18 Station=0 OutputCase=RAR031 CaseType=Combination P=-14,5581988011102 V2=-0,794848099780549 V3=0 T=0 M2=0 M3=-4,91699723581491 FrameElem=18-1
ElemStation=0
Frame=18 Station=9,16500000000001E-02 OutputCase=RAR031 CaseType=Combination P=-14,1915988011102 V2=-3,44399134978055 V3=0 T=0 M2=0 M3=-
4,72247592717315 FrameElem=18-1 ElemStation=9,16500000000001E-02
Frame=18 Station=0,1833 OutputCase=RAR031 CaseType=Combination P=-13,8249988011102 V2=-6,05693284978055 V3=0 T=0 M2=0 M3=-4,28681958486263
FrameElem=18-1 ElemStation=0,1833
Frame=18 Station=0 OutputCase=RAR032 CaseType=Combination P=-14,9395999990809 V2=-0,238627516514021 V3=0 T=0 M2=0 M3=0,377413528030341 FrameElem=18-1
ElemStation=0
Frame=18 Station=9,16500000000001E-02 OutputCase=RAR032 CaseType=Combination P=-14,5729999990809 V2=-0,835269016514021 V3=0 T=0 M2=0
M3=0,426932826481351 FrameElem=18-1 ElemStation=9,16500000000001E-02
Frame=18 Station=0,1833 OutputCase=RAR032 CaseType=Combination P=-14,2063999990809 V2=-1,39158451651402 V3=0 T=0 M2=0 M3=0,529286379457361
FrameElem=18-1 ElemStation=0,1833
Frame=18 Station=0 OutputCase=RAR033 CaseType=Combination P=-74,6995999966964 V2=-0,958734791980489 V3=0 T=0 M2=0 M3=8,24223547875495 FrameElem=18-1
ElemStation=0
Frame=18 Station=9,16500000000001E-02 OutputCase=RAR033 CaseType=Combination P=-74,3329999966964 V2=-1,55537629198049 V3=0 T=0 M2=0 M3=8,3577526900246
FrameElem=18-1 ElemStation=9,16500000000001E-02
Frame=18 Station=0,1833 OutputCase=RAR033 CaseType=Combination P=-73,9663999966964 V2=-2,11169179198049 V3=0 T=0 M2=0 M3=8,52610399377497
FrameElem=18-1 ElemStation=0,1833
Frame=18 Station=0 OutputCase=RAR034 CaseType=Combination P=-67,4516924620472 V2=8,33378547683974 V3=0 T=0 M2=0 M3=3,50489702131649 FrameElem=18-1
ElemStation=0
Frame=18 Station=9,16500000000001E-02 OutputCase=RAR034 CaseType=Combination P=-67,0850924620472 V2=5,68464222683974 V3=0 T=0 M2=0 M3=2,862779062661
FrameElem=18-1 ElemStation=9,16500000000001E-02
Frame=18 Station=0,1833 OutputCase=RAR034 CaseType=Combination P=-66,7184924620473 V2=3,07170072683973 V3=0 T=0 M2=0 M3=2,46179613767427
FrameElem=18-1 ElemStation=0,1833
Frame=18 Station=0 OutputCase=RAR035 CaseType=Combination P=-74,6995999964344 V2=-0,864496765039759 V3=0 T=0 M2=0 M3=3,15799063513891 FrameElem=18-1
ElemStation=0
Frame=18 Station=9,16500000000001E-02 OutputCase=RAR035 CaseType=Combination P=-74,3329999964344 V2=-3,51364001503976 V3=0 T=0 M2=0 M3=3,35889524395168
FrameElem=18-1 ElemStation=9,16500000000001E-02
Frame=18 Station=0,1833 OutputCase=RAR035 CaseType=Combination P=-73,9663999964344 V2=-6,12658151503976 V3=0 T=0 M2=0 M3=3,8009348864332
FrameElem=18-1 ElemStation=0,1833

Società di Progetto
Brebemi SpA



Doc. N.
60235-0000-A00.doc

CODIFICA DOCUMENTO
04RCDII10000000000300A00

REV.
00

FOGLIO
298 di 628

Frame=18 Station=0 OutputCase=RAR036 CaseType=Combination P=-7,69169246443173 V2=9,05389275230621 V3=0 T=0 M2=0 M3=-4,35992492940811 FrameElem=18-1 ElemStation=0
Frame=18 Station=9,1650000000001E-02 OutputCase=RAR036 CaseType=Combination P=-7,32509246443173 V2=6,4047495023062 V3=0 T=0 M2=0 M3=-5,0680407198601 FrameElem=18-1 ElemStation=9,1650000000001E-02
Frame=18 Station=0,1833 OutputCase=RAR036 CaseType=Combination P=-6,95849246443173 V2=3,7918080023062 V3=0 T=0 M2=0 M3=-5,53502147664334 FrameElem=18-1 ElemStation=0,1833
Frame=18 Station=0 OutputCase=RAR037 CaseType=Combination P=-14,9395999988189 V2=-0,144389489573291 V3=0 T=0 M2=0 M3=-4,70683131558569 FrameElem=18-1 ElemStation=0
Frame=18 Station=9,1650000000001E-02 OutputCase=RAR037 CaseType=Combination P=-14,5729999988189 V2=-2,79353273957329 V3=0 T=0 M2=0 M3=-4,57192453856943 FrameElem=18-1 ElemStation=9,1650000000001E-02
Frame=18 Station=0,1833 OutputCase=RAR037 CaseType=Combination P=-14,2063999988189 V2=-5,40647423957329 V3=0 T=0 M2=0 M3=-4,19588272788441 FrameElem=18-1 ElemStation=0,1833
Frame=18 Station=0 OutputCase=RAR038 CaseType=Combination P=-14,9395999988189 V2=0,834078390368973 V3=0 T=0 M2=0 M3=0,377590459618387 FrameElem=18-1 ElemStation=0
Frame=18 Station=9,1650000000001E-02 OutputCase=RAR038 CaseType=Combination P=-14,5729999988189 V2=0,237436890368972 V3=0 T=0 M2=0 M3=0,328796261703571 FrameElem=18-1 ElemStation=9,1650000000001E-02
Frame=18 Station=0,1833 OutputCase=RAR038 CaseType=Combination P=-14,2063999988189 V2=-0,318878609631028 V3=0 T=0 M2=0 M3=0,332836318313755 FrameElem=18-1 ElemStation=0,1833
Frame=18 Station=0 OutputCase=RAR039 CaseType=Combination P=-94,6195999959022 V2=-0,432552045552887 V3=0 T=0 M2=0 M3=10,8639691753689 FrameElem=18-1 ElemStation=0
Frame=18 Station=9,1650000000001E-02 OutputCase=RAR039 CaseType=Combination P=-94,2529999959022 V2=-1,02919354555289 V3=0 T=0 M2=0 M3=10,9312616569063 FrameElem=18-1 ElemStation=9,1650000000001E-02
Frame=18 Station=0,1833 OutputCase=RAR039 CaseType=Combination P=-93,8863999959022 V2=-1,58550904555289 V3=0 T=0 M2=0 M3=11,0513883929687 FrameElem=18-1 ElemStation=0,1833
Frame=18 Station=0 OutputCase=RAR040 CaseType=Combination P=-85,2784559053838 V2=11,6169722389971 V3=0 T=0 M2=0 M3=4,8292082528625 FrameElem=18-1 ElemStation=0
Frame=18 Station=9,1650000000001E-02 OutputCase=RAR040 CaseType=Combination P=-84,9118559053838 V2=8,4016611139971 V3=0 T=0 M2=0 M3=3,91206087263967 FrameElem=18-1 ElemStation=9,1650000000001E-02
Frame=18 Station=0,1833 OutputCase=RAR040 CaseType=Combination P=-84,5452559053838 V2=5,2133867389971 V3=0 T=0 M2=0 M3=3,28835779795433 FrameElem=18-1 ElemStation=0,1833
Frame=18 Station=0 OutputCase=RAR041 CaseType=Combination P=-94,619599995582 V2=-0,208458490021889 V3=0 T=0 M2=0 M3=4,3908652532743 FrameElem=18-1 ElemStation=0
Frame=18 Station=9,1650000000001E-02 OutputCase=RAR041 CaseType=Combination P=-94,252999995582 V2=-3,42376961502189 V3=0 T=0 M2=0 M3=4,55751860141918 FrameElem=18-1 ElemStation=9,1650000000001E-02
Frame=18 Station=0,1833 OutputCase=RAR041 CaseType=Combination P=-93,886399995582 V2=-6,61204399002189 V3=0 T=0 M2=0 M3=5,01761625304844 FrameElem=18-1 ElemStation=0,1833
Frame=18 Station=0 OutputCase=RAR042 CaseType=Combination P=-5,59845590856313 V2=12,5771152729524 V3=0 T=0 M2=0 M3=-5,6572210147703 FrameElem=18-1 ElemStation=0
Frame=18 Station=9,1650000000001E-02 OutputCase=RAR042 CaseType=Combination P=-5,23185590856313 V2=9,36180414795239 V3=0 T=0 M2=0 M3=-6,66236550405514 FrameElem=18-1 ElemStation=9,1650000000001E-02
Frame=18 Station=0,1833 OutputCase=RAR042 CaseType=Combination P=-4,86525590856313 V2=6,17352977295239 V3=0 T=0 M2=0 M3=-7,37406568780248 FrameElem=18-1 ElemStation=0,1833
Frame=18 Station=0 OutputCase=RAR043 CaseType=Combination P=-14,9395999987613 V2=0,751684543933402 V3=0 T=0 M2=0 M3=-6,09556401230538 FrameElem=18-1 ElemStation=0
Frame=18 Station=9,1650000000001E-02 OutputCase=RAR043 CaseType=Combination P=-14,5729999987613 V2=-2,4636265810666 V3=0 T=0 M2=0 M3=-6,0169077527562 FrameElem=18-1 ElemStation=9,1650000000001E-02
Frame=18 Station=0,1833 OutputCase=RAR043 CaseType=Combination P=-14,2063999987613 V2=-5,6519009560666 V3=0 T=0 M2=0 M3=-5,64480723270837 FrameElem=18-1 ElemStation=0,1833
Frame=18 Station=0 OutputCase=RAR044 CaseType=Combination P=-53,1036089170597 V2=22,9610039859806 V3=0 T=0 M2=0 M3=3,0993579601299 FrameElem=18-1 ElemStation=0
Frame=18 Station=9,1650000000001E-02 OutputCase=RAR044 CaseType=Combination P=-52,7370089170597 V2=20,3118607359806 V3=0 T=0 M2=0 M3=1,11665542511165 FrameElem=18-1 ElemStation=9,1650000000001E-02
Frame=18 Station=0,1833 OutputCase=RAR044 CaseType=Combination P=-52,3704089170597 V2=17,6989192359806 V3=0 T=0 M2=0 M3=-0,624912076237852 FrameElem=18-1 ElemStation=0,1833
Frame=18 Station=0 OutputCase=RAR045 CaseType=Combination P=-74,6995999966973 V2=0,113971114902505 V3=0 T=0 M2=0 M3=8,24241241034299 FrameElem=18-1 ElemStation=0
Frame=18 Station=9,1650000000001E-02 OutputCase=RAR045 CaseType=Combination P=-74,3329999966973 V2=-0,482670385097496 V3=0 T=0 M2=0 M3=8,25961604422468 FrameElem=18-1 ElemStation=9,1650000000001E-02
Frame=18 Station=0,1833 OutputCase=RAR045 CaseType=Combination P=-73,9663999966973 V2=-1,0389858850975 V3=0 T=0 M2=0 M3=8,32965393263136 FrameElem=18-1 ElemStation=0,1833
Frame=18 Station=0 OutputCase=RAR046 CaseType=Combination P=-67,4516924620481 V2=9,40649138372273 V3=0 T=0 M2=0 M3=3,50507395290454 FrameElem=18-1 ElemStation=0
Frame=18 Station=9,1650000000001E-02 OutputCase=RAR046 CaseType=Combination P=-67,0850924620481 V2=6,75734813372273 V3=0 T=0 M2=0 M3=2,76464249788322 FrameElem=18-1 ElemStation=9,1650000000001E-02
Frame=18 Station=0,1833 OutputCase=RAR046 CaseType=Combination P=-66,7184924620481 V2=4,14440663372273 V3=0 T=0 M2=0 M3=2,26534607653066 FrameElem=18-1 ElemStation=0,1833
Frame=18 Station=0 OutputCase=RAR047 CaseType=Combination P=-74,6995999964353 V2=0,208209141843234 V3=0 T=0 M2=0 M3=3,15816756672696 FrameElem=18-1 ElemStation=0
Frame=18 Station=9,1650000000001E-02 OutputCase=RAR047 CaseType=Combination P=-74,3329999964353 V2=-2,44093410815677 V3=0 T=0 M2=0 M3=3,2607586791739 FrameElem=18-1 ElemStation=9,1650000000001E-02
Frame=18 Station=0,1833 OutputCase=RAR047 CaseType=Combination P=-73,9663999964353 V2=-5,05387560815677 V3=0 T=0 M2=0 M3=3,60448482528959 FrameElem=18-1 ElemStation=0,1833
Frame=18 Station=0 OutputCase=RAR048 CaseType=Combination P=-7,69169246443261 V2=10,1265986591892 V3=0 T=0 M2=0 M3=-4,35974799782007 FrameElem=18-1 ElemStation=0
Frame=18 Station=9,1650000000001E-02 OutputCase=RAR048 CaseType=Combination P=-7,32509246443261 V2=7,4774554091892 V3=0 T=0 M2=0 M3=-5,16617728463788 FrameElem=18-1 ElemStation=9,1650000000001E-02
Frame=18 Station=0,1833 OutputCase=RAR048 CaseType=Combination P=-6,95849246443261 V2=4,86451390918919 V3=0 T=0 M2=0 M3=-5,73147153778695 FrameElem=18-1 ElemStation=0,1833
Frame=18 Station=0 OutputCase=RAR049 CaseType=Combination P=-14,9395999988198 V2=0,928316417309702 V3=0 T=0 M2=0 M3=-4,70665438399765 FrameElem=18-1 ElemStation=0
Frame=18 Station=9,1650000000001E-02 OutputCase=RAR049 CaseType=Combination P=-14,5729999988198 V2=-1,7208268326903 V3=0 T=0 M2=0 M3=-4,67006110334721 FrameElem=18-1 ElemStation=9,1650000000001E-02
Frame=18 Station=0,1833 OutputCase=RAR049 CaseType=Combination P=-14,2063999988198 V2=-4,3337683326903 V3=0 T=0 M2=0 M3=-4,39233278902802 FrameElem=18-1 ElemStation=0,1833
Frame=18 Station=0 OutputCase=RAR050 CaseType=Combination P=-15,3210011967901 V2=1,02480589762638 V3=0 T=0 M2=0 M3=0,587680552024153 FrameElem=18-1 ElemStation=0
Frame=18 Station=9,1650000000001E-02 OutputCase=RAR050 CaseType=Combination P=-14,9544011967901 V2=0,428164397626376 V3=0 T=0 M2=0 M3=0,521406178069196 FrameElem=18-1 ElemStation=9,1650000000001E-02

Società di Progetto
Brebemi SpA



Doc. N.
60235-00000-A00.doc

CODIFICA DOCUMENTO
04RCDII10000000000300A00

REV.
00

FOGLIO
299 di 628

Frame=18 Station=0,1833 OutputCase=RAR050 CaseType=Combination P=-14,5878011967901 V2=-0,128151102373624 V3=0 T=0 M2=0 M3=0,507966058639238
FrameElem=18-1 ElemStation=0,1833
Frame=18 Station=0 OutputCase=RAR051 CaseType=Combination P=-75,0810011944056 V2=0,304698622159908 V3=0 T=0 M2=0 M3=8,45250250274876 FrameElem=18-1
ElemStation=0
Frame=18 Station=9,16500000000001E-02 OutputCase=RAR051 CaseType=Combination P=-74,7144011944056 V2=-0,291942877840092 V3=0 T=0 M2=0 M3=8,4522259605903
FrameElem=18-1 ElemStation=9,16500000000001E-02
Frame=18 Station=0,1833 OutputCase=RAR051 CaseType=Combination P=-74,3478011944056 V2=-0,848258377840092 V3=0 T=0 M2=0 M3=8,50478367295685
FrameElem=18-1 ElemStation=0,1833
Frame=18 Station=0 OutputCase=RAR052 CaseType=Combination P=-67,8330936597565 V2=9,59721889098013 V3=0 T=0 M2=0 M3=3,7151640453103 FrameElem=18-1
ElemStation=0
Frame=18 Station=9,16500000000001E-02 OutputCase=RAR052 CaseType=Combination P=-67,4664936597565 V2=6,94807564098013 V3=0 T=0 M2=0 M3=2,95725241424885
FrameElem=18-1 ElemStation=9,16500000000001E-02
Frame=18 Station=0,1833 OutputCase=RAR052 CaseType=Combination P=-67,0998936597565 V2=4,33513414098013 V3=0 T=0 M2=0 M3=2,44047581685614
FrameElem=18-1 ElemStation=0,1833
Frame=18 Station=0 OutputCase=RAR053 CaseType=Combination P=-75,0810011941437 V2=0,398936649100638 V3=0 T=0 M2=0 M3=3,36825765913273 FrameElem=18-1
ElemStation=0
Frame=18 Station=9,16500000000001E-02 OutputCase=RAR053 CaseType=Combination P=-74,7144011941436 V2=-2,25020660089936 V3=0 T=0 M2=0 M3=3,45336859553953
FrameElem=18-1 ElemStation=9,16500000000001E-02
Frame=18 Station=0,1833 OutputCase=RAR053 CaseType=Combination P=-74,3478011941437 V2=-4,86314810089937 V3=0 T=0 M2=0 M3=3,77961456561508
FrameElem=18-1 ElemStation=0,1833
Frame=18 Station=0 OutputCase=RAR054 CaseType=Combination P=-8,07309366214094 V2=10,3173261664466 V3=0 T=0 M2=0 M3=-4,1496579054143 FrameElem=18-1
ElemStation=0
Frame=18 Station=9,16500000000001E-02 OutputCase=RAR054 CaseType=Combination P=-7,70649366214094 V2=7,6681829164466 V3=0 T=0 M2=0 M3=-4,97356736827226
FrameElem=18-1 ElemStation=9,16500000000001E-02
Frame=18 Station=0,1833 OutputCase=RAR054 CaseType=Combination P=-7,33989366214094 V2=5,0552414164466 V3=0 T=0 M2=0 M3=-5,55634179746147
FrameElem=18-1 ElemStation=0,1833
Frame=18 Station=0 OutputCase=RAR055 CaseType=Combination P=-15,3210011965281 V2=1,11904392456711 V3=0 T=0 M2=0 M3=-4,49656429159188 FrameElem=18-1
ElemStation=0
Frame=18 Station=9,16500000000001E-02 OutputCase=RAR055 CaseType=Combination P=-14,9544011965281 V2=-1,5300993254329 V3=0 T=0 M2=0 M3=-4,47745118698158
FrameElem=18-1 ElemStation=9,16500000000001E-02
Frame=18 Station=0,1833 OutputCase=RAR055 CaseType=Combination P=-14,5878011965281 V2=-4,1430408254329 V3=0 T=0 M2=0 M3=-4,21720304870253
FrameElem=18-1 ElemStation=0,1833
Frame=18 Station=0 OutputCase=RAR056 CaseType=Combination P=-14,5581988013734 V2=0,64330883111569 V3=0 T=0 M2=0 M3=0,167500367212622 FrameElem=18-1
ElemStation=0
Frame=18 Station=9,16500000000001E-02 OutputCase=RAR056 CaseType=Combination P=-14,1915988013734 V2=4,67093831115683E-02 V3=0 T=0 M2=0
M3=0,136186345337946 FrameElem=18-1 ElemStation=9,16500000000001E-02
Frame=18 Station=0,1833 OutputCase=RAR056 CaseType=Combination P=-13,8249988013734 V2=-0,509606116888432 V3=0 T=0 M2=0 M3=0,157706577988271
FrameElem=18-1 ElemStation=0,1833
Frame=18 Station=0 OutputCase=RAR057 CaseType=Combination P=-74,3181987989889 V2=-7,67563923548991E-02 V3=0 T=0 M2=0 M3=8,03232231793723
FrameElem=18-1 ElemStation=0
Frame=18 Station=9,16500000000001E-02 OutputCase=RAR057 CaseType=Combination P=-73,9515987989889 V2=-0,6733978923549 V3=0 T=0 M2=0 M3=8,06700612785905
FrameElem=18-1 ElemStation=9,16500000000001E-02
Frame=18 Station=0,1833 OutputCase=RAR057 CaseType=Combination P=-73,5849987989889 V2=-1,2297133923549 V3=0 T=0 M2=0 M3=8,15452419230588
FrameElem=18-1 ElemStation=0,1833
Frame=18 Station=0 OutputCase=RAR058 CaseType=Combination P=-67,0702912643398 V2=9,21576387646533 V3=0 T=0 M2=0 M3=3,29498386049877 FrameElem=18-1
ElemStation=0
Frame=18 Station=9,16500000000001E-02 OutputCase=RAR058 CaseType=Combination P=-66,7036912643398 V2=6,56662062646533 V3=0 T=0 M2=0 M3=2,5720325815176
FrameElem=18-1 ElemStation=9,16500000000001E-02
Frame=18 Station=0,1833 OutputCase=RAR058 CaseType=Combination P=-66,3370912643398 V2=3,95367912646532 V3=0 T=0 M2=0 M3=2,09021633620518
FrameElem=18-1 ElemStation=0,1833
Frame=18 Station=0 OutputCase=RAR059 CaseType=Combination P=-74,318198798727 V2=1,74816345858304E-02 V3=0 T=0 M2=0 M3=2,94807747432119 FrameElem=18-1
ElemStation=0
Frame=18 Station=9,16500000000001E-02 OutputCase=RAR059 CaseType=Combination P=-73,951598798727 V2=-2,63166161541417 V3=0 T=0 M2=0 M3=3,06814876280828
FrameElem=18-1 ElemStation=9,16500000000001E-02
Frame=18 Station=0,1833 OutputCase=RAR059 CaseType=Combination P=-73,584998798727 V2=-5,24460311541417 V3=0 T=0 M2=0 M3=3,42935508496411
FrameElem=18-1 ElemStation=0,1833
Frame=18 Station=0 OutputCase=RAR060 CaseType=Combination P=-7,31029126672427 V2=9,9358711519318 V3=0 T=0 M2=0 M3=-4,56983809022583 FrameElem=18-1
ElemStation=0
Frame=18 Station=9,16500000000001E-02 OutputCase=RAR060 CaseType=Combination P=-6,94369126672427 V2=7,28672790193179 V3=0 T=0 M2=0 M3=-5,3587820100351
FrameElem=18-1 ElemStation=9,16500000000001E-02
Frame=18 Station=0,1833 OutputCase=RAR060 CaseType=Combination P=-6,57709126672427 V2=4,67378640193179 V3=0 T=0 M2=0 M3=-5,90660127811243
FrameElem=18-1 ElemStation=0,1833
Frame=18 Station=0 OutputCase=RAR061 CaseType=Combination P=-14,5581988011115 V2=0,737588910052298 V3=0 T=0 M2=0 M3=-4,91674447640341 FrameElem=18-1
ElemStation=0
Frame=18 Station=9,16500000000001E-02 OutputCase=RAR061 CaseType=Combination P=-14,1915988011115 V2=-1,9115543399477 V3=0 T=0 M2=0 M3=-4,86267101971283
FrameElem=18-1 ElemStation=9,16500000000001E-02
Frame=18 Station=0,1833 OutputCase=RAR061 CaseType=Combination P=-13,8249988011115 V2=-4,52449583994771 V3=0 T=0 M2=0 M3=-4,5674625293535
FrameElem=18-1 ElemStation=0,1833
Frame=18 Station=0 OutputCase=RAR062 CaseType=Combination P=-14,9395999990821 V2=1,29380949331883 V3=0 T=0 M2=0 M3=0,377666287441836 FrameElem=18-1
ElemStation=0
Frame=18 Station=9,16500000000001E-02 OutputCase=RAR062 CaseType=Combination P=-14,5729999990821 V2=0,697167993318826 V3=0 T=0 M2=0
M3=0,286737733941665 FrameElem=18-1 ElemStation=9,16500000000001E-02
Frame=18 Station=0,1833 OutputCase=RAR062 CaseType=Combination P=-14,2063999990821 V2=0,140852493318826 V3=0 T=0 M2=0 M3=0,248643434966495
FrameElem=18-1 ElemStation=0,1833
Frame=18 Station=0 OutputCase=RAR063 CaseType=Combination P=-74,6995999966976 V2=0,573702217852359 V3=0 T=0 M2=0 M3=8,24248823816644 FrameElem=18-1
ElemStation=0
Frame=18 Station=9,16500000000001E-02 OutputCase=RAR063 CaseType=Combination P=-74,3329999966976 V2=-2,29392821476417E-02 V3=0 T=0 M2=0
M3=8,21755751646277 FrameElem=18-1 ElemStation=9,16500000000001E-02
Frame=18 Station=0,1833 OutputCase=RAR063 CaseType=Combination P=-73,9663999966976 V2=-0,579254782147642 V3=0 T=0 M2=0 M3=8,2454610492841
FrameElem=18-1 ElemStation=0,1833
Frame=18 Station=0 OutputCase=RAR064 CaseType=Combination P=-67,4516924620485 V2=9,86622248667259 V3=0 T=0 M2=0 M3=3,50514978072799 FrameElem=18-1
ElemStation=0
Frame=18 Station=9,16500000000001E-02 OutputCase=RAR064 CaseType=Combination P=-67,0850924620485 V2=7,21707923667258 V3=0 T=0 M2=0 M3=2,72258397012132
FrameElem=18-1 ElemStation=9,16500000000001E-02
Frame=18 Station=0,1833 OutputCase=RAR064 CaseType=Combination P=-66,7184924620485 V2=4,60413773667258 V3=0 T=0 M2=0 M3=2,1811531931834 FrameElem=18-1
ElemStation=0,1833
Frame=18 Station=0 OutputCase=RAR065 CaseType=Combination P=-74,6995999964357 V2=0,667940244793088 V3=0 T=0 M2=0 M3=3,15824339455041 FrameElem=18-1
ElemStation=0

Società di Progetto
Brebemi SpA



Doc. N.
60235-0000-A00.doc

CODIFICA DOCUMENTO
04RCDII10000000000300A00

REV.
00

FOGLIO
300 di 628

Frame=18 Station=9,16500000000001E-02 OutputCase=RAR065 CaseType=Combination P=-74,3329999964357 V2=-1,98120300520691 V3=0 T=0 M2=0 M3=3,218700151412
FrameElem=18-1 ElemStation=9,16500000000001E-02
Frame=18 Station=0,1833 OutputCase=RAR065 CaseType=Combination P=-73,9663999964357 V2=-4,59414450520692 V3=0 T=0 M2=0 M3=3,52029194194233
FrameElem=18-1 ElemStation=0,1833
Frame=18 Station=0 OutputCase=RAR066 CaseType=Combination P=-7,69169246443298 V2=10,5863297621391 V3=0 T=0 M2=0 M3=-4,35967216999662 FrameElem=18-1
ElemStation=0
Frame=18 Station=9,16500000000001E-02 OutputCase=RAR066 CaseType=Combination P=-7,32509246443298 V2=7,93718651213905 V3=0 T=0 M2=0 M3=-5,20823581239979
FrameElem=18-1 ElemStation=9,16500000000001E-02
Frame=18 Station=0,1833 OutputCase=RAR066 CaseType=Combination P=-6,95849246443298 V2=5,32424501213905 V3=0 T=0 M2=0 M3=-5,81566442113421
FrameElem=18-1 ElemStation=0,1833
Frame=18 Station=0 OutputCase=RAR067 CaseType=Combination P=-14,9395999988202 V2=1,38804752025956 V3=0 T=0 M2=0 M3=-4,706578561742 FrameElem=18-1
ElemStation=0
Frame=18 Station=9,16500000000001E-02 OutputCase=RAR067 CaseType=Combination P=-14,5729999988202 V2=-1,26109572974045 V3=0 T=0 M2=0 M3=-
4,71211963110911 FrameElem=18-1 ElemStation=9,16500000000001E-02
Frame=18 Station=0,1833 OutputCase=RAR067 CaseType=Combination P=-14,2063999988202 V2=-3,87403722974045 V3=0 T=0 M2=0 M3=-4,4765267237528
FrameElem=18-1 ElemStation=0,1833
Frame=18 Station=0 OutputCase=RAR068 CaseType=Combination P=-15,5752686619283 V2=0,385739064214889 V3=0 T=0 M2=0 M3=0,72761423392225 FrameElem=18-1
ElemStation=0
Frame=18 Station=9,16500000000001E-02 OutputCase=RAR068 CaseType=Combination P=-15,2086686619283 V2=-0,210902435785112 V3=0 T=0 M2=0
M3=0,719910335249455 FrameElem=18-1 ElemStation=9,16500000000001E-02
Frame=18 Station=0,1833 OutputCase=RAR068 CaseType=Combination P=-14,8420686619283 V2=-0,767217935785112 V3=0 T=0 M2=0 M3=0,765040691101661
FrameElem=18-1 ElemStation=0,1833
Frame=18 Station=0 OutputCase=RAR069 CaseType=Combination P=-95,0010011936101 V2=-0,701555641245338 V3=0 T=0 M2=0 M3=11,0739834399512 FrameElem=18-1
ElemStation=0
Frame=18 Station=9,16500000000001E-02 OutputCase=RAR069 CaseType=Combination P=-94,6344011936101 V2=-1,29819714124534 V3=0 T=0 M2=0 M3=11,1659301010338
FrameElem=18-1 ElemStation=9,16500000000001E-02
Frame=18 Station=0,1833 OutputCase=RAR069 CaseType=Combination P=-94,2678011936101 V2=-1,85451264124534 V3=0 T=0 M2=0 M3=11,3107110166415
FrameElem=18-1 ElemStation=0,1833
Frame=18 Station=0 OutputCase=RAR070 CaseType=Combination P=-85,6598571030918 V2=11,3479686433047 V3=0 T=0 M2=0 M3=5,03922251744482 FrameElem=18-1
ElemStation=0
Frame=18 Station=9,16500000000001E-02 OutputCase=RAR070 CaseType=Combination P=-85,2932571030918 V2=8,13265751830465 V3=0 T=0 M2=0 M3=4,1467293167672
FrameElem=18-1 ElemStation=9,16500000000001E-02
Frame=18 Station=0,1833 OutputCase=RAR070 CaseType=Combination P=-84,9266571030918 V2=4,94438314330465 V3=0 T=0 M2=0 M3=3,54768042162707
FrameElem=18-1 ElemStation=0,1833
Frame=18 Station=0 OutputCase=RAR071 CaseType=Combination P=-95,00100119329 V2=-0,477462085714339 V3=0 T=0 M2=0 M3=4,60087951990975 FrameElem=18-1
ElemStation=0
Frame=18 Station=9,16500000000001E-02 OutputCase=RAR071 CaseType=Combination P=-94,63440119329 V2=-3,69277321071434 V3=0 T=0 M2=0 M3=4,79218704554671
FrameElem=18-1 ElemStation=9,16500000000001E-02
Frame=18 Station=0,1833 OutputCase=RAR071 CaseType=Combination P=-94,26780119329 V2=-6,88104758571434 V3=0 T=0 M2=0 M3=5,27693887672118 FrameElem=18-1
ElemStation=0,1833
Frame=18 Station=0 OutputCase=RAR072 CaseType=Combination P=-5,97985710627109 V2=12,3081116772599 V3=0 T=0 M2=0 M3=-5,44720675018799 FrameElem=18-1
ElemStation=0
Frame=18 Station=9,16500000000001E-02 OutputCase=RAR072 CaseType=Combination P=-5,61325710627109 V2=9,09280055225994 V3=0 T=0 M2=0 M3=-6,42769705992761
FrameElem=18-1 ElemStation=9,16500000000001E-02
Frame=18 Station=0,1833 OutputCase=RAR072 CaseType=Combination P=-5,24665710627109 V2=5,90452617725994 V3=0 T=0 M2=0 M3=-7,11474306412974
FrameElem=18-1 ElemStation=0,1833
Frame=18 Station=0 OutputCase=RAR073 CaseType=Combination P=-15,3210011964693 V2=0,482680948240952 V3=0 T=0 M2=0 M3=-5,8854974772306 FrameElem=18-1
ElemStation=0
Frame=18 Station=9,16500000000001E-02 OutputCase=RAR073 CaseType=Combination P=-14,9544011964693 V2=-2,73263017675905 V3=0 T=0 M2=0 M3=-
5,78223933114809 FrameElem=18-1 ElemStation=9,16500000000001E-02
Frame=18 Station=0,1833 OutputCase=RAR073 CaseType=Combination P=-14,5878011964693 V2=-5,92090455175905 V3=0 T=0 M2=0 M3=-5,38548460903563
FrameElem=18-1 ElemStation=0,1833
Frame=18 Station=0 OutputCase=RAR074 CaseType=Combination P=-53,4850101147677 V2=22,6920003902882 V3=0 T=0 M2=0 M3=3,30937222471222 FrameElem=18-1
ElemStation=0
Frame=18 Station=9,16500000000001E-02 OutputCase=RAR074 CaseType=Combination P=-53,1184101147676 V2=20,0428571402882 V3=0 T=0 M2=0 M3=1,35132386923918
FrameElem=18-1 ElemStation=9,16500000000001E-02
Frame=18 Station=0,1833 OutputCase=RAR074 CaseType=Combination P=-52,7518101147677 V2=17,4299156402882 V3=0 T=0 M2=0 M3=0,365589452565108
FrameElem=18-1 ElemStation=0,1833
Frame=18 Station=0 OutputCase=RAR075 CaseType=Combination P=-75,3352686595439 V2=-0,334368211251579 V3=0 T=0 M2=0 M3=8,59243618464686 FrameElem=18-1
ElemStation=0
Frame=18 Station=9,16500000000001E-02 OutputCase=RAR075 CaseType=Combination P=-74,9686686595439 V2=-0,93100971125158 V3=0 T=0 M2=0 M3=8,65073011777056
FrameElem=18-1 ElemStation=9,16500000000001E-02
Frame=18 Station=0,1833 OutputCase=RAR075 CaseType=Combination P=-74,6020686595439 V2=-1,48732521125158 V3=0 T=0 M2=0 M3=8,76185830541927
FrameElem=18-1 ElemStation=0,1833
Frame=18 Station=0 OutputCase=RAR076 CaseType=Combination P=-68,0873611248947 V2=8,95815205756865 V3=0 T=0 M2=0 M3=3,8550977272084 FrameElem=18-1
ElemStation=0
Frame=18 Station=9,16500000000001E-02 OutputCase=RAR076 CaseType=Combination P=-67,7207611248947 V2=6,30900880756865 V3=0 T=0 M2=0 M3=3,15575657142911
FrameElem=18-1 ElemStation=9,16500000000001E-02
Frame=18 Station=0,1833 OutputCase=RAR076 CaseType=Combination P=-67,3541611248947 V2=3,69606730756864 V3=0 T=0 M2=0 M3=2,69755044931857
FrameElem=18-1 ElemStation=0,1833
Frame=18 Station=0 OutputCase=RAR077 CaseType=Combination P=-75,3352686592819 V2=-0,24013018431085 V3=0 T=0 M2=0 M3=3,50819134103082 FrameElem=18-1
ElemStation=0
Frame=18 Station=9,16500000000001E-02 OutputCase=RAR077 CaseType=Combination P=-74,9686686592819 V2=-2,88927343431085 V3=0 T=0 M2=0 M3=3,65187275271979
FrameElem=18-1 ElemStation=9,16500000000001E-02
Frame=18 Station=0,1833 OutputCase=RAR077 CaseType=Combination P=-74,6020686592819 V2=-5,50221493431085 V3=0 T=0 M2=0 M3=4,0366891980775
FrameElem=18-1 ElemStation=0,1833
Frame=18 Station=0 OutputCase=RAR078 CaseType=Combination P=-8,3273611272792 V2=9,6782593303511 V3=0 T=0 M2=0 M3=-4,0097242235162 FrameElem=18-1
ElemStation=0
Frame=18 Station=9,16500000000001E-02 OutputCase=RAR078 CaseType=Combination P=-7,9607611272792 V2=7,02911608303511 V3=0 T=0 M2=0 M3=-4,775063211092
FrameElem=18-1 ElemStation=9,16500000000001E-02
Frame=18 Station=0,1833 OutputCase=RAR078 CaseType=Combination P=-7,5941611272792 V2=4,41617458303511 V3=0 T=0 M2=0 M3=-5,29926716499904
FrameElem=18-1 ElemStation=0,1833
Frame=18 Station=0 OutputCase=RAR079 CaseType=Combination P=-15,5752686616664 V2=0,479977091155618 V3=0 T=0 M2=0 M3=4,35663060969378 FrameElem=18-1
ElemStation=0
Frame=18 Station=9,16500000000001E-02 OutputCase=RAR079 CaseType=Combination P=-15,2086686616664 V2=-2,16916615884438 V3=0 T=0 M2=0 M3=-
4,27894702980132 FrameElem=18-1 ElemStation=9,16500000000001E-02
Frame=18 Station=0,1833 OutputCase=RAR079 CaseType=Combination P=-14,8420686616664 V2=-4,78210765884439 V3=0 T=0 M2=0 M3=-3,96012841624011
FrameElem=18-1 ElemStation=0,1833

Società di Progetto
Brebemi SpA



Doc. N.
60235-0000-A00.doc

CODIFICA DOCUMENTO
04RCDII10000000000300A00

REV.
00

FOGLIO
301 di 628

Frame=18 Station=0 OutputCase=RAR080 CaseType=Combination P=-15,575268661928 V2=-7,39920387349656E-02 V3=0 T=0 M2=0 M3=0,727538406098801
FrameElem=18-1 ElemStation=0
Frame=18 Station=9,1650000000001E-02 OutputCase=RAR080 CaseType=Combination P=-15,208668661928 V2=-0,670633538734966 V3=0 T=0 M2=0
M3=0,761968863011361 FrameElem=18-1 ElemStation=9,1650000000001E-02
Frame=18 Station=0,1833 OutputCase=RAR080 CaseType=Combination P=-14,842068661928 V2=-1,22694903873497 V3=0 T=0 M2=0 M3=0,84923357444892
FrameElem=18-1 ElemStation=0,1833
Frame=18 Station=0 OutputCase=RAR081 CaseType=Combination P=-75,3352686595435 V2=-0,794099314201433 V3=0 T=0 M2=0 M3=8,59236035682341 FrameElem=18-1
ElemStation=0
Frame=18 Station=9,1650000000001E-02 OutputCase=RAR081 CaseType=Combination P=-74,9686686595435 V2=-1,39074081420143 V3=0 T=0 M2=0 M3=8,69278864553247
FrameElem=18-1 ElemStation=9,1650000000001E-02
Frame=18 Station=0,1833 OutputCase=RAR081 CaseType=Combination P=-74,6020686595435 V2=-1,94705631420143 V3=0 T=0 M2=0 M3=8,84605118876653
FrameElem=18-1 ElemStation=0,1833
Frame=18 Station=0 OutputCase=RAR082 CaseType=Combination P=-68,0873611248944 V2=8,49842095461879 V3=0 T=0 M2=0 M3=3,85502189938495 FrameElem=18-1
ElemStation=0
Frame=18 Station=9,1650000000001E-02 OutputCase=RAR082 CaseType=Combination P=-67,7207611248944 V2=5,84927770461879 V3=0 T=0 M2=0 M3=3,19781509919101
FrameElem=18-1 ElemStation=9,1650000000001E-02
Frame=18 Station=0,1833 OutputCase=RAR082 CaseType=Combination P=-67,3541611248944 V2=3,23633620461879 V3=0 T=0 M2=0 M3=2,78174333266582
FrameElem=18-1 ElemStation=0,1833
Frame=18 Station=0 OutputCase=RAR083 CaseType=Combination P=-75,3352686592816 V2=-0,699861287260704 V3=0 T=0 M2=0 M3=3,50811551320737 FrameElem=18-1
ElemStation=0
Frame=18 Station=9,1650000000001E-02 OutputCase=RAR083 CaseType=Combination P=-74,9686686592815 V2=-3,34900453726071 V3=0 T=0 M2=0 M3=3,69393128048169
FrameElem=18-1 ElemStation=9,1650000000001E-02
Frame=18 Station=0,1833 OutputCase=RAR083 CaseType=Combination P=-74,6020686592816 V2=-5,96194603726071 V3=0 T=0 M2=0 M3=4,12088208142476
FrameElem=18-1 ElemStation=0,1833
Frame=18 Station=0 OutputCase=RAR084 CaseType=Combination P=-8,32736112727883 V2=9,21852823008526 V3=0 T=0 M2=0 M3=-4,00980005133965 FrameElem=18-1
ElemStation=0
Frame=18 Station=9,1650000000001E-02 OutputCase=RAR084 CaseType=Combination P=-7,96076112727883 V2=6,56938498008526 V3=0 T=0 M2=0 M3=-4,73300468333009
FrameElem=18-1 ElemStation=9,1650000000001E-02
Frame=18 Station=0,1833 OutputCase=RAR084 CaseType=Combination P=-7,59416112727883 V2=3,95644348008526 V3=0 T=0 M2=0 M3=-5,21507428165178
FrameElem=18-1 ElemStation=0,1833
Frame=18 Station=0 OutputCase=RAR085 CaseType=Combination P=-15,575268661666 V2=2,02459882057639E-02 V3=0 T=0 M2=0 M3=-4,35670643751723 FrameElem=18-1
ElemStation=0
Frame=18 Station=9,1650000000001E-02 OutputCase=RAR085 CaseType=Combination P=-15,208668661666 V2=-2,62889726179424 V3=0 T=0 M2=0 M3=-4,23688850203942
FrameElem=18-1 ElemStation=9,1650000000001E-02
Frame=18 Station=0,1833 OutputCase=RAR085 CaseType=Combination P=-14,842068661666 V2=-5,24183876179424 V3=0 T=0 M2=0 M3=-3,87593553289285
FrameElem=18-1 ElemStation=0,1833
Frame=18 Station=0 OutputCase=RAR086 CaseType=Combination P=-15,5752686619287 V2=0,845470167164743 V3=0 T=0 M2=0 M3=0,727690061745698 FrameElem=18-1
ElemStation=0
Frame=18 Station=9,1650000000001E-02 OutputCase=RAR086 CaseType=Combination P=-15,2086686619287 V2=0,248828667164742 V3=0 T=0 M2=0
M3=0,677851807487549 FrameElem=18-1 ElemStation=9,1650000000001E-02
Frame=18 Station=0,1833 OutputCase=RAR086 CaseType=Combination P=-14,8420686619287 V2=-0,307486832835258 V3=0 T=0 M2=0 M3=0,680847807754401
FrameElem=18-1 ElemStation=0,1833
Frame=18 Station=0 OutputCase=RAR087 CaseType=Combination P=-75,3352686595442 V2=0,125362891698275 V3=0 T=0 M2=0 M3=8,5925120124703 FrameElem=18-1
ElemStation=0
Frame=18 Station=9,1650000000001E-02 OutputCase=RAR087 CaseType=Combination P=-74,9686686595442 V2=-0,471278608301726 V3=0 T=0 M2=0
M3=8,60867159000866 FrameElem=18-1 ElemStation=9,1650000000001E-02
Frame=18 Station=0,1833 OutputCase=RAR087 CaseType=Combination P=-74,6020686595442 V2=-1,02759410830173 V3=0 T=0 M2=0 M3=8,67766542207201
FrameElem=18-1 ElemStation=0,1833
Frame=18 Station=0 OutputCase=RAR088 CaseType=Combination P=-68,0873611248951 V2=9,4178831605185 V3=0 T=0 M2=0 M3=3,85517355503185 FrameElem=18-1
ElemStation=0
Frame=18 Station=9,1650000000001E-02 OutputCase=RAR088 CaseType=Combination P=-67,7207611248951 V2=6,7687399105185 V3=0 T=0 M2=0 M3=3,1136980436672
FrameElem=18-1 ElemStation=9,1650000000001E-02
Frame=18 Station=0,1833 OutputCase=RAR088 CaseType=Combination P=-67,3541611248951 V2=4,1557984105185 V3=0 T=0 M2=0 M3=2,61335756597131 FrameElem=18-1
ElemStation=0,1833
Frame=18 Station=0 OutputCase=RAR089 CaseType=Combination P=-75,3352686592823 V2=0,219600918639004 V3=0 T=0 M2=0 M3=3,50826716885427 FrameElem=18-1
ElemStation=0
Frame=18 Station=9,1650000000001E-02 OutputCase=RAR089 CaseType=Combination P=-74,9686686592823 V2=-2,429542331361 V3=0 T=0 M2=0 M3=3,60981422495788
FrameElem=18-1 ElemStation=9,1650000000001E-02
Frame=18 Station=0,1833 OutputCase=RAR089 CaseType=Combination P=-74,6020686592823 V2=-5,042483831361 V3=0 T=0 M2=0 M3=3,95249631473024 FrameElem=18-1
ElemStation=0,1833
Frame=18 Station=0 OutputCase=RAR090 CaseType=Combination P=-8,32736112727958 V2=10,137990435985 V3=0 T=0 M2=0 M3=-4,00964839569276 FrameElem=18-1
ElemStation=0
Frame=18 Station=9,1650000000001E-02 OutputCase=RAR090 CaseType=Combination P=-7,96076112727958 V2=7,48884718598497 V3=0 T=0 M2=0 M3=-4,8171217388539
FrameElem=18-1 ElemStation=9,1650000000001E-02
Frame=18 Station=0,1833 OutputCase=RAR090 CaseType=Combination P=-7,59416112727958 V2=4,87590568598497 V3=0 T=0 M2=0 M3=-5,3834600483463
FrameElem=18-1 ElemStation=0,1833
Frame=18 Station=0 OutputCase=RAR091 CaseType=Combination P=-15,5752686616668 V2=0,939708194105472 V3=0 T=0 M2=0 M3=-4,35655478187034 FrameElem=18-1
ElemStation=0
Frame=18 Station=9,1650000000001E-02 OutputCase=RAR091 CaseType=Combination P=-15,2086686616668 V2=-1,70943505589453 V3=0 T=0 M2=0 M3=-
4,32100555756323 FrameElem=18-1 ElemStation=9,1650000000001E-02
Frame=18 Station=0,1833 OutputCase=RAR091 CaseType=Combination P=-14,8420686616668 V2=-4,32237655589453 V3=0 T=0 M2=0 M3=-4,04432129958737
FrameElem=18-1 ElemStation=0,1833
Frame=18 Station=0 OutputCase=RAR092 CaseType=Combination P=-15,5752686619287 V2=0,845470167164743 V3=0 T=0 M2=0 M3=0,727690061745698 FrameElem=18-1
ElemStation=0
Frame=18 Station=9,1650000000001E-02 OutputCase=RAR092 CaseType=Combination P=-15,2086686619287 V2=0,248828667164742 V3=0 T=0 M2=0
M3=0,677851807487549 FrameElem=18-1 ElemStation=9,1650000000001E-02
Frame=18 Station=0,1833 OutputCase=RAR092 CaseType=Combination P=-14,8420686619287 V2=-0,307486832835258 V3=0 T=0 M2=0 M3=0,680847807754401
FrameElem=18-1 ElemStation=0,1833
Frame=18 Station=0 OutputCase=RAR093 CaseType=Combination P=-75,3352686595442 V2=0,125362891698275 V3=0 T=0 M2=0 M3=8,5925120124703 FrameElem=18-1
ElemStation=0
Frame=18 Station=9,1650000000001E-02 OutputCase=RAR093 CaseType=Combination P=-74,9686686595442 V2=-0,471278608301726 V3=0 T=0 M2=0
M3=8,60867159000866 FrameElem=18-1 ElemStation=9,1650000000001E-02
Frame=18 Station=0,1833 OutputCase=RAR093 CaseType=Combination P=-74,6020686595442 V2=-1,02759410830173 V3=0 T=0 M2=0 M3=8,67766542207201
FrameElem=18-1 ElemStation=0,1833
Frame=18 Station=0 OutputCase=RAR094 CaseType=Combination P=-68,0873611248951 V2=9,4178831605185 V3=0 T=0 M2=0 M3=3,85517355503185 FrameElem=18-1
ElemStation=0
Frame=18 Station=9,1650000000001E-02 OutputCase=RAR094 CaseType=Combination P=-67,7207611248951 V2=6,7687399105185 V3=0 T=0 M2=0 M3=3,1136980436672
FrameElem=18-1 ElemStation=9,1650000000001E-02

APPROVATO SDP
Società di Progetto
Brebemi SpA



Doc. N.
60235-0000-A00.doc

CODIFICA DOCUMENTO
04RCDII10000000000300A00

REV.
00

FOGLIO
302 di 628

Frame=18 Station=0,1833 OutputCase=RAR094 CaseType=Combination P=-67,3541611248951 V2=4,1557984105185 V3=0 T=0 M2=0 M3=2,61335756597131 FrameElem=18-1 ElemStation=0,1833
Frame=18 Station=0 OutputCase=RAR095 CaseType=Combination P=-75,3352686592823 V2=0,219600918639004 V3=0 T=0 M2=0 M3=3,50826716885427 FrameElem=18-1 ElemStation=0
Frame=18 Station=9,1650000000001E-02 OutputCase=RAR095 CaseType=Combination P=-74,9686686592823 V2=-2,429542331361 V3=0 T=0 M2=0 M3=3,60981422495788 FrameElem=18-1 ElemStation=9,1650000000001E-02
Frame=18 Station=0,1833 OutputCase=RAR095 CaseType=Combination P=-74,6020686592823 V2=-5,042483831361 V3=0 T=0 M2=0 M3=3,95249631473024 FrameElem=18-1 ElemStation=0,1833
Frame=18 Station=0 OutputCase=RAR096 CaseType=Combination P=-8,32736112727958 V2=10,137990435985 V3=0 T=0 M2=0 M3=-4,00964839569276 FrameElem=18-1 ElemStation=0
Frame=18 Station=9,1650000000001E-02 OutputCase=RAR096 CaseType=Combination P=-7,96076112727958 V2=7,48884718598497 V3=0 T=0 M2=0 M3=-4,8171217388539 FrameElem=18-1 ElemStation=9,1650000000001E-02
Frame=18 Station=0,1833 OutputCase=RAR096 CaseType=Combination P=-7,59416112727958 V2=4,87590568598497 V3=0 T=0 M2=0 M3=-5,3834600483463 FrameElem=18-1 ElemStation=0,1833
Frame=18 Station=0 OutputCase=RAR097 CaseType=Combination P=-15,5752686616668 V2=0,939708194105472 V3=0 T=0 M2=0 M3=-4,35655478187034 FrameElem=18-1 ElemStation=0
Frame=18 Station=9,1650000000001E-02 OutputCase=RAR097 CaseType=Combination P=-15,2086686616668 V2=-1,70943505589453 V3=0 T=0 M2=0 M3=-4,3210055756323 FrameElem=18-1 ElemStation=9,1650000000001E-02
Frame=18 Station=0,1833 OutputCase=RAR097 CaseType=Combination P=-14,8420686616668 V2=-4,32237655589453 V3=0 T=0 M2=0 M3=-4,04432129958737 FrameElem=18-1 ElemStation=0,1833
Frame=18 Station=0 OutputCase=RAR098 CaseType=Combination P=-14,3039313362339 V2=-0,250019293309791 V3=0 T=0 M2=0 M3=2,73139259030302E-02 FrameElem=18-1 ElemStation=0
Frame=18 Station=9,1650000000001E-02 OutputCase=RAR098 CaseType=Combination P=-13,9373313362339 V2=-0,846660793309791 V3=0 T=0 M2=0 M3=7,78772806973724E-02 FrameElem=18-1 ElemStation=9,1650000000001E-02
Frame=18 Station=0,1833 OutputCase=RAR098 CaseType=Combination P=-13,5707313362339 V2=-1,40297629330979 V3=0 T=0 M2=0 M3=0,181274890016715 FrameElem=18-1 ElemStation=0,1833
Frame=18 Station=0 OutputCase=RAR099 CaseType=Combination P=-94,2381987981935 V2=-1,08301065576015 V3=0 T=0 M2=0 M3=10,6538032551397 FrameElem=18-1 ElemStation=0
Frame=18 Station=9,1650000000001E-02 OutputCase=RAR099 CaseType=Combination P=-93,8715987981935 V2=-1,67965215576015 V3=0 T=0 M2=0 M3=10,7807102683026 FrameElem=18-1 ElemStation=9,1650000000001E-02
Frame=18 Station=0,1833 OutputCase=RAR099 CaseType=Combination P=-93,5049987981935 V2=-2,23596765576015 V3=0 T=0 M2=0 M3=10,9604515359905 FrameElem=18-1 ElemStation=0,1833
Frame=18 Station=0 OutputCase=RAR100 CaseType=Combination P=-84,8970547076751 V2=10,9665136287898 V3=0 T=0 M2=0 M3=4,61904233263329 FrameElem=18-1 ElemStation=0
Frame=18 Station=9,1650000000001E-02 OutputCase=RAR100 CaseType=Combination P=-84,5304547076751 V2=7,75120250378984 V3=0 T=0 M2=0 M3=3,76150948403595 FrameElem=18-1 ElemStation=9,1650000000001E-02
Frame=18 Station=0,1833 OutputCase=RAR100 CaseType=Combination P=-84,1638547076751 V2=4,56292812878984 V3=0 T=0 M2=0 M3=3,19742094097611 FrameElem=18-1 ElemStation=0,1833
Frame=18 Station=0 OutputCase=RAR101 CaseType=Combination P=-94,2381987978733 V2=-0,858917100229146 V3=0 T=0 M2=0 M3=4,18069933509821 FrameElem=18-1 ElemStation=0
Frame=18 Station=9,1650000000001E-02 OutputCase=RAR101 CaseType=Combination P=-93,8715987978733 V2=-4,07422822522915 V3=0 T=0 M2=0 M3=4,40696721281546 FrameElem=18-1 ElemStation=9,1650000000001E-02
Frame=18 Station=0,1833 OutputCase=RAR101 CaseType=Combination P=-93,5049987978733 V2=-7,26250260022915 V3=0 T=0 M2=0 M3=4,92667939607022 FrameElem=18-1 ElemStation=0,1833
Frame=18 Station=0 OutputCase=RAR102 CaseType=Combination P=-5,21705471085442 V2=11,9266566627451 V3=0 T=0 M2=0 M3=-5,86738693499952 FrameElem=18-1 ElemStation=0
Frame=18 Station=9,1650000000001E-02 OutputCase=RAR102 CaseType=Combination P=-4,85045471085442 V2=8,71134553774513 V3=0 T=0 M2=0 M3=-6,81291689265886 FrameElem=18-1 ElemStation=9,1650000000001E-02
Frame=18 Station=0,1833 OutputCase=RAR102 CaseType=Combination P=-4,48385471085442 V2=5,52307116274513 V3=0 T=0 M2=0 M3=-7,4650025447807 FrameElem=18-1 ElemStation=0,1833
Frame=18 Station=0 OutputCase=RAR103 CaseType=Combination P=-14,5581988010526 V2=0,101225933726144 V3=0 T=0 M2=0 M3=-6,30572993253459 FrameElem=18-1 ElemStation=0
Frame=18 Station=9,1650000000001E-02 OutputCase=RAR103 CaseType=Combination P=-14,1915988010526 V2=-3,11408519127386 V3=0 T=0 M2=0 M3=-6,16745916387934 FrameElem=18-1 ElemStation=9,1650000000001E-02
Frame=18 Station=0,1833 OutputCase=RAR103 CaseType=Combination P=-13,8249988010526 V2=-6,30235956627386 V3=0 T=0 M2=0 M3=-5,7357440896866 FrameElem=18-1 ElemStation=0,1833
Frame=18 Station=0 OutputCase=RAR104 CaseType=Combination P=-52,72207719351 V2=22,3105453757734 V3=0 T=0 M2=0 M3=2,88919203990069 FrameElem=18-1 ElemStation=0
Frame=18 Station=9,1650000000001E-02 OutputCase=RAR104 CaseType=Combination P=-52,355607719351 V2=19,6614021257734 V3=0 T=0 M2=0 M3=0,966104036507932 FrameElem=18-1 ElemStation=9,1650000000001E-02
Frame=18 Station=0,1833 OutputCase=RAR104 CaseType=Combination P=-51,989007719351 V2=17,0484606257734 V3=0 T=0 M2=0 M3=-0,715848933216075 FrameElem=18-1 ElemStation=0,1833
Frame=18 Station=0 OutputCase=RAR105 CaseType=Combination P=-74,0639313338494 V2=-0,970126568776259 V3=0 T=0 M2=0 M3=7,89213587662764 FrameElem=18-1 ElemStation=0
Frame=18 Station=9,1650000000001E-02 OutputCase=RAR105 CaseType=Combination P=-73,6973313338494 V2=-1,56676806877626 V3=0 T=0 M2=0 M3=8,00869706321848 FrameElem=18-1 ElemStation=9,1650000000001E-02
Frame=18 Station=0,1833 OutputCase=RAR105 CaseType=Combination P=-73,3307313338494 V2=-2,12308356877626 V3=0 T=0 M2=0 M3=8,17809250433432 FrameElem=18-1 ElemStation=0,1833
Frame=18 Station=0 OutputCase=RAR106 CaseType=Combination P=-66,8160237992003 V2=8,32239370004397 V3=0 T=0 M2=0 M3=3,15479741918918 FrameElem=18-1 ElemStation=0
Frame=18 Station=9,1650000000001E-02 OutputCase=RAR106 CaseType=Combination P=-66,4494237992003 V2=5,67325045004397 V3=0 T=0 M2=0 M3=2,51372351687702 FrameElem=18-1 ElemStation=9,1650000000001E-02
Frame=18 Station=0,1833 OutputCase=RAR106 CaseType=Combination P=-66,0828237992003 V2=3,06030895004396 V3=0 T=0 M2=0 M3=2,11378464823362 FrameElem=18-1 ElemStation=0,1833
Frame=18 Station=0 OutputCase=RAR107 CaseType=Combination P=-74,0639313335875 V2=-0,875888541835529 V3=0 T=0 M2=0 M3=2,8078910330116 FrameElem=18-1 ElemStation=0
Frame=18 Station=9,1650000000001E-02 OutputCase=RAR107 CaseType=Combination P=-73,6973313335875 V2=-3,52503179183553 V3=0 T=0 M2=0 M3=3,0098396981677 FrameElem=18-1 ElemStation=9,1650000000001E-02
Frame=18 Station=0,1833 OutputCase=RAR107 CaseType=Combination P=-73,3307313335875 V2=-6,13797329183553 V3=0 T=0 M2=0 M3=3,45292339699255 FrameElem=18-1 ElemStation=0,1833
Frame=18 Station=0 OutputCase=RAR108 CaseType=Combination P=-7,05602380158476 V2=9,04250097551044 V3=0 T=0 M2=0 M3=-4,71002453153542 FrameElem=18-1 ElemStation=0
Frame=18 Station=9,1650000000001E-02 OutputCase=RAR108 CaseType=Combination P=-6,68942380158476 V2=6,39335772551043 V3=0 T=0 M2=0 M3=-5,41709628564408 FrameElem=18-1 ElemStation=9,1650000000001E-02
Frame=18 Station=0,1833 OutputCase=RAR108 CaseType=Combination P=-6,32282380158476 V2=3,78041622551043 V3=0 T=0 M2=0 M3=-5,88303296608399 FrameElem=18-1 ElemStation=0,1833
Frame=18 Station=0 OutputCase=RAR109 CaseType=Combination P=-14,303931335972 V2=-0,155781266369061 V3=0 T=0 M2=0 M3=-5,056930917713 FrameElem=18-1 ElemStation=0

Società di Progetto
Brebemi SpA



Doc. N.
60235-0000-A00.doc

CODIFICA DOCUMENTO
04RCDII10000000000300A00

REV.
00

FOGLIO
303 di 628

Frame=18 Station=9,16500000000001E-02 OutputCase=RAR109 CaseType=Combination P=-13,93731335972 V2=-2,80492451636906 V3=0 T=0 M2=0 M3=-4,9209800843534
FrameElem=18-1 ElemStation=9,16500000000001E-02
Frame=18 Station=0,1833 OutputCase=RAR109 CaseType=Combination P=-13,570731335972 V2=-5,41786601636907 V3=0 T=0 M2=0 M3=-4,54389421732505
FrameElem=18-1 ElemStation=0,1833
Frame=18 Station=0 OutputCase=RAR110 CaseType=Combination P=-14,3039313362335 V2=-0,709750396259645 V3=0 T=0 M2=0 M3=2,72380980795816E-02
FrameElem=18-1 ElemStation=0
Frame=18 Station=9,16500000000001E-02 OutputCase=RAR110 CaseType=Combination P=-13,937313362335 V2=-1,30639189625965 V3=0 T=0 M2=0
M3=0,119935808459278 FrameElem=18-1 ElemStation=9,16500000000001E-02
Frame=18 Station=0,1833 OutputCase=RAR110 CaseType=Combination P=-13,5707313362335 V2=-1,86270739625965 V3=0 T=0 M2=0 M3=0,265467773363975
FrameElem=18-1 ElemStation=0,1833
Frame=18 Station=0 OutputCase=RAR111 CaseType=Combination P=-74,063931333849 V2=-1,42985767172611 V3=0 T=0 M2=0 M3=7,89206004880419 FrameElem=18-1
ElemStation=0
Frame=18 Station=9,16500000000001E-02 OutputCase=RAR111 CaseType=Combination P=-73,697331333849 V2=-2,02649917172611 V3=0 T=0 M2=0 M3=8,05075559098039
FrameElem=18-1 ElemStation=9,16500000000001E-02
Frame=18 Station=0,1833 OutputCase=RAR111 CaseType=Combination P=-73,330731333849 V2=-2,58281467172611 V3=0 T=0 M2=0 M3=8,26228538768158
FrameElem=18-1 ElemStation=0,1833
Frame=18 Station=0 OutputCase=RAR112 CaseType=Combination P=-66,8160237991999 V2=7,86266259709411 V3=0 T=0 M2=0 M3=3,15472159136573 FrameElem=18-1
ElemStation=0
Frame=18 Station=9,16500000000001E-02 OutputCase=RAR112 CaseType=Combination P=-66,4494237991999 V2=5,21351934709411 V3=0 T=0 M2=0 M3=2,55578204463893
FrameElem=18-1 ElemStation=9,16500000000001E-02
Frame=18 Station=0,1833 OutputCase=RAR112 CaseType=Combination P=-66,0828237991999 V2=2,60057784709411 V3=0 T=0 M2=0 M3=2,19797753158088
FrameElem=18-1 ElemStation=0,1833
Frame=18 Station=0 OutputCase=RAR113 CaseType=Combination P=-74,0639313335871 V2=-1,33561964478538 V3=0 T=0 M2=0 M3=2,80781520518815 FrameElem=18-1
ElemStation=0
Frame=18 Station=9,16500000000001E-02 OutputCase=RAR113 CaseType=Combination P=-73,6973313335871 V2=-3,98476289478538 V3=0 T=0 M2=0 M3=3,05189822592961
FrameElem=18-1 ElemStation=9,16500000000001E-02
Frame=18 Station=0,1833 OutputCase=RAR113 CaseType=Combination P=-73,3307313335871 V2=-6,59770439478539 V3=0 T=0 M2=0 M3=3,53711628033981
FrameElem=18-1 ElemStation=0,1833
Frame=18 Station=0 OutputCase=RAR114 CaseType=Combination P=-7,05602380158438 V2=8,58276987256058 V3=0 T=0 M2=0 M3=-4,71010035935887 FrameElem=18-1
ElemStation=0
Frame=18 Station=9,16500000000001E-02 OutputCase=RAR114 CaseType=Combination P=-6,68942380158438 V2=5,93362662256058 V3=0 T=0 M2=0 M3=-5,37503773788218
FrameElem=18-1 ElemStation=9,16500000000001E-02
Frame=18 Station=0,1833 OutputCase=RAR114 CaseType=Combination P=-6,32282380158438 V2=3,32068512256058 V3=0 T=0 M2=0 M3=-5,79884008273673
FrameElem=18-1 ElemStation=0,1833
Frame=18 Station=0 OutputCase=RAR115 CaseType=Combination P=-14,3039313359716 V2=-0,615512369318915 V3=0 T=0 M2=0 M3=-5,05700674553645 FrameElem=18-1
ElemStation=0
Frame=18 Station=9,16500000000001E-02 OutputCase=RAR115 CaseType=Combination P=-13,937313359716 V2=-3,26465561931892 V3=0 T=0 M2=0 M3=-4,8789215565915
FrameElem=18-1 ElemStation=9,16500000000001E-02
Frame=18 Station=0,1833 OutputCase=RAR115 CaseType=Combination P=-13,5707313359716 V2=-5,87759711931892 V3=0 T=0 M2=0 M3=-4,45970133397779
FrameElem=18-1 ElemStation=0,1833
Frame=18 Station=0 OutputCase=RAR116 CaseType=Combination P=-14,3039313362343 V2=0,209711809640063 V3=0 T=0 M2=0 M3=2,73897537264787E-02
FrameElem=18-1 ElemStation=0
Frame=18 Station=9,16500000000001E-02 OutputCase=RAR116 CaseType=Combination P=-13,937313362343 V2=-0,386929690359937 V3=0 T=0 M2=0
M3=3,58187529354668E-02 FrameElem=18-1 ElemStation=9,16500000000001E-02
Frame=18 Station=0,1833 OutputCase=RAR116 CaseType=Combination P=-13,5707313362343 V2=-0,943245190359937 V3=0 T=0 M2=0 M3=9,70820066694552E-02
FrameElem=18-1 ElemStation=0,1833
Frame=18 Station=0 OutputCase=RAR117 CaseType=Combination P=-74,0639313338498 V2=-0,510395465826404 V3=0 T=0 M2=0 M3=7,89221170445108 FrameElem=18-1
ElemStation=0
Frame=18 Station=9,16500000000001E-02 OutputCase=RAR117 CaseType=Combination P=-73,6973313338498 V2=-1,1070369658264 V3=0 T=0 M2=0 M3=7,96663853545657
FrameElem=18-1 ElemStation=9,16500000000001E-02
Frame=18 Station=0,1833 OutputCase=RAR117 CaseType=Combination P=-73,3307313338498 V2=-1,66335246582641 V3=0 T=0 M2=0 M3=8,09389962098706
FrameElem=18-1 ElemStation=0,1833
Frame=18 Station=0 OutputCase=RAR118 CaseType=Combination P=-66,8160237992007 V2=8,78212480299382 V3=0 T=0 M2=0 M3=3,15487324701263 FrameElem=18-1
ElemStation=0
Frame=18 Station=9,16500000000001E-02 OutputCase=RAR118 CaseType=Combination P=-66,4494237992006 V2=6,13298155299382 V3=0 T=0 M2=0 M3=2,47166498911512
FrameElem=18-1 ElemStation=9,16500000000001E-02
Frame=18 Station=0,1833 OutputCase=RAR118 CaseType=Combination P=-66,0828237992007 V2=3,52004005299382 V3=0 T=0 M2=0 M3=2,02959176488636
FrameElem=18-1 ElemStation=0,1833
Frame=18 Station=0 OutputCase=RAR119 CaseType=Combination P=-74,0639313335878 V2=-0,416157438885675 V3=0 T=0 M2=0 M3=2,80796686083505 FrameElem=18-1
ElemStation=0
Frame=18 Station=9,16500000000001E-02 OutputCase=RAR119 CaseType=Combination P=-73,6973313335878 V2=-3,06530068888568 V3=0 T=0 M2=0 M3=2,9677811704508
FrameElem=18-1 ElemStation=9,16500000000001E-02
Frame=18 Station=0,1833 OutputCase=RAR119 CaseType=Combination P=-73,3307313335878 V2=-5,67824218888568 V3=0 T=0 M2=0 M3=3,36873051364529
FrameElem=18-1 ElemStation=0,1833
Frame=18 Station=0 OutputCase=RAR120 CaseType=Combination P=-7,05602380158513 V2=9,50223207846029 V3=0 T=0 M2=0 M3=-4,70994870371198 FrameElem=18-1
ElemStation=0
Frame=18 Station=9,16500000000001E-02 OutputCase=RAR120 CaseType=Combination P=-6,68942380158513 V2=6,85308882846029 V3=0 T=0 M2=0 M3=-5,45915479340599
FrameElem=18-1 ElemStation=9,16500000000001E-02
Frame=18 Station=0,1833 OutputCase=RAR120 CaseType=Combination P=-6,32282380158513 V2=4,24014732846029 V3=0 T=0 M2=0 M3=-5,96722584943125
FrameElem=18-1 ElemStation=0,1833
Frame=18 Station=0 OutputCase=RAR121 CaseType=Combination P=-14,3039313359723 V2=0,303949836580793 V3=0 T=0 M2=0 M3=-5,05685508988956 FrameElem=18-1
ElemStation=0
Frame=18 Station=9,16500000000001E-02 OutputCase=RAR121 CaseType=Combination P=-13,937313359723 V2=-2,34519341341921 V3=0 T=0 M2=0 M3=-
4,96303861211531 FrameElem=18-1 ElemStation=9,16500000000001E-02
Frame=18 Station=0,1833 OutputCase=RAR121 CaseType=Combination P=-13,5707313359723 V2=-4,95813491341921 V3=0 T=0 M2=0 M3=-4,62808710067231
FrameElem=18-1 ElemStation=0,1833
Frame=18 Station=0 OutputCase=RAR122 CaseType=Combination P=-14,3039313362343 V2=0,209711809640063 V3=0 T=0 M2=0 M3=2,73897537264787E-02
FrameElem=18-1 ElemStation=0
Frame=18 Station=9,16500000000001E-02 OutputCase=RAR122 CaseType=Combination P=-13,937313362343 V2=-0,386929690359937 V3=0 T=0 M2=0
M3=3,58187529354668E-02 FrameElem=18-1 ElemStation=9,16500000000001E-02
Frame=18 Station=0,1833 OutputCase=RAR122 CaseType=Combination P=-13,5707313362343 V2=-0,943245190359937 V3=0 T=0 M2=0 M3=9,70820066694551E-02
FrameElem=18-1 ElemStation=0,1833
Frame=18 Station=0 OutputCase=RAR123 CaseType=Combination P=-74,0639313338498 V2=-0,510395465826404 V3=0 T=0 M2=0 M3=7,89221170445108 FrameElem=18-1
ElemStation=0
Frame=18 Station=9,16500000000001E-02 OutputCase=RAR123 CaseType=Combination P=-73,6973313338498 V2=-1,1070369658264 V3=0 T=0 M2=0 M3=7,96663853545657
FrameElem=18-1 ElemStation=9,16500000000001E-02
Frame=18 Station=0,1833 OutputCase=RAR123 CaseType=Combination P=-73,3307313338498 V2=-1,66335246582641 V3=0 T=0 M2=0 M3=8,09389962098706
FrameElem=18-1 ElemStation=0,1833

Società di Progetto
Brebemi SpA



Doc. N.
60235-00000-A00.doc

CODIFICA DOCUMENTO
04RCDII10000000000300A00

REV.
00

FOGLIO
304 di 628

Frame=18 Station=0 OutputCase=RAR124 CaseType=Combination P=-66,8160237992007 V2=8,78212480299382 V3=0 T=0 M2=0 M3=3,15487324701263 FrameElem=18-1 ElemStation=0
Frame=18 Station=9,1650000000001E-02 OutputCase=RAR124 CaseType=Combination P=-66,4494237992006 V2=6,13298155299382 V3=0 T=0 M2=0 M3=2,47166498911512 FrameElem=18-1 ElemStation=9,1650000000001E-02
Frame=18 Station=0,1833 OutputCase=RAR124 CaseType=Combination P=-66,0828237992007 V2=3,52004005299382 V3=0 T=0 M2=0 M3=2,02959176488636 FrameElem=18-1 ElemStation=0,1833
Frame=18 Station=0 OutputCase=RAR125 CaseType=Combination P=-74,0639313335878 V2=-0,416157438885675 V3=0 T=0 M2=0 M3=2,80796686083505 FrameElem=18-1 ElemStation=0
Frame=18 Station=9,1650000000001E-02 OutputCase=RAR125 CaseType=Combination P=-73,6973313335878 V2=-3,06530068888568 V3=0 T=0 M2=0 M3=2,9677811704058 FrameElem=18-1 ElemStation=9,1650000000001E-02
Frame=18 Station=0,1833 OutputCase=RAR125 CaseType=Combination P=-73,3307313335878 V2=-5,67824218888568 V3=0 T=0 M2=0 M3=3,36873051364529 FrameElem=18-1 ElemStation=0,1833
Frame=18 Station=0 OutputCase=RAR126 CaseType=Combination P=-7,05602380158513 V2=9,50223207846029 V3=0 T=0 M2=0 M3=-4,70994870371198 FrameElem=18-1 ElemStation=0
Frame=18 Station=9,1650000000001E-02 OutputCase=RAR126 CaseType=Combination P=-6,68942380158513 V2=6,85308882846029 V3=0 T=0 M2=0 M3=-5,45915479340599 FrameElem=18-1 ElemStation=9,1650000000001E-02
Frame=18 Station=0,1833 OutputCase=RAR126 CaseType=Combination P=-6,32282380158513 V2=4,24014732846029 V3=0 T=0 M2=0 M3=-5,96722584943125 FrameElem=18-1 ElemStation=0,1833
Frame=18 Station=0 OutputCase=RAR127 CaseType=Combination P=-14,3039313359723 V2=0,303949836580793 V3=0 T=0 M2=0 M3=-5,05685508988956 FrameElem=18-1 ElemStation=0
Frame=18 Station=9,1650000000001E-02 OutputCase=RAR127 CaseType=Combination P=-13,9373313359723 V2=-2,34519341341921 V3=0 T=0 M2=0 M3=-4,96303861211531 FrameElem=18-1 ElemStation=9,1650000000001E-02
Frame=18 Station=0,1833 OutputCase=RAR127 CaseType=Combination P=-13,5707313359723 V2=-4,95813491341921 V3=0 T=0 M2=0 M3=-4,62808710067231 FrameElem=18-1 ElemStation=0,1833
Frame=18 Station=0 OutputCase=RAR128 CaseType=Combination P=-14,939599990817 V2=0,834078390368973 V3=0 T=0 M2=0 M3=0,377590459618387 FrameElem=18-1 ElemStation=0
Frame=18 Station=9,1650000000001E-02 OutputCase=RAR128 CaseType=Combination P=-14,5729999990817 V2=0,237436890368972 V3=0 T=0 M2=0 M3=0,328796261703571 FrameElem=18-1 ElemStation=9,1650000000001E-02
Frame=18 Station=0,1833 OutputCase=RAR128 CaseType=Combination P=-14,2063999990817 V2=0,318878609631028 V3=0 T=0 M2=0 M3=0,332836318313755 FrameElem=18-1 ElemStation=0,1833
Frame=18 Station=0 OutputCase=RAR129 CaseType=Combination P=-94,6195999959022 V2=-0,432552045552887 V3=0 T=0 M2=0 M3=10,8639691753689 FrameElem=18-1 ElemStation=0
Frame=18 Station=9,1650000000001E-02 OutputCase=RAR129 CaseType=Combination P=-94,2529999959022 V2=-1,02919354555289 V3=0 T=0 M2=0 M3=10,9312616569063 FrameElem=18-1 ElemStation=9,1650000000001E-02
Frame=18 Station=0,1833 OutputCase=RAR129 CaseType=Combination P=-93,8863999959022 V2=-1,5855094555289 V3=0 T=0 M2=0 M3=11,0513883929687 FrameElem=18-1 ElemStation=0,1833
Frame=18 Station=0 OutputCase=RAR130 CaseType=Combination P=-85,2784559053838 V2=11,6169722389971 V3=0 T=0 M2=0 M3=4,8292082528625 FrameElem=18-1 ElemStation=0
Frame=18 Station=9,1650000000001E-02 OutputCase=RAR130 CaseType=Combination P=-84,9118559053838 V2=8,4016611139971 V3=0 T=0 M2=0 M3=3,91206087263967 FrameElem=18-1 ElemStation=9,1650000000001E-02
Frame=18 Station=0,1833 OutputCase=RAR130 CaseType=Combination P=-84,5452559053838 V2=5,2133867389971 V3=0 T=0 M2=0 M3=3,28835779795433 FrameElem=18-1 ElemStation=0,1833
Frame=18 Station=0 OutputCase=RAR131 CaseType=Combination P=-94,619599995582 V2=-0,208458490021889 V3=0 T=0 M2=0 M3=4,39086525532743 FrameElem=18-1 ElemStation=0
Frame=18 Station=9,1650000000001E-02 OutputCase=RAR131 CaseType=Combination P=-94,252999995582 V2=-3,42376961502189 V3=0 T=0 M2=0 M3=4,55751860141918 FrameElem=18-1 ElemStation=9,1650000000001E-02
Frame=18 Station=0,1833 OutputCase=RAR131 CaseType=Combination P=-93,886399995582 V2=-6,61204399002189 V3=0 T=0 M2=0 M3=5,01761625304844 FrameElem=18-1 ElemStation=0,1833
Frame=18 Station=0 OutputCase=RAR132 CaseType=Combination P=-5,59845590856313 V2=12,5771152729524 V3=0 T=0 M2=0 M3=-5,6572210147703 FrameElem=18-1 ElemStation=0
Frame=18 Station=9,1650000000001E-02 OutputCase=RAR132 CaseType=Combination P=-5,23185590856313 V2=9,36180414795239 V3=0 T=0 M2=0 M3=-6,66236550405514 FrameElem=18-1 ElemStation=9,1650000000001E-02
Frame=18 Station=0,1833 OutputCase=RAR132 CaseType=Combination P=-4,86525590856313 V2=6,17352977295239 V3=0 T=0 M2=0 M3=-7,37406568780248 FrameElem=18-1 ElemStation=0,1833
Frame=18 Station=0 OutputCase=RAR133 CaseType=Combination P=-14,9395999987613 V2=0,751684543933402 V3=0 T=0 M2=0 M3=-6,09556401230538 FrameElem=18-1 ElemStation=0
Frame=18 Station=9,1650000000001E-02 OutputCase=RAR133 CaseType=Combination P=-14,5729999987613 V2=-2,4636265810666 V3=0 T=0 M2=0 M3=-6,0169077527562 FrameElem=18-1 ElemStation=9,1650000000001E-02
Frame=18 Station=0,1833 OutputCase=RAR133 CaseType=Combination P=-14,2063999987613 V2=-5,6519009560666 V3=0 T=0 M2=0 M3=-5,64480723270837 FrameElem=18-1 ElemStation=0,1833
Frame=18 Station=0 OutputCase=RAR134 CaseType=Combination P=-53,1036089170597 V2=22,9610039859806 V3=0 T=0 M2=0 M3=3,0993579601299 FrameElem=18-1 ElemStation=0
Frame=18 Station=9,1650000000001E-02 OutputCase=RAR134 CaseType=Combination P=-52,7370089170597 V2=20,3118607359806 V3=0 T=0 M2=0 M3=1,11665542511165 FrameElem=18-1 ElemStation=9,1650000000001E-02
Frame=18 Station=0,1833 OutputCase=RAR134 CaseType=Combination P=-52,3704089170597 V2=17,6989192359806 V3=0 T=0 M2=0 M3=-0,624912076237852 FrameElem=18-1 ElemStation=0,1833
Frame=18 Station=0 OutputCase=RAR135 CaseType=Combination P=-74,6995999966973 V2=0,113971114902505 V3=0 T=0 M2=0 M3=8,24241241034299 FrameElem=18-1 ElemStation=0
Frame=18 Station=9,1650000000001E-02 OutputCase=RAR135 CaseType=Combination P=-74,3329999966973 V2=-0,482670385097496 V3=0 T=0 M2=0 M3=8,25961604422468 FrameElem=18-1 ElemStation=9,1650000000001E-02
Frame=18 Station=0,1833 OutputCase=RAR135 CaseType=Combination P=-73,9663999966973 V2=-1,0389858850975 V3=0 T=0 M2=0 M3=8,32965393263136 FrameElem=18-1 ElemStation=0,1833
Frame=18 Station=0 OutputCase=RAR136 CaseType=Combination P=-67,4516924620481 V2=9,40649138372273 V3=0 T=0 M2=0 M3=3,50507395290454 FrameElem=18-1 ElemStation=0
Frame=18 Station=9,1650000000001E-02 OutputCase=RAR136 CaseType=Combination P=-67,0850924620481 V2=6,75734813372273 V3=0 T=0 M2=0 M3=2,7646249788322 FrameElem=18-1 ElemStation=9,1650000000001E-02
Frame=18 Station=0,1833 OutputCase=RAR136 CaseType=Combination P=-66,7184924620481 V2=4,14440663372273 V3=0 T=0 M2=0 M3=2,26534607653066 FrameElem=18-1 ElemStation=0,1833
Frame=18 Station=0 OutputCase=RAR137 CaseType=Combination P=-74,6995999964353 V2=0,208209141843234 V3=0 T=0 M2=0 M3=3,15816756672696 FrameElem=18-1 ElemStation=0
Frame=18 Station=9,1650000000001E-02 OutputCase=RAR137 CaseType=Combination P=-74,3329999964353 V2=-2,44093410815677 V3=0 T=0 M2=0 M3=3,2607586791739 FrameElem=18-1 ElemStation=9,1650000000001E-02
Frame=18 Station=0,1833 OutputCase=RAR137 CaseType=Combination P=-73,9663999964353 V2=-5,05387560815677 V3=0 T=0 M2=0 M3=3,60448482528959 FrameElem=18-1 ElemStation=0,1833
Frame=18 Station=0 OutputCase=RAR138 CaseType=Combination P=-7,69169246443261 V2=10,1265986591892 V3=0 T=0 M2=0 M3=-4,35974799782007 FrameElem=18-1 ElemStation=0
Frame=18 Station=9,1650000000001E-02 OutputCase=RAR138 CaseType=Combination P=-7,32509246443261 V2=7,4774554091892 V3=0 T=0 M2=0 M3=-5,16617728463788 FrameElem=18-1 ElemStation=9,1650000000001E-02

Società di Progetto
Brebemi SpA



Doc. N.
60235-0000-A00.doc

CODIFICA DOCUMENTO
04RCDII10000000000300A00

REV.
00

FOGLIO
305 di 628

Frame=18 Station=0,1833 OutputCase=RAR138 CaseType=Combination P=-6,95849246443261 V2=4,86451390918919 V3=0 T=0 M2=0 M3=-5,73147153778695
FrameElem=18-1 ElemStation=0,1833
Frame=18 Station=0 OutputCase=RAR139 CaseType=Combination P=-14,9395999988198 V2=0,928316417309702 V3=0 T=0 M2=0 M3=-4,70665438399765 FrameElem=18-1
ElemStation=0
Frame=18 Station=9,1650000000001E-02 OutputCase=RAR139 CaseType=Combination P=-14,5729999988198 V2=-1,7208268326903 V3=0 T=0 M2=0 M3=-4,67006110334721
FrameElem=18-1 ElemStation=9,1650000000001E-02
Frame=18 Station=0,1833 OutputCase=RAR139 CaseType=Combination P=-14,2063999988198 V2=-4,3337683326903 V3=0 T=0 M2=0 M3=-4,39233278902802
FrameElem=18-1 ElemStation=0,1833
Frame=18 Station=0 OutputCase=RAR140 CaseType=Combination P=-14,9395999990814 V2=0,374347287419118 V3=0 T=0 M2=0 M3=0,377514631794939 FrameElem=18-1
ElemStation=0
Frame=18 Station=9,1650000000001E-02 OutputCase=RAR140 CaseType=Combination P=-14,5729999990814 V2=-0,222294212580882 V3=0 T=0 M2=0
M3=0,370854789465477 FrameElem=18-1 ElemStation=9,1650000000001E-02
Frame=18 Station=0,1833 OutputCase=RAR140 CaseType=Combination P=-14,2063999990814 V2=-0,778609712580882 V3=0 T=0 M2=0 M3=0,417029201661015
FrameElem=18-1 ElemStation=0,1833
Frame=18 Station=0 OutputCase=RAR141 CaseType=Combination P=-74,6995999966969 V2=-0,345759988047349 V3=0 T=0 M2=0 M3=8,24233658251955 FrameElem=18-1
ElemStation=0
Frame=18 Station=9,1650000000001E-02 OutputCase=RAR141 CaseType=Combination P=-74,3329999966969 V2=-0,94240148804735 V3=0 T=0 M2=0 M3=8,30167457198658
FrameElem=18-1 ElemStation=9,1650000000001E-02
Frame=18 Station=0,1833 OutputCase=RAR141 CaseType=Combination P=-73,9663999966969 V2=-1,49871698804735 V3=0 T=0 M2=0 M3=8,41384681597862
FrameElem=18-1 ElemStation=0,1833
Frame=18 Station=0 OutputCase=RAR142 CaseType=Combination P=-67,4516924620478 V2=8,94676028077288 V3=0 T=0 M2=0 M3=3,50499812508109 FrameElem=18-1
ElemStation=0
Frame=18 Station=9,1650000000001E-02 OutputCase=RAR142 CaseType=Combination P=-67,0850924620478 V2=6,29761703077287 V3=0 T=0 M2=0 M3=2,80670102564513
FrameElem=18-1 ElemStation=9,1650000000001E-02
Frame=18 Station=0,1833 OutputCase=RAR142 CaseType=Combination P=-66,7184924620478 V2=3,68467553077287 V3=0 T=0 M2=0 M3=2,34953895987792
FrameElem=18-1 ElemStation=0,1833
Frame=18 Station=0 OutputCase=RAR143 CaseType=Combination P=-74,699599996435 V2=-0,25152196110662 V3=0 T=0 M2=0 M3=3,15809173890351 FrameElem=18-1
ElemStation=0
Frame=18 Station=9,1650000000001E-02 OutputCase=RAR143 CaseType=Combination P=-74,332999996435 V2=-2,90066521110662 V3=0 T=0 M2=0 M3=3,30281720693581
FrameElem=18-1 ElemStation=9,1650000000001E-02
Frame=18 Station=0,1833 OutputCase=RAR143 CaseType=Combination P=-73,966399996435 V2=-5,51360671110662 V3=0 T=0 M2=0 M3=3,68867770863685
FrameElem=18-1 ElemStation=0,1833
Frame=18 Station=0 OutputCase=RAR144 CaseType=Combination P=-7,69169246443223 V2=9,66686755623934 V3=0 T=0 M2=0 M3=-4,35982382564352 FrameElem=18-1
ElemStation=0
Frame=18 Station=9,1650000000001E-02 OutputCase=RAR144 CaseType=Combination P=-7,32509246443223 V2=7,01772430623934 V3=0 T=0 M2=0 M3=-5,12411875687598
FrameElem=18-1 ElemStation=9,1650000000001E-02
Frame=18 Station=0,1833 OutputCase=RAR144 CaseType=Combination P=-6,95849246443223 V2=4,40478280623934 V3=0 T=0 M2=0 M3=-5,64727865443969
FrameElem=18-1 ElemStation=0,1833
Frame=18 Station=0 OutputCase=RAR145 CaseType=Combination P=-14,9395999988194 V2=0,468585314359848 V3=0 T=0 M2=0 M3=-4,7067302118211 FrameElem=18-1
ElemStation=0
Frame=18 Station=9,1650000000001E-02 OutputCase=RAR145 CaseType=Combination P=-14,5729999988194 V2=-2,18055793564015 V3=0 T=0 M2=0 M3=-4,6280025755853
FrameElem=18-1 ElemStation=9,1650000000001E-02
Frame=18 Station=0,1833 OutputCase=RAR145 CaseType=Combination P=-14,2063999988194 V2=-4,79349943564016 V3=0 T=0 M2=0 M3=-4,30813990568076
FrameElem=18-1 ElemStation=0,1833
Frame=18 Station=0 OutputCase=RAR146 CaseType=Combination P=-14,9395999990821 V2=1,29380949331883 V3=0 T=0 M2=0 M3=0,377666287441836 FrameElem=18-1
ElemStation=0
Frame=18 Station=9,1650000000001E-02 OutputCase=RAR146 CaseType=Combination P=-14,5729999990821 V2=0,697167993318826 V3=0 T=0 M2=0
M3=0,286737733941665 FrameElem=18-1 ElemStation=9,1650000000001E-02
Frame=18 Station=0,1833 OutputCase=RAR146 CaseType=Combination P=-14,2063999990821 V2=0,140852493318826 V3=0 T=0 M2=0 M3=0,248643434966495
FrameElem=18-1 ElemStation=0,1833
Frame=18 Station=0 OutputCase=RAR147 CaseType=Combination P=-74,6995999966976 V2=0,573702217852359 V3=0 T=0 M2=0 M3=8,24248823816644 FrameElem=18-1
ElemStation=0
Frame=18 Station=9,1650000000001E-02 OutputCase=RAR147 CaseType=Combination P=-74,3329999966976 V2=-2,29392821476417E-02 V3=0 T=0 M2=0
M3=8,21755751646277 FrameElem=18-1 ElemStation=9,1650000000001E-02
Frame=18 Station=0,1833 OutputCase=RAR147 CaseType=Combination P=-73,9663999966976 V2=-0,579254782147642 V3=0 T=0 M2=0 M3=8,2454610492841
FrameElem=18-1 ElemStation=0,1833
Frame=18 Station=0 OutputCase=RAR148 CaseType=Combination P=-67,4516924620485 V2=9,86622248667259 V3=0 T=0 M2=0 M3=3,50514978072799 FrameElem=18-1
ElemStation=0
Frame=18 Station=9,1650000000001E-02 OutputCase=RAR148 CaseType=Combination P=-67,0850924620485 V2=7,21707923667258 V3=0 T=0 M2=0 M3=2,72258397012132
FrameElem=18-1 ElemStation=9,1650000000001E-02
Frame=18 Station=0,1833 OutputCase=RAR148 CaseType=Combination P=-66,7184924620485 V2=4,60413773667258 V3=0 T=0 M2=0 M3=2,1811531931834 FrameElem=18-1
ElemStation=0,1833
Frame=18 Station=0 OutputCase=RAR149 CaseType=Combination P=-74,6995999964357 V2=0,667940244793088 V3=0 T=0 M2=0 M3=3,15824339455041 FrameElem=18-1
ElemStation=0
Frame=18 Station=9,1650000000001E-02 OutputCase=RAR149 CaseType=Combination P=-74,3329999964357 V2=-1,98120300520691 V3=0 T=0 M2=0 M3=3,218700151412
FrameElem=18-1 ElemStation=9,1650000000001E-02
Frame=18 Station=0,1833 OutputCase=RAR149 CaseType=Combination P=-73,9663999964357 V2=-4,59414450520692 V3=0 T=0 M2=0 M3=3,52029194194233
FrameElem=18-1 ElemStation=0,1833
Frame=18 Station=0 OutputCase=RAR150 CaseType=Combination P=-7,69169246443298 V2=10,5863297621391 V3=0 T=0 M2=0 M3=-4,35967216999662 FrameElem=18-1
ElemStation=0
Frame=18 Station=9,1650000000001E-02 OutputCase=RAR150 CaseType=Combination P=-7,32509246443298 V2=7,93718651213905 V3=0 T=0 M2=0 M3=-5,20823581239979
FrameElem=18-1 ElemStation=9,1650000000001E-02
Frame=18 Station=0,1833 OutputCase=RAR150 CaseType=Combination P=-6,95849246443298 V2=5,32424501213905 V3=0 T=0 M2=0 M3=-5,81566442113421
FrameElem=18-1 ElemStation=0,1833
Frame=18 Station=0 OutputCase=RAR151 CaseType=Combination P=-14,9395999988202 V2=1,38804752025956 V3=0 T=0 M2=0 M3=-4,7065785561742 FrameElem=18-1
ElemStation=0
Frame=18 Station=9,1650000000001E-02 OutputCase=RAR151 CaseType=Combination P=-14,5729999988202 V2=-1,26109572974045 V3=0 T=0 M2=0 M3=-
4,71211963110911 FrameElem=18-1 ElemStation=9,1650000000001E-02
Frame=18 Station=0,1833 OutputCase=RAR151 CaseType=Combination P=-14,2063999988202 V2=-3,87403722974045 V3=0 T=0 M2=0 M3=-4,47652567237528
FrameElem=18-1 ElemStation=0,1833
Frame=18 Station=0 OutputCase=RAR152 CaseType=Combination P=-15,3210011967901 V2=1,02480589762638 V3=0 T=0 M2=0 M3=0,587680552024153 FrameElem=18-1
ElemStation=0
Frame=18 Station=9,1650000000001E-02 OutputCase=RAR152 CaseType=Combination P=-14,9544011967901 V2=0,428164397626376 V3=0 T=0 M2=0
M3=0,521406178069196 FrameElem=18-1 ElemStation=9,1650000000001E-02
Frame=18 Station=0,1833 OutputCase=RAR152 CaseType=Combination P=-14,5878011967901 V2=-0,128151102373624 V3=0 T=0 M2=0 M3=0,507966058639238
FrameElem=18-1 ElemStation=0,1833
Frame=18 Station=0 OutputCase=RAR153 CaseType=Combination P=-75,0810011944056 V2=0,304698622159908 V3=0 T=0 M2=0 M3=8,45250250274876 FrameElem=18-1
ElemStation=0

Società di Progetto
Brebemi SpA



Doc. N.
60235-0000-A00.doc

CODIFICA DOCUMENTO
04RCDII10000000000300A00

REV.
00

FOGLIO
306 di 628

Frame=18 Station=9,16500000000001E-02 OutputCase=RAR153 CaseType=Combination P=-74,7144011944056 V2=-0,291942877840092 V3=0 T=0 M2=0 M3=8,4522259605903
FrameElem=18-1 ElemStation=9,16500000000001E-02
Frame=18 Station=0,1833 OutputCase=RAR153 CaseType=Combination P=-74,3478011944056 V2=-0,848258377840092 V3=0 T=0 M2=0 M3=8,50478367295685
FrameElem=18-1 ElemStation=0,1833
Frame=18 Station=0 OutputCase=RAR154 CaseType=Combination P=-67,8330936597565 V2=9,59721889098013 V3=0 T=0 M2=0 M3=3,7151640453103 FrameElem=18-1
ElemStation=0
Frame=18 Station=9,16500000000001E-02 OutputCase=RAR154 CaseType=Combination P=-67,4664936597565 V2=6,94807564098013 V3=0 T=0 M2=0 M3=2,95725241424885
FrameElem=18-1 ElemStation=9,16500000000001E-02
Frame=18 Station=0,1833 OutputCase=RAR154 CaseType=Combination P=-67,0998936597565 V2=4,33513414098013 V3=0 T=0 M2=0 M3=2,44047581685614
FrameElem=18-1 ElemStation=0,1833
Frame=18 Station=0 OutputCase=RAR155 CaseType=Combination P=-75,0810011941437 V2=0,398936649100638 V3=0 T=0 M2=0 M3=3,36825765913273 FrameElem=18-1
ElemStation=0
Frame=18 Station=9,16500000000001E-02 OutputCase=RAR155 CaseType=Combination P=-74,7144011941436 V2=-2,25020660089936 V3=0 T=0 M2=0 M3=3,45336859553953
FrameElem=18-1 ElemStation=9,16500000000001E-02
Frame=18 Station=0,1833 OutputCase=RAR155 CaseType=Combination P=-74,3478011941437 V2=-4,86314810089937 V3=0 T=0 M2=0 M3=3,77961456561508
FrameElem=18-1 ElemStation=0,1833
Frame=18 Station=0 OutputCase=RAR156 CaseType=Combination P=-8,07309366214094 V2=10,3173261664466 V3=0 T=0 M2=0 M3=-4,1496579054143 FrameElem=18-1
ElemStation=0
Frame=18 Station=9,16500000000001E-02 OutputCase=RAR156 CaseType=Combination P=-7,70649366214094 V2=7,6681829164466 V3=0 T=0 M2=0 M3=-4,97356736827226
FrameElem=18-1 ElemStation=9,16500000000001E-02
Frame=18 Station=0,1833 OutputCase=RAR156 CaseType=Combination P=-7,33989366214094 V2=5,0552414164466 V3=0 T=0 M2=0 M3=-5,55634179746147
FrameElem=18-1 ElemStation=0,1833
Frame=18 Station=0 OutputCase=RAR157 CaseType=Combination P=-15,3210011965281 V2=1,11904392456711 V3=0 T=0 M2=0 M3=-4,49656429159188 FrameElem=18-1
ElemStation=0
Frame=18 Station=9,16500000000001E-02 OutputCase=RAR157 CaseType=Combination P=-14,9544011965281 V2=-1,5300993254329 V3=0 T=0 M2=0 M3=-4,47745118698158
FrameElem=18-1 ElemStation=9,16500000000001E-02
Frame=18 Station=0,1833 OutputCase=RAR157 CaseType=Combination P=-14,5878011965281 V2=-4,1430408254329 V3=0 T=0 M2=0 M3=-4,21720304870253
FrameElem=18-1 ElemStation=0,1833
Frame=18 Station=0 OutputCase=RAR158 CaseType=Combination P=-14,5581988013734 V2=0,643350883111569 V3=0 T=0 M2=0 M3=0,167500367212622 FrameElem=18-1
ElemStation=0
Frame=18 Station=9,16500000000001E-02 OutputCase=RAR158 CaseType=Combination P=-14,1915988013734 V2=4,67093831115684E-02 V3=0 T=0 M2=0
M3=0,136186345337946 FrameElem=18-1 ElemStation=9,16500000000001E-02
Frame=18 Station=0,1833 OutputCase=RAR158 CaseType=Combination P=-13,8249988013734 V2=-0,509606116888432 V3=0 T=0 M2=0 M3=0,157706577988271
FrameElem=18-1 ElemStation=0,1833
Frame=18 Station=0 OutputCase=RAR159 CaseType=Combination P=-74,3181987989889 V2=-7,67563923548991E-02 V3=0 T=0 M2=0 M3=8,03232231793723
FrameElem=18-1 ElemStation=0
Frame=18 Station=9,16500000000001E-02 OutputCase=RAR159 CaseType=Combination P=-73,9515987989889 V2=-0,6733978923549 V3=0 T=0 M2=0 M3=8,06700612785905
FrameElem=18-1 ElemStation=9,16500000000001E-02
Frame=18 Station=0,1833 OutputCase=RAR159 CaseType=Combination P=-73,5849987989889 V2=-1,2297133923549 V3=0 T=0 M2=0 M3=8,15452419230588
FrameElem=18-1 ElemStation=0,1833
Frame=18 Station=0 OutputCase=RAR160 CaseType=Combination P=-67,0702912643398 V2=9,21576387646533 V3=0 T=0 M2=0 M3=3,29498386049877 FrameElem=18-1
ElemStation=0
Frame=18 Station=9,16500000000001E-02 OutputCase=RAR160 CaseType=Combination P=-66,7036912643398 V2=6,56662062646533 V3=0 T=0 M2=0 M3=2,5720325815176
FrameElem=18-1 ElemStation=9,16500000000001E-02
Frame=18 Station=0,1833 OutputCase=RAR160 CaseType=Combination P=-66,3370912643398 V2=3,95367912646532 V3=0 T=0 M2=0 M3=2,09021633620518
FrameElem=18-1 ElemStation=0,1833
Frame=18 Station=0 OutputCase=RAR161 CaseType=Combination P=-74,318198798727 V2=1,74816345858304E-02 V3=0 T=0 M2=0 M3=2,94807747432119 FrameElem=18-1
ElemStation=0
Frame=18 Station=9,16500000000001E-02 OutputCase=RAR161 CaseType=Combination P=-73,951598798727 V2=-2,63166161541417 V3=0 T=0 M2=0 M3=3,06814876280828
FrameElem=18-1 ElemStation=9,16500000000001E-02
Frame=18 Station=0,1833 OutputCase=RAR161 CaseType=Combination P=-73,584998798727 V2=-5,24460311541417 V3=0 T=0 M2=0 M3=3,42935508496411
FrameElem=18-1 ElemStation=0,1833
Frame=18 Station=0 OutputCase=RAR162 CaseType=Combination P=-7,31029126672427 V2=9,9358711519318 V3=0 T=0 M2=0 M3=-4,56983809022583 FrameElem=18-1
ElemStation=0
Frame=18 Station=9,16500000000001E-02 OutputCase=RAR162 CaseType=Combination P=-6,94369126672427 V2=7,28672790193179 V3=0 T=0 M2=0 M3=-5,35878720100351
FrameElem=18-1 ElemStation=9,16500000000001E-02
Frame=18 Station=0,1833 OutputCase=RAR162 CaseType=Combination P=-6,57709126672427 V2=4,67378640193179 V3=0 T=0 M2=0 M3=-5,90660127811243
FrameElem=18-1 ElemStation=0,1833
Frame=18 Station=0 OutputCase=RAR163 CaseType=Combination P=-14,5581988011115 V2=0,737588910052298 V3=0 T=0 M2=0 M3=-4,91674447640341 FrameElem=18-1
ElemStation=0
Frame=18 Station=9,16500000000001E-02 OutputCase=RAR163 CaseType=Combination P=-14,1915988011115 V2=-1,9115543399477 V3=0 T=0 M2=0 M3=-4,86267101971283
FrameElem=18-1 ElemStation=9,16500000000001E-02
Frame=18 Station=0,1833 OutputCase=RAR163 CaseType=Combination P=-13,8249988011115 V2=-4,52449583994771 V3=0 T=0 M2=0 M3=-4,5674625293535
FrameElem=18-1 ElemStation=0,1833
Frame=18 Station=0 OutputCase=INVRAR CaseType=Combination StepType=Max P=-5,21705471085442 V2=22,9610039859806 V3=0 T=0 M2=0 M3=11,0739834399512
FrameElem=18-1 ElemStation=0
Frame=18 Station=9,16500000000001E-02 OutputCase=INVRAR CaseType=Combination StepType=Max P=-4,85045471085442 V2=20,3118607359806 V3=0 T=0 M2=0
M3=11,1659301010338 FrameElem=18-1 ElemStation=9,16500000000001E-02
Frame=18 Station=0,1833 OutputCase=INVRAR CaseType=Combination StepType=Max P=-4,48385471085442 V2=17,6989192359806 V3=0 T=0 M2=0
M3=11,3107110166415 FrameElem=18-1 ElemStation=0,1833
Frame=18 Station=0 OutputCase=INVRAR CaseType=Combination StepType=Min P=-95,0010011936101 V2=-1,60919340218775 V3=0 T=0 M2=0 M3=-6,30572993253459
FrameElem=18-1 ElemStation=0
Frame=18 Station=9,16500000000001E-02 OutputCase=INVRAR CaseType=Combination StepType=Min P=-94,6344011936101 V2=-4,3423318209216 V3=0 T=0 M2=0 M3=-
6,81291689265886 FrameElem=18-1 ElemStation=9,16500000000001E-02
Frame=18 Station=0,1833 OutputCase=INVRAR CaseType=Combination StepType=Min P=-94,2678011936101 V2=-7,5315061959216 V3=0 T=0 M2=0 M3=-7,4650025447807
FrameElem=18-1 ElemStation=0,1833
Frame=18 Station=0 OutputCase=FRE01 CaseType=Combination P=-14,9395999989938 V2=-0,22746867337753 V3=0 T=0 M2=0 M3=-0,540203534427095 FrameElem=18-1
ElemStation=0
Frame=18 Station=9,16500000000001E-02 OutputCase=FRE01 CaseType=Combination P=-14,5729999989938 V2=-1,17810829837753 V3=0 T=0 M2=0 M3=-0,475306485768294
FrameElem=18-1 ElemStation=9,16500000000001E-02
Frame=18 Station=0,1833 OutputCase=FRE01 CaseType=Combination P=-14,2063999989938 V2=-2,06505117337753 V3=0 T=0 M2=0 M3=-0,326202219046993
FrameElem=18-1 ElemStation=0,1833
Frame=18 Station=0 OutputCase=FRE02 CaseType=Combination P=-74,6995999966966 V2=-0,652247390013919 V3=0 T=0 M2=0 M3=8,24228603063725 FrameElem=18-1
ElemStation=0
Frame=18 Station=9,16500000000001E-02 OutputCase=FRE02 CaseType=Combination P=-74,3329999966966 V2=-1,2488889001392 V3=0 T=0 M2=0 M3=8,32971359049452
FrameElem=18-1 ElemStation=9,16500000000001E-02
Frame=18 Station=0,1833 OutputCase=FRE02 CaseType=Combination P=-73,9663999966966 V2=-1,80520439001392 V3=0 T=0 M2=0 M3=8,4699754048768 FrameElem=18-1
ElemStation=0,1833

Società di Progetto
Brebemi SpA



Doc. N.
60235-00000-A00.doc

CODIFICA DOCUMENTO
04RCDII10000000000300A00

REV.
00

FOGLIO
307 di 628

Frame=18 Station=0 OutputCase=FRE03 CaseType=Combination P=-67,4516924620475 V2=8,64027287880631 V3=0 T=0 M2=0 M3=3,50494757319879 FrameElem=18-1 ElemStation=0
Frame=18 Station=9,1650000000001E-02 OutputCase=FRE03 CaseType=Combination P=-67,0850924620475 V2=5,99112962880631 V3=0 T=0 M2=0 M3=2,83474004415307
FrameElem=18-1 ElemStation=9,1650000000001E-02
Frame=18 Station=0,1833 OutputCase=FRE03 CaseType=Combination P=-66,7184924620475 V2=-3,3781881288063 V3=0 T=0 M2=0 M3=2,40566754877609 FrameElem=18-1 ElemStation=0,1833
Frame=18 Station=0 OutputCase=FRE04 CaseType=Combination P=-74,6995999964347 V2=-0,558009363073189 V3=0 T=0 M2=0 M3=3,15804118702121 FrameElem=18-1 ElemStation=0
Frame=18 Station=9,1650000000001E-02 OutputCase=FRE04 CaseType=Combination P=-74,3329999964347 V2=-3,20715261307319 V3=0 T=0 M2=0 M3=3,33085622544374
FrameElem=18-1 ElemStation=9,1650000000001E-02
Frame=18 Station=0,1833 OutputCase=FRE04 CaseType=Combination P=-73,9663999964347 V2=-5,82009411307319 V3=0 T=0 M2=0 M3=3,74480629753503 FrameElem=18-1 ElemStation=0,1833
Frame=18 Station=0 OutputCase=FRE05 CaseType=Combination P=-7,69169246443198 V2=9,36038015427278 V3=0 T=0 M2=0 M3=-4,35987437752581 FrameElem=18-1 ElemStation=0
Frame=18 Station=9,1650000000001E-02 OutputCase=FRE05 CaseType=Combination P=-7,32509246443198 V2=6,71123690427277 V3=0 T=0 M2=0 M3=-5,09607973836804
FrameElem=18-1 ElemStation=9,1650000000001E-02
Frame=18 Station=0,1833 OutputCase=FRE05 CaseType=Combination P=-6,95849246443198 V2=4,09829540427277 V3=0 T=0 M2=0 M3=-5,59115006554152 FrameElem=18-1 ElemStation=0,1833
Frame=18 Station=0 OutputCase=FRE06 CaseType=Combination P=-14,9395999988192 V2=0,162097912393278 V3=0 T=0 M2=0 M3=-4,70678076370339 FrameElem=18-1 ElemStation=0
Frame=18 Station=9,1650000000001E-02 OutputCase=FRE06 CaseType=Combination P=-14,5729999988192 V2=-2,48704533760672 V3=0 T=0 M2=0 M3=-4,59996355707736
FrameElem=18-1 ElemStation=9,1650000000001E-02
Frame=18 Station=0,1833 OutputCase=FRE06 CaseType=Combination P=-14,2063999988192 V2=-5,09998683760673 V3=0 T=0 M2=0 M3=-4,25201131678258
FrameElem=18-1 ElemStation=0,1833
Frame=18 Station=0 OutputCase=FRE07 CaseType=Combination P=-14,9395999990807 V2=-0,391871217497305 V3=0 T=0 M2=0 M3=0,377388252089191 FrameElem=18-1 ElemStation=0
Frame=18 Station=9,1650000000001E-02 OutputCase=FRE07 CaseType=Combination P=-14,5729999990807 V2=-0,988512717497306 V3=0 T=0 M2=0 M3=0,440952335735319 FrameElem=18-1 ElemStation=9,1650000000001E-02
Frame=18 Station=0,1833 OutputCase=FRE07 CaseType=Combination P=-14,2063999990807 V2=-1,54482821749731 V3=0 T=0 M2=0 M3=0,557350673906448
FrameElem=18-1 ElemStation=0,1833
Frame=18 Station=0 OutputCase=FRE08 CaseType=Combination P=-74,6995999966963 V2=-1,0353566427213 V3=0 T=0 M2=0 M3=8,24222284078437 FrameElem=18-1 ElemStation=0
Frame=18 Station=9,1650000000001E-02 OutputCase=FRE08 CaseType=Combination P=-74,3329999966963 V2=-1,63199814247213 V3=0 T=0 M2=0 M3=8,36476236362944
FrameElem=18-1 ElemStation=9,1650000000001E-02
Frame=18 Station=0,1833 OutputCase=FRE08 CaseType=Combination P=-73,9663999966963 V2=-2,18831364247213 V3=0 T=0 M2=0 M3=8,540136140999951 FrameElem=18-1 ElemStation=0,1833
Frame=18 Station=0 OutputCase=FRE09 CaseType=Combination P=-67,4516924620472 V2=8,2571636263481 V3=0 T=0 M2=0 M3=3,50488438334592 FrameElem=18-1 ElemStation=0
Frame=18 Station=9,1650000000001E-02 OutputCase=FRE09 CaseType=Combination P=-67,0850924620472 V2=5,60802037634809 V3=0 T=0 M2=0 M3=2,86978881728799
FrameElem=18-1 ElemStation=9,1650000000001E-02
Frame=18 Station=0,1833 OutputCase=FRE09 CaseType=Combination P=-66,7184924620472 V2=2,99507887634809 V3=0 T=0 M2=0 M3=2,47582828489881 FrameElem=18-1 ElemStation=0,1833
Frame=18 Station=0 OutputCase=FRE10 CaseType=Combination P=-74,6995999964344 V2=-0,941118615531401 V3=0 T=0 M2=0 M3=3,15797799716834 FrameElem=18-1 ElemStation=0
Frame=18 Station=9,1650000000001E-02 OutputCase=FRE10 CaseType=Combination P=-74,3329999964344 V2=-3,5902618655314 V3=0 T=0 M2=0 M3=3,36590499857867
FrameElem=18-1 ElemStation=9,1650000000001E-02
Frame=18 Station=0,1833 OutputCase=FRE10 CaseType=Combination P=-73,9663999964344 V2=-6,20320336553141 V3=0 T=0 M2=0 M3=3,81496703365774 FrameElem=18-1 ElemStation=0,1833
Frame=18 Station=0 OutputCase=FRE11 CaseType=Combination P=-7,69169246443167 V2=8,97727090181456 V3=0 T=0 M2=0 M3=-4,35993756737869 FrameElem=18-1 ElemStation=0
Frame=18 Station=9,1650000000001E-02 OutputCase=FRE11 CaseType=Combination P=-7,32509246443167 V2=6,32812765181456 V3=0 T=0 M2=0 M3=-5,06103096523312
FrameElem=18-1 ElemStation=9,1650000000001E-02
Frame=18 Station=0,1833 OutputCase=FRE11 CaseType=Combination P=-6,95849246443167 V2=3,71518615181456 V3=0 T=0 M2=0 M3=-5,5209893294188 FrameElem=18-1 ElemStation=0,1833
Frame=18 Station=0 OutputCase=FRE12 CaseType=Combination P=-14,9395999988189 V2=-0,221011340064933 V3=0 T=0 M2=0 M3=-4,70684395355627 FrameElem=18-1 ElemStation=0
Frame=18 Station=9,1650000000001E-02 OutputCase=FRE12 CaseType=Combination P=-14,5729999988189 V2=-2,87015459006494 V3=0 T=0 M2=0 M3=-4,56491478394244
FrameElem=18-1 ElemStation=9,1650000000001E-02
Frame=18 Station=0,1833 OutputCase=FRE12 CaseType=Combination P=-14,2063999988189 V2=-5,48309609006494 V3=0 T=0 M2=0 M3=-4,18185058065987
FrameElem=18-1 ElemStation=0,1833
Frame=18 Station=0 OutputCase=FRE13 CaseType=Combination P=-15,2574343305043 V2=-0,232931628116135 V3=0 T=0 M2=0 M3=0,552463329093996 FrameElem=18-1 ElemStation=0
Frame=18 Station=9,1650000000001E-02 OutputCase=FRE13 CaseType=Combination P=-14,8908343305043 V2=-0,829573128116136 V3=0 T=0 M2=0 M3=0,60146059937334
FrameElem=18-1 ElemStation=9,1650000000001E-02
Frame=18 Station=0,1833 OutputCase=FRE13 CaseType=Combination P=-14,5242343305043 V2=-1,38588862811614 V3=0 T=0 M2=0 M3=0,703292124177684
FrameElem=18-1 ElemStation=0,1833
Frame=18 Station=0 OutputCase=FRE14 CaseType=Combination P=-14,6217656676571 V2=-0,550810806878475 V3=0 T=0 M2=0 M3=0,202313175084386 FrameElem=18-1 ElemStation=0
Frame=18 Station=9,1650000000001E-02 OutputCase=FRE14 CaseType=Combination P=-14,2551656676571 V2=-1,14745230687848 V3=0 T=0 M2=0 M3=0,280444072097299
FrameElem=18-1 ElemStation=9,1650000000001E-02
Frame=18 Station=0,1833 OutputCase=FRE14 CaseType=Combination P=-13,8885656676571 V2=-1,70376780687848 V3=0 T=0 M2=0 M3=0,411409223635211
FrameElem=18-1 ElemStation=0,1833
Frame=18 Station=0 OutputCase=FRE15 CaseType=Combination P=-14,939599999081 V2=-8,76196503909338E-03 V3=0 T=0 M2=0 M3=0,377451441942065 FrameElem=18-1 ElemStation=0
Frame=18 Station=9,1650000000001E-02 OutputCase=FRE15 CaseType=Combination P=-14,572999999081 V2=-0,605403465039094 V3=0 T=0 M2=0 M3=0,405903562600398
FrameElem=18-1 ElemStation=9,1650000000001E-02
Frame=18 Station=0,1833 OutputCase=FRE15 CaseType=Combination P=-14,206399999081 V2=-1,16171896503909 V3=0 T=0 M2=0 M3=0,487189937783731 FrameElem=18-1 ElemStation=0,1833
Frame=18 Station=0 OutputCase=FRE16 CaseType=Combination P=-14,9395999990815 V2=-0,527590988402403 V3=0 T=0 M2=0 M3=0,377539907736088 FrameElem=18-1 ElemStation=0
Frame=18 Station=9,1650000000001E-02 OutputCase=FRE16 CaseType=Combination P=-14,5729999990815 V2=-6,90505115975974E-02 V3=0 T=0 M2=0 M3=0,356835280211508 FrameElem=18-1 ElemStation=9,1650000000001E-02
Frame=18 Station=0,1833 OutputCase=FRE16 CaseType=Combination P=-14,2063999990815 V2=-0,625366011597598 V3=0 T=0 M2=0 M3=0,388964907211928
FrameElem=18-1 ElemStation=0,1833
Frame=18 Station=0 OutputCase=FRE17 CaseType=Combination P=-74,6995999966969 V2=-0,269138137555707 V3=0 T=0 M2=0 M3=8,24234922049012 FrameElem=18-1 ElemStation=0
Frame=18 Station=9,1650000000001E-02 OutputCase=FRE17 CaseType=Combination P=-74,3329999966969 V2=-0,865779637555708 V3=0 T=0 M2=0 M3=8,2946648173596
FrameElem=18-1 ElemStation=9,1650000000001E-02

Società di Progetto
Brebemi SpA



Doc. N.
60235-0000-A00.doc

CODIFICA DOCUMENTO
04RCDII10000000000300A00

REV.
00

FOGLIO
308 di 628

Frame=18 Station=0,1833 OutputCase=FRE17 CaseType=Combination P=-73,96639996697 V2=-1,42209513755571 V3=0 T=0 M2=0 M3=8,39981466875408 FrameElem=18-1 ElemStation=0,1833

Frame=18 Station=0 OutputCase=FRE18 CaseType=Combination P=-67,4516924620478 V2=9,02338213126452 V3=0 T=0 M2=0 M3=3,50501076305166 FrameElem=18-1 ElemStation=0

Frame=18 Station=9,1650000000001E-02 OutputCase=FRE18 CaseType=Combination P=-67,0850924620478 V2=6,37423888126452 V3=0 T=0 M2=0 M3=2,79969127101815 FrameElem=18-1 ElemStation=9,1650000000001E-02

Frame=18 Station=0,1833 OutputCase=FRE18 CaseType=Combination P=-66,7184924620478 V2=3,76129738126452 V3=0 T=0 M2=0 M3=2,33550681265338 FrameElem=18-1 ElemStation=0,1833

Frame=18 Station=0 OutputCase=FRE19 CaseType=Combination P=-74,699599996435 V2=-0,174900110614978 V3=0 T=0 M2=0 M3=3,15810437687409 FrameElem=18-1 ElemStation=0

Frame=18 Station=9,1650000000001E-02 OutputCase=FRE19 CaseType=Combination P=-74,332999996435 V2=-2,82404336061498 V3=0 T=0 M2=0 M3=3,29580745230882 FrameElem=18-1 ElemStation=9,1650000000001E-02

Frame=18 Station=0,1833 OutputCase=FRE19 CaseType=Combination P=-73,966399996435 V2=-5,43698486061498 V3=0 T=0 M2=0 M3=3,67464556141231 FrameElem=18-1 ElemStation=0,1833

Frame=18 Station=0 OutputCase=FRE20 CaseType=Combination P=-7,69169246443229 V2=9,74348940673099 V3=0 T=0 M2=0 M3=-4,35981118767294 FrameElem=18-1 ElemStation=0

Frame=18 Station=9,1650000000001E-02 OutputCase=FRE20 CaseType=Combination P=-7,32509246443229 V2=7,09434615673099 V3=0 T=0 M2=0 M3=-5,13112851150296 FrameElem=18-1 ElemStation=9,1650000000001E-02

Frame=18 Station=0,1833 OutputCase=FRE20 CaseType=Combination P=-6,95849246443229 V2=4,48140465673098 V3=0 T=0 M2=0 M3=-5,66131080166423 FrameElem=18-1 ElemStation=0,1833

Frame=18 Station=0 OutputCase=FRE21 CaseType=Combination P=-14,9395999988195 V2=0,54520716485149 V3=0 T=0 M2=0 M3=-4,70671757385052 FrameElem=18-1 ElemStation=0

Frame=18 Station=9,1650000000001E-02 OutputCase=FRE21 CaseType=Combination P=-14,5729999988195 V2=-2,10393608514851 V3=0 T=0 M2=0 M3=-4,63501233021228 FrameElem=18-1 ElemStation=9,1650000000001E-02

Frame=18 Station=0,1833 OutputCase=FRE21 CaseType=Combination P=-14,2063999988195 V2=-4,71687758514851 V3=0 T=0 M2=0 M3=-4,3221720529053 FrameElem=18-1 ElemStation=0,1833

Frame=18 Station=0 OutputCase=FRE22 CaseType=Combination P=-15,2574343305051 V2=0,686530577783573 V3=0 T=0 M2=0 M3=0,552614984740893 FrameElem=18-1 ElemStation=0

Frame=18 Station=9,1650000000001E-02 OutputCase=FRE22 CaseType=Combination P=-14,8908343305051 V2=8,98890777835724E-02 V3=0 T=0 M2=0 M3=0,517343543849529 FrameElem=18-1 ElemStation=9,1650000000001E-02

Frame=18 Station=0,1833 OutputCase=FRE22 CaseType=Combination P=-14,5242343305051 V2=-0,466426422216428 V3=0 T=0 M2=0 M3=0,534906357483164 FrameElem=18-1 ElemStation=0,1833

Frame=18 Station=0 OutputCase=FRE23 CaseType=Combination P=-14,6217656676579 V2=0,368651399021233 V3=0 T=0 M2=0 M3=0,202464830731284 FrameElem=18-1 ElemStation=0

Frame=18 Station=9,1650000000001E-02 OutputCase=FRE23 CaseType=Combination P=-14,2551656676579 V2=-0,227990100978767 V3=0 T=0 M2=0 M3=0,196327016573487 FrameElem=18-1 ElemStation=9,1650000000001E-02

Frame=18 Station=0,1833 OutputCase=FRE23 CaseType=Combination P=-13,8885656676579 V2=-0,784305600978767 V3=0 T=0 M2=0 M3=0,243023456940692 FrameElem=18-1 ElemStation=0,1833

Frame=18 Station=0 OutputCase=FRE24 CaseType=Combination P=-14,9395999990818 V2=0,910700240860615 V3=0 T=0 M2=0 M3=0,377603097588962 FrameElem=18-1 ElemStation=0

Frame=18 Station=9,1650000000001E-02 OutputCase=FRE24 CaseType=Combination P=-14,5729999990818 V2=0,314058740860614 V3=0 T=0 M2=0 M3=0,321786507076587 FrameElem=18-1 ElemStation=9,1650000000001E-02

Frame=18 Station=0,1833 OutputCase=FRE24 CaseType=Combination P=-14,2063999990818 V2=-0,242256759139386 V3=0 T=0 M2=0 M3=0,318804171089211 FrameElem=18-1 ElemStation=0,1833

Frame=18 Station=0 OutputCase=FRE25 CaseType=Combination P=-15,3210011967894 V2=0,258587392709953 V3=0 T=0 M2=0 M3=0,587554172318406 FrameElem=18-1 ElemStation=0

Frame=18 Station=9,1650000000001E-02 OutputCase=FRE25 CaseType=Combination P=-14,9544011967894 V2=-0,338054107290048 V3=0 T=0 M2=0 M3=0,591503724339038 FrameElem=18-1 ElemStation=9,1650000000001E-02

Frame=18 Station=0,1833 OutputCase=FRE25 CaseType=Combination P=-14,5878011967894 V2=-0,894369607290048 V3=0 T=0 M2=0 M3=0,648287530884671 FrameElem=18-1 ElemStation=0,1833

Frame=18 Station=0 OutputCase=FRE26 CaseType=Combination P=-75,0174343281202 V2=-0,493307800632749 V3=0 T=0 M2=0 M3=8,41736110764205 FrameElem=18-1 ElemStation=0

Frame=18 Station=9,1650000000001E-02 OutputCase=FRE26 CaseType=Combination P=-74,6508343281202 V2=-1,08994930063275 V3=0 T=0 M2=0 M3=8,49022185413254 FrameElem=18-1 ElemStation=9,1650000000001E-02

Frame=18 Station=0,1833 OutputCase=FRE26 CaseType=Combination P=-74,2842343281202 V2=-1,64626480063275 V3=0 T=0 M2=0 M3=8,61591685514803 FrameElem=18-1 ElemStation=0,1833

Frame=18 Station=0 OutputCase=FRE27 CaseType=Combination P=-67,7695267934711 V2=8,79921246818748 V3=0 T=0 M2=0 M3=3,6800226502036 FrameElem=18-1 ElemStation=0

Frame=18 Station=9,1650000000001E-02 OutputCase=FRE27 CaseType=Combination P=-67,4029267934711 V2=6,15006921818748 V3=0 T=0 M2=0 M3=2,99524830779109 FrameElem=18-1 ElemStation=9,1650000000001E-02

Frame=18 Station=0,1833 OutputCase=FRE27 CaseType=Combination P=-67,0363267934711 V2=3,53712771818747 V3=0 T=0 M2=0 M3=2,55160899904733 FrameElem=18-1 ElemStation=0,1833

Frame=18 Station=0 OutputCase=FRE28 CaseType=Combination P=-75,0174343278583 V2=-0,39906977369202 V3=0 T=0 M2=0 M3=3,33311626402602 FrameElem=18-1 ElemStation=0

Frame=18 Station=9,1650000000001E-02 OutputCase=FRE28 CaseType=Combination P=-74,6508343278583 V2=-3,04821302369202 V3=0 T=0 M2=0 M3=3,49136448908176 FrameElem=18-1 ElemStation=9,1650000000001E-02

Frame=18 Station=0,1833 OutputCase=FRE28 CaseType=Combination P=-74,2842343278583 V2=-5,66115452369202 V3=0 T=0 M2=0 M3=3,89074774780626 FrameElem=18-1 ElemStation=0,1833

Frame=18 Station=0 OutputCase=FRE29 CaseType=Combination P=-8,00952679585559 V2=9,51931974365395 V3=0 T=0 M2=0 M3=4,18479930052101 FrameElem=18-1 ElemStation=0

Frame=18 Station=9,1650000000001E-02 OutputCase=FRE29 CaseType=Combination P=-7,64292679585559 V2=6,87017649365394 V3=0 T=0 M2=0 M3=-4,93557147473002 FrameElem=18-1 ElemStation=9,1650000000001E-02

Frame=18 Station=0,1833 OutputCase=FRE29 CaseType=Combination P=-7,27632679585559 V2=4,25723499365394 V3=0 T=0 M2=0 M3=-5,44520861527028 FrameElem=18-1 ElemStation=0,1833

Frame=18 Station=0 OutputCase=FRE30 CaseType=Combination P=-15,2574343302428 V2=0,321037501774448 V3=0 T=0 M2=0 M3=-4,53170568669859 FrameElem=18-1 ElemStation=0

Frame=18 Station=9,1650000000001E-02 OutputCase=FRE30 CaseType=Combination P=-14,8908343302428 V2=-2,32810574822555 V3=0 T=0 M2=0 M3=-4,43945529343934 FrameElem=18-1 ElemStation=9,1650000000001E-02

Frame=18 Station=0,1833 OutputCase=FRE30 CaseType=Combination P=-14,5242343302428 V2=-4,94104724822556 V3=0 T=0 M2=0 M3=-4,10606986651135 FrameElem=18-1 ElemStation=0,1833

Frame=18 Station=0 OutputCase=FRE31 CaseType=Combination P=-15,3210011967891 V2=-0,124521859748259 V3=0 T=0 M2=0 M3=0,587490982465532 FrameElem=18-1 ElemStation=0

Frame=18 Station=9,1650000000001E-02 OutputCase=FRE31 CaseType=Combination P=-14,9544011967891 V2=-0,72116335974826 V3=0 T=0 M2=0 M3=0,62655249747396 FrameElem=18-1 ElemStation=9,1650000000001E-02

Frame=18 Station=0,1833 OutputCase=FRE31 CaseType=Combination P=-14,5878011967891 V2=-1,27747885974826 V3=0 T=0 M2=0 M3=0,718448267007388 FrameElem=18-1 ElemStation=0,1833

Frame=18 Station=0 OutputCase=FRE32 CaseType=Combination P=-15,3210011967898 V2=0,641696645168164 V3=0 T=0 M2=0 M3=0,587617362171279 FrameElem=18-1 ElemStation=0

Società di Progetto
Brebemi SpA



Doc. N.
60235-0000-A00.doc

CODIFICA DOCUMENTO
04RCDII10000000000300A00

REV.
00

FOGLIO
309 di 628

Frame=18 Station=9,16500000000001E-02 OutputCase=FRE32 CaseType=Combination P=-14,9544011967898 V2=0,045055145168164 V3=0 T=0 M2=0 M3=0,556454951204117
FrameElem=18-1 ElemStation=9,16500000000001E-02
Frame=18 Station=0,1833 OutputCase=FRE32 CaseType=Combination P=-14,5878011967898 V2=-0,511260354831836 V3=0 T=0 M2=0 M3=0,578126794761955
FrameElem=18-1 ElemStation=0,1833
Frame=18 Station=0 OutputCase=FRE33 CaseType=Combination P=-15,3210011967898 V2=0,641696645168164 V3=0 T=0 M2=0 M3=0,587617362171279 FrameElem=18-1
ElemStation=0
Frame=18 Station=9,16500000000001E-02 OutputCase=FRE33 CaseType=Combination P=-14,9544011967898 V2=0,045055145168164 V3=0 T=0 M2=0 M3=0,556454951204117
FrameElem=18-1 ElemStation=9,16500000000001E-02
Frame=18 Station=0,1833 OutputCase=FRE33 CaseType=Combination P=-14,5878011967898 V2=-0,511260354831836 V3=0 T=0 M2=0 M3=0,578126794761955
FrameElem=18-1 ElemStation=0,1833
Frame=18 Station=0 OutputCase=FRE34 CaseType=Combination P=-14,5581988013728 V2=-0,122867621804855 V3=0 T=0 M2=0 M3=0,167373987506874 FrameElem=18-1
ElemStation=0
Frame=18 Station=9,16500000000001E-02 OutputCase=FRE34 CaseType=Combination P=-14,1915988013728 V2=-0,719509121804855 V3=0 T=0 M2=0
M3=0,206283891607789 FrameElem=18-1 ElemStation=9,16500000000001E-02
Frame=18 Station=0,1833 OutputCase=FRE34 CaseType=Combination P=-13,8249988013728 V2=-1,27582462180486 V3=0 T=0 M2=0 M3=0,298028050233704
FrameElem=18-1 ElemStation=0,1833
Frame=18 Station=0 OutputCase=FRE35 CaseType=Combination P=-74,381765665273 V2=-0,81186979395089 V3=0 T=0 M2=0 M3=8,06721095363244 FrameElem=18-1
ElemStation=0
Frame=18 Station=9,16500000000001E-02 OutputCase=FRE35 CaseType=Combination P=-74,015165665273 V2=-1,40782847939509 V3=0 T=0 M2=0 M3=8,1692053268565
FrameElem=18-1 ElemStation=9,16500000000001E-02
Frame=18 Station=0,1833 OutputCase=FRE35 CaseType=Combination P=-73,648565665273 V2=-1,96414397939509 V3=0 T=0 M2=0 M3=8,32403395460556 FrameElem=18-1
ElemStation=0,1833
Frame=18 Station=0 OutputCase=FRE36 CaseType=Combination P=-67,1338581306239 V2=8,48133328942514 V3=0 T=0 M2=0 M3=3,32987249619399 FrameElem=18-1
ElemStation=0
Frame=18 Station=9,16500000000001E-02 OutputCase=FRE36 CaseType=Combination P=-66,7672581306239 V2=5,83219003942514 V3=0 T=0 M2=0 M3=2,67423178051505
FrameElem=18-1 ElemStation=9,16500000000001E-02
Frame=18 Station=0,1833 OutputCase=FRE36 CaseType=Combination P=-66,4006581306239 V2=3,21924853942513 V3=0 T=0 M2=0 M3=2,25972609850486 FrameElem=18-1
ElemStation=0,1833
Frame=18 Station=0 OutputCase=FRE37 CaseType=Combination P=-74,3817656650111 V2=-0,716948952454359 V3=0 T=0 M2=0 M3=2,98296611001641 FrameElem=18-1
ElemStation=0
Frame=18 Station=9,16500000000001E-02 OutputCase=FRE37 CaseType=Combination P=-74,0151656650111 V2=-3,36609220245436 V3=0 T=0 M2=0 M3=3,17034796180572
FrameElem=18-1 ElemStation=9,16500000000001E-02
Frame=18 Station=0,1833 OutputCase=FRE37 CaseType=Combination P=-73,6485656650111 V2=-5,97903370245436 V3=0 T=0 M2=0 M3=3,59886484726379 FrameElem=18-1
ElemStation=0,1833
Frame=18 Station=0 OutputCase=FRE38 CaseType=Combination P=-7,37385813300837 V2=9,20144056489161 V3=0 T=0 M2=0 M3=4,53494945453062 FrameElem=18-1
ElemStation=0
Frame=18 Station=9,16500000000001E-02 OutputCase=FRE38 CaseType=Combination P=-7,00725813300837 V2=6,5522973148916 V3=0 T=0 M2=0 M3=-5,25658800200606
FrameElem=18-1 ElemStation=9,16500000000001E-02
Frame=18 Station=0,1833 OutputCase=FRE38 CaseType=Combination P=-6,64065813300837 V2=3,9393558148916 V3=0 T=0 M2=0 M3=-5,73709151581275 FrameElem=18-1
ElemStation=0,1833
Frame=18 Station=0 OutputCase=FRE39 CaseType=Combination P=-14,6217656673956 V2=3,15832301210861E-03 V3=0 T=0 M2=0 M3=-4,8818558407082 FrameElem=18-1
ElemStation=0
Frame=18 Station=9,16500000000001E-02 OutputCase=FRE39 CaseType=Combination P=-14,2551656673956 V2=-2,64598492698789 V3=0 T=0 M2=0 M3=-4,76047182071538
FrameElem=18-1 ElemStation=9,16500000000001E-02
Frame=18 Station=0,1833 OutputCase=FRE39 CaseType=Combination P=-13,8885656673956 V2=-5,2589264269879 V3=0 T=0 M2=0 M3=-4,39795276705382 FrameElem=18-1
ElemStation=0,1833
Frame=18 Station=0 OutputCase=FRE40 CaseType=Combination P=-14,5581988013725 V2=-0,505976874263067 V3=0 T=0 M2=0 M3=0,167310797654 FrameElem=18-1
ElemStation=0
Frame=18 Station=9,16500000000001E-02 OutputCase=FRE40 CaseType=Combination P=-14,1915988013725 V2=-1,10261837426307 V3=0 T=0 M2=0 M3=0,24133266474271
FrameElem=18-1 ElemStation=9,16500000000001E-02
Frame=18 Station=0,1833 OutputCase=FRE40 CaseType=Combination P=-13,8249988013725 V2=-1,65893387426307 V3=0 T=0 M2=0 M3=0,36818878635642 FrameElem=18-1
ElemStation=0,1833
Frame=18 Station=0 OutputCase=FRE41 CaseType=Combination P=-14,5581988013731 V2=0,260241630653357 V3=0 T=0 M2=0 M3=0,167437177359748 FrameElem=18-1
ElemStation=0
Frame=18 Station=9,16500000000001E-02 OutputCase=FRE41 CaseType=Combination P=-14,1915988013731 V2=-0,336399869346643 V3=0 T=0 M2=0
M3=0,171235118472868 FrameElem=18-1 ElemStation=9,16500000000001E-02
Frame=18 Station=0,1833 OutputCase=FRE41 CaseType=Combination P=-13,8249988013731 V2=-0,892715369346644 V3=0 T=0 M2=0 M3=0,227867314110988
FrameElem=18-1 ElemStation=0,1833
Frame=18 Station=0 OutputCase=FRE42 CaseType=Combination P=-14,5581988013731 V2=0,260241630653357 V3=0 T=0 M2=0 M3=0,167437177359748 FrameElem=18-1
ElemStation=0
Frame=18 Station=9,16500000000001E-02 OutputCase=FRE42 CaseType=Combination P=-14,1915988013731 V2=-0,336399869346643 V3=0 T=0 M2=0
M3=0,171235118472868 FrameElem=18-1 ElemStation=9,16500000000001E-02
Frame=18 Station=0,1833 OutputCase=FRE42 CaseType=Combination P=-13,8249988013731 V2=-0,892715369346644 V3=0 T=0 M2=0 M3=0,227867314110988
FrameElem=18-1 ElemStation=0,1833
Frame=18 Station=0 OutputCase=FRE43 CaseType=Combination P=-14,9395999990815 V2=0,527590988402403 V3=0 T=0 M2=0 M3=0,377539907736088 FrameElem=18-1
ElemStation=0
Frame=18 Station=9,16500000000001E-02 OutputCase=FRE43 CaseType=Combination P=-14,5729999990815 V2=-6,90505115975974E-02 V3=0 T=0 M2=0
M3=0,356835280211508 FrameElem=18-1 ElemStation=9,16500000000001E-02
Frame=18 Station=0,1833 OutputCase=FRE43 CaseType=Combination P=-14,2063999990815 V2=-0,625366011597598 V3=0 T=0 M2=0 M3=0,388964907211928
FrameElem=18-1 ElemStation=0,1833
Frame=18 Station=0 OutputCase=FRE44 CaseType=Combination P=-74,699599996969 V2=-0,269138137555707 V3=0 T=0 M2=0 M3=8,24234922049012 FrameElem=18-1
ElemStation=0
Frame=18 Station=9,16500000000001E-02 OutputCase=FRE44 CaseType=Combination P=-74,332999996969 V2=-0,865779637555708 V3=0 T=0 M2=0 M3=8,2946648173596
FrameElem=18-1 ElemStation=9,16500000000001E-02
Frame=18 Station=0,1833 OutputCase=FRE44 CaseType=Combination P=-73,966399996969 V2=-1,42209513755571 V3=0 T=0 M2=0 M3=8,39981466875408 FrameElem=18-1
ElemStation=0,1833
Frame=18 Station=0 OutputCase=FRE45 CaseType=Combination P=-67,4516924620478 V2=9,02338213126452 V3=0 T=0 M2=0 M3=3,50501076305166 FrameElem=18-1
ElemStation=0
Frame=18 Station=9,16500000000001E-02 OutputCase=FRE45 CaseType=Combination P=-67,0850924620478 V2=6,37423888126452 V3=0 T=0 M2=0 M3=2,79969127101815
FrameElem=18-1 ElemStation=9,16500000000001E-02
Frame=18 Station=0,1833 OutputCase=FRE45 CaseType=Combination P=-66,7184924620478 V2=3,76129738126452 V3=0 T=0 M2=0 M3=2,33550681265338 FrameElem=18-1
ElemStation=0,1833
Frame=18 Station=0 OutputCase=FRE46 CaseType=Combination P=-74,699599996435 V2=-0,174900110614978 V3=0 T=0 M2=0 M3=3,15810437687409 FrameElem=18-1
ElemStation=0
Frame=18 Station=9,16500000000001E-02 OutputCase=FRE46 CaseType=Combination P=-74,332999996435 V2=-2,82404336061498 V3=0 T=0 M2=0 M3=3,29580745230882
FrameElem=18-1 ElemStation=9,16500000000001E-02
Frame=18 Station=0,1833 OutputCase=FRE46 CaseType=Combination P=-73,966399996435 V2=-5,43698486061498 V3=0 T=0 M2=0 M3=3,67464556141231 FrameElem=18-1
ElemStation=0,1833

Società di Progetto
Brebemi SpA



Doc. N.
60235-00000-A00.doc

CODIFICA DOCUMENTO
04RCDII10000000000300A00

REV.
00

FOGLIO
310 di 628

Frame=18 Station=0 OutputCase=FRE47 CaseType=Combination P=-7,69169246443229 V2=9,74348940673099 V3=0 T=0 M2=0 M3=-4,35981118767294 FrameElem=18-1 ElemStation=0
Frame=18 Station=9,1650000000001E-02 OutputCase=FRE47 CaseType=Combination P=-7,32509246443229 V2=7,09434615673099 V3=0 T=0 M2=0 M3=-5,13112851150296 FrameElem=18-1 ElemStation=9,1650000000001E-02
Frame=18 Station=0,1833 OutputCase=FRE47 CaseType=Combination P=-6,95849246443229 V2=4,48140465673098 V3=0 T=0 M2=0 M3=-5,66131080166423 FrameElem=18-1 ElemStation=0,1833
Frame=18 Station=0 OutputCase=FRE48 CaseType=Combination P=-14,9395999988195 V2=0,54520716485149 V3=0 T=0 M2=0 M3=-4,70671757385052 FrameElem=18-1 ElemStation=0
Frame=18 Station=9,1650000000001E-02 OutputCase=FRE48 CaseType=Combination P=-14,5729999988195 V2=-2,10393608514851 V3=0 T=0 M2=0 M3=-4,63501233021228 FrameElem=18-1 ElemStation=9,1650000000001E-02
Frame=18 Station=0,1833 OutputCase=FRE48 CaseType=Combination P=-14,2063999988195 V2=-4,71687758514851 V3=0 T=0 M2=0 M3=-4,3221720529053 FrameElem=18-1 ElemStation=0,1833
Frame=18 Station=0 OutputCase=FRE49 CaseType=Combination P=-14,9395999988195 V2=0,910700240860615 V3=0 T=0 M2=0 M3=0,377603097588962 FrameElem=18-1 ElemStation=0
Frame=18 Station=9,1650000000001E-02 OutputCase=FRE49 CaseType=Combination P=-14,5729999988195 V2=0,314058740860614 V3=0 T=0 M2=0 M3=0,321786507076587 FrameElem=18-1 ElemStation=9,1650000000001E-02
Frame=18 Station=0,1833 OutputCase=FRE49 CaseType=Combination P=-14,2063999988195 V2=-0,242256759139386 V3=0 T=0 M2=0 M3=0,318804171089211 FrameElem=18-1 ElemStation=0,1833
Frame=18 Station=0 OutputCase=FRE50 CaseType=Combination P=-15,2574343305051 V2=0,686530577783573 V3=0 T=0 M2=0 M3=0,552614984740893 FrameElem=18-1 ElemStation=0
Frame=18 Station=9,1650000000001E-02 OutputCase=FRE50 CaseType=Combination P=-14,8908343305051 V2=8,98890777835724E-02 V3=0 T=0 M2=0 M3=0,517343543849529 FrameElem=18-1 ElemStation=9,1650000000001E-02
Frame=18 Station=0,1833 OutputCase=FRE50 CaseType=Combination P=-14,54242343305051 V2=-0,466426422216428 V3=0 T=0 M2=0 M3=0,534906357483164 FrameElem=18-1 ElemStation=0,1833
Frame=18 Station=0 OutputCase=FRE51 CaseType=Combination P=-14,6217656676579 V2=0,368651399021233 V3=0 T=0 M2=0 M3=0,202464830731284 FrameElem=18-1 ElemStation=0
Frame=18 Station=9,1650000000001E-02 OutputCase=FRE51 CaseType=Combination P=-14,2551656676579 V2=-0,227990100978767 V3=0 T=0 M2=0 M3=0,196327016573487 FrameElem=18-1 ElemStation=9,1650000000001E-02
Frame=18 Station=0,1833 OutputCase=FRE51 CaseType=Combination P=-13,8885656676579 V2=-0,784305600978767 V3=0 T=0 M2=0 M3=0,243023456940692 FrameElem=18-1 ElemStation=0,1833
Frame=18 Station=0 OutputCase=INVFRE CaseType=Combination StepType=Max P=-7,37385813300837 V2=9,74348940673099 V3=0 T=0 M2=0 M3=8,41736110764205 FrameElem=18-1 ElemStation=0
Frame=18 Station=9,1650000000001E-02 OutputCase=INVFRE CaseType=Combination StepType=Max P=-7,00725813300837 V2=7,09434615673099 V3=0 T=0 M2=0 M3=8,49022185413254 FrameElem=18-1 ElemStation=9,1650000000001E-02
Frame=18 Station=0,1833 OutputCase=INVFRE CaseType=Combination StepType=Max P=-6,64065813300837 V2=4,48140465673098 V3=0 T=0 M2=0 M3=8,61591685514803 FrameElem=18-1 ElemStation=0,1833
Frame=18 Station=0 OutputCase=INVFRE CaseType=Combination StepType=Min P=-75,0174343281202 V2=-1,03535664247213 V3=0 T=0 M2=0 M3=-4,8818558407082 FrameElem=18-1 ElemStation=0
Frame=18 Station=9,1650000000001E-02 OutputCase=INVFRE CaseType=Combination StepType=Min P=-74,6508343281202 V2=-3,5902618655314 V3=0 T=0 M2=0 M3=-5,25658800200606 FrameElem=18-1 ElemStation=9,1650000000001E-02
Frame=18 Station=0,1833 OutputCase=INVFRE CaseType=Combination StepType=Min P=-74,2842343281202 V2=-6,20320336553141 V3=0 T=0 M2=0 M3=-5,73709151581275 FrameElem=18-1 ElemStation=0,1833
Frame=18 Station=0 OutputCase=QPE01 CaseType=Combination P=-15,9077978660353 V2=-1,24897689500847 V3=0 T=0 M2=0 M3=0,304867527807543 FrameElem=18-1 ElemStation=0
Frame=18 Station=9,1650000000001E-02 OutputCase=QPE01 CaseType=Combination P=-15,5411978660353 V2=-1,84561839500847 V3=0 T=0 M2=0 M3=0,446985346797569 FrameElem=18-1 ElemStation=9,1650000000001E-02
Frame=18 Station=0,1833 OutputCase=QPE01 CaseType=Combination P=-15,1745978660353 V2=-2,40193389500847 V3=0 T=0 M2=0 M3=0,641937420312596 FrameElem=18-1 ElemStation=0,1833
Frame=18 Station=0 OutputCase=QPE02 CaseType=Combination P=-15,9077978660349 V2=-1,63208614746668 V3=0 T=0 M2=0 M3=0,304804337954669 FrameElem=18-1 ElemStation=0
Frame=18 Station=9,1650000000001E-02 OutputCase=QPE02 CaseType=Combination P=-15,5411978660349 V2=-2,22872764746668 V3=0 T=0 M2=0 M3=0,482034119932491 FrameElem=18-1 ElemStation=9,1650000000001E-02
Frame=18 Station=0,1833 OutputCase=QPE02 CaseType=Combination P=-15,1745978660349 V2=-2,78504314746668 V3=0 T=0 M2=0 M3=0,712098156435312 FrameElem=18-1 ElemStation=0,1833
Frame=18 Station=0 OutputCase=QPE03 CaseType=Combination P=-15,9077978660356 V2=-0,865867642550256 V3=0 T=0 M2=0 M3=0,304930717660417 FrameElem=18-1 ElemStation=0
Frame=18 Station=9,1650000000001E-02 OutputCase=QPE03 CaseType=Combination P=-15,5411978660356 V2=-1,46250914255026 V3=0 T=0 M2=0 M3=0,411936573662648 FrameElem=18-1 ElemStation=9,1650000000001E-02
Frame=18 Station=0,1833 OutputCase=QPE03 CaseType=Combination P=-15,1745978660356 V2=-2,01882464255026 V3=0 T=0 M2=0 M3=0,571776684189879 FrameElem=18-1 ElemStation=0,1833
Frame=18 Station=0 OutputCase=QPE04 CaseType=Combination P=-16,2256321974589 V2=-1,0900373056273 V3=0 T=0 M2=0 M3=0,479942604812348 FrameElem=18-1 ElemStation=0
Frame=18 Station=9,1650000000001E-02 OutputCase=QPE04 CaseType=Combination P=-15,8590321974589 V2=-1,6866788056273 V3=0 T=0 M2=0 M3=0,60749361043559 FrameElem=18-1 ElemStation=9,1650000000001E-02
Frame=18 Station=0,1833 OutputCase=QPE04 CaseType=Combination P=-15,4924321974589 V2=-2,2429943056273 V3=0 T=0 M2=0 M3=0,787878870583832 FrameElem=18-1 ElemStation=0,1833
Frame=18 Station=0 OutputCase=QPE05 CaseType=Combination P=-15,5899635346116 V2=-1,40791648438964 V3=0 T=0 M2=0 M3=0,12972450802738 FrameElem=18-1 ElemStation=0
Frame=18 Station=9,1650000000001E-02 OutputCase=QPE05 CaseType=Combination P=-15,2233635346116 V2=-2,00455798438964 V3=0 T=0 M2=0 M3=0,286477083159549 FrameElem=18-1 ElemStation=9,1650000000001E-02
Frame=18 Station=0,1833 OutputCase=QPE05 CaseType=Combination P=-14,8567635346116 V2=-2,56087348438964 V3=0 T=0 M2=0 M3=0,495995970041359 FrameElem=18-1 ElemStation=0,1833
Frame=18 Station=0 OutputCase=QPE06 CaseType=Combination P=-15,9077978660356 V2=-0,865867642550256 V3=0 T=0 M2=0 M3=0,304930717660417 FrameElem=18-1 ElemStation=0
Frame=18 Station=9,1650000000001E-02 OutputCase=QPE06 CaseType=Combination P=-15,5411978660356 V2=-1,46250914255026 V3=0 T=0 M2=0 M3=0,411936573662648 FrameElem=18-1 ElemStation=9,1650000000001E-02
Frame=18 Station=0,1833 OutputCase=QPE06 CaseType=Combination P=-15,1745978660356 V2=-2,01882464255026 V3=0 T=0 M2=0 M3=0,571776684189879 FrameElem=18-1 ElemStation=0,1833
Frame=18 Station=0 OutputCase=QPE07 CaseType=Combination P=-16,2256321974586 V2=-1,47314655808551 V3=0 T=0 M2=0 M3=0,479879414959474 FrameElem=18-1 ElemStation=0
Frame=18 Station=9,1650000000001E-02 OutputCase=QPE07 CaseType=Combination P=-15,8590321974586 V2=-2,06978805808551 V3=0 T=0 M2=0 M3=0,642542383570511 FrameElem=18-1 ElemStation=9,1650000000001E-02
Frame=18 Station=0,1833 OutputCase=QPE07 CaseType=Combination P=-15,4924321974586 V2=-2,62610355808551 V3=0 T=0 M2=0 M3=0,858039606706548 FrameElem=18-1 ElemStation=0,1833
Frame=18 Station=0 OutputCase=QPE08 CaseType=Combination P=-15,5899635346113 V2=-1,79102573684785 V3=0 T=0 M2=0 M3=0,129729260949865 FrameElem=18-1 ElemStation=0
Frame=18 Station=9,1650000000001E-02 OutputCase=QPE08 CaseType=Combination P=-15,2233635346113 V2=-2,38766723684785 V3=0 T=0 M2=0 M3=0,32152585629447 FrameElem=18-1 ElemStation=9,1650000000001E-02

Società di Progetto
Brebemi SpA

	Doc. N. 60235-00000-A00.doc	CODIFICA DOCUMENTO 04RCDII100000000000300A00	REV. 00	FOGLIO 311 di 628
--	--------------------------------	---	------------	----------------------

Frame=18 Station=0,1833 OutputCase=QPE08 CaseType=Combination P=-14,8567635346113 V2=-2,94398273684785 V3=0 T=0 M2=0 M3=0,566156706164076
FrameElem=18-1 ElemStation=0,1833

Frame=18 Station=0 OutputCase=QPE09 CaseType=Combination P=-15,9077978660353 V2=-1,24897689500847 V3=0 T=0 M2=0 M3=0,304867527807543 FrameElem=18-1
ElemStation=0

Frame=18 Station=9,16500000000001E-02 OutputCase=QPE09 CaseType=Combination P=-15,5411978660353 V2=-1,84561839500847 V3=0 T=0 M2=0 M3=0,446985346797569
FrameElem=18-1 ElemStation=9,16500000000001E-02

Frame=18 Station=0,1833 OutputCase=QPE09 CaseType=Combination P=-15,1745978660353 V2=-2,40193389500847 V3=0 T=0 M2=0 M3=0,641937420312596
FrameElem=18-1 ElemStation=0,1833

Frame=18 Station=0 OutputCase=QPE10 CaseType=Combination P=-13,9714021320397 V2=1,08936810708349 V3=0 T=0 M2=0 M3=-0,467606982321998 FrameElem=18-1
ElemStation=0

Frame=18 Station=9,16500000000001E-02 OutputCase=QPE10 CaseType=Combination P=-13,6048021320397 V2=0,138728482083487 V3=0 T=0 M2=0 M3=-0,52339802459245
FrameElem=18-1 ElemStation=9,16500000000001E-02

Frame=18 Station=0,1833 OutputCase=QPE10 CaseType=Combination P=-13,2382021320397 V2=-0,748214392916514 V3=0 T=0 M2=0 M3=-0,494981848800401
FrameElem=18-1 ElemStation=0,1833

Frame=18 Station=0 OutputCase=QPE11 CaseType=Combination P=-13,9714021320393 V2=0,706258854625275 V3=0 T=0 M2=0 M3=-0,467670172174872 FrameElem=18-1
ElemStation=0

Frame=18 Station=9,16500000000001E-02 OutputCase=QPE11 CaseType=Combination P=-13,6048021320393 V2=-0,244380770374725 V3=0 T=0 M2=0 M3=-
0,488349251457528 FrameElem=18-1 ElemStation=9,16500000000001E-02

Frame=18 Station=0,1833 OutputCase=QPE11 CaseType=Combination P=-13,2382021320393 V2=-1,13123264537473 V3=0 T=0 M2=0 M3=-0,424821112677685
FrameElem=18-1 ElemStation=0,1833

Frame=18 Station=0 OutputCase=QPE12 CaseType=Combination P=-13,97140213204 V2=1,4724773595417 V3=0 T=0 M2=0 M3=-0,467543792469124 FrameElem=18-1
ElemStation=0

Frame=18 Station=9,16500000000001E-02 OutputCase=QPE12 CaseType=Combination P=-13,60480213204 V2=0,521837734541699 V3=0 T=0 M2=0 M3=-0,558446797727371
FrameElem=18-1 ElemStation=9,16500000000001E-02

Frame=18 Station=0,1833 OutputCase=QPE12 CaseType=Combination P=-13,23820213204 V2=-0,365105140458302 V3=0 T=0 M2=0 M3=-0,565142584923118
FrameElem=18-1 ElemStation=0,1833

Frame=18 Station=0 OutputCase=QPE13 CaseType=Combination P=-14,2892364634633 V2=1,24830769646466 V3=0 T=0 M2=0 M3=-0,292531905317193 FrameElem=18-1
ElemStation=0

Frame=18 Station=9,16500000000001E-02 OutputCase=QPE13 CaseType=Combination P=-13,9226364634633 V2=0,297668071464657 V3=0 T=0 M2=0 M3=-
0,362889760954429 FrameElem=18-1 ElemStation=9,16500000000001E-02

Frame=18 Station=0,1833 OutputCase=QPE13 CaseType=Combination P=-13,5560364634633 V2=-0,589274803535344 V3=0 T=0 M2=0 M3=-0,349040398529165
FrameElem=18-1 ElemStation=0,1833

Frame=18 Station=0 OutputCase=QPE14 CaseType=Combination P=-13,653567800616 V2=0,930428517702317 V3=0 T=0 M2=0 M3=-0,642682059326803 FrameElem=18-1
ElemStation=0

Frame=18 Station=9,16500000000001E-02 OutputCase=QPE14 CaseType=Combination P=-13,286967800616 V2=-2,02111072976829E-02 V3=0 T=0 M2=0 M3=-
0,68390628823047 FrameElem=18-1 ElemStation=9,16500000000001E-02

Frame=18 Station=0,1833 OutputCase=QPE14 CaseType=Combination P=-12,920367800616 V2=-0,907153982297684 V3=0 T=0 M2=0 M3=-0,640923299071638
FrameElem=18-1 ElemStation=0,1833

Frame=18 Station=0 OutputCase=QPE15 CaseType=Combination P=-13,97140213204 V2=1,4724773595417 V3=0 T=0 M2=0 M3=-0,467543792469124 FrameElem=18-1
ElemStation=0

Frame=18 Station=9,16500000000001E-02 OutputCase=QPE15 CaseType=Combination P=-13,60480213204 V2=0,521837734541699 V3=0 T=0 M2=0 M3=-0,558446797727371
FrameElem=18-1 ElemStation=9,16500000000001E-02

Frame=18 Station=0,1833 OutputCase=QPE15 CaseType=Combination P=-13,23820213204 V2=-0,365105140458302 V3=0 T=0 M2=0 M3=-0,565142584923118
FrameElem=18-1 ElemStation=0,1833

Frame=18 Station=0 OutputCase=QPE16 CaseType=Combination P=-14,289236463463 V2=0,865198444006445 V3=0 T=0 M2=0 M3=-0,292595095170067 FrameElem=18-1
ElemStation=0

Frame=18 Station=9,16500000000001E-02 OutputCase=QPE16 CaseType=Combination P=-13,922636463463 V2=-8,54411809935551E-02 V3=0 T=0 M2=0 M3=-
0,327840987819508 FrameElem=18-1 ElemStation=9,16500000000001E-02

Frame=18 Station=0,1833 OutputCase=QPE16 CaseType=Combination P=-13,556036463463 V2=-0,972384055993556 V3=0 T=0 M2=0 M3=-0,278879662406448
FrameElem=18-1 ElemStation=0,1833

Frame=18 Station=0 OutputCase=QPE17 CaseType=Combination P=-13,6535678006157 V2=0,547319265244106 V3=0 T=0 M2=0 M3=-0,642745249179677 FrameElem=18-1
ElemStation=0

Frame=18 Station=9,16500000000001E-02 OutputCase=QPE17 CaseType=Combination P=-13,2869678006157 V2=-0,403320359755895 V3=0 T=0 M2=0 M3=-
0,648857515095549 FrameElem=18-1 ElemStation=9,16500000000001E-02

Frame=18 Station=0,1833 OutputCase=QPE17 CaseType=Combination P=-12,9203678006157 V2=-1,2902632347559 V3=0 T=0 M2=0 M3=-0,570762562948921
FrameElem=18-1 ElemStation=0,1833

Frame=18 Station=0 OutputCase=QPE18 CaseType=Combination P=-13,9714021320397 V2=1,08936810708349 V3=0 T=0 M2=0 M3=-0,467606982321998 FrameElem=18-1
ElemStation=0

Frame=18 Station=9,16500000000001E-02 OutputCase=QPE18 CaseType=Combination P=-13,6048021320397 V2=0,138728482083487 V3=0 T=0 M2=0 M3=-0,52339802459245
FrameElem=18-1 ElemStation=9,16500000000001E-02

Frame=18 Station=0,1833 OutputCase=QPE18 CaseType=Combination P=-13,2382021320397 V2=-0,748214392916514 V3=0 T=0 M2=0 M3=-0,494981848800401
FrameElem=18-1 ElemStation=0,1833

Frame=18 Station=0 OutputCase=INVQPE CaseType=Combination StepType=Max P=-13,6535678006157 V2=1,4724773595417 V3=0 T=0 M2=0 M3=0,479942604812348
FrameElem=18-1 ElemStation=0

Frame=18 Station=9,16500000000001E-02 OutputCase=INVQPE CaseType=Combination StepType=Max P=-13,2869678006157 V2=0,521837734541699 V3=0 T=0 M2=0
M3=0,642542383570511 FrameElem=18-1 ElemStation=9,16500000000001E-02

Frame=18 Station=0,1833 OutputCase=INVQPE CaseType=Combination StepType=Max P=-12,9203678006157 V2=-0,365105140458302 V3=0 T=0 M2=0
M3=0,858039606706548 FrameElem=18-1 ElemStation=0,1833

Frame=18 Station=0 OutputCase=INVQPE CaseType=Combination StepType=Min P=-16,2256321974589 V2=-1,79102573684785 V3=0 T=0 M2=0 M3=-0,642745249179677
FrameElem=18-1 ElemStation=0

Frame=18 Station=9,16500000000001E-02 OutputCase=INVQPE CaseType=Combination StepType=Min P=-15,8590321974589 V2=-2,38766723684785 V3=0 T=0 M2=0
M3=-0,68390628823047 FrameElem=18-1 ElemStation=9,16500000000001E-02

Frame=18 Station=0,1833 OutputCase=INVQPE CaseType=Combination StepType=Min P=-15,4924321974589 V2=-2,94398273684785 V3=0 T=0 M2=0 M3=-
0,640923299071638 FrameElem=18-1 ElemStation=0,1833

Frame=22 Station=0 OutputCase=STR001 CaseType=Combination P=-23,6789999988716 V2=11,2713475417581 V3=0 T=0 M2=0 M3=2,60000919238614 FrameElem=22-1
ElemStation=0

Frame=22 Station=0,05 OutputCase=STR001 CaseType=Combination P=-23,4089999988716 V2=10,2271225417581 V3=0 T=0 M2=0 M3=2,06265431529823 FrameElem=22-1
ElemStation=0,05

Frame=22 Station=0,1 OutputCase=STR001 CaseType=Combination P=-23,1389999988716 V2=9,20854754175807 V3=0 T=0 M2=0 M3=1,57686943821033 FrameElem=22-1
ElemStation=0,1

Frame=22 Station=0 OutputCase=STR002 CaseType=Combination P=-23,6789999988716 V2=5,64299440070775 V3=0 T=0 M2=0 M3=2,86175235142241 FrameElem=22-1
ElemStation=0

Frame=22 Station=0,05 OutputCase=STR002 CaseType=Combination P=-23,4089999988716 V2=5,15799440070775 V3=0 T=0 M2=0 M3=2,59177763138702 FrameElem=22-1
ElemStation=0,05

Frame=22 Station=0,1 OutputCase=STR002 CaseType=Combination P=-23,1389999988716 V2=4,68499440070775 V3=0 T=0 M2=0 M3=2,34575291135163 FrameElem=22-1
ElemStation=0,1

Frame=22 Station=0 OutputCase=STR003 CaseType=Combination P=-131,246999994619 V2=4,3468013048668 V3=0 T=0 M2=0 M3=16,175776731118 FrameElem=22-1
ElemStation=0

Società di Progetto
Brebemi SpA

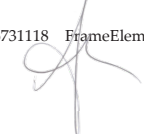

	Doc. N. 60235-00000-A00.doc	CODIFICA DOCUMENTO 04RCDII10000000000300A00	REV. 00	FOGLIO 312 di 628
--	--------------------------------	--	------------	----------------------

Frame=22 Station=0,05 OutputCase=STR003 CaseType=Combination P=-130,976999994619 V2=3,8618013048668 V3=0 T=0 M2=0 M3=15,9706116658746	FrameElem=22-1 ElemStation=0,05
Frame=22 Station=0,1 OutputCase=STR003 CaseType=Combination P=-130,706999994619 V2=3,3888013048668 V3=0 T=0 M2=0 M3=15,7893966006313	FrameElem=22-1 ElemStation=0,1
Frame=22 Station=0 OutputCase=STR004 CaseType=Combination P=-118,065218413406 V2=47,1536708613306 V3=0 T=0 M2=0 M3=27,0194765878694	FrameElem=22-1 ElemStation=0
Frame=22 Station=0,05 OutputCase=STR004 CaseType=Combination P=-117,795218413406 V2=44,7629896113306 V3=0 T=0 M2=0 M3=24,7214658573029	FrameElem=22-1 ElemStation=0,05
Frame=22 Station=0,1 OutputCase=STR004 CaseType=Combination P=-117,525218413406 V2=42,3496958613306 V3=0 T=0 M2=0 M3=22,5435455017364	FrameElem=22-1 ElemStation=0,1
Frame=22 Station=0 OutputCase=STR005 CaseType=Combination P=-131,24699999399 V2=30,4127674722492 V3=0 T=0 M2=0 M3=15,5017260483348	FrameElem=22-1 ElemStation=0
Frame=22 Station=0,05 OutputCase=STR005 CaseType=Combination P=-130,97699999399 V2=28,0220862222492 V3=0 T=0 M2=0 M3=14,0407604872224	FrameElem=22-1 ElemStation=0,05
Frame=22 Station=0,1 OutputCase=STR005 CaseType=Combination P=-130,70699999399 V2=25,6087924722492 V3=0 T=0 M2=0 M3=12,6998943011099	FrameElem=22-1 ElemStation=0,1
Frame=22 Station=0 OutputCase=STR006 CaseType=Combination P=-4,35821841795114 V2=48,2527829419388 V3=0 T=0 M2=0 M3=12,9047136732415	FrameElem=22-1 ElemStation=0
Frame=22 Station=0,05 OutputCase=STR006 CaseType=Combination P=-4,15821841795114 V2=45,8621016919388 V3=0 T=0 M2=0 M3=10,5517473386446	FrameElem=22-1 ElemStation=0,05
Frame=22 Station=0,1 OutputCase=STR006 CaseType=Combination P=-3,95821841795114 V2=43,4488079419388 V3=0 T=0 M2=0 M3=8,31888037904767	FrameElem=22-1 ElemStation=0,1
Frame=22 Station=0 OutputCase=STR007 CaseType=Combination P=-17,5399999985355 V2=31,5118795528574 V3=0 T=0 M2=0 M3=1,38696313370693	FrameElem=22-1 ElemStation=0
Frame=22 Station=0,05 OutputCase=STR007 CaseType=Combination P=-17,3399999985355 V2=29,1211983028574 V3=0 T=0 M2=0 M3=0,128958031435937	FrameElem=22-1 ElemStation=0,05
Frame=22 Station=0,1 OutputCase=STR007 CaseType=Combination P=-17,1399999985355 V2=26,7079045528574 V3=0 T=0 M2=0 M3=1,52477982157881	FrameElem=22-1 ElemStation=0,1
Frame=22 Station=0 OutputCase=STR008 CaseType=Combination P=-74,6291749798656 V2=57,5340154274012 V3=0 T=0 M2=0 M3=32,9821808798877	FrameElem=22-1 ElemStation=0
Frame=22 Station=0,05 OutputCase=STR008 CaseType=Combination P=-74,3591749798656 V2=55,4799482399012 V3=0 T=0 M2=0 M3=30,1567878428926	FrameElem=22-1 ElemStation=0,05
Frame=22 Station=0,1 OutputCase=STR008 CaseType=Combination P=-74,0891749798656 V2=53,4153341774012 V3=0 T=0 M2=0 M3=27,4343618371475	FrameElem=22-1 ElemStation=0,1
Frame=22 Station=0 OutputCase=STR009 CaseType=Combination P=-23,6789999988709 V2=10,3518853358582 V3=0 T=0 M2=0 M3=2,00211515668377	FrameElem=22-1 ElemStation=0
Frame=22 Station=0,05 OutputCase=STR009 CaseType=Combination P=-23,4089999988709 V2=9,30766033585819 V3=0 T=0 M2=0 M3=1,51073338989086	FrameElem=22-1 ElemStation=0,05
Frame=22 Station=0,1 OutputCase=STR009 CaseType=Combination P=-23,1389999988709 V2=8,28908533585819 V3=0 T=0 M2=0 M3=1,07092162309795	FrameElem=22-1 ElemStation=0,1
Frame=22 Station=0 OutputCase=STR010 CaseType=Combination P=-23,6789999988709 V2=4,72353219480787 V3=0 T=0 M2=0 M3=2,26385831572004	FrameElem=22-1 ElemStation=0
Frame=22 Station=0,05 OutputCase=STR010 CaseType=Combination P=-23,4089999988709 V2=4,23853219480787 V3=0 T=0 M2=0 M3=2,03985670597964	FrameElem=22-1 ElemStation=0,05
Frame=22 Station=0,1 OutputCase=STR010 CaseType=Combination P=-23,1389999988709 V2=3,76553219480787 V3=0 T=0 M2=0 M3=1,83980509623925	FrameElem=22-1 ElemStation=0,1
Frame=22 Station=0 OutputCase=STR011 CaseType=Combination P=-131,246999994618 V2=3,79512398132687 V3=0 T=0 M2=0 M3=15,81704303096965	FrameElem=22-1 ElemStation=0
Frame=22 Station=0,05 OutputCase=STR011 CaseType=Combination P=-130,976999994618 V2=3,31012398132687 V3=0 T=0 M2=0 M3=15,6394591106302	FrameElem=22-1 ElemStation=0,05
Frame=22 Station=0,1 OutputCase=STR011 CaseType=Combination P=-130,706999994618 V2=2,83712398132687 V3=0 T=0 M2=0 M3=15,4858279115638	FrameElem=22-1 ElemStation=0,1
Frame=22 Station=0 OutputCase=STR012 CaseType=Combination P=-118,065218413405 V2=46,6019935377907 V3=0 T=0 M2=0 M3=26,660740166448	FrameElem=22-1 ElemStation=0
Frame=22 Station=0,05 OutputCase=STR012 CaseType=Combination P=-117,795218413405 V2=44,2113122877907 V3=0 T=0 M2=0 M3=24,3903133020585	FrameElem=22-1 ElemStation=0,05
Frame=22 Station=0,1 OutputCase=STR012 CaseType=Combination P=-117,525218413405 V2=41,7980185377907 V3=0 T=0 M2=0 M3=22,2399858126689	FrameElem=22-1 ElemStation=0,1
Frame=22 Station=0 OutputCase=STR013 CaseType=Combination P=-131,24699999399 V2=29,8610901487093 V3=0 T=0 M2=0 M3=15,1429896269134	FrameElem=22-1 ElemStation=0
Frame=22 Station=0,05 OutputCase=STR013 CaseType=Combination P=-130,97699999399 V2=27,4704088987093 V3=0 T=0 M2=0 M3=13,7096079319779	FrameElem=22-1 ElemStation=0,05
Frame=22 Station=0,1 OutputCase=STR013 CaseType=Combination P=-130,70699999399 V2=25,0571151487093 V3=0 T=0 M2=0 M3=12,3963256120425	FrameElem=22-1 ElemStation=0,1
Frame=22 Station=0 OutputCase=STR014 CaseType=Combination P=-4,35821841795073 V2=47,7011056183988 V3=0 T=0 M2=0 M3=12,5459772518201	FrameElem=22-1 ElemStation=0
Frame=22 Station=0,05 OutputCase=STR014 CaseType=Combination P=-4,15821841795073 V2=45,3104243683988 V3=0 T=0 M2=0 M3=10,2205947834002	FrameElem=22-1 ElemStation=0,05
Frame=22 Station=0,1 OutputCase=STR014 CaseType=Combination P=-3,95821841795073 V2=42,8971306183988 V3=0 T=0 M2=0 M3=8,01531168998024	FrameElem=22-1 ElemStation=0,1
Frame=22 Station=0 OutputCase=STR015 CaseType=Combination P=-17,5399999985351 V2=30,960202293175 V3=0 T=0 M2=0 M3=1,02822671228551	FrameElem=22-1 ElemStation=0
Frame=22 Station=0,05 OutputCase=STR015 CaseType=Combination P=-17,3399999985351 V2=28,5695209793175 V3=0 T=0 M2=0 M3=0,460110586680362	FrameElem=22-1 ElemStation=0,05
Frame=22 Station=0,1 OutputCase=STR015 CaseType=Combination P=-17,1399999985351 V2=26,1562272293175 V3=0 T=0 M2=0 M3=1,82834851064624	FrameElem=22-1 ElemStation=0,1
Frame=22 Station=0 OutputCase=STR016 CaseType=Combination P=-74,6291749798652 V2=56,9823381038612 V3=0 T=0 M2=0 M3=32,6234444584662	FrameElem=22-1 ElemStation=0
Frame=22 Station=0,05 OutputCase=STR016 CaseType=Combination P=-74,3591749798652 V2=54,9282709163612 V3=0 T=0 M2=0 M3=29,8256352876482	FrameElem=22-1 ElemStation=0,05
Frame=22 Station=0,1 OutputCase=STR016 CaseType=Combination P=-74,0891749798652 V2=52,8636568538612 V3=0 T=0 M2=0 M3=27,1307931480801	FrameElem=22-1 ElemStation=0,1
Frame=22 Station=0 OutputCase=STR017 CaseType=Combination P=-104,354999995681 V2=3,75138737292716 V3=0 T=0 M2=0 M3=12,2493766004917	FrameElem=22-1 ElemStation=0
Frame=22 Station=0,05 OutputCase=STR017 CaseType=Combination P=-104,084999995681 V2=3,26638737292716 V3=0 T=0 M2=0 M3=12,0739822318453	FrameElem=22-1 ElemStation=0,05
Frame=22 Station=0,1 OutputCase=STR017 CaseType=Combination P=-103,814999995681 V2=2,79338737292716 V3=0 T=0 M2=0 M3=11,922537863199	FrameElem=22-1 ElemStation=0,1

Società di Progetto
Brebemi SpA



Doc. N.
60235-00000-A00.doc

CODIFICA DOCUMENTO
04RCDII10000000000300A00

REV.
00

FOGLIO
313 di 628

Frame=22 Station=0 OutputCase=STR018 CaseType=Combination P=-93,9990877649704 V2=37,902203214541 V3=0 T=0 M2=0 M3=20,7670364503275 ElemStation=0	FrameElem=22-1
Frame=22 Station=0,05 OutputCase=STR018 CaseType=Combination P=-93,7290877649704 V2=35,848136027041 V3=0 T=0 M2=0 M3=18,9232340239754 ElemStation=0,05	FrameElem=22-1
Frame=22 Station=0,1 OutputCase=STR018 CaseType=Combination P=-93,4590877649704 V2=33,783521964541 V3=0 T=0 M2=0 M3=17,1823986288734 ElemStation=0,1	FrameElem=22-1
Frame=22 Station=0 OutputCase=STR019 CaseType=Combination P=-104,35499999521 V2=24,7079502837266 V3=0 T=0 M2=0 M3=11,6784027986453 ElemStation=0	FrameElem=22-1
Frame=22 Station=0,05 OutputCase=STR019 CaseType=Combination P=-104,08499999521 V2=22,6538830962266 V3=0 T=0 M2=0 M3=10,494313018834 ElemStation=0,05	FrameElem=22-1
Frame=22 Station=0,1 OutputCase=STR019 CaseType=Combination P=-103,81499999521 V2=20,5892690337266 V3=0 T=0 M2=0 M3=9,41319027027263 ElemStation=0,1	FrameElem=22-1
Frame=22 Station=0 OutputCase=STR020 CaseType=Combination P=-7,18408776845249 V2=38,6772670211889 V3=0 T=0 M2=0 M3=9,98077963062345 ElemStation=0	FrameElem=22-1
Frame=22 Station=0,05 OutputCase=STR020 CaseType=Combination P=-6,98408776845249 V2=36,6231998336889 V3=0 T=0 M2=0 M3=8,09822401393901 ElemStation=0,05	FrameElem=22-1
Frame=22 Station=0,1 OutputCase=STR020 CaseType=Combination P=-6,78408776845249 V2=34,5585857711889 V3=0 T=0 M2=0 M3=6,31863542850456 ElemStation=0,1	FrameElem=22-1
Frame=22 Station=0 OutputCase=STR021 CaseType=Combination P=-17,539999998692 V2=25,4830140903745 V3=0 T=0 M2=0 M3=0,892145978941281 ElemStation=0	FrameElem=22-1
Frame=22 Station=0,05 OutputCase=STR021 CaseType=Combination P=-17,339999998692 V2=23,4289469028745 V3=0 T=0 M2=0 M3=-0,330696991202445 ElemStation=0,05	FrameElem=22-1
Frame=22 Station=0,1 OutputCase=STR021 CaseType=Combination P=-17,139999998692 V2=21,3643328403745 V3=0 T=0 M2=0 M3=-1,45057293009617 ElemStation=0,1	FrameElem=22-1
Frame=22 Station=0 OutputCase=STR022 CaseType=Combination P=-24,1366814361209 V2=10,5807583445671 V3=0 T=0 M2=0 M3=2,40301361053233 ElemStation=0	FrameElem=22-1
Frame=22 Station=0,05 OutputCase=STR022 CaseType=Combination P=-23,8666814361209 V2=9,53653334456708 V3=0 T=0 M2=0 M3=1,90018819330398 ElemStation=0,05	FrameElem=22-1
Frame=22 Station=0,1 OutputCase=STR022 CaseType=Combination P=-23,5966814361209 V2=8,51795834456708 V3=0 T=0 M2=0 M3=1,44893277607562 ElemStation=0,1	FrameElem=22-1
Frame=22 Station=0 OutputCase=STR023 CaseType=Combination P=-24,1366814361209 V2=4,95240520351676 V3=0 T=0 M2=0 M3=2,6647567695686 ElemStation=0	FrameElem=22-1
Frame=22 Station=0,05 OutputCase=STR023 CaseType=Combination P=-23,8666814361209 V2=4,46740520351676 V3=0 T=0 M2=0 M3=2,42931150939276 ElemStation=0,05	FrameElem=22-1
Frame=22 Station=0,1 OutputCase=STR023 CaseType=Combination P=-23,5966814361209 V2=3,99440520351676 V3=0 T=0 M2=0 M3=2,21781624921692 ElemStation=0,1	FrameElem=22-1
Frame=22 Station=0 OutputCase=STR024 CaseType=Combination P=-104,812681432931 V2=3,98026038163605 V3=0 T=0 M2=0 M3=12,6502750543403 ElemStation=0	FrameElem=22-1
Frame=22 Station=0,05 OutputCase=STR024 CaseType=Combination P=-104,542681432931 V2=3,49526038163605 V3=0 T=0 M2=0 M3=12,4634370352585 ElemStation=0,05	FrameElem=22-1
Frame=22 Station=0,1 OutputCase=STR024 CaseType=Combination P=-104,272681432931 V2=3,02226038163605 V3=0 T=0 M2=0 M3=12,3005490161767 ElemStation=0,1	FrameElem=22-1
Frame=22 Station=0 OutputCase=STR025 CaseType=Combination P=-94,4567692022204 V2=38,1310762232499 V3=0 T=0 M2=0 M3=21,167934904176 ElemStation=0	FrameElem=22-1
Frame=22 Station=0,05 OutputCase=STR025 CaseType=Combination P=-94,1867692022204 V2=36,0770090357499 V3=0 T=0 M2=0 M3=19,3126888273885 ElemStation=0,05	FrameElem=22-1
Frame=22 Station=0,1 OutputCase=STR025 CaseType=Combination P=-93,9167692022204 V2=34,0123949732499 V3=0 T=0 M2=0 M3=17,560409781851 ElemStation=0,1	FrameElem=22-1
Frame=22 Station=0 OutputCase=STR026 CaseType=Combination P=-104,81268143246 V2=24,9368232924355 V3=0 T=0 M2=0 M3=12,0793012524938 ElemStation=0	FrameElem=22-1
Frame=22 Station=0,05 OutputCase=STR026 CaseType=Combination P=-104,54268143246 V2=22,8827561049355 V3=0 T=0 M2=0 M3=10,8837678222471 ElemStation=0,05	FrameElem=22-1
Frame=22 Station=0,1 OutputCase=STR026 CaseType=Combination P=-104,27268143246 V2=20,8181420424355 V3=0 T=0 M2=0 M3=9,7912014232503 ElemStation=0,1	FrameElem=22-1
Frame=22 Station=0 OutputCase=STR027 CaseType=Combination P=-7,64176920570249 V2=38,9061400298978 V3=0 T=0 M2=0 M3=10,381678084472 ElemStation=0	FrameElem=22-1
Frame=22 Station=0,05 OutputCase=STR027 CaseType=Combination P=-7,44176920570249 V2=36,8520728423978 V3=0 T=0 M2=0 M3=8,48767881735213 ElemStation=0,05	FrameElem=22-1
Frame=22 Station=0,1 OutputCase=STR027 CaseType=Combination P=-7,24176920570249 V2=34,7874587798978 V3=0 T=0 M2=0 M3=6,69664658148224 ElemStation=0,1	FrameElem=22-1
Frame=22 Station=0 OutputCase=STR028 CaseType=Combination P=-17,997681435942 V2=25,7118870990834 V3=0 T=0 M2=0 M3=1,29304443278984 ElemStation=0	FrameElem=22-1
Frame=22 Station=0,05 OutputCase=STR028 CaseType=Combination P=-17,797681435942 V2=23,6578199115834 V3=0 T=0 M2=0 M3=5,87578122106729E-02 ElemStation=0,05	FrameElem=22-1
Frame=22 Station=0,1 OutputCase=STR028 CaseType=Combination P=-17,597681435942 V2=21,5932058490834 V3=0 T=0 M2=0 M3=-1,0725617771185 ElemStation=0,1	FrameElem=22-1
Frame=22 Station=0 OutputCase=STR029 CaseType=Combination P=-23,2213185616209 V2=10,1230123271493 V3=0 T=0 M2=0 M3=1,60121670283521 ElemStation=0	FrameElem=22-1
Frame=22 Station=0,05 OutputCase=STR029 CaseType=Combination P=-22,9513185616209 V2=9,07878732714929 V3=0 T=0 M2=0 M3=1,12127858647774 ElemStation=0,05	FrameElem=22-1
Frame=22 Station=0,1 OutputCase=STR029 CaseType=Combination P=-22,6813185616209 V2=8,06021232714929 V3=0 T=0 M2=0 M3=0,692910470120277 ElemStation=0,1	FrameElem=22-1
Frame=22 Station=0 OutputCase=STR030 CaseType=Combination P=-23,2213185616209 V2=4,49465918609897 V3=0 T=0 M2=0 M3=1,86295986187148 ElemStation=0	FrameElem=22-1
Frame=22 Station=0,05 OutputCase=STR030 CaseType=Combination P=-22,9513185616209 V2=4,00965918609897 V3=0 T=0 M2=0 M3=1,65040190256653 ElemStation=0,05	FrameElem=22-1
Frame=22 Station=0,1 OutputCase=STR030 CaseType=Combination P=-22,6813185616209 V2=3,53665918609897 V3=0 T=0 M2=0 M3=1,46179394326158 ElemStation=0,1	FrameElem=22-1
Frame=22 Station=0 OutputCase=STR031 CaseType=Combination P=-103,897318558431 V2=3,52251436421826 V3=0 T=0 M2=0 M3=11,8484781466431 ElemStation=0	FrameElem=22-1
Frame=22 Station=0,05 OutputCase=STR031 CaseType=Combination P=-103,627318558431 V2=3,03751436421826 V3=0 T=0 M2=0 M3=11,6845274284322 ElemStation=0,05	FrameElem=22-1
Frame=22 Station=0,1 OutputCase=STR031 CaseType=Combination P=-103,357318558431 V2=2,56451436421826 V3=0 T=0 M2=0 M3=11,5445267102213 ElemStation=0,1	FrameElem=22-1
Frame=22 Station=0 OutputCase=STR032 CaseType=Combination P=-93,5414063277204 V2=37,6733302058321 V3=0 T=0 M2=0 M3=20,3661379964789 ElemStation=0	FrameElem=22-1
Frame=22 Station=0,05 OutputCase=STR032 CaseType=Combination P=-93,2714063277204 V2=35,6192630183321 V3=0 T=0 M2=0 M3=18,5337792205623 ElemStation=0,05	FrameElem=22-1

Società di Progetto
Brebemi SpA

	Doc. N. 60235-0000-A00.doc	CODIFICA DOCUMENTO 04RCDII10000000000300A00	REV. 00	FOGLIO 314 di 628
--	-------------------------------	--	------------	----------------------

Frame=22 Station=0,1 OutputCase=STR032 CaseType=Combination P=-93,0014063277204 V2=33,5546489558321 V3=0 T=0 M2=0 M3=16,8043874758957	FrameElem=22-1 ElemStation=0,1
Frame=22 Station=0 OutputCase=STR033 CaseType=Combination P=-103,89731855796 V2=24,479077250177 V3=0 T=0 M2=0 M3=11,2775043447967	FrameElem=22-1 ElemStation=0
Frame=22 Station=0,05 OutputCase=STR033 CaseType=Combination P=-103,62731855796 V2=22,4250100875177 V3=0 T=0 M2=0 M3=10,1048582154208	FrameElem=22-1 ElemStation=0,05
Frame=22 Station=0,1 OutputCase=STR033 CaseType=Combination P=-103,35731855796 V2=20,3603960250177 V3=0 T=0 M2=0 M3=9,03517911729495	FrameElem=22-1 ElemStation=0,1
Frame=22 Station=0 OutputCase=STR034 CaseType=Combination P=-6,72640633120249 V2=38,44839401248 V3=0 T=0 M2=0 M3=9,57988117677489	FrameElem=22-1 ElemStation=0
Frame=22 Station=0,05 OutputCase=STR034 CaseType=Combination P=-6,52640633120249 V2=36,39432682498 V3=0 T=0 M2=0 M3=7,70876921052589	FrameElem=22-1 ElemStation=0,05
Frame=22 Station=0,1 OutputCase=STR034 CaseType=Combination P=-6,32640633120249 V2=34,32971276248 V3=0 T=0 M2=0 M3=5,94062427552689	FrameElem=22-1 ElemStation=0,1
Frame=22 Station=0 OutputCase=STR035 CaseType=Combination P=-17,082318561442 V2=25,2541410816656 V3=0 T=0 M2=0 M3=0,491247525092718	FrameElem=22-1 ElemStation=0
Frame=22 Station=0,05 OutputCase=STR035 CaseType=Combination P=-16,882318561442 V2=23,2000738941656 V3=0 T=0 M2=0 M3=-0,720151794615564	FrameElem=22-1 ElemStation=0,05
Frame=22 Station=0,1 OutputCase=STR035 CaseType=Combination P=-16,682318561442 V2=21,1354598316656 V3=0 T=0 M2=0 M3=-1,82858408307384	FrameElem=22-1 ElemStation=0,1
Frame=22 Station=0 OutputCase=STR036 CaseType=Combination P=-23,6789999988713 V2=10,9035626593981 V3=0 T=0 M2=0 M3=2,36085157810519	FrameElem=22-1 ElemStation=0
Frame=22 Station=0,05 OutputCase=STR036 CaseType=Combination P=-23,4089999988713 V2=9,85933765939811 V3=0 T=0 M2=0 M3=1,84188594513528	FrameElem=22-1 ElemStation=0,05
Frame=22 Station=0,1 OutputCase=STR036 CaseType=Combination P=-23,1389999988713 V2=8,84076265939811 V3=0 T=0 M2=0 M3=1,37449031216538	FrameElem=22-1 ElemStation=0,1
Frame=22 Station=0 OutputCase=STR037 CaseType=Combination P=-23,6789999988713 V2=5,2752095183478 V3=0 T=0 M2=0 M3=2,62259473714146	FrameElem=22-1 ElemStation=0
Frame=22 Station=0,05 OutputCase=STR037 CaseType=Combination P=-23,4089999988713 V2=4,79020951834779 V3=0 T=0 M2=0 M3=2,37100926122407	FrameElem=22-1 ElemStation=0,05
Frame=22 Station=0,1 OutputCase=STR037 CaseType=Combination P=-23,1389999988713 V2=4,3172095183478 V3=0 T=0 M2=0 M3=2,14337378530668	FrameElem=22-1 ElemStation=0,1
Frame=22 Station=0 OutputCase=STR038 CaseType=Combination P=-104,354999995682 V2=4,30306469646708 V3=0 T=0 M2=0 M3=12,6081130219131	FrameElem=22-1 ElemStation=0
Frame=22 Station=0,05 OutputCase=STR038 CaseType=Combination P=-104,084999995682 V2=3,81806469646708 V3=0 T=0 M2=0 M3=12,4051347870898	FrameElem=22-1 ElemStation=0,05
Frame=22 Station=0,1 OutputCase=STR038 CaseType=Combination P=-103,814999995682 V2=3,34506469646708 V3=0 T=0 M2=0 M3=12,2261065522664	FrameElem=22-1 ElemStation=0,1
Frame=22 Station=0 OutputCase=STR039 CaseType=Combination P=-93,9990877649708 V2=38,4538805380809 V3=0 T=0 M2=0 M3=21,1257728717489	FrameElem=22-1 ElemStation=0
Frame=22 Station=0,05 OutputCase=STR039 CaseType=Combination P=-93,7290877649708 V2=36,3998133505809 V3=0 T=0 M2=0 M3=19,2543865792198	FrameElem=22-1 ElemStation=0,05
Frame=22 Station=0,1 OutputCase=STR039 CaseType=Combination P=-93,4590877649708 V2=34,3351992880809 V3=0 T=0 M2=0 M3=17,4859673179408	FrameElem=22-1 ElemStation=0,1
Frame=22 Station=0 OutputCase=STR040 CaseType=Combination P=-104,35499999521 V2=25,2596276072665 V3=0 T=0 M2=0 M3=12,0371392200667	FrameElem=22-1 ElemStation=0
Frame=22 Station=0,05 OutputCase=STR040 CaseType=Combination P=-104,08499999521 V2=23,2055604197665 V3=0 T=0 M2=0 M3=10,8254655740784	FrameElem=22-1 ElemStation=0,05
Frame=22 Station=0,1 OutputCase=STR040 CaseType=Combination P=-103,81499999521 V2=21,1409463572665 V3=0 T=0 M2=0 M3=9,71675895934006	FrameElem=22-1 ElemStation=0,1
Frame=22 Station=0 OutputCase=STR041 CaseType=Combination P=-7,1840877684529 V2=39,2289443447288 V3=0 T=0 M2=0 M3=10,3395160520449	FrameElem=22-1 ElemStation=0
Frame=22 Station=0,05 OutputCase=STR041 CaseType=Combination P=-6,9840877684529 V2=37,1748771572288 V3=0 T=0 M2=0 M3=8,42937656918344	FrameElem=22-1 ElemStation=0,05
Frame=22 Station=0,1 OutputCase=STR041 CaseType=Combination P=-6,7840877684529 V2=35,1102630947288 V3=0 T=0 M2=0 M3=6,62220411757199	FrameElem=22-1 ElemStation=0,1
Frame=22 Station=0 OutputCase=STR042 CaseType=Combination P=-17,5399999986924 V2=26,0346914139144 V3=0 T=0 M2=0 M3=1,2508824003627	FrameElem=22-1 ElemStation=0
Frame=22 Station=0,05 OutputCase=STR042 CaseType=Combination P=-17,3399999986924 V2=23,9806242264144 V3=0 T=0 M2=0 M3=4,55564041979606E-04	FrameElem=22-1 ElemStation=0,05
Frame=22 Station=0,1 OutputCase=STR042 CaseType=Combination P=-17,1399999986924 V2=21,9160101639144 V3=0 T=0 M2=0 M3=-1,14700424102874	FrameElem=22-1 ElemStation=0,1
Frame=22 Station=0 OutputCase=STR043 CaseType=Combination P=-23,6789999988723 V2=12,1908097476579 V3=0 T=0 M2=0 M3=3,19790322808851	FrameElem=22-1 ElemStation=0
Frame=22 Station=0,05 OutputCase=STR043 CaseType=Combination P=-23,4089999988723 V2=11,1465847476579 V3=0 T=0 M2=0 M3=2,61457524070561	FrameElem=22-1 ElemStation=0,05
Frame=22 Station=0,1 OutputCase=STR043 CaseType=Combination P=-23,1389999988723 V2=10,1280097476579 V3=0 T=0 M2=0 M3=2,08281725332271	FrameElem=22-1 ElemStation=0,1
Frame=22 Station=0 OutputCase=STR044 CaseType=Combination P=-23,6789999988723 V2=6,56245660660763 V3=0 T=0 M2=0 M3=3,45964638712478	FrameElem=22-1 ElemStation=0
Frame=22 Station=0,05 OutputCase=STR044 CaseType=Combination P=-23,4089999988723 V2=6,07745660660763 V3=0 T=0 M2=0 M3=3,14369855679439	FrameElem=22-1 ElemStation=0,05
Frame=22 Station=0,1 OutputCase=STR044 CaseType=Combination P=-23,1389999988723 V2=5,60445660660763 V3=0 T=0 M2=0 M3=2,85170072646401	FrameElem=22-1 ElemStation=0,1
Frame=22 Station=0 OutputCase=STR045 CaseType=Combination P=-131,246999994619 V2=4,89847862840673 V3=0 T=0 M2=0 M3=16,5345131525394	FrameElem=22-1 ElemStation=0
Frame=22 Station=0,05 OutputCase=STR045 CaseType=Combination P=-130,976999994619 V2=4,41347862840673 V3=0 T=0 M2=0 M3=16,301764221119	FrameElem=22-1 ElemStation=0,05
Frame=22 Station=0,1 OutputCase=STR045 CaseType=Combination P=-130,706999994619 V2=3,94047862840673 V3=0 T=0 M2=0 M3=16,0929652896987	FrameElem=22-1 ElemStation=0,1
Frame=22 Station=0 OutputCase=STR046 CaseType=Combination P=-118,065218413406 V2=47,7053481848705 V3=0 T=0 M2=0 M3=27,3782130092909	FrameElem=22-1 ElemStation=0
Frame=22 Station=0,05 OutputCase=STR046 CaseType=Combination P=-117,795218413406 V2=45,3146669348705 V3=0 T=0 M2=0 M3=25,0526184125473	FrameElem=22-1 ElemStation=0,05
Frame=22 Station=0,1 OutputCase=STR046 CaseType=Combination P=-117,525218413406 V2=42,9013731848705 V3=0 T=0 M2=0 M3=22,8471231908038	FrameElem=22-1 ElemStation=0,1
Frame=22 Station=0 OutputCase=STR047 CaseType=Combination P=-131,246999993991 V2=30,9644447957892 V3=0 T=0 M2=0 M3=15,8604624697562	FrameElem=22-1 ElemStation=0

Società di Progetto
Brebemi SpA



Doc. N.
60235-0000-A00.doc

CODIFICA DOCUMENTO
04RCDII10000000000300A00

REV.
00

FOGLIO
315 di 628

Frame=22 Station=0,05 OutputCase=STR047 CaseType=Combination P=-130,976999993991 V2=28,5737635457892 V3=0 T=0 M2=0 M3=14,3719130424668	FrameElem=22-1 ElemStation=0,05
Frame=22 Station=0,1 OutputCase=STR047 CaseType=Combination P=-130,706999993991 V2=26,1604697957892 V3=0 T=0 M2=0 M3=13,0034629901773	FrameElem=22-1 ElemStation=0,1
Frame=22 Station=0 OutputCase=STR048 CaseType=Combination P=-4,35821841795155 V2=48,8044602654787 V3=0 T=0 M2=0 M3=13,263450094663	FrameElem=22-1 ElemStation=0
Frame=22 Station=0,05 OutputCase=STR048 CaseType=Combination P=-4,15821841795155 V2=46,4137790154787 V3=0 T=0 M2=0 M3=10,882899893889	FrameElem=22-1 ElemStation=0,05
Frame=22 Station=0,1 OutputCase=STR048 CaseType=Combination P=-3,95821841795155 V2=44,0004852654787 V3=0 T=0 M2=0 M3=8,6224490681151	FrameElem=22-1 ElemStation=0,1
Frame=22 Station=0 OutputCase=STR049 CaseType=Combination P=-17,5399999985359 V2=32,0635568763973 V3=0 T=0 M2=0 M3=1,7456995512835	FrameElem=22-1 ElemStation=0
Frame=22 Station=0,05 OutputCase=STR049 CaseType=Combination P=-17,3399999985359 V2=29,6728756263973 V3=0 T=0 M2=0 M3=0,202194523808488	FrameElem=22-1 ElemStation=0,05
Frame=22 Station=0,1 OutputCase=STR049 CaseType=Combination P=-17,1399999985359 V2=27,2595818763973 V3=0 T=0 M2=0 M3=-1,22121113251138	FrameElem=22-1 ElemStation=0,1
Frame=22 Station=0 OutputCase=STR050 CaseType=Combination P=-74,629174979866 V2=58,0856927509411 V3=0 T=0 M2=0 M3=33,3409173013091	FrameElem=22-1 ElemStation=0
Frame=22 Station=0,05 OutputCase=STR050 CaseType=Combination P=-74,359174979866 V2=56,0316255634411 V3=0 T=0 M2=0 M3=30,487940398137	FrameElem=22-1 ElemStation=0,05
Frame=22 Station=0,1 OutputCase=STR050 CaseType=Combination P=-74,089174979866 V2=53,9670115009411 V3=0 T=0 M2=0 M3=27,737930526215	FrameElem=22-1 ElemStation=0,1
Frame=22 Station=0 OutputCase=STR051 CaseType=Combination P=-104,354999995683 V2=5,59031178472692 V3=0 T=0 M2=0 M3=13,4451646718964	FrameElem=22-1 ElemStation=0
Frame=22 Station=0,05 OutputCase=STR051 CaseType=Combination P=-104,084999995683 V2=5,10531178472691 V3=0 T=0 M2=0 M3=13,1778240826601	FrameElem=22-1 ElemStation=0,05
Frame=22 Station=0,1 OutputCase=STR051 CaseType=Combination P=-103,814999995683 V2=4,63231178472692 V3=0 T=0 M2=0 M3=12,93433434934237	FrameElem=22-1 ElemStation=0,1
Frame=22 Station=0 OutputCase=STR052 CaseType=Combination P=-93,9990877649717 V2=39,7411276263407 V3=0 T=0 M2=0 M3=21,9628245217322	FrameElem=22-1 ElemStation=0
Frame=22 Station=0,05 OutputCase=STR052 CaseType=Combination P=-93,7290877649717 V2=37,6870604388407 V3=0 T=0 M2=0 M3=20,0270758747902	FrameElem=22-1 ElemStation=0,05
Frame=22 Station=0,1 OutputCase=STR052 CaseType=Combination P=-93,4590877649717 V2=35,6224463763407 V3=0 T=0 M2=0 M3=18,1942942590981	FrameElem=22-1 ElemStation=0,1
Frame=22 Station=0 OutputCase=STR053 CaseType=Combination P=-104,354999995211 V2=26,5468746955263 V3=0 T=0 M2=0 M3=12,87419087005	FrameElem=22-1 ElemStation=0
Frame=22 Station=0,05 OutputCase=STR053 CaseType=Combination P=-104,084999995211 V2=24,4928075080263 V3=0 T=0 M2=0 M3=11,5981548696487	FrameElem=22-1 ElemStation=0,05
Frame=22 Station=0,1 OutputCase=STR053 CaseType=Combination P=-103,814999995211 V2=22,4281934455263 V3=0 T=0 M2=0 M3=10,4250859004974	FrameElem=22-1 ElemStation=0,1
Frame=22 Station=0 OutputCase=STR054 CaseType=Combination P=-7,18408776845386 V2=40,5161914329886 V3=0 T=0 M2=0 M3=11,1765677020282	FrameElem=22-1 ElemStation=0
Frame=22 Station=0,05 OutputCase=STR054 CaseType=Combination P=-6,98408776845386 V2=38,4621242454886 V3=0 T=0 M2=0 M3=9,20206586475376	FrameElem=22-1 ElemStation=0,05
Frame=22 Station=0,1 OutputCase=STR054 CaseType=Combination P=-6,78408776845386 V2=36,3975101829886 V3=0 T=0 M2=0 M3=7,33053105872933	FrameElem=22-1 ElemStation=0,1
Frame=22 Station=0 OutputCase=STR055 CaseType=Combination P=-17,5399999986933 V2=27,3219385021743 V3=0 T=0 M2=0 M3=2,08793405034602	FrameElem=22-1 ElemStation=0
Frame=22 Station=0,05 OutputCase=STR055 CaseType=Combination P=-17,3399999986933 V2=25,2678713146742 V3=0 T=0 M2=0 M3=0,773144859612305	FrameElem=22-1 ElemStation=0,05
Frame=22 Station=0,1 OutputCase=STR055 CaseType=Combination P=-17,1399999986933 V2=23,2032572521742 V3=0 T=0 M2=0 M3=-0,438677299871409	FrameElem=22-1 ElemStation=0,1
Frame=22 Station=0 OutputCase=STR056 CaseType=Combination P=-24,1366814361223 V2=12,4196827563668 V3=0 T=0 M2=0 M3=3,59880168193707	FrameElem=22-1 ElemStation=0
Frame=22 Station=0,05 OutputCase=STR056 CaseType=Combination P=-23,8666814361223 V2=11,3754577563668 V3=0 T=0 M2=0 M3=3,00430004411873	FrameElem=22-1 ElemStation=0,05
Frame=22 Station=0,1 OutputCase=STR056 CaseType=Combination P=-23,5966814361223 V2=10,3568827563668 V3=0 T=0 M2=0 M3=2,46082840630039	FrameElem=22-1 ElemStation=0,1
Frame=22 Station=0 OutputCase=STR057 CaseType=Combination P=-24,1366814361223 V2=6,79132961531652 V3=0 T=0 M2=0 M3=3,86054484097334	FrameElem=22-1 ElemStation=0
Frame=22 Station=0,05 OutputCase=STR057 CaseType=Combination P=-23,8666814361223 V2=6,30632961531652 V3=0 T=0 M2=0 M3=3,53315336020751	FrameElem=22-1 ElemStation=0,05
Frame=22 Station=0,1 OutputCase=STR057 CaseType=Combination P=-23,5966814361223 V2=5,83332961531652 V3=0 T=0 M2=0 M3=3,22971187944169	FrameElem=22-1 ElemStation=0,1
Frame=22 Station=0 OutputCase=STR058 CaseType=Combination P=-104,812681432933 V2=5,81918479343581 V3=0 T=0 M2=0 M3=13,846063125745	FrameElem=22-1 ElemStation=0
Frame=22 Station=0,05 OutputCase=STR058 CaseType=Combination P=-104,542681432933 V2=5,33418479343581 V3=0 T=0 M2=0 M3=13,5672788860732	FrameElem=22-1 ElemStation=0,05
Frame=22 Station=0,1 OutputCase=STR058 CaseType=Combination P=-104,272681432933 V2=4,86118479343581 V3=0 T=0 M2=0 M3=13,3124446464014	FrameElem=22-1 ElemStation=0,1
Frame=22 Station=0 OutputCase=STR059 CaseType=Combination P=-94,4567692022217 V2=39,9700006350496 V3=0 T=0 M2=0 M3=22,3637229755808	FrameElem=22-1 ElemStation=0
Frame=22 Station=0,05 OutputCase=STR059 CaseType=Combination P=-94,1867692022217 V2=37,9159334475496 V3=0 T=0 M2=0 M3=20,4165306782033	FrameElem=22-1 ElemStation=0,05
Frame=22 Station=0,1 OutputCase=STR059 CaseType=Combination P=-93,9167692022217 V2=35,8513193850496 V3=0 T=0 M2=0 M3=18,5723054120758	FrameElem=22-1 ElemStation=0,1
Frame=22 Station=0 OutputCase=STR060 CaseType=Combination P=-104,812681432461 V2=26,7757477042352 V3=0 T=0 M2=0 M3=13,2750893238986	FrameElem=22-1 ElemStation=0
Frame=22 Station=0,05 OutputCase=STR060 CaseType=Combination P=-104,542681432461 V2=24,7216805167352 V3=0 T=0 M2=0 M3=11,9876096730618	FrameElem=22-1 ElemStation=0,05
Frame=22 Station=0,1 OutputCase=STR060 CaseType=Combination P=-104,272681432461 V2=22,6570664542352 V3=0 T=0 M2=0 M3=10,8039070534751	FrameElem=22-1 ElemStation=0,1
Frame=22 Station=0 OutputCase=STR061 CaseType=Combination P=-7,64176920570386 V2=40,7450644416975 V3=0 T=0 M2=0 M3=11,5774661558768	FrameElem=22-1 ElemStation=0
Frame=22 Station=0,05 OutputCase=STR061 CaseType=Combination P=-7,44176920570386 V2=38,6909972541975 V3=0 T=0 M2=0 M3=9,59152066816688	FrameElem=22-1 ElemStation=0,05
Frame=22 Station=0,1 OutputCase=STR061 CaseType=Combination P=-7,24176920570386 V2=36,6263831916975 V3=0 T=0 M2=0 M3=7,708542211707	FrameElem=22-1 ElemStation=0,1

Società di Progetto
Brebemi SpA

	Doc. N. 60235-00000-A00.doc	CODIFICA DOCUMENTO 04RCDII10000000000300A00	REV. 00	FOGLIO 316 di 628
--	--------------------------------	--	------------	----------------------

Frame=22 Station=0 OutputCase=STR062 CaseType=Combination P=-17,9976814359433 V2=27,5508115108831 V3=0 T=0 M2=0 M3=2,48883250419458 FrameElem=22-1 ElemStation=0

Frame=22 Station=0,05 OutputCase=STR062 CaseType=Combination P=-17,7976814359433 V2=25,4967443233831 V3=0 T=0 M2=0 M3=1,16259966302542 FrameElem=22-1 ElemStation=0,05

Frame=22 Station=0,1 OutputCase=STR062 CaseType=Combination P=-17,5976814359433 V2=23,4321302608831 V3=0 T=0 M2=0 M3=-6,06661468937355E-02 FrameElem=22-1 ElemStation=0,1

Frame=22 Station=0 OutputCase=STR063 CaseType=Combination P=-23,2213185616223 V2=11,9619367389491 V3=0 T=0 M2=0 M3=2,79700477423994 FrameElem=22-1 ElemStation=0

Frame=22 Station=0,05 OutputCase=STR063 CaseType=Combination P=-22,9513185616223 V2=10,9177117389491 V3=0 T=0 M2=0 M3=2,22512043729249 FrameElem=22-1 ElemStation=0,05

Frame=22 Station=0,1 OutputCase=STR063 CaseType=Combination P=-22,6813185616223 V2=9,89913673894905 V3=0 T=0 M2=0 M3=1,70480610034504 FrameElem=22-1 ElemStation=0,1

Frame=22 Station=0 OutputCase=STR064 CaseType=Combination P=-23,2213185616223 V2=6,33358359789873 V3=0 T=0 M2=0 M3=3,05874793327621 FrameElem=22-1 ElemStation=0

Frame=22 Station=0,05 OutputCase=STR064 CaseType=Combination P=-22,9513185616223 V2=5,84858359789873 V3=0 T=0 M2=0 M3=2,75424375338128 FrameElem=22-1 ElemStation=0,05

Frame=22 Station=0,1 OutputCase=STR064 CaseType=Combination P=-22,6813185616223 V2=5,37558359789873 V3=0 T=0 M2=0 M3=2,47368957348634 FrameElem=22-1 ElemStation=0,1

Frame=22 Station=0 OutputCase=STR065 CaseType=Combination P=-103,897318558433 V2=5,36143877601802 V3=0 T=0 M2=0 M3=13,0442662180479 FrameElem=22-1 ElemStation=0

Frame=22 Station=0,05 OutputCase=STR065 CaseType=Combination P=-103,627318558433 V2=4,87643877601802 V3=0 T=0 M2=0 M3=12,788369279247 FrameElem=22-1 ElemStation=0,05

Frame=22 Station=0,1 OutputCase=STR065 CaseType=Combination P=-103,357318558433 V2=4,40343877601802 V3=0 T=0 M2=0 M3=12,5564223404461 FrameElem=22-1 ElemStation=0,1

Frame=22 Station=0 OutputCase=STR066 CaseType=Combination P=-93,5414063277217 V2=39,5122546176318 V3=0 T=0 M2=0 M3=21,5619260678836 FrameElem=22-1 ElemStation=0

Frame=22 Station=0,05 OutputCase=STR066 CaseType=Combination P=-93,2714063277217 V2=37,4581874301318 V3=0 T=0 M2=0 M3=19,637621071377 FrameElem=22-1 ElemStation=0,05

Frame=22 Station=0,1 OutputCase=STR066 CaseType=Combination P=-93,0014063277217 V2=35,3935733676318 V3=0 T=0 M2=0 M3=17,8162831061205 FrameElem=22-1 ElemStation=0,1

Frame=22 Station=0 OutputCase=STR067 CaseType=Combination P=-103,897318557961 V2=26,3180016868174 V3=0 T=0 M2=0 M3=12,4732924162015 FrameElem=22-1 ElemStation=0

Frame=22 Station=0,05 OutputCase=STR067 CaseType=Combination P=-103,627318557961 V2=24,2639344993174 V3=0 T=0 M2=0 M3=11,2087000662356 FrameElem=22-1 ElemStation=0,05

Frame=22 Station=0,1 OutputCase=STR067 CaseType=Combination P=-103,357318557961 V2=22,1993204368174 V3=0 T=0 M2=0 M3=10,0470747475197 FrameElem=22-1 ElemStation=0,1

Frame=22 Station=0 OutputCase=STR068 CaseType=Combination P=-6,72640633120386 V2=40,2873184242798 V3=0 T=0 M2=0 M3=10,7756692481796 FrameElem=22-1 ElemStation=0

Frame=22 Station=0,05 OutputCase=STR068 CaseType=Combination P=-6,52640633120386 V2=38,2332512367797 V3=0 T=0 M2=0 M3=8,81261106134064 FrameElem=22-1 ElemStation=0,05

Frame=22 Station=0,1 OutputCase=STR068 CaseType=Combination P=-6,32640633120386 V2=36,1686371742797 V3=0 T=0 M2=0 M3=6,95251990575165 FrameElem=22-1 ElemStation=0,1

Frame=22 Station=0 OutputCase=STR069 CaseType=Combination P=-17,0823185614433 V2=27,0930654934654 V3=0 T=0 M2=0 M3=1,68703559649746 FrameElem=22-1 ElemStation=0

Frame=22 Station=0,05 OutputCase=STR069 CaseType=Combination P=-16,8823185614433 V2=25,0389983059654 V3=0 T=0 M2=0 M3=0,383690056199186 FrameElem=22-1 ElemStation=0,05

Frame=22 Station=0,1 OutputCase=STR069 CaseType=Combination P=-16,6823185614433 V2=22,9743842434653 V3=0 T=0 M2=0 M3=-0,816688452849082 FrameElem=22-1 ElemStation=0,1

Frame=22 Station=0 OutputCase=STR070 CaseType=Combination P=-23,6789999988727 V2=12,7424870711979 V3=0 T=0 M2=0 M3=3,55663964950993 FrameElem=22-1 ElemStation=0

Frame=22 Station=0,05 OutputCase=STR070 CaseType=Combination P=-23,4089999988727 V2=11,6982620711979 V3=0 T=0 M2=0 M3=2,94572779595003 FrameElem=22-1 ElemStation=0,05

Frame=22 Station=0,1 OutputCase=STR070 CaseType=Combination P=-23,1389999988727 V2=10,6796870711979 V3=0 T=0 M2=0 M3=2,38638594239014 FrameElem=22-1 ElemStation=0,1

Frame=22 Station=0 OutputCase=STR071 CaseType=Combination P=-23,6789999988727 V2=7,11413393014755 V3=0 T=0 M2=0 M3=3,8183828085462 FrameElem=22-1 ElemStation=0

Frame=22 Station=0,05 OutputCase=STR071 CaseType=Combination P=-23,4089999988727 V2=6,62913393014755 V3=0 T=0 M2=0 M3=3,47485111203882 FrameElem=22-1 ElemStation=0,05

Frame=22 Station=0,1 OutputCase=STR071 CaseType=Combination P=-23,1389999988727 V2=6,15613393014755 V3=0 T=0 M2=0 M3=3,15526941553144 FrameElem=22-1 ElemStation=0,1

Frame=22 Station=0 OutputCase=STR072 CaseType=Combination P=-104,354999995683 V2=6,14198910826684 V3=0 T=0 M2=0 M3=13,8039010933179 FrameElem=22-1 ElemStation=0

Frame=22 Station=0,05 OutputCase=STR072 CaseType=Combination P=-104,084999995683 V2=5,65698910826684 V3=0 T=0 M2=0 M3=13,5089766379045 FrameElem=22-1 ElemStation=0,05

Frame=22 Station=0,1 OutputCase=STR072 CaseType=Combination P=-103,814999995683 V2=5,18398910826684 V3=0 T=0 M2=0 M3=13,2380021824912 FrameElem=22-1 ElemStation=0,1

Frame=22 Station=0 OutputCase=STR073 CaseType=Combination P=-93,9990877649721 V2=40,2928049498806 V3=0 T=0 M2=0 M3=22,3215609431536 FrameElem=22-1 ElemStation=0

Frame=22 Station=0,05 OutputCase=STR073 CaseType=Combination P=-93,7290877649721 V2=38,2387377623806 V3=0 T=0 M2=0 M3=20,3582284300346 FrameElem=22-1 ElemStation=0,05

Frame=22 Station=0,1 OutputCase=STR073 CaseType=Combination P=-93,4590877649721 V2=36,1741236998806 V3=0 T=0 M2=0 M3=18,4978629481656 FrameElem=22-1 ElemStation=0,1

Frame=22 Station=0 OutputCase=STR074 CaseType=Combination P=-104,354999995212 V2=27,0985520190663 V3=0 T=0 M2=0 M3=13,2329272914714 FrameElem=22-1 ElemStation=0

Frame=22 Station=0,05 OutputCase=STR074 CaseType=Combination P=-104,084999995212 V2=25,0444848315662 V3=0 T=0 M2=0 M3=11,9293074248931 FrameElem=22-1 ElemStation=0,05

Frame=22 Station=0,1 OutputCase=STR074 CaseType=Combination P=-103,814999995212 V2=22,9798707690662 V3=0 T=0 M2=0 M3=10,7286545895648 FrameElem=22-1 ElemStation=0,1

Frame=22 Station=0 OutputCase=STR075 CaseType=Combination P=-7,18408776845426 V2=41,0678687565286 V3=0 T=0 M2=0 M3=11,5353041234496 FrameElem=22-1 ElemStation=0

Frame=22 Station=0,05 OutputCase=STR075 CaseType=Combination P=-6,98408776845427 V2=39,0138015690286 V3=0 T=0 M2=0 M3=9,53321841999819 FrameElem=22-1 ElemStation=0,05

Frame=22 Station=0,1 OutputCase=STR075 CaseType=Combination P=-6,78408776845427 V2=36,9491875065286 V3=0 T=0 M2=0 M3=7,63409974779676 FrameElem=22-1 ElemStation=0,1

Frame=22 Station=0 OutputCase=STR076 CaseType=Combination P=-17,5399999986937 V2=27,8736158257142 V3=0 T=0 M2=0 M3=2,44667047176744 FrameElem=22-1 ElemStation=0

Frame=22 Station=0,05 OutputCase=STR076 CaseType=Combination P=-17,3399999986937 V2=25,8195486382142 V3=0 T=0 M2=0 M3=1,10429741485673 FrameElem=22-1 ElemStation=0,05

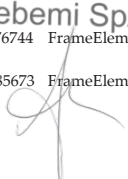
Società di Progetto
Brebemi SpA

	Doc. N. 60235-00000-A00.doc	CODIFICA DOCUMENTO 04RCDII10000000000300A00	REV. 00	FOGLIO 317 di 628
--	--------------------------------	--	------------	----------------------

Frame=22 Station=0,1 OutputCase=STR076 CaseType=Combination P=-17,1399999986937 V2=23,754934575142 V3=0 T=0 M2=0 M3=-0,13510861080398 ElemStation=0,1	Frame=22 Station=0 OutputCase=STR077 CaseType=Combination P=-24,4418023942883 V2=11,6528025562729 V3=0 T=0 M2=0 M3=3,26817328213374 ElemStation=0	Frame=22 Station=0,05 OutputCase=STR077 CaseType=Combination P=-24,1718023942883 V2=10,6085775562729 V3=0 T=0 M2=0 M3=2,7117456543201 ElemStation=0,05	Frame=22 Station=0,1 OutputCase=STR077 CaseType=Combination P=-23,9018023942883 V2=9,59000255627289 V3=0 T=0 M2=0 M3=2,20688802650645 ElemStation=0,1	Frame=22 Station=0 OutputCase=STR078 CaseType=Combination P=-24,4418023942883 V2=6,02444941522257 V3=0 T=0 M2=0 M3=3,52991644117001 ElemStation=0	Frame=22 Station=0,05 OutputCase=STR078 CaseType=Combination P=-24,1718023942883 V2=5,53944941522257 V3=0 T=0 M2=0 M3=3,24086897040888 ElemStation=0,05	Frame=22 Station=0,1 OutputCase=STR078 CaseType=Combination P=-23,9018023942883 V2=5,06644941522257 V3=0 T=0 M2=0 M3=2,97577149964776 ElemStation=0,1	Frame=22 Station=0 OutputCase=STR079 CaseType=Combination P=-131,704681431869 V2=4,5756743135757 V3=0 T=0 M2=0 M3=16,5766751849665 ElemStation=0	Frame=22 Station=0,05 OutputCase=STR079 CaseType=Combination P=-131,434681431869 V2=4,09067431357569 V3=0 T=0 M2=0 M3=16,3600664692877 ElemStation=0,05	Frame=22 Station=0,1 OutputCase=STR079 CaseType=Combination P=-131,164681431869 V2=3,61767431357569 V3=0 T=0 M2=0 M3=16,1674077536089 ElemStation=0,1	Frame=22 Station=0 OutputCase=STR080 CaseType=Combination P=-118,522899850656 V2=47,3825438700395 V3=0 T=0 M2=0 M3=27,420375041718 ElemStation=0	Frame=22 Station=0,05 OutputCase=STR080 CaseType=Combination P=-118,252899850656 V2=44,9918626200395 V3=0 T=0 M2=0 M3=25,110920660716 ElemStation=0,05	Frame=22 Station=0,1 OutputCase=STR080 CaseType=Combination P=-117,982899850656 V2=42,5785688700395 V3=0 T=0 M2=0 M3=22,921565654714 ElemStation=0,1	Frame=22 Station=0 OutputCase=STR081 CaseType=Combination P=-131,70468143124 V2=30,6416404809581 V3=0 T=0 M2=0 M3=15,9026245021834 ElemStation=0	Frame=22 Station=0,05 OutputCase=STR081 CaseType=Combination P=-131,43468143124 V2=28,2509592309581 V3=0 T=0 M2=0 M3=14,4302152906355 ElemStation=0,05	Frame=22 Station=0,1 OutputCase=STR081 CaseType=Combination P=-131,16468143124 V2=25,8376654809581 V3=0 T=0 M2=0 M3=13,0779054540876 ElemStation=0,1	Frame=22 Station=0 OutputCase=STR082 CaseType=Combination P=-4,81589985520114 V2=48,4816559506477 V3=0 T=0 M2=0 M3=13,3056121270901 ElemStation=0	Frame=22 Station=0,05 OutputCase=STR082 CaseType=Combination P=-4,61589985520114 V2=46,0909747006477 V3=0 T=0 M2=0 M3=10,9412021420577 ElemStation=0,05	Frame=22 Station=0,1 OutputCase=STR082 CaseType=Combination P=-4,41589985520114 V2=43,6776809506476 V3=0 T=0 M2=0 M3=8,69689153202534 ElemStation=0,1	Frame=22 Station=0 OutputCase=STR083 CaseType=Combination P=-17,9976814357855 V2=31,7407525615663 V3=0 T=0 M2=0 M3=1,7878615875555 ElemStation=0	Frame=22 Station=0,05 OutputCase=STR083 CaseType=Combination P=-17,7976814357855 V2=29,3500713115663 V3=0 T=0 M2=0 M3=0,260496771977181 ElemStation=0,05	Frame=22 Station=0,1 OutputCase=STR083 CaseType=Combination P=-17,5976814357855 V2=26,9367775615663 V3=0 T=0 M2=0 M3=-1,14676866860113 ElemStation=0,1	Frame=22 Station=0 OutputCase=STR084 CaseType=Combination P=-75,0868564171156 V2=57,7628884361101 V3=0 T=0 M2=0 M3=33,3830793337362 ElemStation=0	Frame=22 Station=0,05 OutputCase=STR084 CaseType=Combination P=-74,8168564171156 V2=55,7088212486101 V3=0 T=0 M2=0 M3=30,5462424643057 ElemStation=0,05	Frame=22 Station=0,1 OutputCase=STR084 CaseType=Combination P=-74,5468564171156 V2=53,6442071861101 V3=0 T=0 M2=0 M3=27,8123729901252 ElemStation=0,1	Frame=22 Station=0 OutputCase=STR085 CaseType=Combination P=-105,117802391099 V2=5,05230459334186 V3=0 T=0 M2=0 M3=13,5154347259417 ElemStation=0	Frame=22 Station=0,05 OutputCase=STR085 CaseType=Combination P=-104,847802391099 V2=4,56730459334186 V3=0 T=0 M2=0 M3=13,2749944962746 ElemStation=0,05	Frame=22 Station=0,1 OutputCase=STR085 CaseType=Combination P=-104,577802391099 V2=4,09430459334186 V3=0 T=0 M2=0 M3=13,0585042666075 ElemStation=0,1	Frame=22 Station=0 OutputCase=STR086 CaseType=Combination P=-94,7618901603877 V2=39,2031204349557 V3=0 T=0 M2=0 M3=22,0330945757774 ElemStation=0	Frame=22 Station=0,05 OutputCase=STR086 CaseType=Combination P=-94,4918901603877 V2=37,1490532474557 V3=0 T=0 M2=0 M3=20,1242462884046 ElemStation=0,05	Frame=22 Station=0,1 OutputCase=STR086 CaseType=Combination P=-94,2218901603877 V2=35,0844391849557 V3=0 T=0 M2=0 M3=18,3183650322819 ElemStation=0,1	Frame=22 Station=0 OutputCase=STR087 CaseType=Combination P=-105,117802390627 V2=26,0088675041413 V3=0 T=0 M2=0 M3=12,9444609240953 ElemStation=0	Frame=22 Station=0,05 OutputCase=STR087 CaseType=Combination P=-104,847802390627 V2=23,9548003166413 V3=0 T=0 M2=0 M3=11,6953252832632 ElemStation=0,05	Frame=22 Station=0,1 OutputCase=STR087 CaseType=Combination P=-104,577802390627 V2=21,8901862541413 V3=0 T=0 M2=0 M3=10,5491566736811 ElemStation=0,1	Frame=22 Station=0 OutputCase=STR088 CaseType=Combination P=-7,94689016386984 V2=39,9781842416036 V3=0 T=0 M2=0 M3=11,2468377560734 ElemStation=0	Frame=22 Station=0,05 OutputCase=STR088 CaseType=Combination P=-7,74689016386984 V2=37,9241170541036 V3=0 T=0 M2=0 M3=9,29923627836825 ElemStation=0,05	Frame=22 Station=0,1 OutputCase=STR088 CaseType=Combination P=-7,54689016386984 V2=35,8595029916036 V3=0 T=0 M2=0 M3=7,45460183191307 ElemStation=0,1	Frame=22 Station=0 OutputCase=STR089 CaseType=Combination P=-18,3028023941093 V2=26,7839313107892 V3=0 T=0 M2=0 M3=2,15820410439125 ElemStation=0	Frame=22 Station=0,05 OutputCase=STR089 CaseType=Combination P=-18,1028023941093 V2=24,7298641232892 V3=0 T=0 M2=0 M3=0,870315273226793 ElemStation=0,05	Frame=22 Station=0,1 OutputCase=STR089 CaseType=Combination P=-17,9028023941093 V2=22,6652500607892 V3=0 T=0 M2=0 M3=-0,314606526687667 ElemStation=0,1	Frame=22 Station=0 OutputCase=STR090 CaseType=Combination P=-24,4418023942878 V2=11,101125232733 V3=0 T=0 M2=0 M3=2,90943686071232 ElemStation=0	Frame=22 Station=0,05 OutputCase=STR090 CaseType=Combination P=-24,1718023942878 V2=10,056900232733 V3=0 T=0 M2=0 M3=2,38059309907567 ElemStation=0,05	Frame=22 Station=0,1 OutputCase=STR090 CaseType=Combination P=-23,9018023942878 V2=9,03832523273296 V3=0 T=0 M2=0 M3=1,90331933743903 ElemStation=0,1	Frame=22 Station=0 OutputCase=STR091 CaseType=Combination P=-24,4418023942878 V2=5,47277209168264 V3=0 T=0 M2=0 M3=3,17118001974859 ElemStation=0
---	---	--	---	---	---	---	--	---	---	--	--	--	--	--	--	---	---	---	--	--	--	---	---	---	---	---	---	---	---	---	---	---	---	---	---	---	---	--	---	--	--	---	---

Società di Progetto
Brebemi SpA

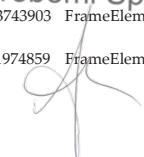



Doc. N.
60235-0000-A00.doc

CODIFICA DOCUMENTO
04RCDII10000000000300A00

REV.
00

FOGLIO
318 di 628

Frame=22 Station=0,05 OutputCase=STR091 CaseType=Combination P=-24,1718023942878 V2=4,9877209168264 V3=0 T=0 M2=0 M3=2,90971641516446 ElemStation=0,05	FrameElem=22-1
Frame=22 Station=0,1 OutputCase=STR091 CaseType=Combination P=-23,9018023942878 V2=4,51477209168264 V3=0 T=0 M2=0 M3=2,67220281058033 ElemStation=0,1	FrameElem=22-1
Frame=22 Station=0 OutputCase=STR092 CaseType=Combination P=-105,117802391098 V2=4,50062726980193 V3=0 T=0 M2=0 M3=13,1566983045202 ElemStation=0	FrameElem=22-1
Frame=22 Station=0,05 OutputCase=STR092 CaseType=Combination P=-104,847802391098 V2=4,01562726980193 V3=0 T=0 M2=0 M3=12,9438419410302 ElemStation=0,05	FrameElem=22-1
Frame=22 Station=0,1 OutputCase=STR092 CaseType=Combination P=-104,577802391098 V2=3,54262726980193 V3=0 T=0 M2=0 M3=12,7549355775401 ElemStation=0,1	FrameElem=22-1
Frame=22 Station=0 OutputCase=STR093 CaseType=Combination P=-94,7618901603873 V2=38,6514431114157 V3=0 T=0 M2=0 M3=21,674358154356 ElemStation=0	FrameElem=22-1
Frame=22 Station=0,05 OutputCase=STR093 CaseType=Combination P=-94,4918901603873 V2=36,5973759239157 V3=0 T=0 M2=0 M3=19,7930937331602 ElemStation=0,05	FrameElem=22-1
Frame=22 Station=0,1 OutputCase=STR093 CaseType=Combination P=-94,2218901603873 V2=34,5327618614157 V3=0 T=0 M2=0 M3=18,0147963432144 ElemStation=0,1	FrameElem=22-1
Frame=22 Station=0 OutputCase=STR094 CaseType=Combination P=-105,117802390627 V2=25,4571901806013 V3=0 T=0 M2=0 M3=12,5857245026738 ElemStation=0	FrameElem=22-1
Frame=22 Station=0,05 OutputCase=STR094 CaseType=Combination P=-104,847802390627 V2=23,4031229931013 V3=0 T=0 M2=0 M3=11,3641727280188 ElemStation=0,05	FrameElem=22-1
Frame=22 Station=0,1 OutputCase=STR094 CaseType=Combination P=-104,577802390627 V2=21,3385089306013 V3=0 T=0 M2=0 M3=10,2455879846137 ElemStation=0,1	FrameElem=22-1
Frame=22 Station=0 OutputCase=STR095 CaseType=Combination P=-7,94689016386943 V2=39,4265069180637 V3=0 T=0 M2=0 M3=10,888101334652 ElemStation=0	FrameElem=22-1
Frame=22 Station=0,05 OutputCase=STR095 CaseType=Combination P=-7,74689016386943 V2=37,3724397305637 V3=0 T=0 M2=0 M3=8,96808372312383 ElemStation=0,05	FrameElem=22-1
Frame=22 Station=0,1 OutputCase=STR095 CaseType=Combination P=-7,54689016386943 V2=35,3078256680637 V3=0 T=0 M2=0 M3=7,15103314284564 ElemStation=0,1	FrameElem=22-1
Frame=22 Station=0 OutputCase=STR096 CaseType=Combination P=-18,3028023941089 V2=26,2322539872493 V3=0 T=0 M2=0 M3=1,79946768296983 ElemStation=0	FrameElem=22-1
Frame=22 Station=0,05 OutputCase=STR096 CaseType=Combination P=-18,1028023941089 V2=24,1781867997493 V3=0 T=0 M2=0 M3=0,539162717982368 ElemStation=0,05	FrameElem=22-1
Frame=22 Station=0,1 OutputCase=STR096 CaseType=Combination P=-17,9028023941089 V2=22,1135727372493 V3=0 T=0 M2=0 M3=0,618175215755096 ElemStation=0,1	FrameElem=22-1
Frame=22 Station=0 OutputCase=STR097 CaseType=Combination P=-24,4418023942887 V2=12,2044798798128 V3=0 T=0 M2=0 M3=3,62690970355517 ElemStation=0	FrameElem=22-1
Frame=22 Station=0,05 OutputCase=STR097 CaseType=Combination P=-24,1718023942887 V2=11,1602548798128 V3=0 T=0 M2=0 M3=3,04289820956452 ElemStation=0,05	FrameElem=22-1
Frame=22 Station=0,1 OutputCase=STR097 CaseType=Combination P=-23,9018023942887 V2=10,1416798798128 V3=0 T=0 M2=0 M3=2,51045671557388 ElemStation=0,1	FrameElem=22-1
Frame=22 Station=0 OutputCase=STR098 CaseType=Combination P=-24,4418023942887 V2=6,5761267387625 V3=0 T=0 M2=0 M3=3,88865286259143 ElemStation=0	FrameElem=22-1
Frame=22 Station=0,05 OutputCase=STR098 CaseType=Combination P=-24,1718023942887 V2=6,0911267387625 V3=0 T=0 M2=0 M3=3,57202152565331 ElemStation=0,05	FrameElem=22-1
Frame=22 Station=0,1 OutputCase=STR098 CaseType=Combination P=-23,9018023942887 V2=5,6181267387625 V3=0 T=0 M2=0 M3=3,27934018871518 ElemStation=0,1	FrameElem=22-1
Frame=22 Station=0 OutputCase=STR099 CaseType=Combination P=-105,117802391099 V2=5,60398191688179 V3=0 T=0 M2=0 M3=13,8741711473631 ElemStation=0	FrameElem=22-1
Frame=22 Station=0,05 OutputCase=STR099 CaseType=Combination P=-104,847802391099 V2=5,11898191688179 V3=0 T=0 M2=0 M3=13,606147051519 ElemStation=0,05	FrameElem=22-1
Frame=22 Station=0,1 OutputCase=STR099 CaseType=Combination P=-104,577802391099 V2=4,64598191688179 V3=0 T=0 M2=0 M3=13,3620729556749 ElemStation=0,1	FrameElem=22-1
Frame=22 Station=0 OutputCase=STR100 CaseType=Combination P=-94,7618901603881 V2=39,7547977584956 V3=0 T=0 M2=0 M3=22,3918309971989 ElemStation=0	FrameElem=22-1
Frame=22 Station=0,05 OutputCase=STR100 CaseType=Combination P=-94,4918901603881 V2=37,7007305709956 V3=0 T=0 M2=0 M3=20,4553988436491 ElemStation=0,05	FrameElem=22-1
Frame=22 Station=0,1 OutputCase=STR100 CaseType=Combination P=-94,2218901603881 V2=35,6361165084956 V3=0 T=0 M2=0 M3=18,6219337213493 ElemStation=0,1	FrameElem=22-1
Frame=22 Station=0 OutputCase=STR101 CaseType=Combination P=-105,117802390628 V2=26,5605448276812 V3=0 T=0 M2=0 M3=13,3031973455167 ElemStation=0	FrameElem=22-1
Frame=22 Station=0,05 OutputCase=STR101 CaseType=Combination P=-104,847802390628 V2=24,5064776401812 V3=0 T=0 M2=0 M3=12,0264778385076 ElemStation=0,05	FrameElem=22-1
Frame=22 Station=0,1 OutputCase=STR101 CaseType=Combination P=-104,577802390628 V2=22,4418635776812 V3=0 T=0 M2=0 M3=10,8527253627486 ElemStation=0,1	FrameElem=22-1
Frame=22 Station=0 OutputCase=STR102 CaseType=Combination P=-7,94689016387025 V2=40,5298615651435 V3=0 T=0 M2=0 M3=11,6055741774948 ElemStation=0	FrameElem=22-1
Frame=22 Station=0,05 OutputCase=STR102 CaseType=Combination P=-7,74689016387025 V2=38,4757943776435 V3=0 T=0 M2=0 M3=9,63038883361267 ElemStation=0,05	FrameElem=22-1
Frame=22 Station=0,1 OutputCase=STR102 CaseType=Combination P=-7,54689016387025 V2=36,4111803151435 V3=0 T=0 M2=0 M3=7,7581705209805 ElemStation=0,1	FrameElem=22-1
Frame=22 Station=0 OutputCase=STR103 CaseType=Combination P=-18,3028023941097 V2=27,3356086343291 V3=0 T=0 M2=0 M3=2,51694052581268 ElemStation=0	FrameElem=22-1
Frame=22 Station=0,05 OutputCase=STR103 CaseType=Combination P=-18,1028023941097 V2=25,2815414468291 V3=0 T=0 M2=0 M3=1,20146782847122 ElemStation=0,05	FrameElem=22-1
Frame=22 Station=0,1 OutputCase=STR103 CaseType=Combination P=-17,9028023941097 V2=23,2169273843291 V3=0 T=0 M2=0 M3=-1,10378376202389E-02 ElemStation=0,1	FrameElem=22-1
Frame=22 Station=0 OutputCase=STR104 CaseType=Combination P=-24,4418023942887 V2=12,2044798798128 V3=0 T=0 M2=0 M3=3,62690970355517 ElemStation=0	FrameElem=22-1
Frame=22 Station=0,05 OutputCase=STR104 CaseType=Combination P=-24,1718023942887 V2=11,1602548798128 V3=0 T=0 M2=0 M3=3,04289820956452 ElemStation=0,05	FrameElem=22-1
Frame=22 Station=0,1 OutputCase=STR104 CaseType=Combination P=-23,9018023942887 V2=10,1416798798128 V3=0 T=0 M2=0 M3=2,51045671557388 ElemStation=0,1	FrameElem=22-1
Frame=22 Station=0 OutputCase=STR105 CaseType=Combination P=-24,4418023942887 V2=6,5761267387625 V3=0 T=0 M2=0 M3=3,88865286259143 ElemStation=0	FrameElem=22-1
Frame=22 Station=0,05 OutputCase=STR105 CaseType=Combination P=-24,1718023942887 V2=6,0911267387625 V3=0 T=0 M2=0 M3=3,57202152565331 ElemStation=0,05	FrameElem=22-1
Frame=22 Station=0,1 OutputCase=STR105 CaseType=Combination P=-23,9018023942887 V2=5,6181267387625 V3=0 T=0 M2=0 M3=3,27934018871518 ElemStation=0,1	FrameElem=22-1

Società di Progetto
Brebemi SpA

	Doc. N. 60235-00000-A00.doc	CODIFICA DOCUMENTO 04RCDII10000000000300A00	REV. 00	FOGLIO 319 di 628
--	--------------------------------	--	------------	----------------------

Frame=22 Station=0 OutputCase=STR106 CaseType=Combination P=-105,117802391099 V2=5,60398191688179 V3=0 T=0 M2=0 M3=13,8741711473631 FrameElem=22-1 ElemStation=0

Frame=22 Station=0,05 OutputCase=STR106 CaseType=Combination P=-104,847802391099 V2=5,11898191688179 V3=0 T=0 M2=0 M3=13,606147051519 FrameElem=22-1 ElemStation=0,05

Frame=22 Station=0,1 OutputCase=STR106 CaseType=Combination P=-104,577802391099 V2=4,64598191688179 V3=0 T=0 M2=0 M3=13,3620729556749 FrameElem=22-1 ElemStation=0,1

Frame=22 Station=0 OutputCase=STR107 CaseType=Combination P=-94,7618901603881 V2=39,7547977584956 V3=0 T=0 M2=0 M3=22,3918309971989 FrameElem=22-1 ElemStation=0

Frame=22 Station=0,05 OutputCase=STR107 CaseType=Combination P=-94,4918901603881 V2=37,7007305709956 V3=0 T=0 M2=0 M3=20,4553988436491 FrameElem=22-1 ElemStation=0,05

Frame=22 Station=0,1 OutputCase=STR107 CaseType=Combination P=-94,2218901603881 V2=35,6361165084956 V3=0 T=0 M2=0 M3=18,6219337213493 FrameElem=22-1 ElemStation=0,1

Frame=22 Station=0 OutputCase=STR108 CaseType=Combination P=-105,117802390628 V2=26,5605448276812 V3=0 T=0 M2=0 M3=13,3031973455167 FrameElem=22-1 ElemStation=0

Frame=22 Station=0,05 OutputCase=STR108 CaseType=Combination P=-104,847802390628 V2=24,5064776401812 V3=0 T=0 M2=0 M3=12,0264778385076 FrameElem=22-1 ElemStation=0,05

Frame=22 Station=0,1 OutputCase=STR108 CaseType=Combination P=-104,577802390628 V2=22,4418635776812 V3=0 T=0 M2=0 M3=10,8527253627486 FrameElem=22-1 ElemStation=0,1

Frame=22 Station=0 OutputCase=STR109 CaseType=Combination P=-7,94689016387025 V2=40,5298615651435 V3=0 T=0 M2=0 M3=11,6055741774948 FrameElem=22-1 ElemStation=0

Frame=22 Station=0,05 OutputCase=STR109 CaseType=Combination P=-7,74689016387025 V2=38,4757943776435 V3=0 T=0 M2=0 M3=9,6038883361267 FrameElem=22-1 ElemStation=0,05

Frame=22 Station=0,1 OutputCase=STR109 CaseType=Combination P=-7,54689016387025 V2=36,4111803151435 V3=0 T=0 M2=0 M3=7,7581705209805 FrameElem=22-1 ElemStation=0,1

Frame=22 Station=0 OutputCase=STR110 CaseType=Combination P=-18,3028023941097 V2=27,3356086343291 V3=0 T=0 M2=0 M3=2,51694052581268 FrameElem=22-1 ElemStation=0

Frame=22 Station=0,05 OutputCase=STR110 CaseType=Combination P=-18,1028023941097 V2=25,2815414468291 V3=0 T=0 M2=0 M3=1,20146782847122 FrameElem=22-1 ElemStation=0,05

Frame=22 Station=0,1 OutputCase=STR110 CaseType=Combination P=-17,9028023941097 V2=23,2169273843291 V3=0 T=0 M2=0 M3=-1,10378376202389E-02 FrameElem=22-1 ElemStation=0,1

Frame=22 Station=0 OutputCase=STR111 CaseType=Combination P=-22,9161976034549 V2=10,8898925272432 V3=0 T=0 M2=0 M3=1,93184510263853 FrameElem=22-1 ElemStation=0

Frame=22 Station=0,05 OutputCase=STR111 CaseType=Combination P=-22,6461976034549 V2=9,84566752724324 V3=0 T=0 M2=0 M3=1,41356297627637 FrameElem=22-1 ElemStation=0,05

Frame=22 Station=0,1 OutputCase=STR111 CaseType=Combination P=-22,3761976034549 V2=8,82709252724324 V3=0 T=0 M2=0 M3=0,946850849914209 FrameElem=22-1 ElemStation=0,1

Frame=22 Station=0 OutputCase=STR112 CaseType=Combination P=-22,9161976034549 V2=5,26153938619292 V3=0 T=0 M2=0 M3=2,1935882616748 FrameElem=22-1 ElemStation=0

Frame=22 Station=0,05 OutputCase=STR112 CaseType=Combination P=-22,6461976034549 V2=4,77653938619292 V3=0 T=0 M2=0 M3=1,94268629236516 FrameElem=22-1 ElemStation=0,05

Frame=22 Station=0,1 OutputCase=STR112 CaseType=Combination P=-22,3761976034549 V2=4,30353938619292 V3=0 T=0 M2=0 M3=1,71573432305551 FrameElem=22-1 ElemStation=0,1

Frame=22 Station=0 OutputCase=STR113 CaseType=Combination P=-130,789318557369 V2=4,11792829615791 V3=0 T=0 M2=0 M3=15,7748782772694 FrameElem=22-1 ElemStation=0

Frame=22 Station=0,05 OutputCase=STR113 CaseType=Combination P=-130,519318557369 V2=3,63292829615791 V3=0 T=0 M2=0 M3=15,5811568624615 FrameElem=22-1 ElemStation=0,05

Frame=22 Station=0,1 OutputCase=STR113 CaseType=Combination P=-130,249318557369 V2=3,15992829615791 V3=0 T=0 M2=0 M3=15,4113854476536 FrameElem=22-1 ElemStation=0,1

Frame=22 Station=0 OutputCase=STR114 CaseType=Combination P=-117,607536976156 V2=46,9247978526217 V3=0 T=0 M2=0 M3=26,6185781340209 FrameElem=22-1 ElemStation=0

Frame=22 Station=0,05 OutputCase=STR114 CaseType=Combination P=-117,337536976156 V2=44,5341166026217 V3=0 T=0 M2=0 M3=24,3320110538898 FrameElem=22-1 ElemStation=0,05

Frame=22 Station=0,1 OutputCase=STR114 CaseType=Combination P=-117,067536976156 V2=42,120828526217 V3=0 T=0 M2=0 M3=22,1655433487587 FrameElem=22-1 ElemStation=0,1

Frame=22 Station=0 OutputCase=STR115 CaseType=Combination P=-130,78931855674 V2=30,1838944635403 V3=0 T=0 M2=0 M3=15,1008275944863 FrameElem=22-1 ElemStation=0

Frame=22 Station=0,05 OutputCase=STR115 CaseType=Combination P=-130,51931855674 V2=27,7932132135403 V3=0 T=0 M2=0 M3=13,6513056838092 FrameElem=22-1 ElemStation=0,05

Frame=22 Station=0,1 OutputCase=STR115 CaseType=Combination P=-130,24931855674 V2=25,3799194635403 V3=0 T=0 M2=0 M3=12,3218831481322 FrameElem=22-1 ElemStation=0,1

Frame=22 Station=0 OutputCase=STR116 CaseType=Combination P=-3,90053698070114 V2=48,0239099332299 V3=0 T=0 M2=0 M3=12,503815219393 FrameElem=22-1 ElemStation=0

Frame=22 Station=0,05 OutputCase=STR116 CaseType=Combination P=-3,70053698070114 V2=45,6332286832299 V3=0 T=0 M2=0 M3=10,1622925352315 FrameElem=22-1 ElemStation=0,05

Frame=22 Station=0,1 OutputCase=STR116 CaseType=Combination P=-3,50053698070114 V2=43,2199349332299 V3=0 T=0 M2=0 M3=7,94086922606999 FrameElem=22-1 ElemStation=0,1

Frame=22 Station=0 OutputCase=STR117 CaseType=Combination P=-17,0823185612855 V2=31,2830065441485 V3=0 T=0 M2=0 M3=0,98606467985837 FrameElem=22-1 ElemStation=0

Frame=22 Station=0,05 OutputCase=STR117 CaseType=Combination P=-16,8823185612855 V2=28,8923252941485 V3=0 T=0 M2=0 M3=0,518412834849056 FrameElem=22-1 ElemStation=0,05

Frame=22 Station=0,1 OutputCase=STR117 CaseType=Combination P=-16,6823185612855 V2=26,4790315441485 V3=0 T=0 M2=0 M3=-1,90279097455648 FrameElem=22-1 ElemStation=0,1

Frame=22 Station=0 OutputCase=STR118 CaseType=Combination P=-74,1714935426156 V2=57,3051424186923 V3=0 T=0 M2=0 M3=32,5812824260391 FrameElem=22-1 ElemStation=0

Frame=22 Station=0,05 OutputCase=STR118 CaseType=Combination P=-73,9014935426156 V2=55,2510752311923 V3=0 T=0 M2=0 M3=29,7673330394795 FrameElem=22-1 ElemStation=0,05

Frame=22 Station=0,1 OutputCase=STR118 CaseType=Combination P=-73,6314935426156 V2=53,1864611686923 V3=0 T=0 M2=0 M3=27,0563506841699 FrameElem=22-1 ElemStation=0,1

Frame=22 Station=0 OutputCase=STR119 CaseType=Combination P=-103,592197600265 V2=4,28939456431221 V3=0 T=0 M2=0 M3=12,1791065464465 FrameElem=22-1 ElemStation=0

Frame=22 Station=0,05 OutputCase=STR119 CaseType=Combination P=-103,322197600265 V2=3,80439456431221 V3=0 T=0 M2=0 M3=11,9768118182308 FrameElem=22-1 ElemStation=0,05

Frame=22 Station=0,1 OutputCase=STR119 CaseType=Combination P=-103,052197600265 V2=3,33139456431221 V3=0 T=0 M2=0 M3=11,7984670900152 FrameElem=22-1 ElemStation=0,1

Frame=22 Station=0 OutputCase=STR120 CaseType=Combination P=-93,2362853695544 V2=38,440210405926 V3=0 T=0 M2=0 M3=20,6967663962822 FrameElem=22-1 ElemStation=0

Frame=22 Station=0,05 OutputCase=STR120 CaseType=Combination P=-92,9662853695544 V2=36,386143218426 V3=0 T=0 M2=0 M3=18,8260636103609 FrameElem=22-1 ElemStation=0,05

Società di Progetto
Brebemi SpA

	Doc. N. 60235-00000-A00.doc	CODIFICA DOCUMENTO 04RCDII10000000000300A00	REV. 00	FOGLIO 320 di 628
--	--------------------------------	--	------------	----------------------

Frame=22 Station=0,1 OutputCase=STR120 ElemStation=0,1	CaseType=Combination	P=-92,6962853695544	V2=34,321529155926	V3=0	T=0	M2=0	M3=17,0583278556896	FrameElem=22-1
Frame=22 Station=0 OutputCase=STR121 ElemStation=0	CaseType=Combination	P=-103,592197599794	V2=25,2459574751116	V3=0	T=0	M2=0	M3=11,6081327446	FrameElem=22-1
Frame=22 Station=0,05 OutputCase=STR121 ElemStation=0,05	CaseType=Combination	P=-103,322197599794	V2=23,1918902876116	V3=0	T=0	M2=0	M3=10,3971426052195	FrameElem=22-1
Frame=22 Station=0,1 OutputCase=STR121 ElemStation=0,1	CaseType=Combination	P=-103,052197599794	V2=21,1272762251116	V3=0	T=0	M2=0	M3=9,28911949708889	FrameElem=22-1
Frame=22 Station=0 OutputCase=STR122 ElemStation=0	CaseType=Combination	P=-6,4212853730365	V2=39,2152742125739	V3=0	T=0	M2=0	M3=9,91050957657822	FrameElem=22-1
Frame=22 Station=0,05 OutputCase=STR122 ElemStation=0,05	CaseType=Combination	P=-6,22128537303651	V2=37,1612070250739	V3=0	T=0	M2=0	M3=8,00105360032452	FrameElem=22-1
Frame=22 Station=0,1 OutputCase=STR122 ElemStation=0,1	CaseType=Combination	P=-6,02128537303651	V2=35,0965929625739	V3=0	T=0	M2=0	M3=6,19456465532082	FrameElem=22-1
Frame=22 Station=0 OutputCase=STR123 ElemStation=0	CaseType=Combination	P=-16,777197603276	V2=26,0210212817595	V3=0	T=0	M2=0	M3=0,821875924896044	FrameElem=22-1
Frame=22 Station=0,05 OutputCase=STR123 ElemStation=0,05	CaseType=Combination	P=-16,577197603276	V2=23,9669540942595	V3=0	T=0	M2=0	M3=-0,427867404816934	FrameElem=22-1
Frame=22 Station=0,1 OutputCase=STR123 ElemStation=0,1	CaseType=Combination	P=-16,377197603276	V2=21,9023400317595	V3=0	T=0	M2=0	M3=-1,57464370327991	FrameElem=22-1
Frame=22 Station=0 OutputCase=STR124 ElemStation=0	CaseType=Combination	P=-22,9161976034545	V2=10,3382152037033	V3=0	T=0	M2=0	M3=1,57310868121711	FrameElem=22-1
Frame=22 Station=0,05 OutputCase=STR124 ElemStation=0,05	CaseType=Combination	P=-22,6461976034545	V2=9,29399020370332	V3=0	T=0	M2=0	M3=1,08241042103195	FrameElem=22-1
Frame=22 Station=0,1 OutputCase=STR124 ElemStation=0,1	CaseType=Combination	P=-22,3761976034545	V2=8,27541520370331	V3=0	T=0	M2=0	M3=0,64328216084678	FrameElem=22-1
Frame=22 Station=0 OutputCase=STR125 ElemStation=0	CaseType=Combination	P=-22,9161976034545	V2=4,709862062653	V3=0	T=0	M2=0	M3=1,83485184025338	FrameElem=22-1
Frame=22 Station=0,05 OutputCase=STR125 ElemStation=0,05	CaseType=Combination	P=-22,6461976034545	V2=4,22486206265299	V3=0	T=0	M2=0	M3=1,61153373712073	FrameElem=22-1
Frame=22 Station=0,1 OutputCase=STR125 ElemStation=0,1	CaseType=Combination	P=-22,3761976034545	V2=3,75186206265299	V3=0	T=0	M2=0	M3=1,41216563398808	FrameElem=22-1
Frame=22 Station=0 OutputCase=STR126 ElemStation=0	CaseType=Combination	P=-103,592197600265	V2=3,73771724077228	V3=0	T=0	M2=0	M3=11,820370125025	FrameElem=22-1
Frame=22 Station=0,05 OutputCase=STR126 ElemStation=0,05	CaseType=Combination	P=-103,322197600265	V2=3,25271724077228	V3=0	T=0	M2=0	M3=11,6456592629864	FrameElem=22-1
Frame=22 Station=0,1 OutputCase=STR126 ElemStation=0,1	CaseType=Combination	P=-103,052197600265	V2=2,77971724077228	V3=0	T=0	M2=0	M3=11,4948984009478	FrameElem=22-1
Frame=22 Station=0 OutputCase=STR127 ElemStation=0	CaseType=Combination	P=-93,236285369554	V2=37,8885330823861	V3=0	T=0	M2=0	M3=20,3380299748608	FrameElem=22-1
Frame=22 Station=0,05 OutputCase=STR127 ElemStation=0,05	CaseType=Combination	P=-92,966285369554	V2=35,8344658948861	V3=0	T=0	M2=0	M3=18,4949110551165	FrameElem=22-1
Frame=22 Station=0,1 OutputCase=STR127 ElemStation=0,1	CaseType=Combination	P=-92,696285369554	V2=33,7698518323861	V3=0	T=0	M2=0	M3=16,7547591666222	FrameElem=22-1
Frame=22 Station=0 OutputCase=STR128 ElemStation=0	CaseType=Combination	P=-103,592197599793	V2=24,6942801515717	V3=0	T=0	M2=0	M3=11,2493963231786	FrameElem=22-1
Frame=22 Station=0,05 OutputCase=STR128 ElemStation=0,05	CaseType=Combination	P=-103,322197599793	V2=22,6402129640717	V3=0	T=0	M2=0	M3=10,065990049975	FrameElem=22-1
Frame=22 Station=0,1 OutputCase=STR128 ElemStation=0,1	CaseType=Combination	P=-103,052197599793	V2=20,5755989015717	V3=0	T=0	M2=0	M3=8,98555080802146	FrameElem=22-1
Frame=22 Station=0 OutputCase=STR129 ElemStation=0	CaseType=Combination	P=-6,4212853730361	V2=38,663596889034	V3=0	T=0	M2=0	M3=9,5517731551568	FrameElem=22-1
Frame=22 Station=0,05 OutputCase=STR129 ElemStation=0,05	CaseType=Combination	P=-6,2212853730361	V2=36,609529701534	V3=0	T=0	M2=0	M3=7,6699010450801	FrameElem=22-1
Frame=22 Station=0,1 OutputCase=STR129 ElemStation=0,1	CaseType=Combination	P=-6,0212853730361	V2=34,544915639034	V3=0	T=0	M2=0	M3=5,8909959625339	FrameElem=22-1
Frame=22 Station=0 OutputCase=STR130 ElemStation=0	CaseType=Combination	P=-16,7771976032756	V2=25,4693439582196	V3=0	T=0	M2=0	M3=0,463139503474623	FrameElem=22-1
Frame=22 Station=0,05 OutputCase=STR130 ElemStation=0,05	CaseType=Combination	P=-16,5771976032756	V2=23,4152767707196	V3=0	T=0	M2=0	M3=-0,759019960061359	FrameElem=22-1
Frame=22 Station=0,1 OutputCase=STR130 ElemStation=0,1	CaseType=Combination	P=-16,3771976032756	V2=21,3506627082196	V3=0	T=0	M2=0	M3=-1,87821239234734	FrameElem=22-1
Frame=22 Station=0 OutputCase=STR131 ElemStation=0	CaseType=Combination	P=-22,9161976034553	V2=11,4415698507832	V3=0	T=0	M2=0	M3=2,29058152405996	FrameElem=22-1
Frame=22 Station=0,05 OutputCase=STR131 ElemStation=0,05	CaseType=Combination	P=-22,6461976034553	V2=10,3973448507832	V3=0	T=0	M2=0	M3=1,7447155315208	FrameElem=22-1
Frame=22 Station=0,1 OutputCase=STR131 ElemStation=0,1	CaseType=Combination	P=-22,3761976034553	V2=9,37876985078317	V3=0	T=0	M2=0	M3=1,25041953898164	FrameElem=22-1
Frame=22 Station=0 OutputCase=STR132 ElemStation=0	CaseType=Combination	P=-22,9161976034553	V2=5,81321670973285	V3=0	T=0	M2=0	M3=2,55232468309622	FrameElem=22-1
Frame=22 Station=0,05 OutputCase=STR132 ElemStation=0,05	CaseType=Combination	P=-22,6461976034553	V2=5,32821670973285	V3=0	T=0	M2=0	M3=2,27383884760958	FrameElem=22-1
Frame=22 Station=0,1 OutputCase=STR132 ElemStation=0,1	CaseType=Combination	P=-22,3761976034553	V2=4,85521670973285	V3=0	T=0	M2=0	M3=2,01930301212294	FrameElem=22-1
Frame=22 Station=0 OutputCase=STR133 ElemStation=0	CaseType=Combination	P=-103,592197600266	V2=4,84107188785214	V3=0	T=0	M2=0	M3=12,5378429678679	FrameElem=22-1
Frame=22 Station=0,05 OutputCase=STR133 ElemStation=0,05	CaseType=Combination	P=-103,322197600266	V2=4,35607188785214	V3=0	T=0	M2=0	M3=12,3079643734753	FrameElem=22-1
Frame=22 Station=0,1 OutputCase=STR133 ElemStation=0,1	CaseType=Combination	P=-103,052197600266	V2=3,88307188785214	V3=0	T=0	M2=0	M3=12,1020357790827	FrameElem=22-1
Frame=22 Station=0 OutputCase=STR134 ElemStation=0	CaseType=Combination	P=-93,2362853695548	V2=38,9918877294659	V3=0	T=0	M2=0	M3=21,0555028177036	FrameElem=22-1
Frame=22 Station=0,05 OutputCase=STR134 ElemStation=0,05	CaseType=Combination	P=-92,9662853695548	V2=36,9378205419659	V3=0	T=0	M2=0	M3=19,1572161656053	FrameElem=22-1
Frame=22 Station=0,1 OutputCase=STR134 ElemStation=0,1	CaseType=Combination	P=-92,6962853695548	V2=34,8732064794659	V3=0	T=0	M2=0	M3=17,3618965447571	FrameElem=22-1
Frame=22 Station=0 OutputCase=STR135 ElemStation=0	CaseType=Combination	P=-103,592197599794	V2=25,7976347986515	V3=0	T=0	M2=0	M3=11,9668691660215	FrameElem=22-1

Società di Progetto
Brebemi SpA



Doc. N.
60235-0000-A00.doc

CODIFICA DOCUMENTO
04RCDII10000000000300A00

REV.
00

FOGLIO
321 di 628

Frame=22 Station=0,05 OutputCase=STR135 CaseType=Combination P=-103,322197599794 V2=23,7435676111515 V3=0 T=0 M2=0 M3=10,7282951604639 FrameElem=22-1 ElemStation=0,05
Frame=22 Station=0,1 OutputCase=STR135 CaseType=Combination P=-103,052197599794 V2=21,6789535486515 V3=0 T=0 M2=0 M3=9,59268818615631 FrameElem=22-1 ElemStation=0,1
Frame=22 Station=0 OutputCase=STR136 CaseType=Combination P=-6,42128537303691 V2=39,7669515361139 V3=0 T=0 M2=0 M3=10,2692459979996 FrameElem=22-1 ElemStation=0
Frame=22 Station=0,05 OutputCase=STR136 CaseType=Combination P=-6,22128537303692 V2=37,7128843486139 V3=0 T=0 M2=0 M3=8,33220615556895 FrameElem=22-1 ElemStation=0,05
Frame=22 Station=0,1 OutputCase=STR136 CaseType=Combination P=-6,02128537303692 V2=35,6482702861139 V3=0 T=0 M2=0 M3=6,49813334438825 FrameElem=22-1 ElemStation=0,1
Frame=22 Station=0 OutputCase=STR137 CaseType=Combination P=-16,7771976032764 V2=26,5726986052995 V3=0 T=0 M2=0 M3=1,18061234631747 FrameElem=22-1 ElemStation=0
Frame=22 Station=0,05 OutputCase=STR137 CaseType=Combination P=-16,5771976032764 V2=24,5186314177995 V3=0 T=0 M2=0 M3=-9,67148495725092E-02 FrameElem=22-1 ElemStation=0,05
Frame=22 Station=0,1 OutputCase=STR137 CaseType=Combination P=-16,3771976032764 V2=22,4540173552995 V3=0 T=0 M2=0 M3=-1,27107501421248 FrameElem=22-1 ElemStation=0,1
Frame=22 Station=0 OutputCase=STR138 CaseType=Combination P=-22,9161976034553 V2=11,4415698507832 V3=0 T=0 M2=0 M3=2,29058152405996 FrameElem=22-1 ElemStation=0
Frame=22 Station=0,05 OutputCase=STR138 CaseType=Combination P=-22,6461976034553 V2=10,3973448507832 V3=0 T=0 M2=0 M3=1,7447155315208 FrameElem=22-1 ElemStation=0,05
Frame=22 Station=0,1 OutputCase=STR138 CaseType=Combination P=-22,3761976034553 V2=9,37876985078317 V3=0 T=0 M2=0 M3=1,25041953898164 FrameElem=22-1 ElemStation=0,1
Frame=22 Station=0 OutputCase=STR139 CaseType=Combination P=-22,9161976034553 V2=5,81321670973285 V3=0 T=0 M2=0 M3=2,55232468309622 FrameElem=22-1 ElemStation=0
Frame=22 Station=0,05 OutputCase=STR139 CaseType=Combination P=-22,6461976034553 V2=5,32821670973285 V3=0 T=0 M2=0 M3=2,27383884760958 FrameElem=22-1 ElemStation=0,05
Frame=22 Station=0,1 OutputCase=STR139 CaseType=Combination P=-22,3761976034553 V2=4,85521670973285 V3=0 T=0 M2=0 M3=2,01930301212294 FrameElem=22-1 ElemStation=0,1
Frame=22 Station=0 OutputCase=STR140 CaseType=Combination P=-103,592197600266 V2=4,84107188785214 V3=0 T=0 M2=0 M3=12,5378429678679 FrameElem=22-1 ElemStation=0
Frame=22 Station=0,05 OutputCase=STR140 CaseType=Combination P=-103,322197600266 V2=4,35607188785214 V3=0 T=0 M2=0 M3=12,3079643734753 FrameElem=22-1 ElemStation=0,05
Frame=22 Station=0,1 OutputCase=STR140 CaseType=Combination P=-103,052197600266 V2=3,88307188785214 V3=0 T=0 M2=0 M3=12,1020357790827 FrameElem=22-1 ElemStation=0,1
Frame=22 Station=0 OutputCase=STR141 CaseType=Combination P=-93,2362853695548 V2=38,9918877294659 V3=0 T=0 M2=0 M3=21,0555028177036 FrameElem=22-1 ElemStation=0
Frame=22 Station=0,05 OutputCase=STR141 CaseType=Combination P=-92,9662853695548 V2=36,9378205419659 V3=0 T=0 M2=0 M3=19,1572161656053 FrameElem=22-1 ElemStation=0,05
Frame=22 Station=0,1 OutputCase=STR141 CaseType=Combination P=-92,6962853695548 V2=34,8732064794659 V3=0 T=0 M2=0 M3=17,3618965447571 FrameElem=22-1 ElemStation=0,1
Frame=22 Station=0 OutputCase=STR142 CaseType=Combination P=-103,592197599794 V2=25,7976347986515 V3=0 T=0 M2=0 M3=11,9668691660215 FrameElem=22-1 ElemStation=0
Frame=22 Station=0,05 OutputCase=STR142 CaseType=Combination P=-103,322197599794 V2=23,7435676111515 V3=0 T=0 M2=0 M3=10,7282951604639 FrameElem=22-1 ElemStation=0,05
Frame=22 Station=0,1 OutputCase=STR142 CaseType=Combination P=-103,052197599794 V2=21,6789535486515 V3=0 T=0 M2=0 M3=9,59268818615631 FrameElem=22-1 ElemStation=0,1
Frame=22 Station=0 OutputCase=STR143 CaseType=Combination P=-6,42128537303691 V2=39,7669515361139 V3=0 T=0 M2=0 M3=10,2692459979996 FrameElem=22-1 ElemStation=0
Frame=22 Station=0,05 OutputCase=STR143 CaseType=Combination P=-6,22128537303692 V2=37,7128843486139 V3=0 T=0 M2=0 M3=8,33220615556895 FrameElem=22-1 ElemStation=0,05
Frame=22 Station=0,1 OutputCase=STR143 CaseType=Combination P=-6,02128537303692 V2=35,6482702861139 V3=0 T=0 M2=0 M3=6,49813334438825 FrameElem=22-1 ElemStation=0,1
Frame=22 Station=0 OutputCase=STR144 CaseType=Combination P=-16,7771976032764 V2=26,5726986052995 V3=0 T=0 M2=0 M3=1,18061234631747 FrameElem=22-1 ElemStation=0
Frame=22 Station=0,05 OutputCase=STR144 CaseType=Combination P=-16,5771976032764 V2=24,5186314177995 V3=0 T=0 M2=0 M3=-9,67148495725093E-02 FrameElem=22-1 ElemStation=0,05
Frame=22 Station=0,1 OutputCase=STR144 CaseType=Combination P=-16,3771976032764 V2=22,4540173552995 V3=0 T=0 M2=0 M3=-1,27107501421248 FrameElem=22-1 ElemStation=0,1
Frame=22 Station=0 OutputCase=STR145 CaseType=Combination P=-23,6789999988723 V2=12,1908097476579 V3=0 T=0 M2=0 M3=3,19790322808851 FrameElem=22-1 ElemStation=0
Frame=22 Station=0,05 OutputCase=STR145 CaseType=Combination P=-23,4089999988723 V2=11,1465847476579 V3=0 T=0 M2=0 M3=2,61457524070561 FrameElem=22-1 ElemStation=0,05
Frame=22 Station=0,1 OutputCase=STR145 CaseType=Combination P=-23,1389999988723 V2=10,1280097476579 V3=0 T=0 M2=0 M3=2,08281725332271 FrameElem=22-1 ElemStation=0,1
Frame=22 Station=0 OutputCase=STR146 CaseType=Combination P=-23,6789999988723 V2=6,56245660660763 V3=0 T=0 M2=0 M3=3,45964638712478 FrameElem=22-1 ElemStation=0
Frame=22 Station=0,05 OutputCase=STR146 CaseType=Combination P=-23,4089999988723 V2=6,07745660660763 V3=0 T=0 M2=0 M3=3,14369855679439 FrameElem=22-1 ElemStation=0,05
Frame=22 Station=0,1 OutputCase=STR146 CaseType=Combination P=-23,1389999988723 V2=5,60445660660763 V3=0 T=0 M2=0 M3=2,85170072646401 FrameElem=22-1 ElemStation=0,1
Frame=22 Station=0 OutputCase=STR147 CaseType=Combination P=-131,246999994619 V2=4,89847862840673 V3=0 T=0 M2=0 M3=16,5345131525394 FrameElem=22-1 ElemStation=0
Frame=22 Station=0,05 OutputCase=STR147 CaseType=Combination P=-130,976999994619 V2=4,41347862840673 V3=0 T=0 M2=0 M3=16,301764221119 FrameElem=22-1 ElemStation=0,05
Frame=22 Station=0,1 OutputCase=STR147 CaseType=Combination P=-130,706999994619 V2=3,94047862840673 V3=0 T=0 M2=0 M3=16,0929652896987 FrameElem=22-1 ElemStation=0,1
Frame=22 Station=0 OutputCase=STR148 CaseType=Combination P=-118,065218413406 V2=47,7053481848705 V3=0 T=0 M2=0 M3=27,3782130092909 FrameElem=22-1 ElemStation=0
Frame=22 Station=0,05 OutputCase=STR148 CaseType=Combination P=-117,795218413406 V2=45,3146669348705 V3=0 T=0 M2=0 M3=25,0526184125473 FrameElem=22-1 ElemStation=0,05
Frame=22 Station=0,1 OutputCase=STR148 CaseType=Combination P=-117,525218413406 V2=42,9013731848705 V3=0 T=0 M2=0 M3=22,8471231908038 FrameElem=22-1 ElemStation=0,1
Frame=22 Station=0 OutputCase=STR149 CaseType=Combination P=-131,246999993991 V2=30,9644447957892 V3=0 T=0 M2=0 M3=15,8604624697562 FrameElem=22-1 ElemStation=0
Frame=22 Station=0,05 OutputCase=STR149 CaseType=Combination P=-130,976999993991 V2=28,5737635457892 V3=0 T=0 M2=0 M3=14,3719130424668 FrameElem=22-1 ElemStation=0,05
Frame=22 Station=0,1 OutputCase=STR149 CaseType=Combination P=-130,706999993991 V2=26,1604697957892 V3=0 T=0 M2=0 M3=13,0034629901773 FrameElem=22-1 ElemStation=0,1

Società di Progetto
Brebemi SpA



Doc. N.
60235-0000-A00.doc

CODIFICA DOCUMENTO
04RCDII10000000000300A00

REV.
00

FOGLIO
322 di 628

Frame=22 Station=0 OutputCase=STR150 CaseType=Combination P=-4,35821841795155 V2=48,8044602654787 V3=0 T=0 M2=0 M3=13,263450094663 ElemStation=0	FrameElem=22-1
Frame=22 Station=0,05 OutputCase=STR150 CaseType=Combination P=-4,15821841795155 V2=46,4137790154787 V3=0 T=0 M2=0 M3=10,882899893889 ElemStation=0,05	FrameElem=22-1
Frame=22 Station=0,1 OutputCase=STR150 CaseType=Combination P=-3,95821841795155 V2=44,0004852654787 V3=0 T=0 M2=0 M3=8,6224490681151 ElemStation=0,1	FrameElem=22-1
Frame=22 Station=0 OutputCase=STR151 CaseType=Combination P=-17,5399999985359 V2=32,0635568763973 V3=0 T=0 M2=0 M3=1,74569955512835 ElemStation=0	FrameElem=22-1
Frame=22 Station=0,05 OutputCase=STR151 CaseType=Combination P=-17,3399999985359 V2=29,6728756263973 V3=0 T=0 M2=0 M3=0,202194523808488 ElemStation=0,05	FrameElem=22-1
Frame=22 Station=0,1 OutputCase=STR151 CaseType=Combination P=-17,1399999985359 V2=27,2595818763973 V3=0 T=0 M2=0 M3=-1,22121113251138 ElemStation=0,1	FrameElem=22-1
Frame=22 Station=0 OutputCase=STR152 CaseType=Combination P=-74,629174979866 V2=58,0856927509411 V3=0 T=0 M2=0 M3=33,3409173013091 ElemStation=0	FrameElem=22-1
Frame=22 Station=0,05 OutputCase=STR152 CaseType=Combination P=-74,359174979866 V2=56,0316255634411 V3=0 T=0 M2=0 M3=30,487940398137 ElemStation=0,05	FrameElem=22-1
Frame=22 Station=0,1 OutputCase=STR152 CaseType=Combination P=-74,089174979866 V2=53,9670115009411 V3=0 T=0 M2=0 M3=27,737930526215 ElemStation=0,1	FrameElem=22-1
Frame=22 Station=0 OutputCase=STR153 CaseType=Combination P=-104,354999995683 V2=5,59031178472692 V3=0 T=0 M2=0 M3=13,4451646718964 ElemStation=0	FrameElem=22-1
Frame=22 Station=0,05 OutputCase=STR153 CaseType=Combination P=-104,084999995683 V2=5,10531178472692 V3=0 T=0 M2=0 M3=13,1778240826601 ElemStation=0,05	FrameElem=22-1
Frame=22 Station=0,1 OutputCase=STR153 CaseType=Combination P=-103,814999995683 V2=4,63231178472692 V3=0 T=0 M2=0 M3=12,9344334934237 ElemStation=0,1	FrameElem=22-1
Frame=22 Station=0 OutputCase=STR154 CaseType=Combination P=-93,9990877649717 V2=39,7411276263407 V3=0 T=0 M2=0 M3=21,9628245217322 ElemStation=0	FrameElem=22-1
Frame=22 Station=0,05 OutputCase=STR154 CaseType=Combination P=-93,7290877649717 V2=37,6870604388407 V3=0 T=0 M2=0 M3=20,0270758747902 ElemStation=0,05	FrameElem=22-1
Frame=22 Station=0,1 OutputCase=STR154 CaseType=Combination P=-93,4590877649717 V2=35,6224463763407 V3=0 T=0 M2=0 M3=18,1942942590981 ElemStation=0,1	FrameElem=22-1
Frame=22 Station=0 OutputCase=STR155 CaseType=Combination P=-104,354999995211 V2=26,5468746955263 V3=0 T=0 M2=0 M3=12,87419087005 ElemStation=0	FrameElem=22-1
Frame=22 Station=0,05 OutputCase=STR155 CaseType=Combination P=-104,084999995211 V2=24,4928075080263 V3=0 T=0 M2=0 M3=11,5981548696487 ElemStation=0,05	FrameElem=22-1
Frame=22 Station=0,1 OutputCase=STR155 CaseType=Combination P=-103,814999995211 V2=22,4281934455263 V3=0 T=0 M2=0 M3=10,4250859004974 ElemStation=0,1	FrameElem=22-1
Frame=22 Station=0 OutputCase=STR156 CaseType=Combination P=-7,18408776845386 V2=40,5161914329886 V3=0 T=0 M2=0 M3=11,1765677020282 ElemStation=0	FrameElem=22-1
Frame=22 Station=0,05 OutputCase=STR156 CaseType=Combination P=-6,98408776845386 V2=38,4621242454886 V3=0 T=0 M2=0 M3=9,20206586475376 ElemStation=0,05	FrameElem=22-1
Frame=22 Station=0,1 OutputCase=STR156 CaseType=Combination P=-6,78408776845386 V2=36,3975101829886 V3=0 T=0 M2=0 M3=7,33053105872933 ElemStation=0,1	FrameElem=22-1
Frame=22 Station=0 OutputCase=STR157 CaseType=Combination P=-17,5399999986933 V2=27,3219385021743 V3=0 T=0 M2=0 M3=2,08793405034602 ElemStation=0	FrameElem=22-1
Frame=22 Station=0,05 OutputCase=STR157 CaseType=Combination P=-17,3399999986933 V2=25,2678713146742 V3=0 T=0 M2=0 M3=0,773144859612305 ElemStation=0,05	FrameElem=22-1
Frame=22 Station=0,1 OutputCase=STR157 CaseType=Combination P=-17,1399999986933 V2=23,2032572521742 V3=0 T=0 M2=0 M3=-0,438677299871409 ElemStation=0,1	FrameElem=22-1
Frame=22 Station=0 OutputCase=STR158 CaseType=Combination P=-23,6789999988719 V2=11,639132424118 V3=0 T=0 M2=0 M3=2,83916680666709 ElemStation=0	FrameElem=22-1
Frame=22 Station=0,05 OutputCase=STR158 CaseType=Combination P=-23,4089999988719 V2=10,594907424118 V3=0 T=0 M2=0 M3=2,28342268546118 ElemStation=0,05	FrameElem=22-1
Frame=22 Station=0,1 OutputCase=STR158 CaseType=Combination P=-23,1389999988719 V2=9,57633242411802 V3=0 T=0 M2=0 M3=1,77924856425528 ElemStation=0,1	FrameElem=22-1
Frame=22 Station=0 OutputCase=STR159 CaseType=Combination P=-23,6789999988719 V2=6,0107792830677 V3=0 T=0 M2=0 M3=3,10090996570336 ElemStation=0	FrameElem=22-1
Frame=22 Station=0,05 OutputCase=STR159 CaseType=Combination P=-23,4089999988719 V2=5,5257792830677 V3=0 T=0 M2=0 M3=2,81254600154997 ElemStation=0,05	FrameElem=22-1
Frame=22 Station=0,1 OutputCase=STR159 CaseType=Combination P=-23,1389999988719 V2=5,0527792830677 V3=0 T=0 M2=0 M3=2,54813203739658 ElemStation=0,1	FrameElem=22-1
Frame=22 Station=0 OutputCase=STR160 CaseType=Combination P=-104,354999995682 V2=5,03863446118699 V3=0 T=0 M2=0 M3=13,086428250475 ElemStation=0	FrameElem=22-1
Frame=22 Station=0,05 OutputCase=STR160 CaseType=Combination P=-104,084999995682 V2=4,55363446118699 V3=0 T=0 M2=0 M3=12,8466715274157 ElemStation=0,05	FrameElem=22-1
Frame=22 Station=0,1 OutputCase=STR160 CaseType=Combination P=-103,814999995682 V2=4,08063446118699 V3=0 T=0 M2=0 M3=12,6308648043563 ElemStation=0,1	FrameElem=22-1
Frame=22 Station=0 OutputCase=STR161 CaseType=Combination P=-93,9990877649713 V2=39,1894503028008 V3=0 T=0 M2=0 M3=21,6040881003108 ElemStation=0	FrameElem=22-1
Frame=22 Station=0,05 OutputCase=STR161 CaseType=Combination P=-93,7290877649713 V2=37,1353831153008 V3=0 T=0 M2=0 M3=19,6959233195457 ElemStation=0,05	FrameElem=22-1
Frame=22 Station=0,1 OutputCase=STR161 CaseType=Combination P=-93,4590877649713 V2=35,0707690528008 V3=0 T=0 M2=0 M3=17,8907255700307 ElemStation=0,1	FrameElem=22-1
Frame=22 Station=0 OutputCase=STR162 CaseType=Combination P=-104,354999995211 V2=25,9951973719864 V3=0 T=0 M2=0 M3=12,5154544486286 ElemStation=0	FrameElem=22-1
Frame=22 Station=0,05 OutputCase=STR162 CaseType=Combination P=-104,084999995211 V2=23,9411301844864 V3=0 T=0 M2=0 M3=11,2670023144043 ElemStation=0,05	FrameElem=22-1
Frame=22 Station=0,1 OutputCase=STR162 CaseType=Combination P=-103,814999995211 V2=21,8765161219864 V3=0 T=0 M2=0 M3=10,12151721143 ElemStation=0,1	FrameElem=22-1
Frame=22 Station=0 OutputCase=STR163 CaseType=Combination P=-7,18408776845345 V2=39,9645141094487 V3=0 T=0 M2=0 M3=10,8178312806068 ElemStation=0	FrameElem=22-1
Frame=22 Station=0,05 OutputCase=STR163 CaseType=Combination P=-6,98408776845345 V2=37,9104469219487 V3=0 T=0 M2=0 M3=8,87091330950934 ElemStation=0,05	FrameElem=22-1
Frame=22 Station=0,1 OutputCase=STR163 CaseType=Combination P=-6,78408776845345 V2=35,8458328594487 V3=0 T=0 M2=0 M3=7,0269623696619 ElemStation=0,1	FrameElem=22-1
Frame=22 Station=0 OutputCase=STR164 CaseType=Combination P=-17,5399999986929 V2=26,7702611786343 V3=0 T=0 M2=0 M3=1,7291976289246 ElemStation=0	FrameElem=22-1
Frame=22 Station=0,05 OutputCase=STR164 CaseType=Combination P=-17,3399999986929 V2=24,7161939911343 V3=0 T=0 M2=0 M3=0,44199230436788 ElemStation=0,05	FrameElem=22-1

Società di Progetto
Brebemi SpA

	Doc. N. 60235-00000-A00.doc	CODIFICA DOCUMENTO 04RCDII10000000000300A00	REV. 00	FOGLIO 323 di 628
--	--------------------------------	--	------------	----------------------

Frame=22 Station=0,1 OutputCase=STR164 CaseType=Combination P=-17,1399999986929 V2=22,6515799286343 V3=0 T=0 M2=0 M3=-0,742245988938837 FrameElem=22-1 ElemStation=0,1

Frame=22 Station=0 OutputCase=STR165 CaseType=Combination P=-23,6789999988727 V2=12,7424870711979 V3=0 T=0 M2=0 M3=3,55663964950993 FrameElem=22-1 ElemStation=0

Frame=22 Station=0,05 OutputCase=STR165 CaseType=Combination P=-23,4089999988727 V2=11,6982620711979 V3=0 T=0 M2=0 M3=2,94572779595003 FrameElem=22-1 ElemStation=0,05

Frame=22 Station=0,1 OutputCase=STR165 CaseType=Combination P=-23,1389999988727 V2=10,6796870711979 V3=0 T=0 M2=0 M3=2,38638594239014 FrameElem=22-1 ElemStation=0,1

Frame=22 Station=0 OutputCase=STR166 CaseType=Combination P=-23,6789999988727 V2=7,11413393014755 V3=0 T=0 M2=0 M3=3,8183828085462 FrameElem=22-1 ElemStation=0

Frame=22 Station=0,05 OutputCase=STR166 CaseType=Combination P=-23,4089999988727 V2=6,62913393014755 V3=0 T=0 M2=0 M3=3,47485111203882 FrameElem=22-1 ElemStation=0,05

Frame=22 Station=0,1 OutputCase=STR166 CaseType=Combination P=-23,1389999988727 V2=6,15613393014755 V3=0 T=0 M2=0 M3=3,15526941553144 FrameElem=22-1 ElemStation=0,1

Frame=22 Station=0 OutputCase=STR167 CaseType=Combination P=-104,354999995683 V2=6,14198910826684 V3=0 T=0 M2=0 M3=13,8039010933179 FrameElem=22-1 ElemStation=0

Frame=22 Station=0,05 OutputCase=STR167 CaseType=Combination P=-104,084999995683 V2=5,65698910826684 V3=0 T=0 M2=0 M3=13,5089766379045 FrameElem=22-1 ElemStation=0,05

Frame=22 Station=0,1 OutputCase=STR167 CaseType=Combination P=-103,814999995683 V2=5,18398910826684 V3=0 T=0 M2=0 M3=13,2380021824912 FrameElem=22-1 ElemStation=0,1

Frame=22 Station=0 OutputCase=STR168 CaseType=Combination P=-93,9990877649721 V2=40,2928049498806 V3=0 T=0 M2=0 M3=22,3215609431536 FrameElem=22-1 ElemStation=0

Frame=22 Station=0,05 OutputCase=STR168 CaseType=Combination P=-93,7290877649721 V2=38,2387377623806 V3=0 T=0 M2=0 M3=20,3582284300346 FrameElem=22-1 ElemStation=0,05

Frame=22 Station=0,1 OutputCase=STR168 CaseType=Combination P=-93,4590877649721 V2=36,1741236998806 V3=0 T=0 M2=0 M3=18,4978629481656 FrameElem=22-1 ElemStation=0,1

Frame=22 Station=0 OutputCase=STR169 CaseType=Combination P=-104,354999995212 V2=27,0985520190663 V3=0 T=0 M2=0 M3=13,2329272914714 FrameElem=22-1 ElemStation=0

Frame=22 Station=0,05 OutputCase=STR169 CaseType=Combination P=-104,084999995212 V2=25,0444848315662 V3=0 T=0 M2=0 M3=11,9293074248931 FrameElem=22-1 ElemStation=0,05

Frame=22 Station=0,1 OutputCase=STR169 CaseType=Combination P=-103,814999995212 V2=22,9798707690662 V3=0 T=0 M2=0 M3=10,7286545895648 FrameElem=22-1 ElemStation=0,1

Frame=22 Station=0 OutputCase=STR170 CaseType=Combination P=-7,18408776845426 V2=41,0678687565286 V3=0 T=0 M2=0 M3=11,5353041234496 FrameElem=22-1 ElemStation=0

Frame=22 Station=0,05 OutputCase=STR170 CaseType=Combination P=-6,98408776845427 V2=39,0138015690286 V3=0 T=0 M2=0 M3=9,53321841999819 FrameElem=22-1 ElemStation=0,05

Frame=22 Station=0,1 OutputCase=STR170 CaseType=Combination P=-6,78408776845427 V2=36,9491875065286 V3=0 T=0 M2=0 M3=7,63409974779676 FrameElem=22-1 ElemStation=0,1

Frame=22 Station=0 OutputCase=STR171 CaseType=Combination P=-17,5399999986937 V2=27,8736158257142 V3=0 T=0 M2=0 M3=2,44667047176744 FrameElem=22-1 ElemStation=0

Frame=22 Station=0,05 OutputCase=STR171 CaseType=Combination P=-17,3399999986937 V2=25,8195486382142 V3=0 T=0 M2=0 M3=1,10429741485673 FrameElem=22-1 ElemStation=0,05

Frame=22 Station=0,1 OutputCase=STR171 CaseType=Combination P=-17,1399999986937 V2=23,7549345757142 V3=0 T=0 M2=0 M3=-0,13510861080398 FrameElem=22-1 ElemStation=0,1

Frame=22 Station=0 OutputCase=STR172 CaseType=Combination P=-24,1366814361223 V2=12,4196827563668 V3=0 T=0 M2=0 M3=3,59880168193707 FrameElem=22-1 ElemStation=0

Frame=22 Station=0,05 OutputCase=STR172 CaseType=Combination P=-23,8666814361223 V2=11,3754577563668 V3=0 T=0 M2=0 M3=3,00403004411873 FrameElem=22-1 ElemStation=0,05

Frame=22 Station=0,1 OutputCase=STR172 CaseType=Combination P=-23,5966814361223 V2=10,3568827563668 V3=0 T=0 M2=0 M3=2,46082840630039 FrameElem=22-1 ElemStation=0,1

Frame=22 Station=0 OutputCase=STR173 CaseType=Combination P=-24,1366814361223 V2=6,79132961531652 V3=0 T=0 M2=0 M3=3,86054484097334 FrameElem=22-1 ElemStation=0

Frame=22 Station=0,05 OutputCase=STR173 CaseType=Combination P=-23,8666814361223 V2=6,30632961531652 V3=0 T=0 M2=0 M3=3,53315336020751 FrameElem=22-1 ElemStation=0,05

Frame=22 Station=0,1 OutputCase=STR173 CaseType=Combination P=-23,5966814361223 V2=5,83332961531652 V3=0 T=0 M2=0 M3=3,22971187944169 FrameElem=22-1 ElemStation=0,1

Frame=22 Station=0 OutputCase=STR174 CaseType=Combination P=-104,812681432933 V2=5,81918479343581 V3=0 T=0 M2=0 M3=13,846063125745 FrameElem=22-1 ElemStation=0

Frame=22 Station=0,05 OutputCase=STR174 CaseType=Combination P=-104,542681432933 V2=5,33418479343581 V3=0 T=0 M2=0 M3=13,5672788860732 FrameElem=22-1 ElemStation=0,05

Frame=22 Station=0,1 OutputCase=STR174 CaseType=Combination P=-104,272681432933 V2=4,86118479343581 V3=0 T=0 M2=0 M3=13,3124446464014 FrameElem=22-1 ElemStation=0,1

Frame=22 Station=0 OutputCase=STR175 CaseType=Combination P=-94,4567692022217 V2=39,9700006350496 V3=0 T=0 M2=0 M3=22,3637229755808 FrameElem=22-1 ElemStation=0

Frame=22 Station=0,05 OutputCase=STR175 CaseType=Combination P=-94,1867692022217 V2=37,9159334475496 V3=0 T=0 M2=0 M3=20,4165306782033 FrameElem=22-1 ElemStation=0,05

Frame=22 Station=0,1 OutputCase=STR175 CaseType=Combination P=-93,9167692022217 V2=35,8513193850496 V3=0 T=0 M2=0 M3=18,5723054120758 FrameElem=22-1 ElemStation=0,1

Frame=22 Station=0 OutputCase=STR176 CaseType=Combination P=-104,812681432461 V2=26,7757477042352 V3=0 T=0 M2=0 M3=13,2750893238986 FrameElem=22-1 ElemStation=0

Frame=22 Station=0,05 OutputCase=STR176 CaseType=Combination P=-104,542681432461 V2=24,7216805167352 V3=0 T=0 M2=0 M3=11,9876096730618 FrameElem=22-1 ElemStation=0,05

Frame=22 Station=0,1 OutputCase=STR176 CaseType=Combination P=-104,272681432461 V2=22,6570664542352 V3=0 T=0 M2=0 M3=10,8039070534751 FrameElem=22-1 ElemStation=0,1

Frame=22 Station=0 OutputCase=STR177 CaseType=Combination P=-7,64176920570386 V2=40,7450644416975 V3=0 T=0 M2=0 M3=11,5774661558768 FrameElem=22-1 ElemStation=0

Frame=22 Station=0,05 OutputCase=STR177 CaseType=Combination P=-7,44176920570386 V2=38,6909972541975 V3=0 T=0 M2=0 M3=9,59152066816688 FrameElem=22-1 ElemStation=0,05

Frame=22 Station=0,1 OutputCase=STR177 CaseType=Combination P=-7,24176920570386 V2=36,6263831916975 V3=0 T=0 M2=0 M3=7,708542211707 FrameElem=22-1 ElemStation=0,1

Frame=22 Station=0 OutputCase=STR178 CaseType=Combination P=-17,9976814359433 V2=27,5508115108831 V3=0 T=0 M2=0 M3=2,48883250419458 FrameElem=22-1 ElemStation=0

Frame=22 Station=0,05 OutputCase=STR178 CaseType=Combination P=-17,7976814359433 V2=25,4967443233831 V3=0 T=0 M2=0 M3=-1,16259966302542 FrameElem=22-1 ElemStation=0,05

Frame=22 Station=0,1 OutputCase=STR178 CaseType=Combination P=-17,5976814359433 V2=23,4321302608831 V3=0 T=0 M2=0 M3=-6,06661468937354E-02 FrameElem=22-1 ElemStation=0,1

Frame=22 Station=0 OutputCase=STR179 CaseType=Combination P=-24,1366814361223 V2=12,4196827563668 V3=0 T=0 M2=0 M3=3,59880168193707 FrameElem=22-1 ElemStation=0

Società di Progetto
Brebemi SpA

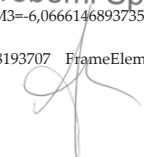



Doc. N.
60235-00000-A00.doc

CODIFICA DOCUMENTO
04RCDII10000000000300A00

REV.
00

FOGLIO
324 di 628

Frame=22 Station=0,05 OutputCase=STR179 CaseType=Combination P=-23,8666814361223 V2=11,3754577563668 V3=0 T=0 M2=0 M3=3,00403004411873	FrameElem=22-1 ElemStation=0,05
Frame=22 Station=0,1 OutputCase=STR179 CaseType=Combination P=-23,5966814361223 V2=10,3568827563668 V3=0 T=0 M2=0 M3=2,46082840630039	FrameElem=22-1 ElemStation=0,1
Frame=22 Station=0 OutputCase=STR180 CaseType=Combination P=-23,2213185616223 V2=11,9619367389491 V3=0 T=0 M2=0 M3=2,79700477423994	FrameElem=22-1 ElemStation=0
Frame=22 Station=0,05 OutputCase=STR180 CaseType=Combination P=-22,9513185616223 V2=10,9177117389491 V3=0 T=0 M2=0 M3=2,22512043729249	FrameElem=22-1 ElemStation=0,05
Frame=22 Station=0,1 OutputCase=STR180 CaseType=Combination P=-22,6813185616223 V2=9,89913673894905 V3=0 T=0 M2=0 M3=1,70480610034504	FrameElem=22-1 ElemStation=0,1
Frame=22 Station=0 OutputCase=STR181 CaseType=Combination P=-23,2213185616223 V2=6,33358359789873 V3=0 T=0 M2=0 M3=3,05874793327621	FrameElem=22-1 ElemStation=0
Frame=22 Station=0,05 OutputCase=STR181 CaseType=Combination P=-22,9513185616223 V2=5,84858359789873 V3=0 T=0 M2=0 M3=2,75424375338128	FrameElem=22-1 ElemStation=0,05
Frame=22 Station=0,1 OutputCase=STR181 CaseType=Combination P=-22,6813185616223 V2=5,37558359789873 V3=0 T=0 M2=0 M3=2,47368957348634	FrameElem=22-1 ElemStation=0,1
Frame=22 Station=0 OutputCase=STR182 CaseType=Combination P=-103,897318558433 V2=5,36143877601802 V3=0 T=0 M2=0 M3=13,0442662180479	FrameElem=22-1 ElemStation=0
Frame=22 Station=0,05 OutputCase=STR182 CaseType=Combination P=-103,627318558433 V2=4,87643877601802 V3=0 T=0 M2=0 M3=12,788369279247	FrameElem=22-1 ElemStation=0,05
Frame=22 Station=0,1 OutputCase=STR182 CaseType=Combination P=-103,357318558433 V2=4,40343877601802 V3=0 T=0 M2=0 M3=12,5564223044461	FrameElem=22-1 ElemStation=0,1
Frame=22 Station=0 OutputCase=STR183 CaseType=Combination P=-93,5414063277217 V2=39,5122546176318 V3=0 T=0 M2=0 M3=21,5619260678836	FrameElem=22-1 ElemStation=0
Frame=22 Station=0,05 OutputCase=STR183 CaseType=Combination P=-93,2714063277217 V2=37,4581874301318 V3=0 T=0 M2=0 M3=19,637621071377	FrameElem=22-1 ElemStation=0,05
Frame=22 Station=0,1 OutputCase=STR183 CaseType=Combination P=-93,0014063277217 V2=35,3935733676318 V3=0 T=0 M2=0 M3=17,8162831061205	FrameElem=22-1 ElemStation=0,1
Frame=22 Station=0 OutputCase=STR184 CaseType=Combination P=-103,897318557961 V2=26,3180016868174 V3=0 T=0 M2=0 M3=12,4732924162015	FrameElem=22-1 ElemStation=0
Frame=22 Station=0,05 OutputCase=STR184 CaseType=Combination P=-103,627318557961 V2=24,2639344993174 V3=0 T=0 M2=0 M3=11,2087000662356	FrameElem=22-1 ElemStation=0,05
Frame=22 Station=0,1 OutputCase=STR184 CaseType=Combination P=-103,357318557961 V2=22,1993204368174 V3=0 T=0 M2=0 M3=10,4070747475197	FrameElem=22-1 ElemStation=0,1
Frame=22 Station=0 OutputCase=STR185 CaseType=Combination P=-6,72640633120385 V2=40,2873184242798 V3=0 T=0 M2=0 M3=10,7756692481796	FrameElem=22-1 ElemStation=0
Frame=22 Station=0,05 OutputCase=STR185 CaseType=Combination P=-6,52640633120386 V2=38,2332512367797 V3=0 T=0 M2=0 M3=8,81261106134064	FrameElem=22-1 ElemStation=0,05
Frame=22 Station=0,1 OutputCase=STR185 CaseType=Combination P=-6,32640633120386 V2=36,1686371742797 V3=0 T=0 M2=0 M3=6,95251990575165	FrameElem=22-1 ElemStation=0,1
Frame=22 Station=0 OutputCase=STR186 CaseType=Combination P=-17,0823185614433 V2=27,0930654934654 V3=0 T=0 M2=0 M3=1,68703559649746	FrameElem=22-1 ElemStation=0
Frame=22 Station=0,05 OutputCase=STR186 CaseType=Combination P=-16,8823185614433 V2=25,0389983059654 V3=0 T=0 M2=0 M3=0,383690056199186	FrameElem=22-1 ElemStation=0,05
Frame=22 Station=0,1 OutputCase=STR186 CaseType=Combination P=-16,6823185614433 V2=22,9743842434653 V3=0 T=0 M2=0 M3=-0,816688452849082	FrameElem=22-1 ElemStation=0,1
Frame=22 Station=0 OutputCase=STR187 CaseType=Combination P=-23,2213185616223 V2=11,9619367389491 V3=0 T=0 M2=0 M3=2,79700477423994	FrameElem=22-1 ElemStation=0
Frame=22 Station=0,05 OutputCase=STR187 CaseType=Combination P=-22,9513185616223 V2=10,9177117389491 V3=0 T=0 M2=0 M3=2,22512043729249	FrameElem=22-1 ElemStation=0,05
Frame=22 Station=0,1 OutputCase=STR187 CaseType=Combination P=-22,6813185616223 V2=9,89913673894905 V3=0 T=0 M2=0 M3=1,70480610034504	FrameElem=22-1 ElemStation=0,1
Frame=22 Station=0 OutputCase=INVSTR CaseType=Combination StepType=Max P=-3,90053698070114 V2=58,0856927509411 V3=0 T=0 M2=0 M3=33,3830793337362	FrameElem=22-1 ElemStation=0
Frame=22 Station=0,05 OutputCase=INVSTR CaseType=Combination StepType=Max P=-3,70053698070114 V2=56,0316255634411 V3=0 T=0 M2=0 M3=30,5462426463057	FrameElem=22-1 ElemStation=0,05
Frame=22 Station=0,1 OutputCase=INVSTR CaseType=Combination StepType=Max P=-3,50053698070114 V2=53,9670115009411 V3=0 T=0 M2=0 M3=27,8123729901252	FrameElem=22-1 ElemStation=0,1
Frame=22 Station=0 OutputCase=INVSTR CaseType=Combination StepType=Min P=-131,704681431869 V2=3,52251436421826 V3=0 T=0 M2=0 M3=0,463139503474623	FrameElem=22-1 ElemStation=0
Frame=22 Station=0,05 OutputCase=INVSTR CaseType=Combination StepType=Min P=-131,434681431869 V2=3,03751436421826 V3=0 T=0 M2=0 M3=0,759019960061359	FrameElem=22-1 ElemStation=0,05
Frame=22 Station=0,1 OutputCase=INVSTR CaseType=Combination StepType=Min P=-131,164681431869 V2=2,56451436421826 V3=0 T=0 M2=0 M3=-1,90279097455648	FrameElem=22-1 ElemStation=0,1
Frame=22 Station=0 OutputCase=SIS01 CaseType=Combination P=-11,2974397236045 V2=18,9876796547753 V3=0 T=0 M2=0 M3=5,90373618984379	FrameElem=22-1 ElemStation=0
Frame=22 Station=0,05 OutputCase=SIS01 CaseType=Combination P=-11,1041897236045 V2=17,9426796547753 V3=0 T=0 M2=0 M3=4,98052720710502	FrameElem=22-1 ElemStation=0,05
Frame=22 Station=0,1 OutputCase=SIS01 CaseType=Combination P=-10,9109397236045 V2=16,9096796547753 V3=0 T=0 M2=0 M3=4,10926822436626	FrameElem=22-1 ElemStation=0,1
Frame=22 Station=0 OutputCase=SIS02 CaseType=Combination P=-11,2974397236042 V2=18,604570402317 V3=0 T=0 M2=0 M3=5,6546136749678	FrameElem=22-1 ElemStation=0
Frame=22 Station=0,05 OutputCase=SIS02 CaseType=Combination P=-11,1041897236042 V2=17,559570402317 V3=0 T=0 M2=0 M3=4,75056015485195	FrameElem=22-1 ElemStation=0,05
Frame=22 Station=0,1 OutputCase=SIS02 CaseType=Combination P=-10,9109397236042 V2=16,526570402317 V3=0 T=0 M2=0 M3=3,8984566347361	FrameElem=22-1 ElemStation=0,1
Frame=22 Station=0 OutputCase=SIS03 CaseType=Combination P=-11,2974397236048 V2=19,3707889072336 V3=0 T=0 M2=0 M3=6,15285870471977	FrameElem=22-1 ElemStation=0
Frame=22 Station=0,05 OutputCase=SIS03 CaseType=Combination P=-11,1041897236048 V2=18,3257889072336 V3=0 T=0 M2=0 M3=5,21049425935809	FrameElem=22-1 ElemStation=0,05
Frame=22 Station=0,1 OutputCase=SIS03 CaseType=Combination P=-10,9109397236048 V2=17,2927889072336 V3=0 T=0 M2=0 M3=4,32007981399642	FrameElem=22-1 ElemStation=0,1
Frame=22 Station=0 OutputCase=SIS04 CaseType=Combination P=-11,6152740550281 V2=19,1466192441564 V3=0 T=0 M2=0 M3=6,18213789390529	FrameElem=22-1 ElemStation=0
Frame=22 Station=0,05 OutputCase=SIS04 CaseType=Combination P=-11,4220240550281 V2=18,1016192441564 V3=0 T=0 M2=0 M3=5,25098193169747	FrameElem=22-1 ElemStation=0,05
Frame=22 Station=0,1 OutputCase=SIS04 CaseType=Combination P=-11,2287740550281 V2=17,0686192441564 V3=0 T=0 M2=0 M3=4,37177596948964	FrameElem=22-1 ElemStation=0,1

Società di Progetto
Brebemi SpA



Doc. N.
60235-0000-A00.doc

CODIFICA DOCUMENTO
04RCDII10000000000300A00

REV.
00

FOGLIO
325 di 628

Frame=22 Station=0 OutputCase=SIS05 CaseType=Combination P=-10,9796053921809 V2=18,8287400653941 V3=0 T=0 M2=0 M3=5,62533448578228	FrameElem=22-1
ElemStation=0	
Frame=22 Station=0,05 OutputCase=SIS05 CaseType=Combination P=-10,7863553921809 V2=17,7837400653941 V3=0 T=0 M2=0 M3=4,71007248251258	FrameElem=22-1
ElemStation=0,05	
Frame=22 Station=0,1 OutputCase=SIS05 CaseType=Combination P=-10,5931053921809 V2=16,7507400653941 V3=0 T=0 M2=0 M3=3,84676047924287	FrameElem=22-1
ElemStation=0,1	
Frame=22 Station=0 OutputCase=SIS06 CaseType=Combination P=-11,2974397236048 V2=19,3707889072336 V3=0 T=0 M2=0 M3=6,15285870471977	FrameElem=22-1
ElemStation=0	
Frame=22 Station=0,05 OutputCase=SIS06 CaseType=Combination P=-11,1041897236048 V2=18,3257889072336 V3=0 T=0 M2=0 M3=5,21049425935809	FrameElem=22-1
ElemStation=0,05	
Frame=22 Station=0,1 OutputCase=SIS06 CaseType=Combination P=-10,9109397236048 V2=17,2927889072336 V3=0 T=0 M2=0 M3=4,32007981399642	FrameElem=22-1
ElemStation=0,1	
Frame=22 Station=0 OutputCase=SIS07 CaseType=Combination P=-11,6152740550278 V2=18,7635099916982 V3=0 T=0 M2=0 M3=5,9330153790293	FrameElem=22-1
ElemStation=0	
Frame=22 Station=0,05 OutputCase=SIS07 CaseType=Combination P=-11,4220240550278 V2=17,7185099916982 V3=0 T=0 M2=0 M3=5,02101487944439	FrameElem=22-1
ElemStation=0,05	
Frame=22 Station=0,1 OutputCase=SIS07 CaseType=Combination P=-11,2287740550278 V2=16,6855099916982 V3=0 T=0 M2=0 M3=4,16096437985948	FrameElem=22-1
ElemStation=0,1	
Frame=22 Station=0 OutputCase=SIS08 CaseType=Combination P=-10,9796053921806 V2=18,4456308129358 V3=0 T=0 M2=0 M3=5,3762119709063	FrameElem=22-1
ElemStation=0	
Frame=22 Station=0,05 OutputCase=SIS08 CaseType=Combination P=-10,7863553921806 V2=17,4006308129358 V3=0 T=0 M2=0 M3=4,48010543025951	FrameElem=22-1
ElemStation=0,05	
Frame=22 Station=0,1 OutputCase=SIS08 CaseType=Combination P=-10,5931053921806 V2=16,3676308129358 V3=0 T=0 M2=0 M3=3,63594888961271	FrameElem=22-1
ElemStation=0,1	
Frame=22 Station=0 OutputCase=SIS09 CaseType=Combination P=-11,2974397236045 V2=18,9876796547753 V3=0 T=0 M2=0 M3=5,90373618984379	FrameElem=22-1
ElemStation=0	
Frame=22 Station=0,05 OutputCase=SIS09 CaseType=Combination P=-11,1041897236045 V2=17,9426796547753 V3=0 T=0 M2=0 M3=4,98052720710502	FrameElem=22-1
ElemStation=0,05	
Frame=22 Station=0,1 OutputCase=SIS09 CaseType=Combination P=-10,9109397236045 V2=16,9096796547753 V3=0 T=0 M2=0 M3=4,10926822436626	FrameElem=22-1
ElemStation=0,1	
Frame=22 Station=0 OutputCase=SIS10 CaseType=Combination P=-12,4739197235525 V2=19,0284507260059 V3=0 T=0 M2=0 M3=6,06046907738019	FrameElem=22-1
ElemStation=0	
Frame=22 Station=0,05 OutputCase=SIS10 CaseType=Combination P=-12,2671697235525 V2=17,9834507260059 V3=0 T=0 M2=0 M3=5,13522154107989	FrameElem=22-1
ElemStation=0,05	
Frame=22 Station=0,1 OutputCase=SIS10 CaseType=Combination P=-12,0604197235525 V2=16,9504507260059 V3=0 T=0 M2=0 M3=4,2619240047796	FrameElem=22-1
ElemStation=0,1	
Frame=22 Station=0 OutputCase=SIS11 CaseType=Combination P=-12,4739197235523 V2=18,6453414735476 V3=0 T=0 M2=0 M3=5,8113465625042	FrameElem=22-1
ElemStation=0	
Frame=22 Station=0,05 OutputCase=SIS11 CaseType=Combination P=-12,2671697235523 V2=17,6003414735476 V3=0 T=0 M2=0 M3=4,90525448882682	FrameElem=22-1
ElemStation=0,05	
Frame=22 Station=0,1 OutputCase=SIS11 CaseType=Combination P=-12,0604197235523 V2=16,5673414735476 V3=0 T=0 M2=0 M3=4,05111241514944	FrameElem=22-1
ElemStation=0,1	
Frame=22 Station=0 OutputCase=SIS12 CaseType=Combination P=-12,4739197235528 V2=19,4115599784642 V3=0 T=0 M2=0 M3=6,30959159225618	FrameElem=22-1
ElemStation=0	
Frame=22 Station=0,05 OutputCase=SIS12 CaseType=Combination P=-12,2671697235528 V2=18,3665599784642 V3=0 T=0 M2=0 M3=5,36518859333296	FrameElem=22-1
ElemStation=0,05	
Frame=22 Station=0,1 OutputCase=SIS12 CaseType=Combination P=-12,0604197235528 V2=17,3335599784642 V3=0 T=0 M2=0 M3=4,47273559440975	FrameElem=22-1
ElemStation=0,1	
Frame=22 Station=0 OutputCase=SIS13 CaseType=Combination P=-12,7917540549761 V2=19,1873903153871 V3=0 T=0 M2=0 M3=6,33887078144169	FrameElem=22-1
ElemStation=0	
Frame=22 Station=0,05 OutputCase=SIS13 CaseType=Combination P=-12,5850040549761 V2=18,1423903153871 V3=0 T=0 M2=0 M3=5,40567626567234	FrameElem=22-1
ElemStation=0,05	
Frame=22 Station=0,1 OutputCase=SIS13 CaseType=Combination P=-12,3782540549761 V2=17,1093903153871 V3=0 T=0 M2=0 M3=4,52443174990298	FrameElem=22-1
ElemStation=0,1	
Frame=22 Station=0 OutputCase=SIS14 CaseType=Combination P=-12,1560853921289 V2=18,8695111366247 V3=0 T=0 M2=0 M3=5,78206737331869	FrameElem=22-1
ElemStation=0	
Frame=22 Station=0,05 OutputCase=SIS14 CaseType=Combination P=-11,9493353921289 V2=17,8245111366248 V3=0 T=0 M2=0 M3=4,86476681648745	FrameElem=22-1
ElemStation=0,05	
Frame=22 Station=0,1 OutputCase=SIS14 CaseType=Combination P=-11,7425853921289 V2=16,7915111366247 V3=0 T=0 M2=0 M3=3,99941625965621	FrameElem=22-1
ElemStation=0,1	
Frame=22 Station=0 OutputCase=SIS15 CaseType=Combination P=-12,4739197235528 V2=19,4115599784642 V3=0 T=0 M2=0 M3=6,30959159225618	FrameElem=22-1
ElemStation=0	
Frame=22 Station=0,05 OutputCase=SIS15 CaseType=Combination P=-12,2671697235528 V2=18,3665599784642 V3=0 T=0 M2=0 M3=5,36518859333296	FrameElem=22-1
ElemStation=0,05	
Frame=22 Station=0,1 OutputCase=SIS15 CaseType=Combination P=-12,0604197235528 V2=17,3335599784642 V3=0 T=0 M2=0 M3=4,47273559440975	FrameElem=22-1
ElemStation=0,1	
Frame=22 Station=0 OutputCase=SIS16 CaseType=Combination P=-12,7917540549759 V2=18,8042810629288 V3=0 T=0 M2=0 M3=6,0897482665657	FrameElem=22-1
ElemStation=0	
Frame=22 Station=0,05 OutputCase=SIS16 CaseType=Combination P=-12,5850040549759 V2=17,7592810629288 V3=0 T=0 M2=0 M3=5,17570921341926	FrameElem=22-1
ElemStation=0,05	
Frame=22 Station=0,1 OutputCase=SIS16 CaseType=Combination P=-12,3782540549759 V2=16,7262810629288 V3=0 T=0 M2=0 M3=4,31362016027282	FrameElem=22-1
ElemStation=0,1	
Frame=22 Station=0 OutputCase=SIS17 CaseType=Combination P=-12,1560853921286 V2=18,4864018841665 V3=0 T=0 M2=0 M3=5,5329448584427	FrameElem=22-1
ElemStation=0	
Frame=22 Station=0,05 OutputCase=SIS17 CaseType=Combination P=-11,9493353921286 V2=17,4414018841665 V3=0 T=0 M2=0 M3=4,63479976423438	FrameElem=22-1
ElemStation=0,05	
Frame=22 Station=0,1 OutputCase=SIS17 CaseType=Combination P=-11,7425853921286 V2=16,4084018841665 V3=0 T=0 M2=0 M3=3,78860467002605	FrameElem=22-1
ElemStation=0,1	
Frame=22 Station=0 OutputCase=SIS18 CaseType=Combination P=-12,4739197235525 V2=19,0284507260059 V3=0 T=0 M2=0 M3=6,06046907738019	FrameElem=22-1
ElemStation=0	
Frame=22 Station=0,05 OutputCase=SIS18 CaseType=Combination P=-12,2671697235525 V2=17,9834507260059 V3=0 T=0 M2=0 M3=5,13522154107989	FrameElem=22-1
ElemStation=0,05	
Frame=22 Station=0,1 OutputCase=SIS18 CaseType=Combination P=-12,0604197235525 V2=16,9504507260059 V3=0 T=0 M2=0 M3=4,2619240047796	FrameElem=22-1
ElemStation=0,1	
Frame=22 Station=0 OutputCase=SIS19 CaseType=Combination P=-12,2024266244436 V2=16,2111634041026 V3=0 T=0 M2=0 M3=4,25470868125495	FrameElem=22-1
ElemStation=0	
Frame=22 Station=0,05 OutputCase=SIS19 CaseType=Combination P=-12,0249266244436 V2=15,1973134041026 V3=0 T=0 M2=0 M3=3,46954676104982	FrameElem=22-1
ElemStation=0,05	

Società di Progetto
Brebemi SpA

	Doc. N. 60235-0000-A00.doc	CODIFICA DOCUMENTO 04RCDII10000000000300A00	REV. 00	FOGLIO 326 di 628
--	-------------------------------	--	------------	----------------------

Frame=22 Station=0,1 OutputCase=SIS19 ElemStation=0,1	CaseType=Combination	P=-11,8474266244436	V2=14,1954634041026	V3=0	T=0	M2=0	M3=2,73477734084469	FrameElem=22-1
Frame=22 Station=0 OutputCase=SIS20 ElemStation=0	CaseType=Combination	P=-12,2024266244433	V2=15,8280541516443	V3=0	T=0	M2=0	M3=4,00558616637896	FrameElem=22-1
Frame=22 Station=0,05 OutputCase=SIS20 ElemStation=0,05	CaseType=Combination	P=-12,0249266244433	V2=14,8142041516443	V3=0	T=0	M2=0	M3=3,23957970879674	FrameElem=22-1
Frame=22 Station=0,1 OutputCase=SIS20 ElemStation=0,1	CaseType=Combination	P=-11,8474266244433	V2=13,8123541516443	V3=0	T=0	M2=0	M3=2,52396575121453	FrameElem=22-1
Frame=22 Station=0 OutputCase=SIS21 ElemStation=0	CaseType=Combination	P=-12,2024266244439	V2=16,5942726565609	V3=0	T=0	M2=0	M3=4,50383119613093	FrameElem=22-1
Frame=22 Station=0,05 OutputCase=SIS21 ElemStation=0,05	CaseType=Combination	P=-12,0249266244439	V2=15,5804226565609	V3=0	T=0	M2=0	M3=3,69951381330289	FrameElem=22-1
Frame=22 Station=0,1 OutputCase=SIS21 ElemStation=0,1	CaseType=Combination	P=-11,8474266244439	V2=14,5785726565609	V3=0	T=0	M2=0	M3=2,94558893047485	FrameElem=22-1
Frame=22 Station=0 OutputCase=SIS22 ElemStation=0	CaseType=Combination	P=-12,5202609558672	V2=16,3701029934838	V3=0	T=0	M2=0	M3=4,53311038531645	FrameElem=22-1
Frame=22 Station=0,05 OutputCase=SIS22 ElemStation=0,05	CaseType=Combination	P=-12,3427609558672	V2=15,3562529934838	V3=0	T=0	M2=0	M3=3,74000148564226	FrameElem=22-1
Frame=22 Station=0,1 OutputCase=SIS22 ElemStation=0,1	CaseType=Combination	P=-12,1652609558672	V2=14,3544029934838	V3=0	T=0	M2=0	M3=2,99728508596807	FrameElem=22-1
Frame=22 Station=0 OutputCase=SIS23 ElemStation=0	CaseType=Combination	P=-11,88459229302	V2=16,0522238147214	V3=0	T=0	M2=0	M3=3,97630697719345	FrameElem=22-1
Frame=22 Station=0,05 OutputCase=SIS23 ElemStation=0,05	CaseType=Combination	P=-11,70709229302	V2=15,0383738147214	V3=0	T=0	M2=0	M3=3,19909203645737	FrameElem=22-1
Frame=22 Station=0,1 OutputCase=SIS23 ElemStation=0,1	CaseType=Combination	P=-11,52959229302	V2=14,0365238147214	V3=0	T=0	M2=0	M3=2,4722695957213	FrameElem=22-1
Frame=22 Station=0 OutputCase=SIS24 ElemStation=0	CaseType=Combination	P=-12,2024266244439	V2=16,5942726565609	V3=0	T=0	M2=0	M3=4,50383119613093	FrameElem=22-1
Frame=22 Station=0,05 OutputCase=SIS24 ElemStation=0,05	CaseType=Combination	P=-12,0249266244439	V2=15,5804226565609	V3=0	T=0	M2=0	M3=3,69951381330289	FrameElem=22-1
Frame=22 Station=0,1 OutputCase=SIS24 ElemStation=0,1	CaseType=Combination	P=-11,8474266244439	V2=14,5785726565609	V3=0	T=0	M2=0	M3=2,94558893047485	FrameElem=22-1
Frame=22 Station=0 OutputCase=SIS25 ElemStation=0	CaseType=Combination	P=-12,5202609558669	V2=15,9869937410255	V3=0	T=0	M2=0	M3=4,28398787044046	FrameElem=22-1
Frame=22 Station=0,05 OutputCase=SIS25 ElemStation=0,05	CaseType=Combination	P=-12,3427609558669	V2=14,9731437410255	V3=0	T=0	M2=0	M3=3,51003443338919	FrameElem=22-1
Frame=22 Station=0,1 OutputCase=SIS25 ElemStation=0,1	CaseType=Combination	P=-12,1652609558669	V2=13,9712937410255	V3=0	T=0	M2=0	M3=2,78647349633791	FrameElem=22-1
Frame=22 Station=0 OutputCase=SIS26 ElemStation=0	CaseType=Combination	P=-11,8845922930197	V2=15,6691145622631	V3=0	T=0	M2=0	M3=3,72718446231746	FrameElem=22-1
Frame=22 Station=0,05 OutputCase=SIS26 ElemStation=0,05	CaseType=Combination	P=-11,7070922930197	V2=14,6552645622631	V3=0	T=0	M2=0	M3=2,9691249842043	FrameElem=22-1
Frame=22 Station=0,1 OutputCase=SIS26 ElemStation=0,1	CaseType=Combination	P=-11,5295922930197	V2=13,6534145622631	V3=0	T=0	M2=0	M3=2,26145800609114	FrameElem=22-1
Frame=22 Station=0 OutputCase=SIS27 ElemStation=0	CaseType=Combination	P=-12,2024266244436	V2=16,2111634041026	V3=0	T=0	M2=0	M3=4,25470868125495	FrameElem=22-1
Frame=22 Station=0,05 OutputCase=SIS27 ElemStation=0,05	CaseType=Combination	P=-12,0249266244436	V2=15,1973134041026	V3=0	T=0	M2=0	M3=3,46954676104982	FrameElem=22-1
Frame=22 Station=0,1 OutputCase=SIS27 ElemStation=0,1	CaseType=Combination	P=-11,8474266244436	V2=14,1954634041026	V3=0	T=0	M2=0	M3=2,73477734084469	FrameElem=22-1
Frame=22 Station=0 OutputCase=SIS28 ElemStation=0	CaseType=Combination	P=-16,1240266242705	V2=16,3470669748715	V3=0	T=0	M2=0	M3=4,77715163970963	FrameElem=22-1
Frame=22 Station=0,05 OutputCase=SIS28 ElemStation=0,05	CaseType=Combination	P=-15,9015266242705	V2=15,3332169748715	V3=0	T=0	M2=0	M3=3,98519454096605	FrameElem=22-1
Frame=22 Station=0,1 OutputCase=SIS28 ElemStation=0,1	CaseType=Combination	P=-15,6790266242705	V2=14,3313669748715	V3=0	T=0	M2=0	M3=3,2436299422248	FrameElem=22-1
Frame=22 Station=0 OutputCase=SIS29 ElemStation=0	CaseType=Combination	P=-16,1240266242702	V2=15,9639577224132	V3=0	T=0	M2=0	M3=4,52802912483364	FrameElem=22-1
Frame=22 Station=0,05 OutputCase=SIS29 ElemStation=0,05	CaseType=Combination	P=-15,9015266242702	V2=14,9501077224132	V3=0	T=0	M2=0	M3=3,75522748871298	FrameElem=22-1
Frame=22 Station=0,1 OutputCase=SIS29 ElemStation=0,1	CaseType=Combination	P=-15,6790266242702	V2=13,9482577224132	V3=0	T=0	M2=0	M3=3,03281835259232	FrameElem=22-1
Frame=22 Station=0 OutputCase=SIS30 ElemStation=0	CaseType=Combination	P=-16,1240266242708	V2=16,7301762273297	V3=0	T=0	M2=0	M3=5,02627415458561	FrameElem=22-1
Frame=22 Station=0,05 OutputCase=SIS30 ElemStation=0,05	CaseType=Combination	P=-15,9015266242708	V2=15,7163262273297	V3=0	T=0	M2=0	M3=4,21516159321913	FrameElem=22-1
Frame=22 Station=0,1 OutputCase=SIS30 ElemStation=0,1	CaseType=Combination	P=-15,6790266242708	V2=14,7144762273297	V3=0	T=0	M2=0	M3=3,45444153185264	FrameElem=22-1
Frame=22 Station=0 OutputCase=SIS31 ElemStation=0	CaseType=Combination	P=-16,4418609556941	V2=16,5060065642526	V3=0	T=0	M2=0	M3=5,0555334377113	FrameElem=22-1
Frame=22 Station=0,05 OutputCase=SIS31 ElemStation=0,05	CaseType=Combination	P=-16,2193609556941	V2=15,4921565642526	V3=0	T=0	M2=0	M3=4,2556492655585	FrameElem=22-1
Frame=22 Station=0,1 OutputCase=SIS31 ElemStation=0,1	CaseType=Combination	P=-15,9968609556941	V2=14,4903065642526	V3=0	T=0	M2=0	M3=3,50613768734586	FrameElem=22-1
Frame=22 Station=0 OutputCase=SIS32 ElemStation=0	CaseType=Combination	P=-15,8061922928469	V2=16,1881273854903	V3=0	T=0	M2=0	M3=4,49874993564812	FrameElem=22-1
Frame=22 Station=0,05 OutputCase=SIS32 ElemStation=0,05	CaseType=Combination	P=-15,5836922928469	V2=15,17427373854903	V3=0	T=0	M2=0	M3=3,71473981637361	FrameElem=22-1
Frame=22 Station=0,1 OutputCase=SIS32 ElemStation=0,1	CaseType=Combination	P=-15,3611922928469	V2=14,1724273854903	V3=0	T=0	M2=0	M3=2,9811221970991	FrameElem=22-1
Frame=22 Station=0 OutputCase=SIS33 ElemStation=0	CaseType=Combination	P=-16,1240266242708	V2=16,7301762273297	V3=0	T=0	M2=0	M3=5,02627415458561	FrameElem=22-1
Frame=22 Station=0,05 OutputCase=SIS33 ElemStation=0,05	CaseType=Combination	P=-15,9015266242708	V2=15,7163262273297	V3=0	T=0	M2=0	M3=4,21516159321913	FrameElem=22-1
Frame=22 Station=0,1 OutputCase=SIS33 ElemStation=0,1	CaseType=Combination	P=-15,6790266242708	V2=14,7144762273297	V3=0	T=0	M2=0	M3=3,45444153185264	FrameElem=22-1
Frame=22 Station=0 OutputCase=SIS34 ElemStation=0	CaseType=Combination	P=-16,4418609556938	V2=16,1228973117944	V3=0	T=0	M2=0	M3=4,80643082889514	FrameElem=22-1

Società di Progetto
Brebemi SpA



Doc. N.
60235-00000-A00.doc

CODIFICA DOCUMENTO
04RCDII10000000000300A00

REV.
00

FOGLIO
327 di 628

Frame=22 Station=0,05 OutputCase=SIS34 CaseType=Combination P=-16,2193609556938 V2=15,1090473117944 V3=0 T=0 M2=0 M3=4,02568221330542	FrameElem=22-1 ElemStation=0,05
Frame=22 Station=0,1 OutputCase=SIS34 CaseType=Combination P=-15,9968609556938 V2=14,1071973117944 V3=0 T=0 M2=0 M3=3,29532609771571	FrameElem=22-1 ElemStation=0,1
Frame=22 Station=0 OutputCase=SIS35 CaseType=Combination P=-15,8061922928466 V2=15,805018133032 V3=0 T=0 M2=0 M3=4,24967242077214	FrameElem=22-1 ElemStation=0
Frame=22 Station=0,05 OutputCase=SIS35 CaseType=Combination P=-15,5836922928466 V2=14,791168133032 V3=0 T=0 M2=0 M3=3,48477276412054	FrameElem=22-1 ElemStation=0,05
Frame=22 Station=0,1 OutputCase=SIS35 CaseType=Combination P=-15,3611922928466 V2=13,789318133032 V3=0 T=0 M2=0 M3=2,77031060746894	FrameElem=22-1 ElemStation=0,1
Frame=22 Station=0 OutputCase=SIS36 CaseType=Combination P=-16,1240266242705 V2=16,3470669748715 V3=0 T=0 M2=0 M3=4,77715163970963	FrameElem=22-1 ElemStation=0
Frame=22 Station=0,05 OutputCase=SIS36 CaseType=Combination P=-15,9015266242705 V2=15,3332169748715 V3=0 T=0 M2=0 M3=3,98519454096605	FrameElem=22-1 ElemStation=0,05
Frame=22 Station=0,1 OutputCase=SIS36 CaseType=Combination P=-15,6790266242705 V2=14,3313669748715 V3=0 T=0 M2=0 M3=3,24362994222248	FrameElem=22-1 ElemStation=0,1
Frame=22 Station=0 OutputCase=INVSIS CaseType=Combination StepType=Max P=-10,9796053921806 V2=19,4115599784642 V3=0 T=0 M2=0 M3=6,33887078144169	FrameElem=22-1 ElemStation=0
Frame=22 Station=0,05 OutputCase=INVSIS CaseType=Combination StepType=Max P=-10,7863553921806 V2=18,3665599784642 V3=0 T=0 M2=0 M3=5,40567626567234	FrameElem=22-1 ElemStation=0,05
Frame=22 Station=0,1 OutputCase=INVSIS CaseType=Combination StepType=Max P=-10,5931053921806 V2=17,3335599784642 V3=0 T=0 M2=0 M3=4,52443174990298	FrameElem=22-1 ElemStation=0,1
Frame=22 Station=0 OutputCase=INVSIS CaseType=Combination StepType=Min P=-16,4418609556941 V2=15,6691145622631 V3=0 T=0 M2=0 M3=3,72718446231746	FrameElem=22-1 ElemStation=0
Frame=22 Station=0,05 OutputCase=INVSIS CaseType=Combination StepType=Min P=-16,2193609556941 V2=14,6552645622631 V3=0 T=0 M2=0 M3=2,9691249842043	FrameElem=22-1 ElemStation=0,05
Frame=22 Station=0,1 OutputCase=INVSIS CaseType=Combination StepType=Min P=-15,9968609556941 V2=13,6534145622631 V3=0 T=0 M2=0 M3=2,26145800609114	FrameElem=22-1 ElemStation=0,1
Frame=22 Station=0 OutputCase=RAR001 CaseType=Combination P=-17,5399999991641 V2=8,3491463272282 V3=0 T=0 M2=0 M3=1,92593273510084	FrameElem=22-1 ElemStation=0
Frame=22 Station=0,05 OutputCase=RAR001 CaseType=Combination P=-17,3399999991641 V2=7,5756463272282 V3=0 T=0 M2=0 M3=1,5278920854061	FrameElem=22-1 ElemStation=0,05
Frame=22 Station=0,1 OutputCase=RAR001 CaseType=Combination P=-17,1399999991641 V2=6,8211463272282 V3=0 T=0 M2=0 M3=1,16805143571136	FrameElem=22-1 ElemStation=0,1
Frame=22 Station=0 OutputCase=RAR002 CaseType=Combination P=-97,2199999960139 V2=4,48577035151871 V3=0 T=0 M2=0 M3=11,923254097746	FrameElem=22-1 ElemStation=0
Frame=22 Station=0,05 OutputCase=RAR002 CaseType=Combination P=-97,0199999960139 V2=4,00077035151871 V3=0 T=0 M2=0 M3=11,7111405801701	FrameElem=22-1 ElemStation=0,05
Frame=22 Station=0,1 OutputCase=RAR002 CaseType=Combination P=-96,8199999960139 V2=3,52777035151871 V3=0 T=0 M2=0 M3=11,5229770625941	FrameElem=22-1 ElemStation=0,1
Frame=22 Station=0 OutputCase=RAR003 CaseType=Combination P=-87,878855905321 V2=34,3534066356112 V3=0 T=0 M2=0 M3=19,6088155499816	FrameElem=22-1 ElemStation=0
Frame=22 Station=0,05 OutputCase=RAR003 CaseType=Combination P=-87,678855905321 V2=32,5825316356111 V3=0 T=0 M2=0 M3=17,9353473015344	FrameElem=22-1 ElemStation=0,05
Frame=22 Station=0,1 OutputCase=RAR003 CaseType=Combination P=-87,478855905321 V2=30,7949066356111 V3=0 T=0 M2=0 M3=16,3508415530871	FrameElem=22-1 ElemStation=0,1
Frame=22 Station=0 OutputCase=RAR004 CaseType=Combination P=-97,2199999955483 V2=22,5279759053698 V3=0 T=0 M2=0 M3=11,4827600358036	FrameElem=22-1 ElemStation=0
Frame=22 Station=0,05 OutputCase=RAR004 CaseType=Combination P=-97,0199999955483 V2=20,7571009053698 V3=0 T=0 M2=0 M3=10,4005633238684	FrameElem=22-1 ElemStation=0,05
Frame=22 Station=0,1 OutputCase=RAR004 CaseType=Combination P=-96,8199999955483 V2=18,9694759053698 V3=0 T=0 M2=0 M3=9,40732911193326	FrameElem=22-1 ElemStation=0,1
Frame=22 Station=0 OutputCase=RAR005 CaseType=Combination P=-8,19885590847116 V2=35,3135496695674 V3=0 T=0 M2=0 M3=9,74657526872562	FrameElem=22-1 ElemStation=0
Frame=22 Station=0,05 OutputCase=RAR005 CaseType=Combination P=-7,99885590847116 V2=33,5426746695674 V3=0 T=0 M2=0 M3=8,02509986858058	FrameElem=22-1 ElemStation=0,05
Frame=22 Station=0,1 OutputCase=RAR005 CaseType=Combination P=-7,79885590847116 V2=31,7550496695674 V3=0 T=0 M2=0 M3=6,39258696843555	FrameElem=22-1 ElemStation=0,1
Frame=22 Station=0 OutputCase=RAR006 CaseType=Combination P=-17,5399999986985 V2=23,4881189393261 V3=0 T=0 M2=0 M3=1,62051975454762	FrameElem=22-1 ElemStation=0
Frame=22 Station=0,05 OutputCase=RAR006 CaseType=Combination P=-17,3399999986985 V2=21,7172439393261 V3=0 T=0 M2=0 M3=0,490315890914645	FrameElem=22-1 ElemStation=0,05
Frame=22 Station=0,1 OutputCase=RAR006 CaseType=Combination P=-17,1399999986985 V2=19,9296189393261 V3=0 T=0 M2=0 M3=0,550925472718324	FrameElem=22-1 ElemStation=0,1
Frame=22 Station=0 OutputCase=RAR007 CaseType=Combination P=-55,7040089175134 V2=42,0425507586264 V3=0 T=0 M2=0 M3=24,0256335440692	FrameElem=22-1 ElemStation=0
Frame=22 Station=0,05 OutputCase=RAR007 CaseType=Combination P=-55,5040089175134 V2=40,5210195086264 V3=0 T=0 M2=0 M3=21,9615117353045	FrameElem=22-1 ElemStation=0,05
Frame=22 Station=0,1 OutputCase=RAR007 CaseType=Combination P=-55,3040089175134 V2=38,9916757586264 V3=0 T=0 M2=0 M3=19,9736618015398	FrameElem=22-1 ElemStation=0,1
Frame=22 Station=0 OutputCase=RAR008 CaseType=Combination P=-17,5399999991636 V2=4,6796948805584 V3=0 T=0 M2=0 M3=1,56276878673809	FrameElem=22-1 ElemStation=0
Frame=22 Station=0,05 OutputCase=RAR008 CaseType=Combination P=-17,3399999991636 V2=4,1946948805584 V3=0 T=0 M2=0 M3=1,34095904271017	FrameElem=22-1 ElemStation=0,05
Frame=22 Station=0,1 OutputCase=RAR008 CaseType=Combination P=-17,1399999991636 V2=3,7216948805584 V3=0 T=0 M2=0 M3=1,14309929868225	FrameElem=22-1 ElemStation=0,1
Frame=22 Station=0 OutputCase=RAR009 CaseType=Combination P=-97,2199999960136 V2=4,02603924856877 V3=0 T=0 M2=0 M3=11,6243070798948	FrameElem=22-1 ElemStation=0
Frame=22 Station=0,05 OutputCase=RAR009 CaseType=Combination P=-97,0199999960136 V2=3,54103924856877 V3=0 T=0 M2=0 M3=11,4351801174664	FrameElem=22-1 ElemStation=0,05
Frame=22 Station=0,1 OutputCase=RAR009 CaseType=Combination P=-96,8199999960136 V2=3,06803924856877 V3=0 T=0 M2=0 M3=11,270003155038	FrameElem=22-1 ElemStation=0,1
Frame=22 Station=0 OutputCase=RAR010 CaseType=Combination P=-87,8788559053206 V2=33,8936755326612 V3=0 T=0 M2=0 M3=19,3098685321304	FrameElem=22-1 ElemStation=0
Frame=22 Station=0,05 OutputCase=RAR010 CaseType=Combination P=-87,6788559053206 V2=32,1228005326612 V3=0 T=0 M2=0 M3=17,6593868388307	FrameElem=22-1 ElemStation=0,05
Frame=22 Station=0,1 OutputCase=RAR010 CaseType=Combination P=-87,4788559053206 V2=30,3351755326612 V3=0 T=0 M2=0 M3=16,0978676455309	FrameElem=22-1 ElemStation=0,1

Società di Progetto
Brebemi SpA



Doc. N.
60235-0000-A00.doc

CODIFICA DOCUMENTO
04RCDII10000000000300A00

REV.
00

FOGLIO
328 di 628

Frame=22 Station=0 OutputCase=RAR011 CaseType=Combination P=-97,2199999955479 V2=22,0682448024199 V3=0 T=0 M2=0 M3=11,1838130179524	FrameElem=22-1 ElemStation=0
Frame=22 Station=0,05 OutputCase=RAR011 CaseType=Combination P=-97,0199999955479 V2=20,2973698024199 V3=0 T=0 M2=0 M3=10,1246028611647	FrameElem=22-1 ElemStation=0,05
Frame=22 Station=0,1 OutputCase=RAR011 CaseType=Combination P=-96,8199999955479 V2=18,5097448024199 V3=0 T=0 M2=0 M3=9,15435520437707	FrameElem=22-1 ElemStation=0,1
Frame=22 Station=0 OutputCase=RAR012 CaseType=Combination P=-8,19885590847082 V2=34,8538185666175 V3=0 T=0 M2=0 M3=9,44762825087444	FrameElem=22-1 ElemStation=0
Frame=22 Station=0,05 OutputCase=RAR012 CaseType=Combination P=-7,99885590847082 V2=33,0829435666175 V3=0 T=0 M2=0 M3=7,7491394058769	FrameElem=22-1 ElemStation=0,05
Frame=22 Station=0,1 OutputCase=RAR012 CaseType=Combination P=-7,79885590847082 V2=31,2953185666175 V3=0 T=0 M2=0 M3=6,13961306087936	FrameElem=22-1 ElemStation=0,1
Frame=22 Station=0 OutputCase=RAR013 CaseType=Combination P=-17,5399999986981 V2=23,0283878363761 V3=0 T=0 M2=0 M3=1,32157273669643	FrameElem=22-1 ElemStation=0
Frame=22 Station=0,05 OutputCase=RAR013 CaseType=Combination P=-17,3399999986981 V2=21,2575128363761 V3=0 T=0 M2=0 M3=0,214355428210958	FrameElem=22-1 ElemStation=0,05
Frame=22 Station=0,1 OutputCase=RAR013 CaseType=Combination P=-17,1399999986981 V2=19,4698878363761 V3=0 T=0 M2=0 M3=-0,803899380274515	FrameElem=22-1 ElemStation=0,1
Frame=22 Station=0 OutputCase=RAR014 CaseType=Combination P=-55,7040089175131 V2=41,5828196556765 V3=0 T=0 M2=0 M3=23,726686526218	FrameElem=22-1 ElemStation=0
Frame=22 Station=0,05 OutputCase=RAR014 CaseType=Combination P=-55,5040089175131 V2=40,0612884056765 V3=0 T=0 M2=0 M3=21,6855512726008	FrameElem=22-1 ElemStation=0,05
Frame=22 Station=0,1 OutputCase=RAR014 CaseType=Combination P=-55,3040089175131 V2=38,5319446556765 V3=0 T=0 M2=0 M3=19,7206878939837	FrameElem=22-1 ElemStation=0,1
Frame=22 Station=0 OutputCase=RAR015 CaseType=Combination P=-77,2999999968009 V2=3,95958760509121 V3=0 T=0 M2=0 M3=8,95944899768005	FrameElem=22-1 ElemStation=0
Frame=22 Station=0,05 OutputCase=RAR015 CaseType=Combination P=-77,0999999968009 V2=3,47458760509121 V3=0 T=0 M2=0 M3=8,77364461742549	FrameElem=22-1 ElemStation=0,05
Frame=22 Station=0,1 OutputCase=RAR015 CaseType=Combination P=-76,8999999968009 V2=3,00158760509121 V3=0 T=0 M2=0 M3=8,61179023717093	FrameElem=22-1 ElemStation=0,1
Frame=22 Station=0 OutputCase=RAR016 CaseType=Combination P=-70,0520924620354 V2=27,415332248554 V3=0 T=0 M2=0 M3=14,9220178522003	FrameElem=22-1 ElemStation=0
Frame=22 Station=0,05 OutputCase=RAR016 CaseType=Combination P=-69,8520924620354 V2=25,893800998554 V3=0 T=0 M2=0 M3=13,5892569689392	FrameElem=22-1 ElemStation=0,05
Frame=22 Station=0,1 OutputCase=RAR016 CaseType=Combination P=-69,6520924620354 V2=24,364457248554 V3=0 T=0 M2=0 M3=12,3327679606782	FrameElem=22-1 ElemStation=0,1
Frame=22 Station=0 OutputCase=RAR017 CaseType=Combination P=-77,2999999964517 V2=18,2170500059178 V3=0 T=0 M2=0 M3=8,59530818087592	FrameElem=22-1 ElemStation=0
Frame=22 Station=0,05 OutputCase=RAR017 CaseType=Combination P=-77,0999999964517 V2=16,6955187559178 V3=0 T=0 M2=0 M3=7,72246140974669	FrameElem=22-1 ElemStation=0,05
Frame=22 Station=0,1 OutputCase=RAR017 CaseType=Combination P=-76,8999999964517 V2=15,1661750059178 V3=0 T=0 M2=0 M3=6,92588651361747	FrameElem=22-1 ElemStation=0,1
Frame=22 Station=0 OutputCase=RAR018 CaseType=Combination P=-10,292092464398 V2=28,1354395240212 V3=0 T=0 M2=0 M3=7,5253376412583	FrameElem=22-1 ElemStation=0
Frame=22 Station=0,05 OutputCase=RAR018 CaseType=Combination P=-10,092092464398 V2=26,6139082740212 V3=0 T=0 M2=0 M3=6,15657139422391	FrameElem=22-1 ElemStation=0,05
Frame=22 Station=0,1 OutputCase=RAR018 CaseType=Combination P=-9,89209246439803 V2=25,0845645240212 V3=0 T=0 M2=0 M3=4,86407702218951	FrameElem=22-1 ElemStation=0,1
Frame=22 Station=0 OutputCase=RAR019 CaseType=Combination P=-17,5399999988143 V2=18,937157281385 V3=0 T=0 M2=0 M3=1,19862796993395	FrameElem=22-1 ElemStation=0
Frame=22 Station=0,05 OutputCase=RAR019 CaseType=Combination P=-17,3399999988143 V2=17,415626031385 V3=0 T=0 M2=0 M3=0,289775835031363	FrameElem=22-1 ElemStation=0,05
Frame=22 Station=0,1 OutputCase=RAR019 CaseType=Combination P=-17,1399999988143 V2=15,886282821385 V3=0 T=0 M2=0 M3=-0,542804424871221	FrameElem=22-1 ElemStation=0,1
Frame=22 Station=0 OutputCase=RAR020 CaseType=Combination P=-17,9214011968719 V2=4,87042238781581 V3=0 T=0 M2=0 M3=1,89685083161189	FrameElem=22-1 ElemStation=0
Frame=22 Station=0,05 OutputCase=RAR020 CaseType=Combination P=-17,7214011968719 V2=4,38542238781581 V3=0 T=0 M2=0 M3=1,6655047122211	FrameElem=22-1 ElemStation=0,05
Frame=22 Station=0,1 OutputCase=RAR020 CaseType=Combination P=-17,5214011968719 V2=3,91242238781581 V3=0 T=0 M2=0 M3=1,45810859283031	FrameElem=22-1 ElemStation=0,1
Frame=22 Station=0 OutputCase=RAR021 CaseType=Combination P=-77,6814011945092 V2=4,15031511234862 V3=0 T=0 M2=0 M3=9,29353104255386	FrameElem=22-1 ElemStation=0
Frame=22 Station=0,05 OutputCase=RAR021 CaseType=Combination P=-77,4814011945092 V2=3,66531511234862 V3=0 T=0 M2=0 M3=9,09819028693643	FrameElem=22-1 ElemStation=0,05
Frame=22 Station=0,1 OutputCase=RAR021 CaseType=Combination P=-77,2814011945092 V2=3,19231511234862 V3=0 T=0 M2=0 M3=8,92679953131899	FrameElem=22-1 ElemStation=0,1
Frame=22 Station=0 OutputCase=RAR022 CaseType=Combination P=-70,4334936597437 V2=27,6060597558114 V3=0 T=0 M2=0 M3=15,2560998970741	FrameElem=22-1 ElemStation=0
Frame=22 Station=0,05 OutputCase=RAR022 CaseType=Combination P=-70,2334936597437 V2=26,0845285058114 V3=0 T=0 M2=0 M3=13,9138026384502	FrameElem=22-1 ElemStation=0,05
Frame=22 Station=0,1 OutputCase=RAR022 CaseType=Combination P=-70,0334936597437 V2=24,5551847558114 V3=0 T=0 M2=0 M3=12,6477772548263	FrameElem=22-1 ElemStation=0,1
Frame=22 Station=0 OutputCase=RAR023 CaseType=Combination P=-77,68140119416 V2=18,4077775131752 V3=0 T=0 M2=0 M3=8,92939022574972	FrameElem=22-1 ElemStation=0
Frame=22 Station=0,05 OutputCase=RAR023 CaseType=Combination P=-77,48140119416 V2=16,8862462631752 V3=0 T=0 M2=0 M3=8,04700707925762	FrameElem=22-1 ElemStation=0,05
Frame=22 Station=0,1 OutputCase=RAR023 CaseType=Combination P=-77,28140119416 V2=15,3569025131752 V3=0 T=0 M2=0 M3=7,24089580776553	FrameElem=22-1 ElemStation=0,1
Frame=22 Station=0 OutputCase=RAR024 CaseType=Combination P=-10,6734936621064 V2=28,3261670312786 V3=0 T=0 M2=0 M3=7,8594196861321	FrameElem=22-1 ElemStation=0
Frame=22 Station=0,05 OutputCase=RAR024 CaseType=Combination P=-10,4734936621064 V2=26,8046357812786 V3=0 T=0 M2=0 M3=6,48111706373484	FrameElem=22-1 ElemStation=0,05
Frame=22 Station=0,1 OutputCase=RAR024 CaseType=Combination P=-10,2734936621064 V2=25,2752920312786 V3=0 T=0 M2=0 M3=5,17908631633757	FrameElem=22-1 ElemStation=0,1
Frame=22 Station=0 OutputCase=RAR025 CaseType=Combination P=-17,9214011965227 V2=19,1278847886424 V3=0 T=0 M2=0 M3=1,53271001480775	FrameElem=22-1 ElemStation=0
Frame=22 Station=0,05 OutputCase=RAR025 CaseType=Combination P=-17,7214011965227 V2=17,6063535386424 V3=0 T=0 M2=0 M3=0,614321504542295	FrameElem=22-1 ElemStation=0,05

Società di Progetto
Brebemi SpA



Doc. N.
60235-0000-A00.doc

CODIFICA DOCUMENTO
04RCDII10000000000300A00

REV.
00

FOGLIO
329 di 628

Frame=22 Station=0,1 OutputCase=RAR025 CaseType=Combination P=-17,5214011965227 V2=16,0770097886424 V3=0 T=0 M2=0 M3=-0,22779513072316 ElemStation=0,1	FrameElem=22-1
Frame=22 Station=0 OutputCase=RAR026 CaseType=Combination P=-17,1585988014552 V2=4,48896737330099 V3=0 T=0 M2=0 M3=1,22868674186428 ElemStation=0	FrameElem=22-1
Frame=22 Station=0,05 OutputCase=RAR026 CaseType=Combination P=-16,9585988014552 V2=4,00396737330099 V3=0 T=0 M2=0 M3=1,01641337319923 ElemStation=0,05	FrameElem=22-1
Frame=22 Station=0,1 OutputCase=RAR026 CaseType=Combination P=-16,7585988014552 V2=3,53096737330099 V3=0 T=0 M2=0 M3=0,828090004534185 ElemStation=0,1	FrameElem=22-1
Frame=22 Station=0 OutputCase=RAR027 CaseType=Combination P=-76,9185987990926 V2=3,7688600978338 V3=0 T=0 M2=0 M3=8,62536695280625 ElemStation=0	FrameElem=22-1
Frame=22 Station=0,05 OutputCase=RAR027 CaseType=Combination P=-76,7185987990926 V2=3,2838600978338 V3=0 T=0 M2=0 M3=8,44909894791456 ElemStation=0,05	FrameElem=22-1
Frame=22 Station=0,1 OutputCase=RAR027 CaseType=Combination P=-76,5185987990926 V2=2,8108600978338 V3=0 T=0 M2=0 M3=8,29678094302287 ElemStation=0,1	FrameElem=22-1
Frame=22 Station=0 OutputCase=RAR028 CaseType=Combination P=-69,670691264327 V2=27,2246047412966 V3=0 T=0 M2=0 M3=14,5879358073265 ElemStation=0	FrameElem=22-1
Frame=22 Station=0,05 OutputCase=RAR028 CaseType=Combination P=-69,470691264327 V2=25,7030734912966 V3=0 T=0 M2=0 M3=13,2647112994283 ElemStation=0,05	FrameElem=22-1
Frame=22 Station=0,1 OutputCase=RAR028 CaseType=Combination P=-69,270691264327 V2=24,1737297412966 V3=0 T=0 M2=0 M3=12,01177586665301 ElemStation=0,1	FrameElem=22-1
Frame=22 Station=0 OutputCase=RAR029 CaseType=Combination P=-76,9185987987433 V2=18,0263224986604 V3=0 T=0 M2=0 M3=8,26122613600211 ElemStation=0	FrameElem=22-1
Frame=22 Station=0,05 OutputCase=RAR029 CaseType=Combination P=-76,7185987987433 V2=16,5047912486604 V3=0 T=0 M2=0 M3=7,39791574023576 ElemStation=0,05	FrameElem=22-1
Frame=22 Station=0,1 OutputCase=RAR029 CaseType=Combination P=-76,5185987987433 V2=14,9754474986604 V3=0 T=0 M2=0 M3=6,6108772194694 ElemStation=0,1	FrameElem=22-1
Frame=22 Station=0 OutputCase=RAR030 CaseType=Combination P=-9,91069126668969 V2=27,9447120167638 V3=0 T=0 M2=0 M3=7,1912555963845 ElemStation=0	FrameElem=22-1
Frame=22 Station=0,05 OutputCase=RAR030 CaseType=Combination P=-9,71069126668969 V2=26,4231807667638 V3=0 T=0 M2=0 M3=5,83202572471297 ElemStation=0,05	FrameElem=22-1
Frame=22 Station=0,1 OutputCase=RAR030 CaseType=Combination P=-9,51069126668969 V2=24,8938370167638 V3=0 T=0 M2=0 M3=4,54906772804145 ElemStation=0,1	FrameElem=22-1
Frame=22 Station=0 OutputCase=RAR031 CaseType=Combination P=-17,158598801106 V2=18,7464297741276 V3=0 T=0 M2=0 M3=0,864545925060146 ElemStation=0	FrameElem=22-1
Frame=22 Station=0,05 OutputCase=RAR031 CaseType=Combination P=-16,958598801106 V2=17,2248985241276 V3=0 T=0 M2=0 M3=-3,47698344795692E-02 ElemStation=0,05	FrameElem=22-1
Frame=22 Station=0,1 OutputCase=RAR031 CaseType=Combination P=-16,758598801106 V2=15,6955547741276 V3=0 T=0 M2=0 M3=-0,857813719019283 ElemStation=0,1	FrameElem=22-1
Frame=22 Station=0 OutputCase=RAR032 CaseType=Combination P=-17,5399999991639 V2=5,13942598350834 V3=0 T=0 M2=0 M3=1,86171580458927 ElemStation=0	FrameElem=22-1
Frame=22 Station=0,05 OutputCase=RAR032 CaseType=Combination P=-17,3399999991639 V2=4,65442598350834 V3=0 T=0 M2=0 M3=1,61691950541385 ElemStation=0,05	FrameElem=22-1
Frame=22 Station=0,1 OutputCase=RAR032 CaseType=Combination P=-17,1399999991639 V2=4,18142598350834 V3=0 T=0 M2=0 M3=1,39607320623844 ElemStation=0,1	FrameElem=22-1
Frame=22 Station=0 OutputCase=RAR033 CaseType=Combination P=-77,2999999968013 V2=4,41931870804115 V3=0 T=0 M2=0 M3=9,25839601553124 ElemStation=0	FrameElem=22-1
Frame=22 Station=0,05 OutputCase=RAR033 CaseType=Combination P=-77,0999999968013 V2=3,93431870804115 V3=0 T=0 M2=0 M3=9,04960508012918 ElemStation=0,05	FrameElem=22-1
Frame=22 Station=0,1 OutputCase=RAR033 CaseType=Combination P=-76,8999999968013 V2=3,46131870804115 V3=0 T=0 M2=0 M3=8,86476414472712 ElemStation=0,1	FrameElem=22-1
Frame=22 Station=0 OutputCase=RAR034 CaseType=Combination P=-70,0520924620357 V2=27,875063351504 V3=0 T=0 M2=0 M3=15,2209648700515 ElemStation=0	FrameElem=22-1
Frame=22 Station=0,05 OutputCase=RAR034 CaseType=Combination P=-69,8520924620357 V2=26,353532101504 V3=0 T=0 M2=0 M3=13,8652174316429 ElemStation=0,05	FrameElem=22-1
Frame=22 Station=0,1 OutputCase=RAR034 CaseType=Combination P=-69,6520924620357 V2=24,824188351504 V3=0 T=0 M2=0 M3=12,5857418682344 ElemStation=0,1	FrameElem=22-1
Frame=22 Station=0 OutputCase=RAR035 CaseType=Combination P=-77,299999996452 V2=18,6767811088678 V3=0 T=0 M2=0 M3=8,8942551987271 ElemStation=0	FrameElem=22-1
Frame=22 Station=0,05 OutputCase=RAR035 CaseType=Combination P=-77,099999996452 V2=17,1552498588678 V3=0 T=0 M2=0 M3=7,99842187245038 ElemStation=0,05	FrameElem=22-1
Frame=22 Station=0,1 OutputCase=RAR035 CaseType=Combination P=-76,899999996452 V2=15,6259061088678 V3=0 T=0 M2=0 M3=7,17886042117366 ElemStation=0,1	FrameElem=22-1
Frame=22 Station=0 OutputCase=RAR036 CaseType=Combination P=-10,2920924643984 V2=28,5951706269712 V3=0 T=0 M2=0 M3=7,82428465910948 ElemStation=0	FrameElem=22-1
Frame=22 Station=0,05 OutputCase=RAR036 CaseType=Combination P=-10,0920924643984 V2=27,0736393769712 V3=0 T=0 M2=0 M3=6,43253185692759 ElemStation=0,05	FrameElem=22-1
Frame=22 Station=0,1 OutputCase=RAR036 CaseType=Combination P=-9,89209246439837 V2=25,5442956269712 V3=0 T=0 M2=0 M3=5,1170509297457 ElemStation=0,1	FrameElem=22-1
Frame=22 Station=0 OutputCase=RAR037 CaseType=Combination P=-17,5399999988147 V2=19,396888384335 V3=0 T=0 M2=0 M3=1,49757498778513 ElemStation=0	FrameElem=22-1
Frame=22 Station=0,05 OutputCase=RAR037 CaseType=Combination P=-17,3399999988147 V2=17,875357134335 V3=0 T=0 M2=0 M3=0,56573629773505 ElemStation=0,05	FrameElem=22-1
Frame=22 Station=0,1 OutputCase=RAR037 CaseType=Combination P=-17,1399999988147 V2=16,346013384335 V3=0 T=0 M2=0 M3=-0,289830517315031 ElemStation=0,1	FrameElem=22-1
Frame=22 Station=0 OutputCase=RAR038 CaseType=Combination P=-17,539999991647 V2=6,21213189039153 V3=0 T=0 M2=0 M3=2,55925884624203 ElemStation=0	FrameElem=22-1
Frame=22 Station=0,05 OutputCase=RAR038 CaseType=Combination P=-17,339999991647 V2=5,72713189039153 V3=0 T=0 M2=0 M3=2,26082725172246 ElemStation=0,05	FrameElem=22-1
Frame=22 Station=0,1 OutputCase=RAR038 CaseType=Combination P=-17,139999991647 V2=5,25413189039153 V3=0 T=0 M2=0 M3=1,98634565720288 ElemStation=0,1	FrameElem=22-1
Frame=22 Station=0 OutputCase=RAR039 CaseType=Combination P=-97,2199999960143 V2=4,94550145446865 V3=0 T=0 M2=0 M3=12,2222011155972 ElemStation=0	FrameElem=22-1
Frame=22 Station=0,05 OutputCase=RAR039 CaseType=Combination P=-97,0199999960143 V2=4,46050145446865 V3=0 T=0 M2=0 M3=11,9871010428738 ElemStation=0,05	FrameElem=22-1
Frame=22 Station=0,1 OutputCase=RAR039 CaseType=Combination P=-96,8199999960143 V2=3,98750145446865 V3=0 T=0 M2=0 M3=11,7759509701503 ElemStation=0,1	FrameElem=22-1
Frame=22 Station=0 OutputCase=RAR040 CaseType=Combination P=-87,878859053213 V2=34,8131377385611 V3=0 T=0 M2=0 M3=19,9077625678328 ElemStation=0	FrameElem=22-1

Società di Progetto
Brebemi SpA



Doc. N.
60235-00000-A00.doc

CODIFICA DOCUMENTO
04RCDII10000000000300A00

REV.
00

FOGLIO
330 di 628

Frame=22 Station=0,05 OutputCase=RAR040 CaseType=Combination P=-87,6788559053213 V2=33,0422627385611 V3=0 T=0 M2=0 M3=18,211307764238 FrameElem=22-1 ElemStation=0,05
Frame=22 Station=0,1 OutputCase=RAR040 CaseType=Combination P=-87,4788559053213 V2=31,2546377385611 V3=0 T=0 M2=0 M3=16,6038154606433 FrameElem=22-1 ElemStation=0,1
Frame=22 Station=0 OutputCase=RAR041 CaseType=Combination P=-97,2199999955486 V2=22,9877070083197 V3=0 T=0 M2=0 M3=11,7817070536548 FrameElem=22-1 ElemStation=0
Frame=22 Station=0,05 OutputCase=RAR041 CaseType=Combination P=-97,0199999955486 V2=21,2168320083197 V3=0 T=0 M2=0 M3=10,6765237865721 FrameElem=22-1 ElemStation=0,05
Frame=22 Station=0,1 OutputCase=RAR041 CaseType=Combination P=-96,8199999955486 V2=19,4292070083197 V3=0 T=0 M2=0 M3=9,66030301948945 FrameElem=22-1 ElemStation=0,1
Frame=22 Station=0 OutputCase=RAR042 CaseType=Combination P=-8,1988559084715 V2=35,7732807725173 V3=0 T=0 M2=0 M3=10,0455222865768 FrameElem=22-1 ElemStation=0
Frame=22 Station=0,05 OutputCase=RAR042 CaseType=Combination P=-7,9988559084715 V2=34,0024057725173 V3=0 T=0 M2=0 M3=8,30106033128427 FrameElem=22-1 ElemStation=0,05
Frame=22 Station=0,1 OutputCase=RAR042 CaseType=Combination P=-7,7988559084715 V2=32,2147807725173 V3=0 T=0 M2=0 M3=6,64556087599174 FrameElem=22-1 ElemStation=0,1
Frame=22 Station=0 OutputCase=RAR043 CaseType=Combination P=-17,5399999986988 V2=23,947850042276 V3=0 T=0 M2=0 M3=1,9194667723988 FrameElem=22-1 ElemStation=0
Frame=22 Station=0,05 OutputCase=RAR043 CaseType=Combination P=-17,3399999986988 V2=22,176975042276 V3=0 T=0 M2=0 M3=0,766276353618332 FrameElem=22-1 ElemStation=0,05
Frame=22 Station=0,1 OutputCase=RAR043 CaseType=Combination P=-17,1399999986988 V2=20,389350042276 V3=0 T=0 M2=0 M3=-0,297951565162134 FrameElem=22-1 ElemStation=0,1
Frame=22 Station=0 OutputCase=RAR044 CaseType=Combination P=-55,7040089175138 V2=42,5022818615763 V3=0 T=0 M2=0 M3=24,3245805619203 FrameElem=22-1 ElemStation=0
Frame=22 Station=0,05 OutputCase=RAR044 CaseType=Combination P=-55,5040089175138 V2=40,9807506115763 V3=0 T=0 M2=0 M3=22,2374721980082 FrameElem=22-1 ElemStation=0,05
Frame=22 Station=0,1 OutputCase=RAR044 CaseType=Combination P=-55,3040089175138 V2=39,4514068615763 V3=0 T=0 M2=0 M3=20,226635709096 FrameElem=22-1 ElemStation=0,1
Frame=22 Station=0 OutputCase=RAR045 CaseType=Combination P=-77,2999999968021 V2=5,49202461492434 V3=0 T=0 M2=0 M3=9,955939057184 FrameElem=22-1 ElemStation=0
Frame=22 Station=0,05 OutputCase=RAR045 CaseType=Combination P=-77,0999999968021 V2=5,00702461492434 V3=0 T=0 M2=0 M3=9,69351282643779 FrameElem=22-1 ElemStation=0,05
Frame=22 Station=0,1 OutputCase=RAR045 CaseType=Combination P=-76,8999999968021 V2=4,53402461492434 V3=0 T=0 M2=0 M3=9,45503659569157 FrameElem=22-1 ElemStation=0,1
Frame=22 Station=0 OutputCase=RAR046 CaseType=Combination P=-70,0520924620365 V2=28,9477692583872 V3=0 T=0 M2=0 M3=15,9185079117042 FrameElem=22-1 ElemStation=0
Frame=22 Station=0,05 OutputCase=RAR046 CaseType=Combination P=-69,8520924620365 V2=27,4262380083872 V3=0 T=0 M2=0 M3=14,5091251779515 FrameElem=22-1 ElemStation=0,05
Frame=22 Station=0,1 OutputCase=RAR046 CaseType=Combination P=-69,6520924620365 V2=25,8968942583872 V3=0 T=0 M2=0 M3=13,1760143191988 FrameElem=22-1 ElemStation=0,1
Frame=22 Station=0 OutputCase=RAR047 CaseType=Combination P=-77,2999999964528 V2=19,749487015751 V3=0 T=0 M2=0 M3=9,59179824037986 FrameElem=22-1 ElemStation=0
Frame=22 Station=0,05 OutputCase=RAR047 CaseType=Combination P=-77,0999999964528 V2=18,227955765751 V3=0 T=0 M2=0 M3=8,64232961875898 FrameElem=22-1 ElemStation=0,05
Frame=22 Station=0,1 OutputCase=RAR047 CaseType=Combination P=-76,8999999964528 V2=16,698612015751 V3=0 T=0 M2=0 M3=7,7691328721381 FrameElem=22-1 ElemStation=0,1
Frame=22 Station=0 OutputCase=RAR048 CaseType=Combination P=-10,2920924643992 V2=29,6678765338544 V3=0 T=0 M2=0 M3=8,52182770076225 FrameElem=22-1 ElemStation=0
Frame=22 Station=0,05 OutputCase=RAR048 CaseType=Combination P=-10,0920924643992 V2=28,1463452838544 V3=0 T=0 M2=0 M3=7,0764396032362 FrameElem=22-1 ElemStation=0,05
Frame=22 Station=0,1 OutputCase=RAR048 CaseType=Combination P=-9,89209246439916 V2=26,6170015338543 V3=0 T=0 M2=0 M3=5,70732338071014 FrameElem=22-1 ElemStation=0,1
Frame=22 Station=0 OutputCase=RAR049 CaseType=Combination P=-17,5399999988155 V2=20,4695942912182 V3=0 T=0 M2=0 M3=2,1951180294379 FrameElem=22-1 ElemStation=0
Frame=22 Station=0,05 OutputCase=RAR049 CaseType=Combination P=-17,3399999988155 V2=18,9480630412182 V3=0 T=0 M2=0 M3=1,20964404404365 FrameElem=22-1 ElemStation=0,05
Frame=22 Station=0,1 OutputCase=RAR049 CaseType=Combination P=-17,1399999988155 V2=17,4187192912182 V3=0 T=0 M2=0 M3=0,300441933649413 FrameElem=22-1 ElemStation=0,1
Frame=22 Station=0 OutputCase=RAR050 CaseType=Combination P=-17,921401196873 V2=6,40285939764894 V3=0 T=0 M2=0 M3=2,89334089111584 FrameElem=22-1 ElemStation=0
Frame=22 Station=0,05 OutputCase=RAR050 CaseType=Combination P=-17,721401196873 V2=5,91785939764894 V3=0 T=0 M2=0 M3=2,58537292123339 FrameElem=22-1 ElemStation=0,05
Frame=22 Station=0,1 OutputCase=RAR050 CaseType=Combination P=-17,521401196873 V2=5,44485939764894 V3=0 T=0 M2=0 M3=2,30135495135094 FrameElem=22-1 ElemStation=0,1
Frame=22 Station=0 OutputCase=RAR051 CaseType=Combination P=-77,6814011945104 V2=5,68275212218175 V3=0 T=0 M2=0 M3=10,2900211020578 FrameElem=22-1 ElemStation=0
Frame=22 Station=0,05 OutputCase=RAR051 CaseType=Combination P=-77,4814011945104 V2=5,19775212218175 V3=0 T=0 M2=0 M3=10,0180584959487 FrameElem=22-1 ElemStation=0,05
Frame=22 Station=0,1 OutputCase=RAR051 CaseType=Combination P=-77,2814011945104 V2=4,72475212218175 V3=0 T=0 M2=0 M3=9,77004588983963 FrameElem=22-1 ElemStation=0,1
Frame=22 Station=0 OutputCase=RAR052 CaseType=Combination P=-70,4334936597448 V2=29,1384967656446 V3=0 T=0 M2=0 M3=16,252589956578 FrameElem=22-1 ElemStation=0
Frame=22 Station=0,05 OutputCase=RAR052 CaseType=Combination P=-70,2334936597448 V2=27,6169655156446 V3=0 T=0 M2=0 M3=14,8336708474625 FrameElem=22-1 ElemStation=0,05
Frame=22 Station=0,1 OutputCase=RAR052 CaseType=Combination P=-70,0334936597448 V2=26,0876217656446 V3=0 T=0 M2=0 M3=13,4910236133469 FrameElem=22-1 ElemStation=0,1
Frame=22 Station=0 OutputCase=RAR053 CaseType=Combination P=-77,6814011941611 V2=19,9402145230084 V3=0 T=0 M2=0 M3=9,92588028525367 FrameElem=22-1 ElemStation=0
Frame=22 Station=0,05 OutputCase=RAR053 CaseType=Combination P=-77,4814011941611 V2=18,4186832730084 V3=0 T=0 M2=0 M3=8,96687528826991 FrameElem=22-1 ElemStation=0,05
Frame=22 Station=0,1 OutputCase=RAR053 CaseType=Combination P=-77,2814011941611 V2=16,8893395230084 V3=0 T=0 M2=0 M3=8,08414216628616 FrameElem=22-1 ElemStation=0,1
Frame=22 Station=0 OutputCase=RAR054 CaseType=Combination P=-10,6734936621075 V2=29,8586040411118 V3=0 T=0 M2=0 M3=8,85590974563605 FrameElem=22-1 ElemStation=0
Frame=22 Station=0,05 OutputCase=RAR054 CaseType=Combination P=-10,4734936621075 V2=28,3370727911118 V3=0 T=0 M2=0 M3=7,40098527274713 FrameElem=22-1 ElemStation=0,05
Frame=22 Station=0,1 OutputCase=RAR054 CaseType=Combination P=-10,2734936621075 V2=26,8077290411118 V3=0 T=0 M2=0 M3=6,02233267485821 FrameElem=22-1 ElemStation=0,1

APPROVATO S.D.P.
Società di Progetto
Brebemi SpA



Doc. N.
60235-00000-A00.doc

CODIFICA DOCUMENTO
04RCDII10000000000300A00

REV.
00

FOGLIO
331 di 628

Frame=22 Station=0 OutputCase=RAR055 CaseType=Combination P=-17,9214011965238 V2=20,6603217984756 V3=0 T=0 M2=0 M3=2,5292000743117	FrameElem=22-1
ElemStation=0	
Frame=22 Station=0,05 OutputCase=RAR055 CaseType=Combination P=-17,7214011965238 V2=19,1387905484756 V3=0 T=0 M2=0 M3=1,53418971355459	FrameElem=22-1
ElemStation=0,05	
Frame=22 Station=0,1 OutputCase=RAR055 CaseType=Combination P=-17,5214011965238 V2=17,6094467984756 V3=0 T=0 M2=0 M3=0,615451227797475	FrameElem=22-1
ElemStation=0,1	
Frame=22 Station=0 OutputCase=RAR056 CaseType=Combination P=-17,1585988014564 V2=6,02140438313412 V3=0 T=0 M2=0 M3=2,22517680136823	FrameElem=22-1
ElemStation=0	
Frame=22 Station=0,05 OutputCase=RAR056 CaseType=Combination P=-16,9585988014564 V2=5,53640438313412 V3=0 T=0 M2=0 M3=1,93628158221153	FrameElem=22-1
ElemStation=0,05	
Frame=22 Station=0,1 OutputCase=RAR056 CaseType=Combination P=-16,7585988014564 V2=5,06340438313412 V3=0 T=0 M2=0 M3=1,67133636305482	FrameElem=22-1
ElemStation=0,1	
Frame=22 Station=0 OutputCase=RAR057 CaseType=Combination P=-76,9185987990937 V2=5,30129710766693 V3=0 T=0 M2=0 M3=9,6218570123102	FrameElem=22-1
ElemStation=0	
Frame=22 Station=0,05 OutputCase=RAR057 CaseType=Combination P=-76,7185987990937 V2=4,81629710766693 V3=0 T=0 M2=0 M3=9,36896715692685	FrameElem=22-1
ElemStation=0,05	
Frame=22 Station=0,1 OutputCase=RAR057 CaseType=Combination P=-76,5185987990937 V2=4,34329710766693 V3=0 T=0 M2=0 M3=9,14002730154351	FrameElem=22-1
ElemStation=0,1	
Frame=22 Station=0 OutputCase=RAR058 CaseType=Combination P=-69,6706912643282 V2=28,7570417511297 V3=0 T=0 M2=0 M3=15,5844258668304	FrameElem=22-1
ElemStation=0	
Frame=22 Station=0,05 OutputCase=RAR058 CaseType=Combination P=-69,4706912643282 V2=27,2355105011297 V3=0 T=0 M2=0 M3=14,1845795084406	FrameElem=22-1
ElemStation=0,05	
Frame=22 Station=0,1 OutputCase=RAR058 CaseType=Combination P=-69,2706912643282 V2=25,7061667511297 V3=0 T=0 M2=0 M3=12,8610050250508	FrameElem=22-1
ElemStation=0,1	
Frame=22 Station=0 OutputCase=RAR059 CaseType=Combination P=-76,9185987987445 V2=19,5587595084936 V3=0 T=0 M2=0 M3=9,25771619550606	FrameElem=22-1
ElemStation=0	
Frame=22 Station=0,05 OutputCase=RAR059 CaseType=Combination P=-76,7185987987445 V2=18,0372282584935 V3=0 T=0 M2=0 M3=8,3177839424805	FrameElem=22-1
ElemStation=0,05	
Frame=22 Station=0,1 OutputCase=RAR059 CaseType=Combination P=-76,5185987987445 V2=16,5078845084935 V3=0 T=0 M2=0 M3=7,45412357799004	FrameElem=22-1
ElemStation=0,1	
Frame=22 Station=0 OutputCase=RAR060 CaseType=Combination P=-9,91069126669083 V2=29,4771490265969 V3=0 T=0 M2=0 M3=8,18774565588845	FrameElem=22-1
ElemStation=0	
Frame=22 Station=0,05 OutputCase=RAR060 CaseType=Combination P=-9,71069126669083 V2=27,9556177765969 V3=0 T=0 M2=0 M3=6,7518939372527	FrameElem=22-1
ElemStation=0,05	
Frame=22 Station=0,1 OutputCase=RAR060 CaseType=Combination P=-9,51069126669083 V2=26,4262740265969 V3=0 T=0 M2=0 M3=5,39231408656208	FrameElem=22-1
ElemStation=0,1	
Frame=22 Station=0 OutputCase=RAR061 CaseType=Combination P=-17,1585988011071 V2=20,2788667839607 V3=0 T=0 M2=0 M3=1,86103598456409	FrameElem=22-1
ElemStation=0	
Frame=22 Station=0,05 OutputCase=RAR061 CaseType=Combination P=-16,9585988011071 V2=18,7573355339607 V3=0 T=0 M2=0 M3=0,885098374532722	FrameElem=22-1
ElemStation=0,05	
Frame=22 Station=0,1 OutputCase=RAR061 CaseType=Combination P=-16,7585988011071 V2=17,2279917839607 V3=0 T=0 M2=0 M3=-1,45673604986478E-02	FrameElem=22-1
ElemStation=0,1	
Frame=22 Station=0 OutputCase=RAR062 CaseType=Combination P=-17,539999999165 V2=6,67186299334147 V3=0 T=0 M2=0 M3=2,85820586409322	FrameElem=22-1
ElemStation=0	
Frame=22 Station=0,05 OutputCase=RAR062 CaseType=Combination P=-17,339999999165 V2=6,18686299334147 V3=0 T=0 M2=0 M3=2,53678771442615	FrameElem=22-1
ElemStation=0,05	
Frame=22 Station=0,1 OutputCase=RAR062 CaseType=Combination P=-17,139999999165 V2=5,71386299334147 V3=0 T=0 M2=0 M3=2,23931956475907	FrameElem=22-1
ElemStation=0,1	
Frame=22 Station=0 OutputCase=RAR063 CaseType=Combination P=-77,2999999968024 V2=5,95175571787428 V3=0 T=0 M2=0 M3=10,2548860750352	FrameElem=22-1
ElemStation=0	
Frame=22 Station=0,05 OutputCase=RAR063 CaseType=Combination P=-77,0999999968024 V2=5,46675571787428 V3=0 T=0 M2=0 M3=9,96947328914147	FrameElem=22-1
ElemStation=0,05	
Frame=22 Station=0,1 OutputCase=RAR063 CaseType=Combination P=-76,8999999968024 V2=4,99375571787428 V3=0 T=0 M2=0 M3=9,70801050324776	FrameElem=22-1
ElemStation=0,1	
Frame=22 Station=0 OutputCase=RAR064 CaseType=Combination P=-70,0520924620369 V2=29,4075003613371 V3=0 T=0 M2=0 M3=16,2174549295554	FrameElem=22-1
ElemStation=0	
Frame=22 Station=0,05 OutputCase=RAR064 CaseType=Combination P=-69,8520924620369 V2=27,8859691113371 V3=0 T=0 M2=0 M3=14,7850856406552	FrameElem=22-1
ElemStation=0,05	
Frame=22 Station=0,1 OutputCase=RAR064 CaseType=Combination P=-69,6520924620368 V2=26,3566253613371 V3=0 T=0 M2=0 M3=13,428988226755	FrameElem=22-1
ElemStation=0,1	
Frame=22 Station=0 OutputCase=RAR065 CaseType=Combination P=-77,2999999964532 V2=20,2092181187009 V3=0 T=0 M2=0 M3=9,89074525823105	FrameElem=22-1
ElemStation=0	
Frame=22 Station=0,05 OutputCase=RAR065 CaseType=Combination P=-77,0999999964532 V2=18,6876868687009 V3=0 T=0 M2=0 M3=8,91829008146267	FrameElem=22-1
ElemStation=0,05	
Frame=22 Station=0,1 OutputCase=RAR065 CaseType=Combination P=-76,8999999964531 V2=17,1583431187009 V3=0 T=0 M2=0 M3=8,02210677969429	FrameElem=22-1
ElemStation=0,1	
Frame=22 Station=0 OutputCase=RAR066 CaseType=Combination P=-10,2920924643995 V2=30,1276076368043 V3=0 T=0 M2=0 M3=8,82077471861343	FrameElem=22-1
ElemStation=0	
Frame=22 Station=0,05 OutputCase=RAR066 CaseType=Combination P=-10,0920924643995 V2=28,606076368043 V3=0 T=0 M2=0 M3=7,35240006593988	FrameElem=22-1
ElemStation=0,05	
Frame=22 Station=0,1 OutputCase=RAR066 CaseType=Combination P=-9,8920924643995 V2=27,0767326368043 V3=0 T=0 M2=0 M3=5,96029728826634	FrameElem=22-1
ElemStation=0,1	
Frame=22 Station=0 OutputCase=RAR067 CaseType=Combination P=-17,5399999988158 V2=20,9293253941681 V3=0 T=0 M2=0 M3=2,49406504728908	FrameElem=22-1
ElemStation=0	
Frame=22 Station=0,05 OutputCase=RAR067 CaseType=Combination P=-17,3399999988158 V2=19,4077941441681 V3=0 T=0 M2=0 M3=1,48560450674734	FrameElem=22-1
ElemStation=0,05	
Frame=22 Station=0,1 OutputCase=RAR067 CaseType=Combination P=-17,1399999988158 V2=17,8784503941681 V3=0 T=0 M2=0 M3=0,553415841205604	FrameElem=22-1
ElemStation=0,1	
Frame=22 Station=0 OutputCase=RAR068 CaseType=Combination P=-18,1756686620114 V2=5,76379256423732 V3=0 T=0 M2=0 M3=2,61781722461306	FrameElem=22-1
ElemStation=0	
Frame=22 Station=0,05 OutputCase=RAR068 CaseType=Combination P=-17,9756686620114 V2=5,27879256423732 V3=0 T=0 M2=0 M3=2,3418025964012	FrameElem=22-1
ElemStation=0,05	
Frame=22 Station=0,1 OutputCase=RAR068 CaseType=Combination P=-17,7756686620114 V2=4,80579256423732 V3=0 T=0 M2=0 M3=2,08973796818933	FrameElem=22-1
ElemStation=0,1	
Frame=22 Station=0 OutputCase=RAR069 CaseType=Combination P=-97,6014011937223 V2=4,67649785877612 V3=0 T=0 M2=0 M3=12,2573361426198	FrameElem=22-1
ElemStation=0	
Frame=22 Station=0,05 OutputCase=RAR069 CaseType=Combination P=-97,4014011937223 V2=4,19149785877612 V3=0 T=0 M2=0 M3=12,035686249681	FrameElem=22-1
ElemStation=0,05	

Società di Progetto
Brebemi SpA



Doc. N.
60235-0000-A00.doc

CODIFICA DOCUMENTO
04RCDII10000000000300A00

REV.
00

FOGLIO
332 di 628

Frame=22 Station=0,1 OutputCase=RAR069 CaseType=Combination P=-97,2014011937223 V2=3,71849785877612 V3=0 T=0 M2=0 M3=11,8379863567422	FrameElem=22-1 ElemStation=0,1
Frame=22 Station=0 OutputCase=RAR070 CaseType=Combination P=-88,2602571030293 V2=34,5441341428686 V3=0 T=0 M2=0 M3=19,9428975948554	FrameElem=22-1 ElemStation=0
Frame=22 Station=0,05 OutputCase=RAR070 CaseType=Combination P=-88,0602571030293 V2=32,7732591428686 V3=0 T=0 M2=0 M3=18,2598929710453	FrameElem=22-1 ElemStation=0,05
Frame=22 Station=0,1 OutputCase=RAR070 CaseType=Combination P=-87,8602571030293 V2=30,9856341428686 V3=0 T=0 M2=0 M3=16,6658508472352	FrameElem=22-1 ElemStation=0,1
Frame=22 Station=0 OutputCase=RAR071 CaseType=Combination P=-97,6014011932566 V2=22,7187034126272 V3=0 T=0 M2=0 M3=11,8168420806774	FrameElem=22-1 ElemStation=0
Frame=22 Station=0,05 OutputCase=RAR071 CaseType=Combination P=-97,4014011932566 V2=20,9478284126272 V3=0 T=0 M2=0 M3=10,7251089933793	FrameElem=22-1 ElemStation=0,05
Frame=22 Station=0,1 OutputCase=RAR071 CaseType=Combination P=-97,2014011932566 V2=19,1602034126272 V3=0 T=0 M2=0 M3=9,72233840608132	FrameElem=22-1 ElemStation=0,1
Frame=22 Station=0 OutputCase=RAR072 CaseType=Combination P=-8,58025710617949 V2=35,5042771768248 V3=0 T=0 M2=0 M3=10,0806573135994	FrameElem=22-1 ElemStation=0
Frame=22 Station=0,05 OutputCase=RAR072 CaseType=Combination P=-8,38025710617949 V2=33,7334021768248 V3=0 T=0 M2=0 M3=8,34964553809152	FrameElem=22-1 ElemStation=0,05
Frame=22 Station=0,1 OutputCase=RAR072 CaseType=Combination P=-8,18025710617949 V2=31,9457771768248 V3=0 T=0 M2=0 M3=6,70759626258361	FrameElem=22-1 ElemStation=0,1
Frame=22 Station=0 OutputCase=RAR073 CaseType=Combination P=-17,9214011964068 V2=23,6788464465835 V3=0 T=0 M2=0 M3=1,95460179942142	FrameElem=22-1 ElemStation=0
Frame=22 Station=0,05 OutputCase=RAR073 CaseType=Combination P=-17,7214011964068 V2=21,9079714465835 V3=0 T=0 M2=0 M3=0,814861560425577	FrameElem=22-1 ElemStation=0,05
Frame=22 Station=0,1 OutputCase=RAR073 CaseType=Combination P=-17,5214011964068 V2=20,1203464465835 V3=0 T=0 M2=0 M3=0,235916178570263	FrameElem=22-1 ElemStation=0,1
Frame=22 Station=0 OutputCase=RAR074 CaseType=Combination P=-56,0854101152218 V2=42,2332782658838 V3=0 T=0 M2=0 M3=24,359715588943	FrameElem=22-1 ElemStation=0
Frame=22 Station=0,05 OutputCase=RAR074 CaseType=Combination P=-55,8854101152218 V2=40,7117470158838 V3=0 T=0 M2=0 M3=22,2860574048154	FrameElem=22-1 ElemStation=0,05
Frame=22 Station=0,1 OutputCase=RAR074 CaseType=Combination P=-55,6854101152218 V2=39,1824032658838 V3=0 T=0 M2=0 M3=20,2886710956879	FrameElem=22-1 ElemStation=0,1
Frame=22 Station=0 OutputCase=RAR075 CaseType=Combination P=-77,9356686596487 V2=5,04368528877013 V3=0 T=0 M2=0 M3=10,014497435555	FrameElem=22-1 ElemStation=0
Frame=22 Station=0,05 OutputCase=RAR075 CaseType=Combination P=-77,7356686596487 V2=4,55868528877013 V3=0 T=0 M2=0 M3=9,77448817111653	FrameElem=22-1 ElemStation=0,05
Frame=22 Station=0,1 OutputCase=RAR075 CaseType=Combination P=-77,5356686596487 V2=4,08568528877013 V3=0 T=0 M2=0 M3=9,55842890667802	FrameElem=22-1 ElemStation=0,1
Frame=22 Station=0 OutputCase=RAR076 CaseType=Combination P=-70,6877611248832 V2=28,499429932233 V3=0 T=0 M2=0 M3=15,9770662900752	FrameElem=22-1 ElemStation=0
Frame=22 Station=0,05 OutputCase=RAR076 CaseType=Combination P=-70,4877611248832 V2=26,9778986822329 V3=0 T=0 M2=0 M3=14,5901005226303	FrameElem=22-1 ElemStation=0,05
Frame=22 Station=0,1 OutputCase=RAR076 CaseType=Combination P=-70,2877611248832 V2=25,4485549322329 V3=0 T=0 M2=0 M3=13,2794066301853	FrameElem=22-1 ElemStation=0,1
Frame=22 Station=0 OutputCase=RAR077 CaseType=Combination P=-77,9356686592995 V2=19,3011476895968 V3=0 T=0 M2=0 M3=9,65035661875089	FrameElem=22-1 ElemStation=0
Frame=22 Station=0,05 OutputCase=RAR077 CaseType=Combination P=-77,7356686592995 V2=17,7796164395968 V3=0 T=0 M2=0 M3=8,72330496343772	FrameElem=22-1 ElemStation=0,05
Frame=22 Station=0,1 OutputCase=RAR077 CaseType=Combination P=-77,5356686592995 V2=16,2502726895967 V3=0 T=0 M2=0 M3=7,87252518312455	FrameElem=22-1 ElemStation=0,1
Frame=22 Station=0 OutputCase=RAR078 CaseType=Combination P=-10,9277611272458 V2=29,2195372077001 V3=0 T=0 M2=0 M3=8,58038607913328	FrameElem=22-1 ElemStation=0
Frame=22 Station=0,05 OutputCase=RAR078 CaseType=Combination P=-10,7277611272458 V2=27,6980059577001 V3=0 T=0 M2=0 M3=7,15741494791494	FrameElem=22-1 ElemStation=0,05
Frame=22 Station=0,1 OutputCase=RAR078 CaseType=Combination P=-10,5277611272458 V2=26,168622077001 V3=0 T=0 M2=0 M3=5,8107156916966	FrameElem=22-1 ElemStation=0,1
Frame=22 Station=0 OutputCase=RAR079 CaseType=Combination P=-18,1756686616621 V2=20,0212549650639 V3=0 T=0 M2=0 M3=2,25367640780893	FrameElem=22-1 ElemStation=0
Frame=22 Station=0,05 OutputCase=RAR079 CaseType=Combination P=-17,9756686616621 V2=18,4997237150639 V3=0 T=0 M2=0 M3=1,29061938872239	FrameElem=22-1 ElemStation=0,05
Frame=22 Station=0,1 OutputCase=RAR079 CaseType=Combination P=-17,7756686616621 V2=16,9703799650639 V3=0 T=0 M2=0 M3=0,403834244635865	FrameElem=22-1 ElemStation=0,1
Frame=22 Station=0 OutputCase=RAR080 CaseType=Combination P=-18,175668662011 V2=5,30406146128738 V3=0 T=0 M2=0 M3=2,31887020676188	FrameElem=22-1 ElemStation=0
Frame=22 Station=0,05 OutputCase=RAR080 CaseType=Combination P=-17,975668662011 V2=4,81906146128738 V3=0 T=0 M2=0 M3=2,06584213369751	FrameElem=22-1 ElemStation=0,05
Frame=22 Station=0,1 OutputCase=RAR080 CaseType=Combination P=-17,775668662011 V2=4,34606146128738 V3=0 T=0 M2=0 M3=1,83676406063314	FrameElem=22-1 ElemStation=0,1
Frame=22 Station=0 OutputCase=RAR081 CaseType=Combination P=-77,9356686596484 V2=4,58395418582019 V3=0 T=0 M2=0 M3=9,71555041770385	FrameElem=22-1 ElemStation=0
Frame=22 Station=0,05 OutputCase=RAR081 CaseType=Combination P=-77,7356686596484 V2=4,09895418582019 V3=0 T=0 M2=0 M3=9,49852770841284	FrameElem=22-1 ElemStation=0,05
Frame=22 Station=0,1 OutputCase=RAR081 CaseType=Combination P=-77,5356686596484 V2=3,62595418582019 V3=0 T=0 M2=0 M3=9,30545499912183	FrameElem=22-1 ElemStation=0,1
Frame=22 Station=0 OutputCase=RAR082 CaseType=Combination P=-70,6877611248828 V2=28,039698829283 V3=0 T=0 M2=0 M3=15,6781192722241	FrameElem=22-1 ElemStation=0
Frame=22 Station=0,05 OutputCase=RAR082 CaseType=Combination P=-70,4877611248828 V2=26,518167579283 V3=0 T=0 M2=0 M3=14,3141400599266	FrameElem=22-1 ElemStation=0,05
Frame=22 Station=0,1 OutputCase=RAR082 CaseType=Combination P=-70,2877611248828 V2=24,988823829283 V3=0 T=0 M2=0 M3=13,0264327226291	FrameElem=22-1 ElemStation=0,1
Frame=22 Station=0 OutputCase=RAR083 CaseType=Combination P=-77,9356686592991 V2=18,8414165866468 V3=0 T=0 M2=0 M3=9,35140960089971	FrameElem=22-1 ElemStation=0
Frame=22 Station=0,05 OutputCase=RAR083 CaseType=Combination P=-77,7356686592991 V2=17,3198853366468 V3=0 T=0 M2=0 M3=8,44734450073403	FrameElem=22-1 ElemStation=0,05
Frame=22 Station=0,1 OutputCase=RAR083 CaseType=Combination P=-77,5356686592991 V2=15,7905415866468 V3=0 T=0 M2=0 M3=7,61955127556836	FrameElem=22-1 ElemStation=0,1
Frame=22 Station=0 OutputCase=RAR084 CaseType=Combination P=-10,9277611272455 V2=28,7598061047502 V3=0 T=0 M2=0 M3=8,28143906128209	FrameElem=22-1 ElemStation=0

APPROVATO SDP
Società di Progetto
Brebemi SpA

	Doc. N. 60235-00000-A00.doc	CODIFICA DOCUMENTO 04RCDII10000000000300A00	REV. 00	FOGLIO 333 di 628
--	--------------------------------	--	------------	----------------------

Frame=22 Station=0,05 OutputCase=RAR084 CaseType=Combination P=-10,7277611272455 V2=27,2382748547502 V3=0 T=0 M2=0 M3=6,88145448521125	FrameElem=22-1 ElemStation=0,05
Frame=22 Station=0,1 OutputCase=RAR084 CaseType=Combination P=-10,5277611272455 V2=25,7089311047502 V3=0 T=0 M2=0 M3=5,55774178414041	FrameElem=22-1 ElemStation=0,1
Frame=22 Station=0 OutputCase=RAR085 CaseType=Combination P=-18,1756686616618 V2=19,561523862114 V3=0 T=0 M2=0 M3=1,95472938995774	FrameElem=22-1 ElemStation=0
Frame=22 Station=0,05 OutputCase=RAR085 CaseType=Combination P=-17,9756686616618 V2=18,03992612114 V3=0 T=0 M2=0 M3=1,01465892601871	FrameElem=22-1 ElemStation=0,05
Frame=22 Station=0,1 OutputCase=RAR085 CaseType=Combination P=-17,7756686616618 V2=16,510648862114 V3=0 T=0 M2=0 M3=0,150860337079674	FrameElem=22-1 ElemStation=0,1
Frame=22 Station=0 OutputCase=RAR086 CaseType=Combination P=-18,1756686620117 V2=6,22352366718726 V3=0 T=0 M2=0 M3=2,91676424246425	FrameElem=22-1 ElemStation=0
Frame=22 Station=0,05 OutputCase=RAR086 CaseType=Combination P=-17,9756686620117 V2=5,73852366718726 V3=0 T=0 M2=0 M3=2,61776305910489	FrameElem=22-1 ElemStation=0,05
Frame=22 Station=0,1 OutputCase=RAR086 CaseType=Combination P=-17,7756686620117 V2=5,26552366718726 V3=0 T=0 M2=0 M3=2,34271187574552	FrameElem=22-1 ElemStation=0,1
Frame=22 Station=0 OutputCase=RAR087 CaseType=Combination P=-77,9356686596491 V2=5,50341639172007 V3=0 T=0 M2=0 M3=10,3134444534062	FrameElem=22-1 ElemStation=0
Frame=22 Station=0,05 OutputCase=RAR087 CaseType=Combination P=-77,7356686596491 V2=5,01841639172007 V3=0 T=0 M2=0 M3=10,0504486338202	FrameElem=22-1 ElemStation=0,05
Frame=22 Station=0,1 OutputCase=RAR087 CaseType=Combination P=-77,5356686596491 V2=4,54541639172007 V3=0 T=0 M2=0 M3=9,81140281423421	FrameElem=22-1 ElemStation=0,1
Frame=22 Station=0 OutputCase=RAR088 CaseType=Combination P=-70,6877611248835 V2=28,9591610351829 V3=0 T=0 M2=0 M3=16,2760133079264	FrameElem=22-1 ElemStation=0
Frame=22 Station=0,05 OutputCase=RAR088 CaseType=Combination P=-70,4877611248835 V2=27,4376297851829 V3=0 T=0 M2=0 M3=14,866060985334	FrameElem=22-1 ElemStation=0,05
Frame=22 Station=0,1 OutputCase=RAR088 CaseType=Combination P=-70,2877611248835 V2=25,9082860351829 V3=0 T=0 M2=0 M3=13,5323805377415	FrameElem=22-1 ElemStation=0,1
Frame=22 Station=0 OutputCase=RAR089 CaseType=Combination P=-77,9356686592998 V2=19,7608787925467 V3=0 T=0 M2=0 M3=9,94930363660208	FrameElem=22-1 ElemStation=0
Frame=22 Station=0,05 OutputCase=RAR089 CaseType=Combination P=-77,7356686592998 V2=18,2393475425467 V3=0 T=0 M2=0 M3=8,99926542614141	FrameElem=22-1 ElemStation=0,05
Frame=22 Station=0,1 OutputCase=RAR089 CaseType=Combination P=-77,5356686592998 V2=16,7100037925467 V3=0 T=0 M2=0 M3=8,12549909068074	FrameElem=22-1 ElemStation=0,1
Frame=22 Station=0 OutputCase=RAR090 CaseType=Combination P=-10,9277611272462 V2=29,6792683106501 V3=0 T=0 M2=0 M3=8,87933309698446	FrameElem=22-1 ElemStation=0
Frame=22 Station=0,05 OutputCase=RAR090 CaseType=Combination P=-10,7277611272462 V2=28,1577370606501 V3=0 T=0 M2=0 M3=7,43337541061863	FrameElem=22-1 ElemStation=0,05
Frame=22 Station=0,1 OutputCase=RAR090 CaseType=Combination P=-10,5277611272462 V2=26,6283933106501 V3=0 T=0 M2=0 M3=6,06368959925279	FrameElem=22-1 ElemStation=0,1
Frame=22 Station=0 OutputCase=RAR091 CaseType=Combination P=-18,1756686616625 V2=20,4809860680139 V3=0 T=0 M2=0 M3=2,55262342566011	FrameElem=22-1 ElemStation=0
Frame=22 Station=0,05 OutputCase=RAR091 CaseType=Combination P=-17,9756686616625 V2=18,9594548180139 V3=0 T=0 M2=0 M3=1,56657985142608	FrameElem=22-1 ElemStation=0,05
Frame=22 Station=0,1 OutputCase=RAR091 CaseType=Combination P=-17,7756686616625 V2=17,4301110680139 V3=0 T=0 M2=0 M3=0,656808152192055	FrameElem=22-1 ElemStation=0,1
Frame=22 Station=0 OutputCase=RAR092 CaseType=Combination P=-18,1756686620117 V2=6,22352366718726 V3=0 T=0 M2=0 M3=2,91676424246425	FrameElem=22-1 ElemStation=0
Frame=22 Station=0,05 OutputCase=RAR092 CaseType=Combination P=-17,9756686620117 V2=5,73852366718726 V3=0 T=0 M2=0 M3=2,61776305910489	FrameElem=22-1 ElemStation=0,05
Frame=22 Station=0,1 OutputCase=RAR092 CaseType=Combination P=-17,7756686620117 V2=5,26552366718726 V3=0 T=0 M2=0 M3=2,34271187574552	FrameElem=22-1 ElemStation=0,1
Frame=22 Station=0 OutputCase=RAR093 CaseType=Combination P=-77,9356686596491 V2=5,50341639172007 V3=0 T=0 M2=0 M3=10,3134444534062	FrameElem=22-1 ElemStation=0
Frame=22 Station=0,05 OutputCase=RAR093 CaseType=Combination P=-77,7356686596491 V2=5,01841639172007 V3=0 T=0 M2=0 M3=10,0504486338202	FrameElem=22-1 ElemStation=0,05
Frame=22 Station=0,1 OutputCase=RAR093 CaseType=Combination P=-77,5356686596491 V2=4,54541639172007 V3=0 T=0 M2=0 M3=9,81140281423421	FrameElem=22-1 ElemStation=0,1
Frame=22 Station=0 OutputCase=RAR094 CaseType=Combination P=-70,6877611248835 V2=28,9591610351829 V3=0 T=0 M2=0 M3=16,2760133079264	FrameElem=22-1 ElemStation=0
Frame=22 Station=0,05 OutputCase=RAR094 CaseType=Combination P=-70,4877611248835 V2=27,4376297851829 V3=0 T=0 M2=0 M3=14,866060985334	FrameElem=22-1 ElemStation=0,05
Frame=22 Station=0,1 OutputCase=RAR094 CaseType=Combination P=-70,2877611248835 V2=25,9082860351829 V3=0 T=0 M2=0 M3=13,5323805377415	FrameElem=22-1 ElemStation=0,1
Frame=22 Station=0 OutputCase=RAR095 CaseType=Combination P=-77,9356686592998 V2=19,7608787925467 V3=0 T=0 M2=0 M3=9,94930363660208	FrameElem=22-1 ElemStation=0
Frame=22 Station=0,05 OutputCase=RAR095 CaseType=Combination P=-77,7356686592998 V2=18,2393475425467 V3=0 T=0 M2=0 M3=8,99926542614141	FrameElem=22-1 ElemStation=0,05
Frame=22 Station=0,1 OutputCase=RAR095 CaseType=Combination P=-77,5356686592998 V2=16,7100037925467 V3=0 T=0 M2=0 M3=8,12549909068074	FrameElem=22-1 ElemStation=0,1
Frame=22 Station=0 OutputCase=RAR096 CaseType=Combination P=-10,9277611272462 V2=29,6792683106501 V3=0 T=0 M2=0 M3=8,87933309698446	FrameElem=22-1 ElemStation=0
Frame=22 Station=0,05 OutputCase=RAR096 CaseType=Combination P=-10,7277611272462 V2=28,1577370606501 V3=0 T=0 M2=0 M3=7,43337541061863	FrameElem=22-1 ElemStation=0,05
Frame=22 Station=0,1 OutputCase=RAR096 CaseType=Combination P=-10,5277611272462 V2=26,6283933106501 V3=0 T=0 M2=0 M3=6,06368959925279	FrameElem=22-1 ElemStation=0,1
Frame=22 Station=0 OutputCase=RAR097 CaseType=Combination P=-18,1756686616625 V2=20,4809860680139 V3=0 T=0 M2=0 M3=2,55262342566011	FrameElem=22-1 ElemStation=0
Frame=22 Station=0,05 OutputCase=RAR097 CaseType=Combination P=-17,9756686616625 V2=18,9594548180139 V3=0 T=0 M2=0 M3=1,56657985142608	FrameElem=22-1 ElemStation=0,05
Frame=22 Station=0,1 OutputCase=RAR097 CaseType=Combination P=-17,7756686616625 V2=17,4301110680139 V3=0 T=0 M2=0 M3=0,656808152192055	FrameElem=22-1 ElemStation=0,1
Frame=22 Station=0 OutputCase=RAR098 CaseType=Combination P=-16,9043313363169 V2=5,12803420671261 V3=0 T=0 M2=0 M3=1,50421040836706	FrameElem=22-1 ElemStation=0
Frame=22 Station=0,05 OutputCase=RAR098 CaseType=Combination P=-16,7043313363169 V2=4,64303420671261 V3=0 T=0 M2=0 M3=1,25998369803143	FrameElem=22-1 ElemStation=0,05
Frame=22 Station=0,1 OutputCase=RAR098 CaseType=Combination P=-16,5043313363169 V2=4,17003420671261 V3=0 T=0 M2=0 M3=1,03970698769579	FrameElem=22-1 ElemStation=0,1

Società di Progetto
Brebemi SpA



Doc. N.
60235-0000-A00.doc

CODIFICA DOCUMENTO
04RCDII10000000000300A00

REV.
00

FOGLIO
334 di 628

Frame=22 Station=0 OutputCase=RAR099 CaseType=Combination P=-96,8385987983056 V2=4,2950428442613 V3=0 T=0 M2=0 M3=11,5891720528722	FrameElem=22-1
ElemStation=0	
Frame=22 Station=0,05 OutputCase=RAR099 CaseType=Combination P=-96,6385987983056 V2=3,8100428442613 V3=0 T=0 M2=0 M3=11,3865949106592	FrameElem=22-1
ElemStation=0,05	
Frame=22 Station=0,1 OutputCase=RAR099 CaseType=Combination P=-96,4385987983056 V2=3,3370428442613 V3=0 T=0 M2=0 M3=11,2079677684461	FrameElem=22-1
ElemStation=0,1	
Frame=22 Station=0 OutputCase=RAR100 CaseType=Combination P=-87,4974547076126 V2=34,1626791283537 V3=0 T=0 M2=0 M3=19,2747335051078	FrameElem=22-1
ElemStation=0	
Frame=22 Station=0,05 OutputCase=RAR100 CaseType=Combination P=-87,2974547076126 V2=32,3918041283537 V3=0 T=0 M2=0 M3=17,6108016320234	FrameElem=22-1
ElemStation=0,05	
Frame=22 Station=0,1 OutputCase=RAR100 CaseType=Combination P=-87,0974547076126 V2=30,6041791283537 V3=0 T=0 M2=0 M3=16,0358322589391	FrameElem=22-1
ElemStation=0,1	
Frame=22 Station=0 OutputCase=RAR101 CaseType=Combination P=-96,83859879784 V2=22,3372483981124 V3=0 T=0 M2=0 M3=11,1486779909298	FrameElem=22-1
ElemStation=0	
Frame=22 Station=0,05 OutputCase=RAR101 CaseType=Combination P=-96,6385987978399 V2=20,5663733981124 V3=0 T=0 M2=0 M3=10,0760176543575	FrameElem=22-1
ElemStation=0,05	
Frame=22 Station=0,1 OutputCase=RAR101 CaseType=Combination P=-96,4385987978399 V2=18,7787483981124 V3=0 T=0 M2=0 M3=9,0923198177852	FrameElem=22-1
ElemStation=0,1	
Frame=22 Station=0 OutputCase=RAR102 CaseType=Combination P=-7,81745471076283 V2=35,12282216231 V3=0 T=0 M2=0 M3=9,41249322385182	FrameElem=22-1
ElemStation=0	
Frame=22 Station=0,05 OutputCase=RAR102 CaseType=Combination P=-7,61745471076283 V2=33,35194716231 V3=0 T=0 M2=0 M3=7,70055419906965	FrameElem=22-1
ElemStation=0,05	
Frame=22 Station=0,1 OutputCase=RAR102 CaseType=Combination P=-7,41745471076283 V2=31,56432216231 V3=0 T=0 M2=0 M3=6,07757767428749	FrameElem=22-1
ElemStation=0,1	
Frame=22 Station=0 OutputCase=RAR103 CaseType=Combination P=-17,1585988009901 V2=23,2973914320686 V3=0 T=0 M2=0 M3=1,28643770967381	FrameElem=22-1
ElemStation=0	
Frame=22 Station=0,05 OutputCase=RAR103 CaseType=Combination P=-16,9585988009901 V2=21,5265164320686 V3=0 T=0 M2=0 M3=0,165770221403713	FrameElem=22-1
ElemStation=0,05	
Frame=22 Station=0,1 OutputCase=RAR103 CaseType=Combination P=-16,7585988009901 V2=19,7388914320686 V3=0 T=0 M2=0 M3=0,865934766866386	FrameElem=22-1
ElemStation=0,1	
Frame=22 Station=0 OutputCase=RAR104 CaseType=Combination P=-55,3226077198051 V2=41,851823251369 V3=0 T=0 M2=0 M3=23,6915514991953	FrameElem=22-1
ElemStation=0	
Frame=22 Station=0,05 OutputCase=RAR104 CaseType=Combination P=-55,1226077198051 V2=40,330292001369 V3=0 T=0 M2=0 M3=21,636960657936	FrameElem=22-1
ElemStation=0,05	
Frame=22 Station=0,1 OutputCase=RAR104 CaseType=Combination P=-54,9226077198051 V2=38,800948251369 V3=0 T=0 M2=0 M3=19,6586525073918	FrameElem=22-1
ElemStation=0,1	
Frame=22 Station=0 OutputCase=RAR105 CaseType=Combination P=-76,6643313339543 V2=4,40792693124542 V3=0 T=0 M2=0 M3=8,90089061930902	FrameElem=22-1
ElemStation=0	
Frame=22 Station=0,05 OutputCase=RAR105 CaseType=Combination P=-76,4643313339543 V2=3,92292693124542 V3=0 T=0 M2=0 M3=8,69266927274675	FrameElem=22-1
ElemStation=0,05	
Frame=22 Station=0,1 OutputCase=RAR105 CaseType=Combination P=-76,2643313339543 V2=3,44992693124542 V3=0 T=0 M2=0 M3=8,50839792618448	FrameElem=22-1
ElemStation=0,1	
Frame=22 Station=0 OutputCase=RAR106 CaseType=Combination P=-69,4164237991887 V2=27,8636715747082 V3=0 T=0 M2=0 M3=14,8634594738292	FrameElem=22-1
ElemStation=0	
Frame=22 Station=0,05 OutputCase=RAR106 CaseType=Combination P=-69,2164237991887 V2=26,3421403247082 V3=0 T=0 M2=0 M3=13,5082816242605	FrameElem=22-1
ElemStation=0,05	
Frame=22 Station=0,1 OutputCase=RAR106 CaseType=Combination P=-69,0164237991887 V2=24,8127965747082 V3=0 T=0 M2=0 M3=12,2293756496917	FrameElem=22-1
ElemStation=0,1	
Frame=22 Station=0 OutputCase=RAR107 CaseType=Combination P=-76,664331333605 V2=18,66538932072 V3=0 T=0 M2=0 M3=8,53674980250489	FrameElem=22-1
ElemStation=0	
Frame=22 Station=0,05 OutputCase=RAR107 CaseType=Combination P=-76,464331333605 V2=17,143858082072 V3=0 T=0 M2=0 M3=7,64148606506795	FrameElem=22-1
ElemStation=0,05	
Frame=22 Station=0,1 OutputCase=RAR107 CaseType=Combination P=-76,264331333605 V2=15,614514332072 V3=0 T=0 M2=0 M3=6,82249420263101	FrameElem=22-1
ElemStation=0,1	
Frame=22 Station=0 OutputCase=RAR108 CaseType=Combination P=-9,65642380155137 V2=28,5837788501754 V3=0 T=0 M2=0 M3=7,46677926288727	FrameElem=22-1
ElemStation=0	
Frame=22 Station=0,05 OutputCase=RAR108 CaseType=Combination P=-9,45642380155137 V2=27,0622476001754 V3=0 T=0 M2=0 M3=6,07559604954516	FrameElem=22-1
ElemStation=0,05	
Frame=22 Station=0,1 OutputCase=RAR108 CaseType=Combination P=-9,25642380155137 V2=25,5329038501754 V3=0 T=0 M2=0 M3=4,76068471120306	FrameElem=22-1
ElemStation=0,1	
Frame=22 Station=0 OutputCase=RAR109 CaseType=Combination P=-16,9043313359677 V2=19,3854966075392 V3=0 T=0 M2=0 M3=1,14006959156292	FrameElem=22-1
ElemStation=0	
Frame=22 Station=0,05 OutputCase=RAR109 CaseType=Combination P=-16,7043313359677 V2=17,8639653575392 V3=0 T=0 M2=0 M3=0,208800490352622	FrameElem=22-1
ElemStation=0,05	
Frame=22 Station=0,1 OutputCase=RAR109 CaseType=Combination P=-16,5043313359677 V2=16,3346216075392 V3=0 T=0 M2=0 M3=0,064196735857673	FrameElem=22-1
ElemStation=0,1	
Frame=22 Station=0 OutputCase=RAR110 CaseType=Combination P=-16,9043313363166 V2=4,66830310376267 V3=0 T=0 M2=0 M3=1,20526339051587	FrameElem=22-1
ElemStation=0	
Frame=22 Station=0,05 OutputCase=RAR110 CaseType=Combination P=-16,7043313363166 V2=4,18330310376267 V3=0 T=0 M2=0 M3=0,984023235327738	FrameElem=22-1
ElemStation=0,05	
Frame=22 Station=0,1 OutputCase=RAR110 CaseType=Combination P=-16,5043313363166 V2=3,71030310376267 V3=0 T=0 M2=0 M3=0,786733080139604	FrameElem=22-1
ElemStation=0,1	
Frame=22 Station=0 OutputCase=RAR111 CaseType=Combination P=-76,6643313339539 V2=3,94819582829548 V3=0 T=0 M2=0 M3=8,60194360145784	FrameElem=22-1
ElemStation=0	
Frame=22 Station=0,05 OutputCase=RAR111 CaseType=Combination P=-76,4643313339539 V2=3,46319582829548 V3=0 T=0 M2=0 M3=8,41670881004307	FrameElem=22-1
ElemStation=0,05	
Frame=22 Station=0,1 OutputCase=RAR111 CaseType=Combination P=-76,2643313339539 V2=2,99019582829548 V3=0 T=0 M2=0 M3=8,25542401862829	FrameElem=22-1
ElemStation=0,1	
Frame=22 Station=0 OutputCase=RAR112 CaseType=Combination P=-69,4164237991884 V2=27,4039404717583 V3=0 T=0 M2=0 M3=14,5645124559781	FrameElem=22-1
ElemStation=0	
Frame=22 Station=0,05 OutputCase=RAR112 CaseType=Combination P=-69,2164237991884 V2=25,8824092217583 V3=0 T=0 M2=0 M3=13,2323211615568	FrameElem=22-1
ElemStation=0,05	
Frame=22 Station=0,1 OutputCase=RAR112 CaseType=Combination P=-69,0164237991884 V2=24,3530654717583 V3=0 T=0 M2=0 M3=11,9764017421356	FrameElem=22-1
ElemStation=0,1	
Frame=22 Station=0 OutputCase=RAR113 CaseType=Combination P=-76,6643313336047 V2=18,2056582291221 V3=0 T=0 M2=0 M3=8,2378027846537	FrameElem=22-1
ElemStation=0	
Frame=22 Station=0,05 OutputCase=RAR113 CaseType=Combination P=-76,4643313336047 V2=16,6841269791221 V3=0 T=0 M2=0 M3=7,36552560236426	FrameElem=22-1
ElemStation=0,05	

Società di Progetto
Brebemi SpA

	Doc. N. 60235-00000-A00.doc	CODIFICA DOCUMENTO 04RCDII10000000000300A00	REV. 00	FOGLIO 335 di 628
--	--------------------------------	--	------------	----------------------

Frame=22 Station=0,1 OutputCase=RAR113 CaseType=Combination P=-76,2643313336047 V2=15,1547832291221 V3=0 T=0 M2=0 M3=6,56952029507482 FrameElem=22-1 ElemStation=0,1

Frame=22 Station=0 OutputCase=RAR114 CaseType=Combination P=-9,65642380155103 V2=28,1240477472255 V3=0 T=0 M2=0 M3=7,16783224503609 FrameElem=22-1 ElemStation=0

Frame=22 Station=0,05 OutputCase=RAR114 CaseType=Combination P=-9,45642380155103 V2=26,6025164972255 V3=0 T=0 M2=0 M3=5,79963558684148 FrameElem=22-1 ElemStation=0,05

Frame=22 Station=0,1 OutputCase=RAR114 CaseType=Combination P=-9,25642380155103 V2=25,0731272472255 V3=0 T=0 M2=0 M3=4,50771080364687 FrameElem=22-1 ElemStation=0,1

Frame=22 Station=0 OutputCase=RAR115 CaseType=Combination P=-16,9043313359673 V2=18,9257655045893 V3=0 T=0 M2=0 M3=0,841122573711734 FrameElem=22-1 ElemStation=0

Frame=22 Station=0,05 OutputCase=RAR115 CaseType=Combination P=-16,7043313359673 V2=17,4042342545893 V3=0 T=0 M2=0 M3=-6,71599723510655E-02 FrameElem=22-1 ElemStation=0,05

Frame=22 Station=0,1 OutputCase=RAR115 CaseType=Combination P=-16,5043313359673 V2=15,8748905045893 V3=0 T=0 M2=0 M3=-0,899170643413863 FrameElem=22-1 ElemStation=0,1

Frame=22 Station=0 OutputCase=RAR116 CaseType=Combination P=-16,9043313363173 V2=5,58776530966255 V3=0 T=0 M2=0 M3=1,80315742621824 FrameElem=22-1 ElemStation=0

Frame=22 Station=0,05 OutputCase=RAR116 CaseType=Combination P=-16,7043313363173 V2=5,10276530966255 V3=0 T=0 M2=0 M3=1,53594416073511 FrameElem=22-1 ElemStation=0,05

Frame=22 Station=0,1 OutputCase=RAR116 CaseType=Combination P=-16,5043313363173 V2=4,62976530966255 V3=0 T=0 M2=0 M3=1,29268089525199 FrameElem=22-1 ElemStation=0,1

Frame=22 Station=0 OutputCase=RAR117 CaseType=Combination P=-76,6643313339546 V2=4,86765803419536 V3=0 T=0 M2=0 M3=9,19983763716021 FrameElem=22-1 ElemStation=0

Frame=22 Station=0,05 OutputCase=RAR117 CaseType=Combination P=-76,4643313339546 V2=4,38265803419536 V3=0 T=0 M2=0 M3=8,96862973545044 FrameElem=22-1 ElemStation=0,05

Frame=22 Station=0,1 OutputCase=RAR117 CaseType=Combination P=-76,2643313339546 V2=3,90965803419536 V3=0 T=0 M2=0 M3=8,76137183374067 FrameElem=22-1 ElemStation=0,1

Frame=22 Station=0 OutputCase=RAR118 CaseType=Combination P=-69,4164237991891 V2=28,3234026776582 V3=0 T=0 M2=0 M3=15,1624064916804 FrameElem=22-1 ElemStation=0

Frame=22 Station=0,05 OutputCase=RAR118 CaseType=Combination P=-69,2164237991891 V2=26,8018714276582 V3=0 T=0 M2=0 M3=13,7842420869642 FrameElem=22-1 ElemStation=0,05

Frame=22 Station=0,1 OutputCase=RAR118 CaseType=Combination P=-69,0164237991891 V2=25,2725276776582 V3=0 T=0 M2=0 M3=12,4823495572479 FrameElem=22-1 ElemStation=0,1

Frame=22 Station=0 OutputCase=RAR119 CaseType=Combination P=-76,6643313336054 V2=19,125120435022 V3=0 T=0 M2=0 M3=8,83569682035607 FrameElem=22-1 ElemStation=0

Frame=22 Station=0,05 OutputCase=RAR119 CaseType=Combination P=-76,4643313336054 V2=17,603589185022 V3=0 T=0 M2=0 M3=7,91744652777164 FrameElem=22-1 ElemStation=0,05

Frame=22 Station=0,1 OutputCase=RAR119 CaseType=Combination P=-76,2643313336054 V2=16,074245435022 V3=0 T=0 M2=0 M3=7,0754681101872 FrameElem=22-1 ElemStation=0,1

Frame=22 Station=0 OutputCase=RAR120 CaseType=Combination P=-9,65642380155171 V2=29,0435099531254 V3=0 T=0 M2=0 M3=7,76572628073845 FrameElem=22-1 ElemStation=0

Frame=22 Station=0,05 OutputCase=RAR120 CaseType=Combination P=-9,45642380155171 V2=27,5219787031254 V3=0 T=0 M2=0 M3=6,35155651224885 FrameElem=22-1 ElemStation=0,05

Frame=22 Station=0,1 OutputCase=RAR120 CaseType=Combination P=-9,25642380155171 V2=25,9926349531254 V3=0 T=0 M2=0 M3=5,01365861875925 FrameElem=22-1 ElemStation=0,1

Frame=22 Station=0 OutputCase=RAR121 CaseType=Combination P=-16,904331335968 V2=19,8452277104892 V3=0 T=0 M2=0 M3=1,4390166094141 FrameElem=22-1 ElemStation=0

Frame=22 Station=0,05 OutputCase=RAR121 CaseType=Combination P=-16,704331335968 V2=18,3236964604892 V3=0 T=0 M2=0 M3=0,484760953056309 FrameElem=22-1 ElemStation=0,05

Frame=22 Station=0,1 OutputCase=RAR121 CaseType=Combination P=-16,504331335968 V2=16,7943527104892 V3=0 T=0 M2=0 M3=-0,393222828301482 FrameElem=22-1 ElemStation=0,1

Frame=22 Station=0 OutputCase=RAR122 CaseType=Combination P=-16,9043313363173 V2=5,58776530966255 V3=0 T=0 M2=0 M3=1,80315742621824 FrameElem=22-1 ElemStation=0

Frame=22 Station=0,05 OutputCase=RAR122 CaseType=Combination P=-16,7043313363173 V2=5,10276530966255 V3=0 T=0 M2=0 M3=1,53594416073511 FrameElem=22-1 ElemStation=0,05

Frame=22 Station=0,1 OutputCase=RAR122 CaseType=Combination P=-16,5043313363173 V2=4,62976530966255 V3=0 T=0 M2=0 M3=1,29268089525199 FrameElem=22-1 ElemStation=0,1

Frame=22 Station=0 OutputCase=RAR123 CaseType=Combination P=-76,6643313339546 V2=4,86765803419536 V3=0 T=0 M2=0 M3=9,19983763716021 FrameElem=22-1 ElemStation=0

Frame=22 Station=0,05 OutputCase=RAR123 CaseType=Combination P=-76,4643313339546 V2=4,38265803419536 V3=0 T=0 M2=0 M3=8,96862973545044 FrameElem=22-1 ElemStation=0,05

Frame=22 Station=0,1 OutputCase=RAR123 CaseType=Combination P=-76,2643313339546 V2=3,90965803419536 V3=0 T=0 M2=0 M3=8,76137183374067 FrameElem=22-1 ElemStation=0,1

Frame=22 Station=0 OutputCase=RAR124 CaseType=Combination P=-69,4164237991891 V2=28,3234026776582 V3=0 T=0 M2=0 M3=15,1624064916804 FrameElem=22-1 ElemStation=0

Frame=22 Station=0,05 OutputCase=RAR124 CaseType=Combination P=-69,2164237991891 V2=26,8018714276582 V3=0 T=0 M2=0 M3=13,7842420869642 FrameElem=22-1 ElemStation=0,05

Frame=22 Station=0,1 OutputCase=RAR124 CaseType=Combination P=-69,0164237991891 V2=25,2725276776582 V3=0 T=0 M2=0 M3=12,4823495572479 FrameElem=22-1 ElemStation=0,1

Frame=22 Station=0 OutputCase=RAR125 CaseType=Combination P=-76,6643313336054 V2=19,125120435022 V3=0 T=0 M2=0 M3=8,83569682035607 FrameElem=22-1 ElemStation=0

Frame=22 Station=0,05 OutputCase=RAR125 CaseType=Combination P=-76,4643313336054 V2=17,603589185022 V3=0 T=0 M2=0 M3=7,91744652777164 FrameElem=22-1 ElemStation=0,05

Frame=22 Station=0,1 OutputCase=RAR125 CaseType=Combination P=-76,2643313336054 V2=16,074245435022 V3=0 T=0 M2=0 M3=7,0754681101872 FrameElem=22-1 ElemStation=0,1

Frame=22 Station=0 OutputCase=RAR126 CaseType=Combination P=-9,65642380155171 V2=29,0435099531254 V3=0 T=0 M2=0 M3=7,76572628073845 FrameElem=22-1 ElemStation=0

Frame=22 Station=0,05 OutputCase=RAR126 CaseType=Combination P=-9,45642380155171 V2=27,5219787031254 V3=0 T=0 M2=0 M3=6,35155651224885 FrameElem=22-1 ElemStation=0,05

Frame=22 Station=0,1 OutputCase=RAR126 CaseType=Combination P=-9,25642380155171 V2=25,9926349531254 V3=0 T=0 M2=0 M3=5,01365861875925 FrameElem=22-1 ElemStation=0,1

Frame=22 Station=0 OutputCase=RAR127 CaseType=Combination P=-16,904331335968 V2=19,8452277104892 V3=0 T=0 M2=0 M3=1,4390166094141 FrameElem=22-1 ElemStation=0

Frame=22 Station=0,05 OutputCase=RAR127 CaseType=Combination P=-16,704331335968 V2=18,3236964604892 V3=0 T=0 M2=0 M3=0,484760953056309 FrameElem=22-1 ElemStation=0,05

Frame=22 Station=0,1 OutputCase=RAR127 CaseType=Combination P=-16,504331335968 V2=16,7943527104892 V3=0 T=0 M2=0 M3=-0,393222828301482 FrameElem=22-1 ElemStation=0,1

Frame=22 Station=0 OutputCase=RAR128 CaseType=Combination P=-17,5399999991647 V2=6,21213189039153 V3=0 T=0 M2=0 M3=2,55925884624203 FrameElem=22-1 ElemStation=0

Società di Progetto
Brebemi SpA

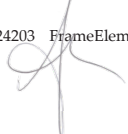

	Doc. N. 60235-00000-A00.doc	CODIFICA DOCUMENTO 04RCDII10000000000300A00	REV. 00	FOGLIO 336 di 628
--	--------------------------------	--	------------	----------------------

Frame=22 Station=0,05 OutputCase=RAR128 CaseType=Combination P=-17,3399999991647 V2=5,72713189039153 V3=0 T=0 M2=0 M3=2,26082725172246	FrameElem=22-1 ElemStation=0,05
Frame=22 Station=0,1 OutputCase=RAR128 CaseType=Combination P=-17,1399999991647 V2=5,25413189039153 V3=0 T=0 M2=0 M3=1,98634565720288	FrameElem=22-1 ElemStation=0,1
Frame=22 Station=0 OutputCase=RAR129 CaseType=Combination P=-97,2199999960143 V2=4,94550145446865 V3=0 T=0 M2=0 M3=12,2222011155972	FrameElem=22-1 ElemStation=0
Frame=22 Station=0,05 OutputCase=RAR129 CaseType=Combination P=-97,0199999960143 V2=4,46050145446865 V3=0 T=0 M2=0 M3=11,9871010428738	FrameElem=22-1 ElemStation=0,05
Frame=22 Station=0,1 OutputCase=RAR129 CaseType=Combination P=-96,8199999960143 V2=3,98750145446865 V3=0 T=0 M2=0 M3=11,775909701503	FrameElem=22-1 ElemStation=0,1
Frame=22 Station=0 OutputCase=RAR130 CaseType=Combination P=-87,8788559053213 V2=34,8131377385611 V3=0 T=0 M2=0 M3=19,9077625678328	FrameElem=22-1 ElemStation=0
Frame=22 Station=0,05 OutputCase=RAR130 CaseType=Combination P=-87,6788559053213 V2=33,0422627385611 V3=0 T=0 M2=0 M3=18,211307764238	FrameElem=22-1 ElemStation=0,05
Frame=22 Station=0,1 OutputCase=RAR130 CaseType=Combination P=-87,4788559053213 V2=31,2546377385611 V3=0 T=0 M2=0 M3=16,6038154606433	FrameElem=22-1 ElemStation=0,1
Frame=22 Station=0 OutputCase=RAR131 CaseType=Combination P=-97,2199999955486 V2=22,9877070083197 V3=0 T=0 M2=0 M3=11,7817070536548	FrameElem=22-1 ElemStation=0
Frame=22 Station=0,05 OutputCase=RAR131 CaseType=Combination P=-97,0199999955486 V2=21,2168320083197 V3=0 T=0 M2=0 M3=10,6765237865721	FrameElem=22-1 ElemStation=0,05
Frame=22 Station=0,1 OutputCase=RAR131 CaseType=Combination P=-96,8199999955486 V2=19,4292070083197 V3=0 T=0 M2=0 M3=9,66030301948945	FrameElem=22-1 ElemStation=0,1
Frame=22 Station=0 OutputCase=RAR132 CaseType=Combination P=-8,1988559084715 V2=35,7732807725173 V3=0 T=0 M2=0 M3=10,045522865768	FrameElem=22-1 ElemStation=0
Frame=22 Station=0,05 OutputCase=RAR132 CaseType=Combination P=-7,9988559084715 V2=34,0024057725173 V3=0 T=0 M2=0 M3=8,30106033128427	FrameElem=22-1 ElemStation=0,05
Frame=22 Station=0,1 OutputCase=RAR132 CaseType=Combination P=-7,7988559084715 V2=32,2147807725173 V3=0 T=0 M2=0 M3=6,64556087599174	FrameElem=22-1 ElemStation=0,1
Frame=22 Station=0 OutputCase=RAR133 CaseType=Combination P=-17,5399999986988 V2=23,947850042276 V3=0 T=0 M2=0 M3=1,9194667723988	FrameElem=22-1 ElemStation=0
Frame=22 Station=0,05 OutputCase=RAR133 CaseType=Combination P=-17,3399999986988 V2=22,176975042276 V3=0 T=0 M2=0 M3=0,766276353618332	FrameElem=22-1 ElemStation=0,05
Frame=22 Station=0,1 OutputCase=RAR133 CaseType=Combination P=-17,1399999986988 V2=20,389350042276 V3=0 T=0 M2=0 M3=-0,297951565162134	FrameElem=22-1 ElemStation=0,1
Frame=22 Station=0 OutputCase=RAR134 CaseType=Combination P=-55,7040089175138 V2=42,5022818615763 V3=0 T=0 M2=0 M3=24,3245805619203	FrameElem=22-1 ElemStation=0
Frame=22 Station=0,05 OutputCase=RAR134 CaseType=Combination P=-55,5040089175138 V2=40,9807506115763 V3=0 T=0 M2=0 M3=22,2374721980082	FrameElem=22-1 ElemStation=0,05
Frame=22 Station=0,1 OutputCase=RAR134 CaseType=Combination P=-55,3040089175138 V2=39,4514068615763 V3=0 T=0 M2=0 M3=20,226635709096	FrameElem=22-1 ElemStation=0,1
Frame=22 Station=0 OutputCase=RAR135 CaseType=Combination P=-77,2999999968021 V2=5,49202461492434 V3=0 T=0 M2=0 M3=9,955939057184	FrameElem=22-1 ElemStation=0
Frame=22 Station=0,05 OutputCase=RAR135 CaseType=Combination P=-77,0999999968021 V2=5,00702461492434 V3=0 T=0 M2=0 M3=9,69351282643779	FrameElem=22-1 ElemStation=0,05
Frame=22 Station=0,1 OutputCase=RAR135 CaseType=Combination P=-76,8999999968021 V2=4,53402461492434 V3=0 T=0 M2=0 M3=9,45503659569157	FrameElem=22-1 ElemStation=0,1
Frame=22 Station=0 OutputCase=RAR136 CaseType=Combination P=-70,0520924620365 V2=28,9477692583872 V3=0 T=0 M2=0 M3=15,9185079117042	FrameElem=22-1 ElemStation=0
Frame=22 Station=0,05 OutputCase=RAR136 CaseType=Combination P=-69,8520924620365 V2=27,4262380083872 V3=0 T=0 M2=0 M3=14,5091251779515	FrameElem=22-1 ElemStation=0,05
Frame=22 Station=0,1 OutputCase=RAR136 CaseType=Combination P=-69,6520924620365 V2=25,8968942583872 V3=0 T=0 M2=0 M3=13,1760143191988	FrameElem=22-1 ElemStation=0,1
Frame=22 Station=0 OutputCase=RAR137 CaseType=Combination P=-77,2999999964528 V2=19,749487015751 V3=0 T=0 M2=0 M3=9,59179824037986	FrameElem=22-1 ElemStation=0
Frame=22 Station=0,05 OutputCase=RAR137 CaseType=Combination P=-77,0999999964528 V2=18,227955765751 V3=0 T=0 M2=0 M3=8,64232961875898	FrameElem=22-1 ElemStation=0,05
Frame=22 Station=0,1 OutputCase=RAR137 CaseType=Combination P=-76,8999999964528 V2=16,698612015751 V3=0 T=0 M2=0 M3=7,7691328721381	FrameElem=22-1 ElemStation=0,1
Frame=22 Station=0 OutputCase=RAR138 CaseType=Combination P=-10,2920924643992 V2=29,6678765338544 V3=0 T=0 M2=0 M3=8,52182770076225	FrameElem=22-1 ElemStation=0
Frame=22 Station=0,05 OutputCase=RAR138 CaseType=Combination P=-10,0920924643992 V2=28,1463452838544 V3=0 T=0 M2=0 M3=7,0764396032362	FrameElem=22-1 ElemStation=0,05
Frame=22 Station=0,1 OutputCase=RAR138 CaseType=Combination P=-9,89209246439916 V2=26,6170015338543 V3=0 T=0 M2=0 M3=5,70732338071014	FrameElem=22-1 ElemStation=0,1
Frame=22 Station=0 OutputCase=RAR139 CaseType=Combination P=-17,5399999988155 V2=20,4695942912182 V3=0 T=0 M2=0 M3=2,1951180294379	FrameElem=22-1 ElemStation=0
Frame=22 Station=0,05 OutputCase=RAR139 CaseType=Combination P=-17,3399999988155 V2=18,9480630412182 V3=0 T=0 M2=0 M3=1,20964404404365	FrameElem=22-1 ElemStation=0,05
Frame=22 Station=0,1 OutputCase=RAR139 CaseType=Combination P=-17,1399999988155 V2=17,4187192912182 V3=0 T=0 M2=0 M3=0,300441933649413	FrameElem=22-1 ElemStation=0,1
Frame=22 Station=0 OutputCase=RAR140 CaseType=Combination P=-17,5399999991644 V2=5,75240078744159 V3=0 T=0 M2=0 M3=2,26031182839085	FrameElem=22-1 ElemStation=0
Frame=22 Station=0,05 OutputCase=RAR140 CaseType=Combination P=-17,3399999991644 V2=5,26740078744159 V3=0 T=0 M2=0 M3=1,98486678901877	FrameElem=22-1 ElemStation=0,05
Frame=22 Station=0,1 OutputCase=RAR140 CaseType=Combination P=-17,1399999991644 V2=4,79440078744159 V3=0 T=0 M2=0 M3=1,73337174964669	FrameElem=22-1 ElemStation=0,1
Frame=22 Station=0 OutputCase=RAR141 CaseType=Combination P=-77,2999999968017 V2=5,0322935119744 V3=0 T=0 M2=0 M3=9,65699203933282	FrameElem=22-1 ElemStation=0
Frame=22 Station=0,05 OutputCase=RAR141 CaseType=Combination P=-77,0999999968017 V2=4,5472935119744 V3=0 T=0 M2=0 M3=9,4175523637341	FrameElem=22-1 ElemStation=0,05
Frame=22 Station=0,1 OutputCase=RAR141 CaseType=Combination P=-76,8999999968017 V2=4,0742935119744 V3=0 T=0 M2=0 M3=9,20206268813538	FrameElem=22-1 ElemStation=0,1
Frame=22 Station=0 OutputCase=RAR142 CaseType=Combination P=-70,0520924620362 V2=28,4880381554372 V3=0 T=0 M2=0 M3=15,619560893853	FrameElem=22-1 ElemStation=0
Frame=22 Station=0,05 OutputCase=RAR142 CaseType=Combination P=-69,8520924620362 V2=26,9665069054372 V3=0 T=0 M2=0 M3=14,2331647152478	FrameElem=22-1 ElemStation=0,05
Frame=22 Station=0,1 OutputCase=RAR142 CaseType=Combination P=-69,6520924620362 V2=25,4371631554372 V3=0 T=0 M2=0 M3=12,9230404116426	FrameElem=22-1 ElemStation=0,1

Società di Progetto
Brebemi SpA



Doc. N.
60235-0000-A00.doc

CODIFICA DOCUMENTO
04RCDII10000000000300A00

REV.
00

FOGLIO
337 di 628

Frame=22 Station=0 OutputCase=RAR143 CaseType=Combination P=-77,2999999964525 V2=19,289755912801 V3=0 T=0 M2=0 M3=9,29285122252868 ElemStation=0	FrameElem=22-1
Frame=22 Station=0,05 OutputCase=RAR143 CaseType=Combination P=-77,0999999964525 V2=17,768224662801 V3=0 T=0 M2=0 M3=8,36636915605529 ElemStation=0,05	FrameElem=22-1
Frame=22 Station=0,1 OutputCase=RAR143 CaseType=Combination P=-76,8999999964525 V2=16,238880912801 V3=0 T=0 M2=0 M3=7,51615896458191 ElemStation=0,1	FrameElem=22-1
Frame=22 Station=0 OutputCase=RAR144 CaseType=Combination P=-10,2920924643988 V2=29,2081454309044 V3=0 T=0 M2=0 M3=8,22288068291106 ElemStation=0	FrameElem=22-1
Frame=22 Station=0,05 OutputCase=RAR144 CaseType=Combination P=-10,0920924643988 V2=27,6866141809044 V3=0 T=0 M2=0 M3=6,80047914053251 ElemStation=0,05	FrameElem=22-1
Frame=22 Station=0,1 OutputCase=RAR144 CaseType=Combination P=-9,89209246439882 V2=26,1572704309044 V3=0 T=0 M2=0 M3=5,45434947315395 ElemStation=0,1	FrameElem=22-1
Frame=22 Station=0 OutputCase=RAR145 CaseType=Combination P=-17,5399999988151 V2=20,0098631882682 V3=0 T=0 M2=0 M3=1,89617101158671 ElemStation=0	FrameElem=22-1
Frame=22 Station=0,05 OutputCase=RAR145 CaseType=Combination P=-17,3399999988151 V2=18,4883319382682 V3=0 T=0 M2=0 M3=0,933683581339967 ElemStation=0,05	FrameElem=22-1
Frame=22 Station=0,1 OutputCase=RAR145 CaseType=Combination P=-17,1399999988151 V2=16,9589881882682 V3=0 T=0 M2=0 M3=4,74680260932229E-02 ElemStation=0,1	FrameElem=22-1
Frame=22 Station=0 OutputCase=RAR146 CaseType=Combination P=-17,539999999165 V2=6,67186299334147 V3=0 T=0 M2=0 M3=2,85820586409322 ElemStation=0	FrameElem=22-1
Frame=22 Station=0,05 OutputCase=RAR146 CaseType=Combination P=-17,339999999165 V2=6,18686299334147 V3=0 T=0 M2=0 M3=2,53678771442615 ElemStation=0,05	FrameElem=22-1
Frame=22 Station=0,1 OutputCase=RAR146 CaseType=Combination P=-17,139999999165 V2=5,71386299334147 V3=0 T=0 M2=0 M3=2,23931956475907 ElemStation=0,1	FrameElem=22-1
Frame=22 Station=0 OutputCase=RAR147 CaseType=Combination P=-77,2999999968024 V2=5,95175571787428 V3=0 T=0 M2=0 M3=10,2548860750352 ElemStation=0	FrameElem=22-1
Frame=22 Station=0,05 OutputCase=RAR147 CaseType=Combination P=-77,0999999968024 V2=5,46675571787428 V3=0 T=0 M2=0 M3=9,96947328914147 ElemStation=0,05	FrameElem=22-1
Frame=22 Station=0,1 OutputCase=RAR147 CaseType=Combination P=-76,8999999968024 V2=4,99375571787428 V3=0 T=0 M2=0 M3=9,70801050324776 ElemStation=0,1	FrameElem=22-1
Frame=22 Station=0 OutputCase=RAR148 CaseType=Combination P=-70,0520924620369 V2=29,4075003613371 V3=0 T=0 M2=0 M3=16,2174549295554 ElemStation=0	FrameElem=22-1
Frame=22 Station=0,05 OutputCase=RAR148 CaseType=Combination P=-69,8520924620369 V2=27,8859691113371 V3=0 T=0 M2=0 M3=14,7850856406552 ElemStation=0,05	FrameElem=22-1
Frame=22 Station=0,1 OutputCase=RAR148 CaseType=Combination P=-69,6520924620368 V2=26,3566253613371 V3=0 T=0 M2=0 M3=13,428988226755 ElemStation=0,1	FrameElem=22-1
Frame=22 Station=0 OutputCase=RAR149 CaseType=Combination P=-77,2999999964532 V2=20,2092181187009 V3=0 T=0 M2=0 M3=9,89074525823105 ElemStation=0	FrameElem=22-1
Frame=22 Station=0,05 OutputCase=RAR149 CaseType=Combination P=-77,0999999964532 V2=18,6876868687009 V3=0 T=0 M2=0 M3=8,91829008146267 ElemStation=0,05	FrameElem=22-1
Frame=22 Station=0,1 OutputCase=RAR149 CaseType=Combination P=-76,8999999964531 V2=17,1583431187009 V3=0 T=0 M2=0 M3=8,02210677969429 ElemStation=0,1	FrameElem=22-1
Frame=22 Station=0 OutputCase=RAR150 CaseType=Combination P=-10,2920924643995 V2=30,1276076368043 V3=0 T=0 M2=0 M3=8,82077471861343 ElemStation=0	FrameElem=22-1
Frame=22 Station=0,05 OutputCase=RAR150 CaseType=Combination P=-10,0920924643995 V2=28,6060763868043 V3=0 T=0 M2=0 M3=7,3524006593988 ElemStation=0,05	FrameElem=22-1
Frame=22 Station=0,1 OutputCase=RAR150 CaseType=Combination P=-9,8920924643995 V2=27,0767326368043 V3=0 T=0 M2=0 M3=5,96029728826634 ElemStation=0,1	FrameElem=22-1
Frame=22 Station=0 OutputCase=RAR151 CaseType=Combination P=-17,5399999988158 V2=20,9293253941681 V3=0 T=0 M2=0 M3=2,49406504728908 ElemStation=0	FrameElem=22-1
Frame=22 Station=0,05 OutputCase=RAR151 CaseType=Combination P=-17,3399999988158 V2=19,4077941441681 V3=0 T=0 M2=0 M3=1,48560450674734 ElemStation=0,05	FrameElem=22-1
Frame=22 Station=0,1 OutputCase=RAR151 CaseType=Combination P=-17,1399999988158 V2=17,8784503941681 V3=0 T=0 M2=0 M3=0,553415841205604 ElemStation=0,1	FrameElem=22-1
Frame=22 Station=0 OutputCase=RAR152 CaseType=Combination P=-17,921401196873 V2=6,40285939764894 V3=0 T=0 M2=0 M3=2,89334089111584 ElemStation=0	FrameElem=22-1
Frame=22 Station=0,05 OutputCase=RAR152 CaseType=Combination P=-17,721401196873 V2=5,91785939764894 V3=0 T=0 M2=0 M3=2,58537292123339 ElemStation=0,05	FrameElem=22-1
Frame=22 Station=0,1 OutputCase=RAR152 CaseType=Combination P=-17,521401196873 V2=5,44485939764894 V3=0 T=0 M2=0 M3=2,30135495135094 ElemStation=0,1	FrameElem=22-1
Frame=22 Station=0 OutputCase=RAR153 CaseType=Combination P=-77,6814011945104 V2=5,68275212218175 V3=0 T=0 M2=0 M3=10,2900211020578 ElemStation=0	FrameElem=22-1
Frame=22 Station=0,05 OutputCase=RAR153 CaseType=Combination P=-77,4814011945104 V2=5,19775212218175 V3=0 T=0 M2=0 M3=10,0180584959487 ElemStation=0,05	FrameElem=22-1
Frame=22 Station=0,1 OutputCase=RAR153 CaseType=Combination P=-77,2814011945104 V2=4,72475212218175 V3=0 T=0 M2=0 M3=9,77004588983963 ElemStation=0,1	FrameElem=22-1
Frame=22 Station=0 OutputCase=RAR154 CaseType=Combination P=-70,4334936597448 V2=29,1384967656446 V3=0 T=0 M2=0 M3=16,252589956578 ElemStation=0	FrameElem=22-1
Frame=22 Station=0,05 OutputCase=RAR154 CaseType=Combination P=-70,2334936597448 V2=27,6169655156446 V3=0 T=0 M2=0 M3=14,8336708474625 ElemStation=0,05	FrameElem=22-1
Frame=22 Station=0,1 OutputCase=RAR154 CaseType=Combination P=-70,0334936597448 V2=26,0876217656446 V3=0 T=0 M2=0 M3=13,4910236133469 ElemStation=0,1	FrameElem=22-1
Frame=22 Station=0 OutputCase=RAR155 CaseType=Combination P=-77,6814011941611 V2=19,9402145230084 V3=0 T=0 M2=0 M3=9,92588028525367 ElemStation=0	FrameElem=22-1
Frame=22 Station=0,05 OutputCase=RAR155 CaseType=Combination P=-77,4814011941611 V2=18,4186832730084 V3=0 T=0 M2=0 M3=8,96687528826991 ElemStation=0,05	FrameElem=22-1
Frame=22 Station=0,1 OutputCase=RAR155 CaseType=Combination P=-77,2814011941611 V2=16,8893395230084 V3=0 T=0 M2=0 M3=8,08414216628616 ElemStation=0,1	FrameElem=22-1
Frame=22 Station=0 OutputCase=RAR156 CaseType=Combination P=-10,6734936621075 V2=29,8586040411118 V3=0 T=0 M2=0 M3=8,85590974563605 ElemStation=0	FrameElem=22-1
Frame=22 Station=0,05 OutputCase=RAR156 CaseType=Combination P=-10,4734936621075 V2=28,3370727911118 V3=0 T=0 M2=0 M3=7,40098527274713 ElemStation=0,05	FrameElem=22-1
Frame=22 Station=0,1 OutputCase=RAR156 CaseType=Combination P=-10,2734936621075 V2=26,8077290411118 V3=0 T=0 M2=0 M3=6,02233267485821 ElemStation=0,1	FrameElem=22-1
Frame=22 Station=0 OutputCase=RAR157 CaseType=Combination P=-17,9214011965238 V2=20,6603217984756 V3=0 T=0 M2=0 M3=2,5292000743117 ElemStation=0	FrameElem=22-1
Frame=22 Station=0,05 OutputCase=RAR157 CaseType=Combination P=-17,7214011965238 V2=19,1387905484756 V3=0 T=0 M2=0 M3=1,53418971355459 ElemStation=0,05	FrameElem=22-1

Società di Progetto
Brebemi SpA



Doc. N.
60235-0000-A00.doc

CODIFICA DOCUMENTO
04RCDII10000000000300A00

REV.
00

FOGLIO
338 di 628

Frame=22 Station=0,1 OutputCase=RAR157 CaseType=Combination P=-17,5214011965238 V2=17,6094467984756 V3=0 T=0 M2=0 M3=0,615451227797475 FrameElem=22-1 ElemStation=0,1

Frame=22 Station=0 OutputCase=RAR158 CaseType=Combination P=-17,1585988014564 V2=6,02140438313412 V3=0 T=0 M2=0 M3=2,22517680136823 FrameElem=22-1 ElemStation=0

Frame=22 Station=0,05 OutputCase=RAR158 CaseType=Combination P=-16,9585988014564 V2=5,53640438313412 V3=0 T=0 M2=0 M3=1,93628158221153 FrameElem=22-1 ElemStation=0,05

Frame=22 Station=0,1 OutputCase=RAR158 CaseType=Combination P=-16,7585988014564 V2=5,06340438313412 V3=0 T=0 M2=0 M3=1,67133636305482 FrameElem=22-1 ElemStation=0,1

Frame=22 Station=0 OutputCase=RAR159 CaseType=Combination P=-76,9185987990937 V2=5,30129710766693 V3=0 T=0 M2=0 M3=9,6218570123102 FrameElem=22-1 ElemStation=0

Frame=22 Station=0,05 OutputCase=RAR159 CaseType=Combination P=-76,7185987990937 V2=4,81629710766693 V3=0 T=0 M2=0 M3=9,36896715692685 FrameElem=22-1 ElemStation=0,05

Frame=22 Station=0,1 OutputCase=RAR159 CaseType=Combination P=-76,5185987990937 V2=4,34329710766693 V3=0 T=0 M2=0 M3=9,14002730154351 FrameElem=22-1 ElemStation=0,1

Frame=22 Station=0 OutputCase=RAR160 CaseType=Combination P=-69,6706912643282 V2=28,7570417511297 V3=0 T=0 M2=0 M3=15,5844258668304 FrameElem=22-1 ElemStation=0

Frame=22 Station=0,05 OutputCase=RAR160 CaseType=Combination P=-69,4706912643282 V2=27,2355105011297 V3=0 T=0 M2=0 M3=14,1845795084406 FrameElem=22-1 ElemStation=0,05

Frame=22 Station=0,1 OutputCase=RAR160 CaseType=Combination P=-69,2706912643282 V2=25,7061667511297 V3=0 T=0 M2=0 M3=12,8610050250508 FrameElem=22-1 ElemStation=0,1

Frame=22 Station=0 OutputCase=RAR161 CaseType=Combination P=-76,9185987987445 V2=19,5587595084936 V3=0 T=0 M2=0 M3=9,25771619550606 FrameElem=22-1 ElemStation=0

Frame=22 Station=0,05 OutputCase=RAR161 CaseType=Combination P=-76,7185987987445 V2=18,0372282584935 V3=0 T=0 M2=0 M3=8,31778394924805 FrameElem=22-1 ElemStation=0,05

Frame=22 Station=0,1 OutputCase=RAR161 CaseType=Combination P=-76,5185987987445 V2=16,5078845084935 V3=0 T=0 M2=0 M3=7,45412357799004 FrameElem=22-1 ElemStation=0,1

Frame=22 Station=0 OutputCase=RAR162 CaseType=Combination P=-9,91069126669083 V2=29,4771490265969 V3=0 T=0 M2=0 M3=8,18774565588845 FrameElem=22-1 ElemStation=0

Frame=22 Station=0,05 OutputCase=RAR162 CaseType=Combination P=-9,71069126669083 V2=27,9556177765969 V3=0 T=0 M2=0 M3=6,75189393372527 FrameElem=22-1 ElemStation=0,05

Frame=22 Station=0,1 OutputCase=RAR162 CaseType=Combination P=-9,51069126669083 V2=26,4262740265969 V3=0 T=0 M2=0 M3=5,39231408656208 FrameElem=22-1 ElemStation=0,1

Frame=22 Station=0 OutputCase=RAR163 CaseType=Combination P=-17,1585988011071 V2=20,2788667839607 V3=0 T=0 M2=0 M3=1,86103598456409 FrameElem=22-1 ElemStation=0

Frame=22 Station=0,05 OutputCase=RAR163 CaseType=Combination P=-16,9585988011071 V2=18,757335339607 V3=0 T=0 M2=0 M3=0,885098374532722 FrameElem=22-1 ElemStation=0,05

Frame=22 Station=0,1 OutputCase=RAR163 CaseType=Combination P=-16,7585988011071 V2=17,2279917839607 V3=0 T=0 M2=0 M3=-1,45673604986478E-02 FrameElem=22-1 ElemStation=0,1

Frame=22 Station=0 OutputCase=INVRAR CaseType=Combination StepType=Max P=-7,81745471076283 V2=42,5022818615763 V3=0 T=0 M2=0 M3=24,359715588943 FrameElem=22-1 ElemStation=0

Frame=22 Station=0,05 OutputCase=INVRAR CaseType=Combination StepType=Max P=-7,61745471076283 V2=40,9807506115763 V3=0 T=0 M2=0 M3=22,286057048154 FrameElem=22-1 ElemStation=0,05

Frame=22 Station=0,1 OutputCase=INVRAR CaseType=Combination StepType=Max P=-7,41745471076283 V2=39,4514068615763 V3=0 T=0 M2=0 M3=20,2886710956879 FrameElem=22-1 ElemStation=0,1

Frame=22 Station=0 OutputCase=INVRAR CaseType=Combination StepType=Min P=-97,6014011937223 V2=3,7688600978338 V3=0 T=0 M2=0 M3=0,841122573711734 FrameElem=22-1 ElemStation=0

Frame=22 Station=0,05 OutputCase=INVRAR CaseType=Combination StepType=Min P=-97,4014011937223 V2=3,2838600978338 V3=0 T=0 M2=0 M3=-6,71599723510655E-02 FrameElem=22-1 ElemStation=0,05

Frame=22 Station=0,1 OutputCase=INVRAR CaseType=Combination StepType=Min P=-97,2014011937223 V2=2,8108600978338 V3=0 T=0 M2=0 M3=-0,899170643413863 FrameElem=22-1 ElemStation=0,1

Frame=22 Station=0 OutputCase=FRE01 CaseType=Combination P=-17,5399999991641 V2=8,3491463272282 V3=0 T=0 M2=0 M3=1,92593273510084 FrameElem=22-1 ElemStation=0

Frame=22 Station=0,05 OutputCase=FRE01 CaseType=Combination P=-17,3399999991641 V2=7,5756463272282 V3=0 T=0 M2=0 M3=1,5278920854061 FrameElem=22-1 ElemStation=0,05

Frame=22 Station=0,1 OutputCase=FRE01 CaseType=Combination P=-17,1399999991641 V2=6,8211463272282 V3=0 T=0 M2=0 M3=1,16805143571136 FrameElem=22-1 ElemStation=0,1

Frame=22 Station=0 OutputCase=FRE02 CaseType=Combination P=-77,2999999968015 V2=4,72580611000777 V3=0 T=0 M2=0 M3=9,45769402743203 FrameElem=22-1 ElemStation=0

Frame=22 Station=0,05 OutputCase=FRE02 CaseType=Combination P=-77,0999999968015 V2=4,24080611000777 V3=0 T=0 M2=0 M3=9,23357872193164 FrameElem=22-1 ElemStation=0,05

Frame=22 Station=0,1 OutputCase=FRE02 CaseType=Combination P=-76,8999999968015 V2=3,76780611000777 V3=0 T=0 M2=0 M3=9,033413411643125 FrameElem=22-1 ElemStation=0,1

Frame=22 Station=0 OutputCase=FRE03 CaseType=Combination P=-70,0520924620359 V2=28,1815507534706 V3=0 T=0 M2=0 M3=15,4202628819522 FrameElem=22-1 ElemStation=0

Frame=22 Station=0,05 OutputCase=FRE03 CaseType=Combination P=-69,8520924620359 V2=26,6600195034706 V3=0 T=0 M2=0 M3=14,0491910734454 FrameElem=22-1 ElemStation=0,05

Frame=22 Station=0,1 OutputCase=FRE03 CaseType=Combination P=-69,6520924620359 V2=25,1306757534706 V3=0 T=0 M2=0 M3=12,7543911399385 FrameElem=22-1 ElemStation=0,1

Frame=22 Station=0 OutputCase=FRE04 CaseType=Combination P=-77,2999999964522 V2=18,9832685108344 V3=0 T=0 M2=0 M3=9,09355321062789 FrameElem=22-1 ElemStation=0

Frame=22 Station=0,05 OutputCase=FRE04 CaseType=Combination P=-77,0999999964522 V2=17,4617372608344 V3=0 T=0 M2=0 M3=8,18239551425284 FrameElem=22-1 ElemStation=0,05

Frame=22 Station=0,1 OutputCase=FRE04 CaseType=Combination P=-76,8999999964522 V2=15,9323935108344 V3=0 T=0 M2=0 M3=7,34750969287778 FrameElem=22-1 ElemStation=0,1

Frame=22 Station=0 OutputCase=FRE05 CaseType=Combination P=-10,2920924643986 V2=28,9016580289378 V3=0 T=0 M2=0 M3=8,02358267101027 FrameElem=22-1 ElemStation=0

Frame=22 Station=0,05 OutputCase=FRE05 CaseType=Combination P=-10,0920924643986 V2=27,3801267789378 V3=0 T=0 M2=0 M3=6,61650549873005 FrameElem=22-1 ElemStation=0,05

Frame=22 Station=0,1 OutputCase=FRE05 CaseType=Combination P=-9,89209246439859 V2=25,8507830289378 V3=0 T=0 M2=0 M3=5,28570020144983 FrameElem=22-1 ElemStation=0,1

Frame=22 Station=0 OutputCase=FRE06 CaseType=Combination P=-17,5399999988149 V2=19,7033757863016 V3=0 T=0 M2=0 M3=1,69687299968592 FrameElem=22-1 ElemStation=0

Frame=22 Station=0,05 OutputCase=FRE06 CaseType=Combination P=-17,3399999988149 V2=18,1818445363016 V3=0 T=0 M2=0 M3=0,7497099393537508 FrameElem=22-1 ElemStation=0,05

Frame=22 Station=0,1 OutputCase=FRE06 CaseType=Combination P=-17,1399999988149 V2=16,6525007863016 V3=0 T=0 M2=0 M3=-0,121181245610904 FrameElem=22-1 ElemStation=0,1

Frame=22 Station=0 OutputCase=FRE07 CaseType=Combination P=-17,5399999991638 V2=4,98618228252503 V3=0 T=0 M2=0 M3=1,76206679863888 FrameElem=22-1 ElemStation=0

Società di Progetto
Brebemi SpA



Doc. N.
60235-0000-A00.doc

CODIFICA DOCUMENTO
04RCDII10000000000300A00

REV.
00

FOGLIO
339 di 628

Frame=22 ElemStation=0,05	Station=0,05	OutputCase=FRE07	CaseType=Combination	P=-17,3399999991638	V2=4,50118228252503	V3=0	T=0	M2=0	M3=1,52493268451262	FrameElem=22-1
Frame=22 ElemStation=0,1	Station=0,1	OutputCase=FRE07	CaseType=Combination	P=-17,1399999991638	V2=4,0281822852503	V3=0	T=0	M2=0	M3=1,31174857038637	FrameElem=22-1
Frame=22 ElemStation=0	Station=0	OutputCase=FRE08	CaseType=Combination	P=-77,2999999968012	V2=4,34269685754949	V3=0	T=0	M2=0	M3=9,20857151255604	FrameElem=22-1
Frame=22 ElemStation=0,05	Station=0,05	OutputCase=FRE08	CaseType=Combination	P=-77,0999999968012	V2=3,85769685754949	V3=0	T=0	M2=0	M3=9,00361166967857	FrameElem=22-1
Frame=22 ElemStation=0,1	Station=0,1	OutputCase=FRE08	CaseType=Combination	P=-76,8999999968012	V2=3,38469685754949	V3=0	T=0	M2=0	M3=8,82260182680109	FrameElem=22-1
Frame=22 ElemStation=0	Station=0	OutputCase=FRE09	CaseType=Combination	P=-70,0520924620357	V2=27,7984415010123	V3=0	T=0	M2=0	M3=15,1711403670763	FrameElem=22-1
Frame=22 ElemStation=0,05	Station=0,05	OutputCase=FRE09	CaseType=Combination	P=-69,8520924620357	V2=26,2769102510123	V3=0	T=0	M2=0	M3=13,8192240211923	FrameElem=22-1
Frame=22 ElemStation=0,1	Station=0,1	OutputCase=FRE09	CaseType=Combination	P=-69,6520924620357	V2=24,7475665010123	V3=0	T=0	M2=0	M3=12,5435795503084	FrameElem=22-1
Frame=22 ElemStation=0	Station=0	OutputCase=FRE10	CaseType=Combination	P=-77,299999996452	V2=18,6001592583761	V3=0	T=0	M2=0	M3=8,8444306957519	FrameElem=22-1
Frame=22 ElemStation=0,05	Station=0,05	OutputCase=FRE10	CaseType=Combination	P=-77,099999996452	V2=17,0786280083761	V3=0	T=0	M2=0	M3=7,95242846199976	FrameElem=22-1
Frame=22 ElemStation=0,1	Station=0,1	OutputCase=FRE10	CaseType=Combination	P=-76,899999996452	V2=15,5492842583761	V3=0	T=0	M2=0	M3=7,13669810324762	FrameElem=22-1
Frame=22 ElemStation=0	Station=0	OutputCase=FRE11	CaseType=Combination	P=-10,2920924643983	V2=28,5185487764795	V3=0	T=0	M2=0	M3=7,77446015613429	FrameElem=22-1
Frame=22 ElemStation=0,05	Station=0,05	OutputCase=FRE11	CaseType=Combination	P=-10,0920924643983	V2=26,9970175264795	V3=0	T=0	M2=0	M3=6,38653844647698	FrameElem=22-1
Frame=22 ElemStation=0,1	Station=0,1	OutputCase=FRE11	CaseType=Combination	P=-9,89209246439831	V2=25,4676737764795	V3=0	T=0	M2=0	M3=5,07488861181967	FrameElem=22-1
Frame=22 ElemStation=0	Station=0	OutputCase=FRE12	CaseType=Combination	P=-17,5399999988146	V2=19,3202665338433	V3=0	T=0	M2=0	M3=1,44775048480994	FrameElem=22-1
Frame=22 ElemStation=0,05	Station=0,05	OutputCase=FRE12	CaseType=Combination	P=-17,3399999988146	V2=17,7987352838433	V3=0	T=0	M2=0	M3=0,519742887284436	FrameElem=22-1
Frame=22 ElemStation=0,1	Station=0,1	OutputCase=FRE12	CaseType=Combination	P=-17,1399999988146	V2=16,2693915338433	V3=0	T=0	M2=0	M3=-0,331992835241063	FrameElem=22-1
Frame=22 ElemStation=0	Station=0	OutputCase=FRE13	CaseType=Combination	P=-17,8578343305874	V2=5,1451218719062	V3=0	T=0	M2=0	M3=2,04046850270038	FrameElem=22-1
Frame=22 ElemStation=0,05	Station=0,05	OutputCase=FRE13	CaseType=Combination	P=-17,6578343305874	V2=4,6601218719062	V3=0	T=0	M2=0	M3=1,79538740910507	FrameElem=22-1
Frame=22 ElemStation=0,1	Station=0,1	OutputCase=FRE13	CaseType=Combination	P=-17,4578343305874	V2=4,1871218719062	V3=0	T=0	M2=0	M3=1,57425631550976	FrameElem=22-1
Frame=22 ElemStation=0	Station=0	OutputCase=FRE14	CaseType=Combination	P=-17,2221656677402	V2=4,82724269314385	V3=0	T=0	M2=0	M3=1,48366509457737	FrameElem=22-1
Frame=22 ElemStation=0,05	Station=0,05	OutputCase=FRE14	CaseType=Combination	P=-17,0221656677402	V2=4,34224269314385	V3=0	T=0	M2=0	M3=1,25447795992018	FrameElem=22-1
Frame=22 ElemStation=0,1	Station=0,1	OutputCase=FRE14	CaseType=Combination	P=-16,8221656677402	V2=3,86924269314385	V3=0	T=0	M2=0	M3=1,04924082526299	FrameElem=22-1
Frame=22 ElemStation=0	Station=0	OutputCase=FRE15	CaseType=Combination	P=-17,5399999991641	V2=5,36929153498331	V3=0	T=0	M2=0	M3=2,01118931351486	FrameElem=22-1
Frame=22 ElemStation=0,05	Station=0,05	OutputCase=FRE15	CaseType=Combination	P=-17,3399999991641	V2=4,88429153498331	V3=0	T=0	M2=0	M3=1,7548997367657	FrameElem=22-1
Frame=22 ElemStation=0,1	Station=0,1	OutputCase=FRE15	CaseType=Combination	P=-17,1399999991641	V2=4,41129153498331	V3=0	T=0	M2=0	M3=1,52256016001653	FrameElem=22-1
Frame=22 ElemStation=0	Station=0	OutputCase=FRE16	CaseType=Combination	P=-17,5399999991645	V2=5,90564448842491	V3=0	T=0	M2=0	M3=2,35996083434125	FrameElem=22-1
Frame=22 ElemStation=0,05	Station=0,05	OutputCase=FRE16	CaseType=Combination	P=-17,3399999991645	V2=5,42064448842491	V3=0	T=0	M2=0	M3=2,07685360992	FrameElem=22-1
Frame=22 ElemStation=0,1	Station=0,1	OutputCase=FRE16	CaseType=Combination	P=-17,1399999991645	V2=4,94764448842491	V3=0	T=0	M2=0	M3=1,81769638549875	FrameElem=22-1
Frame=22 ElemStation=0	Station=0	OutputCase=FRE17	CaseType=Combination	P=-77,2999999968018	V2=5,10891536246606	V3=0	T=0	M2=0	M3=9,70681654230802	FrameElem=22-1
Frame=22 ElemStation=0,05	Station=0,05	OutputCase=FRE17	CaseType=Combination	P=-77,0999999968018	V2=4,62391536246606	V3=0	T=0	M2=0	M3=9,46354577418471	FrameElem=22-1
Frame=22 ElemStation=0,1	Station=0,1	OutputCase=FRE17	CaseType=Combination	P=-76,8999999968018	V2=4,15091536246606	V3=0	T=0	M2=0	M3=9,24422500606141	FrameElem=22-1
Frame=22 ElemStation=0	Station=0	OutputCase=FRE18	CaseType=Combination	P=-70,0520924620362	V2=28,5646600059289	V3=0	T=0	M2=0	M3=15,6693853968282	FrameElem=22-1
Frame=22 ElemStation=0,05	Station=0,05	OutputCase=FRE18	CaseType=Combination	P=-69,8520924620362	V2=27,0431287559289	V3=0	T=0	M2=0	M3=14,2791581256985	FrameElem=22-1
Frame=22 ElemStation=0,1	Station=0,1	OutputCase=FRE18	CaseType=Combination	P=-69,6520924620362	V2=25,5137850059289	V3=0	T=0	M2=0	M3=12,9652027295687	FrameElem=22-1
Frame=22 ElemStation=0	Station=0	OutputCase=FRE19	CaseType=Combination	P=-77,2999999964525	V2=19,3663777632927	V3=0	T=0	M2=0	M3=9,34267572550388	FrameElem=22-1
Frame=22 ElemStation=0,05	Station=0,05	OutputCase=FRE19	CaseType=Combination	P=-77,0999999964525	V2=17,8448465132927	V3=0	T=0	M2=0	M3=8,41236256650591	FrameElem=22-1
Frame=22 ElemStation=0,1	Station=0,1	OutputCase=FRE19	CaseType=Combination	P=-76,8999999964525	V2=16,3155027632927	V3=0	T=0	M2=0	M3=7,55832128250794	FrameElem=22-1
Frame=22 ElemStation=0	Station=0	OutputCase=FRE20	CaseType=Combination	P=-10,2920924643989	V2=29,2847672813961	V3=0	T=0	M2=0	M3=8,27270518588626	FrameElem=22-1
Frame=22 ElemStation=0,05	Station=0,05	OutputCase=FRE20	CaseType=Combination	P=-10,0920924643989	V2=27,7632360313961	V3=0	T=0	M2=0	M3=6,84647255098312	FrameElem=22-1
Frame=22 ElemStation=0,1	Station=0,1	OutputCase=FRE20	CaseType=Combination	P=-9,89209246439888	V2=26,2338922813961	V3=0	T=0	M2=0	M3=5,49651179107999	FrameElem=22-1
Frame=22 ElemStation=0	Station=0	OutputCase=FRE21	CaseType=Combination	P=-17,5399999988152	V2=20,0864850387599	V3=0	T=0	M2=0	M3=1,94599551456191	FrameElem=22-1
Frame=22 ElemStation=0,05	Station=0,05	OutputCase=FRE21	CaseType=Combination	P=-17,3399999988152	V2=18,5649537887599	V3=0	T=0	M2=0	M3=0,979676991790581	FrameElem=22-1
Frame=22 ElemStation=0,1	Station=0,1	OutputCase=FRE21	CaseType=Combination	P=-17,1399999988152	V2=17,0356100387599	V3=0	T=0	M2=0	M3=8,96303440192547E-02	FrameElem=22-1

Società di Progetto
Brebemi SpA

Frame=22 Station=0 OutputCase=FRE22 CaseType=Combination P=-17,8578343305881 V2=6,06458407780608 V3=0 T=0 M2=0 M3=2,63836253840275	FrameElem=22-1 ElemStation=0
Frame=22 Station=0,05 OutputCase=FRE22 CaseType=Combination P=-17,6578343305881 V2=5,57958407780608 V3=0 T=0 M2=0 M3=2,34730833451244	FrameElem=22-1 ElemStation=0,05
Frame=22 Station=0,1 OutputCase=FRE22 CaseType=Combination P=-17,4578343305881 V2=5,10658407780608 V3=0 T=0 M2=0 M3=2,08020413062214	FrameElem=22-1 ElemStation=0,1
Frame=22 Station=0 OutputCase=FRE23 CaseType=Combination P=-17,2221656677409 V2=5,74670489904373 V3=0 T=0 M2=0 M3=2,08155913027974	FrameElem=22-1 ElemStation=0
Frame=22 Station=0,05 OutputCase=FRE23 CaseType=Combination P=-17,0221656677409 V2=5,26170489904373 V3=0 T=0 M2=0 M3=1,80639888532756	FrameElem=22-1 ElemStation=0,05
Frame=22 Station=0,1 OutputCase=FRE23 CaseType=Combination P=-16,8221656677409 V2=4,78870489904373 V3=0 T=0 M2=0 M3=1,55518864037537	FrameElem=22-1 ElemStation=0,1
Frame=22 Station=0 OutputCase=FRE24 CaseType=Combination P=-17,5399999991648 V2=6,28875374088319 V3=0 T=0 M2=0 M3=2,60908334921723	FrameElem=22-1 ElemStation=0
Frame=22 Station=0,05 OutputCase=FRE24 CaseType=Combination P=-17,3399999991648 V2=5,80375374088319 V3=0 T=0 M2=0 M3=2,30682066217307	FrameElem=22-1 ElemStation=0,05
Frame=22 Station=0,1 OutputCase=FRE24 CaseType=Combination P=-17,1399999991648 V2=5,33075374088319 V3=0 T=0 M2=0 M3=2,02850797512891	FrameElem=22-1 ElemStation=0,1
Frame=22 Station=0 OutputCase=FRE25 CaseType=Combination P=-17,9214011968725 V2=5,63664089273238 V3=0 T=0 M2=0 M3=2,39509586136386	FrameElem=22-1 ElemStation=0
Frame=22 Station=0,05 OutputCase=FRE25 CaseType=Combination P=-17,7214011968725 V2=5,15164089273238 V3=0 T=0 M2=0 M3=2,12543881672724	FrameElem=22-1 ElemStation=0,05
Frame=22 Station=0,1 OutputCase=FRE25 CaseType=Combination P=-17,5214011968725 V2=4,67864089273238 V3=0 T=0 M2=0 M3=1,87973177209062	FrameElem=22-1 ElemStation=0,1
Frame=22 Station=0 OutputCase=FRE26 CaseType=Combination P=-77,6178343282251 V2=4,88474569938895 V3=0 T=0 M2=0 M3=9,73609573149353	FrameElem=22-1 ElemStation=0
Frame=22 Station=0,05 OutputCase=FRE26 CaseType=Combination P=-77,4178343282251 V2=4,39974569938895 V3=0 T=0 M2=0 M3=9,50403344652408	FrameElem=22-1 ElemStation=0,05
Frame=22 Station=0,1 OutputCase=FRE26 CaseType=Combination P=-77,2178343282251 V2=3,92674569938895 V3=0 T=0 M2=0 M3=9,29592116155463	FrameElem=22-1 ElemStation=0,1
Frame=22 Station=0 OutputCase=FRE27 CaseType=Combination P=-70,3699267934596 V2=28,3404903428518 V3=0 T=0 M2=0 M3=15,6986645860137	FrameElem=22-1 ElemStation=0
Frame=22 Station=0,05 OutputCase=FRE27 CaseType=Combination P=-70,1699267934596 V2=26,189590928518 V3=0 T=0 M2=0 M3=14,3196457980378	FrameElem=22-1 ElemStation=0,05
Frame=22 Station=0,1 OutputCase=FRE27 CaseType=Combination P=-69,9699267934596 V2=25,2896153428518 V3=0 T=0 M2=0 M3=13,016898850619	FrameElem=22-1 ElemStation=0,1
Frame=22 Station=0 OutputCase=FRE28 CaseType=Combination P=-77,6178343278759 V2=19,1422081002156 V3=0 T=0 M2=0 M3=9,37195491468939	FrameElem=22-1 ElemStation=0
Frame=22 Station=0,05 OutputCase=FRE28 CaseType=Combination P=-77,4178343278759 V2=17,6206768502156 V3=0 T=0 M2=0 M3=8,45285023884528	FrameElem=22-1 ElemStation=0,05
Frame=22 Station=0,1 OutputCase=FRE28 CaseType=Combination P=-77,2178343278759 V2=16,0913331002156 V3=0 T=0 M2=0 M3=7,61001743800117	FrameElem=22-1 ElemStation=0,1
Frame=22 Station=0 OutputCase=FRE29 CaseType=Combination P=-10,6099267958222 V2=29,060597618319 V3=0 T=0 M2=0 M3=8,30198437507178	FrameElem=22-1 ElemStation=0
Frame=22 Station=0,05 OutputCase=FRE29 CaseType=Combination P=-10,4099267958222 V2=27,539066368319 V3=0 T=0 M2=0 M3=6,88696022332249	FrameElem=22-1 ElemStation=0,05
Frame=22 Station=0,1 OutputCase=FRE29 CaseType=Combination P=-10,2099267958222 V2=26,009722618319 V3=0 T=0 M2=0 M3=5,54820794657321	FrameElem=22-1 ElemStation=0,1
Frame=22 Station=0 OutputCase=FRE30 CaseType=Combination P=-17,8578343302385 V2=19,8623153756828 V3=0 T=0 M2=0 M3=1,97527470374742	FrameElem=22-1 ElemStation=0
Frame=22 Station=0,05 OutputCase=FRE30 CaseType=Combination P=-17,6578343302385 V2=18,3407841256828 V3=0 T=0 M2=0 M3=1,02016466412995	FrameElem=22-1 ElemStation=0,05
Frame=22 Station=0,1 OutputCase=FRE30 CaseType=Combination P=-17,4578343302385 V2=16,8114403756828 V3=0 T=0 M2=0 M3=0,14132649951248	FrameElem=22-1 ElemStation=0,1
Frame=22 Station=0 OutputCase=FRE31 CaseType=Combination P=-17,9214011968722 V2=5,2535316402741 V3=0 T=0 M2=0 M3=2,14597334648788	FrameElem=22-1 ElemStation=0
Frame=22 Station=0,05 OutputCase=FRE31 CaseType=Combination P=-17,7214011968722 V2=4,7685316402741 V3=0 T=0 M2=0 M3=1,89547176447417	FrameElem=22-1 ElemStation=0,05
Frame=22 Station=0,1 OutputCase=FRE31 CaseType=Combination P=-17,5214011968722 V2=4,2955316402741 V3=0 T=0 M2=0 M3=1,66892018246047	FrameElem=22-1 ElemStation=0,1
Frame=22 Station=0 OutputCase=FRE32 CaseType=Combination P=-17,9214011968728 V2=6,01975014519066 V3=0 T=0 M2=0 M3=2,64421837623985	FrameElem=22-1 ElemStation=0
Frame=22 Station=0,05 OutputCase=FRE32 CaseType=Combination P=-17,7214011968728 V2=5,53475014519066 V3=0 T=0 M2=0 M3=2,35540586898032	FrameElem=22-1 ElemStation=0,05
Frame=22 Station=0,1 OutputCase=FRE32 CaseType=Combination P=-17,5214011968728 V2=5,06175014519066 V3=0 T=0 M2=0 M3=2,09054336172078	FrameElem=22-1 ElemStation=0,1
Frame=22 Station=0 OutputCase=FRE33 CaseType=Combination P=-17,9214011968728 V2=6,01975014519066 V3=0 T=0 M2=0 M3=2,64421837623985	FrameElem=22-1 ElemStation=0
Frame=22 Station=0,05 OutputCase=FRE33 CaseType=Combination P=-17,7214011968728 V2=5,53475014519066 V3=0 T=0 M2=0 M3=2,35540586898032	FrameElem=22-1 ElemStation=0,05
Frame=22 Station=0,1 OutputCase=FRE33 CaseType=Combination P=-17,5214011968728 V2=5,06175014519066 V3=0 T=0 M2=0 M3=2,09054336172078	FrameElem=22-1 ElemStation=0,1
Frame=22 Station=0 OutputCase=FRE34 CaseType=Combination P=-17,1585988014558 V2=5,25518587821755 V3=0 T=0 M2=0 M3=1,72693177161626	FrameElem=22-1 ElemStation=0
Frame=22 Station=0,05 OutputCase=FRE34 CaseType=Combination P=-16,9585988014558 V2=4,77018587821755 V3=0 T=0 M2=0 M3=1,47634747770538	FrameElem=22-1 ElemStation=0,05
Frame=22 Station=0,1 OutputCase=FRE34 CaseType=Combination P=-16,7585988014558 V2=4,29718587821755 V3=0 T=0 M2=0 M3=1,2497131837945	FrameElem=22-1 ElemStation=0,1
Frame=22 Station=0 OutputCase=FRE35 CaseType=Combination P=-76,9821656653779 V2=4,5668665206266 V3=0 T=0 M2=0 M3=9,17929232337053	FrameElem=22-1 ElemStation=0
Frame=22 Station=0,05 OutputCase=FRE35 CaseType=Combination P=-76,7821656653779 V2=4,0818665206266 V3=0 T=0 M2=0 M3=8,9631239973392	FrameElem=22-1 ElemStation=0,05
Frame=22 Station=0,1 OutputCase=FRE35 CaseType=Combination P=-76,5821656653779 V2=3,6088665206266 V3=0 T=0 M2=0 M3=8,77090567130787	FrameElem=22-1 ElemStation=0,1
Frame=22 Station=0 OutputCase=FRE36 CaseType=Combination P=-69,7342581306123 V2=28,0226111640894 V3=0 T=0 M2=0 M3=15,1418611778907	FrameElem=22-1 ElemStation=0
Frame=22 Station=0,05 OutputCase=FRE36 CaseType=Combination P=-69,5342581306123 V2=26,5010799140894 V3=0 T=0 M2=0 M3=13,7787363488529	FrameElem=22-1 ElemStation=0,05

APPROVATO S.D.P.

Società di Progetto
Brebemi SpA

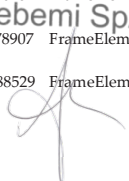



Doc. N.
60235-0000-A00.doc

CODIFICA DOCUMENTO
04RCDII10000000000300A00

REV.
00

FOGLIO
341 di 628

Frame=22 Station=0,1 OutputCase=FRE36 CaseType=Combination P=-69,3342581306123 V2=24,9717361640894 V3=0 T=0 M2=0 M3=12,4918833948151	FrameElem=22-1 ElemStation=0,1
Frame=22 Station=0 OutputCase=FRE37 CaseType=Combination P=-76,9821656650286 V2=18,8243289214532 V3=0 T=0 M2=0 M3=8,81515150656639	FrameElem=22-1 ElemStation=0
Frame=22 Station=0,05 OutputCase=FRE37 CaseType=Combination P=-76,7821656650286 V2=17,3027976714532 V3=0 T=0 M2=0 M3=7,91194078966039	FrameElem=22-1 ElemStation=0,05
Frame=22 Station=0,1 OutputCase=FRE37 CaseType=Combination P=-76,5821656650286 V2=15,7734539214532 V3=0 T=0 M2=0 M3=7,0850019477544	FrameElem=22-1 ElemStation=0,1
Frame=22 Station=0 OutputCase=FRE38 CaseType=Combination P=-9,97425813297498 V2=28,7427184395566 V3=0 T=0 M2=0 M3=7,74518096694877	FrameElem=22-1 ElemStation=0
Frame=22 Station=0,05 OutputCase=FRE38 CaseType=Combination P=-9,77425813297498 V2=27,2211871895566 V3=0 T=0 M2=0 M3=6,34605077413761	FrameElem=22-1 ElemStation=0,05
Frame=22 Station=0,1 OutputCase=FRE38 CaseType=Combination P=-9,57425813297498 V2=25,6918434395566 V3=0 T=0 M2=0 M3=5,02319245632644	FrameElem=22-1 ElemStation=0,1
Frame=22 Station=0 OutputCase=FRE39 CaseType=Combination P=-17,2221656673913 V2=19,5444361969204 V3=0 T=0 M2=0 M3=1,41847129562442	FrameElem=22-1 ElemStation=0
Frame=22 Station=0,05 OutputCase=FRE39 CaseType=Combination P=-17,0221656673913 V2=18,0229049469204 V3=0 T=0 M2=0 M3=0,479255214945065	FrameElem=22-1 ElemStation=0,05
Frame=22 Station=0,1 OutputCase=FRE39 CaseType=Combination P=-16,8221656673913 V2=16,4935611969204 V3=0 T=0 M2=0 M3=-0,383688990734288	FrameElem=22-1 ElemStation=0,1
Frame=22 Station=0 OutputCase=FRE40 CaseType=Combination P=-17,1585988014555 V2=4,87207662575927 V3=0 T=0 M2=0 M3=1,47780925674027	FrameElem=22-1 ElemStation=0
Frame=22 Station=0,05 OutputCase=FRE40 CaseType=Combination P=-16,9585988014555 V2=4,38707662575927 V3=0 T=0 M2=0 M3=1,24638042545231	FrameElem=22-1 ElemStation=0,05
Frame=22 Station=0,1 OutputCase=FRE40 CaseType=Combination P=-16,7585988014555 V2=3,91407662575927 V3=0 T=0 M2=0 M3=1,03890159416434	FrameElem=22-1 ElemStation=0,1
Frame=22 Station=0 OutputCase=FRE41 CaseType=Combination P=-17,1585988014561 V2=5,63829513067584 V3=0 T=0 M2=0 M3=1,97605428649225	FrameElem=22-1 ElemStation=0
Frame=22 Station=0,05 OutputCase=FRE41 CaseType=Combination P=-16,9585988014561 V2=5,15329513067584 V3=0 T=0 M2=0 M3=1,70631452995845	FrameElem=22-1 ElemStation=0,05
Frame=22 Station=0,1 OutputCase=FRE41 CaseType=Combination P=-16,7585988014561 V2=4,68029513067584 V3=0 T=0 M2=0 M3=1,46052477342466	FrameElem=22-1 ElemStation=0,1
Frame=22 Station=0 OutputCase=FRE42 CaseType=Combination P=-17,1585988014561 V2=5,63829513067584 V3=0 T=0 M2=0 M3=1,97605428649225	FrameElem=22-1 ElemStation=0
Frame=22 Station=0,05 OutputCase=FRE42 CaseType=Combination P=-16,9585988014561 V2=5,15329513067584 V3=0 T=0 M2=0 M3=1,70631452995845	FrameElem=22-1 ElemStation=0,05
Frame=22 Station=0,1 OutputCase=FRE42 CaseType=Combination P=-16,7585988014561 V2=4,68029513067584 V3=0 T=0 M2=0 M3=1,46052477342466	FrameElem=22-1 ElemStation=0,1
Frame=22 Station=0 OutputCase=FRE43 CaseType=Combination P=-17,5399999991645 V2=5,90564448842491 V3=0 T=0 M2=0 M3=2,35996083434125	FrameElem=22-1 ElemStation=0
Frame=22 Station=0,05 OutputCase=FRE43 CaseType=Combination P=-17,3399999991645 V2=5,42064448842491 V3=0 T=0 M2=0 M3=2,07685360992	FrameElem=22-1 ElemStation=0,05
Frame=22 Station=0,1 OutputCase=FRE43 CaseType=Combination P=-17,1399999991645 V2=4,94764448842491 V3=0 T=0 M2=0 M3=1,81769638549875	FrameElem=22-1 ElemStation=0,1
Frame=22 Station=0 OutputCase=FRE44 CaseType=Combination P=-77,2999999968018 V2=5,10891536246606 V3=0 T=0 M2=0 M3=9,70681654230802	FrameElem=22-1 ElemStation=0
Frame=22 Station=0,05 OutputCase=FRE44 CaseType=Combination P=-77,0999999968018 V2=4,62391536246606 V3=0 T=0 M2=0 M3=9,46354577418471	FrameElem=22-1 ElemStation=0,05
Frame=22 Station=0,1 OutputCase=FRE44 CaseType=Combination P=-76,8999999968018 V2=4,15091536246606 V3=0 T=0 M2=0 M3=9,24422500606141	FrameElem=22-1 ElemStation=0,1
Frame=22 Station=0 OutputCase=FRE45 CaseType=Combination P=-70,0520924620362 V2=28,5646600059289 V3=0 T=0 M2=0 M3=15,6693853968282	FrameElem=22-1 ElemStation=0
Frame=22 Station=0,05 OutputCase=FRE45 CaseType=Combination P=-69,8520924620362 V2=27,0431287559289 V3=0 T=0 M2=0 M3=14,2791581256985	FrameElem=22-1 ElemStation=0,05
Frame=22 Station=0,1 OutputCase=FRE45 CaseType=Combination P=-69,6520924620362 V2=25,5137850059289 V3=0 T=0 M2=0 M3=12,9652027295687	FrameElem=22-1 ElemStation=0,1
Frame=22 Station=0 OutputCase=FRE46 CaseType=Combination P=-77,2999999964525 V2=19,3663777632927 V3=0 T=0 M2=0 M3=9,34267572550388	FrameElem=22-1 ElemStation=0
Frame=22 Station=0,05 OutputCase=FRE46 CaseType=Combination P=-77,0999999964525 V2=17,8448465132927 V3=0 T=0 M2=0 M3=8,41236256650591	FrameElem=22-1 ElemStation=0,05
Frame=22 Station=0,1 OutputCase=FRE46 CaseType=Combination P=-76,8999999964525 V2=16,3155027632927 V3=0 T=0 M2=0 M3=7,55832128250794	FrameElem=22-1 ElemStation=0,1
Frame=22 Station=0 OutputCase=FRE47 CaseType=Combination P=-10,2920924643989 V2=29,2847672813961 V3=0 T=0 M2=0 M3=8,27270518588626	FrameElem=22-1 ElemStation=0
Frame=22 Station=0,05 OutputCase=FRE47 CaseType=Combination P=-10,0920924643989 V2=27,7632360313961 V3=0 T=0 M2=0 M3=6,84647255098312	FrameElem=22-1 ElemStation=0,05
Frame=22 Station=0,1 OutputCase=FRE47 CaseType=Combination P=-9,89209246439888 V2=26,2338922813961 V3=0 T=0 M2=0 M3=5,49651179107999	FrameElem=22-1 ElemStation=0,1
Frame=22 Station=0 OutputCase=FRE48 CaseType=Combination P=-17,5399999988152 V2=20,0864850387599 V3=0 T=0 M2=0 M3=1,94599551456191	FrameElem=22-1 ElemStation=0
Frame=22 Station=0,05 OutputCase=FRE48 CaseType=Combination P=-17,3399999988152 V2=18,5649537887599 V3=0 T=0 M2=0 M3=0,979676991790581	FrameElem=22-1 ElemStation=0,05
Frame=22 Station=0,1 OutputCase=FRE48 CaseType=Combination P=-17,1399999988152 V2=17,0356100387599 V3=0 T=0 M2=0 M3=8,96303440192547E-02	FrameElem=22-1 ElemStation=0,1
Frame=22 Station=0 OutputCase=FRE49 CaseType=Combination P=-17,5399999991648 V2=6,28875374088319 V3=0 T=0 M2=0 M3=2,60908334921723	FrameElem=22-1 ElemStation=0
Frame=22 Station=0,05 OutputCase=FRE49 CaseType=Combination P=-17,3399999991648 V2=5,80375374088319 V3=0 T=0 M2=0 M3=2,30682066217307	FrameElem=22-1 ElemStation=0,05
Frame=22 Station=0,1 OutputCase=FRE49 CaseType=Combination P=-17,1399999991648 V2=5,33075374088319 V3=0 T=0 M2=0 M3=2,02850797512891	FrameElem=22-1 ElemStation=0,1
Frame=22 Station=0 OutputCase=FRE50 CaseType=Combination P=-17,8578343305881 V2=6,06458407780608 V3=0 T=0 M2=0 M3=2,63836253840275	FrameElem=22-1 ElemStation=0
Frame=22 Station=0,05 OutputCase=FRE50 CaseType=Combination P=-17,6578343305881 V2=5,57958407780608 V3=0 T=0 M2=0 M3=2,34730833451244	FrameElem=22-1 ElemStation=0,05
Frame=22 Station=0,1 OutputCase=FRE50 CaseType=Combination P=-17,4578343305881 V2=5,10658407780608 V3=0 T=0 M2=0 M3=2,08020413062214	FrameElem=22-1 ElemStation=0,1
Frame=22 Station=0 OutputCase=FRE51 CaseType=Combination P=-17,2221656677409 V2=5,74670489904373 V3=0 T=0 M2=0 M3=2,08155913027974	FrameElem=22-1 ElemStation=0

Società di Progetto
Brebemi SpA



Doc. N.
60235-00000-A00.doc

CODIFICA DOCUMENTO
04RCDII10000000000300A00

REV.
00

FOGLIO
342 di 628

Frame=22 Station=0,05 OutputCase=FRE51 CaseType=Combination P=-17,0221656677409 V2=5,26170489904373 V3=0 T=0 M2=0 M3=1,80639888532756 FrameElem=22-1 ElemStation=0,05

Frame=22 Station=0,1 OutputCase=FRE51 CaseType=Combination P=-16,8221656677409 V2=4,78870489904373 V3=0 T=0 M2=0 M3=1,55518864037537 FrameElem=22-1 ElemStation=0,1

Frame=22 Station=0 OutputCase=INVFRE CaseType=Combination StepType=Max P=-9,97425813297498 V2=29,2847672813961 V3=0 T=0 M2=0 M3=15,6986645860137 FrameElem=22-1 ElemStation=0

Frame=22 Station=0,05 OutputCase=INVFRE CaseType=Combination StepType=Max P=-9,77425813297498 V2=27,7632360313961 V3=0 T=0 M2=0 M3=14,3196457980378 FrameElem=22-1 ElemStation=0,05

Frame=22 Station=0,1 OutputCase=INVFRE CaseType=Combination StepType=Max P=-9,57425813297498 V2=26,2338922813961 V3=0 T=0 M2=0 M3=13,0168988850619 FrameElem=22-1 ElemStation=0,1

Frame=22 Station=0 OutputCase=INVFRE CaseType=Combination StepType=Min P=-77,6178343282251 V2=4,34269685754949 V3=0 T=0 M2=0 M3=1,41847129562442 FrameElem=22-1 ElemStation=0

Frame=22 Station=0,05 OutputCase=INVFRE CaseType=Combination StepType=Min P=-77,4178343282251 V2=3,85769685754949 V3=0 T=0 M2=0 M3=0,479255214945065 FrameElem=22-1 ElemStation=0,05

Frame=22 Station=0,1 OutputCase=INVFRE CaseType=Combination StepType=Min P=-77,2178343282251 V2=3,38469685754949 V3=0 T=0 M2=0 M3=0,383688990734288 FrameElem=22-1 ElemStation=0,1

Frame=22 Station=0 OutputCase=QPE01 CaseType=Combination P=-18,5081978661474 V2=4,12907660565423 V3=0 T=0 M2=0 M3=1,13234167372667 FrameElem=22-1 ElemStation=0

Frame=22 Station=0,05 OutputCase=QPE01 CaseType=Combination P=-18,3081978661474 V2=3,64407660565423 V3=0 T=0 M2=0 M3=0,938062843443959 FrameElem=22-1 ElemStation=0,05

Frame=22 Station=0,1 OutputCase=QPE01 CaseType=Combination P=-18,1081978661474 V2=3,17107660565423 V3=0 T=0 M2=0 M3=0,767734013161247 FrameElem=22-1 ElemStation=0,1

Frame=22 Station=0 OutputCase=QPE02 CaseType=Combination P=-18,5081978661471 V2=3,74596735319595 V3=0 T=0 M2=0 M3=0,883219158850684 FrameElem=22-1 ElemStation=0

Frame=22 Station=0,05 OutputCase=QPE02 CaseType=Combination P=-18,3081978661471 V2=3,26096735319595 V3=0 T=0 M2=0 M3=0,708095791190886 FrameElem=22-1 ElemStation=0,05

Frame=22 Station=0,1 OutputCase=QPE02 CaseType=Combination P=-18,1081978661471 V2=2,78796735319595 V3=0 T=0 M2=0 M3=0,556922423531088 FrameElem=22-1 ElemStation=0,1

Frame=22 Station=0 OutputCase=QPE03 CaseType=Combination P=-18,5081978661477 V2=4,51218585811252 V3=0 T=0 M2=0 M3=1,38146418860266 FrameElem=22-1 ElemStation=0

Frame=22 Station=0,05 OutputCase=QPE03 CaseType=Combination P=-18,3081978661477 V2=4,02718585811252 V3=0 T=0 M2=0 M3=1,16802989569703 FrameElem=22-1 ElemStation=0,05

Frame=22 Station=0,1 OutputCase=QPE03 CaseType=Combination P=-18,1081978661477 V2=3,55418585811252 V3=0 T=0 M2=0 M3=0,978545602791406 FrameElem=22-1 ElemStation=0,1

Frame=22 Station=0 OutputCase=QPE04 CaseType=Combination P=-18,826032197571 V2=4,28801619503541 V3=0 T=0 M2=0 M3=1,4107433778817 FrameElem=22-1 ElemStation=0

Frame=22 Station=0,05 OutputCase=QPE04 CaseType=Combination P=-18,626032197571 V2=3,80301619503541 V3=0 T=0 M2=0 M3=1,2085175680364 FrameElem=22-1 ElemStation=0,05

Frame=22 Station=0,1 OutputCase=QPE04 CaseType=Combination P=-18,426032197571 V2=3,33001619503541 V3=0 T=0 M2=0 M3=1,03024175828463 FrameElem=22-1 ElemStation=0,1

Frame=22 Station=0 OutputCase=QPE05 CaseType=Combination P=-18,1903635347238 V2=3,97013701627306 V3=0 T=0 M2=0 M3=0,853939969665169 FrameElem=22-1 ElemStation=0

Frame=22 Station=0,05 OutputCase=QPE05 CaseType=Combination P=-17,9903635347238 V2=3,48513701627306 V3=0 T=0 M2=0 M3=0,667608118851516 FrameElem=22-1 ElemStation=0,05

Frame=22 Station=0,1 OutputCase=QPE05 CaseType=Combination P=-17,7903635347238 V2=3,01213701627306 V3=0 T=0 M2=0 M3=0,505226268037863 FrameElem=22-1 ElemStation=0,1

Frame=22 Station=0 OutputCase=QPE06 CaseType=Combination P=-18,5081978661477 V2=4,51218585811252 V3=0 T=0 M2=0 M3=1,38146418860266 FrameElem=22-1 ElemStation=0

Frame=22 Station=0,05 OutputCase=QPE06 CaseType=Combination P=-18,3081978661477 V2=4,02718585811252 V3=0 T=0 M2=0 M3=1,16802989569703 FrameElem=22-1 ElemStation=0,05

Frame=22 Station=0,1 OutputCase=QPE06 CaseType=Combination P=-18,1081978661477 V2=3,55418585811252 V3=0 T=0 M2=0 M3=0,978545602791406 FrameElem=22-1 ElemStation=0,1

Frame=22 Station=0 OutputCase=QPE07 CaseType=Combination P=-18,8260321975707 V2=3,90490694257713 V3=0 T=0 M2=0 M3=1,16162086291219 FrameElem=22-1 ElemStation=0

Frame=22 Station=0,05 OutputCase=QPE07 CaseType=Combination P=-18,6260321975707 V2=3,41990694257713 V3=0 T=0 M2=0 M3=0,978550515783329 FrameElem=22-1 ElemStation=0,05

Frame=22 Station=0,1 OutputCase=QPE07 CaseType=Combination P=-18,4260321975707 V2=2,94690694257713 V3=0 T=0 M2=0 M3=0,819430168654473 FrameElem=22-1 ElemStation=0,1

Frame=22 Station=0 OutputCase=QPE08 CaseType=Combination P=-18,1903635347235 V2=3,58702776381477 V3=0 T=0 M2=0 M3=0,604817454789182 FrameElem=22-1 ElemStation=0

Frame=22 Station=0,05 OutputCase=QPE08 CaseType=Combination P=-17,9903635347235 V2=3,10202776381477 V3=0 T=0 M2=0 M3=0,437641066598443 FrameElem=22-1 ElemStation=0,05

Frame=22 Station=0,1 OutputCase=QPE08 CaseType=Combination P=-17,7903635347235 V2=2,62902776381477 V3=0 T=0 M2=0 M3=0,294414678407704 FrameElem=22-1 ElemStation=0,1

Frame=22 Station=0 OutputCase=QPE09 CaseType=Combination P=-18,5081978661474 V2=4,12907660565423 V3=0 T=0 M2=0 M3=1,13234167372667 FrameElem=22-1 ElemStation=0

Frame=22 Station=0,05 OutputCase=QPE09 CaseType=Combination P=-18,3081978661474 V2=3,64407660565423 V3=0 T=0 M2=0 M3=0,938062843443959 FrameElem=22-1 ElemStation=0,05

Frame=22 Station=0,1 OutputCase=QPE09 CaseType=Combination P=-18,1081978661474 V2=3,17107660565423 V3=0 T=0 M2=0 M3=0,767734013161247 FrameElem=22-1 ElemStation=0,1

Frame=22 Station=0 OutputCase=QPE10 CaseType=Combination P=-16,5718021321809 V2=9,66598310704893 V3=0 T=0 M2=0 M3=2,5460487786423 FrameElem=22-1 ElemStation=0

Frame=22 Station=0,05 OutputCase=QPE10 CaseType=Combination P=-16,3718021321809 V2=8,89248310704893 V3=0 T=0 M2=0 M3=2,39072238917845 FrameElem=22-1 ElemStation=0,05

Frame=22 Station=0,1 OutputCase=QPE10 CaseType=Combination P=-16,1718021321809 V2=8,13798310704893 V3=0 T=0 M2=0 M3=1,96503990049267 FrameElem=22-1 ElemStation=0,1

Frame=22 Station=0 OutputCase=QPE11 CaseType=Combination P=-16,5718021321806 V2=9,28287385459065 V3=0 T=0 M2=0 M3=2,60548236298825 FrameElem=22-1 ElemStation=0

Frame=22 Station=0,05 OutputCase=QPE11 CaseType=Combination P=-16,3718021321806 V2=8,50937385459065 V3=0 T=0 M2=0 M3=2,16075533692538 FrameElem=22-1 ElemStation=0,05

Frame=22 Station=0,1 OutputCase=QPE11 CaseType=Combination P=-16,1718021321806 V2=7,75487385459065 V3=0 T=0 M2=0 M3=1,75422831086251 FrameElem=22-1 ElemStation=0,1

Frame=22 Station=0 OutputCase=QPE12 CaseType=Combination P=-16,5718021321812 V2=10,0490923595072 V3=0 T=0 M2=0 M3=3,10372739274022 FrameElem=22-1 ElemStation=0

Frame=22 Station=0,05 OutputCase=QPE12 CaseType=Combination P=-16,3718021321812 V2=9,27559235950721 V3=0 T=0 M2=0 M3=2,62068944143153 FrameElem=22-1 ElemStation=0,05

Frame=22 Station=0,1 OutputCase=QPE12 CaseType=Combination P=-16,1718021321812 V2=8,52109235950721 V3=0 T=0 M2=0 M3=2,17585149012283 FrameElem=22-1 ElemStation=0,1

APPROVATO S.D.P.
Società di Progetto
Brebemi SpA



Doc. N.
60235-00000-A00.doc

CODIFICA DOCUMENTO
04RCDII10000000000300A00

REV.
00

FOGLIO
343 di 628

Frame=22 Station=0 OutputCase=QPE13 CaseType=Combination P=-16,8896364636045 V2=9,82492269643011 V3=0 T=0 M2=0 M3=3,13300658192574 FrameElem=22-1 ElemStation=0
Frame=22 Station=0,05 OutputCase=QPE13 CaseType=Combination P=-16,6896364636045 V2=9,05142269643011 V3=0 T=0 M2=0 M3=2,6611771137709 FrameElem=22-1 ElemStation=0,05
Frame=22 Station=0,1 OutputCase=QPE13 CaseType=Combination P=-16,4896364636045 V2=8,29692269643011 V3=0 T=0 M2=0 M3=2,22754764561606 FrameElem=22-1 ElemStation=0,1
Frame=22 Station=0 OutputCase=QPE14 CaseType=Combination P=-16,2539678007573 V2=9,50704351766775 V3=0 T=0 M2=0 M3=2,57620317380273 FrameElem=22-1 ElemStation=0
Frame=22 Station=0,05 OutputCase=QPE14 CaseType=Combination P=-16,0539678007573 V2=8,73354351766775 V3=0 T=0 M2=0 M3=2,12026766458601 FrameElem=22-1 ElemStation=0,05
Frame=22 Station=0,1 OutputCase=QPE14 CaseType=Combination P=-15,8539678007573 V2=7,97904351766775 V3=0 T=0 M2=0 M3=1,70253215536929 FrameElem=22-1 ElemStation=0,1
Frame=22 Station=0 OutputCase=QPE15 CaseType=Combination P=-16,5718021321812 V2=10,0490923595072 V3=0 T=0 M2=0 M3=3,10372739274022 FrameElem=22-1 ElemStation=0
Frame=22 Station=0,05 OutputCase=QPE15 CaseType=Combination P=-16,3718021321812 V2=9,27559235950721 V3=0 T=0 M2=0 M3=2,62068944143153 FrameElem=22-1 ElemStation=0,05
Frame=22 Station=0,1 OutputCase=QPE15 CaseType=Combination P=-16,1718021321812 V2=8,52109235950721 V3=0 T=0 M2=0 M3=2,17585149012283 FrameElem=22-1 ElemStation=0,1
Frame=22 Station=0 OutputCase=QPE16 CaseType=Combination P=-16,8896364636042 V2=9,44181344397182 V3=0 T=0 M2=0 M3=2,88388406704975 FrameElem=22-1 ElemStation=0
Frame=22 Station=0,05 OutputCase=QPE16 CaseType=Combination P=-16,6896364636042 V2=8,66831344397182 V3=0 T=0 M2=0 M3=2,43121006151782 FrameElem=22-1 ElemStation=0,05
Frame=22 Station=0,1 OutputCase=QPE16 CaseType=Combination P=-16,4896364636042 V2=7,91381344397182 V3=0 T=0 M2=0 M3=2,0167360559859 FrameElem=22-1 ElemStation=0,1
Frame=22 Station=0 OutputCase=QPE17 CaseType=Combination P=-16,253967800757 V2=9,12393426520947 V3=0 T=0 M2=0 M3=2,32708065892674 FrameElem=22-1 ElemStation=0
Frame=22 Station=0,05 OutputCase=QPE17 CaseType=Combination P=-16,053967800757 V2=8,35043426520947 V3=0 T=0 M2=0 M3=1,89030061233294 FrameElem=22-1 ElemStation=0,05
Frame=22 Station=0,1 OutputCase=QPE17 CaseType=Combination P=-15,853967800757 V2=7,59593426520947 V3=0 T=0 M2=0 M3=1,49172056573913 FrameElem=22-1 ElemStation=0,1
Frame=22 Station=0 OutputCase=QPE18 CaseType=Combination P=-16,5718021321809 V2=9,66598310704893 V3=0 T=0 M2=0 M3=2,85460487786423 FrameElem=22-1 ElemStation=0
Frame=22 Station=0,05 OutputCase=QPE18 CaseType=Combination P=-16,3718021321809 V2=8,89248310704893 V3=0 T=0 M2=0 M3=2,39072238917845 FrameElem=22-1 ElemStation=0,05
Frame=22 Station=0,1 OutputCase=QPE18 CaseType=Combination P=-16,1718021321809 V2=8,13798310704893 V3=0 T=0 M2=0 M3=1,96503990049267 FrameElem=22-1 ElemStation=0,1
Frame=22 Station=0 OutputCase=INVQPE CaseType=Combination StepType=Max P=-16,253967800757 V2=10,0490923595072 V3=0 T=0 M2=0 M3=3,13300658192574 FrameElem=22-1 ElemStation=0
Frame=22 Station=0,05 OutputCase=INVQPE CaseType=Combination StepType=Max P=-16,053967800757 V2=9,27559235950721 V3=0 T=0 M2=0 M3=2,6611771137709 FrameElem=22-1 ElemStation=0,05
Frame=22 Station=0,1 OutputCase=INVQPE CaseType=Combination StepType=Max P=-15,853967800757 V2=8,52109235950721 V3=0 T=0 M2=0 M3=2,22754764561606 FrameElem=22-1 ElemStation=0,1
Frame=22 Station=0 OutputCase=INVQPE CaseType=Combination StepType=Min P=-18,826032197571 V2=3,58702776381477 V3=0 T=0 M2=0 M3=0,604817454789182 FrameElem=22-1 ElemStation=0
Frame=22 Station=0,05 OutputCase=INVQPE CaseType=Combination StepType=Min P=-18,626032197571 V2=3,10202776381477 V3=0 T=0 M2=0 M3=0,437641066598443 FrameElem=22-1 ElemStation=0,05
Frame=22 Station=0,1 OutputCase=INVQPE CaseType=Combination StepType=Min P=-18,426032197571 V2=2,62902776381477 V3=0 T=0 M2=0 M3=0,294414678407704 FrameElem=22-1 ElemStation=0,1
Frame=24 Station=0 OutputCase=STR001 CaseType=Combination P=-24,6509999985981 V2=15,2430475421174 V3=0 T=0 M2=0 M3=4,98131154985269 FrameElem=24-1 ElemStation=0
Frame=24 Station=0,04 OutputCase=STR001 CaseType=Combination P=-24,4349999985981 V2=14,3316625421174 V3=0 T=0 M2=0 M3=4,389872248168 FrameElem=24-1 ElemStation=0,04
Frame=24 Station=0,08 OutputCase=STR001 CaseType=Combination P=-24,2189999985981 V2=13,4367475421174 V3=0 T=0 M2=0 M3=3,8345589464833 FrameElem=24-1 ElemStation=0,08
Frame=24 Station=0 OutputCase=STR002 CaseType=Combination P=-24,6509999986563 V2=7,48729440081335 V3=0 T=0 M2=0 M3=4,04115867687899 FrameElem=24-1 ElemStation=0
Frame=24 Station=0,04 OutputCase=STR002 CaseType=Combination P=-24,4349999986563 V2=7,06399440081335 V3=0 T=0 M2=0 M3=3,75015890084645 FrameElem=24-1 ElemStation=0,04
Frame=24 Station=0,08 OutputCase=STR002 CaseType=Combination P=-24,2189999986563 V2=6,64849440081335 V3=0 T=0 M2=0 M3=3,47593512481392 FrameElem=24-1 ElemStation=0,08
Frame=24 Station=0 OutputCase=STR003 CaseType=Combination P=-132,21899999181 V2=6,19110130493059 V3=0 T=0 M2=0 M3=17,1218682993154 FrameElem=24-1 ElemStation=0
Frame=24 Station=0,04 OutputCase=STR003 CaseType=Combination P=-132,00299999181 V2=5,76780130493058 V3=0 T=0 M2=0 M3=16,8827162471182 FrameElem=24-1 ElemStation=0,04
Frame=24 Station=0,08 OutputCase=STR003 CaseType=Combination P=-131,78699999181 V2=5,35230130493058 V3=0 T=0 M2=0 M3=16,6603401949209 FrameElem=24-1 ElemStation=0,08
Frame=24 Station=0 OutputCase=STR004 CaseType=Combination P=-119,037218411308 V2=55,5297458656365 V3=0 T=0 M2=0 M3=36,2673835438903 FrameElem=24-1 ElemStation=0
Frame=24 Station=0,04 OutputCase=STR004 CaseType=Combination P=-118,821218411308 V2=53,7087308656365 V3=0 T=0 M2=0 M3=34,0825231092649 FrameElem=24-1 ElemStation=0,04
Frame=24 Station=0,08 OutputCase=STR004 CaseType=Combination P=-118,605218411308 V2=51,8604458656365 V3=0 T=0 M2=0 M3=31,9710486746394 FrameElem=24-1 ElemStation=0,08
Frame=24 Station=0 OutputCase=STR005 CaseType=Combination P=-132,218999991752 V2=38,7888424715609 V3=0 T=0 M2=0 M3=21,7362703938104 FrameElem=24-1 ElemStation=0
Frame=24 Station=0,04 OutputCase=STR005 CaseType=Combination P=-132,002999991752 V2=36,9678274715609 V3=0 T=0 M2=0 M3=20,221046094948 FrameElem=24-1 ElemStation=0,04
Frame=24 Station=0,08 OutputCase=STR005 CaseType=Combination P=-131,786999991752 V2=35,1195424715609 V3=0 T=0 M2=0 M3=18,7792077960855 FrameElem=24-1 ElemStation=0,08
Frame=24 Station=0 OutputCase=STR006 CaseType=Combination P=-5,07821841851692 V2=56,6288579462885 V3=0 T=0 M2=0 M3=22,3504608037798 FrameElem=24-1 ElemStation=0
Frame=24 Station=0,04 OutputCase=STR006 CaseType=Combination P=-4,91821841851691 V2=54,8078429462885 V3=0 T=0 M2=0 M3=20,1216358859282 FrameElem=24-1 ElemStation=0,04
Frame=24 Station=0,08 OutputCase=STR006 CaseType=Combination P=-4,75821841851692 V2=52,9595579462885 V3=0 T=0 M2=0 M3=17,9661969680767 FrameElem=24-1 ElemStation=0,08
Frame=24 Station=0 OutputCase=STR007 CaseType=Combination P=-18,2599999989616 V2=39,8879545522129 V3=0 T=0 M2=0 M3=7,81934765369984 FrameElem=24-1 ElemStation=0
Frame=24 Station=0,04 OutputCase=STR007 CaseType=Combination P=-18,0999999989616 V2=38,0669395522129 V3=0 T=0 M2=0 M3=6,26015887161133 FrameElem=24-1 ElemStation=0,04

Società di Progetto
Brebemi SpA

	Doc. N. 60235-0000-A00.doc	CODIFICA DOCUMENTO 04RCDII10000000000300A00	REV. 00	FOGLIO 344 di 628
--	-------------------------------	--	------------	----------------------

Frame=24 Station=0,08 OutputCase=STR007 CaseType=Combination P=-17,9399999989616 V2=36,2186545522129 V3=0 T=0 M2=0 M3=4,77435608952281	FrameElem=24-1 ElemStation=0,08
Frame=24 Station=0 OutputCase=STR008 CaseType=Combination P=-75,60117149795158 V2=64,8089966825976 V3=0 T=0 M2=0 M3=43,9966032578699	FrameElem=24-1 ElemStation=0
Frame=24 Station=0,04 OutputCase=STR008 CaseType=Combination P=-75,3851749795158 V2=63,2153891825976 V3=0 T=0 M2=0 M3=41,436061090566	FrameElem=24-1 ElemStation=0,04
Frame=24 Station=0,08 OutputCase=STR008 CaseType=Combination P=-75,1691749795158 V2=61,6054466825976 V3=0 T=0 M2=0 M3=38,9395899232621	FrameElem=24-1 ElemStation=0,08
Frame=24 Station=0 OutputCase=STR009 CaseType=Combination P=-24,6509999985974 V2=14,3235853362175 V3=0 T=0 M2=0 M3=4,21791431708835	FrameElem=24-1 ElemStation=0
Frame=24 Station=0,04 OutputCase=STR009 CaseType=Combination P=-24,4349999985974 V2=13,4122003362175 V3=0 T=0 M2=0 M3=3,66325350363965	FrameElem=24-1 ElemStation=0,04
Frame=24 Station=0,08 OutputCase=STR009 CaseType=Combination P=-24,2189999985974 V2=12,5172853362175 V3=0 T=0 M2=0 M3=3,14471869019095	FrameElem=24-1 ElemStation=0,08
Frame=24 Station=0 OutputCase=STR010 CaseType=Combination P=-24,6509999986557 V2=14,3235853362175 V3=0 T=0 M2=0 M3=3,27776144411464	FrameElem=24-1 ElemStation=0
Frame=24 Station=0,04 OutputCase=STR010 CaseType=Combination P=-24,4349999986557 V2=13,4122003362175 V3=0 T=0 M2=0 M3=3,0235401563181	FrameElem=24-1 ElemStation=0,04
Frame=24 Station=0,08 OutputCase=STR010 CaseType=Combination P=-24,2189999986557 V2=12,5172853362175 V3=0 T=0 M2=0 M3=2,78609486852156	FrameElem=24-1 ElemStation=0,08
Frame=24 Station=0 OutputCase=STR011 CaseType=Combination P=-132,21899999181 V2=5,63942398139065 V3=0 T=0 M2=0 M3=16,6638299596568	FrameElem=24-1 ElemStation=0
Frame=24 Station=0,04 OutputCase=STR011 CaseType=Combination P=-132,00299999181 V2=5,21612398139065 V3=0 T=0 M2=0 M3=16,4467450004012	FrameElem=24-1 ElemStation=0,04
Frame=24 Station=0,08 OutputCase=STR011 CaseType=Combination P=-131,78699999181 V2=4,80062398139065 V3=0 T=0 M2=0 M3=16,2464360411455	FrameElem=24-1 ElemStation=0,08
Frame=24 Station=0 OutputCase=STR012 CaseType=Combination P=-119,037218411307 V2=54,9780685420965 V3=0 T=0 M2=0 M3=35,8093452042317	FrameElem=24-1 ElemStation=0
Frame=24 Station=0,04 OutputCase=STR012 CaseType=Combination P=-118,821218411307 V2=53,1570535420965 V3=0 T=0 M2=0 M3=33,6465518625478	FrameElem=24-1 ElemStation=0,04
Frame=24 Station=0,08 OutputCase=STR012 CaseType=Combination P=-118,605218411307 V2=51,3087685420965 V3=0 T=0 M2=0 M3=31,557144520864	FrameElem=24-1 ElemStation=0,08
Frame=24 Station=0 OutputCase=STR013 CaseType=Combination P=-132,218999991752 V2=38,2371651480209 V3=0 T=0 M2=0 M3=21,2782320541518	FrameElem=24-1 ElemStation=0
Frame=24 Station=0,04 OutputCase=STR013 CaseType=Combination P=-132,002999991752 V2=36,4161501480209 V3=0 T=0 M2=0 M3=19,785074848231	FrameElem=24-1 ElemStation=0,04
Frame=24 Station=0,08 OutputCase=STR013 CaseType=Combination P=-131,786999991752 V2=34,5678651480209 V3=0 T=0 M2=0 M3=18,3653036423101	FrameElem=24-1 ElemStation=0,08
Frame=24 Station=0 OutputCase=STR014 CaseType=Combination P=-5,07821841851651 V2=56,0771806227485 V3=0 T=0 M2=0 M3=21,8924224641211	FrameElem=24-1 ElemStation=0
Frame=24 Station=0,04 OutputCase=STR014 CaseType=Combination P=-4,91821841851651 V2=54,2561656227485 V3=0 T=0 M2=0 M3=19,6856646392112	FrameElem=24-1 ElemStation=0,04
Frame=24 Station=0,08 OutputCase=STR014 CaseType=Combination P=-4,75821841851651 V2=52,4078806227485 V3=0 T=0 M2=0 M3=17,5522928143013	FrameElem=24-1 ElemStation=0,08
Frame=24 Station=0 OutputCase=STR015 CaseType=Combination P=-18,2599999989612 V2=39,336277228673 V3=0 T=0 M2=0 M3=7,36130931404124	FrameElem=24-1 ElemStation=0
Frame=24 Station=0,04 OutputCase=STR015 CaseType=Combination P=-18,0999999989612 V2=37,515262228673 V3=0 T=0 M2=0 M3=5,82418762489432	FrameElem=24-1 ElemStation=0,04
Frame=24 Station=0,08 OutputCase=STR015 CaseType=Combination P=-17,9399999989612 V2=35,666977228673 V3=0 T=0 M2=0 M3=4,36045193574739	FrameElem=24-1 ElemStation=0,08
Frame=24 Station=0 OutputCase=STR016 CaseType=Combination P=-75,6011749795154 V2=64,2573193590577 V3=0 T=0 M2=0 M3=43,5385649182113	FrameElem=24-1 ElemStation=0
Frame=24 Station=0,04 OutputCase=STR016 CaseType=Combination P=-75,3851749795154 V2=62,6637118590577 V3=0 T=0 M2=0 M3=41,000089843849	FrameElem=24-1 ElemStation=0,04
Frame=24 Station=0,08 OutputCase=STR016 CaseType=Combination P=-75,1691749795154 V2=61,0537693590577 V3=0 T=0 M2=0 M3=38,5256857694867	FrameElem=24-1 ElemStation=0,08
Frame=24 Station=0 OutputCase=STR017 CaseType=Combination P=-105,326999993521 V2=5,59568737300138 V3=0 T=0 M2=0 M3=13,0882936609419	FrameElem=24-1 ElemStation=0
Frame=24 Station=0,04 OutputCase=STR017 CaseType=Combination P=-105,110999993521 V2=5,17238737300138 V3=0 T=0 M2=0 M3=12,8729581660219	FrameElem=24-1 ElemStation=0,04
Frame=24 Station=0,08 OutputCase=STR017 CaseType=Combination P=-104,894999993521 V2=4,75688737300138 V3=0 T=0 M2=0 M3=12,6743986711018	FrameElem=24-1 ElemStation=0,08
Frame=24 Station=0 OutputCase=STR018 CaseType=Combination P=-94,9710877633632 V2=45,1771844684801 V3=0 T=0 M2=0 M3=28,2477326297308	FrameElem=24-1 ElemStation=0
Frame=24 Station=0,04 OutputCase=STR018 CaseType=Combination P=-94,7550877633632 V2=43,5835769684801 V3=0 T=0 M2=0 M3=26,4724629509916	FrameElem=24-1 ElemStation=0,04
Frame=24 Station=0,08 OutputCase=STR018 CaseType=Combination P=-94,5390877633632 V2=41,9736344684801 V3=0 T=0 M2=0 M3=24,7612642722524	FrameElem=24-1 ElemStation=0,08
Frame=24 Station=0 OutputCase=STR019 CaseType=Combination P=-105,326999993463 V2=31,9829315333001 V3=0 T=0 M2=0 M3=16,7841334500566	FrameElem=24-1 ElemStation=0
Frame=24 Station=0,04 OutputCase=STR019 CaseType=Combination P=-105,110999993463 V2=30,3893240333001 V3=0 T=0 M2=0 M3=15,5366338887246	FrameElem=24-1 ElemStation=0,04
Frame=24 Station=0,08 OutputCase=STR019 CaseType=Combination P=-104,894999993463 V2=28,7793815333001 V3=0 T=0 M2=0 M3=14,3532035273926	FrameElem=24-1 ElemStation=0,08
Frame=24 Station=0 OutputCase=STR020 CaseType=Combination P=-7,90408776886111 V2=45,9522482751614 V3=0 T=0 M2=0 M3=17,6009872952294	FrameElem=24-1 ElemStation=0
Frame=24 Station=0,04 OutputCase=STR020 CaseType=Combination P=-7,74408776886111 V2=44,3586407751614 V3=0 T=0 M2=0 M3=15,7947150642229	FrameElem=24-1 ElemStation=0,04
Frame=24 Station=0,08 OutputCase=STR020 CaseType=Combination P=-7,58408776886111 V2=42,7486982751614 V3=0 T=0 M2=0 M3=14,0525138332165	FrameElem=24-1 ElemStation=0,08
Frame=24 Station=0 OutputCase=STR021 CaseType=Combination P=-18,2599999989609 V2=32,7579953399814 V3=0 T=0 M2=0 M3=6,13738811555517	FrameElem=24-1 ElemStation=0
Frame=24 Station=0,04 OutputCase=STR021 CaseType=Combination P=-18,0999999989609 V2=31,1643878399814 V3=0 T=0 M2=0 M3=4,85888600195591	FrameElem=24-1 ElemStation=0,04
Frame=24 Station=0,08 OutputCase=STR021 CaseType=Combination P=-17,9399999989609 V2=29,5544453399814 V3=0 T=0 M2=0 M3=3,64445488835665	FrameElem=24-1 ElemStation=0,08
Frame=24 Station=0 OutputCase=STR022 CaseType=Combination P=-25,1086814358475 V2=14,5524583449264 V3=0 T=0 M2=0 M3=4,66000991250451	FrameElem=24-1 ElemStation=0

Società di Progetto
Brebemi SpA



Doc. N.
60235-0000-A00.doc

CODIFICA DOCUMENTO
04RCDII10000000000300A00

REV.
00

FOGLIO
345 di 628

Frame=24 Station=0,04 OutputCase=STR022 CaseType=Combination P=-24,8926814358475 V2=13,6410733449264 V3=0 T=0 M2=0 M3=4,09619417870746	FrameElem=24-1 ElemStation=0,04
Frame=24 Station=0,08 OutputCase=STR022 CaseType=Combination P=-24,6766814358475 V2=12,7461583449264 V3=0 T=0 M2=0 M3=3,5685044449104	FrameElem=24-1 ElemStation=0,08
Frame=24 Station=0 OutputCase=STR023 CaseType=Combination P=-25,1086814359057 V2=6,79670520362235 V3=0 T=0 M2=0 M3=3,71985703953081	FrameElem=24-1 ElemStation=0
Frame=24 Station=0,04 OutputCase=STR023 CaseType=Combination P=-24,8926814359057 V2=6,37340520362235 V3=0 T=0 M2=0 M3=3,45648083138591	FrameElem=24-1 ElemStation=0,04
Frame=24 Station=0,08 OutputCase=STR023 CaseType=Combination P=-24,6766814359057 V2=5,95790520362235 V3=0 T=0 M2=0 M3=3,20988062324102	FrameElem=24-1 ElemStation=0,08
Frame=24 Station=0 OutputCase=STR024 CaseType=Combination P=-105,784681430771 V2=5,82456038171027 V3=0 T=0 M2=0 M3=13,5303892563581	FrameElem=24-1 ElemStation=0
Frame=24 Station=0,04 OutputCase=STR024 CaseType=Combination P=-105,568681430771 V2=5,40126038171027 V3=0 T=0 M2=0 M3=13,3058988410897	FrameElem=24-1 ElemStation=0,04
Frame=24 Station=0,08 OutputCase=STR024 CaseType=Combination P=-105,352681430771 V2=4,98576038171027 V3=0 T=0 M2=0 M3=13,0981844258213	FrameElem=24-1 ElemStation=0,08
Frame=24 Station=0 OutputCase=STR025 CaseType=Combination P=-95,4287692006133 V2=45,406057477189 V3=0 T=0 M2=0 M3=28,689828225147	FrameElem=24-1 ElemStation=0
Frame=24 Station=0,04 OutputCase=STR025 CaseType=Combination P=-95,2127692006133 V2=43,812449977189 V3=0 T=0 M2=0 M3=26,9054036260594	FrameElem=24-1 ElemStation=0,04
Frame=24 Station=0,08 OutputCase=STR025 CaseType=Combination P=-94,9967692006133 V2=42,202507477189 V3=0 T=0 M2=0 M3=25,1850500269719	FrameElem=24-1 ElemStation=0,08
Frame=24 Station=0 OutputCase=STR026 CaseType=Combination P=-105,784681430713 V2=32,211804542009 V3=0 T=0 M2=0 M3=17,2262290454728	FrameElem=24-1 ElemStation=0
Frame=24 Station=0,04 OutputCase=STR026 CaseType=Combination P=-105,568681430713 V2=30,618197042009 V3=0 T=0 M2=0 M3=15,9695745637924	FrameElem=24-1 ElemStation=0,04
Frame=24 Station=0,08 OutputCase=STR026 CaseType=Combination P=-105,352681430713 V2=29,008254542009 V3=0 T=0 M2=0 M3=14,7769910821121	FrameElem=24-1 ElemStation=0,08
Frame=24 Station=0 OutputCase=STR027 CaseType=Combination P=-8,36176920611115 V2=46,1811212838703 V3=0 T=0 M2=0 M3=18,0430828906455	FrameElem=24-1 ElemStation=0
Frame=24 Station=0,04 OutputCase=STR027 CaseType=Combination P=-8,20176920611115 V2=44,5875137838703 V3=0 T=0 M2=0 M3=16,2276557392907	FrameElem=24-1 ElemStation=0,04
Frame=24 Station=0,08 OutputCase=STR027 CaseType=Combination P=-8,04176920611115 V2=42,9775712838703 V3=0 T=0 M2=0 M3=14,4762995879359	FrameElem=24-1 ElemStation=0,08
Frame=24 Station=0 OutputCase=STR028 CaseType=Combination P=-18,7176814362109 V2=32,9868683486903 V3=0 T=0 M2=0 M3=6,57948371097133	FrameElem=24-1 ElemStation=0
Frame=24 Station=0,04 OutputCase=STR028 CaseType=Combination P=-18,5576814362109 V2=31,3932608486903 V3=0 T=0 M2=0 M3=5,29182667702371	FrameElem=24-1 ElemStation=0,04
Frame=24 Station=0,08 OutputCase=STR028 CaseType=Combination P=-18,3976814362109 V2=29,7833183486903 V3=0 T=0 M2=0 M3=4,0682406430761	FrameElem=24-1 ElemStation=0,08
Frame=24 Station=0 OutputCase=STR029 CaseType=Combination P=-24,1933185613474 V2=14,0947123275086 V3=0 T=0 M2=0 M3=3,77581872167218	FrameElem=24-1 ElemStation=0
Frame=24 Station=0,04 OutputCase=STR029 CaseType=Combination P=-23,9773185613474 V2=13,1833273275086 V3=0 T=0 M2=0 M3=3,23031282857184	FrameElem=24-1 ElemStation=0,04
Frame=24 Station=0,08 OutputCase=STR029 CaseType=Combination P=-23,7613185613474 V2=12,2884123275086 V3=0 T=0 M2=0 M3=2,72093293547149	FrameElem=24-1 ElemStation=0,08
Frame=24 Station=0 OutputCase=STR030 CaseType=Combination P=-24,1933185614056 V2=6,33895918620457 V3=0 T=0 M2=0 M3=2,83566584869848	FrameElem=24-1 ElemStation=0
Frame=24 Station=0,04 OutputCase=STR030 CaseType=Combination P=-23,9773185614056 V2=5,91565918620457 V3=0 T=0 M2=0 M3=2,59059948125029	FrameElem=24-1 ElemStation=0,04
Frame=24 Station=0,08 OutputCase=STR030 CaseType=Combination P=-23,7613185614056 V2=5,50015918620457 V3=0 T=0 M2=0 M3=2,36230911380211	FrameElem=24-1 ElemStation=0,08
Frame=24 Station=0 OutputCase=STR031 CaseType=Combination P=-104,869318556271 V2=5,36681436429249 V3=0 T=0 M2=0 M3=12,6461980655258	FrameElem=24-1 ElemStation=0
Frame=24 Station=0,04 OutputCase=STR031 CaseType=Combination P=-104,653318556271 V2=4,94351436429249 V3=0 T=0 M2=0 M3=12,4400174909541	FrameElem=24-1 ElemStation=0,04
Frame=24 Station=0,08 OutputCase=STR031 CaseType=Combination P=-104,437318556271 V2=4,52801436429249 V3=0 T=0 M2=0 M3=12,2506129163824	FrameElem=24-1 ElemStation=0,08
Frame=24 Station=0 OutputCase=STR032 CaseType=Combination P=-94,5134063261132 V2=44,9483114597712 V3=0 T=0 M2=0 M3=27,8056370343147	FrameElem=24-1 ElemStation=0
Frame=24 Station=0,04 OutputCase=STR032 CaseType=Combination P=-94,2974063261132 V2=43,3547039597712 V3=0 T=0 M2=0 M3=26,0395222759238	FrameElem=24-1 ElemStation=0,04
Frame=24 Station=0,08 OutputCase=STR032 CaseType=Combination P=-94,0814063261132 V2=41,7447614597712 V3=0 T=0 M2=0 M3=24,337478517533	FrameElem=24-1 ElemStation=0,08
Frame=24 Station=0 OutputCase=STR033 CaseType=Combination P=-104,869318556213 V2=31,7540585245912 V3=0 T=0 M2=0 M3=16,3420378546405	FrameElem=24-1 ElemStation=0
Frame=24 Station=0,04 OutputCase=STR033 CaseType=Combination P=-104,653318556213 V2=30,1604510245912 V3=0 T=0 M2=0 M3=15,1036932136568	FrameElem=24-1 ElemStation=0,04
Frame=24 Station=0,08 OutputCase=STR033 CaseType=Combination P=-104,437318556213 V2=28,5505085245912 V3=0 T=0 M2=0 M3=13,9294195726732	FrameElem=24-1 ElemStation=0,08
Frame=24 Station=0 OutputCase=STR034 CaseType=Combination P=-7,44640633161107 V2=45,7233752664525 V3=0 T=0 M2=0 M3=17,1588916998132	FrameElem=24-1 ElemStation=0
Frame=24 Station=0,04 OutputCase=STR034 CaseType=Combination P=-7,28640633161107 V2=44,1297677664525 V3=0 T=0 M2=0 M3=15,3617743891551	FrameElem=24-1 ElemStation=0,04
Frame=24 Station=0,08 OutputCase=STR034 CaseType=Combination P=-7,12640633161107 V2=42,5198252664525 V3=0 T=0 M2=0 M3=13,628728078497	FrameElem=24-1 ElemStation=0,08
Frame=24 Station=0 OutputCase=STR035 CaseType=Combination P=-17,8023185617109 V2=32,5291223312725 V3=0 T=0 M2=0 M3=5,695292520139	FrameElem=24-1 ElemStation=0
Frame=24 Station=0,04 OutputCase=STR035 CaseType=Combination P=-17,6423185617109 V2=30,9355148312725 V3=0 T=0 M2=0 M3=4,4259453268881	FrameElem=24-1 ElemStation=0,04
Frame=24 Station=0,08 OutputCase=STR035 CaseType=Combination P=-17,4823185617109 V2=29,3255723312725 V3=0 T=0 M2=0 M3=3,2206691336372	FrameElem=24-1 ElemStation=0,08
Frame=24 Station=0 OutputCase=STR036 CaseType=Combination P=-24,6509999985979 V2=14,8752626597574 V3=0 T=0 M2=0 M3=4,67595265674695	FrameElem=24-1 ElemStation=0
Frame=24 Station=0,04 OutputCase=STR036 CaseType=Combination P=-24,4349999985979 V2=13,9638776597574 V3=0 T=0 M2=0 M3=4,09922475035666	FrameElem=24-1 ElemStation=0,04
Frame=24 Station=0,08 OutputCase=STR036 CaseType=Combination P=-24,2189999985979 V2=13,0689626597574 V3=0 T=0 M2=0 M3=3,55862284396636	FrameElem=24-1 ElemStation=0,08

Società di Progetto
Brebemi SpA



Doc. N.
60235-0000-A00.doc

CODIFICA DOCUMENTO
04RCDII10000000000300A00

REV.
00

FOGLIO
346 di 628

Frame=24 Station=0 OutputCase=STR037 CaseType=Combination P=-24,6509999986561 V2=7,1195095184534 V3=0 T=0 M2=0 M3=3,73579978377325	FrameElem=24-1 ElemStation=0
Frame=24 Station=0,04 OutputCase=STR037 CaseType=Combination P=-24,4349999986561 V2=6,6962095184534 V3=0 T=0 M2=0 M3=3,45951140303511	FrameElem=24-1 ElemStation=0,04
Frame=24 Station=0,08 OutputCase=STR037 CaseType=Combination P=-24,2189999986561 V2=6,2807095184534 V3=0 T=0 M2=0 M3=3,1999902229698	FrameElem=24-1 ElemStation=0,08
Frame=24 Station=0 OutputCase=STR038 CaseType=Combination P=-105,326999993522 V2=6,14736469654132 V3=0 T=0 M2=0 M3=13,5463320006005	FrameElem=24-1 ElemStation=0
Frame=24 Station=0,04 OutputCase=STR038 CaseType=Combination P=-105,110999993522 V2=5,72406469654132 V3=0 T=0 M2=0 M3=13,3089294127389	FrameElem=24-1 ElemStation=0,04
Frame=24 Station=0,08 OutputCase=STR038 CaseType=Combination P=-104,894999993522 V2=5,30856469654132 V3=0 T=0 M2=0 M3=13,0883028248772	FrameElem=24-1 ElemStation=0,08
Frame=24 Station=0 OutputCase=STR039 CaseType=Combination P=-94,9710877633636 V2=45,72886179202 V3=0 T=0 M2=0 M3=28,7057709693894	FrameElem=24-1 ElemStation=0
Frame=24 Station=0,04 OutputCase=STR039 CaseType=Combination P=-94,7550877633636 V2=44,13525429202 V3=0 T=0 M2=0 M3=26,9084341977086	FrameElem=24-1 ElemStation=0,04
Frame=24 Station=0,08 OutputCase=STR039 CaseType=Combination P=-94,5390877633636 V2=42,52531179202 V3=0 T=0 M2=0 M3=25,1751684260278	FrameElem=24-1 ElemStation=0,08
Frame=24 Station=0 OutputCase=STR040 CaseType=Combination P=-105,326999993463 V2=32,53460885684 V3=0 T=0 M2=0 M3=17,2421717897152	FrameElem=24-1 ElemStation=0
Frame=24 Station=0,04 OutputCase=STR040 CaseType=Combination P=-105,110999993463 V2=30,94100135684 V3=0 T=0 M2=0 M3=15,9726051354416	FrameElem=24-1 ElemStation=0,04
Frame=24 Station=0,08 OutputCase=STR040 CaseType=Combination P=-104,894999993463 V2=29,33105885684 V3=0 T=0 M2=0 M3=14,767109481168	FrameElem=24-1 ElemStation=0,08
Frame=24 Station=0 OutputCase=STR041 CaseType=Combination P=-7,90408776886152 V2=46,5039255987013 V3=0 T=0 M2=0 M3=18,059025634888	FrameElem=24-1 ElemStation=0
Frame=24 Station=0,04 OutputCase=STR041 CaseType=Combination P=-7,74408776886152 V2=44,9103180987013 V3=0 T=0 M2=0 M3=16,2306863109399	FrameElem=24-1 ElemStation=0,04
Frame=24 Station=0,08 OutputCase=STR041 CaseType=Combination P=-7,58408776886152 V2=43,3003755987013 V3=0 T=0 M2=0 M3=14,4664179869919	FrameElem=24-1 ElemStation=0,08
Frame=24 Station=0 OutputCase=STR042 CaseType=Combination P=-18,2599999989613 V2=33,3096726635214 V3=0 T=0 M2=0 M3=6,59542645521377	FrameElem=24-1 ElemStation=0
Frame=24 Station=0,04 OutputCase=STR042 CaseType=Combination P=-18,0999999989613 V2=31,7160651635214 V3=0 T=0 M2=0 M3=5,29485724867292	FrameElem=24-1 ElemStation=0,04
Frame=24 Station=0,08 OutputCase=STR042 CaseType=Combination P=-17,9399999989613 V2=30,1061226635214 V3=0 T=0 M2=0 M3=4,05835904213206	FrameElem=24-1 ElemStation=0,08
Frame=24 Station=0 OutputCase=STR043 CaseType=Combination P=-24,6509999985988 V2=16,1625097480173 V3=0 T=0 M2=0 M3=5,74470878261704	FrameElem=24-1 ElemStation=0
Frame=24 Station=0,04 OutputCase=STR043 CaseType=Combination P=-24,4349999985988 V2=15,2511247480173 V3=0 T=0 M2=0 M3=5,11649099269635	FrameElem=24-1 ElemStation=0,04
Frame=24 Station=0,08 OutputCase=STR043 CaseType=Combination P=-24,2189999985988 V2=14,3562097480173 V3=0 T=0 M2=0 M3=4,52439920277566	FrameElem=24-1 ElemStation=0,08
Frame=24 Station=0 OutputCase=STR044 CaseType=Combination P=-24,650999998657 V2=8,40675660671325 V3=0 T=0 M2=0 M3=4,80455590964334	FrameElem=24-1 ElemStation=0
Frame=24 Station=0,04 OutputCase=STR044 CaseType=Combination P=-24,434999998657 V2=7,98345660671325 V3=0 T=0 M2=0 M3=4,47677764537481	FrameElem=24-1 ElemStation=0,04
Frame=24 Station=0,08 OutputCase=STR044 CaseType=Combination P=-24,218999998657 V2=7,56795660671325 V3=0 T=0 M2=0 M3=4,16577538110628	FrameElem=24-1 ElemStation=0,08
Frame=24 Station=0 OutputCase=STR045 CaseType=Combination P=-132,218999991811 V2=6,74277862847052 V3=0 T=0 M2=0 M3=17,579906638974	FrameElem=24-1 ElemStation=0
Frame=24 Station=0,04 OutputCase=STR045 CaseType=Combination P=-132,002999991811 V2=6,31947862847052 V3=0 T=0 M2=0 M3=17,3186874938352	FrameElem=24-1 ElemStation=0,04
Frame=24 Station=0,08 OutputCase=STR045 CaseType=Combination P=-131,786999991811 V2=5,90397862847052 V3=0 T=0 M2=0 M3=17,0742443486964	FrameElem=24-1 ElemStation=0,08
Frame=24 Station=0 OutputCase=STR046 CaseType=Combination P=-119,037218411308 V2=56,0814231891764 V3=0 T=0 M2=0 M3=36,7254218835489	FrameElem=24-1 ElemStation=0
Frame=24 Station=0,04 OutputCase=STR046 CaseType=Combination P=-118,821218411308 V2=54,2604081891764 V3=0 T=0 M2=0 M3=34,5184943559819	FrameElem=24-1 ElemStation=0,04
Frame=24 Station=0,08 OutputCase=STR046 CaseType=Combination P=-118,605218411308 V2=52,4121231891764 V3=0 T=0 M2=0 M3=32,3849528284148	FrameElem=24-1 ElemStation=0,08
Frame=24 Station=0 OutputCase=STR047 CaseType=Combination P=-132,218999991753 V2=39,3405197951008 V3=0 T=0 M2=0 M3=22,194308733469	FrameElem=24-1 ElemStation=0
Frame=24 Station=0,04 OutputCase=STR047 CaseType=Combination P=-132,002999991753 V2=37,5195047951008 V3=0 T=0 M2=0 M3=20,657017341665	FrameElem=24-1 ElemStation=0,04
Frame=24 Station=0,08 OutputCase=STR047 CaseType=Combination P=-131,786999991753 V2=35,6712197951008 V3=0 T=0 M2=0 M3=19,1931119498609	FrameElem=24-1 ElemStation=0,08
Frame=24 Station=0 OutputCase=STR048 CaseType=Combination P=-5,07821841851733 V2=57,180532698284 V3=0 T=0 M2=0 M3=22,8084991434384	FrameElem=24-1 ElemStation=0
Frame=24 Station=0,04 OutputCase=STR048 CaseType=Combination P=-4,91821841851732 V2=55,3595202698284 V3=0 T=0 M2=0 M3=20,5576071326452	FrameElem=24-1 ElemStation=0,04
Frame=24 Station=0,08 OutputCase=STR048 CaseType=Combination P=-4,75821841851733 V2=53,5112352698284 V3=0 T=0 M2=0 M3=18,3801011218521	FrameElem=24-1 ElemStation=0,08
Frame=24 Station=0 OutputCase=STR049 CaseType=Combination P=-18,259999998962 V2=40,4396318757528 V3=0 T=0 M2=0 M3=8,27738599335845	FrameElem=24-1 ElemStation=0
Frame=24 Station=0,04 OutputCase=STR049 CaseType=Combination P=-18,099999998962 V2=38,6186168757528 V3=0 T=0 M2=0 M3=6,69613011832834	FrameElem=24-1 ElemStation=0,04
Frame=24 Station=0,08 OutputCase=STR049 CaseType=Combination P=-17,939999998962 V2=36,7703318757528 V3=0 T=0 M2=0 M3=5,18826024329822	FrameElem=24-1 ElemStation=0,08
Frame=24 Station=0 OutputCase=STR050 CaseType=Combination P=-75,6011749795162 V2=65,3606740061375 V3=0 T=0 M2=0 M3=44,4546415975285	FrameElem=24-1 ElemStation=0
Frame=24 Station=0,04 OutputCase=STR050 CaseType=Combination P=-75,3851749795162 V2=63,7670665061375 V3=0 T=0 M2=0 M3=41,872033237283	FrameElem=24-1 ElemStation=0,04
Frame=24 Station=0,08 OutputCase=STR050 CaseType=Combination P=-75,1691749795162 V2=62,1571240061375 V3=0 T=0 M2=0 M3=39,3534940770375	FrameElem=24-1 ElemStation=0,08
Frame=24 Station=0 OutputCase=STR051 CaseType=Combination P=-105,326999993523 V2=7,43461178480117 V3=0 T=0 M2=0 M3=14,6150881264706	FrameElem=24-1 ElemStation=0
Frame=24 Station=0,04 OutputCase=STR051 CaseType=Combination P=-105,110999993523 V2=7,01131178480117 V3=0 T=0 M2=0 M3=14,3261956550786	FrameElem=24-1 ElemStation=0,04

Società di Progetto
Brebemi SpA

	Doc. N. 60235-0000-A00.doc	CODIFICA DOCUMENTO 04RCDII10000000000300A00	REV. 00	FOGLIO 347 di 628
--	-------------------------------	--	------------	----------------------

Frame=24 Station=0,08 OutputCase=STR051 CaseType=Combination P=-104,894999993523 V2=6,59581178480117 V3=0 T=0 M2=0 M3=14,0540791836865	FrameElem=24-1 ElemStation=0,08
Frame=24 Station=0 OutputCase=STR052 CaseType=Combination P=-94,9710877633646 V2=47,0161088802799 V3=0 T=0 M2=0 M3=29,7745270952595	FrameElem=24-1 ElemStation=0
Frame=24 Station=0,04 OutputCase=STR052 CaseType=Combination P=-94,7550877633646 V2=45,4225013802799 V3=0 T=0 M2=0 M3=27,9257004400483	FrameElem=24-1 ElemStation=0,04
Frame=24 Station=0,08 OutputCase=STR052 CaseType=Combination P=-94,5390877633646 V2=43,8125588802799 V3=0 T=0 M2=0 M3=26,1409447848371	FrameElem=24-1 ElemStation=0,08
Frame=24 Station=0 OutputCase=STR053 CaseType=Combination P=-105,326999993464 V2=33,8218559450999 V3=0 T=0 M2=0 M3=18,3109279155853	FrameElem=24-1 ElemStation=0
Frame=24 Station=0,04 OutputCase=STR053 CaseType=Combination P=-105,110999993464 V2=32,2282484450999 V3=0 T=0 M2=0 M3=16,9898713777813	FrameElem=24-1 ElemStation=0,04
Frame=24 Station=0,08 OutputCase=STR053 CaseType=Combination P=-104,894999993464 V2=30,6183059450999 V3=0 T=0 M2=0 M3=15,7328858399773	FrameElem=24-1 ElemStation=0,08
Frame=24 Station=0 OutputCase=STR054 CaseType=Combination P=-7,90408776886247 V2=47,7911726869612 V3=0 T=0 M2=0 M3=19,1277817607581	FrameElem=24-1 ElemStation=0
Frame=24 Station=0,04 OutputCase=STR054 CaseType=Combination P=-7,74408776886247 V2=46,1975651869612 V3=0 T=0 M2=0 M3=17,2479525532796	FrameElem=24-1 ElemStation=0,04
Frame=24 Station=0,08 OutputCase=STR054 CaseType=Combination P=-7,58408776886247 V2=44,5876226869612 V3=0 T=0 M2=0 M3=15,4321943458012	FrameElem=24-1 ElemStation=0,08
Frame=24 Station=0 OutputCase=STR055 CaseType=Combination P=-18,2599999989623 V2=34,5969197517812 V3=0 T=0 M2=0 M3=7,66418258108386	FrameElem=24-1 ElemStation=0
Frame=24 Station=0,04 OutputCase=STR055 CaseType=Combination P=-18,0999999989623 V2=33,0033122517812 V3=0 T=0 M2=0 M3=6,31212349101261	FrameElem=24-1 ElemStation=0,04
Frame=24 Station=0,08 OutputCase=STR055 CaseType=Combination P=-17,9399999989623 V2=31,3933697517812 V3=0 T=0 M2=0 M3=5,02413540094136	FrameElem=24-1 ElemStation=0,08
Frame=24 Station=0 OutputCase=STR056 CaseType=Combination P=-25,1086814358488 V2=16,3913827567262 V3=0 T=0 M2=0 M3=6,1868043780332	FrameElem=24-1 ElemStation=0
Frame=24 Station=0,04 OutputCase=STR056 CaseType=Combination P=-24,8926814358489 V2=15,4799977567262 V3=0 T=0 M2=0 M3=5,54943166776416	FrameElem=24-1 ElemStation=0,04
Frame=24 Station=0,08 OutputCase=STR056 CaseType=Combination P=-24,6766814358489 V2=14,5850827567262 V3=0 T=0 M2=0 M3=4,94818495749511	FrameElem=24-1 ElemStation=0,08
Frame=24 Station=0 OutputCase=STR057 CaseType=Combination P=-25,1086814359071 V2=8,63562961542214 V3=0 T=0 M2=0 M3=5,2466515050595	FrameElem=24-1 ElemStation=0
Frame=24 Station=0,04 OutputCase=STR057 CaseType=Combination P=-24,8926814359071 V2=8,21232961542214 V3=0 T=0 M2=0 M3=4,90971832044261	FrameElem=24-1 ElemStation=0,04
Frame=24 Station=0,08 OutputCase=STR057 CaseType=Combination P=-24,6766814359071 V2=7,79682961542214 V3=0 T=0 M2=0 M3=4,58956113582573	FrameElem=24-1 ElemStation=0,08
Frame=24 Station=0 OutputCase=STR058 CaseType=Combination P=-105,784681430773 V2=7,66348479351007 V3=0 T=0 M2=0 M3=15,0571837218868	FrameElem=24-1 ElemStation=0
Frame=24 Station=0,04 OutputCase=STR058 CaseType=Combination P=-105,568681430773 V2=7,24018479351006 V3=0 T=0 M2=0 M3=14,7591363301464	FrameElem=24-1 ElemStation=0,04
Frame=24 Station=0,08 OutputCase=STR058 CaseType=Combination P=-105,352681430773 V2=6,82468479351007 V3=0 T=0 M2=0 M3=14,477864938406	FrameElem=24-1 ElemStation=0,08
Frame=24 Station=0 OutputCase=STR059 CaseType=Combination P=-95,4287692006146 V2=47,2449818889888 V3=0 T=0 M2=0 M3=30,2166226906757	FrameElem=24-1 ElemStation=0
Frame=24 Station=0,04 OutputCase=STR059 CaseType=Combination P=-95,2127692006146 V2=45,6513743889888 V3=0 T=0 M2=0 M3=28,3586411151161	FrameElem=24-1 ElemStation=0,04
Frame=24 Station=0,08 OutputCase=STR059 CaseType=Combination P=-94,9967692006146 V2=44,0414318889888 V3=0 T=0 M2=0 M3=26,5647305395566	FrameElem=24-1 ElemStation=0,08
Frame=24 Station=0 OutputCase=STR060 CaseType=Combination P=-105,784681430714 V2=34,0507289538088 V3=0 T=0 M2=0 M3=18,7530235110015	FrameElem=24-1 ElemStation=0
Frame=24 Station=0,04 OutputCase=STR060 CaseType=Combination P=-105,568681430714 V2=32,4571214538088 V3=0 T=0 M2=0 M3=17,4228120528491	FrameElem=24-1 ElemStation=0,04
Frame=24 Station=0,08 OutputCase=STR060 CaseType=Combination P=-105,352681430714 V2=30,8471789538088 V3=0 T=0 M2=0 M3=16,1566715946968	FrameElem=24-1 ElemStation=0,08
Frame=24 Station=0 OutputCase=STR061 CaseType=Combination P=-8,36176920611252 V2=48,0200456956701 V3=0 T=0 M2=0 M3=19,5698773561742	FrameElem=24-1 ElemStation=0
Frame=24 Station=0,04 OutputCase=STR061 CaseType=Combination P=-8,20176920611251 V2=46,4264381956701 V3=0 T=0 M2=0 M3=17,6808932283474	FrameElem=24-1 ElemStation=0,04
Frame=24 Station=0,08 OutputCase=STR061 CaseType=Combination P=-8,04176920611252 V2=44,8164956956701 V3=0 T=0 M2=0 M3=15,8559801005206	FrameElem=24-1 ElemStation=0,08
Frame=24 Station=0 OutputCase=STR062 CaseType=Combination P=-18,7176814362123 V2=34,8257927604901 V3=0 T=0 M2=0 M3=8,10627817650002	FrameElem=24-1 ElemStation=0
Frame=24 Station=0,04 OutputCase=STR062 CaseType=Combination P=-18,5576814362123 V2=33,2321852604901 V3=0 T=0 M2=0 M3=6,74506416608042	FrameElem=24-1 ElemStation=0,04
Frame=24 Station=0,08 OutputCase=STR062 CaseType=Combination P=-18,3976814362123 V2=31,6222427604901 V3=0 T=0 M2=0 M3=5,44792115566081	FrameElem=24-1 ElemStation=0,08
Frame=24 Station=0 OutputCase=STR063 CaseType=Combination P=-24,1933185613488 V2=15,9336367393084 V3=0 T=0 M2=0 M3=5,30261318720088	FrameElem=24-1 ElemStation=0
Frame=24 Station=0,04 OutputCase=STR063 CaseType=Combination P=-23,9773185613488 V2=15,0222517393084 V3=0 T=0 M2=0 M3=4,68355031762854	FrameElem=24-1 ElemStation=0,04
Frame=24 Station=0,08 OutputCase=STR063 CaseType=Combination P=-23,7613185613488 V2=14,1273367393084 V3=0 T=0 M2=0 M3=4,1006134480562	FrameElem=24-1 ElemStation=0,08
Frame=24 Station=0 OutputCase=STR064 CaseType=Combination P=-24,193318561407 V2=8,17788359800436 V3=0 T=0 M2=0 M3=4,36246031422717	FrameElem=24-1 ElemStation=0
Frame=24 Station=0,04 OutputCase=STR064 CaseType=Combination P=-23,977318561407 V2=7,75458359800436 V3=0 T=0 M2=0 M3=4,043836970307	FrameElem=24-1 ElemStation=0,04
Frame=24 Station=0,08 OutputCase=STR064 CaseType=Combination P=-23,761318561407 V2=7,33908359800436 V3=0 T=0 M2=0 M3=3,74198962638682	FrameElem=24-1 ElemStation=0,08
Frame=24 Station=0 OutputCase=STR065 CaseType=Combination P=-104,869318556273 V2=7,20573877609228 V3=0 T=0 M2=0 M3=14,1729925310545	FrameElem=24-1 ElemStation=0
Frame=24 Station=0,04 OutputCase=STR065 CaseType=Combination P=-104,653318556273 V2=6,78243877609228 V3=0 T=0 M2=0 M3=13,8932549800108	FrameElem=24-1 ElemStation=0,04
Frame=24 Station=0,08 OutputCase=STR065 CaseType=Combination P=-104,437318556273 V2=6,36693877609228 V3=0 T=0 M2=0 M3=13,6302934289671	FrameElem=24-1 ElemStation=0,08
Frame=24 Station=0 OutputCase=STR066 CaseType=Combination P=-94,5134063261145 V2=46,787235871571 V3=0 T=0 M2=0 M3=29,3324314998434	FrameElem=24-1 ElemStation=0

Società di Progetto
Brebemi SpA

	Doc. N. 60235-0000-A00.doc	CODIFICA DOCUMENTO 04RCDII10000000000300A00	REV. 00	FOGLIO 348 di 628
--	-------------------------------	--	------------	----------------------

Frame=24 Station=0,04 OutputCase=STR066 CaseType=Combination P=-,94,2974063261146 V2=45,193628371571 V3=0 T=0 M2=0 M3=27,4927597649805	FrameElem=24-1 ElemStation=0,04
Frame=24 Station=0,08 OutputCase=STR066 CaseType=Combination P=-,94,0814063261145 V2=43,583685871571 V3=0 T=0 M2=0 M3=25,7171590301177	FrameElem=24-1 ElemStation=0,08
Frame=24 Station=0 OutputCase=STR067 CaseType=Combination P=-,104,869318556214 V2=33,592982936391 V3=0 T=0 M2=0 M3=17,8688323201692	FrameElem=24-1 ElemStation=0
Frame=24 Station=0,04 OutputCase=STR067 CaseType=Combination P=-,104,653318556214 V2=31,999375436391 V3=0 T=0 M2=0 M3=16,556937027135	FrameElem=24-1 ElemStation=0,04
Frame=24 Station=0,08 OutputCase=STR067 CaseType=Combination P=-,104,437318556214 V2=30,389432936391 V3=0 T=0 M2=0 M3=15,3091000852579	FrameElem=24-1 ElemStation=0,08
Frame=24 Station=0 OutputCase=STR068 CaseType=Combination P=-,7,44640633161243 V2=47,5622996782523 V3=0 T=0 M2=0 M3=18,6856861653419	FrameElem=24-1 ElemStation=0
Frame=24 Station=0,04 OutputCase=STR068 CaseType=Combination P=-,7,28640633161243 V2=45,9686921782523 V3=0 T=0 M2=0 M3=16,8150118782118	FrameElem=24-1 ElemStation=0,04
Frame=24 Station=0,08 OutputCase=STR068 CaseType=Combination P=-,7,12640633161243 V2=44,3587496782523 V3=0 T=0 M2=0 M3=15,0084085910817	FrameElem=24-1 ElemStation=0,08
Frame=24 Station=0 OutputCase=STR069 CaseType=Combination P=-,17,8023185617122 V2=34,3680467430723 V3=0 T=0 M2=0 M3=7,2220869856677	FrameElem=24-1 ElemStation=0
Frame=24 Station=0,04 OutputCase=STR069 CaseType=Combination P=-,17,6423185617122 V2=32,7744392430723 V3=0 T=0 M2=0 M3=5,8791828159448	FrameElem=24-1 ElemStation=0,04
Frame=24 Station=0,08 OutputCase=STR069 CaseType=Combination P=-,17,4823185617122 V2=31,1644967430723 V3=0 T=0 M2=0 M3=4,60034964622191	FrameElem=24-1 ElemStation=0,08
Frame=24 Station=0 OutputCase=STR070 CaseType=Combination P=-,24,6509999985992 V2=16,7141870715572 V3=0 T=0 M2=0 M3=6,20274712227565	FrameElem=24-1 ElemStation=0
Frame=24 Station=0,04 OutputCase=STR070 CaseType=Combination P=-,24,4349999985992 V2=15,8028020715572 V3=0 T=0 M2=0 M3=5,55246223941336	FrameElem=24-1 ElemStation=0,04
Frame=24 Station=0,08 OutputCase=STR070 CaseType=Combination P=-,24,2189999985992 V2=14,9078870715572 V3=0 T=0 M2=0 M3=4,9383033565107	FrameElem=24-1 ElemStation=0,08
Frame=24 Station=0 OutputCase=STR071 CaseType=Combination P=-,24,6509999986574 V2=8,95843393025319 V3=0 T=0 M2=0 M3=5,26259424930194	FrameElem=24-1 ElemStation=0
Frame=24 Station=0,04 OutputCase=STR071 CaseType=Combination P=-,24,4349999986574 V2=8,53513393025319 V3=0 T=0 M2=0 M3=4,91274889209182	FrameElem=24-1 ElemStation=0,04
Frame=24 Station=0,08 OutputCase=STR071 CaseType=Combination P=-,24,2189999986574 V2=8,11963393025319 V3=0 T=0 M2=0 M3=4,57967953488169	FrameElem=24-1 ElemStation=0,08
Frame=24 Station=0 OutputCase=STR072 CaseType=Combination P=-,105,326999993523 V2=7,98628910834111 V3=0 T=0 M2=0 M3=15,0731264661292	FrameElem=24-1 ElemStation=0
Frame=24 Station=0,04 OutputCase=STR072 CaseType=Combination P=-,105,110999993523 V2=7,56298910834111 V3=0 T=0 M2=0 M3=14,7621669017956	FrameElem=24-1 ElemStation=0,04
Frame=24 Station=0,08 OutputCase=STR072 CaseType=Combination P=-,104,894999993523 V2=7,14748910834111 V3=0 T=0 M2=0 M3=14,467983337462	FrameElem=24-1 ElemStation=0,08
Frame=24 Station=0 OutputCase=STR073 CaseType=Combination P=-,94,971087763365 V2=47,5677862038198 V3=0 T=0 M2=0 M3=30,2325654349181	FrameElem=24-1 ElemStation=0
Frame=24 Station=0,04 OutputCase=STR073 CaseType=Combination P=-,94,755087763365 V2=45,9741787038198 V3=0 T=0 M2=0 M3=28,3616716867653	FrameElem=24-1 ElemStation=0,04
Frame=24 Station=0,08 OutputCase=STR073 CaseType=Combination P=-,94,539087763365 V2=44,3642362038198 V3=0 T=0 M2=0 M3=26,5548489386125	FrameElem=24-1 ElemStation=0,08
Frame=24 Station=0 OutputCase=STR074 CaseType=Combination P=-,105,326999993465 V2=34,373532686398 V3=0 T=0 M2=0 M3=18,7689662552439	FrameElem=24-1 ElemStation=0
Frame=24 Station=0,04 OutputCase=STR074 CaseType=Combination P=-,105,110999993465 V2=32,7799257686398 V3=0 T=0 M2=0 M3=17,4258426244983	FrameElem=24-1 ElemStation=0,04
Frame=24 Station=0,08 OutputCase=STR074 CaseType=Combination P=-,104,894999993465 V2=31,1699832686398 V3=0 T=0 M2=0 M3=16,1467899937527	FrameElem=24-1 ElemStation=0,08
Frame=24 Station=0 OutputCase=STR075 CaseType=Combination P=-,7,90408776886288 V2=48,3428500105011 V3=0 T=0 M2=0 M3=19,5858201004167	FrameElem=24-1 ElemStation=0
Frame=24 Station=0,04 OutputCase=STR075 CaseType=Combination P=-,7,74408776886288 V2=46,7492425105011 V3=0 T=0 M2=0 M3=17,6839237999966	FrameElem=24-1 ElemStation=0,04
Frame=24 Station=0,08 OutputCase=STR075 CaseType=Combination P=-,7,58408776886288 V2=45,1393000105011 V3=0 T=0 M2=0 M3=15,8460984995766	FrameElem=24-1 ElemStation=0,08
Frame=24 Station=0 OutputCase=STR076 CaseType=Combination P=-,18,2599999989627 V2=35,1485970753212 V3=0 T=0 M2=0 M3=8,12222092074247	FrameElem=24-1 ElemStation=0
Frame=24 Station=0,04 OutputCase=STR076 CaseType=Combination P=-,18,0999999989627 V2=33,5549895753212 V3=0 T=0 M2=0 M3=6,74809473772962	FrameElem=24-1 ElemStation=0,04
Frame=24 Station=0,08 OutputCase=STR076 CaseType=Combination P=-,17,9399999989627 V2=31,9450470753212 V3=0 T=0 M2=0 M3=5,43803955471677	FrameElem=24-1 ElemStation=0,08
Frame=24 Station=0 OutputCase=STR077 CaseType=Combination P=-,25,4138023940149 V2=15,6245025566322 V3=0 T=0 M2=0 M3=5,71813754221297	FrameElem=24-1 ElemStation=0
Frame=24 Station=0,04 OutputCase=STR077 CaseType=Combination P=-,25,1978023940149 V2=14,7131175566322 V3=0 T=0 M2=0 M3=5,11144003994768	FrameElem=24-1 ElemStation=0,04
Frame=24 Station=0,08 OutputCase=STR077 CaseType=Combination P=-,24,9818023940149 V2=13,8182025566322 V3=0 T=0 M2=0 M3=4,54086853768239	FrameElem=24-1 ElemStation=0,08
Frame=24 Station=0 OutputCase=STR078 CaseType=Combination P=-,25,4138023940731 V2=7,86874941532817 V3=0 T=0 M2=0 M3=4,77798466923926	FrameElem=24-1 ElemStation=0
Frame=24 Station=0,04 OutputCase=STR078 CaseType=Combination P=-,25,1978023940731 V2=7,44544941532817 V3=0 T=0 M2=0 M3=4,47172669262613	FrameElem=24-1 ElemStation=0,04
Frame=24 Station=0,08 OutputCase=STR078 CaseType=Combination P=-,24,9818023940731 V2=7,02994941532817 V3=0 T=0 M2=0 M3=4,18224471601301	FrameElem=24-1 ElemStation=0,08
Frame=24 Station=0 OutputCase=STR079 CaseType=Combination P=-,132,67668142906 V2=6,41997431363948 V3=0 T=0 M2=0 M3=17,5639638947316	FrameElem=24-1 ElemStation=0
Frame=24 Station=0,04 OutputCase=STR079 CaseType=Combination P=-,132,46068142906 V2=5,99667431363948 V3=0 T=0 M2=0 M3=17,315656922186	FrameElem=24-1 ElemStation=0,04
Frame=24 Station=0,08 OutputCase=STR079 CaseType=Combination P=-,132,24468142906 V2=5,58117431363948 V3=0 T=0 M2=0 M3=17,0841259496404	FrameElem=24-1 ElemStation=0,08
Frame=24 Station=0 OutputCase=STR080 CaseType=Combination P=-,119,494899848558 V2=55,7586188743454 V3=0 T=0 M2=0 M3=36,7094791393065	FrameElem=24-1 ElemStation=0
Frame=24 Station=0,04 OutputCase=STR080 CaseType=Combination P=-,119,278899848558 V2=53,9376038743453 V3=0 T=0 M2=0 M3=34,5154637843327	FrameElem=24-1 ElemStation=0,04
Frame=24 Station=0,08 OutputCase=STR080 CaseType=Combination P=-,119,062899848558 V2=52,0893188743454 V3=0 T=0 M2=0 M3=32,3948344293589	FrameElem=24-1 ElemStation=0,08

Società di Progetto
Brebemi SpA

	Doc. N. 60235-00000-A00.doc	CODIFICA DOCUMENTO 04RCDII10000000000300A00	REV. 00	FOGLIO 349 di 628
--	--------------------------------	--	------------	----------------------

Frame=24 Station=0 OutputCase=STR081 CaseType=Combination P=-132,676681429002 V2=39,0177154802698 V3=0 T=0 M2=0 M3=22,1783659892266	FrameElem=24-1 ElemStation=0
Frame=24 Station=0,04 OutputCase=STR081 CaseType=Combination P=-132,460681429002 V2=37,1967004802698 V3=0 T=0 M2=0 M3=20,6539867700158	FrameElem=24-1 ElemStation=0,04
Frame=24 Station=0,08 OutputCase=STR081 CaseType=Combination P=-132,244681429002 V2=35,3484154802698 V3=0 T=0 M2=0 M3=19,202993550805	FrameElem=24-1 ElemStation=0,08
Frame=24 Station=0 OutputCase=STR082 CaseType=Combination P=-5,53589985576696 V2=56,8577309549974 V3=0 T=0 M2=0 M3=22,7925563991959	FrameElem=24-1 ElemStation=0
Frame=24 Station=0,04 OutputCase=STR082 CaseType=Combination P=-5,37589985576696 V2=55,0367159549974 V3=0 T=0 M2=0 M3=20,554576560996	FrameElem=24-1 ElemStation=0,04
Frame=24 Station=0,08 OutputCase=STR082 CaseType=Combination P=-5,21589985576696 V2=53,1884309549974 V3=0 T=0 M2=0 M3=18,3899827227961	FrameElem=24-1 ElemStation=0,08
Frame=24 Station=0 OutputCase=STR083 CaseType=Combination P=-18,1716814362116 V2=40,1168275609218 V3=0 T=0 M2=0 M3=8,26144324911601	FrameElem=24-1 ElemStation=0
Frame=24 Station=0,04 OutputCase=STR083 CaseType=Combination P=-18,5576814362116 V2=38,2958125609218 V3=0 T=0 M2=0 M3=6,69309954667913	FrameElem=24-1 ElemStation=0,04
Frame=24 Station=0,08 OutputCase=STR083 CaseType=Combination P=-18,3976814362116 V2=36,4475275609218 V3=0 T=0 M2=0 M3=5,19814184424226	FrameElem=24-1 ElemStation=0,08
Frame=24 Station=0 OutputCase=STR084 CaseType=Combination P=-76,0588564167658 V2=65,0378696913065 V3=0 T=0 M2=0 M3=44,4386988532861	FrameElem=24-1 ElemStation=0
Frame=24 Station=0,04 OutputCase=STR084 CaseType=Combination P=-75,8428564167658 V2=63,4442621913065 V3=0 T=0 M2=0 M3=41,8690017656338	FrameElem=24-1 ElemStation=0,04
Frame=24 Station=0,08 OutputCase=STR084 CaseType=Combination P=-75,6268564167658 V2=61,8343196913065 V3=0 T=0 M2=0 M3=39,3633756779815	FrameElem=24-1 ElemStation=0,08
Frame=24 Station=0 OutputCase=STR085 CaseType=Combination P=-106,089802388939 V2=6,8966045934161 V3=0 T=0 M2=0 M3=14,5885168860666	FrameElem=24-1 ElemStation=0
Frame=24 Station=0,04 OutputCase=STR085 CaseType=Combination P=-105,873802388939 V2=6,4733045934161 V3=0 T=0 M2=0 M3=14,3211447023299	FrameElem=24-1 ElemStation=0,04
Frame=24 Station=0,08 OutputCase=STR085 CaseType=Combination P=-105,657802388939 V2=6,0578045934161 V3=0 T=0 M2=0 M3=14,0705485185933	FrameElem=24-1 ElemStation=0,08
Frame=24 Station=0 OutputCase=STR086 CaseType=Combination P=-95,7338901587806 V2=46,4781016888948 V3=0 T=0 M2=0 M3=29,7479558548554	FrameElem=24-1 ElemStation=0
Frame=24 Station=0,04 OutputCase=STR086 CaseType=Combination P=-95,5178901587807 V2=44,8844941888948 V3=0 T=0 M2=0 M3=27,9206494872997	FrameElem=24-1 ElemStation=0,04
Frame=24 Station=0,08 OutputCase=STR086 CaseType=Combination P=-95,3018901587807 V2=43,2745516888948 V3=0 T=0 M2=0 M3=26,1574141197439	FrameElem=24-1 ElemStation=0,08
Frame=24 Station=0 OutputCase=STR087 CaseType=Combination P=-106,08980238888 V2=33,2838487537148 V3=0 T=0 M2=0 M3=18,2843566751813	FrameElem=24-1 ElemStation=0
Frame=24 Station=0,04 OutputCase=STR087 CaseType=Combination P=-105,87380238888 V2=31,6902412537148 V3=0 T=0 M2=0 M3=16,9848204250327	FrameElem=24-1 ElemStation=0,04
Frame=24 Station=0,08 OutputCase=STR087 CaseType=Combination P=-105,65780238888 V2=30,0802987537148 V3=0 T=0 M2=0 M3=15,7493551748841	FrameElem=24-1 ElemStation=0,08
Frame=24 Station=0 OutputCase=STR088 CaseType=Combination P=-8,66689016427853 V2=47,2531654955761 V3=0 T=0 M2=0 M3=19,101210520354	FrameElem=24-1 ElemStation=0
Frame=24 Station=0,04 OutputCase=STR088 CaseType=Combination P=-8,50689016427853 V2=45,6595579955761 V3=0 T=0 M2=0 M3=17,2429016005309	FrameElem=24-1 ElemStation=0,04
Frame=24 Station=0,08 OutputCase=STR088 CaseType=Combination P=-8,34689016427853 V2=44,0496154955761 V3=0 T=0 M2=0 M3=15,4486636807079	FrameElem=24-1 ElemStation=0,08
Frame=24 Station=0 OutputCase=STR089 CaseType=Combination P=-19,0228023943783 V2=34,0589125603962 V3=0 T=0 M2=0 M3=7,63761134067979	FrameElem=24-1 ElemStation=0
Frame=24 Station=0,04 OutputCase=STR089 CaseType=Combination P=-18,8628023943783 V2=32,4653050603961 V3=0 T=0 M2=0 M3=6,30707253826394	FrameElem=24-1 ElemStation=0,04
Frame=24 Station=0,08 OutputCase=STR089 CaseType=Combination P=-18,7028023943783 V2=30,8553625603961 V3=0 T=0 M2=0 M3=5,04060473584809	FrameElem=24-1 ElemStation=0,08
Frame=24 Station=0 OutputCase=STR090 CaseType=Combination P=-25,4138023940145 V2=15,0728252330922 V3=0 T=0 M2=0 M3=5,26009920255436	FrameElem=24-1 ElemStation=0
Frame=24 Station=0,04 OutputCase=STR090 CaseType=Combination P=-25,1978023940145 V2=14,1614402330923 V3=0 T=0 M2=0 M3=4,67546879323067	FrameElem=24-1 ElemStation=0,04
Frame=24 Station=0,08 OutputCase=STR090 CaseType=Combination P=-24,9818023940145 V2=13,2665252330922 V3=0 T=0 M2=0 M3=4,12696438390698	FrameElem=24-1 ElemStation=0,08
Frame=24 Station=0 OutputCase=STR091 CaseType=Combination P=-25,4138023940727 V2=7,31707209178824 V3=0 T=0 M2=0 M3=4,31994632958065	FrameElem=24-1 ElemStation=0
Frame=24 Station=0,04 OutputCase=STR091 CaseType=Combination P=-25,1978023940727 V2=6,89377209178824 V3=0 T=0 M2=0 M3=4,03575544590912	FrameElem=24-1 ElemStation=0,04
Frame=24 Station=0,08 OutputCase=STR091 CaseType=Combination P=-24,9818023940727 V2=6,47827209178824 V3=0 T=0 M2=0 M3=3,76834056223759	FrameElem=24-1 ElemStation=0,08
Frame=24 Station=0 OutputCase=STR092 CaseType=Combination P=-106,089802388938 V2=6,34492726987616 V3=0 T=0 M2=0 M3=14,130478546408	FrameElem=24-1 ElemStation=0
Frame=24 Station=0,04 OutputCase=STR092 CaseType=Combination P=-105,873802388938 V2=5,92162726987616 V3=0 T=0 M2=0 M3=13,8851734556129	FrameElem=24-1 ElemStation=0,04
Frame=24 Station=0,08 OutputCase=STR092 CaseType=Combination P=-105,657802388938 V2=5,50612726987616 V3=0 T=0 M2=0 M3=13,6566443648179	FrameElem=24-1 ElemStation=0,08
Frame=24 Station=0 OutputCase=STR093 CaseType=Combination P=-95,7338901587802 V2=45,9264243653549 V3=0 T=0 M2=0 M3=29,2899175151968	FrameElem=24-1 ElemStation=0
Frame=24 Station=0,04 OutputCase=STR093 CaseType=Combination P=-95,5178901587802 V2=44,3328168653549 V3=0 T=0 M2=0 M3=27,4846782405826	FrameElem=24-1 ElemStation=0,04
Frame=24 Station=0,08 OutputCase=STR093 CaseType=Combination P=-95,3018901587802 V2=42,7228743653549 V3=0 T=0 M2=0 M3=25,7435099659685	FrameElem=24-1 ElemStation=0,08
Frame=24 Station=0 OutputCase=STR094 CaseType=Combination P=-106,08980238888 V2=32,7321714301749 V3=0 T=0 M2=0 M3=17,8263183355226	FrameElem=24-1 ElemStation=0
Frame=24 Station=0,04 OutputCase=STR094 CaseType=Combination P=-105,87380238888 V2=31,1385639301749 V3=0 T=0 M2=0 M3=16,5488491783156	FrameElem=24-1 ElemStation=0,04
Frame=24 Station=0,08 OutputCase=STR094 CaseType=Combination P=-105,65780238888 V2=29,5286214301749 V3=0 T=0 M2=0 M3=15,3354510211086	FrameElem=24-1 ElemStation=0,08
Frame=24 Station=0 OutputCase=STR095 CaseType=Combination P=-8,66689016427812 V2=46,7014881720362 V3=0 T=0 M2=0 M3=18,6431721806954	FrameElem=24-1 ElemStation=0
Frame=24 Station=0,04 OutputCase=STR095 CaseType=Combination P=-8,50689016427812 V2=45,1078806720362 V3=0 T=0 M2=0 M3=16,8069303538139	FrameElem=24-1 ElemStation=0,04

Società di Progetto
Brebemi SpA

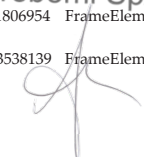

	Doc. N. 60235-00000-A00.doc	CODIFICA DOCUMENTO 04RCDII10000000000300A00	REV. 00	FOGLIO 350 di 628
--	--------------------------------	--	------------	----------------------

Frame=24 Station=0,08 OutputCase=STR095 CaseType=Combination P=-8,34689016427812 V2=43,4979381720362 V3=0 T=0 M2=0 M3=15,0347595269325	FrameElem=24-1 ElemStation=0,08
Frame=24 Station=0 OutputCase=STR096 CaseType=Combination P=-19,0228023943779 V2=33,5072352388562 V3=0 T=0 M2=0 M3=7,17957300102118	FrameElem=24-1 ElemStation=0
Frame=24 Station=0,04 OutputCase=STR096 CaseType=Combination P=-18,8628023943779 V2=31,9136277368562 V3=0 T=0 M2=0 M3=5,87110129154693	FrameElem=24-1 ElemStation=0,04
Frame=24 Station=0,08 OutputCase=STR096 CaseType=Combination P=-18,7028023943779 V2=30,3036852368562 V3=0 T=0 M2=0 M3=4,62670058207268	FrameElem=24-1 ElemStation=0,08
Frame=24 Station=0 OutputCase=STR097 CaseType=Combination P=-25,4138023940153 V2=16,1761798801721 V3=0 T=0 M2=0 M3=6,17617588187157	FrameElem=24-1 ElemStation=0
Frame=24 Station=0,04 OutputCase=STR097 CaseType=Combination P=-25,1978023940153 V2=15,2647948801721 V3=0 T=0 M2=0 M3=5,54741128666469	FrameElem=24-1 ElemStation=0,04
Frame=24 Station=0,08 OutputCase=STR097 CaseType=Combination P=-24,9818023940153 V2=14,3698798801721 V3=0 T=0 M2=0 M3=4,9547726914578	FrameElem=24-1 ElemStation=0,08
Frame=24 Station=0 OutputCase=STR098 CaseType=Combination P=-25,4138023940735 V2=8,42042673886811 V3=0 T=0 M2=0 M3=5,23602300889787	FrameElem=24-1 ElemStation=0
Frame=24 Station=0,04 OutputCase=STR098 CaseType=Combination P=-25,1978023940735 V2=7,99712673886811 V3=0 T=0 M2=0 M3=4,90769793934315	FrameElem=24-1 ElemStation=0,04
Frame=24 Station=0,08 OutputCase=STR098 CaseType=Combination P=-24,9818023940735 V2=7,58162673886811 V3=0 T=0 M2=0 M3=4,59614886978842	FrameElem=24-1 ElemStation=0,08
Frame=24 Station=0 OutputCase=STR099 CaseType=Combination P=-106,089802388939 V2=7,44828191695604 V3=0 T=0 M2=0 M3=15,0465552257252	FrameElem=24-1 ElemStation=0
Frame=24 Station=0,04 OutputCase=STR099 CaseType=Combination P=-105,873802388939 V2=7,02498191695604 V3=0 T=0 M2=0 M3=14,7571159490469	FrameElem=24-1 ElemStation=0,04
Frame=24 Station=0,08 OutputCase=STR099 CaseType=Combination P=-105,657802388939 V2=6,60948191695604 V3=0 T=0 M2=0 M3=14,4844526723687	FrameElem=24-1 ElemStation=0,08
Frame=24 Station=0 OutputCase=STR100 CaseType=Combination P=-95,7338901587811 V2=47,0297790124347 V3=0 T=0 M2=0 M3=30,2059941945141	FrameElem=24-1 ElemStation=0
Frame=24 Station=0,04 OutputCase=STR100 CaseType=Combination P=-95,5178901587811 V2=45,4361715124347 V3=0 T=0 M2=0 M3=28,3566207340167	FrameElem=24-1 ElemStation=0,04
Frame=24 Station=0,08 OutputCase=STR100 CaseType=Combination P=-95,3018901587811 V2=43,8262290124347 V3=0 T=0 M2=0 M3=26,5713182735193	FrameElem=24-1 ElemStation=0,08
Frame=24 Station=0 OutputCase=STR101 CaseType=Combination P=-106,089802388881 V2=33,8355260772548 V3=0 T=0 M2=0 M3=18,7423950148399	FrameElem=24-1 ElemStation=0
Frame=24 Station=0,04 OutputCase=STR101 CaseType=Combination P=-105,873802388881 V2=32,2419185772548 V3=0 T=0 M2=0 M3=17,4207916717497	FrameElem=24-1 ElemStation=0,04
Frame=24 Station=0,08 OutputCase=STR101 CaseType=Combination P=-105,657802388881 V2=30,6319760772548 V3=0 T=0 M2=0 M3=16,1632593286595	FrameElem=24-1 ElemStation=0,08
Frame=24 Station=0 OutputCase=STR102 CaseType=Combination P=-8,66689016427894 V2=47,8048428191161 V3=0 T=0 M2=0 M3=19,5592488600126	FrameElem=24-1 ElemStation=0
Frame=24 Station=0,04 OutputCase=STR102 CaseType=Combination P=-8,506689016427893 V2=46,2112353191161 V3=0 T=0 M2=0 M3=17,678872847248	FrameElem=24-1 ElemStation=0,04
Frame=24 Station=0,08 OutputCase=STR102 CaseType=Combination P=-8,34689016427894 V2=44,6012928191161 V3=0 T=0 M2=0 M3=15,8625678344833	FrameElem=24-1 ElemStation=0,08
Frame=24 Station=0 OutputCase=STR103 CaseType=Combination P=-19,0228023943787 V2=34,6105898839361 V3=0 T=0 M2=0 M3=8,09564968033839	FrameElem=24-1 ElemStation=0
Frame=24 Station=0,04 OutputCase=STR103 CaseType=Combination P=-18,8628023943787 V2=33,0169823839361 V3=0 T=0 M2=0 M3=6,74304378498095	FrameElem=24-1 ElemStation=0,04
Frame=24 Station=0,08 OutputCase=STR103 CaseType=Combination P=-18,7028023943787 V2=31,4070398839361 V3=0 T=0 M2=0 M3=5,45450888962351	FrameElem=24-1 ElemStation=0,08
Frame=24 Station=0 OutputCase=STR104 CaseType=Combination P=-25,4138023940153 V2=16,1761798801721 V3=0 T=0 M2=0 M3=6,17617588187157	FrameElem=24-1 ElemStation=0
Frame=24 Station=0,04 OutputCase=STR104 CaseType=Combination P=-25,1978023940153 V2=15,2647948801721 V3=0 T=0 M2=0 M3=5,54741128666469	FrameElem=24-1 ElemStation=0,04
Frame=24 Station=0,08 OutputCase=STR104 CaseType=Combination P=-24,9818023940153 V2=14,3698798801721 V3=0 T=0 M2=0 M3=4,9547726914578	FrameElem=24-1 ElemStation=0,08
Frame=24 Station=0 OutputCase=STR105 CaseType=Combination P=-25,4138023940735 V2=8,42042673886811 V3=0 T=0 M2=0 M3=5,23602300889787	FrameElem=24-1 ElemStation=0
Frame=24 Station=0,04 OutputCase=STR105 CaseType=Combination P=-25,1978023940735 V2=7,99712673886811 V3=0 T=0 M2=0 M3=4,90769793934315	FrameElem=24-1 ElemStation=0,04
Frame=24 Station=0,08 OutputCase=STR105 CaseType=Combination P=-24,9818023940735 V2=7,58162673886811 V3=0 T=0 M2=0 M3=4,59614886978842	FrameElem=24-1 ElemStation=0,08
Frame=24 Station=0 OutputCase=STR106 CaseType=Combination P=-106,089802388939 V2=7,44828191695604 V3=0 T=0 M2=0 M3=15,0465552257252	FrameElem=24-1 ElemStation=0
Frame=24 Station=0,04 OutputCase=STR106 CaseType=Combination P=-105,873802388939 V2=7,02498191695604 V3=0 T=0 M2=0 M3=14,7571159490469	FrameElem=24-1 ElemStation=0,04
Frame=24 Station=0,08 OutputCase=STR106 CaseType=Combination P=-105,657802388939 V2=6,60948191695604 V3=0 T=0 M2=0 M3=14,4844526723687	FrameElem=24-1 ElemStation=0,08
Frame=24 Station=0 OutputCase=STR107 CaseType=Combination P=-95,7338901587811 V2=47,0297790124347 V3=0 T=0 M2=0 M3=30,2059941945141	FrameElem=24-1 ElemStation=0
Frame=24 Station=0,04 OutputCase=STR107 CaseType=Combination P=-95,5178901587811 V2=45,4361715124347 V3=0 T=0 M2=0 M3=28,3566207340167	FrameElem=24-1 ElemStation=0,04
Frame=24 Station=0,08 OutputCase=STR107 CaseType=Combination P=-95,3018901587811 V2=43,8262290124347 V3=0 T=0 M2=0 M3=26,5713182735193	FrameElem=24-1 ElemStation=0,08
Frame=24 Station=0 OutputCase=STR108 CaseType=Combination P=-106,089802388881 V2=33,8355260772548 V3=0 T=0 M2=0 M3=18,7423950148399	FrameElem=24-1 ElemStation=0
Frame=24 Station=0,04 OutputCase=STR108 CaseType=Combination P=-105,873802388881 V2=32,2419185772548 V3=0 T=0 M2=0 M3=17,4207916717497	FrameElem=24-1 ElemStation=0,04
Frame=24 Station=0,08 OutputCase=STR108 CaseType=Combination P=-105,657802388881 V2=30,6319760772548 V3=0 T=0 M2=0 M3=16,1632593286595	FrameElem=24-1 ElemStation=0,08
Frame=24 Station=0 OutputCase=STR109 CaseType=Combination P=-8,66689016427894 V2=47,8048428191161 V3=0 T=0 M2=0 M3=19,5592488600126	FrameElem=24-1 ElemStation=0
Frame=24 Station=0,04 OutputCase=STR109 CaseType=Combination P=-8,506689016427893 V2=46,2112353191161 V3=0 T=0 M2=0 M3=17,678872847248	FrameElem=24-1 ElemStation=0,04
Frame=24 Station=0,08 OutputCase=STR109 CaseType=Combination P=-8,34689016427894 V2=44,6012928191161 V3=0 T=0 M2=0 M3=15,8625678344833	FrameElem=24-1 ElemStation=0,08
Frame=24 Station=0 OutputCase=STR110 CaseType=Combination P=-19,0228023943787 V2=34,6105898839361 V3=0 T=0 M2=0 M3=8,09564968033839	FrameElem=24-1 ElemStation=0

Società di Progetto
Brebemi SpA

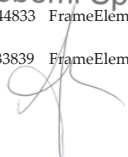

	Doc. N. 60235-0000-A00.doc	CODIFICA DOCUMENTO 04RCDII10000000000300A00	REV. 00	FOGLIO 351 di 628
--	-------------------------------	--	------------	----------------------

Frame=24 Station=0,04 OutputCase=STR110 CaseType=Combination P=-18,8628023943787 V2=33,0169823839361 V3=0 T=0 M2=0 M3=6,74304378498095	FrameElem=24-1 ElemStation=0,04
Frame=24 Station=0,08 OutputCase=STR110 CaseType=Combination P=-18,7028023943787 V2=31,4070398839361 V3=0 T=0 M2=0 M3=5,45450888962351	FrameElem=24-1 ElemStation=0,08
Frame=24 Station=0 OutputCase=STR111 CaseType=Combination P=-23,8881976031814 V2=14,8615925276025 V3=0 T=0 M2=0 M3=4,24448555749242	FrameElem=24-1 ElemStation=0
Frame=24 Station=0,04 OutputCase=STR111 CaseType=Combination P=-23,6721976031814 V2=13,9502075276025 V3=0 T=0 M2=0 M3=3,66830445638832	FrameElem=24-1 ElemStation=0,04
Frame=24 Station=0,08 OutputCase=STR111 CaseType=Combination P=-23,4561976031814 V2=13,0552925276025 V3=0 T=0 M2=0 M3=3,12824935528421	FrameElem=24-1 ElemStation=0,08
Frame=24 Station=0 OutputCase=STR112 CaseType=Combination P=-23,8881976032396 V2=7,10583938629853 V3=0 T=0 M2=0 M3=3,30433268451872	FrameElem=24-1 ElemStation=0
Frame=24 Station=0,04 OutputCase=STR112 CaseType=Combination P=-23,6721976032396 V2=6,68253938629853 V3=0 T=0 M2=0 M3=3,02859110906677	FrameElem=24-1 ElemStation=0,04
Frame=24 Station=0,08 OutputCase=STR112 CaseType=Combination P=-23,4561976032396 V2=6,26703938629853 V3=0 T=0 M2=0 M3=2,7696255361483	FrameElem=24-1 ElemStation=0,08
Frame=24 Station=0 OutputCase=STR113 CaseType=Combination P=-131,76131855456 V2=5,96222829622169 V3=0 T=0 M2=0 M3=16,6797727038992	FrameElem=24-1 ElemStation=0
Frame=24 Station=0,04 OutputCase=STR113 CaseType=Combination P=-131,54531855456 V2=5,53892829622169 V3=0 T=0 M2=0 M3=16,4497755720504	FrameElem=24-1 ElemStation=0,04
Frame=24 Station=0,08 OutputCase=STR113 CaseType=Combination P=-131,32931855456 V2=5,12342829622169 V3=0 T=0 M2=0 M3=16,2365544402015	FrameElem=24-1 ElemStation=0,08
Frame=24 Station=0 OutputCase=STR114 CaseType=Combination P=-118,579536974058 V2=55,3008728569276 V3=0 T=0 M2=0 M3=35,8252879484742	FrameElem=24-1 ElemStation=0
Frame=24 Station=0,04 OutputCase=STR114 CaseType=Combination P=-118,363536974057 V2=53,4798578569276 V3=0 T=0 M2=0 M3=33,6495824341971	FrameElem=24-1 ElemStation=0,04
Frame=24 Station=0,08 OutputCase=STR114 CaseType=Combination P=-118,147536974058 V2=51,6315728569276 V3=0 T=0 M2=0 M3=31,5472629199199	FrameElem=24-1 ElemStation=0,08
Frame=24 Station=0 OutputCase=STR115 CaseType=Combination P=-131,761318554502 V2=38,559969462852 V3=0 T=0 M2=0 M3=21,2941747983942	FrameElem=24-1 ElemStation=0
Frame=24 Station=0,04 OutputCase=STR115 CaseType=Combination P=-131,545318554502 V2=36,738954462852 V3=0 T=0 M2=0 M3=19,7881054198802	FrameElem=24-1 ElemStation=0,04
Frame=24 Station=0,08 OutputCase=STR115 CaseType=Combination P=-131,329318554502 V2=34,890669462852 V3=0 T=0 M2=0 M3=18,3554220413661	FrameElem=24-1 ElemStation=0,08
Frame=24 Station=0 OutputCase=STR116 CaseType=Combination P=-4,62053698126688 V2=56,3999849375796 V3=0 T=0 M2=0 M3=21,9083652083636	FrameElem=24-1 ElemStation=0
Frame=24 Station=0,04 OutputCase=STR116 CaseType=Combination P=-4,46053698126687 V2=54,5789699375796 V3=0 T=0 M2=0 M3=19,6886952108604	FrameElem=24-1 ElemStation=0,04
Frame=24 Station=0,08 OutputCase=STR116 CaseType=Combination P=-4,30053698126688 V2=52,7306849375796 V3=0 T=0 M2=0 M3=17,5424112133572	FrameElem=24-1 ElemStation=0,08
Frame=24 Station=0 OutputCase=STR117 CaseType=Combination P=-17,8023185617115 V2=39,659081543504 V3=0 T=0 M2=0 M3=7,37725205828368	FrameElem=24-1 ElemStation=0
Frame=24 Station=0,04 OutputCase=STR117 CaseType=Combination P=-17,6423185617115 V2=37,838066543504 V3=0 T=0 M2=0 M3=5,82721819654352	FrameElem=24-1 ElemStation=0,04
Frame=24 Station=0,08 OutputCase=STR117 CaseType=Combination P=-17,4823185617115 V2=35,989781543504 V3=0 T=0 M2=0 M3=4,35057033480336	FrameElem=24-1 ElemStation=0,08
Frame=24 Station=0 OutputCase=STR118 CaseType=Combination P=-75,1434935422657 V2=64,5801236738887 V3=0 T=0 M2=0 M3=43,5545076624537	FrameElem=24-1 ElemStation=0
Frame=24 Station=0,04 OutputCase=STR118 CaseType=Combination P=-74,9274935422658 V2=62,9865161738887 V3=0 T=0 M2=0 M3=41,0031204154982	FrameElem=24-1 ElemStation=0,04
Frame=24 Station=0,08 OutputCase=STR118 CaseType=Combination P=-74,7114935422657 V2=61,3765736738887 V3=0 T=0 M2=0 M3=38,5158041685426	FrameElem=24-1 ElemStation=0,08
Frame=24 Station=0 OutputCase=STR119 CaseType=Combination P=-104,564197598105 V2=6,13369456438646 V3=0 T=0 M2=0 M3=13,114864901346	FrameElem=24-1 ElemStation=0
Frame=24 Station=0,04 OutputCase=STR119 CaseType=Combination P=-104,348197598105 V2=5,71039456438646 V3=0 T=0 M2=0 M3=12,8780091187706	FrameElem=24-1 ElemStation=0,04
Frame=24 Station=0,08 OutputCase=STR119 CaseType=Combination P=-104,132197598105 V2=5,29489456438646 V3=0 T=0 M2=0 M3=12,657929361951	FrameElem=24-1 ElemStation=0,08
Frame=24 Station=0 OutputCase=STR120 CaseType=Combination P=-94,2082853679472 V2=45,7151916598652 V3=0 T=0 M2=0 M3=28,2743038701349	FrameElem=24-1 ElemStation=0
Frame=24 Station=0,04 OutputCase=STR120 CaseType=Combination P=-93,9922853679472 V2=44,1215841598652 V3=0 T=0 M2=0 M3=26,4775139037403	FrameElem=24-1 ElemStation=0,04
Frame=24 Station=0,08 OutputCase=STR120 CaseType=Combination P=-93,7762853679472 V2=42,5116416598652 V3=0 T=0 M2=0 M3=24,7447949373457	FrameElem=24-1 ElemStation=0,08
Frame=24 Station=0 OutputCase=STR121 CaseType=Combination P=-104,564197598047 V2=32,5209387246852 V3=0 T=0 M2=0 M3=16,8107046904607	FrameElem=24-1 ElemStation=0
Frame=24 Station=0,04 OutputCase=STR121 CaseType=Combination P=-104,348197598047 V2=30,9273312246852 V3=0 T=0 M2=0 M3=15,5416848414733	FrameElem=24-1 ElemStation=0,04
Frame=24 Station=0,08 OutputCase=STR121 CaseType=Combination P=-104,132197598047 V2=29,3173887246852 V3=0 T=0 M2=0 M3=14,3367359924859	FrameElem=24-1 ElemStation=0,08
Frame=24 Station=0 OutputCase=STR122 CaseType=Combination P=-7,14128537344506 V2=46,4902554665465 V3=0 T=0 M2=0 M3=17,6275585356334	FrameElem=24-1 ElemStation=0
Frame=24 Station=0,04 OutputCase=STR122 CaseType=Combination P=-6,98128537344505 V2=44,8966479665465 V3=0 T=0 M2=0 M3=15,7997660169716	FrameElem=24-1 ElemStation=0,04
Frame=24 Station=0,08 OutputCase=STR122 CaseType=Combination P=-6,82128537344506 V2=43,2867054665465 V3=0 T=0 M2=0 M3=14,0360444983097	FrameElem=24-1 ElemStation=0,08
Frame=24 Station=0 OutputCase=STR123 CaseType=Combination P=-17,4971976035448 V2=33,2960025313665 V3=0 T=0 M2=0 M3=6,16395935595924	FrameElem=24-1 ElemStation=0
Frame=24 Station=0,04 OutputCase=STR123 CaseType=Combination P=-17,3371976035448 V2=31,7023950313665 V3=0 T=0 M2=0 M3=4,86393695470458	FrameElem=24-1 ElemStation=0,04
Frame=24 Station=0,08 OutputCase=STR123 CaseType=Combination P=-17,1771976035448 V2=30,0924525313665 V3=0 T=0 M2=0 M3=3,62798555344992	FrameElem=24-1 ElemStation=0,08
Frame=24 Station=0 OutputCase=STR124 CaseType=Combination P=-23,888197603181 V2=14,3099152040626 V3=0 T=0 M2=0 M3=3,78644721783381	FrameElem=24-1 ElemStation=0
Frame=24 Station=0,04 OutputCase=STR124 CaseType=Combination P=-23,672197603181 V2=13,3985302040626 V3=0 T=0 M2=0 M3=3,23233320967131	FrameElem=24-1 ElemStation=0,04
Frame=24 Station=0,08 OutputCase=STR124 CaseType=Combination P=-23,456197603181 V2=12,5036152040626 V3=0 T=0 M2=0 M3=2,7143452015088	FrameElem=24-1 ElemStation=0,08

Società di Progetto
Brebemi SpA



Doc. N.
60235-0000-A00.doc

CODIFICA DOCUMENTO
04RCDII10000000000300A00

REV.
00

FOGLIO
352 di 628

Frame=24 Station=0 OutputCase=STR125 CaseType=Combination P=-23,8881976032392 V2=6,5541620627586 V3=0 T=0 M2=0 M3=2,84629434486011	FrameElem=24-1
ElemStation=0	
Frame=24 Station=0,04 OutputCase=STR125 CaseType=Combination P=-23,6721976032392 V2=6,1308620627586 V3=0 T=0 M2=0 M3=2,59261986234976	FrameElem=24-1
ElemStation=0,04	
Frame=24 Station=0,08 OutputCase=STR125 CaseType=Combination P=-23,4561976032392 V2=5,7153620627586 V3=0 T=0 M2=0 M3=2,35572137983942	FrameElem=24-1
ElemStation=0,08	
Frame=24 Station=0 OutputCase=STR126 CaseType=Combination P=-104,564197598105 V2=5,58201724084652 V3=0 T=0 M2=0 M3=12,6568265616874	FrameElem=24-1
ElemStation=0	
Frame=24 Station=0,04 OutputCase=STR126 CaseType=Combination P=-104,348197598105 V2=5,15871724084652 V3=0 T=0 M2=0 M3=12,4420378720535	FrameElem=24-1
ElemStation=0,04	
Frame=24 Station=0,08 OutputCase=STR126 CaseType=Combination P=-104,132197598105 V2=4,74321724084652 V3=0 T=0 M2=0 M3=12,2440251824197	FrameElem=24-1
ElemStation=0,08	
Frame=24 Station=0 OutputCase=STR127 CaseType=Combination P=-94,2082853679467 V2=45,1635143363252 V3=0 T=0 M2=0 M3=27,8162655304763	FrameElem=24-1
ElemStation=0	
Frame=24 Station=0,04 OutputCase=STR127 CaseType=Combination P=-93,9922853679468 V2=43,5699068363252 V3=0 T=0 M2=0 M3=26,0415426570233	FrameElem=24-1
ElemStation=0,04	
Frame=24 Station=0,08 OutputCase=STR127 CaseType=Combination P=-93,7762853679468 V2=41,9599643363252 V3=0 T=0 M2=0 M3=24,3308907835703	FrameElem=24-1
ElemStation=0,08	
Frame=24 Station=0 OutputCase=STR128 CaseType=Combination P=-104,564197598047 V2=31,9692614011452 V3=0 T=0 M2=0 M3=16,3526663508021	FrameElem=24-1
ElemStation=0	
Frame=24 Station=0,04 OutputCase=STR128 CaseType=Combination P=-104,348197598047 V2=30,3756539011452 V3=0 T=0 M2=0 M3=15,1057135947563	FrameElem=24-1
ElemStation=0,04	
Frame=24 Station=0,08 OutputCase=STR128 CaseType=Combination P=-104,132197598047 V2=28,7657114011452 V3=0 T=0 M2=0 M3=13,9228318387105	FrameElem=24-1
ElemStation=0,08	
Frame=24 Station=0 OutputCase=STR129 CaseType=Combination P=-7,14128537344465 V2=45,9385781430065 V3=0 T=0 M2=0 M3=17,1695201959748	FrameElem=24-1
ElemStation=0	
Frame=24 Station=0,04 OutputCase=STR129 CaseType=Combination P=-6,98128537344464 V2=44,3449706430065 V3=0 T=0 M2=0 M3=15,3637947702546	FrameElem=24-1
ElemStation=0,04	
Frame=24 Station=0,08 OutputCase=STR129 CaseType=Combination P=-6,82128537344465 V2=42,7350281430066 V3=0 T=0 M2=0 M3=13,6221403445343	FrameElem=24-1
ElemStation=0,08	
Frame=24 Station=0 OutputCase=STR130 CaseType=Combination P=-17,4971976035444 V2=32,7443252078266 V3=0 T=0 M2=0 M3=5,70592101630063	FrameElem=24-1
ElemStation=0	
Frame=24 Station=0,04 OutputCase=STR130 CaseType=Combination P=-17,3371976035444 V2=31,1507177078266 V3=0 T=0 M2=0 M3=4,42796570798757	FrameElem=24-1
ElemStation=0,04	
Frame=24 Station=0,08 OutputCase=STR130 CaseType=Combination P=-17,1771976035444 V2=29,5407752078266 V3=0 T=0 M2=0 M3=3,2140813996745	FrameElem=24-1
ElemStation=0,08	
Frame=24 Station=0 OutputCase=STR131 CaseType=Combination P=-23,8881976031818 V2=15,4132698511425 V3=0 T=0 M2=0 M3=4,70252389715103	FrameElem=24-1
ElemStation=0	
Frame=24 Station=0,04 OutputCase=STR131 CaseType=Combination P=-23,6721976031818 V2=14,5018848511425 V3=0 T=0 M2=0 M3=4,10427570310533	FrameElem=24-1
ElemStation=0,04	
Frame=24 Station=0,08 OutputCase=STR131 CaseType=Combination P=-23,4561976031818 V2=13,6069698511425 V3=0 T=0 M2=0 M3=3,54215350905963	FrameElem=24-1
ElemStation=0,08	
Frame=24 Station=0 OutputCase=STR132 CaseType=Combination P=-23,88819760324 V2=7,65751670983847 V3=0 T=0 M2=0 M3=3,76237102417732	FrameElem=24-1
ElemStation=0	
Frame=24 Station=0,04 OutputCase=STR132 CaseType=Combination P=-23,67219760324 V2=7,23421670983847 V3=0 T=0 M2=0 M3=3,46456235578378	FrameElem=24-1
ElemStation=0,04	
Frame=24 Station=0,08 OutputCase=STR132 CaseType=Combination P=-23,45619760324 V2=6,81871670983847 V3=0 T=0 M2=0 M3=3,18352968739025	FrameElem=24-1
ElemStation=0,08	
Frame=24 Station=0 OutputCase=STR133 CaseType=Combination P=-104,564197598106 V2=6,6853718879264 V3=0 T=0 M2=0 M3=13,5729032410046	FrameElem=24-1
ElemStation=0	
Frame=24 Station=0,04 OutputCase=STR133 CaseType=Combination P=-104,348197598106 V2=6,26207188792639 V3=0 T=0 M2=0 M3=13,3139803654876	FrameElem=24-1
ElemStation=0,04	
Frame=24 Station=0,08 OutputCase=STR133 CaseType=Combination P=-104,132197598106 V2=5,84657188792639 V3=0 T=0 M2=0 M3=13,0178334899705	FrameElem=24-1
ElemStation=0,08	
Frame=24 Station=0 OutputCase=STR134 CaseType=Combination P=-94,2082853679476 V2=46,2668689834051 V3=0 T=0 M2=0 M3=28,7323422097935	FrameElem=24-1
ElemStation=0	
Frame=24 Station=0,04 OutputCase=STR134 CaseType=Combination P=-93,9922853679476 V2=44,6732614834051 V3=0 T=0 M2=0 M3=26,9134851504573	FrameElem=24-1
ElemStation=0,04	
Frame=24 Station=0,08 OutputCase=STR134 CaseType=Combination P=-93,7762853679476 V2=43,0633189834051 V3=0 T=0 M2=0 M3=25,1586990911211	FrameElem=24-1
ElemStation=0,08	
Frame=24 Station=0 OutputCase=STR135 CaseType=Combination P=-104,564197598047 V2=33,0726160482251 V3=0 T=0 M2=0 M3=17,2687430301193	FrameElem=24-1
ElemStation=0	
Frame=24 Station=0,04 OutputCase=STR135 CaseType=Combination P=-104,348197598047 V2=31,4790085482251 V3=0 T=0 M2=0 M3=15,9776560881903	FrameElem=24-1
ElemStation=0,04	
Frame=24 Station=0,08 OutputCase=STR135 CaseType=Combination P=-104,132197598047 V2=29,8690660482251 V3=0 T=0 M2=0 M3=14,7506401462613	FrameElem=24-1
ElemStation=0,08	
Frame=24 Station=0 OutputCase=STR136 CaseType=Combination P=-7,14128537344547 V2=47,0419327900864 V3=0 T=0 M2=0 M3=18,085596875292	FrameElem=24-1
ElemStation=0	
Frame=24 Station=0,04 OutputCase=STR136 CaseType=Combination P=-6,98128537344546 V2=45,4483252900864 V3=0 T=0 M2=0 M3=16,2357372636886	FrameElem=24-1
ElemStation=0,04	
Frame=24 Station=0,08 OutputCase=STR136 CaseType=Combination P=-6,82128537344547 V2=43,8383827900864 V3=0 T=0 M2=0 M3=14,4499486520851	FrameElem=24-1
ElemStation=0,08	
Frame=24 Station=0 OutputCase=STR137 CaseType=Combination P=-17,4971976035452 V2=33,8476798549064 V3=0 T=0 M2=0 M3=6,62199769561785	FrameElem=24-1
ElemStation=0	
Frame=24 Station=0,04 OutputCase=STR137 CaseType=Combination P=-17,3371976035452 V2=32,2540723549064 V3=0 T=0 M2=0 M3=5,29990820142159	FrameElem=24-1
ElemStation=0,04	
Frame=24 Station=0,08 OutputCase=STR137 CaseType=Combination P=-17,1771976035452 V2=30,6441298549064 V3=0 T=0 M2=0 M3=4,04188970722533	FrameElem=24-1
ElemStation=0,08	
Frame=24 Station=0 OutputCase=STR138 CaseType=Combination P=-23,8881976031818 V2=15,4132698511425 V3=0 T=0 M2=0 M3=4,70252389715103	FrameElem=24-1
ElemStation=0	
Frame=24 Station=0,04 OutputCase=STR138 CaseType=Combination P=-23,6721976031818 V2=14,5018848511425 V3=0 T=0 M2=0 M3=4,10427570310533	FrameElem=24-1
ElemStation=0,04	
Frame=24 Station=0,08 OutputCase=STR138 CaseType=Combination P=-23,4561976031818 V2=13,6069698511425 V3=0 T=0 M2=0 M3=3,54215350905963	FrameElem=24-1
ElemStation=0,08	
Frame=24 Station=0 OutputCase=STR139 CaseType=Combination P=-23,88819760324 V2=7,65751670983847 V3=0 T=0 M2=0 M3=3,76237102417732	FrameElem=24-1
ElemStation=0	
Frame=24 Station=0,04 OutputCase=STR139 CaseType=Combination P=-23,67219760324 V2=7,23421670983847 V3=0 T=0 M2=0 M3=3,46456235578378	FrameElem=24-1
ElemStation=0,04	

Società di Progetto
Brebemi SpA

	Doc. N. 60235-0000-A00.doc	CODIFICA DOCUMENTO 04RCDII10000000000300A00	REV. 00	FOGLIO 353 di 628
--	-------------------------------	--	------------	----------------------

Frame=24 Station=0,08 OutputCase=STR139 CaseType=Combination P=-23,45619760324 V2=6,81871670983847 V3=0 T=0 M2=0 M3=3,18352968739025	FrameElem=24-1 ElemStation=0,08
Frame=24 Station=0 OutputCase=STR140 CaseType=Combination P=-104,564197598106 V2=6,6853718879264 V3=0 T=0 M2=0 M3=13,5729032410046	FrameElem=24-1 ElemStation=0
Frame=24 Station=0,04 OutputCase=STR140 CaseType=Combination P=-104,348197598106 V2=6,26207188792639 V3=0 T=0 M2=0 M3=13,3139803654876	FrameElem=24-1 ElemStation=0,04
Frame=24 Station=0,08 OutputCase=STR140 CaseType=Combination P=-104,132197598106 V2=5,84657188792639 V3=0 T=0 M2=0 M3=13,0718334899705	FrameElem=24-1 ElemStation=0,08
Frame=24 Station=0 OutputCase=STR141 CaseType=Combination P=-94,2082853679476 V2=46,2668689834051 V3=0 T=0 M2=0 M3=28,7323422097935	FrameElem=24-1 ElemStation=0
Frame=24 Station=0,04 OutputCase=STR141 CaseType=Combination P=-93,9922853679476 V2=44,6732614834051 V3=0 T=0 M2=0 M3=26,9134851504573	FrameElem=24-1 ElemStation=0,04
Frame=24 Station=0,08 OutputCase=STR141 CaseType=Combination P=-93,7762853679476 V2=43,0633189834051 V3=0 T=0 M2=0 M3=25,1586990911211	FrameElem=24-1 ElemStation=0,08
Frame=24 Station=0 OutputCase=STR142 CaseType=Combination P=-104,564197598047 V2=33,0726160482251 V3=0 T=0 M2=0 M3=17,2687430301193	FrameElem=24-1 ElemStation=0
Frame=24 Station=0,04 OutputCase=STR142 CaseType=Combination P=-104,348197598047 V2=31,4790085482251 V3=0 T=0 M2=0 M3=15,9776560881903	FrameElem=24-1 ElemStation=0,04
Frame=24 Station=0,08 OutputCase=STR142 CaseType=Combination P=-104,132197598047 V2=29,8690660482251 V3=0 T=0 M2=0 M3=14,7506401462613	FrameElem=24-1 ElemStation=0,08
Frame=24 Station=0 OutputCase=STR143 CaseType=Combination P=-7,14128537344547 V2=47,0419327900864 V3=0 T=0 M2=0 M3=18,085596875292	FrameElem=24-1 ElemStation=0
Frame=24 Station=0,04 OutputCase=STR143 CaseType=Combination P=-6,98128537344546 V2=45,4483252900864 V3=0 T=0 M2=0 M3=16,2357372636886	FrameElem=24-1 ElemStation=0,04
Frame=24 Station=0,08 OutputCase=STR143 CaseType=Combination P=-6,82128537344547 V2=43,8383827900864 V3=0 T=0 M2=0 M3=14,4499486520851	FrameElem=24-1 ElemStation=0,08
Frame=24 Station=0 OutputCase=STR144 CaseType=Combination P=-17,4971976035452 V2=33,8476798549064 V3=0 T=0 M2=0 M3=6,62199769561785	FrameElem=24-1 ElemStation=0
Frame=24 Station=0,04 OutputCase=STR144 CaseType=Combination P=-17,3371976035452 V2=32,2540723549064 V3=0 T=0 M2=0 M3=5,29990820142159	FrameElem=24-1 ElemStation=0,04
Frame=24 Station=0,08 OutputCase=STR144 CaseType=Combination P=-17,1771976035452 V2=30,6441298549064 V3=0 T=0 M2=0 M3=4,04188970722533	FrameElem=24-1 ElemStation=0,08
Frame=24 Station=0 OutputCase=STR145 CaseType=Combination P=-24,6509999985988 V2=16,1625097480173 V3=0 T=0 M2=0 M3=5,74470878261704	FrameElem=24-1 ElemStation=0
Frame=24 Station=0,04 OutputCase=STR145 CaseType=Combination P=-24,4349999985988 V2=15,2511247480173 V3=0 T=0 M2=0 M3=5,11649099269635	FrameElem=24-1 ElemStation=0,04
Frame=24 Station=0,08 OutputCase=STR145 CaseType=Combination P=-24,2189999985988 V2=14,3562097480173 V3=0 T=0 M2=0 M3=4,52439920277566	FrameElem=24-1 ElemStation=0,08
Frame=24 Station=0 OutputCase=STR146 CaseType=Combination P=-24,650999998657 V2=8,40675660671325 V3=0 T=0 M2=0 M3=4,80455590964334	FrameElem=24-1 ElemStation=0
Frame=24 Station=0,04 OutputCase=STR146 CaseType=Combination P=-24,434999998657 V2=7,98345660671325 V3=0 T=0 M2=0 M3=4,47677764537481	FrameElem=24-1 ElemStation=0,04
Frame=24 Station=0,08 OutputCase=STR146 CaseType=Combination P=-24,218999998657 V2=7,56795660671325 V3=0 T=0 M2=0 M3=4,16577538110628	FrameElem=24-1 ElemStation=0,08
Frame=24 Station=0 OutputCase=STR147 CaseType=Combination P=-132,218999991811 V2=6,74277862847052 V3=0 T=0 M2=0 M3=17,579906638974	FrameElem=24-1 ElemStation=0
Frame=24 Station=0,04 OutputCase=STR147 CaseType=Combination P=-132,002999991811 V2=6,31947862847052 V3=0 T=0 M2=0 M3=17,3186874938352	FrameElem=24-1 ElemStation=0,04
Frame=24 Station=0,08 OutputCase=STR147 CaseType=Combination P=-131,786999991811 V2=5,90397862847052 V3=0 T=0 M2=0 M3=17,0742443486964	FrameElem=24-1 ElemStation=0,08
Frame=24 Station=0 OutputCase=STR148 CaseType=Combination P=-119,037218411308 V2=56,0814231891764 V3=0 T=0 M2=0 M3=36,7254218835489	FrameElem=24-1 ElemStation=0
Frame=24 Station=0,04 OutputCase=STR148 CaseType=Combination P=-118,821218411308 V2=54,2604081891764 V3=0 T=0 M2=0 M3=34,5184943559819	FrameElem=24-1 ElemStation=0,04
Frame=24 Station=0,08 OutputCase=STR148 CaseType=Combination P=-118,605218411308 V2=52,4121231891764 V3=0 T=0 M2=0 M3=32,3849528284148	FrameElem=24-1 ElemStation=0,08
Frame=24 Station=0 OutputCase=STR149 CaseType=Combination P=-132,218999991753 V2=39,3405197951008 V3=0 T=0 M2=0 M3=22,194308733469	FrameElem=24-1 ElemStation=0
Frame=24 Station=0,04 OutputCase=STR149 CaseType=Combination P=-132,002999991753 V2=37,5195047951008 V3=0 T=0 M2=0 M3=20,657017341665	FrameElem=24-1 ElemStation=0,04
Frame=24 Station=0,08 OutputCase=STR149 CaseType=Combination P=-131,786999991753 V2=35,6712197951008 V3=0 T=0 M2=0 M3=19,1931119498609	FrameElem=24-1 ElemStation=0,08
Frame=24 Station=0 OutputCase=STR150 CaseType=Combination P=-5,07821841851733 V2=57,1805352698284 V3=0 T=0 M2=0 M3=22,8084991434384	FrameElem=24-1 ElemStation=0
Frame=24 Station=0,04 OutputCase=STR150 CaseType=Combination P=-4,91821841851732 V2=55,3595202698284 V3=0 T=0 M2=0 M3=20,5576071326452	FrameElem=24-1 ElemStation=0,04
Frame=24 Station=0,08 OutputCase=STR150 CaseType=Combination P=-4,75821841851733 V2=53,5112352698284 V3=0 T=0 M2=0 M3=18,38011011218521	FrameElem=24-1 ElemStation=0,08
Frame=24 Station=0 OutputCase=STR151 CaseType=Combination P=-18,259999998962 V2=40,4396318757528 V3=0 T=0 M2=0 M3=8,27738599335845	FrameElem=24-1 ElemStation=0
Frame=24 Station=0,04 OutputCase=STR151 CaseType=Combination P=-18,099999998962 V2=38,6186168757528 V3=0 T=0 M2=0 M3=6,69613011832834	FrameElem=24-1 ElemStation=0,04
Frame=24 Station=0,08 OutputCase=STR151 CaseType=Combination P=-17,939999998962 V2=36,7703318757528 V3=0 T=0 M2=0 M3=5,18826024329822	FrameElem=24-1 ElemStation=0,08
Frame=24 Station=0 OutputCase=STR152 CaseType=Combination P=-75,6011749795162 V2=65,3606740061375 V3=0 T=0 M2=0 M3=44,4546415975285	FrameElem=24-1 ElemStation=0
Frame=24 Station=0,04 OutputCase=STR152 CaseType=Combination P=-75,3851749795162 V2=63,7670665061375 V3=0 T=0 M2=0 M3=41,872032337283	FrameElem=24-1 ElemStation=0,04
Frame=24 Station=0,08 OutputCase=STR152 CaseType=Combination P=-75,1691749795162 V2=62,1571240061375 V3=0 T=0 M2=0 M3=39,3534940770375	FrameElem=24-1 ElemStation=0,08
Frame=24 Station=0 OutputCase=STR153 CaseType=Combination P=-105,326999993523 V2=7,43461178480117 V3=0 T=0 M2=0 M3=14,6150881264706	FrameElem=24-1 ElemStation=0
Frame=24 Station=0,04 OutputCase=STR153 CaseType=Combination P=-105,110999993523 V2=7,01131178480117 V3=0 T=0 M2=0 M3=14,3261956550786	FrameElem=24-1 ElemStation=0,04
Frame=24 Station=0,08 OutputCase=STR153 CaseType=Combination P=-104,894999993523 V2=6,59581178480117 V3=0 T=0 M2=0 M3=14,0540791836865	FrameElem=24-1 ElemStation=0,08
Frame=24 Station=0 OutputCase=STR154 CaseType=Combination P=-94,9710877633646 V2=47,0161088802799 V3=0 T=0 M2=0 M3=29,7745270952595	FrameElem=24-1 ElemStation=0

Società di Progetto
Brebemi SpA

Frame=24 Station=0,04 OutputCase=STR154 CaseType=Combination P=-94,7550877633646 V2=45,4225013802799 V3=0 T=0 M2=0 M3=27,9257004400483 FrameElem=24-1 ElemStation=0,04
Frame=24 Station=0,08 OutputCase=STR154 CaseType=Combination P=-94,5390877633646 V2=43,812558802799 V3=0 T=0 M2=0 M3=26,1409447848371 FrameElem=24-1 ElemStation=0,08
Frame=24 Station=0 OutputCase=STR155 CaseType=Combination P=-105,326999993464 V2=33,8218559450999 V3=0 T=0 M2=0 M3=18,3109279155853 FrameElem=24-1 ElemStation=0
Frame=24 Station=0,04 OutputCase=STR155 CaseType=Combination P=-105,110999993464 V2=32,2282484450999 V3=0 T=0 M2=0 M3=16,9898713777813 FrameElem=24-1 ElemStation=0,04
Frame=24 Station=0,08 OutputCase=STR155 CaseType=Combination P=-104,894999993464 V2=30,6183059450999 V3=0 T=0 M2=0 M3=15,7328858399773 FrameElem=24-1 ElemStation=0,08
Frame=24 Station=0 OutputCase=STR156 CaseType=Combination P=-7,90408776886247 V2=47,7911726869612 V3=0 T=0 M2=0 M3=19,1277817607581 FrameElem=24-1 ElemStation=0
Frame=24 Station=0,04 OutputCase=STR156 CaseType=Combination P=-7,74408776886247 V2=46,1975651869612 V3=0 T=0 M2=0 M3=17,247925532796 FrameElem=24-1 ElemStation=0,04
Frame=24 Station=0,08 OutputCase=STR156 CaseType=Combination P=-7,58408776886247 V2=44,5876226869612 V3=0 T=0 M2=0 M3=15,4321943458012 FrameElem=24-1 ElemStation=0,08
Frame=24 Station=0 OutputCase=STR157 CaseType=Combination P=-18,2599999989623 V2=34,5969197517812 V3=0 T=0 M2=0 M3=7,66418258108386 FrameElem=24-1 ElemStation=0
Frame=24 Station=0,04 OutputCase=STR157 CaseType=Combination P=-18,0999999989623 V2=33,0033122517812 V3=0 T=0 M2=0 M3=6,31212349101261 FrameElem=24-1 ElemStation=0,04
Frame=24 Station=0,08 OutputCase=STR157 CaseType=Combination P=-17,9399999989623 V2=31,3933697517812 V3=0 T=0 M2=0 M3=5,02413540094136 FrameElem=24-1 ElemStation=0,08
Frame=24 Station=0 OutputCase=STR158 CaseType=Combination P=-24,6509999985984 V2=15,6108324244773 V3=0 T=0 M2=0 M3=5,28667044295843 FrameElem=24-1 ElemStation=0
Frame=24 Station=0,04 OutputCase=STR158 CaseType=Combination P=-24,4349999985984 V2=14,6994474244773 V3=0 T=0 M2=0 M3=4,68051974597934 FrameElem=24-1 ElemStation=0,04
Frame=24 Station=0,08 OutputCase=STR158 CaseType=Combination P=-24,2189999985984 V2=13,8045324244773 V3=0 T=0 M2=0 M3=4,11049504900024 FrameElem=24-1 ElemStation=0,08
Frame=24 Station=0 OutputCase=STR159 CaseType=Combination P=-24,6509999986566 V2=7,85507928317331 V3=0 T=0 M2=0 M3=4,34651756998473 FrameElem=24-1 ElemStation=0
Frame=24 Station=0,04 OutputCase=STR159 CaseType=Combination P=-24,4349999986566 V2=7,43177928317331 V3=0 T=0 M2=0 M3=4,0480639865779 FrameElem=24-1 ElemStation=0,04
Frame=24 Station=0,08 OutputCase=STR159 CaseType=Combination P=-24,2189999986566 V2=7,01627928317331 V3=0 T=0 M2=0 M3=3,75187122733086 FrameElem=24-1 ElemStation=0,08
Frame=24 Station=0 OutputCase=STR160 CaseType=Combination P=-105,326999993522 V2=6,88293446126124 V3=0 T=0 M2=0 M3=14,157049786812 FrameElem=24-1 ElemStation=0
Frame=24 Station=0,04 OutputCase=STR160 CaseType=Combination P=-105,110999993522 V2=6,45963446126123 V3=0 T=0 M2=0 M3=13,8902244083616 FrameElem=24-1 ElemStation=0,04
Frame=24 Station=0,08 OutputCase=STR160 CaseType=Combination P=-104,894999993522 V2=6,04413446126124 V3=0 T=0 M2=0 M3=13,6401750299111 FrameElem=24-1 ElemStation=0,08
Frame=24 Station=0 OutputCase=STR161 CaseType=Combination P=-94,9710877633642 V2=46,4644315567399 V3=0 T=0 M2=0 M3=29,3164887556009 FrameElem=24-1 ElemStation=0
Frame=24 Station=0,04 OutputCase=STR161 CaseType=Combination P=-94,7550877633642 V2=44,8708240567399 V3=0 T=0 M2=0 M3=27,4897291933313 FrameElem=24-1 ElemStation=0,04
Frame=24 Station=0,08 OutputCase=STR161 CaseType=Combination P=-94,5390877633642 V2=43,2608815567399 V3=0 T=0 M2=0 M3=25,7270406310617 FrameElem=24-1 ElemStation=0,08
Frame=24 Station=0 OutputCase=STR162 CaseType=Combination P=-105,326999993464 V2=33,27017862156 V3=0 T=0 M2=0 M3=17,8528985759267 FrameElem=24-1 ElemStation=0
Frame=24 Station=0,04 OutputCase=STR162 CaseType=Combination P=-105,110999993464 V2=31,67657112156 V3=0 T=0 M2=0 M3=16,5539001310643 FrameElem=24-1 ElemStation=0,04
Frame=24 Station=0,08 OutputCase=STR162 CaseType=Combination P=-104,894999993464 V2=30,06662862156 V3=0 T=0 M2=0 M3=15,3189816862019 FrameElem=24-1 ElemStation=0,08
Frame=24 Station=0 OutputCase=STR163 CaseType=Combination P=-7,90408776886207 V2=47,2394953634213 V3=0 T=0 M2=0 M3=18,6697434210995 FrameElem=24-1 ElemStation=0
Frame=24 Station=0,04 OutputCase=STR163 CaseType=Combination P=-7,74408776886206 V2=45,6458878634213 V3=0 T=0 M2=0 M3=16,8119813065626 FrameElem=24-1 ElemStation=0,04
Frame=24 Station=0,08 OutputCase=STR163 CaseType=Combination P=-7,58408776886206 V2=44,0359453634213 V3=0 T=0 M2=0 M3=15,0182901920258 FrameElem=24-1 ElemStation=0,08
Frame=24 Station=0 OutputCase=STR164 CaseType=Combination P=-18,2599999989618 V2=34,0452424282413 V3=0 T=0 M2=0 M3=7,20614424142525 FrameElem=24-1 ElemStation=0
Frame=24 Station=0,04 OutputCase=STR164 CaseType=Combination P=-18,0999999989618 V2=32,4516349282413 V3=0 T=0 M2=0 M3=5,8761522442956 FrameElem=24-1 ElemStation=0,04
Frame=24 Station=0,08 OutputCase=STR164 CaseType=Combination P=-17,9399999989618 V2=30,8416924282413 V3=0 T=0 M2=0 M3=4,61023124716595 FrameElem=24-1 ElemStation=0,08
Frame=24 Station=0 OutputCase=STR165 CaseType=Combination P=-24,6509999985992 V2=16,7141870715572 V3=0 T=0 M2=0 M3=6,20274712227565 FrameElem=24-1 ElemStation=0
Frame=24 Station=0,04 OutputCase=STR165 CaseType=Combination P=-24,4349999985992 V2=15,8028020715572 V3=0 T=0 M2=0 M3=5,55246223941336 FrameElem=24-1 ElemStation=0,04
Frame=24 Station=0,08 OutputCase=STR165 CaseType=Combination P=-24,2189999985992 V2=14,9078870715572 V3=0 T=0 M2=0 M3=4,93830335655107 FrameElem=24-1 ElemStation=0,08
Frame=24 Station=0 OutputCase=STR166 CaseType=Combination P=-24,6509999986574 V2=8,95843393025319 V3=0 T=0 M2=0 M3=5,26259424930194 FrameElem=24-1 ElemStation=0
Frame=24 Station=0,04 OutputCase=STR166 CaseType=Combination P=-24,4349999986574 V2=8,53513393025319 V3=0 T=0 M2=0 M3=4,91274889209182 FrameElem=24-1 ElemStation=0,04
Frame=24 Station=0,08 OutputCase=STR166 CaseType=Combination P=-24,2189999986574 V2=8,11963393025319 V3=0 T=0 M2=0 M3=4,57967953488169 FrameElem=24-1 ElemStation=0,08
Frame=24 Station=0 OutputCase=STR167 CaseType=Combination P=-105,326999993523 V2=7,98628910834111 V3=0 T=0 M2=0 M3=15,0731264661292 FrameElem=24-1 ElemStation=0
Frame=24 Station=0,04 OutputCase=STR167 CaseType=Combination P=-105,110999993523 V2=7,56298910834111 V3=0 T=0 M2=0 M3=14,7621669017956 FrameElem=24-1 ElemStation=0,04
Frame=24 Station=0,08 OutputCase=STR167 CaseType=Combination P=-104,894999993523 V2=7,14748910834111 V3=0 T=0 M2=0 M3=14,467983337462 FrameElem=24-1 ElemStation=0,08
Frame=24 Station=0 OutputCase=STR168 CaseType=Combination P=-94,971087763365 V2=47,5677862038198 V3=0 T=0 M2=0 M3=30,2325654349181 FrameElem=24-1 ElemStation=0
Frame=24 Station=0,04 OutputCase=STR168 CaseType=Combination P=-94,755087763365 V2=45,9741787038198 V3=0 T=0 M2=0 M3=28,3616716867653 FrameElem=24-1 ElemStation=0,04
Frame=24 Station=0,08 OutputCase=STR168 CaseType=Combination P=-94,539087763365 V2=44,3642362038198 V3=0 T=0 M2=0 M3=26,5548489386125 FrameElem=24-1 ElemStation=0,08

	Doc. N. 60235-0000-A00.doc	CODIFICA DOCUMENTO 04RCDII10000000000300A00	REV. 00	FOGLIO 355 di 628
--	-------------------------------	--	------------	----------------------

Frame=24 Station=0 OutputCase=STR169 CaseType=Combination P=-105,326999993465 V2=34,3735332686398 V3=0 T=0 M2=0 M3=18,7689662552439	FrameElem=24-1 ElemStation=0
Frame=24 Station=0,04 OutputCase=STR169 CaseType=Combination P=-105,110999993465 V2=32,7799257686398 V3=0 T=0 M2=0 M3=17,4258426244983	FrameElem=24-1 ElemStation=0,04
Frame=24 Station=0,08 OutputCase=STR169 CaseType=Combination P=-104,894999993465 V2=31,1699832686398 V3=0 T=0 M2=0 M3=16,1467899937527	FrameElem=24-1 ElemStation=0,08
Frame=24 Station=0 OutputCase=STR170 CaseType=Combination P=-7,90408776886288 V2=48,3428500105011 V3=0 T=0 M2=0 M3=19,5858201004167	FrameElem=24-1 ElemStation=0
Frame=24 Station=0,04 OutputCase=STR170 CaseType=Combination P=-7,74408776886288 V2=46,7492425105011 V3=0 T=0 M2=0 M3=17,6839237999966	FrameElem=24-1 ElemStation=0,04
Frame=24 Station=0,08 OutputCase=STR170 CaseType=Combination P=-7,58408776886288 V2=45,1393000105011 V3=0 T=0 M2=0 M3=15,8460984995766	FrameElem=24-1 ElemStation=0,08
Frame=24 Station=0 OutputCase=STR171 CaseType=Combination P=-18,2599999989627 V2=35,1485970753212 V3=0 T=0 M2=0 M3=8,12222092074247	FrameElem=24-1 ElemStation=0
Frame=24 Station=0,04 OutputCase=STR171 CaseType=Combination P=-18,0999999989627 V2=33,5549895753212 V3=0 T=0 M2=0 M3=6,74809473772962	FrameElem=24-1 ElemStation=0,04
Frame=24 Station=0,08 OutputCase=STR171 CaseType=Combination P=-17,9399999989627 V2=31,9450470753212 V3=0 T=0 M2=0 M3=5,43803955471677	FrameElem=24-1 ElemStation=0,08
Frame=24 Station=0 OutputCase=STR172 CaseType=Combination P=-25,1086814358488 V2=16,3913827567262 V3=0 T=0 M2=0 M3=6,1868043780332	FrameElem=24-1 ElemStation=0
Frame=24 Station=0,04 OutputCase=STR172 CaseType=Combination P=-24,8926814358489 V2=15,4799977567262 V3=0 T=0 M2=0 M3=5,54943166776416	FrameElem=24-1 ElemStation=0,04
Frame=24 Station=0,08 OutputCase=STR172 CaseType=Combination P=-24,6766814358489 V2=14,5850827567262 V3=0 T=0 M2=0 M3=4,94818495749511	FrameElem=24-1 ElemStation=0,08
Frame=24 Station=0 OutputCase=STR173 CaseType=Combination P=-25,1086814359071 V2=8,63562961542214 V3=0 T=0 M2=0 M3=5,2466515050595	FrameElem=24-1 ElemStation=0
Frame=24 Station=0,04 OutputCase=STR173 CaseType=Combination P=-24,8926814359071 V2=8,21232961542214 V3=0 T=0 M2=0 M3=4,90971832044261	FrameElem=24-1 ElemStation=0,04
Frame=24 Station=0,08 OutputCase=STR173 CaseType=Combination P=-24,6766814359071 V2=7,79682961542214 V3=0 T=0 M2=0 M3=4,58956113582573	FrameElem=24-1 ElemStation=0,08
Frame=24 Station=0 OutputCase=STR174 CaseType=Combination P=-105,784681430773 V2=7,66348479351007 V3=0 T=0 M2=0 M3=15,0571837218868	FrameElem=24-1 ElemStation=0
Frame=24 Station=0,04 OutputCase=STR174 CaseType=Combination P=-105,568681430773 V2=7,24018479351006 V3=0 T=0 M2=0 M3=14,7591363301464	FrameElem=24-1 ElemStation=0,04
Frame=24 Station=0,08 OutputCase=STR174 CaseType=Combination P=-105,352681430773 V2=6,82468479351007 V3=0 T=0 M2=0 M3=14,477864938406	FrameElem=24-1 ElemStation=0,08
Frame=24 Station=0 OutputCase=STR175 CaseType=Combination P=-95,4287692006146 V2=47,2449818889888 V3=0 T=0 M2=0 M3=30,2166226906757	FrameElem=24-1 ElemStation=0
Frame=24 Station=0,04 OutputCase=STR175 CaseType=Combination P=-95,2127692006146 V2=45,6513743889888 V3=0 T=0 M2=0 M3=28,3586411151161	FrameElem=24-1 ElemStation=0,04
Frame=24 Station=0,08 OutputCase=STR175 CaseType=Combination P=-94,9967692006146 V2=44,0414318889888 V3=0 T=0 M2=0 M3=26,5647305395566	FrameElem=24-1 ElemStation=0,08
Frame=24 Station=0 OutputCase=STR176 CaseType=Combination P=-105,784681430714 V2=34,0507289538088 V3=0 T=0 M2=0 M3=18,7530235110015	FrameElem=24-1 ElemStation=0
Frame=24 Station=0,04 OutputCase=STR176 CaseType=Combination P=-105,568681430714 V2=32,4571214538088 V3=0 T=0 M2=0 M3=17,4228120528491	FrameElem=24-1 ElemStation=0,04
Frame=24 Station=0,08 OutputCase=STR176 CaseType=Combination P=-105,352681430714 V2=30,8471789538088 V3=0 T=0 M2=0 M3=16,1566715946968	FrameElem=24-1 ElemStation=0,08
Frame=24 Station=0 OutputCase=STR177 CaseType=Combination P=-8,36176920611252 V2=48,0200456956701 V3=0 T=0 M2=0 M3=19,5698773561742	FrameElem=24-1 ElemStation=0
Frame=24 Station=0,04 OutputCase=STR177 CaseType=Combination P=-8,20176920611251 V2=46,4264381956701 V3=0 T=0 M2=0 M3=17,6808932283474	FrameElem=24-1 ElemStation=0,04
Frame=24 Station=0,08 OutputCase=STR177 CaseType=Combination P=-8,04176920611252 V2=44,8164956956701 V3=0 T=0 M2=0 M3=15,8559801005206	FrameElem=24-1 ElemStation=0,08
Frame=24 Station=0 OutputCase=STR178 CaseType=Combination P=-18,7176814362123 V2=34,8257927604901 V3=0 T=0 M2=0 M3=8,10627817650002	FrameElem=24-1 ElemStation=0
Frame=24 Station=0,04 OutputCase=STR178 CaseType=Combination P=-18,5576814362123 V2=33,2321852604901 V3=0 T=0 M2=0 M3=6,74506416608042	FrameElem=24-1 ElemStation=0,04
Frame=24 Station=0,08 OutputCase=STR178 CaseType=Combination P=-18,3976814362123 V2=31,6222427604901 V3=0 T=0 M2=0 M3=5,44792115566081	FrameElem=24-1 ElemStation=0,08
Frame=24 Station=0 OutputCase=STR179 CaseType=Combination P=-25,1086814358488 V2=16,3913827567262 V3=0 T=0 M2=0 M3=6,1868043780332	FrameElem=24-1 ElemStation=0
Frame=24 Station=0,04 OutputCase=STR179 CaseType=Combination P=-24,8926814358489 V2=15,4799977567262 V3=0 T=0 M2=0 M3=5,54943166776416	FrameElem=24-1 ElemStation=0,04
Frame=24 Station=0,08 OutputCase=STR179 CaseType=Combination P=-24,6766814358489 V2=14,5850827567262 V3=0 T=0 M2=0 M3=4,94818495749511	FrameElem=24-1 ElemStation=0,08
Frame=24 Station=0 OutputCase=STR180 CaseType=Combination P=-24,1933185613488 V2=15,9336367393084 V3=0 T=0 M2=0 M3=5,30261318720088	FrameElem=24-1 ElemStation=0
Frame=24 Station=0,04 OutputCase=STR180 CaseType=Combination P=-23,9773185613488 V2=15,0222517393084 V3=0 T=0 M2=0 M3=4,68355031762854	FrameElem=24-1 ElemStation=0,04
Frame=24 Station=0,08 OutputCase=STR180 CaseType=Combination P=-23,7613185613488 V2=14,1273367393084 V3=0 T=0 M2=0 M3=4,10061344805621	FrameElem=24-1 ElemStation=0,08
Frame=24 Station=0 OutputCase=STR181 CaseType=Combination P=-24,193318561407 V2=8,17788359800436 V3=0 T=0 M2=0 M3=4,36246031422717	FrameElem=24-1 ElemStation=0
Frame=24 Station=0,04 OutputCase=STR181 CaseType=Combination P=-23,977318561407 V2=7,75458359800436 V3=0 T=0 M2=0 M3=4,043836970307	FrameElem=24-1 ElemStation=0,04
Frame=24 Station=0,08 OutputCase=STR181 CaseType=Combination P=-23,761318561407 V2=7,33908359800436 V3=0 T=0 M2=0 M3=3,74198962638682	FrameElem=24-1 ElemStation=0,08
Frame=24 Station=0 OutputCase=STR182 CaseType=Combination P=-104,869318556273 V2=7,20573877609228 V3=0 T=0 M2=0 M3=14,1729925310545	FrameElem=24-1 ElemStation=0
Frame=24 Station=0,04 OutputCase=STR182 CaseType=Combination P=-104,653318556273 V2=6,78243877609228 V3=0 T=0 M2=0 M3=13,8932549800108	FrameElem=24-1 ElemStation=0,04
Frame=24 Station=0,08 OutputCase=STR182 CaseType=Combination P=-104,437318556273 V2=6,36693877609228 V3=0 T=0 M2=0 M3=13,6302934289671	FrameElem=24-1 ElemStation=0,08
Frame=24 Station=0 OutputCase=STR183 CaseType=Combination P=-94,5134063261145 V2=46,787235871571 V3=0 T=0 M2=0 M3=29,3324314998434	FrameElem=24-1 ElemStation=0
Frame=24 Station=0,04 OutputCase=STR183 CaseType=Combination P=-94,2974063261146 V2=45,193628371571 V3=0 T=0 M2=0 M3=27,4927597649805	FrameElem=24-1 ElemStation=0,04

Società di Progetto
Brebemi SpA



Doc. N.
60235-00000-A00.doc

CODIFICA DOCUMENTO
04RCDII10000000000300A00

REV.
00

FOGLIO
356 di 628

Frame=24 Station=0,08 OutputCase=STR183 CaseType=Combination P=-,94,0814063261145 V2=43,583685871571 V3=0 T=0 M2=0 M3=25,7171590301177 FrameElem=24-1 ElemStation=0,08

Frame=24 Station=0 OutputCase=STR184 CaseType=Combination P=-,104,869318556214 V2=33,592982936391 V3=0 T=0 M2=0 M3=17,8688323201692 FrameElem=24-1 ElemStation=0

Frame=24 Station=0,04 OutputCase=STR184 CaseType=Combination P=-,104,653318556214 V2=31,999375436391 V3=0 T=0 M2=0 M3=16,5569307027135 FrameElem=24-1 ElemStation=0,04

Frame=24 Station=0,08 OutputCase=STR184 CaseType=Combination P=-,104,437318556214 V2=30,389432936391 V3=0 T=0 M2=0 M3=15,3091000852579 FrameElem=24-1 ElemStation=0,08

Frame=24 Station=0 OutputCase=STR185 CaseType=Combination P=-,7,44640633161243 V2=47,5622996782523 V3=0 T=0 M2=0 M3=18,6856861653419 FrameElem=24-1 ElemStation=0

Frame=24 Station=0,04 OutputCase=STR185 CaseType=Combination P=-,7,28640633161243 V2=45,9686921782523 V3=0 T=0 M2=0 M3=16,8150118782118 FrameElem=24-1 ElemStation=0,04

Frame=24 Station=0,08 OutputCase=STR185 CaseType=Combination P=-,7,12640633161243 V2=44,3587496782523 V3=0 T=0 M2=0 M3=15,0084085910817 FrameElem=24-1 ElemStation=0,08

Frame=24 Station=0 OutputCase=STR186 CaseType=Combination P=-,17,8023185617122 V2=34,3680467430723 V3=0 T=0 M2=0 M3=7,2220869856677 FrameElem=24-1 ElemStation=0

Frame=24 Station=0,04 OutputCase=STR186 CaseType=Combination P=-,17,6423185617122 V2=32,7744392430723 V3=0 T=0 M2=0 M3=5,8791828159448 FrameElem=24-1 ElemStation=0,04

Frame=24 Station=0,08 OutputCase=STR186 CaseType=Combination P=-,17,4823185617122 V2=31,1644967430723 V3=0 T=0 M2=0 M3=4,60034964622191 FrameElem=24-1 ElemStation=0,08

Frame=24 Station=0 OutputCase=STR187 CaseType=Combination P=-,24,1933185613488 V2=15,933637393084 V3=0 T=0 M2=0 M3=5,30261318720088 FrameElem=24-1 ElemStation=0

Frame=24 Station=0,04 OutputCase=STR187 CaseType=Combination P=-,23,9773185613488 V2=15,0222517393084 V3=0 T=0 M2=0 M3=4,68355031762854 FrameElem=24-1 ElemStation=0,04

Frame=24 Station=0,08 OutputCase=STR187 CaseType=Combination P=-,23,7613185613488 V2=14,1273367393084 V3=0 T=0 M2=0 M3=4,10061344805621 FrameElem=24-1 ElemStation=0,08

Frame=24 Station=0 OutputCase=INVSTR CaseType=Combination StepType=Max P=-,4,62053698126688 V2=65,3606740061375 V3=0 T=0 M2=0 M3=44,4546415975285 FrameElem=24-1 ElemStation=0

Frame=24 Station=0,04 OutputCase=INVSTR CaseType=Combination StepType=Max P=-,4,46053698126687 V2=63,7670665061375 V3=0 T=0 M2=0 M3=41,872032337283 FrameElem=24-1 ElemStation=0,04

Frame=24 Station=0,08 OutputCase=INVSTR CaseType=Combination StepType=Max P=-,4,30053698126688 V2=62,1571240061375 V3=0 T=0 M2=0 M3=39,3633756779815 FrameElem=24-1 ElemStation=0,08

Frame=24 Station=0 OutputCase=INVSTR CaseType=Combination StepType=Min P=-,132,67668142906 V2=5,36681436429249 V3=0 T=0 M2=0 M3=2,83566584869848 FrameElem=24-1 ElemStation=0

Frame=24 Station=0,04 OutputCase=INVSTR CaseType=Combination StepType=Min P=-,132,46068142906 V2=4,94351436429249 V3=0 T=0 M2=0 M3=2,59059948125029 FrameElem=24-1 ElemStation=0,04

Frame=24 Station=0,08 OutputCase=INVSTR CaseType=Combination StepType=Min P=-,132,24468142906 V2=4,52801436429249 V3=0 T=0 M2=0 M3=2,35572137983942 FrameElem=24-1 ElemStation=0,08

Frame=24 Station=0 OutputCase=SIS01 CaseType=Combination P=-,11,9931397232926 V2=22,847979654595 V3=0 T=0 M2=0 M3=9,66662586111086 FrameElem=24-1 ElemStation=0

Frame=24 Station=0,04 OutputCase=SIS01 CaseType=Combination P=-,11,8385397232926 V2=21,976679654595 V3=0 T=0 M2=0 M3=8,77015867492706 FrameElem=24-1 ElemStation=0,04

Frame=24 Station=0,08 OutputCase=SIS01 CaseType=Combination P=-,11,6839397232926 V2=21,113179654595 V3=0 T=0 M2=0 M3=7,90838748874326 FrameElem=24-1 ElemStation=0,08

Frame=24 Station=0 OutputCase=SIS02 CaseType=Combination P=-,11,9931397232923 V2=22,4648704021367 V3=0 T=0 M2=0 M3=9,34854368079239 FrameElem=24-1 ElemStation=0

Frame=24 Station=0,04 OutputCase=SIS02 CaseType=Combination P=-,11,8385397232923 V2=21,5935704021367 V3=0 T=0 M2=0 M3=8,46740086470692 FrameElem=24-1 ElemStation=0,04

Frame=24 Station=0,08 OutputCase=SIS02 CaseType=Combination P=-,11,6839397232923 V2=20,7300704021367 V3=0 T=0 M2=0 M3=7,62095404862145 FrameElem=24-1 ElemStation=0,08

Frame=24 Station=0 OutputCase=SIS03 CaseType=Combination P=-,11,9931397232928 V2=23,2310889070533 V3=0 T=0 M2=0 M3=9,98470804142934 FrameElem=24-1 ElemStation=0

Frame=24 Station=0,04 OutputCase=SIS03 CaseType=Combination P=-,11,8385397232928 V2=22,3597889070533 V3=0 T=0 M2=0 M3=9,07291648514721 FrameElem=24-1 ElemStation=0,04

Frame=24 Station=0,08 OutputCase=SIS03 CaseType=Combination P=-,11,6839397232928 V2=21,4962889070533 V3=0 T=0 M2=0 M3=8,19582092886508 FrameElem=24-1 ElemStation=0,08

Frame=24 Station=0 OutputCase=SIS04 CaseType=Combination P=-,12,3109740547162 V2=23,0069192439762 V3=0 T=0 M2=0 M3=9,97363669126098 FrameElem=24-1 ElemStation=0

Frame=24 Station=0,04 OutputCase=SIS04 CaseType=Combination P=-,12,1563740547162 V2=22,1356192439762 V3=0 T=0 M2=0 M3=9,07081192150193 FrameElem=24-1 ElemStation=0,04

Frame=24 Station=0,08 OutputCase=SIS04 CaseType=Combination P=-,12,0017740547162 V2=21,2721192439762 V3=0 T=0 M2=0 M3=8,20268315174288 FrameElem=24-1 ElemStation=0,08

Frame=24 Station=0 OutputCase=SIS05 CaseType=Combination P=-,11,6753053918689 V2=22,6890400652138 V3=0 T=0 M2=0 M3=9,35961503096075 FrameElem=24-1 ElemStation=0

Frame=24 Station=0,04 OutputCase=SIS05 CaseType=Combination P=-,11,5207053918689 V2=21,8177400652138 V3=0 T=0 M2=0 M3=8,4695504283522 FrameElem=24-1 ElemStation=0,04

Frame=24 Station=0,08 OutputCase=SIS05 CaseType=Combination P=-,11,3661053918689 V2=20,9542400652138 V3=0 T=0 M2=0 M3=7,61409182574364 FrameElem=24-1 ElemStation=0,08

Frame=24 Station=0 OutputCase=SIS06 CaseType=Combination P=-,11,9931397232928 V2=23,2310889070533 V3=0 T=0 M2=0 M3=9,98470804142934 FrameElem=24-1 ElemStation=0

Frame=24 Station=0,04 OutputCase=SIS06 CaseType=Combination P=-,11,8385397232928 V2=22,3597889070533 V3=0 T=0 M2=0 M3=9,07291648514721 FrameElem=24-1 ElemStation=0,04

Frame=24 Station=0,08 OutputCase=SIS06 CaseType=Combination P=-,11,6839397232928 V2=21,4962889070533 V3=0 T=0 M2=0 M3=8,19582092886508 FrameElem=24-1 ElemStation=0,08

Frame=24 Station=0 OutputCase=SIS07 CaseType=Combination P=-,12,3109740547159 V2=22,6238099915179 V3=0 T=0 M2=0 M3=9,6555545109425 FrameElem=24-1 ElemStation=0

Frame=24 Station=0,04 OutputCase=SIS07 CaseType=Combination P=-,12,1563740547159 V2=21,7525099915179 V3=0 T=0 M2=0 M3=8,76805411128178 FrameElem=24-1 ElemStation=0,04

Frame=24 Station=0,08 OutputCase=SIS07 CaseType=Combination P=-,12,0017740547159 V2=20,8890099915179 V3=0 T=0 M2=0 M3=7,91524971162107 FrameElem=24-1 ElemStation=0,08

Frame=24 Station=0 OutputCase=SIS08 CaseType=Combination P=-,11,6753053918686 V2=22,3059308127555 V3=0 T=0 M2=0 M3=9,04153285064227 FrameElem=24-1 ElemStation=0

Frame=24 Station=0,04 OutputCase=SIS08 CaseType=Combination P=-,11,5207053918686 V2=21,4346308127555 V3=0 T=0 M2=0 M3=8,16674761813205 FrameElem=24-1 ElemStation=0,04

Frame=24 Station=0,08 OutputCase=SIS08 CaseType=Combination P=-,11,3661053918686 V2=20,5711308127555 V3=0 T=0 M2=0 M3=7,32665838562183 FrameElem=24-1 ElemStation=0,08

Frame=24 Station=0 OutputCase=SIS09 CaseType=Combination P=-,11,9931397232926 V2=22,847979654595 V3=0 T=0 M2=0 M3=9,66662586111086 FrameElem=24-1 ElemStation=0

Società di Progetto
Brebemi SpA

	Doc. N. 60235-00000-A00.doc	CODIFICA DOCUMENTO 04RCDII10000000000300A00	REV. 00	FOGLIO 357 di 628
--	--------------------------------	--	------------	----------------------

Frame=24 ElemStation=0,04	Station=0,04	OutputCase=SIS09	CaseType=Combination	P=-11,8385397232926	V2=21,976679654595	V3=0	T=0	M2=0	M3=8,77015867492706	FrameElem=24-1
Frame=24 ElemStation=0,08	Station=0,08	OutputCase=SIS09	CaseType=Combination	P=-11,6839397232926	V2=21,113179654595	V3=0	T=0	M2=0	M3=7,90838748874326	FrameElem=24-1
Frame=24 ElemStation=0	Station=0	OutputCase=SIS10	CaseType=Combination	P=-13,2182197232265	V2=22,8887507258259	V3=0	T=0	M2=0	M3=9,83069754146885	FrameElem=24-1
Frame=24 ElemStation=0,04	Station=0,04	OutputCase=SIS10	CaseType=Combination	P=-13,0528197232265	V2=22,0174507258259	V3=0	T=0	M2=0	M3=8,93259951243581	FrameElem=24-1
Frame=24 ElemStation=0,08	Station=0,08	OutputCase=SIS10	CaseType=Combination	P=-12,8874197232265	V2=21,1539507258259	V3=0	T=0	M2=0	M3=8,06919748340277	FrameElem=24-1
Frame=24 ElemStation=0	Station=0	OutputCase=SIS11	CaseType=Combination	P=-13,2182197232262	V2=22,5056414733676	V3=0	T=0	M2=0	M3=9,51261536115037	FrameElem=24-1
Frame=24 ElemStation=0,04	Station=0,04	OutputCase=SIS11	CaseType=Combination	P=-13,0528197232262	V2=21,6343414733676	V3=0	T=0	M2=0	M3=8,62984170221566	FrameElem=24-1
Frame=24 ElemStation=0,08	Station=0,08	OutputCase=SIS11	CaseType=Combination	P=-12,8874197232262	V2=20,7708414733676	V3=0	T=0	M2=0	M3=7,78176404328096	FrameElem=24-1
Frame=24 ElemStation=0	Station=0	OutputCase=SIS12	CaseType=Combination	P=-13,2182197232268	V2=23,2718599782842	V3=0	T=0	M2=0	M3=10,1487797217873	FrameElem=24-1
Frame=24 ElemStation=0,04	Station=0,04	OutputCase=SIS12	CaseType=Combination	P=-13,0528197232268	V2=22,4005599782842	V3=0	T=0	M2=0	M3=9,23535732265595	FrameElem=24-1
Frame=24 ElemStation=0,08	Station=0,08	OutputCase=SIS12	CaseType=Combination	P=-12,8874197232268	V2=21,5370599782842	V3=0	T=0	M2=0	M3=8,35663092352459	FrameElem=24-1
Frame=24 ElemStation=0	Station=0	OutputCase=SIS13	CaseType=Combination	P=-13,5360540546501	V2=23,0476903152071	V3=0	T=0	M2=0	M3=10,137708371619	FrameElem=24-1
Frame=24 ElemStation=0,04	Station=0,04	OutputCase=SIS13	CaseType=Combination	P=-13,3706540546501	V2=22,1763903152071	V3=0	T=0	M2=0	M3=9,23325275901067	FrameElem=24-1
Frame=24 ElemStation=0,08	Station=0,08	OutputCase=SIS13	CaseType=Combination	P=-13,2052540546501	V2=21,3128903152071	V3=0	T=0	M2=0	M3=8,36349314640239	FrameElem=24-1
Frame=24 ElemStation=0	Station=0	OutputCase=SIS14	CaseType=Combination	P=-12,9003853918029	V2=22,7298111364447	V3=0	T=0	M2=0	M3=9,52368671131873	FrameElem=24-1
Frame=24 ElemStation=0,04	Station=0,04	OutputCase=SIS14	CaseType=Combination	P=-12,7349853918029	V2=21,8585111364448	V3=0	T=0	M2=0	M3=8,63194626586094	FrameElem=24-1
Frame=24 ElemStation=0,08	Station=0,08	OutputCase=SIS14	CaseType=Combination	P=-12,5695853918029	V2=20,9950111364447	V3=0	T=0	M2=0	M3=7,77490182040315	FrameElem=24-1
Frame=24 ElemStation=0	Station=0	OutputCase=SIS15	CaseType=Combination	P=-13,2182197232268	V2=23,2718599782842	V3=0	T=0	M2=0	M3=10,1487797217873	FrameElem=24-1
Frame=24 ElemStation=0,04	Station=0,04	OutputCase=SIS15	CaseType=Combination	P=-13,0528197232268	V2=22,4005599782842	V3=0	T=0	M2=0	M3=9,23535732265595	FrameElem=24-1
Frame=24 ElemStation=0,08	Station=0,08	OutputCase=SIS15	CaseType=Combination	P=-12,8874197232268	V2=21,5370599782842	V3=0	T=0	M2=0	M3=8,35663092352459	FrameElem=24-1
Frame=24 ElemStation=0	Station=0	OutputCase=SIS16	CaseType=Combination	P=-13,5360540546499	V2=22,6645810627488	V3=0	T=0	M2=0	M3=9,81962619130048	FrameElem=24-1
Frame=24 ElemStation=0,04	Station=0,04	OutputCase=SIS16	CaseType=Combination	P=-13,3706540546499	V2=21,7932810627488	V3=0	T=0	M2=0	M3=8,93049494879053	FrameElem=24-1
Frame=24 ElemStation=0,08	Station=0,08	OutputCase=SIS16	CaseType=Combination	P=-13,2052540546499	V2=20,9297810627488	V3=0	T=0	M2=0	M3=8,07605970628058	FrameElem=24-1
Frame=24 ElemStation=0	Station=0	OutputCase=SIS17	CaseType=Combination	P=-12,9003853918026	V2=22,3467018839865	V3=0	T=0	M2=0	M3=9,20560453100025	FrameElem=24-1
Frame=24 ElemStation=0,04	Station=0,04	OutputCase=SIS17	CaseType=Combination	P=-12,7349853918026	V2=21,4754018839865	V3=0	T=0	M2=0	M3=8,32918845564079	FrameElem=24-1
Frame=24 ElemStation=0,08	Station=0,08	OutputCase=SIS17	CaseType=Combination	P=-12,5695853918026	V2=20,6119018839865	V3=0	T=0	M2=0	M3=7,48746838028134	FrameElem=24-1
Frame=24 ElemStation=0	Station=0	OutputCase=SIS18	CaseType=Combination	P=-13,2182197232265	V2=22,8887507258259	V3=0	T=0	M2=0	M3=9,83069754146885	FrameElem=24-1
Frame=24 ElemStation=0,04	Station=0,04	OutputCase=SIS18	CaseType=Combination	P=-13,0528197232265	V2=22,0174507258259	V3=0	T=0	M2=0	M3=8,93259951243581	FrameElem=24-1
Frame=24 ElemStation=0,08	Station=0,08	OutputCase=SIS18	CaseType=Combination	P=-12,8874197232265	V2=21,1539507258259	V3=0	T=0	M2=0	M3=8,06919748340277	FrameElem=24-1
Frame=24 ElemStation=0	Station=0	OutputCase=SIS19	CaseType=Combination	P=-12,8414266242296	V2=19,9593234029146	V3=0	T=0	M2=0	M3=7,50773282731429	FrameElem=24-1
Frame=24 ElemStation=0,04	Station=0,04	OutputCase=SIS19	CaseType=Combination	P=-12,6994266242296	V2=19,1129434029146	V3=0	T=0	M2=0	M3=6,7263134911977	FrameElem=24-1
Frame=24 ElemStation=0,08	Station=0,08	OutputCase=SIS19	CaseType=Combination	P=-12,5574266242296	V2=18,2743634029146	V3=0	T=0	M2=0	M3=5,97859335508112	FrameElem=24-1
Frame=24 ElemStation=0	Station=0	OutputCase=SIS20	CaseType=Combination	P=-12,8414266242294	V2=19,5762141504563	V3=0	T=0	M2=0	M3=7,18965064699581	FrameElem=24-1
Frame=24 ElemStation=0,04	Station=0,04	OutputCase=SIS20	CaseType=Combination	P=-12,6994266242294	V2=18,7298341504563	V3=0	T=0	M2=0	M3=6,42355568097755	FrameElem=24-1
Frame=24 ElemStation=0,08	Station=0,08	OutputCase=SIS20	CaseType=Combination	P=-12,5574266242294	V2=17,8912541504563	V3=0	T=0	M2=0	M3=5,6911599149593	FrameElem=24-1
Frame=24 ElemStation=0	Station=0	OutputCase=SIS21	CaseType=Combination	P=-12,8414266242299	V2=20,3424326553729	V3=0	T=0	M2=0	M3=7,82581500763276	FrameElem=24-1
Frame=24 ElemStation=0,04	Station=0,04	OutputCase=SIS21	CaseType=Combination	P=-12,6994266242299	V2=19,4960526553729	V3=0	T=0	M2=0	M3=7,02907130141785	FrameElem=24-1
Frame=24 ElemStation=0,08	Station=0,08	OutputCase=SIS21	CaseType=Combination	P=-12,5574266242299	V2=18,6574726553729	V3=0	T=0	M2=0	M3=6,26602679520293	FrameElem=24-1
Frame=24 ElemStation=0	Station=0	OutputCase=SIS22	CaseType=Combination	P=-13,1592609556533	V2=20,1182629922958	V3=0	T=0	M2=0	M3=7,8147436574644	FrameElem=24-1
Frame=24 ElemStation=0,04	Station=0,04	OutputCase=SIS22	CaseType=Combination	P=-13,010712609556533	V2=19,2718829922958	V3=0	T=0	M2=0	M3=7,02696673777257	FrameElem=24-1
Frame=24 ElemStation=0,08	Station=0,08	OutputCase=SIS22	CaseType=Combination	P=-12,8752609556533	V2=18,4333029922958	V3=0	T=0	M2=0	M3=6,27288901808074	FrameElem=24-1
Frame=24 ElemStation=0	Station=0	OutputCase=SIS23	CaseType=Combination	P=-12,523592292806	V2=19,8003838135335	V3=0	T=0	M2=0	M3=7,20072199716417	FrameElem=24-1
Frame=24 ElemStation=0,04	Station=0,04	OutputCase=SIS23	CaseType=Combination	P=-12,381592292806	V2=18,9540038135334	V3=0	T=0	M2=0	M3=6,42566024462283	FrameElem=24-1
Frame=24 ElemStation=0,08	Station=0,08	OutputCase=SIS23	CaseType=Combination	P=-12,239592292806	V2=18,1154238135334	V3=0	T=0	M2=0	M3=5,6842976920815	FrameElem=24-1

Società di Progetto
Brebemi SpA

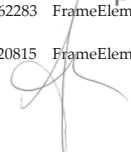

	Doc. N. 60235-00000-A00.doc	CODIFICA DOCUMENTO 04RCDII10000000000300A00	REV. 00	FOGLIO 358 di 628
--	--------------------------------	--	------------	----------------------

Frame=24 Station=0 OutputCase=SIS24 CaseType=Combination P=-12,8414266242299 V2=20,3424326553729 V3=0 T=0 M2=0 M3=7,82581500763276	FrameElem=24-1 ElemStation=0
Frame=24 Station=0,04 OutputCase=SIS24 CaseType=Combination P=-12,6994266242299 V2=19,4960526553729 V3=0 T=0 M2=0 M3=7,02907130141785	FrameElem=24-1 ElemStation=0,04
Frame=24 Station=0,08 OutputCase=SIS24 CaseType=Combination P=-12,5574266242299 V2=18,6574726553729 V3=0 T=0 M2=0 M3=6,26602679520293	FrameElem=24-1 ElemStation=0,08
Frame=24 Station=0 OutputCase=SIS25 CaseType=Combination P=-13,159260955653 V2=19,7351537398375 V3=0 T=0 M2=0 M3=7,49666147714592	FrameElem=24-1 ElemStation=0
Frame=24 Station=0,04 OutputCase=SIS25 CaseType=Combination P=-13,017260955653 V2=18,8887737398375 V3=0 T=0 M2=0 M3=6,72420892755242	FrameElem=24-1 ElemStation=0,04
Frame=24 Station=0,08 OutputCase=SIS25 CaseType=Combination P=-12,875260955653 V2=18,0501937398375 V3=0 T=0 M2=0 M3=5,98545557795892	FrameElem=24-1 ElemStation=0,08
Frame=24 Station=0 OutputCase=SIS26 CaseType=Combination P=-12,5235922928057 V2=19,4172745610752 V3=0 T=0 M2=0 M3=6,88263981684569	FrameElem=24-1 ElemStation=0
Frame=24 Station=0,04 OutputCase=SIS26 CaseType=Combination P=-12,3815922928057 V2=18,5708945610752 V3=0 T=0 M2=0 M3=6,12290243440269	FrameElem=24-1 ElemStation=0,04
Frame=24 Station=0,08 OutputCase=SIS26 CaseType=Combination P=-12,2395922928057 V2=17,7323145610752 V3=0 T=0 M2=0 M3=5,39686425195968	FrameElem=24-1 ElemStation=0,08
Frame=24 Station=0 OutputCase=SIS27 CaseType=Combination P=-12,8414266242296 V2=19,9593234029146 V3=0 T=0 M2=0 M3=7,50773282731429	FrameElem=24-1 ElemStation=0
Frame=24 Station=0,04 OutputCase=SIS27 CaseType=Combination P=-12,6994266242296 V2=19,1129434029146 V3=0 T=0 M2=0 M3=6,7263134911977	FrameElem=24-1 ElemStation=0,04
Frame=24 Station=0,08 OutputCase=SIS27 CaseType=Combination P=-12,5574266242296 V2=18,2743634029146 V3=0 T=0 M2=0 M3=5,97859335508112	FrameElem=24-1 ElemStation=0,08
Frame=24 Station=0 OutputCase=SIS28 CaseType=Combination P=-16,9250266240095 V2=20,0952269736844 V3=0 T=0 M2=0 M3=8,05463842850756	FrameElem=24-1 ElemStation=0
Frame=24 Station=0,04 OutputCase=SIS28 CaseType=Combination P=-16,7470266240095 V2=19,2488469736844 V3=0 T=0 M2=0 M3=7,26778294956018	FrameElem=24-1 ElemStation=0,04
Frame=24 Station=0,08 OutputCase=SIS28 CaseType=Combination P=-16,5690266240095 V2=18,4102669736844 V3=0 T=0 M2=0 M3=6,51462667061281	FrameElem=24-1 ElemStation=0,08
Frame=24 Station=0 OutputCase=SIS29 CaseType=Combination P=-16,9250266240092 V2=19,7121177212261 V3=0 T=0 M2=0 M3=7,73655624818909	FrameElem=24-1 ElemStation=0
Frame=24 Station=0,04 OutputCase=SIS29 CaseType=Combination P=-16,7470266240092 V2=18,8657377212261 V3=0 T=0 M2=0 M3=6,96502513934004	FrameElem=24-1 ElemStation=0,04
Frame=24 Station=0,08 OutputCase=SIS29 CaseType=Combination P=-16,5690266240092 V2=18,0271577212261 V3=0 T=0 M2=0 M3=6,22719323049099	FrameElem=24-1 ElemStation=0,08
Frame=24 Station=0 OutputCase=SIS30 CaseType=Combination P=-16,9250266240098 V2=20,4783362261427 V3=0 T=0 M2=0 M3=8,37272060882604	FrameElem=24-1 ElemStation=0
Frame=24 Station=0,04 OutputCase=SIS30 CaseType=Combination P=-16,7470266240098 V2=19,6319562261427 V3=0 T=0 M2=0 M3=7,57054075978033	FrameElem=24-1 ElemStation=0,04
Frame=24 Station=0,08 OutputCase=SIS30 CaseType=Combination P=-16,5690266240098 V2=18,7933762261427 V3=0 T=0 M2=0 M3=6,80206011073462	FrameElem=24-1 ElemStation=0,08
Frame=24 Station=0 OutputCase=SIS31 CaseType=Combination P=-17,2428609554331 V2=20,2541665630656 V3=0 T=0 M2=0 M3=8,36164925865768	FrameElem=24-1 ElemStation=0
Frame=24 Station=0,04 OutputCase=SIS31 CaseType=Combination P=-17,0648609554331 V2=19,4077865630656 V3=0 T=0 M2=0 M3=7,56843619613505	FrameElem=24-1 ElemStation=0,04
Frame=24 Station=0,08 OutputCase=SIS31 CaseType=Combination P=-16,8868609554331 V2=18,5692065630656 V3=0 T=0 M2=0 M3=6,80892233361243	FrameElem=24-1 ElemStation=0,08
Frame=24 Station=0 OutputCase=SIS32 CaseType=Combination P=-16,6071922925858 V2=19,9362873843033 V3=0 T=0 M2=0 M3=7,74762759835745	FrameElem=24-1 ElemStation=0
Frame=24 Station=0,04 OutputCase=SIS32 CaseType=Combination P=-16,4291922925858 V2=19,0899073843033 V3=0 T=0 M2=0 M3=6,96712970298532	FrameElem=24-1 ElemStation=0,04
Frame=24 Station=0,08 OutputCase=SIS32 CaseType=Combination P=-16,2511922925858 V2=18,2513273843033 V3=0 T=0 M2=0 M3=6,22033100761319	FrameElem=24-1 ElemStation=0,08
Frame=24 Station=0 OutputCase=SIS33 CaseType=Combination P=-16,9250266240098 V2=20,4783362261427 V3=0 T=0 M2=0 M3=8,37272060882604	FrameElem=24-1 ElemStation=0
Frame=24 Station=0,04 OutputCase=SIS33 CaseType=Combination P=-16,7470266240098 V2=19,6319562261427 V3=0 T=0 M2=0 M3=7,57054075978033	FrameElem=24-1 ElemStation=0,04
Frame=24 Station=0,08 OutputCase=SIS33 CaseType=Combination P=-16,5690266240098 V2=18,7933762261427 V3=0 T=0 M2=0 M3=6,80206011073462	FrameElem=24-1 ElemStation=0,08
Frame=24 Station=0 OutputCase=SIS34 CaseType=Combination P=-17,2428609554328 V2=19,8710573106073 V3=0 T=0 M2=0 M3=8,0435670783392	FrameElem=24-1 ElemStation=0
Frame=24 Station=0,04 OutputCase=SIS34 CaseType=Combination P=-17,0648609554328 V2=19,0246773106073 V3=0 T=0 M2=0 M3=7,26567838591491	FrameElem=24-1 ElemStation=0,04
Frame=24 Station=0,08 OutputCase=SIS34 CaseType=Combination P=-16,8868609554328 V2=18,1860973106073 V3=0 T=0 M2=0 M3=6,52148889349061	FrameElem=24-1 ElemStation=0,08
Frame=24 Station=0 OutputCase=SIS35 CaseType=Combination P=-16,6071922925856 V2=19,553178131845 V3=0 T=0 M2=0 M3=7,42954541803897	FrameElem=24-1 ElemStation=0
Frame=24 Station=0,04 OutputCase=SIS35 CaseType=Combination P=-16,4291922925856 V2=18,706798131845 V3=0 T=0 M2=0 M3=6,66437189276517	FrameElem=24-1 ElemStation=0,04
Frame=24 Station=0,08 OutputCase=SIS35 CaseType=Combination P=-16,2511922925856 V2=17,868218131845 V3=0 T=0 M2=0 M3=5,93289756749137	FrameElem=24-1 ElemStation=0,08
Frame=24 Station=0 OutputCase=SIS36 CaseType=Combination P=-16,9250266240095 V2=20,0952269736844 V3=0 T=0 M2=0 M3=8,05463842850756	FrameElem=24-1 ElemStation=0
Frame=24 Station=0,04 OutputCase=SIS36 CaseType=Combination P=-16,7470266240095 V2=19,2488469736844 V3=0 T=0 M2=0 M3=7,26778294956018	FrameElem=24-1 ElemStation=0,04
Frame=24 Station=0,08 OutputCase=SIS36 CaseType=Combination P=-16,5690266240095 V2=18,4102669736844 V3=0 T=0 M2=0 M3=6,51462667061281	FrameElem=24-1 ElemStation=0,08
Frame=24 Station=0 OutputCase=INVSIS CaseType=Combination StepType=Max P=-11,6753053918686 V2=23,2718599782842 V3=0 T=0 M2=0 M3=10,1487797217873	FrameElem=24-1 ElemStation=0
Frame=24 Station=0,04 OutputCase=INVSIS CaseType=Combination StepType=Max P=-11,5207053918686 V2=22,4005599782842 V3=0 T=0 M2=0 M3=9,23535732265595	FrameElem=24-1 ElemStation=0,04
Frame=24 Station=0,08 OutputCase=INVSIS CaseType=Combination StepType=Max P=-11,3661053918686 V2=21,5370599782842 V3=0 T=0 M2=0 M3=8,36349314640239	FrameElem=24-1 ElemStation=0,08
Frame=24 Station=0 OutputCase=INVSIS CaseType=Combination StepType=Min P=-17,2428609554331 V2=19,4172745610752 V3=0 T=0 M2=0 M3=6,88263981684569	FrameElem=24-1 ElemStation=0
Frame=24 Station=0,04 OutputCase=INVSIS CaseType=Combination StepType=Min P=-17,0648609554331 V2=18,5708945610752 V3=0 T=0 M2=0 M3=6,12290243440269	FrameElem=24-1 ElemStation=0,04

Società di Progetto
Brebemi SpA

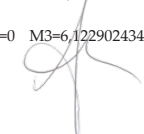



Doc. N.
60235-0000-A00.doc

CODIFICA DOCUMENTO
04RCDII10000000000300A00

REV.
00

FOGLIO
359 di 628

Frame=24 Station=0,08 OutputCase=INVSIS CaseType=Combination StepType=Min P=-16,8868609554331 V2=17,7323145610752 V3=0 T=0 M2=0 M3=5,39686425195968
FrameElem=24-1 ElemStation=0,08
Frame=24 Station=0 OutputCase=RAR001 CaseType=Combination P=-18,2599999989616 V2=11,2911463274943 V3=0 T=0 M2=0 M3=3,68986040729829 FrameElem=24-1
ElemStation=0
Frame=24 Station=0,04 OutputCase=RAR001 CaseType=Combination P=-18,0999999989616 V2=10,6160463274943 V3=0 T=0 M2=0 M3=3,25175722086518 FrameElem=24-1
ElemStation=0,04
Frame=24 Station=0,08 OutputCase=RAR001 CaseType=Combination P=-17,9399999989616 V2=9,9531463274943 V3=0 T=0 M2=0 M3=2,84041403443208 FrameElem=24-1
ElemStation=0,08
Frame=24 Station=0 OutputCase=RAR002 CaseType=Combination P=-97,9399999939487 V2=6,33007035159537 V3=0 T=0 M2=0 M3=12,8943600943429 FrameElem=24-1
ElemStation=0
Frame=24 Station=0,04 OutputCase=RAR002 CaseType=Combination P=-97,7799999939487 V2=5,90677035159537 V3=0 T=0 M2=0 M3=12,6496492802791 FrameElem=24-1
ElemStation=0,04
Frame=24 Station=0,08 OutputCase=RAR002 CaseType=Combination P=-97,6199999939487 V2=5,49127035159537 V3=0 T=0 M2=0 M3=12,4217144662153 FrameElem=24-1
ElemStation=0,08
Frame=24 Station=0 OutputCase=RAR003 CaseType=Combination P=-88,5988559037214 V2=40,5579066387101 V3=0 T=0 M2=0 M3=26,3555740784258 FrameElem=24-1
ElemStation=0
Frame=24 Station=0,04 OutputCase=RAR003 CaseType=Combination P=-88,4388559037214 V2=39,2090066387101 V3=0 T=0 M2=0 M3=24,760168479544 FrameElem=24-1
ElemStation=0,04
Frame=24 Station=0,08 OutputCase=RAR003 CaseType=Combination P=-88,2788559037214 V2=37,8399066387101 V3=0 T=0 M2=0 M3=23,2191228806623 FrameElem=24-1
ElemStation=0,08
Frame=24 Station=0 OutputCase=RAR004 CaseType=Combination P=-97,9399999938905 V2=28,7324759048599 V3=0 T=0 M2=0 M3=16,1009410324521 FrameElem=24-1
ElemStation=0
Frame=24 Station=0,04 OutputCase=RAR004 CaseType=Combination P=-97,7799999938905 V2=27,3835759048599 V3=0 T=0 M2=0 M3=14,9785526629244 FrameElem=24-1
ElemStation=0,04
Frame=24 Station=0,08 OutputCase=RAR004 CaseType=Combination P=-97,6199999938905 V2=26,0144759048599 V3=0 T=0 M2=0 M3=13,9105242933967 FrameElem=24-1
ElemStation=0,08
Frame=24 Station=0 OutputCase=RAR005 CaseType=Combination P=-8,91885590879247 V2=41,5180496726974 V3=0 T=0 M2=0 M3=16,6661595432877 FrameElem=24-1
ElemStation=0
Frame=24 Station=0,04 OutputCase=RAR005 CaseType=Combination P=-8,75885590879247 V2=40,1691496726974 V3=0 T=0 M2=0 M3=15,0323482230465 FrameElem=24-1
ElemStation=0,04
Frame=24 Station=0,08 OutputCase=RAR005 CaseType=Combination P=-8,59885590879247 V2=38,8000496726974 V3=0 T=0 M2=0 M3=13,4528969028052 FrameElem=24-1
ElemStation=0,08
Frame=24 Station=0 OutputCase=RAR006 CaseType=Combination P=-18,2599999989616 V2=29,6926189388471 V3=0 T=0 M2=0 M3=6,41152649731408 FrameElem=24-1
ElemStation=0
Frame=24 Station=0,04 OutputCase=RAR006 CaseType=Combination P=-18,0999999989616 V2=28,3437189388471 V3=0 T=0 M2=0 M3=5,25073240642686 FrameElem=24-1
ElemStation=0,04
Frame=24 Station=0,08 OutputCase=RAR006 CaseType=Combination P=-17,9399999989616 V2=26,9746189388471 V3=0 T=0 M2=0 M3=4,14429831553964 FrameElem=24-1
ElemStation=0,08
Frame=24 Station=0 OutputCase=RAR007 CaseType=Combination P=-56,424008917209 V2=47,4314257623851 V3=0 T=0 M2=0 M3=32,0809220147069 FrameElem=24-1
ElemStation=0
Frame=24 Station=0,04 OutputCase=RAR007 CaseType=Combination P=-56,264008917209 V2=46,2509757623851 V3=0 T=0 M2=0 M3=30,2072336508782 FrameElem=24-1
ElemStation=0,04
Frame=24 Station=0,08 OutputCase=RAR007 CaseType=Combination P=-56,104008917209 V2=45,0584257623851 V3=0 T=0 M2=0 M3=28,3810052870495 FrameElem=24-1
ElemStation=0,08
Frame=24 Station=0 OutputCase=RAR008 CaseType=Combination P=-18,2599999990192 V2=6,52399488066602 V3=0 T=0 M2=0 M3=2,56878119856787 FrameElem=24-1
ElemStation=0
Frame=24 Station=0,04 OutputCase=RAR008 CaseType=Combination P=-18,0999999990192 V2=6,10069488066602 V3=0 T=0 M2=0 M3=2,31631340334123 FrameElem=24-1
ElemStation=0,04
Frame=24 Station=0,08 OutputCase=RAR008 CaseType=Combination P=-17,9399999990192 V2=5,68519488066602 V3=0 T=0 M2=0 M3=2,08062160811459 FrameElem=24-1
ElemStation=0,08
Frame=24 Station=0 OutputCase=RAR009 CaseType=Combination P=-97,9399999939484 V2=5,87033924864542 V3=0 T=0 M2=0 M3=12,5126614779607 FrameElem=24-1
ElemStation=0
Frame=24 Station=0,04 OutputCase=RAR009 CaseType=Combination P=-97,7799999939484 V2=5,44703924864542 V3=0 T=0 M2=0 M3=12,2863399080149 FrameElem=24-1
ElemStation=0,04
Frame=24 Station=0,08 OutputCase=RAR009 CaseType=Combination P=-97,6199999939484 V2=5,03153924864542 V3=0 T=0 M2=0 M3=12,0767943380691 FrameElem=24-1
ElemStation=0,08
Frame=24 Station=0 OutputCase=RAR010 CaseType=Combination P=-88,5988559037211 V2=40,0981755357602 V3=0 T=0 M2=0 M3=25,9738754620436 FrameElem=24-1
ElemStation=0
Frame=24 Station=0,04 OutputCase=RAR010 CaseType=Combination P=-88,4388559037211 V2=38,7492755357602 V3=0 T=0 M2=0 M3=24,3968591072798 FrameElem=24-1
ElemStation=0,04
Frame=24 Station=0,08 OutputCase=RAR010 CaseType=Combination P=-88,2788559037211 V2=37,3801755357602 V3=0 T=0 M2=0 M3=22,8742027525161 FrameElem=24-1
ElemStation=0,08
Frame=24 Station=0 OutputCase=RAR011 CaseType=Combination P=-97,9399999938902 V2=28,27274480191 V3=0 T=0 M2=0 M3=15,71924241607 FrameElem=24-1
ElemStation=0
Frame=24 Station=0,04 OutputCase=RAR011 CaseType=Combination P=-97,7799999938902 V2=26,92384480191 V3=0 T=0 M2=0 M3=14,6152432906602 FrameElem=24-1
ElemStation=0,04
Frame=24 Station=0,08 OutputCase=RAR011 CaseType=Combination P=-97,6199999938902 V2=25,55474480191 V3=0 T=0 M2=0 M3=13,5656041652505 FrameElem=24-1
ElemStation=0,08
Frame=24 Station=0 OutputCase=RAR012 CaseType=Combination P=-8,91885590879212 V2=41,0583185697474 V3=0 T=0 M2=0 M3=16,2844609269055 FrameElem=24-1
ElemStation=0
Frame=24 Station=0,04 OutputCase=RAR012 CaseType=Combination P=-8,75885590879212 V2=39,7094185697474 V3=0 T=0 M2=0 M3=14,6690388507823 FrameElem=24-1
ElemStation=0,04
Frame=24 Station=0,08 OutputCase=RAR012 CaseType=Combination P=-8,59885590879212 V2=38,3403185697474 V3=0 T=0 M2=0 M3=13,107976774659 FrameElem=24-1
ElemStation=0,08
Frame=24 Station=0 OutputCase=RAR013 CaseType=Combination P=-18,2599999989612 V2=29,2328878358972 V3=0 T=0 M2=0 M3=6,0298278809319 FrameElem=24-1
ElemStation=0
Frame=24 Station=0,04 OutputCase=RAR013 CaseType=Combination P=-18,0999999989612 V2=27,8839878358972 V3=0 T=0 M2=0 M3=4,88742303416268 FrameElem=24-1
ElemStation=0,04
Frame=24 Station=0,08 OutputCase=RAR013 CaseType=Combination P=-17,9399999989612 V2=26,5148878358972 V3=0 T=0 M2=0 M3=3,79937818739346 FrameElem=24-1
ElemStation=0,08
Frame=24 Station=0 OutputCase=RAR014 CaseType=Combination P=-56,4240089172087 V2=46,9716946594351 V3=0 T=0 M2=0 M3=31,6992233983248 FrameElem=24-1
ElemStation=0
Frame=24 Station=0,04 OutputCase=RAR014 CaseType=Combination P=-56,2640089172087 V2=45,7912446594351 V3=0 T=0 M2=0 M3=29,843924278614 FrameElem=24-1
ElemStation=0,04
Frame=24 Station=0,08 OutputCase=RAR014 CaseType=Combination P=-56,1040089172087 V2=44,5986946594351 V3=0 T=0 M2=0 M3=28,0360851589033 FrameElem=24-1
ElemStation=0,08
Frame=24 Station=0 OutputCase=RAR015 CaseType=Combination P=-78,0199999952159 V2=5,8038876051756 V3=0 T=0 M2=0 M3=9,83584209992142 FrameElem=24-1
ElemStation=0

Società di Progetto
Brebemi SpA
[Signature]



Doc. N.
60235-0000-A00.doc

CODIFICA DOCUMENTO
04RCDII10000000000300A00

REV.
00

FOGLIO
360 di 628

Frame=24 Station=0,04 OutputCase=RAR015 CaseType=Combination P=-77,8599999952159 V2=5,3805876051756 V3=0 T=0 M2=0 M3=9,6121785957144	FrameElem=24-1 ElemStation=0,04
Frame=24 Station=0,08 OutputCase=RAR015 CaseType=Combination P=-77,6999999952159 V2=4,9650876051756 V3=0 T=0 M2=0 M3=9,40529109150737	FrameElem=24-1 ElemStation=0,08
Frame=24 Station=0 OutputCase=RAR016 CaseType=Combination P=-70,7720924607996 V2=32,8042072513813 V3=0 T=0 M2=0 M3=20,3444069908294	FrameElem=24-1 ElemStation=0
Frame=24 Station=0,04 OutputCase=RAR016 CaseType=Combination P=-70,6120924607996 V2=31,623752513813 V3=0 T=0 M2=0 M3=19,0558073674409	FrameElem=24-1 ElemStation=0,04
Frame=24 Station=0,08 OutputCase=RAR016 CaseType=Combination P=-70,4520924607996 V2=30,4312072513813 V3=0 T=0 M2=0 M3=17,8146677440523	FrameElem=24-1 ElemStation=0,08
Frame=24 Station=0 OutputCase=RAR017 CaseType=Combination P=-78,0199999951577 V2=23,6059250056019 V3=0 T=0 M2=0 M3=12,3620065155267	FrameElem=24-1 ElemStation=0
Frame=24 Station=0,04 OutputCase=RAR017 CaseType=Combination P=-77,8599999951577 V2=22,4254750056019 V3=0 T=0 M2=0 M3=11,4413381819693	FrameElem=24-1 ElemStation=0,04
Frame=24 Station=0,08 OutputCase=RAR017 CaseType=Combination P=-77,6999999951577 V2=21,2329250056019 V3=0 T=0 M2=0 M3=10,5681298484119	FrameElem=24-1 ElemStation=0,08
Frame=24 Station=0 OutputCase=RAR018 CaseType=Combination P=-11,0120924646029 V2=33,5243145268718 V3=0 T=0 M2=0 M3=13,0773460894759	FrameElem=24-1 ElemStation=0
Frame=24 Station=0,04 OutputCase=RAR018 CaseType=Combination P=-10,8520924646029 V2=32,3438645268718 V3=0 T=0 M2=0 M3=11,7599421750677	FrameElem=24-1 ElemStation=0,04
Frame=24 Station=0,08 OutputCase=RAR018 CaseType=Combination P=-10,6920924646029 V2=31,1513145268718 V3=0 T=0 M2=0 M3=10,4899982606595	FrameElem=24-1 ElemStation=0,08
Frame=24 Station=0 OutputCase=RAR019 CaseType=Combination P=-18,259999998961 V2=24,3260322810924 V3=0 T=0 M2=0 M3=5,09494561417318	FrameElem=24-1 ElemStation=0
Frame=24 Station=0,04 OutputCase=RAR019 CaseType=Combination P=-18,099999998961 V2=23,1455822810924 V3=0 T=0 M2=0 M3=4,14547298959615	FrameElem=24-1 ElemStation=0,04
Frame=24 Station=0,08 OutputCase=RAR019 CaseType=Combination P=-17,939999998961 V2=21,9530322810924 V3=0 T=0 M2=0 M3=3,24346036501912	FrameElem=24-1 ElemStation=0,08
Frame=24 Station=0 OutputCase=RAR020 CaseType=Combination P=-18,6414011967276 V2=6,71472238792343 V3=0 T=0 M2=0 M3=2,937194194748	FrameElem=24-1 ElemStation=0
Frame=24 Station=0,04 OutputCase=RAR020 CaseType=Combination P=-18,4814011967276 V2=6,29142238792343 V3=0 T=0 M2=0 M3=2,67709729923107	FrameElem=24-1 ElemStation=0,04
Frame=24 Station=0,08 OutputCase=RAR020 CaseType=Combination P=-18,3214011967276 V2=5,87592238792343 V3=0 T=0 M2=0 M3=2,43377640371413	FrameElem=24-1 ElemStation=0,08
Frame=24 Station=0 OutputCase=RAR021 CaseType=Combination P=-78,4014011929243 V2=5,99461511243301 V3=0 T=0 M2=0 M3=10,2042550961016	FrameElem=24-1 ElemStation=0
Frame=24 Station=0,04 OutputCase=RAR021 CaseType=Combination P=-78,2414011929243 V2=5,57131511243301 V3=0 T=0 M2=0 M3=9,97296249160424	FrameElem=24-1 ElemStation=0,04
Frame=24 Station=0,08 OutputCase=RAR021 CaseType=Combination P=-78,0814011929243 V2=5,15581511243301 V3=0 T=0 M2=0 M3=9,75844588710692	FrameElem=24-1 ElemStation=0,08
Frame=24 Station=0 OutputCase=RAR022 CaseType=Combination P=-71,153493658508 V2=32,9949347586388 V3=0 T=0 M2=0 M3=20,7128199870096	FrameElem=24-1 ElemStation=0
Frame=24 Station=0,04 OutputCase=RAR022 CaseType=Combination P=-70,993493658508 V2=31,8144847586388 V3=0 T=0 M2=0 M3=19,4165912633307	FrameElem=24-1 ElemStation=0,04
Frame=24 Station=0,08 OutputCase=RAR022 CaseType=Combination P=-70,833493658508 V2=30,6219347586388 V3=0 T=0 M2=0 M3=18,1678225396518	FrameElem=24-1 ElemStation=0,08
Frame=24 Station=0 OutputCase=RAR023 CaseType=Combination P=-78,4014011928661 V2=23,7966525128594 V3=0 T=0 M2=0 M3=12,7304195117069	FrameElem=24-1 ElemStation=0
Frame=24 Station=0,04 OutputCase=RAR023 CaseType=Combination P=-78,2414011928661 V2=22,6162025128593 V3=0 T=0 M2=0 M3=11,8021220778592	FrameElem=24-1 ElemStation=0,04
Frame=24 Station=0,08 OutputCase=RAR023 CaseType=Combination P=-78,0814011928661 V2=21,4236525128593 V3=0 T=0 M2=0 M3=10,9212846440115	FrameElem=24-1 ElemStation=0,08
Frame=24 Station=0 OutputCase=RAR024 CaseType=Combination P=-11,3934936623113 V2=33,7150420341292 V3=0 T=0 M2=0 M3=13,445759085656	FrameElem=24-1 ElemStation=0
Frame=24 Station=0,04 OutputCase=RAR024 CaseType=Combination P=-11,2334936623113 V2=32,5345920341292 V3=0 T=0 M2=0 M3=12,1207260709575	FrameElem=24-1 ElemStation=0,04
Frame=24 Station=0,08 OutputCase=RAR024 CaseType=Combination P=-11,0734936623113 V2=31,3420420341292 V3=0 T=0 M2=0 M3=10,843153056259	FrameElem=24-1 ElemStation=0,08
Frame=24 Station=0 OutputCase=RAR025 CaseType=Combination P=-18,6414011966694 V2=24,5167597883498 V3=0 T=0 M2=0 M3=5,46335861035331	FrameElem=24-1 ElemStation=0
Frame=24 Station=0,04 OutputCase=RAR025 CaseType=Combination P=-18,4814011966694 V2=23,3363097883498 V3=0 T=0 M2=0 M3=4,50625688548599	FrameElem=24-1 ElemStation=0,04
Frame=24 Station=0,08 OutputCase=RAR025 CaseType=Combination P=-18,3214011966694 V2=22,1437597883498 V3=0 T=0 M2=0 M3=3,59661516061866	FrameElem=24-1 ElemStation=0,08
Frame=24 Station=0 OutputCase=RAR026 CaseType=Combination P=-17,875988013108 V2=6,33326737340861 V3=0 T=0 M2=0 M3=2,20036820238773	FrameElem=24-1 ElemStation=0
Frame=24 Station=0,04 OutputCase=RAR026 CaseType=Combination P=-17,7185988013108 V2=5,90996737340861 V3=0 T=0 M2=0 M3=1,95552950745139	FrameElem=24-1 ElemStation=0,04
Frame=24 Station=0,08 OutputCase=RAR026 CaseType=Combination P=-17,5585988013108 V2=5,49446737340861 V3=0 T=0 M2=0 M3=1,72746681251504	FrameElem=24-1 ElemStation=0,08
Frame=24 Station=0 OutputCase=RAR027 CaseType=Combination P=-77,6385987975076 V2=5,61316009791819 V3=0 T=0 M2=0 M3=9,46742910374129	FrameElem=24-1 ElemStation=0
Frame=24 Station=0,04 OutputCase=RAR027 CaseType=Combination P=-77,4785987975076 V2=5,18986009791819 V3=0 T=0 M2=0 M3=9,25139469982456	FrameElem=24-1 ElemStation=0,04
Frame=24 Station=0,08 OutputCase=RAR027 CaseType=Combination P=-77,3185987975076 V2=4,77436009791819 V3=0 T=0 M2=0 M3=9,05213629590783	FrameElem=24-1 ElemStation=0,08
Frame=24 Station=0 OutputCase=RAR028 CaseType=Combination P=-70,3906912630913 V2=32,6134797441239 V3=0 T=0 M2=0 M3=19,9759939946493	FrameElem=24-1 ElemStation=0
Frame=24 Station=0,04 OutputCase=RAR028 CaseType=Combination P=-70,2306912630913 V2=31,4330297441239 V3=0 T=0 M2=0 M3=18,695023471551	FrameElem=24-1 ElemStation=0,04
Frame=24 Station=0,08 OutputCase=RAR028 CaseType=Combination P=-70,0706912630913 V2=30,2404797441239 V3=0 T=0 M2=0 M3=17,4615129484527	FrameElem=24-1 ElemStation=0,08
Frame=24 Station=0 OutputCase=RAR029 CaseType=Combination P=-77,6385987974493 V2=23,4151974983445 V3=0 T=0 M2=0 M3=11,9935935193466	FrameElem=24-1 ElemStation=0
Frame=24 Station=0,04 OutputCase=RAR029 CaseType=Combination P=-77,4785987974494 V2=22,2347474983445 V3=0 T=0 M2=0 M3=11,0805542860795	FrameElem=24-1 ElemStation=0,04
Frame=24 Station=0,08 OutputCase=RAR029 CaseType=Combination P=-77,3185987974494 V2=21,0421974983445 V3=0 T=0 M2=0 M3=10,2149750528124	FrameElem=24-1 ElemStation=0,08

Società di Progetto
Brebemi SpA



Doc. N.
60235-0000-A00.doc

CODIFICA DOCUMENTO
04RCDII10000000000300A00

REV.
00

FOGLIO
361 di 628

Frame=24 Station=0 OutputCase=RAR030 CaseType=Combination P=-10,6306912668945 V2=33,3335870196144 V3=0 T=0 M2=0 M3=12,7089330932957 ElemStation=0	FrameElem=24-1
Frame=24 Station=0,04 OutputCase=RAR030 CaseType=Combination P=-10,4706912668945 V2=32,1531370196144 V3=0 T=0 M2=0 M3=11,3991582791778 ElemStation=0,04	FrameElem=24-1
Frame=24 Station=0,08 OutputCase=RAR030 CaseType=Combination P=-10,3106912668945 V2=30,9605870196144 V3=0 T=0 M2=0 M3=10,1368434650599 ElemStation=0,08	FrameElem=24-1
Frame=24 Station=0 OutputCase=RAR031 CaseType=Combination P=-17,8758988012526 V2=24,135304773835 V3=0 T=0 M2=0 M3=4,72653261799304 ElemStation=0	FrameElem=24-1
Frame=24 Station=0,04 OutputCase=RAR031 CaseType=Combination P=-17,7185988012526 V2=22,954854773835 V3=0 T=0 M2=0 M3=3,78468909370631 ElemStation=0,04	FrameElem=24-1
Frame=24 Station=0,08 OutputCase=RAR031 CaseType=Combination P=-17,5585988012526 V2=21,762304773835 V3=0 T=0 M2=0 M3=2,89030556941958 ElemStation=0,08	FrameElem=24-1
Frame=24 Station=0 OutputCase=RAR032 CaseType=Combination P=-18,2599999990196 V2=6,98372598361597 V3=0 T=0 M2=0 M3=2,95047981495004 ElemStation=0	FrameElem=24-1
Frame=24 Station=0,04 OutputCase=RAR032 CaseType=Combination P=-18,0999999990196 V2=6,56042598361597 V3=0 T=0 M2=0 M3=2,6796227756054 ElemStation=0,04	FrameElem=24-1
Frame=24 Station=0,08 OutputCase=RAR032 CaseType=Combination P=-17,9399999990196 V2=6,14492598361597 V3=0 T=0 M2=0 M3=2,42554173626076 ElemStation=0,08	FrameElem=24-1
Frame=24 Station=0 OutputCase=RAR033 CaseType=Combination P=-78,0199999952163 V2=6,26361870812554 V3=0 T=0 M2=0 M3=10,2175407163036 ElemStation=0	FrameElem=24-1
Frame=24 Station=0,04 OutputCase=RAR033 CaseType=Combination P=-77,8599999952163 V2=5,84031870812554 V3=0 T=0 M2=0 M3=9,97548796797857 ElemStation=0,04	FrameElem=24-1
Frame=24 Station=0,08 OutputCase=RAR033 CaseType=Combination P=-77,6999999952163 V2=5,42481870812554 V3=0 T=0 M2=0 M3=9,75021121965355 ElemStation=0,08	FrameElem=24-1
Frame=24 Station=0 OutputCase=RAR034 CaseType=Combination P=-70,7720924608 V2=33,2639383543313 V3=0 T=0 M2=0 M3=20,7261056072116 ElemStation=0	FrameElem=24-1
Frame=24 Station=0,04 OutputCase=RAR034 CaseType=Combination P=-70,6120924608 V2=32,0834883543313 V3=0 T=0 M2=0 M3=19,419116739705 ElemStation=0,04	FrameElem=24-1
Frame=24 Station=0,08 OutputCase=RAR034 CaseType=Combination P=-70,4520924608 V2=30,8909383543313 V3=0 T=0 M2=0 M3=18,1595878721984 ElemStation=0,08	FrameElem=24-1
Frame=24 Station=0 OutputCase=RAR035 CaseType=Combination P=-78,0199999951581 V2=24,0656561085519 V3=0 T=0 M2=0 M3=12,7437051319089 ElemStation=0	FrameElem=24-1
Frame=24 Station=0,04 OutputCase=RAR035 CaseType=Combination P=-77,8599999951581 V2=22,8852061085519 V3=0 T=0 M2=0 M3=11,8046475542335 ElemStation=0,04	FrameElem=24-1
Frame=24 Station=0,08 OutputCase=RAR035 CaseType=Combination P=-77,6999999951581 V2=21,6926561085519 V3=0 T=0 M2=0 M3=10,9130499765581 ElemStation=0,08	FrameElem=24-1
Frame=24 Station=0 OutputCase=RAR036 CaseType=Combination P=-11,0120924646033 V2=33,9840456298217 V3=0 T=0 M2=0 M3=13,4590447058581 ElemStation=0	FrameElem=24-1
Frame=24 Station=0,04 OutputCase=RAR036 CaseType=Combination P=-10,8520924646033 V2=32,8035956298217 V3=0 T=0 M2=0 M3=12,1232515473319 ElemStation=0,04	FrameElem=24-1
Frame=24 Station=0,08 OutputCase=RAR036 CaseType=Combination P=-10,6920924646033 V2=31,6110456298217 V3=0 T=0 M2=0 M3=10,8349183888057 ElemStation=0,08	FrameElem=24-1
Frame=24 Station=0 OutputCase=RAR037 CaseType=Combination P=-18,2599999989613 V2=24,7857633840423 V3=0 T=0 M2=0 M3=5,47664423055535 ElemStation=0	FrameElem=24-1
Frame=24 Station=0,04 OutputCase=RAR037 CaseType=Combination P=-18,0999999989613 V2=23,6053133840423 V3=0 T=0 M2=0 M3=4,50878236186032 ElemStation=0,04	FrameElem=24-1
Frame=24 Station=0,08 OutputCase=RAR037 CaseType=Combination P=-17,9399999989613 V2=22,4127633840423 V3=0 T=0 M2=0 M3=3,5883804931653 ElemStation=0,08	FrameElem=24-1
Frame=24 Station=0 OutputCase=RAR038 CaseType=Combination P=-18,2599999990204 V2=8,05643189049918 V3=0 T=0 M2=0 M3=3,84110991984178 ElemStation=0	FrameElem=24-1
Frame=24 Station=0,04 OutputCase=RAR038 CaseType=Combination P=-18,0999999990204 V2=7,63313189049918 V3=0 T=0 M2=0 M3=3,52734464422181 ElemStation=0,04	FrameElem=24-1
Frame=24 Station=0,08 OutputCase=RAR038 CaseType=Combination P=-17,9399999990204 V2=7,21763189049918 V3=0 T=0 M2=0 M3=3,23035536860184 ElemStation=0,08	FrameElem=24-1
Frame=24 Station=0 OutputCase=RAR039 CaseType=Combination P=-97,9399999939491 V2=6,78980145454531 V3=0 T=0 M2=0 M3=13,2760587107251 ElemStation=0	FrameElem=24-1
Frame=24 Station=0,04 OutputCase=RAR039 CaseType=Combination P=-97,7799999939491 V2=6,36650145454531 V3=0 T=0 M2=0 M3=13,0129586525433 FrameElem=24-1	FrameElem=24-1
Frame=24 Station=0,08 OutputCase=RAR039 CaseType=Combination P=-97,6199999939491 V2=5,95100145454531 V3=0 T=0 M2=0 M3=12,7666345943614 FrameElem=24-1	FrameElem=24-1
Frame=24 Station=0 OutputCase=RAR040 CaseType=Combination P=-88,5988559037218 V2=41,0176377416601 V3=0 T=0 M2=0 M3=26,7372726948079 ElemStation=0	FrameElem=24-1
Frame=24 Station=0,04 OutputCase=RAR040 CaseType=Combination P=-88,4388559037218 V2=39,6687377416601 V3=0 T=0 M2=0 M3=25,1234778518082 ElemStation=0,04	FrameElem=24-1
Frame=24 Station=0,08 OutputCase=RAR040 CaseType=Combination P=-88,2788559037218 V2=38,2996377416601 V3=0 T=0 M2=0 M3=23,5640340088085 ElemStation=0,08	FrameElem=24-1
Frame=24 Station=0 OutputCase=RAR041 CaseType=Combination P=-97,9399999938909 V2=29,1922070078099 V3=0 T=0 M2=0 M3=16,4826396488343 ElemStation=0	FrameElem=24-1
Frame=24 Station=0,04 OutputCase=RAR041 CaseType=Combination P=-97,7799999938909 V2=27,8433070078099 V3=0 T=0 M2=0 M3=15,3418620351886 ElemStation=0,04	FrameElem=24-1
Frame=24 Station=0,08 OutputCase=RAR041 CaseType=Combination P=-97,6199999938909 V2=26,4742070078099 V3=0 T=0 M2=0 M3=14,2554444215429 ElemStation=0,08	FrameElem=24-1
Frame=24 Station=0 OutputCase=RAR042 CaseType=Combination P=-8,91885590879281 V2=41,9777807756473 V3=0 T=0 M2=0 M3=17,0478581596699 ElemStation=0	FrameElem=24-1
Frame=24 Station=0,04 OutputCase=RAR042 CaseType=Combination P=-8,75885590879281 V2=40,6288807756473 V3=0 T=0 M2=0 M3=15,3956575953106 ElemStation=0,04	FrameElem=24-1
Frame=24 Station=0,08 OutputCase=RAR042 CaseType=Combination P=-8,59885590879281 V2=39,2597807756473 V3=0 T=0 M2=0 M3=13,7978170309514 ElemStation=0,08	FrameElem=24-1
Frame=24 Station=0 OutputCase=RAR043 CaseType=Combination P=-18,2599999989619 V2=30,1523500417971 V3=0 T=0 M2=0 M3=6,79322511369625 ElemStation=0	FrameElem=24-1
Frame=24 Station=0,04 OutputCase=RAR043 CaseType=Combination P=-18,0999999989619 V2=28,8034500417971 V3=0 T=0 M2=0 M3=5,61404177869103 ElemStation=0,04	FrameElem=24-1
Frame=24 Station=0,08 OutputCase=RAR043 CaseType=Combination P=-17,9399999989619 V2=27,4343500417971 V3=0 T=0 M2=0 M3=4,48921844368582 ElemStation=0,08	FrameElem=24-1
Frame=24 Station=0 OutputCase=RAR044 CaseType=Combination P=-56,4240089172093 V2=47,891156865335 V3=0 T=0 M2=0 M3=32,4626206310891 ElemStation=0	FrameElem=24-1
Frame=24 Station=0,04 OutputCase=RAR044 CaseType=Combination P=-56,2640089172093 V2=46,710706865335 V3=0 T=0 M2=0 M3=30,5705430231424 ElemStation=0,04	FrameElem=24-1

Società di Progetto
Brebemi SpA



Doc. N.
60235-00000-A00.doc

CODIFICA DOCUMENTO
04RCDII10000000000300A00

REV.
00

FOGLIO
362 di 628

Frame=24 Station=0,08 OutputCase=RAR044 CaseType=Combination P=-56,1040089172093 V2=45,518156865335 V3=0 T=0 M2=0 M3=28,7259254151956 FrameElem=24-1
ElemStation=0,08
Frame=24 Station=0 OutputCase=RAR045 CaseType=Combination P=-78,0199999952171 V2=7,33632461500876 V3=0 T=0 M2=0 M3=11,1081708211953 FrameElem=24-1
ElemStation=0
Frame=24 Station=0,04 OutputCase=RAR045 CaseType=Combination P=-77,8599999952171 V2=6,91302461500876 V3=0 T=0 M2=0 M3=10,823209836595 FrameElem=24-1
ElemStation=0,04
Frame=24 Station=0,08 OutputCase=RAR045 CaseType=Combination P=-77,6999999952171 V2=6,49752461500876 V3=0 T=0 M2=0 M3=10,5550248519946 FrameElem=24-1
ElemStation=0,08
Frame=24 Station=0 OutputCase=RAR046 CaseType=Combination P=-70,7720924608008 V2=34,3366442612145 V3=0 T=0 M2=0 M3=21,6167357121033 FrameElem=24-1
ElemStation=0
Frame=24 Station=0,04 OutputCase=RAR046 CaseType=Combination P=-70,6120924608008 V2=33,1561942612145 V3=0 T=0 M2=0 M3=20,2668386083214 FrameElem=24-1
ElemStation=0,04
Frame=24 Station=0,08 OutputCase=RAR046 CaseType=Combination P=-70,4520924608008 V2=31,9636442612145 V3=0 T=0 M2=0 M3=18,9644015045395 FrameElem=24-1
ElemStation=0,08
Frame=24 Station=0 OutputCase=RAR047 CaseType=Combination P=-78,0199999951589 V2=25,1383620154351 V3=0 T=0 M2=0 M3=13,6343352368006 FrameElem=24-1
ElemStation=0
Frame=24 Station=0,04 OutputCase=RAR047 CaseType=Combination P=-77,8599999951589 V2=23,9579120154351 V3=0 T=0 M2=0 M3=12,6523694228499 FrameElem=24-1
ElemStation=0,04
Frame=24 Station=0,08 OutputCase=RAR047 CaseType=Combination P=-77,6999999951589 V2=22,7653620154351 V3=0 T=0 M2=0 M3=11,7178636088992 FrameElem=24-1
ElemStation=0,08
Frame=24 Station=0 OutputCase=RAR048 CaseType=Combination P=-11,0120924646041 V2=35,0567515367049 V3=0 T=0 M2=0 M3=14,3496748107498 FrameElem=24-1
ElemStation=0
Frame=24 Station=0,04 OutputCase=RAR048 CaseType=Combination P=-10,8520924646041 V2=33,8763015367049 V3=0 T=0 M2=0 M3=12,9709734159483 FrameElem=24-1
ElemStation=0,04
Frame=24 Station=0,08 OutputCase=RAR048 CaseType=Combination P=-10,6920924646041 V2=32,6837515367049 V3=0 T=0 M2=0 M3=11,6397320211467 FrameElem=24-1
ElemStation=0,08
Frame=24 Station=0 OutputCase=RAR049 CaseType=Combination P=-18,2599999989621 V2=25,8584692909255 V3=0 T=0 M2=0 M3=6,36727433544709 FrameElem=24-1
ElemStation=0
Frame=24 Station=0,04 OutputCase=RAR049 CaseType=Combination P=-18,0999999989621 V2=24,6780192909255 V3=0 T=0 M2=0 M3=5,35650423047673 FrameElem=24-1
ElemStation=0,04
Frame=24 Station=0,08 OutputCase=RAR049 CaseType=Combination P=-17,9399999989621 V2=23,4854692909255 V3=0 T=0 M2=0 M3=4,39319412550638 FrameElem=24-1
ElemStation=0,08
Frame=24 Station=0 OutputCase=RAR050 CaseType=Combination P=-18,6414011967287 V2=8,24715939775659 V3=0 T=0 M2=0 M3=4,20952291602192 FrameElem=24-1
ElemStation=0
Frame=24 Station=0,04 OutputCase=RAR050 CaseType=Combination P=-18,4814011967287 V2=7,82385939775659 V3=0 T=0 M2=0 M3=3,88812854011165 FrameElem=24-1
ElemStation=0,04
Frame=24 Station=0,08 OutputCase=RAR050 CaseType=Combination P=-18,3214011967287 V2=7,40835939775659 V3=0 T=0 M2=0 M3=3,58351016420139 FrameElem=24-1
ElemStation=0,08
Frame=24 Station=0 OutputCase=RAR051 CaseType=Combination P=-78,4014011929254 V2=7,52705212226617 V3=0 T=0 M2=0 M3=11,4765838173755 FrameElem=24-1
ElemStation=0
Frame=24 Station=0,04 OutputCase=RAR051 CaseType=Combination P=-78,2414011929254 V2=7,10375212226617 V3=0 T=0 M2=0 M3=11,1839937324848 FrameElem=24-1
ElemStation=0,04
Frame=24 Station=0,08 OutputCase=RAR051 CaseType=Combination P=-78,0814011929254 V2=6,68825212226617 V3=0 T=0 M2=0 M3=10,9081796475942 FrameElem=24-1
ElemStation=0,08
Frame=24 Station=0 OutputCase=RAR052 CaseType=Combination P=-71,1534936585091 V2=34,5273717684719 V3=0 T=0 M2=0 M3=21,9851487082835 FrameElem=24-1
ElemStation=0
Frame=24 Station=0,04 OutputCase=RAR052 CaseType=Combination P=-70,9934936585091 V2=33,3469217684719 V3=0 T=0 M2=0 M3=20,6276225042113 FrameElem=24-1
ElemStation=0,04
Frame=24 Station=0,08 OutputCase=RAR052 CaseType=Combination P=-70,8334936585091 V2=32,1543717684719 V3=0 T=0 M2=0 M3=19,3175563001391 FrameElem=24-1
ElemStation=0,08
Frame=24 Station=0 OutputCase=RAR053 CaseType=Combination P=-78,4014011928672 V2=25,3290895226925 V3=0 T=0 M2=0 M3=14,0027482329808 FrameElem=24-1
ElemStation=0
Frame=24 Station=0,04 OutputCase=RAR053 CaseType=Combination P=-78,2414011928672 V2=24,1486395226925 V3=0 T=0 M2=0 M3=13,0131533187397 FrameElem=24-1
ElemStation=0,04
Frame=24 Station=0,08 OutputCase=RAR053 CaseType=Combination P=-78,0814011928672 V2=22,9560895226925 V3=0 T=0 M2=0 M3=12,0710184044987 FrameElem=24-1
ElemStation=0,08
Frame=24 Station=0 OutputCase=RAR054 CaseType=Combination P=-11,3934936623124 V2=35,2474790439623 V3=0 T=0 M2=0 M3=14,7180878069299 FrameElem=24-1
ElemStation=0
Frame=24 Station=0,04 OutputCase=RAR054 CaseType=Combination P=-11,2334936623124 V2=34,0670290439624 V3=0 T=0 M2=0 M3=13,3317573118381 FrameElem=24-1
ElemStation=0,04
Frame=24 Station=0,08 OutputCase=RAR054 CaseType=Combination P=-11,0734936623124 V2=32,8744790439623 V3=0 T=0 M2=0 M3=11,9928868167463 FrameElem=24-1
ElemStation=0,08
Frame=24 Station=0 OutputCase=RAR055 CaseType=Combination P=-18,6414011966705 V2=26,0491967981829 V3=0 T=0 M2=0 M3=6,73568733162722 FrameElem=24-1
ElemStation=0
Frame=24 Station=0,04 OutputCase=RAR055 CaseType=Combination P=-18,4814011966705 V2=24,8687467981829 V3=0 T=0 M2=0 M3=5,71728812636657 FrameElem=24-1
ElemStation=0,04
Frame=24 Station=0,08 OutputCase=RAR055 CaseType=Combination P=-18,3214011966705 V2=23,6761967981829 V3=0 T=0 M2=0 M3=4,74634892110592 FrameElem=24-1
ElemStation=0,08
Frame=24 Station=0 OutputCase=RAR056 CaseType=Combination P=-17,878598801312 V2=7,86570438324177 V3=0 T=0 M2=0 M3=3,47269692366164 FrameElem=24-1
ElemStation=0
Frame=24 Station=0,04 OutputCase=RAR056 CaseType=Combination P=-17,718598801312 V2=7,44240438324177 V3=0 T=0 M2=0 M3=3,16656074833197 FrameElem=24-1
ElemStation=0,04
Frame=24 Station=0,08 OutputCase=RAR056 CaseType=Combination P=-17,558598801312 V2=7,02690438324177 V3=0 T=0 M2=0 M3=2,8772005730023 FrameElem=24-1
ElemStation=0,08
Frame=24 Station=0 OutputCase=RAR057 CaseType=Combination P=-77,6385987975087 V2=7,14559710775135 V3=0 T=0 M2=0 M3=10,7397578250152 FrameElem=24-1
ElemStation=0
Frame=24 Station=0,04 OutputCase=RAR057 CaseType=Combination P=-77,4785987975087 V2=6,72229710775134 V3=0 T=0 M2=0 M3=10,4624259407051 FrameElem=24-1
ElemStation=0,04
Frame=24 Station=0,08 OutputCase=RAR057 CaseType=Combination P=-77,3185987975087 V2=6,30679710775135 V3=0 T=0 M2=0 M3=10,2018700563951 FrameElem=24-1
ElemStation=0,08
Frame=24 Station=0 OutputCase=RAR058 CaseType=Combination P=-70,3906912630924 V2=34,1459167539571 V3=0 T=0 M2=0 M3=21,2483227159232 FrameElem=24-1
ElemStation=0
Frame=24 Station=0,04 OutputCase=RAR058 CaseType=Combination P=-70,2306912630924 V2=32,9654667539571 V3=0 T=0 M2=0 M3=19,9060547124316 FrameElem=24-1
ElemStation=0,04
Frame=24 Station=0,08 OutputCase=RAR058 CaseType=Combination P=-70,0706912630924 V2=31,7729167539571 V3=0 T=0 M2=0 M3=18,61124670894 FrameElem=24-1
ElemStation=0,08
Frame=24 Station=0 OutputCase=RAR059 CaseType=Combination P=-77,6385987974505 V2=24,9476345081777 V3=0 T=0 M2=0 M3=13,2659222406205 FrameElem=24-1
ElemStation=0

Società di Progetto
Brebemi SpA

	Doc. N. 60235-0000-A00.doc	CODIFICA DOCUMENTO 04RCDII10000000000300A00	REV. 00	FOGLIO 363 di 628
--	-------------------------------	--	------------	----------------------

Frame=24 Station=0,04 OutputCase=RAR059 CaseType=Combination P=-77,4785987974505 V2=23,7671845081777 V3=0 T=0 M2=0 M3=12,2915855269601	FrameElem=24-1 ElemStation=0,04
Frame=24 Station=0,08 OutputCase=RAR059 CaseType=Combination P=-77,3185987974505 V2=22,5746345081777 V3=0 T=0 M2=0 M3=11,3647088132996	FrameElem=24-1 ElemStation=0,08
Frame=24 Station=0 OutputCase=RAR060 CaseType=Combination P=-10,6306912668957 V2=34,8660240294475 V3=0 T=0 M2=0 M3=13,9812618145697	FrameElem=24-1 ElemStation=0
Frame=24 Station=0,04 OutputCase=RAR060 CaseType=Combination P=-10,4706912668957 V2=33,6855740294475 V3=0 T=0 M2=0 M3=12,6101895200584	FrameElem=24-1 ElemStation=0,04
Frame=24 Station=0,08 OutputCase=RAR060 CaseType=Combination P=-10,3106912668957 V2=32,4930240294475 V3=0 T=0 M2=0 M3=11,2865772255472	FrameElem=24-1 ElemStation=0,08
Frame=24 Station=0 OutputCase=RAR061 CaseType=Combination P=-17,8785988012538 V2=25,6677417836681 V3=0 T=0 M2=0 M3=5,99886133926695	FrameElem=24-1 ElemStation=0
Frame=24 Station=0,04 OutputCase=RAR061 CaseType=Combination P=-17,7185988012538 V2=24,4872917836681 V3=0 T=0 M2=0 M3=4,99572033458689	FrameElem=24-1 ElemStation=0,04
Frame=24 Station=0,08 OutputCase=RAR061 CaseType=Combination P=-17,5585988012538 V2=23,2947417836681 V3=0 T=0 M2=0 M3=4,04003932990683	FrameElem=24-1 ElemStation=0,08
Frame=24 Station=0 OutputCase=RAR062 CaseType=Combination P=-18,2599999990207 V2=8,51616299344913 V3=0 T=0 M2=0 M3=4,22280853622395	FrameElem=24-1 ElemStation=0
Frame=24 Station=0,04 OutputCase=RAR062 CaseType=Combination P=-18,0999999990207 V2=8,09286299344913 V3=0 T=0 M2=0 M3=3,89065401648599	FrameElem=24-1 ElemStation=0,04
Frame=24 Station=0,08 OutputCase=RAR062 CaseType=Combination P=-17,9399999990207 V2=7,67736299344913 V3=0 T=0 M2=0 M3=3,57527549674802	FrameElem=24-1 ElemStation=0,08
Frame=24 Station=0 OutputCase=RAR063 CaseType=Combination P=-78,0199999952174 V2=7,7960557179587 V3=0 T=0 M2=0 M3=11,4898694375775	FrameElem=24-1 ElemStation=0
Frame=24 Station=0,04 OutputCase=RAR063 CaseType=Combination P=-77,8599999952174 V2=7,3727557179587 V3=0 T=0 M2=0 M3=11,1865192088592	FrameElem=24-1 ElemStation=0,04
Frame=24 Station=0,08 OutputCase=RAR063 CaseType=Combination P=-77,6999999952174 V2=6,9572557179587 V3=0 T=0 M2=0 M3=10,8999449801408	FrameElem=24-1 ElemStation=0,08
Frame=24 Station=0 OutputCase=RAR064 CaseType=Combination P=-70,7720924608011 V2=34,7963753641645 V3=0 T=0 M2=0 M3=21,9984343284855	FrameElem=24-1 ElemStation=0
Frame=24 Station=0,04 OutputCase=RAR064 CaseType=Combination P=-70,6120924608011 V2=33,6159253641645 V3=0 T=0 M2=0 M3=20,6301479805856	FrameElem=24-1 ElemStation=0,04
Frame=24 Station=0,08 OutputCase=RAR064 CaseType=Combination P=-70,4520924608011 V2=32,4233753641645 V3=0 T=0 M2=0 M3=19,3093216326857	FrameElem=24-1 ElemStation=0,08
Frame=24 Station=0 OutputCase=RAR065 CaseType=Combination P=-78,0199999951592 V2=25,598093118385 V3=0 T=0 M2=0 M3=14,0160338531828	FrameElem=24-1 ElemStation=0
Frame=24 Station=0,04 OutputCase=RAR065 CaseType=Combination P=-77,8599999951592 V2=24,417643118385 V3=0 T=0 M2=0 M3=13,0156787951141	FrameElem=24-1 ElemStation=0,04
Frame=24 Station=0,08 OutputCase=RAR065 CaseType=Combination P=-77,6999999951592 V2=23,225093118385 V3=0 T=0 M2=0 M3=12,0627837370453	FrameElem=24-1 ElemStation=0,08
Frame=24 Station=0 OutputCase=RAR066 CaseType=Combination P=-11,0120924646044 V2=35,5164826396549 V3=0 T=0 M2=0 M3=14,731373427132	FrameElem=24-1 ElemStation=0
Frame=24 Station=0,04 OutputCase=RAR066 CaseType=Combination P=-10,8520924646044 V2=34,3360326396549 V3=0 T=0 M2=0 M3=13,3342827882124	FrameElem=24-1 ElemStation=0,04
Frame=24 Station=0,08 OutputCase=RAR066 CaseType=Combination P=-10,6920924646044 V2=33,1434826396549 V3=0 T=0 M2=0 M3=11,9846521492929	FrameElem=24-1 ElemStation=0,08
Frame=24 Station=0 OutputCase=RAR067 CaseType=Combination P=-18,2599999989625 V2=26,3182003938755 V3=0 T=0 M2=0 M3=6,74897295182926	FrameElem=24-1 ElemStation=0
Frame=24 Station=0,04 OutputCase=RAR067 CaseType=Combination P=-18,0999999989625 V2=25,1377503938755 V3=0 T=0 M2=0 M3=5,71981360274091	FrameElem=24-1 ElemStation=0,04
Frame=24 Station=0,08 OutputCase=RAR067 CaseType=Combination P=-17,9399999989625 V2=23,9452003938755 V3=0 T=0 M2=0 M3=4,73811425365256	FrameElem=24-1 ElemStation=0,08
Frame=24 Station=0 OutputCase=RAR068 CaseType=Combination P=-18,8956686618671 V2=7,60809256434495 V3=0 T=0 M2=0 M3=3,81896721950505	FrameElem=24-1 ElemStation=0
Frame=24 Station=0,04 OutputCase=RAR068 CaseType=Combination P=-18,7356686618671 V2=7,18479256434495 V3=0 T=0 M2=0 M3=3,52313551693125	FrameElem=24-1 ElemStation=0,04
Frame=24 Station=0,08 OutputCase=RAR068 CaseType=Combination P=-18,5756686618671 V2=6,76929256434495 V3=0 T=0 M2=0 M3=3,24407981435745	FrameElem=24-1 ElemStation=0,08
Frame=24 Station=0 OutputCase=RAR069 CaseType=Combination P=-98,3214011916571 V2=6,52079785885278 V3=0 T=0 M2=0 M3=13,262773090523	FrameElem=24-1 ElemStation=0
Frame=24 Station=0,04 OutputCase=RAR069 CaseType=Combination P=-98,1614011916571 V2=6,09749785885278 V3=0 T=0 M2=0 M3=13,0104331761689	FrameElem=24-1 ElemStation=0,04
Frame=24 Station=0,08 OutputCase=RAR069 CaseType=Combination P=-98,0014011916571 V2=5,68199785885278 V3=0 T=0 M2=0 M3=12,7748692618148	FrameElem=24-1 ElemStation=0,08
Frame=24 Station=0 OutputCase=RAR070 CaseType=Combination P=-88,8202571014298 V2=40,7486341459675 V3=0 T=0 M2=0 M3=26,7239870746059	FrameElem=24-1 ElemStation=0
Frame=24 Station=0,04 OutputCase=RAR070 CaseType=Combination P=-88,8202571014298 V2=39,3997341459675 V3=0 T=0 M2=0 M3=25,1209523754339	FrameElem=24-1 ElemStation=0,04
Frame=24 Station=0,08 OutputCase=RAR070 CaseType=Combination P=-88,6602571014298 V2=38,0306341459675 V3=0 T=0 M2=0 M3=23,5722776762618	FrameElem=24-1 ElemStation=0,08
Frame=24 Station=0 OutputCase=RAR071 CaseType=Combination P=-98,3214011915989 V2=28,9232034121173 V3=0 T=0 M2=0 M3=16,4693540286323	FrameElem=24-1 ElemStation=0
Frame=24 Station=0,04 OutputCase=RAR071 CaseType=Combination P=-98,1614011915989 V2=27,5743034121173 V3=0 T=0 M2=0 M3=15,3393365588143	FrameElem=24-1 ElemStation=0,04
Frame=24 Station=0,08 OutputCase=RAR071 CaseType=Combination P=-98,0014011915989 V2=26,2052034121173 V3=0 T=0 M2=0 M3=14,2636790889962	FrameElem=24-1 ElemStation=0,08
Frame=24 Station=0 OutputCase=RAR072 CaseType=Combination P=-9,30025710650083 V2=41,7087771799548 V3=0 T=0 M2=0 M3=17,0345725394678	FrameElem=24-1 ElemStation=0
Frame=24 Station=0,04 OutputCase=RAR072 CaseType=Combination P=-9,14025710650083 V2=40,3598771799548 V3=0 T=0 M2=0 M3=15,3931321189363	FrameElem=24-1 ElemStation=0,04
Frame=24 Station=0,08 OutputCase=RAR072 CaseType=Combination P=-8,98025710650083 V2=38,9907771799548 V3=0 T=0 M2=0 M3=13,8060516984048	FrameElem=24-1 ElemStation=0,08
Frame=24 Station=0 OutputCase=RAR073 CaseType=Combination P=-18,6414011966699 V2=29,8833464461046 V3=0 T=0 M2=0 M3=6,77993949349422	FrameElem=24-1 ElemStation=0
Frame=24 Station=0,04 OutputCase=RAR073 CaseType=Combination P=-18,4814011966699 V2=28,5344464461046 V3=0 T=0 M2=0 M3=5,6115163023167	FrameElem=24-1 ElemStation=0,04
Frame=24 Station=0,08 OutputCase=RAR073 CaseType=Combination P=-18,3214011966699 V2=27,1653464461046 V3=0 T=0 M2=0 M3=4,49745311113918	FrameElem=24-1 ElemStation=0,08

Società di Progetto
Brebemi SpA

	Doc. N. 60235-00000-A00.doc	CODIFICA DOCUMENTO 04RCDII10000000000300A00	REV. 00	FOGLIO 364 di 628
--	--------------------------------	--	------------	----------------------

Frame=24 Station=0 OutputCase=RAR074 CaseType=Combination P=-56,8054101149174 V2=47,6221532696425 V3=0 T=0 M2=0 M3=32,4493350108871 FrameElem=24-1 ElemStation=0

Frame=24 Station=0,04 OutputCase=RAR074 CaseType=Combination P=-56,6454101149174 V2=46,4417032696425 V3=0 T=0 M2=0 M3=30,568017546768 FrameElem=24-1 ElemStation=0,04

Frame=24 Station=0,08 OutputCase=RAR074 CaseType=Combination P=-56,4854101149174 V2=45,2491532696425 V3=0 T=0 M2=0 M3=28,734160082649 FrameElem=24-1 ElemStation=0,08

Frame=24 Station=0 OutputCase=RAR075 CaseType=Combination P=-78,6556686580638 V2=6,88798528885453 V3=0 T=0 M2=0 M3=11,0860281208586 FrameElem=24-1 ElemStation=0

Frame=24 Station=0,04 OutputCase=RAR075 CaseType=Combination P=-78,4956686580638 V2=6,46468528885453 V3=0 T=0 M2=0 M3=10,8190007093044 FrameElem=24-1 ElemStation=0,04

Frame=24 Station=0,08 OutputCase=RAR075 CaseType=Combination P=-78,3356686580638 V2=6,04918528885453 V3=0 T=0 M2=0 M3=10,5687492977502 FrameElem=24-1 ElemStation=0,08

Frame=24 Station=0 OutputCase=RAR076 CaseType=Combination P=-71,4077611236475 V2=33,8883049350603 V3=0 T=0 M2=0 M3=21,5945930117666 FrameElem=24-1 ElemStation=0

Frame=24 Station=0,04 OutputCase=RAR076 CaseType=Combination P=-71,2477611236475 V2=32,7078549350603 V3=0 T=0 M2=0 M3=20,2626294810309 FrameElem=24-1 ElemStation=0,04

Frame=24 Station=0,08 OutputCase=RAR076 CaseType=Combination P=-71,0877611236475 V2=31,5153049350603 V3=0 T=0 M2=0 M3=18,9781259502951 FrameElem=24-1 ElemStation=0,08

Frame=24 Station=0 OutputCase=RAR077 CaseType=Combination P=-78,6556686580056 V2=24,6900226892809 V3=0 T=0 M2=0 M3=13,6121925364639 FrameElem=24-1 ElemStation=0

Frame=24 Station=0,04 OutputCase=RAR077 CaseType=Combination P=-78,4956686580056 V2=23,5095726892809 V3=0 T=0 M2=0 M3=12,6481602955593 FrameElem=24-1 ElemStation=0,04

Frame=24 Station=0,08 OutputCase=RAR077 CaseType=Combination P=-78,3356686580056 V2=22,3170226892809 V3=0 T=0 M2=0 M3=11,7315880546548 FrameElem=24-1 ElemStation=0,08

Frame=24 Station=0 OutputCase=RAR078 CaseType=Combination P=-11,6477611274508 V2=34,6084122105507 V3=0 T=0 M2=0 M3=14,3275321104131 FrameElem=24-1 ElemStation=0

Frame=24 Station=0,04 OutputCase=RAR078 CaseType=Combination P=-11,4877611274508 V2=33,4279622105507 V3=0 T=0 M2=0 M3=12,9667642886577 FrameElem=24-1 ElemStation=0,04

Frame=24 Station=0,08 OutputCase=RAR078 CaseType=Combination P=-11,3277611274508 V2=32,2354122105507 V3=0 T=0 M2=0 M3=11,6534564669023 FrameElem=24-1 ElemStation=0,08

Frame=24 Station=0 OutputCase=RAR079 CaseType=Combination P=-18,8956686618089 V2=25,4101299647713 V3=0 T=0 M2=0 M3=6,34513163511036 FrameElem=24-1 ElemStation=0

Frame=24 Station=0,04 OutputCase=RAR079 CaseType=Combination P=-18,7356686618089 V2=24,2296799647713 V3=0 T=0 M2=0 M3=5,35229510318618 FrameElem=24-1 ElemStation=0,04

Frame=24 Station=0,08 OutputCase=RAR079 CaseType=Combination P=-18,5756686618089 V2=23,0371299647713 V3=0 T=0 M2=0 M3=4,40691857126199 FrameElem=24-1 ElemStation=0,08

Frame=24 Station=0 OutputCase=RAR080 CaseType=Combination P=-18,8956686618667 V2=7,14836146139501 V3=0 T=0 M2=0 M3=3,43726860312288 FrameElem=24-1 ElemStation=0

Frame=24 Station=0,04 OutputCase=RAR080 CaseType=Combination P=-18,7356686618667 V2=6,72506146139501 V3=0 T=0 M2=0 M3=3,15982614466708 FrameElem=24-1 ElemStation=0,04

Frame=24 Station=0,08 OutputCase=RAR080 CaseType=Combination P=-18,5756686618667 V2=6,30956146139501 V3=0 T=0 M2=0 M3=2,89915968621128 FrameElem=24-1 ElemStation=0,08

Frame=24 Station=0 OutputCase=RAR081 CaseType=Combination P=-78,6556686580634 V2=6,42825418590458 V3=0 T=0 M2=0 M3=10,7043295044764 FrameElem=24-1 ElemStation=0

Frame=24 Station=0,04 OutputCase=RAR081 CaseType=Combination P=-78,4956686580634 V2=6,00495418590458 V3=0 T=0 M2=0 M3=10,4556913370402 FrameElem=24-1 ElemStation=0,04

Frame=24 Station=0,08 OutputCase=RAR081 CaseType=Combination P=-78,3356686580634 V2=5,58945418590458 V3=0 T=0 M2=0 M3=10,2238291696041 FrameElem=24-1 ElemStation=0,08

Frame=24 Station=0 OutputCase=RAR082 CaseType=Combination P=-71,4077611236471 V2=33,4285738321103 V3=0 T=0 M2=0 M3=21,2128943953844 FrameElem=24-1 ElemStation=0

Frame=24 Station=0,04 OutputCase=RAR082 CaseType=Combination P=-71,2477611236471 V2=32,2481238321103 V3=0 T=0 M2=0 M3=19,8993201087667 FrameElem=24-1 ElemStation=0,04

Frame=24 Station=0,08 OutputCase=RAR082 CaseType=Combination P=-71,0877611236471 V2=31,0555738321103 V3=0 T=0 M2=0 M3=18,633205822149 FrameElem=24-1 ElemStation=0,08

Frame=24 Station=0 OutputCase=RAR083 CaseType=Combination P=-78,6556686580052 V2=24,2302915863309 V3=0 T=0 M2=0 M3=13,2304939200817 FrameElem=24-1 ElemStation=0

Frame=24 Station=0,04 OutputCase=RAR083 CaseType=Combination P=-78,4956686580052 V2=23,0498415863309 V3=0 T=0 M2=0 M3=12,2848509232952 FrameElem=24-1 ElemStation=0,04

Frame=24 Station=0,08 OutputCase=RAR083 CaseType=Combination P=-78,3356686580052 V2=21,8572915863309 V3=0 T=0 M2=0 M3=11,3866679265086 FrameElem=24-1 ElemStation=0,08

Frame=24 Station=0 OutputCase=RAR084 CaseType=Combination P=-11,6477611274504 V2=34,1486811076008 V3=0 T=0 M2=0 M3=13,9458334940309 FrameElem=24-1 ElemStation=0

Frame=24 Station=0,04 OutputCase=RAR084 CaseType=Combination P=-11,4877611274504 V2=32,9682311076008 V3=0 T=0 M2=0 M3=12,6034549163935 FrameElem=24-1 ElemStation=0,04

Frame=24 Station=0,08 OutputCase=RAR084 CaseType=Combination P=-11,3277611274504 V2=31,7756811076008 V3=0 T=0 M2=0 M3=11,3085363387562 FrameElem=24-1 ElemStation=0,08

Frame=24 Station=0 OutputCase=RAR085 CaseType=Combination P=-18,8956686618085 V2=24,9503988618213 V3=0 T=0 M2=0 M3=5,96343301872819 FrameElem=24-1 ElemStation=0

Frame=24 Station=0,04 OutputCase=RAR085 CaseType=Combination P=-18,7356686618085 V2=23,7699488618213 V3=0 T=0 M2=0 M3=4,988985730922 FrameElem=24-1 ElemStation=0,04

Frame=24 Station=0,08 OutputCase=RAR085 CaseType=Combination P=-18,5756686618085 V2=22,5773988618213 V3=0 T=0 M2=0 M3=4,06199844311581 FrameElem=24-1 ElemStation=0,08

Frame=24 Station=0 OutputCase=RAR086 CaseType=Combination P=-18,8956686618674 V2=8,0678236672949 V3=0 T=0 M2=0 M3=4,20066583588722 FrameElem=24-1 ElemStation=0

Frame=24 Station=0,04 OutputCase=RAR086 CaseType=Combination P=-18,7356686618674 V2=7,6445236672949 V3=0 T=0 M2=0 M3=3,88644488919543 FrameElem=24-1 ElemStation=0,04

Frame=24 Station=0,08 OutputCase=RAR086 CaseType=Combination P=-18,5756686618674 V2=7,2290236672949 V3=0 T=0 M2=0 M3=3,58899994250363 FrameElem=24-1 ElemStation=0,08

Frame=24 Station=0 OutputCase=RAR087 CaseType=Combination P=-78,6556686580641 V2=7,34771639180447 V3=0 T=0 M2=0 M3=11,4677267372408 FrameElem=24-1 ElemStation=0

Frame=24 Station=0,04 OutputCase=RAR087 CaseType=Combination P=-78,4956686580641 V2=6,92441639180447 V3=0 T=0 M2=0 M3=11,1823100815686 FrameElem=24-1 ElemStation=0,04

Frame=24 Station=0,08 OutputCase=RAR087 CaseType=Combination P=-78,3356686580641 V2=6,50891639180447 V3=0 T=0 M2=0 M3=10,9136694258964 FrameElem=24-1 ElemStation=0,08

Frame=24 Station=0 OutputCase=RAR088 CaseType=Combination P=-71,4077611236478 V2=34,3480360380102 V3=0 T=0 M2=0 M3=21,9762916281488 FrameElem=24-1 ElemStation=0

Frame=24 Station=0,04 OutputCase=RAR088 CaseType=Combination P=-71,2477611236478 V2=33,1675860380102 V3=0 T=0 M2=0 M3=20,6259388532951 FrameElem=24-1 ElemStation=0,04

Società di Progetto
Brebemi SpA

	Doc. N. 60235-00000-A00.doc	CODIFICA DOCUMENTO 04RCDII10000000000300A00	REV. 00	FOGLIO 365 di 628
--	--------------------------------	--	------------	----------------------

Frame=24 Station=0,08 OutputCase=RAR088 CaseType=Combination P=-71,0877611236478 V2=31,9750360380102 V3=0 T=0 M2=0 M3=19,3230460784413	FrameElem=24-1 ElemStation=0,08
Frame=24 Station=0 OutputCase=RAR089 CaseType=Combination P=-78,6556686580059 V2=25,1497537922308 V3=0 T=0 M2=0 M3=13,9938911528461	FrameElem=24-1 ElemStation=0
Frame=24 Station=0,04 OutputCase=RAR089 CaseType=Combination P=-78,4956686580059 V2=23,9693037922308 V3=0 T=0 M2=0 M3=13,0114696678235	FrameElem=24-1 ElemStation=0,04
Frame=24 Station=0,08 OutputCase=RAR089 CaseType=Combination P=-78,3356686580059 V2=22,7767537922308 V3=0 T=0 M2=0 M3=12,076508182801	FrameElem=24-1 ElemStation=0,08
Frame=24 Station=0 OutputCase=RAR090 CaseType=Combination P=-11,6477611274511 V2=35,0681433135007 V3=0 T=0 M2=0 M3=14,7092307267952	FrameElem=24-1 ElemStation=0
Frame=24 Station=0,04 OutputCase=RAR090 CaseType=Combination P=-11,4877611274511 V2=33,8876933135006 V3=0 T=0 M2=0 M3=13,3300736609219	FrameElem=24-1 ElemStation=0,04
Frame=24 Station=0,08 OutputCase=RAR090 CaseType=Combination P=-11,3277611274511 V2=32,6951433135007 V3=0 T=0 M2=0 M3=11,9983765950485	FrameElem=24-1 ElemStation=0,08
Frame=24 Station=0 OutputCase=RAR091 CaseType=Combination P=-18,8956686618092 V2=25,8698610677212 V3=0 T=0 M2=0 M3=6,72683025149253	FrameElem=24-1 ElemStation=0
Frame=24 Station=0,04 OutputCase=RAR091 CaseType=Combination P=-18,7356686618092 V2=24,6894110677212 V3=0 T=0 M2=0 M3=5,71560447545035	FrameElem=24-1 ElemStation=0,04
Frame=24 Station=0,08 OutputCase=RAR091 CaseType=Combination P=-18,576686618092 V2=23,4968610677212 V3=0 T=0 M2=0 M3=4,75183869940817	FrameElem=24-1 ElemStation=0,08
Frame=24 Station=0 OutputCase=RAR092 CaseType=Combination P=-18,8956686618674 V2=28,0678236672949 V3=0 T=0 M2=0 M3=4,20066583588722	FrameElem=24-1 ElemStation=0
Frame=24 Station=0,04 OutputCase=RAR092 CaseType=Combination P=-18,7356686618674 V2=27,6445236672949 V3=0 T=0 M2=0 M3=3,88644488919543	FrameElem=24-1 ElemStation=0,04
Frame=24 Station=0,08 OutputCase=RAR092 CaseType=Combination P=-18,576686618674 V2=27,2290236672949 V3=0 T=0 M2=0 M3=3,58899994250363	FrameElem=24-1 ElemStation=0,08
Frame=24 Station=0 OutputCase=RAR093 CaseType=Combination P=-78,6556686580641 V2=7,34771639180447 V3=0 T=0 M2=0 M3=11,4677267372408	FrameElem=24-1 ElemStation=0
Frame=24 Station=0,04 OutputCase=RAR093 CaseType=Combination P=-78,4956686580641 V2=6,92441639180447 V3=0 T=0 M2=0 M3=11,1823100815686	FrameElem=24-1 ElemStation=0,04
Frame=24 Station=0,08 OutputCase=RAR093 CaseType=Combination P=-78,3356686580641 V2=6,50891639180447 V3=0 T=0 M2=0 M3=10,9136694258964	FrameElem=24-1 ElemStation=0,08
Frame=24 Station=0 OutputCase=RAR094 CaseType=Combination P=-71,4077611236478 V2=34,3480360380102 V3=0 T=0 M2=0 M3=21,9762916281488	FrameElem=24-1 ElemStation=0
Frame=24 Station=0,04 OutputCase=RAR094 CaseType=Combination P=-71,2477611236478 V2=33,1675860380102 V3=0 T=0 M2=0 M3=20,6259388532951	FrameElem=24-1 ElemStation=0,04
Frame=24 Station=0,08 OutputCase=RAR094 CaseType=Combination P=-71,0877611236478 V2=31,9750360380102 V3=0 T=0 M2=0 M3=19,3230460784413	FrameElem=24-1 ElemStation=0,08
Frame=24 Station=0 OutputCase=RAR095 CaseType=Combination P=-78,6556686580059 V2=25,1497537922308 V3=0 T=0 M2=0 M3=13,9938911528461	FrameElem=24-1 ElemStation=0
Frame=24 Station=0,04 OutputCase=RAR095 CaseType=Combination P=-78,4956686580059 V2=23,9693037922308 V3=0 T=0 M2=0 M3=13,0114696678235	FrameElem=24-1 ElemStation=0,04
Frame=24 Station=0,08 OutputCase=RAR095 CaseType=Combination P=-78,3356686580059 V2=22,7767537922308 V3=0 T=0 M2=0 M3=12,076508182801	FrameElem=24-1 ElemStation=0,08
Frame=24 Station=0 OutputCase=RAR096 CaseType=Combination P=-11,6477611274511 V2=35,0681433135007 V3=0 T=0 M2=0 M3=14,7092307267952	FrameElem=24-1 ElemStation=0
Frame=24 Station=0,04 OutputCase=RAR096 CaseType=Combination P=-11,4877611274511 V2=33,8876933135006 V3=0 T=0 M2=0 M3=13,3300736609219	FrameElem=24-1 ElemStation=0,04
Frame=24 Station=0,08 OutputCase=RAR096 CaseType=Combination P=-11,3277611274511 V2=32,6951433135007 V3=0 T=0 M2=0 M3=11,9983765950485	FrameElem=24-1 ElemStation=0,08
Frame=24 Station=0 OutputCase=RAR097 CaseType=Combination P=-18,8956686618092 V2=25,8698610677212 V3=0 T=0 M2=0 M3=6,72683025149253	FrameElem=24-1 ElemStation=0
Frame=24 Station=0,04 OutputCase=RAR097 CaseType=Combination P=-18,7356686618092 V2=24,6894110677212 V3=0 T=0 M2=0 M3=5,71560447545035	FrameElem=24-1 ElemStation=0,04
Frame=24 Station=0,08 OutputCase=RAR097 CaseType=Combination P=-18,576686618092 V2=23,4968610677212 V3=0 T=0 M2=0 M3=4,75183869940817	FrameElem=24-1 ElemStation=0,08
Frame=24 Station=0 OutputCase=RAR098 CaseType=Combination P=-17,6243313361725 V2=6,97233420682025 V3=0 T=0 M2=0 M3=2,5909238989046	FrameElem=24-1 ElemStation=0
Frame=24 Station=0,04 OutputCase=RAR098 CaseType=Combination P=-17,4643313361725 V2=6,54903420682025 V3=0 T=0 M2=0 M3=2,32052253063179	FrameElem=24-1 ElemStation=0,04
Frame=24 Station=0,08 OutputCase=RAR098 CaseType=Combination P=-17,3043313361725 V2=6,13353420682025 V3=0 T=0 M2=0 M3=2,06689716235898	FrameElem=24-1 ElemStation=0,08
Frame=24 Station=0 OutputCase=RAR099 CaseType=Combination P=-97,5585987962404 V2=6,13934284433796 V3=0 T=0 M2=0 M3=12,5259470981628	FrameElem=24-1 ElemStation=0
Frame=24 Station=0,04 OutputCase=RAR099 CaseType=Combination P=-97,3985987962404 V2=5,71604284433796 V3=0 T=0 M2=0 M3=12,2888653843892	FrameElem=24-1 ElemStation=0,04
Frame=24 Station=0,08 OutputCase=RAR099 CaseType=Combination P=-97,2385987962404 V2=5,30054284433796 V3=0 T=0 M2=0 M3=12,0685596706157	FrameElem=24-1 ElemStation=0,08
Frame=24 Station=0 OutputCase=RAR100 CaseType=Combination P=-88,217454706013 V2=40,3671791314527 V3=0 T=0 M2=0 M3=25,9871610822456	FrameElem=24-1 ElemStation=0
Frame=24 Station=0,04 OutputCase=RAR100 CaseType=Combination P=-88,057454706013 V2=39,0182791314527 V3=0 T=0 M2=0 M3=24,3993845836542	FrameElem=24-1 ElemStation=0,04
Frame=24 Station=0,08 OutputCase=RAR100 CaseType=Combination P=-87,8974547060131 V2=37,6491791314527 V3=0 T=0 M2=0 M3=22,8659680850627	FrameElem=24-1 ElemStation=0,08
Frame=24 Station=0 OutputCase=RAR101 CaseType=Combination P=-97,5585987961822 V2=28,5417483976025 V3=0 T=0 M2=0 M3=15,732528036272	FrameElem=24-1 ElemStation=0
Frame=24 Station=0,04 OutputCase=RAR101 CaseType=Combination P=-97,3985987961822 V2=27,1928483976025 V3=0 T=0 M2=0 M3=14,6177687670346	FrameElem=24-1 ElemStation=0,04
Frame=24 Station=0,08 OutputCase=RAR101 CaseType=Combination P=-97,2385987961822 V2=25,8237483976025 V3=0 T=0 M2=0 M3=13,5573694977971	FrameElem=24-1 ElemStation=0,08
Frame=24 Station=0 OutputCase=RAR102 CaseType=Combination P=-8,5374547110841 V2=41,32732216544 V3=0 T=0 M2=0 M3=16,2977465471075	FrameElem=24-1 ElemStation=0
Frame=24 Station=0,04 OutputCase=RAR102 CaseType=Combination P=-8,3774547110841 V2=39,97842216544 V3=0 T=0 M2=0 M3=14,6715643271566	FrameElem=24-1 ElemStation=0,04
Frame=24 Station=0,08 OutputCase=RAR102 CaseType=Combination P=-8,2174547110841 V2=38,60932216544 V3=0 T=0 M2=0 M3=13,0997421072057	FrameElem=24-1 ElemStation=0,08
Frame=24 Station=0 OutputCase=RAR103 CaseType=Combination P=-17,8785988012532 V2=29,5018914315897 V3=0 T=0 M2=0 M3=6,04311350113394	FrameElem=24-1 ElemStation=0

Società di Progetto
Brebemi SpA



Doc. N.
60235-0000-A00.doc

CODIFICA DOCUMENTO
04RCDII10000000000300A00

REV.
00

FOGLIO
366 di 628

Frame=24 Station=0,04 OutputCase=RAR103 CaseType=Combination P=-17,7185988012532 V2=28,1529914315897 V3=0 T=0 M2=0 M3=4,88994851053702	FrameElem=24-1 ElemStation=0,04
Frame=24 Station=0,08 OutputCase=RAR103 CaseType=Combination P=-17,5585988012532 V2=26,7838914315897 V3=0 T=0 M2=0 M3=3,7911435199401	FrameElem=24-1 ElemStation=0,08
Frame=24 Station=0 OutputCase=RAR104 CaseType=Combination P=-56,0426077195006 V2=47,2406982551276 V3=0 T=0 M2=0 M3=31,7125090185268	FrameElem=24-1 ElemStation=0
Frame=24 Station=0,04 OutputCase=RAR104 CaseType=Combination P=-55,8826077195006 V2=46,0602482551276 V3=0 T=0 M2=0 M3=29,8464497549884	FrameElem=24-1 ElemStation=0,04
Frame=24 Station=0,08 OutputCase=RAR104 CaseType=Combination P=-55,7226077195006 V2=44,8676982551277 V3=0 T=0 M2=0 M3=28,0278504914499	FrameElem=24-1 ElemStation=0,08
Frame=24 Station=0 OutputCase=RAR105 CaseType=Combination P=-77,3843313323692 V2=6,25222693132983 V3=0 T=0 M2=0 M3=9,85798480025815	FrameElem=24-1 ElemStation=0
Frame=24 Station=0,04 OutputCase=RAR105 CaseType=Combination P=-77,2243313323692 V2=5,82892693132982 V3=0 T=0 M2=0 M3=9,61638772300496	FrameElem=24-1 ElemStation=0,04
Frame=24 Station=0,08 OutputCase=RAR105 CaseType=Combination P=-77,0643313323692 V2=5,41342693132983 V3=0 T=0 M2=0 M3=9,39156664575176	FrameElem=24-1 ElemStation=0,08
Frame=24 Station=0 OutputCase=RAR106 CaseType=Combination P=-70,1364237979529 V2=33,2525465775356 V3=0 T=0 M2=0 M3=20,3665496911662	FrameElem=24-1 ElemStation=0
Frame=24 Station=0,04 OutputCase=RAR106 CaseType=Combination P=-69,9764237979529 V2=32,0720965775356 V3=0 T=0 M2=0 M3=19,0600164947314	FrameElem=24-1 ElemStation=0,04
Frame=24 Station=0,08 OutputCase=RAR106 CaseType=Combination P=-69,8164237979529 V2=30,8795465775356 V3=0 T=0 M2=0 M3=17,8009432982967	FrameElem=24-1 ElemStation=0,08
Frame=24 Station=0 OutputCase=RAR107 CaseType=Combination P=-77,384331332311 V2=24,0542643317562 V3=0 T=0 M2=0 M3=12,3841492158635	FrameElem=24-1 ElemStation=0
Frame=24 Station=0,04 OutputCase=RAR107 CaseType=Combination P=-77,224331332311 V2=22,8738143317562 V3=0 T=0 M2=0 M3=11,4455473092599	FrameElem=24-1 ElemStation=0,04
Frame=24 Station=0,08 OutputCase=RAR107 CaseType=Combination P=-77,064331332311 V2=21,6812643317562 V3=0 T=0 M2=0 M3=10,5544054026563	FrameElem=24-1 ElemStation=0,08
Frame=24 Station=0 OutputCase=RAR108 CaseType=Combination P=-10,3764238017562 V2=33,972653853026 V3=0 T=0 M2=0 M3=13,0994887898126	FrameElem=24-1 ElemStation=0
Frame=24 Station=0,04 OutputCase=RAR108 CaseType=Combination P=-10,2164238017562 V2=32,792203853026 V3=0 T=0 M2=0 M3=11,7641513023582	FrameElem=24-1 ElemStation=0,04
Frame=24 Station=0,08 OutputCase=RAR108 CaseType=Combination P=-10,0564238017562 V2=31,599653853026 V3=0 T=0 M2=0 M3=10,4762738149039	FrameElem=24-1 ElemStation=0,08
Frame=24 Station=0 OutputCase=RAR109 CaseType=Combination P=-17,6243313361143 V2=24,7743716072466 V3=0 T=0 M2=0 M3=5,1170883145099	FrameElem=24-1 ElemStation=0
Frame=24 Station=0,04 OutputCase=RAR109 CaseType=Combination P=-17,4643313361143 V2=23,5939216072466 V3=0 T=0 M2=0 M3=4,14968211688671	FrameElem=24-1 ElemStation=0,04
Frame=24 Station=0,08 OutputCase=RAR109 CaseType=Combination P=-17,3043313361143 V2=22,4013716072466 V3=0 T=0 M2=0 M3=3,22973591926351	FrameElem=24-1 ElemStation=0,08
Frame=24 Station=0 OutputCase=RAR110 CaseType=Combination P=-17,6243313361722 V2=6,51260310387031 V3=0 T=0 M2=0 M3=2,20922528252242	FrameElem=24-1 ElemStation=0
Frame=24 Station=0,04 OutputCase=RAR110 CaseType=Combination P=-17,4643313361722 V2=6,0893031038703 V3=0 T=0 M2=0 M3=1,95721315836761	FrameElem=24-1 ElemStation=0,04
Frame=24 Station=0,08 OutputCase=RAR110 CaseType=Combination P=-17,3043313361722 V2=5,6738031038703 V3=0 T=0 M2=0 M3=1,7219770342128	FrameElem=24-1 ElemStation=0,08
Frame=24 Station=0 OutputCase=RAR111 CaseType=Combination P=-77,3843313323689 V2=5,79249582837988 V3=0 T=0 M2=0 M3=9,47628618387598	FrameElem=24-1 ElemStation=0
Frame=24 Station=0,04 OutputCase=RAR111 CaseType=Combination P=-77,2243313323689 V2=5,36919582837988 V3=0 T=0 M2=0 M3=9,25307835074078	FrameElem=24-1 ElemStation=0,04
Frame=24 Station=0,08 OutputCase=RAR111 CaseType=Combination P=-77,0643313323689 V2=4,95369582837988 V3=0 T=0 M2=0 M3=9,04664651760559	FrameElem=24-1 ElemStation=0,08
Frame=24 Station=0 OutputCase=RAR112 CaseType=Combination P=-70,1364237979526 V2=32,7928154745856 V3=0 T=0 M2=0 M3=19,984851074784	FrameElem=24-1 ElemStation=0
Frame=24 Station=0,04 OutputCase=RAR112 CaseType=Combination P=-69,9764237979526 V2=31,6123654745856 V3=0 T=0 M2=0 M3=18,6967071224672	FrameElem=24-1 ElemStation=0,04
Frame=24 Station=0,08 OutputCase=RAR112 CaseType=Combination P=-69,8164237979526 V2=30,4198154745856 V3=0 T=0 M2=0 M3=17,4560231701505	FrameElem=24-1 ElemStation=0,08
Frame=24 Station=0 OutputCase=RAR113 CaseType=Combination P=-77,3843313323107 V2=23,5945332288062 V3=0 T=0 M2=0 M3=12,0024505994813	FrameElem=24-1 ElemStation=0
Frame=24 Station=0,04 OutputCase=RAR113 CaseType=Combination P=-77,2243313323107 V2=22,4140832288062 V3=0 T=0 M2=0 M3=11,0822379369957	FrameElem=24-1 ElemStation=0,04
Frame=24 Station=0,08 OutputCase=RAR113 CaseType=Combination P=-77,0643313323107 V2=21,2215332288062 V3=0 T=0 M2=0 M3=10,2094852745101	FrameElem=24-1 ElemStation=0,08
Frame=24 Station=0 OutputCase=RAR114 CaseType=Combination P=-10,3764238017559 V2=33,5129227500761 V3=0 T=0 M2=0 M3=12,7177901734304	FrameElem=24-1 ElemStation=0
Frame=24 Station=0,04 OutputCase=RAR114 CaseType=Combination P=-10,2164238017559 V2=32,3324727500761 V3=0 T=0 M2=0 M3=11,4008419300941	FrameElem=24-1 ElemStation=0,04
Frame=24 Station=0,08 OutputCase=RAR114 CaseType=Combination P=-10,0564238017559 V2=31,1399227500761 V3=0 T=0 M2=0 M3=10,1313536867577	FrameElem=24-1 ElemStation=0,08
Frame=24 Station=0 OutputCase=RAR115 CaseType=Combination P=-17,624331336114 V2=24,3146405042966 V3=0 T=0 M2=0 M3=4,73538969812773	FrameElem=24-1 ElemStation=0
Frame=24 Station=0,04 OutputCase=RAR115 CaseType=Combination P=-17,464331336114 V2=23,1341905042966 V3=0 T=0 M2=0 M3=3,78637274462253	FrameElem=24-1 ElemStation=0,04
Frame=24 Station=0,08 OutputCase=RAR115 CaseType=Combination P=-17,304331336114 V2=21,9416405042966 V3=0 T=0 M2=0 M3=2,88481579111733	FrameElem=24-1 ElemStation=0,08
Frame=24 Station=0 OutputCase=RAR116 CaseType=Combination P=-17,6243313361728 V2=7,4320653097702 V3=0 T=0 M2=0 M3=2,97262251528677	FrameElem=24-1 ElemStation=0
Frame=24 Station=0,04 OutputCase=RAR116 CaseType=Combination P=-17,4643313361728 V2=7,0087653097702 V3=0 T=0 M2=0 M3=2,68383190289596	FrameElem=24-1 ElemStation=0,04
Frame=24 Station=0,08 OutputCase=RAR116 CaseType=Combination P=-17,3043313361728 V2=6,5932653097702 V3=0 T=0 M2=0 M3=2,41181729050515	FrameElem=24-1 ElemStation=0,08
Frame=24 Station=0 OutputCase=RAR117 CaseType=Combination P=-77,3843313323696 V2=6,71195803427977 V3=0 T=0 M2=0 M3=10,2396834166403	FrameElem=24-1 ElemStation=0
Frame=24 Station=0,04 OutputCase=RAR117 CaseType=Combination P=-77,2243313323696 V2=6,28865803427977 V3=0 T=0 M2=0 M3=9,97969709526913	FrameElem=24-1 ElemStation=0,04
Frame=24 Station=0,08 OutputCase=RAR117 CaseType=Combination P=-77,0643313323696 V2=5,87315803427977 V3=0 T=0 M2=0 M3=9,73648677389794	FrameElem=24-1 ElemStation=0,08

APPROVATO SDP
Società di Progetto
Brebemi SpA

	Doc. N. 60235-0000-A00.doc	CODIFICA DOCUMENTO 04RCDII10000000000300A00	REV. 00	FOGLIO 367 di 628
--	-------------------------------	--	------------	----------------------

Frame=24 Station=0 OutputCase=RAR118 CaseType=Combination P=-70,1364237979533 V2=33,7122776804855 V3=0 T=0 M2=0 M3=20,7482483075483 ElemStation=0	Frame=24 Station=0,04 OutputCase=RAR118 CaseType=Combination P=-69,9764237979533 V2=32,5318276804855 V3=0 T=0 M2=0 M3=19,4233258669956 ElemStation=0,04	Frame=24 Station=0,08 OutputCase=RAR118 CaseType=Combination P=-69,8164237979533 V2=31,3392776804855 V3=0 T=0 M2=0 M3=18,1458634264428 ElemStation=0,08	Frame=24 Station=0 OutputCase=RAR119 CaseType=Combination P=-77,3843313323113 V2=24,5139954347061 V3=0 T=0 M2=0 M3=12,7658478322456 ElemStation=0	Frame=24 Station=0,04 OutputCase=RAR119 CaseType=Combination P=-77,2243313323114 V2=23,3335454347061 V3=0 T=0 M2=0 M3=11,8088566815241 ElemStation=0,04	Frame=24 Station=0,08 OutputCase=RAR119 CaseType=Combination P=-77,0643313323114 V2=22,1409954347061 V3=0 T=0 M2=0 M3=10,8993255308025 ElemStation=0,08	Frame=24 Station=0 OutputCase=RAR120 CaseType=Combination P=-10,3764238017565 V2=34,432384959759 V3=0 T=0 M2=0 M3=13,4811874061948 ElemStation=0	Frame=24 Station=0,04 OutputCase=RAR120 CaseType=Combination P=-10,2164238017565 V2=33,251934959759 V3=0 T=0 M2=0 M3=12,1274606746224 ElemStation=0,04	Frame=24 Station=0,08 OutputCase=RAR120 CaseType=Combination P=-10,0564238017565 V2=32,059384959759 V3=0 T=0 M2=0 M3=10,82119394305 ElemStation=0,08	Frame=24 Station=0 OutputCase=RAR121 CaseType=Combination P=-17,6243313361146 V2=25,2341027101965 V3=0 T=0 M2=0 M3=5,49878693089208 ElemStation=0	Frame=24 Station=0,04 OutputCase=RAR121 CaseType=Combination P=-17,4643313361146 V2=24,0536527101965 V3=0 T=0 M2=0 M3=4,51299148915088 ElemStation=0,04	Frame=24 Station=0,08 OutputCase=RAR121 CaseType=Combination P=-17,3043313361146 V2=22,8611027101965 V3=0 T=0 M2=0 M3=3,57465604740969 ElemStation=0,08	Frame=24 Station=0 OutputCase=RAR122 CaseType=Combination P=-17,6243313361728 V2=7,4320653097702 V3=0 T=0 M2=0 M3=2,97262251528677 ElemStation=0	Frame=24 Station=0,04 OutputCase=RAR122 CaseType=Combination P=-17,4643313361728 V2=7,0087653097702 V3=0 T=0 M2=0 M3=2,68383190289596 ElemStation=0,04	Frame=24 Station=0,08 OutputCase=RAR122 CaseType=Combination P=-17,3043313361728 V2=6,5932653097702 V3=0 T=0 M2=0 M3=2,41181729050515 ElemStation=0,08	Frame=24 Station=0 OutputCase=RAR123 CaseType=Combination P=-77,3843313323696 V2=6,71195803427977 V3=0 T=0 M2=0 M3=10,2396834166403 ElemStation=0	Frame=24 Station=0,04 OutputCase=RAR123 CaseType=Combination P=-77,2243313323696 V2=6,28865803427977 V3=0 T=0 M2=0 M3=9,97969709526913 ElemStation=0,04	Frame=24 Station=0,08 OutputCase=RAR123 CaseType=Combination P=-77,0643313323696 V2=5,87315803427977 V3=0 T=0 M2=0 M3=9,73648677389794 ElemStation=0,08	Frame=24 Station=0 OutputCase=RAR124 CaseType=Combination P=-70,1364237979533 V2=33,7122776804855 V3=0 T=0 M2=0 M3=20,7482483075483 ElemStation=0	Frame=24 Station=0,04 OutputCase=RAR124 CaseType=Combination P=-69,9764237979533 V2=32,5318276804855 V3=0 T=0 M2=0 M3=19,4233258669956 ElemStation=0,04	Frame=24 Station=0,08 OutputCase=RAR124 CaseType=Combination P=-69,8164237979533 V2=31,3392776804855 V3=0 T=0 M2=0 M3=18,1458634264428 ElemStation=0,08	Frame=24 Station=0 OutputCase=RAR125 CaseType=Combination P=-77,3843313323113 V2=24,5139954347061 V3=0 T=0 M2=0 M3=12,7658478322456 ElemStation=0	Frame=24 Station=0,04 OutputCase=RAR125 CaseType=Combination P=-77,2243313323114 V2=23,3335454347061 V3=0 T=0 M2=0 M3=11,8088566815241 ElemStation=0,04	Frame=24 Station=0,08 OutputCase=RAR125 CaseType=Combination P=-77,0643313323114 V2=22,1409954347061 V3=0 T=0 M2=0 M3=10,8993255308025 ElemStation=0,08	Frame=24 Station=0 OutputCase=RAR126 CaseType=Combination P=-10,3764238017565 V2=34,432384959759 V3=0 T=0 M2=0 M3=13,4811874061948 ElemStation=0	Frame=24 Station=0,04 OutputCase=RAR126 CaseType=Combination P=-10,2164238017565 V2=33,251934959759 V3=0 T=0 M2=0 M3=12,1274606746224 ElemStation=0,04	Frame=24 Station=0,08 OutputCase=RAR126 CaseType=Combination P=-10,0564238017565 V2=32,059384959759 V3=0 T=0 M2=0 M3=10,82119394305 ElemStation=0,08	Frame=24 Station=0 OutputCase=RAR127 CaseType=Combination P=-17,6243313361146 V2=25,2341027101965 V3=0 T=0 M2=0 M3=5,49878693089208 ElemStation=0	Frame=24 Station=0,04 OutputCase=RAR127 CaseType=Combination P=-17,4643313361146 V2=24,0536527101965 V3=0 T=0 M2=0 M3=4,51299148915088 ElemStation=0,04	Frame=24 Station=0,08 OutputCase=RAR127 CaseType=Combination P=-17,3043313361146 V2=22,8611027101965 V3=0 T=0 M2=0 M3=3,57465604740969 ElemStation=0,08	Frame=24 Station=0 OutputCase=RAR128 CaseType=Combination P=-18,259999990204 V2=8,05643189049918 V3=0 T=0 M2=0 M3=3,84110991984178 ElemStation=0	Frame=24 Station=0,04 OutputCase=RAR128 CaseType=Combination P=-18,099999990204 V2=7,63313189049918 V3=0 T=0 M2=0 M3=3,52734464422181 ElemStation=0,04	Frame=24 Station=0,08 OutputCase=RAR128 CaseType=Combination P=-17,939999990204 V2=7,21763189049918 V3=0 T=0 M2=0 M3=3,2303536860184 ElemStation=0,08	Frame=24 Station=0 OutputCase=RAR129 CaseType=Combination P=-97,9399999939491 V2=6,78980145454531 V3=0 T=0 M2=0 M3=13,2760587107251 ElemStation=0	Frame=24 Station=0,04 OutputCase=RAR129 CaseType=Combination P=-97,7799999939491 V2=6,36650145454531 V3=0 T=0 M2=0 M3=13,0129586525433 ElemStation=0,04	Frame=24 Station=0,08 OutputCase=RAR129 CaseType=Combination P=-97,6199999939491 V2=5,95100145454531 V3=0 T=0 M2=0 M3=12,7666345943614 ElemStation=0,08	Frame=24 Station=0 OutputCase=RAR130 CaseType=Combination P=-88,5988559037218 V2=41,0176377416601 V3=0 T=0 M2=0 M3=26,7372726948079 ElemStation=0	Frame=24 Station=0,04 OutputCase=RAR130 CaseType=Combination P=-88,4388559037218 V2=39,6687377416601 V3=0 T=0 M2=0 M3=25,1234778518082 ElemStation=0,04	Frame=24 Station=0,08 OutputCase=RAR130 CaseType=Combination P=-88,2788559037218 V2=38,2996377416601 V3=0 T=0 M2=0 M3=23,5640430088085 ElemStation=0,08	Frame=24 Station=0 OutputCase=RAR131 CaseType=Combination P=-97,9399999938909 V2=29,1922070078099 V3=0 T=0 M2=0 M3=16,4826396488343 ElemStation=0	Frame=24 Station=0,04 OutputCase=RAR131 CaseType=Combination P=-97,7799999938909 V2=27,8433070078099 V3=0 T=0 M2=0 M3=15,3418620351886 ElemStation=0,04	Frame=24 Station=0,08 OutputCase=RAR131 CaseType=Combination P=-97,6199999938909 V2=26,4742070078099 V3=0 T=0 M2=0 M3=14,2554444215429 ElemStation=0,08	Frame=24 Station=0 OutputCase=RAR132 CaseType=Combination P=-8,91885590879281 V2=41,977807756473 V3=0 T=0 M2=0 M3=17,0478581596699 ElemStation=0	Frame=24 Station=0,04 OutputCase=RAR132 CaseType=Combination P=-8,75885590879281 V2=40,6288807756473 V3=0 T=0 M2=0 M3=15,3956575953106 ElemStation=0,04
---	---	---	---	---	---	--	--	--	---	---	---	--	--	--	---	---	---	---	---	---	---	---	---	--	--	--	---	---	---	--	--	---	---	---	---	---	---	---	---	---	---	--	---

Società di Progetto
Brebemi SpA

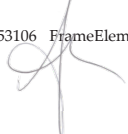



Doc. N.
60235-0000-A00.doc

CODIFICA DOCUMENTO
04RCDII10000000000300A00

REV.
00

FOGLIO
368 di 628

Frame=24 Station=0,08 OutputCase=RAR132 CaseType=Combination P=-8,59885590879281 V2=39,2597807756473 V3=0 T=0 M2=0 M3=13,7978170309514	FrameElem=24-1 ElemStation=0,08
Frame=24 Station=0 OutputCase=RAR133 CaseType=Combination P=-18,2599999989619 V2=30,1523500417971 V3=0 T=0 M2=0 M3=6,79322511369625	FrameElem=24-1 ElemStation=0
Frame=24 Station=0,04 OutputCase=RAR133 CaseType=Combination P=-18,0999999989619 V2=28,8034500417971 V3=0 T=0 M2=0 M3=5,61404177869103	FrameElem=24-1 ElemStation=0,04
Frame=24 Station=0,08 OutputCase=RAR133 CaseType=Combination P=-17,9399999989619 V2=27,4343500417971 V3=0 T=0 M2=0 M3=4,48921844368582	FrameElem=24-1 ElemStation=0,08
Frame=24 Station=0 OutputCase=RAR134 CaseType=Combination P=-56,4240089172093 V2=47,891156865335 V3=0 T=0 M2=0 M3=32,4626206310891	FrameElem=24-1 ElemStation=0
Frame=24 Station=0,04 OutputCase=RAR134 CaseType=Combination P=-56,2640089172093 V2=46,710706865335 V3=0 T=0 M2=0 M3=30,5705430231424	FrameElem=24-1 ElemStation=0,04
Frame=24 Station=0,08 OutputCase=RAR134 CaseType=Combination P=-56,1040089172093 V2=45,518156865335 V3=0 T=0 M2=0 M3=28,7259254151956	FrameElem=24-1 ElemStation=0,08
Frame=24 Station=0 OutputCase=RAR135 CaseType=Combination P=-78,0199999952171 V2=7,33632461500876 V3=0 T=0 M2=0 M3=11,1081708211953	FrameElem=24-1 ElemStation=0
Frame=24 Station=0,04 OutputCase=RAR135 CaseType=Combination P=-77,8599999952171 V2=6,91302461500876 V3=0 T=0 M2=0 M3=10,823209836595	FrameElem=24-1 ElemStation=0,04
Frame=24 Station=0,08 OutputCase=RAR135 CaseType=Combination P=-77,6999999952171 V2=6,49752461500876 V3=0 T=0 M2=0 M3=10,5550248519946	FrameElem=24-1 ElemStation=0,08
Frame=24 Station=0 OutputCase=RAR136 CaseType=Combination P=-70,7720924608008 V2=34,3366442612145 V3=0 T=0 M2=0 M3=21,6167357121033	FrameElem=24-1 ElemStation=0
Frame=24 Station=0,04 OutputCase=RAR136 CaseType=Combination P=-70,6120924608008 V2=33,1561942612145 V3=0 T=0 M2=0 M3=20,2668386083214	FrameElem=24-1 ElemStation=0,04
Frame=24 Station=0,08 OutputCase=RAR136 CaseType=Combination P=-70,4520924608008 V2=31,9636442612145 V3=0 T=0 M2=0 M3=18,9644015045395	FrameElem=24-1 ElemStation=0,08
Frame=24 Station=0 OutputCase=RAR137 CaseType=Combination P=-78,0199999951589 V2=25,1383620154351 V3=0 T=0 M2=0 M3=13,6343352368006	FrameElem=24-1 ElemStation=0
Frame=24 Station=0,04 OutputCase=RAR137 CaseType=Combination P=-77,8599999951589 V2=23,9579120154351 V3=0 T=0 M2=0 M3=12,6523694228499	FrameElem=24-1 ElemStation=0,04
Frame=24 Station=0,08 OutputCase=RAR137 CaseType=Combination P=-77,6999999951589 V2=22,7653620154351 V3=0 T=0 M2=0 M3=11,7178636088992	FrameElem=24-1 ElemStation=0,08
Frame=24 Station=0 OutputCase=RAR138 CaseType=Combination P=-11,0120924646041 V2=35,0567515367049 V3=0 T=0 M2=0 M3=14,3496748107498	FrameElem=24-1 ElemStation=0
Frame=24 Station=0,04 OutputCase=RAR138 CaseType=Combination P=-10,8520924646041 V2=33,8763015367049 V3=0 T=0 M2=0 M3=12,9709734159483	FrameElem=24-1 ElemStation=0,04
Frame=24 Station=0,08 OutputCase=RAR138 CaseType=Combination P=-10,6920924646041 V2=32,6837515367049 V3=0 T=0 M2=0 M3=11,6397320211467	FrameElem=24-1 ElemStation=0,08
Frame=24 Station=0 OutputCase=RAR139 CaseType=Combination P=-18,2599999989621 V2=25,8584692909255 V3=0 T=0 M2=0 M3=6,36727433544709	FrameElem=24-1 ElemStation=0
Frame=24 Station=0,04 OutputCase=RAR139 CaseType=Combination P=-18,0999999989621 V2=24,6780192909255 V3=0 T=0 M2=0 M3=5,35650423047673	FrameElem=24-1 ElemStation=0,04
Frame=24 Station=0,08 OutputCase=RAR139 CaseType=Combination P=-17,9399999989621 V2=23,4854692909255 V3=0 T=0 M2=0 M3=4,39319412550638	FrameElem=24-1 ElemStation=0,08
Frame=24 Station=0 OutputCase=RAR140 CaseType=Combination P=-18,25999999902 V2=7,59670078754924 V3=0 T=0 M2=0 M3=3,45941130345961	FrameElem=24-1 ElemStation=0
Frame=24 Station=0,04 OutputCase=RAR140 CaseType=Combination P=-18,09999999902 V2=7,17340078754923 V3=0 T=0 M2=0 M3=3,16403527195764	FrameElem=24-1 ElemStation=0,04
Frame=24 Station=0,08 OutputCase=RAR140 CaseType=Combination P=-17,93999999902 V2=6,75790078754924 V3=0 T=0 M2=0 M3=2,88543524045567	FrameElem=24-1 ElemStation=0,08
Frame=24 Station=0 OutputCase=RAR141 CaseType=Combination P=-78,0199999952167 V2=6,87659351205881 V3=0 T=0 M2=0 M3=10,7264722048132	FrameElem=24-1 ElemStation=0
Frame=24 Station=0,04 OutputCase=RAR141 CaseType=Combination P=-77,8599999952167 V2=6,45329351205881 V3=0 T=0 M2=0 M3=10,4599004643308	FrameElem=24-1 ElemStation=0,04
Frame=24 Station=0,08 OutputCase=RAR141 CaseType=Combination P=-77,6999999952167 V2=6,03779351205881 V3=0 T=0 M2=0 M3=10,2101047238485	FrameElem=24-1 ElemStation=0,08
Frame=24 Station=0 OutputCase=RAR142 CaseType=Combination P=-70,7720924608004 V2=33,8769131582646 V3=0 T=0 M2=0 M3=21,2350370957212	FrameElem=24-1 ElemStation=0
Frame=24 Station=0,04 OutputCase=RAR142 CaseType=Combination P=-70,6120924608004 V2=32,6964631582646 V3=0 T=0 M2=0 M3=19,9035292360573	FrameElem=24-1 ElemStation=0,04
Frame=24 Station=0,08 OutputCase=RAR142 CaseType=Combination P=-70,4520924608004 V2=31,5039131582646 V3=0 T=0 M2=0 M3=18,6194813763933	FrameElem=24-1 ElemStation=0,08
Frame=24 Station=0 OutputCase=RAR143 CaseType=Combination P=-78,0199999951585 V2=24,6786309124852 V3=0 T=0 M2=0 M3=13,2526366204185	FrameElem=24-1 ElemStation=0
Frame=24 Station=0,04 OutputCase=RAR143 CaseType=Combination P=-77,8599999951585 V2=23,4981809124852 V3=0 T=0 M2=0 M3=12,2890600505857	FrameElem=24-1 ElemStation=0,04
Frame=24 Station=0,08 OutputCase=RAR143 CaseType=Combination P=-77,6999999951585 V2=22,3056309124852 V3=0 T=0 M2=0 M3=11,372943480753	FrameElem=24-1 ElemStation=0,08
Frame=24 Station=0 OutputCase=RAR144 CaseType=Combination P=-11,0120924646037 V2=34,597020433755 V3=0 T=0 M2=0 M3=13,9679761943676	FrameElem=24-1 ElemStation=0
Frame=24 Station=0,04 OutputCase=RAR144 CaseType=Combination P=-10,8520924646037 V2=33,416570433755 V3=0 T=0 M2=0 M3=12,6076640436841	FrameElem=24-1 ElemStation=0,04
Frame=24 Station=0,08 OutputCase=RAR144 CaseType=Combination P=-10,6920924646037 V2=32,224020433755 V3=0 T=0 M2=0 M3=11,2948118930006	FrameElem=24-1 ElemStation=0,08
Frame=24 Station=0 OutputCase=RAR145 CaseType=Combination P=-18,2599999989618 V2=25,3987381879756 V3=0 T=0 M2=0 M3=5,98557571906491	FrameElem=24-1 ElemStation=0
Frame=24 Station=0,04 OutputCase=RAR145 CaseType=Combination P=-18,0999999989618 V2=24,2182881879756 V3=0 T=0 M2=0 M3=4,99319485821256	FrameElem=24-1 ElemStation=0,04
Frame=24 Station=0,08 OutputCase=RAR145 CaseType=Combination P=-17,9399999989618 V2=23,0257381879756 V3=0 T=0 M2=0 M3=4,0482739973602	FrameElem=24-1 ElemStation=0,08
Frame=24 Station=0 OutputCase=RAR146 CaseType=Combination P=-18,2599999990207 V2=8,51616299344913 V3=0 T=0 M2=0 M3=4,22280853622395	FrameElem=24-1 ElemStation=0
Frame=24 Station=0,04 OutputCase=RAR146 CaseType=Combination P=-18,0999999990207 V2=8,09286299344913 V3=0 T=0 M2=0 M3=3,89065401648599	FrameElem=24-1 ElemStation=0,04
Frame=24 Station=0,08 OutputCase=RAR146 CaseType=Combination P=-17,9399999990207 V2=7,67736299344913 V3=0 T=0 M2=0 M3=3,57527549674802	FrameElem=24-1 ElemStation=0,08
Frame=24 Station=0 OutputCase=RAR147 CaseType=Combination P=-78,0199999952174 V2=7,7960557179587 V3=0 T=0 M2=0 M3=11,4898649375775	FrameElem=24-1 ElemStation=0

Società di Progetto
Brebemi SpA

	Doc. N. 60235-0000-A00.doc	CODIFICA DOCUMENTO 04RCDII10000000000300A00	REV. 00	FOGLIO 369 di 628
--	-------------------------------	--	------------	----------------------

Frame=24 Station=0,04 OutputCase=RAR147 CaseType=Combination P=-77,8599999952174 V2=7,3727557179587 V3=0 T=0 M2=0 M3=11,1865192088592	FrameElem=24-1 ElemStation=0,04
Frame=24 Station=0,08 OutputCase=RAR147 CaseType=Combination P=-77,6999999952174 V2=6,9572557179587 V3=0 T=0 M2=0 M3=10,8999449801408	FrameElem=24-1 ElemStation=0,08
Frame=24 Station=0 OutputCase=RAR148 CaseType=Combination P=-70,7720924608011 V2=34,7963753641645 V3=0 T=0 M2=0 M3=21,9984343284855	FrameElem=24-1 ElemStation=0
Frame=24 Station=0,04 OutputCase=RAR148 CaseType=Combination P=-70,6120924608011 V2=33,6159253641645 V3=0 T=0 M2=0 M3=20,6301479805856	FrameElem=24-1 ElemStation=0,04
Frame=24 Station=0,08 OutputCase=RAR148 CaseType=Combination P=-70,4520924608011 V2=32,4233753641645 V3=0 T=0 M2=0 M3=19,3093216326857	FrameElem=24-1 ElemStation=0,08
Frame=24 Station=0 OutputCase=RAR149 CaseType=Combination P=-78,0199999951592 V2=25,598093118385 V3=0 T=0 M2=0 M3=14,0160338531828	FrameElem=24-1 ElemStation=0
Frame=24 Station=0,04 OutputCase=RAR149 CaseType=Combination P=-77,8599999951592 V2=24,417643118385 V3=0 T=0 M2=0 M3=13,0156787951141	FrameElem=24-1 ElemStation=0,04
Frame=24 Station=0,08 OutputCase=RAR149 CaseType=Combination P=-77,6999999951592 V2=23,225093118385 V3=0 T=0 M2=0 M3=12,0627837370453	FrameElem=24-1 ElemStation=0,08
Frame=24 Station=0 OutputCase=RAR150 CaseType=Combination P=-11,0120924646044 V2=35,5164826396549 V3=0 T=0 M2=0 M3=14,731373427132	FrameElem=24-1 ElemStation=0
Frame=24 Station=0,04 OutputCase=RAR150 CaseType=Combination P=-10,8520924646044 V2=34,3360326396549 V3=0 T=0 M2=0 M3=13,3342827882124	FrameElem=24-1 ElemStation=0,04
Frame=24 Station=0,08 OutputCase=RAR150 CaseType=Combination P=-10,6920924646044 V2=33,1434826396549 V3=0 T=0 M2=0 M3=11,9846521492929	FrameElem=24-1 ElemStation=0,08
Frame=24 Station=0 OutputCase=RAR151 CaseType=Combination P=-18,2599999989625 V2=26,3182003938755 V3=0 T=0 M2=0 M3=6,74897295182926	FrameElem=24-1 ElemStation=0
Frame=24 Station=0,04 OutputCase=RAR151 CaseType=Combination P=-18,0999999989625 V2=25,1377503938755 V3=0 T=0 M2=0 M3=5,71981360274091	FrameElem=24-1 ElemStation=0,04
Frame=24 Station=0,08 OutputCase=RAR151 CaseType=Combination P=-17,9399999989625 V2=23,9452003938755 V3=0 T=0 M2=0 M3=4,73811425362526	FrameElem=24-1 ElemStation=0,08
Frame=24 Station=0 OutputCase=RAR152 CaseType=Combination P=-18,6414011967287 V2=8,24715939775659 V3=0 T=0 M2=0 M3=4,20952291602192	FrameElem=24-1 ElemStation=0
Frame=24 Station=0,04 OutputCase=RAR152 CaseType=Combination P=-18,4814011967287 V2=7,82385939775659 V3=0 T=0 M2=0 M3=3,88812854011165	FrameElem=24-1 ElemStation=0,04
Frame=24 Station=0,08 OutputCase=RAR152 CaseType=Combination P=-18,3214011967287 V2=7,40835939775659 V3=0 T=0 M2=0 M3=3,58351016420139	FrameElem=24-1 ElemStation=0,08
Frame=24 Station=0 OutputCase=RAR153 CaseType=Combination P=-78,4014011929254 V2=7,52705212226617 V3=0 T=0 M2=0 M3=11,4765838173755	FrameElem=24-1 ElemStation=0
Frame=24 Station=0,04 OutputCase=RAR153 CaseType=Combination P=-78,2414011929254 V2=7,10375212226617 V3=0 T=0 M2=0 M3=11,1839937324848	FrameElem=24-1 ElemStation=0,04
Frame=24 Station=0,08 OutputCase=RAR153 CaseType=Combination P=-78,0814011929254 V2=6,68825212226617 V3=0 T=0 M2=0 M3=10,9081796475942	FrameElem=24-1 ElemStation=0,08
Frame=24 Station=0 OutputCase=RAR154 CaseType=Combination P=-71,1534936585091 V2=34,5273717684719 V3=0 T=0 M2=0 M3=21,9851487082835	FrameElem=24-1 ElemStation=0
Frame=24 Station=0,04 OutputCase=RAR154 CaseType=Combination P=-70,9934936585091 V2=33,3469217684719 V3=0 T=0 M2=0 M3=20,6272625042113	FrameElem=24-1 ElemStation=0,04
Frame=24 Station=0,08 OutputCase=RAR154 CaseType=Combination P=-70,8334936585091 V2=32,1543717684719 V3=0 T=0 M2=0 M3=19,3175563001391	FrameElem=24-1 ElemStation=0,08
Frame=24 Station=0 OutputCase=RAR155 CaseType=Combination P=-78,4014011928672 V2=25,3290895226925 V3=0 T=0 M2=0 M3=14,0027482329808	FrameElem=24-1 ElemStation=0
Frame=24 Station=0,04 OutputCase=RAR155 CaseType=Combination P=-78,2414011928672 V2=24,1486395226925 V3=0 T=0 M2=0 M3=13,0131533187397	FrameElem=24-1 ElemStation=0,04
Frame=24 Station=0,08 OutputCase=RAR155 CaseType=Combination P=-78,0814011928672 V2=22,9560895226925 V3=0 T=0 M2=0 M3=12,0710184044987	FrameElem=24-1 ElemStation=0,08
Frame=24 Station=0 OutputCase=RAR156 CaseType=Combination P=-11,3934936623124 V2=35,2474790439623 V3=0 T=0 M2=0 M3=14,7180878069299	FrameElem=24-1 ElemStation=0
Frame=24 Station=0,04 OutputCase=RAR156 CaseType=Combination P=-11,2334936623124 V2=34,0670290439624 V3=0 T=0 M2=0 M3=13,3317573118381	FrameElem=24-1 ElemStation=0,04
Frame=24 Station=0,08 OutputCase=RAR156 CaseType=Combination P=-11,0734936623124 V2=32,8744790439623 V3=0 T=0 M2=0 M3=11,9928868167463	FrameElem=24-1 ElemStation=0,08
Frame=24 Station=0 OutputCase=RAR157 CaseType=Combination P=-18,6414011966705 V2=26,0491967981829 V3=0 T=0 M2=0 M3=6,73568733162722	FrameElem=24-1 ElemStation=0
Frame=24 Station=0,04 OutputCase=RAR157 CaseType=Combination P=-18,4814011966705 V2=24,8687467981829 V3=0 T=0 M2=0 M3=5,71728812636657	FrameElem=24-1 ElemStation=0,04
Frame=24 Station=0,08 OutputCase=RAR157 CaseType=Combination P=-18,3214011966705 V2=23,6761967981829 V3=0 T=0 M2=0 M3=4,74634892110592	FrameElem=24-1 ElemStation=0,08
Frame=24 Station=0 OutputCase=RAR158 CaseType=Combination P=-17,878598801312 V2=7,86570438324177 V3=0 T=0 M2=0 M3=3,47269692366164	FrameElem=24-1 ElemStation=0
Frame=24 Station=0,04 OutputCase=RAR158 CaseType=Combination P=-17,718598801312 V2=7,44240438324177 V3=0 T=0 M2=0 M3=3,16656074833197	FrameElem=24-1 ElemStation=0,04
Frame=24 Station=0,08 OutputCase=RAR158 CaseType=Combination P=-17,558598801312 V2=7,02690438324177 V3=0 T=0 M2=0 M3=2,8772005730023	FrameElem=24-1 ElemStation=0,08
Frame=24 Station=0 OutputCase=RAR159 CaseType=Combination P=-77,6385987975087 V2=7,14559710775135 V3=0 T=0 M2=0 M3=10,7397578250152	FrameElem=24-1 ElemStation=0
Frame=24 Station=0,04 OutputCase=RAR159 CaseType=Combination P=-77,4785987975087 V2=6,72229710775134 V3=0 T=0 M2=0 M3=10,4624259407051	FrameElem=24-1 ElemStation=0,04
Frame=24 Station=0,08 OutputCase=RAR159 CaseType=Combination P=-77,3185987975087 V2=6,30679710775135 V3=0 T=0 M2=0 M3=10,2018700563951	FrameElem=24-1 ElemStation=0,08
Frame=24 Station=0 OutputCase=RAR160 CaseType=Combination P=-70,3906912630924 V2=34,1459167539571 V3=0 T=0 M2=0 M3=21,2483227159232	FrameElem=24-1 ElemStation=0
Frame=24 Station=0,04 OutputCase=RAR160 CaseType=Combination P=-70,2306912630924 V2=32,9654667539571 V3=0 T=0 M2=0 M3=19,9060547124316	FrameElem=24-1 ElemStation=0,04
Frame=24 Station=0,08 OutputCase=RAR160 CaseType=Combination P=-70,0706912630924 V2=31,7729167539571 V3=0 T=0 M2=0 M3=18,61124670894	FrameElem=24-1 ElemStation=0,08
Frame=24 Station=0 OutputCase=RAR161 CaseType=Combination P=-77,6385987974505 V2=24,9476345081777 V3=0 T=0 M2=0 M3=13,2659222406205	FrameElem=24-1 ElemStation=0
Frame=24 Station=0,04 OutputCase=RAR161 CaseType=Combination P=-77,4785987974505 V2=23,7671845081777 V3=0 T=0 M2=0 M3=12,2915855269601	FrameElem=24-1 ElemStation=0,04
Frame=24 Station=0,08 OutputCase=RAR161 CaseType=Combination P=-77,3185987974505 V2=22,5746345081777 V3=0 T=0 M2=0 M3=11,3647088132996	FrameElem=24-1 ElemStation=0,08

Società di Progetto
Brebemi SpA

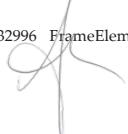



Doc. N.
60235-0000-A00.doc

CODIFICA DOCUMENTO
04RCDII10000000000300A00

REV.
00

FOGLIO
370 di 628

Frame=24 Station=0 OutputCase=RAR162 CaseType=Combination P=-10,6306912668957 V2=34,8660240294475 V3=0 T=0 M2=0 M3=13,9812618145697 FrameElem=24-1 ElemStation=0
Frame=24 Station=0,04 OutputCase=RAR162 CaseType=Combination P=-10,4706912668957 V2=33,6855740294475 V3=0 T=0 M2=0 M3=12,6101895200584 FrameElem=24-1 ElemStation=0,04
Frame=24 Station=0,08 OutputCase=RAR162 CaseType=Combination P=-10,3106912668957 V2=32,4930240294475 V3=0 T=0 M2=0 M3=11,2865772255472 FrameElem=24-1 ElemStation=0,08
Frame=24 Station=0 OutputCase=RAR163 CaseType=Combination P=-17,8758988012538 V2=25,6677417836681 V3=0 T=0 M2=0 M3=5,99886133926695 FrameElem=24-1 ElemStation=0
Frame=24 Station=0,04 OutputCase=RAR163 CaseType=Combination P=-17,7185988012538 V2=24,4872917836681 V3=0 T=0 M2=0 M3=4,99572033458689 FrameElem=24-1 ElemStation=0,04
Frame=24 Station=0,08 OutputCase=RAR163 CaseType=Combination P=-17,5585988012538 V2=23,2947417836681 V3=0 T=0 M2=0 M3=4,04003932990683 FrameElem=24-1 ElemStation=0,08
Frame=24 Station=0 OutputCase=INVRAR CaseType=Combination StepType=Max P=-8,5374547110841 V2=47,891156865335 V3=0 T=0 M2=0 M3=32,4626206310891 FrameElem=24-1 ElemStation=0
Frame=24 Station=0,04 OutputCase=INVRAR CaseType=Combination StepType=Max P=-8,3774547110841 V2=46,710706865335 V3=0 T=0 M2=0 M3=30,5705430231424 FrameElem=24-1 ElemStation=0,04
Frame=24 Station=0,08 OutputCase=INVRAR CaseType=Combination StepType=Max P=-8,2174547110841 V2=45,518156865335 V3=0 T=0 M2=0 M3=28,734160082649 FrameElem=24-1 ElemStation=0,08
Frame=24 Station=0 OutputCase=INVRAR CaseType=Combination StepType=Min P=-98,3214011916571 V2=5,61316009791819 V3=0 T=0 M2=0 M3=2,20036820238773 FrameElem=24-1 ElemStation=0
Frame=24 Station=0,04 OutputCase=INVRAR CaseType=Combination StepType=Min P=-98,1614011916571 V2=5,18986009791819 V3=0 T=0 M2=0 M3=1,95552950745139 FrameElem=24-1 ElemStation=0,04
Frame=24 Station=0,08 OutputCase=INVRAR CaseType=Combination StepType=Min P=-98,0014011916571 V2=4,77436009791819 V3=0 T=0 M2=0 M3=1,7219770342128 FrameElem=24-1 ElemStation=0,08
Frame=24 Station=0 OutputCase=FRE01 CaseType=Combination P=-18,2599999989616 V2=11,2911463274943 V3=0 T=0 M2=0 M3=3,68986040729829 FrameElem=24-1 ElemStation=0
Frame=24 Station=0,04 OutputCase=FRE01 CaseType=Combination P=-18,0999999989616 V2=10,6160463274943 V3=0 T=0 M2=0 M3=3,25175722086518 FrameElem=24-1 ElemStation=0,04
Frame=24 Station=0,08 OutputCase=FRE01 CaseType=Combination P=-17,9399999989616 V2=9,95314632749434 V3=0 T=0 M2=0 M3=2,84041403443208 FrameElem=24-1 ElemStation=0,08
Frame=24 Station=0 OutputCase=FRE02 CaseType=Combination P=-78,0199999952165 V2=6,57010611009218 V3=0 T=0 M2=0 M3=10,4720064605584 FrameElem=24-1 ElemStation=0
Frame=24 Station=0,04 OutputCase=FRE02 CaseType=Combination P=-77,8599999952165 V2=6,14680611009218 V3=0 T=0 M2=0 M3=10,2176942161547 FrameElem=24-1 ElemStation=0,04
Frame=24 Station=0,08 OutputCase=FRE02 CaseType=Combination P=-77,6999999952165 V2=5,73130611009218 V3=0 T=0 M2=0 M3=9,980157971751 FrameElem=24-1 ElemStation=0,08
Frame=24 Station=0 OutputCase=FRE03 CaseType=Combination P=-70,7720924608002 V2=33,5704257562979 V3=0 T=0 M2=0 M3=20,9805713514664 FrameElem=24-1 ElemStation=0
Frame=24 Station=0,04 OutputCase=FRE03 CaseType=Combination P=-70,6120924608002 V2=32,3899757562979 V3=0 T=0 M2=0 M3=19,6613229878812 FrameElem=24-1 ElemStation=0,04
Frame=24 Station=0,08 OutputCase=FRE03 CaseType=Combination P=-70,4520924608002 V2=31,1974257562979 V3=0 T=0 M2=0 M3=18,3895346242959 FrameElem=24-1 ElemStation=0,08
Frame=24 Station=0 OutputCase=FRE04 CaseType=Combination P=-78,0199999951583 V2=24,3721435105185 V3=0 T=0 M2=0 M3=12,9981708761637 FrameElem=24-1 ElemStation=0
Frame=24 Station=0,04 OutputCase=FRE04 CaseType=Combination P=-77,8599999951583 V2=23,1916935105185 V3=0 T=0 M2=0 M3=12,0468538024096 FrameElem=24-1 ElemStation=0,04
Frame=24 Station=0,08 OutputCase=FRE04 CaseType=Combination P=-77,6999999951583 V2=21,9991435105185 V3=0 T=0 M2=0 M3=11,1429967286555 FrameElem=24-1 ElemStation=0,08
Frame=24 Station=0 OutputCase=FRE05 CaseType=Combination P=-11,0120924646035 V2=34,2905330317884 V3=0 T=0 M2=0 M3=13,7135104501128 FrameElem=24-1 ElemStation=0
Frame=24 Station=0,04 OutputCase=FRE05 CaseType=Combination P=-10,8520924646035 V2=33,1100830317884 V3=0 T=0 M2=0 M3=12,365457795508 FrameElem=24-1 ElemStation=0,04
Frame=24 Station=0,08 OutputCase=FRE05 CaseType=Combination P=-10,6920924646035 V2=31,9175330317884 V3=0 T=0 M2=0 M3=11,0648651409031 FrameElem=24-1 ElemStation=0,08
Frame=24 Station=0 OutputCase=FRE06 CaseType=Combination P=-18,2599999989616 V2=25,0922507860089 V3=0 T=0 M2=0 M3=5,73110997481013 FrameElem=24-1 ElemStation=0
Frame=24 Station=0,04 OutputCase=FRE06 CaseType=Combination P=-18,0999999989616 V2=23,9118007860089 V3=0 T=0 M2=0 M3=4,75098861003644 FrameElem=24-1 ElemStation=0,04
Frame=24 Station=0,08 OutputCase=FRE06 CaseType=Combination P=-17,9399999989616 V2=22,7192507860089 V3=0 T=0 M2=0 M3=3,81832724526275 FrameElem=24-1 ElemStation=0,08
Frame=24 Station=0 OutputCase=FRE07 CaseType=Combination P=-18,2599999990194 V2=6,83048228263266 V3=0 T=0 M2=0 M3=2,82324694282265 FrameElem=24-1 ElemStation=0
Frame=24 Station=0,04 OutputCase=FRE07 CaseType=Combination P=-18,0999999990194 V2=6,40718228263265 V3=0 T=0 M2=0 M3=2,55851965151734 FrameElem=24-1 ElemStation=0,04
Frame=24 Station=0,08 OutputCase=FRE07 CaseType=Combination P=-17,9399999990194 V2=5,99168228263266 V3=0 T=0 M2=0 M3=2,31056836021204 FrameElem=24-1 ElemStation=0,08
Frame=24 Station=0 OutputCase=FRE08 CaseType=Combination P=-78,0199999952162 V2=6,18699685763389 V3=0 T=0 M2=0 M3=10,1539242802399 FrameElem=24-1 ElemStation=0
Frame=24 Station=0,04 OutputCase=FRE08 CaseType=Combination P=-77,8599999952162 V2=5,76369685763389 V3=0 T=0 M2=0 M3=9,91493640593454 FrameElem=24-1 ElemStation=0,04
Frame=24 Station=0,08 OutputCase=FRE08 CaseType=Combination P=-77,6999999952162 V2=5,34819685763389 V3=0 T=0 M2=0 M3=9,69272453162919 FrameElem=24-1 ElemStation=0,08
Frame=24 Station=0 OutputCase=FRE09 CaseType=Combination P=-70,7720924607999 V2=33,1873165038396 V3=0 T=0 M2=0 M3=20,6624891711479 FrameElem=24-1 ElemStation=0
Frame=24 Station=0,04 OutputCase=FRE09 CaseType=Combination P=-70,6120924607999 V2=32,0068665038396 V3=0 T=0 M2=0 M3=19,358565177661 FrameElem=24-1 ElemStation=0,04
Frame=24 Station=0,08 OutputCase=FRE09 CaseType=Combination P=-70,4520924607999 V2=30,8143165038396 V3=0 T=0 M2=0 M3=18,1021011841741 FrameElem=24-1 ElemStation=0,08
Frame=24 Station=0 OutputCase=FRE10 CaseType=Combination P=-78,019999995158 V2=23,9890342580602 V3=0 T=0 M2=0 M3=12,6800886958452 FrameElem=24-1 ElemStation=0
Frame=24 Station=0,04 OutputCase=FRE10 CaseType=Combination P=-77,859999995158 V2=22,8085842580602 V3=0 T=0 M2=0 M3=11,7440959921895 FrameElem=24-1 ElemStation=0,04
Frame=24 Station=0,08 OutputCase=FRE10 CaseType=Combination P=-77,699999995158 V2=21,6160342580602 V3=0 T=0 M2=0 M3=10,8555632885337 FrameElem=24-1 ElemStation=0,08
Frame=24 Station=0 OutputCase=FRE11 CaseType=Combination P=-11,0120924646032 V2=33,9074237793301 V3=0 T=0 M2=0 M3=13,3954282697944 FrameElem=24-1 ElemStation=0
Frame=24 Station=0,04 OutputCase=FRE11 CaseType=Combination P=-10,8520924646032 V2=32,7269737793301 V3=0 T=0 M2=0 M3=12,0626999852878 FrameElem=24-1 ElemStation=0,04

APPROVATO SDP
Società di Progetto
Brebemi SpA

	Doc. N. 60235-00000-A00.doc	CODIFICA DOCUMENTO 04RCDII10000000000300A00	REV. 00	FOGLIO 371 di 628
--	--------------------------------	--	------------	----------------------

Frame=24 Station=0,08 OutputCase=FRE11 CaseType=Combination P=-10,6920924646032 V2=31,5344237793301 V3=0 T=0 M2=0 M3=10,7774317007813	FrameElem=24-1 ElemStation=0,08
Frame=24 Station=0 OutputCase=FRE12 CaseType=Combination P=-18,2599999989613 V2=24,7091415335507 V3=0 T=0 M2=0 M3=5,4130277949165	FrameElem=24-1 ElemStation=0
Frame=24 Station=0,04 OutputCase=FRE12 CaseType=Combination P=-18,0999999989613 V2=23,5286915335507 V3=0 T=0 M2=0 M3=4,44823079981629	FrameElem=24-1 ElemStation=0,04
Frame=24 Station=0,08 OutputCase=FRE12 CaseType=Combination P=-17,9399999989613 V2=22,3361415335507 V3=0 T=0 M2=0 M3=3,53089380514093	FrameElem=24-1 ElemStation=0,08
Frame=24 Station=0 OutputCase=FRE13 CaseType=Combination P=-18,5778343304431 V2=6,98942187201383 V3=0 T=0 M2=0 M3=3,13025777297276	FrameElem=24-1 ElemStation=0
Frame=24 Station=0,04 OutputCase=FRE13 CaseType=Combination P=-18,4178343304431 V2=6,56612187201383 V3=0 T=0 M2=0 M3=2,85917289809221	FrameElem=24-1 ElemStation=0,04
Frame=24 Station=0,08 OutputCase=FRE13 CaseType=Combination P=-18,2578343304431 V2=6,15062187201383 V3=0 T=0 M2=0 M3=2,60486402321166	FrameElem=24-1 ElemStation=0,08
Frame=24 Station=0 OutputCase=FRE14 CaseType=Combination P=-17,9421656675958 V2=6,67154269325148 V3=0 T=0 M2=0 M3=2,51623611267254	FrameElem=24-1 ElemStation=0
Frame=24 Station=0,04 OutputCase=FRE14 CaseType=Combination P=-17,7821656675958 V2=6,24824269325148 V3=0 T=0 M2=0 M3=2,25786640494248	FrameElem=24-1 ElemStation=0,04
Frame=24 Station=0,08 OutputCase=FRE14 CaseType=Combination P=-17,6221656675958 V2=5,83274269325148 V3=0 T=0 M2=0 M3=2,01627269721242	FrameElem=24-1 ElemStation=0,08
Frame=24 Station=0 OutputCase=FRE15 CaseType=Combination P=-18,2599999990197 V2=7,21359153509095 V3=0 T=0 M2=0 M3=3,14132912314113	FrameElem=24-1 ElemStation=0
Frame=24 Station=0,04 OutputCase=FRE15 CaseType=Combination P=-18,0999999990197 V2=6,79029153509094 V3=0 T=0 M2=0 M3=2,86127746173749	FrameElem=24-1 ElemStation=0,04
Frame=24 Station=0,08 OutputCase=FRE15 CaseType=Combination P=-17,9399999990197 V2=6,37479153509095 V3=0 T=0 M2=0 M3=2,59800180033385	FrameElem=24-1 ElemStation=0,08
Frame=24 Station=0 OutputCase=FRE16 CaseType=Combination P=-18,2599999990201 V2=7,74994448853255 V3=0 T=0 M2=0 M3=3,586644175587	FrameElem=24-1 ElemStation=0
Frame=24 Station=0,04 OutputCase=FRE16 CaseType=Combination P=-18,0999999990201 V2=7,32644448853255 V3=0 T=0 M2=0 M3=3,28513839604569	FrameElem=24-1 ElemStation=0,04
Frame=24 Station=0,08 OutputCase=FRE16 CaseType=Combination P=-17,9399999990201 V2=6,91114448853255 V3=0 T=0 M2=0 M3=3,00040861650439	FrameElem=24-1 ElemStation=0,08
Frame=24 Station=0 OutputCase=FRE17 CaseType=Combination P=-78,0199999952168 V2=6,95321536255047 V3=0 T=0 M2=0 M3=10,7900886408769	FrameElem=24-1 ElemStation=0
Frame=24 Station=0,04 OutputCase=FRE17 CaseType=Combination P=-77,8599999952168 V2=6,52991536255047 V3=0 T=0 M2=0 M3=10,5204520263748	FrameElem=24-1 ElemStation=0,04
Frame=24 Station=0,08 OutputCase=FRE17 CaseType=Combination P=-77,6999999952168 V2=6,11441536255047 V3=0 T=0 M2=0 M3=10,2675914118728	FrameElem=24-1 ElemStation=0,08
Frame=24 Station=0 OutputCase=FRE18 CaseType=Combination P=-70,7720924608005 V2=33,9535350087562 V3=0 T=0 M2=0 M3=21,2986535317849	FrameElem=24-1 ElemStation=0
Frame=24 Station=0,04 OutputCase=FRE18 CaseType=Combination P=-70,6120924608005 V2=32,7730850087562 V3=0 T=0 M2=0 M3=19,9640807981013	FrameElem=24-1 ElemStation=0,04
Frame=24 Station=0,08 OutputCase=FRE18 CaseType=Combination P=-70,4520924608005 V2=31,5805350087562 V3=0 T=0 M2=0 M3=18,6769680644177	FrameElem=24-1 ElemStation=0,08
Frame=24 Station=0 OutputCase=FRE19 CaseType=Combination P=-78,0199999951586 V2=24,7552527629768 V3=0 T=0 M2=0 M3=13,3162530564822	FrameElem=24-1 ElemStation=0
Frame=24 Station=0,04 OutputCase=FRE19 CaseType=Combination P=-77,8599999951586 V2=23,5748027629768 V3=0 T=0 M2=0 M3=12,3496116126298	FrameElem=24-1 ElemStation=0,04
Frame=24 Station=0,08 OutputCase=FRE19 CaseType=Combination P=-77,6999999951586 V2=22,3822527629768 V3=0 T=0 M2=0 M3=11,4304301687774	FrameElem=24-1 ElemStation=0,08
Frame=24 Station=0 OutputCase=FRE20 CaseType=Combination P=-11,0120924646038 V2=34,6736422842466 V3=0 T=0 M2=0 M3=14,0315926304313	FrameElem=24-1 ElemStation=0
Frame=24 Station=0,04 OutputCase=FRE20 CaseType=Combination P=-10,8520924646038 V2=33,4931922842466 V3=0 T=0 M2=0 M3=12,6682156057281	FrameElem=24-1 ElemStation=0,04
Frame=24 Station=0,08 OutputCase=FRE20 CaseType=Combination P=-10,6920924646038 V2=32,3006422842466 V3=0 T=0 M2=0 M3=11,3522985810249	FrameElem=24-1 ElemStation=0,08
Frame=24 Station=0 OutputCase=FRE21 CaseType=Combination P=-18,2599999989619 V2=25,4753600384672 V3=0 T=0 M2=0 M3=6,04919215512861	FrameElem=24-1 ElemStation=0
Frame=24 Station=0,04 OutputCase=FRE21 CaseType=Combination P=-18,0999999989619 V2=24,2949100384672 V3=0 T=0 M2=0 M3=5,05374642025659	FrameElem=24-1 ElemStation=0,04
Frame=24 Station=0,08 OutputCase=FRE21 CaseType=Combination P=-17,9399999989619 V2=23,1023600384672 V3=0 T=0 M2=0 M3=4,10576068538456	FrameElem=24-1 ElemStation=0,08
Frame=24 Station=0 OutputCase=FRE22 CaseType=Combination P=-18,5778343304438 V2=7,90888407791373 V3=0 T=0 M2=0 M3=3,89365500573711	FrameElem=24-1 ElemStation=0
Frame=24 Station=0,04 OutputCase=FRE22 CaseType=Combination P=-18,4178343304438 V2=7,48558407791373 V3=0 T=0 M2=0 M3=3,58579164262056	FrameElem=24-1 ElemStation=0,04
Frame=24 Station=0,08 OutputCase=FRE22 CaseType=Combination P=-18,2578343304438 V2=7,07008407791373 V3=0 T=0 M2=0 M3=3,29470427950401	FrameElem=24-1 ElemStation=0,08
Frame=24 Station=0 OutputCase=FRE23 CaseType=Combination P=-17,9421656675965 V2=7,59100489915138 V3=0 T=0 M2=0 M3=3,27963334543688	FrameElem=24-1 ElemStation=0
Frame=24 Station=0,04 OutputCase=FRE23 CaseType=Combination P=-17,7821656675965 V2=7,16770489915138 V3=0 T=0 M2=0 M3=2,98448514947083	FrameElem=24-1 ElemStation=0,04
Frame=24 Station=0,08 OutputCase=FRE23 CaseType=Combination P=-17,6221656675965 V2=6,75220489915138 V3=0 T=0 M2=0 M3=2,70611295350477	FrameElem=24-1 ElemStation=0,08
Frame=24 Station=0 OutputCase=FRE24 CaseType=Combination P=-18,2599999990204 V2=8,13305374099084 V3=0 T=0 M2=0 M3=3,90472635590547	FrameElem=24-1 ElemStation=0
Frame=24 Station=0,04 OutputCase=FRE24 CaseType=Combination P=-18,0999999990204 V2=7,70975374099084 V3=0 T=0 M2=0 M3=3,58789620626584	FrameElem=24-1 ElemStation=0,04
Frame=24 Station=0,08 OutputCase=FRE24 CaseType=Combination P=-17,9399999990204 V2=7,29425374099084 V3=0 T=0 M2=0 M3=3,28784205662621	FrameElem=24-1 ElemStation=0,08
Frame=24 Station=0 OutputCase=FRE25 CaseType=Combination P=-18,6414011967282 V2=7,48094089284001 V3=0 T=0 M2=0 M3=3,57335855538496	FrameElem=24-1 ElemStation=0
Frame=24 Station=0,04 OutputCase=FRE25 CaseType=Combination P=-18,4814011967282 V2=7,05764089284001 V3=0 T=0 M2=0 M3=3,28261291967136	FrameElem=24-1 ElemStation=0,04
Frame=24 Station=0,08 OutputCase=FRE25 CaseType=Combination P=-18,3214011967282 V2=6,64214089284001 V3=0 T=0 M2=0 M3=3,00864328395776	FrameElem=24-1 ElemStation=0,08
Frame=24 Station=0 OutputCase=FRE26 CaseType=Combination P=-78,3378343266401 V2=6,72904569947335 V3=0 T=0 M2=0 M3=10,7790172907085	FrameElem=24-1 ElemStation=0

Società di Progetto
Brebemi SpA

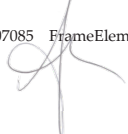



Doc. N.
60235-0000-A00.doc

CODIFICA DOCUMENTO
04RCDII10000000000300A00

REV.
00

FOGLIO
372 di 628

Frame=24 Station=0,04 OutputCase=FRE26 CaseType=Combination P=-78,1778343266401 V2=6,30574569947335 V3=0 T=0 M2=0 M3=10,5183474627296 FrameElem=24-1 ElemStation=0,04
Frame=24 Station=0,08 OutputCase=FRE26 CaseType=Combination P=-78,0178343266401 V2=5,89024569947335 V3=0 T=0 M2=0 M3=10,2744536347506 FrameElem=24-1 ElemStation=0,08
Frame=24 Station=0 OutputCase=FRE27 CaseType=Combination P=-71,0899267922238 V2=33,7293653456791 V3=0 T=0 M2=0 M3=21,2875821816165 FrameElem=24-1 ElemStation=0
Frame=24 Station=0,04 OutputCase=FRE27 CaseType=Combination P=-70,9299267922238 V2=32,5489153456791 V3=0 T=0 M2=0 M3=19,961976234456 FrameElem=24-1 ElemStation=0,04
Frame=24 Station=0,08 OutputCase=FRE27 CaseType=Combination P=-70,7699267922238 V2=31,3563653456791 V3=0 T=0 M2=0 M3=18,6838302872955 FrameElem=24-1 ElemStation=0,08
Frame=24 Station=0 OutputCase=FRE28 CaseType=Combination P=-78,3378343265819 V2=24,5310830998997 V3=0 T=0 M2=0 M3=13,3051817063138 FrameElem=24-1 ElemStation=0
Frame=24 Station=0,04 OutputCase=FRE28 CaseType=Combination P=-78,1778343265819 V2=23,3506330998997 V3=0 T=0 M2=0 M3=12,3475070489845 FrameElem=24-1 ElemStation=0,04
Frame=24 Station=0,08 OutputCase=FRE28 CaseType=Combination P=-78,0178343265819 V2=22,1580830998997 V3=0 T=0 M2=0 M3=11,4372923916552 FrameElem=24-1 ElemStation=0,08
Frame=24 Station=0 OutputCase=FRE29 CaseType=Combination P=-11,3299267960271 V2=34,4494726211695 V3=0 T=0 M2=0 M3=14,020521280263 FrameElem=24-1 ElemStation=0
Frame=24 Station=0,04 OutputCase=FRE29 CaseType=Combination P=-11,1699267960271 V2=33,2690226211695 V3=0 T=0 M2=0 M3=12,6661110420828 FrameElem=24-1 ElemStation=0,04
Frame=24 Station=0,08 OutputCase=FRE29 CaseType=Combination P=-11,0099267960271 V2=32,0764726211695 V3=0 T=0 M2=0 M3=11,3591680390027 FrameElem=24-1 ElemStation=0,08
Frame=24 Station=0 OutputCase=FRE30 CaseType=Combination P=-18,5778343303852 V2=25,2511903753901 V3=0 T=0 M2=0 M3=6,03812080496025 FrameElem=24-1 ElemStation=0
Frame=24 Station=0,04 OutputCase=FRE30 CaseType=Combination P=-18,4178343303852 V2=24,0707403753901 V3=0 T=0 M2=0 M3=5,05164185661131 FrameElem=24-1 ElemStation=0,04
Frame=24 Station=0,08 OutputCase=FRE30 CaseType=Combination P=-18,2578343303852 V2=22,8781903753901 V3=0 T=0 M2=0 M3=4,11262290826237 FrameElem=24-1 ElemStation=0,08
Frame=24 Station=0 OutputCase=FRE31 CaseType=Combination P=-18,6414011967279 V2=7,09783164038172 V3=0 T=0 M2=0 M3=3,25527637506648 FrameElem=24-1 ElemStation=0
Frame=24 Station=0,04 OutputCase=FRE31 CaseType=Combination P=-18,4814011967279 V2=6,67453164038172 V3=0 T=0 M2=0 M3=2,97985510945121 FrameElem=24-1 ElemStation=0,04
Frame=24 Station=0,08 OutputCase=FRE31 CaseType=Combination P=-18,3214011967279 V2=6,25903164038172 V3=0 T=0 M2=0 M3=2,72120984383594 FrameElem=24-1 ElemStation=0,08
Frame=24 Station=0 OutputCase=FRE32 CaseType=Combination P=-18,6414011967284 V2=7,8640501452983 V3=0 T=0 M2=0 M3=3,89144073570344 FrameElem=24-1 ElemStation=0
Frame=24 Station=0,04 OutputCase=FRE32 CaseType=Combination P=-18,4814011967284 V2=7,4407501452983 V3=0 T=0 M2=0 M3=3,58537072989151 FrameElem=24-1 ElemStation=0,04
Frame=24 Station=0,08 OutputCase=FRE32 CaseType=Combination P=-18,3214011967284 V2=7,0252501452983 V3=0 T=0 M2=0 M3=3,29607672407957 FrameElem=24-1 ElemStation=0,08
Frame=24 Station=0 OutputCase=FRE33 CaseType=Combination P=-18,6414011967284 V2=7,8640501452983 V3=0 T=0 M2=0 M3=3,89144073570344 FrameElem=24-1 ElemStation=0
Frame=24 Station=0,04 OutputCase=FRE33 CaseType=Combination P=-18,4814011967284 V2=7,4407501452983 V3=0 T=0 M2=0 M3=3,58537072989151 FrameElem=24-1 ElemStation=0,04
Frame=24 Station=0,08 OutputCase=FRE33 CaseType=Combination P=-18,3214011967284 V2=7,0252501452983 V3=0 T=0 M2=0 M3=3,29607672407957 FrameElem=24-1 ElemStation=0,08
Frame=24 Station=0 OutputCase=FRE34 CaseType=Combination P=-17,8785988013114 V2=7,09948587832519 V3=0 T=0 M2=0 M3=2,83653256302469 FrameElem=24-1 ElemStation=0
Frame=24 Station=0,04 OutputCase=FRE34 CaseType=Combination P=-17,7185988013114 V2=6,67618587832519 V3=0 T=0 M2=0 M3=2,56104512789168 FrameElem=24-1 ElemStation=0,04
Frame=24 Station=0,08 OutputCase=FRE34 CaseType=Combination P=-17,5585988013114 V2=6,26068587832519 V3=0 T=0 M2=0 M3=2,30233369275867 FrameElem=24-1 ElemStation=0,08
Frame=24 Station=0 OutputCase=FRE35 CaseType=Combination P=-77,7021656637929 V2=6,411166520711 V3=0 T=0 M2=0 M3=10,1649956304083 FrameElem=24-1 ElemStation=0
Frame=24 Station=0,04 OutputCase=FRE35 CaseType=Combination P=-77,5421656637929 V2=5,987866520711 V3=0 T=0 M2=0 M3=9,91704096957982 FrameElem=24-1 ElemStation=0,04
Frame=24 Station=0,08 OutputCase=FRE35 CaseType=Combination P=-77,3821656637929 V2=5,572366520711 V3=0 T=0 M2=0 M3=9,68586230875138 FrameElem=24-1 ElemStation=0,08
Frame=24 Station=0 OutputCase=FRE36 CaseType=Combination P=-70,4542581293766 V2=33,4114861669168 V3=0 T=0 M2=0 M3=20,6735605213163 FrameElem=24-1 ElemStation=0
Frame=24 Station=0,04 OutputCase=FRE36 CaseType=Combination P=-70,2942581293766 V2=32,2310361669168 V3=0 T=0 M2=0 M3=19,3606697413063 FrameElem=24-1 ElemStation=0,04
Frame=24 Station=0,08 OutputCase=FRE36 CaseType=Combination P=-70,1342581293766 V2=31,0384861669168 V3=0 T=0 M2=0 M3=18,0952389612963 FrameElem=24-1 ElemStation=0,08
Frame=24 Station=0 OutputCase=FRE37 CaseType=Combination P=-77,7021656637346 V2=24,2132039211373 V3=0 T=0 M2=0 M3=12,6911600461036 FrameElem=24-1 ElemStation=0
Frame=24 Station=0,04 OutputCase=FRE37 CaseType=Combination P=-77,5421656637346 V2=23,0327539211373 V3=0 T=0 M2=0 M3=11,7462005558347 FrameElem=24-1 ElemStation=0,04
Frame=24 Station=0,08 OutputCase=FRE37 CaseType=Combination P=-77,3821656637346 V2=21,8402039211373 V3=0 T=0 M2=0 M3=10,8487010656559 FrameElem=24-1 ElemStation=0,08
Frame=24 Station=0 OutputCase=FRE38 CaseType=Combination P=-10,6942581331798 V2=34,1315934424072 V3=0 T=0 M2=0 M3=13,4064996199627 FrameElem=24-1 ElemStation=0
Frame=24 Station=0,04 OutputCase=FRE38 CaseType=Combination P=-10,5342581331798 V2=32,9511434424072 V3=0 T=0 M2=0 M3=12,0648045489331 FrameElem=24-1 ElemStation=0,04
Frame=24 Station=0,08 OutputCase=FRE38 CaseType=Combination P=-10,3742581331798 V2=31,7585934424072 V3=0 T=0 M2=0 M3=10,7705694779035 FrameElem=24-1 ElemStation=0,08
Frame=24 Station=0 OutputCase=FRE39 CaseType=Combination P=-17,9421656675379 V2=24,9333111966278 V3=0 T=0 M2=0 M3=5,42409914466002 FrameElem=24-1 ElemStation=0
Frame=24 Station=0,04 OutputCase=FRE39 CaseType=Combination P=-17,7821656675379 V2=23,7528611966278 V3=0 T=0 M2=0 M3=4,45033536346157 FrameElem=24-1 ElemStation=0,04
Frame=24 Station=0,08 OutputCase=FRE39 CaseType=Combination P=-17,6221656675379 V2=22,5603111966278 V3=0 T=0 M2=0 M3=3,52403158226313 FrameElem=24-1 ElemStation=0,08
Frame=24 Station=0 OutputCase=FRE40 CaseType=Combination P=-17,8785988013111 V2=6,7163766258669 V3=0 T=0 M2=0 M3=2,51845038270621 FrameElem=24-1 ElemStation=0
Frame=24 Station=0,04 OutputCase=FRE40 CaseType=Combination P=-17,7185988013111 V2=6,2930766258669 V3=0 T=0 M2=0 M3=2,25828731767153 FrameElem=24-1 ElemStation=0,04
Frame=24 Station=0,08 OutputCase=FRE40 CaseType=Combination P=-17,5585988013111 V2=5,8775766258669 V3=0 T=0 M2=0 M3=2,01490025263686 FrameElem=24-1 ElemStation=0,08

Società di Progetto
Brebemi SpA



Doc. N.
60235-0000-A00.doc

CODIFICA DOCUMENTO
04RCDII10000000000300A00

REV.
00

FOGLIO
373 di 628

Frame=24 Station=0 OutputCase=FRE41 CaseType=Combination P=-17,8785988013117 V2=7,48259513078348 V3=0 T=0 M2=0 M3=3,15641474334316	FrameElem=24-1
ElemStation=0	
Frame=24 Station=0,04 OutputCase=FRE41 CaseType=Combination P=-17,7185988013117 V2=7,0529513078348 V3=0 T=0 M2=0 M3=2,86380293811182	FrameElem=24-1
ElemStation=0,04	
Frame=24 Station=0,08 OutputCase=FRE41 CaseType=Combination P=-17,5585988013117 V2=6,64379513078348 V3=0 T=0 M2=0 M3=2,58976713288049	FrameElem=24-1
ElemStation=0,08	
Frame=24 Station=0 OutputCase=FRE42 CaseType=Combination P=-17,8785988013117 V2=7,48259513078348 V3=0 T=0 M2=0 M3=3,15641474334316	FrameElem=24-1
ElemStation=0	
Frame=24 Station=0,04 OutputCase=FRE42 CaseType=Combination P=-17,7185988013117 V2=7,0529513078348 V3=0 T=0 M2=0 M3=2,86380293811182	FrameElem=24-1
ElemStation=0,04	
Frame=24 Station=0,08 OutputCase=FRE42 CaseType=Combination P=-17,5585988013117 V2=6,64379513078348 V3=0 T=0 M2=0 M3=2,58976713288049	FrameElem=24-1
ElemStation=0,08	
Frame=24 Station=0 OutputCase=FRE43 CaseType=Combination P=-18,2599999990201 V2=7,74994448853255 V3=0 T=0 M2=0 M3=3,586644175587	FrameElem=24-1
ElemStation=0	
Frame=24 Station=0,04 OutputCase=FRE43 CaseType=Combination P=-18,0999999990201 V2=7,32664448853255 V3=0 T=0 M2=0 M3=3,28513839604569	FrameElem=24-1
ElemStation=0,04	
Frame=24 Station=0,08 OutputCase=FRE43 CaseType=Combination P=-17,9399999990201 V2=6,91114448853255 V3=0 T=0 M2=0 M3=3,00040861650439	FrameElem=24-1
ElemStation=0,08	
Frame=24 Station=0 OutputCase=FRE44 CaseType=Combination P=-78,0199999952168 V2=6,95321536255047 V3=0 T=0 M2=0 M3=10,7900886408769	FrameElem=24-1
ElemStation=0	
Frame=24 Station=0,04 OutputCase=FRE44 CaseType=Combination P=-77,8599999952168 V2=6,52991536255047 V3=0 T=0 M2=0 M3=10,5204520263748	FrameElem=24-1
ElemStation=0,04	
Frame=24 Station=0,08 OutputCase=FRE44 CaseType=Combination P=-77,6999999952168 V2=6,11441536255047 V3=0 T=0 M2=0 M3=10,2675914118728	FrameElem=24-1
ElemStation=0,08	
Frame=24 Station=0 OutputCase=FRE45 CaseType=Combination P=-70,7720924608005 V2=33,9535350087562 V3=0 T=0 M2=0 M3=21,2986535317849	FrameElem=24-1
ElemStation=0	
Frame=24 Station=0,04 OutputCase=FRE45 CaseType=Combination P=-70,6120924608005 V2=32,7730850087562 V3=0 T=0 M2=0 M3=19,9640807981013	FrameElem=24-1
ElemStation=0,04	
Frame=24 Station=0,08 OutputCase=FRE45 CaseType=Combination P=-70,4520924608005 V2=31,5805350087562 V3=0 T=0 M2=0 M3=18,676980644177	FrameElem=24-1
ElemStation=0,08	
Frame=24 Station=0 OutputCase=FRE46 CaseType=Combination P=-78,0199999951586 V2=24,7552527629768 V3=0 T=0 M2=0 M3=13,3162530564822	FrameElem=24-1
ElemStation=0	
Frame=24 Station=0,04 OutputCase=FRE46 CaseType=Combination P=-77,8599999951586 V2=23,5748027629768 V3=0 T=0 M2=0 M3=12,3496116126298	FrameElem=24-1
ElemStation=0,04	
Frame=24 Station=0,08 OutputCase=FRE46 CaseType=Combination P=-77,6999999951586 V2=22,3822527629768 V3=0 T=0 M2=0 M3=11,4304301687774	FrameElem=24-1
ElemStation=0,08	
Frame=24 Station=0 OutputCase=FRE47 CaseType=Combination P=-11,0120924646038 V2=34,6736422842466 V3=0 T=0 M2=0 M3=14,0315926304313	FrameElem=24-1
ElemStation=0	
Frame=24 Station=0,04 OutputCase=FRE47 CaseType=Combination P=-10,8520924646038 V2=33,4931922842466 V3=0 T=0 M2=0 M3=12,6682156057281	FrameElem=24-1
ElemStation=0,04	
Frame=24 Station=0,08 OutputCase=FRE47 CaseType=Combination P=-10,6920924646038 V2=32,3006422842466 V3=0 T=0 M2=0 M3=11,3522985810249	FrameElem=24-1
ElemStation=0,08	
Frame=24 Station=0 OutputCase=FRE48 CaseType=Combination P=-18,2599999989619 V2=25,4753600384672 V3=0 T=0 M2=0 M3=6,04919215512861	FrameElem=24-1
ElemStation=0	
Frame=24 Station=0,04 OutputCase=FRE48 CaseType=Combination P=-18,0999999989619 V2=24,2949100384672 V3=0 T=0 M2=0 M3=5,05374642025659	FrameElem=24-1
ElemStation=0,04	
Frame=24 Station=0,08 OutputCase=FRE48 CaseType=Combination P=-17,9399999989619 V2=23,1023600384672 V3=0 T=0 M2=0 M3=4,10576068538456	FrameElem=24-1
ElemStation=0,08	
Frame=24 Station=0 OutputCase=FRE49 CaseType=Combination P=-18,2599999990204 V2=8,13305374099084 V3=0 T=0 M2=0 M3=3,90472635590547	FrameElem=24-1
ElemStation=0	
Frame=24 Station=0,04 OutputCase=FRE49 CaseType=Combination P=-18,0999999990204 V2=7,70975374099084 V3=0 T=0 M2=0 M3=3,58789620626584	FrameElem=24-1
ElemStation=0,04	
Frame=24 Station=0,08 OutputCase=FRE49 CaseType=Combination P=-17,9399999990204 V2=7,29425374099084 V3=0 T=0 M2=0 M3=3,28784205662621	FrameElem=24-1
ElemStation=0,08	
Frame=24 Station=0 OutputCase=FRE50 CaseType=Combination P=-18,5778343304438 V2=7,90888407791373 V3=0 T=0 M2=0 M3=3,89365500573711	FrameElem=24-1
ElemStation=0	
Frame=24 Station=0,04 OutputCase=FRE50 CaseType=Combination P=-18,4178343304438 V2=7,48558407791373 V3=0 T=0 M2=0 M3=3,58579164262056	FrameElem=24-1
ElemStation=0,04	
Frame=24 Station=0,08 OutputCase=FRE50 CaseType=Combination P=-18,2578343304438 V2=7,07008407791373 V3=0 T=0 M2=0 M3=3,29470427950401	FrameElem=24-1
ElemStation=0,08	
Frame=24 Station=0 OutputCase=FRE51 CaseType=Combination P=-17,9421656675965 V2=7,59100489915138 V3=0 T=0 M2=0 M3=3,27963334543688	FrameElem=24-1
ElemStation=0	
Frame=24 Station=0,04 OutputCase=FRE51 CaseType=Combination P=-17,7821656675965 V2=7,16770489915138 V3=0 T=0 M2=0 M3=2,98448514947083	FrameElem=24-1
ElemStation=0,04	
Frame=24 Station=0,08 OutputCase=FRE51 CaseType=Combination P=-17,6221656675965 V2=6,75220489915138 V3=0 T=0 M2=0 M3=2,70611295350477	FrameElem=24-1
ElemStation=0,08	
Frame=24 Station=0 OutputCase=INVFRE CaseType=Combination StepType=Max P=-10,6942581331798 V2=34,6736422842466 V3=0 T=0 M2=0 M3=21,2986535317849	FrameElem=24-1
ElemStation=0	
Frame=24 Station=0,04 OutputCase=INVFRE CaseType=Combination StepType=Max P=-10,5342581331798 V2=33,4931922842466 V3=0 T=0 M2=0 M3=19,9640807981013	FrameElem=24-1
ElemStation=0,04	
Frame=24 Station=0,08 OutputCase=INVFRE CaseType=Combination StepType=Max P=-10,3742581331798 V2=32,3006422842466 V3=0 T=0 M2=0 M3=18,6838302872955	FrameElem=24-1
ElemStation=0,08	
Frame=24 Station=0 OutputCase=INVFRE CaseType=Combination StepType=Min P=-78,3378343266401 V2=6,18699685763389 V3=0 T=0 M2=0 M3=2,51623611267254	FrameElem=24-1
ElemStation=0	
Frame=24 Station=0,04 OutputCase=INVFRE CaseType=Combination StepType=Min P=-78,1778343266401 V2=5,76369685763389 V3=0 T=0 M2=0 M3=2,25786640494248	FrameElem=24-1
ElemStation=0,04	
Frame=24 Station=0,08 OutputCase=INVFRE CaseType=Combination StepType=Min P=-78,0178343266401 V2=5,34819685763389 V3=0 T=0 M2=0 M3=2,01490025263686	FrameElem=24-1
ElemStation=0,08	
Frame=24 Station=0 OutputCase=QPE01 CaseType=Combination P=-19,2281978659445 V2=5,97337660401564 V3=0 T=0 M2=0 M3=2,0392427959148	FrameElem=24-1
ElemStation=0	
Frame=24 Station=0,04 OutputCase=QPE01 CaseType=Combination P=-19,0681978659448 V2=5,55007660401564 V3=0 T=0 M2=0 M3=1,80879973175417	FrameElem=24-1
ElemStation=0,04	
Frame=24 Station=0,08 OutputCase=QPE01 CaseType=Combination P=-18,9081978659448 V2=5,13457660401564 V3=0 T=0 M2=0 M3=1,59513266759354	FrameElem=24-1
ElemStation=0,08	
Frame=24 Station=0 OutputCase=QPE02 CaseType=Combination P=-19,2281978659445 V2=5,59026735155735 V3=0 T=0 M2=0 M3=1,72116061559632	FrameElem=24-1
ElemStation=0	
Frame=24 Station=0,04 OutputCase=QPE02 CaseType=Combination P=-19,0681978659445 V2=5,16696735155735 V3=0 T=0 M2=0 M3=1,50604192153402	FrameElem=24-1
ElemStation=0,04	

Società di Progetto
Brebemi SpA



Doc. N.
60235-0000-A00.doc

CODIFICA DOCUMENTO
04RCDII10000000000300A00

REV.
00

FOGLIO
374 di 628

Frame=24 Station=0,08 OutputCase=QPE02 CaseType=Combination P=-18,9081978659445 V2=4,75146735155735 V3=0 T=0 M2=0 M3=1,30769922747173 FrameElem=24-1 ElemStation=0,08
Frame=24 Station=0 OutputCase=QPE03 CaseType=Combination P=-19,2281978659451 V2=6,35648585647393 V3=0 T=0 M2=0 M3=2,35732497623327 FrameElem=24-1 ElemStation=0
Frame=24 Station=0,04 OutputCase=QPE03 CaseType=Combination P=-19,0681978659451 V2=5,93318585647393 V3=0 T=0 M2=0 M3=2,11155754197432 FrameElem=24-1 ElemStation=0,04
Frame=24 Station=0,08 OutputCase=QPE03 CaseType=Combination P=-18,9081978659451 V2=5,51768585647393 V3=0 T=0 M2=0 M3=1,88256610771536 FrameElem=24-1 ElemStation=0,08
Frame=24 Station=0 OutputCase=QPE04 CaseType=Combination P=-19,5460321973685 V2=6,13231619339682 V3=0 T=0 M2=0 M3=2,34625362606491 FrameElem=24-1 ElemStation=0
Frame=24 Station=0,04 OutputCase=QPE04 CaseType=Combination P=-19,3860321973685 V2=5,70901619339682 V3=0 T=0 M2=0 M3=2,10945297832904 FrameElem=24-1 ElemStation=0,04
Frame=24 Station=0,08 OutputCase=QPE04 CaseType=Combination P=-19,2260321973685 V2=5,29351619339682 V3=0 T=0 M2=0 M3=1,88942833059316 FrameElem=24-1 ElemStation=0,08
Frame=24 Station=0 OutputCase=QPE05 CaseType=Combination P=-18,9103635345212 V2=5,81443701463447 V3=0 T=0 M2=0 M3=1,73223196576468 FrameElem=24-1 ElemStation=0
Frame=24 Station=0,04 OutputCase=QPE05 CaseType=Combination P=-18,7503635345212 V2=5,39113701463446 V3=0 T=0 M2=0 M3=1,5081464851793 FrameElem=24-1 ElemStation=0,04
Frame=24 Station=0,08 OutputCase=QPE05 CaseType=Combination P=-18,5903635345212 V2=4,97563701463447 V3=0 T=0 M2=0 M3=1,30083700459392 FrameElem=24-1 ElemStation=0,08
Frame=24 Station=0 OutputCase=QPE06 CaseType=Combination P=-19,2281978659451 V2=6,35648585647393 V3=0 T=0 M2=0 M3=2,35732497623327 FrameElem=24-1 ElemStation=0
Frame=24 Station=0,04 OutputCase=QPE06 CaseType=Combination P=-19,0681978659451 V2=5,93318585647393 V3=0 T=0 M2=0 M3=2,11155754197432 FrameElem=24-1 ElemStation=0,04
Frame=24 Station=0,08 OutputCase=QPE06 CaseType=Combination P=-18,9081978659451 V2=5,51768585647393 V3=0 T=0 M2=0 M3=1,88256610771536 FrameElem=24-1 ElemStation=0,08
Frame=24 Station=0 OutputCase=QPE07 CaseType=Combination P=-19,5460321973682 V2=5,74920694093853 V3=0 T=0 M2=0 M3=2,02817144574643 FrameElem=24-1 ElemStation=0
Frame=24 Station=0,04 OutputCase=QPE07 CaseType=Combination P=-19,3860321973682 V2=5,32590694093853 V3=0 T=0 M2=0 M3=1,80669516810889 FrameElem=24-1 ElemStation=0,04
Frame=24 Station=0,08 OutputCase=QPE07 CaseType=Combination P=-19,2260321973682 V2=4,91040694093853 V3=0 T=0 M2=0 M3=1,60199489047135 FrameElem=24-1 ElemStation=0,08
Frame=24 Station=0 OutputCase=QPE08 CaseType=Combination P=-18,9103635345209 V2=5,43132776217618 V3=0 T=0 M2=0 M3=1,4141497854462 FrameElem=24-1 ElemStation=0
Frame=24 Station=0,04 OutputCase=QPE08 CaseType=Combination P=-18,7503635345209 V2=5,00802776217617 V3=0 T=0 M2=0 M3=1,20538867495916 FrameElem=24-1 ElemStation=0,04
Frame=24 Station=0,08 OutputCase=QPE08 CaseType=Combination P=-18,5903635345209 V2=4,59252776217618 V3=0 T=0 M2=0 M3=1,01340356447211 FrameElem=24-1 ElemStation=0,08
Frame=24 Station=0 OutputCase=QPE09 CaseType=Combination P=-19,2281978659448 V2=5,97337660401564 V3=0 T=0 M2=0 M3=2,0392427959148 FrameElem=24-1 ElemStation=0
Frame=24 Station=0,04 OutputCase=QPE09 CaseType=Combination P=-19,0681978659448 V2=5,55007660401564 V3=0 T=0 M2=0 M3=1,80879973175417 FrameElem=24-1 ElemStation=0,04
Frame=24 Station=0,08 OutputCase=QPE09 CaseType=Combination P=-18,9081978659448 V2=5,13457660401564 V3=0 T=0 M2=0 M3=1,59513266759354 FrameElem=24-1 ElemStation=0,08
Frame=24 Station=0 OutputCase=QPE10 CaseType=Combination P=-17,2918021320365 V2=12,6079831090613 V3=0 T=0 M2=0 M3=4,85556317058832 FrameElem=24-1 ElemStation=0
Frame=24 Station=0,04 OutputCase=QPE10 CaseType=Combination P=-17,1318021320365 V2=11,9328831090613 V3=0 T=0 M2=0 M3=4,36478651289253 FrameElem=24-1 ElemStation=0,04
Frame=24 Station=0,08 OutputCase=QPE10 CaseType=Combination P=-16,9718021320365 V2=11,2699831090613 V3=0 T=0 M2=0 M3=3,90076985519675 FrameElem=24-1 ElemStation=0,08
Frame=24 Station=0 OutputCase=QPE11 CaseType=Combination P=-17,2918021320363 V2=12,224873856603 V3=0 T=0 M2=0 M3=4,53748099026984 FrameElem=24-1 ElemStation=0
Frame=24 Station=0,04 OutputCase=QPE11 CaseType=Combination P=-17,1318021320363 V2=11,549773856603 V3=0 T=0 M2=0 M3=4,06202870267239 FrameElem=24-1 ElemStation=0,04
Frame=24 Station=0,08 OutputCase=QPE11 CaseType=Combination P=-16,9718021320363 V2=10,886873856603 V3=0 T=0 M2=0 M3=3,61333641507493 FrameElem=24-1 ElemStation=0,08
Frame=24 Station=0 OutputCase=QPE12 CaseType=Combination P=-17,2918021320368 V2=12,9910923615196 V3=0 T=0 M2=0 M3=5,1736453509068 FrameElem=24-1 ElemStation=0
Frame=24 Station=0,04 OutputCase=QPE12 CaseType=Combination P=-17,1318021320368 V2=12,3159923615196 V3=0 T=0 M2=0 M3=4,66754432311268 FrameElem=24-1 ElemStation=0,04
Frame=24 Station=0,08 OutputCase=QPE12 CaseType=Combination P=-16,9718021320368 V2=11,6530923615196 V3=0 T=0 M2=0 M3=4,18820329531856 FrameElem=24-1 ElemStation=0,08
Frame=24 Station=0 OutputCase=QPE13 CaseType=Combination P=-17,6096364634602 V2=12,7669226984425 V3=0 T=0 M2=0 M3=5,16257400073843 FrameElem=24-1 ElemStation=0
Frame=24 Station=0,04 OutputCase=QPE13 CaseType=Combination P=-17,4496364634602 V2=12,0918226984425 V3=0 T=0 M2=0 M3=4,6654397594674 FrameElem=24-1 ElemStation=0,04
Frame=24 Station=0,08 OutputCase=QPE13 CaseType=Combination P=-17,2896364634602 V2=11,4289226984425 V3=0 T=0 M2=0 M3=4,19506551819637 FrameElem=24-1 ElemStation=0,08
Frame=24 Station=0 OutputCase=QPE14 CaseType=Combination P=-16,9739678006129 V2=12,4490435196801 V3=0 T=0 M2=0 M3=4,5485523404382 FrameElem=24-1 ElemStation=0
Frame=24 Station=0,04 OutputCase=QPE14 CaseType=Combination P=-16,8139678006129 V2=11,7739435196801 V3=0 T=0 M2=0 M3=4,06413326631767 FrameElem=24-1 ElemStation=0,04
Frame=24 Station=0,08 OutputCase=QPE14 CaseType=Combination P=-16,6539678006129 V2=11,1110435196801 V3=0 T=0 M2=0 M3=3,60647419219713 FrameElem=24-1 ElemStation=0,08
Frame=24 Station=0 OutputCase=QPE15 CaseType=Combination P=-17,2918021320368 V2=12,9910923615196 V3=0 T=0 M2=0 M3=5,1736453509068 FrameElem=24-1 ElemStation=0
Frame=24 Station=0,04 OutputCase=QPE15 CaseType=Combination P=-17,1318021320368 V2=12,3159923615196 V3=0 T=0 M2=0 M3=4,66754432311268 FrameElem=24-1 ElemStation=0,04
Frame=24 Station=0,08 OutputCase=QPE15 CaseType=Combination P=-16,9718021320368 V2=11,6530923615196 V3=0 T=0 M2=0 M3=4,18820329531856 FrameElem=24-1 ElemStation=0,08
Frame=24 Station=0 OutputCase=QPE16 CaseType=Combination P=-17,6096364634599 V2=12,3838134459842 V3=0 T=0 M2=0 M3=4,84449182041995 FrameElem=24-1 ElemStation=0
Frame=24 Station=0,04 OutputCase=QPE16 CaseType=Combination P=-17,4496364634599 V2=11,7087134459842 V3=0 T=0 M2=0 M3=4,36268194924725 FrameElem=24-1 ElemStation=0,04
Frame=24 Station=0,08 OutputCase=QPE16 CaseType=Combination P=-17,2896364634599 V2=11,0458134459842 V3=0 T=0 M2=0 M3=3,90763207807455 FrameElem=24-1 ElemStation=0,08
Frame=24 Station=0 OutputCase=QPE17 CaseType=Combination P=-16,9739678006126 V2=12,0659342672218 V3=0 T=0 M2=0 M3=4,23047016011973 FrameElem=24-1 ElemStation=0

Società di Progetto
Brebemi SpA



Doc. N.
60235-0000-A00.doc

CODIFICA DOCUMENTO
04RCDII10000000000300A00

REV.
00

FOGLIO
375 di 628

Frame=24 Station=0,04 OutputCase=QPE17 CaseType=Combination P=-16,8139678006126 V2=11,3908342672218 V3=0 T=0 M2=0 M3=3,76137545609752 FrameElem=24-1 ElemStation=0,04

Frame=24 Station=0,08 OutputCase=QPE17 CaseType=Combination P=-16,6539678006126 V2=10,7279342672218 V3=0 T=0 M2=0 M3=3,31904075207531 FrameElem=24-1 ElemStation=0,08

Frame=24 Station=0 OutputCase=QPE18 CaseType=Combination P=-17,2918021320365 V2=12,6079831090613 V3=0 T=0 M2=0 M3=4,85556317058832 FrameElem=24-1 ElemStation=0

Frame=24 Station=0,04 OutputCase=QPE18 CaseType=Combination P=-17,1318021320365 V2=11,9328831090613 V3=0 T=0 M2=0 M3=4,36478651289253 FrameElem=24-1 ElemStation=0,04

Frame=24 Station=0,08 OutputCase=QPE18 CaseType=Combination P=-16,9718021320365 V2=11,2699831090613 V3=0 T=0 M2=0 M3=3,90076985519675 FrameElem=24-1 ElemStation=0,08

Frame=24 Station=0 OutputCase=INVQPE CaseType=Combination StepType=Max P=-16,9739678006126 V2=12,9910923615196 V3=0 T=0 M2=0 M3=5,1736453509068 FrameElem=24-1 ElemStation=0

Frame=24 Station=0,04 OutputCase=INVQPE CaseType=Combination StepType=Max P=-16,8139678006126 V2=12,3159923615196 V3=0 T=0 M2=0 M3=4,66754432311268 FrameElem=24-1 ElemStation=0,04

Frame=24 Station=0,08 OutputCase=INVQPE CaseType=Combination StepType=Max P=-16,6539678006126 V2=11,6530923615196 V3=0 T=0 M2=0 M3=4,19506551819637 FrameElem=24-1 ElemStation=0,08

Frame=24 Station=0 OutputCase=INVQPE CaseType=Combination StepType=Min P=-19,5460321973685 V2=5,43132776217618 V3=0 T=0 M2=0 M3=1,4141497854462 FrameElem=24-1 ElemStation=0

Frame=24 Station=0,04 OutputCase=INVQPE CaseType=Combination StepType=Min P=-19,3860321973685 V2=5,00802776217617 V3=0 T=0 M2=0 M3=1,20538867495916 FrameElem=24-1 ElemStation=0,04

Frame=24 Station=0,08 OutputCase=INVQPE CaseType=Combination StepType=Min P=-19,2260321973685 V2=4,59252776217618 V3=0 T=0 M2=0 M3=1,01340356447211 FrameElem=24-1 ElemStation=0,08

Frame=30 Station=0 OutputCase=STR001 CaseType=Combination P=-8,78598720969403 V2=-3,46625999997586 V3=0 T=0 M2=0 M3=2,65927504166647 FrameElem=30-1 ElemStation=0

Frame=30 Station=0,0917 OutputCase=STR001 CaseType=Combination P=-8,78598720969403 V2=-1,73312999997586 V3=0 T=0 M2=0 M3=2,89766707316426 FrameElem=30-1 ElemStation=0,0917

Frame=30 Station=0,1834 OutputCase=STR001 CaseType=Combination P=-8,78598720969403 V2=2,4136248553509E-11 V3=0 T=0 M2=0 M3=2,97713108366204 FrameElem=30-1 ElemStation=0,1834

Frame=30 Station=0 OutputCase=STR002 CaseType=Combination P=-3,67738409966933 V2=-3,46625999997159 V3=0 T=0 M2=0 M3=3,4994567333457 FrameElem=30-1 ElemStation=0

Frame=30 Station=0,0917 OutputCase=STR002 CaseType=Combination P=-3,67738409966933 V2=-1,73312999997159 V3=0 T=0 M2=0 M3=3,7378487648431 FrameElem=30-1 ElemStation=0,0917

Frame=30 Station=0,1834 OutputCase=STR002 CaseType=Combination P=-3,67738409966933 V2=2,84108292447627E-11 V3=0 T=0 M2=0 M3=3,81731277534049 FrameElem=30-1 ElemStation=0,1834

Frame=30 Station=0 OutputCase=STR003 CaseType=Combination P=-4,97357719549106 V2=-27,2349000002916 V3=0 T=0 M2=0 M3=30,7282022836396 FrameElem=30-1 ElemStation=0

Frame=30 Station=0,0917 OutputCase=STR003 CaseType=Combination P=-4,97357719549106 V2=-13,6174500002916 V3=0 T=0 M2=0 M3=32,6012825311664 FrameElem=30-1 ElemStation=0,0917

Frame=30 Station=0,1834 OutputCase=STR003 CaseType=Combination P=-4,97357719549106 V2=-2,91599688839739E-10 V3=0 T=0 M2=0 M3=33,2256426136931 FrameElem=30-1 ElemStation=0,1834

Frame=30 Station=0 OutputCase=STR004 CaseType=Combination P=-21,71448057335 V2=-14,0531184157143 V3=0 T=0 M2=0 M3=30,8278332682928 FrameElem=30-1 ElemStation=0

Frame=30 Station=0,0917 OutputCase=STR004 CaseType=Combination P=-21,71448057335 V2=-0,435668415714288 V3=0 T=0 M2=0 M3=31,4921441445138 FrameElem=30-1 ElemStation=0,0917

Frame=30 Station=0,1834 OutputCase=STR004 CaseType=Combination P=-21,71448057335 V2=13,1817815842857 V3=0 T=0 M2=0 M3=30,9077348557348 FrameElem=30-1 ElemStation=0,1834

Frame=30 Station=0 OutputCase=STR005 CaseType=Combination P=-38,4553839515349 V2=-27,2349000002664 V3=0 T=0 M2=0 M3=26,092386768289 FrameElem=30-1 ElemStation=0

Frame=30 Station=0,0917 OutputCase=STR005 CaseType=Combination P=-38,4553839515349 V2=-13,6174500002664 V3=0 T=0 M2=0 M3=27,9654670158134 FrameElem=30-1 ElemStation=0,0917

Frame=30 Station=0,1834 OutputCase=STR005 CaseType=Combination P=-38,4553839515349 V2=-2,66405564275374E-10 V3=0 T=0 M2=0 M3=28,5898270983378 FrameElem=30-1 ElemStation=0,1834

Frame=30 Station=0 OutputCase=STR006 CaseType=Combination P=-20,6153684927634 V2=10,6141815845988 V3=0 T=0 M2=0 M3=2,50274847239657 FrameElem=30-1 ElemStation=0

Frame=30 Station=0,0917 OutputCase=STR006 CaseType=Combination P=-20,6153684927634 V2=11,8979815845988 V3=0 T=0 M2=0 M3=1,47056579108886 FrameElem=30-1 ElemStation=0,0917

Frame=30 Station=0,1834 OutputCase=STR006 CaseType=Combination P=-20,6153684927634 V2=13,1817815845988 V3=0 T=0 M2=0 M3=0,320658649781144 FrameElem=30-1 ElemStation=0,1834

Frame=30 Station=0 OutputCase=STR007 CaseType=Combination P=-37,3562718709483 V2=-2,56759999995329 V3=0 T=0 M2=0 M3=-2,23269802760726 FrameElem=30-1 ElemStation=0

Frame=30 Station=0,0917 OutputCase=STR007 CaseType=Combination P=-37,3562718709483 V2=-1,28379999995329 V3=0 T=0 M2=0 M3=-2,05611133761154 FrameElem=30-1 ElemStation=0,0917

Frame=30 Station=0,1834 OutputCase=STR007 CaseType=Combination P=-37,3562718709483 V2=4,67093030920296E-11 V3=0 T=0 M2=0 M3=-1,99724910761583 FrameElem=30-1 ElemStation=0,1834

Frame=30 Station=0 OutputCase=STR008 CaseType=Combination P=-13,7090288407639 V2=8,43308502267464 V3=0 T=0 M2=0 M3=27,5292786751552 FrameElem=30-1 ElemStation=0

Frame=30 Station=0,0917 OutputCase=STR008 CaseType=Combination P=-15,7764053407639 V2=19,0794550226746 V3=0 T=0 M2=0 M3=26,2678287140759 FrameElem=30-1 ElemStation=0,0917

Frame=30 Station=0,1834 OutputCase=STR008 CaseType=Combination P=-17,8437818407639 V2=29,7258250226746 V3=0 T=0 M2=0 M3=24,0301066239966 FrameElem=30-1 ElemStation=0,1834

Frame=30 Station=0 OutputCase=STR009 CaseType=Combination P=-9,70544941559243 V2=-3,46625999997586 V3=0 T=0 M2=0 M3=1,89636501263694 FrameElem=30-1 ElemStation=0

Frame=30 Station=0,0917 OutputCase=STR009 CaseType=Combination P=-9,70544941559243 V2=-1,73312999997586 V3=0 T=0 M2=0 M3=2,1347570441347 FrameElem=30-1 ElemStation=0,0917

Frame=30 Station=0,1834 OutputCase=STR009 CaseType=Combination P=-9,70544941559243 V2=2,44005704530537E-11 V3=0 T=0 M2=0 M3=2,21422105463246 FrameElem=30-1 ElemStation=0,1834

Frame=30 Station=0 OutputCase=STR010 CaseType=Combination P=-4,59684630556772 V2=-3,46625999997133 V3=0 T=0 M2=0 M3=2,73654670431617 FrameElem=30-1 ElemStation=0

Frame=30 Station=0,0917 OutputCase=STR010 CaseType=Combination P=-4,59684630556772 V2=-1,73312999997133 V3=0 T=0 M2=0 M3=2,97493873581354 FrameElem=30-1 ElemStation=0,0917

Frame=30 Station=0,1834 OutputCase=STR010 CaseType=Combination P=-4,59684630556772 V2=2,86751511424654E-11 V3=0 T=0 M2=0 M3=3,05440274631091 FrameElem=30-1 ElemStation=0,1834

Frame=30 Station=0 OutputCase=STR011 CaseType=Combination P=-5,52525451903009 V2=-27,2349000002914 V3=0 T=0 M2=0 M3=30,2704562662219 FrameElem=30-1 ElemStation=0

Frame=30 Station=0,0917 OutputCase=STR011 CaseType=Combination P=-5,52525451903009 V2=-13,6174500002914 V3=0 T=0 M2=0 M3=32,1435365137486 FrameElem=30-1 ElemStation=0,0917

Frame=30 Station=0,1834 OutputCase=STR011 CaseType=Combination P=-5,52525451903009 V2=-2,91441095701117E-10 V3=0 T=0 M2=0 M3=32,7678965962754 FrameElem=30-1 ElemStation=0,1834

Società di Progetto
Brebemi SpA



Doc. N.
60235-0000-A00.doc

CODIFICA DOCUMENTO
04RCDII10000000000300A00

REV.
00

FOGLIO
376 di 628

Frame=30 Station=0 OutputCase=STR012 CaseType=Combination P=-22,266157896889 V2=-14,0531184157141 V3=0 T=0 M2=0 M3=30,3700872508751 FrameElem=30-1 ElemStation=0
Frame=30 Station=0,0917 OutputCase=STR012 CaseType=Combination P=-22,266157896889 V2=-0,435668415714129 V3=0 T=0 M2=0 M3=31,0343981270961 FrameElem=30-1 ElemStation=0,0917
Frame=30 Station=0,1834 OutputCase=STR012 CaseType=Combination P=-22,266157896889 V2=13,1817815842859 V3=0 T=0 M2=0 M3=30,4499888383171 FrameElem=30-1 ElemStation=0,1834
Frame=30 Station=0 OutputCase=STR013 CaseType=Combination P=-39,0070612750739 V2=-27,2349000002662 V3=0 T=0 M2=0 M3=25,6346407508713 FrameElem=30-1 ElemStation=0
Frame=30 Station=0,0917 OutputCase=STR013 CaseType=Combination P=-39,0070612750739 V2=-13,6174500002662 V3=0 T=0 M2=0 M3=27,5077209983957 FrameElem=30-1 ElemStation=0,0917
Frame=30 Station=0,1834 OutputCase=STR013 CaseType=Combination P=-39,0070612750739 V2=-2,66246971136752E-10 V3=0 T=0 M2=0 M3=28,1320810809201 FrameElem=30-1 ElemStation=0,1834
Frame=30 Station=0 OutputCase=STR014 CaseType=Combination P=-21,1670458163024 V2=10,614181584599 V3=0 T=0 M2=0 M3=2,04500245497885 FrameElem=30-1 ElemStation=0
Frame=30 Station=0,0917 OutputCase=STR014 CaseType=Combination P=-21,1670458163024 V2=11,897981584599 V3=0 T=0 M2=0 M3=1,01281977367112 FrameElem=30-1 ElemStation=0,0917
Frame=30 Station=0,1834 OutputCase=STR014 CaseType=Combination P=-21,1670458163024 V2=13,181781584599 V3=0 T=0 M2=0 M3=-0,137087367636605 FrameElem=30-1 ElemStation=0,1834
Frame=30 Station=0 OutputCase=STR015 CaseType=Combination P=-37,9079491944873 V2=-2,56759999995313 V3=0 T=0 M2=0 M3=-2,69044404502498 FrameElem=30-1 ElemStation=0
Frame=30 Station=0,0917 OutputCase=STR015 CaseType=Combination P=-37,9079491944873 V2=-1,28379999995313 V3=0 T=0 M2=0 M3=-2,51385735502928 FrameElem=30-1 ElemStation=0,0917
Frame=30 Station=0,1834 OutputCase=STR015 CaseType=Combination P=-37,9079491944873 V2=4,68678962306512E-11 V3=0 T=0 M2=0 M3=-2,45499512503357 FrameElem=30-1 ElemStation=0,1834
Frame=30 Station=0 OutputCase=STR016 CaseType=Combination P=-14,2607061643029 V2=8,4330850226748 V3=0 T=0 M2=0 M3=27,0715326577375 FrameElem=30-1 ElemStation=0
Frame=30 Station=0,0917 OutputCase=STR016 CaseType=Combination P=-16,3280826643029 V2=19,0794550226748 V3=0 T=0 M2=0 M3=25,8100826966582 FrameElem=30-1 ElemStation=0,0917
Frame=30 Station=0,1834 OutputCase=STR016 CaseType=Combination P=-18,3954591643029 V2=29,7258250226748 V3=0 T=0 M2=0 M3=23,5723606065789 FrameElem=30-1 ElemStation=0,1834
Frame=30 Station=0 OutputCase=STR017 CaseType=Combination P=-5,56899112743402 V2=-21,2927400002113 V3=0 T=0 M2=0 M3=23,1581058670366 FrameElem=30-1 ElemStation=0
Frame=30 Station=0,0917 OutputCase=STR017 CaseType=Combination P=-5,56899112743402 V2=-10,6463700002113 V3=0 T=0 M2=0 M3=24,622514060556 FrameElem=30-1 ElemStation=0,0917
Frame=30 Station=0,1834 OutputCase=STR017 CaseType=Combination P=-5,56899112743402 V2=-2,11332737420911E-10 V3=0 T=0 M2=0 M3=25,1106501250754 FrameElem=30-1 ElemStation=0,1834
Frame=30 Station=0 OutputCase=STR018 CaseType=Combination P=-18,7632440495406 V2=-10,9368277668408 V3=0 T=0 M2=0 M3=23,2139266406947 FrameElem=30-1 ElemStation=0
Frame=30 Station=0,0917 OutputCase=STR018 CaseType=Combination P=-18,7632440495406 V2=-0,290457766840822 V3=0 T=0 M2=0 M3=23,728697682414 FrameElem=30-1 ElemStation=0,0917
Frame=30 Station=0,1834 OutputCase=STR018 CaseType=Combination P=-18,7632440495406 V2=10,3559122331592 V3=0 T=0 M2=0 M3=23,2671965951333 FrameElem=30-1 ElemStation=0,1834
Frame=30 Station=0 OutputCase=STR019 CaseType=Combination P=-31,9574969719731 V2=-21,2927400001935 V3=0 T=0 M2=0 M3=19,4711988076038 FrameElem=30-1 ElemStation=0
Frame=30 Station=0,0917 OutputCase=STR019 CaseType=Combination P=-31,9574969719731 V2=-10,6463700001935 V3=0 T=0 M2=0 M3=20,9356070011216 FrameElem=30-1 ElemStation=0,0917
Frame=30 Station=0,1834 OutputCase=STR019 CaseType=Combination P=-31,9574969719731 V2=-1,93506011214595E-10 V3=0 T=0 M2=0 M3=21,4237430656393 FrameElem=30-1 ElemStation=0,1834
Frame=30 Station=0 OutputCase=STR020 CaseType=Combination P=-17,9881802429094 V2=7,78831223339229 V3=0 T=0 M2=0 M3=1,69602823237197 FrameElem=30-1 ElemStation=0
Frame=30 Station=0,0917 OutputCase=STR020 CaseType=Combination P=-17,9881802429094 V2=9,07211223339229 V3=0 T=0 M2=0 M3=0,92297770569894 FrameElem=30-1 ElemStation=0,0917
Frame=30 Station=0,1834 OutputCase=STR020 CaseType=Combination P=-17,9881802429094 V2=10,3559122333923 V3=0 T=0 M2=0 M3=3,22028487678211E-02 FrameElem=30-1 ElemStation=0,1834
Frame=30 Station=0 OutputCase=STR021 CaseType=Combination P=-31,1824331653419 V2=-2,56759999996039 V3=0 T=0 M2=0 M3=-2,04669960071894 FrameElem=30-1 ElemStation=0
Frame=30 Station=0,0917 OutputCase=STR021 CaseType=Combination P=-31,1824331653419 V2=-1,28379999996039 V3=0 T=0 M2=0 M3=-1,87011291072257 FrameElem=30-1 ElemStation=0,0917
Frame=30 Station=0,1834 OutputCase=STR021 CaseType=Combination P=-31,1824331653419 V2=3,96088495335789E-11 V3=0 T=0 M2=0 M3=-1,8112506807262 FrameElem=30-1 ElemStation=0,1834
Frame=30 Station=0 OutputCase=STR022 CaseType=Combination P=-9,47657640688355 V2=-3,92394143722549 V3=0 T=0 M2=0 M3=2,13013542900331 FrameElem=30-1 ElemStation=0
Frame=30 Station=0,0917 OutputCase=STR022 CaseType=Combination P=-9,47657640688355 V2=-2,19081143722549 V3=0 T=0 M2=0 M3=2,41049684829688 FrameElem=30-1 ElemStation=0,0917
Frame=30 Station=0,1834 OutputCase=STR022 CaseType=Combination P=-9,47657640688355 V2=-0,457681437225488 V3=0 T=0 M2=0 M3=2,53193024659046 FrameElem=30-1 ElemStation=0,1834
Frame=30 Station=0 OutputCase=STR023 CaseType=Combination P=-4,36797329685885 V2=-3,92394143722121 V3=0 T=0 M2=0 M3=2,97031712068254 FrameElem=30-1 ElemStation=0
Frame=30 Station=0,0917 OutputCase=STR023 CaseType=Combination P=-4,36797329685885 V2=-2,19081143722121 V3=0 T=0 M2=0 M3=3,25067853997573 FrameElem=30-1 ElemStation=0,0917
Frame=30 Station=0,1834 OutputCase=STR023 CaseType=Combination P=-4,36797329685885 V2=-0,457681437221213 V3=0 T=0 M2=0 M3=3,37211193826891 FrameElem=30-1 ElemStation=0,1834
Frame=30 Station=0 OutputCase=STR024 CaseType=Combination P=-5,34011811872514 V2=-21,7504214374612 V3=0 T=0 M2=0 M3=23,391876283403 FrameElem=30-1 ElemStation=0
Frame=30 Station=0,0917 OutputCase=STR024 CaseType=Combination P=-5,34011811872514 V2=-11,1040514374612 V3=0 T=0 M2=0 M3=24,8982538647182 FrameElem=30-1 ElemStation=0,0917
Frame=30 Station=0,1834 OutputCase=STR024 CaseType=Combination P=-5,34011811872514 V2=-0,457681437461221 V3=0 T=0 M2=0 M3=25,4283593170334 FrameElem=30-1 ElemStation=0,1834
Frame=30 Station=0 OutputCase=STR025 CaseType=Combination P=-18,5343710408317 V2=-11,3945092040907 V3=0 T=0 M2=0 M3=23,4476970570611 FrameElem=30-1 ElemStation=0
Frame=30 Station=0,0917 OutputCase=STR025 CaseType=Combination P=-18,5343710408317 V2=-0,74813920409071 V3=0 T=0 M2=0 M3=24,0044374865762 FrameElem=30-1 ElemStation=0,0917
Frame=30 Station=0,1834 OutputCase=STR025 CaseType=Combination P=-18,5343710408317 V2=9,89823079590929 V3=0 T=0 M2=0 M3=23,5849057870913 FrameElem=30-1 ElemStation=0,1834
Frame=30 Station=0 OutputCase=STR026 CaseType=Combination P=-31,7286239632642 V2=-21,7504214374434 V3=0 T=0 M2=0 M3=19,7049692239702 FrameElem=30-1 ElemStation=0
Frame=30 Station=0,0917 OutputCase=STR026 CaseType=Combination P=-31,7286239632642 V2=-11,1040514374434 V3=0 T=0 M2=0 M3=21,2113468052837 FrameElem=30-1 ElemStation=0,0917

Società di Progetto
Brebemi SpA

APPROVATO SDP



Doc. N.
60235-0000-A00.doc

CODIFICA DOCUMENTO
04RCDII10000000000300A00

REV.
00

FOGLIO
377 di 628

Frame=30 Station=0,1834 OutputCase=STR026 CaseType=Combination P=-31,7286239632642 V2=-0,457681437443394 V3=0 T=0 M2=0 M3=21,7414522575973
FrameElem=30-1 ElemStation=0,1834
Frame=30 Station=0 OutputCase=STR027 CaseType=Combination P=-17,7593072342005 V2=7,3306307961424 V3=0 T=0 M2=0 M3=1,92979864873834 FrameElem=30-1
ElemStation=0
Frame=30 Station=0,0917 OutputCase=STR027 CaseType=Combination P=-17,7593072342005 V2=8,6144307961424 V3=0 T=0 M2=0 M3=1,19871757473208 FrameElem=30-1
ElemStation=0,0917
Frame=30 Station=0,1834 OutputCase=STR027 CaseType=Combination P=-17,7593072342005 V2=9,8982307961424 V3=0 T=0 M2=0 M3=0,349912040725822 FrameElem=30-1
ElemStation=0,1834
Frame=30 Station=0 OutputCase=STR028 CaseType=Combination P=-30,953560156633 V2=-3,02528143721028 V3=0 T=0 M2=0 M3=-1,81292918435256 FrameElem=30-1
ElemStation=0
Frame=30 Station=0,0917 OutputCase=STR028 CaseType=Combination P=-30,953560156633 V2=-1,74148143721028 V3=0 T=0 M2=0 M3=-1,59437310656038
FrameElem=30-1 ElemStation=0,0917
Frame=30 Station=0,1834 OutputCase=STR028 CaseType=Combination P=-30,953560156633 V2=-0,457681437210279 V3=0 T=0 M2=0 M3=-1,4935414887682
FrameElem=30-1 ElemStation=0,1834
Frame=30 Station=0 OutputCase=STR029 CaseType=Combination P=-9,9343224243013 V2=-3,00857856272571 V3=0 T=0 M2=0 M3=1,66259459627056 FrameElem=30-1
ElemStation=0
Frame=30 Station=0,0917 OutputCase=STR029 CaseType=Combination P=-9,9343224243013 V2=-1,27544856272571 V3=0 T=0 M2=0 M3=1,85901723997251 FrameElem=30-1
ElemStation=0,0917
Frame=30 Station=0,1834 OutputCase=STR029 CaseType=Combination P=-9,9343224243013 V2=0,457681437274289 V3=0 T=0 M2=0 M3=1,89651186267446 FrameElem=30-1
ElemStation=0,1834
Frame=30 Station=0 OutputCase=STR030 CaseType=Combination P=-4,8257193142766 V2=-3,00857856272144 V3=0 T=0 M2=0 M3=2,5027762879498 FrameElem=30-1
ElemStation=0
Frame=30 Station=0,0917 OutputCase=STR030 CaseType=Combination P=-4,8257193142766 V2=-1,27544856272144 V3=0 T=0 M2=0 M3=2,69919893165136 FrameElem=30-1
ElemStation=0,0917
Frame=30 Station=0,1834 OutputCase=STR030 CaseType=Combination P=-4,8257193142766 V2=0,457681437278563 V3=0 T=0 M2=0 M3=2,73669355435291 FrameElem=30-1
ElemStation=0,1834
Frame=30 Station=0 OutputCase=STR031 CaseType=Combination P=-5,79786413614289 V2=-20,8350585629614 V3=0 T=0 M2=0 M3=22,9243354506702 FrameElem=30-1
ElemStation=0
Frame=30 Station=0,0917 OutputCase=STR031 CaseType=Combination P=-5,79786413614289 V2=-10,1886885629614 V3=0 T=0 M2=0 M3=24,3467742563938
FrameElem=30-1 ElemStation=0,0917
Frame=30 Station=0,1834 OutputCase=STR031 CaseType=Combination P=-5,79786413614289 V2=0,457681437038555 V3=0 T=0 M2=0 M3=24,7929409331174
FrameElem=30-1 ElemStation=0,1834
Frame=30 Station=0 OutputCase=STR032 CaseType=Combination P=-18,9921170582494 V2=-10,4791463295909 V3=0 T=0 M2=0 M3=22,9801562243283 FrameElem=30-1
ElemStation=0
Frame=30 Station=0,0917 OutputCase=STR032 CaseType=Combination P=-18,9921170582494 V2=0,167223670409066 V3=0 T=0 M2=0 M3=23,4529578782518
FrameElem=30-1 ElemStation=0,0917
Frame=30 Station=0,1834 OutputCase=STR032 CaseType=Combination P=-18,9921170582494 V2=10,8135936704091 V3=0 T=0 M2=0 M3=22,9494874031753 FrameElem=30-1
ElemStation=0,1834
Frame=30 Station=0 OutputCase=STR033 CaseType=Combination P=-32,1863699806819 V2=-20,8350585629436 V3=0 T=0 M2=0 M3=19,2374283912374 FrameElem=30-1
ElemStation=0
Frame=30 Station=0,0917 OutputCase=STR033 CaseType=Combination P=-32,1863699806819 V2=-10,1886885629436 V3=0 T=0 M2=0 M3=20,6598671969594
FrameElem=30-1 ElemStation=0,0917
Frame=30 Station=0,1834 OutputCase=STR033 CaseType=Combination P=-32,1863699806819 V2=0,457681437056382 V3=0 T=0 M2=0 M3=21,1060338736813
FrameElem=30-1 ElemStation=0,1834
Frame=30 Station=0 OutputCase=STR034 CaseType=Combination P=-18,2170532516183 V2=8,24599367064218 V3=0 T=0 M2=0 M3=1,4622578160056 FrameElem=30-1
ElemStation=0
Frame=30 Station=0,0917 OutputCase=STR034 CaseType=Combination P=-18,2170532516183 V2=9,52979367064218 V3=0 T=0 M2=0 M3=0,647237966407708
FrameElem=30-1 ElemStation=0,0917
Frame=30 Station=0,1834 OutputCase=STR034 CaseType=Combination P=-18,2170532516183 V2=10,8135936706422 V3=0 T=0 M2=0 M3=-0,28550634319018
FrameElem=30-1 ElemStation=0,1834
Frame=30 Station=0 OutputCase=STR035 CaseType=Combination P=-31,4113061740508 V2=-2,1099185627105 V3=0 T=0 M2=0 M3=-2,28047001708531 FrameElem=30-1
ElemStation=0
Frame=30 Station=0,0917 OutputCase=STR035 CaseType=Combination P=-31,4113061740508 V2=-0,826118562710504 V3=0 T=0 M2=0 M3=-2,14585271488475
FrameElem=30-1 ElemStation=0,0917
Frame=30 Station=0,1834 OutputCase=STR035 CaseType=Combination P=-31,4113061740508 V2=0,457681437289497 V3=0 T=0 M2=0 M3=-2,1289598726842
FrameElem=30-1 ElemStation=0,1834
Frame=30 Station=0 OutputCase=STR036 CaseType=Combination P=-9,15377209205339 V2=-3,46625999997576 V3=0 T=0 M2=0 M3=2,35411103005466 FrameElem=30-1
ElemStation=0
Frame=30 Station=0,0917 OutputCase=STR036 CaseType=Combination P=-9,15377209205339 V2=-1,73312999997576 V3=0 T=0 M2=0 M3=2,59250306155243
FrameElem=30-1 ElemStation=0,0917
Frame=30 Station=0,1834 OutputCase=STR036 CaseType=Combination P=-9,15377209205339 V2=2,4241977314432E-11 V3=0 T=0 M2=0 M3=2,67196707205021
FrameElem=30-1 ElemStation=0,1834
Frame=30 Station=0 OutputCase=STR037 CaseType=Combination P=-4,04516898202868 V2=-3,46625999997148 V3=0 T=0 M2=0 M3=3,19429272173389 FrameElem=30-1
ElemStation=0
Frame=30 Station=0,0917 OutputCase=STR037 CaseType=Combination P=-4,04516898202868 V2=-1,73312999997148 V3=0 T=0 M2=0 M3=3,43268475323128
FrameElem=30-1 ElemStation=0,0917
Frame=30 Station=0,1834 OutputCase=STR037 CaseType=Combination P=-4,04516898202868 V2=2,85165580038438E-11 V3=0 T=0 M2=0 M3=3,51214876372866
FrameElem=30-1 ElemStation=0,1834
Frame=30 Station=0 OutputCase=STR038 CaseType=Combination P=-5,01731380389498 V2=-21,2927400002115 V3=0 T=0 M2=0 M3=23,6158518844543 FrameElem=30-1
ElemStation=0
Frame=30 Station=0,0917 OutputCase=STR038 CaseType=Combination P=-5,01731380389498 V2=-10,6463700002115 V3=0 T=0 M2=0 M3=25,0802600779737
FrameElem=30-1 ElemStation=0,0917
Frame=30 Station=0,1834 OutputCase=STR038 CaseType=Combination P=-5,01731380389498 V2=-2,11491330559532E-10 V3=0 T=0 M2=0 M3=25,5683961424931
FrameElem=30-1 ElemStation=0,1834
Frame=30 Station=0 OutputCase=STR039 CaseType=Combination P=-18,2115667260015 V2=-10,936827766841 V3=0 T=0 M2=0 M3=23,6716726581124 FrameElem=30-1
ElemStation=0
Frame=30 Station=0,0917 OutputCase=STR039 CaseType=Combination P=-18,2115667260015 V2=-0,290457766840981 V3=0 T=0 M2=0 M3=24,1864436998318
FrameElem=30-1 ElemStation=0,0917
Frame=30 Station=0,1834 OutputCase=STR039 CaseType=Combination P=-18,2115667260015 V2=10,355912233159 V3=0 T=0 M2=0 M3=23,7249426125511 FrameElem=30-1
ElemStation=0,1834
Frame=30 Station=0 OutputCase=STR040 CaseType=Combination P=-31,405819648434 V2=-21,2927400001937 V3=0 T=0 M2=0 M3=19,9289448250215 FrameElem=30-1
ElemStation=0
Frame=30 Station=0,0917 OutputCase=STR040 CaseType=Combination P=-31,405819648434 V2=-10,6463700001937 V3=0 T=0 M2=0 M3=21,3933530185393 FrameElem=30-1
ElemStation=0,0917
Frame=30 Station=0,1834 OutputCase=STR040 CaseType=Combination P=-31,405819648434 V2=-1,93664604353216E-10 V3=0 T=0 M2=0 M3=21,881489083057
FrameElem=30-1 ElemStation=0,1834
Frame=30 Station=0 OutputCase=STR041 CaseType=Combination P=-17,4365029193704 V2=7,78831223339213 V3=0 T=0 M2=0 M3=2,15377424978969 FrameElem=30-1
ElemStation=0

APPROVATO S.D.P.
Società di Progetto
Brebemi SpA



Doc. N.
60235-0000-A00.doc

CODIFICA DOCUMENTO
04RCDII10000000000300A00

REV.
00

FOGLIO
378 di 628

Frame=30 Station=0,0917 OutputCase=STR041 CaseType=Combination P=-17,4365029193704 V2=9,07211223339213 V3=0 T=0 M2=0 M3=1,38072378798763 FrameElem=30-1 ElemStation=0,0917
Frame=30 Station=0,1834 OutputCase=STR041 CaseType=Combination P=-17,4365029193704 V2=10,3559122333921 V3=0 T=0 M2=0 M3=0,48994886618557 FrameElem=30-1 ElemStation=0,1834
Frame=30 Station=0 OutputCase=STR042 CaseType=Combination P=-30,6307558418029 V2=-2,56759999996055 V3=0 T=0 M2=0 M3=-1,58895358330122 FrameElem=30-1 ElemStation=0
Frame=30 Station=0,0917 OutputCase=STR042 CaseType=Combination P=-30,6307558418029 V2=-1,28379999996055 V3=0 T=0 M2=0 M3=-1,41236689330483 FrameElem=30-1 ElemStation=0,0917
Frame=30 Station=0,1834 OutputCase=STR042 CaseType=Combination P=-30,6307558418029 V2=3,94502563949573E-11 V3=0 T=0 M2=0 M3=-1,35350466330845 FrameElem=30-1 ElemStation=0,1834
Frame=30 Station=0 OutputCase=STR043 CaseType=Combination P=-7,86652500379564 V2=-3,46625999997613 V3=0 T=0 M2=0 M3=3,422185070696 FrameElem=30-1 ElemStation=0
Frame=30 Station=0,0917 OutputCase=STR043 CaseType=Combination P=-7,86652500379564 V2=-1,73312999997613 V3=0 T=0 M2=0 M3=3,66057710219381 FrameElem=30-1 ElemStation=0,0917
Frame=30 Station=0,1834 OutputCase=STR043 CaseType=Combination P=-7,86652500379564 V2=2,38719266576481E-11 V3=0 T=0 M2=0 M3=3,74004111269162 FrameElem=30-1 ElemStation=0,1834
Frame=30 Station=0 OutputCase=STR044 CaseType=Combination P=-2,75792189377093 V2=-3,46625999997185 V3=0 T=0 M2=0 M3=4,26236676237524 FrameElem=30-1 ElemStation=0
Frame=30 Station=0,0917 OutputCase=STR044 CaseType=Combination P=-2,75792189377093 V2=-1,73312999997185 V3=0 T=0 M2=0 M3=4,50075879387266 FrameElem=30-1 ElemStation=0,0917
Frame=30 Station=0,1834 OutputCase=STR044 CaseType=Combination P=-2,75792189377093 V2=2,81465073470599E-11 V3=0 T=0 M2=0 M3=4,58022280437007 FrameElem=30-1 ElemStation=0,1834
Frame=30 Station=0 OutputCase=STR045 CaseType=Combination P=-4,42189987195202 V2=-27,2349000002918 V3=0 T=0 M2=0 M3=31,1859483010574 FrameElem=30-1 ElemStation=0
Frame=30 Station=0,0917 OutputCase=STR045 CaseType=Combination P=-4,42189987195202 V2=-13,6174500002918 V3=0 T=0 M2=0 M3=33,0590285485841 FrameElem=30-1 ElemStation=0,0917
Frame=30 Station=0,1834 OutputCase=STR045 CaseType=Combination P=-4,42189987195202 V2=-2,9175828197836E-10 V3=0 T=0 M2=0 M3=33,6833886311109 FrameElem=30-1 ElemStation=0,1834
Frame=30 Station=0 OutputCase=STR046 CaseType=Combination P=-21,1628032498109 V2=-14,0531184157144 V3=0 T=0 M2=0 M3=31,2855792857105 FrameElem=30-1 ElemStation=0
Frame=30 Station=0,0917 OutputCase=STR046 CaseType=Combination P=-21,1628032498109 V2=-0,435668415714444 V3=0 T=0 M2=0 M3=31,9498901619315 FrameElem=30-1 ElemStation=0,0917
Frame=30 Station=0,1834 OutputCase=STR046 CaseType=Combination P=-21,1628032498109 V2=13,1817815842856 V3=0 T=0 M2=0 M3=31,3654808731526 FrameElem=30-1 ElemStation=0,1834
Frame=30 Station=0 OutputCase=STR047 CaseType=Combination P=-37,9037066279958 V2=-27,2349000002666 V3=0 T=0 M2=0 M3=26,5501327857067 FrameElem=30-1 ElemStation=0
Frame=30 Station=0,0917 OutputCase=STR047 CaseType=Combination P=-37,9037066279958 V2=-13,6174500002666 V3=0 T=0 M2=0 M3=28,4232130332311 FrameElem=30-1 ElemStation=0,0917
Frame=30 Station=0,1834 OutputCase=STR047 CaseType=Combination P=-37,9037066279958 V2=-2,66564157413995E-10 V3=0 T=0 M2=0 M3=29,0475731157556 FrameElem=30-1 ElemStation=0,1834
Frame=30 Station=0 OutputCase=STR048 CaseType=Combination P=-20,0636911692243 V2=10,6141815845987 V3=0 T=0 M2=0 M3=2,96049448981429 FrameElem=30-1 ElemStation=0
Frame=30 Station=0,0917 OutputCase=STR048 CaseType=Combination P=-20,0636911692243 V2=11,8979815845987 V3=0 T=0 M2=0 M3=1,92831180850659 FrameElem=30-1 ElemStation=0,0917
Frame=30 Station=0,1834 OutputCase=STR048 CaseType=Combination P=-20,0636911692243 V2=13,1817815845987 V3=0 T=0 M2=0 M3=0,778404667198893 FrameElem=30-1 ElemStation=0,1834
Frame=30 Station=0 OutputCase=STR049 CaseType=Combination P=-36,8045945474092 V2=-2,56759999995345 V3=0 T=0 M2=0 M3=-1,77495201018954 FrameElem=30-1 ElemStation=0
Frame=30 Station=0,0917 OutputCase=STR049 CaseType=Combination P=-36,8045945474092 V2=-1,28379999995345 V3=0 T=0 M2=0 M3=-1,59836532019381 FrameElem=30-1 ElemStation=0,0917
Frame=30 Station=0,1834 OutputCase=STR049 CaseType=Combination P=-36,8045945474092 V2=4,65507099534079E-11 V3=0 T=0 M2=0 M3=-1,53950309019808 FrameElem=30-1 ElemStation=0,1834
Frame=30 Station=0 OutputCase=STR050 CaseType=Combination P=-13,1573515172248 V2=8,43308502267448 V3=0 T=0 M2=0 M3=27,9870246925729 FrameElem=30-1 ElemStation=0
Frame=30 Station=0,0917 OutputCase=STR050 CaseType=Combination P=-15,2247280172248 V2=19,0794550226745 V3=0 T=0 M2=0 M3=26,7255747314936 FrameElem=30-1 ElemStation=0,0917
Frame=30 Station=0,1834 OutputCase=STR050 CaseType=Combination P=-17,2921045172249 V2=29,7258250226745 V3=0 T=0 M2=0 M3=24,4878526414144 FrameElem=30-1 ElemStation=0,1834
Frame=30 Station=0 OutputCase=STR051 CaseType=Combination P=-3,73006671563723 V2=-21,2927400002119 V3=0 T=0 M2=0 M3=24,6839259250957 FrameElem=30-1 ElemStation=0
Frame=30 Station=0,0917 OutputCase=STR051 CaseType=Combination P=-3,73006671563723 V2=-10,6463700002119 V3=0 T=0 M2=0 M3=26,1483341186151 FrameElem=30-1 ElemStation=0,0917
Frame=30 Station=0,1834 OutputCase=STR051 CaseType=Combination P=-3,73006671563723 V2=-2,11861381216316E-10 V3=0 T=0 M2=0 M3=26,6364701831345 FrameElem=30-1 ElemStation=0,1834
Frame=30 Station=0 OutputCase=STR052 CaseType=Combination P=-16,9243196377438 V2=-10,9368277668414 V3=0 T=0 M2=0 M3=24,7397466987538 FrameElem=30-1 ElemStation=0
Frame=30 Station=0,0917 OutputCase=STR052 CaseType=Combination P=-16,9243196377438 V2=-0,290457766841351 V3=0 T=0 M2=0 M3=25,2545177404731 FrameElem=30-1 ElemStation=0,0917
Frame=30 Station=0,1834 OutputCase=STR052 CaseType=Combination P=-16,9243196377438 V2=10,3559122331586 V3=0 T=0 M2=0 M3=24,7930166531925 FrameElem=30-1 ElemStation=0,1834
Frame=30 Station=0 OutputCase=STR053 CaseType=Combination P=-30,1185725601763 V2=-21,292740000194 V3=0 T=0 M2=0 M3=20,9970188656629 FrameElem=30-1 ElemStation=0
Frame=30 Station=0,0917 OutputCase=STR053 CaseType=Combination P=-30,1185725601763 V2=-10,646370000194 V3=0 T=0 M2=0 M3=22,4614270591807 FrameElem=30-1 ElemStation=0,0917
Frame=30 Station=0,1834 OutputCase=STR053 CaseType=Combination P=-30,1185725601763 V2=-1,9403465501E-10 V3=0 T=0 M2=0 M3=22,9495631236985 FrameElem=30-1 ElemStation=0,1834
Frame=30 Station=0 OutputCase=STR054 CaseType=Combination P=-16,1492558311126 V2=7,78831223339176 V3=0 T=0 M2=0 M3=3,22184829043103 FrameElem=30-1 ElemStation=0
Frame=30 Station=0,0917 OutputCase=STR054 CaseType=Combination P=-16,1492558311126 V2=9,07211223339176 V3=0 T=0 M2=0 M3=2,44879782862901 FrameElem=30-1 ElemStation=0,0917
Frame=30 Station=0,1834 OutputCase=STR054 CaseType=Combination P=-16,1492558311126 V2=10,3559122333918 V3=0 T=0 M2=0 M3=1,55802290682698 FrameElem=30-1 ElemStation=0,1834
Frame=30 Station=0 OutputCase=STR055 CaseType=Combination P=-29,3435087535451 V2=-2,56759999996092 V3=0 T=0 M2=0 M3=-0,520879542659869 FrameElem=30-1 ElemStation=0
Frame=30 Station=0,0917 OutputCase=STR055 CaseType=Combination P=-29,3435087535451 V2=-1,28379999996092 V3=0 T=0 M2=0 M3=-0,344292852663452 FrameElem=30-1 ElemStation=0,0917
Frame=30 Station=0,1834 OutputCase=STR055 CaseType=Combination P=-29,3435087535451 V2=3,90802057381734E-11 V3=0 T=0 M2=0 M3=-0,285430622667036 FrameElem=30-1 ElemStation=0,1834

Società di Progetto
Brebemi SpA



Doc. N.
60235-0000-A00.doc

CODIFICA DOCUMENTO
04RCDII10000000000300A00

REV.
00

FOGLIO
379 di 628

Frame=30 Station=0 OutputCase=STR056 CaseType=Combination P=-7,63765199508677 V2=-3,92394143722602 V3=0 T=0 M2=0 M3=3,65595548706237 FrameElem=30-1 ElemStation=0
Frame=30 Station=0,0917 OutputCase=STR056 CaseType=Combination P=-7,63765199508677 V2=-2,19081143722602 V3=0 T=0 M2=0 M3=3,936316906356 FrameElem=30-1 ElemStation=0,0917
Frame=30 Station=0,1834 OutputCase=STR056 CaseType=Combination P=-7,63765199508677 V2=-0,457681437226016 V3=0 T=0 M2=0 M3=4,05775030464963 FrameElem=30-1 ElemStation=0,1834
Frame=30 Station=0 OutputCase=STR057 CaseType=Combination P=-2,52904888506206 V2=-3,92394143722174 V3=0 T=0 M2=0 M3=4,49613717874161 FrameElem=30-1 ElemStation=0
Frame=30 Station=0,0917 OutputCase=STR057 CaseType=Combination P=-2,52904888506206 V2=-2,19081143722174 V3=0 T=0 M2=0 M3=4,77649859803484 FrameElem=30-1 ElemStation=0,0917
Frame=30 Station=0,1834 OutputCase=STR057 CaseType=Combination P=-2,52904888506206 V2=-0,457681437221742 V3=0 T=0 M2=0 M3=4,89793199632808 FrameElem=30-1 ElemStation=0,1834
Frame=30 Station=0 OutputCase=STR058 CaseType=Combination P=-3,50119370692836 V2=-21,7504214374618 V3=0 T=0 M2=0 M3=24,9176963414621 FrameElem=30-1 ElemStation=0
Frame=30 Station=0,0917 OutputCase=STR058 CaseType=Combination P=-3,50119370692836 V2=-11,1040514374618 V3=0 T=0 M2=0 M3=26,4240739227773 FrameElem=30-1 ElemStation=0,0917
Frame=30 Station=0,1834 OutputCase=STR058 CaseType=Combination P=-3,50119370692836 V2=-0,45768143746175 V3=0 T=0 M2=0 M3=26,9541793750925 FrameElem=30-1 ElemStation=0,1834
Frame=30 Station=0 OutputCase=STR059 CaseType=Combination P=-16,6954466290349 V2=-11,3945092040912 V3=0 T=0 M2=0 M3=24,9735171151202 FrameElem=30-1 ElemStation=0
Frame=30 Station=0,0917 OutputCase=STR059 CaseType=Combination P=-16,6954466290349 V2=-0,748139204091239 V3=0 T=0 M2=0 M3=25,5302575446353 FrameElem=30-1 ElemStation=0,0917
Frame=30 Station=0,1834 OutputCase=STR059 CaseType=Combination P=-16,6954466290349 V2=9,89823079590876 V3=0 T=0 M2=0 M3=25,1107258451505 FrameElem=30-1 ElemStation=0,1834
Frame=30 Station=0 OutputCase=STR060 CaseType=Combination P=-29,8896995514674 V2=-21,7504214374439 V3=0 T=0 M2=0 M3=21,2307892820293 FrameElem=30-1 ElemStation=0
Frame=30 Station=0,0917 OutputCase=STR060 CaseType=Combination P=-29,8896995514674 V2=-11,1040514374439 V3=0 T=0 M2=0 M3=22,7371668633429 FrameElem=30-1 ElemStation=0,0917
Frame=30 Station=0,1834 OutputCase=STR060 CaseType=Combination P=-29,8896995514674 V2=-0,457681437443923 V3=0 T=0 M2=0 M3=23,2672723156565 FrameElem=30-1 ElemStation=0,1834
Frame=30 Station=0 OutputCase=STR061 CaseType=Combination P=-15,9203828224037 V2=7,33063079614187 V3=0 T=0 M2=0 M3=3,4556187067974 FrameElem=30-1 ElemStation=0
Frame=30 Station=0,0917 OutputCase=STR061 CaseType=Combination P=-15,9203828224037 V2=8,61443079614187 V3=0 T=0 M2=0 M3=2,7245376327912 FrameElem=30-1 ElemStation=0,0917
Frame=30 Station=0,1834 OutputCase=STR061 CaseType=Combination P=-15,9203828224037 V2=9,89823079614187 V3=0 T=0 M2=0 M3=1,87573209878499 FrameElem=30-1 ElemStation=0,1834
Frame=30 Station=0 OutputCase=STR062 CaseType=Combination P=-29,1146357448362 V2=-3,02528143721081 V3=0 T=0 M2=0 M3=-0,287109126293498 FrameElem=30-1 ElemStation=0
Frame=30 Station=0,0917 OutputCase=STR062 CaseType=Combination P=-29,1146357448362 V2=-1,74148143721081 V3=0 T=0 M2=0 M3=-6,85530485012662E-02 FrameElem=30-1 ElemStation=0,0917
Frame=30 Station=0,1834 OutputCase=STR062 CaseType=Combination P=-29,1146357448362 V2=-0,457681437210808 V3=0 T=0 M2=0 M3=3,22785692909647E-02 FrameElem=30-1 ElemStation=0,1834
Frame=30 Station=0 OutputCase=STR063 CaseType=Combination P=-8,09539801250451 V2=-3,00857856272624 V3=0 T=0 M2=0 M3=3,18841465432963 FrameElem=30-1 ElemStation=0
Frame=30 Station=0,0917 OutputCase=STR063 CaseType=Combination P=-8,09539801250451 V2=-1,27544856272624 V3=0 T=0 M2=0 M3=3,38483729803163 FrameElem=30-1 ElemStation=0,0917
Frame=30 Station=0,1834 OutputCase=STR063 CaseType=Combination P=-8,09539801250451 V2=0,45768143727376 V3=0 T=0 M2=0 M3=3,42233192073362 FrameElem=30-1 ElemStation=0,1834
Frame=30 Station=0 OutputCase=STR064 CaseType=Combination P=-2,98679490247981 V2=-3,00857856272197 V3=0 T=0 M2=0 M3=4,02859634600887 FrameElem=30-1 ElemStation=0
Frame=30 Station=0,0917 OutputCase=STR064 CaseType=Combination P=-2,98679490247981 V2=-1,27544856272197 V3=0 T=0 M2=0 M3=4,22501898971047 FrameElem=30-1 ElemStation=0,0917
Frame=30 Station=0,1834 OutputCase=STR064 CaseType=Combination P=-2,98679490247981 V2=0,457681437278035 V3=0 T=0 M2=0 M3=4,26251361241207 FrameElem=30-1 ElemStation=0,1834
Frame=30 Station=0 OutputCase=STR065 CaseType=Combination P=-3,95893972434611 V2=-20,835058562962 V3=0 T=0 M2=0 M3=24,4501555087293 FrameElem=30-1 ElemStation=0
Frame=30 Station=0,0917 OutputCase=STR065 CaseType=Combination P=-3,95893972434611 V2=-10,188688562962 V3=0 T=0 M2=0 M3=25,8725943144529 FrameElem=30-1 ElemStation=0,0917
Frame=30 Station=0,1834 OutputCase=STR065 CaseType=Combination P=-3,95893972434611 V2=0,457681437038027 V3=0 T=0 M2=0 M3=26,3187609911765 FrameElem=30-1 ElemStation=0,1834
Frame=30 Station=0 OutputCase=STR066 CaseType=Combination P=-17,1531926464526 V2=-10,4791463295915 V3=0 T=0 M2=0 M3=24,5059762823874 FrameElem=30-1 ElemStation=0
Frame=30 Station=0,0917 OutputCase=STR066 CaseType=Combination P=-17,1531926464526 V2=0,167223670408537 V3=0 T=0 M2=0 M3=24,978777936311 FrameElem=30-1 ElemStation=0,0917
Frame=30 Station=0,1834 OutputCase=STR066 CaseType=Combination P=-17,1531926464526 V2=10,8135936704085 V3=0 T=0 M2=0 M3=24,4753074612345 FrameElem=30-1 ElemStation=0,1834
Frame=30 Station=0 OutputCase=STR067 CaseType=Combination P=-30,3474455688851 V2=-20,8350585629441 V3=0 T=0 M2=0 M3=20,7632484492965 FrameElem=30-1 ElemStation=0
Frame=30 Station=0,0917 OutputCase=STR067 CaseType=Combination P=-30,3474455688851 V2=-10,1886885629441 V3=0 T=0 M2=0 M3=22,1856872550185 FrameElem=30-1 ElemStation=0,0917
Frame=30 Station=0,1834 OutputCase=STR067 CaseType=Combination P=-30,3474455688851 V2=0,457681437055853 V3=0 T=0 M2=0 M3=22,6318539317405 FrameElem=30-1 ElemStation=0,1834
Frame=30 Station=0 OutputCase=STR068 CaseType=Combination P=-16,3781288398215 V2=8,24599367064165 V3=0 T=0 M2=0 M3=2,98807787406466 FrameElem=30-1 ElemStation=0
Frame=30 Station=0,0917 OutputCase=STR068 CaseType=Combination P=-16,3781288398215 V2=9,52979367064165 V3=0 T=0 M2=0 M3=2,17305802446682 FrameElem=30-1 ElemStation=0,0917
Frame=30 Station=0,1834 OutputCase=STR068 CaseType=Combination P=-16,3781288398215 V2=10,8135936706416 V3=0 T=0 M2=0 M3=1,24031371486898 FrameElem=30-1 ElemStation=0,1834
Frame=30 Station=0 OutputCase=STR069 CaseType=Combination P=-29,572381762254 V2=-2,10991856271103 V3=0 T=0 M2=0 M3=-0,754649959026241 FrameElem=30-1 ElemStation=0
Frame=30 Station=0,0917 OutputCase=STR069 CaseType=Combination P=-29,572381762254 V2=0,826118562711033 V3=0 T=0 M2=0 M3=-0,620032656825639 FrameElem=30-1 ElemStation=0,0917
Frame=30 Station=0,1834 OutputCase=STR069 CaseType=Combination P=-29,572381762254 V2=0,457681437288968 V3=0 T=0 M2=0 M3=-0,603139814625037 FrameElem=30-1 ElemStation=0,1834
Frame=30 Station=0 OutputCase=STR070 CaseType=Combination P=-7,3148476802566 V2=-3,46625999997629 V3=0 T=0 M2=0 M3=3,87993108811372 FrameElem=30-1 ElemStation=0
Frame=30 Station=0,0917 OutputCase=STR070 CaseType=Combination P=-7,3148476802566 V2=-1,73312999997629 V3=0 T=0 M2=0 M3=4,11832311961155 FrameElem=30-1 ElemStation=0,0917

Società di Progetto
Brebemi SpA



Doc. N.
60235-0000-A00.doc

CODIFICA DOCUMENTO
04RCDII10000000000300A00

REV.
00

FOGLIO
380 di 628

Frame=30 Station=0,1834 OutputCase=STR070 CaseType=Combination P=-7,3148476802566 V2=2,37133335190265E-11 V3=0 T=0 M2=0 M3=4,19778713010937
FrameElem=30-1 ElemStation=0,1834
Frame=30 Station=0 OutputCase=STR071 CaseType=Combination P=-2,2062445702319 V2=-3,46625999997201 V3=0 T=0 M2=0 M3=4,72011277979296 FrameElem=30-1
ElemStation=0
Frame=30 Station=0,0917 OutputCase=STR071 CaseType=Combination P=-2,2062445702319 V2=-1,73312999997201 V3=0 T=0 M2=0 M3=4,95850481129039 FrameElem=30-1
ElemStation=0,0917
Frame=30 Station=0,1834 OutputCase=STR071 CaseType=Combination P=-2,2062445702319 V2=2,79879142084383E-11 V3=0 T=0 M2=0 M3=5,03796882178782
FrameElem=30-1 ElemStation=0,1834
Frame=30 Station=0 OutputCase=STR072 CaseType=Combination P=-3,1783893209819 V2=-21,292740000212 V3=0 T=0 M2=0 M3=25,1416719425134 FrameElem=30-1
ElemStation=0
Frame=30 Station=0,0917 OutputCase=STR072 CaseType=Combination P=-3,1783893209819 V2=-10,646370000212 V3=0 T=0 M2=0 M3=26,6060801360328 FrameElem=30-1
ElemStation=0,0917
Frame=30 Station=0,1834 OutputCase=STR072 CaseType=Combination P=-3,1783893209819 V2=-2,12019974354938E-10 V3=0 T=0 M2=0 M3=27,0942162005523
FrameElem=30-1 ElemStation=0,1834
Frame=30 Station=0 OutputCase=STR073 CaseType=Combination P=-16,3726423142047 V2=-10,9368277668415 V3=0 T=0 M2=0 M3=25,1974927161715 FrameElem=30-1
ElemStation=0
Frame=30 Station=0,0917 OutputCase=STR073 CaseType=Combination P=-16,3726423142047 V2=-0,29045776684151 V3=0 T=0 M2=0 M3=25,7122637578909
FrameElem=30-1 ElemStation=0,0917
Frame=30 Station=0,1834 OutputCase=STR073 CaseType=Combination P=-16,3726423142047 V2=10,3559122331585 V3=0 T=0 M2=0 M3=25,2507626706102 FrameElem=30-1
ElemStation=0,1834
Frame=30 Station=0 OutputCase=STR074 CaseType=Combination P=-29,5668952366372 V2=-21,2927400001942 V3=0 T=0 M2=0 M3=21,4547648830806 FrameElem=30-1
ElemStation=0
Frame=30 Station=0,0917 OutputCase=STR074 CaseType=Combination P=-29,5668952366372 V2=-10,6463700001942 V3=0 T=0 M2=0 M3=22,9191730765984
FrameElem=30-1 ElemStation=0,0917
Frame=30 Station=0,1834 OutputCase=STR074 CaseType=Combination P=-29,5668952366372 V2=-1,94193248148622E-10 V3=0 T=0 M2=0 M3=23,4073091411162
FrameElem=30-1 ElemStation=0,1834
Frame=30 Station=0 OutputCase=STR075 CaseType=Combination P=-15,5975785075736 V2=7,7883122333916 V3=0 T=0 M2=0 M3=3,67959430784875 FrameElem=30-1
ElemStation=0
Frame=30 Station=0,0917 OutputCase=STR075 CaseType=Combination P=-15,5975785075736 V2=9,0721122333916 V3=0 T=0 M2=0 M3=2,90654384604674 FrameElem=30-1
ElemStation=0,0917
Frame=30 Station=0,1834 OutputCase=STR075 CaseType=Combination P=-15,5975785075736 V2=10,3559122333916 V3=0 T=0 M2=0 M3=2,01576892424473 FrameElem=30-1
ElemStation=0,1834
Frame=30 Station=0 OutputCase=STR076 CaseType=Combination P=-28,7918314300061 V2=-2,56759999996108 V3=0 T=0 M2=0 M3=-6,31335252421493E-02
FrameElem=30-1 ElemStation=0
Frame=30 Station=0,0917 OutputCase=STR076 CaseType=Combination P=-28,7918314300061 V2=-1,28379999996108 V3=0 T=0 M2=0 M3=0,113453164754282
FrameElem=30-1 ElemStation=0,0917
Frame=30 Station=0,1834 OutputCase=STR076 CaseType=Combination P=-28,7918314300061 V2=3,89216125995517E-11 V3=0 T=0 M2=0 M3=0,172315394750713
FrameElem=30-1 ElemStation=0,1834
Frame=30 Station=0 OutputCase=STR077 CaseType=Combination P=-8,40453219517924 V2=4,22906239539234 V3=0 T=0 M2=0 M3=3,04889240227709 FrameElem=30-1
ElemStation=0
Frame=30 Station=0,0917 OutputCase=STR077 CaseType=Combination P=-8,40453219517924 V2=-2,49593239539234 V3=0 T=0 M2=0 M3=3,35723341343457
FrameElem=30-1 ElemStation=0,0917
Frame=30 Station=0,1834 OutputCase=STR077 CaseType=Combination P=-8,40453219517924 V2=-0,762802395392344 V3=0 T=0 M2=0 M3=3,50664640359204
FrameElem=30-1 ElemStation=0,1834
Frame=30 Station=0 OutputCase=STR078 CaseType=Combination P=-3,29592908515454 V2=4,22906239538807 V3=0 T=0 M2=0 M3=3,88907409395632 FrameElem=30-1
ElemStation=0
Frame=30 Station=0,0917 OutputCase=STR078 CaseType=Combination P=-3,29592908515454 V2=-2,49593239538807 V3=0 T=0 M2=0 M3=4,19741510511341
FrameElem=30-1 ElemStation=0,0917
Frame=30 Station=0,1834 OutputCase=STR078 CaseType=Combination P=-3,29592908515454 V2=-0,762802395388069 V3=0 T=0 M2=0 M3=4,3468280952705
FrameElem=30-1 ElemStation=0,1834
Frame=30 Station=0 OutputCase=STR079 CaseType=Combination P=-4,74470418678218 V2=-27,6925814375415 V3=0 T=0 M2=0 M3=30,961972700006 FrameElem=30-1
ElemStation=0
Frame=30 Station=0,0917 OutputCase=STR079 CaseType=Combination P=-4,74470418678218 V2=-14,0751314375415 V3=0 T=0 M2=0 M3=32,8770223353286
FrameElem=30-1 ElemStation=0,0917
Frame=30 Station=0,1834 OutputCase=STR079 CaseType=Combination P=-4,74470418678218 V2=-0,457681437541488 V3=0 T=0 M2=0 M3=33,5433518056511
FrameElem=30-1 ElemStation=0,1834
Frame=30 Station=0 OutputCase=STR080 CaseType=Combination P=-21,4856075646411 V2=-14,5107998529642 V3=0 T=0 M2=0 M3=31,0616036846592 FrameElem=30-1
ElemStation=0
Frame=30 Station=0,0917 OutputCase=STR080 CaseType=Combination P=-21,4856075646411 V2=-0,893349852964176 V3=0 T=0 M2=0 M3=31,767883948676
FrameElem=30-1 ElemStation=0,0917
Frame=30 Station=0,1834 OutputCase=STR080 CaseType=Combination P=-21,4856075646411 V2=12,7241001470358 V3=0 T=0 M2=0 M3=31,2254440476928 FrameElem=30-1
ElemStation=0,1834
Frame=30 Station=0 OutputCase=STR081 CaseType=Combination P=-38,226510942826 V2=-27,6925814375163 V3=0 T=0 M2=0 M3=26,3261571846554 FrameElem=30-1
ElemStation=0
Frame=30 Station=0,0917 OutputCase=STR081 CaseType=Combination P=-38,226510942826 V2=-14,0751314375163 V3=0 T=0 M2=0 M3=28,2412068199756 FrameElem=30-1
ElemStation=0,0917
Frame=30 Station=0,1834 OutputCase=STR081 CaseType=Combination P=-38,226510942826 V2=-0,457681437516294 V3=0 T=0 M2=0 M3=28,9075362902958
FrameElem=30-1 ElemStation=0,1834
Frame=30 Station=0 OutputCase=STR082 CaseType=Combination P=-20,3864954840545 V2=10,1565001473489 V3=0 T=0 M2=0 M3=2,73651888876294 FrameElem=30-1
ElemStation=0
Frame=30 Station=0,0917 OutputCase=STR082 CaseType=Combination P=-20,3864954840545 V2=11,4403001473489 V3=0 T=0 M2=0 M3=1,74630559525104 FrameElem=30-1
ElemStation=0,0917
Frame=30 Station=0,1834 OutputCase=STR082 CaseType=Combination P=-20,3864954840545 V2=12,7241001473489 V3=0 T=0 M2=0 M3=0,638367841739145
FrameElem=30-1 ElemStation=0,1834
Frame=30 Station=0 OutputCase=STR083 CaseType=Combination P=-37,1273988622394 V2=-3,02528143720318 V3=0 T=0 M2=0 M3=-1,99892761124089 FrameElem=30-1
ElemStation=0
Frame=30 Station=0,0917 OutputCase=STR083 CaseType=Combination P=-37,1273988622394 V2=-1,74148143720318 V3=0 T=0 M2=0 M3=-1,78037153344936
FrameElem=30-1 ElemStation=0,0917
Frame=30 Station=0,1834 OutputCase=STR083 CaseType=Combination P=-37,1273988622394 V2=-0,457681437203179 V3=0 T=0 M2=0 M3=-1,67953991565782
FrameElem=30-1 ElemStation=0,1834
Frame=30 Station=0 OutputCase=STR084 CaseType=Combination P=-13,480155832055 V2=7,97540358542475 V3=0 T=0 M2=0 M3=27,7630490915216 FrameElem=30-1
ElemStation=0
Frame=30 Station=0,0917 OutputCase=STR084 CaseType=Combination P=-15,547532332055 V2=18,6217735854248 V3=0 T=0 M2=0 M3=26,5435685182381 FrameElem=30-1
ElemStation=0,0917
Frame=30 Station=0,1834 OutputCase=STR084 CaseType=Combination P=-17,614908832055 V2=29,2681435854248 V3=0 T=0 M2=0 M3=24,3478158159547 FrameElem=30-1
ElemStation=0,1834
Frame=30 Station=0 OutputCase=STR085 CaseType=Combination P=-4,26807390702084 V2=-22,0555423956281 V3=0 T=0 M2=0 M3=24,3106332566768 FrameElem=30-1
ElemStation=0

Società di Progetto
Brebemi SpA



Doc. N.
60235-0000-A00.doc

CODIFICA DOCUMENTO
04RCDII10000000000300A00

REV.
00

FOGLIO
381 di 628

Frame=30 Station=0,0917 OutputCase=STR085 CaseType=Combination P=-4,26807390702084 V2=-11,4091723956281 V3=0 T=0 M2=0 M3=25,8449904298559
FrameElem=30-1 ElemStation=0,0917
Frame=30 Station=0,1834 OutputCase=STR085 CaseType=Combination P=-4,26807390702084 V2=-0,762802395628077 V3=0 T=0 M2=0 M3=26,403075474035
FrameElem=30-1 ElemStation=0,1834
Frame=30 Station=0 OutputCase=STR086 CaseType=Combination P=-17,4623268291274 V2=-11,6996301622576 V3=0 T=0 M2=0 M3=24,3664540303349 FrameElem=30-1
ElemStation=0
Frame=30 Station=0,0917 OutputCase=STR086 CaseType=Combination P=-17,4623268291274 V2=-1,05326016225757 V3=0 T=0 M2=0 M3=24,9511740517139
FrameElem=30-1 ElemStation=0,0917
Frame=30 Station=0,1834 OutputCase=STR086 CaseType=Combination P=-17,4623268291274 V2=9,59310983774243 V3=0 T=0 M2=0 M3=24,5596219440929 FrameElem=30-1
ElemStation=0,1834
Frame=30 Station=0 OutputCase=STR087 CaseType=Combination P=-30,6565797515599 V2=-22,0555423956102 V3=0 T=0 M2=0 M3=20,623726197244 FrameElem=30-1
ElemStation=0
Frame=30 Station=0,0917 OutputCase=STR087 CaseType=Combination P=-30,6565797515599 V2=-11,4091723956103 V3=0 T=0 M2=0 M3=22,1580833704214
FrameElem=30-1 ElemStation=0,0917
Frame=30 Station=0,1834 OutputCase=STR087 CaseType=Combination P=-30,6565797515599 V2=-0,762802395610251 V3=0 T=0 M2=0 M3=22,7161684145989
FrameElem=30-1 ElemStation=0,1834
Frame=30 Station=0 OutputCase=STR088 CaseType=Combination P=-16,6872630224962 V2=7,02550983797554 V3=0 T=0 M2=0 M3=2,84855562201212 FrameElem=30-1
ElemStation=0
Frame=30 Station=0,0917 OutputCase=STR088 CaseType=Combination P=-16,6872630224962 V2=8,30930983797555 V3=0 T=0 M2=0 M3=2,14545413986976 FrameElem=30-1
ElemStation=0,0917
Frame=30 Station=0,1834 OutputCase=STR088 CaseType=Combination P=-16,6872630224962 V2=9,59310983797555 V3=0 T=0 M2=0 M3=1,3246281977274 FrameElem=30-1
ElemStation=0,1834
Frame=30 Station=0 OutputCase=STR089 CaseType=Combination P=-29,8815159449287 V2=-3,33040239537714 V3=0 T=0 M2=0 M3=-0,894172211078783 FrameElem=30-1
ElemStation=0
Frame=30 Station=0,0917 OutputCase=STR089 CaseType=Combination P=-29,8815159449287 V2=-2,04660239537714 V3=0 T=0 M2=0 M3=-0,647636541422699
FrameElem=30-1 ElemStation=0,0917
Frame=30 Station=0,1834 OutputCase=STR089 CaseType=Combination P=-29,8815159449287 V2=-0,762802395377136 V3=0 T=0 M2=0 M3=-0,518825331766616
FrameElem=30-1 ElemStation=0,1834
Frame=30 Station=0 OutputCase=STR090 CaseType=Combination P=-8,95620951871828 V2=-4,22906239539219 V3=0 T=0 M2=0 M3=2,59114638485937 FrameElem=30-1
ElemStation=0
Frame=30 Station=0,0917 OutputCase=STR090 CaseType=Combination P=-8,95620951871828 V2=-2,49593239539219 V3=0 T=0 M2=0 M3=2,89948739601683
FrameElem=30-1 ElemStation=0,0917
Frame=30 Station=0,1834 OutputCase=STR090 CaseType=Combination P=-8,95620951871828 V2=-0,762802395392186 V3=0 T=0 M2=0 M3=3,0489003861743
FrameElem=30-1 ElemStation=0,1834
Frame=30 Station=0 OutputCase=STR091 CaseType=Combination P=-3,84760640869357 V2=-4,22906239538791 V3=0 T=0 M2=0 M3=3,4313280765386 FrameElem=30-1
ElemStation=0
Frame=30 Station=0,0917 OutputCase=STR091 CaseType=Combination P=-3,84760640869357 V2=-2,49593239538791 V3=0 T=0 M2=0 M3=3,73966908769567
FrameElem=30-1 ElemStation=0,0917
Frame=30 Station=0,1834 OutputCase=STR091 CaseType=Combination P=-3,84760640869357 V2=-0,762802395387911 V3=0 T=0 M2=0 M3=3,88908207785275
FrameElem=30-1 ElemStation=0,1834
Frame=30 Station=0 OutputCase=STR092 CaseType=Combination P=-4,81975123055987 V2=-22,0555423956279 V3=0 T=0 M2=0 M3=23,8528872392591 FrameElem=30-1
ElemStation=0
Frame=30 Station=0,0917 OutputCase=STR092 CaseType=Combination P=-4,81975123055987 V2=-11,4091723956279 V3=0 T=0 M2=0 M3=25,3872444124381
FrameElem=30-1 ElemStation=0,0917
Frame=30 Station=0,1834 OutputCase=STR092 CaseType=Combination P=-4,81975123055987 V2=-0,762802395627919 V3=0 T=0 M2=0 M3=25,9453294566172
FrameElem=30-1 ElemStation=0,1834
Frame=30 Station=0 OutputCase=STR093 CaseType=Combination P=-18,0140041526664 V2=-11,6996301622574 V3=0 T=0 M2=0 M3=23,9087080129171 FrameElem=30-1
ElemStation=0
Frame=30 Station=0,0917 OutputCase=STR093 CaseType=Combination P=-18,0140041526664 V2=-1,05326016225741 V3=0 T=0 M2=0 M3=24,4934280342962
FrameElem=30-1 ElemStation=0,0917
Frame=30 Station=0,1834 OutputCase=STR093 CaseType=Combination P=-18,0140041526664 V2=9,59310983774259 V3=0 T=0 M2=0 M3=24,1018759266752 FrameElem=30-1
ElemStation=0,1834
Frame=30 Station=0 OutputCase=STR094 CaseType=Combination P=-31,2082570750989 V2=-22,0555423956101 V3=0 T=0 M2=0 M3=20,1659801798262 FrameElem=30-1
ElemStation=0
Frame=30 Station=0,0917 OutputCase=STR094 CaseType=Combination P=-31,2082570750989 V2=-11,4091723956101 V3=0 T=0 M2=0 M3=21,700373530037
FrameElem=30-1 ElemStation=0,0917
Frame=30 Station=0,1834 OutputCase=STR094 CaseType=Combination P=-31,2082570750989 V2=-0,762802395610092 V3=0 T=0 M2=0 M3=22,2584223971811
FrameElem=30-1 ElemStation=0,1834
Frame=30 Station=0 OutputCase=STR095 CaseType=Combination P=-17,2389403460352 V2=7,0255098379757 V3=0 T=0 M2=0 M3=2,3908096045944 FrameElem=30-1
ElemStation=0
Frame=30 Station=0,0917 OutputCase=STR095 CaseType=Combination P=-17,2389403460352 V2=8,3093098379757 V3=0 T=0 M2=0 M3=1,68770812245203 FrameElem=30-1
ElemStation=0,0917
Frame=30 Station=0,1834 OutputCase=STR095 CaseType=Combination P=-17,2389403460352 V2=9,5931098379757 V3=0 T=0 M2=0 M3=0,866882180309655 FrameElem=30-1
ElemStation=0,1834
Frame=30 Station=0 OutputCase=STR096 CaseType=Combination P=-30,4331932684677 V2=-3,33040239537698 V3=0 T=0 M2=0 M3=-1,3519182284965 FrameElem=30-1
ElemStation=0
Frame=30 Station=0,0917 OutputCase=STR096 CaseType=Combination P=-30,4331932684677 V2=-2,04660239537698 V3=0 T=0 M2=0 M3=-1,10538255884043
FrameElem=30-1 ElemStation=0,0917
Frame=30 Station=0,1834 OutputCase=STR096 CaseType=Combination P=-30,4331932684677 V2=-0,762802395376977 V3=0 T=0 M2=0 M3=-0,976571349184365
FrameElem=30-1 ElemStation=0,1834
Frame=30 Station=0 OutputCase=STR097 CaseType=Combination P=-7,85285487164021 V2=-4,2290623953925 V3=0 T=0 M2=0 M3=3,50663841969481 FrameElem=30-1
ElemStation=0
Frame=30 Station=0,0917 OutputCase=STR097 CaseType=Combination P=-7,85285487164021 V2=-2,4959323953925 V3=0 T=0 M2=0 M3=3,8149794308523 FrameElem=30-1
ElemStation=0,0917
Frame=30 Station=0,1834 OutputCase=STR097 CaseType=Combination P=-7,85285487164021 V2=-0,762802395392503 V3=0 T=0 M2=0 M3=3,96439242100979
FrameElem=30-1 ElemStation=0,1834
Frame=30 Station=0 OutputCase=STR098 CaseType=Combination P=-2,7442517616155 V2=-4,22906239538823 V3=0 T=0 M2=0 M3=4,34682011137404 FrameElem=30-1
ElemStation=0
Frame=30 Station=0,0917 OutputCase=STR098 CaseType=Combination P=-2,7442517616155 V2=-2,49593239538823 V3=0 T=0 M2=0 M3=4,65516112253114 FrameElem=30-1
ElemStation=0,0917
Frame=30 Station=0,1834 OutputCase=STR098 CaseType=Combination P=-2,7442517616155 V2=-0,762802395388228 V3=0 T=0 M2=0 M3=4,80457411268824
FrameElem=30-1 ElemStation=0,1834
Frame=30 Station=0 OutputCase=STR099 CaseType=Combination P=-3,7163965834818 V2=-22,0555423956282 V3=0 T=0 M2=0 M3=24,7683792740945 FrameElem=30-1
ElemStation=0
Frame=30 Station=0,0917 OutputCase=STR099 CaseType=Combination P=-3,7163965834818 V2=-11,4091723956282 V3=0 T=0 M2=0 M3=26,3027364472736 FrameElem=30-1
ElemStation=0,0917
Frame=30 Station=0,1834 OutputCase=STR099 CaseType=Combination P=-3,7163965834818 V2=-0,762802395628236 V3=0 T=0 M2=0 M3=26,8608214914527
FrameElem=30-1 ElemStation=0,1834

Società di Progetto
Brebemi SpA



Doc. N.
60235-0000-A00.doc

CODIFICA DOCUMENTO
04RCDII10000000000300A00

REV.
00

FOGLIO
382 di 628

Frame=30 Station=0 OutputCase=STR100 CaseType=Combination P=-16,9106495055883 V2=-11,6996301622577 V3=0 T=0 M2=0 M3=24,8242000477526 FrameElem=30-1 ElemStation=0
Frame=30 Station=0,0917 OutputCase=STR100 CaseType=Combination P=-16,9106495055883 V2=-1,05326016225773 V3=0 T=0 M2=0 M3=25,4089200691316 FrameElem=30-1 ElemStation=0,0917
Frame=30 Station=0,1834 OutputCase=STR100 CaseType=Combination P=-16,9106495055883 V2=9,59310983774227 V3=0 T=0 M2=0 M3=25,0173679615107 FrameElem=30-1 ElemStation=0,1834
Frame=30 Station=0 OutputCase=STR101 CaseType=Combination P=-30,1049024280208 V2=-22,0555423956104 V3=0 T=0 M2=0 M3=21,0814722146617 FrameElem=30-1 ElemStation=0
Frame=30 Station=0,0917 OutputCase=STR101 CaseType=Combination P=-30,1049024280208 V2=-11,4091723956104 V3=0 T=0 M2=0 M3=22,6158293878392 FrameElem=30-1 ElemStation=0,0917
Frame=30 Station=0,1834 OutputCase=STR101 CaseType=Combination P=-30,1049024280208 V2=-0,762802395610409 V3=0 T=0 M2=0 M3=23,1739144320166 FrameElem=30-1 ElemStation=0,1834
Frame=30 Station=0 OutputCase=STR102 CaseType=Combination P=-16,1355856989572 V2=7,02550983797539 V3=0 T=0 M2=0 M3=3,30630163942984 FrameElem=30-1 ElemStation=0
Frame=30 Station=0,0917 OutputCase=STR102 CaseType=Combination P=-16,1355856989572 V2=8,30930983797539 V3=0 T=0 M2=0 M3=2,6032001572875 FrameElem=30-1 ElemStation=0,0917
Frame=30 Station=0,1834 OutputCase=STR102 CaseType=Combination P=-16,1355856989572 V2=9,59310983797539 V3=0 T=0 M2=0 M3=1,78237421514515 FrameElem=30-1 ElemStation=0,1834
Frame=30 Station=0 OutputCase=STR103 CaseType=Combination P=-29,3298386213897 V2=-3,33040239537729 V3=0 T=0 M2=0 M3=-0,436426193661063 FrameElem=30-1 ElemStation=0
Frame=30 Station=0,0917 OutputCase=STR103 CaseType=Combination P=-29,3298386213897 V2=-2,0466023953773 V3=0 T=0 M2=0 M3=-0,189890524004965 FrameElem=30-1 ElemStation=0,0917
Frame=30 Station=0,1834 OutputCase=STR103 CaseType=Combination P=-29,3298386213897 V2=-0,762802395377294 V3=0 T=0 M2=0 M3=-6,10793143488673E-02 FrameElem=30-1 ElemStation=0,1834
Frame=30 Station=0 OutputCase=STR104 CaseType=Combination P=-7,85285487164021 V2=-4,2290623953925 V3=0 T=0 M2=0 M3=3,50663841969481 FrameElem=30-1 ElemStation=0
Frame=30 Station=0,0917 OutputCase=STR104 CaseType=Combination P=-7,85285487164021 V2=-2,4959323953925 V3=0 T=0 M2=0 M3=3,8149794308523 FrameElem=30-1 ElemStation=0,0917
Frame=30 Station=0,1834 OutputCase=STR104 CaseType=Combination P=-7,85285487164021 V2=-0,762802395392503 V3=0 T=0 M2=0 M3=3,96439242100979 FrameElem=30-1 ElemStation=0,1834
Frame=30 Station=0 OutputCase=STR105 CaseType=Combination P=-2,7442517616155 V2=-4,22906239538823 V3=0 T=0 M2=0 M3=4,34682011137404 FrameElem=30-1 ElemStation=0
Frame=30 Station=0,0917 OutputCase=STR105 CaseType=Combination P=-2,7442517616155 V2=-2,49593239538823 V3=0 T=0 M2=0 M3=4,65516112253114 FrameElem=30-1 ElemStation=0,0917
Frame=30 Station=0,1834 OutputCase=STR105 CaseType=Combination P=-2,7442517616155 V2=-0,762802395388228 V3=0 T=0 M2=0 M3=4,80457411268824 FrameElem=30-1 ElemStation=0,1834
Frame=30 Station=0 OutputCase=STR106 CaseType=Combination P=-3,7163965834818 V2=-22,0555423956282 V3=0 T=0 M2=0 M3=24,7683792740945 FrameElem=30-1 ElemStation=0
Frame=30 Station=0,0917 OutputCase=STR106 CaseType=Combination P=-3,7163965834818 V2=-11,4091723956282 V3=0 T=0 M2=0 M3=26,3027364472736 FrameElem=30-1 ElemStation=0,0917
Frame=30 Station=0,1834 OutputCase=STR106 CaseType=Combination P=-3,7163965834818 V2=-0,762802395628236 V3=0 T=0 M2=0 M3=26,8608214914527 FrameElem=30-1 ElemStation=0,1834
Frame=30 Station=0 OutputCase=STR107 CaseType=Combination P=-16,9106495055883 V2=-11,6996301622577 V3=0 T=0 M2=0 M3=24,8242000477526 FrameElem=30-1 ElemStation=0
Frame=30 Station=0,0917 OutputCase=STR107 CaseType=Combination P=-16,9106495055883 V2=-1,05326016225773 V3=0 T=0 M2=0 M3=25,4089200691316 FrameElem=30-1 ElemStation=0,0917
Frame=30 Station=0,1834 OutputCase=STR107 CaseType=Combination P=-16,9106495055883 V2=9,59310983774227 V3=0 T=0 M2=0 M3=25,0173679615107 FrameElem=30-1 ElemStation=0,1834
Frame=30 Station=0 OutputCase=STR108 CaseType=Combination P=-30,1049024280208 V2=-22,0555423956104 V3=0 T=0 M2=0 M3=21,0814722146617 FrameElem=30-1 ElemStation=0
Frame=30 Station=0,0917 OutputCase=STR108 CaseType=Combination P=-30,1049024280208 V2=-11,4091723956104 V3=0 T=0 M2=0 M3=22,6158293878392 FrameElem=30-1 ElemStation=0,0917
Frame=30 Station=0,1834 OutputCase=STR108 CaseType=Combination P=-30,1049024280208 V2=-0,762802395610409 V3=0 T=0 M2=0 M3=23,1739144320166 FrameElem=30-1 ElemStation=0,1834
Frame=30 Station=0 OutputCase=STR109 CaseType=Combination P=-16,1355856989572 V2=7,02550983797539 V3=0 T=0 M2=0 M3=3,30630163942984 FrameElem=30-1 ElemStation=0
Frame=30 Station=0,0917 OutputCase=STR109 CaseType=Combination P=-16,1355856989572 V2=8,30930983797539 V3=0 T=0 M2=0 M3=2,6032001572875 FrameElem=30-1 ElemStation=0,0917
Frame=30 Station=0,1834 OutputCase=STR109 CaseType=Combination P=-16,1355856989572 V2=9,59310983797539 V3=0 T=0 M2=0 M3=1,78237421514515 FrameElem=30-1 ElemStation=0,1834
Frame=30 Station=0 OutputCase=STR110 CaseType=Combination P=-29,3298386213897 V2=-3,33040239537729 V3=0 T=0 M2=0 M3=-0,436426193661063 FrameElem=30-1 ElemStation=0
Frame=30 Station=0,0917 OutputCase=STR110 CaseType=Combination P=-29,3298386213897 V2=-2,0466023953773 V3=0 T=0 M2=0 M3=-0,189890524004965 FrameElem=30-1 ElemStation=0,0917
Frame=30 Station=0,1834 OutputCase=STR110 CaseType=Combination P=-29,3298386213897 V2=-0,762802395377294 V3=0 T=0 M2=0 M3=-6,10793143488673E-02 FrameElem=30-1 ElemStation=0,1834
Frame=30 Station=0 OutputCase=STR111 CaseType=Combination P=-9,16744222420882 V2=-2,70345760455938 V3=0 T=0 M2=0 M3=2,26965768105585 FrameElem=30-1 ElemStation=0
Frame=30 Station=0,0917 OutputCase=STR111 CaseType=Combination P=-9,16744222420882 V2=-0,970327604559383 V3=0 T=0 M2=0 M3=2,43810073289395 FrameElem=30-1 ElemStation=0,0917
Frame=30 Station=0,1834 OutputCase=STR111 CaseType=Combination P=-9,16744222420882 V2=-0,762802395440617 V3=0 T=0 M2=0 M3=2,44761576373204 FrameElem=30-1 ElemStation=0,1834
Frame=30 Station=0 OutputCase=STR112 CaseType=Combination P=-4,05883911418412 V2=-2,70345760455511 V3=0 T=0 M2=0 M3=3,10983937273509 FrameElem=30-1 ElemStation=0
Frame=30 Station=0,0917 OutputCase=STR112 CaseType=Combination P=-4,05883911418412 V2=-0,970327604555109 V3=0 T=0 M2=0 M3=3,27828242457279 FrameElem=30-1 ElemStation=0,0917
Frame=30 Station=0,1834 OutputCase=STR112 CaseType=Combination P=-4,05883911418412 V2=-0,762802395444891 V3=0 T=0 M2=0 M3=3,28779745541049 FrameElem=30-1 ElemStation=0,1834
Frame=30 Station=0 OutputCase=STR113 CaseType=Combination P=-5,20245020419993 V2=-26,7772185630417 V3=0 T=0 M2=0 M3=30,4944318672733 FrameElem=30-1 ElemStation=0
Frame=30 Station=0,0917 OutputCase=STR113 CaseType=Combination P=-5,20245020419993 V2=-13,1597685630417 V3=0 T=0 M2=0 M3=32,3255427270042 FrameElem=30-1 ElemStation=0,0917
Frame=30 Station=0,1834 OutputCase=STR113 CaseType=Combination P=-5,20245020419993 V2=-0,457681436958288 V3=0 T=0 M2=0 M3=32,9079334217351 FrameElem=30-1 ElemStation=0,1834
Frame=30 Station=0 OutputCase=STR114 CaseType=Combination P=-21,9433535820589 V2=-13,5954369784644 V3=0 T=0 M2=0 M3=30,5940628519264 FrameElem=30-1 ElemStation=0
Frame=30 Station=0,0917 OutputCase=STR114 CaseType=Combination P=-21,9433535820589 V2=2,20130215356005E-02 V3=0 T=0 M2=0 M3=31,2164043403516 FrameElem=30-1 ElemStation=0,0917

Società di Progetto
Brebemi SpA



Doc. N.
60235-0000-A00.doc

CODIFICA DOCUMENTO
04RCDII10000000000300A00

REV.
00

FOGLIO
383 di 628

Frame=30 Station=0,1834 OutputCase=STR114 CaseType=Combination P=-21,9433535820589 V2=13,6394630215356 V3=0 T=0 M2=0 M3=30,5900256637768 FrameElem=30-1 ElemStation=0,1834
Frame=30 Station=0 OutputCase=STR115 CaseType=Combination P=-38,6842569602437 V2=-26,7772185630165 V3=0 T=0 M2=0 M3=25,8586163519226 FrameElem=30-1 ElemStation=0
Frame=30 Station=0,0917 OutputCase=STR115 CaseType=Combination P=-38,6842569602437 V2=-13,1597685630165 V3=0 T=0 M2=0 M3=27,6897272116512 FrameElem=30-1 ElemStation=0,0917
Frame=30 Station=0,1834 OutputCase=STR115 CaseType=Combination P=-38,6842569602437 V2=0,457681436983483 V3=0 T=0 M2=0 M3=28,2721179063798 FrameElem=30-1 ElemStation=0,1834
Frame=30 Station=0 OutputCase=STR116 CaseType=Combination P=-20,8442415014723 V2=11,0718630218487 V3=0 T=0 M2=0 M3=2,2689780560302 FrameElem=30-1 ElemStation=0
Frame=30 Station=0,0917 OutputCase=STR116 CaseType=Combination P=-20,8442415014723 V2=12,3556630218487 V3=0 T=0 M2=0 M3=1,19482598692667 FrameElem=30-1 ElemStation=0,0917
Frame=30 Station=0,1834 OutputCase=STR116 CaseType=Combination P=-20,8442415014723 V2=13,6394630218487 V3=0 T=0 M2=0 M3=2,94945782314332E-03 FrameElem=30-1 ElemStation=0,1834
Frame=30 Station=0 OutputCase=STR117 CaseType=Combination P=-37,5851448796571 V2=-2,1099185627034 V3=0 T=0 M2=0 M3=-2,46646844397363 FrameElem=30-1 ElemStation=0
Frame=30 Station=0,0917 OutputCase=STR117 CaseType=Combination P=-37,5851448796571 V2=-0,826118562703402 V3=0 T=0 M2=0 M3=-2,33185114177373 FrameElem=30-1 ElemStation=0,0917
Frame=30 Station=0,1834 OutputCase=STR117 CaseType=Combination P=-37,5851448796571 V2=0,457681437296597 V3=0 T=0 M2=0 M3=-2,31495829957383 FrameElem=30-1 ElemStation=0,1834
Frame=30 Station=0 OutputCase=STR118 CaseType=Combination P=-13,9379018494728 V2=8,89076645992453 V3=0 T=0 M2=0 M3=27,2955082587888 FrameElem=30-1 ElemStation=0
Frame=30 Station=0,0917 OutputCase=STR118 CaseType=Combination P=-16,0052783494728 V2=19,5371364599245 V3=0 T=0 M2=0 M3=25,9920889099137 FrameElem=30-1 ElemStation=0,0917
Frame=30 Station=0,1834 OutputCase=STR118 CaseType=Combination P=-18,0726548494728 V2=30,1835064599245 V3=0 T=0 M2=0 M3=23,7123974320386 FrameElem=30-1 ElemStation=0,1834
Frame=30 Station=0 OutputCase=STR119 CaseType=Combination P=-5,03098393605042 V2=-20,5299376047951 V3=0 T=0 M2=0 M3=23,5313985354555 FrameElem=30-1 ElemStation=0
Frame=30 Station=0,0917 OutputCase=STR119 CaseType=Combination P=-5,03098393605042 V2=-9,88356760479512 V3=0 T=0 M2=0 M3=24,925877493152 FrameElem=30-1 ElemStation=0,0917
Frame=30 Station=0,1834 OutputCase=STR119 CaseType=Combination P=-5,03098393605042 V2=0,762802395204883 V3=0 T=0 M2=0 M3=25,344044834175 FrameElem=30-1 ElemStation=0,1834
Frame=30 Station=0 OutputCase=STR120 CaseType=Combination P=-18,225236858157 V2=-10,1740253714246 V3=0 T=0 M2=0 M3=23,5872193091136 FrameElem=30-1 ElemStation=0
Frame=30 Station=0,0917 OutputCase=STR120 CaseType=Combination P=-18,225236858157 V2=0,472344628575394 V3=0 T=0 M2=0 M3=24,0320413711733 FrameElem=30-1 ElemStation=0,0917
Frame=30 Station=0,1834 OutputCase=STR120 CaseType=Combination P=-18,225236858157 V2=11,1187146285754 V3=0 T=0 M2=0 M3=23,5005913042329 FrameElem=30-1 ElemStation=0,1834
Frame=30 Station=0 OutputCase=STR121 CaseType=Combination P=-31,4194897805895 V2=-20,5299376047773 V3=0 T=0 M2=0 M3=19,8444914760227 FrameElem=30-1 ElemStation=0
Frame=30 Station=0,0917 OutputCase=STR121 CaseType=Combination P=-31,4194897805895 V2=-9,88356760477729 V3=0 T=0 M2=0 M3=21,2389506898808 FrameElem=30-1 ElemStation=0,0917
Frame=30 Station=0,1834 OutputCase=STR121 CaseType=Combination P=-31,4194897805895 V2=0,76280239522271 V3=0 T=0 M2=0 M3=21,6571377747389 FrameElem=30-1 ElemStation=0,1834
Frame=30 Station=0 OutputCase=STR122 CaseType=Combination P=-17,4501730515258 V2=8,55111462880851 V3=0 T=0 M2=0 M3=2,06932090079088 FrameElem=30-1 ElemStation=0
Frame=30 Station=0,0917 OutputCase=STR122 CaseType=Combination P=-17,4501730515258 V2=9,83491462880851 V3=0 T=0 M2=0 M3=1,22632145932914 FrameElem=30-1 ElemStation=0,0917
Frame=30 Station=0,1834 OutputCase=STR122 CaseType=Combination P=-17,4501730515258 V2=11,1187146288085 V3=0 T=0 M2=0 M3=0,265597557867401 FrameElem=30-1 ElemStation=0,1834
Frame=30 Station=0 OutputCase=STR123 CaseType=Combination P=-30,6444259739583 V2=-1,80479760454418 V3=0 T=0 M2=0 M3=-1,67340693230002 FrameElem=30-1 ElemStation=0
Frame=30 Station=0,0917 OutputCase=STR123 CaseType=Combination P=-30,6444259739583 V2=-0,520997604544176 V3=0 T=0 M2=0 M3=-1,56676922196332 FrameElem=30-1 ElemStation=0,0917
Frame=30 Station=0,1834 OutputCase=STR123 CaseType=Combination P=-30,6444259739583 V2=0,762802395455825 V3=0 T=0 M2=0 M3=-1,57785597162662 FrameElem=30-1 ElemStation=0,1834
Frame=30 Station=0 OutputCase=STR124 CaseType=Combination P=-9,71911954774786 V2=-2,70345760455923 V3=0 T=0 M2=0 M3=1,81191166363813 FrameElem=30-1 ElemStation=0
Frame=30 Station=0,0917 OutputCase=STR124 CaseType=Combination P=-9,71911954774786 V2=-0,970327604559225 V3=0 T=0 M2=0 M3=1,98035471547621 FrameElem=30-1 ElemStation=0,0917
Frame=30 Station=0,1834 OutputCase=STR124 CaseType=Combination P=-9,71911954774786 V2=0,762802395440775 V3=0 T=0 M2=0 M3=1,98986974631429 FrameElem=30-1 ElemStation=0,1834
Frame=30 Station=0 OutputCase=STR125 CaseType=Combination P=-4,61051643772315 V2=-2,70345760455495 V3=0 T=0 M2=0 M3=2,6520933531737 FrameElem=30-1 ElemStation=0
Frame=30 Station=0,0917 OutputCase=STR125 CaseType=Combination P=-4,61051643772315 V2=-0,970327604554951 V3=0 T=0 M2=0 M3=2,82053640715505 FrameElem=30-1 ElemStation=0,0917
Frame=30 Station=0,1834 OutputCase=STR125 CaseType=Combination P=-4,61051643772315 V2=0,76280239544505 V3=0 T=0 M2=0 M3=2,83005143799274 FrameElem=30-1 ElemStation=0,1834
Frame=30 Station=0 OutputCase=STR126 CaseType=Combination P=-5,58266125958945 V2=-20,529937604795 V3=0 T=0 M2=0 M3=23,0736525180378 FrameElem=30-1 ElemStation=0
Frame=30 Station=0,0917 OutputCase=STR126 CaseType=Combination P=-5,58266125958945 V2=-9,88356760479496 V3=0 T=0 M2=0 M3=24,4681117318975 FrameElem=30-1 ElemStation=0,0917
Frame=30 Station=0,1834 OutputCase=STR126 CaseType=Combination P=-5,58266125958945 V2=0,762802395205042 V3=0 T=0 M2=0 M3=24,8862988167572 FrameElem=30-1 ElemStation=0,1834
Frame=30 Station=0 OutputCase=STR127 CaseType=Combination P=-18,776914181696 V2=-10,1740253714245 V3=0 T=0 M2=0 M3=23,1294732916959 FrameElem=30-1 ElemStation=0
Frame=30 Station=0,0917 OutputCase=STR127 CaseType=Combination P=-18,776914181696 V2=0,472344628575552 V3=0 T=0 M2=0 M3=23,5742953537555 FrameElem=30-1 ElemStation=0,0917
Frame=30 Station=0,1834 OutputCase=STR127 CaseType=Combination P=-18,776914181696 V2=11,1187146285756 V3=0 T=0 M2=0 M3=23,0428452868152 FrameElem=30-1 ElemStation=0,1834
Frame=30 Station=0 OutputCase=STR128 CaseType=Combination P=-31,9711671041285 V2=-20,5299376047771 V3=0 T=0 M2=0 M3=19,386745458605 FrameElem=30-1 ElemStation=0
Frame=30 Station=0,0917 OutputCase=STR128 CaseType=Combination P=-31,9711671041285 V2=-9,88356760477713 V3=0 T=0 M2=0 M3=20,7812048724631 FrameElem=30-1 ElemStation=0,0917
Frame=30 Station=0,1834 OutputCase=STR128 CaseType=Combination P=-31,9711671041285 V2=0,762802395222869 V3=0 T=0 M2=0 M3=21,1993917573211 FrameElem=30-1 ElemStation=0,1834
Frame=30 Station=0 OutputCase=STR129 CaseType=Combination P=-18,0018503750648 V2=8,55111462880866 V3=0 T=0 M2=0 M3=1,61157488337316 FrameElem=30-1 ElemStation=0

Società di Progetto
Brebemi SpA



Doc. N.
60235-0000-A00.doc

CODIFICA DOCUMENTO
04RCDII10000000000300A00

REV.
00

FOGLIO
384 di 628

Frame=30 Station=0,0917 OutputCase=STR129 CaseType=Combination P=-18,0018503750648 V2=9,83491462880867 V3=0 T=0 M2=0 M3=0,768575441911407
FrameElem=30-1 ElemStation=0,0917
Frame=30 Station=0,1834 OutputCase=STR129 CaseType=Combination P=-18,0018503750648 V2=11,1187146288087 V3=0 T=0 M2=0 M3=0,-192148459550348
FrameElem=30-1 ElemStation=0,1834
Frame=30 Station=0 OutputCase=STR130 CaseType=Combination P=-31,1961032974973 V2=-1,80479760454402 V3=0 T=0 M2=0 M3=-2,13115294971774 FrameElem=30-1
ElemStation=0
Frame=30 Station=0,0917 OutputCase=STR130 CaseType=Combination P=-31,1961032974973 V2=-0,520997604544018 V3=0 T=0 M2=0 M3=-2,02451523938105
FrameElem=30-1 ElemStation=0,0917
Frame=30 Station=0,1834 OutputCase=STR130 CaseType=Combination P=-31,1961032974973 V2=0,762802395455983 V3=0 T=0 M2=0 M3=-2,03560198904437
FrameElem=30-1 ElemStation=0,1834
Frame=30 Station=0 OutputCase=STR131 CaseType=Combination P=-8,61576490066979 V2=-2,70345760455954 V3=0 T=0 M2=0 M3=2,72740369847357 FrameElem=30-1
ElemStation=0
Frame=30 Station=0,0917 OutputCase=STR131 CaseType=Combination P=-8,61576490066979 V2=-0,970327604559542 V3=0 T=0 M2=0 M3=2,89584675031168
FrameElem=30-1 ElemStation=0,0917
Frame=30 Station=0,1834 OutputCase=STR131 CaseType=Combination P=-8,61576490066979 V2=0,762802395440458 V3=0 T=0 M2=0 M3=2,90536178114979
FrameElem=30-1 ElemStation=0,1834
Frame=30 Station=0 OutputCase=STR132 CaseType=Combination P=-3,50716179064508 V2=-2,70345760455527 V3=0 T=0 M2=0 M3=3,56758539015281 FrameElem=30-1
ElemStation=0
Frame=30 Station=0,0917 OutputCase=STR132 CaseType=Combination P=-3,50716179064508 V2=-0,970327604555268 V3=0 T=0 M2=0 M3=3,73602844199052
FrameElem=30-1 ElemStation=0,0917
Frame=30 Station=0,1834 OutputCase=STR132 CaseType=Combination P=-3,50716179064508 V2=0,762802395444733 V3=0 T=0 M2=0 M3=3,74554347282824
FrameElem=30-1 ElemStation=0,1834
Frame=30 Station=0 OutputCase=STR133 CaseType=Combination P=-4,47930661251138 V2=-20,5299376047953 V3=0 T=0 M2=0 M3=23,9891445528733 FrameElem=30-1
ElemStation=0
Frame=30 Station=0,0917 OutputCase=STR133 CaseType=Combination P=-4,47930661251138 V2=-9,88356760479527 V3=0 T=0 M2=0 M3=25,383603766733 FrameElem=30-1
ElemStation=0,0917
Frame=30 Station=0,1834 OutputCase=STR133 CaseType=Combination P=-4,47930661251138 V2=0,762802395204725 V3=0 T=0 M2=0 M3=25,8017908515927
FrameElem=30-1 ElemStation=0,1834
Frame=30 Station=0 OutputCase=STR134 CaseType=Combination P=-17,6735595346179 V2=-10,1740253714248 V3=0 T=0 M2=0 M3=24,0449653265314 FrameElem=30-1
ElemStation=0
Frame=30 Station=0,0917 OutputCase=STR134 CaseType=Combination P=-17,6735595346179 V2=0,472344628575235 V3=0 T=0 M2=0 M3=24,489787388591 FrameElem=30-1
ElemStation=0,0917
Frame=30 Station=0,1834 OutputCase=STR134 CaseType=Combination P=-17,6735595346179 V2=11,1187146285752 V3=0 T=0 M2=0 M3=23,9583373216506 FrameElem=30-1
ElemStation=0,1834
Frame=30 Station=0 OutputCase=STR135 CaseType=Combination P=-30,8678124570504 V2=-20,5299376047775 V3=0 T=0 M2=0 M3=20,3022374934404 FrameElem=30-1
ElemStation=0
Frame=30 Station=0,0917 OutputCase=STR135 CaseType=Combination P=-30,8678124570504 V2=-9,88356760477745 V3=0 T=0 M2=0 M3=21,6966967072985
FrameElem=30-1 ElemStation=0,0917
Frame=30 Station=0,1834 OutputCase=STR135 CaseType=Combination P=-30,8678124570504 V2=0,762802395222551 V3=0 T=0 M2=0 M3=22,1148837921566
FrameElem=30-1 ElemStation=0,1834
Frame=30 Station=0 OutputCase=STR136 CaseType=Combination P=-16,8984957279867 V2=-8,55111462880835 V3=0 T=0 M2=0 M3=2,5270669182086 FrameElem=30-1
ElemStation=0
Frame=30 Station=0,0917 OutputCase=STR136 CaseType=Combination P=-16,8984957279867 V2=9,83491462880835 V3=0 T=0 M2=0 M3=1,68406747674688 FrameElem=30-1
ElemStation=0,0917
Frame=30 Station=0,1834 OutputCase=STR136 CaseType=Combination P=-16,8984957279867 V2=11,1187146288083 V3=0 T=0 M2=0 M3=0,72334357528515 FrameElem=30-1
ElemStation=0,1834
Frame=30 Station=0 OutputCase=STR137 CaseType=Combination P=-30,0927486504192 V2=-1,80479760454433 V3=0 T=0 M2=0 M3=-1,2156609148823 FrameElem=30-1
ElemStation=0
Frame=30 Station=0,0917 OutputCase=STR137 CaseType=Combination P=-30,0927486504192 V2=-0,520997604544335 V3=0 T=0 M2=0 M3=-1,10902320454559
FrameElem=30-1 ElemStation=0,0917
Frame=30 Station=0,1834 OutputCase=STR137 CaseType=Combination P=-30,0927486504192 V2=0,762802395455666 V3=0 T=0 M2=0 M3=-1,12010995420887
FrameElem=30-1 ElemStation=0,1834
Frame=30 Station=0 OutputCase=STR138 CaseType=Combination P=-8,61576490066979 V2=-2,70345760455954 V3=0 T=0 M2=0 M3=2,72740369847357 FrameElem=30-1
ElemStation=0
Frame=30 Station=0,0917 OutputCase=STR138 CaseType=Combination P=-8,61576490066979 V2=-0,970327604559542 V3=0 T=0 M2=0 M3=2,89584675031168
FrameElem=30-1 ElemStation=0,0917
Frame=30 Station=0,1834 OutputCase=STR138 CaseType=Combination P=-8,61576490066979 V2=0,762802395440458 V3=0 T=0 M2=0 M3=2,90536178114979
FrameElem=30-1 ElemStation=0,1834
Frame=30 Station=0 OutputCase=STR139 CaseType=Combination P=-3,50716179064508 V2=-2,70345760455527 V3=0 T=0 M2=0 M3=3,56758539015281 FrameElem=30-1
ElemStation=0
Frame=30 Station=0,0917 OutputCase=STR139 CaseType=Combination P=-3,50716179064508 V2=-0,970327604555268 V3=0 T=0 M2=0 M3=3,73602844199052
FrameElem=30-1 ElemStation=0,0917
Frame=30 Station=0,1834 OutputCase=STR139 CaseType=Combination P=-3,50716179064508 V2=0,762802395444733 V3=0 T=0 M2=0 M3=3,74554347282824
FrameElem=30-1 ElemStation=0,1834
Frame=30 Station=0 OutputCase=STR140 CaseType=Combination P=-4,47930661251138 V2=-20,5299376047953 V3=0 T=0 M2=0 M3=23,9891445528733 FrameElem=30-1
ElemStation=0
Frame=30 Station=0,0917 OutputCase=STR140 CaseType=Combination P=-4,47930661251138 V2=-9,88356760479527 V3=0 T=0 M2=0 M3=25,383603766733 FrameElem=30-1
ElemStation=0,0917
Frame=30 Station=0,1834 OutputCase=STR140 CaseType=Combination P=-4,47930661251138 V2=0,762802395204725 V3=0 T=0 M2=0 M3=25,8017908515927
FrameElem=30-1 ElemStation=0,1834
Frame=30 Station=0 OutputCase=STR141 CaseType=Combination P=-17,6735595346179 V2=-10,1740253714248 V3=0 T=0 M2=0 M3=24,0449653265314 FrameElem=30-1
ElemStation=0
Frame=30 Station=0,0917 OutputCase=STR141 CaseType=Combination P=-17,6735595346179 V2=0,472344628575235 V3=0 T=0 M2=0 M3=24,489787388591 FrameElem=30-1
ElemStation=0,0917
Frame=30 Station=0,1834 OutputCase=STR141 CaseType=Combination P=-17,6735595346179 V2=11,1187146285752 V3=0 T=0 M2=0 M3=23,9583373216506 FrameElem=30-1
ElemStation=0,1834
Frame=30 Station=0 OutputCase=STR142 CaseType=Combination P=-30,8678124570504 V2=-20,5299376047775 V3=0 T=0 M2=0 M3=20,3022374934404 FrameElem=30-1
ElemStation=0
Frame=30 Station=0,0917 OutputCase=STR142 CaseType=Combination P=-30,8678124570504 V2=-9,88356760477745 V3=0 T=0 M2=0 M3=21,6966967072985
FrameElem=30-1 ElemStation=0,0917
Frame=30 Station=0,1834 OutputCase=STR142 CaseType=Combination P=-30,8678124570504 V2=0,762802395222551 V3=0 T=0 M2=0 M3=22,1148837921566
FrameElem=30-1 ElemStation=0,1834
Frame=30 Station=0 OutputCase=STR143 CaseType=Combination P=-16,8984957279867 V2=-8,55111462880835 V3=0 T=0 M2=0 M3=2,5270669182086 FrameElem=30-1
ElemStation=0
Frame=30 Station=0,0917 OutputCase=STR143 CaseType=Combination P=-16,8984957279867 V2=9,83491462880835 V3=0 T=0 M2=0 M3=1,68406747674688 FrameElem=30-1
ElemStation=0,0917
Frame=30 Station=0,1834 OutputCase=STR143 CaseType=Combination P=-16,8984957279867 V2=11,1187146288083 V3=0 T=0 M2=0 M3=0,72334357528515 FrameElem=30-1
ElemStation=0,1834

Società di Progetto
Brebemi SpA



Doc. N.
60235-0000-A00.doc

CODIFICA DOCUMENTO
04RCDII10000000000300A00

REV.
00

FOGLIO
385 di 628

Frame=30 Station=0 OutputCase=STR144 CaseType=Combination P=-30,0927486504192 V2=-1,80479760454433 V3=0 T=0 M2=0 M3=-1,2156609148823 FrameElem=30-1 ElemStation=0
Frame=30 Station=0,0917 OutputCase=STR144 CaseType=Combination P=-30,0927486504192 V2=-0,520997604544335 V3=0 T=0 M2=0 M3=-1,10902320454559
FrameElem=30-1 ElemStation=0,0917
Frame=30 Station=0,1834 OutputCase=STR144 CaseType=Combination P=-30,0927486504192 V2=0,762802395455666 V3=0 T=0 M2=0 M3=-1,12010995420887
FrameElem=30-1 ElemStation=0,1834
Frame=30 Station=0 OutputCase=STR145 CaseType=Combination P=-7,86652500379564 V2=-3,46625999997613 V3=0 T=0 M2=0 M3=3,422185070696 FrameElem=30-1 ElemStation=0
Frame=30 Station=0,0917 OutputCase=STR145 CaseType=Combination P=-7,86652500379564 V2=-1,73312999997613 V3=0 T=0 M2=0 M3=3,66057710219381
FrameElem=30-1 ElemStation=0,0917
Frame=30 Station=0,1834 OutputCase=STR145 CaseType=Combination P=-7,86652500379564 V2=2,38719266576481E-11 V3=0 T=0 M2=0 M3=3,74004111269162
FrameElem=30-1 ElemStation=0,1834
Frame=30 Station=0 OutputCase=STR146 CaseType=Combination P=-2,75792189377093 V2=-3,46625999997185 V3=0 T=0 M2=0 M3=4,26236676237524 FrameElem=30-1 ElemStation=0
Frame=30 Station=0,0917 OutputCase=STR146 CaseType=Combination P=-2,75792189377093 V2=-1,73312999997185 V3=0 T=0 M2=0 M3=4,50075879387266
FrameElem=30-1 ElemStation=0,0917
Frame=30 Station=0,1834 OutputCase=STR146 CaseType=Combination P=-2,75792189377093 V2=2,81465073470599E-11 V3=0 T=0 M2=0 M3=4,58022280437007
FrameElem=30-1 ElemStation=0,1834
Frame=30 Station=0 OutputCase=STR147 CaseType=Combination P=-4,42189987195202 V2=-27,2349000002918 V3=0 T=0 M2=0 M3=31,1859483010574 FrameElem=30-1 ElemStation=0
Frame=30 Station=0,0917 OutputCase=STR147 CaseType=Combination P=-4,42189987195202 V2=-13,6174500002918 V3=0 T=0 M2=0 M3=33,0590285485841
FrameElem=30-1 ElemStation=0,0917
Frame=30 Station=0,1834 OutputCase=STR147 CaseType=Combination P=-4,42189987195202 V2=-2,9175828197836E-10 V3=0 T=0 M2=0 M3=33,6833886311109
FrameElem=30-1 ElemStation=0,1834
Frame=30 Station=0 OutputCase=STR148 CaseType=Combination P=-21,1628032498109 V2=-14,0531184157144 V3=0 T=0 M2=0 M3=31,2855792857105 FrameElem=30-1 ElemStation=0
Frame=30 Station=0,0917 OutputCase=STR148 CaseType=Combination P=-21,1628032498109 V2=-0,435668415714446 V3=0 T=0 M2=0 M3=31,9498901619315
FrameElem=30-1 ElemStation=0,0917
Frame=30 Station=0,1834 OutputCase=STR148 CaseType=Combination P=-21,1628032498109 V2=13,1817815842856 V3=0 T=0 M2=0 M3=31,3654808731526 FrameElem=30-1 ElemStation=0,1834
Frame=30 Station=0 OutputCase=STR149 CaseType=Combination P=-37,9037066279958 V2=-27,2349000002666 V3=0 T=0 M2=0 M3=26,5501327857067 FrameElem=30-1 ElemStation=0
Frame=30 Station=0,0917 OutputCase=STR149 CaseType=Combination P=-37,9037066279958 V2=-13,6174500002666 V3=0 T=0 M2=0 M3=28,4232130323211
FrameElem=30-1 ElemStation=0,0917
Frame=30 Station=0,1834 OutputCase=STR149 CaseType=Combination P=-37,9037066279958 V2=-2,66564157413995E-10 V3=0 T=0 M2=0 M3=29,0475731157556
FrameElem=30-1 ElemStation=0,1834
Frame=30 Station=0 OutputCase=STR150 CaseType=Combination P=-20,0636911692243 V2=10,6141815845987 V3=0 T=0 M2=0 M3=2,96049448981429 FrameElem=30-1 ElemStation=0
Frame=30 Station=0,0917 OutputCase=STR150 CaseType=Combination P=-20,0636911692243 V2=11,8979815845987 V3=0 T=0 M2=0 M3=1,92831180850659 FrameElem=30-1 ElemStation=0,0917
Frame=30 Station=0,1834 OutputCase=STR150 CaseType=Combination P=-20,0636911692243 V2=13,1817815845987 V3=0 T=0 M2=0 M3=0,778404667198893
FrameElem=30-1 ElemStation=0,1834
Frame=30 Station=0 OutputCase=STR151 CaseType=Combination P=-36,8045945474092 V2=-2,56759999995345 V3=0 T=0 M2=0 M3=-1,77495201018954 FrameElem=30-1 ElemStation=0
Frame=30 Station=0,0917 OutputCase=STR151 CaseType=Combination P=-36,8045945474092 V2=-1,28379999995345 V3=0 T=0 M2=0 M3=-1,59836532019381
FrameElem=30-1 ElemStation=0,0917
Frame=30 Station=0,1834 OutputCase=STR151 CaseType=Combination P=-36,8045945474092 V2=4,65507099534079E-11 V3=0 T=0 M2=0 M3=-1,53950309019808
FrameElem=30-1 ElemStation=0,1834
Frame=30 Station=0 OutputCase=STR152 CaseType=Combination P=-13,1573515172248 V2=8,43308502267448 V3=0 T=0 M2=0 M3=27,9870246925729 FrameElem=30-1 ElemStation=0
Frame=30 Station=0,0917 OutputCase=STR152 CaseType=Combination P=-15,2247280172248 V2=19,0794550226745 V3=0 T=0 M2=0 M3=26,7255747314936 FrameElem=30-1 ElemStation=0,0917
Frame=30 Station=0,1834 OutputCase=STR152 CaseType=Combination P=-17,2921045172249 V2=29,7258250226745 V3=0 T=0 M2=0 M3=24,4878526414144 FrameElem=30-1 ElemStation=0,1834
Frame=30 Station=0 OutputCase=STR153 CaseType=Combination P=-3,73006671563723 V2=-21,2927400002119 V3=0 T=0 M2=0 M3=24,6839259250957 FrameElem=30-1 ElemStation=0
Frame=30 Station=0,0917 OutputCase=STR153 CaseType=Combination P=-3,73006671563723 V2=-10,6463700002119 V3=0 T=0 M2=0 M3=26,1483341186151
FrameElem=30-1 ElemStation=0,0917
Frame=30 Station=0,1834 OutputCase=STR153 CaseType=Combination P=-3,73006671563723 V2=-2,11861381216316E-10 V3=0 T=0 M2=0 M3=26,6364701831345
FrameElem=30-1 ElemStation=0,1834
Frame=30 Station=0 OutputCase=STR154 CaseType=Combination P=-16,9243196377438 V2=-10,9368277668414 V3=0 T=0 M2=0 M3=24,7397466987538 FrameElem=30-1 ElemStation=0
Frame=30 Station=0,0917 OutputCase=STR154 CaseType=Combination P=-16,9243196377438 V2=-0,290457766841351 V3=0 T=0 M2=0 M3=25,2545177404731
FrameElem=30-1 ElemStation=0,0917
Frame=30 Station=0,1834 OutputCase=STR154 CaseType=Combination P=-16,9243196377438 V2=10,3559122331586 V3=0 T=0 M2=0 M3=24,7930166531925 FrameElem=30-1 ElemStation=0,1834
Frame=30 Station=0 OutputCase=STR155 CaseType=Combination P=-30,1185725601763 V2=-21,292740000194 V3=0 T=0 M2=0 M3=20,9970188656629 FrameElem=30-1 ElemStation=0
Frame=30 Station=0,0917 OutputCase=STR155 CaseType=Combination P=-30,1185725601763 V2=-10,646370000194 V3=0 T=0 M2=0 M3=22,4614270591807 FrameElem=30-1 ElemStation=0,0917
Frame=30 Station=0,1834 OutputCase=STR155 CaseType=Combination P=-30,1185725601763 V2=-1,9403465501E-10 V3=0 T=0 M2=0 M3=22,9495631236985
FrameElem=30-1 ElemStation=0,1834
Frame=30 Station=0 OutputCase=STR156 CaseType=Combination P=-16,1492558311126 V2=7,78831223339176 V3=0 T=0 M2=0 M3=3,22184829043103 FrameElem=30-1 ElemStation=0
Frame=30 Station=0,0917 OutputCase=STR156 CaseType=Combination P=-16,1492558311126 V2=9,07211223339176 V3=0 T=0 M2=0 M3=2,44879782862901 FrameElem=30-1 ElemStation=0,0917
Frame=30 Station=0,1834 OutputCase=STR156 CaseType=Combination P=-16,1492558311126 V2=10,3559122333918 V3=0 T=0 M2=0 M3=1,55802290682698 FrameElem=30-1 ElemStation=0,1834
Frame=30 Station=0 OutputCase=STR157 CaseType=Combination P=-29,3435087535451 V2=-2,56759999996092 V3=0 T=0 M2=0 M3=-0,520879542659869 FrameElem=30-1 ElemStation=0
Frame=30 Station=0,0917 OutputCase=STR157 CaseType=Combination P=-29,3435087535451 V2=-1,28379999996092 V3=0 T=0 M2=0 M3=-0,344292852663452
FrameElem=30-1 ElemStation=0,0917
Frame=30 Station=0,1834 OutputCase=STR157 CaseType=Combination P=-29,3435087535451 V2=3,90802057381734E-11 V3=0 T=0 M2=0 M3=-0,285430622667036
FrameElem=30-1 ElemStation=0,1834
Frame=30 Station=0 OutputCase=STR158 CaseType=Combination P=-8,41820232733468 V2=-3,46625999997597 V3=0 T=0 M2=0 M3=2,96443905327828 FrameElem=30-1 ElemStation=0
Frame=30 Station=0,0917 OutputCase=STR158 CaseType=Combination P=-8,41820232733468 V2=-1,73312999997597 V3=0 T=0 M2=0 M3=3,20283108477608
FrameElem=30-1 ElemStation=0,0917

APPROVATO S.D.P.

Società di Progetto
Brebemi SpA



Doc. N.
60235-0000-A00.doc

CODIFICA DOCUMENTO
04RCDII10000000000300A00

REV.
00

FOGLIO
386 di 628

Frame=30 Station=0,1834 OutputCase=STR158 CaseType=Combination P=-8,41820232733468 V2=2,40305197962698E-11 V3=0 T=0 M2=0 M3=3,28229509527388
FrameElem=30-1 ElemStation=0,1834
Frame=30 Station=0 OutputCase=STR159 CaseType=Combination P=-3,30959921730997 V2=-3,4662599999717 V3=0 T=0 M2=0 M3=3,80462074495752 FrameElem=30-1
ElemStation=0
Frame=30 Station=0,0917 OutputCase=STR159 CaseType=Combination P=-3,30959921730997 V2=-1,7331299999717 V3=0 T=0 M2=0 M3=4,04301277645492 FrameElem=30-1
ElemStation=0,0917
Frame=30 Station=0,1834 OutputCase=STR159 CaseType=Combination P=-3,30959921730997 V2=2,83051004856816E-11 V3=0 T=0 M2=0 M3=4,12247678695233
FrameElem=30-1 ElemStation=0,1834
Frame=30 Station=0 OutputCase=STR160 CaseType=Combination P=-4,28174403917627 V2=-21,2927400002117 V3=0 T=0 M2=0 M3=24,226179907678 FrameElem=30-1
ElemStation=0
Frame=30 Station=0,0917 OutputCase=STR160 CaseType=Combination P=-4,28174403917627 V2=-10,6463700002117 V3=0 T=0 M2=0 M3=25,6905881011974
FrameElem=30-1 ElemStation=0,0917
Frame=30 Station=0,1834 OutputCase=STR160 CaseType=Combination P=-4,28174403917627 V2=-2,11702788077695E-10 V3=0 T=0 M2=0 M3=26,1787241657168
FrameElem=30-1 ElemStation=0,1834
Frame=30 Station=0 OutputCase=STR161 CaseType=Combination P=-17,4759969612828 V2=-10,9368277668412 V3=0 T=0 M2=0 M3=24,2820006813361 FrameElem=30-1
ElemStation=0
Frame=30 Station=0,0917 OutputCase=STR161 CaseType=Combination P=-17,4759969612828 V2=-0,290457766841192 V3=0 T=0 M2=0 M3=24,7967717230554
FrameElem=30-1 ElemStation=0,0917
Frame=30 Station=0,1834 OutputCase=STR161 CaseType=Combination P=-17,4759969612828 V2=10,3559122331588 V3=0 T=0 M2=0 M3=24,3352706357747 FrameElem=30-1
ElemStation=0,1834
Frame=30 Station=0 OutputCase=STR162 CaseType=Combination P=-30,6702498837153 V2=-21,2927400001939 V3=0 T=0 M2=0 M3=20,5392728482452 FrameElem=30-1
ElemStation=0
Frame=30 Station=0,0917 OutputCase=STR162 CaseType=Combination P=-30,6702498837153 V2=-10,6463700001939 V3=0 T=0 M2=0 M3=22,0036810417629
FrameElem=30-1 ElemStation=0,0917
Frame=30 Station=0,1834 OutputCase=STR162 CaseType=Combination P=-30,6702498837153 V2=-1,93876061871379E-10 V3=0 T=0 M2=0 M3=22,491871062807
FrameElem=30-1 ElemStation=0,1834
Frame=30 Station=0 OutputCase=STR163 CaseType=Combination P=-16,7009331546516 V2=7,78831223339192 V3=0 T=0 M2=0 M3=2,76410227301331 FrameElem=30-1
ElemStation=0
Frame=30 Station=0,0917 OutputCase=STR163 CaseType=Combination P=-16,7009331546516 V2=9,07211223339192 V3=0 T=0 M2=0 M3=1,99105181121127 FrameElem=30-1
ElemStation=0,0917
Frame=30 Station=0,1834 OutputCase=STR163 CaseType=Combination P=-16,7009331546516 V2=10,3559122333919 V3=0 T=0 M2=0 M3=1,10027688940924 FrameElem=30-1
ElemStation=0,1834
Frame=30 Station=0 OutputCase=STR164 CaseType=Combination P=-29,8951860770841 V2=-2,56759999996076 V3=0 T=0 M2=0 M3=-0,978625560077589 FrameElem=30-1
ElemStation=0
Frame=30 Station=0,0917 OutputCase=STR164 CaseType=Combination P=-29,8951860770841 V2=-1,28379999996076 V3=0 T=0 M2=0 M3=-0,802038870081187
FrameElem=30-1 ElemStation=0,0917
Frame=30 Station=0,1834 OutputCase=STR164 CaseType=Combination P=-29,8951860770841 V2=3,9238798876795E-11 V3=0 T=0 M2=0 M3=-0,743176640084785
FrameElem=30-1 ElemStation=0,1834
Frame=30 Station=0 OutputCase=STR165 CaseType=Combination P=-7,3148476802566 V2=-3,46625999997629 V3=0 T=0 M2=0 M3=3,87993108811372 FrameElem=30-1
ElemStation=0
Frame=30 Station=0,0917 OutputCase=STR165 CaseType=Combination P=-7,3148476802566 V2=-1,73312999997629 V3=0 T=0 M2=0 M3=4,11832311961155 FrameElem=30-1
ElemStation=0,0917
Frame=30 Station=0,1834 OutputCase=STR165 CaseType=Combination P=-7,3148476802566 V2=2,3713335190265E-11 V3=0 T=0 M2=0 M3=4,19778713010937
FrameElem=30-1 ElemStation=0,1834
Frame=30 Station=0 OutputCase=STR166 CaseType=Combination P=-2,2062445702319 V2=-3,46625999997201 V3=0 T=0 M2=0 M3=4,72011277979296 FrameElem=30-1
ElemStation=0
Frame=30 Station=0,0917 OutputCase=STR166 CaseType=Combination P=-2,2062445702319 V2=-1,73312999997201 V3=0 T=0 M2=0 M3=4,95850481129039 FrameElem=30-1
ElemStation=0,0917
Frame=30 Station=0,1834 OutputCase=STR166 CaseType=Combination P=-2,2062445702319 V2=2,79879142084383E-11 V3=0 T=0 M2=0 M3=5,03796882178782
FrameElem=30-1 ElemStation=0,1834
Frame=30 Station=0 OutputCase=STR167 CaseType=Combination P=-3,178389320982 V2=-21,292740000212 V3=0 T=0 M2=0 M3=25,1416719425134 FrameElem=30-1
ElemStation=0
Frame=30 Station=0,0917 OutputCase=STR167 CaseType=Combination P=-3,178389320982 V2=-10,646370000212 V3=0 T=0 M2=0 M3=26,6060801360328 FrameElem=30-1
ElemStation=0,0917
Frame=30 Station=0,1834 OutputCase=STR167 CaseType=Combination P=-3,178389320982 V2=-2,12019974354938E-10 V3=0 T=0 M2=0 M3=27,0942162005523
FrameElem=30-1 ElemStation=0,1834
Frame=30 Station=0 OutputCase=STR168 CaseType=Combination P=-16,3726423142047 V2=-10,9368277668415 V3=0 T=0 M2=0 M3=25,1974927161715 FrameElem=30-1
ElemStation=0
Frame=30 Station=0,0917 OutputCase=STR168 CaseType=Combination P=-16,3726423142047 V2=-0,29045776684151 V3=0 T=0 M2=0 M3=25,7122637578909
FrameElem=30-1 ElemStation=0,0917
Frame=30 Station=0,1834 OutputCase=STR168 CaseType=Combination P=-16,3726423142047 V2=10,3559122331585 V3=0 T=0 M2=0 M3=25,2507626706102 FrameElem=30-1
ElemStation=0,1834
Frame=30 Station=0 OutputCase=STR169 CaseType=Combination P=-29,5668952366372 V2=-21,2927400001942 V3=0 T=0 M2=0 M3=21,4547648830806 FrameElem=30-1
ElemStation=0
Frame=30 Station=0,0917 OutputCase=STR169 CaseType=Combination P=-29,5668952366372 V2=-10,6463700001942 V3=0 T=0 M2=0 M3=22,9191730765984
FrameElem=30-1 ElemStation=0,0917
Frame=30 Station=0,1834 OutputCase=STR169 CaseType=Combination P=-29,5668952366372 V2=-1,94193248148622E-10 V3=0 T=0 M2=0 M3=23,4073091411162
FrameElem=30-1 ElemStation=0,1834
Frame=30 Station=0 OutputCase=STR170 CaseType=Combination P=-15,5975785075736 V2=7,7883122333916 V3=0 T=0 M2=0 M3=3,67959430784875 FrameElem=30-1
ElemStation=0
Frame=30 Station=0,0917 OutputCase=STR170 CaseType=Combination P=-15,5975785075736 V2=9,0721122333916 V3=0 T=0 M2=0 M3=2,90654384604674 FrameElem=30-1
ElemStation=0,0917
Frame=30 Station=0,1834 OutputCase=STR170 CaseType=Combination P=-15,5975785075736 V2=10,3559122333916 V3=0 T=0 M2=0 M3=2,01576892424473 FrameElem=30-1
ElemStation=0,1834
Frame=30 Station=0 OutputCase=STR171 CaseType=Combination P=-28,7918314300061 V2=-2,56759999996108 V3=0 T=0 M2=0 M3=-6,31335252421493E-02
FrameElem=30-1 ElemStation=0
Frame=30 Station=0,0917 OutputCase=STR171 CaseType=Combination P=-28,7918314300061 V2=-1,28379999996108 V3=0 T=0 M2=0 M3=0,113453164754282
FrameElem=30-1 ElemStation=0,0917
Frame=30 Station=0,1834 OutputCase=STR171 CaseType=Combination P=-28,7918314300061 V2=3,89216125995517E-11 V3=0 T=0 M2=0 M3=0,172315394750713
FrameElem=30-1 ElemStation=0,1834
Frame=30 Station=0 OutputCase=STR172 CaseType=Combination P=-7,63765199508677 V2=-3,92394143722602 V3=0 T=0 M2=0 M3=3,65595548706237 FrameElem=30-1
ElemStation=0
Frame=30 Station=0,0917 OutputCase=STR172 CaseType=Combination P=-7,63765199508677 V2=-2,19081143722602 V3=0 T=0 M2=0 M3=3,936316906356 FrameElem=30-1
ElemStation=0,0917
Frame=30 Station=0,1834 OutputCase=STR172 CaseType=Combination P=-7,63765199508677 V2=-0,457681437226016 V3=0 T=0 M2=0 M3=4,05775030464963
FrameElem=30-1 ElemStation=0,1834
Frame=30 Station=0 OutputCase=STR173 CaseType=Combination P=-2,52904888506206 V2=-3,92394143722174 V3=0 T=0 M2=0 M3=4,49613717874161 FrameElem=30-1
ElemStation=0

Società di Progetto
Brebemi SpA



Doc. N.
60235-0000-A00.doc

CODIFICA DOCUMENTO
04RCDII10000000000300A00

REV.
00

FOGLIO
387 di 628

Frame=30 Station=0,0917 OutputCase=STR173 CaseType=Combination P=-2,5290488506206 V2=-2,19081143722174 V3=0 T=0 M2=0 M3=4,77649859803484
FrameElem=30-1 ElemStation=0,0917
Frame=30 Station=0,1834 OutputCase=STR173 CaseType=Combination P=-2,5290488506206 V2=-0,457681437221742 V3=0 T=0 M2=0 M3=4,89793199632808
FrameElem=30-1 ElemStation=0,1834
Frame=30 Station=0 OutputCase=STR174 CaseType=Combination P=-3,50119370692836 V2=-21,7504214374618 V3=0 T=0 M2=0 M3=24,9176963414621 FrameElem=30-1
ElemStation=0
Frame=30 Station=0,0917 OutputCase=STR174 CaseType=Combination P=-3,50119370692836 V2=-11,1040514374618 V3=0 T=0 M2=0 M3=26,4240739227773
FrameElem=30-1 ElemStation=0,0917
Frame=30 Station=0,1834 OutputCase=STR174 CaseType=Combination P=-3,50119370692836 V2=-0,45768143746175 V3=0 T=0 M2=0 M3=26,9541793750925
FrameElem=30-1 ElemStation=0,1834
Frame=30 Station=0 OutputCase=STR175 CaseType=Combination P=-16,6954466290349 V2=-11,3945092040912 V3=0 T=0 M2=0 M3=24,9735171151202 FrameElem=30-1
ElemStation=0
Frame=30 Station=0,0917 OutputCase=STR175 CaseType=Combination P=-16,6954466290349 V2=-0,748139204091239 V3=0 T=0 M2=0 M3=25,5302575446353
FrameElem=30-1 ElemStation=0,0917
Frame=30 Station=0,1834 OutputCase=STR175 CaseType=Combination P=-16,6954466290349 V2=9,89823079590876 V3=0 T=0 M2=0 M3=25,1107258451505 FrameElem=30-1
ElemStation=0,1834
Frame=30 Station=0 OutputCase=STR176 CaseType=Combination P=-29,8896995514674 V2=-21,7504214374439 V3=0 T=0 M2=0 M3=21,2307892820293 FrameElem=30-1
ElemStation=0
Frame=30 Station=0,0917 OutputCase=STR176 CaseType=Combination P=-29,8896995514674 V2=-11,1040514374439 V3=0 T=0 M2=0 M3=22,7371668633429
FrameElem=30-1 ElemStation=0,0917
Frame=30 Station=0,1834 OutputCase=STR176 CaseType=Combination P=-29,8896995514674 V2=-0,457681437443923 V3=0 T=0 M2=0 M3=23,2672723156565
FrameElem=30-1 ElemStation=0,1834
Frame=30 Station=0 OutputCase=STR177 CaseType=Combination P=-15,9203828224037 V2=7,33063079614187 V3=0 T=0 M2=0 M3=3,4556187067974 FrameElem=30-1
ElemStation=0
Frame=30 Station=0,0917 OutputCase=STR177 CaseType=Combination P=-15,9203828224037 V2=8,61443079614187 V3=0 T=0 M2=0 M3=2,7245376327912 FrameElem=30-1
ElemStation=0,0917
Frame=30 Station=0,1834 OutputCase=STR177 CaseType=Combination P=-15,9203828224037 V2=9,89823079614187 V3=0 T=0 M2=0 M3=1,87573209878499 FrameElem=30-1
ElemStation=0,1834
Frame=30 Station=0 OutputCase=STR178 CaseType=Combination P=-29,1146357448362 V2=-3,02528143721081 V3=0 T=0 M2=0 M3=-0,287109126293498 FrameElem=30-1
ElemStation=0
Frame=30 Station=0,0917 OutputCase=STR178 CaseType=Combination P=-29,1146357448362 V2=-1,74148143721081 V3=0 T=0 M2=0 M3=-6,85530485012662E-02
FrameElem=30-1 ElemStation=0,0917
Frame=30 Station=0,1834 OutputCase=STR178 CaseType=Combination P=-29,1146357448362 V2=-0,457681437210808 V3=0 T=0 M2=0 M3=3,22785692909647E-02
FrameElem=30-1 ElemStation=0,1834
Frame=30 Station=0 OutputCase=STR179 CaseType=Combination P=-7,63765199508677 V2=-3,92394143722602 V3=0 T=0 M2=0 M3=3,65595548706237 FrameElem=30-1
ElemStation=0
Frame=30 Station=0,0917 OutputCase=STR179 CaseType=Combination P=-7,63765199508677 V2=-2,19081143722602 V3=0 T=0 M2=0 M3=3,936316906356 FrameElem=30-1
ElemStation=0,0917
Frame=30 Station=0,1834 OutputCase=STR179 CaseType=Combination P=-7,63765199508677 V2=-0,457681437226016 V3=0 T=0 M2=0 M3=4,05775030464963
FrameElem=30-1 ElemStation=0,1834
Frame=30 Station=0 OutputCase=STR180 CaseType=Combination P=-8,09539801250451 V2=-3,00857856272624 V3=0 T=0 M2=0 M3=3,18841465432963 FrameElem=30-1
ElemStation=0
Frame=30 Station=0,0917 OutputCase=STR180 CaseType=Combination P=-8,09539801250451 V2=-1,27544856272624 V3=0 T=0 M2=0 M3=3,38483729803163
FrameElem=30-1 ElemStation=0,0917
Frame=30 Station=0,1834 OutputCase=STR180 CaseType=Combination P=-8,09539801250451 V2=0,45768143727376 V3=0 T=0 M2=0 M3=3,42233192073362 FrameElem=30-1
ElemStation=0,1834
Frame=30 Station=0 OutputCase=STR181 CaseType=Combination P=-2,98679490247981 V2=-3,00857856272197 V3=0 T=0 M2=0 M3=4,02859634600887 FrameElem=30-1
ElemStation=0
Frame=30 Station=0,0917 OutputCase=STR181 CaseType=Combination P=-2,98679490247981 V2=-1,27544856272197 V3=0 T=0 M2=0 M3=4,22501898971047
FrameElem=30-1 ElemStation=0,0917
Frame=30 Station=0,1834 OutputCase=STR181 CaseType=Combination P=-2,98679490247981 V2=0,457681437278035 V3=0 T=0 M2=0 M3=4,26251361241207
FrameElem=30-1 ElemStation=0,1834
Frame=30 Station=0 OutputCase=STR182 CaseType=Combination P=-3,95893972434611 V2=-20,835058562962 V3=0 T=0 M2=0 M3=24,4501555087293 FrameElem=30-1
ElemStation=0
Frame=30 Station=0,0917 OutputCase=STR182 CaseType=Combination P=-3,95893972434611 V2=-10,188688562962 V3=0 T=0 M2=0 M3=25,8725943144529 FrameElem=30-1
ElemStation=0,0917
Frame=30 Station=0,1834 OutputCase=STR182 CaseType=Combination P=-3,95893972434611 V2=0,457681437038027 V3=0 T=0 M2=0 M3=26,3187609911765
FrameElem=30-1 ElemStation=0,1834
Frame=30 Station=0 OutputCase=STR183 CaseType=Combination P=-17,1531926464526 V2=-10,4791463295915 V3=0 T=0 M2=0 M3=24,5059762823874 FrameElem=30-1
ElemStation=0
Frame=30 Station=0,0917 OutputCase=STR183 CaseType=Combination P=-17,1531926464526 V2=0,167223670408537 V3=0 T=0 M2=0 M3=24,978777936311 FrameElem=30-1
ElemStation=0,0917
Frame=30 Station=0,1834 OutputCase=STR183 CaseType=Combination P=-17,1531926464526 V2=10,8135936704085 V3=0 T=0 M2=0 M3=24,4753074612345 FrameElem=30-1
ElemStation=0,1834
Frame=30 Station=0 OutputCase=STR184 CaseType=Combination P=-30,3474455688851 V2=-20,8350585629441 V3=0 T=0 M2=0 M3=20,7632484492965 FrameElem=30-1
ElemStation=0
Frame=30 Station=0,0917 OutputCase=STR184 CaseType=Combination P=-30,3474455688851 V2=-10,1886885629441 V3=0 T=0 M2=0 M3=22,1856872550185
FrameElem=30-1 ElemStation=0,0917
Frame=30 Station=0,1834 OutputCase=STR184 CaseType=Combination P=-30,3474455688851 V2=0,457681437055853 V3=0 T=0 M2=0 M3=22,6318539317405
FrameElem=30-1 ElemStation=0,1834
Frame=30 Station=0 OutputCase=STR185 CaseType=Combination P=-16,3781288398215 V2=8,24599367064165 V3=0 T=0 M2=0 M3=2,98807787406466 FrameElem=30-1
ElemStation=0
Frame=30 Station=0,0917 OutputCase=STR185 CaseType=Combination P=-16,3781288398215 V2=9,52979367064165 V3=0 T=0 M2=0 M3=2,17305802446682 FrameElem=30-1
ElemStation=0,0917
Frame=30 Station=0,1834 OutputCase=STR185 CaseType=Combination P=-16,3781288398215 V2=10,8135936706416 V3=0 T=0 M2=0 M3=1,24031371486898 FrameElem=30-1
ElemStation=0,1834
Frame=30 Station=0 OutputCase=STR186 CaseType=Combination P=-29,572381762254 V2=-2,10991856271103 V3=0 T=0 M2=0 M3=-0,754649959026241 FrameElem=30-1
ElemStation=0
Frame=30 Station=0,0917 OutputCase=STR186 CaseType=Combination P=-29,572381762254 V2=-0,826118562711033 V3=0 T=0 M2=0 M3=-0,620032656825639
FrameElem=30-1 ElemStation=0,0917
Frame=30 Station=0,1834 OutputCase=STR186 CaseType=Combination P=-29,572381762254 V2=0,457681437288968 V3=0 T=0 M2=0 M3=-0,603139814625037
FrameElem=30-1 ElemStation=0,1834
Frame=30 Station=0 OutputCase=STR187 CaseType=Combination P=-8,09539801250451 V2=-3,00857856272624 V3=0 T=0 M2=0 M3=3,18841465432963 FrameElem=30-1
ElemStation=0
Frame=30 Station=0,0917 OutputCase=STR187 CaseType=Combination P=-8,09539801250451 V2=-1,27544856272624 V3=0 T=0 M2=0 M3=3,38483729803163
FrameElem=30-1 ElemStation=0,0917
Frame=30 Station=0,1834 OutputCase=STR187 CaseType=Combination P=-8,09539801250451 V2=0,45768143727376 V3=0 T=0 M2=0 M3=3,42233192073362 FrameElem=30-1
ElemStation=0,1834

APPROVATO S.D.P.
Società di Progetto
Brebemi SpA



Doc. N.
60235-0000-A00.doc

CODIFICA DOCUMENTO
04RCDII10000000000300A00

REV.
00

FOGLIO
388 di 628

Frame=30 Station=0 OutputCase=INVSTR CaseType=Combination StepType=Max P=-2,2062445702319 V2=11,0718630218487 V3=0 T=0 M2=0 M3=31,2855792857105
FrameElem=30-1 ElemStation=0
Frame=30 Station=0,0917 OutputCase=INVSTR CaseType=Combination StepType=Max P=-2,2062445702319 V2=19,5371364599245 V3=0 T=0 M2=0 M3=33,0590285485841
FrameElem=30-1 ElemStation=0,0917
Frame=30 Station=0,1834 OutputCase=INVSTR CaseType=Combination StepType=Max P=-2,2062445702319 V2=30,1835064599245 V3=0 T=0 M2=0 M3=33,6833886311109
FrameElem=30-1 ElemStation=0,1834
Frame=30 Station=0 OutputCase=INVSTR CaseType=Combination StepType=Min P=-39,0070612750739 V2=-27,6925814375415 V3=0 T=0 M2=0 M3=-2,69044404502498
FrameElem=30-1 ElemStation=0
Frame=30 Station=0,0917 OutputCase=INVSTR CaseType=Combination StepType=Min P=-39,0070612750739 V2=-14,0751314375415 V3=0 T=0 M2=0 M3=-
2,51385735502928 FrameElem=30-1 ElemStation=0,0917
Frame=30 Station=0,1834 OutputCase=INVSTR CaseType=Combination StepType=Min P=-39,0070612750739 V2=-0,762802395628236 V3=0 T=0 M2=0 M3=-
2,45499512503357 FrameElem=30-1 ElemStation=0,1834
Frame=30 Station=0 OutputCase=SIS01 CaseType=Combination P=-8,91962484847439 V2=3,1725514771977 V3=0 T=0 M2=0 M3=2,52655382194934 FrameElem=30-1
ElemStation=0
Frame=30 Station=0,0917 OutputCase=SIS01 CaseType=Combination P=-9,20481184847439 V2=4,4134358771977 V3=0 T=0 M2=0 M3=2,17873630175031 FrameElem=30-1
ElemStation=0,0917
Frame=30 Station=0,1834 OutputCase=SIS01 CaseType=Combination P=-9,48999884847439 V2=5,6543202771977 V3=0 T=0 M2=0 M3=1,71712968207128 FrameElem=30-1
ElemStation=0,1834
Frame=30 Station=0 OutputCase=SIS02 CaseType=Combination P=-9,30273410093206 V2=3,17255147719781 V3=0 T=0 M2=0 M3=2,20867464318704 FrameElem=30-1
ElemStation=0
Frame=30 Station=0,0917 OutputCase=SIS02 CaseType=Combination P=-9,58792110093206 V2=4,41343587719781 V3=0 T=0 M2=0 M3=1,860857122988 FrameElem=30-1
ElemStation=0,0917
Frame=30 Station=0,1834 OutputCase=SIS02 CaseType=Combination P=-9,87310810093206 V2=5,65432027719781 V3=0 T=0 M2=0 M3=1,39925050330896 FrameElem=30-1
ElemStation=0,1834
Frame=30 Station=0 OutputCase=SIS03 CaseType=Combination P=-8,53651559601673 V2=3,17255147719759 V3=0 T=0 M2=0 M3=2,84443300071165 FrameElem=30-1
ElemStation=0
Frame=30 Station=0,0917 OutputCase=SIS03 CaseType=Combination P=-8,82170259601673 V2=4,41343587719759 V3=0 T=0 M2=0 M3=2,49661548051263 FrameElem=30-1
ElemStation=0,0917
Frame=30 Station=0,1834 OutputCase=SIS03 CaseType=Combination P=-9,10688959601673 V2=5,65432027719759 V3=0 T=0 M2=0 M3=2,03500886083361 FrameElem=30-1
ElemStation=0,1834
Frame=30 Station=0 OutputCase=SIS04 CaseType=Combination P=-8,76068525909323 V2=2,85471714577417 V3=0 T=0 M2=0 M3=2,68889438887043 FrameElem=30-1
ElemStation=0
Frame=30 Station=0,0917 OutputCase=SIS04 CaseType=Combination P=-9,04587225909323 V2=4,09560154577417 V3=0 T=0 M2=0 M3=2,37022227686294 FrameElem=30-1
ElemStation=0,0917
Frame=30 Station=0,1834 OutputCase=SIS04 CaseType=Combination P=-9,33105925909323 V2=5,33648594577417 V3=0 T=0 M2=0 M3=1,93776106537545 FrameElem=30-1
ElemStation=0,1834
Frame=30 Station=0 OutputCase=SIS05 CaseType=Combination P=-9,07856443785556 V2=3,49038580862124 V3=0 T=0 M2=0 M3=2,36421325502825 FrameElem=30-1
ElemStation=0
Frame=30 Station=0,0917 OutputCase=SIS05 CaseType=Combination P=-9,36375143785556 V2=4,73127020862124 V3=0 T=0 M2=0 M3=1,98725032663768 FrameElem=30-1
ElemStation=0,0917
Frame=30 Station=0,1834 OutputCase=SIS05 CaseType=Combination P=-9,64893843785556 V2=5,97215460862124 V3=0 T=0 M2=0 M3=1,49649829876712 FrameElem=30-1
ElemStation=0,1834
Frame=30 Station=0 OutputCase=SIS06 CaseType=Combination P=-8,53651559601673 V2=3,17255147719759 V3=0 T=0 M2=0 M3=2,84443300071165 FrameElem=30-1
ElemStation=0
Frame=30 Station=0,0917 OutputCase=SIS06 CaseType=Combination P=-8,82170259601673 V2=4,41343587719759 V3=0 T=0 M2=0 M3=2,49661548051263 FrameElem=30-1
ElemStation=0,0917
Frame=30 Station=0,1834 OutputCase=SIS06 CaseType=Combination P=-9,10688959601673 V2=5,65432027719759 V3=0 T=0 M2=0 M3=2,03500886083361 FrameElem=30-1
ElemStation=0,1834
Frame=30 Station=0 OutputCase=SIS07 CaseType=Combination P=-9,14379451155089 V2=2,85471714577428 V3=0 T=0 M2=0 M3=2,37101521010813 FrameElem=30-1
ElemStation=0
Frame=30 Station=0,0917 OutputCase=SIS07 CaseType=Combination P=-9,42898151155089 V2=4,09560154577428 V3=0 T=0 M2=0 M3=2,05234309810063 FrameElem=30-1
ElemStation=0,0917
Frame=30 Station=0,1834 OutputCase=SIS07 CaseType=Combination P=-9,71416851155089 V2=5,33648594577428 V3=0 T=0 M2=0 M3=1,61988188661313 FrameElem=30-1
ElemStation=0,1834
Frame=30 Station=0 OutputCase=SIS08 CaseType=Combination P=-9,46167369031322 V2=3,49038580862135 V3=0 T=0 M2=0 M3=2,04633407626595 FrameElem=30-1
ElemStation=0
Frame=30 Station=0,0917 OutputCase=SIS08 CaseType=Combination P=-9,74686069031322 V2=4,73127020862135 V3=0 T=0 M2=0 M3=1,66937114787537 FrameElem=30-1
ElemStation=0,0917
Frame=30 Station=0,1834 OutputCase=SIS08 CaseType=Combination P=-10,03204769031322 V2=5,97215460862135 V3=0 T=0 M2=0 M3=1,17861912000479 FrameElem=30-1
ElemStation=0,1834
Frame=30 Station=0 OutputCase=SIS09 CaseType=Combination P=-8,91962484847439 V2=3,1725514771977 V3=0 T=0 M2=0 M3=2,52655382194934 FrameElem=30-1
ElemStation=0
Frame=30 Station=0,0917 OutputCase=SIS09 CaseType=Combination P=-9,20481184847439 V2=4,4134358771977 V3=0 T=0 M2=0 M3=2,17873630175031 FrameElem=30-1
ElemStation=0,0917
Frame=30 Station=0,1834 OutputCase=SIS09 CaseType=Combination P=-9,48999884847439 V2=5,6543202771977 V3=0 T=0 M2=0 M3=1,71712968207128 FrameElem=30-1
ElemStation=0,1834
Frame=30 Station=0 OutputCase=SIS10 CaseType=Combination P=-8,87885377724389 V2=3,00088907719619 V3=0 T=0 M2=0 M3=2,7368258777521 FrameElem=30-1
ElemStation=0
Frame=30 Station=0,0917 OutputCase=SIS10 CaseType=Combination P=-9,16404077724389 V2=4,32760467719619 V3=0 T=0 M2=0 M3=2,40081443911321 FrameElem=30-1
ElemStation=0,0917
Frame=30 Station=0,1834 OutputCase=SIS10 CaseType=Combination P=-9,44922777724389 V2=5,65432027719619 V3=0 T=0 M2=0 M3=1,94314317995432 FrameElem=30-1
ElemStation=0,1834
Frame=30 Station=0 OutputCase=SIS11 CaseType=Combination P=-9,26196302970155 V2=3,0008890771963 V3=0 T=0 M2=0 M3=2,4189466989898 FrameElem=30-1
ElemStation=0
Frame=30 Station=0,0917 OutputCase=SIS11 CaseType=Combination P=-9,54715002970156 V2=4,3276046771963 V3=0 T=0 M2=0 M3=2,0829352603509 FrameElem=30-1
ElemStation=0,0917
Frame=30 Station=0,1834 OutputCase=SIS11 CaseType=Combination P=-9,83233702970155 V2=5,6543202771963 V3=0 T=0 M2=0 M3=1,625264001192 FrameElem=30-1
ElemStation=0,1834
Frame=30 Station=0 OutputCase=SIS12 CaseType=Combination P=-8,49574452478623 V2=3,00088907719608 V3=0 T=0 M2=0 M3=3,05470505651441 FrameElem=30-1
ElemStation=0
Frame=30 Station=0,0917 OutputCase=SIS12 CaseType=Combination P=-8,78093152478623 V2=4,32760467719608 V3=0 T=0 M2=0 M3=2,71869361787553 FrameElem=30-1
ElemStation=0,0917
Frame=30 Station=0,1834 OutputCase=SIS12 CaseType=Combination P=-9,06611852478623 V2=5,65432027719608 V3=0 T=0 M2=0 M3=2,26102235871665 FrameElem=30-1
ElemStation=0,1834
Frame=30 Station=0 OutputCase=SIS13 CaseType=Combination P=-8,71991418786273 V2=2,68305474577266 V3=0 T=0 M2=0 M3=2,89916644467319 FrameElem=30-1
ElemStation=0
Frame=30 Station=0,0917 OutputCase=SIS13 CaseType=Combination P=-9,00510118786273 V2=4,00977034577266 V3=0 T=0 M2=0 M3=2,59230041422584 FrameElem=30-1
ElemStation=0,0917

Società di Progetto
Brebemi SpA



Doc. N.
60235-0000-A00.doc

CODIFICA DOCUMENTO
04RCDII10000000000300A00

REV.
00

FOGLIO
389 di 628

Frame=30 Station=0,1834 OutputCase=SIS13 CaseType=Combination P=-9,29028818786273 V2=5,33648594577266 V3=0 T=0 M2=0 M3=2,16377456325849 FrameElem=30-1
ElemStation=0,1834
Frame=30 Station=0 OutputCase=SIS14 CaseType=Combination P=-9,03779336662505 V2=3,31872340861972 V3=0 T=0 M2=0 M3=2,57448531083101 FrameElem=30-1
ElemStation=0
Frame=30 Station=0,0917 OutputCase=SIS14 CaseType=Combination P=-9,32298306662506 V2=4,64543900861972 V3=0 T=0 M2=0 M3=2,20932846400058 FrameElem=30-1
ElemStation=0,0917
Frame=30 Station=0,1834 OutputCase=SIS14 CaseType=Combination P=-9,60816736662505 V2=5,97215460861972 V3=0 T=0 M2=0 M3=1,72251179665015 FrameElem=30-1
ElemStation=0,1834
Frame=30 Station=0 OutputCase=SIS15 CaseType=Combination P=-8,49574452478623 V2=3,00088907719608 V3=0 T=0 M2=0 M3=3,05470505651441 FrameElem=30-1
ElemStation=0
Frame=30 Station=0,0917 OutputCase=SIS15 CaseType=Combination P=-8,78093152478623 V2=4,32760467719608 V3=0 T=0 M2=0 M3=2,71869361787553 FrameElem=30-1
ElemStation=0,0917
Frame=30 Station=0,1834 OutputCase=SIS15 CaseType=Combination P=-9,06611852478623 V2=5,65432027719608 V3=0 T=0 M2=0 M3=2,26102235871665 FrameElem=30-1
ElemStation=0,1834
Frame=30 Station=0 OutputCase=SIS16 CaseType=Combination P=-9,10302344032039 V2=2,68305474577277 V3=0 T=0 M2=0 M3=2,58128726591089 FrameElem=30-1
ElemStation=0
Frame=30 Station=0,0917 OutputCase=SIS16 CaseType=Combination P=-9,38821044032039 V2=4,00977034577277 V3=0 T=0 M2=0 M3=2,27442123546353 FrameElem=30-1
ElemStation=0,0917
Frame=30 Station=0,1834 OutputCase=SIS16 CaseType=Combination P=-9,67339744032039 V2=5,33648594577277 V3=0 T=0 M2=0 M3=1,84589538449616 FrameElem=30-1
ElemStation=0,1834
Frame=30 Station=0 OutputCase=SIS17 CaseType=Combination P=-9,42090261908272 V2=3,31872340861983 V3=0 T=0 M2=0 M3=2,25660613206871 FrameElem=30-1
ElemStation=0
Frame=30 Station=0,0917 OutputCase=SIS17 CaseType=Combination P=-9,70608961908272 V2=4,64543900861983 V3=0 T=0 M2=0 M3=1,89144928523827 FrameElem=30-1
ElemStation=0,0917
Frame=30 Station=0,1834 OutputCase=SIS17 CaseType=Combination P=-9,99127661908272 V2=5,97215460861983 V3=0 T=0 M2=0 M3=1,40463261788783 FrameElem=30-1
ElemStation=0,1834
Frame=30 Station=0 OutputCase=SIS18 CaseType=Combination P=-8,87885377724389 V2=3,00088907719619 V3=0 T=0 M2=0 M3=2,7368258777521 FrameElem=30-1
ElemStation=0
Frame=30 Station=0,0917 OutputCase=SIS18 CaseType=Combination P=-9,16404077724389 V2=4,32760467719619 V3=0 T=0 M2=0 M3=2,40081443911321 FrameElem=30-1
ElemStation=0,0917
Frame=30 Station=0,1834 OutputCase=SIS18 CaseType=Combination P=-9,44922777724389 V2=5,65432027719619 V3=0 T=0 M2=0 M3=1,94314317995432 FrameElem=30-1
ElemStation=0,1834
Frame=30 Station=0 OutputCase=SIS19 CaseType=Combination P=-9,36645289881559 V2=1,09527737579956 V3=0 T=0 M2=0 M3=1,86353432182077 FrameElem=30-1
ElemStation=0
Frame=30 Station=0,0917 OutputCase=SIS19 CaseType=Combination P=-9,45200899881559 V2=2,23602537579956 V3=0 T=0 M2=0 M3=1,71079409065995 FrameElem=30-1
ElemStation=0,0917
Frame=30 Station=0,1834 OutputCase=SIS19 CaseType=Combination P=-9,53756509881559 V2=3,37677337579956 V3=0 T=0 M2=0 M3=1,45344726789913 FrameElem=30-1
ElemStation=0,1834
Frame=30 Station=0 OutputCase=SIS20 CaseType=Combination P=-9,74956215127325 V2=1,09527737579967 V3=0 T=0 M2=0 M3=1,54565514305846 FrameElem=30-1
ElemStation=0
Frame=30 Station=0,0917 OutputCase=SIS20 CaseType=Combination P=-9,83511825127325 V2=2,23602537579967 V3=0 T=0 M2=0 M3=1,39291491189763 FrameElem=30-1
ElemStation=0,0917
Frame=30 Station=0,1834 OutputCase=SIS20 CaseType=Combination P=-9,92067435127325 V2=3,37677337579967 V3=0 T=0 M2=0 M3=1,1355680891368 FrameElem=30-1
ElemStation=0,1834
Frame=30 Station=0 OutputCase=SIS21 CaseType=Combination P=-8,98334364635792 V2=1,09527737579945 V3=0 T=0 M2=0 M3=2,18141350058307 FrameElem=30-1
ElemStation=0
Frame=30 Station=0,0917 OutputCase=SIS21 CaseType=Combination P=-9,06889974635792 V2=2,23602537579945 V3=0 T=0 M2=0 M3=2,02867326942226 FrameElem=30-1
ElemStation=0,0917
Frame=30 Station=0,1834 OutputCase=SIS21 CaseType=Combination P=-9,15445584635792 V2=3,37677337579945 V3=0 T=0 M2=0 M3=1,77132644666145 FrameElem=30-1
ElemStation=0,1834
Frame=30 Station=0 OutputCase=SIS22 CaseType=Combination P=-9,20751330943442 V2=0,777443044376027 V3=0 T=0 M2=0 M3=2,02587488874186 FrameElem=30-1
ElemStation=0
Frame=30 Station=0,0917 OutputCase=SIS22 CaseType=Combination P=-9,29306940943442 V2=1,91819104437603 V3=0 T=0 M2=0 M3=1,90228006577258 FrameElem=30-1
ElemStation=0,0917
Frame=30 Station=0,1834 OutputCase=SIS22 CaseType=Combination P=-9,37862550943442 V2=3,05893904437603 V3=0 T=0 M2=0 M3=1,67407865120329 FrameElem=30-1
ElemStation=0,1834
Frame=30 Station=0 OutputCase=SIS23 CaseType=Combination P=-9,52539248819675 V2=1,41311170722309 V3=0 T=0 M2=0 M3=1,70119375489968 FrameElem=30-1
ElemStation=0
Frame=30 Station=0,0917 OutputCase=SIS23 CaseType=Combination P=-9,61094858819675 V2=2,55385970722309 V3=0 T=0 M2=0 M3=1,51930811534732 FrameElem=30-1
ElemStation=0,0917
Frame=30 Station=0,1834 OutputCase=SIS23 CaseType=Combination P=-9,69650468819675 V2=3,69460770722309 V3=0 T=0 M2=0 M3=1,23281588459496 FrameElem=30-1
ElemStation=0,1834
Frame=30 Station=0 OutputCase=SIS24 CaseType=Combination P=-8,98334364635792 V2=1,09527737579945 V3=0 T=0 M2=0 M3=2,18141350058307 FrameElem=30-1
ElemStation=0
Frame=30 Station=0,0917 OutputCase=SIS24 CaseType=Combination P=-9,06889974635792 V2=2,23602537579945 V3=0 T=0 M2=0 M3=2,02867326942226 FrameElem=30-1
ElemStation=0,0917
Frame=30 Station=0,1834 OutputCase=SIS24 CaseType=Combination P=-9,15445584635792 V2=3,37677337579945 V3=0 T=0 M2=0 M3=1,77132644666145 FrameElem=30-1
ElemStation=0,1834
Frame=30 Station=0 OutputCase=SIS25 CaseType=Combination P=-9,59062256189209 V2=0,777443044376137 V3=0 T=0 M2=0 M3=1,70799570997955 FrameElem=30-1
ElemStation=0
Frame=30 Station=0,0917 OutputCase=SIS25 CaseType=Combination P=-9,67617866189209 V2=1,91819104437614 V3=0 T=0 M2=0 M3=1,58440088701026 FrameElem=30-1
ElemStation=0,0917
Frame=30 Station=0,1834 OutputCase=SIS25 CaseType=Combination P=-9,76173476189209 V2=3,05893904437614 V3=0 T=0 M2=0 M3=1,35619947244097 FrameElem=30-1
ElemStation=0,1834
Frame=30 Station=0 OutputCase=SIS26 CaseType=Combination P=-9,90850174065441 V2=1,4131117072232 V3=0 T=0 M2=0 M3=1,38331457613737 FrameElem=30-1
ElemStation=0
Frame=30 Station=0,0917 OutputCase=SIS26 CaseType=Combination P=-9,99405784065441 V2=2,5538597072232 V3=0 T=0 M2=0 M3=1,201428936785 FrameElem=30-1
ElemStation=0,0917
Frame=30 Station=0,1834 OutputCase=SIS26 CaseType=Combination P=-10,0796139406544 V2=3,6946077072232 V3=0 T=0 M2=0 M3=0,914936705832634 FrameElem=30-1
ElemStation=0,1834
Frame=30 Station=0 OutputCase=SIS27 CaseType=Combination P=-9,36645289881559 V2=1,09527737579956 V3=0 T=0 M2=0 M3=1,86353432182077 FrameElem=30-1
ElemStation=0
Frame=30 Station=0,0917 OutputCase=SIS27 CaseType=Combination P=-9,45200899881559 V2=2,23602537579956 V3=0 T=0 M2=0 M3=1,71079409065995 FrameElem=30-1
ElemStation=0,0917
Frame=30 Station=0,1834 OutputCase=SIS27 CaseType=Combination P=-9,53756509881559 V2=3,37677337579956 V3=0 T=0 M2=0 M3=1,45344726789913 FrameElem=30-1
ElemStation=0,1834
Frame=30 Station=0 OutputCase=SIS28 CaseType=Combination P=-9,23054932804725 V2=0,523069375794512 V3=0 T=0 M2=0 M3=2,56444117449664 FrameElem=30-1
ElemStation=0

Società di Progetto
Brebemi SpA



Doc. N.
60235-0000-A00.doc

CODIFICA DOCUMENTO
04RCDII10000000000300A00

REV.
00

FOGLIO
390 di 628

Frame=30 Station=0,0917 OutputCase=SIS28 CaseType=Combination P=-9,31610542804725 V2=1,94992137579451 V3=0 T=0 M2=0 M3=2,45105454853628 FrameElem=30-1 ElemStation=0,0917
Frame=30 Station=0,1834 OutputCase=SIS28 CaseType=Combination P=-9,40166152804725 V2=3,37677337579451 V3=0 T=0 M2=0 M3=2,20682559417592 FrameElem=30-1 ElemStation=0,1834
Frame=30 Station=0 OutputCase=SIS29 CaseType=Combination P=-9,61365858050491 V2=0,523069375794622 V3=0 T=0 M2=0 M3=2,24656199573433 FrameElem=30-1 ElemStation=0
Frame=30 Station=0,0917 OutputCase=SIS29 CaseType=Combination P=-9,69921468050491 V2=1,94992137579462 V3=0 T=0 M2=0 M3=2,13317536977397 FrameElem=30-1 ElemStation=0,0917
Frame=30 Station=0,1834 OutputCase=SIS29 CaseType=Combination P=-9,78477078050491 V2=3,37677337579462 V3=0 T=0 M2=0 M3=1,8889464154136 FrameElem=30-1 ElemStation=0,1834
Frame=30 Station=0 OutputCase=SIS30 CaseType=Combination P=-8,84744007558959 V2=0,523069375794402 V3=0 T=0 M2=0 M3=2,88232035325894 FrameElem=30-1 ElemStation=0
Frame=30 Station=0,0917 OutputCase=SIS30 CaseType=Combination P=-8,93299617558959 V2=1,9499213757944 V3=0 T=0 M2=0 M3=2,7689337272986 FrameElem=30-1 ElemStation=0,0917
Frame=30 Station=0,1834 OutputCase=SIS30 CaseType=Combination P=-9,01855227558959 V2=3,3767733757944 V3=0 T=0 M2=0 M3=2,52470477293825 FrameElem=30-1 ElemStation=0,1834
Frame=30 Station=0 OutputCase=SIS31 CaseType=Combination P=-9,07160973866609 V2=0,205235044370978 V3=0 T=0 M2=0 M3=2,72678174141773 FrameElem=30-1 ElemStation=0
Frame=30 Station=0,0917 OutputCase=SIS31 CaseType=Combination P=-9,15716583866609 V2=1,63208704437098 V3=0 T=0 M2=0 M3=2,64254052364891 FrameElem=30-1 ElemStation=0,0917
Frame=30 Station=0,1834 OutputCase=SIS31 CaseType=Combination P=-9,24272193866609 V2=3,05893904437098 V3=0 T=0 M2=0 M3=2,42745697748009 FrameElem=30-1 ElemStation=0,1834
Frame=30 Station=0 OutputCase=SIS32 CaseType=Combination P=-9,38948891742841 V2=0,840903707218045 V3=0 T=0 M2=0 M3=2,40210060757555 FrameElem=30-1 ElemStation=0
Frame=30 Station=0,0917 OutputCase=SIS32 CaseType=Combination P=-9,47504501742841 V2=2,26775570721805 V3=0 T=0 M2=0 M3=2,25956857342365 FrameElem=30-1 ElemStation=0,0917
Frame=30 Station=0,1834 OutputCase=SIS32 CaseType=Combination P=-9,5606011742841 V2=3,69460770721805 V3=0 T=0 M2=0 M3=1,98619421087176 FrameElem=30-1 ElemStation=0,1834
Frame=30 Station=0 OutputCase=SIS33 CaseType=Combination P=-8,84744007558959 V2=0,523069375794402 V3=0 T=0 M2=0 M3=2,88232035325894 FrameElem=30-1 ElemStation=0
Frame=30 Station=0,0917 OutputCase=SIS33 CaseType=Combination P=-8,93299617558959 V2=1,9499213757944 V3=0 T=0 M2=0 M3=2,7689337272986 FrameElem=30-1 ElemStation=0,0917
Frame=30 Station=0,1834 OutputCase=SIS33 CaseType=Combination P=-9,01855227558959 V2=3,3767733757944 V3=0 T=0 M2=0 M3=2,52470477293825 FrameElem=30-1 ElemStation=0,1834
Frame=30 Station=0 OutputCase=SIS34 CaseType=Combination P=-9,45471899112375 V2=0,205235044371089 V3=0 T=0 M2=0 M3=2,40890256265542 FrameElem=30-1 ElemStation=0
Frame=30 Station=0,0917 OutputCase=SIS34 CaseType=Combination P=-9,54027509112375 V2=1,63208704437109 V3=0 T=0 M2=0 M3=2,32466134488659 FrameElem=30-1 ElemStation=0,0917
Frame=30 Station=0,1834 OutputCase=SIS34 CaseType=Combination P=-9,62583119112375 V2=3,05893904437109 V3=0 T=0 M2=0 M3=2,10957779871777 FrameElem=30-1 ElemStation=0,1834
Frame=30 Station=0 OutputCase=SIS35 CaseType=Combination P=-9,77259816988608 V2=0,840903707218156 V3=0 T=0 M2=0 M3=2,08422142881324 FrameElem=30-1 ElemStation=0
Frame=30 Station=0,0917 OutputCase=SIS35 CaseType=Combination P=-9,85815426988608 V2=2,26775570721816 V3=0 T=0 M2=0 M3=1,94168939466134 FrameElem=30-1 ElemStation=0,0917
Frame=30 Station=0,1834 OutputCase=SIS35 CaseType=Combination P=-9,94371036988608 V2=3,69460770721816 V3=0 T=0 M2=0 M3=1,66831503210943 FrameElem=30-1 ElemStation=0,1834
Frame=30 Station=0 OutputCase=SIS36 CaseType=Combination P=-9,23054932804725 V2=0,523069375794512 V3=0 T=0 M2=0 M3=2,56444117449664 FrameElem=30-1 ElemStation=0
Frame=30 Station=0,0917 OutputCase=SIS36 CaseType=Combination P=-9,31610542804725 V2=1,94992137579451 V3=0 T=0 M2=0 M3=2,45105454853628 FrameElem=30-1 ElemStation=0,0917
Frame=30 Station=0,1834 OutputCase=SIS36 CaseType=Combination P=-9,40166152804725 V2=3,37677337579451 V3=0 T=0 M2=0 M3=2,20682559417592 FrameElem=30-1 ElemStation=0,1834
Frame=30 Station=0 OutputCase=INVSIS CaseType=Combination StepType=Max P=-8,49574452478623 V2=3,49038580862135 V3=0 T=0 M2=0 M3=3,05470505651441 FrameElem=30-1 ElemStation=0
Frame=30 Station=0,0917 OutputCase=INVSIS CaseType=Combination StepType=Max P=-8,78093152478623 V2=4,73127020862135 V3=0 T=0 M2=0 M3=2,7689337272986 FrameElem=30-1 ElemStation=0,0917
Frame=30 Station=0,1834 OutputCase=INVSIS CaseType=Combination StepType=Max P=-9,01855227558959 V2=5,97215460862135 V3=0 T=0 M2=0 M3=2,52470477293825 FrameElem=30-1 ElemStation=0,1834
Frame=30 Station=0 OutputCase=INVSIS CaseType=Combination StepType=Min P=-9,90850174065441 V2=0,205235044370978 V3=0 T=0 M2=0 M3=1,38331457613737 FrameElem=30-1 ElemStation=0
Frame=30 Station=0,0917 OutputCase=INVSIS CaseType=Combination StepType=Min P=-9,99405784065441 V2=1,63208704437098 V3=0 T=0 M2=0 M3=1,201428936785 FrameElem=30-1 ElemStation=0,0917
Frame=30 Station=0,1834 OutputCase=INVSIS CaseType=Combination StepType=Min P=-10,0796139406544 V2=3,05893904437098 V3=0 T=0 M2=0 M3=0,914936705832634 FrameElem=30-1 ElemStation=0,1834
Frame=30 Station=0 OutputCase=RAR001 CaseType=Combination P=-6,50813867384743 V2=-2,5675999998212 V3=0 T=0 M2=0 M3=1,96983336419738 FrameElem=30-1 ElemStation=0
Frame=30 Station=0,0917 OutputCase=RAR001 CaseType=Combination P=-6,50813867384743 V2=-1,28379999998212 V3=0 T=0 M2=0 M3=2,14642005419575 FrameElem=30-1 ElemStation=0,0917
Frame=30 Station=0,1834 OutputCase=RAR001 CaseType=Combination P=-6,50813867384743 V2=1,78785874993537E-11 V3=0 T=0 M2=0 M3=2,20528228419411 FrameElem=30-1 ElemStation=0,1834
Frame=30 Station=0 OutputCase=RAR002 CaseType=Combination P=-4,83460814884648 V2=-20,1740000002155 V3=0 T=0 M2=0 M3=22,5725586361093 FrameElem=30-1 ElemStation=0
Frame=30 Station=0,0917 OutputCase=RAR002 CaseType=Combination P=-4,83460814884648 V2=-10,0870000002155 V3=0 T=0 M2=0 M3=23,960025486129 FrameElem=30-1 ElemStation=0,0917
Frame=30 Station=0,1834 OutputCase=RAR002 CaseType=Combination P=-4,83460814884648 V2=-2,15528261904296E-10 V3=0 T=0 M2=0 M3=24,4225144361488 FrameElem=30-1 ElemStation=0,1834
Frame=30 Station=0 OutputCase=RAR003 CaseType=Combination P=-16,660038871288 V2=-10,8328559071469 V3=0 T=0 M2=0 M3=22,6632920957442 FrameElem=30-1 ElemStation=0
Frame=30 Station=0,0917 OutputCase=RAR003 CaseType=Combination P=-16,660038871288 V2=-0,74585590714695 V3=0 T=0 M2=0 M3=23,1941760324296 FrameElem=30-1 ElemStation=0,0917
Frame=30 Station=0,1834 OutputCase=RAR003 CaseType=Combination P=-16,660038871288 V2=9,34114409285305 V3=0 T=0 M2=0 M3=22,800082069115 FrameElem=30-1 ElemStation=0,1834
Frame=30 Station=0 OutputCase=RAR004 CaseType=Combination P=-28,4854695937295 V2=-20,1740000001973 V3=0 T=0 M2=0 M3=19,3276939024363 FrameElem=30-1 ElemStation=0
Frame=30 Station=0,0917 OutputCase=RAR004 CaseType=Combination P=-28,4854695937295 V2=-10,0870000001973 V3=0 T=0 M2=0 M3=20,7151607524544 FrameElem=30-1 ElemStation=0,0917
Frame=30 Station=0,1834 OutputCase=RAR004 CaseType=Combination P=-28,4854695937295 V2=-1,97339034002653E-10 V3=0 T=0 M2=0 M3=21,1776497024725 FrameElem=30-1 ElemStation=0,1834

Società di Progetto
Brebemi SpA



Doc. N.
60235-0000-A00.doc

CODIFICA DOCUMENTO
04RCDII10000000000300A00

REV.
00

FOGLIO
391 di 628

Frame=30 Station=0 OutputCase=RAR005 CaseType=Combination P=-15,699895837346 V2=6,7735440930901 V3=0 T=0 M2=0 M3=2,49385094737834 FrameElem=30-1 ElemStation=0
Frame=30 Station=0,0917 OutputCase=RAR005 CaseType=Combination P=-15,699895837346 V2=8,0573440930909 V3=0 T=0 M2=0 M3=1,81385472404198 FrameElem=30-1 ElemStation=0,0917
Frame=30 Station=0,1834 OutputCase=RAR005 CaseType=Combination P=-15,699895837346 V2=9,3411440930901 V3=0 T=0 M2=0 M3=1,01613404070562 FrameElem=30-1 ElemStation=0,1834
Frame=30 Station=0 OutputCase=RAR006 CaseType=Combination P=-27,5253265597875 V2=-2,56759999996029 V3=0 T=0 M2=0 M3=-0,841747245292596 FrameElem=30-1 ElemStation=0
Frame=30 Station=0,0917 OutputCase=RAR006 CaseType=Combination P=-27,5253265597875 V2=-1,28379999996029 V3=0 T=0 M2=0 M3=-0,665160555933237 FrameElem=30-1 ElemStation=0,0917
Frame=30 Station=0,1834 OutputCase=RAR006 CaseType=Combination P=-27,5253265597875 V2=3,97069044311138E-11 V3=0 T=0 M2=0 M3=-0,606298325936879 FrameElem=30-1 ElemStation=0,1834
Frame=30 Station=0 OutputCase=RAR007 CaseType=Combination P=-10,7300746249279 V2=5,82359108425226 V3=0 T=0 M2=0 M3=20,2199183230497 FrameElem=30-1 ElemStation=0
Frame=30 Station=0,0917 OutputCase=RAR007 CaseType=Combination P=-12,2614646249279 V2=13,7097910842523 V3=0 T=0 M2=0 M3=19,3243127506238 FrameElem=30-1 ElemStation=0,0917
Frame=30 Station=0,1834 OutputCase=RAR007 CaseType=Combination P=-13,7928546249279 V2=21,5959910842523 V3=0 T=0 M2=0 M3=17,7055426381978 FrameElem=30-1 ElemStation=0,1834
Frame=30 Station=0 OutputCase=RAR008 CaseType=Combination P=-4,64068361981979 V2=-2,56759999997826 V3=0 T=0 M2=0 M3=1,76735913021879 FrameElem=30-1 ElemStation=0
Frame=30 Station=0,0917 OutputCase=RAR008 CaseType=Combination P=-4,64068361981979 V2=-1,28379999997826 V3=0 T=0 M2=0 M3=1,9439458202168 FrameElem=30-1 ElemStation=0,0917
Frame=30 Station=0,1834 OutputCase=RAR008 CaseType=Combination P=-4,64068361981979 V2=2,1736834554531E-11 V3=0 T=0 M2=0 M3=2,0028080502148 FrameElem=30-1 ElemStation=0,1834
Frame=30 Station=0 OutputCase=RAR009 CaseType=Combination P=-5,29433925179568 V2=-20,1740000002154 V3=0 T=0 M2=0 M3=22,1911036215945 FrameElem=30-1 ElemStation=0
Frame=30 Station=0,0917 OutputCase=RAR009 CaseType=Combination P=-5,29433925179568 V2=-10,0870000002154 V3=0 T=0 M2=0 M3=23,5785704716143 FrameElem=30-1 ElemStation=0,0917
Frame=30 Station=0,1834 OutputCase=RAR009 CaseType=Combination P=-5,29433925179568 V2=-2,15396100955445E-10 V3=0 T=0 M2=0 M3=24,041059421634 FrameElem=30-1 ElemStation=0,1834
Frame=30 Station=0 OutputCase=RAR010 CaseType=Combination P=-17,1197699742372 V2=-10,8328559071468 V3=0 T=0 M2=0 M3=22,2818370812295 FrameElem=30-1 ElemStation=0
Frame=30 Station=0,0917 OutputCase=RAR010 CaseType=Combination P=-17,1197699742372 V2=-0,745855907146818 V3=0 T=0 M2=0 M3=22,8127210179148 FrameElem=30-1 ElemStation=0,0917
Frame=30 Station=0,1834 OutputCase=RAR010 CaseType=Combination P=-17,1197699742372 V2=9,34114409285318 V3=0 T=0 M2=0 M3=22,4186270546002 FrameElem=30-1 ElemStation=0,1834
Frame=30 Station=0 OutputCase=RAR011 CaseType=Combination P=-28,9452006966787 V2=-20,1740000001972 V3=0 T=0 M2=0 M3=18,9462388879215 FrameElem=30-1 ElemStation=0
Frame=30 Station=0,0917 OutputCase=RAR011 CaseType=Combination P=-28,9452006966787 V2=-10,0870000001972 V3=0 T=0 M2=0 M3=20,3337057379396 FrameElem=30-1 ElemStation=0,0917
Frame=30 Station=0,1834 OutputCase=RAR011 CaseType=Combination P=-28,9452006966787 V2=-1,97206873053801E-10 V3=0 T=0 M2=0 M3=20,7961946879577 FrameElem=30-1 ElemStation=0,1834
Frame=30 Station=0 OutputCase=RAR012 CaseType=Combination P=-16,1596269402952 V2=6,77354409309023 V3=0 T=0 M2=0 M3=2,11239593286357 FrameElem=30-1 ElemStation=0
Frame=30 Station=0,0917 OutputCase=RAR012 CaseType=Combination P=-16,1596269402952 V2=8,05734409309023 V3=0 T=0 M2=0 M3=1,4323997095272 FrameElem=30-1 ElemStation=0,0917
Frame=30 Station=0,1834 OutputCase=RAR012 CaseType=Combination P=-16,1596269402952 V2=9,34114409309023 V3=0 T=0 M2=0 M3=0,634679026190826 FrameElem=30-1 ElemStation=0,1834
Frame=30 Station=0 OutputCase=RAR013 CaseType=Combination P=-27,9850576627367 V2=-2,56759999996016 V3=0 T=0 M2=0 M3=1,22320226044436 FrameElem=30-1 ElemStation=0
Frame=30 Station=0,0917 OutputCase=RAR013 CaseType=Combination P=-27,9850576627367 V2=-1,28379999996016 V3=0 T=0 M2=0 M3=-1,04661557044802 FrameElem=30-1 ElemStation=0,0917
Frame=30 Station=0,1834 OutputCase=RAR013 CaseType=Combination P=-27,9850576627367 V2=3,98390653799652E-11 V3=0 T=0 M2=0 M3=-0,98775334045167 FrameElem=30-1 ElemStation=0,1834
Frame=30 Station=0 OutputCase=RAR014 CaseType=Combination P=-11,1898057278771 V2=5,82359108425239 V3=0 T=0 M2=0 M3=19,8384633085349 FrameElem=30-1 ElemStation=0
Frame=30 Station=0,0917 OutputCase=RAR014 CaseType=Combination P=-12,7211957278771 V2=13,7097910842524 V3=0 T=0 M2=0 M3=18,942857736109 FrameElem=30-1 ElemStation=0,0917
Frame=30 Station=0,1834 OutputCase=RAR014 CaseType=Combination P=-14,2525857278771 V2=21,5959910842524 V3=0 T=0 M2=0 M3=17,324087623683 FrameElem=30-1 ElemStation=0,1834
Frame=30 Station=0 OutputCase=RAR015 CaseType=Combination P=-5,3607908952763 V2=-15,772400000156 V3=0 T=0 M2=0 M3=16,8944399914932 FrameElem=30-1 ElemStation=0
Frame=30 Station=0,0917 OutputCase=RAR015 CaseType=Combination P=-5,3607908952763 V2=-7,88620000015605 V3=0 T=0 M2=0 M3=17,9791868015075 FrameElem=30-1 ElemStation=0,0917
Frame=30 Station=0,1834 OutputCase=RAR015 CaseType=Combination P=-5,3607908952763 V2=-1,56046786603525E-10 V3=0 T=0 M2=0 M3=18,3407690715218 FrameElem=30-1 ElemStation=0,1834
Frame=30 Station=0 OutputCase=RAR016 CaseType=Combination P=-14,5590731319753 V2=-8,52449246353695 V3=0 T=0 M2=0 M3=16,9527214429836 FrameElem=30-1 ElemStation=0
Frame=30 Station=0,0917 OutputCase=RAR016 CaseType=Combination P=-14,5590731319753 V2=-0,638292463536951 V3=0 T=0 M2=0 M3=17,37283513189 FrameElem=30-1 ElemStation=0,0917
Frame=30 Station=0,1834 OutputCase=RAR016 CaseType=Combination P=-14,5590731319753 V2=7,24790753646305 V3=0 T=0 M2=0 M3=17,0697842807963 FrameElem=30-1 ElemStation=0,1834
Frame=30 Station=0 OutputCase=RAR017 CaseType=Combination P=-23,7573553686743 V2=-15,7724000001433 V3=0 T=0 M2=0 M3=14,3524704103519 FrameElem=30-1 ElemStation=0
Frame=30 Station=0,0917 OutputCase=RAR017 CaseType=Combination P=-23,7573553686743 V2=-7,88620000014331 V3=0 T=0 M2=0 M3=15,4372172203651 FrameElem=30-1 ElemStation=0,0917
Frame=30 Station=0,1834 OutputCase=RAR017 CaseType=Combination P=-23,7573553686743 V2=-1,43313805267553E-10 V3=0 T=0 M2=0 M3=15,7987994903782 FrameElem=30-1 ElemStation=0,1834
Frame=30 Station=0 OutputCase=RAR018 CaseType=Combination P=-13,8389658565188 V2=4,68030753664083 V3=0 T=0 M2=0 M3=1,82564058170923 FrameElem=30-1 ElemStation=0
Frame=30 Station=0,0917 OutputCase=RAR018 CaseType=Combination P=-13,8389658565188 V2=5,96410753664083 V3=0 T=0 M2=0 M3=1,33759415059927 FrameElem=30-1 ElemStation=0,0917
Frame=30 Station=0,1834 OutputCase=RAR018 CaseType=Combination P=-13,8389658565188 V2=7,24790753664083 V3=0 T=0 M2=0 M3=0,731823259489305 FrameElem=30-1 ElemStation=0,1834
Frame=30 Station=0 OutputCase=RAR019 CaseType=Combination P=-23,0372480932178 V2=-2,56759999996553 V3=0 T=0 M2=0 M3=-0,774610450922462 FrameElem=30-1 ElemStation=0
Frame=30 Station=0,0917 OutputCase=RAR019 CaseType=Combination P=-23,0372480932178 V2=-1,28379999996553 V3=0 T=0 M2=0 M3=-0,598023760925623 FrameElem=30-1 ElemStation=0,0917

Società di Progetto
Brebemi SpA



Doc. N.
60235-0000-A00.doc

CODIFICA DOCUMENTO
04RCDII10000000000300A00

REV.
00

FOGLIO
392 di 628

Frame=30 Station=0,1834 OutputCase=RAR019 CaseType=Combination P=-23,0372480932178 V2=3,44702044685619E-11 V3=0 T=0 M2=0 M3=-0,539161530928784
FrameElem=30-1 ElemStation=0,1834
Frame=30 Station=0 OutputCase=RAR020 CaseType=Combination P=-4,44995611256239 V2=-2,9490011976865 V3=0 T=0 M2=0 M3=1,9621678105241 FrameElem=30-1
ElemStation=0
Frame=30 Station=0,0917 OutputCase=RAR020 CaseType=Combination P=-4,44995611256239 V2=-1,6652011976865 V3=0 T=0 M2=0 M3=2,17372899035195
FrameElem=30-1 ElemStation=0,0917
Frame=30 Station=0,1834 OutputCase=RAR020 CaseType=Combination P=-4,44995611256239 V2=-0,381401197686503 V3=0 T=0 M2=0 M3=2,2675657101798
FrameElem=30-1 ElemStation=0,1834
Frame=30 Station=0 OutputCase=RAR021 CaseType=Combination P=-5,17006338801891 V2=-16,1538011978643 V3=0 T=0 M2=0 M3=17,0892486717985 FrameElem=30-1
ElemStation=0
Frame=30 Station=0,0917 OutputCase=RAR021 CaseType=Combination P=-5,17006338801891 V2=-8,26760119786429 V3=0 T=0 M2=0 M3=18,2089699716427
FrameElem=30-1 ElemStation=0,0917
Frame=30 Station=0,1834 OutputCase=RAR021 CaseType=Combination P=-5,17006338801891 V2=-0,381401197864287 V3=0 T=0 M2=0 M3=18,6055267314868
FrameElem=30-1 ElemStation=0,1834
Frame=30 Station=0 OutputCase=RAR022 CaseType=Combination P=-14,3683456247179 V2=-8,90589366124519 V3=0 T=0 M2=0 M3=17,147530123289 FrameElem=30-1
ElemStation=0
Frame=30 Station=0,0917 OutputCase=RAR022 CaseType=Combination P=-14,3683456247179 V2=-1,01969366124519 V3=0 T=0 M2=0 M3=17,6026183020251
FrameElem=30-1 ElemStation=0,0917
Frame=30 Station=0,1834 OutputCase=RAR022 CaseType=Combination P=-14,3683456247179 V2=6,86650633875481 V3=0 T=0 M2=0 M3=17,3345419407613
FrameElem=30-1 ElemStation=0,1834
Frame=30 Station=0 OutputCase=RAR023 CaseType=Combination P=-23,5666278614169 V2=-16,1538011978516 V3=0 T=0 M2=0 M3=14,5472790906573 FrameElem=30-1
ElemStation=0
Frame=30 Station=0,0917 OutputCase=RAR023 CaseType=Combination P=-23,5666278614169 V2=-8,26760119785155 V3=0 T=0 M2=0 M3=15,6670003905002
FrameElem=30-1 ElemStation=0,0917
Frame=30 Station=0,1834 OutputCase=RAR023 CaseType=Combination P=-23,5666278614169 V2=-0,381401197851554 V3=0 T=0 M2=0 M3=16,0635571503432
FrameElem=30-1 ElemStation=0,1834
Frame=30 Station=0 OutputCase=RAR024 CaseType=Combination P=-13,6482383492614 V2=4,29890633893259 V3=0 T=0 M2=0 M3=2,02044926201454 FrameElem=30-1
ElemStation=0
Frame=30 Station=0,0917 OutputCase=RAR024 CaseType=Combination P=-13,6482383492614 V2=5,58270633893259 V3=0 T=0 M2=0 M3=1,56737732073443
FrameElem=30-1 ElemStation=0,0917
Frame=30 Station=0,1834 OutputCase=RAR024 CaseType=Combination P=-13,6482383492614 V2=6,86650633893259 V3=0 T=0 M2=0 M3=0,996580919454306
FrameElem=30-1 ElemStation=0,1834
Frame=30 Station=0 OutputCase=RAR025 CaseType=Combination P=-22,8465205859604 V2=-2,94900119767377 V3=0 T=0 M2=0 M3=-0,579801770617152 FrameElem=30-1
ElemStation=0
Frame=30 Station=0,0917 OutputCase=RAR025 CaseType=Combination P=-22,8465205859604 V2=-1,66520119767377 V3=0 T=0 M2=0 M3=-0,368240590790468
FrameElem=30-1 ElemStation=0,0917
Frame=30 Station=0,1834 OutputCase=RAR025 CaseType=Combination P=-22,8465205859604 V2=-0,38140119767377 V3=0 T=0 M2=0 M3=-0,274403870963783
FrameElem=30-1 ElemStation=0,1834
Frame=30 Station=0 OutputCase=RAR026 CaseType=Combination P=-4,8314112707718 V2=-2,18619880227002 V3=0 T=0 M2=0 M3=1,57255044991348 FrameElem=30-1
ElemStation=0
Frame=30 Station=0,0917 OutputCase=RAR026 CaseType=Combination P=-4,8314112707718 V2=-0,902398802270023 V3=0 T=0 M2=0 M3=1,71416265008164
FrameElem=30-1 ElemStation=0,0917
Frame=30 Station=0,1834 OutputCase=RAR026 CaseType=Combination P=-4,8314112707718 V2=0,381401197729977 V3=0 T=0 M2=0 M3=1,7380503902498
FrameElem=30-1 ElemStation=0,1834
Frame=30 Station=0 OutputCase=RAR027 CaseType=Combination P=-5,5515184025337 V2=-15,3909988024478 V3=0 T=0 M2=0 M3=16,6996313111879 FrameElem=30-1
ElemStation=0
Frame=30 Station=0,0917 OutputCase=RAR027 CaseType=Combination P=-5,5515184025337 V2=-7,50479880244781 V3=0 T=0 M2=0 M3=17,7494036313724
FrameElem=30-1 ElemStation=0,0917
Frame=30 Station=0,1834 OutputCase=RAR027 CaseType=Combination P=-5,5515184025337 V2=0,381401197552193 V3=0 T=0 M2=0 M3=18,0760114115568
FrameElem=30-1 ElemStation=0,1834
Frame=30 Station=0 OutputCase=RAR028 CaseType=Combination P=-14,7498006392327 V2=-8,14309126582871 V3=0 T=0 M2=0 M3=16,7579127626783 FrameElem=30-1
ElemStation=0
Frame=30 Station=0,0917 OutputCase=RAR028 CaseType=Combination P=-14,7498006392327 V2=-0,256891265828711 V3=0 T=0 M2=0 M3=17,1430519617548
FrameElem=30-1 ElemStation=0,0917
Frame=30 Station=0,1834 OutputCase=RAR028 CaseType=Combination P=-14,7498006392327 V2=7,62930873417129 V3=0 T=0 M2=0 M3=16,8050266208313
FrameElem=30-1 ElemStation=0,1834
Frame=30 Station=0 OutputCase=RAR029 CaseType=Combination P=-23,9480828759317 V2=-15,3909988024351 V3=0 T=0 M2=0 M3=14,1576617300466 FrameElem=30-1
ElemStation=0
Frame=30 Station=0,0917 OutputCase=RAR029 CaseType=Combination P=-23,9480828759317 V2=-7,50479880243507 V3=0 T=0 M2=0 M3=15,2074340502299
FrameElem=30-1 ElemStation=0,0917
Frame=30 Station=0,1834 OutputCase=RAR029 CaseType=Combination P=-23,9480828759317 V2=0,381401197564926 V3=0 T=0 M2=0 M3=15,5340418304132
FrameElem=30-1 ElemStation=0,1834
Frame=30 Station=0 OutputCase=RAR030 CaseType=Combination P=-14,0296933637762 V2=5,06170873434907 V3=0 T=0 M2=0 M3=1,63083190140392 FrameElem=30-1
ElemStation=0
Frame=30 Station=0,0917 OutputCase=RAR030 CaseType=Combination P=-14,0296933637762 V2=6,34550873434907 V3=0 T=0 M2=0 M3=1,10781098046411
FrameElem=30-1 ElemStation=0,0917
Frame=30 Station=0,1834 OutputCase=RAR030 CaseType=Combination P=-14,0296933637762 V2=7,62930873434907 V3=0 T=0 M2=0 M3=0,467065599524304
FrameElem=30-1 ElemStation=0,1834
Frame=30 Station=0 OutputCase=RAR031 CaseType=Combination P=-23,2279756004752 V2=-2,18619880225729 V3=0 T=0 M2=0 M3=-0,969419131227772 FrameElem=30-1
ElemStation=0
Frame=30 Station=0,0917 OutputCase=RAR031 CaseType=Combination P=-23,2279756004752 V2=-0,90239880225729 V3=0 T=0 M2=0 M3=-0,827806931060778
FrameElem=30-1 ElemStation=0,0917
Frame=30 Station=0,1834 OutputCase=RAR031 CaseType=Combination P=-23,2279756004752 V2=0,38140119774271 V3=0 T=0 M2=0 M3=-0,803919190893785
FrameElem=30-1 ElemStation=0,1834
Frame=30 Station=0 OutputCase=RAR032 CaseType=Combination P=-4,18095251687059 V2=-2,5675999999784 V3=0 T=0 M2=0 M3=2,1488144473356 FrameElem=30-1
ElemStation=0
Frame=30 Station=0,0917 OutputCase=RAR032 CaseType=Combination P=-4,18095251687059 V2=-1,2837999999784 V3=0 T=0 M2=0 M3=2,32540083473158
FrameElem=30-1 ElemStation=0,0917
Frame=30 Station=0,1834 OutputCase=RAR032 CaseType=Combination P=-4,18095251687059 V2=2,16046736056796E-11 V3=0 T=0 M2=0 M3=2,38426306472959
FrameElem=30-1 ElemStation=0,1834
Frame=30 Station=0 OutputCase=RAR033 CaseType=Combination P=-4,90105979232711 V2=-15,7724000001562 V3=0 T=0 M2=0 M3=17,275895006008 FrameElem=30-1
ElemStation=0
Frame=30 Station=0,0917 OutputCase=RAR033 CaseType=Combination P=-4,90105979232711 V2=-7,88620000015618 V3=0 T=0 M2=0 M3=18,3606418160223
FrameElem=30-1 ElemStation=0,0917
Frame=30 Station=0,1834 OutputCase=RAR033 CaseType=Combination P=-4,90105979232711 V2=-1,56178947552377E-10 V3=0 T=0 M2=0 M3=18,7222240860366
FrameElem=30-1 ElemStation=0,1834
Frame=30 Station=0 OutputCase=RAR034 CaseType=Combination P=-14,0993420290261 V2=-8,52449246353708 V3=0 T=0 M2=0 M3=17,3341764574984 FrameElem=30-1
ElemStation=0

APPROVATO S.D.P.

Società di Progetto
Brebemi SpA



Doc. N.
60235-0000-A00.doc

CODIFICA DOCUMENTO
04RCDII10000000000300A00

REV.
00

FOGLIO
393 di 628

Frame=30 Station=0,0917 OutputCase=RAR034 CaseType=Combination P=-14,0993420290261 V2=-0,638292463537083 V3=0 T=0 M2=0 M3=17,7542901464048 FrameElem=30-1 ElemStation=0,0917
Frame=30 Station=0,1834 OutputCase=RAR034 CaseType=Combination P=-14,0993420290261 V2=7,24790753646292 V3=0 T=0 M2=0 M3=17,4512392953111 FrameElem=30-1 ElemStation=0,1834
Frame=30 Station=0 OutputCase=RAR035 CaseType=Combination P=-23,2976242657251 V2=-15,7724000001434 V3=0 T=0 M2=0 M3=14,7339254248667 FrameElem=30-1 ElemStation=0
Frame=30 Station=0,0917 OutputCase=RAR035 CaseType=Combination P=-23,2976242657251 V2=-7,88620000014345 V3=0 T=0 M2=0 M3=15,8186722348799 FrameElem=30-1 ElemStation=0,0917
Frame=30 Station=0,1834 OutputCase=RAR035 CaseType=Combination P=-23,2976242657251 V2=-1,43445966216404E-10 V3=0 T=0 M2=0 M3=16,180254504893 FrameElem=30-1 ElemStation=0,1834
Frame=30 Station=0 OutputCase=RAR036 CaseType=Combination P=-13,3792347535696 V2=4,6803075366407 V3=0 T=0 M2=0 M3=2,207095596224 FrameElem=30-1 ElemStation=0
Frame=30 Station=0,0917 OutputCase=RAR036 CaseType=Combination P=-13,3792347535696 V2=5,9641075366407 V3=0 T=0 M2=0 M3=1,71904916511405 FrameElem=30-1 ElemStation=0,0917
Frame=30 Station=0,1834 OutputCase=RAR036 CaseType=Combination P=-13,3792347535696 V2=7,2479075366407 V3=0 T=0 M2=0 M3=1,1132782740041 FrameElem=30-1 ElemStation=0,1834
Frame=30 Station=0 OutputCase=RAR037 CaseType=Combination P=-22,5775169902686 V2=-2,56759999996566 V3=0 T=0 M2=0 M3=-0,393155436407696 FrameElem=30-1 ElemStation=0
Frame=30 Station=0,0917 OutputCase=RAR037 CaseType=Combination P=-22,5775169902686 V2=-1,28379999996566 V3=0 T=0 M2=0 M3=-0,216568746410844 FrameElem=30-1 ElemStation=0,0917
Frame=30 Station=0,1834 OutputCase=RAR037 CaseType=Combination P=-22,5775169902686 V2=3,43380435197105E-11 V3=0 T=0 M2=0 M3=-0,157706516413994 FrameElem=30-1 ElemStation=0,1834
Frame=30 Station=0 OutputCase=RAR038 CaseType=Combination P=-3,10824660998913 V2=-2,5675999999787 V3=0 T=0 M2=0 M3=3,03887584526801 FrameElem=30-1 ElemStation=0
Frame=30 Station=0,0917 OutputCase=RAR038 CaseType=Combination P=-3,10824660998913 V2=-1,2837999999787 V3=0 T=0 M2=0 M3=3,21546253526606 FrameElem=30-1 ElemStation=0,0917
Frame=30 Station=0,1834 OutputCase=RAR038 CaseType=Combination P=-3,10824660998913 V2=2,12962980583598E-11 V3=0 T=0 M2=0 M3=3,27432476526411 FrameElem=30-1 ElemStation=0,1834
Frame=30 Station=0 OutputCase=RAR039 CaseType=Combination P=-4,37487704589728 V2=-20,1740000002157 V3=0 T=0 M2=0 M3=22,954013650624 FrameElem=30-1 ElemStation=0
Frame=30 Station=0,0917 OutputCase=RAR039 CaseType=Combination P=-4,37487704589728 V2=-10,0870000002157 V3=0 T=0 M2=0 M3=24,3414805006438 FrameElem=30-1 ElemStation=0,0917
Frame=30 Station=0,1834 OutputCase=RAR039 CaseType=Combination P=-4,37487704589728 V2=-2,15660422853148E-10 V3=0 T=0 M2=0 M3=24,8039694506636 FrameElem=30-1 ElemStation=0,1834
Frame=30 Station=0 OutputCase=RAR040 CaseType=Combination P=-16,2003077683388 V2=-10,8328559071471 V3=0 T=0 M2=0 M3=23,044747110259 FrameElem=30-1 ElemStation=0
Frame=30 Station=0,0917 OutputCase=RAR040 CaseType=Combination P=-16,2003077683388 V2=-0,745855907147082 V3=0 T=0 M2=0 M3=23,5756310469444 FrameElem=30-1 ElemStation=0,0917
Frame=30 Station=0,1834 OutputCase=RAR040 CaseType=Combination P=-16,2003077683388 V2=9,34114409285292 V3=0 T=0 M2=0 M3=23,1815370836298 FrameElem=30-1 ElemStation=0,1834
Frame=30 Station=0 OutputCase=RAR041 CaseType=Combination P=-28,0257384907803 V2=-20,1740000001975 V3=0 T=0 M2=0 M3=19,709148916951 FrameElem=30-1 ElemStation=0
Frame=30 Station=0,0917 OutputCase=RAR041 CaseType=Combination P=-28,0257384907803 V2=-10,0870000001975 V3=0 T=0 M2=0 M3=21,0966157669692 FrameElem=30-1 ElemStation=0,0917
Frame=30 Station=0,1834 OutputCase=RAR041 CaseType=Combination P=-28,0257384907803 V2=-1,97471194951504E-10 V3=0 T=0 M2=0 M3=21,5591047169873 FrameElem=30-1 ElemStation=0,1834
Frame=30 Station=0 OutputCase=RAR042 CaseType=Combination P=-15,2401647343968 V2=6,77354409308996 V3=0 T=0 M2=0 M3=2,87530596189311 FrameElem=30-1 ElemStation=0
Frame=30 Station=0,0917 OutputCase=RAR042 CaseType=Combination P=-15,2401647343968 V2=8,05734409308996 V3=0 T=0 M2=0 M3=2,19530973855676 FrameElem=30-1 ElemStation=0,0917
Frame=30 Station=0,1834 OutputCase=RAR042 CaseType=Combination P=-15,2401647343968 V2=9,34114409308996 V3=0 T=0 M2=0 M3=1,39758905522041 FrameElem=30-1 ElemStation=0,1834
Frame=30 Station=0 OutputCase=RAR043 CaseType=Combination P=-27,0655954568383 V2=-2,56759999996043 V3=0 T=0 M2=0 M3=-0,46029223141483 FrameElem=30-1 ElemStation=0
Frame=30 Station=0,0917 OutputCase=RAR043 CaseType=Combination P=-27,0655954568383 V2=-1,28379999996043 V3=0 T=0 M2=0 M3=-0,283705541418459 FrameElem=30-1 ElemStation=0,0917
Frame=30 Station=0,1834 OutputCase=RAR043 CaseType=Combination P=-27,0655954568383 V2=3,95747434822624E-11 V3=0 T=0 M2=0 M3=-0,224843311422088 FrameElem=30-1 ElemStation=0,1834
Frame=30 Station=0 OutputCase=RAR044 CaseType=Combination P=-10,2703435219787 V2=5,82359108425212 V3=0 T=0 M2=0 M3=20,6013733375645 FrameElem=30-1 ElemStation=0
Frame=30 Station=0,0917 OutputCase=RAR044 CaseType=Combination P=-11,8017335219787 V2=13,7097910842521 V3=0 T=0 M2=0 M3=19,7057677651385 FrameElem=30-1 ElemStation=0,0917
Frame=30 Station=0,1834 OutputCase=RAR044 CaseType=Combination P=-13,3331235219787 V2=21,5959910842521 V3=0 T=0 M2=0 M3=18,0869976527126 FrameElem=30-1 ElemStation=0,1834
Frame=30 Station=0 OutputCase=RAR045 CaseType=Combination P=-3,82835388544565 V2=-15,7724000001565 V3=0 T=0 M2=0 M3=18,1659567065424 FrameElem=30-1 ElemStation=0
Frame=30 Station=0,0917 OutputCase=RAR045 CaseType=Combination P=-3,82835388544565 V2=-7,88620000015649 V3=0 T=0 M2=0 M3=19,2507035165568 FrameElem=30-1 ElemStation=0,0917
Frame=30 Station=0,1834 OutputCase=RAR045 CaseType=Combination P=-3,82835388544565 V2=-1,56487323099697E-10 V3=0 T=0 M2=0 M3=19,6122857865711 FrameElem=30-1 ElemStation=0,1834
Frame=30 Station=0 OutputCase=RAR046 CaseType=Combination P=-13,0266361221447 V2=-8,52449246353739 V3=0 T=0 M2=0 M3=18,2242381580329 FrameElem=30-1 ElemStation=0
Frame=30 Station=0,0917 OutputCase=RAR046 CaseType=Combination P=-13,0266361221447 V2=-0,638292463537391 V3=0 T=0 M2=0 M3=18,6443518469392 FrameElem=30-1 ElemStation=0,0917
Frame=30 Station=0,1834 OutputCase=RAR046 CaseType=Combination P=-13,0266361221447 V2=7,24790753646261 V3=0 T=0 M2=0 M3=18,3413009958456 FrameElem=30-1 ElemStation=0,1834
Frame=30 Station=0 OutputCase=RAR047 CaseType=Combination P=-22,2249183588437 V2=-15,7724000001438 V3=0 T=0 M2=0 M3=15,6239871254012 FrameElem=30-1 ElemStation=0
Frame=30 Station=0,0917 OutputCase=RAR047 CaseType=Combination P=-22,2249183588437 V2=-7,88620000014375 V3=0 T=0 M2=0 M3=16,7087339354144 FrameElem=30-1 ElemStation=0,0917
Frame=30 Station=0,1834 OutputCase=RAR047 CaseType=Combination P=-22,2249183588437 V2=-1,43754341763724E-10 V3=0 T=0 M2=0 M3=17,0703162054275 FrameElem=30-1 ElemStation=0,1834
Frame=30 Station=0 OutputCase=RAR048 CaseType=Combination P=-12,3065288466881 V2=4,68030753664039 V3=0 T=0 M2=0 M3=3,09715729675846 FrameElem=30-1 ElemStation=0
Frame=30 Station=0,0917 OutputCase=RAR048 CaseType=Combination P=-12,3065288466881 V2=5,96410753664039 V3=0 T=0 M2=0 M3=2,60911086564853 FrameElem=30-1 ElemStation=0,0917
Frame=30 Station=0,1834 OutputCase=RAR048 CaseType=Combination P=-12,3065288466881 V2=7,24790753664039 V3=0 T=0 M2=0 M3=2,00333997453861 FrameElem=30-1 ElemStation=0,1834

Società di Progetto
Brebemi SpA



Doc. N.
60235-0000-A00.doc

CODIFICA DOCUMENTO
04RCDII10000000000300A00

REV.
00

FOGLIO
394 di 628

Frame=30 Station=0 OutputCase=RAR049 CaseType=Combination P=-21,5048110833872 V2=-2,56759999996597 V3=0 T=0 M2=0 M3=0,49690626412676 FrameElem=30-1 ElemStation=0
Frame=30 Station=0,0917 OutputCase=RAR049 CaseType=Combination P=-21,5048110833872 V2=-1,28379999996597 V3=0 T=0 M2=0 M3=0,673492954123639
FrameElem=30-1 ElemStation=0,0917
Frame=30 Station=0,1834 OutputCase=RAR049 CaseType=Combination P=-21,5048110833872 V2=3,40296679723906E-11 V3=0 T=0 M2=0 M3=0,732355184120518
FrameElem=30-1 ElemStation=0,1834
Frame=30 Station=0 OutputCase=RAR050 CaseType=Combination P=-2,91751910273173 V2=-2,94900119768694 V3=0 T=0 M2=0 M3=3,23368452557332 FrameElem=30-1 ElemStation=0
Frame=30 Station=0,0917 OutputCase=RAR050 CaseType=Combination P=-2,91751910273173 V2=-1,66520119768694 V3=0 T=0 M2=0 M3=3,44524570540121
FrameElem=30-1 ElemStation=0,0917
Frame=30 Station=0,1834 OutputCase=RAR050 CaseType=Combination P=-2,91751910273173 V2=-0,38140119768694 V3=0 T=0 M2=0 M3=3,53908242522911
FrameElem=30-1 ElemStation=0,1834
Frame=30 Station=0 OutputCase=RAR051 CaseType=Combination P=-3,63762637818825 V2=-16,1538011978647 V3=0 T=0 M2=0 M3=18,3607653868477 FrameElem=30-1 ElemStation=0
Frame=30 Station=0,0917 OutputCase=RAR051 CaseType=Combination P=-3,63762637818825 V2=-8,26760119786473 V3=0 T=0 M2=0 M3=19,4804866866919
FrameElem=30-1 ElemStation=0,0917
Frame=30 Station=0,1834 OutputCase=RAR051 CaseType=Combination P=-3,63762637818825 V2=-0,381401197864727 V3=0 T=0 M2=0 M3=19,8770434465361
FrameElem=30-1 ElemStation=0,1834
Frame=30 Station=0 OutputCase=RAR052 CaseType=Combination P=-12,8359086148873 V2=-8,90589366124563 V3=0 T=0 M2=0 M3=18,4190468383382 FrameElem=30-1 ElemStation=0
Frame=30 Station=0,0917 OutputCase=RAR052 CaseType=Combination P=-12,8359086148873 V2=-1,01969366124563 V3=0 T=0 M2=0 M3=18,8741350170744
FrameElem=30-1 ElemStation=0,0917
Frame=30 Station=0,1834 OutputCase=RAR052 CaseType=Combination P=-12,8359086148873 V2=-6,86650633875437 V3=0 T=0 M2=0 M3=18,6060586558106
FrameElem=30-1 ElemStation=0,1834
Frame=30 Station=0 OutputCase=RAR053 CaseType=Combination P=-22,0341908515863 V2=-16,153801197852 V3=0 T=0 M2=0 M3=15,8187958057065 FrameElem=30-1 ElemStation=0
Frame=30 Station=0,0917 OutputCase=RAR053 CaseType=Combination P=-22,0341908515863 V2=-8,26760119785199 V3=0 T=0 M2=0 M3=16,9385171055495
FrameElem=30-1 ElemStation=0,0917
Frame=30 Station=0,1834 OutputCase=RAR053 CaseType=Combination P=-22,0341908515863 V2=-0,381401197851995 V3=0 T=0 M2=0 M3=17,3350738653925
FrameElem=30-1 ElemStation=0,1834
Frame=30 Station=0 OutputCase=RAR054 CaseType=Combination P=-12,1158013394307 V2=4,29890633893215 V3=0 T=0 M2=0 M3=3,29196597706377 FrameElem=30-1 ElemStation=0
Frame=30 Station=0,0917 OutputCase=RAR054 CaseType=Combination P=-12,1158013394307 V2=5,58270633893215 V3=0 T=0 M2=0 M3=2,83889403578369
FrameElem=30-1 ElemStation=0,0917
Frame=30 Station=0,1834 OutputCase=RAR054 CaseType=Combination P=-12,1158013394307 V2=6,86650633893215 V3=0 T=0 M2=0 M3=2,26809763450361
FrameElem=30-1 ElemStation=0,1834
Frame=30 Station=0 OutputCase=RAR055 CaseType=Combination P=-21,3140835761298 V2=-2,94900119767421 V3=0 T=0 M2=0 M3=0,691714944432069 FrameElem=30-1 ElemStation=0
Frame=30 Station=0,0917 OutputCase=RAR055 CaseType=Combination P=-21,3140835761298 V2=-1,66520119767421 V3=0 T=0 M2=0 M3=0,903276124258794
FrameElem=30-1 ElemStation=0,0917
Frame=30 Station=0,1834 OutputCase=RAR055 CaseType=Combination P=-21,3140835761298 V2=-0,38140119767421 V3=0 T=0 M2=0 M3=0,997112844085519
FrameElem=30-1 ElemStation=0,1834
Frame=30 Station=0 OutputCase=RAR056 CaseType=Combination P=-3,29897411724652 V2=-2,18619880227046 V3=0 T=0 M2=0 M3=2,8440671649627 FrameElem=30-1 ElemStation=0
Frame=30 Station=0,0917 OutputCase=RAR056 CaseType=Combination P=-3,29897411724652 V2=-0,90239880227046 V3=0 T=0 M2=0 M3=2,9856793651309
FrameElem=30-1 ElemStation=0,0917
Frame=30 Station=0,1834 OutputCase=RAR056 CaseType=Combination P=-3,29897411724652 V2=0,381401197729536 V3=0 T=0 M2=0 M3=3,00956710529911
FrameElem=30-1 ElemStation=0,1834
Frame=30 Station=0 OutputCase=RAR057 CaseType=Combination P=-4,01908139270304 V2=-15,3909988024482 V3=0 T=0 M2=0 M3=17,9711480262371 FrameElem=30-1 ElemStation=0
Frame=30 Station=0,0917 OutputCase=RAR057 CaseType=Combination P=-4,01908139270304 V2=-7,50479880244825 V3=0 T=0 M2=0 M3=19,0209203464216
FrameElem=30-1 ElemStation=0,0917
Frame=30 Station=0,1834 OutputCase=RAR057 CaseType=Combination P=-4,01908139270304 V2=0,381401197551753 V3=0 T=0 M2=0 M3=19,3475281266061
FrameElem=30-1 ElemStation=0,1834
Frame=30 Station=0 OutputCase=RAR058 CaseType=Combination P=-13,2173636294021 V2=-8,14309126582915 V3=0 T=0 M2=0 M3=18,029429777276 FrameElem=30-1 ElemStation=0
Frame=30 Station=0,0917 OutputCase=RAR058 CaseType=Combination P=-13,2173636294021 V2=-0,25689126582915 V3=0 T=0 M2=0 M3=18,4145686768041
FrameElem=30-1 ElemStation=0,0917
Frame=30 Station=0,1834 OutputCase=RAR058 CaseType=Combination P=-13,2173636294021 V2=7,62930873417085 V3=0 T=0 M2=0 M3=18,0765433358806
FrameElem=30-1 ElemStation=0,1834
Frame=30 Station=0 OutputCase=RAR059 CaseType=Combination P=-22,4156458661011 V2=-15,3909988024355 V3=0 T=0 M2=0 M3=15,4291784450959 FrameElem=30-1 ElemStation=0
Frame=30 Station=0,0917 OutputCase=RAR059 CaseType=Combination P=-22,4156458661011 V2=-7,50479880243551 V3=0 T=0 M2=0 M3=16,4789507652792
FrameElem=30-1 ElemStation=0,0917
Frame=30 Station=0,1834 OutputCase=RAR059 CaseType=Combination P=-22,4156458661011 V2=0,381401197564486 V3=0 T=0 M2=0 M3=16,8055585454625
FrameElem=30-1 ElemStation=0,1834
Frame=30 Station=0 OutputCase=RAR060 CaseType=Combination P=-12,4972563539455 V2=5,06170873434863 V3=0 T=0 M2=0 M3=2,90234861645315 FrameElem=30-1 ElemStation=0
Frame=30 Station=0,0917 OutputCase=RAR060 CaseType=Combination P=-12,4972563539455 V2=6,34550873434863 V3=0 T=0 M2=0 M3=2,37932769551338
FrameElem=30-1 ElemStation=0,0917
Frame=30 Station=0,1834 OutputCase=RAR060 CaseType=Combination P=-12,4972563539455 V2=7,62930873434863 V3=0 T=0 M2=0 M3=1,73858231457361
FrameElem=30-1 ElemStation=0,1834
Frame=30 Station=0 OutputCase=RAR061 CaseType=Combination P=-21,6955385906446 V2=-2,18619880225773 V3=0 T=0 M2=0 M3=0,30209758382145 FrameElem=30-1 ElemStation=0
Frame=30 Station=0,0917 OutputCase=RAR061 CaseType=Combination P=-21,6955385906446 V2=-0,902398802257731 V3=0 T=0 M2=0 M3=0,443709783988484
FrameElem=30-1 ElemStation=0,0917
Frame=30 Station=0,1834 OutputCase=RAR061 CaseType=Combination P=-21,6955385906446 V2=0,38140119774227 V3=0 T=0 M2=0 M3=0,467597524155517
FrameElem=30-1 ElemStation=0,1834
Frame=30 Station=0 OutputCase=RAR062 CaseType=Combination P=-2,64851550703993 V2=-2,56759999997884 V3=0 T=0 M2=0 M3=3,42033085978278 FrameElem=30-1 ElemStation=0
Frame=30 Station=0,0917 OutputCase=RAR062 CaseType=Combination P=-2,64851550703993 V2=-1,28379999997884 V3=0 T=0 M2=0 M3=3,59691754978084
FrameElem=30-1 ElemStation=0,0917
Frame=30 Station=0,1834 OutputCase=RAR062 CaseType=Combination P=-2,64851550703993 V2=2,11641371095084E-11 V3=0 T=0 M2=0 M3=3,655797797789
FrameElem=30-1 ElemStation=0,1834
Frame=30 Station=0 OutputCase=RAR063 CaseType=Combination P=-3,36862278249645 V2=-15,7724000001566 V3=0 T=0 M2=0 M3=18,5474117210572 FrameElem=30-1 ElemStation=0
Frame=30 Station=0,0917 OutputCase=RAR063 CaseType=Combination P=-3,36862278249645 V2=-7,88620000015662 V3=0 T=0 M2=0 M3=19,6321585310715
FrameElem=30-1 ElemStation=0,0917

APPROVATO S.D.P.
Società di Progetto
Brebemi SpA



Doc. N.
60235-0000-A00.doc

CODIFICA DOCUMENTO
04RCDII10000000000300A00

REV.
00

FOGLIO
395 di 628

Frame=30 Station=0,1834 OutputCase=RAR063 CaseType=Combination P=-3,36862278249645 V2=-1,56619484048548E-10 V3=0 T=0 M2=0 M3=19,9937408010859
FrameElem=30-1 ElemStation=0,1834
Frame=30 Station=0 OutputCase=RAR064 CaseType=Combination P=-12,5669050191955 V2=-8,52449246353752 V3=0 T=0 M2=0 M3=18,6056931725476 FrameElem=30-1
ElemStation=0
Frame=30 Station=0,0917 OutputCase=RAR064 CaseType=Combination P=-12,5669050191955 V2=-0,638292463537524 V3=0 T=0 M2=0 M3=19,025806861454
FrameElem=30-1 ElemStation=0,0917
Frame=30 Station=0,1834 OutputCase=RAR064 CaseType=Combination P=-12,5669050191955 V2=7,24790753646248 V3=0 T=0 M2=0 M3=18,7227560103604
FrameElem=30-1 ElemStation=0,1834
Frame=30 Station=0 OutputCase=RAR065 CaseType=Combination P=-21,7651872558945 V2=-15,7724000001439 V3=0 T=0 M2=0 M3=16,0054421399159 FrameElem=30-1
ElemStation=0
Frame=30 Station=0,0917 OutputCase=RAR065 CaseType=Combination P=-21,7651872558945 V2=-7,88620000014389 V3=0 T=0 M2=0 M3=17,0901889499291
FrameElem=30-1 ElemStation=0,0917
Frame=30 Station=0,1834 OutputCase=RAR065 CaseType=Combination P=-21,7651872558945 V2=-1,43886502712576E-10 V3=0 T=0 M2=0 M3=17,4517712199423
FrameElem=30-1 ElemStation=0,1834
Frame=30 Station=0 OutputCase=RAR066 CaseType=Combination P=-11,8467977437389 V2=4,68030753664026 V3=0 T=0 M2=0 M3=3,47861231127322 FrameElem=30-1
ElemStation=0
Frame=30 Station=0,0917 OutputCase=RAR066 CaseType=Combination P=-11,8467977437389 V2=5,96410753664026 V3=0 T=0 M2=0 M3=2,99056588016331
FrameElem=30-1 ElemStation=0,0917
Frame=30 Station=0,1834 OutputCase=RAR066 CaseType=Combination P=-11,8467977437389 V2=7,24790753664026 V3=0 T=0 M2=0 M3=2,3847949890534 FrameElem=30-1
ElemStation=0,1834
Frame=30 Station=0 OutputCase=RAR067 CaseType=Combination P=-21,045079980438 V2=-2,5675999999661 V3=0 T=0 M2=0 M3=0,878361278641526 FrameElem=30-1
ElemStation=0
Frame=30 Station=0,0917 OutputCase=RAR067 CaseType=Combination P=-21,045079980438 V2=-1,2837999999661 V3=0 T=0 M2=0 M3=1,05494796863842 FrameElem=30-1
ElemStation=0,0917
Frame=30 Station=0,1834 OutputCase=RAR067 CaseType=Combination P=-21,045079980438 V2=3,38975070235392E-11 V3=0 T=0 M2=0 M3=1,11381019863531
FrameElem=30-1 ElemStation=0,1834
Frame=30 Station=0 OutputCase=RAR068 CaseType=Combination P=-3,55658593614213 V2=-3,20326866282555 V3=0 T=0 M2=0 M3=2,72779862158558 FrameElem=30-1
ElemStation=0
Frame=30 Station=0,0917 OutputCase=RAR068 CaseType=Combination P=-3,55658593614213 V2=-1,91946866282555 V3=0 T=0 M2=0 M3=2,96267612796669
FrameElem=30-1 ElemStation=0,0917
Frame=30 Station=0,1834 OutputCase=RAR068 CaseType=Combination P=-3,55658593614213 V2=-0,63566866282555 V3=0 T=0 M2=0 M3=3,07982917434779
FrameElem=30-1 ElemStation=0,1834
Frame=30 Station=0 OutputCase=RAR069 CaseType=Combination P=-4,64388064158909 V2=-20,5554011979238 V3=0 T=0 M2=0 M3=22,7673673164146 FrameElem=30-1
ElemStation=0
Frame=30 Station=0,0917 OutputCase=RAR069 CaseType=Combination P=-4,64388064158909 V2=-10,4684011979238 V3=0 T=0 M2=0 M3=24,1898086562642
FrameElem=30-1 ElemStation=0,0917
Frame=30 Station=0,1834 OutputCase=RAR069 CaseType=Combination P=-4,64388064158909 V2=-0,381401197923768 V3=0 T=0 M2=0 M3=24,6872720961138
FrameElem=30-1 ElemStation=0,1834
Frame=30 Station=0 OutputCase=RAR070 CaseType=Combination P=-16,4693113640306 V2=-11,2142571048552 V3=0 T=0 M2=0 M3=22,8581007760495 FrameElem=30-1
ElemStation=0
Frame=30 Station=0,0917 OutputCase=RAR070 CaseType=Combination P=-16,4693113640306 V2=-1,12725710485519 V3=0 T=0 M2=0 M3=23,4239592025647
FrameElem=30-1 ElemStation=0,0917
Frame=30 Station=0,1834 OutputCase=RAR070 CaseType=Combination P=-16,4693113640306 V2=8,95974289514481 V3=0 T=0 M2=0 M3=23,06483972908 FrameElem=30-1
ElemStation=0,1834
Frame=30 Station=0 OutputCase=RAR071 CaseType=Combination P=-28,2947420864721 V2=-20,5554011979056 V3=0 T=0 M2=0 M3=19,5225025827416 FrameElem=30-1
ElemStation=0
Frame=30 Station=0,0917 OutputCase=RAR071 CaseType=Combination P=-28,2947420864721 V2=-10,4684011979056 V3=0 T=0 M2=0 M3=20,9449439225895
FrameElem=30-1 ElemStation=0,0917
Frame=30 Station=0,1834 OutputCase=RAR071 CaseType=Combination P=-28,2947420864721 V2=-0,381401197905579 V3=0 T=0 M2=0 M3=21,4424073624375
FrameElem=30-1 ElemStation=0,1834
Frame=30 Station=0 OutputCase=RAR072 CaseType=Combination P=-15,5091683300886 V2=6,39214289538185 V3=0 T=0 M2=0 M3=2,68865962768365 FrameElem=30-1
ElemStation=0
Frame=30 Station=0,0917 OutputCase=RAR072 CaseType=Combination P=-15,5091683300886 V2=7,67594289538185 V3=0 T=0 M2=0 M3=2,04363789417713
FrameElem=30-1 ElemStation=0,0917
Frame=30 Station=0,1834 OutputCase=RAR072 CaseType=Combination P=-15,5091683300886 V2=8,95974289538186 V3=0 T=0 M2=0 M3=1,28089170067062
FrameElem=30-1 ElemStation=0,1834
Frame=30 Station=0 OutputCase=RAR073 CaseType=Combination P=-27,3345990525301 V2=-2,94900119766853 V3=0 T=0 M2=0 M3=-0,646938565624287 FrameElem=30-1
ElemStation=0
Frame=30 Station=0,0917 OutputCase=RAR073 CaseType=Combination P=-27,3345990525301 V2=-1,66520119766853 V3=0 T=0 M2=0 M3=-0,435377385798082
FrameElem=30-1 ElemStation=0,0917
Frame=30 Station=0,1834 OutputCase=RAR073 CaseType=Combination P=-27,3345990525301 V2=-0,381401197668533 V3=0 T=0 M2=0 M3=-0,341540665971878
FrameElem=30-1 ElemStation=0,1834
Frame=30 Station=0 OutputCase=RAR074 CaseType=Combination P=-10,5393471176705 V2=5,44218988654402 V3=0 T=0 M2=0 M3=20,414727003355 FrameElem=30-1
ElemStation=0
Frame=30 Station=0,0917 OutputCase=RAR074 CaseType=Combination P=-12,0707371176705 V2=13,328389886544 V3=0 T=0 M2=0 M3=19,5540959207589 FrameElem=30-1
ElemStation=0,0917
Frame=30 Station=0,1834 OutputCase=RAR074 CaseType=Combination P=-13,601271176705 V2=21,214589886544 V3=0 T=0 M2=0 M3=17,9703002981628 FrameElem=30-1
ElemStation=0,1834
Frame=30 Station=0 OutputCase=RAR075 CaseType=Combination P=-4,27669321159865 V2=-16,4080686630033 V3=0 T=0 M2=0 M3=17,85487948286 FrameElem=30-1
ElemStation=0
Frame=30 Station=0,0917 OutputCase=RAR075 CaseType=Combination P=-4,27669321159865 V2=-8,52186866300333 V3=0 T=0 M2=0 M3=18,9979171092574
FrameElem=30-1 ElemStation=0,0917
Frame=30 Station=0,1834 OutputCase=RAR075 CaseType=Combination P=-4,27669321159865 V2=-0,635668663003334 V3=0 T=0 M2=0 M3=19,4177901956548
FrameElem=30-1 ElemStation=0,1834
Frame=30 Station=0 OutputCase=RAR076 CaseType=Combination P=-13,4749754482977 V2=-9,16016112638424 V3=0 T=0 M2=0 M3=17,9131609343504 FrameElem=30-1
ElemStation=0
Frame=30 Station=0,0917 OutputCase=RAR076 CaseType=Combination P=-13,4749754482977 V2=-1,27396112638424 V3=0 T=0 M2=0 M3=18,3915654396399
FrameElem=30-1 ElemStation=0,0917
Frame=30 Station=0,1834 OutputCase=RAR076 CaseType=Combination P=-13,4749754482977 V2=6,61223887361576 V3=0 T=0 M2=0 M3=18,1468054049293
FrameElem=30-1 ElemStation=0,1834
Frame=30 Station=0 OutputCase=RAR077 CaseType=Combination P=-22,6732576849967 V2=-16,4080686629906 V3=0 T=0 M2=0 M3=15,312099017187 FrameElem=30-1
ElemStation=0
Frame=30 Station=0,0917 OutputCase=RAR077 CaseType=Combination P=-22,6732576849967 V2=-8,5218686629906 V3=0 T=0 M2=0 M3=16,455947528115 FrameElem=30-1
ElemStation=0,0917
Frame=30 Station=0,1834 OutputCase=RAR077 CaseType=Combination P=-22,6732576849967 V2=-0,635668662990601 V3=0 T=0 M2=0 M3=16,8758206145112
FrameElem=30-1 ElemStation=0,1834
Frame=30 Station=0 OutputCase=RAR078 CaseType=Combination P=-12,7548681728411 V2=4,04463887379355 V3=0 T=0 M2=0 M3=2,78608007307603 FrameElem=30-1
ElemStation=0

Società di Progetto
Brebemi SpA



Doc. N.
60235-0000-A00.doc

CODIFICA DOCUMENTO
04RCDII10000000000300A00

REV.
00

FOGLIO
396 di 628

Frame=30 Station=0,0917 OutputCase=RAR078 CaseType=Combination P=-12,7548681728411 V2=5,32843887379355 V3=0 T=0 M2=0 M3=2,35632445834916
FrameElem=30-1 ElemStation=0,0917
Frame=30 Station=0,1834 OutputCase=RAR078 CaseType=Combination P=-12,7548681728411 V2=6,61223887379355 V3=0 T=0 M2=0 M3=1,80884438362229
FrameElem=30-1 ElemStation=0,1834
Frame=30 Station=0 OutputCase=RAR079 CaseType=Combination P=-21,9531504095402 V2=-3,20326866281282 V3=0 T=0 M2=0 M3=0,185829040444331
ElemStation=0
Frame=30 Station=0,0917 OutputCase=RAR079 CaseType=Combination P=-21,9531504095402 V2=-1,91946866281282 V3=0 T=0 M2=0 M3=0,420706546824267
FrameElem=30-1 ElemStation=0,0917
Frame=30 Station=0,1834 OutputCase=RAR079 CaseType=Combination P=-21,9531504095402 V2=-0,635668662812817 V3=0 T=0 M2=0 M3=0,537859593204202
FrameElem=30-1 ElemStation=0,1834
Frame=30 Station=0 OutputCase=RAR080 CaseType=Combination P=-4,01631703909133 V2=-3,20326866282542 V3=0 T=0 M2=0 M3=2,34634360707082
ElemStation=0
Frame=30 Station=0,0917 OutputCase=RAR080 CaseType=Combination P=-4,01631703909133 V2=-1,91946866282542 V3=0 T=0 M2=0 M3=2,58122111345191
FrameElem=30-1 ElemStation=0,0917
Frame=30 Station=0,1834 OutputCase=RAR080 CaseType=Combination P=-4,01631703909133 V2=-0,635668662825418 V3=0 T=0 M2=0 M3=2,698374159833
FrameElem=30-1 ElemStation=0,1834
Frame=30 Station=0 OutputCase=RAR081 CaseType=Combination P=-4,73642431454785 V2=-16,4080686630032 V3=0 T=0 M2=0 M3=17,4734244683452
ElemStation=0
Frame=30 Station=0,0917 OutputCase=RAR081 CaseType=Combination P=-4,73642431454785 V2=-8,5218686630032 V3=0 T=0 M2=0 M3=18,164620947426
FrameElem=30-1 ElemStation=0,0917
Frame=30 Station=0,1834 OutputCase=RAR081 CaseType=Combination P=-4,73642431454785 V2=-0,635668663003202 V3=0 T=0 M2=0 M3=19,03633518114
FrameElem=30-1 ElemStation=0,1834
Frame=30 Station=0 OutputCase=RAR082 CaseType=Combination P=-13,9347065512469 V2=-9,16016112638411 V3=0 T=0 M2=0 M3=17,5317059198357
ElemStation=0
Frame=30 Station=0,0917 OutputCase=RAR082 CaseType=Combination P=-13,9347065512469 V2=-1,27396112638411 V3=0 T=0 M2=0 M3=18,0101104251251
FrameElem=30-1 ElemStation=0,0917
Frame=30 Station=0,1834 OutputCase=RAR082 CaseType=Combination P=-13,9347065512469 V2=6,61223887361589 V3=0 T=0 M2=0 M3=17,7653053904145
FrameElem=30-1 ElemStation=0,1834
Frame=30 Station=0 OutputCase=RAR083 CaseType=Combination P=-23,1329887879459 V2=-16,4080686629905 V3=0 T=0 M2=0 M3=14,931454887204
ElemStation=0
Frame=30 Station=0,0917 OutputCase=RAR083 CaseType=Combination P=-23,1329887879459 V2=-8,52186866299047 V3=0 T=0 M2=0 M3=16,0744925136002
FrameElem=30-1 ElemStation=0,0917
Frame=30 Station=0,1834 OutputCase=RAR083 CaseType=Combination P=-23,1329887879459 V2=-0,635668662990469 V3=0 T=0 M2=0 M3=16,4943655999964
FrameElem=30-1 ElemStation=0,1834
Frame=30 Station=0 OutputCase=RAR084 CaseType=Combination P=-13,2145992757903 V2=4,04463887379368 V3=0 T=0 M2=0 M3=2,40462505856126
ElemStation=0
Frame=30 Station=0,0917 OutputCase=RAR084 CaseType=Combination P=-13,2145992757903 V2=5,32843887379368 V3=0 T=0 M2=0 M3=1,97486944383438
FrameElem=30-1 ElemStation=0,0917
Frame=30 Station=0,1834 OutputCase=RAR084 CaseType=Combination P=-13,2145992757903 V2=6,61223887379368 V3=0 T=0 M2=0 M3=1,4273893691075
FrameElem=30-1 ElemStation=0,1834
Frame=30 Station=0 OutputCase=RAR085 CaseType=Combination P=-22,4128815124894 V2=-3,20326866281269 V3=0 T=0 M2=0 M3=-0,195625974070435
ElemStation=0
Frame=30 Station=0,0917 OutputCase=RAR085 CaseType=Combination P=-22,4128815124894 V2=-1,91946866281269 V3=0 T=0 M2=0 M3=3,9251532094882E-02
FrameElem=30-1 ElemStation=0,0917
Frame=30 Station=0,1834 OutputCase=RAR085 CaseType=Combination P=-22,4128815124894 V2=-0,635668662812685 V3=0 T=0 M2=0 M3=0,156404578689411
FrameElem=30-1 ElemStation=0,1834
Frame=30 Station=0 OutputCase=RAR086 CaseType=Combination P=-3,09685483319294 V2=-3,20326866282568 V3=0 T=0 M2=0 M3=3,10925363610035
ElemStation=0
Frame=30 Station=0,0917 OutputCase=RAR086 CaseType=Combination P=-3,09685483319294 V2=-1,91946866282568 V3=0 T=0 M2=0 M3=3,34413114248147
FrameElem=30-1 ElemStation=0,0917
Frame=30 Station=0,1834 OutputCase=RAR086 CaseType=Combination P=-3,09685483319294 V2=-0,635668662825682 V3=0 T=0 M2=0 M3=3,46128418886258
FrameElem=30-1 ElemStation=0,1834
Frame=30 Station=0 OutputCase=RAR087 CaseType=Combination P=-3,81696210864945 V2=-16,4080686630035 V3=0 T=0 M2=0 M3=18,2363344973748
ElemStation=0
Frame=30 Station=0,0917 OutputCase=RAR087 CaseType=Combination P=-3,81696210864945 V2=-8,52186866300347 V3=0 T=0 M2=0 M3=19,3793721237722
FrameElem=30-1 ElemStation=0,0917
Frame=30 Station=0,1834 OutputCase=RAR087 CaseType=Combination P=-3,81696210864945 V2=-0,635668663003466 V3=0 T=0 M2=0 M3=19,7992452101696
FrameElem=30-1 ElemStation=0,1834
Frame=30 Station=0 OutputCase=RAR088 CaseType=Combination P=-13,0152443453485 V2=-9,16016112638437 V3=0 T=0 M2=0 M3=18,2946159488652
ElemStation=0
Frame=30 Station=0,0917 OutputCase=RAR088 CaseType=Combination P=-13,0152443453485 V2=-1,27396112638437 V3=0 T=0 M2=0 M3=18,7730204541547
FrameElem=30-1 ElemStation=0,0917
Frame=30 Station=0,1834 OutputCase=RAR088 CaseType=Combination P=-13,0152443453485 V2=6,61223887361563 V3=0 T=0 M2=0 M3=18,5282604194441
FrameElem=30-1 ElemStation=0,1834
Frame=30 Station=0 OutputCase=RAR089 CaseType=Combination P=-22,2135265820475 V2=-16,4080686629907 V3=0 T=0 M2=0 M3=15,6943649162335
ElemStation=0
Frame=30 Station=0,0917 OutputCase=RAR089 CaseType=Combination P=-22,2135265820475 V2=-8,52186866299073 V3=0 T=0 M2=0 M3=16,8374025426298
FrameElem=30-1 ElemStation=0,0917
Frame=30 Station=0,1834 OutputCase=RAR089 CaseType=Combination P=-22,2135265820475 V2=-0,635668662990733 V3=0 T=0 M2=0 M3=17,257275629026
FrameElem=30-1 ElemStation=0,1834
Frame=30 Station=0 OutputCase=RAR090 CaseType=Combination P=-12,295137069892 V2=4,04463887379341 V3=0 T=0 M2=0 M3=3,16753508759079
ElemStation=0
Frame=30 Station=0,0917 OutputCase=RAR090 CaseType=Combination P=-12,295137069892 V2=5,32843887379341 V3=0 T=0 M2=0 M3=2,73777947286394
FrameElem=30-1 ElemStation=0,0917
Frame=30 Station=0,1834 OutputCase=RAR090 CaseType=Combination P=-12,295137069892 V2=6,61223887379341 V3=0 T=0 M2=0 M3=2,1902993813708
FrameElem=30-1 ElemStation=0,1834
Frame=30 Station=0 OutputCase=RAR091 CaseType=Combination P=-21,493419306591 V2=-3,20326866281295 V3=0 T=0 M2=0 M3=0,567284054959098
ElemStation=0
Frame=30 Station=0,0917 OutputCase=RAR091 CaseType=Combination P=-21,493419306591 V2=-1,91946866281295 V3=0 T=0 M2=0 M3=0,802161561339045
FrameElem=30-1 ElemStation=0,0917
Frame=30 Station=0,1834 OutputCase=RAR091 CaseType=Combination P=-21,493419306591 V2=-0,635668662812949 V3=0 T=0 M2=0 M3=0,919314607718992
FrameElem=30-1 ElemStation=0,1834
Frame=30 Station=0 OutputCase=RAR092 CaseType=Combination P=-3,09685483319294 V2=-3,20326866282568 V3=0 T=0 M2=0 M3=3,10925363610035
ElemStation=0
Frame=30 Station=0,0917 OutputCase=RAR092 CaseType=Combination P=-3,09685483319294 V2=-1,91946866282568 V3=0 T=0 M2=0 M3=3,34413114248147
FrameElem=30-1 ElemStation=0,0917
Frame=30 Station=0,1834 OutputCase=RAR092 CaseType=Combination P=-3,09685483319294 V2=-0,635668662825682 V3=0 T=0 M2=0 M3=3,46128418886258
FrameElem=30-1 ElemStation=0,1834

Società di Progetto
Brebemi SpA



Doc. N.
60235-0000-A00.doc

CODIFICA DOCUMENTO
04RCDII10000000000300A00

REV.
00

FOGLIO
397 di 628

Frame=30 Station=0 OutputCase=RAR093 CaseType=Combination P=-3,81696210864945 V2=-16,4080686630035 V3=0 T=0 M2=0 M3=18,2363344973748 FrameElem=30-1 ElemStation=0
Frame=30 Station=0,0917 OutputCase=RAR093 CaseType=Combination P=-3,81696210864945 V2=-8,52186866300347 V3=0 T=0 M2=0 M3=19,3793721237722 FrameElem=30-1 ElemStation=0,0917
Frame=30 Station=0,1834 OutputCase=RAR093 CaseType=Combination P=-3,81696210864945 V2=-0,635668663003466 V3=0 T=0 M2=0 M3=19,7992452101696 FrameElem=30-1 ElemStation=0,1834
Frame=30 Station=0 OutputCase=RAR094 CaseType=Combination P=-13,0152443453485 V2=-9,16016112638437 V3=0 T=0 M2=0 M3=18,2946159488652 FrameElem=30-1 ElemStation=0
Frame=30 Station=0,0917 OutputCase=RAR094 CaseType=Combination P=-13,0152443453485 V2=-1,27396112638437 V3=0 T=0 M2=0 M3=18,7730204541547 FrameElem=30-1 ElemStation=0,0917
Frame=30 Station=0,1834 OutputCase=RAR094 CaseType=Combination P=-13,0152443453485 V2=6,61223887361563 V3=0 T=0 M2=0 M3=18,5282604194441 FrameElem=30-1 ElemStation=0,1834
Frame=30 Station=0 OutputCase=RAR095 CaseType=Combination P=-22,2135265820475 V2=-16,4080686629907 V3=0 T=0 M2=0 M3=15,6943649162335 FrameElem=30-1 ElemStation=0
Frame=30 Station=0,0917 OutputCase=RAR095 CaseType=Combination P=-22,2135265820475 V2=-8,52186866299073 V3=0 T=0 M2=0 M3=16,8374025426298 FrameElem=30-1 ElemStation=0,0917
Frame=30 Station=0,1834 OutputCase=RAR095 CaseType=Combination P=-22,2135265820475 V2=-0,635668662990733 V3=0 T=0 M2=0 M3=17,257275629026 FrameElem=30-1 ElemStation=0,1834
Frame=30 Station=0 OutputCase=RAR096 CaseType=Combination P=-12,295137069892 V2=4,04463887379341 V3=0 T=0 M2=0 M3=3,16753508759079 FrameElem=30-1 ElemStation=0
Frame=30 Station=0,0917 OutputCase=RAR096 CaseType=Combination P=-12,295137069892 V2=5,32843887379341 V3=0 T=0 M2=0 M3=2,73777947286394 FrameElem=30-1 ElemStation=0,0917
Frame=30 Station=0,1834 OutputCase=RAR096 CaseType=Combination P=-12,295137069892 V2=6,61223887379341 V3=0 T=0 M2=0 M3=2,19029939813708 FrameElem=30-1 ElemStation=0,1834
Frame=30 Station=0 OutputCase=RAR097 CaseType=Combination P=-21,493419306591 V2=-3,20326866281295 V3=0 T=0 M2=0 M3=0,567284054959098 FrameElem=30-1 ElemStation=0
Frame=30 Station=0,0917 OutputCase=RAR097 CaseType=Combination P=-21,493419306591 V2=-1,91946866281295 V3=0 T=0 M2=0 M3=0,802161561339045 FrameElem=30-1 ElemStation=0,0917
Frame=30 Station=0,1834 OutputCase=RAR097 CaseType=Combination P=-21,493419306591 V2=-0,635668662812949 V3=0 T=0 M2=0 M3=0,919314607718992 FrameElem=30-1 ElemStation=0,1834
Frame=30 Station=0 OutputCase=RAR098 CaseType=Combination P=-4,19234429366678 V2=-1,93193133713142 V3=0 T=0 M2=0 M3=2,07843635390122 FrameElem=30-1 ElemStation=0
Frame=30 Station=0,0917 OutputCase=RAR098 CaseType=Combination P=-4,19234429366678 V2=-0,648131337131417 V3=0 T=0 M2=0 M3=2,19673222751617 FrameElem=30-1 ElemStation=0,0917
Frame=30 Station=0,1834 OutputCase=RAR098 CaseType=Combination P=-4,19234429366678 V2=0,635668662868583 V3=0 T=0 M2=0 M3=2,19730364113112 FrameElem=30-1 ElemStation=0,1834
Frame=30 Station=0 OutputCase=RAR099 CaseType=Combination P=-5,02533565610388 V2=-19,7925988025073 V3=0 T=0 M2=0 M3=22,377749955804 FrameElem=30-1 ElemStation=0
Frame=30 Station=0,0917 OutputCase=RAR099 CaseType=Combination P=-5,02533565610388 V2=-9,70559880250729 V3=0 T=0 M2=0 M3=23,7302423159939 FrameElem=30-1 ElemStation=0,0917
Frame=30 Station=0,1834 OutputCase=RAR099 CaseType=Combination P=-5,02533565610388 V2=0,381401197492712 V3=0 T=0 M2=0 M3=24,1577567761838 FrameElem=30-1 ElemStation=0,1834
Frame=30 Station=0 OutputCase=RAR100 CaseType=Combination P=-16,8507663785454 V2=-10,4514547094387 V3=0 T=0 M2=0 M3=22,4684834154389 FrameElem=30-1 ElemStation=0
Frame=30 Station=0,0917 OutputCase=RAR100 CaseType=Combination P=-16,8507663785454 V2=-0,36445470943871 V3=0 T=0 M2=0 M3=22,9643928622944 FrameElem=30-1 ElemStation=0,0917
Frame=30 Station=0,1834 OutputCase=RAR100 CaseType=Combination P=-16,8507663785454 V2=9,72254529056129 V3=0 T=0 M2=0 M3=22,53532440915 FrameElem=30-1 ElemStation=0,1834
Frame=30 Station=0 OutputCase=RAR101 CaseType=Combination P=-28,6761971009869 V2=-19,7925988024891 V3=0 T=0 M2=0 M3=19,132885222131 FrameElem=30-1 ElemStation=0
Frame=30 Station=0,0917 OutputCase=RAR101 CaseType=Combination P=-28,6761971009869 V2=-9,7055988024891 V3=0 T=0 M2=0 M3=20,4853775823192 FrameElem=30-1 ElemStation=0,0917
Frame=30 Station=0,1834 OutputCase=RAR101 CaseType=Combination P=-28,6761971009869 V2=0,381401197510901 V3=0 T=0 M2=0 M3=20,9128920425075 FrameElem=30-1 ElemStation=0,1834
Frame=30 Station=0 OutputCase=RAR102 CaseType=Combination P=-15,8906233446034 V2=7,15494529079834 V3=0 T=0 M2=0 M3=2,29904226707303 FrameElem=30-1 ElemStation=0
Frame=30 Station=0,0917 OutputCase=RAR102 CaseType=Combination P=-15,8906233446034 V2=8,43874529079833 V3=0 T=0 M2=0 M3=1,58407155390682 FrameElem=30-1 ElemStation=0,0917
Frame=30 Station=0,1834 OutputCase=RAR102 CaseType=Combination P=-15,8906233446034 V2=9,72254529079834 V3=0 T=0 M2=0 M3=0,751376380740616 FrameElem=30-1 ElemStation=0,1834
Frame=30 Station=0 OutputCase=RAR103 CaseType=Combination P=-27,7160540670449 V2=-2,18619880225205 V3=0 T=0 M2=0 M3=-1,0365592623491 FrameElem=30-1 ElemStation=0
Frame=30 Station=0,0917 OutputCase=RAR103 CaseType=Combination P=-27,7160540670449 V2=-0,902398802252053 V3=0 T=0 M2=0 M3=-0,894943726068393 FrameElem=30-1 ElemStation=0,0917
Frame=30 Station=0,1834 OutputCase=RAR103 CaseType=Combination P=-27,7160540670449 V2=0,381401197747947 V3=0 T=0 M2=0 M3=-0,87105598590188 FrameElem=30-1 ElemStation=0,1834
Frame=30 Station=0 OutputCase=RAR104 CaseType=Combination P=-10,9208021321853 V2=6,2049922819605 V3=0 T=0 M2=0 M3=20,0251096427444 FrameElem=30-1 ElemStation=0
Frame=30 Station=0,0917 OutputCase=RAR104 CaseType=Combination P=-12,4521921321853 V2=14,0911922819605 V3=0 T=0 M2=0 M3=19,0945295804886 FrameElem=30-1 ElemStation=0,0917
Frame=30 Station=0,1834 OutputCase=RAR104 CaseType=Combination P=-13,9835821321853 V2=21,9773922819605 V3=0 T=0 M2=0 M3=17,4407849782328 FrameElem=30-1 ElemStation=0,1834
Frame=30 Station=0 OutputCase=RAR105 CaseType=Combination P=-4,9124515691233 V2=-15,1367313373092 V3=0 T=0 M2=0 M3=17,2055172151756 FrameElem=30-1 ElemStation=0
Frame=30 Station=0,0917 OutputCase=RAR105 CaseType=Combination P=-4,9124515691233 V2=-7,2505313373092 V3=0 T=0 M2=0 M3=18,2319732088069 FrameElem=30-1 ElemStation=0,0917
Frame=30 Station=0,1834 OutputCase=RAR105 CaseType=Combination P=-4,9124515691233 V2=0,6356686626908 V3=0 T=0 M2=0 M3=18,5352646624381 FrameElem=30-1 ElemStation=0,1834
Frame=30 Station=0 OutputCase=RAR106 CaseType=Combination P=-14,1107338058223 V2=-7,8888238006901 V3=0 T=0 M2=0 M3=17,2637986666661 FrameElem=30-1 ElemStation=0
Frame=30 Station=0,0917 OutputCase=RAR106 CaseType=Combination P=-14,1107338058223 V2=-2,62380069010426E-03 V3=0 T=0 M2=0 M3=17,6256215391894 FrameElem=30-1 ElemStation=0,0917
Frame=30 Station=0,1834 OutputCase=RAR106 CaseType=Combination P=-14,1107338058223 V2=7,8835761993099 V3=0 T=0 M2=0 M3=17,2642798717126 FrameElem=30-1 ElemStation=0,1834
Frame=30 Station=0 OutputCase=RAR107 CaseType=Combination P=-23,3090160425213 V2=-15,1367313372965 V3=0 T=0 M2=0 M3=14,6635476340344 FrameElem=30-1 ElemStation=0
Frame=30 Station=0,0917 OutputCase=RAR107 CaseType=Combination P=-23,3090160425213 V2=-7,25053133729647 V3=0 T=0 M2=0 M3=15,6900036276645 FrameElem=30-1 ElemStation=0,0917

Società di Progetto
Brebemi SpA

	Doc. N. 60235-0000-A00.doc	CODIFICA DOCUMENTO 04RCDII10000000000300A00	REV. 00	FOGLIO 398 di 628
--	-------------------------------	--	------------	----------------------

Frame=30 Station=0,1834 OutputCase=RAR107 CaseType=Combination P=-23,3090160425213 V2=0,635668662703533 V3=0 T=0 M2=0 M3=15,9932950812945
 FrameElem=30-1 ElemStation=0,1834
 Frame=30 Station=0 OutputCase=RAR108 CaseType=Combination P=-13,3906265303658 V2=5,31597619948768 V3=0 T=0 M2=0 M3=2,13671780539166 FrameElem=30-1
 ElemStation=0
 Frame=30 Station=0,0917 OutputCase=RAR108 CaseType=Combination P=-13,3906265303658 V2=6,59977619948768 V3=0 T=0 M2=0 M3=1,59038055789864
 FrameElem=30-1 ElemStation=0,0917
 Frame=30 Station=0,1834 OutputCase=RAR108 CaseType=Combination P=-13,3906265303658 V2=7,88357619948768 V3=0 T=0 M2=0 M3=0,926318850405622
 FrameElem=30-1 ElemStation=0,1834
 Frame=30 Station=0 OutputCase=RAR109 CaseType=Combination P=-22,5889087670648 V2=-1,93193133711868 V3=0 T=0 M2=0 M3=-0,463533227240034 FrameElem=30-1
 ElemStation=0
 Frame=30 Station=0,0917 OutputCase=RAR109 CaseType=Combination P=-22,5889087670648 V2=-0,648131337118683 V3=0 T=0 M2=0 M3=-0,345237353626251
 FrameElem=30-1 ElemStation=0,0917
 Frame=30 Station=0,1834 OutputCase=RAR109 CaseType=Combination P=-22,5889087670648 V2=0,635668662881317 V3=0 T=0 M2=0 M3=-0,344665940012468
 FrameElem=30-1 ElemStation=0,1834
 Frame=30 Station=0 OutputCase=RAR110 CaseType=Combination P=-4,65207539661598 V2=-1,93193133713128 V3=0 T=0 M2=0 M3=1,69698133938645 FrameElem=30-1
 ElemStation=0
 Frame=30 Station=0,0917 OutputCase=RAR110 CaseType=Combination P=-4,65207539661598 V2=-0,648131337131284 V3=0 T=0 M2=0 M3=1,81527721300139
 FrameElem=30-1 ElemStation=0,0917
 Frame=30 Station=0,1834 OutputCase=RAR110 CaseType=Combination P=-4,65207539661598 V2=0,635668662868716 V3=0 T=0 M2=0 M3=1,81584862661633
 FrameElem=30-1 ElemStation=0,1834
 Frame=30 Station=0 OutputCase=RAR111 CaseType=Combination P=-5,3721826720725 V2=-15,1367313373091 V3=0 T=0 M2=0 M3=16,8240622006609 FrameElem=30-1
 ElemStation=0
 Frame=30 Station=0,0917 OutputCase=RAR111 CaseType=Combination P=-5,3721826720725 V2=-7,25053133730907 V3=0 T=0 M2=0 M3=17,8505181942921
 FrameElem=30-1 ElemStation=0,0917
 Frame=30 Station=0,1834 OutputCase=RAR111 CaseType=Combination P=-5,3721826720725 V2=0,635668662690932 V3=0 T=0 M2=0 M3=18,1538096479233
 FrameElem=30-1 ElemStation=0,1834
 Frame=30 Station=0 OutputCase=RAR112 CaseType=Combination P=-14,5704649087715 V2=-7,88882380068997 V3=0 T=0 M2=0 M3=16,8823436521513 FrameElem=30-1
 ElemStation=0
 Frame=30 Station=0,0917 OutputCase=RAR112 CaseType=Combination P=-14,5704649087715 V2=-2,62380068997214E-03 V3=0 T=0 M2=0 M3=17,2441665246746
 FrameElem=30-1 ElemStation=0,0917
 Frame=30 Station=0,1834 OutputCase=RAR112 CaseType=Combination P=-14,5704649087715 V2=7,88357619931003 V3=0 T=0 M2=0 M3=16,8828248571978
 FrameElem=30-1 ElemStation=0,1834
 Frame=30 Station=0 OutputCase=RAR113 CaseType=Combination P=-23,7687471454705 V2=-15,1367313372963 V3=0 T=0 M2=0 M3=14,2820926195196 FrameElem=30-1
 ElemStation=0
 Frame=30 Station=0,0917 OutputCase=RAR113 CaseType=Combination P=-23,7687471454705 V2=-7,25053133729633 V3=0 T=0 M2=0 M3=15,3085486131497
 FrameElem=30-1 ElemStation=0,0917
 Frame=30 Station=0,1834 OutputCase=RAR113 CaseType=Combination P=-23,7687471454705 V2=0,635668662703665 V3=0 T=0 M2=0 M3=15,6118400667798
 FrameElem=30-1 ElemStation=0,1834
 Frame=30 Station=0 OutputCase=RAR114 CaseType=Combination P=-13,850357633315 V2=5,31597619948781 V3=0 T=0 M2=0 M3=1,7552627908769 FrameElem=30-1
 ElemStation=0
 Frame=30 Station=0,0917 OutputCase=RAR114 CaseType=Combination P=-13,850357633315 V2=6,59977619948781 V3=0 T=0 M2=0 M3=1,20892554338386 FrameElem=30-1
 ElemStation=0,0917
 Frame=30 Station=0,1834 OutputCase=RAR114 CaseType=Combination P=-13,850357633315 V2=7,88357619948781 V3=0 T=0 M2=0 M3=0,544863835890831
 FrameElem=30-1 ElemStation=0,1834
 Frame=30 Station=0 OutputCase=RAR115 CaseType=Combination P=-23,048639870014 V2=-1,93193133711855 V3=0 T=0 M2=0 M3=-0,8449882417548 FrameElem=30-1
 ElemStation=0
 Frame=30 Station=0,0917 OutputCase=RAR115 CaseType=Combination P=-23,048639870014 V2=0,648131337118551 V3=0 T=0 M2=0 M3=-0,72692368141029
 FrameElem=30-1 ElemStation=0,0917
 Frame=30 Station=0,1834 OutputCase=RAR115 CaseType=Combination P=-23,048639870014 V2=0,635668662881449 V3=0 T=0 M2=0 M3=-0,726120954527258
 FrameElem=30-1 ElemStation=0,1834
 Frame=30 Station=0 OutputCase=RAR116 CaseType=Combination P=-3,73261319071759 V2=-1,93193133713155 V3=0 T=0 M2=0 M3=2,45989136841599 FrameElem=30-1
 ElemStation=0
 Frame=30 Station=0,0917 OutputCase=RAR116 CaseType=Combination P=-3,73261319071759 V2=0,648131337131549 V3=0 T=0 M2=0 M3=2,57818724203095
 FrameElem=30-1 ElemStation=0,0917
 Frame=30 Station=0,1834 OutputCase=RAR116 CaseType=Combination P=-3,73261319071759 V2=0,635668662868451 V3=0 T=0 M2=0 M3=2,57875865564591
 FrameElem=30-1 ElemStation=0,1834
 Frame=30 Station=0 OutputCase=RAR117 CaseType=Combination P=-4,4527204661741 V2=-15,1367313373093 V3=0 T=0 M2=0 M3=17,5869722296904 FrameElem=30-1
 ElemStation=0
 Frame=30 Station=0,0917 OutputCase=RAR117 CaseType=Combination P=-4,4527204661741 V2=-7,25053133730933 V3=0 T=0 M2=0 M3=18,6134282233217
 FrameElem=30-1 ElemStation=0,0917
 Frame=30 Station=0,1834 OutputCase=RAR117 CaseType=Combination P=-4,4527204661741 V2=0,635668662690668 V3=0 T=0 M2=0 M3=18,9167196769529
 FrameElem=30-1 ElemStation=0,1834
 Frame=30 Station=0 OutputCase=RAR118 CaseType=Combination P=-13,6510027028731 V2=-7,88882380069024 V3=0 T=0 M2=0 M3=17,6452536811808 FrameElem=30-1
 ElemStation=0
 Frame=30 Station=0,0917 OutputCase=RAR118 CaseType=Combination P=-13,6510027028731 V2=-2,62380069023638E-03 V3=0 T=0 M2=0 M3=18,0070765537041
 FrameElem=30-1 ElemStation=0,0917
 Frame=30 Station=0,1834 OutputCase=RAR118 CaseType=Combination P=-13,6510027028731 V2=7,88357619930976 V3=0 T=0 M2=0 M3=17,6457348862274
 FrameElem=30-1 ElemStation=0,1834
 Frame=30 Station=0 OutputCase=RAR119 CaseType=Combination P=-22,8492849395721 V2=-15,1367313372966 V3=0 T=0 M2=0 M3=15,0450026485491 FrameElem=30-1
 ElemStation=0
 Frame=30 Station=0,0917 OutputCase=RAR119 CaseType=Combination P=-22,8492849395721 V2=-7,2505313372966 V3=0 T=0 M2=0 M3=16,0714586421792
 FrameElem=30-1 ElemStation=0,0917
 Frame=30 Station=0,1834 OutputCase=RAR119 CaseType=Combination P=-22,8492849395721 V2=0,635668662703401 V3=0 T=0 M2=0 M3=16,3747500958093
 FrameElem=30-1 ElemStation=0,1834
 Frame=30 Station=0 OutputCase=RAR120 CaseType=Combination P=-12,9308954274166 V2=5,31597619948755 V3=0 T=0 M2=0 M3=2,51817281990643 FrameElem=30-1
 ElemStation=0
 Frame=30 Station=0,0917 OutputCase=RAR120 CaseType=Combination P=-12,9308954274166 V2=6,59977619948755 V3=0 T=0 M2=0 M3=1,97183557241342
 FrameElem=30-1 ElemStation=0,0917
 Frame=30 Station=0,1834 OutputCase=RAR120 CaseType=Combination P=-12,9308954274166 V2=7,88357619948755 V3=0 T=0 M2=0 M3=1,30777386492041
 FrameElem=30-1 ElemStation=0,1834
 Frame=30 Station=0 OutputCase=RAR121 CaseType=Combination P=-22,1291776641156 V2=-1,93193133711882 V3=0 T=0 M2=0 M3=-8,20782127252674E-02
 FrameElem=30-1 ElemStation=0
 Frame=30 Station=0,0917 OutputCase=RAR121 CaseType=Combination P=-22,1291776641156 V2=-0,648131337118816 V3=0 T=0 M2=0 M3=3,6217660883281E-02
 FrameElem=30-1 ElemStation=0,0917
 Frame=30 Station=0,1834 OutputCase=RAR121 CaseType=Combination P=-22,1291776641156 V2=0,635668662881185 V3=0 T=0 M2=0 M3=0,036789074502323
 FrameElem=30-1 ElemStation=0,1834
 Frame=30 Station=0 OutputCase=RAR122 CaseType=Combination P=-3,73261319071759 V2=-1,93193133713155 V3=0 T=0 M2=0 M3=2,45989136841599 FrameElem=30-1
 ElemStation=0

APPROVATO SDP

Società di Progetto
Brebemi SpA

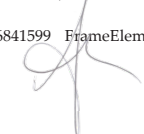



Doc. N.
60235-0000-A00.doc

CODIFICA DOCUMENTO
04RCDII10000000000300A00

REV.
00

FOGLIO
399 di 628

Frame=30 Station=0,0917 OutputCase=RAR122 CaseType=Combination P=-3,73261319071759 V2=-0,648131337131549 V3=0 T=0 M2=0 M3=2,57818724203095
FrameElem=30-1 ElemStation=0,0917
Frame=30 Station=0,1834 OutputCase=RAR122 CaseType=Combination P=-3,73261319071759 V2=0,635668662868451 V3=0 T=0 M2=0 M3=2,5785865654591
FrameElem=30-1 ElemStation=0,1834
Frame=30 Station=0 OutputCase=RAR123 CaseType=Combination P=-4,4527204661741 V2=-15,1367313373093 V3=0 T=0 M2=0 M3=17,5869722296904
FrameElem=30-1 ElemStation=0
Frame=30 Station=0,0917 OutputCase=RAR123 CaseType=Combination P=-4,4527204661741 V2=-7,25053133730933 V3=0 T=0 M2=0 M3=18,6134282233217
FrameElem=30-1 ElemStation=0,0917
Frame=30 Station=0,1834 OutputCase=RAR123 CaseType=Combination P=-4,4527204661741 V2=0,635668662690668 V3=0 T=0 M2=0 M3=18,9167196769529
FrameElem=30-1 ElemStation=0,1834
Frame=30 Station=0 OutputCase=RAR124 CaseType=Combination P=-13,6510027028731 V2=-7,88882380069024 V3=0 T=0 M2=0 M3=17,6452536811808
FrameElem=30-1 ElemStation=0
Frame=30 Station=0,0917 OutputCase=RAR124 CaseType=Combination P=-13,6510027028731 V2=-2,62380069023642E-03 V3=0 T=0 M2=0 M3=18,0070765537041
FrameElem=30-1 ElemStation=0,0917
Frame=30 Station=0,1834 OutputCase=RAR124 CaseType=Combination P=-13,6510027028731 V2=7,88357619930976 V3=0 T=0 M2=0 M3=17,6457348862274
FrameElem=30-1 ElemStation=0,1834
Frame=30 Station=0 OutputCase=RAR125 CaseType=Combination P=-22,8492849395721 V2=-15,1367313372966 V3=0 T=0 M2=0 M3=15,0450026485491
FrameElem=30-1 ElemStation=0
Frame=30 Station=0,0917 OutputCase=RAR125 CaseType=Combination P=-22,8492849395721 V2=-7,2505313372966 V3=0 T=0 M2=0 M3=16,0714586421792
FrameElem=30-1 ElemStation=0,0917
Frame=30 Station=0,1834 OutputCase=RAR125 CaseType=Combination P=-22,8492849395721 V2=0,635668662703401 V3=0 T=0 M2=0 M3=16,3747500958093
FrameElem=30-1 ElemStation=0,1834
Frame=30 Station=0 OutputCase=RAR126 CaseType=Combination P=-12,9308954274166 V2=5,31597619948755 V3=0 T=0 M2=0 M3=2,51817281990643
FrameElem=30-1 ElemStation=0
Frame=30 Station=0,0917 OutputCase=RAR126 CaseType=Combination P=-12,9308954274166 V2=6,59977619948755 V3=0 T=0 M2=0 M3=1,97183557241342
FrameElem=30-1 ElemStation=0,0917
Frame=30 Station=0,1834 OutputCase=RAR126 CaseType=Combination P=-12,9308954274166 V2=7,88357619948755 V3=0 T=0 M2=0 M3=1,30777386492041
FrameElem=30-1 ElemStation=0,1834
Frame=30 Station=0 OutputCase=RAR127 CaseType=Combination P=-22,1291776641156 V2=-1,93193133711882 V3=0 T=0 M2=0 M3=-8,20782127252674E-02
FrameElem=30-1 ElemStation=0
Frame=30 Station=0,0917 OutputCase=RAR127 CaseType=Combination P=-22,1291776641156 V2=-0,648131337118816 V3=0 T=0 M2=0 M3=3,62176608885281E-02
FrameElem=30-1 ElemStation=0,0917
Frame=30 Station=0,1834 OutputCase=RAR127 CaseType=Combination P=-22,1291776641156 V2=0,635668662881185 V3=0 T=0 M2=0 M3=0,036789074502323
FrameElem=30-1 ElemStation=0,1834
Frame=30 Station=0 OutputCase=RAR128 CaseType=Combination P=-3,10824660998913 V2=-2,5675999999787 V3=0 T=0 M2=0 M3=3,03887584526801
FrameElem=30-1 ElemStation=0
Frame=30 Station=0,0917 OutputCase=RAR128 CaseType=Combination P=-3,10824660998913 V2=-1,2837999999787 V3=0 T=0 M2=0 M3=3,21546253526606
FrameElem=30-1 ElemStation=0,0917
Frame=30 Station=0,1834 OutputCase=RAR128 CaseType=Combination P=-3,10824660998913 V2=2,12962980583598E-11 V3=0 T=0 M2=0 M3=3,27432476526411
FrameElem=30-1 ElemStation=0,1834
Frame=30 Station=0 OutputCase=RAR129 CaseType=Combination P=-4,37487704589728 V2=-20,1740000002157 V3=0 T=0 M2=0 M3=22,954013650624
FrameElem=30-1 ElemStation=0
Frame=30 Station=0,0917 OutputCase=RAR129 CaseType=Combination P=-4,37487704589728 V2=-10,0870000002157 V3=0 T=0 M2=0 M3=24,3414805006438
FrameElem=30-1 ElemStation=0,0917
Frame=30 Station=0,1834 OutputCase=RAR129 CaseType=Combination P=-4,37487704589728 V2=-2,15660422853148E-10 V3=0 T=0 M2=0 M3=24,8039694506636
FrameElem=30-1 ElemStation=0,1834
Frame=30 Station=0 OutputCase=RAR130 CaseType=Combination P=-16,2003077683388 V2=-10,8328559071471 V3=0 T=0 M2=0 M3=23,044747110259
FrameElem=30-1 ElemStation=0
Frame=30 Station=0,0917 OutputCase=RAR130 CaseType=Combination P=-16,2003077683388 V2=-0,745855907147082 V3=0 T=0 M2=0 M3=23,576310469444
FrameElem=30-1 ElemStation=0,0917
Frame=30 Station=0,1834 OutputCase=RAR130 CaseType=Combination P=-16,2003077683388 V2=9,34114409285292 V3=0 T=0 M2=0 M3=23,1815370836298
FrameElem=30-1 ElemStation=0,1834
Frame=30 Station=0 OutputCase=RAR131 CaseType=Combination P=-28,0257384907803 V2=-20,1740000001975 V3=0 T=0 M2=0 M3=19,709148916951
FrameElem=30-1 ElemStation=0
Frame=30 Station=0,0917 OutputCase=RAR131 CaseType=Combination P=-28,0257384907803 V2=-10,0870000001975 V3=0 T=0 M2=0 M3=21,0966157669692
FrameElem=30-1 ElemStation=0,0917
Frame=30 Station=0,1834 OutputCase=RAR131 CaseType=Combination P=-28,0257384907803 V2=-1,97471194951504E-10 V3=0 T=0 M2=0 M3=21,5591047169873
FrameElem=30-1 ElemStation=0,1834
Frame=30 Station=0 OutputCase=RAR132 CaseType=Combination P=-15,2401647343968 V2=6,77354409308996 V3=0 T=0 M2=0 M3=2,87530596189311
FrameElem=30-1 ElemStation=0
Frame=30 Station=0,0917 OutputCase=RAR132 CaseType=Combination P=-15,2401647343968 V2=8,05734409308996 V3=0 T=0 M2=0 M3=2,19530973855676
FrameElem=30-1 ElemStation=0,0917
Frame=30 Station=0,1834 OutputCase=RAR132 CaseType=Combination P=-15,2401647343968 V2=9,34114409308996 V3=0 T=0 M2=0 M3=1,39758905522041
FrameElem=30-1 ElemStation=0,1834
Frame=30 Station=0 OutputCase=RAR133 CaseType=Combination P=-27,0655954568383 V2=-2,56759999996043 V3=0 T=0 M2=0 M3=-0,46029223141483
FrameElem=30-1 ElemStation=0
Frame=30 Station=0,0917 OutputCase=RAR133 CaseType=Combination P=-27,0655954568383 V2=-1,28379999996043 V3=0 T=0 M2=0 M3=-0,283705541418459
FrameElem=30-1 ElemStation=0,0917
Frame=30 Station=0,1834 OutputCase=RAR133 CaseType=Combination P=-27,0655954568383 V2=3,95747434822624E-11 V3=0 T=0 M2=0 M3=-0,224843311422088
FrameElem=30-1 ElemStation=0,1834
Frame=30 Station=0 OutputCase=RAR134 CaseType=Combination P=-10,2703435219787 V2=5,82359108425212 V3=0 T=0 M2=0 M3=20,6013733375645
FrameElem=30-1 ElemStation=0
Frame=30 Station=0,0917 OutputCase=RAR134 CaseType=Combination P=-11,8017335219787 V2=13,7097910842521 V3=0 T=0 M2=0 M3=19,7057677651385
FrameElem=30-1 ElemStation=0,0917
Frame=30 Station=0,1834 OutputCase=RAR134 CaseType=Combination P=-13,3331235219787 V2=21,5959910842521 V3=0 T=0 M2=0 M3=18,0869976527126
FrameElem=30-1 ElemStation=0,1834
Frame=30 Station=0 OutputCase=RAR135 CaseType=Combination P=-3,82835388544565 V2=-15,7724000001565 V3=0 T=0 M2=0 M3=18,1659567065424
FrameElem=30-1 ElemStation=0
Frame=30 Station=0,0917 OutputCase=RAR135 CaseType=Combination P=-3,82835388544565 V2=-7,88620000015649 V3=0 T=0 M2=0 M3=19,2507035165568
FrameElem=30-1 ElemStation=0,0917
Frame=30 Station=0,1834 OutputCase=RAR135 CaseType=Combination P=-3,82835388544565 V2=-1,56487323099697E-10 V3=0 T=0 M2=0 M3=19,6122857865711
FrameElem=30-1 ElemStation=0,1834
Frame=30 Station=0 OutputCase=RAR136 CaseType=Combination P=-13,0266361221447 V2=-8,52449246353739 V3=0 T=0 M2=0 M3=18,2242381580329
FrameElem=30-1 ElemStation=0
Frame=30 Station=0,0917 OutputCase=RAR136 CaseType=Combination P=-13,0266361221447 V2=-0,638292463537391 V3=0 T=0 M2=0 M3=18,6443518469392
FrameElem=30-1 ElemStation=0,0917
Frame=30 Station=0,1834 OutputCase=RAR136 CaseType=Combination P=-13,0266361221447 V2=7,24790753646261 V3=0 T=0 M2=0 M3=18,3413009958456
FrameElem=30-1 ElemStation=0,1834

Società di Progetto
Brebemi SpA

	Doc. N. 60235-0000-A00.doc	CODIFICA DOCUMENTO 04RCDII10000000000300A00	REV. 00	FOGLIO 400 di 628
--	-------------------------------	--	------------	----------------------

Frame=30 Station=0 OutputCase=RAR137 CaseType=Combination P=-22,2249183588437 V2=-15,7724000001438 V3=0 T=0 M2=0 M3=15,6239871254012 FrameElem=30-1 ElemStation=0

Frame=30 Station=0,0917 OutputCase=RAR137 CaseType=Combination P=-22,2249183588437 V2=-7,88620000014375 V3=0 T=0 M2=0 M3=16,7087339354144 FrameElem=30-1 ElemStation=0,0917

Frame=30 Station=0,1834 OutputCase=RAR137 CaseType=Combination P=-22,2249183588437 V2=-1,43754341763724E-10 V3=0 T=0 M2=0 M3=17,0703162054275 FrameElem=30-1 ElemStation=0,1834

Frame=30 Station=0 OutputCase=RAR138 CaseType=Combination P=-12,3065288466881 V2=4,68030753664039 V3=0 T=0 M2=0 M3=3,09715729675846 FrameElem=30-1 ElemStation=0

Frame=30 Station=0,0917 OutputCase=RAR138 CaseType=Combination P=-12,3065288466881 V2=5,96410753664039 V3=0 T=0 M2=0 M3=2,60911086564853 FrameElem=30-1 ElemStation=0,0917

Frame=30 Station=0,1834 OutputCase=RAR138 CaseType=Combination P=-12,3065288466881 V2=7,24790753664039 V3=0 T=0 M2=0 M3=2,00333997453861 FrameElem=30-1 ElemStation=0,1834

Frame=30 Station=0 OutputCase=RAR139 CaseType=Combination P=-21,5048110833872 V2=-2,56759999996597 V3=0 T=0 M2=0 M3=0,49690626412676 FrameElem=30-1 ElemStation=0

Frame=30 Station=0,0917 OutputCase=RAR139 CaseType=Combination P=-21,5048110833872 V2=-1,28379999996597 V3=0 T=0 M2=0 M3=0,673492954123639 FrameElem=30-1 ElemStation=0,0917

Frame=30 Station=0,1834 OutputCase=RAR139 CaseType=Combination P=-21,5048110833872 V2=3,40296679723906E-11 V3=0 T=0 M2=0 M3=0,732355184120518 FrameElem=30-1 ElemStation=0,1834

Frame=30 Station=0 OutputCase=RAR140 CaseType=Combination P=-3,56797771293833 V2=-2,56759999997857 V3=0 T=0 M2=0 M3=2,65742083075325 FrameElem=30-1 ElemStation=0

Frame=30 Station=0,0917 OutputCase=RAR140 CaseType=Combination P=-3,56797771293833 V2=-1,28379999997857 V3=0 T=0 M2=0 M3=2,83400752075128 FrameElem=30-1 ElemStation=0,0917

Frame=30 Station=0,1834 OutputCase=RAR140 CaseType=Combination P=-3,56797771293833 V2=2,14284590072111E-11 V3=0 T=0 M2=0 M3=2,89286975074932 FrameElem=30-1 ElemStation=0,1834

Frame=30 Station=0 OutputCase=RAR141 CaseType=Combination P=-4,28808498839484 V2=-15,7724000001564 V3=0 T=0 M2=0 M3=17,7845016920277 FrameElem=30-1 ElemStation=0

Frame=30 Station=0,0917 OutputCase=RAR141 CaseType=Combination P=-4,28808498839484 V2=-7,88620000015635 V3=0 T=0 M2=0 M3=18,869248502042 FrameElem=30-1 ElemStation=0,0917

Frame=30 Station=0,1834 OutputCase=RAR141 CaseType=Combination P=-4,28808498839484 V2=-1,56355162150845E-10 V3=0 T=0 M2=0 M3=19,2308307720563 FrameElem=30-1 ElemStation=0,1834

Frame=30 Station=0 OutputCase=RAR142 CaseType=Combination P=-13,4863672250939 V2=-8,52449246353726 V3=0 T=0 M2=0 M3=17,8427831435181 FrameElem=30-1 ElemStation=0

Frame=30 Station=0,0917 OutputCase=RAR142 CaseType=Combination P=-13,4863672250939 V2=-0,638292463537259 V3=0 T=0 M2=0 M3=18,2628968324245 FrameElem=30-1 ElemStation=0,0917

Frame=30 Station=0,1834 OutputCase=RAR142 CaseType=Combination P=-13,4863672250939 V2=7,24790753646274 V3=0 T=0 M2=0 M3=17,9598459813308 FrameElem=30-1 ElemStation=0,1834

Frame=30 Station=0 OutputCase=RAR143 CaseType=Combination P=-22,6846494617929 V2=-15,7724000001436 V3=0 T=0 M2=0 M3=15,2425321108864 FrameElem=30-1 ElemStation=0

Frame=30 Station=0,0917 OutputCase=RAR143 CaseType=Combination P=-22,6846494617929 V2=-7,88620000014362 V3=0 T=0 M2=0 M3=16,3272789208996 FrameElem=30-1 ElemStation=0,0917

Frame=30 Station=0,1834 OutputCase=RAR143 CaseType=Combination P=-22,6846494617929 V2=-1,43622180814873E-10 V3=0 T=0 M2=0 M3=16,6888611909127 FrameElem=30-1 ElemStation=0,1834

Frame=30 Station=0 OutputCase=RAR144 CaseType=Combination P=-12,7662599496373 V2=4,68030753664052 V3=0 T=0 M2=0 M3=2,71570228224369 FrameElem=30-1 ElemStation=0

Frame=30 Station=0,0917 OutputCase=RAR144 CaseType=Combination P=-12,7662599496373 V2=5,96410753664052 V3=0 T=0 M2=0 M3=2,22765585113375 FrameElem=30-1 ElemStation=0,0917

Frame=30 Station=0,1834 OutputCase=RAR144 CaseType=Combination P=-12,7662599496373 V2=7,24790753664052 V3=0 T=0 M2=0 M3=1,62188496002382 FrameElem=30-1 ElemStation=0,1834

Frame=30 Station=0 OutputCase=RAR145 CaseType=Combination P=-21,9645421863364 V2=-2,56759999996584 V3=0 T=0 M2=0 M3=0,115451249611993 FrameElem=30-1 ElemStation=0

Frame=30 Station=0,0917 OutputCase=RAR145 CaseType=Combination P=-21,9645421863364 V2=-1,28379999996584 V3=0 T=0 M2=0 M3=0,292037939608861 FrameElem=30-1 ElemStation=0,0917

Frame=30 Station=0,1834 OutputCase=RAR145 CaseType=Combination P=-21,9645421863364 V2=3,4161828921242E-11 V3=0 T=0 M2=0 M3=0,350900169605728 FrameElem=30-1 ElemStation=0,1834

Frame=30 Station=0 OutputCase=RAR146 CaseType=Combination P=-2,64851550703993 V2=-2,56759999997884 V3=0 T=0 M2=0 M3=3,42033085978278 FrameElem=30-1 ElemStation=0

Frame=30 Station=0,0917 OutputCase=RAR146 CaseType=Combination P=-2,64851550703993 V2=-1,28379999997884 V3=0 T=0 M2=0 M3=3,59691754978084 FrameElem=30-1 ElemStation=0,0917

Frame=30 Station=0,1834 OutputCase=RAR146 CaseType=Combination P=-2,64851550703993 V2=2,11641371095084E-11 V3=0 T=0 M2=0 M3=3,6557977979789 FrameElem=30-1 ElemStation=0,1834

Frame=30 Station=0 OutputCase=RAR147 CaseType=Combination P=-3,36862278249645 V2=-15,7724000001566 V3=0 T=0 M2=0 M3=18,5474117210572 FrameElem=30-1 ElemStation=0

Frame=30 Station=0,0917 OutputCase=RAR147 CaseType=Combination P=-3,36862278249645 V2=-7,88620000015662 V3=0 T=0 M2=0 M3=19,6321585310715 FrameElem=30-1 ElemStation=0,0917

Frame=30 Station=0,1834 OutputCase=RAR147 CaseType=Combination P=-3,36862278249645 V2=-1,56619484048548E-10 V3=0 T=0 M2=0 M3=19,9937408010859 FrameElem=30-1 ElemStation=0,1834

Frame=30 Station=0 OutputCase=RAR148 CaseType=Combination P=-12,5669050191955 V2=-8,52449246353752 V3=0 T=0 M2=0 M3=18,6056931725476 FrameElem=30-1 ElemStation=0

Frame=30 Station=0,0917 OutputCase=RAR148 CaseType=Combination P=-12,5669050191955 V2=-0,638292463537524 V3=0 T=0 M2=0 M3=19,025806861454 FrameElem=30-1 ElemStation=0,0917

Frame=30 Station=0,1834 OutputCase=RAR148 CaseType=Combination P=-12,5669050191955 V2=7,24790753646248 V3=0 T=0 M2=0 M3=18,7227560103604 FrameElem=30-1 ElemStation=0,1834

Frame=30 Station=0 OutputCase=RAR149 CaseType=Combination P=-21,7651872558945 V2=-15,7724000001439 V3=0 T=0 M2=0 M3=16,0054421399159 FrameElem=30-1 ElemStation=0

Frame=30 Station=0,0917 OutputCase=RAR149 CaseType=Combination P=-21,7651872558945 V2=-7,88620000014389 V3=0 T=0 M2=0 M3=17,0901889499291 FrameElem=30-1 ElemStation=0,0917

Frame=30 Station=0,1834 OutputCase=RAR149 CaseType=Combination P=-21,7651872558945 V2=-1,43886502712576E-10 V3=0 T=0 M2=0 M3=17,4517712199423 FrameElem=30-1 ElemStation=0,1834

Frame=30 Station=0 OutputCase=RAR150 CaseType=Combination P=-11,8467977437389 V2=4,68030753664026 V3=0 T=0 M2=0 M3=3,47861231127322 FrameElem=30-1 ElemStation=0

Frame=30 Station=0,0917 OutputCase=RAR150 CaseType=Combination P=-11,8467977437389 V2=5,96410753664026 V3=0 T=0 M2=0 M3=2,99056588016331 FrameElem=30-1 ElemStation=0,0917

Frame=30 Station=0,1834 OutputCase=RAR150 CaseType=Combination P=-11,8467977437389 V2=7,24790753664026 V3=0 T=0 M2=0 M3=2,3847949890534 FrameElem=30-1 ElemStation=0,1834

Frame=30 Station=0 OutputCase=RAR151 CaseType=Combination P=-21,045079980438 V2=-2,5675999999661 V3=0 T=0 M2=0 M3=0,878361278641526 FrameElem=30-1 ElemStation=0

Frame=30 Station=0,0917 OutputCase=RAR151 CaseType=Combination P=-21,045079980438 V2=-1,2837999999661 V3=0 T=0 M2=0 M3=1,05494796863842 FrameElem=30-1 ElemStation=0,0917

APPROVATO S.D.P.

Società di Progetto
Brebemi SpA

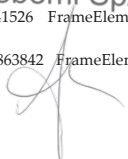

	Doc. N. 60235-0000-A00.doc	CODIFICA DOCUMENTO 04RCDII10000000000300A00	REV. 00	FOGLIO 401 di 628
--	-------------------------------	--	------------	----------------------

Frame=30 Station=0,1834 OutputCase=RAR151 CaseType=Combination P=-21,045079980438 V2=3,38975070235392E-11 V3=0 T=0 M2=0 M3=1,11381019863531
FrameElem=30-1 ElemStation=0,1834

Frame=30 Station=0 OutputCase=RAR152 CaseType=Combination P=-2,91751910273173 V2=-2,94900119768694 V3=0 T=0 M2=0 M3=3,23368452557332 FrameElem=30-1
ElemStation=0

Frame=30 Station=0,0917 OutputCase=RAR152 CaseType=Combination P=-2,91751910273173 V2=-1,66520119768694 V3=0 T=0 M2=0 M3=3,44524570540121
FrameElem=30-1 ElemStation=0,0917

Frame=30 Station=0,1834 OutputCase=RAR152 CaseType=Combination P=-2,91751910273173 V2=-0,381401197686944 V3=0 T=0 M2=0 M3=3,53908242522911
FrameElem=30-1 ElemStation=0,1834

Frame=30 Station=0 OutputCase=RAR153 CaseType=Combination P=-3,63762637818825 V2=-16,1538011978647 V3=0 T=0 M2=0 M3=18,3607653868477 FrameElem=30-1
ElemStation=0

Frame=30 Station=0,0917 OutputCase=RAR153 CaseType=Combination P=-3,63762637818825 V2=-8,26760119786473 V3=0 T=0 M2=0 M3=19,4804866866919
FrameElem=30-1 ElemStation=0,0917

Frame=30 Station=0,1834 OutputCase=RAR153 CaseType=Combination P=-3,63762637818825 V2=-0,381401197864727 V3=0 T=0 M2=0 M3=19,87704344465361
FrameElem=30-1 ElemStation=0,1834

Frame=30 Station=0 OutputCase=RAR154 CaseType=Combination P=-12,8359086148873 V2=-8,90589366124563 V3=0 T=0 M2=0 M3=18,4190468383382 FrameElem=30-1
ElemStation=0

Frame=30 Station=0,0917 OutputCase=RAR154 CaseType=Combination P=-12,8359086148873 V2=-1,01969366124563 V3=0 T=0 M2=0 M3=18,8741350170744
FrameElem=30-1 ElemStation=0,0917

Frame=30 Station=0,1834 OutputCase=RAR154 CaseType=Combination P=-12,8359086148873 V2=6,86650633875437 V3=0 T=0 M2=0 M3=18,6060586558106
FrameElem=30-1 ElemStation=0,1834

Frame=30 Station=0 OutputCase=RAR155 CaseType=Combination P=-22,0341908515863 V2=-16,15380119785199 V3=0 T=0 M2=0 M3=15,8187958057065 FrameElem=30-1
ElemStation=0

Frame=30 Station=0,0917 OutputCase=RAR155 CaseType=Combination P=-22,0341908515863 V2=-8,26760119785199 V3=0 T=0 M2=0 M3=16,9385171055495
FrameElem=30-1 ElemStation=0,0917

Frame=30 Station=0,1834 OutputCase=RAR155 CaseType=Combination P=-22,0341908515863 V2=-0,381401197851995 V3=0 T=0 M2=0 M3=17,3350738653925
FrameElem=30-1 ElemStation=0,1834

Frame=30 Station=0 OutputCase=RAR156 CaseType=Combination P=-12,1158013394307 V2=4,29890633893215 V3=0 T=0 M2=0 M3=3,29196597706377 FrameElem=30-1
ElemStation=0

Frame=30 Station=0,0917 OutputCase=RAR156 CaseType=Combination P=-12,1158013394307 V2=5,58270633893215 V3=0 T=0 M2=0 M3=2,83889403578369
FrameElem=30-1 ElemStation=0,0917

Frame=30 Station=0,1834 OutputCase=RAR156 CaseType=Combination P=-12,1158013394307 V2=6,86650633893215 V3=0 T=0 M2=0 M3=2,26809763450361
FrameElem=30-1 ElemStation=0,1834

Frame=30 Station=0 OutputCase=RAR157 CaseType=Combination P=-21,3140835761298 V2=-2,94900119767421 V3=0 T=0 M2=0 M3=0,691714944432069 FrameElem=30-1
ElemStation=0

Frame=30 Station=0,0917 OutputCase=RAR157 CaseType=Combination P=-21,3140835761298 V2=-1,66520119767421 V3=0 T=0 M2=0 M3=0,903276124258794
FrameElem=30-1 ElemStation=0,0917

Frame=30 Station=0,1834 OutputCase=RAR157 CaseType=Combination P=-21,3140835761298 V2=-0,38140119767421 V3=0 T=0 M2=0 M3=0,997112844085519
FrameElem=30-1 ElemStation=0,1834

Frame=30 Station=0 OutputCase=RAR158 CaseType=Combination P=-3,29897411724652 V2=-2,18619880227046 V3=0 T=0 M2=0 M3=2,8440671649627 FrameElem=30-1
ElemStation=0

Frame=30 Station=0,0917 OutputCase=RAR158 CaseType=Combination P=-3,29897411724652 V2=-0,902398802270464 V3=0 T=0 M2=0 M3=2,9856793651309
FrameElem=30-1 ElemStation=0,0917

Frame=30 Station=0,1834 OutputCase=RAR158 CaseType=Combination P=-3,29897411724652 V2=0,381401197729536 V3=0 T=0 M2=0 M3=3,00956710529911
FrameElem=30-1 ElemStation=0,1834

Frame=30 Station=0 OutputCase=RAR159 CaseType=Combination P=-4,01908139270304 V2=-15,3909988024482 V3=0 T=0 M2=0 M3=17,9711480262371 FrameElem=30-1
ElemStation=0

Frame=30 Station=0,0917 OutputCase=RAR159 CaseType=Combination P=-4,01908139270304 V2=-7,50479880244825 V3=0 T=0 M2=0 M3=19,0209203464216
FrameElem=30-1 ElemStation=0,0917

Frame=30 Station=0,1834 OutputCase=RAR159 CaseType=Combination P=-4,01908139270304 V2=0,381401197551753 V3=0 T=0 M2=0 M3=19,3475281266061
FrameElem=30-1 ElemStation=0,1834

Frame=30 Station=0 OutputCase=RAR160 CaseType=Combination P=-13,2173636294021 V2=-8,14309126582915 V3=0 T=0 M2=0 M3=18,0294294777276 FrameElem=30-1
ElemStation=0

Frame=30 Station=0,0917 OutputCase=RAR160 CaseType=Combination P=-13,2173636294021 V2=-0,256891265829151 V3=0 T=0 M2=0 M3=18,4145686768041
FrameElem=30-1 ElemStation=0,0917

Frame=30 Station=0,1834 OutputCase=RAR160 CaseType=Combination P=-13,2173636294021 V2=7,62930873417085 V3=0 T=0 M2=0 M3=18,0765433358806
FrameElem=30-1 ElemStation=0,1834

Frame=30 Station=0 OutputCase=RAR161 CaseType=Combination P=-22,4156458661011 V2=-15,3909988024355 V3=0 T=0 M2=0 M3=15,4291784450959 FrameElem=30-1
ElemStation=0

Frame=30 Station=0,0917 OutputCase=RAR161 CaseType=Combination P=-22,4156458661011 V2=-7,50479880243551 V3=0 T=0 M2=0 M3=16,4789507652792
FrameElem=30-1 ElemStation=0,0917

Frame=30 Station=0,1834 OutputCase=RAR161 CaseType=Combination P=-22,4156458661011 V2=0,381401197564486 V3=0 T=0 M2=0 M3=16,8055585454625
FrameElem=30-1 ElemStation=0,1834

Frame=30 Station=0 OutputCase=RAR162 CaseType=Combination P=-12,4972563539455 V2=5,06170873434863 V3=0 T=0 M2=0 M3=2,90234861645315 FrameElem=30-1
ElemStation=0

Frame=30 Station=0,0917 OutputCase=RAR162 CaseType=Combination P=-12,4972563539455 V2=6,34550873434863 V3=0 T=0 M2=0 M3=2,37932769551338
FrameElem=30-1 ElemStation=0,0917

Frame=30 Station=0,1834 OutputCase=RAR162 CaseType=Combination P=-12,4972563539455 V2=7,62930873434863 V3=0 T=0 M2=0 M3=1,73858231457361
FrameElem=30-1 ElemStation=0,1834

Frame=30 Station=0 OutputCase=RAR163 CaseType=Combination P=-21,6955385906446 V2=-2,18619880225773 V3=0 T=0 M2=0 M3=0,30209758382145 FrameElem=30-1
ElemStation=0

Frame=30 Station=0,0917 OutputCase=RAR163 CaseType=Combination P=-21,6955385906446 V2=-0,902398802257731 V3=0 T=0 M2=0 M3=0,443709783988484
FrameElem=30-1 ElemStation=0,0917

Frame=30 Station=0,1834 OutputCase=RAR163 CaseType=Combination P=-21,6955385906446 V2=0,38140119774227 V3=0 T=0 M2=0 M3=0,467597524155517
FrameElem=30-1 ElemStation=0,1834

Frame=30 Station=0 OutputCase=INVRAR CaseType=Combination StepType=Max P=-2,64851550703993 V2=7,15494529079834 V3=0 T=0 M2=0 M3=23,044747110259
FrameElem=30-1 ElemStation=0

Frame=30 Station=0,0917 OutputCase=INVRAR CaseType=Combination StepType=Max P=-2,64851550703993 V2=14,0911922819605 V3=0 T=0 M2=0
M3=24,3414805006438 FrameElem=30-1 ElemStation=0,0917

Frame=30 Station=0,1834 OutputCase=INVRAR CaseType=Combination StepType=Max P=-2,64851550703993 V2=21,9773922819605 V3=0 T=0 M2=0
M3=24,8039694506636 FrameElem=30-1 ElemStation=0,1834

Frame=30 Station=0 OutputCase=INVRAR CaseType=Combination StepType=Min P=-28,9452006966787 V2=-20,5554011979238 V3=0 T=0 M2=0 M3=-1,22320226044436
FrameElem=30-1 ElemStation=0

Frame=30 Station=0,0917 OutputCase=INVRAR CaseType=Combination StepType=Min P=-28,9452006966787 V2=-10,4684011979238 V3=0 T=0 M2=0 M3=-
1,04661557044802 FrameElem=30-1 ElemStation=0,0917

Frame=30 Station=0,1834 OutputCase=INVRAR CaseType=Combination StepType=Min P=-28,9452006966787 V2=-0,635668663003466 V3=0 T=0 M2=0 M3=-
0,98775334045167 FrameElem=30-1 ElemStation=0,1834

Frame=30 Station=0 OutputCase=FRE01 CaseType=Combination P=-6,50813867384743 V2=-2,56759999998212 V3=0 T=0 M2=0 M3=1,96983336419738 FrameElem=30-1
ElemStation=0

APPROVATO S.D.P.

Società di Progetto
Brebemi SpA





Doc. N.
60235-0000-A00.doc

CODIFICA DOCUMENTO
04RCDII10000000000300A00

REV.
00

FOGLIO
402 di 628

Frame=30 Station=0,0917 OutputCase=FRE01 CaseType=Combination P=-6,50813867384743 V2=-1,28379999998212 V3=0 T=0 M2=0 M3=2,14642005419575 FrameElem=30-1 ElemStation=0,0917
Frame=30 Station=0,1834 OutputCase=FRE01 CaseType=Combination P=-6,50813867384743 V2=1,78785874993537E-11 V3=0 T=0 M2=0 M3=2,20528228419411 FrameElem=30-1 ElemStation=0,1834
Frame=30 Station=0 OutputCase=FRE02 CaseType=Combination P=-4,59457239036098 V2=-15,7724000001563 V3=0 T=0 M2=0 M3=17,5301983490178 FrameElem=30-1 ElemStation=0
Frame=30 Station=0,0917 OutputCase=FRE02 CaseType=Combination P=-4,59457239036098 V2=-7,88620000015627 V3=0 T=0 M2=0 M3=18,6149451590321 FrameElem=30-1 ElemStation=0,0917
Frame=30 Station=0,1834 OutputCase=FRE02 CaseType=Combination P=-4,59457239036098 V2=-1,56267054851611E-10 V3=0 T=0 M2=0 M3=18,9765274290465 FrameElem=30-1 ElemStation=0,1834
Frame=30 Station=0 OutputCase=FRE03 CaseType=Combination P=-13,79285462706 V2=-8,52449246353717 V3=0 T=0 M2=0 M3=17,5884798005083 FrameElem=30-1 ElemStation=0
Frame=30 Station=0,0917 OutputCase=FRE03 CaseType=Combination P=-13,79285462706 V2=-0,638292463537171 V3=0 T=0 M2=0 M3=18,0085934894146 FrameElem=30-1 ElemStation=0,0917
Frame=30 Station=0,1834 OutputCase=FRE03 CaseType=Combination P=-13,79285462706 V2=7,24790753646283 V3=0 T=0 M2=0 M3=17,705542638321 FrameElem=30-1 ElemStation=0,1834
Frame=30 Station=0 OutputCase=FRE04 CaseType=Combination P=-22,991136863759 V2=-15,7724000001435 V3=0 T=0 M2=0 M3=14,9882287678766 FrameElem=30-1 ElemStation=0
Frame=30 Station=0,0917 OutputCase=FRE04 CaseType=Combination P=-22,991136863759 V2=-7,88620000014353 V3=0 T=0 M2=0 M3=16,0729755778897 FrameElem=30-1 ElemStation=0,0917
Frame=30 Station=0,1834 OutputCase=FRE04 CaseType=Combination P=-22,991136863759 V2=-1,43534073515639E-10 V3=0 T=0 M2=0 M3=16,4345578479029 FrameElem=30-1 ElemStation=0,1834
Frame=30 Station=0 OutputCase=FRE05 CaseType=Combination P=-13,0727473516035 V2=4,68030753664061 V3=0 T=0 M2=0 M3=2,46139893923385 FrameElem=30-1 ElemStation=0
Frame=30 Station=0,0917 OutputCase=FRE05 CaseType=Combination P=-13,0727473516035 V2=5,96410753664061 V3=0 T=0 M2=0 M3=1,9733525081239 FrameElem=30-1 ElemStation=0,0917
Frame=30 Station=0,1834 OutputCase=FRE05 CaseType=Combination P=-13,0727473516035 V2=7,24790753664061 V3=0 T=0 M2=0 M3=1,36758161701396 FrameElem=30-1 ElemStation=0,1834
Frame=30 Station=0 OutputCase=FRE06 CaseType=Combination P=-22,2710295883025 V2=-2,56759999996575 V3=0 T=0 M2=0 M3=-0,138852093397851 FrameElem=30-1 ElemStation=0
Frame=30 Station=0,0917 OutputCase=FRE06 CaseType=Combination P=-22,2710295883025 V2=-1,28379999996575 V3=0 T=0 M2=0 M3=-3,77345965990081E-02 FrameElem=30-1 ElemStation=0,0917
Frame=30 Station=0,1834 OutputCase=FRE06 CaseType=Combination P=-22,2710295883025 V2=3,42499362204762E-11 V3=0 T=0 M2=0 M3=0,096596826595867 FrameElem=30-1 ElemStation=0,1834
Frame=30 Station=0 OutputCase=FRE07 CaseType=Combination P=-4,33419621785365 V2=-2,56759999997835 V3=0 T=0 M2=0 M3=2,02166247322863 FrameElem=30-1 ElemStation=0
Frame=30 Station=0,0917 OutputCase=FRE07 CaseType=Combination P=-4,33419621785365 V2=-1,28379999997835 V3=0 T=0 M2=0 M3=2,19824916322665 FrameElem=30-1 ElemStation=0,0917
Frame=30 Station=0,1834 OutputCase=FRE07 CaseType=Combination P=-4,33419621785365 V2=2,16487272552968E-11 V3=0 T=0 M2=0 M3=2,25711139322466 FrameElem=30-1 ElemStation=0,1834
Frame=30 Station=0 OutputCase=FRE08 CaseType=Combination P=-4,97768164281864 V2=-15,7724000001562 V3=0 T=0 M2=0 M3=17,2123191702555 FrameElem=30-1 ElemStation=0
Frame=30 Station=0,0917 OutputCase=FRE08 CaseType=Combination P=-4,97768164281864 V2=-7,88620000015616 V3=0 T=0 M2=0 M3=18,2970659802698 FrameElem=30-1 ElemStation=0,0917
Frame=30 Station=0,1834 OutputCase=FRE08 CaseType=Combination P=-4,97768164281864 V2=-1,56156920727568E-10 V3=0 T=0 M2=0 M3=18,6586482502841 FrameElem=30-1 ElemStation=0,1834
Frame=30 Station=0 OutputCase=FRE09 CaseType=Combination P=-14,1759638795177 V2=-8,52449246353706 V3=0 T=0 M2=0 M3=17,2706006217459 FrameElem=30-1 ElemStation=0
Frame=30 Station=0,0917 OutputCase=FRE09 CaseType=Combination P=-14,1759638795177 V2=-0,638292463537061 V3=0 T=0 M2=0 M3=17,6907143106523 FrameElem=30-1 ElemStation=0,0917
Frame=30 Station=0,1834 OutputCase=FRE09 CaseType=Combination P=-14,1759638795177 V2=7,24790753646294 V3=0 T=0 M2=0 M3=17,3876634595586 FrameElem=30-1 ElemStation=0,1834
Frame=30 Station=0 OutputCase=FRE10 CaseType=Combination P=-23,3742461162167 V2=-15,7724000001434 V3=0 T=0 M2=0 M3=14,6703495891143 FrameElem=30-1 ElemStation=0
Frame=30 Station=0,0917 OutputCase=FRE10 CaseType=Combination P=-23,3742461162167 V2=-7,88620000014342 V3=0 T=0 M2=0 M3=15,7550963991274 FrameElem=30-1 ElemStation=0,0917
Frame=30 Station=0,1834 OutputCase=FRE10 CaseType=Combination P=-23,3742461162167 V2=-1,43423939391596E-10 V3=0 T=0 M2=0 M3=16,1166786691406 FrameElem=30-1 ElemStation=0,1834
Frame=30 Station=0 OutputCase=FRE11 CaseType=Combination P=-13,4558566040611 V2=4,68030753664072 V3=0 T=0 M2=0 M3=2,14351976047154 FrameElem=30-1 ElemStation=0
Frame=30 Station=0,0917 OutputCase=FRE11 CaseType=Combination P=-13,4558566040611 V2=5,96410753664072 V3=0 T=0 M2=0 M3=1,65547332936159 FrameElem=30-1 ElemStation=0,0917
Frame=30 Station=0,1834 OutputCase=FRE11 CaseType=Combination P=-13,4558566040611 V2=-7,24790753664072 V3=0 T=0 M2=0 M3=1,04970243825163 FrameElem=30-1 ElemStation=0,1834
Frame=30 Station=0 OutputCase=FRE12 CaseType=Combination P=-22,6541388407602 V2=-2,56759999996564 V3=0 T=0 M2=0 M3=-0,456731272160157 FrameElem=30-1 ElemStation=0
Frame=30 Station=0,0917 OutputCase=FRE12 CaseType=Combination P=-22,6541388407602 V2=-1,28379999996564 V3=0 T=0 M2=0 M3=-0,280144582163307 FrameElem=30-1 ElemStation=0,0917
Frame=30 Station=0,1834 OutputCase=FRE12 CaseType=Combination P=-22,6541388407602 V2=3,4360070344519E-11 V3=0 T=0 M2=0 M3=-0,221282352166459 FrameElem=30-1 ElemStation=0,1834
Frame=30 Station=0 OutputCase=FRE13 CaseType=Combination P=-4,17525662847249 V2=-2,88543433140188 V3=0 T=0 M2=0 M3=2,18400304014973 FrameElem=30-1 ElemStation=0
Frame=30 Station=0,0917 OutputCase=FRE13 CaseType=Combination P=-4,17525662847249 V2=-1,60163433140188 V3=0 T=0 M2=0 M3=2,38973513833928 FrameElem=30-1 ElemStation=0,0917
Frame=30 Station=0,1834 OutputCase=FRE13 CaseType=Combination P=-4,17525662847249 V2=-0,317834331445182 V3=0 T=0 M2=0 M3=2,47774277652883 FrameElem=30-1 ElemStation=0,1834
Frame=30 Station=0 OutputCase=FRE14 CaseType=Combination P=-4,49313580723482 V2=-2,24976566855482 V3=0 T=0 M2=0 M3=1,85932190630754 FrameElem=30-1 ElemStation=0
Frame=30 Station=0,0917 OutputCase=FRE14 CaseType=Combination P=-4,49313580723482 V2=-0,965965668554818 V3=0 T=0 M2=0 M3=2,00676318811402 FrameElem=30-1 ElemStation=0,0917
Frame=30 Station=0,1834 OutputCase=FRE14 CaseType=Combination P=-4,49313580723482 V2=0,317834331445182 V3=0 T=0 M2=0 M3=2,0364800099205 FrameElem=30-1 ElemStation=0,1834
Frame=30 Station=0 OutputCase=FRE15 CaseType=Combination P=-3,95108696539599 V2=-2,56759999997846 V3=0 T=0 M2=0 M3=2,33954165199094 FrameElem=30-1 ElemStation=0
Frame=30 Station=0,0917 OutputCase=FRE15 CaseType=Combination P=-3,95108696539599 V2=-1,28379999997846 V3=0 T=0 M2=0 M3=2,51612834198896 FrameElem=30-1 ElemStation=0,0917
Frame=30 Station=0,1834 OutputCase=FRE15 CaseType=Combination P=-3,95108696539599 V2=2,15385931212539E-11 V3=0 T=0 M2=0 M3=2,57499057198699 FrameElem=30-1 ElemStation=0,1834

Società di Progetto
Brebemi SpA



Doc. N.
60235-0000-A00.doc

CODIFICA DOCUMENTO
04RCDII10000000000300A00

REV.
00

FOGLIO
403 di 628

Frame=30 Station=0 OutputCase=FRE16 CaseType=Combination P=-3,41473401195526 V2=-2,56759999997862 V3=0 T=0 M2=0 M3=2,78457250225817 FrameElem=30-1 ElemStation=0
Frame=30 Station=0,0917 OutputCase=FRE16 CaseType=Combination P=-3,41473401195526 V2=-1,283799999997862 V3=0 T=0 M2=0 M3=2,96115919225621 FrameElem=30-1 ElemStation=0,0917
Frame=30 Station=0,1834 OutputCase=FRE16 CaseType=Combination P=-3,41473401195526 V2=2,1384405357594E-11 V3=0 T=0 M2=0 M3=3,02002142225425 FrameElem=30-1 ElemStation=0,1834
Frame=30 Station=0 OutputCase=FRE17 CaseType=Combination P=-4,21146313790331 V2=-15,7724000001564 V3=0 T=0 M2=0 M3=17,8480775277801 FrameElem=30-1 ElemStation=0
Frame=30 Station=0,0917 OutputCase=FRE17 CaseType=Combination P=-4,21146313790331 V2=-7,88620000015638 V3=0 T=0 M2=0 M3=18,9328243377945 FrameElem=30-1 ElemStation=0,0917
Frame=30 Station=0,1834 OutputCase=FRE17 CaseType=Combination P=-4,21146313790331 V2=-1,56377188975654E-10 V3=0 T=0 M2=0 M3=19,2944066078088 FrameElem=30-1 ElemStation=0,1834
Frame=30 Station=0 OutputCase=FRE18 CaseType=Combination P=-13,4097453746023 V2=-8,52449246353728 V3=0 T=0 M2=0 M3=17,9063589792706 FrameElem=30-1 ElemStation=0
Frame=30 Station=0,0917 OutputCase=FRE18 CaseType=Combination P=-13,4097453746023 V2=-0,638292463537281 V3=0 T=0 M2=0 M3=18,3264726681769 FrameElem=30-1 ElemStation=0,0917
Frame=30 Station=0,1834 OutputCase=FRE18 CaseType=Combination P=-13,4097453746023 V2=7,24790753646272 V3=0 T=0 M2=0 M3=18,0234218170833 FrameElem=30-1 ElemStation=0,1834
Frame=30 Station=0 OutputCase=FRE19 CaseType=Combination P=-22,6080276113013 V2=-15,7724000001436 V3=0 T=0 M2=0 M3=15,3061079466389 FrameElem=30-1 ElemStation=0
Frame=30 Station=0,0917 OutputCase=FRE19 CaseType=Combination P=-22,6080276113013 V2=-7,88620000014364 V3=0 T=0 M2=0 M3=16,390854756652 FrameElem=30-1 ElemStation=0,0917
Frame=30 Station=0,1834 OutputCase=FRE19 CaseType=Combination P=-22,6080276113013 V2=-1,43644207639682E-10 V3=0 T=0 M2=0 M3=16,7524370266652 FrameElem=30-1 ElemStation=0,1834
Frame=30 Station=0 OutputCase=FRE20 CaseType=Combination P=-12,6896380991458 V2=4,6803075366405 V3=0 T=0 M2=0 M3=2,77927811799615 FrameElem=30-1 ElemStation=0
Frame=30 Station=0,0917 OutputCase=FRE20 CaseType=Combination P=-12,6896380991458 V2=5,9641075366405 V3=0 T=0 M2=0 M3=2,29123168688622 FrameElem=30-1 ElemStation=0,0917
Frame=30 Station=0,1834 OutputCase=FRE20 CaseType=Combination P=-12,6896380991458 V2=7,2479075366405 V3=0 T=0 M2=0 M3=1,68546079577628 FrameElem=30-1 ElemStation=0,1834
Frame=30 Station=0 OutputCase=FRE21 CaseType=Combination P=-21,8879203358448 V2=-2,56759999996586 V3=0 T=0 M2=0 M3=0,179027085364454 FrameElem=30-1 ElemStation=0
Frame=30 Station=0,0917 OutputCase=FRE21 CaseType=Combination P=-21,8879203358448 V2=-1,28379999996586 V3=0 T=0 M2=0 M3=0,355613775361324 FrameElem=30-1 ElemStation=0,0917
Frame=30 Station=0,1834 OutputCase=FRE21 CaseType=Combination P=-21,8879203358448 V2=3,41398020964334E-11 V3=0 T=0 M2=0 M3=0,414476005358193 FrameElem=30-1 ElemStation=0,1834
Frame=30 Station=0 OutputCase=FRE22 CaseType=Combination P=-3,2557944225741 V2=-2,88543433140215 V3=0 T=0 M2=0 M3=2,94691306917926 FrameElem=30-1 ElemStation=0
Frame=30 Station=0,0917 OutputCase=FRE22 CaseType=Combination P=-3,2557944225741 V2=-1,60163433140215 V3=0 T=0 M2=0 M3=3,15264516736884 FrameElem=30-1 ElemStation=0,0917
Frame=30 Station=0,1834 OutputCase=FRE22 CaseType=Combination P=-3,2557944225741 V2=-0,317834331402149 V3=0 T=0 M2=0 M3=3,24065280555841 FrameElem=30-1 ElemStation=0,1834
Frame=30 Station=0 OutputCase=FRE23 CaseType=Combination P=-3,57367360133642 V2=-2,24976566855508 V3=0 T=0 M2=0 M3=2,62223193533708 FrameElem=30-1 ElemStation=0
Frame=30 Station=0,0917 OutputCase=FRE23 CaseType=Combination P=-3,57367360133642 V2=-0,965965668555082 V3=0 T=0 M2=0 M3=2,76967321714358 FrameElem=30-1 ElemStation=0,0917
Frame=30 Station=0,1834 OutputCase=FRE23 CaseType=Combination P=-3,57367360133642 V2=0,317834331444918 V3=0 T=0 M2=0 M3=2,79939003895008 FrameElem=30-1 ElemStation=0,1834
Frame=30 Station=0 OutputCase=FRE24 CaseType=Combination P=-3,0316247594976 V2=-2,56759999997873 V3=0 T=0 M2=0 M3=3,10245168102047 FrameElem=30-1 ElemStation=0
Frame=30 Station=0,0917 OutputCase=FRE24 CaseType=Combination P=-3,0316247594976 V2=-1,28379999997873 V3=0 T=0 M2=0 M3=3,27903837101852 FrameElem=30-1 ElemStation=0,0917
Frame=30 Station=0,1834 OutputCase=FRE24 CaseType=Combination P=-3,0316247594976 V2=2,12742712335512E-11 V3=0 T=0 M2=0 M3=3,33790060101657 FrameElem=30-1 ElemStation=0,1834
Frame=30 Station=0 OutputCase=FRE25 CaseType=Combination P=-3,68373760764706 V2=-2,94900119768672 V3=0 T=0 M2=0 M3=2,59792616804871 FrameElem=30-1 ElemStation=0
Frame=30 Station=0,0917 OutputCase=FRE25 CaseType=Combination P=-3,68373760764706 V2=-1,66520119768672 V3=0 T=0 M2=0 M3=2,80948734787658 FrameElem=30-1 ElemStation=0,0917
Frame=30 Station=0,1834 OutputCase=FRE25 CaseType=Combination P=-3,68373760764706 V2=-0,381401197686724 V3=0 T=0 M2=0 M3=2,90332406770446 FrameElem=30-1 ElemStation=0,1834
Frame=30 Station=0 OutputCase=FRE26 CaseType=Combination P=-4,43563280097981 V2=-16,0902343315798 V3=0 T=0 M2=0 M3=17,6925389159389 FrameElem=30-1 ElemStation=0
Frame=30 Station=0,0917 OutputCase=FRE26 CaseType=Combination P=-4,43563280097981 V2=-8,2040343315798 V3=0 T=0 M2=0 M3=18,8064311341448 FrameElem=30-1 ElemStation=0,0917
Frame=30 Station=0,1834 OutputCase=FRE26 CaseType=Combination P=-4,43563280097981 V2=-0,317834331579801 V3=0 T=0 M2=0 M3=19,1971588123506 FrameElem=30-1 ElemStation=0,1834
Frame=30 Station=0 OutputCase=FRE27 CaseType=Combination P=-13,6339150376788 V2=-8,84232679496071 V3=0 T=0 M2=0 M3=17,7508203674293 FrameElem=30-1 ElemStation=0
Frame=30 Station=0,0917 OutputCase=FRE27 CaseType=Combination P=-13,6339150376788 V2=-0,956126794960705 V3=0 T=0 M2=0 M3=18,2000794645272 FrameElem=30-1 ElemStation=0,0917
Frame=30 Station=0,1834 OutputCase=FRE27 CaseType=Combination P=-13,6339150376788 V2=6,9300732050393 V3=0 T=0 M2=0 M3=17,9261740216251 FrameElem=30-1 ElemStation=0,1834
Frame=30 Station=0 OutputCase=FRE28 CaseType=Combination P=-22,8321972743778 V2=-16,0902343315671 V3=0 T=0 M2=0 M3=15,1505693347976 FrameElem=30-1 ElemStation=0
Frame=30 Station=0,0917 OutputCase=FRE28 CaseType=Combination P=-22,8321972743778 V2=-8,20403433156707 V3=0 T=0 M2=0 M3=16,2644615530024 FrameElem=30-1 ElemStation=0,0917
Frame=30 Station=0,1834 OutputCase=FRE28 CaseType=Combination P=-22,8321972743778 V2=-0,317834331567068 V3=0 T=0 M2=0 M3=16,655189231207 FrameElem=30-1 ElemStation=0,1834
Frame=30 Station=0 OutputCase=FRE29 CaseType=Combination P=-12,9138077622223 V2=4,36247320521708 V3=0 T=0 M2=0 M3=2,62373950615494 FrameElem=30-1 ElemStation=0
Frame=30 Station=0,0917 OutputCase=FRE29 CaseType=Combination P=-12,9138077622223 V2=5,64627320521708 V3=0 T=0 M2=0 M3=2,16483848323653 FrameElem=30-1 ElemStation=0,0917
Frame=30 Station=0,1834 OutputCase=FRE29 CaseType=Combination P=-12,9138077622223 V2=6,93007320521708 V3=0 T=0 M2=0 M3=1,58821300031812 FrameElem=30-1 ElemStation=0,1834
Frame=30 Station=0 OutputCase=FRE30 CaseType=Combination P=-22,112089989213 V2=-2,88543433138928 V3=0 T=0 M2=0 M3=2,34884735232401E-02 FrameElem=30-1 ElemStation=0
Frame=30 Station=0,0917 OutputCase=FRE30 CaseType=Combination P=-22,112089989213 V2=-1,60163433138928 V3=0 T=0 M2=0 M3=0,229220571711637 FrameElem=30-1 ElemStation=0,0917

Società di Progetto
Brebemi SpA



Doc. N.
60235-00000-A00.doc

CODIFICA DOCUMENTO
04RCDII10000000000300A00

REV.
00

FOGLIO
404 di 628

Frame=30 Station=0,1834 OutputCase=FRE30 CaseType=Combination P=-22,1120899989213 V2=-0,317834331389284 V3=0 T=0 M2=0 M3=0,317228209900034
FrameElem=30-1 ElemStation=0,1834
Frame=30 Station=0 OutputCase=FRE31 CaseType=Combination P=-4,06684686010473 V2=-2,94900119768661 V3=0 T=0 M2=0 M3=2,28004698928641 FrameElem=30-1
ElemStation=0
Frame=30 Station=0,0917 OutputCase=FRE31 CaseType=Combination P=-4,06684686010473 V2=-1,66520119768661 V3=0 T=0 M2=0 M3=2,49160816911427 FrameElem=30-1
ElemStation=0,0917
Frame=30 Station=0,1834 OutputCase=FRE31 CaseType=Combination P=-4,06684686010473 V2=-0,381401197686613 V3=0 T=0 M2=0 M3=2,58544488894213
FrameElem=30-1 ElemStation=0,1834
Frame=30 Station=0 OutputCase=FRE32 CaseType=Combination P=-3,3006283551894 V2=-2,94900119768683 V3=0 T=0 M2=0 M3=2,91580534681102 FrameElem=30-1
ElemStation=0
Frame=30 Station=0,0917 OutputCase=FRE32 CaseType=Combination P=-3,3006283551894 V2=-1,66520119768683 V3=0 T=0 M2=0 M3=3,1273665266389 FrameElem=30-1
ElemStation=0,0917
Frame=30 Station=0,1834 OutputCase=FRE32 CaseType=Combination P=-3,3006283551894 V2=-0,381401197686834 V3=0 T=0 M2=0 M3=3,22120324646678 FrameElem=30-1
ElemStation=0,1834
Frame=30 Station=0 OutputCase=FRE33 CaseType=Combination P=-3,3006283551894 V2=-2,94900119768683 V3=0 T=0 M2=0 M3=2,91580534681102 FrameElem=30-1
ElemStation=0
Frame=30 Station=0,0917 OutputCase=FRE33 CaseType=Combination P=-3,3006283551894 V2=-1,66520119768683 V3=0 T=0 M2=0 M3=3,1273665266389 FrameElem=30-1
ElemStation=0,0917
Frame=30 Station=0,1834 OutputCase=FRE33 CaseType=Combination P=-3,3006283551894 V2=-0,381401197686834 V3=0 T=0 M2=0 M3=3,22120324646678 FrameElem=30-1
ElemStation=0,1834
Frame=30 Station=0 OutputCase=FRE34 CaseType=Combination P=-4,06519262216185 V2=-2,18619880227024 V3=0 T=0 M2=0 M3=2,20830880743809 FrameElem=30-1
ElemStation=0
Frame=30 Station=0,0917 OutputCase=FRE34 CaseType=Combination P=-4,06519262216185 V2=-0,902398802270243 V3=0 T=0 M2=0 M3=2,34992100760627
FrameElem=30-1 ElemStation=0,0917
Frame=30 Station=0,1834 OutputCase=FRE34 CaseType=Combination P=-4,06519262216185 V2=-0,381401197729757 V3=0 T=0 M2=0 M3=2,37380874777445
FrameElem=30-1 ElemStation=0,1834
Frame=30 Station=0 OutputCase=FRE35 CaseType=Combination P=-4,75351197974214 V2=-15,4545656687327 V3=0 T=0 M2=0 M3=17,3678577820967 FrameElem=30-1
ElemStation=0
Frame=30 Station=0,0917 OutputCase=FRE35 CaseType=Combination P=-4,75351197974214 V2=-7,56836566873273 V3=0 T=0 M2=0 M3=18,4234591839195 FrameElem=30-1
ElemStation=0,0917
Frame=30 Station=0,1834 OutputCase=FRE35 CaseType=Combination P=-4,75351197974214 V2=0,317834331267266 V3=0 T=0 M2=0 M3=18,7558960457423
FrameElem=30-1 ElemStation=0,1834
Frame=30 Station=0 OutputCase=FRE36 CaseType=Combination P=-13,9517942164412 V2=-8,20665813211364 V3=0 T=0 M2=0 M3=17,4261392335872 FrameElem=30-1
ElemStation=0
Frame=30 Station=0,0917 OutputCase=FRE36 CaseType=Combination P=-13,9517942164412 V2=-0,320458132113638 V3=0 T=0 M2=0 M3=17,817107514302 FrameElem=30-1
ElemStation=0,0917
Frame=30 Station=0,1834 OutputCase=FRE36 CaseType=Combination P=-13,9517942164412 V2=-7,56574186788636 V3=0 T=0 M2=0 M3=17,4849112550168 FrameElem=30-1
ElemStation=0,1834
Frame=30 Station=0 OutputCase=FRE37 CaseType=Combination P=-23,1500764531402 V2=-15,45456566872 V3=0 T=0 M2=0 M3=14,8258882009555 FrameElem=30-1
ElemStation=0
Frame=30 Station=0,0917 OutputCase=FRE37 CaseType=Combination P=-23,1500764531402 V2=-7,56836566872 V3=0 T=0 M2=0 M3=15,8814896027771 FrameElem=30-1
ElemStation=0,0917
Frame=30 Station=0,1834 OutputCase=FRE37 CaseType=Combination P=-23,1500764531402 V2=0,317834331279999 V3=0 T=0 M2=0 M3=16,2139264645987
FrameElem=30-1 ElemStation=0,1834
Frame=30 Station=0 OutputCase=FRE38 CaseType=Combination P=-13,2316869409846 V2=4,99814186806415 V3=0 T=0 M2=0 M3=2,29905837231275 FrameElem=30-1
ElemStation=0
Frame=30 Station=0,0917 OutputCase=FRE38 CaseType=Combination P=-13,2316869409846 V2=6,28194186806415 V3=0 T=0 M2=0 M3=1,78186653301127 FrameElem=30-1
ElemStation=0,0917
Frame=30 Station=0,1834 OutputCase=FRE38 CaseType=Combination P=-13,2316869409846 V2=7,56574186806415 V3=0 T=0 M2=0 M3=1,14695023370979 FrameElem=30-1
ElemStation=0,1834
Frame=30 Station=0 OutputCase=FRE39 CaseType=Combination P=-22,4299691776837 V2=-2,24976566854222 V3=0 T=0 M2=0 M3=-0,301192660318943 FrameElem=30-1
ElemStation=0
Frame=30 Station=0,0917 OutputCase=FRE39 CaseType=Combination P=-22,4299691776837 V2=-0,965965668542217 V3=0 T=0 M2=0 M3=-0,153751378513621
FrameElem=30-1 ElemStation=0,0917
Frame=30 Station=0,1834 OutputCase=FRE39 CaseType=Combination P=-22,4299691776837 V2=0,317834331457783 V3=0 T=0 M2=0 M3=-0,1240345567083 FrameElem=30-1
ElemStation=0,1834
Frame=30 Station=0 OutputCase=FRE40 CaseType=Combination P=-4,44830187461952 V2=-2,18619880227013 V3=0 T=0 M2=0 M3=1,89042962867579 FrameElem=30-1
ElemStation=0
Frame=30 Station=0,0917 OutputCase=FRE40 CaseType=Combination P=-4,44830187461952 V2=-0,902398802270133 V3=0 T=0 M2=0 M3=2,03204182884396
FrameElem=30-1 ElemStation=0,0917
Frame=30 Station=0,1834 OutputCase=FRE40 CaseType=Combination P=-4,44830187461952 V2=0,381401197729867 V3=0 T=0 M2=0 M3=2,05592956901213
FrameElem=30-1 ElemStation=0,1834
Frame=30 Station=0 OutputCase=FRE41 CaseType=Combination P=-3,68208336970419 V2=-2,18619880227035 V3=0 T=0 M2=0 M3=2,5261879862004 FrameElem=30-1
ElemStation=0
Frame=30 Station=0,0917 OutputCase=FRE41 CaseType=Combination P=-3,68208336970419 V2=-0,902398802270354 V3=0 T=0 M2=0 M3=2,66780018636859
FrameElem=30-1 ElemStation=0,0917
Frame=30 Station=0,1834 OutputCase=FRE41 CaseType=Combination P=-3,68208336970419 V2=0,381401197729647 V3=0 T=0 M2=0 M3=2,69168792653678
FrameElem=30-1 ElemStation=0,1834
Frame=30 Station=0 OutputCase=FRE42 CaseType=Combination P=-3,68208336970419 V2=-2,18619880227035 V3=0 T=0 M2=0 M3=2,5261879862004 FrameElem=30-1
ElemStation=0
Frame=30 Station=0,0917 OutputCase=FRE42 CaseType=Combination P=-3,68208336970419 V2=-0,902398802270354 V3=0 T=0 M2=0 M3=2,66780018636859
FrameElem=30-1 ElemStation=0,0917
Frame=30 Station=0,1834 OutputCase=FRE42 CaseType=Combination P=-3,68208336970419 V2=0,381401197729647 V3=0 T=0 M2=0 M3=2,69168792653678
FrameElem=30-1 ElemStation=0,1834
Frame=30 Station=0 OutputCase=FRE43 CaseType=Combination P=-3,41473401195526 V2=-2,5675999997862 V3=0 T=0 M2=0 M3=2,78457250225817 FrameElem=30-1
ElemStation=0
Frame=30 Station=0,0917 OutputCase=FRE43 CaseType=Combination P=-3,41473401195526 V2=-1,28379999997862 V3=0 T=0 M2=0 M3=2,96115919225621 FrameElem=30-1
ElemStation=0,0917
Frame=30 Station=0,1834 OutputCase=FRE43 CaseType=Combination P=-3,41473401195526 V2=2,1384405357594E-11 V3=0 T=0 M2=0 M3=3,02002142225425
FrameElem=30-1 ElemStation=0,1834
Frame=30 Station=0 OutputCase=FRE44 CaseType=Combination P=-4,21146313790331 V2=-15,7724000001564 V3=0 T=0 M2=0 M3=17,8480775277801 FrameElem=30-1
ElemStation=0
Frame=30 Station=0,0917 OutputCase=FRE44 CaseType=Combination P=-4,21146313790331 V2=-7,88620000015638 V3=0 T=0 M2=0 M3=18,9328243377945 FrameElem=30-1
ElemStation=0,0917
Frame=30 Station=0,1834 OutputCase=FRE44 CaseType=Combination P=-4,21146313790331 V2=-1,56377188975654E-10 V3=0 T=0 M2=0 M3=19,2944066078088
FrameElem=30-1 ElemStation=0,1834
Frame=30 Station=0 OutputCase=FRE45 CaseType=Combination P=-13,4097453746023 V2=-8,52449246353728 V3=0 T=0 M2=0 M3=17,9063589792706 FrameElem=30-1
ElemStation=0

Società di Progetto
Brebemi SpA



Doc. N.
60235-0000-A00.doc

CODIFICA DOCUMENTO
04RCDII10000000000300A00

REV.
00

FOGLIO
405 di 628

Frame=30 Station=0,0917 OutputCase=FRE45 CaseType=Combination P=-13,4097453746023 V2=-0,638292463537281 V3=0 T=0 M2=0 M3=18,3264726681769
FrameElem=30-1 ElemStation=0,0917
Frame=30 Station=0,1834 OutputCase=FRE45 CaseType=Combination P=-13,4097453746023 V2=-7,24790753646272 V3=0 T=0 M2=0 M3=18,0234218170833 FrameElem=30-1
ElemStation=0,1834
Frame=30 Station=0 OutputCase=FRE46 CaseType=Combination P=-22,6080276113013 V2=-15,7724000001436 V3=0 T=0 M2=0 M3=15,3061079466389 FrameElem=30-1
ElemStation=0
Frame=30 Station=0,0917 OutputCase=FRE46 CaseType=Combination P=-22,6080276113013 V2=-7,88620000014364 V3=0 T=0 M2=0 M3=16,390854756652 FrameElem=30-1
ElemStation=0,0917
Frame=30 Station=0,1834 OutputCase=FRE46 CaseType=Combination P=-22,6080276113013 V2=-1,43644207639682E-10 V3=0 T=0 M2=0 M3=16,7524370266652
FrameElem=30-1 ElemStation=0,1834
Frame=30 Station=0 OutputCase=FRE47 CaseType=Combination P=-12,6896380991458 V2=4,6803075366405 V3=0 T=0 M2=0 M3=2,77927811799615 FrameElem=30-1
ElemStation=0
Frame=30 Station=0,0917 OutputCase=FRE47 CaseType=Combination P=-12,6896380991458 V2=5,9641075366405 V3=0 T=0 M2=0 M3=2,29123168688622 FrameElem=30-1
ElemStation=0,0917
Frame=30 Station=0,1834 OutputCase=FRE47 CaseType=Combination P=-12,6896380991458 V2=7,2479075366405 V3=0 T=0 M2=0 M3=1,68546079577628 FrameElem=30-1
ElemStation=0,1834
Frame=30 Station=0 OutputCase=FRE48 CaseType=Combination P=-21,8879203358448 V2=-2,56759999996586 V3=0 T=0 M2=0 M3=0,179027085364454 FrameElem=30-1
ElemStation=0
Frame=30 Station=0,0917 OutputCase=FRE48 CaseType=Combination P=-21,8879203358448 V2=-1,28379999996586 V3=0 T=0 M2=0 M3=0,355613775361324
FrameElem=30-1 ElemStation=0,0917
Frame=30 Station=0,1834 OutputCase=FRE48 CaseType=Combination P=-21,8879203358448 V2=3,41398020964334E-11 V3=0 T=0 M2=0 M3=0,414476005358193
FrameElem=30-1 ElemStation=0,1834
Frame=30 Station=0 OutputCase=FRE49 CaseType=Combination P=-3,0316247594976 V2=-2,56759999997873 V3=0 T=0 M2=0 M3=3,10245168102047 FrameElem=30-1
ElemStation=0
Frame=30 Station=0,0917 OutputCase=FRE49 CaseType=Combination P=-3,0316247594976 V2=-1,28379999997873 V3=0 T=0 M2=0 M3=3,27903837101852 FrameElem=30-1
ElemStation=0,0917
Frame=30 Station=0,1834 OutputCase=FRE49 CaseType=Combination P=-3,0316247594976 V2=2,12742712335512E-11 V3=0 T=0 M2=0 M3=3,33790060101657
FrameElem=30-1 ElemStation=0,1834
Frame=30 Station=0 OutputCase=FRE50 CaseType=Combination P=-3,2557944225741 V2=-2,88543433140215 V3=0 T=0 M2=0 M3=2,94691306917926 FrameElem=30-1
ElemStation=0
Frame=30 Station=0,0917 OutputCase=FRE50 CaseType=Combination P=-3,2557944225741 V2=-1,60163433140215 V3=0 T=0 M2=0 M3=3,15264516736884 FrameElem=30-1
ElemStation=0,0917
Frame=30 Station=0,1834 OutputCase=FRE50 CaseType=Combination P=-3,2557944225741 V2=-0,317834331402149 V3=0 T=0 M2=0 M3=3,24065280555841 FrameElem=30-1
ElemStation=0,1834
Frame=30 Station=0 OutputCase=FRE51 CaseType=Combination P=-3,57367360133642 V2=-2,24976566855508 V3=0 T=0 M2=0 M3=2,62223193533708 FrameElem=30-1
ElemStation=0
Frame=30 Station=0,0917 OutputCase=FRE51 CaseType=Combination P=-3,57367360133642 V2=-0,965965668555082 V3=0 T=0 M2=0 M3=2,76967321714358
FrameElem=30-1 ElemStation=0,0917
Frame=30 Station=0,1834 OutputCase=FRE51 CaseType=Combination P=-3,57367360133642 V2=0,317834331444918 V3=0 T=0 M2=0 M3=2,79939003895008
FrameElem=30-1 ElemStation=0,1834
Frame=30 Station=0 OutputCase=INVFRE CaseType=Combination StepType=Max P=-3,0316247594976 V2=4,99814186806415 V3=0 T=0 M2=0 M3=17,9063589792706
FrameElem=30-1 ElemStation=0
Frame=30 Station=0,0917 OutputCase=INVFRE CaseType=Combination StepType=Max P=-3,0316247594976 V2=6,28194186806415 V3=0 T=0 M2=0 M3=18,9328243377945
FrameElem=30-1 ElemStation=0,0917
Frame=30 Station=0,1834 OutputCase=INVFRE CaseType=Combination StepType=Max P=-3,0316247594976 V2=7,56574186806415 V3=0 T=0 M2=0 M3=19,2944066078088
FrameElem=30-1 ElemStation=0,1834
Frame=30 Station=0 OutputCase=INVFRE CaseType=Combination StepType=Min P=-23,3742461162167 V2=-16,0902343315798 V3=0 T=0 M2=0 M3=-0,456731272160157
FrameElem=30-1 ElemStation=0
Frame=30 Station=0,0917 OutputCase=INVFRE CaseType=Combination StepType=Min P=-23,3742461162167 V2=-8,2040343315798 V3=0 T=0 M2=0 M3=-
0,280144582163307 FrameElem=30-1 ElemStation=0,0917
Frame=30 Station=0,1834 OutputCase=INVFRE CaseType=Combination StepType=Min P=-23,3742461162167 V2=-0,381401197686834 V3=0 T=0 M2=0 M3=-
0,221282352166459 FrameElem=30-1 ElemStation=0,1834
Frame=30 Station=0 OutputCase=QPE01 CaseType=Combination P=-5,19130189437595 V2=-3,53579786725277 V3=0 T=0 M2=0 M3=2,00890793714043 FrameElem=30-1
ElemStation=0
Frame=30 Station=0,0917 OutputCase=QPE01 CaseType=Combination P=-5,19130189437595 V2=-2,25199786725277 V3=0 T=0 M2=0 M3=2,27427837156751 FrameElem=30-1
ElemStation=0,0917
Frame=30 Station=0,1834 OutputCase=QPE01 CaseType=Combination P=-5,19130189437595 V2=-0,968197867252768 V3=0 T=0 M2=0 M3=2,42192434599459
FrameElem=30-1 ElemStation=0,1834
Frame=30 Station=0 OutputCase=QPE02 CaseType=Combination P=-5,57441114683361 V2=-3,53579786725266 V3=0 T=0 M2=0 M3=1,69102875837812 FrameElem=30-1
ElemStation=0
Frame=30 Station=0,0917 OutputCase=QPE02 CaseType=Combination P=-5,57441114683361 V2=-2,25199786725266 V3=0 T=0 M2=0 M3=1,95639919280519 FrameElem=30-1
ElemStation=0,0917
Frame=30 Station=0,1834 OutputCase=QPE02 CaseType=Combination P=-5,57441114683361 V2=-0,968197867252658 V3=0 T=0 M2=0 M3=2,10404516723226
FrameElem=30-1 ElemStation=0,1834
Frame=30 Station=0 OutputCase=QPE03 CaseType=Combination P=-4,80819264191828 V2=-3,53579786725288 V3=0 T=0 M2=0 M3=2,32678711590273 FrameElem=30-1
ElemStation=0
Frame=30 Station=0,0917 OutputCase=QPE03 CaseType=Combination P=-4,80819264191828 V2=-2,25199786725288 V3=0 T=0 M2=0 M3=2,59215755032982 FrameElem=30-1
ElemStation=0,0917
Frame=30 Station=0,1834 OutputCase=QPE03 CaseType=Combination P=-4,80819264191828 V2=-0,968197867252878 V3=0 T=0 M2=0 M3=2,73980352475691
FrameElem=30-1 ElemStation=0,1834
Frame=30 Station=0 OutputCase=QPE04 CaseType=Combination P=-5,03236230499478 V2=-3,8536321986763 V3=0 T=0 M2=0 M3=2,17124850406152 FrameElem=30-1
ElemStation=0
Frame=30 Station=0,0917 OutputCase=QPE04 CaseType=Combination P=-5,03236230499478 V2=-2,5698321986763 V3=0 T=0 M2=0 M3=2,46576434668014 FrameElem=30-1
ElemStation=0,0917
Frame=30 Station=0,1834 OutputCase=QPE04 CaseType=Combination P=-5,03236230499478 V2=-1,2860321986763 V3=0 T=0 M2=0 M3=2,64255572929875 FrameElem=30-1
ElemStation=0,1834
Frame=30 Station=0 OutputCase=QPE05 CaseType=Combination P=-5,35024148375711 V2=-3,21796353582923 V3=0 T=0 M2=0 M3=1,84656737021934 FrameElem=30-1
ElemStation=0
Frame=30 Station=0,0917 OutputCase=QPE05 CaseType=Combination P=-5,35024148375711 V2=-1,93416353582923 V3=0 T=0 M2=0 M3=2,08279239645488 FrameElem=30-1
ElemStation=0,0917
Frame=30 Station=0,1834 OutputCase=QPE05 CaseType=Combination P=-5,35024148375711 V2=-0,650363535829234 V3=0 T=0 M2=0 M3=2,20129296269042
FrameElem=30-1 ElemStation=0,1834
Frame=30 Station=0 OutputCase=QPE06 CaseType=Combination P=-4,80819264191828 V2=-3,53579786725288 V3=0 T=0 M2=0 M3=2,32678711590273 FrameElem=30-1
ElemStation=0
Frame=30 Station=0,0917 OutputCase=QPE06 CaseType=Combination P=-4,80819264191828 V2=-2,25199786725288 V3=0 T=0 M2=0 M3=2,59215755032982 FrameElem=30-1
ElemStation=0,0917
Frame=30 Station=0,1834 OutputCase=QPE06 CaseType=Combination P=-4,80819264191828 V2=-0,968197867252878 V3=0 T=0 M2=0 M3=2,73980352475691
FrameElem=30-1 ElemStation=0,1834

Società di Progetto
Brebemi SpA



Doc. N.
60235-0000-A00.doc

CODIFICA DOCUMENTO
04RCDII10000000000300A00

REV.
00

FOGLIO
406 di 628

Frame=30 Station=0 OutputCase=QPE07 CaseType=Combination P=-5,41547155745245 V2=-3,85363219867619 V3=0 T=0 M2=0 M3=1,85336932529921 FrameElem=30-1 ElemStation=0
Frame=30 Station=0,0917 OutputCase=QPE07 CaseType=Combination P=-5,41547155745245 V2=-2,56983219867619 V3=0 T=0 M2=0 M3=2,14788516791782 FrameElem=30-1 ElemStation=0,0917
Frame=30 Station=0,1834 OutputCase=QPE07 CaseType=Combination P=-5,41547155745245 V2=-1,28603219867619 V3=0 T=0 M2=0 M3=2,32467655053643 FrameElem=30-1 ElemStation=0,1834
Frame=30 Station=0 OutputCase=QPE08 CaseType=Combination P=-5,73335073621477 V2=-3,21796353582912 V3=0 T=0 M2=0 M3=1,52868819145703 FrameElem=30-1 ElemStation=0
Frame=30 Station=0,0917 OutputCase=QPE08 CaseType=Combination P=-5,73335073621477 V2=-1,93416353582912 V3=0 T=0 M2=0 M3=1,76491321769256 FrameElem=30-1 ElemStation=0,0917
Frame=30 Station=0,1834 OutputCase=QPE08 CaseType=Combination P=-5,73335073621477 V2=-0,650363535829124 V3=0 T=0 M2=0 M3=1,88341378392809 FrameElem=30-1 ElemStation=0,1834
Frame=30 Station=0 OutputCase=QPE09 CaseType=Combination P=-5,19130189437595 V2=-3,53579786725277 V3=0 T=0 M2=0 M3=2,00890793714043 FrameElem=30-1 ElemStation=0
Frame=30 Station=0,0917 OutputCase=QPE09 CaseType=Combination P=-5,19130189437595 V2=-2,25199786725277 V3=0 T=0 M2=0 M3=2,27427837156751 FrameElem=30-1 ElemStation=0,0917
Frame=30 Station=0,1834 OutputCase=QPE09 CaseType=Combination P=-5,19130189437595 V2=-0,968197867252768 V3=0 T=0 M2=0 M3=2,42192434599459 FrameElem=30-1 ElemStation=0,1834
Frame=30 Station=0 OutputCase=QPE10 CaseType=Combination P=-5,19130189437595 V2=-1,59940213270784 V3=0 T=0 M2=0 M3=2,36404291480036 FrameElem=30-1 ElemStation=0
Frame=30 Station=0,0917 OutputCase=QPE10 CaseType=Combination P=-5,19130189437595 V2=-0,315602132707837 V3=0 T=0 M2=0 M3=2,45184586036967 FrameElem=30-1 ElemStation=0,0917
Frame=30 Station=0,1834 OutputCase=QPE10 CaseType=Combination P=-5,19130189437595 V2=0,968197867292163 V3=0 T=0 M2=0 M3=2,42192434593897 FrameElem=30-1 ElemStation=0,1834
Frame=30 Station=0 OutputCase=QPE11 CaseType=Combination P=-5,57441114683361 V2=-1,59940213270773 V3=0 T=0 M2=0 M3=2,04616373603805 FrameElem=30-1 ElemStation=0
Frame=30 Station=0,0917 OutputCase=QPE11 CaseType=Combination P=-5,57441114683361 V2=-0,315602132707727 V3=0 T=0 M2=0 M3=2,1339668160735 FrameElem=30-1 ElemStation=0,0917
Frame=30 Station=0,1834 OutputCase=QPE11 CaseType=Combination P=-5,57441114683361 V2=0,968197867292273 V3=0 T=0 M2=0 M3=2,1040516717665 FrameElem=30-1 ElemStation=0,1834
Frame=30 Station=0 OutputCase=QPE12 CaseType=Combination P=-4,80819264191828 V2=-1,59940213270795 V3=0 T=0 M2=0 M3=2,68192209356266 FrameElem=30-1 ElemStation=0
Frame=30 Station=0,0917 OutputCase=QPE12 CaseType=Combination P=-4,80819264191828 V2=-0,315602132707947 V3=0 T=0 M2=0 M3=2,76972503913198 FrameElem=30-1 ElemStation=0,0917
Frame=30 Station=0,1834 OutputCase=QPE12 CaseType=Combination P=-4,80819264191828 V2=0,968197867292053 V3=0 T=0 M2=0 M3=2,7398035247013 FrameElem=30-1 ElemStation=0,1834
Frame=30 Station=0 OutputCase=QPE13 CaseType=Combination P=-5,03236230499478 V2=-1,91723646413137 V3=0 T=0 M2=0 M3=2,52638348172145 FrameElem=30-1 ElemStation=0
Frame=30 Station=0,0917 OutputCase=QPE13 CaseType=Combination P=-5,03236230499478 V2=-0,633436464131371 V3=0 T=0 M2=0 M3=2,6433318354823 FrameElem=30-1 ElemStation=0,0917
Frame=30 Station=0,1834 OutputCase=QPE13 CaseType=Combination P=-5,03236230499478 V2=0,650363535868629 V3=0 T=0 M2=0 M3=2,64255572924314 FrameElem=30-1 ElemStation=0,1834
Frame=30 Station=0 OutputCase=QPE14 CaseType=Combination P=-5,35024148375711 V2=-1,2815678012843 V3=0 T=0 M2=0 M3=2,20170234787927 FrameElem=30-1 ElemStation=0
Frame=30 Station=0,0917 OutputCase=QPE14 CaseType=Combination P=-5,35024148375711 V2=2,23219871569635E-03 V3=0 T=0 M2=0 M3=2,26035988525704 FrameElem=30-1 ElemStation=0,0917
Frame=30 Station=0,1834 OutputCase=QPE14 CaseType=Combination P=-5,35024148375711 V2=1,2860321987157 V3=0 T=0 M2=0 M3=2,20129296263481 FrameElem=30-1 ElemStation=0,1834
Frame=30 Station=0 OutputCase=QPE15 CaseType=Combination P=-4,80819264191828 V2=-1,59940213270795 V3=0 T=0 M2=0 M3=2,68192209356266 FrameElem=30-1 ElemStation=0
Frame=30 Station=0,0917 OutputCase=QPE15 CaseType=Combination P=-4,80819264191828 V2=-0,315602132707947 V3=0 T=0 M2=0 M3=2,76972503913198 FrameElem=30-1 ElemStation=0,0917
Frame=30 Station=0,1834 OutputCase=QPE15 CaseType=Combination P=-4,80819264191828 V2=0,968197867292053 V3=0 T=0 M2=0 M3=2,7398035247013 FrameElem=30-1 ElemStation=0,1834
Frame=30 Station=0 OutputCase=QPE16 CaseType=Combination P=-5,41547155745245 V2=-1,91723646413126 V3=0 T=0 M2=0 M3=2,20850430295914 FrameElem=30-1 ElemStation=0
Frame=30 Station=0,0917 OutputCase=QPE16 CaseType=Combination P=-5,41547155745245 V2=-0,63343646413126 V3=0 T=0 M2=0 M3=2,32545265671998 FrameElem=30-1 ElemStation=0,0917
Frame=30 Station=0,1834 OutputCase=QPE16 CaseType=Combination P=-5,41547155745245 V2=0,65036353586874 V3=0 T=0 M2=0 M3=2,32467655048082 FrameElem=30-1 ElemStation=0,1834
Frame=30 Station=0 OutputCase=QPE17 CaseType=Combination P=-5,73335073621477 V2=-1,28156780128419 V3=0 T=0 M2=0 M3=1,88382316911696 FrameElem=30-1 ElemStation=0
Frame=30 Station=0,0917 OutputCase=QPE17 CaseType=Combination P=-5,73335073621477 V2=2,23219871580649E-03 V3=0 T=0 M2=0 M3=1,94248070649472 FrameElem=30-1 ElemStation=0,0917
Frame=30 Station=0,1834 OutputCase=QPE17 CaseType=Combination P=-5,73335073621477 V2=1,28603219871581 V3=0 T=0 M2=0 M3=1,88341378387248 FrameElem=30-1 ElemStation=0,1834
Frame=30 Station=0 OutputCase=QPE18 CaseType=Combination P=-5,19130189437595 V2=-1,59940213270784 V3=0 T=0 M2=0 M3=2,36404291480036 FrameElem=30-1 ElemStation=0
Frame=30 Station=0,0917 OutputCase=QPE18 CaseType=Combination P=-5,19130189437595 V2=-0,315602132707837 V3=0 T=0 M2=0 M3=2,45184586036967 FrameElem=30-1 ElemStation=0,0917
Frame=30 Station=0,1834 OutputCase=QPE18 CaseType=Combination P=-5,19130189437595 V2=0,968197867292163 V3=0 T=0 M2=0 M3=2,42192434593897 FrameElem=30-1 ElemStation=0,1834
Frame=30 Station=0 OutputCase=INVQPE CaseType=Combination StepType=Max P=-4,80819264191828 V2=-1,28156780128419 V3=0 T=0 M2=0 M3=2,68192209356266 FrameElem=30-1 ElemStation=0
Frame=30 Station=0,0917 OutputCase=INVQPE CaseType=Combination StepType=Max P=-4,80819264191828 V2=2,23219871580649E-03 V3=0 T=0 M2=0 M3=2,76972503913198 FrameElem=30-1 ElemStation=0,0917
Frame=30 Station=0,1834 OutputCase=INVQPE CaseType=Combination StepType=Max P=-4,80819264191828 V2=1,28603219871581 V3=0 T=0 M2=0 M3=2,73980352475691 FrameElem=30-1 ElemStation=0,1834
Frame=30 Station=0 OutputCase=INVQPE CaseType=Combination StepType=Min P=-5,73335073621477 V2=-3,8536321986763 V3=0 T=0 M2=0 M3=1,52868819145703 FrameElem=30-1 ElemStation=0
Frame=30 Station=0,0917 OutputCase=INVQPE CaseType=Combination StepType=Min P=-5,73335073621477 V2=-2,5698321986763 V3=0 T=0 M2=0 M3=1,76491321769256 FrameElem=30-1 ElemStation=0,0917
Frame=30 Station=0,1834 OutputCase=INVQPE CaseType=Combination StepType=Min P=-5,73335073621477 V2=-1,2860321986763 V3=0 T=0 M2=0 M3=1,88341378387248 FrameElem=30-1 ElemStation=0,1834
Frame=31 Station=0 OutputCase=STR001 CaseType=Combination P=-8,78598720843675 V2=-1,71893610456664E-11 V3=0 T=0 M2=0 M3=2,97713108367452 FrameElem=31-1 ElemStation=0
Frame=31 Station=0,0917 OutputCase=STR001 CaseType=Combination P=-8,78598720843675 V2=1,73312999998281 V3=0 T=0 M2=0 M3=2,8976670731761 FrameElem=31-1 ElemStation=0,0917

Società di Progetto
Brebemi SpA



Doc. N.
60235-00000-A00.doc

CODIFICA DOCUMENTO
04RCDII10000000000300A00

REV.
00

FOGLIO
407 di 628

Frame=31 Station=0,1834 OutputCase=STR001 CaseType=Combination P=-8,7859820843675 V2=3,46625999998281 V3=0 T=0 M2=0 M3=2,65927504167677 FrameElem=31-1 ElemStation=0,1834
Frame=31 Station=0 OutputCase=STR002 CaseType=Combination P=-3,67738409966933 V2=-1,78261849725914E-11 V3=0 T=0 M2=0 M3=3,81731277535373 FrameElem=31-1 ElemStation=0
Frame=31 Station=0,0917 OutputCase=STR002 CaseType=Combination P=-3,67738409966933 V2=1,73312999998217 V3=0 T=0 M2=0 M3=3,73784876485536 FrameElem=31-1 ElemStation=0,0917
Frame=31 Station=0,1834 OutputCase=STR002 CaseType=Combination P=-3,67738409966933 V2=3,46625999998217 V3=0 T=0 M2=0 M3=3,499456733357 FrameElem=31-1 ElemStation=0,1834
Frame=31 Station=0 OutputCase=STR003 CaseType=Combination P=-4,97357719549106 V2=-8,00364219344374E-12 V3=0 T=0 M2=0 M3=33,2256426136767 FrameElem=31-1 ElemStation=0
Frame=31 Station=0,0917 OutputCase=STR003 CaseType=Combination P=-4,97357719549106 V2=13,617449999992 V3=0 T=0 M2=0 M3=32,6012825311774 FrameElem=31-1 ElemStation=0,0917
Frame=31 Station=0,1834 OutputCase=STR003 CaseType=Combination P=-4,97357719549106 V2=27,23489999992 V3=0 T=0 M2=0 M3=30,7282022836782 FrameElem=31-1 ElemStation=0,1834
Frame=31 Station=0 OutputCase=STR004 CaseType=Combination P=-21,7144805728843 V2=13,1817815845386 V3=0 T=0 M2=0 M3=30,9077348557264 FrameElem=31-1 ElemStation=0
Frame=31 Station=0,0917 OutputCase=STR004 CaseType=Combination P=-21,7144805728843 V2=26,7992315845386 V3=0 T=0 M2=0 M3=29,0746054019242 FrameElem=31-1 ElemStation=0,0917
Frame=31 Station=0,1834 OutputCase=STR004 CaseType=Combination P=-21,7144805728843 V2=40,4166815845386 V3=0 T=0 M2=0 M3=25,992755783122 FrameElem=31-1 ElemStation=0,1834
Frame=31 Station=0 OutputCase=STR005 CaseType=Combination P=-38,4553839502776 V2=-2,70112820999202E-11 V3=0 T=0 M2=0 M3=28,5898270983287 FrameElem=31-1 ElemStation=0
Frame=31 Station=0,0917 OutputCase=STR005 CaseType=Combination P=-38,4553839502776 V2=13,617449999973 V3=0 T=0 M2=0 M3=27,9654670158312 FrameElem=31-1 ElemStation=0,0917
Frame=31 Station=0,1834 OutputCase=STR005 CaseType=Combination P=-38,4553839502776 V2=27,234899999973 V3=0 T=0 M2=0 M3=26,0923867683337 FrameElem=31-1 ElemStation=0,1834
Frame=31 Station=0 OutputCase=STR006 CaseType=Combination P=-20,6153684922977 V2=13,1817815845339 V3=0 T=0 M2=0 M3=0,320658649798963 FrameElem=31-1 ElemStation=0
Frame=31 Station=0,0917 OutputCase=STR006 CaseType=Combination P=-20,6153684922977 V2=14,4655815845339 V3=0 T=0 M2=0 M3=-0,946972951502794 FrameElem=31-1 ElemStation=0,0917
Frame=31 Station=0,1834 OutputCase=STR006 CaseType=Combination P=-20,6153684922977 V2=15,7493815845339 V3=0 T=0 M2=0 M3=-2,33232901280455 FrameElem=31-1 ElemStation=0,1834
Frame=31 Station=0 OutputCase=STR007 CaseType=Combination P=-37,356271869691 V2=-3,17399440064037E-11 V3=0 T=0 M2=0 M3=-1,99724910759869 FrameElem=31-1 ElemStation=0
Frame=31 Station=0,0917 OutputCase=STR007 CaseType=Combination P=-37,356271869691 V2=1,28379999996826 V3=0 T=0 M2=0 M3=-2,05611133759578 FrameElem=31-1 ElemStation=0,0917
Frame=31 Station=0,1834 OutputCase=STR007 CaseType=Combination P=-37,356271869691 V2=2,56759999996826 V3=0 T=0 M2=0 M3=-2,23269802759287 FrameElem=31-1 ElemStation=0,1834
Frame=31 Station=0 OutputCase=STR008 CaseType=Combination P=-17,8437818431765 V2=29,7258250228426 V3=0 T=0 M2=0 M3=24,0301066239977 FrameElem=31-1 ElemStation=0
Frame=31 Station=0,0917 OutputCase=STR008 CaseType=Combination P=-19,9111583431765 V2=40,3721950228426 V3=0 T=0 M2=0 M3=20,816112404903 FrameElem=31-1 ElemStation=0,0917
Frame=31 Station=0,1834 OutputCase=STR008 CaseType=Combination P=-21,9785348431765 V2=51,0185650228426 V3=0 T=0 M2=0 M3=16,6258460568084 FrameElem=31-1 ElemStation=0,1834
Frame=31 Station=0 OutputCase=STR009 CaseType=Combination P=-9,70544941433509 V2=-1,69420921736219E-11 V3=0 T=0 M2=0 M3=2,21422105464494 FrameElem=31-1 ElemStation=0
Frame=31 Station=0,0917 OutputCase=STR009 CaseType=Combination P=-9,70544941433509 V2=1,73312999998306 V3=0 T=0 M2=0 M3=2,13475704414649 FrameElem=31-1 ElemStation=0,0917
Frame=31 Station=0,1834 OutputCase=STR009 CaseType=Combination P=-9,70544941433509 V2=3,46625999998306 V3=0 T=0 M2=0 M3=1,89636501264805 FrameElem=31-1 ElemStation=0,1834
Frame=31 Station=0 OutputCase=STR010 CaseType=Combination P=-4,59684630556767 V2=-1,75789161005468E-11 V3=0 T=0 M2=0 M3=3,05440274632415 FrameElem=31-1 ElemStation=0
Frame=31 Station=0,0917 OutputCase=STR010 CaseType=Combination P=-4,59684630556767 V2=1,73312999998242 V3=0 T=0 M2=0 M3=2,97493873582576 FrameElem=31-1 ElemStation=0,0917
Frame=31 Station=0,1834 OutputCase=STR010 CaseType=Combination P=-4,59684630556767 V2=3,46625999998242 V3=0 T=0 M2=0 M3=2,73654670432737 FrameElem=31-1 ElemStation=0,1834
Frame=31 Station=0 OutputCase=STR011 CaseType=Combination P=-5,52525451903007 V2=-7,85528087021703E-12 V3=0 T=0 M2=0 M3=32,767896596259 FrameElem=31-1 ElemStation=0
Frame=31 Station=0,0917 OutputCase=STR011 CaseType=Combination P=-5,52525451903007 V2=13,6174499999921 V3=0 T=0 M2=0 M3=32,1435365137597 FrameElem=31-1 ElemStation=0,0917
Frame=31 Station=0,1834 OutputCase=STR011 CaseType=Combination P=-5,52525451903007 V2=27,2348999999921 V3=0 T=0 M2=0 M3=30,2704562662604 FrameElem=31-1 ElemStation=0,1834
Frame=31 Station=0 OutputCase=STR012 CaseType=Combination P=-22,2661578964233 V2=13,1817815845388 V3=0 T=0 M2=0 M3=30,449888383086 FrameElem=31-1 ElemStation=0
Frame=31 Station=0,0917 OutputCase=STR012 CaseType=Combination P=-22,2661578964233 V2=26,7992315845388 V3=0 T=0 M2=0 M3=28,6168593845064 FrameElem=31-1 ElemStation=0,0917
Frame=31 Station=0,1834 OutputCase=STR012 CaseType=Combination P=-22,2661578964233 V2=40,4166815845388 V3=0 T=0 M2=0 M3=25,5350097657042 FrameElem=31-1 ElemStation=0,1834
Frame=31 Station=0 OutputCase=STR013 CaseType=Combination P=-39,0070612738166 V2=-2,68629207766935E-11 V3=0 T=0 M2=0 M3=28,132081080911 FrameElem=31-1 ElemStation=0
Frame=31 Station=0,0917 OutputCase=STR013 CaseType=Combination P=-39,0070612738166 V2=13,6174499999731 V3=0 T=0 M2=0 M3=27,5077209984134 FrameElem=31-1 ElemStation=0,0917
Frame=31 Station=0,1834 OutputCase=STR013 CaseType=Combination P=-39,0070612738166 V2=27,2348999999731 V3=0 T=0 M2=0 M3=25,6346407509159 FrameElem=31-1 ElemStation=0,1834
Frame=31 Station=0 OutputCase=STR014 CaseType=Combination P=-21,1670458158367 V2=13,181781584534 V3=0 T=0 M2=0 M3=-0,137087367618786 FrameElem=31-1 ElemStation=0
Frame=31 Station=0,0917 OutputCase=STR014 CaseType=Combination P=-21,1670458158367 V2=14,465581584534 V3=0 T=0 M2=0 M3=-1,40471896892056 FrameElem=31-1 ElemStation=0,0917
Frame=31 Station=0,1834 OutputCase=STR014 CaseType=Combination P=-21,1670458158367 V2=15,749381584534 V3=0 T=0 M2=0 M3=-2,79007503022233 FrameElem=31-1 ElemStation=0,1834
Frame=31 Station=0 OutputCase=STR015 CaseType=Combination P=-37,90794919323 V2=-3,1591582683177E-11 V3=0 T=0 M2=0 M3=-2,45499512501644 FrameElem=31-1 ElemStation=0
Frame=31 Station=0,0917 OutputCase=STR015 CaseType=Combination P=-37,90794919323 V2=1,28379999996841 V3=0 T=0 M2=0 M3=-2,51385735501354 FrameElem=31-1 ElemStation=0,0917
Frame=31 Station=0,1834 OutputCase=STR015 CaseType=Combination P=-37,90794919323 V2=2,56759999996841 V3=0 T=0 M2=0 M3=-2,69044404501065 FrameElem=31-1 ElemStation=0,1834
Frame=31 Station=0 OutputCase=STR016 CaseType=Combination P=-18,3954591667155 V2=29,7258250228428 V3=0 T=0 M2=0 M3=23,57236060658 FrameElem=31-1 ElemStation=0

Società di Progetto
Brebemi SpA



Doc. N.
60235-00000-A00.doc

CODIFICA DOCUMENTO
04RCDII10000000000300A00

REV.
00

FOGLIO
408 di 628

Frame=31 Station=0,0917 OutputCase=STR016 CaseType=Combination P=-20,4628356667155 V2=40,3721950228428 V3=0 T=0 M2=0 M3=20,3583663874853 FrameElem=31-1 ElemStation=0,0917
Frame=31 Station=0,1834 OutputCase=STR016 CaseType=Combination P=-22,5302121667155 V2=51,0185650228428 V3=0 T=0 M2=0 M3=16,1681000393906 FrameElem=31-1 ElemStation=0,1834
Frame=31 Station=0 OutputCase=STR017 CaseType=Combination P=-5,56899112743397 V2=-1,02120090161861E-11 V3=0 T=0 M2=0 M3=25,1106501250664 FrameElem=31-1 ElemStation=0
Frame=31 Station=0,0917 OutputCase=STR017 CaseType=Combination P=-5,56899112743397 V2=10,6463699999898 V3=0 T=0 M2=0 M3=24,6225140605673 FrameElem=31-1 ElemStation=0,0917
Frame=31 Station=0,1834 OutputCase=STR017 CaseType=Combination P=-5,56899112743397 V2=21,2927399999898 V3=0 T=0 M2=0 M3=23,1581058670683 FrameElem=31-1 ElemStation=0,1834
Frame=31 Station=0 OutputCase=STR018 CaseType=Combination P=-18,7632440490748 V2=10,355912233337 V3=0 T=0 M2=0 M3=23,2671965951302 FrameElem=31-1 ElemStation=0
Frame=31 Station=0,0917 OutputCase=STR018 CaseType=Combination P=-18,7632440490748 V2=21,002282233337 V3=0 T=0 M2=0 M3=21,8294233788332 FrameElem=31-1 ElemStation=0,0917
Frame=31 Station=0,1834 OutputCase=STR018 CaseType=Combination P=-18,7632440490748 V2=31,648652233337 V3=0 T=0 M2=0 M3=19,4153780335362 FrameElem=31-1 ElemStation=0,1834
Frame=31 Station=0 OutputCase=STR019 CaseType=Combination P=-31,9574969707157 V2=-2,43108644326639E-11 V3=0 T=0 M2=0 M3=21,4237430656356 FrameElem=31-1 ElemStation=0
Frame=31 Station=0,0917 OutputCase=STR019 CaseType=Combination P=-31,9574969707157 V2=10,6463699999757 V3=0 T=0 M2=0 M3=20,9356070011378 FrameElem=31-1 ElemStation=0,0917
Frame=31 Station=0,1834 OutputCase=STR019 CaseType=Combination P=-31,9574969707157 V2=21,2927399999757 V3=0 T=0 M2=0 M3=19,47119880764 FrameElem=31-1 ElemStation=0,1834
Frame=31 Station=0 OutputCase=STR020 CaseType=Combination P=-17,9881802424437 V2=10,3559122333347 V3=0 T=0 M2=0 M3=3,22028487835382E-02 FrameElem=31-1 ElemStation=0
Frame=31 Station=0,0917 OutputCase=STR020 CaseType=Combination P=-17,9881802424437 V2=11,6397122333347 V3=0 T=0 M2=0 M3=-0,976296533013253 FrameElem=31-1 ElemStation=0,0917
Frame=31 Station=0,1834 OutputCase=STR020 CaseType=Combination P=-17,9881802424437 V2=12,9235122333347 V3=0 T=0 M2=0 M3=-2,10252037481004 FrameElem=31-1 ElemStation=0,1834
Frame=31 Station=0 OutputCase=STR021 CaseType=Combination P=-31,1824331640845 V2=-2,65828248302569E-11 V3=0 T=0 M2=0 M3=-1,81125068071108 FrameElem=31-1 ElemStation=0
Frame=31 Station=0,0917 OutputCase=STR021 CaseType=Combination P=-31,1824331640845 V2=1,28379999997342 V3=0 T=0 M2=0 M3=-1,87011291070864 FrameElem=31-1 ElemStation=0,0917
Frame=31 Station=0,1834 OutputCase=STR021 CaseType=Combination P=-31,1824331640845 V2=2,56759999997342 V3=0 T=0 M2=0 M3=-2,0466996007062 FrameElem=31-1 ElemStation=0,1834
Frame=31 Station=0 OutputCase=STR022 CaseType=Combination P=-9,47657640562622 V2=-0,457681437266841 V3=0 T=0 M2=0 M3=2,53193024660294 FrameElem=31-1 ElemStation=0
Frame=31 Station=0,0917 OutputCase=STR022 CaseType=Combination P=-9,47657640562622 V2=11,27544856273316 V3=0 T=0 M2=0 M3=2,49443562390031 FrameElem=31-1 ElemStation=0,0917
Frame=31 Station=0,1834 OutputCase=STR022 CaseType=Combination P=-9,47657640562622 V2=3,00857856273316 V3=0 T=0 M2=0 M3=2,29801298019768 FrameElem=31-1 ElemStation=0,1834
Frame=31 Station=0 OutputCase=STR023 CaseType=Combination P=-4,3679732968588 V2=-0,457681437267477 V3=0 T=0 M2=0 M3=3,37211193828215 FrameElem=31-1 ElemStation=0
Frame=31 Station=0,0917 OutputCase=STR023 CaseType=Combination P=-4,3679732968588 V2=11,27544856273252 V3=0 T=0 M2=0 M3=3,33461731557958 FrameElem=31-1 ElemStation=0,0917
Frame=31 Station=0,1834 OutputCase=STR023 CaseType=Combination P=-4,3679732968588 V2=3,00857856273252 V3=0 T=0 M2=0 M3=3,13819467187701 FrameElem=31-1 ElemStation=0,1834
Frame=31 Station=0 OutputCase=STR024 CaseType=Combination P=-5,3401181187251 V2=-0,45768143726011 V3=0 T=0 M2=0 M3=25,4283593170244 FrameElem=31-1 ElemStation=0
Frame=31 Station=0,0917 OutputCase=STR024 CaseType=Combination P=-5,3401181187251 V2=10,1886885627399 V3=0 T=0 M2=0 M3=24,9821926403211 FrameElem=31-1 ElemStation=0,0917
Frame=31 Station=0,1834 OutputCase=STR024 CaseType=Combination P=-5,3401181187251 V2=20,8350585627399 V3=0 T=0 M2=0 M3=23,5597538346179 FrameElem=31-1 ElemStation=0,1834
Frame=31 Station=0 OutputCase=STR025 CaseType=Combination P=-18,534371040366 V2=9,89823079608707 V3=0 T=0 M2=0 M3=23,5849057870882 FrameElem=31-1 ElemStation=0
Frame=31 Station=0,0917 OutputCase=STR025 CaseType=Combination P=-18,534371040366 V2=20,5446007960871 V3=0 T=0 M2=0 M3=22,189101958587 FrameElem=31-1 ElemStation=0,0917
Frame=31 Station=0,1834 OutputCase=STR025 CaseType=Combination P=-18,534371040366 V2=31,1909707960871 V3=0 T=0 M2=0 M3=19,8170260010858 FrameElem=31-1 ElemStation=0,1834
Frame=31 Station=0 OutputCase=STR026 CaseType=Combination P=-31,7286239620068 V2=-0,457681437274209 V3=0 T=0 M2=0 M3=21,7414522575936 FrameElem=31-1 ElemStation=0
Frame=31 Station=0,0917 OutputCase=STR026 CaseType=Combination P=-31,7286239620068 V2=10,1886885627258 V3=0 T=0 M2=0 M3=21,2952855808916 FrameElem=31-1 ElemStation=0,0917
Frame=31 Station=0,1834 OutputCase=STR026 CaseType=Combination P=-31,7286239620068 V2=20,8350585627258 V3=0 T=0 M2=0 M3=19,8728467751897 FrameElem=31-1 ElemStation=0,1834
Frame=31 Station=0 OutputCase=STR027 CaseType=Combination P=-17,7593072337348 V2=9,8982307960848 V3=0 T=0 M2=0 M3=0,349912040741539 FrameElem=31-1 ElemStation=0
Frame=31 Station=0,0917 OutputCase=STR027 CaseType=Combination P=-17,7593072337348 V2=11,1820307960848 V3=0 T=0 M2=0 M3=-0,616617953259436 FrameElem=31-1 ElemStation=0,0917
Frame=31 Station=0,1834 OutputCase=STR027 CaseType=Combination P=-17,7593072337348 V2=12,4658307960848 V3=0 T=0 M2=0 M3=-1,70087240726041 FrameElem=31-1 ElemStation=0,1834
Frame=31 Station=0 OutputCase=STR028 CaseType=Combination P=-30,9535601553757 V2=-0,457681437276481 V3=0 T=0 M2=0 M3=-1,49354148875308 FrameElem=31-1 ElemStation=0
Frame=31 Station=0,0917 OutputCase=STR028 CaseType=Combination P=-30,9535601553757 V2=0,826118562723518 V3=0 T=0 M2=0 M3=-1,51043433095482 FrameElem=31-1 ElemStation=0,0917
Frame=31 Station=0,1834 OutputCase=STR028 CaseType=Combination P=-30,9535601553757 V2=2,10991856272352 V3=0 T=0 M2=0 M3=-1,64505163315657 FrameElem=31-1 ElemStation=0,1834
Frame=31 Station=0 OutputCase=STR029 CaseType=Combination P=-9,93432242304397 V2=0,457681437232956 V3=0 T=0 M2=0 M3=1,89651186268694 FrameElem=31-1 ElemStation=0
Frame=31 Station=0,0917 OutputCase=STR029 CaseType=Combination P=-9,93432242304397 V2=2,19081143723296 V3=0 T=0 M2=0 M3=1,77507846439268 FrameElem=31-1 ElemStation=0,0917
Frame=31 Station=0,1834 OutputCase=STR029 CaseType=Combination P=-9,93432242304397 V2=3,92394143723296 V3=0 T=0 M2=0 M3=1,49471704509842 FrameElem=31-1 ElemStation=0,1834
Frame=31 Station=0 OutputCase=STR030 CaseType=Combination P=-4,82571931427655 V2=0,457681437232319 V3=0 T=0 M2=0 M3=2,73669355436615 FrameElem=31-1 ElemStation=0
Frame=31 Station=0,0917 OutputCase=STR030 CaseType=Combination P=-4,82571931427655 V2=2,19081143723232 V3=0 T=0 M2=0 M3=2,61526015607194 FrameElem=31-1 ElemStation=0,0917
Frame=31 Station=0,1834 OutputCase=STR030 CaseType=Combination P=-4,82571931427655 V2=3,92394143723232 V3=0 T=0 M2=0 M3=2,33489873677774 FrameElem=31-1 ElemStation=0,1834

Società di Progetto
Brebemi SpA



Doc. N.
60235-0000-A00.doc

CODIFICA DOCUMENTO
04RCDII10000000000300A00

REV.
00

FOGLIO
409 di 628

Frame=31 Station=0 OutputCase=STR031 CaseType=Combination P=-5,79786413614284 V2=0,457681437239686 V3=0 T=0 M2=0 M3=24,7929409331084 FrameElem=31-1 ElemStation=0
Frame=31 Station=0,0917 OutputCase=STR031 CaseType=Combination P=-5,79786413614284 V2=11,1040514372397 V3=0 T=0 M2=0 M3=24,2628354808135 FrameElem=31-1 ElemStation=0,0917
Frame=31 Station=0,1834 OutputCase=STR031 CaseType=Combination P=-5,79786413614284 V2=21,7504214372397 V3=0 T=0 M2=0 M3=22,7564578995186 FrameElem=31-1 ElemStation=0,1834
Frame=31 Station=0 OutputCase=STR032 CaseType=Combination P=-18,9921170577837 V2=10,8135936705869 V3=0 T=0 M2=0 M3=22,9494874031722 FrameElem=31-1 ElemStation=0
Frame=31 Station=0,0917 OutputCase=STR032 CaseType=Combination P=-18,9921170577837 V2=21,4599636705869 V3=0 T=0 M2=0 M3=21,4697447990794 FrameElem=31-1 ElemStation=0,0917
Frame=31 Station=0,1834 OutputCase=STR032 CaseType=Combination P=-18,9921170577837 V2=32,1063336705869 V3=0 T=0 M2=0 M3=19,0137300659866 FrameElem=31-1 ElemStation=0,1834
Frame=31 Station=0 OutputCase=STR033 CaseType=Combination P=-32,1863699794246 V2=0,457681437225588 V3=0 T=0 M2=0 M3=21,1060338736776 FrameElem=31-1 ElemStation=0
Frame=31 Station=0,0917 OutputCase=STR033 CaseType=Combination P=-32,1863699794246 V2=11,1040514372256 V3=0 T=0 M2=0 M3=20,575928421384 FrameElem=31-1 ElemStation=0,0917
Frame=31 Station=0,1834 OutputCase=STR033 CaseType=Combination P=-32,1863699794246 V2=21,7504214372256 V3=0 T=0 M2=0 M3=19,0695508400904 FrameElem=31-1 ElemStation=0,1834
Frame=31 Station=0 OutputCase=STR034 CaseType=Combination P=-18,2170532511525 V2=10,8135936705846 V3=0 T=0 M2=0 M3=-0,285506343174463 FrameElem=31-1 ElemStation=0
Frame=31 Station=0,0917 OutputCase=STR034 CaseType=Combination P=-18,2170532511525 V2=12,0973936705846 V3=0 T=0 M2=0 M3=-1,33597511276707 FrameElem=31-1 ElemStation=0,0917
Frame=31 Station=0,1834 OutputCase=STR034 CaseType=Combination P=-18,2170532511525 V2=13,3811936705846 V3=0 T=0 M2=0 M3=-2,50416834235968 FrameElem=31-1 ElemStation=0,1834
Frame=31 Station=0 OutputCase=STR035 CaseType=Combination P=-31,4113061727934 V2=0,457681437223316 V3=0 T=0 M2=0 M3=-2,12895987266908 FrameElem=31-1 ElemStation=0
Frame=31 Station=0,0917 OutputCase=STR035 CaseType=Combination P=-31,4113061727934 V2=1,74148143722332 V3=0 T=0 M2=0 M3=-2,22979149046246 FrameElem=31-1 ElemStation=0,0917
Frame=31 Station=0,1834 OutputCase=STR035 CaseType=Combination P=-31,4113061727934 V2=3,02528143722331 V3=0 T=0 M2=0 M3=-2,44834756825583 FrameElem=31-1 ElemStation=0,1834
Frame=31 Station=0 OutputCase=STR036 CaseType=Combination P=-9,15377209079609 V2=-1,70904534968486E-11 V3=0 T=0 M2=0 M3=2,67196707206269 FrameElem=31-1 ElemStation=0
Frame=31 Station=0,0917 OutputCase=STR036 CaseType=Combination P=-9,15377209079609 V2=1,73312999998291 V3=0 T=0 M2=0 M3=2,59250306156426 FrameElem=31-1 ElemStation=0,0917
Frame=31 Station=0,1834 OutputCase=STR036 CaseType=Combination P=-9,15377209079609 V2=3,46625999998291 V3=0 T=0 M2=0 M3=2,35411103006582 FrameElem=31-1 ElemStation=0,1834
Frame=31 Station=0 OutputCase=STR037 CaseType=Combination P=-4,04516898202866 V2=-1,77272774237736E-11 V3=0 T=0 M2=0 M3=3,5121487637419 FrameElem=31-1 ElemStation=0
Frame=31 Station=0,0917 OutputCase=STR037 CaseType=Combination P=-4,04516898202866 V2=1,73312999998227 V3=0 T=0 M2=0 M3=3,43268475324352 FrameElem=31-1 ElemStation=0,0917
Frame=31 Station=0,1834 OutputCase=STR037 CaseType=Combination P=-4,04516898202866 V2=3,46625999998227 V3=0 T=0 M2=0 M3=3,19429272174515 FrameElem=31-1 ElemStation=0,1834
Frame=31 Station=0 OutputCase=STR038 CaseType=Combination P=-5,01731380389496 V2=-1,03603703394128E-11 V3=0 T=0 M2=0 M3=25,5683961424841 FrameElem=31-1 ElemStation=0
Frame=31 Station=0,0917 OutputCase=STR038 CaseType=Combination P=-5,01731380389496 V2=10,6463699999896 V3=0 T=0 M2=0 M3=25,082600779851 FrameElem=31-1 ElemStation=0,0917
Frame=31 Station=0,1834 OutputCase=STR038 CaseType=Combination P=-5,01731380389496 V2=21,2927399999896 V3=0 T=0 M2=0 M3=23,615851884486 FrameElem=31-1 ElemStation=0,1834
Frame=31 Station=0 OutputCase=STR039 CaseType=Combination P=-18,2115667255358 V2=10,3559122333368 V3=0 T=0 M2=0 M3=23,7249426125479 FrameElem=31-1 ElemStation=0
Frame=31 Station=0,0917 OutputCase=STR039 CaseType=Combination P=-18,2115667255358 V2=21,0022822333368 V3=0 T=0 M2=0 M3=22,287169396251 FrameElem=31-1 ElemStation=0,0917
Frame=31 Station=0,1834 OutputCase=STR039 CaseType=Combination P=-18,2115667255358 V2=31,6486522333368 V3=0 T=0 M2=0 M3=19,873124050954 FrameElem=31-1 ElemStation=0,1834
Frame=31 Station=0 OutputCase=STR040 CaseType=Combination P=-31,4058196471767 V2=-2,44592257558907E-11 V3=0 T=0 M2=0 M3=21,8814890830533 FrameElem=31-1 ElemStation=0
Frame=31 Station=0,0917 OutputCase=STR040 CaseType=Combination P=-31,4058196471767 V2=10,6463699999755 V3=0 T=0 M2=0 M3=21,3933530185556 FrameElem=31-1 ElemStation=0,0917
Frame=31 Station=0,1834 OutputCase=STR040 CaseType=Combination P=-31,4058196471767 V2=21,2927399999755 V3=0 T=0 M2=0 M3=19,9289448250578 FrameElem=31-1 ElemStation=0,1834
Frame=31 Station=0 OutputCase=STR041 CaseType=Combination P=-17,4365029189047 V2=10,3559122333345 V3=0 T=0 M2=0 M3=0,489948866201287 FrameElem=31-1 ElemStation=0
Frame=31 Station=0,0917 OutputCase=STR041 CaseType=Combination P=-17,4365029189047 V2=11,6397122333345 V3=0 T=0 M2=0 M3=-0,518550515595491 FrameElem=31-1 ElemStation=0,0917
Frame=31 Station=0,1834 OutputCase=STR041 CaseType=Combination P=-17,4365029189047 V2=12,9235122333345 V3=0 T=0 M2=0 M3=-1,64477435739227 FrameElem=31-1 ElemStation=0,1834
Frame=31 Station=0 OutputCase=STR042 CaseType=Combination P=-30,6307558405455 V2=-2,67311861534836E-11 V3=0 T=0 M2=0 M3=-1,35350466329333 FrameElem=31-1 ElemStation=0
Frame=31 Station=0,0917 OutputCase=STR042 CaseType=Combination P=-30,6307558405455 V2=1,28379999997327 V3=0 T=0 M2=0 M3=-1,41236689329088 FrameElem=31-1 ElemStation=0,0917
Frame=31 Station=0,1834 OutputCase=STR042 CaseType=Combination P=-30,6307558405455 V2=2,56759999997327 V3=0 T=0 M2=0 M3=-1,58895358328843 FrameElem=31-1 ElemStation=0,1834
Frame=31 Station=0 OutputCase=STR043 CaseType=Combination P=-7,8665250025384 V2=-1,74366299177109E-11 V3=0 T=0 M2=0 M3=3,7400411127041 FrameElem=31-1 ElemStation=0
Frame=31 Station=0,0917 OutputCase=STR043 CaseType=Combination P=-7,8665250025384 V2=1,73312999998256 V3=0 T=0 M2=0 M3=3,6605771022057 FrameElem=31-1 ElemStation=0,0917
Frame=31 Station=0,1834 OutputCase=STR043 CaseType=Combination P=-7,8665250025384 V2=3,46625999998256 V3=0 T=0 M2=0 M3=3,4221850707073 FrameElem=31-1 ElemStation=0,1834
Frame=31 Station=0 OutputCase=STR044 CaseType=Combination P=-2,75792189377098 V2=-1,80734538446359E-11 V3=0 T=0 M2=0 M3=4,58022280438331 FrameElem=31-1 ElemStation=0
Frame=31 Station=0,0917 OutputCase=STR044 CaseType=Combination P=-2,75792189377098 V2=1,73312999998193 V3=0 T=0 M2=0 M3=4,50075879388497 FrameElem=31-1 ElemStation=0,0917
Frame=31 Station=0,1834 OutputCase=STR044 CaseType=Combination P=-2,75792189377098 V2=3,46625999998193 V3=0 T=0 M2=0 M3=4,26236676238663 FrameElem=31-1 ElemStation=0,1834
Frame=31 Station=0 OutputCase=STR045 CaseType=Combination P=-4,42189987195205 V2=-8,15200351667045E-12 V3=0 T=0 M2=0 M3=33,6833886310945 FrameElem=31-1 ElemStation=0
Frame=31 Station=0,0917 OutputCase=STR045 CaseType=Combination P=-4,42189987195205 V2=13,6174499999918 V3=0 T=0 M2=0 M3=33,0590285485952 FrameElem=31-1 ElemStation=0,0917

APPROVATO SDP
Società di Progetto
Brebemi SpA



Doc. N.
60235-00000-A00.doc

CODIFICA DOCUMENTO
04RCDII10000000000300A00

REV.
00

FOGLIO
410 di 628

Frame=31 Station=0,1834 OutputCase=STR045 CaseType=Combination P=-4,42189987195205 V2=27,2348999999919 V3=0 T=0 M2=0 M3=31,1859483010959 FrameElem=31-1 ElemStation=0,1834

Frame=31 Station=0 OutputCase=STR046 CaseType=Combination P=-21,1628032493453 V2=13,1817815845385 V3=0 T=0 M2=0 M3=31,3654808731441 FrameElem=31-1 ElemStation=0

Frame=31 Station=0,0917 OutputCase=STR046 CaseType=Combination P=-21,1628032493453 V2=26,7992315845385 V3=0 T=0 M2=0 M3=29,5323514193419 FrameElem=31-1 ElemStation=0,0917

Frame=31 Station=0,1834 OutputCase=STR046 CaseType=Combination P=-21,1628032493453 V2=40,4166815845385 V3=0 T=0 M2=0 M3=26,4505018005398 FrameElem=31-1 ElemStation=0,1834

Frame=31 Station=0 OutputCase=STR047 CaseType=Combination P=-37,9037066267386 V2=-2,71596434231469E-11 V3=0 T=0 M2=0 M3=29,0475731157465 FrameElem=31-1 ElemStation=0

Frame=31 Station=0,0917 OutputCase=STR047 CaseType=Combination P=-37,9037066267386 V2=13,6174499999728 V3=0 T=0 M2=0 M3=28,423213033249 FrameElem=31-1 ElemStation=0,0917

Frame=31 Station=0,1834 OutputCase=STR047 CaseType=Combination P=-37,9037066267386 V2=27,2348999999728 V3=0 T=0 M2=0 M3=26,5501327857514 FrameElem=31-1 ElemStation=0,1834

Frame=31 Station=0 OutputCase=STR048 CaseType=Combination P=-20,0636911687587 V2=13,1817815845337 V3=0 T=0 M2=0 M3=0,778404667216712 FrameElem=31-1 ElemStation=0

Frame=31 Station=0,0917 OutputCase=STR048 CaseType=Combination P=-20,0636911687587 V2=14,4655815845337 V3=0 T=0 M2=0 M3=-0,489226934085032 FrameElem=31-1 ElemStation=0,0917

Frame=31 Station=0,1834 OutputCase=STR048 CaseType=Combination P=-20,0636911687587 V2=15,7493815845337 V3=0 T=0 M2=0 M3=-1,87458299538678 FrameElem=31-1 ElemStation=0,1834

Frame=31 Station=0 OutputCase=STR049 CaseType=Combination P=-36,804594546152 V2=-3,18883053296304E-11 V3=0 T=0 M2=0 M3=-1,53950309018094 FrameElem=31-1 ElemStation=0

Frame=31 Station=0,0917 OutputCase=STR049 CaseType=Combination P=-36,804594546152 V2=1,28379999996811 V3=0 T=0 M2=0 M3=-1,59836532017802 FrameElem=31-1 ElemStation=0,0917

Frame=31 Station=0,1834 OutputCase=STR049 CaseType=Combination P=-36,804594546152 V2=2,56759999996811 V3=0 T=0 M2=0 M3=-1,77495201017509 FrameElem=31-1 ElemStation=0,1834

Frame=31 Station=0 OutputCase=STR050 CaseType=Combination P=-17,2921045196375 V2=29,7258250228425 V3=0 T=0 M2=0 M3=24,4878526414155 FrameElem=31-1 ElemStation=0

Frame=31 Station=0,0917 OutputCase=STR050 CaseType=Combination P=-19,3594810196375 V2=40,3721950228425 V3=0 T=0 M2=0 M3=21,2738584223208 FrameElem=31-1 ElemStation=0,0917

Frame=31 Station=0,1834 OutputCase=STR050 CaseType=Combination P=-21,4268575196375 V2=51,0185650228425 V3=0 T=0 M2=0 M3=17,0835920742262 FrameElem=31-1 ElemStation=0,1834

Frame=31 Station=0 OutputCase=STR051 CaseType=Combination P=-3,73006671563728 V2=-1,07065467602752E-11 V3=0 T=0 M2=0 M3=26,6364701831255 FrameElem=31-1 ElemStation=0

Frame=31 Station=0,0917 OutputCase=STR051 CaseType=Combination P=-3,73006671563728 V2=10,6463699999893 V3=0 T=0 M2=0 M3=26,1483341186265 FrameElem=31-1 ElemStation=0,0917

Frame=31 Station=0,1834 OutputCase=STR051 CaseType=Combination P=-3,73006671563728 V2=21,2927399999893 V3=0 T=0 M2=0 M3=24,6839259251275 FrameElem=31-1 ElemStation=0,1834

Frame=31 Station=0 OutputCase=STR052 CaseType=Combination P=-16,9243196372782 V2=10,3559122333365 V3=0 T=0 M2=0 M3=24,7930166531894 FrameElem=31-1 ElemStation=0

Frame=31 Station=0,0917 OutputCase=STR052 CaseType=Combination P=-16,9243196372782 V2=21,0022822333365 V3=0 T=0 M2=0 M3=23,3552434368924 FrameElem=31-1 ElemStation=0,0917

Frame=31 Station=0,1834 OutputCase=STR052 CaseType=Combination P=-16,9243196372782 V2=31,6486522333365 V3=0 T=0 M2=0 M3=20,9411980915955 FrameElem=31-1 ElemStation=0,1834

Frame=31 Station=0 OutputCase=STR053 CaseType=Combination P=-30,118572558919 V2=-2,4805402176753E-11 V3=0 T=0 M2=0 M3=22,9495631236947 FrameElem=31-1 ElemStation=0

Frame=31 Station=0,0917 OutputCase=STR053 CaseType=Combination P=-30,118572558919 V2=10,6463699999752 V3=0 T=0 M2=0 M3=22,461427059197 FrameElem=31-1 ElemStation=0,0917

Frame=31 Station=0,1834 OutputCase=STR053 CaseType=Combination P=-30,118572558919 V2=21,2927399999752 V3=0 T=0 M2=0 M3=20,9970188656993 FrameElem=31-1 ElemStation=0,1834

Frame=31 Station=0 OutputCase=STR054 CaseType=Combination P=-16,149255830647 V2=10,3559122333342 V3=0 T=0 M2=0 M3=1,5580229068427 FrameElem=31-1 ElemStation=0

Frame=31 Station=0,0917 OutputCase=STR054 CaseType=Combination P=-16,149255830647 V2=11,6397122333342 V3=0 T=0 M2=0 M3=0,549523525045954 FrameElem=31-1 ElemStation=0,0917

Frame=31 Station=0,1834 OutputCase=STR054 CaseType=Combination P=-16,149255830647 V2=12,9235122333342 V3=0 T=0 M2=0 M3=-0,576700316750792 FrameElem=31-1 ElemStation=0,1834

Frame=31 Station=0 OutputCase=STR055 CaseType=Combination P=-29,3435087522879 V2=-2,70773625743459E-11 V3=0 T=0 M2=0 M3=0,285430622651916 FrameElem=31-1 ElemStation=0

Frame=31 Station=0,0917 OutputCase=STR055 CaseType=Combination P=-29,3435087522879 V2=1,28379999997292 V3=0 T=0 M2=0 M3=-0,344292852649433 FrameElem=31-1 ElemStation=0,0917

Frame=31 Station=0,1834 OutputCase=STR055 CaseType=Combination P=-29,3435087522879 V2=2,56759999997292 V3=0 T=0 M2=0 M3=-0,52087954264695 FrameElem=31-1 ElemStation=0,1834

Frame=31 Station=0 OutputCase=STR056 CaseType=Combination P=-7,63765199382953 V2=0,457681437267335 V3=0 T=0 M2=0 M3=4,0577503046621 FrameElem=31-1 ElemStation=0

Frame=31 Station=0,0917 OutputCase=STR056 CaseType=Combination P=-7,63765199382953 V2=1,27544856273267 V3=0 T=0 M2=0 M3=4,02025568195952 FrameElem=31-1 ElemStation=0,0917

Frame=31 Station=0,1834 OutputCase=STR056 CaseType=Combination P=-7,63765199382953 V2=3,00857856273267 V3=0 T=0 M2=0 M3=3,82383303825693 FrameElem=31-1 ElemStation=0,1834

Frame=31 Station=0 OutputCase=STR057 CaseType=Combination P=-2,52904888506211 V2=0,457681437267972 V3=0 T=0 M2=0 M3=4,89793199634131 FrameElem=31-1 ElemStation=0

Frame=31 Station=0,0917 OutputCase=STR057 CaseType=Combination P=-2,52904888506211 V2=1,27544856273203 V3=0 T=0 M2=0 M3=4,86043737363878 FrameElem=31-1 ElemStation=0,0917

Frame=31 Station=0,1834 OutputCase=STR057 CaseType=Combination P=-2,52904888506211 V2=3,00857856273203 V3=0 T=0 M2=0 M3=4,66401472993626 FrameElem=31-1 ElemStation=0,1834

Frame=31 Station=0 OutputCase=STR058 CaseType=Combination P=-3,50119370692841 V2=0,457681437260605 V3=0 T=0 M2=0 M3=26,9541793750835 FrameElem=31-1 ElemStation=0

Frame=31 Station=0,0917 OutputCase=STR058 CaseType=Combination P=-3,50119370692841 V2=10,1886885627394 V3=0 T=0 M2=0 M3=26,5080126983803 FrameElem=31-1 ElemStation=0,0917

Frame=31 Station=0,1834 OutputCase=STR058 CaseType=Combination P=-3,50119370692841 V2=20,8350585627394 V3=0 T=0 M2=0 M3=25,0855738926771 FrameElem=31-1 ElemStation=0,1834

Frame=31 Station=0 OutputCase=STR059 CaseType=Combination P=-16,6954466285693 V2=9,89823079608658 V3=0 T=0 M2=0 M3=25,1107258451474 FrameElem=31-1 ElemStation=0

Frame=31 Station=0,0917 OutputCase=STR059 CaseType=Combination P=-16,6954466285693 V2=20,5446007960866 V3=0 T=0 M2=0 M3=23,7149220166462 FrameElem=31-1 ElemStation=0,0917

Frame=31 Station=0,1834 OutputCase=STR059 CaseType=Combination P=-16,6954466285693 V2=31,1909707960866 V3=0 T=0 M2=0 M3=21,3428460591451 FrameElem=31-1 ElemStation=0,1834

Frame=31 Station=0 OutputCase=STR060 CaseType=Combination P=-29,8896995502102 V2=0,457681437274704 V3=0 T=0 M2=0 M3=23,2672723156527 FrameElem=31-1 ElemStation=0

Società di Progetto
Brebemi SpA



Doc. N.
60235-00000-A00.doc

CODIFICA DOCUMENTO
04RCDII10000000000300A00

REV.
00

FOGLIO
411 di 628

Frame=31 Station=0,0917 OutputCase=STR060 CaseType=Combination P=-29,8896995502102 V2=10,1886885627253 V3=0 T=0 M2=0 M3=22,8211056389508 FrameElem=31-1 ElemStation=0,0917
Frame=31 Station=0,1834 OutputCase=STR060 CaseType=Combination P=-29,8896995502102 V2=20,8350585627253 V3=0 T=0 M2=0 M3=21,3986668332489 FrameElem=31-1 ElemStation=0,1834
Frame=31 Station=0 OutputCase=STR061 CaseType=Combination P=-15,9203828219381 V2=9,8982307960843 V3=0 T=0 M2=0 M3=1,8757320988007 FrameElem=31-1 ElemStation=0
Frame=31 Station=0,0917 OutputCase=STR061 CaseType=Combination P=-15,9203828219381 V2=11,1820307960843 V3=0 T=0 M2=0 M3=0,909202104799771 FrameElem=31-1 ElemStation=0,0917
Frame=31 Station=0,1834 OutputCase=STR061 CaseType=Combination P=-15,9203828219381 V2=12,4658307960843 V3=0 T=0 M2=0 M3=-0,17505234920116 FrameElem=31-1 ElemStation=0,1834
Frame=31 Station=0 OutputCase=STR062 CaseType=Combination P=-29,114635743579 V2=-0,457681437276976 V3=0 T=0 M2=0 M3=3,22785693060854E-02 FrameElem=31-1 ElemStation=0
Frame=31 Station=0,0917 OutputCase=STR062 CaseType=Combination P=-29,114635743579 V2=0,826118562723024 V3=0 T=0 M2=0 M3=0,015385727104384 FrameElem=31-1 ElemStation=0,0917
Frame=31 Station=0,1834 OutputCase=STR062 CaseType=Combination P=-29,114635743579 V2=2,10991856272302 V3=0 T=0 M2=0 M3=-0,119231575097317 FrameElem=31-1 ElemStation=0,1834
Frame=31 Station=0 OutputCase=STR063 CaseType=Combination P=-8,09539801124728 V2=0,457681437232462 V3=0 T=0 M2=0 M3=3,4223319207461 FrameElem=31-1 ElemStation=0
Frame=31 Station=0,0917 OutputCase=STR063 CaseType=Combination P=-8,09539801124728 V2=2,19081143723246 V3=0 T=0 M2=0 M3=3,30089852245188 FrameElem=31-1 ElemStation=0,0917
Frame=31 Station=0,1834 OutputCase=STR063 CaseType=Combination P=-8,09539801124728 V2=3,92394143723246 V3=0 T=0 M2=0 M3=3,02053710315767 FrameElem=31-1 ElemStation=0,1834
Frame=31 Station=0 OutputCase=STR064 CaseType=Combination P=-2,98679490247986 V2=0,457681437231825 V3=0 T=0 M2=0 M3=4,26251361242531 FrameElem=31-1 ElemStation=0
Frame=31 Station=0,0917 OutputCase=STR064 CaseType=Combination P=-2,98679490247986 V2=2,19081143723183 V3=0 T=0 M2=0 M3=4,14108021413115 FrameElem=31-1 ElemStation=0,0917
Frame=31 Station=0,1834 OutputCase=STR064 CaseType=Combination P=-2,98679490247986 V2=3,92394143723183 V3=0 T=0 M2=0 M3=3,86071879483699 FrameElem=31-1 ElemStation=0,1834
Frame=31 Station=0 OutputCase=STR065 CaseType=Combination P=-3,95893972434616 V2=0,457681437239192 V3=0 T=0 M2=0 M3=26,3187609911675 FrameElem=31-1 ElemStation=0
Frame=31 Station=0,0917 OutputCase=STR065 CaseType=Combination P=-3,95893972434616 V2=11,1040514372392 V3=0 T=0 M2=0 M3=25,7886555388727 FrameElem=31-1 ElemStation=0,0917
Frame=31 Station=0,1834 OutputCase=STR065 CaseType=Combination P=-3,95893972434616 V2=21,7504214372392 V3=0 T=0 M2=0 M3=24,2822779575779 FrameElem=31-1 ElemStation=0,1834
Frame=31 Station=0 OutputCase=STR066 CaseType=Combination P=-17,153192645987 V2=10,8135936705864 V3=0 T=0 M2=0 M3=24,4753074612314 FrameElem=31-1 ElemStation=0
Frame=31 Station=0,0917 OutputCase=STR066 CaseType=Combination P=-17,153192645987 V2=21,4599636705864 V3=0 T=0 M2=0 M3=22,9955648571386 FrameElem=31-1 ElemStation=0,0917
Frame=31 Station=0,1834 OutputCase=STR066 CaseType=Combination P=-17,153192645987 V2=32,1063336705864 V3=0 T=0 M2=0 M3=20,5395501240458 FrameElem=31-1 ElemStation=0,1834
Frame=31 Station=0 OutputCase=STR067 CaseType=Combination P=-30,3474455676279 V2=0,457681437225093 V3=0 T=0 M2=0 M3=22,6318539317367 FrameElem=31-1 ElemStation=0
Frame=31 Station=0,0917 OutputCase=STR067 CaseType=Combination P=-30,3474455676279 V2=11,1040514372251 V3=0 T=0 M2=0 M3=22,1017484794432 FrameElem=31-1 ElemStation=0,0917
Frame=31 Station=0,1834 OutputCase=STR067 CaseType=Combination P=-30,3474455676279 V2=21,7504214372251 V3=0 T=0 M2=0 M3=20,5953708981497 FrameElem=31-1 ElemStation=0,1834
Frame=31 Station=0 OutputCase=STR068 CaseType=Combination P=-16,3781288393559 V2=10,8135936705841 V3=0 T=0 M2=0 M3=1,2403137148847 FrameElem=31-1 ElemStation=0
Frame=31 Station=0,0917 OutputCase=STR068 CaseType=Combination P=-16,3781288393559 V2=12,0973936705841 V3=0 T=0 M2=0 M3=0,189844945292137 FrameElem=31-1 ElemStation=0,0917
Frame=31 Station=0,1834 OutputCase=STR068 CaseType=Combination P=-16,3781288393559 V2=13,3811936705841 V3=0 T=0 M2=0 M3=-0,978348284300425 FrameElem=31-1 ElemStation=0,1834
Frame=31 Station=0 OutputCase=STR069 CaseType=Combination P=-29,5723817609967 V2=0,457681437222821 V3=0 T=0 M2=0 M3=-0,603139814609917 FrameElem=31-1 ElemStation=0
Frame=31 Station=0,0917 OutputCase=STR069 CaseType=Combination P=-29,5723817609967 V2=1,74148143722282 V3=0 T=0 M2=0 M3=-0,70397143240325 FrameElem=31-1 ElemStation=0,0917
Frame=31 Station=0,1834 OutputCase=STR069 CaseType=Combination P=-29,5723817609967 V2=3,02528143722282 V3=0 T=0 M2=0 M3=-0,922527510196582 FrameElem=31-1 ElemStation=0,1834
Frame=31 Station=0 OutputCase=STR070 CaseType=Combination P=-7,3148476789994 V2=-1,75849912409376E-11 V3=0 T=0 M2=0 M3=4,19778713012185 FrameElem=31-1 ElemStation=0
Frame=31 Station=0,0917 OutputCase=STR070 CaseType=Combination P=-7,3148476789994 V2=1,73312999998242 V3=0 T=0 M2=0 M3=4,11832311962346 FrameElem=31-1 ElemStation=0,0917
Frame=31 Station=0,1834 OutputCase=STR070 CaseType=Combination P=-7,3148476789994 V2=3,46625999998242 V3=0 T=0 M2=0 M3=3,87993108812508 FrameElem=31-1 ElemStation=0,1834
Frame=31 Station=0 OutputCase=STR071 CaseType=Combination P=-2,20624457023198 V2=-1,82218151678626E-11 V3=0 T=0 M2=0 M3=5,03796882180106 FrameElem=31-1 ElemStation=0
Frame=31 Station=0,0917 OutputCase=STR071 CaseType=Combination P=-2,20624457023198 V2=1,73312999998178 V3=0 T=0 M2=0 M3=4,95850481130273 FrameElem=31-1 ElemStation=0,0917
Frame=31 Station=0,1834 OutputCase=STR071 CaseType=Combination P=-2,20624457023198 V2=3,46625999998178 V3=0 T=0 M2=0 M3=4,72011217798044 FrameElem=31-1 ElemStation=0,1834
Frame=31 Station=0 OutputCase=STR072 CaseType=Combination P=-3,1783893209828 V2=-1,08549080835019E-11 V3=0 T=0 M2=0 M3=27,0942162005433 FrameElem=31-1 ElemStation=0
Frame=31 Station=0,0917 OutputCase=STR072 CaseType=Combination P=-3,1783893209828 V2=10,6463699999891 V3=0 T=0 M2=0 M3=26,6060801360443 FrameElem=31-1 ElemStation=0,0917
Frame=31 Station=0,1834 OutputCase=STR072 CaseType=Combination P=-3,1783893209828 V2=21,2927399999891 V3=0 T=0 M2=0 M3=25,1416719425453 FrameElem=31-1 ElemStation=0,1834
Frame=31 Station=0 OutputCase=STR073 CaseType=Combination P=-16,3726423137391 V2=10,3559122333363 V3=0 T=0 M2=0 M3=25,2507626706071 FrameElem=31-1 ElemStation=0
Frame=31 Station=0,0917 OutputCase=STR073 CaseType=Combination P=-16,3726423137391 V2=21,0022822333363 V3=0 T=0 M2=0 M3=23,8129894543102 FrameElem=31-1 ElemStation=0,0917
Frame=31 Station=0,1834 OutputCase=STR073 CaseType=Combination P=-16,3726423137391 V2=31,6486522333363 V3=0 T=0 M2=0 M3=21,3989441090132 FrameElem=31-1 ElemStation=0,1834
Frame=31 Station=0 OutputCase=STR074 CaseType=Combination P=-29,56689523538 V2=-2,49537634999797E-11 V3=0 T=0 M2=0 M3=23,4073091411125 FrameElem=31-1 ElemStation=0
Frame=31 Station=0,0917 OutputCase=STR074 CaseType=Combination P=-29,56689523538 V2=10,646369999975 V3=0 T=0 M2=0 M3=22,9191730766148 FrameElem=31-1 ElemStation=0,0917
Frame=31 Station=0,1834 OutputCase=STR074 CaseType=Combination P=-29,56689523538 V2=21,292739999975 V3=0 T=0 M2=0 M3=21,4547648831171 FrameElem=31-1 ElemStation=0,1834

Società di Progetto
Brebemi SpA



Doc. N.
60235-0000-A00.doc

CODIFICA DOCUMENTO
04RCDII10000000000300A00

REV.
00

FOGLIO
412 di 628

Frame=31 Station=0 OutputCase=STR075 CaseType=Combination P=-15,597578507108 V2=10,3559122333341 V3=0 T=0 M2=0 M3=2,01576892426045 FrameElem=31-1 ElemStation=0

Frame=31 Station=0,0917 OutputCase=STR075 CaseType=Combination P=-15,597578507108 V2=11,6397122333341 V3=0 T=0 M2=0 M3=1,00726954246372 FrameElem=31-1 ElemStation=0,0917

Frame=31 Station=0,1834 OutputCase=STR075 CaseType=Combination P=-15,597578507108 V2=12,9235122333341 V3=0 T=0 M2=0 M3=-0,118954299333017 FrameElem=31-1 ElemStation=0,1834

Frame=31 Station=0 OutputCase=STR076 CaseType=Combination P=-28,7918314287489 V2=-2,72257238975726E-11 V3=0 T=0 M2=0 M3=0,172315394765833 FrameElem=31-1 ElemStation=0

Frame=31 Station=0,0917 OutputCase=STR076 CaseType=Combination P=-28,7918314287489 V2=1,28379999997277 V3=0 T=0 M2=0 M3=0,113453164768329 FrameElem=31-1 ElemStation=0,0917

Frame=31 Station=0,1834 OutputCase=STR076 CaseType=Combination P=-28,7918314287489 V2=2,56759999997277 V3=0 T=0 M2=0 M3=-6,31335252291741E-02 FrameElem=31-1 ElemStation=0,1834

Frame=31 Station=0 OutputCase=STR077 CaseType=Combination P=-8,40453219392196 V2=-0,762802395433687 V3=0 T=0 M2=0 M3=3,50664640360452 FrameElem=31-1 ElemStation=0

Frame=31 Station=0,0917 OutputCase=STR077 CaseType=Combination P=-8,40453219392196 V2=0,970327604566314 V3=0 T=0 M2=0 M3=3,49713137276579 FrameElem=31-1 ElemStation=0,0917

Frame=31 Station=0,1834 OutputCase=STR077 CaseType=Combination P=-8,40453219392196 V2=2,70345760456631 V3=0 T=0 M2=0 M3=3,32868832092706 FrameElem=31-1 ElemStation=0,1834

Frame=31 Station=0 OutputCase=STR078 CaseType=Combination P=-3,29592908515454 V2=-0,762802395434323 V3=0 T=0 M2=0 M3=4,34682809528373 FrameElem=31-1 ElemStation=0

Frame=31 Station=0,0917 OutputCase=STR078 CaseType=Combination P=-3,29592908515454 V2=0,970327604565677 V3=0 T=0 M2=0 M3=4,33731306444506 FrameElem=31-1 ElemStation=0,0917

Frame=31 Station=0,1834 OutputCase=STR078 CaseType=Combination P=-3,29592908515454 V2=2,70345760456568 V3=0 T=0 M2=0 M3=4,16887001260639 FrameElem=31-1 ElemStation=0,1834

Frame=31 Station=0 OutputCase=STR079 CaseType=Combination P=-4,74470418678218 V2=-0,457681437257902 V3=0 T=0 M2=0 M3=33,5433518056347 FrameElem=31-1 ElemStation=0

Frame=31 Station=0,0917 OutputCase=STR079 CaseType=Combination P=-4,74470418678218 V2=13,1597685627421 V3=0 T=0 M2=0 M3=32,9609611109313 FrameElem=31-1 ElemStation=0,0917

Frame=31 Station=0,1834 OutputCase=STR079 CaseType=Combination P=-4,74470418678218 V2=26,7772185627421 V3=0 T=0 M2=0 M3=31,1298502512278 FrameElem=31-1 ElemStation=0,1834

Frame=31 Station=0 OutputCase=STR080 CaseType=Combination P=-21,4856075641754 V2=12,7241001472887 V3=0 T=0 M2=0 M3=31,254440476844 FrameElem=31-1 ElemStation=0

Frame=31 Station=0,0917 OutputCase=STR080 CaseType=Combination P=-21,4856075641754 V2=26,3415501472887 V3=0 T=0 M2=0 M3=29,434283981678 FrameElem=31-1 ElemStation=0,0917

Frame=31 Station=0,1834 OutputCase=STR080 CaseType=Combination P=-21,4856075641754 V2=39,9590001472887 V3=0 T=0 M2=0 M3=26,3944037506716 FrameElem=31-1 ElemStation=0,1834

Frame=31 Station=0 OutputCase=STR081 CaseType=Combination P=-38,2265109415687 V2=-0,45768143727691 V3=0 T=0 M2=0 M3=28,9075362902867 FrameElem=31-1 ElemStation=0

Frame=31 Station=0,0917 OutputCase=STR081 CaseType=Combination P=-38,2265109415687 V2=13,1597685627231 V3=0 T=0 M2=0 M3=28,325145595585 FrameElem=31-1 ElemStation=0,0917

Frame=31 Station=0,1834 OutputCase=STR081 CaseType=Combination P=-38,2265109415687 V2=26,7772185627231 V3=0 T=0 M2=0 M3=26,4940347358833 FrameElem=31-1 ElemStation=0,1834

Frame=31 Station=0 OutputCase=STR082 CaseType=Combination P=-20,3864954835888 V2=12,724100147284 V3=0 T=0 M2=0 M3=0,638367841756964 FrameElem=31-1 ElemStation=0

Frame=31 Station=0,0917 OutputCase=STR082 CaseType=Combination P=-20,3864954835888 V2=14,007900147284 V3=0 T=0 M2=0 M3=-0,587294371748978 FrameElem=31-1 ElemStation=0,0917

Frame=31 Station=0,1834 OutputCase=STR082 CaseType=Combination P=-20,3864954835888 V2=15,291700147284 V3=0 T=0 M2=0 M3=-1,93068104525492 FrameElem=31-1 ElemStation=0,1834

Frame=31 Station=0 OutputCase=STR083 CaseType=Combination P=-37,1273988609821 V2=-0,457681437281638 V3=0 T=0 M2=0 M3=-1,67953991564069 FrameElem=31-1 ElemStation=0

Frame=31 Station=0,0917 OutputCase=STR083 CaseType=Combination P=-37,1273988609821 V2=0,826118562718361 V3=0 T=0 M2=0 M3=-1,69643275784196 FrameElem=31-1 ElemStation=0,0917

Frame=31 Station=0,1834 OutputCase=STR083 CaseType=Combination P=-37,1273988609821 V2=2,10991856271836 V3=0 T=0 M2=0 M3=-1,83105006004324 FrameElem=31-1 ElemStation=0,1834

Frame=31 Station=0 OutputCase=STR084 CaseType=Combination P=-17,6149088344676 V2=29,2681435855927 V3=0 T=0 M2=0 M3=24,3478158159557 FrameElem=31-1 ElemStation=0

Frame=31 Station=0,0917 OutputCase=STR084 CaseType=Combination P=-19,6822853344676 V2=39,9145135855927 V3=0 T=0 M2=0 M3=21,1757909846569 FrameElem=31-1 ElemStation=0,0917

Frame=31 Station=0,1834 OutputCase=STR084 CaseType=Combination P=-21,7496618344676 V2=50,5608835855927 V3=0 T=0 M2=0 M3=17,027494024358 FrameElem=31-1 ElemStation=0,1834

Frame=31 Station=0 OutputCase=STR085 CaseType=Combination P=-4,26807390702084 V2=-0,762802395426957 V3=0 T=0 M2=0 M3=26,403075474026 FrameElem=31-1 ElemStation=0

Frame=31 Station=0,0917 OutputCase=STR085 CaseType=Combination P=-4,26807390702084 V2=9,88356760457304 V3=0 T=0 M2=0 M3=25,9848883891866 FrameElem=31-1 ElemStation=0,0917

Frame=31 Station=0,1834 OutputCase=STR085 CaseType=Combination P=-4,26807390702084 V2=20,529937604573 V3=0 T=0 M2=0 M3=24,5904291753473 FrameElem=31-1 ElemStation=0,1834

Frame=31 Station=0 OutputCase=STR086 CaseType=Combination P=-17,4623268286617 V2=9,59310983792022 V3=0 T=0 M2=0 M3=24,5596219440898 FrameElem=31-1 ElemStation=0

Frame=31 Station=0,0917 OutputCase=STR086 CaseType=Combination P=-17,4623268286617 V2=20,2394798379202 V3=0 T=0 M2=0 M3=23,1917977074525 FrameElem=31-1 ElemStation=0,0917

Frame=31 Station=0,1834 OutputCase=STR086 CaseType=Combination P=-17,4623268286617 V2=30,8858498379202 V3=0 T=0 M2=0 M3=20,8477013418152 FrameElem=31-1 ElemStation=0,1834

Frame=31 Station=0 OutputCase=STR087 CaseType=Combination P=-30,6565797503026 V2=-0,762802395441055 V3=0 T=0 M2=0 M3=22,7161684145952 FrameElem=31-1 ElemStation=0

Frame=31 Station=0,0917 OutputCase=STR087 CaseType=Combination P=-30,6565797503026 V2=9,88356760455894 V3=0 T=0 M2=0 M3=22,2979813297571 FrameElem=31-1 ElemStation=0,0917

Frame=31 Station=0,1834 OutputCase=STR087 CaseType=Combination P=-30,6565797503026 V2=20,5299376045589 V3=0 T=0 M2=0 M3=20,9035221159191 FrameElem=31-1 ElemStation=0,1834

Frame=31 Station=0 OutputCase=STR088 CaseType=Combination P=-16,6872630220305 V2=9,59310983791795 V3=0 T=0 M2=0 M3=1,32462819774312 FrameElem=31-1 ElemStation=0

Frame=31 Station=0,0917 OutputCase=STR088 CaseType=Combination P=-16,6872630220305 V2=10,8769098379179 V3=0 T=0 M2=0 M3=0,386077795606045 FrameElem=31-1 ElemStation=0,0917

Frame=31 Station=0,1834 OutputCase=STR088 CaseType=Combination P=-16,6872630220305 V2=12,160709837918 V3=0 T=0 M2=0 M3=-0,670197066531031 FrameElem=31-1 ElemStation=0,1834

Frame=31 Station=0 OutputCase=STR089 CaseType=Combination P=-29,8815159436714 V2=-0,762802395443327 V3=0 T=0 M2=0 M3=-0,518825331751495 FrameElem=31-1 ElemStation=0

Frame=31 Station=0,0917 OutputCase=STR089 CaseType=Combination P=-29,8815159436714 V2=0,520997604556672 V3=0 T=0 M2=0 M3=-0,507738582089342 FrameElem=31-1 ElemStation=0,0917

Società di Progetto
Brebemi SpA



Doc. N.
60235-0000-A00.doc

CODIFICA DOCUMENTO
04RCDII10000000000300A00

REV.
00

FOGLIO
413 di 628

Frame=31 Station=0,1834 OutputCase=STR089 CaseType=Combination P=-29,8815159436714 V2=1,80479760455667 V3=0 T=0 M2=0 M3=-0,614376292427189
FrameElem=31-1 ElemStation=0,1834
Frame=31 Station=0 OutputCase=STR090 CaseType=Combination P=-8,95620951746096 V2=-0,762802395433538 V3=0 T=0 M2=0 M3=3,04890038618678 FrameElem=31-1
ElemStation=0
Frame=31 Station=0,0917 OutputCase=STR090 CaseType=Combination P=-8,95620951746096 V2=0,970327604566462 V3=0 T=0 M2=0 M3=3,03938535534803
FrameElem=31-1 ElemStation=0,0917
Frame=31 Station=0,1834 OutputCase=STR090 CaseType=Combination P=-8,95620951746096 V2=2,70345760456646 V3=0 T=0 M2=0 M3=2,87094230350929 FrameElem=31-1
ElemStation=0,1834
Frame=31 Station=0 OutputCase=STR091 CaseType=Combination P=-3,84760640869354 V2=-0,762802395434175 V3=0 T=0 M2=0 M3=3,88908207786598 FrameElem=31-1
ElemStation=0
Frame=31 Station=0,0917 OutputCase=STR091 CaseType=Combination P=-3,84760640869354 V2=0,970327604565825 V3=0 T=0 M2=0 M3=3,8795670470273 FrameElem=31-1
ElemStation=0,0917
Frame=31 Station=0,1834 OutputCase=STR091 CaseType=Combination P=-3,84760640869354 V2=2,70345760456583 V3=0 T=0 M2=0 M3=3,71112399518861 FrameElem=31-1
ElemStation=0,1834
Frame=31 Station=0 OutputCase=STR092 CaseType=Combination P=-4,81975123055984 V2=-0,762802395426808 V3=0 T=0 M2=0 M3=25,9453294566082 FrameElem=31-1
ElemStation=0
Frame=31 Station=0,0917 OutputCase=STR092 CaseType=Combination P=-4,81975123055984 V2=9,88356760457319 V3=0 T=0 M2=0 M3=25,5271423717689 FrameElem=31-1
ElemStation=0,0917
Frame=31 Station=0,1834 OutputCase=STR092 CaseType=Combination P=-4,81975123055984 V2=20,5299376045732 V3=0 T=0 M2=0 M3=24,1326831579295 FrameElem=31-1
ElemStation=0,1834
Frame=31 Station=0 OutputCase=STR093 CaseType=Combination P=-18,0140041522007 V2=9,59310983792037 V3=0 T=0 M2=0 M3=24,101875926672 FrameElem=31-1
ElemStation=0
Frame=31 Station=0,0917 OutputCase=STR093 CaseType=Combination P=-18,0140041522007 V2=20,2394798379204 V3=0 T=0 M2=0 M3=22,7340516900347 FrameElem=31-1
ElemStation=0,0917
Frame=31 Station=0,1834 OutputCase=STR093 CaseType=Combination P=-18,0140041522007 V2=30,8858498379204 V3=0 T=0 M2=0 M3=20,3899553243974 FrameElem=31-1
ElemStation=0,1834
Frame=31 Station=0 OutputCase=STR094 CaseType=Combination P=-31,2082570738416 V2=-0,762802395440907 V3=0 T=0 M2=0 M3=22,2584223971774 FrameElem=31-1
ElemStation=0
Frame=31 Station=0,0917 OutputCase=STR094 CaseType=Combination P=-31,2082570738416 V2=9,88356760455909 V3=0 T=0 M2=0 M3=21,8402353123394 FrameElem=31-1
ElemStation=0,0917
Frame=31 Station=0,1834 OutputCase=STR094 CaseType=Combination P=-31,2082570738416 V2=20,5299376045591 V3=0 T=0 M2=0 M3=20,4457760985013 FrameElem=31-1
ElemStation=0,1834
Frame=31 Station=0 OutputCase=STR095 CaseType=Combination P=-17,2389403455695 V2=9,5931098379181 V3=0 T=0 M2=0 M3=0,866882180325373 FrameElem=31-1
ElemStation=0
Frame=31 Station=0,0917 OutputCase=STR095 CaseType=Combination P=-17,2389403455695 V2=10,8769098379181 V3=0 T=0 M2=0 M3=-7,16682218117171E-02
FrameElem=31-1 ElemStation=0,0917
Frame=31 Station=0,1834 OutputCase=STR095 CaseType=Combination P=-17,2389403455695 V2=12,1607098379181 V3=0 T=0 M2=0 M3=-1,12794308394881
FrameElem=31-1 ElemStation=0,1834
Frame=31 Station=0 OutputCase=STR096 CaseType=Combination P=-30,4331932672104 V2=-0,762802395443179 V3=0 T=0 M2=0 M3=-0,976571349169243 FrameElem=31-1
ElemStation=0
Frame=31 Station=0,0917 OutputCase=STR096 CaseType=Combination P=-30,4331932672104 V2=0,52099760455682 V3=0 T=0 M2=0 M3=-0,965484599507104
FrameElem=31-1 ElemStation=0,0917
Frame=31 Station=0,1834 OutputCase=STR096 CaseType=Combination P=-30,4331932672104 V2=1,80479760455682 V3=0 T=0 M2=0 M3=-1,07212230984496
FrameElem=31-1 ElemStation=0,1834
Frame=31 Station=0 OutputCase=STR097 CaseType=Combination P=-7,85285487038295 V2=-0,762802395433835 V3=0 T=0 M2=0 M3=3,96439242102227 FrameElem=31-1
ElemStation=0
Frame=31 Station=0,0917 OutputCase=STR097 CaseType=Combination P=-7,85285487038295 V2=0,970327604566166 V3=0 T=0 M2=0 M3=3,95487739018355
FrameElem=31-1 ElemStation=0,0917
Frame=31 Station=0,1834 OutputCase=STR097 CaseType=Combination P=-7,85285487038295 V2=2,70345760456617 V3=0 T=0 M2=0 M3=3,78643433834484 FrameElem=31-1
ElemStation=0,1834
Frame=31 Station=0 OutputCase=STR098 CaseType=Combination P=-2,74425176161553 V2=-0,762802395434472 V3=0 T=0 M2=0 M3=4,80457411270148 FrameElem=31-1
ElemStation=0
Frame=31 Station=0,0917 OutputCase=STR098 CaseType=Combination P=-2,74425176161553 V2=0,970327604565529 V3=0 T=0 M2=0 M3=4,79505908186282
FrameElem=31-1 ElemStation=0,0917
Frame=31 Station=0,1834 OutputCase=STR098 CaseType=Combination P=-2,74425176161553 V2=2,70345760456553 V3=0 T=0 M2=0 M3=4,62661603002416 FrameElem=31-1
ElemStation=0,1834
Frame=31 Station=0 OutputCase=STR099 CaseType=Combination P=-3,71639658348183 V2=-0,762802395427105 V3=0 T=0 M2=0 M3=26,8608214914437 FrameElem=31-1
ElemStation=0
Frame=31 Station=0,0917 OutputCase=STR099 CaseType=Combination P=-3,71639658348183 V2=9,88356760457289 V3=0 T=0 M2=0 M3=26,4426344066044 FrameElem=31-1
ElemStation=0,0917
Frame=31 Station=0,1834 OutputCase=STR099 CaseType=Combination P=-3,71639658348183 V2=20,5299376045729 V3=0 T=0 M2=0 M3=25,048175192765 FrameElem=31-1
ElemStation=0,1834
Frame=31 Station=0 OutputCase=STR100 CaseType=Combination P=-16,9106495051227 V2=9,59310983792007 V3=0 T=0 M2=0 M3=25,0173679615075 FrameElem=31-1
ElemStation=0
Frame=31 Station=0,0917 OutputCase=STR100 CaseType=Combination P=-16,9106495051227 V2=20,2394798379201 V3=0 T=0 M2=0 M3=23,6495437248703 FrameElem=31-1
ElemStation=0,0917
Frame=31 Station=0,1834 OutputCase=STR100 CaseType=Combination P=-16,9106495051227 V2=30,8858498379201 V3=0 T=0 M2=0 M3=21,305447359233 FrameElem=31-1
ElemStation=0,1834
Frame=31 Station=0 OutputCase=STR101 CaseType=Combination P=-30,1049024267636 V2=-0,762802395441204 V3=0 T=0 M2=0 M3=23,1739144320129 FrameElem=31-1
ElemStation=0
Frame=31 Station=0,0917 OutputCase=STR101 CaseType=Combination P=-30,1049024267636 V2=9,8835676045588 V3=0 T=0 M2=0 M3=22,7557273471749 FrameElem=31-1
ElemStation=0,0917
Frame=31 Station=0,1834 OutputCase=STR101 CaseType=Combination P=-30,1049024267636 V2=20,5299376045588 V3=0 T=0 M2=0 M3=21,3612681333368 FrameElem=31-1
ElemStation=0,1834
Frame=31 Station=0 OutputCase=STR102 CaseType=Combination P=-16,1355856984915 V2=9,5931098379178 V3=0 T=0 M2=0 M3=1,78237421516087 FrameElem=31-1
ElemStation=0
Frame=31 Station=0,0917 OutputCase=STR102 CaseType=Combination P=-16,1355856984915 V2=10,8769098379178 V3=0 T=0 M2=0 M3=0,843823813023807
FrameElem=31-1 ElemStation=0,0917
Frame=31 Station=0,1834 OutputCase=STR102 CaseType=Combination P=-16,1355856984915 V2=12,1607098379178 V3=0 T=0 M2=0 M3=-0,212451049113255
FrameElem=31-1 ElemStation=0,1834
Frame=31 Station=0 OutputCase=STR103 CaseType=Combination P=-29,3298386201324 V2=-0,762802395443476 V3=0 T=0 M2=0 M3=-6,10793143337461E-02
FrameElem=31-1 ElemStation=0
Frame=31 Station=0,0917 OutputCase=STR103 CaseType=Combination P=-29,3298386201324 V2=0,520997604556524 V3=0 T=0 M2=0 M3=-4,99925646715795E-02
FrameElem=31-1 ElemStation=0,0917
Frame=31 Station=0,1834 OutputCase=STR103 CaseType=Combination P=-29,3298386201324 V2=1,80479760455652 V3=0 T=0 M2=0 M3=-0,156630275009413
FrameElem=31-1 ElemStation=0,1834
Frame=31 Station=0 OutputCase=STR104 CaseType=Combination P=-7,85285487038295 V2=-0,762802395433835 V3=0 T=0 M2=0 M3=3,96439242102227 FrameElem=31-1
ElemStation=0

Società di Progetto
Brebemi SpA



Doc. N.
60235-0000-A00.doc

CODIFICA DOCUMENTO
04RCDII10000000000300A00

REV.
00

FOGLIO
414 di 628

Frame=31 Station=0,0917 OutputCase=STR104 CaseType=Combination P=-7,85285487038295 V2=0,970327604566166 V3=0 T=0 M2=0 M3=3,95487739018356
FrameElem=31-1 ElemStation=0,0917
Frame=31 Station=0,1834 OutputCase=STR104 CaseType=Combination P=-7,85285487038295 V2=2,70345760456617 V3=0 T=0 M2=0 M3=3,78643433834484 FrameElem=31-1
ElemStation=0,1834
Frame=31 Station=0 OutputCase=STR105 CaseType=Combination P=-2,74425176161553 V2=-0,762802395434472 V3=0 T=0 M2=0 M3=4,80457411270148 FrameElem=31-1
ElemStation=0
Frame=31 Station=0,0917 OutputCase=STR105 CaseType=Combination P=-2,74425176161553 V2=0,970327604566529 V3=0 T=0 M2=0 M3=4,79505908186282
FrameElem=31-1 ElemStation=0,0917
Frame=31 Station=0,1834 OutputCase=STR105 CaseType=Combination P=-2,74425176161553 V2=2,7034576045653 V3=0 T=0 M2=0 M3=4,62661603002416 FrameElem=31-1
ElemStation=0,1834
Frame=31 Station=0 OutputCase=STR106 CaseType=Combination P=-3,71639658348183 V2=-0,762802395427105 V3=0 T=0 M2=0 M3=26,8608214914437 FrameElem=31-1
ElemStation=0
Frame=31 Station=0,0917 OutputCase=STR106 CaseType=Combination P=-3,71639658348183 V2=9,88356760457289 V3=0 T=0 M2=0 M3=26,4426344066044 FrameElem=31-1
ElemStation=0,0917
Frame=31 Station=0,1834 OutputCase=STR106 CaseType=Combination P=-3,71639658348183 V2=20,5299376045729 V3=0 T=0 M2=0 M3=25,048175192765 FrameElem=31-1
ElemStation=0,1834
Frame=31 Station=0 OutputCase=STR107 CaseType=Combination P=-16,9106495051227 V2=9,59310983792007 V3=0 T=0 M2=0 M3=25,0173679615075 FrameElem=31-1
ElemStation=0
Frame=31 Station=0,0917 OutputCase=STR107 CaseType=Combination P=-16,9106495051227 V2=20,2394798379201 V3=0 T=0 M2=0 M3=23,6495437248703 FrameElem=31-1
ElemStation=0,0917
Frame=31 Station=0,1834 OutputCase=STR107 CaseType=Combination P=-16,9106495051227 V2=30,8858498379201 V3=0 T=0 M2=0 M3=21,305447359233 FrameElem=31-1
ElemStation=0,1834
Frame=31 Station=0 OutputCase=STR108 CaseType=Combination P=-30,1049024267636 V2=-0,762802395441204 V3=0 T=0 M2=0 M3=23,1739144320129 FrameElem=31-1
ElemStation=0
Frame=31 Station=0,0917 OutputCase=STR108 CaseType=Combination P=-30,1049024267636 V2=9,8835676045588 V3=0 T=0 M2=0 M3=22,7557273471749 FrameElem=31-1
ElemStation=0,0917
Frame=31 Station=0,1834 OutputCase=STR108 CaseType=Combination P=-30,1049024267636 V2=20,5299376045588 V3=0 T=0 M2=0 M3=21,3612681333368 FrameElem=31-1
ElemStation=0,1834
Frame=31 Station=0 OutputCase=STR109 CaseType=Combination P=-16,1355856984915 V2=9,5931098379178 V3=0 T=0 M2=0 M3=1,78237421516087 FrameElem=31-1
ElemStation=0
Frame=31 Station=0,0917 OutputCase=STR109 CaseType=Combination P=-16,1355856984915 V2=10,8769098379178 V3=0 T=0 M2=0 M3=0,843823813023807
FrameElem=31-1 ElemStation=0,0917
Frame=31 Station=0,1834 OutputCase=STR109 CaseType=Combination P=-16,1355856984915 V2=12,1607098379178 V3=0 T=0 M2=0 M3=-0,212451049113255
FrameElem=31-1 ElemStation=0,1834
Frame=31 Station=0 OutputCase=STR110 CaseType=Combination P=-29,3298386201324 V2=-0,762802395443476 V3=0 T=0 M2=0 M3=-6,10793143337461E-02
FrameElem=31-1 ElemStation=0
Frame=31 Station=0,0917 OutputCase=STR110 CaseType=Combination P=-29,3298386201324 V2=0,520997604556524 V3=0 T=0 M2=0 M3=-4,99925646715795E-02
FrameElem=31-1 ElemStation=0,0917
Frame=31 Station=0,1834 OutputCase=STR110 CaseType=Combination P=-29,3298386201324 V2=1,80479760455652 V3=0 T=0 M2=0 M3=-0,156630275009413
FrameElem=31-1 ElemStation=0,1834
Frame=31 Station=0 OutputCase=STR111 CaseType=Combination P=-9,16744222295154 V2=0,762802395399308 V3=0 T=0 M2=0 M3=2,44761576374452 FrameElem=31-1
ElemStation=0
Frame=31 Station=0,0917 OutputCase=STR111 CaseType=Combination P=-9,16744222295154 V2=2,49593239539931 V3=0 T=0 M2=0 M3=2,2982027735864 FrameElem=31-1
ElemStation=0,0917
Frame=31 Station=0,1834 OutputCase=STR111 CaseType=Combination P=-9,16744222295154 V2=4,22906239539931 V3=0 T=0 M2=0 M3=1,98986176242829 FrameElem=31-1
ElemStation=0,1834
Frame=31 Station=0 OutputCase=STR112 CaseType=Combination P=-4,05883911418412 V2=0,762802395398671 V3=0 T=0 M2=0 M3=3,28779745542373 FrameElem=31-1
ElemStation=0
Frame=31 Station=0,0917 OutputCase=STR112 CaseType=Combination P=-4,05883911418412 V2=2,49593239539867 V3=0 T=0 M2=0 M3=3,13838446526567 FrameElem=31-1
ElemStation=0,0917
Frame=31 Station=0,1834 OutputCase=STR112 CaseType=Combination P=-4,05883911418412 V2=4,22906239539867 V3=0 T=0 M2=0 M3=2,83004345410761 FrameElem=31-1
ElemStation=0,1834
Frame=31 Station=0 OutputCase=STR113 CaseType=Combination P=-5,20245020419993 V2=0,457681437241895 V3=0 T=0 M2=0 M3=32,9079334217187 FrameElem=31-1
ElemStation=0
Frame=31 Station=0,0917 OutputCase=STR113 CaseType=Combination P=-5,20245020419993 V2=14,0751314372419 V3=0 T=0 M2=0 M3=32,2416039514236 FrameElem=31-1
ElemStation=0,0917
Frame=31 Station=0,1834 OutputCase=STR113 CaseType=Combination P=-5,20245020419993 V2=27,6925814372419 V3=0 T=0 M2=0 M3=30,3265543161285 FrameElem=31-1
ElemStation=0,1834
Frame=31 Station=0 OutputCase=STR114 CaseType=Combination P=-21,9433535815932 V2=13,6394630217885 V3=0 T=0 M2=0 M3=30,5900256637684 FrameElem=31-1
ElemStation=0
Frame=31 Station=0,0917 OutputCase=STR114 CaseType=Combination P=-21,9433535815932 V2=27,2569130217885 V3=0 T=0 M2=0 M3=28,7149268221704 FrameElem=31-1
ElemStation=0,0917
Frame=31 Station=0,1834 OutputCase=STR114 CaseType=Combination P=-21,9433535815932 V2=40,8743630217885 V3=0 T=0 M2=0 M3=25,5911078155724 FrameElem=31-1
ElemStation=0,1834
Frame=31 Station=0 OutputCase=STR115 CaseType=Combination P=-38,6842569589865 V2=0,457681437222887 V3=0 T=0 M2=0 M3=28,2721179063707 FrameElem=31-1
ElemStation=0
Frame=31 Station=0,0917 OutputCase=STR115 CaseType=Combination P=-38,6842569589865 V2=14,0751314372229 V3=0 T=0 M2=0 M3=27,6057884360774 FrameElem=31-1
ElemStation=0,0917
Frame=31 Station=0,1834 OutputCase=STR115 CaseType=Combination P=-38,6842569589865 V2=27,6925814372229 V3=0 T=0 M2=0 M3=25,690738800784 FrameElem=31-1
ElemStation=0,1834
Frame=31 Station=0 OutputCase=STR116 CaseType=Combination P=-20,8442415010066 V2=13,6394630217838 V3=0 T=0 M2=0 M3=2,94945784096173E-03 FrameElem=31-1
ElemStation=0
Frame=31 Station=0,0917 OutputCase=STR116 CaseType=Combination P=-20,8442415010066 V2=14,9232630217838 V3=0 T=0 M2=0 M3=-1,30665153125661
FrameElem=31-1 ElemStation=0,0917
Frame=31 Station=0,1834 OutputCase=STR116 CaseType=Combination P=-20,8442415010066 V2=16,2070630217838 V3=0 T=0 M2=0 M3=-2,73397698035418
FrameElem=31-1 ElemStation=0,1834
Frame=31 Station=0 OutputCase=STR117 CaseType=Combination P=-37,5851448783999 V2=0,457681437218158 V3=0 T=0 M2=0 M3=-2,31495829955669 FrameElem=31-1
ElemStation=0
Frame=31 Station=0,0917 OutputCase=STR117 CaseType=Combination P=-37,5851448783999 V2=1,74148143721816 V3=0 T=0 M2=0 M3=-2,4157899173496 FrameElem=31-1
ElemStation=0,0917
Frame=31 Station=0,1834 OutputCase=STR117 CaseType=Combination P=-37,5851448783999 V2=3,02528143721816 V3=0 T=0 M2=0 M3=-2,6343459951425 FrameElem=31-1
ElemStation=0,1834
Frame=31 Station=0 OutputCase=STR118 CaseType=Combination P=-18,0726548518854 V2=30,1835064600925 V3=0 T=0 M2=0 M3=23,7123974320397 FrameElem=31-1
ElemStation=0
Frame=31 Station=0,0917 OutputCase=STR118 CaseType=Combination P=-20,1400313518854 V2=40,8298764600925 V3=0 T=0 M2=0 M3=20,4564338251492 FrameElem=31-1
ElemStation=0,0917
Frame=31 Station=0,1834 OutputCase=STR118 CaseType=Combination P=-22,2074078518854 V2=51,4762464600925 V3=0 T=0 M2=0 M3=16,2241980892587 FrameElem=31-1
ElemStation=0,1834

APPROVATO S.D.P.
Società di Progetto
Brebemi SpA



Doc. N.
60235-0000-A00.doc

CODIFICA DOCUMENTO
04RCDII10000000000300A00

REV.
00

FOGLIO
415 di 628

Frame=31 Station=0 OutputCase=STR119 CaseType=Combination P=-5,03098393605042 V2=0,762802395406038 V3=0 T=0 M2=0 M3=25,344044834166 FrameElem=31-1 ElemStation=0
Frame=31 Station=0,0917 OutputCase=STR119 CaseType=Combination P=-5,03098393605042 V2=11,409172395406 V3=0 T=0 M2=0 M3=24,7859597900072 FrameElem=31-1 ElemStation=0,0917
Frame=31 Station=0,1834 OutputCase=STR119 CaseType=Combination P=-5,03098393605042 V2=22,055542395406 V3=0 T=0 M2=0 M3=23,2516026168485 FrameElem=31-1 ElemStation=0,1834
Frame=31 Station=0 OutputCase=STR120 CaseType=Combination P=-18,2252368576913 V2=11,1187146287532 V3=0 T=0 M2=0 M3=23,5005913042298 FrameElem=31-1 ElemStation=0
Frame=31 Station=0,0917 OutputCase=STR120 CaseType=Combination P=-18,2252368576913 V2=21,7650846287532 V3=0 T=0 M2=0 M3=21,9928691082731 FrameElem=31-1 ElemStation=0,0917
Frame=31 Station=0,1834 OutputCase=STR120 CaseType=Combination P=-18,2252368576913 V2=32,4114546287532 V3=0 T=0 M2=0 M3=19,5088747833164 FrameElem=31-1 ElemStation=0,1834
Frame=31 Station=0 OutputCase=STR121 CaseType=Combination P=-31,4194897793322 V2=0,762802395391939 V3=0 T=0 M2=0 M3=21,6571377747352 FrameElem=31-1 ElemStation=0
Frame=31 Station=0,0917 OutputCase=STR121 CaseType=Combination P=-31,4194897793322 V2=11,4091723953919 V3=0 T=0 M2=0 M3=21,0990527305777 FrameElem=31-1 ElemStation=0,0917
Frame=31 Station=0,1834 OutputCase=STR121 CaseType=Combination P=-31,4194897793322 V2=22,0555423953919 V3=0 T=0 M2=0 M3=19,5646955574203 FrameElem=31-1 ElemStation=0,1834
Frame=31 Station=0 OutputCase=STR122 CaseType=Combination P=-17,4501730510601 V2=11,1187146287509 V3=0 T=0 M2=0 M3=0,265597557883117 FrameElem=31-1 ElemStation=0
Frame=31 Station=0,0917 OutputCase=STR122 CaseType=Combination P=-17,4501730510601 V2=12,4025146287509 V3=0 T=0 M2=0 M3=-0,812850803573345 FrameElem=31-1 ElemStation=0,0917
Frame=31 Station=0,1834 OutputCase=STR122 CaseType=Combination P=-17,4501730510601 V2=13,6863146287509 V3=0 T=0 M2=0 M3=-2,00902362502981 FrameElem=31-1 ElemStation=0,1834
Frame=31 Station=0 OutputCase=STR123 CaseType=Combination P=-30,644425972701 V2=0,762802395389667 V3=0 T=0 M2=0 M3=-1,5778559716115 FrameElem=31-1 ElemStation=0
Frame=31 Station=0,0917 OutputCase=STR123 CaseType=Combination P=-30,644425972701 V2=2,04660239538967 V3=0 T=0 M2=0 M3=-1,70666718126873 FrameElem=31-1 ElemStation=0,0917
Frame=31 Station=0,1834 OutputCase=STR123 CaseType=Combination P=-30,644425972701 V2=3,33040239538967 V3=0 T=0 M2=0 M3=-1,95320285092596 FrameElem=31-1 ElemStation=0,1834
Frame=31 Station=0 OutputCase=STR124 CaseType=Combination P=-9,71911954649054 V2=0,762802395399456 V3=0 T=0 M2=0 M3=1,98986974632677 FrameElem=31-1 ElemStation=0
Frame=31 Station=0,0917 OutputCase=STR124 CaseType=Combination P=-9,71911954649054 V2=2,49593239539946 V3=0 T=0 M2=0 M3=1,84045675616864 FrameElem=31-1 ElemStation=0,0917
Frame=31 Station=0,1834 OutputCase=STR124 CaseType=Combination P=-9,71911954649054 V2=4,22906239539946 V3=0 T=0 M2=0 M3=1,53211574501051 FrameElem=31-1 ElemStation=0,1834
Frame=31 Station=0 OutputCase=STR125 CaseType=Combination P=-4,61051643772312 V2=0,762802395398819 V3=0 T=0 M2=0 M3=2,83005143800598 FrameElem=31-1 ElemStation=0
Frame=31 Station=0,0917 OutputCase=STR125 CaseType=Combination P=-4,61051643772312 V2=2,49593239539882 V3=0 T=0 M2=0 M3=2,68063844784791 FrameElem=31-1 ElemStation=0,0917
Frame=31 Station=0,1834 OutputCase=STR125 CaseType=Combination P=-4,61051643772312 V2=4,22906239539882 V3=0 T=0 M2=0 M3=2,32729743668984 FrameElem=31-1 ElemStation=0,1834
Frame=31 Station=0 OutputCase=STR126 CaseType=Combination P=-5,58266125958942 V2=0,762802395406186 V3=0 T=0 M2=0 M3=24,8862988167482 FrameElem=31-1 ElemStation=0
Frame=31 Station=0,0917 OutputCase=STR126 CaseType=Combination P=-5,58266125958942 V2=11,4091723954062 V3=0 T=0 M2=0 M3=24,3282137725895 FrameElem=31-1 ElemStation=0,0917
Frame=31 Station=0,1834 OutputCase=STR126 CaseType=Combination P=-5,58266125958942 V2=22,0555423954062 V3=0 T=0 M2=0 M3=22,7938565994307 FrameElem=31-1 ElemStation=0,1834
Frame=31 Station=0 OutputCase=STR127 CaseType=Combination P=-18,7769141812303 V2=11,1187146287534 V3=0 T=0 M2=0 M3=23,042845286812 FrameElem=31-1 ElemStation=0
Frame=31 Station=0,0917 OutputCase=STR127 CaseType=Combination P=-18,7769141812303 V2=21,7650846287534 V3=0 T=0 M2=0 M3=21,5351230908553 FrameElem=31-1 ElemStation=0,0917
Frame=31 Station=0,1834 OutputCase=STR127 CaseType=Combination P=-18,7769141812303 V2=32,4114546287534 V3=0 T=0 M2=0 M3=19,0511287658987 FrameElem=31-1 ElemStation=0,1834
Frame=31 Station=0 OutputCase=STR128 CaseType=Combination P=-31,9711671028712 V2=0,762802395392088 V3=0 T=0 M2=0 M3=21,1993917573174 FrameElem=31-1 ElemStation=0
Frame=31 Station=0,0917 OutputCase=STR128 CaseType=Combination P=-31,9711671028712 V2=11,4091723953921 V3=0 T=0 M2=0 M3=20,64130671316 FrameElem=31-1 ElemStation=0,0917
Frame=31 Station=0,1834 OutputCase=STR128 CaseType=Combination P=-31,9711671028712 V2=22,0555423953921 V3=0 T=0 M2=0 M3=19,1069495400025 FrameElem=31-1 ElemStation=0,1834
Frame=31 Station=0 OutputCase=STR129 CaseType=Combination P=-18,0018503745991 V2=11,1187146287511 V3=0 T=0 M2=0 M3=-0,192148459534632 FrameElem=31-1 ElemStation=0
Frame=31 Station=0,0917 OutputCase=STR129 CaseType=Combination P=-18,0018503745991 V2=12,4025146287511 V3=0 T=0 M2=0 M3=-1,27059682099111 FrameElem=31-1 ElemStation=0,0917
Frame=31 Station=0,1834 OutputCase=STR129 CaseType=Combination P=-18,0018503745991 V2=13,6863146287511 V3=0 T=0 M2=0 M3=-2,4667964244758 FrameElem=31-1 ElemStation=0,1834
Frame=31 Station=0 OutputCase=STR130 CaseType=Combination P=-31,19610329624 V2=0,762802395389816 V3=0 T=0 M2=0 M3=-2,03560198902925 FrameElem=31-1 ElemStation=0
Frame=31 Station=0,0917 OutputCase=STR130 CaseType=Combination P=-31,19610329624 V2=2,04660239538982 V3=0 T=0 M2=0 M3=-2,16441319868649 FrameElem=31-1 ElemStation=0,0917
Frame=31 Station=0,1834 OutputCase=STR130 CaseType=Combination P=-31,19610329624 V2=3,33040239538981 V3=0 T=0 M2=0 M3=-2,41094886834374 FrameElem=31-1 ElemStation=0,1834
Frame=31 Station=0 OutputCase=STR131 CaseType=Combination P=-8,61576489941253 V2=0,76280239539916 V3=0 T=0 M2=0 M3=2,90536178116227 FrameElem=31-1 ElemStation=0
Frame=31 Station=0,0917 OutputCase=STR131 CaseType=Combination P=-8,61576489941253 V2=2,49593239539916 V3=0 T=0 M2=0 M3=2,75594879100417 FrameElem=31-1 ElemStation=0,0917
Frame=31 Station=0,1834 OutputCase=STR131 CaseType=Combination P=-8,61576489941253 V2=4,22906239539916 V3=0 T=0 M2=0 M3=2,44760777984606 FrameElem=31-1 ElemStation=0,1834
Frame=31 Station=0 OutputCase=STR132 CaseType=Combination P=-3,50716179064511 V2=0,762802395398523 V3=0 T=0 M2=0 M3=3,74554347284148 FrameElem=31-1 ElemStation=0
Frame=31 Station=0,0917 OutputCase=STR132 CaseType=Combination P=-3,50716179064511 V2=2,49593239539852 V3=0 T=0 M2=0 M3=3,59613048268343 FrameElem=31-1 ElemStation=0,0917
Frame=31 Station=0,1834 OutputCase=STR132 CaseType=Combination P=-3,50716179064511 V2=4,22906239539852 V3=0 T=0 M2=0 M3=3,28778947152539 FrameElem=31-1 ElemStation=0,1834
Frame=31 Station=0 OutputCase=STR133 CaseType=Combination P=-4,47930661251141 V2=0,76280239540589 V3=0 T=0 M2=0 M3=25,8017908515837 FrameElem=31-1 ElemStation=0
Frame=31 Station=0,0917 OutputCase=STR133 CaseType=Combination P=-4,47930661251141 V2=11,4091723954059 V3=0 T=0 M2=0 M3=25,243705807425 FrameElem=31-1 ElemStation=0,0917

Società di Progetto
Brebemi SpA



Doc. N.
60235-00000-A00.doc

CODIFICA DOCUMENTO
04RCDII10000000000300A00

REV.
00

FOGLIO
416 di 628

Frame=31 Station=0,1834 OutputCase=STR133 CaseType=Combination P=-4,47930661251141 V2=22,0555423954059 V3=0 T=0 M2=0 M3=23,7093486342663 FrameElem=31-1 ElemStation=0,1834
Frame=31 Station=0 OutputCase=STR134 CaseType=Combination P=-17,6735595341523 V2=11,1187146287531 V3=0 T=0 M2=0 M3=23,9583373216475 FrameElem=31-1 ElemStation=0
Frame=31 Station=0,0917 OutputCase=STR134 CaseType=Combination P=-17,6735595341523 V2=21,7650846287531 V3=0 T=0 M2=0 M3=22,4506151256909 FrameElem=31-1 ElemStation=0,0917
Frame=31 Station=0,1834 OutputCase=STR134 CaseType=Combination P=-17,6735595341523 V2=32,4114546287531 V3=0 T=0 M2=0 M3=19,9666208007342 FrameElem=31-1 ElemStation=0,1834
Frame=31 Station=0 OutputCase=STR135 CaseType=Combination P=-30,8678124557932 V2=0,762802395391791 V3=0 T=0 M2=0 M3=22,1148837921529 FrameElem=31-1 ElemStation=0
Frame=31 Station=0,0917 OutputCase=STR135 CaseType=Combination P=-30,8678124557932 V2=11,4091723953918 V3=0 T=0 M2=0 M3=21,5567987479955 FrameElem=31-1 ElemStation=0,0917
Frame=31 Station=0,1834 OutputCase=STR135 CaseType=Combination P=-30,8678124557932 V2=22,0555423953918 V3=0 T=0 M2=0 M3=20,0224415748381 FrameElem=31-1 ElemStation=0,1834
Frame=31 Station=0 OutputCase=STR136 CaseType=Combination P=-16,8984957275211 V2=11,1187146287508 V3=0 T=0 M2=0 M3=0,723343575300866 FrameElem=31-1 ElemStation=0
Frame=31 Station=0,0917 OutputCase=STR136 CaseType=Combination P=-16,8984957275211 V2=12,4025146287508 V3=0 T=0 M2=0 M3=-0,355104786155582 FrameElem=31-1 ElemStation=0,0917
Frame=31 Station=0,1834 OutputCase=STR136 CaseType=Combination P=-16,8984957275211 V2=13,6863146287508 V3=0 T=0 M2=0 M3=-1,55127760761203 FrameElem=31-1 ElemStation=0,1834
Frame=31 Station=0 OutputCase=STR137 CaseType=Combination P=-30,092748649162 V2=0,762802395389519 V3=0 T=0 M2=0 M3=-1,12010995419375 FrameElem=31-1 ElemStation=0
Frame=31 Station=0,0917 OutputCase=STR137 CaseType=Combination P=-30,092748649162 V2=2,04660239538952 V3=0 T=0 M2=0 M3=-1,24892116385097 FrameElem=31-1 ElemStation=0,0917
Frame=31 Station=0,1834 OutputCase=STR137 CaseType=Combination P=-30,092748649162 V2=3,33040239538952 V3=0 T=0 M2=0 M3=-1,49545683350819 FrameElem=31-1 ElemStation=0,1834
Frame=31 Station=0 OutputCase=STR138 CaseType=Combination P=-8,61576489941253 V2=0,76280239539916 V3=0 T=0 M2=0 M3=2,90536178116227 FrameElem=31-1 ElemStation=0
Frame=31 Station=0,0917 OutputCase=STR138 CaseType=Combination P=-8,61576489941253 V2=2,49593239539916 V3=0 T=0 M2=0 M3=2,75594879100416 FrameElem=31-1 ElemStation=0,0917
Frame=31 Station=0,1834 OutputCase=STR138 CaseType=Combination P=-8,61576489941253 V2=4,22906239539916 V3=0 T=0 M2=0 M3=2,4476077984606 FrameElem=31-1 ElemStation=0,1834
Frame=31 Station=0 OutputCase=STR139 CaseType=Combination P=-3,50716179064511 V2=0,762802395398523 V3=0 T=0 M2=0 M3=3,74554347284148 FrameElem=31-1 ElemStation=0
Frame=31 Station=0,0917 OutputCase=STR139 CaseType=Combination P=-3,50716179064511 V2=2,49593239539852 V3=0 T=0 M2=0 M3=3,59613048268343 FrameElem=31-1 ElemStation=0,0917
Frame=31 Station=0,1834 OutputCase=STR139 CaseType=Combination P=-3,50716179064511 V2=4,22906239539852 V3=0 T=0 M2=0 M3=3,28778947152539 FrameElem=31-1 ElemStation=0,1834
Frame=31 Station=0 OutputCase=STR140 CaseType=Combination P=-4,47930661251141 V2=0,76280239540589 V3=0 T=0 M2=0 M3=25,8017908515837 FrameElem=31-1 ElemStation=0
Frame=31 Station=0,0917 OutputCase=STR140 CaseType=Combination P=-4,47930661251141 V2=11,4091723954059 V3=0 T=0 M2=0 M3=25,243705807425 FrameElem=31-1 ElemStation=0,0917
Frame=31 Station=0,1834 OutputCase=STR140 CaseType=Combination P=-4,47930661251141 V2=22,0555423954059 V3=0 T=0 M2=0 M3=23,7093486342663 FrameElem=31-1 ElemStation=0,1834
Frame=31 Station=0 OutputCase=STR141 CaseType=Combination P=-17,6735595341523 V2=11,1187146287531 V3=0 T=0 M2=0 M3=23,9583373216475 FrameElem=31-1 ElemStation=0
Frame=31 Station=0,0917 OutputCase=STR141 CaseType=Combination P=-17,6735595341523 V2=21,7650846287531 V3=0 T=0 M2=0 M3=22,4506151256909 FrameElem=31-1 ElemStation=0,0917
Frame=31 Station=0,1834 OutputCase=STR141 CaseType=Combination P=-17,6735595341523 V2=32,4114546287531 V3=0 T=0 M2=0 M3=19,9666208007342 FrameElem=31-1 ElemStation=0,1834
Frame=31 Station=0 OutputCase=STR142 CaseType=Combination P=-30,8678124557932 V2=0,762802395391791 V3=0 T=0 M2=0 M3=22,1148837921529 FrameElem=31-1 ElemStation=0
Frame=31 Station=0,0917 OutputCase=STR142 CaseType=Combination P=-30,8678124557932 V2=11,4091723953918 V3=0 T=0 M2=0 M3=21,5567987479955 FrameElem=31-1 ElemStation=0,0917
Frame=31 Station=0,1834 OutputCase=STR142 CaseType=Combination P=-30,8678124557932 V2=22,0555423953918 V3=0 T=0 M2=0 M3=20,0224415748381 FrameElem=31-1 ElemStation=0,1834
Frame=31 Station=0 OutputCase=STR143 CaseType=Combination P=-16,8984957275211 V2=11,1187146287508 V3=0 T=0 M2=0 M3=0,723343575300866 FrameElem=31-1 ElemStation=0
Frame=31 Station=0,0917 OutputCase=STR143 CaseType=Combination P=-16,8984957275211 V2=12,4025146287508 V3=0 T=0 M2=0 M3=-0,355104786155582 FrameElem=31-1 ElemStation=0,0917
Frame=31 Station=0,1834 OutputCase=STR143 CaseType=Combination P=-16,8984957275211 V2=13,6863146287508 V3=0 T=0 M2=0 M3=-1,55127760761203 FrameElem=31-1 ElemStation=0,1834
Frame=31 Station=0 OutputCase=STR144 CaseType=Combination P=-30,092748649162 V2=0,762802395389519 V3=0 T=0 M2=0 M3=-1,12010995419375 FrameElem=31-1 ElemStation=0
Frame=31 Station=0,0917 OutputCase=STR144 CaseType=Combination P=-30,092748649162 V2=2,04660239538952 V3=0 T=0 M2=0 M3=-1,24892116385097 FrameElem=31-1 ElemStation=0,0917
Frame=31 Station=0,1834 OutputCase=STR144 CaseType=Combination P=-30,092748649162 V2=3,33040239538952 V3=0 T=0 M2=0 M3=-1,49545683350819 FrameElem=31-1 ElemStation=0,1834
Frame=31 Station=0 OutputCase=STR145 CaseType=Combination P=-7,8665250025384 V2=-1,74366299177109E-11 V3=0 T=0 M2=0 M3=3,7400411127041 FrameElem=31-1 ElemStation=0
Frame=31 Station=0,0917 OutputCase=STR145 CaseType=Combination P=-7,8665250025384 V2=1,73312999998256 V3=0 T=0 M2=0 M3=3,6605771022057 FrameElem=31-1 ElemStation=0,0917
Frame=31 Station=0,1834 OutputCase=STR145 CaseType=Combination P=-7,8665250025384 V2=3,46625999998256 V3=0 T=0 M2=0 M3=3,4221850707073 FrameElem=31-1 ElemStation=0,1834
Frame=31 Station=0 OutputCase=STR146 CaseType=Combination P=-2,75792189377098 V2=-1,80734538446359E-11 V3=0 T=0 M2=0 M3=4,58022280438331 FrameElem=31-1 ElemStation=0
Frame=31 Station=0,0917 OutputCase=STR146 CaseType=Combination P=-2,75792189377098 V2=1,73312999998193 V3=0 T=0 M2=0 M3=4,50075879388497 FrameElem=31-1 ElemStation=0,0917
Frame=31 Station=0,1834 OutputCase=STR146 CaseType=Combination P=-2,75792189377098 V2=3,46625999998193 V3=0 T=0 M2=0 M3=4,26236676238663 FrameElem=31-1 ElemStation=0,1834
Frame=31 Station=0 OutputCase=STR147 CaseType=Combination P=-4,42189987195205 V2=-8,15200351667045E-12 V3=0 T=0 M2=0 M3=33,6833886310945 FrameElem=31-1 ElemStation=0
Frame=31 Station=0,0917 OutputCase=STR147 CaseType=Combination P=-4,42189987195205 V2=13,6174499999918 V3=0 T=0 M2=0 M3=33,0590285485952 FrameElem=31-1 ElemStation=0,0917
Frame=31 Station=0,1834 OutputCase=STR147 CaseType=Combination P=-4,42189987195205 V2=27,2348999999919 V3=0 T=0 M2=0 M3=31,1859483010959 FrameElem=31-1 ElemStation=0,1834
Frame=31 Station=0 OutputCase=STR148 CaseType=Combination P=-21,1628032493453 V2=13,1817815845385 V3=0 T=0 M2=0 M3=31,3654808731441 FrameElem=31-1 ElemStation=0

Società di Progetto
Brebemi SpA



Doc. N.
60235-0000-A00.doc

CODIFICA DOCUMENTO
04RCDII10000000000300A00

REV.
00

FOGLIO
417 di 628

Frame=31 Station=0,0917 OutputCase=STR148 CaseType=Combination P=-21,1628032493453 V2=26,7992315845385 V3=0 T=0 M2=0 M3=29,5323514193419 FrameElem=31-1 ElemStation=0,0917
Frame=31 Station=0,1834 OutputCase=STR148 CaseType=Combination P=-21,1628032493453 V2=40,4166815845385 V3=0 T=0 M2=0 M3=26,4505018005398 FrameElem=31-1 ElemStation=0,1834
Frame=31 Station=0 OutputCase=STR149 CaseType=Combination P=-37,9037066267386 V2=-2,71596434231469E-11 V3=0 T=0 M2=0 M3=29,0475731157465 FrameElem=31-1 ElemStation=0
Frame=31 Station=0,0917 OutputCase=STR149 CaseType=Combination P=-37,9037066267386 V2=13,6174499999728 V3=0 T=0 M2=0 M3=28,423213033249 FrameElem=31-1 ElemStation=0,0917
Frame=31 Station=0,1834 OutputCase=STR149 CaseType=Combination P=-37,9037066267386 V2=27,2348999999728 V3=0 T=0 M2=0 M3=26,5501327857514 FrameElem=31-1 ElemStation=0,1834
Frame=31 Station=0 OutputCase=STR150 CaseType=Combination P=-20,0636911687587 V2=13,1817815845337 V3=0 T=0 M2=0 M3=0,778404667216712 FrameElem=31-1 ElemStation=0
Frame=31 Station=0,0917 OutputCase=STR150 CaseType=Combination P=-20,0636911687587 V2=14,4655815845337 V3=0 T=0 M2=0 M3=-0,489226934085032 FrameElem=31-1 ElemStation=0,0917
Frame=31 Station=0,1834 OutputCase=STR150 CaseType=Combination P=-20,0636911687587 V2=15,7493815845337 V3=0 T=0 M2=0 M3=-1,87458299538678 FrameElem=31-1 ElemStation=0,1834
Frame=31 Station=0 OutputCase=STR151 CaseType=Combination P=-36,804594546152 V2=-3,18883053296304E-11 V3=0 T=0 M2=0 M3=-1,53950309018094 FrameElem=31-1 ElemStation=0
Frame=31 Station=0,0917 OutputCase=STR151 CaseType=Combination P=-36,804594546152 V2=1,28379999996811 V3=0 T=0 M2=0 M3=-1,59836532017802 FrameElem=31-1 ElemStation=0,0917
Frame=31 Station=0,1834 OutputCase=STR151 CaseType=Combination P=-36,804594546152 V2=2,56759999996811 V3=0 T=0 M2=0 M3=-1,77495201017509 FrameElem=31-1 ElemStation=0,1834
Frame=31 Station=0 OutputCase=STR152 CaseType=Combination P=-17,2921045196375 V2=29,7258250228425 V3=0 T=0 M2=0 M3=24,4878526414155 FrameElem=31-1 ElemStation=0
Frame=31 Station=0,0917 OutputCase=STR152 CaseType=Combination P=-19,3594810196375 V2=40,3721950228425 V3=0 T=0 M2=0 M3=21,2738584223208 FrameElem=31-1 ElemStation=0,0917
Frame=31 Station=0,1834 OutputCase=STR152 CaseType=Combination P=-21,4268575196375 V2=51,0185650228425 V3=0 T=0 M2=0 M3=17,0835920742262 FrameElem=31-1 ElemStation=0,1834
Frame=31 Station=0 OutputCase=STR153 CaseType=Combination P=-3,73006671563728 V2=-1,07065467602752E-11 V3=0 T=0 M2=0 M3=26,6364701831255 FrameElem=31-1 ElemStation=0
Frame=31 Station=0,0917 OutputCase=STR153 CaseType=Combination P=-3,73006671563728 V2=10,6463699999893 V3=0 T=0 M2=0 M3=26,1483341186265 FrameElem=31-1 ElemStation=0,0917
Frame=31 Station=0,1834 OutputCase=STR153 CaseType=Combination P=-3,73006671563728 V2=21,2927399999893 V3=0 T=0 M2=0 M3=24,6839259251275 FrameElem=31-1 ElemStation=0,1834
Frame=31 Station=0 OutputCase=STR154 CaseType=Combination P=-16,9243196372782 V2=10,3559122333365 V3=0 T=0 M2=0 M3=24,7930166531894 FrameElem=31-1 ElemStation=0
Frame=31 Station=0,0917 OutputCase=STR154 CaseType=Combination P=-16,9243196372782 V2=21,0022822333365 V3=0 T=0 M2=0 M3=23,3552434368924 FrameElem=31-1 ElemStation=0,0917
Frame=31 Station=0,1834 OutputCase=STR154 CaseType=Combination P=-16,9243196372782 V2=31,6486522333365 V3=0 T=0 M2=0 M3=20,9411980915955 FrameElem=31-1 ElemStation=0,1834
Frame=31 Station=0 OutputCase=STR155 CaseType=Combination P=-30,118572558919 V2=-2,4805402176753E-11 V3=0 T=0 M2=0 M3=22,9495631236947 FrameElem=31-1 ElemStation=0
Frame=31 Station=0,0917 OutputCase=STR155 CaseType=Combination P=-30,118572558919 V2=10,6463699999752 V3=0 T=0 M2=0 M3=22,461427059197 FrameElem=31-1 ElemStation=0,0917
Frame=31 Station=0,1834 OutputCase=STR155 CaseType=Combination P=-30,118572558919 V2=21,2927399999752 V3=0 T=0 M2=0 M3=20,9970188656993 FrameElem=31-1 ElemStation=0,1834
Frame=31 Station=0 OutputCase=STR156 CaseType=Combination P=-16,149255830647 V2=10,3559122333342 V3=0 T=0 M2=0 M3=1,5580229068427 FrameElem=31-1 ElemStation=0
Frame=31 Station=0,0917 OutputCase=STR156 CaseType=Combination P=-16,149255830647 V2=11,6397122333342 V3=0 T=0 M2=0 M3=0,549523525045954 FrameElem=31-1 ElemStation=0,0917
Frame=31 Station=0,1834 OutputCase=STR156 CaseType=Combination P=-16,149255830647 V2=12,9235122333342 V3=0 T=0 M2=0 M3=-0,576700316750792 FrameElem=31-1 ElemStation=0,1834
Frame=31 Station=0 OutputCase=STR157 CaseType=Combination P=-29,3435087522879 V2=-2,70773625743459E-11 V3=0 T=0 M2=0 M3=-0,285430622651916 FrameElem=31-1 ElemStation=0
Frame=31 Station=0,0917 OutputCase=STR157 CaseType=Combination P=-29,3435087522879 V2=1,28379999997292 V3=0 T=0 M2=0 M3=-0,344292852649433 FrameElem=31-1 ElemStation=0,0917
Frame=31 Station=0,1834 OutputCase=STR157 CaseType=Combination P=-29,3435087522879 V2=2,56759999997292 V3=0 T=0 M2=0 M3=-0,52087954264695 FrameElem=31-1 ElemStation=0,1834
Frame=31 Station=0 OutputCase=STR158 CaseType=Combination P=-8,41820232607741 V2=-1,72882685944842E-11 V3=0 T=0 M2=0 M3=3,28229509528635 FrameElem=31-1 ElemStation=0
Frame=31 Station=0,0917 OutputCase=STR158 CaseType=Combination P=-8,41820232607741 V2=1,73312999998271 V3=0 T=0 M2=0 M3=3,20283108478794 FrameElem=31-1 ElemStation=0,0917
Frame=31 Station=0,1834 OutputCase=STR158 CaseType=Combination P=-8,41820232607741 V2=3,46625999998271 V3=0 T=0 M2=0 M3=2,96443905328952 FrameElem=31-1 ElemStation=0,1834
Frame=31 Station=0 OutputCase=STR159 CaseType=Combination P=-3,30959921730999 V2=-1,79250925214092E-11 V3=0 T=0 M2=0 M3=4,12247678696556 FrameElem=31-1 ElemStation=0
Frame=31 Station=0,0917 OutputCase=STR159 CaseType=Combination P=-3,30959921730999 V2=1,73312999998208 V3=0 T=0 M2=0 M3=4,04301277646721 FrameElem=31-1 ElemStation=0,0917
Frame=31 Station=0,1834 OutputCase=STR159 CaseType=Combination P=-3,30959921730999 V2=3,46625999998208 V3=0 T=0 M2=0 M3=3,80462074496885 FrameElem=31-1 ElemStation=0,1834
Frame=31 Station=0 OutputCase=STR160 CaseType=Combination P=-4,28174403917629 V2=-1,05581854370484E-11 V3=0 T=0 M2=0 M3=26,1787241657078 FrameElem=31-1 ElemStation=0
Frame=31 Station=0,0917 OutputCase=STR160 CaseType=Combination P=-4,28174403917629 V2=10,6463699999894 V3=0 T=0 M2=0 M3=25,6905881012088 FrameElem=31-1 ElemStation=0,0917
Frame=31 Station=0,1834 OutputCase=STR160 CaseType=Combination P=-4,28174403917629 V2=21,2927399999894 V3=0 T=0 M2=0 M3=24,2261799077097 FrameElem=31-1 ElemStation=0,1834
Frame=31 Station=0 OutputCase=STR161 CaseType=Combination P=-17,4759969608172 V2=10,3559122333366 V3=0 T=0 M2=0 M3=24,3352706357716 FrameElem=31-1 ElemStation=0
Frame=31 Station=0,0917 OutputCase=STR161 CaseType=Combination P=-17,4759969608172 V2=21,0022822333366 V3=0 T=0 M2=0 M3=22,8974974194746 FrameElem=31-1 ElemStation=0,0917
Frame=31 Station=0,1834 OutputCase=STR161 CaseType=Combination P=-17,4759969608172 V2=31,6486522333366 V3=0 T=0 M2=0 M3=20,4834520741777 FrameElem=31-1 ElemStation=0,1834
Frame=31 Station=0 OutputCase=STR162 CaseType=Combination P=-30,670249882458 V2=-2,46570408535263E-11 V3=0 T=0 M2=0 M3=22,491817106277 FrameElem=31-1 ElemStation=0
Frame=31 Station=0,0917 OutputCase=STR162 CaseType=Combination P=-30,670249882458 V2=10,6463699999753 V3=0 T=0 M2=0 M3=22,0036810417793 FrameElem=31-1 ElemStation=0,0917
Frame=31 Station=0,1834 OutputCase=STR162 CaseType=Combination P=-30,670249882458 V2=21,2927399999753 V3=0 T=0 M2=0 M3=20,5392728482815 FrameElem=31-1 ElemStation=0,1834

Società di Progetto
Brebemi SpA



Doc. N.
60235-0000-A00.doc

CODIFICA DOCUMENTO
04RCDII10000000000300A00

REV.
00

FOGLIO
418 di 628

Frame=31 Station=0 OutputCase=STR163 CaseType=Combination P=-16,700933154186 V2=10,3559122333343 V3=0 T=0 M2=0 M3=1,10027688942495 FrameElem=31-1 ElemStation=0
Frame=31 Station=0,0917 OutputCase=STR163 CaseType=Combination P=-16,700933154186 V2=11,6397122333343 V3=0 T=0 M2=0 M3=9,17775076281917E-02 FrameElem=31-1 ElemStation=0,0917
Frame=31 Station=0,1834 OutputCase=STR163 CaseType=Combination P=-16,700933154186 V2=12,9235122333343 V3=0 T=0 M2=0 M3=-1,03444633416857 FrameElem=31-1 ElemStation=0,1834
Frame=31 Station=0 OutputCase=STR164 CaseType=Combination P=-29,8951860758269 V2=-2,69290012511192E-11 V3=0 T=0 M2=0 M3=-0,743176640069664 FrameElem=31-1 ElemStation=0
Frame=31 Station=0,0917 OutputCase=STR164 CaseType=Combination P=-29,8951860758269 V2=-1,28379999997307 V3=0 T=0 M2=0 M3=-0,802038870067195 FrameElem=31-1 ElemStation=0,0917
Frame=31 Station=0,1834 OutputCase=STR164 CaseType=Combination P=-29,8951860758269 V2=-2,56759999997307 V3=0 T=0 M2=0 M3=-0,978625560064726 FrameElem=31-1 ElemStation=0,1834
Frame=31 Station=0 OutputCase=STR165 CaseType=Combination P=-7,3148476789994 V2=-1,75849912409376E-11 V3=0 T=0 M2=0 M3=4,19778713012185 FrameElem=31-1 ElemStation=0
Frame=31 Station=0,0917 OutputCase=STR165 CaseType=Combination P=-7,3148476789994 V2=-1,73312999998242 V3=0 T=0 M2=0 M3=4,11832311962346 FrameElem=31-1 ElemStation=0,0917
Frame=31 Station=0,1834 OutputCase=STR165 CaseType=Combination P=-7,3148476789994 V2=3,46625999998242 V3=0 T=0 M2=0 M3=3,87993108812508 FrameElem=31-1 ElemStation=0,1834
Frame=31 Station=0 OutputCase=STR166 CaseType=Combination P=-2,20624457023198 V2=-1,82218151678626E-11 V3=0 T=0 M2=0 M3=5,03796882180106 FrameElem=31-1 ElemStation=0
Frame=31 Station=0,0917 OutputCase=STR166 CaseType=Combination P=-2,20624457023198 V2=-1,73312999998178 V3=0 T=0 M2=0 M3=4,95850481130273 FrameElem=31-1 ElemStation=0,0917
Frame=31 Station=0,1834 OutputCase=STR166 CaseType=Combination P=-2,20624457023198 V2=3,46625999998178 V3=0 T=0 M2=0 M3=4,7201127798044 FrameElem=31-1 ElemStation=0,1834
Frame=31 Station=0 OutputCase=STR167 CaseType=Combination P=-3,17838939209828 V2=-1,08549080835019E-11 V3=0 T=0 M2=0 M3=27,0942162005433 FrameElem=31-1 ElemStation=0
Frame=31 Station=0,0917 OutputCase=STR167 CaseType=Combination P=-3,17838939209828 V2=10,6463699999891 V3=0 T=0 M2=0 M3=26,6060801360443 FrameElem=31-1 ElemStation=0,0917
Frame=31 Station=0,1834 OutputCase=STR167 CaseType=Combination P=-3,17838939209828 V2=21,2927399999891 V3=0 T=0 M2=0 M3=25,1416719425453 FrameElem=31-1 ElemStation=0,1834
Frame=31 Station=0 OutputCase=STR168 CaseType=Combination P=-16,3726423137391 V2=10,3559122333363 V3=0 T=0 M2=0 M3=25,2507626706071 FrameElem=31-1 ElemStation=0
Frame=31 Station=0,0917 OutputCase=STR168 CaseType=Combination P=-16,3726423137391 V2=21,0022822333363 V3=0 T=0 M2=0 M3=23,8129894543102 FrameElem=31-1 ElemStation=0,0917
Frame=31 Station=0,1834 OutputCase=STR168 CaseType=Combination P=-16,3726423137391 V2=31,6486522333363 V3=0 T=0 M2=0 M3=21,3989441090132 FrameElem=31-1 ElemStation=0,1834
Frame=31 Station=0 OutputCase=STR169 CaseType=Combination P=-29,56689523538 V2=-2,49537634999797E-11 V3=0 T=0 M2=0 M3=23,4073091411125 FrameElem=31-1 ElemStation=0
Frame=31 Station=0,0917 OutputCase=STR169 CaseType=Combination P=-29,56689523538 V2=10,6463699999975 V3=0 T=0 M2=0 M3=22,9191730766148 FrameElem=31-1 ElemStation=0,0917
Frame=31 Station=0,1834 OutputCase=STR169 CaseType=Combination P=-29,56689523538 V2=21,2927399999975 V3=0 T=0 M2=0 M3=21,4547648831171 FrameElem=31-1 ElemStation=0,1834
Frame=31 Station=0 OutputCase=STR170 CaseType=Combination P=-15,597578507108 V2=10,3559122333341 V3=0 T=0 M2=0 M3=2,01576892426045 FrameElem=31-1 ElemStation=0
Frame=31 Station=0,0917 OutputCase=STR170 CaseType=Combination P=-15,597578507108 V2=11,6397122333341 V3=0 T=0 M2=0 M3=1,00726954246372 FrameElem=31-1 ElemStation=0,0917
Frame=31 Station=0,1834 OutputCase=STR170 CaseType=Combination P=-15,597578507108 V2=12,9235122333341 V3=0 T=0 M2=0 M3=-0,118954299333017 FrameElem=31-1 ElemStation=0,1834
Frame=31 Station=0 OutputCase=STR171 CaseType=Combination P=-28,7918314287489 V2=-2,72257238975726E-11 V3=0 T=0 M2=0 M3=0,172315394765833 FrameElem=31-1 ElemStation=0
Frame=31 Station=0,0917 OutputCase=STR171 CaseType=Combination P=-28,7918314287489 V2=1,28379999997277 V3=0 T=0 M2=0 M3=0,113453164768329 FrameElem=31-1 ElemStation=0,0917
Frame=31 Station=0,1834 OutputCase=STR171 CaseType=Combination P=-28,7918314287489 V2=2,56759999997277 V3=0 T=0 M2=0 M3=-6,31335252291741E-02 FrameElem=31-1 ElemStation=0,1834
Frame=31 Station=0 OutputCase=STR172 CaseType=Combination P=-7,63765199382953 V2=-0,457681437267335 V3=0 T=0 M2=0 M3=4,0577503046621 FrameElem=31-1 ElemStation=0
Frame=31 Station=0,0917 OutputCase=STR172 CaseType=Combination P=-7,63765199382953 V2=1,27544856273267 V3=0 T=0 M2=0 M3=4,02025568195952 FrameElem=31-1 ElemStation=0,0917
Frame=31 Station=0,1834 OutputCase=STR172 CaseType=Combination P=-7,63765199382953 V2=3,00857856273267 V3=0 T=0 M2=0 M3=3,82383303825693 FrameElem=31-1 ElemStation=0,1834
Frame=31 Station=0 OutputCase=STR173 CaseType=Combination P=-2,52904888506211 V2=-0,457681437267972 V3=0 T=0 M2=0 M3=4,89793199634131 FrameElem=31-1 ElemStation=0
Frame=31 Station=0,0917 OutputCase=STR173 CaseType=Combination P=-2,52904888506211 V2=1,27544856273203 V3=0 T=0 M2=0 M3=4,86043737363878 FrameElem=31-1 ElemStation=0,0917
Frame=31 Station=0,1834 OutputCase=STR173 CaseType=Combination P=-2,52904888506211 V2=3,00857856273203 V3=0 T=0 M2=0 M3=4,66401472993626 FrameElem=31-1 ElemStation=0,1834
Frame=31 Station=0 OutputCase=STR174 CaseType=Combination P=-3,50119370692841 V2=-0,457681437260605 V3=0 T=0 M2=0 M3=26,9541793750835 FrameElem=31-1 ElemStation=0
Frame=31 Station=0,0917 OutputCase=STR174 CaseType=Combination P=-3,50119370692841 V2=10,1886885627394 V3=0 T=0 M2=0 M3=26,5080126983803 FrameElem=31-1 ElemStation=0,0917
Frame=31 Station=0,1834 OutputCase=STR174 CaseType=Combination P=-3,50119370692841 V2=20,8350585627394 V3=0 T=0 M2=0 M3=25,0855738926771 FrameElem=31-1 ElemStation=0,1834
Frame=31 Station=0 OutputCase=STR175 CaseType=Combination P=-16,6954466285693 V2=9,89823079608658 V3=0 T=0 M2=0 M3=25,1107258451474 FrameElem=31-1 ElemStation=0
Frame=31 Station=0,0917 OutputCase=STR175 CaseType=Combination P=-16,6954466285693 V2=20,5446007960866 V3=0 T=0 M2=0 M3=23,7149220166462 FrameElem=31-1 ElemStation=0,0917
Frame=31 Station=0,1834 OutputCase=STR175 CaseType=Combination P=-16,6954466285693 V2=31,1909707960866 V3=0 T=0 M2=0 M3=21,3428460591451 FrameElem=31-1 ElemStation=0,1834
Frame=31 Station=0 OutputCase=STR176 CaseType=Combination P=-29,8896995502102 V2=-0,457681437274704 V3=0 T=0 M2=0 M3=23,2672723156527 FrameElem=31-1 ElemStation=0
Frame=31 Station=0,0917 OutputCase=STR176 CaseType=Combination P=-29,8896995502102 V2=10,1886885627253 V3=0 T=0 M2=0 M3=22,8211056389508 FrameElem=31-1 ElemStation=0,0917
Frame=31 Station=0,1834 OutputCase=STR176 CaseType=Combination P=-29,8896995502102 V2=20,8350585627253 V3=0 T=0 M2=0 M3=21,398668332489 FrameElem=31-1 ElemStation=0,1834
Frame=31 Station=0 OutputCase=STR177 CaseType=Combination P=-15,9203828219381 V2=9,8982307960843 V3=0 T=0 M2=0 M3=1,8757320988007 FrameElem=31-1 ElemStation=0
Frame=31 Station=0,0917 OutputCase=STR177 CaseType=Combination P=-15,9203828219381 V2=11,1820307960843 V3=0 T=0 M2=0 M3=0,909202104799771 FrameElem=31-1 ElemStation=0,0917

Società di Progetto
Brebemi SpA



Doc. N.
60235-00000-A00.doc

CODIFICA DOCUMENTO
04RCDII10000000000300A00

REV.
00

FOGLIO
419 di 628

Frame=31 Station=0,1834 OutputCase=STR177 CaseType=Combination P=-15,9203828219381 V2=12,4658307960843 V3=0 T=0 M2=0 M3=-0,17505234920116
FrameElem=31-1 ElemStation=0,1834
Frame=31 Station=0 OutputCase=STR178 CaseType=Combination P=-29,114635743579 V2=-0,457681437276976 V3=0 T=0 M2=0 M3=3,22785693060854E-02 FrameElem=31-1
ElemStation=0
Frame=31 Station=0,0917 OutputCase=STR178 CaseType=Combination P=-29,114635743579 V2=0,826118562723024 V3=0 T=0 M2=0 M3=0,015385727104384
FrameElem=31-1 ElemStation=0,0917
Frame=31 Station=0,1834 OutputCase=STR178 CaseType=Combination P=-29,114635743579 V2=2,10991856272302 V3=0 T=0 M2=0 M3=-0,119231575097317
FrameElem=31-1 ElemStation=0,1834
Frame=31 Station=0 OutputCase=STR179 CaseType=Combination P=-7,63765199382953 V2=-0,457681437267335 V3=0 T=0 M2=0 M3=4,0577503046621 FrameElem=31-1
ElemStation=0
Frame=31 Station=0,0917 OutputCase=STR179 CaseType=Combination P=-7,63765199382953 V2=1,27544856273267 V3=0 T=0 M2=0 M3=4,02025568195952 FrameElem=31-1
ElemStation=0,0917
Frame=31 Station=0,1834 OutputCase=STR179 CaseType=Combination P=-7,63765199382953 V2=3,00857856273267 V3=0 T=0 M2=0 M3=3,82383303825693 FrameElem=31-1
ElemStation=0,1834
Frame=31 Station=0 OutputCase=STR180 CaseType=Combination P=-8,09539801124728 V2=0,457681437232462 V3=0 T=0 M2=0 M3=3,4223319207461 FrameElem=31-1
ElemStation=0
Frame=31 Station=0,0917 OutputCase=STR180 CaseType=Combination P=-8,09539801124728 V2=2,19081143723246 V3=0 T=0 M2=0 M3=3,30089852245188 FrameElem=31-1
ElemStation=0,0917
Frame=31 Station=0,1834 OutputCase=STR180 CaseType=Combination P=-8,09539801124728 V2=3,92394143723246 V3=0 T=0 M2=0 M3=3,02053710315767 FrameElem=31-1
ElemStation=0,1834
Frame=31 Station=0 OutputCase=STR181 CaseType=Combination P=-2,98679490247986 V2=0,457681437231825 V3=0 T=0 M2=0 M3=4,26251361242531 FrameElem=31-1
ElemStation=0
Frame=31 Station=0,0917 OutputCase=STR181 CaseType=Combination P=-2,98679490247986 V2=2,19081143723183 V3=0 T=0 M2=0 M3=4,14108021413115 FrameElem=31-1
ElemStation=0,0917
Frame=31 Station=0,1834 OutputCase=STR181 CaseType=Combination P=-2,98679490247986 V2=3,92394143723183 V3=0 T=0 M2=0 M3=3,86071879483699 FrameElem=31-1
ElemStation=0,1834
Frame=31 Station=0 OutputCase=STR182 CaseType=Combination P=-3,95893972434616 V2=0,457681437239192 V3=0 T=0 M2=0 M3=26,3187609911675 FrameElem=31-1
ElemStation=0
Frame=31 Station=0,0917 OutputCase=STR182 CaseType=Combination P=-3,95893972434616 V2=11,1040514372392 V3=0 T=0 M2=0 M3=25,7886555388727 FrameElem=31-1
ElemStation=0,0917
Frame=31 Station=0,1834 OutputCase=STR182 CaseType=Combination P=-3,95893972434616 V2=21,7504214372392 V3=0 T=0 M2=0 M3=24,2822779575779 FrameElem=31-1
ElemStation=0,1834
Frame=31 Station=0 OutputCase=STR183 CaseType=Combination P=-17,153192645987 V2=10,8135936705864 V3=0 T=0 M2=0 M3=24,4753074612314 FrameElem=31-1
ElemStation=0
Frame=31 Station=0,0917 OutputCase=STR183 CaseType=Combination P=-17,153192645987 V2=21,4599636705864 V3=0 T=0 M2=0 M3=22,9955648571386 FrameElem=31-1
ElemStation=0,0917
Frame=31 Station=0,1834 OutputCase=STR183 CaseType=Combination P=-17,153192645987 V2=32,1063336705864 V3=0 T=0 M2=0 M3=20,5395501240458 FrameElem=31-1
ElemStation=0,1834
Frame=31 Station=0 OutputCase=STR184 CaseType=Combination P=-30,3474455676279 V2=0,45768143725093 V3=0 T=0 M2=0 M3=22,6318539317367 FrameElem=31-1
ElemStation=0
Frame=31 Station=0,0917 OutputCase=STR184 CaseType=Combination P=-30,3474455676279 V2=11,1040514372251 V3=0 T=0 M2=0 M3=22,1017484794432 FrameElem=31-1
ElemStation=0,0917
Frame=31 Station=0,1834 OutputCase=STR184 CaseType=Combination P=-30,3474455676279 V2=21,7504214372251 V3=0 T=0 M2=0 M3=20,5953708981497 FrameElem=31-1
ElemStation=0,1834
Frame=31 Station=0 OutputCase=STR185 CaseType=Combination P=-16,3781288393559 V2=10,8135936705841 V3=0 T=0 M2=0 M3=1,2403137148847 FrameElem=31-1
ElemStation=0
Frame=31 Station=0,0917 OutputCase=STR185 CaseType=Combination P=-16,3781288393559 V2=12,0973936705841 V3=0 T=0 M2=0 M3=0,189844945292137
FrameElem=31-1 ElemStation=0,0917
Frame=31 Station=0,1834 OutputCase=STR185 CaseType=Combination P=-16,3781288393559 V2=13,3811936705841 V3=0 T=0 M2=0 M3=-0,978348284300425
FrameElem=31-1 ElemStation=0,1834
Frame=31 Station=0 OutputCase=STR186 CaseType=Combination P=-29,5723817609967 V2=0,457681437222821 V3=0 T=0 M2=0 M3=-0,603139814609917 FrameElem=31-1
ElemStation=0
Frame=31 Station=0,0917 OutputCase=STR186 CaseType=Combination P=-29,5723817609967 V2=1,74148143722282 V3=0 T=0 M2=0 M3=-0,70397143240325
FrameElem=31-1 ElemStation=0,0917
Frame=31 Station=0,1834 OutputCase=STR186 CaseType=Combination P=-29,5723817609967 V2=3,02528143722282 V3=0 T=0 M2=0 M3=-0,922527510196582
FrameElem=31-1 ElemStation=0,1834
Frame=31 Station=0 OutputCase=STR187 CaseType=Combination P=-8,09539801124728 V2=0,457681437232462 V3=0 T=0 M2=0 M3=3,4223319207461 FrameElem=31-1
ElemStation=0
Frame=31 Station=0,0917 OutputCase=STR187 CaseType=Combination P=-8,09539801124728 V2=2,19081143723246 V3=0 T=0 M2=0 M3=3,30089852245188 FrameElem=31-1
ElemStation=0,0917
Frame=31 Station=0,1834 OutputCase=STR187 CaseType=Combination P=-8,09539801124728 V2=3,92394143723246 V3=0 T=0 M2=0 M3=3,02053710315767 FrameElem=31-1
ElemStation=0,1834
Frame=31 Station=0 OutputCase=INVSTR CaseType=Combination StepType=Max P=-2,20624457023198 V2=30,1835064600925 V3=0 T=0 M2=0 M3=33,6833886310945
FrameElem=31-1 ElemStation=0
Frame=31 Station=0,0917 OutputCase=INVSTR CaseType=Combination StepType=Max P=-2,20624457023198 V2=40,8298764600925 V3=0 T=0 M2=0
M3=33,0590285485952 FrameElem=31-1 ElemStation=0,0917
Frame=31 Station=0,1834 OutputCase=INVSTR CaseType=Combination StepType=Max P=-2,20624457023198 V2=51,4762464600925 V3=0 T=0 M2=0
M3=31,1859483010959 FrameElem=31-1 ElemStation=0,1834
Frame=31 Station=0 OutputCase=INVSTR CaseType=Combination StepType=Min P=-39,0070612738166 V2=-0,762802395443476 V3=0 T=0 M2=0 M3=-2,45499512501644
FrameElem=31-1 ElemStation=0
Frame=31 Station=0,0917 OutputCase=INVSTR CaseType=Combination StepType=Min P=-39,0070612738166 V2=0,520997604556524 V3=0 T=0 M2=0 M3=-
2,51385735501354 FrameElem=31-1 ElemStation=0,0917
Frame=31 Station=0,1834 OutputCase=INVSTR CaseType=Combination StepType=Min P=-39,0070612738166 V2=1,80479760455652 V3=0 T=0 M2=0 M3=-
2,79007503022233 FrameElem=31-1 ElemStation=0,1834
Frame=31 Station=0 OutputCase=SIS01 CaseType=Combination P=-9,48999884882627 V2=5,65432027717343 V3=0 T=0 M2=0 M3=1,71712968208321 FrameElem=31-1
ElemStation=0
Frame=31 Station=0,0917 OutputCase=SIS01 CaseType=Combination P=-9,77518584882627 V2=6,89520467717343 V3=0 T=0 M2=0 M3=1,14173396292641 FrameElem=31-1
ElemStation=0,0917
Frame=31 Station=0,1834 OutputCase=SIS01 CaseType=Combination P=-10,0603728488263 V2=8,13608907717343 V3=0 T=0 M2=0 M3=0,452549144289607 FrameElem=31-1
ElemStation=0,1834
Frame=31 Station=0 OutputCase=SIS02 CaseType=Combination P=-9,87310810128391 V2=5,65432027717353 V3=0 T=0 M2=0 M3=1,39925053032089 FrameElem=31-1
ElemStation=0
Frame=31 Station=0,0917 OutputCase=SIS02 CaseType=Combination P=-10,1582951012839 V2=6,89520467717353 V3=0 T=0 M2=0 M3=0,823854784164076 FrameElem=31-1
ElemStation=0,0917
Frame=31 Station=0,1834 OutputCase=SIS02 CaseType=Combination P=-10,4434821012839 V2=8,13608907717353 V3=0 T=0 M2=0 M3=0,134669965527263 FrameElem=31-1
ElemStation=0,1834
Frame=31 Station=0 OutputCase=SIS03 CaseType=Combination P=-9,10688959636863 V2=5,65432027717333 V3=0 T=0 M2=0 M3=2,03500886084554 FrameElem=31-1
ElemStation=0

Società di Progetto
Brebemi SpA



Doc. N.
60235-0000-A00.doc

CODIFICA DOCUMENTO
04RCDII10000000000300A00

REV.
00

FOGLIO
420 di 628

Frame=31 Station=0,0917 OutputCase=SIS03 CaseType=Combination P=-9,39207659636863 V2=6,89520467717333 V3=0 T=0 M2=0 M3=1,45961314168875 FrameElem=31-1
ElemStation=0,0917
Frame=31 Station=0,1834 OutputCase=SIS03 CaseType=Combination P=-9,67726359636863 V2=8,13608907717333 V3=0 T=0 M2=0 M3=0,770428323051952 FrameElem=31-1
ElemStation=0,1834
Frame=31 Station=0 OutputCase=SIS04 CaseType=Combination P=-9,33105925944511 V2=5,33648594574989 V3=0 T=0 M2=0 M3=1,93776106538738 FrameElem=31-1
ElemStation=0
Frame=31 Station=0,0917 OutputCase=SIS04 CaseType=Combination P=-9,61624625944511 V2=6,57737034574989 V3=0 T=0 M2=0 M3=1,39151075442212 FrameElem=31-1
ElemStation=0,0917
Frame=31 Station=0,1834 OutputCase=SIS04 CaseType=Combination P=-9,90143325944511 V2=7,81825474574989 V3=0 T=0 M2=0 M3=0,731471343976852 FrameElem=31-1
ElemStation=0,1834
Frame=31 Station=0 OutputCase=SIS05 CaseType=Combination P=-9,64893843820743 V2=5,97215460859697 V3=0 T=0 M2=0 M3=1,49649829877905 FrameElem=31-1
ElemStation=0
Frame=31 Station=0,0917 OutputCase=SIS05 CaseType=Combination P=-9,93412543820743 V2=7,2130900859697 V3=0 T=0 M2=0 M3=0,891957171430704 FrameElem=31-1
ElemStation=0,0917
Frame=31 Station=0,1834 OutputCase=SIS05 CaseType=Combination P=-10,2193124382074 V2=8,45392340859697 V3=0 T=0 M2=0 M3=0,173626944602363 FrameElem=31-1
ElemStation=0,1834
Frame=31 Station=0 OutputCase=SIS06 CaseType=Combination P=-9,10688959636863 V2=5,65432027717333 V3=0 T=0 M2=0 M3=2,03500886084554 FrameElem=31-1
ElemStation=0
Frame=31 Station=0,0917 OutputCase=SIS06 CaseType=Combination P=-9,39207659636863 V2=6,89520467717333 V3=0 T=0 M2=0 M3=1,45961314168875 FrameElem=31-1
ElemStation=0,0917
Frame=31 Station=0,1834 OutputCase=SIS06 CaseType=Combination P=-9,67726359636863 V2=8,13608907717333 V3=0 T=0 M2=0 M3=0,770428323051952 FrameElem=31-1
ElemStation=0,1834
Frame=31 Station=0 OutputCase=SIS07 CaseType=Combination P=-9,71416851190275 V2=5,33648594574999 V3=0 T=0 M2=0 M3=1,6198818862506 FrameElem=31-1
ElemStation=0
Frame=31 Station=0,0917 OutputCase=SIS07 CaseType=Combination P=-9,99935551190275 V2=6,57737034574999 V3=0 T=0 M2=0 M3=1,07363157565978 FrameElem=31-1
ElemStation=0,0917
Frame=31 Station=0,1834 OutputCase=SIS07 CaseType=Combination P=-10,2845425119027 V2=7,81825474574999 V3=0 T=0 M2=0 M3=0,413592165214508 FrameElem=31-1
ElemStation=0,1834
Frame=31 Station=0 OutputCase=SIS08 CaseType=Combination P=-10,0320476906651 V2=5,97215460859707 V3=0 T=0 M2=0 M3=1,17861912001672 FrameElem=31-1
ElemStation=0
Frame=31 Station=0,0917 OutputCase=SIS08 CaseType=Combination P=-10,3172346906651 V2=7,2130900859707 V3=0 T=0 M2=0 M3=0,574077992668369 FrameElem=31-1
ElemStation=0,0917
Frame=31 Station=0,1834 OutputCase=SIS08 CaseType=Combination P=-10,6024216906651 V2=8,45392340859707 V3=0 T=0 M2=0 M3=0,144252234159982 FrameElem=31-1
ElemStation=0,1834
Frame=31 Station=0 OutputCase=SIS09 CaseType=Combination P=-9,48999884882627 V2=5,65432027717343 V3=0 T=0 M2=0 M3=1,71712968208321 FrameElem=31-1
ElemStation=0
Frame=31 Station=0,0917 OutputCase=SIS09 CaseType=Combination P=-9,77518584882627 V2=6,89520467717343 V3=0 T=0 M2=0 M3=1,14173396292641 FrameElem=31-1
ElemStation=0,0917
Frame=31 Station=0,1834 OutputCase=SIS09 CaseType=Combination P=-10,0603728488263 V2=8,13608907717343 V3=0 T=0 M2=0 M3=0,452549144289607 FrameElem=31-1
ElemStation=0,1834
Frame=31 Station=0 OutputCase=SIS10 CaseType=Combination P=-9,44922777759577 V2=5,65432027717561 V3=0 T=0 M2=0 M3=1,94314317996618 FrameElem=31-1
ElemStation=0
Frame=31 Station=0,0917 OutputCase=SIS10 CaseType=Combination P=-9,73441477759577 V2=6,98103587717561 V3=0 T=0 M2=0 M3=1,36381210028918 FrameElem=31-1
ElemStation=0,0917
Frame=31 Station=0,1834 OutputCase=SIS10 CaseType=Combination P=-10,0196017775958 V2=8,30775147717561 V3=0 T=0 M2=0 M3=0,662821200092175 FrameElem=31-1
ElemStation=0,1834
Frame=31 Station=0 OutputCase=SIS11 CaseType=Combination P=-9,83233703005341 V2=5,65432027717571 V3=0 T=0 M2=0 M3=1,62526400120386 FrameElem=31-1
ElemStation=0
Frame=31 Station=0,0917 OutputCase=SIS11 CaseType=Combination P=-10,1175240300534 V2=6,98103587717571 V3=0 T=0 M2=0 M3=1,04593292152684 FrameElem=31-1
ElemStation=0,0917
Frame=31 Station=0,1834 OutputCase=SIS11 CaseType=Combination P=-10,4027110300534 V2=8,30775147717572 V3=0 T=0 M2=0 M3=0,344942021329831 FrameElem=31-1
ElemStation=0,1834
Frame=31 Station=0 OutputCase=SIS12 CaseType=Combination P=-9,06611852513812 V2=5,65432027717551 V3=0 T=0 M2=0 M3=2,26102235872851 FrameElem=31-1
ElemStation=0
Frame=31 Station=0,0917 OutputCase=SIS12 CaseType=Combination P=-9,35130552513813 V2=6,98103587717551 V3=0 T=0 M2=0 M3=1,68169127905151 FrameElem=31-1
ElemStation=0,0917
Frame=31 Station=0,1834 OutputCase=SIS12 CaseType=Combination P=-9,63649252513812 V2=8,30775147717551 V3=0 T=0 M2=0 M3=0,98070037885452 FrameElem=31-1
ElemStation=0,1834
Frame=31 Station=0 OutputCase=SIS13 CaseType=Combination P=-9,29028818821461 V2=5,33648594575207 V3=0 T=0 M2=0 M3=2,16377456327035 FrameElem=31-1
ElemStation=0
Frame=31 Station=0,0917 OutputCase=SIS13 CaseType=Combination P=-9,57547518821461 V2=6,66320154575207 V3=0 T=0 M2=0 M3=1,61358889178488 FrameElem=31-1
ElemStation=0,0917
Frame=31 Station=0,1834 OutputCase=SIS13 CaseType=Combination P=-9,8606621882146 V2=7,98991714575207 V3=0 T=0 M2=0 M3=0,94174339977942 FrameElem=31-1
ElemStation=0,1834
Frame=31 Station=0 OutputCase=SIS14 CaseType=Combination P=-9,60816736697693 V2=5,97215460859915 V3=0 T=0 M2=0 M3=1,72251179666201 FrameElem=31-1
ElemStation=0
Frame=31 Station=0,0917 OutputCase=SIS14 CaseType=Combination P=-9,89335436697693 V2=7,29887020859915 V3=0 T=0 M2=0 M3=1,11403530879347 FrameElem=31-1
ElemStation=0,0917
Frame=31 Station=0,1834 OutputCase=SIS14 CaseType=Combination P=-10,1785413669769 V2=8,62558580859915 V3=0 T=0 M2=0 M3=0,383899000404931 FrameElem=31-1
ElemStation=0,1834
Frame=31 Station=0 OutputCase=SIS15 CaseType=Combination P=-9,06611852513812 V2=5,65432027717551 V3=0 T=0 M2=0 M3=2,26102235872851 FrameElem=31-1
ElemStation=0
Frame=31 Station=0,0917 OutputCase=SIS15 CaseType=Combination P=-9,35130552513813 V2=6,98103587717551 V3=0 T=0 M2=0 M3=1,68169127905151 FrameElem=31-1
ElemStation=0,0917
Frame=31 Station=0,1834 OutputCase=SIS15 CaseType=Combination P=-9,63649252513812 V2=8,30775147717551 V3=0 T=0 M2=0 M3=0,98070037885452 FrameElem=31-1
ElemStation=0,1834
Frame=31 Station=0 OutputCase=SIS16 CaseType=Combination P=-9,67339744067225 V2=5,33648594575217 V3=0 T=0 M2=0 M3=1,84589538450802 FrameElem=31-1
ElemStation=0
Frame=31 Station=0,0917 OutputCase=SIS16 CaseType=Combination P=-9,95858444067225 V2=6,66320154575217 V3=0 T=0 M2=0 M3=1,29570971302255 FrameElem=31-1
ElemStation=0,0917
Frame=31 Station=0,1834 OutputCase=SIS16 CaseType=Combination P=-10,2437714406722 V2=7,98991714575217 V3=0 T=0 M2=0 M3=0,623864221017076 FrameElem=31-1
ElemStation=0,1834
Frame=31 Station=0 OutputCase=SIS17 CaseType=Combination P=-9,99127661943457 V2=5,97215460859926 V3=0 T=0 M2=0 M3=1,40463261789969 FrameElem=31-1
ElemStation=0
Frame=31 Station=0,0917 OutputCase=SIS17 CaseType=Combination P=-10,2764636194346 V2=7,29887020859926 V3=0 T=0 M2=0 M3=0,796156130031138 FrameElem=31-1
ElemStation=0,0917
Frame=31 Station=0,1834 OutputCase=SIS17 CaseType=Combination P=-10,5616506194346 V2=8,62558580859926 V3=0 T=0 M2=0 M3=6,60198216425858E-02
FrameElem=31-1 ElemStation=0,1834

Società di Progetto
Brebemi SpA



Doc. N.
60235-0000-A00.doc

CODIFICA DOCUMENTO
04RCDII10000000000300A00

REV.
00

FOGLIO
421 di 628

Frame=31 Station=0 OutputCase=SIS18 CaseType=Combination P=-9,4492277759577 V2=5,65432027717561 V3=0 T=0 M2=0 M3=1,94314317996618 FrameElem=31-1
ElemStation=0
Frame=31 Station=0,0917 OutputCase=SIS18 CaseType=Combination P=-9,73441477759577 V2=6,98103587717561 V3=0 T=0 M2=0 M3=1,36381210028918 FrameElem=31-1
ElemStation=0,0917
Frame=31 Station=0,1834 OutputCase=SIS18 CaseType=Combination P=-10,0196017775958 V2=8,30775147717561 V3=0 T=0 M2=0 M3=0,662821200092175 FrameElem=31-1
ElemStation=0,1834
Frame=31 Station=0 OutputCase=SIS19 CaseType=Combination P=-9,53756509859519 V2=3,37677337577097 V3=0 T=0 M2=0 M3=1,45344726791029 FrameElem=31-1
ElemStation=0
Frame=31 Station=0,0917 OutputCase=SIS19 CaseType=Combination P=-9,62312119859519 V2=4,51752137577097 V3=0 T=0 M2=0 M3=1,09149385355209 FrameElem=31-1
ElemStation=0,0917
Frame=31 Station=0,1834 OutputCase=SIS19 CaseType=Combination P=-9,70867729859519 V2=5,65826937577097 V3=0 T=0 M2=0 M3=0,624933847593896 FrameElem=31-1
ElemStation=0,1834
Frame=31 Station=0 OutputCase=SIS20 CaseType=Combination P=-9,92067435105283 V2=3,37677337577108 V3=0 T=0 M2=0 M3=1,13556808914797 FrameElem=31-1
ElemStation=0
Frame=31 Station=0,0917 OutputCase=SIS20 CaseType=Combination P=-10,0062304510528 V2=4,51752137577108 V3=0 T=0 M2=0 M3=0,773614674789759 FrameElem=31-1
ElemStation=0,0917
Frame=31 Station=0,1834 OutputCase=SIS20 CaseType=Combination P=-10,0917865510528 V2=5,65826937577108 V3=0 T=0 M2=0 M3=0,307054668831551 FrameElem=31-1
ElemStation=0,1834
Frame=31 Station=0 OutputCase=SIS21 CaseType=Combination P=-9,15445584613754 V2=3,37677337577087 V3=0 T=0 M2=0 M3=1,77132644667262 FrameElem=31-1
ElemStation=0
Frame=31 Station=0,0917 OutputCase=SIS21 CaseType=Combination P=-9,24001194613754 V2=4,51752137577087 V3=0 T=0 M2=0 M3=1,40937303231443 FrameElem=31-1
ElemStation=0,0917
Frame=31 Station=0,1834 OutputCase=SIS21 CaseType=Combination P=-9,32556804613754 V2=5,65826937577087 V3=0 T=0 M2=0 M3=0,94281302635624 FrameElem=31-1
ElemStation=0,1834
Frame=31 Station=0 OutputCase=SIS22 CaseType=Combination P=-9,37862550921402 V2=3,05893904434743 V3=0 T=0 M2=0 M3=1,67407865121446 FrameElem=31-1
ElemStation=0
Frame=31 Station=0,0917 OutputCase=SIS22 CaseType=Combination P=-9,46418160921402 V2=4,19968704434743 V3=0 T=0 M2=0 M3=1,3412706450478 FrameElem=31-1
ElemStation=0,0917
Frame=31 Station=0,1834 OutputCase=SIS22 CaseType=Combination P=-9,54973770921402 V2=5,34043504434743 V3=0 T=0 M2=0 M3=0,90385604728114 FrameElem=31-1
ElemStation=0,1834
Frame=31 Station=0 OutputCase=SIS23 CaseType=Combination P=-9,69650468797635 V2=3,69460770719451 V3=0 T=0 M2=0 M3=1,23281588460612 FrameElem=31-1
ElemStation=0
Frame=31 Station=0,0917 OutputCase=SIS23 CaseType=Combination P=-9,78206078797635 V2=4,83535570719451 V3=0 T=0 M2=0 M3=0,841717062056387 FrameElem=31-1
ElemStation=0,0917
Frame=31 Station=0,1834 OutputCase=SIS23 CaseType=Combination P=-9,86761688797635 V2=5,97610370719451 V3=0 T=0 M2=0 M3=0,346011647906651 FrameElem=31-1
ElemStation=0,1834
Frame=31 Station=0 OutputCase=SIS24 CaseType=Combination P=-9,15445584613754 V2=3,37677337577087 V3=0 T=0 M2=0 M3=1,77132644667262 FrameElem=31-1
ElemStation=0
Frame=31 Station=0,0917 OutputCase=SIS24 CaseType=Combination P=-9,24001194613754 V2=4,51752137577087 V3=0 T=0 M2=0 M3=1,40937303231443 FrameElem=31-1
ElemStation=0,0917
Frame=31 Station=0,1834 OutputCase=SIS24 CaseType=Combination P=-9,32556804613754 V2=5,65826937577087 V3=0 T=0 M2=0 M3=0,94281302635624 FrameElem=31-1
ElemStation=0,1834
Frame=31 Station=0 OutputCase=SIS25 CaseType=Combination P=-9,76173476167167 V2=3,05893904434753 V3=0 T=0 M2=0 M3=1,35619947245213 FrameElem=31-1
ElemStation=0
Frame=31 Station=0,0917 OutputCase=SIS25 CaseType=Combination P=-9,84729086167167 V2=4,19968704434753 V3=0 T=0 M2=0 M3=1,02339146628546 FrameElem=31-1
ElemStation=0,0917
Frame=31 Station=0,1834 OutputCase=SIS25 CaseType=Combination P=-9,93284696167167 V2=5,34043504434753 V3=0 T=0 M2=0 M3=0,5859766868518796 FrameElem=31-1
ElemStation=0,1834
Frame=31 Station=0 OutputCase=SIS26 CaseType=Combination P=-10,079613940434 V2=3,69460770719462 V3=0 T=0 M2=0 M3=0,914936705843799 FrameElem=31-1
ElemStation=0
Frame=31 Station=0,0917 OutputCase=SIS26 CaseType=Combination P=-10,165170040434 V2=4,83535570719462 V3=0 T=0 M2=0 M3=0,523837883294053 FrameElem=31-1
ElemStation=0,0917
Frame=31 Station=0,1834 OutputCase=SIS26 CaseType=Combination P=-10,250726140434 V2=5,97610370719462 V3=0 T=0 M2=0 M3=2,81324691443063E-02
FrameElem=31-1 ElemStation=0,1834
Frame=31 Station=0 OutputCase=SIS27 CaseType=Combination P=-9,53756509859519 V2=3,37677337577097 V3=0 T=0 M2=0 M3=1,45344726791029 FrameElem=31-1
ElemStation=0
Frame=31 Station=0,0917 OutputCase=SIS27 CaseType=Combination P=-9,62312119859519 V2=4,51752137577097 V3=0 T=0 M2=0 M3=1,09149385355209 FrameElem=31-1
ElemStation=0,0917
Frame=31 Station=0,1834 OutputCase=SIS27 CaseType=Combination P=-9,70867729859519 V2=5,65826937577097 V3=0 T=0 M2=0 M3=0,624933847593896 FrameElem=31-1
ElemStation=0,1834
Frame=31 Station=0 OutputCase=SIS28 CaseType=Combination P=-9,40166152782685 V2=3,37677337577825 V3=0 T=0 M2=0 M3=2,20682559418685 FrameElem=31-1
ElemStation=0
Frame=31 Station=0,0917 OutputCase=SIS28 CaseType=Combination P=-9,48721762782685 V2=4,80362537577825 V3=0 T=0 M2=0 M3=1,83175431142799 FrameElem=31-1
ElemStation=0,0917
Frame=31 Station=0,1834 OutputCase=SIS28 CaseType=Combination P=-9,57277372782685 V2=6,23047737577825 V3=0 T=0 M2=0 M3=1,32584070026912 FrameElem=31-1
ElemStation=0,1834
Frame=31 Station=0 OutputCase=SIS29 CaseType=Combination P=-9,78477078028449 V2=3,37677337577835 V3=0 T=0 M2=0 M3=1,88894641542453 FrameElem=31-1
ElemStation=0
Frame=31 Station=0,0917 OutputCase=SIS29 CaseType=Combination P=-9,87032688028449 V2=4,80362537577835 V3=0 T=0 M2=0 M3=1,51387513266565 FrameElem=31-1
ElemStation=0,0917
Frame=31 Station=0,1834 OutputCase=SIS29 CaseType=Combination P=-9,95588298028449 V2=6,23047737577835 V3=0 T=0 M2=0 M3=1,00796152150678 FrameElem=31-1
ElemStation=0,1834
Frame=31 Station=0 OutputCase=SIS30 CaseType=Combination P=-9,01855227536921 V2=3,37677337577815 V3=0 T=0 M2=0 M3=2,52470477294918 FrameElem=31-1
ElemStation=0
Frame=31 Station=0,0917 OutputCase=SIS30 CaseType=Combination P=-9,10410837536921 V2=4,80362537577814 V3=0 T=0 M2=0 M3=2,14963349019032 FrameElem=31-1
ElemStation=0,0917
Frame=31 Station=0,1834 OutputCase=SIS30 CaseType=Combination P=-9,18966447536921 V2=6,23047737577815 V3=0 T=0 M2=0 M3=1,64371987903147 FrameElem=31-1
ElemStation=0,1834
Frame=31 Station=0 OutputCase=SIS31 CaseType=Combination P=-9,24272193844569 V2=3,05893904435471 V3=0 T=0 M2=0 M3=2,42745697749102 FrameElem=31-1
ElemStation=0
Frame=31 Station=0,0917 OutputCase=SIS31 CaseType=Combination P=-9,32827803844569 V2=4,48579104435471 V3=0 T=0 M2=0 M3=2,08153110292369 FrameElem=31-1
ElemStation=0,0917
Frame=31 Station=0,1834 OutputCase=SIS31 CaseType=Combination P=-9,41383413844569 V2=5,91264304435471 V3=0 T=0 M2=0 M3=1,60476289995637 FrameElem=31-1
ElemStation=0,1834
Frame=31 Station=0 OutputCase=SIS32 CaseType=Combination P=-9,56060111720801 V2=3,69460770720179 V3=0 T=0 M2=0 M3=1,98619421088269 FrameElem=31-1
ElemStation=0
Frame=31 Station=0,0917 OutputCase=SIS32 CaseType=Combination P=-9,64615721720801 V2=5,12145970720179 V3=0 T=0 M2=0 M3=1,58197751993228 FrameElem=31-1
ElemStation=0,0917

Società di Progetto
Brebemi SpA



Doc. N.
60235-0000-A00.doc

CODIFICA DOCUMENTO
04RCDII10000000000300A00

REV.
00

FOGLIO
422 di 628

Frame=31 Station=0,1834 OutputCase=SIS32 CaseType=Combination P=-9,73171331720801 V2=6,54831170720179 V3=0 T=0 M2=0 M3=1,04681580058188 FrameElem=31-1 ElemStation=0,1834

Frame=31 Station=0 OutputCase=SIS33 CaseType=Combination P=-9,01855227536921 V2=3,37677337577815 V3=0 T=0 M2=0 M3=2,52470477294918 FrameElem=31-1 ElemStation=0

Frame=31 Station=0,0917 OutputCase=SIS33 CaseType=Combination P=-9,10410837536921 V2=4,80362537577814 V3=0 T=0 M2=0 M3=2,14963349019032 FrameElem=31-1 ElemStation=0,0917

Frame=31 Station=0,1834 OutputCase=SIS33 CaseType=Combination P=-9,18966447536921 V2=6,23047737577815 V3=0 T=0 M2=0 M3=1,64371987903147 FrameElem=31-1 ElemStation=0,1834

Frame=31 Station=0 OutputCase=SIS34 CaseType=Combination P=-9,62583119090333 V2=3,05893904435481 V3=0 T=0 M2=0 M3=2,1095777987287 FrameElem=31-1 ElemStation=0

Frame=31 Station=0,0917 OutputCase=SIS34 CaseType=Combination P=-9,71138729090333 V2=4,48579104435481 V3=0 T=0 M2=0 M3=1,76365192416136 FrameElem=31-1 ElemStation=0,0917

Frame=31 Station=0,1834 OutputCase=SIS34 CaseType=Combination P=-9,79694339090333 V2=5,91264304435481 V3=0 T=0 M2=0 M3=1,28688372119402 FrameElem=31-1 ElemStation=0,1834

Frame=31 Station=0 OutputCase=SIS35 CaseType=Combination P=-9,94371036966566 V2=3,69460770720189 V3=0 T=0 M2=0 M3=1,66831503212036 FrameElem=31-1 ElemStation=0

Frame=31 Station=0,0917 OutputCase=SIS35 CaseType=Combination P=-10,0292664696657 V2=5,12145970720189 V3=0 T=0 M2=0 M3=1,26409834116995 FrameElem=31-1 ElemStation=0,0917

Frame=31 Station=0,1834 OutputCase=SIS35 CaseType=Combination P=-10,1148225696657 V2=6,54831170720189 V3=0 T=0 M2=0 M3=0,729039321819533 FrameElem=31-1 ElemStation=0,1834

Frame=31 Station=0 OutputCase=SIS36 CaseType=Combination P=-9,40166152782685 V2=3,37677337577825 V3=0 T=0 M2=0 M3=2,20682559418685 FrameElem=31-1 ElemStation=0

Frame=31 Station=0,0917 OutputCase=SIS36 CaseType=Combination P=-9,4872162782685 V2=4,80362537577825 V3=0 T=0 M2=0 M3=1,83175431142799 FrameElem=31-1 ElemStation=0,0917

Frame=31 Station=0,1834 OutputCase=SIS36 CaseType=Combination P=-9,57277372782685 V2=6,23047737577825 V3=0 T=0 M2=0 M3=1,32584070026912 FrameElem=31-1 ElemStation=0,1834

Frame=31 Station=0 OutputCase=INVSIS CaseType=Combination StepType=Max P=-9,01855227536921 V2=5,97215460859926 V3=0 T=0 M2=0 M3=2,52470477294918 FrameElem=31-1 ElemStation=0

Frame=31 Station=0,0917 OutputCase=INVSIS CaseType=Combination StepType=Max P=-9,10410837536921 V2=7,29887020859926 V3=0 T=0 M2=0 M3=2,14963349019032 FrameElem=31-1 ElemStation=0,0917

Frame=31 Station=0,1834 OutputCase=INVSIS CaseType=Combination StepType=Max P=-9,18966447536921 V2=8,62558580859926 V3=0 T=0 M2=0 M3=1,64371987903147 FrameElem=31-1 ElemStation=0,1834

Frame=31 Station=0 OutputCase=INVSIS CaseType=Combination StepType=Min P=-10,079613940434 V2=3,05893904434743 V3=0 T=0 M2=0 M3=0,914936705843799 FrameElem=31-1 ElemStation=0

Frame=31 Station=0,0917 OutputCase=INVSIS CaseType=Combination StepType=Min P=-10,3172346906651 V2=4,19968704434743 V3=0 T=0 M2=0 M3=0,523837883294053 FrameElem=31-1 ElemStation=0,0917

Frame=31 Station=0,1834 OutputCase=INVSIS CaseType=Combination StepType=Min P=-10,6024216906651 V2=5,34043504434743 V3=0 T=0 M2=0 M3=0,144252234159982 FrameElem=31-1 ElemStation=0,1834

Frame=31 Station=0 OutputCase=RAR001 CaseType=Combination P=-6,50813867291611 V2=-1,2732925824821E-11 V3=0 T=0 M2=0 M3=2,20528228420335 FrameElem=31-1 ElemStation=0

Frame=31 Station=0,0917 OutputCase=RAR001 CaseType=Combination P=-6,50813867291611 V2=1,28379999998727 V3=0 T=0 M2=0 M3=2,14642005420452 FrameElem=31-1 ElemStation=0,0917

Frame=31 Station=0,1834 OutputCase=RAR001 CaseType=Combination P=-6,50813867291611 V2=2,56759999998727 V3=0 T=0 M2=0 M3=1,96983336420568 FrameElem=31-1 ElemStation=0,1834

Frame=31 Station=0 OutputCase=RAR002 CaseType=Combination P=-4,83460814884648 V2=-5,45696821063757E-12 V3=0 T=0 M2=0 M3=24,4225144361367 FrameElem=31-1 ElemStation=0

Frame=31 Station=0,0917 OutputCase=RAR002 CaseType=Combination P=-4,83460814884648 V2=10,0869999999945 V3=0 T=0 M2=0 M3=23,9600254861372 FrameElem=31-1 ElemStation=0,0917

Frame=31 Station=0,1834 OutputCase=RAR002 CaseType=Combination P=-4,83460814884648 V2=20,1739999999945 V3=0 T=0 M2=0 M3=22,5725586361377 FrameElem=31-1 ElemStation=0,1834

Frame=31 Station=0 OutputCase=RAR003 CaseType=Combination P=-16,6600388708223 V2=9,34114409304038 V3=0 T=0 M2=0 M3=22,8000820691085 FrameElem=31-1 ElemStation=0

Frame=31 Station=0,0917 OutputCase=RAR003 CaseType=Combination P=-16,6600388708223 V2=19,4281440930404 V3=0 T=0 M2=0 M3=21,4810102057767 FrameElem=31-1 ElemStation=0,0917

Frame=31 Station=0,1834 OutputCase=RAR003 CaseType=Combination P=-16,6600388708223 V2=29,5151440930404 V3=0 T=0 M2=0 M3=19,2369604424449 FrameElem=31-1 ElemStation=0,1834

Frame=31 Station=0 OutputCase=RAR004 CaseType=Combination P=-28,4854695927982 V2=-2,00088834390044E-11 V3=0 T=0 M2=0 M3=21,1776497024657 FrameElem=31-1 ElemStation=0

Frame=31 Station=0,0917 OutputCase=RAR004 CaseType=Combination P=-28,4854695927982 V2=10,08699999998 V3=0 T=0 M2=0 M3=20,7151607524676 FrameElem=31-1 ElemStation=0,0917

Frame=31 Station=0,1834 OutputCase=RAR004 CaseType=Combination P=-28,4854695927982 V2=20,17399999998 V3=0 T=0 M2=0 M3=19,3276939024694 FrameElem=31-1 ElemStation=0,1834

Frame=31 Station=0 OutputCase=RAR005 CaseType=Combination P=-15,6998958368803 V2=9,34114409303311 V3=0 T=0 M2=0 M3=1,01613404072111 FrameElem=31-1 ElemStation=0

Frame=31 Station=0,0917 OutputCase=RAR005 CaseType=Combination P=-15,6998958368803 V2=10,6249440930331 V3=0 T=0 M2=0 M3=0,100688897389976 FrameElem=31-1 ElemStation=0,0917

Frame=31 Station=0,1834 OutputCase=RAR005 CaseType=Combination P=-15,6998958368803 V2=11,9087440930331 V3=0 T=0 M2=0 M3=-0,93248070594116 FrameElem=31-1 ElemStation=0,1834

Frame=31 Station=0 OutputCase=RAR006 CaseType=Combination P=-27,5253265588562 V2=-2,72848410531878E-11 V3=0 T=0 M2=0 M3=-0,606298325921671 FrameElem=31-1 ElemStation=0

Frame=31 Station=0,0917 OutputCase=RAR006 CaseType=Combination P=-27,5253265588562 V2=1,28379999997271 V3=0 T=0 M2=0 M3=-0,665160555919169 FrameElem=31-1 ElemStation=0,0917

Frame=31 Station=0,1834 OutputCase=RAR006 CaseType=Combination P=-27,5253265588562 V2=2,56759999997272 V3=0 T=0 M2=0 M3=-0,841747245916667 FrameElem=31-1 ElemStation=0,1834

Frame=31 Station=0 OutputCase=RAR007 CaseType=Combination P=-13,7928546265943 V2=21,5959910843767 V3=0 T=0 M2=0 M3=17,7055426381984 FrameElem=31-1 ElemStation=0

Frame=31 Station=0,0917 OutputCase=RAR007 CaseType=Combination P=-15,3242446265943 V2=29,4821910843767 V3=0 T=0 M2=0 M3=15,363607985761 FrameElem=31-1 ElemStation=0,0917

Frame=31 Station=0,1834 OutputCase=RAR007 CaseType=Combination P=-16,8556346265943 V2=37,3683910843767 V3=0 T=0 M2=0 M3=12,2985087933237 FrameElem=31-1 ElemStation=0,1834

Frame=31 Station=0 OutputCase=RAR008 CaseType=Combination P=-4,64068361981975 V2=-1,25268684314506E-11 V3=0 T=0 M2=0 M3=2,00280805022464 FrameElem=31-1 ElemStation=0

Frame=31 Station=0,0917 OutputCase=RAR008 CaseType=Combination P=-4,64068361981975 V2=1,28379999998747 V3=0 T=0 M2=0 M3=1,94394582022579 FrameElem=31-1 ElemStation=0,0917

Frame=31 Station=0,1834 OutputCase=RAR008 CaseType=Combination P=-4,64068361981975 V2=2,56759999998747 V3=0 T=0 M2=0 M3=1,76735913022694 FrameElem=31-1 ElemStation=0,1834

Frame=31 Station=0 OutputCase=RAR009 CaseType=Combination P=-5,29433925179565 V2=-5,33333377461531E-12 V3=0 T=0 M2=0 M3=24,0410594216219 FrameElem=31-1 ElemStation=0

APPROVATO S.D.P.
Società di Progetto
Brebemi SpA



Doc. N.
60235-0000-A00.doc

CODIFICA DOCUMENTO
04RCDII10000000000300A00

REV.
00

FOGLIO
423 di 628

Frame=31 Station=0,0917 OutputCase=RAR009 CaseType=Combination P=-5,29433925179565 V2=10,08699999999947 V3=0 T=0 M2=0 M3=23,5785704716224
FrameElem=31-1 ElemStation=0,0917
Frame=31 Station=0,1834 OutputCase=RAR009 CaseType=Combination P=-5,29433925179565 V2=20,17399999999947 V3=0 T=0 M2=0 M3=22,1911036216229
FrameElem=31-1 ElemStation=0,1834
Frame=31 Station=0 OutputCase=RAR010 CaseType=Combination P=-17,1197699737715 V2=9,34114409304051 V3=0 T=0 M2=0 M3=22,4186270545937
FrameElem=31-1 ElemStation=0
Frame=31 Station=0,0917 OutputCase=RAR010 CaseType=Combination P=-17,1197699737715 V2=19,4281440930405 V3=0 T=0 M2=0 M3=21,0995551912619
FrameElem=31-1 ElemStation=0,0917
Frame=31 Station=0,1834 OutputCase=RAR010 CaseType=Combination P=-17,1197699737715 V2=29,5151440930405 V3=0 T=0 M2=0 M3=18,8555054279301
FrameElem=31-1 ElemStation=0,1834
Frame=31 Station=0 OutputCase=RAR011 CaseType=Combination P=-28,9452006957474 V2=-1,98852490029822E-11 V3=0 T=0 M2=0 M3=20,7961946879509
FrameElem=31-1 ElemStation=0
Frame=31 Station=0,0917 OutputCase=RAR011 CaseType=Combination P=-28,9452006957474 V2=10,08699999999801 V3=0 T=0 M2=0 M3=20,3337057379527
FrameElem=31-1 ElemStation=0,0917
Frame=31 Station=0,1834 OutputCase=RAR011 CaseType=Combination P=-28,9452006957474 V2=20,17399999999801 V3=0 T=0 M2=0 M3=18,9462388879546
FrameElem=31-1 ElemStation=0,1834
Frame=31 Station=0 OutputCase=RAR012 CaseType=Combination P=-16,1596269398295 V2=9,34114409303323 V3=0 T=0 M2=0 M3=0,634679026206322
FrameElem=31-1 ElemStation=0
Frame=31 Station=0,0917 OutputCase=RAR012 CaseType=Combination P=-16,1596269398295 V2=10,6249440930332 V3=0 T=0 M2=0 M3=-0,280766117124825
FrameElem=31-1 ElemStation=0,0917
Frame=31 Station=0,1834 OutputCase=RAR012 CaseType=Combination P=-16,1596269398295 V2=11,9087440930332 V3=0 T=0 M2=0 M3=-1,31393572045597
FrameElem=31-1 ElemStation=0,1834
Frame=31 Station=0 OutputCase=RAR013 CaseType=Combination P=-27,9850576618054 V2=-2,71612066171656E-11 V3=0 T=0 M2=0 M3=-0,987753340436461
FrameElem=31-1 ElemStation=0
Frame=31 Station=0,0917 OutputCase=RAR013 CaseType=Combination P=-27,9850576618054 V2=1,28379999997284 V3=0 T=0 M2=0 M3=-1,04661557043397
FrameElem=31-1 ElemStation=0,0917
Frame=31 Station=0,1834 OutputCase=RAR013 CaseType=Combination P=-27,9850576618054 V2=-2,56759999997284 V3=0 T=0 M2=0 M3=-1,22320226043148
FrameElem=31-1 ElemStation=0,1834
Frame=31 Station=0 OutputCase=RAR014 CaseType=Combination P=-14,2525857295435 V2=21,5959910843768 V3=0 T=0 M2=0 M3=17,3240876236836
FrameElem=31-1 ElemStation=0
Frame=31 Station=0,0917 OutputCase=RAR014 CaseType=Combination P=-15,7839757295435 V2=29,4821910843768 V3=0 T=0 M2=0 M3=14,9821529712462
FrameElem=31-1 ElemStation=0,0917
Frame=31 Station=0,1834 OutputCase=RAR014 CaseType=Combination P=-17,3153657295435 V2=37,3683910843768 V3=0 T=0 M2=0 M3=11,9170537788089
FrameElem=31-1 ElemStation=0,1834
Frame=31 Station=0 OutputCase=RAR015 CaseType=Combination P=-5,36079089527626 V2=-7,069900220813E-12 V3=0 T=0 M2=0 M3=18,3407690715152
FrameElem=31-1 ElemStation=0
Frame=31 Station=0,0917 OutputCase=RAR015 CaseType=Combination P=-5,36079089527626 V2=7,88619999999293 V3=0 T=0 M2=0 M3=17,9791868015158
FrameElem=31-1 ElemStation=0,0917
Frame=31 Station=0,1834 OutputCase=RAR015 CaseType=Combination P=-5,36079089527626 V2=15,7723999999929 V3=0 T=0 M2=0 M3=16,8944399915165
FrameElem=31-1 ElemStation=0,1834
Frame=31 Station=0 OutputCase=RAR016 CaseType=Combination P=-14,5590731315096 V2=7,24790753659475 V3=0 T=0 M2=0 M3=17,0697842807938
FrameElem=31-1 ElemStation=0
Frame=31 Station=0,0917 OutputCase=RAR016 CaseType=Combination P=-14,5590731315096 V2=15,1341075365947 V3=0 T=0 M2=0 M3=16,0435688896881
FrameElem=31-1 ElemStation=0,0917
Frame=31 Station=0,1834 OutputCase=RAR016 CaseType=Combination P=-14,5590731315096 V2=23,0203075365947 V3=0 T=0 M2=0 M3=14,2941889585823
FrameElem=31-1 ElemStation=0,1834
Frame=31 Station=0 OutputCase=RAR017 CaseType=Combination P=-23,757355367743 V2=-1,79838366420881E-11 V3=0 T=0 M2=0 M3=15,7987994903755
FrameElem=31-1 ElemStation=0
Frame=31 Station=0,0917 OutputCase=RAR017 CaseType=Combination P=-23,757355367743 V2=7,88619999998202 V3=0 T=0 M2=0 M3=15,4372172203771
FrameElem=31-1 ElemStation=0,0917
Frame=31 Station=0,1834 OutputCase=RAR017 CaseType=Combination P=-23,757355367743 V2=15,772399999982 V3=0 T=0 M2=0 M3=14,3524704103788
FrameElem=31-1 ElemStation=0,1834
Frame=31 Station=0 OutputCase=RAR018 CaseType=Combination P=-13,8389658560531 V2=7,24790753658929 V3=0 T=0 M2=0 M3=0,731823259503244
FrameElem=31-1 ElemStation=0
Frame=31 Station=0,0917 OutputCase=RAR018 CaseType=Combination P=-13,8389658560531 V2=8,53170753658929 V3=0 T=0 M2=0 M3=8,32790839800612E-03
FrameElem=31-1 ElemStation=0,0917
Frame=31 Station=0,1834 OutputCase=RAR018 CaseType=Combination P=-13,8389658560531 V2=9,81550753658929 V3=0 T=0 M2=0 M3=-0,832891902707232
FrameElem=31-1 ElemStation=0,1834
Frame=31 Station=0 OutputCase=RAR019 CaseType=Combination P=-23,0372480922865 V2=-2,34408048527257E-11 V3=0 T=0 M2=0 M3=-0,539161530915067
FrameElem=31-1 ElemStation=0
Frame=31 Station=0,0917 OutputCase=RAR019 CaseType=Combination P=-23,0372480922865 V2=1,28379999997656 V3=0 T=0 M2=0 M3=-0,598023760912917
FrameElem=31-1 ElemStation=0,0917
Frame=31 Station=0,1834 OutputCase=RAR019 CaseType=Combination P=-23,0372480922865 V2=2,56759999997656 V3=0 T=0 M2=0 M3=-0,774610450910768
FrameElem=31-1 ElemStation=0,1834
Frame=31 Station=0 OutputCase=RAR020 CaseType=Combination P=-4,44995611256235 V2=-0,381401197720776 V3=0 T=0 M2=0 M3=2,26756571018965
FrameElem=31-1 ElemStation=0
Frame=31 Station=0,0917 OutputCase=RAR020 CaseType=Combination P=-4,44995611256235 V2=0,902398802279225 V3=0 T=0 M2=0 M3=2,24367797002064
FrameElem=31-1 ElemStation=0,0917
Frame=31 Station=0,1834 OutputCase=RAR020 CaseType=Combination P=-4,44995611256235 V2=2,18619880227922 V3=0 T=0 M2=0 M3=2,10206576985164
FrameElem=31-1 ElemStation=0,1834
Frame=31 Station=0 OutputCase=RAR021 CaseType=Combination P=-5,17006338801887 V2=-0,381401197715319 V3=0 T=0 M2=0 M3=18,6055267314802
FrameElem=31-1 ElemStation=0
Frame=31 Station=0,0917 OutputCase=RAR021 CaseType=Combination P=-5,17006338801887 V2=7,50479880228468 V3=0 T=0 M2=0 M3=18,2789189513107
FrameElem=31-1 ElemStation=0,0917
Frame=31 Station=0,1834 OutputCase=RAR021 CaseType=Combination P=-5,17006338801887 V2=15,3909988022847 V3=0 T=0 M2=0 M3=17,2291466311412
FrameElem=31-1 ElemStation=0,1834
Frame=31 Station=0 OutputCase=RAR022 CaseType=Combination P=-14,3683456242522 V2=6,8665063388865 V3=0 T=0 M2=0 M3=17,3345419407588
FrameElem=31-1 ElemStation=0
Frame=31 Station=0,0917 OutputCase=RAR022 CaseType=Combination P=-14,3683456242522 V2=14,7527063388865 V3=0 T=0 M2=0 M3=16,3433010394829
FrameElem=31-1 ElemStation=0,0917
Frame=31 Station=0,1834 OutputCase=RAR022 CaseType=Combination P=-14,3683456242522 V2=22,6389063388865 V3=0 T=0 M2=0 M3=14,628895598207
FrameElem=31-1 ElemStation=0,1834
Frame=31 Station=0 OutputCase=RAR023 CaseType=Combination P=-23,5666278604856 V2=-0,381401197726232 V3=0 T=0 M2=0 M3=16,0635571503405
FrameElem=31-1 ElemStation=0
Frame=31 Station=0,0917 OutputCase=RAR023 CaseType=Combination P=-23,5666278604856 V2=7,50479880227377 V3=0 T=0 M2=0 M3=15,736949370172
FrameElem=31-1 ElemStation=0,0917
Frame=31 Station=0,1834 OutputCase=RAR023 CaseType=Combination P=-23,5666278604856 V2=15,3909988022738 V3=0 T=0 M2=0 M3=14,6871770500035
FrameElem=31-1 ElemStation=0,1834

Società di Progetto
Brebemi SpA

	Doc. N. 60235-0000-A00.doc	CODIFICA DOCUMENTO 04RCDII10000000000300A00	REV. 00	FOGLIO 424 di 628
--	-------------------------------	--	------------	----------------------

Frame=31 Station=0 OutputCase=RAR024 CaseType=Combination P=-13,6482383487957 V2=6,86650633888104 V3=0 T=0 M2=0 M3=0,996580919468245 FrameElem=31-1 ElemStation=0

Frame=31 Station=0,0917 OutputCase=RAR024 CaseType=Combination P=-13,6482383487957 V2=8,15030633888104 V3=0 T=0 M2=0 M3=0,308060058192854 FrameElem=31-1 ElemStation=0,0917

Frame=31 Station=0,1834 OutputCase=RAR024 CaseType=Combination P=-13,6482383487957 V2=9,43410633888104 V3=0 T=0 M2=0 M3=-0,498185263082538 FrameElem=31-1 ElemStation=0,1834

Frame=31 Station=0 OutputCase=RAR025 CaseType=Combination P=-22,8465205850291 V2=-0,381401197731689 V3=0 T=0 M2=0 M3=-0,274403870950066 FrameElem=31-1 ElemStation=0

Frame=31 Station=0,0917 OutputCase=RAR025 CaseType=Combination P=-22,8465205850291 V2=0,902398802268311 V3=0 T=0 M2=0 M3=-0,29829161111807 FrameElem=31-1 ElemStation=0,0917

Frame=31 Station=0,1834 OutputCase=RAR025 CaseType=Combination P=-22,8465205850291 V2=2,18619880226831 V3=0 T=0 M2=0 M3=-0,439903811286074 FrameElem=31-1 ElemStation=0,1834

Frame=31 Station=0 OutputCase=RAR026 CaseType=Combination P=-4,83141112707714 V2=0,381401197695722 V3=0 T=0 M2=0 M3=1,73805039025964 FrameElem=31-1 ElemStation=0

Frame=31 Station=0,0917 OutputCase=RAR026 CaseType=Combination P=-4,83141112707714 V2=1,66520119769572 V3=0 T=0 M2=0 M3=1,64421367043094 FrameElem=31-1 ElemStation=0,0917

Frame=31 Station=0,1834 OutputCase=RAR026 CaseType=Combination P=-4,83141112707714 V2=2,94900119769572 V3=0 T=0 M2=0 M3=1,43265249060225 FrameElem=31-1 ElemStation=0,1834

Frame=31 Station=0 OutputCase=RAR027 CaseType=Combination P=-5,55151840253366 V2=0,381401197701179 V3=0 T=0 M2=0 M3=18,0760114115502 FrameElem=31-1 ElemStation=0

Frame=31 Station=0,0917 OutputCase=RAR027 CaseType=Combination P=-5,55151840253366 V2=8,26760119770118 V3=0 T=0 M2=0 M3=17,679454651721 FrameElem=31-1 ElemStation=0,0917

Frame=31 Station=0,1834 OutputCase=RAR027 CaseType=Combination P=-5,55151840253366 V2=16,1538011977012 V3=0 T=0 M2=0 M3=16,5597333518918 FrameElem=31-1 ElemStation=0,1834

Frame=31 Station=0 OutputCase=RAR028 CaseType=Combination P=-14,749800638767 V2=7,62930873430299 V3=0 T=0 M2=0 M3=16,8050266208288 FrameElem=31-1 ElemStation=0

Frame=31 Station=0,0917 OutputCase=RAR028 CaseType=Combination P=-14,749800638767 V2=15,515508734303 V3=0 T=0 M2=0 M3=15,7438367398932 FrameElem=31-1 ElemStation=0,0917

Frame=31 Station=0,1834 OutputCase=RAR028 CaseType=Combination P=-14,749800638767 V2=23,401708734303 V3=0 T=0 M2=0 M3=13,9594823189576 FrameElem=31-1 ElemStation=0,1834

Frame=31 Station=0 OutputCase=RAR029 CaseType=Combination P=-23,9480828750004 V2=0,381401197690265 V3=0 T=0 M2=0 M3=15,5340418304105 FrameElem=31-1 ElemStation=0

Frame=31 Station=0,0917 OutputCase=RAR029 CaseType=Combination P=-23,9480828750004 V2=8,26760119769027 V3=0 T=0 M2=0 M3=15,1374850705823 FrameElem=31-1 ElemStation=0,0917

Frame=31 Station=0,1834 OutputCase=RAR029 CaseType=Combination P=-23,9480828750004 V2=16,1538011976903 V3=0 T=0 M2=0 M3=14,0177637707541 FrameElem=31-1 ElemStation=0,1834

Frame=31 Station=0 OutputCase=RAR030 CaseType=Combination P=-14,0296933633105 V2=7,62930873429754 V3=0 T=0 M2=0 M3=0,467065599538243 FrameElem=31-1 ElemStation=0

Frame=31 Station=0,0917 OutputCase=RAR030 CaseType=Combination P=-14,0296933633105 V2=8,91310873429754 V3=0 T=0 M2=0 M3=-0,291404241396841 FrameElem=31-1 ElemStation=0,0917

Frame=31 Station=0,1834 OutputCase=RAR030 CaseType=Combination P=-14,0296933633105 V2=10,1969087342975 V3=0 T=0 M2=0 M3=-1,16759854233193 FrameElem=31-1 ElemStation=0,1834

Frame=31 Station=0 OutputCase=RAR031 CaseType=Combination P=-23,2279755995439 V2=0,381401197684808 V3=0 T=0 M2=0 M3=-0,803919190880068 FrameElem=31-1 ElemStation=0

Frame=31 Station=0,0917 OutputCase=RAR031 CaseType=Combination P=-23,2279755995439 V2=1,66520119768481 V3=0 T=0 M2=0 M3=-0,897755910707765 FrameElem=31-1 ElemStation=0,0917

Frame=31 Station=0,1834 OutputCase=RAR031 CaseType=Combination P=-23,2279755995439 V2=2,94900119768481 V3=0 T=0 M2=0 M3=-1,10931709053546 FrameElem=31-1 ElemStation=0,1834

Frame=31 Station=0 OutputCase=RAR032 CaseType=Combination P=-4,18095251687057 V2=-1,26505028674728E-11 V3=0 T=0 M2=0 M3=2,38426306473943 FrameElem=31-1 ElemStation=0

Frame=31 Station=0,0917 OutputCase=RAR032 CaseType=Combination P=-4,18095251687057 V2=1,28379999998735 V3=0 T=0 M2=0 M3=2,32540083474059 FrameElem=31-1 ElemStation=0,0917

Frame=31 Station=0,1834 OutputCase=RAR032 CaseType=Combination P=-4,18095251687057 V2=2,56759999998735 V3=0 T=0 M2=0 M3=2,14881414474175 FrameElem=31-1 ElemStation=0,1834

Frame=31 Station=0 OutputCase=RAR033 CaseType=Combination P=-4,90105979232709 V2=-7,19353465683525E-12 V3=0 T=0 M2=0 M3=18,72222408603 FrameElem=31-1 ElemStation=0

Frame=31 Station=0,0917 OutputCase=RAR033 CaseType=Combination P=-4,90105979232709 V2=7,88619999999281 V3=0 T=0 M2=0 M3=18,3606418160306 FrameElem=31-1 ElemStation=0,0917

Frame=31 Station=0,1834 OutputCase=RAR033 CaseType=Combination P=-4,90105979232709 V2=15,7723999999928 V3=0 T=0 M2=0 M3=17,2758950060313 FrameElem=31-1 ElemStation=0,1834

Frame=31 Station=0 OutputCase=RAR034 CaseType=Combination P=-14,0993420285604 V2=7,24790753659462 V3=0 T=0 M2=0 M3=17,4512392953086 FrameElem=31-1 ElemStation=0

Frame=31 Station=0,0917 OutputCase=RAR034 CaseType=Combination P=-14,0993420285604 V2=15,1341075365946 V3=0 T=0 M2=0 M3=16,4250239042029 FrameElem=31-1 ElemStation=0,0917

Frame=31 Station=0,1834 OutputCase=RAR034 CaseType=Combination P=-14,0993420285604 V2=23,0203075365946 V3=0 T=0 M2=0 M3=14,6756439730971 FrameElem=31-1 ElemStation=0,1834

Frame=31 Station=0 OutputCase=RAR035 CaseType=Combination P=-23,2976242647938 V2=-1,81074710781104E-11 V3=0 T=0 M2=0 M3=16,1802545048903 FrameElem=31-1 ElemStation=0

Frame=31 Station=0,0917 OutputCase=RAR035 CaseType=Combination P=-23,2976242647938 V2=7,88619999998189 V3=0 T=0 M2=0 M3=15,8186722348919 FrameElem=31-1 ElemStation=0,0917

Frame=31 Station=0,1834 OutputCase=RAR035 CaseType=Combination P=-23,2976242647938 V2=15,7723999999819 V3=0 T=0 M2=0 M3=14,7339254248936 FrameElem=31-1 ElemStation=0,1834

Frame=31 Station=0 OutputCase=RAR036 CaseType=Combination P=-13,3792347531039 V2=7,24790753658916 V3=0 T=0 M2=0 M3=1,11327827401803 FrameElem=31-1 ElemStation=0

Frame=31 Station=0,0917 OutputCase=RAR036 CaseType=Combination P=-13,3792347531039 V2=8,53170753658916 V3=0 T=0 M2=0 M3=0,389782922912808 FrameElem=31-1 ElemStation=0,0917

Frame=31 Station=0,1834 OutputCase=RAR036 CaseType=Combination P=-13,3792347531039 V2=9,81550753658916 V3=0 T=0 M2=0 M3=-0,451436888192419 FrameElem=31-1 ElemStation=0,1834

Frame=31 Station=0 OutputCase=RAR037 CaseType=Combination P=-22,5775169893373 V2=-2,3564439288748E-11 V3=0 T=0 M2=0 M3=-0,157706516400276 FrameElem=31-1 ElemStation=0

Frame=31 Station=0,0917 OutputCase=RAR037 CaseType=Combination P=-22,5775169893373 V2=1,28379999997644 V3=0 T=0 M2=0 M3=0,216568746398115 FrameElem=31-1 ElemStation=0,0917

Frame=31 Station=0,1834 OutputCase=RAR037 CaseType=Combination P=-22,5775169893373 V2=2,56759999997644 V3=0 T=0 M2=0 M3=0,393155436395955 FrameElem=31-1 ElemStation=0,1834

Frame=31 Station=0 OutputCase=RAR038 CaseType=Combination P=-3,10824660998917 V2=-1,29389832181914E-11 V3=0 T=0 M2=0 M3=3,27432476527395 FrameElem=31-1 ElemStation=0

Frame=31 Station=0,0917 OutputCase=RAR038 CaseType=Combination P=-3,10824660998917 V2=1,28379999998706 V3=0 T=0 M2=0 M3=3,21546253527513 FrameElem=31-1 ElemStation=0,0917

APPROVATO S.D.P.

Società di Progetto
Brebemi SpA



	Doc. N. 60235-0000-A00.doc	CODIFICA DOCUMENTO 04RCDII10000000000300A00	REV. 00	FOGLIO 425 di 628
--	-------------------------------	--	------------	----------------------

Frame=31 Station=0,1834 OutputCase=RAR038 CaseType=Combination P=-3,10824660998917 V2=2,56759999998706 V3=0 T=0 M2=0 M3=3,03887584527632
 FrameElem=31-1 ElemStation=0,1834
 Frame=31 Station=0 OutputCase=RAR039 CaseType=Combination P=-4,37487704589731 V2=-5,58060264665983E-12 V3=0 T=0 M2=0 M3=24,8039694506515
 FrameElem=31-1 ElemStation=0
 Frame=31 Station=0,0917 OutputCase=RAR039 CaseType=Combination P=-4,37487704589731 V2=10,0869999999944 V3=0 T=0 M2=0 M3=24,341480500652 FrameElem=31-1 ElemStation=0,0917
 Frame=31 Station=0,1834 OutputCase=RAR039 CaseType=Combination P=-4,37487704589731 V2=20,1739999999944 V3=0 T=0 M2=0 M3=22,9540136506525
 FrameElem=31-1 ElemStation=0,1834
 Frame=31 Station=0 OutputCase=RAR040 CaseType=Combination P=-16,2003077678732 V2=9,34114409304026 V3=0 T=0 M2=0 M3=23,1815370836233 FrameElem=31-1 ElemStation=0
 Frame=31 Station=0,0917 OutputCase=RAR040 CaseType=Combination P=-16,2003077678732 V2=19,4281440930403 V3=0 T=0 M2=0 M3=21,8624652202915
 FrameElem=31-1 ElemStation=0,0917
 Frame=31 Station=0,1834 OutputCase=RAR040 CaseType=Combination P=-16,2003077678732 V2=29,5151440930403 V3=0 T=0 M2=0 M3=19,6184154569597
 FrameElem=31-1 ElemStation=0,1834
 Frame=31 Station=0 OutputCase=RAR041 CaseType=Combination P=-28,025738489849 V2=-2,01325178750267E-11 V3=0 T=0 M2=0 M3=21,5591047169805 FrameElem=31-1 ElemStation=0
 Frame=31 Station=0,0917 OutputCase=RAR041 CaseType=Combination P=-28,025738489849 V2=10,0869999999799 V3=0 T=0 M2=0 M3=21,0966157669824 FrameElem=31-1 ElemStation=0,0917
 Frame=31 Station=0,1834 OutputCase=RAR041 CaseType=Combination P=-28,025738489849 V2=20,1739999999799 V3=0 T=0 M2=0 M3=19,7091489169842 FrameElem=31-1 ElemStation=0,1834
 Frame=31 Station=0 OutputCase=RAR042 CaseType=Combination P=-15,2401647339311 V2=9,34114409303298 V3=0 T=0 M2=0 M3=1,3975890552359 FrameElem=31-1 ElemStation=0
 Frame=31 Station=0,0917 OutputCase=RAR042 CaseType=Combination P=-15,2401647339311 V2=10,624944093033 V3=0 T=0 M2=0 M3=0,482143911904778
 FrameElem=31-1 ElemStation=0,0917
 Frame=31 Station=0,1834 OutputCase=RAR042 CaseType=Combination P=-15,2401647339311 V2=11,908744093033 V3=0 T=0 M2=0 M3=-0,551025691426347
 FrameElem=31-1 ElemStation=0,1834
 Frame=31 Station=0 OutputCase=RAR043 CaseType=Combination P=-27,065595455907 V2=-2,74084754892101E-11 V3=0 T=0 M2=0 M3=-0,22484331140688
 FrameElem=31-1 ElemStation=0
 Frame=31 Station=0,0917 OutputCase=RAR043 CaseType=Combination P=-27,065595455907 V2=1,28379999997259 V3=0 T=0 M2=0 M3=-0,283705541404367
 FrameElem=31-1 ElemStation=0,0917
 Frame=31 Station=0,1834 OutputCase=RAR043 CaseType=Combination P=-27,065595455907 V2=2,56759999997259 V3=0 T=0 M2=0 M3=-0,460292231401854
 FrameElem=31-1 ElemStation=0,1834
 Frame=31 Station=0 OutputCase=RAR044 CaseType=Combination P=-13,3331235236452 V2=21,5959910843766 V3=0 T=0 M2=0 M3=18,0869976527132 FrameElem=31-1 ElemStation=0
 Frame=31 Station=0,0917 OutputCase=RAR044 CaseType=Combination P=-14,8645135236452 V2=29,4821910843766 V3=0 T=0 M2=0 M3=15,7450630002758
 FrameElem=31-1 ElemStation=0,0917
 Frame=31 Station=0,1834 OutputCase=RAR044 CaseType=Combination P=-16,3959035236452 V2=37,3683910843766 V3=0 T=0 M2=0 M3=12,6799638078385
 FrameElem=31-1 ElemStation=0,1834
 Frame=31 Station=0 OutputCase=RAR045 CaseType=Combination P=-3,82835388544569 V2=-7,48201500755386E-12 V3=0 T=0 M2=0 M3=19,6122857865645
 FrameElem=31-1 ElemStation=0
 Frame=31 Station=0,0917 OutputCase=RAR045 CaseType=Combination P=-3,82835388544569 V2=7,88619999999252 V3=0 T=0 M2=0 M3=19,2507035165652
 FrameElem=31-1 ElemStation=0,0917
 Frame=31 Station=0,1834 OutputCase=RAR045 CaseType=Combination P=-3,82835388544569 V2=15,7723999999925 V3=0 T=0 M2=0 M3=18,1659567065659
 FrameElem=31-1 ElemStation=0,1834
 Frame=31 Station=0 OutputCase=RAR046 CaseType=Combination P=-13,026636121679 V2=7,24790753659433 V3=0 T=0 M2=0 M3=18,3413009958431 FrameElem=31-1 ElemStation=0
 Frame=31 Station=0,0917 OutputCase=RAR046 CaseType=Combination P=-13,026636121679 V2=15,1341075365943 V3=0 T=0 M2=0 M3=17,3150856047374 FrameElem=31-1 ElemStation=0,0917
 Frame=31 Station=0,1834 OutputCase=RAR046 CaseType=Combination P=-13,026636121679 V2=23,0203075365943 V3=0 T=0 M2=0 M3=15,5657056736317 FrameElem=31-1 ElemStation=0,1834
 Frame=31 Station=0 OutputCase=RAR047 CaseType=Combination P=-22,2249183579124 V2=-1,8395951428829E-11 V3=0 T=0 M2=0 M3=17,0703162054248 FrameElem=31-1 ElemStation=0
 Frame=31 Station=0,0917 OutputCase=RAR047 CaseType=Combination P=-22,2249183579124 V2=7,8861999999816 V3=0 T=0 M2=0 M3=16,7087339354265 FrameElem=31-1 ElemStation=0,0917
 Frame=31 Station=0,1834 OutputCase=RAR047 CaseType=Combination P=-22,2249183579124 V2=15,7723999999816 V3=0 T=0 M2=0 M3=15,6239871254281
 FrameElem=31-1 ElemStation=0,1834
 Frame=31 Station=0 OutputCase=RAR048 CaseType=Combination P=-12,3065288462225 V2=7,24790753658888 V3=0 T=0 M2=0 M3=2,00333997455255 FrameElem=31-1 ElemStation=0
 Frame=31 Station=0,0917 OutputCase=RAR048 CaseType=Combination P=-12,3065288462225 V2=8,53170753658888 V3=0 T=0 M2=0 M3=1,27984462344735
 FrameElem=31-1 ElemStation=0,0917
 Frame=31 Station=0,1834 OutputCase=RAR048 CaseType=Combination P=-12,3065288462225 V2=9,81550753658888 V3=0 T=0 M2=0 M3=0,438624812342145
 FrameElem=31-1 ElemStation=0,1834
 Frame=31 Station=0 OutputCase=RAR049 CaseType=Combination P=-21,5048110824559 V2=-2,38529196394666E-11 V3=0 T=0 M2=0 M3=0,732355184134235
 FrameElem=31-1 ElemStation=0
 Frame=31 Station=0,0917 OutputCase=RAR049 CaseType=Combination P=-21,5048110824559 V2=1,28379999997615 V3=0 T=0 M2=0 M3=0,673492954136422
 FrameElem=31-1 ElemStation=0,0917
 Frame=31 Station=0,1834 OutputCase=RAR049 CaseType=Combination P=-21,5048110824559 V2=2,56759999997615 V3=0 T=0 M2=0 M3=0,496906264138609
 FrameElem=31-1 ElemStation=0,1834
 Frame=31 Station=0 OutputCase=RAR050 CaseType=Combination P=-2,91751910273178 V2=-0,381401197721188 V3=0 T=0 M2=0 M3=3,53908242523895 FrameElem=31-1 ElemStation=0
 Frame=31 Station=0,0917 OutputCase=RAR050 CaseType=Combination P=-2,91751910273178 V2=0,902398802278813 V3=0 T=0 M2=0 M3=3,51519468506998
 FrameElem=31-1 ElemStation=0,0917
 Frame=31 Station=0,1834 OutputCase=RAR050 CaseType=Combination P=-2,91751910273178 V2=2,18619880227881 V3=0 T=0 M2=0 M3=3,37358248490101
 FrameElem=31-1 ElemStation=0,1834
 Frame=31 Station=0 OutputCase=RAR051 CaseType=Combination P=-3,63762637818829 V2=-0,381401197715731 V3=0 T=0 M2=0 M3=19,8770434465295 FrameElem=31-1 ElemStation=0
 Frame=31 Station=0,0917 OutputCase=RAR051 CaseType=Combination P=-3,63762637818829 V2=7,50479880228427 V3=0 T=0 M2=0 M3=19,55043566636 FrameElem=31-1 ElemStation=0,0917
 Frame=31 Station=0,1834 OutputCase=RAR051 CaseType=Combination P=-3,63762637818829 V2=15,3909988022843 V3=0 T=0 M2=0 M3=18,5006633461906
 FrameElem=31-1 ElemStation=0,1834
 Frame=31 Station=0 OutputCase=RAR052 CaseType=Combination P=-12,8359086144216 V2=6,86650633888608 V3=0 T=0 M2=0 M3=18,6060586558081 FrameElem=31-1 ElemStation=0
 Frame=31 Station=0,0917 OutputCase=RAR052 CaseType=Combination P=-12,8359086144216 V2=14,7527063388861 V3=0 T=0 M2=0 M3=17,614817545322
 FrameElem=31-1 ElemStation=0,0917
 Frame=31 Station=0,1834 OutputCase=RAR052 CaseType=Combination P=-12,8359086144216 V2=22,6389063388861 V3=0 T=0 M2=0 M3=15,9004123132564
 FrameElem=31-1 ElemStation=0,1834
 Frame=31 Station=0 OutputCase=RAR053 CaseType=Combination P=-22,034190850655 V2=-0,381401197726645 V3=0 T=0 M2=0 M3=17,3350738653898 FrameElem=31-1 ElemStation=0

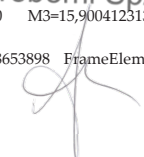
Società di Progetto
Brebemi SpA



Doc. N.
60235-0000-A00.doc

CODIFICA DOCUMENTO
04RCDII10000000000300A00

REV.
00

FOGLIO
426 di 628

Frame=31 Station=0,0917 OutputCase=RAR053 CaseType=Combination P=-22,034190850655 V2=7,50479880227336 V3=0 T=0 M2=0 M3=17,0084660852213 FrameElem=31-1 ElemStation=0,0917
Frame=31 Station=0,1834 OutputCase=RAR053 CaseType=Combination P=-22,034190850655 V2=15,3909988022734 V3=0 T=0 M2=0 M3=15,9586937650528 FrameElem=31-1 ElemStation=0,1834
Frame=31 Station=0 OutputCase=RAR054 CaseType=Combination P=-12,1158013389651 V2=6,86650633888063 V3=0 T=0 M2=0 M3=2,26809763451755 FrameElem=31-1 ElemStation=0
Frame=31 Station=0,0917 OutputCase=RAR054 CaseType=Combination P=-12,1158013389651 V2=8,15030633888063 V3=0 T=0 M2=0 M3=1,57957677324219 FrameElem=31-1 ElemStation=0,0917
Frame=31 Station=0,1834 OutputCase=RAR054 CaseType=Combination P=-12,1158013389651 V2=9,43410633888063 V3=0 T=0 M2=0 M3=0,773331451966839 FrameElem=31-1 ElemStation=0,1834
Frame=31 Station=0 OutputCase=RAR055 CaseType=Combination P=-21,3140835751985 V2=0,381401197732102 V3=0 T=0 M2=0 M3=0,997112844099236 FrameElem=31-1 ElemStation=0
Frame=31 Station=0,0917 OutputCase=RAR055 CaseType=Combination P=-21,3140835751985 V2=0,902398802267899 V3=0 T=0 M2=0 M3=0,97322510393127 FrameElem=31-1 ElemStation=0,0917
Frame=31 Station=0,1834 OutputCase=RAR055 CaseType=Combination P=-21,3140835751985 V2=2,1861988022679 V3=0 T=0 M2=0 M3=0,831612903763303 FrameElem=31-1 ElemStation=0,1834
Frame=31 Station=0 OutputCase=RAR056 CaseType=Combination P=-3,29897411724657 V2=0,38140119769531 V3=0 T=0 M2=0 M3=3,00956710530894 FrameElem=31-1 ElemStation=0
Frame=31 Station=0,0917 OutputCase=RAR056 CaseType=Combination P=-3,29897411724657 V2=1,66520119769531 V3=0 T=0 M2=0 M3=2,91573038548028 FrameElem=31-1 ElemStation=0,0917
Frame=31 Station=0,1834 OutputCase=RAR056 CaseType=Combination P=-3,29897411724657 V2=2,94900119769531 V3=0 T=0 M2=0 M3=2,70416920565162 FrameElem=31-1 ElemStation=0,1834
Frame=31 Station=0 OutputCase=RAR057 CaseType=Combination P=-4,01908139270308 V2=0,381401197700767 V3=0 T=0 M2=0 M3=19,3475281265995 FrameElem=31-1 ElemStation=0
Frame=31 Station=0,0917 OutputCase=RAR057 CaseType=Combination P=-4,01908139270308 V2=8,26760119770077 V3=0 T=0 M2=0 M3=18,9509713667703 FrameElem=31-1 ElemStation=0,0917
Frame=31 Station=0,1834 OutputCase=RAR057 CaseType=Combination P=-4,01908139270308 V2=16,1538011977008 V3=0 T=0 M2=0 M3=17,8312500669412 FrameElem=31-1 ElemStation=0,1834
Frame=31 Station=0 OutputCase=RAR058 CaseType=Combination P=-13,2173636289364 V2=7,62930873430258 V3=0 T=0 M2=0 M3=18,0765433358781 FrameElem=31-1 ElemStation=0
Frame=31 Station=0,0917 OutputCase=RAR058 CaseType=Combination P=-13,2173636289364 V2=15,5155087343026 V3=0 T=0 M2=0 M3=17,0153534549425 FrameElem=31-1 ElemStation=0,0917
Frame=31 Station=0,1834 OutputCase=RAR058 CaseType=Combination P=-13,2173636289364 V2=23,4017087343026 V3=0 T=0 M2=0 M3=15,230999034007 FrameElem=31-1 ElemStation=0,1834
Frame=31 Station=0 OutputCase=RAR059 CaseType=Combination P=-22,4156458651698 V2=0,381401197689853 V3=0 T=0 M2=0 M3=16,8055585454598 FrameElem=31-1 ElemStation=0
Frame=31 Station=0,0917 OutputCase=RAR059 CaseType=Combination P=-22,4156458651698 V2=8,26760119768985 V3=0 T=0 M2=0 M3=16,4090017856316 FrameElem=31-1 ElemStation=0,0917
Frame=31 Station=0,1834 OutputCase=RAR059 CaseType=Combination P=-22,4156458651698 V2=16,1538011976899 V3=0 T=0 M2=0 M3=15,2892804858035 FrameElem=31-1 ElemStation=0,1834
Frame=31 Station=0 OutputCase=RAR060 CaseType=Combination P=-12,4972563534799 V2=7,62930873429712 V3=0 T=0 M2=0 M3=1,73858231458754 FrameElem=31-1 ElemStation=0
Frame=31 Station=0,0917 OutputCase=RAR060 CaseType=Combination P=-12,4972563534799 V2=8,91310873429712 V3=0 T=0 M2=0 M3=0,980112473652498 FrameElem=31-1 ElemStation=0,0917
Frame=31 Station=0,1834 OutputCase=RAR060 CaseType=Combination P=-12,4972563534799 V2=10,1969087342971 V3=0 T=0 M2=0 M3=0,103918172717452 FrameElem=31-1 ElemStation=0,1834
Frame=31 Station=0 OutputCase=RAR061 CaseType=Combination P=-21,6955385897133 V2=0,381401197684396 V3=0 T=0 M2=0 M3=0,467597524169234 FrameElem=31-1 ElemStation=0
Frame=31 Station=0,0917 OutputCase=RAR061 CaseType=Combination P=-21,6955385897133 V2=1,6652011976844 V3=0 T=0 M2=0 M3=0,373760804341575 FrameElem=31-1 ElemStation=0,0917
Frame=31 Station=0,1834 OutputCase=RAR061 CaseType=Combination P=-21,6955385897133 V2=2,9490011976844 V3=0 T=0 M2=0 M3=0,162199624513916 FrameElem=31-1 ElemStation=0,1834
Frame=31 Station=0 OutputCase=RAR062 CaseType=Combination P=-2,64851550704 V2=-1,30626176542137E-11 V3=0 T=0 M2=0 M3=3,65577977978874 FrameElem=31-1 ElemStation=0
Frame=31 Station=0,0917 OutputCase=RAR062 CaseType=Combination P=-2,64851550704 V2=1,28379999998694 V3=0 T=0 M2=0 M3=3,59691754978993 FrameElem=31-1 ElemStation=0,0917
Frame=31 Station=0,1834 OutputCase=RAR062 CaseType=Combination P=-2,64851550704 V2=2,56759999998694 V3=0 T=0 M2=0 M3=3,42033085979113 FrameElem=31-1 ElemStation=0,1834
Frame=31 Station=0 OutputCase=RAR063 CaseType=Combination P=-3,36862278249652 V2=-7,60564944357611E-12 V3=0 T=0 M2=0 M3=19,9937408010793 FrameElem=31-1 ElemStation=0
Frame=31 Station=0,0917 OutputCase=RAR063 CaseType=Combination P=-3,36862278249652 V2=7,8861999999924 V3=0 T=0 M2=0 M3=19,63215853108 FrameElem=31-1 ElemStation=0,0917
Frame=31 Station=0,1834 OutputCase=RAR063 CaseType=Combination P=-3,36862278249652 V2=15,7723999999924 V3=0 T=0 M2=0 M3=18,5474117210807 FrameElem=31-1 ElemStation=0,1834
Frame=31 Station=0 OutputCase=RAR064 CaseType=Combination P=-12,5669050187299 V2=7,24790753659421 V3=0 T=0 M2=0 M3=18,7227560103579 FrameElem=31-1 ElemStation=0
Frame=31 Station=0,0917 OutputCase=RAR064 CaseType=Combination P=-12,5669050187299 V2=15,1341075365942 V3=0 T=0 M2=0 M3=17,6965406192522 FrameElem=31-1 ElemStation=0,0917
Frame=31 Station=0,1834 OutputCase=RAR064 CaseType=Combination P=-12,5669050187299 V2=23,0203075365942 V3=0 T=0 M2=0 M3=15,9471606881465 FrameElem=31-1 ElemStation=0,1834
Frame=31 Station=0 OutputCase=RAR065 CaseType=Combination P=-21,7651872549632 V2=-1,85195858648513E-11 V3=0 T=0 M2=0 M3=17,4517712199396 FrameElem=31-1 ElemStation=0
Frame=31 Station=0,0917 OutputCase=RAR065 CaseType=Combination P=-21,7651872549632 V2=7,88619999998148 V3=0 T=0 M2=0 M3=17,0901889499413 FrameElem=31-1 ElemStation=0,0917
Frame=31 Station=0,1834 OutputCase=RAR065 CaseType=Combination P=-21,7651872549632 V2=15,7723999999815 V3=0 T=0 M2=0 M3=16,005442139943 FrameElem=31-1 ElemStation=0,1834
Frame=31 Station=0 OutputCase=RAR066 CaseType=Combination P=-11,8467977432734 V2=7,24790753658875 V3=0 T=0 M2=0 M3=2,38479498906734 FrameElem=31-1 ElemStation=0
Frame=31 Station=0,0917 OutputCase=RAR066 CaseType=Combination P=-11,8467977432734 V2=8,53170753658875 V3=0 T=0 M2=0 M3=1,66129963796215 FrameElem=31-1 ElemStation=0,0917
Frame=31 Station=0,1834 OutputCase=RAR066 CaseType=Combination P=-11,8467977432734 V2=9,81550753658875 V3=0 T=0 M2=0 M3=0,820079826856959 FrameElem=31-1 ElemStation=0,1834
Frame=31 Station=0 OutputCase=RAR067 CaseType=Combination P=-21,0450799795067 V2=-2,39765540754888E-11 V3=0 T=0 M2=0 M3=1,11381019864903 FrameElem=31-1 ElemStation=0
Frame=31 Station=0,0917 OutputCase=RAR067 CaseType=Combination P=-21,0450799795067 V2=1,28379999997602 V3=0 T=0 M2=0 M3=1,05494796865122 FrameElem=31-1 ElemStation=0,0917
Frame=31 Station=0,1834 OutputCase=RAR067 CaseType=Combination P=-21,0450799795067 V2=2,56759999997602 V3=0 T=0 M2=0 M3=0,878361278653423 FrameElem=31-1 ElemStation=0,1834

Società di Progetto
Brebemi SpA



Doc. N.
60235-0000-A00.doc

CODIFICA DOCUMENTO
04RCDII10000000000300A00

REV.
00

FOGLIO
427 di 628

Frame=31 Station=0 OutputCase=RAR068 CaseType=Combination P=-3,55658593614213 V2=-0,635668662859814 V3=0 T=0 M2=0 M3=3,07982917435763 FrameElem=31-1 ElemStation=0
Frame=31 Station=0,0917 OutputCase=RAR068 CaseType=Combination P=-3,55658593614213 V2=0,648131337140186 V3=0 T=0 M2=0 M3=3,07925776074187 FrameElem=31-1 ElemStation=0,0917
Frame=31 Station=0,1834 OutputCase=RAR068 CaseType=Combination P=-3,55658593614213 V2=1,93193133714019 V3=0 T=0 M2=0 M3=2,96096188712612 FrameElem=31-1 ElemStation=0,1834
Frame=31 Station=0 OutputCase=RAR069 CaseType=Combination P=-4,64388064158909 V2=-0,381401197713706 V3=0 T=0 M2=0 M3=24,6872720961017 FrameElem=31-1 ElemStation=0
Frame=31 Station=0,0917 OutputCase=RAR069 CaseType=Combination P=-4,64388064158909 V2=9,7055988022863 V3=0 T=0 M2=0 M3=24,259757635932 FrameElem=31-1 ElemStation=0,0917
Frame=31 Station=0,1834 OutputCase=RAR069 CaseType=Combination P=-4,64388064158909 V2=19,7925988022863 V3=0 T=0 M2=0 M3=22,9072652757624 FrameElem=31-1 ElemStation=0,1834
Frame=31 Station=0 OutputCase=RAR070 CaseType=Combination P=-16,4693113635649 V2=8,95974289533214 V3=0 T=0 M2=0 M3=23,0648397290735 FrameElem=31-1 ElemStation=0
Frame=31 Station=0,0917 OutputCase=RAR070 CaseType=Combination P=-16,4693113635649 V2=19,0467428953321 V3=0 T=0 M2=0 M3=21,7807423555715 FrameElem=31-1 ElemStation=0,0917
Frame=31 Station=0,1834 OutputCase=RAR070 CaseType=Combination P=-16,4693113635649 V2=29,1337428953321 V3=0 T=0 M2=0 M3=19,5716670820696 FrameElem=31-1 ElemStation=0,1834
Frame=31 Station=0 OutputCase=RAR071 CaseType=Combination P=-28,2947420855408 V2=-0,381401197728258 V3=0 T=0 M2=0 M3=21,4424073624307 FrameElem=31-1 ElemStation=0
Frame=31 Station=0,0917 OutputCase=RAR071 CaseType=Combination P=-28,2947420855408 V2=9,70559880227175 V3=0 T=0 M2=0 M3=21,0148929022624 FrameElem=31-1 ElemStation=0,0917
Frame=31 Station=0,1834 OutputCase=RAR071 CaseType=Combination P=-28,2947420855408 V2=19,7925988022717 V3=0 T=0 M2=0 M3=19,6624005420941 FrameElem=31-1 ElemStation=0,1834
Frame=31 Station=0 OutputCase=RAR072 CaseType=Combination P=-15,5091683296229 V2=8,95974289532486 V3=0 T=0 M2=0 M3=1,28089170068611 FrameElem=31-1 ElemStation=0
Frame=31 Station=0,0917 OutputCase=RAR072 CaseType=Combination P=-15,5091683296229 V2=10,2435428953249 V3=0 T=0 M2=0 M3=0,400421047184824 FrameElem=31-1 ElemStation=0,0917
Frame=31 Station=0,1834 OutputCase=RAR072 CaseType=Combination P=-15,5091683296229 V2=11,5273428953249 V3=0 T=0 M2=0 M3=-0,597774066316466 FrameElem=31-1 ElemStation=0,1834
Frame=31 Station=0 OutputCase=RAR073 CaseType=Combination P=-27,3345990515988 V2=-0,381401197735533 V3=0 T=0 M2=0 M3=-0,34154066595667 FrameElem=31-1 ElemStation=0
Frame=31 Station=0,0917 OutputCase=RAR073 CaseType=Combination P=-27,3345990515988 V2=0,902398802264466 V3=0 T=0 M2=0 M3=-0,365428406124321 FrameElem=31-1 ElemStation=0,0917
Frame=31 Station=0,1834 OutputCase=RAR073 CaseType=Combination P=-27,3345990515988 V2=2,18619880226447 V3=0 T=0 M2=0 M3=-0,507040606291973 FrameElem=31-1 ElemStation=0,1834
Frame=31 Station=0 OutputCase=RAR074 CaseType=Combination P=-13,6021271193369 V2=21,2145898666684 V3=0 T=0 M2=0 M3=17,9703002981634 FrameElem=31-1 ElemStation=0
Frame=31 Station=0,0917 OutputCase=RAR074 CaseType=Combination P=-15,1335171193369 V2=29,1007898866684 V3=0 T=0 M2=0 M3=15,6633401355559 FrameElem=31-1 ElemStation=0,0917
Frame=31 Station=0,1834 OutputCase=RAR074 CaseType=Combination P=-16,6649071193369 V2=36,9869898866684 V3=0 T=0 M2=0 M3=12,6332154329484 FrameElem=31-1 ElemStation=0,1834
Frame=31 Station=0 OutputCase=RAR075 CaseType=Combination P=-4,27669321159865 V2=-0,635668662854357 V3=0 T=0 M2=0 M3=19,4177901956482 FrameElem=31-1 ElemStation=0
Frame=31 Station=0,0917 OutputCase=RAR075 CaseType=Combination P=-4,27669321159865 V2=7,25053133714564 V3=0 T=0 M2=0 M3=19,1144987420319 FrameElem=31-1 ElemStation=0,0917
Frame=31 Station=0,1834 OutputCase=RAR075 CaseType=Combination P=-4,27669321159865 V2=15,1367313371456 V3=0 T=0 M2=0 M3=18,0880427484157 FrameElem=31-1 ElemStation=0,1834
Frame=31 Station=0 OutputCase=RAR076 CaseType=Combination P=-13,474975447832 V2=6,122388737474 V3=0 T=0 M2=0 M3=18,1468054049268 FrameElem=31-1 ElemStation=0
Frame=31 Station=0,0917 OutputCase=RAR076 CaseType=Combination P=-13,474975447832 V2=14,4984388737475 V3=0 T=0 M2=0 M3=17,1788808302041 FrameElem=31-1 ElemStation=0,0917
Frame=31 Station=0,1834 OutputCase=RAR076 CaseType=Combination P=-13,474975447832 V2=22,3846388737475 V3=0 T=0 M2=0 M3=15,4877917154815 FrameElem=31-1 ElemStation=0,1834
Frame=31 Station=0 OutputCase=RAR077 CaseType=Combination P=-22,6732576840654 V2=-0,635668662865271 V3=0 T=0 M2=0 M3=16,8758206145085 FrameElem=31-1 ElemStation=0
Frame=31 Station=0,0917 OutputCase=RAR077 CaseType=Combination P=-22,6732576840654 V2=7,25053133713473 V3=0 T=0 M2=0 M3=16,5725291608932 FrameElem=31-1 ElemStation=0,0917
Frame=31 Station=0,1834 OutputCase=RAR077 CaseType=Combination P=-22,6732576840654 V2=15,1367313371347 V3=0 T=0 M2=0 M3=15,5460731627279 FrameElem=31-1 ElemStation=0,1834
Frame=31 Station=0 OutputCase=RAR078 CaseType=Combination P=-12,7548681723755 V2=6,122388737474 V3=0 T=0 M2=0 M3=1,80884438363623 FrameElem=31-1 ElemStation=0
Frame=31 Station=0,0917 OutputCase=RAR078 CaseType=Combination P=-12,7548681723755 V2=7,896038873742 V3=0 T=0 M2=0 M3=1,14363984891409 FrameElem=31-1 ElemStation=0,0917
Frame=31 Station=0,1834 OutputCase=RAR078 CaseType=Combination P=-12,7548681723755 V2=9,179838873742 V3=0 T=0 M2=0 M3=0,360710854191947 FrameElem=31-1 ElemStation=0,1834
Frame=31 Station=0 OutputCase=RAR079 CaseType=Combination P=-21,9531504086088 V2=-0,635668662870728 V3=0 T=0 M2=0 M3=0,537859593217919 FrameElem=31-1 ElemStation=0
Frame=31 Station=0,0917 OutputCase=RAR079 CaseType=Combination P=-21,9531504086088 V2=0,648131337129272 V3=0 T=0 M2=0 M3=0,537288179603165 FrameElem=31-1 ElemStation=0,0917
Frame=31 Station=0,1834 OutputCase=RAR079 CaseType=Combination P=-21,9531504086088 V2=1,93193133712927 V3=0 T=0 M2=0 M3=0,418992305988411 FrameElem=31-1 ElemStation=0,1834
Frame=31 Station=0 OutputCase=RAR080 CaseType=Combination P=-4,01631703909131 V2=-0,63566866285969 V3=0 T=0 M2=0 M3=2,69837415984284 FrameElem=31-1 ElemStation=0
Frame=31 Station=0,0917 OutputCase=RAR080 CaseType=Combination P=-4,01631703909131 V2=0,64813133714031 V3=0 T=0 M2=0 M3=2,69780274622707 FrameElem=31-1 ElemStation=0,0917
Frame=31 Station=0,1834 OutputCase=RAR080 CaseType=Combination P=-4,01631703909131 V2=1,93193133714031 V3=0 T=0 M2=0 M3=2,57950687261131 FrameElem=31-1 ElemStation=0,1834
Frame=31 Station=0 OutputCase=RAR081 CaseType=Combination P=-4,73642431454782 V2=-0,635668662854233 V3=0 T=0 M2=0 M3=19,0363351811334 FrameElem=31-1 ElemStation=0
Frame=31 Station=0,0917 OutputCase=RAR081 CaseType=Combination P=-4,73642431454782 V2=7,25053133714577 V3=0 T=0 M2=0 M3=18,7330437275171 FrameElem=31-1 ElemStation=0,0917
Frame=31 Station=0,1834 OutputCase=RAR081 CaseType=Combination P=-4,73642431454782 V2=15,1367313371458 V3=0 T=0 M2=0 M3=17,7065877339008 FrameElem=31-1 ElemStation=0,1834
Frame=31 Station=0 OutputCase=RAR082 CaseType=Combination P=-13,9347065507812 V2=6,1223887374758 V3=0 T=0 M2=0 M3=17,765350390412 FrameElem=31-1 ElemStation=0
Frame=31 Station=0,0917 OutputCase=RAR082 CaseType=Combination P=-13,9347065507812 V2=14,4984388737476 V3=0 T=0 M2=0 M3=16,7974258156893 FrameElem=31-1 ElemStation=0,0917

Società di Progetto
Brebemi SpA

	Doc. N. 60235-0000-A00.doc	CODIFICA DOCUMENTO 04RCDII10000000000300A00	REV. 00	FOGLIO 428 di 628
--	-------------------------------	--	------------	----------------------

Frame=31 Station=0,1834 OutputCase=RAR082 CaseType=Combination P=-13,9347065507812 V2=22,3846388737476 V3=0 T=0 M2=0 M3=15,1063367009667
 FrameElem=31-1 ElemStation=0,1834
 Frame=31 Station=0 OutputCase=RAR083 CaseType=Combination P=-23,1329887870145 V2=-0,635668662865147 V3=0 T=0 M2=0 M3=16,4943655999937 FrameElem=31-1
 ElemStation=0
 Frame=31 Station=0,0917 OutputCase=RAR083 CaseType=Combination P=-23,1329887870145 V2=7,25053133713485 V3=0 T=0 M2=0 M3=16,1910741463784
 FrameElem=31-1 ElemStation=0,0917
 Frame=31 Station=0,1834 OutputCase=RAR083 CaseType=Combination P=-23,1329887870145 V2=15,1367313371349 V3=0 T=0 M2=0 M3=15,1646181527631
 FrameElem=31-1 ElemStation=0,1834
 Frame=31 Station=0 OutputCase=RAR084 CaseType=Combination P=-13,2145992753247 V2=6,61223887374212 V3=0 T=0 M2=0 M3=1,42738936912144 FrameElem=31-1
 ElemStation=0
 Frame=31 Station=0,0917 OutputCase=RAR084 CaseType=Combination P=-13,2145992753247 V2=7,89603887374212 V3=0 T=0 M2=0 M3=0,762184834399286
 FrameElem=31-1 ElemStation=0,0917
 Frame=31 Station=0,1834 OutputCase=RAR084 CaseType=Combination P=-13,2145992753247 V2=9,17983887374213 V3=0 T=0 M2=0 M3=-2,07441603228665E-02
 FrameElem=31-1 ElemStation=0,1834
 Frame=31 Station=0 OutputCase=RAR085 CaseType=Combination P=-22,412881511558 V2=-0,635668662870604 V3=0 T=0 M2=0 M3=0,156404578703129 FrameElem=31-1
 ElemStation=0
 Frame=31 Station=0,0917 OutputCase=RAR085 CaseType=Combination P=-22,412881511558 V2=0,648131337129396 V3=0 T=0 M2=0 M3=0,155833165088363
 FrameElem=31-1 ElemStation=0,0917
 Frame=31 Station=0,1834 OutputCase=RAR085 CaseType=Combination P=-22,412881511558 V2=1,9319313371294 V3=0 T=0 M2=0 M3=3,75372914735974E-02
 FrameElem=31-1 ElemStation=0,1834
 Frame=31 Station=0 OutputCase=RAR086 CaseType=Combination P=-3,09685483319296 V2=-0,635668662859938 V3=0 T=0 M2=0 M3=3,46128418887242 FrameElem=31-1
 ElemStation=0
 Frame=31 Station=0,0917 OutputCase=RAR086 CaseType=Combination P=-3,09685483319296 V2=0,648131337140063 V3=0 T=0 M2=0 M3=3,46071277525668
 FrameElem=31-1 ElemStation=0,0917
 Frame=31 Station=0,1834 OutputCase=RAR086 CaseType=Combination P=-3,09685483319296 V2=1,93193133714006 V3=0 T=0 M2=0 M3=3,34241690164093
 FrameElem=31-1 ElemStation=0,1834
 Frame=31 Station=0 OutputCase=RAR087 CaseType=Combination P=-3,81696210864948 V2=-0,635668662854481 V3=0 T=0 M2=0 M3=19,799245210163 FrameElem=31-1
 ElemStation=0
 Frame=31 Station=0,0917 OutputCase=RAR087 CaseType=Combination P=-3,81696210864948 V2=7,25053133714552 V3=0 T=0 M2=0 M3=19,4959537565467
 FrameElem=31-1 ElemStation=0,0917
 Frame=31 Station=0,1834 OutputCase=RAR087 CaseType=Combination P=-3,81696210864948 V2=15,1367313371455 V3=0 T=0 M2=0 M3=18,4694977629305
 FrameElem=31-1 ElemStation=0,1834
 Frame=31 Station=0 OutputCase=RAR088 CaseType=Combination P=-13,0152443448828 V2=6,61223887374733 V3=0 T=0 M2=0 M3=18,5282604194416 FrameElem=31-1
 ElemStation=0
 Frame=31 Station=0,0917 OutputCase=RAR088 CaseType=Combination P=-13,0152443448828 V2=14,4984388737473 V3=0 T=0 M2=0 M3=17,5603358447189
 FrameElem=31-1 ElemStation=0,0917
 Frame=31 Station=0,1834 OutputCase=RAR088 CaseType=Combination P=-13,0152443448828 V2=22,3846388737473 V3=0 T=0 M2=0 M3=15,8692467299963
 FrameElem=31-1 ElemStation=0,1834
 Frame=31 Station=0 OutputCase=RAR089 CaseType=Combination P=-22,2135265811162 V2=-0,635668662865395 V3=0 T=0 M2=0 M3=17,2572756290233 FrameElem=31-1
 ElemStation=0
 Frame=31 Station=0,0917 OutputCase=RAR089 CaseType=Combination P=-22,2135265811162 V2=7,25053133713461 V3=0 T=0 M2=0 M3=16,953984175408 FrameElem=31-1
 ElemStation=0,0917
 Frame=31 Station=0,1834 OutputCase=RAR089 CaseType=Combination P=-22,2135265811162 V2=15,1367313371346 V3=0 T=0 M2=0 M3=15,9275281817928
 FrameElem=31-1 ElemStation=0,1834
 Frame=31 Station=0 OutputCase=RAR090 CaseType=Combination P=-12,2951370694263 V2=6,61223887374188 V3=0 T=0 M2=0 M3=2,19029939815102 FrameElem=31-1
 ElemStation=0
 Frame=31 Station=0,0917 OutputCase=RAR090 CaseType=Combination P=-12,2951370694263 V2=7,89603887374188 V3=0 T=0 M2=0 M3=1,52509486342889
 FrameElem=31-1 ElemStation=0,0917
 Frame=31 Station=0,1834 OutputCase=RAR090 CaseType=Combination P=-12,2951370694263 V2=9,17983887374188 V3=0 T=0 M2=0 M3=0,74216586870676
 FrameElem=31-1 ElemStation=0,1834
 Frame=31 Station=0 OutputCase=RAR091 CaseType=Combination P=-21,4934193056597 V2=-0,635668662870852 V3=0 T=0 M2=0 M3=0,91931460773271 FrameElem=31-1
 ElemStation=0
 Frame=31 Station=0,0917 OutputCase=RAR091 CaseType=Combination P=-21,4934193056597 V2=0,648131337129149 V3=0 T=0 M2=0 M3=0,918743194117967
 FrameElem=31-1 ElemStation=0,0917
 Frame=31 Station=0,1834 OutputCase=RAR091 CaseType=Combination P=-21,4934193056597 V2=1,93193133712915 V3=0 T=0 M2=0 M3=0,800447320503224
 FrameElem=31-1 ElemStation=0,1834
 Frame=31 Station=0 OutputCase=RAR092 CaseType=Combination P=-3,09685483319296 V2=-0,635668662859938 V3=0 T=0 M2=0 M3=3,46128418887242 FrameElem=31-1
 ElemStation=0
 Frame=31 Station=0,0917 OutputCase=RAR092 CaseType=Combination P=-3,09685483319296 V2=0,648131337140063 V3=0 T=0 M2=0 M3=3,46071277525668
 FrameElem=31-1 ElemStation=0,0917
 Frame=31 Station=0,1834 OutputCase=RAR092 CaseType=Combination P=-3,09685483319296 V2=1,93193133714006 V3=0 T=0 M2=0 M3=3,34241690164093
 FrameElem=31-1 ElemStation=0,1834
 Frame=31 Station=0 OutputCase=RAR093 CaseType=Combination P=-3,81696210864948 V2=-0,635668662854481 V3=0 T=0 M2=0 M3=19,799245210163 FrameElem=31-1
 ElemStation=0
 Frame=31 Station=0,0917 OutputCase=RAR093 CaseType=Combination P=-3,81696210864948 V2=7,25053133714552 V3=0 T=0 M2=0 M3=19,4959537565467
 FrameElem=31-1 ElemStation=0,0917
 Frame=31 Station=0,1834 OutputCase=RAR093 CaseType=Combination P=-3,81696210864948 V2=15,1367313371455 V3=0 T=0 M2=0 M3=18,4694977629305
 FrameElem=31-1 ElemStation=0,1834
 Frame=31 Station=0 OutputCase=RAR094 CaseType=Combination P=-13,0152443448828 V2=6,61223887374733 V3=0 T=0 M2=0 M3=18,5282604194416 FrameElem=31-1
 ElemStation=0
 Frame=31 Station=0,0917 OutputCase=RAR094 CaseType=Combination P=-13,0152443448828 V2=14,4984388737473 V3=0 T=0 M2=0 M3=17,5603358447189
 FrameElem=31-1 ElemStation=0,0917
 Frame=31 Station=0,1834 OutputCase=RAR094 CaseType=Combination P=-13,0152443448828 V2=22,3846388737473 V3=0 T=0 M2=0 M3=15,8692467299963
 FrameElem=31-1 ElemStation=0,1834
 Frame=31 Station=0 OutputCase=RAR095 CaseType=Combination P=-22,2135265811162 V2=-0,635668662865395 V3=0 T=0 M2=0 M3=17,2572756290233 FrameElem=31-1
 ElemStation=0
 Frame=31 Station=0,0917 OutputCase=RAR095 CaseType=Combination P=-22,2135265811162 V2=7,25053133713461 V3=0 T=0 M2=0 M3=16,953984175408 FrameElem=31-1
 ElemStation=0,0917
 Frame=31 Station=0,1834 OutputCase=RAR095 CaseType=Combination P=-22,2135265811162 V2=15,1367313371346 V3=0 T=0 M2=0 M3=15,9275281817928
 FrameElem=31-1 ElemStation=0,1834
 Frame=31 Station=0 OutputCase=RAR096 CaseType=Combination P=-12,2951370694263 V2=6,61223887374188 V3=0 T=0 M2=0 M3=2,19029939815102 FrameElem=31-1
 ElemStation=0
 Frame=31 Station=0,0917 OutputCase=RAR096 CaseType=Combination P=-12,2951370694263 V2=7,89603887374188 V3=0 T=0 M2=0 M3=1,52509486342889
 FrameElem=31-1 ElemStation=0,0917
 Frame=31 Station=0,1834 OutputCase=RAR096 CaseType=Combination P=-12,2951370694263 V2=9,17983887374188 V3=0 T=0 M2=0 M3=0,74216586870676
 FrameElem=31-1 ElemStation=0,1834
 Frame=31 Station=0 OutputCase=RAR097 CaseType=Combination P=-21,4934193056597 V2=-0,635668662870852 V3=0 T=0 M2=0 M3=0,91931460773271 FrameElem=31-1
 ElemStation=0

APPROVATO S.D.P.

Società di Progetto
Brebemi SpA

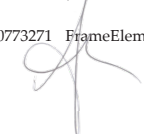



Doc. N.
60235-0000-A00.doc

CODIFICA DOCUMENTO
04RCDII10000000000300A00

REV.
00

FOGLIO
429 di 628

Frame=31 Station=0,0917 OutputCase=RAR097 CaseType=Combination P=-21,4934193056597 V2=0,648131337129149 V3=0 T=0 M2=0 M3=0,918743194117967
FrameElem=31-1 ElemStation=0,0917
Frame=31 Station=0,1834 OutputCase=RAR097 CaseType=Combination P=-21,4934193056597 V2=1,93193133712915 V3=0 T=0 M2=0 M3=0,800447320503224
FrameElem=31-1 ElemStation=0,1834
Frame=31 Station=0 OutputCase=RAR098 CaseType=Combination P=-4,19234429366678 V2=0,635668662834348 V3=0 T=0 M2=0 M3=2,19730364114096 FrameElem=31-1
ElemStation=0
Frame=31 Station=0,0917 OutputCase=RAR098 CaseType=Combination P=-4,19234429366678 V2=1,91946866283435 V3=0 T=0 M2=0 M3=2,08015059475905
FrameElem=31-1 ElemStation=0,0917
Frame=31 Station=0,1834 OutputCase=RAR098 CaseType=Combination P=-4,19234429366678 V2=3,20326866283435 V3=0 T=0 M2=0 M3=1,84527308837714
FrameElem=31-1 ElemStation=0,1834
Frame=31 Station=0 OutputCase=RAR099 CaseType=Combination P=-5,02533565610388 V2=0,381401197702792 V3=0 T=0 M2=0 M3=24,1577567761717 FrameElem=31-1
ElemStation=0
Frame=31 Station=0,0917 OutputCase=RAR099 CaseType=Combination P=-5,02533565610388 V2=10,4684011977028 V3=0 T=0 M2=0 M3=23,6602933363423
FrameElem=31-1 ElemStation=0,0917
Frame=31 Station=0,1834 OutputCase=RAR099 CaseType=Combination P=-5,02533565610388 V2=20,5554011977028 V3=0 T=0 M2=0 M3=22,237851996513 FrameElem=31-1
ElemStation=0,1834
Frame=31 Station=0 OutputCase=RAR100 CaseType=Combination P=-16,8507663780797 V2=9,72254529074863 V3=0 T=0 M2=0 M3=22,5353244091435 FrameElem=31-1
ElemStation=0
Frame=31 Station=0,0917 OutputCase=RAR100 CaseType=Combination P=-16,8507663780797 V2=19,8095452907486 V3=0 T=0 M2=0 M3=21,1812780559818
FrameElem=31-1 ElemStation=0,0917
Frame=31 Station=0,1834 OutputCase=RAR100 CaseType=Combination P=-16,8507663780797 V2=29,8965452907486 V3=0 T=0 M2=0 M3=18,9022538028202
FrameElem=31-1 ElemStation=0,1834
Frame=31 Station=0 OutputCase=RAR101 CaseType=Combination P=-28,6761971000556 V2=0,38140119768824 V3=0 T=0 M2=0 M3=20,9128920425007 FrameElem=31-1
ElemStation=0
Frame=31 Station=0,0917 OutputCase=RAR101 CaseType=Combination P=-28,6761971000556 V2=10,4684011976882 V3=0 T=0 M2=0 M3=20,4154286026727
FrameElem=31-1 ElemStation=0,0917
Frame=31 Station=0,1834 OutputCase=RAR101 CaseType=Combination P=-28,6761971000556 V2=20,5554011976882 V3=0 T=0 M2=0 M3=18,9929872628447
FrameElem=31-1 ElemStation=0,1834
Frame=31 Station=0 OutputCase=RAR102 CaseType=Combination P=-15,8906233441377 V2=9,72254529074136 V3=0 T=0 M2=0 M3=0,751376380756112 FrameElem=31-1
ElemStation=0
Frame=31 Station=0,0917 OutputCase=RAR102 CaseType=Combination P=-15,8906233441377 V2=11,0063452907414 V3=0 T=0 M2=0 M3=-0,199043252404871
FrameElem=31-1 ElemStation=0,0917
Frame=31 Station=0,1834 OutputCase=RAR102 CaseType=Combination P=-15,8906233441377 V2=12,2901452907414 V3=0 T=0 M2=0 M3=-1,26718734556585
FrameElem=31-1 ElemStation=0,1834
Frame=31 Station=0 OutputCase=RAR103 CaseType=Combination P=-27,7160540661136 V2=0,381401197680964 V3=0 T=0 M2=0 M3=-0,871055985886672 FrameElem=31-1
ElemStation=0
Frame=31 Station=0,0917 OutputCase=RAR103 CaseType=Combination P=-27,7160540661136 V2=1,66520119768096 V3=0 T=0 M2=0 M3=-0,964892705714016
FrameElem=31-1 ElemStation=0,0917
Frame=31 Station=0,1834 OutputCase=RAR103 CaseType=Combination P=-27,7160540661136 V2=2,94900119768096 V3=0 T=0 M2=0 M3=-1,17645388554136
FrameElem=31-1 ElemStation=0,1834
Frame=31 Station=0 OutputCase=RAR104 CaseType=Combination P=-13,9835821338517 V2=21,9773922820849 V3=0 T=0 M2=0 M3=17,4407849782334 FrameElem=31-1
ElemStation=0
Frame=31 Station=0,0917 OutputCase=RAR104 CaseType=Combination P=-15,5149721338517 V2=29,8635922820849 V3=0 T=0 M2=0 M3=15,0638758359662
FrameElem=31-1 ElemStation=0,0917
Frame=31 Station=0,1834 OutputCase=RAR104 CaseType=Combination P=-17,0463621338517 V2=37,7497922820849 V3=0 T=0 M2=0 M3=11,963802153699 FrameElem=31-1
ElemStation=0,1834
Frame=31 Station=0 OutputCase=RAR105 CaseType=Combination P=-4,9124515691233 V2=0,635668662839805 V3=0 T=0 M2=0 M3=18,5352646624315 FrameElem=31-1
ElemStation=0
Frame=31 Station=0,0917 OutputCase=RAR105 CaseType=Combination P=-4,9124515691233 V2=8,52186866283981 V3=0 T=0 M2=0 M3=18,1153915760491 FrameElem=31-1
ElemStation=0,0917
Frame=31 Station=0,1834 OutputCase=RAR105 CaseType=Combination P=-4,9124515691233 V2=16,4080686628398 V3=0 T=0 M2=0 M3=16,9723539496667 FrameElem=31-1
ElemStation=0,1834
Frame=31 Station=0 OutputCase=RAR106 CaseType=Combination P=-14,1107338053567 V2=7,88357619944162 V3=0 T=0 M2=0 M3=17,2642798717101 FrameElem=31-1
ElemStation=0
Frame=31 Station=0,0917 OutputCase=RAR106 CaseType=Combination P=-14,1107338053567 V2=15,7697761994416 V3=0 T=0 M2=0 M3=16,1797736642213
FrameElem=31-1 ElemStation=0,0917
Frame=31 Station=0,1834 OutputCase=RAR106 CaseType=Combination P=-14,1107338053567 V2=23,6559761994416 V3=0 T=0 M2=0 M3=14,3721029167325
FrameElem=31-1 ElemStation=0,1834
Frame=31 Station=0 OutputCase=RAR107 CaseType=Combination P=-23,30901604159 V2=0,635668662828891 V3=0 T=0 M2=0 M3=15,9932950812918 FrameElem=31-1
ElemStation=0
Frame=31 Station=0,0917 OutputCase=RAR107 CaseType=Combination P=-23,30901604159 V2=8,52186866282889 V3=0 T=0 M2=0 M3=15,5734219949104 FrameElem=31-1
ElemStation=0,0917
Frame=31 Station=0,1834 OutputCase=RAR107 CaseType=Combination P=-23,30901604159 V2=16,4080686628289 V3=0 T=0 M2=0 M3=14,430384368529 FrameElem=31-1
ElemStation=0,1834
Frame=31 Station=0 OutputCase=RAR108 CaseType=Combination P=-13,3906265299001 V2=7,88357619943616 V3=0 T=0 M2=0 M3=0,92631885041956 FrameElem=31-1
ElemStation=0
Frame=31 Station=0,0917 OutputCase=RAR108 CaseType=Combination P=-13,3906265299001 V2=9,16737619943616 V3=0 T=0 M2=0 M3=0,144532682931263
FrameElem=31-1 ElemStation=0,0917
Frame=31 Station=0,1834 OutputCase=RAR108 CaseType=Combination P=-13,3906265299001 V2=10,4511761994362 V3=0 T=0 M2=0 M3=-0,754977944557033
FrameElem=31-1 ElemStation=0,1834
Frame=31 Station=0 OutputCase=RAR109 CaseType=Combination P=-22,5889087661335 V2=0,635668662823434 V3=0 T=0 M2=0 M3=-0,344665939998751 FrameElem=31-1
ElemStation=0
Frame=31 Station=0,0917 OutputCase=RAR109 CaseType=Combination P=-22,5889087661335 V2=1,91946866282343 V3=0 T=0 M2=0 M3=-0,46181898637966
FrameElem=31-1 ElemStation=0,0917
Frame=31 Station=0,1834 OutputCase=RAR109 CaseType=Combination P=-22,5889087661335 V2=3,20326866282343 V3=0 T=0 M2=0 M3=-0,696696492760569
FrameElem=31-1 ElemStation=0,1834
Frame=31 Station=0 OutputCase=RAR110 CaseType=Combination P=-4,65207539661596 V2=0,635668662834472 V3=0 T=0 M2=0 M3=1,81584862662617 FrameElem=31-1
ElemStation=0
Frame=31 Station=0,0917 OutputCase=RAR110 CaseType=Combination P=-4,65207539661596 V2=1,91946866283447 V3=0 T=0 M2=0 M3=1,69869558024425
FrameElem=31-1 ElemStation=0,0917
Frame=31 Station=0,1834 OutputCase=RAR110 CaseType=Combination P=-4,65207539661596 V2=3,20326866283447 V3=0 T=0 M2=0 M3=1,46381807386233
FrameElem=31-1 ElemStation=0,1834
Frame=31 Station=0 OutputCase=RAR111 CaseType=Combination P=-5,37218267207247 V2=0,635668662839929 V3=0 T=0 M2=0 M3=18,1538096479167 FrameElem=31-1
ElemStation=0
Frame=31 Station=0,0917 OutputCase=RAR111 CaseType=Combination P=-5,37218267207247 V2=8,52186866283993 V3=0 T=0 M2=0 M3=17,7339365615343
FrameElem=31-1 ElemStation=0,0917
Frame=31 Station=0,1834 OutputCase=RAR111 CaseType=Combination P=-5,37218267207247 V2=16,4080686628399 V3=0 T=0 M2=0 M3=16,5908989351519
FrameElem=31-1 ElemStation=0,1834

Società di Progetto
Brebemi SpA

	Doc. N. 60235-0000-A00.doc	CODIFICA DOCUMENTO 04RCDII10000000000300A00	REV. 00	FOGLIO 430 di 628
--	-------------------------------	--	------------	----------------------

Frame=31 Station=0 OutputCase=RAR112 CaseType=Combination P=-14,5704649083058 V2=7,88357619944174 V3=0 T=0 M2=0 M3=16,8828248571953 FrameElem=31-1 ElemStation=0

Frame=31 Station=0,0917 OutputCase=RAR112 CaseType=Combination P=-14,5704649083058 V2=15,7697761994417 V3=0 T=0 M2=0 M3=15,7983186497065 FrameElem=31-1 ElemStation=0,0917

Frame=31 Station=0,1834 OutputCase=RAR112 CaseType=Combination P=-14,5704649083058 V2=23,6559761994417 V3=0 T=0 M2=0 M3=13,9906479022177 FrameElem=31-1 ElemStation=0,1834

Frame=31 Station=0 OutputCase=RAR113 CaseType=Combination P=-23,7687471445392 V2=0,635668662829015 V3=0 T=0 M2=0 M3=15,611840066777 FrameElem=31-1 ElemStation=0

Frame=31 Station=0,0917 OutputCase=RAR113 CaseType=Combination P=-23,7687471445392 V2=8,52186866282901 V3=0 T=0 M2=0 M3=15,1919669803956 FrameElem=31-1 ElemStation=0,0917

Frame=31 Station=0,1834 OutputCase=RAR113 CaseType=Combination P=-23,7687471445392 V2=16,408068662829 V3=0 T=0 M2=0 M3=14,0489293540142 FrameElem=31-1 ElemStation=0,1834

Frame=31 Station=0 OutputCase=RAR114 CaseType=Combination P=-13,8503576328493 V2=7,88357619943629 V3=0 T=0 M2=0 M3=0,544863835904769 FrameElem=31-1 ElemStation=0

Frame=31 Station=0,0917 OutputCase=RAR114 CaseType=Combination P=-13,8503576328493 V2=9,16737619943629 V3=0 T=0 M2=0 M3=-0,236922331583538 FrameElem=31-1 ElemStation=0,0917

Frame=31 Station=0,1834 OutputCase=RAR114 CaseType=Combination P=-13,8503576328493 V2=10,4511761994363 V3=0 T=0 M2=0 M3=-1,13643295907185 FrameElem=31-1 ElemStation=0,1834

Frame=31 Station=0 OutputCase=RAR115 CaseType=Combination P=-23,0486398690827 V2=0,635668662823558 V3=0 T=0 M2=0 M3=-0,726120954513541 FrameElem=31-1 ElemStation=0

Frame=31 Station=0,0917 OutputCase=RAR115 CaseType=Combination P=-23,0486398690827 V2=1,91946866282356 V3=0 T=0 M2=0 M3=-0,843274000894462 FrameElem=31-1 ElemStation=0,0917

Frame=31 Station=0,1834 OutputCase=RAR115 CaseType=Combination P=-23,0486398690827 V2=3,20326866282356 V3=0 T=0 M2=0 M3=-1,07815150727538 FrameElem=31-1 ElemStation=0,1834

Frame=31 Station=0 OutputCase=RAR116 CaseType=Combination P=-3,73261319071761 V2=0,635668662834225 V3=0 T=0 M2=0 M3=2,57875865565575 FrameElem=31-1 ElemStation=0

Frame=31 Station=0,0917 OutputCase=RAR116 CaseType=Combination P=-3,73261319071761 V2=1,91946866283422 V3=0 T=0 M2=0 M3=2,46160560927385 FrameElem=31-1 ElemStation=0,0917

Frame=31 Station=0,1834 OutputCase=RAR116 CaseType=Combination P=-3,73261319071761 V2=3,20326866283423 V3=0 T=0 M2=0 M3=2,22672810289195 FrameElem=31-1 ElemStation=0,1834

Frame=31 Station=0 OutputCase=RAR117 CaseType=Combination P=-4,45272046617413 V2=0,635668662839681 V3=0 T=0 M2=0 M3=18,9167196769463 FrameElem=31-1 ElemStation=0

Frame=31 Station=0,0917 OutputCase=RAR117 CaseType=Combination P=-4,45272046617413 V2=8,52186866283968 V3=0 T=0 M2=0 M3=18,4968465905639 FrameElem=31-1 ElemStation=0,0917

Frame=31 Station=0,1834 OutputCase=RAR117 CaseType=Combination P=-4,45272046617413 V2=16,4080686628397 V3=0 T=0 M2=0 M3=17,3538089641815 FrameElem=31-1 ElemStation=0,1834

Frame=31 Station=0 OutputCase=RAR118 CaseType=Combination P=-13,6510027024075 V2=7,8835761994415 V3=0 T=0 M2=0 M3=17,6457348862249 FrameElem=31-1 ElemStation=0

Frame=31 Station=0,0917 OutputCase=RAR118 CaseType=Combination P=-13,6510027024075 V2=15,7697761994415 V3=0 T=0 M2=0 M3=16,5612286787361 FrameElem=31-1 ElemStation=0,0917

Frame=31 Station=0,1834 OutputCase=RAR118 CaseType=Combination P=-13,6510027024075 V2=23,6559761994415 V3=0 T=0 M2=0 M3=14,7535579312473 FrameElem=31-1 ElemStation=0,1834

Frame=31 Station=0 OutputCase=RAR119 CaseType=Combination P=-22,8492849386408 V2=0,635668662828768 V3=0 T=0 M2=0 M3=16,3747500958066 FrameElem=31-1 ElemStation=0

Frame=31 Station=0,0917 OutputCase=RAR119 CaseType=Combination P=-22,8492849386408 V2=8,52186866282877 V3=0 T=0 M2=0 M3=15,9548770094252 FrameElem=31-1 ElemStation=0,0917

Frame=31 Station=0,1834 OutputCase=RAR119 CaseType=Combination P=-22,8492849386408 V2=16,4080686628288 V3=0 T=0 M2=0 M3=14,8118393830438 FrameElem=31-1 ElemStation=0,1834

Frame=31 Station=0 OutputCase=RAR120 CaseType=Combination P=-12,930895426951 V2=7,88357619943604 V3=0 T=0 M2=0 M3=1,30777386493435 FrameElem=31-1 ElemStation=0

Frame=31 Station=0,0917 OutputCase=RAR120 CaseType=Combination P=-12,930895426951 V2=9,16737619943604 V3=0 T=0 M2=0 M3=0,525987697446065 FrameElem=31-1 ElemStation=0,0917

Frame=31 Station=0,1834 OutputCase=RAR120 CaseType=Combination P=-12,930895426951 V2=10,451176199436 V3=0 T=0 M2=0 M3=-0,37352293004222 FrameElem=31-1 ElemStation=0,1834

Frame=31 Station=0 OutputCase=RAR121 CaseType=Combination P=-22,1291776631843 V2=0,635668662823311 V3=0 T=0 M2=0 M3=3,67890745160396E-02 FrameElem=31-1 ElemStation=0

Frame=31 Station=0,0917 OutputCase=RAR121 CaseType=Combination P=-22,1291776631843 V2=1,91946866282331 V3=0 T=0 M2=0 M3=-8,03639718648581E-02 FrameElem=31-1 ElemStation=0,0917

Frame=31 Station=0,1834 OutputCase=RAR121 CaseType=Combination P=-22,1291776631843 V2=3,20326866282331 V3=0 T=0 M2=0 M3=-0,315241478245756 FrameElem=31-1 ElemStation=0,1834

Frame=31 Station=0 OutputCase=RAR122 CaseType=Combination P=-3,73261319071761 V2=0,635668662834225 V3=0 T=0 M2=0 M3=2,57875865565575 FrameElem=31-1 ElemStation=0

Frame=31 Station=0,0917 OutputCase=RAR122 CaseType=Combination P=-3,73261319071761 V2=1,91946866283422 V3=0 T=0 M2=0 M3=2,46160560927385 FrameElem=31-1 ElemStation=0,0917

Frame=31 Station=0,1834 OutputCase=RAR122 CaseType=Combination P=-3,73261319071761 V2=3,20326866283423 V3=0 T=0 M2=0 M3=2,22672810289195 FrameElem=31-1 ElemStation=0,1834

Frame=31 Station=0 OutputCase=RAR123 CaseType=Combination P=-4,45272046617413 V2=0,635668662839681 V3=0 T=0 M2=0 M3=18,9167196769463 FrameElem=31-1 ElemStation=0

Frame=31 Station=0,0917 OutputCase=RAR123 CaseType=Combination P=-4,45272046617413 V2=8,52186866283968 V3=0 T=0 M2=0 M3=18,4968465905639 FrameElem=31-1 ElemStation=0,0917

Frame=31 Station=0,1834 OutputCase=RAR123 CaseType=Combination P=-4,45272046617413 V2=16,4080686628397 V3=0 T=0 M2=0 M3=17,3538089641815 FrameElem=31-1 ElemStation=0,1834

Frame=31 Station=0 OutputCase=RAR124 CaseType=Combination P=-13,6510027024075 V2=7,8835761994415 V3=0 T=0 M2=0 M3=17,6457348862249 FrameElem=31-1 ElemStation=0

Frame=31 Station=0,0917 OutputCase=RAR124 CaseType=Combination P=-13,6510027024075 V2=15,7697761994415 V3=0 T=0 M2=0 M3=16,5612286787361 FrameElem=31-1 ElemStation=0,0917

Frame=31 Station=0,1834 OutputCase=RAR124 CaseType=Combination P=-13,6510027024075 V2=23,6559761994415 V3=0 T=0 M2=0 M3=14,7535579312473 FrameElem=31-1 ElemStation=0,1834

Frame=31 Station=0 OutputCase=RAR125 CaseType=Combination P=-22,8492849386408 V2=0,635668662828768 V3=0 T=0 M2=0 M3=16,3747500958066 FrameElem=31-1 ElemStation=0

Frame=31 Station=0,0917 OutputCase=RAR125 CaseType=Combination P=-22,8492849386408 V2=8,52186866282877 V3=0 T=0 M2=0 M3=15,9548770094252 FrameElem=31-1 ElemStation=0,0917

Frame=31 Station=0,1834 OutputCase=RAR125 CaseType=Combination P=-22,8492849386408 V2=16,4080686628288 V3=0 T=0 M2=0 M3=14,8118393830438 FrameElem=31-1 ElemStation=0,1834

Frame=31 Station=0 OutputCase=RAR126 CaseType=Combination P=-12,930895426951 V2=7,88357619943604 V3=0 T=0 M2=0 M3=1,30777386493435 FrameElem=31-1 ElemStation=0

Frame=31 Station=0,0917 OutputCase=RAR126 CaseType=Combination P=-12,930895426951 V2=9,16737619943604 V3=0 T=0 M2=0 M3=0,525987697446065 FrameElem=31-1 ElemStation=0,0917

Società di Progetto
Brebemi SpA

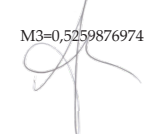



Doc. N.
60235-0000-A00.doc

CODIFICA DOCUMENTO
04RCDII10000000000300A00

REV.
00

FOGLIO
431 di 628

Frame=31 Station=0,1834 OutputCase=RAR126 CaseType=Combination P=-12,930895426951 V2=10,451176199436 V3=0 T=0 M2=0 M3=-0,37352293004222 FrameElem=31-1 ElemStation=0,1834
Frame=31 Station=0 OutputCase=RAR127 CaseType=Combination P=-22,1291776631843 V2=0,635668662823311 V3=0 T=0 M2=0 M3=3,67890745160396E-02 FrameElem=31-1 ElemStation=0
Frame=31 Station=0,0917 OutputCase=RAR127 CaseType=Combination P=-22,1291776631843 V2=1,91946866282331 V3=0 T=0 M2=0 M3=-8,03639718648581E-02 FrameElem=31-1 ElemStation=0,0917
Frame=31 Station=0,1834 OutputCase=RAR127 CaseType=Combination P=-22,1291776631843 V2=3,20326866282331 V3=0 T=0 M2=0 M3=-0,315241478245756 FrameElem=31-1 ElemStation=0,1834
Frame=31 Station=0 OutputCase=RAR128 CaseType=Combination P=-3,10824660998917 V2=-1,29389832181914E-11 V3=0 T=0 M2=0 M3=3,27432746527395 FrameElem=31-1 ElemStation=0
Frame=31 Station=0,0917 OutputCase=RAR128 CaseType=Combination P=-3,10824660998917 V2=1,28379999998706 V3=0 T=0 M2=0 M3=3,21546253527513 FrameElem=31-1 ElemStation=0,0917
Frame=31 Station=0,1834 OutputCase=RAR128 CaseType=Combination P=-3,10824660998917 V2=2,56759999998706 V3=0 T=0 M2=0 M3=3,03887584527632 FrameElem=31-1 ElemStation=0,1834
Frame=31 Station=0 OutputCase=RAR129 CaseType=Combination P=-4,37487704589731 V2=-5,58060264665983E-12 V3=0 T=0 M2=0 M3=24,8039694506515 FrameElem=31-1 ElemStation=0
Frame=31 Station=0,0917 OutputCase=RAR129 CaseType=Combination P=-4,37487704589731 V2=10,086999999994 V3=0 T=0 M2=0 M3=24,341480500652 FrameElem=31-1 ElemStation=0,0917
Frame=31 Station=0,1834 OutputCase=RAR129 CaseType=Combination P=-4,37487704589731 V2=20,173999999994 V3=0 T=0 M2=0 M3=22,9540136506525 FrameElem=31-1 ElemStation=0,1834
Frame=31 Station=0 OutputCase=RAR130 CaseType=Combination P=-16,2003077678732 V2=9,34114409304026 V3=0 T=0 M2=0 M3=23,1815370836233 FrameElem=31-1 ElemStation=0
Frame=31 Station=0,0917 OutputCase=RAR130 CaseType=Combination P=-16,2003077678732 V2=19,4281440930403 V3=0 T=0 M2=0 M3=21,8624652202915 FrameElem=31-1 ElemStation=0,0917
Frame=31 Station=0,1834 OutputCase=RAR130 CaseType=Combination P=-16,2003077678732 V2=29,5151440930403 V3=0 T=0 M2=0 M3=19,6184154569597 FrameElem=31-1 ElemStation=0,1834
Frame=31 Station=0 OutputCase=RAR131 CaseType=Combination P=-28,025738489849 V2=-2,01325178750267E-11 V3=0 T=0 M2=0 M3=21,5591047169805 FrameElem=31-1 ElemStation=0
Frame=31 Station=0,0917 OutputCase=RAR131 CaseType=Combination P=-28,025738489849 V2=10,0869999999799 V3=0 T=0 M2=0 M3=21,0966157669824 FrameElem=31-1 ElemStation=0,0917
Frame=31 Station=0,1834 OutputCase=RAR131 CaseType=Combination P=-28,025738489849 V2=20,1739999999799 V3=0 T=0 M2=0 M3=19,7091489169842 FrameElem=31-1 ElemStation=0,1834
Frame=31 Station=0 OutputCase=RAR132 CaseType=Combination P=-15,2401647339311 V2=9,34114409303298 V3=0 T=0 M2=0 M3=1,3975890552359 FrameElem=31-1 ElemStation=0
Frame=31 Station=0,0917 OutputCase=RAR132 CaseType=Combination P=-15,2401647339311 V2=10,624944093033 V3=0 T=0 M2=0 M3=0,482143911904778 FrameElem=31-1 ElemStation=0,0917
Frame=31 Station=0,1834 OutputCase=RAR132 CaseType=Combination P=-15,2401647339311 V2=11,908744093033 V3=0 T=0 M2=0 M3=-0,551025691426347 FrameElem=31-1 ElemStation=0,1834
Frame=31 Station=0 OutputCase=RAR133 CaseType=Combination P=-27,065595455907 V2=-2,74084754892101E-11 V3=0 T=0 M2=0 M3=-0,22484331140688 FrameElem=31-1 ElemStation=0
Frame=31 Station=0,0917 OutputCase=RAR133 CaseType=Combination P=-27,065595455907 V2=1,28379999997259 V3=0 T=0 M2=0 M3=-0,283705541404367 FrameElem=31-1 ElemStation=0,0917
Frame=31 Station=0,1834 OutputCase=RAR133 CaseType=Combination P=-27,065595455907 V2=2,56759999997259 V3=0 T=0 M2=0 M3=-0,460292231401854 FrameElem=31-1 ElemStation=0,1834
Frame=31 Station=0 OutputCase=RAR134 CaseType=Combination P=-13,3331235236452 V2=21,5959910843766 V3=0 T=0 M2=0 M3=18,0869976527132 FrameElem=31-1 ElemStation=0
Frame=31 Station=0,0917 OutputCase=RAR134 CaseType=Combination P=-14,8645135236452 V2=29,4821910843766 V3=0 T=0 M2=0 M3=15,7450630002758 FrameElem=31-1 ElemStation=0,0917
Frame=31 Station=0,1834 OutputCase=RAR134 CaseType=Combination P=-16,3959035236452 V2=37,3683910843766 V3=0 T=0 M2=0 M3=12,6799638078385 FrameElem=31-1 ElemStation=0,1834
Frame=31 Station=0 OutputCase=RAR135 CaseType=Combination P=-3,82835388544569 V2=-7,48201500755386E-12 V3=0 T=0 M2=0 M3=19,6122857865645 FrameElem=31-1 ElemStation=0
Frame=31 Station=0,0917 OutputCase=RAR135 CaseType=Combination P=-3,82835388544569 V2=7,88619999999252 V3=0 T=0 M2=0 M3=19,2507035165652 FrameElem=31-1 ElemStation=0,0917
Frame=31 Station=0,1834 OutputCase=RAR135 CaseType=Combination P=-3,82835388544569 V2=15,7723999999925 V3=0 T=0 M2=0 M3=18,1659567065659 FrameElem=31-1 ElemStation=0,1834
Frame=31 Station=0 OutputCase=RAR136 CaseType=Combination P=-13,026636121679 V2=7,24790753659433 V3=0 T=0 M2=0 M3=18,3413009958431 FrameElem=31-1 ElemStation=0
Frame=31 Station=0,0917 OutputCase=RAR136 CaseType=Combination P=-13,026636121679 V2=15,1341075365943 V3=0 T=0 M2=0 M3=17,3150856047374 FrameElem=31-1 ElemStation=0,0917
Frame=31 Station=0,1834 OutputCase=RAR136 CaseType=Combination P=-13,026636121679 V2=23,0203075365943 V3=0 T=0 M2=0 M3=15,5657056736317 FrameElem=31-1 ElemStation=0,1834
Frame=31 Station=0 OutputCase=RAR137 CaseType=Combination P=-22,2249183579124 V2=-1,8395951428829E-11 V3=0 T=0 M2=0 M3=17,0703162054248 FrameElem=31-1 ElemStation=0
Frame=31 Station=0,0917 OutputCase=RAR137 CaseType=Combination P=-22,2249183579124 V2=7,8861999999816 V3=0 T=0 M2=0 M3=16,7087339354265 FrameElem=31-1 ElemStation=0,0917
Frame=31 Station=0,1834 OutputCase=RAR137 CaseType=Combination P=-22,2249183579124 V2=15,7723999999816 V3=0 T=0 M2=0 M3=15,6239871254281 FrameElem=31-1 ElemStation=0,1834
Frame=31 Station=0 OutputCase=RAR138 CaseType=Combination P=-12,3065288462225 V2=7,24790753658888 V3=0 T=0 M2=0 M3=2,00333997455255 FrameElem=31-1 ElemStation=0
Frame=31 Station=0,0917 OutputCase=RAR138 CaseType=Combination P=-12,3065288462225 V2=8,53170753658888 V3=0 T=0 M2=0 M3=1,27984462344735 FrameElem=31-1 ElemStation=0,0917
Frame=31 Station=0,1834 OutputCase=RAR138 CaseType=Combination P=-12,3065288462225 V2=9,81550753658888 V3=0 T=0 M2=0 M3=0,438624812342145 FrameElem=31-1 ElemStation=0,1834
Frame=31 Station=0 OutputCase=RAR139 CaseType=Combination P=-21,5048110824559 V2=-2,38529196394666E-11 V3=0 T=0 M2=0 M3=0,732355184134235 FrameElem=31-1 ElemStation=0
Frame=31 Station=0,0917 OutputCase=RAR139 CaseType=Combination P=-21,5048110824559 V2=1,28379999997615 V3=0 T=0 M2=0 M3=0,673492954136422 FrameElem=31-1 ElemStation=0,0917
Frame=31 Station=0,1834 OutputCase=RAR139 CaseType=Combination P=-21,5048110824559 V2=2,56759999997615 V3=0 T=0 M2=0 M3=0,496906264138609 FrameElem=31-1 ElemStation=0,1834
Frame=31 Station=0 OutputCase=RAR140 CaseType=Combination P=-3,56797771293834 V2=-1,28153487821692E-11 V3=0 T=0 M2=0 M3=2,89286975075916 FrameElem=31-1 ElemStation=0
Frame=31 Station=0,0917 OutputCase=RAR140 CaseType=Combination P=-3,56797771293834 V2=1,28379999998718 V3=0 T=0 M2=0 M3=2,83400732076033 FrameElem=31-1 ElemStation=0,0917
Frame=31 Station=0,1834 OutputCase=RAR140 CaseType=Combination P=-3,56797771293834 V2=2,56759999998719 V3=0 T=0 M2=0 M3=2,65742083076151 FrameElem=31-1 ElemStation=0,1834
Frame=31 Station=0 OutputCase=RAR141 CaseType=Combination P=-4,28808498839486 V2=-7,3583805715316E-12 V3=0 T=0 M2=0 M3=19,2308307720497 FrameElem=31-1 ElemStation=0

APPROVATO S.D.P.
Società di Progetto
Brebemi SpA



Doc. N.
60235-0000-A00.doc

CODIFICA DOCUMENTO
04RCDII10000000000300A00

REV.
00

FOGLIO
432 di 628

Frame=31 Station=0,0917 OutputCase=RAR141 CaseType=Combination P=-4,28808498839486 V2=7,88619999999264 V3=0 T=0 M2=0 M3=18,8692485020504
FrameElem=31-1 ElemStation=0,0917
Frame=31 Station=0,1834 OutputCase=RAR141 CaseType=Combination P=-4,28808498839486 V2=15,7723999999926 V3=0 T=0 M2=0 M3=17,784501692051 FrameElem=31-1
ElemStation=0,1834
Frame=31 Station=0 OutputCase=RAR142 CaseType=Combination P=-13,4863672246282 V2=7,24790753659446 V3=0 T=0 M2=0 M3=17,9598459813283 FrameElem=31-1
ElemStation=0
Frame=31 Station=0,0917 OutputCase=RAR142 CaseType=Combination P=-13,4863672246282 V2=15,1341075365945 V3=0 T=0 M2=0 M3=16,9336305902226
FrameElem=31-1 ElemStation=0,0917
Frame=31 Station=0,1834 OutputCase=RAR142 CaseType=Combination P=-13,4863672246282 V2=23,0203075365945 V3=0 T=0 M2=0 M3=15,1842506591169
FrameElem=31-1 ElemStation=0,1834
Frame=31 Station=0 OutputCase=RAR143 CaseType=Combination P=-22,6846494608616 V2=1,82723169928067E-11 V3=0 T=0 M2=0 M3=16,68886119091 FrameElem=31-1
ElemStation=0
Frame=31 Station=0,0917 OutputCase=RAR143 CaseType=Combination P=-22,6846494608616 V2=7,88619999998173 V3=0 T=0 M2=0 M3=16,3272789209117
FrameElem=31-1 ElemStation=0,0917
Frame=31 Station=0,1834 OutputCase=RAR143 CaseType=Combination P=-22,6846494608616 V2=15,77239999998173 V3=0 T=0 M2=0 M3=15,2425321109133
FrameElem=31-1 ElemStation=0,1834
Frame=31 Station=0 OutputCase=RAR144 CaseType=Combination P=-12,7662599491717 V2=7,247907536589 V3=0 T=0 M2=0 M3=1,62188496003776 FrameElem=31-1
ElemStation=0
Frame=31 Station=0,0917 OutputCase=RAR144 CaseType=Combination P=-12,7662599491717 V2=8,531707536589 V3=0 T=0 M2=0 M3=0,898389608932544 FrameElem=31-1
ElemStation=0,0917
Frame=31 Station=0,1834 OutputCase=RAR144 CaseType=Combination P=-12,7662599491717 V2=9,815507536589 V3=0 T=0 M2=0 M3=5,71697978273323E-02
FrameElem=31-1 ElemStation=0,1834
Frame=31 Station=0 OutputCase=RAR145 CaseType=Combination P=-21,9645421854051 V2=-2,37292852034443E-11 V3=0 T=0 M2=0 M3=0,350900169619445
FrameElem=31-1 ElemStation=0
Frame=31 Station=0,0917 OutputCase=RAR145 CaseType=Combination P=-21,9645421854051 V2=1,28379999997627 V3=0 T=0 M2=0 M3=0,29203793962162
FrameElem=31-1 ElemStation=0,0917
Frame=31 Station=0,1834 OutputCase=RAR145 CaseType=Combination P=-21,9645421854051 V2=2,56759999997627 V3=0 T=0 M2=0 M3=0,115451249623796
FrameElem=31-1 ElemStation=0,1834
Frame=31 Station=0 OutputCase=RAR146 CaseType=Combination P=-2,64851550704 V2=-1,30626176542137E-11 V3=0 T=0 M2=0 M3=3,65577979778874 FrameElem=31-1
ElemStation=0
Frame=31 Station=0,0917 OutputCase=RAR146 CaseType=Combination P=-2,64851550704 V2=1,28379999998694 V3=0 T=0 M2=0 M3=3,59691754978993 FrameElem=31-1
ElemStation=0,0917
Frame=31 Station=0,1834 OutputCase=RAR146 CaseType=Combination P=-2,64851550704 V2=2,56759999998694 V3=0 T=0 M2=0 M3=3,42033085979113 FrameElem=31-1
ElemStation=0,1834
Frame=31 Station=0 OutputCase=RAR147 CaseType=Combination P=-3,36862278249652 V2=-7,60564944357611E-12 V3=0 T=0 M2=0 M3=19,9937408010793
FrameElem=31-1 ElemStation=0
Frame=31 Station=0,0917 OutputCase=RAR147 CaseType=Combination P=-3,36862278249652 V2=7,8861999999924 V3=0 T=0 M2=0 M3=19,63215853108 FrameElem=31-1
ElemStation=0,0917
Frame=31 Station=0,1834 OutputCase=RAR147 CaseType=Combination P=-3,36862278249652 V2=15,7723999999924 V3=0 T=0 M2=0 M3=18,5474117210807
FrameElem=31-1 ElemStation=0,1834
Frame=31 Station=0 OutputCase=RAR148 CaseType=Combination P=-12,5669050187299 V2=7,24790753659421 V3=0 T=0 M2=0 M3=18,7227560103579 FrameElem=31-1
ElemStation=0
Frame=31 Station=0,0917 OutputCase=RAR148 CaseType=Combination P=-12,5669050187299 V2=15,1341075365942 V3=0 T=0 M2=0 M3=17,6965406192522
FrameElem=31-1 ElemStation=0,0917
Frame=31 Station=0,1834 OutputCase=RAR148 CaseType=Combination P=-12,5669050187299 V2=23,0203075365942 V3=0 T=0 M2=0 M3=15,9471606881465
FrameElem=31-1 ElemStation=0,1834
Frame=31 Station=0 OutputCase=RAR149 CaseType=Combination P=-21,7651872549632 V2=-1,85195858648513E-11 V3=0 T=0 M2=0 M3=17,4517712199396
FrameElem=31-1 ElemStation=0
Frame=31 Station=0,0917 OutputCase=RAR149 CaseType=Combination P=-21,7651872549632 V2=7,88619999998148 V3=0 T=0 M2=0 M3=17,0901889499413
FrameElem=31-1 ElemStation=0,0917
Frame=31 Station=0,1834 OutputCase=RAR149 CaseType=Combination P=-21,7651872549632 V2=15,7723999999815 V3=0 T=0 M2=0 M3=16,005442139943 FrameElem=31-1
ElemStation=0,1834
Frame=31 Station=0 OutputCase=RAR150 CaseType=Combination P=-11,8467977432734 V2=7,24790753658875 V3=0 T=0 M2=0 M3=2,38479498906734 FrameElem=31-1
ElemStation=0
Frame=31 Station=0,0917 OutputCase=RAR150 CaseType=Combination P=-11,8467977432734 V2=8,53170753658875 V3=0 T=0 M2=0 M3=1,66129963796215
FrameElem=31-1 ElemStation=0,0917
Frame=31 Station=0,1834 OutputCase=RAR150 CaseType=Combination P=-11,8467977432734 V2=9,81550753658875 V3=0 T=0 M2=0 M3=0,820079826856959
FrameElem=31-1 ElemStation=0,1834
Frame=31 Station=0 OutputCase=RAR151 CaseType=Combination P=-21,0450799795067 V2=-2,39765540754888E-11 V3=0 T=0 M2=0 M3=1,11381019864903
FrameElem=31-1 ElemStation=0
Frame=31 Station=0,0917 OutputCase=RAR151 CaseType=Combination P=-21,0450799795067 V2=1,28379999997602 V3=0 T=0 M2=0 M3=1,05494796865122
FrameElem=31-1 ElemStation=0,0917
Frame=31 Station=0,1834 OutputCase=RAR151 CaseType=Combination P=-21,0450799795067 V2=2,56759999997602 V3=0 T=0 M2=0 M3=0,878361278653423
FrameElem=31-1 ElemStation=0,1834
Frame=31 Station=0 OutputCase=RAR152 CaseType=Combination P=-2,91751910273178 V2=-0,381401197721188 V3=0 T=0 M2=0 M3=3,53908242523895 FrameElem=31-1
ElemStation=0
Frame=31 Station=0,0917 OutputCase=RAR152 CaseType=Combination P=-2,91751910273178 V2=0,902398802278813 V3=0 T=0 M2=0 M3=3,51519468506998
FrameElem=31-1 ElemStation=0,0917
Frame=31 Station=0,1834 OutputCase=RAR152 CaseType=Combination P=-2,91751910273178 V2=2,18619880227881 V3=0 T=0 M2=0 M3=3,37358248490101
FrameElem=31-1 ElemStation=0,1834
Frame=31 Station=0 OutputCase=RAR153 CaseType=Combination P=-3,63762637818829 V2=-0,381401197715731 V3=0 T=0 M2=0 M3=19,8770434465295 FrameElem=31-1
ElemStation=0
Frame=31 Station=0,0917 OutputCase=RAR153 CaseType=Combination P=-3,63762637818829 V2=7,50479880228427 V3=0 T=0 M2=0 M3=19,55043566636 FrameElem=31-1
ElemStation=0,0917
Frame=31 Station=0,1834 OutputCase=RAR153 CaseType=Combination P=-3,63762637818829 V2=15,3909988022843 V3=0 T=0 M2=0 M3=18,5006633461906
FrameElem=31-1 ElemStation=0,1834
Frame=31 Station=0 OutputCase=RAR154 CaseType=Combination P=-12,8359086144216 V2=6,86650633888608 V3=0 T=0 M2=0 M3=18,6060586558081 FrameElem=31-1
ElemStation=0
Frame=31 Station=0,0917 OutputCase=RAR154 CaseType=Combination P=-12,8359086144216 V2=14,7527063388861 V3=0 T=0 M2=0 M3=17,6148177545322
FrameElem=31-1 ElemStation=0,0917
Frame=31 Station=0,1834 OutputCase=RAR154 CaseType=Combination P=-12,8359086144216 V2=22,6389063388861 V3=0 T=0 M2=0 M3=15,9004123132564
FrameElem=31-1 ElemStation=0,1834
Frame=31 Station=0 OutputCase=RAR155 CaseType=Combination P=-22,034190850655 V2=-0,381401197726645 V3=0 T=0 M2=0 M3=17,3350738653898 FrameElem=31-1
ElemStation=0
Frame=31 Station=0,0917 OutputCase=RAR155 CaseType=Combination P=-22,034190850655 V2=7,50479880227336 V3=0 T=0 M2=0 M3=17,0084660852213 FrameElem=31-1
ElemStation=0,0917
Frame=31 Station=0,1834 OutputCase=RAR155 CaseType=Combination P=-22,034190850655 V2=15,3909988022734 V3=0 T=0 M2=0 M3=15,9586937650528 FrameElem=31-1
ElemStation=0,1834

Società di Progetto
Brebemi SpA



Doc. N.
60235-0000-A00.doc

CODIFICA DOCUMENTO
04RCDII10000000000300A00

REV.
00

FOGLIO
433 di 628

Frame=31 Station=0 OutputCase=RAR156 CaseType=Combination P=-12,1158013389651 V2=6,86650633888063 V3=0 T=0 M2=0 M3=2,26809763451755 FrameElem=31-1 ElemStation=0
Frame=31 Station=0,0917 OutputCase=RAR156 CaseType=Combination P=-12,1158013389651 V2=8,15030633888063 V3=0 T=0 M2=0 M3=1,57957677324219 FrameElem=31-1 ElemStation=0,0917
Frame=31 Station=0,1834 OutputCase=RAR156 CaseType=Combination P=-12,1158013389651 V2=9,43410633888063 V3=0 T=0 M2=0 M3=0,773331451966839 FrameElem=31-1 ElemStation=0,1834
Frame=31 Station=0 OutputCase=RAR157 CaseType=Combination P=-21,3140835751985 V2=-0,381401197732102 V3=0 T=0 M2=0 M3=0,997112844099236 FrameElem=31-1 ElemStation=0
Frame=31 Station=0,0917 OutputCase=RAR157 CaseType=Combination P=-21,3140835751985 V2=0,902398802267899 V3=0 T=0 M2=0 M3=0,97322510393127 FrameElem=31-1 ElemStation=0,0917
Frame=31 Station=0,1834 OutputCase=RAR157 CaseType=Combination P=-21,3140835751985 V2=2,1861988022679 V3=0 T=0 M2=0 M3=0,831612903763303 FrameElem=31-1 ElemStation=0,1834
Frame=31 Station=0 OutputCase=RAR158 CaseType=Combination P=-3,29897411724657 V2=0,38140119769531 V3=0 T=0 M2=0 M3=3,00956710530894 FrameElem=31-1 ElemStation=0
Frame=31 Station=0,0917 OutputCase=RAR158 CaseType=Combination P=-3,29897411724657 V2=1,66520119769531 V3=0 T=0 M2=0 M3=2,91573038548028 FrameElem=31-1 ElemStation=0,0917
Frame=31 Station=0,1834 OutputCase=RAR158 CaseType=Combination P=-3,29897411724657 V2=2,94900119769531 V3=0 T=0 M2=0 M3=2,70416920565162 FrameElem=31-1 ElemStation=0,1834
Frame=31 Station=0 OutputCase=RAR159 CaseType=Combination P=-4,01908139270308 V2=0,381401197700767 V3=0 T=0 M2=0 M3=19,3475281265995 FrameElem=31-1 ElemStation=0
Frame=31 Station=0,0917 OutputCase=RAR159 CaseType=Combination P=-4,01908139270308 V2=8,26760119770077 V3=0 T=0 M2=0 M3=18,9509713667703 FrameElem=31-1 ElemStation=0,0917
Frame=31 Station=0,1834 OutputCase=RAR159 CaseType=Combination P=-4,01908139270308 V2=16,1538011977008 V3=0 T=0 M2=0 M3=17,8312500669412 FrameElem=31-1 ElemStation=0,1834
Frame=31 Station=0 OutputCase=RAR160 CaseType=Combination P=-13,2173636289364 V2=7,62930873430258 V3=0 T=0 M2=0 M3=18,0765433358781 FrameElem=31-1 ElemStation=0
Frame=31 Station=0,0917 OutputCase=RAR160 CaseType=Combination P=-13,2173636289364 V2=15,5155087343026 V3=0 T=0 M2=0 M3=17,0153534549425 FrameElem=31-1 ElemStation=0,0917
Frame=31 Station=0,1834 OutputCase=RAR160 CaseType=Combination P=-13,2173636289364 V2=23,4017087343026 V3=0 T=0 M2=0 M3=15,230999034007 FrameElem=31-1 ElemStation=0,1834
Frame=31 Station=0 OutputCase=RAR161 CaseType=Combination P=-22,4156458651698 V2=0,381401197689853 V3=0 T=0 M2=0 M3=16,8055585454598 FrameElem=31-1 ElemStation=0
Frame=31 Station=0,0917 OutputCase=RAR161 CaseType=Combination P=-22,4156458651698 V2=8,26760119768985 V3=0 T=0 M2=0 M3=16,4090017856316 FrameElem=31-1 ElemStation=0,0917
Frame=31 Station=0,1834 OutputCase=RAR161 CaseType=Combination P=-22,4156458651698 V2=16,1538011976899 V3=0 T=0 M2=0 M3=15,2892804858035 FrameElem=31-1 ElemStation=0,1834
Frame=31 Station=0 OutputCase=RAR162 CaseType=Combination P=-12,4972563534799 V2=7,62930873429712 V3=0 T=0 M2=0 M3=1,73858231458754 FrameElem=31-1 ElemStation=0
Frame=31 Station=0,0917 OutputCase=RAR162 CaseType=Combination P=-12,4972563534799 V2=8,91310873429712 V3=0 T=0 M2=0 M3=0,980112473652498 FrameElem=31-1 ElemStation=0,0917
Frame=31 Station=0,1834 OutputCase=RAR162 CaseType=Combination P=-12,4972563534799 V2=10,1969087342971 V3=0 T=0 M2=0 M3=0,103918172717452 FrameElem=31-1 ElemStation=0,1834
Frame=31 Station=0 OutputCase=RAR163 CaseType=Combination P=-21,6955385897133 V2=0,381401197684396 V3=0 T=0 M2=0 M3=0,467597524169234 FrameElem=31-1 ElemStation=0
Frame=31 Station=0,0917 OutputCase=RAR163 CaseType=Combination P=-21,6955385897133 V2=1,6652011976844 V3=0 T=0 M2=0 M3=0,373760804341575 FrameElem=31-1 ElemStation=0,0917
Frame=31 Station=0,1834 OutputCase=RAR163 CaseType=Combination P=-21,6955385897133 V2=2,9490011976844 V3=0 T=0 M2=0 M3=0,162199624513916 FrameElem=31-1 ElemStation=0,1834
Frame=31 Station=0 OutputCase=INVRAR CaseType=Combination StepType=Max P=-2,64851550704 V2=21,9773922820849 V3=0 T=0 M2=0 M3=24,8039694506515 FrameElem=31-1 ElemStation=0
Frame=31 Station=0,0917 OutputCase=INVRAR CaseType=Combination StepType=Max P=-2,64851550704 V2=29,8635922820849 V3=0 T=0 M2=0 M3=24,341480500652 FrameElem=31-1 ElemStation=0,0917
Frame=31 Station=0,1834 OutputCase=INVRAR CaseType=Combination StepType=Max P=-2,64851550704 V2=37,7497922820849 V3=0 T=0 M2=0 M3=22,9540136506525 FrameElem=31-1 ElemStation=0,1834
Frame=31 Station=0 OutputCase=INVRAR CaseType=Combination StepType=Min P=-28,9452006957474 V2=-0,635668662870852 V3=0 T=0 M2=0 M3=-0,987753340436461 FrameElem=31-1 ElemStation=0
Frame=31 Station=0,0917 OutputCase=INVRAR CaseType=Combination StepType=Min P=-28,9452006957474 V2=0,648131337129149 V3=0 T=0 M2=0 M3=-1,04661557043397 FrameElem=31-1 ElemStation=0,0917
Frame=31 Station=0,1834 OutputCase=INVRAR CaseType=Combination StepType=Min P=-28,9452006957474 V2=1,93193133712915 V3=0 T=0 M2=0 M3=-1,31393572045597 FrameElem=31-1 ElemStation=0,1834
Frame=31 Station=0 OutputCase=FRE01 CaseType=Combination P=-6,50813867291611 V2=-1,2732925824821E-11 V3=0 T=0 M2=0 M3=2,20528228420335 FrameElem=31-1 ElemStation=0
Frame=31 Station=0,0917 OutputCase=FRE01 CaseType=Combination P=-6,50813867291611 V2=1,28379999998727 V3=0 T=0 M2=0 M3=2,14642005420452 FrameElem=31-1 ElemStation=0,0917
Frame=31 Station=0,1834 OutputCase=FRE01 CaseType=Combination P=-6,50813867291611 V2=2,56759999998727 V3=0 T=0 M2=0 M3=1,96983336420568 FrameElem=31-1 ElemStation=0,1834
Frame=31 Station=0 OutputCase=FRE02 CaseType=Combination P=-4,59457239036098 V2=-7,27595761418343E-12 V3=0 T=0 M2=0 M3=18,9765274290398 FrameElem=31-1 ElemStation=0
Frame=31 Station=0,0917 OutputCase=FRE02 CaseType=Combination P=-4,59457239036098 V2=7,88619999999272 V3=0 T=0 M2=0 M3=18,6149451590405 FrameElem=31-1 ElemStation=0,0917
Frame=31 Station=0,1834 OutputCase=FRE02 CaseType=Combination P=-4,59457239036098 V2=15,7723999999927 V3=0 T=0 M2=0 M3=17,5301983490412 FrameElem=31-1 ElemStation=0,1834
Frame=31 Station=0 OutputCase=FRE03 CaseType=Combination P=-13,7928546265943 V2=7,24790753659454 V3=0 T=0 M2=0 M3=17,7055426383184 FrameElem=31-1 ElemStation=0
Frame=31 Station=0,0917 OutputCase=FRE03 CaseType=Combination P=-13,7928546265943 V2=15,1341075365945 V3=0 T=0 M2=0 M3=16,6793272472127 FrameElem=31-1 ElemStation=0,0917
Frame=31 Station=0,1834 OutputCase=FRE03 CaseType=Combination P=-13,7928546265943 V2=23,0203075365945 V3=0 T=0 M2=0 M3=14,929947316107 FrameElem=31-1 ElemStation=0,1834
Frame=31 Station=0 OutputCase=FRE04 CaseType=Combination P=-22,9911368628277 V2=-1,81898940354586E-11 V3=0 T=0 M2=0 M3=16,4345578479001 FrameElem=31-1 ElemStation=0
Frame=31 Station=0,0917 OutputCase=FRE04 CaseType=Combination P=-22,9911368628277 V2=7,88619999998181 V3=0 T=0 M2=0 M3=16,0729755779018 FrameElem=31-1 ElemStation=0,0917
Frame=31 Station=0,1834 OutputCase=FRE04 CaseType=Combination P=-22,9911368628277 V2=15,7723999999818 V3=0 T=0 M2=0 M3=14,9882287679035 FrameElem=31-1 ElemStation=0,1834
Frame=31 Station=0 OutputCase=FRE05 CaseType=Combination P=-13,0727473511378 V2=7,24790753658908 V3=0 T=0 M2=0 M3=1,36758161702789 FrameElem=31-1 ElemStation=0
Frame=31 Station=0,0917 OutputCase=FRE05 CaseType=Combination P=-13,0727473511378 V2=8,53170753658908 V3=0 T=0 M2=0 M3=0,644086265922676 FrameElem=31-1 ElemStation=0,0917

Società di Progetto
Brebemi SpA



Doc. N.
60235-0000-A00.doc

CODIFICA DOCUMENTO
04RCDII10000000000300A00

REV.
00

FOGLIO
434 di 628

Frame=31 Station=0,1834 OutputCase=FRE05 CaseType=Combination P=-13,0727473511378 V2=9,81550753658908 V3=0 T=0 M2=0 M3=-0,197133545182543
FrameElem=31-1 ElemStation=0,1834
Frame=31 Station=0 OutputCase=FRE06 CaseType=Combination P=-22,2710295873712 V2=-2,36468622460961E-11 V3=0 T=0 M2=0 M3=9,65968266095842E-02
FrameElem=31-1 ElemStation=0
Frame=31 Station=0,0917 OutputCase=FRE06 CaseType=Combination P=-22,2710295873712 V2=1,28379999997635 V3=0 T=0 M2=0 M3=3,77345966117525E-02
FrameElem=31-1 ElemStation=0,0917
Frame=31 Station=0,1834 OutputCase=FRE06 CaseType=Combination P=-22,2710295873712 V2=2,56759999997635 V3=0 T=0 M2=0 M3=-0,138852093386709
FrameElem=31-1 ElemStation=0,1834
Frame=31 Station=0 OutputCase=FRE07 CaseType=Combination P=-4,33419621785363 V2=-1,26092913887987E-11 V3=0 T=0 M2=0 M3=2,25711113932345 FrameElem=31-1
ElemStation=0
Frame=31 Station=0,0917 OutputCase=FRE07 CaseType=Combination P=-4,33419621785363 V2=1,28379999998739 V3=0 T=0 M2=0 M3=2,19824916323566 FrameElem=31-1
ElemStation=0,0917
Frame=31 Station=0,1834 OutputCase=FRE07 CaseType=Combination P=-4,33419621785363 V2=2,56759999998739 V3=0 T=0 M2=0 M3=2,02166247323682 FrameElem=31-1
ElemStation=0,1834
Frame=31 Station=0 OutputCase=FRE08 CaseType=Combination P=-4,97768164281862 V2=-7,17292891749821E-12 V3=0 T=0 M2=0 M3=18,6586482502775 FrameElem=31-1
ElemStation=0
Frame=31 Station=0,0917 OutputCase=FRE08 CaseType=Combination P=-4,97768164281862 V2=7,88619999999283 V3=0 T=0 M2=0 M3=18,2970659802782 FrameElem=31-1
ElemStation=0,0917
Frame=31 Station=0,1834 OutputCase=FRE08 CaseType=Combination P=-4,97768164281862 V2=15,7723999999928 V3=0 T=0 M2=0 M3=17,2123191702788 FrameElem=31-1
ElemStation=0,1834
Frame=31 Station=0 OutputCase=FRE09 CaseType=Combination P=-14,175963879052 V2=7,2479075365946 V3=0 T=0 M2=0 M3=17,3876634595561 FrameElem=31-1
ElemStation=0
Frame=31 Station=0,0917 OutputCase=FRE09 CaseType=Combination P=-14,175963879052 V2=15,1341075365946 V3=0 T=0 M2=0 M3=16,3614480684504 FrameElem=31-1
ElemStation=0,0917
Frame=31 Station=0,1834 OutputCase=FRE09 CaseType=Combination P=-14,175963879052 V2=23,0203075365946 V3=0 T=0 M2=0 M3=14,6120681373447 FrameElem=31-1
ElemStation=0,1834
Frame=31 Station=0 OutputCase=FRE10 CaseType=Combination P=-23,3742461152853 V2=-1,80868653387734E-11 V3=0 T=0 M2=0 M3=16,1166786691378 FrameElem=31-1
ElemStation=0
Frame=31 Station=0,0917 OutputCase=FRE10 CaseType=Combination P=-23,3742461152853 V2=7,88619999998191 V3=0 T=0 M2=0 M3=15,7550963991395 FrameElem=31-1
ElemStation=0,0917
Frame=31 Station=0,1834 OutputCase=FRE10 CaseType=Combination P=-23,3742461152853 V2=15,7723999999819 V3=0 T=0 M2=0 M3=14,6703495891411 FrameElem=31-1
ElemStation=0,1834
Frame=31 Station=0 OutputCase=FRE11 CaseType=Combination P=-13,4558566035955 V2=7,24790753658919 V3=0 T=0 M2=0 M3=1,04970243826557 FrameElem=31-1
ElemStation=0
Frame=31 Station=0,0917 OutputCase=FRE11 CaseType=Combination P=-13,4558566035955 V2=8,53170753658918 V3=0 T=0 M2=0 M3=-0,326207087160341
FrameElem=31-1 ElemStation=0,0917
Frame=31 Station=0,1834 OutputCase=FRE11 CaseType=Combination P=-13,4558566035955 V2=9,81550753658919 V3=0 T=0 M2=0 M3=-0,515012723944887
FrameElem=31-1 ElemStation=0,1834
Frame=31 Station=0 OutputCase=FRE12 CaseType=Combination P=-22,6541388398288 V2=-2,35438335494109E-11 V3=0 T=0 M2=0 M3=-0,221282352152741
FrameElem=31-1 ElemStation=0
Frame=31 Station=0,0917 OutputCase=FRE12 CaseType=Combination P=-22,6541388398288 V2=1,28379999997646 V3=0 T=0 M2=0 M3=-0,280144582150582
FrameElem=31-1 ElemStation=0,0917
Frame=31 Station=0,1834 OutputCase=FRE12 CaseType=Combination P=-22,6541388398288 V2=2,56759999997646 V3=0 T=0 M2=0 M3=-0,456731272148423
FrameElem=31-1 ElemStation=0,1834
Frame=31 Station=0 OutputCase=FRE13 CaseType=Combination P=-4,17525662847247 V2=-0,31783433143615 V3=0 T=0 M2=0 M3=2,47774277653867 FrameElem=31-1
ElemStation=0
Frame=31 Station=0,0917 OutputCase=FRE13 CaseType=Combination P=-4,17525662847247 V2=0,96596566856385 V3=0 T=0 M2=0 M3=2,44802594573137 FrameElem=31-1
ElemStation=0,0917
Frame=31 Station=0,1834 OutputCase=FRE13 CaseType=Combination P=-4,17525662847247 V2=2,2497566856385 V3=0 T=0 M2=0 M3=2,30058467292406 FrameElem=31-1
ElemStation=0,1834
Frame=31 Station=0 OutputCase=FRE14 CaseType=Combination P=-4,49313580723479 V2=0,317834331410931 V3=0 T=0 M2=0 M3=2,03648000993034 FrameElem=31-1
ElemStation=0
Frame=31 Station=0,0917 OutputCase=FRE14 CaseType=Combination P=-4,49313580723479 V2=1,60163433141093 V3=0 T=0 M2=0 M3=1,94847237173995 FrameElem=31-1
ElemStation=0,0917
Frame=31 Station=0,1834 OutputCase=FRE14 CaseType=Combination P=-4,49313580723479 V2=2,88543433141093 V3=0 T=0 M2=0 M3=1,74274027354957 FrameElem=31-1
ElemStation=0,1834
Frame=31 Station=0 OutputCase=FRE15 CaseType=Combination P=-3,95108696539599 V2=-1,2712320085484E-11 V3=0 T=0 M2=0 M3=2,57499057199683 FrameElem=31-1
ElemStation=0
Frame=31 Station=0,0917 OutputCase=FRE15 CaseType=Combination P=-3,95108696539599 V2=1,28379999998729 V3=0 T=0 M2=0 M3=2,516128341998 FrameElem=31-1
ElemStation=0,0917
Frame=31 Station=0,1834 OutputCase=FRE15 CaseType=Combination P=-3,95108696539599 V2=2,56759999998729 V3=0 T=0 M2=0 M3=2,33954165199916 FrameElem=31-1
ElemStation=0,1834
Frame=31 Station=0 OutputCase=FRE16 CaseType=Combination P=-3,41473401195529 V2=-1,2856502608433E-11 V3=0 T=0 M2=0 M3=3,02002142226409 FrameElem=31-1
ElemStation=0
Frame=31 Station=0,0917 OutputCase=FRE16 CaseType=Combination P=-3,41473401195529 V2=1,28379999998714 V3=0 T=0 M2=0 M3=2,96115912926526 FrameElem=31-1
ElemStation=0,0917
Frame=31 Station=0,1834 OutputCase=FRE16 CaseType=Combination P=-3,41473401195529 V2=2,56759999998714 V3=0 T=0 M2=0 M3=2,78457250226644 FrameElem=31-1
ElemStation=0,1834
Frame=31 Station=0 OutputCase=FRE17 CaseType=Combination P=-4,21146313790333 V2=-7,37898631086864E-12 V3=0 T=0 M2=0 M3=19,2944066078022 FrameElem=31-1
ElemStation=0
Frame=31 Station=0,0917 OutputCase=FRE17 CaseType=Combination P=-4,21146313790333 V2=7,88619999999262 V3=0 T=0 M2=0 M3=18,9328243378028 FrameElem=31-1
ElemStation=0,0917
Frame=31 Station=0,1834 OutputCase=FRE17 CaseType=Combination P=-4,21146313790333 V2=15,7723999999926 V3=0 T=0 M2=0 M3=17,8480775278035 FrameElem=31-1
ElemStation=0,1834
Frame=31 Station=0 OutputCase=FRE18 CaseType=Combination P=-13,4097453741367 V2=7,24790753659444 V3=0 T=0 M2=0 M3=18,0234218170808 FrameElem=31-1
ElemStation=0
Frame=31 Station=0,0917 OutputCase=FRE18 CaseType=Combination P=-13,4097453741367 V2=15,1341075365944 V3=0 T=0 M2=0 M3=16,9972064259751 FrameElem=31-1
ElemStation=0,0917
Frame=31 Station=0,1834 OutputCase=FRE18 CaseType=Combination P=-13,4097453741367 V2=23,0203075365944 V3=0 T=0 M2=0 M3=15,2478264948693 FrameElem=31-1
ElemStation=0,1834
Frame=31 Station=0 OutputCase=FRE19 CaseType=Combination P=-22,60802761037 V2=-1,82929227321438E-11 V3=0 T=0 M2=0 M3=16,7524370266624 FrameElem=31-1
ElemStation=0
Frame=31 Station=0,0917 OutputCase=FRE19 CaseType=Combination P=-22,60802761037 V2=7,88619999998171 V3=0 T=0 M2=0 M3=16,3908547566641 FrameElem=31-1
ElemStation=0,0917
Frame=31 Station=0,1834 OutputCase=FRE19 CaseType=Combination P=-22,60802761037 V2=15,7723999999817 V3=0 T=0 M2=0 M3=15,3061079466658 FrameElem=31-1
ElemStation=0,1834
Frame=31 Station=0 OutputCase=FRE20 CaseType=Combination P=-12,6896380986802 V2=7,24790753658898 V3=0 T=0 M2=0 M3=1,68546079579022 FrameElem=31-1
ElemStation=0

Società di Progetto
Brebemi SpA



Doc. N.
60235-0000-A00.doc

CODIFICA DOCUMENTO
04RCDII10000000000300A00

REV.
00

FOGLIO
435 di 628

Frame=31 Station=0,0917 OutputCase=FRE20 CaseType=Combination P=-12,6896380986802 V2=8,53170753658898 V3=0 T=0 M2=0 M3=0,961965444685011
FrameElem=31-1 ElemStation=0,0917
Frame=31 Station=0,1834 OutputCase=FRE20 CaseType=Combination P=-12,6896380986802 V2=9,81550753658898 V3=0 T=0 M2=0 M3=0,120745633579801
FrameElem=31-1 ElemStation=0,1834
Frame=31 Station=0 OutputCase=FRE21 CaseType=Combination P=-21,8879203349135 V2=-2,37498909427813E-11 V3=0 T=0 M2=0 M3=0,41447600537191 FrameElem=31-1
ElemStation=0
Frame=31 Station=0,0917 OutputCase=FRE21 CaseType=Combination P=-21,8879203349135 V2=1,28379999997625 V3=0 T=0 M2=0 M3=0,355613775374087
FrameElem=31-1 ElemStation=0,0917
Frame=31 Station=0,1834 OutputCase=FRE21 CaseType=Combination P=-21,8879203349135 V2=2,56759999997625 V3=0 T=0 M2=0 M3=0,179027085376265
FrameElem=31-1 ElemStation=0,1834
Frame=31 Station=0 OutputCase=FRE22 CaseType=Combination P=-3,25579442257412 V2=-0,317834331436397 V3=0 T=0 M2=0 M3=3,24065280556825 FrameElem=31-1
ElemStation=0
Frame=31 Station=0,0917 OutputCase=FRE22 CaseType=Combination P=-3,25579442257412 V2=0,965965668563603 V3=0 T=0 M2=0 M3=3,21093598376097
FrameElem=31-1 ElemStation=0,0917
Frame=31 Station=0,1834 OutputCase=FRE22 CaseType=Combination P=-3,25579442257412 V2=2,2497656685636 V3=0 T=0 M2=0 M3=3,06349470195369 FrameElem=31-1
ElemStation=0,1834
Frame=31 Station=0 OutputCase=FRE23 CaseType=Combination P=-3,57367360133645 V2=0,317834331410684 V3=0 T=0 M2=0 M3=2,79939003895992 FrameElem=31-1
ElemStation=0
Frame=31 Station=0,0917 OutputCase=FRE23 CaseType=Combination P=-3,57367360133645 V2=1,60163433141068 V3=0 T=0 M2=0 M3=2,71138240076956 FrameElem=31-1
ElemStation=0,0917
Frame=31 Station=0,1834 OutputCase=FRE23 CaseType=Combination P=-3,57367360133645 V2=2,88543433141068 V3=0 T=0 M2=0 M3=2,5056503025792 FrameElem=31-1
ElemStation=0,1834
Frame=31 Station=0 OutputCase=FRE24 CaseType=Combination P=-3,03162475949764 V2=-1,29595889575285E-11 V3=0 T=0 M2=0 M3=3,33790060102641 FrameElem=31-1
ElemStation=0
Frame=31 Station=0,0917 OutputCase=FRE24 CaseType=Combination P=-3,03162475949764 V2=1,28379999998704 V3=0 T=0 M2=0 M3=3,2790383710276 FrameElem=31-1
ElemStation=0,0917
Frame=31 Station=0,1834 OutputCase=FRE24 CaseType=Combination P=-3,03162475949764 V2=2,56759999998704 V3=0 T=0 M2=0 M3=3,10245168102879 FrameElem=31-1
ElemStation=0,1834
Frame=31 Station=0 OutputCase=FRE25 CaseType=Combination P=-3,68373760764706 V2=-0,381401197720982 V3=0 T=0 M2=0 M3=2,9033240677143 FrameElem=31-1
ElemStation=0
Frame=31 Station=0,0917 OutputCase=FRE25 CaseType=Combination P=-3,68373760764706 V2=0,902398802279019 V3=0 T=0 M2=0 M3=2,87943632754531
FrameElem=31-1 ElemStation=0,0917
Frame=31 Station=0,1834 OutputCase=FRE25 CaseType=Combination P=-3,68373760764706 V2=2,18619880227902 V3=0 T=0 M2=0 M3=2,73782412737632 FrameElem=31-1
ElemStation=0,1834
Frame=31 Station=0 OutputCase=FRE26 CaseType=Combination P=-4,43563280097981 V2=-0,317834331430817 V3=0 T=0 M2=0 M3=19,197158812344 FrameElem=31-1
ElemStation=0
Frame=31 Station=0,0917 OutputCase=FRE26 CaseType=Combination P=-4,43563280097981 V2=7,56836566856918 V3=0 T=0 M2=0 M3=18,8647219505362 FrameElem=31-1
ElemStation=0,0917
Frame=31 Station=0,1834 OutputCase=FRE26 CaseType=Combination P=-4,43563280097981 V2=15,4545656685692 V3=0 T=0 M2=0 M3=17,8091205487284 FrameElem=31-1
ElemStation=0,1834
Frame=31 Station=0 OutputCase=FRE27 CaseType=Combination P=-13,6339150372132 V2=6,930073205171 V3=0 T=0 M2=0 M3=17,9261740216226 FrameElem=31-1
ElemStation=0
Frame=31 Station=0,0917 OutputCase=FRE27 CaseType=Combination P=-13,6339150372132 V2=14,816273205171 V3=0 T=0 M2=0 M3=16,9291040387084 FrameElem=31-1
ElemStation=0,0917
Frame=31 Station=0,1834 OutputCase=FRE27 CaseType=Combination P=-13,6339150372132 V2=22,702473205171 V3=0 T=0 M2=0 M3=15,2088695157942 FrameElem=31-1
ElemStation=0,1834
Frame=31 Station=0 OutputCase=FRE28 CaseType=Combination P=-22,8321972734465 V2=-0,31783433144173 V3=0 T=0 M2=0 M3=16,6551892312043 FrameElem=31-1
ElemStation=0
Frame=31 Station=0,0917 OutputCase=FRE28 CaseType=Combination P=-22,8321972734465 V2=7,56836566855827 V3=0 T=0 M2=0 M3=16,3227523693975 FrameElem=31-1
ElemStation=0,0917
Frame=31 Station=0,1834 OutputCase=FRE28 CaseType=Combination P=-22,8321972734465 V2=15,4545656685583 V3=0 T=0 M2=0 M3=15,2671509675907 FrameElem=31-1
ElemStation=0,1834
Frame=31 Station=0 OutputCase=FRE29 CaseType=Combination P=-12,9138077617566 V2=6,93007320516554 V3=0 T=0 M2=0 M3=1,58821300033206 FrameElem=31-1
ElemStation=0
Frame=31 Station=0,0917 OutputCase=FRE29 CaseType=Combination P=-12,9138077617566 V2=8,21387320516554 V3=0 T=0 M2=0 M3=0,893863057418382
FrameElem=31-1 ElemStation=0,0917
Frame=31 Station=0,1834 OutputCase=FRE29 CaseType=Combination P=-12,9138077617566 V2=9,49767320516554 V3=0 T=0 M2=0 M3=8,17886545047017E-02
FrameElem=31-1 ElemStation=0,1834
Frame=31 Station=0 OutputCase=FRE30 CaseType=Combination P=-22,11208999799 V2=-0,317834331447187 V3=0 T=0 M2=0 M3=0,317228209913752 FrameElem=31-1
ElemStation=0
Frame=31 Station=0,0917 OutputCase=FRE30 CaseType=Combination P=-22,11208999799 V2=0,965965668552813 V3=0 T=0 M2=0 M3=0,287511388107459 FrameElem=31-1
ElemStation=0,0917
Frame=31 Station=0,1834 OutputCase=FRE30 CaseType=Combination P=-22,11208999799 V2=2,24976566855281 V3=0 T=0 M2=0 M3=0,140070106301166 FrameElem=31-1
ElemStation=0,1834
Frame=31 Station=0 OutputCase=FRE31 CaseType=Combination P=4,06684686010471 V2=-0,381401197720879 V3=0 T=0 M2=0 M3=2,58544488895197 FrameElem=31-1
ElemStation=0
Frame=31 Station=0,0917 OutputCase=FRE31 CaseType=Combination P=4,06684686010471 V2=0,902398802279122 V3=0 T=0 M2=0 M3=2,56155714878297
FrameElem=31-1 ElemStation=0,0917
Frame=31 Station=0,1834 OutputCase=FRE31 CaseType=Combination P=4,06684686010471 V2=2,18619880227912 V3=0 T=0 M2=0 M3=2,41994494861398 FrameElem=31-1
ElemStation=0,1834
Frame=31 Station=0 OutputCase=FRE32 CaseType=Combination P=-3,30062835518942 V2=-0,381401197721085 V3=0 T=0 M2=0 M3=3,22120324647662 FrameElem=31-1
ElemStation=0
Frame=31 Station=0,0917 OutputCase=FRE32 CaseType=Combination P=-3,30062835518942 V2=0,902398802278916 V3=0 T=0 M2=0 M3=3,19731550630764
FrameElem=31-1 ElemStation=0,0917
Frame=31 Station=0,1834 OutputCase=FRE32 CaseType=Combination P=-3,30062835518942 V2=2,18619880227892 V3=0 T=0 M2=0 M3=3,05570330613867 FrameElem=31-1
ElemStation=0,1834
Frame=31 Station=0 OutputCase=FRE33 CaseType=Combination P=-3,30062835518942 V2=-0,381401197721085 V3=0 T=0 M2=0 M3=3,22120324647662 FrameElem=31-1
ElemStation=0
Frame=31 Station=0,0917 OutputCase=FRE33 CaseType=Combination P=-3,30062835518942 V2=0,902398802278916 V3=0 T=0 M2=0 M3=3,19731550630764
FrameElem=31-1 ElemStation=0,0917
Frame=31 Station=0,1834 OutputCase=FRE33 CaseType=Combination P=-3,30062835518942 V2=2,18619880227892 V3=0 T=0 M2=0 M3=3,05570330613867 FrameElem=31-1
ElemStation=0,1834
Frame=31 Station=0 OutputCase=FRE34 CaseType=Combination P=4,06519262216185 V2=0,381401197695516 V3=0 T=0 M2=0 M3=2,37380874778429 FrameElem=31-1
ElemStation=0
Frame=31 Station=0,0917 OutputCase=FRE34 CaseType=Combination P=4,06519262216185 V2=1,66520119769552 V3=0 T=0 M2=0 M3=2,27997202795561 FrameElem=31-1
ElemStation=0,0917
Frame=31 Station=0,1834 OutputCase=FRE34 CaseType=Combination P=4,06519262216185 V2=2,94900119769552 V3=0 T=0 M2=0 M3=2,06841084812694 FrameElem=31-1
ElemStation=0,1834

Società di Progetto
Brebemi SpA



Doc. N.
60235-0000-A00.doc

CODIFICA DOCUMENTO
04RCDII10000000000300A00

REV.
00

FOGLIO
436 di 628

Frame=31 Station=0 OutputCase=FRE35 CaseType=Combination P=-4,75351197974214 V2=0,317834331416265 V3=0 T=0 M2=0 M3=18,7558960457357 FrameElem=31-1 ElemStation=0
Frame=31 Station=0,0917 OutputCase=FRE35 CaseType=Combination P=-4,75351197974214 V2=8,20403433141627 V3=0 T=0 M2=0 M3=18,3651683675448 FrameElem=31-1 ElemStation=0,0917
Frame=31 Station=0,1834 OutputCase=FRE35 CaseType=Combination P=-4,75351197974214 V2=16,0902343314163 V3=0 T=0 M2=0 M3=17,2512761493539 FrameElem=31-1 ElemStation=0,1834
Frame=31 Station=0 OutputCase=FRE36 CaseType=Combination P=-13,9517942159755 V2=7,56574186801808 V3=0 T=0 M2=0 M3=17,4849112550143 FrameElem=31-1 ElemStation=0
Frame=31 Station=0,0917 OutputCase=FRE36 CaseType=Combination P=-13,9517942159755 V2=15,4519418680181 V3=0 T=0 M2=0 M3=16,429550455717 FrameElem=31-1 ElemStation=0,0917
Frame=31 Station=0,1834 OutputCase=FRE36 CaseType=Combination P=-13,9517942159755 V2=23,3381418680181 V3=0 T=0 M2=0 M3=14,6510251164198 FrameElem=31-1 ElemStation=0,1834
Frame=31 Station=0 OutputCase=FRE37 CaseType=Combination P=-23,1500764522088 V2=0,317834331405351 V3=0 T=0 M2=0 M3=16,213926464596 FrameElem=31-1 ElemStation=0
Frame=31 Station=0,0917 OutputCase=FRE37 CaseType=Combination P=-23,1500764522088 V2=8,20403433140535 V3=0 T=0 M2=0 M3=15,8231987864061 FrameElem=31-1 ElemStation=0,0917
Frame=31 Station=0,1834 OutputCase=FRE37 CaseType=Combination P=-23,1500764522088 V2=16,0902343314054 V3=0 T=0 M2=0 M3=14,7093065682162 FrameElem=31-1 ElemStation=0,1834
Frame=31 Station=0 OutputCase=FRE38 CaseType=Combination P=-13,231686940519 V2=7,56574186801262 V3=0 T=0 M2=0 M3=1,14695023372373 FrameElem=31-1 ElemStation=0
Frame=31 Station=0,0917 OutputCase=FRE38 CaseType=Combination P=-13,231686940519 V2=8,84954186801262 V3=0 T=0 M2=0 M3=0,39430947442697 FrameElem=31-1 ElemStation=0,0917
Frame=31 Station=0,1834 OutputCase=FRE38 CaseType=Combination P=-13,231686940519 V2=10,1333418680126 V3=0 T=0 M2=0 M3=-0,476055744869788 FrameElem=31-1 ElemStation=0,1834
Frame=31 Station=0 OutputCase=FRE39 CaseType=Combination P=-22,4299691767523 V2=0,317834331399894 V3=0 T=0 M2=0 M3=-0,124034556694583 FrameElem=31-1 ElemStation=0
Frame=31 Station=0,0917 OutputCase=FRE39 CaseType=Combination P=-22,4299691767523 V2=1,60163433139989 V3=0 T=0 M2=0 M3=-0,212042194883954 FrameElem=31-1 ElemStation=0,0917
Frame=31 Station=0,1834 OutputCase=FRE39 CaseType=Combination P=-22,4299691767523 V2=2,88543433139989 V3=0 T=0 M2=0 M3=-0,417774293073324 FrameElem=31-1 ElemStation=0,1834
Frame=31 Station=0 OutputCase=FRE40 CaseType=Combination P=-4,4483018746195 V2=0,381401197695619 V3=0 T=0 M2=0 M3=2,05592956902197 FrameElem=31-1 ElemStation=0
Frame=31 Station=0,0917 OutputCase=FRE40 CaseType=Combination P=-4,4483018746195 V2=1,66520119769562 V3=0 T=0 M2=0 M3=1,96209284919328 FrameElem=31-1 ElemStation=0,0917
Frame=31 Station=0,1834 OutputCase=FRE40 CaseType=Combination P=-4,4483018746195 V2=2,94900119769562 V3=0 T=0 M2=0 M3=1,75053166936459 FrameElem=31-1 ElemStation=0,1834
Frame=31 Station=0 OutputCase=FRE41 CaseType=Combination P=-3,68208336970421 V2=0,381401197695413 V3=0 T=0 M2=0 M3=2,69168792654662 FrameElem=31-1 ElemStation=0
Frame=31 Station=0,0917 OutputCase=FRE41 CaseType=Combination P=-3,68208336970421 V2=1,66520119769541 V3=0 T=0 M2=0 M3=2,59785120671795 FrameElem=31-1 ElemStation=0,0917
Frame=31 Station=0,1834 OutputCase=FRE41 CaseType=Combination P=-3,68208336970421 V2=2,94900119769541 V3=0 T=0 M2=0 M3=2,38629002688928 FrameElem=31-1 ElemStation=0,1834
Frame=31 Station=0 OutputCase=FRE42 CaseType=Combination P=-3,68208336970421 V2=0,381401197695413 V3=0 T=0 M2=0 M3=2,69168792654662 FrameElem=31-1 ElemStation=0
Frame=31 Station=0,0917 OutputCase=FRE42 CaseType=Combination P=-3,68208336970421 V2=1,66520119769541 V3=0 T=0 M2=0 M3=2,59785120671795 FrameElem=31-1 ElemStation=0,0917
Frame=31 Station=0,1834 OutputCase=FRE42 CaseType=Combination P=-3,68208336970421 V2=2,94900119769541 V3=0 T=0 M2=0 M3=2,38629002688928 FrameElem=31-1 ElemStation=0,1834
Frame=31 Station=0 OutputCase=FRE43 CaseType=Combination P=-3,41473401195529 V2=-1,28565602608433E-11 V3=0 T=0 M2=0 M3=3,02002142226409 FrameElem=31-1 ElemStation=0
Frame=31 Station=0,0917 OutputCase=FRE43 CaseType=Combination P=-3,41473401195529 V2=1,28379999998714 V3=0 T=0 M2=0 M3=2,96115919226526 FrameElem=31-1 ElemStation=0,0917
Frame=31 Station=0,1834 OutputCase=FRE43 CaseType=Combination P=-3,41473401195529 V2=2,56759999998714 V3=0 T=0 M2=0 M3=2,78452750226644 FrameElem=31-1 ElemStation=0,1834
Frame=31 Station=0 OutputCase=FRE44 CaseType=Combination P=-4,21146313790333 V2=-7,37898631086864E-12 V3=0 T=0 M2=0 M3=19,2944066078022 FrameElem=31-1 ElemStation=0
Frame=31 Station=0,0917 OutputCase=FRE44 CaseType=Combination P=-4,21146313790333 V2=7,88619999999262 V3=0 T=0 M2=0 M3=18,9328243378028 FrameElem=31-1 ElemStation=0,0917
Frame=31 Station=0,1834 OutputCase=FRE44 CaseType=Combination P=-4,21146313790333 V2=15,7723999999926 V3=0 T=0 M2=0 M3=17,8480775278035 FrameElem=31-1 ElemStation=0,1834
Frame=31 Station=0 OutputCase=FRE45 CaseType=Combination P=-13,4097453741367 V2=7,24790753659444 V3=0 T=0 M2=0 M3=18,0234218170808 FrameElem=31-1 ElemStation=0
Frame=31 Station=0,0917 OutputCase=FRE45 CaseType=Combination P=-13,4097453741367 V2=15,1341075365944 V3=0 T=0 M2=0 M3=16,9972064259751 FrameElem=31-1 ElemStation=0,0917
Frame=31 Station=0,1834 OutputCase=FRE45 CaseType=Combination P=-13,4097453741367 V2=23,0203075365944 V3=0 T=0 M2=0 M3=15,2478264948693 FrameElem=31-1 ElemStation=0,1834
Frame=31 Station=0 OutputCase=FRE46 CaseType=Combination P=-22,60802761037 V2=-1,82929227321438E-11 V3=0 T=0 M2=0 M3=16,7524370266624 FrameElem=31-1 ElemStation=0
Frame=31 Station=0,0917 OutputCase=FRE46 CaseType=Combination P=-22,60802761037 V2=7,88619999998171 V3=0 T=0 M2=0 M3=16,3908547566641 FrameElem=31-1 ElemStation=0,0917
Frame=31 Station=0,1834 OutputCase=FRE46 CaseType=Combination P=-22,60802761037 V2=15,7723999999817 V3=0 T=0 M2=0 M3=15,3061079466658 FrameElem=31-1 ElemStation=0,1834
Frame=31 Station=0 OutputCase=FRE47 CaseType=Combination P=-12,6896380986802 V2=7,24790753658898 V3=0 T=0 M2=0 M3=1,68546079579022 FrameElem=31-1 ElemStation=0
Frame=31 Station=0,0917 OutputCase=FRE47 CaseType=Combination P=-12,6896380986802 V2=8,53170753658898 V3=0 T=0 M2=0 M3=0,961965444685011 FrameElem=31-1 ElemStation=0,0917
Frame=31 Station=0,1834 OutputCase=FRE47 CaseType=Combination P=-12,6896380986802 V2=9,81550753658898 V3=0 T=0 M2=0 M3=0,120745633579801 FrameElem=31-1 ElemStation=0,1834
Frame=31 Station=0 OutputCase=FRE48 CaseType=Combination P=-21,8879203349135 V2=-2,37498909427813E-11 V3=0 T=0 M2=0 M3=0,41447600537191 FrameElem=31-1 ElemStation=0
Frame=31 Station=0,0917 OutputCase=FRE48 CaseType=Combination P=-21,8879203349135 V2=1,28379999997625 V3=0 T=0 M2=0 M3=0,355613775374087 FrameElem=31-1 ElemStation=0,0917
Frame=31 Station=0,1834 OutputCase=FRE48 CaseType=Combination P=-21,8879203349135 V2=2,56759999997625 V3=0 T=0 M2=0 M3=0,179027083376265 FrameElem=31-1 ElemStation=0,1834
Frame=31 Station=0 OutputCase=FRE49 CaseType=Combination P=-3,03162475949764 V2=-1,29595889575285E-11 V3=0 T=0 M2=0 M3=3,33790060102641 FrameElem=31-1 ElemStation=0
Frame=31 Station=0,0917 OutputCase=FRE49 CaseType=Combination P=-3,03162475949764 V2=1,28379999998704 V3=0 T=0 M2=0 M3=3,2790383710276 FrameElem=31-1 ElemStation=0,0917

Società di Progetto
Brebemi SpA



Doc. N.
60235-00000-A00.doc

CODIFICA DOCUMENTO
04RCDII10000000000300A00

REV.
00

FOGLIO
437 di 628

Frame=31 Station=0,1834 OutputCase=FRE49 CaseType=Combination P=-3,03162475949764 V2=2,56759999998704 V3=0 T=0 M2=0 M3=3,10245168102879 FrameElem=31-1 ElemStation=0,1834

Frame=31 Station=0 OutputCase=FRE50 CaseType=Combination P=-3,25579442257412 V2=-0,317834331436397 V3=0 T=0 M2=0 M3=3,24065280556825 FrameElem=31-1 ElemStation=0

Frame=31 Station=0,0917 OutputCase=FRE50 CaseType=Combination P=-3,25579442257412 V2=0,965965668563603 V3=0 T=0 M2=0 M3=3,21093598376097 FrameElem=31-1 ElemStation=0,0917

Frame=31 Station=0,1834 OutputCase=FRE50 CaseType=Combination P=-3,25579442257412 V2=2,2497656685636 V3=0 T=0 M2=0 M3=3,06349470195369 FrameElem=31-1 ElemStation=0,1834

Frame=31 Station=0 OutputCase=FRE51 CaseType=Combination P=-3,57367360133645 V2=0,317834331410684 V3=0 T=0 M2=0 M3=2,79939003895992 FrameElem=31-1 ElemStation=0

Frame=31 Station=0,0917 OutputCase=FRE51 CaseType=Combination P=-3,57367360133645 V2=1,60163433141068 V3=0 T=0 M2=0 M3=2,71138240076956 FrameElem=31-1 ElemStation=0,0917

Frame=31 Station=0,1834 OutputCase=FRE51 CaseType=Combination P=-3,57367360133645 V2=2,88543433141068 V3=0 T=0 M2=0 M3=2,5056503025792 FrameElem=31-1 ElemStation=0,1834

Frame=31 Station=0 OutputCase=INVFRE CaseType=Combination StepType=Max P=-3,03162475949764 V2=7,56574186801808 V3=0 T=0 M2=0 M3=19,2944066078022 FrameElem=31-1 ElemStation=0

Frame=31 Station=0,0917 OutputCase=INVFRE CaseType=Combination StepType=Max P=-3,03162475949764 V2=15,4519418680181 V3=0 T=0 M2=0 M3=18,9328243378028 FrameElem=31-1 ElemStation=0,0917

Frame=31 Station=0,1834 OutputCase=INVFRE CaseType=Combination StepType=Max P=-3,03162475949764 V2=23,3381418680181 V3=0 T=0 M2=0 M3=17,848075278035 FrameElem=31-1 ElemStation=0,1834

Frame=31 Station=0 OutputCase=INVFRE CaseType=Combination StepType=Min P=-23,3742461152853 V2=-0,381401197721085 V3=0 T=0 M2=0 M3=-0,221282352152741 FrameElem=31-1 ElemStation=0

Frame=31 Station=0,0917 OutputCase=INVFRE CaseType=Combination StepType=Min P=-23,3742461152853 V2=0,902398802278916 V3=0 T=0 M2=0 M3=-0,280144582150582 FrameElem=31-1 ElemStation=0,0917

Frame=31 Station=0,1834 OutputCase=INVFRE CaseType=Combination StepType=Min P=-23,3742461152853 V2=2,18619880227892 V3=0 T=0 M2=0 M3=-0,515012723944887 FrameElem=31-1 ElemStation=0,1834

Frame=31 Station=0 OutputCase=QPE01 CaseType=Combination P=-5,19130189391028 V2=-0,96819786728247 V3=0 T=0 M2=0 M3=2,4219243460044 FrameElem=31-1 ElemStation=0

Frame=31 Station=0,0917 OutputCase=QPE01 CaseType=Combination P=-5,19130189391028 V2=0,31560213271753 V3=0 T=0 M2=0 M3=2,4518458604342 FrameElem=31-1 ElemStation=0,0917

Frame=31 Station=0,1834 OutputCase=QPE01 CaseType=Combination P=-5,19130189391028 V2=1,59940213271753 V3=0 T=0 M2=0 M3=2,36404291486401 FrameElem=31-1 ElemStation=0,1834

Frame=31 Station=0 OutputCase=QPE02 CaseType=Combination P=-5,57441114636793 V2=-0,968197867282367 V3=0 T=0 M2=0 M3=2,10404516724208 FrameElem=31-1 ElemStation=0

Frame=31 Station=0,0917 OutputCase=QPE02 CaseType=Combination P=-5,57441114636793 V2=0,315602132717633 V3=0 T=0 M2=0 M3=2,1339668167187 FrameElem=31-1 ElemStation=0,0917

Frame=31 Station=0,1834 OutputCase=QPE02 CaseType=Combination P=-5,57441114636793 V2=1,59940213271763 V3=0 T=0 M2=0 M3=2,0461673610166 FrameElem=31-1 ElemStation=0,1834

Frame=31 Station=0 OutputCase=QPE03 CaseType=Combination P=-4,80819264145264 V2=-0,968197867282573 V3=0 T=0 M2=0 M3=2,73980352476673 FrameElem=31-1 ElemStation=0

Frame=31 Station=0,0917 OutputCase=QPE03 CaseType=Combination P=-4,80819264145264 V2=0,315602132717427 V3=0 T=0 M2=0 M3=2,76972503919654 FrameElem=31-1 ElemStation=0,0917

Frame=31 Station=0,1834 OutputCase=QPE03 CaseType=Combination P=-4,80819264145264 V2=1,59940213271743 V3=0 T=0 M2=0 M3=2,68192209362635 FrameElem=31-1 ElemStation=0,1834

Frame=31 Station=0 OutputCase=QPE04 CaseType=Combination P=-5,03236230452912 V2=-1,28603219870601 V3=0 T=0 M2=0 M3=2,64255572930857 FrameElem=31-1 ElemStation=0

Frame=31 Station=0,0917 OutputCase=QPE04 CaseType=Combination P=-5,03236230452912 V2=-2,2321987060101E-03 V3=0 T=0 M2=0 M3=2,70162265192991 FrameElem=31-1 ElemStation=0,0917

Frame=31 Station=0,1834 OutputCase=QPE04 CaseType=Combination P=-5,03236230452912 V2=1,28156780129399 V3=0 T=0 M2=0 M3=2,64296511455125 FrameElem=31-1 ElemStation=0,1834

Frame=31 Station=0 OutputCase=QPE05 CaseType=Combination P=-5,35024148329145 V2=-0,650363535858929 V3=0 T=0 M2=0 M3=2,20129296270024 FrameElem=31-1 ElemStation=0

Frame=31 Station=0,0917 OutputCase=QPE05 CaseType=Combination P=-5,35024148329145 V2=0,633436464141071 V3=0 T=0 M2=0 M3=2,2020609689385 FrameElem=31-1 ElemStation=0,0917

Frame=31 Station=0,1834 OutputCase=QPE05 CaseType=Combination P=-5,35024148329145 V2=1,91723646414107 V3=0 T=0 M2=0 M3=2,08512071517676 FrameElem=31-1 ElemStation=0,1834

Frame=31 Station=0 OutputCase=QPE06 CaseType=Combination P=-4,80819264145264 V2=-0,968197867282573 V3=0 T=0 M2=0 M3=2,73980352476673 FrameElem=31-1 ElemStation=0

Frame=31 Station=0,0917 OutputCase=QPE06 CaseType=Combination P=-4,80819264145264 V2=0,315602132717427 V3=0 T=0 M2=0 M3=2,76972503919654 FrameElem=31-1 ElemStation=0,0917

Frame=31 Station=0,1834 OutputCase=QPE06 CaseType=Combination P=-4,80819264145264 V2=1,59940213271743 V3=0 T=0 M2=0 M3=2,68192209362635 FrameElem=31-1 ElemStation=0,1834

Frame=31 Station=0 OutputCase=QPE07 CaseType=Combination P=-5,41547155698676 V2=-1,28603219870591 V3=0 T=0 M2=0 M3=2,32467655054624 FrameElem=31-1 ElemStation=0

Frame=31 Station=0,0917 OutputCase=QPE07 CaseType=Combination P=-5,41547155698676 V2=-2,23219870590707E-03 V3=0 T=0 M2=0 M3=2,38374347316758 FrameElem=31-1 ElemStation=0,0917

Frame=31 Station=0,1834 OutputCase=QPE07 CaseType=Combination P=-5,41547155698676 V2=1,28156780129409 V3=0 T=0 M2=0 M3=2,32508593578891 FrameElem=31-1 ElemStation=0,1834

Frame=31 Station=0 OutputCase=QPE08 CaseType=Combination P=-5,73335073574909 V2=-0,650363535858826 V3=0 T=0 M2=0 M3=1,88341378393791 FrameElem=31-1 ElemStation=0

Frame=31 Station=0,0917 OutputCase=QPE08 CaseType=Combination P=-5,73335073574909 V2=0,633436464141174 V3=0 T=0 M2=0 M3=1,88418989017616 FrameElem=31-1 ElemStation=0,0917

Frame=31 Station=0,1834 OutputCase=QPE08 CaseType=Combination P=-5,73335073574909 V2=1,91723646414117 V3=0 T=0 M2=0 M3=1,76724153641442 FrameElem=31-1 ElemStation=0,1834

Frame=31 Station=0 OutputCase=QPE09 CaseType=Combination P=-5,19130189391028 V2=-0,96819786728247 V3=0 T=0 M2=0 M3=2,4219243460044 FrameElem=31-1 ElemStation=0

Frame=31 Station=0,0917 OutputCase=QPE09 CaseType=Combination P=-5,19130189391028 V2=0,31560213271753 V3=0 T=0 M2=0 M3=2,4518458604342 FrameElem=31-1 ElemStation=0,0917

Frame=31 Station=0,1834 OutputCase=QPE09 CaseType=Combination P=-5,19130189391028 V2=1,59940213271753 V3=0 T=0 M2=0 M3=2,36404291486401 FrameElem=31-1 ElemStation=0,1834

Frame=31 Station=0 OutputCase=QPE10 CaseType=Combination P=-5,19130189391028 V2=0,968197867257004 V3=0 T=0 M2=0 M3=2,42192434594824 FrameElem=31-1 ElemStation=0

Frame=31 Station=0,0917 OutputCase=QPE10 CaseType=Combination P=-5,19130189391028 V2=2,251997867257 V3=0 T=0 M2=0 M3=2,27427837152077 FrameElem=31-1 ElemStation=0,0917

Frame=31 Station=0,1834 OutputCase=QPE10 CaseType=Combination P=-5,19130189391028 V2=3,535797867257 V3=0 T=0 M2=0 M3=2,00890793709331 FrameElem=31-1 ElemStation=0,1834

Frame=31 Station=0 OutputCase=QPE11 CaseType=Combination P=-5,57441114636793 V2=0,968197867257107 V3=0 T=0 M2=0 M3=2,10404516718592 FrameElem=31-1 ElemStation=0

APPROVATO S.D.P.
Società di Progetto
Brebemi SpA



Doc. N.
60235-0000-A00.doc

CODIFICA DOCUMENTO
04RCDII10000000000300A00

REV.
00

FOGLIO
438 di 628

Frame=31 Station=0,0917 OutputCase=QPE11 CaseType=Combination P=-5,57441114636793 V2=2,25199786725711 V3=0 T=0 M2=0 M3=1,95639919275844 FrameElem=31-1 ElemStation=0,0917
Frame=31 Station=0,1834 OutputCase=QPE11 CaseType=Combination P=-5,57441114636793 V2=3,53579786725711 V3=0 T=0 M2=0 M3=1,69102875833096 FrameElem=31-1 ElemStation=0,1834
Frame=31 Station=0 OutputCase=QPE12 CaseType=Combination P=-4,80819264145264 V2=0,968197867256901 V3=0 T=0 M2=0 M3=2,73980352471057 FrameElem=31-1 ElemStation=0
Frame=31 Station=0,0917 OutputCase=QPE12 CaseType=Combination P=-4,80819264145264 V2=2,2519978672569 V3=0 T=0 M2=0 M3=2,59215755028311 FrameElem=31-1 ElemStation=0,0917
Frame=31 Station=0,1834 OutputCase=QPE12 CaseType=Combination P=-4,80819264145264 V2=3,5357978672569 V3=0 T=0 M2=0 M3=2,32678711585565 FrameElem=31-1 ElemStation=0,1834
Frame=31 Station=0 OutputCase=QPE13 CaseType=Combination P=-5,03236230452912 V2=0,650363535833463 V3=0 T=0 M2=0 M3=2,64255572925241 FrameElem=31-1 ElemStation=0
Frame=31 Station=0,0917 OutputCase=QPE13 CaseType=Combination P=-5,03236230452912 V2=1,93416353583346 V3=0 T=0 M2=0 M3=2,52405516301648 FrameElem=31-1 ElemStation=0,0917
Frame=31 Station=0,1834 OutputCase=QPE13 CaseType=Combination P=-5,03236230452912 V2=3,21796353583346 V3=0 T=0 M2=0 M3=2,28783013678055 FrameElem=31-1 ElemStation=0,1834
Frame=31 Station=0 OutputCase=QPE14 CaseType=Combination P=-5,35024148329145 V2=1,28603219868054 V3=0 T=0 M2=0 M3=2,20129296264407 FrameElem=31-1 ElemStation=0
Frame=31 Station=0,0917 OutputCase=QPE14 CaseType=Combination P=-5,35024148329145 V2=2,56983219868054 V3=0 T=0 M2=0 M3=2,02450158002507 FrameElem=31-1 ElemStation=0,0917
Frame=31 Station=0,1834 OutputCase=QPE14 CaseType=Combination P=-5,35024148329145 V2=3,85363219868055 V3=0 T=0 M2=0 M3=1,72998573740606 FrameElem=31-1 ElemStation=0,1834
Frame=31 Station=0 OutputCase=QPE15 CaseType=Combination P=-4,80819264145264 V2=0,968197867256901 V3=0 T=0 M2=0 M3=2,73980352471057 FrameElem=31-1 ElemStation=0
Frame=31 Station=0,0917 OutputCase=QPE15 CaseType=Combination P=-4,80819264145264 V2=2,2519978672569 V3=0 T=0 M2=0 M3=2,59215755028311 FrameElem=31-1 ElemStation=0,0917
Frame=31 Station=0,1834 OutputCase=QPE15 CaseType=Combination P=-4,80819264145264 V2=3,5357978672569 V3=0 T=0 M2=0 M3=2,32678711585565 FrameElem=31-1 ElemStation=0,1834
Frame=31 Station=0 OutputCase=QPE16 CaseType=Combination P=-5,41547155698676 V2=0,650363535833566 V3=0 T=0 M2=0 M3=2,32467655049008 FrameElem=31-1 ElemStation=0
Frame=31 Station=0,0917 OutputCase=QPE16 CaseType=Combination P=-5,41547155698676 V2=1,93416353583357 V3=0 T=0 M2=0 M3=2,20617598425415 FrameElem=31-1 ElemStation=0,0917
Frame=31 Station=0,1834 OutputCase=QPE16 CaseType=Combination P=-5,41547155698676 V2=3,21796353583357 V3=0 T=0 M2=0 M3=1,96995095801821 FrameElem=31-1 ElemStation=0,1834
Frame=31 Station=0 OutputCase=QPE17 CaseType=Combination P=-5,73335073574909 V2=1,28603219868065 V3=0 T=0 M2=0 M3=1,88341378388175 FrameElem=31-1 ElemStation=0
Frame=31 Station=0,0917 OutputCase=QPE17 CaseType=Combination P=-5,73335073574909 V2=2,56983219868065 V3=0 T=0 M2=0 M3=1,70662240126273 FrameElem=31-1 ElemStation=0,0917
Frame=31 Station=0,1834 OutputCase=QPE17 CaseType=Combination P=-5,73335073574909 V2=3,85363219868065 V3=0 T=0 M2=0 M3=1,41210655864372 FrameElem=31-1 ElemStation=0,1834
Frame=31 Station=0 OutputCase=QPE18 CaseType=Combination P=-5,19130189391028 V2=0,968197867257004 V3=0 T=0 M2=0 M3=2,42192434594824 FrameElem=31-1 ElemStation=0
Frame=31 Station=0,0917 OutputCase=QPE18 CaseType=Combination P=-5,19130189391028 V2=2,251997867257 V3=0 T=0 M2=0 M3=2,27427837152077 FrameElem=31-1 ElemStation=0,0917
Frame=31 Station=0,1834 OutputCase=QPE18 CaseType=Combination P=-5,19130189391028 V2=3,535797867257 V3=0 T=0 M2=0 M3=2,00890793709331 FrameElem=31-1 ElemStation=0,1834
Frame=31 Station=0 OutputCase=INVQPE CaseType=Combination StepType=Max P=-4,80819264145264 V2=1,28603219868065 V3=0 T=0 M2=0 M3=2,73980352476673 FrameElem=31-1 ElemStation=0
Frame=31 Station=0,0917 OutputCase=INVQPE CaseType=Combination StepType=Max P=-4,80819264145264 V2=2,56983219868065 V3=0 T=0 M2=0 M3=2,76972503919654 FrameElem=31-1 ElemStation=0,0917
Frame=31 Station=0,1834 OutputCase=INVQPE CaseType=Combination StepType=Max P=-4,80819264145264 V2=3,85363219868065 V3=0 T=0 M2=0 M3=2,68192209362635 FrameElem=31-1 ElemStation=0,1834
Frame=31 Station=0 OutputCase=INVQPE CaseType=Combination StepType=Min P=-5,73335073574909 V2=-1,28603219870601 V3=0 T=0 M2=0 M3=1,88341378388175 FrameElem=31-1 ElemStation=0
Frame=31 Station=0,0917 OutputCase=INVQPE CaseType=Combination StepType=Min P=-5,73335073574909 V2=-2,2321987060101E-03 V3=0 T=0 M2=0 M3=1,70662240126273 FrameElem=31-1 ElemStation=0,0917
Frame=31 Station=0,1834 OutputCase=INVQPE CaseType=Combination StepType=Min P=-5,73335073574909 V2=1,28156780129399 V3=0 T=0 M2=0 M3=1,41210655864372 FrameElem=31-1 ElemStation=0,1834
Frame=34 Station=0 OutputCase=STR001 CaseType=Combination P=-8,78598720843539 V2=10,3949999999371 V3=0 T=0 M2=0 M3=0,118506083701141 FrameElem=34-1 ElemStation=0
Frame=34 Station=0,05 OutputCase=STR001 CaseType=Combination P=-8,78598720843539 V2=11,3399999999371 V3=0 T=0 M2=0 M3=0,424868916295716 FrameElem=34-1 ElemStation=0,05
Frame=34 Station=0,1 OutputCase=STR001 CaseType=Combination P=-8,78598720843539 V2=12,2849999999371 V3=0 T=0 M2=0 M3=-1,01549391629257 FrameElem=34-1 ElemStation=0,1
Frame=34 Station=0 OutputCase=STR002 CaseType=Combination P=-3,67738410059929 V2=10,3950000000157 V3=0 T=0 M2=0 M3=0,958687775390308 FrameElem=34-1 ElemStation=0
Frame=34 Station=0,05 OutputCase=STR002 CaseType=Combination P=-3,67738410059929 V2=11,3400000000157 V3=0 T=0 M2=0 M3=0,415312775389522 FrameElem=34-1 ElemStation=0,05
Frame=34 Station=0,1 OutputCase=STR002 CaseType=Combination P=-3,67738410059929 V2=12,2850000000157 V3=0 T=0 M2=0 M3=0,175312224611263 FrameElem=34-1 ElemStation=0,1
Frame=34 Station=0 OutputCase=STR003 CaseType=Combination P=-4,97357719641853 V2=81,67499999998035 V3=0 T=0 M2=0 M3=10,7650176138514 FrameElem=34-1 ElemStation=0
Frame=34 Station=0,05 OutputCase=STR003 CaseType=Combination P=-4,97357719641853 V2=89,09999999998036 V3=0 T=0 M2=0 M3=6,49564261386126 FrameElem=34-1 ElemStation=0,05
Frame=34 Station=0,1 OutputCase=STR003 CaseType=Combination P=-4,97357719641853 V2=96,52499999998036 V3=0 T=0 M2=0 M3=1,85501761387108 FrameElem=34-1 ElemStation=0,1
Frame=34 Station=0 OutputCase=STR004 CaseType=Combination P=-21,7144805563495 V2=94,856781584244 V3=0 T=0 M2=0 M3=1,19712998441451 FrameElem=34-1 ElemStation=0
Frame=34 Station=0,05 OutputCase=STR004 CaseType=Combination P=-21,7144805563495 V2=102,281781584244 V3=0 T=0 M2=0 M3=-3,7313340947977 FrameElem=34-1 ElemStation=0,05
Frame=34 Station=0,1 OutputCase=STR004 CaseType=Combination P=-21,7144805563495 V2=109,706781584244 V3=0 T=0 M2=0 M3=-9,03104817400991 FrameElem=34-1 ElemStation=0,1
Frame=34 Station=0 OutputCase=STR005 CaseType=Combination P=-38,4553839502737 V2=81,6749999999725 V3=0 T=0 M2=0 M3=6,12920209845174 FrameElem=34-1 ElemStation=0
Frame=34 Station=0,05 OutputCase=STR005 CaseType=Combination P=-38,4553839502737 V2=89,0999999999725 V3=0 T=0 M2=0 M3=1,85982709846549 FrameElem=34-1 ElemStation=0,05
Frame=34 Station=0,1 OutputCase=STR005 CaseType=Combination P=-38,4553839502737 V2=96,5249999999725 V3=0 T=0 M2=0 M3=-2,78079790152076 FrameElem=34-1 ElemStation=0,1

Società di Progetto
Brebemi SpA

	Doc. N. 60235-0000-A00.doc	CODIFICA DOCUMENTO 04RCDII10000000000300A00	REV. 00	FOGLIO 439 di 628
--	-------------------------------	--	------------	----------------------

Frame=34 Station=0 OutputCase=STR006 CaseType=Combination P=-20,6153684757657 V2=20,8817815844523 V3=0 T=0 M2=0 M3=-9,04682122166018 FrameElem=34-1
ElemStation=0

Frame=34 Station=0,05 OutputCase=STR006 CaseType=Combination P=-20,6153684757657 V2=21,5817815844523 V3=0 T=0 M2=0 M3=-10,1084103008828 FrameElem=34-1
ElemStation=0,05

Frame=34 Station=0,1 OutputCase=STR006 CaseType=Combination P=-20,6153684757657 V2=22,2817815844523 V3=0 T=0 M2=0 M3=-11,2049993801054 FrameElem=34-1
ElemStation=0,1

Frame=34 Station=0 OutputCase=STR007 CaseType=Combination P=-37,35627186969 V2=7,6999999993306 V3=0 T=0 M2=0 M3=-4,11474910762295 FrameElem=34-1
ElemStation=0

Frame=34 Station=0,05 OutputCase=STR007 CaseType=Combination P=-37,35627186969 V2=8,3999999993306 V3=0 T=0 M2=0 M3=-4,5172491076196 FrameElem=34-1
ElemStation=0,05

Frame=34 Station=0,1 OutputCase=STR007 CaseType=Combination P=-37,35627186969 V2=9,0999999993306 V3=0 T=0 M2=0 M3=-4,95474910761626 FrameElem=34-1
ElemStation=0,1

Frame=34 Station=0 OutputCase=STR008 CaseType=Combination P=-30,2435318235745 V2=93,5808250227903 V3=0 T=0 M2=0 M3=-9,87922213839687 FrameElem=34-1
ElemStation=0

Frame=34 Station=0,05 OutputCase=STR008 CaseType=Combination P=-31,3707818235745 V2=99,3858250227903 V3=0 T=0 M2=0 M3=-14,7033883895364 FrameElem=34-1
ElemStation=0,05

Frame=34 Station=0,1 OutputCase=STR008 CaseType=Combination P=-32,4980318235745 V2=105,1908250227903 V3=0 T=0 M2=0 M3=-19,8178046406759 FrameElem=34-1
ElemStation=0,1

Frame=34 Station=0 OutputCase=STR009 CaseType=Combination P=-9,7054494143321 V2=10,394999999374 V3=0 T=0 M2=0 M3=-0,644403945328589 FrameElem=34-1
ElemStation=0

Frame=34 Station=0,05 OutputCase=STR009 CaseType=Combination P=-9,7054494143321 V2=11,339999999374 V3=0 T=0 M2=0 M3=-1,18777894532546 FrameElem=34-1
ElemStation=0,05

Frame=34 Station=0,1 OutputCase=STR009 CaseType=Combination P=-9,7054494143321 V2=12,284999999374 V3=0 T=0 M2=0 M3=-1,77840394532233 FrameElem=34-1
ElemStation=0,1

Frame=34 Station=0 OutputCase=STR010 CaseType=Combination P=-4,596846306496 V2=10,395000000016 V3=0 T=0 M2=0 M3=-0,19577746360578 FrameElem=34-1
ElemStation=0

Frame=34 Station=0,05 OutputCase=STR010 CaseType=Combination P=-4,596846306496 V2=11,340000000016 V3=0 T=0 M2=0 M3=-0,34759725364022 FrameElem=34-1
ElemStation=0,05

Frame=34 Station=0,1 OutputCase=STR010 CaseType=Combination P=-4,596846306496 V2=12,285000000016 V3=0 T=0 M2=0 M3=-0,93822253641019 FrameElem=34-1
ElemStation=0,1

Frame=34 Station=0 OutputCase=STR011 CaseType=Combination P=-5,52525451995656 V2=81,6749999998037 V3=0 T=0 M2=0 M3=-10,3072715964336 FrameElem=34-1
ElemStation=0

Frame=34 Station=0,05 OutputCase=STR011 CaseType=Combination P=-5,52525451995656 V2=89,0999999998037 V3=0 T=0 M2=0 M3=-6,03789659644341 FrameElem=34-1
ElemStation=0,05

Frame=34 Station=0,1 OutputCase=STR011 CaseType=Combination P=-5,52525451995656 V2=96,5249999998037 V3=0 T=0 M2=0 M3=-1,39727159645323 FrameElem=34-1
ElemStation=0,1

Frame=34 Station=0 OutputCase=STR012 CaseType=Combination P=-22,2661578798875 V2=94,8567815842443 V3=0 T=0 M2=0 M3=-0,739383966996668 FrameElem=34-1
ElemStation=0

Frame=34 Station=0,05 OutputCase=STR012 CaseType=Combination P=-22,2661578798875 V2=102,281781584244 V3=0 T=0 M2=0 M3=-4,18908011221555 FrameElem=34-1
ElemStation=0,05

Frame=34 Station=0,1 OutputCase=STR012 CaseType=Combination P=-22,2661578798875 V2=109,706781584244 V3=0 T=0 M2=0 M3=-9,48879419142776 FrameElem=34-1
ElemStation=0,1

Frame=34 Station=0 OutputCase=STR013 CaseType=Combination P=-39,0070612738118 V2=81,6749999997251 V3=0 T=0 M2=0 M3=-5,6714560810339 FrameElem=34-1
ElemStation=0

Frame=34 Station=0,05 OutputCase=STR013 CaseType=Combination P=-39,0070612738118 V2=89,0999999997251 V3=0 T=0 M2=0 M3=-1,40208108104765 FrameElem=34-1
ElemStation=0,05

Frame=34 Station=0,1 OutputCase=STR013 CaseType=Combination P=-39,0070612738118 V2=96,5249999997252 V3=0 T=0 M2=0 M3=-3,23854391893861 FrameElem=34-1
ElemStation=0,1

Frame=34 Station=0 OutputCase=STR014 CaseType=Combination P=-21,1670457993038 V2=20,8817815844524 V3=0 T=0 M2=0 M3=-9,50456723907802 FrameElem=34-1
ElemStation=0

Frame=34 Station=0,05 OutputCase=STR014 CaseType=Combination P=-21,1670457993038 V2=21,5817815844524 V3=0 T=0 M2=0 M3=-10,5661563183006 FrameElem=34-1
ElemStation=0,05

Frame=34 Station=0,1 OutputCase=STR014 CaseType=Combination P=-21,1670457993038 V2=22,2817815844524 V3=0 T=0 M2=0 M3=-11,6627453975233 FrameElem=34-1
ElemStation=0,1

Frame=34 Station=0 OutputCase=STR015 CaseType=Combination P=-37,907949193228 V2=7,6999999993321 V3=0 T=0 M2=0 M3=-4,57249512504079 FrameElem=34-1
ElemStation=0

Frame=34 Station=0,05 OutputCase=STR015 CaseType=Combination P=-37,907949193228 V2=8,3999999993321 V3=0 T=0 M2=0 M3=-4,97499512503745 FrameElem=34-1
ElemStation=0,05

Frame=34 Station=0,1 OutputCase=STR015 CaseType=Combination P=-37,907949193228 V2=9,0999999993322 V3=0 T=0 M2=0 M3=-5,41249512503411 FrameElem=34-1
ElemStation=0,1

Frame=34 Station=0 OutputCase=STR016 CaseType=Combination P=-30,7952091471125 V2=93,5808250227904 V3=0 T=0 M2=0 M3=-10,3369681558147 FrameElem=34-1
ElemStation=0

Frame=34 Station=0,05 OutputCase=STR016 CaseType=Combination P=-31,9224591471125 V2=99,3858250227905 V3=0 T=0 M2=0 M3=-15,1611344069542 FrameElem=34-1
ElemStation=0,05

Frame=34 Station=0,1 OutputCase=STR016 CaseType=Combination P=-33,0497091471125 V2=105,1908250227905 V3=0 T=0 M2=0 M3=-20,2755506580938 FrameElem=34-1
ElemStation=0,1

Frame=34 Station=0 OutputCase=STR017 CaseType=Combination P=-5,56899112836043 V2=63,8549999998569 V3=0 T=0 M2=0 M3=-7,55052512520642 FrameElem=34-1
ElemStation=0

Frame=34 Station=0,05 OutputCase=STR017 CaseType=Combination P=-5,56899112836043 V2=69,6599999998569 V3=0 T=0 M2=0 M3=-4,21265012521358 FrameElem=34-1
ElemStation=0,05

Frame=34 Station=0,1 OutputCase=STR017 CaseType=Combination P=-5,56899112836043 V2=75,4649999998568 V3=0 T=0 M2=0 M3=-0,584525125220738 FrameElem=34-1
ElemStation=0,1

Frame=34 Station=0 OutputCase=STR018 CaseType=Combination P=-18,7632440363109 V2=74,2109122331275 V3=0 T=0 M2=0 M3=1,13198669411283E-02 FrameElem=34-1
ElemStation=0

Frame=34 Station=0,05 OutputCase=STR018 CaseType=Combination P=-18,7632440363109 V2=80,0159122331275 V3=0 T=0 M2=0 M3=-3,84435074471525 FrameElem=34-1
ElemStation=0,05

Frame=34 Station=0,1 OutputCase=STR018 CaseType=Combination P=-18,7632440363109 V2=85,8209122331275 V3=0 T=0 M2=0 M3=-7,99027135637162 FrameElem=34-1
ElemStation=0,1

Frame=34 Station=0 OutputCase=STR019 CaseType=Combination P=-31,9574969707108 V2=63,8549999997783 V3=0 T=0 M2=0 M3=3,86361806573436 FrameElem=34-1
ElemStation=0

Frame=34 Station=0,05 OutputCase=STR019 CaseType=Combination P=-31,9574969707108 V2=69,6599999997783 V3=0 T=0 M2=0 M3=0,525743065745448 FrameElem=34-1
ElemStation=0,05

Frame=34 Station=0,1 OutputCase=STR019 CaseType=Combination P=-31,9574969707108 V2=75,4649999997783 V3=0 T=0 M2=0 M3=-3,10238193424346 FrameElem=34-1
ElemStation=0,1

Frame=34 Station=0 OutputCase=STR020 CaseType=Combination P=-17,9881802296819 V2=18,0559122332825 V3=0 T=0 M2=0 M3=-7,78104887951828 FrameElem=34-1
ElemStation=0

Frame=34 Station=0,05 OutputCase=STR020 CaseType=Combination P=-17,9881802296819 V2=18,7559122332825 V3=0 T=0 M2=0 M3=-8,70134449118241 FrameElem=34-1
ElemStation=0,05

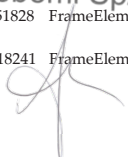
Società di Progetto
Brebemi SpA



Doc. N.
60235-0000-A00.doc

CODIFICA DOCUMENTO
04RCDII10000000000300A00

REV.
00

FOGLIO
440 di 628

Frame=34 Station=0,1 OutputCase=STR020 CaseType=Combination P=-17,9881802296819 V2=19,455912232825 V3=0 T=0 M2=0 M3=-9,65664010284653 FrameElem=34-1 ElemStation=0,1
Frame=34 Station=0 OutputCase=STR021 CaseType=Combination P=-31,1824331640819 V2=7,69999999993332 V3=0 T=0 M2=0 M3=-3,92875068072505 FrameElem=34-1 ElemStation=0
Frame=34 Station=0,05 OutputCase=STR021 CaseType=Combination P=-31,1824331640819 V2=8,39999999993332 V3=0 T=0 M2=0 M3=-4,33125068072171 FrameElem=34-1 ElemStation=0,05
Frame=34 Station=0,1 OutputCase=STR021 CaseType=Combination P=-31,1824331640819 V2=9,09999999993332 V3=0 T=0 M2=0 M3=-4,76875068071838 FrameElem=34-1 ElemStation=0,1
Frame=34 Station=0 OutputCase=STR022 CaseType=Combination P=-9,4765764056232 V2=9,9373185626875 V3=0 T=0 M2=0 M3=-7,49699628831497E-02 FrameElem=34-1 ElemStation=0
Frame=34 Station=0,05 OutputCase=STR022 CaseType=Combination P=-9,4765764056232 V2=10,8823185626875 V3=0 T=0 M2=0 M3=-0,595460891017525 FrameElem=34-1 ElemStation=0,05
Frame=34 Station=0,1 OutputCase=STR022 CaseType=Combination P=-9,4765764056232 V2=11,8273185626875 V3=0 T=0 M2=0 M3=-1,1632018191519 FrameElem=34-1 ElemStation=0,1
Frame=34 Station=0 OutputCase=STR023 CaseType=Combination P=-4,3679732977871 V2=9,9373185627668 V3=0 T=0 M2=0 M3=0,765211728806018 FrameElem=34-1 ElemStation=0
Frame=34 Station=0,05 OutputCase=STR023 CaseType=Combination P=-4,3679732977871 V2=10,8823185627661 V3=0 T=0 M2=0 M3=0,244720800667714 FrameElem=34-1 ElemStation=0,05
Frame=34 Station=0,1 OutputCase=STR023 CaseType=Combination P=-4,3679732977871 V2=11,8273185627661 V3=0 T=0 M2=0 M3=-0,323020127470591 FrameElem=34-1 ElemStation=0,1
Frame=34 Station=0 OutputCase=STR024 CaseType=Combination P=-5,34011811965153 V2=63,397318562607 V3=0 T=0 M2=0 M3=8,11995910765186 FrameElem=34-1 ElemStation=0
Frame=34 Station=0,05 OutputCase=STR024 CaseType=Combination P=-5,34011811965153 V2=69,202318562607 V3=0 T=0 M2=0 M3=4,80496817952151 FrameElem=34-1 ElemStation=0,05
Frame=34 Station=0,1 OutputCase=STR024 CaseType=Combination P=-5,34011811965153 V2=75,007318562607 V3=0 T=0 M2=0 M3=1,19972725139117 FrameElem=34-1 ElemStation=0,1
Frame=34 Station=0 OutputCase=STR025 CaseType=Combination P=-18,534371027602 V2=73,7532307958776 V3=0 T=0 M2=0 M3=0,580753849386568 FrameElem=34-1 ElemStation=0
Frame=34 Station=0,05 OutputCase=STR025 CaseType=Combination P=-18,534371027602 V2=79,5582307958776 V3=0 T=0 M2=0 M3=-3,25203269040731 FrameElem=34-1 ElemStation=0,05
Frame=34 Station=0,1 OutputCase=STR025 CaseType=Combination P=-18,534371027602 V2=85,3632307958776 V3=0 T=0 M2=0 M3=-7,37506923020119 FrameElem=34-1 ElemStation=0,1
Frame=34 Station=0 OutputCase=STR026 CaseType=Combination P=-31,728623962002 V2=63,3973185625284 V3=0 T=0 M2=0 M3=4,4330520481798 FrameElem=34-1 ElemStation=0
Frame=34 Station=0,05 OutputCase=STR026 CaseType=Combination P=-31,728623962002 V2=69,2023185625284 V3=0 T=0 M2=0 M3=1,11806112005338 FrameElem=34-1 ElemStation=0,05
Frame=34 Station=0,1 OutputCase=STR026 CaseType=Combination P=-31,728623962002 V2=75,0073185625284 V3=0 T=0 M2=0 M3=-2,48717980807304 FrameElem=34-1 ElemStation=0,1
Frame=34 Station=0 OutputCase=STR027 CaseType=Combination P=-17,759307220973 V2=17,5982307960327 V3=0 T=0 M2=0 M3=-7,21161489707284 FrameElem=34-1 ElemStation=0
Frame=34 Station=0,05 OutputCase=STR027 CaseType=Combination P=-17,759307220973 V2=18,2982307960327 V3=0 T=0 M2=0 M3=-8,10902643687447 FrameElem=34-1 ElemStation=0,05
Frame=34 Station=0,1 OutputCase=STR027 CaseType=Combination P=-17,759307220973 V2=18,9982307960327 V3=0 T=0 M2=0 M3=-9,04143797667611 FrameElem=34-1 ElemStation=0,1
Frame=34 Station=0 OutputCase=STR028 CaseType=Combination P=-30,953560155373 V2=7,24231856268343 V3=0 T=0 M2=0 M3=-3,35931669827961 FrameElem=34-1 ElemStation=0
Frame=34 Station=0,05 OutputCase=STR028 CaseType=Combination P=-30,953560155373 V2=7,94231856268343 V3=0 T=0 M2=0 M3=-3,73893262641378 FrameElem=34-1 ElemStation=0,05
Frame=34 Station=0,1 OutputCase=STR028 CaseType=Combination P=-30,953560155373 V2=8,64231856268343 V3=0 T=0 M2=0 M3=-4,15354855454795 FrameElem=34-1 ElemStation=0,1
Frame=34 Station=0 OutputCase=STR029 CaseType=Combination P=-9,93432242304099 V2=10,8526814371873 V3=0 T=0 M2=0 M3=-1,21383792777403 FrameElem=34-1 ElemStation=0
Frame=34 Station=0,05 OutputCase=STR029 CaseType=Combination P=-9,93432242304099 V2=11,7976814371873 V3=0 T=0 M2=0 M3=-1,7800969963339 FrameElem=34-1 ElemStation=0,05
Frame=34 Station=0,1 OutputCase=STR029 CaseType=Combination P=-9,93432242304099 V2=12,7426814371873 V3=0 T=0 M2=0 M3=-2,39360607149276 FrameElem=34-1 ElemStation=0,1
Frame=34 Station=0 OutputCase=STR030 CaseType=Combination P=-4,82571931520489 V2=10,8526814372659 V3=0 T=0 M2=0 M3=-0,373656236084862 FrameElem=34-1 ElemStation=0
Frame=34 Station=0,05 OutputCase=STR030 CaseType=Combination P=-4,82571931520489 V2=11,7976814372659 V3=0 T=0 M2=0 M3=-0,939915307948155 FrameElem=34-1 ElemStation=0,05
Frame=34 Station=0,1 OutputCase=STR030 CaseType=Combination P=-4,82571931520489 V2=12,7426814372659 V3=0 T=0 M2=0 M3=-1,55342437981145 FrameElem=34-1 ElemStation=0,1
Frame=34 Station=0 OutputCase=STR031 CaseType=Combination P=-5,79786413706932 V2=64,3126814371067 V3=0 T=0 M2=0 M3=6,98109114276098 FrameElem=34-1 ElemStation=0
Frame=34 Station=0,05 OutputCase=STR031 CaseType=Combination P=-5,79786413706932 V2=70,1176814371067 V3=0 T=0 M2=0 M3=3,62033207090565 FrameElem=34-1 ElemStation=0,05
Frame=34 Station=0,1 OutputCase=STR031 CaseType=Combination P=-5,79786413706932 V2=75,9226814371067 V3=0 T=0 M2=0 M3=-3,06770009496903E-02 FrameElem=34-1 ElemStation=0,1
Frame=34 Station=0 OutputCase=STR032 CaseType=Combination P=-18,9921170450198 V2=74,6685936703774 V3=0 T=0 M2=0 M3=-0,558114115504311 FrameElem=34-1 ElemStation=0
Frame=34 Station=0,05 OutputCase=STR032 CaseType=Combination P=-18,9921170450198 V2=80,4735936703774 V3=0 T=0 M2=0 M3=-4,43666879902318 FrameElem=34-1 ElemStation=0,05
Frame=34 Station=0,1 OutputCase=STR032 CaseType=Combination P=-18,9921170450198 V2=86,2785936703774 V3=0 T=0 M2=0 M3=-8,60547348254205 FrameElem=34-1 ElemStation=0,1
Frame=34 Station=0 OutputCase=STR033 CaseType=Combination P=-32,1863699794197 V2=64,3126814370281 V3=0 T=0 M2=0 M3=3,29418408328892 FrameElem=34-1 ElemStation=0
Frame=34 Station=0,05 OutputCase=STR033 CaseType=Combination P=-32,1863699794197 V2=70,1176814370282 V3=0 T=0 M2=0 M3=-6,65749885624862E-02 FrameElem=34-1 ElemStation=0,05
Frame=34 Station=0,1 OutputCase=STR033 CaseType=Combination P=-32,1863699794197 V2=75,9226814370282 V3=0 T=0 M2=0 M3=-3,71758406041389 FrameElem=34-1 ElemStation=0,1
Frame=34 Station=0 OutputCase=STR034 CaseType=Combination P=-18,2170532383908 V2=18,5135936705324 V3=0 T=0 M2=0 M3=-8,35048286196372 FrameElem=34-1 ElemStation=0
Frame=34 Station=0,05 OutputCase=STR034 CaseType=Combination P=-18,2170532383908 V2=19,2135936705324 V3=0 T=0 M2=0 M3=-9,29366254549034 FrameElem=34-1 ElemStation=0,05
Frame=34 Station=0,1 OutputCase=STR034 CaseType=Combination P=-18,2170532383908 V2=19,9135936705324 V3=0 T=0 M2=0 M3=-10,271842229017 FrameElem=34-1 ElemStation=0,1
Frame=34 Station=0 OutputCase=STR035 CaseType=Combination P=-31,4113061727908 V2=8,15768143718321 V3=0 T=0 M2=0 M3=-4,49818466317049 FrameElem=34-1 ElemStation=0

Società di Progetto
Brebemi SpA



Doc. N.
60235-0000-A00.doc

CODIFICA DOCUMENTO
04RCDII10000000000300A00

REV.
00

FOGLIO
441 di 628

Frame=34 Station=0,05 OutputCase=STR035 CaseType=Combination P=-31,4113061727908 V2=8,8576814371832 V3=0 T=0 M2=0 M3=-4,92356873502965 FrameElem=34-1 ElemStation=0,05
Frame=34 Station=0,1 OutputCase=STR035 CaseType=Combination P=-31,4113061727908 V2=9,55768143718321 V3=0 T=0 M2=0 M3=-5,38395280688881 FrameElem=34-1 ElemStation=0,1
Frame=34 Station=0 OutputCase=STR036 CaseType=Combination P=-9,15377209079407 V2=10,3949999999372 V3=0 T=0 M2=0 M3=-0,186657927910751 FrameElem=34-1 ElemStation=0
Frame=34 Station=0,05 OutputCase=STR036 CaseType=Combination P=-9,15377209079407 V2=11,3399999999372 V3=0 T=0 M2=0 M3=-0,730032927907614 FrameElem=34-1 ElemStation=0,05
Frame=34 Station=0,1 OutputCase=STR036 CaseType=Combination P=-9,15377209079407 V2=12,2849999999372 V3=0 T=0 M2=0 M3=-1,32065792790448 FrameElem=34-1 ElemStation=0,1
Frame=34 Station=0 OutputCase=STR037 CaseType=Combination P=-4,04516898295797 V2=10,3950000000158 V3=0 T=0 M2=0 M3=-0,653523763778416 FrameElem=34-1 ElemStation=0
Frame=34 Station=0,05 OutputCase=STR037 CaseType=Combination P=-4,04516898295797 V2=11,3400000000158 V3=0 T=0 M2=0 M3=-0,110148763777625 FrameElem=34-1 ElemStation=0,05
Frame=34 Station=0,1 OutputCase=STR037 CaseType=Combination P=-4,04516898295797 V2=12,2850000000158 V3=0 T=0 M2=0 M3=-0,480476236223166 FrameElem=34-1 ElemStation=0,1
Frame=34 Station=0 OutputCase=STR038 CaseType=Combination P=-5,0173138048224 V2=63,8549999998567 V3=0 T=0 M2=0 M3=8,00827114262426 FrameElem=34-1 ElemStation=0
Frame=34 Station=0,05 OutputCase=STR038 CaseType=Combination P=-5,0173138048224 V2=69,6599999998567 V3=0 T=0 M2=0 M3=4,67039614263143 FrameElem=34-1 ElemStation=0,05
Frame=34 Station=0,1 OutputCase=STR038 CaseType=Combination P=-5,0173138048224 V2=75,4649999998567 V3=0 T=0 M2=0 M3=1,04227114263859 FrameElem=34-1 ElemStation=0,1
Frame=34 Station=0 OutputCase=STR039 CaseType=Combination P=-18,2115667127728 V2=74,2109122331273 V3=0 T=0 M2=0 M3=0,469065884358966 FrameElem=34-1 ElemStation=0
Frame=34 Station=0,05 OutputCase=STR039 CaseType=Combination P=-18,2115667127728 V2=80,0159122331273 V3=0 T=0 M2=0 M3=-3,3866047272974 FrameElem=34-1 ElemStation=0,05
Frame=34 Station=0,1 OutputCase=STR039 CaseType=Combination P=-18,2115667127728 V2=85,8209122331273 V3=0 T=0 M2=0 M3=-7,53252533895377 FrameElem=34-1 ElemStation=0,1
Frame=34 Station=0 OutputCase=STR040 CaseType=Combination P=-31,4058196471728 V2=63,8549999997781 V3=0 T=0 M2=0 M3=4,3213640831522 FrameElem=34-1 ElemStation=0
Frame=34 Station=0,05 OutputCase=STR040 CaseType=Combination P=-31,4058196471728 V2=69,6599999997781 V3=0 T=0 M2=0 M3=0,983489083163294 FrameElem=34-1 ElemStation=0,05
Frame=34 Station=0,1 OutputCase=STR040 CaseType=Combination P=-31,4058196471728 V2=75,4649999997781 V3=0 T=0 M2=0 M3=-2,64463591682561 FrameElem=34-1 ElemStation=0,1
Frame=34 Station=0 OutputCase=STR041 CaseType=Combination P=-17,4365029061439 V2=18,0559122332824 V3=0 T=0 M2=0 M3=-7,32330286210044 FrameElem=34-1 ElemStation=0
Frame=34 Station=0,05 OutputCase=STR041 CaseType=Combination P=-17,4365029061439 V2=18,7559122332824 V3=0 T=0 M2=0 M3=-8,24359847376456 FrameElem=34-1 ElemStation=0,05
Frame=34 Station=0,1 OutputCase=STR041 CaseType=Combination P=-17,4365029061439 V2=19,4559122332824 V3=0 T=0 M2=0 M3=-9,19889408542868 FrameElem=34-1 ElemStation=0,1
Frame=34 Station=0 OutputCase=STR042 CaseType=Combination P=-30,6307558405439 V2=7,69999999993316 V3=0 T=0 M2=0 M3=-3,47100466330721 FrameElem=34-1 ElemStation=0
Frame=34 Station=0,05 OutputCase=STR042 CaseType=Combination P=-30,6307558405439 V2=8,39999999993316 V3=0 T=0 M2=0 M3=-3,87350466330387 FrameElem=34-1 ElemStation=0,05
Frame=34 Station=0,1 OutputCase=STR042 CaseType=Combination P=-30,6307558405439 V2=9,09999999993317 V3=0 T=0 M2=0 M3=-4,31100466330053 FrameElem=34-1 ElemStation=0,1
Frame=34 Station=0 OutputCase=STR043 CaseType=Combination P=-7,86652500253868 V2=10,3949999999369 V3=0 T=0 M2=0 M3=0,881416112730871 FrameElem=34-1 ElemStation=0
Frame=34 Station=0,05 OutputCase=STR043 CaseType=Combination P=-7,86652500253868 V2=11,3399999999369 V3=0 T=0 M2=0 M3=0,338041112734026 FrameElem=34-1 ElemStation=0,05
Frame=34 Station=0,1 OutputCase=STR043 CaseType=Combination P=-7,86652500253868 V2=12,2849999999369 V3=0 T=0 M2=0 M3=-0,252583887262818 FrameElem=34-1 ElemStation=0,1
Frame=34 Station=0 OutputCase=STR044 CaseType=Combination P=-2,75792189470258 V2=10,3950000000155 V3=0 T=0 M2=0 M3=1,72159780442004 FrameElem=34-1 ElemStation=0
Frame=34 Station=0,05 OutputCase=STR044 CaseType=Combination P=-2,75792189470258 V2=11,3400000000155 V3=0 T=0 M2=0 M3=1,1782280441927 FrameElem=34-1 ElemStation=0,05
Frame=34 Station=0,1 OutputCase=STR044 CaseType=Combination P=-2,75792189470258 V2=12,2850000000155 V3=0 T=0 M2=0 M3=0,587597804418492 FrameElem=34-1 ElemStation=0,1
Frame=34 Station=0 OutputCase=STR045 CaseType=Combination P=-4,42189987288051 V2=81,6749999998034 V3=0 T=0 M2=0 M3=11,2227636312693 FrameElem=34-1 ElemStation=0
Frame=34 Station=0,05 OutputCase=STR045 CaseType=Combination P=-4,42189987288051 V2=89,0999999998034 V3=0 T=0 M2=0 M3=6,9533886312791 FrameElem=34-1 ElemStation=0,05
Frame=34 Station=0,1 OutputCase=STR045 CaseType=Combination P=-4,42189987288051 V2=96,5249999998034 V3=0 T=0 M2=0 M3=2,31276363128893 FrameElem=34-1 ElemStation=0,1
Frame=34 Station=0 OutputCase=STR046 CaseType=Combination P=-21,1628032328115 V2=94,856781584244 V3=0 T=0 M2=0 M3=1,65487600183234 FrameElem=34-1 ElemStation=0
Frame=34 Station=0,05 OutputCase=STR046 CaseType=Combination P=-21,1628032328115 V2=102,281781584244 V3=0 T=0 M2=0 M3=-3,27358807737986 FrameElem=34-1 ElemStation=0,05
Frame=34 Station=0,1 OutputCase=STR046 CaseType=Combination P=-21,1628032328115 V2=109,706781584244 V3=0 T=0 M2=0 M3=-8,57330215659206 FrameElem=34-1 ElemStation=0,1
Frame=34 Station=0 OutputCase=STR047 CaseType=Combination P=-37,9037066267357 V2=81,6749999997248 V3=0 T=0 M2=0 M3=6,58694811586958 FrameElem=34-1 ElemStation=0
Frame=34 Station=0,05 OutputCase=STR047 CaseType=Combination P=-37,9037066267357 V2=89,0999999997248 V3=0 T=0 M2=0 M3=2,31757311588334 FrameElem=34-1 ElemStation=0,05
Frame=34 Station=0,1 OutputCase=STR047 CaseType=Combination P=-37,9037066267357 V2=96,5249999997248 V3=0 T=0 M2=0 M3=-2,3230518841029 FrameElem=34-1 ElemStation=0,1
Frame=34 Station=0 OutputCase=STR048 CaseType=Combination P=-20,0636911522277 V2=20,8817815844521 V3=0 T=0 M2=0 M3=-8,58907520424235 FrameElem=34-1 ElemStation=0
Frame=34 Station=0,05 OutputCase=STR048 CaseType=Combination P=-20,0636911522277 V2=21,5817815844521 V3=0 T=0 M2=0 M3=-9,65066428346495 FrameElem=34-1 ElemStation=0,05
Frame=34 Station=0,1 OutputCase=STR048 CaseType=Combination P=-20,0636911522277 V2=22,2817815844521 V3=0 T=0 M2=0 M3=-10,7472533626876 FrameElem=34-1 ElemStation=0,1
Frame=34 Station=0 OutputCase=STR049 CaseType=Combination P=-36,804594546152 V2=7,69999999993291 V3=0 T=0 M2=0 M3=-3,65700309020511 FrameElem=34-1 ElemStation=0
Frame=34 Station=0,05 OutputCase=STR049 CaseType=Combination P=-36,804594546152 V2=8,39999999993291 V3=0 T=0 M2=0 M3=-4,05950309020175 FrameElem=34-1 ElemStation=0,05
Frame=34 Station=0,1 OutputCase=STR049 CaseType=Combination P=-36,804594546152 V2=9,09999999993291 V3=0 T=0 M2=0 M3=-4,4970030901984 FrameElem=34-1 ElemStation=0,1

APPROVATO S.D.P.
Società di Progetto
Brebemi SpA

	Doc. N. 60235-0000-A00.doc	CODIFICA DOCUMENTO 04RCDII10000000000300A00	REV. 00	FOGLIO 442 di 628
--	-------------------------------	--	------------	----------------------

Frame=34 Station=0 OutputCase=STR050 CaseType=Combination P=-29,6918545000365 V2=93,5808250227901 V3=0 T=0 M2=0 M3=-9,42147612097903 ElemStation=0	Frame=34 Station=0,05 OutputCase=STR050 CaseType=Combination P=-30,8191045000365 V2=99,3858250227901 V3=0 T=0 M2=0 M3=-14,2456423721185 ElemStation=0,05	Frame=34 Station=0,1 OutputCase=STR050 CaseType=Combination P=-31,9463545000365 V2=105,19082502279 V3=0 T=0 M2=0 M3=-19,360058623258 ElemStation=0,1	Frame=34 Station=0 OutputCase=STR051 CaseType=Combination P=-3,73006671656702 V2=63,8549999998563 V3=0 T=0 M2=0 M3=9,07634518326588 ElemStation=0	Frame=34 Station=0,05 OutputCase=STR051 CaseType=Combination P=-3,73006671656702 V2=69,6599999998563 V3=0 T=0 M2=0 M3=5,73847018327307 ElemStation=0,05	Frame=34 Station=0,1 OutputCase=STR051 CaseType=Combination P=-3,73006671656702 V2=75,4649999998563 V3=0 T=0 M2=0 M3=2,11034518328025 ElemStation=0,1	Frame=34 Station=0 OutputCase=STR052 CaseType=Combination P=-16,9243196245174 V2=74,210912233127 V3=0 T=0 M2=0 M3=1,53713992500059 ElemStation=0	Frame=34 Station=0,05 OutputCase=STR052 CaseType=Combination P=-16,9243196245174 V2=80,015912233127 V3=0 T=0 M2=0 M3=-2,31853068665576 ElemStation=0,05	Frame=34 Station=0,1 OutputCase=STR052 CaseType=Combination P=-16,9243196245174 V2=85,820912233127 V3=0 T=0 M2=0 M3=-6,46445129831211 ElemStation=0,1	Frame=34 Station=0 OutputCase=STR053 CaseType=Combination P=-30,1185725589174 V2=63,8549999997778 V3=0 T=0 M2=0 M3=5,38943812379382 ElemStation=0	Frame=34 Station=0,05 OutputCase=STR053 CaseType=Combination P=-30,1185725589174 V2=69,6599999997778 V3=0 T=0 M2=0 M3=2,05156312380493 ElemStation=0,05	Frame=34 Station=0,1 OutputCase=STR053 CaseType=Combination P=-30,1185725589174 V2=75,4649999997778 V3=0 T=0 M2=0 M3=-1,57656187618395 ElemStation=0,1	Frame=34 Station=0 OutputCase=STR054 CaseType=Combination P=-16,1492558178885 V2=18,055912233282 V3=0 T=0 M2=0 M3=-6,25522882145882 ElemStation=0	Frame=34 Station=0,05 OutputCase=STR054 CaseType=Combination P=-16,1492558178885 V2=18,755912233282 V3=0 T=0 M2=0 M3=-7,17552443312292 ElemStation=0,05	Frame=34 Station=0,1 OutputCase=STR054 CaseType=Combination P=-16,1492558178885 V2=19,455912233282 V3=0 T=0 M2=0 M3=-8,13082004478702 ElemStation=0,1	Frame=34 Station=0 OutputCase=STR055 CaseType=Combination P=-29,3435087522885 V2=7,69999999993281 V3=0 T=0 M2=0 M3=-2,40293062266559 ElemStation=0	Frame=34 Station=0,05 OutputCase=STR055 CaseType=Combination P=-29,3435087522885 V2=8,3999999999328 V3=0 T=0 M2=0 M3=-2,80543062266223 ElemStation=0,05	Frame=34 Station=0,1 OutputCase=STR055 CaseType=Combination P=-29,3435087522885 V2=9,09999999993281 V3=0 T=0 M2=0 M3=-3,24293062265887 ElemStation=0,1	Frame=34 Station=0 OutputCase=STR056 CaseType=Combination P=-7,63765199382979 V2=9,93731856268699 V3=0 T=0 M2=0 M3=1,45085009517631 ElemStation=0	Frame=34 Station=0,05 OutputCase=STR056 CaseType=Combination P=-7,63765199382979 V2=10,882318562687 V3=0 T=0 M2=0 M3=0,930359167041961 ElemStation=0,05	Frame=34 Station=0,1 OutputCase=STR056 CaseType=Combination P=-7,63765199382979 V2=11,827318562687 V3=0 T=0 M2=0 M3=0,362618238907611 ElemStation=0,1	Frame=34 Station=0 OutputCase=STR057 CaseType=Combination P=-2,52904888599369 V2=9,93731856276557 V3=0 T=0 M2=0 M3=2,29103178686548 ElemStation=0	Frame=34 Station=0,05 OutputCase=STR057 CaseType=Combination P=-2,52904888599369 V2=10,8823185627656 V3=0 T=0 M2=0 M3=1,7705408587272 ElemStation=0,05	Frame=34 Station=0,1 OutputCase=STR057 CaseType=Combination P=-2,52904888599369 V2=11,8273185627656 V3=0 T=0 M2=0 M3=1,20279993058892 ElemStation=0,1	Frame=34 Station=0 OutputCase=STR058 CaseType=Combination P=-3,50119370785812 V2=63,3973185626065 V3=0 T=0 M2=0 M3=9,64577916571132 ElemStation=0	Frame=34 Station=0,05 OutputCase=STR058 CaseType=Combination P=-3,50119370785812 V2=69,2023185626065 V3=0 T=0 M2=0 M3=6,330788237581 ElemStation=0,05	Frame=34 Station=0,1 OutputCase=STR058 CaseType=Combination P=-3,50119370785812 V2=75,0073185626064 V3=0 T=0 M2=0 M3=2,72554730945068 ElemStation=0,1	Frame=34 Station=0 OutputCase=STR059 CaseType=Combination P=-16,6954466158085 V2=73,7532307958771 V3=0 T=0 M2=0 M3=2,10657390744603 ElemStation=0	Frame=34 Station=0,05 OutputCase=STR059 CaseType=Combination P=-16,6954466158085 V2=79,5582307958771 V3=0 T=0 M2=0 M3=-1,72621263234783 ElemStation=0,05	Frame=34 Station=0,1 OutputCase=STR059 CaseType=Combination P=-16,6954466158085 V2=85,3632307958771 V3=0 T=0 M2=0 M3=-5,84924917214168 ElemStation=0,1	Frame=34 Station=0 OutputCase=STR060 CaseType=Combination P=-29,8896995502085 V2=63,3973185625279 V3=0 T=0 M2=0 M3=5,95887210623926 ElemStation=0	Frame=34 Station=0,05 OutputCase=STR060 CaseType=Combination P=-29,8896995502085 V2=69,2023185625279 V3=0 T=0 M2=0 M3=2,64388117811287 ElemStation=0,05	Frame=34 Station=0,1 OutputCase=STR060 CaseType=Combination P=-29,8896995502085 V2=75,0073185625279 V3=0 T=0 M2=0 M3=-0,961359750013525 ElemStation=0,1	Frame=34 Station=0 OutputCase=STR061 CaseType=Combination P=-15,9203828091796 V2=17,5982307960321 V3=0 T=0 M2=0 M3=-5,68579483901338 ElemStation=0	Frame=34 Station=0,05 OutputCase=STR061 CaseType=Combination P=-15,9203828091796 V2=18,2982307960321 V3=0 T=0 M2=0 M3=-6,58320637881499 ElemStation=0,05	Frame=34 Station=0,1 OutputCase=STR061 CaseType=Combination P=-15,9203828091796 V2=18,9982307960321 V3=0 T=0 M2=0 M3=-7,51561791861659 ElemStation=0,1	Frame=34 Station=0 OutputCase=STR062 CaseType=Combination P=-29,1146357435796 V2=7,24231856268292 V3=0 T=0 M2=0 M3=-1,83349664022015 ElemStation=0	Frame=34 Station=0,05 OutputCase=STR062 CaseType=Combination P=-29,1146357435796 V2=7,94231856268292 V3=0 T=0 M2=0 M3=-2,21311256835429 ElemStation=0,05	Frame=34 Station=0,1 OutputCase=STR062 CaseType=Combination P=-29,1146357435796 V2=8,64231856268292 V3=0 T=0 M2=0 M3=-2,62772849648844 ElemStation=0,1	Frame=34 Station=0 OutputCase=STR063 CaseType=Combination P=-8,09539801124758 V2=10,8526814371868 V3=0 T=0 M2=0 M3=0,311982130285431 ElemStation=0	Frame=34 Station=0,05 OutputCase=STR063 CaseType=Combination P=-8,09539801124758 V2=11,7976814371868 V3=0 T=0 M2=0 M3=-0,254276941573908 ElemStation=0,05	Frame=34 Station=0,1 OutputCase=STR063 CaseType=Combination P=-8,09539801124758 V2=12,7426814371868 V3=0 T=0 M2=0 M3=-0,867786013433246 ElemStation=0,1	Frame=34 Station=0 OutputCase=STR064 CaseType=Combination P=-2,98679490341148 V2=10,8526814372653 V3=0 T=0 M2=0 M3=1,1521638219746 ElemStation=0	Frame=34 Station=0,05 OutputCase=STR064 CaseType=Combination P=-2,98679490341148 V2=11,7976814372654 V3=0 T=0 M2=0 M3=0,585904750111331 ElemStation=0,05
--	--	--	---	---	---	--	---	---	---	---	--	---	---	---	--	---	--	---	---	---	---	--	---	---	---	---	---	--	--	---	---	---	--	--	--	--	--	--	--	---	---	--	--

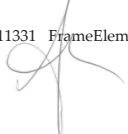
Società di Progetto
Brebemi SpA



Doc. N.
60235-00000-A00.doc

CODIFICA DOCUMENTO
04RCDII10000000000300A00

REV.
00

FOGLIO
443 di 628

Frame=34 Station=0,1 OutputCase=STR064 CaseType=Combination P=-2,98679490341148 V2=12,7426814372654 V3=0 T=0 M2=0 M3=-2,76043217519362E-02
FrameElem=34-1 ElemStation=0,1
Frame=34 Station=0 OutputCase=STR065 CaseType=Combination P=-3,95893972527591 V2=64,3126814371062 V3=0 T=0 M2=0 M3=8,50691120082044 FrameElem=34-1
ElemStation=0
Frame=34 Station=0,05 OutputCase=STR065 CaseType=Combination P=-3,95893972527591 V2=70,1176814371062 V3=0 T=0 M2=0 M3=5,14615212896513 FrameElem=34-1
ElemStation=0,05
Frame=34 Station=0,1 OutputCase=STR065 CaseType=Combination P=-3,95893972527591 V2=75,9226814371062 V3=0 T=0 M2=0 M3=1,49514305710982 FrameElem=34-1
ElemStation=0,1
Frame=34 Station=0 OutputCase=STR066 CaseType=Combination P=-17,1531926332263 V2=74,6685936703769 V3=0 T=0 M2=0 M3=0,967705942555149 FrameElem=34-1
ElemStation=0
Frame=34 Station=0,05 OutputCase=STR066 CaseType=Combination P=-17,1531926332263 V2=80,4735936703769 V3=0 T=0 M2=0 M3=-2,91084874096369 FrameElem=34-1
ElemStation=0,05
Frame=34 Station=0,1 OutputCase=STR066 CaseType=Combination P=-17,1531926332263 V2=86,2785936703769 V3=0 T=0 M2=0 M3=-7,0796532448254 FrameElem=34-1
ElemStation=0,1
Frame=34 Station=0 OutputCase=STR067 CaseType=Combination P=-30,3474455676263 V2=64,3126814370276 V3=0 T=0 M2=0 M3=4,82000414134838 FrameElem=34-1
ElemStation=0
Frame=34 Station=0,05 OutputCase=STR067 CaseType=Combination P=-30,3474455676263 V2=70,1176814370276 V3=0 T=0 M2=0 M3=1,459245069497 FrameElem=34-1
ElemStation=0,05
Frame=34 Station=0,1 OutputCase=STR067 CaseType=Combination P=-30,3474455676263 V2=75,9226814370276 V3=0 T=0 M2=0 M3=-2,19176400235438 FrameElem=34-1
ElemStation=0,1
Frame=34 Station=0 OutputCase=STR068 CaseType=Combination P=-16,3781288265974 V2=18,5135936705319 V3=0 T=0 M2=0 M3=-6,82466280390426 FrameElem=34-1
ElemStation=0
Frame=34 Station=0,05 OutputCase=STR068 CaseType=Combination P=-16,3781288265974 V2=19,2135936705319 V3=0 T=0 M2=0 M3=-7,76784248743085 FrameElem=34-1
ElemStation=0,05
Frame=34 Station=0,1 OutputCase=STR068 CaseType=Combination P=-16,3781288265974 V2=19,9135936705319 V3=0 T=0 M2=0 M3=-8,74602217095745 FrameElem=34-1
ElemStation=0,1
Frame=34 Station=0 OutputCase=STR069 CaseType=Combination P=-29,5723817609974 V2=8,15768143718269 V3=0 T=0 M2=0 M3=-2,97236460511103 FrameElem=34-1
ElemStation=0
Frame=34 Station=0,05 OutputCase=STR069 CaseType=Combination P=-29,5723817609974 V2=8,85768143718269 V3=0 T=0 M2=0 M3=-3,39774867697016 FrameElem=34-1
ElemStation=0,05
Frame=34 Station=0,1 OutputCase=STR069 CaseType=Combination P=-29,5723817609974 V2=9,5576814371827 V3=0 T=0 M2=0 M3=-3,8581327488293 FrameElem=34-1
ElemStation=0,1
Frame=34 Station=0 OutputCase=STR070 CaseType=Combination P=-7,31484767900066 V2=10,3949999999367 V3=0 T=0 M2=0 M3=1,33916213014871 FrameElem=34-1
ElemStation=0
Frame=34 Station=0,05 OutputCase=STR070 CaseType=Combination P=-7,31484767900066 V2=11,3399999999367 V3=0 T=0 M2=0 M3=0,795787130151872 FrameElem=34-1
ElemStation=0,05
Frame=34 Station=0,1 OutputCase=STR070 CaseType=Combination P=-7,31484767900066 V2=12,2849999999367 V3=0 T=0 M2=0 M3=0,205162130155036 FrameElem=34-1
ElemStation=0,1
Frame=34 Station=0 OutputCase=STR071 CaseType=Combination P=-2,20624457116456 V2=10,3950000000153 V3=0 T=0 M2=0 M3=2,17934382183788 FrameElem=34-1
ElemStation=0
Frame=34 Station=0,05 OutputCase=STR071 CaseType=Combination P=-2,20624457116456 V2=11,3400000000153 V3=0 T=0 M2=0 M3=1,63596882183711 FrameElem=34-1
ElemStation=0,05
Frame=34 Station=0,1 OutputCase=STR071 CaseType=Combination P=-2,20624457116456 V2=12,2850000000153 V3=0 T=0 M2=0 M3=1,04534382183635 FrameElem=34-1
ElemStation=0,1
Frame=34 Station=0 OutputCase=STR072 CaseType=Combination P=-3,17838939302899 V2=63,8549999998562 V3=0 T=0 M2=0 M3=9,53409120068372 FrameElem=34-1
ElemStation=0
Frame=34 Station=0,05 OutputCase=STR072 CaseType=Combination P=-3,17838939302899 V2=69,6599999998562 V3=0 T=0 M2=0 M3=6,19621620069091 FrameElem=34-1
ElemStation=0,05
Frame=34 Station=0,1 OutputCase=STR072 CaseType=Combination P=-3,17838939302899 V2=75,4649999998562 V3=0 T=0 M2=0 M3=2,5680912006981 FrameElem=34-1
ElemStation=0,1
Frame=34 Station=0 OutputCase=STR073 CaseType=Combination P=-16,3726423009794 V2=74,2109122331268 V3=0 T=0 M2=0 M3=1,99488594241843 FrameElem=34-1
ElemStation=0
Frame=34 Station=0,05 OutputCase=STR073 CaseType=Combination P=-16,3726423009794 V2=80,0159122331268 V3=0 T=0 M2=0 M3=-1,86078466923791 FrameElem=34-1
ElemStation=0,05
Frame=34 Station=0,1 OutputCase=STR073 CaseType=Combination P=-16,3726423009794 V2=85,8209122331268 V3=0 T=0 M2=0 M3=-6,00670528089425 FrameElem=34-1
ElemStation=0,1
Frame=34 Station=0 OutputCase=STR074 CaseType=Combination P=-29,5668952353794 V2=63,8549999997776 V3=0 T=0 M2=0 M3=5,84718414121166 FrameElem=34-1
ElemStation=0
Frame=34 Station=0,05 OutputCase=STR074 CaseType=Combination P=-29,5668952353794 V2=69,6599999997776 V3=0 T=0 M2=0 M3=2,50930914122278 FrameElem=34-1
ElemStation=0,05
Frame=34 Station=0,1 OutputCase=STR074 CaseType=Combination P=-29,5668952353794 V2=75,4649999997776 V3=0 T=0 M2=0 M3=-1,1188158587661 FrameElem=34-1
ElemStation=0,1
Frame=34 Station=0 OutputCase=STR075 CaseType=Combination P=-15,5975784943505 V2=18,0559122332819 V3=0 T=0 M2=0 M3=5,79748280404098 FrameElem=34-1
ElemStation=0
Frame=34 Station=0,05 OutputCase=STR075 CaseType=Combination P=-15,5975784943505 V2=18,7559122332819 V3=0 T=0 M2=0 M3=-6,71777841570507 FrameElem=34-1
ElemStation=0,05
Frame=34 Station=0,1 OutputCase=STR075 CaseType=Combination P=-15,5975784943505 V2=19,4559122332819 V3=0 T=0 M2=0 M3=7,67307402736917 FrameElem=34-1
ElemStation=0,1
Frame=34 Station=0 OutputCase=STR076 CaseType=Combination P=-28,7918314287505 V2=7,6999999993265 V3=0 T=0 M2=0 M3=-1,94518460524775 FrameElem=34-1
ElemStation=0
Frame=34 Station=0,05 OutputCase=STR076 CaseType=Combination P=-28,7918314287505 V2=8,3999999993265 V3=0 T=0 M2=0 M3=-2,34768460524438 FrameElem=34-1
ElemStation=0,05
Frame=34 Station=0,1 OutputCase=STR076 CaseType=Combination P=-28,7918314287505 V2=9,0999999993265 V3=0 T=0 M2=0 M3=-2,78518460524102 FrameElem=34-1
ElemStation=0,1
Frame=34 Station=0 OutputCase=STR077 CaseType=Combination P=-8,40453219392056 V2=9,63219760452066 V3=0 T=0 M2=0 M3=1,06756272111021 FrameElem=34-1
ElemStation=0
Frame=34 Station=0,05 OutputCase=STR077 CaseType=Combination P=-8,40453219392056 V2=10,5771976045207 V3=0 T=0 M2=0 M3=0,562327840884174 FrameElem=34-1
ElemStation=0,05
Frame=34 Station=0,1 OutputCase=STR077 CaseType=Combination P=-8,40453219392056 V2=11,5221976045207 V3=0 T=0 M2=0 M3=9,84296065814094E-03
FrameElem=34-1 ElemStation=0,1
Frame=34 Station=0 OutputCase=STR078 CaseType=Combination P=-3,29592908608447 V2=9,63219760459924 V3=0 T=0 M2=0 M3=1,90774441279937 FrameElem=34-1
ElemStation=0
Frame=34 Station=0,05 OutputCase=STR078 CaseType=Combination P=-3,29592908608447 V2=10,5771976045992 V3=0 T=0 M2=0 M3=1,40250953256941 FrameElem=34-1
ElemStation=0,05
Frame=34 Station=0,1 OutputCase=STR078 CaseType=Combination P=-3,29592908608447 V2=11,5221976045992 V3=0 T=0 M2=0 M3=0,850024652339451 FrameElem=34-1
ElemStation=0,1
Frame=34 Station=0 OutputCase=STR079 CaseType=Combination P=-4,74470418770964 V2=81,2173185625537 V3=0 T=0 M2=0 M3=11,3344515962969 FrameElem=34-1
ElemStation=0

Società di Progetto
Brebemi SpA

	Doc. N. 60235-00000-A00.doc	CODIFICA DOCUMENTO 04RCDII10000000000300A00	REV. 00	FOGLIO 444 di 628
--	--------------------------------	--	------------	----------------------

Frame=34 Station=0,05 OutputCase=STR079 CaseType=Combination P=-4,74470418770964 V2=88,6423185625537 V3=0 T=0 M2=0 M3=7,08796066816919	FrameElem=34-1 ElemStation=0,05
Frame=34 Station=0,1 OutputCase=STR079 CaseType=Combination P=-4,74470418770964 V2=96,0673185625537 V3=0 T=0 M2=0 M3=2,47021974004151	FrameElem=34-1 ElemStation=0,1
Frame=34 Station=0 OutputCase=STR080 CaseType=Combination P=-21,4856075476406 V2=94,3991001469943 V3=0 T=0 M2=0 M3=1,76656396685995	FrameElem=34-1 ElemStation=0
Frame=34 Station=0,05 OutputCase=STR080 CaseType=Combination P=-21,4856075476406 V2=101,824100146994 V3=0 T=0 M2=0 M3=-3,13901604048977	FrameElem=34-1 ElemStation=0,05
Frame=34 Station=0,1 OutputCase=STR080 CaseType=Combination P=-21,4856075476406 V2=109,249100146994 V3=0 T=0 M2=0 M3=-8,41584604783948	FrameElem=34-1 ElemStation=0,1
Frame=34 Station=0 OutputCase=STR081 CaseType=Combination P=-38,2265109415648 V2=81,2173185624751 V3=0 T=0 M2=0 M3=6,69863608089718	FrameElem=34-1 ElemStation=0
Frame=34 Station=0,05 OutputCase=STR081 CaseType=Combination P=-38,2265109415648 V2=88,6423185624751 V3=0 T=0 M2=0 M3=2,45214515277343	FrameElem=34-1 ElemStation=0,05
Frame=34 Station=0,1 OutputCase=STR081 CaseType=Combination P=-38,2265109415648 V2=96,0673185624751 V3=0 T=0 M2=0 M3=-2,1659577535033	FrameElem=34-1 ElemStation=0,1
Frame=34 Station=0 OutputCase=STR082 CaseType=Combination P=-20,3864954670568 V2=20,4241001472024 V3=0 T=0 M2=0 M3=-8,47738723921475	FrameElem=34-1 ElemStation=0
Frame=34 Station=0,05 OutputCase=STR082 CaseType=Combination P=-20,3864954670568 V2=21,1241001472024 V3=0 T=0 M2=0 M3=-9,51609224657486	FrameElem=34-1 ElemStation=0,05
Frame=34 Station=0,1 OutputCase=STR082 CaseType=Combination P=-20,3864954670568 V2=21,8241001472024 V3=0 T=0 M2=0 M3=-10,589797253935	FrameElem=34-1 ElemStation=0,1
Frame=34 Station=0 OutputCase=STR083 CaseType=Combination P=-37,1273988609811 V2=7,24231856268317 V3=0 T=0 M2=0 M3=-3,54531512517751	FrameElem=34-1 ElemStation=0
Frame=34 Station=0,05 OutputCase=STR083 CaseType=Combination P=-37,1273988609811 V2=7,94231856268317 V3=0 T=0 M2=0 M3=-3,92493105331167	FrameElem=34-1 ElemStation=0,05
Frame=34 Station=0,1 OutputCase=STR083 CaseType=Combination P=-37,1273988609811 V2=8,64231856268318 V3=0 T=0 M2=0 M3=-4,33954698144583	FrameElem=34-1 ElemStation=0,1
Frame=34 Station=0 OutputCase=STR084 CaseType=Combination P=-30,0146588148656 V2=93,1231435855404 V3=0 T=0 M2=0 M3=-9,30978815595143	FrameElem=34-1 ElemStation=0
Frame=34 Station=0,05 OutputCase=STR084 CaseType=Combination P=-31,1419088148656 V2=98,9281435855404 V3=0 T=0 M2=0 M3=-14,1110703352285	FrameElem=34-1 ElemStation=0,05
Frame=34 Station=0,1 OutputCase=STR084 CaseType=Combination P=-32,2691588148656 V2=104,73314358554 V3=0 T=0 M2=0 M3=-19,2026025145055	FrameElem=34-1 ElemStation=0,1
Frame=34 Station=0 OutputCase=STR085 CaseType=Combination P=-4,2680739079489 V2=63,0921976044401 V3=0 T=0 M2=0 M3=9,26249179164522	FrameElem=34-1 ElemStation=0
Frame=34 Station=0,05 OutputCase=STR085 CaseType=Combination P=-4,2680739079489 V2=68,8971976044401 V3=0 T=0 M2=0 M3=5,96275691142321	FrameElem=34-1 ElemStation=0,05
Frame=34 Station=0,1 OutputCase=STR085 CaseType=Combination P=-4,2680739079489 V2=74,7021976044401 V3=0 T=0 M2=0 M3=2,37277203120121	FrameElem=34-1 ElemStation=0,1
Frame=34 Station=0 OutputCase=STR086 CaseType=Combination P=-17,4623268158993 V2=73,4481098377107 V3=0 T=0 M2=0 M3=1,72328653337992	FrameElem=34-1 ElemStation=0
Frame=34 Station=0,05 OutputCase=STR086 CaseType=Combination P=-17,4623268158993 V2=79,2531098377108 V3=0 T=0 M2=0 M3=-2,09424395850561	FrameElem=34-1 ElemStation=0,05
Frame=34 Station=0,1 OutputCase=STR086 CaseType=Combination P=-17,4623268158993 V2=85,0581098377107 V3=0 T=0 M2=0 M3=-6,20202445039115	FrameElem=34-1 ElemStation=0,1
Frame=34 Station=0 OutputCase=STR087 CaseType=Combination P=-30,6565797502993 V2=63,0921976043615 V3=0 T=0 M2=0 M3=5,57558473217316	FrameElem=34-1 ElemStation=0
Frame=34 Station=0,05 OutputCase=STR087 CaseType=Combination P=-30,6565797502993 V2=68,8971976043615 V3=0 T=0 M2=0 M3=2,27584985195508	FrameElem=34-1 ElemStation=0,05
Frame=34 Station=0,1 OutputCase=STR087 CaseType=Combination P=-30,6565797502993 V2=74,7021976043615 V3=0 T=0 M2=0 M3=-1,31413502826299	FrameElem=34-1 ElemStation=0,1
Frame=34 Station=0 OutputCase=STR088 CaseType=Combination P=-16,6872630092704 V2=17,2931098378658 V3=0 T=0 M2=0 M3=-6,06908221307948	FrameElem=34-1 ElemStation=0
Frame=34 Station=0,05 OutputCase=STR088 CaseType=Combination P=-16,6872630092704 V2=17,9931098378658 V3=0 T=0 M2=0 M3=-6,95123770497277	FrameElem=34-1 ElemStation=0,05
Frame=34 Station=0,1 OutputCase=STR088 CaseType=Combination P=-16,6872630092704 V2=18,6931098378658 V3=0 T=0 M2=0 M3=-7,86839319686606	FrameElem=34-1 ElemStation=0,1
Frame=34 Station=0 OutputCase=STR089 CaseType=Combination P=-29,8815159436704 V2=6,93719760451658 V3=0 T=0 M2=0 M3=-2,21678401428625	FrameElem=34-1 ElemStation=0
Frame=34 Station=0,05 OutputCase=STR089 CaseType=Combination P=-29,8815159436704 V2=7,63719760451658 V3=0 T=0 M2=0 M3=-2,58114389451208	FrameElem=34-1 ElemStation=0,05
Frame=34 Station=0,1 OutputCase=STR089 CaseType=Combination P=-29,8815159436704 V2=8,33719760451658 V3=0 T=0 M2=0 M3=-2,98050377473791	FrameElem=34-1 ElemStation=0,1
Frame=34 Station=0 OutputCase=STR090 CaseType=Combination P=-8,95620951745859 V2=9,63219760452081 V3=0 T=0 M2=0 M3=0,609816703692369	FrameElem=34-1 ElemStation=0
Frame=34 Station=0,05 OutputCase=STR090 CaseType=Combination P=-8,95620951745859 V2=10,5771976045208 V3=0 T=0 M2=0 M3=0,104581823466328	FrameElem=34-1 ElemStation=0,05
Frame=34 Station=0,1 OutputCase=STR090 CaseType=Combination P=-8,95620951745859 V2=11,5221976045208 V3=0 T=0 M2=0 M3=-0,447903056759712	FrameElem=34-1 ElemStation=0,1
Frame=34 Station=0 OutputCase=STR091 CaseType=Combination P=-3,84760640962249 V2=9,63219760459939 V3=0 T=0 M2=0 M3=1,4499839538154	FrameElem=34-1 ElemStation=0
Frame=34 Station=0,05 OutputCase=STR091 CaseType=Combination P=-3,84760640962249 V2=10,5771976045994 V3=0 T=0 M2=0 M3=0,944763515151567	FrameElem=34-1 ElemStation=0,05
Frame=34 Station=0,1 OutputCase=STR091 CaseType=Combination P=-3,84760640962249 V2=11,5221976045994 V3=0 T=0 M2=0 M3=0,392278634921597	FrameElem=34-1 ElemStation=0,1
Frame=34 Station=0 OutputCase=STR092 CaseType=Combination P=-4,81975123148692 V2=63,0921976044403 V3=0 T=0 M2=0 M3=8,80474577422738	FrameElem=34-1 ElemStation=0
Frame=34 Station=0,05 OutputCase=STR092 CaseType=Combination P=-4,81975123148692 V2=68,8971976044403 V3=0 T=0 M2=0 M3=5,50501089400537	FrameElem=34-1 ElemStation=0,05
Frame=34 Station=0,1 OutputCase=STR092 CaseType=Combination P=-4,81975123148692 V2=74,7021976044403 V3=0 T=0 M2=0 M3=1,91502601378336	FrameElem=34-1 ElemStation=0,1
Frame=34 Station=0 OutputCase=STR093 CaseType=Combination P=-18,0140041394374 V2=73,4481098377109 V3=0 T=0 M2=0 M3=1,26554051596209	FrameElem=34-1 ElemStation=0
Frame=34 Station=0,05 OutputCase=STR093 CaseType=Combination P=-18,0140041394374 V2=79,2531098377109 V3=0 T=0 M2=0 M3=-2,55198997592346	FrameElem=34-1 ElemStation=0,05
Frame=34 Station=0,1 OutputCase=STR093 CaseType=Combination P=-18,0140041394374 V2=85,0581098377109 V3=0 T=0 M2=0 M3=-6,659770467809	FrameElem=34-1 ElemStation=0,1

Società di Progetto
Brebemi SpA

	Doc. N. 60235-00000-A00.doc	CODIFICA DOCUMENTO 04RCDII10000000000300A00	REV. 00	FOGLIO 445 di 628
--	--------------------------------	--	------------	----------------------

Frame=34 Station=0 OutputCase=STR094 CaseType=Combination P=-31,2082570738373 V2=63,0921976043617 V3=0 T=0 M2=0 M3=5,11783871475532 FrameElem=34-1
ElemStation=0

Frame=34 Station=0,05 OutputCase=STR094 CaseType=Combination P=-31,2082570738373 V2=68,8971976043617 V3=0 T=0 M2=0 M3=1,81810383453724 FrameElem=34-1
ElemStation=0,05

Frame=34 Station=0,1 OutputCase=STR094 CaseType=Combination P=-31,2082570738373 V2=74,7021976043617 V3=0 T=0 M2=0 M3=-1,77188104568085 FrameElem=34-1
ElemStation=0,1

Frame=34 Station=0 OutputCase=STR095 CaseType=Combination P=-17,2389403328084 V2=17,293109837866 V3=0 T=0 M2=0 M3=-6,52682823049732 FrameElem=34-1
ElemStation=0

Frame=34 Station=0,05 OutputCase=STR095 CaseType=Combination P=-17,2389403328084 V2=17,993109837866 V3=0 T=0 M2=0 M3=-7,40898372239062 FrameElem=34-1
ElemStation=0,05

Frame=34 Station=0,1 OutputCase=STR095 CaseType=Combination P=-17,2389403328084 V2=18,693109837866 V3=0 T=0 M2=0 M3=-8,32613921428392 FrameElem=34-1
ElemStation=0,1

Frame=34 Station=0 OutputCase=STR096 CaseType=Combination P=-30,4331932672084 V2=6,93719760451673 V3=0 T=0 M2=0 M3=-2,67453003170409 FrameElem=34-1
ElemStation=0

Frame=34 Station=0,05 OutputCase=STR096 CaseType=Combination P=-30,4331932672084 V2=7,63719760451673 V3=0 T=0 M2=0 M3=-3,03888991192993 FrameElem=34-1
ElemStation=0,05

Frame=34 Station=0,1 OutputCase=STR096 CaseType=Combination P=-30,4331932672084 V2=8,33719760451674 V3=0 T=0 M2=0 M3=-3,43824979215576 FrameElem=34-1
ElemStation=0,1

Frame=34 Station=0 OutputCase=STR097 CaseType=Combination P=-7,85285487038254 V2=9,6321976045205 V3=0 T=0 M2=0 M3=1,52530873852805 FrameElem=34-1
ElemStation=0

Frame=34 Station=0,05 OutputCase=STR097 CaseType=Combination P=-7,85285487038254 V2=10,5771976045205 V3=0 T=0 M2=0 M3=1,02007385830202 FrameElem=34-1
ElemStation=0,05

Frame=34 Station=0,1 OutputCase=STR097 CaseType=Combination P=-7,85285487038254 V2=11,5221976045205 V3=0 T=0 M2=0 M3=0,467588978075994 FrameElem=34-1
ElemStation=0,1

Frame=34 Station=0 OutputCase=STR098 CaseType=Combination P=-2,74425176254644 V2=9,63219760459908 V3=0 T=0 M2=0 M3=2,36549043021721 FrameElem=34-1
ElemStation=0

Frame=34 Station=0,05 OutputCase=STR098 CaseType=Combination P=-2,74425176254644 V2=10,5771976045991 V3=0 T=0 M2=0 M3=1,86025554998726 FrameElem=34-1
ElemStation=0,05

Frame=34 Station=0,1 OutputCase=STR098 CaseType=Combination P=-2,74425176254644 V2=11,5221976045991 V3=0 T=0 M2=0 M3=1,3077706697573 FrameElem=34-1
ElemStation=0,1

Frame=34 Station=0 OutputCase=STR099 CaseType=Combination P=-3,71639658441087 V2=63,09219760444 V3=0 T=0 M2=0 M3=9,72023780960306 FrameElem=34-1
ElemStation=0

Frame=34 Station=0,05 OutputCase=STR099 CaseType=Combination P=-3,71639658441087 V2=68,89719760444 V3=0 T=0 M2=0 M3=6,42050292884106 FrameElem=34-1
ElemStation=0,05

Frame=34 Station=0,1 OutputCase=STR099 CaseType=Combination P=-3,71639658441087 V2=74,7021976044399 V3=0 T=0 M2=0 M3=2,83051804861906 FrameElem=34-1
ElemStation=0,1

Frame=34 Station=0 OutputCase=STR100 CaseType=Combination P=-16,9106494923613 V2=73,4481098377106 V3=0 T=0 M2=0 M3=2,18103255079776 FrameElem=34-1
ElemStation=0

Frame=34 Station=0,05 OutputCase=STR100 CaseType=Combination P=-16,9106494923613 V2=79,2531098377106 V3=0 T=0 M2=0 M3=-1,63649794108777 FrameElem=34-1
ElemStation=0,05

Frame=34 Station=0,1 OutputCase=STR100 CaseType=Combination P=-16,9106494923613 V2=85,0581098377106 V3=0 T=0 M2=0 M3=-5,7442784329733 FrameElem=34-1
ElemStation=0,1

Frame=34 Station=0 OutputCase=STR101 CaseType=Combination P=-30,1049024267613 V2=63,0921976043614 V3=0 T=0 M2=0 M3=6,033330749591 FrameElem=34-1
ElemStation=0

Frame=34 Station=0,05 OutputCase=STR101 CaseType=Combination P=-30,1049024267613 V2=68,8971976043614 V3=0 T=0 M2=0 M3=2,73359586937293 FrameElem=34-1
ElemStation=0,05

Frame=34 Station=0,1 OutputCase=STR101 CaseType=Combination P=-30,1049024267613 V2=74,7021976043614 V3=0 T=0 M2=0 M3=-0,856389010845141 FrameElem=34-1
ElemStation=0,1

Frame=34 Station=0 OutputCase=STR102 CaseType=Combination P=-16,1355856857324 V2=17,2931098378657 V3=0 T=0 M2=0 M3=5,61133619566164 FrameElem=34-1
ElemStation=0

Frame=34 Station=0,05 OutputCase=STR102 CaseType=Combination P=-16,1355856857324 V2=17,9931098378657 V3=0 T=0 M2=0 M3=-6,49349168755493 FrameElem=34-1
ElemStation=0,05

Frame=34 Station=0,1 OutputCase=STR102 CaseType=Combination P=-16,1355856857324 V2=18,6931098378657 V3=0 T=0 M2=0 M3=-7,41064717944821 FrameElem=34-1
ElemStation=0,1

Frame=34 Station=0 OutputCase=STR103 CaseType=Combination P=-29,3298386201324 V2=6,93719760451643 V3=0 T=0 M2=0 M3=-1,75903799686841 FrameElem=34-1
ElemStation=0

Frame=34 Station=0,05 OutputCase=STR103 CaseType=Combination P=-29,3298386201324 V2=7,63719760451643 V3=0 T=0 M2=0 M3=-2,12339787709423 FrameElem=34-1
ElemStation=0,05

Frame=34 Station=0,1 OutputCase=STR103 CaseType=Combination P=-29,3298386201324 V2=8,33719760451643 V3=0 T=0 M2=0 M3=-2,52275775732006 FrameElem=34-1
ElemStation=0,1

Frame=34 Station=0 OutputCase=STR104 CaseType=Combination P=-7,85285487038254 V2=9,6321976045205 V3=0 T=0 M2=0 M3=1,52530873852805 FrameElem=34-1
ElemStation=0

Frame=34 Station=0,05 OutputCase=STR104 CaseType=Combination P=-7,85285487038254 V2=10,5771976045205 V3=0 T=0 M2=0 M3=1,02007385830202 FrameElem=34-1
ElemStation=0,05

Frame=34 Station=0,1 OutputCase=STR104 CaseType=Combination P=-7,85285487038254 V2=11,5221976045205 V3=0 T=0 M2=0 M3=0,467588978075994 FrameElem=34-1
ElemStation=0,1

Frame=34 Station=0 OutputCase=STR105 CaseType=Combination P=-2,74425176254644 V2=9,63219760459908 V3=0 T=0 M2=0 M3=2,36549043021721 FrameElem=34-1
ElemStation=0

Frame=34 Station=0,05 OutputCase=STR105 CaseType=Combination P=-2,74425176254644 V2=10,5771976045991 V3=0 T=0 M2=0 M3=1,86025554998726 FrameElem=34-1
ElemStation=0,05

Frame=34 Station=0,1 OutputCase=STR105 CaseType=Combination P=-2,74425176254644 V2=11,5221976045991 V3=0 T=0 M2=0 M3=1,3077706697573 FrameElem=34-1
ElemStation=0,1

Frame=34 Station=0 OutputCase=STR106 CaseType=Combination P=-3,71639658441087 V2=63,09219760444 V3=0 T=0 M2=0 M3=9,72023780960306 FrameElem=34-1
ElemStation=0

Frame=34 Station=0,05 OutputCase=STR106 CaseType=Combination P=-3,71639658441087 V2=68,89719760444 V3=0 T=0 M2=0 M3=6,42050292884106 FrameElem=34-1
ElemStation=0,05

Frame=34 Station=0,1 OutputCase=STR106 CaseType=Combination P=-3,71639658441087 V2=74,7021976044399 V3=0 T=0 M2=0 M3=2,83051804861906 FrameElem=34-1
ElemStation=0,1

Frame=34 Station=0 OutputCase=STR107 CaseType=Combination P=-16,9106494923613 V2=73,4481098377106 V3=0 T=0 M2=0 M3=2,18103255079776 FrameElem=34-1
ElemStation=0

Frame=34 Station=0,05 OutputCase=STR107 CaseType=Combination P=-16,9106494923613 V2=79,2531098377106 V3=0 T=0 M2=0 M3=-1,63649794108777 FrameElem=34-1
ElemStation=0,05

Frame=34 Station=0,1 OutputCase=STR107 CaseType=Combination P=-16,9106494923613 V2=85,0581098377106 V3=0 T=0 M2=0 M3=-5,7442784329733 FrameElem=34-1
ElemStation=0,1

Frame=34 Station=0 OutputCase=STR108 CaseType=Combination P=-30,1049024267613 V2=63,0921976043614 V3=0 T=0 M2=0 M3=6,033330749591 FrameElem=34-1
ElemStation=0

Frame=34 Station=0,05 OutputCase=STR108 CaseType=Combination P=-30,1049024267613 V2=68,8971976043614 V3=0 T=0 M2=0 M3=2,73359586937293 FrameElem=34-1
ElemStation=0,05

Società di Progetto
Brebemi SpA

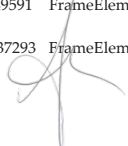

	Doc. N. 60235-00000-A00.doc	CODIFICA DOCUMENTO 04RCDII10000000000300A00	REV. 00	FOGLIO 446 di 628
--	--------------------------------	--	------------	----------------------

Frame=34 Station=0,1 OutputCase=STR108 CaseType=Combination P=-30,1049024267613 V2=74,7021976043614 V3=0 T=0 M2=0 M3=-0,856389010845141 FrameElem=34-1
ElemStation=0,1

Frame=34 Station=0 OutputCase=STR109 CaseType=Combination P=-16,1355856857324 V2=17,2931098378657 V3=0 T=0 M2=0 M3=-5,61133619566164 FrameElem=34-1
ElemStation=0

Frame=34 Station=0,05 OutputCase=STR109 CaseType=Combination P=-16,1355856857324 V2=17,9931098378657 V3=0 T=0 M2=0 M3=-6,49349168755493 FrameElem=34-1
ElemStation=0,05

Frame=34 Station=0,1 OutputCase=STR109 CaseType=Combination P=-16,1355856857324 V2=18,6931098378657 V3=0 T=0 M2=0 M3=-7,41064717944821 FrameElem=34-1
ElemStation=0,1

Frame=34 Station=0 OutputCase=STR110 CaseType=Combination P=-29,3298386201324 V2=6,93719760451643 V3=0 T=0 M2=0 M3=-1,75903799686841 FrameElem=34-1
ElemStation=0

Frame=34 Station=0,05 OutputCase=STR110 CaseType=Combination P=-29,3298386201324 V2=7,63719760451643 V3=0 T=0 M2=0 M3=-2,12339787709423 FrameElem=34-1
ElemStation=0,05

Frame=34 Station=0,1 OutputCase=STR110 CaseType=Combination P=-29,3298386201324 V2=8,33719760451643 V3=0 T=0 M2=0 M3=-2,52275775732006 FrameElem=34-1
ElemStation=0,1

Frame=34 Station=0 OutputCase=STR111 CaseType=Combination P=-9,16744222295021 V2=11,1578023953536 V3=0 T=0 M2=0 M3=-0,830550553707926 FrameElem=34-1
ElemStation=0

Frame=34 Station=0,05 OutputCase=STR111 CaseType=Combination P=-9,16744222295021 V2=12,1028023953536 V3=0 T=0 M2=0 M3=-1,41206567347561 FrameElem=34-1
ElemStation=0,05

Frame=34 Station=0,1 OutputCase=STR111 CaseType=Combination P=-9,16744222295021 V2=13,0478023953536 V3=0 T=0 M2=0 M3=-2,04083079324329 FrameElem=34-1
ElemStation=0,1

Frame=34 Station=0 OutputCase=STR112 CaseType=Combination P=-4,05883911511412 V2=11,1578023954322 V3=0 T=0 M2=0 M3=9,63113798124193E-03 FrameElem=34-1
ElemStation=0

Frame=34 Station=0,05 OutputCase=STR112 CaseType=Combination P=-4,05883911511412 V2=12,1028023954322 V3=0 T=0 M2=0 M3=-0,571883981790368 FrameElem=34-1
ElemStation=0,05

Frame=34 Station=0,1 OutputCase=STR112 CaseType=Combination P=-4,05883911511412 V2=13,0478023954322 V3=0 T=0 M2=0 M3=-1,20064910156198 FrameElem=34-1
ElemStation=0,1

Frame=34 Station=0 OutputCase=STR113 CaseType=Combination P=-5,20245020512743 V2=82,1326814370534 V3=0 T=0 M2=0 M3=10,195583631406 FrameElem=34-1
ElemStation=0

Frame=34 Station=0,05 OutputCase=STR113 CaseType=Combination P=-5,20245020512743 V2=89,5576814370535 V3=0 T=0 M2=0 M3=5,90332455955332 FrameElem=34-1
ElemStation=0,05

Frame=34 Station=0,1 OutputCase=STR113 CaseType=Combination P=-5,20245020512743 V2=96,9826814370535 V3=0 T=0 M2=0 M3=1,23981548770065 FrameElem=34-1
ElemStation=0,1

Frame=34 Station=0 OutputCase=STR114 CaseType=Combination P=-21,9433535650584 V2=95,314463021494 V3=0 T=0 M2=0 M3=0,627696001969066 FrameElem=34-1
ElemStation=0

Frame=34 Station=0,05 OutputCase=STR114 CaseType=Combination P=-21,9433535650584 V2=102,739463021494 V3=0 T=0 M2=0 M3=-4,32365214910564 FrameElem=34-1
ElemStation=0,05

Frame=34 Station=0,1 OutputCase=STR114 CaseType=Combination P=-21,9433535650584 V2=110,164463021494 V3=0 T=0 M2=0 M3=-9,64625030018034 FrameElem=34-1
ElemStation=0,1

Frame=34 Station=0 OutputCase=STR115 CaseType=Combination P=-38,6842569589826 V2=82,1326814369749 V3=0 T=0 M2=0 M3=5,5597681160063 FrameElem=34-1
ElemStation=0

Frame=34 Station=0,05 OutputCase=STR115 CaseType=Combination P=-38,6842569589826 V2=89,5576814369749 V3=0 T=0 M2=0 M3=1,26750904415756 FrameElem=34-1
ElemStation=0,05

Frame=34 Station=0,1 OutputCase=STR115 CaseType=Combination P=-38,6842569589826 V2=96,9826814369749 V3=0 T=0 M2=0 M3=-3,39600002769118 FrameElem=34-1
ElemStation=0,1

Frame=34 Station=0 OutputCase=STR116 CaseType=Combination P=-20,8442414844746 V2=21,3394630217021 V3=0 T=0 M2=0 M3=-9,61625520410562 FrameElem=34-1
ElemStation=0

Frame=34 Station=0,05 OutputCase=STR116 CaseType=Combination P=-20,8442414844746 V2=22,0394630217021 V3=0 T=0 M2=0 M3=-10,7007283551907 FrameElem=34-1
ElemStation=0,05

Frame=34 Station=0,1 OutputCase=STR116 CaseType=Combination P=-20,8442414844746 V2=22,7394630217021 V3=0 T=0 M2=0 M3=-11,8202015062758 FrameElem=34-1
ElemStation=0,1

Frame=34 Station=0 OutputCase=STR117 CaseType=Combination P=-37,5851448783989 V2=8,15768143718295 V3=0 T=0 M2=0 M3=-4,68418309006839 FrameElem=34-1
ElemStation=0

Frame=34 Station=0,05 OutputCase=STR117 CaseType=Combination P=-37,5851448783989 V2=8,85768143718295 V3=0 T=0 M2=0 M3=-5,10956716192753 FrameElem=34-1
ElemStation=0,05

Frame=34 Station=0,1 OutputCase=STR117 CaseType=Combination P=-37,5851448783989 V2=9,55768143718295 V3=0 T=0 M2=0 M3=-5,56995123378668 FrameElem=34-1
ElemStation=0,1

Frame=34 Station=0 OutputCase=STR118 CaseType=Combination P=-30,4724048322834 V2=94,0385064600402 V3=0 T=0 M2=0 M3=-10,4486561208423 FrameElem=34-1
ElemStation=0

Frame=34 Station=0,05 OutputCase=STR118 CaseType=Combination P=-31,5996548322834 V2=99,8435064600402 V3=0 T=0 M2=0 M3=-15,2957064438443 FrameElem=34-1
ElemStation=0,05

Frame=34 Station=0,1 OutputCase=STR118 CaseType=Combination P=-32,7269048322834 V2=105,64850646004 V3=0 T=0 M2=0 M3=-20,4330067668463 FrameElem=34-1
ElemStation=0,1

Frame=34 Station=0 OutputCase=STR119 CaseType=Combination P=-5,03098393697855 V2=64,6178023952731 V3=0 T=0 M2=0 M3=7,36437851682708 FrameElem=34-1
ElemStation=0

Frame=34 Station=0,05 OutputCase=STR119 CaseType=Combination P=-5,03098393697855 V2=70,4228023952731 V3=0 T=0 M2=0 M3=3,98836339706343 FrameElem=34-1
ElemStation=0,05

Frame=34 Station=0,1 OutputCase=STR119 CaseType=Combination P=-5,03098393697855 V2=76,2278023952731 V3=0 T=0 M2=0 M3=0,32209827729978 FrameElem=34-1
ElemStation=0,1

Frame=34 Station=0 OutputCase=STR120 CaseType=Combination P=-18,225236844929 V2=74,9737146285437 V3=0 T=0 M2=0 M3=-0,174826741438208 FrameElem=34-1
ElemStation=0

Frame=34 Station=0,05 OutputCase=STR120 CaseType=Combination P=-18,225236844929 V2=80,7787146285437 V3=0 T=0 M2=0 M3=-4,06863747286539 FrameElem=34-1
ElemStation=0,05

Frame=34 Station=0,1 OutputCase=STR120 CaseType=Combination P=-18,225236844929 V2=86,5837146285437 V3=0 T=0 M2=0 M3=-8,25269820429258 FrameElem=34-1
ElemStation=0,1

Frame=34 Station=0 OutputCase=STR121 CaseType=Combination P=-31,419489779329 V2=64,6178023951945 V3=0 T=0 M2=0 M3=3,67747145735503 FrameElem=34-1
ElemStation=0

Frame=34 Station=0,05 OutputCase=STR121 CaseType=Combination P=-31,419489779329 V2=70,4228023951945 V3=0 T=0 M2=0 M3=0,301456337595301 FrameElem=34-1
ElemStation=0,05

Frame=34 Station=0,1 OutputCase=STR121 CaseType=Combination P=-31,419489779329 V2=76,2278023951945 V3=0 T=0 M2=0 M3=-3,36480878216442 FrameElem=34-1
ElemStation=0,1

Frame=34 Station=0 OutputCase=STR122 CaseType=Combination P=-17,4501730383 V2=18,8187146286988 V3=0 T=0 M2=0 M3=-7,96719548789762 FrameElem=34-1
ElemStation=0

Frame=34 Station=0,05 OutputCase=STR122 CaseType=Combination P=-17,4501730383 V2=19,5187146286988 V3=0 T=0 M2=0 M3=-8,92563121933255 FrameElem=34-1
ElemStation=0,05

Frame=34 Station=0,1 OutputCase=STR122 CaseType=Combination P=-17,4501730383 V2=20,2187146286988 V3=0 T=0 M2=0 M3=-9,91906695076749 FrameElem=34-1
ElemStation=0,1

Frame=34 Station=0 OutputCase=STR123 CaseType=Combination P=-30,6444259727 V2=8,46280239534954 V3=0 T=0 M2=0 M3=-4,11489728910438 FrameElem=34-1
ElemStation=0

Società di Progetto
Brebemi SpA

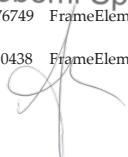

	Doc. N. 60235-0000-A00.doc	CODIFICA DOCUMENTO 04RCDII10000000000300A00	REV. 00	FOGLIO 447 di 628
--	-------------------------------	--	------------	----------------------

Frame=34 Station=0,05 OutputCase=STR123 CaseType=Combination P=-30,6444259727 V2=9,16280239534954 V3=0 T=0 M2=0 M3=-4,55553740887186	FrameElem=34-1 ElemStation=0,05
Frame=34 Station=0,1 OutputCase=STR123 CaseType=Combination P=-30,6444259727 V2=9,86280239534954 V3=0 T=0 M2=0 M3=-5,03117752863934	FrameElem=34-1 ElemStation=0,1
Frame=34 Station=0 OutputCase=STR124 CaseType=Combination P=-9,71911954648824 V2=11,1578023953538 V3=0 T=0 M2=0 M3=-1,28829657112576	FrameElem=34-1 ElemStation=0
Frame=34 Station=0,05 OutputCase=STR124 CaseType=Combination P=-9,71911954648824 V2=12,1028023953538 V3=0 T=0 M2=0 M3=-1,86981169089345	FrameElem=34-1 ElemStation=0,05
Frame=34 Station=0,1 OutputCase=STR124 CaseType=Combination P=-9,71911954648824 V2=13,0478023953538 V3=0 T=0 M2=0 M3=-2,49857681066114	FrameElem=34-1 ElemStation=0,1
Frame=34 Station=0 OutputCase=STR125 CaseType=Combination P=-4,61051643865214 V2=11,1578023954324 V3=0 T=0 M2=0 M3=-0,448114879436596	FrameElem=34-1 ElemStation=0
Frame=34 Station=0,05 OutputCase=STR125 CaseType=Combination P=-4,61051643865214 V2=12,1028023954324 V3=0 T=0 M2=0 M3=-1,02962999920821	FrameElem=34-1 ElemStation=0,05
Frame=34 Station=0,1 OutputCase=STR125 CaseType=Combination P=-4,61051643865214 V2=13,0478023954324 V3=0 T=0 M2=0 M3=-1,65839511897983	FrameElem=34-1 ElemStation=0,1
Frame=34 Station=0 OutputCase=STR126 CaseType=Combination P=-5,58266126051657 V2=64,6178023952732 V3=0 T=0 M2=0 M3=6,90663249940925	FrameElem=34-1 ElemStation=0
Frame=34 Station=0,05 OutputCase=STR126 CaseType=Combination P=-5,58266126051657 V2=70,4228023952732 V3=0 T=0 M2=0 M3=3,53061737964559	FrameElem=34-1 ElemStation=0,05
Frame=34 Station=0,1 OutputCase=STR126 CaseType=Combination P=-5,58266126051657 V2=76,2278023952732 V3=0 T=0 M2=0 M3=-0,135647740118074	FrameElem=34-1 ElemStation=0,1
Frame=34 Station=0 OutputCase=STR127 CaseType=Combination P=-18,776914168467 V2=74,9737146285439 V3=0 T=0 M2=0 M3=-0,632572758856046	FrameElem=34-1 ElemStation=0
Frame=34 Station=0,05 OutputCase=STR127 CaseType=Combination P=-18,776914168467 V2=80,7787146285439 V3=0 T=0 M2=0 M3=-4,52638349028324	FrameElem=34-1 ElemStation=0,05
Frame=34 Station=0,1 OutputCase=STR127 CaseType=Combination P=-18,776914168467 V2=86,5837146285439 V3=0 T=0 M2=0 M3=-8,71044422171043	FrameElem=34-1 ElemStation=0,1
Frame=34 Station=0 OutputCase=STR128 CaseType=Combination P=-31,971167102867 V2=64,6178023951946 V3=0 T=0 M2=0 M3=3,21972543993719	FrameElem=34-1 ElemStation=0
Frame=34 Station=0,05 OutputCase=STR128 CaseType=Combination P=-31,971167102867 V2=70,4228023951947 V3=0 T=0 M2=0 M3=-0,156289679822545	FrameElem=34-1 ElemStation=0,05
Frame=34 Station=0,1 OutputCase=STR128 CaseType=Combination P=-31,971167102867 V2=76,2278023951947 V3=0 T=0 M2=0 M3=-3,82255479958228	FrameElem=34-1 ElemStation=0,1
Frame=34 Station=0 OutputCase=STR129 CaseType=Combination P=-18,001850361838 V2=18,8187146286989 V3=0 T=0 M2=0 M3=-8,42494150531545	FrameElem=34-1 ElemStation=0
Frame=34 Station=0,05 OutputCase=STR129 CaseType=Combination P=-18,001850361838 V2=19,5187146286989 V3=0 T=0 M2=0 M3=-9,383377267504	FrameElem=34-1 ElemStation=0,05
Frame=34 Station=0,1 OutputCase=STR129 CaseType=Combination P=-18,001850361838 V2=20,2187146286989 V3=0 T=0 M2=0 M3=-10,3768129681853	FrameElem=34-1 ElemStation=0,1
Frame=34 Station=0 OutputCase=STR130 CaseType=Combination P=-31,196103296238 V2=8,46280239534969 V3=0 T=0 M2=0 M3=-4,57264330652222	FrameElem=34-1 ElemStation=0
Frame=34 Station=0,05 OutputCase=STR130 CaseType=Combination P=-31,196103296238 V2=9,16280239534969 V3=0 T=0 M2=0 M3=-5,01328342628971	FrameElem=34-1 ElemStation=0,05
Frame=34 Station=0,1 OutputCase=STR130 CaseType=Combination P=-31,196103296238 V2=9,8628023953497 V3=0 T=0 M2=0 M3=-5,48892354605719	FrameElem=34-1 ElemStation=0,1
Frame=34 Station=0 OutputCase=STR131 CaseType=Combination P=-8,61576489941219 V2=11,1578023953535 V3=0 T=0 M2=0 M3=-0,372804536290088	FrameElem=34-1 ElemStation=0
Frame=34 Station=0,05 OutputCase=STR131 CaseType=Combination P=-8,61576489941219 V2=12,1028023953535 V3=0 T=0 M2=0 M3=-0,954319656057761	FrameElem=34-1 ElemStation=0,05
Frame=34 Station=0,1 OutputCase=STR131 CaseType=Combination P=-8,61576489941219 V2=13,0478023953535 V3=0 T=0 M2=0 M3=-1,58308477582543	FrameElem=34-1 ElemStation=0,1
Frame=34 Station=0 OutputCase=STR132 CaseType=Combination P=-3,50716179157609 V2=11,157802395432 V3=0 T=0 M2=0 M3=0,46737715539908	FrameElem=34-1 ElemStation=0
Frame=34 Station=0,05 OutputCase=STR132 CaseType=Combination P=-3,50716179157609 V2=12,102802395432 V3=0 T=0 M2=0 M3=-0,114137964372522	FrameElem=34-1 ElemStation=0,05
Frame=34 Station=0,1 OutputCase=STR132 CaseType=Combination P=-3,50716179157609 V2=13,047802395432 V3=0 T=0 M2=0 M3=-0,742903084144124	FrameElem=34-1 ElemStation=0,1
Frame=34 Station=0 OutputCase=STR133 CaseType=Combination P=-4,47930661344052 V2=64,6178023952729 V3=0 T=0 M2=0 M3=7,82212453424492	FrameElem=34-1 ElemStation=0
Frame=34 Station=0,05 OutputCase=STR133 CaseType=Combination P=-4,47930661344052 V2=70,4228023952729 V3=0 T=0 M2=0 M3=4,44610941448128	FrameElem=34-1 ElemStation=0,05
Frame=34 Station=0,1 OutputCase=STR133 CaseType=Combination P=-4,47930661344052 V2=76,2278023952729 V3=0 T=0 M2=0 M3=0,779844294717633	FrameElem=34-1 ElemStation=0,1
Frame=34 Station=0 OutputCase=STR134 CaseType=Combination P=-17,673559521391 V2=74,9737146285436 V3=0 T=0 M2=0 M3=0,28291927597963	FrameElem=34-1 ElemStation=0
Frame=34 Station=0,05 OutputCase=STR134 CaseType=Combination P=-17,673559521391 V2=80,7787146285436 V3=0 T=0 M2=0 M3=-3,61089145544755	FrameElem=34-1 ElemStation=0,05
Frame=34 Station=0,1 OutputCase=STR134 CaseType=Combination P=-17,673559521391 V2=86,5837146285436 V3=0 T=0 M2=0 M3=-7,79495218687472	FrameElem=34-1 ElemStation=0,1
Frame=34 Station=0 OutputCase=STR135 CaseType=Combination P=-30,8678124557909 V2=64,6178023951943 V3=0 T=0 M2=0 M3=4,13521747477286	FrameElem=34-1 ElemStation=0
Frame=34 Station=0,05 OutputCase=STR135 CaseType=Combination P=-30,8678124557909 V2=70,4228023951943 V3=0 T=0 M2=0 M3=0,759202355013146	FrameElem=34-1 ElemStation=0,05
Frame=34 Station=0,1 OutputCase=STR135 CaseType=Combination P=-30,8678124557909 V2=76,2278023951943 V3=0 T=0 M2=0 M3=-2,90706276474657	FrameElem=34-1 ElemStation=0,1
Frame=34 Station=0 OutputCase=STR136 CaseType=Combination P=-16,898495714762 V2=18,8187146286986 V3=0 T=0 M2=0 M3=-7,50944947047978	FrameElem=34-1 ElemStation=0
Frame=34 Station=0,05 OutputCase=STR136 CaseType=Combination P=-16,898495714762 V2=19,5187146286986 V3=0 T=0 M2=0 M3=-8,46788520191471	FrameElem=34-1 ElemStation=0,05
Frame=34 Station=0,1 OutputCase=STR136 CaseType=Combination P=-16,898495714762 V2=20,2187146286986 V3=0 T=0 M2=0 M3=-9,46132093334964	FrameElem=34-1 ElemStation=0,1
Frame=34 Station=0 OutputCase=STR137 CaseType=Combination P=-30,092748649162 V2=8,46280239534939 V3=0 T=0 M2=0 M3=-3,65715127168654	FrameElem=34-1 ElemStation=0
Frame=34 Station=0,05 OutputCase=STR137 CaseType=Combination P=-30,092748649162 V2=9,16280239534939 V3=0 T=0 M2=0 M3=-4,09779139145401	FrameElem=34-1 ElemStation=0,05
Frame=34 Station=0,1 OutputCase=STR137 CaseType=Combination P=-30,092748649162 V2=9,86280239534939 V3=0 T=0 M2=0 M3=-4,57343151122149	FrameElem=34-1 ElemStation=0,1

Società di Progetto
Brebemi SpA

	Doc. N. 60235-00000-A00.doc	CODIFICA DOCUMENTO 04RCDII10000000000300A00	REV. 00	FOGLIO 448 di 628
--	--------------------------------	--	------------	----------------------

Frame=34 Station=0 OutputCase=STR138 CaseType=Combination P=-8,61576489941219 V2=11,1578023953535 V3=0 T=0 M2=0 M3=-0,372804536290088 FrameElem=34-1
ElemStation=0

Frame=34 Station=0,05 OutputCase=STR138 CaseType=Combination P=-8,61576489941219 V2=12,1028023953535 V3=0 T=0 M2=0 M3=-0,954319656057761 FrameElem=34-1
ElemStation=0,05

Frame=34 Station=0,1 OutputCase=STR138 CaseType=Combination P=-8,61576489941219 V2=13,0478023953535 V3=0 T=0 M2=0 M3=-1,58308477582543 FrameElem=34-1
ElemStation=0,1

Frame=34 Station=0 OutputCase=STR139 CaseType=Combination P=-3,50716179157609 V2=11,157802395432 V3=0 T=0 M2=0 M3=-0,46737715539908 FrameElem=34-1
ElemStation=0

Frame=34 Station=0,05 OutputCase=STR139 CaseType=Combination P=-3,50716179157609 V2=12,102802395432 V3=0 T=0 M2=0 M3=-0,114137964372522 FrameElem=34-1
ElemStation=0,05

Frame=34 Station=0,1 OutputCase=STR139 CaseType=Combination P=-3,50716179157609 V2=13,047802395432 V3=0 T=0 M2=0 M3=-0,742903084144124 FrameElem=34-1
ElemStation=0,1

Frame=34 Station=0 OutputCase=STR140 CaseType=Combination P=-4,47930661344052 V2=64,6178023952729 V3=0 T=0 M2=0 M3=7,82212453424492 FrameElem=34-1
ElemStation=0

Frame=34 Station=0,05 OutputCase=STR140 CaseType=Combination P=-4,47930661344052 V2=70,4228023952729 V3=0 T=0 M2=0 M3=4,44610941448128 FrameElem=34-1
ElemStation=0,05

Frame=34 Station=0,1 OutputCase=STR140 CaseType=Combination P=-4,47930661344052 V2=76,2278023952729 V3=0 T=0 M2=0 M3=0,779844294717633 FrameElem=34-1
ElemStation=0,1

Frame=34 Station=0 OutputCase=STR141 CaseType=Combination P=-17,673559521391 V2=74,9737146285436 V3=0 T=0 M2=0 M3=0,28291927597963 FrameElem=34-1
ElemStation=0

Frame=34 Station=0,05 OutputCase=STR141 CaseType=Combination P=-17,673559521391 V2=80,7787146285436 V3=0 T=0 M2=0 M3=-3,61089145544755 FrameElem=34-1
ElemStation=0,05

Frame=34 Station=0,1 OutputCase=STR141 CaseType=Combination P=-17,673559521391 V2=86,5837146285436 V3=0 T=0 M2=0 M3=-7,79495218687472 FrameElem=34-1
ElemStation=0,1

Frame=34 Station=0 OutputCase=STR142 CaseType=Combination P=-30,8678124557909 V2=64,6178023951943 V3=0 T=0 M2=0 M3=4,13521747477286 FrameElem=34-1
ElemStation=0

Frame=34 Station=0,05 OutputCase=STR142 CaseType=Combination P=-30,8678124557909 V2=70,4228023951943 V3=0 T=0 M2=0 M3=0,759202355013146 FrameElem=34-1
ElemStation=0,05

Frame=34 Station=0,1 OutputCase=STR142 CaseType=Combination P=-30,8678124557909 V2=76,2278023951943 V3=0 T=0 M2=0 M3=-2,90706276474657 FrameElem=34-1
ElemStation=0,1

Frame=34 Station=0 OutputCase=STR143 CaseType=Combination P=-16,898495714762 V2=18,8187146286986 V3=0 T=0 M2=0 M3=-7,50944947047978 FrameElem=34-1
ElemStation=0

Frame=34 Station=0,05 OutputCase=STR143 CaseType=Combination P=-16,898495714762 V2=19,5187146286986 V3=0 T=0 M2=0 M3=-8,46788520191471 FrameElem=34-1
ElemStation=0,05

Frame=34 Station=0,1 OutputCase=STR143 CaseType=Combination P=-16,898495714762 V2=20,2187146286986 V3=0 T=0 M2=0 M3=-9,46132093334964 FrameElem=34-1
ElemStation=0,1

Frame=34 Station=0 OutputCase=STR144 CaseType=Combination P=-30,092748649162 V2=8,46280239534939 V3=0 T=0 M2=0 M3=-3,65715127168654 FrameElem=34-1
ElemStation=0

Frame=34 Station=0,05 OutputCase=STR144 CaseType=Combination P=-30,092748649162 V2=9,16280239534939 V3=0 T=0 M2=0 M3=-4,09779139145401 FrameElem=34-1
ElemStation=0,05

Frame=34 Station=0,1 OutputCase=STR144 CaseType=Combination P=-30,092748649162 V2=9,86280239534939 V3=0 T=0 M2=0 M3=-4,57343151122149 FrameElem=34-1
ElemStation=0,1

Frame=34 Station=0 OutputCase=STR145 CaseType=Combination P=-7,86652500253868 V2=10,3949999999369 V3=0 T=0 M2=0 M3=0,881416112730871 FrameElem=34-1
ElemStation=0

Frame=34 Station=0,05 OutputCase=STR145 CaseType=Combination P=-7,86652500253868 V2=11,3399999999369 V3=0 T=0 M2=0 M3=0,338041112734026 FrameElem=34-1
ElemStation=0,05

Frame=34 Station=0,1 OutputCase=STR145 CaseType=Combination P=-7,86652500253868 V2=12,2849999999369 V3=0 T=0 M2=0 M3=-0,252583887262818 FrameElem=34-1
ElemStation=0,1

Frame=34 Station=0 OutputCase=STR146 CaseType=Combination P=-2,75792189470258 V2=10,3950000000155 V3=0 T=0 M2=0 M3=1,72159780442004 FrameElem=34-1
ElemStation=0

Frame=34 Station=0,05 OutputCase=STR146 CaseType=Combination P=-2,75792189470258 V2=11,3400000000155 V3=0 T=0 M2=0 M3=1,17822280441927 FrameElem=34-1
ElemStation=0,05

Frame=34 Station=0,1 OutputCase=STR146 CaseType=Combination P=-2,75792189470258 V2=12,2850000000155 V3=0 T=0 M2=0 M3=0,587597804418492 FrameElem=34-1
ElemStation=0,1

Frame=34 Station=0 OutputCase=STR147 CaseType=Combination P=-4,42189987288051 V2=81,6749999998034 V3=0 T=0 M2=0 M3=11,2227636312693 FrameElem=34-1
ElemStation=0

Frame=34 Station=0,05 OutputCase=STR147 CaseType=Combination P=-4,42189987288051 V2=89,0999999998034 V3=0 T=0 M2=0 M3=6,9533886312791 FrameElem=34-1
ElemStation=0,05

Frame=34 Station=0,1 OutputCase=STR147 CaseType=Combination P=-4,42189987288051 V2=96,5249999998034 V3=0 T=0 M2=0 M3=2,31276363128893 FrameElem=34-1
ElemStation=0,1

Frame=34 Station=0 OutputCase=STR148 CaseType=Combination P=-21,1628032328115 V2=94,856781584244 V3=0 T=0 M2=0 M3=1,65487600183234 FrameElem=34-1
ElemStation=0

Frame=34 Station=0,05 OutputCase=STR148 CaseType=Combination P=-21,1628032328115 V2=102,281781584244 V3=0 T=0 M2=0 M3=-3,27358807737986 FrameElem=34-1
ElemStation=0,05

Frame=34 Station=0,1 OutputCase=STR148 CaseType=Combination P=-21,1628032328115 V2=109,706781584244 V3=0 T=0 M2=0 M3=-8,57330215659206 FrameElem=34-1
ElemStation=0,1

Frame=34 Station=0 OutputCase=STR149 CaseType=Combination P=-37,9037066267357 V2=81,6749999997248 V3=0 T=0 M2=0 M3=6,58694811586958 FrameElem=34-1
ElemStation=0

Frame=34 Station=0,05 OutputCase=STR149 CaseType=Combination P=-37,9037066267357 V2=89,0999999997248 V3=0 T=0 M2=0 M3=2,31757311588334 FrameElem=34-1
ElemStation=0,05

Frame=34 Station=0,1 OutputCase=STR149 CaseType=Combination P=-37,9037066267357 V2=96,5249999997248 V3=0 T=0 M2=0 M3=-2,3230518841029 FrameElem=34-1
ElemStation=0,1

Frame=34 Station=0 OutputCase=STR150 CaseType=Combination P=-20,0636911522277 V2=20,8817815844521 V3=0 T=0 M2=0 M3=-8,58907520424235 FrameElem=34-1
ElemStation=0

Frame=34 Station=0,05 OutputCase=STR150 CaseType=Combination P=-20,0636911522277 V2=21,5817815844521 V3=0 T=0 M2=0 M3=-9,65066428346495 FrameElem=34-1
ElemStation=0,05

Frame=34 Station=0,1 OutputCase=STR150 CaseType=Combination P=-20,0636911522277 V2=22,2817815844521 V3=0 T=0 M2=0 M3=-10,7472533626876 FrameElem=34-1
ElemStation=0,1

Frame=34 Station=0 OutputCase=STR151 CaseType=Combination P=-36,804594546152 V2=7,6999999993291 V3=0 T=0 M2=0 M3=-3,65700309020511 FrameElem=34-1
ElemStation=0

Frame=34 Station=0,05 OutputCase=STR151 CaseType=Combination P=-36,804594546152 V2=8,3999999993291 V3=0 T=0 M2=0 M3=-4,05950309020175 FrameElem=34-1
ElemStation=0,05

Frame=34 Station=0,1 OutputCase=STR151 CaseType=Combination P=-36,804594546152 V2=9,0999999993291 V3=0 T=0 M2=0 M3=-4,4970030901984 FrameElem=34-1
ElemStation=0,1

Frame=34 Station=0 OutputCase=STR152 CaseType=Combination P=-29,6918545000365 V2=93,5808250227901 V3=0 T=0 M2=0 M3=-9,42147612097903 FrameElem=34-1
ElemStation=0

Frame=34 Station=0,05 OutputCase=STR152 CaseType=Combination P=-30,8191045000365 V2=99,3858250227901 V3=0 T=0 M2=0 M3=-14,2456423721185 FrameElem=34-1
ElemStation=0,05

Società di Progetto
Brebemi SpA

	Doc. N. 60235-00000-A00.doc	CODIFICA DOCUMENTO 04RCDII10000000000300A00	REV. 00	FOGLIO 449 di 628
--	--------------------------------	--	------------	----------------------

Frame=34 Station=0,1 OutputCase=STR152 CaseType=Combination P=-31,9463545000365 V2=105,19082502279 V3=0 T=0 M2=0 M3=-19,360058623258	FrameElem=34-1 ElemStation=0,1
Frame=34 Station=0 OutputCase=STR153 CaseType=Combination P=-3,73006671656702 V2=63,8549999998563 V3=0 T=0 M2=0 M3=9,07634518326588	FrameElem=34-1 ElemStation=0
Frame=34 Station=0,05 OutputCase=STR153 CaseType=Combination P=-3,73006671656702 V2=69,6599999998563 V3=0 T=0 M2=0 M3=5,73847018327307	FrameElem=34-1 ElemStation=0,05
Frame=34 Station=0,1 OutputCase=STR153 CaseType=Combination P=-3,73006671656702 V2=75,4649999998563 V3=0 T=0 M2=0 M3=2,11034518328025	FrameElem=34-1 ElemStation=0,1
Frame=34 Station=0 OutputCase=STR154 CaseType=Combination P=-16,9243196245174 V2=74,210912233127 V3=0 T=0 M2=0 M3=1,53713992500059	FrameElem=34-1 ElemStation=0
Frame=34 Station=0,05 OutputCase=STR154 CaseType=Combination P=-16,9243196245174 V2=80,015912233127 V3=0 T=0 M2=0 M3=2,31853068665576	FrameElem=34-1 ElemStation=0,05
Frame=34 Station=0,1 OutputCase=STR154 CaseType=Combination P=-16,9243196245174 V2=85,820912233127 V3=0 T=0 M2=0 M3=-6,46445129831211	FrameElem=34-1 ElemStation=0,1
Frame=34 Station=0 OutputCase=STR155 CaseType=Combination P=-30,1185725589174 V2=63,8549999997778 V3=0 T=0 M2=0 M3=5,38943812379382	FrameElem=34-1 ElemStation=0
Frame=34 Station=0,05 OutputCase=STR155 CaseType=Combination P=-30,1185725589174 V2=69,6599999997778 V3=0 T=0 M2=0 M3=2,05156312380493	FrameElem=34-1 ElemStation=0,05
Frame=34 Station=0,1 OutputCase=STR155 CaseType=Combination P=-30,1185725589174 V2=75,4649999997778 V3=0 T=0 M2=0 M3=-1,57656187618395	FrameElem=34-1 ElemStation=0,1
Frame=34 Station=0 OutputCase=STR156 CaseType=Combination P=-16,1492558178885 V2=18,055912233282 V3=0 T=0 M2=0 M3=-6,25522882145882	FrameElem=34-1 ElemStation=0
Frame=34 Station=0,05 OutputCase=STR156 CaseType=Combination P=-16,1492558178885 V2=18,755912233282 V3=0 T=0 M2=0 M3=-7,17552443312292	FrameElem=34-1 ElemStation=0,05
Frame=34 Station=0,1 OutputCase=STR156 CaseType=Combination P=-16,1492558178885 V2=19,455912233282 V3=0 T=0 M2=0 M3=-8,13082004478702	FrameElem=34-1 ElemStation=0,1
Frame=34 Station=0 OutputCase=STR157 CaseType=Combination P=-29,3435087522885 V2=7,69999999993281 V3=0 T=0 M2=0 M3=-2,40293062266559	FrameElem=34-1 ElemStation=0
Frame=34 Station=0,05 OutputCase=STR157 CaseType=Combination P=-29,3435087522885 V2=8,3999999999328 V3=0 T=0 M2=0 M3=-2,80543062266223	FrameElem=34-1 ElemStation=0,05
Frame=34 Station=0,1 OutputCase=STR157 CaseType=Combination P=-29,3435087522885 V2=9,09999999993281 V3=0 T=0 M2=0 M3=-3,24293062265887	FrameElem=34-1 ElemStation=0,1
Frame=34 Station=0 OutputCase=STR158 CaseType=Combination P=-8,41820232607671 V2=10,394999999937 V3=0 T=0 M2=0 M3=0,423670095313033	FrameElem=34-1 ElemStation=0
Frame=34 Station=0,05 OutputCase=STR158 CaseType=Combination P=-8,41820232607671 V2=11,339999999937 V3=0 T=0 M2=0 M3=-0,119704904683819	FrameElem=34-1 ElemStation=0,05
Frame=34 Station=0,1 OutputCase=STR158 CaseType=Combination P=-8,41820232607671 V2=12,284999999937 V3=0 T=0 M2=0 M3=-0,710329904680671	FrameElem=34-1 ElemStation=0,1
Frame=34 Station=0 OutputCase=STR159 CaseType=Combination P=-3,30959921824061 V2=10,3950000000156 V3=0 T=0 M2=0 M3=1,2638517870022	FrameElem=34-1 ElemStation=0
Frame=34 Station=0,05 OutputCase=STR159 CaseType=Combination P=-3,30959921824061 V2=11,3400000000156 V3=0 T=0 M2=0 M3=0,72047678700142	FrameElem=34-1 ElemStation=0,05
Frame=34 Station=0,1 OutputCase=STR159 CaseType=Combination P=-3,30959921824061 V2=12,2850000000156 V3=0 T=0 M2=0 M3=0,129851787000639	FrameElem=34-1 ElemStation=0,1
Frame=34 Station=0 OutputCase=STR160 CaseType=Combination P=-4,28174404010504 V2=63,8549999998565 V3=0 T=0 M2=0 M3=8,61859916584804	FrameElem=34-1 ElemStation=0
Frame=34 Station=0,05 OutputCase=STR160 CaseType=Combination P=-4,28174404010504 V2=69,6599999998565 V3=0 T=0 M2=0 M3=5,28072416585522	FrameElem=34-1 ElemStation=0,05
Frame=34 Station=0,1 OutputCase=STR160 CaseType=Combination P=-4,28174404010504 V2=75,4649999998565 V3=0 T=0 M2=0 M3=1,6525991658624	FrameElem=34-1 ElemStation=0,1
Frame=34 Station=0 OutputCase=STR161 CaseType=Combination P=-17,4759969480555 V2=74,2109122331271 V3=0 T=0 M2=0 M3=1,07939390758275	FrameElem=34-1 ElemStation=0
Frame=34 Station=0,05 OutputCase=STR161 CaseType=Combination P=-17,4759969480555 V2=80,0159122331271 V3=0 T=0 M2=0 M3=-2,77627670407361	FrameElem=34-1 ElemStation=0,05
Frame=34 Station=0,1 OutputCase=STR161 CaseType=Combination P=-17,4759969480555 V2=85,8209122331271 V3=0 T=0 M2=0 M3=-6,92219731572996	FrameElem=34-1 ElemStation=0,1
Frame=34 Station=0 OutputCase=STR162 CaseType=Combination P=-30,6702498824555 V2=63,8549999997779 V3=0 T=0 M2=0 M3=4,93169210637598	FrameElem=34-1 ElemStation=0
Frame=34 Station=0,05 OutputCase=STR162 CaseType=Combination P=-30,6702498824555 V2=69,6599999997779 V3=0 T=0 M2=0 M3=1,59381710638709	FrameElem=34-1 ElemStation=0,05
Frame=34 Station=0,1 OutputCase=STR162 CaseType=Combination P=-30,6702498824555 V2=75,4649999997779 V3=0 T=0 M2=0 M3=-2,03430789360181	FrameElem=34-1 ElemStation=0,1
Frame=34 Station=0 OutputCase=STR163 CaseType=Combination P=-16,7009331414265 V2=18,0559122332822 V3=0 T=0 M2=0 M3=-6,71297483887666	FrameElem=34-1 ElemStation=0
Frame=34 Station=0,05 OutputCase=STR163 CaseType=Combination P=-16,7009331414265 V2=18,7559122332822 V3=0 T=0 M2=0 M3=-7,63327045054077	FrameElem=34-1 ElemStation=0,05
Frame=34 Station=0,1 OutputCase=STR163 CaseType=Combination P=-16,7009331414265 V2=19,4559122332822 V3=0 T=0 M2=0 M3=-8,58856606220488	FrameElem=34-1 ElemStation=0,1
Frame=34 Station=0 OutputCase=STR164 CaseType=Combination P=-29,8951860758265 V2=7,69999999993296 V3=0 T=0 M2=0 M3=-2,86067664008342	FrameElem=34-1 ElemStation=0
Frame=34 Station=0,05 OutputCase=STR164 CaseType=Combination P=-29,8951860758265 V2=8,39999999993296 V3=0 T=0 M2=0 M3=-3,26317664008007	FrameElem=34-1 ElemStation=0,05
Frame=34 Station=0,1 OutputCase=STR164 CaseType=Combination P=-29,8951860758265 V2=9,09999999993296 V3=0 T=0 M2=0 M3=-3,70067664007672	FrameElem=34-1 ElemStation=0,1
Frame=34 Station=0 OutputCase=STR165 CaseType=Combination P=-7,31484767900066 V2=10,3949999999367 V3=0 T=0 M2=0 M3=1,33916213014871	FrameElem=34-1 ElemStation=0
Frame=34 Station=0,05 OutputCase=STR165 CaseType=Combination P=-7,31484767900066 V2=11,3399999999367 V3=0 T=0 M2=0 M3=0,795787130151872	FrameElem=34-1 ElemStation=0,05
Frame=34 Station=0,1 OutputCase=STR165 CaseType=Combination P=-7,31484767900066 V2=12,2849999999367 V3=0 T=0 M2=0 M3=0,205162130155036	FrameElem=34-1 ElemStation=0,1
Frame=34 Station=0 OutputCase=STR166 CaseType=Combination P=-2,20624457116456 V2=10,3950000000153 V3=0 T=0 M2=0 M3=2,17934382183788	FrameElem=34-1 ElemStation=0
Frame=34 Station=0,05 OutputCase=STR166 CaseType=Combination P=-2,20624457116456 V2=11,3400000000153 V3=0 T=0 M2=0 M3=1,63596882183711	FrameElem=34-1 ElemStation=0,05
Frame=34 Station=0,1 OutputCase=STR166 CaseType=Combination P=-2,20624457116456 V2=12,2850000000153 V3=0 T=0 M2=0 M3=1,04534382183635	FrameElem=34-1 ElemStation=0,1
Frame=34 Station=0 OutputCase=STR167 CaseType=Combination P=-3,17838939302899 V2=63,8549999998562 V3=0 T=0 M2=0 M3=9,53409120068372	FrameElem=34-1 ElemStation=0

Società di Progetto
Brebemi SpA

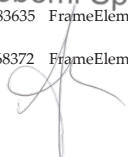

	Doc. N. 60235-00000-A00.doc	CODIFICA DOCUMENTO 04RCDII10000000000300A00	REV. 00	FOGLIO 450 di 628
--	--------------------------------	--	------------	----------------------

Frame=34 Station=0,05 OutputCase=STR167 CaseType=Combination P=-3,17838939302899 V2=69,6599999998562 V3=0 T=0 M2=0 M3=6,19621620069091 FrameElem=34-1 ElemStation=0,05

Frame=34 Station=0,1 OutputCase=STR167 CaseType=Combination P=-3,17838939302899 V2=75,4649999998562 V3=0 T=0 M2=0 M3=2,5680912006981 FrameElem=34-1 ElemStation=0,1

Frame=34 Station=0 OutputCase=STR168 CaseType=Combination P=-16,3726423009794 V2=74,2109122331268 V3=0 T=0 M2=0 M3=1,99488594241843 FrameElem=34-1 ElemStation=0

Frame=34 Station=0,05 OutputCase=STR168 CaseType=Combination P=-16,3726423009794 V2=80,0159122331268 V3=0 T=0 M2=0 M3=-1,86078466923791 FrameElem=34-1 ElemStation=0,05

Frame=34 Station=0,1 OutputCase=STR168 CaseType=Combination P=-16,3726423009794 V2=85,8209122331268 V3=0 T=0 M2=0 M3=-6,00670528089425 FrameElem=34-1 ElemStation=0,1

Frame=34 Station=0 OutputCase=STR169 CaseType=Combination P=-29,5668952353794 V2=63,8549999997776 V3=0 T=0 M2=0 M3=5,84718414121166 FrameElem=34-1 ElemStation=0

Frame=34 Station=0,05 OutputCase=STR169 CaseType=Combination P=-29,5668952353794 V2=69,6599999997776 V3=0 T=0 M2=0 M3=2,50930914122278 FrameElem=34-1 ElemStation=0,05

Frame=34 Station=0,1 OutputCase=STR169 CaseType=Combination P=-29,5668952353794 V2=75,4649999997776 V3=0 T=0 M2=0 M3=-1,1188158587661 FrameElem=34-1 ElemStation=0,1

Frame=34 Station=0 OutputCase=STR170 CaseType=Combination P=-15,5975784943505 V2=18,0559122332819 V3=0 T=0 M2=0 M3=-5,79748280404098 FrameElem=34-1 ElemStation=0

Frame=34 Station=0,05 OutputCase=STR170 CaseType=Combination P=-15,5975784943505 V2=18,7559122332819 V3=0 T=0 M2=0 M3=-6,71777841570507 FrameElem=34-1 ElemStation=0,05

Frame=34 Station=0,1 OutputCase=STR170 CaseType=Combination P=-15,5975784943505 V2=19,4559122332819 V3=0 T=0 M2=0 M3=-7,67307402736917 FrameElem=34-1 ElemStation=0,1

Frame=34 Station=0 OutputCase=STR171 CaseType=Combination P=-28,7918314287505 V2=7,69999999993265 V3=0 T=0 M2=0 M3=-1,94518460524775 FrameElem=34-1 ElemStation=0

Frame=34 Station=0,05 OutputCase=STR171 CaseType=Combination P=-28,7918314287505 V2=8,39999999993265 V3=0 T=0 M2=0 M3=-2,34768460524438 FrameElem=34-1 ElemStation=0,05

Frame=34 Station=0,1 OutputCase=STR171 CaseType=Combination P=-28,7918314287505 V2=9,09999999993265 V3=0 T=0 M2=0 M3=-2,78518460524102 FrameElem=34-1 ElemStation=0,1

Frame=34 Station=0 OutputCase=STR172 CaseType=Combination P=-7,63765199382979 V2=9,93731856268699 V3=0 T=0 M2=0 M3=1,45085009517631 FrameElem=34-1 ElemStation=0

Frame=34 Station=0,05 OutputCase=STR172 CaseType=Combination P=-7,63765199382979 V2=10,882318562687 V3=0 T=0 M2=0 M3=0,930359167041961 FrameElem=34-1 ElemStation=0,05

Frame=34 Station=0,1 OutputCase=STR172 CaseType=Combination P=-7,63765199382979 V2=11,827318562687 V3=0 T=0 M2=0 M3=0,362618238907611 FrameElem=34-1 ElemStation=0,1

Frame=34 Station=0 OutputCase=STR173 CaseType=Combination P=-2,52904888599369 V2=9,93731856276557 V3=0 T=0 M2=0 M3=2,29103178686548 FrameElem=34-1 ElemStation=0

Frame=34 Station=0,05 OutputCase=STR173 CaseType=Combination P=-2,52904888599369 V2=10,8823185627656 V3=0 T=0 M2=0 M3=1,7705408587272 FrameElem=34-1 ElemStation=0,05

Frame=34 Station=0,1 OutputCase=STR173 CaseType=Combination P=-2,52904888599369 V2=11,8273185627656 V3=0 T=0 M2=0 M3=1,20279993058892 FrameElem=34-1 ElemStation=0,1

Frame=34 Station=0 OutputCase=STR174 CaseType=Combination P=-3,50119370785812 V2=63,3973185626065 V3=0 T=0 M2=0 M3=9,64577916571132 FrameElem=34-1 ElemStation=0

Frame=34 Station=0,05 OutputCase=STR174 CaseType=Combination P=-3,50119370785812 V2=69,2023185626065 V3=0 T=0 M2=0 M3=6,330788237581 FrameElem=34-1 ElemStation=0,05

Frame=34 Station=0,1 OutputCase=STR174 CaseType=Combination P=-3,50119370785812 V2=75,0073185626064 V3=0 T=0 M2=0 M3=2,72554730945068 FrameElem=34-1 ElemStation=0,1

Frame=34 Station=0 OutputCase=STR175 CaseType=Combination P=-16,6954466158085 V2=73,7532307958771 V3=0 T=0 M2=0 M3=2,10657390744603 FrameElem=34-1 ElemStation=0

Frame=34 Station=0,05 OutputCase=STR175 CaseType=Combination P=-16,6954466158085 V2=79,5582307958771 V3=0 T=0 M2=0 M3=-1,72621263234783 FrameElem=34-1 ElemStation=0,05

Frame=34 Station=0,1 OutputCase=STR175 CaseType=Combination P=-16,6954466158085 V2=85,3632307958771 V3=0 T=0 M2=0 M3=-5,84924917214168 FrameElem=34-1 ElemStation=0,1

Frame=34 Station=0 OutputCase=STR176 CaseType=Combination P=-29,8896995502085 V2=63,3973185625279 V3=0 T=0 M2=0 M3=5,95887210623926 FrameElem=34-1 ElemStation=0

Frame=34 Station=0,05 OutputCase=STR176 CaseType=Combination P=-29,8896995502085 V2=69,2023185625279 V3=0 T=0 M2=0 M3=2,64388117811287 FrameElem=34-1 ElemStation=0,05

Frame=34 Station=0,1 OutputCase=STR176 CaseType=Combination P=-29,8896995502085 V2=75,0073185625279 V3=0 T=0 M2=0 M3=-0,961359750013525 FrameElem=34-1 ElemStation=0,1

Frame=34 Station=0 OutputCase=STR177 CaseType=Combination P=-15,9203828091796 V2=17,5982307960321 V3=0 T=0 M2=0 M3=-5,68579483901338 FrameElem=34-1 ElemStation=0

Frame=34 Station=0,05 OutputCase=STR177 CaseType=Combination P=-15,9203828091796 V2=18,2982307960321 V3=0 T=0 M2=0 M3=-6,58320637881499 FrameElem=34-1 ElemStation=0,05

Frame=34 Station=0,1 OutputCase=STR177 CaseType=Combination P=-15,9203828091796 V2=18,9982307960321 V3=0 T=0 M2=0 M3=-7,51561791861659 FrameElem=34-1 ElemStation=0,1

Frame=34 Station=0 OutputCase=STR178 CaseType=Combination P=-29,1146357435796 V2=7,24231856268292 V3=0 T=0 M2=0 M3=-1,83349664022015 FrameElem=34-1 ElemStation=0

Frame=34 Station=0,05 OutputCase=STR178 CaseType=Combination P=-29,1146357435796 V2=7,94231856268292 V3=0 T=0 M2=0 M3=-2,21311256835429 FrameElem=34-1 ElemStation=0,05

Frame=34 Station=0,1 OutputCase=STR178 CaseType=Combination P=-29,1146357435796 V2=8,64231856268292 V3=0 T=0 M2=0 M3=-2,62772849648844 FrameElem=34-1 ElemStation=0,1

Frame=34 Station=0 OutputCase=STR179 CaseType=Combination P=-7,63765199382979 V2=9,93731856268699 V3=0 T=0 M2=0 M3=1,45085009517631 FrameElem=34-1 ElemStation=0

Frame=34 Station=0,05 OutputCase=STR179 CaseType=Combination P=-7,63765199382979 V2=10,882318562687 V3=0 T=0 M2=0 M3=0,930359167041961 FrameElem=34-1 ElemStation=0,05

Frame=34 Station=0,1 OutputCase=STR179 CaseType=Combination P=-7,63765199382979 V2=11,827318562687 V3=0 T=0 M2=0 M3=0,362618238907611 FrameElem=34-1 ElemStation=0,1

Frame=34 Station=0 OutputCase=STR180 CaseType=Combination P=-8,09539801124758 V2=10,8526814371868 V3=0 T=0 M2=0 M3=0,311982130285431 FrameElem=34-1 ElemStation=0

Frame=34 Station=0,05 OutputCase=STR180 CaseType=Combination P=-8,09539801124758 V2=11,7976814371868 V3=0 T=0 M2=0 M3=0,254276941573908 FrameElem=34-1 ElemStation=0,05

Frame=34 Station=0,1 OutputCase=STR180 CaseType=Combination P=-8,09539801124758 V2=12,7426814371868 V3=0 T=0 M2=0 M3=-0,867786013433246 FrameElem=34-1 ElemStation=0,1

Frame=34 Station=0 OutputCase=STR181 CaseType=Combination P=-2,98679490341148 V2=10,8526814372653 V3=0 T=0 M2=0 M3=1,1521638219746 FrameElem=34-1 ElemStation=0

Frame=34 Station=0,05 OutputCase=STR181 CaseType=Combination P=-2,98679490341148 V2=11,7976814372654 V3=0 T=0 M2=0 M3=0,58590475011331 FrameElem=34-1 ElemStation=0,05

Frame=34 Station=0,1 OutputCase=STR181 CaseType=Combination P=-2,98679490341148 V2=12,7426814372654 V3=0 T=0 M2=0 M3=-2,76043217519362E-02 FrameElem=34-1 ElemStation=0,1

Società di Progetto
Brebemi SpA

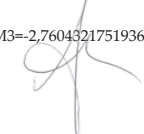

	Doc. N. 60235-00000-A00.doc	CODIFICA DOCUMENTO 04RCDII10000000000300A00	REV. 00	FOGLIO 451 di 628
--	--------------------------------	--	------------	----------------------

Frame=34 Station=0 OutputCase=STR182 CaseType=Combination P=-3,95893972527591 V2=64,3126814371062 V3=0 T=0 M2=0 M3=8,50691120082044 FrameElem=34-1 ElemStation=0

Frame=34 Station=0,05 OutputCase=STR182 CaseType=Combination P=-3,95893972527591 V2=70,1176814371062 V3=0 T=0 M2=0 M3=5,14615212896513 FrameElem=34-1 ElemStation=0,05

Frame=34 Station=0,1 OutputCase=STR182 CaseType=Combination P=-3,95893972527591 V2=75,9226814371062 V3=0 T=0 M2=0 M3=1,49514305710982 FrameElem=34-1 ElemStation=0,1

Frame=34 Station=0 OutputCase=STR183 CaseType=Combination P=-17,1531926332263 V2=74,6685936703769 V3=0 T=0 M2=0 M3=0,967705942555149 FrameElem=34-1 ElemStation=0

Frame=34 Station=0,05 OutputCase=STR183 CaseType=Combination P=-17,1531926332263 V2=80,4735936703769 V3=0 T=0 M2=0 M3=-2,91084874096369 FrameElem=34-1 ElemStation=0,05

Frame=34 Station=0,1 OutputCase=STR183 CaseType=Combination P=-17,1531926332263 V2=86,2785936703769 V3=0 T=0 M2=0 M3=-7,07965342448254 FrameElem=34-1 ElemStation=0,1

Frame=34 Station=0 OutputCase=STR184 CaseType=Combination P=-30,3474455676263 V2=64,3126814370276 V3=0 T=0 M2=0 M3=4,82000414134838 FrameElem=34-1 ElemStation=0

Frame=34 Station=0,05 OutputCase=STR184 CaseType=Combination P=-30,3474455676263 V2=70,1176814370276 V3=0 T=0 M2=0 M3=1,459245069497 FrameElem=34-1 ElemStation=0,05

Frame=34 Station=0,1 OutputCase=STR184 CaseType=Combination P=-30,3474455676263 V2=75,9226814370276 V3=0 T=0 M2=0 M3=-2,19176400235438 FrameElem=34-1 ElemStation=0,1

Frame=34 Station=0 OutputCase=STR185 CaseType=Combination P=-16,3781288265974 V2=18,5135936705319 V3=0 T=0 M2=0 M3=-6,82466280390426 FrameElem=34-1 ElemStation=0

Frame=34 Station=0,05 OutputCase=STR185 CaseType=Combination P=-16,3781288265974 V2=19,2135936705319 V3=0 T=0 M2=0 M3=-7,76784248743086 FrameElem=34-1 ElemStation=0,05

Frame=34 Station=0,1 OutputCase=STR185 CaseType=Combination P=-16,3781288265974 V2=19,9135936705319 V3=0 T=0 M2=0 M3=-8,74602217095745 FrameElem=34-1 ElemStation=0,1

Frame=34 Station=0 OutputCase=STR186 CaseType=Combination P=-29,5723817609974 V2=8,15768143718269 V3=0 T=0 M2=0 M3=-2,97236460511103 FrameElem=34-1 ElemStation=0

Frame=34 Station=0,05 OutputCase=STR186 CaseType=Combination P=-29,5723817609974 V2=8,85768143718269 V3=0 T=0 M2=0 M3=-3,39774867697016 FrameElem=34-1 ElemStation=0,05

Frame=34 Station=0,1 OutputCase=STR186 CaseType=Combination P=-29,5723817609974 V2=9,5576814371827 V3=0 T=0 M2=0 M3=-3,8581327488293 FrameElem=34-1 ElemStation=0,1

Frame=34 Station=0 OutputCase=STR187 CaseType=Combination P=-8,09539801124758 V2=10,8526814371868 V3=0 T=0 M2=0 M3=0,311982130285431 FrameElem=34-1 ElemStation=0

Frame=34 Station=0,05 OutputCase=STR187 CaseType=Combination P=-8,09539801124758 V2=11,7976814371868 V3=0 T=0 M2=0 M3=0,254276941573908 FrameElem=34-1 ElemStation=0,05

Frame=34 Station=0,1 OutputCase=STR187 CaseType=Combination P=-8,09539801124758 V2=12,7426814371868 V3=0 T=0 M2=0 M3=-0,867786013433246 FrameElem=34-1 ElemStation=0,1

Frame=34 Station=0 OutputCase=INVSTR CaseType=Combination StepType=Max P=-2,20624457116456 V2=95,314463021494 V3=0 T=0 M2=0 M3=11,3344515962969 FrameElem=34-1 ElemStation=0

Frame=34 Station=0,05 OutputCase=INVSTR CaseType=Combination StepType=Max P=-2,20624457116456 V2=102,739463021494 V3=0 T=0 M2=0 M3=7,08796066816919 FrameElem=34-1 ElemStation=0,05

Frame=34 Station=0,1 OutputCase=INVSTR CaseType=Combination StepType=Max P=-2,20624457116456 V2=110,164463021494 V3=0 T=0 M2=0 M3=2,83051804861906 FrameElem=34-1 ElemStation=0,1

Frame=34 Station=0 OutputCase=INVSTR CaseType=Combination StepType=Min P=-39,0070612738118 V2=6,93719760451643 V3=0 T=0 M2=0 M3=-10,4486561208423 FrameElem=34-1 ElemStation=0

Frame=34 Station=0,05 OutputCase=INVSTR CaseType=Combination StepType=Min P=-39,0070612738118 V2=7,63719760451643 V3=0 T=0 M2=0 M3=-15,2957064438443 FrameElem=34-1 ElemStation=0,05

Frame=34 Station=0,1 OutputCase=INVSTR CaseType=Combination StepType=Min P=-39,0070612738118 V2=8,33719760451643 V3=0 T=0 M2=0 M3=-20,4330067668463 FrameElem=34-1 ElemStation=0,1

Frame=34 Station=0 OutputCase=SIS01 CaseType=Combination P=-11,2004988456104 V2=13,096920277227 V3=0 T=0 M2=0 M3=-3,43946147033612 FrameElem=34-1 ElemStation=0

Frame=34 Station=0,05 OutputCase=SIS01 CaseType=Combination P=-11,3559988456104 V2=13,773520277227 V3=0 T=0 M2=0 M3=-4,11122248419747 FrameElem=34-1 ElemStation=0,05

Frame=34 Station=0,1 OutputCase=SIS01 CaseType=Combination P=-11,5114988456104 V2=14,450120277227 V3=0 T=0 M2=0 M3=-4,81681349805882 FrameElem=34-1 ElemStation=0,1

Frame=34 Station=0 OutputCase=SIS02 CaseType=Combination P=-11,5836080980674 V2=13,096920277227 V3=0 T=0 M2=0 M3=-3,75734064909851 FrameElem=34-1 ElemStation=0

Frame=34 Station=0,05 OutputCase=SIS02 CaseType=Combination P=-11,7391080980674 V2=13,773520277227 V3=0 T=0 M2=0 M3=-4,42910166295986 FrameElem=34-1 ElemStation=0,05

Frame=34 Station=0,1 OutputCase=SIS02 CaseType=Combination P=-11,8946080980674 V2=14,450120277227 V3=0 T=0 M2=0 M3=-5,13469267682122 FrameElem=34-1 ElemStation=0,1

Frame=34 Station=0 OutputCase=SIS03 CaseType=Combination P=-10,8173895931535 V2=13,0969202772269 V3=0 T=0 M2=0 M3=-3,12158229157373 FrameElem=34-1 ElemStation=0

Frame=34 Station=0,05 OutputCase=SIS03 CaseType=Combination P=-10,9728895931535 V2=13,7735202772269 V3=0 T=0 M2=0 M3=-3,79334330543508 FrameElem=34-1 ElemStation=0,05

Frame=34 Station=0,1 OutputCase=SIS03 CaseType=Combination P=-11,1283895931535 V2=14,4501202772269 V3=0 T=0 M2=0 M3=-4,49893431929642 FrameElem=34-1 ElemStation=0,1

Frame=34 Station=0 OutputCase=SIS04 CaseType=Combination P=-11,0415592562293 V2=12,7790859458035 V3=0 T=0 M2=0 M3=-3,04402120474901 FrameElem=34-1 ElemStation=0

Frame=34 Station=0,05 OutputCase=SIS04 CaseType=Combination P=-11,1970592562293 V2=13,4556859458035 V3=0 T=0 M2=0 M3=-3,69989050203918 FrameElem=34-1 ElemStation=0,05

Frame=34 Station=0,1 OutputCase=SIS04 CaseType=Combination P=-11,3525592562293 V2=14,1322859458035 V3=0 T=0 M2=0 M3=-4,38958979932936 FrameElem=34-1 ElemStation=0,1

Frame=34 Station=0 OutputCase=SIS05 CaseType=Combination P=-11,3594384349916 V2=13,4147546086506 V3=0 T=0 M2=0 M3=-3,83490173592323 FrameElem=34-1 ElemStation=0

Frame=34 Station=0,05 OutputCase=SIS05 CaseType=Combination P=-11,5149384349916 V2=14,0913546086506 V3=0 T=0 M2=0 M3=-4,52255446635576 FrameElem=34-1 ElemStation=0,05

Frame=34 Station=0,1 OutputCase=SIS05 CaseType=Combination P=-11,6704384349916 V2=14,7679546086506 V3=0 T=0 M2=0 M3=-5,24403719678829 FrameElem=34-1 ElemStation=0,1

Frame=34 Station=0 OutputCase=SIS06 CaseType=Combination P=-10,8173895931535 V2=13,0969202772269 V3=0 T=0 M2=0 M3=-3,12158229157373 FrameElem=34-1 ElemStation=0

Frame=34 Station=0,05 OutputCase=SIS06 CaseType=Combination P=-10,9728895931535 V2=13,7735202772269 V3=0 T=0 M2=0 M3=-3,79334330543508 FrameElem=34-1 ElemStation=0,05

Frame=34 Station=0,1 OutputCase=SIS06 CaseType=Combination P=-11,1283895931535 V2=14,4501202772269 V3=0 T=0 M2=0 M3=-4,49893431929642 FrameElem=34-1 ElemStation=0,1

Frame=34 Station=0 OutputCase=SIS07 CaseType=Combination P=-11,4246685086862 V2=12,7790859458036 V3=0 T=0 M2=0 M3=-3,3619003835114 FrameElem=34-1 ElemStation=0

Frame=34 Station=0,05 OutputCase=SIS07 CaseType=Combination P=-11,5801685086862 V2=13,4556859458036 V3=0 T=0 M2=0 M3=-4,01776968080158 FrameElem=34-1 ElemStation=0,05

Società di Progetto
Brebemi SpA

	Doc. N. 60235-00000-A00.doc	CODIFICA DOCUMENTO 04RCDII10000000000300A00	REV. 00	FOGLIO 452 di 628
--	--------------------------------	--	------------	----------------------

Frame=34 ElemStation=0,1	Station=0,1	OutputCase=SIS07	CaseType=Combination	P=-11,7356685086862	V2=14,1322859458036	V3=0	T=0	M2=0	M3=-4,70746897809176	FrameElem=34-1
Frame=34 ElemStation=0	Station=0	OutputCase=SIS08	CaseType=Combination	P=-11,7425476874486	V2=13,4147546086507	V3=0	T=0	M2=0	M3=-4,15278091468562	FrameElem=34-1
Frame=34 ElemStation=0,05	Station=0,05	OutputCase=SIS08	CaseType=Combination	P=-11,8980476874486	V2=14,0913546086507	V3=0	T=0	M2=0	M3=-4,84043364511815	FrameElem=34-1
Frame=34 ElemStation=0,1	Station=0,1	OutputCase=SIS08	CaseType=Combination	P=-12,0535476874486	V2=14,7679546086507	V3=0	T=0	M2=0	M3=-5,56191637555069	FrameElem=34-1
Frame=34 ElemStation=0	Station=0	OutputCase=SIS09	CaseType=Combination	P=-11,2004988456104	V2=13,096920277227	V3=0	T=0	M2=0	M3=-3,43946147033612	FrameElem=34-1
Frame=34 ElemStation=0,05	Station=0,05	OutputCase=SIS09	CaseType=Combination	P=-11,3559988456104	V2=13,773520277227	V3=0	T=0	M2=0	M3=-4,1122248419747	FrameElem=34-1
Frame=34 ElemStation=0,1	Station=0,1	OutputCase=SIS09	CaseType=Combination	P=-11,5114988456104	V2=14,450120277227	V3=0	T=0	M2=0	M3=-4,81681349805882	FrameElem=34-1
Frame=34 ElemStation=0	Station=0	OutputCase=SIS10	CaseType=Combination	P=-11,1597277743797	V2=13,6117202772271	V3=0	T=0	M2=0	M3=-3,35501797245151	FrameElem=34-1
Frame=34 ElemStation=0,05	Station=0,05	OutputCase=SIS10	CaseType=Combination	P=-11,3152277743797	V2=14,3351202772271	V3=0	T=0	M2=0	M3=-4,05368898631287	FrameElem=34-1
Frame=34 ElemStation=0,1	Station=0,1	OutputCase=SIS10	CaseType=Combination	P=-11,4707277743797	V2=15,0585202772271	V3=0	T=0	M2=0	M3=-4,78853000017423	FrameElem=34-1
Frame=34 ElemStation=0	Station=0	OutputCase=SIS11	CaseType=Combination	P=-11,5428370268367	V2=13,6117202772272	V3=0	T=0	M2=0	M3=-3,6728971512139	FrameElem=34-1
Frame=34 ElemStation=0,05	Station=0,05	OutputCase=SIS11	CaseType=Combination	P=-11,6983370268367	V2=14,3351202772272	V3=0	T=0	M2=0	M3=-4,37156816507526	FrameElem=34-1
Frame=34 ElemStation=0,1	Station=0,1	OutputCase=SIS11	CaseType=Combination	P=-11,8538370268367	V2=15,0585202772272	V3=0	T=0	M2=0	M3=-5,10640917893663	FrameElem=34-1
Frame=34 ElemStation=0	Station=0	OutputCase=SIS12	CaseType=Combination	P=-10,7766185219228	V2=13,611720277227	V3=0	T=0	M2=0	M3=-3,03713879368913	FrameElem=34-1
Frame=34 ElemStation=0,05	Station=0,05	OutputCase=SIS12	CaseType=Combination	P=-10,9321185219228	V2=14,335120277227	V3=0	T=0	M2=0	M3=-3,73580980755048	FrameElem=34-1
Frame=34 ElemStation=0,1	Station=0,1	OutputCase=SIS12	CaseType=Combination	P=-11,0876185219228	V2=15,058520277227	V3=0	T=0	M2=0	M3=-4,47065082141183	FrameElem=34-1
Frame=34 ElemStation=0	Station=0	OutputCase=SIS13	CaseType=Combination	P=-11,0007881849985	V2=13,2938859458036	V3=0	T=0	M2=0	M3=-2,9595777068644	FrameElem=34-1
Frame=34 ElemStation=0,05	Station=0,05	OutputCase=SIS13	CaseType=Combination	P=-11,1562881849985	V2=14,0172859458036	V3=0	T=0	M2=0	M3=-3,64235700415458	FrameElem=34-1
Frame=34 ElemStation=0,1	Station=0,1	OutputCase=SIS13	CaseType=Combination	P=-11,3117881849985	V2=14,7406859458036	V3=0	T=0	M2=0	M3=-4,36130630144477	FrameElem=34-1
Frame=34 ElemStation=0	Station=0	OutputCase=SIS14	CaseType=Combination	P=-11,3186673637609	V2=13,9295546086507	V3=0	T=0	M2=0	M3=-3,75045823803863	FrameElem=34-1
Frame=34 ElemStation=0,05	Station=0,05	OutputCase=SIS14	CaseType=Combination	P=-11,4741673637609	V2=14,6529546086507	V3=0	T=0	M2=0	M3=-4,46502096847116	FrameElem=34-1
Frame=34 ElemStation=0,1	Station=0,1	OutputCase=SIS14	CaseType=Combination	P=-11,6296673637609	V2=15,3763546086507	V3=0	T=0	M2=0	M3=-5,21575369890369	FrameElem=34-1
Frame=34 ElemStation=0	Station=0	OutputCase=SIS15	CaseType=Combination	P=-10,7766185219228	V2=13,611720277227	V3=0	T=0	M2=0	M3=-3,03713879368913	FrameElem=34-1
Frame=34 ElemStation=0,05	Station=0,05	OutputCase=SIS15	CaseType=Combination	P=-10,9321185219228	V2=14,335120277227	V3=0	T=0	M2=0	M3=-3,73580980755048	FrameElem=34-1
Frame=34 ElemStation=0,1	Station=0,1	OutputCase=SIS15	CaseType=Combination	P=-11,0876185219228	V2=15,058520277227	V3=0	T=0	M2=0	M3=-4,47065082141183	FrameElem=34-1
Frame=34 ElemStation=0	Station=0	OutputCase=SIS16	CaseType=Combination	P=-11,3838974374555	V2=13,2938859458037	V3=0	T=0	M2=0	M3=-3,27745688562679	FrameElem=34-1
Frame=34 ElemStation=0,05	Station=0,05	OutputCase=SIS16	CaseType=Combination	P=-11,5393974374555	V2=14,0172859458037	V3=0	T=0	M2=0	M3=-3,96023618291698	FrameElem=34-1
Frame=34 ElemStation=0,1	Station=0,1	OutputCase=SIS16	CaseType=Combination	P=-11,6948974374555	V2=14,7406859458037	V3=0	T=0	M2=0	M3=-4,67918548020716	FrameElem=34-1
Frame=34 ElemStation=0	Station=0	OutputCase=SIS17	CaseType=Combination	P=-11,7017766162179	V2=13,9295546086508	V3=0	T=0	M2=0	M3=-4,06833741680101	FrameElem=34-1
Frame=34 ElemStation=0,05	Station=0,05	OutputCase=SIS17	CaseType=Combination	P=-11,8572766162179	V2=14,6529546086508	V3=0	T=0	M2=0	M3=-4,78290014723355	FrameElem=34-1
Frame=34 ElemStation=0,1	Station=0,1	OutputCase=SIS17	CaseType=Combination	P=-12,0127766162179	V2=15,3763546086508	V3=0	T=0	M2=0	M3=-5,53363287766609	FrameElem=34-1
Frame=34 ElemStation=0	Station=0	OutputCase=SIS18	CaseType=Combination	P=-11,1597277743797	V2=13,6117202772271	V3=0	T=0	M2=0	M3=-3,35501797245151	FrameElem=34-1
Frame=34 ElemStation=0,05	Station=0,05	OutputCase=SIS18	CaseType=Combination	P=-11,3152277743797	V2=14,3351202772271	V3=0	T=0	M2=0	M3=-4,05368898631287	FrameElem=34-1
Frame=34 ElemStation=0,1	Station=0,1	OutputCase=SIS18	CaseType=Combination	P=-11,4707277743797	V2=15,0585202772271	V3=0	T=0	M2=0	M3=-4,78853000017423	FrameElem=34-1
Frame=34 ElemStation=0	Station=0	OutputCase=SIS19	CaseType=Combination	P=-10,0507150966522	V2=10,2187733758372	V3=0	T=0	M2=0	M3=-2,28532808874425	FrameElem=34-1
Frame=34 ElemStation=0,05	Station=0,05	OutputCase=SIS19	CaseType=Combination	P=-10,0973650966522	V2=10,8407733758372	V3=0	T=0	M2=0	M3=-2,8118167575361	FrameElem=34-1
Frame=34 ElemStation=0,1	Station=0,1	OutputCase=SIS19	CaseType=Combination	P=-10,1440150966522	V2=11,4627733758372	V3=0	T=0	M2=0	M3=-3,36940542632796	FrameElem=34-1
Frame=34 ElemStation=0	Station=0	OutputCase=SIS20	CaseType=Combination	P=-10,4338243491091	V2=10,2187733758373	V3=0	T=0	M2=0	M3=-2,60320726750663	FrameElem=34-1
Frame=34 ElemStation=0,05	Station=0,05	OutputCase=SIS20	CaseType=Combination	P=-10,4804743491091	V2=10,8407733758373	V3=0	T=0	M2=0	M3=-3,1296959362985	FrameElem=34-1
Frame=34 ElemStation=0,1	Station=0,1	OutputCase=SIS20	CaseType=Combination	P=-10,5271243491091	V2=11,4627733758373	V3=0	T=0	M2=0	M3=-3,68728460509036	FrameElem=34-1
Frame=34 ElemStation=0	Station=0	OutputCase=SIS21	CaseType=Combination	P=-9,66760584419522	V2=10,2187733758371	V3=0	T=0	M2=0	M3=-1,96744890998186	FrameElem=34-1
Frame=34 ElemStation=0,05	Station=0,05	OutputCase=SIS21	CaseType=Combination	P=-9,71425584419521	V2=10,8407733758371	V3=0	T=0	M2=0	M3=-2,4939375787371	FrameElem=34-1
Frame=34 ElemStation=0,1	Station=0,1	OutputCase=SIS21	CaseType=Combination	P=-9,76090584419522	V2=11,4627733758371	V3=0	T=0	M2=0	M3=-3,05152624756557	FrameElem=34-1
Frame=34 ElemStation=0	Station=0	OutputCase=SIS22	CaseType=Combination	P=-9,891775507271	V2=9,90093904441366	V3=0	T=0	M2=0	M3=-1,88988782315713	FrameElem=34-1

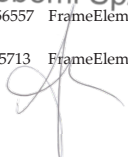
Società di Progetto
Brebemi SpA

Frame=34 ElemStation=0,05	Station=0,05	OutputCase=SIS22	CaseType=Combination	P=-9,938425507271	V2=10,5229390444137	V3=0	T=0	M2=0	M3=-2,4004847753782	FrameElem=34-1
Frame=34 ElemStation=0,1	Station=0,1	OutputCase=SIS22	CaseType=Combination	P=-9,985075507271	V2=11,1449390444137	V3=0	T=0	M2=0	M3=-2,9421817275985	FrameElem=34-1
Frame=34 ElemStation=0	Station=0	OutputCase=SIS23	CaseType=Combination	P=-10,2096546860334	V2=10,5366077072607	V3=0	T=0	M2=0	M3=-2,68076835433136	FrameElem=34-1
Frame=34 ElemStation=0,05	Station=0,05	OutputCase=SIS23	CaseType=Combination	P=-10,2563046860334	V2=11,1586077072607	V3=0	T=0	M2=0	M3=-3,22314873969439	FrameElem=34-1
Frame=34 ElemStation=0,1	Station=0,1	OutputCase=SIS23	CaseType=Combination	P=-10,3029546860334	V2=11,7806077072607	V3=0	T=0	M2=0	M3=-3,79662912505743	FrameElem=34-1
Frame=34 ElemStation=0	Station=0	OutputCase=SIS24	CaseType=Combination	P=-9,66760584419522	V2=10,2187733758371	V3=0	T=0	M2=0	M3=-1,96744890998186	FrameElem=34-1
Frame=34 ElemStation=0,05	Station=0,05	OutputCase=SIS24	CaseType=Combination	P=-9,71425584419521	V2=10,8407733758371	V3=0	T=0	M2=0	M3=-2,49393757877371	FrameElem=34-1
Frame=34 ElemStation=0,1	Station=0,1	OutputCase=SIS24	CaseType=Combination	P=-9,76090584419522	V2=11,4627733758371	V3=0	T=0	M2=0	M3=-3,05152624756557	FrameElem=34-1
Frame=34 ElemStation=0	Station=0	OutputCase=SIS25	CaseType=Combination	P=-10,274884759728	V2=9,90093904441376	V3=0	T=0	M2=0	M3=-2,20776700191952	FrameElem=34-1
Frame=34 ElemStation=0,05	Station=0,05	OutputCase=SIS25	CaseType=Combination	P=-10,321534759728	V2=10,5229390444138	V3=0	T=0	M2=0	M3=-2,71836395414021	FrameElem=34-1
Frame=34 ElemStation=0,1	Station=0,1	OutputCase=SIS25	CaseType=Combination	P=-10,368184759728	V2=11,1449390444138	V3=0	T=0	M2=0	M3=-3,2600609063609	FrameElem=34-1
Frame=34 ElemStation=0	Station=0	OutputCase=SIS26	CaseType=Combination	P=-10,5927639384903	V2=10,5366077072608	V3=0	T=0	M2=0	M3=-2,99864753309374	FrameElem=34-1
Frame=34 ElemStation=0,05	Station=0,05	OutputCase=SIS26	CaseType=Combination	P=-10,6394139384903	V2=11,1586077072608	V3=0	T=0	M2=0	M3=-3,54102791845679	FrameElem=34-1
Frame=34 ElemStation=0,1	Station=0,1	OutputCase=SIS26	CaseType=Combination	P=-10,6860639384903	V2=11,7806077072608	V3=0	T=0	M2=0	M3=-4,11450830381983	FrameElem=34-1
Frame=34 ElemStation=0	Station=0	OutputCase=SIS27	CaseType=Combination	P=-10,0507150966522	V2=10,2187733758372	V3=0	T=0	M2=0	M3=-2,28532808874425	FrameElem=34-1
Frame=34 ElemStation=0,05	Station=0,05	OutputCase=SIS27	CaseType=Combination	P=-10,0973650966522	V2=10,8407733758372	V3=0	T=0	M2=0	M3=-2,8118167575361	FrameElem=34-1
Frame=34 ElemStation=0,1	Station=0,1	OutputCase=SIS27	CaseType=Combination	P=-10,1440150966522	V2=11,4627733758372	V3=0	T=0	M2=0	M3=-3,36940542632796	FrameElem=34-1
Frame=34 ElemStation=0	Station=0	OutputCase=SIS28	CaseType=Combination	P=-9,91481152588311	V2=11,9347733758375	V3=0	T=0	M2=0	M3=-2,00384976246223	FrameElem=34-1
Frame=34 ElemStation=0,05	Station=0,05	OutputCase=SIS28	CaseType=Combination	P=-9,96146152588311	V2=12,7127733758375	V3=0	T=0	M2=0	M3=-2,62003843125411	FrameElem=34-1
Frame=34 ElemStation=0,1	Station=0,1	OutputCase=SIS28	CaseType=Combination	P=-10,0081115258831	V2=13,4907733758375	V3=0	T=0	M2=0	M3=-3,27512710004599	FrameElem=34-1
Frame=34 ElemStation=0	Station=0	OutputCase=SIS29	CaseType=Combination	P=-10,2979207783401	V2=11,9347733758376	V3=0	T=0	M2=0	M3=-2,32172894122462	FrameElem=34-1
Frame=34 ElemStation=0,05	Station=0,05	OutputCase=SIS29	CaseType=Combination	P=-10,3445707783401	V2=12,7127733758376	V3=0	T=0	M2=0	M3=-2,9379176100165	FrameElem=34-1
Frame=34 ElemStation=0,1	Station=0,1	OutputCase=SIS29	CaseType=Combination	P=-10,3912207783401	V2=13,4907733758376	V3=0	T=0	M2=0	M3=-3,59300627880838	FrameElem=34-1
Frame=34 ElemStation=0	Station=0	OutputCase=SIS30	CaseType=Combination	P=-9,53170227342615	V2=11,9347733758374	V3=0	T=0	M2=0	M3=-1,68597058369984	FrameElem=34-1
Frame=34 ElemStation=0,05	Station=0,05	OutputCase=SIS30	CaseType=Combination	P=-9,57835227342615	V2=12,7127733758374	V3=0	T=0	M2=0	M3=-2,30215925249172	FrameElem=34-1
Frame=34 ElemStation=0,1	Station=0,1	OutputCase=SIS30	CaseType=Combination	P=-9,62500227342615	V2=13,4907733758374	V3=0	T=0	M2=0	M3=-2,95724792128359	FrameElem=34-1
Frame=34 ElemStation=0	Station=0	OutputCase=SIS31	CaseType=Combination	P=-9,75587193650194	V2=11,61939044414	V3=0	T=0	M2=0	M3=-1,60840949687512	FrameElem=34-1
Frame=34 ElemStation=0,05	Station=0,05	OutputCase=SIS31	CaseType=Combination	P=-9,80252193650194	V2=12,394939044414	V3=0	T=0	M2=0	M3=-2,20870644909582	FrameElem=34-1
Frame=34 ElemStation=0,1	Station=0,1	OutputCase=SIS31	CaseType=Combination	P=-9,84917193650194	V2=13,172939044414	V3=0	T=0	M2=0	M3=-2,84790340131652	FrameElem=34-1
Frame=34 ElemStation=0	Station=0	OutputCase=SIS32	CaseType=Combination	P=-10,0737511152643	V2=12,2526077072611	V3=0	T=0	M2=0	M3=-2,39929002804934	FrameElem=34-1
Frame=34 ElemStation=0,05	Station=0,05	OutputCase=SIS32	CaseType=Combination	P=-10,1204011152643	V2=13,0306077072611	V3=0	T=0	M2=0	M3=-3,0313704134124	FrameElem=34-1
Frame=34 ElemStation=0,1	Station=0,1	OutputCase=SIS32	CaseType=Combination	P=-10,1670511152643	V2=13,8086077072611	V3=0	T=0	M2=0	M3=-3,70235079877545	FrameElem=34-1
Frame=34 ElemStation=0	Station=0	OutputCase=SIS33	CaseType=Combination	P=-9,53170227342615	V2=11,9347733758374	V3=0	T=0	M2=0	M3=-1,68597058369984	FrameElem=34-1
Frame=34 ElemStation=0,05	Station=0,05	OutputCase=SIS33	CaseType=Combination	P=-9,57835227342615	V2=12,7127733758374	V3=0	T=0	M2=0	M3=-2,30215925249172	FrameElem=34-1
Frame=34 ElemStation=0,1	Station=0,1	OutputCase=SIS33	CaseType=Combination	P=-9,62500227342615	V2=13,4907733758374	V3=0	T=0	M2=0	M3=-2,95724792128359	FrameElem=34-1
Frame=34 ElemStation=0	Station=0	OutputCase=SIS34	CaseType=Combination	P=-10,1389811889589	V2=11,619390444141	V3=0	T=0	M2=0	M3=-1,92628867563751	FrameElem=34-1
Frame=34 ElemStation=0,05	Station=0,05	OutputCase=SIS34	CaseType=Combination	P=-10,1856311889589	V2=12,3949390444141	V3=0	T=0	M2=0	M3=-2,52658562785821	FrameElem=34-1
Frame=34 ElemStation=0,1	Station=0,1	OutputCase=SIS34	CaseType=Combination	P=-10,2322811889589	V2=13,1729390444141	V3=0	T=0	M2=0	M3=-3,16578258007892	FrameElem=34-1
Frame=34 ElemStation=0	Station=0	OutputCase=SIS35	CaseType=Combination	P=-10,4568603677213	V2=12,2526077072612	V3=0	T=0	M2=0	M3=-2,71716920681173	FrameElem=34-1
Frame=34 ElemStation=0,05	Station=0,05	OutputCase=SIS35	CaseType=Combination	P=-10,5035103677213	V2=13,0306077072612	V3=0	T=0	M2=0	M3=-3,34924959217479	FrameElem=34-1
Frame=34 ElemStation=0,1	Station=0,1	OutputCase=SIS35	CaseType=Combination	P=-10,5501603677213	V2=13,8086077072612	V3=0	T=0	M2=0	M3=-4,02022997753785	FrameElem=34-1
Frame=34 ElemStation=0	Station=0	OutputCase=SIS36	CaseType=Combination	P=-9,91481152588311	V2=11,9347733758375	V3=0	T=0	M2=0	M3=-2,00384976246223	FrameElem=34-1
Frame=34 ElemStation=0,05	Station=0,05	OutputCase=SIS36	CaseType=Combination	P=-9,96146152588311	V2=12,7127733758375	V3=0	T=0	M2=0	M3=-2,62003843125411	FrameElem=34-1
Frame=34 ElemStation=0,1	Station=0,1	OutputCase=SIS36	CaseType=Combination	P=-10,0081115258831	V2=13,4907733758375	V3=0	T=0	M2=0	M3=-3,27512710004599	FrameElem=34-1

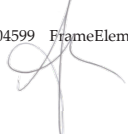



Doc. N.
60235-0000-A00.doc

CODIFICA DOCUMENTO
04RCDII10000000000300A00

REV.
00

FOGLIO
454 di 628

Frame=34 Station=0 OutputCase=INVSIS CaseType=Combination StepType=Max P=-9,53170227342615 V2=13,9295546086508 V3=0 T=0 M2=0 M3=-1,60840949687512
FrameElem=34-1 ElemStation=0
Frame=34 Station=0,05 OutputCase=INVSIS CaseType=Combination StepType=Max P=-9,57835227342615 V2=14,6529546086508 V3=0 T=0 M2=0 M3=-2,20870644909582
FrameElem=34-1 ElemStation=0,05
Frame=34 Station=0,1 OutputCase=INVSIS CaseType=Combination StepType=Max P=-9,62500227342615 V2=15,3763546086508 V3=0 T=0 M2=0 M3=-2,84790340131652
FrameElem=34-1 ElemStation=0,1
Frame=34 Station=0 OutputCase=INVSIS CaseType=Combination StepType=Min P=-11,7425476874486 V2=9,90093904441366 V3=0 T=0 M2=0 M3=-4,15278091468562
FrameElem=34-1 ElemStation=0
Frame=34 Station=0,05 OutputCase=INVSIS CaseType=Combination StepType=Min P=-11,8980476874486 V2=10,5229390444137 V3=0 T=0 M2=0 M3=-4,84043364511815
FrameElem=34-1 ElemStation=0,05
Frame=34 Station=0,1 OutputCase=INVSIS CaseType=Combination StepType=Min P=-12,0535476874486 V2=11,1449390444137 V3=0 T=0 M2=0 M3=-5,56191637555069
FrameElem=34-1 ElemStation=0,1
Frame=34 Station=0 OutputCase=RAR001 CaseType=Combination P=-6,5081386729151 V2=7,69999999995343 V3=0 T=0 M2=0 M3=8,77828242230671E-02 FrameElem=34-1
ElemStation=0
Frame=34 Station=0,05 OutputCase=RAR001 CaseType=Combination P=-6,5081386729151 V2=8,39999999995343 V3=0 T=0 M2=0 M3=-0,314717715774605 FrameElem=34-1
ElemStation=0,05
Frame=34 Station=0,1 OutputCase=RAR001 CaseType=Combination P=-6,5081386729151 V2=9,09999999995343 V3=0 T=0 M2=0 M3=-0,752217715772276 FrameElem=34-1
ElemStation=0,1
Frame=34 Station=0 OutputCase=RAR002 CaseType=Combination P=-4,83460814977495 V2=60,4999999998545 V3=0 T=0 M2=0 M3=7,78501443626647 FrameElem=34-1
ElemStation=0
Frame=34 Station=0,05 OutputCase=RAR002 CaseType=Combination P=-4,83460814977495 V2=65,9999999998545 V3=0 T=0 M2=0 M3=4,62251443627374 FrameElem=34-1
ElemStation=0,05
Frame=34 Station=0,1 OutputCase=RAR002 CaseType=Combination P=-4,83460814977495 V2=71,4999999998545 V3=0 T=0 M2=0 M3=1,18501443628102 FrameElem=34-1
ElemStation=0,1
Frame=34 Station=0 OutputCase=RAR003 CaseType=Combination P=-16,660038859178 V2=69,8411440928176 V3=0 T=0 M2=0 M3=1,02495281807205 FrameElem=34-1
ElemStation=0
Frame=34 Station=0,05 OutputCase=RAR003 CaseType=Combination P=-16,660038859178 V2=75,3411440928176 V3=0 T=0 M2=0 M3=-2,60460438656883 FrameElem=34-1
ElemStation=0,05
Frame=34 Station=0,1 OutputCase=RAR003 CaseType=Combination P=-16,660038859178 V2=80,8411440928176 V3=0 T=0 M2=0 M3=-6,5091615912097 FrameElem=34-1
ElemStation=0,1
Frame=34 Station=0 OutputCase=RAR004 CaseType=Combination P=-28,4854695927954 V2=60,4999999997963 V3=0 T=0 M2=0 M3=4,54014970255685 FrameElem=34-1
ElemStation=0
Frame=34 Station=0,05 OutputCase=RAR004 CaseType=Combination P=-28,4854695927954 V2=65,9999999997963 V3=0 T=0 M2=0 M3=1,37764970256703 FrameElem=34-1
ElemStation=0,05
Frame=34 Station=0,1 OutputCase=RAR004 CaseType=Combination P=-28,4854695927954 V2=71,4999999997963 V3=0 T=0 M2=0 M3=-2,05985029742278 FrameElem=34-1
ElemStation=0,1
Frame=34 Station=0 OutputCase=RAR005 CaseType=Combination P=-15,6998958252378 V2=17,0411440929747 V3=0 T=0 M2=0 M3=-6,23899521041767 FrameElem=34-1
ElemStation=0
Frame=34 Station=0,05 OutputCase=RAR005 CaseType=Combination P=-15,6998958252378 V2=17,7411440929747 V3=0 T=0 M2=0 M3=-7,10855241506641 FrameElem=34-1
ElemStation=0,05
Frame=34 Station=0,1 OutputCase=RAR005 CaseType=Combination P=-15,6998958252378 V2=18,4411440929747 V3=0 T=0 M2=0 M3=-8,01310961971514 FrameElem=34-1
ElemStation=0,1
Frame=34 Station=0 OutputCase=RAR006 CaseType=Combination P=-27,5253265588552 V2=7,69999999995343 V3=0 T=0 M2=0 M3=-2,72379832593288 FrameElem=34-1
ElemStation=0
Frame=34 Station=0,05 OutputCase=RAR006 CaseType=Combination P=-27,5253265588552 V2=8,39999999995343 V3=0 T=0 M2=0 M3=-3,12629832593055 FrameElem=34-1
ElemStation=0,05
Frame=34 Station=0,1 OutputCase=RAR006 CaseType=Combination P=-27,5253265588552 V2=9,09999999995343 V3=0 T=0 M2=0 M3=-3,56379832592822 FrameElem=34-1
ElemStation=0,1
Frame=34 Station=0 OutputCase=RAR007 CaseType=Combination P=-22,977854612678 V2=68,8959910843332 V3=0 T=0 M2=0 M3=-7,17975245808452 FrameElem=34-1
ElemStation=0
Frame=34 Station=0,05 OutputCase=RAR007 CaseType=Combination P=-23,812854612678 V2=73,1959910843332 V3=0 T=0 M2=0 M3=-10,7320520123012 FrameElem=34-1
ElemStation=0,05
Frame=34 Station=0,1 OutputCase=RAR007 CaseType=Combination P=-24,647854612678 V2=77,4959910843332 V3=0 T=0 M2=0 M3=-14,4993515665178 FrameElem=34-1
ElemStation=0,1
Frame=34 Station=0 OutputCase=RAR008 CaseType=Combination P=-4,6406836207487 V2=7,7000000001185 V3=0 T=0 M2=0 M3=-0,114691949748032 FrameElem=34-1
ElemStation=0
Frame=34 Station=0,05 OutputCase=RAR008 CaseType=Combination P=-4,6406836207487 V2=8,4000000001185 V3=0 T=0 M2=0 M3=-0,517191949748625 FrameElem=34-1
ElemStation=0,05
Frame=34 Station=0,1 OutputCase=RAR008 CaseType=Combination P=-4,6406836207487 V2=9,1000000001186 V3=0 T=0 M2=0 M3=-0,954691949749217 FrameElem=34-1
ElemStation=0,1
Frame=34 Station=0 OutputCase=RAR009 CaseType=Combination P=-5,29433925272331 V2=60,4999999998546 V3=0 T=0 M2=0 M3=7,4035594217516 FrameElem=34-1
ElemStation=0
Frame=34 Station=0,05 OutputCase=RAR009 CaseType=Combination P=-5,29433925272331 V2=65,9999999998546 V3=0 T=0 M2=0 M3=4,24105942175887 FrameElem=34-1
ElemStation=0,05
Frame=34 Station=0,1 OutputCase=RAR009 CaseType=Combination P=-5,29433925272331 V2=71,4999999998546 V3=0 T=0 M2=0 M3=0,803559421766141 FrameElem=34-1
ElemStation=0,1
Frame=34 Station=0 OutputCase=RAR010 CaseType=Combination P=-17,1197699621263 V2=69,8411440928177 V3=0 T=0 M2=0 M3=0,643497803557187 FrameElem=34-1
ElemStation=0
Frame=34 Station=0,05 OutputCase=RAR010 CaseType=Combination P=-17,1197699621263 V2=75,3411440928177 V3=0 T=0 M2=0 M3=-2,9860594010837 FrameElem=34-1
ElemStation=0,05
Frame=34 Station=0,1 OutputCase=RAR010 CaseType=Combination P=-17,1197699621263 V2=80,8411440928177 V3=0 T=0 M2=0 M3=-6,89061660572458 FrameElem=34-1
ElemStation=0,1
Frame=34 Station=0 OutputCase=RAR011 CaseType=Combination P=-28,9452006957437 V2=60,4999999997964 V3=0 T=0 M2=0 M3=4,15869468804198 FrameElem=34-1
ElemStation=0
Frame=34 Station=0,05 OutputCase=RAR011 CaseType=Combination P=-28,9452006957437 V2=65,9999999997964 V3=0 T=0 M2=0 M3=0,996194688052161 FrameElem=34-1
ElemStation=0,05
Frame=34 Station=0,1 OutputCase=RAR011 CaseType=Combination P=-28,9452006957437 V2=71,4999999997964 V3=0 T=0 M2=0 M3=-2,44130531193766 FrameElem=34-1
ElemStation=0,1
Frame=34 Station=0 OutputCase=RAR012 CaseType=Combination P=-16,1596269281861 V2=17,0411440929748 V3=0 T=0 M2=0 M3=-6,62045022493253 FrameElem=34-1
ElemStation=0
Frame=34 Station=0,05 OutputCase=RAR012 CaseType=Combination P=-16,1596269281861 V2=17,7411440929748 V3=0 T=0 M2=0 M3=-7,49000742958128 FrameElem=34-1
ElemStation=0,05
Frame=34 Station=0,1 OutputCase=RAR012 CaseType=Combination P=-16,1596269281861 V2=18,4411440929748 V3=0 T=0 M2=0 M3=-8,39456463423002 FrameElem=34-1
ElemStation=0,1
Frame=34 Station=0 OutputCase=RAR013 CaseType=Combination P=-27,9850576618035 V2=7,69999999995356 V3=0 T=0 M2=0 M3=-3,10525334044774 FrameElem=34-1
ElemStation=0
Frame=34 Station=0,05 OutputCase=RAR013 CaseType=Combination P=-27,9850576618035 V2=8,39999999995356 V3=0 T=0 M2=0 M3=-3,50775334044542 FrameElem=34-1
ElemStation=0,05

Società di Progetto
Brebemi SpA



Doc. N.
60235-0000-A00.doc

CODIFICA DOCUMENTO
04RCDII10000000000300A00

REV.
00

FOGLIO
455 di 628

Frame=34 Station=0,1 OutputCase=RAR013 CaseType=Combination P=-27,9850576618035 V2=9,09999999995356 V3=0 T=0 M2=0 M3=-3,9452533404431 FrameElem=34-1 ElemStation=0,1

Frame=34 Station=0 OutputCase=RAR014 CaseType=Combination P=-23,4375857156263 V2=68,8959910843333 V3=0 T=0 M2=0 M3=-7,56120747259939 FrameElem=34-1 ElemStation=0

Frame=34 Station=0,05 OutputCase=RAR014 CaseType=Combination P=-24,2725857156263 V2=73,1959910843334 V3=0 T=0 M2=0 M3=-11,1135070268161 FrameElem=34-1 ElemStation=0,05

Frame=34 Station=0,1 OutputCase=RAR014 CaseType=Combination P=-25,1075857156263 V2=77,4959910843334 V3=0 T=0 M2=0 M3=-14,8808065810327 FrameElem=34-1 ElemStation=0,1

Frame=34 Station=0 OutputCase=RAR015 CaseType=Combination P=-5,36079089620383 V2=47,2999999999894 V3=0 T=0 M2=0 M3=5,33326907161926 FrameElem=34-1 ElemStation=0

Frame=34 Station=0,05 OutputCase=RAR015 CaseType=Combination P=-5,36079089620383 V2=51,5999999999894 V3=0 T=0 M2=0 M3=2,86076907162456 FrameElem=34-1 ElemStation=0,05

Frame=34 Station=0,1 OutputCase=RAR015 CaseType=Combination P=-5,36079089620383 V2=55,8999999999894 V3=0 T=0 M2=0 M3=0,173269071629862 FrameElem=34-1 ElemStation=0,1

Frame=34 Station=0 OutputCase=RAR016 CaseType=Combination P=-14,5590731226583 V2=54,5479075364349 V3=0 T=0 M2=0 M3=7,59351357742055E-02 FrameElem=34-1 ElemStation=0

Frame=34 Station=0,05 OutputCase=RAR016 CaseType=Combination P=-14,5590731226583 V2=58,8479075364349 V3=0 T=0 M2=0 M3=-2,75896024104754 FrameElem=34-1 ElemStation=0,05

Frame=34 Station=0,1 OutputCase=RAR016 CaseType=Combination P=-14,5590731226583 V2=63,1479075364349 V3=0 T=0 M2=0 M3=-5,80885561786928 FrameElem=34-1 ElemStation=0,1

Frame=34 Station=0 OutputCase=RAR017 CaseType=Combination P=-23,7573553677392 V2=47,29999999998358 V3=0 T=0 M2=0 M3=2,79129949044863 FrameElem=34-1 ElemStation=0

Frame=34 Station=0,05 OutputCase=RAR017 CaseType=Combination P=-23,7573553677392 V2=51,59999999998358 V3=0 T=0 M2=0 M3=0,318799490456837 FrameElem=34-1 ElemStation=0,05

Frame=34 Station=0,1 OutputCase=RAR017 CaseType=Combination P=-23,7573553677392 V2=55,89999999998358 V3=0 T=0 M2=0 M3=-2,36870050953495 FrameElem=34-1 ElemStation=0,1

Frame=34 Station=0 OutputCase=RAR018 CaseType=Combination P=-13,8389658472032 V2=14,9479075365527 V3=0 T=0 M2=0 M3=-5,37202588559309 FrameElem=34-1 ElemStation=0

Frame=34 Station=0,05 OutputCase=RAR018 CaseType=Combination P=-13,8389658472032 V2=15,6479075365527 V3=0 T=0 M2=0 M3=-6,13692126242072 FrameElem=34-1 ElemStation=0,05

Frame=34 Station=0,1 OutputCase=RAR018 CaseType=Combination P=-13,8389658472032 V2=16,3479075365527 V3=0 T=0 M2=0 M3=-6,93681663924836 FrameElem=34-1 ElemStation=0,1

Frame=34 Station=0 OutputCase=RAR019 CaseType=Combination P=-23,0372480922841 V2=7,69999999995365 V3=0 T=0 M2=0 M3=-2,65666153091867 FrameElem=34-1 ElemStation=0

Frame=34 Station=0,05 OutputCase=RAR019 CaseType=Combination P=-23,0372480922841 V2=8,39999999995365 V3=0 T=0 M2=0 M3=-3,05916153091635 FrameElem=34-1 ElemStation=0,05

Frame=34 Station=0,1 OutputCase=RAR019 CaseType=Combination P=-23,0372480922841 V2=9,09999999995365 V3=0 T=0 M2=0 M3=-3,49666153091403 FrameElem=34-1 ElemStation=0,1

Frame=34 Station=0 OutputCase=RAR020 CaseType=Combination P=-4,44995611349128 V2=7,31859880230361 V3=0 T=0 M2=0 M3=0,359836368956501 FrameElem=34-1 ElemStation=0

Frame=34 Station=0,05 OutputCase=RAR020 CaseType=Combination P=-4,44995611349128 V2=8,01859880230361 V3=0 T=0 M2=0 M3=-2,35935711586794E-02 FrameElem=34-1 ElemStation=0,05

Frame=34 Station=0,1 OutputCase=RAR020 CaseType=Combination P=-4,44995611349128 V2=8,71859880230362 V3=0 T=0 M2=0 M3=-0,44202351127386 FrameElem=34-1 ElemStation=0,1

Frame=34 Station=0 OutputCase=RAR021 CaseType=Combination P=-5,17006338894642 V2=46,9185988021857 V3=0 T=0 M2=0 M3=5,807797390323279 FrameElem=34-1 ElemStation=0

Frame=34 Station=0,05 OutputCase=RAR021 CaseType=Combination P=-5,17006338894642 V2=51,2185988021857 V3=0 T=0 M2=0 M3=3,35436745021451 FrameElem=34-1 ElemStation=0,05

Frame=34 Station=0,1 OutputCase=RAR021 CaseType=Combination P=-5,17006338894642 V2=55,5185988021858 V3=0 T=0 M2=0 M3=0,68593751010522 FrameElem=34-1 ElemStation=0,1

Frame=34 Station=0 OutputCase=RAR022 CaseType=Combination P=-14,3683456154009 V2=54,1665063387266 V3=0 T=0 M2=0 M3=0,550463454478739 FrameElem=34-1 ElemStation=0

Frame=34 Station=0,05 OutputCase=RAR022 CaseType=Combination P=-14,3683456154009 V2=58,4665063387266 V3=0 T=0 M2=0 M3=-2,26536186245759 FrameElem=34-1 ElemStation=0,05

Frame=34 Station=0,1 OutputCase=RAR022 CaseType=Combination P=-14,3683456154009 V2=62,7665063387266 V3=0 T=0 M2=0 M3=-5,29618717939392 FrameElem=34-1 ElemStation=0,1

Frame=34 Station=0 OutputCase=RAR023 CaseType=Combination P=-23,5666278604818 V2=46,9185988021275 V3=0 T=0 M2=0 M3=3,26582780915316 FrameElem=34-1 ElemStation=0

Frame=34 Station=0,05 OutputCase=RAR023 CaseType=Combination P=-23,5666278604818 V2=51,2185988021275 V3=0 T=0 M2=0 M3=0,812397869046782 FrameElem=34-1 ElemStation=0,05

Frame=34 Station=0,1 OutputCase=RAR023 CaseType=Combination P=-23,5666278604818 V2=55,5185988021275 V3=0 T=0 M2=0 M3=-1,85603207105959 FrameElem=34-1 ElemStation=0,1

Frame=34 Station=0 OutputCase=RAR024 CaseType=Combination P=-13,6482383399458 V2=14,5665063388445 V3=0 T=0 M2=0 M3=-4,89749756688855 FrameElem=34-1 ElemStation=0

Frame=34 Station=0,05 OutputCase=RAR024 CaseType=Combination P=-13,6482383399458 V2=15,2665063388445 V3=0 T=0 M2=0 M3=-5,64332288383078 FrameElem=34-1 ElemStation=0,05

Frame=34 Station=0,1 OutputCase=RAR024 CaseType=Combination P=-13,6482383399458 V2=15,9665063388445 V3=0 T=0 M2=0 M3=-6,424148200773 FrameElem=34-1 ElemStation=0,1

Frame=34 Station=0 OutputCase=RAR025 CaseType=Combination P=-22,8465205850267 V2=7,31859880224541 V3=0 T=0 M2=0 M3=-2,18213321221413 FrameElem=34-1 ElemStation=0

Frame=34 Station=0,05 OutputCase=RAR025 CaseType=Combination P=-22,8465205850267 V2=8,01859880224541 V3=0 T=0 M2=0 M3=-2,5655631523264 FrameElem=34-1 ElemStation=0,05

Frame=34 Station=0,1 OutputCase=RAR025 CaseType=Combination P=-22,8465205850267 V2=8,71859880224541 V3=0 T=0 M2=0 M3=-2,98399309243867 FrameElem=34-1 ElemStation=0,1

Frame=34 Station=0 OutputCase=RAR026 CaseType=Combination P=-4,83141112800611 V2=8,08140119772009 V3=0 T=0 M2=0 M3=0,589220268452565 FrameElem=34-1 ElemStation=0

Frame=34 Station=0,05 OutputCase=RAR026 CaseType=Combination P=-4,83141112800611 V2=8,78140119772009 V3=0 T=0 M2=0 M3=-1,01079032833857 FrameElem=34-1 ElemStation=0,05

Frame=34 Station=0,1 OutputCase=RAR026 CaseType=Combination P=-4,83141112800611 V2=9,48140119772009 V3=0 T=0 M2=0 M3=-1,46736038822457 FrameElem=34-1 ElemStation=0,1

Frame=34 Station=0 OutputCase=RAR027 CaseType=Combination P=-5,55151840346124 V2=47,6814011976022 V3=0 T=0 M2=0 M3=4,85874075291473 FrameElem=34-1 ElemStation=0

Frame=34 Station=0,05 OutputCase=RAR027 CaseType=Combination P=-5,55151840346124 V2=51,9814011976022 V3=0 T=0 M2=0 M3=2,36717069303462 FrameElem=34-1 ElemStation=0,05

Frame=34 Station=0,1 OutputCase=RAR027 CaseType=Combination P=-5,55151840346124 V2=56,2814011976022 V3=0 T=0 M2=0 M3=-0,339399366845495 FrameElem=34-1 ElemStation=0,1

Frame=34 Station=0 OutputCase=RAR028 CaseType=Combination P=-14,7498006299157 V2=54,9293087341431 V3=0 T=0 M2=0 M3=0,398593182930328 FrameElem=34-1 ElemStation=0

Società di Progetto
Brebemi SpA



Doc. N.
60235-0000-A00.doc

CODIFICA DOCUMENTO
04RCDII10000000000300A00

REV.
00

FOGLIO
456 di 628

Frame=34 Station=0,05 OutputCase=RAR028 CaseType=Combination P=-14,7498006299157 V2=59,2293087341431 V3=0 T=0 M2=0 M3=-3,25255861963748 FrameElem=34-1 ElemStation=0,05
Frame=34 Station=0,1 OutputCase=RAR028 CaseType=Combination P=-14,7498006299157 V2=63,5293087341431 V3=0 T=0 M2=0 M3=-6,32152405634464 FrameElem=34-1 ElemStation=0,1
Frame=34 Station=0 OutputCase=RAR029 CaseType=Combination P=-23,9480828749966 V2=47,681401197544 V3=0 T=0 M2=0 M3=2,31677117174409 FrameElem=34-1 ElemStation=0
Frame=34 Station=0,05 OutputCase=RAR029 CaseType=Combination P=-23,9480828749966 V2=51,981401197544 V3=0 T=0 M2=0 M3=-0,174798888133108 FrameElem=34-1 ElemStation=0,05
Frame=34 Station=0,1 OutputCase=RAR029 CaseType=Combination P=-23,9480828749966 V2=56,281401197544 V3=0 T=0 M2=0 M3=2,88136894801031 FrameElem=34-1 ElemStation=0,1
Frame=34 Station=0 OutputCase=RAR030 CaseType=Combination P=-14,0296933544606 V2=15,329308734261 V3=0 T=0 M2=0 M3=-5,84655420429762 FrameElem=34-1 ElemStation=0
Frame=34 Station=0,05 OutputCase=RAR030 CaseType=Combination P=-14,0296933544606 V2=16,029308734261 V3=0 T=0 M2=0 M3=-6,63051964101067 FrameElem=34-1 ElemStation=0,05
Frame=34 Station=0,1 OutputCase=RAR030 CaseType=Combination P=-14,0296933544606 V2=16,729308734261 V3=0 T=0 M2=0 M3=-7,44948507772372 FrameElem=34-1 ElemStation=0,1
Frame=34 Station=0 OutputCase=RAR031 CaseType=Combination P=-23,2279755995415 V2=8,08140119766189 V3=0 T=0 M2=0 M3=-3,1311898496232 FrameElem=34-1 ElemStation=0
Frame=34 Station=0,05 OutputCase=RAR031 CaseType=Combination P=-23,2279755995415 V2=8,78140119766189 V3=0 T=0 M2=0 M3=-3,55275990950629 FrameElem=34-1 ElemStation=0,05
Frame=34 Station=0,1 OutputCase=RAR031 CaseType=Combination P=-23,2279755995415 V2=9,48140119766189 V3=0 T=0 M2=0 M3=-4,00932996938939 FrameElem=34-1 ElemStation=0,1
Frame=34 Station=0 OutputCase=RAR032 CaseType=Combination P=-4,18095251780034 V2=7,7000000001173 V3=0 T=0 M2=0 M3=0,266763064766833 FrameElem=34-1 ElemStation=0
Frame=34 Station=0,05 OutputCase=RAR032 CaseType=Combination P=-4,18095251780034 V2=8,4000000001173 V3=0 T=0 M2=0 M3=-0,135736935233753 FrameElem=34-1 ElemStation=0,05
Frame=34 Station=0,1 OutputCase=RAR032 CaseType=Combination P=-4,18095251780034 V2=9,1000000001173 V3=0 T=0 M2=0 M3=-0,573236935234339 FrameElem=34-1 ElemStation=0,1
Frame=34 Station=0 OutputCase=RAR033 CaseType=Combination P=-4,90105979325548 V2=47,2999999998939 V3=0 T=0 M2=0 M3=5,71472408613412 FrameElem=34-1 ElemStation=0
Frame=34 Station=0,05 OutputCase=RAR033 CaseType=Combination P=-4,90105979325548 V2=51,5999999998939 V3=0 T=0 M2=0 M3=3,24222408613943 FrameElem=34-1 ElemStation=0,05
Frame=34 Station=0,1 OutputCase=RAR033 CaseType=Combination P=-4,90105979325548 V2=55,8999999998939 V3=0 T=0 M2=0 M3=0,55472408614474 FrameElem=34-1 ElemStation=0,1
Frame=34 Station=0 OutputCase=RAR034 CaseType=Combination P=-14,0993420197099 V2=54,5479075364347 V3=0 T=0 M2=0 M3=0,457390150289071 FrameElem=34-1 ElemStation=0
Frame=34 Station=0,05 OutputCase=RAR034 CaseType=Combination P=-14,0993420197099 V2=58,8479075364347 V3=0 T=0 M2=0 M3=-2,37750522653267 FrameElem=34-1 ElemStation=0,05
Frame=34 Station=0,1 OutputCase=RAR034 CaseType=Combination P=-14,0993420197099 V2=63,1479075364347 V3=0 T=0 M2=0 M3=-5,4274006033544 FrameElem=34-1 ElemStation=0,1
Frame=34 Station=0 OutputCase=RAR035 CaseType=Combination P=-23,2976242647909 V2=47,2999999998356 V3=0 T=0 M2=0 M3=3,17275450496349 FrameElem=34-1 ElemStation=0
Frame=34 Station=0,05 OutputCase=RAR035 CaseType=Combination P=-23,2976242647909 V2=51,5999999998357 V3=0 T=0 M2=0 M3=0,700254504971708 FrameElem=34-1 ElemStation=0,05
Frame=34 Station=0,1 OutputCase=RAR035 CaseType=Combination P=-23,2976242647909 V2=55,8999999998357 V3=0 T=0 M2=0 M3=-1,98724549502007 FrameElem=34-1 ElemStation=0,1
Frame=34 Station=0 OutputCase=RAR036 CaseType=Combination P=-13,3792347442548 V2=14,9479075365526 V3=0 T=0 M2=0 M3=4,99057087107822 FrameElem=34-1 ElemStation=0
Frame=34 Station=0,05 OutputCase=RAR036 CaseType=Combination P=-13,3792347442548 V2=15,6479075365526 V3=0 T=0 M2=0 M3=-5,75546624790585 FrameElem=34-1 ElemStation=0,05
Frame=34 Station=0,1 OutputCase=RAR036 CaseType=Combination P=-13,3792347442548 V2=16,3479075365526 V3=0 T=0 M2=0 M3=-6,55536162473348 FrameElem=34-1 ElemStation=0,1
Frame=34 Station=0 OutputCase=RAR037 CaseType=Combination P=-22,5775169893357 V2=7,69999999995352 V3=0 T=0 M2=0 M3=-2,2752065164038 FrameElem=34-1 ElemStation=0
Frame=34 Station=0,05 OutputCase=RAR037 CaseType=Combination P=-22,5775169893357 V2=8,39999999995352 V3=0 T=0 M2=0 M3=-2,67770651640148 FrameElem=34-1 ElemStation=0,05
Frame=34 Station=0,1 OutputCase=RAR037 CaseType=Combination P=-22,5775169893357 V2=9,09999999995352 V3=0 T=0 M2=0 M3=-3,11520651639915 FrameElem=34-1 ElemStation=0,1
Frame=34 Station=0 OutputCase=RAR038 CaseType=Combination P=-3,10824661092085 V2=7,7000000001143 V3=0 T=0 M2=0 M3=1,15682476530152 FrameElem=34-1 ElemStation=0
Frame=34 Station=0,05 OutputCase=RAR038 CaseType=Combination P=-3,10824661092085 V2=8,4000000001143 V3=0 T=0 M2=0 M3=0,754324765300947 FrameElem=34-1 ElemStation=0,05
Frame=34 Station=0,1 OutputCase=RAR038 CaseType=Combination P=-3,10824661092085 V2=9,1000000001143 V3=0 T=0 M2=0 M3=0,316824765300376 FrameElem=34-1 ElemStation=0,1
Frame=34 Station=0 OutputCase=RAR039 CaseType=Combination P=-4,3748770468266 V2=60,4999999998544 V3=0 T=0 M2=0 M3=8,16646945078133 FrameElem=34-1 ElemStation=0
Frame=34 Station=0,05 OutputCase=RAR039 CaseType=Combination P=-4,3748770468266 V2=65,9999999998544 V3=0 T=0 M2=0 M3=5,00396945078861 FrameElem=34-1 ElemStation=0,05
Frame=34 Station=0,1 OutputCase=RAR039 CaseType=Combination P=-4,3748770468266 V2=71,4999999998544 V3=0 T=0 M2=0 M3=1,5664694507959 FrameElem=34-1 ElemStation=0,1
Frame=34 Station=0 OutputCase=RAR040 CaseType=Combination P=-16,2003077562296 V2=69,8411440928174 V3=0 T=0 M2=0 M3=1,40640783258692 FrameElem=34-1 ElemStation=0
Frame=34 Station=0,05 OutputCase=RAR040 CaseType=Combination P=-16,2003077562296 V2=75,3411440928174 V3=0 T=0 M2=0 M3=-2,22314937205395 FrameElem=34-1 ElemStation=0,05
Frame=34 Station=0,1 OutputCase=RAR040 CaseType=Combination P=-16,2003077562296 V2=80,8411440928174 V3=0 T=0 M2=0 M3=-6,12770657669483 FrameElem=34-1 ElemStation=0,1
Frame=34 Station=0 OutputCase=RAR041 CaseType=Combination P=-28,025738489847 V2=60,4999999997961 V3=0 T=0 M2=0 M3=4,92160471707171 FrameElem=34-1 ElemStation=0
Frame=34 Station=0,05 OutputCase=RAR041 CaseType=Combination P=-28,025738489847 V2=65,9999999997961 V3=0 T=0 M2=0 M3=1,7591047170819 FrameElem=34-1 ElemStation=0,05
Frame=34 Station=0,1 OutputCase=RAR041 CaseType=Combination P=-28,025738489847 V2=71,4999999997962 V3=0 T=0 M2=0 M3=-1,6783952829079 FrameElem=34-1 ElemStation=0,1
Frame=34 Station=0 OutputCase=RAR042 CaseType=Combination P=-15,2401647222894 V2=17,0411440929746 V3=0 T=0 M2=0 M3=-5,85754019590281 FrameElem=34-1 ElemStation=0
Frame=34 Station=0,05 OutputCase=RAR042 CaseType=Combination P=-15,2401647222894 V2=17,7411440929746 V3=0 T=0 M2=0 M3=-6,72709740055153 FrameElem=34-1 ElemStation=0,05
Frame=34 Station=0,1 OutputCase=RAR042 CaseType=Combination P=-15,2401647222894 V2=18,4411440929746 V3=0 T=0 M2=0 M3=-7,63165460520027 FrameElem=34-1 ElemStation=0,1

Società di Progetto
Brebemi SpA

	Doc. N. 60235-00000-A00.doc	CODIFICA DOCUMENTO 04RCDII10000000000300A00	REV. 00	FOGLIO 457 di 628
--	--------------------------------	--	------------	----------------------

Frame=34 Station=0 OutputCase=RAR043 CaseType=Combination P=-27,0655954559068 V2=7,69999999995331 V3=0 T=0 M2=0 M3=-2,34234331141801 FrameElem=34-1 ElemStation=0

Frame=34 Station=0,05 OutputCase=RAR043 CaseType=Combination P=-27,0655954559068 V2=8,39999999995331 V3=0 T=0 M2=0 M3=-2,74484331141568 FrameElem=34-1 ElemStation=0,05

Frame=34 Station=0,1 OutputCase=RAR043 CaseType=Combination P=-27,0655954559068 V2=9,0999999999533 V3=0 T=0 M2=0 M3=-3,18234331141334 FrameElem=34-1 ElemStation=0,1

Frame=34 Station=0 OutputCase=RAR044 CaseType=Combination P=-22,5181235097296 V2=68,8959910843331 V3=0 T=0 M2=0 M3=-6,79829744356966 FrameElem=34-1 ElemStation=0

Frame=34 Station=0,05 OutputCase=RAR044 CaseType=Combination P=-23,3531235097296 V2=73,1959910843331 V3=0 T=0 M2=0 M3=-10,3505969977863 FrameElem=34-1 ElemStation=0,05

Frame=34 Station=0,1 OutputCase=RAR044 CaseType=Combination P=-24,1881235097296 V2=77,4959910843331 V3=0 T=0 M2=0 M3=-14,117896552003 FrameElem=34-1 ElemStation=0,1

Frame=34 Station=0 OutputCase=RAR045 CaseType=Combination P=-3,82835388637599 V2=47,2999999998936 V3=0 T=0 M2=0 M3=6,60478578666881 FrameElem=34-1 ElemStation=0

Frame=34 Station=0,05 OutputCase=RAR045 CaseType=Combination P=-3,82835388637599 V2=51,5999999998936 V3=0 T=0 M2=0 M3=4,13228578667413 FrameElem=34-1 ElemStation=0,05

Frame=34 Station=0,1 OutputCase=RAR045 CaseType=Combination P=-3,82835388637599 V2=55,8999999998936 V3=0 T=0 M2=0 M3=1,44478578667946 FrameElem=34-1 ElemStation=0,1

Frame=34 Station=0 OutputCase=RAR046 CaseType=Combination P=-13,0266361128305 V2=54,5479075364344 V3=0 T=0 M2=0 M3=1,34745185082376 FrameElem=34-1 ElemStation=0

Frame=34 Station=0,05 OutputCase=RAR046 CaseType=Combination P=-13,0266361128305 V2=58,8479075364344 V3=0 T=0 M2=0 M3=-1,48744352599797 FrameElem=34-1 ElemStation=0,05

Frame=34 Station=0,1 OutputCase=RAR046 CaseType=Combination P=-13,0266361128305 V2=63,1479075364344 V3=0 T=0 M2=0 M3=-4,53733890281969 FrameElem=34-1 ElemStation=0,1

Frame=34 Station=0 OutputCase=RAR047 CaseType=Combination P=-22,2249183579114 V2=47,2999999998354 V3=0 T=0 M2=0 M3=4,06281620549818 FrameElem=34-1 ElemStation=0

Frame=34 Station=0,05 OutputCase=RAR047 CaseType=Combination P=-22,2249183579114 V2=51,5999999998354 V3=0 T=0 M2=0 M3=1,59031620550641 FrameElem=34-1 ElemStation=0,05

Frame=34 Station=0,1 OutputCase=RAR047 CaseType=Combination P=-22,2249183579114 V2=55,8999999998354 V3=0 T=0 M2=0 M3=-1,09718379448536 FrameElem=34-1 ElemStation=0,1

Frame=34 Station=0 OutputCase=RAR048 CaseType=Combination P=-12,3065288373753 V2=14,9479075365523 V3=0 T=0 M2=0 M3=-4,10050917054354 FrameElem=34-1 ElemStation=0

Frame=34 Station=0,05 OutputCase=RAR048 CaseType=Combination P=-12,3065288373753 V2=15,6479075365523 V3=0 T=0 M2=0 M3=-4,86540454737115 FrameElem=34-1 ElemStation=0,05

Frame=34 Station=0,1 OutputCase=RAR048 CaseType=Combination P=-12,3065288373753 V2=16,3479075365523 V3=0 T=0 M2=0 M3=-5,66529992419877 FrameElem=34-1 ElemStation=0,1

Frame=34 Station=0 OutputCase=RAR049 CaseType=Combination P=-21,5048110824562 V2=7,6999999995322 V3=0 T=0 M2=0 M3=-1,38514481586911 FrameElem=34-1 ElemStation=0

Frame=34 Station=0,05 OutputCase=RAR049 CaseType=Combination P=-21,5048110824562 V2=8,3999999995322 V3=0 T=0 M2=0 M3=-1,78764481586678 FrameElem=34-1 ElemStation=0,05

Frame=34 Station=0,1 OutputCase=RAR049 CaseType=Combination P=-21,5048110824562 V2=9,0999999995322 V3=0 T=0 M2=0 M3=-2,22514481586444 FrameElem=34-1 ElemStation=0,1

Frame=34 Station=0 OutputCase=RAR050 CaseType=Combination P=-2,91751910366344 V2=7,31859880230319 V3=0 T=0 M2=0 M3=1,63135308400605 FrameElem=34-1 ElemStation=0

Frame=34 Station=0,05 OutputCase=RAR050 CaseType=Combination P=-2,91751910366344 V2=8,01859880230319 V3=0 T=0 M2=0 M3=1,24792314389089 FrameElem=34-1 ElemStation=0,05

Frame=34 Station=0,1 OutputCase=RAR050 CaseType=Combination P=-2,91751910366344 V2=8,71859880230319 V3=0 T=0 M2=0 M3=0,829493203775733 FrameElem=34-1 ElemStation=0,1

Frame=34 Station=0 OutputCase=RAR051 CaseType=Combination P=-3,63762637911857 V2=46,9185988021853 V3=0 T=0 M2=0 M3=7,07931410537334 FrameElem=34-1 ElemStation=0

Frame=34 Station=0,05 OutputCase=RAR051 CaseType=Combination P=-3,63762637911857 V2=51,2185988021853 V3=0 T=0 M2=0 M3=4,62588416526408 FrameElem=34-1 ElemStation=0,05

Frame=34 Station=0,1 OutputCase=RAR051 CaseType=Combination P=-3,63762637911857 V2=55,5185988021853 V3=0 T=0 M2=0 M3=1,95745422515481 FrameElem=34-1 ElemStation=0,1

Frame=34 Station=0 OutputCase=RAR052 CaseType=Combination P=-12,835908605573 V2=54,1665063387262 V3=0 T=0 M2=0 M3=1,82198016952829 FrameElem=34-1 ElemStation=0

Frame=34 Station=0,05 OutputCase=RAR052 CaseType=Combination P=-12,835908605573 V2=58,4665063387262 V3=0 T=0 M2=0 M3=-0,993845147408021 FrameElem=34-1 ElemStation=0,05

Frame=34 Station=0,1 OutputCase=RAR052 CaseType=Combination P=-12,835908605573 V2=62,7665063387262 V3=0 T=0 M2=0 M3=-4,02467046434433 FrameElem=34-1 ElemStation=0,1

Frame=34 Station=0 OutputCase=RAR053 CaseType=Combination P=-22,034190850654 V2=46,9185988021271 V3=0 T=0 M2=0 M3=4,53734452420271 FrameElem=34-1 ElemStation=0

Frame=34 Station=0,05 OutputCase=RAR053 CaseType=Combination P=-22,034190850654 V2=51,2185988021271 V3=0 T=0 M2=0 M3=2,08391458409635 FrameElem=34-1 ElemStation=0,05

Frame=34 Station=0,1 OutputCase=RAR053 CaseType=Combination P=-22,034190850654 V2=55,5185988021271 V3=0 T=0 M2=0 M3=-0,584515356010001 FrameElem=34-1 ElemStation=0,1

Frame=34 Station=0 OutputCase=RAR054 CaseType=Combination P=-12,1158013301179 V2=14,5665063388441 V3=0 T=0 M2=0 M3=-3,625980851839 FrameElem=34-1 ElemStation=0

Frame=34 Station=0,05 OutputCase=RAR054 CaseType=Combination P=-12,1158013301179 V2=15,2665063388441 V3=0 T=0 M2=0 M3=-4,37180616878121 FrameElem=34-1 ElemStation=0,05

Frame=34 Station=0,1 OutputCase=RAR054 CaseType=Combination P=-12,1158013301179 V2=15,9665063388441 V3=0 T=0 M2=0 M3=-5,15263148572341 FrameElem=34-1 ElemStation=0,1

Frame=34 Station=0 OutputCase=RAR055 CaseType=Combination P=-21,3140835751988 V2=7,31859880224498 V3=0 T=0 M2=0 M3=-0,910616497164582 FrameElem=34-1 ElemStation=0

Frame=34 Station=0,05 OutputCase=RAR055 CaseType=Combination P=-21,3140835751988 V2=8,01859880224498 V3=0 T=0 M2=0 M3=-1,29404643727683 FrameElem=34-1 ElemStation=0,05

Frame=34 Station=0,1 OutputCase=RAR055 CaseType=Combination P=-21,3140835751988 V2=8,71859880224498 V3=0 T=0 M2=0 M3=-1,71247637738908 FrameElem=34-1 ElemStation=0,1

Frame=34 Station=0 OutputCase=RAR056 CaseType=Combination P=-3,29897411817826 V2=8,08140119771967 V3=0 T=0 M2=0 M3=0,682296446596985 FrameElem=34-1 ElemStation=0

Frame=34 Station=0,05 OutputCase=RAR056 CaseType=Combination P=-3,29897411817826 V2=8,78140119771967 V3=0 T=0 M2=0 M3=0,260726386711002 FrameElem=34-1 ElemStation=0,05

Frame=34 Station=0,1 OutputCase=RAR056 CaseType=Combination P=-3,29897411817826 V2=9,48140119771967 V3=0 T=0 M2=0 M3=-0,195842673174982 FrameElem=34-1 ElemStation=0,1

Frame=34 Station=0 OutputCase=RAR057 CaseType=Combination P=-4,0190813936334 V2=47,6814011976018 V3=0 T=0 M2=0 M3=6,13025746796428 FrameElem=34-1 ElemStation=0

Frame=34 Station=0,05 OutputCase=RAR057 CaseType=Combination P=-4,0190813936334 V2=51,9814011976018 V3=0 T=0 M2=0 M3=3,63868740808419 FrameElem=34-1 ElemStation=0,05

Società di Progetto
Brebemi SpA

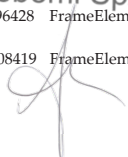



Doc. N.
60235-00000-A00.doc

CODIFICA DOCUMENTO
04RCDII10000000000300A00

REV.
00

FOGLIO
458 di 628

Frame=34 Station=0,1 OutputCase=RAR057 CaseType=Combination P=-4,0190813936334 V2=56,2814011976018 V3=0 T=0 M2=0 M3=0,932117348204098 FrameElem=34-1 ElemStation=0,1
Frame=34 Station=0 OutputCase=RAR058 CaseType=Combination P=-13,2173636200879 V2=54,9293087341427 V3=0 T=0 M2=0 M3=0,872923532119223 FrameElem=34-1 ElemStation=0
Frame=34 Station=0,05 OutputCase=RAR058 CaseType=Combination P=-13,2173636200879 V2=59,2293087341427 V3=0 T=0 M2=0 M3=-1,98104190458791 FrameElem=34-1 ElemStation=0,05
Frame=34 Station=0,1 OutputCase=RAR058 CaseType=Combination P=-13,2173636200879 V2=63,5293087341427 V3=0 T=0 M2=0 M3=-5,050000734129504 FrameElem=34-1 ElemStation=0,1
Frame=34 Station=0 OutputCase=RAR059 CaseType=Combination P=-22,4156458651688 V2=47,6814011975436 V3=0 T=0 M2=0 M3=3,58828788679364 FrameElem=34-1 ElemStation=0
Frame=34 Station=0,05 OutputCase=RAR059 CaseType=Combination P=-22,4156458651688 V2=51,9814011975436 V3=0 T=0 M2=0 M3=1,09671782691646 FrameElem=34-1 ElemStation=0,05
Frame=34 Station=0,1 OutputCase=RAR059 CaseType=Combination P=-22,4156458651688 V2=56,2814011975436 V3=0 T=0 M2=0 M3=-1,60985223296072 FrameElem=34-1 ElemStation=0,1
Frame=34 Station=0 OutputCase=RAR060 CaseType=Combination P=-12,4972563446327 V2=15,3293087342605 V3=0 T=0 M2=0 M3=-4,57503748924807 FrameElem=34-1 ElemStation=0
Frame=34 Station=0,05 OutputCase=RAR060 CaseType=Combination P=-12,4972563446327 V2=16,0293087342605 V3=0 T=0 M2=0 M3=-5,3590029259611 FrameElem=34-1 ElemStation=0,05
Frame=34 Station=0,1 OutputCase=RAR060 CaseType=Combination P=-12,4972563446327 V2=16,7293087342605 V3=0 T=0 M2=0 M3=-6,17796836267412 FrameElem=34-1 ElemStation=0,1
Frame=34 Station=0 OutputCase=RAR061 CaseType=Combination P=-21,6955385897136 V2=8,08140119766146 V3=0 T=0 M2=0 M3=-1,85967313457365 FrameElem=34-1 ElemStation=0
Frame=34 Station=0,05 OutputCase=RAR061 CaseType=Combination P=-21,6955385897136 V2=8,78140119766146 V3=0 T=0 M2=0 M3=-2,28124319445672 FrameElem=34-1 ElemStation=0,05
Frame=34 Station=0,1 OutputCase=RAR061 CaseType=Combination P=-21,6955385897136 V2=9,48140119766146 V3=0 T=0 M2=0 M3=-2,73781325433979 FrameElem=34-1 ElemStation=0,1
Frame=34 Station=0 OutputCase=RAR062 CaseType=Combination P=-2,6485155079725 V2=7,7000000000113 V3=0 T=0 M2=0 M3=1,53827977981638 FrameElem=34-1 ElemStation=0
Frame=34 Station=0,05 OutputCase=RAR062 CaseType=Combination P=-2,6485155079725 V2=8,4000000000113 V3=0 T=0 M2=0 M3=1,13577977981582 FrameElem=34-1 ElemStation=0,05
Frame=34 Station=0,1 OutputCase=RAR062 CaseType=Combination P=-2,6485155079725 V2=9,1000000000113 V3=0 T=0 M2=0 M3=0,698279779815254 FrameElem=34-1 ElemStation=0,1
Frame=34 Station=0 OutputCase=RAR063 CaseType=Combination P=-3,36862278342763 V2=47,2999999998934 V3=0 T=0 M2=0 M3=6,98624080118367 FrameElem=34-1 ElemStation=0
Frame=34 Station=0,05 OutputCase=RAR063 CaseType=Combination P=-3,36862278342763 V2=51,5999999998934 V3=0 T=0 M2=0 M3=4,513740801189 FrameElem=34-1 ElemStation=0,05
Frame=34 Station=0,1 OutputCase=RAR063 CaseType=Combination P=-3,36862278342763 V2=55,8999999998934 V3=0 T=0 M2=0 M3=1,82624080119433 FrameElem=34-1 ElemStation=0,1
Frame=34 Station=0 OutputCase=RAR064 CaseType=Combination P=-12,5669050098821 V2=54,5479075364343 V3=0 T=0 M2=0 M3=1,72890686533862 FrameElem=34-1 ElemStation=0
Frame=34 Station=0,05 OutputCase=RAR064 CaseType=Combination P=-12,5669050098821 V2=58,8479075364343 V3=0 T=0 M2=0 M3=-1,10598851148309 FrameElem=34-1 ElemStation=0,05
Frame=34 Station=0,1 OutputCase=RAR064 CaseType=Combination P=-12,5669050098821 V2=63,1479075364343 V3=0 T=0 M2=0 M3=-4,15588388830481 FrameElem=34-1 ElemStation=0,1
Frame=34 Station=0 OutputCase=RAR065 CaseType=Combination P=-21,765187254963 V2=47,2999999998352 V3=0 T=0 M2=0 M3=4,44427122001304 FrameElem=34-1 ElemStation=0
Frame=34 Station=0,05 OutputCase=RAR065 CaseType=Combination P=-21,765187254963 V2=51,5999999998352 V3=0 T=0 M2=0 M3=1,97177122002128 FrameElem=34-1 ElemStation=0,05
Frame=34 Station=0,1 OutputCase=RAR065 CaseType=Combination P=-21,765187254963 V2=55,8999999998352 V3=0 T=0 M2=0 M3=-0,715728779970481 FrameElem=34-1 ElemStation=0,1
Frame=34 Station=0 OutputCase=RAR066 CaseType=Combination P=-11,846797734427 V2=14,9479075365522 V3=0 T=0 M2=0 M3=-3,71905415602867 FrameElem=34-1 ElemStation=0
Frame=34 Station=0,05 OutputCase=RAR066 CaseType=Combination P=-11,846797734427 V2=15,6479075365522 V3=0 T=0 M2=0 M3=-4,48394953285628 FrameElem=34-1 ElemStation=0,05
Frame=34 Station=0,1 OutputCase=RAR066 CaseType=Combination P=-11,846797734427 V2=16,3479075365522 V3=0 T=0 M2=0 M3=-5,28384490968389 FrameElem=34-1 ElemStation=0,1
Frame=34 Station=0 OutputCase=RAR067 CaseType=Combination P=-21,0450799795079 V2=7,69999999995309 V3=0 T=0 M2=0 M3=-1,00368980135425 FrameElem=34-1 ElemStation=0
Frame=34 Station=0,05 OutputCase=RAR067 CaseType=Combination P=-21,0450799795079 V2=8,39999999995309 V3=0 T=0 M2=0 M3=-1,40618980135191 FrameElem=34-1 ElemStation=0,05
Frame=34 Station=0,1 OutputCase=RAR067 CaseType=Combination P=-21,0450799795079 V2=9,09999999995309 V3=0 T=0 M2=0 M3=-1,84368980134956 FrameElem=34-1 ElemStation=0,1
Frame=34 Station=0 OutputCase=RAR068 CaseType=Combination P=-3,55658593707242 V2=7,06433133716457 V3=0 T=0 M2=0 M3=1,31194693895097 FrameElem=34-1 ElemStation=0
Frame=34 Station=0,05 OutputCase=RAR068 CaseType=Combination P=-3,55658593707242 V2=7,76433133716457 V3=0 T=0 M2=0 M3=0,941230372092737 FrameElem=34-1 ElemStation=0,05
Frame=34 Station=0,1 OutputCase=RAR068 CaseType=Combination P=-3,55658593707242 V2=8,46433133716458 V3=0 T=0 M2=0 M3=0,535513805234508 FrameElem=34-1 ElemStation=0,1
Frame=34 Station=0 OutputCase=RAR069 CaseType=Combination P=-4,64388064251754 V2=60,1185988021462 V3=0 T=0 M2=0 M3=8,259542754971 FrameElem=34-1 ElemStation=0
Frame=34 Station=0,05 OutputCase=RAR069 CaseType=Combination P=-4,64388064251754 V2=65,6185988021462 V3=0 T=0 M2=0 M3=5,11611281486369 FrameElem=34-1 ElemStation=0,05
Frame=34 Station=0,1 OutputCase=RAR069 CaseType=Combination P=-4,64388064251754 V2=71,1185988021463 V3=0 T=0 M2=0 M3=1,69768287475638 FrameElem=34-1 ElemStation=0,1
Frame=34 Station=0 OutputCase=RAR070 CaseType=Combination P=-16,4693113519205 V2=69,4597428951093 V3=0 T=0 M2=0 M3=1,49948113677659 FrameElem=34-1 ElemStation=0
Frame=34 Station=0,05 OutputCase=RAR070 CaseType=Combination P=-16,4693113519205 V2=74,9597428951093 V3=0 T=0 M2=0 M3=-2,11100600797888 FrameElem=34-1 ElemStation=0,05
Frame=34 Station=0,1 OutputCase=RAR070 CaseType=Combination P=-16,4693113519205 V2=80,4597428951093 V3=0 T=0 M2=0 M3=-5,99649315273435 FrameElem=34-1 ElemStation=0,1
Frame=34 Station=0 OutputCase=RAR071 CaseType=Combination P=-28,2947420855379 V2=60,118598802088 V3=0 T=0 M2=0 M3=5,01467802126138 FrameElem=34-1 ElemStation=0
Frame=34 Station=0,05 OutputCase=RAR071 CaseType=Combination P=-28,2947420855379 V2=65,618598802088 V3=0 T=0 M2=0 M3=1,87124808115698 FrameElem=34-1 ElemStation=0,05
Frame=34 Station=0,1 OutputCase=RAR071 CaseType=Combination P=-28,2947420855379 V2=71,118598802088 V3=0 T=0 M2=0 M3=-1,54718185894742 FrameElem=34-1 ElemStation=0,1
Frame=34 Station=0 OutputCase=RAR072 CaseType=Combination P=-15,5091683179804 V2=16,6597428952665 V3=0 T=0 M2=0 M3=-5,76446689171314 FrameElem=34-1 ElemStation=0

Società di Progetto
Brebemi SpA

	Doc. N. 60235-00000-A00.doc	CODIFICA DOCUMENTO 04RCDII10000000000300A00	REV. 00	FOGLIO 459 di 628
--	--------------------------------	--	------------	----------------------

Frame=34 Station=0,05 OutputCase=RAR072 CaseType=Combination P=-15,5091683179804 V2=17,3597428952665 V3=0 T=0 M2=0 M3=-6,61495403647646 FrameElem=34-1 ElemStation=0,05

Frame=34 Station=0,1 OutputCase=RAR072 CaseType=Combination P=-15,5091683179804 V2=18,0597428952665 V3=0 T=0 M2=0 M3=-7,50044118123979 FrameElem=34-1 ElemStation=0,1

Frame=34 Station=0 OutputCase=RAR073 CaseType=Combination P=-27,3345990515978 V2=7,31859880224519 V3=0 T=0 M2=0 M3=-2,24927000722834 FrameElem=34-1 ElemStation=0

Frame=34 Station=0,05 OutputCase=RAR073 CaseType=Combination P=-27,3345990515978 V2=8,01859880224519 V3=0 T=0 M2=0 M3=-2,6326999473406 FrameElem=34-1 ElemStation=0,05

Frame=34 Station=0,1 OutputCase=RAR073 CaseType=Combination P=-27,3345990515978 V2=8,71859880224519 V3=0 T=0 M2=0 M3=-3,05112988745286 FrameElem=34-1 ElemStation=0,1

Frame=34 Station=0 OutputCase=RAR074 CaseType=Combination P=-22,7871271054206 V2=68,514589886625 V3=0 T=0 M2=0 M3=-6,70522413937999 FrameElem=34-1 ElemStation=0

Frame=34 Station=0,05 OutputCase=RAR074 CaseType=Combination P=-23,6221271054206 V2=72,814589886625 V3=0 T=0 M2=0 M3=-10,2384536337112 FrameElem=34-1 ElemStation=0,05

Frame=34 Station=0,1 OutputCase=RAR074 CaseType=Combination P=-24,4571271054206 V2=77,114589886625 V3=0 T=0 M2=0 M3=-13,9866831280425 FrameElem=34-1 ElemStation=0,1

Frame=34 Station=0 OutputCase=RAR075 CaseType=Combination P=-4,27669321252755 V2=46,6643313370467 V3=0 T=0 M2=0 M3=6,75990796031826 FrameElem=34-1 ElemStation=0

Frame=34 Station=0,05 OutputCase=RAR075 CaseType=Combination P=-4,27669321252755 V2=50,9643313370467 V3=0 T=0 M2=0 M3=4,31919139346592 FrameElem=34-1 ElemStation=0,05

Frame=34 Station=0,1 OutputCase=RAR075 CaseType=Combination P=-4,27669321252755 V2=55,2643313370467 V3=0 T=0 M2=0 M3=1,66347482661359 FrameElem=34-1 ElemStation=0,1

Frame=34 Station=0 OutputCase=RAR076 CaseType=Combination P=-13,447975438982 V2=53,9122388735876 V3=0 T=0 M2=0 M3=1,5025740244732 FrameElem=34-1 ElemStation=0

Frame=34 Station=0,05 OutputCase=RAR076 CaseType=Combination P=-13,447975438982 V2=58,2122388735876 V3=0 T=0 M2=0 M3=-1,30053791920618 FrameElem=34-1 ElemStation=0,05

Frame=34 Station=0,1 OutputCase=RAR076 CaseType=Combination P=-13,447975438982 V2=62,5122388735876 V3=0 T=0 M2=0 M3=-4,31864986288556 FrameElem=34-1 ElemStation=0,1

Frame=34 Station=0 OutputCase=RAR077 CaseType=Combination P=-22,6732576840629 V2=46,6643313369885 V3=0 T=0 M2=0 M3=4,21793837914762 FrameElem=34-1 ElemStation=0

Frame=34 Station=0,05 OutputCase=RAR077 CaseType=Combination P=-22,6732576840629 V2=50,9643313369885 V3=0 T=0 M2=0 M3=1,7772218122982 FrameElem=34-1 ElemStation=0,05

Frame=34 Station=0,1 OutputCase=RAR077 CaseType=Combination P=-22,6732576840629 V2=55,2643313369885 V3=0 T=0 M2=0 M3=0,878494754551227 FrameElem=34-1 ElemStation=0,1

Frame=34 Station=0 OutputCase=RAR078 CaseType=Combination P=-12,7548681635269 V2=14,3122388737055 V3=0 T=0 M2=0 M3=-3,94538699689409 FrameElem=34-1 ElemStation=0

Frame=34 Station=0,05 OutputCase=RAR078 CaseType=Combination P=-12,7548681635269 V2=15,0122388737055 V3=0 T=0 M2=0 M3=-4,67849894057936 FrameElem=34-1 ElemStation=0,05

Frame=34 Station=0,1 OutputCase=RAR078 CaseType=Combination P=-12,7548681635269 V2=15,7122388737055 V3=0 T=0 M2=0 M3=-5,44661088426463 FrameElem=34-1 ElemStation=0,1

Frame=34 Station=0 OutputCase=RAR079 CaseType=Combination P=-21,9531504086078 V2=7,06433133710637 V3=0 T=0 M2=0 M3=-1,23002264221967 FrameElem=34-1 ElemStation=0

Frame=34 Station=0,05 OutputCase=RAR079 CaseType=Combination P=-21,9531504086078 V2=7,76433133710637 V3=0 T=0 M2=0 M3=-1,60073920907499 FrameElem=34-1 ElemStation=0,05

Frame=34 Station=0,1 OutputCase=RAR079 CaseType=Combination P=-21,9531504086078 V2=8,46433133710637 V3=0 T=0 M2=0 M3=-2,00645577593031 FrameElem=34-1 ElemStation=0,1

Frame=34 Station=0 OutputCase=RAR080 CaseType=Combination P=-4,01631704002077 V2=7,0643313371647 V3=0 T=0 M2=0 M3=0,9304919244361 FrameElem=34-1 ElemStation=0

Frame=34 Station=0,05 OutputCase=RAR080 CaseType=Combination P=-4,01631704002077 V2=7,7643313371647 V3=0 T=0 M2=0 M3=0,559775357577865 FrameElem=34-1 ElemStation=0,05

Frame=34 Station=0,1 OutputCase=RAR080 CaseType=Combination P=-4,01631704002077 V2=8,4643313371647 V3=0 T=0 M2=0 M3=0,15405879071963 FrameElem=34-1 ElemStation=0,1

Frame=34 Station=0 OutputCase=RAR081 CaseType=Combination P=-4,73642431547591 V2=46,6643313370468 V3=0 T=0 M2=0 M3=6,37845294580339 FrameElem=34-1 ElemStation=0

Frame=34 Station=0,05 OutputCase=RAR081 CaseType=Combination P=-4,73642431547591 V2=50,9643313370468 V3=0 T=0 M2=0 M3=3,93773637895105 FrameElem=34-1 ElemStation=0,05

Frame=34 Station=0,1 OutputCase=RAR081 CaseType=Combination P=-4,73642431547591 V2=55,2643313370468 V3=0 T=0 M2=0 M3=1,28201981209871 FrameElem=34-1 ElemStation=0,1

Frame=34 Station=0 OutputCase=RAR082 CaseType=Combination P=-13,9347065419304 V2=53,9122388735877 V3=0 T=0 M2=0 M3=1,12111900995834 FrameElem=34-1 ElemStation=0

Frame=34 Station=0,05 OutputCase=RAR082 CaseType=Combination P=-13,9347065419304 V2=58,2122388735877 V3=0 T=0 M2=0 M3=-1,68199293372105 FrameElem=34-1 ElemStation=0,05

Frame=34 Station=0,1 OutputCase=RAR082 CaseType=Combination P=-13,9347065419304 V2=62,5122388735877 V3=0 T=0 M2=0 M3=-4,70010487740043 FrameElem=34-1 ElemStation=0,1

Frame=34 Station=0 OutputCase=RAR083 CaseType=Combination P=-23,1329887870113 V2=46,6643313369886 V3=0 T=0 M2=0 M3=3,83648336463276 FrameElem=34-1 ElemStation=0

Frame=34 Station=0,05 OutputCase=RAR083 CaseType=Combination P=-23,1329887870113 V2=50,9643313369886 V3=0 T=0 M2=0 M3=1,39576679778333 FrameElem=34-1 ElemStation=0,05

Frame=34 Station=0,1 OutputCase=RAR083 CaseType=Combination P=-23,1329887870113 V2=55,2643313369886 V3=0 T=0 M2=0 M3=-1,2599497690661 FrameElem=34-1 ElemStation=0,1

Frame=34 Station=0 OutputCase=RAR084 CaseType=Combination P=-13,2145992664752 V2=14,3122388737056 V3=0 T=0 M2=0 M3=-4,32684201140895 FrameElem=34-1 ElemStation=0

Frame=34 Station=0,05 OutputCase=RAR084 CaseType=Combination P=-13,2145992664752 V2=15,0122388737056 V3=0 T=0 M2=0 M3=-5,05995395509423 FrameElem=34-1 ElemStation=0,05

Frame=34 Station=0,1 OutputCase=RAR084 CaseType=Combination P=-13,2145992664752 V2=15,7122388737056 V3=0 T=0 M2=0 M3=-5,82806589877951 FrameElem=34-1 ElemStation=0,1

Frame=34 Station=0 OutputCase=RAR085 CaseType=Combination P=-22,4128815115562 V2=7,06433133710649 V3=0 T=0 M2=0 M3=-1,61147765673453 FrameElem=34-1 ElemStation=0

Frame=34 Station=0,05 OutputCase=RAR085 CaseType=Combination P=-22,4128815115562 V2=7,76433133710649 V3=0 T=0 M2=0 M3=-1,98219422358986 FrameElem=34-1 ElemStation=0,05

Frame=34 Station=0,1 OutputCase=RAR085 CaseType=Combination P=-22,4128815115562 V2=8,4643313371065 V3=0 T=0 M2=0 M3=-2,38791079044518 FrameElem=34-1 ElemStation=0,1

Frame=34 Station=0 OutputCase=RAR086 CaseType=Combination P=-3,09685483412407 V2=7,06433133716445 V3=0 T=0 M2=0 M3=1,69340195346583 FrameElem=34-1 ElemStation=0

Frame=34 Station=0,05 OutputCase=RAR086 CaseType=Combination P=-3,09685483412407 V2=7,76433133716445 V3=0 T=0 M2=0 M3=1,32268538660761 FrameElem=34-1 ElemStation=0,05

Frame=34 Station=0,1 OutputCase=RAR086 CaseType=Combination P=-3,09685483412407 V2=8,46433133716445 V3=0 T=0 M2=0 M3=0,916968819749386 FrameElem=34-1 ElemStation=0,1

Società di Progetto
Brebemi SpA

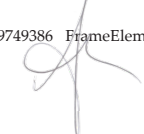



Doc. N.
60235-0000-A00.doc

CODIFICA DOCUMENTO
04RCDII10000000000300A00

REV.
00

FOGLIO
460 di 628

Frame=34 Station=0 OutputCase=RAR087 CaseType=Combination P=-3,8169621095792 V2=46,6643313370466 V3=0 T=0 M2=0 M3=7,14136297483312 FrameElem=34-1 ElemStation=0
Frame=34 Station=0,05 OutputCase=RAR087 CaseType=Combination P=-3,8169621095792 V2=50,9643313370466 V3=0 T=0 M2=0 M3=4,70064640798079 FrameElem=34-1 ElemStation=0,05
Frame=34 Station=0,1 OutputCase=RAR087 CaseType=Combination P=-3,8169621095792 V2=55,2643313370466 V3=0 T=0 M2=0 M3=2,04492984112847 FrameElem=34-1 ElemStation=0,1
Frame=34 Station=0 OutputCase=RAR088 CaseType=Combination P=-13,0152443360337 V2=53,9122388735875 V3=0 T=0 M2=0 M3=1,88402903898807 FrameElem=34-1 ElemStation=0
Frame=34 Station=0,05 OutputCase=RAR088 CaseType=Combination P=-13,0152443360337 V2=58,2122388735875 V3=0 T=0 M2=0 M3=-0,919082904691305 FrameElem=34-1 ElemStation=0,05
Frame=34 Station=0,1 OutputCase=RAR088 CaseType=Combination P=-13,0152443360337 V2=62,5122388735875 V3=0 T=0 M2=0 M3=-3,93719484837068 FrameElem=34-1 ElemStation=0,1
Frame=34 Station=0 OutputCase=RAR089 CaseType=Combination P=-22,2135265811146 V2=46,6643313369884 V3=0 T=0 M2=0 M3=4,59939339366249 FrameElem=34-1 ElemStation=0
Frame=34 Station=0,05 OutputCase=RAR089 CaseType=Combination P=-22,2135265811146 V2=50,9643313369884 V3=0 T=0 M2=0 M3=2,15867682681307 FrameElem=34-1 ElemStation=0,05
Frame=34 Station=0,1 OutputCase=RAR089 CaseType=Combination P=-22,2135265811146 V2=55,2643313369884 V3=0 T=0 M2=0 M3=-0,497039740036349 FrameElem=34-1 ElemStation=0,1
Frame=34 Station=0 OutputCase=RAR090 CaseType=Combination P=-12,2951370605785 V2=14,3122388737053 V3=0 T=0 M2=0 M3=-3,56393198237922 FrameElem=34-1 ElemStation=0
Frame=34 Station=0,05 OutputCase=RAR090 CaseType=Combination P=-12,2951370605785 V2=15,0122388737053 V3=0 T=0 M2=0 M3=-4,29704392606449 FrameElem=34-1 ElemStation=0,05
Frame=34 Station=0,1 OutputCase=RAR090 CaseType=Combination P=-12,2951370605785 V2=15,7122388737053 V3=0 T=0 M2=0 M3=-5,06515586974976 FrameElem=34-1 ElemStation=0,1
Frame=34 Station=0 OutputCase=RAR091 CaseType=Combination P=-21,4934193056595 V2=7,06433133710624 V3=0 T=0 M2=0 M3=-0,848567627704803 FrameElem=34-1 ElemStation=0
Frame=34 Station=0,05 OutputCase=RAR091 CaseType=Combination P=-21,4934193056595 V2=7,76433133710624 V3=0 T=0 M2=0 M3=-1,21928419456012 FrameElem=34-1 ElemStation=0,05
Frame=34 Station=0,1 OutputCase=RAR091 CaseType=Combination P=-21,4934193056595 V2=8,46433133710624 V3=0 T=0 M2=0 M3=-1,62500076141543 FrameElem=34-1 ElemStation=0,1
Frame=34 Station=0 OutputCase=RAR092 CaseType=Combination P=-3,09685483412407 V2=7,06433133716445 V3=0 T=0 M2=0 M3=1,69340195346583 FrameElem=34-1 ElemStation=0
Frame=34 Station=0,05 OutputCase=RAR092 CaseType=Combination P=-3,09685483412407 V2=7,76433133716445 V3=0 T=0 M2=0 M3=1,32268538660761 FrameElem=34-1 ElemStation=0,05
Frame=34 Station=0,1 OutputCase=RAR092 CaseType=Combination P=-3,09685483412407 V2=8,46433133716445 V3=0 T=0 M2=0 M3=0,916968819749386 FrameElem=34-1 ElemStation=0,1
Frame=34 Station=0 OutputCase=RAR093 CaseType=Combination P=-3,8169621095792 V2=46,6643313370466 V3=0 T=0 M2=0 M3=7,14136297483312 FrameElem=34-1 ElemStation=0
Frame=34 Station=0,05 OutputCase=RAR093 CaseType=Combination P=-3,8169621095792 V2=50,9643313370466 V3=0 T=0 M2=0 M3=4,70064640798079 FrameElem=34-1 ElemStation=0,05
Frame=34 Station=0,1 OutputCase=RAR093 CaseType=Combination P=-3,8169621095792 V2=55,2643313370466 V3=0 T=0 M2=0 M3=2,04492984112847 FrameElem=34-1 ElemStation=0,1
Frame=34 Station=0 OutputCase=RAR094 CaseType=Combination P=-13,0152443360337 V2=53,9122388735875 V3=0 T=0 M2=0 M3=1,88402903898807 FrameElem=34-1 ElemStation=0
Frame=34 Station=0,05 OutputCase=RAR094 CaseType=Combination P=-13,0152443360337 V2=58,2122388735875 V3=0 T=0 M2=0 M3=-0,919082904691305 FrameElem=34-1 ElemStation=0,05
Frame=34 Station=0,1 OutputCase=RAR094 CaseType=Combination P=-13,0152443360337 V2=62,5122388735875 V3=0 T=0 M2=0 M3=-3,93719484837068 FrameElem=34-1 ElemStation=0,1
Frame=34 Station=0 OutputCase=RAR095 CaseType=Combination P=-22,2135265811146 V2=46,6643313369884 V3=0 T=0 M2=0 M3=4,59939339366249 FrameElem=34-1 ElemStation=0
Frame=34 Station=0,05 OutputCase=RAR095 CaseType=Combination P=-22,2135265811146 V2=50,9643313369884 V3=0 T=0 M2=0 M3=2,15867682681307 FrameElem=34-1 ElemStation=0,05
Frame=34 Station=0,1 OutputCase=RAR095 CaseType=Combination P=-22,2135265811146 V2=55,2643313369884 V3=0 T=0 M2=0 M3=-0,497039740036349 FrameElem=34-1 ElemStation=0,1
Frame=34 Station=0 OutputCase=RAR096 CaseType=Combination P=-12,2951370605785 V2=14,3122388737053 V3=0 T=0 M2=0 M3=-3,56393198237922 FrameElem=34-1 ElemStation=0
Frame=34 Station=0,05 OutputCase=RAR096 CaseType=Combination P=-12,2951370605785 V2=15,0122388737053 V3=0 T=0 M2=0 M3=-4,29704392606449 FrameElem=34-1 ElemStation=0,05
Frame=34 Station=0,1 OutputCase=RAR096 CaseType=Combination P=-12,2951370605785 V2=15,7122388737053 V3=0 T=0 M2=0 M3=-5,06515586974976 FrameElem=34-1 ElemStation=0,1
Frame=34 Station=0 OutputCase=RAR097 CaseType=Combination P=-21,4934193056595 V2=7,06433133710624 V3=0 T=0 M2=0 M3=-0,848567627704803 FrameElem=34-1 ElemStation=0
Frame=34 Station=0,05 OutputCase=RAR097 CaseType=Combination P=-21,4934193056595 V2=7,76433133710624 V3=0 T=0 M2=0 M3=-1,21928419456012 FrameElem=34-1 ElemStation=0,05
Frame=34 Station=0,1 OutputCase=RAR097 CaseType=Combination P=-21,4934193056595 V2=8,46433133710624 V3=0 T=0 M2=0 M3=-1,62500076141543 FrameElem=34-1 ElemStation=0,1
Frame=34 Station=0 OutputCase=RAR098 CaseType=Combination P=-4,19234429459713 V2=8,33566866285871 V3=0 T=0 M2=0 M3=-0,269814123397479 FrameElem=34-1 ElemStation=0
Frame=34 Station=0,05 OutputCase=RAR098 CaseType=Combination P=-4,19234429459713 V2=9,03566866285871 V3=0 T=0 M2=0 M3=-0,704097556540414 FrameElem=34-1 ElemStation=0,05
Frame=34 Station=0,1 OutputCase=RAR098 CaseType=Combination P=-4,19234429459713 V2=9,73566866285871 V3=0 T=0 M2=0 M3=-1,17338098968335 FrameElem=34-1 ElemStation=0,1
Frame=34 Station=0 OutputCase=RAR099 CaseType=Combination P=-5,02533565703237 V2=60,8814011975627 V3=0 T=0 M2=0 M3=7,31048611756193 FrameElem=34-1 ElemStation=0
Frame=34 Station=0,05 OutputCase=RAR099 CaseType=Combination P=-5,02533565703237 V2=66,3814011975627 V3=0 T=0 M2=0 M3=4,1289160576838 FrameElem=34-1 ElemStation=0,05
Frame=34 Station=0,1 OutputCase=RAR099 CaseType=Combination P=-5,02533565703237 V2=71,8814011975627 V3=0 T=0 M2=0 M3=0,672345997805662 FrameElem=34-1 ElemStation=0,1
Frame=34 Station=0 OutputCase=RAR100 CaseType=Combination P=-16,8507663664354 V2=70,2225452905258 V3=0 T=0 M2=0 M3=0,550424499367519 FrameElem=34-1 ElemStation=0
Frame=34 Station=0,05 OutputCase=RAR100 CaseType=Combination P=-16,8507663664354 V2=75,7225452905258 V3=0 T=0 M2=0 M3=-3,09820276515877 FrameElem=34-1 ElemStation=0,05
Frame=34 Station=0,1 OutputCase=RAR100 CaseType=Combination P=-16,8507663664354 V2=81,2225452905258 V3=0 T=0 M2=0 M3=-7,02183002968506 FrameElem=34-1 ElemStation=0,1
Frame=34 Station=0 OutputCase=RAR101 CaseType=Combination P=-28,6761971000528 V2=60,8814011975045 V3=0 T=0 M2=0 M3=4,06562138385231 FrameElem=34-1 ElemStation=0
Frame=34 Station=0,05 OutputCase=RAR101 CaseType=Combination P=-28,6761971000528 V2=66,3814011975045 V3=0 T=0 M2=0 M3=0,884051323977087 FrameElem=34-1 ElemStation=0,05

APPROVATO SDP
Società di Progetto
Brebemi SpA



Doc. N.
60235-0000-A00.doc

CODIFICA DOCUMENTO
04RCDII10000000000300A00

REV.
00

FOGLIO
461 di 628

Frame=34 Station=0,1 OutputCase=RAR101 CaseType=Combination P=-28,676197100528 V2=71,8814011975045 V3=0 T=0 M2=0 M3=-2,57251873589814 FrameElem=34-1 ElemStation=0,1

Frame=34 Station=0 OutputCase=RAR102 CaseType=Combination P=-15,8906233324952 V2=17,422545290683 V3=0 T=0 M2=0 M3=-6,7135235291222 FrameElem=34-1 ElemStation=0

Frame=34 Station=0,05 OutputCase=RAR102 CaseType=Combination P=-15,8906233324952 V2=18,122545290683 V3=0 T=0 M2=0 M3=-7,60215079365635 FrameElem=34-1 ElemStation=0,05

Frame=34 Station=0,1 OutputCase=RAR102 CaseType=Combination P=-15,8906233324952 V2=18,822545290683 V3=0 T=0 M2=0 M3=-8,5257780581905 FrameElem=34-1 ElemStation=0,1

Frame=34 Station=0 OutputCase=RAR103 CaseType=Combination P=-27,7160540661126 V2=8,08140119766167 V3=0 T=0 M2=0 M3=-3,19832664463741 FrameElem=34-1 ElemStation=0

Frame=34 Station=0,05 OutputCase=RAR103 CaseType=Combination P=-27,7160540661126 V2=8,78140119766167 V3=0 T=0 M2=0 M3=-3,61989670452049 FrameElem=34-1 ElemStation=0,05

Frame=34 Station=0,1 OutputCase=RAR103 CaseType=Combination P=-27,7160540661126 V2=9,48140119766167 V3=0 T=0 M2=0 M3=-4,07646676440358 FrameElem=34-1 ElemStation=0,1

Frame=34 Station=0 OutputCase=RAR104 CaseType=Combination P=-23,1685821199354 V2=69,2773922820415 V3=0 T=0 M2=0 M3=-7,65428077678906 FrameElem=34-1 ElemStation=0

Frame=34 Station=0,05 OutputCase=RAR104 CaseType=Combination P=-24,0035821199354 V2=73,5773922820415 V3=0 T=0 M2=0 M3=-11,2256503908911 FrameElem=34-1 ElemStation=0,05

Frame=34 Station=0,1 OutputCase=RAR104 CaseType=Combination P=-24,8385821199354 V2=77,8773922820415 V3=0 T=0 M2=0 M3=-15,0120200049932 FrameElem=34-1 ElemStation=0,1

Frame=34 Station=0 OutputCase=RAR105 CaseType=Combination P=-4,91245157005226 V2=47,9356686627408 V3=0 T=0 M2=0 M3=5,17814689796981 FrameElem=34-1 ElemStation=0

Frame=34 Station=0,05 OutputCase=RAR105 CaseType=Combination P=-4,91245157005226 V2=52,2356686627408 V3=0 T=0 M2=0 M3=2,67386346483277 FrameElem=34-1 ElemStation=0,05

Frame=34 Station=0,1 OutputCase=RAR105 CaseType=Combination P=-4,91245157005226 V2=56,5356686627408 V3=0 T=0 M2=0 M3=-4,54199683042698E-02 FrameElem=34-1 ElemStation=0,1

Frame=34 Station=0 OutputCase=RAR106 CaseType=Combination P=-14,1107337965067 V2=55,1835761992817 V3=0 T=0 M2=0 M3=-7,91870378752413E-02 FrameElem=34-1 ElemStation=0

Frame=34 Station=0,05 OutputCase=RAR106 CaseType=Combination P=-14,1107337965067 V2=59,4835761992817 V3=0 T=0 M2=0 M3=-2,94586584783933 FrameElem=34-1 ElemStation=0,05

Frame=34 Station=0,1 OutputCase=RAR106 CaseType=Combination P=-14,1107337965067 V2=63,7835761992817 V3=0 T=0 M2=0 M3=-6,02754465780341 FrameElem=34-1 ElemStation=0,1

Frame=34 Station=0 OutputCase=RAR107 CaseType=Combination P=-23,3090160415876 V2=47,9356686626826 V3=0 T=0 M2=0 M3=2,63617731679918 FrameElem=34-1 ElemStation=0

Frame=34 Station=0,05 OutputCase=RAR107 CaseType=Combination P=-23,3090160415876 V2=52,2356686626826 V3=0 T=0 M2=0 M3=0,131893883665047 FrameElem=34-1 ElemStation=0,05

Frame=34 Station=0,1 OutputCase=RAR107 CaseType=Combination P=-23,3090160415876 V2=56,5356686626826 V3=0 T=0 M2=0 M3=-2,58738954946908 FrameElem=34-1 ElemStation=0,1

Frame=34 Station=0 OutputCase=RAR108 CaseType=Combination P=-13,3906265210516 V2=15,5835761993996 V3=0 T=0 M2=0 M3=-5,52714805924253 FrameElem=34-1 ElemStation=0

Frame=34 Station=0,05 OutputCase=RAR108 CaseType=Combination P=-13,3906265210516 V2=16,2835761993996 V3=0 T=0 M2=0 M3=-6,32382686921251 FrameElem=34-1 ElemStation=0,05

Frame=34 Station=0,1 OutputCase=RAR108 CaseType=Combination P=-13,3906265210516 V2=16,9835761993996 V3=0 T=0 M2=0 M3=-7,15550567918249 FrameElem=34-1 ElemStation=0,1

Frame=34 Station=0 OutputCase=RAR109 CaseType=Combination P=-22,5889087661325 V2=8,3356686628005 V3=0 T=0 M2=0 M3=-2,81178370456811 FrameElem=34-1 ElemStation=0

Frame=34 Station=0,05 OutputCase=RAR109 CaseType=Combination P=-22,5889087661325 V2=9,0356686628005 V3=0 T=0 M2=0 M3=-3,24606713770814 FrameElem=34-1 ElemStation=0,05

Frame=34 Station=0,1 OutputCase=RAR109 CaseType=Combination P=-22,5889087661325 V2=9,7356686628005 V3=0 T=0 M2=0 M3=-3,71535057084816 FrameElem=34-1 ElemStation=0,1

Frame=34 Station=0 OutputCase=RAR110 CaseType=Combination P=-4,65207539754548 V2=8,33566866285884 V3=0 T=0 M2=0 M3=-0,651269137912344 FrameElem=34-1 ElemStation=0

Frame=34 Station=0,05 OutputCase=RAR110 CaseType=Combination P=-4,65207539754548 V2=9,03566866285884 V3=0 T=0 M2=0 M3=-1,08555257105529 FrameElem=34-1 ElemStation=0,05

Frame=34 Station=0,1 OutputCase=RAR110 CaseType=Combination P=-4,65207539754548 V2=9,73566866285884 V3=0 T=0 M2=0 M3=-1,55483600419823 FrameElem=34-1 ElemStation=0,1

Frame=34 Station=0 OutputCase=RAR111 CaseType=Combination P=-5,37218267300062 V2=47,935668662741 V3=0 T=0 M2=0 M3=4,79669188345495 FrameElem=34-1 ElemStation=0

Frame=34 Station=0,05 OutputCase=RAR111 CaseType=Combination P=-5,37218267300062 V2=52,235668662741 V3=0 T=0 M2=0 M3=2,2924084503179 FrameElem=34-1 ElemStation=0,05

Frame=34 Station=0,1 OutputCase=RAR111 CaseType=Combination P=-5,37218267300062 V2=56,535668662741 V3=0 T=0 M2=0 M3=-0,426874982819148 FrameElem=34-1 ElemStation=0,1

Frame=34 Station=0 OutputCase=RAR112 CaseType=Combination P=-14,5704648994551 V2=55,1835761992818 V3=0 T=0 M2=0 M3=-0,460642052390106 FrameElem=34-1 ElemStation=0

Frame=34 Station=0,05 OutputCase=RAR112 CaseType=Combination P=-14,5704648994551 V2=59,4835761992818 V3=0 T=0 M2=0 M3=-3,3273208623542 FrameElem=34-1 ElemStation=0,05

Frame=34 Station=0,1 OutputCase=RAR112 CaseType=Combination P=-14,5704648994551 V2=63,7835761992819 V3=0 T=0 M2=0 M3=-6,40899967231829 FrameElem=34-1 ElemStation=0,1

Frame=34 Station=0 OutputCase=RAR113 CaseType=Combination P=-23,768747144536 V2=47,9356686626828 V3=0 T=0 M2=0 M3=2,25472230228431 FrameElem=34-1 ElemStation=0

Frame=34 Station=0,05 OutputCase=RAR113 CaseType=Combination P=-23,768747144536 V2=52,2356686626828 V3=0 T=0 M2=0 M3=-0,249561130849824 FrameElem=34-1 ElemStation=0,05

Frame=34 Station=0,1 OutputCase=RAR113 CaseType=Combination P=-23,768747144536 V2=56,5356686626828 V3=0 T=0 M2=0 M3=-2,96884456398396 FrameElem=34-1 ElemStation=0,1

Frame=34 Station=0 OutputCase=RAR114 CaseType=Combination P=-13,8503576239999 V2=15,5835761993997 V3=0 T=0 M2=0 M3=-5,9086030737574 FrameElem=34-1 ElemStation=0

Frame=34 Station=0,05 OutputCase=RAR114 CaseType=Combination P=-13,8503576239999 V2=16,2835761993997 V3=0 T=0 M2=0 M3=-6,70528188372738 FrameElem=34-1 ElemStation=0,05

Frame=34 Station=0,1 OutputCase=RAR114 CaseType=Combination P=-13,8503576239999 V2=16,9835761993997 V3=0 T=0 M2=0 M3=-7,53690609369737 FrameElem=34-1 ElemStation=0,1

Frame=34 Station=0 OutputCase=RAR115 CaseType=Combination P=-23,0486398690809 V2=8,33566866280063 V3=0 T=0 M2=0 M3=-3,19323871908298 FrameElem=34-1 ElemStation=0

Frame=34 Station=0,05 OutputCase=RAR115 CaseType=Combination P=-23,0486398690809 V2=9,03566866280063 V3=0 T=0 M2=0 M3=-3,62752215222301 FrameElem=34-1 ElemStation=0,05

Frame=34 Station=0,1 OutputCase=RAR115 CaseType=Combination P=-23,0486398690809 V2=9,73566866280063 V3=0 T=0 M2=0 M3=-4,09680558536304 FrameElem=34-1 ElemStation=0,1

Frame=34 Station=0 OutputCase=RAR116 CaseType=Combination P=-3,73261319164877 V2=8,33566866285858 V3=0 T=0 M2=0 M3=0,111640891117386 FrameElem=34-1 ElemStation=0

APPROVATO SDP
Società di Progetto
Brebemi SpA



Doc. N.
60235-0000-A00.doc

CODIFICA DOCUMENTO
04RCDII10000000000300A00

REV.
00

FOGLIO
462 di 628

Frame=34 Station=0,05 OutputCase=RAR116 CaseType=Combination P=-3,73261319164877 V2=9,03566866285858 V3=0 T=0 M2=0 M3=-0,322642542025543
FrameElem=34-1 ElemStation=0,05
Frame=34 Station=0,1 OutputCase=RAR116 CaseType=Combination P=-3,73261319164877 V2=9,73566866285858 V3=0 T=0 M2=0 M3=-0,791925975168472 FrameElem=34-1
ElemStation=0,1
Frame=34 Station=0 OutputCase=RAR117 CaseType=Combination P=-4,45272046710391 V2=47,9356686627407 V3=0 T=0 M2=0 M3=5,55960191248468 FrameElem=34-1
ElemStation=0
Frame=34 Station=0,05 OutputCase=RAR117 CaseType=Combination P=-4,45272046710391 V2=52,2356686627407 V3=0 T=0 M2=0 M3=3,05531847934764 FrameElem=34-1
ElemStation=0,05
Frame=34 Station=0,1 OutputCase=RAR117 CaseType=Combination P=-4,45272046710391 V2=56,5356686627407 V3=0 T=0 M2=0 M3=0,336035046210608 FrameElem=34-1
ElemStation=0,1
Frame=34 Station=0 OutputCase=RAR118 CaseType=Combination P=-13,6510026935584 V2=55,1835761992816 V3=0 T=0 M2=0 M3=0,302267976639624 FrameElem=34-1
ElemStation=0
Frame=34 Station=0,05 OutputCase=RAR118 CaseType=Combination P=-13,6510026935584 V2=59,4835761992816 V3=0 T=0 M2=0 M3=-2,56441083332446 FrameElem=34-1
ElemStation=0,05
Frame=34 Station=0,1 OutputCase=RAR118 CaseType=Combination P=-13,6510026935584 V2=63,7835761992816 V3=0 T=0 M2=0 M3=-5,64608964328853 FrameElem=34-1
ElemStation=0,1
Frame=34 Station=0 OutputCase=RAR119 CaseType=Combination P=-22,8492849386393 V2=47,9356686626825 V3=0 T=0 M2=0 M3=3,01763233131404 FrameElem=34-1
ElemStation=0
Frame=34 Station=0,05 OutputCase=RAR119 CaseType=Combination P=-22,8492849386393 V2=52,2356686626825 V3=0 T=0 M2=0 M3=0,513348898179919 FrameElem=34-1
ElemStation=0,05
Frame=34 Station=0,1 OutputCase=RAR119 CaseType=Combination P=-22,8492849386393 V2=56,5356686626825 V3=0 T=0 M2=0 M3=-2,20593453495421 FrameElem=34-1
ElemStation=0,1
Frame=34 Station=0 OutputCase=RAR120 CaseType=Combination P=-12,9308954181032 V2=15,5835761993995 V3=0 T=0 M2=0 M3=-5,14569304472767 FrameElem=34-1
ElemStation=0
Frame=34 Station=0,05 OutputCase=RAR120 CaseType=Combination P=-12,9308954181032 V2=16,2835761993995 V3=0 T=0 M2=0 M3=-5,94237185469764 FrameElem=34-1
ElemStation=0,05
Frame=34 Station=0,1 OutputCase=RAR120 CaseType=Combination P=-12,9308954181032 V2=16,9835761993995 V3=0 T=0 M2=0 M3=-6,77405066466761 FrameElem=34-1
ElemStation=0,1
Frame=34 Station=0 OutputCase=RAR121 CaseType=Combination P=-22,1291776631842 V2=8,33566866280037 V3=0 T=0 M2=0 M3=-2,43032869005325 FrameElem=34-1
ElemStation=0
Frame=34 Station=0,05 OutputCase=RAR121 CaseType=Combination P=-22,1291776631842 V2=9,03566866280037 V3=0 T=0 M2=0 M3=-2,86461212319327 FrameElem=34-1
ElemStation=0,05
Frame=34 Station=0,1 OutputCase=RAR121 CaseType=Combination P=-22,1291776631842 V2=9,73566866280037 V3=0 T=0 M2=0 M3=-3,33389555633328 FrameElem=34-1
ElemStation=0,1
Frame=34 Station=0 OutputCase=RAR122 CaseType=Combination P=-3,73261319164877 V2=8,33566866285858 V3=0 T=0 M2=0 M3=0,111640891117386 FrameElem=34-1
ElemStation=0
Frame=34 Station=0,05 OutputCase=RAR122 CaseType=Combination P=-3,73261319164877 V2=9,03566866285858 V3=0 T=0 M2=0 M3=-0,322642542025543
FrameElem=34-1 ElemStation=0,05
Frame=34 Station=0,1 OutputCase=RAR122 CaseType=Combination P=-3,73261319164877 V2=9,73566866285858 V3=0 T=0 M2=0 M3=-0,791925975168472 FrameElem=34-1
ElemStation=0,1
Frame=34 Station=0 OutputCase=RAR123 CaseType=Combination P=-4,45272046710391 V2=47,9356686627407 V3=0 T=0 M2=0 M3=5,55960191248468 FrameElem=34-1
ElemStation=0
Frame=34 Station=0,05 OutputCase=RAR123 CaseType=Combination P=-4,45272046710391 V2=52,2356686627407 V3=0 T=0 M2=0 M3=3,05531847934764 FrameElem=34-1
ElemStation=0,05
Frame=34 Station=0,1 OutputCase=RAR123 CaseType=Combination P=-4,45272046710391 V2=56,5356686627407 V3=0 T=0 M2=0 M3=0,336035046210608 FrameElem=34-1
ElemStation=0,1
Frame=34 Station=0 OutputCase=RAR124 CaseType=Combination P=-13,6510026935584 V2=55,1835761992816 V3=0 T=0 M2=0 M3=0,302267976639624 FrameElem=34-1
ElemStation=0
Frame=34 Station=0,05 OutputCase=RAR124 CaseType=Combination P=-13,6510026935584 V2=59,4835761992816 V3=0 T=0 M2=0 M3=-2,56441083332446 FrameElem=34-1
ElemStation=0,05
Frame=34 Station=0,1 OutputCase=RAR124 CaseType=Combination P=-13,6510026935584 V2=63,7835761992816 V3=0 T=0 M2=0 M3=-5,64608964328853 FrameElem=34-1
ElemStation=0,1
Frame=34 Station=0 OutputCase=RAR125 CaseType=Combination P=-22,8492849386393 V2=47,9356686626825 V3=0 T=0 M2=0 M3=3,01763233131404 FrameElem=34-1
ElemStation=0
Frame=34 Station=0,05 OutputCase=RAR125 CaseType=Combination P=-22,8492849386393 V2=52,2356686626825 V3=0 T=0 M2=0 M3=0,513348898179919 FrameElem=34-1
ElemStation=0,05
Frame=34 Station=0,1 OutputCase=RAR125 CaseType=Combination P=-22,8492849386393 V2=56,5356686626825 V3=0 T=0 M2=0 M3=-2,20593453495421 FrameElem=34-1
ElemStation=0,1
Frame=34 Station=0 OutputCase=RAR126 CaseType=Combination P=-12,9308954181032 V2=15,5835761993995 V3=0 T=0 M2=0 M3=-5,14569304472767 FrameElem=34-1
ElemStation=0
Frame=34 Station=0,05 OutputCase=RAR126 CaseType=Combination P=-12,9308954181032 V2=16,2835761993995 V3=0 T=0 M2=0 M3=-5,94237185469764 FrameElem=34-1
ElemStation=0,05
Frame=34 Station=0,1 OutputCase=RAR126 CaseType=Combination P=-12,9308954181032 V2=16,9835761993995 V3=0 T=0 M2=0 M3=-6,77405066466761 FrameElem=34-1
ElemStation=0,1
Frame=34 Station=0 OutputCase=RAR127 CaseType=Combination P=-22,1291776631842 V2=8,33566866280037 V3=0 T=0 M2=0 M3=-2,43032869005325 FrameElem=34-1
ElemStation=0
Frame=34 Station=0,05 OutputCase=RAR127 CaseType=Combination P=-22,1291776631842 V2=9,03566866280037 V3=0 T=0 M2=0 M3=-2,86461212319327 FrameElem=34-1
ElemStation=0,05
Frame=34 Station=0,1 OutputCase=RAR127 CaseType=Combination P=-22,1291776631842 V2=9,73566866280037 V3=0 T=0 M2=0 M3=-3,33389555633328 FrameElem=34-1
ElemStation=0,1
Frame=34 Station=0 OutputCase=RAR128 CaseType=Combination P=-3,10824661092085 V2=7,7000000001143 V3=0 T=0 M2=0 M3=1,15682476530152 FrameElem=34-1
ElemStation=0
Frame=34 Station=0,05 OutputCase=RAR128 CaseType=Combination P=-3,10824661092085 V2=8,4000000001143 V3=0 T=0 M2=0 M3=0,754324765300947 FrameElem=34-1
ElemStation=0,05
Frame=34 Station=0,1 OutputCase=RAR128 CaseType=Combination P=-3,10824661092085 V2=9,1000000001143 V3=0 T=0 M2=0 M3=0,316824765300376 FrameElem=34-1
ElemStation=0,1
Frame=34 Station=0 OutputCase=RAR129 CaseType=Combination P=-4,3748770468266 V2=60,4999999998544 V3=0 T=0 M2=0 M3=8,16646945078133 FrameElem=34-1
ElemStation=0
Frame=34 Station=0,05 OutputCase=RAR129 CaseType=Combination P=-4,3748770468266 V2=65,9999999998544 V3=0 T=0 M2=0 M3=5,00396945078861 FrameElem=34-1
ElemStation=0,05
Frame=34 Station=0,1 OutputCase=RAR129 CaseType=Combination P=-4,3748770468266 V2=71,4999999998544 V3=0 T=0 M2=0 M3=1,5664694507959 FrameElem=34-1
ElemStation=0,1
Frame=34 Station=0 OutputCase=RAR130 CaseType=Combination P=-16,2003077562296 V2=69,8411440928174 V3=0 T=0 M2=0 M3=1,40640783258692 FrameElem=34-1
ElemStation=0
Frame=34 Station=0,05 OutputCase=RAR130 CaseType=Combination P=-16,2003077562296 V2=75,3411440928174 V3=0 T=0 M2=0 M3=-2,22314937205395 FrameElem=34-1
ElemStation=0,05
Frame=34 Station=0,1 OutputCase=RAR130 CaseType=Combination P=-16,2003077562296 V2=80,8411440928174 V3=0 T=0 M2=0 M3=-6,12770657669483 FrameElem=34-1
ElemStation=0,1

Società di Progetto
Brebemi SpA

	Doc. N. 60235-00000-A00.doc	CODIFICA DOCUMENTO 04RCDII10000000000300A00	REV. 00	FOGLIO 463 di 628
--	--------------------------------	--	------------	----------------------

Frame=34 Station=0 OutputCase=RAR131 CaseType=Combination P=-28,025738489847 V2=60,4999999997961 V3=0 T=0 M2=0 M3=4,92160471707171 FrameElem=34-1 ElemStation=0

Frame=34 Station=0,05 OutputCase=RAR131 CaseType=Combination P=-28,025738489847 V2=65,9999999997961 V3=0 T=0 M2=0 M3=1,7591047170819 FrameElem=34-1 ElemStation=0,05

Frame=34 Station=0,1 OutputCase=RAR131 CaseType=Combination P=-28,025738489847 V2=71,4999999997962 V3=0 T=0 M2=0 M3=-1,6783952829079 FrameElem=34-1 ElemStation=0,1

Frame=34 Station=0 OutputCase=RAR132 CaseType=Combination P=-15,2401647222894 V2=17,0411440929746 V3=0 T=0 M2=0 M3=-5,85754019590281 FrameElem=34-1 ElemStation=0

Frame=34 Station=0,05 OutputCase=RAR132 CaseType=Combination P=-15,2401647222894 V2=17,7411440929746 V3=0 T=0 M2=0 M3=-6,72709740055153 FrameElem=34-1 ElemStation=0,05

Frame=34 Station=0,1 OutputCase=RAR132 CaseType=Combination P=-15,2401647222894 V2=18,4411440929746 V3=0 T=0 M2=0 M3=-7,63165460520027 FrameElem=34-1 ElemStation=0,1

Frame=34 Station=0 OutputCase=RAR133 CaseType=Combination P=-27,0655954559068 V2=7,6999999995331 V3=0 T=0 M2=0 M3=-2,34234331141801 FrameElem=34-1 ElemStation=0

Frame=34 Station=0,05 OutputCase=RAR133 CaseType=Combination P=-27,0655954559068 V2=8,3999999995331 V3=0 T=0 M2=0 M3=-2,74484331141568 FrameElem=34-1 ElemStation=0,05

Frame=34 Station=0,1 OutputCase=RAR133 CaseType=Combination P=-27,0655954559068 V2=9,099999999533 V3=0 T=0 M2=0 M3=-3,18234331141334 FrameElem=34-1 ElemStation=0,1

Frame=34 Station=0 OutputCase=RAR134 CaseType=Combination P=-22,5181235097296 V2=68,8959910843331 V3=0 T=0 M2=0 M3=-6,79829744356966 FrameElem=34-1 ElemStation=0

Frame=34 Station=0,05 OutputCase=RAR134 CaseType=Combination P=-23,3531235097296 V2=73,1959910843331 V3=0 T=0 M2=0 M3=-10,3505969977863 FrameElem=34-1 ElemStation=0,05

Frame=34 Station=0,1 OutputCase=RAR134 CaseType=Combination P=-24,1881235097296 V2=77,4959910843331 V3=0 T=0 M2=0 M3=-14,117896552003 FrameElem=34-1 ElemStation=0,1

Frame=34 Station=0 OutputCase=RAR135 CaseType=Combination P=-3,82835388637599 V2=47,2999999998936 V3=0 T=0 M2=0 M3=6,60478578666881 FrameElem=34-1 ElemStation=0

Frame=34 Station=0,05 OutputCase=RAR135 CaseType=Combination P=-3,82835388637599 V2=51,5999999998936 V3=0 T=0 M2=0 M3=4,13228578667413 FrameElem=34-1 ElemStation=0,05

Frame=34 Station=0,1 OutputCase=RAR135 CaseType=Combination P=-3,82835388637599 V2=55,8999999998936 V3=0 T=0 M2=0 M3=1,44478578667946 FrameElem=34-1 ElemStation=0,1

Frame=34 Station=0 OutputCase=RAR136 CaseType=Combination P=-13,0266361128305 V2=54,5479075364344 V3=0 T=0 M2=0 M3=1,34745185082376 FrameElem=34-1 ElemStation=0

Frame=34 Station=0,05 OutputCase=RAR136 CaseType=Combination P=-13,0266361128305 V2=58,8479075364344 V3=0 T=0 M2=0 M3=-1,48744352599797 FrameElem=34-1 ElemStation=0,05

Frame=34 Station=0,1 OutputCase=RAR136 CaseType=Combination P=-13,0266361128305 V2=63,1479075364344 V3=0 T=0 M2=0 M3=-4,53733890281969 FrameElem=34-1 ElemStation=0,1

Frame=34 Station=0 OutputCase=RAR137 CaseType=Combination P=-22,2249183579114 V2=47,2999999998354 V3=0 T=0 M2=0 M3=4,06281620549818 FrameElem=34-1 ElemStation=0

Frame=34 Station=0,05 OutputCase=RAR137 CaseType=Combination P=-22,2249183579114 V2=51,5999999998354 V3=0 T=0 M2=0 M3=1,59031620550641 FrameElem=34-1 ElemStation=0,05

Frame=34 Station=0,1 OutputCase=RAR137 CaseType=Combination P=-22,2249183579114 V2=55,8999999998354 V3=0 T=0 M2=0 M3=-1,09718379448536 FrameElem=34-1 ElemStation=0,1

Frame=34 Station=0 OutputCase=RAR138 CaseType=Combination P=-12,3065288373753 V2=14,9479075365523 V3=0 T=0 M2=0 M3=-4,10050917054354 FrameElem=34-1 ElemStation=0

Frame=34 Station=0,05 OutputCase=RAR138 CaseType=Combination P=-12,3065288373753 V2=15,6479075365523 V3=0 T=0 M2=0 M3=-4,86540454737115 FrameElem=34-1 ElemStation=0,05

Frame=34 Station=0,1 OutputCase=RAR138 CaseType=Combination P=-12,3065288373753 V2=16,3479075365523 V3=0 T=0 M2=0 M3=-5,66529992419877 FrameElem=34-1 ElemStation=0,1

Frame=34 Station=0 OutputCase=RAR139 CaseType=Combination P=-21,5048110824562 V2=7,6999999995322 V3=0 T=0 M2=0 M3=-1,38514481586911 FrameElem=34-1 ElemStation=0

Frame=34 Station=0,05 OutputCase=RAR139 CaseType=Combination P=-21,5048110824562 V2=8,3999999995322 V3=0 T=0 M2=0 M3=-1,78764481586678 FrameElem=34-1 ElemStation=0,05

Frame=34 Station=0,1 OutputCase=RAR139 CaseType=Combination P=-21,5048110824562 V2=9,0999999995322 V3=0 T=0 M2=0 M3=-2,22514481586444 FrameElem=34-1 ElemStation=0,1

Frame=34 Station=0 OutputCase=RAR140 CaseType=Combination P=-3,5679777138692 V2=7,7000000001156 V3=0 T=0 M2=0 M3=0,775369750786653 FrameElem=34-1 ElemStation=0

Frame=34 Station=0,05 OutputCase=RAR140 CaseType=Combination P=-3,5679777138692 V2=8,4000000001156 V3=0 T=0 M2=0 M3=0,372869750786076 FrameElem=34-1 ElemStation=0,05

Frame=34 Station=0,1 OutputCase=RAR140 CaseType=Combination P=-3,5679777138692 V2=9,1000000001156 V3=0 T=0 M2=0 M3=-6,46302492145023E-02 FrameElem=34-1 ElemStation=0,1

Frame=34 Station=0 OutputCase=RAR141 CaseType=Combination P=-4,28808498932434 V2=47,2999999998937 V3=0 T=0 M2=0 M3=6,2233077215395 FrameElem=34-1 ElemStation=0

Frame=34 Station=0,05 OutputCase=RAR141 CaseType=Combination P=-4,28808498932434 V2=51,5999999998937 V3=0 T=0 M2=0 M3=3,75083077215926 FrameElem=34-1 ElemStation=0,05

Frame=34 Station=0,1 OutputCase=RAR141 CaseType=Combination P=-4,28808498932434 V2=55,8999999998937 V3=0 T=0 M2=0 M3=1,06333077216458 FrameElem=34-1 ElemStation=0,1

Frame=34 Station=0 OutputCase=RAR142 CaseType=Combination P=-13,4863672157788 V2=54,5479075364346 V3=0 T=0 M2=0 M3=0,965996836308891 FrameElem=34-1 ElemStation=0

Frame=34 Station=0,05 OutputCase=RAR142 CaseType=Combination P=-13,4863672157788 V2=58,8479075364346 V3=0 T=0 M2=0 M3=-1,86889854051284 FrameElem=34-1 ElemStation=0,05

Frame=34 Station=0,1 OutputCase=RAR142 CaseType=Combination P=-13,4863672157788 V2=63,1479075364346 V3=0 T=0 M2=0 M3=-4,91879391733457 FrameElem=34-1 ElemStation=0,1

Frame=34 Station=0 OutputCase=RAR143 CaseType=Combination P=-22,6846494608597 V2=47,2999999998355 V3=0 T=0 M2=0 M3=3,68136119098331 FrameElem=34-1 ElemStation=0

Frame=34 Station=0,05 OutputCase=RAR143 CaseType=Combination P=-22,6846494608597 V2=51,5999999998355 V3=0 T=0 M2=0 M3=1,20886119099154 FrameElem=34-1 ElemStation=0,05

Frame=34 Station=0,1 OutputCase=RAR143 CaseType=Combination P=-22,6846494608597 V2=55,8999999998355 V3=0 T=0 M2=0 M3=-1,47863880900024 FrameElem=34-1 ElemStation=0,1

Frame=34 Station=0 OutputCase=RAR144 CaseType=Combination P=-12,7662599403237 V2=14,9479075365524 V3=0 T=0 M2=0 M3=-4,4819641850584 FrameElem=34-1 ElemStation=0

Frame=34 Station=0,05 OutputCase=RAR144 CaseType=Combination P=-12,7662599403237 V2=15,6479075365524 V3=0 T=0 M2=0 M3=-5,24685956188602 FrameElem=34-1 ElemStation=0,05

Frame=34 Station=0,1 OutputCase=RAR144 CaseType=Combination P=-12,7662599403237 V2=16,3479075365524 V3=0 T=0 M2=0 M3=-6,04675493871364 FrameElem=34-1 ElemStation=0,1

Frame=34 Station=0 OutputCase=RAR145 CaseType=Combination P=-21,9645421854046 V2=7,6999999995335 V3=0 T=0 M2=0 M3=-1,76659983038398 FrameElem=34-1 ElemStation=0

Frame=34 Station=0,05 OutputCase=RAR145 CaseType=Combination P=-21,9645421854046 V2=8,3999999995335 V3=0 T=0 M2=0 M3=-2,16909983038165 FrameElem=34-1 ElemStation=0,05

APPROVATO SDP

Società di Progetto
Brebemi SpA

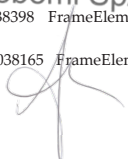

	Doc. N. 60235-00000-A00.doc	CODIFICA DOCUMENTO 04RCDII10000000000300A00	REV. 00	FOGLIO 464 di 628
--	--------------------------------	--	------------	----------------------

Frame=34 Station=0,1 OutputCase=RAR145 CaseType=Combination P=-21,9645421854046 V2=9,09999999995335 V3=0 T=0 M2=0 M3=-2,60659983037932 FrameElem=34-1 ElemStation=0,1

Frame=34 Station=0 OutputCase=RAR146 CaseType=Combination P=-2,6485155079725 V2=7,7000000000113 V3=0 T=0 M2=0 M3=-1,53827977981638 FrameElem=34-1 ElemStation=0

Frame=34 Station=0,05 OutputCase=RAR146 CaseType=Combination P=-2,6485155079725 V2=8,4000000000113 V3=0 T=0 M2=0 M3=1,13577977981582 FrameElem=34-1 ElemStation=0,05

Frame=34 Station=0,1 OutputCase=RAR146 CaseType=Combination P=-2,6485155079725 V2=9,1000000000113 V3=0 T=0 M2=0 M3=0,698279779815254 FrameElem=34-1 ElemStation=0,1

Frame=34 Station=0 OutputCase=RAR147 CaseType=Combination P=-3,36862278342763 V2=47,2999999998934 V3=0 T=0 M2=0 M3=6,98624080118367 FrameElem=34-1 ElemStation=0

Frame=34 Station=0,05 OutputCase=RAR147 CaseType=Combination P=-3,36862278342763 V2=51,5999999998934 V3=0 T=0 M2=0 M3=4,513740801189 FrameElem=34-1 ElemStation=0,05

Frame=34 Station=0,1 OutputCase=RAR147 CaseType=Combination P=-3,36862278342763 V2=55,8999999998934 V3=0 T=0 M2=0 M3=-1,82624080119433 FrameElem=34-1 ElemStation=0,1

Frame=34 Station=0 OutputCase=RAR148 CaseType=Combination P=-12,5669050098821 V2=54,5479075364343 V3=0 T=0 M2=0 M3=1,72890686533862 FrameElem=34-1 ElemStation=0

Frame=34 Station=0,05 OutputCase=RAR148 CaseType=Combination P=-12,5669050098821 V2=58,8479075364343 V3=0 T=0 M2=0 M3=-1,10598851148309 FrameElem=34-1 ElemStation=0,05

Frame=34 Station=0,1 OutputCase=RAR148 CaseType=Combination P=-12,5669050098821 V2=63,1479075364343 V3=0 T=0 M2=0 M3=-4,15588388830481 FrameElem=34-1 ElemStation=0,1

Frame=34 Station=0 OutputCase=RAR149 CaseType=Combination P=-21,765187254963 V2=47,2999999998352 V3=0 T=0 M2=0 M3=4,44427122001304 FrameElem=34-1 ElemStation=0

Frame=34 Station=0,05 OutputCase=RAR149 CaseType=Combination P=-21,765187254963 V2=51,5999999998352 V3=0 T=0 M2=0 M3=1,97177122002128 FrameElem=34-1 ElemStation=0,05

Frame=34 Station=0,1 OutputCase=RAR149 CaseType=Combination P=-21,765187254963 V2=55,8999999998352 V3=0 T=0 M2=0 M3=-0,715278779970481 FrameElem=34-1 ElemStation=0,1

Frame=34 Station=0 OutputCase=RAR150 CaseType=Combination P=-11,846797734427 V2=14,9479075365522 V3=0 T=0 M2=0 M3=-3,71905415602867 FrameElem=34-1 ElemStation=0

Frame=34 Station=0,05 OutputCase=RAR150 CaseType=Combination P=-11,846797734427 V2=15,6479075365522 V3=0 T=0 M2=0 M3=-4,48394953285628 FrameElem=34-1 ElemStation=0,05

Frame=34 Station=0,1 OutputCase=RAR150 CaseType=Combination P=-11,846797734427 V2=16,3479075365522 V3=0 T=0 M2=0 M3=-5,28384490968389 FrameElem=34-1 ElemStation=0,1

Frame=34 Station=0 OutputCase=RAR151 CaseType=Combination P=-21,0450799795079 V2=7,69999999995309 V3=0 T=0 M2=0 M3=-1,00368980135425 FrameElem=34-1 ElemStation=0

Frame=34 Station=0,05 OutputCase=RAR151 CaseType=Combination P=-21,0450799795079 V2=8,39999999995309 V3=0 T=0 M2=0 M3=-1,40618980135191 FrameElem=34-1 ElemStation=0,05

Frame=34 Station=0,1 OutputCase=RAR151 CaseType=Combination P=-21,0450799795079 V2=9,09999999995309 V3=0 T=0 M2=0 M3=-1,84368980134956 FrameElem=34-1 ElemStation=0,1

Frame=34 Station=0 OutputCase=RAR152 CaseType=Combination P=-2,91751910366344 V2=7,31859880230319 V3=0 T=0 M2=0 M3=1,63135308400605 FrameElem=34-1 ElemStation=0

Frame=34 Station=0,05 OutputCase=RAR152 CaseType=Combination P=-2,91751910366344 V2=8,01859880230319 V3=0 T=0 M2=0 M3=1,24792314389089 FrameElem=34-1 ElemStation=0,05

Frame=34 Station=0,1 OutputCase=RAR152 CaseType=Combination P=-2,91751910366344 V2=8,71859880230319 V3=0 T=0 M2=0 M3=0,829493203775733 FrameElem=34-1 ElemStation=0,1

Frame=34 Station=0 OutputCase=RAR153 CaseType=Combination P=-3,63762637911857 V2=46,9185988021853 V3=0 T=0 M2=0 M3=7,07931410537334 FrameElem=34-1 ElemStation=0

Frame=34 Station=0,05 OutputCase=RAR153 CaseType=Combination P=-3,63762637911857 V2=51,2185988021853 V3=0 T=0 M2=0 M3=4,62588416526408 FrameElem=34-1 ElemStation=0,05

Frame=34 Station=0,1 OutputCase=RAR153 CaseType=Combination P=-3,63762637911857 V2=55,5185988021853 V3=0 T=0 M2=0 M3=1,95745422515481 FrameElem=34-1 ElemStation=0,1

Frame=34 Station=0 OutputCase=RAR154 CaseType=Combination P=-12,835908605573 V2=54,1665063387262 V3=0 T=0 M2=0 M3=1,82198016952829 FrameElem=34-1 ElemStation=0

Frame=34 Station=0,05 OutputCase=RAR154 CaseType=Combination P=-12,835908605573 V2=58,4665063387262 V3=0 T=0 M2=0 M3=-0,993845147408021 FrameElem=34-1 ElemStation=0,05

Frame=34 Station=0,1 OutputCase=RAR154 CaseType=Combination P=-12,835908605573 V2=62,7665063387262 V3=0 T=0 M2=0 M3=-4,02467046434433 FrameElem=34-1 ElemStation=0,1

Frame=34 Station=0 OutputCase=RAR155 CaseType=Combination P=-22,034190850654 V2=46,9185988021271 V3=0 T=0 M2=0 M3=4,53734452420271 FrameElem=34-1 ElemStation=0

Frame=34 Station=0,05 OutputCase=RAR155 CaseType=Combination P=-22,034190850654 V2=51,2185988021271 V3=0 T=0 M2=0 M3=2,08391458409635 FrameElem=34-1 ElemStation=0,05

Frame=34 Station=0,1 OutputCase=RAR155 CaseType=Combination P=-22,034190850654 V2=55,5185988021271 V3=0 T=0 M2=0 M3=-0,584515356010002 FrameElem=34-1 ElemStation=0,1

Frame=34 Station=0 OutputCase=RAR156 CaseType=Combination P=-12,1158013301179 V2=14,5665063388441 V3=0 T=0 M2=0 M3=-3,625980851839 FrameElem=34-1 ElemStation=0

Frame=34 Station=0,05 OutputCase=RAR156 CaseType=Combination P=-12,1158013301179 V2=15,2665063388441 V3=0 T=0 M2=0 M3=-4,37180616878121 FrameElem=34-1 ElemStation=0,05

Frame=34 Station=0,1 OutputCase=RAR156 CaseType=Combination P=-12,1158013301179 V2=15,9665063388441 V3=0 T=0 M2=0 M3=-5,15263148572341 FrameElem=34-1 ElemStation=0,1

Frame=34 Station=0 OutputCase=RAR157 CaseType=Combination P=-21,3140835751988 V2=7,31859880224498 V3=0 T=0 M2=0 M3=-0,910616497164582 FrameElem=34-1 ElemStation=0

Frame=34 Station=0,05 OutputCase=RAR157 CaseType=Combination P=-21,3140835751988 V2=8,01859880224498 V3=0 T=0 M2=0 M3=-1,29404643727683 FrameElem=34-1 ElemStation=0,05

Frame=34 Station=0,1 OutputCase=RAR157 CaseType=Combination P=-21,3140835751988 V2=8,71859880224498 V3=0 T=0 M2=0 M3=-1,71247637738908 FrameElem=34-1 ElemStation=0,1

Frame=34 Station=0 OutputCase=RAR158 CaseType=Combination P=-3,29897411817826 V2=8,08140119771967 V3=0 T=0 M2=0 M3=0,682296446596985 FrameElem=34-1 ElemStation=0

Frame=34 Station=0,05 OutputCase=RAR158 CaseType=Combination P=-3,29897411817826 V2=8,78140119771967 V3=0 T=0 M2=0 M3=0,260726386711002 FrameElem=34-1 ElemStation=0,05

Frame=34 Station=0,1 OutputCase=RAR158 CaseType=Combination P=-3,29897411817826 V2=9,48140119771967 V3=0 T=0 M2=0 M3=-0,195843673174982 FrameElem=34-1 ElemStation=0,1

Frame=34 Station=0 OutputCase=RAR159 CaseType=Combination P=-4,0190813936334 V2=47,6814011976018 V3=0 T=0 M2=0 M3=6,13025746796428 FrameElem=34-1 ElemStation=0

Frame=34 Station=0,05 OutputCase=RAR159 CaseType=Combination P=-4,0190813936334 V2=51,9814011976018 V3=0 T=0 M2=0 M3=3,63868740808419 FrameElem=34-1 ElemStation=0,05

Frame=34 Station=0,1 OutputCase=RAR159 CaseType=Combination P=-4,0190813936334 V2=56,2814011976018 V3=0 T=0 M2=0 M3=0,932117348204098 FrameElem=34-1 ElemStation=0,1

Frame=34 Station=0 OutputCase=RAR160 CaseType=Combination P=-13,2173636200879 V2=54,9293087341427 V3=0 T=0 M2=0 M3=0,872923532119223 FrameElem=34-1 ElemStation=0

Società di Progetto
Brebemi SpA

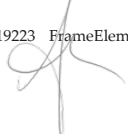

	Doc. N. 60235-0000-A00.doc	CODIFICA DOCUMENTO 04RCDII10000000000300A00	REV. 00	FOGLIO 465 di 628
--	-------------------------------	--	------------	----------------------

Frame=34 Station=0,05 OutputCase=RAR160 CaseType=Combination P=-13,2173636200879 V2=59,2293087341427 V3=0 T=0 M2=0 M3=-1,98104190458791 FrameElem=34-1 ElemStation=0,05

Frame=34 Station=0,1 OutputCase=RAR160 CaseType=Combination P=-13,2173636200879 V2=63,5293087341427 V3=0 T=0 M2=0 M3=-5,05000734129504 FrameElem=34-1 ElemStation=0,1

Frame=34 Station=0 OutputCase=RAR161 CaseType=Combination P=-22,4156458651688 V2=47,6814011975436 V3=0 T=0 M2=0 M3=3,58828788679364 FrameElem=34-1 ElemStation=0

Frame=34 Station=0,05 OutputCase=RAR161 CaseType=Combination P=-22,4156458651688 V2=51,9814011975436 V3=0 T=0 M2=0 M3=1,09671782691646 FrameElem=34-1 ElemStation=0,05

Frame=34 Station=0,1 OutputCase=RAR161 CaseType=Combination P=-22,4156458651688 V2=56,2814011975436 V3=0 T=0 M2=0 M3=-1,60985223296072 FrameElem=34-1 ElemStation=0,1

Frame=34 Station=0 OutputCase=RAR162 CaseType=Combination P=-12,4972563446327 V2=15,3293087342605 V3=0 T=0 M2=0 M3=-4,57503748924807 FrameElem=34-1 ElemStation=0

Frame=34 Station=0,05 OutputCase=RAR162 CaseType=Combination P=-12,4972563446327 V2=16,0293087342605 V3=0 T=0 M2=0 M3=-5,3590029259611 FrameElem=34-1 ElemStation=0,05

Frame=34 Station=0,1 OutputCase=RAR162 CaseType=Combination P=-12,4972563446327 V2=16,7293087342605 V3=0 T=0 M2=0 M3=-6,17796836267412 FrameElem=34-1 ElemStation=0,1

Frame=34 Station=0 OutputCase=RAR163 CaseType=Combination P=-21,6955385897136 V2=8,08140119766146 V3=0 T=0 M2=0 M3=-1,85967313457365 FrameElem=34-1 ElemStation=0

Frame=34 Station=0,05 OutputCase=RAR163 CaseType=Combination P=-21,6955385897136 V2=8,78140119766146 V3=0 T=0 M2=0 M3=-2,28124319445672 FrameElem=34-1 ElemStation=0,05

Frame=34 Station=0,1 OutputCase=RAR163 CaseType=Combination P=-21,6955385897136 V2=9,48140119766146 V3=0 T=0 M2=0 M3=-2,73781325433979 FrameElem=34-1 ElemStation=0,1

Frame=34 Station=0 OutputCase=INVRAR CaseType=Combination StepType=Max P=-2,6485155079725 V2=70,2225452905258 V3=0 T=0 M2=0 M3=8,259542754971 FrameElem=34-1 ElemStation=0

Frame=34 Station=0,05 OutputCase=INVRAR CaseType=Combination StepType=Max P=-2,6485155079725 V2=75,7225452905258 V3=0 T=0 M2=0 M3=5,11611281486369 FrameElem=34-1 ElemStation=0,05

Frame=34 Station=0,1 OutputCase=INVRAR CaseType=Combination StepType=Max P=-2,6485155079725 V2=81,2225452905258 V3=0 T=0 M2=0 M3=2,04492984112847 FrameElem=34-1 ElemStation=0,1

Frame=34 Station=0 OutputCase=INVRAR CaseType=Combination StepType=Min P=-28,9452006957437 V2=7,06433133710624 V3=0 T=0 M2=0 M3=-7,65428077678906 FrameElem=34-1 ElemStation=0

Frame=34 Station=0,05 OutputCase=INVRAR CaseType=Combination StepType=Min P=-28,9452006957437 V2=7,76433133710624 V3=0 T=0 M2=0 M3=-11,225603908911 FrameElem=34-1 ElemStation=0,05

Frame=34 Station=0,1 OutputCase=INVRAR CaseType=Combination StepType=Min P=-28,9452006957437 V2=8,46433133710624 V3=0 T=0 M2=0 M3=-15,0120200049932 FrameElem=34-1 ElemStation=0,1

Frame=34 Station=0 OutputCase=FRE01 CaseType=Combination P=-6,5081386729151 V2=7,6999999995343 V3=0 T=0 M2=0 M3=8,77822842230671E-02 FrameElem=34-1 ElemStation=0

Frame=34 Station=0,05 OutputCase=FRE01 CaseType=Combination P=-6,5081386729151 V2=8,3999999995343 V3=0 T=0 M2=0 M3=-0,314717715774605 FrameElem=34-1 ElemStation=0,05

Frame=34 Station=0,1 OutputCase=FRE01 CaseType=Combination P=-6,5081386729151 V2=9,0999999995343 V3=0 T=0 M2=0 M3=-0,752217715772276 FrameElem=34-1 ElemStation=0,1

Frame=34 Station=0 OutputCase=FRE02 CaseType=Combination P=-4,59457239128991 V2=47,2999999998938 V3=0 T=0 M2=0 M3=5,96902742914403 FrameElem=34-1 ElemStation=0

Frame=34 Station=0,05 OutputCase=FRE02 CaseType=Combination P=-4,59457239128991 V2=51,5999999998938 V3=0 T=0 M2=0 M3=3,49652742914935 FrameElem=34-1 ElemStation=0,05

Frame=34 Station=0,1 OutputCase=FRE02 CaseType=Combination P=-4,59457239128991 V2=55,8999999998938 V3=0 T=0 M2=0 M3=0,809027429154659 FrameElem=34-1 ElemStation=0,1

Frame=34 Station=0 OutputCase=FRE03 CaseType=Combination P=-13,7928546177444 V2=54,5479075364347 V3=0 T=0 M2=0 M3=0,711693493298981 FrameElem=34-1 ElemStation=0

Frame=34 Station=0,05 OutputCase=FRE03 CaseType=Combination P=-13,7928546177444 V2=58,8479075364347 V3=0 T=0 M2=0 M3=-2,12320188352275 FrameElem=34-1 ElemStation=0,05

Frame=34 Station=0,1 OutputCase=FRE03 CaseType=Combination P=-13,7928546177444 V2=63,1479075364347 V3=0 T=0 M2=0 M3=-5,17309726034448 FrameElem=34-1 ElemStation=0,1

Frame=34 Station=0 OutputCase=FRE04 CaseType=Combination P=-22,9911368628253 V2=47,2999999998935 V3=0 T=0 M2=0 M3=3,4270578479734 FrameElem=34-1 ElemStation=0

Frame=34 Station=0,05 OutputCase=FRE04 CaseType=Combination P=-22,9911368628253 V2=51,5999999998935 V3=0 T=0 M2=0 M3=0,954557847981623 FrameElem=34-1 ElemStation=0,05

Frame=34 Station=0,1 OutputCase=FRE04 CaseType=Combination P=-22,9911368628253 V2=55,8999999998935 V3=0 T=0 M2=0 M3=-1,73294215201016 FrameElem=34-1 ElemStation=0,1

Frame=34 Station=0 OutputCase=FRE05 CaseType=Combination P=-13,0727473422892 V2=14,9479075365525 V3=0 T=0 M2=0 M3=4,73626752806831 FrameElem=34-1 ElemStation=0

Frame=34 Station=0,05 OutputCase=FRE05 CaseType=Combination P=-13,0727473422892 V2=15,6479075365525 V3=0 T=0 M2=0 M3=-5,50116290489594 FrameElem=34-1 ElemStation=0,05

Frame=34 Station=0,1 OutputCase=FRE05 CaseType=Combination P=-13,0727473422892 V2=16,3479075365525 V3=0 T=0 M2=0 M3=-6,30105828172356 FrameElem=34-1 ElemStation=0,1

Frame=34 Station=0 OutputCase=FRE06 CaseType=Combination P=-22,2710295873702 V2=7,6999999995343 V3=0 T=0 M2=0 M3=-2,02090317339389 FrameElem=34-1 ElemStation=0

Frame=34 Station=0,05 OutputCase=FRE06 CaseType=Combination P=-22,2710295873702 V2=8,3999999995343 V3=0 T=0 M2=0 M3=-2,42340317339156 FrameElem=34-1 ElemStation=0,05

Frame=34 Station=0,1 OutputCase=FRE06 CaseType=Combination P=-22,2710295873702 V2=9,0999999995343 V3=0 T=0 M2=0 M3=-2,86090317338923 FrameElem=34-1 ElemStation=0,1

Frame=34 Station=0 OutputCase=FRE07 CaseType=Combination P=-4,33419621878313 V2=7,7000000001177 V3=0 T=0 M2=0 M3=0,139611393261878 FrameElem=34-1 ElemStation=0

Frame=34 Station=0,05 OutputCase=FRE07 CaseType=Combination P=-4,33419621878313 V2=8,4000000001177 V3=0 T=0 M2=0 M3=-0,26288860673871 FrameElem=34-1 ElemStation=0,05

Frame=34 Station=0,1 OutputCase=FRE07 CaseType=Combination P=-4,33419621878313 V2=9,1000000001177 V3=0 T=0 M2=0 M3=-0,700388606739299 FrameElem=34-1 ElemStation=0,1

Frame=34 Station=0 OutputCase=FRE08 CaseType=Combination P=-4,97768164374687 V2=47,2999999998939 V3=0 T=0 M2=0 M3=5,65114825038165 FrameElem=34-1 ElemStation=0

Frame=34 Station=0,05 OutputCase=FRE08 CaseType=Combination P=-4,97768164374687 V2=51,5999999998939 V3=0 T=0 M2=0 M3=3,17864825038695 FrameElem=34-1 ElemStation=0,05

Frame=34 Station=0,1 OutputCase=FRE08 CaseType=Combination P=-4,97768164374687 V2=55,8999999998939 V3=0 T=0 M2=0 M3=0,491148250392261 FrameElem=34-1 ElemStation=0,1

Frame=34 Station=0 OutputCase=FRE09 CaseType=Combination P=-14,1759638702013 V2=54,5479075364348 V3=0 T=0 M2=0 M3=0,393814314536593 FrameElem=34-1 ElemStation=0

Frame=34 Station=0,05 OutputCase=FRE09 CaseType=Combination P=-14,1759638702013 V2=58,8479075364348 V3=0 T=0 M2=0 M3=-2,44108106228515 FrameElem=34-1 ElemStation=0,05

Frame=34 Station=0,1 OutputCase=FRE09 CaseType=Combination P=-14,1759638702013 V2=63,1479075364348 V3=0 T=0 M2=0 M3=-5,49097643910688 FrameElem=34-1 ElemStation=0,1

Società di Progetto
Brebemi SpA



Doc. N.
60235-0000-A00.doc

CODIFICA DOCUMENTO
04RCDII10000000000300A00

REV.
00

FOGLIO
466 di 628

Frame=34 Station=0 OutputCase=FRE10 CaseType=Combination P=-23,3742461152823 V2=47,2999999998357 V3=0 T=0 M2=0 M3=3,10917866921101 ElemStation=0	Frame=34 Station=0,05 OutputCase=FRE10 CaseType=Combination P=-23,3742461152823 V2=51,5999999998357 V3=0 T=0 M2=0 M3=0,63667866921923 ElemStation=0,05	Frame=34 Station=0,1 OutputCase=FRE10 CaseType=Combination P=-23,3742461152823 V2=55,8999999998357 V3=0 T=0 M2=0 M3=-2,05082133077255 ElemStation=0,1	Frame=34 Station=0 OutputCase=FRE11 CaseType=Combination P=-13,4558565947462 V2=14,9479075365526 V3=0 T=0 M2=0 M3=-5,0541467068307 ElemStation=0	Frame=34 Station=0,05 OutputCase=FRE11 CaseType=Combination P=-13,4558565947462 V2=15,6479075365526 V3=0 T=0 M2=0 M3=-5,81904208365833 ElemStation=0,05	Frame=34 Station=0,1 OutputCase=FRE11 CaseType=Combination P=-13,4558565947462 V2=16,3479075365526 V3=0 T=0 M2=0 M3=-6,61893746048596 ElemStation=0,1	Frame=34 Station=0 OutputCase=FRE12 CaseType=Combination P=-22,6541388398271 V2=7,6999999995354 V3=0 T=0 M2=0 M3=-2,33878235215628 ElemStation=0	Frame=34 Station=0,05 OutputCase=FRE12 CaseType=Combination P=-22,6541388398271 V2=8,3999999995354 V3=0 T=0 M2=0 M3=-2,74128235215396 ElemStation=0,05	Frame=34 Station=0,1 OutputCase=FRE12 CaseType=Combination P=-22,6541388398271 V2=9,0999999995354 V3=0 T=0 M2=0 M3=-3,17878235215163 ElemStation=0,1	Frame=34 Station=0 OutputCase=FRE13 CaseType=Combination P=-4,17525662940195 V2=7,38216566858824 V3=0 T=0 M2=0 M3=0,535051658848989 ElemStation=0	Frame=34 Station=0,05 OutputCase=FRE13 CaseType=Combination P=-4,17525662940195 V2=8,08216566858824 V3=0 T=0 M2=0 M3=0,148443375419577 ElemStation=0,05	Frame=34 Station=0,1 OutputCase=FRE13 CaseType=Combination P=-4,17525662940195 V2=8,78216566858824 V3=0 T=0 M2=0 M3=0,273164908009835 ElemStation=0,1	Frame=34 Station=0 OutputCase=FRE14 CaseType=Combination P=-4,4931358081643 V2=8,0178343314353 V3=0 T=0 M2=0 M3=0,255828872325233 ElemStation=0	Frame=34 Station=0,05 OutputCase=FRE14 CaseType=Combination P=-4,4931358081643 V2=8,7178343314353 V3=0 T=0 M2=0 M3=0,674220588896998 ElemStation=0,05	Frame=34 Station=0,1 OutputCase=FRE14 CaseType=Combination P=-4,4931358081643 V2=9,4178343314353 V3=0 T=0 M2=0 M3=-1,12761230546876 ElemStation=0,1	Frame=34 Station=0 OutputCase=FRE15 CaseType=Combination P=-3,95108696632617 V2=7,7000000001166 V3=0 T=0 M2=0 M3=0,457490572024266 ElemStation=0	Frame=34 Station=0,05 OutputCase=FRE15 CaseType=Combination P=-3,95108696632617 V2=8,4000000001166 V3=0 T=0 M2=0 M3=5,49905720236827E-02 FrameElem=34-1 ElemStation=0,05	Frame=34 Station=0,1 OutputCase=FRE15 CaseType=Combination P=-3,95108696632617 V2=9,1000000001166 V3=0 T=0 M2=0 M3=-0,382509427976901 ElemStation=0,1	Frame=34 Station=0 OutputCase=FRE16 CaseType=Combination P=-3,41473401288642 V2=7,7000000001151 V3=0 T=0 M2=0 M3=0,902521422291608 ElemStation=0	Frame=34 Station=0,05 OutputCase=FRE16 CaseType=Combination P=-3,41473401288642 V2=8,4000000001151 V3=0 T=0 M2=0 M3=0,500021422291033 ElemStation=0,05	Frame=34 Station=0,1 OutputCase=FRE16 CaseType=Combination P=-3,41473401288642 V2=9,1000000001151 V3=0 T=0 M2=0 M3=0,062521422290457 ElemStation=0,1	Frame=34 Station=0 OutputCase=FRE17 CaseType=Combination P=-4,21146313883295 V2=47,2999999998937 V3=0 T=0 M2=0 M3=6,28690660790642 ElemStation=0	Frame=34 Station=0,05 OutputCase=FRE17 CaseType=Combination P=-4,21146313883295 V2=51,5999999998937 V3=0 T=0 M2=0 M3=3,81440660791174 ElemStation=0,05	Frame=34 Station=0,1 OutputCase=FRE17 CaseType=Combination P=-4,21146313883295 V2=55,8999999998937 V3=0 T=0 M2=0 M3=1,12690660791706 ElemStation=0,1	Frame=34 Station=0 OutputCase=FRE18 CaseType=Combination P=-13,4097453652874 V2=54,5479075364345 V3=0 T=0 M2=0 M3=1,02957267206137 ElemStation=0	Frame=34 Station=0,05 OutputCase=FRE18 CaseType=Combination P=-13,4097453652874 V2=58,8479075364345 V3=0 T=0 M2=0 M3=-1,80532270476036 ElemStation=0,05	Frame=34 Station=0,1 OutputCase=FRE18 CaseType=Combination P=-13,4097453652874 V2=63,1479075364346 V3=0 T=0 M2=0 M3=-4,85521808158209 ElemStation=0,1	Frame=34 Station=0 OutputCase=FRE19 CaseType=Combination P=-22,6080276103683 V2=47,2999999998355 V3=0 T=0 M2=0 M3=3,74493702673579 ElemStation=0	Frame=34 Station=0,05 OutputCase=FRE19 CaseType=Combination P=-22,6080276103683 V2=51,5999999998355 V3=0 T=0 M2=0 M3=1,27243702674402 ElemStation=0,05	Frame=34 Station=0,1 OutputCase=FRE19 CaseType=Combination P=-22,6080276103683 V2=55,8999999998355 V3=0 T=0 M2=0 M3=-1,41506297324776 ElemStation=0,1	Frame=34 Station=0 OutputCase=FRE20 CaseType=Combination P=-12,6896380898323 V2=14,9479075365524 V3=0 T=0 M2=0 M3=-4,41838834930592 ElemStation=0	Frame=34 Station=0,05 OutputCase=FRE20 CaseType=Combination P=-12,6896380898323 V2=15,6479075365524 V3=0 T=0 M2=0 M3=-5,18328372613354 ElemStation=0,05	Frame=34 Station=0,1 OutputCase=FRE20 CaseType=Combination P=-12,6896380898323 V2=16,3479075365524 V3=0 T=0 M2=0 M3=-5,98317910296116 ElemStation=0,1	Frame=34 Station=0 OutputCase=FRE21 CaseType=Combination P=-21,8879203349132 V2=7,6999999995333 V3=0 T=0 M2=0 M3=-1,7030239946315 ElemStation=0	Frame=34 Station=0,05 OutputCase=FRE21 CaseType=Combination P=-21,8879203349132 V2=8,3999999995333 V3=0 T=0 M2=0 M3=-2,10552399462917 ElemStation=0,05	Frame=34 Station=0,1 OutputCase=FRE21 CaseType=Combination P=-21,8879203349132 V2=9,0999999995333 V3=0 T=0 M2=0 M3=-2,54302399462684 ElemStation=0,1	Frame=34 Station=0 OutputCase=FRE22 CaseType=Combination P=-3,25579442350524 V2=7,38216566858798 V3=0 T=0 M2=0 M3=1,29796168787872 ElemStation=0	Frame=34 Station=0,05 OutputCase=FRE22 CaseType=Combination P=-3,25579442350524 V2=8,08216566858798 V3=0 T=0 M2=0 M3=0,91135340444932 ElemStation=0,05	Frame=34 Station=0,1 OutputCase=FRE22 CaseType=Combination P=-3,25579442350524 V2=8,78216566858798 V3=0 T=0 M2=0 M3=0,489745121019921 ElemStation=0,1	Frame=34 Station=0 OutputCase=FRE23 CaseType=Combination P=-3,5736736022676 V2=8,01783433143505 V3=0 T=0 M2=0 M3=0,507081156704497 ElemStation=0	Frame=34 Station=0,05 OutputCase=FRE23 CaseType=Combination P=-3,5736736022676 V2=8,71783433143505 V3=0 T=0 M2=0 M3=0,088689440132745 ElemStation=0,05	Frame=34 Station=0,1 OutputCase=FRE23 CaseType=Combination P=-3,5736736022676 V2=9,41783433143505 V3=0 T=0 M2=0 M3=-0,364702276439007 ElemStation=0,1	Frame=34 Station=0 OutputCase=FRE24 CaseType=Combination P=-3,03162476042946 V2=7,7000000001141 V3=0 T=0 M2=0 M3=1,220400601054 ElemStation=0	Frame=34 Station=0,05 OutputCase=FRE24 CaseType=Combination P=-3,03162476042946 V2=8,4000000001141 V3=0 T=0 M2=0 M3=0,817900601053426 ElemStation=0,05
--	--	---	--	---	---	--	--	--	---	---	---	---	---	---	--	--	---	--	--	--	--	--	--	--	---	---	--	--	---	---	---	---	---	--	--	--	--	---	--	--	---	---	--

APPROVATO SDP
Società di Progetto
Brebemi SpA

	Doc. N. 60235-00000-A00.doc	CODIFICA DOCUMENTO 04RCDII10000000000300A00	REV. 00	FOGLIO 467 di 628
--	--------------------------------	--	------------	----------------------

Frame=34	Station=0,1	OutputCase=FRE24	CaseType=Combination	P=-3,03162476042946	V2=9,10000000001141	V3=0	T=0	M2=0	M3=0,380400601052855	FrameElem=34-1
ElemStation=0,1										
Frame=34	Station=0	OutputCase=FRE25	CaseType=Combination	P=-3,68373760857736	V2=7,3185988023034	V3=0	T=0	M2=0	M3=0,995594726481276	FrameElem=34-1
ElemStation=0										
Frame=34	Station=0,05	OutputCase=FRE25	CaseType=Combination	P=-3,68373760857736	V2=8,0185988023034	V3=0	T=0	M2=0	M3=0,612164786366106	FrameElem=34-1
ElemStation=0,05										
Frame=34	Station=0,1	OutputCase=FRE25	CaseType=Combination	P=-3,68373760857736	V2=8,7185988023034	V3=0	T=0	M2=0	M3=0,193734846250936	FrameElem=34-1
ElemStation=0,1										
Frame=34	Station=0	OutputCase=FRE26	CaseType=Combination	P=-4,43563280190873	V2=46,9821656684702	V3=0	T=0	M2=0	M3=6,36446769473115	FrameElem=34-1
ElemStation=0										
Frame=34	Station=0,05	OutputCase=FRE26	CaseType=Combination	P=-4,43563280190873	V2=51,2821656684702	V3=0	T=0	M2=0	M3=3,90785941130763	FrameElem=34-1
ElemStation=0,05										
Frame=34	Station=0,1	OutputCase=FRE26	CaseType=Combination	P=-4,43563280190873	V2=55,5821656684702	V3=0	T=0	M2=0	M3=1,23625112788412	FrameElem=34-1
ElemStation=0,1										
Frame=34	Station=0	OutputCase=FRE27	CaseType=Combination	P=-13,6339150283632	V2=54,2300732050111	V3=0	T=0	M2=0	M3=1,10713375888609	FrameElem=34-1
ElemStation=0										
Frame=34	Station=0,05	OutputCase=FRE27	CaseType=Combination	P=-13,6339150283632	V2=58,5300732050111	V3=0	T=0	M2=0	M3=-1,71186990136446	FrameElem=34-1
ElemStation=0,05										
Frame=34	Station=0,1	OutputCase=FRE27	CaseType=Combination	P=-13,6339150283632	V2=62,8300732050111	V3=0	T=0	M2=0	M3=-4,74587356161502	FrameElem=34-1
ElemStation=0,1										
Frame=34	Station=0	OutputCase=FRE28	CaseType=Combination	P=-22,8321972734441	V2=46,982165668412	V3=0	T=0	M2=0	M3=3,82249811356051	FrameElem=34-1
ElemStation=0										
Frame=34	Station=0,05	OutputCase=FRE28	CaseType=Combination	P=-22,8321972734441	V2=51,282165668412	V3=0	T=0	M2=0	M3=1,36588983013991	FrameElem=34-1
ElemStation=0,05										
Frame=34	Station=0,1	OutputCase=FRE28	CaseType=Combination	P=-22,8321972734441	V2=55,582165668412	V3=0	T=0	M2=0	M3=-1,30571845328069	FrameElem=34-1
ElemStation=0,1										
Frame=34	Station=0	OutputCase=FRE29	CaseType=Combination	P=-12,9138077529081	V2=14,630073205129	V3=0	T=0	M2=0	M3=-4,3408272624812	FrameElem=34-1
ElemStation=0										
Frame=34	Station=0,05	OutputCase=FRE29	CaseType=Combination	P=-12,9138077529081	V2=15,330073205129	V3=0	T=0	M2=0	M3=-5,08983092273765	FrameElem=34-1
ElemStation=0,05										
Frame=34	Station=0,1	OutputCase=FRE29	CaseType=Combination	P=-12,9138077529081	V2=16,030073205129	V3=0	T=0	M2=0	M3=-5,8738345829941	FrameElem=34-1
ElemStation=0,1										
Frame=34	Station=0	OutputCase=FRE30	CaseType=Combination	P=-22,112089997989	V2=7,3821656685299	V3=0	T=0	M2=0	M3=-1,62546290780678	FrameElem=34-1
ElemStation=0										
Frame=34	Station=0,05	OutputCase=FRE30	CaseType=Combination	P=-22,112089997989	V2=8,0821656685299	V3=0	T=0	M2=0	M3=-2,01207119123328	FrameElem=34-1
ElemStation=0,05										
Frame=34	Station=0,1	OutputCase=FRE30	CaseType=Combination	P=-22,112089997989	V2=8,7821656685299	V3=0	T=0	M2=0	M3=-2,43367947465977	FrameElem=34-1
ElemStation=0,1										
Frame=34	Station=0	OutputCase=FRE31	CaseType=Combination	P=-4,06684686103432	V2=7,31859880230351	V3=0	T=0	M2=0	M3=0,677715547718889	FrameElem=34-1
ElemStation=0										
Frame=34	Station=0,05	OutputCase=FRE31	CaseType=Combination	P=-4,06684686103432	V2=8,01859880230351	V3=0	T=0	M2=0	M3=0,294285607603713	FrameElem=34-1
ElemStation=0,05										
Frame=34	Station=0,1	OutputCase=FRE31	CaseType=Combination	P=-4,06684686103432	V2=8,71859880230351	V3=0	T=0	M2=0	M3=-0,124144332511462	FrameElem=34-1
ElemStation=0,1										
Frame=34	Station=0	OutputCase=FRE32	CaseType=Combination	P=-3,3006283561204	V2=7,31859880230329	V3=0	T=0	M2=0	M3=1,31347390524366	FrameElem=34-1
ElemStation=0										
Frame=34	Station=0,05	OutputCase=FRE32	CaseType=Combination	P=-3,3006283561204	V2=8,01859880230329	V3=0	T=0	M2=0	M3=0,930043965128499	FrameElem=34-1
ElemStation=0,05										
Frame=34	Station=0,1	OutputCase=FRE32	CaseType=Combination	P=-3,3006283561204	V2=8,7185988023033	V3=0	T=0	M2=0	M3=0,511614205013335	FrameElem=34-1
ElemStation=0,1										
Frame=34	Station=0	OutputCase=FRE33	CaseType=Combination	P=-3,3006283561204	V2=7,31859880230329	V3=0	T=0	M2=0	M3=1,31347390524366	FrameElem=34-1
ElemStation=0										
Frame=34	Station=0,05	OutputCase=FRE33	CaseType=Combination	P=-3,3006283561204	V2=8,01859880230329	V3=0	T=0	M2=0	M3=0,930043965128499	FrameElem=34-1
ElemStation=0,05										
Frame=34	Station=0,1	OutputCase=FRE33	CaseType=Combination	P=-3,3006283561204	V2=8,7185988023033	V3=0	T=0	M2=0	M3=0,511614205013335	FrameElem=34-1
ElemStation=0,1										
Frame=34	Station=0	OutputCase=FRE34	CaseType=Combination	P=-4,06519262309219	V2=8,08140119771988	V3=0	T=0	M2=0	M3=4,65380890722101E-02	FrameElem=34-1
ElemStation=0										
Frame=34	Station=0,05	OutputCase=FRE34	CaseType=Combination	P=-4,06519262309219	V2=8,78140119771988	V3=0	T=0	M2=0	M3=-0,375031970813784	FrameElem=34-1
ElemStation=0,05										
Frame=34	Station=0,1	OutputCase=FRE34	CaseType=Combination	P=-4,06519262309219	V2=9,48140119771988	V3=0	T=0	M2=0	M3=-0,831602030699778	FrameElem=34-1
ElemStation=0,1										
Frame=34	Station=0	OutputCase=FRE35	CaseType=Combination	P=-4,75351198067109	V2=47,6178343313173	V3=0	T=0	M2=0	M3=5,57358716355692	FrameElem=34-1
ElemStation=0										
Frame=34	Station=0,05	OutputCase=FRE35	CaseType=Combination	P=-4,75351198067109	V2=51,9178343313173	V3=0	T=0	M2=0	M3=3,08519544699106	FrameElem=34-1
ElemStation=0,05										
Frame=34	Station=0,1	OutputCase=FRE35	CaseType=Combination	P=-4,75351198067109	V2=56,2178343313173	V3=0	T=0	M2=0	M3=0,381803730425195	FrameElem=34-1
ElemStation=0,1										
Frame=34	Station=0	OutputCase=FRE36	CaseType=Combination	P=-13,9517942071256	V2=54,8657418678582	V3=0	T=0	M2=0	M3=0,31625322771187	FrameElem=34-1
ElemStation=0										
Frame=34	Station=0,05	OutputCase=FRE36	CaseType=Combination	P=-13,9517942071256	V2=59,1657418678582	V3=0	T=0	M2=0	M3=-2,53453386568104	FrameElem=34-1
ElemStation=0,05										
Frame=34	Station=0,1	OutputCase=FRE36	CaseType=Combination	P=-13,9517942071256	V2=63,4657418678582	V3=0	T=0	M2=0	M3=-5,60032095907395	FrameElem=34-1
ElemStation=0,1										
Frame=34	Station=0	OutputCase=FRE37	CaseType=Combination	P=-23,1500764522065	V2=47,6178343312591	V3=0	T=0	M2=0	M3=3,03161758238629	FrameElem=34-1
ElemStation=0										
Frame=34	Station=0,05	OutputCase=FRE37	CaseType=Combination	P=-23,1500764522065	V2=51,9178343312591	V3=0	T=0	M2=0	M3=0,543225865823335	FrameElem=34-1
ElemStation=0,05										
Frame=34	Station=0,1	OutputCase=FRE37	CaseType=Combination	P=-23,1500764522065	V2=56,2178343312591	V3=0	T=0	M2=0	M3=-2,16016585073962	FrameElem=34-1
ElemStation=0,1										
Frame=34	Station=0	OutputCase=FRE38	CaseType=Combination	P=-13,2316869316704	V2=15,2657418679761	V3=0	T=0	M2=0	M3=-5,13170779365542	FrameElem=34-1
ElemStation=0										
Frame=34	Station=0,05	OutputCase=FRE38	CaseType=Combination	P=-13,2316869316704	V2=15,9657418679761	V3=0	T=0	M2=0	M3=-5,91249488705423	FrameElem=34-1
ElemStation=0,05										
Frame=34	Station=0,1	OutputCase=FRE38	CaseType=Combination	P=-13,2316869316704	V2=16,6657418679761	V3=0	T=0	M2=0	M3=-6,72828198045303	FrameElem=34-1
ElemStation=0,1										
Frame=34	Station=0	OutputCase=FRE39	CaseType=Combination	P=-22,4299691767513	V2=8,01783433137697	V3=0	T=0	M2=0	M3=-2,416343438981	FrameElem=34-1
ElemStation=0										

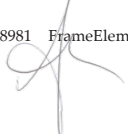
Società di Progetto
Brebemi SpA



Doc. N.
60235-0000-A00.doc

CODIFICA DOCUMENTO
04RCDII10000000000300A00

REV.
00

FOGLIO
468 di 628

Frame=34 Station=0,05 OutputCase=FRE39 CaseType=Combination P=-22,4299691767513 V2=8,71783433137697 V3=0 T=0 M2=0 M3=-2,83473515554985 FrameElem=34-1
ElemStation=0,05
Frame=34 Station=0,1 OutputCase=FRE39 CaseType=Combination P=-22,4299691767513 V2=9,41783433137697 V3=0 T=0 M2=0 M3=-3,2881268721187 FrameElem=34-1
ElemStation=0,1
Frame=34 Station=0 OutputCase=FRE40 CaseType=Combination P=-4,44830187554915 V2=8,08140119771999 V3=0 T=0 M2=0 M3=-0,271341089690177 FrameElem=34-1
ElemStation=0
Frame=34 Station=0,05 OutputCase=FRE40 CaseType=Combination P=-4,44830187554915 V2=8,78140119771999 V3=0 T=0 M2=0 M3=-0,692911149576177 FrameElem=34-1
ElemStation=0,05
Frame=34 Station=0,1 OutputCase=FRE40 CaseType=Combination P=-4,44830187554915 V2=9,48140119771999 V3=0 T=0 M2=0 M3=-1,14948120946218 FrameElem=34-1
ElemStation=0,1
Frame=34 Station=0 OutputCase=FRE41 CaseType=Combination P=-3,68208337063523 V2=8,08140119771977 V3=0 T=0 M2=0 M3=-0,364417267834598 FrameElem=34-1
ElemStation=0
Frame=34 Station=0,05 OutputCase=FRE41 CaseType=Combination P=-3,68208337063523 V2=8,78140119771977 V3=0 T=0 M2=0 M3=-0,057152792051391 FrameElem=34-1
ElemStation=0,05
Frame=34 Station=0,1 OutputCase=FRE41 CaseType=Combination P=-3,68208337063523 V2=9,48140119771977 V3=0 T=0 M2=0 M3=-0,51372285193738 FrameElem=34-1
ElemStation=0,1
Frame=34 Station=0 OutputCase=FRE42 CaseType=Combination P=-3,68208337063523 V2=8,08140119771977 V3=0 T=0 M2=0 M3=-0,364417267834598 FrameElem=34-1
ElemStation=0
Frame=34 Station=0,05 OutputCase=FRE42 CaseType=Combination P=-3,68208337063523 V2=8,78140119771977 V3=0 T=0 M2=0 M3=-0,057152792051391 FrameElem=34-1
ElemStation=0,05
Frame=34 Station=0,1 OutputCase=FRE42 CaseType=Combination P=-3,68208337063523 V2=9,48140119771977 V3=0 T=0 M2=0 M3=-0,51372285193738 FrameElem=34-1
ElemStation=0,1
Frame=34 Station=0 OutputCase=FRE43 CaseType=Combination P=-3,41473401288642 V2=7,7000000001151 V3=0 T=0 M2=0 M3=-0,902521422291608 FrameElem=34-1
ElemStation=0
Frame=34 Station=0,05 OutputCase=FRE43 CaseType=Combination P=-3,41473401288642 V2=8,4000000001151 V3=0 T=0 M2=0 M3=-0,500021422291033 FrameElem=34-1
ElemStation=0,05
Frame=34 Station=0,1 OutputCase=FRE43 CaseType=Combination P=-3,41473401288642 V2=9,1000000001151 V3=0 T=0 M2=0 M3=-0,062521422290457 FrameElem=34-1
ElemStation=0,1
Frame=34 Station=0 OutputCase=FRE44 CaseType=Combination P=-4,21146313883295 V2=47,2999999998937 V3=0 T=0 M2=0 M3=-6,28690660790642 FrameElem=34-1
ElemStation=0
Frame=34 Station=0,05 OutputCase=FRE44 CaseType=Combination P=-4,21146313883295 V2=51,5999999998937 V3=0 T=0 M2=0 M3=-3,81440660791174 FrameElem=34-1
ElemStation=0,05
Frame=34 Station=0,1 OutputCase=FRE44 CaseType=Combination P=-4,21146313883295 V2=55,8999999998937 V3=0 T=0 M2=0 M3=-1,12690660791706 FrameElem=34-1
ElemStation=0,1
Frame=34 Station=0 OutputCase=FRE45 CaseType=Combination P=-13,4097453652874 V2=54,5479075364345 V3=0 T=0 M2=0 M3=-1,02957267206137 FrameElem=34-1
ElemStation=0
Frame=34 Station=0,05 OutputCase=FRE45 CaseType=Combination P=-13,4097453652874 V2=58,8479075364345 V3=0 T=0 M2=0 M3=-1,80532270476036 FrameElem=34-1
ElemStation=0,05
Frame=34 Station=0,1 OutputCase=FRE45 CaseType=Combination P=-13,4097453652874 V2=63,1479075364346 V3=0 T=0 M2=0 M3=-4,85521808158209 FrameElem=34-1
ElemStation=0,1
Frame=34 Station=0 OutputCase=FRE46 CaseType=Combination P=-22,6080276103683 V2=47,2999999998355 V3=0 T=0 M2=0 M3=-3,74493702673579 FrameElem=34-1
ElemStation=0
Frame=34 Station=0,05 OutputCase=FRE46 CaseType=Combination P=-22,6080276103683 V2=51,5999999998355 V3=0 T=0 M2=0 M3=-1,27243702674402 FrameElem=34-1
ElemStation=0,05
Frame=34 Station=0,1 OutputCase=FRE46 CaseType=Combination P=-22,6080276103683 V2=55,8999999998355 V3=0 T=0 M2=0 M3=-1,41506297324776 FrameElem=34-1
ElemStation=0,1
Frame=34 Station=0 OutputCase=FRE47 CaseType=Combination P=-12,6896380898323 V2=14,9479075365524 V3=0 T=0 M2=0 M3=-4,41838834930592 FrameElem=34-1
ElemStation=0
Frame=34 Station=0,05 OutputCase=FRE47 CaseType=Combination P=-12,6896380898323 V2=15,6479075365524 V3=0 T=0 M2=0 M3=-5,18328372613354 FrameElem=34-1
ElemStation=0,05
Frame=34 Station=0,1 OutputCase=FRE47 CaseType=Combination P=-12,6896380898323 V2=16,3479075365524 V3=0 T=0 M2=0 M3=-5,98317910296116 FrameElem=34-1
ElemStation=0,1
Frame=34 Station=0 OutputCase=FRE48 CaseType=Combination P=-21,8879203349132 V2=7,69999999995333 V3=0 T=0 M2=0 M3=-1,7030239946315 FrameElem=34-1
ElemStation=0
Frame=34 Station=0,05 OutputCase=FRE48 CaseType=Combination P=-21,8879203349132 V2=8,39999999995333 V3=0 T=0 M2=0 M3=-2,10552399462917 FrameElem=34-1
ElemStation=0,05
Frame=34 Station=0,1 OutputCase=FRE48 CaseType=Combination P=-21,8879203349132 V2=9,09999999995333 V3=0 T=0 M2=0 M3=-2,54302399462684 FrameElem=34-1
ElemStation=0,1
Frame=34 Station=0 OutputCase=FRE49 CaseType=Combination P=-3,03162476042946 V2=7,7000000001141 V3=0 T=0 M2=0 M3=-1,220400601054 FrameElem=34-1
ElemStation=0
Frame=34 Station=0,05 OutputCase=FRE49 CaseType=Combination P=-3,03162476042946 V2=8,4000000001141 V3=0 T=0 M2=0 M3=-0,817900601053426 FrameElem=34-1
ElemStation=0,05
Frame=34 Station=0,1 OutputCase=FRE49 CaseType=Combination P=-3,03162476042946 V2=9,1000000001141 V3=0 T=0 M2=0 M3=-0,380400601052855 FrameElem=34-1
ElemStation=0,1
Frame=34 Station=0 OutputCase=FRE50 CaseType=Combination P=-3,25579442350524 V2=7,38216566858798 V3=0 T=0 M2=0 M3=-1,29796168787872 FrameElem=34-1
ElemStation=0
Frame=34 Station=0,05 OutputCase=FRE50 CaseType=Combination P=-3,25579442350524 V2=8,08216566858798 V3=0 T=0 M2=0 M3=-0,91135340444932 FrameElem=34-1
ElemStation=0,05
Frame=34 Station=0,1 OutputCase=FRE50 CaseType=Combination P=-3,25579442350524 V2=8,78216566858798 V3=0 T=0 M2=0 M3=-0,489745121019921 FrameElem=34-1
ElemStation=0,1
Frame=34 Station=0 OutputCase=FRE51 CaseType=Combination P=-3,5736736022676 V2=8,01783433143505 V3=0 T=0 M2=0 M3=-0,507081156704497 FrameElem=34-1
ElemStation=0
Frame=34 Station=0,05 OutputCase=FRE51 CaseType=Combination P=-3,5736736022676 V2=8,71783433143505 V3=0 T=0 M2=0 M3=-0,088689440132745 FrameElem=34-1
ElemStation=0,05
Frame=34 Station=0,1 OutputCase=FRE51 CaseType=Combination P=-3,5736736022676 V2=9,41783433143505 V3=0 T=0 M2=0 M3=-0,364702276439007 FrameElem=34-1
ElemStation=0,1
Frame=34 Station=0 OutputCase=INVFRE CaseType=Combination StepType=Max P=-3,03162476042946 V2=54,8657418678582 V3=0 T=0 M2=0 M3=-6,36446769473115
FrameElem=34-1 ElemStation=0
Frame=34 Station=0,05 OutputCase=INVFRE CaseType=Combination StepType=Max P=-3,03162476042946 V2=59,1657418678582 V3=0 T=0 M2=0 M3=-3,90785941130763
FrameElem=34-1 ElemStation=0,05
Frame=34 Station=0,1 OutputCase=INVFRE CaseType=Combination StepType=Max P=-3,03162476042946 V2=63,4657418678582 V3=0 T=0 M2=0 M3=-1,23625112788412
FrameElem=34-1 ElemStation=0,1
Frame=34 Station=0 OutputCase=INVFRE CaseType=Combination StepType=Min P=-23,3742461152823 V2=7,31859880230329 V3=0 T=0 M2=0 M3=-5,13170779365542
FrameElem=34-1 ElemStation=0
Frame=34 Station=0,05 OutputCase=INVFRE CaseType=Combination StepType=Min P=-23,3742461152823 V2=8,01859880230329 V3=0 T=0 M2=0 M3=-5,91249488705423
FrameElem=34-1 ElemStation=0,05
Frame=34 Station=0,1 OutputCase=INVFRE CaseType=Combination StepType=Min P=-23,3742461152823 V2=8,7185988023033 V3=0 T=0 M2=0 M3=-6,72828198045303
FrameElem=34-1 ElemStation=0,1

Società di Progetto
Brebemi SpA



Doc. N.
60235-0000-A00.doc

CODIFICA DOCUMENTO
04RCDII10000000000300A00

REV.
00

FOGLIO
469 di 628

Frame=34 Station=0 OutputCase=QPE01 CaseType=Combination P=-5,19130189530626 V2=6,73180213267915 V3=0 T=0 M2=0 M3=0,836933173020043 FrameElem=34-1 ElemStation=0
Frame=34 Station=0,05 OutputCase=QPE01 CaseType=Combination P=-5,19130189530626 V2=7,43180213267915 V3=0 T=0 M2=0 M3=0,482843066386085 FrameElem=34-1 ElemStation=0,05
Frame=34 Station=0,1 OutputCase=QPE01 CaseType=Combination P=-5,19130189530626 V2=8,13180213267915 V3=0 T=0 M2=0 M3=9,37529597521278E-02 FrameElem=34-1 ElemStation=0,1
Frame=34 Station=0 OutputCase=QPE02 CaseType=Combination P=-5,57441114776322 V2=6,73180213267926 V3=0 T=0 M2=0 M3=0,519053994257655 FrameElem=34-1 ElemStation=0
Frame=34 Station=0,05 OutputCase=QPE02 CaseType=Combination P=-5,57441114776322 V2=7,43180213267926 V3=0 T=0 M2=0 M3=0,164963887623692 FrameElem=34-1 ElemStation=0,05
Frame=34 Station=0,1 OutputCase=QPE02 CaseType=Combination P=-5,57441114776322 V2=8,13180213267926 V3=0 T=0 M2=0 M3=0,22412621901027 FrameElem=34-1 ElemStation=0,1
Frame=34 Station=0 OutputCase=QPE03 CaseType=Combination P=-4,8081926428493 V2=6,73180213267904 V3=0 T=0 M2=0 M3=1,15481235178243 FrameElem=34-1 ElemStation=0
Frame=34 Station=0,05 OutputCase=QPE03 CaseType=Combination P=-4,8081926428493 V2=7,43180213267904 V3=0 T=0 M2=0 M3=0,800722245148478 FrameElem=34-1 ElemStation=0,05
Frame=34 Station=0,1 OutputCase=QPE03 CaseType=Combination P=-4,8081926428493 V2=8,13180213267904 V3=0 T=0 M2=0 M3=0,411632138514526 FrameElem=34-1 ElemStation=0,1
Frame=34 Station=0 OutputCase=QPE04 CaseType=Combination P=-5,03236230592508 V2=6,41396780125562 V3=0 T=0 M2=0 M3=1,23237343860715 FrameElem=34-1 ElemStation=0
Frame=34 Station=0,05 OutputCase=QPE04 CaseType=Combination P=-5,03236230592508 V2=7,11396780125562 V3=0 T=0 M2=0 M3=0,894175048544373 FrameElem=34-1 ElemStation=0,05
Frame=34 Station=0,1 OutputCase=QPE04 CaseType=Combination P=-5,03236230592508 V2=7,81396780125562 V3=0 T=0 M2=0 M3=0,520976658481592 FrameElem=34-1 ElemStation=0,1
Frame=34 Station=0 OutputCase=QPE05 CaseType=Combination P=-5,35024148468744 V2=7,04963646410268 V3=0 T=0 M2=0 M3=0,441492907432932 FrameElem=34-1 ElemStation=0
Frame=34 Station=0,05 OutputCase=QPE05 CaseType=Combination P=-5,35024148468744 V2=7,74963646410268 V3=0 T=0 M2=0 M3=7,15110842277977E-02 FrameElem=34-1 ElemStation=0,05
Frame=34 Station=0,1 OutputCase=QPE05 CaseType=Combination P=-5,35024148468744 V2=8,44963646410268 V3=0 T=0 M2=0 M3=0,333470738977336 FrameElem=34-1 ElemStation=0,1
Frame=34 Station=0 OutputCase=QPE06 CaseType=Combination P=-4,8081926428493 V2=6,73180213267904 V3=0 T=0 M2=0 M3=1,15481235178243 FrameElem=34-1 ElemStation=0
Frame=34 Station=0,05 OutputCase=QPE06 CaseType=Combination P=-4,8081926428493 V2=7,43180213267904 V3=0 T=0 M2=0 M3=0,800722245148478 FrameElem=34-1 ElemStation=0,05
Frame=34 Station=0,1 OutputCase=QPE06 CaseType=Combination P=-4,8081926428493 V2=8,13180213267904 V3=0 T=0 M2=0 M3=0,411632138514526 FrameElem=34-1 ElemStation=0,1
Frame=34 Station=0 OutputCase=QPE07 CaseType=Combination P=-5,41547155838204 V2=6,41396780125572 V3=0 T=0 M2=0 M3=0,914494259844766 FrameElem=34-1 ElemStation=0
Frame=34 Station=0,05 OutputCase=QPE07 CaseType=Combination P=-5,41547155838204 V2=7,11396780125572 V3=0 T=0 M2=0 M3=0,57629586978198 FrameElem=34-1 ElemStation=0,05
Frame=34 Station=0,1 OutputCase=QPE07 CaseType=Combination P=-5,41547155838204 V2=7,81396780125572 V3=0 T=0 M2=0 M3=0,203097479719194 FrameElem=34-1 ElemStation=0,1
Frame=34 Station=0 OutputCase=QPE08 CaseType=Combination P=-5,7333507371444 V2=7,04963646410279 V3=0 T=0 M2=0 M3=0,123613728670544 FrameElem=34-1 ElemStation=0
Frame=34 Station=0,05 OutputCase=QPE08 CaseType=Combination P=-5,7333507371444 V2=7,74963646410279 V3=0 T=0 M2=0 M3=-0,246368094534595 FrameElem=34-1 ElemStation=0,05
Frame=34 Station=0,1 OutputCase=QPE08 CaseType=Combination P=-5,7333507371444 V2=8,44963646410279 V3=0 T=0 M2=0 M3=-0,651349917739735 FrameElem=34-1 ElemStation=0,1
Frame=34 Station=0 OutputCase=QPE09 CaseType=Combination P=-5,19130189530626 V2=6,73180213267915 V3=0 T=0 M2=0 M3=0,836933173020043 FrameElem=34-1 ElemStation=0
Frame=34 Station=0,05 OutputCase=QPE09 CaseType=Combination P=-5,19130189530626 V2=7,43180213267915 V3=0 T=0 M2=0 M3=0,482843066386085 FrameElem=34-1 ElemStation=0,05
Frame=34 Station=0,1 OutputCase=QPE09 CaseType=Combination P=-5,19130189530626 V2=8,13180213267915 V3=0 T=0 M2=0 M3=9,37529597521278E-02 FrameElem=34-1 ElemStation=0,1
Frame=34 Station=0 OutputCase=QPE10 CaseType=Combination P=-5,19130189344362 V2=8,66819786728593 V3=0 T=0 M2=0 M3=0,228084481020232 FrameElem=34-1 ElemStation=0
Frame=34 Station=0,05 OutputCase=QPE10 CaseType=Combination P=-5,19130189344362 V2=9,36819786728593 V3=0 T=0 M2=0 M3=-0,678994374384529 FrameElem=34-1 ElemStation=0,05
Frame=34 Station=0,1 OutputCase=QPE10 CaseType=Combination P=-5,19130189344362 V2=10,06819786728593 V3=0 T=0 M2=0 M3=-1,16490426774883 FrameElem=34-1 ElemStation=0,1
Frame=34 Station=0 OutputCase=QPE11 CaseType=Combination P=-5,57441114590058 V2=8,66819786728603 V3=0 T=0 M2=0 M3=0,54596365978262 FrameElem=34-1 ElemStation=0
Frame=34 Station=0,05 OutputCase=QPE11 CaseType=Combination P=-5,57441114590058 V2=9,36819786728603 V3=0 T=0 M2=0 M3=-0,996873553146922 FrameElem=34-1 ElemStation=0,05
Frame=34 Station=0,1 OutputCase=QPE11 CaseType=Combination P=-5,57441114590058 V2=10,06819786728603 V3=0 T=0 M2=0 M3=-1,48278344651122 FrameElem=34-1 ElemStation=0,1
Frame=34 Station=0 OutputCase=QPE12 CaseType=Combination P=-4,80819264098665 V2=8,66819786728582 V3=0 T=0 M2=0 M3=8,97946977421551E-02 FrameElem=34-1 ElemStation=0
Frame=34 Station=0,05 OutputCase=QPE12 CaseType=Combination P=-4,80819264098665 V2=9,36819786728582 V3=0 T=0 M2=0 M3=-0,361115195622136 FrameElem=34-1 ElemStation=0,05
Frame=34 Station=0,1 OutputCase=QPE12 CaseType=Combination P=-4,80819264098665 V2=10,06819786728582 V3=0 T=0 M2=0 M3=-0,847025088986427 FrameElem=34-1 ElemStation=0,1
Frame=34 Station=0 OutputCase=QPE13 CaseType=Combination P=-5,03236230406244 V2=8,35036353586239 V3=0 T=0 M2=0 M3=0,167355784566878 FrameElem=34-1 ElemStation=0
Frame=34 Station=0,05 OutputCase=QPE13 CaseType=Combination P=-5,03236230406244 V2=9,05036353586239 V3=0 T=0 M2=0 M3=-0,267662392226241 FrameElem=34-1 ElemStation=0,05
Frame=34 Station=0,1 OutputCase=QPE13 CaseType=Combination P=-5,03236230406244 V2=9,75036353586239 V3=0 T=0 M2=0 M3=-0,737680569019361 FrameElem=34-1 ElemStation=0,1
Frame=34 Station=0 OutputCase=QPE14 CaseType=Combination P=-5,35024148282479 V2=8,98603219870946 V3=0 T=0 M2=0 M3=-0,623524746607343 FrameElem=34-1 ElemStation=0
Frame=34 Station=0,05 OutputCase=QPE14 CaseType=Combination P=-5,35024148282479 V2=9,68603219870946 V3=0 T=0 M2=0 M3=-1,09032635654282 FrameElem=34-1 ElemStation=0,05
Frame=34 Station=0,1 OutputCase=QPE14 CaseType=Combination P=-5,35024148282479 V2=10,38603219870946 V3=0 T=0 M2=0 M3=-1,59212796647829 FrameElem=34-1 ElemStation=0,1
Frame=34 Station=0 OutputCase=QPE15 CaseType=Combination P=-4,80819264098665 V2=8,66819786728582 V3=0 T=0 M2=0 M3=8,97946977421551E-02 FrameElem=34-1 ElemStation=0
Frame=34 Station=0,05 OutputCase=QPE15 CaseType=Combination P=-4,80819264098665 V2=9,36819786728582 V3=0 T=0 M2=0 M3=-0,361115195622136 FrameElem=34-1 ElemStation=0,05

Società di Progetto
Brebemi SpA



Doc. N.
60235-0000-A00.doc

CODIFICA DOCUMENTO
04RCDII10000000000300A00

REV.
00

FOGLIO
470 di 628

Frame=34 Station=0,1 OutputCase=QPE15 CaseType=Combination P=-4,80819264098665 V2=10,0681978672858 V3=0 T=0 M2=0 M3=-0,847025088986427 FrameElem=34-1 ElemStation=0,1

Frame=34 Station=0 OutputCase=QPE16 CaseType=Combination P=-5,4154715565194 V2=8,3503635358625 V3=0 T=0 M2=0 M3=-0,150523394195509 FrameElem=34-1 ElemStation=0

Frame=34 Station=0,05 OutputCase=QPE16 CaseType=Combination P=-5,4154715565194 V2=9,0503635358625 V3=0 T=0 M2=0 M3=-0,585541570988634 FrameElem=34-1 ElemStation=0,05

Frame=34 Station=0,1 OutputCase=QPE16 CaseType=Combination P=-5,4154715565194 V2=9,7503635358625 V3=0 T=0 M2=0 M3=-1,0555974778176 FrameElem=34-1 ElemStation=0,1

Frame=34 Station=0 OutputCase=QPE17 CaseType=Combination P=-5,73335073528175 V2=8,98603219870957 V3=0 T=0 M2=0 M3=-0,941403925369731 FrameElem=34-1 ElemStation=0

Frame=34 Station=0,05 OutputCase=QPE17 CaseType=Combination P=-5,73335073528175 V2=9,68603219870957 V3=0 T=0 M2=0 M3=-1,40820553530521 FrameElem=34-1 ElemStation=0,05

Frame=34 Station=0,1 OutputCase=QPE17 CaseType=Combination P=-5,73335073528175 V2=10,3860321987096 V3=0 T=0 M2=0 M3=-1,91000714524069 FrameElem=34-1 ElemStation=0,1

Frame=34 Station=0 OutputCase=QPE18 CaseType=Combination P=-5,19130189344362 V2=8,66819786728593 V3=0 T=0 M2=0 M3=-0,228084481020232 FrameElem=34-1 ElemStation=0

Frame=34 Station=0,05 OutputCase=QPE18 CaseType=Combination P=-5,19130189344362 V2=9,36819786728593 V3=0 T=0 M2=0 M3=-0,678994374384529 FrameElem=34-1 ElemStation=0,05

Frame=34 Station=0,1 OutputCase=QPE18 CaseType=Combination P=-5,19130189344362 V2=10,0681978672859 V3=0 T=0 M2=0 M3=-1,16490426774883 FrameElem=34-1 ElemStation=0,1

Frame=34 Station=0 OutputCase=INVQPE CaseType=Combination StepType=Max P=-4,80819264098665 V2=8,98603219870957 V3=0 T=0 M2=0 M3=1,23237343860715 FrameElem=34-1 ElemStation=0

Frame=34 Station=0,05 OutputCase=INVQPE CaseType=Combination StepType=Max P=-4,80819264098665 V2=9,68603219870957 V3=0 T=0 M2=0 M3=0,894175048544373 FrameElem=34-1 ElemStation=0,05

Frame=34 Station=0,1 OutputCase=INVQPE CaseType=Combination StepType=Max P=-4,80819264098665 V2=10,3860321987096 V3=0 T=0 M2=0 M3=0,520976658481592 FrameElem=34-1 ElemStation=0,1

Frame=34 Station=0 OutputCase=INVQPE CaseType=Combination StepType=Min P=-5,7333507371444 V2=6,41396780125562 V3=0 T=0 M2=0 M3=-0,941403925369731 FrameElem=34-1 ElemStation=0

Frame=34 Station=0,05 OutputCase=INVQPE CaseType=Combination StepType=Min P=-5,7333507371444 V2=7,11396780125562 V3=0 T=0 M2=0 M3=-1,40820553530521 FrameElem=34-1 ElemStation=0,05

Frame=34 Station=0,1 OutputCase=INVQPE CaseType=Combination StepType=Min P=-5,7333507371444 V2=7,81396780125562 V3=0 T=0 M2=0 M3=-1,91000714524069 FrameElem=34-1 ElemStation=0,1

Frame=36 Station=0 OutputCase=STR001 CaseType=Combination P=-8,78598720340786 V2=14,1750000001179 V3=0 T=0 M2=0 M3=-2,33849391627145 FrameElem=36-1 ElemStation=0

Frame=36 Station=0,04 OutputCase=STR001 CaseType=Combination P=-8,78598720340786 V2=14,9310000001179 V3=0 T=0 M2=0 M3=-2,92061391627617 FrameElem=36-1 ElemStation=0,04

Frame=36 Station=0,08 OutputCase=STR001 CaseType=Combination P=-8,78598720340786 V2=15,6870000001179 V3=0 T=0 M2=0 M3=-3,53297391628088 FrameElem=36-1 ElemStation=0,08

Frame=36 Station=0 OutputCase=STR002 CaseType=Combination P=-3,67738409966958 V2=14,1750000000015 V3=0 T=0 M2=0 M3=-1,49831222457824 FrameElem=36-1 ElemStation=0

Frame=36 Station=0,04 OutputCase=STR002 CaseType=Combination P=-3,67738409966958 V2=14,9310000000015 V3=0 T=0 M2=0 M3=-2,0804322245783 FrameElem=36-1 ElemStation=0,04

Frame=36 Station=0,08 OutputCase=STR002 CaseType=Combination P=-3,67738409966958 V2=15,6870000000015 V3=0 T=0 M2=0 M3=-2,69279222457836 FrameElem=36-1 ElemStation=0,08

Frame=36 Station=0 OutputCase=STR003 CaseType=Combination P=-4,97357719542984 V2=111,3750000000669 V3=0 T=0 M2=0 M3=-8,53998238606987 FrameElem=36-1 ElemStation=0

Frame=36 Station=0,04 OutputCase=STR003 CaseType=Combination P=-4,97357719542984 V2=117,3150000000669 V3=0 T=0 M2=0 M3=-13,1137823860966 FrameElem=36-1 ElemStation=0,04

Frame=36 Station=0,08 OutputCase=STR003 CaseType=Combination P=-4,97357719542984 V2=123,2550000000669 V3=0 T=0 M2=0 M3=-17,9251823861234 FrameElem=36-1 ElemStation=0,08

Frame=36 Station=0 OutputCase=STR004 CaseType=Combination P=-21,7144805564784 V2=124,556781585954 V3=0 T=0 M2=0 M3=-20,7442263324376 FrameElem=36-1 ElemStation=0

Frame=36 Station=0,04 OutputCase=STR004 CaseType=Combination P=-21,7144805564784 V2=130,496781585954 V3=0 T=0 M2=0 M3=-25,8452975958758 FrameElem=36-1 ElemStation=0,04

Frame=36 Station=0,08 OutputCase=STR004 CaseType=Combination P=-21,7144805564784 V2=136,436781585954 V3=0 T=0 M2=0 M3=-31,1839688593139 FrameElem=36-1 ElemStation=0,08

Frame=36 Station=0 OutputCase=STR005 CaseType=Combination P=-38,4553839451872 V2=111,375000001729 V3=0 T=0 M2=0 M3=-13,1757979015129 FrameElem=36-1 ElemStation=0

Frame=36 Station=0,04 OutputCase=STR005 CaseType=Combination P=-38,4553839451872 V2=117,315000001729 V3=0 T=0 M2=0 M3=-17,7495979015821 FrameElem=36-1 ElemStation=0,04

Frame=36 Station=0,08 OutputCase=STR005 CaseType=Combination P=-38,4553839451872 V2=123,255000001729 V3=0 T=0 M2=0 M3=-22,5609979016512 FrameElem=36-1 ElemStation=0,08

Frame=36 Station=0 OutputCase=STR006 CaseType=Combination P=-20,6153684759532 V2=23,6817815852555 V3=0 T=0 M2=0 M3=-13,5031775385625 FrameElem=36-1 ElemStation=0

Frame=36 Station=0,04 OutputCase=STR006 CaseType=Combination P=-20,6153684759532 V2=24,2417815852555 V3=0 T=0 M2=0 M3=-14,4616488019727 FrameElem=36-1 ElemStation=0,04

Frame=36 Station=0,08 OutputCase=STR006 CaseType=Combination P=-20,6153684759532 V2=24,8017815852555 V3=0 T=0 M2=0 M3=-15,442520065383 FrameElem=36-1 ElemStation=0,08

Frame=36 Station=0 OutputCase=STR007 CaseType=Combination P=-37,356271864662 V2=10,5000000010303 V3=0 T=0 M2=0 M3=-5,9347491076378 FrameElem=36-1 ElemStation=0

Frame=36 Station=0,04 OutputCase=STR007 CaseType=Combination P=-37,356271864662 V2=11,0600000010303 V3=0 T=0 M2=0 M3=-6,36594910767901 FrameElem=36-1 ElemStation=0,04

Frame=36 Station=0,08 OutputCase=STR007 CaseType=Combination P=-37,356271864662 V2=11,6200000010303 V3=0 T=0 M2=0 M3=-6,81954910772022 FrameElem=36-1 ElemStation=0,08

Frame=36 Station=0 OutputCase=STR008 CaseType=Combination P=-34,7525318386044 V2=116,800825024555 V3=0 T=0 M2=0 M3=-30,9173871428553 FrameElem=36-1 ElemStation=0

Frame=36 Station=0,04 OutputCase=STR008 CaseType=Combination P=-35,6543318386044 V2=121,444825024555 V3=0 T=0 M2=0 M3=-35,6823001438375 FrameElem=36-1 ElemStation=0,04

Frame=36 Station=0,08 OutputCase=STR008 CaseType=Combination P=-36,5561318386044 V2=126,088825024555 V3=0 T=0 M2=0 M3=-40,6329731448197 FrameElem=36-1 ElemStation=0,08

Frame=36 Station=0 OutputCase=STR009 CaseType=Combination P=-9,70544940930675 V2=14,1750000001182 V3=0 T=0 M2=0 M3=-3,10140394530124 FrameElem=36-1 ElemStation=0

Frame=36 Station=0,04 OutputCase=STR009 CaseType=Combination P=-9,70544940930675 V2=14,9310000001182 V3=0 T=0 M2=0 M3=-3,68352394530596 FrameElem=36-1 ElemStation=0,04

Frame=36 Station=0,08 OutputCase=STR009 CaseType=Combination P=-9,70544940930675 V2=15,6870000001182 V3=0 T=0 M2=0 M3=-4,29588394531069 FrameElem=36-1 ElemStation=0,08

Frame=36 Station=0 OutputCase=STR010 CaseType=Combination P=-4,59684630556847 V2=14,1750000000018 V3=0 T=0 M2=0 M3=-2,26122225360802 FrameElem=36-1 ElemStation=0

Società di Progetto
Brebemi SpA

	Doc. N. 60235-00000-A00.doc	CODIFICA DOCUMENTO 04RCDII100000000000300A00	REV. 00	FOGLIO 471 di 628
--	--------------------------------	---	------------	----------------------

Frame=36 Station=0,04 OutputCase=STR010 ElemStation=0,04	CaseType=Combination	P=-4,59684630556847	V2=14,93100000000018	V3=0	T=0	M2=0	M3=-2,84334225360809	FrameElem=36-1
Frame=36 Station=0,08 OutputCase=STR010 ElemStation=0,08	CaseType=Combination	P=-4,59684630556847	V2=15,68700000000018	V3=0	T=0	M2=0	M3=-3,45570225360816	FrameElem=36-1
Frame=36 Station=0 OutputCase=STR011 ElemStation=0	CaseType=Combination	P=-5,52525451896918	V2=111,375000000067	V3=0	T=0	M2=0	M3=-8,99772840348774	FrameElem=36-1
Frame=36 Station=0,04 OutputCase=STR011 ElemStation=0,04	CaseType=Combination	P=-5,52525451896918	V2=117,315000000067	V3=0	T=0	M2=0	M3=-13,5715284035145	FrameElem=36-1
Frame=36 Station=0,08 OutputCase=STR011 ElemStation=0,08	CaseType=Combination	P=-5,52525451896918	V2=123,255000000067	V3=0	T=0	M2=0	M3=-18,3829284035413	FrameElem=36-1
Frame=36 Station=0 OutputCase=STR012 ElemStation=0	CaseType=Combination	P=-22,2661578800177	V2=124,556781585954	V3=0	T=0	M2=0	M3=-21,2019723498555	FrameElem=36-1
Frame=36 Station=0,04 OutputCase=STR012 ElemStation=0,04	CaseType=Combination	P=-22,2661578800177	V2=130,496781585954	V3=0	T=0	M2=0	M3=-26,3030436132937	FrameElem=36-1
Frame=36 Station=0,08 OutputCase=STR012 ElemStation=0,08	CaseType=Combination	P=-22,2661578800177	V2=136,436781585954	V3=0	T=0	M2=0	M3=-31,6417148767318	FrameElem=36-1
Frame=36 Station=0 OutputCase=STR013 ElemStation=0	CaseType=Combination	P=-39,0070612687266	V2=111,375000001729	V3=0	T=0	M2=0	M3=-13,6335439189308	FrameElem=36-1
Frame=36 Station=0,04 OutputCase=STR013 ElemStation=0,04	CaseType=Combination	P=-39,0070612687266	V2=117,315000001729	V3=0	T=0	M2=0	M3=-18,2073439189999	FrameElem=36-1
Frame=36 Station=0,08 OutputCase=STR013 ElemStation=0,08	CaseType=Combination	P=-39,0070612687266	V2=123,255000001729	V3=0	T=0	M2=0	M3=-23,0187439190691	FrameElem=36-1
Frame=36 Station=0 OutputCase=STR014 ElemStation=0	CaseType=Combination	P=-21,1670457994925	V2=23,6817815852557	V3=0	T=0	M2=0	M3=-13,9609235559804	FrameElem=36-1
Frame=36 Station=0,04 OutputCase=STR014 ElemStation=0,04	CaseType=Combination	P=-21,1670457994925	V2=24,2417815852557	V3=0	T=0	M2=0	M3=-14,9193948193906	FrameElem=36-1
Frame=36 Station=0,08 OutputCase=STR014 ElemStation=0,08	CaseType=Combination	P=-21,1670457994925	V2=24,8017815852557	V3=0	T=0	M2=0	M3=-15,9002660828008	FrameElem=36-1
Frame=36 Station=0 OutputCase=STR015 ElemStation=0	CaseType=Combination	P=-37,9079491882014	V2=10,5000000010305	V3=0	T=0	M2=0	M3=-6,39249512505567	FrameElem=36-1
Frame=36 Station=0,04 OutputCase=STR015 ElemStation=0,04	CaseType=Combination	P=-37,9079491882014	V2=11,0600000010305	V3=0	T=0	M2=0	M3=-6,82369512509689	FrameElem=36-1
Frame=36 Station=0,08 OutputCase=STR015 ElemStation=0,08	CaseType=Combination	P=-37,9079491882014	V2=11,6200000010305	V3=0	T=0	M2=0	M3=-7,2729512513811	FrameElem=36-1
Frame=36 Station=0 OutputCase=STR016 ElemStation=0	CaseType=Combination	P=-35,3042091621438	V2=116,800825024555	V3=0	T=0	M2=0	M3=-31,3751331602732	FrameElem=36-1
Frame=36 Station=0,04 OutputCase=STR016 ElemStation=0,04	CaseType=Combination	P=-36,2060091621438	V2=121,444825024555	V3=0	T=0	M2=0	M3=-36,1400461612554	FrameElem=36-1
Frame=36 Station=0,08 OutputCase=STR016 ElemStation=0,08	CaseType=Combination	P=-37,1078091621438	V2=126,088825024555	V3=0	T=0	M2=0	M3=-41,0907191622376	FrameElem=36-1
Frame=36 Station=0 OutputCase=STR017 ElemStation=0	CaseType=Combination	P=-5,56899112738867	V2=87,0750000005028	V3=0	T=0	M2=0	M3=-7,54247487472674	FrameElem=36-1
Frame=36 Station=0,04 OutputCase=STR017 ElemStation=0,04	CaseType=Combination	P=-5,56899112738867	V2=91,7190000005027	V3=0	T=0	M2=0	M3=-11,1183548747469	FrameElem=36-1
Frame=36 Station=0,08 OutputCase=STR017 ElemStation=0,08	CaseType=Combination	P=-5,56899112738867	V2=96,3630000005027	V3=0	T=0	M2=0	M3=-14,879994874767	FrameElem=36-1
Frame=36 Station=0 OutputCase=STR018 ElemStation=0	CaseType=Combination	P=-18,7632440364567	V2=97,430912234421	V3=0	T=0	M2=0	M3=-17,1528625796771	FrameElem=36-1
Frame=36 Station=0,04 OutputCase=STR018 ElemStation=0,04	CaseType=Combination	P=-18,7632440364567	V2=102,074912234421	V3=0	T=0	M2=0	M3=-21,1429790690539	FrameElem=36-1
Frame=36 Station=0,08 OutputCase=STR018 ElemStation=0,08	CaseType=Combination	P=-18,7632440364567	V2=106,718912234421	V3=0	T=0	M2=0	M3=-25,318855584308	FrameElem=36-1
Frame=36 Station=0 OutputCase=STR019 ElemStation=0	CaseType=Combination	P=-31,9574969656413	V2=87,0750000013264	V3=0	T=0	M2=0	M3=-11,2293819342323	FrameElem=36-1
Frame=36 Station=0,04 OutputCase=STR019 ElemStation=0,04	CaseType=Combination	P=-31,9574969656413	V2=91,7190000013264	V3=0	T=0	M2=0	M3=-14,8052619342854	FrameElem=36-1
Frame=36 Station=0,08 OutputCase=STR019 ElemStation=0,08	CaseType=Combination	P=-31,9574969656413	V2=96,3630000013264	V3=0	T=0	M2=0	M3=-18,5669019343384	FrameElem=36-1
Frame=36 Station=0 OutputCase=STR020 ElemStation=0	CaseType=Combination	P=-17,9881802298716	V2=20,8559122338894	V3=0	T=0	M2=0	M3=-11,6722313261749	FrameElem=36-1
Frame=36 Station=0,04 OutputCase=STR020 ElemStation=0,04	CaseType=Combination	P=-17,9881802298716	V2=21,4159122338894	V3=0	T=0	M2=0	M3=-12,5176678155305	FrameElem=36-1
Frame=36 Station=0,08 OutputCase=STR020 ElemStation=0,08	CaseType=Combination	P=-17,9881802298716	V2=21,9759122338894	V3=0	T=0	M2=0	M3=-13,385504304886	FrameElem=36-1
Frame=36 Station=0 OutputCase=STR021 ElemStation=0	CaseType=Combination	P=-31,1824331590561	V2=10,5000000007949	V3=0	T=0	M2=0	M3=-5,74875068073013	FrameElem=36-1
Frame=36 Station=0,04 OutputCase=STR021 ElemStation=0,04	CaseType=Combination	P=-31,1824331590561	V2=11,0600000007949	V3=0	T=0	M2=0	M3=-6,17995068076192	FrameElem=36-1
Frame=36 Station=0,08 OutputCase=STR021 ElemStation=0,08	CaseType=Combination	P=-31,1824331590561	V2=11,6200000007949	V3=0	T=0	M2=0	M3=-6,63355068079372	FrameElem=36-1
Frame=36 Station=0 OutputCase=STR022 ElemStation=0	CaseType=Combination	P=-9,47657640059787	V2=13,7173185628683	V3=0	T=0	M2=0	M3=-2,44043367540582	FrameElem=36-1
Frame=36 Station=0,04 OutputCase=STR022 ElemStation=0,04	CaseType=Combination	P=-9,47657640059787	V2=14,4733185628683	V3=0	T=0	M2=0	M3=-3,00424641792055	FrameElem=36-1
Frame=36 Station=0,08 OutputCase=STR022 ElemStation=0,08	CaseType=Combination	P=-9,47657640059787	V2=15,2293185628683	V3=0	T=0	M2=0	M3=-3,59829916043529	FrameElem=36-1
Frame=36 Station=0 OutputCase=STR023 ElemStation=0	CaseType=Combination	P=-4,36797329685959	V2=13,7173185627519	V3=0	T=0	M2=0	M3=-1,60025198371261	FrameElem=36-1
Frame=36 Station=0,04 OutputCase=STR023 ElemStation=0,04	CaseType=Combination	P=-4,36797329685959	V2=14,4733185627519	V3=0	T=0	M2=0	M3=-2,16406472622268	FrameElem=36-1
Frame=36 Station=0,08 OutputCase=STR023 ElemStation=0,08	CaseType=Combination	P=-4,36797329685959	V2=15,2293185627519	V3=0	T=0	M2=0	M3=-2,75811746873276	FrameElem=36-1
Frame=36 Station=0 OutputCase=STR024 ElemStation=0	CaseType=Combination	P=-5,34011811867979	V2=86,6173185632529	V3=0	T=0	M2=0	M3=-6,88150460483133	FrameElem=36-1
Frame=36 Station=0,04 OutputCase=STR024 ElemStation=0,04	CaseType=Combination	P=-5,34011811867979	V2=91,2613185632529	V3=0	T=0	M2=0	M3=-10,4390773473614	FrameElem=36-1
Frame=36 Station=0,08 OutputCase=STR024 ElemStation=0,08	CaseType=Combination	P=-5,34011811867979	V2=95,9053185632528	V3=0	T=0	M2=0	M3=-14,1824100898916	FrameElem=36-1

APPROVATO SDP

Società di Progetto
Brebemi SpA

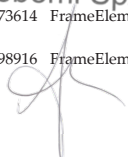



Doc. N.
60235-0000-A00.doc

CODIFICA DOCUMENTO
04RCDII10000000000300A00

REV.
00

FOGLIO
472 di 628

Frame=36 Station=0 OutputCase=STR025 CaseType=Combination P=-18,5343710277478 V2=96,9732307971711 V3=0 T=0 M2=0 M3=-16,4918923097817 FrameElem=36-1
ElemStation=0
Frame=36 Station=0,04 OutputCase=STR025 CaseType=Combination P=-18,5343710277478 V2=101,617230797171 V3=0 T=0 M2=0 M3=-20,4637015416685 FrameElem=36-1
ElemStation=0,04
Frame=36 Station=0,08 OutputCase=STR025 CaseType=Combination P=-18,5343710277478 V2=106,261230797171 V3=0 T=0 M2=0 M3=-24,6212707735553 FrameElem=36-1
ElemStation=0,08
Frame=36 Station=0 OutputCase=STR026 CaseType=Combination P=-31,7286239569324 V2=86,6173185640765 V3=0 T=0 M2=0 M3=-10,5684116643369 FrameElem=36-1
ElemStation=0
Frame=36 Station=0,04 OutputCase=STR026 CaseType=Combination P=-31,7286239569324 V2=91,2613185640765 V3=0 T=0 M2=0 M3=-14,1259844069 FrameElem=36-1
ElemStation=0,04
Frame=36 Station=0,08 OutputCase=STR026 CaseType=Combination P=-31,7286239569324 V2=95,9053185640765 V3=0 T=0 M2=0 M3=-17,869317149463 FrameElem=36-1
ElemStation=0,08
Frame=36 Station=0 OutputCase=STR027 CaseType=Combination P=-17,7593072211627 V2=20,3982307966396 V3=0 T=0 M2=0 M3=-11,0112610562795 FrameElem=36-1
ElemStation=0
Frame=36 Station=0,04 OutputCase=STR027 CaseType=Combination P=-17,7593072211627 V2=20,9582307966396 V3=0 T=0 M2=0 M3=-11,8383902881451 FrameElem=36-1
ElemStation=0,04
Frame=36 Station=0,08 OutputCase=STR027 CaseType=Combination P=-17,7593072211627 V2=21,5182307966396 V3=0 T=0 M2=0 M3=-12,6879195200106 FrameElem=36-1
ElemStation=0,08
Frame=36 Station=0 OutputCase=STR028 CaseType=Combination P=-30,9535601503473 V2=10,042318563545 V3=0 T=0 M2=0 M3=-5,08778041083471 FrameElem=36-1
ElemStation=0
Frame=36 Station=0,04 OutputCase=STR028 CaseType=Combination P=-30,9535601503473 V2=10,602318563545 V3=0 T=0 M2=0 M3=-5,50067315337651 FrameElem=36-1
ElemStation=0,04
Frame=36 Station=0,08 OutputCase=STR028 CaseType=Combination P=-30,9535601503473 V2=11,162318563545 V3=0 T=0 M2=0 M3=-5,93596589591831 FrameElem=36-1
ElemStation=0,08
Frame=36 Station=0 OutputCase=STR029 CaseType=Combination P=-9,93432241801562 V2=14,6326814373681 V3=0 T=0 M2=0 M3=-3,76237421519665 FrameElem=36-1
ElemStation=0
Frame=36 Station=0,04 OutputCase=STR029 CaseType=Combination P=-9,93432241801562 V2=15,3886814373681 V3=0 T=0 M2=0 M3=-4,36280147269138 FrameElem=36-1
ElemStation=0,04
Frame=36 Station=0,08 OutputCase=STR029 CaseType=Combination P=-9,93432241801562 V2=16,1446814373681 V3=0 T=0 M2=0 M3=-4,9934687301861 FrameElem=36-1
ElemStation=0,08
Frame=36 Station=0 OutputCase=STR030 CaseType=Combination P=-4,82571931427734 V2=14,6326814372517 V3=0 T=0 M2=0 M3=-2,92219252350344 FrameElem=36-1
ElemStation=0
Frame=36 Station=0,04 OutputCase=STR030 CaseType=Combination P=-4,82571931427734 V2=15,3886814372517 V3=0 T=0 M2=0 M3=-3,5226197809935 FrameElem=36-1
ElemStation=0,04
Frame=36 Station=0,08 OutputCase=STR030 CaseType=Combination P=-4,82571931427734 V2=16,1446814372517 V3=0 T=0 M2=0 M3=-4,15328703848357 FrameElem=36-1
ElemStation=0,08
Frame=36 Station=0 OutputCase=STR031 CaseType=Combination P=-5,79786413609754 V2=87,5326814377526 V3=0 T=0 M2=0 M3=-8,20344514462216 FrameElem=36-1
ElemStation=0
Frame=36 Station=0,04 OutputCase=STR031 CaseType=Combination P=-5,79786413609754 V2=92,1766814377526 V3=0 T=0 M2=0 M3=-11,7976324201323 FrameElem=36-1
ElemStation=0,04
Frame=36 Station=0,08 OutputCase=STR031 CaseType=Combination P=-5,79786413609754 V2=96,8206814377526 V3=0 T=0 M2=0 M3=-15,5775796596424 FrameElem=36-1
ElemStation=0,08
Frame=36 Station=0 OutputCase=STR032 CaseType=Combination P=-18,9921170451656 V2=97,8885936716708 V3=0 T=0 M2=0 M3=-17,8138328495725 FrameElem=36-1
ElemStation=0
Frame=36 Station=0,04 OutputCase=STR032 CaseType=Combination P=-18,9921170451656 V2=102,532593671671 V3=0 T=0 M2=0 M3=-21,8222565964393 FrameElem=36-1
ElemStation=0,04
Frame=36 Station=0,08 OutputCase=STR032 CaseType=Combination P=-18,9921170451656 V2=107,176593671671 V3=0 T=0 M2=0 M3=-26,0164403433062 FrameElem=36-1
ElemStation=0,08
Frame=36 Station=0 OutputCase=STR033 CaseType=Combination P=-32,1863699743501 V2=87,5326814385763 V3=0 T=0 M2=0 M3=-11,8903522041277 FrameElem=36-1
ElemStation=0
Frame=36 Station=0,04 OutputCase=STR033 CaseType=Combination P=-32,1863699743501 V2=92,1766814385763 V3=0 T=0 M2=0 M3=-15,4845394616708 FrameElem=36-1
ElemStation=0,04
Frame=36 Station=0,08 OutputCase=STR033 CaseType=Combination P=-32,1863699743501 V2=96,8206814385763 V3=0 T=0 M2=0 M3=-19,2644867192138 FrameElem=36-1
ElemStation=0,08
Frame=36 Station=0 OutputCase=STR034 CaseType=Combination P=-18,2170532385804 V2=21,3135936711393 V3=0 T=0 M2=0 M3=-12,3332015960703 FrameElem=36-1
ElemStation=0
Frame=36 Station=0,04 OutputCase=STR034 CaseType=Combination P=-18,2170532385804 V2=21,8735936711393 V3=0 T=0 M2=0 M3=-13,1969453429159 FrameElem=36-1
ElemStation=0,04
Frame=36 Station=0,08 OutputCase=STR034 CaseType=Combination P=-18,2170532385804 V2=22,4335936711393 V3=0 T=0 M2=0 M3=-14,0830890897614 FrameElem=36-1
ElemStation=0,08
Frame=36 Station=0 OutputCase=STR035 CaseType=Combination P=-31,411306167765 V2=10,9576814380448 V3=0 T=0 M2=0 M3=-6,40972095062554 FrameElem=36-1
ElemStation=0
Frame=36 Station=0,04 OutputCase=STR035 CaseType=Combination P=-31,411306167765 V2=11,5176814380448 V3=0 T=0 M2=0 M3=-6,85922820814734 FrameElem=36-1
ElemStation=0,04
Frame=36 Station=0,08 OutputCase=STR035 CaseType=Combination P=-31,411306167765 V2=12,0776814380448 V3=0 T=0 M2=0 M3=-7,33113546566912 FrameElem=36-1
ElemStation=0,08
Frame=36 Station=0 OutputCase=STR036 CaseType=Combination P=-9,15377208576741 V2=14,175000000118 V3=0 T=0 M2=0 M3=-2,64365792788337 FrameElem=36-1
ElemStation=0
Frame=36 Station=0,04 OutputCase=STR036 CaseType=Combination P=-9,15377208576741 V2=14,931000000118 V3=0 T=0 M2=0 M3=-3,22577792788809 FrameElem=36-1
ElemStation=0,04
Frame=36 Station=0,08 OutputCase=STR036 CaseType=Combination P=-9,15377208576741 V2=15,687000000118 V3=0 T=0 M2=0 M3=-3,83813792789281 FrameElem=36-1
ElemStation=0,08
Frame=36 Station=0 OutputCase=STR037 CaseType=Combination P=-4,04516898202913 V2=14,175000000016 V3=0 T=0 M2=0 M3=-1,80347623619015 FrameElem=36-1
ElemStation=0
Frame=36 Station=0,04 OutputCase=STR037 CaseType=Combination P=-4,04516898202913 V2=14,931000000016 V3=0 T=0 M2=0 M3=-2,38559623619022 FrameElem=36-1
ElemStation=0,04
Frame=36 Station=0,08 OutputCase=STR037 CaseType=Combination P=-4,04516898202913 V2=15,687000000016 V3=0 T=0 M2=0 M3=-2,99795623619028 FrameElem=36-1
ElemStation=0,08
Frame=36 Station=0 OutputCase=STR038 CaseType=Combination P=-5,01731380384933 V2=87,0750000005026 V3=0 T=0 M2=0 M3=-7,08427885730887 FrameElem=36-1
ElemStation=0
Frame=36 Station=0,04 OutputCase=STR038 CaseType=Combination P=-5,01731380384933 V2=91,7190000005025 V3=0 T=0 M2=0 M3=-10,660608857329 FrameElem=36-1
ElemStation=0,04
Frame=36 Station=0,08 OutputCase=STR038 CaseType=Combination P=-5,01731380384933 V2=96,3630000005025 V3=0 T=0 M2=0 M3=-14,4222488573491 FrameElem=36-1
ElemStation=0,08
Frame=36 Station=0 OutputCase=STR039 CaseType=Combination P=-18,2115667129174 V2=97,4309122344208 V3=0 T=0 M2=0 M3=-16,6951165622592 FrameElem=36-1
ElemStation=0
Frame=36 Station=0,04 OutputCase=STR039 CaseType=Combination P=-18,2115667129174 V2=102,074912234421 V3=0 T=0 M2=0 M3=-20,685233051636 FrameElem=36-1
ElemStation=0,04

Società di Progetto
Brebemi SpA

	Doc. N. 60235-00000-A00.doc	CODIFICA DOCUMENTO 04RCDII10000000000300A00	REV. 00	FOGLIO 473 di 628
--	--------------------------------	--	------------	----------------------

Frame=36 Station=0,08 OutputCase=STR039 CaseType=Combination P=-18,2115667129174 V2=106,718912234421 V3=0 T=0 M2=0 M3=-24,8611095410129 FrameElem=36-1 ElemStation=0,08

Frame=36 Station=0 OutputCase=STR040 CaseType=Combination P=-31,4058196421019 V2=87,0750000013262 V3=0 T=0 M2=0 M3=-10,7716359168144 FrameElem=36-1 ElemStation=0

Frame=36 Station=0,04 OutputCase=STR040 CaseType=Combination P=-31,4058196421019 V2=91,7190000013262 V3=0 T=0 M2=0 M3=-14,3475159168675 FrameElem=36-1 ElemStation=0,04

Frame=36 Station=0,08 OutputCase=STR040 CaseType=Combination P=-31,4058196421019 V2=96,3630000013262 V3=0 T=0 M2=0 M3=-18,1091559169205 FrameElem=36-1 ElemStation=0,08

Frame=36 Station=0 OutputCase=STR041 CaseType=Combination P=-17,4365029063322 V2=20,8559122338892 V3=0 T=0 M2=0 M3=-11,214485308757 FrameElem=36-1 ElemStation=0

Frame=36 Station=0,04 OutputCase=STR041 CaseType=Combination P=-17,4365029063322 V2=21,4159122338892 V3=0 T=0 M2=0 M3=-12,0599217981126 FrameElem=36-1 ElemStation=0,04

Frame=36 Station=0,08 OutputCase=STR041 CaseType=Combination P=-17,4365029063322 V2=21,9759122338892 V3=0 T=0 M2=0 M3=-12,9277582874682 FrameElem=36-1 ElemStation=0,08

Frame=36 Station=0 OutputCase=STR042 CaseType=Combination P=-30,6307558355168 V2=10,500000007947 V3=0 T=0 M2=0 M3=-5,29100466331226 FrameElem=36-1 ElemStation=0

Frame=36 Station=0,04 OutputCase=STR042 CaseType=Combination P=-30,6307558355168 V2=11,060000007947 V3=0 T=0 M2=0 M3=-5,72220466334405 FrameElem=36-1 ElemStation=0,04

Frame=36 Station=0,08 OutputCase=STR042 CaseType=Combination P=-30,6307558355168 V2=11,620000007947 V3=0 T=0 M2=0 M3=-6,17580466337583 FrameElem=36-1 ElemStation=0,08

Frame=36 Station=0 OutputCase=STR043 CaseType=Combination P=-7,86652499750897 V2=14,175000001175 V3=0 T=0 M2=0 M3=-1,57558388724167 FrameElem=36-1 ElemStation=0

Frame=36 Station=0,04 OutputCase=STR043 CaseType=Combination P=-7,86652499750897 V2=14,931000001175 V3=0 T=0 M2=0 M3=-2,15770388724638 FrameElem=36-1 ElemStation=0,04

Frame=36 Station=0,08 OutputCase=STR043 CaseType=Combination P=-7,86652499750897 V2=15,687000001175 V3=0 T=0 M2=0 M3=-2,77006388725108 FrameElem=36-1 ElemStation=0,08

Frame=36 Station=0 OutputCase=STR044 CaseType=Combination P=-2,75792189377069 V2=14,175000000011 V3=0 T=0 M2=0 M3=-0,735402195548459 FrameElem=36-1 ElemStation=0

Frame=36 Station=0,04 OutputCase=STR044 CaseType=Combination P=-2,75792189377069 V2=14,931000000011 V3=0 T=0 M2=0 M3=-1,3175221955485 FrameElem=36-1 ElemStation=0,04

Frame=36 Station=0,08 OutputCase=STR044 CaseType=Combination P=-2,75792189377069 V2=15,687000000011 V3=0 T=0 M2=0 M3=-1,92988219554855 FrameElem=36-1 ElemStation=0,08

Frame=36 Station=0 OutputCase=STR045 CaseType=Combination P=-4,42189987189051 V2=111,375000000669 V3=0 T=0 M2=0 M3=-8,082236368652 FrameElem=36-1 ElemStation=0

Frame=36 Station=0,04 OutputCase=STR045 CaseType=Combination P=-4,42189987189051 V2=117,315000000669 V3=0 T=0 M2=0 M3=-12,6560363686788 FrameElem=36-1 ElemStation=0,04

Frame=36 Station=0,08 OutputCase=STR045 CaseType=Combination P=-4,42189987189051 V2=123,255000000669 V3=0 T=0 M2=0 M3=-17,4674363687055 FrameElem=36-1 ElemStation=0,08

Frame=36 Station=0 OutputCase=STR046 CaseType=Combination P=-21,1628032329391 V2=124,556781585954 V3=0 T=0 M2=0 M3=-20,2864803150198 FrameElem=36-1 ElemStation=0

Frame=36 Station=0,04 OutputCase=STR046 CaseType=Combination P=-21,1628032329391 V2=130,496781585954 V3=0 T=0 M2=0 M3=-25,3875515784579 FrameElem=36-1 ElemStation=0,04

Frame=36 Station=0,08 OutputCase=STR046 CaseType=Combination P=-21,1628032329391 V2=136,436781585954 V3=0 T=0 M2=0 M3=-30,7262228418961 FrameElem=36-1 ElemStation=0,08

Frame=36 Station=0 OutputCase=STR047 CaseType=Combination P=-37,9037066216479 V2=111,375000001729 V3=0 T=0 M2=0 M3=-12,718051884095 FrameElem=36-1 ElemStation=0

Frame=36 Station=0,04 OutputCase=STR047 CaseType=Combination P=-37,9037066216479 V2=117,315000001729 V3=0 T=0 M2=0 M3=-17,2918518841642 FrameElem=36-1 ElemStation=0,04

Frame=36 Station=0,08 OutputCase=STR047 CaseType=Combination P=-37,9037066216479 V2=123,255000001729 V3=0 T=0 M2=0 M3=-22,1032518842333 FrameElem=36-1 ElemStation=0,08

Frame=36 Station=0 OutputCase=STR048 CaseType=Combination P=-20,0636911524139 V2=23,6817815852553 V3=0 T=0 M2=0 M3=-13,0454315211447 FrameElem=36-1 ElemStation=0

Frame=36 Station=0,04 OutputCase=STR048 CaseType=Combination P=-20,0636911524139 V2=24,2417815852553 V3=0 T=0 M2=0 M3=-14,0039027845549 FrameElem=36-1 ElemStation=0,04

Frame=36 Station=0,08 OutputCase=STR048 CaseType=Combination P=-20,0636911524139 V2=24,8017815852553 V3=0 T=0 M2=0 M3=-14,9847740479651 FrameElem=36-1 ElemStation=0,08

Frame=36 Station=0 OutputCase=STR049 CaseType=Combination P=-36,8045945411227 V2=10,500000010301 V3=0 T=0 M2=0 M3=-5,47700309021993 FrameElem=36-1 ElemStation=0

Frame=36 Station=0,04 OutputCase=STR049 CaseType=Combination P=-36,8045945411227 V2=11,060000010301 V3=0 T=0 M2=0 M3=-5,90820309026113 FrameElem=36-1 ElemStation=0,04

Frame=36 Station=0,08 OutputCase=STR049 CaseType=Combination P=-36,8045945411227 V2=11,620000010301 V3=0 T=0 M2=0 M3=-6,36180309030234 FrameElem=36-1 ElemStation=0,08

Frame=36 Station=0 OutputCase=STR050 CaseType=Combination P=-34,2008545150651 V2=116,800825024555 V3=0 T=0 M2=0 M3=-30,4596411254374 FrameElem=36-1 ElemStation=0

Frame=36 Station=0,04 OutputCase=STR050 CaseType=Combination P=-35,1026545150651 V2=121,444825024555 V3=0 T=0 M2=0 M3=-35,2245541264196 FrameElem=36-1 ElemStation=0,04

Frame=36 Station=0,08 OutputCase=STR050 CaseType=Combination P=-36,0044545150651 V2=126,088825024555 V3=0 T=0 M2=0 M3=-40,1752271274018 FrameElem=36-1 ElemStation=0,08

Frame=36 Station=0 OutputCase=STR051 CaseType=Combination P=-3,73006671559089 V2=87,075000005021 V3=0 T=0 M2=0 M3=-6,01665481666718 FrameElem=36-1 ElemStation=0

Frame=36 Station=0,04 OutputCase=STR051 CaseType=Combination P=-3,73006671559089 V2=91,719000005021 V3=0 T=0 M2=0 M3=-9,59253481668726 FrameElem=36-1 ElemStation=0,04

Frame=36 Station=0,08 OutputCase=STR051 CaseType=Combination P=-3,73006671559089 V2=96,363000005021 V3=0 T=0 M2=0 M3=-13,3541748167073 FrameElem=36-1 ElemStation=0,08

Frame=36 Station=0 OutputCase=STR052 CaseType=Combination P=-16,9243196246589 V2=97,4309122344203 V3=0 T=0 M2=0 M3=-15,6270425216175 FrameElem=36-1 ElemStation=0

Frame=36 Station=0,04 OutputCase=STR052 CaseType=Combination P=-16,9243196246589 V2=102,07491223442 V3=0 T=0 M2=0 M3=-19,6171590109943 FrameElem=36-1 ElemStation=0,04

Frame=36 Station=0,08 OutputCase=STR052 CaseType=Combination P=-16,9243196246589 V2=106,71891223442 V3=0 T=0 M2=0 M3=-23,7930355003711 FrameElem=36-1 ElemStation=0,08

Frame=36 Station=0 OutputCase=STR053 CaseType=Combination P=-30,1185725538435 V2=87,0750000013257 V3=0 T=0 M2=0 M3=-9,70356187617275 FrameElem=36-1 ElemStation=0

Frame=36 Station=0,04 OutputCase=STR053 CaseType=Combination P=-30,1185725538435 V2=91,7190000013257 V3=0 T=0 M2=0 M3=-13,2794418762258 FrameElem=36-1 ElemStation=0,04

Frame=36 Station=0,08 OutputCase=STR053 CaseType=Combination P=-30,1185725538435 V2=96,3630000013257 V3=0 T=0 M2=0 M3=-17,0410818762788 FrameElem=36-1 ElemStation=0,08

Frame=36 Station=0 OutputCase=STR054 CaseType=Combination P=-16,1492558180738 V2=20,8559122338888 V3=0 T=0 M2=0 M3=-10,1464112681153 FrameElem=36-1 ElemStation=0

Società di Progetto
Brebemi SpA



Doc. N.
60235-0000-A00.doc

CODIFICA DOCUMENTO
04RCDII10000000000300A00

REV.
00

FOGLIO
474 di 628

Frame=36 Station=0,04 OutputCase=STR054 CaseType=Combination P=-16,1492558180738 V2=21,4159122338888 V3=0 T=0 M2=0 M3=-10,9918477574709 FrameElem=36-1 ElemStation=0,04
Frame=36 Station=0,08 OutputCase=STR054 CaseType=Combination P=-16,1492558180738 V2=21,9759122338888 V3=0 T=0 M2=0 M3=-11,8596842468264 FrameElem=36-1 ElemStation=0,08
Frame=36 Station=0 OutputCase=STR055 CaseType=Combination P=-29,3435087472584 V2=10,5000000007942 V3=0 T=0 M2=0 M3=-4,22293062267056 FrameElem=36-1 ElemStation=0
Frame=36 Station=0,04 OutputCase=STR055 CaseType=Combination P=-29,3435087472584 V2=11,0600000007942 V3=0 T=0 M2=0 M3=-4,65413062270233 FrameElem=36-1 ElemStation=0,04
Frame=36 Station=0,08 OutputCase=STR055 CaseType=Combination P=-29,3435087472584 V2=11,6200000007942 V3=0 T=0 M2=0 M3=-5,1077306227341 FrameElem=36-1 ElemStation=0,08
Frame=36 Station=0 OutputCase=STR056 CaseType=Combination P=-7,63765198880009 V2=13,7173185628676 V3=0 T=0 M2=0 M3=-0,914613617346258 FrameElem=36-1 ElemStation=0
Frame=36 Station=0,04 OutputCase=STR056 CaseType=Combination P=-7,63765198880009 V2=14,4733185628676 V3=0 T=0 M2=0 M3=-1,47842635986096 FrameElem=36-1 ElemStation=0,04
Frame=36 Station=0,08 OutputCase=STR056 CaseType=Combination P=-7,63765198880009 V2=15,2293185628676 V3=0 T=0 M2=0 M3=-2,07247910237567 FrameElem=36-1 ElemStation=0,08
Frame=36 Station=0 OutputCase=STR057 CaseType=Combination P=-2,52904888506181 V2=13,7173185627512 V3=0 T=0 M2=0 M3=-7,44319256530429E-02 FrameElem=36-1 ElemStation=0
Frame=36 Station=0,04 OutputCase=STR057 CaseType=Combination P=-2,52904888506181 V2=14,4733185627512 V3=0 T=0 M2=0 M3=-0,638244668163092 FrameElem=36-1 ElemStation=0,04
Frame=36 Station=0,08 OutputCase=STR057 CaseType=Combination P=-2,52904888506181 V2=15,2293185627512 V3=0 T=0 M2=0 M3=-1,23229741067314 FrameElem=36-1 ElemStation=0,08
Frame=36 Station=0 OutputCase=STR058 CaseType=Combination P=-3,50119370688201 V2=86,6173185632522 V3=0 T=0 M2=0 M3=-5,35568454677177 FrameElem=36-1 ElemStation=0
Frame=36 Station=0,04 OutputCase=STR058 CaseType=Combination P=-3,50119370688201 V2=91,2613185632522 V3=0 T=0 M2=0 M3=-8,91325728930185 FrameElem=36-1 ElemStation=0,04
Frame=36 Station=0,08 OutputCase=STR058 CaseType=Combination P=-3,50119370688201 V2=95,9053185632522 V3=0 T=0 M2=0 M3=-12,6565900318319 FrameElem=36-1 ElemStation=0,08
Frame=36 Station=0 OutputCase=STR059 CaseType=Combination P=-16,69544661595 V2=96,9732307971704 V3=0 T=0 M2=0 M3=-14,9660722517221 FrameElem=36-1 ElemStation=0
Frame=36 Station=0,04 OutputCase=STR059 CaseType=Combination P=-16,69544661595 V2=101,61723079717 V3=0 T=0 M2=0 M3=-18,9378814836089 FrameElem=36-1 ElemStation=0,04
Frame=36 Station=0,08 OutputCase=STR059 CaseType=Combination P=-16,69544661595 V2=106,26123079717 V3=0 T=0 M2=0 M3=-23,0954507154957 FrameElem=36-1 ElemStation=0,08
Frame=36 Station=0 OutputCase=STR060 CaseType=Combination P=-29,8896995451346 V2=86,6173185640758 V3=0 T=0 M2=0 M3=-9,04259160627734 FrameElem=36-1 ElemStation=0
Frame=36 Station=0,04 OutputCase=STR060 CaseType=Combination P=-29,8896995451346 V2=91,2613185640758 V3=0 T=0 M2=0 M3=-12,6001643488404 FrameElem=36-1 ElemStation=0,04
Frame=36 Station=0,08 OutputCase=STR060 CaseType=Combination P=-29,8896995451346 V2=95,9053185640758 V3=0 T=0 M2=0 M3=-16,3434970914034 FrameElem=36-1 ElemStation=0,08
Frame=36 Station=0 OutputCase=STR061 CaseType=Combination P=-15,9203828093649 V2=20,3982307966389 V3=0 T=0 M2=0 M3=-9,48544099821991 FrameElem=36-1 ElemStation=0
Frame=36 Station=0,04 OutputCase=STR061 CaseType=Combination P=-15,9203828093649 V2=20,9582307966389 V3=0 T=0 M2=0 M3=-10,3125702300855 FrameElem=36-1 ElemStation=0,04
Frame=36 Station=0,08 OutputCase=STR061 CaseType=Combination P=-15,9203828093649 V2=21,5182307966389 V3=0 T=0 M2=0 M3=-11,162099461951 FrameElem=36-1 ElemStation=0,08
Frame=36 Station=0 OutputCase=STR062 CaseType=Combination P=-29,1146357385495 V2=10,0423185635443 V3=0 T=0 M2=0 M3=-3,56196035277515 FrameElem=36-1 ElemStation=0
Frame=36 Station=0,04 OutputCase=STR062 CaseType=Combination P=-29,1146357385495 V2=10,6023185635443 V3=0 T=0 M2=0 M3=-3,97485309531692 FrameElem=36-1 ElemStation=0,04
Frame=36 Station=0,08 OutputCase=STR062 CaseType=Combination P=-29,1146357385495 V2=11,1623185635443 V3=0 T=0 M2=0 M3=-4,41014583785869 FrameElem=36-1 ElemStation=0,08
Frame=36 Station=0 OutputCase=STR063 CaseType=Combination P=-8,09539800621784 V2=14,6326814373674 V3=0 T=0 M2=0 M3=-2,23655415713709 FrameElem=36-1 ElemStation=0
Frame=36 Station=0,04 OutputCase=STR063 CaseType=Combination P=-8,09539800621784 V2=15,3886814373674 V3=0 T=0 M2=0 M3=-2,83698141463179 FrameElem=36-1 ElemStation=0,04
Frame=36 Station=0,08 OutputCase=STR063 CaseType=Combination P=-8,09539800621784 V2=16,1446814373674 V3=0 T=0 M2=0 M3=-3,46764867212648 FrameElem=36-1 ElemStation=0,08
Frame=36 Station=0 OutputCase=STR064 CaseType=Combination P=-2,98679490247956 V2=14,632681437251 V3=0 T=0 M2=0 M3=-1,39637246544387 FrameElem=36-1 ElemStation=0
Frame=36 Station=0,04 OutputCase=STR064 CaseType=Combination P=-2,98679490247956 V2=15,388681437251 V3=0 T=0 M2=0 M3=-1,99679972293391 FrameElem=36-1 ElemStation=0,04
Frame=36 Station=0,08 OutputCase=STR064 CaseType=Combination P=-2,98679490247956 V2=16,144681437251 V3=0 T=0 M2=0 M3=-2,62746698042395 FrameElem=36-1 ElemStation=0,08
Frame=36 Station=0 OutputCase=STR065 CaseType=Combination P=-3,95893972429976 V2=87,532681437752 V3=0 T=0 M2=0 M3=-6,6776250865626 FrameElem=36-1 ElemStation=0
Frame=36 Station=0,04 OutputCase=STR065 CaseType=Combination P=-3,95893972429976 V2=92,176681437752 V3=0 T=0 M2=0 M3=-10,2718123440727 FrameElem=36-1 ElemStation=0,04
Frame=36 Station=0,08 OutputCase=STR065 CaseType=Combination P=-3,95893972429976 V2=96,8206814377519 V3=0 T=0 M2=0 M3=-14,0517596015827 FrameElem=36-1 ElemStation=0,08
Frame=36 Station=0 OutputCase=STR066 CaseType=Combination P=-17,1531926333678 V2=97,8885936716702 V3=0 T=0 M2=0 M3=-16,2880127915129 FrameElem=36-1 ElemStation=0
Frame=36 Station=0,04 OutputCase=STR066 CaseType=Combination P=-17,1531926333678 V2=102,53259367167 V3=0 T=0 M2=0 M3=-20,2964365383797 FrameElem=36-1 ElemStation=0,04
Frame=36 Station=0,08 OutputCase=STR066 CaseType=Combination P=-17,1531926333678 V2=107,17659367167 V3=0 T=0 M2=0 M3=-24,4906202852465 FrameElem=36-1 ElemStation=0,08
Frame=36 Station=0 OutputCase=STR067 CaseType=Combination P=-30,3474455625524 V2=87,5326814385756 V3=0 T=0 M2=0 M3=-10,3645321460682 FrameElem=36-1 ElemStation=0
Frame=36 Station=0,04 OutputCase=STR067 CaseType=Combination P=-30,3474455625524 V2=92,1766814385756 V3=0 T=0 M2=0 M3=-13,9587194036112 FrameElem=36-1 ElemStation=0,04
Frame=36 Station=0,08 OutputCase=STR067 CaseType=Combination P=-30,3474455625524 V2=96,8206814385756 V3=0 T=0 M2=0 M3=-17,7386666611542 FrameElem=36-1 ElemStation=0,08
Frame=36 Station=0 OutputCase=STR068 CaseType=Combination P=-16,3781288267827 V2=21,3135936711386 V3=0 T=0 M2=0 M3=-10,8073815380107 FrameElem=36-1 ElemStation=0
Frame=36 Station=0,04 OutputCase=STR068 CaseType=Combination P=-16,3781288267827 V2=21,8735936711387 V3=0 T=0 M2=0 M3=-11,6711252848563 FrameElem=36-1 ElemStation=0,04
Frame=36 Station=0,08 OutputCase=STR068 CaseType=Combination P=-16,3781288267827 V2=22,4335936711387 V3=0 T=0 M2=0 M3=-12,5572690317018 FrameElem=36-1 ElemStation=0,08

Società di Progetto
Brebemi SpA



Doc. N.
60235-00000-A00.doc

CODIFICA DOCUMENTO
04RCDII10000000000300A00

REV.
00

FOGLIO
475 di 628

Frame=36 Station=0 OutputCase=STR069 CaseType=Combination P=-29,5723817559672 V2=10,9576814380441 V3=0 T=0 M2=0 M3=-4,88390089256598	FrameElem=36-1
ElemStation=0	
Frame=36 Station=0,04 OutputCase=STR069 CaseType=Combination P=-29,5723817559672 V2=11,5176814380441 V3=0 T=0 M2=0 M3=-5,33340815008775	FrameElem=36-1
ElemStation=0,04	
Frame=36 Station=0,08 OutputCase=STR069 CaseType=Combination P=-29,5723817559672 V2=12,0776814380441 V3=0 T=0 M2=0 M3=-5,80531540760951	FrameElem=36-1
ElemStation=0,08	
Frame=36 Station=0 OutputCase=STR070 CaseType=Combination P=-7,31484767396963 V2=14,1750000001173 V3=0 T=0 M2=0 M3=-1,1178378698238	FrameElem=36-1
ElemStation=0	
Frame=36 Station=0,04 OutputCase=STR070 CaseType=Combination P=-7,31484767396963 V2=14,9310000001173 V3=0 T=0 M2=0 M3=-1,6999578698285	FrameElem=36-1
ElemStation=0,04	
Frame=36 Station=0,08 OutputCase=STR070 CaseType=Combination P=-7,31484767396963 V2=15,6870000001173 V3=0 T=0 M2=0 M3=-2,31231786983319	FrameElem=36-1
ElemStation=0,08	
Frame=36 Station=0 OutputCase=STR071 CaseType=Combination P=-2,20624457023136 V2=14,1750000000009 V3=0 T=0 M2=0 M3=-0,27765617813059	FrameElem=36-1
ElemStation=0	
Frame=36 Station=0,04 OutputCase=STR071 CaseType=Combination P=-2,20624457023136 V2=14,9310000000009 V3=0 T=0 M2=0 M3=-0,859776178130627	FrameElem=36-1
ElemStation=0,04	
Frame=36 Station=0,08 OutputCase=STR071 CaseType=Combination P=-2,20624457023136 V2=15,6870000000009 V3=0 T=0 M2=0 M3=-1,47213617813066	FrameElem=36-1
ElemStation=0,08	
Frame=36 Station=0 OutputCase=STR072 CaseType=Combination P=-3,17838939205155 V2=87,0750000005019 V3=0 T=0 M2=0 M3=-5,55890879924931	FrameElem=36-1
ElemStation=0	
Frame=36 Station=0,04 OutputCase=STR072 CaseType=Combination P=-3,17838939205155 V2=91,7190000005019 V3=0 T=0 M2=0 M3=-9,13478879926938	FrameElem=36-1
ElemStation=0,04	
Frame=36 Station=0,08 OutputCase=STR072 CaseType=Combination P=-3,17838939205155 V2=96,3630000005019 V3=0 T=0 M2=0 M3=-12,8964287992895	FrameElem=36-1
ElemStation=0,08	
Frame=36 Station=0 OutputCase=STR073 CaseType=Combination P=-16,3726423011196 V2=97,4309122344201 V3=0 T=0 M2=0 M3=-15,1692965041996	FrameElem=36-1
ElemStation=0	
Frame=36 Station=0,04 OutputCase=STR073 CaseType=Combination P=-16,3726423011196 V2=102,07491223442 V3=0 T=0 M2=0 M3=-19,1594129935764	FrameElem=36-1
ElemStation=0,04	
Frame=36 Station=0,08 OutputCase=STR073 CaseType=Combination P=-16,3726423011196 V2=106,71891223442 V3=0 T=0 M2=0 M3=-23,3352894829533	FrameElem=36-1
ElemStation=0,08	
Frame=36 Station=0 OutputCase=STR074 CaseType=Combination P=-29,5668952303042 V2=87,0750000013255 V3=0 T=0 M2=0 M3=-9,24581585875489	FrameElem=36-1
ElemStation=0	
Frame=36 Station=0,04 OutputCase=STR074 CaseType=Combination P=-29,5668952303042 V2=91,7190000013255 V3=0 T=0 M2=0 M3=-12,8216958588079	FrameElem=36-1
ElemStation=0,04	
Frame=36 Station=0,08 OutputCase=STR074 CaseType=Combination P=-29,5668952303042 V2=96,3630000013255 V3=0 T=0 M2=0 M3=-16,5833358588609	FrameElem=36-1
ElemStation=0,08	
Frame=36 Station=0 OutputCase=STR075 CaseType=Combination P=-15,5975784945344 V2=20,8559122338886 V3=0 T=0 M2=0 M3=-9,68866525069746	FrameElem=36-1
ElemStation=0	
Frame=36 Station=0,04 OutputCase=STR075 CaseType=Combination P=-15,5975784945344 V2=21,4159122338886 V3=0 T=0 M2=0 M3=-10,534101740053	FrameElem=36-1
ElemStation=0,04	
Frame=36 Station=0,08 OutputCase=STR075 CaseType=Combination P=-15,5975784945344 V2=21,9759122338886 V3=0 T=0 M2=0 M3=-11,4019382294085	FrameElem=36-1
ElemStation=0,08	
Frame=36 Station=0 OutputCase=STR076 CaseType=Combination P=-28,791831423719 V2=10,500000000794 V3=0 T=0 M2=0 M3=-3,7651846052527	FrameElem=36-1
ElemStation=0	
Frame=36 Station=0,04 OutputCase=STR076 CaseType=Combination P=-28,791831423719 V2=11,060000000794 V3=0 T=0 M2=0 M3=-4,19638460528446	FrameElem=36-1
ElemStation=0,04	
Frame=36 Station=0,08 OutputCase=STR076 CaseType=Combination P=-28,791831423719 V2=11,620000000794 V3=0 T=0 M2=0 M3=-4,64998460531621	FrameElem=36-1
ElemStation=0,08	
Frame=36 Station=0 OutputCase=STR077 CaseType=Combination P=-8,40453218889307 V2=13,4121976047014 V3=0 T=0 M2=0 M3=-1,2368767997791	FrameElem=36-1
ElemStation=0	
Frame=36 Station=0,04 OutputCase=STR077 CaseType=Combination P=-8,40453218889307 V2=14,1681976047014 V3=0 T=0 M2=0 M3=-1,78848470396715	FrameElem=36-1
ElemStation=0,04	
Frame=36 Station=0,08 OutputCase=STR077 CaseType=Combination P=-8,40453218889307 V2=14,9241976047014 V3=0 T=0 M2=0 M3=-2,37033260815521	FrameElem=36-1
ElemStation=0,08	
Frame=36 Station=0 OutputCase=STR078 CaseType=Combination P=-3,29592908515479 V2=13,412197604585 V3=0 T=0 M2=0 M3=-0,39669510808588	FrameElem=36-1
ElemStation=0	
Frame=36 Station=0,04 OutputCase=STR078 CaseType=Combination P=-3,29592908515479 V2=14,168197604585 V3=0 T=0 M2=0 M3=-0,948303012269279	FrameElem=36-1
ElemStation=0,04	
Frame=36 Station=0,08 OutputCase=STR078 CaseType=Combination P=-3,29592908515479 V2=14,924197604585 V3=0 T=0 M2=0 M3=-1,53015091645268	FrameElem=36-1
ElemStation=0,08	
Frame=36 Station=0 OutputCase=STR079 CaseType=Combination P=-4,74470418672097 V2=110,91731856342 V3=0 T=0 M2=0 M3=-7,87901211617445	FrameElem=36-1
ElemStation=0	
Frame=36 Station=0,04 OutputCase=STR079 CaseType=Combination P=-4,74470418672097 V2=116,85731856342 V3=0 T=0 M2=0 M3=-12,4345048587112	FrameElem=36-1
ElemStation=0,04	
Frame=36 Station=0,08 OutputCase=STR079 CaseType=Combination P=-4,74470418672097 V2=122,79731856342 V3=0 T=0 M2=0 M3=-17,227597601248	FrameElem=36-1
ElemStation=0,08	
Frame=36 Station=0 OutputCase=STR080 CaseType=Combination P=-21,4856075477695 V2=124,099100148704 V3=0 T=0 M2=0 M3=-20,0832560625422	FrameElem=36-1
ElemStation=0	
Frame=36 Station=0,04 OutputCase=STR080 CaseType=Combination P=-21,4856075477695 V2=130,039100148704 V3=0 T=0 M2=0 M3=-25,1660200684904	FrameElem=36-1
ElemStation=0,04	
Frame=36 Station=0,08 OutputCase=STR080 CaseType=Combination P=-21,4856075477695 V2=135,979100148704 V3=0 T=0 M2=0 M3=-30,4863840744385	FrameElem=36-1
ElemStation=0,08	
Frame=36 Station=0 OutputCase=STR081 CaseType=Combination P=-38,2265109364783 V2=110,917318564479 V3=0 T=0 M2=0 M3=-12,5148276316175	FrameElem=36-1
ElemStation=0	
Frame=36 Station=0,04 OutputCase=STR081 CaseType=Combination P=-38,2265109364783 V2=116,857318564479 V3=0 T=0 M2=0 M3=-17,0703203741966	FrameElem=36-1
ElemStation=0,04	
Frame=36 Station=0,08 OutputCase=STR081 CaseType=Combination P=-38,2265109364783 V2=122,797318564479 V3=0 T=0 M2=0 M3=-21,8634131167758	FrameElem=36-1
ElemStation=0,08	
Frame=36 Station=0 OutputCase=STR082 CaseType=Combination P=-20,3864954672443 V2=23,2241001480056 V3=0 T=0 M2=0 M3=-12,8422072686671	FrameElem=36-1
ElemStation=0	
Frame=36 Station=0,04 OutputCase=STR082 CaseType=Combination P=-20,3864954672443 V2=23,7841001480056 V3=0 T=0 M2=0 M3=-13,7823712745873	FrameElem=36-1
ElemStation=0,04	
Frame=36 Station=0,08 OutputCase=STR082 CaseType=Combination P=-20,3864954672443 V2=24,3441001480056 V3=0 T=0 M2=0 M3=-14,7449352805076	FrameElem=36-1
ElemStation=0,08	
Frame=36 Station=0 OutputCase=STR083 CaseType=Combination P=-37,1273988559532 V2=10,0423185637804 V3=0 T=0 M2=0 M3=-5,27377883774239	FrameElem=36-1
ElemStation=0	
Frame=36 Station=0,04 OutputCase=STR083 CaseType=Combination P=-37,1273988559532 V2=10,6023185637804 V3=0 T=0 M2=0 M3=-5,6866715802936	FrameElem=36-1
ElemStation=0,04	

Società di Progetto
Brebemi SpA



Doc. N.
60235-00000-A00.doc

CODIFICA DOCUMENTO
04RCDII10000000000300A00

REV.
00

FOGLIO
476 di 628

Frame=36 Station=0,08 OutputCase=STR083 CaseType=Combination P=-37,1273988559532 V2=11,1623185637804 V3=0 T=0 M2=0 M3=-6,12196432284481 FrameElem=36-1 ElemStation=0,08
Frame=36 Station=0 OutputCase=STR084 CaseType=Combination P=-34,5236588298956 V2=116,343143587305 V3=0 T=0 M2=0 M3=-30,2564168729599 FrameElem=36-1 ElemStation=0
Frame=36 Station=0,04 OutputCase=STR084 CaseType=Combination P=-35,4254588298955 V2=120,987143587305 V3=0 T=0 M2=0 M3=-35,0030226164521 FrameElem=36-1 ElemStation=0,04
Frame=36 Station=0,08 OutputCase=STR084 CaseType=Combination P=-36,3272588298955 V2=125,631143587305 V3=0 T=0 M2=0 M3=-39,9353883599443 FrameElem=36-1 ElemStation=0,08
Frame=36 Station=0 OutputCase=STR085 CaseType=Combination P=-4,26807390697499 V2=86,3121976050859 V3=0 T=0 M2=0 M3=-5,6779477292046 FrameElem=36-1 ElemStation=0
Frame=36 Station=0,04 OutputCase=STR085 CaseType=Combination P=-4,26807390697499 V2=90,9561976050859 V3=0 T=0 M2=0 M3=-9,22331563340804 FrameElem=36-1 ElemStation=0,04
Frame=36 Station=0,08 OutputCase=STR085 CaseType=Combination P=-4,26807390697499 V2=95,6001976050859 V3=0 T=0 M2=0 M3=-12,9544435376115 FrameElem=36-1 ElemStation=0,08
Frame=36 Station=0 OutputCase=STR086 CaseType=Combination P=-17,462326816043 V2=96,6681098390041 V3=0 T=0 M2=0 M3=-15,2883354341549 FrameElem=36-1 ElemStation=0
Frame=36 Station=0,04 OutputCase=STR086 CaseType=Combination P=-17,462326816043 V2=101,312109839004 V3=0 T=0 M2=0 M3=-19,2479398277151 FrameElem=36-1 ElemStation=0,04
Frame=36 Station=0,08 OutputCase=STR086 CaseType=Combination P=-17,462326816043 V2=105,956109839004 V3=0 T=0 M2=0 M3=-23,3933042212753 FrameElem=36-1 ElemStation=0,08
Frame=36 Station=0 OutputCase=STR087 CaseType=Combination P=-30,6565797452276 V2=86,3121976050906 V3=0 T=0 M2=0 M3=-9,36485478871018 FrameElem=36-1 ElemStation=0
Frame=36 Station=0,04 OutputCase=STR087 CaseType=Combination P=-30,6565797452276 V2=90,9561976050906 V3=0 T=0 M2=0 M3=-12,910226929466 FrameElem=36-1 ElemStation=0,04
Frame=36 Station=0,08 OutputCase=STR087 CaseType=Combination P=-30,6565797452276 V2=95,6001976050906 V3=0 T=0 M2=0 M3=-16,6413505971829 FrameElem=36-1 ElemStation=0,08
Frame=36 Station=0 OutputCase=STR088 CaseType=Combination P=-16,6872630094579 V2=20,0931098384726 V3=0 T=0 M2=0 M3=-9,80770418065275 FrameElem=36-1 ElemStation=0
Frame=36 Station=0,04 OutputCase=STR088 CaseType=Combination P=-16,6872630094579 V2=20,6531098384726 V3=0 T=0 M2=0 M3=-10,6226285741917 FrameElem=36-1 ElemStation=0,04
Frame=36 Station=0,08 OutputCase=STR088 CaseType=Combination P=-16,6872630094579 V2=21,2131098384726 V3=0 T=0 M2=0 M3=-11,4599529677306 FrameElem=36-1 ElemStation=0,08
Frame=36 Station=0 OutputCase=STR089 CaseType=Combination P=-29,8815159386425 V2=9,73719760537806 V3=0 T=0 M2=0 M3=-3,88422353520799 FrameElem=36-1 ElemStation=0
Frame=36 Station=0,04 OutputCase=STR089 CaseType=Combination P=-29,8815159386425 V2=10,2971976053781 V3=0 T=0 M2=0 M3=-4,28491143942311 FrameElem=36-1 ElemStation=0,04
Frame=36 Station=0,08 OutputCase=STR089 CaseType=Combination P=-29,8815159386425 V2=10,8571976053781 V3=0 T=0 M2=0 M3=-4,70799934363823 FrameElem=36-1 ElemStation=0,08
Frame=36 Station=0 OutputCase=STR090 CaseType=Combination P=-8,9562095124324 V2=13,4121976047016 V3=0 T=0 M2=0 M3=-1,69462281719696 FrameElem=36-1 ElemStation=0
Frame=36 Station=0,04 OutputCase=STR090 CaseType=Combination P=-8,9562095124324 V2=14,1681976047016 V3=0 T=0 M2=0 M3=-2,24623072138503 FrameElem=36-1 ElemStation=0,04
Frame=36 Station=0,08 OutputCase=STR090 CaseType=Combination P=-8,9562095124324 V2=14,9241976047016 V3=0 T=0 M2=0 M3=-2,82807862557309 FrameElem=36-1 ElemStation=0,08
Frame=36 Station=0 OutputCase=STR091 CaseType=Combination P=-3,84760640869412 V2=13,4121976045852 V3=0 T=0 M2=0 M3=-0,854441125503749 FrameElem=36-1 ElemStation=0
Frame=36 Station=0,04 OutputCase=STR091 CaseType=Combination P=-3,84760640869412 V2=14,1681976045852 V3=0 T=0 M2=0 M3=-1,40604902968716 FrameElem=36-1 ElemStation=0,04
Frame=36 Station=0,08 OutputCase=STR091 CaseType=Combination P=-3,84760640869412 V2=14,9241976045852 V3=0 T=0 M2=0 M3=-1,98789693387056 FrameElem=36-1 ElemStation=0,08
Frame=36 Station=0 OutputCase=STR092 CaseType=Combination P=-4,81975123051432 V2=86,3121976050861 V3=0 T=0 M2=0 M3=-6,13569374662247 FrameElem=36-1 ElemStation=0
Frame=36 Station=0,04 OutputCase=STR092 CaseType=Combination P=-4,81975123051432 V2=90,9561976050861 V3=0 T=0 M2=0 M3=-9,68106165082591 FrameElem=36-1 ElemStation=0,04
Frame=36 Station=0,08 OutputCase=STR092 CaseType=Combination P=-4,81975123051432 V2=95,6001976050861 V3=0 T=0 M2=0 M3=-13,4121895550294 FrameElem=36-1 ElemStation=0,08
Frame=36 Station=0 OutputCase=STR093 CaseType=Combination P=-18,0140041395823 V2=96,6681098390043 V3=0 T=0 M2=0 M3=-15,7460814515728 FrameElem=36-1 ElemStation=0
Frame=36 Station=0,04 OutputCase=STR093 CaseType=Combination P=-18,0140041395823 V2=101,312109839004 V3=0 T=0 M2=0 M3=-19,705685845133 FrameElem=36-1 ElemStation=0,04
Frame=36 Station=0,08 OutputCase=STR093 CaseType=Combination P=-18,0140041395823 V2=105,956109839004 V3=0 T=0 M2=0 M3=-23,8510502386932 FrameElem=36-1 ElemStation=0,08
Frame=36 Station=0 OutputCase=STR094 CaseType=Combination P=-31,2082570687669 V2=86,3121976050908 V3=0 T=0 M2=0 M3=-9,82260080612804 FrameElem=36-1 ElemStation=0
Frame=36 Station=0,04 OutputCase=STR094 CaseType=Combination P=-31,2082570687669 V2=90,9561976050908 V3=0 T=0 M2=0 M3=-13,3679687103644 FrameElem=36-1 ElemStation=0,04
Frame=36 Station=0,08 OutputCase=STR094 CaseType=Combination P=-31,2082570687669 V2=95,6001976050907 V3=0 T=0 M2=0 M3=-17,0990966146008 FrameElem=36-1 ElemStation=0,08
Frame=36 Station=0 OutputCase=STR095 CaseType=Combination P=-17,2389403329972 V2=20,0931098384728 V3=0 T=0 M2=0 M3=-10,2654501980706 FrameElem=36-1 ElemStation=0
Frame=36 Station=0,04 OutputCase=STR095 CaseType=Combination P=-17,2389403329972 V2=20,6531098384728 V3=0 T=0 M2=0 M3=-11,0803745916095 FrameElem=36-1 ElemStation=0,04
Frame=36 Station=0,08 OutputCase=STR095 CaseType=Combination P=-17,2389403329972 V2=21,2131098384728 V3=0 T=0 M2=0 M3=-11,9176989851484 FrameElem=36-1 ElemStation=0,08
Frame=36 Station=0 OutputCase=STR096 CaseType=Combination P=-30,4331932621818 V2=9,73719760537826 V3=0 T=0 M2=0 M3=-4,34196955262586 FrameElem=36-1 ElemStation=0
Frame=36 Station=0,04 OutputCase=STR096 CaseType=Combination P=-30,4331932621818 V2=10,2971976053783 V3=0 T=0 M2=0 M3=-4,74265745684099 FrameElem=36-1 ElemStation=0,04
Frame=36 Station=0,08 OutputCase=STR096 CaseType=Combination P=-30,4331932621818 V2=10,8571976053783 V3=0 T=0 M2=0 M3=-5,16574536105612 FrameElem=36-1 ElemStation=0,08
Frame=36 Station=0 OutputCase=STR097 CaseType=Combination P=-7,85285486535373 V2=13,4121976047012 V3=0 T=0 M2=0 M3=-0,779130782361227 FrameElem=36-1 ElemStation=0
Frame=36 Station=0,04 OutputCase=STR097 CaseType=Combination P=-7,85285486535373 V2=14,1681976047012 V3=0 T=0 M2=0 M3=-1,33073868654927 FrameElem=36-1 ElemStation=0,04
Frame=36 Station=0,08 OutputCase=STR097 CaseType=Combination P=-7,85285486535373 V2=14,9241976047012 V3=0 T=0 M2=0 M3=-1,91258659073732 FrameElem=36-1 ElemStation=0,08
Frame=36 Station=0 OutputCase=STR098 CaseType=Combination P=-2,74425176161545 V2=13,4121976045848 V3=0 T=0 M2=0 M3=6,10509093319882E-02 FrameElem=36-1 ElemStation=0

APPROVATO SDP
Società di Progetto
Brebemi SpA

Frame=36 1 ElemStation=0,04	Station=0,04	OutputCase=STR098	CaseType=Combination	P=-2,74425176161545	V2=14,1681976045848	V3=0	T=0	M2=0	M3=-0,490556994851403	FrameElem=36-1
Frame=36 ElemStation=0,08	Station=0,08	OutputCase=STR098	CaseType=Combination	P=-2,74425176161545	V2=14,9241976045848	V3=0	T=0	M2=0	M3=-1,07240489903479	FrameElem=36-1
Frame=36 ElemStation=0	Station=0	OutputCase=STR099	CaseType=Combination	P=-3,71639658343565	V2=86,3121976050857	V3=0	T=0	M2=0	M3=-5,22020171178673	FrameElem=36-1
Frame=36 ElemStation=0,04	Station=0,04	OutputCase=STR099	CaseType=Combination	P=-3,71639658343565	V2=90,9561976050857	V3=0	T=0	M2=0	M3=-8,76556961599016	FrameElem=36-1
Frame=36 ElemStation=0,08	Station=0,08	OutputCase=STR099	CaseType=Combination	P=-3,71639658343565	V2=95,6001976050857	V3=0	T=0	M2=0	M3=-12,4966975201936	FrameElem=36-1
Frame=36 ElemStation=0	Station=0	OutputCase=STR100	CaseType=Combination	P=-16,9106494925037	V2=96,6681098390039	V3=0	T=0	M2=0	M3=-14,8305894167371	FrameElem=36-1
Frame=36 ElemStation=0,04	Station=0,04	OutputCase=STR100	CaseType=Combination	P=-16,9106494925037	V2=101,312109839004	V3=0	T=0	M2=0	M3=-18,7901938102972	FrameElem=36-1
Frame=36 ElemStation=0,08	Station=0,08	OutputCase=STR100	CaseType=Combination	P=-16,9106494925037	V2=105,956109839004	V3=0	T=0	M2=0	M3=-22,9355582038574	FrameElem=36-1
Frame=36 ElemStation=0	Station=0	OutputCase=STR101	CaseType=Combination	P=-30,1049024216883	V2=86,3121976059094	V3=0	T=0	M2=0	M3=-8,90710877129231	FrameElem=36-1
Frame=36 ElemStation=0,04	Station=0,04	OutputCase=STR101	CaseType=Combination	P=-30,1049024216883	V2=90,9561976059094	V3=0	T=0	M2=0	M3=-12,4524766755287	FrameElem=36-1
Frame=36 ElemStation=0,08	Station=0,08	OutputCase=STR101	CaseType=Combination	P=-30,1049024216883	V2=95,6001976059093	V3=0	T=0	M2=0	M3=-16,183604579765	FrameElem=36-1
Frame=36 ElemStation=0	Station=0	OutputCase=STR102	CaseType=Combination	P=-16,1355856859185	V2=20,0931098384724	V3=0	T=0	M2=0	M3=-9,34995816323488	FrameElem=36-1
Frame=36 ElemStation=0,04	Station=0,04	OutputCase=STR102	CaseType=Combination	P=-16,1355856859185	V2=20,6531098384724	V3=0	T=0	M2=0	M3=-10,1648825567738	FrameElem=36-1
Frame=36 ElemStation=0,08	Station=0,08	OutputCase=STR102	CaseType=Combination	P=-16,1355856859185	V2=21,2131098384724	V3=0	T=0	M2=0	M3=-11,0022069503127	FrameElem=36-1
Frame=36 ElemStation=0	Station=0	OutputCase=STR103	CaseType=Combination	P=-29,3298386151031	V2=9,73719760537785	V3=0	T=0	M2=0	M3=-3,42647751779012	FrameElem=36-1
Frame=36 ElemStation=0,04	Station=0,04	OutputCase=STR103	CaseType=Combination	P=-29,3298386151031	V2=10,2971976053778	V3=0	T=0	M2=0	M3=-3,82716542200523	FrameElem=36-1
Frame=36 ElemStation=0,08	Station=0,08	OutputCase=STR103	CaseType=Combination	P=-29,3298386151031	V2=10,8571976053778	V3=0	T=0	M2=0	M3=-4,25025332622034	FrameElem=36-1
Frame=36 ElemStation=0	Station=0	OutputCase=STR104	CaseType=Combination	P=-7,85285486535373	V2=13,4121976047012	V3=0	T=0	M2=0	M3=-0,779130782361227	FrameElem=36-1
Frame=36 ElemStation=0,04	Station=0,04	OutputCase=STR104	CaseType=Combination	P=-7,85285486535373	V2=14,1681976047012	V3=0	T=0	M2=0	M3=-1,33073868654927	FrameElem=36-1
Frame=36 ElemStation=0,08	Station=0,08	OutputCase=STR104	CaseType=Combination	P=-7,85285486535373	V2=14,9241976047012	V3=0	T=0	M2=0	M3=-1,91258659073732	FrameElem=36-1
Frame=36 1 ElemStation=0	Station=0	OutputCase=STR105	CaseType=Combination	P=-2,74425176161545	V2=13,4121976045848	V3=0	T=0	M2=0	M3=6,10509093319883E-02	FrameElem=36-1
Frame=36 1 ElemStation=0,04	Station=0,04	OutputCase=STR105	CaseType=Combination	P=-2,74425176161545	V2=14,1681976045848	V3=0	T=0	M2=0	M3=-0,490556994851403	FrameElem=36-1
Frame=36 ElemStation=0,08	Station=0,08	OutputCase=STR105	CaseType=Combination	P=-2,74425176161545	V2=14,9241976045848	V3=0	T=0	M2=0	M3=-1,07240489903479	FrameElem=36-1
Frame=36 ElemStation=0	Station=0	OutputCase=STR106	CaseType=Combination	P=-3,71639658343565	V2=86,3121976050857	V3=0	T=0	M2=0	M3=-5,22020171178673	FrameElem=36-1
Frame=36 ElemStation=0,04	Station=0,04	OutputCase=STR106	CaseType=Combination	P=-3,71639658343565	V2=90,9561976050857	V3=0	T=0	M2=0	M3=-8,76556961599016	FrameElem=36-1
Frame=36 ElemStation=0,08	Station=0,08	OutputCase=STR106	CaseType=Combination	P=-3,71639658343565	V2=95,6001976050857	V3=0	T=0	M2=0	M3=-12,4966975201936	FrameElem=36-1
Frame=36 ElemStation=0	Station=0	OutputCase=STR107	CaseType=Combination	P=-16,9106494925037	V2=96,6681098390039	V3=0	T=0	M2=0	M3=-14,8305894167371	FrameElem=36-1
Frame=36 ElemStation=0,04	Station=0,04	OutputCase=STR107	CaseType=Combination	P=-16,9106494925037	V2=101,312109839004	V3=0	T=0	M2=0	M3=-18,7901938102972	FrameElem=36-1
Frame=36 ElemStation=0,08	Station=0,08	OutputCase=STR107	CaseType=Combination	P=-16,9106494925037	V2=105,956109839004	V3=0	T=0	M2=0	M3=-22,9355582038574	FrameElem=36-1
Frame=36 ElemStation=0	Station=0	OutputCase=STR108	CaseType=Combination	P=-30,1049024216883	V2=86,3121976059094	V3=0	T=0	M2=0	M3=-8,90710877129231	FrameElem=36-1
Frame=36 ElemStation=0,04	Station=0,04	OutputCase=STR108	CaseType=Combination	P=-30,1049024216883	V2=90,9561976059094	V3=0	T=0	M2=0	M3=-12,4524766755287	FrameElem=36-1
Frame=36 ElemStation=0,08	Station=0,08	OutputCase=STR108	CaseType=Combination	P=-30,1049024216883	V2=95,6001976059093	V3=0	T=0	M2=0	M3=-16,183604579765	FrameElem=36-1
Frame=36 ElemStation=0	Station=0	OutputCase=STR109	CaseType=Combination	P=-16,1355856859185	V2=20,0931098384724	V3=0	T=0	M2=0	M3=-9,34995816323488	FrameElem=36-1
Frame=36 ElemStation=0,04	Station=0,04	OutputCase=STR109	CaseType=Combination	P=-16,1355856859185	V2=20,6531098384724	V3=0	T=0	M2=0	M3=-10,1648825567738	FrameElem=36-1
Frame=36 ElemStation=0,08	Station=0,08	OutputCase=STR109	CaseType=Combination	P=-16,1355856859185	V2=21,2131098384724	V3=0	T=0	M2=0	M3=-11,0022069503127	FrameElem=36-1
Frame=36 ElemStation=0	Station=0	OutputCase=STR110	CaseType=Combination	P=-29,3298386151031	V2=9,73719760537785	V3=0	T=0	M2=0	M3=-3,42647751779012	FrameElem=36-1
Frame=36 ElemStation=0,04	Station=0,04	OutputCase=STR110	CaseType=Combination	P=-29,3298386151031	V2=10,2971976053778	V3=0	T=0	M2=0	M3=-3,82716542200523	FrameElem=36-1
Frame=36 ElemStation=0,08	Station=0,08	OutputCase=STR110	CaseType=Combination	P=-29,3298386151031	V2=10,8571976053778	V3=0	T=0	M2=0	M3=-4,25025332622034	FrameElem=36-1
Frame=36 ElemStation=0	Station=0	OutputCase=STR111	CaseType=Combination	P=-9,16744221792265	V2=14,9378023955344	V3=0	T=0	M2=0	M3=-3,44011103276381	FrameElem=36-1
Frame=36 ElemStation=0,04	Station=0,04	OutputCase=STR111	CaseType=Combination	P=-9,16744221792265	V2=15,6938023955344	V3=0	T=0	M2=0	M3=-4,05274312858519	FrameElem=36-1
Frame=36 ElemStation=0,08	Station=0,08	OutputCase=STR111	CaseType=Combination	P=-9,16744221792265	V2=16,4498023955343	V3=0	T=0	M2=0	M3=-4,69561522440656	FrameElem=36-1
Frame=36 ElemStation=0	Station=0	OutputCase=STR112	CaseType=Combination	P=-4,05883911418437	V2=14,9378023954179	V3=0	T=0	M2=0	M3=-2,5999293410706	FrameElem=36-1
Frame=36 ElemStation=0,04	Station=0,04	OutputCase=STR112	CaseType=Combination	P=-4,05883911418437	V2=15,6938023954179	V3=0	T=0	M2=0	M3=-3,21256143688732	FrameElem=36-1
Frame=36 ElemStation=0,08	Station=0,08	OutputCase=STR112	CaseType=Combination	P=-4,05883911418437	V2=16,4498023954179	V3=0	T=0	M2=0	M3=-3,85543353270403	FrameElem=36-1



Doc. N.
60235-00000-A00.doc

CODIFICA DOCUMENTO
04RCDII10000000000300A00

REV.
00

FOGLIO
478 di 628

Frame=36 Station=0 OutputCase=STR113 CaseType=Combination P=-5,20245020413872 V2=111,832681437919 V3=0 T=0 M2=0 M3=-9,20095265596528	FrameElem=36-1
ElemStation=0	
Frame=36 Station=0,04 OutputCase=STR113 CaseType=Combination P=-5,20245020413872 V2=117,772681437919 V3=0 T=0 M2=0 M3=-13,7930599134821	FrameElem=36-1
ElemStation=0,04	
Frame=36 Station=0,08 OutputCase=STR113 CaseType=Combination P=-5,20245020413872 V2=123,712681437919 V3=0 T=0 M2=0 M3=-18,6227671709988	FrameElem=36-1
ElemStation=0,08	
Frame=36 Station=0 OutputCase=STR114 CaseType=Combination P=-21,9433535651873 V2=125,014463023204 V3=0 T=0 M2=0 M3=-21,405196602333	FrameElem=36-1
ElemStation=0	
Frame=36 Station=0,04 OutputCase=STR114 CaseType=Combination P=-21,9433535651873 V2=130,954463023204 V3=0 T=0 M2=0 M3=-26,5245751232612	FrameElem=36-1
ElemStation=0,04	
Frame=36 Station=0,08 OutputCase=STR114 CaseType=Combination P=-21,9433535651873 V2=136,894463023204 V3=0 T=0 M2=0 M3=-31,8815536441893	FrameElem=36-1
ElemStation=0,08	
Frame=36 Station=0 OutputCase=STR115 CaseType=Combination P=-38,6842569538961 V2=111,832681438979 V3=0 T=0 M2=0 M3=-13,8367681714083	FrameElem=36-1
ElemStation=0	
Frame=36 Station=0,04 OutputCase=STR115 CaseType=Combination P=-38,6842569538961 V2=117,772681438979 V3=0 T=0 M2=0 M3=-18,4288754289675	FrameElem=36-1
ElemStation=0,04	
Frame=36 Station=0,08 OutputCase=STR115 CaseType=Combination P=-38,6842569538961 V2=123,712681438979 V3=0 T=0 M2=0 M3=-23,2585826865266	FrameElem=36-1
ElemStation=0,08	
Frame=36 Station=0 OutputCase=STR116 CaseType=Combination P=-20,8442414846621 V2=24,1394630225054 V3=0 T=0 M2=0 M3=-14,1641478084579	FrameElem=36-1
ElemStation=0	
Frame=36 Station=0,04 OutputCase=STR116 CaseType=Combination P=-20,8442414846621 V2=24,6994630225054 V3=0 T=0 M2=0 M3=-15,1409263293582	FrameElem=36-1
ElemStation=0,04	
Frame=36 Station=0,08 OutputCase=STR116 CaseType=Combination P=-20,8442414846621 V2=25,2594630225054 V3=0 T=0 M2=0 M3=-16,1401048502584	FrameElem=36-1
ElemStation=0,08	
Frame=36 Station=0 OutputCase=STR117 CaseType=Combination P=-37,5851448733709 V2=10,9576814382802 V3=0 T=0 M2=0 M3=-6,59571937753322	FrameElem=36-1
ElemStation=0	
Frame=36 Station=0,04 OutputCase=STR117 CaseType=Combination P=-37,5851448733709 V2=11,5176814382802 V3=0 T=0 M2=0 M3=-7,04522663506442	FrameElem=36-1
ElemStation=0,04	
Frame=36 Station=0,08 OutputCase=STR117 CaseType=Combination P=-37,5851448733709 V2=12,0776814382802 V3=0 T=0 M2=0 M3=-7,51713389259563	FrameElem=36-1
ElemStation=0,08	
Frame=36 Station=0 OutputCase=STR118 CaseType=Combination P=-34,9814048473133 V2=117,258506461805 V3=0 T=0 M2=0 M3=-31,5783574127507	FrameElem=36-1
ElemStation=0	
Frame=36 Station=0,04 OutputCase=STR118 CaseType=Combination P=-35,8832048473133 V2=121,902506461805 V3=0 T=0 M2=0 M3=-36,3615776712229	FrameElem=36-1
ElemStation=0,04	
Frame=36 Station=0,08 OutputCase=STR118 CaseType=Combination P=-36,7850048473133 V2=126,546506461805 V3=0 T=0 M2=0 M3=-41,3305579296951	FrameElem=36-1
ElemStation=0,08	
Frame=36 Station=0 OutputCase=STR119 CaseType=Combination P=-5,03098393600457 V2=87,8378023959189 V3=0 T=0 M2=0 M3=-7,88118196218932	FrameElem=36-1
ElemStation=0	
Frame=36 Station=0,04 OutputCase=STR119 CaseType=Combination P=-5,03098393600457 V2=92,4818023959189 V3=0 T=0 M2=0 M3=-11,4875740580261	FrameElem=36-1
ElemStation=0,04	
Frame=36 Station=0,08 OutputCase=STR119 CaseType=Combination P=-5,03098393600457 V2=97,1258023959189 V3=0 T=0 M2=0 M3=-15,2797261538628	FrameElem=36-1
ElemStation=0,08	
Frame=36 Station=0 OutputCase=STR120 CaseType=Combination P=-18,2252368450726 V2=98,1937146298371 V3=0 T=0 M2=0 M3=-17,4915696671397	FrameElem=36-1
ElemStation=0	
Frame=36 Station=0,04 OutputCase=STR120 CaseType=Combination P=-18,2252368450726 V2=102,837714629837 V3=0 T=0 M2=0 M3=-21,5121982523331	FrameElem=36-1
ElemStation=0,04	
Frame=36 Station=0,08 OutputCase=STR120 CaseType=Combination P=-18,2252368450726 V2=107,481714629837 V3=0 T=0 M2=0 M3=-25,7185868375266	FrameElem=36-1
ElemStation=0,08	
Frame=36 Station=0 OutputCase=STR121 CaseType=Combination P=-31,4194897742572 V2=87,8378023967425 V3=0 T=0 M2=0 M3=-11,5680890216949	FrameElem=36-1
ElemStation=0	
Frame=36 Station=0,04 OutputCase=STR121 CaseType=Combination P=-31,4194897742572 V2=92,4818023967425 V3=0 T=0 M2=0 M3=-15,1744811175646	FrameElem=36-1
ElemStation=0,04	
Frame=36 Station=0,08 OutputCase=STR121 CaseType=Combination P=-31,4194897742572 V2=97,1258023967425 V3=0 T=0 M2=0 M3=-18,9666332134343	FrameElem=36-1
ElemStation=0,08	
Frame=36 Station=0 OutputCase=STR122 CaseType=Combination P=-17,4501730384875 V2=21,6187146293056 V3=0 T=0 M2=0 M3=-12,0109384136375	FrameElem=36-1
ElemStation=0	
Frame=36 Station=0,04 OutputCase=STR122 CaseType=Combination P=-17,4501730384875 V2=22,1787146293056 V3=0 T=0 M2=0 M3=-12,8868869988097	FrameElem=36-1
ElemStation=0,04	
Frame=36 Station=0,08 OutputCase=STR122 CaseType=Combination P=-17,4501730384875 V2=22,7387146293056 V3=0 T=0 M2=0 M3=-13,7852355839819	FrameElem=36-1
ElemStation=0,08	
Frame=36 Station=0 OutputCase=STR123 CaseType=Combination P=-30,644425967672 V2=11,262802396211 V3=0 T=0 M2=0 M3=-6,0874577681927	FrameElem=36-1
ElemStation=0	
Frame=36 Station=0,04 OutputCase=STR123 CaseType=Combination P=-30,644425967672 V2=11,822802396211 V3=0 T=0 M2=0 M3=-6,54916986404115	FrameElem=36-1
ElemStation=0,04	
Frame=36 Station=0,08 OutputCase=STR123 CaseType=Combination P=-30,644425967672 V2=12,382802396211 V3=0 T=0 M2=0 M3=-7,03328195988959	FrameElem=36-1
ElemStation=0,08	
Frame=36 Station=0 OutputCase=STR124 CaseType=Combination P=-9,71911954146198 V2=14,9378023955346 V3=0 T=0 M2=0 M3=-3,89785705018168	FrameElem=36-1
ElemStation=0	
Frame=36 Station=0,04 OutputCase=STR124 CaseType=Combination P=-9,71911954146198 V2=15,6938023955346 V3=0 T=0 M2=0 M3=-4,51048914600307	FrameElem=36-1
ElemStation=0,04	
Frame=36 Station=0,08 OutputCase=STR124 CaseType=Combination P=-9,71911954146198 V2=16,4498023955346 V3=0 T=0 M2=0 M3=-5,15336124182445	FrameElem=36-1
ElemStation=0,08	
Frame=36 Station=0 OutputCase=STR125 CaseType=Combination P=-4,6105164377237 V2=14,9378023954181 V3=0 T=0 M2=0 M3=-3,05767535848847	FrameElem=36-1
ElemStation=0	
Frame=36 Station=0,04 OutputCase=STR125 CaseType=Combination P=-4,6105164377237 V2=15,6938023954181 V3=0 T=0 M2=0 M3=-3,67030745430519	FrameElem=36-1
ElemStation=0,04	
Frame=36 Station=0,08 OutputCase=STR125 CaseType=Combination P=-4,6105164377237 V2=16,4498023954181 V3=0 T=0 M2=0 M3=-4,31317955012192	FrameElem=36-1
ElemStation=0,08	
Frame=36 Station=0 OutputCase=STR126 CaseType=Combination P=-5,5826612595439 V2=87,8378023959191 V3=0 T=0 M2=0 M3=-8,33892797960719	FrameElem=36-1
ElemStation=0	
Frame=36 Station=0,04 OutputCase=STR126 CaseType=Combination P=-5,5826612595439 V2=92,4818023959191 V3=0 T=0 M2=0 M3=-11,945320075444	FrameElem=36-1
ElemStation=0,04	
Frame=36 Station=0,08 OutputCase=STR126 CaseType=Combination P=-5,5826612595439 V2=97,1258023959191 V3=0 T=0 M2=0 M3=-15,7374221712807	FrameElem=36-1
ElemStation=0,08	
Frame=36 Station=0 OutputCase=STR127 CaseType=Combination P=-18,7769141686119 V2=98,1937146298373 V3=0 T=0 M2=0 M3=-17,9493156845575	FrameElem=36-1
ElemStation=0	
Frame=36 Station=0,04 OutputCase=STR127 CaseType=Combination P=-18,7769141686119 V2=102,837714629837 V3=0 T=0 M2=0 M3=-21,969944269751	FrameElem=36-1
ElemStation=0,04	

Società di Progetto
Brebemi SpA



Doc. N.
60235-0000-A00.doc

CODIFICA DOCUMENTO
04RCDII10000000000300A00

REV.
00

FOGLIO
479 di 628

Frame=36 Station=0,08 OutputCase=STR127 CaseType=Combination P=-18,7769141686119 V2=107,481714629837 V3=0 T=0 M2=0 M3=-26,1763328549445 FrameElem=36-1 ElemStation=0,08
Frame=36 Station=0 OutputCase=STR128 CaseType=Combination P=-31,9711670977965 V2=87,8378023967427 V3=0 T=0 M2=0 M3=-12,0258350391128 FrameElem=36-1 ElemStation=0
Frame=36 Station=0,04 OutputCase=STR128 CaseType=Combination P=-31,9711670977965 V2=92,4818023967427 V3=0 T=0 M2=0 M3=-15,6322271349825 FrameElem=36-1 ElemStation=0,04
Frame=36 Station=0,08 OutputCase=STR128 CaseType=Combination P=-31,9711670977965 V2=97,1258023967427 V3=0 T=0 M2=0 M3=-19,4243792308522 FrameElem=36-1 ElemStation=0,08
Frame=36 Station=0 OutputCase=STR129 CaseType=Combination P=-18,0018503620268 V2=21,6187146293058 V3=0 T=0 M2=0 M3=-12,4686844310553 FrameElem=36-1 ElemStation=0
Frame=36 Station=0,04 OutputCase=STR129 CaseType=Combination P=-18,0018503620268 V2=22,1787146293058 V3=0 T=0 M2=0 M3=-13,3446330162276 FrameElem=36-1 ElemStation=0,04
Frame=36 Station=0,08 OutputCase=STR129 CaseType=Combination P=-18,0018503620268 V2=22,7387146293058 V3=0 T=0 M2=0 M3=-14,2429816013998 FrameElem=36-1 ElemStation=0,08
Frame=36 Station=0 OutputCase=STR130 CaseType=Combination P=-31,1961032912114 V2=11,2628023962112 V3=0 T=0 M2=0 M3=-6,54520378561057 FrameElem=36-1 ElemStation=0
Frame=36 Station=0,04 OutputCase=STR130 CaseType=Combination P=-31,1961032912114 V2=11,8228023962112 V3=0 T=0 M2=0 M3=-7,00691588145902 FrameElem=36-1 ElemStation=0,04
Frame=36 Station=0,08 OutputCase=STR130 CaseType=Combination P=-31,1961032912114 V2=12,3828023962112 V3=0 T=0 M2=0 M3=-7,49102797730747 FrameElem=36-1 ElemStation=0,08
Frame=36 Station=0 OutputCase=STR131 CaseType=Combination P=-8,61576489438331 V2=14,9378023955341 V3=0 T=0 M2=0 M3=-2,98236501534595 FrameElem=36-1 ElemStation=0
Frame=36 Station=0,04 OutputCase=STR131 CaseType=Combination P=-8,61576489438331 V2=15,6938023955341 V3=0 T=0 M2=0 M3=-3,59499711116731 FrameElem=36-1 ElemStation=0,04
Frame=36 Station=0,08 OutputCase=STR131 CaseType=Combination P=-8,61576489438331 V2=16,4498023955341 V3=0 T=0 M2=0 M3=-4,23786920698868 FrameElem=36-1 ElemStation=0,08
Frame=36 Station=0 OutputCase=STR132 CaseType=Combination P=-3,50716179064504 V2=14,9378023954177 V3=0 T=0 M2=0 M3=-2,14218332365273 FrameElem=36-1 ElemStation=0
Frame=36 Station=0,04 OutputCase=STR132 CaseType=Combination P=-3,50716179064504 V2=15,6938023954177 V3=0 T=0 M2=0 M3=-2,75481541946944 FrameElem=36-1 ElemStation=0,04
Frame=36 Station=0,08 OutputCase=STR132 CaseType=Combination P=-3,50716179064504 V2=16,4498023954177 V3=0 T=0 M2=0 M3=-3,39768751528615 FrameElem=36-1 ElemStation=0,08
Frame=36 Station=0 OutputCase=STR133 CaseType=Combination P=-4,47930661246523 V2=87,8378023959187 V3=0 T=0 M2=0 M3=-7,42343594477145 FrameElem=36-1 ElemStation=0
Frame=36 Station=0,04 OutputCase=STR133 CaseType=Combination P=-4,47930661246523 V2=92,4818023959187 V3=0 T=0 M2=0 M3=-11,0298280406082 FrameElem=36-1 ElemStation=0,04
Frame=36 Station=0,08 OutputCase=STR133 CaseType=Combination P=-4,47930661246523 V2=97,1258023959187 V3=0 T=0 M2=0 M3=-14,8219801364449 FrameElem=36-1 ElemStation=0,08
Frame=36 Station=0 OutputCase=STR134 CaseType=Combination P=-17,6735595215333 V2=98,1937146298369 V3=0 T=0 M2=0 M3=-17,0338236497218 FrameElem=36-1 ElemStation=0
Frame=36 Station=0,04 OutputCase=STR134 CaseType=Combination P=-17,6735595215333 V2=102,837714629837 V3=0 T=0 M2=0 M3=-21,0544522349153 FrameElem=36-1 ElemStation=0,04
Frame=36 Station=0,08 OutputCase=STR134 CaseType=Combination P=-17,6735595215333 V2=107,481714629837 V3=0 T=0 M2=0 M3=-25,2608408201087 FrameElem=36-1 ElemStation=0,08
Frame=36 Station=0 OutputCase=STR135 CaseType=Combination P=-30,8678124507178 V2=87,8378023967423 V3=0 T=0 M2=0 M3=-11,110343004277 FrameElem=36-1 ElemStation=0
Frame=36 Station=0,04 OutputCase=STR135 CaseType=Combination P=-30,8678124507178 V2=92,4818023967423 V3=0 T=0 M2=0 M3=-14,7167351001467 FrameElem=36-1 ElemStation=0,04
Frame=36 Station=0,08 OutputCase=STR135 CaseType=Combination P=-30,8678124507178 V2=97,1258023967423 V3=0 T=0 M2=0 M3=-18,5088871960164 FrameElem=36-1 ElemStation=0,08
Frame=36 Station=0 OutputCase=STR136 CaseType=Combination P=-16,8984957149481 V2=21,6187146293054 V3=0 T=0 M2=0 M3=-11,5531923962196 FrameElem=36-1 ElemStation=0
Frame=36 Station=0,04 OutputCase=STR136 CaseType=Combination P=-16,8984957149481 V2=22,1787146293054 V3=0 T=0 M2=0 M3=-12,4291409813918 FrameElem=36-1 ElemStation=0,04
Frame=36 Station=0,08 OutputCase=STR136 CaseType=Combination P=-16,8984957149481 V2=22,7387146293054 V3=0 T=0 M2=0 M3=-13,327489566564 FrameElem=36-1 ElemStation=0,08
Frame=36 Station=0 OutputCase=STR137 CaseType=Combination P=-30,0927486441327 V2=11,2628023962108 V3=0 T=0 M2=0 M3=-5,62971175077484 FrameElem=36-1 ElemStation=0
Frame=36 Station=0,04 OutputCase=STR137 CaseType=Combination P=-30,0927486441327 V2=11,8228023962108 V3=0 T=0 M2=0 M3=-6,09142384662327 FrameElem=36-1 ElemStation=0,04
Frame=36 Station=0,08 OutputCase=STR137 CaseType=Combination P=-30,0927486441327 V2=12,3828023962108 V3=0 T=0 M2=0 M3=-6,5755359424717 FrameElem=36-1 ElemStation=0,08
Frame=36 Station=0 OutputCase=STR138 CaseType=Combination P=-8,61576489438331 V2=14,9378023955341 V3=0 T=0 M2=0 M3=-2,98236501534595 FrameElem=36-1 ElemStation=0
Frame=36 Station=0,04 OutputCase=STR138 CaseType=Combination P=-8,61576489438331 V2=15,6938023955341 V3=0 T=0 M2=0 M3=-3,59499711116731 FrameElem=36-1 ElemStation=0,04
Frame=36 Station=0,08 OutputCase=STR138 CaseType=Combination P=-8,61576489438331 V2=16,4498023955341 V3=0 T=0 M2=0 M3=-4,23786920698868 FrameElem=36-1 ElemStation=0,08
Frame=36 Station=0 OutputCase=STR139 CaseType=Combination P=-3,50716179064504 V2=14,9378023954177 V3=0 T=0 M2=0 M3=-2,14218332365273 FrameElem=36-1 ElemStation=0
Frame=36 Station=0,04 OutputCase=STR139 CaseType=Combination P=-3,50716179064504 V2=15,6938023954177 V3=0 T=0 M2=0 M3=-2,75481541946944 FrameElem=36-1 ElemStation=0,04
Frame=36 Station=0,08 OutputCase=STR139 CaseType=Combination P=-3,50716179064504 V2=16,4498023954177 V3=0 T=0 M2=0 M3=-3,39768751528615 FrameElem=36-1 ElemStation=0,08
Frame=36 Station=0 OutputCase=STR140 CaseType=Combination P=-4,47930661246523 V2=87,8378023959187 V3=0 T=0 M2=0 M3=-7,42343594477145 FrameElem=36-1 ElemStation=0
Frame=36 Station=0,04 OutputCase=STR140 CaseType=Combination P=-4,47930661246523 V2=92,4818023959187 V3=0 T=0 M2=0 M3=-11,0298280406082 FrameElem=36-1 ElemStation=0,04
Frame=36 Station=0,08 OutputCase=STR140 CaseType=Combination P=-4,47930661246523 V2=97,1258023959187 V3=0 T=0 M2=0 M3=-14,8219801364449 FrameElem=36-1 ElemStation=0,08
Frame=36 Station=0 OutputCase=STR141 CaseType=Combination P=-17,6735595215333 V2=98,1937146298369 V3=0 T=0 M2=0 M3=-17,0338236497218 FrameElem=36-1 ElemStation=0
Frame=36 Station=0,04 OutputCase=STR141 CaseType=Combination P=-17,6735595215333 V2=102,837714629837 V3=0 T=0 M2=0 M3=-21,0544522349153 FrameElem=36-1 ElemStation=0,04
Frame=36 Station=0,08 OutputCase=STR141 CaseType=Combination P=-17,6735595215333 V2=107,481714629837 V3=0 T=0 M2=0 M3=-25,2608408201087 FrameElem=36-1 ElemStation=0,08
Frame=36 Station=0 OutputCase=STR142 CaseType=Combination P=-30,8678124507178 V2=87,8378023967423 V3=0 T=0 M2=0 M3=-11,110343004277 FrameElem=36-1 ElemStation=0

Società di Progetto
Brebemi SpA

	Doc. N. 60235-00000-A00.doc	CODIFICA DOCUMENTO 04RCDII10000000000300A00	REV. 00	FOGLIO 480 di 628
--	--------------------------------	--	------------	----------------------

Frame=36 Station=0,04 OutputCase=STR142 CaseType=Combination P=-30,8678124507178 V2=92,4818023967423 V3=0 T=0 M2=0 M3=-14,7167351001467 FrameElem=36-1 ElemStation=0,04

Frame=36 Station=0,08 OutputCase=STR142 CaseType=Combination P=-30,8678124507178 V2=97,1258023967423 V3=0 T=0 M2=0 M3=-18,5088871960164 FrameElem=36-1 ElemStation=0,08

Frame=36 Station=0 OutputCase=STR143 CaseType=Combination P=-16,8984957149481 V2=21,6187146293054 V3=0 T=0 M2=0 M3=-11,5531923962196 FrameElem=36-1 ElemStation=0

Frame=36 Station=0,04 OutputCase=STR143 CaseType=Combination P=-16,8984957149481 V2=22,1787146293054 V3=0 T=0 M2=0 M3=-12,4291409813918 FrameElem=36-1 ElemStation=0,04

Frame=36 Station=0,08 OutputCase=STR143 CaseType=Combination P=-16,8984957149481 V2=22,7387146293054 V3=0 T=0 M2=0 M3=-13,327489566564 FrameElem=36-1 ElemStation=0,08

Frame=36 Station=0 OutputCase=STR144 CaseType=Combination P=-30,0927486441327 V2=11,2628023962108 V3=0 T=0 M2=0 M3=-5,62971175077484 FrameElem=36-1 ElemStation=0

Frame=36 Station=0,04 OutputCase=STR144 CaseType=Combination P=-30,0927486441327 V2=11,8228023962108 V3=0 T=0 M2=0 M3=-6,09142384662327 FrameElem=36-1 ElemStation=0,04

Frame=36 Station=0,08 OutputCase=STR144 CaseType=Combination P=-30,0927486441327 V2=12,3828023962108 V3=0 T=0 M2=0 M3=-6,5755359424717 FrameElem=36-1 ElemStation=0,08

Frame=36 Station=0 OutputCase=STR145 CaseType=Combination P=-7,86652499750897 V2=14,1750000001175 V3=0 T=0 M2=0 M3=-1,57558388724167 FrameElem=36-1 ElemStation=0

Frame=36 Station=0,04 OutputCase=STR145 CaseType=Combination P=-7,86652499750897 V2=14,9310000001175 V3=0 T=0 M2=0 M3=-2,15770388724638 FrameElem=36-1 ElemStation=0,04

Frame=36 Station=0,08 OutputCase=STR145 CaseType=Combination P=-7,86652499750897 V2=15,6870000001175 V3=0 T=0 M2=0 M3=-2,77006388725108 FrameElem=36-1 ElemStation=0,08

Frame=36 Station=0 OutputCase=STR146 CaseType=Combination P=-2,75792189377069 V2=14,1750000000011 V3=0 T=0 M2=0 M3=-0,735402195548459 FrameElem=36-1 ElemStation=0

Frame=36 Station=0,04 OutputCase=STR146 CaseType=Combination P=-2,75792189377069 V2=14,9310000000011 V3=0 T=0 M2=0 M3=-1,3172521955485 FrameElem=36-1 ElemStation=0,04

Frame=36 Station=0,08 OutputCase=STR146 CaseType=Combination P=-2,75792189377069 V2=15,6870000000011 V3=0 T=0 M2=0 M3=-1,92988219554855 FrameElem=36-1 ElemStation=0,08

Frame=36 Station=0 OutputCase=STR147 CaseType=Combination P=-4,42189987189051 V2=111,375000000669 V3=0 T=0 M2=0 M3=-8,082236368652 FrameElem=36-1 ElemStation=0

Frame=36 Station=0,04 OutputCase=STR147 CaseType=Combination P=-4,42189987189051 V2=117,315000000669 V3=0 T=0 M2=0 M3=-12,6560363686788 FrameElem=36-1 ElemStation=0,04

Frame=36 Station=0,08 OutputCase=STR147 CaseType=Combination P=-4,42189987189051 V2=123,255000000669 V3=0 T=0 M2=0 M3=-17,4674363687055 FrameElem=36-1 ElemStation=0,08

Frame=36 Station=0 OutputCase=STR148 CaseType=Combination P=-21,1628032329391 V2=124,556781585954 V3=0 T=0 M2=0 M3=-20,2864803150198 FrameElem=36-1 ElemStation=0

Frame=36 Station=0,04 OutputCase=STR148 CaseType=Combination P=-21,1628032329391 V2=130,496781585954 V3=0 T=0 M2=0 M3=-25,3875515784579 FrameElem=36-1 ElemStation=0,04

Frame=36 Station=0,08 OutputCase=STR148 CaseType=Combination P=-21,1628032329391 V2=136,436781585954 V3=0 T=0 M2=0 M3=-30,7262228418961 FrameElem=36-1 ElemStation=0,08

Frame=36 Station=0 OutputCase=STR149 CaseType=Combination P=-37,9037066216479 V2=111,3750000001729 V3=0 T=0 M2=0 M3=-12,718051884095 FrameElem=36-1 ElemStation=0

Frame=36 Station=0,04 OutputCase=STR149 CaseType=Combination P=-37,9037066216479 V2=117,3150000001729 V3=0 T=0 M2=0 M3=-17,2918518841642 FrameElem=36-1 ElemStation=0,04

Frame=36 Station=0,08 OutputCase=STR149 CaseType=Combination P=-37,9037066216479 V2=123,2550000001729 V3=0 T=0 M2=0 M3=-22,1032518842333 FrameElem=36-1 ElemStation=0,08

Frame=36 Station=0 OutputCase=STR150 CaseType=Combination P=-20,0636911524139 V2=23,6817815852553 V3=0 T=0 M2=0 M3=-13,0454315211447 FrameElem=36-1 ElemStation=0

Frame=36 Station=0,04 OutputCase=STR150 CaseType=Combination P=-20,0636911524139 V2=24,2417815852553 V3=0 T=0 M2=0 M3=-14,0039027845549 FrameElem=36-1 ElemStation=0,04

Frame=36 Station=0,08 OutputCase=STR150 CaseType=Combination P=-20,0636911524139 V2=24,8017815852553 V3=0 T=0 M2=0 M3=-14,9847740479651 FrameElem=36-1 ElemStation=0,08

Frame=36 Station=0 OutputCase=STR151 CaseType=Combination P=-36,8045945411227 V2=10,5000000010301 V3=0 T=0 M2=0 M3=-5,47700309021993 FrameElem=36-1 ElemStation=0

Frame=36 Station=0,04 OutputCase=STR151 CaseType=Combination P=-36,8045945411227 V2=11,0600000010301 V3=0 T=0 M2=0 M3=-5,90820309026113 FrameElem=36-1 ElemStation=0,04

Frame=36 Station=0,08 OutputCase=STR151 CaseType=Combination P=-36,8045945411227 V2=11,6200000010301 V3=0 T=0 M2=0 M3=-6,36180309030234 FrameElem=36-1 ElemStation=0,08

Frame=36 Station=0 OutputCase=STR152 CaseType=Combination P=-34,2008545150651 V2=116,800825024555 V3=0 T=0 M2=0 M3=-30,4596411254374 FrameElem=36-1 ElemStation=0

Frame=36 Station=0,04 OutputCase=STR152 CaseType=Combination P=-35,1026545150651 V2=121,444825024555 V3=0 T=0 M2=0 M3=-35,2245541264196 FrameElem=36-1 ElemStation=0,04

Frame=36 Station=0,08 OutputCase=STR152 CaseType=Combination P=-36,0044545150651 V2=126,088825024555 V3=0 T=0 M2=0 M3=-40,1752271274018 FrameElem=36-1 ElemStation=0,08

Frame=36 Station=0 OutputCase=STR153 CaseType=Combination P=-3,73006671559089 V2=87,0750000005021 V3=0 T=0 M2=0 M3=-6,01665481666718 FrameElem=36-1 ElemStation=0

Frame=36 Station=0,04 OutputCase=STR153 CaseType=Combination P=-3,73006671559089 V2=91,7190000005021 V3=0 T=0 M2=0 M3=-9,59253481668726 FrameElem=36-1 ElemStation=0,04

Frame=36 Station=0,08 OutputCase=STR153 CaseType=Combination P=-3,73006671559089 V2=96,3630000005021 V3=0 T=0 M2=0 M3=-13,3541748167073 FrameElem=36-1 ElemStation=0,08

Frame=36 Station=0 OutputCase=STR154 CaseType=Combination P=-16,9243196246589 V2=97,4309122344203 V3=0 T=0 M2=0 M3=-15,6270425216175 FrameElem=36-1 ElemStation=0

Frame=36 Station=0,04 OutputCase=STR154 CaseType=Combination P=-16,9243196246589 V2=102,07491223442 V3=0 T=0 M2=0 M3=-19,6171590109943 FrameElem=36-1 ElemStation=0,04

Frame=36 Station=0,08 OutputCase=STR154 CaseType=Combination P=-16,9243196246589 V2=106,71891223442 V3=0 T=0 M2=0 M3=-23,7930355003711 FrameElem=36-1 ElemStation=0,08

Frame=36 Station=0 OutputCase=STR155 CaseType=Combination P=-30,1185725538435 V2=87,0750000013257 V3=0 T=0 M2=0 M3=-9,70356187617275 FrameElem=36-1 ElemStation=0

Frame=36 Station=0,04 OutputCase=STR155 CaseType=Combination P=-30,1185725538435 V2=91,7190000013257 V3=0 T=0 M2=0 M3=-13,2794418762258 FrameElem=36-1 ElemStation=0,04

Frame=36 Station=0,08 OutputCase=STR155 CaseType=Combination P=-30,1185725538435 V2=96,3630000013257 V3=0 T=0 M2=0 M3=-17,0410818762788 FrameElem=36-1 ElemStation=0,08

Frame=36 Station=0 OutputCase=STR156 CaseType=Combination P=-16,1492558180738 V2=20,8559122338888 V3=0 T=0 M2=0 M3=-10,1464112681153 FrameElem=36-1 ElemStation=0

Frame=36 Station=0,04 OutputCase=STR156 CaseType=Combination P=-16,1492558180738 V2=21,4159122338888 V3=0 T=0 M2=0 M3=-10,9918477574709 FrameElem=36-1 ElemStation=0,04

Frame=36 Station=0,08 OutputCase=STR156 CaseType=Combination P=-16,1492558180738 V2=21,9759122338888 V3=0 T=0 M2=0 M3=-11,8596842468264 FrameElem=36-1 ElemStation=0,08

Società di Progetto
Brebemi SpA

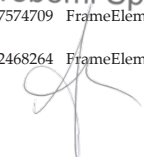



Doc. N.
60235-0000-A00.doc

CODIFICA DOCUMENTO
04RCDII10000000000300A00

REV.
00

FOGLIO
481 di 628

Frame=36 Station=0 OutputCase=STR157 CaseType=Combination P=-29,343508742584 V2=10,5000000007942 V3=0 T=0 M2=0 M3=-4,22293062267056 FrameElem=36-1
ElemStation=0
Frame=36 Station=0,04 OutputCase=STR157 CaseType=Combination P=-29,343508742584 V2=11,0600000007942 V3=0 T=0 M2=0 M3=-4,65413062270233 FrameElem=36-1
ElemStation=0,04
Frame=36 Station=0,08 OutputCase=STR157 CaseType=Combination P=-29,343508742584 V2=11,6200000007942 V3=0 T=0 M2=0 M3=-5,1077306227341 FrameElem=36-1
ElemStation=0,08
Frame=36 Station=0 OutputCase=STR158 CaseType=Combination P=-8,4182023210483 V2=14,1750000001177 V3=0 T=0 M2=0 M3=-2,0332990465954 FrameElem=36-1
ElemStation=0
Frame=36 Station=0,04 OutputCase=STR158 CaseType=Combination P=-8,4182023210483 V2=14,9310000001177 V3=0 T=0 M2=0 M3=-2,61544990466425 FrameElem=36-1
ElemStation=0,04
Frame=36 Station=0,08 OutputCase=STR158 CaseType=Combination P=-8,4182023210483 V2=15,6870000001177 V3=0 T=0 M2=0 M3=-3,22780990466896 FrameElem=36-1
ElemStation=0,08
Frame=36 Station=0 OutputCase=STR159 CaseType=Combination P=-3,30959921731002 V2=14,1750000000013 V3=0 T=0 M2=0 M3=-1,19314821296633 FrameElem=36-1
ElemStation=0
Frame=36 Station=0,04 OutputCase=STR159 CaseType=Combination P=-3,30959921731002 V2=14,9310000000013 V3=0 T=0 M2=0 M3=-1,77526821296638 FrameElem=36-1
ElemStation=0,04
Frame=36 Station=0,08 OutputCase=STR159 CaseType=Combination P=-3,30959921731002 V2=15,6870000000013 V3=0 T=0 M2=0 M3=-2,38762821296643 FrameElem=36-1
ElemStation=0,08
Frame=36 Station=0 OutputCase=STR160 CaseType=Combination P=-4,28174403913022 V2=87,0750000005023 V3=0 T=0 M2=0 M3=-6,47440083408505 FrameElem=36-1
ElemStation=0
Frame=36 Station=0,04 OutputCase=STR160 CaseType=Combination P=-4,28174403913022 V2=91,7190000005023 V3=0 T=0 M2=0 M3=-10,0502080341051 FrameElem=36-1
ElemStation=0,04
Frame=36 Station=0,08 OutputCase=STR160 CaseType=Combination P=-4,28174403913022 V2=96,3630000005023 V3=0 T=0 M2=0 M3=-13,8119208341252 FrameElem=36-1
ElemStation=0,08
Frame=36 Station=0 OutputCase=STR161 CaseType=Combination P=-17,4759969481982 V2=97,4309122344205 V3=0 T=0 M2=0 M3=-16,0847885390354 FrameElem=36-1
ElemStation=0
Frame=36 Station=0,04 OutputCase=STR161 CaseType=Combination P=-17,4759969481982 V2=102,07491223442 V3=0 T=0 M2=0 M3=-20,0749050284122 FrameElem=36-1
ElemStation=0,04
Frame=36 Station=0,08 OutputCase=STR161 CaseType=Combination P=-17,4759969481982 V2=106,71891223442 V3=0 T=0 M2=0 M3=-24,250781517789 FrameElem=36-1
ElemStation=0,08
Frame=36 Station=0 OutputCase=STR162 CaseType=Combination P=-30,6702498773828 V2=87,0750000013259 V3=0 T=0 M2=0 M3=-10,1613078935906 FrameElem=36-1
ElemStation=0
Frame=36 Station=0,04 OutputCase=STR162 CaseType=Combination P=-30,6702498773828 V2=91,7190000013259 V3=0 T=0 M2=0 M3=-13,7371878936437 FrameElem=36-1
ElemStation=0,04
Frame=36 Station=0,08 OutputCase=STR162 CaseType=Combination P=-30,6702498773828 V2=96,3630000013259 V3=0 T=0 M2=0 M3=-17,4988278936967 FrameElem=36-1
ElemStation=0,08
Frame=36 Station=0 OutputCase=STR163 CaseType=Combination P=-16,7009331416131 V2=20,855912233889 V3=0 T=0 M2=0 M3=-10,6041572855332 FrameElem=36-1
ElemStation=0
Frame=36 Station=0,04 OutputCase=STR163 CaseType=Combination P=-16,7009331416131 V2=21,415912233889 V3=0 T=0 M2=0 M3=-11,4495937748888 FrameElem=36-1
ElemStation=0,04
Frame=36 Station=0,08 OutputCase=STR163 CaseType=Combination P=-16,7009331416131 V2=21,975912233889 V3=0 T=0 M2=0 M3=-12,3174302642443 FrameElem=36-1
ElemStation=0,08
Frame=36 Station=0 OutputCase=STR164 CaseType=Combination P=-29,8951860707977 V2=10,5000000007944 V3=0 T=0 M2=0 M3=-4,68067664008843 FrameElem=36-1
ElemStation=0
Frame=36 Station=0,04 OutputCase=STR164 CaseType=Combination P=-29,8951860707977 V2=11,0600000007944 V3=0 T=0 M2=0 M3=-5,11187664012021 FrameElem=36-1
ElemStation=0,04
Frame=36 Station=0,08 OutputCase=STR164 CaseType=Combination P=-29,8951860707977 V2=11,6200000007944 V3=0 T=0 M2=0 M3=-5,56547664015198 FrameElem=36-1
ElemStation=0,08
Frame=36 Station=0 OutputCase=STR165 CaseType=Combination P=-7,31484767396963 V2=14,1750000001173 V3=0 T=0 M2=0 M3=-1,1178378698238 FrameElem=36-1
ElemStation=0
Frame=36 Station=0,04 OutputCase=STR165 CaseType=Combination P=-7,31484767396963 V2=14,9310000001173 V3=0 T=0 M2=0 M3=-1,6999578698285 FrameElem=36-1
ElemStation=0,04
Frame=36 Station=0,08 OutputCase=STR165 CaseType=Combination P=-7,31484767396963 V2=15,6870000001173 V3=0 T=0 M2=0 M3=-2,31231786983319 FrameElem=36-1
ElemStation=0,08
Frame=36 Station=0 OutputCase=STR166 CaseType=Combination P=-2,20624457023136 V2=14,1750000000009 V3=0 T=0 M2=0 M3=-0,27765617813059 FrameElem=36-1
ElemStation=0
Frame=36 Station=0,04 OutputCase=STR166 CaseType=Combination P=-2,20624457023136 V2=14,9310000000009 V3=0 T=0 M2=0 M3=-0,859776178130626 FrameElem=36-1
ElemStation=0,04
Frame=36 Station=0,08 OutputCase=STR166 CaseType=Combination P=-2,20624457023136 V2=15,6870000000009 V3=0 T=0 M2=0 M3=-1,47213617813066 FrameElem=36-1
ElemStation=0,08
Frame=36 Station=0 OutputCase=STR167 CaseType=Combination P=-3,17838939205155 V2=87,0750000005019 V3=0 T=0 M2=0 M3=-5,55890879924931 FrameElem=36-1
ElemStation=0
Frame=36 Station=0,04 OutputCase=STR167 CaseType=Combination P=-3,17838939205155 V2=91,7190000005019 V3=0 T=0 M2=0 M3=-9,13478879926938 FrameElem=36-1
ElemStation=0,04
Frame=36 Station=0,08 OutputCase=STR167 CaseType=Combination P=-3,17838939205155 V2=96,3630000005019 V3=0 T=0 M2=0 M3=-12,8964287992895 FrameElem=36-1
ElemStation=0,08
Frame=36 Station=0 OutputCase=STR168 CaseType=Combination P=-16,3726423011196 V2=97,4309122344201 V3=0 T=0 M2=0 M3=-15,1692965041996 FrameElem=36-1
ElemStation=0
Frame=36 Station=0,04 OutputCase=STR168 CaseType=Combination P=-16,3726423011196 V2=102,07491223442 V3=0 T=0 M2=0 M3=-19,1594129935764 FrameElem=36-1
ElemStation=0,04
Frame=36 Station=0,08 OutputCase=STR168 CaseType=Combination P=-16,3726423011196 V2=106,71891223442 V3=0 T=0 M2=0 M3=-23,3352894829533 FrameElem=36-1
ElemStation=0,08
Frame=36 Station=0 OutputCase=STR169 CaseType=Combination P=-29,5668952303042 V2=87,0750000013255 V3=0 T=0 M2=0 M3=-9,24581585875489 FrameElem=36-1
ElemStation=0
Frame=36 Station=0,04 OutputCase=STR169 CaseType=Combination P=-29,5668952303042 V2=91,7190000013255 V3=0 T=0 M2=0 M3=-12,8216958588079 FrameElem=36-1
ElemStation=0,04
Frame=36 Station=0,08 OutputCase=STR169 CaseType=Combination P=-29,5668952303042 V2=96,3630000013255 V3=0 T=0 M2=0 M3=-16,5833358588609 FrameElem=36-1
ElemStation=0,08
Frame=36 Station=0 OutputCase=STR170 CaseType=Combination P=-15,5975784945344 V2=20,8559122338886 V3=0 T=0 M2=0 M3=-9,68866525069746 FrameElem=36-1
ElemStation=0
Frame=36 Station=0,04 OutputCase=STR170 CaseType=Combination P=-15,5975784945344 V2=21,4159122338886 V3=0 T=0 M2=0 M3=-10,534101740053 FrameElem=36-1
ElemStation=0,04
Frame=36 Station=0,08 OutputCase=STR170 CaseType=Combination P=-15,5975784945344 V2=21,9759122338886 V3=0 T=0 M2=0 M3=-11,4019382294085 FrameElem=36-1
ElemStation=0,08
Frame=36 Station=0 OutputCase=STR171 CaseType=Combination P=-28,791831423719 V2=10,500000000794 V3=0 T=0 M2=0 M3=-3,7651846052527 FrameElem=36-1
ElemStation=0
Frame=36 Station=0,04 OutputCase=STR171 CaseType=Combination P=-28,791831423719 V2=11,060000000794 V3=0 T=0 M2=0 M3=-4,19638460528446 FrameElem=36-1
ElemStation=0,04

Società di Progetto
Brebemi SpA

	Doc. N. 60235-0000-A00.doc	CODIFICA DOCUMENTO 04RCDII10000000000300A00	REV. 00	FOGLIO 482 di 628
--	-------------------------------	--	------------	----------------------

Frame=36 Station=0,08 OutputCase=STR171 CaseType=Combination P=-,28,791831423719 V2=11,620000000794 V3=0 T=0 M2=0 M3=-4,64998460531621 FrameElem=36-1 ElemStation=0,08

Frame=36 Station=0 OutputCase=STR172 CaseType=Combination P=-,7,63765198880009 V2=13,7173185628676 V3=0 T=0 M2=0 M3=-0,914613617346258 FrameElem=36-1 ElemStation=0

Frame=36 Station=0,04 OutputCase=STR172 CaseType=Combination P=-,7,63765198880009 V2=14,4733185628676 V3=0 T=0 M2=0 M3=-1,47842635986096 FrameElem=36-1 ElemStation=0,04

Frame=36 Station=0,08 OutputCase=STR172 CaseType=Combination P=-,7,63765198880009 V2=15,2293185628676 V3=0 T=0 M2=0 M3=-2,07247910237567 FrameElem=36-1 ElemStation=0,08

Frame=36 Station=0 OutputCase=STR173 CaseType=Combination P=-,2,52904888506181 V2=13,7173185627512 V3=0 T=0 M2=0 M3=-,7,44319256530429E-02 FrameElem=36-1 ElemStation=0

Frame=36 Station=0,04 OutputCase=STR173 CaseType=Combination P=-,2,52904888506181 V2=14,4733185627512 V3=0 T=0 M2=0 M3=-0,638244668163092 FrameElem=36-1 ElemStation=0,04

Frame=36 Station=0,08 OutputCase=STR173 CaseType=Combination P=-,2,52904888506181 V2=15,2293185627512 V3=0 T=0 M2=0 M3=-1,23229741067314 FrameElem=36-1 ElemStation=0,08

Frame=36 Station=0 OutputCase=STR174 CaseType=Combination P=-,3,50119370688201 V2=86,6173185632522 V3=0 T=0 M2=0 M3=-5,35568454677177 FrameElem=36-1 ElemStation=0

Frame=36 Station=0,04 OutputCase=STR174 CaseType=Combination P=-,3,50119370688201 V2=91,2613185632522 V3=0 T=0 M2=0 M3=-8,91325728930185 FrameElem=36-1 ElemStation=0,04

Frame=36 Station=0,08 OutputCase=STR174 CaseType=Combination P=-,3,50119370688201 V2=95,9053185632522 V3=0 T=0 M2=0 M3=-12,6565900318319 FrameElem=36-1 ElemStation=0,08

Frame=36 Station=0 OutputCase=STR175 CaseType=Combination P=-,16,69544661595 V2=96,9732307971704 V3=0 T=0 M2=0 M3=-14,9660722517221 FrameElem=36-1 ElemStation=0

Frame=36 Station=0,04 OutputCase=STR175 CaseType=Combination P=-,16,69544661595 V2=101,61723079717 V3=0 T=0 M2=0 M3=-18,9378814836089 FrameElem=36-1 ElemStation=0,04

Frame=36 Station=0,08 OutputCase=STR175 CaseType=Combination P=-,16,69544661595 V2=106,26123079717 V3=0 T=0 M2=0 M3=-23,0954507154957 FrameElem=36-1 ElemStation=0,08

Frame=36 Station=0 OutputCase=STR176 CaseType=Combination P=-,29,8896995451346 V2=86,6173185640758 V3=0 T=0 M2=0 M3=-9,04259160627734 FrameElem=36-1 ElemStation=0

Frame=36 Station=0,04 OutputCase=STR176 CaseType=Combination P=-,29,8896995451346 V2=91,2613185640758 V3=0 T=0 M2=0 M3=-12,6001643488404 FrameElem=36-1 ElemStation=0,04

Frame=36 Station=0,08 OutputCase=STR176 CaseType=Combination P=-,29,8896995451346 V2=95,9053185640758 V3=0 T=0 M2=0 M3=-16,3434970914034 FrameElem=36-1 ElemStation=0,08

Frame=36 Station=0 OutputCase=STR177 CaseType=Combination P=-,15,9203828093649 V2=20,3982307966389 V3=0 T=0 M2=0 M3=-9,48544099821991 FrameElem=36-1 ElemStation=0

Frame=36 Station=0,04 OutputCase=STR177 CaseType=Combination P=-,15,9203828093649 V2=20,9582307966389 V3=0 T=0 M2=0 M3=-10,3125702300855 FrameElem=36-1 ElemStation=0,04

Frame=36 Station=0,08 OutputCase=STR177 CaseType=Combination P=-,15,9203828093649 V2=21,5182307966389 V3=0 T=0 M2=0 M3=-11,162099461951 FrameElem=36-1 ElemStation=0,08

Frame=36 Station=0 OutputCase=STR178 CaseType=Combination P=-,29,1146357385495 V2=10,0423185635443 V3=0 T=0 M2=0 M3=-3,56196035277515 FrameElem=36-1 ElemStation=0

Frame=36 Station=0,04 OutputCase=STR178 CaseType=Combination P=-,29,1146357385495 V2=10,6023185635443 V3=0 T=0 M2=0 M3=-3,97485309531692 FrameElem=36-1 ElemStation=0,04

Frame=36 Station=0,08 OutputCase=STR178 CaseType=Combination P=-,29,1146357385495 V2=11,1623185635443 V3=0 T=0 M2=0 M3=-4,41014583785869 FrameElem=36-1 ElemStation=0,08

Frame=36 Station=0 OutputCase=STR179 CaseType=Combination P=-,7,63765198880009 V2=13,7173185628676 V3=0 T=0 M2=0 M3=-0,914613617346258 FrameElem=36-1 ElemStation=0

Frame=36 Station=0,04 OutputCase=STR179 CaseType=Combination P=-,7,63765198880009 V2=14,4733185628676 V3=0 T=0 M2=0 M3=-1,47842635986096 FrameElem=36-1 ElemStation=0,04

Frame=36 Station=0,08 OutputCase=STR179 CaseType=Combination P=-,7,63765198880009 V2=15,2293185628676 V3=0 T=0 M2=0 M3=-2,07247910237567 FrameElem=36-1 ElemStation=0,08

Frame=36 Station=0 OutputCase=STR180 CaseType=Combination P=-,8,09539800621784 V2=14,6326814373674 V3=0 T=0 M2=0 M3=-2,23655415713709 FrameElem=36-1 ElemStation=0

Frame=36 Station=0,04 OutputCase=STR180 CaseType=Combination P=-,8,09539800621784 V2=15,3886814373674 V3=0 T=0 M2=0 M3=-2,83698141463179 FrameElem=36-1 ElemStation=0,04

Frame=36 Station=0,08 OutputCase=STR180 CaseType=Combination P=-,8,09539800621784 V2=16,1446814373674 V3=0 T=0 M2=0 M3=-3,4674867212648 FrameElem=36-1 ElemStation=0,08

Frame=36 Station=0 OutputCase=STR181 CaseType=Combination P=-,2,98679490247956 V2=14,632681437251 V3=0 T=0 M2=0 M3=-1,39637246544387 FrameElem=36-1 ElemStation=0

Frame=36 Station=0,04 OutputCase=STR181 CaseType=Combination P=-,2,98679490247956 V2=15,388681437251 V3=0 T=0 M2=0 M3=-1,99679972293391 FrameElem=36-1 ElemStation=0,04

Frame=36 Station=0,08 OutputCase=STR181 CaseType=Combination P=-,2,98679490247956 V2=16,144681437251 V3=0 T=0 M2=0 M3=-2,62746698042395 FrameElem=36-1 ElemStation=0,08

Frame=36 Station=0 OutputCase=STR182 CaseType=Combination P=-,3,95893972429976 V2=87,532681437752 V3=0 T=0 M2=0 M3=-6,6776250865626 FrameElem=36-1 ElemStation=0

Frame=36 Station=0,04 OutputCase=STR182 CaseType=Combination P=-,3,95893972429976 V2=92,176681437752 V3=0 T=0 M2=0 M3=-10,2718123440727 FrameElem=36-1 ElemStation=0,04

Frame=36 Station=0,08 OutputCase=STR182 CaseType=Combination P=-,3,95893972429976 V2=96,8206814377519 V3=0 T=0 M2=0 M3=-14,0517596015827 FrameElem=36-1 ElemStation=0,08

Frame=36 Station=0 OutputCase=STR183 CaseType=Combination P=-,17,1531926333678 V2=97,8885936716702 V3=0 T=0 M2=0 M3=-16,2880127915129 FrameElem=36-1 ElemStation=0

Frame=36 Station=0,04 OutputCase=STR183 CaseType=Combination P=-,17,1531926333678 V2=102,53259367167 V3=0 T=0 M2=0 M3=-20,2964365383797 FrameElem=36-1 ElemStation=0,04

Frame=36 Station=0,08 OutputCase=STR183 CaseType=Combination P=-,17,1531926333678 V2=107,17659367167 V3=0 T=0 M2=0 M3=-24,4906202852465 FrameElem=36-1 ElemStation=0,08

Frame=36 Station=0 OutputCase=STR184 CaseType=Combination P=-,30,3474455625524 V2=87,5326814385756 V3=0 T=0 M2=0 M3=-10,3645321460682 FrameElem=36-1 ElemStation=0

Frame=36 Station=0,04 OutputCase=STR184 CaseType=Combination P=-,30,3474455625524 V2=92,1766814385756 V3=0 T=0 M2=0 M3=-13,9587194036112 FrameElem=36-1 ElemStation=0,04

Frame=36 Station=0,08 OutputCase=STR184 CaseType=Combination P=-,30,3474455625524 V2=96,8206814385756 V3=0 T=0 M2=0 M3=-17,7386666611542 FrameElem=36-1 ElemStation=0,08

Frame=36 Station=0 OutputCase=STR185 CaseType=Combination P=-,16,3781288267827 V2=21,3135936711386 V3=0 T=0 M2=0 M3=-10,8073815380107 FrameElem=36-1 ElemStation=0

Frame=36 Station=0,04 OutputCase=STR185 CaseType=Combination P=-,16,3781288267827 V2=21,8735936711387 V3=0 T=0 M2=0 M3=-11,6711252848563 FrameElem=36-1 ElemStation=0,04

Frame=36 Station=0,08 OutputCase=STR185 CaseType=Combination P=-,16,3781288267827 V2=22,4335936711387 V3=0 T=0 M2=0 M3=-12,5572690317018 FrameElem=36-1 ElemStation=0,08

Frame=36 Station=0 OutputCase=STR186 CaseType=Combination P=-,29,5723817559672 V2=10,9576814380441 V3=0 T=0 M2=0 M3=-4,88390089256598 FrameElem=36-1 ElemStation=0

Società di Progetto
Brebemi SpA



Doc. N.
60235-0000-A00.doc

CODIFICA DOCUMENTO
04RCDII10000000000300A00

REV.
00

FOGLIO
483 di 628

Frame=36 Station=0,04 OutputCase=STR186 CaseType=Combination P=-29,5723817559672 V2=11,5176814380441 V3=0 T=0 M2=0 M3=-5,33340815008775 FrameElem=36-1 ElemStation=0,04

Frame=36 Station=0,08 OutputCase=STR186 CaseType=Combination P=-29,5723817559672 V2=12,0776814380441 V3=0 T=0 M2=0 M3=-5,80531540760951 FrameElem=36-1 ElemStation=0,08

Frame=36 Station=0 OutputCase=STR187 CaseType=Combination P=-8,09539800621784 V2=14,6326814373674 V3=0 T=0 M2=0 M3=-2,23655415713709 FrameElem=36-1 ElemStation=0

Frame=36 Station=0,04 OutputCase=STR187 CaseType=Combination P=-8,09539800621784 V2=15,3886814373674 V3=0 T=0 M2=0 M3=-2,83698141463179 FrameElem=36-1 ElemStation=0,04

Frame=36 Station=0,08 OutputCase=STR187 CaseType=Combination P=-8,09539800621784 V2=16,1446814373674 V3=0 T=0 M2=0 M3=-3,46764867212648 FrameElem=36-1 ElemStation=0,08

Frame=36 Station=0 OutputCase=INVSTR CaseType=Combination StepType=Max P=-2,20624457023136 V2=125,014463023204 V3=0 T=0 M2=0 M3=6,10509093319883E-02 FrameElem=36-1 ElemStation=0

Frame=36 Station=0,04 OutputCase=INVSTR CaseType=Combination StepType=Max P=-2,20624457023136 V2=130,954463023204 V3=0 T=0 M2=0 M3=-0,490556994851403 FrameElem=36-1 ElemStation=0,04

Frame=36 Station=0,08 OutputCase=INVSTR CaseType=Combination StepType=Max P=-2,20624457023136 V2=136,894463023204 V3=0 T=0 M2=0 M3=-1,07240489903479 FrameElem=36-1 ElemStation=0,08

Frame=36 Station=0 OutputCase=INVSTR CaseType=Combination StepType=Min P=-39,0070612687266 V2=9,73719760537785 V3=0 T=0 M2=0 M3=-31,5783574127507 FrameElem=36-1 ElemStation=0

Frame=36 Station=0,04 OutputCase=INVSTR CaseType=Combination StepType=Min P=-39,0070612687266 V2=10,2971976053778 V3=0 T=0 M2=0 M3=-36,3615776712229 FrameElem=36-1 ElemStation=0,04

Frame=36 Station=0,08 OutputCase=INVSTR CaseType=Combination StepType=Min P=-39,0070612687266 V2=10,8571976053778 V3=0 T=0 M2=0 M3=-41,3305579296951 FrameElem=36-1 ElemStation=0,08

Frame=36 Station=0 OutputCase=SIS01 CaseType=Combination P=-11,8224988446543 V2=15,8033202775339 V3=0 T=0 M2=0 M3=-6,32948552578214 FrameElem=36-1 ElemStation=0

Frame=36 Station=0,04 OutputCase=SIS01 CaseType=Combination P=-11,9468988446543 V2=16,3446002775339 V3=0 T=0 M2=0 M3=-6,9724439368835 FrameElem=36-1 ElemStation=0,04

Frame=36 Station=0,08 OutputCase=SIS01 CaseType=Combination P=-12,0712988446543 V2=16,8858802775339 V3=0 T=0 M2=0 M3=-7,63705354798485 FrameElem=36-1 ElemStation=0,08

Frame=36 Station=0 OutputCase=SIS02 CaseType=Combination P=-12,2056080971122 V2=15,8033202775341 V3=0 T=0 M2=0 M3=-6,64736470454455 FrameElem=36-1 ElemStation=0

Frame=36 Station=0,04 OutputCase=SIS02 CaseType=Combination P=-12,3300080971122 V2=16,3446002775341 V3=0 T=0 M2=0 M3=-7,29032311564591 FrameElem=36-1 ElemStation=0,04

Frame=36 Station=0,08 OutputCase=SIS02 CaseType=Combination P=-12,4544080971122 V2=16,8858802775341 V3=0 T=0 M2=0 M3=-7,95493272674727 FrameElem=36-1 ElemStation=0,08

Frame=36 Station=0 OutputCase=SIS03 CaseType=Combination P=-11,4393895921964 V2=15,8033202775338 V3=0 T=0 M2=0 M3=-6,01160634701973 FrameElem=36-1 ElemStation=0

Frame=36 Station=0,04 OutputCase=SIS03 CaseType=Combination P=-11,5637895921964 V2=16,3446002775338 V3=0 T=0 M2=0 M3=-6,65456475812108 FrameElem=36-1 ElemStation=0,04

Frame=36 Station=0,08 OutputCase=SIS03 CaseType=Combination P=-11,6881895921964 V2=16,8858802775338 V3=0 T=0 M2=0 M3=-7,31917436922243 FrameElem=36-1 ElemStation=0,08

Frame=36 Station=0 OutputCase=SIS04 CaseType=Combination P=-11,6635592552731 V2=15,4854859461104 V3=0 T=0 M2=0 M3=-5,87047839391032 FrameElem=36-1 ElemStation=0

Frame=36 Station=0,04 OutputCase=SIS04 CaseType=Combination P=-11,7879592552731 V2=16,0267659461104 V3=0 T=0 M2=0 M3=-6,50072343175474 FrameElem=36-1 ElemStation=0,04

Frame=36 Station=0,08 OutputCase=SIS04 CaseType=Combination P=-11,9123592552731 V2=16,5680459461104 V3=0 T=0 M2=0 M3=-7,15261966959915 FrameElem=36-1 ElemStation=0,08

Frame=36 Station=0 OutputCase=SIS05 CaseType=Combination P=-11,9814384340355 V2=16,1211546089575 V3=0 T=0 M2=0 M3=-6,78849265765395 FrameElem=36-1 ElemStation=0

Frame=36 Station=0,04 OutputCase=SIS05 CaseType=Combination P=-12,1058384340355 V2=16,6624346089575 V3=0 T=0 M2=0 M3=-7,44416444201225 FrameElem=36-1 ElemStation=0,04

Frame=36 Station=0,08 OutputCase=SIS05 CaseType=Combination P=-12,2302384340355 V2=17,2037146089575 V3=0 T=0 M2=0 M3=-8,12148742637055 FrameElem=36-1 ElemStation=0,08

Frame=36 Station=0 OutputCase=SIS06 CaseType=Combination P=-11,4393895921964 V2=15,8033202775338 V3=0 T=0 M2=0 M3=-6,01160634701973 FrameElem=36-1 ElemStation=0

Frame=36 Station=0,04 OutputCase=SIS06 CaseType=Combination P=-11,5637895921964 V2=16,3446002775338 V3=0 T=0 M2=0 M3=-6,65456475812108 FrameElem=36-1 ElemStation=0,04

Frame=36 Station=0,08 OutputCase=SIS06 CaseType=Combination P=-11,6881895921964 V2=16,8858802775338 V3=0 T=0 M2=0 M3=-7,31917436922243 FrameElem=36-1 ElemStation=0,08

Frame=36 Station=0 OutputCase=SIS07 CaseType=Combination P=-12,04668507731 V2=15,4854859461105 V3=0 T=0 M2=0 M3=-6,18835757267273 FrameElem=36-1 ElemStation=0

Frame=36 Station=0,04 OutputCase=SIS07 CaseType=Combination P=-12,171068507731 V2=16,0267659461105 V3=0 T=0 M2=0 M3=-6,81860261051715 FrameElem=36-1 ElemStation=0,04

Frame=36 Station=0,08 OutputCase=SIS07 CaseType=Combination P=-12,295468507731 V2=16,5680459461105 V3=0 T=0 M2=0 M3=-7,47049884836157 FrameElem=36-1 ElemStation=0,08

Frame=36 Station=0 OutputCase=SIS08 CaseType=Combination P=-12,3645476864933 V2=16,1211546089576 V3=0 T=0 M2=0 M3=-7,10637183641636 FrameElem=36-1 ElemStation=0

Frame=36 Station=0,04 OutputCase=SIS08 CaseType=Combination P=-12,4889476864933 V2=16,6624346089576 V3=0 T=0 M2=0 M3=-7,76204362077467 FrameElem=36-1 ElemStation=0,04

Frame=36 Station=0,08 OutputCase=SIS08 CaseType=Combination P=-12,6133476864933 V2=17,2037146089576 V3=0 T=0 M2=0 M3=-8,4393660513297 FrameElem=36-1 ElemStation=0,08

Frame=36 Station=0 OutputCase=SIS09 CaseType=Combination P=-11,8224988446543 V2=15,8033202775339 V3=0 T=0 M2=0 M3=-6,32948552578214 FrameElem=36-1 ElemStation=0

Frame=36 Station=0,04 OutputCase=SIS09 CaseType=Combination P=-11,9468988446543 V2=16,3446002775339 V3=0 T=0 M2=0 M3=-6,9724439368835 FrameElem=36-1 ElemStation=0,04

Frame=36 Station=0,08 OutputCase=SIS09 CaseType=Combination P=-12,0712988446543 V2=16,8858802775339 V3=0 T=0 M2=0 M3=-7,63705354798485 FrameElem=36-1 ElemStation=0,08

Frame=36 Station=0 OutputCase=SIS10 CaseType=Combination P=-11,7817277734235 V2=16,5053202775372 V3=0 T=0 M2=0 M3=-6,36672202789728 FrameElem=36-1 ElemStation=0

Frame=36 Station=0,04 OutputCase=SIS10 CaseType=Combination P=-11,9061277734235 V2=17,0840402775372 V3=0 T=0 M2=0 M3=-7,03850923899877 FrameElem=36-1 ElemStation=0,04

Frame=36 Station=0,08 OutputCase=SIS10 CaseType=Combination P=-12,0305277734235 V2=17,6627602775372 V3=0 T=0 M2=0 M3=-7,73344525010026 FrameElem=36-1 ElemStation=0,08

Frame=36 Station=0 OutputCase=SIS11 CaseType=Combination P=-12,1648370258813 V2=16,5053202775374 V3=0 T=0 M2=0 M3=-6,68460120665969 FrameElem=36-1 ElemStation=0

Frame=36 Station=0,04 OutputCase=SIS11 CaseType=Combination P=-12,2892370258813 V2=17,0840402775374 V3=0 T=0 M2=0 M3=-7,35638841776118 FrameElem=36-1 ElemStation=0,04

Frame=36 Station=0,08 OutputCase=SIS11 CaseType=Combination P=-12,4136370258813 V2=17,6627602775374 V3=0 T=0 M2=0 M3=-8,05132442886268 FrameElem=36-1 ElemStation=0,08

Società di Progetto
Brebemi SpA

	Doc. N. 60235-00000-A00.doc	CODIFICA DOCUMENTO 04RCDII10000000000300A00	REV. 00	FOGLIO 484 di 628
--	--------------------------------	--	------------	----------------------

Frame=36 Station=0 OutputCase=SIS12 CaseType=Combination P=-11,3986185209656 V2=16,5053202775371 V3=0 T=0 M2=0 M3=-6,04884284913487	FrameElem=36-1
ElemStation=0	
Frame=36 Station=0,04 OutputCase=SIS12 CaseType=Combination P=-11,5230185209656 V2=17,0840402775371 V3=0 T=0 M2=0 M3=-6,72063006023635	FrameElem=36-1
ElemStation=0,04	
Frame=36 Station=0,08 OutputCase=SIS12 CaseType=Combination P=-11,6474185209656 V2=17,6627602775371 V3=0 T=0 M2=0 M3=-7,41556607133784	FrameElem=36-1
ElemStation=0,08	
Frame=36 Station=0 OutputCase=SIS13 CaseType=Combination P=-11,6227881840423 V2=16,1874859461137 V3=0 T=0 M2=0 M3=-5,90771489602546	FrameElem=36-1
ElemStation=0	
Frame=36 Station=0,04 OutputCase=SIS13 CaseType=Combination P=-11,7471881840423 V2=16,7662059461137 V3=0 T=0 M2=0 M3=-6,56678873387001	FrameElem=36-1
ElemStation=0,04	
Frame=36 Station=0,08 OutputCase=SIS13 CaseType=Combination P=-11,8715881840423 V2=17,3449259461137 V3=0 T=0 M2=0 M3=-7,24901137171456	FrameElem=36-1
ElemStation=0,08	
Frame=36 Station=0 OutputCase=SIS14 CaseType=Combination P=-11,9406673628046 V2=16,8231546089608 V3=0 T=0 M2=0 M3=-6,82572915976909	FrameElem=36-1
ElemStation=0	
Frame=36 Station=0,04 OutputCase=SIS14 CaseType=Combination P=-12,0650673628046 V2=17,4018746089608 V3=0 T=0 M2=0 M3=-7,51022974412752	FrameElem=36-1
ElemStation=0,04	
Frame=36 Station=0,08 OutputCase=SIS14 CaseType=Combination P=-12,1894673628046 V2=17,9805946089608 V3=0 T=0 M2=0 M3=-8,21787912848596	FrameElem=36-1
ElemStation=0,08	
Frame=36 Station=0 OutputCase=SIS15 CaseType=Combination P=-11,3986185209656 V2=16,5053202775371 V3=0 T=0 M2=0 M3=-6,04884284913487	FrameElem=36-1
ElemStation=0	
Frame=36 Station=0,04 OutputCase=SIS15 CaseType=Combination P=-11,5230185209656 V2=17,0840402775371 V3=0 T=0 M2=0 M3=-6,72063006023635	FrameElem=36-1
ElemStation=0,04	
Frame=36 Station=0,08 OutputCase=SIS15 CaseType=Combination P=-11,6474185209656 V2=17,6627602775371 V3=0 T=0 M2=0 M3=-7,41556607133784	FrameElem=36-1
ElemStation=0,08	
Frame=36 Station=0 OutputCase=SIS16 CaseType=Combination P=-12,0058974365002 V2=16,1874859461139 V3=0 T=0 M2=0 M3=-6,22559407478787	FrameElem=36-1
ElemStation=0	
Frame=36 Station=0,04 OutputCase=SIS16 CaseType=Combination P=-12,1302974365002 V2=16,7662059461139 V3=0 T=0 M2=0 M3=-6,88466791263242	FrameElem=36-1
ElemStation=0,04	
Frame=36 Station=0,08 OutputCase=SIS16 CaseType=Combination P=-12,2546974365002 V2=17,3449259461139 V3=0 T=0 M2=0 M3=-7,56689055047698	FrameElem=36-1
ElemStation=0,08	
Frame=36 Station=0 OutputCase=SIS17 CaseType=Combination P=-12,3237766152625 V2=16,8231546089609 V3=0 T=0 M2=0 M3=-7,143603385315	FrameElem=36-1
ElemStation=0	
Frame=36 Station=0,04 OutputCase=SIS17 CaseType=Combination P=-12,4481766152625 V2=17,4018746089609 V3=0 T=0 M2=0 M3=-7,82810892288994	FrameElem=36-1
ElemStation=0,04	
Frame=36 Station=0,08 OutputCase=SIS17 CaseType=Combination P=-12,5725766152625 V2=17,9805946089609 V3=0 T=0 M2=0 M3=-8,53575830724838	FrameElem=36-1
ElemStation=0,08	
Frame=36 Station=0 OutputCase=SIS18 CaseType=Combination P=-11,7817277734235 V2=16,5053202775372 V3=0 T=0 M2=0 M3=-6,36672202789728	FrameElem=36-1
ElemStation=0	
Frame=36 Station=0,04 OutputCase=SIS18 CaseType=Combination P=-11,9061277734235 V2=17,0840402775372 V3=0 T=0 M2=0 M3=-7,03850923899877	FrameElem=36-1
ElemStation=0,04	
Frame=36 Station=0,08 OutputCase=SIS18 CaseType=Combination P=-12,0305277734235 V2=17,6627602775372 V3=0 T=0 M2=0 M3=-7,73344525010026	FrameElem=36-1
ElemStation=0,08	
Frame=36 Station=0 OutputCase=SIS19 CaseType=Combination P=-10,2373150934327 V2=12,7067733760588 V3=0 T=0 M2=0 M3=-4,57788276390829	FrameElem=36-1
ElemStation=0	
Frame=36 Station=0,04 OutputCase=SIS19 CaseType=Combination P=-10,2746350934327 V2=13,2043733760588 V3=0 T=0 M2=0 M3=-5,09610569895065	FrameElem=36-1
ElemStation=0,04	
Frame=36 Station=0,08 OutputCase=SIS19 CaseType=Combination P=-10,3119550934327 V2=13,7019733760588 V3=0 T=0 M2=0 M3=-5,634232633993	FrameElem=36-1
ElemStation=0,08	
Frame=36 Station=0 OutputCase=SIS20 CaseType=Combination P=-10,6204243458906 V2=12,7067733760588 V3=0 T=0 M2=0 M3=-4,8957619426707	FrameElem=36-1
ElemStation=0	
Frame=36 Station=0,04 OutputCase=SIS20 CaseType=Combination P=-10,6577443458906 V2=13,2043733760588 V3=0 T=0 M2=0 M3=-5,41398487771306	FrameElem=36-1
ElemStation=0,04	
Frame=36 Station=0,08 OutputCase=SIS20 CaseType=Combination P=-10,6950643458906 V2=13,7019733760588 V3=0 T=0 M2=0 M3=-5,95211181275542	FrameElem=36-1
ElemStation=0,08	
Frame=36 Station=0 OutputCase=SIS21 CaseType=Combination P=-9,85420584097482 V2=12,7067733760587 V3=0 T=0 M2=0 M3=-4,26000358514588	FrameElem=36-1
ElemStation=0	
Frame=36 Station=0,04 OutputCase=SIS21 CaseType=Combination P=-9,89152584097482 V2=13,2043733760587 V3=0 T=0 M2=0 M3=-4,77822652018823	FrameElem=36-1
ElemStation=0,04	
Frame=36 Station=0,08 OutputCase=SIS21 CaseType=Combination P=-9,92884584097482 V2=13,7019733760587 V3=0 T=0 M2=0 M3=-5,31635345523058	FrameElem=36-1
ElemStation=0,08	
Frame=36 Station=0 OutputCase=SIS22 CaseType=Combination P=-10,0783755040515 V2=12,3889390446353 V3=0 T=0 M2=0 M3=-4,11887563203648	FrameElem=36-1
ElemStation=0	
Frame=36 Station=0,04 OutputCase=SIS22 CaseType=Combination P=-10,1156955040515 V2=12,8865390446353 V3=0 T=0 M2=0 M3=-4,62438519382189	FrameElem=36-1
ElemStation=0,04	
Frame=36 Station=0,08 OutputCase=SIS22 CaseType=Combination P=-10,1530155040515 V2=13,3841390446353 V3=0 T=0 M2=0 M3=-5,1497987556073	FrameElem=36-1
ElemStation=0,08	
Frame=36 Station=0 OutputCase=SIS23 CaseType=Combination P=-10,3962546828139 V2=13,0246077074824 V3=0 T=0 M2=0 M3=-5,03688989578011	FrameElem=36-1
ElemStation=0	
Frame=36 Station=0,04 OutputCase=SIS23 CaseType=Combination P=-10,4335746828139 V2=13,5222077074824 V3=0 T=0 M2=0 M3=-5,5678262040794	FrameElem=36-1
ElemStation=0,04	
Frame=36 Station=0,08 OutputCase=SIS23 CaseType=Combination P=-10,4708946828139 V2=14,0198077074824 V3=0 T=0 M2=0 M3=-6,1186665123787	FrameElem=36-1
ElemStation=0,08	
Frame=36 Station=0 OutputCase=SIS24 CaseType=Combination P=-9,85420584097482 V2=12,7067733760587 V3=0 T=0 M2=0 M3=-4,26000358514588	FrameElem=36-1
ElemStation=0	
Frame=36 Station=0,04 OutputCase=SIS24 CaseType=Combination P=-9,89152584097482 V2=13,2043733760587 V3=0 T=0 M2=0 M3=-4,77822652018823	FrameElem=36-1
ElemStation=0,04	
Frame=36 Station=0,08 OutputCase=SIS24 CaseType=Combination P=-9,92884584097482 V2=13,7019733760587 V3=0 T=0 M2=0 M3=-5,31635345523058	FrameElem=36-1
ElemStation=0,08	
Frame=36 Station=0 OutputCase=SIS25 CaseType=Combination P=-10,4614847565094 V2=12,3889390446355 V3=0 T=0 M2=0 M3=-4,43675481079888	FrameElem=36-1
ElemStation=0	
Frame=36 Station=0,04 OutputCase=SIS25 CaseType=Combination P=-10,4988047565094 V2=12,8865390446355 V3=0 T=0 M2=0 M3=-4,9422643725843	FrameElem=36-1
ElemStation=0,04	
Frame=36 Station=0,08 OutputCase=SIS25 CaseType=Combination P=-10,5361247565094 V2=13,3841390446355 V3=0 T=0 M2=0 M3=-5,46767793436972	FrameElem=36-1
ElemStation=0,08	
Frame=36 Station=0 OutputCase=SIS26 CaseType=Combination P=-10,7793639352717 V2=13,0246077074825 V3=0 T=0 M2=0 M3=-5,35476907454252	FrameElem=36-1
ElemStation=0	
Frame=36 Station=0,04 OutputCase=SIS26 CaseType=Combination P=-10,8166839352717 V2=13,5222077074825 V3=0 T=0 M2=0 M3=-5,88570538284182	FrameElem=36-1
ElemStation=0,04	

Società di Progetto
Brebemi SpA

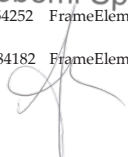



Doc. N.
60235-0000-A00.doc

CODIFICA DOCUMENTO
04RCDII10000000000300A00

REV.
00

FOGLIO
485 di 628

Frame=36 Station=0,08 OutputCase=SIS26 CaseType=Combination P=-10,8540039352717 V2=14,0198077074825 V3=0 T=0 M2=0 M3=-6,43654569114112 FrameElem=36-1 ElemStation=0,08

Frame=36 Station=0 OutputCase=SIS27 CaseType=Combination P=-10,2373150934327 V2=12,7067733760588 V3=0 T=0 M2=0 M3=-4,57788276390829 FrameElem=36-1 ElemStation=0

Frame=36 Station=0,04 OutputCase=SIS27 CaseType=Combination P=-10,2746350934327 V2=13,2043733760588 V3=0 T=0 M2=0 M3=-5,09610569895065 FrameElem=36-1 ElemStation=0,04

Frame=36 Station=0,08 OutputCase=SIS27 CaseType=Combination P=-10,3119550934327 V2=13,7019733760588 V3=0 T=0 M2=0 M3=-5,634232633993 FrameElem=36-1 ElemStation=0,08

Frame=36 Station=0 OutputCase=SIS28 CaseType=Combination P=-10,1014115226632 V2=15,0467733760699 V3=0 T=0 M2=0 M3=-4,70200443762542 FrameElem=36-1 ElemStation=0

Frame=36 Station=0,04 OutputCase=SIS28 CaseType=Combination P=-10,1387315226632 V2=15,6691733760699 V3=0 T=0 M2=0 M3=-5,31632337266822 FrameElem=36-1 ElemStation=0,04

Frame=36 Station=0,08 OutputCase=SIS28 CaseType=Combination P=-10,1760515226632 V2=16,2915733760699 V3=0 T=0 M2=0 M3=-5,95553830771101 FrameElem=36-1 ElemStation=0,08

Frame=36 Station=0 OutputCase=SIS29 CaseType=Combination P=-10,4845207751211 V2=15,04677337607 V3=0 T=0 M2=0 M3=-5,01988361638783 FrameElem=36-1 ElemStation=0

Frame=36 Station=0,04 OutputCase=SIS29 CaseType=Combination P=-10,5218407751211 V2=15,66917337607 V3=0 T=0 M2=0 M3=-5,63420255143063 FrameElem=36-1 ElemStation=0,04

Frame=36 Station=0,08 OutputCase=SIS29 CaseType=Combination P=-10,5591607751211 V2=16,29157337607 V3=0 T=0 M2=0 M3=-6,27341748647343 FrameElem=36-1 ElemStation=0,08

Frame=36 Station=0 OutputCase=SIS30 CaseType=Combination P=-9,71830227020534 V2=15,0467733760698 V3=0 T=0 M2=0 M3=-4,38412525886301 FrameElem=36-1 ElemStation=0

Frame=36 Station=0,04 OutputCase=SIS30 CaseType=Combination P=-9,75562227020534 V2=15,6691733760698 V3=0 T=0 M2=0 M3=-4,9984441939058 FrameElem=36-1 ElemStation=0,04

Frame=36 Station=0,08 OutputCase=SIS30 CaseType=Combination P=-9,79294227020534 V2=16,2915733760698 V3=0 T=0 M2=0 M3=-5,63765912894859 FrameElem=36-1 ElemStation=0,08

Frame=36 Station=0 OutputCase=SIS31 CaseType=Combination P=-9,94247193328205 V2=14,7289390446464 V3=0 T=0 M2=0 M3=-4,2429973057536 FrameElem=36-1 ElemStation=0

Frame=36 Station=0,04 OutputCase=SIS31 CaseType=Combination P=-9,97979193328205 V2=15,3513390446464 V3=0 T=0 M2=0 M3=-4,84460286753946 FrameElem=36-1 ElemStation=0,04

Frame=36 Station=0,08 OutputCase=SIS31 CaseType=Combination P=-10,017111933282 V2=15,9737390446464 V3=0 T=0 M2=0 M3=-5,47110442932531 FrameElem=36-1 ElemStation=0,08

Frame=36 Station=0 OutputCase=SIS32 CaseType=Combination P=-10,2603511120444 V2=15,3646077074934 V3=0 T=0 M2=0 M3=-5,16101156949724 FrameElem=36-1 ElemStation=0

Frame=36 Station=0,04 OutputCase=SIS32 CaseType=Combination P=-10,2976711120444 V2=15,9870077074934 V3=0 T=0 M2=0 M3=-5,7880438779697 FrameElem=36-1 ElemStation=0,04

Frame=36 Station=0,08 OutputCase=SIS32 CaseType=Combination P=-10,3349911120444 V2=16,6094077074934 V3=0 T=0 M2=0 M3=-6,43997218609671 FrameElem=36-1 ElemStation=0,08

Frame=36 Station=0 OutputCase=SIS33 CaseType=Combination P=-9,71830227020534 V2=15,0467733760698 V3=0 T=0 M2=0 M3=-4,38412525886301 FrameElem=36-1 ElemStation=0

Frame=36 Station=0,04 OutputCase=SIS33 CaseType=Combination P=-9,75562227020534 V2=15,6691733760698 V3=0 T=0 M2=0 M3=-4,9984441939058 FrameElem=36-1 ElemStation=0,04

Frame=36 Station=0,08 OutputCase=SIS33 CaseType=Combination P=-9,79294227020534 V2=16,2915733760698 V3=0 T=0 M2=0 M3=-5,63765912894859 FrameElem=36-1 ElemStation=0,08

Frame=36 Station=0 OutputCase=SIS34 CaseType=Combination P=-10,3255811857399 V2=14,7289390446465 V3=0 T=0 M2=0 M3=-4,56087648451601 FrameElem=36-1 ElemStation=0

Frame=36 Station=0,04 OutputCase=SIS34 CaseType=Combination P=-10,3629011857399 V2=15,3513390446465 V3=0 T=0 M2=0 M3=-5,16248204630187 FrameElem=36-1 ElemStation=0,04

Frame=36 Station=0,08 OutputCase=SIS34 CaseType=Combination P=-10,4002211857399 V2=15,9737390446465 V3=0 T=0 M2=0 M3=-5,7889360808773 FrameElem=36-1 ElemStation=0,08

Frame=36 Station=0 OutputCase=SIS35 CaseType=Combination P=-10,6434603645022 V2=15,3646077074936 V3=0 T=0 M2=0 M3=-5,47889074825964 FrameElem=36-1 ElemStation=0

Frame=36 Station=0,04 OutputCase=SIS35 CaseType=Combination P=-10,6807803645022 V2=15,9870077074936 V3=0 T=0 M2=0 M3=-6,10592305655939 FrameElem=36-1 ElemStation=0,04

Frame=36 Station=0,08 OutputCase=SIS35 CaseType=Combination P=-10,7181003645022 V2=16,6094077074936 V3=0 T=0 M2=0 M3=-6,75785136485913 FrameElem=36-1 ElemStation=0,08

Frame=36 Station=0 OutputCase=SIS36 CaseType=Combination P=-10,1014115226632 V2=15,0467733760699 V3=0 T=0 M2=0 M3=-4,70200443762542 FrameElem=36-1 ElemStation=0

Frame=36 Station=0,04 OutputCase=SIS36 CaseType=Combination P=-10,1387315226632 V2=15,6691733760699 V3=0 T=0 M2=0 M3=-5,31632337266822 FrameElem=36-1 ElemStation=0,04

Frame=36 Station=0,08 OutputCase=SIS36 CaseType=Combination P=-10,1760515226632 V2=16,2915733760699 V3=0 T=0 M2=0 M3=-5,95553830771101 FrameElem=36-1 ElemStation=0,08

Frame=36 Station=0 OutputCase=INVSIS CaseType=Combination StepType=Max P=-9,71830227020534 V2=16,8231546089609 V3=0 T=0 M2=0 M3=-4,11887563203648 FrameElem=36-1 ElemStation=0

Frame=36 Station=0,04 OutputCase=INVSIS CaseType=Combination StepType=Max P=-9,75562227020534 V2=17,4018746089609 V3=0 T=0 M2=0 M3=-4,62438519382189 FrameElem=36-1 ElemStation=0,04

Frame=36 Station=0,08 OutputCase=INVSIS CaseType=Combination StepType=Max P=-9,79294227020534 V2=17,9805946089609 V3=0 T=0 M2=0 M3=-5,1497987556073 FrameElem=36-1 ElemStation=0,08

Frame=36 Station=0 OutputCase=INVSIS CaseType=Combination StepType=Min P=-12,3645476864933 V2=12,3889390446353 V3=0 T=0 M2=0 M3=-7,1436083385315 FrameElem=36-1 ElemStation=0

Frame=36 Station=0,04 OutputCase=INVSIS CaseType=Combination StepType=Min P=-12,4889476864933 V2=12,8865390446353 V3=0 T=0 M2=0 M3=-7,82810892288994 FrameElem=36-1 ElemStation=0,04

Frame=36 Station=0,08 OutputCase=INVSIS CaseType=Combination StepType=Min P=-12,6133476864933 V2=13,3841390446353 V3=0 T=0 M2=0 M3=-8,53575830724838 FrameElem=36-1 ElemStation=0,08

Frame=36 Station=0 OutputCase=RAR001 CaseType=Combination P=-6,50813866919101 V2=10,5000000000873 V3=0 T=0 M2=0 M3=-1,73221771575663 FrameElem=36-1 ElemStation=0

Frame=36 Station=0,04 OutputCase=RAR001 CaseType=Combination P=-6,50813866919101 V2=11,0600000000873 V3=0 T=0 M2=0 M3=-2,16341771576013 FrameElem=36-1 ElemStation=0,04

Frame=36 Station=0,08 OutputCase=RAR001 CaseType=Combination P=-6,50813866919101 V2=11,6200000000873 V3=0 T=0 M2=0 M3=-2,61701771576362 FrameElem=36-1 ElemStation=0,08

Frame=36 Station=0 OutputCase=RAR002 CaseType=Combination P=-4,83460814880114 V2=82,5000000004657 V3=0 T=0 M2=0 M3=-6,51498556367005 FrameElem=36-1 ElemStation=0

Frame=36 Station=0,04 OutputCase=RAR002 CaseType=Combination P=-4,83460814880114 V2=86,9000000004657 V3=0 T=0 M2=0 M3=-9,90298556368868 FrameElem=36-1 ElemStation=0,04

Frame=36 Station=0,08 OutputCase=RAR002 CaseType=Combination P=-4,83460814880114 V2=91,3000000004657 V3=0 T=0 M2=0 M3=-13,4669855637073 FrameElem=36-1 ElemStation=0,08

Frame=36 Station=0 OutputCase=RAR003 CaseType=Combination P=-16,6600388586698 V2=91,841144094069 V3=0 T=0 M2=0 M3=-15,1432760004918 FrameElem=36-1 ElemStation=0

Società di Progetto
Brebemi SpA



Doc. N.
60235-0000-A00.doc

CODIFICA DOCUMENTO
04RCDII10000000000300A00

REV.
00

FOGLIO
486 di 628

Frame=36 Station=0,04 OutputCase=RAR003 CaseType=Combination P=-16,6600388586698 V2=96,241144094069 V3=0 T=0 M2=0 M3=-18,9049217642546 FrameElem=36-1
ElemStation=0,04
Frame=36 Station=0,08 OutputCase=RAR003 CaseType=Combination P=-16,6600388586698 V2=100,641144094069 V3=0 T=0 M2=0 M3=-22,8425675280173 FrameElem=36-1
ElemStation=0,08
Frame=36 Station=0 OutputCase=RAR004 CaseType=Combination P=-28,4854695890276 V2=82,500000012806 V3=0 T=0 M2=0 M3=-9,75985029741696 FrameElem=36-1
ElemStation=0
Frame=36 Station=0,04 OutputCase=RAR004 CaseType=Combination P=-28,4854695890276 V2=86,900000012806 V3=0 T=0 M2=0 M3=-13,1478502974682 FrameElem=36-1
ElemStation=0,04
Frame=36 Station=0,08 OutputCase=RAR004 CaseType=Combination P=-28,4854695890276 V2=91,300000012806 V3=0 T=0 M2=0 M3=-16,7118502975194 FrameElem=36-1
ElemStation=0,08
Frame=36 Station=0 OutputCase=RAR005 CaseType=Combination P=-15,6998958247733 V2=19,8411440935743 V3=0 T=0 M2=0 M3=-9,92722402901654 FrameElem=36-1
ElemStation=0
Frame=36 Station=0,04 OutputCase=RAR005 CaseType=Combination P=-15,6998958247733 V2=20,4011440935743 V3=0 T=0 M2=0 M3=-10,7320697927595 FrameElem=36-1
ElemStation=0,04
Frame=36 Station=0,08 OutputCase=RAR005 CaseType=Combination P=-15,6998958247733 V2=20,9611440935743 V3=0 T=0 M2=0 M3=-11,5593155565025 FrameElem=36-1
ElemStation=0,08
Frame=36 Station=0 OutputCase=RAR006 CaseType=Combination P=-27,5253265551311 V2=10,500000007858 V3=0 T=0 M2=0 M3=-4,54379832594168 FrameElem=36-1
ElemStation=0
Frame=36 Station=0,04 OutputCase=RAR006 CaseType=Combination P=-27,5253265551311 V2=11,060000007858 V3=0 T=0 M2=0 M3=-4,97499832597311 FrameElem=36-1
ElemStation=0,04
Frame=36 Station=0,08 OutputCase=RAR006 CaseType=Combination P=-27,5253265551311 V2=11,620000007858 V3=0 T=0 M2=0 M3=-5,42859832600454 FrameElem=36-1
ElemStation=0,08
Frame=36 Station=0 OutputCase=RAR007 CaseType=Combination P=-26,3178546232076 V2=86,0959910856254 V3=0 T=0 M2=0 M3=-22,6789506748753 FrameElem=36-1
ElemStation=0
Frame=36 Station=0,04 OutputCase=RAR007 CaseType=Combination P=-26,3178546232076 V2=89,5359910856254 V3=0 T=0 M2=0 M3=-26,1915903183003 FrameElem=36-1
ElemStation=0,04
Frame=36 Station=0,08 OutputCase=RAR007 CaseType=Combination P=-27,6538546232076 V2=92,9759910856254 V3=0 T=0 M2=0 M3=-29,8418299617253 FrameElem=36-1
ElemStation=0,08
Frame=36 Station=0 OutputCase=RAR008 CaseType=Combination P=-4,64068361982039 V2=10,499999999712 V3=0 T=0 M2=0 M3=-1,93469194971959 FrameElem=36-1
ElemStation=0
Frame=36 Station=0,04 OutputCase=RAR008 CaseType=Combination P=-4,64068361982039 V2=11,059999999712 V3=0 T=0 M2=0 M3=-2,36589194971844 FrameElem=36-1
ElemStation=0,04
Frame=36 Station=0,08 OutputCase=RAR008 CaseType=Combination P=-4,64068361982039 V2=11,619999999712 V3=0 T=0 M2=0 M3=-2,81949194971728 FrameElem=36-1
ElemStation=0,08
Frame=36 Station=0 OutputCase=RAR009 CaseType=Combination P=-5,29433925175058 V2=82,500000004658 V3=0 T=0 M2=0 M3=-6,89644057818494 FrameElem=36-1
ElemStation=0
Frame=36 Station=0,04 OutputCase=RAR009 CaseType=Combination P=-5,29433925175058 V2=86,900000004658 V3=0 T=0 M2=0 M3=-10,2844405782036 FrameElem=36-1
ElemStation=0,04
Frame=36 Station=0,08 OutputCase=RAR009 CaseType=Combination P=-5,29433925175058 V2=91,300000004658 V3=0 T=0 M2=0 M3=-13,8484405782222 FrameElem=36-1
ElemStation=0,08
Frame=36 Station=0 OutputCase=RAR010 CaseType=Combination P=-17,1197699616193 V2=91,8411440940692 V3=0 T=0 M2=0 M3=-15,5247310150067 FrameElem=36-1
ElemStation=0
Frame=36 Station=0,04 OutputCase=RAR010 CaseType=Combination P=-17,1197699616193 V2=96,2411440940692 V3=0 T=0 M2=0 M3=-19,2863767787695 FrameElem=36-1
ElemStation=0,04
Frame=36 Station=0,08 OutputCase=RAR010 CaseType=Combination P=-17,1197699616193 V2=100,641144094069 V3=0 T=0 M2=0 M3=-23,2240225425322 FrameElem=36-1
ElemStation=0,08
Frame=36 Station=0 OutputCase=RAR011 CaseType=Combination P=-28,945200691977 V2=82,500000012807 V3=0 T=0 M2=0 M3=-10,1413053119319 FrameElem=36-1
ElemStation=0
Frame=36 Station=0,04 OutputCase=RAR011 CaseType=Combination P=-28,945200691977 V2=86,900000012807 V3=0 T=0 M2=0 M3=-13,5293053119831 FrameElem=36-1
ElemStation=0,04
Frame=36 Station=0,08 OutputCase=RAR011 CaseType=Combination P=-28,945200691977 V2=91,300000012808 V3=0 T=0 M2=0 M3=-17,0933053120343 FrameElem=36-1
ElemStation=0,08
Frame=36 Station=0 OutputCase=RAR012 CaseType=Combination P=-16,1596269277228 V2=19,8411440935744 V3=0 T=0 M2=0 M3=-10,3086790435314 FrameElem=36-1
ElemStation=0
Frame=36 Station=0,04 OutputCase=RAR012 CaseType=Combination P=-16,1596269277228 V2=20,4011440935744 V3=0 T=0 M2=0 M3=-11,1135248072744 FrameElem=36-1
ElemStation=0,04
Frame=36 Station=0,08 OutputCase=RAR012 CaseType=Combination P=-16,1596269277228 V2=20,9611440935744 V3=0 T=0 M2=0 M3=-11,9407705710174 FrameElem=36-1
ElemStation=0,08
Frame=36 Station=0 OutputCase=RAR013 CaseType=Combination P=-27,9850576580805 V2=10,50000000786 V3=0 T=0 M2=0 M3=-4,92525334045657 FrameElem=36-1
ElemStation=0
Frame=36 Station=0,04 OutputCase=RAR013 CaseType=Combination P=-27,9850576580805 V2=11,06000000786 V3=0 T=0 M2=0 M3=-5,35645334048801 FrameElem=36-1
ElemStation=0,04
Frame=36 Station=0,08 OutputCase=RAR013 CaseType=Combination P=-27,9850576580805 V2=11,62000000786 V3=0 T=0 M2=0 M3=-5,81005334051945 FrameElem=36-1
ElemStation=0,08
Frame=36 Station=0 OutputCase=RAR014 CaseType=Combination P=-26,777587261571 V2=86,0959910856256 V3=0 T=0 M2=0 M3=-23,0604056893902 FrameElem=36-1
ElemStation=0
Frame=36 Station=0,04 OutputCase=RAR014 CaseType=Combination P=-27,4455857261571 V2=89,5359910856256 V3=0 T=0 M2=0 M3=-26,5730453328152 FrameElem=36-1
ElemStation=0,04
Frame=36 Station=0,08 OutputCase=RAR014 CaseType=Combination P=-28,1135857261571 V2=92,9759910856256 V3=0 T=0 M2=0 M3=-30,2232849762402 FrameElem=36-1
ElemStation=0,08
Frame=36 Station=0 OutputCase=RAR015 CaseType=Combination P=-5,36079089524276 V2=64,500000003423 V3=0 T=0 M2=0 M3=-5,84673092832605 FrameElem=36-1
ElemStation=0
Frame=36 Station=0,04 OutputCase=RAR015 CaseType=Combination P=-5,36079089524276 V2=67,940000003423 V3=0 T=0 M2=0 M3=-8,49553092833974 FrameElem=36-1
ElemStation=0,04
Frame=36 Station=0,08 OutputCase=RAR015 CaseType=Combination P=-5,36079089524276 V2=71,380000003423 V3=0 T=0 M2=0 M3=-11,2819309283534 FrameElem=36-1
ElemStation=0,08
Frame=36 Station=0 OutputCase=RAR016 CaseType=Combination P=-14,5590731221629 V2=71,7479075373779 V3=0 T=0 M2=0 M3=-12,5536463715053 FrameElem=36-1
ElemStation=0
Frame=36 Station=0,04 OutputCase=RAR016 CaseType=Combination P=-14,5590731221629 V2=75,1879075373779 V3=0 T=0 M2=0 M3=-15,4923626730004 FrameElem=36-1
ElemStation=0,04
Frame=36 Station=0,08 OutputCase=RAR016 CaseType=Combination P=-14,5590731221629 V2=78,6279075373779 V3=0 T=0 M2=0 M3=-18,5686789744955 FrameElem=36-1
ElemStation=0,08
Frame=36 Station=0 OutputCase=RAR017 CaseType=Combination P=-23,7573553639842 V2=64,500000009825 V3=0 T=0 M2=0 M3=-8,3887005095267 FrameElem=36-1
ElemStation=0
Frame=36 Station=0,04 OutputCase=RAR017 CaseType=Combination P=-23,7573553639842 V2=67,940000009825 V3=0 T=0 M2=0 M3=-11,037500509566 FrameElem=36-1
ElemStation=0,04
Frame=36 Station=0,08 OutputCase=RAR017 CaseType=Combination P=-23,7573553639842 V2=71,380000009825 V3=0 T=0 M2=0 M3=-13,8239005096053 FrameElem=36-1
ElemStation=0,08

Società di Progetto
Brebemi SpA



Doc. N.
60235-0000-A00.doc

CODIFICA DOCUMENTO
04RCDII10000000000300A00

REV.
00

FOGLIO
487 di 628

Frame=36 Station=0 OutputCase=RAR018 CaseType=Combination P=-13,8389658467405 V2=17,7479075370068 V3=0 T=0 M2=0 M3=-8,64160739289883 FrameElem=36-1 ElemStation=0
Frame=36 Station=0,04 OutputCase=RAR018 CaseType=Combination P=-13,8389658467405 V2=18,3079075370068 V3=0 T=0 M2=0 M3=-9,3627236943791 FrameElem=36-1 ElemStation=0,04
Frame=36 Station=0,08 OutputCase=RAR018 CaseType=Combination P=-13,8389658467405 V2=18,8679075370068 V3=0 T=0 M2=0 M3=-10,1062399958594 FrameElem=36-1 ElemStation=0,08
Frame=36 Station=0 OutputCase=RAR019 CaseType=Combination P=-23,0372480885618 V2=10,5000000006115 V3=0 T=0 M2=0 M3=-4,47666153092024 FrameElem=36-1 ElemStation=0
Frame=36 Station=0,04 OutputCase=RAR019 CaseType=Combination P=-23,0372480885618 V2=11,0600000006115 V3=0 T=0 M2=0 M3=-4,90786153094469 FrameElem=36-1 ElemStation=0,04
Frame=36 Station=0,08 OutputCase=RAR019 CaseType=Combination P=-23,0372480885618 V2=11,6200000006115 V3=0 T=0 M2=0 M3=-5,36146153096915 FrameElem=36-1 ElemStation=0,08
Frame=36 Station=0 OutputCase=RAR020 CaseType=Combination P=-4,44995611256299 V2=10,1185988022629 V3=0 T=0 M2=0 M3=-1,38388339147341 FrameElem=36-1 ElemStation=0
Frame=36 Station=0,04 OutputCase=RAR020 CaseType=Combination P=-4,44995611256299 V2=10,6785988022629 V3=0 T=0 M2=0 M3=-1,79982734356393 FrameElem=36-1 ElemStation=0,04
Frame=36 Station=0,08 OutputCase=RAR020 CaseType=Combination P=-4,44995611256299 V2=11,2385988022629 V3=0 T=0 M2=0 M3=-2,23817129565444 FrameElem=36-1 ElemStation=0,08
Frame=36 Station=0 OutputCase=RAR021 CaseType=Combination P=-5,17006338798536 V2=64,118598802634 V3=0 T=0 M2=0 M3=-5,29592237007987 FrameElem=36-1 ElemStation=0
Frame=36 Station=0,04 OutputCase=RAR021 CaseType=Combination P=-5,17006338798536 V2=67,558598802634 V3=0 T=0 M2=0 M3=-7,92946632218523 FrameElem=36-1 ElemStation=0,04
Frame=36 Station=0,08 OutputCase=RAR021 CaseType=Combination P=-5,17006338798536 V2=70,998598802634 V3=0 T=0 M2=0 M3=-10,7006102742906 FrameElem=36-1 ElemStation=0,08
Frame=36 Station=0 OutputCase=RAR022 CaseType=Combination P=-14,3683456149055 V2=71,3665063396697 V3=0 T=0 M2=0 M3=-12,0028378132591 FrameElem=36-1 ElemStation=0
Frame=36 Station=0,04 OutputCase=RAR022 CaseType=Combination P=-14,3683456149055 V2=74,8065063396697 V3=0 T=0 M2=0 M3=-14,9262980668459 FrameElem=36-1 ElemStation=0,04
Frame=36 Station=0,08 OutputCase=RAR022 CaseType=Combination P=-14,3683456149055 V2=78,2465063396697 V3=0 T=0 M2=0 M3=-17,9873583204327 FrameElem=36-1 ElemStation=0,08
Frame=36 Station=0 OutputCase=RAR023 CaseType=Combination P=-23,5666278567268 V2=64,1185988032743 V3=0 T=0 M2=0 M3=-7,83789195128052 FrameElem=36-1 ElemStation=0
Frame=36 Station=0,04 OutputCase=RAR023 CaseType=Combination P=-23,5666278567268 V2=67,5585988032743 V3=0 T=0 M2=0 M3=-10,4714359034115 FrameElem=36-1 ElemStation=0,04
Frame=36 Station=0,08 OutputCase=RAR023 CaseType=Combination P=-23,5666278567268 V2=70,9985988032743 V3=0 T=0 M2=0 M3=-13,2425798555425 FrameElem=36-1 ElemStation=0,08
Frame=36 Station=0 OutputCase=RAR024 CaseType=Combination P=-13,6482383394831 V2=17,3665063392986 V3=0 T=0 M2=0 M3=-8,09079883465265 FrameElem=36-1 ElemStation=0
Frame=36 Station=0,04 OutputCase=RAR024 CaseType=Combination P=-13,6482383394831 V2=17,9265063392986 V3=0 T=0 M2=0 M3=-8,79665908822459 FrameElem=36-1 ElemStation=0,04
Frame=36 Station=0,08 OutputCase=RAR024 CaseType=Combination P=-13,6482383394831 V2=18,4865063392986 V3=0 T=0 M2=0 M3=-9,52491934179654 FrameElem=36-1 ElemStation=0,08
Frame=36 Station=0 OutputCase=RAR025 CaseType=Combination P=-22,8465205813044 V2=10,1185988029032 V3=0 T=0 M2=0 M3=-3,92585297267406 FrameElem=36-1 ElemStation=0
Frame=36 Station=0,04 OutputCase=RAR025 CaseType=Combination P=-22,8465205813044 V2=10,6785988029032 V3=0 T=0 M2=0 M3=-4,34179692479019 FrameElem=36-1 ElemStation=0,04
Frame=36 Station=0,08 OutputCase=RAR025 CaseType=Combination P=-22,8465205813044 V2=11,2385988029032 V3=0 T=0 M2=0 M3=-4,78014087690631 FrameElem=36-1 ElemStation=0,08
Frame=36 Station=0 OutputCase=RAR026 CaseType=Combination P=-4,83141112707778 V2=10,8814011976794 V3=0 T=0 M2=0 M3=-2,48550050796577 FrameElem=36-1 ElemStation=0
Frame=36 Station=0,04 OutputCase=RAR026 CaseType=Combination P=-4,83141112707778 V2=11,4414011976794 V3=0 T=0 M2=0 M3=-2,93195655587295 FrameElem=36-1 ElemStation=0,04
Frame=36 Station=0,08 OutputCase=RAR026 CaseType=Combination P=-4,83141112707778 V2=12,0014011976794 V3=0 T=0 M2=0 M3=-3,40081260378012 FrameElem=36-1 ElemStation=0,08
Frame=36 Station=0 OutputCase=RAR027 CaseType=Combination P=-5,55151840250015 V2=64,8814011980505 V3=0 T=0 M2=0 M3=-6,39753948657223 FrameElem=36-1 ElemStation=0
Frame=36 Station=0,04 OutputCase=RAR027 CaseType=Combination P=-5,55151840250015 V2=68,3214011980505 V3=0 T=0 M2=0 M3=-9,06159553449425 FrameElem=36-1 ElemStation=0,04
Frame=36 Station=0,08 OutputCase=RAR027 CaseType=Combination P=-5,55151840250015 V2=71,7614011980505 V3=0 T=0 M2=0 M3=-11,8632515824163 FrameElem=36-1 ElemStation=0,08
Frame=36 Station=0 OutputCase=RAR028 CaseType=Combination P=-14,7498006294203 V2=72,1293087350861 V3=0 T=0 M2=0 M3=-13,1044549297515 FrameElem=36-1 ElemStation=0
Frame=36 Station=0,04 OutputCase=RAR028 CaseType=Combination P=-14,7498006294203 V2=75,5693087350861 V3=0 T=0 M2=0 M3=-16,0584272791549 FrameElem=36-1 ElemStation=0,04
Frame=36 Station=0,08 OutputCase=RAR028 CaseType=Combination P=-14,7498006294203 V2=79,0093087350861 V3=0 T=0 M2=0 M3=-19,1499996285584 FrameElem=36-1 ElemStation=0,08
Frame=36 Station=0 OutputCase=RAR029 CaseType=Combination P=-23,9480828712416 V2=64,8814011986908 V3=0 T=0 M2=0 M3=-8,93950906777288 FrameElem=36-1 ElemStation=0
Frame=36 Station=0,04 OutputCase=RAR029 CaseType=Combination P=-23,9480828712416 V2=68,3214011986908 V3=0 T=0 M2=0 M3=-11,6035651157205 FrameElem=36-1 ElemStation=0,04
Frame=36 Station=0,08 OutputCase=RAR029 CaseType=Combination P=-23,9480828712416 V2=71,7614011986908 V3=0 T=0 M2=0 M3=-14,4052211636681 FrameElem=36-1 ElemStation=0,08
Frame=36 Station=0 OutputCase=RAR030 CaseType=Combination P=-14,0296933539979 V2=18,1293087347151 V3=0 T=0 M2=0 M3=-9,19241595114501 FrameElem=36-1 ElemStation=0
Frame=36 Station=0,04 OutputCase=RAR030 CaseType=Combination P=-14,0296933539979 V2=18,6893087347151 V3=0 T=0 M2=0 M3=-9,92878830053361 FrameElem=36-1 ElemStation=0,04
Frame=36 Station=0,08 OutputCase=RAR030 CaseType=Combination P=-14,0296933539979 V2=19,2493087347151 V3=0 T=0 M2=0 M3=-10,6875606499222 FrameElem=36-1 ElemStation=0,08
Frame=36 Station=0 OutputCase=RAR031 CaseType=Combination P=-23,2279755958192 V2=10,8814011983197 V3=0 T=0 M2=0 M3=-5,02747008916642 FrameElem=36-1 ElemStation=0
Frame=36 Station=0,04 OutputCase=RAR031 CaseType=Combination P=-23,2279755958192 V2=11,4414011983197 V3=0 T=0 M2=0 M3=-5,4739261370992 FrameElem=36-1 ElemStation=0,04
Frame=36 Station=0,08 OutputCase=RAR031 CaseType=Combination P=-23,2279755958192 V2=12,0014011983197 V3=0 T=0 M2=0 M3=-5,94278218503199 FrameElem=36-1 ElemStation=0,08
Frame=36 Station=0 OutputCase=RAR032 CaseType=Combination P=-4,18095251687094 V2=10,499999999971 V3=0 T=0 M2=0 M3=-1,5532369352047 FrameElem=36-1 ElemStation=0
Frame=36 Station=0,04 OutputCase=RAR032 CaseType=Combination P=-4,18095251687094 V2=11,059999999971 V3=0 T=0 M2=0 M3=-1,98443693520354 FrameElem=36-1 ElemStation=0,04

Società di Progetto
Brebemi SpA

	Doc. N. 60235-00000-A00.doc	CODIFICA DOCUMENTO 04RCDII10000000000300A00	REV. 00	FOGLIO 488 di 628
--	--------------------------------	--	------------	----------------------

Frame=36 Station=0,08 OutputCase=RAR032 CaseType=Combination P=-4,18095251687094 V2=11,619999999971 V3=0 T=0 M2=0 M3=-2,43803693520238 FrameElem=36-1 ElemStation=0,08

Frame=36 Station=0 OutputCase=RAR033 CaseType=Combination P=-4,90105979229331 V2=64,5000000003421 V3=0 T=0 M2=0 M3=-5,46527591381116 FrameElem=36-1 ElemStation=0

Frame=36 Station=0,04 OutputCase=RAR033 CaseType=Combination P=-4,90105979229331 V2=67,9400000003421 V3=0 T=0 M2=0 M3=-8,11407591382484 FrameElem=36-1 ElemStation=0,04

Frame=36 Station=0,08 OutputCase=RAR033 CaseType=Combination P=-4,90105979229331 V2=71,3800000003421 V3=0 T=0 M2=0 M3=-10,9004759138385 FrameElem=36-1 ElemStation=0,08

Frame=36 Station=0 OutputCase=RAR034 CaseType=Combination P=-14,0993420192134 V2=71,7479075373777 V3=0 T=0 M2=0 M3=-12,1721913569904 FrameElem=36-1 ElemStation=0

Frame=36 Station=0,04 OutputCase=RAR034 CaseType=Combination P=-14,0993420192134 V2=75,1879075373777 V3=0 T=0 M2=0 M3=-15,1109076584855 FrameElem=36-1 ElemStation=0,04

Frame=36 Station=0,08 OutputCase=RAR034 CaseType=Combination P=-14,0993420192134 V2=78,6279075373777 V3=0 T=0 M2=0 M3=-18,1872239599806 FrameElem=36-1 ElemStation=0,08

Frame=36 Station=0 OutputCase=RAR035 CaseType=Combination P=-23,2976242610347 V2=64,5000000009824 V3=0 T=0 M2=0 M3=-8,00724549501181 FrameElem=36-1 ElemStation=0

Frame=36 Station=0,04 OutputCase=RAR035 CaseType=Combination P=-23,2976242610347 V2=67,9400000009824 V3=0 T=0 M2=0 M3=-10,6560454950511 FrameElem=36-1 ElemStation=0,04

Frame=36 Station=0,08 OutputCase=RAR035 CaseType=Combination P=-23,2976242610347 V2=71,3800000009824 V3=0 T=0 M2=0 M3=-13,4424454950904 FrameElem=36-1 ElemStation=0,08

Frame=36 Station=0 OutputCase=RAR036 CaseType=Combination P=-13,3792347437911 V2=17,7479075370067 V3=0 T=0 M2=0 M3=-8,2601523783894 FrameElem=36-1 ElemStation=0

Frame=36 Station=0,04 OutputCase=RAR036 CaseType=Combination P=-13,3792347437911 V2=18,3079075370067 V3=0 T=0 M2=0 M3=-8,98126867986421 FrameElem=36-1 ElemStation=0,04

Frame=36 Station=0,08 OutputCase=RAR036 CaseType=Combination P=-13,3792347437911 V2=18,8679075370067 V3=0 T=0 M2=0 M3=-9,72478498134447 FrameElem=36-1 ElemStation=0,08

Frame=36 Station=0 OutputCase=RAR037 CaseType=Combination P=-22,5775169856124 V2=10,5000000006113 V3=0 T=0 M2=0 M3=-4,09520651640535 FrameElem=36-1 ElemStation=0

Frame=36 Station=0,04 OutputCase=RAR037 CaseType=Combination P=-22,5775169856124 V2=11,0600000006113 V3=0 T=0 M2=0 M3=-4,5264065164298 FrameElem=36-1 ElemStation=0,04

Frame=36 Station=0,08 OutputCase=RAR037 CaseType=Combination P=-22,5775169856124 V2=11,6200000006113 V3=0 T=0 M2=0 M3=-4,98000651645425 FrameElem=36-1 ElemStation=0,08

Frame=36 Station=0 OutputCase=RAR038 CaseType=Combination P=-3,1082466099889 V2=10,499999999706 V3=0 T=0 M2=0 M3=-0,663175234669954 FrameElem=36-1 ElemStation=0

Frame=36 Station=0,04 OutputCase=RAR038 CaseType=Combination P=-3,1082466099889 V2=11,059999999706 V3=0 T=0 M2=0 M3=-1,09437523466878 FrameElem=36-1 ElemStation=0,04

Frame=36 Station=0,08 OutputCase=RAR038 CaseType=Combination P=-3,1082466099889 V2=11,619999999706 V3=0 T=0 M2=0 M3=-1,5479752346676 FrameElem=36-1 ElemStation=0,08

Frame=36 Station=0 OutputCase=RAR039 CaseType=Combination P=-4,37487704585169 V2=82,5000000004655 V3=0 T=0 M2=0 M3=-6,1333054915516 FrameElem=36-1 ElemStation=0

Frame=36 Station=0,04 OutputCase=RAR039 CaseType=Combination P=-4,37487704585169 V2=86,9000000004655 V3=0 T=0 M2=0 M3=-9,52153054917378 FrameElem=36-1 ElemStation=0,04

Frame=36 Station=0,08 OutputCase=RAR039 CaseType=Combination P=-4,37487704585169 V2=91,3000000004655 V3=0 T=0 M2=0 M3=-13,0855305491924 FrameElem=36-1 ElemStation=0,08

Frame=36 Station=0 OutputCase=RAR040 CaseType=Combination P=-16,2003077557204 V2=91,8411440940689 V3=0 T=0 M2=0 M3=-14,7618209859769 FrameElem=36-1 ElemStation=0

Frame=36 Station=0,04 OutputCase=RAR040 CaseType=Combination P=-16,2003077557204 V2=96,2411440940689 V3=0 T=0 M2=0 M3=-18,5234667497397 FrameElem=36-1 ElemStation=0,04

Frame=36 Station=0,08 OutputCase=RAR040 CaseType=Combination P=-16,2003077557204 V2=100,6411440940689 V3=0 T=0 M2=0 M3=-22,4611125135024 FrameElem=36-1 ElemStation=0,08

Frame=36 Station=0 OutputCase=RAR041 CaseType=Combination P=-28,0257384860781 V2=82,5000000012804 V3=0 T=0 M2=0 M3=-9,37839528290207 FrameElem=36-1 ElemStation=0

Frame=36 Station=0,04 OutputCase=RAR041 CaseType=Combination P=-28,0257384860781 V2=86,9000000012804 V3=0 T=0 M2=0 M3=-12,7663952829533 FrameElem=36-1 ElemStation=0,04

Frame=36 Station=0,08 OutputCase=RAR041 CaseType=Combination P=-28,0257384860781 V2=91,3000000012804 V3=0 T=0 M2=0 M3=-16,3303952830045 FrameElem=36-1 ElemStation=0,08

Frame=36 Station=0 OutputCase=RAR042 CaseType=Combination P=-15,2401647218239 V2=19,8411440935741 V3=0 T=0 M2=0 M3=-9,54576901450165 FrameElem=36-1 ElemStation=0

Frame=36 Station=0,04 OutputCase=RAR042 CaseType=Combination P=-15,2401647218239 V2=20,4011440935741 V3=0 T=0 M2=0 M3=-10,3506147782446 FrameElem=36-1 ElemStation=0,04

Frame=36 Station=0,08 OutputCase=RAR042 CaseType=Combination P=-15,2401647218239 V2=20,9611440935741 V3=0 T=0 M2=0 M3=-11,1778605419876 FrameElem=36-1 ElemStation=0,08

Frame=36 Station=0 OutputCase=RAR043 CaseType=Combination P=-27,0655954521816 V2=10,5000000007856 V3=0 T=0 M2=0 M3=-4,16234331142679 FrameElem=36-1 ElemStation=0

Frame=36 Station=0,04 OutputCase=RAR043 CaseType=Combination P=-27,0655954521816 V2=11,0600000007856 V3=0 T=0 M2=0 M3=-4,59354331145821 FrameElem=36-1 ElemStation=0,04

Frame=36 Station=0,08 OutputCase=RAR043 CaseType=Combination P=-27,0655954521816 V2=11,6200000007856 V3=0 T=0 M2=0 M3=-5,04714331148964 FrameElem=36-1 ElemStation=0,08

Frame=36 Station=0 OutputCase=RAR044 CaseType=Combination P=-25,8581235202582 V2=86,0959910856253 V3=0 T=0 M2=0 M3=-22,2974956603604 FrameElem=36-1 ElemStation=0

Frame=36 Station=0,04 OutputCase=RAR044 CaseType=Combination P=-26,5261235202582 V2=89,5359910856253 V3=0 T=0 M2=0 M3=-25,8101353037854 FrameElem=36-1 ElemStation=0,04

Frame=36 Station=0,08 OutputCase=RAR044 CaseType=Combination P=-27,1941235202582 V2=92,9759910856253 V3=0 T=0 M2=0 M3=-29,4603749472104 FrameElem=36-1 ElemStation=0,08

Frame=36 Station=0 OutputCase=RAR045 CaseType=Combination P=-3,82835388541127 V2=64,5000000003417 V3=0 T=0 M2=0 M3=-4,57521421327641 FrameElem=36-1 ElemStation=0

Frame=36 Station=0,04 OutputCase=RAR045 CaseType=Combination P=-3,82835388541127 V2=67,9400000003417 V3=0 T=0 M2=0 M3=-7,22401421329008 FrameElem=36-1 ElemStation=0,04

Frame=36 Station=0,08 OutputCase=RAR045 CaseType=Combination P=-3,82835388541127 V2=71,3800000003417 V3=0 T=0 M2=0 M3=-10,104142133037 FrameElem=36-1 ElemStation=0,08

Frame=36 Station=0 OutputCase=RAR046 CaseType=Combination P=-13,0266361123314 V2=71,7479075373773 V3=0 T=0 M2=0 M3=-11,2821296564557 FrameElem=36-1 ElemStation=0

Frame=36 Station=0,04 OutputCase=RAR046 CaseType=Combination P=-13,0266361123314 V2=75,1879075373773 V3=0 T=0 M2=0 M3=-14,2208459579507 FrameElem=36-1 ElemStation=0,04

Frame=36 Station=0,08 OutputCase=RAR046 CaseType=Combination P=-13,0266361123314 V2=78,6279075373773 V3=0 T=0 M2=0 M3=-17,2971622594458 FrameElem=36-1 ElemStation=0,08

Frame=36 Station=0 OutputCase=RAR047 CaseType=Combination P=-22,2249183541527 V2=64,500000000982 V3=0 T=0 M2=0 M3=-7,11718379447706 FrameElem=36-1 ElemStation=0

Società di Progetto
Brebemi SpA



Doc. N.
60235-0000-A00.doc

CODIFICA DOCUMENTO
04RCDII10000000000300A00

REV.
00

FOGLIO
489 di 628

Frame=36 Station=0,04 OutputCase=RAR047 CaseType=Combination P=-22,2249183541527 V2=67,940000000982 V3=0 T=0 M2=0 M3=-9,76598379451634 FrameElem=36-1 ElemStation=0,04

Frame=36 Station=0,08 OutputCase=RAR047 CaseType=Combination P=-22,2249183541527 V2=71,380000000982 V3=0 T=0 M2=0 M3=-12,5523837945556 FrameElem=36-1 ElemStation=0,08

Frame=36 Station=0 OutputCase=RAR048 CaseType=Combination P=-12,306528836909 V2=17,7479075370063 V3=0 T=0 M2=0 M3=-7,37009067784919 FrameElem=36-1 ElemStation=0

Frame=36 Station=0,04 OutputCase=RAR048 CaseType=Combination P=-12,306528836909 V2=18,3079075370063 V3=0 T=0 M2=0 M3=-8,09120697932945 FrameElem=36-1 ElemStation=0,04

Frame=36 Station=0,08 OutputCase=RAR048 CaseType=Combination P=-12,306528836909 V2=18,8679075370063 V3=0 T=0 M2=0 M3=-8,83472328080969 FrameElem=36-1 ElemStation=0,08

Frame=36 Station=0 OutputCase=RAR049 CaseType=Combination P=-21,5048110787303 V2=10,5000000006109 V3=0 T=0 M2=0 M3=-3,2051448158706 FrameElem=36-1 ElemStation=0

Frame=36 Station=0,04 OutputCase=RAR049 CaseType=Combination P=-21,5048110787303 V2=11,0600000006109 V3=0 T=0 M2=0 M3=-3,63634481589504 FrameElem=36-1 ElemStation=0,04

Frame=36 Station=0,08 OutputCase=RAR049 CaseType=Combination P=-21,5048110787303 V2=11,6200000006109 V3=0 T=0 M2=0 M3=-4,08994481591947 FrameElem=36-1 ElemStation=0,08

Frame=36 Station=0 OutputCase=RAR050 CaseType=Combination P=-2,91751910273151 V2=10,1185988022624 V3=0 T=0 M2=0 M3=-0,112366676423774 FrameElem=36-1 ElemStation=0

Frame=36 Station=0,04 OutputCase=RAR050 CaseType=Combination P=-2,91751910273151 V2=10,6785988022624 V3=0 T=0 M2=0 M3=-0,528310628514269 FrameElem=36-1 ElemStation=0,04

Frame=36 Station=0,08 OutputCase=RAR050 CaseType=Combination P=-2,91751910273151 V2=11,2385988022624 V3=0 T=0 M2=0 M3=-0,966654580604763 FrameElem=36-1 ElemStation=0,08

Frame=36 Station=0 OutputCase=RAR051 CaseType=Combination P=-3,63762637815388 V2=64,1185988026334 V3=0 T=0 M2=0 M3=-0,02440565503023 FrameElem=36-1 ElemStation=0

Frame=36 Station=0,04 OutputCase=RAR051 CaseType=Combination P=-3,63762637815388 V2=67,5585988026334 V3=0 T=0 M2=0 M3=-6,65794960713557 FrameElem=36-1 ElemStation=0,04

Frame=36 Station=0,08 OutputCase=RAR051 CaseType=Combination P=-3,63762637815388 V2=70,9985988026334 V3=0 T=0 M2=0 M3=-9,42909355924091 FrameElem=36-1 ElemStation=0,08

Frame=36 Station=0 OutputCase=RAR052 CaseType=Combination P=-12,835908605074 V2=71,3665063396691 V3=0 T=0 M2=0 M3=-10,7313210982095 FrameElem=36-1 ElemStation=0

Frame=36 Station=0,04 OutputCase=RAR052 CaseType=Combination P=-12,835908605074 V2=74,8065063396691 V3=0 T=0 M2=0 M3=-13,6547813517962 FrameElem=36-1 ElemStation=0,04

Frame=36 Station=0,08 OutputCase=RAR052 CaseType=Combination P=-12,835908605074 V2=78,2465063396691 V3=0 T=0 M2=0 M3=-16,715841605383 FrameElem=36-1 ElemStation=0,08

Frame=36 Station=0 OutputCase=RAR053 CaseType=Combination P=-22,0341908468953 V2=64,1185988032737 V3=0 T=0 M2=0 M3=-6,56637523623088 FrameElem=36-1 ElemStation=0

Frame=36 Station=0,04 OutputCase=RAR053 CaseType=Combination P=-22,0341908468953 V2=67,5585988032737 V3=0 T=0 M2=0 M3=-9,19991918836183 FrameElem=36-1 ElemStation=0,04

Frame=36 Station=0,08 OutputCase=RAR053 CaseType=Combination P=-22,0341908468953 V2=70,9985988032737 V3=0 T=0 M2=0 M3=-11,9710631404928 FrameElem=36-1 ElemStation=0,08

Frame=36 Station=0 OutputCase=RAR054 CaseType=Combination P=-12,1158013296516 V2=17,366506339298 V3=0 T=0 M2=0 M3=-6,81928211960301 FrameElem=36-1 ElemStation=0

Frame=36 Station=0,04 OutputCase=RAR054 CaseType=Combination P=-12,1158013296516 V2=17,926506339298 V3=0 T=0 M2=0 M3=-7,52514237317494 FrameElem=36-1 ElemStation=0,04

Frame=36 Station=0,08 OutputCase=RAR054 CaseType=Combination P=-12,1158013296516 V2=18,486506339298 V3=0 T=0 M2=0 M3=-8,25340262674685 FrameElem=36-1 ElemStation=0,08

Frame=36 Station=0 OutputCase=RAR055 CaseType=Combination P=-21,3140835714729 V2=10,1185988029027 V3=0 T=0 M2=0 M3=-2,65433625762442 FrameElem=36-1 ElemStation=0

Frame=36 Station=0,04 OutputCase=RAR055 CaseType=Combination P=-21,3140835714729 V2=10,6785988029027 V3=0 T=0 M2=0 M3=-3,07028020974053 FrameElem=36-1 ElemStation=0,04

Frame=36 Station=0,08 OutputCase=RAR055 CaseType=Combination P=-21,3140835714729 V2=11,2385988029027 V3=0 T=0 M2=0 M3=-3,50862416185663 FrameElem=36-1 ElemStation=0,08

Frame=36 Station=0 OutputCase=RAR056 CaseType=Combination P=-3,2989741172463 V2=10,8814011976789 V3=0 T=0 M2=0 M3=-1,21398379291613 FrameElem=36-1 ElemStation=0

Frame=36 Station=0,04 OutputCase=RAR056 CaseType=Combination P=-3,2989741172463 V2=11,4414011976789 V3=0 T=0 M2=0 M3=-1,66043984082329 FrameElem=36-1 ElemStation=0,04

Frame=36 Station=0,08 OutputCase=RAR056 CaseType=Combination P=-3,2989741172463 V2=12,0014011976789 V3=0 T=0 M2=0 M3=-2,12929588873044 FrameElem=36-1 ElemStation=0,08

Frame=36 Station=0 OutputCase=RAR057 CaseType=Combination P=-4,01908139266867 V2=64,8814011980499 V3=0 T=0 M2=0 M3=-5,12602277152259 FrameElem=36-1 ElemStation=0

Frame=36 Station=0,04 OutputCase=RAR057 CaseType=Combination P=-4,01908139266867 V2=68,3214011980499 V3=0 T=0 M2=0 M3=-7,79007881944459 FrameElem=36-1 ElemStation=0,04

Frame=36 Station=0,08 OutputCase=RAR057 CaseType=Combination P=-4,01908139266867 V2=71,7614011980499 V3=0 T=0 M2=0 M3=-10,5917348673666 FrameElem=36-1 ElemStation=0,08

Frame=36 Station=0 OutputCase=RAR058 CaseType=Combination P=-13,2173636195888 V2=72,1293087350856 V3=0 T=0 M2=0 M3=-11,8329382147018 FrameElem=36-1 ElemStation=0

Frame=36 Station=0,04 OutputCase=RAR058 CaseType=Combination P=-13,2173636195888 V2=75,5693087350856 V3=0 T=0 M2=0 M3=-14,7869105641053 FrameElem=36-1 ElemStation=0,04

Frame=36 Station=0,08 OutputCase=RAR058 CaseType=Combination P=-13,2173636195888 V2=79,0093087350856 V3=0 T=0 M2=0 M3=-17,8784829135087 FrameElem=36-1 ElemStation=0,08

Frame=36 Station=0 OutputCase=RAR059 CaseType=Combination P=-22,4156458614101 V2=64,8814011986902 V3=0 T=0 M2=0 M3=-7,66799235272324 FrameElem=36-1 ElemStation=0

Frame=36 Station=0,04 OutputCase=RAR059 CaseType=Combination P=-22,4156458614101 V2=68,3214011986902 V3=0 T=0 M2=0 M3=-10,3320484006708 FrameElem=36-1 ElemStation=0,04

Frame=36 Station=0,08 OutputCase=RAR059 CaseType=Combination P=-22,4156458614101 V2=71,7614011986902 V3=0 T=0 M2=0 M3=-13,1337044486185 FrameElem=36-1 ElemStation=0,08

Frame=36 Station=0 OutputCase=RAR060 CaseType=Combination P=-12,4972563441664 V2=18,1293087347145 V3=0 T=0 M2=0 M3=-7,92089923609537 FrameElem=36-1 ElemStation=0

Frame=36 Station=0,04 OutputCase=RAR060 CaseType=Combination P=-12,4972563441664 V2=18,6893087347145 V3=0 T=0 M2=0 M3=-8,65727158548395 FrameElem=36-1 ElemStation=0,04

Frame=36 Station=0,08 OutputCase=RAR060 CaseType=Combination P=-12,4972563441664 V2=19,2493087347145 V3=0 T=0 M2=0 M3=-9,41604393487253 FrameElem=36-1 ElemStation=0,08

Frame=36 Station=0 OutputCase=RAR061 CaseType=Combination P=-21,6955385859877 V2=10,8814011983191 V3=0 T=0 M2=0 M3=-3,75595337411678 FrameElem=36-1 ElemStation=0

Frame=36 Station=0,04 OutputCase=RAR061 CaseType=Combination P=-21,6955385859877 V2=11,4414011983191 V3=0 T=0 M2=0 M3=-4,20240942204955 FrameElem=36-1 ElemStation=0,04

Frame=36 Station=0,08 OutputCase=RAR061 CaseType=Combination P=-21,6955385859877 V2=12,0014011983191 V3=0 T=0 M2=0 M3=-4,67126546998231 FrameElem=36-1 ElemStation=0,08

Società di Progetto
Brebemi SpA



Doc. N.
60235-0000-A00.doc

CODIFICA DOCUMENTO
04RCDII10000000000300A00

REV.
00

FOGLIO
490 di 628

Frame=36 Station=0 OutputCase=RAR062 CaseType=Combination P=-2,64851550703946 V2=10,4999999999704 V3=0 T=0 M2=0 M3=-0,281720220155063 FrameElem=36-1 ElemStation=0

Frame=36 Station=0,04 OutputCase=RAR062 CaseType=Combination P=-2,64851550703946 V2=11,0599999999704 V3=0 T=0 M2=0 M3=-0,712920220153881 FrameElem=36-1 ElemStation=0,04

Frame=36 Station=0,08 OutputCase=RAR062 CaseType=Combination P=-2,64851550703946 V2=11,6199999999704 V3=0 T=0 M2=0 M3=-1,1665202201527 FrameElem=36-1 ElemStation=0,08

Frame=36 Station=0 OutputCase=RAR063 CaseType=Combination P=-3,36862278246183 V2=64,5000000003415 V3=0 T=0 M2=0 M3=-4,19375919876152 FrameElem=36-1 ElemStation=0

Frame=36 Station=0,04 OutputCase=RAR063 CaseType=Combination P=-3,36862278246183 V2=67,9400000003415 V3=0 T=0 M2=0 M3=-6,84255919877518 FrameElem=36-1 ElemStation=0,04

Frame=36 Station=0,08 OutputCase=RAR063 CaseType=Combination P=-3,36862278246183 V2=71,3800000003415 V3=0 T=0 M2=0 M3=-9,62895919878884 FrameElem=36-1 ElemStation=0,08

Frame=36 Station=0 OutputCase=RAR064 CaseType=Combination P=-12,566905009382 V2=71,7479075373772 V3=0 T=0 M2=0 M3=-10,9006746419408 FrameElem=36-1 ElemStation=0

Frame=36 Station=0,04 OutputCase=RAR064 CaseType=Combination P=-12,566905009382 V2=75,1879075373772 V3=0 T=0 M2=0 M3=-13,8393909434359 FrameElem=36-1 ElemStation=0,04

Frame=36 Station=0,08 OutputCase=RAR064 CaseType=Combination P=-12,566905009382 V2=78,6279075373772 V3=0 T=0 M2=0 M3=-16,9157072449309 FrameElem=36-1 ElemStation=0,08

Frame=36 Station=0 OutputCase=RAR065 CaseType=Combination P=-21,7651872512032 V2=64,5000000009818 V3=0 T=0 M2=0 M3=-6,73572877996217 FrameElem=36-1 ElemStation=0

Frame=36 Station=0,04 OutputCase=RAR065 CaseType=Combination P=-21,7651872512032 V2=67,9400000009818 V3=0 T=0 M2=0 M3=-9,38452878000144 FrameElem=36-1 ElemStation=0,04

Frame=36 Station=0,08 OutputCase=RAR065 CaseType=Combination P=-21,7651872512032 V2=71,3800000009818 V3=0 T=0 M2=0 M3=-12,1709287800407 FrameElem=36-1 ElemStation=0,08

Frame=36 Station=0 OutputCase=RAR066 CaseType=Combination P=-11,8467977339596 V2=17,7479075370061 V3=0 T=0 M2=0 M3=-6,9886356633343 FrameElem=36-1 ElemStation=0

Frame=36 Station=0,04 OutputCase=RAR066 CaseType=Combination P=-11,8467977339596 V2=18,3079075370061 V3=0 T=0 M2=0 M3=-7,70975196481455 FrameElem=36-1 ElemStation=0,04

Frame=36 Station=0,08 OutputCase=RAR066 CaseType=Combination P=-11,8467977339596 V2=18,8679075370061 V3=0 T=0 M2=0 M3=-8,45326826629479 FrameElem=36-1 ElemStation=0,08

Frame=36 Station=0 OutputCase=RAR067 CaseType=Combination P=-21,0450799757809 V2=10,5000000006107 V3=0 T=0 M2=0 M3=-2,82368980135571 FrameElem=36-1 ElemStation=0

Frame=36 Station=0,04 OutputCase=RAR067 CaseType=Combination P=-21,0450799757809 V2=11,0600000006107 V3=0 T=0 M2=0 M3=-3,25488980138014 FrameElem=36-1 ElemStation=0,04

Frame=36 Station=0,08 OutputCase=RAR067 CaseType=Combination P=-21,0450799757809 V2=11,6200000006107 V3=0 T=0 M2=0 M3=-3,70848980140457 FrameElem=36-1 ElemStation=0,08

Frame=36 Station=0 OutputCase=RAR068 CaseType=Combination P=-3,55658593614232 V2=9,86433133712383 V3=0 T=0 M2=0 M3=-0,380919328451138 FrameElem=36-1 ElemStation=0

Frame=36 Station=0,04 OutputCase=RAR068 CaseType=Combination P=-3,55658593614232 V2=10,4243313371238 V3=0 T=0 M2=0 M3=-0,786692581936092 FrameElem=36-1 ElemStation=0,04

Frame=36 Station=0,08 OutputCase=RAR068 CaseType=Combination P=-3,55658593614232 V2=10,9843313371238 V3=0 T=0 M2=0 M3=-1,21486583542104 FrameElem=36-1 ElemStation=0,08

Frame=36 Station=0 OutputCase=RAR069 CaseType=Combination P=-4,64388064154374 V2=82,1185988027574 V3=0 T=0 M2=0 M3=-5,96417700542387 FrameElem=36-1 ElemStation=0

Frame=36 Station=0,04 OutputCase=RAR069 CaseType=Combination P=-4,64388064154374 V2=86,5185988027574 V3=0 T=0 M2=0 M3=-9,33692095753417 FrameElem=36-1 ElemStation=0,04

Frame=36 Station=0,08 OutputCase=RAR069 CaseType=Combination P=-4,64388064154374 V2=90,9185988027574 V3=0 T=0 M2=0 M3=-12,8856649096445 FrameElem=36-1 ElemStation=0,08

Frame=36 Station=0 OutputCase=RAR070 CaseType=Combination P=-16,4693113514124 V2=91,4597428963608 V3=0 T=0 M2=0 M3=-14,5924674422456 FrameElem=36-1 ElemStation=0

Frame=36 Station=0,04 OutputCase=RAR070 CaseType=Combination P=-16,4693113514124 V2=95,8597428963608 V3=0 T=0 M2=0 M3=-18,3388571581001 FrameElem=36-1 ElemStation=0,04

Frame=36 Station=0,08 OutputCase=RAR070 CaseType=Combination P=-16,4693113514124 V2=100,259742896361 V3=0 T=0 M2=0 M3=-22,2612468739545 FrameElem=36-1 ElemStation=0,08

Frame=36 Station=0 OutputCase=RAR071 CaseType=Combination P=-28,2947420817702 V2=82,1185988035723 V3=0 T=0 M2=0 M3=-9,20904173917078 FrameElem=36-1 ElemStation=0

Frame=36 Station=0,04 OutputCase=RAR071 CaseType=Combination P=-28,2947420817702 V2=86,5185988035723 V3=0 T=0 M2=0 M3=-12,5817856913137 FrameElem=36-1 ElemStation=0,04

Frame=36 Station=0,08 OutputCase=RAR071 CaseType=Combination P=-28,2947420817702 V2=90,9185988035723 V3=0 T=0 M2=0 M3=-16,1305296434566 FrameElem=36-1 ElemStation=0,08

Frame=36 Station=0 OutputCase=RAR072 CaseType=Combination P=-15,5091683175159 V2=19,459742895866 V3=0 T=0 M2=0 M3=-9,37641547077036 FrameElem=36-1 ElemStation=0

Frame=36 Station=0,04 OutputCase=RAR072 CaseType=Combination P=-15,5091683175159 V2=20,019742895866 V3=0 T=0 M2=0 M3=-10,166005186605 FrameElem=36-1 ElemStation=0,04

Frame=36 Station=0,08 OutputCase=RAR072 CaseType=Combination P=-15,5091683175159 V2=20,579742895866 V3=0 T=0 M2=0 M3=-10,9779949024396 FrameElem=36-1 ElemStation=0,08

Frame=36 Station=0 OutputCase=RAR073 CaseType=Combination P=-27,3345990478737 V2=10,1185988030776 V3=0 T=0 M2=0 M3=-3,9929897676955 FrameElem=36-1 ElemStation=0

Frame=36 Station=0,04 OutputCase=RAR073 CaseType=Combination P=-27,3345990478737 V2=10,6785988030776 V3=0 T=0 M2=0 M3=-4,4089337198186 FrameElem=36-1 ElemStation=0,04

Frame=36 Station=0,08 OutputCase=RAR073 CaseType=Combination P=-27,3345990478737 V2=11,2385988030776 V3=0 T=0 M2=0 M3=-4,8472776719417 FrameElem=36-1 ElemStation=0,08

Frame=36 Station=0 OutputCase=RAR074 CaseType=Combination P=-26,1271271159502 V2=85,7145898879172 V3=0 T=0 M2=0 M3=-22,1281421166291 FrameElem=36-1 ElemStation=0

Frame=36 Station=0,04 OutputCase=RAR074 CaseType=Combination P=-26,7951271159502 V2=89,1545898879172 V3=0 T=0 M2=0 M3=-25,6255257121458 FrameElem=36-1 ElemStation=0,04

Frame=36 Station=0,08 OutputCase=RAR074 CaseType=Combination P=-27,4631271159502 V2=92,5945898879172 V3=0 T=0 M2=0 M3=-29,2605093076625 FrameElem=36-1 ElemStation=0,08

Frame=36 Station=0 OutputCase=RAR075 CaseType=Combination P=-4,27669321156469 V2=63,8643313374949 V3=0 T=0 M2=0 M3=-4,2929583070576 FrameElem=36-1 ElemStation=0

Frame=36 Station=0,04 OutputCase=RAR075 CaseType=Combination P=-4,27669321156469 V2=67,3043313374949 V3=0 T=0 M2=0 M3=-6,91633156055739 FrameElem=36-1 ElemStation=0,04

Frame=36 Station=0,08 OutputCase=RAR075 CaseType=Combination P=-4,27669321156469 V2=70,7443313374949 V3=0 T=0 M2=0 M3=-9,67730481405719 FrameElem=36-1 ElemStation=0,08

Frame=36 Station=0 OutputCase=RAR076 CaseType=Combination P=-13,4749754384848 V2=71,1122388745305 V3=0 T=0 M2=0 M3=-10,9998737502368 FrameElem=36-1 ElemStation=0

Frame=36 Station=0,04 OutputCase=RAR076 CaseType=Combination P=-13,4749754384848 V2=74,5522388745305 V3=0 T=0 M2=0 M3=-13,9131633052181 FrameElem=36-1 ElemStation=0,04

Società di Progetto
Brebemi SpA



Doc. N.
60235-00000-A00.doc

CODIFICA DOCUMENTO
04RCDII10000000000300A00

REV.
00

FOGLIO
491 di 628

Frame=36 Station=0,08 OutputCase=RAR076 CaseType=Combination P=-13,474975438484 V2=77,9922388745305 V3=0 T=0 M2=0 M3=-16,9640528601993 FrameElem=36-1 ElemStation=0,08
Frame=36 Station=0 OutputCase=RAR077 CaseType=Combination P=-22,6732576803061 V2=63,8643313381352 V3=0 T=0 M2=0 M3=-6,83492788825825 FrameElem=36-1 ElemStation=0
Frame=36 Station=0,04 OutputCase=RAR077 CaseType=Combination P=-22,6732576803061 V2=67,3043313381352 V3=0 T=0 M2=0 M3=-9,45830114178365 FrameElem=36-1 ElemStation=0,04
Frame=36 Station=0,08 OutputCase=RAR077 CaseType=Combination P=-22,6732576803061 V2=70,7443313381352 V3=0 T=0 M2=0 M3=-12,2192743953091 FrameElem=36-1 ElemStation=0,08
Frame=36 Station=0 OutputCase=RAR078 CaseType=Combination P=-12,7548681630624 V2=17,1122388741595 V3=0 T=0 M2=0 M3=-7,08783477163038 FrameElem=36-1 ElemStation=0
Frame=36 Station=0,04 OutputCase=RAR078 CaseType=Combination P=-12,7548681630624 V2=17,6722388741595 V3=0 T=0 M2=0 M3=-7,78352432659676 FrameElem=36-1 ElemStation=0,04
Frame=36 Station=0,08 OutputCase=RAR078 CaseType=Combination P=-12,7548681630624 V2=18,2322388741595 V3=0 T=0 M2=0 M3=-8,50161388156314 FrameElem=36-1 ElemStation=0,08
Frame=36 Station=0 OutputCase=RAR079 CaseType=Combination P=-21,9531504048837 V2=9,86433133776411 V3=0 T=0 M2=0 M3=-2,92288890965178 FrameElem=36-1 ElemStation=0
Frame=36 Station=0,04 OutputCase=RAR079 CaseType=Combination P=-21,9531504048837 V2=10,4243313377641 V3=0 T=0 M2=0 M3=-3,32866216316235 FrameElem=36-1 ElemStation=0,04
Frame=36 Station=0,08 OutputCase=RAR079 CaseType=Combination P=-21,9531504048837 V2=10,9843313377641 V3=0 T=0 M2=0 M3=-3,75683541667291 FrameElem=36-1 ElemStation=0,08
Frame=36 Station=0 OutputCase=RAR080 CaseType=Combination P=-4,01631703909176 V2=9,864331337124 V3=0 T=0 M2=0 M3=-0,762374342966029 FrameElem=36-1 ElemStation=0
Frame=36 Station=0,04 OutputCase=RAR080 CaseType=Combination P=-4,01631703909176 V2=10,424331337124 V3=0 T=0 M2=0 M3=-1,16814759645099 FrameElem=36-1 ElemStation=0,04
Frame=36 Station=0,08 OutputCase=RAR080 CaseType=Combination P=-4,01631703909176 V2=10,984331337124 V3=0 T=0 M2=0 M3=-1,59632084993595 FrameElem=36-1 ElemStation=0,08
Frame=36 Station=0 OutputCase=RAR081 CaseType=Combination P=-4,73642431451413 V2=63,8643313374951 V3=0 T=0 M2=0 M3=-4,67441332157249 FrameElem=36-1 ElemStation=0
Frame=36 Station=0,04 OutputCase=RAR081 CaseType=Combination P=-4,73642431451413 V2=67,3043313374951 V3=0 T=0 M2=0 M3=-7,29778657507229 FrameElem=36-1 ElemStation=0,04
Frame=36 Station=0,08 OutputCase=RAR081 CaseType=Combination P=-4,73642431451413 V2=70,7443313374951 V3=0 T=0 M2=0 M3=-10,0587598285721 FrameElem=36-1 ElemStation=0,08
Frame=36 Station=0 OutputCase=RAR082 CaseType=Combination P=-13,9347065414343 V2=71,1122388745307 V3=0 T=0 M2=0 M3=-11,3813287647517 FrameElem=36-1 ElemStation=0
Frame=36 Station=0,04 OutputCase=RAR082 CaseType=Combination P=-13,9347065414343 V2=74,5522388745307 V3=0 T=0 M2=0 M3=-14,294618319733 FrameElem=36-1 ElemStation=0,04
Frame=36 Station=0,08 OutputCase=RAR082 CaseType=Combination P=-13,9347065414343 V2=77,9922388745307 V3=0 T=0 M2=0 M3=-17,3455078747142 FrameElem=36-1 ElemStation=0,08
Frame=36 Station=0 OutputCase=RAR083 CaseType=Combination P=-23,1329887832556 V2=63,8643313381354 V3=0 T=0 M2=0 M3=-7,21638290277314 FrameElem=36-1 ElemStation=0
Frame=36 Station=0,04 OutputCase=RAR083 CaseType=Combination P=-23,1329887832556 V2=67,3043313381354 V3=0 T=0 M2=0 M3=-9,83975615629855 FrameElem=36-1 ElemStation=0,04
Frame=36 Station=0,08 OutputCase=RAR083 CaseType=Combination P=-23,1329887832556 V2=70,7443313381354 V3=0 T=0 M2=0 M3=-12,600729409824 FrameElem=36-1 ElemStation=0,08
Frame=36 Station=0 OutputCase=RAR084 CaseType=Combination P=-13,2145992660119 V2=17,1122388741596 V3=0 T=0 M2=0 M3=-7,46928978614527 FrameElem=36-1 ElemStation=0
Frame=36 Station=0,04 OutputCase=RAR084 CaseType=Combination P=-13,2145992660119 V2=17,6722388741596 V3=0 T=0 M2=0 M3=-8,16497934111166 FrameElem=36-1 ElemStation=0,04
Frame=36 Station=0,08 OutputCase=RAR084 CaseType=Combination P=-13,2145992660119 V2=18,2322388741596 V3=0 T=0 M2=0 M3=-8,88306889607804 FrameElem=36-1 ElemStation=0,08
Frame=36 Station=0 OutputCase=RAR085 CaseType=Combination P=-22,4128815078332 V2=9,86433133776428 V3=0 T=0 M2=0 M3=-3,30434392416668 FrameElem=36-1 ElemStation=0
Frame=36 Station=0,04 OutputCase=RAR085 CaseType=Combination P=-22,4128815078332 V2=10,4243313377643 V3=0 T=0 M2=0 M3=-3,71011717767725 FrameElem=36-1 ElemStation=0,04
Frame=36 Station=0,08 OutputCase=RAR085 CaseType=Combination P=-22,4128815078332 V2=10,9843313377643 V3=0 T=0 M2=0 M3=-4,13829043118782 FrameElem=36-1 ElemStation=0,08
Frame=36 Station=0 OutputCase=RAR086 CaseType=Combination P=-3,09685483319287 V2=9,86433133712366 V3=0 T=0 M2=0 M3=5,35686063752316E-04 FrameElem=36-1 ElemStation=0
Frame=36 Station=0,04 OutputCase=RAR086 CaseType=Combination P=-3,09685483319287 V2=10,4243313371237 V3=0 T=0 M2=0 M3=-0,405237567421194 FrameElem=36-1 ElemStation=0,04
Frame=36 Station=0,08 OutputCase=RAR086 CaseType=Combination P=-3,09685483319287 V2=10,9843313371237 V3=0 T=0 M2=0 M3=-0,83341082090614 FrameElem=36-1 ElemStation=0,08
Frame=36 Station=0 OutputCase=RAR087 CaseType=Combination P=-3,81696210861524 V2=63,8643313374947 V3=0 T=0 M2=0 M3=-3,91150329254271 FrameElem=36-1 ElemStation=0
Frame=36 Station=0,04 OutputCase=RAR087 CaseType=Combination P=-3,81696210861524 V2=67,3043313374947 V3=0 T=0 M2=0 M3=-6,5348765460425 FrameElem=36-1 ElemStation=0,04
Frame=36 Station=0,08 OutputCase=RAR087 CaseType=Combination P=-3,81696210861524 V2=70,7443313374947 V3=0 T=0 M2=0 M3=-9,29584979954228 FrameElem=36-1 ElemStation=0,08
Frame=36 Station=0 OutputCase=RAR088 CaseType=Combination P=-13,0152443355354 V2=71,1122388745304 V3=0 T=0 M2=0 M3=-10,6184187357219 FrameElem=36-1 ElemStation=0
Frame=36 Station=0,04 OutputCase=RAR088 CaseType=Combination P=-13,0152443355354 V2=74,5522388745304 V3=0 T=0 M2=0 M3=-13,5317082907032 FrameElem=36-1 ElemStation=0,04
Frame=36 Station=0,08 OutputCase=RAR088 CaseType=Combination P=-13,0152443355354 V2=77,9922388745304 V3=0 T=0 M2=0 M3=-16,5825978456844 FrameElem=36-1 ElemStation=0,08
Frame=36 Station=0 OutputCase=RAR089 CaseType=Combination P=-22,2135265773567 V2=63,864331338135 V3=0 T=0 M2=0 M3=-6,45347287374336 FrameElem=36-1 ElemStation=0
Frame=36 Station=0,04 OutputCase=RAR089 CaseType=Combination P=-22,2135265773567 V2=67,304331338135 V3=0 T=0 M2=0 M3=-9,07684612726876 FrameElem=36-1 ElemStation=0,04
Frame=36 Station=0,08 OutputCase=RAR089 CaseType=Combination P=-22,2135265773567 V2=70,744331338135 V3=0 T=0 M2=0 M3=-11,8378193807942 FrameElem=36-1 ElemStation=0,08
Frame=36 Station=0 OutputCase=RAR090 CaseType=Combination P=-12,295137060113 V2=17,1122388741593 V3=0 T=0 M2=0 M3=-6,70637975711549 FrameElem=36-1 ElemStation=0
Frame=36 Station=0,04 OutputCase=RAR090 CaseType=Combination P=-12,295137060113 V2=17,6722388741593 V3=0 T=0 M2=0 M3=-7,40206931208186 FrameElem=36-1 ElemStation=0,04
Frame=36 Station=0,08 OutputCase=RAR090 CaseType=Combination P=-12,295137060113 V2=18,2322388741593 V3=0 T=0 M2=0 M3=-8,12015886704823 FrameElem=36-1 ElemStation=0,08
Frame=36 Station=0 OutputCase=RAR091 CaseType=Combination P=-21,4934193019343 V2=9,86433133776394 V3=0 T=0 M2=0 M3=-2,54143389513689 FrameElem=36-1 ElemStation=0

Società di Progetto
Brebemi SpA



Doc. N.
60235-0000-A00.doc

CODIFICA DOCUMENTO
04RCDII10000000000300A00

REV.
00

FOGLIO
492 di 628

Frame=36 Station=0,04 OutputCase=RAR091 CaseType=Combination P=-,21,4934193019343 V2=10,4243313377639 V3=0 T=0 M2=0 M3=-,2,94720714864745 FrameElem=36-1 ElemStation=0,04
Frame=36 Station=0,08 OutputCase=RAR091 CaseType=Combination P=-,21,4934193019343 V2=10,9843313377639 V3=0 T=0 M2=0 M3=-,3,37538040215801 FrameElem=36-1 ElemStation=0,08
Frame=36 Station=0 OutputCase=RAR092 CaseType=Combination P=-,3,09685483319287 V2=9,86433133712366 V3=0 T=0 M2=0 M3=5,35686063752261E-04 FrameElem=36-1 ElemStation=0
Frame=36 Station=0,04 OutputCase=RAR092 CaseType=Combination P=-,3,09685483319287 V2=10,4243313371237 V3=0 T=0 M2=0 M3=-,0,405237567421194 FrameElem=36-1 ElemStation=0,04
Frame=36 Station=0,08 OutputCase=RAR092 CaseType=Combination P=-,3,09685483319287 V2=10,9843313371237 V3=0 T=0 M2=0 M3=-,0,83341082090614 FrameElem=36-1 ElemStation=0,08
Frame=36 Station=0 OutputCase=RAR093 CaseType=Combination P=-,3,81696210861524 V2=63,8643313374947 V3=0 T=0 M2=0 M3=-,3,91150329254271 FrameElem=36-1 ElemStation=0
Frame=36 Station=0,04 OutputCase=RAR093 CaseType=Combination P=-,3,81696210861524 V2=67,3043313374947 V3=0 T=0 M2=0 M3=-,6,5348765460425 FrameElem=36-1 ElemStation=0,04
Frame=36 Station=0,08 OutputCase=RAR093 CaseType=Combination P=-,3,81696210861524 V2=70,7443313374947 V3=0 T=0 M2=0 M3=-,9,29584979954228 FrameElem=36-1 ElemStation=0,08
Frame=36 Station=0 OutputCase=RAR094 CaseType=Combination P=-,13,0152443355354 V2=71,1122388745304 V3=0 T=0 M2=0 M3=-,10,6184187357219 FrameElem=36-1 ElemStation=0
Frame=36 Station=0,04 OutputCase=RAR094 CaseType=Combination P=-,13,0152443355354 V2=74,5522388745304 V3=0 T=0 M2=0 M3=-,13,5317082907032 FrameElem=36-1 ElemStation=0,04
Frame=36 Station=0,08 OutputCase=RAR094 CaseType=Combination P=-,13,0152443355354 V2=77,9922388745304 V3=0 T=0 M2=0 M3=-,16,5825978456844 FrameElem=36-1 ElemStation=0,08
Frame=36 Station=0 OutputCase=RAR095 CaseType=Combination P=-,22,2135265773567 V2=63,864331338135 V3=0 T=0 M2=0 M3=-,6,45347287374336 FrameElem=36-1 ElemStation=0
Frame=36 Station=0,04 OutputCase=RAR095 CaseType=Combination P=-,22,2135265773567 V2=67,304331338135 V3=0 T=0 M2=0 M3=-,9,07684612726876 FrameElem=36-1 ElemStation=0,04
Frame=36 Station=0,08 OutputCase=RAR095 CaseType=Combination P=-,22,2135265773567 V2=70,744331338135 V3=0 T=0 M2=0 M3=-,11,8378193807942 FrameElem=36-1 ElemStation=0,08
Frame=36 Station=0 OutputCase=RAR096 CaseType=Combination P=-,12,295137060113 V2=17,1122388741593 V3=0 T=0 M2=0 M3=-,6,70637975711549 FrameElem=36-1 ElemStation=0
Frame=36 Station=0,04 OutputCase=RAR096 CaseType=Combination P=-,12,295137060113 V2=17,6722388741593 V3=0 T=0 M2=0 M3=-,7,40206931208186 FrameElem=36-1 ElemStation=0,04
Frame=36 Station=0,08 OutputCase=RAR096 CaseType=Combination P=-,12,295137060113 V2=18,2322388741593 V3=0 T=0 M2=0 M3=-,8,12015886704823 FrameElem=36-1 ElemStation=0,08
Frame=36 Station=0 OutputCase=RAR097 CaseType=Combination P=-,21,4934193019343 V2=9,86433133776394 V3=0 T=0 M2=0 M3=-,2,54143389513689 FrameElem=36-1 ElemStation=0
Frame=36 Station=0,04 OutputCase=RAR097 CaseType=Combination P=-,21,4934193019343 V2=10,4243313377639 V3=0 T=0 M2=0 M3=-,2,94720714864745 FrameElem=36-1 ElemStation=0,04
Frame=36 Station=0,08 OutputCase=RAR097 CaseType=Combination P=-,21,4934193019343 V2=10,9843313377639 V3=0 T=0 M2=0 M3=-,3,37538040215801 FrameElem=36-1 ElemStation=0,08
Frame=36 Station=0 OutputCase=RAR098 CaseType=Combination P=-,4,19234429366697 V2=11,135668662818 V3=0 T=0 M2=0 M3=-,2,2169478559384 FrameElem=36-1 ElemStation=0
Frame=36 Station=0,04 OutputCase=RAR098 CaseType=Combination P=-,4,19234429366697 V2=11,695668662818 V3=0 T=0 M2=0 M3=-,2,67357460245112 FrameElem=36-1 ElemStation=0,04
Frame=36 Station=0,08 OutputCase=RAR098 CaseType=Combination P=-,4,19234429366697 V2=12,255668662818 V3=0 T=0 M2=0 M3=-,3,15260134896384 FrameElem=36-1 ElemStation=0,08
Frame=36 Station=0 OutputCase=RAR099 CaseType=Combination P=-,5,02533565605853 V2=82,8814011981739 V3=0 T=0 M2=0 M3=-,7,06579412191623 FrameElem=36-1 ElemStation=0
Frame=36 Station=0,04 OutputCase=RAR099 CaseType=Combination P=-,5,02533565605853 V2=87,2814011981739 V3=0 T=0 M2=0 M3=-,10,4690501698432 FrameElem=36-1 ElemStation=0,04
Frame=36 Station=0,08 OutputCase=RAR099 CaseType=Combination P=-,5,02533565605853 V2=91,6814011981739 V3=0 T=0 M2=0 M3=-,14,0483062177701 FrameElem=36-1 ElemStation=0,08
Frame=36 Station=0 OutputCase=RAR100 CaseType=Combination P=-,16,8507663659272 V2=92,2225452917773 V3=0 T=0 M2=0 M3=-,15,694048558738 FrameElem=36-1 ElemStation=0
Frame=36 Station=0,04 OutputCase=RAR100 CaseType=Combination P=-,16,8507663659272 V2=96,6225452917773 V3=0 T=0 M2=0 M3=-,19,4709863704091 FrameElem=36-1 ElemStation=0,04
Frame=36 Station=0,08 OutputCase=RAR100 CaseType=Combination P=-,16,8507663659272 V2=101,022545291777 V3=0 T=0 M2=0 M3=-,23,4238881820802 FrameElem=36-1 ElemStation=0,08
Frame=36 Station=0 OutputCase=RAR101 CaseType=Combination P=-,28,676197096285 V2=82,8814011989888 V3=0 T=0 M2=0 M3=-,10,3106588556631 FrameElem=36-1 ElemStation=0
Frame=36 Station=0,04 OutputCase=RAR101 CaseType=Combination P=-,28,676197096285 V2=87,2814011989888 V3=0 T=0 M2=0 M3=-,13,7139149036227 FrameElem=36-1 ElemStation=0,04
Frame=36 Station=0,08 OutputCase=RAR101 CaseType=Combination P=-,28,676197096285 V2=91,6814011989888 V3=0 T=0 M2=0 M3=-,17,2931709515822 FrameElem=36-1 ElemStation=0,08
Frame=36 Station=0 OutputCase=RAR102 CaseType=Combination P=-,15,8906233320307 V2=20,2225452912825 V3=0 T=0 M2=0 M3=-,10,4780325872627 FrameElem=36-1 ElemStation=0
Frame=36 Station=0,04 OutputCase=RAR102 CaseType=Combination P=-,15,8906233320307 V2=20,7825452912825 V3=0 T=0 M2=0 M3=-,11,298134398914 FrameElem=36-1 ElemStation=0,04
Frame=36 Station=0,08 OutputCase=RAR102 CaseType=Combination P=-,15,8906233320307 V2=21,3425452912825 V3=0 T=0 M2=0 M3=-,12,1406362105653 FrameElem=36-1 ElemStation=0,08
Frame=36 Station=0 OutputCase=RAR103 CaseType=Combination P=-,27,7160540623885 V2=10,881401198494 V3=0 T=0 M2=0 M3=-,5,09460688418786 FrameElem=36-1 ElemStation=0
Frame=36 Station=0,04 OutputCase=RAR103 CaseType=Combination P=-,27,7160540623885 V2=11,441401198494 V3=0 T=0 M2=0 M3=-,5,54106293212762 FrameElem=36-1 ElemStation=0,04
Frame=36 Station=0,08 OutputCase=RAR103 CaseType=Combination P=-,27,7160540623885 V2=12,001401198494 V3=0 T=0 M2=0 M3=-,6,00991898006738 FrameElem=36-1 ElemStation=0,08
Frame=36 Station=0 OutputCase=RAR104 CaseType=Combination P=-,26,508582130465 V2=86,4773922833337 V3=0 T=0 M2=0 M3=-,23,2297592331215 FrameElem=36-1 ElemStation=0
Frame=36 Station=0,04 OutputCase=RAR104 CaseType=Combination P=-,27,176582130465 V2=89,9173922833337 V3=0 T=0 M2=0 M3=-,26,7576549244548 FrameElem=36-1 ElemStation=0,04
Frame=36 Station=0,08 OutputCase=RAR104 CaseType=Combination P=-,27,844582130465 V2=93,3573922833337 V3=0 T=0 M2=0 M3=-,30,4231506157882 FrameElem=36-1 ElemStation=0,08
Frame=36 Station=0 OutputCase=RAR105 CaseType=Combination P=-,4,91245156908934 V2=65,135668663189 V3=0 T=0 M2=0 M3=-,6,12898683454486 FrameElem=36-1 ElemStation=0
Frame=36 Station=0,04 OutputCase=RAR105 CaseType=Combination P=-,4,91245156908934 V2=68,575668663189 V3=0 T=0 M2=0 M3=-,8,80321358107243 FrameElem=36-1 ElemStation=0,04
Frame=36 Station=0,08 OutputCase=RAR105 CaseType=Combination P=-,4,91245156908934 V2=72,015668663189 V3=0 T=0 M2=0 M3=-,11,6150403276 FrameElem=36-1 ElemStation=0,08

Società di Progetto
Brebemi SpA

	Doc. N. 60235-0000-A00.doc	CODIFICA DOCUMENTO 04RCDII10000000000300A00	REV. 00	FOGLIO 493 di 628
--	-------------------------------	--	------------	----------------------

Frame=36 Station=0 OutputCase=RAR106 CaseType=Combination P=-14,1107337960095 V2=72,3835762002247 V3=0 T=0 M2=0 M3=-12,8359022777241 FrameElem=36-1 ElemStation=0

Frame=36 Station=0,04 OutputCase=RAR106 CaseType=Combination P=-14,1107337960095 V2=75,8235762002247 V3=0 T=0 M2=0 M3=-15,8000453257331 FrameElem=36-1 ElemStation=0,04

Frame=36 Station=0,08 OutputCase=RAR106 CaseType=Combination P=-14,1107337960095 V2=79,2635762002247 V3=0 T=0 M2=0 M3=-18,9017883737421 FrameElem=36-1 ElemStation=0,08

Frame=36 Station=0 OutputCase=RAR107 CaseType=Combination P=-23,3090160378308 V2=65,1356686638293 V3=0 T=0 M2=0 M3=-8,67095641574551 FrameElem=36-1 ElemStation=0

Frame=36 Station=0,04 OutputCase=RAR107 CaseType=Combination P=-23,3090160378308 V2=68,5756686638293 V3=0 T=0 M2=0 M3=-11,3451831622987 FrameElem=36-1 ElemStation=0,04

Frame=36 Station=0,08 OutputCase=RAR107 CaseType=Combination P=-23,3090160378308 V2=72,0156686638293 V3=0 T=0 M2=0 M3=-14,1570099088519 FrameElem=36-1 ElemStation=0,08

Frame=36 Station=0 OutputCase=RAR108 CaseType=Combination P=-13,3906265205871 V2=18,3835761998536 V3=0 T=0 M2=0 M3=-8,92386329911765 FrameElem=36-1 ElemStation=0

Frame=36 Station=0,04 OutputCase=RAR108 CaseType=Combination P=-13,3906265205871 V2=18,9435761998536 V3=0 T=0 M2=0 M3=-9,67040634711179 FrameElem=36-1 ElemStation=0,04

Frame=36 Station=0,08 OutputCase=RAR108 CaseType=Combination P=-13,3906265205871 V2=19,5035761998536 V3=0 T=0 M2=0 M3=-10,4393493951059 FrameElem=36-1 ElemStation=0,08

Frame=36 Station=0 OutputCase=RAR109 CaseType=Combination P=-22,5889087624084 V2=11,1356686634582 V3=0 T=0 M2=0 M3=-4,75891743713905 FrameElem=36-1 ElemStation=0

Frame=36 Station=0,04 OutputCase=RAR109 CaseType=Combination P=-22,5889087624084 V2=11,6956686634582 V3=0 T=0 M2=0 M3=-5,21554418367738 FrameElem=36-1 ElemStation=0,04

Frame=36 Station=0,08 OutputCase=RAR109 CaseType=Combination P=-22,5889087624084 V2=12,2556686634582 V3=0 T=0 M2=0 M3=-5,69457093021571 FrameElem=36-1 ElemStation=0,08

Frame=36 Station=0 OutputCase=RAR110 CaseType=Combination P=-4,65207539661641 V2=11,1356686628181 V3=0 T=0 M2=0 M3=-2,59840287045329 FrameElem=36-1 ElemStation=0

Frame=36 Station=0,04 OutputCase=RAR110 CaseType=Combination P=-4,65207539661641 V2=11,6956686628181 V3=0 T=0 M2=0 M3=-3,05502961696602 FrameElem=36-1 ElemStation=0,04

Frame=36 Station=0,08 OutputCase=RAR110 CaseType=Combination P=-4,65207539661641 V2=12,2556686628181 V3=0 T=0 M2=0 M3=-3,53405636347875 FrameElem=36-1 ElemStation=0,08

Frame=36 Station=0 OutputCase=RAR111 CaseType=Combination P=-5,37218267203879 V2=65,1356686631892 V3=0 T=0 M2=0 M3=-6,51044184905976 FrameElem=36-1 ElemStation=0

Frame=36 Station=0,04 OutputCase=RAR111 CaseType=Combination P=-5,37218267203879 V2=68,5756686631892 V3=0 T=0 M2=0 M3=-9,18466859558732 FrameElem=36-1 ElemStation=0,04

Frame=36 Station=0,08 OutputCase=RAR111 CaseType=Combination P=-5,37218267203879 V2=72,0156686631892 V3=0 T=0 M2=0 M3=-11,9964953421149 FrameElem=36-1 ElemStation=0,08

Frame=36 Station=0 OutputCase=RAR112 CaseType=Combination P=-14,5704648989589 V2=72,3835762002249 V3=0 T=0 M2=0 M3=-13,217357292239 FrameElem=36-1 ElemStation=0

Frame=36 Station=0,04 OutputCase=RAR112 CaseType=Combination P=-14,5704648989589 V2=75,8235762002248 V3=0 T=0 M2=0 M3=-16,181500340248 FrameElem=36-1 ElemStation=0,04

Frame=36 Station=0,08 OutputCase=RAR112 CaseType=Combination P=-14,5704648989589 V2=79,2635762002248 V3=0 T=0 M2=0 M3=-19,283243388257 FrameElem=36-1 ElemStation=0,08

Frame=36 Station=0 OutputCase=RAR113 CaseType=Combination P=-23,7687471407802 V2=65,1356686638295 V3=0 T=0 M2=0 M3=-9,0524114302604 FrameElem=36-1 ElemStation=0

Frame=36 Station=0,04 OutputCase=RAR113 CaseType=Combination P=-23,7687471407802 V2=68,5756686638295 V3=0 T=0 M2=0 M3=-11,7266381768136 FrameElem=36-1 ElemStation=0,04

Frame=36 Station=0,08 OutputCase=RAR113 CaseType=Combination P=-23,7687471407802 V2=72,0156686638295 V3=0 T=0 M2=0 M3=-14,5384649233668 FrameElem=36-1 ElemStation=0,08

Frame=36 Station=0 OutputCase=RAR114 CaseType=Combination P=-13,8503576235365 V2=18,3835761998538 V3=0 T=0 M2=0 M3=-9,30531831363254 FrameElem=36-1 ElemStation=0

Frame=36 Station=0,04 OutputCase=RAR114 CaseType=Combination P=-13,8503576235365 V2=18,9435761998538 V3=0 T=0 M2=0 M3=-10,0518613616267 FrameElem=36-1 ElemStation=0,04

Frame=36 Station=0,08 OutputCase=RAR114 CaseType=Combination P=-13,8503576235365 V2=19,5035761998538 V3=0 T=0 M2=0 M3=-10,8208044096208 FrameElem=36-1 ElemStation=0,08

Frame=36 Station=0 OutputCase=RAR115 CaseType=Combination P=-23,0486398653578 V2=11,1356686634584 V3=0 T=0 M2=0 M3=-5,14037245165394 FrameElem=36-1 ElemStation=0

Frame=36 Station=0,04 OutputCase=RAR115 CaseType=Combination P=-23,0486398653578 V2=11,6956686634584 V3=0 T=0 M2=0 M3=-5,596999198192228 FrameElem=36-1 ElemStation=0,04

Frame=36 Station=0,08 OutputCase=RAR115 CaseType=Combination P=-23,0486398653578 V2=12,2556686634584 V3=0 T=0 M2=0 M3=-6,07602594473061 FrameElem=36-1 ElemStation=0,08

Frame=36 Station=0 OutputCase=RAR116 CaseType=Combination P=-3,73261319071753 V2=11,1356686628178 V3=0 T=0 M2=0 M3=-1,83549284142351 FrameElem=36-1 ElemStation=0

Frame=36 Station=0,04 OutputCase=RAR116 CaseType=Combination P=-3,73261319071753 V2=11,6956686628178 V3=0 T=0 M2=0 M3=-2,29211958793623 FrameElem=36-1 ElemStation=0,04

Frame=36 Station=0,08 OutputCase=RAR116 CaseType=Combination P=-3,73261319071753 V2=12,2556686628178 V3=0 T=0 M2=0 M3=-2,77114633444894 FrameElem=36-1 ElemStation=0,08

Frame=36 Station=0 OutputCase=RAR117 CaseType=Combination P=-4,45272046613989 V2=65,1356686631889 V3=0 T=0 M2=0 M3=-5,74753182002997 FrameElem=36-1 ElemStation=0

Frame=36 Station=0,04 OutputCase=RAR117 CaseType=Combination P=-4,45272046613989 V2=68,5756686631889 V3=0 T=0 M2=0 M3=-8,4217585655753 FrameElem=36-1 ElemStation=0,04

Frame=36 Station=0,08 OutputCase=RAR117 CaseType=Combination P=-4,45272046613989 V2=72,0156686631889 V3=0 T=0 M2=0 M3=-11,2335853130851 FrameElem=36-1 ElemStation=0,08

Frame=36 Station=0 OutputCase=RAR118 CaseType=Combination P=-13,65100269306 V2=72,3835762002245 V3=0 T=0 M2=0 M3=-12,4544472632092 FrameElem=36-1 ElemStation=0

Frame=36 Station=0,04 OutputCase=RAR118 CaseType=Combination P=-13,65100269306 V2=75,8235762002245 V3=0 T=0 M2=0 M3=-15,4185903112182 FrameElem=36-1 ElemStation=0,04

Frame=36 Station=0,08 OutputCase=RAR118 CaseType=Combination P=-13,65100269306 V2=79,2635762002245 V3=0 T=0 M2=0 M3=-18,5203333592272 FrameElem=36-1 ElemStation=0,08

Frame=36 Station=0 OutputCase=RAR119 CaseType=Combination P=-22,8492849348813 V2=65,1356686638292 V3=0 T=0 M2=0 M3=-8,28950140123062 FrameElem=36-1 ElemStation=0

Frame=36 Station=0,04 OutputCase=RAR119 CaseType=Combination P=-22,8492849348813 V2=68,5756686638291 V3=0 T=0 M2=0 M3=-10,9637281477838 FrameElem=36-1 ElemStation=0,04

Frame=36 Station=0,08 OutputCase=RAR119 CaseType=Combination P=-22,8492849348813 V2=72,0156686638291 V3=0 T=0 M2=0 M3=-13,775548943369 FrameElem=36-1 ElemStation=0,08

Frame=36 Station=0 OutputCase=RAR120 CaseType=Combination P=-12,9308954176377 V2=18,3835761998534 V3=0 T=0 M2=0 M3=-8,54240828460276 FrameElem=36-1 ElemStation=0

Frame=36 Station=0,04 OutputCase=RAR120 CaseType=Combination P=-12,9308954176377 V2=18,9435761998534 V3=0 T=0 M2=0 M3=-9,28895133259689 FrameElem=36-1 ElemStation=0,04

Società di Progetto
Brebemi SpA





Doc. N.
60235-0000-A00.doc

CODIFICA DOCUMENTO
04RCDII10000000000300A00

REV.
00

FOGLIO
494 di 628

Frame=36 Station=0,08 OutputCase=RAR120 CaseType=Combination P=-,12,9308954176377 V2=19,5035761998534 V3=0 T=0 M2=0 M3=-,10,057894380591 FrameElem=36-1 ElemStation=0,08

Frame=36 Station=0 OutputCase=RAR121 CaseType=Combination P=-,22,1291776594589 V2=11,1356686634581 V3=0 T=0 M2=0 M3=-,4,37746242262416 FrameElem=36-1 ElemStation=0

Frame=36 Station=0,04 OutputCase=RAR121 CaseType=Combination P=-,22,1291776594589 V2=11,6956686634581 V3=0 T=0 M2=0 M3=-,4,83408916916248 FrameElem=36-1 ElemStation=0,04

Frame=36 Station=0,08 OutputCase=RAR121 CaseType=Combination P=-,22,1291776594589 V2=12,2556686634581 V3=0 T=0 M2=0 M3=-,5,3131159157008 FrameElem=36-1 ElemStation=0,08

Frame=36 Station=0 OutputCase=RAR122 CaseType=Combination P=-,3,73261319071753 V2=11,1356686628178 V3=0 T=0 M2=0 M3=-,1,83549284142351 FrameElem=36-1 ElemStation=0

Frame=36 Station=0,04 OutputCase=RAR122 CaseType=Combination P=-,3,73261319071753 V2=11,6956686628178 V3=0 T=0 M2=0 M3=-,2,29211958793623 FrameElem=36-1 ElemStation=0,04

Frame=36 Station=0,08 OutputCase=RAR122 CaseType=Combination P=-,3,73261319071753 V2=12,2556686628178 V3=0 T=0 M2=0 M3=-,2,77114633444894 FrameElem=36-1 ElemStation=0,08

Frame=36 Station=0 OutputCase=RAR123 CaseType=Combination P=-,4,45272046613989 V2=65,1356686631889 V3=0 T=0 M2=0 M3=-,5,74753182002997 FrameElem=36-1 ElemStation=0

Frame=36 Station=0,04 OutputCase=RAR123 CaseType=Combination P=-,4,45272046613989 V2=68,5756686631889 V3=0 T=0 M2=0 M3=-,8,42175856655753 FrameElem=36-1 ElemStation=0,04

Frame=36 Station=0,08 OutputCase=RAR123 CaseType=Combination P=-,4,45272046613989 V2=72,0156686631889 V3=0 T=0 M2=0 M3=-,11,2335853130851 FrameElem=36-1 ElemStation=0,08

Frame=36 Station=0 OutputCase=RAR124 CaseType=Combination P=-,13,65100269306 V2=72,3835762002245 V3=0 T=0 M2=0 M3=-,12,4544472632092 FrameElem=36-1 ElemStation=0

Frame=36 Station=0,04 OutputCase=RAR124 CaseType=Combination P=-,13,65100269306 V2=75,8235762002245 V3=0 T=0 M2=0 M3=-,15,4185903112182 FrameElem=36-1 ElemStation=0,04

Frame=36 Station=0,08 OutputCase=RAR124 CaseType=Combination P=-,13,65100269306 V2=79,2635762002245 V3=0 T=0 M2=0 M3=-,18,5203333592272 FrameElem=36-1 ElemStation=0,08

Frame=36 Station=0 OutputCase=RAR125 CaseType=Combination P=-,22,8492849348813 V2=65,1356686638292 V3=0 T=0 M2=0 M3=-,8,28950140123062 FrameElem=36-1 ElemStation=0

Frame=36 Station=0,04 OutputCase=RAR125 CaseType=Combination P=-,22,8492849348813 V2=68,5756686638291 V3=0 T=0 M2=0 M3=-,10,9637281477838 FrameElem=36-1 ElemStation=0,04

Frame=36 Station=0,08 OutputCase=RAR125 CaseType=Combination P=-,22,8492849348813 V2=72,0156686638291 V3=0 T=0 M2=0 M3=-,13,775548943369 FrameElem=36-1 ElemStation=0,08

Frame=36 Station=0 OutputCase=RAR126 CaseType=Combination P=-,12,9308954176377 V2=18,3835761998534 V3=0 T=0 M2=0 M3=-,8,54240828460275 FrameElem=36-1 ElemStation=0

Frame=36 Station=0,04 OutputCase=RAR126 CaseType=Combination P=-,12,9308954176377 V2=18,9435761998534 V3=0 T=0 M2=0 M3=-,9,28895133259689 FrameElem=36-1 ElemStation=0,04

Frame=36 Station=0,08 OutputCase=RAR126 CaseType=Combination P=-,12,9308954176377 V2=19,5035761998534 V3=0 T=0 M2=0 M3=-,10,057894380591 FrameElem=36-1 ElemStation=0,08

Frame=36 Station=0 OutputCase=RAR127 CaseType=Combination P=-,22,1291776594589 V2=11,1356686634581 V3=0 T=0 M2=0 M3=-,4,37746242262416 FrameElem=36-1 ElemStation=0

Frame=36 Station=0,04 OutputCase=RAR127 CaseType=Combination P=-,22,1291776594589 V2=11,6956686634581 V3=0 T=0 M2=0 M3=-,4,83408916916248 FrameElem=36-1 ElemStation=0,04

Frame=36 Station=0,08 OutputCase=RAR127 CaseType=Combination P=-,22,1291776594589 V2=12,2556686634581 V3=0 T=0 M2=0 M3=-,5,3131159157008 FrameElem=36-1 ElemStation=0,08

Frame=36 Station=0 OutputCase=RAR128 CaseType=Combination P=-,3,1082466099889 V2=10,499999999706 V3=0 T=0 M2=0 M3=-,0,663175234669954 FrameElem=36-1 ElemStation=0

Frame=36 Station=0,04 OutputCase=RAR128 CaseType=Combination P=-,3,1082466099889 V2=11,059999999706 V3=0 T=0 M2=0 M3=-,1,09437523466878 FrameElem=36-1 ElemStation=0,04

Frame=36 Station=0,08 OutputCase=RAR128 CaseType=Combination P=-,3,1082466099889 V2=11,619999999706 V3=0 T=0 M2=0 M3=-,1,547952346676 FrameElem=36-1 ElemStation=0,08

Frame=36 Station=0 OutputCase=RAR129 CaseType=Combination P=-,4,37487704585169 V2=82,500000004655 V3=0 T=0 M2=0 M3=-,6,13353054915516 FrameElem=36-1 ElemStation=0

Frame=36 Station=0,04 OutputCase=RAR129 CaseType=Combination P=-,4,37487704585169 V2=86,900000004655 V3=0 T=0 M2=0 M3=-,9,52153054917378 FrameElem=36-1 ElemStation=0,04

Frame=36 Station=0,08 OutputCase=RAR129 CaseType=Combination P=-,4,37487704585169 V2=91,300000004655 V3=0 T=0 M2=0 M3=-,13,0855305491924 FrameElem=36-1 ElemStation=0,08

Frame=36 Station=0 OutputCase=RAR130 CaseType=Combination P=-,16,2003077557204 V2=91,8411440940689 V3=0 T=0 M2=0 M3=-,14,7618209859769 FrameElem=36-1 ElemStation=0

Frame=36 Station=0,04 OutputCase=RAR130 CaseType=Combination P=-,16,2003077557204 V2=96,2411440940689 V3=0 T=0 M2=0 M3=-,18,5234667497397 FrameElem=36-1 ElemStation=0,04

Frame=36 Station=0,08 OutputCase=RAR130 CaseType=Combination P=-,16,2003077557204 V2=100,6411440940689 V3=0 T=0 M2=0 M3=-,22,4611125135024 FrameElem=36-1 ElemStation=0,08

Frame=36 Station=0 OutputCase=RAR131 CaseType=Combination P=-,28,0257384860781 V2=82,500000012804 V3=0 T=0 M2=0 M3=-,9,37839528290207 FrameElem=36-1 ElemStation=0

Frame=36 Station=0,04 OutputCase=RAR131 CaseType=Combination P=-,28,0257384860781 V2=86,900000012804 V3=0 T=0 M2=0 M3=-,12,7663952829533 FrameElem=36-1 ElemStation=0,04

Frame=36 Station=0,08 OutputCase=RAR131 CaseType=Combination P=-,28,0257384860781 V2=91,300000012804 V3=0 T=0 M2=0 M3=-,16,3303952830045 FrameElem=36-1 ElemStation=0,08

Frame=36 Station=0 OutputCase=RAR132 CaseType=Combination P=-,15,2401647218239 V2=19,8411440935741 V3=0 T=0 M2=0 M3=-,9,54576901450165 FrameElem=36-1 ElemStation=0

Frame=36 Station=0,04 OutputCase=RAR132 CaseType=Combination P=-,15,2401647218239 V2=20,4011440935741 V3=0 T=0 M2=0 M3=-,10,3506147782446 FrameElem=36-1 ElemStation=0,04

Frame=36 Station=0,08 OutputCase=RAR132 CaseType=Combination P=-,15,2401647218239 V2=20,9611440935741 V3=0 T=0 M2=0 M3=-,11,1778605419876 FrameElem=36-1 ElemStation=0,08

Frame=36 Station=0 OutputCase=RAR133 CaseType=Combination P=-,27,0655954521816 V2=10,500000007856 V3=0 T=0 M2=0 M3=-,4,16234331142679 FrameElem=36-1 ElemStation=0

Frame=36 Station=0,04 OutputCase=RAR133 CaseType=Combination P=-,27,0655954521816 V2=11,060000007856 V3=0 T=0 M2=0 M3=-,4,59354331145821 FrameElem=36-1 ElemStation=0,04

Frame=36 Station=0,08 OutputCase=RAR133 CaseType=Combination P=-,27,0655954521816 V2=11,620000007856 V3=0 T=0 M2=0 M3=-,5,04714331148964 FrameElem=36-1 ElemStation=0,08

Frame=36 Station=0 OutputCase=RAR134 CaseType=Combination P=-,25,8581235202582 V2=86,0959910856253 V3=0 T=0 M2=0 M3=-,22,2974956603604 FrameElem=36-1 ElemStation=0

Frame=36 Station=0,04 OutputCase=RAR134 CaseType=Combination P=-,26,5261235202582 V2=89,5359910856253 V3=0 T=0 M2=0 M3=-,25,8101353037854 FrameElem=36-1 ElemStation=0,04

Frame=36 Station=0,08 OutputCase=RAR134 CaseType=Combination P=-,27,1941235202582 V2=92,9759910856253 V3=0 T=0 M2=0 M3=-,29,4603749472104 FrameElem=36-1 ElemStation=0,08

Frame=36 Station=0 OutputCase=RAR135 CaseType=Combination P=-,3,82835388541127 V2=64,500000003417 V3=0 T=0 M2=0 M3=-,4,57521421327641 FrameElem=36-1 ElemStation=0

Società di Progetto
Brebemi SpA



Doc. N.
60235-0000-A00.doc

CODIFICA DOCUMENTO
04RCDII10000000000300A00

REV.
00

FOGLIO
495 di 628

Frame=36 Station=0,04 OutputCase=RAR135 CaseType=Combination P=-3,82835388541127 V2=67,9400000003417 V3=0 T=0 M2=0 M3=-7,22401421329008 FrameElem=36-1 ElemStation=0,04

Frame=36 Station=0,08 OutputCase=RAR135 CaseType=Combination P=-3,82835388541127 V2=71,3800000003417 V3=0 T=0 M2=0 M3=-10,0104142133037 FrameElem=36-1 ElemStation=0,08

Frame=36 Station=0 OutputCase=RAR136 CaseType=Combination P=-13,0266361123314 V2=71,7479075373773 V3=0 T=0 M2=0 M3=-11,2821296564557 FrameElem=36-1 ElemStation=0

Frame=36 Station=0,04 OutputCase=RAR136 CaseType=Combination P=-13,0266361123314 V2=75,1879075373773 V3=0 T=0 M2=0 M3=-14,2208459579507 FrameElem=36-1 ElemStation=0,04

Frame=36 Station=0,08 OutputCase=RAR136 CaseType=Combination P=-13,0266361123314 V2=78,6279075373773 V3=0 T=0 M2=0 M3=-17,2971622594458 FrameElem=36-1 ElemStation=0,08

Frame=36 Station=0 OutputCase=RAR137 CaseType=Combination P=-22,2249183541527 V2=64,500000000982 V3=0 T=0 M2=0 M3=-7,11718379447706 FrameElem=36-1 ElemStation=0

Frame=36 Station=0,04 OutputCase=RAR137 CaseType=Combination P=-22,2249183541527 V2=67,940000000982 V3=0 T=0 M2=0 M3=-9,76598379451634 FrameElem=36-1 ElemStation=0,04

Frame=36 Station=0,08 OutputCase=RAR137 CaseType=Combination P=-22,2249183541527 V2=71,380000000982 V3=0 T=0 M2=0 M3=-12,5523837945556 FrameElem=36-1 ElemStation=0,08

Frame=36 Station=0 OutputCase=RAR138 CaseType=Combination P=-12,306528836909 V2=17,7479075370063 V3=0 T=0 M2=0 M3=-7,37009067784919 FrameElem=36-1 ElemStation=0

Frame=36 Station=0,04 OutputCase=RAR138 CaseType=Combination P=-12,306528836909 V2=18,3079075370063 V3=0 T=0 M2=0 M3=-8,09120697932945 FrameElem=36-1 ElemStation=0,04

Frame=36 Station=0,08 OutputCase=RAR138 CaseType=Combination P=-12,306528836909 V2=18,8679075370063 V3=0 T=0 M2=0 M3=-8,83473238080969 FrameElem=36-1 ElemStation=0,08

Frame=36 Station=0 OutputCase=RAR139 CaseType=Combination P=-21,5048110787303 V2=10,5000000006109 V3=0 T=0 M2=0 M3=-3,2051448158706 FrameElem=36-1 ElemStation=0

Frame=36 Station=0,04 OutputCase=RAR139 CaseType=Combination P=-21,5048110787303 V2=11,0600000006109 V3=0 T=0 M2=0 M3=-3,63634481589504 FrameElem=36-1 ElemStation=0,04

Frame=36 Station=0,08 OutputCase=RAR139 CaseType=Combination P=-21,5048110787303 V2=11,6200000006109 V3=0 T=0 M2=0 M3=-4,08994481591947 FrameElem=36-1 ElemStation=0,08

Frame=36 Station=0 OutputCase=RAR140 CaseType=Combination P=-3,56797771293835 V2=10,499999999708 V3=0 T=0 M2=0 M3=-1,04463024918484 FrameElem=36-1 ElemStation=0

Frame=36 Station=0,04 OutputCase=RAR140 CaseType=Combination P=-3,56797771293835 V2=11,059999999708 V3=0 T=0 M2=0 M3=-1,47583024918368 FrameElem=36-1 ElemStation=0,04

Frame=36 Station=0,08 OutputCase=RAR140 CaseType=Combination P=-3,56797771293835 V2=11,619999999708 V3=0 T=0 M2=0 M3=-1,92943024918251 FrameElem=36-1 ElemStation=0,08

Frame=36 Station=0 OutputCase=RAR141 CaseType=Combination P=-4,28808498836072 V2=64,5000000003419 V3=0 T=0 M2=0 M3=-4,956692277913 FrameElem=36-1 ElemStation=0

Frame=36 Station=0,04 OutputCase=RAR141 CaseType=Combination P=-4,28808498836072 V2=67,9400000003419 V3=0 T=0 M2=0 M3=-7,60546922780498 FrameElem=36-1 ElemStation=0,04

Frame=36 Station=0,08 OutputCase=RAR141 CaseType=Combination P=-4,28808498836072 V2=71,3800000003419 V3=0 T=0 M2=0 M3=-10,3918692278186 FrameElem=36-1 ElemStation=0,08

Frame=36 Station=0 OutputCase=RAR142 CaseType=Combination P=-13,4863672152808 V2=71,7479075373775 V3=0 T=0 M2=0 M3=-11,6635846709705 FrameElem=36-1 ElemStation=0

Frame=36 Station=0,04 OutputCase=RAR142 CaseType=Combination P=-13,4863672152808 V2=75,1879075373775 V3=0 T=0 M2=0 M3=-14,6023009724656 FrameElem=36-1 ElemStation=0,04

Frame=36 Station=0,08 OutputCase=RAR142 CaseType=Combination P=-13,4863672152808 V2=78,6279075373775 V3=0 T=0 M2=0 M3=-17,6786172739607 FrameElem=36-1 ElemStation=0,08

Frame=36 Station=0 OutputCase=RAR143 CaseType=Combination P=-22,6846494571021 V2=64,5000000009821 V3=0 T=0 M2=0 M3=-7,49863880899195 FrameElem=36-1 ElemStation=0

Frame=36 Station=0,04 OutputCase=RAR143 CaseType=Combination P=-22,6846494571021 V2=67,9400000009821 V3=0 T=0 M2=0 M3=-10,1474388090312 FrameElem=36-1 ElemStation=0,04

Frame=36 Station=0,08 OutputCase=RAR143 CaseType=Combination P=-22,6846494571021 V2=71,3800000009821 V3=0 T=0 M2=0 M3=-12,9338388090705 FrameElem=36-1 ElemStation=0,08

Frame=36 Station=0 OutputCase=RAR144 CaseType=Combination P=-12,7662599398585 V2=17,7479075370064 V3=0 T=0 M2=0 M3=-7,75154569236409 FrameElem=36-1 ElemStation=0

Frame=36 Station=0,04 OutputCase=RAR144 CaseType=Combination P=-12,7662599398585 V2=18,3079075370064 V3=0 T=0 M2=0 M3=-8,47266199384434 FrameElem=36-1 ElemStation=0,04

Frame=36 Station=0,08 OutputCase=RAR144 CaseType=Combination P=-12,7662599398585 V2=18,8679075370064 V3=0 T=0 M2=0 M3=-9,2161782953246 FrameElem=36-1 ElemStation=0,08

Frame=36 Station=0 OutputCase=RAR145 CaseType=Combination P=-21,9645421816798 V2=10,5000000006111 V3=0 T=0 M2=0 M3=-3,58659983038549 FrameElem=36-1 ElemStation=0

Frame=36 Station=0,04 OutputCase=RAR145 CaseType=Combination P=-21,9645421816798 V2=11,0600000006111 V3=0 T=0 M2=0 M3=-4,01779983040993 FrameElem=36-1 ElemStation=0,04

Frame=36 Station=0,08 OutputCase=RAR145 CaseType=Combination P=-21,9645421816798 V2=11,6200000006111 V3=0 T=0 M2=0 M3=-4,47139983043437 FrameElem=36-1 ElemStation=0,08

Frame=36 Station=0 OutputCase=RAR146 CaseType=Combination P=-2,64851550703946 V2=10,499999999704 V3=0 T=0 M2=0 M3=-0,281720220155063 FrameElem=36-1 ElemStation=0

Frame=36 Station=0,04 OutputCase=RAR146 CaseType=Combination P=-2,64851550703946 V2=11,059999999704 V3=0 T=0 M2=0 M3=-0,712920220153881 FrameElem=36-1 ElemStation=0,04

Frame=36 Station=0,08 OutputCase=RAR146 CaseType=Combination P=-2,64851550703946 V2=11,619999999704 V3=0 T=0 M2=0 M3=-1,1665202201527 FrameElem=36-1 ElemStation=0,08

Frame=36 Station=0 OutputCase=RAR147 CaseType=Combination P=-3,36862278246183 V2=64,5000000003415 V3=0 T=0 M2=0 M3=-4,19375919876152 FrameElem=36-1 ElemStation=0

Frame=36 Station=0,04 OutputCase=RAR147 CaseType=Combination P=-3,36862278246183 V2=67,9400000003415 V3=0 T=0 M2=0 M3=-6,84255919877518 FrameElem=36-1 ElemStation=0,04

Frame=36 Station=0,08 OutputCase=RAR147 CaseType=Combination P=-3,36862278246183 V2=71,3800000003415 V3=0 T=0 M2=0 M3=-9,62895919878884 FrameElem=36-1 ElemStation=0,08

Frame=36 Station=0 OutputCase=RAR148 CaseType=Combination P=-12,566905009382 V2=71,7479075373772 V3=0 T=0 M2=0 M3=-10,9006746419408 FrameElem=36-1 ElemStation=0

Frame=36 Station=0,04 OutputCase=RAR148 CaseType=Combination P=-12,566905009382 V2=75,1879075373772 V3=0 T=0 M2=0 M3=-13,8393909434359 FrameElem=36-1 ElemStation=0,04

Frame=36 Station=0,08 OutputCase=RAR148 CaseType=Combination P=-12,566905009382 V2=78,6279075373772 V3=0 T=0 M2=0 M3=-16,9157072449309 FrameElem=36-1 ElemStation=0,08

Frame=36 Station=0 OutputCase=RAR149 CaseType=Combination P=-21,7651872512032 V2=64,5000000009818 V3=0 T=0 M2=0 M3=-6,73572877996217 FrameElem=36-1 ElemStation=0

Frame=36 Station=0,04 OutputCase=RAR149 CaseType=Combination P=-21,7651872512032 V2=67,9400000009818 V3=0 T=0 M2=0 M3=-9,38452878000144 FrameElem=36-1 ElemStation=0,04

Frame=36 Station=0,08 OutputCase=RAR149 CaseType=Combination P=-21,7651872512032 V2=71,3800000009818 V3=0 T=0 M2=0 M3=-12,1709287800407 FrameElem=36-1 ElemStation=0,08

Società di Progetto
Brebemi SpA



Doc. N.
60235-0000-A00.doc

CODIFICA DOCUMENTO
04RCDII10000000000300A00

REV.
00

FOGLIO
496 di 628

Frame=36 Station=0 OutputCase=RAR150 CaseType=Combination P=-11,8467977339596 V2=17,7479075370061 V3=0 T=0 M2=0 M3=-6,9886356633343 FrameElem=36-1 ElemStation=0
Frame=36 Station=0,04 OutputCase=RAR150 CaseType=Combination P=-11,8467977339596 V2=18,3079075370061 V3=0 T=0 M2=0 M3=-7,70795196481455 FrameElem=36-1 ElemStation=0,04
Frame=36 Station=0,08 OutputCase=RAR150 CaseType=Combination P=-11,8467977339596 V2=18,8679075370061 V3=0 T=0 M2=0 M3=-8,45326826629479 FrameElem=36-1 ElemStation=0,08
Frame=36 Station=0 OutputCase=RAR151 CaseType=Combination P=-21,0450799757809 V2=10,5000000006107 V3=0 T=0 M2=0 M3=-2,82368980135571 FrameElem=36-1 ElemStation=0
Frame=36 Station=0,04 OutputCase=RAR151 CaseType=Combination P=-21,0450799757809 V2=11,0600000006107 V3=0 T=0 M2=0 M3=-3,25488980138014 FrameElem=36-1 ElemStation=0,04
Frame=36 Station=0,08 OutputCase=RAR151 CaseType=Combination P=-21,0450799757809 V2=11,6200000006107 V3=0 T=0 M2=0 M3=-3,70848980140457 FrameElem=36-1 ElemStation=0,08
Frame=36 Station=0 OutputCase=RAR152 CaseType=Combination P=-2,91751910273151 V2=10,1185988022624 V3=0 T=0 M2=0 M3=-0,112366676423774 FrameElem=36-1 ElemStation=0
Frame=36 Station=0,04 OutputCase=RAR152 CaseType=Combination P=-2,91751910273151 V2=10,6785988022624 V3=0 T=0 M2=0 M3=-0,528310628514269 FrameElem=36-1 ElemStation=0,04
Frame=36 Station=0,08 OutputCase=RAR152 CaseType=Combination P=-2,91751910273151 V2=11,2385988022624 V3=0 T=0 M2=0 M3=-0,966654580604764 FrameElem=36-1 ElemStation=0,08
Frame=36 Station=0 OutputCase=RAR153 CaseType=Combination P=-3,63762637815388 V2=64,1185988026334 V3=0 T=0 M2=0 M3=-4,02440565503023 FrameElem=36-1 ElemStation=0
Frame=36 Station=0,04 OutputCase=RAR153 CaseType=Combination P=-3,63762637815388 V2=67,5585988026334 V3=0 T=0 M2=0 M3=-6,65794960713557 FrameElem=36-1 ElemStation=0,04
Frame=36 Station=0,08 OutputCase=RAR153 CaseType=Combination P=-3,63762637815388 V2=70,9985988026334 V3=0 T=0 M2=0 M3=-9,42909355924091 FrameElem=36-1 ElemStation=0,08
Frame=36 Station=0 OutputCase=RAR154 CaseType=Combination P=-12,835908605074 V2=71,3665063396691 V3=0 T=0 M2=0 M3=-10,7313210982095 FrameElem=36-1 ElemStation=0
Frame=36 Station=0,04 OutputCase=RAR154 CaseType=Combination P=-12,835908605074 V2=74,8065063396691 V3=0 T=0 M2=0 M3=-13,6547813517962 FrameElem=36-1 ElemStation=0,04
Frame=36 Station=0,08 OutputCase=RAR154 CaseType=Combination P=-12,835908605074 V2=78,2465063396691 V3=0 T=0 M2=0 M3=-16,715841605383 FrameElem=36-1 ElemStation=0,08
Frame=36 Station=0 OutputCase=RAR155 CaseType=Combination P=-22,0341908468953 V2=64,1185988032737 V3=0 T=0 M2=0 M3=-6,56637523623088 FrameElem=36-1 ElemStation=0
Frame=36 Station=0,04 OutputCase=RAR155 CaseType=Combination P=-22,0341908468953 V2=67,5585988032737 V3=0 T=0 M2=0 M3=-9,19991918836183 FrameElem=36-1 ElemStation=0,04
Frame=36 Station=0,08 OutputCase=RAR155 CaseType=Combination P=-22,0341908468953 V2=70,9985988032737 V3=0 T=0 M2=0 M3=-11,9710631404928 FrameElem=36-1 ElemStation=0,08
Frame=36 Station=0 OutputCase=RAR156 CaseType=Combination P=-12,1158013296516 V2=17,366506339298 V3=0 T=0 M2=0 M3=-6,81928211960301 FrameElem=36-1 ElemStation=0
Frame=36 Station=0,04 OutputCase=RAR156 CaseType=Combination P=-12,1158013296516 V2=17,926506339298 V3=0 T=0 M2=0 M3=-7,52514237317494 FrameElem=36-1 ElemStation=0,04
Frame=36 Station=0,08 OutputCase=RAR156 CaseType=Combination P=-12,1158013296516 V2=18,486506339298 V3=0 T=0 M2=0 M3=-8,25340262674685 FrameElem=36-1 ElemStation=0,08
Frame=36 Station=0 OutputCase=RAR157 CaseType=Combination P=-21,3140835714729 V2=10,1185988029027 V3=0 T=0 M2=0 M3=-2,65433625762442 FrameElem=36-1 ElemStation=0
Frame=36 Station=0,04 OutputCase=RAR157 CaseType=Combination P=-21,3140835714729 V2=10,6785988029027 V3=0 T=0 M2=0 M3=-3,07028020974053 FrameElem=36-1 ElemStation=0,04
Frame=36 Station=0,08 OutputCase=RAR157 CaseType=Combination P=-21,3140835714729 V2=11,2385988029027 V3=0 T=0 M2=0 M3=-3,50862416185663 FrameElem=36-1 ElemStation=0,08
Frame=36 Station=0 OutputCase=RAR158 CaseType=Combination P=-3,2989741172463 V2=10,8814011976789 V3=0 T=0 M2=0 M3=-1,21398379291613 FrameElem=36-1 ElemStation=0
Frame=36 Station=0,04 OutputCase=RAR158 CaseType=Combination P=-3,2989741172463 V2=11,4414011976789 V3=0 T=0 M2=0 M3=-1,66043984082329 FrameElem=36-1 ElemStation=0,04
Frame=36 Station=0,08 OutputCase=RAR158 CaseType=Combination P=-3,2989741172463 V2=12,0014011976789 V3=0 T=0 M2=0 M3=-2,12929588873044 FrameElem=36-1 ElemStation=0,08
Frame=36 Station=0 OutputCase=RAR159 CaseType=Combination P=-4,01908139266867 V2=64,8814011980499 V3=0 T=0 M2=0 M3=-5,12602277152259 FrameElem=36-1 ElemStation=0
Frame=36 Station=0,04 OutputCase=RAR159 CaseType=Combination P=-4,01908139266867 V2=68,3214011980499 V3=0 T=0 M2=0 M3=-7,79007881944459 FrameElem=36-1 ElemStation=0,04
Frame=36 Station=0,08 OutputCase=RAR159 CaseType=Combination P=-4,01908139266867 V2=71,7614011980499 V3=0 T=0 M2=0 M3=-10,5917348673666 FrameElem=36-1 ElemStation=0,08
Frame=36 Station=0 OutputCase=RAR160 CaseType=Combination P=-13,2173636195888 V2=72,1293087350856 V3=0 T=0 M2=0 M3=-11,8329382147018 FrameElem=36-1 ElemStation=0
Frame=36 Station=0,04 OutputCase=RAR160 CaseType=Combination P=-13,2173636195888 V2=75,5693087350856 V3=0 T=0 M2=0 M3=-14,7869105641053 FrameElem=36-1 ElemStation=0,04
Frame=36 Station=0,08 OutputCase=RAR160 CaseType=Combination P=-13,2173636195888 V2=79,0093087350856 V3=0 T=0 M2=0 M3=-17,8784829135087 FrameElem=36-1 ElemStation=0,08
Frame=36 Station=0 OutputCase=RAR161 CaseType=Combination P=-22,4156458614101 V2=64,8814011986902 V3=0 T=0 M2=0 M3=-7,66799235272324 FrameElem=36-1 ElemStation=0
Frame=36 Station=0,04 OutputCase=RAR161 CaseType=Combination P=-22,4156458614101 V2=68,3214011986902 V3=0 T=0 M2=0 M3=-10,3320484006708 FrameElem=36-1 ElemStation=0,04
Frame=36 Station=0,08 OutputCase=RAR161 CaseType=Combination P=-22,4156458614101 V2=71,7614011986902 V3=0 T=0 M2=0 M3=-13,1337044486185 FrameElem=36-1 ElemStation=0,08
Frame=36 Station=0 OutputCase=RAR162 CaseType=Combination P=-12,4972563441664 V2=18,1293087347145 V3=0 T=0 M2=0 M3=-7,92089923609537 FrameElem=36-1 ElemStation=0
Frame=36 Station=0,04 OutputCase=RAR162 CaseType=Combination P=-12,4972563441664 V2=18,6893087347145 V3=0 T=0 M2=0 M3=-8,65727158548395 FrameElem=36-1 ElemStation=0,04
Frame=36 Station=0,08 OutputCase=RAR162 CaseType=Combination P=-12,4972563441664 V2=19,2493087347145 V3=0 T=0 M2=0 M3=-9,41604393487253 FrameElem=36-1 ElemStation=0,08
Frame=36 Station=0 OutputCase=RAR163 CaseType=Combination P=-21,6955385859877 V2=10,8814011983191 V3=0 T=0 M2=0 M3=-3,75595337411678 FrameElem=36-1 ElemStation=0
Frame=36 Station=0,04 OutputCase=RAR163 CaseType=Combination P=-21,6955385859877 V2=11,4414011983191 V3=0 T=0 M2=0 M3=-4,20240942204955 FrameElem=36-1 ElemStation=0,04
Frame=36 Station=0,08 OutputCase=RAR163 CaseType=Combination P=-21,6955385859877 V2=12,0014011983191 V3=0 T=0 M2=0 M3=-4,67126546998231 FrameElem=36-1 ElemStation=0,08
Frame=36 Station=0 OutputCase=INVRAR CaseType=Combination StepType=Max P=-2,64851550703946 V2=92,2225452917773 V3=0 T=0 M2=0 M3=-5,35686063752316E-04 FrameElem=36-1 ElemStation=0
Frame=36 Station=0,04 OutputCase=INVRAR CaseType=Combination StepType=Max P=-2,64851550703946 V2=96,6225452917773 V3=0 T=0 M2=0 M3=-

Società di Progetto
Brebemi SpA



Doc. N.
60235-00000-A00.doc

CODIFICA DOCUMENTO
04RCDII10000000000300A00

REV.
00

FOGLIO
497 di 628

Frame=36 Station=0,08 OutputCase=INVRAR CaseType=Combination StepType=Max P=-2,64851550703946 V2=101,022545291777 V3=0 T=0 M2=0 M3=-0,83341082090614
FrameElem=36-1 ElemStation=0,08
Frame=36 Station=0 OutputCase=INVRAR CaseType=Combination StepType=Min P=-28,945200691977 V2=9,86433133712366 V3=0 T=0 M2=0 M3=-23,2297592331215
FrameElem=36-1 ElemStation=0
Frame=36 Station=0,04 OutputCase=INVRAR CaseType=Combination StepType=Min P=-28,945200691977 V2=10,4243313371237 V3=0 T=0 M2=0 M3=-26,7576549244548
FrameElem=36-1 ElemStation=0,04
Frame=36 Station=0,08 OutputCase=INVRAR CaseType=Combination StepType=Min P=-28,945200691977 V2=10,9843313371237 V3=0 T=0 M2=0 M3=-30,4231506157882
FrameElem=36-1 ElemStation=0,08
Frame=36 Station=0 OutputCase=FRE01 CaseType=Combination P=-6,50813866919101 V2=10,5000000000873 V3=0 T=0 M2=0 M3=-1,73221771575663 FrameElem=36-1
ElemStation=0
Frame=36 Station=0,04 OutputCase=FRE01 CaseType=Combination P=-6,50813866919101 V2=11,0600000000873 V3=0 T=0 M2=0 M3=-2,16341771576013 FrameElem=36-1
ElemStation=0,04
Frame=36 Station=0,08 OutputCase=FRE01 CaseType=Combination P=-6,50813866919101 V2=11,6200000000873 V3=0 T=0 M2=0 M3=-2,61701771576362 FrameElem=36-1
ElemStation=0,08
Frame=36 Station=0 OutputCase=FRE02 CaseType=Combination P=-4,59457239032701 V2=64,500000000342 V3=0 T=0 M2=0 M3=-5,21097257080123 FrameElem=36-1
ElemStation=0
Frame=36 Station=0,04 OutputCase=FRE02 CaseType=Combination P=-4,59457239032701 V2=67,940000000342 V3=0 T=0 M2=0 M3=-7,85977257081491 FrameElem=36-1
ElemStation=0,04
Frame=36 Station=0,08 OutputCase=FRE02 CaseType=Combination P=-4,59457239032701 V2=71,380000000342 V3=0 T=0 M2=0 M3=-10,6461725708286 FrameElem=36-1
ElemStation=0,08
Frame=36 Station=0 OutputCase=FRE03 CaseType=Combination P=-13,7928546172471 V2=71,7479075373776 V3=0 T=0 M2=0 M3=-11,9178880139805 FrameElem=36-1
ElemStation=0
Frame=36 Station=0,04 OutputCase=FRE03 CaseType=Combination P=-13,7928546172471 V2=75,1879075373776 V3=0 T=0 M2=0 M3=-14,8566043154756 FrameElem=36-1
ElemStation=0,04
Frame=36 Station=0,08 OutputCase=FRE03 CaseType=Combination P=-13,7928546172471 V2=78,6279075373776 V3=0 T=0 M2=0 M3=-17,9329206169707 FrameElem=36-1
ElemStation=0,08
Frame=36 Station=0 OutputCase=FRE04 CaseType=Combination P=-22,9911368590684 V2=64,5000000009823 V3=0 T=0 M2=0 M3=-7,75294215200188 FrameElem=36-1
ElemStation=0
Frame=36 Station=0,04 OutputCase=FRE04 CaseType=Combination P=-22,9911368590684 V2=67,9400000009823 V3=0 T=0 M2=0 M3=-10,4017421520412 FrameElem=36-1
ElemStation=0,04
Frame=36 Station=0,08 OutputCase=FRE04 CaseType=Combination P=-22,9911368590684 V2=71,3800000009823 V3=0 T=0 M2=0 M3=-13,1881421520805 FrameElem=36-1
ElemStation=0,08
Frame=36 Station=0 OutputCase=FRE05 CaseType=Combination P=-13,0727473418248 V2=17,7479075370065 V3=0 T=0 M2=0 M3=-8,005849033537401 FrameElem=36-1
ElemStation=0
Frame=36 Station=0,04 OutputCase=FRE05 CaseType=Combination P=-13,0727473418248 V2=18,3079075370065 V3=0 T=0 M2=0 M3=-8,72696533685427 FrameElem=36-1
ElemStation=0,04
Frame=36 Station=0,08 OutputCase=FRE05 CaseType=Combination P=-13,0727473418248 V2=18,8679075370065 V3=0 T=0 M2=0 M3=-9,47048163833453 FrameElem=36-1
ElemStation=0,08
Frame=36 Station=0 OutputCase=FRE06 CaseType=Combination P=-22,2710295836461 V2=10,5000000006112 V3=0 T=0 M2=0 M3=-3,84090317339542 FrameElem=36-1
ElemStation=0
Frame=36 Station=0,04 OutputCase=FRE06 CaseType=Combination P=-22,2710295836461 V2=11,0600000006112 V3=0 T=0 M2=0 M3=-4,27210317341987 FrameElem=36-1
ElemStation=0,04
Frame=36 Station=0,08 OutputCase=FRE06 CaseType=Combination P=-22,2710295836461 V2=11,6200000006112 V3=0 T=0 M2=0 M3=-4,72570317344431 FrameElem=36-1
ElemStation=0,08
Frame=36 Station=0 OutputCase=FRE07 CaseType=Combination P=-4,33419621785409 V2=10,4999999999711 V3=0 T=0 M2=0 M3=-1,68038860670966 FrameElem=36-1
ElemStation=0
Frame=36 Station=0,04 OutputCase=FRE07 CaseType=Combination P=-4,33419621785409 V2=11,0599999999711 V3=0 T=0 M2=0 M3=-2,1115886067085 FrameElem=36-1
ElemStation=0,04
Frame=36 Station=0,08 OutputCase=FRE07 CaseType=Combination P=-4,33419621785409 V2=11,6199999999711 V3=0 T=0 M2=0 M3=-2,56518860670735 FrameElem=36-1
ElemStation=0,08
Frame=36 Station=0 OutputCase=FRE08 CaseType=Combination P=-4,97768164278489 V2=64,5000000003421 V3=0 T=0 M2=0 M3=-5,52885174956364 FrameElem=36-1
ElemStation=0
Frame=36 Station=0,04 OutputCase=FRE08 CaseType=Combination P=-4,97768164278489 V2=67,9400000003421 V3=0 T=0 M2=0 M3=-8,17765174957732 FrameElem=36-1
ElemStation=0,04
Frame=36 Station=0,08 OutputCase=FRE08 CaseType=Combination P=-4,97768164278489 V2=71,3800000003421 V3=0 T=0 M2=0 M3=-10,964051749591 FrameElem=36-1
ElemStation=0,08
Frame=36 Station=0 OutputCase=FRE09 CaseType=Combination P=-14,175963869705 V2=71,7479075373778 V3=0 T=0 M2=0 M3=-12,2357671927429 FrameElem=36-1
ElemStation=0
Frame=36 Station=0,04 OutputCase=FRE09 CaseType=Combination P=-14,175963869705 V2=75,1879075373778 V3=0 T=0 M2=0 M3=-15,174483494238 FrameElem=36-1
ElemStation=0,04
Frame=36 Station=0,08 OutputCase=FRE09 CaseType=Combination P=-14,175963869705 V2=78,6279075373778 V3=0 T=0 M2=0 M3=-18,2507997957331 FrameElem=36-1
ElemStation=0,08
Frame=36 Station=0 OutputCase=FRE10 CaseType=Combination P=-23,3742461115263 V2=64,5000000009824 V3=0 T=0 M2=0 M3=-8,07082133076429 FrameElem=36-1
ElemStation=0
Frame=36 Station=0,04 OutputCase=FRE10 CaseType=Combination P=-23,3742461115263 V2=67,9400000009824 V3=0 T=0 M2=0 M3=-10,7196213308036 FrameElem=36-1
ElemStation=0,04
Frame=36 Station=0,08 OutputCase=FRE10 CaseType=Combination P=-23,3742461115263 V2=71,3800000009824 V3=0 T=0 M2=0 M3=-13,5060213308429 FrameElem=36-1
ElemStation=0,08
Frame=36 Station=0 OutputCase=FRE11 CaseType=Combination P=-13,4558565942826 V2=17,7479075370067 V3=0 T=0 M2=0 M3=-8,32372821413642 FrameElem=36-1
ElemStation=0
Frame=36 Station=0,04 OutputCase=FRE11 CaseType=Combination P=-13,4558565942826 V2=18,3079075370067 V3=0 T=0 M2=0 M3=-9,04484451561669 FrameElem=36-1
ElemStation=0,04
Frame=36 Station=0,08 OutputCase=FRE11 CaseType=Combination P=-13,4558565942826 V2=18,8679075370067 V3=0 T=0 M2=0 M3=-9,78836081709695 FrameElem=36-1
ElemStation=0,08
Frame=36 Station=0 OutputCase=FRE12 CaseType=Combination P=-22,6541388361039 V2=10,5000000006113 V3=0 T=0 M2=0 M3=-4,15878235215783 FrameElem=36-1
ElemStation=0
Frame=36 Station=0,04 OutputCase=FRE12 CaseType=Combination P=-22,6541388361039 V2=11,0600000006113 V3=0 T=0 M2=0 M3=-4,58998235218228 FrameElem=36-1
ElemStation=0,04
Frame=36 Station=0,08 OutputCase=FRE12 CaseType=Combination P=-22,6541388361039 V2=11,6200000006113 V3=0 T=0 M2=0 M3=-5,04358235220673 FrameElem=36-1
ElemStation=0,08
Frame=36 Station=0 OutputCase=FRE13 CaseType=Combination P=-4,17525662847293 V2=10,1821656685475 V3=0 T=0 M2=0 M3=-1,22138147483785 FrameElem=36-1
ElemStation=0
Frame=36 Station=0,04 OutputCase=FRE13 CaseType=Combination P=-4,17525662847293 V2=10,7421656685475 V3=0 T=0 M2=0 M3=-1,63986810157975 FrameElem=36-1
ElemStation=0,04
Frame=36 Station=0,08 OutputCase=FRE13 CaseType=Combination P=-4,17525662847293 V2=11,3021656685475 V3=0 T=0 M2=0 M3=-2,08075472832165 FrameElem=36-1
ElemStation=0,08
Frame=36 Station=0 OutputCase=FRE14 CaseType=Combination P=-4,49313580723525 V2=10,8178343313946 V3=0 T=0 M2=0 M3=-2,13939573858148 FrameElem=36-1
ElemStation=0

Società di Progetto
Brebemi SpA

Frame=36 Station=0,04 OutputCase=FRE14 CaseType=Combination P=-4,49313580723525 V2=11,3778343313946 V3=0 T=0 M2=0 M3=-2,58330911183726	FrameElem=36-1 ElemStation=0,04
Frame=36 Station=0,08 OutputCase=FRE14 CaseType=Combination P=-4,49313580723525 V2=11,9378343313946 V3=0 T=0 M2=0 M3=-3,04962248509305	FrameElem=36-1 ElemStation=0,08
Frame=36 Station=0 OutputCase=FRE15 CaseType=Combination P=-3,95108696539622 V2=10,4999999999709 V3=0 T=0 M2=0 M3=-1,36250942794725	FrameElem=36-1 ElemStation=0
Frame=36 Station=0,04 OutputCase=FRE15 CaseType=Combination P=-3,95108696539622 V2=11,0599999999709 V3=0 T=0 M2=0 M3=-1,79370942794609	FrameElem=36-1 ElemStation=0,04
Frame=36 Station=0,08 OutputCase=FRE15 CaseType=Combination P=-3,95108696539622 V2=11,6199999999709 V3=0 T=0 M2=0 M3=-2,24730942794493	FrameElem=36-1 ElemStation=0,08
Frame=36 Station=0 OutputCase=FRE16 CaseType=Combination P=-3,4147340119552 V2=10,4999999999707 V3=0 T=0 M2=0 M3=-0,917478577679881	FrameElem=36-1 ElemStation=0
Frame=36 Station=0,04 OutputCase=FRE16 CaseType=Combination P=-3,4147340119552 V2=11,0599999999707 V3=0 T=0 M2=0 M3=-1,34867857767871	FrameElem=36-1 ElemStation=0,04
Frame=36 Station=0,08 OutputCase=FRE16 CaseType=Combination P=-3,4147340119552 V2=11,6199999999707 V3=0 T=0 M2=0 M3=-1,80227857767754	FrameElem=36-1 ElemStation=0,08
Frame=36 Station=0 OutputCase=FRE17 CaseType=Combination P=-4,21146313786914 V2=64,5000000003418 V3=0 T=0 M2=0 M3=-4,89309339203882	FrameElem=36-1 ElemStation=0
Frame=36 Station=0,04 OutputCase=FRE17 CaseType=Combination P=-4,21146313786914 V2=67,94000000003418 V3=0 T=0 M2=0 M3=-7,5418933920525	FrameElem=36-1 ElemStation=0,04
Frame=36 Station=0,08 OutputCase=FRE17 CaseType=Combination P=-4,21146313786914 V2=71,38000000003418 V3=0 T=0 M2=0 M3=-10,3282933920662	FrameElem=36-1 ElemStation=0,08
Frame=36 Station=0 OutputCase=FRE18 CaseType=Combination P=-13,4097453647893 V2=71,7479075373775 V3=0 T=0 M2=0 M3=-11,600088352181	FrameElem=36-1 ElemStation=0
Frame=36 Station=0,04 OutputCase=FRE18 CaseType=Combination P=-13,4097453647893 V2=75,1879075373775 V3=0 T=0 M2=0 M3=-14,5387251367132	FrameElem=36-1 ElemStation=0,04
Frame=36 Station=0,08 OutputCase=FRE18 CaseType=Combination P=-13,4097453647893 V2=78,6279075373775 V3=0 T=0 M2=0 M3=-17,6150414382083	FrameElem=36-1 ElemStation=0,08
Frame=36 Station=0 OutputCase=FRE19 CaseType=Combination P=-22,6080276066106 V2=64,5000000009821 V3=0 T=0 M2=0 M3=-7,43506297323947	FrameElem=36-1 ElemStation=0
Frame=36 Station=0,04 OutputCase=FRE19 CaseType=Combination P=-22,6080276066106 V2=67,9400000009821 V3=0 T=0 M2=0 M3=-10,0838629732788	FrameElem=36-1 ElemStation=0,04
Frame=36 Station=0,08 OutputCase=FRE19 CaseType=Combination P=-22,6080276066106 V2=71,3800000009821 V3=0 T=0 M2=0 M3=-12,870262973318	FrameElem=36-1 ElemStation=0,08
Frame=36 Station=0 OutputCase=FRE20 CaseType=Combination P=-12,6896380893669 V2=17,7479075370064 V3=0 T=0 M2=0 M3=-7,6879698566116	FrameElem=36-1 ElemStation=0
Frame=36 Station=0,04 OutputCase=FRE20 CaseType=Combination P=-12,6896380893669 V2=18,3079075370064 V3=0 T=0 M2=0 M3=-8,40908615809186	FrameElem=36-1 ElemStation=0,04
Frame=36 Station=0,08 OutputCase=FRE20 CaseType=Combination P=-12,6896380893669 V2=18,8679075370064 V3=0 T=0 M2=0 M3=-9,15260245957212	FrameElem=36-1 ElemStation=0,08
Frame=36 Station=0 OutputCase=FRE21 CaseType=Combination P=-21,8879203311882 V2=10,500000000611 V3=0 T=0 M2=0 M3=-3,52302399463301	FrameElem=36-1 ElemStation=0
Frame=36 Station=0,04 OutputCase=FRE21 CaseType=Combination P=-21,8879203311882 V2=11,060000000611 V3=0 T=0 M2=0 M3=-3,95422399465745	FrameElem=36-1 ElemStation=0,04
Frame=36 Station=0,08 OutputCase=FRE21 CaseType=Combination P=-21,8879203311882 V2=11,620000000611 V3=0 T=0 M2=0 M3=-4,40782399468189	FrameElem=36-1 ElemStation=0,08
Frame=36 Station=0 OutputCase=FRE22 CaseType=Combination P=-3,25579442257404 V2=10,1821656685472 V3=0 T=0 M2=0 M3=-0,458471445808064	FrameElem=36-1 ElemStation=0
Frame=36 Station=0,04 OutputCase=FRE22 CaseType=Combination P=-3,25579442257404 V2=10,7421656685472 V3=0 T=0 M2=0 M3=-0,876958072549952	FrameElem=36-1 ElemStation=0,04
Frame=36 Station=0,08 OutputCase=FRE22 CaseType=Combination P=-3,25579442257404 V2=11,3021656685472 V3=0 T=0 M2=0 M3=-1,31784469929184	FrameElem=36-1 ElemStation=0,08
Frame=36 Station=0 OutputCase=FRE23 CaseType=Combination P=-3,57367360133636 V2=10,8178343313943 V3=0 T=0 M2=0 M3=-1,3764857095517	FrameElem=36-1 ElemStation=0
Frame=36 Station=0,04 OutputCase=FRE23 CaseType=Combination P=-3,57367360133636 V2=11,3778343313943 V3=0 T=0 M2=0 M3=-1,82039908280747	FrameElem=36-1 ElemStation=0,04
Frame=36 Station=0,08 OutputCase=FRE23 CaseType=Combination P=-3,57367360133636 V2=11,9378343313943 V3=0 T=0 M2=0 M3=-2,28671245606324	FrameElem=36-1 ElemStation=0,08
Frame=36 Station=0 OutputCase=FRE24 CaseType=Combination P=-3,03162475949733 V2=10,4999999999706 V3=0 T=0 M2=0 M3=-0,599599398917472	FrameElem=36-1 ElemStation=0
Frame=36 Station=0,04 OutputCase=FRE24 CaseType=Combination P=-3,03162475949733 V2=11,0599999999706 V3=0 T=0 M2=0 M3=-1,0307993989163	FrameElem=36-1 ElemStation=0,04
Frame=36 Station=0,08 OutputCase=FRE24 CaseType=Combination P=-3,03162475949733 V2=11,6199999999706 V3=0 T=0 M2=0 M3=-1,48439939891512	FrameElem=36-1 ElemStation=0,08
Frame=36 Station=0 OutputCase=FRE25 CaseType=Combination P=-3,68373760764725 V2=10,1185988022627 V3=0 T=0 M2=0 M3=-0,748125033948592	FrameElem=36-1 ElemStation=0
Frame=36 Station=0,04 OutputCase=FRE25 CaseType=Combination P=-3,68373760764725 V2=10,6785988022627 V3=0 T=0 M2=0 M3=-1,1640689860391	FrameElem=36-1 ElemStation=0,04
Frame=36 Station=0,08 OutputCase=FRE25 CaseType=Combination P=-3,68373760764725 V2=11,2385988022627 V3=0 T=0 M2=0 M3=-1,6024129381296	FrameElem=36-1 ElemStation=0,08
Frame=36 Station=0 OutputCase=FRE26 CaseType=Combination P=-4,43563280094585 V2=64,1821656689184 V3=0 T=0 M2=0 M3=-4,75196543892942	FrameElem=36-1 ElemStation=0
Frame=36 Station=0,04 OutputCase=FRE26 CaseType=Combination P=-4,43563280094585 V2=67,6221656689184 V3=0 T=0 M2=0 M3=-7,38805206568615	FrameElem=36-1 ElemStation=0,04
Frame=36 Station=0,08 OutputCase=FRE26 CaseType=Combination P=-4,43563280094585 V2=71,0621656689184 V3=0 T=0 M2=0 M3=-10,1617386924429	FrameElem=36-1 ElemStation=0,08
Frame=36 Station=0 OutputCase=FRE27 CaseType=Combination P=-13,633915027866 V2=71,4300732059541 V3=0 T=0 M2=0 M3=-11,4588808821087	FrameElem=36-1 ElemStation=0
Frame=36 Station=0,04 OutputCase=FRE27 CaseType=Combination P=-13,633915027866 V2=74,8700732059541 V3=0 T=0 M2=0 M3=-14,3848838103468	FrameElem=36-1 ElemStation=0,04
Frame=36 Station=0,08 OutputCase=FRE27 CaseType=Combination P=-13,633915027866 V2=78,3100732059541 V3=0 T=0 M2=0 M3=-17,448486738585	FrameElem=36-1 ElemStation=0,08
Frame=36 Station=0 OutputCase=FRE28 CaseType=Combination P=-22,8321972696873 V2=64,1821656695587 V3=0 T=0 M2=0 M3=-7,29393502013006	FrameElem=36-1 ElemStation=0
Frame=36 Station=0,04 OutputCase=FRE28 CaseType=Combination P=-22,8321972696873 V2=67,6221656695587 V3=0 T=0 M2=0 M3=-9,93002164691241	FrameElem=36-1 ElemStation=0,04
Frame=36 Station=0,08 OutputCase=FRE28 CaseType=Combination P=-22,8321972696873 V2=71,0621656695587 V3=0 T=0 M2=0 M3=-12,7037082736948	FrameElem=36-1 ElemStation=0,08

Società di Progetto
Brebemi SpA

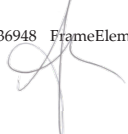

	Doc. N. 60235-00000-A00.doc	CODIFICA DOCUMENTO 04RCDII10000000000300A00	REV. 00	FOGLIO 499 di 628
--	--------------------------------	--	------------	----------------------

Frame=36 Station=0 OutputCase=FRE29 CaseType=Combination P=-12,9138077524436 V2=17,430073205583 V3=0 T=0 M2=0 M3=-7,5468419035022 ElemStation=0	FrameElem=36-1
Frame=36 Station=0,04 OutputCase=FRE29 CaseType=Combination P=-12,9138077524436 V2=17,990073205583 V3=0 T=0 M2=0 M3=-8,25524483172552 ElemStation=0,04	FrameElem=36-1
Frame=36 Station=0,08 OutputCase=FRE29 CaseType=Combination P=-12,9138077524436 V2=18,550073205583 V3=0 T=0 M2=0 M3=-8,98604775994884 ElemStation=0,08	FrameElem=36-1
Frame=36 Station=0 OutputCase=FRE30 CaseType=Combination P=-22,1120899942649 V2=10,1821656691876 V3=0 T=0 M2=0 M3=-3,3818960415236 ElemStation=0	FrameElem=36-1
Frame=36 Station=0,04 OutputCase=FRE30 CaseType=Combination P=-22,1120899942649 V2=10,7421656691876 V3=0 T=0 M2=0 M3=-3,80038266829111 ElemStation=0,04	FrameElem=36-1
Frame=36 Station=0,08 OutputCase=FRE30 CaseType=Combination P=-22,1120899942649 V2=11,3021656691876 V3=0 T=0 M2=0 M3=-4,24126929505861 ElemStation=0,08	FrameElem=36-1
Frame=36 Station=0 OutputCase=FRE31 CaseType=Combination P=-4,06684686010512 V2=10,1185988022628 V3=0 T=0 M2=0 M3=-1,066004212711 ElemStation=0	FrameElem=36-1
Frame=36 Station=0,04 OutputCase=FRE31 CaseType=Combination P=-4,06684686010512 V2=10,6785988022628 V3=0 T=0 M2=0 M3=-1,48194816480151 ElemStation=0,04	FrameElem=36-1
Frame=36 Station=0,08 OutputCase=FRE31 CaseType=Combination P=-4,06684686010512 V2=11,2385988022628 V3=0 T=0 M2=0 M3=-1,92029211689202 ElemStation=0,08	FrameElem=36-1
Frame=36 Station=0 OutputCase=FRE32 CaseType=Combination P=-3,30062835518938 V2=10,1185988022625 V3=0 T=0 M2=0 M3=-0,430245855186183 ElemStation=0	FrameElem=36-1
Frame=36 Station=0,04 OutputCase=FRE32 CaseType=Combination P=-3,30062835518938 V2=10,6785988022625 V3=0 T=0 M2=0 M3=-0,846189807276683 ElemStation=0,04	FrameElem=36-1
Frame=36 Station=0,08 OutputCase=FRE32 CaseType=Combination P=-3,30062835518938 V2=11,2385988022625 V3=0 T=0 M2=0 M3=-1,28453375936718 ElemStation=0,08	FrameElem=36-1
Frame=36 Station=0 OutputCase=FRE33 CaseType=Combination P=-3,30062835518938 V2=10,1185988022625 V3=0 T=0 M2=0 M3=-0,430245855186183 ElemStation=0	FrameElem=36-1
Frame=36 Station=0,04 OutputCase=FRE33 CaseType=Combination P=-3,30062835518938 V2=10,6785988022625 V3=0 T=0 M2=0 M3=-0,846189807276683 ElemStation=0,04	FrameElem=36-1
Frame=36 Station=0,08 OutputCase=FRE33 CaseType=Combination P=-3,30062835518938 V2=11,2385988022625 V3=0 T=0 M2=0 M3=-1,28453375936718 ElemStation=0,08	FrameElem=36-1
Frame=36 Station=0 OutputCase=FRE34 CaseType=Combination P=-4,06519262216204 V2=10,8814011976791 V3=0 T=0 M2=0 M3=-1,84974215044095 ElemStation=0	FrameElem=36-1
Frame=36 Station=0,04 OutputCase=FRE34 CaseType=Combination P=-4,06519262216204 V2=11,4414011976791 V3=0 T=0 M2=0 M3=-2,29619819834812 ElemStation=0,04	FrameElem=36-1
Frame=36 Station=0,08 OutputCase=FRE34 CaseType=Combination P=-4,06519262216204 V2=12,0014011976791 V3=0 T=0 M2=0 M3=-2,76505424625528 ElemStation=0,08	FrameElem=36-1
Frame=36 Station=0 OutputCase=FRE35 CaseType=Combination P=-4,75351197970818 V2=64,8178343317655 V3=0 T=0 M2=0 M3=-5,66997970267305 ElemStation=0	FrameElem=36-1
Frame=36 Station=0,04 OutputCase=FRE35 CaseType=Combination P=-4,75351197970818 V2=68,2578343317655 V3=0 T=0 M2=0 M3=-8,33149307594367 ElemStation=0,04	FrameElem=36-1
Frame=36 Station=0,08 OutputCase=FRE35 CaseType=Combination P=-4,75351197970818 V2=71,6978343317655 V3=0 T=0 M2=0 M3=-11,1306064492143 ElemStation=0,08	FrameElem=36-1
Frame=36 Station=0 OutputCase=FRE36 CaseType=Combination P=-13,9517942066283 V2=72,0657418688012 V3=0 T=0 M2=0 M3=-12,3768951458523 ElemStation=0	FrameElem=36-1
Frame=36 Station=0,04 OutputCase=FRE36 CaseType=Combination P=-13,9517942066283 V2=75,5057418688012 V3=0 T=0 M2=0 M3=-15,3283248206043 ElemStation=0,04	FrameElem=36-1
Frame=36 Station=0,08 OutputCase=FRE36 CaseType=Combination P=-13,9517942066283 V2=78,9457418688012 V3=0 T=0 M2=0 M3=-18,4173544953564 ElemStation=0,08	FrameElem=36-1
Frame=36 Station=0 OutputCase=FRE37 CaseType=Combination P=-23,1500764484496 V2=64,8178343324058 V3=0 T=0 M2=0 M3=-8,21194928387369 ElemStation=0	FrameElem=36-1
Frame=36 Station=0,04 OutputCase=FRE37 CaseType=Combination P=-23,1500764484496 V2=68,2578343324058 V3=0 T=0 M2=0 M3=-10,8734626571699 ElemStation=0,04	FrameElem=36-1
Frame=36 Station=0,08 OutputCase=FRE37 CaseType=Combination P=-23,1500764484496 V2=71,6978343324058 V3=0 T=0 M2=0 M3=-13,6725760304662 ElemStation=0,08	FrameElem=36-1
Frame=36 Station=0 OutputCase=FRE38 CaseType=Combination P=-13,2316869312059 V2=18,0657418684301 V3=0 T=0 M2=0 M3=-8,46485616724583 ElemStation=0	FrameElem=36-1
Frame=36 Station=0,04 OutputCase=FRE38 CaseType=Combination P=-13,2316869312059 V2=18,6257418684301 V3=0 T=0 M2=0 M3=-9,19868584198303 ElemStation=0,04	FrameElem=36-1
Frame=36 Station=0,08 OutputCase=FRE38 CaseType=Combination P=-13,2316869312059 V2=19,1857418684301 V3=0 T=0 M2=0 M3=-9,95491551672023 ElemStation=0,08	FrameElem=36-1
Frame=36 Station=0 OutputCase=FRE39 CaseType=Combination P=-22,4299691730272 V2=10,8178343320347 V3=0 T=0 M2=0 M3=-4,29991030526723 ElemStation=0	FrameElem=36-1
Frame=36 Station=0,04 OutputCase=FRE39 CaseType=Combination P=-22,4299691730272 V2=11,3778343320347 V3=0 T=0 M2=0 M3=-4,74382367854862 ElemStation=0,04	FrameElem=36-1
Frame=36 Station=0,08 OutputCase=FRE39 CaseType=Combination P=-22,4299691730272 V2=11,9378343320347 V3=0 T=0 M2=0 M3=-5,21013705183001 ElemStation=0,08	FrameElem=36-1
Frame=36 Station=0 OutputCase=FRE40 CaseType=Combination P=-4,44830187461991 V2=10,8814011976793 V3=0 T=0 M2=0 M3=-2,16762132920336 ElemStation=0	FrameElem=36-1
Frame=36 Station=0,04 OutputCase=FRE40 CaseType=Combination P=-4,44830187461991 V2=11,4414011976793 V3=0 T=0 M2=0 M3=-2,61407737711053 ElemStation=0,04	FrameElem=36-1
Frame=36 Station=0,08 OutputCase=FRE40 CaseType=Combination P=-4,44830187461991 V2=12,0014011976793 V3=0 T=0 M2=0 M3=-3,0829334250177 ElemStation=0,08	FrameElem=36-1
Frame=36 Station=0 OutputCase=FRE41 CaseType=Combination P=-3,68208336970417 V2=10,881401197679 V3=0 T=0 M2=0 M3=-1,53186297167854 ElemStation=0	FrameElem=36-1
Frame=36 Station=0,04 OutputCase=FRE41 CaseType=Combination P=-3,68208336970417 V2=11,441401197679 V3=0 T=0 M2=0 M3=-1,9783190195857 ElemStation=0,04	FrameElem=36-1
Frame=36 Station=0,08 OutputCase=FRE41 CaseType=Combination P=-3,68208336970417 V2=12,001401197679 V3=0 T=0 M2=0 M3=-2,44717506749286 ElemStation=0,08	FrameElem=36-1
Frame=36 Station=0 OutputCase=FRE42 CaseType=Combination P=-3,68208336970417 V2=10,881401197679 V3=0 T=0 M2=0 M3=-1,53186297167854 ElemStation=0	FrameElem=36-1
Frame=36 Station=0,04 OutputCase=FRE42 CaseType=Combination P=-3,68208336970417 V2=11,441401197679 V3=0 T=0 M2=0 M3=-1,9783190195857 ElemStation=0,04	FrameElem=36-1
Frame=36 Station=0,08 OutputCase=FRE42 CaseType=Combination P=-3,68208336970417 V2=12,001401197679 V3=0 T=0 M2=0 M3=-2,44717506749286 ElemStation=0,08	FrameElem=36-1
Frame=36 Station=0 OutputCase=FRE43 CaseType=Combination P=-3,4147340119552 V2=10,499999999707 V3=0 T=0 M2=0 M3=-0,917478577679881 ElemStation=0	FrameElem=36-1
Frame=36 Station=0,04 OutputCase=FRE43 CaseType=Combination P=-3,4147340119552 V2=11,059999999707 V3=0 T=0 M2=0 M3=-1,34867857767871 ElemStation=0,04	FrameElem=36-1

Società di Progetto
Brebemi SpA



Doc. N.
60235-00000-A00.doc

CODIFICA DOCUMENTO
04RCDII10000000000300A00

REV.
00

FOGLIO
500 di 628

Frame=36 Station=0,08 OutputCase=FRE43 CaseType=Combination P=-3,4147340119552 V2=11,6199999999707 V3=0 T=0 M2=0 M3=-1,80227857767754 FrameElem=36-1 ElemStation=0,08

Frame=36 Station=0 OutputCase=FRE44 CaseType=Combination P=-4,21146313786914 V2=64,5000000003418 V3=0 T=0 M2=0 M3=-4,89309339203882 FrameElem=36-1 ElemStation=0

Frame=36 Station=0,04 OutputCase=FRE44 CaseType=Combination P=-4,21146313786914 V2=67,9400000003418 V3=0 T=0 M2=0 M3=-7,5418933920525 FrameElem=36-1 ElemStation=0,04

Frame=36 Station=0,08 OutputCase=FRE44 CaseType=Combination P=-4,21146313786914 V2=71,3800000003418 V3=0 T=0 M2=0 M3=-10,3282933920662 FrameElem=36-1 ElemStation=0,08

Frame=36 Station=0 OutputCase=FRE45 CaseType=Combination P=-13,4097453647893 V2=71,7479075373775 V3=0 T=0 M2=0 M3=-11,6000088352181 FrameElem=36-1 ElemStation=0

Frame=36 Station=0,04 OutputCase=FRE45 CaseType=Combination P=-13,4097453647893 V2=75,1879075373775 V3=0 T=0 M2=0 M3=-14,5387251367132 FrameElem=36-1 ElemStation=0,04

Frame=36 Station=0,08 OutputCase=FRE45 CaseType=Combination P=-13,4097453647893 V2=78,6279075373775 V3=0 T=0 M2=0 M3=-17,6150414382083 FrameElem=36-1 ElemStation=0,08

Frame=36 Station=0 OutputCase=FRE46 CaseType=Combination P=-22,6080276066106 V2=64,5000000009821 V3=0 T=0 M2=0 M3=-7,43506297323947 FrameElem=36-1 ElemStation=0

Frame=36 Station=0,04 OutputCase=FRE46 CaseType=Combination P=-22,6080276066106 V2=67,9400000009821 V3=0 T=0 M2=0 M3=-10,0838629732788 FrameElem=36-1 ElemStation=0,04

Frame=36 Station=0,08 OutputCase=FRE46 CaseType=Combination P=-22,6080276066106 V2=71,3800000009821 V3=0 T=0 M2=0 M3=-12,870262973318 FrameElem=36-1 ElemStation=0,08

Frame=36 Station=0 OutputCase=FRE47 CaseType=Combination P=-12,6896380893669 V2=17,7479075370064 V3=0 T=0 M2=0 M3=-7,6879698566116 FrameElem=36-1 ElemStation=0

Frame=36 Station=0,04 OutputCase=FRE47 CaseType=Combination P=-12,6896380893669 V2=18,3079075370064 V3=0 T=0 M2=0 M3=-8,40908615809186 FrameElem=36-1 ElemStation=0,04

Frame=36 Station=0,08 OutputCase=FRE47 CaseType=Combination P=-12,6896380893669 V2=18,8679075370064 V3=0 T=0 M2=0 M3=-9,1526204597212 FrameElem=36-1 ElemStation=0,08

Frame=36 Station=0 OutputCase=FRE48 CaseType=Combination P=-21,8879203311882 V2=10,500000000611 V3=0 T=0 M2=0 M3=-3,52302399463301 FrameElem=36-1 ElemStation=0

Frame=36 Station=0,04 OutputCase=FRE48 CaseType=Combination P=-21,8879203311882 V2=11,060000000611 V3=0 T=0 M2=0 M3=-3,95422399465745 FrameElem=36-1 ElemStation=0,04

Frame=36 Station=0,08 OutputCase=FRE48 CaseType=Combination P=-21,8879203311882 V2=11,620000000611 V3=0 T=0 M2=0 M3=-4,40782399468189 FrameElem=36-1 ElemStation=0,08

Frame=36 Station=0 OutputCase=FRE49 CaseType=Combination P=-3,03162475949733 V2=10,4999999999706 V3=0 T=0 M2=0 M3=-0,599599398917472 FrameElem=36-1 ElemStation=0

Frame=36 Station=0,04 OutputCase=FRE49 CaseType=Combination P=-3,03162475949733 V2=11,0599999999706 V3=0 T=0 M2=0 M3=-1,0307993989163 FrameElem=36-1 ElemStation=0,04

Frame=36 Station=0,08 OutputCase=FRE49 CaseType=Combination P=-3,03162475949733 V2=11,6199999999706 V3=0 T=0 M2=0 M3=-1,48439939891512 FrameElem=36-1 ElemStation=0,08

Frame=36 Station=0 OutputCase=FRE50 CaseType=Combination P=-3,25579442257404 V2=10,1821656685472 V3=0 T=0 M2=0 M3=-0,458471445808064 FrameElem=36-1 ElemStation=0

Frame=36 Station=0,04 OutputCase=FRE50 CaseType=Combination P=-3,25579442257404 V2=10,7421656685472 V3=0 T=0 M2=0 M3=-0,876958072549952 FrameElem=36-1 ElemStation=0,04

Frame=36 Station=0,08 OutputCase=FRE50 CaseType=Combination P=-3,25579442257404 V2=11,3021656685472 V3=0 T=0 M2=0 M3=-1,31784469929184 FrameElem=36-1 ElemStation=0,08

Frame=36 Station=0 OutputCase=FRE51 CaseType=Combination P=-3,57367360133636 V2=10,8178343313943 V3=0 T=0 M2=0 M3=-1,3764857095517 FrameElem=36-1 ElemStation=0

Frame=36 Station=0,04 OutputCase=FRE51 CaseType=Combination P=-3,57367360133636 V2=11,3778343313943 V3=0 T=0 M2=0 M3=-1,82039908280747 FrameElem=36-1 ElemStation=0,04

Frame=36 Station=0,08 OutputCase=FRE51 CaseType=Combination P=-3,57367360133636 V2=11,9378343313943 V3=0 T=0 M2=0 M3=-2,28671245606324 FrameElem=36-1 ElemStation=0,08

Frame=36 Station=0 OutputCase=INVFRE CaseType=Combination StepType=Max P=-3,03162475949733 V2=72,0657418688012 V3=0 T=0 M2=0 M3=-0,430245855186183 FrameElem=36-1 ElemStation=0

Frame=36 Station=0,04 OutputCase=INVFRE CaseType=Combination StepType=Max P=-3,03162475949733 V2=75,5057418688012 V3=0 T=0 M2=0 M3=-0,846189807276683 FrameElem=36-1 ElemStation=0,04

Frame=36 Station=0,08 OutputCase=INVFRE CaseType=Combination StepType=Max P=-3,03162475949733 V2=78,9457418688012 V3=0 T=0 M2=0 M3=-1,28453375936718 FrameElem=36-1 ElemStation=0,08

Frame=36 Station=0 OutputCase=INVFRE CaseType=Combination StepType=Min P=-23,3742461115263 V2=10,1185988022625 V3=0 T=0 M2=0 M3=-12,3768951458523 FrameElem=36-1 ElemStation=0

Frame=36 Station=0,04 OutputCase=INVFRE CaseType=Combination StepType=Min P=-23,3742461115263 V2=10,6785988022625 V3=0 T=0 M2=0 M3=-15,3283248206043 FrameElem=36-1 ElemStation=0,04

Frame=36 Station=0,08 OutputCase=INVFRE CaseType=Combination StepType=Min P=-23,3742461115263 V2=11,2385988022625 V3=0 T=0 M2=0 M3=-18,4173544953564 FrameElem=36-1 ElemStation=0,08

Frame=36 Station=0 OutputCase=QPE01 CaseType=Combination P=-5,1913018911165 V2=9,53180213275482 V3=0 T=0 M2=0 M3=-0,789427253504982 FrameElem=36-1 ElemStation=0

Frame=36 Station=0,04 OutputCase=QPE01 CaseType=Combination P=-5,1913018911165 V2=10,0918021327548 V3=0 T=0 M2=0 M3=-1,18189933881518 FrameElem=36-1 ElemStation=0,04

Frame=36 Station=0,08 OutputCase=QPE01 CaseType=Combination P=-5,1913018911165 V2=10,6518021327548 V3=0 T=0 M2=0 M3=-1,59677142412537 FrameElem=36-1 ElemStation=0,08

Frame=36 Station=0 OutputCase=QPE02 CaseType=Combination P=-5,57441114357437 V2=9,53180213275496 V3=0 T=0 M2=0 M3=-1,10730643226739 FrameElem=36-1 ElemStation=0

Frame=36 Station=0,04 OutputCase=QPE02 CaseType=Combination P=-5,57441114357437 V2=10,091802132755 V3=0 T=0 M2=0 M3=-1,49977851757759 FrameElem=36-1 ElemStation=0,04

Frame=36 Station=0,08 OutputCase=QPE02 CaseType=Combination P=-5,57441114357437 V2=10,651802132755 V3=0 T=0 M2=0 M3=-1,91465060288779 FrameElem=36-1 ElemStation=0,08

Frame=36 Station=0 OutputCase=QPE03 CaseType=Combination P=-4,80819263865863 V2=9,53180213275468 V3=0 T=0 M2=0 M3=-0,471548074742573 FrameElem=36-1 ElemStation=0

Frame=36 Station=0,04 OutputCase=QPE03 CaseType=Combination P=-4,80819263865863 V2=10,0918021327547 V3=0 T=0 M2=0 M3=-0,864020160052761 FrameElem=36-1 ElemStation=0,04

Frame=36 Station=0,08 OutputCase=QPE03 CaseType=Combination P=-4,80819263865863 V2=10,6518021327547 V3=0 T=0 M2=0 M3=-1,27889224536295 FrameElem=36-1 ElemStation=0,08

Frame=36 Station=0 OutputCase=QPE04 CaseType=Combination P=-5,03236230173534 V2=9,21396780133129 V3=0 T=0 M2=0 M3=-0,330420121633166 FrameElem=36-1 ElemStation=0

Frame=36 Station=0,04 OutputCase=QPE04 CaseType=Combination P=-5,03236230173534 V2=9,77396780133128 V3=0 T=0 M2=0 M3=-0,710178833686417 FrameElem=36-1 ElemStation=0,04

Frame=36 Station=0,08 OutputCase=QPE04 CaseType=Combination P=-5,03236230173534 V2=10,3339678013313 V3=0 T=0 M2=0 M3=-1,11233754573967 FrameElem=36-1 ElemStation=0,08

Frame=36 Station=0 OutputCase=QPE05 CaseType=Combination P=-5,35024148049767 V2=9,84963646417835 V3=0 T=0 M2=0 M3=-1,2484343853768 FrameElem=36-1 ElemStation=0

Società di Progetto
Brebemi SpA



Doc. N.
60235-0000-A00.doc

CODIFICA DOCUMENTO
04RCDII10000000000300A00

REV.
00

FOGLIO
501 di 628

Frame=36 Station=0,04 OutputCase=QPE05 CaseType=Combination P=-5,35024148049767 V2=10,4096364641784 V3=0 T=0 M2=0 M3=-1,65361984394393 FrameElem=36-1 ElemStation=0,04

Frame=36 Station=0,08 OutputCase=QPE05 CaseType=Combination P=-5,35024148049767 V2=10,9696364641784 V3=0 T=0 M2=0 M3=-2,08120530251107 FrameElem=36-1 ElemStation=0,08

Frame=36 Station=0 OutputCase=QPE06 CaseType=Combination P=-4,80819263865863 V2=9,53180213275468 V3=0 T=0 M2=0 M3=-0,471548074742573 FrameElem=36-1 ElemStation=0

Frame=36 Station=0,04 OutputCase=QPE06 CaseType=Combination P=-4,80819263865863 V2=10,0918021327547 V3=0 T=0 M2=0 M3=-0,864020160052761 FrameElem=36-1 ElemStation=0,04

Frame=36 Station=0,08 OutputCase=QPE06 CaseType=Combination P=-4,80819263865863 V2=10,6518021327547 V3=0 T=0 M2=0 M3=-1,27889224536295 FrameElem=36-1 ElemStation=0,08

Frame=36 Station=0 OutputCase=QPE07 CaseType=Combination P=-5,41547155419321 V2=9,21396780133143 V3=0 T=0 M2=0 M3=-0,648299300395575 FrameElem=36-1 ElemStation=0

Frame=36 Station=0,04 OutputCase=QPE07 CaseType=Combination P=-5,41547155419321 V2=9,77396780133143 V3=0 T=0 M2=0 M3=-1,02805801244883 FrameElem=36-1 ElemStation=0,04

Frame=36 Station=0,08 OutputCase=QPE07 CaseType=Combination P=-5,41547155419321 V2=10,3339678013314 V3=0 T=0 M2=0 M3=-1,43021672450209 FrameElem=36-1 ElemStation=0,08

Frame=36 Station=0 OutputCase=QPE08 CaseType=Combination P=-5,73335073295554 V2=9,8496364641785 V3=0 T=0 M2=0 M3=-1,56631356413921 FrameElem=36-1 ElemStation=0

Frame=36 Station=0,04 OutputCase=QPE08 CaseType=Combination P=-5,73335073295554 V2=10,4096364641785 V3=0 T=0 M2=0 M3=-1,97149902270635 FrameElem=36-1 ElemStation=0,04

Frame=36 Station=0,08 OutputCase=QPE08 CaseType=Combination P=-5,73335073295554 V2=10,9696364641785 V3=0 T=0 M2=0 M3=-2,39908448127349 FrameElem=36-1 ElemStation=0,08

Frame=36 Station=0 OutputCase=QPE09 CaseType=Combination P=-5,1913018911165 V2=9,53180213275482 V3=0 T=0 M2=0 M3=-0,789427253504982 FrameElem=36-1 ElemStation=0

Frame=36 Station=0,04 OutputCase=QPE09 CaseType=Combination P=-5,1913018911165 V2=10,0918021327548 V3=0 T=0 M2=0 M3=-1,18189933881518 FrameElem=36-1 ElemStation=0,04

Frame=36 Station=0,08 OutputCase=QPE09 CaseType=Combination P=-5,1913018911165 V2=10,6518021327548 V3=0 T=0 M2=0 M3=-1,59677142412537 FrameElem=36-1 ElemStation=0,08

Frame=36 Station=0 OutputCase=QPE10 CaseType=Combination P=-5,19130189297915 V2=11,4681978673034 V3=0 T=0 M2=0 M3=-2,24172405444642 FrameElem=36-1 ElemStation=0

Frame=36 Station=0,04 OutputCase=QPE10 CaseType=Combination P=-5,19130189297915 V2=12,0281978673034 V3=0 T=0 M2=0 M3=-2,71165196913856 FrameElem=36-1 ElemStation=0,04

Frame=36 Station=0,08 OutputCase=QPE10 CaseType=Combination P=-5,19130189297915 V2=12,5881978673034 V3=0 T=0 M2=0 M3=-3,20397988383069 FrameElem=36-1 ElemStation=0,08

Frame=36 Station=0 OutputCase=QPE11 CaseType=Combination P=-5,57441114543702 V2=11,4681978673035 V3=0 T=0 M2=0 M3=-2,55960323320883 FrameElem=36-1 ElemStation=0

Frame=36 Station=0,04 OutputCase=QPE11 CaseType=Combination P=-5,57441114543702 V2=12,0281978673035 V3=0 T=0 M2=0 M3=-3,02953114790097 FrameElem=36-1 ElemStation=0,04

Frame=36 Station=0,08 OutputCase=QPE11 CaseType=Combination P=-5,57441114543702 V2=12,5881978673035 V3=0 T=0 M2=0 M3=-3,52185906259311 FrameElem=36-1 ElemStation=0,08

Frame=36 Station=0 OutputCase=QPE12 CaseType=Combination P=-4,80819264052128 V2=11,4681978673032 V3=0 T=0 M2=0 M3=-1,92384487568401 FrameElem=36-1 ElemStation=0

Frame=36 Station=0,04 OutputCase=QPE12 CaseType=Combination P=-4,80819264052128 V2=12,0281978673032 V3=0 T=0 M2=0 M3=-2,39377279037614 FrameElem=36-1 ElemStation=0,04

Frame=36 Station=0,08 OutputCase=QPE12 CaseType=Combination P=-4,80819264052128 V2=12,5881978673032 V3=0 T=0 M2=0 M3=-2,88610070506827 FrameElem=36-1 ElemStation=0,08

Frame=36 Station=0 OutputCase=QPE13 CaseType=Combination P=-5,03236230359799 V2=11,1503635358799 V3=0 T=0 M2=0 M3=-1,78271692257461 FrameElem=36-1 ElemStation=0

Frame=36 Station=0,04 OutputCase=QPE13 CaseType=Combination P=-5,03236230359799 V2=11,7103635358799 V3=0 T=0 M2=0 M3=-2,2399314640098 FrameElem=36-1 ElemStation=0,04

Frame=36 Station=0,08 OutputCase=QPE13 CaseType=Combination P=-5,03236230359799 V2=12,2703635358799 V3=0 T=0 M2=0 M3=-2,71954600544499 FrameElem=36-1 ElemStation=0,08

Frame=36 Station=0 OutputCase=QPE14 CaseType=Combination P=-5,35024148236031 V2=11,7860321987269 V3=0 T=0 M2=0 M3=-2,70073118631824 FrameElem=36-1 ElemStation=0

Frame=36 Station=0,04 OutputCase=QPE14 CaseType=Combination P=-5,35024148236031 V2=12,3460321987269 V3=0 T=0 M2=0 M3=-3,18337247426732 FrameElem=36-1 ElemStation=0,04

Frame=36 Station=0,08 OutputCase=QPE14 CaseType=Combination P=-5,35024148236031 V2=12,9060321987269 V3=0 T=0 M2=0 M3=-3,68841376221639 FrameElem=36-1 ElemStation=0,08

Frame=36 Station=0 OutputCase=QPE15 CaseType=Combination P=-4,80819264052128 V2=11,4681978673032 V3=0 T=0 M2=0 M3=-1,92384487568401 FrameElem=36-1 ElemStation=0

Frame=36 Station=0,04 OutputCase=QPE15 CaseType=Combination P=-4,80819264052128 V2=12,0281978673032 V3=0 T=0 M2=0 M3=-2,39377279037614 FrameElem=36-1 ElemStation=0,04

Frame=36 Station=0,08 OutputCase=QPE15 CaseType=Combination P=-4,80819264052128 V2=12,5881978673032 V3=0 T=0 M2=0 M3=-2,88610070506827 FrameElem=36-1 ElemStation=0,08

Frame=36 Station=0 OutputCase=QPE16 CaseType=Combination P=-5,41547155605586 V2=11,15036353588 V3=0 T=0 M2=0 M3=-2,10059610133701 FrameElem=36-1 ElemStation=0

Frame=36 Station=0,04 OutputCase=QPE16 CaseType=Combination P=-5,41547155605586 V2=11,71036353588 V3=0 T=0 M2=0 M3=-2,55781064277221 FrameElem=36-1 ElemStation=0,04

Frame=36 Station=0,08 OutputCase=QPE16 CaseType=Combination P=-5,41547155605586 V2=12,27036353588 V3=0 T=0 M2=0 M3=-3,03742518420741 FrameElem=36-1 ElemStation=0,08

Frame=36 Station=0 OutputCase=QPE17 CaseType=Combination P=-5,73335073481818 V2=11,7860321987271 V3=0 T=0 M2=0 M3=-3,01861036508065 FrameElem=36-1 ElemStation=0

Frame=36 Station=0,04 OutputCase=QPE17 CaseType=Combination P=-5,73335073481818 V2=12,3460321987271 V3=0 T=0 M2=0 M3=-3,50125165302973 FrameElem=36-1 ElemStation=0,04

Frame=36 Station=0,08 OutputCase=QPE17 CaseType=Combination P=-5,73335073481818 V2=12,9060321987271 V3=0 T=0 M2=0 M3=-4,00629294097881 FrameElem=36-1 ElemStation=0,08

Frame=36 Station=0 OutputCase=QPE18 CaseType=Combination P=-5,19130189297915 V2=11,4681978673034 V3=0 T=0 M2=0 M3=-2,24172405444642 FrameElem=36-1 ElemStation=0

Frame=36 Station=0,04 OutputCase=QPE18 CaseType=Combination P=-5,19130189297915 V2=12,0281978673034 V3=0 T=0 M2=0 M3=-2,71165196913856 FrameElem=36-1 ElemStation=0,04

Frame=36 Station=0,08 OutputCase=QPE18 CaseType=Combination P=-5,19130189297915 V2=12,5881978673034 V3=0 T=0 M2=0 M3=-3,20397988383069 FrameElem=36-1 ElemStation=0,08

Frame=36 Station=0 OutputCase=INVQPE CaseType=Combination StepType=Max P=-4,80819263865863 V2=11,7860321987271 V3=0 T=0 M2=0 M3=-0,330420121633166 FrameElem=36-1 ElemStation=0

Frame=36 Station=0,04 OutputCase=INVQPE CaseType=Combination StepType=Max P=-4,80819263865863 V2=12,3460321987271 V3=0 T=0 M2=0 M3=-0,710178833686417 FrameElem=36-1 ElemStation=0,04

Frame=36 Station=0,08 OutputCase=INVQPE CaseType=Combination StepType=Max P=-4,80819263865863 V2=12,9060321987271 V3=0 T=0 M2=0 M3=-1,11233754573967 FrameElem=36-1 ElemStation=0,08

Società di Progetto
Brebemi SpA



Doc. N.
60235-0000-A00.doc

CODIFICA DOCUMENTO
04RCDII10000000000300A00

REV.
00

FOGLIO
502 di 628

Frame=36 Station=0 OutputCase=INVQPE CaseType=Combination StepType=Min P=-5,73335073481818 V2=9,21396780133129 V3=0 T=0 M2=0 M3=-3,01861036508065
FrameElem=36-1 ElemStation=0
Frame=36 Station=0,04 OutputCase=INVQPE CaseType=Combination StepType=Min P=-5,73335073481818 V2=9,77396780133128 V3=0 T=0 M2=0 M3=-3,50125165302973
FrameElem=36-1 ElemStation=0,04
Frame=36 Station=0,08 OutputCase=INVQPE CaseType=Combination StepType=Min P=-5,73335073481818 V2=10,3339678013313 V3=0 T=0 M2=0 M3=-4,00629294097881
FrameElem=36-1 ElemStation=0,08
Frame=40 Station=0 OutputCase=STR001 CaseType=Combination P=-15,2429585633381 V2=20,8038735001508 V3=0 T=0 M2=0 M3=4,98131154984562 FrameElem=40-1
ElemStation=0
Frame=40 Station=0,04 OutputCase=STR001 CaseType=Combination P=-15,2429585633381 V2=21,0198735001508 V3=0 T=0 M2=0 M3=4,14483660983959 FrameElem=40-1
ElemStation=0,04
Frame=40 Station=0,08 OutputCase=STR001 CaseType=Combination P=-15,2429585633381 V2=21,2358735001508 V3=0 T=0 M2=0 M3=3,29972166983356 FrameElem=40-1
ElemStation=0,08
Frame=40 Station=0 OutputCase=STR002 CaseType=Combination P=-7,48725069100508 V2=20,8019472108121 V3=0 T=0 M2=0 M3=4,04115867688224 FrameElem=40-1
ElemStation=0
Frame=40 Station=0,04 OutputCase=STR002 CaseType=Combination P=-7,48725069100508 V2=21,0179472108121 V3=0 T=0 M2=0 M3=3,20476078844976 FrameElem=40-1
ElemStation=0,04
Frame=40 Station=0,08 OutputCase=STR002 CaseType=Combination P=-7,48725069100508 V2=21,2339472108121 V3=0 T=0 M2=0 M3=2,35972290001728 FrameElem=40-1
ElemStation=0,08
Frame=40 Station=0 OutputCase=STR003 CaseType=Combination P=-6,19106516141805 V2=114,142780710476 V3=0 T=0 M2=0 M3=17,1218682993124 FrameElem=40-1
ElemStation=0
Frame=40 Station=0,04 OutputCase=STR003 CaseType=Combination P=-6,19106516141805 V2=114,358780710476 V3=0 T=0 M2=0 M3=12,5518370708933 FrameElem=40-1
ElemStation=0,04
Frame=40 Station=0,08 OutputCase=STR003 CaseType=Combination P=-6,19106516141805 V2=114,574780710476 V3=0 T=0 M2=0 M3=7,97316584247431 FrameElem=40-1
ElemStation=0,08
Frame=40 Station=0 OutputCase=STR004 CaseType=Combination P=-22,4898406107667 V2=112,076272863736 V3=0 T=0 M2=0 M3=36,2673835438161 FrameElem=40-1
ElemStation=0
Frame=40 Station=0,04 OutputCase=STR004 CaseType=Combination P=-22,4898406107667 V2=112,292272863736 V3=0 T=0 M2=0 M3=31,7800126292667 FrameElem=40-1
ElemStation=0,04
Frame=40 Station=0,08 OutputCase=STR004 CaseType=Combination P=-22,4898406107667 V2=112,508272863736 V3=0 T=0 M2=0 M3=27,2840017147173 FrameElem=40-1
ElemStation=0,08
Frame=40 Station=0 OutputCase=STR005 CaseType=Combination P=-38,7886160513143 V2=114,152235209082 V3=0 T=0 M2=0 M3=21,7362703937283 FrameElem=40-1
ElemStation=0
Frame=40 Station=0,04 OutputCase=STR005 CaseType=Combination P=-38,7886160513143 V2=114,368235209082 V3=0 T=0 M2=0 M3=17,1658609853651 FrameElem=40-1
ElemStation=0,04
Frame=40 Station=0,08 OutputCase=STR005 CaseType=Combination P=-38,7886160513143 V2=114,584235209082 V3=0 T=0 M2=0 M3=12,5868115770018 FrameElem=40-1
ElemStation=0,08
Frame=40 Station=0 OutputCase=STR006 CaseType=Combination P=-23,5889462755424 V2=13,3427752728487 V3=0 T=0 M2=0 M3=22,3504608037134 FrameElem=40-1
ElemStation=0
Frame=40 Station=0,04 OutputCase=STR006 CaseType=Combination P=-23,5889462755424 V2=13,5027752728487 V3=0 T=0 M2=0 M3=21,8135497297994 FrameElem=40-1
ElemStation=0,04
Frame=40 Station=0,08 OutputCase=STR006 CaseType=Combination P=-23,5889462755424 V2=13,6627752728487 V3=0 T=0 M2=0 M3=21,2702387818855 FrameElem=40-1
ElemStation=0,08
Frame=40 Station=0 OutputCase=STR007 CaseType=Combination P=-39,88772171609 V2=15,4187376181944 V3=0 T=0 M2=0 M3=7,81934765362553 FrameElem=40-1
ElemStation=0
Frame=40 Station=0,04 OutputCase=STR007 CaseType=Combination P=-39,88772171609 V2=15,5787376181944 V3=0 T=0 M2=0 M3=7,19939814889775 FrameElem=40-1
ElemStation=0,04
Frame=40 Station=0,08 OutputCase=STR007 CaseType=Combination P=-39,88772171609 V2=15,7387376181944 V3=0 T=0 M2=0 M3=6,57304864416997 FrameElem=40-1
ElemStation=0,08
Frame=40 Station=0 OutputCase=STR008 CaseType=Combination P=-19,7086566197399 V2=82,2698402426023 V3=0 T=0 M2=0 M3=43,9966032578317 FrameElem=40-1
ElemStation=0
Frame=40 Station=0,04 OutputCase=STR008 CaseType=Combination P=-19,7086566197399 V2=82,4858402426024 V3=0 T=0 M2=0 M3=40,7014896481276 FrameElem=40-1
ElemStation=0,04
Frame=40 Station=0,08 OutputCase=STR008 CaseType=Combination P=-19,7086566197399 V2=82,7018402426024 V3=0 T=0 M2=0 M3=37,3977360384235 FrameElem=40-1
ElemStation=0,08
Frame=40 Station=0 OutputCase=STR009 CaseType=Combination P=-14,3235017246222 V2=20,8023093672168 V3=0 T=0 M2=0 M3=4,21791431708127 FrameElem=40-1
ElemStation=0
Frame=40 Station=0,04 OutputCase=STR009 CaseType=Combination P=-14,3235017246222 V2=21,0183093672168 V3=0 T=0 M2=0 M3=3,3815019423926 FrameElem=40-1
ElemStation=0,04
Frame=40 Station=0,08 OutputCase=STR009 CaseType=Combination P=-14,3235017246222 V2=21,2343093672168 V3=0 T=0 M2=0 M3=2,53644956770393 FrameElem=40-1
ElemStation=0,08
Frame=40 Station=0 OutputCase=STR010 CaseType=Combination P=-6,56779385228918 V2=20,8003830778781 V3=0 T=0 M2=0 M3=3,27776144411789 FrameElem=40-1
ElemStation=0
Frame=40 Station=0,04 OutputCase=STR010 CaseType=Combination P=-6,56779385228918 V2=21,0163830778781 V3=0 T=0 M2=0 M3=2,44142612100277 FrameElem=40-1
ElemStation=0,04
Frame=40 Station=0,08 OutputCase=STR010 CaseType=Combination P=-6,56779385228918 V2=21,2323830778781 V3=0 T=0 M2=0 M3=1,59645079788765 FrameElem=40-1
ElemStation=0,08
Frame=40 Station=0 OutputCase=STR011 CaseType=Combination P=-5,63939105818851 V2=114,141842230716 V3=0 T=0 M2=0 M3=16,6638299596538 FrameElem=40-1
ElemStation=0
Frame=40 Station=0,04 OutputCase=STR011 CaseType=Combination P=-5,63939105818851 V2=114,357842230716 V3=0 T=0 M2=0 M3=12,0938362704252 FrameElem=40-1
ElemStation=0,04
Frame=40 Station=0,08 OutputCase=STR011 CaseType=Combination P=-5,63939105818851 V2=114,573842230716 V3=0 T=0 M2=0 M3=7,51520258119654 FrameElem=40-1
ElemStation=0,08
Frame=40 Station=0 OutputCase=STR012 CaseType=Combination P=-21,9381665075371 V2=112,075334383976 V3=0 T=0 M2=0 M3=35,8093452041575 FrameElem=40-1
ElemStation=0
Frame=40 Station=0,04 OutputCase=STR012 CaseType=Combination P=-21,9381665075371 V2=112,291334383976 V3=0 T=0 M2=0 M3=31,3220118287985 FrameElem=40-1
ElemStation=0,04
Frame=40 Station=0,08 OutputCase=STR012 CaseType=Combination P=-21,9381665075371 V2=112,507334383976 V3=0 T=0 M2=0 M3=26,8260384534395 FrameElem=40-1
ElemStation=0,08
Frame=40 Station=0 OutputCase=STR013 CaseType=Combination P=-38,2369419480847 V2=114,151296729321 V3=0 T=0 M2=0 M3=21,2782320540697 FrameElem=40-1
ElemStation=0
Frame=40 Station=0,04 OutputCase=STR013 CaseType=Combination P=-38,2369419480847 V2=114,367296729321 V3=0 T=0 M2=0 M3=16,7078601848969 FrameElem=40-1
ElemStation=0,04
Frame=40 Station=0,08 OutputCase=STR013 CaseType=Combination P=-38,2369419480847 V2=114,583296729321 V3=0 T=0 M2=0 M3=12,128848315724 FrameElem=40-1
ElemStation=0,08
Frame=40 Station=0 OutputCase=STR014 CaseType=Combination P=-23,0372721723129 V2=13,3418367930883 V3=0 T=0 M2=0 M3=21,8924224640547 FrameElem=40-1
ElemStation=0
Frame=40 Station=0,04 OutputCase=STR014 CaseType=Combination P=-23,0372721723129 V2=13,5018367930883 V3=0 T=0 M2=0 M3=21,3555489923312 FrameElem=40-1
ElemStation=0,04

Società di Progetto
Brebemi SpA



Doc. N.
60235-0000-A00.doc

CODIFICA DOCUMENTO
04RCDII10000000000300A00

REV.
00

FOGLIO
503 di 628

Frame=40 Station=0,08 OutputCase=STR014 CaseType=Combination P=-23,0372721723129 V2=13,6618367930883 V3=0 T=0 M2=0 M3=20,8122755206077	FrameElem=40-1 ElemStation=0,08
Frame=40 Station=0 OutputCase=STR015 CaseType=Combination P=-39,3360476128605 V2=15,417799138434 V3=0 T=0 M2=0 M3=7,3613093139692	FrameElem=40-1 ElemStation=0
Frame=40 Station=0,04 OutputCase=STR015 CaseType=Combination P=-39,3360476128605 V2=15,577799138434 V3=0 T=0 M2=0 M3=6,74139734842956	FrameElem=40-1 ElemStation=0,04
Frame=40 Station=0,08 OutputCase=STR015 CaseType=Combination P=-39,3360476128605 V2=15,737799138434 V3=0 T=0 M2=0 M3=6,1150853828922	FrameElem=40-1 ElemStation=0,08
Frame=40 Station=0 OutputCase=STR016 CaseType=Combination P=-19,1569825165103 V2=82,2689017628419 V3=0 T=0 M2=0 M3=43,5385649187131	FrameElem=40-1 ElemStation=0
Frame=40 Station=0,04 OutputCase=STR016 CaseType=Combination P=-19,1569825165103 V2=82,4849017628419 V3=0 T=0 M2=0 M3=40,2434888476594	FrameElem=40-1 ElemStation=0,04
Frame=40 Station=0,08 OutputCase=STR016 CaseType=Combination P=-19,1569825165103 V2=82,700901762842 V3=0 T=0 M2=0 M3=36,9397727771457	FrameElem=40-1 ElemStation=0,08
Frame=40 Station=0 OutputCase=STR017 CaseType=Combination P=-5,59565470509891 V2=90,8060082026259 V3=0 T=0 M2=0 M3=13,0882936609405	FrameElem=40-1 ElemStation=0
Frame=40 Station=0,04 OutputCase=STR017 CaseType=Combination P=-5,59565470509891 V2=91,0220082026259 V3=0 T=0 M2=0 M3=9,45173333283546	FrameElem=40-1 ElemStation=0,04
Frame=40 Station=0,08 OutputCase=STR017 CaseType=Combination P=-5,59565470509891 V2=91,2380082026259 V3=0 T=0 M2=0 M3=5,80653300473042	FrameElem=40-1 ElemStation=0,08
Frame=40 Station=0 OutputCase=STR018 CaseType=Combination P=-18,7891997759948 V2=89,2157722384491 V3=0 T=0 M2=0 M3=28,2477326296729	FrameElem=40-1 ElemStation=0
Frame=40 Station=0,04 OutputCase=STR018 CaseType=Combination P=-18,7891997759948 V2=89,4317722384491 V3=0 T=0 M2=0 M3=24,674781740135	FrameElem=40-1 ElemStation=0,04
Frame=40 Station=0,08 OutputCase=STR018 CaseType=Combination P=-18,7891997759948 V2=89,6477722384491 V3=0 T=0 M2=0 M3=21,093190850597	FrameElem=40-1 ElemStation=0,08
Frame=40 Station=0 OutputCase=STR019 CaseType=Combination P=-31,9827448406043 V2=90,8135806489151 V3=0 T=0 M2=0 M3=16,7841334499933	FrameElem=40-1 ElemStation=0
Frame=40 Station=0,04 OutputCase=STR019 CaseType=Combination P=-31,9827448406043 V2=91,0295806489151 V3=0 T=0 M2=0 M3=13,1472702240367	FrameElem=40-1 ElemStation=0,04
Frame=40 Station=0,08 OutputCase=STR019 CaseType=Combination P=-31,9827448406043 V2=91,2455806489151 V3=0 T=0 M2=0 M3=9,50176699808009	FrameElem=40-1 ElemStation=0,08
Frame=40 Station=0 OutputCase=STR020 CaseType=Combination P=-19,5642590583738 V2=13,8174830224777 V3=0 T=0 M2=0 M3=17,6009872951777	FrameElem=40-1 ElemStation=0
Frame=40 Station=0,04 OutputCase=STR020 CaseType=Combination P=-19,5642590583738 V2=13,9774830224777 V3=0 T=0 M2=0 M3=17,0450879742786	FrameElem=40-1 ElemStation=0,04
Frame=40 Station=0,08 OutputCase=STR020 CaseType=Combination P=-19,5642590583738 V2=14,1374830224777 V3=0 T=0 M2=0 M3=16,4827886533795	FrameElem=40-1 ElemStation=0,08
Frame=40 Station=0 OutputCase=STR021 CaseType=Combination P=-32,7578041229833 V2=15,4152914329436 V3=0 T=0 M2=0 M3=6,13738811549804	FrameElem=40-1 ElemStation=0
Frame=40 Station=0,04 OutputCase=STR021 CaseType=Combination P=-32,7578041229833 V2=15,5752914329436 V3=0 T=0 M2=0 M3=5,51757645818029	FrameElem=40-1 ElemStation=0,04
Frame=40 Station=0,08 OutputCase=STR021 CaseType=Combination P=-32,7578041229833 V2=15,7352914329436 V3=0 T=0 M2=0 M3=4,89136480086255	FrameElem=40-1 ElemStation=0,08
Frame=40 Station=0 OutputCase=STR022 CaseType=Combination P=-14,5523733973288 V2=21,2602487110893 V3=0 T=0 M2=0 M3=4,66000991249744	FrameElem=40-1 ElemStation=0
Frame=40 Station=0,04 OutputCase=STR022 CaseType=Combination P=-14,5523733973288 V2=21,4762487110893 V3=0 T=0 M2=0 M3=3,80527996405387	FrameElem=40-1 ElemStation=0,04
Frame=40 Station=0,08 OutputCase=STR022 CaseType=Combination P=-14,5523733973288 V2=21,6922487110893 V3=0 T=0 M2=0 M3=2,94191001561029	FrameElem=40-1 ElemStation=0,08
Frame=40 Station=0 OutputCase=STR023 CaseType=Combination P=-6,79666552499579 V2=21,2583224217506 V3=0 T=0 M2=0 M3=3,71985703953406	FrameElem=40-1 ElemStation=0
Frame=40 Station=0,04 OutputCase=STR023 CaseType=Combination P=-6,79666552499579 V2=21,4743224217506 V3=0 T=0 M2=0 M3=2,86520414266403	FrameElem=40-1 ElemStation=0,04
Frame=40 Station=0,08 OutputCase=STR023 CaseType=Combination P=-6,79666552499579 V2=21,6903224217506 V3=0 T=0 M2=0 M3=2,00191124579401	FrameElem=40-1 ElemStation=0,08
Frame=40 Station=0 OutputCase=STR024 CaseType=Combination P=-5,82452637780552 V2=91,2639475464985 V3=0 T=0 M2=0 M3=13,5303892563567	FrameElem=40-1 ElemStation=0
Frame=40 Station=0,04 OutputCase=STR024 CaseType=Combination P=-5,82452637780552 V2=91,4799475464985 V3=0 T=0 M2=0 M3=9,87551135449672	FrameElem=40-1 ElemStation=0,04
Frame=40 Station=0,08 OutputCase=STR024 CaseType=Combination P=-5,82452637780552 V2=91,6959475464985 V3=0 T=0 M2=0 M3=6,21199345263679	FrameElem=40-1 ElemStation=0,08
Frame=40 Station=0 OutputCase=STR025 CaseType=Combination P=-19,0180714487014 V2=89,6737115823216 V3=0 T=0 M2=0 M3=28,6898282250891	FrameElem=40-1 ElemStation=0
Frame=40 Station=0,04 OutputCase=STR025 CaseType=Combination P=-19,0180714487014 V2=89,8897115823216 V3=0 T=0 M2=0 M3=25,0985597617963	FrameElem=40-1 ElemStation=0,04
Frame=40 Station=0,08 OutputCase=STR025 CaseType=Combination P=-19,0180714487014 V2=90,1057115823216 V3=0 T=0 M2=0 M3=21,4986512985034	FrameElem=40-1 ElemStation=0,08
Frame=40 Station=0 OutputCase=STR026 CaseType=Combination P=-32,211616513311 V2=91,2715199927876 V3=0 T=0 M2=0 M3=17,2262290454095	FrameElem=40-1 ElemStation=0
Frame=40 Station=0,04 OutputCase=STR026 CaseType=Combination P=-32,211616513311 V2=91,4875199927876 V3=0 T=0 M2=0 M3=13,571048245698	FrameElem=40-1 ElemStation=0,04
Frame=40 Station=0,08 OutputCase=STR026 CaseType=Combination P=-32,211616513311 V2=91,7035199927876 V3=0 T=0 M2=0 M3=9,90722744598646	FrameElem=40-1 ElemStation=0,08
Frame=40 Station=0 OutputCase=STR027 CaseType=Combination P=-19,7931307310804 V2=14,2754223663502 V3=0 T=0 M2=0 M3=18,0430828905939	FrameElem=40-1 ElemStation=0
Frame=40 Station=0,04 OutputCase=STR027 CaseType=Combination P=-19,7931307310804 V2=14,4354223663502 V3=0 T=0 M2=0 M3=17,4688659959399	FrameElem=40-1 ElemStation=0,04
Frame=40 Station=0,08 OutputCase=STR027 CaseType=Combination P=-19,7931307310804 V2=14,5954223663502 V3=0 T=0 M2=0 M3=16,8882491012858	FrameElem=40-1 ElemStation=0,08
Frame=40 Station=0 OutputCase=STR028 CaseType=Combination P=-32,98667579569 V2=15,8732307768161 V3=0 T=0 M2=0 M3=6,5794837109142	FrameElem=40-1 ElemStation=0
Frame=40 Station=0,04 OutputCase=STR028 CaseType=Combination P=-32,98667579569 V2=16,0332307768161 V3=0 T=0 M2=0 M3=5,94135447984156	FrameElem=40-1 ElemStation=0,04
Frame=40 Station=0,08 OutputCase=STR028 CaseType=Combination P=-32,98667579569 V2=16,1932307768161 V3=0 T=0 M2=0 M3=5,29682524876891	FrameElem=40-1 ElemStation=0,08
Frame=40 Station=0 OutputCase=STR029 CaseType=Combination P=-14,0946300519156 V2=20,3443700233443 V3=0 T=0 M2=0 M3=3,77581872166511	FrameElem=40-1 ElemStation=0

Società di Progetto
Brebemi SpA

	Doc. N. 60235-0000-A00.doc	CODIFICA DOCUMENTO 04RCDII10000000000300A00	REV. 00	FOGLIO 504 di 628
--	-------------------------------	--	------------	----------------------

Frame=40 Station=0,04 OutputCase=STR029 CaseType=Combination P=-14,0946300519156 V2=20,5603700233443 V3=0 T=0 M2=0 M3=2,95772392073134	FrameElem=40-1 ElemStation=0,04
Frame=40 Station=0,08 OutputCase=STR029 CaseType=Combination P=-14,0946300519156 V2=20,7763700233443 V3=0 T=0 M2=0 M3=2,13098911979757	FrameElem=40-1 ElemStation=0,08
Frame=40 Station=0 OutputCase=STR030 CaseType=Combination P=-6,33892217958257 V2=20,3424437340055 V3=0 T=0 M2=0 M3=2,83566584870173	FrameElem=40-1 ElemStation=0
Frame=40 Station=0,04 OutputCase=STR030 CaseType=Combination P=-6,33892217958257 V2=20,5584437340055 V3=0 T=0 M2=0 M3=2,01764809934151	FrameElem=40-1 ElemStation=0,04
Frame=40 Station=0,08 OutputCase=STR030 CaseType=Combination P=-6,33892217958257 V2=20,7744437340055 V3=0 T=0 M2=0 M3=1,19099034998128	FrameElem=40-1 ElemStation=0,08
Frame=40 Station=0 OutputCase=STR031 CaseType=Combination P=-5,36678303239229 V2=90,3480688587534 V3=0 T=0 M2=0 M3=12,6461980655243	FrameElem=40-1 ElemStation=0
Frame=40 Station=0,04 OutputCase=STR031 CaseType=Combination P=-5,36678303239229 V2=90,5640688587534 V3=0 T=0 M2=0 M3=9,0279553111742	FrameElem=40-1 ElemStation=0,04
Frame=40 Station=0,08 OutputCase=STR031 CaseType=Combination P=-5,36678303239229 V2=90,7800688587534 V3=0 T=0 M2=0 M3=5,40107255682406	FrameElem=40-1 ElemStation=0,08
Frame=40 Station=0 OutputCase=STR032 CaseType=Combination P=-18,5603281032882 V2=88,7578328945766 V3=0 T=0 M2=0 M3=27,8056370342568	FrameElem=40-1 ElemStation=0
Frame=40 Station=0,04 OutputCase=STR032 CaseType=Combination P=-18,5603281032882 V2=88,9738328945766 V3=0 T=0 M2=0 M3=24,2510037184737	FrameElem=40-1 ElemStation=0,04
Frame=40 Station=0,08 OutputCase=STR032 CaseType=Combination P=-18,5603281032882 V2=89,1898328945766 V3=0 T=0 M2=0 M3=20,6877304026907	FrameElem=40-1 ElemStation=0,08
Frame=40 Station=0 OutputCase=STR033 CaseType=Combination P=-31,7538731678977 V2=90,3556413050425 V3=0 T=0 M2=0 M3=16,3420378545771	FrameElem=40-1 ElemStation=0
Frame=40 Station=0,04 OutputCase=STR033 CaseType=Combination P=-31,7538731678977 V2=90,5716413050425 V3=0 T=0 M2=0 M3=12,7234922023754	FrameElem=40-1 ElemStation=0,04
Frame=40 Station=0,08 OutputCase=STR033 CaseType=Combination P=-31,7538731678977 V2=90,7876413050425 V3=0 T=0 M2=0 M3=9,09630655017373	FrameElem=40-1 ElemStation=0,08
Frame=40 Station=0 OutputCase=STR034 CaseType=Combination P=-19,3353873856672 V2=13,3595436786052 V3=0 T=0 M2=0 M3=17,1588916997615	FrameElem=40-1 ElemStation=0
Frame=40 Station=0,04 OutputCase=STR034 CaseType=Combination P=-19,3353873856672 V2=13,5195436786052 V3=0 T=0 M2=0 M3=16,6213099526173	FrameElem=40-1 ElemStation=0,04
Frame=40 Station=0,08 OutputCase=STR034 CaseType=Combination P=-19,3353873856672 V2=13,6795436786052 V3=0 T=0 M2=0 M3=16,0773282054731	FrameElem=40-1 ElemStation=0,08
Frame=40 Station=0 OutputCase=STR035 CaseType=Combination P=-32,5289324502767 V2=14,9573520890711 V3=0 T=0 M2=0 M3=5,69529252008187	FrameElem=40-1 ElemStation=0
Frame=40 Station=0,04 OutputCase=STR035 CaseType=Combination P=-32,5289324502767 V2=15,1173520890711 V3=0 T=0 M2=0 M3=5,09379843651903	FrameElem=40-1 ElemStation=0,04
Frame=40 Station=0,08 OutputCase=STR035 CaseType=Combination P=-32,5289324502767 V2=15,2773520890711 V3=0 T=0 M2=0 M3=4,48590435295619	FrameElem=40-1 ElemStation=0,08
Frame=40 Station=0 OutputCase=STR036 CaseType=Combination P=-14,8751758278517 V2=20,8032478469772 V3=0 T=0 M2=0 M3=4,67595265673988	FrameElem=40-1 ElemStation=0
Frame=40 Station=0,04 OutputCase=STR036 CaseType=Combination P=-14,8751758278517 V2=21,0192478469772 V3=0 T=0 M2=0 M3=3,8395027428608	FrameElem=40-1 ElemStation=0,04
Frame=40 Station=0,08 OutputCase=STR036 CaseType=Combination P=-14,8751758278517 V2=21,2352478469772 V3=0 T=0 M2=0 M3=2,99441282898171	FrameElem=40-1 ElemStation=0,08
Frame=40 Station=0 OutputCase=STR037 CaseType=Combination P=-7,11946795551872 V2=20,8013215576385 V3=0 T=0 M2=0 M3=3,7357997837765	FrameElem=40-1 ElemStation=0
Frame=40 Station=0,04 OutputCase=STR037 CaseType=Combination P=-7,11946795551872 V2=21,0173215576385 V3=0 T=0 M2=0 M3=2,89942692147096	FrameElem=40-1 ElemStation=0,04
Frame=40 Station=0,08 OutputCase=STR037 CaseType=Combination P=-7,11946795551872 V2=21,2333215576385 V3=0 T=0 M2=0 M3=2,05441405916543	FrameElem=40-1 ElemStation=0,08
Frame=40 Station=0 OutputCase=STR038 CaseType=Combination P=-6,14732880832845 V2=90,8069466823864 V3=0 T=0 M2=0 M3=13,5463320005991	FrameElem=40-1 ElemStation=0
Frame=40 Station=0,04 OutputCase=STR038 CaseType=Combination P=-6,14732880832845 V2=91,0229466823863 V3=0 T=0 M2=0 M3=9,90973413330365	FrameElem=40-1 ElemStation=0,04
Frame=40 Station=0,08 OutputCase=STR038 CaseType=Combination P=-6,14732880832845 V2=91,2389466823864 V3=0 T=0 M2=0 M3=6,2644962660082	FrameElem=40-1 ElemStation=0,08
Frame=40 Station=0 OutputCase=STR039 CaseType=Combination P=-19,3408738792244 V2=89,2167107182095 V3=0 T=0 M2=0 M3=28,7057709693316	FrameElem=40-1 ElemStation=0
Frame=40 Station=0,04 OutputCase=STR039 CaseType=Combination P=-19,3408738792244 V2=89,4327107182095 V3=0 T=0 M2=0 M3=25,1327825406032	FrameElem=40-1 ElemStation=0,04
Frame=40 Station=0,08 OutputCase=STR039 CaseType=Combination P=-19,3408738792244 V2=89,6487107182095 V3=0 T=0 M2=0 M3=21,5511541118748	FrameElem=40-1 ElemStation=0,08
Frame=40 Station=0 OutputCase=STR040 CaseType=Combination P=-32,5344189438339 V2=90,8145191286755 V3=0 T=0 M2=0 M3=17,2421717896519	FrameElem=40-1 ElemStation=0
Frame=40 Station=0,04 OutputCase=STR040 CaseType=Combination P=-32,5344189438339 V2=91,0305191286755 V3=0 T=0 M2=0 M3=13,6052710245049	FrameElem=40-1 ElemStation=0,04
Frame=40 Station=0,08 OutputCase=STR040 CaseType=Combination P=-32,5344189438339 V2=91,2465191286755 V3=0 T=0 M2=0 M3=9,95973025935787	FrameElem=40-1 ElemStation=0,08
Frame=40 Station=0 OutputCase=STR041 CaseType=Combination P=-20,1159331616034 V2=13,8184215022381 V3=0 T=0 M2=0 M3=18,0590256348363	FrameElem=40-1 ElemStation=0
Frame=40 Station=0,04 OutputCase=STR041 CaseType=Combination P=-20,1159331616034 V2=13,9784215022381 V3=0 T=0 M2=0 M3=17,5030887747468	FrameElem=40-1 ElemStation=0,04
Frame=40 Station=0,08 OutputCase=STR041 CaseType=Combination P=-20,1159331616034 V2=14,1384215022381 V3=0 T=0 M2=0 M3=16,9407519146573	FrameElem=40-1 ElemStation=0,08
Frame=40 Station=0 OutputCase=STR042 CaseType=Combination P=-33,3094782262129 V2=15,416229912704 V3=0 T=0 M2=0 M3=6,59542645515665	FrameElem=40-1 ElemStation=0
Frame=40 Station=0,04 OutputCase=STR042 CaseType=Combination P=-33,3094782262129 V2=15,576229912704 V3=0 T=0 M2=0 M3=5,97557725864849	FrameElem=40-1 ElemStation=0,04
Frame=40 Station=0,08 OutputCase=STR042 CaseType=Combination P=-33,3094782262129 V2=15,736229912704 V3=0 T=0 M2=0 M3=5,34932806214033	FrameElem=40-1 ElemStation=0,08
Frame=40 Station=0 OutputCase=STR043 CaseType=Combination P=-16,162415402054 V2=20,8054376330848 V3=0 T=0 M2=0 M3=5,74470878260997	FrameElem=40-1 ElemStation=0
Frame=40 Station=0,04 OutputCase=STR043 CaseType=Combination P=-16,162415402054 V2=21,0214376330848 V3=0 T=0 M2=0 M3=4,90817127728658	FrameElem=40-1 ElemStation=0,04
Frame=40 Station=0,08 OutputCase=STR043 CaseType=Combination P=-16,162415402054 V2=21,2374376330848 V3=0 T=0 M2=0 M3=4,06299377196319	FrameElem=40-1 ElemStation=0,08

Società di Progetto
Brebemi SpA

	Doc. N. 60235-00000-A00.doc	CODIFICA DOCUMENTO 04RCDII10000000000300A00	REV. 00	FOGLIO 505 di 628
--	--------------------------------	--	------------	----------------------

Frame=40 Station=0 OutputCase=STR044 CaseType=Combination P=-8,40670752972098 V2=20,8035113437461 V3=0 T=0 M2=0 M3=4,80455590964659	FrameElem=40-1
ElemStation=0	
Frame=40 Station=0,04 OutputCase=STR044 CaseType=Combination P=-8,40670752972098 V2=21,0195113437461 V3=0 T=0 M2=0 M3=3,96809545589675	FrameElem=40-1
ElemStation=0,04	
Frame=40 Station=0,08 OutputCase=STR044 CaseType=Combination P=-8,40670752972098 V2=21,2355113437461 V3=0 T=0 M2=0 M3=3,12299500214691	FrameElem=40-1
ElemStation=0,08	
Frame=40 Station=0 OutputCase=STR045 CaseType=Combination P=-6,7427392646476 V2=114,143719190236 V3=0 T=0 M2=0 M3=17,579906638971	FrameElem=40-1
ElemStation=0	
Frame=40 Station=0,04 OutputCase=STR045 CaseType=Combination P=-6,7427392646476 V2=114,359719190236 V3=0 T=0 M2=0 M3=13,0098378713615	FrameElem=40-1
ElemStation=0,04	
Frame=40 Station=0,08 OutputCase=STR045 CaseType=Combination P=-6,7427392646476 V2=114,575719190236 V3=0 T=0 M2=0 M3=8,43112910375209	FrameElem=40-1
ElemStation=0,08	
Frame=40 Station=0 OutputCase=STR046 CaseType=Combination P=-23,0415147139962 V2=112,077211343496 V3=0 T=0 M2=0 M3=36,7254218834748	FrameElem=40-1
ElemStation=0	
Frame=40 Station=0,04 OutputCase=STR046 CaseType=Combination P=-23,0415147139962 V2=112,293211343496 V3=0 T=0 M2=0 M3=32,2380134297349	FrameElem=40-1
ElemStation=0,04	
Frame=40 Station=0,08 OutputCase=STR046 CaseType=Combination P=-23,0415147139962 V2=112,509211343496 V3=0 T=0 M2=0 M3=27,741964975995	FrameElem=40-1
ElemStation=0,08	
Frame=40 Station=0 OutputCase=STR047 CaseType=Combination P=-39,3402901545438 V2=114,153173688842 V3=0 T=0 M2=0 M3=22,1943087333869	FrameElem=40-1
ElemStation=0	
Frame=40 Station=0,04 OutputCase=STR047 CaseType=Combination P=-39,3402901545438 V2=114,369173688842 V3=0 T=0 M2=0 M3=17,6238617858332	FrameElem=40-1
ElemStation=0,04	
Frame=40 Station=0,08 OutputCase=STR047 CaseType=Combination P=-39,3402901545438 V2=114,585173688842 V3=0 T=0 M2=0 M3=13,0447748382796	FrameElem=40-1
ElemStation=0,08	
Frame=40 Station=0 OutputCase=STR048 CaseType=Combination P=-24,140620378772 V2=13,3437137526091 V3=0 T=0 M2=0 M3=22,808499143372	FrameElem=40-1
ElemStation=0	
Frame=40 Station=0,04 OutputCase=STR048 CaseType=Combination P=-24,140620378772 V2=13,5037137526091 V3=0 T=0 M2=0 M3=22,2715505932676	FrameElem=40-1
ElemStation=0,04	
Frame=40 Station=0,08 OutputCase=STR048 CaseType=Combination P=-24,140620378772 V2=13,6637137526091 V3=0 T=0 M2=0 M3=21,7282020431632	FrameElem=40-1
ElemStation=0,08	
Frame=40 Station=0 OutputCase=STR049 CaseType=Combination P=-40,4393958193196 V2=15,4196760979548 V3=0 T=0 M2=0 M3=8,27738599328414	FrameElem=40-1
ElemStation=0	
Frame=40 Station=0,04 OutputCase=STR049 CaseType=Combination P=-40,4393958193196 V2=15,5796760979548 V3=0 T=0 M2=0 M3=7,65739894936595	FrameElem=40-1
ElemStation=0,04	
Frame=40 Station=0,08 OutputCase=STR049 CaseType=Combination P=-40,4393958193196 V2=15,7396760979548 V3=0 T=0 M2=0 M3=7,03101190544775	FrameElem=40-1
ElemStation=0,08	
Frame=40 Station=0 OutputCase=STR050 CaseType=Combination P=-20,2603307229694 V2=82,2707787223628 V3=0 T=0 M2=0 M3=44,4546415974903	FrameElem=40-1
ElemStation=0	
Frame=40 Station=0,04 OutputCase=STR050 CaseType=Combination P=-20,2603307229694 V2=82,4867787223628 V3=0 T=0 M2=0 M3=41,1594904485958	FrameElem=40-1
ElemStation=0,04	
Frame=40 Station=0,08 OutputCase=STR050 CaseType=Combination P=-20,2603307229694 V2=82,7027787223628 V3=0 T=0 M2=0 M3=37,8556992997013	FrameElem=40-1
ElemStation=0,08	
Frame=40 Station=0 OutputCase=STR051 CaseType=Combination P=-7,43456838253071 V2=90,809136468494 V3=0 T=0 M2=0 M3=14,6150881264692	FrameElem=40-1
ElemStation=0	
Frame=40 Station=0,04 OutputCase=STR051 CaseType=Combination P=-7,43456838253071 V2=91,025136468494 V3=0 T=0 M2=0 M3=10,9784026677294	FrameElem=40-1
ElemStation=0,04	
Frame=40 Station=0,08 OutputCase=STR051 CaseType=Combination P=-7,43456838253071 V2=91,241136468494 V3=0 T=0 M2=0 M3=7,33307720898968	FrameElem=40-1
ElemStation=0,08	
Frame=40 Station=0 OutputCase=STR052 CaseType=Combination P=-20,6281134534266 V2=89,2189005043171 V3=0 T=0 M2=0 M3=29,7745270952017	FrameElem=40-1
ElemStation=0	
Frame=40 Station=0,04 OutputCase=STR052 CaseType=Combination P=-20,6281134534266 V2=89,4349005043171 V3=0 T=0 M2=0 M3=26,201451075029	FrameElem=40-1
ElemStation=0,04	
Frame=40 Station=0,08 OutputCase=STR052 CaseType=Combination P=-20,6281134534266 V2=89,6509005043171 V3=0 T=0 M2=0 M3=22,6197350548563	FrameElem=40-1
ElemStation=0,08	
Frame=40 Station=0 OutputCase=STR053 CaseType=Combination P=-33,8216585180361 V2=90,8167089147831 V3=0 T=0 M2=0 M3=18,310927915522	FrameElem=40-1
ElemStation=0	
Frame=40 Station=0,04 OutputCase=STR053 CaseType=Combination P=-33,8216585180361 V2=91,0327089147831 V3=0 T=0 M2=0 M3=14,6739395589307	FrameElem=40-1
ElemStation=0,04	
Frame=40 Station=0,08 OutputCase=STR053 CaseType=Combination P=-33,8216585180361 V2=91,2487089147831 V3=0 T=0 M2=0 M3=11,0283112023394	FrameElem=40-1
ElemStation=0,08	
Frame=40 Station=0 OutputCase=STR054 CaseType=Combination P=-21,4031727358056 V2=13,8206112883457 V3=0 T=0 M2=0 M3=19,1277817607064	FrameElem=40-1
ElemStation=0	
Frame=40 Station=0,04 OutputCase=STR054 CaseType=Combination P=-21,4031727358056 V2=13,9806112883457 V3=0 T=0 M2=0 M3=18,5717573091726	FrameElem=40-1
ElemStation=0,04	
Frame=40 Station=0,08 OutputCase=STR054 CaseType=Combination P=-21,4031727358056 V2=14,1406112883457 V3=0 T=0 M2=0 M3=18,0093328576387	FrameElem=40-1
ElemStation=0,08	
Frame=40 Station=0 OutputCase=STR055 CaseType=Combination P=-34,5967178004151 V2=15,4184196988116 V3=0 T=0 M2=0 M3=7,66418258102674	FrameElem=40-1
ElemStation=0	
Frame=40 Station=0,04 OutputCase=STR055 CaseType=Combination P=-34,5967178004151 V2=15,5784196988116 V3=0 T=0 M2=0 M3=7,04424579307427	FrameElem=40-1
ElemStation=0,04	
Frame=40 Station=0,08 OutputCase=STR055 CaseType=Combination P=-34,5967178004151 V2=15,7384196988116 V3=0 T=0 M2=0 M3=6,41790900512181	FrameElem=40-1
ElemStation=0,08	
Frame=40 Station=0 OutputCase=STR056 CaseType=Combination P=-16,3912870747606 V2=21,2633769769573 V3=0 T=0 M2=0 M3=6,18680437802614	FrameElem=40-1
ElemStation=0	
Frame=40 Station=0,04 OutputCase=STR056 CaseType=Combination P=-16,3912870747606 V2=21,4793769769573 V3=0 T=0 M2=0 M3=5,33194929894785	FrameElem=40-1
ElemStation=0,04	
Frame=40 Station=0,08 OutputCase=STR056 CaseType=Combination P=-16,3912870747606 V2=21,6953769769573 V3=0 T=0 M2=0 M3=4,46845421986955	FrameElem=40-1
ElemStation=0,08	
Frame=40 Station=0 OutputCase=STR057 CaseType=Combination P=-8,6355792024276 V2=21,2614506876186 V3=0 T=0 M2=0 M3=5,24665150506276	FrameElem=40-1
ElemStation=0	
Frame=40 Station=0,04 OutputCase=STR057 CaseType=Combination P=-8,6355792024276 V2=21,4774506876186 V3=0 T=0 M2=0 M3=4,39187347755801	FrameElem=40-1
ElemStation=0,04	
Frame=40 Station=0,08 OutputCase=STR057 CaseType=Combination P=-8,6355792024276 V2=21,6934506876186 V3=0 T=0 M2=0 M3=3,52845545005327	FrameElem=40-1
ElemStation=0,08	
Frame=40 Station=0 OutputCase=STR058 CaseType=Combination P=-7,66344005523733 V2=91,2670758123665 V3=0 T=0 M2=0 M3=15,0571837218854	FrameElem=40-1
ElemStation=0	
Frame=40 Station=0,04 OutputCase=STR058 CaseType=Combination P=-7,66344005523733 V2=91,4830758123665 V3=0 T=0 M2=0 M3=11,4021806893907	FrameElem=40-1
ElemStation=0,04	

Società di Progetto
Brebemi SpA

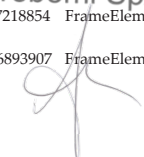



Doc. N.
60235-0000-A00.doc

CODIFICA DOCUMENTO
04RCDII10000000000300A00

REV.
00

FOGLIO
506 di 628

Frame=40 Station=0,08 OutputCase=STR058 CaseType=Combination P=-7,66344005523733 V2=91,6990758123665 V3=0 T=0 M2=0 M3=7,73853765689605 FrameElem=40-1 ElemStation=0,08
Frame=40 Station=0 OutputCase=STR059 CaseType=Combination P=-20,8569851261333 V2=89,6768398481896 V3=0 T=0 M2=0 M3=30,2166226906178 FrameElem=40-1 ElemStation=0
Frame=40 Station=0,04 OutputCase=STR059 CaseType=Combination P=-20,8569851261333 V2=89,8928398481897 V3=0 T=0 M2=0 M3=26,6252290966902 FrameElem=40-1 ElemStation=0,04
Frame=40 Station=0,08 OutputCase=STR059 CaseType=Combination P=-20,8569851261333 V2=90,1088398481897 V3=0 T=0 M2=0 M3=23,0251955027626 FrameElem=40-1 ElemStation=0,08
Frame=40 Station=0 OutputCase=STR060 CaseType=Combination P=-34,0505301907428 V2=91,2746482586556 V3=0 T=0 M2=0 M3=18,7530235109382 FrameElem=40-1 ElemStation=0
Frame=40 Station=0,04 OutputCase=STR060 CaseType=Combination P=-34,0505301907428 V2=91,4906482586556 V3=0 T=0 M2=0 M3=15,0977175805919 FrameElem=40-1 ElemStation=0,04
Frame=40 Station=0,08 OutputCase=STR060 CaseType=Combination P=-34,0505301907428 V2=91,7066482586556 V3=0 T=0 M2=0 M3=11,4337716502457 FrameElem=40-1 ElemStation=0,08
Frame=40 Station=0 OutputCase=STR061 CaseType=Combination P=-21,6320444085123 V2=14,2785506322182 V3=0 T=0 M2=0 M3=19,5698773561226 FrameElem=40-1 ElemStation=0
Frame=40 Station=0,04 OutputCase=STR061 CaseType=Combination P=-21,6320444085123 V2=14,4385506322182 V3=0 T=0 M2=0 M3=18,9955353308338 FrameElem=40-1 ElemStation=0,04
Frame=40 Station=0,08 OutputCase=STR061 CaseType=Combination P=-21,6320444085123 V2=14,5985506322182 V3=0 T=0 M2=0 M3=18,4147933055451 FrameElem=40-1 ElemStation=0,08
Frame=40 Station=0 OutputCase=STR062 CaseType=Combination P=-34,8255894731218 V2=15,8763590426842 V3=0 T=0 M2=0 M3=8,1062781764429 FrameElem=40-1 ElemStation=0
Frame=40 Station=0,04 OutputCase=STR062 CaseType=Combination P=-34,8255894731218 V2=16,0363590426842 V3=0 T=0 M2=0 M3=7,46802381473554 FrameElem=40-1 ElemStation=0,04
Frame=40 Station=0,08 OutputCase=STR062 CaseType=Combination P=-34,8255894731218 V2=16,1963590426842 V3=0 T=0 M2=0 M3=6,82336945302817 FrameElem=40-1 ElemStation=0,08
Frame=40 Station=0 OutputCase=STR063 CaseType=Combination P=-15,9335437293474 V2=20,3474982892123 V3=0 T=0 M2=0 M3=5,30261318719381 FrameElem=40-1 ElemStation=0
Frame=40 Station=0,04 OutputCase=STR063 CaseType=Combination P=-15,9335437293474 V2=20,5634982892123 V3=0 T=0 M2=0 M3=4,48439325562532 FrameElem=40-1 ElemStation=0,04
Frame=40 Station=0,08 OutputCase=STR063 CaseType=Combination P=-15,9335437293474 V2=20,7794982892123 V3=0 T=0 M2=0 M3=3,65753332405683 FrameElem=40-1 ElemStation=0,08
Frame=40 Station=0 OutputCase=STR064 CaseType=Combination P=-8,17783585701437 V2=20,3455719998736 V3=0 T=0 M2=0 M3=4,36246031423043 FrameElem=40-1 ElemStation=0
Frame=40 Station=0,04 OutputCase=STR064 CaseType=Combination P=-8,17783585701437 V2=20,5615719998736 V3=0 T=0 M2=0 M3=3,54431743423549 FrameElem=40-1 ElemStation=0,04
Frame=40 Station=0,08 OutputCase=STR064 CaseType=Combination P=-8,17783585701437 V2=20,7775719998736 V3=0 T=0 M2=0 M3=2,71753455424054 FrameElem=40-1 ElemStation=0,08
Frame=40 Station=0 OutputCase=STR065 CaseType=Combination P=-7,2056967098241 V2=90,3511971246214 V3=0 T=0 M2=0 M3=14,172992531053 FrameElem=40-1 ElemStation=0
Frame=40 Station=0,04 OutputCase=STR065 CaseType=Combination P=-7,2056967098241 V2=90,5671971246214 V3=0 T=0 M2=0 M3=10,5546246460682 FrameElem=40-1 ElemStation=0,04
Frame=40 Station=0,08 OutputCase=STR065 CaseType=Combination P=-7,2056967098241 V2=90,7831971246214 V3=0 T=0 M2=0 M3=6,92761676108332 FrameElem=40-1 ElemStation=0,08
Frame=40 Station=0 OutputCase=STR066 CaseType=Combination P=-20,39924178072 V2=88,7609611604446 V3=0 T=0 M2=0 M3=29,3324314997855 FrameElem=40-1 ElemStation=0
Frame=40 Station=0,04 OutputCase=STR066 CaseType=Combination P=-20,39924178072 V2=88,9769611604446 V3=0 T=0 M2=0 M3=25,7776730533677 FrameElem=40-1 ElemStation=0,04
Frame=40 Station=0,08 OutputCase=STR066 CaseType=Combination P=-20,39924178072 V2=89,1929611604446 V3=0 T=0 M2=0 M3=22,2142746069499 FrameElem=40-1 ElemStation=0,08
Frame=40 Station=0 OutputCase=STR067 CaseType=Combination P=-33,5927868453295 V2=90,3587695709105 V3=0 T=0 M2=0 M3=17,8688323201058 FrameElem=40-1 ElemStation=0
Frame=40 Station=0,04 OutputCase=STR067 CaseType=Combination P=-33,5927868453295 V2=90,5747695709105 V3=0 T=0 M2=0 M3=14,2501615372694 FrameElem=40-1 ElemStation=0,04
Frame=40 Station=0,08 OutputCase=STR067 CaseType=Combination P=-33,5927868453295 V2=90,7907695709106 V3=0 T=0 M2=0 M3=10,622850754433 FrameElem=40-1 ElemStation=0,08
Frame=40 Station=0 OutputCase=STR068 CaseType=Combination P=-21,174301063099 V2=13,3626719444732 V3=0 T=0 M2=0 M3=18,6856861652902 FrameElem=40-1 ElemStation=0
Frame=40 Station=0,04 OutputCase=STR068 CaseType=Combination P=-21,174301063099 V2=13,5226719444732 V3=0 T=0 M2=0 M3=18,1479792875113 FrameElem=40-1 ElemStation=0,04
Frame=40 Station=0,08 OutputCase=STR068 CaseType=Combination P=-21,174301063099 V2=13,6826719444732 V3=0 T=0 M2=0 M3=17,6038724097324 FrameElem=40-1 ElemStation=0,08
Frame=40 Station=0 OutputCase=STR069 CaseType=Combination P=-34,3678461277085 V2=14,9604803549391 V3=0 T=0 M2=0 M3=7,22208698561057 FrameElem=40-1 ElemStation=0
Frame=40 Station=0,04 OutputCase=STR069 CaseType=Combination P=-34,3678461277085 V2=15,1204803549391 V3=0 T=0 M2=0 M3=6,62046777141301 FrameElem=40-1 ElemStation=0,04
Frame=40 Station=0,08 OutputCase=STR069 CaseType=Combination P=-34,3678461277085 V2=15,2804803549391 V3=0 T=0 M2=0 M3=6,01244855721545 FrameElem=40-1 ElemStation=0,08
Frame=40 Station=0 OutputCase=STR070 CaseType=Combination P=-16,7140895052835 V2=20,8063761128452 V3=0 T=0 M2=0 M3=6,20274712226858 FrameElem=40-1 ElemStation=0
Frame=40 Station=0,04 OutputCase=STR070 CaseType=Combination P=-16,7140895052835 V2=21,0223761128452 V3=0 T=0 M2=0 M3=5,36617207775478 FrameElem=40-1 ElemStation=0,04
Frame=40 Station=0,08 OutputCase=STR070 CaseType=Combination P=-16,7140895052835 V2=21,2383761128452 V3=0 T=0 M2=0 M3=4,52095703324097 FrameElem=40-1 ElemStation=0,08
Frame=40 Station=0 OutputCase=STR071 CaseType=Combination P=-8,95838163295053 V2=20,8044498235065 V3=0 T=0 M2=0 M3=5,2625942493052 FrameElem=40-1 ElemStation=0
Frame=40 Station=0,04 OutputCase=STR071 CaseType=Combination P=-8,95838163295053 V2=21,0204498235065 V3=0 T=0 M2=0 M3=4,42609625636494 FrameElem=40-1 ElemStation=0,04
Frame=40 Station=0,08 OutputCase=STR071 CaseType=Combination P=-8,95838163295053 V2=21,2364498235065 V3=0 T=0 M2=0 M3=3,58095826342469 FrameElem=40-1 ElemStation=0,08
Frame=40 Station=0 OutputCase=STR072 CaseType=Combination P=-7,98624248576026 V2=90,8100749482544 V3=0 T=0 M2=0 M3=15,0731264661278 FrameElem=40-1 ElemStation=0
Frame=40 Station=0,04 OutputCase=STR072 CaseType=Combination P=-7,98624248576026 V2=91,0260749482544 V3=0 T=0 M2=0 M3=11,4364034681976 FrameElem=40-1 ElemStation=0,04
Frame=40 Station=0,08 OutputCase=STR072 CaseType=Combination P=-7,98624248576026 V2=91,2420749482544 V3=0 T=0 M2=0 M3=7,79104047026746 FrameElem=40-1 ElemStation=0,08
Frame=40 Station=0 OutputCase=STR073 CaseType=Combination P=-21,1797875566562 V2=89,219839840775 V3=0 T=0 M2=0 M3=30,2325654348603 FrameElem=40-1 ElemStation=0

Società di Progetto
Brebemi SpA



Doc. N.
60235-0000-A00.doc

CODIFICA DOCUMENTO
04RCDII10000000000300A00

REV.
00

FOGLIO
507 di 628

Frame=40 Station=0,04 OutputCase=STR073 CaseType=Combination P=-21,1797875566562 V2=89,4358389840775 V3=0 T=0 M2=0 M3=26,6594518754972	FrameElem=40-1
ElemStation=0,04	
Frame=40 Station=0,08 OutputCase=STR073 CaseType=Combination P=-21,1797875566562 V2=89,6518389840775 V3=0 T=0 M2=0 M3=23,0776983161341	FrameElem=40-1
ElemStation=0,08	
Frame=40 Station=0 OutputCase=STR074 CaseType=Combination P=-34,3733326212657 V2=90,8176473945435 V3=0 T=0 M2=0 M3=18,7689662551806	FrameElem=40-1
ElemStation=0	
Frame=40 Station=0,04 OutputCase=STR074 CaseType=Combination P=-34,3733326212657 V2=91,0336473945435 V3=0 T=0 M2=0 M3=15,1319403593989	FrameElem=40-1
ElemStation=0,04	
Frame=40 Station=0,08 OutputCase=STR074 CaseType=Combination P=-34,3733326212657 V2=91,2496473945435 V3=0 T=0 M2=0 M3=11,4862744636171	FrameElem=40-1
ElemStation=0,08	
Frame=40 Station=0 OutputCase=STR075 CaseType=Combination P=-21,9548468390352 V2=13,8215497681061 V3=0 T=0 M2=0 M3=19,585820100365	FrameElem=40-1
ElemStation=0	
Frame=40 Station=0,04 OutputCase=STR075 CaseType=Combination P=-21,9548468390352 V2=13,9815497681061 V3=0 T=0 M2=0 M3=19,0297581096408	FrameElem=40-1
ElemStation=0,04	
Frame=40 Station=0,08 OutputCase=STR075 CaseType=Combination P=-21,9548468390352 V2=14,1415497681061 V3=0 T=0 M2=0 M3=18,4672961189165	FrameElem=40-1
ElemStation=0,08	
Frame=40 Station=0 OutputCase=STR076 CaseType=Combination P=-35,1483919036447 V2=15,419358178572 V3=0 T=0 M2=0 M3=8,12222092068535	FrameElem=40-1
ElemStation=0	
Frame=40 Station=0,04 OutputCase=STR076 CaseType=Combination P=-35,1483919036447 V2=15,579358178572 V3=0 T=0 M2=0 M3=7,50224659354247	FrameElem=40-1
ElemStation=0,04	
Frame=40 Station=0,08 OutputCase=STR076 CaseType=Combination P=-35,1483919036447 V2=15,739358178572 V3=0 T=0 M2=0 M3=6,87587226639959	FrameElem=40-1
ElemStation=0,08	
Frame=40 Station=0 OutputCase=STR077 CaseType=Combination P=-15,6244113511824 V2=21,5671057399383 V3=0 T=0 M2=0 M3=5,7181375422059	FrameElem=40-1
ElemStation=0	
Frame=40 Station=0,04 OutputCase=STR077 CaseType=Combination P=-15,6244113511824 V2=21,7831057399383 V3=0 T=0 M2=0 M3=4,85113331260836	FrameElem=40-1
ElemStation=0,04	
Frame=40 Station=0,08 OutputCase=STR077 CaseType=Combination P=-15,6244113511824 V2=21,9991057399383 V3=0 T=0 M2=0 M3=3,97548908301083	FrameElem=40-1
ElemStation=0,08	
Frame=40 Station=0 OutputCase=STR078 CaseType=Combination P=-7,86870347884944 V2=21,5651794505996 V3=0 T=0 M2=0 M3=4,77798466924252	FrameElem=40-1
ElemStation=0	
Frame=40 Station=0,04 OutputCase=STR078 CaseType=Combination P=-7,86870347884944 V2=21,7811794505996 V3=0 T=0 M2=0 M3=3,91105749121853	FrameElem=40-1
ElemStation=0,04	
Frame=40 Station=0,08 OutputCase=STR078 CaseType=Combination P=-7,86870347884944 V2=21,9971794505996 V3=0 T=0 M2=0 M3=3,03549031319455	FrameElem=40-1
ElemStation=0,08	
Frame=40 Station=0 OutputCase=STR079 CaseType=Combination P=-6,41993683412467 V2=114,600720054348 V3=0 T=0 M2=0 M3=17,5639638947285	FrameElem=40-1
ElemStation=0	
Frame=40 Station=0,04 OutputCase=STR079 CaseType=Combination P=-6,41993683412467 V2=114,816720054348 V3=0 T=0 M2=0 M3=12,9756150925546	FrameElem=40-1
ElemStation=0,04	
Frame=40 Station=0,08 OutputCase=STR079 CaseType=Combination P=-6,41993683412467 V2=115,032720054348 V3=0 T=0 M2=0 M3=8,37862629038068	FrameElem=40-1
ElemStation=0,08	
Frame=40 Station=0 OutputCase=STR080 CaseType=Combination P=-22,7187122834733 V2=112,534212207609 V3=0 T=0 M2=0 M3=36,7094791392323	FrameElem=40-1
ElemStation=0	
Frame=40 Station=0,04 OutputCase=STR080 CaseType=Combination P=-22,7187122834733 V2=112,750212207609 V3=0 T=0 M2=0 M3=32,203790650928	FrameElem=40-1
ElemStation=0,04	
Frame=40 Station=0,08 OutputCase=STR080 CaseType=Combination P=-22,7187122834733 V2=112,966212207609 V3=0 T=0 M2=0 M3=27,6894621626236	FrameElem=40-1
ElemStation=0,08	
Frame=40 Station=0 OutputCase=STR081 CaseType=Combination P=-39,0174877240209 V2=114,610174552954 V3=0 T=0 M2=0 M3=22,1783659891445	FrameElem=40-1
ElemStation=0	
Frame=40 Station=0,04 OutputCase=STR081 CaseType=Combination P=-39,0174877240209 V2=114,826174552954 V3=0 T=0 M2=0 M3=17,5896390070263	FrameElem=40-1
ElemStation=0,04	
Frame=40 Station=0,08 OutputCase=STR081 CaseType=Combination P=-39,0174877240209 V2=115,042174552954 V3=0 T=0 M2=0 M3=12,9922720249081	FrameElem=40-1
ElemStation=0,08	
Frame=40 Station=0 OutputCase=STR082 CaseType=Combination P=-23,817817948249 V2=13,8007146167212 V3=0 T=0 M2=0 M3=22,7925563991295	FrameElem=40-1
ElemStation=0	
Frame=40 Station=0,04 OutputCase=STR082 CaseType=Combination P=-23,817817948249 V2=13,9607146167212 V3=0 T=0 M2=0 M3=22,2373278144607	FrameElem=40-1
ElemStation=0,04	
Frame=40 Station=0,08 OutputCase=STR082 CaseType=Combination P=-23,817817948249 V2=14,1207146167212 V3=0 T=0 M2=0 M3=21,6756992297918	FrameElem=40-1
ElemStation=0,08	
Frame=40 Station=0 OutputCase=STR083 CaseType=Combination P=-40,1165933887967 V2=15,8766769620669 V3=0 T=0 M2=0 M3=8,26144324904169	FrameElem=40-1
ElemStation=0	
Frame=40 Station=0,04 OutputCase=STR083 CaseType=Combination P=-40,1165933887967 V2=16,0366769620669 V3=0 T=0 M2=0 M3=7,62317617055902	FrameElem=40-1
ElemStation=0,04	
Frame=40 Station=0,08 OutputCase=STR083 CaseType=Combination P=-40,1165933887967 V2=16,1966769620669 V3=0 T=0 M2=0 M3=6,97850909207634	FrameElem=40-1
ElemStation=0,08	
Frame=40 Station=0 OutputCase=STR084 CaseType=Combination P=-19,9375282924465 V2=82,7277795864749 V3=0 T=0 M2=0 M3=44,4386988532478	FrameElem=40-1
ElemStation=0	
Frame=40 Station=0,04 OutputCase=STR084 CaseType=Combination P=-19,9375282924465 V2=82,9437795864749 V3=0 T=0 M2=0 M3=41,1252676697888	FrameElem=40-1
ElemStation=0,04	
Frame=40 Station=0,08 OutputCase=STR084 CaseType=Combination P=-19,9375282924465 V2=83,1597795864749 V3=0 T=0 M2=0 M3=37,8031964863298	FrameElem=40-1
ElemStation=0,08	
Frame=40 Station=0 OutputCase=STR085 CaseType=Combination P=-6,89656433165917 V2=91,5708045753475 V3=0 T=0 M2=0 M3=14,5885168860651	FrameElem=40-1
ElemStation=0	
Frame=40 Station=0,04 OutputCase=STR085 CaseType=Combination P=-6,89656433165917 V2=91,7868045753475 V3=0 T=0 M2=0 M3=10,9213647030512	FrameElem=40-1
ElemStation=0,04	
Frame=40 Station=0,08 OutputCase=STR085 CaseType=Combination P=-6,89656433165917 V2=92,0028045753475 V3=0 T=0 M2=0 M3=7,24557252003733	FrameElem=40-1
ElemStation=0,08	
Frame=40 Station=0 OutputCase=STR086 CaseType=Combination P=-20,0901094025551 V2=89,9805686111706 V3=0 T=0 M2=0 M3=29,7479558547976	FrameElem=40-1
ElemStation=0	
Frame=40 Station=0,04 OutputCase=STR086 CaseType=Combination P=-20,0901094025551 V2=90,1965686111706 V3=0 T=0 M2=0 M3=26,1444131103508	FrameElem=40-1
ElemStation=0,04	
Frame=40 Station=0,08 OutputCase=STR086 CaseType=Combination P=-20,0901094025551 V2=90,4125686111707 V3=0 T=0 M2=0 M3=22,5322303659039	FrameElem=40-1
ElemStation=0,08	
Frame=40 Station=0 OutputCase=STR087 CaseType=Combination P=-33,2836544671646 V2=91,5783770216366 V3=0 T=0 M2=0 M3=18,2843566751179	FrameElem=40-1
ElemStation=0	
Frame=40 Station=0,04 OutputCase=STR087 CaseType=Combination P=-33,2836544671646 V2=91,7943770216366 V3=0 T=0 M2=0 M3=14,6169015942525	FrameElem=40-1
ElemStation=0,04	
Frame=40 Station=0,08 OutputCase=STR087 CaseType=Combination P=-33,2836544671646 V2=92,0103770216366 V3=0 T=0 M2=0 M3=10,940806513387	FrameElem=40-1
ElemStation=0,08	

Società di Progetto
Brebemi SpA



Doc. N.
60235-0000-A00.doc

CODIFICA DOCUMENTO
04RCDII10000000000300A00

REV.
00

FOGLIO
508 di 628

Frame=40 Station=0 OutputCase=STR088 CaseType=Combination P=-20,8651686849341 V2=14,5822793951992 V3=0 T=0 M2=0 M3=19,1012105203023 ElemStation=0	Frame=40 Station=0,04 OutputCase=STR088 CaseType=Combination P=-20,8651686849341 V2=14,7422793951992 V3=0 T=0 M2=0 M3=18,5147193444943 ElemStation=0,04	Frame=40 Station=0,08 OutputCase=STR088 CaseType=Combination P=-20,8651686849341 V2=14,9022793951992 V3=0 T=0 M2=0 M3=17,9218281686864 ElemStation=0,08	Frame=40 Station=0 OutputCase=STR089 CaseType=Combination P=-34,0587137495436 V2=16,1800878056652 V3=0 T=0 M2=0 M3=7,63761134062266 ElemStation=0	Frame=40 Station=0,04 OutputCase=STR089 CaseType=Combination P=-34,0587137495436 V2=16,3400878056652 V3=0 T=0 M2=0 M3=6,98720782839606 ElemStation=0,04	Frame=40 Station=0,08 OutputCase=STR089 CaseType=Combination P=-34,0587137495436 V2=16,5000878056652 V3=0 T=0 M2=0 M3=6,33040431616945 ElemStation=0,08	Frame=40 Station=0 OutputCase=STR090 CaseType=Combination P=-15,0727372479529 V2=21,5661672601779 V3=0 T=0 M2=0 M3=5,26009920254729 ElemStation=0	Frame=40 Station=0,04 OutputCase=STR090 CaseType=Combination P=-15,0727372479529 V2=21,7821672601779 V3=0 T=0 M2=0 M3=4,39313251214017 ElemStation=0,04	Frame=40 Station=0,08 OutputCase=STR090 CaseType=Combination P=-15,0727372479529 V2=21,9981672601779 V3=0 T=0 M2=0 M3=3,51752582173305 ElemStation=0,08	Frame=40 Station=0 OutputCase=STR091 CaseType=Combination P=-7,3170293756199 V2=21,5642409708392 V3=0 T=0 M2=0 M3=4,31994632958391 ElemStation=0	Frame=40 Station=0,04 OutputCase=STR091 CaseType=Combination P=-7,3170293756199 V2=21,7802409708392 V3=0 T=0 M2=0 M3=3,45305669075034 ElemStation=0,04	Frame=40 Station=0,08 OutputCase=STR091 CaseType=Combination P=-7,3170293756199 V2=21,9962409708392 V3=0 T=0 M2=0 M3=2,57752705191677 ElemStation=0,08	Frame=40 Station=0 OutputCase=STR092 CaseType=Combination P=-6,34489022842963 V2=91,5698660955871 V3=0 T=0 M2=0 M3=14,1304785464065 ElemStation=0	Frame=40 Station=0,04 OutputCase=STR092 CaseType=Combination P=-6,34489022842963 V2=91,7858660955871 V3=0 T=0 M2=0 M3=10,463363902583 ElemStation=0,04	Frame=40 Station=0,08 OutputCase=STR092 CaseType=Combination P=-6,34489022842963 V2=92,0018660955871 V3=0 T=0 M2=0 M3=6,78760925875955 ElemStation=0,08	Frame=40 Station=0 OutputCase=STR093 CaseType=Combination P=-19,5384352993256 V2=89,9796301314102 V3=0 T=0 M2=0 M3=29,289917515139 ElemStation=0	Frame=40 Station=0,04 OutputCase=STR093 CaseType=Combination P=-19,5384352993256 V2=90,1956301314102 V3=0 T=0 M2=0 M3=25,6864123098826 ElemStation=0,04	Frame=40 Station=0,08 OutputCase=STR093 CaseType=Combination P=-19,5384352993256 V2=90,4116301314102 V3=0 T=0 M2=0 M3=22,0742671046261 ElemStation=0,08	Frame=40 Station=0 OutputCase=STR094 CaseType=Combination P=-32,7319803639351 V2=91,5774385418762 V3=0 T=0 M2=0 M3=17,8263183354593 ElemStation=0	Frame=40 Station=0,04 OutputCase=STR094 CaseType=Combination P=-32,7319803639351 V2=91,7934385418762 V3=0 T=0 M2=0 M3=14,1589007937843 ElemStation=0,04	Frame=40 Station=0,08 OutputCase=STR094 CaseType=Combination P=-32,7319803639351 V2=92,0094385418762 V3=0 T=0 M2=0 M3=10,4828432521092 ElemStation=0,08	Frame=40 Station=0 OutputCase=STR095 CaseType=Combination P=-20,3134945817046 V2=14,5813409154388 V3=0 T=0 M2=0 M3=18,6431721806437 ElemStation=0	Frame=40 Station=0,04 OutputCase=STR095 CaseType=Combination P=-20,3134945817046 V2=14,7413409154388 V3=0 T=0 M2=0 M3=18,0567185440262 ElemStation=0,04	Frame=40 Station=0,08 OutputCase=STR095 CaseType=Combination P=-20,3134945817046 V2=14,9013409154388 V3=0 T=0 M2=0 M3=17,4638649074086 ElemStation=0,08	Frame=40 Station=0 OutputCase=STR096 CaseType=Combination P=-33,5070396463141 V2=16,1791493259048 V3=0 T=0 M2=0 M3=7,17957300096405 ElemStation=0	Frame=40 Station=0,04 OutputCase=STR096 CaseType=Combination P=-33,5070396463141 V2=16,3391493259048 V3=0 T=0 M2=0 M3=6,52920702792786 ElemStation=0,04	Frame=40 Station=0,08 OutputCase=STR096 CaseType=Combination P=-33,5070396463141 V2=16,4991493259048 V3=0 T=0 M2=0 M3=5,87244105489167 ElemStation=0,08	Frame=40 Station=0 OutputCase=STR097 CaseType=Combination P=-16,176085454412 V2=21,5680442196987 V3=0 T=0 M2=0 M3=6,17617588186451 ElemStation=0	Frame=40 Station=0,04 OutputCase=STR097 CaseType=Combination P=-16,176085454412 V2=21,7840442196987 V3=0 T=0 M2=0 M3=5,30913411307656 ElemStation=0,04	Frame=40 Station=0,08 OutputCase=STR097 CaseType=Combination P=-16,176085454412 V2=22,0000442196987 V3=0 T=0 M2=0 M3=4,43345234428861 ElemStation=0,08	Frame=40 Station=0 OutputCase=STR098 CaseType=Combination P=-8,42037758207898 V2=21,56611793036 V3=0 T=0 M2=0 M3=5,23602300890113 ElemStation=0	Frame=40 Station=0,04 OutputCase=STR098 CaseType=Combination P=-8,42037758207898 V2=21,78211793036 V3=0 T=0 M2=0 M3=4,36905829168673 ElemStation=0,04	Frame=40 Station=0,08 OutputCase=STR098 CaseType=Combination P=-8,42037758207898 V2=21,99811793036 V3=0 T=0 M2=0 M3=3,49345357447233 ElemStation=0,08	Frame=40 Station=0 OutputCase=STR099 CaseType=Combination P=-7,44823843488871 V2=91,5717430551079 V3=0 T=0 M2=0 M3=15,0465552257237 ElemStation=0	Frame=40 Station=0,04 OutputCase=STR099 CaseType=Combination P=-7,44823843488871 V2=91,7877430551079 V3=0 T=0 M2=0 M3=11,3793655035194 ElemStation=0,04	Frame=40 Station=0,08 OutputCase=STR099 CaseType=Combination P=-7,44823843488871 V2=92,0037430551079 V3=0 T=0 M2=0 M3=7,7033537813151 ElemStation=0,08	Frame=40 Station=0 OutputCase=STR100 CaseType=Combination P=-20,6417835057846 V2=89,981507090931 V3=0 T=0 M2=0 M3=30,2059941944562 ElemStation=0	Frame=40 Station=0,04 OutputCase=STR100 CaseType=Combination P=-20,6417835057846 V2=90,1975070909311 V3=0 T=0 M2=0 M3=26,6024139108189 ElemStation=0,04	Frame=40 Station=0,08 OutputCase=STR100 CaseType=Combination P=-20,6417835057846 V2=90,4135070909311 V3=0 T=0 M2=0 M3=22,9901936271817 ElemStation=0,08	Frame=40 Station=0 OutputCase=STR101 CaseType=Combination P=-33,8353285703941 V2=91,579315501397 V3=0 T=0 M2=0 M3=18,7423950147765 ElemStation=0	Frame=40 Station=0,04 OutputCase=STR101 CaseType=Combination P=-33,8353285703941 V2=91,795315501397 V3=0 T=0 M2=0 M3=15,074023947206 ElemStation=0,04	Frame=40 Station=0,08 OutputCase=STR101 CaseType=Combination P=-33,8353285703941 V2=92,011315501397 V3=0 T=0 M2=0 M3=11,3987697746648 ElemStation=0,08	Frame=40 Station=0 OutputCase=STR102 CaseType=Combination P=-21,4168427881636 V2=14,5832178749596 V3=0 T=0 M2=0 M3=19,5592488599609 ElemStation=0	Frame=40 Station=0,04 OutputCase=STR102 CaseType=Combination P=-21,4168427881636 V2=14,7432178749596 V3=0 T=0 M2=0 M3=18,9727201449625 ElemStation=0,04
---	---	---	---	---	---	---	---	---	--	--	--	---	--	---	--	---	---	---	---	---	---	---	---	---	---	---	--	--	--	---	---	---	---	---	--	--	---	---	--	---	--	---	---

Società di Progetto
Brebemi SpA

	Doc. N. 60235-00000-A00.doc	CODIFICA DOCUMENTO 04RCDII10000000000300A00	REV. 00	FOGLIO 509 di 628
--	--------------------------------	--	------------	----------------------

Frame=40 Station=0,08 OutputCase=STR102 CaseType=Combination P=-21,4168427881636 V2=14,9032178749596 V3=0 T=0 M2=0 M3=18,3797914299642	FrameElem=40-1 ElemStation=0,08
Frame=40 Station=0 OutputCase=STR103 CaseType=Combination P=-34,6103878527731 V2=16,1810262854256 V3=0 T=0 M2=0 M3=8,09564968028127	FrameElem=40-1 ElemStation=0
Frame=40 Station=0,04 OutputCase=STR103 CaseType=Combination P=-34,6103878527731 V2=16,3410262854256 V3=0 T=0 M2=0 M3=7,44520862886425	FrameElem=40-1 ElemStation=0,04
Frame=40 Station=0,08 OutputCase=STR103 CaseType=Combination P=-34,6103878527731 V2=16,5010262854256 V3=0 T=0 M2=0 M3=6,78836757744723	FrameElem=40-1 ElemStation=0,08
Frame=40 Station=0 OutputCase=STR104 CaseType=Combination P=-16,176085454412 V2=21,5680442196987 V3=0 T=0 M2=0 M3=6,17617588186451	FrameElem=40-1 ElemStation=0
Frame=40 Station=0,04 OutputCase=STR104 CaseType=Combination P=-16,176085454412 V2=21,7840442196987 V3=0 T=0 M2=0 M3=5,30913411307656	FrameElem=40-1 ElemStation=0,04
Frame=40 Station=0,08 OutputCase=STR104 CaseType=Combination P=-16,176085454412 V2=22,0000442196987 V3=0 T=0 M2=0 M3=4,43345234428861	FrameElem=40-1 ElemStation=0,08
Frame=40 Station=0 OutputCase=STR105 CaseType=Combination P=-8,42037758207898 V2=21,56611793036 V3=0 T=0 M2=0 M3=5,23602300890113	FrameElem=40-1 ElemStation=0
Frame=40 Station=0,04 OutputCase=STR105 CaseType=Combination P=-8,42037758207898 V2=21,78211793036 V3=0 T=0 M2=0 M3=4,36905829168673	FrameElem=40-1 ElemStation=0,04
Frame=40 Station=0,08 OutputCase=STR105 CaseType=Combination P=-8,42037758207898 V2=21,99811793036 V3=0 T=0 M2=0 M3=3,49345357447233	FrameElem=40-1 ElemStation=0,08
Frame=40 Station=0 OutputCase=STR106 CaseType=Combination P=-7,44823843488871 V2=91,5717430551079 V3=0 T=0 M2=0 M3=15,0465552527237	FrameElem=40-1 ElemStation=0
Frame=40 Station=0,04 OutputCase=STR106 CaseType=Combination P=-7,44823843488871 V2=91,7877430551079 V3=0 T=0 M2=0 M3=11,3793655035194	FrameElem=40-1 ElemStation=0,04
Frame=40 Station=0,08 OutputCase=STR106 CaseType=Combination P=-7,44823843488871 V2=92,0037430551079 V3=0 T=0 M2=0 M3=7,7035357813151	FrameElem=40-1 ElemStation=0,08
Frame=40 Station=0 OutputCase=STR107 CaseType=Combination P=-20,6417835057846 V2=89,981507090931 V3=0 T=0 M2=0 M3=30,2059941944562	FrameElem=40-1 ElemStation=0
Frame=40 Station=0,04 OutputCase=STR107 CaseType=Combination P=-20,6417835057846 V2=90,1975070909311 V3=0 T=0 M2=0 M3=26,6024139108189	FrameElem=40-1 ElemStation=0,04
Frame=40 Station=0,08 OutputCase=STR107 CaseType=Combination P=-20,6417835057846 V2=90,4135070909311 V3=0 T=0 M2=0 M3=22,9901936271817	FrameElem=40-1 ElemStation=0,08
Frame=40 Station=0 OutputCase=STR108 CaseType=Combination P=-33,8353285703941 V2=91,579315501397 V3=0 T=0 M2=0 M3=18,7423950147765	FrameElem=40-1 ElemStation=0
Frame=40 Station=0,04 OutputCase=STR108 CaseType=Combination P=-33,8353285703941 V2=91,795315501397 V3=0 T=0 M2=0 M3=15,0749023947206	FrameElem=40-1 ElemStation=0,04
Frame=40 Station=0,08 OutputCase=STR108 CaseType=Combination P=-33,8353285703941 V2=92,011315501397 V3=0 T=0 M2=0 M3=11,3987697746648	FrameElem=40-1 ElemStation=0,08
Frame=40 Station=0 OutputCase=STR109 CaseType=Combination P=-21,4168427881636 V2=14,5832178749596 V3=0 T=0 M2=0 M3=19,5592488599609	FrameElem=40-1 ElemStation=0
Frame=40 Station=0,04 OutputCase=STR109 CaseType=Combination P=-21,4168427881636 V2=14,7432178749596 V3=0 T=0 M2=0 M3=18,9727201449625	FrameElem=40-1 ElemStation=0,04
Frame=40 Station=0,08 OutputCase=STR109 CaseType=Combination P=-21,4168427881636 V2=14,9032178749596 V3=0 T=0 M2=0 M3=18,3797914299642	FrameElem=40-1 ElemStation=0,08
Frame=40 Station=0 OutputCase=STR110 CaseType=Combination P=-34,6103878527731 V2=16,1810262854256 V3=0 T=0 M2=0 M3=8,09564968028127	FrameElem=40-1 ElemStation=0
Frame=40 Station=0,04 OutputCase=STR110 CaseType=Combination P=-34,6103878527731 V2=16,3410262854256 V3=0 T=0 M2=0 M3=7,44520862886425	FrameElem=40-1 ElemStation=0,04
Frame=40 Station=0,08 OutputCase=STR110 CaseType=Combination P=-34,6103878527731 V2=16,5010262854256 V3=0 T=0 M2=0 M3=6,78836757744723	FrameElem=40-1 ElemStation=0,08
Frame=40 Station=0 OutputCase=STR111 CaseType=Combination P=-14,8615057754937 V2=20,0406412603633 V3=0 T=0 M2=0 M3=4,24448555748535	FrameElem=40-1 ElemStation=0
Frame=40 Station=0,04 OutputCase=STR111 CaseType=Combination P=-14,8615057754937 V2=20,2566412603633 V3=0 T=0 M2=0 M3=3,4385399070782	FrameElem=40-1 ElemStation=0,04
Frame=40 Station=0,08 OutputCase=STR111 CaseType=Combination P=-14,8615057754937 V2=20,4726412603633 V3=0 T=0 M2=0 M3=2,62395425665629	FrameElem=40-1 ElemStation=0,08
Frame=40 Station=0 OutputCase=STR112 CaseType=Combination P=-7,10579790316072 V2=20,0387149710245 V3=0 T=0 M2=0 M3=3,30433268452197	FrameElem=40-1 ElemStation=0
Frame=40 Station=0,04 OutputCase=STR112 CaseType=Combination P=-7,10579790316072 V2=20,2547149710245 V3=0 T=0 M2=0 M3=2,49846408568099	FrameElem=40-1 ElemStation=0,04
Frame=40 Station=0,08 OutputCase=STR112 CaseType=Combination P=-7,10579790316072 V2=20,4707149710245 V3=0 T=0 M2=0 M3=1,68395548684001	FrameElem=40-1 ElemStation=0,08
Frame=40 Station=0 OutputCase=STR113 CaseType=Combination P=-5,96219348871144 V2=113,684841366603 V3=0 T=0 M2=0 M3=16,6797727038962	FrameElem=40-1 ElemStation=0
Frame=40 Station=0,04 OutputCase=STR113 CaseType=Combination P=-5,96219348871144 V2=113,900841366603 V3=0 T=0 M2=0 M3=12,1280590492321	FrameElem=40-1 ElemStation=0,04
Frame=40 Station=0,08 OutputCase=STR113 CaseType=Combination P=-5,96219348871144 V2=114,116841366603 V3=0 T=0 M2=0 M3=7,56770539456795	FrameElem=40-1 ElemStation=0,08
Frame=40 Station=0 OutputCase=STR114 CaseType=Combination P=-22,2609689380601 V2=111,618333519864 V3=0 T=0 M2=0 M3=35,8252879484	FrameElem=40-1 ElemStation=0
Frame=40 Station=0,04 OutputCase=STR114 CaseType=Combination P=-22,2609689380601 V2=111,834333519864 V3=0 T=0 M2=0 M3=31,3562346076054	FrameElem=40-1 ElemStation=0,04
Frame=40 Station=0,08 OutputCase=STR114 CaseType=Combination P=-22,2609689380601 V2=112,050333519864 V3=0 T=0 M2=0 M3=26,8785412668109	FrameElem=40-1 ElemStation=0,08
Frame=40 Station=0 OutputCase=STR115 CaseType=Combination P=-38,5597443786077 V2=113,694295865209 V3=0 T=0 M2=0 M3=21,2941747983122	FrameElem=40-1 ElemStation=0
Frame=40 Station=0,04 OutputCase=STR115 CaseType=Combination P=-38,5597443786077 V2=113,910295865209 V3=0 T=0 M2=0 M3=16,7420829637038	FrameElem=40-1 ElemStation=0,04
Frame=40 Station=0,08 OutputCase=STR115 CaseType=Combination P=-38,5597443786077 V2=114,126295865209 V3=0 T=0 M2=0 M3=12,1813511290954	FrameElem=40-1 ElemStation=0,08
Frame=40 Station=0 OutputCase=STR116 CaseType=Combination P=-23,3600746028358 V2=12,8848359289761 V3=0 T=0 M2=0 M3=21,9083652082972	FrameElem=40-1 ElemStation=0
Frame=40 Station=0,04 OutputCase=STR116 CaseType=Combination P=-23,3600746028358 V2=13,0448359289761 V3=0 T=0 M2=0 M3=21,3897717711381	FrameElem=40-1 ElemStation=0,04
Frame=40 Station=0,08 OutputCase=STR116 CaseType=Combination P=-23,3600746028358 V2=13,2048359289761 V3=0 T=0 M2=0 M3=20,8647783339791	FrameElem=40-1 ElemStation=0,08
Frame=40 Station=0 OutputCase=STR117 CaseType=Combination P=-39,6588500433834 V2=14,9607982743219 V3=0 T=0 M2=0 M3=7,37725205820936	FrameElem=40-1 ElemStation=0

Società di Progetto
Brebemi SpA

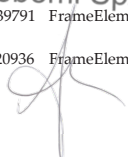

	Doc. N. 60235-0000-A00.doc	CODIFICA DOCUMENTO 04RCDII10000000000300A00	REV. 00	FOGLIO 510 di 628
--	-------------------------------	--	------------	----------------------

Frame=40 ElemStation=0,04	Station=0,04	OutputCase=STR117	CaseType=Combination	P=-,39,6588500433834	V2=15,1207982743219	V3=0	T=0	M2=0	M3=6,77562012723649	FrameElem=40-1
Frame=40 ElemStation=0,08	Station=0,08	OutputCase=STR117	CaseType=Combination	P=-,39,6588500433834	V2=15,2807982743219	V3=0	T=0	M2=0	M3=6,16758819626361	FrameElem=40-1
Frame=40 ElemStation=0	Station=0	OutputCase=STR118	CaseType=Combination	P=-,19,4797849470333	V2=81,8119008987298	V3=0	T=0	M2=0	M3=43,5545076624155	FrameElem=40-1
Frame=40 ElemStation=0,04	Station=0,04	OutputCase=STR118	CaseType=Combination	P=-,19,4797849470333	V2=82,0279008987298	V3=0	T=0	M2=0	M3=40,2777116264663	FrameElem=40-1
Frame=40 ElemStation=0,08	Station=0,08	OutputCase=STR118	CaseType=Combination	P=-,19,4797849470333	V2=82,2439008987298	V3=0	T=0	M2=0	M3=36,9922755905171	FrameElem=40-1
Frame=40 ElemStation=0	Station=0	OutputCase=STR119	CaseType=Combination	P=-,6,13365875597045	V2=90,0443400957724	V3=0	T=0	M2=0	M3=13,1148649013446	FrameElem=40-1
Frame=40 ElemStation=0,04	Station=0,04	OutputCase=STR119	CaseType=Combination	P=-,6,13365875597045	V2=90,2603400957724	V3=0	T=0	M2=0	M3=9,50877129751368	FrameElem=40-1
Frame=40 ElemStation=0,08	Station=0,08	OutputCase=STR119	CaseType=Combination	P=-,6,13365875597045	V2=90,4763400957724	V3=0	T=0	M2=0	M3=5,89403769368278	FrameElem=40-1
Frame=40 ElemStation=0	Station=0	OutputCase=STR120	CaseType=Combination	P=-,19,3272038268664	V2=88,4541041315956	V3=0	T=0	M2=0	M3=28,274303870077	FrameElem=40-1
Frame=40 ElemStation=0,04	Station=0,04	OutputCase=STR120	CaseType=Combination	P=-,19,3272038268664	V2=88,6701041315956	V3=0	T=0	M2=0	M3=24,7318197048132	FrameElem=40-1
Frame=40 ElemStation=0,08	Station=0,08	OutputCase=STR120	CaseType=Combination	P=-,19,3272038268664	V2=88,8861041315956	V3=0	T=0	M2=0	M3=21,1806955395494	FrameElem=40-1
Frame=40 ElemStation=0	Station=0	OutputCase=STR121	CaseType=Combination	P=-,32,5207488914759	V2=90,0519125420615	V3=0	T=0	M2=0	M3=16,8107046903974	FrameElem=40-1
Frame=40 ElemStation=0,04	Station=0,04	OutputCase=STR121	CaseType=Combination	P=-,32,5207488914759	V2=90,2679125420615	V3=0	T=0	M2=0	M3=13,2043081887149	FrameElem=40-1
Frame=40 ElemStation=0,08	Station=0,08	OutputCase=STR121	CaseType=Combination	P=-,32,5207488914759	V2=90,4839125420615	V3=0	T=0	M2=0	M3=9,58927168703245	FrameElem=40-1
Frame=40 ElemStation=0	Station=0	OutputCase=STR122	CaseType=Combination	P=-,20,1022631092454	V2=13,0558149156242	V3=0	T=0	M2=0	M3=17,6275585355818	FrameElem=40-1
Frame=40 ElemStation=0,04	Station=0,04	OutputCase=STR122	CaseType=Combination	P=-,20,1022631092454	V2=13,2158149156242	V3=0	T=0	M2=0	M3=17,1021259389568	FrameElem=40-1
Frame=40 ElemStation=0,08	Station=0,08	OutputCase=STR122	CaseType=Combination	P=-,20,1022631092454	V2=13,3758149156242	V3=0	T=0	M2=0	M3=16,5702933423318	FrameElem=40-1
Frame=40 ElemStation=0	Station=0	OutputCase=STR123	CaseType=Combination	P=-,33,2958081738549	V2=14,6536233260901	V3=0	T=0	M2=0	M3=6,16395935590211	FrameElem=40-1
Frame=40 ElemStation=0,04	Station=0,04	OutputCase=STR123	CaseType=Combination	P=-,33,2958081738549	V2=14,8136233260901	V3=0	T=0	M2=0	M3=5,57461442285851	FrameElem=40-1
Frame=40 ElemStation=0,08	Station=0,08	OutputCase=STR123	CaseType=Combination	P=-,33,2958081738549	V2=14,9736233260901	V3=0	T=0	M2=0	M3=4,97886948981491	FrameElem=40-1
Frame=40 ElemStation=0	Station=0	OutputCase=STR124	CaseType=Combination	P=-,14,3098316722642	V2=20,0397027806029	V3=0	T=0	M2=0	M3=3,78644721782674	FrameElem=40-1
Frame=40 ElemStation=0,04	Station=0,04	OutputCase=STR124	CaseType=Combination	P=-,14,3098316722642	V2=20,2557027806029	V3=0	T=0	M2=0	M3=2,98053910660263	FrameElem=40-1
Frame=40 ElemStation=0,08	Station=0,08	OutputCase=STR124	CaseType=Combination	P=-,14,3098316722642	V2=20,4717027806029	V3=0	T=0	M2=0	M3=2,16599099537851	FrameElem=40-1
Frame=40 ElemStation=0	Station=0	OutputCase=STR125	CaseType=Combination	P=-,6,55412379993118	V2=20,0377764912641	V3=0	T=0	M2=0	M3=2,84629434486336	FrameElem=40-1
Frame=40 ElemStation=0,04	Station=0,04	OutputCase=STR125	CaseType=Combination	P=-,6,55412379993118	V2=20,2537764912641	V3=0	T=0	M2=0	M3=2,04046328521279	FrameElem=40-1
Frame=40 ElemStation=0,08	Station=0,08	OutputCase=STR125	CaseType=Combination	P=-,6,55412379993118	V2=20,4697764912641	V3=0	T=0	M2=0	M3=1,22599222556223	FrameElem=40-1
Frame=40 ElemStation=0	Station=0	OutputCase=STR126	CaseType=Combination	P=-,5,58198465274091	V2=90,043401616012	V3=0	T=0	M2=0	M3=12,656826561686	FrameElem=40-1
Frame=40 ElemStation=0,04	Station=0,04	OutputCase=STR126	CaseType=Combination	P=-,5,58198465274091	V2=90,259401616012	V3=0	T=0	M2=0	M3=9,05077049704548	FrameElem=40-1
Frame=40 ElemStation=0,08	Station=0,08	OutputCase=STR126	CaseType=Combination	P=-,5,58198465274091	V2=90,475401616012	V3=0	T=0	M2=0	M3=5,43607443240501	FrameElem=40-1
Frame=40 ElemStation=0	Station=0	OutputCase=STR127	CaseType=Combination	P=-,18,7755297236368	V2=88,4531656518352	V3=0	T=0	M2=0	M3=27,8162655304184	FrameElem=40-1
Frame=40 ElemStation=0,04	Station=0,04	OutputCase=STR127	CaseType=Combination	P=-,18,7755297236368	V2=88,6691656518352	V3=0	T=0	M2=0	M3=24,273818904345	FrameElem=40-1
Frame=40 ElemStation=0,08	Station=0,08	OutputCase=STR127	CaseType=Combination	P=-,18,7755297236368	V2=88,8851656518352	V3=0	T=0	M2=0	M3=20,7227322782716	FrameElem=40-1
Frame=40 ElemStation=0	Station=0	OutputCase=STR128	CaseType=Combination	P=-,31,9690747882463	V2=90,0509740623011	V3=0	T=0	M2=0	M3=16,3526663507388	FrameElem=40-1
Frame=40 ElemStation=0,04	Station=0,04	OutputCase=STR128	CaseType=Combination	P=-,31,9690747882463	V2=90,2669740623011	V3=0	T=0	M2=0	M3=12,7463073882467	FrameElem=40-1
Frame=40 ElemStation=0,08	Station=0,08	OutputCase=STR128	CaseType=Combination	P=-,31,9690747882463	V2=90,4829740623011	V3=0	T=0	M2=0	M3=9,13130842575467	FrameElem=40-1
Frame=40 ElemStation=0	Station=0	OutputCase=STR129	CaseType=Combination	P=-,19,5505890060158	V2=13,0548764358637	V3=0	T=0	M2=0	M3=17,16952011959232	FrameElem=40-1
Frame=40 ElemStation=0,04	Station=0,04	OutputCase=STR129	CaseType=Combination	P=-,19,5505890060158	V2=13,2148764358637	V3=0	T=0	M2=0	M3=16,6441251384886	FrameElem=40-1
Frame=40 ElemStation=0,08	Station=0,08	OutputCase=STR129	CaseType=Combination	P=-,19,5505890060158	V2=13,3748764358637	V3=0	T=0	M2=0	M3=16,1123300810541	FrameElem=40-1
Frame=40 ElemStation=0	Station=0	OutputCase=STR130	CaseType=Combination	P=-,32,7441340706253	V2=14,6526848463297	V3=0	T=0	M2=0	M3=5,7059210162435	FrameElem=40-1
Frame=40 ElemStation=0,04	Station=0,04	OutputCase=STR130	CaseType=Combination	P=-,32,7441340706253	V2=14,8126848463297	V3=0	T=0	M2=0	M3=5,11661362239032	FrameElem=40-1
Frame=40 ElemStation=0,08	Station=0,08	OutputCase=STR130	CaseType=Combination	P=-,32,7441340706253	V2=14,9726848463297	V3=0	T=0	M2=0	M3=4,52090622853713	FrameElem=40-1
Frame=40 ElemStation=0	Station=0	OutputCase=STR131	CaseType=Combination	P=-,15,4131798787233	V2=20,0415797401237	V3=0	T=0	M2=0	M3=4,70252389714396	FrameElem=40-1
Frame=40 ElemStation=0,04	Station=0,04	OutputCase=STR131	CaseType=Combination	P=-,15,4131798787233	V2=20,2575797401237	V3=0	T=0	M2=0	M3=3,89654070753901	FrameElem=40-1
Frame=40 ElemStation=0,08	Station=0,08	OutputCase=STR131	CaseType=Combination	P=-,15,4131798787233	V2=20,4735797401237	V3=0	T=0	M2=0	M3=3,08191751793407	FrameElem=40-1

Società di Progetto
Brebemi SpA



Doc. N.
60235-0000-A00.doc

CODIFICA DOCUMENTO
04RCDII10000000000300A00

REV.
00

FOGLIO
511 di 628

Frame=40 Station=0 OutputCase=STR132 CaseType=Combination P=-7,65747200639027 V2=20,0396534507849 V3=0 T=0 M2=0 M3=3,76237102418058	FrameElem=40-1
ElemStation=0	
Frame=40 Station=0,04 OutputCase=STR132 CaseType=Combination P=-7,65747200639027 V2=20,2556534507849 V3=0 T=0 M2=0 M3=2,95646488614918	FrameElem=40-1
ElemStation=0,04	
Frame=40 Station=0,08 OutputCase=STR132 CaseType=Combination P=-7,65747200639027 V2=20,4716534507849 V3=0 T=0 M2=0 M3=2,14191874811778	FrameElem=40-1
ElemStation=0,08	
Frame=40 Station=0 OutputCase=STR133 CaseType=Combination P=-6,68533285919999 V2=90,0452785755328 V3=0 T=0 M2=0 M3=13,5729032410032	FrameElem=40-1
ElemStation=0	
Frame=40 Station=0,04 OutputCase=STR133 CaseType=Combination P=-6,68533285919999 V2=90,2612785755328 V3=0 T=0 M2=0 M3=9,96677209798187	FrameElem=40-1
ElemStation=0,04	
Frame=40 Station=0,08 OutputCase=STR133 CaseType=Combination P=-6,68533285919999 V2=90,4772785755328 V3=0 T=0 M2=0 M3=6,35200095496056	FrameElem=40-1
ElemStation=0,08	
Frame=40 Station=0 OutputCase=STR134 CaseType=Combination P=-19,8788779300959 V2=88,455042611356 V3=0 T=0 M2=0 M3=28,7323422097356	FrameElem=40-1
ElemStation=0	
Frame=40 Station=0,04 OutputCase=STR134 CaseType=Combination P=-19,8788779300959 V2=88,671042611356 V3=0 T=0 M2=0 M3=25,1898205052814	FrameElem=40-1
ElemStation=0,04	
Frame=40 Station=0,08 OutputCase=STR134 CaseType=Combination P=-19,8788779300959 V2=88,887042611356 V3=0 T=0 M2=0 M3=21,6386588008272	FrameElem=40-1
ElemStation=0,08	
Frame=40 Station=0 OutputCase=STR135 CaseType=Combination P=-33,0724229947054 V2=90,0528510218219 V3=0 T=0 M2=0 M3=17,268743030056	FrameElem=40-1
ElemStation=0	
Frame=40 Station=0,04 OutputCase=STR135 CaseType=Combination P=-33,0724229947054 V2=90,2688510218219 V3=0 T=0 M2=0 M3=13,6623089891831	FrameElem=40-1
ElemStation=0,04	
Frame=40 Station=0,08 OutputCase=STR135 CaseType=Combination P=-33,0724229947054 V2=90,484851021822 V3=0 T=0 M2=0 M3=10,0472349483102	FrameElem=40-1
ElemStation=0,08	
Frame=40 Station=0 OutputCase=STR136 CaseType=Combination P=-20,6539372124749 V2=13,0567533953846 V3=0 T=0 M2=0 M3=18,0855968752404	FrameElem=40-1
ElemStation=0	
Frame=40 Station=0,04 OutputCase=STR136 CaseType=Combination P=-20,6539372124749 V2=13,2167533953846 V3=0 T=0 M2=0 M3=17,560126739425	FrameElem=40-1
ElemStation=0,04	
Frame=40 Station=0,08 OutputCase=STR136 CaseType=Combination P=-20,6539372124749 V2=13,3767533953846 V3=0 T=0 M2=0 M3=17,0282566036096	FrameElem=40-1
ElemStation=0,08	
Frame=40 Station=0 OutputCase=STR137 CaseType=Combination P=-33,8474822770844 V2=14,6545618058505 V3=0 T=0 M2=0 M3=6,62199769556072	FrameElem=40-1
ElemStation=0	
Frame=40 Station=0,04 OutputCase=STR137 CaseType=Combination P=-33,8474822770844 V2=14,8145618058505 V3=0 T=0 M2=0 M3=6,03261522332671	FrameElem=40-1
ElemStation=0,04	
Frame=40 Station=0,08 OutputCase=STR137 CaseType=Combination P=-33,8474822770844 V2=14,9745618058505 V3=0 T=0 M2=0 M3=5,43683275109269	FrameElem=40-1
ElemStation=0,08	
Frame=40 Station=0 OutputCase=STR138 CaseType=Combination P=-15,4131798787233 V2=20,0415797401237 V3=0 T=0 M2=0 M3=4,70252389714396	FrameElem=40-1
ElemStation=0	
Frame=40 Station=0,04 OutputCase=STR138 CaseType=Combination P=-15,4131798787233 V2=20,2575797401237 V3=0 T=0 M2=0 M3=3,89654070753901	FrameElem=40-1
ElemStation=0,04	
Frame=40 Station=0,08 OutputCase=STR138 CaseType=Combination P=-15,4131798787233 V2=20,4735797401237 V3=0 T=0 M2=0 M3=3,08191751793407	FrameElem=40-1
ElemStation=0,08	
Frame=40 Station=0 OutputCase=STR139 CaseType=Combination P=-7,65747200639027 V2=20,0396534507849 V3=0 T=0 M2=0 M3=3,76237102418058	FrameElem=40-1
ElemStation=0	
Frame=40 Station=0,04 OutputCase=STR139 CaseType=Combination P=-7,65747200639027 V2=20,2556534507849 V3=0 T=0 M2=0 M3=2,95646488614918	FrameElem=40-1
ElemStation=0,04	
Frame=40 Station=0,08 OutputCase=STR139 CaseType=Combination P=-7,65747200639027 V2=20,4716534507849 V3=0 T=0 M2=0 M3=2,14191874811778	FrameElem=40-1
ElemStation=0,08	
Frame=40 Station=0 OutputCase=STR140 CaseType=Combination P=-6,68533285919999 V2=90,0452785755328 V3=0 T=0 M2=0 M3=13,5729032410032	FrameElem=40-1
ElemStation=0	
Frame=40 Station=0,04 OutputCase=STR140 CaseType=Combination P=-6,68533285919999 V2=90,2612785755328 V3=0 T=0 M2=0 M3=9,96677209798187	FrameElem=40-1
ElemStation=0,04	
Frame=40 Station=0,08 OutputCase=STR140 CaseType=Combination P=-6,68533285919999 V2=90,4772785755328 V3=0 T=0 M2=0 M3=6,35200095496056	FrameElem=40-1
ElemStation=0,08	
Frame=40 Station=0 OutputCase=STR141 CaseType=Combination P=-19,8788779300959 V2=88,455042611356 V3=0 T=0 M2=0 M3=28,7323422097356	FrameElem=40-1
ElemStation=0	
Frame=40 Station=0,04 OutputCase=STR141 CaseType=Combination P=-19,8788779300959 V2=88,671042611356 V3=0 T=0 M2=0 M3=25,1898205052814	FrameElem=40-1
ElemStation=0,04	
Frame=40 Station=0,08 OutputCase=STR141 CaseType=Combination P=-19,8788779300959 V2=88,887042611356 V3=0 T=0 M2=0 M3=21,6386588008272	FrameElem=40-1
ElemStation=0,08	
Frame=40 Station=0 OutputCase=STR142 CaseType=Combination P=-33,0724229947054 V2=90,0528510218219 V3=0 T=0 M2=0 M3=17,268743030056	FrameElem=40-1
ElemStation=0	
Frame=40 Station=0,04 OutputCase=STR142 CaseType=Combination P=-33,0724229947054 V2=90,2688510218219 V3=0 T=0 M2=0 M3=13,6623089891831	FrameElem=40-1
ElemStation=0,04	
Frame=40 Station=0,08 OutputCase=STR142 CaseType=Combination P=-33,0724229947054 V2=90,484851021822 V3=0 T=0 M2=0 M3=10,0472349483102	FrameElem=40-1
ElemStation=0,08	
Frame=40 Station=0 OutputCase=STR143 CaseType=Combination P=-20,6539372124749 V2=13,0567533953846 V3=0 T=0 M2=0 M3=18,0855968752404	FrameElem=40-1
ElemStation=0	
Frame=40 Station=0,04 OutputCase=STR143 CaseType=Combination P=-20,6539372124749 V2=13,2167533953846 V3=0 T=0 M2=0 M3=17,560126739425	FrameElem=40-1
ElemStation=0,04	
Frame=40 Station=0,08 OutputCase=STR143 CaseType=Combination P=-20,6539372124749 V2=13,3767533953846 V3=0 T=0 M2=0 M3=17,0282566036096	FrameElem=40-1
ElemStation=0,08	
Frame=40 Station=0 OutputCase=STR144 CaseType=Combination P=-33,8474822770844 V2=14,6545618058505 V3=0 T=0 M2=0 M3=6,62199769556072	FrameElem=40-1
ElemStation=0	
Frame=40 Station=0,04 OutputCase=STR144 CaseType=Combination P=-33,8474822770844 V2=14,8145618058505 V3=0 T=0 M2=0 M3=6,03261522332671	FrameElem=40-1
ElemStation=0,04	
Frame=40 Station=0,08 OutputCase=STR144 CaseType=Combination P=-33,8474822770844 V2=14,9745618058505 V3=0 T=0 M2=0 M3=5,43683275109269	FrameElem=40-1
ElemStation=0,08	
Frame=40 Station=0 OutputCase=STR145 CaseType=Combination P=-16,162415402054 V2=20,8054376330848 V3=0 T=0 M2=0 M3=5,74470878260997	FrameElem=40-1
ElemStation=0	
Frame=40 Station=0,04 OutputCase=STR145 CaseType=Combination P=-16,162415402054 V2=21,0214376330848 V3=0 T=0 M2=0 M3=4,90817127728658	FrameElem=40-1
ElemStation=0,04	
Frame=40 Station=0,08 OutputCase=STR145 CaseType=Combination P=-16,162415402054 V2=21,2374376330848 V3=0 T=0 M2=0 M3=4,06299377196319	FrameElem=40-1
ElemStation=0,08	
Frame=40 Station=0 OutputCase=STR146 CaseType=Combination P=-8,40670752972098 V2=20,8035113437461 V3=0 T=0 M2=0 M3=4,80455590964659	FrameElem=40-1
ElemStation=0	
Frame=40 Station=0,04 OutputCase=STR146 CaseType=Combination P=-8,40670752972098 V2=21,0195113437461 V3=0 T=0 M2=0 M3=3,96809545589675	FrameElem=40-1
ElemStation=0,04	

Società di Progetto
Brebemi SpA



Doc. N.
60235-0000-A00.doc

CODIFICA DOCUMENTO
04RCDII10000000000300A00

REV.
00

FOGLIO
512 di 628

Frame=40 Station=0,08 OutputCase=STR146 CaseType=Combination P=-8,40670752972098 V2=21,2355113437461 V3=0 T=0 M2=0 M3=3,12299500214691	FrameElem=40-1 ElemStation=0,08
Frame=40 Station=0 OutputCase=STR147 CaseType=Combination P=-6,7427392646476 V2=114,143719190236 V3=0 T=0 M2=0 M3=17,579906638971	FrameElem=40-1 ElemStation=0
Frame=40 Station=0,04 OutputCase=STR147 CaseType=Combination P=-6,7427392646476 V2=114,359719190236 V3=0 T=0 M2=0 M3=13,0098378713615	FrameElem=40-1 ElemStation=0,04
Frame=40 Station=0,08 OutputCase=STR147 CaseType=Combination P=-6,7427392646476 V2=114,575719190236 V3=0 T=0 M2=0 M3=8,43112910375209	FrameElem=40-1 ElemStation=0,08
Frame=40 Station=0 OutputCase=STR148 CaseType=Combination P=-23,0415147139962 V2=112,077211343496 V3=0 T=0 M2=0 M3=36,7254218834748	FrameElem=40-1 ElemStation=0
Frame=40 Station=0,04 OutputCase=STR148 CaseType=Combination P=-23,0415147139962 V2=112,293211343496 V3=0 T=0 M2=0 M3=32,2380134297349	FrameElem=40-1 ElemStation=0,04
Frame=40 Station=0,08 OutputCase=STR148 CaseType=Combination P=-23,0415147139962 V2=112,509211343496 V3=0 T=0 M2=0 M3=27,741964975995	FrameElem=40-1 ElemStation=0,08
Frame=40 Station=0 OutputCase=STR149 CaseType=Combination P=-39,3402901545438 V2=114,153173688842 V3=0 T=0 M2=0 M3=22,1943087333869	FrameElem=40-1 ElemStation=0
Frame=40 Station=0,04 OutputCase=STR149 CaseType=Combination P=-39,3402901545438 V2=114,369173688842 V3=0 T=0 M2=0 M3=17,6238617858332	FrameElem=40-1 ElemStation=0,04
Frame=40 Station=0,08 OutputCase=STR149 CaseType=Combination P=-39,3402901545438 V2=114,585173688842 V3=0 T=0 M2=0 M3=13,0447748382796	FrameElem=40-1 ElemStation=0,08
Frame=40 Station=0 OutputCase=STR150 CaseType=Combination P=-24,140620378772 V2=13,3437137526091 V3=0 T=0 M2=0 M3=22,808499143372	FrameElem=40-1 ElemStation=0
Frame=40 Station=0,04 OutputCase=STR150 CaseType=Combination P=-24,140620378772 V2=13,5037137526091 V3=0 T=0 M2=0 M3=22,2715505932676	FrameElem=40-1 ElemStation=0,04
Frame=40 Station=0,08 OutputCase=STR150 CaseType=Combination P=-24,140620378772 V2=13,6637137526091 V3=0 T=0 M2=0 M3=21,7282020431632	FrameElem=40-1 ElemStation=0,08
Frame=40 Station=0 OutputCase=STR151 CaseType=Combination P=-40,4393958193196 V2=15,4196760979548 V3=0 T=0 M2=0 M3=8,27738599328414	FrameElem=40-1 ElemStation=0
Frame=40 Station=0,04 OutputCase=STR151 CaseType=Combination P=-40,4393958193196 V2=15,5796760979548 V3=0 T=0 M2=0 M3=7,65739894936595	FrameElem=40-1 ElemStation=0,04
Frame=40 Station=0,08 OutputCase=STR151 CaseType=Combination P=-40,4393958193196 V2=15,7396760979548 V3=0 T=0 M2=0 M3=7,03101190544775	FrameElem=40-1 ElemStation=0,08
Frame=40 Station=0 OutputCase=STR152 CaseType=Combination P=-20,2603307229694 V2=82,2707787223627 V3=0 T=0 M2=0 M3=44,4546415974903	FrameElem=40-1 ElemStation=0
Frame=40 Station=0,04 OutputCase=STR152 CaseType=Combination P=-20,2603307229694 V2=82,4867787223628 V3=0 T=0 M2=0 M3=41,1594904485958	FrameElem=40-1 ElemStation=0,04
Frame=40 Station=0,08 OutputCase=STR152 CaseType=Combination P=-20,2603307229694 V2=82,7027787223628 V3=0 T=0 M2=0 M3=37,8556992997013	FrameElem=40-1 ElemStation=0,08
Frame=40 Station=0 OutputCase=STR153 CaseType=Combination P=-7,43456838253071 V2=90,809136468494 V3=0 T=0 M2=0 M3=14,6150881264692	FrameElem=40-1 ElemStation=0
Frame=40 Station=0,04 OutputCase=STR153 CaseType=Combination P=-7,43456838253071 V2=91,025136468494 V3=0 T=0 M2=0 M3=10,9784026677294	FrameElem=40-1 ElemStation=0,04
Frame=40 Station=0,08 OutputCase=STR153 CaseType=Combination P=-7,43456838253071 V2=91,241136468494 V3=0 T=0 M2=0 M3=7,33307720898968	FrameElem=40-1 ElemStation=0,08
Frame=40 Station=0 OutputCase=STR154 CaseType=Combination P=-20,6281134534266 V2=89,2189005043171 V3=0 T=0 M2=0 M3=29,7745270952017	FrameElem=40-1 ElemStation=0
Frame=40 Station=0,04 OutputCase=STR154 CaseType=Combination P=-20,6281134534266 V2=89,4349005043171 V3=0 T=0 M2=0 M3=26,201451075029	FrameElem=40-1 ElemStation=0,04
Frame=40 Station=0,08 OutputCase=STR154 CaseType=Combination P=-20,6281134534266 V2=89,6509005043171 V3=0 T=0 M2=0 M3=22,6197350548563	FrameElem=40-1 ElemStation=0,08
Frame=40 Station=0 OutputCase=STR155 CaseType=Combination P=-33,8216585180361 V2=90,8167089147831 V3=0 T=0 M2=0 M3=18,310927915522	FrameElem=40-1 ElemStation=0
Frame=40 Station=0,04 OutputCase=STR155 CaseType=Combination P=-33,8216585180361 V2=91,0327089147831 V3=0 T=0 M2=0 M3=14,6739395589307	FrameElem=40-1 ElemStation=0,04
Frame=40 Station=0,08 OutputCase=STR155 CaseType=Combination P=-33,8216585180361 V2=91,2487089147831 V3=0 T=0 M2=0 M3=11,0283112023394	FrameElem=40-1 ElemStation=0,08
Frame=40 Station=0 OutputCase=STR156 CaseType=Combination P=-21,4031727358056 V2=13,8206112883457 V3=0 T=0 M2=0 M3=19,1277817607064	FrameElem=40-1 ElemStation=0
Frame=40 Station=0,04 OutputCase=STR156 CaseType=Combination P=-21,4031727358056 V2=13,9806112883457 V3=0 T=0 M2=0 M3=18,5717573091726	FrameElem=40-1 ElemStation=0,04
Frame=40 Station=0,08 OutputCase=STR156 CaseType=Combination P=-21,4031727358056 V2=14,1406112883457 V3=0 T=0 M2=0 M3=18,0093328576387	FrameElem=40-1 ElemStation=0,08
Frame=40 Station=0 OutputCase=STR157 CaseType=Combination P=-34,5967178004151 V2=15,4184196988116 V3=0 T=0 M2=0 M3=7,66418258102674	FrameElem=40-1 ElemStation=0
Frame=40 Station=0,04 OutputCase=STR157 CaseType=Combination P=-34,5967178004151 V2=15,5784196988116 V3=0 T=0 M2=0 M3=7,04424579307427	FrameElem=40-1 ElemStation=0,04
Frame=40 Station=0,08 OutputCase=STR157 CaseType=Combination P=-34,5967178004151 V2=15,7384196988116 V3=0 T=0 M2=0 M3=6,41790900512181	FrameElem=40-1 ElemStation=0,08
Frame=40 Station=0 OutputCase=STR158 CaseType=Combination P=-15,6107412988245 V2=20,8044991533244 V3=0 T=0 M2=0 M3=5,28667044295136	FrameElem=40-1 ElemStation=0
Frame=40 Station=0,04 OutputCase=STR158 CaseType=Combination P=-15,6107412988245 V2=21,0204991533244 V3=0 T=0 M2=0 M3=4,45017047681839	FrameElem=40-1 ElemStation=0,04
Frame=40 Station=0,08 OutputCase=STR158 CaseType=Combination P=-15,6107412988245 V2=21,2364991533244 V3=0 T=0 M2=0 M3=3,60503051068541	FrameElem=40-1 ElemStation=0,08
Frame=40 Station=0 OutputCase=STR159 CaseType=Combination P=-7,85503342649144 V2=20,8025728639857 V3=0 T=0 M2=0 M3=4,34651756998798	FrameElem=40-1 ElemStation=0
Frame=40 Station=0,04 OutputCase=STR159 CaseType=Combination P=-7,85503342649144 V2=21,0185728639857 V3=0 T=0 M2=0 M3=3,51009465542856	FrameElem=40-1 ElemStation=0,04
Frame=40 Station=0,08 OutputCase=STR159 CaseType=Combination P=-7,85503342649144 V2=21,2345728639857 V3=0 T=0 M2=0 M3=2,66503174086913	FrameElem=40-1 ElemStation=0,08
Frame=40 Station=0 OutputCase=STR160 CaseType=Combination P=-6,88289427930117 V2=90,8081979887336 V3=0 T=0 M2=0 M3=14,1570497868106	FrameElem=40-1 ElemStation=0
Frame=40 Station=0,04 OutputCase=STR160 CaseType=Combination P=-6,88289427930117 V2=91,0241979887335 V3=0 T=0 M2=0 M3=10,5204018672612	FrameElem=40-1 ElemStation=0,04
Frame=40 Station=0,08 OutputCase=STR160 CaseType=Combination P=-6,88289427930117 V2=91,2401979887336 V3=0 T=0 M2=0 M3=6,87511394771191	FrameElem=40-1 ElemStation=0,08
Frame=40 Station=0 OutputCase=STR161 CaseType=Combination P=-20,0764393501971 V2=89,2179620245567 V3=0 T=0 M2=0 M3=29,316488755543	FrameElem=40-1 ElemStation=0

Società di Progetto
Brebemi SpA



Doc. N.
60235-0000-A00.doc

CODIFICA DOCUMENTO
04RCDII10000000000300A00

REV.
00

FOGLIO
513 di 628

Frame=40 Station=0,04 OutputCase=STR161 CaseType=Combination P=-20,0764393501971 V2=89,4339620245567 V3=0 T=0 M2=0 M3=25,7434502745608 FrameElem=40-1 ElemStation=0,04
Frame=40 Station=0,08 OutputCase=STR161 CaseType=Combination P=-20,0764393501971 V2=89,6499620245567 V3=0 T=0 M2=0 M3=22,1617717935785 FrameElem=40-1 ElemStation=0,08
Frame=40 Station=0 OutputCase=STR162 CaseType=Combination P=-33,2699844148066 V2=90,8157704350227 V3=0 T=0 M2=0 M3=17,8528895758634 FrameElem=40-1 ElemStation=0
Frame=40 Station=0,04 OutputCase=STR162 CaseType=Combination P=-33,2699844148066 V2=91,0317704350227 V3=0 T=0 M2=0 M3=14,2159387584625 FrameElem=40-1 ElemStation=0,04
Frame=40 Station=0,08 OutputCase=STR162 CaseType=Combination P=-33,2699844148066 V2=91,2477704350227 V3=0 T=0 M2=0 M3=10,5703479410616 FrameElem=40-1 ElemStation=0,08
Frame=40 Station=0 OutputCase=STR163 CaseType=Combination P=-20,8514986325761 V2=13,8196728085853 V3=0 T=0 M2=0 M3=18,6697434210478 FrameElem=40-1 ElemStation=0
Frame=40 Station=0,04 OutputCase=STR163 CaseType=Combination P=-20,8514986325761 V2=13,9796728085853 V3=0 T=0 M2=0 M3=18,1137565087044 FrameElem=40-1 ElemStation=0,04
Frame=40 Station=0,08 OutputCase=STR163 CaseType=Combination P=-20,8514986325761 V2=14,1396728085853 V3=0 T=0 M2=0 M3=17,551369596361 FrameElem=40-1 ElemStation=0,08
Frame=40 Station=0 OutputCase=STR164 CaseType=Combination P=-34,0450436971856 V2=15,4174812190512 V3=0 T=0 M2=0 M3=7,20614424136813 FrameElem=40-1 ElemStation=0
Frame=40 Station=0,04 OutputCase=STR164 CaseType=Combination P=-34,0450436971856 V2=15,5774812190512 V3=0 T=0 M2=0 M3=6,58624499260608 FrameElem=40-1 ElemStation=0,04
Frame=40 Station=0,08 OutputCase=STR164 CaseType=Combination P=-34,0450436971856 V2=15,7374812190512 V3=0 T=0 M2=0 M3=5,95994574384403 FrameElem=40-1 ElemStation=0,08
Frame=40 Station=0 OutputCase=STR165 CaseType=Combination P=-16,7140895052835 V2=20,8063761128452 V3=0 T=0 M2=0 M3=6,20274712226858 FrameElem=40-1 ElemStation=0
Frame=40 Station=0,04 OutputCase=STR165 CaseType=Combination P=-16,7140895052835 V2=21,0223761128452 V3=0 T=0 M2=0 M3=5,36617207775478 FrameElem=40-1 ElemStation=0,04
Frame=40 Station=0,08 OutputCase=STR165 CaseType=Combination P=-16,7140895052835 V2=21,2383761128452 V3=0 T=0 M2=0 M3=4,52095703324097 FrameElem=40-1 ElemStation=0,08
Frame=40 Station=0 OutputCase=STR166 CaseType=Combination P=-8,95838163295053 V2=20,8044498235065 V3=0 T=0 M2=0 M3=5,2625942493052 FrameElem=40-1 ElemStation=0
Frame=40 Station=0,04 OutputCase=STR166 CaseType=Combination P=-8,95838163295053 V2=21,0204498235065 V3=0 T=0 M2=0 M3=4,42609625636494 FrameElem=40-1 ElemStation=0,04
Frame=40 Station=0,08 OutputCase=STR166 CaseType=Combination P=-8,95838163295053 V2=21,2364498235065 V3=0 T=0 M2=0 M3=3,58095826342469 FrameElem=40-1 ElemStation=0,08
Frame=40 Station=0 OutputCase=STR167 CaseType=Combination P=-7,98624248576026 V2=90,8100749482544 V3=0 T=0 M2=0 M3=15,0731264661278 FrameElem=40-1 ElemStation=0
Frame=40 Station=0,04 OutputCase=STR167 CaseType=Combination P=-7,98624248576026 V2=91,0260749482544 V3=0 T=0 M2=0 M3=11,4364034681976 FrameElem=40-1 ElemStation=0,04
Frame=40 Station=0,08 OutputCase=STR167 CaseType=Combination P=-7,98624248576026 V2=91,2420749482544 V3=0 T=0 M2=0 M3=7,79104047026746 FrameElem=40-1 ElemStation=0,08
Frame=40 Station=0 OutputCase=STR168 CaseType=Combination P=-21,1797875566562 V2=89,2198389840775 V3=0 T=0 M2=0 M3=30,2325654348603 FrameElem=40-1 ElemStation=0
Frame=40 Station=0,04 OutputCase=STR168 CaseType=Combination P=-21,1797875566562 V2=89,4358389840775 V3=0 T=0 M2=0 M3=26,6594518754972 FrameElem=40-1 ElemStation=0,04
Frame=40 Station=0,08 OutputCase=STR168 CaseType=Combination P=-21,1797875566562 V2=89,6518389840775 V3=0 T=0 M2=0 M3=23,0776983161341 FrameElem=40-1 ElemStation=0,08
Frame=40 Station=0 OutputCase=STR169 CaseType=Combination P=-34,3733326212657 V2=90,8176473945435 V3=0 T=0 M2=0 M3=18,7689662551806 FrameElem=40-1 ElemStation=0
Frame=40 Station=0,04 OutputCase=STR169 CaseType=Combination P=-34,3733326212657 V2=91,0336473945435 V3=0 T=0 M2=0 M3=15,1319403593989 FrameElem=40-1 ElemStation=0,04
Frame=40 Station=0,08 OutputCase=STR169 CaseType=Combination P=-34,3733326212657 V2=91,2496473945435 V3=0 T=0 M2=0 M3=11,4862744636171 FrameElem=40-1 ElemStation=0,08
Frame=40 Station=0 OutputCase=STR170 CaseType=Combination P=-21,9548468390352 V2=13,8215497681061 V3=0 T=0 M2=0 M3=19,585820100365 FrameElem=40-1 ElemStation=0
Frame=40 Station=0,04 OutputCase=STR170 CaseType=Combination P=-21,9548468390352 V2=13,9815497681061 V3=0 T=0 M2=0 M3=19,0297581096408 FrameElem=40-1 ElemStation=0,04
Frame=40 Station=0,08 OutputCase=STR170 CaseType=Combination P=-21,9548468390352 V2=14,1415497681061 V3=0 T=0 M2=0 M3=18,4672961189165 FrameElem=40-1 ElemStation=0,08
Frame=40 Station=0 OutputCase=STR171 CaseType=Combination P=-35,1483919036447 V2=15,419358178572 V3=0 T=0 M2=0 M3=8,12222092068535 FrameElem=40-1 ElemStation=0
Frame=40 Station=0,04 OutputCase=STR171 CaseType=Combination P=-35,1483919036447 V2=15,579358178572 V3=0 T=0 M2=0 M3=7,50224659354247 FrameElem=40-1 ElemStation=0,04
Frame=40 Station=0,08 OutputCase=STR171 CaseType=Combination P=-35,1483919036447 V2=15,739358178572 V3=0 T=0 M2=0 M3=6,87587226639959 FrameElem=40-1 ElemStation=0,08
Frame=40 Station=0 OutputCase=STR172 CaseType=Combination P=-16,3912870747606 V2=21,2633769769573 V3=0 T=0 M2=0 M3=6,18680437802614 FrameElem=40-1 ElemStation=0
Frame=40 Station=0,04 OutputCase=STR172 CaseType=Combination P=-16,3912870747606 V2=21,4793769769573 V3=0 T=0 M2=0 M3=5,3319429894785 FrameElem=40-1 ElemStation=0,04
Frame=40 Station=0,08 OutputCase=STR172 CaseType=Combination P=-16,3912870747606 V2=21,6953769769573 V3=0 T=0 M2=0 M3=4,46845421986955 FrameElem=40-1 ElemStation=0,08
Frame=40 Station=0 OutputCase=STR173 CaseType=Combination P=-8,6355792024276 V2=21,2614506876186 V3=0 T=0 M2=0 M3=5,24665150506276 FrameElem=40-1 ElemStation=0
Frame=40 Station=0,04 OutputCase=STR173 CaseType=Combination P=-8,6355792024276 V2=21,4774506876186 V3=0 T=0 M2=0 M3=4,39187347755801 FrameElem=40-1 ElemStation=0,04
Frame=40 Station=0,08 OutputCase=STR173 CaseType=Combination P=-8,6355792024276 V2=21,6934506876186 V3=0 T=0 M2=0 M3=3,52845545005327 FrameElem=40-1 ElemStation=0,08
Frame=40 Station=0 OutputCase=STR174 CaseType=Combination P=-7,66344005523733 V2=91,2670758123665 V3=0 T=0 M2=0 M3=15,0571837218854 FrameElem=40-1 ElemStation=0
Frame=40 Station=0,04 OutputCase=STR174 CaseType=Combination P=-7,66344005523733 V2=91,4830758123665 V3=0 T=0 M2=0 M3=11,4021806893907 FrameElem=40-1 ElemStation=0,04
Frame=40 Station=0,08 OutputCase=STR174 CaseType=Combination P=-7,66344005523733 V2=91,6990758123665 V3=0 T=0 M2=0 M3=7,73853765689605 FrameElem=40-1 ElemStation=0,08
Frame=40 Station=0 OutputCase=STR175 CaseType=Combination P=-20,8569851261333 V2=89,678398481896 V3=0 T=0 M2=0 M3=30,2166226906178 FrameElem=40-1 ElemStation=0
Frame=40 Station=0,04 OutputCase=STR175 CaseType=Combination P=-20,8569851261333 V2=89,8928398481897 V3=0 T=0 M2=0 M3=26,6252290966902 FrameElem=40-1 ElemStation=0,04
Frame=40 Station=0,08 OutputCase=STR175 CaseType=Combination P=-20,8569851261333 V2=90,1088398481897 V3=0 T=0 M2=0 M3=23,0251955027626 FrameElem=40-1 ElemStation=0,08

APPROVATO S.D.P.
Società di Progetto
Brebemi SpA



Doc. N.
60235-0000-A00.doc

CODIFICA DOCUMENTO
04RCDII10000000000300A00

REV.
00

FOGLIO
514 di 628

Frame=40 Station=0 OutputCase=STR176 CaseType=Combination P=-34,0505301907428 V2=91,2746482586556 V3=0 T=0 M2=0 M3=18,7530235109382 FrameElem=40-1 ElemStation=0
Frame=40 Station=0,04 OutputCase=STR176 CaseType=Combination P=-34,0505301907428 V2=91,4906482586556 V3=0 T=0 M2=0 M3=15,0977175805919 FrameElem=40-1 ElemStation=0,04
Frame=40 Station=0,08 OutputCase=STR176 CaseType=Combination P=-34,0505301907428 V2=91,7066482586556 V3=0 T=0 M2=0 M3=11,4337716502457 FrameElem=40-1 ElemStation=0,08
Frame=40 Station=0 OutputCase=STR177 CaseType=Combination P=-21,6320444085123 V2=14,2785506322182 V3=0 T=0 M2=0 M3=19,5698773561226 FrameElem=40-1 ElemStation=0
Frame=40 Station=0,04 OutputCase=STR177 CaseType=Combination P=-21,6320444085123 V2=14,4385506322182 V3=0 T=0 M2=0 M3=18,9955353308338 FrameElem=40-1 ElemStation=0,04
Frame=40 Station=0,08 OutputCase=STR177 CaseType=Combination P=-21,6320444085123 V2=14,5985506322182 V3=0 T=0 M2=0 M3=18,4147933055451 FrameElem=40-1 ElemStation=0,08
Frame=40 Station=0 OutputCase=STR178 CaseType=Combination P=-34,8255894731218 V2=15,8763590426842 V3=0 T=0 M2=0 M3=8,1062781764429 FrameElem=40-1 ElemStation=0
Frame=40 Station=0,04 OutputCase=STR178 CaseType=Combination P=-34,8255894731218 V2=16,0363590426842 V3=0 T=0 M2=0 M3=7,46802381473554 FrameElem=40-1 ElemStation=0,04
Frame=40 Station=0,08 OutputCase=STR178 CaseType=Combination P=-34,8255894731218 V2=16,1963590426842 V3=0 T=0 M2=0 M3=6,82336945302817 FrameElem=40-1 ElemStation=0,08
Frame=40 Station=0 OutputCase=STR179 CaseType=Combination P=-16,3912870747606 V2=21,2633769769573 V3=0 T=0 M2=0 M3=6,18680437802614 FrameElem=40-1 ElemStation=0
Frame=40 Station=0,04 OutputCase=STR179 CaseType=Combination P=-16,3912870747606 V2=21,4793769769573 V3=0 T=0 M2=0 M3=5,33194929894785 FrameElem=40-1 ElemStation=0,04
Frame=40 Station=0,08 OutputCase=STR179 CaseType=Combination P=-16,3912870747606 V2=21,6953769769573 V3=0 T=0 M2=0 M3=4,46845421986955 FrameElem=40-1 ElemStation=0,08
Frame=40 Station=0 OutputCase=STR180 CaseType=Combination P=-15,9335437293474 V2=20,3474982892123 V3=0 T=0 M2=0 M3=5,30261318719381 FrameElem=40-1 ElemStation=0
Frame=40 Station=0,04 OutputCase=STR180 CaseType=Combination P=-15,9335437293474 V2=20,5634982892123 V3=0 T=0 M2=0 M3=4,48439325562532 FrameElem=40-1 ElemStation=0,04
Frame=40 Station=0,08 OutputCase=STR180 CaseType=Combination P=-15,9335437293474 V2=20,7794982892123 V3=0 T=0 M2=0 M3=3,65753332405683 FrameElem=40-1 ElemStation=0,08
Frame=40 Station=0 OutputCase=STR181 CaseType=Combination P=-8,17783585701437 V2=20,3455719998736 V3=0 T=0 M2=0 M3=4,36246031423043 FrameElem=40-1 ElemStation=0
Frame=40 Station=0,04 OutputCase=STR181 CaseType=Combination P=-8,17783585701437 V2=20,5615719998736 V3=0 T=0 M2=0 M3=3,54431743423549 FrameElem=40-1 ElemStation=0,04
Frame=40 Station=0,08 OutputCase=STR181 CaseType=Combination P=-8,17783585701437 V2=20,7775719998736 V3=0 T=0 M2=0 M3=2,71753455424054 FrameElem=40-1 ElemStation=0,08
Frame=40 Station=0 OutputCase=STR182 CaseType=Combination P=-7,2056967098241 V2=90,3511971246214 V3=0 T=0 M2=0 M3=14,172992531053 FrameElem=40-1 ElemStation=0
Frame=40 Station=0,04 OutputCase=STR182 CaseType=Combination P=-7,2056967098241 V2=90,5671971246214 V3=0 T=0 M2=0 M3=10,5546246460682 FrameElem=40-1 ElemStation=0,04
Frame=40 Station=0,08 OutputCase=STR182 CaseType=Combination P=-7,2056967098241 V2=90,7831971246214 V3=0 T=0 M2=0 M3=6,92761676108332 FrameElem=40-1 ElemStation=0,08
Frame=40 Station=0 OutputCase=STR183 CaseType=Combination P=-20,39924178072 V2=88,7609611604446 V3=0 T=0 M2=0 M3=29,3324314997855 FrameElem=40-1 ElemStation=0
Frame=40 Station=0,04 OutputCase=STR183 CaseType=Combination P=-20,39924178072 V2=88,9769611604446 V3=0 T=0 M2=0 M3=25,7776730533677 FrameElem=40-1 ElemStation=0,04
Frame=40 Station=0,08 OutputCase=STR183 CaseType=Combination P=-20,39924178072 V2=89,1929611604446 V3=0 T=0 M2=0 M3=22,2142746069499 FrameElem=40-1 ElemStation=0,08
Frame=40 Station=0 OutputCase=STR184 CaseType=Combination P=-33,5927868453295 V2=90,3587695709105 V3=0 T=0 M2=0 M3=17,8688323201058 FrameElem=40-1 ElemStation=0
Frame=40 Station=0,04 OutputCase=STR184 CaseType=Combination P=-33,5927868453295 V2=90,5747695709105 V3=0 T=0 M2=0 M3=14,2501615372694 FrameElem=40-1 ElemStation=0,04
Frame=40 Station=0,08 OutputCase=STR184 CaseType=Combination P=-33,5927868453295 V2=90,7907695709106 V3=0 T=0 M2=0 M3=10,622850754433 FrameElem=40-1 ElemStation=0,08
Frame=40 Station=0 OutputCase=STR185 CaseType=Combination P=-21,174301063099 V2=13,3626719444732 V3=0 T=0 M2=0 M3=18,6856861652902 FrameElem=40-1 ElemStation=0
Frame=40 Station=0,04 OutputCase=STR185 CaseType=Combination P=-21,174301063099 V2=13,5226719444732 V3=0 T=0 M2=0 M3=18,1479792875113 FrameElem=40-1 ElemStation=0,04
Frame=40 Station=0,08 OutputCase=STR185 CaseType=Combination P=-21,174301063099 V2=13,6826719444732 V3=0 T=0 M2=0 M3=17,6038724097324 FrameElem=40-1 ElemStation=0,08
Frame=40 Station=0 OutputCase=STR186 CaseType=Combination P=-34,3678461277085 V2=14,9604803549391 V3=0 T=0 M2=0 M3=7,22208698561057 FrameElem=40-1 ElemStation=0
Frame=40 Station=0,04 OutputCase=STR186 CaseType=Combination P=-34,3678461277085 V2=15,1204803549391 V3=0 T=0 M2=0 M3=6,62046777141301 FrameElem=40-1 ElemStation=0,04
Frame=40 Station=0,08 OutputCase=STR186 CaseType=Combination P=-34,3678461277085 V2=15,2804803549391 V3=0 T=0 M2=0 M3=6,0124485721545 FrameElem=40-1 ElemStation=0,08
Frame=40 Station=0 OutputCase=STR187 CaseType=Combination P=-15,9335437293474 V2=20,3474982892123 V3=0 T=0 M2=0 M3=5,30261318719381 FrameElem=40-1 ElemStation=0
Frame=40 Station=0,04 OutputCase=STR187 CaseType=Combination P=-15,9335437293474 V2=20,5634982892123 V3=0 T=0 M2=0 M3=4,48439325562532 FrameElem=40-1 ElemStation=0,04
Frame=40 Station=0,08 OutputCase=STR187 CaseType=Combination P=-15,9335437293474 V2=20,7794982892123 V3=0 T=0 M2=0 M3=3,65753332405683 FrameElem=40-1 ElemStation=0,08
Frame=40 Station=0 OutputCase=INVSTR CaseType=Combination StepType=Max P=-5,36678303239229 V2=114,610174552954 V3=0 T=0 M2=0 M3=44,4546415974903 FrameElem=40-1 ElemStation=0
Frame=40 Station=0,04 OutputCase=INVSTR CaseType=Combination StepType=Max P=-5,36678303239229 V2=114,826174552954 V3=0 T=0 M2=0 M3=41,1594904485958 FrameElem=40-1 ElemStation=0,04
Frame=40 Station=0,08 OutputCase=INVSTR CaseType=Combination StepType=Max P=-5,36678303239229 V2=115,042174552954 V3=0 T=0 M2=0 M3=37,8556992997013 FrameElem=40-1 ElemStation=0,08
Frame=40 Station=0 OutputCase=INVSTR CaseType=Combination StepType=Min P=-40,4393958193196 V2=12,8848359289761 V3=0 T=0 M2=0 M3=2,83566584870173 FrameElem=40-1 ElemStation=0
Frame=40 Station=0,04 OutputCase=INVSTR CaseType=Combination StepType=Min P=-40,4393958193196 V2=13,0448359289761 V3=0 T=0 M2=0 M3=2,01764809934151 FrameElem=40-1 ElemStation=0,04
Frame=40 Station=0,08 OutputCase=INVSTR CaseType=Combination StepType=Min P=-40,4393958193196 V2=13,2048359289761 V3=0 T=0 M2=0 M3=1,19099034998128 FrameElem=40-1 ElemStation=0,08
Frame=40 Station=0 OutputCase=SIS01 CaseType=Combination P=-13,5492038058727 V2=13,3853033725529 V3=0 T=0 M2=0 M3=9,66662586117038 FrameElem=40-1 ElemStation=0
Frame=40 Station=0,04 OutputCase=SIS01 CaseType=Combination P=-13,5492038058727 V2=13,5453033725529 V3=0 T=0 M2=0 M3=9,12801372626827 FrameElem=40-1 ElemStation=0,04

Società di Progetto
Brebemi SpA

	Doc. N. 60235-00000-A00.doc	CODIFICA DOCUMENTO 04RCDII10000000000300A00	REV. 00	FOGLIO 515 di 628
--	--------------------------------	--	------------	----------------------

Frame=40 ElemStation=0,08	Station=0,08	OutputCase=SIS01	CaseType=Combination	P=-13,5492038058727	V2=13,7053033725529	V3=0	T=0	M2=0	M3=8,58300159136615	FrameElem=40-1
Frame=40 ElemStation=0	Station=0	OutputCase=SIS02	CaseType=Combination	P=-13,166096789741	V2=13,384651650497	V3=0	T=0	M2=0	M3=9,3485436808519	FrameElem=40-1
Frame=40 ElemStation=0,04	Station=0,04	OutputCase=SIS02	CaseType=Combination	P=-13,166096789741	V2=13,544651650497	V3=0	T=0	M2=0	M3=8,80995761483202	FrameElem=40-1
Frame=40 ElemStation=0,08	Station=0,08	OutputCase=SIS02	CaseType=Combination	P=-13,166096789741	V2=13,704651650497	V3=0	T=0	M2=0	M3=8,26497154881214	FrameElem=40-1
Frame=40 ElemStation=0	Station=0	OutputCase=SIS03	CaseType=Combination	P=-13,9323108220043	V2=13,3859550946087	V3=0	T=0	M2=0	M3=9,98470804148886	FrameElem=40-1
Frame=40 ElemStation=0,04	Station=0,04	OutputCase=SIS03	CaseType=Combination	P=-13,9323108220043	V2=13,5459550946087	V3=0	T=0	M2=0	M3=9,44606983770451	FrameElem=40-1
Frame=40 ElemStation=0,08	Station=0,08	OutputCase=SIS03	CaseType=Combination	P=-13,9323108220043	V2=13,7059550946087	V3=0	T=0	M2=0	M3=8,90103163392016	FrameElem=40-1
Frame=40 ElemStation=0	Station=0	OutputCase=SIS04	CaseType=Combination	P=-13,7081424674745	V2=13,7033168057977	V3=0	T=0	M2=0	M3=9,9736366913205	FrameElem=40-1
Frame=40 ElemStation=0,04	Station=0,04	OutputCase=SIS04	CaseType=Combination	P=-13,7081424674745	V2=13,8633168057977	V3=0	T=0	M2=0	M3=9,42230401908859	FrameElem=40-1
Frame=40 ElemStation=0,08	Station=0,08	OutputCase=SIS04	CaseType=Combination	P=-13,7081424674745	V2=14,0233168057977	V3=0	T=0	M2=0	M3=8,86457134685668	FrameElem=40-1
Frame=40 ElemStation=0	Station=0	OutputCase=SIS05	CaseType=Combination	P=-13,3902651442708	V2=13,0672899393081	V3=0	T=0	M2=0	M3=9,35961503102027	FrameElem=40-1
Frame=40 ElemStation=0,04	Station=0,04	OutputCase=SIS05	CaseType=Combination	P=-13,3902651442708	V2=13,2272899393081	V3=0	T=0	M2=0	M3=8,83372343344795	FrameElem=40-1
Frame=40 ElemStation=0,08	Station=0,08	OutputCase=SIS05	CaseType=Combination	P=-13,3902651442708	V2=13,3872899393081	V3=0	T=0	M2=0	M3=8,30143183587562	FrameElem=40-1
Frame=40 ElemStation=0	Station=0	OutputCase=SIS06	CaseType=Combination	P=-13,9323108220043	V2=13,3859550946087	V3=0	T=0	M2=0	M3=9,98470804148886	FrameElem=40-1
Frame=40 ElemStation=0,04	Station=0,04	OutputCase=SIS06	CaseType=Combination	P=-13,9323108220043	V2=13,5459550946087	V3=0	T=0	M2=0	M3=9,44606983770451	FrameElem=40-1
Frame=40 ElemStation=0,08	Station=0,08	OutputCase=SIS06	CaseType=Combination	P=-13,9323108220043	V2=13,7059550946087	V3=0	T=0	M2=0	M3=8,90103163392016	FrameElem=40-1
Frame=40 ElemStation=0	Station=0	OutputCase=SIS07	CaseType=Combination	P=-13,3250354513428	V2=13,7026650837418	V3=0	T=0	M2=0	M3=9,6555451100202	FrameElem=40-1
Frame=40 ElemStation=0,04	Station=0,04	OutputCase=SIS07	CaseType=Combination	P=-13,3250354513428	V2=13,8626650837418	V3=0	T=0	M2=0	M3=9,10424790765234	FrameElem=40-1
Frame=40 ElemStation=0,08	Station=0,08	OutputCase=SIS07	CaseType=Combination	P=-13,3250354513428	V2=14,0226650837418	V3=0	T=0	M2=0	M3=8,54654130430267	FrameElem=40-1
Frame=40 ElemStation=0	Station=0	OutputCase=SIS08	CaseType=Combination	P=-13,0071581281392	V2=13,0666382172522	V3=0	T=0	M2=0	M3=9,04153285070179	FrameElem=40-1
Frame=40 ElemStation=0,04	Station=0,04	OutputCase=SIS08	CaseType=Combination	P=-13,0071581281392	V2=13,2266382172522	V3=0	T=0	M2=0	M3=8,5156673220117	FrameElem=40-1
Frame=40 ElemStation=0,08	Station=0,08	OutputCase=SIS08	CaseType=Combination	P=-13,0071581281392	V2=13,3866382172522	V3=0	T=0	M2=0	M3=7,98340179332161	FrameElem=40-1
Frame=40 ElemStation=0	Station=0	OutputCase=SIS09	CaseType=Combination	P=-13,5492038058727	V2=13,3853033725529	V3=0	T=0	M2=0	M3=9,66662586117038	FrameElem=40-1
Frame=40 ElemStation=0,04	Station=0,04	OutputCase=SIS09	CaseType=Combination	P=-13,5492038058727	V2=13,5453033725529	V3=0	T=0	M2=0	M3=9,12801372626827	FrameElem=40-1
Frame=40 ElemStation=0,08	Station=0,08	OutputCase=SIS09	CaseType=Combination	P=-13,5492038058727	V2=13,7053033725529	V3=0	T=0	M2=0	M3=8,58300159136615	FrameElem=40-1
Frame=40 ElemStation=0	Station=0	OutputCase=SIS10	CaseType=Combination	P=-13,5899746391107	V2=14,4483826863514	V3=0	T=0	M2=0	M3=9,830697541528	FrameElem=40-1
Frame=40 ElemStation=0,04	Station=0,04	OutputCase=SIS10	CaseType=Combination	P=-13,5899746391107	V2=14,6083826863514	V3=0	T=0	M2=0	M3=9,24956223407395	FrameElem=40-1
Frame=40 ElemStation=0,08	Station=0,08	OutputCase=SIS10	CaseType=Combination	P=-13,5899746391107	V2=14,7683826863514	V3=0	T=0	M2=0	M3=8,66202692661989	FrameElem=40-1
Frame=40 ElemStation=0	Station=0	OutputCase=SIS11	CaseType=Combination	P=-13,206867622979	V2=14,4477309642956	V3=0	T=0	M2=0	M3=9,51261536120952	FrameElem=40-1
Frame=40 ElemStation=0,04	Station=0,04	OutputCase=SIS11	CaseType=Combination	P=-13,206867622979	V2=14,6077309642956	V3=0	T=0	M2=0	M3=8,9315061226377	FrameElem=40-1
Frame=40 ElemStation=0,08	Station=0,08	OutputCase=SIS11	CaseType=Combination	P=-13,206867622979	V2=14,7677309642956	V3=0	T=0	M2=0	M3=8,34399688406588	FrameElem=40-1
Frame=40 ElemStation=0	Station=0	OutputCase=SIS12	CaseType=Combination	P=-13,9730816552423	V2=14,4490344084072	V3=0	T=0	M2=0	M3=10,1487797218465	FrameElem=40-1
Frame=40 ElemStation=0,04	Station=0,04	OutputCase=SIS12	CaseType=Combination	P=-13,9730816552423	V2=14,6090344084072	V3=0	T=0	M2=0	M3=9,56761834551019	FrameElem=40-1
Frame=40 ElemStation=0,08	Station=0,08	OutputCase=SIS12	CaseType=Combination	P=-13,9730816552423	V2=14,7690344084072	V3=0	T=0	M2=0	M3=8,9800569691739	FrameElem=40-1
Frame=40 ElemStation=0	Station=0	OutputCase=SIS13	CaseType=Combination	P=-13,7489133007125	V2=14,7663961195962	V3=0	T=0	M2=0	M3=10,1377083716781	FrameElem=40-1
Frame=40 ElemStation=0,04	Station=0,04	OutputCase=SIS13	CaseType=Combination	P=-13,7489133007125	V2=14,9263961195962	V3=0	T=0	M2=0	M3=9,54385252689427	FrameElem=40-1
Frame=40 ElemStation=0,08	Station=0,08	OutputCase=SIS13	CaseType=Combination	P=-13,7489133007125	V2=15,0863961195962	V3=0	T=0	M2=0	M3=8,94359668211042	FrameElem=40-1
Frame=40 ElemStation=0	Station=0	OutputCase=SIS14	CaseType=Combination	P=-13,4310359775088	V2=14,1303692531066	V3=0	T=0	M2=0	M3=9,52368671137789	FrameElem=40-1
Frame=40 ElemStation=0,04	Station=0,04	OutputCase=SIS14	CaseType=Combination	P=-13,4310359775088	V2=14,2903692531066	V3=0	T=0	M2=0	M3=8,95527194125362	FrameElem=40-1
Frame=40 ElemStation=0,08	Station=0,08	OutputCase=SIS14	CaseType=Combination	P=-13,4310359775088	V2=14,4503692531066	V3=0	T=0	M2=0	M3=8,38045717112936	FrameElem=40-1
Frame=40 ElemStation=0	Station=0	OutputCase=SIS15	CaseType=Combination	P=-13,9730816552423	V2=14,4490344084072	V3=0	T=0	M2=0	M3=10,1487797218465	FrameElem=40-1
Frame=40 ElemStation=0,04	Station=0,04	OutputCase=SIS15	CaseType=Combination	P=-13,9730816552423	V2=14,6090344084072	V3=0	T=0	M2=0	M3=9,56761834551019	FrameElem=40-1
Frame=40 ElemStation=0,08	Station=0,08	OutputCase=SIS15	CaseType=Combination	P=-13,9730816552423	V2=14,7690344084072	V3=0	T=0	M2=0	M3=8,9800569691739	FrameElem=40-1
Frame=40 ElemStation=0	Station=0	OutputCase=SIS16	CaseType=Combination	P=-13,3658062845808	V2=14,7657443975404	V3=0	T=0	M2=0	M3=9,81962619135964	FrameElem=40-1

Società di Progetto
Brebemi SpA

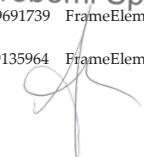

	Doc. N. 60235-00000-A00.doc	CODIFICA DOCUMENTO 04RCDII10000000000300A00	REV. 00	FOGLIO 516 di 628
--	--------------------------------	--	------------	----------------------

Frame=40 ElemStation=0,04	Station=0,04	OutputCase=SIS16	CaseType=Combination	P=-13,3658062845808	V2=14,9257443975404	V3=0	T=0	M2=0	M3=9,22579641545802	FrameElem=40-1
Frame=40 ElemStation=0,08	Station=0,08	OutputCase=SIS16	CaseType=Combination	P=-13,3658062845808	V2=15,0857443975404	V3=0	T=0	M2=0	M3=8,62556663955641	FrameElem=40-1
Frame=40 ElemStation=0	Station=0	OutputCase=SIS17	CaseType=Combination	P=-13,0479289613772	V2=14,1297175310508	V3=0	T=0	M2=0	M3=9,20560453105941	FrameElem=40-1
Frame=40 ElemStation=0,04	Station=0,04	OutputCase=SIS17	CaseType=Combination	P=-13,0479289613772	V2=14,2897175310508	V3=0	T=0	M2=0	M3=8,63721582981738	FrameElem=40-1
Frame=40 ElemStation=0,08	Station=0,08	OutputCase=SIS17	CaseType=Combination	P=-13,0479289613772	V2=14,4497175310508	V3=0	T=0	M2=0	M3=8,06242712857535	FrameElem=40-1
Frame=40 ElemStation=0	Station=0	OutputCase=SIS18	CaseType=Combination	P=-13,5899746391107	V2=14,4483826863514	V3=0	T=0	M2=0	M3=9,830697541528	FrameElem=40-1
Frame=40 ElemStation=0,04	Station=0,04	OutputCase=SIS18	CaseType=Combination	P=-13,5899746391107	V2=14,6083826863514	V3=0	T=0	M2=0	M3=9,24956223407395	FrameElem=40-1
Frame=40 ElemStation=0,08	Station=0,08	OutputCase=SIS18	CaseType=Combination	P=-13,5899746391107	V2=14,7683826863514	V3=0	T=0	M2=0	M3=8,66202692661989	FrameElem=40-1
Frame=40 ElemStation=0	Station=0	OutputCase=SIS19	CaseType=Combination	P=-13,5016378344136	V2=12,8797394549256	V3=0	T=0	M2=0	M3=7,50773282737805	FrameElem=40-1
Frame=40 ElemStation=0,04	Station=0,04	OutputCase=SIS19	CaseType=Combination	P=-13,5016378344136	V2=13,0397394549256	V3=0	T=0	M2=0	M3=6,98934324918103	FrameElem=40-1
Frame=40 ElemStation=0,08	Station=0,08	OutputCase=SIS19	CaseType=Combination	P=-13,5016378344136	V2=13,1997394549256	V3=0	T=0	M2=0	M3=6,464553670984	FrameElem=40-1
Frame=40 ElemStation=0	Station=0	OutputCase=SIS20	CaseType=Combination	P=-13,1185308182819	V2=12,8790877328697	V3=0	T=0	M2=0	M3=7,18965064705957	FrameElem=40-1
Frame=40 ElemStation=0,04	Station=0,04	OutputCase=SIS20	CaseType=Combination	P=-13,1185308182819	V2=13,0390877328697	V3=0	T=0	M2=0	M3=6,67128713774478	FrameElem=40-1
Frame=40 ElemStation=0,08	Station=0,08	OutputCase=SIS20	CaseType=Combination	P=-13,1185308182819	V2=13,1990877328697	V3=0	T=0	M2=0	M3=6,14652362842999	FrameElem=40-1
Frame=40 ElemStation=0	Station=0	OutputCase=SIS21	CaseType=Combination	P=-13,8847448505452	V2=12,8803911769814	V3=0	T=0	M2=0	M3=7,82581500769653	FrameElem=40-1
Frame=40 ElemStation=0,04	Station=0,04	OutputCase=SIS21	CaseType=Combination	P=-13,8847448505452	V2=13,0403911769814	V3=0	T=0	M2=0	M3=7,30739936061727	FrameElem=40-1
Frame=40 ElemStation=0,08	Station=0,08	OutputCase=SIS21	CaseType=Combination	P=-13,8847448505452	V2=13,2003911769814	V3=0	T=0	M2=0	M3=6,78258371353802	FrameElem=40-1
Frame=40 ElemStation=0	Station=0	OutputCase=SIS22	CaseType=Combination	P=-13,6605764960154	V2=13,1977528881704	V3=0	T=0	M2=0	M3=7,81474365752816	FrameElem=40-1
Frame=40 ElemStation=0,04	Station=0,04	OutputCase=SIS22	CaseType=Combination	P=-13,6605764960154	V2=13,3577528881704	V3=0	T=0	M2=0	M3=7,28363354200135	FrameElem=40-1
Frame=40 ElemStation=0,08	Station=0,08	OutputCase=SIS22	CaseType=Combination	P=-13,6605764960154	V2=13,5177528881704	V3=0	T=0	M2=0	M3=6,74612342647453	FrameElem=40-1
Frame=40 ElemStation=0	Station=0	OutputCase=SIS23	CaseType=Combination	P=-13,3426991728118	V2=12,5617260216808	V3=0	T=0	M2=0	M3=7,20072199722794	FrameElem=40-1
Frame=40 ElemStation=0,04	Station=0,04	OutputCase=SIS23	CaseType=Combination	P=-13,3426991728118	V2=12,7217260216808	V3=0	T=0	M2=0	M3=6,6950529563607	FrameElem=40-1
Frame=40 ElemStation=0,08	Station=0,08	OutputCase=SIS23	CaseType=Combination	P=-13,3426991728118	V2=12,8817260216808	V3=0	T=0	M2=0	M3=6,18298391549347	FrameElem=40-1
Frame=40 ElemStation=0	Station=0	OutputCase=SIS24	CaseType=Combination	P=-13,8847448505452	V2=12,8803911769814	V3=0	T=0	M2=0	M3=7,82581500769653	FrameElem=40-1
Frame=40 ElemStation=0,04	Station=0,04	OutputCase=SIS24	CaseType=Combination	P=-13,8847448505452	V2=13,0403911769814	V3=0	T=0	M2=0	M3=7,30739936061727	FrameElem=40-1
Frame=40 ElemStation=0,08	Station=0,08	OutputCase=SIS24	CaseType=Combination	P=-13,8847448505452	V2=13,2003911769814	V3=0	T=0	M2=0	M3=6,78258371353802	FrameElem=40-1
Frame=40 ElemStation=0	Station=0	OutputCase=SIS25	CaseType=Combination	P=-13,2774694798838	V2=13,1971011661146	V3=0	T=0	M2=0	M3=7,49666147720968	FrameElem=40-1
Frame=40 ElemStation=0,04	Station=0,04	OutputCase=SIS25	CaseType=Combination	P=-13,2774694798838	V2=13,3571011661146	V3=0	T=0	M2=0	M3=6,9655774305651	FrameElem=40-1
Frame=40 ElemStation=0,08	Station=0,08	OutputCase=SIS25	CaseType=Combination	P=-13,2774694798838	V2=13,5171011661146	V3=0	T=0	M2=0	M3=6,42809338392052	FrameElem=40-1
Frame=40 ElemStation=0	Station=0	OutputCase=SIS26	CaseType=Combination	P=-12,9595921566801	V2=12,5610742996249	V3=0	T=0	M2=0	M3=6,88263981690946	FrameElem=40-1
Frame=40 ElemStation=0,04	Station=0,04	OutputCase=SIS26	CaseType=Combination	P=-12,9595921566801	V2=12,7210742996249	V3=0	T=0	M2=0	M3=6,37699684492446	FrameElem=40-1
Frame=40 ElemStation=0,08	Station=0,08	OutputCase=SIS26	CaseType=Combination	P=-12,9595921566801	V2=12,8810742996249	V3=0	T=0	M2=0	M3=5,86495387293946	FrameElem=40-1
Frame=40 ElemStation=0	Station=0	OutputCase=SIS27	CaseType=Combination	P=-13,5016378344136	V2=12,8797394549256	V3=0	T=0	M2=0	M3=7,50773282737805	FrameElem=40-1
Frame=40 ElemStation=0,04	Station=0,04	OutputCase=SIS27	CaseType=Combination	P=-13,5016378344136	V2=13,0397394549256	V3=0	T=0	M2=0	M3=6,98934324918103	FrameElem=40-1
Frame=40 ElemStation=0,08	Station=0,08	OutputCase=SIS27	CaseType=Combination	P=-13,5016378344136	V2=13,1997394549256	V3=0	T=0	M2=0	M3=6,464553670984	FrameElem=40-1
Frame=40 ElemStation=0	Station=0	OutputCase=SIS28	CaseType=Combination	P=-13,6375406118736	V2=16,4233371675873	V3=0	T=0	M2=0	M3=8,05463842857012	FrameElem=40-1
Frame=40 ElemStation=0,04	Station=0,04	OutputCase=SIS28	CaseType=Combination	P=-13,6375406118736	V2=16,5833371675873	V3=0	T=0	M2=0	M3=7,39450494186662	FrameElem=40-1
Frame=40 ElemStation=0,08	Station=0,08	OutputCase=SIS28	CaseType=Combination	P=-13,6375406118736	V2=16,7433371675873	V3=0	T=0	M2=0	M3=6,72797145516313	FrameElem=40-1
Frame=40 ElemStation=0	Station=0	OutputCase=SIS29	CaseType=Combination	P=-13,254433595742	V2=16,4226854455315	V3=0	T=0	M2=0	M3=7,73655624825164	FrameElem=40-1
Frame=40 ElemStation=0,04	Station=0,04	OutputCase=SIS29	CaseType=Combination	P=-13,254433595742	V2=16,5826854455315	V3=0	T=0	M2=0	M3=7,07644883043038	FrameElem=40-1
Frame=40 ElemStation=0,08	Station=0,08	OutputCase=SIS29	CaseType=Combination	P=-13,254433595742	V2=16,7426854455315	V3=0	T=0	M2=0	M3=6,40994141260912	FrameElem=40-1
Frame=40 ElemStation=0	Station=0	OutputCase=SIS30	CaseType=Combination	P=-14,0206476280052	V2=16,4239888896431	V3=0	T=0	M2=0	M3=8,37272060888859	FrameElem=40-1
Frame=40 ElemStation=0,04	Station=0,04	OutputCase=SIS30	CaseType=Combination	P=-14,0206476280052	V2=16,5839888896431	V3=0	T=0	M2=0	M3=7,71256105330287	FrameElem=40-1
Frame=40 ElemStation=0,08	Station=0,08	OutputCase=SIS30	CaseType=Combination	P=-14,0206476280052	V2=16,7439888896431	V3=0	T=0	M2=0	M3=7,04600149771714	FrameElem=40-1

Società di Progetto
Brebemi SpA



Doc. N.
60235-00000-A00.doc

CODIFICA DOCUMENTO
04RCDII10000000000300A00

REV.
00

FOGLIO
517 di 628

Frame=40 Station=0 OutputCase=SIS31 CaseType=Combination P=-13,7964792734754 V2=16,7413506008321 V3=0 T=0 M2=0 M3=8,36164925872023 ElemStation=0	Frame=40 Station=0,04 OutputCase=SIS31 CaseType=Combination P=-13,7964792734754 V2=16,9013506008321 V3=0 T=0 M2=0 M3=7,68879523468695 ElemStation=0,04	Frame=40 Station=0,08 OutputCase=SIS31 CaseType=Combination P=-13,7964792734754 V2=17,0613506008321 V3=0 T=0 M2=0 M3=7,00954121065366 ElemStation=0,08	Frame=40 Station=0 OutputCase=SIS32 CaseType=Combination P=-13,4786019502718 V2=16,1053237343425 V3=0 T=0 M2=0 M3=7,74762759842 ElemStation=0	Frame=40 Station=0,04 OutputCase=SIS32 CaseType=Combination P=-13,4786019502718 V2=16,2653237343425 V3=0 T=0 M2=0 M3=7,1002146490463 ElemStation=0,04	Frame=40 Station=0,08 OutputCase=SIS32 CaseType=Combination P=-13,4786019502718 V2=16,4253237343425 V3=0 T=0 M2=0 M3=6,4464016996726 ElemStation=0,08	Frame=40 Station=0 OutputCase=SIS33 CaseType=Combination P=-14,0206476280052 V2=16,4239888896431 V3=0 T=0 M2=0 M3=8,3727206088859 ElemStation=0	Frame=40 Station=0,04 OutputCase=SIS33 CaseType=Combination P=-14,0206476280052 V2=16,5839888896431 V3=0 T=0 M2=0 M3=7,71256105330287 ElemStation=0,04	Frame=40 Station=0,08 OutputCase=SIS33 CaseType=Combination P=-14,0206476280052 V2=16,7439888896431 V3=0 T=0 M2=0 M3=7,04600149771714 ElemStation=0,08	Frame=40 Station=0 OutputCase=SIS34 CaseType=Combination P=-13,4133722573438 V2=16,7406988787763 V3=0 T=0 M2=0 M3=8,04356707840175 ElemStation=0	Frame=40 Station=0,04 OutputCase=SIS34 CaseType=Combination P=-13,4133722573438 V2=16,9006988787763 V3=0 T=0 M2=0 M3=7,3707391232507 ElemStation=0,04	Frame=40 Station=0,08 OutputCase=SIS34 CaseType=Combination P=-13,4133722573438 V2=17,0606988787763 V3=0 T=0 M2=0 M3=6,69151116809965 ElemStation=0,08	Frame=40 Station=0 OutputCase=SIS35 CaseType=Combination P=-13,0954949341401 V2=16,1046720122867 V3=0 T=0 M2=0 M3=7,42954541810152 ElemStation=0	Frame=40 Station=0,04 OutputCase=SIS35 CaseType=Combination P=-13,0954949341401 V2=16,2646720122867 V3=0 T=0 M2=0 M3=6,78215853761005 ElemStation=0,04	Frame=40 Station=0,08 OutputCase=SIS35 CaseType=Combination P=-13,0954949341401 V2=16,4246720122867 V3=0 T=0 M2=0 M3=6,12837165711859 ElemStation=0,08	Frame=40 Station=0 OutputCase=SIS36 CaseType=Combination P=-13,6375406118736 V2=16,4233371675873 V3=0 T=0 M2=0 M3=8,05463842857012 ElemStation=0	Frame=40 Station=0,04 OutputCase=SIS36 CaseType=Combination P=-13,6375406118736 V2=16,5833371675873 V3=0 T=0 M2=0 M3=7,39450494186662 ElemStation=0,04	Frame=40 Station=0,08 OutputCase=SIS36 CaseType=Combination P=-13,6375406118736 V2=16,7433371675873 V3=0 T=0 M2=0 M3=6,72797145516313 ElemStation=0,08	Frame=40 Station=0 OutputCase=INVSIS CaseType=Combination StepType=Max P=-12,9595921566801 V2=16,7413506008321 V3=0 T=0 M2=0 M3=10,1487797218465 ElemStation=0	Frame=40 Station=0,04 OutputCase=INVSIS CaseType=Combination StepType=Max P=-12,9595921566801 V2=16,9013506008321 V3=0 T=0 M2=0 M3=9,56761834551019 ElemStation=0,04	Frame=40 Station=0,08 OutputCase=INVSIS CaseType=Combination StepType=Max P=-12,9595921566801 V2=17,0613506008321 V3=0 T=0 M2=0 M3=8,9800569691739 ElemStation=0,08	Frame=40 Station=0 OutputCase=INVSIS CaseType=Combination StepType=Min P=-14,0206476280052 V2=12,5610742996249 V3=0 T=0 M2=0 M3=6,88263981690946 ElemStation=0	Frame=40 Station=0,04 OutputCase=INVSIS CaseType=Combination StepType=Min P=-14,0206476280052 V2=12,7210742996249 V3=0 T=0 M2=0 M3=6,37699684492446 ElemStation=0,04	Frame=40 Station=0,08 OutputCase=INVSIS CaseType=Combination StepType=Min P=-14,0206476280052 V2=12,8810742996249 V3=0 T=0 M2=0 M3=5,86495387293946 ElemStation=0,08	Frame=40 Station=0 OutputCase=RAR001 CaseType=Combination P=-11,2910804172875 V2=15,4102766667784 V3=0 T=0 M2=0 M3=3,68986040729305 ElemStation=0	Frame=40 Station=0,04 OutputCase=RAR001 CaseType=Combination P=-11,2910804172875 V2=15,5702766667784 V3=0 T=0 M2=0 M3=3,07024934062192 ElemStation=0,04	Frame=40 Station=0,08 OutputCase=RAR001 CaseType=Combination P=-11,2910804172875 V2=15,7302766667784 V3=0 T=0 M2=0 M3=2,44423827395079 ElemStation=0,08	Frame=40 Station=0 OutputCase=RAR002 CaseType=Combination P=-6,33003339687009 V2=84,5506412674877 V3=0 T=0 M2=0 M3=12,894360094343 ElemStation=0	Frame=40 Station=0,04 OutputCase=RAR002 CaseType=Combination P=-6,33003339687009 V2=84,7106412674877 V3=0 T=0 M2=0 M3=9,50913444364352 ElemStation=0,04	Frame=40 Station=0,08 OutputCase=RAR002 CaseType=Combination P=-6,33003339687009 V2=84,8706412674877 V3=0 T=0 M2=0 M3=6,11750879294402 ElemStation=0,08	Frame=40 Station=0 OutputCase=RAR003 CaseType=Combination P=-17,531170794774 V2=83,0564031443791 V3=0 T=0 M2=0 M3=26,3555740783722 ElemStation=0	Frame=40 Station=0,04 OutputCase=RAR003 CaseType=Combination P=-17,531170794774 V2=83,2164031443791 V3=0 T=0 M2=0 M3=23,0301179525971 ElemStation=0,04	Frame=40 Station=0,08 OutputCase=RAR003 CaseType=Combination P=-17,531170794774 V2=83,3764031443791 V3=0 T=0 M2=0 M3=19,6982618268219 ElemStation=0,08	Frame=40 Station=0 OutputCase=RAR004 CaseType=Combination P=-28,7323081861587 V2=84,5572112659866 V3=0 T=0 M2=0 M3=16,1009410323913 ElemStation=0	Frame=40 Station=0,04 OutputCase=RAR004 CaseType=Combination P=-28,7323081861587 V2=84,7172112659866 V3=0 T=0 M2=0 M3=12,7154525817519 ElemStation=0,04	Frame=40 Station=0,08 OutputCase=RAR004 CaseType=Combination P=-28,7323081861587 V2=84,8772112659866 V3=0 T=0 M2=0 M3=9,32356413111243 ElemStation=0,08	Frame=40 Station=0 OutputCase=RAR005 CaseType=Combination P=-18,4913082240978 V2=13,91504499648 V3=0 T=0 M2=0 M3=16,6661595432388 ElemStation=0	Frame=40 Station=0,04 OutputCase=RAR005 CaseType=Combination P=-18,4913082240978 V2=14,07504499648 V3=0 T=0 M2=0 M3=16,1063577433796 ElemStation=0,04	Frame=40 Station=0,08 OutputCase=RAR005 CaseType=Combination P=-18,4913082240978 V2=14,23504499648 V3=0 T=0 M2=0 M3=15,5401559435204 ElemStation=0,08	Frame=40 Station=0 OutputCase=RAR006 CaseType=Combination P=-29,6924456154825 V2=15,4158531180874 V3=0 T=0 M2=0 M3=6,41152649725791 ElemStation=0	Frame=40 Station=0,04 OutputCase=RAR006 CaseType=Combination P=-29,6924456154825 V2=15,5758531180874 V3=0 T=0 M2=0 M3=5,79169237253442 ElemStation=0,04	Frame=40 Station=0,08 OutputCase=RAR006 CaseType=Combination P=-29,6924456154825 V2=15,7358531180874 V3=0 T=0 M2=0 M3=5,16545824781092 ElemStation=0,08	Frame=40 Station=0 OutputCase=RAR007 CaseType=Combination P=-15,4710345051246 V2=60,9775641657616 V3=0 T=0 M2=0 M3=32,08092201468 ElemStation=0	Frame=40 Station=0,04 OutputCase=RAR007 CaseType=Combination P=-15,4710345051246 V2=61,1375641657616 V3=0 T=0 M2=0 M3=29,6386194480496 ElemStation=0,04
--	--	--	---	---	---	---	--	--	--	---	--	--	--	--	--	--	--	--	--	---	--	--	--	---	---	---	--	---	---	--	--	--	---	---	---	---	---	---	---	---	---	---	---

Società di Progetto
Brebemi SpA

	Doc. N. 60235-0000-A00.doc	CODIFICA DOCUMENTO 04RCDII10000000000300A00	REV. 00	FOGLIO 518 di 628
--	-------------------------------	--	------------	----------------------

Frame=40 Station=0,08 OutputCase=RAR007 CaseType=Combination P=-15,4710345051246 V2=61,2975641657616 V3=0 T=0 M2=0 M3=27,1899168814191	FrameElem=40-1 ElemStation=0,08
Frame=40 Station=0 OutputCase=RAR008 CaseType=Combination P=-6,52395679393056 V2=15,4079796754768 V3=0 T=0 M2=0 M3=2,56878119857263	FrameElem=40-1 ElemStation=0
Frame=40 Station=0,04 OutputCase=RAR008 CaseType=Combination P=-6,52395679393056 V2=15,5679796754768 V3=0 T=0 M2=0 M3=1,94926201155356	FrameElem=40-1 ElemStation=0,04
Frame=40 Station=0,08 OutputCase=RAR008 CaseType=Combination P=-6,52395679393056 V2=15,7279796754768 V3=0 T=0 M2=0 M3=1,32334282453449	FrameElem=40-1 ElemStation=0,08
Frame=40 Station=0 OutputCase=RAR009 CaseType=Combination P=-5,87030497751214 V2=84,5498592010207 V3=0 T=0 M2=0 M3=12,5126614779609	FrameElem=40-1 ElemStation=0
Frame=40 Station=0,04 OutputCase=RAR009 CaseType=Combination P=-5,87030497751214 V2=84,7098592010207 V3=0 T=0 M2=0 M3=9,12746710992003	FrameElem=40-1 ElemStation=0,04
Frame=40 Station=0,08 OutputCase=RAR009 CaseType=Combination P=-5,87030497751214 V2=84,8698592010207 V3=0 T=0 M2=0 M3=5,7358727418792	FrameElem=40-1 ElemStation=0,08
Frame=40 Station=0 OutputCase=RAR010 CaseType=Combination P=-17,0714423754161 V2=83,0556210779122 V3=0 T=0 M2=0 M3=25,9738754619901	FrameElem=40-1 ElemStation=0
Frame=40 Station=0,04 OutputCase=RAR010 CaseType=Combination P=-17,0714423754161 V2=83,2156210779122 V3=0 T=0 M2=0 M3=22,6484506188736	FrameElem=40-1 ElemStation=0,04
Frame=40 Station=0,08 OutputCase=RAR010 CaseType=Combination P=-17,0714423754161 V2=83,3756210779122 V3=0 T=0 M2=0 M3=19,3166257757571	FrameElem=40-1 ElemStation=0,08
Frame=40 Station=0 OutputCase=RAR011 CaseType=Combination P=-28,2725797668008 V2=84,5564291995196 V3=0 T=0 M2=0 M3=15,7192424160092	FrameElem=40-1 ElemStation=0
Frame=40 Station=0,04 OutputCase=RAR011 CaseType=Combination P=-28,2725797668008 V2=84,7164291995196 V3=0 T=0 M2=0 M3=12,3337852480284	FrameElem=40-1 ElemStation=0,04
Frame=40 Station=0,08 OutputCase=RAR011 CaseType=Combination P=-28,2725797668008 V2=84,8764291995195 V3=0 T=0 M2=0 M3=8,94192808004761	FrameElem=40-1 ElemStation=0,08
Frame=40 Station=0 OutputCase=RAR012 CaseType=Combination P=-18,0315798047398 V2=13,914262930013 V3=0 T=0 M2=0 M3=16,284460268566	FrameElem=40-1 ElemStation=0
Frame=40 Station=0,04 OutputCase=RAR012 CaseType=Combination P=-18,0315798047398 V2=14,074262930013 V3=0 T=0 M2=0 M3=15,7246904096561	FrameElem=40-1 ElemStation=0,04
Frame=40 Station=0,08 OutputCase=RAR012 CaseType=Combination P=-18,0315798047398 V2=14,234262930013 V3=0 T=0 M2=0 M3=15,1585198924556	FrameElem=40-1 ElemStation=0,08
Frame=40 Station=0 OutputCase=RAR013 CaseType=Combination P=-29,2327171961245 V2=15,4150710516204 V3=0 T=0 M2=0 M3=6,02982788087574	FrameElem=40-1 ElemStation=0
Frame=40 Station=0,04 OutputCase=RAR013 CaseType=Combination P=-29,2327171961245 V2=15,5750710516204 V3=0 T=0 M2=0 M3=5,41002530881092	FrameElem=40-1 ElemStation=0,04
Frame=40 Station=0,08 OutputCase=RAR013 CaseType=Combination P=-29,2327171961245 V2=15,7350710516204 V3=0 T=0 M2=0 M3=4,7838221967461	FrameElem=40-1 ElemStation=0,08
Frame=40 Station=0 OutputCase=RAR014 CaseType=Combination P=-15,0113060857666 V2=60,9767820992946 V3=0 T=0 M2=0 M3=31,6992233982979	FrameElem=40-1 ElemStation=0
Frame=40 Station=0,04 OutputCase=RAR014 CaseType=Combination P=-15,0113060857666 V2=61,1367820992946 V3=0 T=0 M2=0 M3=29,2569521143261	FrameElem=40-1 ElemStation=0,04
Frame=40 Station=0,08 OutputCase=RAR014 CaseType=Combination P=-15,0113060857666 V2=61,2967820992946 V3=0 T=0 M2=0 M3=26,8082808303543	FrameElem=40-1 ElemStation=0,08
Frame=40 Station=0 OutputCase=RAR015 CaseType=Combination P=-5,80385372193777 V2=67,2639982864012 V3=0 T=0 M2=0 M3=9,83584209992271	FrameElem=40-1 ElemStation=0
Frame=40 Station=0,04 OutputCase=RAR015 CaseType=Combination P=-5,80385372193777 V2=67,4239982864012 V3=0 T=0 M2=0 M3=7,14208216846666	FrameElem=40-1 ElemStation=0,04
Frame=40 Station=0,08 OutputCase=RAR015 CaseType=Combination P=-5,80385372193777 V2=67,5839982864012 V3=0 T=0 M2=0 M3=4,44192223701062	FrameElem=40-1 ElemStation=0,08
Frame=40 Station=0 OutputCase=RAR016 CaseType=Combination P=-14,704820469136 V2=66,1225541503764 V3=0 T=0 M2=0 M3=20,344406990788	FrameElem=40-1 ElemStation=0
Frame=40 Station=0,04 OutputCase=RAR016 CaseType=Combination P=-14,704820469136 V2=66,2825541503764 V3=0 T=0 M2=0 M3=17,6963048247729	FrameElem=40-1 ElemStation=0,04
Frame=40 Station=0,08 OutputCase=RAR016 CaseType=Combination P=-14,704820469136 V2=66,4425541503764 V3=0 T=0 M2=0 M3=15,0418026587579	FrameElem=40-1 ElemStation=0,08
Frame=40 Station=0 OutputCase=RAR017 CaseType=Combination P=-23,6057872116777 V2=67,2691741720728 V3=0 T=0 M2=0 M3=12,3620065154798	FrameElem=40-1 ElemStation=0
Frame=40 Station=0,04 OutputCase=RAR017 CaseType=Combination P=-23,6057872116777 V2=67,4291741720728 V3=0 T=0 M2=0 M3=9,6680395485969	FrameElem=40-1 ElemStation=0,04
Frame=40 Station=0,08 OutputCase=RAR017 CaseType=Combination P=-23,6057872116777 V2=67,5891741720728 V3=0 T=0 M2=0 M3=6,96767258171399	FrameElem=40-1 ElemStation=0,08
Frame=40 Station=0 OutputCase=RAR018 CaseType=Combination P=-15,4249235411288 V2=14,26653539452 V3=0 T=0 M2=0 M3=13,0773460894379	FrameElem=40-1 ElemStation=0
Frame=40 Station=0,04 OutputCase=RAR018 CaseType=Combination P=-15,4249235411288 V2=14,42653539452 V3=0 T=0 M2=0 M3=12,5034846678598	FrameElem=40-1 ElemStation=0,04
Frame=40 Station=0,08 OutputCase=RAR018 CaseType=Combination P=-15,4249235411288 V2=14,58653539452 V3=0 T=0 M2=0 M3=11,9232232462817	FrameElem=40-1 ElemStation=0,08
Frame=40 Station=0 OutputCase=RAR019 CaseType=Combination P=-24,3258902836705 V2=15,4131555611485 V3=0 T=0 M2=0 M3=5,09494561412974	FrameElem=40-1 ElemStation=0
Frame=40 Station=0,04 OutputCase=RAR019 CaseType=Combination P=-24,3258902836705 V2=15,5731555611485 V3=0 T=0 M2=0 M3=4,4752193916838	FrameElem=40-1 ElemStation=0,04
Frame=40 Station=0,08 OutputCase=RAR019 CaseType=Combination P=-24,3258902836705 V2=15,7331555611485 V3=0 T=0 M2=0 M3=3,84909316923786	FrameElem=40-1 ElemStation=0,08
Frame=40 Station=0 OutputCase=RAR020 CaseType=Combination P=-6,71468318785274 V2=15,7895957953706 V3=0 T=0 M2=0 M3=2,93719419475277	FrameElem=40-1 ElemStation=0
Frame=40 Station=0,04 OutputCase=RAR020 CaseType=Combination P=-6,71468318785274 V2=15,9495957953706 V3=0 T=0 M2=0 M3=2,30241036293794	FrameElem=40-1 ElemStation=0,04
Frame=40 Station=0,08 OutputCase=RAR020 CaseType=Combination P=-6,71468318785274 V2=16,1095957953706 V3=0 T=0 M2=0 M3=1,66122653112312	FrameElem=40-1 ElemStation=0,08
Frame=40 Station=0 OutputCase=RAR021 CaseType=Combination P=-5,99458011585995 V2=67,645614406295 V3=0 T=0 M2=0 M3=10,2042550961028	FrameElem=40-1 ElemStation=0
Frame=40 Station=0,04 OutputCase=RAR021 CaseType=Combination P=-5,99458011585995 V2=67,805614406295 V3=0 T=0 M2=0 M3=7,49523051985105	FrameElem=40-1 ElemStation=0,04
Frame=40 Station=0,08 OutputCase=RAR021 CaseType=Combination P=-5,99458011585995 V2=67,965614406295 V3=0 T=0 M2=0 M3=4,77980594359925	FrameElem=40-1 ElemStation=0,08
Frame=40 Station=0 OutputCase=RAR022 CaseType=Combination P=-14,8955468630582 V2=66,5041702702072 V3=0 T=0 M2=0 M3=20,7128199869681	FrameElem=40-1 ElemStation=0

Società di Progetto
Brebemi SpA

	Doc. N. 60235-0000-A00.doc	CODIFICA DOCUMENTO 04RCDII10000000000300A00	REV. 00	FOGLIO 519 di 628
--	-------------------------------	--	------------	----------------------

Frame=40 Station=0,04 OutputCase=RAR022 ElemStation=0,04	CaseType=Combination	P=-14,8955468630582	V2=66,6641702702702	V3=0	T=0	M2=0	M3=18,0494531761573	FrameElem=40-1
Frame=40 Station=0,08 OutputCase=RAR022 ElemStation=0,08	CaseType=Combination	P=-14,8955468630582	V2=66,8241702702702	V3=0	T=0	M2=0	M3=15,3796863653465	FrameElem=40-1
Frame=40 Station=0 OutputCase=RAR023 ElemStation=0	CaseType=Combination	P=-23,7965136055998	V2=67,6507902919666	V3=0	T=0	M2=0	M3=12,73041951166	FrameElem=40-1
Frame=40 Station=0,04 OutputCase=RAR023 ElemStation=0,04	CaseType=Combination	P=-23,7965136055998	V2=67,8107902919666	V3=0	T=0	M2=0	M3=10,021187899813	FrameElem=40-1
Frame=40 Station=0,08 OutputCase=RAR023 ElemStation=0,08	CaseType=Combination	P=-23,7965136055998	V2=67,9707902919666	V3=0	T=0	M2=0	M3=7,30555628830263	FrameElem=40-1
Frame=40 Station=0 OutputCase=RAR024 ElemStation=0	CaseType=Combination	P=-15,615649935051	V2=14,6481516593458	V3=0	T=0	M2=0	M3=13,445759085618	FrameElem=40-1
Frame=40 Station=0,04 OutputCase=RAR024 ElemStation=0,04	CaseType=Combination	P=-15,615649935051	V2=14,8081516593458	V3=0	T=0	M2=0	M3=12,8566330192442	FrameElem=40-1
Frame=40 Station=0,08 OutputCase=RAR024 ElemStation=0,08	CaseType=Combination	P=-15,615649935051	V2=14,9681516593458	V3=0	T=0	M2=0	M3=12,2611069528704	FrameElem=40-1
Frame=40 Station=0 OutputCase=RAR025 ElemStation=0	CaseType=Combination	P=-24,5166166775926	V2=15,7947716810422	V3=0	T=0	M2=0	M3=5,46335861030987	FrameElem=40-1
Frame=40 Station=0,04 OutputCase=RAR025 ElemStation=0,04	CaseType=Combination	P=-24,5166166775926	V2=15,9547716810422	V3=0	T=0	M2=0	M3=4,82836774306819	FrameElem=40-1
Frame=40 Station=0,08 OutputCase=RAR025 ElemStation=0,08	CaseType=Combination	P=-24,5166166775926	V2=16,1147716810422	V3=0	T=0	M2=0	M3=4,18697687582649	FrameElem=40-1
Frame=40 Station=0 OutputCase=RAR026 ElemStation=0	CaseType=Combination	P=-6,33323040000838	V2=15,0263635555831	V3=0	T=0	M2=0	M3=2,2003682023925	FrameElem=40-1
Frame=40 Station=0,04 OutputCase=RAR026 ElemStation=0,04	CaseType=Combination	P=-6,33323040000838	V2=15,1863635555831	V3=0	T=0	M2=0	M3=1,59611366016917	FrameElem=40-1
Frame=40 Station=0,08 OutputCase=RAR026 ElemStation=0,08	CaseType=Combination	P=-6,33323040000838	V2=15,3463635555831	V3=0	T=0	M2=0	M3=0,98545911794585	FrameElem=40-1
Frame=40 Station=0 OutputCase=RAR027 ElemStation=0	CaseType=Combination	P=-5,61312732801559	V2=66,8823821665074	V3=0	T=0	M2=0	M3=9,46742910374257	FrameElem=40-1
Frame=40 Station=0,04 OutputCase=RAR027 ElemStation=0,04	CaseType=Combination	P=-5,61312732801559	V2=67,0423821665074	V3=0	T=0	M2=0	M3=6,78893381708228	FrameElem=40-1
Frame=40 Station=0,08 OutputCase=RAR027 ElemStation=0,08	CaseType=Combination	P=-5,61312732801559	V2=67,2023821665074	V3=0	T=0	M2=0	M3=4,10403853042198	FrameElem=40-1
Frame=40 Station=0 OutputCase=RAR028 ElemStation=0	CaseType=Combination	P=-14,5140940752138	V2=65,7409380304826	V3=0	T=0	M2=0	M3=19,9759939946078	FrameElem=40-1
Frame=40 Station=0,04 OutputCase=RAR028 ElemStation=0,04	CaseType=Combination	P=-14,5140940752138	V2=65,9009380304826	V3=0	T=0	M2=0	M3=17,3431564733885	FrameElem=40-1
Frame=40 Station=0,08 OutputCase=RAR028 ElemStation=0,08	CaseType=Combination	P=-14,5140940752138	V2=66,0609380304826	V3=0	T=0	M2=0	M3=14,7039189521692	FrameElem=40-1
Frame=40 Station=0 OutputCase=RAR029 ElemStation=0	CaseType=Combination	P=-23,4150608177555	V2=66,8875580521791	V3=0	T=0	M2=0	M3=11,9935935192997	FrameElem=40-1
Frame=40 Station=0,04 OutputCase=RAR029 ElemStation=0,04	CaseType=Combination	P=-23,4150608177555	V2=67,0475580521791	V3=0	T=0	M2=0	M3=9,31489119721252	FrameElem=40-1
Frame=40 Station=0,08 OutputCase=RAR029 ElemStation=0,08	CaseType=Combination	P=-23,4150608177555	V2=67,2075580521791	V3=0	T=0	M2=0	M3=6,62978887512535	FrameElem=40-1
Frame=40 Station=0 OutputCase=RAR030 ElemStation=0	CaseType=Combination	P=-15,2341971472066	V2=13,8849194195583	V3=0	T=0	M2=0	M3=12,7089330932578	FrameElem=40-1
Frame=40 Station=0,04 OutputCase=RAR030 ElemStation=0,04	CaseType=Combination	P=-15,2341971472066	V2=14,0449194195583	V3=0	T=0	M2=0	M3=12,1503363164754	FrameElem=40-1
Frame=40 Station=0,08 OutputCase=RAR030 ElemStation=0,08	CaseType=Combination	P=-15,2341971472066	V2=14,2049194195583	V3=0	T=0	M2=0	M3=11,5853395396931	FrameElem=40-1
Frame=40 Station=0 OutputCase=RAR031 ElemStation=0	CaseType=Combination	P=-24,1351638897483	V2=15,0315394412547	V3=0	T=0	M2=0	M3=4,7265326179496	FrameElem=40-1
Frame=40 Station=0,04 OutputCase=RAR031 ElemStation=0,04	CaseType=Combination	P=-24,1351638897483	V2=15,1915394412547	V3=0	T=0	M2=0	M3=4,12207104029941	FrameElem=40-1
Frame=40 Station=0,08 OutputCase=RAR031 ElemStation=0,08	CaseType=Combination	P=-24,1351638897483	V2=15,3515394412547	V3=0	T=0	M2=0	M3=3,51120946264922	FrameElem=40-1
Frame=40 Station=0 OutputCase=RAR032 ElemStation=0	CaseType=Combination	P=-6,98368521328851	V2=15,4087617419438	V3=0	T=0	M2=0	M3=2,95047981495481	FrameElem=40-1
Frame=40 Station=0,04 OutputCase=RAR032 ElemStation=0,04	CaseType=Combination	P=-6,98368521328851	V2=15,5687617419438	V3=0	T=0	M2=0	M3=2,33092934527705	FrameElem=40-1
Frame=40 Station=0,08 OutputCase=RAR032 ElemStation=0,08	CaseType=Combination	P=-6,98368521328851	V2=15,7287617419438	V3=0	T=0	M2=0	M3=1,7049788755993	FrameElem=40-1
Frame=40 Station=0 OutputCase=RAR033 ElemStation=0	CaseType=Combination	P=-6,26358214129572	V2=67,2647803528682	V3=0	T=0	M2=0	M3=10,2175407163049	FrameElem=40-1
Frame=40 Station=0,04 OutputCase=RAR033 ElemStation=0,04	CaseType=Combination	P=-6,26358214129572	V2=67,4247803528682	V3=0	T=0	M2=0	M3=7,52374950219016	FrameElem=40-1
Frame=40 Station=0,08 OutputCase=RAR033 ElemStation=0,08	CaseType=Combination	P=-6,26358214129572	V2=67,5847803528682	V3=0	T=0	M2=0	M3=4,82355828807543	FrameElem=40-1
Frame=40 Station=0 OutputCase=RAR034 ElemStation=0	CaseType=Combination	P=-15,164548888494	V2=66,1233362168434	V3=0	T=0	M2=0	M3=20,7261056071702	FrameElem=40-1
Frame=40 Station=0,04 OutputCase=RAR034 ElemStation=0,04	CaseType=Combination	P=-15,164548888494	V2=66,2833362168434	V3=0	T=0	M2=0	M3=18,0779721584964	FrameElem=40-1
Frame=40 Station=0,08 OutputCase=RAR034 ElemStation=0,08	CaseType=Combination	P=-15,164548888494	V2=66,4433362168434	V3=0	T=0	M2=0	M3=15,4234387098227	FrameElem=40-1
Frame=40 Station=0 OutputCase=RAR035 ElemStation=0	CaseType=Combination	P=-24,0655156310356	V2=67,2699562385398	V3=0	T=0	M2=0	M3=12,743705131862	FrameElem=40-1
Frame=40 Station=0,04 OutputCase=RAR035 ElemStation=0,04	CaseType=Combination	P=-24,0655156310356	V2=67,4299562385398	V3=0	T=0	M2=0	M3=10,0497068823204	FrameElem=40-1
Frame=40 Station=0,08 OutputCase=RAR035 ElemStation=0,08	CaseType=Combination	P=-24,0655156310356	V2=67,5899562385398	V3=0	T=0	M2=0	M3=7,34930863277881	FrameElem=40-1
Frame=40 Station=0 OutputCase=RAR036 ElemStation=0	CaseType=Combination	P=-15,8846519604868	V2=14,267317605919	V3=0	T=0	M2=0	M3=13,4590447058201	FrameElem=40-1
Frame=40 Station=0,04 OutputCase=RAR036 ElemStation=0,04	CaseType=Combination	P=-15,8846519604868	V2=14,427317605919	V3=0	T=0	M2=0	M3=12,8851520015833	FrameElem=40-1
Frame=40 Station=0,08 OutputCase=RAR036 ElemStation=0,08	CaseType=Combination	P=-15,8846519604868	V2=14,587317605919	V3=0	T=0	M2=0	M3=12,3048592973466	FrameElem=40-1

Società di Progetto
Brebemi SpA



Doc. N.
60235-00000-A00.doc

CODIFICA DOCUMENTO
04RCDII10000000000300A00

REV.
00

FOGLIO
520 di 628

Frame=40 Station=0 OutputCase=RAR037 CaseType=Combination P=-24,7856187030284 V2=15,4139376276155 V3=0 T=0 M2=0 M3=5,47664423051191	FrameElem=40-1
ElemStation=0	
Frame=40 Station=0,04 OutputCase=RAR037 CaseType=Combination P=-24,7856187030284 V2=15,5739376276155 V3=0 T=0 M2=0 M3=4,85688672540729	FrameElem=40-1
ElemStation=0,04	
Frame=40 Station=0,08 OutputCase=RAR037 CaseType=Combination P=-24,7856187030284 V2=15,7339376276155 V3=0 T=0 M2=0 M3=4,23072922030267	FrameElem=40-1
ElemStation=0,08	
Frame=40 Station=0 OutputCase=RAR038 CaseType=Combination P=-8,05638485845707 V2=15,4105865637002 V3=0 T=0 M2=0 M3=3,84110991984655	FrameElem=40-1
ElemStation=0	
Frame=40 Station=0,04 OutputCase=RAR038 CaseType=Combination P=-8,05638485845707 V2=15,5705865637002 V3=0 T=0 M2=0 M3=3,22148645729854	FrameElem=40-1
ElemStation=0,04	
Frame=40 Station=0,08 OutputCase=RAR038 CaseType=Combination P=-8,05638485845707 V2=15,7305865637002 V3=0 T=0 M2=0 M3=2,59546299475054	FrameElem=40-1
ElemStation=0,08	
Frame=40 Station=0 OutputCase=RAR039 CaseType=Combination P=-6,78976181622804 V2=84,5514233339547 V3=0 T=0 M2=0 M3=13,2760587107252	FrameElem=40-1
ElemStation=0	
Frame=40 Station=0,04 OutputCase=RAR039 CaseType=Combination P=-6,78976181622804 V2=84,7114233339547 V3=0 T=0 M2=0 M3=9,89080177736702	FrameElem=40-1
ElemStation=0,04	
Frame=40 Station=0,08 OutputCase=RAR039 CaseType=Combination P=-6,78976181622804 V2=84,8714233339547 V3=0 T=0 M2=0 M3=6,49914484400883	FrameElem=40-1
ElemStation=0,08	
Frame=40 Station=0 OutputCase=RAR040 CaseType=Combination P=-17,990899214132 V2=83,0571852108461 V3=0 T=0 M2=0 M3=26,7372726947544	FrameElem=40-1
ElemStation=0	
Frame=40 Station=0,04 OutputCase=RAR040 CaseType=Combination P=-17,990899214132 V2=83,2171852108461 V3=0 T=0 M2=0 M3=23,4117852863206	FrameElem=40-1
ElemStation=0,04	
Frame=40 Station=0,08 OutputCase=RAR040 CaseType=Combination P=-17,990899214132 V2=83,3771852108461 V3=0 T=0 M2=0 M3=20,0798978778867	FrameElem=40-1
ElemStation=0,08	
Frame=40 Station=0 OutputCase=RAR041 CaseType=Combination P=-29,1920366055167 V2=84,5579933324535 V3=0 T=0 M2=0 M3=16,4826396487735	FrameElem=40-1
ElemStation=0	
Frame=40 Station=0,04 OutputCase=RAR041 CaseType=Combination P=-29,1920366055167 V2=84,7179933324535 V3=0 T=0 M2=0 M3=13,0971199154754	FrameElem=40-1
ElemStation=0,04	
Frame=40 Station=0,08 OutputCase=RAR041 CaseType=Combination P=-29,1920366055167 V2=84,8779933324535 V3=0 T=0 M2=0 M3=9,70520018217724	FrameElem=40-1
ElemStation=0,08	
Frame=40 Station=0 OutputCase=RAR042 CaseType=Combination P=-18,9510366434557 V2=13,915827062947 V3=0 T=0 M2=0 M3=17,047858159621	FrameElem=40-1
ElemStation=0	
Frame=40 Station=0,04 OutputCase=RAR042 CaseType=Combination P=-18,9510366434557 V2=14,075827062947 V3=0 T=0 M2=0 M3=16,4880250771031	FrameElem=40-1
ElemStation=0,04	
Frame=40 Station=0,08 OutputCase=RAR042 CaseType=Combination P=-18,9510366434557 V2=14,235827062947 V3=0 T=0 M2=0 M3=15,9217919945852	FrameElem=40-1
ElemStation=0,08	
Frame=40 Station=0 OutputCase=RAR043 CaseType=Combination P=-30,1521740348404 V2=15,4166351845544 V3=0 T=0 M2=0 M3=6,79322511364008	FrameElem=40-1
ElemStation=0	
Frame=40 Station=0,04 OutputCase=RAR043 CaseType=Combination P=-30,1521740348404 V2=15,5766351845544 V3=0 T=0 M2=0 M3=6,17335970625791	FrameElem=40-1
ElemStation=0,04	
Frame=40 Station=0,08 OutputCase=RAR043 CaseType=Combination P=-30,1521740348404 V2=15,7366351845544 V3=0 T=0 M2=0 M3=5,54709429887573	FrameElem=40-1
ElemStation=0,08	
Frame=40 Station=0 OutputCase=RAR044 CaseType=Combination P=-15,9307629244825 V2=60,9783462322286 V3=0 T=0 M2=0 M3=32,4626206310622	FrameElem=40-1
ElemStation=0	
Frame=40 Station=0,04 OutputCase=RAR044 CaseType=Combination P=-15,9307629244825 V2=61,1383462322286 V3=0 T=0 M2=0 M3=30,0202867817731	FrameElem=40-1
ElemStation=0,04	
Frame=40 Station=0,08 OutputCase=RAR044 CaseType=Combination P=-15,9307629244825 V2=61,2983462322286 V3=0 T=0 M2=0 M3=27,551529324839	FrameElem=40-1
ElemStation=0,08	
Frame=40 Station=0 OutputCase=RAR045 CaseType=Combination P=-7,33628178646427 V2=67,2666051746245 V3=0 T=0 M2=0 M3=11,1081708211966	FrameElem=40-1
ElemStation=0	
Frame=40 Station=0,04 OutputCase=RAR045 CaseType=Combination P=-7,33628178646427 V2=67,4266051746245 V3=0 T=0 M2=0 M3=8,41430661421165	FrameElem=40-1
ElemStation=0,04	
Frame=40 Station=0,08 OutputCase=RAR045 CaseType=Combination P=-7,33628178646427 V2=67,5866051746245 V3=0 T=0 M2=0 M3=5,71404240722667	FrameElem=40-1
ElemStation=0,08	
Frame=40 Station=0 OutputCase=RAR046 CaseType=Combination P=-16,2372485336625 V2=66,1251610385997 V3=0 T=0 M2=0 M3=21,6167357120619	FrameElem=40-1
ElemStation=0	
Frame=40 Station=0,04 OutputCase=RAR046 CaseType=Combination P=-16,2372485336625 V2=66,2851610385997 V3=0 T=0 M2=0 M3=18,9685292705179	FrameElem=40-1
ElemStation=0,04	
Frame=40 Station=0,08 OutputCase=RAR046 CaseType=Combination P=-16,2372485336625 V2=66,4451610385997 V3=0 T=0 M2=0 M3=16,3139228289739	FrameElem=40-1
ElemStation=0,08	
Frame=40 Station=0 OutputCase=RAR047 CaseType=Combination P=-25,1382152762042 V2=67,2717810602962 V3=0 T=0 M2=0 M3=13,6343352367537	FrameElem=40-1
ElemStation=0	
Frame=40 Station=0,04 OutputCase=RAR047 CaseType=Combination P=-25,1382152762042 V2=67,4317810602962 V3=0 T=0 M2=0 M3=10,9402639943419	FrameElem=40-1
ElemStation=0,04	
Frame=40 Station=0,08 OutputCase=RAR047 CaseType=Combination P=-25,1382152762042 V2=67,5917810602962 V3=0 T=0 M2=0 M3=8,239729275193004	FrameElem=40-1
ElemStation=0,08	
Frame=40 Station=0 OutputCase=RAR048 CaseType=Combination P=-16,9573516056553 V2=14,2691424276754 V3=0 T=0 M2=0 M3=14,3496748107118	FrameElem=40-1
ElemStation=0	
Frame=40 Station=0,04 OutputCase=RAR048 CaseType=Combination P=-16,9573516056553 V2=14,4291424276754 V3=0 T=0 M2=0 M3=13,7757091136048	FrameElem=40-1
ElemStation=0,04	
Frame=40 Station=0,08 OutputCase=RAR048 CaseType=Combination P=-16,9573516056553 V2=14,5891424276754 V3=0 T=0 M2=0 M3=13,1953434164978	FrameElem=40-1
ElemStation=0,08	
Frame=40 Station=0 OutputCase=RAR049 CaseType=Combination P=-25,858318348197 V2=15,4157624493718 V3=0 T=0 M2=0 M3=6,36727433540365	FrameElem=40-1
ElemStation=0	
Frame=40 Station=0,04 OutputCase=RAR049 CaseType=Combination P=-25,858318348197 V2=15,5757624493718 V3=0 T=0 M2=0 M3=5,74744383742878	FrameElem=40-1
ElemStation=0,04	
Frame=40 Station=0,08 OutputCase=RAR049 CaseType=Combination P=-25,858318348197 V2=15,7357624493718 V3=0 T=0 M2=0 M3=5,12121333945391	FrameElem=40-1
ElemStation=0,08	
Frame=40 Station=0 OutputCase=RAR050 CaseType=Combination P=-8,24711125237924 V2=15,7922026835939 V3=0 T=0 M2=0 M3=4,20952291602669	FrameElem=40-1
ElemStation=0	
Frame=40 Station=0,04 OutputCase=RAR050 CaseType=Combination P=-8,24711125237924 V2=15,9522026835939 V3=0 T=0 M2=0 M3=3,57463480868293	FrameElem=40-1
ElemStation=0,04	
Frame=40 Station=0,08 OutputCase=RAR050 CaseType=Combination P=-8,24711125237924 V2=16,1122026835939 V3=0 T=0 M2=0 M3=2,93334670133917	FrameElem=40-1
ElemStation=0,08	
Frame=40 Station=0 OutputCase=RAR051 CaseType=Combination P=-7,52700818038645 V2=67,6482212945183 V3=0 T=0 M2=0 M3=11,4765838173768	FrameElem=40-1
ElemStation=0	
Frame=40 Station=0,04 OutputCase=RAR051 CaseType=Combination P=-7,52700818038645 V2=67,8082212945183 V3=0 T=0 M2=0 M3=8,76745496559603	FrameElem=40-1
ElemStation=0,04	

Società di Progetto
Brebemi SpA



Doc. N.
60235-0000-A00.doc

CODIFICA DOCUMENTO
04RCDII10000000000300A00

REV.
00

FOGLIO
521 di 628

Frame=40 Station=0,08 OutputCase=RAR051 CaseType=Combination P=-7,52700818038645 V2=67,9682212945183 V3=0 T=0 M2=0 M3=6,0519261138153 FrameElem=40-1 ElemStation=0,08
Frame=40 Station=0 OutputCase=RAR052 CaseType=Combination P=-16,4279749275847 V2=66,5067771584935 V3=0 T=0 M2=0 M3=21,985148708242 FrameElem=40-1 ElemStation=0
Frame=40 Station=0,04 OutputCase=RAR052 CaseType=Combination P=-16,4279749275847 V2=66,6667771584935 V3=0 T=0 M2=0 M3=19,3216776219023 FrameElem=40-1 ElemStation=0,04
Frame=40 Station=0,08 OutputCase=RAR052 CaseType=Combination P=-16,4279749275847 V2=66,8267771584935 V3=0 T=0 M2=0 M3=16,6518065355626 FrameElem=40-1 ElemStation=0,08
Frame=40 Station=0 OutputCase=RAR053 CaseType=Combination P=-25,3289416701263 V2=67,6533971801899 V3=0 T=0 M2=0 M3=14,0027482329339 FrameElem=40-1 ElemStation=0
Frame=40 Station=0,04 OutputCase=RAR053 CaseType=Combination P=-25,3289416701263 V2=67,8133971801899 V3=0 T=0 M2=0 M3=11,2934123457263 FrameElem=40-1 ElemStation=0,04
Frame=40 Station=0,08 OutputCase=RAR053 CaseType=Combination P=-25,3289416701263 V2=67,9733971801899 V3=0 T=0 M2=0 M3=8,57767645851868 FrameElem=40-1 ElemStation=0,08
Frame=40 Station=0 OutputCase=RAR054 CaseType=Combination P=-17,1480779995775 V2=14,6507585475691 V3=0 T=0 M2=0 M3=14,718087806892 FrameElem=40-1 ElemStation=0
Frame=40 Station=0,04 OutputCase=RAR054 CaseType=Combination P=-17,1480779995775 V2=14,8107585475691 V3=0 T=0 M2=0 M3=14,1288574649892 FrameElem=40-1 ElemStation=0,04
Frame=40 Station=0,08 OutputCase=RAR054 CaseType=Combination P=-17,1480779995775 V2=14,9707585475691 V3=0 T=0 M2=0 M3=13,5332271230864 FrameElem=40-1 ElemStation=0,08
Frame=40 Station=0 OutputCase=RAR055 CaseType=Combination P=-26,0490447421191 V2=15,7973785692656 V3=0 T=0 M2=0 M3=6,73568733158379 FrameElem=40-1 ElemStation=0
Frame=40 Station=0,04 OutputCase=RAR055 CaseType=Combination P=-26,0490447421191 V2=15,9573785692656 V3=0 T=0 M2=0 M3=6,10059218881317 FrameElem=40-1 ElemStation=0,04
Frame=40 Station=0,08 OutputCase=RAR055 CaseType=Combination P=-26,0490447421191 V2=16,1173785692656 V3=0 T=0 M2=0 M3=5,45909704604254 FrameElem=40-1 ElemStation=0,08
Frame=40 Station=0 OutputCase=RAR056 CaseType=Combination P=-7,86565846453489 V2=15,0289704438064 V3=0 T=0 M2=0 M3=3,47269692366641 FrameElem=40-1 ElemStation=0
Frame=40 Station=0,04 OutputCase=RAR056 CaseType=Combination P=-7,86565846453489 V2=15,1889704438064 V3=0 T=0 M2=0 M3=2,86833810591416 FrameElem=40-1 ElemStation=0,04
Frame=40 Station=0,08 OutputCase=RAR056 CaseType=Combination P=-7,86565846453489 V2=15,3489704438064 V3=0 T=0 M2=0 M3=2,2575792881619 FrameElem=40-1 ElemStation=0,08
Frame=40 Station=0 OutputCase=RAR057 CaseType=Combination P=-7,14555539254209 V2=66,8849890547308 V3=0 T=0 M2=0 M3=10,7397578250165 FrameElem=40-1 ElemStation=0
Frame=40 Station=0,04 OutputCase=RAR057 CaseType=Combination P=-7,14555539254209 V2=67,0449890547308 V3=0 T=0 M2=0 M3=8,06115826282726 FrameElem=40-1 ElemStation=0,04
Frame=40 Station=0,08 OutputCase=RAR057 CaseType=Combination P=-7,14555539254209 V2=67,2049890547308 V3=0 T=0 M2=0 M3=5,37615870063803 FrameElem=40-1 ElemStation=0,08
Frame=40 Station=0 OutputCase=RAR058 CaseType=Combination P=-16,0465221397403 V2=65,743544918706 V3=0 T=0 M2=0 M3=21,2483227158818 FrameElem=40-1 ElemStation=0
Frame=40 Station=0,04 OutputCase=RAR058 CaseType=Combination P=-16,0465221397403 V2=65,903544918706 V3=0 T=0 M2=0 M3=18,6153809191335 FrameElem=40-1 ElemStation=0,04
Frame=40 Station=0,08 OutputCase=RAR058 CaseType=Combination P=-16,0465221397403 V2=66,063544918706 V3=0 T=0 M2=0 M3=15,9760391223853 FrameElem=40-1 ElemStation=0,08
Frame=40 Station=0 OutputCase=RAR059 CaseType=Combination P=-24,947488882282 V2=66,8901649404024 V3=0 T=0 M2=0 M3=13,2659222405736 FrameElem=40-1 ElemStation=0
Frame=40 Station=0,04 OutputCase=RAR059 CaseType=Combination P=-24,947488882282 V2=67,0501649404024 V3=0 T=0 M2=0 M3=10,5871156429575 FrameElem=40-1 ElemStation=0,04
Frame=40 Station=0,08 OutputCase=RAR059 CaseType=Combination P=-24,947488882282 V2=67,2101649404024 V3=0 T=0 M2=0 M3=7,9019090453414 FrameElem=40-1 ElemStation=0,08
Frame=40 Station=0 OutputCase=RAR060 CaseType=Combination P=-16,7666252117331 V2=13,8875263077816 V3=0 T=0 M2=0 M3=13,9812618145317 FrameElem=40-1 ElemStation=0
Frame=40 Station=0,04 OutputCase=RAR060 CaseType=Combination P=-16,7666252117331 V2=14,0475263077816 V3=0 T=0 M2=0 M3=13,4225607622204 FrameElem=40-1 ElemStation=0,04
Frame=40 Station=0,08 OutputCase=RAR060 CaseType=Combination P=-16,7666252117331 V2=14,2075263077816 V3=0 T=0 M2=0 M3=12,8574597099092 FrameElem=40-1 ElemStation=0,08
Frame=40 Station=0 OutputCase=RAR061 CaseType=Combination P=-25,6675919542748 V2=15,034146329478 V3=0 T=0 M2=0 M3=5,99886133922352 FrameElem=40-1 ElemStation=0
Frame=40 Station=0,04 OutputCase=RAR061 CaseType=Combination P=-25,6675919542748 V2=15,194146329478 V3=0 T=0 M2=0 M3=5,3942954860444 FrameElem=40-1 ElemStation=0,04
Frame=40 Station=0,08 OutputCase=RAR061 CaseType=Combination P=-25,6675919542748 V2=15,354146329478 V3=0 T=0 M2=0 M3=4,78332963286527 FrameElem=40-1 ElemStation=0,08
Frame=40 Station=0 OutputCase=RAR062 CaseType=Combination P=-8,51611327781502 V2=15,4113686301672 V3=0 T=0 M2=0 M3=4,22280853622872 FrameElem=40-1 ElemStation=0
Frame=40 Station=0,04 OutputCase=RAR062 CaseType=Combination P=-8,51611327781502 V2=15,5713686301672 V3=0 T=0 M2=0 M3=3,60315379102204 FrameElem=40-1 ElemStation=0,04
Frame=40 Station=0,08 OutputCase=RAR062 CaseType=Combination P=-8,51611327781502 V2=15,7313686301672 V3=0 T=0 M2=0 M3=2,97709904581535 FrameElem=40-1 ElemStation=0,08
Frame=40 Station=0 OutputCase=RAR063 CaseType=Combination P=-7,79601020582222 V2=67,2673872410915 V3=0 T=0 M2=0 M3=11,4898694375788 FrameElem=40-1 ElemStation=0
Frame=40 Station=0,04 OutputCase=RAR063 CaseType=Combination P=-7,79601020582222 V2=67,4273872410915 V3=0 T=0 M2=0 M3=8,79597394793514 FrameElem=40-1 ElemStation=0,04
Frame=40 Station=0,08 OutputCase=RAR063 CaseType=Combination P=-7,79601020582222 V2=67,5873872410915 V3=0 T=0 M2=0 M3=6,09567845829148 FrameElem=40-1 ElemStation=0,08
Frame=40 Station=0 OutputCase=RAR064 CaseType=Combination P=-16,6969769530205 V2=66,1259431050667 V3=0 T=0 M2=0 M3=21,9984343284441 FrameElem=40-1 ElemStation=0
Frame=40 Station=0,04 OutputCase=RAR064 CaseType=Combination P=-16,6969769530205 V2=66,2859431050667 V3=0 T=0 M2=0 M3=19,3501966042414 FrameElem=40-1 ElemStation=0,04
Frame=40 Station=0,08 OutputCase=RAR064 CaseType=Combination P=-16,6969769530205 V2=66,4459431050667 V3=0 T=0 M2=0 M3=16,6955588800387 FrameElem=40-1 ElemStation=0,08
Frame=40 Station=0 OutputCase=RAR065 CaseType=Combination P=-25,5979436955621 V2=67,2725631267632 V3=0 T=0 M2=0 M3=14,0160338531359 FrameElem=40-1 ElemStation=0
Frame=40 Station=0,04 OutputCase=RAR065 CaseType=Combination P=-25,5979436955621 V2=67,4325631267632 V3=0 T=0 M2=0 M3=11,3219313280654 FrameElem=40-1 ElemStation=0,04
Frame=40 Station=0,08 OutputCase=RAR065 CaseType=Combination P=-25,5979436955621 V2=67,5925631267632 V3=0 T=0 M2=0 M3=8,62142880299485 FrameElem=40-1 ElemStation=0,08
Frame=40 Station=0 OutputCase=RAR066 CaseType=Combination P=-17,4170800250133 V2=14,2699244941424 V3=0 T=0 M2=0 M3=14,731373427094 FrameElem=40-1 ElemStation=0

APPROVATO S.D.P.
Società di Progetto
Brebemi SpA



Doc. N.
60235-0000-A00.doc

CODIFICA DOCUMENTO
04RCDII10000000000300A00

REV.
00

FOGLIO
522 di 628

Frame=40 Station=0,04 OutputCase=RAR066 CaseType=Combination P=-17,4170800250133 V2=14,4299244941424 V3=0 T=0 M2=0 M3=14,1573764473283	FrameElem=40-1 ElemStation=0,04
Frame=40 Station=0,08 OutputCase=RAR066 CaseType=Combination P=-17,4170800250133 V2=14,5899244941424 V3=0 T=0 M2=0 M3=13,5769794675626	FrameElem=40-1 ElemStation=0,08
Frame=40 Station=0 OutputCase=RAR067 CaseType=Combination P=-26,3180467675549 V2=15,4165445158388 V3=0 T=0 M2=0 M3=6,74897295178583	FrameElem=40-1 ElemStation=0
Frame=40 Station=0,04 OutputCase=RAR067 CaseType=Combination P=-26,3180467675549 V2=15,5765445158388 V3=0 T=0 M2=0 M3=6,12911117115228	FrameElem=40-1 ElemStation=0,04
Frame=40 Station=0,08 OutputCase=RAR067 CaseType=Combination P=-26,3180467675549 V2=15,7365445158388 V3=0 T=0 M2=0 M3=5,50284939051872	FrameElem=40-1 ElemStation=0,08
Frame=40 Station=0 OutputCase=RAR068 CaseType=Combination P=-7,60804814939744 V2=16,0453099860781 V3=0 T=0 M2=0 M3=3,81896721950982	FrameElem=40-1 ElemStation=0
Frame=40 Station=0,04 OutputCase=RAR068 CaseType=Combination P=-7,60804814939744 V2=16,2053099860781 V3=0 T=0 M2=0 M3=3,17395482006669	FrameElem=40-1 ElemStation=0,04
Frame=40 Station=0,08 OutputCase=RAR068 CaseType=Combination P=-7,60804814939744 V2=16,3653099860781 V3=0 T=0 M2=0 M3=2,52254242062357	FrameElem=40-1 ElemStation=0,08
Frame=40 Station=0 OutputCase=RAR069 CaseType=Combination P=-6,52075979079227 V2=84,9322573873814 V3=0 T=0 M2=0 M3=13,2627730905232	FrameElem=40-1 ElemStation=0
Frame=40 Station=0,04 OutputCase=RAR069 CaseType=Combination P=-6,52075979079227 V2=85,0922573873814 V3=0 T=0 M2=0 M3=9,86228279502791	FrameElem=40-1 ElemStation=0,04
Frame=40 Station=0,08 OutputCase=RAR069 CaseType=Combination P=-6,52075979079227 V2=85,2522573873814 V3=0 T=0 M2=0 M3=6,45539249953265	FrameElem=40-1 ElemStation=0,08
Frame=40 Station=0 OutputCase=RAR070 CaseType=Combination P=-17,7218971886962 V2=83,4380192642729 V3=0 T=0 M2=0 M3=26,7239870745524	FrameElem=40-1 ElemStation=0
Frame=40 Station=0,04 OutputCase=RAR070 CaseType=Combination P=-17,7218971886962 V2=83,5980192642729 V3=0 T=0 M2=0 M3=23,382663039815	FrameElem=40-1 ElemStation=0,04
Frame=40 Station=0,08 OutputCase=RAR070 CaseType=Combination P=-17,7218971886962 V2=83,7580192642729 V3=0 T=0 M2=0 M3=20,0361455334105	FrameElem=40-1 ElemStation=0,08
Frame=40 Station=0 OutputCase=RAR071 CaseType=Combination P=-28,9230345800809 V2=84,9388273858803 V3=0 T=0 M2=0 M3=16,4693540285715	FrameElem=40-1 ElemStation=0
Frame=40 Station=0,04 OutputCase=RAR071 CaseType=Combination P=-28,9230345800809 V2=85,0988273858803 V3=0 T=0 M2=0 M3=13,0686009331363	FrameElem=40-1 ElemStation=0,04
Frame=40 Station=0,08 OutputCase=RAR071 CaseType=Combination P=-28,9230345800809 V2=85,2588273858803 V3=0 T=0 M2=0 M3=9,66144783770106	FrameElem=40-1 ElemStation=0,08
Frame=40 Station=0 OutputCase=RAR072 CaseType=Combination P=-18,6820346180199 V2=14,2966611163738 V3=0 T=0 M2=0 M3=17,0345725394189	FrameElem=40-1 ElemStation=0
Frame=40 Station=0,04 OutputCase=RAR072 CaseType=Combination P=-18,6820346180199 V2=14,4566611163738 V3=0 T=0 M2=0 M3=16,459506094764	FrameElem=40-1 ElemStation=0,04
Frame=40 Station=0,08 OutputCase=RAR072 CaseType=Combination P=-18,6820346180199 V2=14,6166611163738 V3=0 T=0 M2=0 M3=15,878039650109	FrameElem=40-1 ElemStation=0,08
Frame=40 Station=0 OutputCase=RAR073 CaseType=Combination P=-29,8831720094046 V2=15,7974692379812 V3=0 T=0 M2=0 M3=6,77993949343805	FrameElem=40-1 ElemStation=0
Frame=40 Station=0,04 OutputCase=RAR073 CaseType=Combination P=-29,8831720094046 V2=15,9574692379812 V3=0 T=0 M2=0 M3=6,1448407239188	FrameElem=40-1 ElemStation=0,04
Frame=40 Station=0,08 OutputCase=RAR073 CaseType=Combination P=-29,8831720094046 V2=16,1174692379812 V3=0 T=0 M2=0 M3=5,50334195439955	FrameElem=40-1 ElemStation=0,08
Frame=40 Station=0 OutputCase=RAR074 CaseType=Combination P=-15,6617608990467 V2=61,3591802856553 V3=0 T=0 M2=0 M3=32,4493350108602	FrameElem=40-1 ElemStation=0
Frame=40 Station=0,04 OutputCase=RAR074 CaseType=Combination P=-15,6617608990467 V2=61,5191802856553 V3=0 T=0 M2=0 M3=29,991767799434	FrameElem=40-1 ElemStation=0,04
Frame=40 Station=0,08 OutputCase=RAR074 CaseType=Combination P=-15,6617608990467 V2=61,6791802856553 V3=0 T=0 M2=0 M3=27,5278005880077	FrameElem=40-1 ElemStation=0,08
Frame=40 Station=0 OutputCase=RAR075 CaseType=Combination P=-6,88794507740465 V2=67,9013285970025 V3=0 T=0 M2=0 M3=11,0860281208599	FrameElem=40-1 ElemStation=0
Frame=40 Station=0,04 OutputCase=RAR075 CaseType=Combination P=-6,88794507740465 V2=68,0613285970025 V3=0 T=0 M2=0 M3=8,3667749769798	FrameElem=40-1 ElemStation=0,04
Frame=40 Station=0,08 OutputCase=RAR075 CaseType=Combination P=-6,88794507740465 V2=68,2213285970025 V3=0 T=0 M2=0 M3=5,6411218330997	FrameElem=40-1 ElemStation=0,08
Frame=40 Station=0 OutputCase=RAR076 CaseType=Combination P=-15,7889118246029 V2=66,7598844609777 V3=0 T=0 M2=0 M3=21,5945930117252	FrameElem=40-1 ElemStation=0
Frame=40 Station=0,04 OutputCase=RAR076 CaseType=Combination P=-15,7889118246029 V2=66,9198844609777 V3=0 T=0 M2=0 M3=18,9209976332861	FrameElem=40-1 ElemStation=0,04
Frame=40 Station=0,08 OutputCase=RAR076 CaseType=Combination P=-15,7889118246029 V2=67,0798844609777 V3=0 T=0 M2=0 M3=16,241002254847	FrameElem=40-1 ElemStation=0,08
Frame=40 Station=0 OutputCase=RAR077 CaseType=Combination P=-24,6898785671445 V2=67,9065044826741 V3=0 T=0 M2=0 M3=13,612192536417	FrameElem=40-1 ElemStation=0
Frame=40 Station=0,04 OutputCase=RAR077 CaseType=Combination P=-24,6898785671445 V2=68,0665044826741 V3=0 T=0 M2=0 M3=10,89273235711	FrameElem=40-1 ElemStation=0,04
Frame=40 Station=0,08 OutputCase=RAR077 CaseType=Combination P=-24,6898785671445 V2=68,2265044826741 V3=0 T=0 M2=0 M3=8,16687217780308	FrameElem=40-1 ElemStation=0,08
Frame=40 Station=0 OutputCase=RAR078 CaseType=Combination P=-16,5090148965957 V2=14,9038658500533 V3=0 T=0 M2=0 M3=14,3275231103751	FrameElem=40-1 ElemStation=0
Frame=40 Station=0,04 OutputCase=RAR078 CaseType=Combination P=-16,5090148965957 V2=15,0638658500533 V3=0 T=0 M2=0 M3=13,728177476373	FrameElem=40-1 ElemStation=0,04
Frame=40 Station=0,08 OutputCase=RAR078 CaseType=Combination P=-16,5090148965957 V2=15,2238658500533 V3=0 T=0 M2=0 M3=13,122428423708	FrameElem=40-1 ElemStation=0,08
Frame=40 Station=0 OutputCase=RAR079 CaseType=Combination P=-25,4099816391373 V2=16,0504858717498 V3=0 T=0 M2=0 M3=6,34513163506692	FrameElem=40-1 ElemStation=0
Frame=40 Station=0,04 OutputCase=RAR079 CaseType=Combination P=-25,4099816391373 V2=16,2104858717498 V3=0 T=0 M2=0 M3=5,69991220019693	FrameElem=40-1 ElemStation=0,04
Frame=40 Station=0,08 OutputCase=RAR079 CaseType=Combination P=-25,4099816391373 V2=16,3704858717498 V3=0 T=0 M2=0 M3=5,04829276532694	FrameElem=40-1 ElemStation=0,08
Frame=40 Station=0 OutputCase=RAR080 CaseType=Combination P=-7,14831973003949 V2=16,0445279196111 V3=0 T=0 M2=0 M3=3,43726860312764	FrameElem=40-1 ElemStation=0
Frame=40 Station=0,04 OutputCase=RAR080 CaseType=Combination P=-7,14831973003949 V2=16,2045279196111 V3=0 T=0 M2=0 M3=2,7922874863432	FrameElem=40-1 ElemStation=0,04
Frame=40 Station=0,08 OutputCase=RAR080 CaseType=Combination P=-7,14831973003949 V2=16,3645279196111 V3=0 T=0 M2=0 M3=2,14090636955876	FrameElem=40-1 ElemStation=0,08

APPROVATO SDP
Società di Progetto
Brebemi SpA



Doc. N.
60235-0000-A00.doc

CODIFICA DOCUMENTO
04RCDII10000000000300A00

REV.
00

FOGLIO
523 di 628

Frame=40 Station=0 OutputCase=RAR081 CaseType=Combination P=-6,4282166580467 V2=67,9005465305355 V3=0 T=0 M2=0 M3=10,7043295044777 ElemStation=0	Frame=40 Station=0,04 OutputCase=RAR081 CaseType=Combination P=-6,4282166580467 V2=68,0605465305355 V3=0 T=0 M2=0 M3=7,9851076432563 ElemStation=0,04	Frame=40 Station=0,08 OutputCase=RAR081 CaseType=Combination P=-6,4282166580467 V2=68,2205465305355 V3=0 T=0 M2=0 M3=5,25948578203489 ElemStation=0,08	Frame=40 Station=0 OutputCase=RAR082 CaseType=Combination P=-15,329183405245 V2=66,7591023945107 V3=0 T=0 M2=0 M3=21,212894395343 ElemStation=0	Frame=40 Station=0,04 OutputCase=RAR082 CaseType=Combination P=-15,329183405245 V2=66,9191023945107 V3=0 T=0 M2=0 M3=18,5393302995626 ElemStation=0,04	Frame=40 Station=0,08 OutputCase=RAR082 CaseType=Combination P=-15,329183405245 V2=67,0791023945107 V3=0 T=0 M2=0 M3=15,8593662037821 ElemStation=0,08	Frame=40 Station=0 OutputCase=RAR083 CaseType=Combination P=-24,2301501477866 V2=67,9057224162071 V3=0 T=0 M2=0 M3=13,2304939200348 ElemStation=0	Frame=40 Station=0,04 OutputCase=RAR083 CaseType=Combination P=-24,2301501477866 V2=68,0657224162071 V3=0 T=0 M2=0 M3=10,5110650233865 ElemStation=0,04	Frame=40 Station=0,08 OutputCase=RAR083 CaseType=Combination P=-24,2301501477866 V2=68,2257224162071 V3=0 T=0 M2=0 M3=7,78523612673826 ElemStation=0,08	Frame=40 Station=0 OutputCase=RAR084 CaseType=Combination P=-16,0492864772377 V2=14,9030837835863 V3=0 T=0 M2=0 M3=13,9458334939929 ElemStation=0	Frame=40 Station=0,04 OutputCase=RAR084 CaseType=Combination P=-16,0492864772377 V2=15,0630837835863 V3=0 T=0 M2=0 M3=13,3465101426495 ElemStation=0,04	Frame=40 Station=0,08 OutputCase=RAR084 CaseType=Combination P=-16,0492864772377 V2=15,2230837835863 V3=0 T=0 M2=0 M3=12,740786791306 ElemStation=0,08	Frame=40 Station=0 OutputCase=RAR085 CaseType=Combination P=-24,9502532197794 V2=16,0497038052827 V3=0 T=0 M2=0 M3=5,96343301868475 ElemStation=0	Frame=40 Station=0,04 OutputCase=RAR085 CaseType=Combination P=-24,9502532197794 V2=16,2097038052828 V3=0 T=0 M2=0 M3=5,31824486647344 ElemStation=0,04	Frame=40 Station=0,08 OutputCase=RAR085 CaseType=Combination P=-24,9502532197794 V2=16,3697038052827 V3=0 T=0 M2=0 M3=4,66665671426213 ElemStation=0,08	Frame=40 Station=0 OutputCase=RAR086 CaseType=Combination P=-8,0677765687554 V2=16,0460920525451 V3=0 T=0 M2=0 M3=4,20066583589199 ElemStation=0	Frame=40 Station=0,04 OutputCase=RAR086 CaseType=Combination P=-8,0677765687554 V2=16,2060920525451 V3=0 T=0 M2=0 M3=3,55562215379019 ElemStation=0,04	Frame=40 Station=0,08 OutputCase=RAR086 CaseType=Combination P=-8,0677765687554 V2=16,3660920525451 V3=0 T=0 M2=0 M3=2,90417847168839 ElemStation=0,08	Frame=40 Station=0 OutputCase=RAR087 CaseType=Combination P=-7,3476734967626 V2=67,9021106634695 V3=0 T=0 M2=0 M3=11,4677267372421 ElemStation=0	Frame=40 Station=0,04 OutputCase=RAR087 CaseType=Combination P=-7,3476734967626 V2=68,0621106634695 V3=0 T=0 M2=0 M3=8,74844231070329 ElemStation=0,04	Frame=40 Station=0,08 OutputCase=RAR087 CaseType=Combination P=-7,3476734967626 V2=68,2221106634695 V3=0 T=0 M2=0 M3=6,02275788416452 ElemStation=0,08	Frame=40 Station=0 OutputCase=RAR088 CaseType=Combination P=-16,2486402439609 V2=66,7606665274447 V3=0 T=0 M2=0 M3=21,9762916281073 ElemStation=0	Frame=40 Station=0,04 OutputCase=RAR088 CaseType=Combination P=-16,2486402439609 V2=66,9206665274447 V3=0 T=0 M2=0 M3=19,3026649670096 ElemStation=0,04	Frame=40 Station=0,08 OutputCase=RAR088 CaseType=Combination P=-16,2486402439609 V2=67,0806665274447 V3=0 T=0 M2=0 M3=16,6226383059118 ElemStation=0,08	Frame=40 Station=0 OutputCase=RAR089 CaseType=Combination P=-25,1496069865025 V2=67,9072865491411 V3=0 T=0 M2=0 M3=13,9938911527992 ElemStation=0	Frame=40 Station=0,04 OutputCase=RAR089 CaseType=Combination P=-25,1496069865025 V2=68,0672865491411 V3=0 T=0 M2=0 M3=11,2743996908335 ElemStation=0,04	Frame=40 Station=0,08 OutputCase=RAR089 CaseType=Combination P=-25,1496069865025 V2=68,2272865491411 V3=0 T=0 M2=0 M3=8,54850822886789 ElemStation=0,08	Frame=40 Station=0 OutputCase=RAR090 CaseType=Combination P=-16,9687433159536 V2=14,9046479165203 V3=0 T=0 M2=0 M3=14,7092307267573 ElemStation=0	Frame=40 Station=0,04 OutputCase=RAR090 CaseType=Combination P=-16,9687433159536 V2=15,0646479165203 V3=0 T=0 M2=0 M3=14,1098448100965 ElemStation=0,04	Frame=40 Station=0,08 OutputCase=RAR090 CaseType=Combination P=-16,9687433159536 V2=15,2246479165203 V3=0 T=0 M2=0 M3=13,5040588934356 ElemStation=0,08	Frame=40 Station=0 OutputCase=RAR091 CaseType=Combination P=-25,8697100584953 V2=16,0512679382168 V3=0 T=0 M2=0 M3=6,7268302514491 ElemStation=0	Frame=40 Station=0,04 OutputCase=RAR091 CaseType=Combination P=-25,8697100584953 V2=16,2112679382168 V3=0 T=0 M2=0 M3=6,08157953392043 ElemStation=0,04	Frame=40 Station=0,08 OutputCase=RAR091 CaseType=Combination P=-25,8697100584953 V2=16,3712679382168 V3=0 T=0 M2=0 M3=5,42992881639176 ElemStation=0,08	Frame=40 Station=0 OutputCase=RAR092 CaseType=Combination P=-8,0677765687554 V2=16,0460920525451 V3=0 T=0 M2=0 M3=4,20066583589199 ElemStation=0	Frame=40 Station=0,04 OutputCase=RAR092 CaseType=Combination P=-8,0677765687554 V2=16,2060920525451 V3=0 T=0 M2=0 M3=3,55562215379019 ElemStation=0,04	Frame=40 Station=0,08 OutputCase=RAR092 CaseType=Combination P=-8,0677765687554 V2=16,3660920525451 V3=0 T=0 M2=0 M3=2,90417847168839 ElemStation=0,08	Frame=40 Station=0 OutputCase=RAR093 CaseType=Combination P=-7,3476734967626 V2=67,9021106634695 V3=0 T=0 M2=0 M3=11,4677267372421 ElemStation=0	Frame=40 Station=0,04 OutputCase=RAR093 CaseType=Combination P=-7,3476734967626 V2=68,0621106634695 V3=0 T=0 M2=0 M3=8,74844231070329 ElemStation=0,04	Frame=40 Station=0,08 OutputCase=RAR093 CaseType=Combination P=-7,3476734967626 V2=68,2221106634695 V3=0 T=0 M2=0 M3=6,02275788416452 ElemStation=0,08	Frame=40 Station=0 OutputCase=RAR094 CaseType=Combination P=-16,2486402439609 V2=66,7606665274447 V3=0 T=0 M2=0 M3=21,9762916281073 ElemStation=0	Frame=40 Station=0,04 OutputCase=RAR094 CaseType=Combination P=-16,2486402439609 V2=66,9206665274447 V3=0 T=0 M2=0 M3=19,3026649670096 ElemStation=0,04	Frame=40 Station=0,08 OutputCase=RAR094 CaseType=Combination P=-16,2486402439609 V2=67,0806665274447 V3=0 T=0 M2=0 M3=16,6226383059118 ElemStation=0,08	Frame=40 Station=0 OutputCase=RAR095 CaseType=Combination P=-25,1496069865025 V2=67,9072865491411 V3=0 T=0 M2=0 M3=13,9938911527992 ElemStation=0	Frame=40 Station=0,04 OutputCase=RAR095 CaseType=Combination P=-25,1496069865025 V2=68,0672865491411 V3=0 T=0 M2=0 M3=11,2743996908335 ElemStation=0,04
--	---	--	---	--	--	---	---	---	---	---	--	---	---	---	--	--	--	--	--	--	---	---	---	---	---	---	---	---	---	--	---	---	--	--	--	--	--	--	---	---	---	---	---

Società di Progetto
Brebemi SpA



Doc. N.
60235-0000-A00.doc

CODIFICA DOCUMENTO
04RCDII10000000000300A00

REV.
00

FOGLIO
524 di 628

Frame=40 Station=0,08 OutputCase=RAR095 CaseType=Combination P=-,25,1496069865025 V2=68,2272865491411 V3=0 T=0 M2=0 M3=8,54850822886789 FrameElem=40-1
ElemStation=0,08
Frame=40 Station=0 OutputCase=RAR096 CaseType=Combination P=-,16,9687433159536 V2=14,9046479165203 V3=0 T=0 M2=0 M3=14,70923072675753 FrameElem=40-1
ElemStation=0
Frame=40 Station=0,04 OutputCase=RAR096 CaseType=Combination P=-,16,9687433159536 V2=15,0646479165203 V3=0 T=0 M2=0 M3=14,1098448100965 FrameElem=40-1
ElemStation=0,04
Frame=40 Station=0,08 OutputCase=RAR096 CaseType=Combination P=-,16,9687433159536 V2=15,2246479165203 V3=0 T=0 M2=0 M3=13,5040588934356 FrameElem=40-1
ElemStation=0,08
Frame=40 Station=0 OutputCase=RAR097 CaseType=Combination P=-,25,8697100584953 V2=16,0512679382168 V3=0 T=0 M2=0 M3=6,7268302514491 FrameElem=40-1
ElemStation=0
Frame=40 Station=0,04 OutputCase=RAR097 CaseType=Combination P=-,25,8697100584953 V2=16,2112679382168 V3=0 T=0 M2=0 M3=6,08157953392043 FrameElem=40-1
ElemStation=0,04
Frame=40 Station=0,08 OutputCase=RAR097 CaseType=Combination P=-,25,8697100584953 V2=16,3712679382168 V3=0 T=0 M2=0 M3=5,42992881639176 FrameElem=40-1
ElemStation=0,08
Frame=40 Station=0 OutputCase=RAR098 CaseType=Combination P=-,6,97229350299018 V2=14,773262530989 V3=0 T=0 M2=0 M3=2,59092389890936 FrameElem=40-1
ElemStation=0
Frame=40 Station=0,04 OutputCase=RAR098 CaseType=Combination P=-,6,97229350299018 V2=14,933262530989 V3=0 T=0 M2=0 M3=1,99679364878541 FrameElem=40-1
ElemStation=0,04
Frame=40 Station=0,08 OutputCase=RAR098 CaseType=Combination P=-,6,97229350299018 V2=15,093262530989 V3=0 T=0 M2=0 M3=1,39626339866145 FrameElem=40-1
ElemStation=0,08
Frame=40 Station=0 OutputCase=RAR099 CaseType=Combination P=-,6,13930700294791 V2=84,1690251475939 V3=0 T=0 M2=0 M3=12,5259470981629 FrameElem=40-1
ElemStation=0
Frame=40 Station=0,04 OutputCase=RAR099 CaseType=Combination P=-,6,13930700294791 V2=84,3290251475939 V3=0 T=0 M2=0 M3=9,15598609225914 FrameElem=40-1
ElemStation=0,04
Frame=40 Station=0,08 OutputCase=RAR099 CaseType=Combination P=-,6,13930700294791 V2=84,4890251475939 V3=0 T=0 M2=0 M3=5,77962508635538 FrameElem=40-1
ElemStation=0,08
Frame=40 Station=0 OutputCase=RAR100 CaseType=Combination P=-,17,3404444008519 V2=82,6747870244854 V3=0 T=0 M2=0 M3=25,9871610821921 FrameElem=40-1
ElemStation=0
Frame=40 Station=0,04 OutputCase=RAR100 CaseType=Combination P=-,17,3404444008519 V2=82,8347870244854 V3=0 T=0 M2=0 M3=22,6769696012127 FrameElem=40-1
ElemStation=0,04
Frame=40 Station=0,08 OutputCase=RAR100 CaseType=Combination P=-,17,3404444008519 V2=82,9947870244854 V3=0 T=0 M2=0 M3=19,3603781202333 FrameElem=40-1
ElemStation=0,08
Frame=40 Station=0 OutputCase=RAR101 CaseType=Combination P=-,28,5415817922365 V2=84,1755951460928 V3=0 T=0 M2=0 M3=15,7325280362112 FrameElem=40-1
ElemStation=0
Frame=40 Station=0,04 OutputCase=RAR101 CaseType=Combination P=-,28,5415817922365 V2=84,3355951460928 V3=0 T=0 M2=0 M3=12,3623042303675 FrameElem=40-1
ElemStation=0,04
Frame=40 Station=0,08 OutputCase=RAR101 CaseType=Combination P=-,28,5415817922365 V2=84,4955951460928 V3=0 T=0 M2=0 M3=8,98568042452379 FrameElem=40-1
ElemStation=0,08
Frame=40 Station=0 OutputCase=RAR102 CaseType=Combination P=-,18,3005818301756 V2=13,5334288765862 V3=0 T=0 M2=0 M3=16,2977465470587 FrameElem=40-1
ElemStation=0
Frame=40 Station=0,04 OutputCase=RAR102 CaseType=Combination P=-,18,3005818301756 V2=13,6934288765862 V3=0 T=0 M2=0 M3=15,7532039319952 FrameElem=40-1
ElemStation=0,04
Frame=40 Station=0,08 OutputCase=RAR102 CaseType=Combination P=-,18,3005818301756 V2=13,8534288765862 V3=0 T=0 M2=0 M3=15,2022722369318 FrameElem=40-1
ElemStation=0,08
Frame=40 Station=0 OutputCase=RAR103 CaseType=Combination P=-,29,5017192215603 V2=15,0342369981936 V3=0 T=0 M2=0 M3=6,04311350107777 FrameElem=40-1
ElemStation=0
Frame=40 Station=0,04 OutputCase=RAR103 CaseType=Combination P=-,29,5017192215603 V2=15,1942369981936 V3=0 T=0 M2=0 M3=5,43854402115003 FrameElem=40-1
ElemStation=0,04
Frame=40 Station=0,08 OutputCase=RAR103 CaseType=Combination P=-,29,5017192215603 V2=15,3542369981936 V3=0 T=0 M2=0 M3=4,82757454122228 FrameElem=40-1
ElemStation=0,08
Frame=40 Station=0 OutputCase=RAR104 CaseType=Combination P=-,15,2803081112024 V2=60,5959480458678 V3=0 T=0 M2=0 M3=31,7125090184999 FrameElem=40-1
ElemStation=0
Frame=40 Station=0,04 OutputCase=RAR104 CaseType=Combination P=-,15,2803081112024 V2=60,7559480458678 V3=0 T=0 M2=0 M3=29,2854710966652 FrameElem=40-1
ElemStation=0,04
Frame=40 Station=0,08 OutputCase=RAR104 CaseType=Combination P=-,15,2803081112024 V2=60,9159480458678 V3=0 T=0 M2=0 M3=26,8520331748305 FrameElem=40-1
ElemStation=0,08
Frame=40 Station=0 OutputCase=RAR105 CaseType=Combination P=-,6,25219043099739 V2=66,6292748640233 V3=0 T=0 M2=0 M3=9,85798480025944 FrameElem=40-1
ElemStation=0
Frame=40 Station=0,04 OutputCase=RAR105 CaseType=Combination P=-,6,25219043099739 V2=66,7892748640233 V3=0 T=0 M2=0 M3=7,18961380569851 FrameElem=40-1
ElemStation=0,04
Frame=40 Station=0,08 OutputCase=RAR105 CaseType=Combination P=-,6,25219043099739 V2=66,9492748640233 V3=0 T=0 M2=0 M3=4,51484281113758 FrameElem=40-1
ElemStation=0,08
Frame=40 Station=0 OutputCase=RAR106 CaseType=Combination P=-,15,1531571781956 V2=65,4878307279985 V3=0 T=0 M2=0 M3=20,3665496911247 FrameElem=40-1
ElemStation=0
Frame=40 Station=0,04 OutputCase=RAR106 CaseType=Combination P=-,15,1531571781956 V2=65,6478307279985 V3=0 T=0 M2=0 M3=17,7438364620048 FrameElem=40-1
ElemStation=0,04
Frame=40 Station=0,08 OutputCase=RAR106 CaseType=Combination P=-,15,1531571781956 V2=65,8078307279985 V3=0 T=0 M2=0 M3=15,1147232328848 FrameElem=40-1
ElemStation=0,08
Frame=40 Station=0 OutputCase=RAR107 CaseType=Combination P=-,24,0541239207373 V2=66,6344507496949 V3=0 T=0 M2=0 M3=12,3841492158165 FrameElem=40-1
ElemStation=0
Frame=40 Station=0,04 OutputCase=RAR107 CaseType=Combination P=-,24,0541239207373 V2=66,7944507496949 V3=0 T=0 M2=0 M3=9,71557118582875 FrameElem=40-1
ElemStation=0,04
Frame=40 Station=0,08 OutputCase=RAR107 CaseType=Combination P=-,24,0541239207373 V2=66,9544507496949 V3=0 T=0 M2=0 M3=7,04059315584096 FrameElem=40-1
ElemStation=0,08
Frame=40 Station=0 OutputCase=RAR108 CaseType=Combination P=-,15,8732602501884 V2=13,6318121170741 V3=0 T=0 M2=0 M3=13,0994887897746 FrameElem=40-1
ElemStation=0
Frame=40 Station=0,04 OutputCase=RAR108 CaseType=Combination P=-,15,8732602501884 V2=13,7918121170741 V3=0 T=0 M2=0 M3=12,5510163050917 FrameElem=40-1
ElemStation=0,04
Frame=40 Station=0,08 OutputCase=RAR108 CaseType=Combination P=-,15,8732602501884 V2=13,9518121170741 V3=0 T=0 M2=0 M3=11,9961438204087 FrameElem=40-1
ElemStation=0,08
Frame=40 Station=0 OutputCase=RAR109 CaseType=Combination P=-,24,7742269927301 V2=14,7784321387705 V3=0 T=0 M2=0 M3=5,11708831446647 FrameElem=40-1
ElemStation=0
Frame=40 Station=0,04 OutputCase=RAR109 CaseType=Combination P=-,24,7742269927301 V2=14,9384321387705 V3=0 T=0 M2=0 M3=4,52275102891565 FrameElem=40-1
ElemStation=0,04
Frame=40 Station=0,08 OutputCase=RAR109 CaseType=Combination P=-,24,7742269927301 V2=15,0984321387705 V3=0 T=0 M2=0 M3=3,92201374336482 FrameElem=40-1
ElemStation=0,08
Frame=40 Station=0 OutputCase=RAR110 CaseType=Combination P=-,6,51256508363223 V2=14,7724741866319 V3=0 T=0 M2=0 M3=2,20922528252719 FrameElem=40-1
ElemStation=0

Società di Progetto
Brebemi SpA

	Doc. N. 60235-0000-A00.doc	CODIFICA DOCUMENTO 04RCDII10000000000300A00	REV. 00	FOGLIO 525 di 628
--	-------------------------------	--	------------	----------------------

Frame=40 Station=0,04 OutputCase=RAR110 CaseType=Combination P=-6,51256508363223 V2=14,9324741866319 V3=0 T=0 M2=0 M3=1,61512631506191	FrameElem=40-1 ElemStation=0,04
Frame=40 Station=0,08 OutputCase=RAR110 CaseType=Combination P=-6,51256508363223 V2=15,0924741866319 V3=0 T=0 M2=0 M3=1,01462734759664	FrameElem=40-1 ElemStation=0,08
Frame=40 Station=0 OutputCase=RAR111 CaseType=Combination P=-5,79246201163944 V2=66,6284927975563 V3=0 T=0 M2=0 M3=9,47628618387727	FrameElem=40-1 ElemStation=0
Frame=40 Station=0,04 OutputCase=RAR111 CaseType=Combination P=-5,79246201163944 V2=66,7884927975563 V3=0 T=0 M2=0 M3=6,80794647197502	FrameElem=40-1 ElemStation=0,04
Frame=40 Station=0,08 OutputCase=RAR111 CaseType=Combination P=-5,79246201163944 V2=66,9484927975563 V3=0 T=0 M2=0 M3=4,13320676007277	FrameElem=40-1 ElemStation=0,08
Frame=40 Station=0 OutputCase=RAR112 CaseType=Combination P=-14,6934287588377 V2=65,4870486615315 V3=0 T=0 M2=0 M3=19,9848510747425	FrameElem=40-1 ElemStation=0
Frame=40 Station=0,04 OutputCase=RAR112 CaseType=Combination P=-14,6934287588377 V2=65,6470486615315 V3=0 T=0 M2=0 M3=17,3621691282813	FrameElem=40-1 ElemStation=0,04
Frame=40 Station=0,08 OutputCase=RAR112 CaseType=Combination P=-14,6934287588377 V2=65,8070486615315 V3=0 T=0 M2=0 M3=14,73308718182	FrameElem=40-1 ElemStation=0,08
Frame=40 Station=0 OutputCase=RAR113 CaseType=Combination P=-23,5943955013793 V2=66,6336686832279 V3=0 T=0 M2=0 M3=12,0024505994344	FrameElem=40-1 ElemStation=0
Frame=40 Station=0,04 OutputCase=RAR113 CaseType=Combination P=-23,5943955013793 V2=66,7936686832279 V3=0 T=0 M2=0 M3=9,33390385210525	FrameElem=40-1 ElemStation=0,04
Frame=40 Station=0,08 OutputCase=RAR113 CaseType=Combination P=-23,5943955013793 V2=66,9536686832279 V3=0 T=0 M2=0 M3=6,65895710477614	FrameElem=40-1 ElemStation=0,08
Frame=40 Station=0 OutputCase=RAR114 CaseType=Combination P=-15,4135318308305 V2=13,6310300506071 V3=0 T=0 M2=0 M3=12,7177901733925	FrameElem=40-1 ElemStation=0
Frame=40 Station=0,04 OutputCase=RAR114 CaseType=Combination P=-15,4135318308305 V2=13,7910300506071 V3=0 T=0 M2=0 M3=12,1693489713682	FrameElem=40-1 ElemStation=0,04
Frame=40 Station=0,08 OutputCase=RAR114 CaseType=Combination P=-15,4135318308305 V2=13,9510300506071 V3=0 T=0 M2=0 M3=11,6145077693439	FrameElem=40-1 ElemStation=0,08
Frame=40 Station=0 OutputCase=RAR115 CaseType=Combination P=-24,3144985733721 V2=14,7776500723035 V3=0 T=0 M2=0 M3=4,73538969808429	FrameElem=40-1 ElemStation=0
Frame=40 Station=0,04 OutputCase=RAR115 CaseType=Combination P=-24,3144985733721 V2=14,9376500723035 V3=0 T=0 M2=0 M3=4,14108369519215	FrameElem=40-1 ElemStation=0,04
Frame=40 Station=0,08 OutputCase=RAR115 CaseType=Combination P=-24,3144985733721 V2=15,0976500723035 V3=0 T=0 M2=0 M3=3,54037769230001	FrameElem=40-1 ElemStation=0,08
Frame=40 Station=0 OutputCase=RAR116 CaseType=Combination P=-7,43202192234813 V2=14,7740383195659 V3=0 T=0 M2=0 M3=2,97262251529154	FrameElem=40-1 ElemStation=0
Frame=40 Station=0,04 OutputCase=RAR116 CaseType=Combination P=-7,43202192234813 V2=14,9340383195659 V3=0 T=0 M2=0 M3=2,3784609825089	FrameElem=40-1 ElemStation=0,04
Frame=40 Station=0,08 OutputCase=RAR116 CaseType=Combination P=-7,43202192234813 V2=15,0940383195659 V3=0 T=0 M2=0 M3=1,77789944972627	FrameElem=40-1 ElemStation=0,08
Frame=40 Station=0 OutputCase=RAR117 CaseType=Combination P=-6,71191885035534 V2=66,6300569304903 V3=0 T=0 M2=0 M3=10,2396834166416	FrameElem=40-1 ElemStation=0
Frame=40 Station=0,04 OutputCase=RAR117 CaseType=Combination P=-6,71191885035534 V2=66,7900569304903 V3=0 T=0 M2=0 M3=7,57128113942201	FrameElem=40-1 ElemStation=0,04
Frame=40 Station=0,08 OutputCase=RAR117 CaseType=Combination P=-6,71191885035534 V2=66,9500569304903 V3=0 T=0 M2=0 M3=4,8964788622024	FrameElem=40-1 ElemStation=0,08
Frame=40 Station=0 OutputCase=RAR118 CaseType=Combination P=-15,6128855975536 V2=65,4886127944655 V3=0 T=0 M2=0 M3=20,7482483075069	FrameElem=40-1 ElemStation=0
Frame=40 Station=0,04 OutputCase=RAR118 CaseType=Combination P=-15,6128855975536 V2=65,6486127944655 V3=0 T=0 M2=0 M3=18,1255037957283	FrameElem=40-1 ElemStation=0,04
Frame=40 Station=0,08 OutputCase=RAR118 CaseType=Combination P=-15,6128855975536 V2=65,8086127944655 V3=0 T=0 M2=0 M3=15,4963592839497	FrameElem=40-1 ElemStation=0,08
Frame=40 Station=0 OutputCase=RAR119 CaseType=Combination P=-24,5138523400952 V2=66,6352328161619 V3=0 T=0 M2=0 M3=12,7658478321987	FrameElem=40-1 ElemStation=0
Frame=40 Station=0,04 OutputCase=RAR119 CaseType=Combination P=-24,5138523400952 V2=66,7952328161619 V3=0 T=0 M2=0 M3=10,0972385195522	FrameElem=40-1 ElemStation=0,04
Frame=40 Station=0,08 OutputCase=RAR119 CaseType=Combination P=-24,5138523400952 V2=66,9552328161619 V3=0 T=0 M2=0 M3=7,42222920690577	FrameElem=40-1 ElemStation=0,08
Frame=40 Station=0 OutputCase=RAR120 CaseType=Combination P=-16,3329886695464 V2=13,6325941835411 V3=0 T=0 M2=0 M3=13,4811874061568	FrameElem=40-1 ElemStation=0
Frame=40 Station=0,04 OutputCase=RAR120 CaseType=Combination P=-16,3329886695464 V2=13,7925941835411 V3=0 T=0 M2=0 M3=12,9326836388152	FrameElem=40-1 ElemStation=0,04
Frame=40 Station=0,08 OutputCase=RAR120 CaseType=Combination P=-16,3329886695464 V2=13,9525941835411 V3=0 T=0 M2=0 M3=12,3777798714735	FrameElem=40-1 ElemStation=0,08
Frame=40 Station=0 OutputCase=RAR121 CaseType=Combination P=-25,233955412088 V2=14,7792142052375 V3=0 T=0 M2=0 M3=5,49878693084864	FrameElem=40-1 ElemStation=0
Frame=40 Station=0,04 OutputCase=RAR121 CaseType=Combination P=-25,233955412088 V2=14,9392142052375 V3=0 T=0 M2=0 M3=4,90441836263914	FrameElem=40-1 ElemStation=0,04
Frame=40 Station=0,08 OutputCase=RAR121 CaseType=Combination P=-25,233955412088 V2=15,0992142052375 V3=0 T=0 M2=0 M3=4,30364979442964	FrameElem=40-1 ElemStation=0,08
Frame=40 Station=0 OutputCase=RAR122 CaseType=Combination P=-7,43202192234813 V2=14,7740383195659 V3=0 T=0 M2=0 M3=2,97262251529154	FrameElem=40-1 ElemStation=0
Frame=40 Station=0,04 OutputCase=RAR122 CaseType=Combination P=-7,43202192234813 V2=14,9340383195659 V3=0 T=0 M2=0 M3=2,3784609825089	FrameElem=40-1 ElemStation=0,04
Frame=40 Station=0,08 OutputCase=RAR122 CaseType=Combination P=-7,43202192234813 V2=15,0940383195659 V3=0 T=0 M2=0 M3=1,77789944972627	FrameElem=40-1 ElemStation=0,08
Frame=40 Station=0 OutputCase=RAR123 CaseType=Combination P=-6,71191885035534 V2=66,6300569304903 V3=0 T=0 M2=0 M3=10,2396834166416	FrameElem=40-1 ElemStation=0
Frame=40 Station=0,04 OutputCase=RAR123 CaseType=Combination P=-6,71191885035534 V2=66,7900569304903 V3=0 T=0 M2=0 M3=7,57128113942201	FrameElem=40-1 ElemStation=0,04
Frame=40 Station=0,08 OutputCase=RAR123 CaseType=Combination P=-6,71191885035534 V2=66,9500569304903 V3=0 T=0 M2=0 M3=4,8964788622024	FrameElem=40-1 ElemStation=0,08
Frame=40 Station=0 OutputCase=RAR124 CaseType=Combination P=-15,6128855975536 V2=65,4886127944655 V3=0 T=0 M2=0 M3=20,7482483075069	FrameElem=40-1 ElemStation=0
Frame=40 Station=0,04 OutputCase=RAR124 CaseType=Combination P=-15,6128855975536 V2=65,6486127944655 V3=0 T=0 M2=0 M3=18,1255037957283	FrameElem=40-1 ElemStation=0,04
Frame=40 Station=0,08 OutputCase=RAR124 CaseType=Combination P=-15,6128855975536 V2=65,8086127944655 V3=0 T=0 M2=0 M3=15,4963592839497	FrameElem=40-1 ElemStation=0,08

Società di Progetto
Brebemi SpA

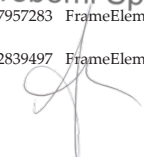



Doc. N.
60235-0000-A00.doc

CODIFICA DOCUMENTO
04RCDII10000000000300A00

REV.
00

FOGLIO
526 di 628

Frame=40 Station=0 OutputCase=RAR125 CaseType=Combination P=-24,5138523400952 V2=66,6352328161619 V3=0 T=0 M2=0 M3=12,7658478321987 FrameElem=40-1
ElemStation=0
Frame=40 Station=0,04 OutputCase=RAR125 CaseType=Combination P=-24,5138523400952 V2=66,7952328161619 V3=0 T=0 M2=0 M3=10,0972385195522 FrameElem=40-1
ElemStation=0,04
Frame=40 Station=0,08 OutputCase=RAR125 CaseType=Combination P=-24,5138523400952 V2=66,9552328161619 V3=0 T=0 M2=0 M3=7,42222920690577 FrameElem=40-1
ElemStation=0,08
Frame=40 Station=0 OutputCase=RAR126 CaseType=Combination P=-16,3329886695464 V2=13,6325941835411 V3=0 T=0 M2=0 M3=13,4811874061568 FrameElem=40-1
ElemStation=0
Frame=40 Station=0,04 OutputCase=RAR126 CaseType=Combination P=-16,3329886695464 V2=13,7925941835411 V3=0 T=0 M2=0 M3=12,9326836388152 FrameElem=40-1
ElemStation=0,04
Frame=40 Station=0,08 OutputCase=RAR126 CaseType=Combination P=-16,3329886695464 V2=13,9525941835411 V3=0 T=0 M2=0 M3=12,3777798714735 FrameElem=40-1
ElemStation=0,08
Frame=40 Station=0 OutputCase=RAR127 CaseType=Combination P=-25,233955412088 V2=14,7792142052375 V3=0 T=0 M2=0 M3=5,49878693084864 FrameElem=40-1
ElemStation=0
Frame=40 Station=0,04 OutputCase=RAR127 CaseType=Combination P=-25,233955412088 V2=14,9392142052375 V3=0 T=0 M2=0 M3=4,90441836263914 FrameElem=40-1
ElemStation=0,04
Frame=40 Station=0,08 OutputCase=RAR127 CaseType=Combination P=-25,233955412088 V2=15,0992142052375 V3=0 T=0 M2=0 M3=4,30364979442964 FrameElem=40-1
ElemStation=0,08
Frame=40 Station=0 OutputCase=RAR128 CaseType=Combination P=-8,05638485845707 V2=15,4105865637002 V3=0 T=0 M2=0 M3=3,84110991984655 FrameElem=40-1
ElemStation=0
Frame=40 Station=0,04 OutputCase=RAR128 CaseType=Combination P=-8,05638485845707 V2=15,5705865637002 V3=0 T=0 M2=0 M3=3,22148645729854 FrameElem=40-1
ElemStation=0,04
Frame=40 Station=0,08 OutputCase=RAR128 CaseType=Combination P=-8,05638485845707 V2=15,7305865637002 V3=0 T=0 M2=0 M3=2,59546299475054 FrameElem=40-1
ElemStation=0,08
Frame=40 Station=0 OutputCase=RAR129 CaseType=Combination P=-6,78976181622804 V2=84,551423339547 V3=0 T=0 M2=0 M3=13,2760587107252 FrameElem=40-1
ElemStation=0
Frame=40 Station=0,04 OutputCase=RAR129 CaseType=Combination P=-6,78976181622804 V2=84,711423339547 V3=0 T=0 M2=0 M3=9,89080177736702 FrameElem=40-1
ElemStation=0,04
Frame=40 Station=0,08 OutputCase=RAR129 CaseType=Combination P=-6,78976181622804 V2=84,871423339547 V3=0 T=0 M2=0 M3=6,49914484400883 FrameElem=40-1
ElemStation=0,08
Frame=40 Station=0 OutputCase=RAR130 CaseType=Combination P=-17,990899214132 V2=83,0571852108461 V3=0 T=0 M2=0 M3=26,7372726947544 FrameElem=40-1
ElemStation=0
Frame=40 Station=0,04 OutputCase=RAR130 CaseType=Combination P=-17,990899214132 V2=83,2171852108461 V3=0 T=0 M2=0 M3=23,4117852863206 FrameElem=40-1
ElemStation=0,04
Frame=40 Station=0,08 OutputCase=RAR130 CaseType=Combination P=-17,990899214132 V2=83,3771852108461 V3=0 T=0 M2=0 M3=20,0798978778867 FrameElem=40-1
ElemStation=0,08
Frame=40 Station=0 OutputCase=RAR131 CaseType=Combination P=-29,1920366055167 V2=84,557993324535 V3=0 T=0 M2=0 M3=16,4826396487735 FrameElem=40-1
ElemStation=0
Frame=40 Station=0,04 OutputCase=RAR131 CaseType=Combination P=-29,1920366055167 V2=84,717993324535 V3=0 T=0 M2=0 M3=13,0971199154754 FrameElem=40-1
ElemStation=0,04
Frame=40 Station=0,08 OutputCase=RAR131 CaseType=Combination P=-29,1920366055167 V2=84,877993324535 V3=0 T=0 M2=0 M3=9,70520018217724 FrameElem=40-1
ElemStation=0,08
Frame=40 Station=0 OutputCase=RAR132 CaseType=Combination P=-18,9510366434557 V2=13,915827062947 V3=0 T=0 M2=0 M3=17,047858159621 FrameElem=40-1
ElemStation=0
Frame=40 Station=0,04 OutputCase=RAR132 CaseType=Combination P=-18,9510366434557 V2=14,075827062947 V3=0 T=0 M2=0 M3=16,4880250771031 FrameElem=40-1
ElemStation=0,04
Frame=40 Station=0,08 OutputCase=RAR132 CaseType=Combination P=-18,9510366434557 V2=14,235827062947 V3=0 T=0 M2=0 M3=15,9217919945852 FrameElem=40-1
ElemStation=0,08
Frame=40 Station=0 OutputCase=RAR133 CaseType=Combination P=-30,1521740348404 V2=15,4166351845544 V3=0 T=0 M2=0 M3=6,79322511364008 FrameElem=40-1
ElemStation=0
Frame=40 Station=0,04 OutputCase=RAR133 CaseType=Combination P=-30,1521740348404 V2=15,5766351845544 V3=0 T=0 M2=0 M3=6,17335970625791 FrameElem=40-1
ElemStation=0,04
Frame=40 Station=0,08 OutputCase=RAR133 CaseType=Combination P=-30,1521740348404 V2=15,7366351845544 V3=0 T=0 M2=0 M3=5,54709429887573 FrameElem=40-1
ElemStation=0,08
Frame=40 Station=0 OutputCase=RAR134 CaseType=Combination P=-15,9307629244825 V2=60,9783462322286 V3=0 T=0 M2=0 M3=32,4626206310622 FrameElem=40-1
ElemStation=0
Frame=40 Station=0,04 OutputCase=RAR134 CaseType=Combination P=-15,9307629244825 V2=61,1383462322286 V3=0 T=0 M2=0 M3=30,0202867817731 FrameElem=40-1
ElemStation=0,04
Frame=40 Station=0,08 OutputCase=RAR134 CaseType=Combination P=-15,9307629244825 V2=61,2983462322286 V3=0 T=0 M2=0 M3=27,571529324839 FrameElem=40-1
ElemStation=0,08
Frame=40 Station=0 OutputCase=RAR135 CaseType=Combination P=-7,33628178646427 V2=67,2666051746245 V3=0 T=0 M2=0 M3=11,1081708211966 FrameElem=40-1
ElemStation=0
Frame=40 Station=0,04 OutputCase=RAR135 CaseType=Combination P=-7,33628178646427 V2=67,4266051746245 V3=0 T=0 M2=0 M3=8,41430661421165 FrameElem=40-1
ElemStation=0,04
Frame=40 Station=0,08 OutputCase=RAR135 CaseType=Combination P=-7,33628178646427 V2=67,5866051746245 V3=0 T=0 M2=0 M3=5,71404240722667 FrameElem=40-1
ElemStation=0,08
Frame=40 Station=0 OutputCase=RAR136 CaseType=Combination P=-16,2372485336625 V2=66,1251610385997 V3=0 T=0 M2=0 M3=21,6167357120619 FrameElem=40-1
ElemStation=0
Frame=40 Station=0,04 OutputCase=RAR136 CaseType=Combination P=-16,2372485336625 V2=66,2851610385997 V3=0 T=0 M2=0 M3=18,9685292705179 FrameElem=40-1
ElemStation=0,04
Frame=40 Station=0,08 OutputCase=RAR136 CaseType=Combination P=-16,2372485336625 V2=66,4451610385997 V3=0 T=0 M2=0 M3=16,3139228289739 FrameElem=40-1
ElemStation=0,08
Frame=40 Station=0 OutputCase=RAR137 CaseType=Combination P=-25,1382152762042 V2=67,2717810602962 V3=0 T=0 M2=0 M3=13,6343352367537 FrameElem=40-1
ElemStation=0
Frame=40 Station=0,04 OutputCase=RAR137 CaseType=Combination P=-25,1382152762042 V2=67,4317810602962 V3=0 T=0 M2=0 M3=10,9402639943419 FrameElem=40-1
ElemStation=0,04
Frame=40 Station=0,08 OutputCase=RAR137 CaseType=Combination P=-25,1382152762042 V2=67,5917810602962 V3=0 T=0 M2=0 M3=8,23979275193004 FrameElem=40-1
ElemStation=0,08
Frame=40 Station=0 OutputCase=RAR138 CaseType=Combination P=-16,9573516056553 V2=14,2691424276754 V3=0 T=0 M2=0 M3=14,3496748107118 FrameElem=40-1
ElemStation=0
Frame=40 Station=0,04 OutputCase=RAR138 CaseType=Combination P=-16,9573516056553 V2=14,4291424276754 V3=0 T=0 M2=0 M3=13,7757091136048 FrameElem=40-1
ElemStation=0,04
Frame=40 Station=0,08 OutputCase=RAR138 CaseType=Combination P=-16,9573516056553 V2=14,5891424276754 V3=0 T=0 M2=0 M3=13,1953434164978 FrameElem=40-1
ElemStation=0,08
Frame=40 Station=0 OutputCase=RAR139 CaseType=Combination P=-25,858318348197 V2=15,4157624493718 V3=0 T=0 M2=0 M3=6,36727433540365 FrameElem=40-1
ElemStation=0
Frame=40 Station=0,04 OutputCase=RAR139 CaseType=Combination P=-25,858318348197 V2=15,5757624493718 V3=0 T=0 M2=0 M3=5,74744383742878 FrameElem=40-1
ElemStation=0,04

Società di Progetto
Brebemi SpA



Doc. N.
60235-0000-A00.doc

CODIFICA DOCUMENTO
04RCDII10000000000300A00

REV.
00

FOGLIO
527 di 628

Frame=40 Station=0,08 OutputCase=RAR139 CaseType=Combination P=-25,858318348197 V2=15,7357624493718 V3=0 T=0 M2=0 M3=5,12121333945391 ElemStation=0,08	FrameElem=40-1
Frame=40 Station=0 OutputCase=RAR140 CaseType=Combination P=-7,59665643909911 V2=15,4098044972332 V3=0 T=0 M2=0 M3=3,45941130346437 ElemStation=0	FrameElem=40-1
Frame=40 Station=0,04 OutputCase=RAR140 CaseType=Combination P=-7,59665643909911 V2=15,5698044972332 V3=0 T=0 M2=0 M3=2,83981912357505 ElemStation=0,04	FrameElem=40-1
Frame=40 Station=0,08 OutputCase=RAR140 CaseType=Combination P=-7,59665643909911 V2=15,7298044972332 V3=0 T=0 M2=0 M3=2,21382694368572 ElemStation=0,08	FrameElem=40-1
Frame=40 Station=0 OutputCase=RAR141 CaseType=Combination P=-6,87655336710632 V2=67,2658231081575 V3=0 T=0 M2=0 M3=10,7264722048145 ElemStation=0	FrameElem=40-1
Frame=40 Station=0,04 OutputCase=RAR141 CaseType=Combination P=-6,87655336710632 V2=67,4258231081575 V3=0 T=0 M2=0 M3=8,03263928048815 ElemStation=0,04	FrameElem=40-1
Frame=40 Station=0,08 OutputCase=RAR141 CaseType=Combination P=-6,87655336710632 V2=67,5858231081575 V3=0 T=0 M2=0 M3=5,33240635616185 ElemStation=0,08	FrameElem=40-1
Frame=40 Station=0 OutputCase=RAR142 CaseType=Combination P=-15,7775201143046 V2=66,1243789721327 V3=0 T=0 M2=0 M3=21,2350370956797 ElemStation=0	FrameElem=40-1
Frame=40 Station=0,04 OutputCase=RAR142 CaseType=Combination P=-15,7775201143046 V2=66,2843789721327 V3=0 T=0 M2=0 M3=18,5868619367944 ElemStation=0,04	FrameElem=40-1
Frame=40 Station=0,08 OutputCase=RAR142 CaseType=Combination P=-15,7775201143046 V2=66,4443789721327 V3=0 T=0 M2=0 M3=15,9322867779091 ElemStation=0,08	FrameElem=40-1
Frame=40 Station=0 OutputCase=RAR143 CaseType=Combination P=-24,6784868568462 V2=67,2709989938292 V3=0 T=0 M2=0 M3=13,2526366203716 ElemStation=0	FrameElem=40-1
Frame=40 Station=0,04 OutputCase=RAR143 CaseType=Combination P=-24,6784868568462 V2=67,4309989938292 V3=0 T=0 M2=0 M3=10,5585966606184 ElemStation=0,04	FrameElem=40-1
Frame=40 Station=0,08 OutputCase=RAR143 CaseType=Combination P=-24,6784868568462 V2=67,5909989938292 V3=0 T=0 M2=0 M3=7,85815670086523 ElemStation=0,08	FrameElem=40-1
Frame=40 Station=0 OutputCase=RAR144 CaseType=Combination P=-16,4976231862974 V2=14,2683603612084 V3=0 T=0 M2=0 M3=13,9679761943296 ElemStation=0	FrameElem=40-1
Frame=40 Station=0,04 OutputCase=RAR144 CaseType=Combination P=-16,4976231862974 V2=14,4283603612084 V3=0 T=0 M2=0 M3=13,3940417798813 ElemStation=0,04	FrameElem=40-1
Frame=40 Station=0,08 OutputCase=RAR144 CaseType=Combination P=-16,4976231862974 V2=14,5883603612084 V3=0 T=0 M2=0 M3=12,813707365433 ElemStation=0,08	FrameElem=40-1
Frame=40 Station=0 OutputCase=RAR145 CaseType=Combination P=-25,398589928839 V2=15,4149803829048 V3=0 T=0 M2=0 M3=5,98557571902148 ElemStation=0	FrameElem=40-1
Frame=40 Station=0,04 OutputCase=RAR145 CaseType=Combination P=-25,398589928839 V2=15,5749803829048 V3=0 T=0 M2=0 M3=5,36577650370529 ElemStation=0,04	FrameElem=40-1
Frame=40 Station=0,08 OutputCase=RAR145 CaseType=Combination P=-25,398589928839 V2=15,7349803829048 V3=0 T=0 M2=0 M3=4,73957728838909 ElemStation=0,08	FrameElem=40-1
Frame=40 Station=0 OutputCase=RAR146 CaseType=Combination P=-8,51611327781502 V2=15,4113686301672 V3=0 T=0 M2=0 M3=4,22280853622872 ElemStation=0	FrameElem=40-1
Frame=40 Station=0,04 OutputCase=RAR146 CaseType=Combination P=-8,51611327781502 V2=15,5713686301672 V3=0 T=0 M2=0 M3=3,60315379102204 ElemStation=0,04	FrameElem=40-1
Frame=40 Station=0,08 OutputCase=RAR146 CaseType=Combination P=-8,51611327781502 V2=15,7313686301672 V3=0 T=0 M2=0 M3=2,97709904581535 ElemStation=0,08	FrameElem=40-1
Frame=40 Station=0 OutputCase=RAR147 CaseType=Combination P=-7,79601020582222 V2=67,2673872410915 V3=0 T=0 M2=0 M3=11,4898694375788 ElemStation=0	FrameElem=40-1
Frame=40 Station=0,04 OutputCase=RAR147 CaseType=Combination P=-7,79601020582222 V2=67,4273872410915 V3=0 T=0 M2=0 M3=8,79597394793514 ElemStation=0,04	FrameElem=40-1
Frame=40 Station=0,08 OutputCase=RAR147 CaseType=Combination P=-7,79601020582222 V2=67,5873872410915 V3=0 T=0 M2=0 M3=6,09567845829148 ElemStation=0,08	FrameElem=40-1
Frame=40 Station=0 OutputCase=RAR148 CaseType=Combination P=-16,6969769530205 V2=66,1259431050667 V3=0 T=0 M2=0 M3=21,9984343284441 ElemStation=0	FrameElem=40-1
Frame=40 Station=0,04 OutputCase=RAR148 CaseType=Combination P=-16,6969769530205 V2=66,2859431050667 V3=0 T=0 M2=0 M3=19,3501966042414 ElemStation=0,04	FrameElem=40-1
Frame=40 Station=0,08 OutputCase=RAR148 CaseType=Combination P=-16,6969769530205 V2=66,4459431050667 V3=0 T=0 M2=0 M3=16,6955588800387 ElemStation=0,08	FrameElem=40-1
Frame=40 Station=0 OutputCase=RAR149 CaseType=Combination P=-25,5979436955621 V2=67,2725631267632 V3=0 T=0 M2=0 M3=14,0160338531359 ElemStation=0	FrameElem=40-1
Frame=40 Station=0,04 OutputCase=RAR149 CaseType=Combination P=-25,5979436955621 V2=67,4325631267632 V3=0 T=0 M2=0 M3=11,3219313280654 ElemStation=0,04	FrameElem=40-1
Frame=40 Station=0,08 OutputCase=RAR149 CaseType=Combination P=-25,5979436955621 V2=67,5925631267632 V3=0 T=0 M2=0 M3=8,62142880299485 ElemStation=0,08	FrameElem=40-1
Frame=40 Station=0 OutputCase=RAR150 CaseType=Combination P=-17,4170800250133 V2=14,2699244941424 V3=0 T=0 M2=0 M3=14,731373427094 ElemStation=0	FrameElem=40-1
Frame=40 Station=0,04 OutputCase=RAR150 CaseType=Combination P=-17,4170800250133 V2=14,4299244941424 V3=0 T=0 M2=0 M3=14,1573764473283 ElemStation=0,04	FrameElem=40-1
Frame=40 Station=0,08 OutputCase=RAR150 CaseType=Combination P=-17,4170800250133 V2=14,5899244941424 V3=0 T=0 M2=0 M3=13,5769794675626 ElemStation=0,08	FrameElem=40-1
Frame=40 Station=0 OutputCase=RAR151 CaseType=Combination P=-26,3180467675549 V2=15,4165445158388 V3=0 T=0 M2=0 M3=6,74897295178583 ElemStation=0	FrameElem=40-1
Frame=40 Station=0,04 OutputCase=RAR151 CaseType=Combination P=-26,3180467675549 V2=15,5765445158388 V3=0 T=0 M2=0 M3=6,12911117115228 ElemStation=0,04	FrameElem=40-1
Frame=40 Station=0,08 OutputCase=RAR151 CaseType=Combination P=-26,3180467675549 V2=15,7365445158388 V3=0 T=0 M2=0 M3=5,50284939051872 ElemStation=0,08	FrameElem=40-1
Frame=40 Station=0 OutputCase=RAR152 CaseType=Combination P=-8,24711125237924 V2=15,7922026835939 V3=0 T=0 M2=0 M3=4,20952291602669 ElemStation=0	FrameElem=40-1
Frame=40 Station=0,04 OutputCase=RAR152 CaseType=Combination P=-8,24711125237924 V2=15,9522026835939 V3=0 T=0 M2=0 M3=3,57463480868293 ElemStation=0,04	FrameElem=40-1
Frame=40 Station=0,08 OutputCase=RAR152 CaseType=Combination P=-8,24711125237924 V2=16,1122026835939 V3=0 T=0 M2=0 M3=2,93334670133917 ElemStation=0,08	FrameElem=40-1
Frame=40 Station=0 OutputCase=RAR153 CaseType=Combination P=-7,52700818038645 V2=67,6482212945183 V3=0 T=0 M2=0 M3=11,4765838173768 ElemStation=0	FrameElem=40-1
Frame=40 Station=0,04 OutputCase=RAR153 CaseType=Combination P=-7,52700818038645 V2=67,8082212945183 V3=0 T=0 M2=0 M3=8,76745496559603 ElemStation=0,04	FrameElem=40-1
Frame=40 Station=0,08 OutputCase=RAR153 CaseType=Combination P=-7,52700818038645 V2=67,9682212945183 V3=0 T=0 M2=0 M3=6,0519261138153 ElemStation=0,08	FrameElem=40-1
Frame=40 Station=0 OutputCase=RAR154 CaseType=Combination P=-16,4279749275847 V2=66,5067771584935 V3=0 T=0 M2=0 M3=21,985148708242 ElemStation=0	FrameElem=40-1

Società di Progetto
Brebemi SpA

	Doc. N. 60235-0000-A00.doc	CODIFICA DOCUMENTO 04RCDII10000000000300A00	REV. 00	FOGLIO 528 di 628
--	-------------------------------	--	------------	----------------------

Frame=40 Station=0,04 OutputCase=RAR154 CaseType=Combination P=-16,4279749275847 V2=66,6667771584935 V3=0 T=0 M2=0 M3=19,3216776219023 FrameElem=40-1 ElemStation=0,04

Frame=40 Station=0,08 OutputCase=RAR154 CaseType=Combination P=-16,4279749275847 V2=66,8267771584935 V3=0 T=0 M2=0 M3=16,6518065355626 FrameElem=40-1 ElemStation=0,08

Frame=40 Station=0 OutputCase=RAR155 CaseType=Combination P=-25,3289416701263 V2=67,6533971801899 V3=0 T=0 M2=0 M3=14,0027482329339 FrameElem=40-1 ElemStation=0

Frame=40 Station=0,04 OutputCase=RAR155 CaseType=Combination P=-25,3289416701263 V2=67,8133971801899 V3=0 T=0 M2=0 M3=11,2934123457263 FrameElem=40-1 ElemStation=0,04

Frame=40 Station=0,08 OutputCase=RAR155 CaseType=Combination P=-25,3289416701263 V2=67,9733971801899 V3=0 T=0 M2=0 M3=8,57767645851868 FrameElem=40-1 ElemStation=0,08

Frame=40 Station=0 OutputCase=RAR156 CaseType=Combination P=-17,1480779995775 V2=14,6507585475691 V3=0 T=0 M2=0 M3=14,718087806892 FrameElem=40-1 ElemStation=0

Frame=40 Station=0,04 OutputCase=RAR156 CaseType=Combination P=-17,1480779995775 V2=14,8107585475691 V3=0 T=0 M2=0 M3=14,1288574649892 FrameElem=40-1 ElemStation=0,04

Frame=40 Station=0,08 OutputCase=RAR156 CaseType=Combination P=-17,1480779995775 V2=14,9707585475691 V3=0 T=0 M2=0 M3=13,5332271230864 FrameElem=40-1 ElemStation=0,08

Frame=40 Station=0 OutputCase=RAR157 CaseType=Combination P=-26,0490447421191 V2=15,7973785692656 V3=0 T=0 M2=0 M3=6,73568733158379 FrameElem=40-1 ElemStation=0

Frame=40 Station=0,04 OutputCase=RAR157 CaseType=Combination P=-26,0490447421191 V2=15,9573785692656 V3=0 T=0 M2=0 M3=6,10059218881317 FrameElem=40-1 ElemStation=0,04

Frame=40 Station=0,08 OutputCase=RAR157 CaseType=Combination P=-26,0490447421191 V2=16,1173785692656 V3=0 T=0 M2=0 M3=5,45909704604254 FrameElem=40-1 ElemStation=0,08

Frame=40 Station=0 OutputCase=RAR158 CaseType=Combination P=-7,86565846453489 V2=15,0289704438064 V3=0 T=0 M2=0 M3=3,47269692366641 FrameElem=40-1 ElemStation=0

Frame=40 Station=0,04 OutputCase=RAR158 CaseType=Combination P=-7,86565846453489 V2=15,1889704438064 V3=0 T=0 M2=0 M3=2,86833810591416 FrameElem=40-1 ElemStation=0,04

Frame=40 Station=0,08 OutputCase=RAR158 CaseType=Combination P=-7,86565846453489 V2=15,3489704438064 V3=0 T=0 M2=0 M3=2,257592881619 FrameElem=40-1 ElemStation=0,08

Frame=40 Station=0 OutputCase=RAR159 CaseType=Combination P=-7,1455539254209 V2=66,8849890547308 V3=0 T=0 M2=0 M3=10,7397578250165 FrameElem=40-1 ElemStation=0

Frame=40 Station=0,04 OutputCase=RAR159 CaseType=Combination P=-7,1455539254209 V2=67,0449890547308 V3=0 T=0 M2=0 M3=8,06115826282726 FrameElem=40-1 ElemStation=0,04

Frame=40 Station=0,08 OutputCase=RAR159 CaseType=Combination P=-7,1455539254209 V2=67,2049890547308 V3=0 T=0 M2=0 M3=5,37615870063803 FrameElem=40-1 ElemStation=0,08

Frame=40 Station=0 OutputCase=RAR160 CaseType=Combination P=-16,0465221397403 V2=65,743544918706 V3=0 T=0 M2=0 M3=21,2483227158818 FrameElem=40-1 ElemStation=0

Frame=40 Station=0,04 OutputCase=RAR160 CaseType=Combination P=-16,0465221397403 V2=65,903544918706 V3=0 T=0 M2=0 M3=18,6153809191335 FrameElem=40-1 ElemStation=0,04

Frame=40 Station=0,08 OutputCase=RAR160 CaseType=Combination P=-16,0465221397403 V2=66,063544918706 V3=0 T=0 M2=0 M3=15,9760391223853 FrameElem=40-1 ElemStation=0,08

Frame=40 Station=0 OutputCase=RAR161 CaseType=Combination P=-24,947488882282 V2=66,8901649404024 V3=0 T=0 M2=0 M3=13,2659222405736 FrameElem=40-1 ElemStation=0

Frame=40 Station=0,04 OutputCase=RAR161 CaseType=Combination P=-24,947488882282 V2=67,0501649404024 V3=0 T=0 M2=0 M3=10,5871156429575 FrameElem=40-1 ElemStation=0,04

Frame=40 Station=0,08 OutputCase=RAR161 CaseType=Combination P=-24,947488882282 V2=67,2101649404024 V3=0 T=0 M2=0 M3=7,90190904534141 FrameElem=40-1 ElemStation=0,08

Frame=40 Station=0 OutputCase=RAR162 CaseType=Combination P=-16,7666252117331 V2=13,8875263077816 V3=0 T=0 M2=0 M3=13,9812618145317 FrameElem=40-1 ElemStation=0

Frame=40 Station=0,04 OutputCase=RAR162 CaseType=Combination P=-16,7666252117331 V2=14,0475263077816 V3=0 T=0 M2=0 M3=13,4225607622204 FrameElem=40-1 ElemStation=0,04

Frame=40 Station=0,08 OutputCase=RAR162 CaseType=Combination P=-16,7666252117331 V2=14,2075263077816 V3=0 T=0 M2=0 M3=12,8574597099092 FrameElem=40-1 ElemStation=0,08

Frame=40 Station=0 OutputCase=RAR163 CaseType=Combination P=-25,6675919542748 V2=15,034146329478 V3=0 T=0 M2=0 M3=5,99886133922352 FrameElem=40-1 ElemStation=0

Frame=40 Station=0,04 OutputCase=RAR163 CaseType=Combination P=-25,6675919542748 V2=15,194146329478 V3=0 T=0 M2=0 M3=5,3942954860444 FrameElem=40-1 ElemStation=0,04

Frame=40 Station=0,08 OutputCase=RAR163 CaseType=Combination P=-25,6675919542748 V2=15,354146329478 V3=0 T=0 M2=0 M3=4,78332963286527 FrameElem=40-1 ElemStation=0,08

Frame=40 Station=0 OutputCase=INVRAR CaseType=Combination StepType=Max P=-5,61312732801559 V2=84,9388273858803 V3=0 T=0 M2=0 M3=32,4626206310622 FrameElem=40-1 ElemStation=0

Frame=40 Station=0,04 OutputCase=INVRAR CaseType=Combination StepType=Max P=-5,61312732801559 V2=85,0988273858803 V3=0 T=0 M2=0 M3=30,0202867817731 FrameElem=40-1 ElemStation=0,04

Frame=40 Station=0,08 OutputCase=INVRAR CaseType=Combination StepType=Max P=-5,61312732801559 V2=85,2588273858803 V3=0 T=0 M2=0 M3=27,5715529324839 FrameElem=40-1 ElemStation=0,08

Frame=40 Station=0 OutputCase=INVRAR CaseType=Combination StepType=Min P=-30,1521740348404 V2=13,5334288765862 V3=0 T=0 M2=0 M3=2,2003682023925 FrameElem=40-1 ElemStation=0

Frame=40 Station=0,04 OutputCase=INVRAR CaseType=Combination StepType=Min P=-30,1521740348404 V2=13,6934288765862 V3=0 T=0 M2=0 M3=1,59611366016917 FrameElem=40-1 ElemStation=0,04

Frame=40 Station=0,08 OutputCase=INVRAR CaseType=Combination StepType=Min P=-30,1521740348404 V2=13,8534288765862 V3=0 T=0 M2=0 M3=0,98545911794585 FrameElem=40-1 ElemStation=0,08

Frame=40 Station=0 OutputCase=FRE01 CaseType=Combination P=-11,2910804172875 V2=15,4102766667784 V3=0 T=0 M2=0 M3=3,68986040729305 FrameElem=40-1 ElemStation=0

Frame=40 Station=0,04 OutputCase=FRE01 CaseType=Combination P=-11,2910804172875 V2=15,5702766667784 V3=0 T=0 M2=0 M3=3,07024934062192 FrameElem=40-1 ElemStation=0,04

Frame=40 Station=0,08 OutputCase=FRE01 CaseType=Combination P=-11,2910804172875 V2=15,7302766667784 V3=0 T=0 M2=0 M3=2,44423827395079 FrameElem=40-1 ElemStation=0,08

Frame=40 Station=0 OutputCase=FRE02 CaseType=Combination P=-6,57006775420102 V2=67,2653017305129 V3=0 T=0 M2=0 M3=10,4720064605597 FrameElem=40-1 ElemStation=0

Frame=40 Station=0,04 OutputCase=FRE02 CaseType=Combination P=-6,57006775420102 V2=67,4253017305129 V3=0 T=0 M2=0 M3=7,77819439133915 FrameElem=40-1 ElemStation=0,04

Frame=40 Station=0,08 OutputCase=FRE02 CaseType=Combination P=-6,57006775420102 V2=67,5853017305129 V3=0 T=0 M2=0 M3=5,07798232211864 FrameElem=40-1 ElemStation=0,08

Frame=40 Station=0 OutputCase=FRE03 CaseType=Combination P=-15,4710345013993 V2=66,1238575944881 V3=0 T=0 M2=0 M3=20,9805713514249 FrameElem=40-1 ElemStation=0

Frame=40 Station=0,04 OutputCase=FRE03 CaseType=Combination P=-15,4710345013993 V2=66,2838575944881 V3=0 T=0 M2=0 M3=18,3324170476454 FrameElem=40-1 ElemStation=0,04

Frame=40 Station=0,08 OutputCase=FRE03 CaseType=Combination P=-15,4710345013993 V2=66,4438575944881 V3=0 T=0 M2=0 M3=15,6778627438659 FrameElem=40-1 ElemStation=0,08

Società di Progetto
Brebemi SpA

Frame=40 Station=0 OutputCase=FRE04 CaseType=Combination P=-24,3720012439409 V2=67,2704776161845 V3=0 T=0 M2=0 M3=12,9981708761168	FrameElem=40-1
ElemStation=0	
Frame=40 Station=0,04 OutputCase=FRE04 CaseType=Combination P=-24,3720012439409 V2=67,4304776161845 V3=0 T=0 M2=0 M3=10,3041517714694	FrameElem=40-1
ElemStation=0,04	
Frame=40 Station=0,08 OutputCase=FRE04 CaseType=Combination P=-24,3720012439409 V2=67,5904776161845 V3=0 T=0 M2=0 M3=7,60373266682202	FrameElem=40-1
ElemStation=0,08	
Frame=40 Station=0 OutputCase=FRE05 CaseType=Combination P=-16,1911375733921 V2=14,2678389835637 V3=0 T=0 M2=0 M3=13,7135104500749	FrameElem=40-1
ElemStation=0	
Frame=40 Station=0,04 OutputCase=FRE05 CaseType=Combination P=-16,1911375733921 V2=14,4278389835637 V3=0 T=0 M2=0 M3=13,1395968907323	FrameElem=40-1
ElemStation=0,04	
Frame=40 Station=0,08 OutputCase=FRE05 CaseType=Combination P=-16,1911375733921 V2=14,5878389835637 V3=0 T=0 M2=0 M3=12,5592833313898	FrameElem=40-1
ElemStation=0,08	
Frame=40 Station=0 OutputCase=FRE06 CaseType=Combination P=-25,0921043159337 V2=15,4144590052601 V3=0 T=0 M2=0 M3=5,7311099747667	FrameElem=40-1
ElemStation=0	
Frame=40 Station=0,04 OutputCase=FRE06 CaseType=Combination P=-25,0921043159337 V2=15,5744590052601 V3=0 T=0 M2=0 M3=5,11133161455629	FrameElem=40-1
ElemStation=0,04	
Frame=40 Station=0,08 OutputCase=FRE06 CaseType=Combination P=-25,0921043159337 V2=15,7344590052601 V3=0 T=0 M2=0 M3=4,48515325434588	FrameElem=40-1
ElemStation=0,08	
Frame=40 Station=0 OutputCase=FRE07 CaseType=Combination P=-6,83044240683586 V2=15,4085010531215 V3=0 T=0 M2=0 M3=2,82324694282742	FrameElem=40-1
ElemStation=0	
Frame=40 Station=0,04 OutputCase=FRE07 CaseType=Combination P=-6,83044240683586 V2=15,5685010531215 V3=0 T=0 M2=0 M3=2,20370690070256	FrameElem=40-1
ElemStation=0,04	
Frame=40 Station=0,08 OutputCase=FRE07 CaseType=Combination P=-6,83044240683586 V2=15,7285010531215 V3=0 T=0 M2=0 M3=1,5777668585777	FrameElem=40-1
ElemStation=0,08	
Frame=40 Station=0 OutputCase=FRE08 CaseType=Combination P=-6,18696073806939 V2=67,264650008457 V3=0 T=0 M2=0 M3=10,1539242802412	FrameElem=40-1
ElemStation=0	
Frame=40 Station=0,04 OutputCase=FRE08 CaseType=Combination P=-6,18696073806939 V2=67,424650008457 V3=0 T=0 M2=0 M3=7,46013827990291	FrameElem=40-1
ElemStation=0,04	
Frame=40 Station=0,08 OutputCase=FRE08 CaseType=Combination P=-6,18696073806939 V2=67,584650008457 V3=0 T=0 M2=0 M3=4,75995227956463	FrameElem=40-1
ElemStation=0,08	
Frame=40 Station=0 OutputCase=FRE09 CaseType=Combination P=-15,0879274852676 V2=66,1232058724322 V3=0 T=0 M2=0 M3=20,6624891711065	FrameElem=40-1
ElemStation=0	
Frame=40 Station=0,04 OutputCase=FRE09 CaseType=Combination P=-15,0879274852676 V2=66,2832058724322 V3=0 T=0 M2=0 M3=18,0143609362092	FrameElem=40-1
ElemStation=0,04	
Frame=40 Station=0,08 OutputCase=FRE09 CaseType=Combination P=-15,0879274852676 V2=66,4432058724322 V3=0 T=0 M2=0 M3=15,3598327013119	FrameElem=40-1
ElemStation=0,08	
Frame=40 Station=0 OutputCase=FRE10 CaseType=Combination P=-23,9888942278093 V2=67,2698258941287 V3=0 T=0 M2=0 M3=12,6800886957983	FrameElem=40-1
ElemStation=0	
Frame=40 Station=0,04 OutputCase=FRE10 CaseType=Combination P=-23,9888942278093 V2=67,4298258941287 V3=0 T=0 M2=0 M3=9,98609566003315	FrameElem=40-1
ElemStation=0,04	
Frame=40 Station=0,08 OutputCase=FRE10 CaseType=Combination P=-23,9888942278093 V2=67,5898258941287 V3=0 T=0 M2=0 M3=7,285702624268	FrameElem=40-1
ElemStation=0,08	
Frame=40 Station=0 OutputCase=FRE11 CaseType=Combination P=-15,8080305572604 V2=14,2671872615079 V3=0 T=0 M2=0 M3=13,3954282697564	FrameElem=40-1
ElemStation=0	
Frame=40 Station=0,04 OutputCase=FRE11 CaseType=Combination P=-15,8080305572604 V2=14,4271872615079 V3=0 T=0 M2=0 M3=12,8215407792961	FrameElem=40-1
ElemStation=0,04	
Frame=40 Station=0,08 OutputCase=FRE11 CaseType=Combination P=-15,8080305572604 V2=14,5871872615079 V3=0 T=0 M2=0 M3=12,2412532888358	FrameElem=40-1
ElemStation=0,08	
Frame=40 Station=0 OutputCase=FRE12 CaseType=Combination P=-24,7089972998021 V2=15,4138072832043 V3=0 T=0 M2=0 M3=5,4130277944822	FrameElem=40-1
ElemStation=0	
Frame=40 Station=0,04 OutputCase=FRE12 CaseType=Combination P=-24,7089972998021 V2=15,5738072832043 V3=0 T=0 M2=0 M3=4,79327550312005	FrameElem=40-1
ElemStation=0,04	
Frame=40 Station=0,08 OutputCase=FRE12 CaseType=Combination P=-24,7089972998021 V2=15,7338072832043 V3=0 T=0 M2=0 M3=4,16712321179187	FrameElem=40-1
ElemStation=0,08	
Frame=40 Station=0 OutputCase=FRE13 CaseType=Combination P=-6,98938106843768 V2=15,7265144863663 V3=0 T=0 M2=0 M3=3,13025777297753	FrameElem=40-1
ElemStation=0	
Frame=40 Station=0,04 OutputCase=FRE13 CaseType=Combination P=-6,98938106843768 V2=15,8865144863663 V3=0 T=0 M2=0 M3=2,49799719352288	FrameElem=40-1
ElemStation=0,04	
Frame=40 Station=0,08 OutputCase=FRE13 CaseType=Combination P=-6,98938106843768 V2=16,0465144863663 V3=0 T=0 M2=0 M3=1,85933661406823	FrameElem=40-1
ElemStation=0,08	
Frame=40 Station=0 OutputCase=FRE14 CaseType=Combination P=-6,67150374523405 V2=15,0904876198767 V3=0 T=0 M2=0 M3=2,5162361126773	FrameElem=40-1
ElemStation=0	
Frame=40 Station=0,04 OutputCase=FRE14 CaseType=Combination P=-6,67150374523405 V2=15,2504876198767 V3=0 T=0 M2=0 M3=1,90941660788223	FrameElem=40-1
ElemStation=0,04	
Frame=40 Station=0,08 OutputCase=FRE14 CaseType=Combination P=-6,67150374523405 V2=15,4104876198767 V3=0 T=0 M2=0 M3=1,29619710308717	FrameElem=40-1
ElemStation=0,08	
Frame=40 Station=0 OutputCase=FRE15 CaseType=Combination P=-7,21354942296749 V2=15,4091527751773 V3=0 T=0 M2=0 M3=3,1413291231459	FrameElem=40-1
ElemStation=0	
Frame=40 Station=0,04 OutputCase=FRE15 CaseType=Combination P=-7,21354942296749 V2=15,5691527751773 V3=0 T=0 M2=0 M3=2,5217630121388	FrameElem=40-1
ElemStation=0,04	
Frame=40 Station=0,08 OutputCase=FRE15 CaseType=Combination P=-7,21354942296749 V2=15,7291527751773 V3=0 T=0 M2=0 M3=1,89579690113171	FrameElem=40-1
ElemStation=0,08	
Frame=40 Station=0 OutputCase=FRE16 CaseType=Combination P=-7,74989924555176 V2=15,4100651860555 V3=0 T=0 M2=0 M3=3,58664417559177	FrameElem=40-1
ElemStation=0	
Frame=40 Station=0,04 OutputCase=FRE16 CaseType=Combination P=-7,74989924555176 V2=15,5700651860555 V3=0 T=0 M2=0 M3=2,96704156814955	FrameElem=40-1
ElemStation=0,04	
Frame=40 Station=0,08 OutputCase=FRE16 CaseType=Combination P=-7,74989924555176 V2=15,7300651860555 V3=0 T=0 M2=0 M3=2,34103896070733	FrameElem=40-1
ElemStation=0,08	
Frame=40 Station=0 OutputCase=FRE17 CaseType=Combination P=-6,95317477033265 V2=67,2659534525687 V3=0 T=0 M2=0 M3=10,7900886408781	FrameElem=40-1
ElemStation=0	
Frame=40 Station=0,04 OutputCase=FRE17 CaseType=Combination P=-6,95317477033265 V2=67,4259534525687 V3=0 T=0 M2=0 M3=8,0962505027754	FrameElem=40-1
ElemStation=0,04	
Frame=40 Station=0,08 OutputCase=FRE17 CaseType=Combination P=-6,95317477033265 V2=67,5859534525687 V3=0 T=0 M2=0 M3=5,39601236467265	FrameElem=40-1
ElemStation=0,08	
Frame=40 Station=0 OutputCase=FRE18 CaseType=Combination P=-15,8541415175309 V2=66,1245093165439 V3=0 T=0 M2=0 M3=21,2986535317434	FrameElem=40-1
ElemStation=0	
Frame=40 Station=0,04 OutputCase=FRE18 CaseType=Combination P=-15,8541415175309 V2=66,2845093165439 V3=0 T=0 M2=0 M3=18,6504731590817	FrameElem=40-1
ElemStation=0,04	

Società di Progetto
Brebemi SpA



Doc. N.
60235-00000-A00.doc

CODIFICA DOCUMENTO
04RCDII10000000000300A00

REV.
00

FOGLIO
530 di 628

Frame=40 Station=0,08 OutputCase=FRE18 CaseType=Combination P=-15,8541415175309 V2=66,4445093165439 V3=0 T=0 M2=0 M3=15,9958927864199 ElemStation=0,08	FrameElem=40-1
Frame=40 Station=0 OutputCase=FRE19 CaseType=Combination P=-24,7551082600725 V2=67,2711293382403 V3=0 T=0 M2=0 M3=13,3162530564353 ElemStation=0	FrameElem=40-1
Frame=40 Station=0,04 OutputCase=FRE19 CaseType=Combination P=-24,7551082600725 V2=67,4311293382403 V3=0 T=0 M2=0 M3=10,6222078829056 ElemStation=0,04	FrameElem=40-1
Frame=40 Station=0,08 OutputCase=FRE19 CaseType=Combination P=-24,7551082600725 V2=67,5911293382403 V3=0 T=0 M2=0 M3=7,92176270937603 ElemStation=0,08	FrameElem=40-1
Frame=40 Station=0 OutputCase=FRE20 CaseType=Combination P=-16,5742445895237 V2=14,2684907056195 V3=0 T=0 M2=0 M3=14,0315926303933 ElemStation=0	FrameElem=40-1
Frame=40 Station=0,04 OutputCase=FRE20 CaseType=Combination P=-16,5742445895237 V2=14,4284907056195 V3=0 T=0 M2=0 M3=13,4576530021686 ElemStation=0,04	FrameElem=40-1
Frame=40 Station=0,08 OutputCase=FRE20 CaseType=Combination P=-16,5742445895237 V2=14,5884907056195 V3=0 T=0 M2=0 M3=12,8773133739438 ElemStation=0,08	FrameElem=40-1
Frame=40 Station=0 OutputCase=FRE21 CaseType=Combination P=-25,4752113320653 V2=15,415110727316 V3=0 T=0 M2=0 M3=6,04919215508517 ElemStation=0	FrameElem=40-1
Frame=40 Station=0,04 OutputCase=FRE21 CaseType=Combination P=-25,4752113320653 V2=15,575110727316 V3=0 T=0 M2=0 M3=5,42938772599254 ElemStation=0,04	FrameElem=40-1
Frame=40 Station=0,08 OutputCase=FRE21 CaseType=Combination P=-25,4752113320653 V2=15,735110727316 V3=0 T=0 M2=0 M3=4,8031832968999 ElemStation=0,08	FrameElem=40-1
Frame=40 Station=0 OutputCase=FRE22 CaseType=Combination P=-7,90883790715358 V2=15,7280786193003 V3=0 T=0 M2=0 M3=3,89365500574188 ElemStation=0	FrameElem=40-1
Frame=40 Station=0,04 OutputCase=FRE22 CaseType=Combination P=-7,90883790715358 V2=15,8880786193003 V3=0 T=0 M2=0 M3=3,26133186096987 ElemStation=0,04	FrameElem=40-1
Frame=40 Station=0,08 OutputCase=FRE22 CaseType=Combination P=-7,90883790715358 V2=16,0480786193003 V3=0 T=0 M2=0 M3=2,62260871619786 ElemStation=0,08	FrameElem=40-1
Frame=40 Station=0 OutputCase=FRE23 CaseType=Combination P=-7,59096058394995 V2=15,0920517528107 V3=0 T=0 M2=0 M3=3,27963334544165 ElemStation=0	FrameElem=40-1
Frame=40 Station=0,04 OutputCase=FRE23 CaseType=Combination P=-7,59096058394995 V2=15,2520517528107 V3=0 T=0 M2=0 M3=2,67275127532922 ElemStation=0,04	FrameElem=40-1
Frame=40 Station=0,08 OutputCase=FRE23 CaseType=Combination P=-7,59096058394995 V2=15,4120517528107 V3=0 T=0 M2=0 M3=2,0594692052168 ElemStation=0,08	FrameElem=40-1
Frame=40 Station=0 OutputCase=FRE24 CaseType=Combination P=-8,13300626168339 V2=15,4107169081113 V3=0 T=0 M2=0 M3=3,90472635591025 ElemStation=0	FrameElem=40-1
Frame=40 Station=0,04 OutputCase=FRE24 CaseType=Combination P=-8,13300626168339 V2=15,5707169081113 V3=0 T=0 M2=0 M3=3,28509767958579 ElemStation=0,04	FrameElem=40-1
Frame=40 Station=0,08 OutputCase=FRE24 CaseType=Combination P=-8,13300626168339 V2=15,7307169081113 V3=0 T=0 M2=0 M3=2,65906900326134 ElemStation=0,08	FrameElem=40-1
Frame=40 Station=0 OutputCase=FRE25 CaseType=Combination P=-7,48089722011599 V2=15,7908992394823 V3=0 T=0 M2=0 M3=3,57335855538973 ElemStation=0	FrameElem=40-1
Frame=40 Station=0,04 OutputCase=FRE25 CaseType=Combination P=-7,48089722011599 V2=15,9508992394823 V3=0 T=0 M2=0 M3=2,93852258581044 ElemStation=0,04	FrameElem=40-1
Frame=40 Station=0,08 OutputCase=FRE25 CaseType=Combination P=-7,48089722011599 V2=16,1108992394823 V3=0 T=0 M2=0 M3=2,29728661623115 ElemStation=0,08	FrameElem=40-1
Frame=40 Station=0 OutputCase=FRE26 CaseType=Combination P=-6,72900641580284 V2=67,5833151637577 V3=0 T=0 M2=0 M3=10,7790172907098 ElemStation=0	FrameElem=40-1
Frame=40 Station=0,04 OutputCase=FRE26 CaseType=Combination P=-6,72900641580284 V2=67,7433151637577 V3=0 T=0 M2=0 M3=8,07248468415948 ElemStation=0,04	FrameElem=40-1
Frame=40 Station=0,08 OutputCase=FRE26 CaseType=Combination P=-6,72900641580284 V2=67,9033151637577 V3=0 T=0 M2=0 M3=5,35955207760917 ElemStation=0,08	FrameElem=40-1
Frame=40 Station=0 OutputCase=FRE27 CaseType=Combination P=-15,6299731630011 V2=66,4418710277329 V3=0 T=0 M2=0 M3=21,2875821815751 ElemStation=0	FrameElem=40-1
Frame=40 Station=0,04 OutputCase=FRE27 CaseType=Combination P=-15,6299731630011 V2=66,6018710277329 V3=0 T=0 M2=0 M3=18,6267073404657 ElemStation=0,04	FrameElem=40-1
Frame=40 Station=0,08 OutputCase=FRE27 CaseType=Combination P=-15,6299731630011 V2=66,7618710277329 V3=0 T=0 M2=0 M3=15,9594324993564 ElemStation=0,08	FrameElem=40-1
Frame=40 Station=0 OutputCase=FRE28 CaseType=Combination P=-24,5309399055427 V2=67,5884910494293 V3=0 T=0 M2=0 M3=13,3051817062669 ElemStation=0	FrameElem=40-1
Frame=40 Station=0,04 OutputCase=FRE28 CaseType=Combination P=-24,5309399055427 V2=67,7484910494293 V3=0 T=0 M2=0 M3=10,5984420642897 ElemStation=0,04	FrameElem=40-1
Frame=40 Station=0,08 OutputCase=FRE28 CaseType=Combination P=-24,5309399055427 V2=67,9084910494293 V3=0 T=0 M2=0 M3=7,88530242231255 ElemStation=0,08	FrameElem=40-1
Frame=40 Station=0 OutputCase=FRE29 CaseType=Combination P=-16,3500762349939 V2=14,5858524168085 V3=0 T=0 M2=0 M3=14,020521280225 ElemStation=0	FrameElem=40-1
Frame=40 Station=0,04 OutputCase=FRE29 CaseType=Combination P=-16,3500762349939 V2=14,7458524168085 V3=0 T=0 M2=0 M3=13,4338871835526 ElemStation=0,04	FrameElem=40-1
Frame=40 Station=0,08 OutputCase=FRE29 CaseType=Combination P=-16,3500762349939 V2=14,9058524168085 V3=0 T=0 M2=0 M3=12,8408530868803 ElemStation=0,08	FrameElem=40-1
Frame=40 Station=0 OutputCase=FRE30 CaseType=Combination P=-25,2510429775355 V2=15,7324724385049 V3=0 T=0 M2=0 M3=6,03812080491681 ElemStation=0	FrameElem=40-1
Frame=40 Station=0,04 OutputCase=FRE30 CaseType=Combination P=-25,2510429775355 V2=15,8924724385049 V3=0 T=0 M2=0 M3=5,40562190737661 ElemStation=0,04	FrameElem=40-1
Frame=40 Station=0,08 OutputCase=FRE30 CaseType=Combination P=-25,2510429775355 V2=16,0524724385049 V3=0 T=0 M2=0 M3=4,76672300983641 ElemStation=0,08	FrameElem=40-1
Frame=40 Station=0 OutputCase=FRE31 CaseType=Combination P=-7,09779020398437 V2=15,7902475174264 V3=0 T=0 M2=0 M3=3,25527637507125 ElemStation=0	FrameElem=40-1
Frame=40 Station=0,04 OutputCase=FRE31 CaseType=Combination P=-7,09779020398437 V2=15,9502475174264 V3=0 T=0 M2=0 M3=2,62046647437419 ElemStation=0,04	FrameElem=40-1
Frame=40 Station=0,08 OutputCase=FRE31 CaseType=Combination P=-7,09779020398437 V2=16,1102475174264 V3=0 T=0 M2=0 M3=1,97925657367713 ElemStation=0,08	FrameElem=40-1
Frame=40 Station=0 OutputCase=FRE32 CaseType=Combination P=-7,86400423624762 V2=15,7915509615381 V3=0 T=0 M2=0 M3=3,89144073570821 ElemStation=0	FrameElem=40-1
Frame=40 Station=0,04 OutputCase=FRE32 CaseType=Combination P=-7,86400423624762 V2=15,9515509615381 V3=0 T=0 M2=0 M3=3,25657869724668 ElemStation=0,04	FrameElem=40-1
Frame=40 Station=0,08 OutputCase=FRE32 CaseType=Combination P=-7,86400423624762 V2=16,1115509615381 V3=0 T=0 M2=0 M3=2,61531665878516 ElemStation=0,08	FrameElem=40-1
Frame=40 Station=0 OutputCase=FRE33 CaseType=Combination P=-7,86400423624762 V2=15,7915509615381 V3=0 T=0 M2=0 M3=3,89144073570821 ElemStation=0	FrameElem=40-1

Società di Progetto
Brebemi SpA

	Doc. N. 60235-0000-A00.doc	CODIFICA DOCUMENTO 04RCDII10000000000300A00	REV. 00	FOGLIO 531 di 628
--	-------------------------------	--	------------	----------------------

Frame=40 ElemStation=0,04	Station=0,04	OutputCase=FRE33	CaseType=Combination	P=-7,86400423624762	V2=15,9515509615381	V3=0	T=0	M2=0	M3=3,25657869724668	FrameElem=40-1
Frame=40 ElemStation=0,08	Station=0,08	OutputCase=FRE33	CaseType=Combination	P=-7,86400423624762	V2=16,1115509615381	V3=0	T=0	M2=0	M3=2,61531665878516	FrameElem=40-1
Frame=40 ElemStation=0	Station=0	OutputCase=FRE34	CaseType=Combination	P=-7,09944443227163	V2=15,0276669996947	V3=0	T=0	M2=0	M3=2,83653256302945	FrameElem=40-1
Frame=40 ElemStation=0,04	Station=0,04	OutputCase=FRE34	CaseType=Combination	P=-7,09944443227163	V2=15,1876669996947	V3=0	T=0	M2=0	M3=2,23222588304166	FrameElem=40-1
Frame=40 ElemStation=0,08	Station=0,08	OutputCase=FRE34	CaseType=Combination	P=-7,09944443227163	V2=15,3476669996947	V3=0	T=0	M2=0	M3=1,62151920305388	FrameElem=40-1
Frame=40 ElemStation=0	Station=0	OutputCase=FRE35	CaseType=Combination	P=-6,4111290925992	V2=66,9472882972681	V3=0	T=0	M2=0	M3=10,1649956304096	FrameElem=40-1
Frame=40 ElemStation=0,04	Station=0,04	OutputCase=FRE35	CaseType=Combination	P=-6,4111290925992	V2=67,1072882972681	V3=0	T=0	M2=0	M3=7,48390409851883	FrameElem=40-1
Frame=40 ElemStation=0,08	Station=0,08	OutputCase=FRE35	CaseType=Combination	P=-6,4111290925992	V2=67,2672882972681	V3=0	T=0	M2=0	M3=4,79641256662811	FrameElem=40-1
Frame=40 ElemStation=0	Station=0	OutputCase=FRE36	CaseType=Combination	P=-15,3120958397975	V2=65,8058441612433	V3=0	T=0	M2=0	M3=20,6735605212748	FrameElem=40-1
Frame=40 ElemStation=0,04	Station=0,04	OutputCase=FRE36	CaseType=Combination	P=-15,3120958397975	V2=65,9658441612433	V3=0	T=0	M2=0	M3=18,0381267548251	FrameElem=40-1
Frame=40 ElemStation=0,08	Station=0,08	OutputCase=FRE36	CaseType=Combination	P=-15,3120958397975	V2=66,1258441612433	V3=0	T=0	M2=0	M3=15,3962929883754	FrameElem=40-1
Frame=40 ElemStation=0	Station=0	OutputCase=FRE37	CaseType=Combination	P=-24,2130625823391	V2=66,9524641829397	V3=0	T=0	M2=0	M3=12,6911600459667	FrameElem=40-1
Frame=40 ElemStation=0,04	Station=0,04	OutputCase=FRE37	CaseType=Combination	P=-24,2130625823391	V2=67,1124641829397	V3=0	T=0	M2=0	M3=10,0098614786491	FrameElem=40-1
Frame=40 ElemStation=0,08	Station=0,08	OutputCase=FRE37	CaseType=Combination	P=-24,2130625823391	V2=67,2724641829397	V3=0	T=0	M2=0	M3=7,32216291133149	FrameElem=40-1
Frame=40 ElemStation=0	Station=0	OutputCase=FRE38	CaseType=Combination	P=-16,0321989117903	V2=13,9498255503189	V3=0	T=0	M2=0	M3=13,4064996199247	FrameElem=40-1
Frame=40 ElemStation=0,04	Station=0,04	OutputCase=FRE38	CaseType=Combination	P=-16,0321989117903	V2=14,1098255503189	V3=0	T=0	M2=0	M3=12,845306597912	FrameElem=40-1
Frame=40 ElemStation=0,08	Station=0,08	OutputCase=FRE38	CaseType=Combination	P=-16,0321989117903	V2=14,2698255503189	V3=0	T=0	M2=0	M3=12,2777135758992	FrameElem=40-1
Frame=40 ElemStation=0	Station=0	OutputCase=FRE39	CaseType=Combination	P=-24,9331656543319	V2=15,0964455720153	V3=0	T=0	M2=0	M3=5,42409914461658	FrameElem=40-1
Frame=40 ElemStation=0,04	Station=0,04	OutputCase=FRE39	CaseType=Combination	P=-24,9331656543319	V2=15,2564455720153	V3=0	T=0	M2=0	M3=4,81704132173597	FrameElem=40-1
Frame=40 ElemStation=0,08	Station=0,08	OutputCase=FRE39	CaseType=Combination	P=-24,9331656543319	V2=15,4164455720153	V3=0	T=0	M2=0	M3=4,20358349885535	FrameElem=40-1
Frame=40 ElemStation=0	Station=0	OutputCase=FRE40	CaseType=Combination	P=-6,71633741614001	V2=15,0270152776389	V3=0	T=0	M2=0	M3=2,51845038271098	FrameElem=40-1
Frame=40 ElemStation=0,04	Station=0,04	OutputCase=FRE40	CaseType=Combination	P=-6,71633741614001	V2=15,1870152776389	V3=0	T=0	M2=0	M3=1,91416977160542	FrameElem=40-1
Frame=40 ElemStation=0,08	Station=0,08	OutputCase=FRE40	CaseType=Combination	P=-6,71633741614001	V2=15,3470152776389	V3=0	T=0	M2=0	M3=1,30348916049986	FrameElem=40-1
Frame=40 ElemStation=0	Station=0	OutputCase=FRE41	CaseType=Combination	P=-7,48255144840326	V2=15,0283187217506	V3=0	T=0	M2=0	M3=3,15461474334793	FrameElem=40-1
Frame=40 ElemStation=0,04	Station=0,04	OutputCase=FRE41	CaseType=Combination	P=-7,48255144840326	V2=15,1883187217506	V3=0	T=0	M2=0	M3=2,55028199447791	FrameElem=40-1
Frame=40 ElemStation=0,08	Station=0,08	OutputCase=FRE41	CaseType=Combination	P=-7,48255144840326	V2=15,3483187217506	V3=0	T=0	M2=0	M3=1,93954924560789	FrameElem=40-1
Frame=40 ElemStation=0	Station=0	OutputCase=FRE42	CaseType=Combination	P=-7,48255144840326	V2=15,0283187217506	V3=0	T=0	M2=0	M3=3,15461474334793	FrameElem=40-1
Frame=40 ElemStation=0,04	Station=0,04	OutputCase=FRE42	CaseType=Combination	P=-7,48255144840326	V2=15,1883187217506	V3=0	T=0	M2=0	M3=2,55028199447791	FrameElem=40-1
Frame=40 ElemStation=0,08	Station=0,08	OutputCase=FRE42	CaseType=Combination	P=-7,48255144840326	V2=15,3483187217506	V3=0	T=0	M2=0	M3=1,93954924560789	FrameElem=40-1
Frame=40 ElemStation=0	Station=0	OutputCase=FRE43	CaseType=Combination	P=-7,74989924555176	V2=15,4100651860555	V3=0	T=0	M2=0	M3=3,58664417559177	FrameElem=40-1
Frame=40 ElemStation=0,04	Station=0,04	OutputCase=FRE43	CaseType=Combination	P=-7,74989924555176	V2=15,5700651860555	V3=0	T=0	M2=0	M3=2,96704156814955	FrameElem=40-1
Frame=40 ElemStation=0,08	Station=0,08	OutputCase=FRE43	CaseType=Combination	P=-7,74989924555176	V2=15,7300651860555	V3=0	T=0	M2=0	M3=2,34103896070733	FrameElem=40-1
Frame=40 ElemStation=0	Station=0	OutputCase=FRE44	CaseType=Combination	P=-6,95317477033265	V2=67,2659534525687	V3=0	T=0	M2=0	M3=10,7900886408781	FrameElem=40-1
Frame=40 ElemStation=0,04	Station=0,04	OutputCase=FRE44	CaseType=Combination	P=-6,95317477033265	V2=67,4259534525687	V3=0	T=0	M2=0	M3=8,0962505027754	FrameElem=40-1
Frame=40 ElemStation=0,08	Station=0,08	OutputCase=FRE44	CaseType=Combination	P=-6,95317477033265	V2=67,5859534525687	V3=0	T=0	M2=0	M3=5,39601236467265	FrameElem=40-1
Frame=40 ElemStation=0	Station=0	OutputCase=FRE45	CaseType=Combination	P=-15,8541415175309	V2=66,1245093165439	V3=0	T=0	M2=0	M3=21,2986535317434	FrameElem=40-1
Frame=40 ElemStation=0,04	Station=0,04	OutputCase=FRE45	CaseType=Combination	P=-15,8541415175309	V2=66,2845093165439	V3=0	T=0	M2=0	M3=18,6504731590817	FrameElem=40-1
Frame=40 ElemStation=0,08	Station=0,08	OutputCase=FRE45	CaseType=Combination	P=-15,8541415175309	V2=66,4445093165439	V3=0	T=0	M2=0	M3=15,9958927864199	FrameElem=40-1
Frame=40 ElemStation=0	Station=0	OutputCase=FRE46	CaseType=Combination	P=-24,7551082600725	V2=67,2711293382403	V3=0	T=0	M2=0	M3=13,3162530564353	FrameElem=40-1
Frame=40 ElemStation=0,04	Station=0,04	OutputCase=FRE46	CaseType=Combination	P=-24,7551082600725	V2=67,4311293382403	V3=0	T=0	M2=0	M3=10,6222078829056	FrameElem=40-1
Frame=40 ElemStation=0,08	Station=0,08	OutputCase=FRE46	CaseType=Combination	P=-24,7551082600725	V2=67,5911293382403	V3=0	T=0	M2=0	M3=7,92176270937603	FrameElem=40-1
Frame=40 ElemStation=0	Station=0	OutputCase=FRE47	CaseType=Combination	P=-16,5742445895237	V2=14,2684907056195	V3=0	T=0	M2=0	M3=14,0315926303933	FrameElem=40-1
Frame=40 ElemStation=0,04	Station=0,04	OutputCase=FRE47	CaseType=Combination	P=-16,5742445895237	V2=14,4284907056195	V3=0	T=0	M2=0	M3=13,4576530021686	FrameElem=40-1
Frame=40 ElemStation=0,08	Station=0,08	OutputCase=FRE47	CaseType=Combination	P=-16,5742445895237	V2=14,5884907056195	V3=0	T=0	M2=0	M3=12,8773133739438	FrameElem=40-1

Società di Progetto
Brebemi SpA

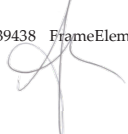



Doc. N.
60235-0000-A00.doc

CODIFICA DOCUMENTO
04RCDII10000000000300A00

REV.
00

FOGLIO
532 di 628

Frame=40 Station=0 OutputCase=FRE48 CaseType=Combination P=-25,4752113320653 V2=15,415110727316 V3=0 T=0 M2=0 M3=6,04919215508517	FrameElem=40-1
ElemStation=0	
Frame=40 Station=0,04 OutputCase=FRE48 CaseType=Combination P=-25,4752113320653 V2=15,575110727316 V3=0 T=0 M2=0 M3=5,42938772599254	FrameElem=40-1
ElemStation=0,04	
Frame=40 Station=0,08 OutputCase=FRE48 CaseType=Combination P=-25,4752113320653 V2=15,735110727316 V3=0 T=0 M2=0 M3=4,8031832968999	FrameElem=40-1
ElemStation=0,08	
Frame=40 Station=0 OutputCase=FRE49 CaseType=Combination P=-8,13300626168339 V2=15,4107169081113 V3=0 T=0 M2=0 M3=3,90472635591025	FrameElem=40-1
ElemStation=0	
Frame=40 Station=0,04 OutputCase=FRE49 CaseType=Combination P=-8,13300626168339 V2=15,5707169081113 V3=0 T=0 M2=0 M3=3,28509767958579	FrameElem=40-1
ElemStation=0,04	
Frame=40 Station=0,08 OutputCase=FRE49 CaseType=Combination P=-8,13300626168339 V2=15,7307169081113 V3=0 T=0 M2=0 M3=2,65906900326134	FrameElem=40-1
ElemStation=0,08	
Frame=40 Station=0 OutputCase=FRE50 CaseType=Combination P=-7,90883790715358 V2=15,7280786193003 V3=0 T=0 M2=0 M3=3,89365500574188	FrameElem=40-1
ElemStation=0	
Frame=40 Station=0,04 OutputCase=FRE50 CaseType=Combination P=-7,90883790715358 V2=15,8880786193003 V3=0 T=0 M2=0 M3=3,26133186096987	FrameElem=40-1
ElemStation=0,04	
Frame=40 Station=0,08 OutputCase=FRE50 CaseType=Combination P=-7,90883790715358 V2=16,0480786193003 V3=0 T=0 M2=0 M3=2,62260871619786	FrameElem=40-1
ElemStation=0,08	
Frame=40 Station=0 OutputCase=FRE51 CaseType=Combination P=-7,59096058394995 V2=15,0920517528107 V3=0 T=0 M2=0 M3=3,27963334544165	FrameElem=40-1
ElemStation=0	
Frame=40 Station=0,04 OutputCase=FRE51 CaseType=Combination P=-7,59096058394995 V2=15,2520517528107 V3=0 T=0 M2=0 M3=2,67275127532922	FrameElem=40-1
ElemStation=0,04	
Frame=40 Station=0,08 OutputCase=FRE51 CaseType=Combination P=-7,59096058394995 V2=15,4120517528107 V3=0 T=0 M2=0 M3=2,0594692052168	FrameElem=40-1
ElemStation=0,08	
Frame=40 Station=0 OutputCase=INVFRE CaseType=Combination StepType=Max P=-6,18696073806939 V2=67,5884910494293 V3=0 T=0 M2=0 M3=21,2986535317434	FrameElem=40-1
ElemStation=0	
Frame=40 Station=0,04 OutputCase=INVFRE CaseType=Combination StepType=Max P=-6,18696073806939 V2=67,7484910494293 V3=0 T=0 M2=0 M3=18,6504731590817	FrameElem=40-1
ElemStation=0,04	
Frame=40 Station=0,08 OutputCase=INVFRE CaseType=Combination StepType=Max P=-6,18696073806939 V2=67,9084910494293 V3=0 T=0 M2=0 M3=15,9958927864199	FrameElem=40-1
ElemStation=0,08	
Frame=40 Station=0 OutputCase=INVFRE CaseType=Combination StepType=Min P=-25,4752113320653 V2=13,9498255503189 V3=0 T=0 M2=0 M3=2,5162361126773	FrameElem=40-1
ElemStation=0	
Frame=40 Station=0,04 OutputCase=INVFRE CaseType=Combination StepType=Min P=-25,4752113320653 V2=14,1098255503189 V3=0 T=0 M2=0 M3=1,90941660788223	FrameElem=40-1
ElemStation=0,04	
Frame=40 Station=0,08 OutputCase=INVFRE CaseType=Combination StepType=Min P=-25,4752113320653 V2=14,2698255503189 V3=0 T=0 M2=0 M3=1,29619710308717	FrameElem=40-1
ElemStation=0,08	
Frame=40 Station=0 OutputCase=QPE01 CaseType=Combination P=-9,2906256222063 V2=15,493338841552 V3=0 T=0 M2=0 M3=2,03924279591956	FrameElem=40-1
ElemStation=0	
Frame=40 Station=0,04 OutputCase=QPE01 CaseType=Combination P=-9,2906256222063 V2=15,653338841552 V3=0 T=0 M2=0 M3=1,41630924225748	FrameElem=40-1
ElemStation=0,04	
Frame=40 Station=0,08 OutputCase=QPE01 CaseType=Combination P=-9,2906256222063 V2=15,813338841552 V3=0 T=0 M2=0 M3=0,786975688595401	FrameElem=40-1
ElemStation=0,08	
Frame=40 Station=0 OutputCase=QPE02 CaseType=Combination P=-8,90751860607468 V2=15,4926871194962 V3=0 T=0 M2=0 M3=1,72116061560108	FrameElem=40-1
ElemStation=0	
Frame=40 Station=0,04 OutputCase=QPE02 CaseType=Combination P=-8,90751860607468 V2=15,6526871194962 V3=0 T=0 M2=0 M3=1,09825313082124	FrameElem=40-1
ElemStation=0,04	
Frame=40 Station=0,08 OutputCase=QPE02 CaseType=Combination P=-8,90751860607468 V2=15,8126871194962 V3=0 T=0 M2=0 M3=0,468945646041388	FrameElem=40-1
ElemStation=0,08	
Frame=40 Station=0 OutputCase=QPE03 CaseType=Combination P=-9,67373263833793 V2=15,4939905636079 V3=0 T=0 M2=0 M3=2,35732497623804	FrameElem=40-1
ElemStation=0	
Frame=40 Station=0,04 OutputCase=QPE03 CaseType=Combination P=-9,67373263833793 V2=15,6539905636079 V3=0 T=0 M2=0 M3=1,73436535369373	FrameElem=40-1
ElemStation=0,04	
Frame=40 Station=0,08 OutputCase=QPE03 CaseType=Combination P=-9,67373263833793 V2=15,8139905636079 V3=0 T=0 M2=0 M3=1,10500573114941	FrameElem=40-1
ElemStation=0,08	
Frame=40 Station=0 OutputCase=QPE04 CaseType=Combination P=-9,44956428380812 V2=15,8113522747968 V3=0 T=0 M2=0 M3=2,34625362606968	FrameElem=40-1
ElemStation=0	
Frame=40 Station=0,04 OutputCase=QPE04 CaseType=Combination P=-9,44956428380812 V2=15,9713522747968 V3=0 T=0 M2=0 M3=1,710599530778	FrameElem=40-1
ElemStation=0,04	
Frame=40 Station=0,08 OutputCase=QPE04 CaseType=Combination P=-9,44956428380812 V2=16,1313522747968 V3=0 T=0 M2=0 M3=1,06854544408593	FrameElem=40-1
ElemStation=0,08	
Frame=40 Station=0 OutputCase=QPE05 CaseType=Combination P=-9,13168696060449 V2=15,1753254083072 V3=0 T=0 M2=0 M3=1,73223196576945	FrameElem=40-1
ElemStation=0	
Frame=40 Station=0,04 OutputCase=QPE05 CaseType=Combination P=-9,13168696060449 V2=15,3353254083072 V3=0 T=0 M2=0 M3=1,12201894943716	FrameElem=40-1
ElemStation=0,04	
Frame=40 Station=0,08 OutputCase=QPE05 CaseType=Combination P=-9,13168696060449 V2=15,4953254083072 V3=0 T=0 M2=0 M3=0,505405933104871	FrameElem=40-1
ElemStation=0,08	
Frame=40 Station=0 OutputCase=QPE06 CaseType=Combination P=-9,67373263833793 V2=15,4939905636079 V3=0 T=0 M2=0 M3=2,35732497623804	FrameElem=40-1
ElemStation=0	
Frame=40 Station=0,04 OutputCase=QPE06 CaseType=Combination P=-9,67373263833793 V2=15,6539905636079 V3=0 T=0 M2=0 M3=1,73436535369373	FrameElem=40-1
ElemStation=0,04	
Frame=40 Station=0,08 OutputCase=QPE06 CaseType=Combination P=-9,67373263833793 V2=15,8139905636079 V3=0 T=0 M2=0 M3=1,10500573114941	FrameElem=40-1
ElemStation=0,08	
Frame=40 Station=0 OutputCase=QPE07 CaseType=Combination P=-9,06645726767649 V2=15,810700552741 V3=0 T=0 M2=0 M3=2,0281714457512	FrameElem=40-1
ElemStation=0	
Frame=40 Station=0,04 OutputCase=QPE07 CaseType=Combination P=-9,06645726767649 V2=15,970700552741 V3=0 T=0 M2=0 M3=1,39254342364156	FrameElem=40-1
ElemStation=0,04	
Frame=40 Station=0,08 OutputCase=QPE07 CaseType=Combination P=-9,06645726767649 V2=16,130700552741 V3=0 T=0 M2=0 M3=0,750515401531918	FrameElem=40-1
ElemStation=0,08	
Frame=40 Station=0 OutputCase=QPE08 CaseType=Combination P=-8,74857994447286 V2=15,1746736862514 V3=0 T=0 M2=0 M3=1,41414978545097	FrameElem=40-1
ElemStation=0	
Frame=40 Station=0,04 OutputCase=QPE08 CaseType=Combination P=-8,74857994447286 V2=15,3346736862514 V3=0 T=0 M2=0 M3=0,803962838000914	FrameElem=40-1
ElemStation=0,04	
Frame=40 Station=0,08 OutputCase=QPE08 CaseType=Combination P=-8,74857994447286 V2=15,4946736862514 V3=0 T=0 M2=0 M3=0,187375890550859	FrameElem=40-1
ElemStation=0,08	
Frame=40 Station=0 OutputCase=QPE09 CaseType=Combination P=-9,2906256222063 V2=15,493338841552 V3=0 T=0 M2=0 M3=2,03924279591956	FrameElem=40-1
ElemStation=0	
Frame=40 Station=0,04 OutputCase=QPE09 CaseType=Combination P=-9,2906256222063 V2=15,653338841552 V3=0 T=0 M2=0 M3=1,41630924225748	FrameElem=40-1
ElemStation=0,04	

Società di Progetto
Brebemi SpA



Doc. N.
60235-0000-A00.doc

CODIFICA DOCUMENTO
04RCDII10000000000300A00

REV.
00

FOGLIO
533 di 628

Frame=40 Station=0,08 OutputCase=QPE09 CaseType=Combination P=-9,290625622063 V2=15,813338841552 V3=0 T=0 M2=0 M3=0,786975688595401	FrameElem=40-1 ElemStation=0,08
Frame=40 Station=0 OutputCase=QPE10 CaseType=Combination P=-9,29062562127498 V2=15,3262209448148 V3=0 T=0 M2=0 M3=4,85556317058308	FrameElem=40-1 ElemStation=0
Frame=40 Station=0,04 OutputCase=QPE10 CaseType=Combination P=-9,29062562127498 V2=15,4862209448148 V3=0 T=0 M2=0 M3=4,23931433279049	FrameElem=40-1 ElemStation=0,04
Frame=40 Station=0,08 OutputCase=QPE10 CaseType=Combination P=-9,29062562127498 V2=15,6462209448148 V3=0 T=0 M2=0 M3=3,6166654949979	FrameElem=40-1 ElemStation=0,08
Frame=40 Station=0 OutputCase=QPE11 CaseType=Combination P=-8,90751860514335 V2=15,325569222759 V3=0 T=0 M2=0 M3=4,5374809902646	FrameElem=40-1 ElemStation=0
Frame=40 Station=0,04 OutputCase=QPE11 CaseType=Combination P=-8,90751860514335 V2=15,485569222759 V3=0 T=0 M2=0 M3=3,92125822135424	FrameElem=40-1 ElemStation=0,04
Frame=40 Station=0,08 OutputCase=QPE11 CaseType=Combination P=-8,90751860514335 V2=15,645569222759 V3=0 T=0 M2=0 M3=3,29863545244388	FrameElem=40-1 ElemStation=0,08
Frame=40 Station=0 OutputCase=QPE12 CaseType=Combination P=-9,67373263740661 V2=15,3268726668707 V3=0 T=0 M2=0 M3=5,17364535090156	FrameElem=40-1 ElemStation=0
Frame=40 Station=0,04 OutputCase=QPE12 CaseType=Combination P=-9,67373263740661 V2=15,4868726668707 V3=0 T=0 M2=0 M3=4,55737044422673	FrameElem=40-1 ElemStation=0,04
Frame=40 Station=0,08 OutputCase=QPE12 CaseType=Combination P=-9,67373263740661 V2=15,6468726668707 V3=0 T=0 M2=0 M3=3,93469553755191	FrameElem=40-1 ElemStation=0,08
Frame=40 Station=0 OutputCase=QPE13 CaseType=Combination P=-9,4495642828768 V2=15,6442343780597 V3=0 T=0 M2=0 M3=5,1625740007332	FrameElem=40-1 ElemStation=0
Frame=40 Station=0,04 OutputCase=QPE13 CaseType=Combination P=-9,4495642828768 V2=15,8042343780597 V3=0 T=0 M2=0 M3=4,53360462561081	FrameElem=40-1 ElemStation=0,04
Frame=40 Station=0,08 OutputCase=QPE13 CaseType=Combination P=-9,4495642828768 V2=15,9642343780597 V3=0 T=0 M2=0 M3=3,89823525048843	FrameElem=40-1 ElemStation=0,08
Frame=40 Station=0 OutputCase=QPE14 CaseType=Combination P=-9,13168695967316 V2=15,00820751157 V3=0 T=0 M2=0 M3=4,54855234043297	FrameElem=40-1 ElemStation=0
Frame=40 Station=0,04 OutputCase=QPE14 CaseType=Combination P=-9,13168695967316 V2=15,16820751157 V3=0 T=0 M2=0 M3=3,94502403997017	FrameElem=40-1 ElemStation=0,04
Frame=40 Station=0,08 OutputCase=QPE14 CaseType=Combination P=-9,13168695967316 V2=15,32820751157 V3=0 T=0 M2=0 M3=3,33509573950737	FrameElem=40-1 ElemStation=0,08
Frame=40 Station=0 OutputCase=QPE15 CaseType=Combination P=-9,67373263740661 V2=15,3268726668707 V3=0 T=0 M2=0 M3=5,17364535090156	FrameElem=40-1 ElemStation=0
Frame=40 Station=0,04 OutputCase=QPE15 CaseType=Combination P=-9,67373263740661 V2=15,4868726668707 V3=0 T=0 M2=0 M3=4,55737044422673	FrameElem=40-1 ElemStation=0,04
Frame=40 Station=0,08 OutputCase=QPE15 CaseType=Combination P=-9,67373263740661 V2=15,6468726668707 V3=0 T=0 M2=0 M3=3,93469553755191	FrameElem=40-1 ElemStation=0,08
Frame=40 Station=0 OutputCase=QPE16 CaseType=Combination P=-9,06645726674517 V2=15,6435826560038 V3=0 T=0 M2=0 M3=4,84449182041472	FrameElem=40-1 ElemStation=0
Frame=40 Station=0,04 OutputCase=QPE16 CaseType=Combination P=-9,06645726674517 V2=15,8035826560038 V3=0 T=0 M2=0 M3=4,21554851417456	FrameElem=40-1 ElemStation=0,04
Frame=40 Station=0,08 OutputCase=QPE16 CaseType=Combination P=-9,06645726674517 V2=15,9635826560038 V3=0 T=0 M2=0 M3=3,58020520793441	FrameElem=40-1 ElemStation=0,08
Frame=40 Station=0 OutputCase=QPE17 CaseType=Combination P=-8,74857994354154 V2=15,0075557895142 V3=0 T=0 M2=0 M3=4,23047016011449	FrameElem=40-1 ElemStation=0
Frame=40 Station=0,04 OutputCase=QPE17 CaseType=Combination P=-8,74857994354154 V2=15,1675557895142 V3=0 T=0 M2=0 M3=3,62696792853392	FrameElem=40-1 ElemStation=0,04
Frame=40 Station=0,08 OutputCase=QPE17 CaseType=Combination P=-8,74857994354154 V2=15,3275557895142 V3=0 T=0 M2=0 M3=3,01706569695335	FrameElem=40-1 ElemStation=0,08
Frame=40 Station=0 OutputCase=QPE18 CaseType=Combination P=-9,29062562127498 V2=15,3262209448148 V3=0 T=0 M2=0 M3=4,85556317058308	FrameElem=40-1 ElemStation=0
Frame=40 Station=0,04 OutputCase=QPE18 CaseType=Combination P=-9,29062562127498 V2=15,4862209448148 V3=0 T=0 M2=0 M3=4,23931433279049	FrameElem=40-1 ElemStation=0,04
Frame=40 Station=0,08 OutputCase=QPE18 CaseType=Combination P=-9,29062562127498 V2=15,6462209448148 V3=0 T=0 M2=0 M3=3,6166654949979	FrameElem=40-1 ElemStation=0,08
Frame=40 Station=0 OutputCase=INVQPE CaseType=Combination StepType=Max P=-8,74857994354154 V2=15,8113522747968 V3=0 T=0 M2=0 M3=5,17364535090156	FrameElem=40-1 ElemStation=0
Frame=40 Station=0,04 OutputCase=INVQPE CaseType=Combination StepType=Max P=-8,74857994354154 V2=15,9713522747968 V3=0 T=0 M2=0 M3=4,55737044422673	FrameElem=40-1 ElemStation=0,04
Frame=40 Station=0,08 OutputCase=INVQPE CaseType=Combination StepType=Max P=-8,74857994354154 V2=16,1313522747968 V3=0 T=0 M2=0 M3=3,93469553755191	FrameElem=40-1 ElemStation=0,08
Frame=40 Station=0 OutputCase=INVQPE CaseType=Combination StepType=Min P=-9,67373263833793 V2=15,0075557895142 V3=0 T=0 M2=0 M3=1,41414978545097	FrameElem=40-1 ElemStation=0
Frame=40 Station=0,04 OutputCase=INVQPE CaseType=Combination StepType=Min P=-9,67373263833793 V2=15,1675557895142 V3=0 T=0 M2=0 M3=0,803962838000914	FrameElem=40-1 ElemStation=0,04
Frame=40 Station=0,08 OutputCase=INVQPE CaseType=Combination StepType=Min P=-9,67373263833793 V2=15,3275557895142 V3=0 T=0 M2=0 M3=0,187375890550859	FrameElem=40-1 ElemStation=0,08
Frame=42 Station=0 OutputCase=STR001 CaseType=Combination P=-15,2429585645904 V2=15,6872763782158 V3=0 T=0 M2=0 M3=1,43759850129386	FrameElem=42-1 ElemStation=0
Frame=42 Station=0,05 OutputCase=STR001 CaseType=Combination P=-15,2429585645904 V2=15,9572763782158 V3=0 T=0 M2=0 M3=0,646484682383072	FrameElem=42-1 ElemStation=0,05
Frame=42 Station=0,1 OutputCase=STR001 CaseType=Combination P=-15,2429585645904 V2=16,2272763782158 V3=0 T=0 M2=0 M3=-0,158129136527715	FrameElem=42-1 ElemStation=0,1
Frame=42 Station=0 OutputCase=STR002 CaseType=Combination P=-7,48725069519102 V2=15,6837708820909 V3=0 T=0 M2=0 M3=0,497892818419223	FrameElem=42-1 ElemStation=0
Frame=42 Station=0,05 OutputCase=STR002 CaseType=Combination P=-7,48725069519102 V2=15,9537708820909 V3=0 T=0 M2=0 M3=0,293045725685322	FrameElem=42-1 ElemStation=0,05
Frame=42 Station=0,1 OutputCase=STR002 CaseType=Combination P=-7,48725069519102 V2=16,2237708820909 V3=0 T=0 M2=0 M3=-1,09748426978987	FrameElem=42-1 ElemStation=0,1
Frame=42 Station=0 OutputCase=STR003 CaseType=Combination P=-6,19106516563279 V2=86,5244224578244 V3=0 T=0 M2=0 M3=-2,15644822052654	FrameElem=42-1 ElemStation=0
Frame=42 Station=0,05 OutputCase=STR003 CaseType=Combination P=-6,19106516563279 V2=86,7944224578244 V3=0 T=0 M2=0 M3=-6,48941934341777	FrameElem=42-1 ElemStation=0,05
Frame=42 Station=0,1 OutputCase=STR003 CaseType=Combination P=-6,19106516563279 V2=87,0644224578244 V3=0 T=0 M2=0 M3=-10,835890466309	FrameElem=42-1 ElemStation=0,1
Frame=42 Station=0 OutputCase=STR004 CaseType=Combination P=-22,4898406126531 V2=99,2327073041721 V3=0 T=0 M2=0 M3=16,6081315325764	FrameElem=42-1 ElemStation=0

APPROVATO SDP
Società di Progetto
Brebemi SpA



Doc. N.
60235-0000-A00.doc

CODIFICA DOCUMENTO
04RCDII10000000000300A00

REV.
00

FOGLIO
534 di 628

Frame=42 Station=0,05 OutputCase=STR004 CaseType=Combination P=-22,4898406126531 V2=99,5027073041721 V3=0 T=0 M2=0 M3=11,6397461673678 FrameElem=42-1 ElemStation=0,05
Frame=42 Station=0,1 OutputCase=STR004 CaseType=Combination P=-22,4898406126531 V2=99,7727073041721 V3=0 T=0 M2=0 M3=6,6578608021592 FrameElem=42-1 ElemStation=0,1
Frame=42 Station=0 OutputCase=STR005 CaseType=Combination P=-38,7886160576245 V2=86,5416279239595 V3=0 T=0 M2=0 M3=2,45575900214521 FrameElem=42-1 ElemStation=0
Frame=42 Station=0,05 OutputCase=STR005 CaseType=Combination P=-38,7886160576245 V2=86,8116279239595 V3=0 T=0 M2=0 M3=-1,87807239405276 FrameElem=42-1 ElemStation=0,05
Frame=42 Station=0,1 OutputCase=STR005 CaseType=Combination P=-38,7886160576245 V2=87,0816279239595 V3=0 T=0 M2=0 M3=-6,22540379025073 FrameElem=42-1 ElemStation=0,1
Frame=42 Station=0 OutputCase=STR006 CaseType=Combination P=-23,5889462774014 V2=24,3266814956885 V3=0 T=0 M2=0 M3=19,3447833367771 FrameElem=42-1 ElemStation=0
Frame=42 Station=0,05 OutputCase=STR006 CaseType=Combination P=-23,5889462774014 V2=24,5266814956885 V3=0 T=0 M2=0 M3=18,1234492619926 FrameElem=42-1 ElemStation=0,05
Frame=42 Station=0,1 OutputCase=STR006 CaseType=Combination P=-23,5889462774014 V2=24,7266814956885 V3=0 T=0 M2=0 M3=16,8921151872082 FrameElem=42-1 ElemStation=0,1
Frame=42 Station=0 OutputCase=STR007 CaseType=Combination P=-39,8877217223728 V2=11,6356021154759 V3=0 T=0 M2=0 M3=5,19241080634588 FrameElem=42-1 ElemStation=0
Frame=42 Station=0,05 OutputCase=STR007 CaseType=Combination P=-39,8877217223728 V2=11,8356021154759 V3=0 T=0 M2=0 M3=4,60563070057208 FrameElem=42-1 ElemStation=0,05
Frame=42 Station=0,1 OutputCase=STR007 CaseType=Combination P=-39,8877217223728 V2=12,0356021154759 V3=0 T=0 M2=0 M3=4,00885059479829 FrameElem=42-1 ElemStation=0,1
Frame=42 Station=0 OutputCase=STR008 CaseType=Combination P=-19,70865661659 V2=88,444738859234 V3=0 T=0 M2=0 M3=28,7535041043885 FrameElem=42-1 ElemStation=0
Frame=42 Station=0,05 OutputCase=STR008 CaseType=Combination P=-19,70865661659 V2=88,714738859234 V3=0 T=0 M2=0 M3=24,3245171614268 FrameElem=42-1 ElemStation=0,05
Frame=42 Station=0,1 OutputCase=STR008 CaseType=Combination P=-19,70865661659 V2=88,984738859234 V3=0 T=0 M2=0 M3=19,8820302184651 FrameElem=42-1 ElemStation=0,1
Frame=42 Station=0 OutputCase=STR009 CaseType=Combination P=-14,3235017258745 V2=15,6844299411652 V3=0 T=0 M2=0 M3=0,674564383625649 FrameElem=42-1 ElemStation=0
Frame=42 Station=0,05 OutputCase=STR009 CaseType=Combination P=-14,3235017258745 V2=15,9544299411652 V3=0 T=0 M2=0 M3=-0,116407113432608 FrameElem=42-1 ElemStation=0,05
Frame=42 Station=0,1 OutputCase=STR009 CaseType=Combination P=-14,3235017258745 V2=16,2244299411652 V3=0 T=0 M2=0 M3=-0,920878610490866 FrameElem=42-1 ElemStation=0,1
Frame=42 Station=0 OutputCase=STR010 CaseType=Combination P=-6,56779385647513 V2=15,6809244450403 V3=0 T=0 M2=0 M3=-0,265141299248988 FrameElem=42-1 ElemStation=0
Frame=42 Station=0,05 OutputCase=STR010 CaseType=Combination P=-6,56779385647513 V2=15,9509244450403 V3=0 T=0 M2=0 M3=-1,055937521501 FrameElem=42-1 ElemStation=0,05
Frame=42 Station=0,1 OutputCase=STR010 CaseType=Combination P=-6,56779385647513 V2=16,2209244450403 V3=0 T=0 M2=0 M3=-1,86023374375302 FrameElem=42-1 ElemStation=0,1
Frame=42 Station=0 OutputCase=STR011 CaseType=Combination P=-5,63939106240326 V2=86,5227145955941 V3=0 T=0 M2=0 M3=-2,61426869112747 FrameElem=42-1 ElemStation=0
Frame=42 Station=0,05 OutputCase=STR011 CaseType=Combination P=-5,63939106240326 V2=86,792714595594 V3=0 T=0 M2=0 M3=-6,94715442090717 FrameElem=42-1 ElemStation=0,05
Frame=42 Station=0,1 OutputCase=STR011 CaseType=Combination P=-5,63939106240326 V2=87,062714595594 V3=0 T=0 M2=0 M3=-11,2935401506869 FrameElem=42-1 ElemStation=0,1
Frame=42 Station=0 OutputCase=STR012 CaseType=Combination P=-21,9381665094236 V2=99,2309994419417 V3=0 T=0 M2=0 M3=16,1503110619755 FrameElem=42-1 ElemStation=0
Frame=42 Station=0,05 OutputCase=STR012 CaseType=Combination P=-21,9381665094236 V2=99,5009994419417 V3=0 T=0 M2=0 M3=11,1820110898784 FrameElem=42-1 ElemStation=0,05
Frame=42 Station=0,1 OutputCase=STR012 CaseType=Combination P=-21,9381665094236 V2=99,7709994419417 V3=0 T=0 M2=0 M3=6,20021111778131 FrameElem=42-1 ElemStation=0,1
Frame=42 Station=0 OutputCase=STR013 CaseType=Combination P=-38,236941954395 V2=86,5399200617291 V3=0 T=0 M2=0 M3=1,99793853154429 FrameElem=42-1 ElemStation=0
Frame=42 Station=0,05 OutputCase=STR013 CaseType=Combination P=-38,236941954395 V2=86,8099200617291 V3=0 T=0 M2=0 M3=-2,33580747154217 FrameElem=42-1 ElemStation=0,05
Frame=42 Station=0,1 OutputCase=STR013 CaseType=Combination P=-38,236941954395 V2=87,0799200617291 V3=0 T=0 M2=0 M3=-6,68305347462862 FrameElem=42-1 ElemStation=0,1
Frame=42 Station=0 OutputCase=STR014 CaseType=Combination P=-23,0372721741718 V2=24,3249736334582 V3=0 T=0 M2=0 M3=18,8869628661761 FrameElem=42-1 ElemStation=0
Frame=42 Station=0,05 OutputCase=STR014 CaseType=Combination P=-23,0372721741718 V2=24,5249736334582 V3=0 T=0 M2=0 M3=17,6657141845032 FrameElem=42-1 ElemStation=0,05
Frame=42 Station=0,1 OutputCase=STR014 CaseType=Combination P=-23,0372721741718 V2=24,7249736334582 V3=0 T=0 M2=0 M3=16,4344655028303 FrameElem=42-1 ElemStation=0,1
Frame=42 Station=0 OutputCase=STR015 CaseType=Combination P=-39,3360476191432 V2=11,6338942532456 V3=0 T=0 M2=0 M3=4,73459033574496 FrameElem=42-1 ElemStation=0
Frame=42 Station=0,05 OutputCase=STR015 CaseType=Combination P=-39,3360476191432 V2=11,8338942532456 V3=0 T=0 M2=0 M3=4,14789562308268 FrameElem=42-1 ElemStation=0,05
Frame=42 Station=0,1 OutputCase=STR015 CaseType=Combination P=-39,3360476191432 V2=12,0338942532456 V3=0 T=0 M2=0 M3=3,5512009104204 FrameElem=42-1 ElemStation=0,1
Frame=42 Station=0 OutputCase=STR016 CaseType=Combination P=-19,1569825133604 V2=88,4430309970036 V3=0 T=0 M2=0 M3=28,2956836337876 FrameElem=42-1 ElemStation=0
Frame=42 Station=0,05 OutputCase=STR016 CaseType=Combination P=-19,1569825133604 V2=88,7130309970036 V3=0 T=0 M2=0 M3=23,8667820839374 FrameElem=42-1 ElemStation=0,05
Frame=42 Station=0,1 OutputCase=STR016 CaseType=Combination P=-19,1569825133604 V2=88,9830309970036 V3=0 T=0 M2=0 M3=19,4243805340872 FrameElem=42-1 ElemStation=0,1
Frame=42 Station=0 OutputCase=STR017 CaseType=Combination P=-5,59565470930646 V2=68,8114131268404 V3=0 T=0 M2=0 M3=-2,25589707845831 FrameElem=42-1 ElemStation=0
Frame=42 Station=0,05 OutputCase=STR017 CaseType=Combination P=-5,59565470930646 V2=69,0814131268404 V3=0 T=0 M2=0 M3=-5,70321773480033 FrameElem=42-1 ElemStation=0,05
Frame=42 Station=0,1 OutputCase=STR017 CaseType=Combination P=-5,59565470930646 V2=69,3514131268404 V3=0 T=0 M2=0 M3=-9,16403839114236 FrameElem=42-1 ElemStation=0,1
Frame=42 Station=0 OutputCase=STR018 CaseType=Combination P=-18,7891997778741 V2=78,8727628652013 V3=0 T=0 M2=0 M3=12,5960317385391 FrameElem=42-1 ElemStation=0
Frame=42 Station=0,05 OutputCase=STR018 CaseType=Combination P=-18,7891997778741 V2=79,1427628652013 V3=0 T=0 M2=0 M3=8,64564359527907 FrameElem=42-1 ElemStation=0,05
Frame=42 Station=0,1 OutputCase=STR018 CaseType=Combination P=-18,7891997778741 V2=79,4127628652013 V3=0 T=0 M2=0 M3=4,68175545201901 FrameElem=42-1 ElemStation=0,1

APPROVATO SDP
Società di Progetto
Brebemi SpA



Doc. N.
60235-0000-A00.doc

CODIFICA DOCUMENTO
04RCDII10000000000300A00

REV.
00

FOGLIO
535 di 628

Frame=42 Station=0 OutputCase=STR019 CaseType=Combination P=-31,9827448456501 V2=68,8251936004729 V3=0 T=0 M2=0 M3=1,43818475926416	FrameElem=42-1
ElemStation=0	
Frame=42 Station=0,05 OutputCase=STR019 CaseType=Combination P=-31,9827448456501 V2=69,0951936004729 V3=0 T=0 M2=0 M3=-2,00982492075948	FrameElem=42-1
ElemStation=0,05	
Frame=42 Station=0,1 OutputCase=STR019 CaseType=Combination P=-31,9827448456501 V2=69,3651936004729 V3=0 T=0 M2=0 M3=-5,47133460078312	FrameElem=42-1
ElemStation=0,1	
Frame=42 Station=0 OutputCase=STR020 CaseType=Combination P=-19,5642590602328 V2=21,6768999506511 V3=0 T=0 M2=0 M3=14,6609982830034	FrameElem=42-1
ElemStation=0	
Frame=42 Station=0,05 OutputCase=STR020 CaseType=Combination P=-19,5642590602328 V2=21,8768999506511 V3=0 T=0 M2=0 M3=13,5802532854708	FrameElem=42-1
ElemStation=0,05	
Frame=42 Station=0,1 OutputCase=STR020 CaseType=Combination P=-19,5642590602328 V2=22,0768999506511 V3=0 T=0 M2=0 M3=12,4814082879382	FrameElem=42-1
ElemStation=0,1	
Frame=42 Station=0 OutputCase=STR021 CaseType=Combination P=-32,7578041280088 V2=11,6293306859228 V3=0 T=0 M2=0 M3=3,51125130372839	FrameElem=42-1
ElemStation=0	
Frame=42 Station=0,05 OutputCase=STR021 CaseType=Combination P=-32,7578041280088 V2=11,8293306859228 V3=0 T=0 M2=0 M3=2,92478476943225	FrameElem=42-1
ElemStation=0,05	
Frame=42 Station=0,1 OutputCase=STR021 CaseType=Combination P=-32,7578041280088 V2=12,0293306859228 V3=0 T=0 M2=0 M3=2,32831823513611	FrameElem=42-1
ElemStation=0,1	
Frame=42 Station=0 OutputCase=STR022 CaseType=Combination P=-14,5523733985811 V2=16,1424848274529 V3=0 T=0 M2=0 M3=1,03422077297422	FrameElem=42-1
ElemStation=0	
Frame=42 Station=0,05 OutputCase=STR022 CaseType=Combination P=-14,5523733985811 V2=16,4124848274529 V3=0 T=0 M2=0 M3=0,220346531601574	FrameElem=42-1
ElemStation=0,05	
Frame=42 Station=0,1 OutputCase=STR022 CaseType=Combination P=-14,5523733985811 V2=16,6824848274529 V3=0 T=0 M2=0 M3=-0,607027709771068	FrameElem=42-1
ElemStation=0,1	
Frame=42 Station=0 OutputCase=STR023 CaseType=Combination P=-6,79666552918175 V2=16,138979331328 V3=0 T=0 M2=0 M3=9,45150900995799E-02	FrameElem=42-1
ElemStation=0	
Frame=42 Station=0,05 OutputCase=STR023 CaseType=Combination P=-6,79666552918175 V2=16,408979331328 V3=0 T=0 M2=0 M3=-0,719183876466821	FrameElem=42-1
ElemStation=0,05	
Frame=42 Station=0,1 OutputCase=STR023 CaseType=Combination P=-6,79666552918175 V2=16,678979331328 V3=0 T=0 M2=0 M3=-1,54638284303322	FrameElem=42-1
ElemStation=0,1	
Frame=42 Station=0 OutputCase=STR024 CaseType=Combination P=-5,82452638201308 V2=69,2694680131281 V3=0 T=0 M2=0 M3=-1,89624068910975	FrameElem=42-1
ElemStation=0	
Frame=42 Station=0,05 OutputCase=STR024 CaseType=Combination P=-5,82452638201308 V2=69,5394680131281 V3=0 T=0 M2=0 M3=-5,36646408976615	FrameElem=42-1
ElemStation=0,05	
Frame=42 Station=0,1 OutputCase=STR024 CaseType=Combination P=-5,82452638201308 V2=69,8094680131281 V3=0 T=0 M2=0 M3=-8,85018749042256	FrameElem=42-1
ElemStation=0,1	
Frame=42 Station=0 OutputCase=STR025 CaseType=Combination P=-19,0180714505807 V2=79,330817751489 V3=0 T=0 M2=0 M3=12,9556881278877	FrameElem=42-1
ElemStation=0	
Frame=42 Station=0,05 OutputCase=STR025 CaseType=Combination P=-19,0180714505807 V2=79,600817751489 V3=0 T=0 M2=0 M3=8,98239724031326	FrameElem=42-1
ElemStation=0,05	
Frame=42 Station=0,1 OutputCase=STR025 CaseType=Combination P=-19,0180714505807 V2=79,870817751489 V3=0 T=0 M2=0 M3=4,99560635273881	FrameElem=42-1
ElemStation=0,1	
Frame=42 Station=0 OutputCase=STR026 CaseType=Combination P=-32,2116165183567 V2=69,2832484867606 V3=0 T=0 M2=0 M3=1,79784114861273	FrameElem=42-1
ElemStation=0	
Frame=42 Station=0,05 OutputCase=STR026 CaseType=Combination P=-32,2116165183567 V2=69,5532484867606 V3=0 T=0 M2=0 M3=-1,6730712757253	FrameElem=42-1
ElemStation=0,05	
Frame=42 Station=0,1 OutputCase=STR026 CaseType=Combination P=-32,2116165183567 V2=69,8232484867606 V3=0 T=0 M2=0 M3=-5,15748370006333	FrameElem=42-1
ElemStation=0,1	
Frame=42 Station=0 OutputCase=STR027 CaseType=Combination P=-19,7931307329394 V2=22,1349548369388 V3=0 T=0 M2=0 M3=15,0287546723519	FrameElem=42-1
ElemStation=0	
Frame=42 Station=0,05 OutputCase=STR027 CaseType=Combination P=-19,7931307329394 V2=22,3349548369388 V3=0 T=0 M2=0 M3=13,917006930505	FrameElem=42-1
ElemStation=0,05	
Frame=42 Station=0,1 OutputCase=STR027 CaseType=Combination P=-19,7931307329394 V2=22,5349548369389 V3=0 T=0 M2=0 M3=12,795259188658	FrameElem=42-1
ElemStation=0,1	
Frame=42 Station=0 OutputCase=STR028 CaseType=Combination P=-32,9866758007154 V2=12,0873855722105 V3=0 T=0 M2=0 M3=3,87090769307696	FrameElem=42-1
ElemStation=0	
Frame=42 Station=0,05 OutputCase=STR028 CaseType=Combination P=-32,9866758007154 V2=12,2873855722105 V3=0 T=0 M2=0 M3=3,26153841446643	FrameElem=42-1
ElemStation=0,05	
Frame=42 Station=0,1 OutputCase=STR028 CaseType=Combination P=-32,9866758007154 V2=12,4873855722105 V3=0 T=0 M2=0 M3=2,64216913585591	FrameElem=42-1
ElemStation=0,1	
Frame=42 Station=0 OutputCase=STR029 CaseType=Combination P=-14,0946300531679 V2=15,2263750548775 V3=0 T=0 M2=0 M3=0,314907994277081	FrameElem=42-1
ElemStation=0	
Frame=42 Station=0,05 OutputCase=STR029 CaseType=Combination P=-14,0946300531679 V2=15,4963750548775 V3=0 T=0 M2=0 M3=-0,453160758466791	FrameElem=42-1
ElemStation=0,05	
Frame=42 Station=0,1 OutputCase=STR029 CaseType=Combination P=-14,0946300531679 V2=15,7663750548775 V3=0 T=0 M2=0 M3=-1,23472951121066	FrameElem=42-1
ElemStation=0,1	
Frame=42 Station=0 OutputCase=STR030 CaseType=Combination P=-6,33892218376851 V2=15,2228695587526 V3=0 T=0 M2=0 M3=-0,624797688597555	FrameElem=42-1
ElemStation=0	
Frame=42 Station=0,05 OutputCase=STR030 CaseType=Combination P=-6,33892218376851 V2=15,4928695587526 V3=0 T=0 M2=0 M3=-1,39269116653519	FrameElem=42-1
ElemStation=0,05	
Frame=42 Station=0,1 OutputCase=STR030 CaseType=Combination P=-6,33892218376851 V2=15,7628695587526 V3=0 T=0 M2=0 M3=-2,17408464447282	FrameElem=42-1
ElemStation=0,1	
Frame=42 Station=0 OutputCase=STR031 CaseType=Combination P=-5,36678303659984 V2=68,3533582405527 V3=0 T=0 M2=0 M3=-2,61555346780688	FrameElem=42-1
ElemStation=0	
Frame=42 Station=0,05 OutputCase=STR031 CaseType=Combination P=-5,36678303659984 V2=68,6233582405527 V3=0 T=0 M2=0 M3=-6,03997137983452	FrameElem=42-1
ElemStation=0,05	
Frame=42 Station=0,1 OutputCase=STR031 CaseType=Combination P=-5,36678303659984 V2=68,8933582405527 V3=0 T=0 M2=0 M3=-9,47788929186215	FrameElem=42-1
ElemStation=0,1	
Frame=42 Station=0 OutputCase=STR032 CaseType=Combination P=-18,5603281051675 V2=78,4147079789136 V3=0 T=0 M2=0 M3=12,2363753491906	FrameElem=42-1
ElemStation=0	
Frame=42 Station=0,05 OutputCase=STR032 CaseType=Combination P=-18,5603281051675 V2=78,6847079789136 V3=0 T=0 M2=0 M3=8,30888995024489	FrameElem=42-1
ElemStation=0,05	
Frame=42 Station=0,1 OutputCase=STR032 CaseType=Combination P=-18,5603281051675 V2=78,9547079789136 V3=0 T=0 M2=0 M3=4,36790455129921	FrameElem=42-1
ElemStation=0,1	
Frame=42 Station=0 OutputCase=STR033 CaseType=Combination P=-31,7538731729435 V2=68,3671387141852 V3=0 T=0 M2=0 M3=1,0785283699156	FrameElem=42-1
ElemStation=0	
Frame=42 Station=0,05 OutputCase=STR033 CaseType=Combination P=-31,7538731729435 V2=68,6371387141852 V3=0 T=0 M2=0 M3=-2,34657856579366	FrameElem=42-1
ElemStation=0,05	

Società di Progetto
Brebemi SpA

	Doc. N. 60235-00000-A00.doc	CODIFICA DOCUMENTO 04RCDII10000000000300A00	REV. 00	FOGLIO 536 di 628
--	--------------------------------	--	------------	----------------------

Frame=42 Station=0,1 OutputCase=STR033 CaseType=Combination P=-31,7538731729435 V2=68,9071387141852 V3=0 T=0 M2=0 M3=-5,78518550150292 ElemStation=0,1	FrameElem=42-1
Frame=42 Station=0 OutputCase=STR034 CaseType=Combination P=-19,3353873875262 V2=21,2188450643634 V3=0 T=0 M2=0 M3=14,3094418936548 ElemStation=0	FrameElem=42-1
Frame=42 Station=0,05 OutputCase=STR034 CaseType=Combination P=-19,3353873875262 V2=21,4188450643634 V3=0 T=0 M2=0 M3=13,2434996404366 ElemStation=0,05	FrameElem=42-1
Frame=42 Station=0,1 OutputCase=STR034 CaseType=Combination P=-19,3353873875262 V2=21,6188450643634 V3=0 T=0 M2=0 M3=12,1675573872184 ElemStation=0,1	FrameElem=42-1
Frame=42 Station=0 OutputCase=STR035 CaseType=Combination P=-32,5289324553022 V2=11,1712757996351 V3=0 T=0 M2=0 M3=3,15159491437982 ElemStation=0	FrameElem=42-1
Frame=42 Station=0,05 OutputCase=STR035 CaseType=Combination P=-32,5289324553022 V2=11,3712757996351 V3=0 T=0 M2=0 M3=2,58803112439807 ElemStation=0,05	FrameElem=42-1
Frame=42 Station=0,1 OutputCase=STR035 CaseType=Combination P=-32,5289324553022 V2=11,5712757996351 V3=0 T=0 M2=0 M3=2,01446733441632 ElemStation=0,1	FrameElem=42-1
Frame=42 Station=0 OutputCase=STR036 CaseType=Combination P=-14,875175829104 V2=15,6861378033955 V3=0 T=0 M2=0 M3=1,13238485422658 ElemStation=0	FrameElem=42-1
Frame=42 Station=0,05 OutputCase=STR036 CaseType=Combination P=-14,875175829104 V2=15,9561378033955 V3=0 T=0 M2=0 M3=0,3413279640568 ElemStation=0,05	FrameElem=42-1
Frame=42 Station=0,1 OutputCase=STR036 CaseType=Combination P=-14,875175829104 V2=16,2261378033955 V3=0 T=0 M2=0 M3=-0,463228926112975 ElemStation=0,1	FrameElem=42-1
Frame=42 Station=0 OutputCase=STR037 CaseType=Combination P=-7,11946795970466 V2=15,6826323072707 V3=0 T=0 M2=0 M3=0,192679171351939 ElemStation=0	FrameElem=42-1
Frame=42 Station=0,05 OutputCase=STR037 CaseType=Combination P=-7,11946795970466 V2=15,9526323072707 V3=0 T=0 M2=0 M3=0,598202444011595 ElemStation=0,05	FrameElem=42-1
Frame=42 Station=0,1 OutputCase=STR037 CaseType=Combination P=-7,11946795970466 V2=16,22626323072707 V3=0 T=0 M2=0 M3=-1,40258405937513 ElemStation=0,1	FrameElem=42-1
Frame=42 Station=0 OutputCase=STR038 CaseType=Combination P=-6,14732881253599 V2=68,8131209890708 V3=0 T=0 M2=0 M3=-1,79807660785739 ElemStation=0	FrameElem=42-1
Frame=42 Station=0,05 OutputCase=STR038 CaseType=Combination P=-6,14732881253599 V2=69,0831209890708 V3=0 T=0 M2=0 M3=-5,24548265731093 ElemStation=0,05	FrameElem=42-1
Frame=42 Station=0,1 OutputCase=STR038 CaseType=Combination P=-6,14732881253599 V2=69,3531209890708 V3=0 T=0 M2=0 M3=-8,70638870676446 ElemStation=0,1	FrameElem=42-1
Frame=42 Station=0 OutputCase=STR039 CaseType=Combination P=-19,3408738811036 V2=78,8744707274317 V3=0 T=0 M2=0 M3=13,0538522091401 ElemStation=0	FrameElem=42-1
Frame=42 Station=0,05 OutputCase=STR039 CaseType=Combination P=-19,3408738811036 V2=79,1444707274317 V3=0 T=0 M2=0 M3=9,10337862726848 ElemStation=0,05	FrameElem=42-1
Frame=42 Station=0,1 OutputCase=STR039 CaseType=Combination P=-19,3408738811036 V2=79,4144707274317 V3=0 T=0 M2=0 M3=5,1394051363969 ElemStation=0,1	FrameElem=42-1
Frame=42 Station=0 OutputCase=STR040 CaseType=Combination P=-32,5344189488796 V2=68,8269014627033 V3=0 T=0 M2=0 M3=1,89600522986509 ElemStation=0	FrameElem=42-1
Frame=42 Station=0,05 OutputCase=STR040 CaseType=Combination P=-32,5344189488796 V2=69,0969014627033 V3=0 T=0 M2=0 M3=-1,55208984327007 ElemStation=0,05	FrameElem=42-1
Frame=42 Station=0,1 OutputCase=STR040 CaseType=Combination P=-32,5344189488796 V2=69,3669014627033 V3=0 T=0 M2=0 M3=-5,01368491640523 ElemStation=0,1	FrameElem=42-1
Frame=42 Station=0 OutputCase=STR041 CaseType=Combination P=-20,1159331634623 V2=21,6786078128815 V3=0 T=0 M2=0 M3=15,1269187536043 ElemStation=0	FrameElem=42-1
Frame=42 Station=0,05 OutputCase=STR041 CaseType=Combination P=-20,1159331634623 V2=21,8786078128815 V3=0 T=0 M2=0 M3=14,0379883629602 ElemStation=0,05	FrameElem=42-1
Frame=42 Station=0,1 OutputCase=STR041 CaseType=Combination P=-20,1159331634623 V2=22,0786078128815 V3=0 T=0 M2=0 M3=12,9390579723161 ElemStation=0,1	FrameElem=42-1
Frame=42 Station=0 OutputCase=STR042 CaseType=Combination P=-33,3094782312383 V2=11,6310385481531 V3=0 T=0 M2=0 M3=3,96907177432931 ElemStation=0	FrameElem=42-1
Frame=42 Station=0,05 OutputCase=STR042 CaseType=Combination P=-33,3094782312383 V2=11,8310385481531 V3=0 T=0 M2=0 M3=3,38251984692166 ElemStation=0,05	FrameElem=42-1
Frame=42 Station=0,1 OutputCase=STR042 CaseType=Combination P=-33,3094782312383 V2=12,0310385481531 V3=0 T=0 M2=0 M3=2,785967919514 ElemStation=0,1	FrameElem=42-1
Frame=42 Station=0 OutputCase=STR043 CaseType=Combination P=-16,1624154033063 V2=15,6901228152664 V3=0 T=0 M2=0 M3=2,20063261896207 ElemStation=0	FrameElem=42-1
Frame=42 Station=0,05 OutputCase=STR043 CaseType=Combination P=-16,1624154033063 V2=15,9601228152664 V3=0 T=0 M2=0 M3=1,40937647819875 ElemStation=0,05	FrameElem=42-1
Frame=42 Station=0,1 OutputCase=STR043 CaseType=Combination P=-16,1624154033063 V2=16,2301228152664 V3=0 T=0 M2=0 M3=0,604620337435435 ElemStation=0,1	FrameElem=42-1
Frame=42 Station=0 OutputCase=STR044 CaseType=Combination P=-8,40670753390691 V2=15,6866173191415 V3=0 T=0 M2=0 M3=1,26092693608743 ElemStation=0	FrameElem=42-1
Frame=42 Station=0,05 OutputCase=STR044 CaseType=Combination P=-8,40670753390691 V2=15,9566173191415 V3=0 T=0 M2=0 M3=0,469846070130358 ElemStation=0,05	FrameElem=42-1
Frame=42 Station=0,1 OutputCase=STR044 CaseType=Combination P=-8,40670753390691 V2=16,2266173191415 V3=0 T=0 M2=0 M3=-0,334734795826717 ElemStation=0,1	FrameElem=42-1
Frame=42 Station=0 OutputCase=STR045 CaseType=Combination P=-6,74273926886233 V2=86,5261303200548 V3=0 T=0 M2=0 M3=-1,69862774992562 ElemStation=0	FrameElem=42-1
Frame=42 Station=0,05 OutputCase=STR045 CaseType=Combination P=-6,74273926886233 V2=86,7961303200548 V3=0 T=0 M2=0 M3=-6,03168426592836 ElemStation=0,05	FrameElem=42-1
Frame=42 Station=0,1 OutputCase=STR045 CaseType=Combination P=-6,74273926886233 V2=87,0661303200548 V3=0 T=0 M2=0 M3=-10,3782407819311 ElemStation=0,1	FrameElem=42-1
Frame=42 Station=0 OutputCase=STR046 CaseType=Combination P=-23,0415147158826 V2=99,2344151664024 V3=0 T=0 M2=0 M3=17,0659520031773 ElemStation=0	FrameElem=42-1
Frame=42 Station=0,05 OutputCase=STR046 CaseType=Combination P=-23,0415147158826 V2=99,5044151664024 V3=0 T=0 M2=0 M3=12,0974812448572 ElemStation=0,05	FrameElem=42-1
Frame=42 Station=0,1 OutputCase=STR046 CaseType=Combination P=-23,0415147158826 V2=99,7744151664024 V3=0 T=0 M2=0 M3=7,11551048653709 ElemStation=0,1	FrameElem=42-1
Frame=42 Station=0 OutputCase=STR047 CaseType=Combination P=-39,340290160854 V2=86,5433357861898 V3=0 T=0 M2=0 M3=2,91357947274614 ElemStation=0	FrameElem=42-1
Frame=42 Station=0,05 OutputCase=STR047 CaseType=Combination P=-39,340290160854 V2=86,8133357861898 V3=0 T=0 M2=0 M3=-1,42033731656335 ElemStation=0,05	FrameElem=42-1
Frame=42 Station=0,1 OutputCase=STR047 CaseType=Combination P=-39,340290160854 V2=87,0833357861898 V3=0 T=0 M2=0 M3=-5,76775410587284 ElemStation=0,1	FrameElem=42-1
Frame=42 Station=0 OutputCase=STR048 CaseType=Combination P=-24,1406203806309 V2=24,3283893579189 V3=0 T=0 M2=0 M3=19,802603807378 ElemStation=0	FrameElem=42-1

Società di Progetto
Brebemi SpA



	Doc. N. 60235-00000-A00.doc	CODIFICA DOCUMENTO 04RCDII10000000000300A00	REV. 00	FOGLIO 537 di 628
--	--------------------------------	--	------------	----------------------

Frame=42 Station=0,05 OutputCase=STR048 CaseType=Combination P=-24,1406203806309 V2=24,5283893579189 V3=0 T=0 M2=0 M3=18,5811843394821	FrameElem=42-1 ElemStation=0,05
Frame=42 Station=0,1 OutputCase=STR048 CaseType=Combination P=-24,1406203806309 V2=24,7283893579189 V3=0 T=0 M2=0 M3=17,3497648715861	FrameElem=42-1 ElemStation=0,1
Frame=42 Station=0 OutputCase=STR049 CaseType=Combination P=-40,4393958256023 V2=11,6373099777063 V3=0 T=0 M2=0 M3=5,65023127694681	FrameElem=42-1 ElemStation=0
Frame=42 Station=0,05 OutputCase=STR049 CaseType=Combination P=-40,4393958256023 V2=11,8373099777063 V3=0 T=0 M2=0 M3=5,06336577806149	FrameElem=42-1 ElemStation=0,05
Frame=42 Station=0,1 OutputCase=STR049 CaseType=Combination P=-40,4393958256023 V2=12,0373099777063 V3=0 T=0 M2=0 M3=4,46650027917618	FrameElem=42-1 ElemStation=0,1
Frame=42 Station=0 OutputCase=STR050 CaseType=Combination P=-20,2603307198195 V2=88,4464467214643 V3=0 T=0 M2=0 M3=29,2113245749895	FrameElem=42-1 ElemStation=0
Frame=42 Station=0,05 OutputCase=STR050 CaseType=Combination P=-20,2603307198195 V2=88,7164467214644 V3=0 T=0 M2=0 M3=24,7822522389162	FrameElem=42-1 ElemStation=0,05
Frame=42 Station=0,1 OutputCase=STR050 CaseType=Combination P=-20,2603307198195 V2=88,9864467214643 V3=0 T=0 M2=0 M3=20,339679902843	FrameElem=42-1 ElemStation=0,1
Frame=42 Station=0 OutputCase=STR051 CaseType=Combination P=-7,43456838673824 V2=68,8171060009416 V3=0 T=0 M2=0 M3=-0,729828843121892	FrameElem=42-1 ElemStation=0
Frame=42 Station=0,05 OutputCase=STR051 CaseType=Combination P=-7,43456838673824 V2=69,0871060009416 V3=0 T=0 M2=0 M3=-4,17743414316897	FrameElem=42-1 ElemStation=0,05
Frame=42 Station=0,1 OutputCase=STR051 CaseType=Combination P=-7,43456838673824 V2=69,3571060009416 V3=0 T=0 M2=0 M3=-7,63853944321605	FrameElem=42-1 ElemStation=0,1
Frame=42 Station=0 OutputCase=STR052 CaseType=Combination P=-20,6281134553059 V2=78,8784557393025 V3=0 T=0 M2=0 M3=14,1220999738756	FrameElem=42-1 ElemStation=0
Frame=42 Station=0,05 OutputCase=STR052 CaseType=Combination P=-20,6281134553059 V2=79,1484557393025 V3=0 T=0 M2=0 M3=10,1714271869104	FrameElem=42-1 ElemStation=0,05
Frame=42 Station=0,1 OutputCase=STR052 CaseType=Combination P=-20,6281134553059 V2=79,4184557393025 V3=0 T=0 M2=0 M3=6,20725439994531	FrameElem=42-1 ElemStation=0,1
Frame=42 Station=0 OutputCase=STR053 CaseType=Combination P=-33,8216585230819 V2=68,8308864745741 V3=0 T=0 M2=0 M3=2,96425299460059	FrameElem=42-1 ElemStation=0
Frame=42 Station=0,05 OutputCase=STR053 CaseType=Combination P=-33,8216585230819 V2=69,1008864745741 V3=0 T=0 M2=0 M3=-0,484041329128119	FrameElem=42-1 ElemStation=0,05
Frame=42 Station=0,1 OutputCase=STR053 CaseType=Combination P=-33,8216585230819 V2=69,3708864745741 V3=0 T=0 M2=0 M3=-3,94583565285682	FrameElem=42-1 ElemStation=0,1
Frame=42 Station=0 OutputCase=STR054 CaseType=Combination P=-21,4031727376646 V2=21,6825928247523 V3=0 T=0 M2=0 M3=16,1951665183398	FrameElem=42-1 ElemStation=0
Frame=42 Station=0,05 OutputCase=STR054 CaseType=Combination P=-21,4031727376646 V2=21,8825928247523 V3=0 T=0 M2=0 M3=15,1060368771022	FrameElem=42-1 ElemStation=0,05
Frame=42 Station=0,1 OutputCase=STR054 CaseType=Combination P=-21,4031727376646 V2=22,0825928247523 V3=0 T=0 M2=0 M3=14,0069072358645	FrameElem=42-1 ElemStation=0,1
Frame=42 Station=0 OutputCase=STR055 CaseType=Combination P=-34,5967178054406 V2=11,635023560024 V3=0 T=0 M2=0 M3=5,03731953906481	FrameElem=42-1 ElemStation=0
Frame=42 Station=0,05 OutputCase=STR055 CaseType=Combination P=-34,5967178054406 V2=11,835023560024 V3=0 T=0 M2=0 M3=4,45056836106361	FrameElem=42-1 ElemStation=0,05
Frame=42 Station=0,1 OutputCase=STR055 CaseType=Combination P=-34,5967178054406 V2=12,035023560024 V3=0 T=0 M2=0 M3=3,85381718306241	FrameElem=42-1 ElemStation=0,1
Frame=42 Station=0 OutputCase=STR056 CaseType=Combination P=-16,3912870760129 V2=16,1481777015541 V3=0 T=0 M2=0 M3=2,56028900831064	FrameElem=42-1 ElemStation=0
Frame=42 Station=0,05 OutputCase=STR056 CaseType=Combination P=-16,3912870760129 V2=16,4181777015541 V3=0 T=0 M2=0 M3=1,74613012323294	FrameElem=42-1 ElemStation=0,05
Frame=42 Station=0,1 OutputCase=STR056 CaseType=Combination P=-16,3912870760129 V2=16,6881777015541 V3=0 T=0 M2=0 M3=0,918471238155233	FrameElem=42-1 ElemStation=0,1
Frame=42 Station=0 OutputCase=STR057 CaseType=Combination P=-8,63557920661353 V2=16,1446722054292 V3=0 T=0 M2=0 M3=1,620583325436	FrameElem=42-1 ElemStation=0
Frame=42 Station=0,05 OutputCase=STR057 CaseType=Combination P=-8,63557920661353 V2=16,4146722054292 V3=0 T=0 M2=0 M3=0,806599715164541	FrameElem=42-1 ElemStation=0,05
Frame=42 Station=0,1 OutputCase=STR057 CaseType=Combination P=-8,63557920661353 V2=16,6846722054292 V3=0 T=0 M2=0 M3=-2,08838951069195E-02	FrameElem=42-1 ElemStation=0,1
Frame=42 Station=0 OutputCase=STR058 CaseType=Combination P=-7,66344005944486 V2=69,2751608872293 V3=0 T=0 M2=0 M3=-0,370172453773325	FrameElem=42-1 ElemStation=0
Frame=42 Station=0,05 OutputCase=STR058 CaseType=Combination P=-7,66344005944486 V2=69,5451608872293 V3=0 T=0 M2=0 M3=-3,84068049813479	FrameElem=42-1 ElemStation=0,05
Frame=42 Station=0,1 OutputCase=STR058 CaseType=Combination P=-7,66344005944486 V2=69,8151608872293 V3=0 T=0 M2=0 M3=-7,32468854249626	FrameElem=42-1 ElemStation=0,1
Frame=42 Station=0 OutputCase=STR059 CaseType=Combination P=-20,8569851280125 V2=79,3365106255902 V3=0 T=0 M2=0 M3=14,4817563632241	FrameElem=42-1 ElemStation=0
Frame=42 Station=0,05 OutputCase=STR059 CaseType=Combination P=-20,8569851280125 V2=79,6065106255902 V3=0 T=0 M2=0 M3=10,5081808319446	FrameElem=42-1 ElemStation=0,05
Frame=42 Station=0,1 OutputCase=STR059 CaseType=Combination P=-20,8569851280125 V2=79,8765106255902 V3=0 T=0 M2=0 M3=6,52110530066511	FrameElem=42-1 ElemStation=0,1
Frame=42 Station=0 OutputCase=STR060 CaseType=Combination P=-34,0505301957885 V2=69,2889413608618 V3=0 T=0 M2=0 M3=3,32390938394915	FrameElem=42-1 ElemStation=0
Frame=42 Station=0,05 OutputCase=STR060 CaseType=Combination P=-34,0505301957885 V2=69,5589413608618 V3=0 T=0 M2=0 M3=-0,147287684093937	FrameElem=42-1 ElemStation=0,05
Frame=42 Station=0,1 OutputCase=STR060 CaseType=Combination P=-34,0505301957885 V2=69,8289413608618 V3=0 T=0 M2=0 M3=-3,63198475213703	FrameElem=42-1 ElemStation=0,1
Frame=42 Station=0 OutputCase=STR061 CaseType=Combination P=-21,6320444103712 V2=22,14064771104 V3=0 T=0 M2=0 M3=16,5548229076884	FrameElem=42-1 ElemStation=0
Frame=42 Station=0,05 OutputCase=STR061 CaseType=Combination P=-21,6320444103712 V2=22,34064771104 V3=0 T=0 M2=0 M3=15,4427905221363	FrameElem=42-1 ElemStation=0,05
Frame=42 Station=0,1 OutputCase=STR061 CaseType=Combination P=-21,6320444103712 V2=22,5406477110401 V3=0 T=0 M2=0 M3=14,3207581365843	FrameElem=42-1 ElemStation=0,1
Frame=42 Station=0 OutputCase=STR062 CaseType=Combination P=-34,8255894781472 V2=12,0930784463117 V3=0 T=0 M2=0 M3=5,39697592841338	FrameElem=42-1 ElemStation=0
Frame=42 Station=0,05 OutputCase=STR062 CaseType=Combination P=-34,8255894781472 V2=12,2930784463117 V3=0 T=0 M2=0 M3=4,78732200609779	FrameElem=42-1 ElemStation=0,05
Frame=42 Station=0,1 OutputCase=STR062 CaseType=Combination P=-34,8255894781472 V2=12,4930784463117 V3=0 T=0 M2=0 M3=4,16766808378221	FrameElem=42-1 ElemStation=0,1

APPROVATO SDP

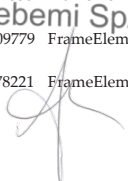
Società di Progetto
Brebemi SpA



	Doc. N. 60235-00000-A00.doc	CODIFICA DOCUMENTO 04RCDII10000000000300A00	REV. 00	FOGLIO 538 di 628
--	--------------------------------	--	------------	----------------------

Frame=42 Station=0 OutputCase=STR063 CaseType=Combination P=-15,9335437305996 V2=15,2320679289787 V3=0 T=0 M2=0 M3=1,8409762296135	FrameElem=42-1
ElemStation=0	
Frame=42 Station=0,05 OutputCase=STR063 CaseType=Combination P=-15,9335437305996 V2=15,5020679289787 V3=0 T=0 M2=0 M3=1,0726228316457	FrameElem=42-1
ElemStation=0,05	
Frame=42 Station=0,1 OutputCase=STR063 CaseType=Combination P=-15,9335437305996 V2=15,7720679289787 V3=0 T=0 M2=0 M3=0,290769436715638	FrameElem=42-1
ElemStation=0,1	
Frame=42 Station=0 OutputCase=STR064 CaseType=Combination P=-8,1778358612003 V2=15,2285624328538 V3=0 T=0 M2=0 M3=0,901270546738866	FrameElem=42-1
ElemStation=0	
Frame=42 Station=0,05 OutputCase=STR064 CaseType=Combination P=-8,1778358612003 V2=15,4985624328538 V3=0 T=0 M2=0 M3=0,133092425096176	FrameElem=42-1
ElemStation=0,05	
Frame=42 Station=0,1 OutputCase=STR064 CaseType=Combination P=-8,1778358612003 V2=15,7685624328538 V3=0 T=0 M2=0 M3=-0,648585696546514	FrameElem=42-1
ElemStation=0,1	
Frame=42 Station=0 OutputCase=STR065 CaseType=Combination P=-7,20569671403162 V2=68,3590511146539 V3=0 T=0 M2=0 M3=-1,08948523247046	FrameElem=42-1
ElemStation=0	
Frame=42 Station=0,05 OutputCase=STR065 CaseType=Combination P=-7,20569671403162 V2=68,6290511146539 V3=0 T=0 M2=0 M3=-4,51418778820315	FrameElem=42-1
ElemStation=0,05	
Frame=42 Station=0,1 OutputCase=STR065 CaseType=Combination P=-7,20569671403162 V2=68,8990511146539 V3=0 T=0 M2=0 M3=-7,95239034393585	FrameElem=42-1
ElemStation=0,1	
Frame=42 Station=0 OutputCase=STR066 CaseType=Combination P=-20,3992417825992 V2=78,4204008530148 V3=0 T=0 M2=0 M3=13,762443584527	FrameElem=42-1
ElemStation=0	
Frame=42 Station=0,05 OutputCase=STR066 CaseType=Combination P=-20,3992417825992 V2=78,6904008530148 V3=0 T=0 M2=0 M3=9,83467354187625	FrameElem=42-1
ElemStation=0,05	
Frame=42 Station=0,1 OutputCase=STR066 CaseType=Combination P=-20,3992417825992 V2=78,9604008530148 V3=0 T=0 M2=0 M3=5,89340349922551	FrameElem=42-1
ElemStation=0,1	
Frame=42 Station=0 OutputCase=STR067 CaseType=Combination P=-33,5927868503752 V2=68,3728315882864 V3=0 T=0 M2=0 M3=2,60459660525202	FrameElem=42-1
ElemStation=0	
Frame=42 Station=0,05 OutputCase=STR067 CaseType=Combination P=-33,5927868503752 V2=68,6428315882864 V3=0 T=0 M2=0 M3=-0,820794974162301	FrameElem=42-1
ElemStation=0,05	
Frame=42 Station=0,1 OutputCase=STR067 CaseType=Combination P=-33,5927868503752 V2=68,9128315882864 V3=0 T=0 M2=0 M3=-4,25968655357662	FrameElem=42-1
ElemStation=0,1	
Frame=42 Station=0 OutputCase=STR068 CaseType=Combination P=-21,1743010649579 V2=21,2245379384646 V3=0 T=0 M2=0 M3=15,8355101289912	FrameElem=42-1
ElemStation=0	
Frame=42 Station=0,05 OutputCase=STR068 CaseType=Combination P=-21,1743010649579 V2=21,4245379384646 V3=0 T=0 M2=0 M3=14,769283232068	FrameElem=42-1
ElemStation=0,05	
Frame=42 Station=0,1 OutputCase=STR068 CaseType=Combination P=-21,1743010649579 V2=21,6245379384646 V3=0 T=0 M2=0 M3=13,6930563351448	FrameElem=42-1
ElemStation=0,1	
Frame=42 Station=0 OutputCase=STR069 CaseType=Combination P=-34,3678461327339 V2=11,1769686737363 V3=0 T=0 M2=0 M3=4,67766314971624	FrameElem=42-1
ElemStation=0	
Frame=42 Station=0,05 OutputCase=STR069 CaseType=Combination P=-34,3678461327339 V2=11,3769686737363 V3=0 T=0 M2=0 M3=4,11381471602943	FrameElem=42-1
ElemStation=0,05	
Frame=42 Station=0,1 OutputCase=STR069 CaseType=Combination P=-34,3678461327339 V2=11,5769686737363 V3=0 T=0 M2=0 M3=3,53996628234262	FrameElem=42-1
ElemStation=0,1	
Frame=42 Station=0 OutputCase=STR070 CaseType=Combination P=-16,7140895065358 V2=15,6918306774967 V3=0 T=0 M2=0 M3=2,658453089563	FrameElem=42-1
ElemStation=0	
Frame=42 Station=0,05 OutputCase=STR070 CaseType=Combination P=-16,7140895065358 V2=15,9618306774967 V3=0 T=0 M2=0 M3=1,86711155568816	FrameElem=42-1
ElemStation=0,05	
Frame=42 Station=0,1 OutputCase=STR070 CaseType=Combination P=-16,7140895065358 V2=16,2318306774967 V3=0 T=0 M2=0 M3=1,06227002181333	FrameElem=42-1
ElemStation=0,1	
Frame=42 Station=0 OutputCase=STR071 CaseType=Combination P=-8,95838163713645 V2=15,6883251813719 V3=0 T=0 M2=0 M3=1,71874740668836	FrameElem=42-1
ElemStation=0	
Frame=42 Station=0,05 OutputCase=STR071 CaseType=Combination P=-8,95838163713645 V2=15,9583251813719 V3=0 T=0 M2=0 M3=0,927581147619767	FrameElem=42-1
ElemStation=0,05	
Frame=42 Station=0,1 OutputCase=STR071 CaseType=Combination P=-8,95838163713645 V2=16,2283251813719 V3=0 T=0 M2=0 M3=0,122914888551174	FrameElem=42-1
ElemStation=0,1	
Frame=42 Station=0 OutputCase=STR072 CaseType=Combination P=-7,98624248996778 V2=68,818813863172 V3=0 T=0 M2=0 M3=-0,272008372520966	FrameElem=42-1
ElemStation=0	
Frame=42 Station=0,05 OutputCase=STR072 CaseType=Combination P=-7,98624248996778 V2=69,088813863172 V3=0 T=0 M2=0 M3=-3,71969906567956	FrameElem=42-1
ElemStation=0,05	
Frame=42 Station=0,1 OutputCase=STR072 CaseType=Combination P=-7,98624248996778 V2=69,358813863172 V3=0 T=0 M2=0 M3=-7,18088975883816	FrameElem=42-1
ElemStation=0,1	
Frame=42 Station=0 OutputCase=STR073 CaseType=Combination P=-21,1797875585354 V2=78,8801636015329 V3=0 T=0 M2=0 M3=14,5799204444765	FrameElem=42-1
ElemStation=0	
Frame=42 Station=0,05 OutputCase=STR073 CaseType=Combination P=-21,1797875585354 V2=79,1501636015329 V3=0 T=0 M2=0 M3=10,6291622643998	FrameElem=42-1
ElemStation=0,05	
Frame=42 Station=0,1 OutputCase=STR073 CaseType=Combination P=-21,1797875585354 V2=79,4201636015329 V3=0 T=0 M2=0 M3=6,6649040843232	FrameElem=42-1
ElemStation=0,1	
Frame=42 Station=0 OutputCase=STR074 CaseType=Combination P=-34,3733326263114 V2=68,8325943368045 V3=0 T=0 M2=0 M3=3,42207346520151	FrameElem=42-1
ElemStation=0	
Frame=42 Station=0,05 OutputCase=STR074 CaseType=Combination P=-34,3733326263114 V2=69,1025943368045 V3=0 T=0 M2=0 M3=-2,63062516387108E-02	FrameElem=42-1
ElemStation=0,05	
Frame=42 Station=0,1 OutputCase=STR074 CaseType=Combination P=-34,3733326263114 V2=69,3725943368045 V3=0 T=0 M2=0 M3=-3,48818596847893	FrameElem=42-1
ElemStation=0,1	
Frame=42 Station=0 OutputCase=STR075 CaseType=Combination P=-21,9548468408941 V2=21,6843006869827 V3=0 T=0 M2=0 M3=16,6529869889407	FrameElem=42-1
ElemStation=0	
Frame=42 Station=0,05 OutputCase=STR075 CaseType=Combination P=-21,9548468408941 V2=21,8843006869827 V3=0 T=0 M2=0 M3=15,5637719545916	FrameElem=42-1
ElemStation=0,05	
Frame=42 Station=0,1 OutputCase=STR075 CaseType=Combination P=-21,9548468408941 V2=22,0843006869827 V3=0 T=0 M2=0 M3=14,4645569202424	FrameElem=42-1
ElemStation=0,1	
Frame=42 Station=0 OutputCase=STR076 CaseType=Combination P=-35,1483919086701 V2=11,6367314222543 V3=0 T=0 M2=0 M3=5,49514000966574	FrameElem=42-1
ElemStation=0	
Frame=42 Station=0,05 OutputCase=STR076 CaseType=Combination P=-35,1483919086701 V2=11,8367314222543 V3=0 T=0 M2=0 M3=4,90830343855302	FrameElem=42-1
ElemStation=0,05	
Frame=42 Station=0,1 OutputCase=STR076 CaseType=Combination P=-35,1483919086701 V2=12,0367314222543 V3=0 T=0 M2=0 M3=4,3114668674403	FrameElem=42-1
ElemStation=0,1	
Frame=42 Station=0 OutputCase=STR077 CaseType=Combination P=-15,6244113524347 V2=16,4507011886953 V3=0 T=0 M2=0 M3=2,03702581687481	FrameElem=42-1
ElemStation=0	
Frame=42 Station=0,05 OutputCase=STR077 CaseType=Combination P=-15,6244113524347 V2=16,7207011886953 V3=0 T=0 M2=0 M3=1,20774075744004	FrameElem=42-1
ElemStation=0,05	

Società di Progetto
Brebemi SpA

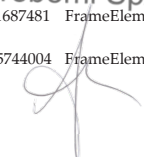

	Doc. N. 60235-00000-A00.doc	CODIFICA DOCUMENTO 04RCDII10000000000300A00	REV. 00	FOGLIO 539 di 628
--	--------------------------------	--	------------	----------------------

Frame=42 Station=0,1 OutputCase=STR077 CaseType=Combination P=-15,6244113524347 V2=16,9907011886953 V3=0 T=0 M2=0 M3=0,36495569800528	FrameElem=42-1 ElemStation=0,1
Frame=42 Station=0 OutputCase=STR078 CaseType=Combination P=-7,86870348303538 V2=16,44719562925704 V3=0 T=0 M2=0 M3=1,09732013400017	FrameElem=42-1 ElemStation=0
Frame=42 Station=0,05 OutputCase=STR078 CaseType=Combination P=-7,86870348303538 V2=16,71719562925704 V3=0 T=0 M2=0 M3=0,268210349371648	FrameElem=42-1 ElemStation=0,05
Frame=42 Station=0,1 OutputCase=STR078 CaseType=Combination P=-7,86870348303538 V2=16,98719562925704 V3=0 T=0 M2=0 M3=-0,574399435256872	FrameElem=42-1 ElemStation=0,1
Frame=42 Station=0 OutputCase=STR079 CaseType=Combination P=-6,41993683833941 V2=86,9824773441121 V3=0 T=0 M2=0 M3=-1,79679183117798	FrameElem=42-1 ElemStation=0
Frame=42 Station=0,05 OutputCase=STR079 CaseType=Combination P=-6,41993683833941 V2=87,2524773441121 V3=0 T=0 M2=0 M3=-6,15266569838358	FrameElem=42-1 ElemStation=0,05
Frame=42 Station=0,1 OutputCase=STR079 CaseType=Combination P=-6,41993683833941 V2=87,5224773441121 V3=0 T=0 M2=0 M3=-10,5220395655892	FrameElem=42-1 ElemStation=0,1
Frame=42 Station=0 OutputCase=STR080 CaseType=Combination P=-22,7187122853597 V2=99,6907621904598 V3=0 T=0 M2=0 M3=16,967787921925	FrameElem=42-1 ElemStation=0
Frame=42 Station=0,05 OutputCase=STR080 CaseType=Combination P=-22,7187122853597 V2=99,9607621904598 V3=0 T=0 M2=0 M3=11,976499812402	FrameElem=42-1 ElemStation=0,05
Frame=42 Station=0,1 OutputCase=STR080 CaseType=Combination P=-22,7187122853597 V2=100,23076219046 V3=0 T=0 M2=0 M3=6,971711702879	FrameElem=42-1 ElemStation=0,1
Frame=42 Station=0 OutputCase=STR081 CaseType=Combination P=-39,0174877303311 V2=86,9996828102472 V3=0 T=0 M2=0 M3=2,81541539149378	FrameElem=42-1 ElemStation=0
Frame=42 Station=0,05 OutputCase=STR081 CaseType=Combination P=-39,0174877303311 V2=87,2696828102472 V3=0 T=0 M2=0 M3=-1,54131874901858	FrameElem=42-1 ElemStation=0,05
Frame=42 Station=0,1 OutputCase=STR081 CaseType=Combination P=-39,0174877303311 V2=87,5396828102472 V3=0 T=0 M2=0 M3=-5,91155288953093	FrameElem=42-1 ElemStation=0,1
Frame=42 Station=0 OutputCase=STR082 CaseType=Combination P=-23,817817950108 V2=24,7847363819762 V3=0 T=0 M2=0 M3=19,7044397261256	FrameElem=42-1 ElemStation=0
Frame=42 Station=0,05 OutputCase=STR082 CaseType=Combination P=-23,817817950108 V2=24,9847363819762 V3=0 T=0 M2=0 M3=18,4602029070268	FrameElem=42-1 ElemStation=0,05
Frame=42 Station=0,1 OutputCase=STR082 CaseType=Combination P=-23,817817950108 V2=25,1847363819762 V3=0 T=0 M2=0 M3=17,205966087928	FrameElem=42-1 ElemStation=0,1
Frame=42 Station=0 OutputCase=STR083 CaseType=Combination P=-40,1165933950794 V2=12,0936570017636 V3=0 T=0 M2=0 M3=5,55206719569445	FrameElem=42-1 ElemStation=0
Frame=42 Station=0,05 OutputCase=STR083 CaseType=Combination P=-40,1165933950794 V2=12,2936570017636 V3=0 T=0 M2=0 M3=4,94238434560627	FrameElem=42-1 ElemStation=0,05
Frame=42 Station=0,1 OutputCase=STR083 CaseType=Combination P=-40,1165933950794 V2=12,4936570017636 V3=0 T=0 M2=0 M3=4,32270149551809	FrameElem=42-1 ElemStation=0,1
Frame=42 Station=0 OutputCase=STR084 CaseType=Combination P=-19,9375282892966 V2=88,9027937455217 V3=0 T=0 M2=0 M3=29,1131604937371	FrameElem=42-1 ElemStation=0
Frame=42 Station=0,05 OutputCase=STR084 CaseType=Combination P=-19,9375282892966 V2=89,1727937455217 V3=0 T=0 M2=0 M3=24,661270806461	FrameElem=42-1 ElemStation=0,05
Frame=42 Station=0,1 OutputCase=STR084 CaseType=Combination P=-19,9375282892966 V2=89,4427937455217 V3=0 T=0 M2=0 M3=20,1958811191849	FrameElem=42-1 ElemStation=0,1
Frame=42 Station=0 OutputCase=STR085 CaseType=Combination P=-6,89656433586671 V2=69,5776843743705 V3=0 T=0 M2=0 M3=-0,893435645209157	FrameElem=42-1 ElemStation=0
Frame=42 Station=0,05 OutputCase=STR085 CaseType=Combination P=-6,89656433586671 V2=69,8476843743705 V3=0 T=0 M2=0 M3=-4,37906986392768	FrameElem=42-1 ElemStation=0,05
Frame=42 Station=0,1 OutputCase=STR085 CaseType=Combination P=-6,89656433586671 V2=70,1176843743705 V3=0 T=0 M2=0 M3=-7,87820408264621	FrameElem=42-1 ElemStation=0,1
Frame=42 Station=0 OutputCase=STR086 CaseType=Combination P=-20,0901094044343 V2=79,6390341127314 V3=0 T=0 M2=0 M3=13,9584931717883	FrameElem=42-1 ElemStation=0
Frame=42 Station=0,05 OutputCase=STR086 CaseType=Combination P=-20,0901094044343 V2=79,9090341127314 V3=0 T=0 M2=0 M3=9,96979146615172	FrameElem=42-1 ElemStation=0,05
Frame=42 Station=0,1 OutputCase=STR086 CaseType=Combination P=-20,0901094044343 V2=80,1790341127314 V3=0 T=0 M2=0 M3=5,96758976051516	FrameElem=42-1 ElemStation=0,1
Frame=42 Station=0 OutputCase=STR087 CaseType=Combination P=-33,2836544722103 V2=69,591464848003 V3=0 T=0 M2=0 M3=2,80064619251332	FrameElem=42-1 ElemStation=0
Frame=42 Station=0,05 OutputCase=STR087 CaseType=Combination P=-33,2836544722103 V2=69,861464848003 V3=0 T=0 M2=0 M3=-0,685677049886829	FrameElem=42-1 ElemStation=0,05
Frame=42 Station=0,1 OutputCase=STR087 CaseType=Combination P=-33,2836544722103 V2=70,131464848003 V3=0 T=0 M2=0 M3=-4,18550029228698	FrameElem=42-1 ElemStation=0,1
Frame=42 Station=0 OutputCase=STR088 CaseType=Combination P=-20,865168686793 V2=22,4431711981813 V3=0 T=0 M2=0 M3=16,0315597162525	FrameElem=42-1 ElemStation=0
Frame=42 Station=0,05 OutputCase=STR088 CaseType=Combination P=-20,865168686793 V2=22,6431711981813 V3=0 T=0 M2=0 M3=14,9044011563435	FrameElem=42-1 ElemStation=0,05
Frame=42 Station=0,1 OutputCase=STR088 CaseType=Combination P=-20,865168686793 V2=22,8431711981813 V3=0 T=0 M2=0 M3=13,7672425964344	FrameElem=42-1 ElemStation=0,1
Frame=42 Station=0 OutputCase=STR089 CaseType=Combination P=-34,058713754569 V2=12,3956019334529 V3=0 T=0 M2=0 M3=4,87371273697754	FrameElem=42-1 ElemStation=0
Frame=42 Station=0,05 OutputCase=STR089 CaseType=Combination P=-34,058713754569 V2=12,5956019334529 V3=0 T=0 M2=0 M3=4,2489326403049	FrameElem=42-1 ElemStation=0,05
Frame=42 Station=0,1 OutputCase=STR089 CaseType=Combination P=-34,058713754569 V2=12,7956019334529 V3=0 T=0 M2=0 M3=3,61415254363226	FrameElem=42-1 ElemStation=0,1
Frame=42 Station=0 OutputCase=STR090 CaseType=Combination P=-15,0727372492052 V2=16,4489933264649 V3=0 T=0 M2=0 M3=1,57920534627388	FrameElem=42-1 ElemStation=0
Frame=42 Station=0,05 OutputCase=STR090 CaseType=Combination P=-15,0727372492052 V2=16,7189933264649 V3=0 T=0 M2=0 M3=0,750005679950635	FrameElem=42-1 ElemStation=0,05
Frame=42 Station=0,1 OutputCase=STR090 CaseType=Combination P=-15,0727372492052 V2=16,9889933264649 V3=0 T=0 M2=0 M3=-9,26939863726101E-02	FrameElem=42-1 ElemStation=0,1
Frame=42 Station=0 OutputCase=STR091 CaseType=Combination P=-7,31702937980585 V2=16,4454878303401 V3=0 T=0 M2=0 M3=0,639499663399242	FrameElem=42-1 ElemStation=0
Frame=42 Station=0,05 OutputCase=STR091 CaseType=Combination P=-7,31702937980585 V2=16,7154878303401 V3=0 T=0 M2=0 M3=-0,18952472811776	FrameElem=42-1 ElemStation=0,05
Frame=42 Station=0,1 OutputCase=STR091 CaseType=Combination P=-7,31702937980585 V2=16,9854878303401 V3=0 T=0 M2=0 M3=-1,03204911963476	FrameElem=42-1 ElemStation=0,1
Frame=42 Station=0 OutputCase=STR092 CaseType=Combination P=-6,34489023263718 V2=69,5759765121402 V3=0 T=0 M2=0 M3=-1,35125611581008	FrameElem=42-1 ElemStation=0

Società di Progetto
Brebemi SpA

	Doc. N. 60235-00000-A00.doc	CODIFICA DOCUMENTO 04RCDII10000000000300A00	REV. 00	FOGLIO 540 di 628
--	--------------------------------	--	------------	----------------------

Frame=42 Station=0,05 OutputCase=STR092 CaseType=Combination P=-6,34489023263718 V2=69,8459765121402 V3=0 T=0 M2=0 M3=-4,83680494141709	FrameElem=42-1 ElemStation=0,05
Frame=42 Station=0,1 OutputCase=STR092 CaseType=Combination P=-6,34489023263718 V2=70,1159765121402 V3=0 T=0 M2=0 M3=-8,3358537670241	FrameElem=42-1 ElemStation=0,1
Frame=42 Station=0 OutputCase=STR093 CaseType=Combination P=-19,5384353012048 V2=79,637326250501 V3=0 T=0 M2=0 M3=13,5006727011874	FrameElem=42-1 ElemStation=0
Frame=42 Station=0,05 OutputCase=STR093 CaseType=Combination P=-19,5384353012048 V2=79,9073262505011 V3=0 T=0 M2=0 M3=9,51205638866232	FrameElem=42-1 ElemStation=0,05
Frame=42 Station=0,1 OutputCase=STR093 CaseType=Combination P=-19,5384353012048 V2=80,1773262505011 V3=0 T=0 M2=0 M3=5,50994007613727	FrameElem=42-1 ElemStation=0,1
Frame=42 Station=0 OutputCase=STR094 CaseType=Combination P=-32,7319803689808 V2=69,5897569857727 V3=0 T=0 M2=0 M3=2,34282572191239	FrameElem=42-1 ElemStation=0
Frame=42 Station=0,05 OutputCase=STR094 CaseType=Combination P=-32,7319803689808 V2=69,8597569857727 V3=0 T=0 M2=0 M3=-1,14341212737624	FrameElem=42-1 ElemStation=0,05
Frame=42 Station=0,1 OutputCase=STR094 CaseType=Combination P=-32,7319803689808 V2=70,1297569857727 V3=0 T=0 M2=0 M3=4,64314997666487	FrameElem=42-1 ElemStation=0,1
Frame=42 Station=0 OutputCase=STR095 CaseType=Combination P=-20,3134945835635 V2=22,4414633359509 V3=0 T=0 M2=0 M3=15,5737392456516	FrameElem=42-1 ElemStation=0
Frame=42 Station=0,05 OutputCase=STR095 CaseType=Combination P=-20,3134945835635 V2=22,6414633359509 V3=0 T=0 M2=0 M3=14,446666078854	FrameElem=42-1 ElemStation=0,05
Frame=42 Station=0,1 OutputCase=STR095 CaseType=Combination P=-20,3134945835635 V2=22,8414633359509 V3=0 T=0 M2=0 M3=13,3095929120565	FrameElem=42-1 ElemStation=0,1
Frame=42 Station=0 OutputCase=STR096 CaseType=Combination P=-33,5070396513395 V2=12,3938940712225 V3=0 T=0 M2=0 M3=4,41589226637662	FrameElem=42-1 ElemStation=0
Frame=42 Station=0,05 OutputCase=STR096 CaseType=Combination P=-33,5070396513395 V2=12,5938940712225 V3=0 T=0 M2=0 M3=3,79119756281549	FrameElem=42-1 ElemStation=0,05
Frame=42 Station=0,1 OutputCase=STR096 CaseType=Combination P=-33,5070396513395 V2=12,7938940712225 V3=0 T=0 M2=0 M3=3,15650285925437	FrameElem=42-1 ElemStation=0,1
Frame=42 Station=0 OutputCase=STR097 CaseType=Combination P=-16,1760854556643 V2=16,4524090509256 V3=0 T=0 M2=0 M3=2,49484628747573	FrameElem=42-1 ElemStation=0
Frame=42 Station=0,05 OutputCase=STR097 CaseType=Combination P=-16,1760854556643 V2=16,7224090509256 V3=0 T=0 M2=0 M3=1,66547583492945	FrameElem=42-1 ElemStation=0,05
Frame=42 Station=0,1 OutputCase=STR097 CaseType=Combination P=-16,1760854556643 V2=16,9924090509256 V3=0 T=0 M2=0 M3=0,822605382383171	FrameElem=42-1 ElemStation=0,1
Frame=42 Station=0 OutputCase=STR098 CaseType=Combination P=-8,42037758626492 V2=16,4489035548008 V3=0 T=0 M2=0 M3=1,5551406046011	FrameElem=42-1 ElemStation=0
Frame=42 Station=0,05 OutputCase=STR098 CaseType=Combination P=-8,42037758626492 V2=16,7189035548008 V3=0 T=0 M2=0 M3=0,725945246861057	FrameElem=42-1 ElemStation=0,05
Frame=42 Station=0,1 OutputCase=STR098 CaseType=Combination P=-8,42037758626492 V2=16,9889035548008 V3=0 T=0 M2=0 M3=-0,116749750878982	FrameElem=42-1 ElemStation=0,1
Frame=42 Station=0 OutputCase=STR099 CaseType=Combination P=-7,44823843909625 V2=69,5793922366009 V3=0 T=0 M2=0 M3=-0,435615174608231	FrameElem=42-1 ElemStation=0
Frame=42 Station=0,05 OutputCase=STR099 CaseType=Combination P=-7,44823843909625 V2=69,8493922366009 V3=0 T=0 M2=0 M3=-3,92133478643827	FrameElem=42-1 ElemStation=0,05
Frame=42 Station=0,1 OutputCase=STR099 CaseType=Combination P=-7,44823843909625 V2=70,1193922366009 V3=0 T=0 M2=0 M3=-7,42055439826832	FrameElem=42-1 ElemStation=0,1
Frame=42 Station=0 OutputCase=STR100 CaseType=Combination P=-20,6417835076639 V2=79,6407419749618 V3=0 T=0 M2=0 M3=14,4163136423892	FrameElem=42-1 ElemStation=0
Frame=42 Station=0,05 OutputCase=STR100 CaseType=Combination P=-20,6417835076639 V2=79,9107419749618 V3=0 T=0 M2=0 M3=10,4275265436411	FrameElem=42-1 ElemStation=0,05
Frame=42 Station=0,1 OutputCase=STR100 CaseType=Combination P=-20,6417835076639 V2=80,1807419749618 V3=0 T=0 M2=0 M3=6,42523944489305	FrameElem=42-1 ElemStation=0,1
Frame=42 Station=0 OutputCase=STR101 CaseType=Combination P=-33,8353285754399 V2=69,5931727102334 V3=0 T=0 M2=0 M3=3,25846666311425	FrameElem=42-1 ElemStation=0
Frame=42 Station=0,05 OutputCase=STR101 CaseType=Combination P=-33,8353285754399 V2=69,8631727102334 V3=0 T=0 M2=0 M3=-0,227941972397421	FrameElem=42-1 ElemStation=0,05
Frame=42 Station=0,1 OutputCase=STR101 CaseType=Combination P=-33,8353285754399 V2=70,1331727102334 V3=0 T=0 M2=0 M3=-3,72785067090909	FrameElem=42-1 ElemStation=0,1
Frame=42 Station=0 OutputCase=STR102 CaseType=Combination P=-21,4168427900226 V2=22,4448790604116 V3=0 T=0 M2=0 M3=16,4893801868534	FrameElem=42-1 ElemStation=0
Frame=42 Station=0,05 OutputCase=STR102 CaseType=Combination P=-21,4168427900226 V2=22,6448790604116 V3=0 T=0 M2=0 M3=15,3621362338329	FrameElem=42-1 ElemStation=0,05
Frame=42 Station=0,1 OutputCase=STR102 CaseType=Combination P=-21,4168427900226 V2=22,8448790604116 V3=0 T=0 M2=0 M3=14,2248922808123	FrameElem=42-1 ElemStation=0,1
Frame=42 Station=0 OutputCase=STR103 CaseType=Combination P=-34,6103878577986 V2=12,3973097956832 V3=0 T=0 M2=0 M3=5,33153320757847	FrameElem=42-1 ElemStation=0
Frame=42 Station=0,05 OutputCase=STR103 CaseType=Combination P=-34,6103878577986 V2=12,5973097956832 V3=0 T=0 M2=0 M3=4,7066671779431	FrameElem=42-1 ElemStation=0,05
Frame=42 Station=0,1 OutputCase=STR103 CaseType=Combination P=-34,6103878577986 V2=12,7973097956832 V3=0 T=0 M2=0 M3=4,07180222801015	FrameElem=42-1 ElemStation=0,1
Frame=42 Station=0 OutputCase=STR104 CaseType=Combination P=-16,1760854556643 V2=16,4524090509256 V3=0 T=0 M2=0 M3=2,49484628747573	FrameElem=42-1 ElemStation=0
Frame=42 Station=0,05 OutputCase=STR104 CaseType=Combination P=-16,1760854556643 V2=16,7224090509256 V3=0 T=0 M2=0 M3=1,66547583492945	FrameElem=42-1 ElemStation=0,05
Frame=42 Station=0,1 OutputCase=STR104 CaseType=Combination P=-16,1760854556643 V2=16,9924090509256 V3=0 T=0 M2=0 M3=0,822605382383171	FrameElem=42-1 ElemStation=0,1
Frame=42 Station=0 OutputCase=STR105 CaseType=Combination P=-8,42037758626492 V2=16,4489035548008 V3=0 T=0 M2=0 M3=1,5551406046011	FrameElem=42-1 ElemStation=0
Frame=42 Station=0,05 OutputCase=STR105 CaseType=Combination P=-8,42037758626492 V2=16,7189035548008 V3=0 T=0 M2=0 M3=0,725945246861057	FrameElem=42-1 ElemStation=0,05
Frame=42 Station=0,1 OutputCase=STR105 CaseType=Combination P=-8,42037758626492 V2=16,9889035548008 V3=0 T=0 M2=0 M3=-0,116749750878982	FrameElem=42-1 ElemStation=0,1
Frame=42 Station=0 OutputCase=STR106 CaseType=Combination P=-7,44823843909625 V2=69,5793922366009 V3=0 T=0 M2=0 M3=-0,435615174608231	FrameElem=42-1 ElemStation=0
Frame=42 Station=0,05 OutputCase=STR106 CaseType=Combination P=-7,44823843909625 V2=69,8493922366009 V3=0 T=0 M2=0 M3=-3,92133478643827	FrameElem=42-1 ElemStation=0,05
Frame=42 Station=0,1 OutputCase=STR106 CaseType=Combination P=-7,44823843909625 V2=70,1193922366009 V3=0 T=0 M2=0 M3=-7,42055439826832	FrameElem=42-1 ElemStation=0,1

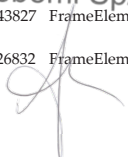
Società di Progetto
Brebemi SpA

	Doc. N. 60235-00000-A00.doc	CODIFICA DOCUMENTO 04RCDII10000000000300A00	REV. 00	FOGLIO 541 di 628
--	--------------------------------	--	------------	----------------------

Frame=42 Station=0 OutputCase=STR107 CaseType=Combination P=-20,6417835076639 V2=79,6407419749618 V3=0 T=0 M2=0 M3=14,4163136423892 FrameElem=42-1 ElemStation=0

Frame=42 Station=0,05 OutputCase=STR107 CaseType=Combination P=-20,6417835076639 V2=79,9107419749618 V3=0 T=0 M2=0 M3=10,4275265436411 FrameElem=42-1 ElemStation=0,05

Frame=42 Station=0,1 OutputCase=STR107 CaseType=Combination P=-20,6417835076639 V2=80,1807419749618 V3=0 T=0 M2=0 M3=6,42523944489305 FrameElem=42-1 ElemStation=0,1

Frame=42 Station=0 OutputCase=STR108 CaseType=Combination P=-33,8353285754399 V2=69,5931727102334 V3=0 T=0 M2=0 M3=3,25846666311425 FrameElem=42-1 ElemStation=0

Frame=42 Station=0,05 OutputCase=STR108 CaseType=Combination P=-33,8353285754399 V2=69,8631727102334 V3=0 T=0 M2=0 M3=0,227941972397421 FrameElem=42-1 ElemStation=0,05

Frame=42 Station=0,1 OutputCase=STR108 CaseType=Combination P=-33,8353285754399 V2=70,1331727102334 V3=0 T=0 M2=0 M3=3,72785060790909 FrameElem=42-1 ElemStation=0,1

Frame=42 Station=0 OutputCase=STR109 CaseType=Combination P=-21,4168427900226 V2=22,4448790604116 V3=0 T=0 M2=0 M3=16,4893801868534 FrameElem=42-1 ElemStation=0

Frame=42 Station=0,05 OutputCase=STR109 CaseType=Combination P=-21,4168427900226 V2=22,6448790604116 V3=0 T=0 M2=0 M3=15,3621362338329 FrameElem=42-1 ElemStation=0,05

Frame=42 Station=0,1 OutputCase=STR109 CaseType=Combination P=-21,4168427900226 V2=22,8448790604116 V3=0 T=0 M2=0 M3=14,2248922808123 FrameElem=42-1 ElemStation=0,1

Frame=42 Station=0 OutputCase=STR110 CaseType=Combination P=-34,6103878577986 V2=12,3973097956832 V3=0 T=0 M2=0 M3=5,33153320757847 FrameElem=42-1 ElemStation=0

Frame=42 Station=0,05 OutputCase=STR110 CaseType=Combination P=-34,6103878577986 V2=12,5973097956832 V3=0 T=0 M2=0 M3=4,70666771779431 FrameElem=42-1 ElemStation=0,05

Frame=42 Station=0,1 OutputCase=STR110 CaseType=Combination P=-34,6103878577986 V2=12,7973097956832 V3=0 T=0 M2=0 M3=4,07180222801015 FrameElem=42-1 ElemStation=0,1

Frame=42 Station=0 OutputCase=STR111 CaseType=Combination P=-14,861505776746 V2=14,9238515677363 V3=0 T=0 M2=0 M3=0,838171185712913 FrameElem=42-1 ElemStation=0

Frame=42 Station=0,05 OutputCase=STR111 CaseType=Combination P=-14,861505776746 V2=15,1938515677363 V3=0 T=0 M2=0 M3=8,52286073261017E-02 FrameElem=42-1 ElemStation=0,05

Frame=42 Station=0,1 OutputCase=STR111 CaseType=Combination P=-14,861505776746 V2=15,4638515677362 V3=0 T=0 M2=0 M3=0,68121397106071 FrameElem=42-1 ElemStation=0,1

Frame=42 Station=0 OutputCase=STR112 CaseType=Combination P=-7,10579790734666 V2=14,9203460716114 V3=0 T=0 M2=0 M3=0,101534497161723 FrameElem=42-1 ElemStation=0

Frame=42 Station=0,05 OutputCase=STR112 CaseType=Combination P=-7,10579790734666 V2=15,1903460716114 V3=0 T=0 M2=0 M3=0,854301800742293 FrameElem=42-1 ElemStation=0,05

Frame=42 Station=0,1 OutputCase=STR112 CaseType=Combination P=-7,10579790734666 V2=15,4603460716114 V3=0 T=0 M2=0 M3=1,62056910432286 FrameElem=42-1 ElemStation=0,1

Frame=42 Station=0 OutputCase=STR113 CaseType=Combination P=-5,96219349292618 V2=86,0663675715367 V3=0 T=0 M2=0 M3=2,51610460987511 FrameElem=42-1 ElemStation=0

Frame=42 Station=0,05 OutputCase=STR113 CaseType=Combination P=-5,96219349292618 V2=86,3363675715367 V3=0 T=0 M2=0 M3=6,82617298845195 FrameElem=42-1 ElemStation=0,05

Frame=42 Station=0,1 OutputCase=STR113 CaseType=Combination P=-5,96219349292618 V2=86,6063675715367 V3=0 T=0 M2=0 M3=11,1497413670288 FrameElem=42-1 ElemStation=0,1

Frame=42 Station=0 OutputCase=STR114 CaseType=Combination P=-22,2609689399465 V2=98,7746524178844 V3=0 T=0 M2=0 M3=16,2484751432278 FrameElem=42-1 ElemStation=0

Frame=42 Station=0,05 OutputCase=STR114 CaseType=Combination P=-22,2609689399465 V2=99,0446524178844 V3=0 T=0 M2=0 M3=11,3029925223336 FrameElem=42-1 ElemStation=0,05

Frame=42 Station=0,1 OutputCase=STR114 CaseType=Combination P=-22,2609689399465 V2=99,3146524178844 V3=0 T=0 M2=0 M3=6,3440090143941 FrameElem=42-1 ElemStation=0,1

Frame=42 Station=0 OutputCase=STR115 CaseType=Combination P=-38,5597443849179 V2=86,0835730376718 V3=0 T=0 M2=0 M3=2,09610261279665 FrameElem=42-1 ElemStation=0

Frame=42 Station=0,05 OutputCase=STR115 CaseType=Combination P=-38,5597443849179 V2=86,3535730376718 V3=0 T=0 M2=0 M3=2,21482603908694 FrameElem=42-1 ElemStation=0,05

Frame=42 Station=0,1 OutputCase=STR115 CaseType=Combination P=-38,5597443849179 V2=86,6235730376718 V3=0 T=0 M2=0 M3=6,53925469097052 FrameElem=42-1 ElemStation=0,1

Frame=42 Station=0 OutputCase=STR116 CaseType=Combination P=-23,3600746046947 V2=23,8686266094008 V3=0 T=0 M2=0 M3=18,9851269474285 FrameElem=42-1 ElemStation=0

Frame=42 Station=0,05 OutputCase=STR116 CaseType=Combination P=-23,3600746046947 V2=24,0686266094008 V3=0 T=0 M2=0 M3=17,7866956169585 FrameElem=42-1 ElemStation=0,05

Frame=42 Station=0,1 OutputCase=STR116 CaseType=Combination P=-23,3600746046947 V2=24,2686266094008 V3=0 T=0 M2=0 M3=16,5782642864884 FrameElem=42-1 ElemStation=0,1

Frame=42 Station=0 OutputCase=STR117 CaseType=Combination P=-39,6588500496661 V2=11,1775472291882 V3=0 T=0 M2=0 M3=4,83275441699731 FrameElem=42-1 ElemStation=0

Frame=42 Station=0,05 OutputCase=STR117 CaseType=Combination P=-39,6588500496661 V2=11,3775472291882 V3=0 T=0 M2=0 M3=4,2688770555379 FrameElem=42-1 ElemStation=0,05

Frame=42 Station=0,1 OutputCase=STR117 CaseType=Combination P=-39,6588500496661 V2=11,5775472291882 V3=0 T=0 M2=0 M3=3,69499969407849 FrameElem=42-1 ElemStation=0,1

Frame=42 Station=0 OutputCase=STR118 CaseType=Combination P=-19,4797849438834 V2=87,9866839729463 V3=0 T=0 M2=0 M3=28,39384771504 FrameElem=42-1 ElemStation=0

Frame=42 Station=0,05 OutputCase=STR118 CaseType=Combination P=-19,4797849438834 V2=88,2566839729463 V3=0 T=0 M2=0 M3=23,9877635163926 FrameElem=42-1 ElemStation=0,05

Frame=42 Station=0,1 OutputCase=STR118 CaseType=Combination P=-19,4797849438834 V2=88,5266839729463 V3=0 T=0 M2=0 M3=19,5681793177453 FrameElem=42-1 ElemStation=0,1

Frame=42 Station=0 OutputCase=STR119 CaseType=Combination P=-6,13365876017799 V2=68,0508347534115 V3=0 T=0 M2=0 M3=2,09229027637105 FrameElem=42-1 ElemStation=0

Frame=42 Station=0,05 OutputCase=STR119 CaseType=Combination P=-6,13365876017799 V2=68,3208347534115 V3=0 T=0 M2=0 M3=5,50158201404162 FrameElem=42-1 ElemStation=0,05

Frame=42 Station=0,1 OutputCase=STR119 CaseType=Combination P=-6,13365876017799 V2=68,5908347534115 V3=0 T=0 M2=0 M3=8,9243737517122 FrameElem=42-1 ElemStation=0,1

Frame=42 Station=0 OutputCase=STR120 CaseType=Combination P=-19,3272038287456 V2=78,1121844917724 V3=0 T=0 M2=0 M3=12,7596385406264 FrameElem=42-1 ElemStation=0

Frame=42 Station=0,05 OutputCase=STR120 CaseType=Combination P=-19,3272038287456 V2=78,3821844917724 V3=0 T=0 M2=0 M3=8,84727931603778 FrameElem=42-1 ElemStation=0,05

Frame=42 Station=0,1 OutputCase=STR120 CaseType=Combination P=-19,3272038287456 V2=78,6521844917724 V3=0 T=0 M2=0 M3=4,92142009144917 FrameElem=42-1 ElemStation=0,1

Frame=42 Station=0 OutputCase=STR121 CaseType=Combination P=-32,5207488965216 V2=68,064615227044 V3=0 T=0 M2=0 M3=1,60179156135143 FrameElem=42-1 ElemStation=0

Frame=42 Station=0,05 OutputCase=STR121 CaseType=Combination P=-32,5207488965216 V2=68,334615227044 V3=0 T=0 M2=0 M3=1,80818920000077 FrameElem=42-1 ElemStation=0,05

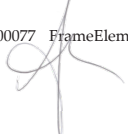
Società di Progetto
Brebemi SpA

	Doc. N. 60235-00000-A00.doc	CODIFICA DOCUMENTO 04RCDII10000000000300A00	REV. 00	FOGLIO 542 di 628
--	--------------------------------	--	------------	----------------------

Frame=42 Station=0,1 OutputCase=STR121 CaseType=Combination P=-32,5207488965216 V2=68,604615227044 V3=0 T=0 M2=0 M3=-5,23166996135297 ElemStation=0,1	FrameElem=42-1
Frame=42 Station=0 OutputCase=STR122 CaseType=Combination P=-20,1022631111043 V2=20,9163215772222 V3=0 T=0 M2=0 M3=14,8327050850906 ElemStation=0	FrameElem=42-1
Frame=42 Station=0,05 OutputCase=STR122 CaseType=Combination P=-20,1022631111043 V2=21,1163215772222 V3=0 T=0 M2=0 M3=13,7818890062295 ElemStation=0,05	FrameElem=42-1
Frame=42 Station=0,1 OutputCase=STR122 CaseType=Combination P=-20,1022631111043 V2=21,3163215772222 V3=0 T=0 M2=0 M3=12,7210729273684 ElemStation=0,1	FrameElem=42-1
Frame=42 Station=0 OutputCase=STR123 CaseType=Combination P=-33,2958081788803 V2=10,8687523124939 V3=0 T=0 M2=0 M3=3,67485810581565 ElemStation=0	FrameElem=42-1
Frame=42 Station=0,05 OutputCase=STR123 CaseType=Combination P=-33,2958081788803 V2=11,0687523124939 V3=0 T=0 M2=0 M3=3,12642049019096 ElemStation=0,05	FrameElem=42-1
Frame=42 Station=0,1 OutputCase=STR123 CaseType=Combination P=-33,2958081788803 V2=11,2687523124939 V3=0 T=0 M2=0 M3=2,56798287456627 ElemStation=0,1	FrameElem=42-1
Frame=42 Station=0 OutputCase=STR124 CaseType=Combination P=-14,3098316735165 V2=14,9221437055059 V3=0 T=0 M2=0 M3=0,380350715111987 ElemStation=0	FrameElem=42-1
Frame=42 Station=0,05 OutputCase=STR124 CaseType=Combination P=-14,3098316735165 V2=15,1921437055059 V3=0 T=0 M2=0 M3=-0,372506470163307 ElemStation=0,05	FrameElem=42-1
Frame=42 Station=0,1 OutputCase=STR124 CaseType=Combination P=-14,3098316735165 V2=15,4621437055059 V3=0 T=0 M2=0 M3=-1,1388636554386 ElemStation=0,1	FrameElem=42-1
Frame=42 Station=0 OutputCase=STR125 CaseType=Combination P=-6,55412380411712 V2=14,918638209381 V3=0 T=0 M2=0 M3=-0,559354967762649 ElemStation=0	FrameElem=42-1
Frame=42 Station=0,05 OutputCase=STR125 CaseType=Combination P=-6,55412380411712 V2=15,188638209381 V3=0 T=0 M2=0 M3=-1,3120368782317 ElemStation=0,05	FrameElem=42-1
Frame=42 Station=0,1 OutputCase=STR125 CaseType=Combination P=-6,55412380411712 V2=15,458638209381 V3=0 T=0 M2=0 M3=-2,07821878870075 ElemStation=0,1	FrameElem=42-1
Frame=42 Station=0 OutputCase=STR126 CaseType=Combination P=-5,58198465694845 V2=68,0491268911812 V3=0 T=0 M2=0 M3=-2,55011074697198 ElemStation=0	FrameElem=42-1
Frame=42 Station=0,05 OutputCase=STR126 CaseType=Combination P=-5,58198465694845 V2=68,3191268911812 V3=0 T=0 M2=0 M3=-5,95931709153103 ElemStation=0,05	FrameElem=42-1
Frame=42 Station=0,1 OutputCase=STR126 CaseType=Combination P=-5,58198465694845 V2=68,5891268911812 V3=0 T=0 M2=0 M3=-9,38202343609009 ElemStation=0,1	FrameElem=42-1
Frame=42 Station=0 OutputCase=STR127 CaseType=Combination P=-18,7755297255161 V2=78,110476629542 V3=0 T=0 M2=0 M3=12,3018180700255 ElemStation=0	FrameElem=42-1
Frame=42 Station=0,05 OutputCase=STR127 CaseType=Combination P=-18,7755297255161 V2=78,380476629542 V3=0 T=0 M2=0 M3=8,38954423854837 ElemStation=0,05	FrameElem=42-1
Frame=42 Station=0,1 OutputCase=STR127 CaseType=Combination P=-18,7755297255161 V2=78,650476629542 V3=0 T=0 M2=0 M3=4,46377040707127 ElemStation=0,1	FrameElem=42-1
Frame=42 Station=0 OutputCase=STR128 CaseType=Combination P=-31,9690747932921 V2=68,0629073648137 V3=0 T=0 M2=0 M3=1,1439710907505 ElemStation=0	FrameElem=42-1
Frame=42 Station=0,05 OutputCase=STR128 CaseType=Combination P=-31,9690747932921 V2=68,3329073648137 V3=0 T=0 M2=0 M3=-2,26592427749018 ElemStation=0,05	FrameElem=42-1
Frame=42 Station=0,1 OutputCase=STR128 CaseType=Combination P=-31,9690747932921 V2=68,6029073648137 V3=0 T=0 M2=0 M3=-5,68931964573086 ElemStation=0,1	FrameElem=42-1
Frame=42 Station=0 OutputCase=STR129 CaseType=Combination P=-19,5505890078748 V2=20,9146137149919 V3=0 T=0 M2=0 M3=14,3748846144897 ElemStation=0	FrameElem=42-1
Frame=42 Station=0,05 OutputCase=STR129 CaseType=Combination P=-19,5505890078748 V2=21,1146137149919 V3=0 T=0 M2=0 M3=13,3241539287401 ElemStation=0,05	FrameElem=42-1
Frame=42 Station=0,1 OutputCase=STR129 CaseType=Combination P=-19,5505890078748 V2=21,3146137149919 V3=0 T=0 M2=0 M3=12,2634232429905 ElemStation=0,1	FrameElem=42-1
Frame=42 Station=0 OutputCase=STR130 CaseType=Combination P=-32,7441340756508 V2=10,8670444502635 V3=0 T=0 M2=0 M3=3,21703763521473 ElemStation=0	FrameElem=42-1
Frame=42 Station=0,05 OutputCase=STR130 CaseType=Combination P=-32,7441340756508 V2=11,0670444502635 V3=0 T=0 M2=0 M3=2,66868541270155 ElemStation=0,05	FrameElem=42-1
Frame=42 Station=0,1 OutputCase=STR130 CaseType=Combination P=-32,7441340756508 V2=11,2670444502635 V3=0 T=0 M2=0 M3=2,11033319018838 ElemStation=0,1	FrameElem=42-1
Frame=42 Station=0 OutputCase=STR131 CaseType=Combination P=-15,4131798799755 V2=14,9255594299666 V3=0 T=0 M2=0 M3=1,29599165631384 ElemStation=0	FrameElem=42-1
Frame=42 Station=0,05 OutputCase=STR131 CaseType=Combination P=-15,4131798799755 V2=15,1955594299666 V3=0 T=0 M2=0 M3=0,54296368481551 ElemStation=0,05	FrameElem=42-1
Frame=42 Station=0,1 OutputCase=STR131 CaseType=Combination P=-15,4131798799755 V2=15,4655594299666 V3=0 T=0 M2=0 M3=0,22356428668282 ElemStation=0,1	FrameElem=42-1
Frame=42 Station=0 OutputCase=STR132 CaseType=Combination P=-7,65747201057619 V2=14,9220539338418 V3=0 T=0 M2=0 M3=0,356285973439203 ElemStation=0	FrameElem=42-1
Frame=42 Station=0,05 OutputCase=STR132 CaseType=Combination P=-7,65747201057619 V2=15,1920539338418 V3=0 T=0 M2=0 M3=-0,396566723252885 ElemStation=0,05	FrameElem=42-1
Frame=42 Station=0,1 OutputCase=STR132 CaseType=Combination P=-7,65747201057619 V2=15,4620539338418 V3=0 T=0 M2=0 M3=-1,16291941994497 ElemStation=0,1	FrameElem=42-1
Frame=42 Station=0 OutputCase=STR133 CaseType=Combination P=-6,68533286340752 V2=68,0525426156419 V3=0 T=0 M2=0 M3=-1,63446980577012 ElemStation=0	FrameElem=42-1
Frame=42 Station=0,05 OutputCase=STR133 CaseType=Combination P=-6,68533286340752 V2=68,3225426156419 V3=0 T=0 M2=0 M3=-5,04384693655222 ElemStation=0,05	FrameElem=42-1
Frame=42 Station=0,1 OutputCase=STR133 CaseType=Combination P=-6,68533286340752 V2=68,5925426156419 V3=0 T=0 M2=0 M3=-8,46672406733431 ElemStation=0,1	FrameElem=42-1
Frame=42 Station=0 OutputCase=STR134 CaseType=Combination P=-19,8788779319751 V2=78,1138923540028 V3=0 T=0 M2=0 M3=13,2174590112273 ElemStation=0	FrameElem=42-1
Frame=42 Station=0,05 OutputCase=STR134 CaseType=Combination P=-19,8788779319751 V2=78,3838923540028 V3=0 T=0 M2=0 M3=9,30501439352719 ElemStation=0,05	FrameElem=42-1
Frame=42 Station=0,1 OutputCase=STR134 CaseType=Combination P=-19,8788779319751 V2=78,6538923540028 V3=0 T=0 M2=0 M3=5,37906977582706 ElemStation=0,1	FrameElem=42-1
Frame=42 Station=0 OutputCase=STR135 CaseType=Combination P=-33,0724229997511 V2=68,0663230892744 V3=0 T=0 M2=0 M3=2,05961203195236 ElemStation=0	FrameElem=42-1
Frame=42 Station=0,05 OutputCase=STR135 CaseType=Combination P=-33,0724229997511 V2=68,3363230892744 V3=0 T=0 M2=0 M3=-1,35045412251136 ElemStation=0,05	FrameElem=42-1
Frame=42 Station=0,1 OutputCase=STR135 CaseType=Combination P=-33,0724229997511 V2=68,6063230892744 V3=0 T=0 M2=0 M3=-4,77402027697508 ElemStation=0,1	FrameElem=42-1
Frame=42 Station=0 OutputCase=STR136 CaseType=Combination P=-20,6539372143338 V2=20,9180294394526 V3=0 T=0 M2=0 M3=15,2905255556916 ElemStation=0	FrameElem=42-1

Società di Progetto
Brebemi SpA

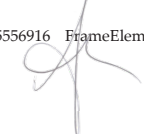

	Doc. N. 60235-00000-A00.doc	CODIFICA DOCUMENTO 04RCDII100000000000300A00	REV. 00	FOGLIO 543 di 628
--	--------------------------------	---	------------	----------------------

Frame=42 Station=0,05 OutputCase=STR136 CaseType=Combination P=-20,6539372143338 V2=21,1180294394526 V3=0 T=0 M2=0 M3=14,2396240837189	FrameElem=42-1 ElemStation=0,05
Frame=42 Station=0,1 OutputCase=STR136 CaseType=Combination P=-20,6539372143338 V2=21,3180294394526 V3=0 T=0 M2=0 M3=13,1787226117463	FrameElem=42-1 ElemStation=0,1
Frame=42 Station=0 OutputCase=STR137 CaseType=Combination P=-33,8474822821098 V2=10,8704601747242 V3=0 T=0 M2=0 M3=4,13267857641658	FrameElem=42-1 ElemStation=0
Frame=42 Station=0,05 OutputCase=STR137 CaseType=Combination P=-33,8474822821098 V2=11,0704601747242 V3=0 T=0 M2=0 M3=3,58415556768037	FrameElem=42-1 ElemStation=0,05
Frame=42 Station=0,1 OutputCase=STR137 CaseType=Combination P=-33,8474822821098 V2=11,2704601747242 V3=0 T=0 M2=0 M3=3,02563255894416	FrameElem=42-1 ElemStation=0,1
Frame=42 Station=0 OutputCase=STR138 CaseType=Combination P=-15,4131798799755 V2=14,9255594299666 V3=0 T=0 M2=0 M3=1,29599165631384	FrameElem=42-1 ElemStation=0
Frame=42 Station=0,05 OutputCase=STR138 CaseType=Combination P=-15,4131798799755 V2=15,1955594299666 V3=0 T=0 M2=0 M3=0,54296368481551	FrameElem=42-1 ElemStation=0,05
Frame=42 Station=0,1 OutputCase=STR138 CaseType=Combination P=-15,4131798799755 V2=15,4655594299666 V3=0 T=0 M2=0 M3=0,22356428668282	FrameElem=42-1 ElemStation=0,1
Frame=42 Station=0 OutputCase=STR139 CaseType=Combination P=-7,65747201057619 V2=14,9220539338418 V3=0 T=0 M2=0 M3=0,356285973439203	FrameElem=42-1 ElemStation=0
Frame=42 Station=0,05 OutputCase=STR139 CaseType=Combination P=-7,65747201057619 V2=15,1920539338418 V3=0 T=0 M2=0 M3=0,396566723252885	FrameElem=42-1 ElemStation=0,05
Frame=42 Station=0,1 OutputCase=STR139 CaseType=Combination P=-7,65747201057619 V2=15,4620539338418 V3=0 T=0 M2=0 M3=1,16291941994497	FrameElem=42-1 ElemStation=0,1
Frame=42 Station=0 OutputCase=STR140 CaseType=Combination P=-6,68533286340752 V2=68,0525426156419 V3=0 T=0 M2=0 M3=1,63446980577012	FrameElem=42-1 ElemStation=0
Frame=42 Station=0,05 OutputCase=STR140 CaseType=Combination P=-6,68533286340752 V2=68,3225426156419 V3=0 T=0 M2=0 M3=5,04384693655222	FrameElem=42-1 ElemStation=0,05
Frame=42 Station=0,1 OutputCase=STR140 CaseType=Combination P=-6,68533286340752 V2=68,5925426156419 V3=0 T=0 M2=0 M3=8,46672406733431	FrameElem=42-1 ElemStation=0,1
Frame=42 Station=0 OutputCase=STR141 CaseType=Combination P=-19,8788779319751 V2=78,1138923540028 V3=0 T=0 M2=0 M3=13,2174590112273	FrameElem=42-1 ElemStation=0
Frame=42 Station=0,05 OutputCase=STR141 CaseType=Combination P=-19,8788779319751 V2=78,3838923540028 V3=0 T=0 M2=0 M3=9,30501439352719	FrameElem=42-1 ElemStation=0,05
Frame=42 Station=0,1 OutputCase=STR141 CaseType=Combination P=-19,8788779319751 V2=78,6538923540028 V3=0 T=0 M2=0 M3=5,37906977582706	FrameElem=42-1 ElemStation=0,1
Frame=42 Station=0 OutputCase=STR142 CaseType=Combination P=-33,0724229997511 V2=68,0663230892744 V3=0 T=0 M2=0 M3=2,05961203195236	FrameElem=42-1 ElemStation=0
Frame=42 Station=0,05 OutputCase=STR142 CaseType=Combination P=-33,0724229997511 V2=68,3363230892744 V3=0 T=0 M2=0 M3=1,35045412251136	FrameElem=42-1 ElemStation=0,05
Frame=42 Station=0,1 OutputCase=STR142 CaseType=Combination P=-33,0724229997511 V2=68,6063230892744 V3=0 T=0 M2=0 M3=4,77402027697508	FrameElem=42-1 ElemStation=0,1
Frame=42 Station=0 OutputCase=STR143 CaseType=Combination P=-20,6539372143338 V2=20,9180294394526 V3=0 T=0 M2=0 M3=15,2905255556916	FrameElem=42-1 ElemStation=0
Frame=42 Station=0,05 OutputCase=STR143 CaseType=Combination P=-20,6539372143338 V2=21,1180294394526 V3=0 T=0 M2=0 M3=14,2396240837189	FrameElem=42-1 ElemStation=0,05
Frame=42 Station=0,1 OutputCase=STR143 CaseType=Combination P=-20,6539372143338 V2=21,3180294394526 V3=0 T=0 M2=0 M3=13,1787226117463	FrameElem=42-1 ElemStation=0,1
Frame=42 Station=0 OutputCase=STR144 CaseType=Combination P=-33,8474822821098 V2=10,8704601747242 V3=0 T=0 M2=0 M3=4,13267857641658	FrameElem=42-1 ElemStation=0
Frame=42 Station=0,05 OutputCase=STR144 CaseType=Combination P=-33,8474822821098 V2=11,0704601747242 V3=0 T=0 M2=0 M3=3,58415556768037	FrameElem=42-1 ElemStation=0,05
Frame=42 Station=0,1 OutputCase=STR144 CaseType=Combination P=-33,8474822821098 V2=11,2704601747242 V3=0 T=0 M2=0 M3=3,02563255894416	FrameElem=42-1 ElemStation=0,1
Frame=42 Station=0 OutputCase=STR145 CaseType=Combination P=-16,1624154033063 V2=15,6901228152664 V3=0 T=0 M2=0 M3=2,20063261896207	FrameElem=42-1 ElemStation=0
Frame=42 Station=0,05 OutputCase=STR145 CaseType=Combination P=-16,1624154033063 V2=15,9601228152664 V3=0 T=0 M2=0 M3=1,40937647819875	FrameElem=42-1 ElemStation=0,05
Frame=42 Station=0,1 OutputCase=STR145 CaseType=Combination P=-16,1624154033063 V2=16,2301228152664 V3=0 T=0 M2=0 M3=0,604620337435435	FrameElem=42-1 ElemStation=0,1
Frame=42 Station=0 OutputCase=STR146 CaseType=Combination P=-8,40670753390691 V2=15,6866173191415 V3=0 T=0 M2=0 M3=1,26092693608743	FrameElem=42-1 ElemStation=0
Frame=42 Station=0,05 OutputCase=STR146 CaseType=Combination P=-8,40670753390691 V2=15,9566173191415 V3=0 T=0 M2=0 M3=0,469846070130358	FrameElem=42-1 ElemStation=0,05
Frame=42 Station=0,1 OutputCase=STR146 CaseType=Combination P=-8,40670753390691 V2=16,2266173191415 V3=0 T=0 M2=0 M3=0,334734795826717	FrameElem=42-1 ElemStation=0,1
Frame=42 Station=0 OutputCase=STR147 CaseType=Combination P=-6,74273926886233 V2=86,5261303200548 V3=0 T=0 M2=0 M3=1,69862774992562	FrameElem=42-1 ElemStation=0
Frame=42 Station=0,05 OutputCase=STR147 CaseType=Combination P=-6,74273926886233 V2=86,7961303200548 V3=0 T=0 M2=0 M3=6,03168426592836	FrameElem=42-1 ElemStation=0,05
Frame=42 Station=0,1 OutputCase=STR147 CaseType=Combination P=-6,74273926886233 V2=87,0661303200548 V3=0 T=0 M2=0 M3=10,3782407819311	FrameElem=42-1 ElemStation=0,1
Frame=42 Station=0 OutputCase=STR148 CaseType=Combination P=-23,0415147158826 V2=99,2344151664024 V3=0 T=0 M2=0 M3=17,0659520031773	FrameElem=42-1 ElemStation=0
Frame=42 Station=0,05 OutputCase=STR148 CaseType=Combination P=-23,0415147158826 V2=99,5044151664024 V3=0 T=0 M2=0 M3=12,0974812448572	FrameElem=42-1 ElemStation=0,05
Frame=42 Station=0,1 OutputCase=STR148 CaseType=Combination P=-23,0415147158826 V2=99,7744151664024 V3=0 T=0 M2=0 M3=7,11551048653709	FrameElem=42-1 ElemStation=0,1
Frame=42 Station=0 OutputCase=STR149 CaseType=Combination P=-39,340290160854 V2=86,5433357861898 V3=0 T=0 M2=0 M3=2,91357947274614	FrameElem=42-1 ElemStation=0
Frame=42 Station=0,05 OutputCase=STR149 CaseType=Combination P=-39,340290160854 V2=86,8133357861898 V3=0 T=0 M2=0 M3=1,42033731656335	FrameElem=42-1 ElemStation=0,05
Frame=42 Station=0,1 OutputCase=STR149 CaseType=Combination P=-39,340290160854 V2=87,0833357861898 V3=0 T=0 M2=0 M3=5,76775410587284	FrameElem=42-1 ElemStation=0,1
Frame=42 Station=0 OutputCase=STR150 CaseType=Combination P=-24,1406203806309 V2=24,3283893579189 V3=0 T=0 M2=0 M3=19,802603807378	FrameElem=42-1 ElemStation=0
Frame=42 Station=0,05 OutputCase=STR150 CaseType=Combination P=-24,1406203806309 V2=24,5283893579189 V3=0 T=0 M2=0 M3=18,5811843394821	FrameElem=42-1 ElemStation=0,05
Frame=42 Station=0,1 OutputCase=STR150 CaseType=Combination P=-24,1406203806309 V2=24,7283893579189 V3=0 T=0 M2=0 M3=17,3497648715861	FrameElem=42-1 ElemStation=0,1

Società di Progetto
Brebemi SpA

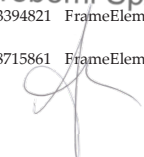

	Doc. N. 60235-00000-A00.doc	CODIFICA DOCUMENTO 04RCDII10000000000300A00	REV. 00	FOGLIO 544 di 628
--	--------------------------------	--	------------	----------------------

Frame=42 Station=0 OutputCase=STR151 CaseType=Combination P=-40,4393958256023 V2=11,6373099777063 V3=0 T=0 M2=0 M3=5,65023127694681 FrameElem=42-1 ElemStation=0

Frame=42 Station=0,05 OutputCase=STR151 CaseType=Combination P=-40,4393958256023 V2=11,8373099777063 V3=0 T=0 M2=0 M3=5,06336577806149 FrameElem=42-1 ElemStation=0,05

Frame=42 Station=0,1 OutputCase=STR151 CaseType=Combination P=-40,4393958256023 V2=12,0373099777063 V3=0 T=0 M2=0 M3=4,46650027917618 FrameElem=42-1 ElemStation=0,1

Frame=42 Station=0 OutputCase=STR152 CaseType=Combination P=-20,2603307198195 V2=88,4464467214643 V3=0 T=0 M2=0 M3=29,2113245749895 FrameElem=42-1 ElemStation=0

Frame=42 Station=0,05 OutputCase=STR152 CaseType=Combination P=-20,2603307198195 V2=88,7164467214644 V3=0 T=0 M2=0 M3=24,7822522389162 FrameElem=42-1 ElemStation=0,05

Frame=42 Station=0,1 OutputCase=STR152 CaseType=Combination P=-20,2603307198195 V2=88,9864467214643 V3=0 T=0 M2=0 M3=20,339679902843 FrameElem=42-1 ElemStation=0,1

Frame=42 Station=0 OutputCase=STR153 CaseType=Combination P=-7,43456838673824 V2=68,8171060009416 V3=0 T=0 M2=0 M3=-0,729828843121892 FrameElem=42-1 ElemStation=0

Frame=42 Station=0,05 OutputCase=STR153 CaseType=Combination P=-7,43456838673824 V2=69,0871060009416 V3=0 T=0 M2=0 M3=-4,17743414316897 FrameElem=42-1 ElemStation=0,05

Frame=42 Station=0,1 OutputCase=STR153 CaseType=Combination P=-7,43456838673824 V2=69,3571060009416 V3=0 T=0 M2=0 M3=-7,63853944321605 FrameElem=42-1 ElemStation=0,1

Frame=42 Station=0 OutputCase=STR154 CaseType=Combination P=-20,6281134553059 V2=78,8784557393025 V3=0 T=0 M2=0 M3=14,1220999738756 FrameElem=42-1 ElemStation=0

Frame=42 Station=0,05 OutputCase=STR154 CaseType=Combination P=-20,6281134553059 V2=79,1484557393025 V3=0 T=0 M2=0 M3=10,1714271869104 FrameElem=42-1 ElemStation=0,05

Frame=42 Station=0,1 OutputCase=STR154 CaseType=Combination P=-20,6281134553059 V2=79,4184557393025 V3=0 T=0 M2=0 M3=6,20725439994531 FrameElem=42-1 ElemStation=0,1

Frame=42 Station=0 OutputCase=STR155 CaseType=Combination P=-33,8216585230819 V2=68,8308864745741 V3=0 T=0 M2=0 M3=2,96425299460059 FrameElem=42-1 ElemStation=0

Frame=42 Station=0,05 OutputCase=STR155 CaseType=Combination P=-33,8216585230819 V2=69,1008864745741 V3=0 T=0 M2=0 M3=-0,484041329128119 FrameElem=42-1 ElemStation=0,05

Frame=42 Station=0,1 OutputCase=STR155 CaseType=Combination P=-33,8216585230819 V2=69,3708864745741 V3=0 T=0 M2=0 M3=-3,94583565285682 FrameElem=42-1 ElemStation=0,1

Frame=42 Station=0 OutputCase=STR156 CaseType=Combination P=-21,4031727376646 V2=21,6825928247523 V3=0 T=0 M2=0 M3=16,1951665183398 FrameElem=42-1 ElemStation=0

Frame=42 Station=0,05 OutputCase=STR156 CaseType=Combination P=-21,4031727376646 V2=21,8825928247523 V3=0 T=0 M2=0 M3=15,1060368771022 FrameElem=42-1 ElemStation=0,05

Frame=42 Station=0,1 OutputCase=STR156 CaseType=Combination P=-21,4031727376646 V2=22,0825928247523 V3=0 T=0 M2=0 M3=14,0069072358645 FrameElem=42-1 ElemStation=0,1

Frame=42 Station=0 OutputCase=STR157 CaseType=Combination P=-34,5967178054406 V2=11,635023560024 V3=0 T=0 M2=0 M3=5,03731953906481 FrameElem=42-1 ElemStation=0

Frame=42 Station=0,05 OutputCase=STR157 CaseType=Combination P=-34,5967178054406 V2=11,835023560024 V3=0 T=0 M2=0 M3=4,45056836106361 FrameElem=42-1 ElemStation=0,05

Frame=42 Station=0,1 OutputCase=STR157 CaseType=Combination P=-34,5967178054406 V2=12,035023560024 V3=0 T=0 M2=0 M3=3,85381718306241 FrameElem=42-1 ElemStation=0,1

Frame=42 Station=0 OutputCase=STR158 CaseType=Combination P=-15,6107413000767 V2=15,688414953036 V3=0 T=0 M2=0 M3=1,74281214836114 FrameElem=42-1 ElemStation=0

Frame=42 Station=0,05 OutputCase=STR158 CaseType=Combination P=-15,6107413000767 V2=15,958414953036 V3=0 T=0 M2=0 M3=0,951641400709345 FrameElem=42-1 ElemStation=0,05

Frame=42 Station=0,1 OutputCase=STR158 CaseType=Combination P=-15,6107413000767 V2=16,228414953036 V3=0 T=0 M2=0 M3=0,146970653057545 FrameElem=42-1 ElemStation=0,1

Frame=42 Station=0 OutputCase=STR159 CaseType=Combination P=-7,85503343067738 V2=15,6849094569111 V3=0 T=0 M2=0 M3=0,803106465486507 FrameElem=42-1 ElemStation=0

Frame=42 Station=0,05 OutputCase=STR159 CaseType=Combination P=-7,85503343067738 V2=15,9549094569111 V3=0 T=0 M2=0 M3=1,21109926409501E-02 FrameElem=42-1 ElemStation=0,05

Frame=42 Station=0,1 OutputCase=STR159 CaseType=Combination P=-7,85503343067738 V2=16,2249094569111 V3=0 T=0 M2=0 M3=-0,792384480204607 FrameElem=42-1 ElemStation=0,1

Frame=42 Station=0 OutputCase=STR160 CaseType=Combination P=-6,88289428350871 V2=68,8153981387113 V3=0 T=0 M2=0 M3=-1,18764931372282 FrameElem=42-1 ElemStation=0

Frame=42 Station=0,05 OutputCase=STR160 CaseType=Combination P=-6,88289428350871 V2=69,0853981387113 V3=0 T=0 M2=0 M3=4,63516922065838 FrameElem=42-1 ElemStation=0,05

Frame=42 Station=0,1 OutputCase=STR160 CaseType=Combination P=-6,88289428350871 V2=69,3553981387113 V3=0 T=0 M2=0 M3=-8,09618912759395 FrameElem=42-1 ElemStation=0,1

Frame=42 Station=0 OutputCase=STR161 CaseType=Combination P=-20,0764393520763 V2=78,8767478770721 V3=0 T=0 M2=0 M3=13,6642795032746 FrameElem=42-1 ElemStation=0

Frame=42 Station=0,05 OutputCase=STR161 CaseType=Combination P=-20,0764393520763 V2=79,1467478770721 V3=0 T=0 M2=0 M3=9,71369210942103 FrameElem=42-1 ElemStation=0,05

Frame=42 Station=0,1 OutputCase=STR161 CaseType=Combination P=-20,0764393520763 V2=79,4167478770721 V3=0 T=0 M2=0 M3=5,74960471556742 FrameElem=42-1 ElemStation=0,1

Frame=42 Station=0 OutputCase=STR162 CaseType=Combination P=-33,2699844198523 V2=68,8291786123438 V3=0 T=0 M2=0 M3=2,50643252399966 FrameElem=42-1 ElemStation=0

Frame=42 Station=0,05 OutputCase=STR162 CaseType=Combination P=-33,2699844198523 V2=69,0991786123438 V3=0 T=0 M2=0 M3=-0,941776406617527 FrameElem=42-1 ElemStation=0,05

Frame=42 Station=0,1 OutputCase=STR162 CaseType=Combination P=-33,2699844198523 V2=69,3691786123438 V3=0 T=0 M2=0 M3=-4,4034853723471 FrameElem=42-1 ElemStation=0,1

Frame=42 Station=0 OutputCase=STR163 CaseType=Combination P=-20,851498634435 V2=21,680884962522 V3=0 T=0 M2=0 M3=15,7373460477389 FrameElem=42-1 ElemStation=0

Frame=42 Station=0,05 OutputCase=STR163 CaseType=Combination P=-20,851498634435 V2=21,880884962522 V3=0 T=0 M2=0 M3=14,6483017996128 FrameElem=42-1 ElemStation=0,05

Frame=42 Station=0,1 OutputCase=STR163 CaseType=Combination P=-20,851498634435 V2=22,080884962522 V3=0 T=0 M2=0 M3=13,5492575514867 FrameElem=42-1 ElemStation=0,1

Frame=42 Station=0 OutputCase=STR164 CaseType=Combination P=-34,045043702211 V2=11,6333156977936 V3=0 T=0 M2=0 M3=4,57949906846388 FrameElem=42-1 ElemStation=0

Frame=42 Station=0,05 OutputCase=STR164 CaseType=Combination P=-34,045043702211 V2=11,8333156977936 V3=0 T=0 M2=0 M3=3,9928332835742 FrameElem=42-1 ElemStation=0,05

Frame=42 Station=0,1 OutputCase=STR164 CaseType=Combination P=-34,045043702211 V2=12,0333156977936 V3=0 T=0 M2=0 M3=3,39616749868452 FrameElem=42-1 ElemStation=0,1

Frame=42 Station=0 OutputCase=STR165 CaseType=Combination P=-16,7140895065358 V2=15,6918306774967 V3=0 T=0 M2=0 M3=2,658453089563 FrameElem=42-1 ElemStation=0

Frame=42 Station=0,05 OutputCase=STR165 CaseType=Combination P=-16,7140895065358 V2=15,9618306774967 V3=0 T=0 M2=0 M3=1,86711155568816 FrameElem=42-1 ElemStation=0,05

Società di Progetto
Brebemi SpA



Doc. N.
60235-00000-A00.doc

CODIFICA DOCUMENTO
04RCDII10000000000300A00

REV.
00

FOGLIO
545 di 628

Frame=42 Station=0,1 OutputCase=STR165 CaseType=Combination P=-16,7140895065358 V2=16,2318306774967 V3=0 T=0 M2=0 M3=1,06227002181333 FrameElem=42-1 ElemStation=0,1

Frame=42 Station=0 OutputCase=STR166 CaseType=Combination P=-8,95838163713645 V2=15,6883251813719 V3=0 T=0 M2=0 M3=1,71874740668836 FrameElem=42-1 ElemStation=0

Frame=42 Station=0,05 OutputCase=STR166 CaseType=Combination P=-8,95838163713645 V2=15,9583251813719 V3=0 T=0 M2=0 M3=0,927581147619767 FrameElem=42-1 ElemStation=0,05

Frame=42 Station=0,1 OutputCase=STR166 CaseType=Combination P=-8,95838163713645 V2=16,2283251813719 V3=0 T=0 M2=0 M3=0,122914888551174 FrameElem=42-1 ElemStation=0,1

Frame=42 Station=0 OutputCase=STR167 CaseType=Combination P=-7,98624248996778 V2=68,818813863172 V3=0 T=0 M2=0 M3=0,272008372520966 FrameElem=42-1 ElemStation=0

Frame=42 Station=0,05 OutputCase=STR167 CaseType=Combination P=-7,98624248996778 V2=69,088813863172 V3=0 T=0 M2=0 M3=-3,71969906567956 FrameElem=42-1 ElemStation=0,05

Frame=42 Station=0,1 OutputCase=STR167 CaseType=Combination P=-7,98624248996778 V2=69,358813863172 V3=0 T=0 M2=0 M3=-7,18088975883816 FrameElem=42-1 ElemStation=0,1

Frame=42 Station=0 OutputCase=STR168 CaseType=Combination P=-21,1797875585354 V2=78,8801636015329 V3=0 T=0 M2=0 M3=14,5799204444765 FrameElem=42-1 ElemStation=0

Frame=42 Station=0,05 OutputCase=STR168 CaseType=Combination P=-21,1797875585354 V2=79,1501636015329 V3=0 T=0 M2=0 M3=10,6291622643998 FrameElem=42-1 ElemStation=0,05

Frame=42 Station=0,1 OutputCase=STR168 CaseType=Combination P=-21,1797875585354 V2=79,4201636015329 V3=0 T=0 M2=0 M3=6,6649040843232 FrameElem=42-1 ElemStation=0,1

Frame=42 Station=0 OutputCase=STR169 CaseType=Combination P=-34,3733326263114 V2=68,8325943368045 V3=0 T=0 M2=0 M3=3,42207346520151 FrameElem=42-1 ElemStation=0

Frame=42 Station=0,05 OutputCase=STR169 CaseType=Combination P=-34,3733326263114 V2=69,1025943368045 V3=0 T=0 M2=0 M3=-2,63062516387108E-02 FrameElem=42-1 ElemStation=0,05

Frame=42 Station=0,1 OutputCase=STR169 CaseType=Combination P=-34,3733326263114 V2=69,3725943368045 V3=0 T=0 M2=0 M3=-3,48818596847893 FrameElem=42-1 ElemStation=0,1

Frame=42 Station=0 OutputCase=STR170 CaseType=Combination P=-21,9548468408941 V2=21,6843006869827 V3=0 T=0 M2=0 M3=16,6529896889407 FrameElem=42-1 ElemStation=0

Frame=42 Station=0,05 OutputCase=STR170 CaseType=Combination P=-21,9548468408941 V2=21,8843006869827 V3=0 T=0 M2=0 M3=15,5637719545916 FrameElem=42-1 ElemStation=0,05

Frame=42 Station=0,1 OutputCase=STR170 CaseType=Combination P=-21,9548468408941 V2=22,0843006869827 V3=0 T=0 M2=0 M3=14,4645569202424 FrameElem=42-1 ElemStation=0,1

Frame=42 Station=0 OutputCase=STR171 CaseType=Combination P=-35,1483919086701 V2=11,6367314222543 V3=0 T=0 M2=0 M3=5,49514000966574 FrameElem=42-1 ElemStation=0

Frame=42 Station=0,05 OutputCase=STR171 CaseType=Combination P=-35,1483919086701 V2=11,8367314222543 V3=0 T=0 M2=0 M3=4,90830343855302 FrameElem=42-1 ElemStation=0,05

Frame=42 Station=0,1 OutputCase=STR171 CaseType=Combination P=-35,1483919086701 V2=12,0367314222543 V3=0 T=0 M2=0 M3=4,3114668674403 FrameElem=42-1 ElemStation=0,1

Frame=42 Station=0 OutputCase=STR172 CaseType=Combination P=-16,3912870760129 V2=16,1481777015541 V3=0 T=0 M2=0 M3=2,56028900831064 FrameElem=42-1 ElemStation=0

Frame=42 Station=0,05 OutputCase=STR172 CaseType=Combination P=-16,3912870760129 V2=16,4181777015541 V3=0 T=0 M2=0 M3=1,74613012323294 FrameElem=42-1 ElemStation=0,05

Frame=42 Station=0,1 OutputCase=STR172 CaseType=Combination P=-16,3912870760129 V2=16,6881777015541 V3=0 T=0 M2=0 M3=0,918471238155233 FrameElem=42-1 ElemStation=0,1

Frame=42 Station=0 OutputCase=STR173 CaseType=Combination P=-8,63557920661353 V2=16,1446722054292 V3=0 T=0 M2=0 M3=1,620583325436 FrameElem=42-1 ElemStation=0

Frame=42 Station=0,05 OutputCase=STR173 CaseType=Combination P=-8,63557920661353 V2=16,4146722054292 V3=0 T=0 M2=0 M3=0,806599715164541 FrameElem=42-1 ElemStation=0,05

Frame=42 Station=0,1 OutputCase=STR173 CaseType=Combination P=-8,63557920661353 V2=16,6846722054292 V3=0 T=0 M2=0 M3=-2,08838951069196E-02 FrameElem=42-1 ElemStation=0,1

Frame=42 Station=0 OutputCase=STR174 CaseType=Combination P=-7,66344005944486 V2=69,2751608872293 V3=0 T=0 M2=0 M3=-0,370172453773325 FrameElem=42-1 ElemStation=0

Frame=42 Station=0,05 OutputCase=STR174 CaseType=Combination P=-7,66344005944486 V2=69,5451608872293 V3=0 T=0 M2=0 M3=-3,84068049813479 FrameElem=42-1 ElemStation=0,05

Frame=42 Station=0,1 OutputCase=STR174 CaseType=Combination P=-7,66344005944486 V2=69,8151608872293 V3=0 T=0 M2=0 M3=-7,32468854249626 FrameElem=42-1 ElemStation=0,1

Frame=42 Station=0 OutputCase=STR175 CaseType=Combination P=-20,8569851280125 V2=79,3365106255902 V3=0 T=0 M2=0 M3=14,4817563632241 FrameElem=42-1 ElemStation=0

Frame=42 Station=0,05 OutputCase=STR175 CaseType=Combination P=-20,8569851280125 V2=79,6065106255902 V3=0 T=0 M2=0 M3=10,5081808319446 FrameElem=42-1 ElemStation=0,05

Frame=42 Station=0,1 OutputCase=STR175 CaseType=Combination P=-20,8569851280125 V2=79,8765106255902 V3=0 T=0 M2=0 M3=6,52110530066511 FrameElem=42-1 ElemStation=0,1

Frame=42 Station=0 OutputCase=STR176 CaseType=Combination P=-34,0505301957885 V2=69,2889413608618 V3=0 T=0 M2=0 M3=3,32390938394915 FrameElem=42-1 ElemStation=0

Frame=42 Station=0,05 OutputCase=STR176 CaseType=Combination P=-34,0505301957885 V2=69,5589413608618 V3=0 T=0 M2=0 M3=-0,147287684093937 FrameElem=42-1 ElemStation=0,05

Frame=42 Station=0,1 OutputCase=STR176 CaseType=Combination P=-34,0505301957885 V2=69,8289413608618 V3=0 T=0 M2=0 M3=-3,63198475213703 FrameElem=42-1 ElemStation=0,1

Frame=42 Station=0 OutputCase=STR177 CaseType=Combination P=-21,6320444103712 V2=22,14064771104 V3=0 T=0 M2=0 M3=16,5548229076883 FrameElem=42-1 ElemStation=0

Frame=42 Station=0,05 OutputCase=STR177 CaseType=Combination P=-21,6320444103712 V2=22,34064771104 V3=0 T=0 M2=0 M3=15,4427905221363 FrameElem=42-1 ElemStation=0,05

Frame=42 Station=0,1 OutputCase=STR177 CaseType=Combination P=-21,6320444103712 V2=22,5406477110401 V3=0 T=0 M2=0 M3=14,3207581365843 FrameElem=42-1 ElemStation=0,1

Frame=42 Station=0 OutputCase=STR178 CaseType=Combination P=-34,8255894781472 V2=12,0930784463117 V3=0 T=0 M2=0 M3=5,39697592841338 FrameElem=42-1 ElemStation=0

Frame=42 Station=0,05 OutputCase=STR178 CaseType=Combination P=-34,8255894781472 V2=12,2930784463117 V3=0 T=0 M2=0 M3=4,78732200609779 FrameElem=42-1 ElemStation=0,05

Frame=42 Station=0,1 OutputCase=STR178 CaseType=Combination P=-34,8255894781472 V2=12,4930784463117 V3=0 T=0 M2=0 M3=4,16766808378221 FrameElem=42-1 ElemStation=0,1

Frame=42 Station=0 OutputCase=STR179 CaseType=Combination P=-16,3912870760129 V2=16,1481777015541 V3=0 T=0 M2=0 M3=2,56028900831064 FrameElem=42-1 ElemStation=0

Frame=42 Station=0,05 OutputCase=STR179 CaseType=Combination P=-16,3912870760129 V2=16,4181777015541 V3=0 T=0 M2=0 M3=1,74613012323294 FrameElem=42-1 ElemStation=0,05

Frame=42 Station=0,1 OutputCase=STR179 CaseType=Combination P=-16,3912870760129 V2=16,6881777015541 V3=0 T=0 M2=0 M3=0,918471238155233 FrameElem=42-1 ElemStation=0,1

Frame=42 Station=0 OutputCase=STR180 CaseType=Combination P=-15,9335437305996 V2=15,2320679289787 V3=0 T=0 M2=0 M3=1,8409762296135 FrameElem=42-1 ElemStation=0

Società di Progetto
Brebemi SpA



Doc. N.
60235-0000-A00.doc

CODIFICA DOCUMENTO
04RCDII10000000000300A00

REV.
00

FOGLIO
546 di 628

Frame=42 Station=0,05 OutputCase=STR180 CaseType=Combination P=-15,9335437305996 V2=15,5020679289787 V3=0 T=0 M2=0 M3=1,07262283316457 ElemStation=0,05	FrameElem=42-1
Frame=42 Station=0,1 OutputCase=STR180 CaseType=Combination P=-15,9335437305996 V2=15,7720679289787 V3=0 T=0 M2=0 M3=0,290769436715638 ElemStation=0,1	FrameElem=42-1
Frame=42 Station=0 OutputCase=STR181 CaseType=Combination P=-8,1778358612003 V2=15,2285624328538 V3=0 T=0 M2=0 M3=0,901270546738866 ElemStation=0	FrameElem=42-1
Frame=42 Station=0,05 OutputCase=STR181 CaseType=Combination P=-8,1778358612003 V2=15,4985624328538 V3=0 T=0 M2=0 M3=0,133092425096176 ElemStation=0,05	FrameElem=42-1
Frame=42 Station=0,1 OutputCase=STR181 CaseType=Combination P=-8,1778358612003 V2=15,7685624328538 V3=0 T=0 M2=0 M3=0,648585696546514 ElemStation=0,1	FrameElem=42-1
Frame=42 Station=0 OutputCase=STR182 CaseType=Combination P=-7,20569671403162 V2=68,3590511146539 V3=0 T=0 M2=0 M3=-1,08948523247046 ElemStation=0	FrameElem=42-1
Frame=42 Station=0,05 OutputCase=STR182 CaseType=Combination P=-7,20569671403162 V2=68,6290511146539 V3=0 T=0 M2=0 M3=-4,51418778820315 ElemStation=0,05	FrameElem=42-1
Frame=42 Station=0,1 OutputCase=STR182 CaseType=Combination P=-7,20569671403162 V2=68,8990511146539 V3=0 T=0 M2=0 M3=-7,95239034393585 ElemStation=0,1	FrameElem=42-1
Frame=42 Station=0 OutputCase=STR183 CaseType=Combination P=-20,3992417825992 V2=78,4204008530148 V3=0 T=0 M2=0 M3=13,762443584527 ElemStation=0	FrameElem=42-1
Frame=42 Station=0,05 OutputCase=STR183 CaseType=Combination P=-20,3992417825992 V2=78,6904008530148 V3=0 T=0 M2=0 M3=9,83467354187625 ElemStation=0,05	FrameElem=42-1
Frame=42 Station=0,1 OutputCase=STR183 CaseType=Combination P=-20,3992417825992 V2=78,9604008530148 V3=0 T=0 M2=0 M3=5,89340349922551 ElemStation=0,1	FrameElem=42-1
Frame=42 Station=0 OutputCase=STR184 CaseType=Combination P=-33,5927868503752 V2=68,3728315882864 V3=0 T=0 M2=0 M3=2,60459660525202 ElemStation=0	FrameElem=42-1
Frame=42 Station=0,05 OutputCase=STR184 CaseType=Combination P=-33,5927868503752 V2=68,6428315882864 V3=0 T=0 M2=0 M3=-0,820794974162301 ElemStation=0,05	FrameElem=42-1
Frame=42 Station=0,1 OutputCase=STR184 CaseType=Combination P=-33,5927868503752 V2=68,9128315882864 V3=0 T=0 M2=0 M3=-4,25968655357662 ElemStation=0,1	FrameElem=42-1
Frame=42 Station=0 OutputCase=STR185 CaseType=Combination P=-21,1743010649579 V2=21,2245379384646 V3=0 T=0 M2=0 M3=15,8355101289912 ElemStation=0	FrameElem=42-1
Frame=42 Station=0,05 OutputCase=STR185 CaseType=Combination P=-21,1743010649579 V2=21,4245379384646 V3=0 T=0 M2=0 M3=14,769283232068 ElemStation=0,05	FrameElem=42-1
Frame=42 Station=0,1 OutputCase=STR185 CaseType=Combination P=-21,1743010649579 V2=21,6245379384646 V3=0 T=0 M2=0 M3=13,693063351448 ElemStation=0,1	FrameElem=42-1
Frame=42 Station=0 OutputCase=STR186 CaseType=Combination P=-34,3678461327339 V2=11,1769686737363 V3=0 T=0 M2=0 M3=4,67766314971624 ElemStation=0	FrameElem=42-1
Frame=42 Station=0,05 OutputCase=STR186 CaseType=Combination P=-34,3678461327339 V2=11,3769686737363 V3=0 T=0 M2=0 M3=4,11381471602943 ElemStation=0,05	FrameElem=42-1
Frame=42 Station=0,1 OutputCase=STR186 CaseType=Combination P=-34,3678461327339 V2=11,5769686737363 V3=0 T=0 M2=0 M3=3,53996628234262 ElemStation=0,1	FrameElem=42-1
Frame=42 Station=0 OutputCase=STR187 CaseType=Combination P=-15,9335437305996 V2=15,2320679289787 V3=0 T=0 M2=0 M3=1,8409762296135 ElemStation=0	FrameElem=42-1
Frame=42 Station=0,05 OutputCase=STR187 CaseType=Combination P=-15,9335437305996 V2=15,5020679289787 V3=0 T=0 M2=0 M3=1,07262283316457 ElemStation=0,05	FrameElem=42-1
Frame=42 Station=0,1 OutputCase=STR187 CaseType=Combination P=-15,9335437305996 V2=15,7720679289787 V3=0 T=0 M2=0 M3=0,290769436715638 ElemStation=0,1	FrameElem=42-1
Frame=42 Station=0 OutputCase=INVSTR CaseType=Combination StepType=Max P=-5,36678303659984 V2=99,6907621904598 V3=0 T=0 M2=0 M3=29,2113245749895 FrameElem=42-1 ElemStation=0	FrameElem=42-1
Frame=42 Station=0,05 OutputCase=INVSTR CaseType=Combination StepType=Max P=-5,36678303659984 V2=99,9607621904598 V3=0 T=0 M2=0 M3=24,7822522389162 FrameElem=42-1 ElemStation=0,05	FrameElem=42-1
Frame=42 Station=0,1 OutputCase=INVSTR CaseType=Combination StepType=Max P=-5,36678303659984 V2=100,23076219046 V3=0 T=0 M2=0 M3=20,339679902843 FrameElem=42-1 ElemStation=0,1	FrameElem=42-1
Frame=42 Station=0 OutputCase=INVSTR CaseType=Combination StepType=Min P=-40,4393958256023 V2=10,8670444502635 V3=0 T=0 M2=0 M3=-2,61555346780688 FrameElem=42-1 ElemStation=0	FrameElem=42-1
Frame=42 Station=0,05 OutputCase=INVSTR CaseType=Combination StepType=Min P=-40,4393958256023 V2=11,0670444502635 V3=0 T=0 M2=0 M3=-6,94715442090717 FrameElem=42-1 ElemStation=0,05	FrameElem=42-1
Frame=42 Station=0,1 OutputCase=INVSTR CaseType=Combination StepType=Min P=-40,4393958256023 V2=11,2670444502635 V3=0 T=0 M2=0 M3=-11,2935401506869 FrameElem=42-1 ElemStation=0,1	FrameElem=42-1
Frame=42 Station=0 OutputCase=SIS01 CaseType=Combination P=-13,5492038119228 V2=15,2549254572376 V3=0 T=0 M2=0 M3=7,11820958766709 ElemStation=0	FrameElem=42-1
Frame=42 Station=0,05 OutputCase=SIS01 CaseType=Combination P=-13,5492038119228 V2=15,4549254572376 V3=0 T=0 M2=0 M3=6,35046331480522 ElemStation=0,05	FrameElem=42-1
Frame=42 Station=0,1 OutputCase=SIS01 CaseType=Combination P=-13,5492038119228 V2=15,6549254572376 V3=0 T=0 M2=0 M3=5,57271704194334 ElemStation=0,1	FrameElem=42-1
Frame=42 Station=0 OutputCase=SIS02 CaseType=Combination P=-13,1660967957912 V2=15,2537394417998 V3=0 T=0 M2=0 M3=6,80027870530534 ElemStation=0	FrameElem=42-1
Frame=42 Station=0,05 OutputCase=SIS02 CaseType=Combination P=-13,1660967957912 V2=15,4537394417998 V3=0 T=0 M2=0 M3=6,03259173321535 ElemStation=0,05	FrameElem=42-1
Frame=42 Station=0,1 OutputCase=SIS02 CaseType=Combination P=-13,1660967957912 V2=15,6537394417998 V3=0 T=0 M2=0 M3=5,25490476112536 ElemStation=0,1	FrameElem=42-1
Frame=42 Station=0 OutputCase=SIS03 CaseType=Combination P=-13,9323108280544 V2=15,2561114726753 V3=0 T=0 M2=0 M3=7,43614047002885 ElemStation=0	FrameElem=42-1
Frame=42 Station=0,05 OutputCase=SIS03 CaseType=Combination P=-13,9323108280544 V2=15,4561114726753 V3=0 T=0 M2=0 M3=6,66833489639508 ElemStation=0,05	FrameElem=42-1
Frame=42 Station=0,1 OutputCase=SIS03 CaseType=Combination P=-13,9323108280544 V2=15,6561114726753 V3=0 T=0 M2=0 M3=5,89052932276132 ElemStation=0,1	FrameElem=42-1
Frame=42 Station=0 OutputCase=SIS04 CaseType=Combination P=-13,7081424735246 V2=15,5730191282707 V3=0 T=0 M2=0 M3=7,36797096915915 ElemStation=0	FrameElem=42-1
Frame=42 Station=0,05 OutputCase=SIS04 CaseType=Combination P=-13,7081424735246 V2=15,7730191282707 V3=0 T=0 M2=0 M3=6,58432001274562 ElemStation=0,05	FrameElem=42-1
Frame=42 Station=0,1 OutputCase=SIS04 CaseType=Combination P=-13,7081424735246 V2=15,9730191282707 V3=0 T=0 M2=0 M3=5,79066905633209 ElemStation=0,1	FrameElem=42-1
Frame=42 Station=0 OutputCase=SIS05 CaseType=Combination P=-13,390265150321 V2=14,9368317862044 V3=0 T=0 M2=0 M3=6,86844820617503 ElemStation=0	FrameElem=42-1
Frame=42 Station=0,05 OutputCase=SIS05 CaseType=Combination P=-13,390265150321 V2=15,1368317862044 V3=0 T=0 M2=0 M3=6,11660661686481 ElemStation=0,05	FrameElem=42-1
Frame=42 Station=0,1 OutputCase=SIS05 CaseType=Combination P=-13,390265150321 V2=15,3368317862044 V3=0 T=0 M2=0 M3=5,35476502755459 ElemStation=0,1	FrameElem=42-1

Società di Progetto
Brebemi SpA

	Doc. N. 60235-00000-A00.doc	CODIFICA DOCUMENTO 04RCDII10000000000300A00	REV. 00	FOGLIO 547 di 628
--	--------------------------------	--	------------	----------------------

Frame=42 Station=0 OutputCase=SIS06 CaseType=Combination P=-13,9323108280544 V2=15,2561114726753 V3=0 T=0 M2=0 M3=7,43614047002885	FrameElem=42-1
ElemStation=0	
Frame=42 Station=0,05 OutputCase=SIS06 CaseType=Combination P=-13,9323108280544 V2=15,4561114726753 V3=0 T=0 M2=0 M3=6,66833489639508	FrameElem=42-1
ElemStation=0,05	
Frame=42 Station=0,1 OutputCase=SIS06 CaseType=Combination P=-13,9323108280544 V2=15,6561114726753 V3=0 T=0 M2=0 M3=5,89052932276132	FrameElem=42-1
ElemStation=0,1	
Frame=42 Station=0 OutputCase=SIS07 CaseType=Combination P=-13,325035457393 V2=15,5718331128329 V3=0 T=0 M2=0 M3=7,0500400867974	FrameElem=42-1
ElemStation=0	
Frame=42 Station=0,05 OutputCase=SIS07 CaseType=Combination P=-13,325035457393 V2=15,7718331128329 V3=0 T=0 M2=0 M3=6,26644843115575	FrameElem=42-1
ElemStation=0,05	
Frame=42 Station=0,1 OutputCase=SIS07 CaseType=Combination P=-13,325035457393 V2=15,9718331128329 V3=0 T=0 M2=0 M3=5,47285677551411	FrameElem=42-1
ElemStation=0,1	
Frame=42 Station=0 OutputCase=SIS08 CaseType=Combination P=-13,0071581341893 V2=14,9356457707667 V3=0 T=0 M2=0 M3=6,55051732381328	FrameElem=42-1
ElemStation=0	
Frame=42 Station=0,05 OutputCase=SIS08 CaseType=Combination P=-13,0071581341893 V2=15,1356457707667 V3=0 T=0 M2=0 M3=5,79873503527494	FrameElem=42-1
ElemStation=0,05	
Frame=42 Station=0,1 OutputCase=SIS08 CaseType=Combination P=-13,0071581341893 V2=15,3356457707667 V3=0 T=0 M2=0 M3=5,03695274673661	FrameElem=42-1
ElemStation=0,1	
Frame=42 Station=0 OutputCase=SIS09 CaseType=Combination P=-13,5492038119228 V2=15,2549254572376 V3=0 T=0 M2=0 M3=7,11820958766709	FrameElem=42-1
ElemStation=0	
Frame=42 Station=0,05 OutputCase=SIS09 CaseType=Combination P=-13,5492038119228 V2=15,4549254572376 V3=0 T=0 M2=0 M3=6,35046331480522	FrameElem=42-1
ElemStation=0,05	
Frame=42 Station=0,1 OutputCase=SIS09 CaseType=Combination P=-13,5492038119228 V2=15,6549254572375 V3=0 T=0 M2=0 M3=5,57271704194334	FrameElem=42-1
ElemStation=0,1	
Frame=42 Station=0 OutputCase=SIS10 CaseType=Combination P=-13,5899746451603 V2=16,061778057948 V3=0 T=0 M2=0 M3=7,10306934342263	FrameElem=42-1
ElemStation=0	
Frame=42 Station=0,05 OutputCase=SIS10 CaseType=Combination P=-13,5899746451603 V2=16,261778057948 V3=0 T=0 M2=0 M3=6,29498044052524	FrameElem=42-1
ElemStation=0,05	
Frame=42 Station=0,1 OutputCase=SIS10 CaseType=Combination P=-13,5899746451603 V2=16,461778057948 V3=0 T=0 M2=0 M3=5,47689153762784	FrameElem=42-1
ElemStation=0,1	
Frame=42 Station=0 OutputCase=SIS11 CaseType=Combination P=-13,2068676290287 V2=16,0605920425102 V3=0 T=0 M2=0 M3=6,78513846106088	FrameElem=42-1
ElemStation=0	
Frame=42 Station=0,05 OutputCase=SIS11 CaseType=Combination P=-13,2068676290287 V2=16,2605920425102 V3=0 T=0 M2=0 M3=5,97710885893537	FrameElem=42-1
ElemStation=0,05	
Frame=42 Station=0,1 OutputCase=SIS11 CaseType=Combination P=-13,2068676290287 V2=16,4605920425102 V3=0 T=0 M2=0 M3=5,15907925680986	FrameElem=42-1
ElemStation=0,1	
Frame=42 Station=0 OutputCase=SIS12 CaseType=Combination P=-13,9730816612919 V2=16,0629640733857 V3=0 T=0 M2=0 M3=7,42100022578439	FrameElem=42-1
ElemStation=0	
Frame=42 Station=0,05 OutputCase=SIS12 CaseType=Combination P=-13,9730816612919 V2=16,2629640733857 V3=0 T=0 M2=0 M3=6,6128520221151	FrameElem=42-1
ElemStation=0,05	
Frame=42 Station=0,1 OutputCase=SIS12 CaseType=Combination P=-13,9730816612919 V2=16,4629640733857 V3=0 T=0 M2=0 M3=5,79470381844582	FrameElem=42-1
ElemStation=0,1	
Frame=42 Station=0 OutputCase=SIS13 CaseType=Combination P=-13,7489133067621 V2=16,3798717289811 V3=0 T=0 M2=0 M3=7,3528307249147	FrameElem=42-1
ElemStation=0	
Frame=42 Station=0,05 OutputCase=SIS13 CaseType=Combination P=-13,7489133067621 V2=16,5798717289811 V3=0 T=0 M2=0 M3=6,52883713846564	FrameElem=42-1
ElemStation=0,05	
Frame=42 Station=0,1 OutputCase=SIS13 CaseType=Combination P=-13,7489133067621 V2=16,7798717289811 V3=0 T=0 M2=0 M3=5,69484355201659	FrameElem=42-1
ElemStation=0,1	
Frame=42 Station=0 OutputCase=SIS14 CaseType=Combination P=-13,4310359835585 V2=15,7436843869148 V3=0 T=0 M2=0 M3=6,85330796193057	FrameElem=42-1
ElemStation=0	
Frame=42 Station=0,05 OutputCase=SIS14 CaseType=Combination P=-13,4310359835585 V2=15,9436843869148 V3=0 T=0 M2=0 M3=6,06112374258483	FrameElem=42-1
ElemStation=0,05	
Frame=42 Station=0,1 OutputCase=SIS14 CaseType=Combination P=-13,4310359835585 V2=16,1436843869148 V3=0 T=0 M2=0 M3=5,25893952323909	FrameElem=42-1
ElemStation=0,1	
Frame=42 Station=0 OutputCase=SIS15 CaseType=Combination P=-13,9730816612919 V2=16,0629640733857 V3=0 T=0 M2=0 M3=7,42100022578439	FrameElem=42-1
ElemStation=0	
Frame=42 Station=0,05 OutputCase=SIS15 CaseType=Combination P=-13,9730816612919 V2=16,2629640733857 V3=0 T=0 M2=0 M3=6,6128520221151	FrameElem=42-1
ElemStation=0,05	
Frame=42 Station=0,1 OutputCase=SIS15 CaseType=Combination P=-13,9730816612919 V2=16,4629640733857 V3=0 T=0 M2=0 M3=5,79470381844582	FrameElem=42-1
ElemStation=0,1	
Frame=42 Station=0 OutputCase=SIS16 CaseType=Combination P=-13,3658062906305 V2=16,3786857135433 V3=0 T=0 M2=0 M3=7,03489984255294	FrameElem=42-1
ElemStation=0	
Frame=42 Station=0,05 OutputCase=SIS16 CaseType=Combination P=-13,3658062906305 V2=16,5786857135433 V3=0 T=0 M2=0 M3=6,21096555687578	FrameElem=42-1
ElemStation=0,05	
Frame=42 Station=0,1 OutputCase=SIS16 CaseType=Combination P=-13,3658062906305 V2=16,7786857135433 V3=0 T=0 M2=0 M3=5,37703127119861	FrameElem=42-1
ElemStation=0,1	
Frame=42 Station=0 OutputCase=SIS17 CaseType=Combination P=-13,0479289674269 V2=15,7424983714771 V3=0 T=0 M2=0 M3=6,53537707956882	FrameElem=42-1
ElemStation=0	
Frame=42 Station=0,05 OutputCase=SIS17 CaseType=Combination P=-13,0479289674269 V2=15,9424983714771 V3=0 T=0 M2=0 M3=5,74325216099497	FrameElem=42-1
ElemStation=0,05	
Frame=42 Station=0,1 OutputCase=SIS17 CaseType=Combination P=-13,0479289674269 V2=16,1424983714771 V3=0 T=0 M2=0 M3=4,94112724242111	FrameElem=42-1
ElemStation=0,1	
Frame=42 Station=0 OutputCase=SIS18 CaseType=Combination P=-13,5899746451603 V2=16,061778057948 V3=0 T=0 M2=0 M3=7,10306934342263	FrameElem=42-1
ElemStation=0	
Frame=42 Station=0,05 OutputCase=SIS18 CaseType=Combination P=-13,5899746451603 V2=16,261778057948 V3=0 T=0 M2=0 M3=6,29498044052524	FrameElem=42-1
ElemStation=0,05	
Frame=42 Station=0,1 OutputCase=SIS18 CaseType=Combination P=-13,5899746451603 V2=16,461778057948 V3=0 T=0 M2=0 M3=5,47689153762784	FrameElem=42-1
ElemStation=0,1	
Frame=42 Station=0 OutputCase=SIS19 CaseType=Combination P=-13,5016378398124 V2=12,9969899091244 V3=0 T=0 M2=0 M3=5,14067442128776	FrameElem=42-1
ElemStation=0	
Frame=42 Station=0,05 OutputCase=SIS19 CaseType=Combination P=-13,5016378398124 V2=13,1969899091244 V3=0 T=0 M2=0 M3=4,48582492583154	FrameElem=42-1
ElemStation=0,05	
Frame=42 Station=0,1 OutputCase=SIS19 CaseType=Combination P=-13,5016378398124 V2=13,3969899091244 V3=0 T=0 M2=0 M3=3,82097543037532	FrameElem=42-1
ElemStation=0,1	
Frame=42 Station=0 OutputCase=SIS20 CaseType=Combination P=-13,1185308236807 V2=12,9958038936866 V3=0 T=0 M2=0 M3=4,822743538926	FrameElem=42-1
ElemStation=0	
Frame=42 Station=0,05 OutputCase=SIS20 CaseType=Combination P=-13,1185308236807 V2=13,1958038936866 V3=0 T=0 M2=0 M3=4,16795334424167	FrameElem=42-1
ElemStation=0,05	

Società di Progetto
Brebemi SpA



Doc. N.
60235-0000-A00.doc

CODIFICA DOCUMENTO
04RCDII10000000000300A00

REV.
00

FOGLIO
548 di 628

Frame=42 Station=0,1 OutputCase=SIS20 CaseType=Combination P=-13,1185308236807 V2=13,3958038936866 V3=0 T=0 M2=0 M3=3,50316314955734	FrameElem=42-1 ElemStation=0,1
Frame=42 Station=0 OutputCase=SIS21 CaseType=Combination P=-13,884744855944 V2=12,9981759245621 V3=0 T=0 M2=0 M3=5,45860530364951	FrameElem=42-1 ElemStation=0
Frame=42 Station=0,05 OutputCase=SIS21 CaseType=Combination P=-13,884744855944 V2=13,1981759245621 V3=0 T=0 M2=0 M3=4,80369650742141	FrameElem=42-1 ElemStation=0,05
Frame=42 Station=0,1 OutputCase=SIS21 CaseType=Combination P=-13,884744855944 V2=13,3981759245621 V3=0 T=0 M2=0 M3=4,1387877111933	FrameElem=42-1 ElemStation=0,1
Frame=42 Station=0 OutputCase=SIS22 CaseType=Combination P=-13,6605765014142 V2=13,3150835801575 V3=0 T=0 M2=0 M3=5,39043580277982	FrameElem=42-1 ElemStation=0
Frame=42 Station=0,05 OutputCase=SIS22 CaseType=Combination P=-13,6605765014142 V2=13,5150835801575 V3=0 T=0 M2=0 M3=4,71968162377194	FrameElem=42-1 ElemStation=0,05
Frame=42 Station=0,1 OutputCase=SIS22 CaseType=Combination P=-13,6605765014142 V2=13,7150835801575 V3=0 T=0 M2=0 M3=4,03892744476407	FrameElem=42-1 ElemStation=0,1
Frame=42 Station=0 OutputCase=SIS23 CaseType=Combination P=-13,3426991782105 V2=12,6788962380913 V3=0 T=0 M2=0 M3=4,8909130397957	FrameElem=42-1 ElemStation=0
Frame=42 Station=0,05 OutputCase=SIS23 CaseType=Combination P=-13,3426991782105 V2=12,8788962380913 V3=0 T=0 M2=0 M3=4,25196822789114	FrameElem=42-1 ElemStation=0,05
Frame=42 Station=0,1 OutputCase=SIS23 CaseType=Combination P=-13,3426991782105 V2=13,0788962380913 V3=0 T=0 M2=0 M3=3,60302341598657	FrameElem=42-1 ElemStation=0,1
Frame=42 Station=0 OutputCase=SIS24 CaseType=Combination P=-13,884744855944 V2=12,9981759245621 V3=0 T=0 M2=0 M3=5,45860530364951	FrameElem=42-1 ElemStation=0
Frame=42 Station=0,05 OutputCase=SIS24 CaseType=Combination P=-13,884744855944 V2=13,1981759245621 V3=0 T=0 M2=0 M3=4,80369650742141	FrameElem=42-1 ElemStation=0,05
Frame=42 Station=0,1 OutputCase=SIS24 CaseType=Combination P=-13,884744855944 V2=13,3981759245621 V3=0 T=0 M2=0 M3=4,1387877111933	FrameElem=42-1 ElemStation=0,1
Frame=42 Station=0 OutputCase=SIS25 CaseType=Combination P=-13,2774694852826 V2=13,3138975647198 V3=0 T=0 M2=0 M3=5,07250492041806	FrameElem=42-1 ElemStation=0
Frame=42 Station=0,05 OutputCase=SIS25 CaseType=Combination P=-13,2774694852826 V2=13,5138975647198 V3=0 T=0 M2=0 M3=4,40181004218208	FrameElem=42-1 ElemStation=0,05
Frame=42 Station=0,1 OutputCase=SIS25 CaseType=Combination P=-13,2774694852826 V2=13,7138975647198 V3=0 T=0 M2=0 M3=3,72111516394609	FrameElem=42-1 ElemStation=0,1
Frame=42 Station=0 OutputCase=SIS26 CaseType=Combination P=-12,9595921620789 V2=12,6777102226535 V3=0 T=0 M2=0 M3=4,57298215743394	FrameElem=42-1 ElemStation=0
Frame=42 Station=0,05 OutputCase=SIS26 CaseType=Combination P=-12,9595921620789 V2=12,8777102226535 V3=0 T=0 M2=0 M3=3,93409664630127	FrameElem=42-1 ElemStation=0,05
Frame=42 Station=0,1 OutputCase=SIS26 CaseType=Combination P=-12,9595921620789 V2=13,0777102226535 V3=0 T=0 M2=0 M3=3,28521113516859	FrameElem=42-1 ElemStation=0,1
Frame=42 Station=0 OutputCase=SIS27 CaseType=Combination P=-13,5016378398124 V2=12,9969899091244 V3=0 T=0 M2=0 M3=5,14067442128776	FrameElem=42-1 ElemStation=0
Frame=42 Station=0,05 OutputCase=SIS27 CaseType=Combination P=-13,5016378398124 V2=13,1969899091244 V3=0 T=0 M2=0 M3=4,48582492583154	FrameElem=42-1 ElemStation=0,05
Frame=42 Station=0,1 OutputCase=SIS27 CaseType=Combination P=-13,5016378398124 V2=13,3969899091244 V3=0 T=0 M2=0 M3=3,82097543037532	FrameElem=42-1 ElemStation=0,1
Frame=42 Station=0 OutputCase=SIS28 CaseType=Combination P=-13,6375406172707 V2=15,6864985781591 V3=0 T=0 M2=0 M3=5,0902069404729	FrameElem=42-1 ElemStation=0
Frame=42 Station=0,05 OutputCase=SIS28 CaseType=Combination P=-13,6375406172707 V2=15,8864985781591 V3=0 T=0 M2=0 M3=4,30088201156495	FrameElem=42-1 ElemStation=0,05
Frame=42 Station=0,1 OutputCase=SIS28 CaseType=Combination P=-13,6375406172707 V2=16,0864985781591 V3=0 T=0 M2=0 M3=3,50155708265699	FrameElem=42-1 ElemStation=0,1
Frame=42 Station=0 OutputCase=SIS29 CaseType=Combination P=-13,2544336011391 V2=15,6853125627213 V3=0 T=0 M2=0 M3=4,77227605811115	FrameElem=42-1 ElemStation=0
Frame=42 Station=0,05 OutputCase=SIS29 CaseType=Combination P=-13,2544336011391 V2=15,8853125627213 V3=0 T=0 M2=0 M3=3,98301042997508	FrameElem=42-1 ElemStation=0,05
Frame=42 Station=0,1 OutputCase=SIS29 CaseType=Combination P=-13,2544336011391 V2=16,0853125627213 V3=0 T=0 M2=0 M3=3,18374480183901	FrameElem=42-1 ElemStation=0,1
Frame=42 Station=0 OutputCase=SIS30 CaseType=Combination P=-14,0206476334023 V2=15,6876845935968 V3=0 T=0 M2=0 M3=5,40813782283465	FrameElem=42-1 ElemStation=0
Frame=42 Station=0,05 OutputCase=SIS30 CaseType=Combination P=-14,0206476334023 V2=15,8876845935968 V3=0 T=0 M2=0 M3=4,61875359315481	FrameElem=42-1 ElemStation=0,05
Frame=42 Station=0,1 OutputCase=SIS30 CaseType=Combination P=-14,0206476334023 V2=16,0876845935968 V3=0 T=0 M2=0 M3=3,81936936347497	FrameElem=42-1 ElemStation=0,1
Frame=42 Station=0 OutputCase=SIS31 CaseType=Combination P=-13,7964792788725 V2=16,0045922491922 V3=0 T=0 M2=0 M3=5,33996832196496	FrameElem=42-1 ElemStation=0
Frame=42 Station=0,05 OutputCase=SIS31 CaseType=Combination P=-13,7964792788725 V2=16,2045922491922 V3=0 T=0 M2=0 M3=4,53473870950535	FrameElem=42-1 ElemStation=0,05
Frame=42 Station=0,1 OutputCase=SIS31 CaseType=Combination P=-13,7964792788725 V2=16,4045922491922 V3=0 T=0 M2=0 M3=3,71950909704574	FrameElem=42-1 ElemStation=0,1
Frame=42 Station=0 OutputCase=SIS32 CaseType=Combination P=-13,4786019556689 V2=15,368404907126 V3=0 T=0 M2=0 M3=4,84044555898084	FrameElem=42-1 ElemStation=0
Frame=42 Station=0,05 OutputCase=SIS32 CaseType=Combination P=-13,4786019556689 V2=15,568404907126 V3=0 T=0 M2=0 M3=4,06702531362454	FrameElem=42-1 ElemStation=0,05
Frame=42 Station=0,1 OutputCase=SIS32 CaseType=Combination P=-13,4786019556689 V2=15,768404907126 V3=0 T=0 M2=0 M3=3,28360506826824	FrameElem=42-1 ElemStation=0,1
Frame=42 Station=0 OutputCase=SIS33 CaseType=Combination P=-14,0206476334023 V2=15,6876845935968 V3=0 T=0 M2=0 M3=5,40813782283465	FrameElem=42-1 ElemStation=0
Frame=42 Station=0,05 OutputCase=SIS33 CaseType=Combination P=-14,0206476334023 V2=15,8876845935968 V3=0 T=0 M2=0 M3=4,61875359315481	FrameElem=42-1 ElemStation=0,05
Frame=42 Station=0,1 OutputCase=SIS33 CaseType=Combination P=-14,0206476334023 V2=16,0876845935968 V3=0 T=0 M2=0 M3=3,81936936347497	FrameElem=42-1 ElemStation=0,1
Frame=42 Station=0 OutputCase=SIS34 CaseType=Combination P=-13,4133722627409 V2=16,0034062337545 V3=0 T=0 M2=0 M3=5,02203743960321	FrameElem=42-1 ElemStation=0
Frame=42 Station=0,05 OutputCase=SIS34 CaseType=Combination P=-13,4133722627409 V2=16,2034062337545 V3=0 T=0 M2=0 M3=4,21686712791548	FrameElem=42-1 ElemStation=0,05
Frame=42 Station=0,1 OutputCase=SIS34 CaseType=Combination P=-13,4133722627409 V2=16,4034062337545 V3=0 T=0 M2=0 M3=3,40169681622776	FrameElem=42-1 ElemStation=0,1
Frame=42 Station=0 OutputCase=SIS35 CaseType=Combination P=-13,0954949395373 V2=15,3672188916882 V3=0 T=0 M2=0 M3=4,52251467661908	FrameElem=42-1 ElemStation=0

Società di Progetto
Brebemi SpA

	Doc. N. 60235-00000-A00.doc	CODIFICA DOCUMENTO 04RCDII10000000000300A00	REV. 00	FOGLIO 549 di 628
--	--------------------------------	--	------------	----------------------

Frame=42 Station=0,05 OutputCase=SIS35 CaseType=Combination P=-13,0954949395373 V2=15,5672188916882 V3=0 T=0 M2=0 M3=3,74915373203467 FrameElem=42-1 ElemStation=0,05

Frame=42 Station=0,1 OutputCase=SIS35 CaseType=Combination P=-13,0954949395373 V2=15,7672188916882 V3=0 T=0 M2=0 M3=2,96579278745026 FrameElem=42-1 ElemStation=0,1

Frame=42 Station=0 OutputCase=SIS36 CaseType=Combination P=-13,6375406172707 V2=15,6864985781591 V3=0 T=0 M2=0 M3=5,0902069404729 FrameElem=42-1 ElemStation=0

Frame=42 Station=0,05 OutputCase=SIS36 CaseType=Combination P=-13,6375406172707 V2=15,8864985781591 V3=0 T=0 M2=0 M3=4,30088201156495 FrameElem=42-1 ElemStation=0,05

Frame=42 Station=0,1 OutputCase=SIS36 CaseType=Combination P=-13,6375406172707 V2=16,0864985781591 V3=0 T=0 M2=0 M3=3,50155708265699 FrameElem=42-1 ElemStation=0,1

Frame=42 Station=0 OutputCase=INVSIS CaseType=Combination StepType=Max P=-12,9595921620789 V2=16,3798717289811 V3=0 T=0 M2=0 M3=7,43614047002885 FrameElem=42-1 ElemStation=0

Frame=42 Station=0,05 OutputCase=INVSIS CaseType=Combination StepType=Max P=-12,9595921620789 V2=16,5798717289811 V3=0 T=0 M2=0 M3=6,66833489639508 FrameElem=42-1 ElemStation=0,05

Frame=42 Station=0,1 OutputCase=INVSIS CaseType=Combination StepType=Max P=-12,9595921620789 V2=16,7798717289811 V3=0 T=0 M2=0 M3=5,89052932276132 FrameElem=42-1 ElemStation=0,1

Frame=42 Station=0 OutputCase=INVSIS CaseType=Combination StepType=Min P=-14,0206476334023 V2=12,6777102226535 V3=0 T=0 M2=0 M3=4,52251467661908 FrameElem=42-1 ElemStation=0

Frame=42 Station=0,05 OutputCase=INVSIS CaseType=Combination StepType=Min P=-14,0206476334023 V2=12,8777102226535 V3=0 T=0 M2=0 M3=3,74915373203467 FrameElem=42-1 ElemStation=0,05

Frame=42 Station=0,1 OutputCase=INVSIS CaseType=Combination StepType=Min P=-14,0206476334023 V2=13,0777102226535 V3=0 T=0 M2=0 M3=2,96579278745026 FrameElem=42-1 ElemStation=0,1

Frame=42 Station=0 OutputCase=RAR001 CaseType=Combination P=-11,2910804182151 V2=11,6202047246043 V3=0 T=0 M2=0 M3=1,06488777873619 FrameElem=42-1 ElemStation=0

Frame=42 Station=0,05 OutputCase=RAR001 CaseType=Combination P=-11,2910804182151 V2=11,8202047246043 V3=0 T=0 M2=0 M3=0,478877542505979 FrameElem=42-1 ElemStation=0,05

Frame=42 Station=0,1 OutputCase=RAR001 CaseType=Combination P=-11,2910804182151 V2=12,0202047246043 V3=0 T=0 M2=0 M3=0,117132693724233 FrameElem=42-1 ElemStation=0,1

Frame=42 Station=0 OutputCase=RAR002 CaseType=Combination P=-6,33003340107866 V2=64,0929533721064 V3=0 T=0 M2=0 M3=-1,38597496369312 FrameElem=42-1 ElemStation=0

Frame=42 Station=0,05 OutputCase=RAR002 CaseType=Combination P=-6,33003340107866 V2=64,2929533721064 V3=0 T=0 M2=0 M3=-4,59562263229844 FrameElem=42-1 ElemStation=0,05

Frame=42 Station=0,1 OutputCase=RAR002 CaseType=Combination P=-6,33003340107866 V2=64,4929533721064 V3=0 T=0 M2=0 M3=-7,81527030090376 FrameElem=42-1 ElemStation=0,1

Frame=42 Station=0 OutputCase=RAR003 CaseType=Combination P=-17,5311707966543 V2=73,0291236050543 V3=0 T=0 M2=0 M3=11,8126807103695 FrameElem=42-1 ElemStation=0

Frame=42 Station=0,05 OutputCase=RAR003 CaseType=Combination P=-17,5311707966543 V2=73,2291236050543 V3=0 T=0 M2=0 M3=8,15622453011676 FrameElem=42-1 ElemStation=0,05

Frame=42 Station=0,1 OutputCase=RAR003 CaseType=Combination P=-17,5311707966543 V2=73,4291236050543 V3=0 T=0 M2=0 M3=4,48976834986405 FrameElem=42-1 ElemStation=0,1

Frame=42 Station=0 OutputCase=RAR004 CaseType=Combination P=-28,732308190833 V2=64,1049095733033 V3=0 T=0 M2=0 M3=1,81908074232979 FrameElem=42-1 ElemStation=0

Frame=42 Station=0,05 OutputCase=RAR004 CaseType=Combination P=-28,732308190833 V2=64,3049095733033 V3=0 T=0 M2=0 M3=-1,39116473633538 FrameElem=42-1 ElemStation=0,05

Frame=42 Station=0,1 OutputCase=RAR004 CaseType=Combination P=-28,732308190833 V2=64,5049095733033 V3=0 T=0 M2=0 M3=-4,61141021500054 FrameElem=42-1 ElemStation=0,1

Frame=42 Station=0 OutputCase=RAR005 CaseType=Combination P=-18,4913082259567 V2=20,5545668822888 V3=0 T=0 M2=0 M3=13,7788592577367 FrameElem=42-1 ElemStation=0

Frame=42 Station=0,05 OutputCase=RAR005 CaseType=Combination P=-18,4913082259567 V2=20,7545668822888 V3=0 T=0 M2=0 M3=12,7461309136223 FrameElem=42-1 ElemStation=0,05

Frame=42 Station=0,1 OutputCase=RAR005 CaseType=Combination P=-18,4913082259567 V2=20,9545668822888 V3=0 T=0 M2=0 M3=11,7034025695078 FrameElem=42-1 ElemStation=0,1

Frame=42 Station=0 OutputCase=RAR006 CaseType=Combination P=-29,6924456201354 V2=11,6303528505377 V3=0 T=0 M2=0 M3=3,78525928969702 FrameElem=42-1 ElemStation=0

Frame=42 Station=0,05 OutputCase=RAR006 CaseType=Combination P=-29,6924456201354 V2=11,8303528505377 V3=0 T=0 M2=0 M3=3,19874164717014 FrameElem=42-1 ElemStation=0,05

Frame=42 Station=0,1 OutputCase=RAR006 CaseType=Combination P=-29,6924456201354 V2=12,0303528505377 V3=0 T=0 M2=0 M3=2,60222400464325 FrameElem=42-1 ElemStation=0,1

Frame=42 Station=0 OutputCase=RAR007 CaseType=Combination P=-15,4710345032742 V2=65,0380358680632 V3=0 T=0 M2=0 M3=20,8092529857859 FrameElem=42-1 ElemStation=0

Frame=42 Station=0,05 OutputCase=RAR007 CaseType=Combination P=-15,4710345032742 V2=65,2380358680632 V3=0 T=0 M2=0 M3=17,5523511923827 FrameElem=42-1 ElemStation=0,05

Frame=42 Station=0,1 OutputCase=RAR007 CaseType=Combination P=-15,4710345032742 V2=65,4380358680632 V3=0 T=0 M2=0 M3=14,2854493989795 FrameElem=42-1 ElemStation=0,1

Frame=42 Station=0 OutputCase=RAR008 CaseType=Combination P=-6,52395679811781 V2=11,6160246184654 V3=0 T=0 M2=0 M3=-0,055658181049389 FrameElem=42-1 ElemStation=0

Frame=42 Station=0,05 OutputCase=RAR008 CaseType=Combination P=-6,52395679811781 V2=11,8160246184654 V3=0 T=0 M2=0 M3=-0,641459411972657 FrameElem=42-1 ElemStation=0,05

Frame=42 Station=0,1 OutputCase=RAR008 CaseType=Combination P=-6,52395679811781 V2=12,0160246184654 V3=0 T=0 M2=0 M3=-1,23726064289593 FrameElem=42-1 ElemStation=0,1

Frame=42 Station=0 OutputCase=RAR009 CaseType=Combination P=-5,87030498172071 V2=64,0915301535811 V3=0 T=0 M2=0 M3=-1,76749202252722 FrameElem=42-1 ElemStation=0

Frame=42 Station=0,05 OutputCase=RAR009 CaseType=Combination P=-5,87030498172071 V2=64,2915301535811 V3=0 T=0 M2=0 M3=-4,97706853020628 FrameElem=42-1 ElemStation=0,05

Frame=42 Station=0,1 OutputCase=RAR009 CaseType=Combination P=-5,87030498172071 V2=64,4915301535811 V3=0 T=0 M2=0 M3=-8,19664503788533 FrameElem=42-1 ElemStation=0,1

Frame=42 Station=0 OutputCase=RAR010 CaseType=Combination P=-17,0714423772964 V2=73,027700386529 V3=0 T=0 M2=0 M3=11,4311636515354 FrameElem=42-1 ElemStation=0

Frame=42 Station=0,05 OutputCase=RAR010 CaseType=Combination P=-17,0714423772964 V2=73,227700386529 V3=0 T=0 M2=0 M3=7,77477863220892 FrameElem=42-1 ElemStation=0,05

Frame=42 Station=0,1 OutputCase=RAR010 CaseType=Combination P=-17,0714423772964 V2=73,427700386529 V3=0 T=0 M2=0 M3=4,10839361288247 FrameElem=42-1 ElemStation=0,1

Frame=42 Station=0 OutputCase=RAR011 CaseType=Combination P=-28,272579771475 V2=64,103486354778 V3=0 T=0 M2=0 M3=1,43756368349568 FrameElem=42-1 ElemStation=0

Frame=42 Station=0,05 OutputCase=RAR011 CaseType=Combination P=-28,272579771475 V2=64,303486354778 V3=0 T=0 M2=0 M3=-1,77261063424322 FrameElem=42-1 ElemStation=0,05

Frame=42 Station=0,1 OutputCase=RAR011 CaseType=Combination P=-28,272579771475 V2=64,503486354778 V3=0 T=0 M2=0 M3=-4,99278495198211 FrameElem=42-1 ElemStation=0,1

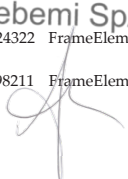
Società di Progetto
Brebemi SpA



Doc. N.
60235-0000-A00.doc

CODIFICA DOCUMENTO
04RCDII10000000000300A00

REV.
00

FOGLIO
550 di 628

Frame=42 Station=0 OutputCase=RAR012 CaseType=Combination P=-18,0315798065987 V2=20,5531436637635 V3=0 T=0 M2=0 M3=13,3973421989026 FrameElem=42-1 ElemStation=0
Frame=42 Station=0,05 OutputCase=RAR012 CaseType=Combination P=-18,0315798065987 V2=20,7531436637635 V3=0 T=0 M2=0 M3=12,3646850157144 FrameElem=42-1 ElemStation=0,05
Frame=42 Station=0,1 OutputCase=RAR012 CaseType=Combination P=-18,0315798065987 V2=20,9531436637635 V3=0 T=0 M2=0 M3=11,3220278325263 FrameElem=42-1 ElemStation=0,1
Frame=42 Station=0 OutputCase=RAR013 CaseType=Combination P=-29,2327172007774 V2=11,6289296320124 V3=0 T=0 M2=0 M3=3,40374223086292 FrameElem=42-1 ElemStation=0
Frame=42 Station=0,05 OutputCase=RAR013 CaseType=Combination P=-29,2327172007774 V2=11,8289296320124 V3=0 T=0 M2=0 M3=2,8172957492623 FrameElem=42-1 ElemStation=0,05
Frame=42 Station=0,1 OutputCase=RAR013 CaseType=Combination P=-29,2327172007774 V2=12,0289296320124 V3=0 T=0 M2=0 M3=2,22084926766168 FrameElem=42-1 ElemStation=0,1
Frame=42 Station=0 OutputCase=RAR014 CaseType=Combination P=-15,0113060839163 V2=65,0366126495379 V3=0 T=0 M2=0 M3=20,4277359269518 FrameElem=42-1 ElemStation=0
Frame=42 Station=0,05 OutputCase=RAR014 CaseType=Combination P=-15,0113060839163 V2=65,2366126495379 V3=0 T=0 M2=0 M3=17,1709052944749 FrameElem=42-1 ElemStation=0,05
Frame=42 Station=0,1 OutputCase=RAR014 CaseType=Combination P=-15,0113060839163 V2=65,4366126495379 V3=0 T=0 M2=0 M3=13,904074661998 FrameElem=42-1 ElemStation=0,1
Frame=42 Station=0 OutputCase=RAR015 CaseType=Combination P=-5,80385372614101 V2=50,9719421605395 V3=0 T=0 M2=0 M3=-1,53029209157482 FrameElem=42-1 ElemStation=0
Frame=42 Station=0,05 OutputCase=RAR015 CaseType=Combination P=-5,80385372614101 V2=51,1719421605395 V3=0 T=0 M2=0 M3=-4,08388919960179 FrameElem=42-1 ElemStation=0,05
Frame=42 Station=0,1 OutputCase=RAR015 CaseType=Combination P=-5,80385372614101 V2=51,3719421605395 V3=0 T=0 M2=0 M3=-6,64748630762877 FrameElem=42-1 ElemStation=0,1
Frame=42 Station=0 OutputCase=RAR016 CaseType=Combination P=-14,704820471011 V2=57,9474197209046 V3=0 T=0 M2=0 M3=8,77010362981704 FrameElem=42-1 ElemStation=0
Frame=42 Station=0,05 OutputCase=RAR016 CaseType=Combination P=-14,704820471011 V2=58,1474197209046 V3=0 T=0 M2=0 M3=5,8677326437718 FrameElem=42-1 ElemStation=0,05
Frame=42 Station=0,1 OutputCase=RAR016 CaseType=Combination P=-14,704820471011 V2=58,3474197209046 V3=0 T=0 M2=0 M3=2,95536165772657 FrameElem=42-1 ElemStation=0,1
Frame=42 Station=0 OutputCase=RAR017 CaseType=Combination P=-23,6057872154152 V2=50,981361330253 V3=0 T=0 M2=0 M3=0,994670736707881 FrameElem=42-1 ElemStation=0
Frame=42 Station=0,05 OutputCase=RAR017 CaseType=Combination P=-23,6057872154152 V2=51,181361330253 V3=0 T=0 M2=0 M3=-1,55939732980477 FrameElem=42-1 ElemStation=0,05
Frame=42 Station=0,1 OutputCase=RAR017 CaseType=Combination P=-23,6057872154152 V2=51,381361330253 V3=0 T=0 M2=0 M3=-4,12346539631742 FrameElem=42-1 ElemStation=0,1
Frame=42 Station=0 OutputCase=RAR018 CaseType=Combination P=-15,4249235429878 V2=18,5915021788305 V3=0 T=0 M2=0 M3=10,2447375403425 FrameElem=42-1 ElemStation=0
Frame=42 Station=0,05 OutputCase=RAR018 CaseType=Combination P=-15,4249235429878 V2=18,7915021788305 V3=0 T=0 M2=0 M3=9,31016243140094 FrameElem=42-1 ElemStation=0,05
Frame=42 Station=0,1 OutputCase=RAR018 CaseType=Combination P=-15,4249235429878 V2=18,9915021788305 V3=0 T=0 M2=0 M3=8,36558732245942 FrameElem=42-1 ElemStation=0,1
Frame=42 Station=0 OutputCase=RAR019 CaseType=Combination P=-24,325890287392 V2=11,6254437881789 V3=0 T=0 M2=0 M3=2,46930464723331 FrameElem=42-1 ElemStation=0
Frame=42 Station=0,05 OutputCase=RAR019 CaseType=Combination P=-24,325890287392 V2=11,8254437881789 V3=0 T=0 M2=0 M3=1,88303245782436 FrameElem=42-1 ElemStation=0,05
Frame=42 Station=0,1 OutputCase=RAR019 CaseType=Combination P=-24,325890287392 V2=12,0254437881789 V3=0 T=0 M2=0 M3=1,28676026841542 FrameElem=42-1 ElemStation=0,1
Frame=42 Station=0 OutputCase=RAR020 CaseType=Combination P=-6,71468319203999 V2=11,9977370237051 V3=0 T=0 M2=0 M3=0,244055476741084 FrameElem=42-1 ElemStation=0
Frame=42 Station=0,05 OutputCase=RAR020 CaseType=Combination P=-6,71468319203999 V2=12,1977370237051 V3=0 T=0 M2=0 M3=-0,360831374444172 FrameElem=42-1 ElemStation=0,05
Frame=42 Station=0,1 OutputCase=RAR020 CaseType=Combination P=-6,71468319203999 V2=12,3977370237051 V3=0 T=0 M2=0 M3=-0,975718225629428 FrameElem=42-1 ElemStation=0,1
Frame=42 Station=0 OutputCase=RAR021 CaseType=Combination P=-5,9945801200632 V2=51,3536545657793 V3=0 T=0 M2=0 M3=-1,23057843378434 FrameElem=42-1 ElemStation=0
Frame=42 Station=0,05 OutputCase=RAR021 CaseType=Combination P=-5,9945801200632 V2=51,5536545657793 V3=0 T=0 M2=0 M3=-3,80326116207331 FrameElem=42-1 ElemStation=0,05
Frame=42 Station=0,1 OutputCase=RAR021 CaseType=Combination P=-5,9945801200632 V2=51,7536545657793 V3=0 T=0 M2=0 M3=-6,38594389036227 FrameElem=42-1 ElemStation=0,1
Frame=42 Station=0 OutputCase=RAR022 CaseType=Combination P=-14,8955468649331 V2=58,3291321261444 V3=0 T=0 M2=0 M3=9,06981728760751 FrameElem=42-1 ElemStation=0
Frame=42 Station=0,05 OutputCase=RAR022 CaseType=Combination P=-14,8955468649331 V2=58,5291321261444 V3=0 T=0 M2=0 M3=6,14836068130029 FrameElem=42-1 ElemStation=0,05
Frame=42 Station=0,1 OutputCase=RAR022 CaseType=Combination P=-14,8955468649331 V2=58,7291321261444 V3=0 T=0 M2=0 M3=3,21690407499307 FrameElem=42-1 ElemStation=0,1
Frame=42 Station=0 OutputCase=RAR023 CaseType=Combination P=-23,7965136093374 V2=51,3630737354928 V3=0 T=0 M2=0 M3=1,29438439449835 FrameElem=42-1 ElemStation=0
Frame=42 Station=0,05 OutputCase=RAR023 CaseType=Combination P=-23,7965136093374 V2=51,5630737354928 V3=0 T=0 M2=0 M3=-1,27876929227629 FrameElem=42-1 ElemStation=0,05
Frame=42 Station=0,1 OutputCase=RAR023 CaseType=Combination P=-23,7965136093374 V2=51,7630737354928 V3=0 T=0 M2=0 M3=-3,86192297905092 FrameElem=42-1 ElemStation=0,1
Frame=42 Station=0 OutputCase=RAR024 CaseType=Combination P=-15,6156499369099 V2=18,9732145840702 V3=0 T=0 M2=0 M3=10,5444511981329 FrameElem=42-1 ElemStation=0
Frame=42 Station=0,05 OutputCase=RAR024 CaseType=Combination P=-15,6156499369099 V2=19,1732145840702 V3=0 T=0 M2=0 M3=9,59079046892942 FrameElem=42-1 ElemStation=0,05
Frame=42 Station=0,1 OutputCase=RAR024 CaseType=Combination P=-15,6156499369099 V2=19,3732145840702 V3=0 T=0 M2=0 M3=8,62712973972591 FrameElem=42-1 ElemStation=0,1
Frame=42 Station=0 OutputCase=RAR025 CaseType=Combination P=-24,5166166813142 V2=12,0071561934186 V3=0 T=0 M2=0 M3=2,76901830502378 FrameElem=42-1 ElemStation=0
Frame=42 Station=0,05 OutputCase=RAR025 CaseType=Combination P=-24,5166166813142 V2=12,2071561934186 V3=0 T=0 M2=0 M3=2,16366049535285 FrameElem=42-1 ElemStation=0,05
Frame=42 Station=0,1 OutputCase=RAR025 CaseType=Combination P=-24,5166166813142 V2=12,4071561934186 V3=0 T=0 M2=0 M3=1,54830268568192 FrameElem=42-1 ElemStation=0,1
Frame=42 Station=0 OutputCase=RAR026 CaseType=Combination P=-6,33323040419563 V2=11,2343122132256 V3=0 T=0 M2=0 M3=-0,355371838839862 FrameElem=42-1 ElemStation=0
Frame=42 Station=0,05 OutputCase=RAR026 CaseType=Combination P=-6,33323040419563 V2=11,4343122132256 V3=0 T=0 M2=0 M3=-0,922087449501143 FrameElem=42-1 ElemStation=0,05

Società di Progetto
Brebemi SpA



Doc. N.
60235-0000-A00.doc

CODIFICA DOCUMENTO
04RCDII10000000000300A00

REV.
00

FOGLIO
551 di 628

Frame=42 Station=0,1 OutputCase=RAR026 CaseType=Combination P=-6,33323040419563 V2=11,6343122132256 V3=0 T=0 M2=0 M3=-1,49880306016242 FrameElem=42-1 ElemStation=0,1

Frame=42 Station=0 OutputCase=RAR027 CaseType=Combination P=-5,61312733221883 V2=50,5902297552998 V3=0 T=0 M2=0 M3=-1,83000574936529 FrameElem=42-1 ElemStation=0

Frame=42 Station=0,05 OutputCase=RAR027 CaseType=Combination P=-5,61312733221883 V2=50,7902297552998 V3=0 T=0 M2=0 M3=-4,36451723713028 FrameElem=42-1 ElemStation=0,05

Frame=42 Station=0,1 OutputCase=RAR027 CaseType=Combination P=-5,61312733221883 V2=50,9902297552998 V3=0 T=0 M2=0 M3=-6,90902872489527 FrameElem=42-1 ElemStation=0,1

Frame=42 Station=0 OutputCase=RAR028 CaseType=Combination P=-14,5140940770888 V2=57,5657073156649 V3=0 T=0 M2=0 M3=8,47038997202656 FrameElem=42-1 ElemStation=0

Frame=42 Station=0,05 OutputCase=RAR028 CaseType=Combination P=-14,5140940770888 V2=57,7657073156649 V3=0 T=0 M2=0 M3=5,58710460624332 FrameElem=42-1 ElemStation=0,05

Frame=42 Station=0,1 OutputCase=RAR028 CaseType=Combination P=-14,5140940770888 V2=57,9657073156649 V3=0 T=0 M2=0 M3=2,693819240646007 FrameElem=42-1 ElemStation=0,1

Frame=42 Station=0 OutputCase=RAR029 CaseType=Combination P=-23,4150608214931 V2=50,5996489250133 V3=0 T=0 M2=0 M3=0,694957078917408 FrameElem=42-1 ElemStation=0

Frame=42 Station=0,05 OutputCase=RAR029 CaseType=Combination P=-23,4150608214931 V2=50,7996489250133 V3=0 T=0 M2=0 M3=-1,84002536733326 FrameElem=42-1 ElemStation=0,05

Frame=42 Station=0,1 OutputCase=RAR029 CaseType=Combination P=-23,4150608214931 V2=50,9996489250133 V3=0 T=0 M2=0 M3=-4,38500781358392 FrameElem=42-1 ElemStation=0,1

Frame=42 Station=0 OutputCase=RAR030 CaseType=Combination P=-15,2341971490656 V2=18,2097897735907 V3=0 T=0 M2=0 M3=9,94502388255199 FrameElem=42-1 ElemStation=0

Frame=42 Station=0,05 OutputCase=RAR030 CaseType=Combination P=-15,2341971490656 V2=18,4097897735907 V3=0 T=0 M2=0 M3=9,02953439387245 FrameElem=42-1 ElemStation=0,05

Frame=42 Station=0,1 OutputCase=RAR030 CaseType=Combination P=-15,2341971490656 V2=18,6097897735907 V3=0 T=0 M2=0 M3=8,10440490519292 FrameElem=42-1 ElemStation=0,1

Frame=42 Station=0 OutputCase=RAR031 CaseType=Combination P=-24,1351638934699 V2=11,2437313829391 V3=0 T=0 M2=0 M3=2,16959098944283 FrameElem=42-1 ElemStation=0

Frame=42 Station=0,05 OutputCase=RAR031 CaseType=Combination P=-24,1351638934699 V2=11,4437313829391 V3=0 T=0 M2=0 M3=1,60240442029588 FrameElem=42-1 ElemStation=0,05

Frame=42 Station=0,1 OutputCase=RAR031 CaseType=Combination P=-24,1351638934699 V2=11,6437313829391 V3=0 T=0 M2=0 M3=1,02521785114892 FrameElem=42-1 ElemStation=0,1

Frame=42 Station=0 OutputCase=RAR032 CaseType=Combination P=-6,98368521747575 V2=11,6174478369907 V3=0 T=0 M2=0 M3=0,325858877784716 FrameElem=42-1 ElemStation=0

Frame=42 Station=0,05 OutputCase=RAR032 CaseType=Combination P=-6,98368521747575 V2=11,8174478369907 V3=0 T=0 M2=0 M3=-0,260013514064817 FrameElem=42-1 ElemStation=0,05

Frame=42 Station=0,1 OutputCase=RAR032 CaseType=Combination P=-6,98368521747575 V2=12,0174478369907 V3=0 T=0 M2=0 M3=-0,85588590591435 FrameElem=42-1 ElemStation=0,1

Frame=42 Station=0 OutputCase=RAR033 CaseType=Combination P=-6,26358214549896 V2=50,9733653790648 V3=0 T=0 M2=0 M3=-1,14877503274071 FrameElem=42-1 ElemStation=0

Frame=42 Station=0,05 OutputCase=RAR033 CaseType=Combination P=-6,26358214549896 V2=51,1733653790648 V3=0 T=0 M2=0 M3=-3,70244330169395 FrameElem=42-1 ElemStation=0,05

Frame=42 Station=0,1 OutputCase=RAR033 CaseType=Combination P=-6,26358214549896 V2=51,3733653790648 V3=0 T=0 M2=0 M3=-6,26611157064719 FrameElem=42-1 ElemStation=0,1

Frame=42 Station=0 OutputCase=RAR034 CaseType=Combination P=-15,1645488903689 V2=57,9488429394299 V3=0 T=0 M2=0 M3=9,15162068865114 FrameElem=42-1 ElemStation=0

Frame=42 Station=0,05 OutputCase=RAR034 CaseType=Combination P=-15,1645488903689 V2=58,1488429394299 V3=0 T=0 M2=0 M3=6,24917854167964 FrameElem=42-1 ElemStation=0,05

Frame=42 Station=0,1 OutputCase=RAR034 CaseType=Combination P=-15,1645488903689 V2=58,3488429394299 V3=0 T=0 M2=0 M3=3,33673639470815 FrameElem=42-1 ElemStation=0,1

Frame=42 Station=0 OutputCase=RAR035 CaseType=Combination P=-24,0655156347732 V2=50,9827845487783 V3=0 T=0 M2=0 M3=1,37618779554199 FrameElem=42-1 ElemStation=0

Frame=42 Station=0,05 OutputCase=RAR035 CaseType=Combination P=-24,0655156347732 V2=51,1827845487783 V3=0 T=0 M2=0 M3=-1,17795143189693 FrameElem=42-1 ElemStation=0,05

Frame=42 Station=0,1 OutputCase=RAR035 CaseType=Combination P=-24,0655156347732 V2=51,3827845487783 V3=0 T=0 M2=0 M3=-3,74209065933585 FrameElem=42-1 ElemStation=0,1

Frame=42 Station=0 OutputCase=RAR036 CaseType=Combination P=-15,8846519623457 V2=18,5929253973558 V3=0 T=0 M2=0 M3=10,6262545991766 FrameElem=42-1 ElemStation=0

Frame=42 Station=0,05 OutputCase=RAR036 CaseType=Combination P=-15,8846519623457 V2=18,7929253973558 V3=0 T=0 M2=0 M3=9,69160832930878 FrameElem=42-1 ElemStation=0,05

Frame=42 Station=0,1 OutputCase=RAR036 CaseType=Combination P=-15,8846519623457 V2=18,9929253973558 V3=0 T=0 M2=0 M3=8,74696205944099 FrameElem=42-1 ElemStation=0,1

Frame=42 Station=0 OutputCase=RAR037 CaseType=Combination P=-24,78561870675 V2=11,6268670067042 V3=0 T=0 M2=0 M3=2,85082170606741 FrameElem=42-1 ElemStation=0

Frame=42 Station=0,05 OutputCase=RAR037 CaseType=Combination P=-24,78561870675 V2=11,8268670067042 V3=0 T=0 M2=0 M3=2,26447835573221 FrameElem=42-1 ElemStation=0,05

Frame=42 Station=0,1 OutputCase=RAR037 CaseType=Combination P=-24,78561870675 V2=12,0268670067042 V3=0 T=0 M2=0 M3=1,668135005397 FrameElem=42-1 ElemStation=0,1

Frame=42 Station=0 OutputCase=RAR038 CaseType=Combination P=-8,05638486264429 V2=11,6207686802164 V3=0 T=0 M2=0 M3=1,21606534839763 FrameElem=42-1 ElemStation=0

Frame=42 Station=0,05 OutputCase=RAR038 CaseType=Combination P=-8,05638486264429 V2=11,8207686802164 V3=0 T=0 M2=0 M3=0,63002691438681 FrameElem=42-1 ElemStation=0,05

Frame=42 Station=0,1 OutputCase=RAR038 CaseType=Combination P=-8,05638486264429 V2=12,0207686802164 V3=0 T=0 M2=0 M3=3,39884803759922E-02 FrameElem=42-1 ElemStation=0,1

Frame=42 Station=0 OutputCase=RAR039 CaseType=Combination P=-6,78976182043661 V2=64,0943765906317 V3=0 T=0 M2=0 M3=-1,00445790485901 FrameElem=42-1 ElemStation=0

Frame=42 Station=0,05 OutputCase=RAR039 CaseType=Combination P=-6,78976182043661 V2=64,2943765906317 V3=0 T=0 M2=0 M3=-4,2141767343906 FrameElem=42-1 ElemStation=0,05

Frame=42 Station=0,1 OutputCase=RAR039 CaseType=Combination P=-6,78976182043661 V2=64,4943765906317 V3=0 T=0 M2=0 M3=-7,43389556392218 FrameElem=42-1 ElemStation=0,1

Frame=42 Station=0 OutputCase=RAR040 CaseType=Combination P=-17,9908992160122 V2=73,0305468235796 V3=0 T=0 M2=0 M3=12,1941977692036 FrameElem=42-1 ElemStation=0

Frame=42 Station=0,05 OutputCase=RAR040 CaseType=Combination P=-17,9908992160122 V2=73,2305468235796 V3=0 T=0 M2=0 M3=8,5376704280246 FrameElem=42-1 ElemStation=0,05

Frame=42 Station=0,1 OutputCase=RAR040 CaseType=Combination P=-17,9908992160122 V2=73,4305468235796 V3=0 T=0 M2=0 M3=4,87114308684562 FrameElem=42-1 ElemStation=0,1

Frame=42 Station=0 OutputCase=RAR041 CaseType=Combination P=-29,1920366101909 V2=64,1063327918286 V3=0 T=0 M2=0 M3=2,20059780116389 FrameElem=42-1 ElemStation=0

Società di Progetto
Brebemi SpA

	Doc. N. 60235-00000-A00.doc	CODIFICA DOCUMENTO 04RCDII10000000000300A00	REV. 00	FOGLIO 552 di 628
--	--------------------------------	--	------------	----------------------

Frame=42 Station=0,05 OutputCase=RAR041 CaseType=Combination P=-,29,1920366101909 V2=64,3063327918286 V3=0 T=0 M2=0 M3=-,1,00971883842754 FrameElem=42-1 ElemStation=0,05

Frame=42 Station=0,1 OutputCase=RAR041 CaseType=Combination P=-,29,1920366101909 V2=64,5063327918286 V3=0 T=0 M2=0 M3=-,4,23003547801896 FrameElem=42-1 ElemStation=0,1

Frame=42 Station=0 OutputCase=RAR042 CaseType=Combination P=-,18,9510366453146 V2=20,5559901008141 V3=0 T=0 M2=0 M3=14,1603763165708 FrameElem=42-1 ElemStation=0

Frame=42 Station=0,05 OutputCase=RAR042 CaseType=Combination P=-,18,9510366453146 V2=20,7559901008141 V3=0 T=0 M2=0 M3=13,1275768115301 FrameElem=42-1 ElemStation=0,05

Frame=42 Station=0,1 OutputCase=RAR042 CaseType=Combination P=-,18,9510366453146 V2=20,9559901008141 V3=0 T=0 M2=0 M3=12,0847773064894 FrameElem=42-1 ElemStation=0,1

Frame=42 Station=0 OutputCase=RAR043 CaseType=Combination P=-,30,1521740394933 V2=11,631776069063 V3=0 T=0 M2=0 M3=4,16677634853113 FrameElem=42-1 ElemStation=0

Frame=42 Station=0,05 OutputCase=RAR043 CaseType=Combination P=-,30,1521740394933 V2=11,831776069063 V3=0 T=0 M2=0 M3=3,58018754507798 FrameElem=42-1 ElemStation=0,05

Frame=42 Station=0,1 OutputCase=RAR043 CaseType=Combination P=-,30,1521740394933 V2=12,031776069063 V3=0 T=0 M2=0 M3=2,98359874162483 FrameElem=42-1 ElemStation=0,1

Frame=42 Station=0 OutputCase=RAR044 CaseType=Combination P=-,15,9307629226321 V2=65,0394590865885 V3=0 T=0 M2=0 M3=21,19077004462 FrameElem=42-1 ElemStation=0

Frame=42 Station=0,05 OutputCase=RAR044 CaseType=Combination P=-,15,9307629226321 V2=65,2394590865885 V3=0 T=0 M2=0 M3=17,9337970920905 FrameElem=42-1 ElemStation=0,05

Frame=42 Station=0,1 OutputCase=RAR044 CaseType=Combination P=-,15,9307629226321 V2=65,4394590865885 V3=0 T=0 M2=0 M3=14,6668241359611 FrameElem=42-1 ElemStation=0,1

Frame=42 Station=0 OutputCase=RAR045 CaseType=Combination P=-,7,3362817906675 V2=50,9766862222905 V3=0 T=0 M2=0 M3=-,0,258568562127798 FrameElem=42-1 ElemStation=0

Frame=42 Station=0,05 OutputCase=RAR045 CaseType=Combination P=-,7,3362817906675 V2=51,1766862222905 V3=0 T=0 M2=0 M3=-,2,81240287324232 FrameElem=42-1 ElemStation=0,05

Frame=42 Station=0,1 OutputCase=RAR045 CaseType=Combination P=-,7,3362817906675 V2=51,3766862222905 V3=0 T=0 M2=0 M3=-,5,37623718435685 FrameElem=42-1 ElemStation=0,1

Frame=42 Station=0 OutputCase=RAR046 CaseType=Combination P=-,16,2372485355374 V2=57,9521637826556 V3=0 T=0 M2=0 M3=10,0418271592641 FrameElem=42-1 ElemStation=0

Frame=42 Station=0,05 OutputCase=RAR046 CaseType=Combination P=-,16,2372485355374 V2=58,1521637826556 V3=0 T=0 M2=0 M3=7,13921897013127 FrameElem=42-1 ElemStation=0,05

Frame=42 Station=0,1 OutputCase=RAR046 CaseType=Combination P=-,16,2372485355374 V2=58,3521637826556 V3=0 T=0 M2=0 M3=4,22661078099849 FrameElem=42-1 ElemStation=0,1

Frame=42 Station=0 OutputCase=RAR047 CaseType=Combination P=-,25,1382152799417 V2=50,986105392004 V3=0 T=0 M2=0 M3=2,2663942661549 FrameElem=42-1 ElemStation=0

Frame=42 Station=0,05 OutputCase=RAR047 CaseType=Combination P=-,25,1382152799417 V2=51,186105392004 V3=0 T=0 M2=0 M3=-,0,287911003445304 FrameElem=42-1 ElemStation=0,05

Frame=42 Station=0,1 OutputCase=RAR047 CaseType=Combination P=-,25,1382152799417 V2=51,386105392004 V3=0 T=0 M2=0 M3=-,2,8522162730455 FrameElem=42-1 ElemStation=0,1

Frame=42 Station=0 OutputCase=RAR048 CaseType=Combination P=-,16,9573516075142 V2=18,5962462405815 V3=0 T=0 M2=0 M3=11,5164610697895 FrameElem=42-1 ElemStation=0

Frame=42 Station=0,05 OutputCase=RAR048 CaseType=Combination P=-,16,9573516075142 V2=18,7962462405815 V3=0 T=0 M2=0 M3=10,5816487577604 FrameElem=42-1 ElemStation=0,05

Frame=42 Station=0,1 OutputCase=RAR048 CaseType=Combination P=-,16,9573516075142 V2=18,9962462405815 V3=0 T=0 M2=0 M3=9,63683644573133 FrameElem=42-1 ElemStation=0,1

Frame=42 Station=0 OutputCase=RAR049 CaseType=Combination P=-,25,8583183519185 V2=11,6301878499299 V3=0 T=0 M2=0 M3=3,74102817668032 FrameElem=42-1 ElemStation=0

Frame=42 Station=0,05 OutputCase=RAR049 CaseType=Combination P=-,25,8583183519185 V2=11,8301878499299 V3=0 T=0 M2=0 M3=3,15451878418383 FrameElem=42-1 ElemStation=0,05

Frame=42 Station=0,1 OutputCase=RAR049 CaseType=Combination P=-,25,8583183519185 V2=12,0301878499299 V3=0 T=0 M2=0 M3=2,55800939168734 FrameElem=42-1 ElemStation=0,1

Frame=42 Station=0 OutputCase=RAR050 CaseType=Combination P=-,8,24711125656648 V2=12,0024810854561 V3=0 T=0 M2=0 M3=1,5157790061881 FrameElem=42-1 ElemStation=0

Frame=42 Station=0,05 OutputCase=RAR050 CaseType=Combination P=-,8,24711125656648 V2=12,2024810854561 V3=0 T=0 M2=0 M3=0,910654951915296 FrameElem=42-1 ElemStation=0,05

Frame=42 Station=0,1 OutputCase=RAR050 CaseType=Combination P=-,8,24711125656648 V2=12,4024810854561 V3=0 T=0 M2=0 M3=0,295530897642429 FrameElem=42-1 ElemStation=0,1

Frame=42 Station=0 OutputCase=RAR051 CaseType=Combination P=-,7,52700818458968 V2=51,3583986275303 V3=0 T=0 M2=0 M3=0,041145095662675 FrameElem=42-1 ElemStation=0

Frame=42 Station=0,05 OutputCase=RAR051 CaseType=Combination P=-,7,52700818458968 V2=51,5583986275303 V3=0 T=0 M2=0 M3=-,2,53177483571384 FrameElem=42-1 ElemStation=0,05

Frame=42 Station=0,1 OutputCase=RAR051 CaseType=Combination P=-,7,52700818458968 V2=51,7583986275303 V3=0 T=0 M2=0 M3=-,5,11469476709035 FrameElem=42-1 ElemStation=0,1

Frame=42 Station=0 OutputCase=RAR052 CaseType=Combination P=-,16,4279749294596 V2=58,3338761878954 V3=0 T=0 M2=0 M3=10,3415408170545 FrameElem=42-1 ElemStation=0

Frame=42 Station=0,05 OutputCase=RAR052 CaseType=Combination P=-,16,4279749294596 V2=58,5338761878954 V3=0 T=0 M2=0 M3=7,41984700765976 FrameElem=42-1 ElemStation=0,05

Frame=42 Station=0,1 OutputCase=RAR052 CaseType=Combination P=-,16,4279749294596 V2=58,7338761878954 V3=0 T=0 M2=0 M3=4,48815319826499 FrameElem=42-1 ElemStation=0,1

Frame=42 Station=0 OutputCase=RAR053 CaseType=Combination P=-,25,3289416738639 V2=51,3678177972438 V3=0 T=0 M2=0 M3=2,56610792394537 FrameElem=42-1 ElemStation=0

Frame=42 Station=0,05 OutputCase=RAR053 CaseType=Combination P=-,25,3289416738639 V2=51,5678177972438 V3=0 T=0 M2=0 M3=-,7,28296591681821E-03 FrameElem=42-1 ElemStation=0,05

Frame=42 Station=0,1 OutputCase=RAR053 CaseType=Combination P=-,25,3289416738639 V2=51,7678177972438 V3=0 T=0 M2=0 M3=-,2,59067385577901 FrameElem=42-1 ElemStation=0,1

Frame=42 Station=0 OutputCase=RAR054 CaseType=Combination P=-,17,1480780014364 V2=18,9779586458212 V3=0 T=0 M2=0 M3=11,81617472758 FrameElem=42-1 ElemStation=0

Frame=42 Station=0,05 OutputCase=RAR054 CaseType=Combination P=-,17,1480780014364 V2=19,1779586458212 V3=0 T=0 M2=0 M3=10,8622767952889 FrameElem=42-1 ElemStation=0,05

Frame=42 Station=0,1 OutputCase=RAR054 CaseType=Combination P=-,17,1480780014364 V2=19,3779586458212 V3=0 T=0 M2=0 M3=9,89837886299783 FrameElem=42-1 ElemStation=0,1

Frame=42 Station=0 OutputCase=RAR055 CaseType=Combination P=-,26,0490447458407 V2=12,0119002551696 V3=0 T=0 M2=0 M3=4,0407418344708 FrameElem=42-1 ElemStation=0

Frame=42 Station=0,05 OutputCase=RAR055 CaseType=Combination P=-,26,0490447458407 V2=12,2119002551696 V3=0 T=0 M2=0 M3=3,43514682171232 FrameElem=42-1 ElemStation=0,05

Frame=42 Station=0,1 OutputCase=RAR055 CaseType=Combination P=-,26,0490447458407 V2=12,4119002551696 V3=0 T=0 M2=0 M3=2,81955180895384 FrameElem=42-1 ElemStation=0,1

Società di Progetto
Brebemi SpA



Doc. N.
60235-0000-A00.doc

CODIFICA DOCUMENTO
04RCDII10000000000300A00

REV.
00

FOGLIO
553 di 628

Frame=42 Station=0 OutputCase=RAR056 CaseType=Combination P=-7,86565846872211 V2=11,2390562749766 V3=0 T=0 M2=0 M3=0,916351690607155 FrameElem=42-1 ElemStation=0
Frame=42 Station=0,05 OutputCase=RAR056 CaseType=Combination P=-7,86565846872211 V2=11,4390562749766 V3=0 T=0 M2=0 M3=0,349398876858325 FrameElem=42-1 ElemStation=0,05
Frame=42 Station=0,1 OutputCase=RAR056 CaseType=Combination P=-7,86565846872211 V2=11,6390562749766 V3=0 T=0 M2=0 M3=0,227553936890505 FrameElem=42-1 ElemStation=0,1
Frame=42 Station=0 OutputCase=RAR057 CaseType=Combination P=-7,1455539674532 V2=50,5949738170508 V3=0 T=0 M2=0 M3=-0,558282219918271 FrameElem=42-1 ElemStation=0
Frame=42 Station=0,05 OutputCase=RAR057 CaseType=Combination P=-7,1455539674532 V2=50,7949738170508 V3=0 T=0 M2=0 M3=-3,09303091077081 FrameElem=42-1 ElemStation=0,05
Frame=42 Station=0,1 OutputCase=RAR057 CaseType=Combination P=-7,1455539674532 V2=50,9949738170508 V3=0 T=0 M2=0 M3=-5,63777960162335 FrameElem=42-1 ElemStation=0,1
Frame=42 Station=0 OutputCase=RAR058 CaseType=Combination P=-16,0465221416153 V2=57,5704513774159 V3=0 T=0 M2=0 M3=9,74211350147358 FrameElem=42-1 ElemStation=0
Frame=42 Station=0,05 OutputCase=RAR058 CaseType=Combination P=-16,0465221416153 V2=57,7704513774159 V3=0 T=0 M2=0 M3=6,85859093260279 FrameElem=42-1 ElemStation=0,05
Frame=42 Station=0,1 OutputCase=RAR058 CaseType=Combination P=-16,0465221416153 V2=57,9704513774159 V3=0 T=0 M2=0 M3=3,96506836373199 FrameElem=42-1 ElemStation=0,1
Frame=42 Station=0 OutputCase=RAR059 CaseType=Combination P=-24,947488860196 V2=50,6043929867643 V3=0 T=0 M2=0 M3=1,96668060836443 FrameElem=42-1 ElemStation=0
Frame=42 Station=0,05 OutputCase=RAR059 CaseType=Combination P=-24,947488860196 V2=50,8043929867643 V3=0 T=0 M2=0 M3=-0,568539040973789 FrameElem=42-1 ElemStation=0,05
Frame=42 Station=0,1 OutputCase=RAR059 CaseType=Combination P=-24,947488860196 V2=51,0043929867643 V3=0 T=0 M2=0 M3=-3,113758690312 FrameElem=42-1 ElemStation=0,1
Frame=42 Station=0 OutputCase=RAR060 CaseType=Combination P=-16,7666252135921 V2=18,2145338353417 V3=0 T=0 M2=0 M3=11,216747411999 FrameElem=42-1 ElemStation=0
Frame=42 Station=0,05 OutputCase=RAR060 CaseType=Combination P=-16,7666252135921 V2=18,4145338353417 V3=0 T=0 M2=0 M3=10,3010207202319 FrameElem=42-1 ElemStation=0,05
Frame=42 Station=0,1 OutputCase=RAR060 CaseType=Combination P=-16,7666252135921 V2=18,6145338353417 V3=0 T=0 M2=0 M3=9,37529402846484 FrameElem=42-1 ElemStation=0,1
Frame=42 Station=0 OutputCase=RAR061 CaseType=Combination P=-25,6675919579963 V2=11,2484754446901 V3=0 T=0 M2=0 M3=3,44131451888985 FrameElem=42-1 ElemStation=0
Frame=42 Station=0,05 OutputCase=RAR061 CaseType=Combination P=-25,6675919579963 V2=11,4484754446901 V3=0 T=0 M2=0 M3=2,87389074665535 FrameElem=42-1 ElemStation=0,05
Frame=42 Station=0,1 OutputCase=RAR061 CaseType=Combination P=-25,6675919579963 V2=11,6484754446901 V3=0 T=0 M2=0 M3=2,29646697442084 FrameElem=42-1 ElemStation=0,1
Frame=42 Station=0 OutputCase=RAR062 CaseType=Combination P=-8,51611328200224 V2=11,6221918987417 V3=0 T=0 M2=0 M3=1,59758240723173 FrameElem=42-1 ElemStation=0
Frame=42 Station=0,05 OutputCase=RAR062 CaseType=Combination P=-8,51611328200224 V2=11,8221918987417 V3=0 T=0 M2=0 M3=1,01147281229465 FrameElem=42-1 ElemStation=0,05
Frame=42 Station=0,1 OutputCase=RAR062 CaseType=Combination P=-8,51611328200224 V2=12,0221918987417 V3=0 T=0 M2=0 M3=0,415363217357567 FrameElem=42-1 ElemStation=0,1
Frame=42 Station=0 OutputCase=RAR063 CaseType=Combination P=-7,79601021002545 V2=50,9781094408158 V3=0 T=0 M2=0 M3=0,122948496706307 FrameElem=42-1 ElemStation=0
Frame=42 Station=0,05 OutputCase=RAR063 CaseType=Combination P=-7,79601021002545 V2=51,1781094408158 V3=0 T=0 M2=0 M3=-2,43095697533448 FrameElem=42-1 ElemStation=0,05
Frame=42 Station=0,1 OutputCase=RAR063 CaseType=Combination P=-7,79601021002545 V2=51,3781094408158 V3=0 T=0 M2=0 M3=-4,99486244737528 FrameElem=42-1 ElemStation=0,1
Frame=42 Station=0 OutputCase=RAR064 CaseType=Combination P=-16,6969769548954 V2=57,9535870011809 V3=0 T=0 M2=0 M3=10,4233442180982 FrameElem=42-1 ElemStation=0
Frame=42 Station=0,05 OutputCase=RAR064 CaseType=Combination P=-16,6969769548954 V2=58,1535870011809 V3=0 T=0 M2=0 M3=7,52066486803911 FrameElem=42-1 ElemStation=0,05
Frame=42 Station=0,1 OutputCase=RAR064 CaseType=Combination P=-16,6969769548954 V2=58,3535870011809 V3=0 T=0 M2=0 M3=4,60798551798007 FrameElem=42-1 ElemStation=0,1
Frame=42 Station=0 OutputCase=RAR065 CaseType=Combination P=-25,5979436992997 V2=50,9875286105293 V3=0 T=0 M2=0 M3=2,647911324989 FrameElem=42-1 ElemStation=0
Frame=42 Station=0,05 OutputCase=RAR065 CaseType=Combination P=-25,5979436992997 V2=51,1875286105293 V3=0 T=0 M2=0 M3=-9,35348944625368E-02 FrameElem=42-1 ElemStation=0,05
Frame=42 Station=0,1 OutputCase=RAR065 CaseType=Combination P=-25,5979436992997 V2=51,3875286105293 V3=0 T=0 M2=0 M3=-2,47084153606393 FrameElem=42-1 ElemStation=0,1
Frame=42 Station=0 OutputCase=RAR066 CaseType=Combination P=-17,4170800268722 V2=18,5976694591068 V3=0 T=0 M2=0 M3=11,8979781286236 FrameElem=42-1 ElemStation=0
Frame=42 Station=0,05 OutputCase=RAR066 CaseType=Combination P=-17,4170800268722 V2=18,7976694591068 V3=0 T=0 M2=0 M3=10,9630946556682 FrameElem=42-1 ElemStation=0,05
Frame=42 Station=0,1 OutputCase=RAR066 CaseType=Combination P=-17,4170800268722 V2=18,9976694591068 V3=0 T=0 M2=0 M3=10,0182111827129 FrameElem=42-1 ElemStation=0,1
Frame=42 Station=0 OutputCase=RAR067 CaseType=Combination P=-26,3180467712765 V2=11,6316110684552 V3=0 T=0 M2=0 M3=4,12254523551443 FrameElem=42-1 ElemStation=0
Frame=42 Station=0,05 OutputCase=RAR067 CaseType=Combination P=-26,3180467712765 V2=11,8316110684552 V3=0 T=0 M2=0 M3=3,53596468209167 FrameElem=42-1 ElemStation=0,05
Frame=42 Station=0,1 OutputCase=RAR067 CaseType=Combination P=-26,3180467712765 V2=12,0316110684552 V3=0 T=0 M2=0 M3=2,93938412866891 FrameElem=42-1 ElemStation=0,1
Frame=42 Station=0 OutputCase=RAR068 CaseType=Combination P=-7,60804815358469 V2=12,2545839914071 V3=0 T=0 M2=0 M3=1,07972634665824 FrameElem=42-1 ElemStation=0
Frame=42 Station=0,05 OutputCase=RAR068 CaseType=Combination P=-7,60804815358469 V2=12,4545839914071 V3=0 T=0 M2=0 M3=0,461997147087885 FrameElem=42-1 ElemStation=0,05
Frame=42 Station=0,1 OutputCase=RAR068 CaseType=Combination P=-7,60804815358469 V2=12,6545839914071 V3=0 T=0 M2=0 M3=-0,16573205248247 FrameElem=42-1 ElemStation=0,1
Frame=42 Station=0 OutputCase=RAR069 CaseType=Combination P=-6,52075979500084 V2=64,4746657773462 V3=0 T=0 M2=0 M3=-1,08626130590264 FrameElem=42-1 ElemStation=0
Frame=42 Station=0,05 OutputCase=RAR069 CaseType=Combination P=-6,52075979500084 V2=64,6746657773462 V3=0 T=0 M2=0 M3=-4,31499459476995 FrameElem=42-1 ElemStation=0,05
Frame=42 Station=0,1 OutputCase=RAR069 CaseType=Combination P=-6,52075979500084 V2=64,8746657773462 V3=0 T=0 M2=0 M3=-7,55372788363726 FrameElem=42-1 ElemStation=0,1
Frame=42 Station=0 OutputCase=RAR070 CaseType=Combination P=-17,7218971905765 V2=73,4108360102941 V3=0 T=0 M2=0 M3=12,11239436816 FrameElem=42-1 ElemStation=0
Frame=42 Station=0,05 OutputCase=RAR070 CaseType=Combination P=-17,7218971905765 V2=73,6108360102941 V3=0 T=0 M2=0 M3=8,43685256764525 FrameElem=42-1 ElemStation=0,05

Società di Progetto
Brebemi SpA



Doc. N.
60235-0000-A00.doc

CODIFICA DOCUMENTO
04RCDII10000000000300A00

REV.
00

FOGLIO
554 di 628

Frame=42 Station=0,1 OutputCase=RAR070 CaseType=Combination P=-17,7218971905765 V2=73,8108360102941 V3=0 T=0 M2=0 M3=4,75131076713054 FrameElem=42-1 ElemStation=0,1
Frame=42 Station=0 OutputCase=RAR071 CaseType=Combination P=-28,9230345847551 V2=64,4866219785431 V3=0 T=0 M2=0 M3=2,11879440012026 FrameElem=42-1 ElemStation=0
Frame=42 Station=0,05 OutputCase=RAR071 CaseType=Combination P=-28,9230345847551 V2=64,4866219785431 V3=0 T=0 M2=0 M3=-1,11053669880689 FrameElem=42-1 ElemStation=0,05
Frame=42 Station=0,1 OutputCase=RAR071 CaseType=Combination P=-28,9230345847551 V2=64,4866219785431 V3=0 T=0 M2=0 M3=-4,34986779773404 FrameElem=42-1 ElemStation=0,1
Frame=42 Station=0 OutputCase=RAR072 CaseType=Combination P=-18,6820346198789 V2=20,9362792875285 V3=0 T=0 M2=0 M3=14,0785729155272 FrameElem=42-1 ElemStation=0
Frame=42 Station=0,05 OutputCase=RAR072 CaseType=Combination P=-18,6820346198789 V2=21,1362792875285 V3=0 T=0 M2=0 M3=13,0267589511508 FrameElem=42-1 ElemStation=0,05
Frame=42 Station=0,1 OutputCase=RAR072 CaseType=Combination P=-18,6820346198789 V2=21,3362792875285 V3=0 T=0 M2=0 M3=11,9649449867743 FrameElem=42-1 ElemStation=0,1
Frame=42 Station=0 OutputCase=RAR073 CaseType=Combination P=-29,8831720140575 V2=12,0120652557775 V3=0 T=0 M2=0 M3=4,0849729474875 FrameElem=42-1 ElemStation=0
Frame=42 Station=0,05 OutputCase=RAR073 CaseType=Combination P=-29,8831720140575 V2=12,2120652557775 V3=0 T=0 M2=0 M3=3,47936968469862 FrameElem=42-1 ElemStation=0,05
Frame=42 Station=0,1 OutputCase=RAR073 CaseType=Combination P=-29,8831720140575 V2=12,4120652557775 V3=0 T=0 M2=0 M3=2,86376642190975 FrameElem=42-1 ElemStation=0,1
Frame=42 Station=0 OutputCase=RAR074 CaseType=Combination P=-15,6617608971964 V2=65,4197482733029 V3=0 T=0 M2=0 M3=21,1089666435763 FrameElem=42-1 ElemStation=0
Frame=42 Station=0,05 OutputCase=RAR074 CaseType=Combination P=-15,6617608971964 V2=65,6197482733029 V3=0 T=0 M2=0 M3=17,8329792299112 FrameElem=42-1 ElemStation=0,05
Frame=42 Station=0,1 OutputCase=RAR074 CaseType=Combination P=-15,6617608971964 V2=65,8197482733029 V3=0 T=0 M2=0 M3=14,546991816246 FrameElem=42-1 ElemStation=0,1
Frame=42 Station=0 OutputCase=RAR075 CaseType=Combination P=-6,88794508160789 V2=51,6105015334813 V3=0 T=0 M2=0 M3=-0,394907563867185 FrameElem=42-1 ElemStation=0
Frame=42 Station=0,05 OutputCase=RAR075 CaseType=Combination P=-6,88794508160789 V2=51,8105015334813 V3=0 T=0 M2=0 M3=-2,98043264054125 FrameElem=42-1 ElemStation=0,05
Frame=42 Station=0,1 OutputCase=RAR075 CaseType=Combination P=-6,88794508160789 V2=52,0105015334813 V3=0 T=0 M2=0 M3=-5,57595771721531 FrameElem=42-1 ElemStation=0,1
Frame=42 Station=0 OutputCase=RAR076 CaseType=Combination P=-15,7889118264778 V2=58,5859790938464 V3=0 T=0 M2=0 M3=9,90548815752467 FrameElem=42-1 ElemStation=0
Frame=42 Station=0,05 OutputCase=RAR076 CaseType=Combination P=-15,7889118264778 V2=58,7859790938464 V3=0 T=0 M2=0 M3=6,97118920283235 FrameElem=42-1 ElemStation=0,05
Frame=42 Station=0,1 OutputCase=RAR076 CaseType=Combination P=-15,7889118264778 V2=58,9859790938464 V3=0 T=0 M2=0 M3=4,02689024814003 FrameElem=42-1 ElemStation=0,1
Frame=42 Station=0 OutputCase=RAR077 CaseType=Combination P=-24,6898785708821 V2=51,6199207031948 V3=0 T=0 M2=0 M3=2,13005526441551 FrameElem=42-1 ElemStation=0
Frame=42 Station=0,05 OutputCase=RAR077 CaseType=Combination P=-24,6898785708821 V2=51,8199207031948 V3=0 T=0 M2=0 M3=-0,455940770744228 FrameElem=42-1 ElemStation=0,05
Frame=42 Station=0,1 OutputCase=RAR077 CaseType=Combination P=-24,6898785708821 V2=52,0199207031948 V3=0 T=0 M2=0 M3=-3,05193680590397 FrameElem=42-1 ElemStation=0,1
Frame=42 Station=0 OutputCase=RAR078 CaseType=Combination P=-16,5090148984546 V2=19,2300615517722 V3=0 T=0 M2=0 M3=11,3801220680501 FrameElem=42-1 ElemStation=0
Frame=42 Station=0,05 OutputCase=RAR078 CaseType=Combination P=-16,5090148984546 V2=19,4300615517722 V3=0 T=0 M2=0 M3=10,4136189904615 FrameElem=42-1 ElemStation=0,05
Frame=42 Station=0,1 OutputCase=RAR078 CaseType=Combination P=-16,5090148984546 V2=19,6300615517722 V3=0 T=0 M2=0 M3=9,43711591287287 FrameElem=42-1 ElemStation=0,1
Frame=42 Station=0 OutputCase=RAR079 CaseType=Combination P=-25,4099816428589 V2=12,2640031611206 V3=0 T=0 M2=0 M3=3,60468917494094 FrameElem=42-1 ElemStation=0
Frame=42 Station=0,05 OutputCase=RAR079 CaseType=Combination P=-25,4099816428589 V2=12,4640031611206 V3=0 T=0 M2=0 M3=2,98648901688491 FrameElem=42-1 ElemStation=0,05
Frame=42 Station=0,1 OutputCase=RAR079 CaseType=Combination P=-25,4099816428589 V2=12,6640031611206 V3=0 T=0 M2=0 M3=2,3582885882888 FrameElem=42-1 ElemStation=0,1
Frame=42 Station=0 OutputCase=RAR080 CaseType=Combination P=-7,14831973422674 V2=12,2531607728818 V3=0 T=0 M2=0 M3=0,698209287824136 FrameElem=42-1 ElemStation=0
Frame=42 Station=0,05 OutputCase=RAR080 CaseType=Combination P=-7,14831973422674 V2=12,4531607728818 V3=0 T=0 M2=0 M3=-8,05512491800452E-02 FrameElem=42-1 ElemStation=0,05
Frame=42 Station=0,1 OutputCase=RAR080 CaseType=Combination P=-7,14831973422674 V2=12,6531607728818 V3=0 T=0 M2=0 M3=-0,547106789464046 FrameElem=42-1 ElemStation=0,1
Frame=42 Station=0 OutputCase=RAR081 CaseType=Combination P=-6,42821666224995 V2=51,609078314956 V3=0 T=0 M2=0 M3=-0,77642462270129 FrameElem=42-1 ElemStation=0
Frame=42 Station=0,05 OutputCase=RAR081 CaseType=Combination P=-6,42821666224995 V2=51,809078314956 V3=0 T=0 M2=0 M3=-3,36187853844909 FrameElem=42-1 ElemStation=0,05
Frame=42 Station=0,1 OutputCase=RAR081 CaseType=Combination P=-6,42821666224995 V2=52,009078314956 V3=0 T=0 M2=0 M3=-5,95733245419689 FrameElem=42-1 ElemStation=0,1
Frame=42 Station=0 OutputCase=RAR082 CaseType=Combination P=-15,3291834071199 V2=58,5845558753211 V3=0 T=0 M2=0 M3=9,52397109869056 FrameElem=42-1 ElemStation=0
Frame=42 Station=0,05 OutputCase=RAR082 CaseType=Combination P=-15,3291834071199 V2=58,7845558753211 V3=0 T=0 M2=0 M3=6,58974330492451 FrameElem=42-1 ElemStation=0,05
Frame=42 Station=0,1 OutputCase=RAR082 CaseType=Combination P=-15,3291834071199 V2=58,9845558753211 V3=0 T=0 M2=0 M3=3,64551551115845 FrameElem=42-1 ElemStation=0,1
Frame=42 Station=0 OutputCase=RAR083 CaseType=Combination P=-24,2301501515242 V2=51,6184974846695 V3=0 T=0 M2=0 M3=1,74853820558141 FrameElem=42-1 ElemStation=0
Frame=42 Station=0,05 OutputCase=RAR083 CaseType=Combination P=-24,2301501515242 V2=51,8184974846695 V3=0 T=0 M2=0 M3=-0,837386668652069 FrameElem=42-1 ElemStation=0,05
Frame=42 Station=0,1 OutputCase=RAR083 CaseType=Combination P=-24,2301501515242 V2=52,0184974846695 V3=0 T=0 M2=0 M3=-3,43331154288554 FrameElem=42-1 ElemStation=0,1
Frame=42 Station=0 OutputCase=RAR084 CaseType=Combination P=-16,0492864790967 V2=19,2286383332469 V3=0 T=0 M2=0 M3=10,998605009216 FrameElem=42-1 ElemStation=0
Frame=42 Station=0,05 OutputCase=RAR084 CaseType=Combination P=-16,0492864790967 V2=19,4286383332469 V3=0 T=0 M2=0 M3=10,0321730925536 FrameElem=42-1 ElemStation=0,05
Frame=42 Station=0,1 OutputCase=RAR084 CaseType=Combination P=-16,0492864790967 V2=19,6286383332469 V3=0 T=0 M2=0 M3=9,0557411758913 FrameElem=42-1 ElemStation=0,1
Frame=42 Station=0 OutputCase=RAR085 CaseType=Combination P=-24,950253223501 V2=12,2625799425953 V3=0 T=0 M2=0 M3=3,22317211610683 FrameElem=42-1 ElemStation=0

APPROVATO S.D.P.
Società di Progetto
Brebemi SpA



Doc. N.
60235-0000-A00.doc

CODIFICA DOCUMENTO
04RCDII10000000000300A00

REV.
00

FOGLIO
555 di 628

Frame=42 Station=0,05 OutputCase=RAR085 CaseType=Combination P=-24,950253223501 V2=12,4625799425953 V3=0 T=0 M2=0 M3=2,60504311897707 FrameElem=42-1 ElemStation=0,05

Frame=42 Station=0,1 OutputCase=RAR085 CaseType=Combination P=-24,950253223501 V2=12,6625799425953 V3=0 T=0 M2=0 M3=1,9769141218473 FrameElem=42-1 ElemStation=0,1

Frame=42 Station=0 OutputCase=RAR086 CaseType=Combination P=-8,06777657294263 V2=12,2560072099324 V3=0 T=0 M2=0 M3=1,46124340549235 FrameElem=42-1 ElemStation=0

Frame=42 Station=0,05 OutputCase=RAR086 CaseType=Combination P=-8,06777657294263 V2=12,4560072099324 V3=0 T=0 M2=0 M3=0,843443044995726 FrameElem=42-1 ElemStation=0,05

Frame=42 Station=0,1 OutputCase=RAR086 CaseType=Combination P=-8,06777657294263 V2=12,6560072099324 V3=0 T=0 M2=0 M3=0,215642684499105 FrameElem=42-1 ElemStation=0,1

Frame=42 Station=0 OutputCase=RAR087 CaseType=Combination P=-7,34767350096584 V2=51,6119247520066 V3=0 T=0 M2=0 M3=-1,339050530798E-02 FrameElem=42-1 ElemStation=0

Frame=42 Station=0,05 OutputCase=RAR087 CaseType=Combination P=-7,34767350096584 V2=51,8119247520066 V3=0 T=0 M2=0 M3=-2,59898674263341 FrameElem=42-1 ElemStation=0,05

Frame=42 Station=0,1 OutputCase=RAR087 CaseType=Combination P=-7,34767350096584 V2=52,0119247520066 V3=0 T=0 M2=0 M3=-5,19458298023374 FrameElem=42-1 ElemStation=0,1

Frame=42 Station=0 OutputCase=RAR088 CaseType=Combination P=-16,2486402458358 V2=58,5874023123717 V3=0 T=0 M2=0 M3=10,2870052163588 FrameElem=42-1 ElemStation=0

Frame=42 Station=0,05 OutputCase=RAR088 CaseType=Combination P=-16,2486402458358 V2=58,7874023123717 V3=0 T=0 M2=0 M3=7,35263510074019 FrameElem=42-1 ElemStation=0,05

Frame=42 Station=0,1 OutputCase=RAR088 CaseType=Combination P=-16,2486402458358 V2=58,9874023123717 V3=0 T=0 M2=0 M3=4,4082649851216 FrameElem=42-1 ElemStation=0,1

Frame=42 Station=0 OutputCase=RAR089 CaseType=Combination P=-25,1496069902401 V2=51,6213439217201 V3=0 T=0 M2=0 M3=2,51157232324962 FrameElem=42-1 ElemStation=0

Frame=42 Station=0,05 OutputCase=RAR089 CaseType=Combination P=-25,1496069902401 V2=51,8213439217201 V3=0 T=0 M2=0 M3=-7,44948728363881E-02 FrameElem=42-1 ElemStation=0,05

Frame=42 Station=0,1 OutputCase=RAR089 CaseType=Combination P=-25,1496069902401 V2=52,0213439217201 V3=0 T=0 M2=0 M3=-2,67056206892239 FrameElem=42-1 ElemStation=0,1

Frame=42 Station=0 OutputCase=RAR090 CaseType=Combination P=-16,9687433178126 V2=19,2314847702975 V3=0 T=0 M2=0 M3=11,7616391268842 FrameElem=42-1 ElemStation=0

Frame=42 Station=0,05 OutputCase=RAR090 CaseType=Combination P=-16,9687433178126 V2=19,4314847702975 V3=0 T=0 M2=0 M3=10,7950648883693 FrameElem=42-1 ElemStation=0,05

Frame=42 Station=0,1 OutputCase=RAR090 CaseType=Combination P=-16,9687433178126 V2=19,6314847702975 V3=0 T=0 M2=0 M3=9,81849064985445 FrameElem=42-1 ElemStation=0,1

Frame=42 Station=0 OutputCase=RAR091 CaseType=Combination P=-25,8697100622169 V2=12,2654263796459 V3=0 T=0 M2=0 M3=3,98620623377504 FrameElem=42-1 ElemStation=0

Frame=42 Station=0,05 OutputCase=RAR091 CaseType=Combination P=-25,8697100622169 V2=12,4654263796459 V3=0 T=0 M2=0 M3=3,36793491479275 FrameElem=42-1 ElemStation=0,05

Frame=42 Station=0,1 OutputCase=RAR091 CaseType=Combination P=-25,8697100622169 V2=12,6654263796459 V3=0 T=0 M2=0 M3=2,73966359581045 FrameElem=42-1 ElemStation=0,1

Frame=42 Station=0 OutputCase=RAR092 CaseType=Combination P=-8,06777657294263 V2=12,2560072099324 V3=0 T=0 M2=0 M3=1,46124340549235 FrameElem=42-1 ElemStation=0

Frame=42 Station=0,05 OutputCase=RAR092 CaseType=Combination P=-8,06777657294263 V2=12,4560072099324 V3=0 T=0 M2=0 M3=0,843443044995726 FrameElem=42-1 ElemStation=0,05

Frame=42 Station=0,1 OutputCase=RAR092 CaseType=Combination P=-8,06777657294263 V2=12,6560072099324 V3=0 T=0 M2=0 M3=0,215642684499105 FrameElem=42-1 ElemStation=0,1

Frame=42 Station=0 OutputCase=RAR093 CaseType=Combination P=-7,34767350096584 V2=51,6119247520066 V3=0 T=0 M2=0 M3=-1,339050530798E-02 FrameElem=42-1 ElemStation=0

Frame=42 Station=0,05 OutputCase=RAR093 CaseType=Combination P=-7,34767350096584 V2=51,8119247520066 V3=0 T=0 M2=0 M3=-2,59898674263341 FrameElem=42-1 ElemStation=0,05

Frame=42 Station=0,1 OutputCase=RAR093 CaseType=Combination P=-7,34767350096584 V2=52,0119247520066 V3=0 T=0 M2=0 M3=-5,19458298023374 FrameElem=42-1 ElemStation=0,1

Frame=42 Station=0 OutputCase=RAR094 CaseType=Combination P=-16,2486402458358 V2=58,5874023123717 V3=0 T=0 M2=0 M3=10,2870052163588 FrameElem=42-1 ElemStation=0

Frame=42 Station=0,05 OutputCase=RAR094 CaseType=Combination P=-16,2486402458358 V2=58,7874023123717 V3=0 T=0 M2=0 M3=7,35263510074019 FrameElem=42-1 ElemStation=0,05

Frame=42 Station=0,1 OutputCase=RAR094 CaseType=Combination P=-16,2486402458358 V2=58,9874023123717 V3=0 T=0 M2=0 M3=4,4082649851216 FrameElem=42-1 ElemStation=0,1

Frame=42 Station=0 OutputCase=RAR095 CaseType=Combination P=-25,1496069902401 V2=51,6213439217201 V3=0 T=0 M2=0 M3=2,51157232324962 FrameElem=42-1 ElemStation=0

Frame=42 Station=0,05 OutputCase=RAR095 CaseType=Combination P=-25,1496069902401 V2=51,8213439217201 V3=0 T=0 M2=0 M3=-7,44948728363881E-02 FrameElem=42-1 ElemStation=0,05

Frame=42 Station=0,1 OutputCase=RAR095 CaseType=Combination P=-25,1496069902401 V2=52,0213439217201 V3=0 T=0 M2=0 M3=-2,67056206892239 FrameElem=42-1 ElemStation=0,1

Frame=42 Station=0 OutputCase=RAR096 CaseType=Combination P=-16,9687433178126 V2=19,2314847702975 V3=0 T=0 M2=0 M3=11,7616391268842 FrameElem=42-1 ElemStation=0

Frame=42 Station=0,05 OutputCase=RAR096 CaseType=Combination P=-16,9687433178126 V2=19,4314847702975 V3=0 T=0 M2=0 M3=10,7950648883693 FrameElem=42-1 ElemStation=0,05

Frame=42 Station=0,1 OutputCase=RAR096 CaseType=Combination P=-16,9687433178126 V2=19,6314847702975 V3=0 T=0 M2=0 M3=9,81849064985445 FrameElem=42-1 ElemStation=0,1

Frame=42 Station=0 OutputCase=RAR097 CaseType=Combination P=-25,8697100622169 V2=12,2654263796459 V3=0 T=0 M2=0 M3=3,98620623377504 FrameElem=42-1 ElemStation=0

Frame=42 Station=0,05 OutputCase=RAR097 CaseType=Combination P=-25,8697100622169 V2=12,4654263796459 V3=0 T=0 M2=0 M3=3,36793491479275 FrameElem=42-1 ElemStation=0,05

Frame=42 Station=0,1 OutputCase=RAR097 CaseType=Combination P=-25,8697100622169 V2=12,6654263796459 V3=0 T=0 M2=0 M3=2,73966359581045 FrameElem=42-1 ElemStation=0,1

Frame=42 Station=0 OutputCase=RAR098 CaseType=Combination P=-6,97229350717742 V2=10,9822093072746 V3=0 T=0 M2=0 M3=0,080680820689998 FrameElem=42-1 ElemStation=0

Frame=42 Station=0,05 OutputCase=RAR098 CaseType=Combination P=-6,97229350717742 V2=11,1822093072746 V3=0 T=0 M2=0 M3=-0,473429644673732 FrameElem=42-1 ElemStation=0,05

Frame=42 Station=0,1 OutputCase=RAR098 CaseType=Combination P=-6,97229350717742 V2=11,3822093072746 V3=0 T=0 M2=0 M3=-1,03754011003746 FrameElem=42-1 ElemStation=0,1

Frame=42 Station=0 OutputCase=RAR099 CaseType=Combination P=-6,13930700715648 V2=63,7112409668667 V3=0 T=0 M2=0 M3=-1,68568862148359 FrameElem=42-1 ElemStation=0

Frame=42 Station=0,05 OutputCase=RAR099 CaseType=Combination P=-6,13930700715648 V2=63,9112409668667 V3=0 T=0 M2=0 M3=-4,87625066982692 FrameElem=42-1 ElemStation=0,05

Frame=42 Station=0,1 OutputCase=RAR099 CaseType=Combination P=-6,13930700715648 V2=64,1112409668667 V3=0 T=0 M2=0 M3=-8,07681271817025 FrameElem=42-1 ElemStation=0,1

Società di Progetto
Brebemi SpA

	Doc. N. 60235-00000-A00.doc	CODIFICA DOCUMENTO 04RCDII10000000000300A00	REV. 00	FOGLIO 556 di 628
--	--------------------------------	--	------------	----------------------

Frame=42 Station=0 OutputCase=RAR100 CaseType=Combination P=-17,3404444027321 V2=72,6474111998146 V3=0 T=0 M2=0 M3=11,512967052579 FrameElem=42-1 ElemStation=0

Frame=42 Station=0,05 OutputCase=RAR100 CaseType=Combination P=-17,3404444027321 V2=72,8474111998146 V3=0 T=0 M2=0 M3=7,87559649258828 FrameElem=42-1 ElemStation=0,05

Frame=42 Station=0,1 OutputCase=RAR100 CaseType=Combination P=-17,3404444027321 V2=73,0474111998146 V3=0 T=0 M2=0 M3=4,22822593259755 FrameElem=42-1 ElemStation=0,1

Frame=42 Station=0 OutputCase=RAR101 CaseType=Combination P=-28,5415817969108 V2=63,7231971680636 V3=0 T=0 M2=0 M3=1,51936708453932 FrameElem=42-1 ElemStation=0

Frame=42 Station=0,05 OutputCase=RAR101 CaseType=Combination P=-28,5415817969108 V2=63,9231971680636 V3=0 T=0 M2=0 M3=-1,67179277386386 FrameElem=42-1 ElemStation=0,05

Frame=42 Station=0,1 OutputCase=RAR101 CaseType=Combination P=-28,5415817969108 V2=64,1231971680636 V3=0 T=0 M2=0 M3=-4,87295263226704 FrameElem=42-1 ElemStation=0,1

Frame=42 Station=0 OutputCase=RAR102 CaseType=Combination P=-18,3005818320345 V2=20,172854477049 V3=0 T=0 M2=0 M3=13,4791455999462 FrameElem=42-1 ElemStation=0

Frame=42 Station=0,05 OutputCase=RAR102 CaseType=Combination P=-18,3005818320345 V2=20,372854477049 V3=0 T=0 M2=0 M3=12,4655028760938 FrameElem=42-1 ElemStation=0,05

Frame=42 Station=0,1 OutputCase=RAR102 CaseType=Combination P=-18,3005818320345 V2=20,572854477049 V3=0 T=0 M2=0 M3=11,4418601522413 FrameElem=42-1 ElemStation=0,1

Frame=42 Station=0 OutputCase=RAR103 CaseType=Combination P=-29,5017192262132 V2=11,248640445298 V3=0 T=0 M2=0 M3=3,48554563190655 FrameElem=42-1 ElemStation=0

Frame=42 Station=0,05 OutputCase=RAR103 CaseType=Combination P=-29,5017192262132 V2=11,448640445298 V3=0 T=0 M2=0 M3=2,91811360946165 FrameElem=42-1 ElemStation=0,05

Frame=42 Station=0,1 OutputCase=RAR103 CaseType=Combination P=-29,5017192262132 V2=11,648640445298 V3=0 T=0 M2=0 M3=2,34068158737675 FrameElem=42-1 ElemStation=0,1

Frame=42 Station=0 OutputCase=RAR104 CaseType=Combination P=-15,280308109352 V2=64,6563234628234 V3=0 T=0 M2=0 M3=20,5095393279954 FrameElem=42-1 ElemStation=0

Frame=42 Station=0,05 OutputCase=RAR104 CaseType=Combination P=-15,280308109352 V2=64,8563234628234 V3=0 T=0 M2=0 M3=17,2717231548542 FrameElem=42-1 ElemStation=0,05

Frame=42 Station=0,1 OutputCase=RAR104 CaseType=Combination P=-15,280308109352 V2=65,0563234628234 V3=0 T=0 M2=0 M3=14,023906981713 FrameElem=42-1 ElemStation=0,1

Frame=42 Station=0 OutputCase=RAR105 CaseType=Combination P=-6,25219043520062 V2=50,3381268493488 V3=0 T=0 M2=0 M3=-1,39395308983543 FrameElem=42-1 ElemStation=0

Frame=42 Station=0,05 OutputCase=RAR105 CaseType=Combination P=-6,25219043520062 V2=50,5381268493488 V3=0 T=0 M2=0 M3=-3,91585943230287 FrameElem=42-1 ElemStation=0,05

Frame=42 Station=0,1 OutputCase=RAR105 CaseType=Combination P=-6,25219043520062 V2=50,7381268493488 V3=0 T=0 M2=0 M3=-6,44776577477031 FrameElem=42-1 ElemStation=0,1

Frame=42 Station=0 OutputCase=RAR106 CaseType=Combination P=-15,1531571800706 V2=57,3136044097139 V3=0 T=0 M2=0 M3=8,90644263155642 FrameElem=42-1 ElemStation=0

Frame=42 Station=0,05 OutputCase=RAR106 CaseType=Combination P=-15,1531571800706 V2=57,5136044097139 V3=0 T=0 M2=0 M3=6,03576241107073 FrameElem=42-1 ElemStation=0,05

Frame=42 Station=0,1 OutputCase=RAR106 CaseType=Combination P=-15,1531571800706 V2=57,7136044097139 V3=0 T=0 M2=0 M3=3,15508219058504 FrameElem=42-1 ElemStation=0,1

Frame=42 Station=0 OutputCase=RAR107 CaseType=Combination P=-24,0541239244749 V2=50,3475460190623 V3=0 T=0 M2=0 M3=1,13100973844727 FrameElem=42-1 ElemStation=0

Frame=42 Station=0,05 OutputCase=RAR107 CaseType=Combination P=-24,0541239244749 V2=50,5475460190623 V3=0 T=0 M2=0 M3=-1,39136756250585 FrameElem=42-1 ElemStation=0,05

Frame=42 Station=0,1 OutputCase=RAR107 CaseType=Combination P=-24,0541239244749 V2=50,7475460190623 V3=0 T=0 M2=0 M3=-3,92374486345896 FrameElem=42-1 ElemStation=0,1

Frame=42 Station=0 OutputCase=RAR108 CaseType=Combination P=-15,8732602520474 V2=17,9576868676397 V3=0 T=0 M2=0 M3=10,3810765420818 FrameElem=42-1 ElemStation=0

Frame=42 Station=0,05 OutputCase=RAR108 CaseType=Combination P=-15,8732602520474 V2=18,1576868676397 V3=0 T=0 M2=0 M3=9,47819219869986 FrameElem=42-1 ElemStation=0,05

Frame=42 Station=0,1 OutputCase=RAR108 CaseType=Combination P=-15,8732602520474 V2=18,3576868676397 V3=0 T=0 M2=0 M3=8,56530785531788 FrameElem=42-1 ElemStation=0,1

Frame=42 Station=0 OutputCase=RAR109 CaseType=Combination P=-24,7742269964516 V2=10,9916284769881 V3=0 T=0 M2=0 M3=2,60564364897269 FrameElem=42-1 ElemStation=0

Frame=42 Station=0,05 OutputCase=RAR109 CaseType=Combination P=-24,7742269964516 V2=11,1916284769881 V3=0 T=0 M2=0 M3=2,05106222512329 FrameElem=42-1 ElemStation=0,05

Frame=42 Station=0,1 OutputCase=RAR109 CaseType=Combination P=-24,7742269964516 V2=11,3916284769881 V3=0 T=0 M2=0 M3=1,48648080127388 FrameElem=42-1 ElemStation=0,1

Frame=42 Station=0 OutputCase=RAR110 CaseType=Combination P=-6,51256508781947 V2=10,9807860887493 V3=0 T=0 M2=0 M3=0,300836238144107 FrameElem=42-1 ElemStation=0

Frame=42 Station=0,05 OutputCase=RAR110 CaseType=Combination P=-6,51256508781947 V2=11,1807860887493 V3=0 T=0 M2=0 M3=-0,854875542581573 FrameElem=42-1 ElemStation=0,05

Frame=42 Station=0,1 OutputCase=RAR110 CaseType=Combination P=-6,51256508781947 V2=11,3807860887493 V3=0 T=0 M2=0 M3=-1,41891484701904 FrameElem=42-1 ElemStation=0,1

Frame=42 Station=0 OutputCase=RAR111 CaseType=Combination P=-5,79246201584268 V2=50,3367036308235 V3=0 T=0 M2=0 M3=-1,77547014866953 FrameElem=42-1 ElemStation=0

Frame=42 Station=0,05 OutputCase=RAR111 CaseType=Combination P=-5,79246201584268 V2=50,5367036308235 V3=0 T=0 M2=0 M3=-4,29730533021071 FrameElem=42-1 ElemStation=0,05

Frame=42 Station=0,1 OutputCase=RAR111 CaseType=Combination P=-5,79246201584268 V2=50,7367036308235 V3=0 T=0 M2=0 M3=-6,82914051175188 FrameElem=42-1 ElemStation=0,1

Frame=42 Station=0 OutputCase=RAR112 CaseType=Combination P=-14,6934287607126 V2=57,3121811911886 V3=0 T=0 M2=0 M3=8,52492557272232 FrameElem=42-1 ElemStation=0

Frame=42 Station=0,05 OutputCase=RAR112 CaseType=Combination P=-14,6934287607126 V2=57,5121811911886 V3=0 T=0 M2=0 M3=5,65431651316289 FrameElem=42-1 ElemStation=0,05

Frame=42 Station=0,1 OutputCase=RAR112 CaseType=Combination P=-14,6934287607126 V2=57,7121811911886 V3=0 T=0 M2=0 M3=2,77370745360346 FrameElem=42-1 ElemStation=0,1

Frame=42 Station=0 OutputCase=RAR113 CaseType=Combination P=-23,5943955051169 V2=50,346122800537 V3=0 T=0 M2=0 M3=0,749492679613162 FrameElem=42-1 ElemStation=0

Frame=42 Station=0,05 OutputCase=RAR113 CaseType=Combination P=-23,5943955051169 V2=50,546122800537 V3=0 T=0 M2=0 M3=-1,77281346041369 FrameElem=42-1 ElemStation=0,05

Frame=42 Station=0,1 OutputCase=RAR113 CaseType=Combination P=-23,5943955051169 V2=50,746122800537 V3=0 T=0 M2=0 M3=-4,30511960044053 FrameElem=42-1 ElemStation=0,1

Frame=42 Station=0 OutputCase=RAR114 CaseType=Combination P=-15,4135318326894 V2=17,9562636491144 V3=0 T=0 M2=0 M3=9,99955948324774 FrameElem=42-1 ElemStation=0

Frame=42 Station=0,05 OutputCase=RAR114 CaseType=Combination P=-15,4135318326894 V2=18,1562636491144 V3=0 T=0 M2=0 M3=9,09674630079202 FrameElem=42-1 ElemStation=0,05

Società di Progetto
Brebemi SpA

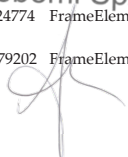



Doc. N.
60235-0000-A00.doc

CODIFICA DOCUMENTO
04RCDII10000000000300A00

REV.
00

FOGLIO
557 di 628

Frame=42 Station=0,1 OutputCase=RAR114 CaseType=Combination P=-15,413518326894 V2=18,3562636491144 V3=0 T=0 M2=0 M3=8,1839331183363 FrameElem=42-1 ElemStation=0,1

Frame=42 Station=0 OutputCase=RAR115 CaseType=Combination P=-24,3144985770937 V2=10,9902052584628 V3=0 T=0 M2=0 M3=2,22412659013859 FrameElem=42-1 ElemStation=0

Frame=42 Station=0,05 OutputCase=RAR115 CaseType=Combination P=-24,3144985770937 V2=11,1902052584628 V3=0 T=0 M2=0 M3=1,66961632721545 FrameElem=42-1 ElemStation=0,05

Frame=42 Station=0,1 OutputCase=RAR115 CaseType=Combination P=-24,3144985770937 V2=11,3902052584628 V3=0 T=0 M2=0 M3=1,10510606429231 FrameElem=42-1 ElemStation=0,1

Frame=42 Station=0 OutputCase=RAR116 CaseType=Combination P=-7,43202192653536 V2=10,9836325257999 V3=0 T=0 M2=0 M3=0,462197879524103 FrameElem=42-1 ElemStation=0

Frame=42 Station=0,05 OutputCase=RAR116 CaseType=Combination P=-7,43202192653536 V2=11,1836325257999 V3=0 T=0 M2=0 M3=-0,091983746765892 FrameElem=42-1 ElemStation=0,05

Frame=42 Station=0,1 OutputCase=RAR116 CaseType=Combination P=-7,43202192653536 V2=11,3836325257999 V3=0 T=0 M2=0 M3=-0,656165373055887 FrameElem=42-1 ElemStation=0,1

Frame=42 Station=0 OutputCase=RAR117 CaseType=Combination P=-6,71191885455857 V2=50,3395500678741 V3=0 T=0 M2=0 M3=-1,01243603100132 FrameElem=42-1 ElemStation=0

Frame=42 Station=0,05 OutputCase=RAR117 CaseType=Combination P=-6,71191885455857 V2=50,5395500678741 V3=0 T=0 M2=0 M3=-3,53441353439503 FrameElem=42-1 ElemStation=0,05

Frame=42 Station=0,1 OutputCase=RAR117 CaseType=Combination P=-6,71191885455857 V2=50,7395500678741 V3=0 T=0 M2=0 M3=-6,06639103778873 FrameElem=42-1 ElemStation=0,1

Frame=42 Station=0 OutputCase=RAR118 CaseType=Combination P=-15,6128855994285 V2=57,3150276282392 V3=0 T=0 M2=0 M3=9,28795969039053 FrameElem=42-1 ElemStation=0

Frame=42 Station=0,05 OutputCase=RAR118 CaseType=Combination P=-15,6128855994285 V2=57,5150276282392 V3=0 T=0 M2=0 M3=6,41720830897857 FrameElem=42-1 ElemStation=0,05

Frame=42 Station=0,1 OutputCase=RAR118 CaseType=Combination P=-15,6128855994285 V2=57,7150276282392 V3=0 T=0 M2=0 M3=3,53645692756661 FrameElem=42-1 ElemStation=0,1

Frame=42 Station=0 OutputCase=RAR119 CaseType=Combination P=-24,5138523438328 V2=50,3489692375876 V3=0 T=0 M2=0 M3=1,51252679728137 FrameElem=42-1 ElemStation=0

Frame=42 Station=0,05 OutputCase=RAR119 CaseType=Combination P=-24,5138523438328 V2=50,5489692375876 V3=0 T=0 M2=0 M3=-1,00992166459801 FrameElem=42-1 ElemStation=0,05

Frame=42 Station=0,1 OutputCase=RAR119 CaseType=Combination P=-24,5138523438328 V2=50,7489692375876 V3=0 T=0 M2=0 M3=-3,54237012647738 FrameElem=42-1 ElemStation=0,1

Frame=42 Station=0 OutputCase=RAR120 CaseType=Combination P=-16,3329886714053 V2=17,959110086165 V3=0 T=0 M2=0 M3=10,762593600916 FrameElem=42-1 ElemStation=0

Frame=42 Station=0,05 OutputCase=RAR120 CaseType=Combination P=-16,3329886714053 V2=18,159110086165 V3=0 T=0 M2=0 M3=9,8596380966077 FrameElem=42-1 ElemStation=0,05

Frame=42 Station=0,1 OutputCase=RAR120 CaseType=Combination P=-16,3329886714053 V2=18,359110086165 V3=0 T=0 M2=0 M3=8,94668259229945 FrameElem=42-1 ElemStation=0,1

Frame=42 Station=0 OutputCase=RAR121 CaseType=Combination P=-25,2339554158096 V2=10,9930516955134 V3=0 T=0 M2=0 M3=2,9871607078068 FrameElem=42-1 ElemStation=0

Frame=42 Station=0,05 OutputCase=RAR121 CaseType=Combination P=-25,2339554158096 V2=11,1930516955134 V3=0 T=0 M2=0 M3=2,43250812303113 FrameElem=42-1 ElemStation=0,05

Frame=42 Station=0,1 OutputCase=RAR121 CaseType=Combination P=-25,2339554158096 V2=11,3930516955134 V3=0 T=0 M2=0 M3=1,8678553825546 FrameElem=42-1 ElemStation=0,1

Frame=42 Station=0 OutputCase=RAR122 CaseType=Combination P=-7,43202192653536 V2=10,9836325257999 V3=0 T=0 M2=0 M3=0,462197879524103 FrameElem=42-1 ElemStation=0

Frame=42 Station=0,05 OutputCase=RAR122 CaseType=Combination P=-7,43202192653536 V2=11,1836325257999 V3=0 T=0 M2=0 M3=-0,091983746765892 FrameElem=42-1 ElemStation=0,05

Frame=42 Station=0,1 OutputCase=RAR122 CaseType=Combination P=-7,43202192653536 V2=11,3836325257999 V3=0 T=0 M2=0 M3=-0,656165373055887 FrameElem=42-1 ElemStation=0,1

Frame=42 Station=0 OutputCase=RAR123 CaseType=Combination P=-6,71191885455857 V2=50,3395500678741 V3=0 T=0 M2=0 M3=-1,01243603100132 FrameElem=42-1 ElemStation=0

Frame=42 Station=0,05 OutputCase=RAR123 CaseType=Combination P=-6,71191885455857 V2=50,5395500678741 V3=0 T=0 M2=0 M3=-3,53441353439503 FrameElem=42-1 ElemStation=0,05

Frame=42 Station=0,1 OutputCase=RAR123 CaseType=Combination P=-6,71191885455857 V2=50,7395500678741 V3=0 T=0 M2=0 M3=-6,06639103778873 FrameElem=42-1 ElemStation=0,1

Frame=42 Station=0 OutputCase=RAR124 CaseType=Combination P=-15,6128855994285 V2=57,3150276282392 V3=0 T=0 M2=0 M3=9,28795969039053 FrameElem=42-1 ElemStation=0

Frame=42 Station=0,05 OutputCase=RAR124 CaseType=Combination P=-15,6128855994285 V2=57,5150276282392 V3=0 T=0 M2=0 M3=6,41720830897857 FrameElem=42-1 ElemStation=0,05

Frame=42 Station=0,1 OutputCase=RAR124 CaseType=Combination P=-15,6128855994285 V2=57,7150276282392 V3=0 T=0 M2=0 M3=3,53645692756661 FrameElem=42-1 ElemStation=0,1

Frame=42 Station=0 OutputCase=RAR125 CaseType=Combination P=-24,5138523438328 V2=50,3489692375876 V3=0 T=0 M2=0 M3=1,51252679728137 FrameElem=42-1 ElemStation=0

Frame=42 Station=0,05 OutputCase=RAR125 CaseType=Combination P=-24,5138523438328 V2=50,5489692375876 V3=0 T=0 M2=0 M3=-1,00992166459801 FrameElem=42-1 ElemStation=0,05

Frame=42 Station=0,1 OutputCase=RAR125 CaseType=Combination P=-24,5138523438328 V2=50,7489692375876 V3=0 T=0 M2=0 M3=-3,54237012647738 FrameElem=42-1 ElemStation=0,1

Frame=42 Station=0 OutputCase=RAR126 CaseType=Combination P=-16,3329886714053 V2=17,959110086165 V3=0 T=0 M2=0 M3=10,762593600916 FrameElem=42-1 ElemStation=0

Frame=42 Station=0,05 OutputCase=RAR126 CaseType=Combination P=-16,3329886714053 V2=18,159110086165 V3=0 T=0 M2=0 M3=9,8596380966077 FrameElem=42-1 ElemStation=0,05

Frame=42 Station=0,1 OutputCase=RAR126 CaseType=Combination P=-16,3329886714053 V2=18,359110086165 V3=0 T=0 M2=0 M3=8,94668259229945 FrameElem=42-1 ElemStation=0,1

Frame=42 Station=0 OutputCase=RAR127 CaseType=Combination P=-25,2339554158096 V2=10,9930516955134 V3=0 T=0 M2=0 M3=2,9871607078068 FrameElem=42-1 ElemStation=0

Frame=42 Station=0,05 OutputCase=RAR127 CaseType=Combination P=-25,2339554158096 V2=11,1930516955134 V3=0 T=0 M2=0 M3=2,43250812303113 FrameElem=42-1 ElemStation=0,05

Frame=42 Station=0,1 OutputCase=RAR127 CaseType=Combination P=-25,2339554158096 V2=11,3930516955134 V3=0 T=0 M2=0 M3=1,8678553825546 FrameElem=42-1 ElemStation=0,1

Frame=42 Station=0 OutputCase=RAR128 CaseType=Combination P=-8,05638486264429 V2=11,6207686802164 V3=0 T=0 M2=0 M3=1,21606534839763 FrameElem=42-1 ElemStation=0

Frame=42 Station=0,05 OutputCase=RAR128 CaseType=Combination P=-8,05638486264429 V2=11,8207686802164 V3=0 T=0 M2=0 M3=0,63002691438681 FrameElem=42-1 ElemStation=0,05

Frame=42 Station=0,1 OutputCase=RAR128 CaseType=Combination P=-8,05638486264429 V2=12,0207686802164 V3=0 T=0 M2=0 M3=3,39884803759922E-02 FrameElem=42-1 ElemStation=0,1

Frame=42 Station=0 OutputCase=RAR129 CaseType=Combination P=-6,78976182043661 V2=64,0943765906317 V3=0 T=0 M2=0 M3=-1,00445790485901 FrameElem=42-1 ElemStation=0

Società di Progetto
Brebemi SpA



Doc. N.
60235-00000-A00.doc

CODIFICA DOCUMENTO
04RCDII10000000000300A00

REV.
00

FOGLIO
558 di 628

Frame=42 Station=0,05 OutputCase=RAR129 CaseType=Combination P=-6,78976182043661 V2=64,2943765906317 V3=0 T=0 M2=0 M3=-4,2141767343906 FrameElem=42-1 ElemStation=0,05

Frame=42 Station=0,1 OutputCase=RAR129 CaseType=Combination P=-6,78976182043661 V2=64,4943765906317 V3=0 T=0 M2=0 M3=-7,43389556392218 FrameElem=42-1 ElemStation=0,1

Frame=42 Station=0 OutputCase=RAR130 CaseType=Combination P=-17,9908992160122 V2=73,0305468235796 V3=0 T=0 M2=0 M3=12,1941977692036 FrameElem=42-1 ElemStation=0

Frame=42 Station=0,05 OutputCase=RAR130 CaseType=Combination P=-17,9908992160122 V2=73,2305468235796 V3=0 T=0 M2=0 M3=8,5376704280246 FrameElem=42-1 ElemStation=0,05

Frame=42 Station=0,1 OutputCase=RAR130 CaseType=Combination P=-17,9908992160122 V2=73,4305468235796 V3=0 T=0 M2=0 M3=4,87114308684562 FrameElem=42-1 ElemStation=0,1

Frame=42 Station=0 OutputCase=RAR131 CaseType=Combination P=-29,1920366101909 V2=64,1063327918286 V3=0 T=0 M2=0 M3=2,20059780116389 FrameElem=42-1 ElemStation=0

Frame=42 Station=0,05 OutputCase=RAR131 CaseType=Combination P=-29,1920366101909 V2=64,3063327918286 V3=0 T=0 M2=0 M3=-1,00971883842754 FrameElem=42-1 ElemStation=0,05

Frame=42 Station=0,1 OutputCase=RAR131 CaseType=Combination P=-29,1920366101909 V2=64,5063327918286 V3=0 T=0 M2=0 M3=-4,23003547801896 FrameElem=42-1 ElemStation=0,1

Frame=42 Station=0 OutputCase=RAR132 CaseType=Combination P=-18,9510366453146 V2=20,5559901008141 V3=0 T=0 M2=0 M3=14,1603763165708 FrameElem=42-1 ElemStation=0

Frame=42 Station=0,05 OutputCase=RAR132 CaseType=Combination P=-18,9510366453146 V2=20,7559901008141 V3=0 T=0 M2=0 M3=13,1275768115301 FrameElem=42-1 ElemStation=0,05

Frame=42 Station=0,1 OutputCase=RAR132 CaseType=Combination P=-18,9510366453146 V2=20,9559901008141 V3=0 T=0 M2=0 M3=12,0847773064894 FrameElem=42-1 ElemStation=0,1

Frame=42 Station=0 OutputCase=RAR133 CaseType=Combination P=-30,1521740394933 V2=11,631776069063 V3=0 T=0 M2=0 M3=4,16677634853113 FrameElem=42-1 ElemStation=0

Frame=42 Station=0,05 OutputCase=RAR133 CaseType=Combination P=-30,1521740394933 V2=11,831776069063 V3=0 T=0 M2=0 M3=3,58018754507798 FrameElem=42-1 ElemStation=0,05

Frame=42 Station=0,1 OutputCase=RAR133 CaseType=Combination P=-30,1521740394933 V2=12,031776069063 V3=0 T=0 M2=0 M3=2,98359874162483 FrameElem=42-1 ElemStation=0,1

Frame=42 Station=0 OutputCase=RAR134 CaseType=Combination P=-15,9307629226321 V2=65,0394590865885 V3=0 T=0 M2=0 M3=21,19077004462 FrameElem=42-1 ElemStation=0

Frame=42 Station=0,05 OutputCase=RAR134 CaseType=Combination P=-15,9307629226321 V2=65,2394590865885 V3=0 T=0 M2=0 M3=17,9337970902905 FrameElem=42-1 ElemStation=0,05

Frame=42 Station=0,1 OutputCase=RAR134 CaseType=Combination P=-15,9307629226321 V2=65,4394590865885 V3=0 T=0 M2=0 M3=14,6668241359611 FrameElem=42-1 ElemStation=0,1

Frame=42 Station=0 OutputCase=RAR135 CaseType=Combination P=-7,3362817906675 V2=50,9766862222905 V3=0 T=0 M2=0 M3=-0,258568562127798 FrameElem=42-1 ElemStation=0

Frame=42 Station=0,05 OutputCase=RAR135 CaseType=Combination P=-7,3362817906675 V2=51,1766862222905 V3=0 T=0 M2=0 M3=-2,81240287324232 FrameElem=42-1 ElemStation=0,05

Frame=42 Station=0,1 OutputCase=RAR135 CaseType=Combination P=-7,3362817906675 V2=51,3766862222905 V3=0 T=0 M2=0 M3=-5,37623718435685 FrameElem=42-1 ElemStation=0,1

Frame=42 Station=0 OutputCase=RAR136 CaseType=Combination P=-16,2372485355374 V2=57,9521637826556 V3=0 T=0 M2=0 M3=10,0418271592641 FrameElem=42-1 ElemStation=0

Frame=42 Station=0,05 OutputCase=RAR136 CaseType=Combination P=-16,2372485355374 V2=58,1521637826556 V3=0 T=0 M2=0 M3=7,13921897013127 FrameElem=42-1 ElemStation=0,05

Frame=42 Station=0,1 OutputCase=RAR136 CaseType=Combination P=-16,2372485355374 V2=58,3521637826556 V3=0 T=0 M2=0 M3=4,22661078099849 FrameElem=42-1 ElemStation=0,1

Frame=42 Station=0 OutputCase=RAR137 CaseType=Combination P=-25,1382152799417 V2=50,986105392004 V3=0 T=0 M2=0 M3=2,2663942661549 FrameElem=42-1 ElemStation=0

Frame=42 Station=0,05 OutputCase=RAR137 CaseType=Combination P=-25,1382152799417 V2=51,186105392004 V3=0 T=0 M2=0 M3=-0,287911003445304 FrameElem=42-1 ElemStation=0,05

Frame=42 Station=0,1 OutputCase=RAR137 CaseType=Combination P=-25,1382152799417 V2=51,386105392004 V3=0 T=0 M2=0 M3=-2,8522162730455 FrameElem=42-1 ElemStation=0,1

Frame=42 Station=0 OutputCase=RAR138 CaseType=Combination P=-16,9573516075142 V2=18,5962462405815 V3=0 T=0 M2=0 M3=11,5164610697895 FrameElem=42-1 ElemStation=0

Frame=42 Station=0,05 OutputCase=RAR138 CaseType=Combination P=-16,9573516075142 V2=18,7962462405815 V3=0 T=0 M2=0 M3=10,5816487577604 FrameElem=42-1 ElemStation=0,05

Frame=42 Station=0,1 OutputCase=RAR138 CaseType=Combination P=-16,9573516075142 V2=18,9962462405815 V3=0 T=0 M2=0 M3=9,63683644573133 FrameElem=42-1 ElemStation=0,1

Frame=42 Station=0 OutputCase=RAR139 CaseType=Combination P=-25,8583183519185 V2=11,6301878499299 V3=0 T=0 M2=0 M3=3,74102817668032 FrameElem=42-1 ElemStation=0

Frame=42 Station=0,05 OutputCase=RAR139 CaseType=Combination P=-25,8583183519185 V2=11,8301878499299 V3=0 T=0 M2=0 M3=3,15451878418383 FrameElem=42-1 ElemStation=0,05

Frame=42 Station=0,1 OutputCase=RAR139 CaseType=Combination P=-25,8583183519185 V2=12,0301878499299 V3=0 T=0 M2=0 M3=2,55800939168734 FrameElem=42-1 ElemStation=0,1

Frame=42 Station=0 OutputCase=RAR140 CaseType=Combination P=-7,59665644328635 V2=11,6193454616911 V3=0 T=0 M2=0 M3=0,834548289563523 FrameElem=42-1 ElemStation=0

Frame=42 Station=0,05 OutputCase=RAR140 CaseType=Combination P=-7,59665644328635 V2=11,8193454616911 V3=0 T=0 M2=0 M3=0,24858101647897 FrameElem=42-1 ElemStation=0,05

Frame=42 Station=0,1 OutputCase=RAR140 CaseType=Combination P=-7,59665644328635 V2=12,0193454616911 V3=0 T=0 M2=0 M3=-0,347386256605583 FrameElem=42-1 ElemStation=0,1

Frame=42 Station=0 OutputCase=RAR141 CaseType=Combination P=-6,87655337130956 V2=50,9752630037652 V3=0 T=0 M2=0 M3=-0,640085620961903 FrameElem=42-1 ElemStation=0

Frame=42 Station=0,05 OutputCase=RAR141 CaseType=Combination P=-6,87655337130956 V2=51,1752630037652 V3=0 T=0 M2=0 M3=-3,19384877115016 FrameElem=42-1 ElemStation=0,05

Frame=42 Station=0,1 OutputCase=RAR141 CaseType=Combination P=-6,87655337130956 V2=51,3752630037652 V3=0 T=0 M2=0 M3=-5,75761192133843 FrameElem=42-1 ElemStation=0,1

Frame=42 Station=0 OutputCase=RAR142 CaseType=Combination P=-15,7775201161795 V2=57,9507405641303 V3=0 T=0 M2=0 M3=9,66031010042995 FrameElem=42-1 ElemStation=0

Frame=42 Station=0,05 OutputCase=RAR142 CaseType=Combination P=-15,7775201161795 V2=58,1507405641303 V3=0 T=0 M2=0 M3=6,75777307222343 FrameElem=42-1 ElemStation=0,05

Frame=42 Station=0,1 OutputCase=RAR142 CaseType=Combination P=-15,7775201161795 V2=58,3507405641303 V3=0 T=0 M2=0 M3=3,84523604401692 FrameElem=42-1 ElemStation=0,1

Frame=42 Station=0 OutputCase=RAR143 CaseType=Combination P=-24,6784868605838 V2=50,9846821734787 V3=0 T=0 M2=0 M3=1,88487720732079 FrameElem=42-1 ElemStation=0

Frame=42 Station=0,05 OutputCase=RAR143 CaseType=Combination P=-24,6784868605838 V2=51,1846821734787 V3=0 T=0 M2=0 M3=0,669356901353144 FrameElem=42-1 ElemStation=0,05

Frame=42 Station=0,1 OutputCase=RAR143 CaseType=Combination P=-24,6784868605838 V2=51,3846821734787 V3=0 T=0 M2=0 M3=-3,23359101002708 FrameElem=42-1 ElemStation=0,1

APPROVATO S.D.P.
Società di Progetto
Brebemi SpA



Doc. N.
60235-00000-A00.doc

CODIFICA DOCUMENTO
04RCDII10000000000300A00

REV.
00

FOGLIO
559 di 628

Frame=42 Station=0 OutputCase=RAR144 CaseType=Combination P=-16,4976231881563 V2=18,5948230220562 V3=0 T=0 M2=0 M3=11,1349440109554 FrameElem=42-1 ElemStation=0
Frame=42 Station=0,05 OutputCase=RAR144 CaseType=Combination P=-16,4976231881563 V2=18,7948230220562 V3=0 T=0 M2=0 M3=10,2002028598526 FrameElem=42-1 ElemStation=0,05
Frame=42 Station=0,1 OutputCase=RAR144 CaseType=Combination P=-16,4976231881563 V2=18,9948230220562 V3=0 T=0 M2=0 M3=9,25546170874976 FrameElem=42-1 ElemStation=0,1
Frame=42 Station=0 OutputCase=RAR145 CaseType=Combination P=-25,3985899325606 V2=11,6287646314046 V3=0 T=0 M2=0 M3=3,35951111784622 FrameElem=42-1 ElemStation=0
Frame=42 Station=0,05 OutputCase=RAR145 CaseType=Combination P=-25,3985899325606 V2=11,8287646314046 V3=0 T=0 M2=0 M3=2,77307288627599 FrameElem=42-1 ElemStation=0,05
Frame=42 Station=0,1 OutputCase=RAR145 CaseType=Combination P=-25,3985899325606 V2=12,0287646314046 V3=0 T=0 M2=0 M3=2,17663465470576 FrameElem=42-1 ElemStation=0,1
Frame=42 Station=0 OutputCase=RAR146 CaseType=Combination P=-8,51611328200224 V2=11,6221918987417 V3=0 T=0 M2=0 M3=1,59758240723173 FrameElem=42-1 ElemStation=0
Frame=42 Station=0,05 OutputCase=RAR146 CaseType=Combination P=-8,51611328200224 V2=11,8221918987417 V3=0 T=0 M2=0 M3=1,01147281229465 FrameElem=42-1 ElemStation=0,05
Frame=42 Station=0,1 OutputCase=RAR146 CaseType=Combination P=-8,51611328200224 V2=12,0221918987417 V3=0 T=0 M2=0 M3=0,415363217357567 FrameElem=42-1 ElemStation=0,1
Frame=42 Station=0 OutputCase=RAR147 CaseType=Combination P=-7,79601021002545 V2=50,9781094408158 V3=0 T=0 M2=0 M3=0,122948496706307 FrameElem=42-1 ElemStation=0
Frame=42 Station=0,05 OutputCase=RAR147 CaseType=Combination P=-7,79601021002545 V2=51,1781094408158 V3=0 T=0 M2=0 M3=-2,43095697533448 FrameElem=42-1 ElemStation=0,05
Frame=42 Station=0,1 OutputCase=RAR147 CaseType=Combination P=-7,79601021002545 V2=51,3781094408158 V3=0 T=0 M2=0 M3=4,99486244737528 FrameElem=42-1 ElemStation=0,1
Frame=42 Station=0 OutputCase=RAR148 CaseType=Combination P=-16,6969769548954 V2=57,9535870011809 V3=0 T=0 M2=0 M3=10,4233442180982 FrameElem=42-1 ElemStation=0
Frame=42 Station=0,05 OutputCase=RAR148 CaseType=Combination P=-16,6969769548954 V2=58,1535870011809 V3=0 T=0 M2=0 M3=7,52066486803911 FrameElem=42-1 ElemStation=0,05
Frame=42 Station=0,1 OutputCase=RAR148 CaseType=Combination P=-16,6969769548954 V2=58,3535870011809 V3=0 T=0 M2=0 M3=4,60798551798007 FrameElem=42-1 ElemStation=0,1
Frame=42 Station=0 OutputCase=RAR149 CaseType=Combination P=-25,5979436992997 V2=50,9875286105293 V3=0 T=0 M2=0 M3=2,647911324989 FrameElem=42-1 ElemStation=0
Frame=42 Station=0,05 OutputCase=RAR149 CaseType=Combination P=-25,5979436992997 V2=51,1875286105293 V3=0 T=0 M2=0 M3=9,35348944625368E-02 FrameElem=42-1 ElemStation=0,05
Frame=42 Station=0,1 OutputCase=RAR149 CaseType=Combination P=-25,5979436992997 V2=51,3875286105293 V3=0 T=0 M2=0 M3=-2,47084153606393 FrameElem=42-1 ElemStation=0,1
Frame=42 Station=0 OutputCase=RAR150 CaseType=Combination P=-17,4170800268722 V2=18,5976694591068 V3=0 T=0 M2=0 M3=11,8979781286236 FrameElem=42-1 ElemStation=0
Frame=42 Station=0,05 OutputCase=RAR150 CaseType=Combination P=-17,4170800268722 V2=18,7976694591068 V3=0 T=0 M2=0 M3=10,9630946556682 FrameElem=42-1 ElemStation=0,05
Frame=42 Station=0,1 OutputCase=RAR150 CaseType=Combination P=-17,4170800268722 V2=18,9976694591068 V3=0 T=0 M2=0 M3=10,0182111827129 FrameElem=42-1 ElemStation=0,1
Frame=42 Station=0 OutputCase=RAR151 CaseType=Combination P=-26,3180467712765 V2=11,6316110684552 V3=0 T=0 M2=0 M3=4,12254523551443 FrameElem=42-1 ElemStation=0
Frame=42 Station=0,05 OutputCase=RAR151 CaseType=Combination P=-26,3180467712765 V2=11,8316110684552 V3=0 T=0 M2=0 M3=3,53596468209167 FrameElem=42-1 ElemStation=0,05
Frame=42 Station=0,1 OutputCase=RAR151 CaseType=Combination P=-26,3180467712765 V2=12,0316110684552 V3=0 T=0 M2=0 M3=2,93938412866891 FrameElem=42-1 ElemStation=0,1
Frame=42 Station=0 OutputCase=RAR152 CaseType=Combination P=-8,24711125656648 V2=12,0024810854561 V3=0 T=0 M2=0 M3=1,5157790061881 FrameElem=42-1 ElemStation=0
Frame=42 Station=0,05 OutputCase=RAR152 CaseType=Combination P=-8,24711125656648 V2=12,2024810854561 V3=0 T=0 M2=0 M3=0,910654951915296 FrameElem=42-1 ElemStation=0,05
Frame=42 Station=0,1 OutputCase=RAR152 CaseType=Combination P=-8,24711125656648 V2=12,4024810854561 V3=0 T=0 M2=0 M3=0,29553089764249 FrameElem=42-1 ElemStation=0,1
Frame=42 Station=0 OutputCase=RAR153 CaseType=Combination P=-7,52700818458968 V2=51,3583986275303 V3=0 T=0 M2=0 M3=0,041145095662675 FrameElem=42-1 ElemStation=0
Frame=42 Station=0,05 OutputCase=RAR153 CaseType=Combination P=-7,52700818458968 V2=51,5583986275303 V3=0 T=0 M2=0 M3=-2,53177483571384 FrameElem=42-1 ElemStation=0,05
Frame=42 Station=0,1 OutputCase=RAR153 CaseType=Combination P=-7,52700818458968 V2=51,7583986275303 V3=0 T=0 M2=0 M3=-5,11469476709035 FrameElem=42-1 ElemStation=0,1
Frame=42 Station=0 OutputCase=RAR154 CaseType=Combination P=-16,4279749294596 V2=58,3338761878954 V3=0 T=0 M2=0 M3=10,3415408170545 FrameElem=42-1 ElemStation=0
Frame=42 Station=0,05 OutputCase=RAR154 CaseType=Combination P=-16,4279749294596 V2=58,5338761878954 V3=0 T=0 M2=0 M3=7,41984700765976 FrameElem=42-1 ElemStation=0,05
Frame=42 Station=0,1 OutputCase=RAR154 CaseType=Combination P=-16,4279749294596 V2=58,7338761878954 V3=0 T=0 M2=0 M3=4,48815319826499 FrameElem=42-1 ElemStation=0,1
Frame=42 Station=0 OutputCase=RAR155 CaseType=Combination P=-25,3289416738639 V2=51,3678177972438 V3=0 T=0 M2=0 M3=2,56610792394537 FrameElem=42-1 ElemStation=0
Frame=42 Station=0,05 OutputCase=RAR155 CaseType=Combination P=-25,3289416738639 V2=51,5678177972438 V3=0 T=0 M2=0 M3=-7,28296591681821E-03 FrameElem=42-1 ElemStation=0,05
Frame=42 Station=0,1 OutputCase=RAR155 CaseType=Combination P=-25,3289416738639 V2=51,7678177972438 V3=0 T=0 M2=0 M3=-2,59067385577901 FrameElem=42-1 ElemStation=0,1
Frame=42 Station=0 OutputCase=RAR156 CaseType=Combination P=-17,1480780014364 V2=18,9779586458212 V3=0 T=0 M2=0 M3=11,81617472758 FrameElem=42-1 ElemStation=0
Frame=42 Station=0,05 OutputCase=RAR156 CaseType=Combination P=-17,1480780014364 V2=19,1779586458212 V3=0 T=0 M2=0 M3=10,8622767952889 FrameElem=42-1 ElemStation=0,05
Frame=42 Station=0,1 OutputCase=RAR156 CaseType=Combination P=-17,1480780014364 V2=19,3779586458212 V3=0 T=0 M2=0 M3=9,89837886299783 FrameElem=42-1 ElemStation=0,1
Frame=42 Station=0 OutputCase=RAR157 CaseType=Combination P=-26,0490447458407 V2=12,0119002551696 V3=0 T=0 M2=0 M3=4,0407418344708 FrameElem=42-1 ElemStation=0
Frame=42 Station=0,05 OutputCase=RAR157 CaseType=Combination P=-26,0490447458407 V2=12,2119002551696 V3=0 T=0 M2=0 M3=3,43514682171232 FrameElem=42-1 ElemStation=0,05
Frame=42 Station=0,1 OutputCase=RAR157 CaseType=Combination P=-26,0490447458407 V2=12,4119002551696 V3=0 T=0 M2=0 M3=2,81955180895384 FrameElem=42-1 ElemStation=0,1
Frame=42 Station=0 OutputCase=RAR158 CaseType=Combination P=-7,86565846872211 V2=11,2390562749766 V3=0 T=0 M2=0 M3=0,916351690607155 FrameElem=42-1 ElemStation=0
Frame=42 Station=0,05 OutputCase=RAR158 CaseType=Combination P=-7,86565846872211 V2=11,4390562749766 V3=0 T=0 M2=0 M3=0,349398876858325 FrameElem=42-1 ElemStation=0,05

APPROVATO SDP
Società di Progetto
Brebemi SpA



Doc. N.
60235-0000-A00.doc

CODIFICA DOCUMENTO
04RCDII10000000000300A00

REV.
00

FOGLIO
560 di 628

Frame=42 Station=0,1 OutputCase=RAR158 CaseType=Combination P=-7,86565846872211 V2=11,6390562749766 V3=0 T=0 M2=0 M3=-0,227553936890506 FrameElem=42-1 ElemStation=0,1

Frame=42 Station=0 OutputCase=RAR159 CaseType=Combination P=-7,14555539674532 V2=50,5949738170508 V3=0 T=0 M2=0 M3=-0,558282219918271 FrameElem=42-1 ElemStation=0

Frame=42 Station=0,05 OutputCase=RAR159 CaseType=Combination P=-7,14555539674532 V2=50,7949738170508 V3=0 T=0 M2=0 M3=-3,09303091077081 FrameElem=42-1 ElemStation=0,05

Frame=42 Station=0,1 OutputCase=RAR159 CaseType=Combination P=-7,14555539674532 V2=50,9949738170508 V3=0 T=0 M2=0 M3=-5,63777960162335 FrameElem=42-1 ElemStation=0,1

Frame=42 Station=0 OutputCase=RAR160 CaseType=Combination P=-16,0465221416153 V2=57,5704513774159 V3=0 T=0 M2=0 M3=9,74211350147358 FrameElem=42-1 ElemStation=0

Frame=42 Station=0,05 OutputCase=RAR160 CaseType=Combination P=-16,0465221416153 V2=57,7704513774159 V3=0 T=0 M2=0 M3=6,85859093260279 FrameElem=42-1 ElemStation=0,05

Frame=42 Station=0,1 OutputCase=RAR160 CaseType=Combination P=-16,0465221416153 V2=57,9704513774159 V3=0 T=0 M2=0 M3=3,96506836373199 FrameElem=42-1 ElemStation=0,1

Frame=42 Station=0 OutputCase=RAR161 CaseType=Combination P=-24,9474888860196 V2=50,6043929867643 V3=0 T=0 M2=0 M3=1,96668060836443 FrameElem=42-1 ElemStation=0

Frame=42 Station=0,05 OutputCase=RAR161 CaseType=Combination P=-24,9474888860196 V2=50,8043929867643 V3=0 T=0 M2=0 M3=-0,568539040973789 FrameElem=42-1 ElemStation=0,05

Frame=42 Station=0,1 OutputCase=RAR161 CaseType=Combination P=-24,9474888860196 V2=51,0043929867643 V3=0 T=0 M2=0 M3=-3,113758690312 FrameElem=42-1 ElemStation=0,1

Frame=42 Station=0 OutputCase=RAR162 CaseType=Combination P=-16,7666252135921 V2=18,2145338353417 V3=0 T=0 M2=0 M3=11,216747411999 FrameElem=42-1 ElemStation=0

Frame=42 Station=0,05 OutputCase=RAR162 CaseType=Combination P=-16,7666252135921 V2=18,4145338353417 V3=0 T=0 M2=0 M3=10,3010207202319 FrameElem=42-1 ElemStation=0,05

Frame=42 Station=0,1 OutputCase=RAR162 CaseType=Combination P=-16,7666252135921 V2=18,6145338353417 V3=0 T=0 M2=0 M3=9,37529402846484 FrameElem=42-1 ElemStation=0,1

Frame=42 Station=0 OutputCase=RAR163 CaseType=Combination P=-25,6675919579963 V2=11,2484754446901 V3=0 T=0 M2=0 M3=3,44131451888985 FrameElem=42-1 ElemStation=0

Frame=42 Station=0,05 OutputCase=RAR163 CaseType=Combination P=-25,6675919579963 V2=11,4484754446901 V3=0 T=0 M2=0 M3=2,87389074665535 FrameElem=42-1 ElemStation=0,05

Frame=42 Station=0,1 OutputCase=RAR163 CaseType=Combination P=-25,6675919579963 V2=11,6484754446901 V3=0 T=0 M2=0 M3=2,29646697442084 FrameElem=42-1 ElemStation=0,1

Frame=42 Station=0 OutputCase=INVRAR CaseType=Combination StepType=Max P=-5,61312733221883 V2=73,4108360102941 V3=0 T=0 M2=0 M3=21,19077004462 FrameElem=42-1 ElemStation=0

Frame=42 Station=0,05 OutputCase=INVRAR CaseType=Combination StepType=Max P=-5,61312733221883 V2=73,6108360102941 V3=0 T=0 M2=0 M3=17,9337970920905 FrameElem=42-1 ElemStation=0,05

Frame=42 Station=0,1 OutputCase=INVRAR CaseType=Combination StepType=Max P=-5,61312733221883 V2=73,8108360102941 V3=0 T=0 M2=0 M3=14,6668241359611 FrameElem=42-1 ElemStation=0,1

Frame=42 Station=0 OutputCase=INVRAR CaseType=Combination StepType=Min P=-30,1521740394933 V2=10,9807860887493 V3=0 T=0 M2=0 M3=-1,83000574936529 FrameElem=42-1 ElemStation=0

Frame=42 Station=0,05 OutputCase=INVRAR CaseType=Combination StepType=Min P=-30,1521740394933 V2=11,1807860887493 V3=0 T=0 M2=0 M3=-4,97706853020628 FrameElem=42-1 ElemStation=0,05

Frame=42 Station=0,1 OutputCase=INVRAR CaseType=Combination StepType=Min P=-30,1521740394933 V2=11,3807860887493 V3=0 T=0 M2=0 M3=-8,19664503788533 FrameElem=42-1 ElemStation=0,1

Frame=42 Station=0 OutputCase=FRE01 CaseType=Combination P=-11,2910804182151 V2=11,6202047246043 V3=0 T=0 M2=0 M3=1,06488777873619 FrameElem=42-1 ElemStation=0

Frame=42 Station=0,05 OutputCase=FRE01 CaseType=Combination P=-11,2910804182151 V2=11,8202047246043 V3=0 T=0 M2=0 M3=0,47887754205979 FrameElem=42-1 ElemStation=0,05

Frame=42 Station=0,1 OutputCase=FRE01 CaseType=Combination P=-11,2910804182151 V2=12,0202047246043 V3=0 T=0 M2=0 M3=-0,117132693724233 FrameElem=42-1 ElemStation=0,1

Frame=42 Station=0 OutputCase=FRE02 CaseType=Combination P=-6,57006775840426 V2=50,974314191415 V3=0 T=0 M2=0 M3=-0,894430326851307 FrameElem=42-1 ElemStation=0

Frame=42 Station=0,05 OutputCase=FRE02 CaseType=Combination P=-6,57006775840426 V2=51,174314191415 V3=0 T=0 M2=0 M3=-3,44814603642206 FrameElem=42-1 ElemStation=0,05

Frame=42 Station=0,1 OutputCase=FRE02 CaseType=Combination P=-6,57006775840426 V2=51,374314191415 V3=0 T=0 M2=0 M3=-6,01186174599281 FrameElem=42-1 ElemStation=0,1

Frame=42 Station=0 OutputCase=FRE03 CaseType=Combination P=-15,4710345032742 V2=57,9497917517801 V3=0 T=0 M2=0 M3=9,40596539454054 FrameElem=42-1 ElemStation=0

Frame=42 Station=0,05 OutputCase=FRE03 CaseType=Combination P=-15,4710345032742 V2=58,1497917517801 V3=0 T=0 M2=0 M3=6,50347580695154 FrameElem=42-1 ElemStation=0,05

Frame=42 Station=0,1 OutputCase=FRE03 CaseType=Combination P=-15,4710345032742 V2=58,3497917517801 V3=0 T=0 M2=0 M3=3,59098621936253 FrameElem=42-1 ElemStation=0,1

Frame=42 Station=0 OutputCase=FRE04 CaseType=Combination P=-24,3720012476785 V2=50,9837333611285 V3=0 T=0 M2=0 M3=1,63053250143139 FrameElem=42-1 ElemStation=0

Frame=42 Station=0,05 OutputCase=FRE04 CaseType=Combination P=-24,3720012476785 V2=51,1837333611285 V3=0 T=0 M2=0 M3=-0,923654166625037 FrameElem=42-1 ElemStation=0,05

Frame=42 Station=0,1 OutputCase=FRE04 CaseType=Combination P=-24,3720012476785 V2=51,3837333611285 V3=0 T=0 M2=0 M3=-3,48784083468146 FrameElem=42-1 ElemStation=0,1

Frame=42 Station=0 OutputCase=FRE05 CaseType=Combination P=-16,191137575251 V2=18,593874209706 V3=0 T=0 M2=0 M3=10,880599305066 FrameElem=42-1 ElemStation=0

Frame=42 Station=0,05 OutputCase=FRE05 CaseType=Combination P=-16,191137575251 V2=18,793874209706 V3=0 T=0 M2=0 M3=9,94590559458067 FrameElem=42-1 ElemStation=0,05

Frame=42 Station=0,1 OutputCase=FRE05 CaseType=Combination P=-16,191137575251 V2=18,993874209706 V3=0 T=0 M2=0 M3=9,00121188409537 FrameElem=42-1 ElemStation=0,1

Frame=42 Station=0 OutputCase=FRE06 CaseType=Combination P=-25,0921043196553 V2=11,6278158190544 V3=0 T=0 M2=0 M3=3,10516641195682 FrameElem=42-1 ElemStation=0

Frame=42 Station=0,05 OutputCase=FRE06 CaseType=Combination P=-25,0921043196553 V2=11,8278158190544 V3=0 T=0 M2=0 M3=2,5187756210041 FrameElem=42-1 ElemStation=0,05

Frame=42 Station=0,1 OutputCase=FRE06 CaseType=Combination P=-25,0921043196553 V2=12,0278158190544 V3=0 T=0 M2=0 M3=1,92238483005138 FrameElem=42-1 ElemStation=0,1

Frame=42 Station=0 OutputCase=FRE07 CaseType=Combination P=-6,83044241102311 V2=11,6169734308156 V3=0 T=0 M2=0 M3=0,198686524840014 FrameElem=42-1 ElemStation=0

Frame=42 Station=0,05 OutputCase=FRE07 CaseType=Combination P=-6,83044241102311 V2=11,8169734308156 V3=0 T=0 M2=0 M3=-0,387162146700764 FrameElem=42-1 ElemStation=0,05

Frame=42 Station=0,1 OutputCase=FRE07 CaseType=Combination P=-6,83044241102311 V2=12,0169734308156 V3=0 T=0 M2=0 M3=-0,983010818241542 FrameElem=42-1 ElemStation=0,1

Frame=42 Station=0 OutputCase=FRE08 CaseType=Combination P=-6,18696074227264 V2=50,9731281759773 V3=0 T=0 M2=0 M3=-1,21236120921306 FrameElem=42-1 ElemStation=0

Società di Progetto
Brebemi SpA



Doc. N.
60235-00000-A00.doc

CODIFICA DOCUMENTO
04RCDII10000000000300A00

REV.
00

FOGLIO
561 di 628

Frame=42 Station=0,05 OutputCase=FRE08 CaseType=Combination P=-6,18696074227264 V2=51,1731281759773 V3=0 T=0 M2=0 M3=-3,76601761801192	FrameElem=42-1 ElemStation=0,05
Frame=42 Station=0,1 OutputCase=FRE08 CaseType=Combination P=-6,18696074227264 V2=51,3731281759773 V3=0 T=0 M2=0 M3=-6,32967402681079	FrameElem=42-1 ElemStation=0,1
Frame=42 Station=0 OutputCase=FRE09 CaseType=Combination P=-15,0879274871426 V2=57,9486057363424 V3=0 T=0 M2=0 M3=9,08803451217879	FrameElem=42-1 ElemStation=0
Frame=42 Station=0,05 OutputCase=FRE09 CaseType=Combination P=-15,0879274871426 V2=58,1486057363424 V3=0 T=0 M2=0 M3=-6,18560422536167	FrameElem=42-1 ElemStation=0,05
Frame=42 Station=0,1 OutputCase=FRE09 CaseType=Combination P=-15,0879274871426 V2=58,3486057363424 V3=0 T=0 M2=0 M3=3,27317393854455	FrameElem=42-1 ElemStation=0,1
Frame=42 Station=0 OutputCase=FRE10 CaseType=Combination P=-23,9888942315469 V2=50,9825473456908 V3=0 T=0 M2=0 M3=1,31260161906964	FrameElem=42-1 ElemStation=0
Frame=42 Station=0,05 OutputCase=FRE10 CaseType=Combination P=-23,9888942315469 V2=51,1825473456908 V3=0 T=0 M2=0 M3=-1,2415257482149	FrameElem=42-1 ElemStation=0,05
Frame=42 Station=0,1 OutputCase=FRE10 CaseType=Combination P=-23,9888942315469 V2=51,3825473456908 V3=0 T=0 M2=0 M3=-3,80565311549944	FrameElem=42-1 ElemStation=0,1
Frame=42 Station=0 OutputCase=FRE11 CaseType=Combination P=-15,8080305591194 V2=18,5926881942682 V3=0 T=0 M2=0 M3=10,5626684227042	FrameElem=42-1 ElemStation=0
Frame=42 Station=0,05 OutputCase=FRE11 CaseType=Combination P=-15,8080305591194 V2=18,7926881942682 V3=0 T=0 M2=0 M3=9,62803401299081	FrameElem=42-1 ElemStation=0,05
Frame=42 Station=0,1 OutputCase=FRE11 CaseType=Combination P=-15,8080305591194 V2=18,9926881942682 V3=0 T=0 M2=0 M3=8,6833996032774	FrameElem=42-1 ElemStation=0,1
Frame=42 Station=0 OutputCase=FRE12 CaseType=Combination P=-24,7089973035237 V2=11,6266298036166 V3=0 T=0 M2=0 M3=2,78723552959506	FrameElem=42-1 ElemStation=0
Frame=42 Station=0,05 OutputCase=FRE12 CaseType=Combination P=-24,7089973035237 V2=11,8266298036166 V3=0 T=0 M2=0 M3=2,20090403941423	FrameElem=42-1 ElemStation=0,05
Frame=42 Station=0,1 OutputCase=FRE12 CaseType=Combination P=-24,7089973035237 V2=12,0266298036166 V3=0 T=0 M2=0 M3=1,6045725492334	FrameElem=42-1 ElemStation=0,1
Frame=42 Station=0 OutputCase=FRE13 CaseType=Combination P=-6,98938107262492 V2=11,9350671018487 V3=0 T=0 M2=0 M3=0,448447906332075	FrameElem=42-1 ElemStation=0
Frame=42 Station=0,05 OutputCase=FRE13 CaseType=Combination P=-6,98938107262492 V2=12,1350671018487 V3=0 T=0 M2=0 M3=-0,153305448760359	FrameElem=42-1 ElemStation=0,05
Frame=42 Station=0,1 OutputCase=FRE13 CaseType=Combination P=-6,98938107262492 V2=12,3350671018487 V3=0 T=0 M2=0 M3=-0,765058803852794	FrameElem=42-1 ElemStation=0,1
Frame=42 Station=0 OutputCase=FRE14 CaseType=Combination P=-6,67150374942129 V2=11,2988797597824 V3=0 T=0 M2=0 M3=-5,10748656520464E-02	FrameElem=42-1 ElemStation=0
Frame=42 Station=0,05 OutputCase=FRE14 CaseType=Combination P=-6,67150374942129 V2=11,4988797597824 V3=0 T=0 M2=0 M3=-0,621018844641168	FrameElem=42-1 ElemStation=0,05
Frame=42 Station=0,1 OutputCase=FRE14 CaseType=Combination P=-6,67150374942129 V2=11,6988797597824 V3=0 T=0 M2=0 M3=-1,20096283263029	FrameElem=42-1 ElemStation=0,1
Frame=42 Station=0 OutputCase=FRE15 CaseType=Combination P=-7,21354942715473 V2=11,6181594462533 V3=0 T=0 M2=0 M3=0,516617407201769	FrameElem=42-1 ElemStation=0
Frame=42 Station=0,05 OutputCase=FRE15 CaseType=Combination P=-7,21354942715473 V2=11,8181594462533 V3=0 T=0 M2=0 M3=-6,92905651108968E-02	FrameElem=42-1 ElemStation=0,05
Frame=42 Station=0,1 OutputCase=FRE15 CaseType=Combination P=-7,21354942715473 V2=12,0181594462533 V3=0 T=0 M2=0 M3=-0,665198537423562	FrameElem=42-1 ElemStation=0,1
Frame=42 Station=0 OutputCase=FRE16 CaseType=Combination P=-7,749899249739 V2=11,6198198678662 V3=0 T=0 M2=0 M3=0,961720642508225	FrameElem=42-1 ElemStation=0
Frame=42 Station=0,05 OutputCase=FRE16 CaseType=Combination P=-7,749899249739 V2=11,8198198678662 V3=0 T=0 M2=0 M3=0,375729649114917	FrameElem=42-1 ElemStation=0,05
Frame=42 Station=0,1 OutputCase=FRE16 CaseType=Combination P=-7,749899249739 V2=12,0198198678662 V3=0 T=0 M2=0 M3=-0,220261344278391	FrameElem=42-1 ElemStation=0,1
Frame=42 Station=0 OutputCase=FRE17 CaseType=Combination P=-6,95317477453588 V2=50,9755002068528 V3=0 T=0 M2=0 M3=-0,576499444489552	FrameElem=42-1 ElemStation=0
Frame=42 Station=0,05 OutputCase=FRE17 CaseType=Combination P=-6,95317477453588 V2=51,1755002068528 V3=0 T=0 M2=0 M3=-3,13027445483219	FrameElem=42-1 ElemStation=0,05
Frame=42 Station=0,1 OutputCase=FRE17 CaseType=Combination P=-6,95317477453588 V2=51,3755002068528 V3=0 T=0 M2=0 M3=-5,69404946517483	FrameElem=42-1 ElemStation=0,1
Frame=42 Station=0 OutputCase=FRE18 CaseType=Combination P=-15,8541415194058 V2=57,950977762179 V3=0 T=0 M2=0 M3=9,7238962769023	FrameElem=42-1 ElemStation=0
Frame=42 Station=0,05 OutputCase=FRE18 CaseType=Combination P=-15,8541415194058 V2=58,150977762179 V3=0 T=0 M2=0 M3=6,8213473885414	FrameElem=42-1 ElemStation=0,05
Frame=42 Station=0,1 OutputCase=FRE18 CaseType=Combination P=-15,8541415194058 V2=58,350977762179 V3=0 T=0 M2=0 M3=3,90879850018051	FrameElem=42-1 ElemStation=0,1
Frame=42 Station=0 OutputCase=FRE19 CaseType=Combination P=-24,7551082638101 V2=50,9849193765663 V3=0 T=0 M2=0 M3=1,94846338379314	FrameElem=42-1 ElemStation=0
Frame=42 Station=0,05 OutputCase=FRE19 CaseType=Combination P=-24,7551082638101 V2=51,1849193765663 V3=0 T=0 M2=0 M3=-0,60578258503517	FrameElem=42-1 ElemStation=0,05
Frame=42 Station=0,1 OutputCase=FRE19 CaseType=Combination P=-24,7551082638101 V2=51,3849193765663 V3=0 T=0 M2=0 M3=3,17002855386348	FrameElem=42-1 ElemStation=0,1
Frame=42 Station=0 OutputCase=FRE20 CaseType=Combination P=-16,5742445913826 V2=18,5950602251437 V3=0 T=0 M2=0 M3=11,1985301874277	FrameElem=42-1 ElemStation=0
Frame=42 Station=0,05 OutputCase=FRE20 CaseType=Combination P=-16,5742445913826 V2=18,7950602251437 V3=0 T=0 M2=0 M3=10,2637771761705	FrameElem=42-1 ElemStation=0,05
Frame=42 Station=0,1 OutputCase=FRE20 CaseType=Combination P=-16,5742445913826 V2=18,9950602251437 V3=0 T=0 M2=0 M3=9,31902416491335	FrameElem=42-1 ElemStation=0,1
Frame=42 Station=0 OutputCase=FRE21 CaseType=Combination P=-25,4752113357869 V2=11,6290018344921 V3=0 T=0 M2=0 M3=3,42309729431857	FrameElem=42-1 ElemStation=0
Frame=42 Station=0,05 OutputCase=FRE21 CaseType=Combination P=-25,4752113357869 V2=11,8290018344921 V3=0 T=0 M2=0 M3=2,83664720259397	FrameElem=42-1 ElemStation=0,05
Frame=42 Station=0,1 OutputCase=FRE21 CaseType=Combination P=-25,4752113357869 V2=12,0290018344921 V3=0 T=0 M2=0 M3=2,24019711086936	FrameElem=42-1 ElemStation=0,1
Frame=42 Station=0 OutputCase=FRE22 CaseType=Combination P=-7,90883791134081 V2=11,9379135388993 V3=0 T=0 M2=0 M3=1,21148202400029	FrameElem=42-1 ElemStation=0
Frame=42 Station=0,05 OutputCase=FRE22 CaseType=Combination P=-7,90883791134081 V2=12,1379135388993 V3=0 T=0 M2=0 M3=0,609586347055321	FrameElem=42-1 ElemStation=0,05
Frame=42 Station=0,1 OutputCase=FRE22 CaseType=Combination P=-7,90883791134081 V2=12,3379135388993 V3=0 T=0 M2=0 M3=-2,30932988964327E-03	FrameElem=42-1 ElemStation=0,1

Società di Progetto
Brebemi SpA

	Doc. N. 60235-00000-A00.doc	CODIFICA DOCUMENTO 04RCDII10000000000300A00	REV. 00	FOGLIO 562 di 628
--	--------------------------------	--	------------	----------------------

Frame=42 Station=0 OutputCase=FRE23 CaseType=Combination P=-7,59096058813718 V2=11,301726196833 V3=0 T=0 M2=0 M3=0,711959261016164	FrameElem=42-1 ElemStation=0
Frame=42 Station=0,05 OutputCase=FRE23 CaseType=Combination P=-7,59096058813718 V2=11,501726196833 V3=0 T=0 M2=0 M3=0,141872951174512	FrameElem=42-1 ElemStation=0,05
Frame=42 Station=0,1 OutputCase=FRE23 CaseType=Combination P=-7,59096058813718 V2=11,701726196833 V3=0 T=0 M2=0 M3=-0,438213358667139	FrameElem=42-1 ElemStation=0,1
Frame=42 Station=0 OutputCase=FRE24 CaseType=Combination P=-8,13300626587062 V2=11,6210058833039 V3=0 T=0 M2=0 M3=1,27965152486998	FrameElem=42-1 ElemStation=0
Frame=42 Station=0,05 OutputCase=FRE24 CaseType=Combination P=-8,13300626587062 V2=11,8210058833039 V3=0 T=0 M2=0 M3=0,693601230704784	FrameElem=42-1 ElemStation=0,05
Frame=42 Station=0,1 OutputCase=FRE24 CaseType=Combination P=-8,13300626587062 V2=12,0210058833039 V3=0 T=0 M2=0 M3=9,75509365395881E-02	FrameElem=42-1 ElemStation=0,1
Frame=42 Station=0 OutputCase=FRE25 CaseType=Combination P=-7,48089722430323 V2=12,0001090545806 V3=0 T=0 M2=0 M3=0,879917241464593	FrameElem=42-1 ElemStation=0
Frame=42 Station=0,05 OutputCase=FRE25 CaseType=Combination P=-7,48089722430323 V2=12,2001090545806 V3=0 T=0 M2=0 M3=0,274911788735562	FrameElem=42-1 ElemStation=0,05
Frame=42 Station=0,1 OutputCase=FRE25 CaseType=Combination P=-7,48089722430323 V2=12,4001090545806 V3=0 T=0 M2=0 M3=-0,340093663993469	FrameElem=42-1 ElemStation=0,1
Frame=42 Station=0 OutputCase=FRE26 CaseType=Combination P=-6,72900642000608 V2=51,2924078624482 V3=0 T=0 M2=0 M3=-0,644668945359246	FrameElem=42-1 ElemStation=0
Frame=42 Station=0,05 OutputCase=FRE26 CaseType=Combination P=-6,72900642000608 V2=51,4924078624482 V3=0 T=0 M2=0 M3=-3,21428933848165	FrameElem=42-1 ElemStation=0,05
Frame=42 Station=0,1 OutputCase=FRE26 CaseType=Combination P=-6,72900642000608 V2=51,6924078624482 V3=0 T=0 M2=0 M3=-5,79390973160406	FrameElem=42-1 ElemStation=0,1
Frame=42 Station=0 OutputCase=FRE27 CaseType=Combination P=-15,629973164876 V2=58,2678854228133 V3=0 T=0 M2=0 M3=9,6557267760326	FrameElem=42-1 ElemStation=0
Frame=42 Station=0,05 OutputCase=FRE27 CaseType=Combination P=-15,629973164876 V2=58,4678854228133 V3=0 T=0 M2=0 M3=6,73733250489194	FrameElem=42-1 ElemStation=0,05
Frame=42 Station=0,1 OutputCase=FRE27 CaseType=Combination P=-15,629973164876 V2=58,6678854228133 V3=0 T=0 M2=0 M3=3,80893823375128	FrameElem=42-1 ElemStation=0,1
Frame=42 Station=0 OutputCase=FRE28 CaseType=Combination P=-24,5309399092803 V2=51,3018270321617 V3=0 T=0 M2=0 M3=1,88029388292345	FrameElem=42-1 ElemStation=0
Frame=42 Station=0,05 OutputCase=FRE28 CaseType=Combination P=-24,5309399092803 V2=51,5018270321617 V3=0 T=0 M2=0 M3=-0,689797468684633	FrameElem=42-1 ElemStation=0,05
Frame=42 Station=0,1 OutputCase=FRE28 CaseType=Combination P=-24,5309399092803 V2=51,7018270321617 V3=0 T=0 M2=0 M3=-3,26988882029272	FrameElem=42-1 ElemStation=0,1
Frame=42 Station=0 OutputCase=FRE29 CaseType=Combination P=-16,3500762368528 V2=18,9119678807391 V3=0 T=0 M2=0 M3=11,130360686558	FrameElem=42-1 ElemStation=0
Frame=42 Station=0,05 OutputCase=FRE29 CaseType=Combination P=-16,3500762368528 V2=19,1119678807391 V3=0 T=0 M2=0 M3=10,1797622925211	FrameElem=42-1 ElemStation=0,05
Frame=42 Station=0,1 OutputCase=FRE29 CaseType=Combination P=-16,3500762368528 V2=19,3119678807391 V3=0 T=0 M2=0 M3=9,21916389848412	FrameElem=42-1 ElemStation=0,1
Frame=42 Station=0 OutputCase=FRE30 CaseType=Combination P=-25,2510429812571 V2=11,9459094900875 V3=0 T=0 M2=0 M3=3,35492779344888	FrameElem=42-1 ElemStation=0
Frame=42 Station=0,05 OutputCase=FRE30 CaseType=Combination P=-25,2510429812571 V2=12,1459094900875 V3=0 T=0 M2=0 M3=2,7526323189445	FrameElem=42-1 ElemStation=0,05
Frame=42 Station=0,1 OutputCase=FRE30 CaseType=Combination P=-25,2510429812571 V2=12,3459094900875 V3=0 T=0 M2=0 M3=2,14033684444013	FrameElem=42-1 ElemStation=0,1
Frame=42 Station=0 OutputCase=FRE31 CaseType=Combination P=-7,09779020817161 V2=11,9989230391429 V3=0 T=0 M2=0 M3=0,561986359102838	FrameElem=42-1 ElemStation=0
Frame=42 Station=0,05 OutputCase=FRE31 CaseType=Combination P=-7,09779020817161 V2=12,1989230391429 V3=0 T=0 M2=0 M3=-0,04295972854305	FrameElem=42-1 ElemStation=0,05
Frame=42 Station=0,1 OutputCase=FRE31 CaseType=Combination P=-7,09779020817161 V2=12,3989230391429 V3=0 T=0 M2=0 M3=-0,657905944811448	FrameElem=42-1 ElemStation=0,1
Frame=42 Station=0 OutputCase=FRE32 CaseType=Combination P=-7,86400424043485 V2=12,0012950700184 V3=0 T=0 M2=0 M3=1,19784812382635	FrameElem=42-1 ElemStation=0
Frame=42 Station=0,05 OutputCase=FRE32 CaseType=Combination P=-7,86400424043485 V2=12,2012950700184 V3=0 T=0 M2=0 M3=0,592783370325429	FrameElem=42-1 ElemStation=0,05
Frame=42 Station=0,1 OutputCase=FRE32 CaseType=Combination P=-7,86400424043485 V2=12,4012950700184 V3=0 T=0 M2=0 M3=-2,22813831754895E-02	FrameElem=42-1 ElemStation=0,1
Frame=42 Station=0 OutputCase=FRE33 CaseType=Combination P=-7,86400424043485 V2=12,0012950700184 V3=0 T=0 M2=0 M3=1,19784812382635	FrameElem=42-1 ElemStation=0
Frame=42 Station=0,05 OutputCase=FRE33 CaseType=Combination P=-7,86400424043485 V2=12,2012950700184 V3=0 T=0 M2=0 M3=0,592783370325429	FrameElem=42-1 ElemStation=0,05
Frame=42 Station=0,1 OutputCase=FRE33 CaseType=Combination P=-7,86400424043485 V2=12,4012950700184 V3=0 T=0 M2=0 M3=-2,22813831754895E-02	FrameElem=42-1 ElemStation=0,1
Frame=42 Station=0 OutputCase=FRE34 CaseType=Combination P=-7,09944443645887 V2=11,2366842441011 V3=0 T=0 M2=0 M3=0,280489925883647	FrameElem=42-1 ElemStation=0
Frame=42 Station=0,05 OutputCase=FRE34 CaseType=Combination P=-7,09944443645887 V2=11,4366842441011 V3=0 T=0 M2=0 M3=-0,286344286321409	FrameElem=42-1 ElemStation=0,05
Frame=42 Station=0,1 OutputCase=FRE34 CaseType=Combination P=-7,09944443645887 V2=11,6366842441011 V3=0 T=0 M2=0 M3=-0,863178498526464	FrameElem=42-1 ElemStation=0,1
Frame=42 Station=0 OutputCase=FRE35 CaseType=Combination P=-6,41112909680244 V2=50,6562205203819 V3=0 T=0 M2=0 M3=-1,14419170834337	FrameElem=42-1 ElemStation=0
Frame=42 Station=0,05 OutputCase=FRE35 CaseType=Combination P=-6,41112909680244 V2=50,8562205203819 V3=0 T=0 M2=0 M3=-3,68200273436246	FrameElem=42-1 ElemStation=0,05
Frame=42 Station=0,1 OutputCase=FRE35 CaseType=Combination P=-6,41112909680244 V2=51,0562205203819 V3=0 T=0 M2=0 M3=-6,22981376038156	FrameElem=42-1 ElemStation=0,1
Frame=42 Station=0 OutputCase=FRE36 CaseType=Combination P=-15,3120958416724 V2=57,631698080747 V3=0 T=0 M2=0 M3=9,15620401304848	FrameElem=42-1 ElemStation=0
Frame=42 Station=0,05 OutputCase=FRE36 CaseType=Combination P=-15,3120958416724 V2=57,831698080747 V3=0 T=0 M2=0 M3=6,26961910901113	FrameElem=42-1 ElemStation=0,05
Frame=42 Station=0,1 OutputCase=FRE36 CaseType=Combination P=-15,3120958416724 V2=58,031698080747 V3=0 T=0 M2=0 M3=3,37303420497378	FrameElem=42-1 ElemStation=0,1
Frame=42 Station=0 OutputCase=FRE37 CaseType=Combination P=-24,2130625860767 V2=50,6656396900954 V3=0 T=0 M2=0 M3=1,38077111993933	FrameElem=42-1 ElemStation=0
Frame=42 Station=0,05 OutputCase=FRE37 CaseType=Combination P=-24,2130625860767 V2=50,8656396900954 V3=0 T=0 M2=0 M3=-1,15751086456544	FrameElem=42-1 ElemStation=0,05

APPROVATO S.D.P.
 Società di Progetto
Brebemi SpA



Doc. N.
60235-0000-A00.doc

CODIFICA DOCUMENTO
04RCDII10000000000300A00

REV.
00

FOGLIO
563 di 628

Frame=42 Station=0,1 OutputCase=FRE37 CaseType=Combination P=-24,2130625860767 V2=51,0656396900954 V3=0 T=0 M2=0 M3=-3,70579284907021 FrameElem=42-1 ElemStation=0,1

Frame=42 Station=0 OutputCase=FRE38 CaseType=Combination P=-16,0321989136492 V2=18,2757805386728 V3=0 T=0 M2=0 M3=10,6308379235739 FrameElem=42-1 ElemStation=0

Frame=42 Station=0,05 OutputCase=FRE38 CaseType=Combination P=-16,0321989136492 V2=18,4757805386728 V3=0 T=0 M2=0 M3=9,71204889664027 FrameElem=42-1 ElemStation=0,05

Frame=42 Station=0,1 OutputCase=FRE38 CaseType=Combination P=-16,0321989136492 V2=18,6757805386728 V3=0 T=0 M2=0 M3=8,78325986970663 FrameElem=42-1 ElemStation=0,1

Frame=42 Station=0 OutputCase=FRE39 CaseType=Combination P=-24,9331656580535 V2=11,3097221480212 V3=0 T=0 M2=0 M3=2,85540503046475 FrameElem=42-1 ElemStation=0

Frame=42 Station=0,05 OutputCase=FRE39 CaseType=Combination P=-24,9331656580535 V2=11,5097221480212 V3=0 T=0 M2=0 M3=2,28491892306369 FrameElem=42-1 ElemStation=0,05

Frame=42 Station=0,1 OutputCase=FRE39 CaseType=Combination P=-24,9331656580535 V2=11,7097221480212 V3=0 T=0 M2=0 M3=1,70443281566263 FrameElem=42-1 ElemStation=0,1

Frame=42 Station=0 OutputCase=FRE40 CaseType=Combination P=-6,71633742032725 V2=11,2354982286634 V3=0 T=0 M2=0 M3=-3,74409564781076E-02 FrameElem=42-1 ElemStation=0

Frame=42 Station=0,05 OutputCase=FRE40 CaseType=Combination P=-6,71633742032725 V2=11,4354982286634 V3=0 T=0 M2=0 M3=-0,604215867911276 FrameElem=42-1 ElemStation=0,05

Frame=42 Station=0,1 OutputCase=FRE40 CaseType=Combination P=-6,71633742032725 V2=11,6354982286634 V3=0 T=0 M2=0 M3=-1,18099077934444 FrameElem=42-1 ElemStation=0,1

Frame=42 Station=0 OutputCase=FRE41 CaseType=Combination P=-7,48255145259049 V2=11,2378702595389 V3=0 T=0 M2=0 M3=0,598420808245401 FrameElem=42-1 ElemStation=0

Frame=42 Station=0,05 OutputCase=FRE41 CaseType=Combination P=-7,48255145259049 V2=11,4378702595389 V3=0 T=0 M2=0 M3=3,15272952684582E-02 FrameElem=42-1 ElemStation=0,05

Frame=42 Station=0,1 OutputCase=FRE41 CaseType=Combination P=-7,48255145259049 V2=11,6378702595389 V3=0 T=0 M2=0 M3=-0,545366217708485 FrameElem=42-1 ElemStation=0,1

Frame=42 Station=0 OutputCase=FRE42 CaseType=Combination P=-7,48255145259049 V2=11,2378702595389 V3=0 T=0 M2=0 M3=0,598420808245401 FrameElem=42-1 ElemStation=0

Frame=42 Station=0,05 OutputCase=FRE42 CaseType=Combination P=-7,48255145259049 V2=11,4378702595389 V3=0 T=0 M2=0 M3=3,15272952684582E-02 FrameElem=42-1 ElemStation=0,05

Frame=42 Station=0,1 OutputCase=FRE42 CaseType=Combination P=-7,48255145259049 V2=11,6378702595389 V3=0 T=0 M2=0 M3=-0,545366217708485 FrameElem=42-1 ElemStation=0,1

Frame=42 Station=0 OutputCase=FRE43 CaseType=Combination P=-7,749899249739 V2=11,6198198678662 V3=0 T=0 M2=0 M3=0,961720642508225 FrameElem=42-1 ElemStation=0

Frame=42 Station=0,05 OutputCase=FRE43 CaseType=Combination P=-7,749899249739 V2=11,8198198678662 V3=0 T=0 M2=0 M3=0,375729649114917 FrameElem=42-1 ElemStation=0,05

Frame=42 Station=0,1 OutputCase=FRE43 CaseType=Combination P=-7,749899249739 V2=12,0198198678662 V3=0 T=0 M2=0 M3=-0,220261344278391 FrameElem=42-1 ElemStation=0,1

Frame=42 Station=0 OutputCase=FRE44 CaseType=Combination P=-6,95317477453588 V2=50,9755002068528 V3=0 T=0 M2=0 M3=-0,576499444489552 FrameElem=42-1 ElemStation=0

Frame=42 Station=0,05 OutputCase=FRE44 CaseType=Combination P=-6,95317477453588 V2=51,1755002068528 V3=0 T=0 M2=0 M3=-3,13027445483219 FrameElem=42-1 ElemStation=0,05

Frame=42 Station=0,1 OutputCase=FRE44 CaseType=Combination P=-6,95317477453588 V2=51,3755002068528 V3=0 T=0 M2=0 M3=5,69404946517483 FrameElem=42-1 ElemStation=0,1

Frame=42 Station=0 OutputCase=FRE45 CaseType=Combination P=-15,8541415194058 V2=57,9509777672179 V3=0 T=0 M2=0 M3=9,7238962769023 FrameElem=42-1 ElemStation=0

Frame=42 Station=0,05 OutputCase=FRE45 CaseType=Combination P=-15,8541415194058 V2=58,1509777672179 V3=0 T=0 M2=0 M3=6,8213473885414 FrameElem=42-1 ElemStation=0,05

Frame=42 Station=0,1 OutputCase=FRE45 CaseType=Combination P=-15,8541415194058 V2=58,3509777672179 V3=0 T=0 M2=0 M3=3,90879850018051 FrameElem=42-1 ElemStation=0,1

Frame=42 Station=0 OutputCase=FRE46 CaseType=Combination P=-24,7551082638101 V2=50,9849193765663 V3=0 T=0 M2=0 M3=1,94846338379314 FrameElem=42-1 ElemStation=0

Frame=42 Station=0,05 OutputCase=FRE46 CaseType=Combination P=-24,7551082638101 V2=51,1849193765663 V3=0 T=0 M2=0 M3=-0,60578258503517 FrameElem=42-1 ElemStation=0,05

Frame=42 Station=0,1 OutputCase=FRE46 CaseType=Combination P=-24,7551082638101 V2=51,3849193765663 V3=0 T=0 M2=0 M3=-3,17002855386348 FrameElem=42-1 ElemStation=0,1

Frame=42 Station=0 OutputCase=FRE47 CaseType=Combination P=-16,5742445913826 V2=18,5950602251437 V3=0 T=0 M2=0 M3=11,1985301874277 FrameElem=42-1 ElemStation=0

Frame=42 Station=0,05 OutputCase=FRE47 CaseType=Combination P=-16,5742445913826 V2=18,7950602251437 V3=0 T=0 M2=0 M3=10,263771761705 FrameElem=42-1 ElemStation=0,05

Frame=42 Station=0,1 OutputCase=FRE47 CaseType=Combination P=-16,5742445913826 V2=18,9950602251437 V3=0 T=0 M2=0 M3=9,31902416491335 FrameElem=42-1 ElemStation=0,1

Frame=42 Station=0 OutputCase=FRE48 CaseType=Combination P=-25,4752113357869 V2=11,6290018344921 V3=0 T=0 M2=0 M3=3,42309729431857 FrameElem=42-1 ElemStation=0

Frame=42 Station=0,05 OutputCase=FRE48 CaseType=Combination P=-25,4752113357869 V2=11,8290018344921 V3=0 T=0 M2=0 M3=2,83664720259397 FrameElem=42-1 ElemStation=0,05

Frame=42 Station=0,1 OutputCase=FRE48 CaseType=Combination P=-25,4752113357869 V2=12,0290018344921 V3=0 T=0 M2=0 M3=2,24019711086936 FrameElem=42-1 ElemStation=0,1

Frame=42 Station=0 OutputCase=FRE49 CaseType=Combination P=-8,13300626587062 V2=11,6210058833039 V3=0 T=0 M2=0 M3=1,27965152486998 FrameElem=42-1 ElemStation=0

Frame=42 Station=0,05 OutputCase=FRE49 CaseType=Combination P=-8,13300626587062 V2=11,8210058833039 V3=0 T=0 M2=0 M3=0,693601230704784 FrameElem=42-1 ElemStation=0,05

Frame=42 Station=0,1 OutputCase=FRE49 CaseType=Combination P=-8,13300626587062 V2=12,0210058833039 V3=0 T=0 M2=0 M3=9,75509365395881E-02 FrameElem=42-1 ElemStation=0,1

Frame=42 Station=0 OutputCase=FRE50 CaseType=Combination P=-7,90883791134081 V2=11,9379135388993 V3=0 T=0 M2=0 M3=1,21148202400029 FrameElem=42-1 ElemStation=0

Frame=42 Station=0,05 OutputCase=FRE50 CaseType=Combination P=-7,90883791134081 V2=12,1379135388993 V3=0 T=0 M2=0 M3=0,609586347055321 FrameElem=42-1 ElemStation=0,05

Frame=42 Station=0,1 OutputCase=FRE50 CaseType=Combination P=-7,90883791134081 V2=12,3379135388993 V3=0 T=0 M2=0 M3=-2,30932988964327E-03 FrameElem=42-1 ElemStation=0,1

Frame=42 Station=0 OutputCase=FRE51 CaseType=Combination P=-7,59096058813718 V2=11,301726196833 V3=0 T=0 M2=0 M3=0,711959261016164 FrameElem=42-1 ElemStation=0

Frame=42 Station=0,05 OutputCase=FRE51 CaseType=Combination P=-7,59096058813718 V2=11,501726196833 V3=0 T=0 M2=0 M3=0,141872951174512 FrameElem=42-1 ElemStation=0,05

Frame=42 Station=0,1 OutputCase=FRE51 CaseType=Combination P=-7,59096058813718 V2=11,701726196833 V3=0 T=0 M2=0 M3=-0,438213358667139 FrameElem=42-1 ElemStation=0,1

Frame=42 Station=0 OutputCase=INVFRE CaseType=Combination StepType=Max P=-6,18696074227264 V2=58,2678854228133 V3=0 T=0 M2=0 M3=11,1985301874277 FrameElem=42-1 ElemStation=0

Società di Progetto
Brebemi SpA



Doc. N.
60235-0000-A00.doc

CODIFICA DOCUMENTO
04RCDII10000000000300A00

REV.
00

FOGLIO
564 di 628

Frame=42 Station=0,05 OutputCase=INVFRE CaseType=Combination StepType=Max P=-6,18696074227264 V2=58,4678854228133 V3=0 T=0 M2=0 M3=10,2637771761705
FrameElem=42-1 ElemStation=0,05
Frame=42 Station=0,1 OutputCase=INVFRE CaseType=Combination StepType=Max P=-6,18696074227264 V2=58,6678854228133 V3=0 T=0 M2=0 M3=9,31902416491335
FrameElem=42-1 ElemStation=0,1
Frame=42 Station=0 OutputCase=INVFRE CaseType=Combination StepType=Min P=-25,4752113357869 V2=11,2354982286634 V3=0 T=0 M2=0 M3=-1,21236120921306
FrameElem=42-1 ElemStation=0
Frame=42 Station=0,05 OutputCase=INVFRE CaseType=Combination StepType=Min P=-25,4752113357869 V2=11,4354982286634 V3=0 T=0 M2=0 M3=-3,76601761801192
FrameElem=42-1 ElemStation=0,05
Frame=42 Station=0,1 OutputCase=INVFRE CaseType=Combination StepType=Min P=-25,4752113357869 V2=11,6354982286634 V3=0 T=0 M2=0 M3=-6,32967402681079
FrameElem=42-1 ElemStation=0,1
Frame=42 Station=0 OutputCase=QPE01 CaseType=Combination P=-9,29062562546222 V2=10,5268051819876 V3=0 T=0 M2=0 M3=-0,540728084643433 FrameElem=42-1
ElemStation=0
Frame=42 Station=0,05 OutputCase=QPE01 CaseType=Combination P=-9,29062562546222 V2=10,7268051819876 V3=0 T=0 M2=0 M3=-1,07206834374281 FrameElem=42-1
ElemStation=0,05
Frame=42 Station=0,1 OutputCase=QPE01 CaseType=Combination P=-9,29062562546222 V2=10,9268051819876 V3=0 T=0 M2=0 M3=-1,61340860284219 FrameElem=42-1
ElemStation=0,1
Frame=42 Station=0 OutputCase=QPE02 CaseType=Combination P=-8,9075186093306 V2=10,5256191665498 V3=0 T=0 M2=0 M3=-0,858658967005188 FrameElem=42-1
ElemStation=0
Frame=42 Station=0,05 OutputCase=QPE02 CaseType=Combination P=-8,9075186093306 V2=10,7256191665498 V3=0 T=0 M2=0 M3=-1,38993992533268 FrameElem=42-1
ElemStation=0,05
Frame=42 Station=0,1 OutputCase=QPE02 CaseType=Combination P=-8,9075186093306 V2=10,9256191665498 V3=0 T=0 M2=0 M3=-1,93122088366017 FrameElem=42-1
ElemStation=0,1
Frame=42 Station=0 OutputCase=QPE03 CaseType=Combination P=-9,67373264159384 V2=10,5279911974253 V3=0 T=0 M2=0 M3=-0,222797202281679 FrameElem=42-1
ElemStation=0
Frame=42 Station=0,05 OutputCase=QPE03 CaseType=Combination P=-9,67373264159384 V2=10,7279911974253 V3=0 T=0 M2=0 M3=-0,754196762152945 FrameElem=42-1
ElemStation=0,05
Frame=42 Station=0,1 OutputCase=QPE03 CaseType=Combination P=-9,67373264159384 V2=10,9279911974253 V3=0 T=0 M2=0 M3=-1,29559632202421 FrameElem=42-1
ElemStation=0,1
Frame=42 Station=0 OutputCase=QPE04 CaseType=Combination P=-9,44956428706404 V2=10,8448988530207 V3=0 T=0 M2=0 M3=-0,290966703151372 FrameElem=42-1
ElemStation=0
Frame=42 Station=0,05 OutputCase=QPE04 CaseType=Combination P=-9,44956428706404 V2=11,0448988530207 V3=0 T=0 M2=0 M3=-0,838211645802408 FrameElem=42-1
ElemStation=0,05
Frame=42 Station=0,1 OutputCase=QPE04 CaseType=Combination P=-9,44956428706404 V2=11,2448988530207 V3=0 T=0 M2=0 M3=-1,39545658845344 FrameElem=42-1
ElemStation=0,1
Frame=42 Station=0 OutputCase=QPE05 CaseType=Combination P=-9,1316869638604 V2=10,2087115109545 V3=0 T=0 M2=0 M3=-0,790489466135494 FrameElem=42-1
ElemStation=0
Frame=42 Station=0,05 OutputCase=QPE05 CaseType=Combination P=-9,1316869638604 V2=10,4087115109545 V3=0 T=0 M2=0 M3=-1,30592504168322 FrameElem=42-1
ElemStation=0,05
Frame=42 Station=0,1 OutputCase=QPE05 CaseType=Combination P=-9,1316869638604 V2=10,6087115109545 V3=0 T=0 M2=0 M3=-1,83136061723094 FrameElem=42-1
ElemStation=0,1
Frame=42 Station=0 OutputCase=QPE06 CaseType=Combination P=-9,67373264159384 V2=10,5279911974253 V3=0 T=0 M2=0 M3=-0,222797202281679 FrameElem=42-1
ElemStation=0
Frame=42 Station=0,05 OutputCase=QPE06 CaseType=Combination P=-9,67373264159384 V2=10,7279911974253 V3=0 T=0 M2=0 M3=-0,754196762152945 FrameElem=42-1
ElemStation=0,05
Frame=42 Station=0,1 OutputCase=QPE06 CaseType=Combination P=-9,67373264159384 V2=10,9279911974253 V3=0 T=0 M2=0 M3=-1,29559632202421 FrameElem=42-1
ElemStation=0,1
Frame=42 Station=0 OutputCase=QPE07 CaseType=Combination P=-9,06645727093242 V2=10,843712837583 V3=0 T=0 M2=0 M3=-0,608897585513127 FrameElem=42-1
ElemStation=0
Frame=42 Station=0,05 OutputCase=QPE07 CaseType=Combination P=-9,06645727093242 V2=11,043712837583 V3=0 T=0 M2=0 M3=-1,15608322739227 FrameElem=42-1
ElemStation=0,05
Frame=42 Station=0,1 OutputCase=QPE07 CaseType=Combination P=-9,06645727093242 V2=11,243712837583 V3=0 T=0 M2=0 M3=-1,71326886927142 FrameElem=42-1
ElemStation=0,1
Frame=42 Station=0 OutputCase=QPE08 CaseType=Combination P=-8,74857994772878 V2=10,2075254955167 V3=0 T=0 M2=0 M3=-1,10842034849725 FrameElem=42-1
ElemStation=0
Frame=42 Station=0,05 OutputCase=QPE08 CaseType=Combination P=-8,74857994772878 V2=10,4075254955167 V3=0 T=0 M2=0 M3=-1,62379662327308 FrameElem=42-1
ElemStation=0,05
Frame=42 Station=0,1 OutputCase=QPE08 CaseType=Combination P=-8,74857994772878 V2=10,6075254955167 V3=0 T=0 M2=0 M3=-2,14917289804892 FrameElem=42-1
ElemStation=0,1
Frame=42 Station=0 OutputCase=QPE09 CaseType=Combination P=-9,29062562546222 V2=10,5268051819876 V3=0 T=0 M2=0 M3=-0,540728084643433 FrameElem=42-1
ElemStation=0
Frame=42 Station=0,05 OutputCase=QPE09 CaseType=Combination P=-9,29062562546222 V2=10,7268051819876 V3=0 T=0 M2=0 M3=-1,07206834374281 FrameElem=42-1
ElemStation=0,05
Frame=42 Station=0,1 OutputCase=QPE09 CaseType=Combination P=-9,29062562546222 V2=10,9268051819876 V3=0 T=0 M2=0 M3=-1,61340860284219 FrameElem=42-1
ElemStation=0,1
Frame=42 Station=0 OutputCase=QPE10 CaseType=Combination P=-9,29062562313391 V2=12,7117961919575 V3=0 T=0 M2=0 M3=2,18581944705375 FrameElem=42-1
ElemStation=0
Frame=42 Station=0,05 OutputCase=QPE10 CaseType=Combination P=-9,29062562313391 V2=12,9117961919575 V3=0 T=0 M2=0 M3=1,54522963745587 FrameElem=42-1
ElemStation=0,05
Frame=42 Station=0,1 OutputCase=QPE10 CaseType=Combination P=-9,29062562313391 V2=13,1117961919575 V3=0 T=0 M2=0 M3=0,894639827857991 FrameElem=42-1
ElemStation=0,1
Frame=42 Station=0 OutputCase=QPE11 CaseType=Combination P=-8,90751860700229 V2=12,7106101765198 V3=0 T=0 M2=0 M3=1,86788856469199 FrameElem=42-1
ElemStation=0
Frame=42 Station=0,05 OutputCase=QPE11 CaseType=Combination P=-8,90751860700229 V2=12,9106101765198 V3=0 T=0 M2=0 M3=1,227358055866 FrameElem=42-1
ElemStation=0,05
Frame=42 Station=0,1 OutputCase=QPE11 CaseType=Combination P=-8,90751860700229 V2=13,1106101765198 V3=0 T=0 M2=0 M3=0,576827547040012 FrameElem=42-1
ElemStation=0,1
Frame=42 Station=0 OutputCase=QPE12 CaseType=Combination P=-9,67373263926553 V2=12,7129822073953 V3=0 T=0 M2=0 M3=2,5037503294155 FrameElem=42-1
ElemStation=0
Frame=42 Station=0,05 OutputCase=QPE12 CaseType=Combination P=-9,67373263926553 V2=12,9129822073953 V3=0 T=0 M2=0 M3=1,86310121904574 FrameElem=42-1
ElemStation=0,05
Frame=42 Station=0,1 OutputCase=QPE12 CaseType=Combination P=-9,67373263926553 V2=13,1129822073953 V3=0 T=0 M2=0 M3=1,21245210867597 FrameElem=42-1
ElemStation=0,1
Frame=42 Station=0 OutputCase=QPE13 CaseType=Combination P=-9,44956428473573 V2=13,0298898629907 V3=0 T=0 M2=0 M3=2,43558082854581 FrameElem=42-1
ElemStation=0
Frame=42 Station=0,05 OutputCase=QPE13 CaseType=Combination P=-9,44956428473573 V2=13,2298898629907 V3=0 T=0 M2=0 M3=1,77908633539627 FrameElem=42-1
ElemStation=0,05
Frame=42 Station=0,1 OutputCase=QPE13 CaseType=Combination P=-9,44956428473573 V2=13,4298898629907 V3=0 T=0 M2=0 M3=1,11259184224674 FrameElem=42-1
ElemStation=0,1

Società di Progetto
Brebemi SpA



Doc. N.
60235-0000-A00.doc

CODIFICA DOCUMENTO
04RCDII10000000000300A00

REV.
00

FOGLIO
565 di 628

Frame=42 Station=0 OutputCase=QPE14 CaseType=Combination P=-,9,1316869615321 V2=12,3937025209244 V3=0 T=0 M2=0 M3=1,93605806556168 FrameElem=42-1 ElemStation=0
Frame=42 Station=0,05 OutputCase=QPE14 CaseType=Combination P=-,9,1316869615321 V2=12,5937025209244 V3=0 T=0 M2=0 M3=1,31137293951546 FrameElem=42-1 ElemStation=0,05
Frame=42 Station=0,1 OutputCase=QPE14 CaseType=Combination P=-,9,1316869615321 V2=12,7937025209244 V3=0 T=0 M2=0 M3=0,676687813469243 FrameElem=42-1 ElemStation=0,1
Frame=42 Station=0 OutputCase=QPE15 CaseType=Combination P=-,9,67373263926553 V2=12,7129822073953 V3=0 T=0 M2=0 M3=2,5037503294155 FrameElem=42-1 ElemStation=0
Frame=42 Station=0,05 OutputCase=QPE15 CaseType=Combination P=-,9,67373263926553 V2=12,9129822073953 V3=0 T=0 M2=0 M3=1,86310121904574 FrameElem=42-1 ElemStation=0,05
Frame=42 Station=0,1 OutputCase=QPE15 CaseType=Combination P=-,9,67373263926553 V2=13,1129822073953 V3=0 T=0 M2=0 M3=1,21245210867597 FrameElem=42-1 ElemStation=0,1
Frame=42 Station=0 OutputCase=QPE16 CaseType=Combination P=-,9,06645726860411 V2=13,0287038475529 V3=0 T=0 M2=0 M3=2,11764994618405 FrameElem=42-1 ElemStation=0
Frame=42 Station=0,05 OutputCase=QPE16 CaseType=Combination P=-,9,06645726860411 V2=13,2287038475529 V3=0 T=0 M2=0 M3=1,46121475380641 FrameElem=42-1 ElemStation=0,05
Frame=42 Station=0,1 OutputCase=QPE16 CaseType=Combination P=-,9,06645726860411 V2=13,4287038475529 V3=0 T=0 M2=0 M3=0,79477956142876 FrameElem=42-1 ElemStation=0,1
Frame=42 Station=0 OutputCase=QPE17 CaseType=Combination P=-,8,74857994540047 V2=12,3925165054867 V3=0 T=0 M2=0 M3=1,61812718319993 FrameElem=42-1 ElemStation=0
Frame=42 Station=0,05 OutputCase=QPE17 CaseType=Combination P=-,8,74857994540047 V2=12,5925165054867 V3=0 T=0 M2=0 M3=0,993501357925597 FrameElem=42-1 ElemStation=0,05
Frame=42 Station=0,1 OutputCase=QPE17 CaseType=Combination P=-,8,74857994540047 V2=12,7925165054867 V3=0 T=0 M2=0 M3=0,358875532651264 FrameElem=42-1 ElemStation=0,1
Frame=42 Station=0 OutputCase=QPE18 CaseType=Combination P=-,9,29062562313391 V2=12,7117961919575 V3=0 T=0 M2=0 M3=2,18581944705375 FrameElem=42-1 ElemStation=0
Frame=42 Station=0,05 OutputCase=QPE18 CaseType=Combination P=-,9,29062562313391 V2=12,9117961919575 V3=0 T=0 M2=0 M3=1,54522963745587 FrameElem=42-1 ElemStation=0,05
Frame=42 Station=0,1 OutputCase=QPE18 CaseType=Combination P=-,9,29062562313391 V2=13,1117961919575 V3=0 T=0 M2=0 M3=0,894639827857991 FrameElem=42-1 ElemStation=0,1
Frame=42 Station=0 OutputCase=INVQPE CaseType=Combination StepType=Max P=-,8,74857994540047 V2=13,0298898629907 V3=0 T=0 M2=0 M3=2,5037503294155 FrameElem=42-1 ElemStation=0
Frame=42 Station=0,05 OutputCase=INVQPE CaseType=Combination StepType=Max P=-,8,74857994540047 V2=13,2298898629907 V3=0 T=0 M2=0 M3=1,86310121904574 FrameElem=42-1 ElemStation=0,05
Frame=42 Station=0,1 OutputCase=INVQPE CaseType=Combination StepType=Max P=-,8,74857994540047 V2=13,4298898629907 V3=0 T=0 M2=0 M3=1,21245210867597 FrameElem=42-1 ElemStation=0,1
Frame=42 Station=0 OutputCase=INVQPE CaseType=Combination StepType=Min P=-,9,67373264159384 V2=10,2075254955167 V3=0 T=0 M2=0 M3=-1,10842034849725 FrameElem=42-1 ElemStation=0
Frame=42 Station=0,05 OutputCase=INVQPE CaseType=Combination StepType=Min P=-,9,67373264159384 V2=10,4075254955167 V3=0 T=0 M2=0 M3=-1,62379662327308 FrameElem=42-1 ElemStation=0,05
Frame=42 Station=0,1 OutputCase=INVQPE CaseType=Combination StepType=Min P=-,9,67373264159384 V2=10,6075254955167 V3=0 T=0 M2=0 M3=-2,14917289804892 FrameElem=42-1 ElemStation=0,1
Frame=45 Station=0 OutputCase=STR001 CaseType=Combination P=-,15,2429585627174 V2=1,94077067374128 V3=0 T=0 M2=0 M3=-3,73153046723166 FrameElem=45-1 ElemStation=0
Frame=45 Station=0,0917 OutputCase=STR001 CaseType=Combination P=-,15,2429585627174 V2=2,43595067374128 V3=0 T=0 M2=0 M3=-3,93220314101374 FrameElem=45-1 ElemStation=0,0917
Frame=45 Station=0,1834 OutputCase=STR001 CaseType=Combination P=-,15,2429585627174 V2=2,93113067374128 V3=0 T=0 M2=0 M3=-4,17828382079581 FrameElem=45-1 ElemStation=0,1834
Frame=45 Station=0 OutputCase=STR002 CaseType=Combination P=-,7,48725069450553 V2=1,93980003680826 V3=0 T=0 M2=0 M3=4,66972428207734 FrameElem=45-1 ElemStation=0
Frame=45 Station=0,0917 OutputCase=STR002 CaseType=Combination P=-,7,48725069450553 V2=2,43498003680827 V3=0 T=0 M2=0 M3=4,87037094845266 FrameElem=45-1 ElemStation=0,0917
Frame=45 Station=0,1834 OutputCase=STR002 CaseType=Combination P=-,7,48725069450553 V2=2,93016003680827 V3=0 T=0 M2=0 M3=-5,11629962082798 FrameElem=45-1 ElemStation=0,1834
Frame=45 Station=0 OutputCase=STR003 CaseType=Combination P=-,6,19106516497527 V2=12,7505591887841 V3=0 T=0 M2=0 M3=-30,2685651349594 FrameElem=45-1 ElemStation=0
Frame=45 Station=0,0917 OutputCase=STR003 CaseType=Combination P=-,6,19106516497527 V2=13,2457391887841 V3=0 T=0 M2=0 M3=-31,4604954155709 FrameElem=45-1 ElemStation=0,0917
Frame=45 Station=0,1834 OutputCase=STR003 CaseType=Combination P=-,6,19106516497527 V2=13,7409191887841 V3=0 T=0 M2=0 M3=-32,6978337021824 FrameElem=45-1 ElemStation=0,1834
Frame=45 Station=0 OutputCase=STR004 CaseType=Combination P=-,22,4898406078279 V2=45,3559577141933 V3=0 T=0 M2=0 M3=-21,986778524667 FrameElem=45-1 ElemStation=0
Frame=45 Station=0,0917 OutputCase=STR004 CaseType=Combination P=-,22,4898406078279 V2=45,8511377141933 V3=0 T=0 M2=0 M3=-26,1686238500586 FrameElem=45-1 ElemStation=0,0917
Frame=45 Station=0,1834 OutputCase=STR004 CaseType=Combination P=-,22,4898406078279 V2=46,3463177141933 V3=0 T=0 M2=0 M3=-30,3958771814501 FrameElem=45-1 ElemStation=0,1834
Frame=45 Station=0 OutputCase=STR005 CaseType=Combination P=-,38,7886160482358 V2=12,7553232109381 V3=0 T=0 M2=0 M3=-25,6637783724931 FrameElem=45-1 ElemStation=0
Frame=45 Station=0,0917 OutputCase=STR005 CaseType=Combination P=-,38,7886160482358 V2=13,2505032109382 V3=0 T=0 M2=0 M3=-26,8561455139361 FrameElem=45-1 ElemStation=0,0917
Frame=45 Station=0,1834 OutputCase=STR005 CaseType=Combination P=-,38,7886160482358 V2=13,7456832109382 V3=0 T=0 M2=0 M3=-28,0939206613792 FrameElem=45-1 ElemStation=0,1834
Frame=45 Station=0 OutputCase=STR006 CaseType=Combination P=-,23,5889462725448 V2=34,04205057938781 V3=0 T=0 M2=0 M3=5,03378556863167 FrameElem=45-1 ElemStation=0
Frame=45 Station=0,0917 OutputCase=STR006 CaseType=Combination P=-,23,5889462725448 V2=34,4093057938781 V3=0 T=0 M2=0 M3=1,89527000733304 FrameElem=45-1 ElemStation=0,0917
Frame=45 Station=0,1834 OutputCase=STR006 CaseType=Combination P=-,23,5889462725448 V2=34,7761057938781 V3=0 T=0 M2=0 M3=-1,27688111396558 FrameElem=45-1 ElemStation=0,1834
Frame=45 Station=0 OutputCase=STR007 CaseType=Combination P=-,39,8877217129527 V2=1,44187129062302 V3=0 T=0 M2=0 M3=1,35678572080561 FrameElem=45-1 ElemStation=0
Frame=45 Station=0,0917 OutputCase=STR007 CaseType=Combination P=-,39,8877217129527 V2=1,80867129062302 V3=0 T=0 M2=0 M3=1,20774834345548 FrameElem=45-1 ElemStation=0,0917
Frame=45 Station=0,1834 OutputCase=STR007 CaseType=Combination P=-,39,8877217129527 V2=2,17547129062302 V3=0 T=0 M2=0 M3=1,02507540610534 FrameElem=45-1 ElemStation=0,1834
Frame=45 Station=0 OutputCase=STR008 CaseType=Combination P=-,19,7086566155296 V2=67,6283773620952 V3=0 T=0 M2=0 M3=-11,464870395894 FrameElem=45-1 ElemStation=0
Frame=45 Station=0,0917 OutputCase=STR008 CaseType=Combination P=-,19,7086566155296 V2=68,1235573620952 V3=0 T=0 M2=0 M3=-17,6890966029982 FrameElem=45-1 ElemStation=0,0917

Società di Progetto
Brebemi SpA



Doc. N.
60235-00000-A00.doc

CODIFICA DOCUMENTO
04RCDII10000000000300A00

REV.
00

FOGLIO
566 di 628

Frame=45 Station=0,1834 OutputCase=STR008 CaseType=Combination P=-19,7086566155296 V2=68,6187373620952 V3=0 T=0 M2=0 M3=-23,9587308161023
FrameElem=45-1 ElemStation=0,1834
Frame=45 Station=0 OutputCase=STR009 CaseType=Combination P=-14,3235017240015 V2=1,93998252367284 V3=0 T=0 M2=0 M3=-4,49333695916322 FrameElem=45-1
ElemStation=0
Frame=45 Station=0,0917 OutputCase=STR009 CaseType=Combination P=-14,3235017240015 V2=2,43516252367284 V3=0 T=0 M2=0 M3=-4,69393735958402
FrameElem=45-1 ElemStation=0,0917
Frame=45 Station=0,1834 OutputCase=STR009 CaseType=Combination P=-14,3235017240015 V2=2,93034252367284 V3=0 T=0 M2=0 M3=-4,93994576600482
FrameElem=45-1 ElemStation=0,1834
Frame=45 Station=0 OutputCase=STR010 CaseType=Combination P=-6,56779385578962 V2=1,93901188673983 V3=0 T=0 M2=0 M3=-5,4315307740089 FrameElem=45-1
ElemStation=0
Frame=45 Station=0,0917 OutputCase=STR010 CaseType=Combination P=-6,56779385578962 V2=2,43419188673983 V3=0 T=0 M2=0 M3=-5,63204216702294
FrameElem=45-1 ElemStation=0,0917
Frame=45 Station=0,1834 OutputCase=STR010 CaseType=Combination P=-6,56779385578962 V2=2,92937188673983 V3=0 T=0 M2=0 M3=-5,87796156603698
FrameElem=45-1 ElemStation=0,1834
Frame=45 Station=0 OutputCase=STR011 CaseType=Combination P=-5,63939106174573 V2=12,750086298743 V3=0 T=0 M2=0 M3=-30,7256490301184 FrameElem=45-1
ElemStation=0
Frame=45 Station=0,0917 OutputCase=STR011 CaseType=Combination P=-5,63939106174573 V2=13,245266298743 V3=0 T=0 M2=0 M3=-31,9175359467131 FrameElem=45-1
ElemStation=0,0917
Frame=45 Station=0,1834 OutputCase=STR011 CaseType=Combination P=-5,63939106174573 V2=13,740446298743 V3=0 T=0 M2=0 M3=-33,1548308693078 FrameElem=45-1
ElemStation=0,1834
Frame=45 Station=0 OutputCase=STR012 CaseType=Combination P=-21,9381665045984 V2=45,3554848241522 V3=0 T=0 M2=0 M3=-22,443862419826 FrameElem=45-1
ElemStation=0
Frame=45 Station=0,0917 OutputCase=STR012 CaseType=Combination P=-21,9381665045984 V2=45,8506648241522 V3=0 T=0 M2=0 M3=-26,6256643812007
FrameElem=45-1 ElemStation=0,0917
Frame=45 Station=0,1834 OutputCase=STR012 CaseType=Combination P=-21,9381665045984 V2=46,3458448241522 V3=0 T=0 M2=0 M3=-30,8528743485755
FrameElem=45-1 ElemStation=0,1834
Frame=45 Station=0 OutputCase=STR013 CaseType=Combination P=-38,2369419450063 V2=12,7548503208971 V3=0 T=0 M2=0 M3=-26,120862267652 FrameElem=45-1
ElemStation=0
Frame=45 Station=0,0917 OutputCase=STR013 CaseType=Combination P=-38,2369419450063 V2=13,2500303208971 V3=0 T=0 M2=0 M3=-27,3131860450783
FrameElem=45-1 ElemStation=0,0917
Frame=45 Station=0,1834 OutputCase=STR013 CaseType=Combination P=-38,2369419450063 V2=13,7452103208971 V3=0 T=0 M2=0 M3=-28,5509178285046
FrameElem=45-1 ElemStation=0,1834
Frame=45 Station=0 OutputCase=STR014 CaseType=Combination P=-23,0372721693153 V2=34,0420329038371 V3=0 T=0 M2=0 M3=4,57670167347273 FrameElem=45-1
ElemStation=0
Frame=45 Station=0,0917 OutputCase=STR014 CaseType=Combination P=-23,0372721693153 V2=34,4088329038371 V3=0 T=0 M2=0 M3=1,43822947619087 FrameElem=45-1
ElemStation=0,0917
Frame=45 Station=0,1834 OutputCase=STR014 CaseType=Combination P=-23,0372721693153 V2=34,7756329038371 V3=0 T=0 M2=0 M3=-1,73387828109098
FrameElem=45-1 ElemStation=0,1834
Frame=45 Station=0 OutputCase=STR015 CaseType=Combination P=-39,3360476097232 V2=1,44139840058196 V3=0 T=0 M2=0 M3=0,899701825646673 FrameElem=45-1
ElemStation=0
Frame=45 Station=0,0917 OutputCase=STR015 CaseType=Combination P=-39,3360476097232 V2=1,80819840058196 V3=0 T=0 M2=0 M3=0,750707812313308
FrameElem=45-1 ElemStation=0,0917
Frame=45 Station=0,1834 OutputCase=STR015 CaseType=Combination P=-39,3360476097232 V2=2,17499840058196 V3=0 T=0 M2=0 M3=0,568078238979942
FrameElem=45-1 ElemStation=0,1834
Frame=45 Station=0 OutputCase=STR016 CaseType=Combination P=-19,1569825123001 V2=67,6279044720541 V3=0 T=0 M2=0 M3=-11,921954291053 FrameElem=45-1
ElemStation=0
Frame=45 Station=0,0917 OutputCase=STR016 CaseType=Combination P=-19,1569825123001 V2=68,1230844720541 V3=0 T=0 M2=0 M3=-18,1461371341403
FrameElem=45-1 ElemStation=0,0917
Frame=45 Station=0,1834 OutputCase=STR016 CaseType=Combination P=-19,1569825123001 V2=68,6182644720541 V3=0 T=0 M2=0 M3=-24,4157279832277
FrameElem=45-1 ElemStation=0,1834
Frame=45 Station=0 OutputCase=STR017 CaseType=Combination P=-5,59565470864193 V2=10,0470812507217 V3=0 T=0 M2=0 M3=-24,6306614136705 FrameElem=45-1
ElemStation=0
Frame=45 Station=0,0917 OutputCase=STR017 CaseType=Combination P=-5,59565470864193 V2=10,5422612507217 V3=0 T=0 M2=0 M3=-25,5746827673616
FrameElem=45-1 ElemStation=0,0917
Frame=45 Station=0,1834 OutputCase=STR017 CaseType=Combination P=-5,59565470864193 V2=11,0374412507217 V3=0 T=0 M2=0 M3=-26,5641121270528
FrameElem=45-1 ElemStation=0,1834
Frame=45 Station=0 OutputCase=STR018 CaseType=Combination P=-18,7891997742992 V2=35,7993723895981 V3=0 T=0 M2=0 M3=-18,0639718532309 FrameElem=45-1
ElemStation=0
Frame=45 Station=0,0917 OutputCase=STR018 CaseType=Combination P=-18,7891997742992 V2=36,2945523895981 V3=0 T=0 M2=0 M3=-21,369478304357 FrameElem=45-1
ElemStation=0,0917
Frame=45 Station=0,1834 OutputCase=STR018 CaseType=Combination P=-18,7891997742992 V2=36,7897323895981 V3=0 T=0 M2=0 M3=-24,7203927614832
FrameElem=45-1 ElemStation=0,1834
Frame=45 Station=0 OutputCase=STR019 CaseType=Combination P=-31,9827448381403 V2=10,0508969265705 V3=0 T=0 M2=0 M3=-20,9425228881093 FrameElem=45-1
ElemStation=0
Frame=45 Station=0,0917 OutputCase=STR019 CaseType=Combination P=-31,9827448381403 V2=10,5460769265705 V3=0 T=0 M2=0 M3=-21,8868941392758
FrameElem=45-1 ElemStation=0,0917
Frame=45 Station=0,1834 OutputCase=STR019 CaseType=Combination P=-31,9827448381403 V2=11,0412569265705 V3=0 T=0 M2=0 M3=-22,8766733964423
FrameElem=45-1 ElemStation=0,1834
Frame=45 Station=0 OutputCase=STR020 CaseType=Combination P=-19,5642590566335 V2=27,1886102572769 V3=0 T=0 M2=0 M3=2,55688202684728 FrameElem=45-1
ElemStation=0
Frame=45 Station=0,0917 OutputCase=STR020 CaseType=Combination P=-19,5642590566335 V2=27,5554102572769 V3=0 T=0 M2=0 M3=4,68686862549911E-02
FrameElem=45-1 ElemStation=0,0917
Frame=45 Station=0,1834 OutputCase=STR020 CaseType=Combination P=-19,5642590566335 V2=27,9222102572769 V3=0 T=0 M2=0 M3=-2,49678021433373 FrameElem=45-1
ElemStation=0,1834
Frame=45 Station=0 OutputCase=STR021 CaseType=Combination P=-32,7578041204747 V2=1,44013479424931 V3=0 T=0 M2=0 M3=-0,32166900803111 FrameElem=45-1
ElemStation=0
Frame=45 Station=0,0917 OutputCase=STR021 CaseType=Combination P=-32,7578041204747 V2=1,80693479424931 V3=0 T=0 M2=0 M3=-0,470547148663772
FrameElem=45-1 ElemStation=0,0917
Frame=45 Station=0,1834 OutputCase=STR021 CaseType=Combination P=-32,7578041204747 V2=2,17373479424931 V3=0 T=0 M2=0 M3=-0,653060849296435
FrameElem=45-1 ElemStation=0,1834
Frame=45 Station=0 OutputCase=STR022 CaseType=Combination P=-14,5523733967081 V2=2,39754180428066 V3=0 T=0 M2=0 M3=-4,34734201764716 FrameElem=45-1
ElemStation=0
Frame=45 Station=0,0917 OutputCase=STR022 CaseType=Combination P=-14,5523733967081 V2=2,89272180428066 V3=0 T=0 M2=0 M3=-4,5899006040997 FrameElem=45-1
ElemStation=0,0917
Frame=45 Station=0,1834 OutputCase=STR022 CaseType=Combination P=-14,5523733967081 V2=3,38790180428066 V3=0 T=0 M2=0 M3=-4,87786719655224
FrameElem=45-1 ElemStation=0,1834
Frame=45 Station=0 OutputCase=STR023 CaseType=Combination P=-6,79666552849624 V2=2,39657116734764 V3=0 T=0 M2=0 M3=-5,28553583249284 FrameElem=45-1
ElemStation=0

Società di Progetto
Brebemi SpA



Doc. N.
60235-0000-A00.doc

CODIFICA DOCUMENTO
04RCDII10000000000300A00

REV.
00

FOGLIO
567 di 628

Frame=45 Station=0,0917 OutputCase=STR023 CaseType=Combination P=-6,79666552849624 V2=2,89175116734764 V3=0 T=0 M2=0 M3=-5,52800541153862
FrameElem=45-1 ElemStation=0,0917
Frame=45 Station=0,1834 OutputCase=STR023 CaseType=Combination P=-6,79666552849624 V2=3,38693116734764 V3=0 T=0 M2=0 M3=-5,8158829965844 FrameElem=45-1
ElemStation=0,1834
Frame=45 Station=0 OutputCase=STR024 CaseType=Combination P=-5,82452638134855 V2=10,5046405313295 V3=0 T=0 M2=0 M3=-24,4846664721544 FrameElem=45-1
ElemStation=0
Frame=45 Station=0,0917 OutputCase=STR024 CaseType=Combination P=-5,82452638134855 V2=10,9998205313295 V3=0 T=0 M2=0 M3=-25,4706460118773
FrameElem=45-1 ElemStation=0,0917
Frame=45 Station=0,1834 OutputCase=STR024 CaseType=Combination P=-5,82452638134855 V2=11,4950005313295 V3=0 T=0 M2=0 M3=-26,5020335576002
FrameElem=45-1 ElemStation=0,1834
Frame=45 Station=0 OutputCase=STR025 CaseType=Combination P=-19,0180714470058 V2=36,2569316702059 V3=0 T=0 M2=0 M3=-17,9179769117148 FrameElem=45-1
ElemStation=0
Frame=45 Station=0,0917 OutputCase=STR025 CaseType=Combination P=-19,0180714470058 V2=36,7521116702059 V3=0 T=0 M2=0 M3=-21,2654415488727
FrameElem=45-1 ElemStation=0,0917
Frame=45 Station=0,1834 OutputCase=STR025 CaseType=Combination P=-19,0180714470058 V2=37,2472916702059 V3=0 T=0 M2=0 M3=-24,6583141920306
FrameElem=45-1 ElemStation=0,1834
Frame=45 Station=0 OutputCase=STR026 CaseType=Combination P=-32,2116165108469 V2=10,5084562071783 V3=0 T=0 M2=0 M3=-20,7965279465932 FrameElem=45-1
ElemStation=0
Frame=45 Station=0,0917 OutputCase=STR026 CaseType=Combination P=-32,2116165108469 V2=11,0036362071783 V3=0 T=0 M2=0 M3=-21,782573837915
FrameElem=45-1 ElemStation=0,0917
Frame=45 Station=0,1834 OutputCase=STR026 CaseType=Combination P=-32,2116165108469 V2=11,4988162071783 V3=0 T=0 M2=0 M3=-22,8145948269897
FrameElem=45-1 ElemStation=0,1834
Frame=45 Station=0 OutputCase=STR027 CaseType=Combination P=-19,7931307293401 V2=27,6461695378847 V3=0 T=0 M2=0 M3=2,70287696836334 FrameElem=45-1
ElemStation=0
Frame=45 Station=0,0917 OutputCase=STR027 CaseType=Combination P=-19,7931307293401 V2=28,0129695378847 V3=0 T=0 M2=0 M3=0,15090544173931 FrameElem=45-1
ElemStation=0,0917
Frame=45 Station=0,1834 OutputCase=STR027 CaseType=Combination P=-19,7931307293401 V2=28,3797695378847 V3=0 T=0 M2=0 M3=-2,43470164488472
FrameElem=45-1 ElemStation=0,1834
Frame=45 Station=0 OutputCase=STR028 CaseType=Combination P=-32,9866757931813 V2=1,89769407485713 V3=0 T=0 M2=0 M3=0,175674066515055 FrameElem=45-1
ElemStation=0
Frame=45 Station=0,0917 OutputCase=STR028 CaseType=Combination P=-32,9866757931813 V2=2,26449407485713 V3=0 T=0 M2=0 M3=-0,366510393179454
FrameElem=45-1 ElemStation=0,0917
Frame=45 Station=0,1834 OutputCase=STR028 CaseType=Combination P=-32,9866757931813 V2=2,63129407485713 V3=0 T=0 M2=0 M3=-0,590982279843853
FrameElem=45-1 ElemStation=0,1834
Frame=45 Station=0 OutputCase=STR029 CaseType=Combination P=-14,0946300512949 V2=1,48242324306502 V3=0 T=0 M2=0 M3=4,63933190067927 FrameElem=45-1
ElemStation=0
Frame=45 Station=0,0917 OutputCase=STR029 CaseType=Combination P=-14,0946300512949 V2=1,97760324306503 V3=0 T=0 M2=0 M3=4,79797411506833
FrameElem=45-1 ElemStation=0,0917
Frame=45 Station=0,1834 OutputCase=STR029 CaseType=Combination P=-14,0946300512949 V2=2,47278324306503 V3=0 T=0 M2=0 M3=-5,0020423354574 FrameElem=45-1
ElemStation=0,1834
Frame=45 Station=0 OutputCase=STR030 CaseType=Combination P=-6,338922183083 V2=1,48145260613201 V3=0 T=0 M2=0 M3=-5,57752571552495 FrameElem=45-1
ElemStation=0
Frame=45 Station=0,0917 OutputCase=STR030 CaseType=Combination P=-6,338922183083 V2=1,97663260613201 V3=0 T=0 M2=0 M3=-5,73607892250726 FrameElem=45-1
ElemStation=0,0917
Frame=45 Station=0,1834 OutputCase=STR030 CaseType=Combination P=-6,338922183083 V2=2,47181260613201 V3=0 T=0 M2=0 M3=-5,94004013548956 FrameElem=45-1
ElemStation=0,1834
Frame=45 Station=0 OutputCase=STR031 CaseType=Combination P=-5,36678303593531 V2=9,58952197011386 V3=0 T=0 M2=0 M3=-24,7766563551865 FrameElem=45-1
ElemStation=0
Frame=45 Station=0,0917 OutputCase=STR031 CaseType=Combination P=-5,36678303593531 V2=10,0847019701139 V3=0 T=0 M2=0 M3=-25,678719522846 FrameElem=45-1
ElemStation=0,0917
Frame=45 Station=0,1834 OutputCase=STR031 CaseType=Combination P=-5,36678303593531 V2=10,5798819701139 V3=0 T=0 M2=0 M3=-26,6261906965054
FrameElem=45-1 ElemStation=0,1834
Frame=45 Station=0 OutputCase=STR032 CaseType=Combination P=-18,5603281015925 V2=35,3418131089903 V3=0 T=0 M2=0 M3=-18,209966794747 FrameElem=45-1
ElemStation=0
Frame=45 Station=0,0917 OutputCase=STR032 CaseType=Combination P=-18,5603281015925 V2=35,8369931089903 V3=0 T=0 M2=0 M3=-21,4735150598414
FrameElem=45-1 ElemStation=0,0917
Frame=45 Station=0,1834 OutputCase=STR032 CaseType=Combination P=-18,5603281015925 V2=36,3321731089903 V3=0 T=0 M2=0 M3=-24,7824713309358
FrameElem=45-1 ElemStation=0,1834
Frame=45 Station=0 OutputCase=STR033 CaseType=Combination P=-31,7538731654337 V2=9,59333764596267 V3=0 T=0 M2=0 M3=-21,0885178296253 FrameElem=45-1
ElemStation=0
Frame=45 Station=0,0917 OutputCase=STR033 CaseType=Combination P=-31,7538731654337 V2=10,0885176459627 V3=0 T=0 M2=0 M3=-21,9909308947601
FrameElem=45-1 ElemStation=0,0917
Frame=45 Station=0,1834 OutputCase=STR033 CaseType=Combination P=-31,7538731654337 V2=10,5836976459627 V3=0 T=0 M2=0 M3=-22,9387519658949
FrameElem=45-1 ElemStation=0,1834
Frame=45 Station=0 OutputCase=STR034 CaseType=Combination P=-19,3353873839269 V2=26,7310509766691 V3=0 T=0 M2=0 M3=2,41088708533123 FrameElem=45-1
ElemStation=0
Frame=45 Station=0,0917 OutputCase=STR034 CaseType=Combination P=-19,3353873839269 V2=27,0978509766691 V3=0 T=0 M2=0 M3=-5,7168062293275E-02
FrameElem=45-1 ElemStation=0,0917
Frame=45 Station=0,1834 OutputCase=STR034 CaseType=Combination P=-19,3353873839269 V2=27,4646509766691 V3=0 T=0 M2=0 M3=-2,55885878378988
FrameElem=45-1 ElemStation=0,1834
Frame=45 Station=0 OutputCase=STR035 CaseType=Combination P=-32,528932447768 V2=0,982575513641496 V3=0 T=0 M2=0 M3=-0,467663949547166 FrameElem=45-1
ElemStation=0
Frame=45 Station=0,0917 OutputCase=STR035 CaseType=Combination P=-32,528932447768 V2=1,34937551364149 V3=0 T=0 M2=0 M3=-0,574583904148091
FrameElem=45-1 ElemStation=0,0917
Frame=45 Station=0,1834 OutputCase=STR035 CaseType=Combination P=-32,528932447768 V2=1,71617551364149 V3=0 T=0 M2=0 M3=-0,715139418749016
FrameElem=45-1 ElemStation=0,1834
Frame=45 Station=0 OutputCase=STR036 CaseType=Combination P=-14,8751758272311 V2=1,9404554137139 V3=0 T=0 M2=0 M3=4,03625306400428 FrameElem=45-1
ElemStation=0
Frame=45 Station=0,0917 OutputCase=STR036 CaseType=Combination P=-14,8751758272311 V2=2,43563541371391 V3=0 T=0 M2=0 M3=-4,23689682844185
FrameElem=45-1 ElemStation=0,0917
Frame=45 Station=0,1834 OutputCase=STR036 CaseType=Combination P=-14,8751758272311 V2=2,93081541371391 V3=0 T=0 M2=0 M3=-4,48294859887941
FrameElem=45-1 ElemStation=0,1834
Frame=45 Station=0 OutputCase=STR037 CaseType=Combination P=-7,11946795901916 V2=1,93948477678089 V3=0 T=0 M2=0 M3=4,97444687884996 FrameElem=45-1
ElemStation=0
Frame=45 Station=0,0917 OutputCase=STR037 CaseType=Combination P=-7,11946795901916 V2=2,43466477678089 V3=0 T=0 M2=0 M3=-5,17500163588077
FrameElem=45-1 ElemStation=0,0917
Frame=45 Station=0,1834 OutputCase=STR037 CaseType=Combination P=-7,11946795901916 V2=2,92984477678089 V3=0 T=0 M2=0 M3=-5,42096439891158
FrameElem=45-1 ElemStation=0,1834

Società di Progetto
Brebemi SpA



Doc. N.
60235-0000-A00.doc

CODIFICA DOCUMENTO
04RCDII10000000000300A00

REV.
00

FOGLIO
568 di 628

Frame=45 Station=0 OutputCase=STR038 CaseType=Combination P=-6,14732881187147 V2=10,0475541407627 V3=0 T=0 M2=0 M3=-24,1735775185115 FrameElem=45-1 ElemStation=0
Frame=45 Station=0,0917 OutputCase=STR038 CaseType=Combination P=-6,14732881187147 V2=10,5427341407627 V3=0 T=0 M2=0 M3=-25,1176422362195 FrameElem=45-1 ElemStation=0,0917
Frame=45 Station=0,1834 OutputCase=STR038 CaseType=Combination P=-6,14732881187147 V2=11,0379141407627 V3=0 T=0 M2=0 M3=-26,1071149599274 FrameElem=45-1 ElemStation=0,1834
Frame=45 Station=0 OutputCase=STR039 CaseType=Combination P=-19,3408738775287 V2=35,7998452796391 V3=0 T=0 M2=0 M3=-17,606887958072 FrameElem=45-1 ElemStation=0
Frame=45 Station=0,0917 OutputCase=STR039 CaseType=Combination P=-19,3408738775287 V2=36,2950252796391 V3=0 T=0 M2=0 M3=-20,9124377732149 FrameElem=45-1 ElemStation=0,0917
Frame=45 Station=0,1834 OutputCase=STR039 CaseType=Combination P=-19,3408738775287 V2=36,7902052796391 V3=0 T=0 M2=0 M3=-24,2633955943578 FrameElem=45-1 ElemStation=0,1834
Frame=45 Station=0 OutputCase=STR040 CaseType=Combination P=-32,5344189413699 V2=10,0513698166116 V3=0 T=0 M2=0 M3=-20,4854389929504 FrameElem=45-1 ElemStation=0
Frame=45 Station=0,0917 OutputCase=STR040 CaseType=Combination P=-32,5344189413699 V2=10,5465498166116 V3=0 T=0 M2=0 M3=-21,4298536081336 FrameElem=45-1 ElemStation=0,0917
Frame=45 Station=0,1834 OutputCase=STR040 CaseType=Combination P=-32,5344189413699 V2=11,0417298166116 V3=0 T=0 M2=0 M3=-22,4196762293169 FrameElem=45-1 ElemStation=0,1834
Frame=45 Station=0 OutputCase=STR041 CaseType=Combination P=-20,1159331598631 V2=27,189083147318 V3=0 T=0 M2=0 M3=3,01396592200622 FrameElem=45-1 ElemStation=0
Frame=45 Station=0,0917 OutputCase=STR041 CaseType=Combination P=-20,1159331598631 V2=27,555883147318 V3=0 T=0 M2=0 M3=0,503909217397159 FrameElem=45-1 ElemStation=0,0917
Frame=45 Station=0,1834 OutputCase=STR041 CaseType=Combination P=-20,1159331598631 V2=27,922683147318 V3=0 T=0 M2=0 M3=-2,0397830472119 FrameElem=45-1 ElemStation=0,1834
Frame=45 Station=0 OutputCase=STR042 CaseType=Combination P=-33,3094782237042 V2=1,44060768429038 V3=0 T=0 M2=0 M3=0,135414887127823 FrameElem=45-1 ElemStation=0
Frame=45 Station=0,0917 OutputCase=STR042 CaseType=Combination P=-33,3094782237042 V2=1,80740768429037 V3=0 T=0 M2=0 M3=-1,35066175216048E-02 FrameElem=45-1 ElemStation=0,0917
Frame=45 Station=0,1834 OutputCase=STR042 CaseType=Combination P=-33,3094782237042 V2=2,17420768429038 V3=0 T=0 M2=0 M3=-0,196063682171033 FrameElem=45-1 ElemStation=0,1834
Frame=45 Station=0 OutputCase=STR043 CaseType=Combination P=-16,1624154014333 V2=1,94155882380972 V3=0 T=0 M2=0 M3=-2,96972397530011 FrameElem=45-1 ElemStation=0
Frame=45 Station=0,0917 OutputCase=STR043 CaseType=Combination P=-16,1624154014333 V2=2,43673882380972 V3=0 T=0 M2=0 M3=-3,17046892244346 FrameElem=45-1 ElemStation=0,0917
Frame=45 Station=0,1834 OutputCase=STR043 CaseType=Combination P=-16,1624154014333 V2=2,93191882380972 V3=0 T=0 M2=0 M3=-3,41662187558681 FrameElem=45-1 ElemStation=0,1834
Frame=45 Station=0 OutputCase=STR044 CaseType=Combination P=-8,40670753322143 V2=1,9405881868767 V3=0 T=0 M2=0 M3=-3,90791779014579 FrameElem=45-1 ElemStation=0
Frame=45 Station=0,0917 OutputCase=STR044 CaseType=Combination P=-8,40670753322143 V2=2,4357681868767 V3=0 T=0 M2=0 M3=-4,10857372988238 FrameElem=45-1 ElemStation=0,0917
Frame=45 Station=0,1834 OutputCase=STR044 CaseType=Combination P=-8,40670753322143 V2=2,9309481868767 V3=0 T=0 M2=0 M3=-4,35463767561897 FrameElem=45-1 ElemStation=0,1834
Frame=45 Station=0 OutputCase=STR045 CaseType=Combination P=-6,74273926820482 V2=12,7510320788251 V3=0 T=0 M2=0 M3=-29,8114812398005 FrameElem=45-1 ElemStation=0
Frame=45 Station=0,0917 OutputCase=STR045 CaseType=Combination P=-6,74273926820482 V2=13,2462120788251 V3=0 T=0 M2=0 M3=-31,0034548844288 FrameElem=45-1 ElemStation=0,0917
Frame=45 Station=0,1834 OutputCase=STR045 CaseType=Combination P=-6,74273926820482 V2=13,7413920788251 V3=0 T=0 M2=0 M3=-32,240836535057 FrameElem=45-1 ElemStation=0,1834
Frame=45 Station=0 OutputCase=STR046 CaseType=Combination P=-23,0415147110575 V2=45,3564306042343 V3=0 T=0 M2=0 M3=-21,5296946295081 FrameElem=45-1 ElemStation=0
Frame=45 Station=0,0917 OutputCase=STR046 CaseType=Combination P=-23,0415147110575 V2=45,8516106042343 V3=0 T=0 M2=0 M3=-25,7115833189164 FrameElem=45-1 ElemStation=0,0917
Frame=45 Station=0,1834 OutputCase=STR046 CaseType=Combination P=-23,0415147110575 V2=46,3467906042343 V3=0 T=0 M2=0 M3=-29,9388800143247 FrameElem=45-1 ElemStation=0,1834
Frame=45 Station=0 OutputCase=STR047 CaseType=Combination P=-39,3402901514654 V2=12,7557961009792 V3=0 T=0 M2=0 M3=-25,2066944773342 FrameElem=45-1 ElemStation=0
Frame=45 Station=0,0917 OutputCase=STR047 CaseType=Combination P=-39,3402901514654 V2=13,2509761009792 V3=0 T=0 M2=0 M3=-26,399104982794 FrameElem=45-1 ElemStation=0,0917
Frame=45 Station=0,1834 OutputCase=STR047 CaseType=Combination P=-39,3402901514654 V2=13,7461561009792 V3=0 T=0 M2=0 M3=-27,6369234942538 FrameElem=45-1 ElemStation=0,1834
Frame=45 Station=0 OutputCase=STR048 CaseType=Combination P=-24,1406203757744 V2=34,0429786839192 V3=0 T=0 M2=0 M3=5,4908694637906 FrameElem=45-1 ElemStation=0
Frame=45 Station=0,0917 OutputCase=STR048 CaseType=Combination P=-24,1406203757744 V2=34,4097786839192 V3=0 T=0 M2=0 M3=2,35231053847521 FrameElem=45-1 ElemStation=0,0917
Frame=45 Station=0,1834 OutputCase=STR048 CaseType=Combination P=-24,1406203757744 V2=34,7765786839192 V3=0 T=0 M2=0 M3=-0,819883946840181 FrameElem=45-1 ElemStation=0,1834
Frame=45 Station=0 OutputCase=STR049 CaseType=Combination P=-40,4393958161823 V2=1,44234418066408 V3=0 T=0 M2=0 M3=1,81386961596454 FrameElem=45-1 ElemStation=0
Frame=45 Station=0,0917 OutputCase=STR049 CaseType=Combination P=-40,4393958161823 V2=1,80914418066408 V3=0 T=0 M2=0 M3=1,66478887459764 FrameElem=45-1 ElemStation=0,0917
Frame=45 Station=0,1834 OutputCase=STR049 CaseType=Combination P=-40,4393958161823 V2=2,17594418066408 V3=0 T=0 M2=0 M3=1,48207257323075 FrameElem=45-1 ElemStation=0,1834
Frame=45 Station=0 OutputCase=STR050 CaseType=Combination P=-20,2603307187592 V2=67,6288502521362 V3=0 T=0 M2=0 M3=-11,0077865007351 FrameElem=45-1 ElemStation=0
Frame=45 Station=0,0917 OutputCase=STR050 CaseType=Combination P=-20,2603307187592 V2=68,1240302521362 V3=0 T=0 M2=0 M3=-17,232056071856 FrameElem=45-1 ElemStation=0,0917
Frame=45 Station=0,1834 OutputCase=STR050 CaseType=Combination P=-20,2603307187592 V2=68,6192102521362 V3=0 T=0 M2=0 M3=-23,5017336489769 FrameElem=45-1 ElemStation=0,1834
Frame=45 Station=0 OutputCase=STR051 CaseType=Combination P=-7,43456838607374 V2=10,0486575508586 V3=0 T=0 M2=0 M3=-23,1070484298073 FrameElem=45-1 ElemStation=0
Frame=45 Station=0,0917 OutputCase=STR051 CaseType=Combination P=-7,43456838607374 V2=10,5438375508586 V3=0 T=0 M2=0 M3=-24,0512143302211 FrameElem=45-1 ElemStation=0,0917
Frame=45 Station=0,1834 OutputCase=STR051 CaseType=Combination P=-7,43456838607374 V2=11,0390175508586 V3=0 T=0 M2=0 M3=-25,0407882366348 FrameElem=45-1 ElemStation=0,1834
Frame=45 Station=0 OutputCase=STR052 CaseType=Combination P=-20,628113451731 V2=35,8009486897349 V3=0 T=0 M2=0 M3=-16,5403588693678 FrameElem=45-1 ElemStation=0
Frame=45 Station=0,0917 OutputCase=STR052 CaseType=Combination P=-20,628113451731 V2=36,296128689735 V3=0 T=0 M2=0 M3=-19,8460098672165 FrameElem=45-1 ElemStation=0,0917

Società di Progetto
Brebemi SpA



Doc. N.
60235-0000-A00.doc

CODIFICA DOCUMENTO
04RCDII10000000000300A00

REV.
00

FOGLIO
569 di 628

Frame=45 Station=0,1834 OutputCase=STR052 CaseType=Combination P=-20,628113451731 V2=36,791308689735 V3=0 T=0 M2=0 M3=-23,1970688710652 FrameElem=45-1 ElemStation=0,1834
Frame=45 Station=0 OutputCase=STR053 CaseType=Combination P=-33,8216585155721 V2=10,0524732267074 V3=0 T=0 M2=0 M3=-19,4189099042462 FrameElem=45-1 ElemStation=0
Frame=45 Station=0,0917 OutputCase=STR053 CaseType=Combination P=-33,8216585155721 V2=10,5476532267074 V3=0 T=0 M2=0 M3=-20,3634257021353 FrameElem=45-1 ElemStation=0,0917
Frame=45 Station=0,1834 OutputCase=STR053 CaseType=Combination P=-33,8216585155721 V2=11,0428332267074 V3=0 T=0 M2=0 M3=-21,3533495060243 FrameElem=45-1 ElemStation=0,1834
Frame=45 Station=0 OutputCase=STR054 CaseType=Combination P=-21,4031727340653 V2=27,1901865574138 V3=0 T=0 M2=0 M3=4,08049501071039 FrameElem=45-1 ElemStation=0
Frame=45 Station=0,0917 OutputCase=STR054 CaseType=Combination P=-21,4031727340653 V2=27,5569865574138 V3=0 T=0 M2=0 M3=1,57033712339555 FrameElem=45-1 ElemStation=0,0917
Frame=45 Station=0,1834 OutputCase=STR054 CaseType=Combination P=-21,4031727340653 V2=27,9237865574138 V3=0 T=0 M2=0 M3=-0,973456323919294 FrameElem=45-1 ElemStation=0,1834
Frame=45 Station=0 OutputCase=STR055 CaseType=Combination P=-34,5967177979065 V2=1,44171109438619 V3=0 T=0 M2=0 M3=1,201943975832 FrameElem=45-1 ElemStation=0
Frame=45 Station=0,0917 OutputCase=STR055 CaseType=Combination P=-34,5967177979065 V2=1,80851109438619 V3=0 T=0 M2=0 M3=1,05292128847679 FrameElem=45-1 ElemStation=0,0917
Frame=45 Station=0,1834 OutputCase=STR055 CaseType=Combination P=-34,5967177979065 V2=2,17531109438619 V3=0 T=0 M2=0 M3=0,870263041121572 FrameElem=45-1 ElemStation=0,1834
Frame=45 Station=0 OutputCase=STR056 CaseType=Combination P=-16,39128707414 V2=2,39911810441754 V3=0 T=0 M2=0 M3=-2,82372903378405 FrameElem=45-1 ElemStation=0
Frame=45 Station=0,0917 OutputCase=STR056 CaseType=Combination P=-16,39128707414 V2=2,89429810441754 V3=0 T=0 M2=0 M3=-3,06643216695914 FrameElem=45-1 ElemStation=0,0917
Frame=45 Station=0,1834 OutputCase=STR056 CaseType=Combination P=-16,39128707414 V2=3,38947810441754 V3=0 T=0 M2=0 M3=-3,35454330613423 FrameElem=45-1 ElemStation=0,1834
Frame=45 Station=0 OutputCase=STR057 CaseType=Combination P=-8,63557920592805 V2=2,39814746748452 V3=0 T=0 M2=0 M3=-3,76192284862973 FrameElem=45-1 ElemStation=0
Frame=45 Station=0,0917 OutputCase=STR057 CaseType=Combination P=-8,63557920592805 V2=2,89332746748452 V3=0 T=0 M2=0 M3=-4,00453697439806 FrameElem=45-1 ElemStation=0,0917
Frame=45 Station=0,1834 OutputCase=STR057 CaseType=Combination P=-8,63557920592805 V2=3,38850746748452 V3=0 T=0 M2=0 M3=-4,29255910616639 FrameElem=45-1 ElemStation=0,1834
Frame=45 Station=0 OutputCase=STR058 CaseType=Combination P=-7,66344005878036 V2=10,5062168314664 V3=0 T=0 M2=0 M3=-22,9610534882913 FrameElem=45-1 ElemStation=0
Frame=45 Station=0,0917 OutputCase=STR058 CaseType=Combination P=-7,66344005878036 V2=11,0013968314664 V3=0 T=0 M2=0 M3=-23,9471775747368 FrameElem=45-1 ElemStation=0,0917
Frame=45 Station=0,1834 OutputCase=STR058 CaseType=Combination P=-7,66344005878036 V2=11,4965768314664 V3=0 T=0 M2=0 M3=-24,9787096671822 FrameElem=45-1 ElemStation=0,1834
Frame=45 Station=0 OutputCase=STR059 CaseType=Combination P=-20,8569851244376 V2=36,2585079703428 V3=0 T=0 M2=0 M3=-16,3943639278517 FrameElem=45-1 ElemStation=0
Frame=45 Station=0,0917 OutputCase=STR059 CaseType=Combination P=-20,8569851244376 V2=36,7536879703428 V3=0 T=0 M2=0 M3=-19,7419731117322 FrameElem=45-1 ElemStation=0,0917
Frame=45 Station=0,1834 OutputCase=STR059 CaseType=Combination P=-20,8569851244376 V2=37,2488679703428 V3=0 T=0 M2=0 M3=-23,1349903016126 FrameElem=45-1 ElemStation=0,1834
Frame=45 Station=0 OutputCase=STR060 CaseType=Combination P=-34,0505301882788 V2=10,5100325073152 V3=0 T=0 M2=0 M3=-19,2729149627301 FrameElem=45-1 ElemStation=0
Frame=45 Station=0,0917 OutputCase=STR060 CaseType=Combination P=-34,0505301882788 V2=11,0052125073152 V3=0 T=0 M2=0 M3=-20,2593889466509 FrameElem=45-1 ElemStation=0,0917
Frame=45 Station=0,1834 OutputCase=STR060 CaseType=Combination P=-34,0505301882788 V2=11,5003925073152 V3=0 T=0 M2=0 M3=-21,2912709365717 FrameElem=45-1 ElemStation=0,1834
Frame=45 Station=0 OutputCase=STR061 CaseType=Combination P=-21,632044406772 V2=27,6477458380216 V3=0 T=0 M2=0 M3=4,22648995222645 FrameElem=45-1 ElemStation=0
Frame=45 Station=0,0917 OutputCase=STR061 CaseType=Combination P=-21,632044406772 V2=28,0145458380216 V3=0 T=0 M2=0 M3=1,67437387887987 FrameElem=45-1 ElemStation=0,0917
Frame=45 Station=0,1834 OutputCase=STR061 CaseType=Combination P=-21,632044406772 V2=28,3813458380216 V3=0 T=0 M2=0 M3=-0,91137754466712 FrameElem=45-1 ElemStation=0,1834
Frame=45 Station=0 OutputCase=STR062 CaseType=Combination P=-34,8255894706131 V2=1,89927037499401 V3=0 T=0 M2=0 M3=1,34793891734805 FrameElem=45-1 ElemStation=0
Frame=45 Station=0,0917 OutputCase=STR062 CaseType=Combination P=-34,8255894706131 V2=2,26607037499401 V3=0 T=0 M2=0 M3=1,1569580439611 FrameElem=45-1 ElemStation=0,0917
Frame=45 Station=0,1834 OutputCase=STR062 CaseType=Combination P=-34,8255894706131 V2=2,63287037499401 V3=0 T=0 M2=0 M3=0,932341610574154 FrameElem=45-1 ElemStation=0,1834
Frame=45 Station=0 OutputCase=STR063 CaseType=Combination P=-15,9335437287267 V2=1,4839995432019 V3=0 T=0 M2=0 M3=3,11571891681616 FrameElem=45-1 ElemStation=0
Frame=45 Station=0,0917 OutputCase=STR063 CaseType=Combination P=-15,9335437287267 V2=1,9791795432019 V3=0 T=0 M2=0 M3=-3,27450567792778 FrameElem=45-1 ElemStation=0,0917
Frame=45 Station=0,1834 OutputCase=STR063 CaseType=Combination P=-15,9335437287267 V2=2,4743595432019 V3=0 T=0 M2=0 M3=-3,47870044503939 FrameElem=45-1 ElemStation=0,1834
Frame=45 Station=0 OutputCase=STR064 CaseType=Combination P=-8,17783586051481 V2=1,48302890626889 V3=0 T=0 M2=0 M3=4,05391273166184 FrameElem=45-1 ElemStation=0
Frame=45 Station=0,0917 OutputCase=STR064 CaseType=Combination P=-8,17783586051481 V2=1,97820890626889 V3=0 T=0 M2=0 M3=-4,2126104853667 FrameElem=45-1 ElemStation=0,0917
Frame=45 Station=0,1834 OutputCase=STR064 CaseType=Combination P=-8,17783586051481 V2=2,47338890626889 V3=0 T=0 M2=0 M3=-4,41671624507155 FrameElem=45-1 ElemStation=0,1834
Frame=45 Station=0 OutputCase=STR065 CaseType=Combination P=-7,20569671336712 V2=9,59109827025074 V3=0 T=0 M2=0 M3=-23,2530433713234 FrameElem=45-1 ElemStation=0
Frame=45 Station=0,0917 OutputCase=STR065 CaseType=Combination P=-7,20569671336712 V2=10,0862782702507 V3=0 T=0 M2=0 M3=-24,1552510857054 FrameElem=45-1 ElemStation=0,0917
Frame=45 Station=0,1834 OutputCase=STR065 CaseType=Combination P=-7,20569671336712 V2=10,5814582702507 V3=0 T=0 M2=0 M3=-25,1028686060874 FrameElem=45-1 ElemStation=0,1834
Frame=45 Station=0 OutputCase=STR066 CaseType=Combination P=-20,3992417790244 V2=35,3433894091271 V3=0 T=0 M2=0 M3=-16,6863538108838 FrameElem=45-1 ElemStation=0
Frame=45 Station=0,0917 OutputCase=STR066 CaseType=Combination P=-20,3992417790244 V2=35,8385694091271 V3=0 T=0 M2=0 M3=-19,9500466227008 FrameElem=45-1 ElemStation=0,0917
Frame=45 Station=0,1834 OutputCase=STR066 CaseType=Combination P=-20,3992417790244 V2=36,3337494091271 V3=0 T=0 M2=0 M3=-23,2591474405178 FrameElem=45-1 ElemStation=0,1834
Frame=45 Station=0 OutputCase=STR067 CaseType=Combination P=-33,5927868428655 V2=9,59491394609955 V3=0 T=0 M2=0 M3=-19,5649048457622 FrameElem=45-1 ElemStation=0

APPROVATO S.D.P.

Società di Progetto
Brebemi SpA



Doc. N.
60235-00000-A00.doc

CODIFICA DOCUMENTO
04RCDII10000000000300A00

REV.
00

FOGLIO
570 di 628

Frame=45 Station=0,0917 OutputCase=STR067 CaseType=Combination P=-33,5927868428655 V2=10,0900939460996 V3=0 T=0 M2=0 M3=-20,4674624576196
FrameElem=45-1 ElemStation=0,0917
Frame=45 Station=0,1834 OutputCase=STR067 CaseType=Combination P=-33,5927868428655 V2=10,5852739460996 V3=0 T=0 M2=0 M3=-21,4154280754769
FrameElem=45-1 ElemStation=0,1834
Frame=45 Station=0 OutputCase=STR068 CaseType=Combination P=-21,1743010613587 V2=26,732627276806 V3=0 T=0 M2=0 M3=3,93450006919434 FrameElem=45-1
ElemStation=0
Frame=45 Station=0,0917 OutputCase=STR068 CaseType=Combination P=-21,1743010613587 V2=27,099427276806 V3=0 T=0 M2=0 M3=1,46630036791123 FrameElem=45-1
ElemStation=0,0917
Frame=45 Station=0,1834 OutputCase=STR068 CaseType=Combination P=-21,1743010613587 V2=27,466227276806 V3=0 T=0 M2=0 M3=-1,03553489337188 FrameElem=45-1
ElemStation=0,1834
Frame=45 Station=0 OutputCase=STR069 CaseType=Combination P=-34,3678461251999 V2=0,984151813778374 V3=0 T=0 M2=0 M3=1,05594903431594 FrameElem=45-1
ElemStation=0
Frame=45 Station=0,0917 OutputCase=STR069 CaseType=Combination P=-34,3678461251999 V2=1,35095181377837 V3=0 T=0 M2=0 M3=0,948884532992467
FrameElem=45-1 ElemStation=0,0917
Frame=45 Station=0,1834 OutputCase=STR069 CaseType=Combination P=-34,3678461251999 V2=1,71775181377837 V3=0 T=0 M2=0 M3=0,80818447166899 FrameElem=45-1
ElemStation=0,1834
Frame=45 Station=0 OutputCase=STR070 CaseType=Combination P=-16,7140895046629 V2=1,94203171385078 V3=0 T=0 M2=0 M3=2,51264008014117 FrameElem=45-1
ElemStation=0
Frame=45 Station=0,0917 OutputCase=STR070 CaseType=Combination P=-16,7140895046629 V2=2,43721171385078 V3=0 T=0 M2=0 M3=-2,71342839130129
FrameElem=45-1 ElemStation=0,0917
Frame=45 Station=0,1834 OutputCase=STR070 CaseType=Combination P=-16,7140895046629 V2=2,93239171385078 V3=0 T=0 M2=0 M3=-2,95962470846141
FrameElem=45-1 ElemStation=0,1834
Frame=45 Station=0 OutputCase=STR071 CaseType=Combination P=-8,95838163645098 V2=1,94106107691777 V3=0 T=0 M2=0 M3=-3,45083389498685 FrameElem=45-1
ElemStation=0
Frame=45 Station=0,0917 OutputCase=STR071 CaseType=Combination P=-8,95838163645098 V2=2,43624107691777 V3=0 T=0 M2=0 M3=-3,65153319874021
FrameElem=45-1 ElemStation=0,0917
Frame=45 Station=0,1834 OutputCase=STR071 CaseType=Combination P=-8,95838163645098 V2=2,93142107691777 V3=0 T=0 M2=0 M3=-3,89764058049357
FrameElem=45-1 ElemStation=0,1834
Frame=45 Station=0 OutputCase=STR072 CaseType=Combination P=-7,98624248930329 V2=10,0491304408996 V3=0 T=0 M2=0 M3=-22,6499645346484 FrameElem=45-1
ElemStation=0
Frame=45 Station=0,0917 OutputCase=STR072 CaseType=Combination P=-7,98624248930329 V2=10,5443104408996 V3=0 T=0 M2=0 M3=-23,5941737990789
FrameElem=45-1 ElemStation=0,0917
Frame=45 Station=0,1834 OutputCase=STR072 CaseType=Combination P=-7,98624248930329 V2=11,0394904408996 V3=0 T=0 M2=0 M3=-24,5837910695094
FrameElem=45-1 ElemStation=0,1834
Frame=45 Station=0 OutputCase=STR073 CaseType=Combination P=-21,1797875549605 V2=35,801421579776 V3=0 T=0 M2=0 M3=-16,0832749742089 FrameElem=45-1
ElemStation=0
Frame=45 Station=0,0917 OutputCase=STR073 CaseType=Combination P=-21,1797875549605 V2=36,296601579776 V3=0 T=0 M2=0 M3=-19,38896933670743 FrameElem=45-1
ElemStation=0,0917
Frame=45 Station=0,1834 OutputCase=STR073 CaseType=Combination P=-21,1797875549605 V2=36,791781579776 V3=0 T=0 M2=0 M3=-22,7400717039398 FrameElem=45-1
ElemStation=0,1834
Frame=45 Station=0 OutputCase=STR074 CaseType=Combination P=-34,3733326188017 V2=10,0529461167484 V3=0 T=0 M2=0 M3=-18,9618260090873 FrameElem=45-1
ElemStation=0
Frame=45 Station=0,0917 OutputCase=STR074 CaseType=Combination P=-34,3733326188017 V2=10,5481261167484 V3=0 T=0 M2=0 M3=-19,9063851709931
FrameElem=45-1 ElemStation=0,0917
Frame=45 Station=0,1834 OutputCase=STR074 CaseType=Combination P=-34,3733326188017 V2=11,0433061167484 V3=0 T=0 M2=0 M3=-20,8963523388989
FrameElem=45-1 ElemStation=0,1834
Frame=45 Station=0 OutputCase=STR075 CaseType=Combination P=-21,9548468372949 V2=27,1906594474548 V3=0 T=0 M2=0 M3=4,53757890586932 FrameElem=45-1
ElemStation=0
Frame=45 Station=0,0917 OutputCase=STR075 CaseType=Combination P=-21,9548468372949 V2=27,5574594474548 V3=0 T=0 M2=0 M3=2,02737765453772 FrameElem=45-1
ElemStation=0,0917
Frame=45 Station=0,1834 OutputCase=STR075 CaseType=Combination P=-21,9548468372949 V2=27,9242594474548 V3=0 T=0 M2=0 M3=-0,516459156793892
FrameElem=45-1 ElemStation=0,1834
Frame=45 Station=0 OutputCase=STR076 CaseType=Combination P=-35,148391901136 V2=1,44218398442725 V3=0 T=0 M2=0 M3=1,65902787099093 FrameElem=45-1
ElemStation=0
Frame=45 Station=0,0917 OutputCase=STR076 CaseType=Combination P=-35,148391901136 V2=1,80898398442725 V3=0 T=0 M2=0 M3=1,50996181961895 FrameElem=45-1
ElemStation=0,0917
Frame=45 Station=0,1834 OutputCase=STR076 CaseType=Combination P=-35,148391901136 V2=2,17578398442725 V3=0 T=0 M2=0 M3=1,32726020824697 FrameElem=45-1
ElemStation=0,1834
Frame=45 Station=0 OutputCase=STR077 CaseType=Combination P=-15,6244113505618 V2=2,70336947475431 V3=0 T=0 M2=0 M3=-3,4882055647049 FrameElem=45-1
ElemStation=0
Frame=45 Station=0,0917 OutputCase=STR077 CaseType=Combination P=-15,6244113505618 V2=3,19854947475431 V3=0 T=0 M2=0 M3=-3,75880854853987
FrameElem=45-1 ElemStation=0,0917
Frame=45 Station=0,1834 OutputCase=STR077 CaseType=Combination P=-15,6244113505618 V2=3,69372947475431 V3=0 T=0 M2=0 M3=-4,07481953837484
FrameElem=45-1 ElemStation=0,1834
Frame=45 Station=0 OutputCase=STR078 CaseType=Combination P=-7,8687034823499 V2=2,70239883782129 V3=0 T=0 M2=0 M3=-4,42639937955058 FrameElem=45-1
ElemStation=0
Frame=45 Station=0,0917 OutputCase=STR078 CaseType=Combination P=-7,8687034823499 V2=3,19757883782129 V3=0 T=0 M2=0 M3=-4,69691335597879 FrameElem=45-1
ElemStation=0,0917
Frame=45 Station=0,1834 OutputCase=STR078 CaseType=Combination P=-7,8687034823499 V2=3,69275883782129 V3=0 T=0 M2=0 M3=-5,01283533840701 FrameElem=45-1
ElemStation=0,1834
Frame=45 Station=0 OutputCase=STR079 CaseType=Combination P=-6,41993683768189 V2=13,2081184693919 V3=0 T=0 M2=0 M3=-30,1225701934434 FrameElem=45-1
ElemStation=0
Frame=45 Station=0,0917 OutputCase=STR079 CaseType=Combination P=-6,41993683768189 V2=13,7032984693919 V3=0 T=0 M2=0 M3=-31,3564586600866
FrameElem=45-1 ElemStation=0,0917
Frame=45 Station=0,1834 OutputCase=STR079 CaseType=Combination P=-6,41993683768189 V2=14,1984784693919 V3=0 T=0 M2=0 M3=-32,6357551327298
FrameElem=45-1 ElemStation=0,1834
Frame=45 Station=0 OutputCase=STR080 CaseType=Combination P=-22,7187122805345 V2=45,8135169948011 V3=0 T=0 M2=0 M3=-21,840783583151 FrameElem=45-1
ElemStation=0
Frame=45 Station=0,0917 OutputCase=STR080 CaseType=Combination P=-22,7187122805345 V2=46,3086969948011 V3=0 T=0 M2=0 M3=-26,0645870945742
FrameElem=45-1 ElemStation=0,0917
Frame=45 Station=0,1834 OutputCase=STR080 CaseType=Combination P=-22,7187122805345 V2=46,8038769948011 V3=0 T=0 M2=0 M3=-30,3337986119975
FrameElem=45-1 ElemStation=0,1834
Frame=45 Station=0 OutputCase=STR081 CaseType=Combination P=-39,0174877209425 V2=13,212882491546 V3=0 T=0 M2=0 M3=-25,5177834309771 FrameElem=45-1
ElemStation=0
Frame=45 Station=0,0917 OutputCase=STR081 CaseType=Combination P=-39,0174877209425 V2=13,708062491546 V3=0 T=0 M2=0 M3=-26,7521087584518 FrameElem=45-1
ElemStation=0,0917
Frame=45 Station=0,1834 OutputCase=STR081 CaseType=Combination P=-39,0174877209425 V2=14,203242491546 V3=0 T=0 M2=0 M3=-28,0318420919266 FrameElem=45-1
ElemStation=0,1834

Società di Progetto
Brebemi SpA



Doc. N.
60235-0000-A00.doc

CODIFICA DOCUMENTO
04RCDII10000000000300A00

REV.
00

FOGLIO
571 di 628

Frame=45 Station=0 OutputCase=STR082 CaseType=Combination P=-23,8178179452514 V2=34,500650744859 V3=0 T=0 M2=0 M3=5,17978051014772 FrameElem=45-1 ElemStation=0
Frame=45 Station=0,0917 OutputCase=STR082 CaseType=Combination P=-23,8178179452514 V2=34,8668650744859 V3=0 T=0 M2=0 M3=1,99930676281736 FrameElem=45-1 ElemStation=0,0917
Frame=45 Station=0,1834 OutputCase=STR082 CaseType=Combination P=-23,8178179452514 V2=35,2336650744859 V3=0 T=0 M2=0 M3=-1,214802544513 FrameElem=45-1 ElemStation=0,1834
Frame=45 Station=0 OutputCase=STR083 CaseType=Combination P=-40,1165933856594 V2=1,89943057123084 V3=0 T=0 M2=0 M3=1,50278066232166 FrameElem=45-1 ElemStation=0
Frame=45 Station=0,0917 OutputCase=STR083 CaseType=Combination P=-40,1165933856594 V2=2,26623057123084 V3=0 T=0 M2=0 M3=1,31178509893979 FrameElem=45-1 ElemStation=0,0917
Frame=45 Station=0,1834 OutputCase=STR083 CaseType=Combination P=-40,1165933856594 V2=2,63303057123084 V3=0 T=0 M2=0 M3=1,08715397555793 FrameElem=45-1 ElemStation=0,1834
Frame=45 Station=0 OutputCase=STR084 CaseType=Combination P=-19,9375282882363 V2=68,085936642703 V3=0 T=0 M2=0 M3=-11,318875454378 FrameElem=45-1 ElemStation=0
Frame=45 Station=0,0917 OutputCase=STR084 CaseType=Combination P=-19,9375282882363 V2=68,581116642703 V3=0 T=0 M2=0 M3=-17,5850598475138 FrameElem=45-1 ElemStation=0,0917
Frame=45 Station=0,1834 OutputCase=STR084 CaseType=Combination P=-19,9375282882363 V2=69,076296642703 V3=0 T=0 M2=0 M3=-23,8966522466497 FrameElem=45-1 ElemStation=0,1834
Frame=45 Station=0 OutputCase=STR085 CaseType=Combination P=-6,8965643352022 V2=10,8104682018031 V3=0 T=0 M2=0 M3=-23,6255300192121 FrameElem=45-1 ElemStation=0
Frame=45 Station=0,0917 OutputCase=STR085 CaseType=Combination P=-6,8965643352022 V2=11,3056482018031 V3=0 T=0 M2=0 M3=-24,6395539563175 FrameElem=45-1 ElemStation=0,0917
Frame=45 Station=0,1834 OutputCase=STR085 CaseType=Combination P=-6,8965643352022 V2=11,8008282018031 V3=0 T=0 M2=0 M3=-25,6989858994228 FrameElem=45-1 ElemStation=0,1834
Frame=45 Station=0 OutputCase=STR086 CaseType=Combination P=-20,0901094008594 V2=36,5627593406795 V3=0 T=0 M2=0 M3=-17,0588404587726 FrameElem=45-1 ElemStation=0
Frame=45 Station=0,0917 OutputCase=STR086 CaseType=Combination P=-20,0901094008594 V2=37,0579393406795 V3=0 T=0 M2=0 M3=-20,4343494933129 FrameElem=45-1 ElemStation=0,0917
Frame=45 Station=0,1834 OutputCase=STR086 CaseType=Combination P=-20,0901094008594 V2=37,5531193406795 V3=0 T=0 M2=0 M3=-23,8552665338532 FrameElem=45-1 ElemStation=0,1834
Frame=45 Station=0 OutputCase=STR087 CaseType=Combination P=-33,2836544647006 V2=10,814283877652 V3=0 T=0 M2=0 M3=-19,937391493651 FrameElem=45-1 ElemStation=0
Frame=45 Station=0,0917 OutputCase=STR087 CaseType=Combination P=-33,2836544647006 V2=11,309463877652 V3=0 T=0 M2=0 M3=-20,9517653282317 FrameElem=45-1 ElemStation=0,0917
Frame=45 Station=0,1834 OutputCase=STR087 CaseType=Combination P=-33,2836544647006 V2=11,804643877652 V3=0 T=0 M2=0 M3=-22,0115471688124 FrameElem=45-1 ElemStation=0,1834
Frame=45 Station=0 OutputCase=STR088 CaseType=Combination P=-20,8651686831938 V2=27,9519972083584 V3=0 T=0 M2=0 M3=3,5620134213056 FrameElem=45-1 ElemStation=0
Frame=45 Station=0,0917 OutputCase=STR088 CaseType=Combination P=-20,8651686831938 V2=28,3187972083584 V3=0 T=0 M2=0 M3=0,981997497299135 FrameElem=45-1 ElemStation=0,0917
Frame=45 Station=0,1834 OutputCase=STR088 CaseType=Combination P=-20,8651686831938 V2=28,6855972083584 V3=0 T=0 M2=0 M3=-1,63165398670733 FrameElem=45-1 ElemStation=0,1834
Frame=45 Station=0 OutputCase=STR089 CaseType=Combination P=-34,0587137470349 V2=2,20352174533078 V3=0 T=0 M2=0 M3=0,683462386427204 FrameElem=45-1 ElemStation=0
Frame=45 Station=0,0917 OutputCase=STR089 CaseType=Combination P=-34,0587137470349 V2=2,57032174533078 V3=0 T=0 M2=0 M3=0,464581662380371 FrameElem=45-1 ElemStation=0,0917
Frame=45 Station=0,1834 OutputCase=STR089 CaseType=Combination P=-34,0587137470349 V2=2,93712174533078 V3=0 T=0 M2=0 M3=0,212065378333538 FrameElem=45-1 ElemStation=0,1834
Frame=45 Station=0 OutputCase=STR090 CaseType=Combination P=-15,0727327473323 V2=2,70289658471324 V3=0 T=0 M2=0 M3=3,94528945986384 FrameElem=45-1 ElemStation=0
Frame=45 Station=0,0917 OutputCase=STR090 CaseType=Combination P=-15,0727327473323 V2=3,19807658471325 V3=0 T=0 M2=0 M3=-4,21584907968204 FrameElem=45-1 ElemStation=0,0917
Frame=45 Station=0,1834 OutputCase=STR090 CaseType=Combination P=-15,0727327473323 V2=3,69325658471325 V3=0 T=0 M2=0 M3=-4,53181670550025 FrameElem=45-1 ElemStation=0,1834
Frame=45 Station=0 OutputCase=STR091 CaseType=Combination P=-7,31702937912035 V2=2,70192594778023 V3=0 T=0 M2=0 M3=4,88348327470951 FrameElem=45-1 ElemStation=0
Frame=45 Station=0,0917 OutputCase=STR091 CaseType=Combination P=-7,31702937912035 V2=3,19710594778023 V3=0 T=0 M2=0 M3=-5,15395388712096 FrameElem=45-1 ElemStation=0,0917
Frame=45 Station=0,1834 OutputCase=STR091 CaseType=Combination P=-7,31702937912035 V2=3,69228594778023 V3=0 T=0 M2=0 M3=-5,46983250553241 FrameElem=45-1 ElemStation=0,1834
Frame=45 Station=0 OutputCase=STR092 CaseType=Combination P=-6,34489023197266 V2=10,8099953117621 V3=0 T=0 M2=0 M3=-24,0826139143711 FrameElem=45-1 ElemStation=0
Frame=45 Station=0,0917 OutputCase=STR092 CaseType=Combination P=-6,34489023197266 V2=11,3051753117621 V3=0 T=0 M2=0 M3=-25,0965944874597 FrameElem=45-1 ElemStation=0,0917
Frame=45 Station=0,1834 OutputCase=STR092 CaseType=Combination P=-6,34489023197266 V2=11,8003553117621 V3=0 T=0 M2=0 M3=-26,1559830665482 FrameElem=45-1 ElemStation=0,1834
Frame=45 Station=0 OutputCase=STR093 CaseType=Combination P=-19,5384352976299 V2=36,5622864506385 V3=0 T=0 M2=0 M3=-17,5159243539315 FrameElem=45-1 ElemStation=0
Frame=45 Station=0,0917 OutputCase=STR093 CaseType=Combination P=-19,5384352976299 V2=37,0574664506385 V3=0 T=0 M2=0 M3=-20,8913900244551 FrameElem=45-1 ElemStation=0,0917
Frame=45 Station=0,1834 OutputCase=STR093 CaseType=Combination P=-19,5384352976299 V2=37,5526464506385 V3=0 T=0 M2=0 M3=-24,3122637009786 FrameElem=45-1 ElemStation=0,1834
Frame=45 Station=0 OutputCase=STR094 CaseType=Combination P=-32,731980361471 V2=10,8138109876109 V3=0 T=0 M2=0 M3=-20,3944753888099 FrameElem=45-1 ElemStation=0
Frame=45 Station=0,0917 OutputCase=STR094 CaseType=Combination P=-32,731980361471 V2=11,3089909876109 V3=0 T=0 M2=0 M3=-21,4088058593738 FrameElem=45-1 ElemStation=0,0917
Frame=45 Station=0,1834 OutputCase=STR094 CaseType=Combination P=-32,731980361471 V2=11,8041709876109 V3=0 T=0 M2=0 M3=-22,4685443359378 FrameElem=45-1 ElemStation=0,1834
Frame=45 Station=0 OutputCase=STR095 CaseType=Combination P=-20,3134945799642 V2=27,9515243183173 V3=0 T=0 M2=0 M3=3,10492952614666 FrameElem=45-1 ElemStation=0
Frame=45 Station=0,0917 OutputCase=STR095 CaseType=Combination P=-20,3134945799642 V2=28,3183243183173 V3=0 T=0 M2=0 M3=0,524956966156967 FrameElem=45-1 ElemStation=0,0917
Frame=45 Station=0,1834 OutputCase=STR095 CaseType=Combination P=-20,3134945799642 V2=28,6851243183173 V3=0 T=0 M2=0 M3=2,08865118383273 FrameElem=45-1 ElemStation=0,1834
Frame=45 Station=0 OutputCase=STR096 CaseType=Combination P=-33,5070396438054 V2=2,20304885528972 V3=0 T=0 M2=0 M3=0,226378491268271 FrameElem=45-1 ElemStation=0
Frame=45 Station=0,0917 OutputCase=STR096 CaseType=Combination P=-33,5070396438054 V2=2,56984885528971 V3=0 T=0 M2=0 M3=7,54113123820363E-03 FrameElem=45-1 ElemStation=0,0917

Società di Progetto
Brebemi SpA



Doc. N.
60235-0000-A00.doc

CODIFICA DOCUMENTO
04RCDII10000000000300A00

REV.
00

FOGLIO
572 di 628

Frame=45 Station=0,1834 OutputCase=STR096 CaseType=Combination P=-33,5070396438054 V2=2,93664885528972 V3=0 T=0 M2=0 M3=-0,244931788791864
FrameElem=45-1 ElemStation=0,1834
Frame=45 Station=0 OutputCase=STR097 CaseType=Combination P=-16,1760854537913 V2=2,70384236479537 V3=0 T=0 M2=0 M3=-3,03112166954597 FrameElem=45-1
ElemStation=0
Frame=45 Station=0,0917 OutputCase=STR097 CaseType=Combination P=-16,1760854537913 V2=3,19902236479537 V3=0 T=0 M2=0 M3=-3,30176801739771
FrameElem=45-1 ElemStation=0,0917
Frame=45 Station=0,1834 OutputCase=STR097 CaseType=Combination P=-16,1760854537913 V2=3,69420236479537 V3=0 T=0 M2=0 M3=-3,61782237124944
FrameElem=45-1 ElemStation=0,1834
Frame=45 Station=0 OutputCase=STR098 CaseType=Combination P=-8,42037758557944 V2=2,70287172786236 V3=0 T=0 M2=0 M3=-3,96931548439165 FrameElem=45-1
ElemStation=0
Frame=45 Station=0,0917 OutputCase=STR098 CaseType=Combination P=-8,42037758557944 V2=3,19805172786236 V3=0 T=0 M2=0 M3=-4,23987282483663
FrameElem=45-1 ElemStation=0,0917
Frame=45 Station=0,1834 OutputCase=STR098 CaseType=Combination P=-8,42037758557944 V2=3,69323172786236 V3=0 T=0 M2=0 M3=-4,5558381712816 FrameElem=45-1
ElemStation=0,1834
Frame=45 Station=0 OutputCase=STR099 CaseType=Combination P=-7,44823843843175 V2=10,8109410918442 V3=0 T=0 M2=0 M3=-23,1684461240532 FrameElem=45-1
ElemStation=0
Frame=45 Station=0,0917 OutputCase=STR099 CaseType=Combination P=-7,44823843843175 V2=11,3061210918442 V3=0 T=0 M2=0 M3=-24,1825134251753
FrameElem=45-1 ElemStation=0,0917
Frame=45 Station=0,1834 OutputCase=STR099 CaseType=Combination P=-7,44823843843175 V2=11,8013010918442 V3=0 T=0 M2=0 M3=-25,2419887322974
FrameElem=45-1 ElemStation=0,1834
Frame=45 Station=0 OutputCase=STR100 CaseType=Combination P=-20,641783504089 V2=36,5632322307206 V3=0 T=0 M2=0 M3=-16,6017565636137 FrameElem=45-1
ElemStation=0
Frame=45 Station=0,0917 OutputCase=STR100 CaseType=Combination P=-20,641783504089 V2=37,0584122307206 V3=0 T=0 M2=0 M3=-19,9773089621707 FrameElem=45-1
ElemStation=0,0917
Frame=45 Station=0,1834 OutputCase=STR100 CaseType=Combination P=-20,641783504089 V2=37,5535922307206 V3=0 T=0 M2=0 M3=-23,3982693667278 FrameElem=45-1
ElemStation=0,1834
Frame=45 Station=0 OutputCase=STR101 CaseType=Combination P=-33,8353285679301 V2=10,814756767693 V3=0 T=0 M2=0 M3=-19,480307598492 FrameElem=45-1
ElemStation=0
Frame=45 Station=0,0917 OutputCase=STR101 CaseType=Combination P=-33,8353285679301 V2=11,309936767693 V3=0 T=0 M2=0 M3=-20,4947247970895 FrameElem=45-1
ElemStation=0,0917
Frame=45 Station=0,1834 OutputCase=STR101 CaseType=Combination P=-33,8353285679301 V2=11,805116767693 V3=0 T=0 M2=0 M3=-21,554550001687 FrameElem=45-1
ElemStation=0,1834
Frame=45 Station=0 OutputCase=STR102 CaseType=Combination P=-21,4168427864233 V2=27,9524700983994 V3=0 T=0 M2=0 M3=4,01909731646453 FrameElem=45-1
ElemStation=0
Frame=45 Station=0,0917 OutputCase=STR102 CaseType=Combination P=-21,4168427864233 V2=28,3192700983994 V3=0 T=0 M2=0 M3=1,4390380284413 FrameElem=45-1
ElemStation=0,0917
Frame=45 Station=0,1834 OutputCase=STR102 CaseType=Combination P=-21,4168427864233 V2=28,6860700983994 V3=0 T=0 M2=0 M3=-1,17465681958193
FrameElem=45-1 ElemStation=0,1834
Frame=45 Station=0 OutputCase=STR103 CaseType=Combination P=-34,6103878502645 V2=2,20399463537184 V3=0 T=0 M2=0 M3=1,14054628158614 FrameElem=45-1
ElemStation=0
Frame=45 Station=0,0917 OutputCase=STR103 CaseType=Combination P=-34,6103878502645 V2=2,57079463537184 V3=0 T=0 M2=0 M3=0,921622193522539
FrameElem=45-1 ElemStation=0,0917
Frame=45 Station=0,1834 OutputCase=STR103 CaseType=Combination P=-34,6103878502645 V2=2,93759463537184 V3=0 T=0 M2=0 M3=0,66906254545894 FrameElem=45-1
ElemStation=0,1834
Frame=45 Station=0 OutputCase=STR104 CaseType=Combination P=-16,1760854537913 V2=2,70384236479537 V3=0 T=0 M2=0 M3=-3,03112166954597 FrameElem=45-1
ElemStation=0
Frame=45 Station=0,0917 OutputCase=STR104 CaseType=Combination P=-16,1760854537913 V2=3,19902236479537 V3=0 T=0 M2=0 M3=-3,30176801739771
FrameElem=45-1 ElemStation=0,0917
Frame=45 Station=0,1834 OutputCase=STR104 CaseType=Combination P=-16,1760854537913 V2=3,69420236479537 V3=0 T=0 M2=0 M3=-3,61782237124944
FrameElem=45-1 ElemStation=0,1834
Frame=45 Station=0 OutputCase=STR105 CaseType=Combination P=-8,42037758557944 V2=2,70287172786236 V3=0 T=0 M2=0 M3=-3,96931548439165 FrameElem=45-1
ElemStation=0
Frame=45 Station=0,0917 OutputCase=STR105 CaseType=Combination P=-8,42037758557944 V2=3,19805172786236 V3=0 T=0 M2=0 M3=-4,23987282483663
FrameElem=45-1 ElemStation=0,0917
Frame=45 Station=0,1834 OutputCase=STR105 CaseType=Combination P=-8,42037758557944 V2=3,69323172786236 V3=0 T=0 M2=0 M3=-4,5558381712816 FrameElem=45-1
ElemStation=0,1834
Frame=45 Station=0 OutputCase=STR106 CaseType=Combination P=-7,44823843843175 V2=10,8109410918442 V3=0 T=0 M2=0 M3=-23,1684461240532 FrameElem=45-1
ElemStation=0
Frame=45 Station=0,0917 OutputCase=STR106 CaseType=Combination P=-7,44823843843175 V2=11,3061210918442 V3=0 T=0 M2=0 M3=-24,1825134251753
FrameElem=45-1 ElemStation=0,0917
Frame=45 Station=0,1834 OutputCase=STR106 CaseType=Combination P=-7,44823843843175 V2=11,8013010918442 V3=0 T=0 M2=0 M3=-25,2419887322974
FrameElem=45-1 ElemStation=0,1834
Frame=45 Station=0 OutputCase=STR107 CaseType=Combination P=-20,641783504089 V2=36,5632322307206 V3=0 T=0 M2=0 M3=-16,6017565636137 FrameElem=45-1
ElemStation=0
Frame=45 Station=0,0917 OutputCase=STR107 CaseType=Combination P=-20,641783504089 V2=37,0584122307206 V3=0 T=0 M2=0 M3=-19,9773089621707 FrameElem=45-1
ElemStation=0,0917
Frame=45 Station=0,1834 OutputCase=STR107 CaseType=Combination P=-20,641783504089 V2=37,5535922307206 V3=0 T=0 M2=0 M3=-23,3982693667278 FrameElem=45-1
ElemStation=0,1834
Frame=45 Station=0 OutputCase=STR108 CaseType=Combination P=-33,8353285679301 V2=10,814756767693 V3=0 T=0 M2=0 M3=-19,480307598492 FrameElem=45-1
ElemStation=0
Frame=45 Station=0,0917 OutputCase=STR108 CaseType=Combination P=-33,8353285679301 V2=11,309936767693 V3=0 T=0 M2=0 M3=-20,4947247970895 FrameElem=45-1
ElemStation=0,0917
Frame=45 Station=0,1834 OutputCase=STR108 CaseType=Combination P=-33,8353285679301 V2=11,805116767693 V3=0 T=0 M2=0 M3=-21,554550001687 FrameElem=45-1
ElemStation=0,1834
Frame=45 Station=0 OutputCase=STR109 CaseType=Combination P=-21,4168427864233 V2=27,9524700983994 V3=0 T=0 M2=0 M3=4,01909731646453 FrameElem=45-1
ElemStation=0
Frame=45 Station=0,0917 OutputCase=STR109 CaseType=Combination P=-21,4168427864233 V2=28,3192700983994 V3=0 T=0 M2=0 M3=1,4390380284413 FrameElem=45-1
ElemStation=0,0917
Frame=45 Station=0,1834 OutputCase=STR109 CaseType=Combination P=-21,4168427864233 V2=28,6860700983994 V3=0 T=0 M2=0 M3=-1,17465681958193
FrameElem=45-1 ElemStation=0,1834
Frame=45 Station=0 OutputCase=STR110 CaseType=Combination P=-34,6103878502645 V2=2,20399463537184 V3=0 T=0 M2=0 M3=1,14054628158614 FrameElem=45-1
ElemStation=0
Frame=45 Station=0,0917 OutputCase=STR110 CaseType=Combination P=-34,6103878502645 V2=2,57079463537184 V3=0 T=0 M2=0 M3=0,921622193522539
FrameElem=45-1 ElemStation=0,0917
Frame=45 Station=0,1834 OutputCase=STR110 CaseType=Combination P=-34,6103878502645 V2=2,93759463537184 V3=0 T=0 M2=0 M3=0,66906254545894 FrameElem=45-1
ElemStation=0,1834
Frame=45 Station=0 OutputCase=STR111 CaseType=Combination P=-14,8615057748731 V2=1,17817187272825 V3=0 T=0 M2=0 M3=-3,97485536975842 FrameElem=45-1
ElemStation=0

Società di Progetto
Brebemi SpA

	Doc. N. 60235-0000-A00.doc	CODIFICA DOCUMENTO 04RCDII10000000000300A00	REV. 00	FOGLIO 573 di 628
--	-------------------------------	--	------------	----------------------

Frame=45 Station=0,0917 OutputCase=STR111 CaseType=Combination P=-14,8615057748731 V2=1,67335187272825 V3=0 T=0 M2=0 M3=-4,1055977334876 FrameElem=45-1 ElemStation=0,0917

Frame=45 Station=0,1834 OutputCase=STR111 CaseType=Combination P=-14,8615057748731 V2=2,16853187272825 V3=0 T=0 M2=0 M3=-4,28174810321678 FrameElem=45-1 ElemStation=0,1834

Frame=45 Station=0 OutputCase=STR112 CaseType=Combination P=-7,10579790666116 V2=1,17720123579524 V3=0 T=0 M2=0 M3=-4,9130491846041 FrameElem=45-1 ElemStation=0

Frame=45 Station=0,0917 OutputCase=STR112 CaseType=Combination P=-7,10579790666116 V2=1,67238123579524 V3=0 T=0 M2=0 M3=-5,04370254092652 FrameElem=45-1 ElemStation=0,0917

Frame=45 Station=0,1834 OutputCase=STR112 CaseType=Combination P=-7,10579790666116 V2=2,16756123579524 V3=0 T=0 M2=0 M3=-5,21976390324895 FrameElem=45-1 ElemStation=0,1834

Frame=45 Station=0 OutputCase=STR113 CaseType=Combination P=-5,96219349226865 V2=12,2929999081762 V3=0 T=0 M2=0 M3=-30,4145600764755 FrameElem=45-1 ElemStation=0

Frame=45 Station=0,0917 OutputCase=STR113 CaseType=Combination P=-5,96219349226865 V2=12,7881799081763 V3=0 T=0 M2=0 M3=-31,5645321710552 FrameElem=45-1 ElemStation=0,0917

Frame=45 Station=0,1834 OutputCase=STR113 CaseType=Combination P=-5,96219349226865 V2=13,2833599081762 V3=0 T=0 M2=0 M3=-32,759912271635 FrameElem=45-1 ElemStation=0,1834

Frame=45 Station=0 OutputCase=STR114 CaseType=Combination P=-22,2609689351213 V2=44,8983984335854 V3=0 T=0 M2=0 M3=-22,1327734661831 FrameElem=45-1 ElemStation=0

Frame=45 Station=0,0917 OutputCase=STR114 CaseType=Combination P=-22,2609689351213 V2=45,3935784335854 V3=0 T=0 M2=0 M3=-26,2726606055429 FrameElem=45-1 ElemStation=0,0917

Frame=45 Station=0,1834 OutputCase=STR114 CaseType=Combination P=-22,2609689351213 V2=45,8887584335854 V3=0 T=0 M2=0 M3=-30,4579557509027 FrameElem=45-1 ElemStation=0,1834

Frame=45 Station=0 OutputCase=STR115 CaseType=Combination P=-38,5597443755292 V2=12,2977639303303 V3=0 T=0 M2=0 M3=-25,8097733140092 FrameElem=45-1 ElemStation=0

Frame=45 Station=0,0917 OutputCase=STR115 CaseType=Combination P=-38,5597443755292 V2=12,7929439303303 V3=0 T=0 M2=0 M3=-26,9601822694205 FrameElem=45-1 ElemStation=0,0917

Frame=45 Station=0,1834 OutputCase=STR115 CaseType=Combination P=-38,5597443755292 V2=13,2881239303303 V3=0 T=0 M2=0 M3=-28,1559992308317 FrameElem=45-1 ElemStation=0,1834

Frame=45 Station=0 OutputCase=STR116 CaseType=Combination P=-23,3600745998382 V2=33,5849465132703 V3=0 T=0 M2=0 M3=4,88779062711561 FrameElem=45-1 ElemStation=0

Frame=45 Station=0,0917 OutputCase=STR116 CaseType=Combination P=-23,3600745998382 V2=33,9517465132703 V3=0 T=0 M2=0 M3=1,79123325184872 FrameElem=45-1 ElemStation=0,0917

Frame=45 Station=0,1834 OutputCase=STR116 CaseType=Combination P=-23,3600745998382 V2=34,3185465132703 V3=0 T=0 M2=0 M3=-1,33895968341816 FrameElem=45-1 ElemStation=0,1834

Frame=45 Station=0 OutputCase=STR117 CaseType=Combination P=-39,6588500402461 V2=0,984312010015203 V3=0 T=0 M2=0 M3=1,21079077928955 FrameElem=45-1 ElemStation=0

Frame=45 Station=0,0917 OutputCase=STR117 CaseType=Combination P=-39,6588500402461 V2=1,3511120100152 V3=0 T=0 M2=0 M3=1,10371158797116 FrameElem=45-1 ElemStation=0,0917

Frame=45 Station=0,1834 OutputCase=STR117 CaseType=Combination P=-39,6588500402461 V2=1,7179120100152 V3=0 T=0 M2=0 M3=0,962996836652763 FrameElem=45-1 ElemStation=0,1834

Frame=45 Station=0 OutputCase=STR118 CaseType=Combination P=-19,479784942823 V2=67,1708180814874 V3=0 T=0 M2=0 M3=-11,6108653374101 FrameElem=45-1 ElemStation=0

Frame=45 Station=0,0917 OutputCase=STR118 CaseType=Combination P=-19,479784942823 V2=67,6659980814874 V3=0 T=0 M2=0 M3=-17,7931333584825 FrameElem=45-1 ElemStation=0,0917

Frame=45 Station=0,1834 OutputCase=STR118 CaseType=Combination P=-19,479784942823 V2=68,1611780814874 V3=0 T=0 M2=0 M3=-24,0208093855549 FrameElem=45-1 ElemStation=0,1834

Frame=45 Station=0 OutputCase=STR119 CaseType=Combination P=-6,13365875951347 V2=9,28527059977709 V3=0 T=0 M2=0 M3=-24,1121798242657 FrameElem=45-1 ElemStation=0

Frame=45 Station=0,0917 OutputCase=STR119 CaseType=Combination P=-6,13365875951347 V2=9,78045059977709 V3=0 T=0 M2=0 M3=-24,9863431412652 FrameElem=45-1 ElemStation=0,0917

Frame=45 Station=0,1834 OutputCase=STR119 CaseType=Combination P=-6,13365875951347 V2=10,2756305997771 V3=0 T=0 M2=0 M3=-25,9059144642648 FrameElem=45-1 ElemStation=0,1834

Frame=45 Station=0 OutputCase=STR120 CaseType=Combination P=-19,3272038251707 V2=35,0375617386535 V3=0 T=0 M2=0 M3=-17,5454902638261 FrameElem=45-1 ElemStation=0

Frame=45 Station=0,0917 OutputCase=STR120 CaseType=Combination P=-19,3272038251707 V2=35,5327417386535 V3=0 T=0 M2=0 M3=-20,7811386782606 FrameElem=45-1 ElemStation=0,0917

Frame=45 Station=0,1834 OutputCase=STR120 CaseType=Combination P=-19,3272038251707 V2=36,0279217386535 V3=0 T=0 M2=0 M3=-24,0621950986952 FrameElem=45-1 ElemStation=0,1834

Frame=45 Station=0 OutputCase=STR121 CaseType=Combination P=-32,5207488890119 V2=9,2890862756259 V3=0 T=0 M2=0 M3=-20,4240412987045 FrameElem=45-1 ElemStation=0

Frame=45 Station=0,0917 OutputCase=STR121 CaseType=Combination P=-32,5207488890119 V2=9,7842662756259 V3=0 T=0 M2=0 M3=-21,2985545131794 FrameElem=45-1 ElemStation=0,0917

Frame=45 Station=0,1834 OutputCase=STR121 CaseType=Combination P=-32,5207488890119 V2=10,2794462756259 V3=0 T=0 M2=0 M3=-22,2184757336543 FrameElem=45-1 ElemStation=0,1834

Frame=45 Station=0 OutputCase=STR122 CaseType=Combination P=-20,1022631075051 V2=26,4267996063323 V3=0 T=0 M2=0 M3=3,07536361625208 FrameElem=45-1 ElemStation=0

Frame=45 Station=0,0917 OutputCase=STR122 CaseType=Combination P=-20,1022631075051 V2=26,7935996063323 V3=0 T=0 M2=0 M3=0,635208312351406 FrameElem=45-1 ElemStation=0,0917

Frame=45 Station=0,1834 OutputCase=STR122 CaseType=Combination P=-20,1022631075051 V2=27,1603996063323 V3=0 T=0 M2=0 M3=-1,83858255154927 FrameElem=45-1 ElemStation=0,1834

Frame=45 Station=0 OutputCase=STR123 CaseType=Combination P=-33,2958081713462 V2=0,678324143304724 V3=0 T=0 M2=0 M3=0,196812581373686 FrameElem=45-1 ElemStation=0

Frame=45 Station=0,0917 OutputCase=STR123 CaseType=Combination P=-33,2958081713462 V2=1,04512414330472 V3=0 T=0 M2=0 M3=0,117792477432643 FrameElem=45-1 ElemStation=0,0917

Frame=45 Station=0,1834 OutputCase=STR123 CaseType=Combination P=-33,2958081713462 V2=1,41192414330472 V3=0 T=0 M2=0 M3=5,1368134915991E-03 FrameElem=45-1 ElemStation=0,1834

Frame=45 Station=0 OutputCase=STR124 CaseType=Combination P=-14,3098316716435 V2=1,17769898268719 V3=0 T=0 M2=0 M3=-4,43193926491735 FrameElem=45-1 ElemStation=0

Frame=45 Station=0,0917 OutputCase=STR124 CaseType=Combination P=-14,3098316716435 V2=1,67287898268719 V3=0 T=0 M2=0 M3=-4,56263826462977 FrameElem=45-1 ElemStation=0,0917

Frame=45 Station=0,1834 OutputCase=STR124 CaseType=Combination P=-14,3098316716435 V2=2,16805898268719 V3=0 T=0 M2=0 M3=-4,73874527034218 FrameElem=45-1 ElemStation=0,1834

Frame=45 Station=0 OutputCase=STR125 CaseType=Combination P=-6,55412380343161 V2=1,17672834575417 V3=0 T=0 M2=0 M3=-5,37013307976303 FrameElem=45-1 ElemStation=0

Frame=45 Station=0,0917 OutputCase=STR125 CaseType=Combination P=-6,55412380343161 V2=1,67190834575417 V3=0 T=0 M2=0 M3=-5,50074307206869 FrameElem=45-1 ElemStation=0,0917

Frame=45 Station=0,1834 OutputCase=STR125 CaseType=Combination P=-6,55412380343161 V2=2,16708834575417 V3=0 T=0 M2=0 M3=-5,67676107037435 FrameElem=45-1 ElemStation=0,1834

Società di Progetto
Brebemi SpA

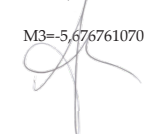



Doc. N.
60235-0000-A00.doc

CODIFICA DOCUMENTO
04RCDII10000000000300A00

REV.
00

FOGLIO
574 di 628

Frame=45 Station=0 OutputCase=STR126 CaseType=Combination P=-5,58198465628392 V2=9,28479770973602 V3=0 T=0 M2=0 M3=-24,5692637194246 FrameElem=45-1 ElemStation=0
Frame=45 Station=0,0917 OutputCase=STR126 CaseType=Combination P=-5,58198465628392 V2=9,77997770973602 V3=0 T=0 M2=0 M3=-25,4433836724074 FrameElem=45-1 ElemStation=0,0917
Frame=45 Station=0,1834 OutputCase=STR126 CaseType=Combination P=-5,58198465628392 V2=10,275157709736 V3=0 T=0 M2=0 M3=-26,3629116313902 FrameElem=45-1 ElemStation=0,1834
Frame=45 Station=0 OutputCase=STR127 CaseType=Combination P=-18,7755297219412 V2=35,0370888486124 V3=0 T=0 M2=0 M3=-18,002574158985 FrameElem=45-1 ElemStation=0
Frame=45 Station=0,0917 OutputCase=STR127 CaseType=Combination P=-18,7755297219412 V2=35,5322688486124 V3=0 T=0 M2=0 M3=-21,2381792094028 FrameElem=45-1 ElemStation=0,0917
Frame=45 Station=0,1834 OutputCase=STR127 CaseType=Combination P=-18,7755297219412 V2=36,0274488486124 V3=0 T=0 M2=0 M3=-24,5191922658206 FrameElem=45-1 ElemStation=0,1834
Frame=45 Station=0 OutputCase=STR128 CaseType=Combination P=-31,9690747857823 V2=9,28861338558484 V3=0 T=0 M2=0 M3=-20,8811251938634 FrameElem=45-1 ElemStation=0
Frame=45 Station=0,0917 OutputCase=STR128 CaseType=Combination P=-31,9690747857823 V2=9,78379338558484 V3=0 T=0 M2=0 M3=-21,7555950443216 FrameElem=45-1 ElemStation=0,0917
Frame=45 Station=0,1834 OutputCase=STR128 CaseType=Combination P=-31,9690747857823 V2=10,2789733855848 V3=0 T=0 M2=0 M3=-22,6754729007797 FrameElem=45-1 ElemStation=0,1834
Frame=45 Station=0 OutputCase=STR129 CaseType=Combination P=-19,5505890042755 V2=26,4263267162912 V3=0 T=0 M2=0 M3=2,61827972109315 FrameElem=45-1 ElemStation=0
Frame=45 Station=0,0917 OutputCase=STR129 CaseType=Combination P=-19,5505890042755 V2=26,7931267162912 V3=0 T=0 M2=0 M3=0,178167781209239 FrameElem=45-1 ElemStation=0,0917
Frame=45 Station=0,1834 OutputCase=STR129 CaseType=Combination P=-19,5505890042755 V2=27,1599267162912 V3=0 T=0 M2=0 M3=-2,29557971867467 FrameElem=45-1 ElemStation=0,1834
Frame=45 Station=0 OutputCase=STR130 CaseType=Combination P=-32,7441340681167 V2=0,67785125326366 V3=0 T=0 M2=0 M3=-0,260271313785247 FrameElem=45-1 ElemStation=0
Frame=45 Station=0,0917 OutputCase=STR130 CaseType=Combination P=-32,7441340681167 V2=1,04465125326366 V3=0 T=0 M2=0 M3=-0,339248053709525 FrameElem=45-1 ElemStation=0,0917
Frame=45 Station=0,1834 OutputCase=STR130 CaseType=Combination P=-32,7441340681167 V2=1,41145125326366 V3=0 T=0 M2=0 M3=-0,451860353633803 FrameElem=45-1 ElemStation=0,1834
Frame=45 Station=0 OutputCase=STR131 CaseType=Combination P=-15,4131798781026 V2=1,17864476276932 V3=0 T=0 M2=0 M3=-3,51777147459949 FrameElem=45-1 ElemStation=0
Frame=45 Station=0,0917 OutputCase=STR131 CaseType=Combination P=-15,4131798781026 V2=1,67382476276932 V3=0 T=0 M2=0 M3=-3,64855720234543 FrameElem=45-1 ElemStation=0,0917
Frame=45 Station=0,1834 OutputCase=STR131 CaseType=Combination P=-15,4131798781026 V2=2,16900476276932 V3=0 T=0 M2=0 M3=-3,82475093609138 FrameElem=45-1 ElemStation=0,1834
Frame=45 Station=0 OutputCase=STR132 CaseType=Combination P=-7,6574720098907 V2=1,1776741258363 V3=0 T=0 M2=0 M3=-4,45596528944517 FrameElem=45-1 ElemStation=0
Frame=45 Station=0,0917 OutputCase=STR132 CaseType=Combination P=-7,6574720098907 V2=1,6728541258363 V3=0 T=0 M2=0 M3=-4,58666200978436 FrameElem=45-1 ElemStation=0,0917
Frame=45 Station=0,1834 OutputCase=STR132 CaseType=Combination P=-7,6574720098907 V2=2,1680341258363 V3=0 T=0 M2=0 M3=-4,76276673612354 FrameElem=45-1 ElemStation=0,1834
Frame=45 Station=0 OutputCase=STR133 CaseType=Combination P=-6,68533286274301 V2=9,28574348981815 V3=0 T=0 M2=0 M3=-23,6550959291067 FrameElem=45-1 ElemStation=0
Frame=45 Station=0,0917 OutputCase=STR133 CaseType=Combination P=-6,68533286274301 V2=9,78092348981815 V3=0 T=0 M2=0 M3=-24,5293026101231 FrameElem=45-1 ElemStation=0,0917
Frame=45 Station=0,1834 OutputCase=STR133 CaseType=Combination P=-6,68533286274301 V2=10,2761034898181 V3=0 T=0 M2=0 M3=-25,4489172971394 FrameElem=45-1 ElemStation=0,1834
Frame=45 Station=0 OutputCase=STR134 CaseType=Combination P=-19,8788779284002 V2=35,0380346286945 V3=0 T=0 M2=0 M3=-17,0884063686672 FrameElem=45-1 ElemStation=0
Frame=45 Station=0,0917 OutputCase=STR134 CaseType=Combination P=-19,8788779284002 V2=35,5332146286946 V3=0 T=0 M2=0 M3=-20,3240981471185 FrameElem=45-1 ElemStation=0,0917
Frame=45 Station=0,1834 OutputCase=STR134 CaseType=Combination P=-19,8788779284002 V2=36,0283946286946 V3=0 T=0 M2=0 M3=-23,6051979315698 FrameElem=45-1 ElemStation=0,1834
Frame=45 Station=0 OutputCase=STR135 CaseType=Combination P=-33,0724229922414 V2=9,28955916566697 V3=0 T=0 M2=0 M3=-19,9669574035456 FrameElem=45-1 ElemStation=0
Frame=45 Station=0,0917 OutputCase=STR135 CaseType=Combination P=-33,0724229922414 V2=9,78473916566697 V3=0 T=0 M2=0 M3=-20,8415139820372 FrameElem=45-1 ElemStation=0,0917
Frame=45 Station=0,1834 OutputCase=STR135 CaseType=Combination P=-33,0724229922414 V2=10,2799191656667 V3=0 T=0 M2=0 M3=-21,7614785665289 FrameElem=45-1 ElemStation=0,1834
Frame=45 Station=0 OutputCase=STR136 CaseType=Combination P=-20,6539372107346 V2=26,4272724963734 V3=0 T=0 M2=0 M3=3,53244751141101 FrameElem=45-1 ElemStation=0
Frame=45 Station=0,0917 OutputCase=STR136 CaseType=Combination P=-20,6539372107346 V2=26,7940724963734 V3=0 T=0 M2=0 M3=1,09224884349357 FrameElem=45-1 ElemStation=0,0917
Frame=45 Station=0,1834 OutputCase=STR136 CaseType=Combination P=-20,6539372107346 V2=27,1608724963734 V3=0 T=0 M2=0 M3=-1,38158538442387 FrameElem=45-1 ElemStation=0,1834
Frame=45 Station=0 OutputCase=STR137 CaseType=Combination P=-33,8474822745758 V2=0,678797033345787 V3=0 T=0 M2=0 M3=0,653896476532619 FrameElem=45-1 ElemStation=0
Frame=45 Station=0,0917 OutputCase=STR137 CaseType=Combination P=-33,8474822745758 V2=1,04559703334579 V3=0 T=0 M2=0 M3=0,57483300857481 FrameElem=45-1 ElemStation=0,0917
Frame=45 Station=0,1834 OutputCase=STR137 CaseType=Combination P=-33,8474822745758 V2=1,41239703334579 V3=0 T=0 M2=0 M3=0,462133980617001 FrameElem=45-1 ElemStation=0,1834
Frame=45 Station=0 OutputCase=STR138 CaseType=Combination P=-15,4131798781026 V2=1,17864476276932 V3=0 T=0 M2=0 M3=-3,51777147459949 FrameElem=45-1 ElemStation=0
Frame=45 Station=0,0917 OutputCase=STR138 CaseType=Combination P=-15,4131798781026 V2=1,67382476276932 V3=0 T=0 M2=0 M3=-3,64855720234543 FrameElem=45-1 ElemStation=0,0917
Frame=45 Station=0,1834 OutputCase=STR138 CaseType=Combination P=-15,4131798781026 V2=2,16900476276932 V3=0 T=0 M2=0 M3=-3,82475093609138 FrameElem=45-1 ElemStation=0,1834
Frame=45 Station=0 OutputCase=STR139 CaseType=Combination P=-7,6574720098907 V2=1,1776741258363 V3=0 T=0 M2=0 M3=-4,45596528944517 FrameElem=45-1 ElemStation=0
Frame=45 Station=0,0917 OutputCase=STR139 CaseType=Combination P=-7,6574720098907 V2=1,6728541258363 V3=0 T=0 M2=0 M3=-4,58666200978436 FrameElem=45-1 ElemStation=0,0917
Frame=45 Station=0,1834 OutputCase=STR139 CaseType=Combination P=-7,6574720098907 V2=2,1680341258363 V3=0 T=0 M2=0 M3=-4,76276673612354 FrameElem=45-1 ElemStation=0,1834
Frame=45 Station=0 OutputCase=STR140 CaseType=Combination P=-6,68533286274301 V2=9,28574348981815 V3=0 T=0 M2=0 M3=-23,6550959291067 FrameElem=45-1 ElemStation=0
Frame=45 Station=0,0917 OutputCase=STR140 CaseType=Combination P=-6,68533286274301 V2=9,78092348981815 V3=0 T=0 M2=0 M3=-24,5293026101231 FrameElem=45-1 ElemStation=0,0917

Società di Progetto
Brebemi SpA



Doc. N.
60235-00000-A00.doc

CODIFICA DOCUMENTO
04RCDII10000000000300A00

REV.
00

FOGLIO
575 di 628

Frame=45 Station=0,1834 OutputCase=STR140 CaseType=Combination P=-6,68533286274301 V2=10,2761034898181 V3=0 T=0 M2=0 M3=-25,4489172971394
FrameElem=45-1 ElemStation=0,1834
Frame=45 Station=0 OutputCase=STR141 CaseType=Combination P=-19,8788779284002 V2=35,0380346286945 V3=0 T=0 M2=0 M3=-17,0884063686672 FrameElem=45-1
ElemStation=0
Frame=45 Station=0,0917 OutputCase=STR141 CaseType=Combination P=-19,8788779284002 V2=35,5332146286946 V3=0 T=0 M2=0 M3=-20,3240981471185
FrameElem=45-1 ElemStation=0,0917
Frame=45 Station=0,1834 OutputCase=STR141 CaseType=Combination P=-19,8788779284002 V2=36,0283946286946 V3=0 T=0 M2=0 M3=-23,6051979315698
FrameElem=45-1 ElemStation=0,1834
Frame=45 Station=0 OutputCase=STR142 CaseType=Combination P=-33,0724229922414 V2=9,28955916566697 V3=0 T=0 M2=0 M3=-19,9669574035456 FrameElem=45-1
ElemStation=0
Frame=45 Station=0,0917 OutputCase=STR142 CaseType=Combination P=-33,0724229922414 V2=9,78473916566697 V3=0 T=0 M2=0 M3=-20,8415139820372
FrameElem=45-1 ElemStation=0,0917
Frame=45 Station=0,1834 OutputCase=STR142 CaseType=Combination P=-33,0724229922414 V2=10,2799191656667 V3=0 T=0 M2=0 M3=-21,7614785665289 FrameElem=45-1
ElemStation=0,1834
Frame=45 Station=0 OutputCase=STR143 CaseType=Combination P=-20,6539372107346 V2=26,4272724963734 V3=0 T=0 M2=0 M3=3,53244751141101 FrameElem=45-1
ElemStation=0
Frame=45 Station=0,0917 OutputCase=STR143 CaseType=Combination P=-20,6539372107346 V2=26,7940724963734 V3=0 T=0 M2=0 M3=1,09224884349357 FrameElem=45-1
ElemStation=0,0917
Frame=45 Station=0,1834 OutputCase=STR143 CaseType=Combination P=-20,6539372107346 V2=27,1608724963734 V3=0 T=0 M2=0 M3=-1,38158538442387
FrameElem=45-1 ElemStation=0,1834
Frame=45 Station=0 OutputCase=STR144 CaseType=Combination P=-33,8474822745758 V2=0,678797033345787 V3=0 T=0 M2=0 M3=0,653896476532619 FrameElem=45-1
ElemStation=0
Frame=45 Station=0,0917 OutputCase=STR144 CaseType=Combination P=-33,8474822745758 V2=1,04559703334579 V3=0 T=0 M2=0 M3=0,57483300857481 FrameElem=45-1
ElemStation=0,0917
Frame=45 Station=0,1834 OutputCase=STR144 CaseType=Combination P=-33,8474822745758 V2=1,41239703334579 V3=0 T=0 M2=0 M3=0,462133980617001
FrameElem=45-1 ElemStation=0,1834
Frame=45 Station=0 OutputCase=STR145 CaseType=Combination P=-16,1624154014333 V2=1,94155882380972 V3=0 T=0 M2=0 M3=-2,96972397530011 FrameElem=45-1
ElemStation=0
Frame=45 Station=0,0917 OutputCase=STR145 CaseType=Combination P=-16,1624154014333 V2=2,43673882380972 V3=0 T=0 M2=0 M3=-3,17046892244346
FrameElem=45-1 ElemStation=0,0917
Frame=45 Station=0,1834 OutputCase=STR145 CaseType=Combination P=-16,1624154014333 V2=2,93191882380972 V3=0 T=0 M2=0 M3=-3,41662187558681
FrameElem=45-1 ElemStation=0,1834
Frame=45 Station=0 OutputCase=STR146 CaseType=Combination P=-8,40670753322143 V2=1,9405881868767 V3=0 T=0 M2=0 M3=-3,90791779014579 FrameElem=45-1
ElemStation=0
Frame=45 Station=0,0917 OutputCase=STR146 CaseType=Combination P=-8,40670753322143 V2=2,4357681868767 V3=0 T=0 M2=0 M3=-4,10857372988238 FrameElem=45-1
ElemStation=0,0917
Frame=45 Station=0,1834 OutputCase=STR146 CaseType=Combination P=-8,40670753322143 V2=2,9309481868767 V3=0 T=0 M2=0 M3=-4,35463767561897 FrameElem=45-1
ElemStation=0,1834
Frame=45 Station=0 OutputCase=STR147 CaseType=Combination P=-6,74273926820482 V2=12,7510320788251 V3=0 T=0 M2=0 M3=-29,8114812398005 FrameElem=45-1
ElemStation=0
Frame=45 Station=0,0917 OutputCase=STR147 CaseType=Combination P=-6,74273926820482 V2=13,2462120788251 V3=0 T=0 M2=0 M3=-31,0034548844288
FrameElem=45-1 ElemStation=0,0917
Frame=45 Station=0,1834 OutputCase=STR147 CaseType=Combination P=-6,74273926820482 V2=13,7413920788251 V3=0 T=0 M2=0 M3=-32,240836535057 FrameElem=45-1
ElemStation=0,1834
Frame=45 Station=0 OutputCase=STR148 CaseType=Combination P=-23,0415147110575 V2=45,3564306042343 V3=0 T=0 M2=0 M3=-21,5296946295081 FrameElem=45-1
ElemStation=0
Frame=45 Station=0,0917 OutputCase=STR148 CaseType=Combination P=-23,0415147110575 V2=45,8516106042343 V3=0 T=0 M2=0 M3=-25,7115833189164
FrameElem=45-1 ElemStation=0,0917
Frame=45 Station=0,1834 OutputCase=STR148 CaseType=Combination P=-23,0415147110575 V2=46,3467906042343 V3=0 T=0 M2=0 M3=-29,9388800143247
FrameElem=45-1 ElemStation=0,1834
Frame=45 Station=0 OutputCase=STR149 CaseType=Combination P=-39,3402901514654 V2=12,7557961009792 V3=0 T=0 M2=0 M3=-25,2066944773342 FrameElem=45-1
ElemStation=0
Frame=45 Station=0,0917 OutputCase=STR149 CaseType=Combination P=-39,3402901514654 V2=13,2509761009792 V3=0 T=0 M2=0 M3=-26,399104982794 FrameElem=45-1
ElemStation=0,0917
Frame=45 Station=0,1834 OutputCase=STR149 CaseType=Combination P=-39,3402901514654 V2=13,7461561009792 V3=0 T=0 M2=0 M3=-27,6369234942538
FrameElem=45-1 ElemStation=0,1834
Frame=45 Station=0 OutputCase=STR150 CaseType=Combination P=-24,1406203757744 V2=34,0429786839192 V3=0 T=0 M2=0 M3=5,4908694637906 FrameElem=45-1
ElemStation=0
Frame=45 Station=0,0917 OutputCase=STR150 CaseType=Combination P=-24,1406203757744 V2=34,0497786839192 V3=0 T=0 M2=0 M3=2,35231053847521 FrameElem=45-1
ElemStation=0,0917
Frame=45 Station=0,1834 OutputCase=STR150 CaseType=Combination P=-24,1406203757744 V2=34,7765786839192 V3=0 T=0 M2=0 M3=-0,819883946840181
FrameElem=45-1 ElemStation=0,1834
Frame=45 Station=0 OutputCase=STR151 CaseType=Combination P=-40,4393958161823 V2=1,44234418066408 V3=0 T=0 M2=0 M3=1,81386961596454 FrameElem=45-1
ElemStation=0
Frame=45 Station=0,0917 OutputCase=STR151 CaseType=Combination P=-40,4393958161823 V2=1,80914418066408 V3=0 T=0 M2=0 M3=1,66478887459764 FrameElem=45-1
ElemStation=0,0917
Frame=45 Station=0,1834 OutputCase=STR151 CaseType=Combination P=-40,4393958161823 V2=2,17594418066408 V3=0 T=0 M2=0 M3=1,48207257323075 FrameElem=45-1
ElemStation=0,1834
Frame=45 Station=0 OutputCase=STR152 CaseType=Combination P=-20,2603307187592 V2=67,6288502521362 V3=0 T=0 M2=0 M3=-11,0077865007351 FrameElem=45-1
ElemStation=0
Frame=45 Station=0,0917 OutputCase=STR152 CaseType=Combination P=-20,2603307187592 V2=68,1240302521362 V3=0 T=0 M2=0 M3=-17,232056071856 FrameElem=45-1
ElemStation=0,0917
Frame=45 Station=0,1834 OutputCase=STR152 CaseType=Combination P=-20,2603307187592 V2=68,6192102521362 V3=0 T=0 M2=0 M3=-23,5017336489769
FrameElem=45-1 ElemStation=0,1834
Frame=45 Station=0 OutputCase=STR153 CaseType=Combination P=-7,43456838607374 V2=10,0486575508586 V3=0 T=0 M2=0 M3=-23,1070484298073 FrameElem=45-1
ElemStation=0
Frame=45 Station=0,0917 OutputCase=STR153 CaseType=Combination P=-7,43456838607374 V2=10,5438375508586 V3=0 T=0 M2=0 M3=-24,0512143302211
FrameElem=45-1 ElemStation=0,0917
Frame=45 Station=0,1834 OutputCase=STR153 CaseType=Combination P=-7,43456838607374 V2=11,0390175508586 V3=0 T=0 M2=0 M3=-25,0407882366348
FrameElem=45-1 ElemStation=0,1834
Frame=45 Station=0 OutputCase=STR154 CaseType=Combination P=-20,628113451731 V2=35,8009486897349 V3=0 T=0 M2=0 M3=-16,5403588693678 FrameElem=45-1
ElemStation=0
Frame=45 Station=0,0917 OutputCase=STR154 CaseType=Combination P=-20,628113451731 V2=36,296128689735 V3=0 T=0 M2=0 M3=-19,8460098672165 FrameElem=45-1
ElemStation=0,0917
Frame=45 Station=0,1834 OutputCase=STR154 CaseType=Combination P=-20,628113451731 V2=36,791308689735 V3=0 T=0 M2=0 M3=-23,1970688710652 FrameElem=45-1
ElemStation=0,1834
Frame=45 Station=0 OutputCase=STR155 CaseType=Combination P=-33,8216585155721 V2=10,0524732267074 V3=0 T=0 M2=0 M3=-19,4189099042462 FrameElem=45-1
ElemStation=0

APPROVATO SDP
Società di Progetto
Brebemi SpA



Doc. N.
60235-0000-A00.doc

CODIFICA DOCUMENTO
04RCDII10000000000300A00

REV.
00

FOGLIO
576 di 628

Frame=45 Station=0,0917 OutputCase=STR155 CaseType=Combination P=-33,8216585155721 V2=10,5476532267074 V3=0 T=0 M2=0 M3=-20,3634257021353
FrameElem=45-1 ElemStation=0,0917
Frame=45 Station=0,1834 OutputCase=STR155 CaseType=Combination P=-33,8216585155721 V2=11,0428332267074 V3=0 T=0 M2=0 M3=-21,3533495060243
FrameElem=45-1 ElemStation=0,1834
Frame=45 Station=0 OutputCase=STR156 CaseType=Combination P=-21,4031727340653 V2=27,1901865574138 V3=0 T=0 M2=0 M3=4,08049501071039 FrameElem=45-1
ElemStation=0
Frame=45 Station=0,0917 OutputCase=STR156 CaseType=Combination P=-21,4031727340653 V2=27,5569865574138 V3=0 T=0 M2=0 M3=1,57033712339555 FrameElem=45-1
ElemStation=0,0917
Frame=45 Station=0,1834 OutputCase=STR156 CaseType=Combination P=-21,4031727340653 V2=27,9237865574138 V3=0 T=0 M2=0 M3=-0,973456323919294
FrameElem=45-1 ElemStation=0,1834
Frame=45 Station=0 OutputCase=STR157 CaseType=Combination P=-34,5967177979065 V2=1,44171109438619 V3=0 T=0 M2=0 M3=1,201943975832 FrameElem=45-1
ElemStation=0
Frame=45 Station=0,0917 OutputCase=STR157 CaseType=Combination P=-34,5967177979065 V2=1,80851109438619 V3=0 T=0 M2=0 M3=1,05292128847679 FrameElem=45-1
ElemStation=0,0917
Frame=45 Station=0,1834 OutputCase=STR157 CaseType=Combination P=-34,5967177979065 V2=2,17531109438619 V3=0 T=0 M2=0 M3=0,870263041121572
FrameElem=45-1 ElemStation=0,1834
Frame=45 Station=0 OutputCase=STR158 CaseType=Combination P=-15,6107412982038 V2=1,94108593376866 V3=0 T=0 M2=0 M3=-3,42680787045904 FrameElem=45-1
ElemStation=0
Frame=45 Station=0,0917 OutputCase=STR158 CaseType=Combination P=-15,6107412982038 V2=2,43626593376866 V3=0 T=0 M2=0 M3=-3,62750945358563
FrameElem=45-1 ElemStation=0,0917
Frame=45 Station=0,1834 OutputCase=STR158 CaseType=Combination P=-15,6107412982038 V2=2,93144593376866 V3=0 T=0 M2=0 M3=-3,87361904271221
FrameElem=45-1 ElemStation=0,1834
Frame=45 Station=0 OutputCase=STR159 CaseType=Combination P=-7,85503342999189 V2=1,94011529683564 V3=0 T=0 M2=0 M3=-4,36500168530472 FrameElem=45-1
ElemStation=0
Frame=45 Station=0,0917 OutputCase=STR159 CaseType=Combination P=-7,85503342999189 V2=2,43529529683564 V3=0 T=0 M2=0 M3=-4,56561426102455
FrameElem=45-1 ElemStation=0,0917
Frame=45 Station=0,1834 OutputCase=STR159 CaseType=Combination P=-7,85503342999189 V2=2,93047529683564 V3=0 T=0 M2=0 M3=-4,81163484274437
FrameElem=45-1 ElemStation=0,1834
Frame=45 Station=0 OutputCase=STR160 CaseType=Combination P=-6,8828942828442 V2=10,0481846608175 V3=0 T=0 M2=0 M3=-23,5641323249663 FrameElem=45-1
ElemStation=0
Frame=45 Station=0,0917 OutputCase=STR160 CaseType=Combination P=-6,8828942828442 V2=10,5433646608175 V3=0 T=0 M2=0 M3=-24,5082548613632 FrameElem=45-1
ElemStation=0,0917
Frame=45 Station=0,1834 OutputCase=STR160 CaseType=Combination P=-6,8828942828442 V2=11,0385446608175 V3=0 T=0 M2=0 M3=-25,4977854037602 FrameElem=45-1
ElemStation=0,1834
Frame=45 Station=0 OutputCase=STR161 CaseType=Combination P=-20,0764393485014 V2=35,8004757996939 V3=0 T=0 M2=0 M3=-16,9974427645267 FrameElem=45-1
ElemStation=0
Frame=45 Station=0,0917 OutputCase=STR161 CaseType=Combination P=-20,0764393485014 V2=36,2956557996939 V3=0 T=0 M2=0 M3=-20,3030503983587
FrameElem=45-1 ElemStation=0,0917
Frame=45 Station=0,1834 OutputCase=STR161 CaseType=Combination P=-20,0764393485014 V2=36,7908357996939 V3=0 T=0 M2=0 M3=-23,6540660381906
FrameElem=45-1 ElemStation=0,1834
Frame=45 Station=0 OutputCase=STR162 CaseType=Combination P=-33,2699844123426 V2=10,0520003366663 V3=0 T=0 M2=0 M3=-19,8759937994051 FrameElem=45-1
ElemStation=0
Frame=45 Station=0,0917 OutputCase=STR162 CaseType=Combination P=-33,2699844123426 V2=10,5471803366663 V3=0 T=0 M2=0 M3=-20,8204662332774
FrameElem=45-1 ElemStation=0,0917
Frame=45 Station=0,1834 OutputCase=STR162 CaseType=Combination P=-33,2699844123426 V2=11,0423603366663 V3=0 T=0 M2=0 M3=-21,8103466731497
FrameElem=45-1 ElemStation=0,1834
Frame=45 Station=0 OutputCase=STR163 CaseType=Combination P=-20,8514986308358 V2=27,1897136673727 V3=0 T=0 M2=0 M3=3,6234111555146 FrameElem=45-1
ElemStation=0
Frame=45 Station=0,0917 OutputCase=STR163 CaseType=Combination P=-20,8514986308358 V2=27,5565136673727 V3=0 T=0 M2=0 M3=1,11329659225338 FrameElem=45-1
ElemStation=0,0917
Frame=45 Station=0,1834 OutputCase=STR163 CaseType=Combination P=-20,8514986308358 V2=27,9233136673727 V3=0 T=0 M2=0 M3=-1,4304534910447 FrameElem=45-1
ElemStation=0,1834
Frame=45 Station=0 OutputCase=STR164 CaseType=Combination P=-34,0450436946769 V2=1,44123820434513 V3=0 T=0 M2=0 M3=0,744860080673067 FrameElem=45-1
ElemStation=0
Frame=45 Station=0,0917 OutputCase=STR164 CaseType=Combination P=-34,0450436946769 V2=1,80803820434512 V3=0 T=0 M2=0 M3=0,595880757334619
FrameElem=45-1 ElemStation=0,0917
Frame=45 Station=0,1834 OutputCase=STR164 CaseType=Combination P=-34,0450436946769 V2=2,17483820434513 V3=0 T=0 M2=0 M3=0,41326587399617 FrameElem=45-1
ElemStation=0,1834
Frame=45 Station=0 OutputCase=STR165 CaseType=Combination P=-16,7140895046629 V2=1,94203171385078 V3=0 T=0 M2=0 M3=-2,51264008014117 FrameElem=45-1
ElemStation=0
Frame=45 Station=0,0917 OutputCase=STR165 CaseType=Combination P=-16,7140895046629 V2=2,43721171385078 V3=0 T=0 M2=0 M3=-2,71342839130129
FrameElem=45-1 ElemStation=0,0917
Frame=45 Station=0,1834 OutputCase=STR165 CaseType=Combination P=-16,7140895046629 V2=2,93239171385078 V3=0 T=0 M2=0 M3=-2,95962470846141
FrameElem=45-1 ElemStation=0,1834
Frame=45 Station=0 OutputCase=STR166 CaseType=Combination P=-8,95838163645098 V2=1,94106107691777 V3=0 T=0 M2=0 M3=-3,45083389498685 FrameElem=45-1
ElemStation=0
Frame=45 Station=0,0917 OutputCase=STR166 CaseType=Combination P=-8,95838163645098 V2=2,43624107691777 V3=0 T=0 M2=0 M3=-3,65153319874021
FrameElem=45-1 ElemStation=0,0917
Frame=45 Station=0,1834 OutputCase=STR166 CaseType=Combination P=-8,95838163645098 V2=2,93142107691777 V3=0 T=0 M2=0 M3=-3,89764050849357
FrameElem=45-1 ElemStation=0,1834
Frame=45 Station=0 OutputCase=STR167 CaseType=Combination P=-7,98624248930329 V2=10,0491304408996 V3=0 T=0 M2=0 M3=-22,6499645346484 FrameElem=45-1
ElemStation=0
Frame=45 Station=0,0917 OutputCase=STR167 CaseType=Combination P=-7,98624248930329 V2=10,5443104408996 V3=0 T=0 M2=0 M3=-23,5941737990789
FrameElem=45-1 ElemStation=0,0917
Frame=45 Station=0,1834 OutputCase=STR167 CaseType=Combination P=-7,98624248930329 V2=11,0394904408996 V3=0 T=0 M2=0 M3=-24,5837910695094
FrameElem=45-1 ElemStation=0,1834
Frame=45 Station=0 OutputCase=STR168 CaseType=Combination P=-21,1797875549605 V2=35,801421579776 V3=0 T=0 M2=0 M3=-16,0832749742089 FrameElem=45-1
ElemStation=0
Frame=45 Station=0,0917 OutputCase=STR168 CaseType=Combination P=-21,1797875549605 V2=36,296601579776 V3=0 T=0 M2=0 M3=-19,3889693360743 FrameElem=45-1
ElemStation=0,0917
Frame=45 Station=0,1834 OutputCase=STR168 CaseType=Combination P=-21,1797875549605 V2=36,791781579776 V3=0 T=0 M2=0 M3=-22,7400717039398 FrameElem=45-1
ElemStation=0,1834
Frame=45 Station=0 OutputCase=STR169 CaseType=Combination P=-34,3733326188017 V2=10,0529461167484 V3=0 T=0 M2=0 M3=-18,9618260090873 FrameElem=45-1
ElemStation=0
Frame=45 Station=0,0917 OutputCase=STR169 CaseType=Combination P=-34,3733326188017 V2=10,5481261167484 V3=0 T=0 M2=0 M3=-19,9063851709931
FrameElem=45-1 ElemStation=0,0917
Frame=45 Station=0,1834 OutputCase=STR169 CaseType=Combination P=-34,3733326188017 V2=11,0433061167484 V3=0 T=0 M2=0 M3=-20,8963523388989
FrameElem=45-1 ElemStation=0,1834

Società di Progetto
Brebemi SpA



Doc. N.
60235-0000-A00.doc

CODIFICA DOCUMENTO
04RCDII10000000000300A00

REV.
00

FOGLIO
577 di 628

Frame=45 Station=0 OutputCase=STR170 CaseType=Combination P=-21,9548468372949 V2=27,1906594474548 V3=0 T=0 M2=0 M3=4,53757890586933 FrameElem=45-1 ElemStation=0
Frame=45 Station=0,0917 OutputCase=STR170 CaseType=Combination P=-21,9548468372949 V2=27,5574594474548 V3=0 T=0 M2=0 M3=2,02737765453772 FrameElem=45-1 ElemStation=0,0917
Frame=45 Station=0,1834 OutputCase=STR170 CaseType=Combination P=-21,9548468372949 V2=27,9242594474548 V3=0 T=0 M2=0 M3=-0,516459156793892 FrameElem=45-1 ElemStation=0,1834
Frame=45 Station=0 OutputCase=STR171 CaseType=Combination P=-35,148391901136 V2=1,44218398442725 V3=0 T=0 M2=0 M3=1,65902787099093 FrameElem=45-1 ElemStation=0
Frame=45 Station=0,0917 OutputCase=STR171 CaseType=Combination P=-35,148391901136 V2=1,80898398442725 V3=0 T=0 M2=0 M3=1,50996181961895 FrameElem=45-1 ElemStation=0,0917
Frame=45 Station=0,1834 OutputCase=STR171 CaseType=Combination P=-35,148391901136 V2=2,17578398442725 V3=0 T=0 M2=0 M3=1,32726020824697 FrameElem=45-1 ElemStation=0,1834
Frame=45 Station=0 OutputCase=STR172 CaseType=Combination P=-16,39128707414 V2=2,39911810441754 V3=0 T=0 M2=0 M3=-2,82372903378405 FrameElem=45-1 ElemStation=0
Frame=45 Station=0,0917 OutputCase=STR172 CaseType=Combination P=-16,39128707414 V2=2,89429810441754 V3=0 T=0 M2=0 M3=-3,06643216695914 FrameElem=45-1 ElemStation=0,0917
Frame=45 Station=0,1834 OutputCase=STR172 CaseType=Combination P=-16,39128707414 V2=3,38947810441754 V3=0 T=0 M2=0 M3=-3,35454330613423 FrameElem=45-1 ElemStation=0,1834
Frame=45 Station=0 OutputCase=STR173 CaseType=Combination P=-8,63557920592805 V2=2,39814746748452 V3=0 T=0 M2=0 M3=-3,76192284862973 FrameElem=45-1 ElemStation=0
Frame=45 Station=0,0917 OutputCase=STR173 CaseType=Combination P=-8,63557920592805 V2=2,89332746748452 V3=0 T=0 M2=0 M3=-4,00453697439806 FrameElem=45-1 ElemStation=0,0917
Frame=45 Station=0,1834 OutputCase=STR173 CaseType=Combination P=-8,63557920592805 V2=3,38850746748452 V3=0 T=0 M2=0 M3=-4,29255910616639 FrameElem=45-1 ElemStation=0,1834
Frame=45 Station=0 OutputCase=STR174 CaseType=Combination P=-7,66344005878036 V2=10,5062168314664 V3=0 T=0 M2=0 M3=-22,9610534882913 FrameElem=45-1 ElemStation=0
Frame=45 Station=0,0917 OutputCase=STR174 CaseType=Combination P=-7,66344005878036 V2=11,0013968314664 V3=0 T=0 M2=0 M3=-23,9471775747368 FrameElem=45-1 ElemStation=0,0917
Frame=45 Station=0,1834 OutputCase=STR174 CaseType=Combination P=-7,66344005878036 V2=11,4965768314664 V3=0 T=0 M2=0 M3=-24,9787096671822 FrameElem=45-1 ElemStation=0,1834
Frame=45 Station=0 OutputCase=STR175 CaseType=Combination P=-20,8569851244376 V2=36,2585079703428 V3=0 T=0 M2=0 M3=-16,3943639278517 FrameElem=45-1 ElemStation=0
Frame=45 Station=0,0917 OutputCase=STR175 CaseType=Combination P=-20,8569851244376 V2=36,7536879703428 V3=0 T=0 M2=0 M3=-19,7419731117322 FrameElem=45-1 ElemStation=0,0917
Frame=45 Station=0,1834 OutputCase=STR175 CaseType=Combination P=-20,8569851244376 V2=37,2488679703428 V3=0 T=0 M2=0 M3=-23,1349903016126 FrameElem=45-1 ElemStation=0,1834
Frame=45 Station=0 OutputCase=STR176 CaseType=Combination P=-34,0505301882788 V2=10,5100325073152 V3=0 T=0 M2=0 M3=-19,2729149627301 FrameElem=45-1 ElemStation=0
Frame=45 Station=0,0917 OutputCase=STR176 CaseType=Combination P=-34,0505301882788 V2=11,0052125073152 V3=0 T=0 M2=0 M3=-20,2593889466509 FrameElem=45-1 ElemStation=0,0917
Frame=45 Station=0,1834 OutputCase=STR176 CaseType=Combination P=-34,0505301882788 V2=11,5003925073152 V3=0 T=0 M2=0 M3=-21,2912709365717 FrameElem=45-1 ElemStation=0,1834
Frame=45 Station=0 OutputCase=STR177 CaseType=Combination P=-21,632044406772 V2=27,6477458380216 V3=0 T=0 M2=0 M3=4,22648995222645 FrameElem=45-1 ElemStation=0
Frame=45 Station=0,0917 OutputCase=STR177 CaseType=Combination P=-21,632044406772 V2=28,0145458380216 V3=0 T=0 M2=0 M3=1,67437387887987 FrameElem=45-1 ElemStation=0,0917
Frame=45 Station=0,1834 OutputCase=STR177 CaseType=Combination P=-21,632044406772 V2=28,3813458380216 V3=0 T=0 M2=0 M3=-0,91137754466712 FrameElem=45-1 ElemStation=0,1834
Frame=45 Station=0 OutputCase=STR178 CaseType=Combination P=-34,8255894706131 V2=1,89927037499401 V3=0 T=0 M2=0 M3=1,34793891734805 FrameElem=45-1 ElemStation=0
Frame=45 Station=0,0917 OutputCase=STR178 CaseType=Combination P=-34,8255894706131 V2=2,26607037499401 V3=0 T=0 M2=0 M3=1,1569580439611 FrameElem=45-1 ElemStation=0,0917
Frame=45 Station=0,1834 OutputCase=STR178 CaseType=Combination P=-34,8255894706131 V2=2,63287037499401 V3=0 T=0 M2=0 M3=0,932341610574154 FrameElem=45-1 ElemStation=0,1834
Frame=45 Station=0 OutputCase=STR179 CaseType=Combination P=-16,39128707414 V2=2,39911810441754 V3=0 T=0 M2=0 M3=-2,82372903378405 FrameElem=45-1 ElemStation=0
Frame=45 Station=0,0917 OutputCase=STR179 CaseType=Combination P=-16,39128707414 V2=2,89429810441754 V3=0 T=0 M2=0 M3=-3,06643216695914 FrameElem=45-1 ElemStation=0,0917
Frame=45 Station=0,1834 OutputCase=STR179 CaseType=Combination P=-16,39128707414 V2=3,38947810441754 V3=0 T=0 M2=0 M3=-3,35454330613423 FrameElem=45-1 ElemStation=0,1834
Frame=45 Station=0 OutputCase=STR180 CaseType=Combination P=-15,9335437287267 V2=1,4839995432019 V3=0 T=0 M2=0 M3=-3,11571891681616 FrameElem=45-1 ElemStation=0
Frame=45 Station=0,0917 OutputCase=STR180 CaseType=Combination P=-15,9335437287267 V2=1,9791795432019 V3=0 T=0 M2=0 M3=-3,27450567792778 FrameElem=45-1 ElemStation=0,0917
Frame=45 Station=0,1834 OutputCase=STR180 CaseType=Combination P=-15,9335437287267 V2=2,4743595432019 V3=0 T=0 M2=0 M3=-3,47870044503939 FrameElem=45-1 ElemStation=0,1834
Frame=45 Station=0 OutputCase=STR181 CaseType=Combination P=-8,17783586051481 V2=1,48302890626889 V3=0 T=0 M2=0 M3=4,05391273166184 FrameElem=45-1 ElemStation=0
Frame=45 Station=0,0917 OutputCase=STR181 CaseType=Combination P=-8,17783586051481 V2=1,97820890626889 V3=0 T=0 M2=0 M3=4,2126104853667 FrameElem=45-1 ElemStation=0,0917
Frame=45 Station=0,1834 OutputCase=STR181 CaseType=Combination P=-8,17783586051481 V2=2,47338890626889 V3=0 T=0 M2=0 M3=-4,41671624507155 FrameElem=45-1 ElemStation=0,1834
Frame=45 Station=0 OutputCase=STR182 CaseType=Combination P=-7,20569671336712 V2=9,59109827025074 V3=0 T=0 M2=0 M3=-23,2530433713234 FrameElem=45-1 ElemStation=0
Frame=45 Station=0,0917 OutputCase=STR182 CaseType=Combination P=-7,20569671336712 V2=10,0862782702507 V3=0 T=0 M2=0 M3=-24,1552510857054 FrameElem=45-1 ElemStation=0,0917
Frame=45 Station=0,1834 OutputCase=STR182 CaseType=Combination P=-7,20569671336712 V2=10,5814582702507 V3=0 T=0 M2=0 M3=-25,1028668060874 FrameElem=45-1 ElemStation=0,1834
Frame=45 Station=0 OutputCase=STR183 CaseType=Combination P=-20,3992417790244 V2=35,3433894091271 V3=0 T=0 M2=0 M3=-16,6863538108838 FrameElem=45-1 ElemStation=0
Frame=45 Station=0,0917 OutputCase=STR183 CaseType=Combination P=-20,3992417790244 V2=35,8385694091271 V3=0 T=0 M2=0 M3=-19,9500466227008 FrameElem=45-1 ElemStation=0,0917
Frame=45 Station=0,1834 OutputCase=STR183 CaseType=Combination P=-20,3992417790244 V2=36,3337494091271 V3=0 T=0 M2=0 M3=-23,2591474405178 FrameElem=45-1 ElemStation=0,1834
Frame=45 Station=0 OutputCase=STR184 CaseType=Combination P=-33,5927868428655 V2=9,59491394609955 V3=0 T=0 M2=0 M3=-19,5649048457622 FrameElem=45-1 ElemStation=0
Frame=45 Station=0,0917 OutputCase=STR184 CaseType=Combination P=-33,5927868428655 V2=10,0900939460996 V3=0 T=0 M2=0 M3=-20,4674624576196 FrameElem=45-1 ElemStation=0,0917

Società di Progetto
Brebemi SpA



Doc. N.
60235-00000-A00.doc

CODIFICA DOCUMENTO
04RCDII10000000000300A00

REV.
00

FOGLIO
578 di 628

Frame=45 Station=0,1834 OutputCase=STR184 CaseType=Combination P=-33,5927868428655 V2=10,5852739460996 V3=0 T=0 M2=0 M3=-21,4154280754769
FrameElem=45-1 ElemStation=0,1834
Frame=45 Station=0 OutputCase=STR185 CaseType=Combination P=-21,1743010613587 V2=26,732627276806 V3=0 T=0 M2=0 M3=3,93450006919434 FrameElem=45-1
ElemStation=0
Frame=45 Station=0,0917 OutputCase=STR185 CaseType=Combination P=-21,1743010613587 V2=27,099427276806 V3=0 T=0 M2=0 M3=1,46630036791123 FrameElem=45-1
ElemStation=0,0917
Frame=45 Station=0,1834 OutputCase=STR185 CaseType=Combination P=-21,1743010613587 V2=27,466227276806 V3=0 T=0 M2=0 M3=-1,03553489337188 FrameElem=45-1
ElemStation=0,1834
Frame=45 Station=0 OutputCase=STR186 CaseType=Combination P=-34,3678461251999 V2=0,984151813778374 V3=0 T=0 M2=0 M3=1,05594903431594 FrameElem=45-1
ElemStation=0
Frame=45 Station=0,0917 OutputCase=STR186 CaseType=Combination P=-34,3678461251999 V2=1,35095181377837 V3=0 T=0 M2=0 M3=0,948884532992468
FrameElem=45-1 ElemStation=0,0917
Frame=45 Station=0,1834 OutputCase=STR186 CaseType=Combination P=-34,3678461251999 V2=1,71775181377837 V3=0 T=0 M2=0 M3=0,80818447166899 FrameElem=45-1
ElemStation=0,1834
Frame=45 Station=0 OutputCase=STR187 CaseType=Combination P=-15,9335437287267 V2=1,4839995432019 V3=0 T=0 M2=0 M3=-3,11571891681616 FrameElem=45-1
ElemStation=0
Frame=45 Station=0,0917 OutputCase=STR187 CaseType=Combination P=-15,9335437287267 V2=1,9791795432019 V3=0 T=0 M2=0 M3=-3,27450567792778 FrameElem=45-1
ElemStation=0,0917
Frame=45 Station=0,1834 OutputCase=STR187 CaseType=Combination P=-15,9335437287267 V2=2,4743595432019 V3=0 T=0 M2=0 M3=-3,47870044503939 FrameElem=45-1
ElemStation=0,1834
Frame=45 Station=0 OutputCase=INVSTR CaseType=Combination StepType=Max P=-5,36678303593531 V2=68,085936642703 V3=0 T=0 M2=0 M3=5,4908696437906
FrameElem=45-1 ElemStation=0
Frame=45 Station=0,0917 OutputCase=INVSTR CaseType=Combination StepType=Max P=-5,36678303593531 V2=68,58116642703 V3=0 T=0 M2=0 M3=2,35231053847521
FrameElem=45-1 ElemStation=0,0917
Frame=45 Station=0,1834 OutputCase=INVSTR CaseType=Combination StepType=Max P=-5,36678303593531 V2=69,076296642703 V3=0 T=0 M2=0 M3=1,48207257323075
FrameElem=45-1 ElemStation=0,1834
Frame=45 Station=0 OutputCase=INVSTR CaseType=Combination StepType=Min P=-40,4393958161823 V2=0,67785125326366 V3=0 T=0 M2=0 M3=-30,7256490301184
FrameElem=45-1 ElemStation=0
Frame=45 Station=0,0917 OutputCase=INVSTR CaseType=Combination StepType=Min P=-40,4393958161823 V2=1,04465125326366 V3=0 T=0 M2=0 M3=-
31,9175359467131 FrameElem=45-1 ElemStation=0,0917
Frame=45 Station=0,1834 OutputCase=INVSTR CaseType=Combination StepType=Min P=-40,4393958161823 V2=1,41145125326366 V3=0 T=0 M2=0 M3=-
33,1548308693078 FrameElem=45-1 ElemStation=0,1834
Frame=45 Station=0 OutputCase=SIS01 CaseType=Combination P=-13,549203811234 V2=12,8666149506294 V3=0 T=0 M2=0 M3=0,-169389354344518 FrameElem=45-1
ElemStation=0
Frame=45 Station=0,0917 OutputCase=SIS01 CaseType=Combination P=-13,549203811234 V2=13,2334149506294 V3=0 T=0 M2=0 M3=-1,36607572531724 FrameElem=45-1
ElemStation=0,0917
Frame=45 Station=0,1834 OutputCase=SIS01 CaseType=Combination P=-13,549203811234 V2=13,6002149506294 V3=0 T=0 M2=0 M3=-2,59639765628996 FrameElem=45-1
ElemStation=0,1834
Frame=45 Station=0 OutputCase=SIS02 CaseType=Combination P=-13,1660967951024 V2=12,8662865547676 V3=0 T=0 M2=0 M3=0,-486808725982666 FrameElem=45-1
ElemStation=0
Frame=45 Station=0,0917 OutputCase=SIS02 CaseType=Combination P=-13,1660967951024 V2=13,2330865547676 V3=0 T=0 M2=0 M3=-1,68346498305486 FrameElem=45-1
ElemStation=0,0917
Frame=45 Station=0,1834 OutputCase=SIS02 CaseType=Combination P=-13,1660967951024 V2=13,5998865547676 V3=0 T=0 M2=0 M3=-2,91375680012704 FrameElem=45-1
ElemStation=0,1834
Frame=45 Station=0 OutputCase=SIS03 CaseType=Combination P=-13,9323108273656 V2=12,8669433464913 V3=0 T=0 M2=0 M3=0,148030017293629 FrameElem=45-1
ElemStation=0
Frame=45 Station=0,0917 OutputCase=SIS03 CaseType=Combination P=-13,9323108273656 V2=13,2337433464913 V3=0 T=0 M2=0 M3=-1,04868646757962 FrameElem=45-1
ElemStation=0,0917
Frame=45 Station=0,1834 OutputCase=SIS03 CaseType=Combination P=-13,9323108273656 V2=13,6005433464913 V3=0 T=0 M2=0 M3=-2,27903851245287 FrameElem=45-1
ElemStation=0,1834
Frame=45 Station=0 OutputCase=SIS04 CaseType=Combination P=-13,7081424728358 V2=13,1843644510515 V3=0 T=0 M2=0 M3=-6,80039782917024E-02 FrameElem=45-1
ElemStation=0
Frame=45 Station=0,0917 OutputCase=SIS04 CaseType=Combination P=-13,7081424728358 V2=13,5511644510515 V3=0 T=0 M2=0 M3=-1,29382797845313 FrameElem=45-1
ElemStation=0,0917
Frame=45 Station=0,1834 OutputCase=SIS04 CaseType=Combination P=-13,7081424728358 V2=13,9179644510515 V3=0 T=0 M2=0 M3=-2,55328753861455 FrameElem=45-1
ElemStation=0,1834
Frame=45 Station=0 OutputCase=SIS05 CaseType=Combination P=-13,3902651496322 V2=12,5488654502073 V3=0 T=0 M2=0 M3=0,-270774730397335 FrameElem=45-1
ElemStation=0
Frame=45 Station=0,0917 OutputCase=SIS05 CaseType=Combination P=-13,3902651496322 V2=12,9156654502074 V3=0 T=0 M2=0 M3=-1,43832347218135 FrameElem=45-1
ElemStation=0,0917
Frame=45 Station=0,1834 OutputCase=SIS05 CaseType=Combination P=-13,3902651496322 V2=13,2824654502074 V3=0 T=0 M2=0 M3=-2,63950777396536 FrameElem=45-1
ElemStation=0,1834
Frame=45 Station=0 OutputCase=SIS06 CaseType=Combination P=-13,9323108273656 V2=12,8669433464913 V3=0 T=0 M2=0 M3=0,148030017293629 FrameElem=45-1
ElemStation=0
Frame=45 Station=0,0917 OutputCase=SIS06 CaseType=Combination P=-13,9323108273656 V2=13,2337433464913 V3=0 T=0 M2=0 M3=-1,04868646757962 FrameElem=45-1
ElemStation=0,0917
Frame=45 Station=0,1834 OutputCase=SIS06 CaseType=Combination P=-13,9323108273656 V2=13,6005433464913 V3=0 T=0 M2=0 M3=-2,27903851245287 FrameElem=45-1
ElemStation=0,1834
Frame=45 Station=0 OutputCase=SIS07 CaseType=Combination P=-13,3250354567042 V2=13,1840360551897 V3=0 T=0 M2=0 M3=0,-38542334992985 FrameElem=45-1
ElemStation=0
Frame=45 Station=0,0917 OutputCase=SIS07 CaseType=Combination P=-13,3250354567042 V2=13,5508360551897 V3=0 T=0 M2=0 M3=-1,61121723619075 FrameElem=45-1
ElemStation=0,0917
Frame=45 Station=0,1834 OutputCase=SIS07 CaseType=Combination P=-13,3250354567042 V2=13,9176360551897 V3=0 T=0 M2=0 M3=-2,87064668245164 FrameElem=45-1
ElemStation=0,1834
Frame=45 Station=0 OutputCase=SIS08 CaseType=Combination P=-13,0071581335006 V2=12,5485370543455 V3=0 T=0 M2=0 M3=0,-588194102035483 FrameElem=45-1
ElemStation=0
Frame=45 Station=0,0917 OutputCase=SIS08 CaseType=Combination P=-13,0071581335006 V2=12,9153370543455 V3=0 T=0 M2=0 M3=-1,75571272991897 FrameElem=45-1
ElemStation=0,0917
Frame=45 Station=0,1834 OutputCase=SIS08 CaseType=Combination P=-13,0071581335006 V2=13,2821370543455 V3=0 T=0 M2=0 M3=-2,95686691780245 FrameElem=45-1
ElemStation=0,1834
Frame=45 Station=0 OutputCase=SIS09 CaseType=Combination P=-13,549203811234 V2=12,8666149506294 V3=0 T=0 M2=0 M3=0,-169389354344518 FrameElem=45-1
ElemStation=0
Frame=45 Station=0,0917 OutputCase=SIS09 CaseType=Combination P=-13,549203811234 V2=13,2334149506294 V3=0 T=0 M2=0 M3=-1,36607572531724 FrameElem=45-1
ElemStation=0,0917
Frame=45 Station=0,1834 OutputCase=SIS09 CaseType=Combination P=-13,549203811234 V2=13,6002149506294 V3=0 T=0 M2=0 M3=-2,59639765628996 FrameElem=45-1
ElemStation=0,1834
Frame=45 Station=0 OutputCase=SIS10 CaseType=Combination P=-13,5899746444713 V2=12,9897530718612 V3=0 T=0 M2=0 M3=0,-445866235088458 FrameElem=45-1
ElemStation=0

Società di Progetto
Brebemi SpA



Doc. N.
60235-0000-A00.doc

CODIFICA DOCUMENTO
04RCDII10000000000300A00

REV.
00

FOGLIO
579 di 628

Frame=45 Station=0,0917 OutputCase=SIS10 CaseType=Combination P=-13,5899746444713 V2=13,3565530718612 V3=0 T=0 M2=0 M3=-1,65384437177813 FrameElem=45-1
ElemStation=0,0917
Frame=45 Station=0,1834 OutputCase=SIS10 CaseType=Combination P=-13,5899746444713 V2=13,7233530718612 V3=0 T=0 M2=0 M3=-2,8954580684678 FrameElem=45-1
ElemStation=0,1834
Frame=45 Station=0 OutputCase=SIS11 CaseType=Combination P=-13,2068676283397 V2=12,9894246759993 V3=0 T=0 M2=0 M3=-0,763285606726606 FrameElem=45-1
ElemStation=0
Frame=45 Station=0,0917 OutputCase=SIS11 CaseType=Combination P=-13,2068676283397 V2=13,3562246759993 V3=0 T=0 M2=0 M3=-1,97123362951575 FrameElem=45-1
ElemStation=0,0917
Frame=45 Station=0,1834 OutputCase=SIS11 CaseType=Combination P=-13,2068676283397 V2=13,7230246759993 V3=0 T=0 M2=0 M3=-3,21281721230489 FrameElem=45-1
ElemStation=0,1834
Frame=45 Station=0 OutputCase=SIS12 CaseType=Combination P=-13,973081660603 V2=12,990081467723 V3=0 T=0 M2=0 M3=-0,12844686345031 FrameElem=45-1
ElemStation=0
Frame=45 Station=0,0917 OutputCase=SIS12 CaseType=Combination P=-13,973081660603 V2=13,356881467723 V3=0 T=0 M2=0 M3=-1,33645511404051 FrameElem=45-1
ElemStation=0,0917
Frame=45 Station=0,1834 OutputCase=SIS12 CaseType=Combination P=-13,973081660603 V2=13,723681467723 V3=0 T=0 M2=0 M3=-2,57809892463072 FrameElem=45-1
ElemStation=0,1834
Frame=45 Station=0 OutputCase=SIS13 CaseType=Combination P=-13,7489133060732 V2=13,3075025722833 V3=0 T=0 M2=0 M3=-0,344480859035642 FrameElem=45-1
ElemStation=0
Frame=45 Station=0,0917 OutputCase=SIS13 CaseType=Combination P=-13,7489133060732 V2=13,6743025722833 V3=0 T=0 M2=0 M3=-1,58159662491402 FrameElem=45-1
ElemStation=0,0917
Frame=45 Station=0,1834 OutputCase=SIS13 CaseType=Combination P=-13,7489133060732 V2=14,0411025722833 V3=0 T=0 M2=0 M3=-2,8523479507924 FrameElem=45-1
ElemStation=0,1834
Frame=45 Station=0 OutputCase=SIS14 CaseType=Combination P=-13,4310359828695 V2=12,6720035714391 V3=0 T=0 M2=0 M3=-0,547251611141274 FrameElem=45-1
ElemStation=0
Frame=45 Station=0,0917 OutputCase=SIS14 CaseType=Combination P=-13,4310359828695 V2=13,0388035714391 V3=0 T=0 M2=0 M3=-1,72609211864224 FrameElem=45-1
ElemStation=0,0917
Frame=45 Station=0,1834 OutputCase=SIS14 CaseType=Combination P=-13,4310359828695 V2=13,4056035714391 V3=0 T=0 M2=0 M3=-2,9385681861432 FrameElem=45-1
ElemStation=0,1834
Frame=45 Station=0 OutputCase=SIS15 CaseType=Combination P=-13,973081660603 V2=12,990081467723 V3=0 T=0 M2=0 M3=-0,12844686345031 FrameElem=45-1
ElemStation=0
Frame=45 Station=0,0917 OutputCase=SIS15 CaseType=Combination P=-13,973081660603 V2=13,356881467723 V3=0 T=0 M2=0 M3=-1,33645511404051 FrameElem=45-1
ElemStation=0,0917
Frame=45 Station=0,1834 OutputCase=SIS15 CaseType=Combination P=-13,973081660603 V2=13,723681467723 V3=0 T=0 M2=0 M3=-2,57809892463072 FrameElem=45-1
ElemStation=0,1834
Frame=45 Station=0 OutputCase=SIS16 CaseType=Combination P=-13,3658062899415 V2=13,3071741764214 V3=0 T=0 M2=0 M3=-0,66190023067379 FrameElem=45-1
ElemStation=0
Frame=45 Station=0,0917 OutputCase=SIS16 CaseType=Combination P=-13,3658062899415 V2=13,6739741764214 V3=0 T=0 M2=0 M3=-1,8989588265164 FrameElem=45-1
ElemStation=0,0917
Frame=45 Station=0,1834 OutputCase=SIS16 CaseType=Combination P=-13,3658062899415 V2=14,0407741764214 V3=0 T=0 M2=0 M3=-3,16970709462948 FrameElem=45-1
ElemStation=0,1834
Frame=45 Station=0 OutputCase=SIS17 CaseType=Combination P=-13,0479289667379 V2=12,6716751755773 V3=0 T=0 M2=0 M3=-0,864670982779422 FrameElem=45-1
ElemStation=0
Frame=45 Station=0,0917 OutputCase=SIS17 CaseType=Combination P=-13,0479289667379 V2=13,0384751755773 V3=0 T=0 M2=0 M3=-2,04348137637986 FrameElem=45-1
ElemStation=0,0917
Frame=45 Station=0,1834 OutputCase=SIS17 CaseType=Combination P=-13,0479289667379 V2=13,4052751755773 V3=0 T=0 M2=0 M3=-3,25592732998029 FrameElem=45-1
ElemStation=0,1834
Frame=45 Station=0 OutputCase=SIS18 CaseType=Combination P=-13,5899746444713 V2=12,9897530718612 V3=0 T=0 M2=0 M3=-0,445866235088458 FrameElem=45-1
ElemStation=0
Frame=45 Station=0,0917 OutputCase=SIS18 CaseType=Combination P=-13,5899746444713 V2=13,3565530718612 V3=0 T=0 M2=0 M3=-1,65384437177813 FrameElem=45-1
ElemStation=0,0917
Frame=45 Station=0,1834 OutputCase=SIS18 CaseType=Combination P=-13,5899746444713 V2=13,7233530718612 V3=0 T=0 M2=0 M3=-2,8954580684678 FrameElem=45-1
ElemStation=0,1834
Frame=45 Station=0 OutputCase=SIS19 CaseType=Combination P=-13,5016378387978 V2=8,64194730299969 V3=0 T=0 M2=0 M3=-0,595289586739099 FrameElem=45-1
ElemStation=0
Frame=45 Station=0,0917 OutputCase=SIS19 CaseType=Combination P=-13,5016378387978 V2=9,00874730299969 V3=0 T=0 M2=0 M3=-1,40457393442417 FrameElem=45-1
ElemStation=0,0917
Frame=45 Station=0,1834 OutputCase=SIS19 CaseType=Combination P=-13,5016378387978 V2=9,37554730299969 V3=0 T=0 M2=0 M3=-2,24749384210924 FrameElem=45-1
ElemStation=0,1834
Frame=45 Station=0 OutputCase=SIS20 CaseType=Combination P=-13,1185308226662 V2=8,64161890713784 V3=0 T=0 M2=0 M3=-0,912708958377247 FrameElem=45-1
ElemStation=0
Frame=45 Station=0,0917 OutputCase=SIS20 CaseType=Combination P=-13,1185308226662 V2=9,00841890713784 V3=0 T=0 M2=0 M3=-1,72196319216179 FrameElem=45-1
ElemStation=0,0917
Frame=45 Station=0,1834 OutputCase=SIS20 CaseType=Combination P=-13,1185308226662 V2=9,37521890713784 V3=0 T=0 M2=0 M3=-2,56485298594633 FrameElem=45-1
ElemStation=0,1834
Frame=45 Station=0 OutputCase=SIS21 CaseType=Combination P=-13,8847448549295 V2=8,64227569886154 V3=0 T=0 M2=0 M3=-0,277870215100951 FrameElem=45-1
ElemStation=0
Frame=45 Station=0,0917 OutputCase=SIS21 CaseType=Combination P=-13,8847448549295 V2=9,00907569886154 V3=0 T=0 M2=0 M3=-1,08718467668655 FrameElem=45-1
ElemStation=0,0917
Frame=45 Station=0,1834 OutputCase=SIS21 CaseType=Combination P=-13,8847448549295 V2=9,37587569886154 V3=0 T=0 M2=0 M3=-1,93013469827216 FrameElem=45-1
ElemStation=0,1834
Frame=45 Station=0 OutputCase=SIS22 CaseType=Combination P=-13,6605765003996 V2=8,95969680342178 V3=0 T=0 M2=0 M3=-0,493904210686283 FrameElem=45-1
ElemStation=0
Frame=45 Station=0,0917 OutputCase=SIS22 CaseType=Combination P=-13,6605765003996 V2=9,32649680342178 V3=0 T=0 M2=0 M3=-1,33232618756006 FrameElem=45-1
ElemStation=0,0917
Frame=45 Station=0,1834 OutputCase=SIS22 CaseType=Combination P=-13,6605765003996 V2=9,69329680342178 V3=0 T=0 M2=0 M3=-2,20438372443384 FrameElem=45-1
ElemStation=0,1834
Frame=45 Station=0 OutputCase=SIS23 CaseType=Combination P=-13,342699177196 V2=8,32419780257759 V3=0 T=0 M2=0 M3=-0,696674962791915 FrameElem=45-1
ElemStation=0
Frame=45 Station=0,0917 OutputCase=SIS23 CaseType=Combination P=-13,342699177196 V2=8,69099780257759 V3=0 T=0 M2=0 M3=-1,47682168128828 FrameElem=45-1
ElemStation=0,0917
Frame=45 Station=0,1834 OutputCase=SIS23 CaseType=Combination P=-13,342699177196 V2=9,05779780257759 V3=0 T=0 M2=0 M3=-2,29060395978465 FrameElem=45-1
ElemStation=0,1834
Frame=45 Station=0 OutputCase=SIS24 CaseType=Combination P=-13,8847448549295 V2=8,64227569886154 V3=0 T=0 M2=0 M3=-0,277870215100951 FrameElem=45-1
ElemStation=0
Frame=45 Station=0,0917 OutputCase=SIS24 CaseType=Combination P=-13,8847448549295 V2=9,00907569886154 V3=0 T=0 M2=0 M3=-1,08718467668655 FrameElem=45-1
ElemStation=0,0917
Frame=45 Station=0,1834 OutputCase=SIS24 CaseType=Combination P=-13,8847448549295 V2=9,37587569886154 V3=0 T=0 M2=0 M3=-1,93013469827216 FrameElem=45-1
ElemStation=0,1834

Società di Progetto
Brebemi SpA



Doc. N.
60235-0000-A00.doc

CODIFICA DOCUMENTO
04RCDII10000000000300A00

REV.
00

FOGLIO
580 di 628

Frame=45 Station=0 OutputCase=SIS25 CaseType=Combination P=-13,277469484268 V2=8,95936840755993 V3=0 T=0 M2=0 M3=-0,811323582324431 FrameElem=45-1 ElemStation=0
Frame=45 Station=0,0917 OutputCase=SIS25 CaseType=Combination P=-13,277469484268 V2=9,32616840755993 V3=0 T=0 M2=0 M3=-1,64971544529768 FrameElem=45-1 ElemStation=0,0917
Frame=45 Station=0,1834 OutputCase=SIS25 CaseType=Combination P=-13,277469484268 V2=9,69296840755993 V3=0 T=0 M2=0 M3=-2,52174286827092 FrameElem=45-1 ElemStation=0,1834
Frame=45 Station=0 OutputCase=SIS26 CaseType=Combination P=-12,9595921610644 V2=8,32386940671574 V3=0 T=0 M2=0 M3=-1,01409433443006 FrameElem=45-1 ElemStation=0
Frame=45 Station=0,0917 OutputCase=SIS26 CaseType=Combination P=-12,9595921610644 V2=8,69066940671574 V3=0 T=0 M2=0 M3=-1,7942109390259 FrameElem=45-1 ElemStation=0,0917
Frame=45 Station=0,1834 OutputCase=SIS26 CaseType=Combination P=-12,9595921610644 V2=9,05746940671574 V3=0 T=0 M2=0 M3=-2,60796310362173 FrameElem=45-1 ElemStation=0,1834
Frame=45 Station=0 OutputCase=SIS27 CaseType=Combination P=-13,5016378387978 V2=8,64194730299969 V3=0 T=0 M2=0 M3=-0,595289586739099 FrameElem=45-1 ElemStation=0
Frame=45 Station=0,0917 OutputCase=SIS27 CaseType=Combination P=-13,5016378387978 V2=9,00874730299969 V3=0 T=0 M2=0 M3=-1,40457393442417 FrameElem=45-1 ElemStation=0,0917
Frame=45 Station=0,1834 OutputCase=SIS27 CaseType=Combination P=-13,5016378387978 V2=9,37554730299969 V3=0 T=0 M2=0 M3=-2,24749384210924 FrameElem=45-1 ElemStation=0,1834
Frame=45 Station=0 OutputCase=SIS28 CaseType=Combination P=-13,6375406162556 V2=9,05240770710552 V3=0 T=0 M2=0 M3=-1,5168791892189 FrameElem=45-1 ElemStation=0
Frame=45 Station=0,0917 OutputCase=SIS28 CaseType=Combination P=-13,6375406162556 V2=9,41920770710552 V3=0 T=0 M2=0 M3=-2,36380275596047 FrameElem=45-1 ElemStation=0,0917
Frame=45 Station=0,1834 OutputCase=SIS28 CaseType=Combination P=-13,6375406162556 V2=9,78600770710552 V3=0 T=0 M2=0 M3=-3,24436188270205 FrameElem=45-1 ElemStation=0,1834
Frame=45 Station=0 OutputCase=SIS29 CaseType=Combination P=-13,254433600124 V2=9,05207931124367 V3=0 T=0 M2=0 M3=-1,83429856085705 FrameElem=45-1 ElemStation=0
Frame=45 Station=0,0917 OutputCase=SIS29 CaseType=Combination P=-13,254433600124 V2=9,41887931124367 V3=0 T=0 M2=0 M3=-2,68119201369809 FrameElem=45-1 ElemStation=0,0917
Frame=45 Station=0,1834 OutputCase=SIS29 CaseType=Combination P=-13,254433600124 V2=9,78567931124367 V3=0 T=0 M2=0 M3=-3,56172102653913 FrameElem=45-1 ElemStation=0,1834
Frame=45 Station=0 OutputCase=SIS30 CaseType=Combination P=-14,0206476323872 V2=9,05273610296737 V3=0 T=0 M2=0 M3=-1,19945981758075 FrameElem=45-1 ElemStation=0
Frame=45 Station=0,0917 OutputCase=SIS30 CaseType=Combination P=-14,0206476323872 V2=9,41953610296737 V3=0 T=0 M2=0 M3=-2,04641349822286 FrameElem=45-1 ElemStation=0,0917
Frame=45 Station=0,1834 OutputCase=SIS30 CaseType=Combination P=-14,0206476323872 V2=9,78633610296737 V3=0 T=0 M2=0 M3=-2,92700273886497 FrameElem=45-1 ElemStation=0,1834
Frame=45 Station=0 OutputCase=SIS31 CaseType=Combination P=-13,7964792778574 V2=9,37015720752762 V3=0 T=0 M2=0 M3=-1,41549381316608 FrameElem=45-1 ElemStation=0
Frame=45 Station=0,0917 OutputCase=SIS31 CaseType=Combination P=-13,7964792778574 V2=9,73695720752762 V3=0 T=0 M2=0 M3=-2,29155500909636 FrameElem=45-1 ElemStation=0,0917
Frame=45 Station=0,1834 OutputCase=SIS31 CaseType=Combination P=-13,7964792778574 V2=10,10375720752762 V3=0 T=0 M2=0 M3=-3,20125176502665 FrameElem=45-1 ElemStation=0,1834
Frame=45 Station=0 OutputCase=SIS32 CaseType=Combination P=-13,4786019546538 V2=8,73465820668343 V3=0 T=0 M2=0 M3=-1,61826456527171 FrameElem=45-1 ElemStation=0
Frame=45 Station=0,0917 OutputCase=SIS32 CaseType=Combination P=-13,4786019546538 V2=9,10145820668343 V3=0 T=0 M2=0 M3=-2,43605050282458 FrameElem=45-1 ElemStation=0,0917
Frame=45 Station=0,1834 OutputCase=SIS32 CaseType=Combination P=-13,4786019546538 V2=9,46825820668343 V3=0 T=0 M2=0 M3=-3,28747200037745 FrameElem=45-1 ElemStation=0,1834
Frame=45 Station=0 OutputCase=SIS33 CaseType=Combination P=-14,0206476323872 V2=9,05273610296737 V3=0 T=0 M2=0 M3=-1,19945981758075 FrameElem=45-1 ElemStation=0
Frame=45 Station=0,0917 OutputCase=SIS33 CaseType=Combination P=-14,0206476323872 V2=9,41953610296737 V3=0 T=0 M2=0 M3=-2,04641349822286 FrameElem=45-1 ElemStation=0,0917
Frame=45 Station=0,1834 OutputCase=SIS33 CaseType=Combination P=-14,0206476323872 V2=9,78633610296737 V3=0 T=0 M2=0 M3=-2,92700273886497 FrameElem=45-1 ElemStation=0,1834
Frame=45 Station=0 OutputCase=SIS34 CaseType=Combination P=-13,4133722617258 V2=9,36982881166577 V3=0 T=0 M2=0 M3=-1,73291318480423 FrameElem=45-1 ElemStation=0
Frame=45 Station=0,0917 OutputCase=SIS34 CaseType=Combination P=-13,4133722617258 V2=9,73662881166577 V3=0 T=0 M2=0 M3=-2,60894426683398 FrameElem=45-1 ElemStation=0,0917
Frame=45 Station=0,1834 OutputCase=SIS34 CaseType=Combination P=-13,4133722617258 V2=10,10342881166577 V3=0 T=0 M2=0 M3=-3,51861090886373 FrameElem=45-1 ElemStation=0,1834
Frame=45 Station=0 OutputCase=SIS35 CaseType=Combination P=-13,0954949385221 V2=8,73432981082158 V3=0 T=0 M2=0 M3=-1,93568393690986 FrameElem=45-1 ElemStation=0
Frame=45 Station=0,0917 OutputCase=SIS35 CaseType=Combination P=-13,0954949385221 V2=9,10112981082158 V3=0 T=0 M2=0 M3=-2,7534397605622 FrameElem=45-1 ElemStation=0,0917
Frame=45 Station=0,1834 OutputCase=SIS35 CaseType=Combination P=-13,0954949385221 V2=9,4672981082158 V3=0 T=0 M2=0 M3=-3,60483114421454 FrameElem=45-1 ElemStation=0,1834
Frame=45 Station=0 OutputCase=SIS36 CaseType=Combination P=-13,6375406162556 V2=9,05240770710552 V3=0 T=0 M2=0 M3=-1,5168791892189 FrameElem=45-1 ElemStation=0
Frame=45 Station=0,0917 OutputCase=SIS36 CaseType=Combination P=-13,6375406162556 V2=9,41920770710552 V3=0 T=0 M2=0 M3=-2,36380275596047 FrameElem=45-1 ElemStation=0,0917
Frame=45 Station=0,1834 OutputCase=SIS36 CaseType=Combination P=-13,6375406162556 V2=9,78600770710552 V3=0 T=0 M2=0 M3=-3,24436188270205 FrameElem=45-1 ElemStation=0,1834
Frame=45 Station=0 OutputCase=INVSIS CaseType=Combination StepType=Max P=-12,9595921610644 V2=13,3075025722833 V3=0 T=0 M2=0 M3=0,148030017293629 FrameElem=45-1 ElemStation=0
Frame=45 Station=0,0917 OutputCase=INVSIS CaseType=Combination StepType=Max P=-12,9595921610644 V2=13,6743025722833 V3=0 T=0 M2=0 M3=-1,04868646757962 FrameElem=45-1 ElemStation=0,0917
Frame=45 Station=0,1834 OutputCase=INVSIS CaseType=Combination StepType=Max P=-12,9595921610644 V2=14,0411025722833 V3=0 T=0 M2=0 M3=-1,93013469827216 FrameElem=45-1 ElemStation=0,1834
Frame=45 Station=0 OutputCase=INVSIS CaseType=Combination StepType=Min P=-14,0206476323872 V2=8,32386940671574 V3=0 T=0 M2=0 M3=-1,93568393690986 FrameElem=45-1 ElemStation=0
Frame=45 Station=0,0917 OutputCase=INVSIS CaseType=Combination StepType=Min P=-14,0206476323872 V2=8,69066940671574 V3=0 T=0 M2=0 M3=-2,7534397605622 FrameElem=45-1 ElemStation=0,0917
Frame=45 Station=0,1834 OutputCase=INVSIS CaseType=Combination StepType=Min P=-14,0206476323872 V2=9,05746940671574 V3=0 T=0 M2=0 M3=-3,60483114421454 FrameElem=45-1 ElemStation=0,1834
Frame=45 Station=0 OutputCase=RAR001 CaseType=Combination P=-11,2910804168277 V2=1,43760790647502 V3=0 T=0 M2=0 M3=-2,76409664239382 FrameElem=45-1 ElemStation=0
Frame=45 Station=0,0917 OutputCase=RAR001 CaseType=Combination P=-11,2910804168277 V2=1,80440790647502 V3=0 T=0 M2=0 M3=-2,91274306741758 FrameElem=45-1 ElemStation=0,0917

Società di Progetto
Brebemi SpA

	Doc. N. 60235-00000-A00.doc	CODIFICA DOCUMENTO 04RCDII10000000000300A00	REV. 00	FOGLIO 581 di 628
--	--------------------------------	--	------------	----------------------

Frame=45 Station=0,1834 OutputCase=RAR001 CaseType=Combination P=-,11,2910804168277 V2=2,17120790647502 V3=0 T=0 M2=0 M3=-3,09502505244134
 FrameElem=45-1 ElemStation=0,1834
 Frame=45 Station=0 OutputCase=RAR002 CaseType=Combination P=-,6,33003340041052 V2=9,44507701067323 V3=0 T=0 M2=0 M3=-22,2101053771289 FrameElem=45-1
 ElemStation=0
 Frame=45 Station=0,0917 OutputCase=RAR002 CaseType=Combination P=-,6,33003340041052 V2=9,81187701067323 V3=0 T=0 M2=0 M3=-23,0930367190077
 FrameElem=45-1 ElemStation=0,0917
 Frame=45 Station=0,1834 OutputCase=RAR002 CaseType=Combination P=-,6,33003340041052 V2=10,1786770106732 V3=0 T=0 M2=0 M3=-24,0096036208864
 FrameElem=45-1 ElemStation=0,1834
 Frame=45 Station=0 OutputCase=RAR003 CaseType=Combination P=-,17,5311707929594 V2=32,4279607380622 V3=0 T=0 M2=0 M3=-16,3953984913632 FrameElem=45-1
 ElemStation=0
 Frame=45 Station=0,0917 OutputCase=RAR003 CaseType=Combination P=-,17,5311707929594 V2=32,7947607380622 V3=0 T=0 M2=0 M3=-19,3858602710436
 FrameElem=45-1 ElemStation=0,0917
 Frame=45 Station=0,1834 OutputCase=RAR003 CaseType=Combination P=-,17,5311707929594 V2=33,1615607380622 V3=0 T=0 M2=0 M3=-22,4099576107239
 FrameElem=45-1 ElemStation=0,1834
 Frame=45 Station=0 OutputCase=RAR004 CaseType=Combination P=-,28,7323081838784 V2=9,44838756365789 V3=0 T=0 M2=0 M3=-19,0102062018467 FrameElem=45-1
 ElemStation=0
 Frame=45 Station=0,0917 OutputCase=RAR004 CaseType=Combination P=-,28,7323081838784 V2=9,81518756365789 V3=0 T=0 M2=0 M3=-19,8934411214342
 FrameElem=45-1 ElemStation=0,0917
 Frame=45 Station=0,1834 OutputCase=RAR004 CaseType=Combination P=-,28,7323081838784 V2=10,1819875636579 V3=0 T=0 M2=0 M3=-20,8103116010216
 FrameElem=45-1 ElemStation=0,1834
 Frame=45 Station=0 OutputCase=RAR005 CaseType=Combination P=-,18,491308222241 V2=24,4199909958579 V3=0 T=0 M2=0 M3=2,56670584410496 FrameElem=45-1
 ElemStation=0
 Frame=45 Station=0,0917 OutputCase=RAR005 CaseType=Combination P=-,18,491308222241 V2=24,7867909958579 V3=0 T=0 M2=0 M3=0,310574889784792
 FrameElem=45-1 ElemStation=0,0917
 Frame=45 Station=0,1834 OutputCase=RAR005 CaseType=Combination P=-,18,491308222241 V2=25,1535909958579 V3=0 T=0 M2=0 M3=-1,97919162453538
 FrameElem=45-1 ElemStation=0,1834
 Frame=45 Station=0 OutputCase=RAR006 CaseType=Combination P=-,29,6924456131601 V2=1,44041782145359 V3=0 T=0 M2=0 M3=-4,81018663785306E-02
 FrameElem=45-1 ElemStation=0
 Frame=45 Station=0,0917 OutputCase=RAR006 CaseType=Combination P=-,29,6924456131601 V2=1,80721782145359 V3=0 T=0 M2=0 M3=-0,197005960605825
 FrameElem=45-1 ElemStation=0,0917
 Frame=45 Station=0,1834 OutputCase=RAR006 CaseType=Combination P=-,29,6924456131601 V2=2,17401782145359 V3=0 T=0 M2=0 M3=-0,379545614833119
 FrameElem=45-1 ElemStation=0,1834
 Frame=45 Station=0 OutputCase=RAR007 CaseType=Combination P=-,15,4710345023681 V2=48,9260493661377 V3=0 T=0 M2=0 M3=-8,60139247004991 FrameElem=45-1
 ElemStation=0
 Frame=45 Station=0,0917 OutputCase=RAR007 CaseType=Combination P=-,15,4710345023681 V2=49,2928493661377 V3=0 T=0 M2=0 M3=-13,1047289769247
 FrameElem=45-1 ElemStation=0,0917
 Frame=45 Station=0,1834 OutputCase=RAR007 CaseType=Combination P=-,15,4710345023681 V2=49,6596493661377 V3=0 T=0 M2=0 M3=-17,6417010437996
 FrameElem=45-1 ElemStation=0,1834
 Frame=45 Station=0 OutputCase=RAR008 CaseType=Combination P=-,6,52395679742893 V2=1,43645047674524 V3=0 T=0 M2=0 M3=-3,88283978493701 FrameElem=45-1
 ElemStation=0
 Frame=45 Station=0,0917 OutputCase=RAR008 CaseType=Combination P=-,6,52395679742893 V2=1,80325047674524 V3=0 T=0 M2=0 M3=-4,03138007365455
 FrameElem=45-1 ElemStation=0,0917
 Frame=45 Station=0,1834 OutputCase=RAR008 CaseType=Combination P=-,6,52395679742893 V2=2,17005047674524 V3=0 T=0 M2=0 M3=-4,2135592237209
 FrameElem=45-1 ElemStation=0,1834
 Frame=45 Station=0 OutputCase=RAR009 CaseType=Combination P=-,5,87030498105256 V2=9,44468293563901 V3=0 T=0 M2=0 M3=-22,5910086230947 FrameElem=45-1
 ElemStation=0
 Frame=45 Station=0,0917 OutputCase=RAR009 CaseType=Combination P=-,5,87030498105256 V2=9,81148293563901 V3=0 T=0 M2=0 M3=-23,4739038282928
 FrameElem=45-1 ElemStation=0,0917
 Frame=45 Station=0,1834 OutputCase=RAR009 CaseType=Combination P=-,5,87030498105256 V2=10,178282935639 V3=0 T=0 M2=0 M3=-24,3904345934909
 FrameElem=45-1 ElemStation=0,1834
 Frame=45 Station=0 OutputCase=RAR010 CaseType=Combination P=-,17,0714423736014 V2=32,427566663028 V3=0 T=0 M2=0 M3=-16,776301737329 FrameElem=45-1
 ElemStation=0
 Frame=45 Station=0,0917 OutputCase=RAR010 CaseType=Combination P=-,17,0714423736014 V2=32,794366663028 V3=0 T=0 M2=0 M3=-19,7667273803287
 FrameElem=45-1 ElemStation=0,0917
 Frame=45 Station=0,1834 OutputCase=RAR010 CaseType=Combination P=-,17,0714423736014 V2=33,161166663028 V3=0 T=0 M2=0 M3=-22,7907885833284
 FrameElem=45-1 ElemStation=0,1834
 Frame=45 Station=0 OutputCase=RAR011 CaseType=Combination P=-,28,2725797645204 V2=9,44799348862367 V3=0 T=0 M2=0 M3=-19,3911094478125 FrameElem=45-1
 ElemStation=0
 Frame=45 Station=0,0917 OutputCase=RAR011 CaseType=Combination P=-,28,2725797645204 V2=9,81479348862367 V3=0 T=0 M2=0 M3=-20,2743082307193
 FrameElem=45-1 ElemStation=0,0917
 Frame=45 Station=0,1834 OutputCase=RAR011 CaseType=Combination P=-,28,2725797645204 V2=10,1815934886237 V3=0 T=0 M2=0 M3=-21,1911425736261
 FrameElem=45-1 ElemStation=0,1834
 Frame=45 Station=0 OutputCase=RAR012 CaseType=Combination P=-,18,0315798028831 V2=24,4195969208237 V3=0 T=0 M2=0 M3=2,18580259813919 FrameElem=45-1
 ElemStation=0
 Frame=45 Station=0,0917 OutputCase=RAR012 CaseType=Combination P=-,18,0315798028831 V2=24,7863969208237 V3=0 T=0 M2=0 M3=-7,02922195003476E-02
 FrameElem=45-1 ElemStation=0,0917
 Frame=45 Station=0,1834 OutputCase=RAR012 CaseType=Combination P=-,18,0315798028831 V2=25,1531969208237 V3=0 T=0 M2=0 M3=-2,36002259713988
 FrameElem=45-1 ElemStation=0,1834
 Frame=45 Station=0 OutputCase=RAR013 CaseType=Combination P=-,29,2327171938021 V2=1,44002374641937 V3=0 T=0 M2=0 M3=-0,429005112344308 FrameElem=45-1
 ElemStation=0
 Frame=45 Station=0,0917 OutputCase=RAR013 CaseType=Combination P=-,29,2327171938021 V2=1,80682374641937 V3=0 T=0 M2=0 M3=-0,577873069890964
 FrameElem=45-1 ElemStation=0,0917
 Frame=45 Station=0,1834 OutputCase=RAR013 CaseType=Combination P=-,29,2327171938021 V2=2,17362374641937 V3=0 T=0 M2=0 M3=-0,760376587437621
 FrameElem=45-1 ElemStation=0,1834
 Frame=45 Station=0 OutputCase=RAR014 CaseType=Combination P=-,15,0113060830101 V2=48,925652911035 V3=0 T=0 M2=0 M3=-8,98229571601569 FrameElem=45-1
 ElemStation=0
 Frame=45 Station=0,0917 OutputCase=RAR014 CaseType=Combination P=-,15,0113060830101 V2=49,2924552911035 V3=0 T=0 M2=0 M3=-13,4855960862099
 FrameElem=45-1 ElemStation=0,0917
 Frame=45 Station=0,1834 OutputCase=RAR014 CaseType=Combination P=-,15,0113060830101 V2=49,6592552911035 V3=0 T=0 M2=0 M3=-18,0225320164041
 FrameElem=45-1 ElemStation=0,1834
 Frame=45 Station=0 OutputCase=RAR015 CaseType=Combination P=-,5,80385372546768 V2=7,44242778339846 V3=0 T=0 M2=0 M3=-18,1044180365382 FrameElem=45-1
 ElemStation=0
 Frame=45 Station=0,0917 OutputCase=RAR015 CaseType=Combination P=-,5,80385372546768 V2=7,80922778339846 V3=0 T=0 M2=0 M3=-18,803706442758
 FrameElem=45-1 ElemStation=0,0917
 Frame=45 Station=0,1834 OutputCase=RAR015 CaseType=Combination P=-,5,80385372546768 V2=8,17602778339846 V3=0 T=0 M2=0 M3=-19,5366304120134
 FrameElem=45-1 ElemStation=0,1834
 Frame=45 Station=0 OutputCase=RAR016 CaseType=Combination P=-,14,7048204682422 V2=25,3489356689113 V3=0 T=0 M2=0 M3=-13,5601534099227 FrameElem=45-1
 ElemStation=0

Società di Progetto
Brebemi SpA

	Doc. N. 60235-0000-A00.doc	CODIFICA DOCUMENTO 04RCDII10000000000300A00	REV. 00	FOGLIO 582 di 628
--	-------------------------------	--	------------	----------------------

Frame=45 Station=0,0917 OutputCase=RAR016 CaseType=Combination P=-14,7048204682422 V2=25,7157356689113 V3=0 T=0 M2=0 M3=-15,9014685907619	FrameElem=45-1 ElemStation=0,0917
Frame=45 Station=0,1834 OutputCase=RAR016 CaseType=Combination P=-14,7048204682422 V2=26,0825356689113 V3=0 T=0 M2=0 M3=-18,2764193316011	FrameElem=45-1 ElemStation=0,1834
Frame=45 Station=0 OutputCase=RAR017 CaseType=Combination P=-23,6057872098525 V2=7,44503585763847 V3=0 T=0 M2=0 M3=-15,5835175552598	FrameElem=45-1 ElemStation=0
Frame=45 Station=0,0917 OutputCase=RAR017 CaseType=Combination P=-23,6057872098525 V2=7,81183585763847 V3=0 T=0 M2=0 M3=-16,2830451234053	FrameElem=45-1 ElemStation=0,0917
Frame=45 Station=0,1834 OutputCase=RAR017 CaseType=Combination P=-23,6057872098525 V2=8,17863585763847 V3=0 T=0 M2=0 M3=-17,0162082515507	FrameElem=45-1 ElemStation=0,1834
Frame=45 Station=0 OutputCase=RAR018 CaseType=Combination P=-15,4249235402034 V2=19,3429583622581 V3=0 T=0 M2=0 M3=0,661424841678423	FrameElem=45-1 ElemStation=0
Frame=45 Station=0,0917 OutputCase=RAR018 CaseType=Combination P=-15,4249235402034 V2=19,7097583622581 V3=0 T=0 M2=0 M3=-1,12914222014064	FrameElem=45-1 ElemStation=0,0917
Frame=45 Station=0,1834 OutputCase=RAR018 CaseType=Combination P=-15,4249235402034 V2=20,0765583622581 V3=0 T=0 M2=0 M3=-2,95334484195971	FrameElem=45-1 ElemStation=0,1834
Frame=45 Station=0 OutputCase=RAR019 CaseType=Combination P=-24,3258902818137 V2=1,43905855098525 V3=0 T=0 M2=0 M3=-1,36193930365865	FrameElem=45-1 ElemStation=0
Frame=45 Station=0,0917 OutputCase=RAR019 CaseType=Combination P=-24,3258902818137 V2=1,80585855098525 V3=0 T=0 M2=0 M3=-1,510718752784	FrameElem=45-1 ElemStation=0,0917
Frame=45 Station=0,1834 OutputCase=RAR019 CaseType=Combination P=-24,3258902818137 V2=2,17265855098525 V3=0 T=0 M2=0 M3=-1,69313376190934	FrameElem=45-1 ElemStation=0,1834
Frame=45 Station=0 OutputCase=RAR020 CaseType=Combination P=-6,71468319135112 V2=1,81774987725175 V3=0 T=0 M2=0 M3=-3,76117733367363	FrameElem=45-1 ElemStation=0
Frame=45 Station=0,0917 OutputCase=RAR020 CaseType=Combination P=-6,71468319135112 V2=2,18454987725175 V3=0 T=0 M2=0 M3=-3,94468277741762	FrameElem=45-1 ElemStation=0,0917
Frame=45 Station=0,1834 OutputCase=RAR020 CaseType=Combination P=-6,71468319135112 V2=2,55134987725175 V3=0 T=0 M2=0 M3=-4,1618237811616	FrameElem=45-1 ElemStation=0,1834
Frame=45 Station=0 OutputCase=RAR021 CaseType=Combination P=-5,99458011938986 V2=7,82372718390497 V3=0 T=0 M2=0 M3=-17,9827555852748	FrameElem=45-1 ElemStation=0
Frame=45 Station=0,0917 OutputCase=RAR021 CaseType=Combination P=-5,99458011938986 V2=8,19052718390497 V3=0 T=0 M2=0 M3=-18,170091480389	FrameElem=45-1 ElemStation=0,0917
Frame=45 Station=0,1834 OutputCase=RAR021 CaseType=Combination P=-5,99458011938986 V2=8,55732718390497 V3=0 T=0 M2=0 M3=-19,484898270803	FrameElem=45-1 ElemStation=0,1834
Frame=45 Station=0 OutputCase=RAR022 CaseType=Combination P=-14,8955468621643 V2=25,7302350694178 V3=0 T=0 M2=0 M3=-13,438490586594	FrameElem=45-1 ElemStation=0
Frame=45 Station=0,0917 OutputCase=RAR022 CaseType=Combination P=-14,8955468621643 V2=26,0970350694178 V3=0 T=0 M2=0 M3=-15,814771294525	FrameElem=45-1 ElemStation=0,0917
Frame=45 Station=0,1834 OutputCase=RAR022 CaseType=Combination P=-14,8955468621643 V2=26,4638350694178 V3=0 T=0 M2=0 M3=-18,2246871903906	FrameElem=45-1 ElemStation=0,1834
Frame=45 Station=0 OutputCase=RAR023 CaseType=Combination P=-23,7965136037746 V2=7,82633525814499 V3=0 T=0 M2=0 M3=-15,4618551039964	FrameElem=45-1 ElemStation=0
Frame=45 Station=0,0917 OutputCase=RAR023 CaseType=Combination P=-23,7965136037746 V2=8,19313525814498 V3=0 T=0 M2=0 M3=-16,1963478271683	FrameElem=45-1 ElemStation=0,0917
Frame=45 Station=0,1834 OutputCase=RAR023 CaseType=Combination P=-23,7965136037746 V2=8,55993525814499 V3=0 T=0 M2=0 M3=-16,9644761103402	FrameElem=45-1 ElemStation=0,1834
Frame=45 Station=0 OutputCase=RAR024 CaseType=Combination P=-15,6156499341256 V2=19,7242577627646 V3=0 T=0 M2=0 M3=0,783087292941803	FrameElem=45-1 ElemStation=0
Frame=45 Station=0,0917 OutputCase=RAR024 CaseType=Combination P=-15,6156499341256 V2=20,0910577627646 V3=0 T=0 M2=0 M3=-1,04244492390371	FrameElem=45-1 ElemStation=0,0917
Frame=45 Station=0,1834 OutputCase=RAR024 CaseType=Combination P=-15,6156499341256 V2=20,4578577627646 V3=0 T=0 M2=0 M3=-2,90161270074922	FrameElem=45-1 ElemStation=0,1834
Frame=45 Station=0 OutputCase=RAR025 CaseType=Combination P=-24,5166166757359 V2=1,82035795149177 V3=0 T=0 M2=0 M3=-1,24027685239527	FrameElem=45-1 ElemStation=0
Frame=45 Station=0,0917 OutputCase=RAR025 CaseType=Combination P=-24,5166166757359 V2=2,18715795149176 V3=0 T=0 M2=0 M3=-1,42402145654706	FrameElem=45-1 ElemStation=0,0917
Frame=45 Station=0,1834 OutputCase=RAR025 CaseType=Combination P=-24,5166166757359 V2=2,55395795149176 V3=0 T=0 M2=0 M3=-1,64140162069886	FrameElem=45-1 ElemStation=0,1834
Frame=45 Station=0 OutputCase=RAR026 CaseType=Combination P=-6,33323040350675 V2=1,05515107623872 V3=0 T=0 M2=0 M3=-4,00450223620039	FrameElem=45-1 ElemStation=0
Frame=45 Station=0,0917 OutputCase=RAR026 CaseType=Combination P=-6,33323040350675 V2=1,42195107623872 V3=0 T=0 M2=0 M3=-4,11807736989148	FrameElem=45-1 ElemStation=0,0917
Frame=45 Station=0,1834 OutputCase=RAR026 CaseType=Combination P=-6,33323040350675 V2=1,78875107623872 V3=0 T=0 M2=0 M3=-4,26528806358257	FrameElem=45-1 ElemStation=0,1834
Frame=45 Station=0 OutputCase=RAR027 CaseType=Combination P=-5,61312733154549 V2=7,06112838289194 V3=0 T=0 M2=0 M3=-18,2260804878016	FrameElem=45-1 ElemStation=0
Frame=45 Station=0,0917 OutputCase=RAR027 CaseType=Combination P=-5,61312733154549 V2=7,42792838289194 V3=0 T=0 M2=0 M3=-18,8904037405127	FrameElem=45-1 ElemStation=0,0917
Frame=45 Station=0,1834 OutputCase=RAR027 CaseType=Combination P=-5,61312733154549 V2=7,79472838289194 V3=0 T=0 M2=0 M3=-19,5883625532239	FrameElem=45-1 ElemStation=0,1834
Frame=45 Station=0 OutputCase=RAR028 CaseType=Combination P=-14,51409407432 V2=24,9676362684048 V3=0 T=0 M2=0 M3=-13,6818158611861	FrameElem=45-1 ElemStation=0
Frame=45 Station=0,0917 OutputCase=RAR028 CaseType=Combination P=-14,51409407432 V2=25,3344362684048 V3=0 T=0 M2=0 M3=-15,9881658869988	FrameElem=45-1 ElemStation=0,0917
Frame=45 Station=0,1834 OutputCase=RAR028 CaseType=Combination P=-14,51409407432 V2=25,7012362684048 V3=0 T=0 M2=0 M3=-18,3281514728116	FrameElem=45-1 ElemStation=0,1834
Frame=45 Station=0 OutputCase=RAR029 CaseType=Combination P=-23,4150608159303 V2=7,06373645713196 V3=0 T=0 M2=0 M3=-15,7051800065232	FrameElem=45-1 ElemStation=0
Frame=45 Station=0,0917 OutputCase=RAR029 CaseType=Combination P=-23,4150608159303 V2=7,43053645713196 V3=0 T=0 M2=0 M3=-16,3697424196422	FrameElem=45-1 ElemStation=0,0917
Frame=45 Station=0,1834 OutputCase=RAR029 CaseType=Combination P=-23,4150608159303 V2=7,79733645713196 V3=0 T=0 M2=0 M3=-17,0679403927612	FrameElem=45-1 ElemStation=0,1834
Frame=45 Station=0 OutputCase=RAR030 CaseType=Combination P=-15,2341971462812 V2=18,9616589617516 V3=0 T=0 M2=0 M3=0,539762390415044	FrameElem=45-1 ElemStation=0
Frame=45 Station=0,0917 OutputCase=RAR030 CaseType=Combination P=-15,2341971462812 V2=19,3284589617516 V3=0 T=0 M2=0 M3=-1,21583951637757	FrameElem=45-1 ElemStation=0,0917
Frame=45 Station=0,1834 OutputCase=RAR030 CaseType=Combination P=-15,2341971462812 V2=19,6952589617516 V3=0 T=0 M2=0 M3=-3,00507698317019	FrameElem=45-1 ElemStation=0,1834

Società di Progetto
Brebemi SpA

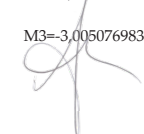

	Doc. N. 60235-0000-A00.doc	CODIFICA DOCUMENTO 04RCDII10000000000300A00	REV. 00	FOGLIO 583 di 628
--	-------------------------------	--	------------	----------------------

Frame=45 Station=0 OutputCase=RAR031 CaseType=Combination P=-24,1351638878915 V2=1,05775915047874 V3=0 T=0 M2=0 M3=-1,48360175492203 FrameElem=45-1 ElemStation=0

Frame=45 Station=0,0917 OutputCase=RAR031 CaseType=Combination P=-24,1351638878915 V2=1,42455915047874 V3=0 T=0 M2=0 M3=-1,59741604902093 FrameElem=45-1 ElemStation=0,0917

Frame=45 Station=0,1834 OutputCase=RAR031 CaseType=Combination P=-24,1351638878915 V2=1,79135915047874 V3=0 T=0 M2=0 M3=-1,74486590311983 FrameElem=45-1 ElemStation=0,1834

Frame=45 Station=0 OutputCase=RAR032 CaseType=Combination P=-6,98368521678688 V2=1,43684455177946 V3=0 T=0 M2=0 M3=-3,50193653897124 FrameElem=45-1 ElemStation=0

Frame=45 Station=0,0917 OutputCase=RAR032 CaseType=Combination P=-6,98368521678688 V2=1,80364455177946 V3=0 T=0 M2=0 M3=-3,65051296436941 FrameElem=45-1 ElemStation=0,0917

Frame=45 Station=0,1834 OutputCase=RAR032 CaseType=Combination P=-6,98368521678688 V2=2,17044455177946 V3=0 T=0 M2=0 M3=-3,83272494976759 FrameElem=45-1 ElemStation=0,1834

Frame=45 Station=0 OutputCase=RAR033 CaseType=Combination P=-6,26358214482563 V2=7,44282185843268 V3=0 T=0 M2=0 M3=-17,7235147905724 FrameElem=45-1 ElemStation=0

Frame=45 Station=0,0917 OutputCase=RAR033 CaseType=Combination P=-6,26358214482563 V2=7,80962185843268 V3=0 T=0 M2=0 M3=-18,4228393349907 FrameElem=45-1 ElemStation=0,0917

Frame=45 Station=0,1834 OutputCase=RAR033 CaseType=Combination P=-6,26358214482563 V2=8,17642185843268 V3=0 T=0 M2=0 M3=-19,1557994394089 FrameElem=45-1 ElemStation=0,1834

Frame=45 Station=0 OutputCase=RAR034 CaseType=Combination P=-15,1645488876001 V2=25,3493297439455 V3=0 T=0 M2=0 M3=-13,179250163957 FrameElem=45-1 ElemStation=0

Frame=45 Station=0,0917 OutputCase=RAR034 CaseType=Combination P=-15,1645488876001 V2=25,7161297439455 V3=0 T=0 M2=0 M3=-15,5206014814768 FrameElem=45-1 ElemStation=0,0917

Frame=45 Station=0,1834 OutputCase=RAR034 CaseType=Combination P=-15,1645488876001 V2=26,0829297439455 V3=0 T=0 M2=0 M3=-17,8955883589966 FrameElem=45-1 ElemStation=0,1834

Frame=45 Station=0 OutputCase=RAR035 CaseType=Combination P=-24,0655156292104 V2=7,44542993267269 V3=0 T=0 M2=0 M3=-15,202614309294 FrameElem=45-1 ElemStation=0

Frame=45 Station=0,0917 OutputCase=RAR035 CaseType=Combination P=-24,0655156292104 V2=7,81222993267269 V3=0 T=0 M2=0 M3=-15,9021780141201 FrameElem=45-1 ElemStation=0,0917

Frame=45 Station=0,1834 OutputCase=RAR035 CaseType=Combination P=-24,0655156292104 V2=8,17902993267269 V3=0 T=0 M2=0 M3=-16,6353772789462 FrameElem=45-1 ElemStation=0,1834

Frame=45 Station=0 OutputCase=RAR036 CaseType=Combination P=-15,8846519595614 V2=19,3433524372923 V3=0 T=0 M2=0 M3=1,0423280876442 FrameElem=45-1 ElemStation=0

Frame=45 Station=0,0917 OutputCase=RAR036 CaseType=Combination P=-15,8846519595614 V2=19,7101524372923 V3=0 T=0 M2=0 M3=-0,748275110855502 FrameElem=45-1 ElemStation=0,0917

Frame=45 Station=0,1834 OutputCase=RAR036 CaseType=Combination P=-15,8846519595614 V2=20,0769524372923 V3=0 T=0 M2=0 M3=-2,57251386935521 FrameElem=45-1 ElemStation=0,1834

Frame=45 Station=0 OutputCase=RAR037 CaseType=Combination P=-24,7856187011717 V2=1,43945262601947 V3=0 T=0 M2=0 M3=-0,981036057692872 FrameElem=45-1 ElemStation=0

Frame=45 Station=0,0917 OutputCase=RAR037 CaseType=Combination P=-24,7856187011717 V2=1,80625262601947 V3=0 T=0 M2=0 M3=-1,12985164349886 FrameElem=45-1 ElemStation=0,0917

Frame=45 Station=0,1834 OutputCase=RAR037 CaseType=Combination P=-24,7856187011717 V2=2,17305262601947 V3=0 T=0 M2=0 M3=-1,31230278930484 FrameElem=45-1 ElemStation=0,1834

Frame=45 Station=0 OutputCase=RAR038 CaseType=Combination P=-8,05638486195544 V2=1,43776406019263 V3=0 T=0 M2=0 M3=-2,61316229838442 FrameElem=45-1 ElemStation=0

Frame=45 Station=0,0917 OutputCase=RAR038 CaseType=Combination P=-8,05638486195544 V2=1,80456406019263 V3=0 T=0 M2=0 M3=-2,76182304270409 FrameElem=45-1 ElemStation=0,0917

Frame=45 Station=0,1834 OutputCase=RAR038 CaseType=Combination P=-8,05638486195544 V2=2,17136406019263 V3=0 T=0 M2=0 M3=-2,94411934702375 FrameElem=45-1 ElemStation=0,1834

Frame=45 Station=0 OutputCase=RAR039 CaseType=Combination P=-6,78976181976847 V2=9,44547108570745 V3=0 T=0 M2=0 M3=-21,8292021311632 FrameElem=45-1 ElemStation=0

Frame=45 Station=0,0917 OutputCase=RAR039 CaseType=Combination P=-6,78976181976847 V2=9,81227108570745 V3=0 T=0 M2=0 M3=-22,7121696097225 FrameElem=45-1 ElemStation=0,0917

Frame=45 Station=0,1834 OutputCase=RAR039 CaseType=Combination P=-6,78976181976847 V2=10,1790710857074 V3=0 T=0 M2=0 M3=-23,6287726482819 FrameElem=45-1 ElemStation=0,1834

Frame=45 Station=0 OutputCase=RAR040 CaseType=Combination P=-17,9908992123173 V2=32,4283548130964 V3=0 T=0 M2=0 M3=-16,0144952453975 FrameElem=45-1 ElemStation=0

Frame=45 Station=0,0917 OutputCase=RAR040 CaseType=Combination P=-17,9908992123173 V2=32,7951548130964 V3=0 T=0 M2=0 M3=-19,0049931617584 FrameElem=45-1 ElemStation=0,0917

Frame=45 Station=0,1834 OutputCase=RAR040 CaseType=Combination P=-17,9908992123173 V2=33,1619548130964 V3=0 T=0 M2=0 M3=-22,0291266381194 FrameElem=45-1 ElemStation=0,1834

Frame=45 Station=0 OutputCase=RAR041 CaseType=Combination P=-29,1920366032363 V2=9,44878163869211 V3=0 T=0 M2=0 M3=-18,629302955881 FrameElem=45-1 ElemStation=0

Frame=45 Station=0,0917 OutputCase=RAR041 CaseType=Combination P=-29,1920366032363 V2=9,81558163869211 V3=0 T=0 M2=0 M3=-19,512574012149 FrameElem=45-1 ElemStation=0,0917

Frame=45 Station=0,1834 OutputCase=RAR041 CaseType=Combination P=-29,1920366032363 V2=10,1823816386921 V3=0 T=0 M2=0 M3=-20,4294806284171 FrameElem=45-1 ElemStation=0,1834

Frame=45 Station=0 OutputCase=RAR042 CaseType=Combination P=-18,951036641599 V2=24,4203850708921 V3=0 T=0 M2=0 M3=2,94760909007074 FrameElem=45-1 ElemStation=0

Frame=45 Station=0,0917 OutputCase=RAR042 CaseType=Combination P=-18,951036641599 V2=24,7871850708921 V3=0 T=0 M2=0 M3=0,691441999069932 FrameElem=45-1 ElemStation=0,0917

Frame=45 Station=0,1834 OutputCase=RAR042 CaseType=Combination P=-18,951036641599 V2=25,1539850708921 V3=0 T=0 M2=0 M3=-1,59836065193088 FrameElem=45-1 ElemStation=0,1834

Frame=45 Station=0 OutputCase=RAR043 CaseType=Combination P=-30,152174032518 V2=1,44081189648781 V3=0 T=0 M2=0 M3=0,332801379587247 FrameElem=45-1 ElemStation=0

Frame=45 Station=0,0917 OutputCase=RAR043 CaseType=Combination P=-30,152174032518 V2=1,80761189648781 V3=0 T=0 M2=0 M3=0,183861148679315 FrameElem=45-1 ElemStation=0,0917

Frame=45 Station=0,1834 OutputCase=RAR043 CaseType=Combination P=-30,152174032518 V2=2,17441189648781 V3=0 T=0 M2=0 M3=1,28535777138256E-03 FrameElem=45-1 ElemStation=0,1834

Frame=45 Station=0 OutputCase=RAR044 CaseType=Combination P=-15,930762921726 V2=48,9264434411719 V3=0 T=0 M2=0 M3=-8,22048922408414 FrameElem=45-1 ElemStation=0

Frame=45 Station=0,0917 OutputCase=RAR044 CaseType=Combination P=-15,930762921726 V2=49,2932434411719 V3=0 T=0 M2=0 M3=-12,7238618676396 FrameElem=45-1 ElemStation=0,0917

Frame=45 Station=0,1834 OutputCase=RAR044 CaseType=Combination P=-15,930762921726 V2=49,6600434411719 V3=0 T=0 M2=0 M3=-17,2608708711951 FrameElem=45-1 ElemStation=0,1834

Frame=45 Station=0 OutputCase=RAR045 CaseType=Combination P=-7,33628178999419 V2=7,44374136684586 V3=0 T=0 M2=0 M3=-16,8347405499856 FrameElem=45-1 ElemStation=0

Frame=45 Station=0,0917 OutputCase=RAR045 CaseType=Combination P=-7,33628178999419 V2=7,81054136684586 V3=0 T=0 M2=0 M3=-17,5341494133253 FrameElem=45-1 ElemStation=0,0917

Società di Progetto
Brebemi SpA

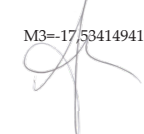

	Doc. N. 60235-00000-A00.doc	CODIFICA DOCUMENTO 04RCDII10000000000300A00	REV. 00	FOGLIO 584 di 628
--	--------------------------------	--	------------	----------------------

Frame=45 Station=0,1834 OutputCase=RAR045 CaseType=Combination P=-7,33628179999419 V2=8,17734136684586 V3=0 T=0 M2=0 M3=-18,2671938366651
 FrameElem=45-1 ElemStation=0,1834
 Frame=45 Station=0 OutputCase=RAR046 CaseType=Combination P=-16,2372485327687 V2=25,3502492523587 V3=0 T=0 M2=0 M3=-12,2904759233701 FrameElem=45-1
 ElemStation=0
 Frame=45 Station=0,0917 OutputCase=RAR046 CaseType=Combination P=-16,2372485327687 V2=25,7170492523587 V3=0 T=0 M2=0 M3=-14,6319115598114
 FrameElem=45-1 ElemStation=0,0917
 Frame=45 Station=0,1834 OutputCase=RAR046 CaseType=Combination P=-16,2372485327687 V2=26,0838492523587 V3=0 T=0 M2=0 M3=-17,0069827562527
 FrameElem=45-1 ElemStation=0,1834
 Frame=45 Station=0 OutputCase=RAR047 CaseType=Combination P=-25,138215274379 V2=7,44634944108587 V3=0 T=0 M2=0 M3=-14,3138400687072 FrameElem=45-1
 ElemStation=0
 Frame=45 Station=0,0917 OutputCase=RAR047 CaseType=Combination P=-25,138215274379 V2=7,81314944108587 V3=0 T=0 M2=0 M3=-15,0134880924548
 FrameElem=45-1 ElemStation=0,0917
 Frame=45 Station=0,1834 OutputCase=RAR047 CaseType=Combination P=-25,138215274379 V2=8,17994944108587 V3=0 T=0 M2=0 M3=-15,7467716762024
 FrameElem=45-1 ElemStation=0,1834
 Frame=45 Station=0 OutputCase=RAR048 CaseType=Combination P=-16,9573516047299 V2=19,3442719457055 V3=0 T=0 M2=0 M3=1,93110232823101 FrameElem=45-1
 ElemStation=0
 Frame=45 Station=0,0917 OutputCase=RAR048 CaseType=Combination P=-16,9573516047299 V2=19,7110719457055 V3=0 T=0 M2=0 M3=0,140414810809824
 FrameElem=45-1 ElemStation=0,0917
 Frame=45 Station=0,1834 OutputCase=RAR048 CaseType=Combination P=-16,9573516047299 V2=20,0778719457055 V3=0 T=0 M2=0 M3=-1,68390826661137
 FrameElem=45-1 ElemStation=0,1834
 Frame=45 Station=0 OutputCase=RAR049 CaseType=Combination P=-25,8583183463402 V2=1,44037213443265 V3=0 T=0 M2=0 M3=-9,22618171060581E-02
 FrameElem=45-1 ElemStation=0
 Frame=45 Station=0,0917 OutputCase=RAR049 CaseType=Combination P=-25,8583183463402 V2=1,80717213443265 V3=0 T=0 M2=0 M3=-0,241161721833531
 FrameElem=45-1 ElemStation=0,0917
 Frame=45 Station=0,1834 OutputCase=RAR049 CaseType=Combination P=-25,8583183463402 V2=2,17397213443265 V3=0 T=0 M2=0 M3=-0,423697186561005
 FrameElem=45-1 ElemStation=0,1834
 Frame=45 Station=0 OutputCase=RAR050 CaseType=Combination P=-8,24711125587763 V2=1,81906346069915 V3=0 T=0 M2=0 M3=-2,49149984712104 FrameElem=45-1
 ElemStation=0
 Frame=45 Station=0,0917 OutputCase=RAR050 CaseType=Combination P=-8,24711125587763 V2=2,18586346069915 V3=0 T=0 M2=0 M3=-2,67512574646715
 FrameElem=45-1 ElemStation=0,0917
 Frame=45 Station=0,1834 OutputCase=RAR050 CaseType=Combination P=-8,24711125587763 V2=2,55266346069915 V3=0 T=0 M2=0 M3=-2,89238720581327
 FrameElem=45-1 ElemStation=0,1834
 Frame=45 Station=0 OutputCase=RAR051 CaseType=Combination P=-7,52700818391637 V2=7,82504076735237 V3=0 T=0 M2=0 M3=-16,7130780987222 FrameElem=45-1
 ElemStation=0
 Frame=45 Station=0,0917 OutputCase=RAR051 CaseType=Combination P=-7,52700818391637 V2=8,19184076735237 V3=0 T=0 M2=0 M3=-17,4474521170884
 FrameElem=45-1 ElemStation=0,0917
 Frame=45 Station=0,1834 OutputCase=RAR051 CaseType=Combination P=-7,52700818391637 V2=8,55864076735237 V3=0 T=0 M2=0 M3=-18,2154616954546
 FrameElem=45-1 ElemStation=0,1834
 Frame=45 Station=0 OutputCase=RAR052 CaseType=Combination P=-16,4279749266908 V2=25,7315486528652 V3=0 T=0 M2=0 M3=-12,1688134721068 FrameElem=45-1
 ElemStation=0
 Frame=45 Station=0,0917 OutputCase=RAR052 CaseType=Combination P=-16,4279749266908 V2=26,0983486528652 V3=0 T=0 M2=0 M3=-14,5452142635745
 FrameElem=45-1 ElemStation=0,0917
 Frame=45 Station=0,1834 OutputCase=RAR052 CaseType=Combination P=-16,4279749266908 V2=26,4651486528652 V3=0 T=0 M2=0 M3=-16,9552506150422
 FrameElem=45-1 ElemStation=0,1834
 Frame=45 Station=0 OutputCase=RAR053 CaseType=Combination P=-25,3289416683012 V2=7,82764884159239 V3=0 T=0 M2=0 M3=-14,1921776174438 FrameElem=45-1
 ElemStation=0
 Frame=45 Station=0,0917 OutputCase=RAR053 CaseType=Combination P=-25,3289416683012 V2=8,19444884159238 V3=0 T=0 M2=0 M3=-14,9267907962179
 FrameElem=45-1 ElemStation=0,0917
 Frame=45 Station=0,1834 OutputCase=RAR053 CaseType=Combination P=-25,3289416683012 V2=8,56124884159238 V3=0 T=0 M2=0 M3=-15,6950395349919
 FrameElem=45-1 ElemStation=0,1834
 Frame=45 Station=0 OutputCase=RAR054 CaseType=Combination P=-17,1480779986521 V2=19,725571346212 V3=0 T=0 M2=0 M3=2,05276477949439 FrameElem=45-1
 ElemStation=0
 Frame=45 Station=0,0917 OutputCase=RAR054 CaseType=Combination P=-17,1480779986521 V2=20,092371346212 V3=0 T=0 M2=0 M3=0,227112107046756
 FrameElem=45-1 ElemStation=0,0917
 Frame=45 Station=0,1834 OutputCase=RAR054 CaseType=Combination P=-17,1480779986521 V2=20,459171346212 V3=0 T=0 M2=0 M3=-1,63217612540088
 FrameElem=45-1 ElemStation=0,1834
 Frame=45 Station=0 OutputCase=RAR055 CaseType=Combination P=-26,0490447402624 V2=1,82167153493916 V3=0 T=0 M2=0 M3=2,94006341573214E-02 FrameElem=45-1
 ElemStation=0
 Frame=45 Station=0,0917 OutputCase=RAR055 CaseType=Combination P=-26,0490447402624 V2=2,18847153493916 V3=0 T=0 M2=0 M3=-0,154464425596599
 FrameElem=45-1 ElemStation=0,0917
 Frame=45 Station=0,1834 OutputCase=RAR055 CaseType=Combination P=-26,0490447402624 V2=2,55257153493916 V3=0 T=0 M2=0 M3=-0,371965045350521
 FrameElem=45-1 ElemStation=0,1834
 Frame=45 Station=0 OutputCase=RAR056 CaseType=Combination P=-7,86565846803326 V2=1,05646465968612 V3=0 T=0 M2=0 M3=-2,7348247496478 FrameElem=45-1
 ElemStation=0
 Frame=45 Station=0,0917 OutputCase=RAR056 CaseType=Combination P=-7,86565846803326 V2=1,42326465968612 V3=0 T=0 M2=0 M3=-2,84852033894102
 FrameElem=45-1 ElemStation=0,0917
 Frame=45 Station=0,1834 OutputCase=RAR056 CaseType=Combination P=-7,86565846803326 V2=1,79006465968612 V3=0 T=0 M2=0 M3=-2,99585148823424
 FrameElem=45-1 ElemStation=0,1834
 Frame=45 Station=0 OutputCase=RAR057 CaseType=Combination P=-7,145555396072 V2=7,06244196633934 V3=0 T=0 M2=0 M3=-16,956403001249 FrameElem=45-1
 ElemStation=0
 Frame=45 Station=0,0917 OutputCase=RAR057 CaseType=Combination P=-7,145555396072 V2=7,42924196633934 V3=0 T=0 M2=0 M3=-17,6208467095623 FrameElem=45-1
 ElemStation=0,0917
 Frame=45 Station=0,1834 OutputCase=RAR057 CaseType=Combination P=-7,145555396072 V2=7,79604196633934 V3=0 T=0 M2=0 M3=-18,3189259778756 FrameElem=45-1
 ElemStation=0,1834
 Frame=45 Station=0 OutputCase=RAR058 CaseType=Combination P=-16,0465221388465 V2=24,9689498518522 V3=0 T=0 M2=0 M3=-12,4121383746335 FrameElem=45-1
 ElemStation=0
 Frame=45 Station=0,0917 OutputCase=RAR058 CaseType=Combination P=-16,0465221388465 V2=25,3357498518522 V3=0 T=0 M2=0 M3=-14,7186088560484
 FrameElem=45-1 ElemStation=0,0917
 Frame=45 Station=0,1834 OutputCase=RAR058 CaseType=Combination P=-16,0465221388465 V2=25,7025498518522 V3=0 T=0 M2=0 M3=-17,0587148974632
 FrameElem=45-1 ElemStation=0,1834
 Frame=45 Station=0 OutputCase=RAR059 CaseType=Combination P=-24,9474888804568 V2=7,06505004057936 V3=0 T=0 M2=0 M3=-14,4355025199706 FrameElem=45-1
 ElemStation=0
 Frame=45 Station=0,0917 OutputCase=RAR059 CaseType=Combination P=-24,9474888804568 V2=7,43185004057936 V3=0 T=0 M2=0 M3=-15,1001833886917
 FrameElem=45-1 ElemStation=0,0917
 Frame=45 Station=0,1834 OutputCase=RAR059 CaseType=Combination P=-24,9474888804568 V2=7,79865004057936 V3=0 T=0 M2=0 M3=-15,7985038174129
 FrameElem=45-1 ElemStation=0,1834
 Frame=45 Station=0 OutputCase=RAR060 CaseType=Combination P=-16,7666252108077 V2=18,962972545199 V3=0 T=0 M2=0 M3=1,80943987696764 FrameElem=45-1
 ElemStation=0

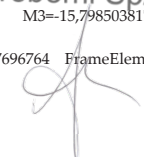
Società di Progetto
Brebemi SpA



Doc. N.
60235-0000-A00.doc

CODIFICA DOCUMENTO
04RCDII10000000000300A00

REV.
00

FOGLIO
585 di 628

Frame=45 Station=0,0917 OutputCase=RAR060 CaseType=Combination P=-16,7666252108077 V2=19,329772545199 V3=0 T=0 M2=0 M3=5,37175145728915E-02
FrameElem=45-1 ElemStation=0,0917
Frame=45 Station=0,1834 OutputCase=RAR060 CaseType=Combination P=-16,7666252108077 V2=19,696572545199 V3=0 T=0 M2=0 M3=-1,73564040782185
FrameElem=45-1 ElemStation=0,1834
Frame=45 Station=0 OutputCase=RAR061 CaseType=Combination P=-25,6675919524181 V2=1,05907273392614 V3=0 T=0 M2=0 M3=-0,213924268369438 FrameElem=45-1
ElemStation=0
Frame=45 Station=0,0917 OutputCase=RAR061 CaseType=Combination P=-25,6675919524181 V2=1,42587273392613 V3=0 T=0 M2=0 M3=-0,327859018070464
FrameElem=45-1 ElemStation=0,0917
Frame=45 Station=0,1834 OutputCase=RAR061 CaseType=Combination P=-25,6675919524181 V2=1,79267273392614 V3=0 T=0 M2=0 M3=-0,47542932777149
FrameElem=45-1 ElemStation=0,1834
Frame=45 Station=0 OutputCase=RAR062 CaseType=Combination P=-8,5161132813134 V2=1,43815813522685 V3=0 T=0 M2=0 M3=-2,23225905241864 FrameElem=45-1
ElemStation=0
Frame=45 Station=0,0917 OutputCase=RAR062 CaseType=Combination P=-8,5161132813134 V2=1,80495813522685 V3=0 T=0 M2=0 M3=-2,38095593341895
FrameElem=45-1 ElemStation=0,0917
Frame=45 Station=0,1834 OutputCase=RAR062 CaseType=Combination P=-8,5161132813134 V2=2,17175813522685 V3=0 T=0 M2=0 M3=-2,56328837441925
FrameElem=45-1 ElemStation=0,1834
Frame=45 Station=0 OutputCase=RAR063 CaseType=Combination P=-7,79601020935214 V2=7,44413544188008 V3=0 T=0 M2=0 M3=-16,4538373040198 FrameElem=45-1
ElemStation=0
Frame=45 Station=0,0917 OutputCase=RAR063 CaseType=Combination P=-7,79601020935214 V2=7,81093544188008 V3=0 T=0 M2=0 M3=-17,1532823040402
FrameElem=45-1 ElemStation=0,0917
Frame=45 Station=0,1834 OutputCase=RAR063 CaseType=Combination P=-7,79601020935214 V2=8,17773544188007 V3=0 T=0 M2=0 M3=-17,8863628640606
FrameElem=45-1 ElemStation=0,1834
Frame=45 Station=0 OutputCase=RAR064 CaseType=Combination P=-16,6969769521266 V2=25,3506433273929 V3=0 T=0 M2=0 M3=-11,9095726774044 FrameElem=45-1
ElemStation=0
Frame=45 Station=0,0917 OutputCase=RAR064 CaseType=Combination P=-16,6969769521266 V2=25,7174433273929 V3=0 T=0 M2=0 M3=-14,2510444505263
FrameElem=45-1 ElemStation=0,0917
Frame=45 Station=0,1834 OutputCase=RAR064 CaseType=Combination P=-16,6969769521266 V2=26,0842433273929 V3=0 T=0 M2=0 M3=-16,6261517836482
FrameElem=45-1 ElemStation=0,1834
Frame=45 Station=0 OutputCase=RAR065 CaseType=Combination P=-25,5979436937369 V2=7,44674351612009 V3=0 T=0 M2=0 M3=-13,9329368227414 FrameElem=45-1
ElemStation=0
Frame=45 Station=0,0917 OutputCase=RAR065 CaseType=Combination P=-25,5979436937369 V2=7,81354351612009 V3=0 T=0 M2=0 M3=-14,6326209831697
FrameElem=45-1 ElemStation=0,0917
Frame=45 Station=0,1834 OutputCase=RAR065 CaseType=Combination P=-25,5979436937369 V2=8,18034351612009 V3=0 T=0 M2=0 M3=-15,3659407035979
FrameElem=45-1 ElemStation=0,1834
Frame=45 Station=0 OutputCase=RAR066 CaseType=Combination P=-17,4170800240879 V2=19,3446660207397 V3=0 T=0 M2=0 M3=2,31200557419679 FrameElem=45-1
ElemStation=0
Frame=45 Station=0,0917 OutputCase=RAR066 CaseType=Combination P=-17,4170800240879 V2=19,7114660207397 V3=0 T=0 M2=0 M3=0,521281920094963
FrameElem=45-1 ElemStation=0,0917
Frame=45 Station=0,1834 OutputCase=RAR066 CaseType=Combination P=-17,4170800240879 V2=20,0782660207397 V3=0 T=0 M2=0 M3=-1,30307729400687
FrameElem=45-1 ElemStation=0,1834
Frame=45 Station=0 OutputCase=RAR067 CaseType=Combination P=-26,3180467656982 V2=1,44076620946687 V3=0 T=0 M2=0 M3=0,288641428859719 FrameElem=45-1
ElemStation=0
Frame=45 Station=0,0917 OutputCase=RAR067 CaseType=Combination P=-26,3180467656982 V2=1,80756620946687 V3=0 T=0 M2=0 M3=0,139705387451608
FrameElem=45-1 ElemStation=0,0917
Frame=45 Station=0,1834 OutputCase=RAR067 CaseType=Combination P=-26,3180467656982 V2=2,17436620946687 V3=0 T=0 M2=0 M3=-4,28662139565036E-02
FrameElem=45-1 ElemStation=0,1834
Frame=45 Station=0 OutputCase=RAR068 CaseType=Combination P=-7,60804815289583 V2=2,07260626931313 V3=0 T=0 M2=0 M3=-3,04523028955509 FrameElem=45-1
ElemStation=0
Frame=45 Station=0,0917 OutputCase=RAR068 CaseType=Combination P=-7,60804815289583 V2=2,43940626931312 V3=0 T=0 M2=0 M3=-3,2521060644511
FrameElem=45-1 ElemStation=0,0917
Frame=45 Station=0,1834 OutputCase=RAR068 CaseType=Combination P=-7,60804815289583 V2=2,80620626931313 V3=0 T=0 M2=0 M3=-3,49261739934711
FrameElem=45-1 ElemStation=0,1834
Frame=45 Station=0 OutputCase=RAR069 CaseType=Combination P=-6,5207597943327 V2=9,82637641117974 V3=0 T=0 M2=0 M3=-22,0884429258656 FrameElem=45-1
ElemStation=0
Frame=45 Station=0,0917 OutputCase=RAR069 CaseType=Combination P=-6,5207597943327 V2=10,1931764111797 V3=0 T=0 M2=0 M3=-23,0063394227707
FrameElem=45-1 ElemStation=0,0917
Frame=45 Station=0,1834 OutputCase=RAR069 CaseType=Combination P=-6,5207597943327 V2=10,5599764111797 V3=0 T=0 M2=0 M3=-23,9578714796759
FrameElem=45-1 ElemStation=0,1834
Frame=45 Station=0 OutputCase=RAR070 CaseType=Combination P=-17,7218971868815 V2=32,8092601385687 V3=0 T=0 M2=0 M3=-16,2737360400999 FrameElem=45-1
ElemStation=0
Frame=45 Station=0,0917 OutputCase=RAR070 CaseType=Combination P=-17,7218971868815 V2=33,1760601385687 V3=0 T=0 M2=0 M3=-19,2991629748066
FrameElem=45-1 ElemStation=0,0917
Frame=45 Station=0,1834 OutputCase=RAR070 CaseType=Combination P=-17,7218971868815 V2=33,5428601385687 V3=0 T=0 M2=0 M3=-22,3582254695134
FrameElem=45-1 ElemStation=0,1834
Frame=45 Station=0 OutputCase=RAR071 CaseType=Combination P=-28,9230345778006 V2=9,8296869641644 V3=0 T=0 M2=0 M3=-18,8885437505834 FrameElem=45-1
ElemStation=0
Frame=45 Station=0,0917 OutputCase=RAR071 CaseType=Combination P=-28,9230345778006 V2=10,1964869641644 V3=0 T=0 M2=0 M3=-19,8067438251972
FrameElem=45-1 ElemStation=0,0917
Frame=45 Station=0,1834 OutputCase=RAR071 CaseType=Combination P=-28,9230345778006 V2=10,5632869641644 V3=0 T=0 M2=0 M3=-20,7585794598111
FrameElem=45-1 ElemStation=0,1834
Frame=45 Station=0 OutputCase=RAR072 CaseType=Combination P=-18,6820346161632 V2=24,8012903963644 V3=0 T=0 M2=0 M3=2,68836829536834 FrameElem=45-1
ElemStation=0
Frame=45 Station=0,0917 OutputCase=RAR072 CaseType=Combination P=-18,6820346161632 V2=25,1680903963644 V3=0 T=0 M2=0 M3=0,397272186021724
FrameElem=45-1 ElemStation=0,0917
Frame=45 Station=0,1834 OutputCase=RAR072 CaseType=Combination P=-18,6820346161632 V2=25,5348903963644 V3=0 T=0 M2=0 M3=-1,92745948332489
FrameElem=45-1 ElemStation=0,1834
Frame=45 Station=0 OutputCase=RAR073 CaseType=Combination P=-29,8831720070822 V2=1,82171722196011 V3=0 T=0 M2=0 M3=7,35605848848488E-02 FrameElem=45-1
ElemStation=0
Frame=45 Station=0,0917 OutputCase=RAR073 CaseType=Combination P=-29,8831720070822 V2=2,18851722196011 V3=0 T=0 M2=0 M3=-0,110308664368893
FrameElem=45-1 ElemStation=0,0917
Frame=45 Station=0,1834 OutputCase=RAR073 CaseType=Combination P=-29,8831720070822 V2=2,55531722196011 V3=0 T=0 M2=0 M3=-0,327813473622634
FrameElem=45-1 ElemStation=0,1834
Frame=45 Station=0 OutputCase=RAR074 CaseType=Combination P=-15,6617608962902 V2=49,3073487666442 V3=0 T=0 M2=0 M3=-8,47973001878653 FrameElem=45-1
ElemStation=0
Frame=45 Station=0,0917 OutputCase=RAR074 CaseType=Combination P=-15,6617608962902 V2=49,6741487666442 V3=0 T=0 M2=0 M3=-13,0180316806878
FrameElem=45-1 ElemStation=0,0917
Frame=45 Station=0,1834 OutputCase=RAR074 CaseType=Combination P=-15,6617608962902 V2=50,0409487666442 V3=0 T=0 M2=0 M3=-17,5899689025891
FrameElem=45-1 ElemStation=0,1834

Società di Progetto
Brebemi SpA

	Doc. N. 60235-0000-A00.doc	CODIFICA DOCUMENTO 04RCDII10000000000300A00	REV. 00	FOGLIO 586 di 628
--	-------------------------------	--	------------	----------------------

Frame=45 Station=0 OutputCase=RAR075 CaseType=Combination P=-6,88794508093457 V2=8,07858357596635 V3=0 T=0 M2=0 M3=-17,2668085411562 FrameElem=45-1 ElemStation=0

Frame=45 Station=0,0917 OutputCase=RAR075 CaseType=Combination P=-6,88794508093457 V2=8,44538357596635 V3=0 T=0 M2=0 M3=-18,0244324350724 FrameElem=45-1 ElemStation=0,0917

Frame=45 Station=0,1834 OutputCase=RAR075 CaseType=Combination P=-6,88794508093457 V2=8,81218357596635 V3=0 T=0 M2=0 M3=-18,8156918889885 FrameElem=45-1 ElemStation=0,1834

Frame=45 Station=0 OutputCase=RAR076 CaseType=Combination P=-15,788911823709 V2=25,9850914614792 V3=0 T=0 M2=0 M3=-12,7225439145408 FrameElem=45-1 ElemStation=0

Frame=45 Station=0,0917 OutputCase=RAR076 CaseType=Combination P=-15,788911823709 V2=26,3518914614792 V3=0 T=0 M2=0 M3=-15,1221945815584 FrameElem=45-1 ElemStation=0,0917

Frame=45 Station=0,1834 OutputCase=RAR076 CaseType=Combination P=-15,788911823709 V2=26,7186914614792 V3=0 T=0 M2=0 M3=-17,5554808085761 FrameElem=45-1 ElemStation=0,1834

Frame=45 Station=0 OutputCase=RAR077 CaseType=Combination P=-24,6898785653194 V2=8,08119165020636 V3=0 T=0 M2=0 M3=-14,7459080598779 FrameElem=45-1 ElemStation=0

Frame=45 Station=0,0917 OutputCase=RAR077 CaseType=Combination P=-24,6898785653194 V2=8,44799165020636 V3=0 T=0 M2=0 M3=-15,5037711142018 FrameElem=45-1 ElemStation=0,0917

Frame=45 Station=0,1834 OutputCase=RAR077 CaseType=Combination P=-24,6898785653194 V2=8,81479165020636 V3=0 T=0 M2=0 M3=-16,2952697285257 FrameElem=45-1 ElemStation=0,1834

Frame=45 Station=0 OutputCase=RAR078 CaseType=Combination P=-16,5090148956703 V2=19,979114154826 V3=0 T=0 M2=0 M3=1,49903433706035 FrameElem=45-1 ElemStation=0

Frame=45 Station=0,0917 OutputCase=RAR078 CaseType=Combination P=-16,5090148956703 V2=20,345914154826 V3=0 T=0 M2=0 M3=-0,349868210937189 FrameElem=45-1 ElemStation=0,0917

Frame=45 Station=0,1834 OutputCase=RAR078 CaseType=Combination P=-16,5090148956703 V2=20,712714154826 V3=0 T=0 M2=0 M3=-2,23240631893473 FrameElem=45-1 ElemStation=0,1834

Frame=45 Station=0 OutputCase=RAR079 CaseType=Combination P=-25,4099816372806 V2=2,07521434355314 V3=0 T=0 M2=0 M3=-0,524329808276721 FrameElem=45-1 ElemStation=0

Frame=45 Station=0,0917 OutputCase=RAR079 CaseType=Combination P=-25,4099816372806 V2=2,44201434355314 V3=0 T=0 M2=0 M3=-0,731444743580544 FrameElem=45-1 ElemStation=0,0917

Frame=45 Station=0,1834 OutputCase=RAR079 CaseType=Combination P=-25,4099816372806 V2=2,80881434355314 V3=0 T=0 M2=0 M3=-0,972195238884367 FrameElem=45-1 ElemStation=0,1834

Frame=45 Station=0 OutputCase=RAR080 CaseType=Combination P=-7,14831973353787 V2=2,07221219427891 V3=0 T=0 M2=0 M3=-3,42613353552086 FrameElem=45-1 ElemStation=0

Frame=45 Station=0,0917 OutputCase=RAR080 CaseType=Combination P=-7,14831973353787 V2=2,4390121942789 V3=0 T=0 M2=0 M3=-3,63297317373624 FrameElem=45-1 ElemStation=0,0917

Frame=45 Station=0,1834 OutputCase=RAR080 CaseType=Combination P=-7,14831973353787 V2=2,80581219427891 V3=0 T=0 M2=0 M3=-3,87344837195161 FrameElem=45-1 ElemStation=0,1834

Frame=45 Station=0 OutputCase=RAR081 CaseType=Combination P=-6,42821666157662 V2=8,07818950093213 V3=0 T=0 M2=0 M3=-17,647711787122 FrameElem=45-1 ElemStation=0

Frame=45 Station=0,0917 OutputCase=RAR081 CaseType=Combination P=-6,42821666157662 V2=8,44498950093213 V3=0 T=0 M2=0 M3=-18,4052995443575 FrameElem=45-1 ElemStation=0,0917

Frame=45 Station=0,1834 OutputCase=RAR081 CaseType=Combination P=-6,42821666157662 V2=8,81178950093213 V3=0 T=0 M2=0 M3=-19,196522861593 FrameElem=45-1 ElemStation=0,1834

Frame=45 Station=0 OutputCase=RAR082 CaseType=Combination P=-15,3291834043511 V2=25,984697386445 V3=0 T=0 M2=0 M3=-13,1034471605066 FrameElem=45-1 ElemStation=0

Frame=45 Station=0,0917 OutputCase=RAR082 CaseType=Combination P=-15,3291834043511 V2=26,351497386445 V3=0 T=0 M2=0 M3=-15,5030616908436 FrameElem=45-1 ElemStation=0,0917

Frame=45 Station=0,1834 OutputCase=RAR082 CaseType=Combination P=-15,3291834043511 V2=26,718297386445 V3=0 T=0 M2=0 M3=-17,9363117811806 FrameElem=45-1 ElemStation=0,1834

Frame=45 Station=0 OutputCase=RAR083 CaseType=Combination P=-24,2301501459614 V2=8,08079757517214 V3=0 T=0 M2=0 M3=-15,1268113058437 FrameElem=45-1 ElemStation=0

Frame=45 Station=0,0917 OutputCase=RAR083 CaseType=Combination P=-24,2301501459614 V2=8,44759757517214 V3=0 T=0 M2=0 M3=-15,8846382234869 FrameElem=45-1 ElemStation=0,0917

Frame=45 Station=0,1834 OutputCase=RAR083 CaseType=Combination P=-24,2301501459614 V2=8,81439757517214 V3=0 T=0 M2=0 M3=-16,6761007011302 FrameElem=45-1 ElemStation=0,1834

Frame=45 Station=0 OutputCase=RAR084 CaseType=Combination P=-16,0492864763123 V2=19,9787200797917 V3=0 T=0 M2=0 M3=-1,11813109109457 FrameElem=45-1 ElemStation=0

Frame=45 Station=0,0917 OutputCase=RAR084 CaseType=Combination P=-16,0492864763123 V2=20,3455200797917 V3=0 T=0 M2=0 M3=-0,730735320222328 FrameElem=45-1 ElemStation=0,0917

Frame=45 Station=0,1834 OutputCase=RAR084 CaseType=Combination P=-16,0492864763123 V2=20,7123200797917 V3=0 T=0 M2=0 M3=-2,61323729153923 FrameElem=45-1 ElemStation=0,1834

Frame=45 Station=0 OutputCase=RAR085 CaseType=Combination P=-24,9502532179227 V2=2,07482026851892 V3=0 T=0 M2=0 M3=-0,905233054242499 FrameElem=45-1 ElemStation=0

Frame=45 Station=0,0917 OutputCase=RAR085 CaseType=Combination P=-24,9502532179227 V2=2,44162026851892 V3=0 T=0 M2=0 M3=-1,11231185286568 FrameElem=45-1 ElemStation=0,0917

Frame=45 Station=0,1834 OutputCase=RAR085 CaseType=Combination P=-24,9502532179227 V2=2,80842026851892 V3=0 T=0 M2=0 M3=-1,35302621148887 FrameElem=45-1 ElemStation=0,1834

Frame=45 Station=0 OutputCase=RAR086 CaseType=Combination P=-8,06777657225378 V2=2,07300034434734 V3=0 T=0 M2=0 M3=-2,66432704358931 FrameElem=45-1 ElemStation=0

Frame=45 Station=0,0917 OutputCase=RAR086 CaseType=Combination P=-8,06777657225378 V2=2,43980034434734 V3=0 T=0 M2=0 M3=-2,87123895516596 FrameElem=45-1 ElemStation=0,0917

Frame=45 Station=0,1834 OutputCase=RAR086 CaseType=Combination P=-8,06777657225378 V2=2,80660034434734 V3=0 T=0 M2=0 M3=-3,11178642674261 FrameElem=45-1 ElemStation=0,1834

Frame=45 Station=0 OutputCase=RAR087 CaseType=Combination P=-7,34767350029253 V2=8,07897765100057 V3=0 T=0 M2=0 M3=-16,8859052951905 FrameElem=45-1 ElemStation=0

Frame=45 Station=0,0917 OutputCase=RAR087 CaseType=Combination P=-7,34767350029253 V2=8,44577765100057 V3=0 T=0 M2=0 M3=-17,6435653257872 FrameElem=45-1 ElemStation=0,0917

Frame=45 Station=0,1834 OutputCase=RAR087 CaseType=Combination P=-7,34767350029253 V2=8,81257765100056 V3=0 T=0 M2=0 M3=-18,434860916384 FrameElem=45-1 ElemStation=0,1834

Frame=45 Station=0 OutputCase=RAR088 CaseType=Combination P=-16,248640243067 V2=25,9854855365134 V3=0 T=0 M2=0 M3=-12,341640668575 FrameElem=45-1 ElemStation=0

Frame=45 Station=0,0917 OutputCase=RAR088 CaseType=Combination P=-16,248640243067 V2=26,3522855365134 V3=0 T=0 M2=0 M3=-14,7413274722733 FrameElem=45-1 ElemStation=0,0917

Frame=45 Station=0,1834 OutputCase=RAR088 CaseType=Combination P=-16,248640243067 V2=26,7190855365134 V3=0 T=0 M2=0 M3=-17,1746498359716 FrameElem=45-1 ElemStation=0,1834

Frame=45 Station=0 OutputCase=RAR089 CaseType=Combination P=-25,1496069846773 V2=8,08158572524058 V3=0 T=0 M2=0 M3=-14,3650048139121 FrameElem=45-1 ElemStation=0

Frame=45 Station=0,0917 OutputCase=RAR089 CaseType=Combination P=-25,1496069846773 V2=8,44838572524058 V3=0 T=0 M2=0 M3=-15,1229040049167 FrameElem=45-1 ElemStation=0,0917

Società di Progetto
Brebemi SpA

	Doc. N. 60235-00000-A00.doc	CODIFICA DOCUMENTO 04RCDII10000000000300A00	REV. 00	FOGLIO 587 di 628
--	--------------------------------	--	------------	----------------------

Frame=45 Station=0,1834 OutputCase=RAR089 CaseType=Combination P=-25,1496069846773 V2=8,81518572524058 V3=0 T=0 M2=0 M3=-15,9144387559212
 FrameElem=45-1 ElemStation=0,1834
 Frame=45 Station=0 OutputCase=RAR090 CaseType=Combination P=-16,9687433150283 V2=19,9795082298602 V3=0 T=0 M2=0 M3=1,87993758302613 FrameElem=45-1
 ElemStation=0
 Frame=45 Station=0,0917 OutputCase=RAR090 CaseType=Combination P=-16,9687433150283 V2=20,3463082298602 V3=0 T=0 M2=0 M3=3,09988983479508E-02
 FrameElem=45-1 ElemStation=0,0917
 Frame=45 Station=0,1834 OutputCase=RAR090 CaseType=Combination P=-16,9687433150283 V2=20,7131082298602 V3=0 T=0 M2=0 M3=-1,85157534633023
 FrameElem=45-1 ElemStation=0,1834
 Frame=45 Station=0 OutputCase=RAR091 CaseType=Combination P=-25,8697100566386 V2=2,07560841858736 V3=0 T=0 M2=0 M3=-0,143426562310944 FrameElem=45-1
 ElemStation=0
 Frame=45 Station=0,0917 OutputCase=RAR091 CaseType=Combination P=-25,8697100566386 V2=2,44240841858736 V3=0 T=0 M2=0 M3=-0,350577634295404
 FrameElem=45-1 ElemStation=0,0917
 Frame=45 Station=0,1834 OutputCase=RAR091 CaseType=Combination P=-25,8697100566386 V2=2,80920841858736 V3=0 T=0 M2=0 M3=-0,591364266279865
 FrameElem=45-1 ElemStation=0,1834
 Frame=45 Station=0 OutputCase=RAR092 CaseType=Combination P=-8,06777657225378 V2=2,07300034434734 V3=0 T=0 M2=0 M3=-2,66432704358931 FrameElem=45-1
 ElemStation=0
 Frame=45 Station=0,0917 OutputCase=RAR092 CaseType=Combination P=-8,06777657225378 V2=2,43980034434734 V3=0 T=0 M2=0 M3=-2,87123895516596
 FrameElem=45-1 ElemStation=0,0917
 Frame=45 Station=0,1834 OutputCase=RAR092 CaseType=Combination P=-8,06777657225378 V2=2,80660034434734 V3=0 T=0 M2=0 M3=-3,11178642674261
 FrameElem=45-1 ElemStation=0,1834
 Frame=45 Station=0 OutputCase=RAR093 CaseType=Combination P=-7,34767350029253 V2=8,07897765100057 V3=0 T=0 M2=0 M3=-16,8859052951905 FrameElem=45-1
 ElemStation=0
 Frame=45 Station=0,0917 OutputCase=RAR093 CaseType=Combination P=-7,34767350029253 V2=8,44577765100057 V3=0 T=0 M2=0 M3=-17,6435653257872
 FrameElem=45-1 ElemStation=0,0917
 Frame=45 Station=0,1834 OutputCase=RAR093 CaseType=Combination P=-7,34767350029253 V2=8,81257765100056 V3=0 T=0 M2=0 M3=-18,434860916384
 FrameElem=45-1 ElemStation=0,1834
 Frame=45 Station=0 OutputCase=RAR094 CaseType=Combination P=-16,248640243067 V2=25,985485565134 V3=0 T=0 M2=0 M3=-12,341640668575 FrameElem=45-1
 ElemStation=0
 Frame=45 Station=0,0917 OutputCase=RAR094 CaseType=Combination P=-16,248640243067 V2=26,3522855365134 V3=0 T=0 M2=0 M3=-14,7413274722733
 FrameElem=45-1 ElemStation=0,0917
 Frame=45 Station=0,1834 OutputCase=RAR094 CaseType=Combination P=-16,248640243067 V2=26,7190855365134 V3=0 T=0 M2=0 M3=-17,1746498359716
 FrameElem=45-1 ElemStation=0,1834
 Frame=45 Station=0 OutputCase=RAR095 CaseType=Combination P=-25,1496069846773 V2=8,08158572524058 V3=0 T=0 M2=0 M3=-14,3650048139121 FrameElem=45-1
 ElemStation=0
 Frame=45 Station=0,0917 OutputCase=RAR095 CaseType=Combination P=-25,1496069846773 V2=8,44838572524058 V3=0 T=0 M2=0 M3=-15,1229040049167
 FrameElem=45-1 ElemStation=0,0917
 Frame=45 Station=0,1834 OutputCase=RAR095 CaseType=Combination P=-25,1496069846773 V2=8,81518572524058 V3=0 T=0 M2=0 M3=-15,9144387559212
 FrameElem=45-1 ElemStation=0,1834
 Frame=45 Station=0 OutputCase=RAR096 CaseType=Combination P=-16,9687433150283 V2=19,9795082298602 V3=0 T=0 M2=0 M3=1,87993758302613 FrameElem=45-1
 ElemStation=0
 Frame=45 Station=0,0917 OutputCase=RAR096 CaseType=Combination P=-16,9687433150283 V2=20,3463082298602 V3=0 T=0 M2=0 M3=3,09988983479508E-02
 FrameElem=45-1 ElemStation=0,0917
 Frame=45 Station=0,1834 OutputCase=RAR096 CaseType=Combination P=-16,9687433150283 V2=20,7131082298602 V3=0 T=0 M2=0 M3=-1,85157534633023
 FrameElem=45-1 ElemStation=0,1834
 Frame=45 Station=0 OutputCase=RAR097 CaseType=Combination P=-25,8697100566386 V2=2,07560841858736 V3=0 T=0 M2=0 M3=-0,143426562310944 FrameElem=45-1
 ElemStation=0
 Frame=45 Station=0,0917 OutputCase=RAR097 CaseType=Combination P=-25,8697100566386 V2=2,44240841858736 V3=0 T=0 M2=0 M3=-0,350577634295404
 FrameElem=45-1 ElemStation=0,0917
 Frame=45 Station=0,1834 OutputCase=RAR097 CaseType=Combination P=-25,8697100566386 V2=2,80920841858736 V3=0 T=0 M2=0 M3=-0,591364266279865
 FrameElem=45-1 ElemStation=0,1834
 Frame=45 Station=0 OutputCase=RAR098 CaseType=Combination P=-6,97229350648855 V2=0,80160826762475 V3=0 T=0 M2=0 M3=-3,45077179376635 FrameElem=45-1
 ElemStation=0
 Frame=45 Station=0,0917 OutputCase=RAR098 CaseType=Combination P=-6,97229350648855 V2=1,16840826762474 V3=0 T=0 M2=0 M3=-3,54109705190754
 FrameElem=45-1 ElemStation=0,0917
 Frame=45 Station=0,1834 OutputCase=RAR098 CaseType=Combination P=-6,97229350648855 V2=1,53520826762475 V3=0 T=0 M2=0 M3=-3,66505787004873
 FrameElem=45-1 ElemStation=0,1834
 Frame=45 Station=0 OutputCase=RAR099 CaseType=Combination P=-6,13930700648833 V2=9,06377761016672 V3=0 T=0 M2=0 M3=-22,3317678283923 FrameElem=45-1
 ElemStation=0
 Frame=45 Station=0,0917 OutputCase=RAR099 CaseType=Combination P=-6,13930700648833 V2=9,43057761016672 V3=0 T=0 M2=0 M3=-23,1797340152446
 FrameElem=45-1 ElemStation=0,0917
 Frame=45 Station=0,1834 OutputCase=RAR099 CaseType=Combination P=-6,13930700648833 V2=9,79737761016672 V3=0 T=0 M2=0 M3=-24,0613357620969
 FrameElem=45-1 ElemStation=0,1834
 Frame=45 Station=0 OutputCase=RAR100 CaseType=Combination P=-17,3404443990372 V2=32,0466613375557 V3=0 T=0 M2=0 M3=-16,5170609426266 FrameElem=45-1
 ElemStation=0
 Frame=45 Station=0,0917 OutputCase=RAR100 CaseType=Combination P=-17,3404443990372 V2=32,4134613375557 V3=0 T=0 M2=0 M3=-19,4725575672805
 FrameElem=45-1 ElemStation=0,0917
 Frame=45 Station=0,1834 OutputCase=RAR100 CaseType=Combination P=-17,3404443990372 V2=32,7802613375557 V3=0 T=0 M2=0 M3=-22,4616897519343
 FrameElem=45-1 ElemStation=0,1834
 Frame=45 Station=0 OutputCase=RAR101 CaseType=Combination P=-28,5415817899562 V2=9,06708816315138 V3=0 T=0 M2=0 M3=-19,1318686531101 FrameElem=45-1
 ElemStation=0
 Frame=45 Station=0,0917 OutputCase=RAR101 CaseType=Combination P=-28,5415817899562 V2=9,43388816315137 V3=0 T=0 M2=0 M3=-19,9801384176711
 FrameElem=45-1 ElemStation=0,0917
 Frame=45 Station=0,1834 OutputCase=RAR101 CaseType=Combination P=-28,5415817899562 V2=9,80068816315137 V3=0 T=0 M2=0 M3=-20,8620437422321
 FrameElem=45-1 ElemStation=0,1834
 Frame=45 Station=0 OutputCase=RAR102 CaseType=Combination P=-18,3005818283188 V2=24,0386915953514 V3=0 T=0 M2=0 M3=2,44504339284158 FrameElem=45-1
 ElemStation=0
 Frame=45 Station=0,0917 OutputCase=RAR102 CaseType=Combination P=-18,3005818283188 V2=24,4054915953514 V3=0 T=0 M2=0 M3=0,22387759354786
 FrameElem=45-1 ElemStation=0,0917
 Frame=45 Station=0,1834 OutputCase=RAR102 CaseType=Combination P=-18,3005818283188 V2=24,7722915953514 V3=0 T=0 M2=0 M3=-2,03092376574586
 FrameElem=45-1 ElemStation=0,1834
 Frame=45 Station=0 OutputCase=RAR103 CaseType=Combination P=-29,5017192192379 V2=1,05911842094708 V3=0 T=0 M2=0 M3=-0,16976431764191 FrameElem=45-1
 ElemStation=0
 Frame=45 Station=0,0917 OutputCase=RAR103 CaseType=Combination P=-29,5017192192379 V2=1,42591842094708 V3=0 T=0 M2=0 M3=-0,283703258842757
 FrameElem=45-1 ElemStation=0,0917
 Frame=45 Station=0,1834 OutputCase=RAR103 CaseType=Combination P=-29,5017192192379 V2=1,79271842094708 V3=0 T=0 M2=0 M3=-0,43127756043604
 FrameElem=45-1 ElemStation=0,1834
 Frame=45 Station=0 OutputCase=RAR104 CaseType=Combination P=-15,2803081084459 V2=48,5447499656312 V3=0 T=0 M2=0 M3=-8,72305492131329 FrameElem=45-1
 ElemStation=0

Società di Progetto
Brebemi SpA

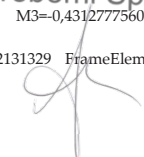



Doc. N.
60235-0000-A00.doc

CODIFICA DOCUMENTO
04RCDII10000000000300A00

REV.
00

FOGLIO
588 di 628

Frame=45 Station=0,0917 OutputCase=RAR104 CaseType=Combination P=-15,2803081084459 V2=48,9115499656312 V3=0 T=0 M2=0 M3=-13,1914262731617
FrameElem=45-1 ElemStation=0,0917
Frame=45 Station=0,1834 OutputCase=RAR104 CaseType=Combination P=-15,2803081084459 V2=49,2783499656312 V3=0 T=0 M2=0 M3=-17,6934331850101
FrameElem=45-1 ElemStation=0,1834
Frame=45 Station=0 OutputCase=RAR105 CaseType=Combination P=-6,25219043452729 V2=6,80758557427797 V3=0 T=0 M2=0 M3=-17,6723500453675
FrameElem=45-1 ElemStation=0
Frame=45 Station=0,0917 OutputCase=RAR105 CaseType=Combination P=-6,25219043452729 V2=7,17438557427797 V3=0 T=0 M2=0 M3=-18,3134234225288
FrameElem=45-1 ElemStation=0,0917
Frame=45 Station=0,1834 OutputCase=RAR105 CaseType=Combination P=-6,25219043452729 V2=7,54118557427797 V3=0 T=0 M2=0 M3=-18,9881323596901
FrameElem=45-1 ElemStation=0,1834
Frame=45 Station=0 OutputCase=RAR106 CaseType=Combination P=-15,1531571773018 V2=24,7140934597908 V3=0 T=0 M2=0 M3=-13,1280854187521
FrameElem=45-1 ElemStation=0
Frame=45 Station=0,0917 OutputCase=RAR106 CaseType=Combination P=-15,1531571773018 V2=25,0808934597908 V3=0 T=0 M2=0 M3=-15,4111855690149
FrameElem=45-1 ElemStation=0,0917
Frame=45 Station=0,1834 OutputCase=RAR106 CaseType=Combination P=-15,1531571773018 V2=25,4476934597908 V3=0 T=0 M2=0 M3=-17,7279212792777
FrameElem=45-1 ElemStation=0,1834
Frame=45 Station=0 OutputCase=RAR107 CaseType=Combination P=-24,0541239189121 V2=6,81019364851798 V3=0 T=0 M2=0 M3=-15,1514495640891
FrameElem=45-1 ElemStation=0
Frame=45 Station=0,0917 OutputCase=RAR107 CaseType=Combination P=-24,0541239189121 V2=7,17699364851798 V3=0 T=0 M2=0 M3=-15,7927621016582
FrameElem=45-1 ElemStation=0,0917
Frame=45 Station=0,1834 OutputCase=RAR107 CaseType=Combination P=-24,0541239189121 V2=7,54379364851798 V3=0 T=0 M2=0 M3=-16,4677101992273
FrameElem=45-1 ElemStation=0,1834
Frame=45 Station=0 OutputCase=RAR108 CaseType=Combination P=-15,873260249263 V2=18,7081161531376 V3=0 T=0 M2=0 M3=1,09349283284909
FrameElem=45-1 ElemStation=0
Frame=45 Station=0,0917 OutputCase=RAR108 CaseType=Combination P=-15,873260249263 V2=19,0749161531376 V3=0 T=0 M2=0 M3=-0,638859198393629
FrameElem=45-1 ElemStation=0,0917
Frame=45 Station=0,1834 OutputCase=RAR108 CaseType=Combination P=-15,873260249263 V2=19,4417161531376 V3=0 T=0 M2=0 M3=-2,40484678963635
FrameElem=45-1 ElemStation=0,1834
Frame=45 Station=0 OutputCase=RAR109 CaseType=Combination P=-24,7742269908733 V2=0,804216341864761 V3=0 T=0 M2=0 M3=-0,929871312487986
FrameElem=45-1 ElemStation=0
Frame=45 Station=0,0917 OutputCase=RAR109 CaseType=Combination P=-24,7742269908733 V2=1,17101634186476 V3=0 T=0 M2=0 M3=-1,02043573103698
FrameElem=45-1 ElemStation=0,0917
Frame=45 Station=0,1834 OutputCase=RAR109 CaseType=Combination P=-24,7742269908733 V2=1,53781634186476 V3=0 T=0 M2=0 M3=-1,14463570958598
FrameElem=45-1 ElemStation=0,1834
Frame=45 Station=0 OutputCase=RAR110 CaseType=Combination P=-6,51256508713059 V2=0,801214192590526 V3=0 T=0 M2=0 M3=-3,83167503973213
FrameElem=45-1 ElemStation=0
Frame=45 Station=0,0917 OutputCase=RAR110 CaseType=Combination P=-6,51256508713059 V2=1,16801419259053 V3=0 T=0 M2=0 M3=-3,92196416119268
FrameElem=45-1 ElemStation=0,0917
Frame=45 Station=0,1834 OutputCase=RAR110 CaseType=Combination P=-6,51256508713059 V2=1,53481419259053 V3=0 T=0 M2=0 M3=-4,0458884265323
FrameElem=45-1 ElemStation=0,1834
Frame=45 Station=0 OutputCase=RAR111 CaseType=Combination P=-5,79246201516934 V2=6,80719149924375 V3=0 T=0 M2=0 M3=-18,0532532913333
FrameElem=45-1 ElemStation=0
Frame=45 Station=0,0917 OutputCase=RAR111 CaseType=Combination P=-5,79246201516934 V2=7,17399149924375 V3=0 T=0 M2=0 M3=-18,6942905318139
FrameElem=45-1 ElemStation=0,0917
Frame=45 Station=0,1834 OutputCase=RAR111 CaseType=Combination P=-5,79246201516934 V2=7,54079149924375 V3=0 T=0 M2=0 M3=-19,3689633322946
FrameElem=45-1 ElemStation=0,1834
Frame=45 Station=0 OutputCase=RAR112 CaseType=Combination P=-14,6934287579438 V2=24,7136993847566 V3=0 T=0 M2=0 M3=-13,508988647178
FrameElem=45-1 ElemStation=0
Frame=45 Station=0,0917 OutputCase=RAR112 CaseType=Combination P=-14,6934287579438 V2=25,0804993847566 V3=0 T=0 M2=0 M3=-15,7920526783
FrameElem=45-1 ElemStation=0,0917
Frame=45 Station=0,1834 OutputCase=RAR112 CaseType=Combination P=-14,6934287579438 V2=25,4472993847566 V3=0 T=0 M2=0 M3=-18,1087522518822
FrameElem=45-1 ElemStation=0,1834
Frame=45 Station=0 OutputCase=RAR113 CaseType=Combination P=-23,5943954995541 V2=6,80979957348376 V3=0 T=0 M2=0 M3=-15,5323528100549
FrameElem=45-1 ElemStation=0
Frame=45 Station=0,0917 OutputCase=RAR113 CaseType=Combination P=-23,5943954995541 V2=7,17659957348376 V3=0 T=0 M2=0 M3=-16,1736292109434
FrameElem=45-1 ElemStation=0,0917
Frame=45 Station=0,1834 OutputCase=RAR113 CaseType=Combination P=-23,5943954995541 V2=7,54339957348376 V3=0 T=0 M2=0 M3=-16,8485411718319
FrameElem=45-1 ElemStation=0,1834
Frame=45 Station=0 OutputCase=RAR114 CaseType=Combination P=-15,4135318299051 V2=18,7077220781034 V3=0 T=0 M2=0 M3=0,712589586883309
FrameElem=45-1 ElemStation=0
Frame=45 Station=0,0917 OutputCase=RAR114 CaseType=Combination P=-15,4135318299051 V2=19,0745220781034 V3=0 T=0 M2=0 M3=-1,01972630767877
FrameElem=45-1 ElemStation=0,0917
Frame=45 Station=0,1834 OutputCase=RAR114 CaseType=Combination P=-15,4135318299051 V2=19,4413220781034 V3=0 T=0 M2=0 M3=-2,78567776224085
FrameElem=45-1 ElemStation=0,1834
Frame=45 Station=0 OutputCase=RAR115 CaseType=Combination P=-24,3144985715154 V2=0,803822266830541 V3=0 T=0 M2=0 M3=-1,31077455845376
FrameElem=45-1 ElemStation=0
Frame=45 Station=0,0917 OutputCase=RAR115 CaseType=Combination P=-24,3144985715154 V2=1,17062226683054 V3=0 T=0 M2=0 M3=-1,40130284032212
FrameElem=45-1 ElemStation=0,0917
Frame=45 Station=0,1834 OutputCase=RAR115 CaseType=Combination P=-24,3144985715154 V2=1,53742226683054 V3=0 T=0 M2=0 M3=-1,52546668219048
FrameElem=45-1 ElemStation=0,1834
Frame=45 Station=0 OutputCase=RAR116 CaseType=Combination P=-7,4320219258465 V2=0,802002342658965 V3=0 T=0 M2=0 M3=-3,06986854780057
FrameElem=45-1 ElemStation=0
Frame=45 Station=0,0917 OutputCase=RAR116 CaseType=Combination P=-7,4320219258465 V2=1,16880234265896 V3=0 T=0 M2=0 M3=-3,1602299426224
FrameElem=45-1 ElemStation=0,0917
Frame=45 Station=0,1834 OutputCase=RAR116 CaseType=Combination P=-7,4320219258465 V2=1,53560234265897 V3=0 T=0 M2=0 M3=-3,28422689744423
FrameElem=45-1 ElemStation=0,1834
Frame=45 Station=0 OutputCase=RAR117 CaseType=Combination P=-6,71191885388525 V2=6,80797964931219 V3=0 T=0 M2=0 M3=-17,2914467994017
FrameElem=45-1 ElemStation=0
Frame=45 Station=0,0917 OutputCase=RAR117 CaseType=Combination P=-6,71191885388525 V2=7,17477964931219 V3=0 T=0 M2=0 M3=-17,9325563132437
FrameElem=45-1 ElemStation=0,0917
Frame=45 Station=0,1834 OutputCase=RAR117 CaseType=Combination P=-6,71191885388525 V2=7,54157964931218 V3=0 T=0 M2=0 M3=-18,6073013870856
FrameElem=45-1 ElemStation=0,1834
Frame=45 Station=0 OutputCase=RAR118 CaseType=Combination P=-15,6128855966597 V2=24,714487534825 V3=0 T=0 M2=0 M3=-12,7471821727863
FrameElem=45-1 ElemStation=0
Frame=45 Station=0,0917 OutputCase=RAR118 CaseType=Combination P=-15,6128855966597 V2=25,081287534825 V3=0 T=0 M2=0 M3=-15,0303184597297
FrameElem=45-1 ElemStation=0,0917
Frame=45 Station=0,1834 OutputCase=RAR118 CaseType=Combination P=-15,6128855966597 V2=25,448087534825 V3=0 T=0 M2=0 M3=-17,3470903066732
FrameElem=45-1 ElemStation=0,1834

Società di Progetto
Brebemi SpA



Doc. N.
60235-0000-A00.doc

CODIFICA DOCUMENTO
04RCDII10000000000300A00

REV.
00

FOGLIO
589 di 628

Frame=45 Station=0 OutputCase=RAR119 CaseType=Combination P=-24,51385233827 V2=6,8105877235522 V3=0 T=0 M2=0 M3=-14,7705463181234 FrameElem=45-1 ElemStation=0
Frame=45 Station=0,0917 OutputCase=RAR119 CaseType=Combination P=-24,51385233827 V2=7,1773877235522 V3=0 T=0 M2=0 M3=-15,4118949923731 FrameElem=45-1 ElemStation=0,0917
Frame=45 Station=0,1834 OutputCase=RAR119 CaseType=Combination P=-24,51385233827 V2=7,5441877235522 V3=0 T=0 M2=0 M3=-16,0868792266228 FrameElem=45-1 ElemStation=0,1834
Frame=45 Station=0 OutputCase=RAR120 CaseType=Combination P=-16,332988668621 V2=18,7085102281718 V3=0 T=0 M2=0 M3=1,47439607881486 FrameElem=45-1 ElemStation=0
Frame=45 Station=0,0917 OutputCase=RAR120 CaseType=Combination P=-16,332988668621 V2=19,0753102281718 V3=0 T=0 M2=0 M3=-0,25799208910849 FrameElem=45-1 ElemStation=0,0917
Frame=45 Station=0,1834 OutputCase=RAR120 CaseType=Combination P=-16,332988668621 V2=19,4421102281718 V3=0 T=0 M2=0 M3=-2,02401581703184 FrameElem=45-1 ElemStation=0,1834
Frame=45 Station=0 OutputCase=RAR121 CaseType=Combination P=-25,2339554102313 V2=0,80461041689898 V3=0 T=0 M2=0 M3=-0,548968066522209 FrameElem=45-1 ElemStation=0
Frame=45 Station=0,0917 OutputCase=RAR121 CaseType=Combination P=-25,2339554102313 V2=1,17141041689898 V3=0 T=0 M2=0 M3=-0,639568621751845 FrameElem=45-1 ElemStation=0,0917
Frame=45 Station=0,1834 OutputCase=RAR121 CaseType=Combination P=-25,2339554102313 V2=1,53821041689898 V3=0 T=0 M2=0 M3=-0,763804736981481 FrameElem=45-1 ElemStation=0,1834
Frame=45 Station=0 OutputCase=RAR122 CaseType=Combination P=-7,4320219258465 V2=0,802002342658965 V3=0 T=0 M2=0 M3=-3,06986854780057 FrameElem=45-1 ElemStation=0
Frame=45 Station=0,0917 OutputCase=RAR122 CaseType=Combination P=-7,4320219258465 V2=1,16880234265896 V3=0 T=0 M2=0 M3=-3,1602299426224 FrameElem=45-1 ElemStation=0,0917
Frame=45 Station=0,1834 OutputCase=RAR122 CaseType=Combination P=-7,4320219258465 V2=1,53560234265896 V3=0 T=0 M2=0 M3=-3,28422689744423 FrameElem=45-1 ElemStation=0,1834
Frame=45 Station=0 OutputCase=RAR123 CaseType=Combination P=-6,71191885388525 V2=6,80797964931219 V3=0 T=0 M2=0 M3=-17,2914467994017 FrameElem=45-1 ElemStation=0
Frame=45 Station=0,0917 OutputCase=RAR123 CaseType=Combination P=-6,71191885388525 V2=7,17477964931219 V3=0 T=0 M2=0 M3=-17,9325563132437 FrameElem=45-1 ElemStation=0,0917
Frame=45 Station=0,1834 OutputCase=RAR123 CaseType=Combination P=-6,71191885388525 V2=7,54157964931219 V3=0 T=0 M2=0 M3=-18,6073013870856 FrameElem=45-1 ElemStation=0,1834
Frame=45 Station=0 OutputCase=RAR124 CaseType=Combination P=-15,6128855966597 V2=24,714487534825 V3=0 T=0 M2=0 M3=-12,7471821727863 FrameElem=45-1 ElemStation=0
Frame=45 Station=0,0917 OutputCase=RAR124 CaseType=Combination P=-15,6128855966597 V2=25,081287534825 V3=0 T=0 M2=0 M3=-15,0303184597297 FrameElem=45-1 ElemStation=0,0917
Frame=45 Station=0,1834 OutputCase=RAR124 CaseType=Combination P=-15,6128855966597 V2=25,448087534825 V3=0 T=0 M2=0 M3=-17,3470903066732 FrameElem=45-1 ElemStation=0,1834
Frame=45 Station=0 OutputCase=RAR125 CaseType=Combination P=-24,51385233827 V2=6,8105877235522 V3=0 T=0 M2=0 M3=-14,7705463181234 FrameElem=45-1 ElemStation=0
Frame=45 Station=0,0917 OutputCase=RAR125 CaseType=Combination P=-24,51385233827 V2=7,1773877235522 V3=0 T=0 M2=0 M3=-15,4118949923731 FrameElem=45-1 ElemStation=0,0917
Frame=45 Station=0,1834 OutputCase=RAR125 CaseType=Combination P=-24,51385233827 V2=7,5441877235522 V3=0 T=0 M2=0 M3=-16,0868792266228 FrameElem=45-1 ElemStation=0,1834
Frame=45 Station=0 OutputCase=RAR126 CaseType=Combination P=-16,332988668621 V2=18,7085102281718 V3=0 T=0 M2=0 M3=1,47439607881486 FrameElem=45-1 ElemStation=0
Frame=45 Station=0,0917 OutputCase=RAR126 CaseType=Combination P=-16,332988668621 V2=19,0753102281718 V3=0 T=0 M2=0 M3=-0,25799208910849 FrameElem=45-1 ElemStation=0,0917
Frame=45 Station=0,1834 OutputCase=RAR126 CaseType=Combination P=-16,332988668621 V2=19,4421102281718 V3=0 T=0 M2=0 M3=-2,02401581703184 FrameElem=45-1 ElemStation=0,1834
Frame=45 Station=0 OutputCase=RAR127 CaseType=Combination P=-25,2339554102313 V2=0,80461041689898 V3=0 T=0 M2=0 M3=-0,548968066522209 FrameElem=45-1 ElemStation=0
Frame=45 Station=0,0917 OutputCase=RAR127 CaseType=Combination P=-25,2339554102313 V2=1,17141041689898 V3=0 T=0 M2=0 M3=-0,639568621751845 FrameElem=45-1 ElemStation=0,0917
Frame=45 Station=0,1834 OutputCase=RAR127 CaseType=Combination P=-25,2339554102313 V2=1,53821041689898 V3=0 T=0 M2=0 M3=-0,763804736981481 FrameElem=45-1 ElemStation=0,1834
Frame=45 Station=0 OutputCase=RAR128 CaseType=Combination P=-8,05638486195544 V2=1,43776406019263 V3=0 T=0 M2=0 M3=-2,61316229838442 FrameElem=45-1 ElemStation=0
Frame=45 Station=0,0917 OutputCase=RAR128 CaseType=Combination P=-8,05638486195544 V2=1,80456406019263 V3=0 T=0 M2=0 M3=-2,76182304270409 FrameElem=45-1 ElemStation=0,0917
Frame=45 Station=0,1834 OutputCase=RAR128 CaseType=Combination P=-8,05638486195544 V2=2,17136406019263 V3=0 T=0 M2=0 M3=-2,94411934702375 FrameElem=45-1 ElemStation=0,1834
Frame=45 Station=0 OutputCase=RAR129 CaseType=Combination P=-6,78976181976847 V2=9,44547108570745 V3=0 T=0 M2=0 M3=-21,8292021311632 FrameElem=45-1 ElemStation=0
Frame=45 Station=0,0917 OutputCase=RAR129 CaseType=Combination P=-6,78976181976847 V2=9,81227108570745 V3=0 T=0 M2=0 M3=-22,7121696097225 FrameElem=45-1 ElemStation=0,0917
Frame=45 Station=0,1834 OutputCase=RAR129 CaseType=Combination P=-6,78976181976847 V2=10,1790710857074 V3=0 T=0 M2=0 M3=-23,6287726482819 FrameElem=45-1 ElemStation=0,1834
Frame=45 Station=0 OutputCase=RAR130 CaseType=Combination P=-17,9908992123173 V2=32,4283548130964 V3=0 T=0 M2=0 M3=-16,0144952453975 FrameElem=45-1 ElemStation=0
Frame=45 Station=0,0917 OutputCase=RAR130 CaseType=Combination P=-17,9908992123173 V2=32,7951548130964 V3=0 T=0 M2=0 M3=-19,0049931617584 FrameElem=45-1 ElemStation=0,0917
Frame=45 Station=0,1834 OutputCase=RAR130 CaseType=Combination P=-17,9908992123173 V2=33,1619548130964 V3=0 T=0 M2=0 M3=-22,0291266381194 FrameElem=45-1 ElemStation=0,1834
Frame=45 Station=0 OutputCase=RAR131 CaseType=Combination P=-29,1920366032363 V2=9,44878163869211 V3=0 T=0 M2=0 M3=-18,629302955881 FrameElem=45-1 ElemStation=0
Frame=45 Station=0,0917 OutputCase=RAR131 CaseType=Combination P=-29,1920366032363 V2=9,81558163869211 V3=0 T=0 M2=0 M3=-19,512574012149 FrameElem=45-1 ElemStation=0,0917
Frame=45 Station=0,1834 OutputCase=RAR131 CaseType=Combination P=-29,1920366032363 V2=10,1823816386921 V3=0 T=0 M2=0 M3=-20,4294806284171 FrameElem=45-1 ElemStation=0,1834
Frame=45 Station=0 OutputCase=RAR132 CaseType=Combination P=-18,951036641599 V2=24,4203850708921 V3=0 T=0 M2=0 M3=2,94760909007074 FrameElem=45-1 ElemStation=0
Frame=45 Station=0,0917 OutputCase=RAR132 CaseType=Combination P=-18,951036641599 V2=24,7871850708921 V3=0 T=0 M2=0 M3=0,691441999069932 FrameElem=45-1 ElemStation=0,0917
Frame=45 Station=0,1834 OutputCase=RAR132 CaseType=Combination P=-18,951036641599 V2=25,1539850708921 V3=0 T=0 M2=0 M3=-1,59836068193088 FrameElem=45-1 ElemStation=0,1834
Frame=45 Station=0 OutputCase=RAR133 CaseType=Combination P=-30,152174032518 V2=1,44081189648781 V3=0 T=0 M2=0 M3=0,332801379587247 FrameElem=45-1 ElemStation=0
Frame=45 Station=0,0917 OutputCase=RAR133 CaseType=Combination P=-30,152174032518 V2=1,80761189648781 V3=0 T=0 M2=0 M3=0,183861148679315 FrameElem=45-1 ElemStation=0,0917

Società di Progetto
Brebemi SpA

	Doc. N. 60235-00000-A00.doc	CODIFICA DOCUMENTO 04RCDII10000000000300A00	REV. 00	FOGLIO 590 di 628
--	--------------------------------	--	------------	----------------------

Frame=45 Station=0,1834 OutputCase=RAR133 CaseType=Combination P=-30,152174032518 V2=2,17441189648781 V3=0 T=0 M2=0 M3=1,28535777138256E-03
 FrameElem=45-1 ElemStation=0,1834
 Frame=45 Station=0 OutputCase=RAR134 CaseType=Combination P=-15,930762921726 V2=48,9264434411719 V3=0 T=0 M2=0 M3=-8,22048922408414 FrameElem=45-1
 ElemStation=0
 Frame=45 Station=0,0917 OutputCase=RAR134 CaseType=Combination P=-15,930762921726 V2=49,2932434411719 V3=0 T=0 M2=0 M3=-12,7238618676396
 FrameElem=45-1 ElemStation=0,0917
 Frame=45 Station=0,1834 OutputCase=RAR134 CaseType=Combination P=-15,930762921726 V2=49,6600434411719 V3=0 T=0 M2=0 M3=-17,2608700711951
 FrameElem=45-1 ElemStation=0,1834
 Frame=45 Station=0 OutputCase=RAR135 CaseType=Combination P=-7,33628178999419 V2=7,44374136684586 V3=0 T=0 M2=0 M3=-16,8347405499856 FrameElem=45-1
 ElemStation=0
 Frame=45 Station=0,0917 OutputCase=RAR135 CaseType=Combination P=-7,33628178999419 V2=7,81054136684586 V3=0 T=0 M2=0 M3=-17,5341494133253
 FrameElem=45-1 ElemStation=0,0917
 Frame=45 Station=0,1834 OutputCase=RAR135 CaseType=Combination P=-7,33628178999419 V2=8,17734136684586 V3=0 T=0 M2=0 M3=-18,2671938366651
 FrameElem=45-1 ElemStation=0,1834
 Frame=45 Station=0 OutputCase=RAR136 CaseType=Combination P=-16,2372485327687 V2=25,3502492523587 V3=0 T=0 M2=0 M3=-12,2904759233701 FrameElem=45-1
 ElemStation=0
 Frame=45 Station=0,0917 OutputCase=RAR136 CaseType=Combination P=-16,2372485327687 V2=25,7170492523587 V3=0 T=0 M2=0 M3=-14,6319115598114
 FrameElem=45-1 ElemStation=0,0917
 Frame=45 Station=0,1834 OutputCase=RAR136 CaseType=Combination P=-16,2372485327687 V2=26,0838492523587 V3=0 T=0 M2=0 M3=-17,0069827562527
 FrameElem=45-1 ElemStation=0,1834
 Frame=45 Station=0 OutputCase=RAR137 CaseType=Combination P=-25,138215274379 V2=7,44634944108587 V3=0 T=0 M2=0 M3=-14,3138400687072 FrameElem=45-1
 ElemStation=0
 Frame=45 Station=0,0917 OutputCase=RAR137 CaseType=Combination P=-25,138215274379 V2=7,81314944108587 V3=0 T=0 M2=0 M3=-15,0134880924548
 FrameElem=45-1 ElemStation=0,0917
 Frame=45 Station=0,1834 OutputCase=RAR137 CaseType=Combination P=-25,138215274379 V2=8,17994944108587 V3=0 T=0 M2=0 M3=-15,7467716762024
 FrameElem=45-1 ElemStation=0,1834
 Frame=45 Station=0 OutputCase=RAR138 CaseType=Combination P=-16,9573516047299 V2=19,3442719457055 V3=0 T=0 M2=0 M3=1,93110232823101 FrameElem=45-1
 ElemStation=0
 Frame=45 Station=0,0917 OutputCase=RAR138 CaseType=Combination P=-16,9573516047299 V2=19,7110719457055 V3=0 T=0 M2=0 M3=0,140414810809824
 FrameElem=45-1 ElemStation=0,0917
 Frame=45 Station=0,1834 OutputCase=RAR138 CaseType=Combination P=-16,9573516047299 V2=20,0778719457055 V3=0 T=0 M2=0 M3=-1,68390826661137
 FrameElem=45-1 ElemStation=0,1834
 Frame=45 Station=0 OutputCase=RAR139 CaseType=Combination P=-25,8583183463402 V2=1,44037213443265 V3=0 T=0 M2=0 M3=-9,2261871060581E-02
 FrameElem=45-1 ElemStation=0
 Frame=45 Station=0,0917 OutputCase=RAR139 CaseType=Combination P=-25,8583183463402 V2=1,80717213443265 V3=0 T=0 M2=0 M3=0,241161721833531
 FrameElem=45-1 ElemStation=0,0917
 Frame=45 Station=0,1834 OutputCase=RAR139 CaseType=Combination P=-25,8583183463402 V2=2,17397213443265 V3=0 T=0 M2=0 M3=0,423697186561005
 FrameElem=45-1 ElemStation=0,1834
 Frame=45 Station=0 OutputCase=RAR140 CaseType=Combination P=-7,59665644259749 V2=1,43736998515841 V3=0 T=0 M2=0 M3=-2,9940655443502 FrameElem=45-1
 ElemStation=0
 Frame=45 Station=0,0917 OutputCase=RAR140 CaseType=Combination P=-7,59665644259749 V2=1,80416998515841 V3=0 T=0 M2=0 M3=-3,14269015198923
 FrameElem=45-1 ElemStation=0,0917
 Frame=45 Station=0,1834 OutputCase=RAR140 CaseType=Combination P=-7,59665644259749 V2=2,17096998515841 V3=0 T=0 M2=0 M3=-3,32495031962825
 FrameElem=45-1 ElemStation=0,1834
 Frame=45 Station=0 OutputCase=RAR141 CaseType=Combination P=-6,8765537063624 V2=7,44334729181164 V3=0 T=0 M2=0 M3=-17,2156437959514 FrameElem=45-1
 ElemStation=0
 Frame=45 Station=0,0917 OutputCase=RAR141 CaseType=Combination P=-6,8765537063624 V2=7,81014729181164 V3=0 T=0 M2=0 M3=-17,9150165226105
 FrameElem=45-1 ElemStation=0,0917
 Frame=45 Station=0,1834 OutputCase=RAR141 CaseType=Combination P=-6,8765537063624 V2=8,17694729181164 V3=0 T=0 M2=0 M3=-18,6480248092696
 FrameElem=45-1 ElemStation=0,1834
 Frame=45 Station=0 OutputCase=RAR142 CaseType=Combination P=-15,7775201134107 V2=25,3498551773245 V3=0 T=0 M2=0 M3=-12,6713791693359 FrameElem=45-1
 ElemStation=0
 Frame=45 Station=0,0917 OutputCase=RAR142 CaseType=Combination P=-15,7775201134107 V2=25,7166551773245 V3=0 T=0 M2=0 M3=-15,0127786690966
 FrameElem=45-1 ElemStation=0,0917
 Frame=45 Station=0,1834 OutputCase=RAR142 CaseType=Combination P=-15,7775201134107 V2=26,0834551773245 V3=0 T=0 M2=0 M3=-17,3878137288572
 FrameElem=45-1 ElemStation=0,1834
 Frame=45 Station=0 OutputCase=RAR143 CaseType=Combination P=-24,678486855021 V2=7,44595536605165 V3=0 T=0 M2=0 M3=-14,694743314673 FrameElem=45-1
 ElemStation=0
 Frame=45 Station=0,0917 OutputCase=RAR143 CaseType=Combination P=-24,678486855021 V2=7,81275536605165 V3=0 T=0 M2=0 M3=-15,3943552017399
 FrameElem=45-1 ElemStation=0,0917
 Frame=45 Station=0,1834 OutputCase=RAR143 CaseType=Combination P=-24,678486855021 V2=8,17955536605165 V3=0 T=0 M2=0 M3=-16,1276026488069
 FrameElem=45-1 ElemStation=0,1834
 Frame=45 Station=0 OutputCase=RAR144 CaseType=Combination P=-16,497623185372 V2=19,3438778706713 V3=0 T=0 M2=0 M3=1,55019908226524 FrameElem=45-1
 ElemStation=0
 Frame=45 Station=0,0917 OutputCase=RAR144 CaseType=Combination P=-16,497623185372 V2=19,7106778706713 V3=0 T=0 M2=0 M3=0,240452298475316
 FrameElem=45-1 ElemStation=0,0917
 Frame=45 Station=0,1834 OutputCase=RAR144 CaseType=Combination P=-16,497623185372 V2=20,0774778706713 V3=0 T=0 M2=0 M3=-2,06473923921587
 FrameElem=45-1 ElemStation=0,1834
 Frame=45 Station=0 OutputCase=RAR145 CaseType=Combination P=-25,3985899269823 V2=1,43997805939843 V3=0 T=0 M2=0 M3=-0,473165063071836 FrameElem=45-1
 ElemStation=0
 Frame=45 Station=0,0917 OutputCase=RAR145 CaseType=Combination P=-25,3985899269823 V2=1,80677805939843 V3=0 T=0 M2=0 M3=0,622028831118671
 FrameElem=45-1 ElemStation=0,0917
 Frame=45 Station=0,1834 OutputCase=RAR145 CaseType=Combination P=-25,3985899269823 V2=2,17357805939843 V3=0 T=0 M2=0 M3=0,804528159165507
 FrameElem=45-1 ElemStation=0,1834
 Frame=45 Station=0 OutputCase=RAR146 CaseType=Combination P=-8,5161132813134 V2=1,43815813522685 V3=0 T=0 M2=0 M3=-2,23225905241864 FrameElem=45-1
 ElemStation=0
 Frame=45 Station=0,0917 OutputCase=RAR146 CaseType=Combination P=-8,5161132813134 V2=1,80495813522685 V3=0 T=0 M2=0 M3=-2,38095593341895
 FrameElem=45-1 ElemStation=0,0917
 Frame=45 Station=0,1834 OutputCase=RAR146 CaseType=Combination P=-8,5161132813134 V2=2,17175813522685 V3=0 T=0 M2=0 M3=-2,56328837441925
 FrameElem=45-1 ElemStation=0,1834
 Frame=45 Station=0 OutputCase=RAR147 CaseType=Combination P=-7,79601020935214 V2=7,44413544188008 V3=0 T=0 M2=0 M3=-16,4538373040198 FrameElem=45-1
 ElemStation=0
 Frame=45 Station=0,0917 OutputCase=RAR147 CaseType=Combination P=-7,79601020935214 V2=7,81093544188008 V3=0 T=0 M2=0 M3=-17,1532823040402
 FrameElem=45-1 ElemStation=0,0917
 Frame=45 Station=0,1834 OutputCase=RAR147 CaseType=Combination P=-7,79601020935214 V2=8,17773544188007 V3=0 T=0 M2=0 M3=-17,8863628640606
 FrameElem=45-1 ElemStation=0,1834
 Frame=45 Station=0 OutputCase=RAR148 CaseType=Combination P=-16,6969769521266 V2=25,3506433273929 V3=0 T=0 M2=0 M3=-11,9095726774044 FrameElem=45-1
 ElemStation=0

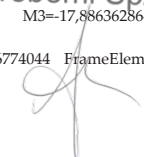
Società di Progetto
Brebemi SpA

	Doc. N. 60235-00000-A00.doc	CODIFICA DOCUMENTO 04RCDII10000000000300A00	REV. 00	FOGLIO 591 di 628
--	--------------------------------	--	------------	----------------------

Frame=45 Station=0,0917 OutputCase=RAR148 CaseType=Combination P=-16,6969769521266 V2=25,7174433273929 V3=0 T=0 M2=0 M3=-14,2510444505263
 FrameElem=45-1 ElemStation=0,0917
 Frame=45 Station=0,1834 OutputCase=RAR148 CaseType=Combination P=-16,6969769521266 V2=26,0842433273929 V3=0 T=0 M2=0 M3=-16,6261517836482
 FrameElem=45-1 ElemStation=0,1834
 Frame=45 Station=0 OutputCase=RAR149 CaseType=Combination P=-25,5979436937369 V2=7,44674351612009 V3=0 T=0 M2=0 M3=-13,9329368227414 FrameElem=45-1
 ElemStation=0
 Frame=45 Station=0,0917 OutputCase=RAR149 CaseType=Combination P=-25,5979436937369 V2=7,81354351612009 V3=0 T=0 M2=0 M3=-14,6326209831697
 FrameElem=45-1 ElemStation=0,0917
 Frame=45 Station=0,1834 OutputCase=RAR149 CaseType=Combination P=-25,5979436937369 V2=8,18034351612009 V3=0 T=0 M2=0 M3=-15,3659407035979
 FrameElem=45-1 ElemStation=0,1834
 Frame=45 Station=0 OutputCase=RAR150 CaseType=Combination P=-17,4170800240879 V2=19,3446660207397 V3=0 T=0 M2=0 M3=2,31200557419679 FrameElem=45-1
 ElemStation=0
 Frame=45 Station=0,0917 OutputCase=RAR150 CaseType=Combination P=-17,4170800240879 V2=19,7114660207397 V3=0 T=0 M2=0 M3=0,521281920094963
 FrameElem=45-1 ElemStation=0,0917
 Frame=45 Station=0,1834 OutputCase=RAR150 CaseType=Combination P=-17,4170800240879 V2=20,0782660207397 V3=0 T=0 M2=0 M3=-1,30307729400687
 FrameElem=45-1 ElemStation=0,1834
 Frame=45 Station=0 OutputCase=RAR151 CaseType=Combination P=-26,3180467656982 V2=1,44076620946687 V3=0 T=0 M2=0 M3=0,288641428859719 FrameElem=45-1
 ElemStation=0
 Frame=45 Station=0,0917 OutputCase=RAR151 CaseType=Combination P=-26,3180467656982 V2=1,80756620946687 V3=0 T=0 M2=0 M3=0,139705387451608
 FrameElem=45-1 ElemStation=0,0917
 Frame=45 Station=0,1834 OutputCase=RAR151 CaseType=Combination P=-26,3180467656982 V2=2,17436620946687 V3=0 T=0 M2=0 M3=-4,28662139565037E-02
 FrameElem=45-1 ElemStation=0,1834
 Frame=45 Station=0 OutputCase=RAR152 CaseType=Combination P=-8,24711125587763 V2=1,81906346069915 V3=0 T=0 M2=0 M3=-2,49149984712104 FrameElem=45-1
 ElemStation=0
 Frame=45 Station=0,0917 OutputCase=RAR152 CaseType=Combination P=-8,24711125587763 V2=2,18586346069915 V3=0 T=0 M2=0 M3=-2,67512574646715
 FrameElem=45-1 ElemStation=0,0917
 Frame=45 Station=0,1834 OutputCase=RAR152 CaseType=Combination P=-8,24711125587763 V2=2,55266346069915 V3=0 T=0 M2=0 M3=-2,89238720581327
 FrameElem=45-1 ElemStation=0,1834
 Frame=45 Station=0 OutputCase=RAR153 CaseType=Combination P=-7,52700818391637 V2=7,82504076735237 V3=0 T=0 M2=0 M3=-16,7130780987222 FrameElem=45-1
 ElemStation=0
 Frame=45 Station=0,0917 OutputCase=RAR153 CaseType=Combination P=-7,52700818391637 V2=8,19184076735237 V3=0 T=0 M2=0 M3=-17,4474521170884
 FrameElem=45-1 ElemStation=0,0917
 Frame=45 Station=0,1834 OutputCase=RAR153 CaseType=Combination P=-7,52700818391637 V2=8,55864076735237 V3=0 T=0 M2=0 M3=-18,2154616954546
 FrameElem=45-1 ElemStation=0,1834
 Frame=45 Station=0 OutputCase=RAR154 CaseType=Combination P=-16,4279749266908 V2=25,7315486528652 V3=0 T=0 M2=0 M3=-12,1688134721068 FrameElem=45-1
 ElemStation=0
 Frame=45 Station=0,0917 OutputCase=RAR154 CaseType=Combination P=-16,4279749266908 V2=26,0983486528652 V3=0 T=0 M2=0 M3=-14,5452142635745
 FrameElem=45-1 ElemStation=0,0917
 Frame=45 Station=0,1834 OutputCase=RAR154 CaseType=Combination P=-16,4279749266908 V2=26,4651486528652 V3=0 T=0 M2=0 M3=-16,9552506150422
 FrameElem=45-1 ElemStation=0,1834
 Frame=45 Station=0 OutputCase=RAR155 CaseType=Combination P=-25,3289416683012 V2=7,82764884159239 V3=0 T=0 M2=0 M3=-14,1921776174438 FrameElem=45-1
 ElemStation=0
 Frame=45 Station=0,0917 OutputCase=RAR155 CaseType=Combination P=-25,3289416683012 V2=8,19444884159238 V3=0 T=0 M2=0 M3=-14,9267907962179
 FrameElem=45-1 ElemStation=0,0917
 Frame=45 Station=0,1834 OutputCase=RAR155 CaseType=Combination P=-25,3289416683012 V2=8,56124884159238 V3=0 T=0 M2=0 M3=-15,6950395349919
 FrameElem=45-1 ElemStation=0,1834
 Frame=45 Station=0 OutputCase=RAR156 CaseType=Combination P=-17,1480779986521 V2=19,725571346212 V3=0 T=0 M2=0 M3=2,05276477949439 FrameElem=45-1
 ElemStation=0
 Frame=45 Station=0,0917 OutputCase=RAR156 CaseType=Combination P=-17,1480779986521 V2=20,092371346212 V3=0 T=0 M2=0 M3=0,227112107046756
 FrameElem=45-1 ElemStation=0,0917
 Frame=45 Station=0,1834 OutputCase=RAR156 CaseType=Combination P=-17,1480779986521 V2=20,459171346212 V3=0 T=0 M2=0 M3=-1,63217612540088
 FrameElem=45-1 ElemStation=0,1834
 Frame=45 Station=0 OutputCase=RAR157 CaseType=Combination P=-26,0490447402624 V2=1,82167153493916 V3=0 T=0 M2=0 M3=2,94006341573214E-02 FrameElem=45-1
 ElemStation=0
 Frame=45 Station=0,0917 OutputCase=RAR157 CaseType=Combination P=-26,0490447402624 V2=2,18847153493916 V3=0 T=0 M2=0 M3=0,15446425596599
 FrameElem=45-1 ElemStation=0,0917
 Frame=45 Station=0,1834 OutputCase=RAR157 CaseType=Combination P=-26,0490447402624 V2=2,55527153493916 V3=0 T=0 M2=0 M3=0,371965045350521
 FrameElem=45-1 ElemStation=0,1834
 Frame=45 Station=0 OutputCase=RAR158 CaseType=Combination P=-7,86565846803326 V2=1,05646465968612 V3=0 T=0 M2=0 M3=-2,7348247496478 FrameElem=45-1
 ElemStation=0
 Frame=45 Station=0,0917 OutputCase=RAR158 CaseType=Combination P=-7,86565846803326 V2=1,42326465968612 V3=0 T=0 M2=0 M3=-2,84852033894102
 FrameElem=45-1 ElemStation=0,0917
 Frame=45 Station=0,1834 OutputCase=RAR158 CaseType=Combination P=-7,86565846803326 V2=1,79006465968612 V3=0 T=0 M2=0 M3=-2,99585148823424
 FrameElem=45-1 ElemStation=0,1834
 Frame=45 Station=0 OutputCase=RAR159 CaseType=Combination P=-7,14555396072 V2=7,06244196633934 V3=0 T=0 M2=0 M3=-16,956403001249 FrameElem=45-1
 ElemStation=0
 Frame=45 Station=0,0917 OutputCase=RAR159 CaseType=Combination P=-7,14555396072 V2=7,42924196633934 V3=0 T=0 M2=0 M3=-17,6208467095623 FrameElem=45-1
 ElemStation=0,0917
 Frame=45 Station=0,1834 OutputCase=RAR159 CaseType=Combination P=-7,14555396072 V2=7,79604196633934 V3=0 T=0 M2=0 M3=-18,3189259778756 FrameElem=45-1
 ElemStation=0,1834
 Frame=45 Station=0 OutputCase=RAR160 CaseType=Combination P=-16,0465221388465 V2=24,9689498518522 V3=0 T=0 M2=0 M3=-12,4121383746335 FrameElem=45-1
 ElemStation=0
 Frame=45 Station=0,0917 OutputCase=RAR160 CaseType=Combination P=-16,0465221388465 V2=25,3357498518522 V3=0 T=0 M2=0 M3=-14,7186088560484
 FrameElem=45-1 ElemStation=0,0917
 Frame=45 Station=0,1834 OutputCase=RAR160 CaseType=Combination P=-16,0465221388465 V2=25,7025498518522 V3=0 T=0 M2=0 M3=-17,0587148974632
 FrameElem=45-1 ElemStation=0,1834
 Frame=45 Station=0 OutputCase=RAR161 CaseType=Combination P=-24,9474888804568 V2=7,06505004057936 V3=0 T=0 M2=0 M3=-14,4355025199706 FrameElem=45-1
 ElemStation=0
 Frame=45 Station=0,0917 OutputCase=RAR161 CaseType=Combination P=-24,9474888804568 V2=7,43185004057936 V3=0 T=0 M2=0 M3=-15,1001853886917
 FrameElem=45-1 ElemStation=0,0917
 Frame=45 Station=0,1834 OutputCase=RAR161 CaseType=Combination P=-24,9474888804568 V2=7,79865004057936 V3=0 T=0 M2=0 M3=-15,7985038174129
 FrameElem=45-1 ElemStation=0,1834
 Frame=45 Station=0 OutputCase=RAR162 CaseType=Combination P=-16,7666252108077 V2=18,962972545199 V3=0 T=0 M2=0 M3=1,80943987696764 FrameElem=45-1
 ElemStation=0
 Frame=45 Station=0,0917 OutputCase=RAR162 CaseType=Combination P=-16,7666252108077 V2=19,329772545199 V3=0 T=0 M2=0 M3=5,37175145728915E-02
 FrameElem=45-1 ElemStation=0,0917
 Frame=45 Station=0,1834 OutputCase=RAR162 CaseType=Combination P=-16,7666252108077 V2=19,696572545199 V3=0 T=0 M2=0 M3=-1,73564040782185
 FrameElem=45-1 ElemStation=0,1834

Società di Progetto
Brebemi SpA

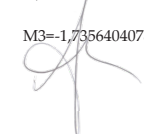



Doc. N.
60235-00000-A00.doc

CODIFICA DOCUMENTO
04RCDII10000000000300A00

REV.
00

FOGLIO
592 di 628

Frame=45 Station=0 OutputCase=RAR163 CaseType=Combination P=-25,6675919524181 V2=1,05907273392614 V3=0 T=0 M2=0 M3=-0,213924268369438 FrameElem=45-1 ElemStation=0
Frame=45 Station=0,0917 OutputCase=RAR163 CaseType=Combination P=-25,6675919524181 V2=1,42587273392613 V3=0 T=0 M2=0 M3=-0,327859018070464 FrameElem=45-1 ElemStation=0,0917
Frame=45 Station=0,1834 OutputCase=RAR163 CaseType=Combination P=-25,6675919524181 V2=1,79267273392614 V3=0 T=0 M2=0 M3=-0,47542932777149 FrameElem=45-1 ElemStation=0,1834
Frame=45 Station=0 OutputCase=INVRAR CaseType=Combination StepType=Max P=-5,61312733154549 V2=49,3073487666442 V3=0 T=0 M2=0 M3=2,94760900907074 FrameElem=45-1 ElemStation=0
Frame=45 Station=0,0917 OutputCase=INVRAR CaseType=Combination StepType=Max P=-5,61312733154549 V2=49,6741487666442 V3=0 T=0 M2=0 M3=0,691441999069932 FrameElem=45-1 ElemStation=0,0917
Frame=45 Station=0,1834 OutputCase=INVRAR CaseType=Combination StepType=Max P=-5,61312733154549 V2=50,0409487666442 V3=0 T=0 M2=0 M3=1,28535777138256E-03 FrameElem=45-1 ElemStation=0,1834
Frame=45 Station=0 OutputCase=INVRAR CaseType=Combination StepType=Min P=-30,152174032518 V2=0,801214192590526 V3=0 T=0 M2=0 M3=-22,5910086230947 FrameElem=45-1 ElemStation=0
Frame=45 Station=0,0917 OutputCase=INVRAR CaseType=Combination StepType=Min P=-30,152174032518 V2=1,16801419259053 V3=0 T=0 M2=0 M3=-23,4739038282928 FrameElem=45-1 ElemStation=0,0917
Frame=45 Station=0,1834 OutputCase=INVRAR CaseType=Combination StepType=Min P=-30,152174032518 V2=1,53481419259053 V3=0 T=0 M2=0 M3=-24,3904345934909 FrameElem=45-1 ElemStation=0,1834
Frame=45 Station=0 OutputCase=FRE01 CaseType=Combination P=-11,2910804168277 V2=1,43760790647502 V3=0 T=0 M2=0 M3=-2,76409664239382 FrameElem=45-1 ElemStation=0
Frame=45 Station=0,0917 OutputCase=FRE01 CaseType=Combination P=-11,2910804168277 V2=1,80440790647502 V3=0 T=0 M2=0 M3=-2,91274306741758 FrameElem=45-1 ElemStation=0,0917
Frame=45 Station=0,1834 OutputCase=FRE01 CaseType=Combination P=-11,2910804168277 V2=2,17120790647502 V3=0 T=0 M2=0 M3=-3,09502505244134 FrameElem=45-1 ElemStation=0,1834
Frame=45 Station=0 OutputCase=FRE02 CaseType=Combination P=-6,57006775773093 V2=7,44308457512216 V3=0 T=0 M2=0 M3=-17,4695792932619 FrameElem=45-1 ElemStation=0
Frame=45 Station=0,0917 OutputCase=FRE02 CaseType=Combination P=-6,57006775773093 V2=7,80988457512216 V3=0 T=0 M2=0 M3=-18,1689279288006 FrameElem=45-1 ElemStation=0,0917
Frame=45 Station=0,1834 OutputCase=FRE02 CaseType=Combination P=-6,57006775773093 V2=8,17668457512216 V3=0 T=0 M2=0 M3=-18,9019121243393 FrameElem=45-1 ElemStation=0,1834
Frame=45 Station=0 OutputCase=FRE03 CaseType=Combination P=-15,4710345005054 V2=25,349592460635 V3=0 T=0 M2=0 M3=-12,9253146666464 FrameElem=45-1 ElemStation=0
Frame=45 Station=0,0917 OutputCase=FRE03 CaseType=Combination P=-15,4710345005054 V2=25,716392460635 V3=0 T=0 M2=0 M3=-15,2666900752867 FrameElem=45-1 ElemStation=0,0917
Frame=45 Station=0,1834 OutputCase=FRE03 CaseType=Combination P=-15,4710345005054 V2=26,083192460635 V3=0 T=0 M2=0 M3=-17,6417010439269 FrameElem=45-1 ElemStation=0,1834
Frame=45 Station=0 OutputCase=FRE04 CaseType=Combination P=-24,3720012421157 V2=7,44569264936217 V3=0 T=0 M2=0 M3=-14,9486788119835 FrameElem=45-1 ElemStation=0
Frame=45 Station=0,0917 OutputCase=FRE04 CaseType=Combination P=-24,3720012421157 V2=7,81249264936217 V3=0 T=0 M2=0 M3=-15,64826660793 FrameElem=45-1 ElemStation=0,0917
Frame=45 Station=0,1834 OutputCase=FRE04 CaseType=Combination P=-24,3720012421157 V2=8,17929264936217 V3=0 T=0 M2=0 M3=-16,3814899638765 FrameElem=45-1 ElemStation=0,1834
Frame=45 Station=0 OutputCase=FRE05 CaseType=Combination P=-16,1911375724667 V2=19,3436151539818 V3=0 T=0 M2=0 M3=-1,29626358495472 FrameElem=45-1 ElemStation=0
Frame=45 Station=0,0917 OutputCase=FRE05 CaseType=Combination P=-16,1911375724667 V2=19,7104151539818 V3=0 T=0 M2=0 M3=-0,494363704665409 FrameElem=45-1 ElemStation=0,0917
Frame=45 Station=0,1834 OutputCase=FRE05 CaseType=Combination P=-16,1911375724667 V2=20,0772151539818 V3=0 T=0 M2=0 M3=-2,31862655428554 FrameElem=45-1 ElemStation=0,1834
Frame=45 Station=0 OutputCase=FRE06 CaseType=Combination P=-25,092104314077 V2=1,43971534270895 V3=0 T=0 M2=0 M3=-0,727100560382354 FrameElem=45-1 ElemStation=0
Frame=45 Station=0,0917 OutputCase=FRE06 CaseType=Combination P=-25,092104314077 V2=1,80651534270895 V3=0 T=0 M2=0 M3=-0,875940237308764 FrameElem=45-1 ElemStation=0,0917
Frame=45 Station=0,1834 OutputCase=FRE06 CaseType=Combination P=-25,092104314077 V2=2,17331534270895 V3=0 T=0 M2=0 M3=-1,05841547423517 FrameElem=45-1 ElemStation=0,1834
Frame=45 Station=0 OutputCase=FRE07 CaseType=Combination P=-6,83044241033423 V2=1,43671319343472 V3=0 T=0 M2=0 M3=-3,6289042876265 FrameElem=45-1 ElemStation=0
Frame=45 Station=0,0917 OutputCase=FRE07 CaseType=Combination P=-6,83044241033423 V2=1,80351319343472 V3=0 T=0 M2=0 M3=-3,77746866746446 FrameElem=45-1 ElemStation=0,0917
Frame=45 Station=0,1834 OutputCase=FRE07 CaseType=Combination P=-6,83044241033423 V2=2,17031319343472 V3=0 T=0 M2=0 M3=-3,95966860730242 FrameElem=45-1 ElemStation=0,1834
Frame=45 Station=0 OutputCase=FRE08 CaseType=Combination P=-6,18696074159931 V2=7,44275617926031 V3=0 T=0 M2=0 M3=-17,7869986649 FrameElem=45-1 ElemStation=0
Frame=45 Station=0,0917 OutputCase=FRE08 CaseType=Combination P=-6,18696074159931 V2=7,80955617926031 V3=0 T=0 M2=0 M3=-18,4863171865382 FrameElem=45-1 ElemStation=0,0917
Frame=45 Station=0,1834 OutputCase=FRE08 CaseType=Combination P=-6,18696074159931 V2=8,17635617926031 V3=0 T=0 M2=0 M3=-19,2192712681764 FrameElem=45-1 ElemStation=0,1834
Frame=45 Station=0 OutputCase=FRE09 CaseType=Combination P=-15,0879274843738 V2=25,3492640647731 V3=0 T=0 M2=0 M3=-13,2427340382846 FrameElem=45-1 ElemStation=0
Frame=45 Station=0,0917 OutputCase=FRE09 CaseType=Combination P=-15,0879274843738 V2=25,7160640647731 V3=0 T=0 M2=0 M3=-15,5840793302043 FrameElem=45-1 ElemStation=0,0917
Frame=45 Station=0,1834 OutputCase=FRE09 CaseType=Combination P=-15,0879274843738 V2=26,0828640647731 V3=0 T=0 M2=0 M3=-17,959060187764 FrameElem=45-1 ElemStation=0,1834
Frame=45 Station=0 OutputCase=FRE10 CaseType=Combination P=-23,9888942259841 V2=7,44536425350032 V3=0 T=0 M2=0 M3=-15,2660981836217 FrameElem=45-1 ElemStation=0
Frame=45 Station=0,0917 OutputCase=FRE10 CaseType=Combination P=-23,9888942259841 V2=7,81216425350032 V3=0 T=0 M2=0 M3=-15,965558656676 FrameElem=45-1 ElemStation=0,0917
Frame=45 Station=0,1834 OutputCase=FRE10 CaseType=Combination P=-23,9888942259841 V2=8,17896425350032 V3=0 T=0 M2=0 M3=-16,6988491077136 FrameElem=45-1 ElemStation=0,1834
Frame=45 Station=0 OutputCase=FRE11 CaseType=Combination P=-15,808030556335 V2=19,3432867581199 V3=0 T=0 M2=0 M3=-0,978844213316571 FrameElem=45-1 ElemStation=0
Frame=45 Station=0,0917 OutputCase=FRE11 CaseType=Combination P=-15,808030556335 V2=19,7100867581199 V3=0 T=0 M2=0 M3=-0,811752962403025 FrameElem=45-1 ElemStation=0,0917
Frame=45 Station=0,1834 OutputCase=FRE11 CaseType=Combination P=-15,808030556335 V2=20,0768867581199 V3=0 T=0 M2=0 M3=-2,63598569812262 FrameElem=45-1 ElemStation=0,1834
Frame=45 Station=0 OutputCase=FRE12 CaseType=Combination P=-24,7089972979453 V2=1,4393869468471 V3=0 T=0 M2=0 M3=-1,0445199320205 FrameElem=45-1 ElemStation=0
Frame=45 Station=0,0917 OutputCase=FRE12 CaseType=Combination P=-24,7089972979453 V2=1,8061869468471 V3=0 T=0 M2=0 M3=-1,19332949504638 FrameElem=45-1 ElemStation=0,0917

APPROVATO S.D.P.
Società di Progetto
Brebemi SpA



Doc. N.
60235-00000-A00.doc

CODIFICA DOCUMENTO
04RCDII10000000000300A00

REV.
00

FOGLIO
593 di 628

Frame=45 Station=0,1834 OutputCase=FRE12 CaseType=Combination P=-24,7089972979453 V2=2,1729869468471 V3=0 T=0 M2=0 M3=-1,37577461807226 FrameElem=45-1
ElemStation=0,1834
Frame=45 Station=0 OutputCase=FRE13 CaseType=Combination P=-6,98938107193605 V2=1,75446269385681 V3=0 T=0 M2=0 M3=-3,52751891157368 FrameElem=45-1
ElemStation=0
Frame=45 Station=0,0917 OutputCase=FRE13 CaseType=Combination P=-6,98938107193605 V2=2,12126269385681 V3=0 T=0 M2=0 M3=-3,70522092060035 FrameElem=45-1
ElemStation=0,0917
Frame=45 Station=0,1834 OutputCase=FRE13 CaseType=Combination P=-6,98938107193605 V2=2,48806269385681 V3=0 T=0 M2=0 M3=-3,91655848962702 FrameElem=45-1
ElemStation=0,1834
Frame=45 Station=0 OutputCase=FRE14 CaseType=Combination P=-6,67150374873241 V2=1,11896369301262 V3=0 T=0 M2=0 M3=-3,73028966367931 FrameElem=45-1
ElemStation=0
Frame=45 Station=0,0917 OutputCase=FRE14 CaseType=Combination P=-6,67150374873241 V2=1,48576369301262 V3=0 T=0 M2=0 M3=-3,84971641432857 FrameElem=45-1
ElemStation=0,0917
Frame=45 Station=0,1834 OutputCase=FRE14 CaseType=Combination P=-6,67150374873241 V2=1,85256369301262 V3=0 T=0 M2=0 M3=-4,0027782497783 FrameElem=45-1
ElemStation=0,1834
Frame=45 Station=0 OutputCase=FRE15 CaseType=Combination P=-7,21354942646586 V2=1,43704158929657 V3=0 T=0 M2=0 M3=-3,31148491598835 FrameElem=45-1
ElemStation=0
Frame=45 Station=0,0917 OutputCase=FRE15 CaseType=Combination P=-7,21354942646586 V2=1,80384158929656 V3=0 T=0 M2=0 M3=-3,46007940972684 FrameElem=45-1
ElemStation=0,0917
Frame=45 Station=0,1834 OutputCase=FRE15 CaseType=Combination P=-7,21354942646586 V2=2,17064158929657 V3=0 T=0 M2=0 M3=-3,64230946346534 FrameElem=45-1
ElemStation=0,1834
Frame=45 Station=0 OutputCase=FRE16 CaseType=Combination P=-7,74989924905014 V2=1,43750134350315 V3=0 T=0 M2=0 M3=-2,86709779569494 FrameElem=45-1
ElemStation=0
Frame=45 Station=0,0917 OutputCase=FRE16 CaseType=Combination P=-7,74989924905014 V2=1,80430134350315 V3=0 T=0 M2=0 M3=-3,01573444889418 FrameElem=45-1
ElemStation=0,0917
Frame=45 Station=0,1834 OutputCase=FRE16 CaseType=Combination P=-7,74989924905014 V2=2,17110134350316 V3=0 T=0 M2=0 M3=-3,19800666209342 FrameElem=45-1
ElemStation=0,1834
Frame=45 Station=0 OutputCase=FRE17 CaseType=Combination P=-6,95317477386256 V2=7,44341297098401 V3=0 T=0 M2=0 M3=-17,1521599216237 FrameElem=45-1
ElemStation=0
Frame=45 Station=0,0917 OutputCase=FRE17 CaseType=Combination P=-6,95317477386256 V2=7,81021297098401 V3=0 T=0 M2=0 M3=-17,851538671063 FrameElem=45-1
ElemStation=0,0917
Frame=45 Station=0,1834 OutputCase=FRE17 CaseType=Combination P=-6,95317477386256 V2=8,17701297098401 V3=0 T=0 M2=0 M3=-18,5845529805022 FrameElem=45-1
ElemStation=0,1834
Frame=45 Station=0 OutputCase=FRE18 CaseType=Combination P=-15,854141516637 V2=25,3499208564968 V3=0 T=0 M2=0 M3=-12,6078952950083 FrameElem=45-1
ElemStation=0
Frame=45 Station=0,0917 OutputCase=FRE18 CaseType=Combination P=-15,854141516637 V2=25,7167208564968 V3=0 T=0 M2=0 M3=-14,9493008175491 FrameElem=45-1
ElemStation=0,0917
Frame=45 Station=0,1834 OutputCase=FRE18 CaseType=Combination P=-15,854141516637 V2=26,0835208564968 V3=0 T=0 M2=0 M3=-17,3243419000898 FrameElem=45-1
ElemStation=0,1834
Frame=45 Station=0 OutputCase=FRE19 CaseType=Combination P=-24,7551082582474 V2=7,44602104522402 V3=0 T=0 M2=0 M3=-14,6312594403454 FrameElem=45-1
ElemStation=0
Frame=45 Station=0,0917 OutputCase=FRE19 CaseType=Combination P=-24,7551082582474 V2=7,81282104522402 V3=0 T=0 M2=0 M3=-15,3308773501924 FrameElem=45-1
ElemStation=0,0917
Frame=45 Station=0,1834 OutputCase=FRE19 CaseType=Combination P=-24,7551082582474 V2=8,17962104522402 V3=0 T=0 M2=0 M3=-16,0641308200395 FrameElem=45-1
ElemStation=0,1834
Frame=45 Station=0 OutputCase=FRE20 CaseType=Combination P=-16,5742445885983 V2=19,3439435498436 V3=0 T=0 M2=0 M3=-1,61368295659287 FrameElem=45-1
ElemStation=0
Frame=45 Station=0,0917 OutputCase=FRE20 CaseType=Combination P=-16,5742445885983 V2=19,7107435498436 V3=0 T=0 M2=0 M3=-0,176974446927793 FrameElem=45-1
ElemStation=0,0917
Frame=45 Station=0,1834 OutputCase=FRE20 CaseType=Combination P=-16,5742445885983 V2=20,0775435498436 V3=0 T=0 M2=0 M3=-2,00126741044845 FrameElem=45-1
ElemStation=0,1834
Frame=45 Station=0 OutputCase=FRE21 CaseType=Combination P=-25,4752113302086 V2=1,4400437385708 V3=0 T=0 M2=0 M3=-0,409681188744206 FrameElem=45-1
ElemStation=0
Frame=45 Station=0,0917 OutputCase=FRE21 CaseType=Combination P=-25,4752113302086 V2=1,8068437385708 V3=0 T=0 M2=0 M3=-0,558550975971148 FrameElem=45-1
ElemStation=0,0917
Frame=45 Station=0,1834 OutputCase=FRE21 CaseType=Combination P=-25,4752113302086 V2=2,1736437385708 V3=0 T=0 M2=0 M3=-0,74105633039809 FrameElem=45-1
ElemStation=0,1834
Frame=45 Station=0 OutputCase=FRE22 CaseType=Combination P=-7,90883791065196 V2=1,75525084392525 V3=0 T=0 M2=0 M3=-2,76571241964212 FrameElem=45-1
ElemStation=0
Frame=45 Station=0,0917 OutputCase=FRE22 CaseType=Combination P=-7,90883791065196 V2=2,12205084392525 V3=0 T=0 M2=0 M3=-2,94348670203007 FrameElem=45-1
ElemStation=0,0917
Frame=45 Station=0,1834 OutputCase=FRE22 CaseType=Combination P=-7,90883791065196 V2=2,48885084392525 V3=0 T=0 M2=0 M3=-3,15489654441801 FrameElem=45-1
ElemStation=0,1834
Frame=45 Station=0 OutputCase=FRE23 CaseType=Combination P=-7,59096058744832 V2=1,11975184308106 V3=0 T=0 M2=0 M3=-2,96848317174776 FrameElem=45-1
ElemStation=0
Frame=45 Station=0,0917 OutputCase=FRE23 CaseType=Combination P=-7,59096058744832 V2=1,48655184308106 V3=0 T=0 M2=0 M3=-3,08798219575829 FrameElem=45-1
ElemStation=0,0917
Frame=45 Station=0,1834 OutputCase=FRE23 CaseType=Combination P=-7,59096058744832 V2=1,85335184308106 V3=0 T=0 M2=0 M3=-3,24111677976882 FrameElem=45-1
ElemStation=0,1834
Frame=45 Station=0 OutputCase=FRE24 CaseType=Combination P=-8,13300626518177 V2=1,437829739365 V3=0 T=0 M2=0 M3=-2,54967842405679 FrameElem=45-1
ElemStation=0
Frame=45 Station=0,0917 OutputCase=FRE24 CaseType=Combination P=-8,13300626518177 V2=1,804629739365 V3=0 T=0 M2=0 M3=-2,69834519115656 FrameElem=45-1
ElemStation=0,0917
Frame=45 Station=0,1834 OutputCase=FRE24 CaseType=Combination P=-8,13300626518177 V2=2,171429739365 V3=0 T=0 M2=0 M3=-2,88064751825633 FrameElem=45-1
ElemStation=0,1834
Frame=45 Station=0 OutputCase=FRE25 CaseType=Combination P=-7,48089722361437 V2=1,81840666897545 V3=0 T=0 M2=0 M3=-3,12633859039734 FrameElem=45-1
ElemStation=0
Frame=45 Station=0,0917 OutputCase=FRE25 CaseType=Combination P=-7,48089722361437 V2=2,18520666897545 V3=0 T=0 M2=0 M3=-3,30990426194239 FrameElem=45-1
ElemStation=0,0917
Frame=45 Station=0,1834 OutputCase=FRE25 CaseType=Combination P=-7,48089722361437 V2=2,55200666897545 V3=0 T=0 M2=0 M3=-3,52710549348744 FrameElem=45-1
ElemStation=0,1834
Frame=45 Station=0 OutputCase=FRE26 CaseType=Combination P=-6,72900641933275 V2=7,76083407554425 V3=0 T=0 M2=0 M3=-17,3681939172091 FrameElem=45-1
ElemStation=0
Frame=45 Station=0,0917 OutputCase=FRE26 CaseType=Combination P=-6,72900641933275 V2=8,12763407554425 V3=0 T=0 M2=0 M3=-18,0966801819365 FrameElem=45-1
ElemStation=0,0917
Frame=45 Station=0,1834 OutputCase=FRE26 CaseType=Combination P=-6,72900641933275 V2=8,49443407554425 V3=0 T=0 M2=0 M3=-18,8588020066639 FrameElem=45-1
ElemStation=0,1834
Frame=45 Station=0 OutputCase=FRE27 CaseType=Combination P=-15,6299731621072 V2=25,6673419610571 V3=0 T=0 M2=0 M3=-12,8239292905936 FrameElem=45-1
ElemStation=0

Società di Progetto
Brebemi SpA



Doc. N.
60235-0000-A00.doc

CODIFICA DOCUMENTO
04RCDII10000000000300A00

REV.
00

FOGLIO
594 di 628

Frame=45 Station=0,0917 OutputCase=FRE27 CaseType=Combination P=-15,6299731621072 V2=26,0341419610571 V3=0 T=0 M2=0 M3=-15,1944423284226 FrameElem=45-1 ElemStation=0,0917
Frame=45 Station=0,1834 OutputCase=FRE27 CaseType=Combination P=-15,6299731621072 V2=26,4009419610571 V3=0 T=0 M2=0 M3=-17,5985909262515 FrameElem=45-1 ElemStation=0,1834
Frame=45 Station=0 OutputCase=FRE28 CaseType=Combination P=-24,5309399037175 V2=7,76344214978427 V3=0 T=0 M2=0 M3=-14,8472934359307 FrameElem=45-1 ElemStation=0
Frame=45 Station=0,0917 OutputCase=FRE28 CaseType=Combination P=-24,5309399037175 V2=8,13024214978427 V3=0 T=0 M2=0 M3=-15,5760188610659 FrameElem=45-1 ElemStation=0,0917
Frame=45 Station=0,1834 OutputCase=FRE28 CaseType=Combination P=-24,5309399037175 V2=8,49704214978427 V3=0 T=0 M2=0 M3=-16,3383798462011 FrameElem=45-1 ElemStation=0,1834
Frame=45 Station=0 OutputCase=FRE29 CaseType=Combination P=-16,3500762340685 V2=19,6613646544039 V3=0 T=0 M2=0 M3=1,39764896100754 FrameElem=45-1 ElemStation=0
Frame=45 Station=0,0917 OutputCase=FRE29 CaseType=Combination P=-16,3500762340685 V2=20,0281646544039 V3=0 T=0 M2=0 M3=-0,422115957801299 FrameElem=45-1 ElemStation=0,0917
Frame=45 Station=0,1834 OutputCase=FRE29 CaseType=Combination P=-16,3500762340685 V2=20,3949646544039 V3=0 T=0 M2=0 M3=-2,27551643661013 FrameElem=45-1 ElemStation=0,1834
Frame=45 Station=0 OutputCase=FRE30 CaseType=Combination P=-25,2510429756788 V2=1,75746484313105 V3=0 T=0 M2=0 M3=-0,625715184329538 FrameElem=45-1 ElemStation=0
Frame=45 Station=0,0917 OutputCase=FRE30 CaseType=Combination P=-25,2510429756788 V2=2,12426484313104 V3=0 T=0 M2=0 M3=-0,803692490444654 FrameElem=45-1 ElemStation=0,0917
Frame=45 Station=0,1834 OutputCase=FRE30 CaseType=Combination P=-25,2510429756788 V2=2,49106484313104 V3=0 T=0 M2=0 M3=-1,01530535655977 FrameElem=45-1 ElemStation=0,1834
Frame=45 Station=0 OutputCase=FRE31 CaseType=Combination P=-7,09779020748274 V2=1,8180782731136 V3=0 T=0 M2=0 M3=-3,44375796203549 FrameElem=45-1 ElemStation=0
Frame=45 Station=0,0917 OutputCase=FRE31 CaseType=Combination P=-7,09779020748274 V2=2,1848782731136 V3=0 T=0 M2=0 M3=-3,62729351968 FrameElem=45-1 ElemStation=0,0917
Frame=45 Station=0,1834 OutputCase=FRE31 CaseType=Combination P=-7,09779020748274 V2=2,5516782731136 V3=0 T=0 M2=0 M3=-3,84446463732452 FrameElem=45-1 ElemStation=0,1834
Frame=45 Station=0 OutputCase=FRE32 CaseType=Combination P=-7,864004239746 V2=1,8187350648373 V3=0 T=0 M2=0 M3=-2,80891921875919 FrameElem=45-1 ElemStation=0
Frame=45 Station=0,0917 OutputCase=FRE32 CaseType=Combination P=-7,864004239746 V2=2,1855350648373 V3=0 T=0 M2=0 M3=-2,99251500420477 FrameElem=45-1 ElemStation=0,0917
Frame=45 Station=0,1834 OutputCase=FRE32 CaseType=Combination P=-7,864004239746 V2=2,5523350648373 V3=0 T=0 M2=0 M3=-3,20974634965035 FrameElem=45-1 ElemStation=0,1834
Frame=45 Station=0 OutputCase=FRE33 CaseType=Combination P=-7,864004239746 V2=1,8187350648373 V3=0 T=0 M2=0 M3=-2,80891921875919 FrameElem=45-1 ElemStation=0
Frame=45 Station=0,0917 OutputCase=FRE33 CaseType=Combination P=-7,864004239746 V2=2,1855350648373 V3=0 T=0 M2=0 M3=-2,99251500420477 FrameElem=45-1 ElemStation=0,0917
Frame=45 Station=0,1834 OutputCase=FRE33 CaseType=Combination P=-7,864004239746 V2=2,5523350648373 V3=0 T=0 M2=0 M3=-3,20974634965035 FrameElem=45-1 ElemStation=0,1834
Frame=45 Station=0 OutputCase=FRE34 CaseType=Combination P=-7,09944443577 V2=1,05580786796242 V3=0 T=0 M2=0 M3=-3,3696634929241 FrameElem=45-1 ElemStation=0
Frame=45 Station=0,0917 OutputCase=FRE34 CaseType=Combination P=-7,09944443577 V2=1,42260786796242 V3=0 T=0 M2=0 M3=-3,48329885441625 FrameElem=45-1 ElemStation=0,0917
Frame=45 Station=0,1834 OutputCase=FRE34 CaseType=Combination P=-7,09944443577 V2=1,78940786796242 V3=0 T=0 M2=0 M3=-3,63056977590841 FrameElem=45-1 ElemStation=0,1834
Frame=45 Station=0 OutputCase=FRE35 CaseType=Combination P=-6,41112909612911 V2=7,12533507470006 V3=0 T=0 M2=0 M3=-17,5709646693147 FrameElem=45-1 ElemStation=0
Frame=45 Station=0,0917 OutputCase=FRE35 CaseType=Combination P=-6,41112909612911 V2=7,49213507470006 V3=0 T=0 M2=0 M3=-18,2411756756647 FrameElem=45-1 ElemStation=0,0917
Frame=45 Station=0,1834 OutputCase=FRE35 CaseType=Combination P=-6,41112909612911 V2=7,85893507470006 V3=0 T=0 M2=0 M3=-18,9450222420147 FrameElem=45-1 ElemStation=0,1834
Frame=45 Station=0 OutputCase=FRE36 CaseType=Combination P=-15,3120958389036 V2=25,0318429602129 V3=0 T=0 M2=0 M3=-13,0267000426993 FrameElem=45-1 ElemStation=0
Frame=45 Station=0,0917 OutputCase=FRE36 CaseType=Combination P=-15,3120958389036 V2=25,3986429602129 V3=0 T=0 M2=0 M3=-15,3389378221508 FrameElem=45-1 ElemStation=0,0917
Frame=45 Station=0,1834 OutputCase=FRE36 CaseType=Combination P=-15,3120958389036 V2=25,7654429602129 V3=0 T=0 M2=0 M3=-17,6848111616023 FrameElem=45-1 ElemStation=0,1834
Frame=45 Station=0 OutputCase=FRE37 CaseType=Combination P=-24,2130625805139 V2=7,12794314894008 V3=0 T=0 M2=0 M3=-15,0500641880363 FrameElem=45-1 ElemStation=0
Frame=45 Station=0,0917 OutputCase=FRE37 CaseType=Combination P=-24,2130625805139 V2=7,49474314894008 V3=0 T=0 M2=0 M3=-15,7205143547941 FrameElem=45-1 ElemStation=0,0917
Frame=45 Station=0,1834 OutputCase=FRE37 CaseType=Combination P=-24,2130625805139 V2=7,86154314894008 V3=0 T=0 M2=0 M3=-16,4246000815519 FrameElem=45-1 ElemStation=0,1834
Frame=45 Station=0 OutputCase=FRE38 CaseType=Combination P=-16,0321989108648 V2=19,0258656535597 V3=0 T=0 M2=0 M3=1,1948782089019 FrameElem=45-1 ElemStation=0
Frame=45 Station=0,0917 OutputCase=FRE38 CaseType=Combination P=-16,0321989108648 V2=19,3926656535597 V3=0 T=0 M2=0 M3=-0,566611451529519 FrameElem=45-1 ElemStation=0,0917
Frame=45 Station=0,1834 OutputCase=FRE38 CaseType=Combination P=-16,0321989108648 V2=19,7594656535597 V3=0 T=0 M2=0 M3=-2,36173667196094 FrameElem=45-1 ElemStation=0,1834
Frame=45 Station=0 OutputCase=FRE39 CaseType=Combination P=-24,9331656524752 V2=1,12196584228686 V3=0 T=0 M2=0 M3=-0,82848593643517 FrameElem=45-1 ElemStation=0
Frame=45 Station=0,0917 OutputCase=FRE39 CaseType=Combination P=-24,9331656524752 V2=1,48876584228685 V3=0 T=0 M2=0 M3=-0,948187984172874 FrameElem=45-1 ElemStation=0,0917
Frame=45 Station=0,1834 OutputCase=FRE39 CaseType=Combination P=-24,9331656524752 V2=1,8556584228685 V3=0 T=0 M2=0 M3=-1,10152559191058 FrameElem=45-1 ElemStation=0,1834
Frame=45 Station=0 OutputCase=FRE40 CaseType=Combination P=-6,71633741963837 V2=1,05547947210057 V3=0 T=0 M2=0 M3=-3,68708286456225 FrameElem=45-1 ElemStation=0
Frame=45 Station=0,0917 OutputCase=FRE40 CaseType=Combination P=-6,71633741963837 V2=1,4227947210057 V3=0 T=0 M2=0 M3=-3,80068811215387 FrameElem=45-1 ElemStation=0,0917
Frame=45 Station=0,1834 OutputCase=FRE40 CaseType=Combination P=-6,71633741963837 V2=1,78907947210057 V3=0 T=0 M2=0 M3=-3,94792891974549 FrameElem=45-1 ElemStation=0,1834
Frame=45 Station=0 OutputCase=FRE41 CaseType=Combination P=-7,48255145190163 V2=1,05613626382427 V3=0 T=0 M2=0 M3=-3,05224412128595 FrameElem=45-1 ElemStation=0
Frame=45 Station=0,0917 OutputCase=FRE41 CaseType=Combination P=-7,48255145190163 V2=1,42293626382427 V3=0 T=0 M2=0 M3=-3,16590959667863 FrameElem=45-1 ElemStation=0,0917
Frame=45 Station=0,1834 OutputCase=FRE41 CaseType=Combination P=-7,48255145190163 V2=1,78973626382427 V3=0 T=0 M2=0 M3=-3,31321063207132 FrameElem=45-1 ElemStation=0,1834

Società di Progetto
Brebemi SpA



Doc. N.
60235-0000-A00.doc

CODIFICA DOCUMENTO
04RCDII10000000000300A00

REV.
00

FOGLIO
595 di 628

Frame=45 Station=0 OutputCase=FRE42 CaseType=Combination P=-7,48255145190163 V2=1,05613626382427 V3=0 T=0 M2=0 M3=-3,05224412128595 FrameElem=45-1 ElemStation=0

Frame=45 Station=0,0917 OutputCase=FRE42 CaseType=Combination P=-7,48255145190163 V2=1,42293626382427 V3=0 T=0 M2=0 M3=-3,16590959667863 FrameElem=45-1 ElemStation=0,0917

Frame=45 Station=0,1834 OutputCase=FRE42 CaseType=Combination P=-7,48255145190163 V2=1,78973626382427 V3=0 T=0 M2=0 M3=-3,31321063207132 FrameElem=45-1 ElemStation=0,1834

Frame=45 Station=0 OutputCase=FRE43 CaseType=Combination P=-7,74989924905014 V2=1,43750134350315 V3=0 T=0 M2=0 M3=-2,86709779569494 FrameElem=45-1 ElemStation=0

Frame=45 Station=0,0917 OutputCase=FRE43 CaseType=Combination P=-7,74989924905014 V2=1,80430134350315 V3=0 T=0 M2=0 M3=-3,01573444889418 FrameElem=45-1 ElemStation=0,0917

Frame=45 Station=0,1834 OutputCase=FRE43 CaseType=Combination P=-7,74989924905014 V2=2,17110134350316 V3=0 T=0 M2=0 M3=-3,19800666209342 FrameElem=45-1 ElemStation=0,1834

Frame=45 Station=0 OutputCase=FRE44 CaseType=Combination P=-6,95317477386256 V2=7,44341297098401 V3=0 T=0 M2=0 M3=-17,1521599216237 FrameElem=45-1 ElemStation=0

Frame=45 Station=0,0917 OutputCase=FRE44 CaseType=Combination P=-6,95317477386256 V2=7,81021297098401 V3=0 T=0 M2=0 M3=-17,851538671063 FrameElem=45-1 ElemStation=0,0917

Frame=45 Station=0,1834 OutputCase=FRE44 CaseType=Combination P=-6,95317477386256 V2=8,17701297098401 V3=0 T=0 M2=0 M3=-18,5845529805022 FrameElem=45-1 ElemStation=0,1834

Frame=45 Station=0 OutputCase=FRE45 CaseType=Combination P=-15,854141516637 V2=25,3499208564968 V3=0 T=0 M2=0 M3=-12,6078952950083 FrameElem=45-1 ElemStation=0

Frame=45 Station=0,0917 OutputCase=FRE45 CaseType=Combination P=-15,854141516637 V2=25,7167208564968 V3=0 T=0 M2=0 M3=-14,9493008175491 FrameElem=45-1 ElemStation=0,0917

Frame=45 Station=0,1834 OutputCase=FRE45 CaseType=Combination P=-15,854141516637 V2=26,0835208564968 V3=0 T=0 M2=0 M3=-17,3243419000898 FrameElem=45-1 ElemStation=0,1834

Frame=45 Station=0 OutputCase=FRE46 CaseType=Combination P=-24,7551082582474 V2=7,44602104522402 V3=0 T=0 M2=0 M3=-14,6312594403454 FrameElem=45-1 ElemStation=0

Frame=45 Station=0,0917 OutputCase=FRE46 CaseType=Combination P=-24,7551082582474 V2=7,81282104522402 V3=0 T=0 M2=0 M3=-15,3308773501924 FrameElem=45-1 ElemStation=0,0917

Frame=45 Station=0,1834 OutputCase=FRE46 CaseType=Combination P=-24,7551082582474 V2=8,17962104522402 V3=0 T=0 M2=0 M3=-16,0641308200395 FrameElem=45-1 ElemStation=0,1834

Frame=45 Station=0 OutputCase=FRE47 CaseType=Combination P=-16,5742445885983 V2=19,3439435498436 V3=0 T=0 M2=0 M3=1,61368295659287 FrameElem=45-1 ElemStation=0

Frame=45 Station=0,0917 OutputCase=FRE47 CaseType=Combination P=-16,5742445885983 V2=19,7107435498436 V3=0 T=0 M2=0 M3=-0,176974446927793 FrameElem=45-1 ElemStation=0,0917

Frame=45 Station=0,1834 OutputCase=FRE47 CaseType=Combination P=-16,5742445885983 V2=20,0775435498436 V3=0 T=0 M2=0 M3=-2,00126741044845 FrameElem=45-1 ElemStation=0,1834

Frame=45 Station=0 OutputCase=FRE48 CaseType=Combination P=-25,4752113302086 V2=1,4400437385708 V3=0 T=0 M2=0 M3=0,409681188744206 FrameElem=45-1 ElemStation=0

Frame=45 Station=0,0917 OutputCase=FRE48 CaseType=Combination P=-25,4752113302086 V2=1,8068437385708 V3=0 T=0 M2=0 M3=-0,55855097571148 FrameElem=45-1 ElemStation=0,0917

Frame=45 Station=0,1834 OutputCase=FRE48 CaseType=Combination P=-25,4752113302086 V2=2,1736437385708 V3=0 T=0 M2=0 M3=-0,74105633039809 FrameElem=45-1 ElemStation=0,1834

Frame=45 Station=0 OutputCase=FRE49 CaseType=Combination P=-8,13300626518177 V2=1,437829739365 V3=0 T=0 M2=0 M3=-2,54967842405679 FrameElem=45-1 ElemStation=0

Frame=45 Station=0,0917 OutputCase=FRE49 CaseType=Combination P=-8,13300626518177 V2=1,804629739365 V3=0 T=0 M2=0 M3=-2,69834519115656 FrameElem=45-1 ElemStation=0,0917

Frame=45 Station=0,1834 OutputCase=FRE49 CaseType=Combination P=-8,13300626518177 V2=2,171429739365 V3=0 T=0 M2=0 M3=-2,88064751825633 FrameElem=45-1 ElemStation=0,1834

Frame=45 Station=0 OutputCase=FRE50 CaseType=Combination P=-7,90883791065196 V2=1,75525084392525 V3=0 T=0 M2=0 M3=-2,76571241964212 FrameElem=45-1 ElemStation=0

Frame=45 Station=0,0917 OutputCase=FRE50 CaseType=Combination P=-7,90883791065196 V2=2,12205084392525 V3=0 T=0 M2=0 M3=-2,94348670203007 FrameElem=45-1 ElemStation=0,0917

Frame=45 Station=0,1834 OutputCase=FRE50 CaseType=Combination P=-7,90883791065196 V2=2,48885084392525 V3=0 T=0 M2=0 M3=-3,15489564441801 FrameElem=45-1 ElemStation=0,1834

Frame=45 Station=0 OutputCase=FRE51 CaseType=Combination P=-7,59096058744832 V2=1,11975184308106 V3=0 T=0 M2=0 M3=-2,96848317174776 FrameElem=45-1 ElemStation=0

Frame=45 Station=0,0917 OutputCase=FRE51 CaseType=Combination P=-7,59096058744832 V2=1,48655184308106 V3=0 T=0 M2=0 M3=-3,08798219575829 FrameElem=45-1 ElemStation=0,0917

Frame=45 Station=0,1834 OutputCase=FRE51 CaseType=Combination P=-7,59096058744832 V2=1,85335184308106 V3=0 T=0 M2=0 M3=-3,24111677976882 FrameElem=45-1 ElemStation=0,1834

Frame=45 Station=0 OutputCase=INVFRE CaseType=Combination StepType=Max P=-6,18696074159931 V2=25,6673419610571 V3=0 T=0 M2=0 M3=1,61368295659287 FrameElem=45-1 ElemStation=0

Frame=45 Station=0,0917 OutputCase=INVFRE CaseType=Combination StepType=Max P=-6,18696074159931 V2=26,0341419610571 V3=0 T=0 M2=0 M3=-0,176974446927793 FrameElem=45-1 ElemStation=0,0917

Frame=45 Station=0,1834 OutputCase=INVFRE CaseType=Combination StepType=Max P=-6,18696074159931 V2=26,4009419610571 V3=0 T=0 M2=0 M3=-0,74105633039809 FrameElem=45-1 ElemStation=0,1834

Frame=45 Station=0 OutputCase=INVFRE CaseType=Combination StepType=Min P=-25,4752113302086 V2=1,05547947210057 V3=0 T=0 M2=0 M3=-17,7869986649 FrameElem=45-1 ElemStation=0

Frame=45 Station=0,0917 OutputCase=INVFRE CaseType=Combination StepType=Min P=-25,4752113302086 V2=1,42227947210057 V3=0 T=0 M2=0 M3=-18,4863171865382 FrameElem=45-1 ElemStation=0,0917

Frame=45 Station=0,1834 OutputCase=INVFRE CaseType=Combination StepType=Min P=-25,4752113302086 V2=1,78907947210057 V3=0 T=0 M2=0 M3=-19,2192712681764 FrameElem=45-1 ElemStation=0,1834

Frame=45 Station=0 OutputCase=QPE01 CaseType=Combination P=-9,29062562337637 V2=1,23977245340939 V3=0 T=0 M2=0 M3=-3,49703449155853 FrameElem=45-1 ElemStation=0

Frame=45 Station=0,0917 OutputCase=QPE01 CaseType=Combination P=-9,29062562337637 V2=-0,872972453409387 V3=0 T=0 M2=0 M3=-3,40016513758089 FrameElem=45-1 ElemStation=0,0917

Frame=45 Station=0,1834 OutputCase=QPE01 CaseType=Combination P=-9,29062562337637 V2=-0,506172453409387 V3=0 T=0 M2=0 M3=-3,33693134360325 FrameElem=45-1 ElemStation=0,1834

Frame=45 Station=0 OutputCase=QPE02 CaseType=Combination P=-8,90751860724474 V2=1,24010084927124 V3=0 T=0 M2=0 M3=-3,81445386319668 FrameElem=45-1 ElemStation=0

Frame=45 Station=0,0917 OutputCase=QPE02 CaseType=Combination P=-8,90751860724474 V2=-0,873300849271237 V3=0 T=0 M2=0 M3=-3,71755439531851 FrameElem=45-1 ElemStation=0,0917

Frame=45 Station=0,1834 OutputCase=QPE02 CaseType=Combination P=-8,90751860724474 V2=-0,506500849271236 V3=0 T=0 M2=0 M3=-3,65429048744033 FrameElem=45-1 ElemStation=0,1834

Frame=45 Station=0 OutputCase=QPE03 CaseType=Combination P=-9,673732639508 V2=1,23944405754754 V3=0 T=0 M2=0 M3=-3,17961511992038 FrameElem=45-1 ElemStation=0

Frame=45 Station=0,0917 OutputCase=QPE03 CaseType=Combination P=-9,673732639508 V2=-0,872644057547538 V3=0 T=0 M2=0 M3=-3,08277587984327 FrameElem=45-1 ElemStation=0,0917

Società di Progetto
Brebemi SpA



Doc. N.
60235-0000-A00.doc

CODIFICA DOCUMENTO
04RCDII10000000000300A00

REV.
00

FOGLIO
596 di 628

Frame=45 Station=0,1834 OutputCase=QPE03 CaseType=Combination P=-9,673732639508 V2=-0,505844057547537 V3=0 T=0 M2=0 M3=-3,01957219976616 FrameElem=45-1 ElemStation=0,1834

Frame=45 Station=0 OutputCase=QPE04 CaseType=Combination P=-9,44956428497819 V2=-0,922022952987292 V3=0 T=0 M2=0 M3=-3,39564911550571 FrameElem=45-1 ElemStation=0

Frame=45 Station=0,0917 OutputCase=QPE04 CaseType=Combination P=-9,44956428497819 V2=-0,555222952987292 V3=0 T=0 M2=0 M3=-3,32791739071678 FrameElem=45-1 ElemStation=0,0917

Frame=45 Station=0,1834 OutputCase=QPE04 CaseType=Combination P=-9,44956428497819 V2=-0,188422952987292 V3=0 T=0 M2=0 M3=-3,29382122592784 FrameElem=45-1 ElemStation=0,1834

Frame=45 Station=0 OutputCase=QPE05 CaseType=Combination P=-9,13168696177455 V2=-1,55752195383148 V3=0 T=0 M2=0 M3=-3,59841986761135 FrameElem=45-1 ElemStation=0

Frame=45 Station=0,0917 OutputCase=QPE05 CaseType=Combination P=-9,13168696177455 V2=-1,19072195383148 V3=0 T=0 M2=0 M3=-3,472412884445 FrameElem=45-1 ElemStation=0,0917

Frame=45 Station=0,1834 OutputCase=QPE05 CaseType=Combination P=-9,13168696177455 V2=-0,823921953831482 V3=0 T=0 M2=0 M3=-3,38004146127865 FrameElem=45-1 ElemStation=0,1834

Frame=45 Station=0 OutputCase=QPE06 CaseType=Combination P=-9,673732639508 V2=-1,23944405754754 V3=0 T=0 M2=0 M3=-3,17961511992038 FrameElem=45-1 ElemStation=0

Frame=45 Station=0,0917 OutputCase=QPE06 CaseType=Combination P=-9,673732639508 V2=-0,872644057547538 V3=0 T=0 M2=0 M3=-3,08277587984327 FrameElem=45-1 ElemStation=0,0917

Frame=45 Station=0,1834 OutputCase=QPE06 CaseType=Combination P=-9,673732639508 V2=-0,505844057547537 V3=0 T=0 M2=0 M3=-3,01957219976616 FrameElem=45-1 ElemStation=0,1834

Frame=45 Station=0 OutputCase=QPE07 CaseType=Combination P=-9,06645726884656 V2=-0,922351348849141 V3=0 T=0 M2=0 M3=-3,71306848714386 FrameElem=45-1 ElemStation=0

Frame=45 Station=0,0917 OutputCase=QPE07 CaseType=Combination P=-9,06645726884656 V2=-0,555551348849142 V3=0 T=0 M2=0 M3=-3,6453066484544 FrameElem=45-1 ElemStation=0,0917

Frame=45 Station=0,1834 OutputCase=QPE07 CaseType=Combination P=-9,06645726884656 V2=-0,188751348849141 V3=0 T=0 M2=0 M3=-3,61118036976493 FrameElem=45-1 ElemStation=0,1834

Frame=45 Station=0 OutputCase=QPE08 CaseType=Combination P=-8,74857994564292 V2=-1,55785034969333 V3=0 T=0 M2=0 M3=-3,91583923924949 FrameElem=45-1 ElemStation=0

Frame=45 Station=0,0917 OutputCase=QPE08 CaseType=Combination P=-8,74857994564292 V2=-1,19105034969333 V3=0 T=0 M2=0 M3=-3,78980214218262 FrameElem=45-1 ElemStation=0,0917

Frame=45 Station=0,1834 OutputCase=QPE08 CaseType=Combination P=-8,74857994564292 V2=-0,824250349693331 V3=0 T=0 M2=0 M3=-3,69740060511574 FrameElem=45-1 ElemStation=0,1834

Frame=45 Station=0 OutputCase=QPE09 CaseType=Combination P=-9,29062562337637 V2=-1,23977245340939 V3=0 T=0 M2=0 M3=-3,49703449155853 FrameElem=45-1 ElemStation=0

Frame=45 Station=0,0917 OutputCase=QPE09 CaseType=Combination P=-9,29062562337637 V2=-0,872972453409387 V3=0 T=0 M2=0 M3=-3,40016513758089 FrameElem=45-1 ElemStation=0,0917

Frame=45 Station=0,1834 OutputCase=QPE09 CaseType=Combination P=-9,29062562337637 V2=-0,506172453409387 V3=0 T=0 M2=0 M3=-3,33693134360325 FrameElem=45-1 ElemStation=0,1834

Frame=45 Station=0 OutputCase=QPE10 CaseType=Combination P=-9,29062562314354 V2=4,11448762835334 V3=0 T=0 M2=0 M3=-2,51506319249601 FrameElem=45-1 ElemStation=0

Frame=45 Station=0,0917 OutputCase=QPE10 CaseType=Combination P=-9,29062562314354 V2=4,48128762835334 V3=0 T=0 M2=0 M3=-2,90917948801601 FrameElem=45-1 ElemStation=0,0917

Frame=45 Station=0,1834 OutputCase=QPE10 CaseType=Combination P=-9,29062562314354 V2=4,84808762835334 V3=0 T=0 M2=0 M3=-3,33693134353601 FrameElem=45-1 ElemStation=0,1834

Frame=45 Station=0 OutputCase=QPE11 CaseType=Combination P=-8,90751860701191 V2=4,1141592324915 V3=0 T=0 M2=0 M3=-2,83248256413416 FrameElem=45-1 ElemStation=0

Frame=45 Station=0,0917 OutputCase=QPE11 CaseType=Combination P=-8,90751860701191 V2=4,48095923249149 V3=0 T=0 M2=0 M3=-3,22656874575363 FrameElem=45-1 ElemStation=0,0917

Frame=45 Station=0,1834 OutputCase=QPE11 CaseType=Combination P=-8,90751860701191 V2=4,84775923249149 V3=0 T=0 M2=0 M3=-3,6542904873731 FrameElem=45-1 ElemStation=0,1834

Frame=45 Station=0 OutputCase=QPE12 CaseType=Combination P=-9,67373263927517 V2=4,11481602421519 V3=0 T=0 M2=0 M3=-2,19764382085786 FrameElem=45-1 ElemStation=0

Frame=45 Station=0,0917 OutputCase=QPE12 CaseType=Combination P=-9,67373263927517 V2=4,48161602421519 V3=0 T=0 M2=0 M3=-2,5917902302784 FrameElem=45-1 ElemStation=0,0917

Frame=45 Station=0,1834 OutputCase=QPE12 CaseType=Combination P=-9,67373263927517 V2=4,84841602421519 V3=0 T=0 M2=0 M3=-3,01957219969893 FrameElem=45-1 ElemStation=0,1834

Frame=45 Station=0 OutputCase=QPE13 CaseType=Combination P=-9,44956428474536 V2=4,43223712877544 V3=0 T=0 M2=0 M3=-2,4136778164432 FrameElem=45-1 ElemStation=0

Frame=45 Station=0,0917 OutputCase=QPE13 CaseType=Combination P=-9,44956428474536 V2=4,79903712877544 V3=0 T=0 M2=0 M3=-2,8369317411519 FrameElem=45-1 ElemStation=0,0917

Frame=45 Station=0,1834 OutputCase=QPE13 CaseType=Combination P=-9,44956428474536 V2=5,16583712877544 V3=0 T=0 M2=0 M3=-3,29382122586061 FrameElem=45-1 ElemStation=0,1834

Frame=45 Station=0 OutputCase=QPE14 CaseType=Combination P=-9,13168696154172 V2=3,79673812793125 V3=0 T=0 M2=0 M3=-2,61644856854883 FrameElem=45-1 ElemStation=0

Frame=45 Station=0,0917 OutputCase=QPE14 CaseType=Combination P=-9,13168696154172 V2=4,16353812793125 V3=0 T=0 M2=0 M3=-2,98142723488012 FrameElem=45-1 ElemStation=0,0917

Frame=45 Station=0,1834 OutputCase=QPE14 CaseType=Combination P=-9,13168696154172 V2=4,53033812793125 V3=0 T=0 M2=0 M3=-3,38004146121142 FrameElem=45-1 ElemStation=0,1834

Frame=45 Station=0 OutputCase=QPE15 CaseType=Combination P=-9,67373263927517 V2=4,11481602421519 V3=0 T=0 M2=0 M3=-2,19764382085786 FrameElem=45-1 ElemStation=0

Frame=45 Station=0,0917 OutputCase=QPE15 CaseType=Combination P=-9,67373263927517 V2=4,48161602421519 V3=0 T=0 M2=0 M3=-2,5917902302784 FrameElem=45-1 ElemStation=0,0917

Frame=45 Station=0,1834 OutputCase=QPE15 CaseType=Combination P=-9,67373263927517 V2=4,84841602421519 V3=0 T=0 M2=0 M3=-3,01957219969893 FrameElem=45-1 ElemStation=0,1834

Frame=45 Station=0 OutputCase=QPE16 CaseType=Combination P=-9,06645726861373 V2=4,43190873291359 V3=0 T=0 M2=0 M3=-2,73109718808134 FrameElem=45-1 ElemStation=0

Frame=45 Station=0,0917 OutputCase=QPE16 CaseType=Combination P=-9,06645726861373 V2=4,79870873291359 V3=0 T=0 M2=0 M3=-3,15432099888952 FrameElem=45-1 ElemStation=0,0917

Frame=45 Station=0,1834 OutputCase=QPE16 CaseType=Combination P=-9,06645726861373 V2=5,16550873291359 V3=0 T=0 M2=0 M3=-3,6111803696977 FrameElem=45-1 ElemStation=0,1834

Frame=45 Station=0 OutputCase=QPE17 CaseType=Combination P=-8,74857994541009 V2=3,7964097320694 V3=0 T=0 M2=0 M3=-2,93386794018698 FrameElem=45-1 ElemStation=0

Frame=45 Station=0,0917 OutputCase=QPE17 CaseType=Combination P=-8,74857994541009 V2=4,1632097320694 V3=0 T=0 M2=0 M3=-3,29881649261774 FrameElem=45-1 ElemStation=0,0917

Frame=45 Station=0,1834 OutputCase=QPE17 CaseType=Combination P=-8,74857994541009 V2=4,5300097320694 V3=0 T=0 M2=0 M3=-3,6974006050485 FrameElem=45-1 ElemStation=0,1834

Frame=45 Station=0 OutputCase=QPE18 CaseType=Combination P=-9,29062562314354 V2=4,11448762835334 V3=0 T=0 M2=0 M3=-2,51506319249601 FrameElem=45-1 ElemStation=0

Società di Progetto
Brebemi SpA



Doc. N.
60235-0000-A00.doc

CODIFICA DOCUMENTO
04RCDII10000000000300A00

REV.
00

FOGLIO
597 di 628

Frame=45 Station=0,0917 OutputCase=QPE18 CaseType=Combination P=-9,29062562314354 V2=4,48128762835334 V3=0 T=0 M2=0 M3=-2,90917948801601 FrameElem=45-1 ElemStation=0,0917
Frame=45 Station=0,1834 OutputCase=QPE18 CaseType=Combination P=-9,29062562314354 V2=4,84808762835334 V3=0 T=0 M2=0 M3=-3,33693134353601 FrameElem=45-1 ElemStation=0,1834
Frame=45 Station=0 OutputCase=INVQPE CaseType=Combination StepType=Max P=-8,74857994541009 V2=4,43223712877544 V3=0 T=0 M2=0 M3=-2,19764382085786 FrameElem=45-1 ElemStation=0
Frame=45 Station=0,0917 OutputCase=INVQPE CaseType=Combination StepType=Max P=-8,74857994541009 V2=4,79903712877544 V3=0 T=0 M2=0 M3=-2,5917902302784 FrameElem=45-1 ElemStation=0,0917
Frame=45 Station=0,1834 OutputCase=INVQPE CaseType=Combination StepType=Max P=-8,74857994541009 V2=5,16583712877544 V3=0 T=0 M2=0 M3=-3,01957219969893 FrameElem=45-1 ElemStation=0,1834
Frame=45 Station=0 OutputCase=INVQPE CaseType=Combination StepType=Min P=-9,673732639508 V2=-1,55785034969333 V3=0 T=0 M2=0 M3=-3,91583923924949 FrameElem=45-1 ElemStation=0
Frame=45 Station=0,0917 OutputCase=INVQPE CaseType=Combination StepType=Min P=-9,673732639508 V2=-1,19105034969333 V3=0 T=0 M2=0 M3=-3,78980214218262 FrameElem=45-1 ElemStation=0,0917
Frame=45 Station=0,1834 OutputCase=INVQPE CaseType=Combination StepType=Min P=-9,673732639508 V2=-0,82425034969333 V3=0 T=0 M2=0 M3=-3,69740060511574 FrameElem=45-1 ElemStation=0,1834
Frame=46 Station=0 OutputCase=STR001 CaseType=Combination P=-15,242958565232 V2=-2,93113067367071 V3=0 T=0 M2=0 M3=-4,17828382080191 FrameElem=46-1 ElemStation=0
Frame=46 Station=0,0917 OutputCase=STR001 CaseType=Combination P=-15,242958565232 V2=-2,43595067367071 V3=0 T=0 M2=0 M3=-3,93220314102631 FrameElem=46-1 ElemStation=0,0917
Frame=46 Station=0,1834 OutputCase=STR001 CaseType=Combination P=-15,242958565232 V2=-1,94077067367071 V3=0 T=0 M2=0 M3=-3,7315304672507 FrameElem=46-1 ElemStation=0,1834
Frame=46 Station=0 OutputCase=STR002 CaseType=Combination P=-7,48725069497119 V2=-2,93016003673529 V3=0 T=0 M2=0 M3=-5,11629962083216 FrameElem=46-1 ElemStation=0
Frame=46 Station=0,0917 OutputCase=STR002 CaseType=Combination P=-7,48725069497119 V2=-2,43498003673529 V3=0 T=0 M2=0 M3=-4,87030794846353 FrameElem=46-1 ElemStation=0,0917
Frame=46 Station=0,1834 OutputCase=STR002 CaseType=Combination P=-7,48725069497119 V2=-1,93980003673529 V3=0 T=0 M2=0 M3=-4,66972428209491 FrameElem=46-1 ElemStation=0,1834
Frame=46 Station=0 OutputCase=STR003 CaseType=Combination P=-6,19106516544093 V2=-13,7409191885146 V3=0 T=0 M2=0 M3=-32,6978337022251 FrameElem=46-1 ElemStation=0
Frame=46 Station=0,0917 OutputCase=STR003 CaseType=Combination P=-6,19106516544093 V2=-13,2457391885146 V3=0 T=0 M2=0 M3=-31,4604954156383 FrameElem=46-1 ElemStation=0,0917
Frame=46 Station=0,1834 OutputCase=STR003 CaseType=Combination P=-6,19106516544093 V2=-12,7505591885146 V3=0 T=0 M2=0 M3=-30,2685651350515 FrameElem=46-1 ElemStation=0,1834
Frame=46 Station=0 OutputCase=STR004 CaseType=Combination P=-22,4898406126941 V2=18,8597153147399 V3=0 T=0 M2=0 M3=-30,3958771814894 FrameElem=46-1 ElemStation=0
Frame=46 Station=0,0917 OutputCase=STR004 CaseType=Combination P=-22,4898406126941 V2=19,3548953147399 V3=0 T=0 M2=0 M3=-32,148017078851 FrameElem=46-1 ElemStation=0,0917
Frame=46 Station=0,1834 OutputCase=STR004 CaseType=Combination P=-22,4898406126941 V2=19,8500753147399 V3=0 T=0 M2=0 M3=-33,9455649822127 FrameElem=46-1 ElemStation=0,1834
Frame=46 Station=0 OutputCase=STR005 CaseType=Combination P=-38,7886160557795 V2=-13,7456832106711 V3=0 T=0 M2=0 M3=-28,0939206614175 FrameElem=46-1 ElemStation=0
Frame=46 Station=0,0917 OutputCase=STR005 CaseType=Combination P=-38,7886160557795 V2=-13,2505032106711 V3=0 T=0 M2=0 M3=-26,8561455139989 FrameElem=46-1 ElemStation=0,0917
Frame=46 Station=0,1834 OutputCase=STR005 CaseType=Combination P=-38,7886160557795 V2=-12,7553232106711 V3=0 T=0 M2=0 M3=-25,6637783725804 FrameElem=46-1 ElemStation=0,1834
Frame=46 Station=0 OutputCase=STR006 CaseType=Combination P=-23,588946277411 V2=30,4299272348406 V3=0 T=0 M2=0 M3=-1,2768811396513 FrameElem=46-1 ElemStation=0
Frame=46 Station=0,0917 OutputCase=STR006 CaseType=Combination P=-23,588946277411 V2=30,7967272348406 V3=0 T=0 M2=0 M3=-4,08412322140002 FrameElem=46-1 ElemStation=0,0917
Frame=46 Station=0,1834 OutputCase=STR006 CaseType=Combination P=-23,588946277411 V2=31,1635272348406 V3=0 T=0 M2=0 M3=-6,92500088883491 FrameElem=46-1 ElemStation=0,1834
Frame=46 Station=0 OutputCase=STR007 CaseType=Combination P=-39,8877217204965 V2=-2,17547129057043 V3=0 T=0 M2=0 M3=1,02507540610674 FrameElem=46-1 ElemStation=0
Frame=46 Station=0,0917 OutputCase=STR007 CaseType=Combination P=-39,8877217204965 V2=-1,80867129057043 V3=0 T=0 M2=0 M3=1,20774834345205 FrameElem=46-1 ElemStation=0,0917
Frame=46 Station=0,1834 OutputCase=STR007 CaseType=Combination P=-39,8877217204965 V2=-1,44187129057043 V3=0 T=0 M2=0 M3=1,35678572079736 FrameElem=46-1 ElemStation=0,1834
Frame=46 Station=0 OutputCase=STR008 CaseType=Combination P=-19,7086566197672 V2=46,5384628848466 V3=0 T=0 M2=0 M3=-23,9587308161305 FrameElem=46-1 ElemStation=0
Frame=46 Station=0,0917 OutputCase=STR008 CaseType=Combination P=-19,7086566197672 V2=47,0336428848466 V3=0 T=0 M2=0 M3=-28,249011865671 FrameElem=46-1 ElemStation=0,0917
Frame=46 Station=0,1834 OutputCase=STR008 CaseType=Combination P=-19,7086566197672 V2=47,5288228848466 V3=0 T=0 M2=0 M3=-32,5847009212114 FrameElem=46-1 ElemStation=0,1834
Frame=46 Station=0 OutputCase=STR009 CaseType=Combination P=-14,3235017265161 V2=-2,93034252360162 V3=0 T=0 M2=0 M3=-4,93994576601092 FrameElem=46-1 ElemStation=0
Frame=46 Station=0,0917 OutputCase=STR009 CaseType=Combination P=-14,3235017265161 V2=-2,43516252360162 V3=0 T=0 M2=0 M3=-4,69393735959665 FrameElem=46-1 ElemStation=0,0917
Frame=46 Station=0,1834 OutputCase=STR009 CaseType=Combination P=-14,3235017265161 V2=-1,93998252360162 V3=0 T=0 M2=0 M3=-4,49333695918238 FrameElem=46-1 ElemStation=0,1834
Frame=46 Station=0 OutputCase=STR010 CaseType=Combination P=-6,56779385625528 V2=-2,92937188666619 V3=0 T=0 M2=0 M3=-5,87796156604116 FrameElem=46-1 ElemStation=0
Frame=46 Station=0,0917 OutputCase=STR010 CaseType=Combination P=-6,56779385625528 V2=-2,43419188666619 V3=0 T=0 M2=0 M3=-5,63204216703387 FrameElem=46-1 ElemStation=0,0917
Frame=46 Station=0,1834 OutputCase=STR010 CaseType=Combination P=-6,56779385625528 V2=-1,93901188666619 V3=0 T=0 M2=0 M3=-5,43153077402658 FrameElem=46-1 ElemStation=0,1834
Frame=46 Station=0 OutputCase=STR011 CaseType=Combination P=-5,63939106221139 V2=-13,7404462984732 V3=0 T=0 M2=0 M3=-33,1548308693505 FrameElem=46-1 ElemStation=0
Frame=46 Station=0,0917 OutputCase=STR011 CaseType=Combination P=-5,63939106221139 V2=-13,2452662984732 V3=0 T=0 M2=0 M3=-31,9175359467805 FrameElem=46-1 ElemStation=0,0917
Frame=46 Station=0,1834 OutputCase=STR011 CaseType=Combination P=-5,63939106221139 V2=-12,7500862984732 V3=0 T=0 M2=0 M3=-30,7256490302105 FrameElem=46-1 ElemStation=0,1834
Frame=46 Station=0 OutputCase=STR012 CaseType=Combination P=-21,9381665094645 V2=18,8601882047814 V3=0 T=0 M2=0 M3=-30,8528743486148 FrameElem=46-1 ElemStation=0
Frame=46 Station=0,0917 OutputCase=STR012 CaseType=Combination P=-21,9381665094645 V2=19,3553682047814 V3=0 T=0 M2=0 M3=-32,6050576099932 FrameElem=46-1 ElemStation=0,0917
Frame=46 Station=0,1834 OutputCase=STR012 CaseType=Combination P=-21,9381665094645 V2=19,8505482047814 V3=0 T=0 M2=0 M3=-34,4026488773717 FrameElem=46-1 ElemStation=0,1834

Società di Progetto
Brebemi SpA

	Doc. N. 60235-0000-A00.doc	CODIFICA DOCUMENTO 04RCDII10000000000300A00	REV. 00	FOGLIO 598 di 628
--	-------------------------------	--	------------	----------------------

Frame=46 Station=0 OutputCase=STR013 CaseType=Combination P=-38,23694195255 V2=-13,7452103206297 V3=0 T=0 M2=0 M3=-28,5509178285429 FrameElem=46-1 ElemStation=0

Frame=46 Station=0,0917 OutputCase=STR013 CaseType=Combination P=-38,23694195255 V2=-13,2500303206297 V3=0 T=0 M2=0 M3=-27,3131860451412 FrameElem=46-1 ElemStation=0,0917

Frame=46 Station=0,1834 OutputCase=STR013 CaseType=Combination P=-38,23694195255 V2=-12,7548503206297 V3=0 T=0 M2=0 M3=-26,1208622677394 FrameElem=46-1 ElemStation=0,1834

Frame=46 Station=0 OutputCase=STR014 CaseType=Combination P=-23,0372721741814 V2=30,4304001248821 V3=0 T=0 M2=0 M3=-1,73387828109054 FrameElem=46-1 ElemStation=0

Frame=46 Station=0,0917 OutputCase=STR014 CaseType=Combination P=-23,0372721741814 V2=30,7972001248821 V3=0 T=0 M2=0 M3=-4,54116375254222 FrameElem=46-1 ElemStation=0,0917

Frame=46 Station=0,1834 OutputCase=STR014 CaseType=Combination P=-23,0372721741814 V2=31,1640001248821 V3=0 T=0 M2=0 M3=-7,38208478399391 FrameElem=46-1 ElemStation=0,1834

Frame=46 Station=0 OutputCase=STR015 CaseType=Combination P=-39,3360476172669 V2=-2,17499840052897 V3=0 T=0 M2=0 M3=0,568078238981335 FrameElem=46-1 ElemStation=0

Frame=46 Station=0,0917 OutputCase=STR015 CaseType=Combination P=-39,3360476172669 V2=-1,80819840052897 V3=0 T=0 M2=0 M3=0,750707812309843 FrameElem=46-1 ElemStation=0,0917

Frame=46 Station=0,1834 OutputCase=STR015 CaseType=Combination P=-39,3360476172669 V2=-1,44139840052897 V3=0 T=0 M2=0 M3=0,89970182563835 FrameElem=46-1 ElemStation=0,1834

Frame=46 Station=0 OutputCase=STR016 CaseType=Combination P=-19,1569825165376 V2=46,5389357748881 V3=0 T=0 M2=0 M3=-24,4157279832559 FrameElem=46-1 ElemStation=0

Frame=46 Station=0,0917 OutputCase=STR016 CaseType=Combination P=-19,1569825165376 V2=47,0341157748881 V3=0 T=0 M2=0 M3=-28,7060523968132 FrameElem=46-1 ElemStation=0,0917

Frame=46 Station=0,1834 OutputCase=STR016 CaseType=Combination P=-19,1569825165376 V2=47,5292957748881 V3=0 T=0 M2=0 M3=-33,0417848163704 FrameElem=46-1 ElemStation=0,1834

Frame=46 Station=0 OutputCase=STR017 CaseType=Combination P=-5,59565470910759 V2=-11,0374412505007 V3=0 T=0 M2=0 M3=-26,5641121270859 FrameElem=46-1 ElemStation=0

Frame=46 Station=0,0917 OutputCase=STR017 CaseType=Combination P=-5,59565470910759 V2=-10,5422612505007 V3=0 T=0 M2=0 M3=-25,574682767415 FrameElem=46-1 ElemStation=0,0917

Frame=46 Station=0,1834 OutputCase=STR017 CaseType=Combination P=-5,59565470910759 V2=-10,0470812505007 V3=0 T=0 M2=0 M3=-24,6306614137441 FrameElem=46-1 ElemStation=0,1834

Frame=46 Station=0 OutputCase=STR018 CaseType=Combination P=-18,7891997785367 V2=14,7110342125263 V3=0 T=0 M2=0 M3=-24,7203927615139 FrameElem=46-1 ElemStation=0

Frame=46 Station=0,0917 OutputCase=STR018 CaseType=Combination P=-18,7891997785367 V2=15,2062142125263 V3=0 T=0 M2=0 M3=-26,0920986018026 FrameElem=46-1 ElemStation=0,0917

Frame=46 Station=0,1834 OutputCase=STR018 CaseType=Combination P=-18,7891997785367 V2=15,7013942125263 V3=0 T=0 M2=0 M3=-27,5092124480912 FrameElem=46-1 ElemStation=0,1834

Frame=46 Station=0 OutputCase=STR019 CaseType=Combination P=-31,9827448444267 V2=-11,0412569263519 V3=0 T=0 M2=0 M3=-22,8766733964726 FrameElem=46-1 ElemStation=0

Frame=46 Station=0,0917 OutputCase=STR019 CaseType=Combination P=-31,9827448444267 V2=-10,5460769263519 V3=0 T=0 M2=0 M3=-21,8868941393261 FrameElem=46-1 ElemStation=0,0917

Frame=46 Station=0,1834 OutputCase=STR019 CaseType=Combination P=-31,9827448444267 V2=-10,0508969263519 V3=0 T=0 M2=0 M3=-20,9425228881796 FrameElem=46-1 ElemStation=0,1834

Frame=46 Station=0 OutputCase=STR020 CaseType=Combination P=-19,564259060871 V2=23,5785563446822 V3=0 T=0 M2=0 M3=-2,49678021433792 FrameElem=46-1 ElemStation=0

Frame=46 Station=0,0917 OutputCase=STR020 CaseType=Combination P=-19,564259060871 V2=23,9453563446822 V3=0 T=0 M2=0 M3=-4,67575161114528 FrameElem=46-1 ElemStation=0,0917

Frame=46 Station=0,1834 OutputCase=STR020 CaseType=Combination P=-19,564259060871 V2=24,3121563446822 V3=0 T=0 M2=0 M3=-6,88835856795264 FrameElem=46-1 ElemStation=0,1834

Frame=46 Station=0 OutputCase=STR021 CaseType=Combination P=-32,7578041267611 V2=-2,17373479419606 V3=0 T=0 M2=0 M3=0,653060849296615 FrameElem=46-1 ElemStation=0

Frame=46 Station=0,0917 OutputCase=STR021 CaseType=Combination P=-32,7578041267611 V2=-1,80693479419607 V3=0 T=0 M2=0 M3=-0,470547148668835 FrameElem=46-1 ElemStation=0,0917

Frame=46 Station=0,1834 OutputCase=STR021 CaseType=Combination P=-32,7578041267611 V2=-1,44013479419607 V3=0 T=0 M2=0 M3=-0,321669008041054 FrameElem=46-1 ElemStation=0,1834

Frame=46 Station=0 OutputCase=STR022 CaseType=Combination P=-14,5523733992227 V2=-2,47291171791392 V3=0 T=0 M2=0 M3=-4,87786719655834 FrameElem=46-1 ElemStation=0

Frame=46 Station=0,0917 OutputCase=STR022 CaseType=Combination P=-14,5523733992227 V2=-1,97773171791392 V3=0 T=0 M2=0 M3=-4,67380519502563 FrameElem=46-1 ElemStation=0,0917

Frame=46 Station=0,1834 OutputCase=STR022 CaseType=Combination P=-14,5523733992227 V2=-1,48255171791392 V3=0 T=0 M2=0 M3=-4,51515119949292 FrameElem=46-1 ElemStation=0,1834

Frame=46 Station=0 OutputCase=STR023 CaseType=Combination P=-6,796655289619 V2=-2,4719410809785 V3=0 T=0 M2=0 M3=-5,81588299658858 FrameElem=46-1 ElemStation=0

Frame=46 Station=0,0917 OutputCase=STR023 CaseType=Combination P=-6,796655289619 V2=-1,9767610809785 V3=0 T=0 M2=0 M3=-5,61191000246285 FrameElem=46-1 ElemStation=0,0917

Frame=46 Station=0,1834 OutputCase=STR023 CaseType=Combination P=-6,796655289619 V2=-1,4815810809785 V3=0 T=0 M2=0 M3=-5,45334501433712 FrameElem=46-1 ElemStation=0,1834

Frame=46 Station=0 OutputCase=STR024 CaseType=Combination P=-5,82452638181421 V2=-10,580010444813 V3=0 T=0 M2=0 M3=-26,5020335576333 FrameElem=46-1 ElemStation=0

Frame=46 Station=0,0917 OutputCase=STR024 CaseType=Combination P=-5,82452638181421 V2=-10,084830444813 V3=0 T=0 M2=0 M3=-25,554550602844 FrameElem=46-1 ElemStation=0,0917

Frame=46 Station=0,1834 OutputCase=STR024 CaseType=Combination P=-5,82452638181421 V2=-9,58965044481301 V3=0 T=0 M2=0 M3=-24,6524756540546 FrameElem=46-1 ElemStation=0,1834

Frame=46 Station=0 OutputCase=STR025 CaseType=Combination P=-19,0180714512433 V2=15,168465018214 V3=0 T=0 M2=0 M3=-24,6583141920613 FrameElem=46-1 ElemStation=0

Frame=46 Station=0,0917 OutputCase=STR025 CaseType=Combination P=-19,0180714512433 V2=15,663645018214 V3=0 T=0 M2=0 M3=-26,0719664372315 FrameElem=46-1 ElemStation=0,0917

Frame=46 Station=0,1834 OutputCase=STR025 CaseType=Combination P=-19,0180714512433 V2=16,158825018214 V3=0 T=0 M2=0 M3=-27,5310266884018 FrameElem=46-1 ElemStation=0,1834

Frame=46 Station=0 OutputCase=STR026 CaseType=Combination P=-32,2116165171334 V2=-10,5838261206642 V3=0 T=0 M2=0 M3=-22,81459482702 FrameElem=46-1 ElemStation=0

Frame=46 Station=0,0917 OutputCase=STR026 CaseType=Combination P=-32,2116165171334 V2=-10,0886461206642 V3=0 T=0 M2=0 M3=-21,8667619747551 FrameElem=46-1 ElemStation=0,0917

Frame=46 Station=0,1834 OutputCase=STR026 CaseType=Combination P=-32,2116165171334 V2=-9,59346612066424 V3=0 T=0 M2=0 M3=-20,9643374284902 FrameElem=46-1 ElemStation=0,1834

Frame=46 Station=0 OutputCase=STR027 CaseType=Combination P=-19,7931307335777 V2=24,0359871503699 V3=0 T=0 M2=0 M3=-2,43470164488534 FrameElem=46-1 ElemStation=0

Frame=46 Station=0,0917 OutputCase=STR027 CaseType=Combination P=-19,7931307335777 V2=24,4027871503699 V3=0 T=0 M2=0 M3=-4,65561944657426 FrameElem=46-1 ElemStation=0,0917

Società di Progetto
Brebemi SpA

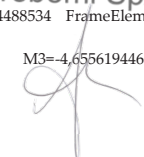



Doc. N.
60235-0000-A00.doc

CODIFICA DOCUMENTO
04RCDII10000000000300A00

REV.
00

FOGLIO
599 di 628

Frame=46 Station=0,1834 OutputCase=STR027 CaseType=Combination P=-19,7931307335777 V2=24,7695871503699 V3=0 T=0 M2=0 M3=-6,91017280826318
FrameElem=46-1 ElemStation=0,1834
Frame=46 Station=0 OutputCase=STR028 CaseType=Combination P=-32,9866757994677 V2=-1,71630398850837 V3=0 T=0 M2=0 M3=-0,590982279844033 FrameElem=46-1
ElemStation=0
Frame=46 Station=0,0917 OutputCase=STR028 CaseType=Combination P=-32,9866757994677 V2=-1,34950398850837 V3=0 T=0 M2=0 M3=-0,450414984097815
FrameElem=46-1 ElemStation=0,0917
Frame=46 Station=0,1834 OutputCase=STR028 CaseType=Combination P=-32,9866757994677 V2=0,982703988508371 V3=0 T=0 M2=0 M3=-0,34383248351595
FrameElem=46-1 ElemStation=0,1834
Frame=46 Station=0 OutputCase=STR029 CaseType=Combination P=-14,0946300538095 V2=-3,38777332928931 V3=0 T=0 M2=0 M3=-5,0020423354635 FrameElem=46-1
ElemStation=0
Frame=46 Station=0,0917 OutputCase=STR029 CaseType=Combination P=-14,0946300538095 V2=-2,89259332928931 V3=0 T=0 M2=0 M3=-4,71406952416767
FrameElem=46-1 ElemStation=0,0917
Frame=46 Station=0,1834 OutputCase=STR029 CaseType=Combination P=-14,0946300538095 V2=-2,39741332928931 V3=0 T=0 M2=0 M3=-4,47152271887184
FrameElem=46-1 ElemStation=0,1834
Frame=46 Station=0 OutputCase=STR030 CaseType=Combination P=-6,33892218354866 V2=-3,38680269235389 V3=0 T=0 M2=0 M3=-5,94004013549374 FrameElem=46-1
ElemStation=0
Frame=46 Station=0,0917 OutputCase=STR030 CaseType=Combination P=-6,33892218354866 V2=-2,89162269235389 V3=0 T=0 M2=0 M3=-5,65217433160489
FrameElem=46-1 ElemStation=0,0917
Frame=46 Station=0,1834 OutputCase=STR030 CaseType=Combination P=-6,33892218354866 V2=-2,39644269235389 V3=0 T=0 M2=0 M3=-5,40971653371604
FrameElem=46-1 ElemStation=0,1834
Frame=46 Station=0 OutputCase=STR031 CaseType=Combination P=-5,36678303640097 V2=-11,4948720561884 V3=0 T=0 M2=0 M3=-26,6261906965385 FrameElem=46-1
ElemStation=0
Frame=46 Station=0,0917 OutputCase=STR031 CaseType=Combination P=-5,36678303640097 V2=-10,9996920561884 V3=0 T=0 M2=0 M3=-25,594814931986
FrameElem=46-1 ElemStation=0,0917
Frame=46 Station=0,1834 OutputCase=STR031 CaseType=Combination P=-5,36678303640097 V2=-10,5045120561884 V3=0 T=0 M2=0 M3=-24,6088471734335
FrameElem=46-1 ElemStation=0,1834
Frame=46 Station=0 OutputCase=STR032 CaseType=Combination P=-18,5603281058301 V2=14,2536034068386 V3=0 T=0 M2=0 M3=-24,7824713309665 FrameElem=46-1
ElemStation=0
Frame=46 Station=0,0917 OutputCase=STR032 CaseType=Combination P=-18,5603281058301 V2=14,7487834068386 V3=0 T=0 M2=0 M3=-26,1122307663736
FrameElem=46-1 ElemStation=0,0917
Frame=46 Station=0,1834 OutputCase=STR032 CaseType=Combination P=-18,5603281058301 V2=15,2439634068386 V3=0 T=0 M2=0 M3=-27,4873982077807
FrameElem=46-1 ElemStation=0,1834
Frame=46 Station=0 OutputCase=STR033 CaseType=Combination P=-31,7538731717201 V2=-11,4986877320396 V3=0 T=0 M2=0 M3=-22,9387519659252 FrameElem=46-1
ElemStation=0
Frame=46 Station=0,0917 OutputCase=STR033 CaseType=Combination P=-31,7538731717201 V2=-11,0035077320396 V3=0 T=0 M2=0 M3=-21,9070263038971
FrameElem=46-1 ElemStation=0,0917
Frame=46 Station=0,1834 OutputCase=STR033 CaseType=Combination P=-31,7538731717201 V2=-10,5083277320396 V3=0 T=0 M2=0 M3=-20,9207086478691
FrameElem=46-1 ElemStation=0,1834
Frame=46 Station=0 OutputCase=STR034 CaseType=Combination P=-19,3353873881644 V2=23,1211255389945 V3=0 T=0 M2=0 M3=-2,5588587837905 FrameElem=46-1
ElemStation=0
Frame=46 Station=0,0917 OutputCase=STR034 CaseType=Combination P=-19,3353873881644 V2=23,4879255389945 V3=0 T=0 M2=0 M3=-4,6958837757163 FrameElem=46-1
ElemStation=0,0917
Frame=46 Station=0,1834 OutputCase=STR034 CaseType=Combination P=-19,3353873881644 V2=23,8547255389945 V3=0 T=0 M2=0 M3=-6,86654432764209
FrameElem=46-1 ElemStation=0,1834
Frame=46 Station=0 OutputCase=STR035 CaseType=Combination P=-32,5289324540545 V2=-2,63116559988376 V3=0 T=0 M2=0 M3=-0,715139418749197 FrameElem=46-1
ElemStation=0
Frame=46 Station=0,0917 OutputCase=STR035 CaseType=Combination P=-32,5289324540545 V2=-2,26436559988376 V3=0 T=0 M2=0 M3=-0,490679313239855
FrameElem=46-1 ElemStation=0,0917
Frame=46 Station=0,1834 OutputCase=STR035 CaseType=Combination P=-32,5289324540545 V2=-1,89756559988376 V3=0 T=0 M2=0 M3=-0,299854767730513
FrameElem=46-1 ElemStation=0,1834
Frame=46 Station=0 OutputCase=STR036 CaseType=Combination P=-14,8751758297456 V2=-2,93081541364307 V3=0 T=0 M2=0 M3=-4,48294859888551 FrameElem=46-1
ElemStation=0
Frame=46 Station=0,0917 OutputCase=STR036 CaseType=Combination P=-14,8751758297456 V2=-2,43563541364308 V3=0 T=0 M2=0 M3=-4,23689682845445
FrameElem=46-1 ElemStation=0,0917
Frame=46 Station=0,1834 OutputCase=STR036 CaseType=Combination P=-14,8751758297456 V2=-1,94045541364308 V3=0 T=0 M2=0 M3=-4,03625306402337
FrameElem=46-1 ElemStation=0,1834
Frame=46 Station=0 OutputCase=STR037 CaseType=Combination P=-7,11946795948483 V2=-2,92984477670765 V3=0 T=0 M2=0 M3=-5,42096439891576 FrameElem=46-1
ElemStation=0
Frame=46 Station=0,0917 OutputCase=STR037 CaseType=Combination P=-7,11946795948483 V2=-2,43466477670765 V3=0 T=0 M2=0 M3=-5,17500163589167
FrameElem=46-1 ElemStation=0,0917
Frame=46 Station=0,1834 OutputCase=STR037 CaseType=Combination P=-7,11946795948483 V2=-1,93948477670765 V3=0 T=0 M2=0 M3=-4,97444687886758
FrameElem=46-1 ElemStation=0,1834
Frame=46 Station=0 OutputCase=STR038 CaseType=Combination P=-6,14732881233713 V2=-11,0379141405422 V3=0 T=0 M2=0 M3=-26,1071149599605 FrameElem=46-1
ElemStation=0
Frame=46 Station=0,0917 OutputCase=STR038 CaseType=Combination P=-6,14732881233713 V2=-10,5427341405422 V3=0 T=0 M2=0 M3=-25,1176422362728
FrameElem=46-1 ElemStation=0,0917
Frame=46 Station=0,1834 OutputCase=STR038 CaseType=Combination P=-6,14732881233713 V2=-10,0475541405422 V3=0 T=0 M2=0 M3=-24,1735775185851
FrameElem=46-1 ElemStation=0,1834
Frame=46 Station=0 OutputCase=STR039 CaseType=Combination P=-19,3408738817662 V2=14,7105613224849 V3=0 T=0 M2=0 M3=-24,2633955943885 FrameElem=46-1
ElemStation=0
Frame=46 Station=0,0917 OutputCase=STR039 CaseType=Combination P=-19,3408738817662 V2=15,2057413224849 V3=0 T=0 M2=0 M3=-25,6350580706604
FrameElem=46-1 ElemStation=0,0917
Frame=46 Station=0,1834 OutputCase=STR039 CaseType=Combination P=-19,3408738817662 V2=15,7009213224849 V3=0 T=0 M2=0 M3=-27,0521285529322
FrameElem=46-1 ElemStation=0,1834
Frame=46 Station=0 OutputCase=STR040 CaseType=Combination P=-32,5344189476563 V2=-11,0417298163934 V3=0 T=0 M2=0 M3=-22,4196762293472 FrameElem=46-1
ElemStation=0
Frame=46 Station=0,0917 OutputCase=STR040 CaseType=Combination P=-32,5344189476563 V2=-10,5465498163934 V3=0 T=0 M2=0 M3=-21,4298536081839
FrameElem=46-1 ElemStation=0,0917
Frame=46 Station=0,1834 OutputCase=STR040 CaseType=Combination P=-32,5344189476563 V2=-10,0513698163934 V3=0 T=0 M2=0 M3=-20,4854389930206
FrameElem=46-1 ElemStation=0,1834
Frame=46 Station=0 OutputCase=STR041 CaseType=Combination P=-20,1159331641006 V2=23,5780834546407 V3=0 T=0 M2=0 M3=-2,03978304721252 FrameElem=46-1
ElemStation=0
Frame=46 Station=0,0917 OutputCase=STR041 CaseType=Combination P=-20,1159331641006 V2=23,9448834546407 V3=0 T=0 M2=0 M3=-4,21871108000308
FrameElem=46-1 ElemStation=0,0917
Frame=46 Station=0,1834 OutputCase=STR041 CaseType=Combination P=-20,1159331641006 V2=24,3116834546407 V3=0 T=0 M2=0 M3=-6,43127467279363
FrameElem=46-1 ElemStation=0,1834
Frame=46 Station=0 OutputCase=STR042 CaseType=Combination P=-33,3094782299906 V2=-2,17420768423752 V3=0 T=0 M2=0 M3=-0,196063682171213 FrameElem=46-1
ElemStation=0

Società di Progetto
Brebemi SpA



Doc. N.
60235-0000-A00.doc

CODIFICA DOCUMENTO
04RCDII10000000000300A00

REV.
00

FOGLIO
600 di 628

Frame=46 Station=0,0917 OutputCase=STR042 CaseType=Combination P=-33,3094782299906 V2=-1,80740768423752 V3=0 T=0 M2=0 M3=-1,35066175266317E-02
FrameElem=46-1 ElemStation=0,0917
Frame=46 Station=0,1834 OutputCase=STR042 CaseType=Combination P=-33,3094782299906 V2=-1,44060768423752 V3=0 T=0 M2=0 M3=0,135414887117951
FrameElem=46-1 ElemStation=0,1834
Frame=46 Station=0 OutputCase=STR043 CaseType=Combination P=-16,1624154039479 V2=-2,93191882373981 V3=0 T=0 M2=0 M3=-3,41662187559291 FrameElem=46-1
ElemStation=0
Frame=46 Station=0,0917 OutputCase=STR043 CaseType=Combination P=-16,1624154039479 V2=-2,43673882373981 V3=0 T=0 M2=0 M3=-3,17046892245597
FrameElem=46-1 ElemStation=0,0917
Frame=46 Station=0,1834 OutputCase=STR043 CaseType=Combination P=-16,1624154039479 V2=-1,94155882373981 V3=0 T=0 M2=0 M3=-2,96972397531903
FrameElem=46-1 ElemStation=0,1834
Frame=46 Station=0 OutputCase=STR044 CaseType=Combination P=-8,4067075336871 V2=-2,93094818680438 V3=0 T=0 M2=0 M3=-4,35463767562316 FrameElem=46-1
ElemStation=0
Frame=46 Station=0,0917 OutputCase=STR044 CaseType=Combination P=-8,4067075336871 V2=-2,43576818680438 V3=0 T=0 M2=0 M3=-4,10857327989319
FrameElem=46-1 ElemStation=0,0917
Frame=46 Station=0,1834 OutputCase=STR044 CaseType=Combination P=-8,4067075336871 V2=-1,94058818680438 V3=0 T=0 M2=0 M3=-3,90791779016323
FrameElem=46-1 ElemStation=0,1834
Frame=46 Station=0 OutputCase=STR045 CaseType=Combination P=-6,74273926867048 V2=-13,7413920785561 V3=0 T=0 M2=0 M3=-32,2408365350997 FrameElem=46-1
ElemStation=0
Frame=46 Station=0,0917 OutputCase=STR045 CaseType=Combination P=-6,74273926867048 V2=-13,2462120785561 V3=0 T=0 M2=0 M3=-31,0034548844961
FrameElem=46-1 ElemStation=0,0917
Frame=46 Station=0,1834 OutputCase=STR045 CaseType=Combination P=-6,74273926867048 V2=-12,7510320785561 V3=0 T=0 M2=0 M3=-29,8114812398925
FrameElem=46-1 ElemStation=0,1834
Frame=46 Station=0 OutputCase=STR046 CaseType=Combination P=-23,0415147159236 V2=18,8592424246985 V3=0 T=0 M2=0 M3=-29,938880014364 FrameElem=46-1
ElemStation=0
Frame=46 Station=0,0917 OutputCase=STR046 CaseType=Combination P=-23,0415147159236 V2=19,3544224246985 V3=0 T=0 M2=0 M3=-31,6909765477088
FrameElem=46-1 ElemStation=0,0917
Frame=46 Station=0,1834 OutputCase=STR046 CaseType=Combination P=-23,0415147159236 V2=19,8496024246985 V3=0 T=0 M2=0 M3=-33,4884810870537
FrameElem=46-1 ElemStation=0,1834
Frame=46 Station=0 OutputCase=STR047 CaseType=Combination P=-39,3402901590091 V2=-13,7461561007126 V3=0 T=0 M2=0 M3=-27,6369234942921 FrameElem=46-1
ElemStation=0
Frame=46 Station=0,0917 OutputCase=STR047 CaseType=Combination P=-39,3402901590091 V2=-13,2509761007126 V3=0 T=0 M2=0 M3=-26,3991049828567
FrameElem=46-1 ElemStation=0,0917
Frame=46 Station=0,1834 OutputCase=STR047 CaseType=Combination P=-39,3402901590091 V2=-12,7557961007126 V3=0 T=0 M2=0 M3=-25,2066944774214
FrameElem=46-1 ElemStation=0,1834
Frame=46 Station=0 OutputCase=STR048 CaseType=Combination P=-24,1406203806405 V2=30,4294543447992 V3=0 T=0 M2=0 M3=-0,819883946839733 FrameElem=46-1
ElemStation=0
Frame=46 Station=0,0917 OutputCase=STR048 CaseType=Combination P=-24,1406203806405 V2=30,7962543447992 V3=0 T=0 M2=0 M3=-3,62708269025782
FrameElem=46-1 ElemStation=0,0917
Frame=46 Station=0,1834 OutputCase=STR048 CaseType=Combination P=-24,1406203806405 V2=31,1630543447992 V3=0 T=0 M2=0 M3=-6,4679169936759 FrameElem=46-1
ElemStation=0,1834
Frame=46 Station=0 OutputCase=STR049 CaseType=Combination P=-40,439395823726 V2=-2,17594418061189 V3=0 T=0 M2=0 M3=1,48207257323214 FrameElem=46-1
ElemStation=0
Frame=46 Station=0,0917 OutputCase=STR049 CaseType=Combination P=-40,439395823726 V2=-1,80914418061189 V3=0 T=0 M2=0 M3=1,66478887459425 FrameElem=46-1
ElemStation=0,0917
Frame=46 Station=0,1834 OutputCase=STR049 CaseType=Combination P=-40,439395823726 V2=-1,44234418061189 V3=0 T=0 M2=0 M3=1,81386961595636 FrameElem=46-1
ElemStation=0,1834
Frame=46 Station=0 OutputCase=STR050 CaseType=Combination P=-20,2603307229967 V2=46,5379899948052 V3=0 T=0 M2=0 M3=-23,5017336490051 FrameElem=46-1
ElemStation=0
Frame=46 Station=0,0917 OutputCase=STR050 CaseType=Combination P=-20,2603307229967 V2=47,0331699948051 V3=0 T=0 M2=0 M3=-27,7919713345288
FrameElem=46-1 ElemStation=0,0917
Frame=46 Station=0,1834 OutputCase=STR050 CaseType=Combination P=-20,2603307229967 V2=47,5283499948051 V3=0 T=0 M2=0 M3=-32,1276170260524
FrameElem=46-1 ElemStation=0,1834
Frame=46 Station=0 OutputCase=STR051 CaseType=Combination P=-7,4345683865394 V2=-11,0390175506389 V3=0 T=0 M2=0 M3=-25,0407882366679 FrameElem=46-1
ElemStation=0
Frame=46 Station=0,0917 OutputCase=STR051 CaseType=Combination P=-7,4345683865394 V2=-10,5438375506389 V3=0 T=0 M2=0 M3=-24,0512143302743
FrameElem=46-1 ElemStation=0,0917
Frame=46 Station=0,1834 OutputCase=STR051 CaseType=Combination P=-7,4345683865394 V2=-10,0486575506389 V3=0 T=0 M2=0 M3=-23,1070484298807
FrameElem=46-1 ElemStation=0,1834
Frame=46 Station=0 OutputCase=STR052 CaseType=Combination P=-20,6281134559685 V2=14,7094579123881 V3=0 T=0 M2=0 M3=-23,1970688710959 FrameElem=46-1
ElemStation=0
Frame=46 Station=0,0917 OutputCase=STR052 CaseType=Combination P=-20,6281134559685 V2=15,2046379123881 V3=0 T=0 M2=0 M3=-24,5686301646619
FrameElem=46-1 ElemStation=0,0917
Frame=46 Station=0,1834 OutputCase=STR052 CaseType=Combination P=-20,6281134559685 V2=15,6998179123881 V3=0 T=0 M2=0 M3=-25,9855994642279
FrameElem=46-1 ElemStation=0,1834
Frame=46 Station=0 OutputCase=STR053 CaseType=Combination P=-33,8216585218586 V2=-11,0428332264901 V3=0 T=0 M2=0 M3=-21,3533495060546 FrameElem=46-1
ElemStation=0
Frame=46 Station=0,0917 OutputCase=STR053 CaseType=Combination P=-33,8216585218586 V2=-10,5476532264901 V3=0 T=0 M2=0 M3=-20,3634257021854
FrameElem=46-1 ElemStation=0,0917
Frame=46 Station=0,1834 OutputCase=STR053 CaseType=Combination P=-33,8216585218586 V2=-10,0524732264901 V3=0 T=0 M2=0 M3=-19,4189099043163
FrameElem=46-1 ElemStation=0,1834
Frame=46 Station=0 OutputCase=STR054 CaseType=Combination P=-21,4031727383028 V2=23,576980044544 V3=0 T=0 M2=0 M3=-0,973456323919915 FrameElem=46-1
ElemStation=0
Frame=46 Station=0,0917 OutputCase=STR054 CaseType=Combination P=-21,4031727383028 V2=23,943780044544 V3=0 T=0 M2=0 M3=-3,1522831740046 FrameElem=46-1
ElemStation=0,0917
Frame=46 Station=0,1834 OutputCase=STR054 CaseType=Combination P=-21,4031727383028 V2=24,310580044544 V3=0 T=0 M2=0 M3=-5,36474558408929 FrameElem=46-1
ElemStation=0,1834
Frame=46 Station=0 OutputCase=STR055 CaseType=Combination P=-34,5967178041929 V2=-2,17531109433426 V3=0 T=0 M2=0 M3=0,870263041121391 FrameElem=46-1
ElemStation=0
Frame=46 Station=0,0917 OutputCase=STR055 CaseType=Combination P=-34,5967178041929 V2=-1,80851109433426 V3=0 T=0 M2=0 M3=1,05292128847184
FrameElem=46-1 ElemStation=0,0917
Frame=46 Station=0,1834 OutputCase=STR055 CaseType=Combination P=-34,5967178041929 V2=-1,44171109433426 V3=0 T=0 M2=0 M3=1,2019439758223 FrameElem=46-1
ElemStation=0,1834
Frame=46 Station=0 OutputCase=STR056 CaseType=Combination P=-16,3912870766545 V2=-2,47448801805212 V3=0 T=0 M2=0 M3=-3,35454330614033 FrameElem=46-1
ElemStation=0
Frame=46 Station=0,0917 OutputCase=STR056 CaseType=Combination P=-16,3912870766545 V2=-1,97930801805212 V3=0 T=0 M2=0 M3=-3,15033675788495
FrameElem=46-1 ElemStation=0,0917
Frame=46 Station=0,1834 OutputCase=STR056 CaseType=Combination P=-16,3912870766545 V2=-1,48412801805212 V3=0 T=0 M2=0 M3=-2,99153821562957
FrameElem=46-1 ElemStation=0,1834

Società di Progetto
Brebemi SpA



Doc. N.
60235-0000-A00.doc

CODIFICA DOCUMENTO
04RCDII10000000000300A00

REV.
00

FOGLIO
601 di 628

Frame=46 Station=0 OutputCase=STR057 CaseType=Combination P=-8,63557920639372 V2=-2,47351738111669 V3=0 T=0 M2=0 M3=-4,29255910617058 FrameElem=46-1 ElemStation=0
Frame=46 Station=0,0917 OutputCase=STR057 CaseType=Combination P=-8,63557920639372 V2=-1,97833738111669 V3=0 T=0 M2=0 M3=-4,08844156532217 FrameElem=46-1 ElemStation=0,0917
Frame=46 Station=0,1834 OutputCase=STR057 CaseType=Combination P=-8,63557920639372 V2=-1,48315738111669 V3=0 T=0 M2=0 M3=-3,92973203047377 FrameElem=46-1 ElemStation=0,1834
Frame=46 Station=0 OutputCase=STR058 CaseType=Combination P=-7,66344005924602 V2=-10,5815867449512 V3=0 T=0 M2=0 M3=-24,9787096672153 FrameElem=46-1 ElemStation=0
Frame=46 Station=0,0917 OutputCase=STR058 CaseType=Combination P=-7,66344005924602 V2=-10,0864067449512 V3=0 T=0 M2=0 M3=-24,0310821657033 FrameElem=46-1 ElemStation=0,0917
Frame=46 Station=0,1834 OutputCase=STR058 CaseType=Combination P=-7,66344005924602 V2=-9,5912267449512 V3=0 T=0 M2=0 M3=-23,1288626701912 FrameElem=46-1 ElemStation=0,1834
Frame=46 Station=0 OutputCase=STR059 CaseType=Combination P=-20,8569851286751 V2=15,1668887180758 V3=0 T=0 M2=0 M3=-23,1349903016433 FrameElem=46-1 ElemStation=0
Frame=46 Station=0,0917 OutputCase=STR059 CaseType=Combination P=-20,8569851286751 V2=15,6620687180758 V3=0 T=0 M2=0 M3=-24,5484980000909 FrameElem=46-1 ElemStation=0,0917
Frame=46 Station=0,1834 OutputCase=STR059 CaseType=Combination P=-20,8569851286751 V2=16,1572487180758 V3=0 T=0 M2=0 M3=-26,0074137045384 FrameElem=46-1 ElemStation=0,1834
Frame=46 Station=0 OutputCase=STR060 CaseType=Combination P=-34,0505301945652 V2=-10,5854024208024 V3=0 T=0 M2=0 M3=-21,291270936602 FrameElem=46-1 ElemStation=0
Frame=46 Station=0,0917 OutputCase=STR060 CaseType=Combination P=-34,0505301945652 V2=-10,0902224208024 V3=0 T=0 M2=0 M3=-20,3432935376144 FrameElem=46-1 ElemStation=0,0917
Frame=46 Station=0,1834 OutputCase=STR060 CaseType=Combination P=-34,0505301945652 V2=-9,59504242080243 V3=0 T=0 M2=0 M3=-19,4407241446268 FrameElem=46-1 ElemStation=0,1834
Frame=46 Station=0 OutputCase=STR061 CaseType=Combination P=-21,6320444110095 V2=24,0344108502317 V3=0 T=0 M2=0 M3=-0,911377754467333 FrameElem=46-1 ElemStation=0
Frame=46 Station=0,0917 OutputCase=STR061 CaseType=Combination P=-21,6320444110095 V2=24,4012108502317 V3=0 T=0 M2=0 M3=-3,13215100943358 FrameElem=46-1 ElemStation=0,0917
Frame=46 Station=0,1834 OutputCase=STR061 CaseType=Combination P=-21,6320444110095 V2=24,7680108502317 V3=0 T=0 M2=0 M3=-5,38655982439983 FrameElem=46-1 ElemStation=0,1834
Frame=46 Station=0 OutputCase=STR062 CaseType=Combination P=-34,8255894768995 V2=-1,71788028864656 V3=0 T=0 M2=0 M3=-0,932341610573973 FrameElem=46-1 ElemStation=0
Frame=46 Station=0,0917 OutputCase=STR062 CaseType=Combination P=-34,8255894768995 V2=-1,35108028864656 V3=0 T=0 M2=0 M3=-1,07305345304286 FrameElem=46-1 ElemStation=0,0917
Frame=46 Station=0,1834 OutputCase=STR062 CaseType=Combination P=-34,8255894768995 V2=-0,98428028864656 V3=0 T=0 M2=0 M3=1,18012973551175 FrameElem=46-1 ElemStation=0,1834
Frame=46 Station=0 OutputCase=STR063 CaseType=Combination P=-15,9335437312413 V2=-3,3893496294275 V3=0 T=0 M2=0 M3=-3,47870044504549 FrameElem=46-1 ElemStation=0
Frame=46 Station=0,0917 OutputCase=STR063 CaseType=Combination P=-15,9335437312413 V2=-2,8941696294275 V3=0 T=0 M2=0 M3=-3,19060108702699 FrameElem=46-1 ElemStation=0,0917
Frame=46 Station=0,1834 OutputCase=STR063 CaseType=Combination P=-15,9335437312413 V2=-2,3989896294275 V3=0 T=0 M2=0 M3=-2,94790973500849 FrameElem=46-1 ElemStation=0,1834
Frame=46 Station=0 OutputCase=STR064 CaseType=Combination P=-8,17783586098047 V2=-3,38837899249208 V3=0 T=0 M2=0 M3=-4,41671624507574 FrameElem=46-1 ElemStation=0
Frame=46 Station=0,0917 OutputCase=STR064 CaseType=Combination P=-8,17783586098047 V2=-2,89319899249208 V3=0 T=0 M2=0 M3=-4,12870589446421 FrameElem=46-1 ElemStation=0,0917
Frame=46 Station=0,1834 OutputCase=STR064 CaseType=Combination P=-8,17783586098047 V2=-2,39801899249208 V3=0 T=0 M2=0 M3=-3,88610354985269 FrameElem=46-1 ElemStation=0,1834
Frame=46 Station=0 OutputCase=STR065 CaseType=Combination P=-7,20569671383278 V2=-11,4964483563266 V3=0 T=0 M2=0 M3=-25,1028668061205 FrameElem=46-1 ElemStation=0
Frame=46 Station=0,0917 OutputCase=STR065 CaseType=Combination P=-7,20569671383278 V2=-11,0012683563266 V3=0 T=0 M2=0 M3=-24,0713464948453 FrameElem=46-1 ElemStation=0,0917
Frame=46 Station=0,1834 OutputCase=STR065 CaseType=Combination P=-7,20569671383278 V2=-10,5060883563266 V3=0 T=0 M2=0 M3=-23,0852341895702 FrameElem=46-1 ElemStation=0,1834
Frame=46 Station=0 OutputCase=STR066 CaseType=Combination P=-20,3992417832619 V2=14,2520271067004 V3=0 T=0 M2=0 M3=-23,2591474405485 FrameElem=46-1 ElemStation=0
Frame=46 Station=0,0917 OutputCase=STR066 CaseType=Combination P=-20,3992417832619 V2=14,7472071067004 V3=0 T=0 M2=0 M3=-24,5887623292329 FrameElem=46-1 ElemStation=0,0917
Frame=46 Station=0,1834 OutputCase=STR066 CaseType=Combination P=-20,3992417832619 V2=15,2423871067004 V3=0 T=0 M2=0 M3=-25,9637852239173 FrameElem=46-1 ElemStation=0,1834
Frame=46 Station=0 OutputCase=STR067 CaseType=Combination P=-33,5927868491519 V2=-11,5002640321778 V3=0 T=0 M2=0 M3=-21,4154280755072 FrameElem=46-1 ElemStation=0
Frame=46 Station=0,0917 OutputCase=STR067 CaseType=Combination P=-33,5927868491519 V2=-11,0050840321778 V3=0 T=0 M2=0 M3=-20,3835578667565 FrameElem=46-1 ElemStation=0,0917
Frame=46 Station=0,1834 OutputCase=STR067 CaseType=Combination P=-33,5927868491519 V2=-10,5099040321778 V3=0 T=0 M2=0 M3=-19,3970956640058 FrameElem=46-1 ElemStation=0,1834
Frame=46 Station=0 OutputCase=STR068 CaseType=Combination P=-21,1743010655962 V2=23,1195492388563 V3=0 T=0 M2=0 M3=-1,0355348933725 FrameElem=46-1 ElemStation=0
Frame=46 Station=0,0917 OutputCase=STR068 CaseType=Combination P=-21,1743010655962 V2=23,4863492388563 V3=0 T=0 M2=0 M3=-3,17241533857562 FrameElem=46-1 ElemStation=0,0917
Frame=46 Station=0,1834 OutputCase=STR068 CaseType=Combination P=-21,1743010655962 V2=23,8531492388563 V3=0 T=0 M2=0 M3=-5,34293134377874 FrameElem=46-1 ElemStation=0,1834
Frame=46 Station=0 OutputCase=STR069 CaseType=Combination P=-34,3678461314863 V2=-2,63274190002195 V3=0 T=0 M2=0 M3=0,808184471668809 FrameElem=46-1 ElemStation=0
Frame=46 Station=0,0917 OutputCase=STR069 CaseType=Combination P=-34,3678461314863 V2=-2,26594190002195 V3=0 T=0 M2=0 M3=1,03278912390082 FrameElem=46-1 ElemStation=0,0917
Frame=46 Station=0,1834 OutputCase=STR069 CaseType=Combination P=-34,3678461314863 V2=-1,89914190002195 V3=0 T=0 M2=0 M3=1,22375821613284 FrameElem=46-1 ElemStation=0,1834
Frame=46 Station=0 OutputCase=STR070 CaseType=Combination P=-16,7140895071775 V2=-2,93239171378127 V3=0 T=0 M2=0 M3=-2,95962470846751 FrameElem=46-1 ElemStation=0
Frame=46 Station=0,0917 OutputCase=STR070 CaseType=Combination P=-16,7140895071775 V2=-2,43721171378127 V3=0 T=0 M2=0 M3=-2,71342839131377 FrameElem=46-1 ElemStation=0,0917
Frame=46 Station=0,1834 OutputCase=STR070 CaseType=Combination P=-16,7140895071775 V2=-1,94203171378127 V3=0 T=0 M2=0 M3=-2,51264008016002 FrameElem=46-1 ElemStation=0,1834
Frame=46 Station=0 OutputCase=STR071 CaseType=Combination P=-8,95838163691664 V2=-2,93142107684584 V3=0 T=0 M2=0 M3=-3,89764050849776 FrameElem=46-1 ElemStation=0
Frame=46 Station=0,0917 OutputCase=STR071 CaseType=Combination P=-8,95838163691664 V2=-2,43624107684584 V3=0 T=0 M2=0 M3=-3,65153319875099 FrameElem=46-1 ElemStation=0,0917

Società di Progetto
Brebemi SpA



Doc. N.
60235-0000-A00.doc

CODIFICA DOCUMENTO
04RCDII10000000000300A00

REV.
00

FOGLIO
602 di 628

Frame=46 Station=0,1834 OutputCase=STR071 CaseType=Combination P=-8,95838163691664 V2=-1,94106107684584 V3=0 T=0 M2=0 M3=-3,45083389500423
FrameElem=46-1 ElemStation=0,1834
Frame=46 Station=0 OutputCase=STR072 CaseType=Combination P=-7,98624248976895 V2=-11,0394904406804 V3=0 T=0 M2=0 M3=-24,5837910695425 FrameElem=46-1
ElemStation=0
Frame=46 Station=0,0917 OutputCase=STR072 CaseType=Combination P=-7,98624248976895 V2=-10,5443104406804 V3=0 T=0 M2=0 M3=-23,5941737991321
FrameElem=46-1 ElemStation=0,0917
Frame=46 Station=0,1834 OutputCase=STR072 CaseType=Combination P=-7,98624248976895 V2=-10,0491304406804 V3=0 T=0 M2=0 M3=-22,6499645347217
FrameElem=46-1 ElemStation=0,1834
Frame=46 Station=0 OutputCase=STR073 CaseType=Combination P=-21,179787559198 V2=14,7089850223467 V3=0 T=0 M2=0 M3=-22,7400717039705 FrameElem=46-1
ElemStation=0
Frame=46 Station=0,0917 OutputCase=STR073 CaseType=Combination P=-21,179787559198 V2=15,2041650223467 V3=0 T=0 M2=0 M3=-24,115896335197 FrameElem=46-1
ElemStation=0,0917
Frame=46 Station=0,1834 OutputCase=STR073 CaseType=Combination P=-21,179787559198 V2=15,6993450223467 V3=0 T=0 M2=0 M3=-25,5285155690689 FrameElem=46-1
ElemStation=0,1834
Frame=46 Station=0 OutputCase=STR074 CaseType=Combination P=-34,3733326250881 V2=-11,0433061165316 V3=0 T=0 M2=0 M3=-20,8963523389292 FrameElem=46-1
ElemStation=0
Frame=46 Station=0,0917 OutputCase=STR074 CaseType=Combination P=-34,3733326250881 V2=-10,5481261165316 V3=0 T=0 M2=0 M3=-19,9063851710432
FrameElem=46-1 ElemStation=0,0917
Frame=46 Station=0,1834 OutputCase=STR074 CaseType=Combination P=-34,3733326250881 V2=-10,0529461165316 V3=0 T=0 M2=0 M3=-18,9618260091573
FrameElem=46-1 ElemStation=0,1834
Frame=46 Station=0 OutputCase=STR075 CaseType=Combination P=-21,9548468415324 V2=23,5765071545025 V3=0 T=0 M2=0 M3=-0,516459156794513 FrameElem=46-1
ElemStation=0
Frame=46 Station=0,0917 OutputCase=STR075 CaseType=Combination P=-21,9548468415324 V2=23,9433071545025 V3=0 T=0 M2=0 M3=-2,6952426428624 FrameElem=46-1
ElemStation=0,0917
Frame=46 Station=0,1834 OutputCase=STR075 CaseType=Combination P=-21,9548468415324 V2=24,3101071545026 V3=0 T=0 M2=0 M3=-4,90766168893028
FrameElem=46-1 ElemStation=0,1834
Frame=46 Station=0 OutputCase=STR076 CaseType=Combination P=-35,1483919074225 V2=-2,17578398437571 V3=0 T=0 M2=0 M3=1,32726020824679 FrameElem=46-1
ElemStation=0
Frame=46 Station=0,0917 OutputCase=STR076 CaseType=Combination P=-35,1483919074225 V2=-1,80898398437572 V3=0 T=0 M2=0 M3=1,50996181961405
FrameElem=46-1 ElemStation=0,0917
Frame=46 Station=0,1834 OutputCase=STR076 CaseType=Combination P=-35,1483919074225 V2=-1,44218398437571 V3=0 T=0 M2=0 M3=1,6590278709813 FrameElem=46-1
ElemStation=0,1834
Frame=46 Station=0 OutputCase=STR077 CaseType=Combination P=-15,6244113530764 V2=-2,16874599752456 V3=0 T=0 M2=0 M3=-4,07481953838094 FrameElem=46-1
ElemStation=0
Frame=46 Station=0,0917 OutputCase=STR077 CaseType=Combination P=-15,6244113530764 V2=-1,67356599752456 V3=0 T=0 M2=0 M3=-3,89864953340794
FrameElem=46-1 ElemStation=0,0917
Frame=46 Station=0,1834 OutputCase=STR077 CaseType=Combination P=-15,6244113530764 V2=-1,17838599752456 V3=0 T=0 M2=0 M3=-3,76788753443494
FrameElem=46-1 ElemStation=0,1834
Frame=46 Station=0 OutputCase=STR078 CaseType=Combination P=-7,86870348281556 V2=-2,1677536058913 V3=0 T=0 M2=0 M3=-5,01283533841119 FrameElem=46-1
ElemStation=0
Frame=46 Station=0,0917 OutputCase=STR078 CaseType=Combination P=-7,86870348281556 V2=-1,67259536058913 V3=0 T=0 M2=0 M3=-4,83675434084517
FrameElem=46-1 ElemStation=0,0917
Frame=46 Station=0,1834 OutputCase=STR078 CaseType=Combination P=-7,86870348281556 V2=-1,17741536058913 V3=0 T=0 M2=0 M3=-4,70608134927914
FrameElem=46-1 ElemStation=0,1834
Frame=46 Station=0 OutputCase=STR079 CaseType=Combination P=-6,41993683814755 V2=-13,2834883828269 V3=0 T=0 M2=0 M3=-32,6357551327726 FrameElem=46-1
ElemStation=0
Frame=46 Station=0,0917 OutputCase=STR079 CaseType=Combination P=-6,41993683814755 V2=-12,7883083828269 V3=0 T=0 M2=0 M3=-31,4403632510673
FrameElem=46-1 ElemStation=0,0917
Frame=46 Station=0,1834 OutputCase=STR079 CaseType=Combination P=-6,41993683814755 V2=-12,2931283828269 V3=0 T=0 M2=0 M3=-30,2903793753621
FrameElem=46-1 ElemStation=0,1834
Frame=46 Station=0 OutputCase=STR080 CaseType=Combination P=-22,7187122854007 V2=19,3171461204276 V3=0 T=0 M2=0 M3=-30,3337986120368 FrameElem=46-1
ElemStation=0
Frame=46 Station=0,0917 OutputCase=STR080 CaseType=Combination P=-22,7187122854007 V2=19,8123261204276 V3=0 T=0 M2=0 M3=-32,12788491428 FrameElem=46-1
ElemStation=0,0917
Frame=46 Station=0,1834 OutputCase=STR080 CaseType=Combination P=-22,7187122854007 V2=20,3075061204276 V3=0 T=0 M2=0 M3=-33,9673792225232
FrameElem=46-1 ElemStation=0,1834
Frame=46 Station=0 OutputCase=STR081 CaseType=Combination P=-39,0174877284862 V2=-13,2882524049834 V3=0 T=0 M2=0 M3=-28,0318420919649 FrameElem=46-1
ElemStation=0
Frame=46 Station=0,0917 OutputCase=STR081 CaseType=Combination P=-39,0174877284862 V2=-12,7930724049834 V3=0 T=0 M2=0 M3=-26,8360133494279
FrameElem=46-1 ElemStation=0,0917
Frame=46 Station=0,1834 OutputCase=STR081 CaseType=Combination P=-39,0174877284862 V2=-12,2978924049834 V3=0 T=0 M2=0 M3=-25,6855926128909
FrameElem=46-1 ElemStation=0,1834
Frame=46 Station=0 OutputCase=STR082 CaseType=Combination P=-23,8178179501176 V2=30,8873580405283 V3=0 T=0 M2=0 M3=-1,21480254451255 FrameElem=46-1
ElemStation=0
Frame=46 Station=0,0917 OutputCase=STR082 CaseType=Combination P=-23,8178179501176 V2=31,2541580405283 V3=0 T=0 M2=0 M3=-4,063991056829 FrameElem=46-1
ElemStation=0,0917
Frame=46 Station=0,1834 OutputCase=STR082 CaseType=Combination P=-23,8178179501176 V2=31,6209580405283 V3=0 T=0 M2=0 M3=-6,94681512914545
FrameElem=46-1 ElemStation=0,1834
Frame=46 Station=0 OutputCase=STR083 CaseType=Combination P=-40,1165933932031 V2=-1,71804048488273 V3=0 T=0 M2=0 M3=1,08715397555932 FrameElem=46-1
ElemStation=0
Frame=46 Station=0,0917 OutputCase=STR083 CaseType=Combination P=-40,1165933932031 V2=-1,35124048488274 V3=0 T=0 M2=0 M3=1,22788050802307
FrameElem=46-1 ElemStation=0,0917
Frame=46 Station=0,1834 OutputCase=STR083 CaseType=Combination P=-40,1165933932031 V2=-0,984440484882735 V3=0 T=0 M2=0 M3=1,33497148048681
FrameElem=46-1 ElemStation=0,1834
Frame=46 Station=0 OutputCase=STR084 CaseType=Combination P=-19,9375282924738 V2=46,9958936905343 V3=0 T=0 M2=0 M3=-23,896652246678 FrameElem=46-1
ElemStation=0
Frame=46 Station=0,0917 OutputCase=STR084 CaseType=Combination P=-19,9375282924738 V2=47,4910736905343 V3=0 T=0 M2=0 M3=-28,2288797011 FrameElem=46-1
ElemStation=0,0917
Frame=46 Station=0,1834 OutputCase=STR084 CaseType=Combination P=-19,9375282924738 V2=47,9862536905343 V3=0 T=0 M2=0 M3=-32,606515161522 FrameElem=46-1
ElemStation=0,1834
Frame=46 Station=0 OutputCase=STR085 CaseType=Combination P=-6,89656433566787 V2=-10,2758447244236 V3=0 T=0 M2=0 M3=-25,6989858994559 FrameElem=46-1
ElemStation=0
Frame=46 Station=0,0917 OutputCase=STR085 CaseType=Combination P=-6,89656433566787 V2=-9,78066472442364 V3=0 T=0 M2=0 M3=-24,7793949412263
FrameElem=46-1 ElemStation=0,0917
Frame=46 Station=0,1834 OutputCase=STR085 CaseType=Combination P=-6,89656433566787 V2=-9,28548472442364 V3=0 T=0 M2=0 M3=-23,9052119889966
FrameElem=46-1 ElemStation=0,1834
Frame=46 Station=0 OutputCase=STR086 CaseType=Combination P=-20,090109405097 V2=15,4726307386034 V3=0 T=0 M2=0 M3=-23,8552665338839 FrameElem=46-1
ElemStation=0

Società di Progetto
Brebemi SpA



Doc. N.
60235-0000-A00.doc

CODIFICA DOCUMENTO
04RCDII10000000000300A00

REV.
00

FOGLIO
603 di 628

Frame=46 Station=0,0917 OutputCase=STR086 CaseType=Combination P=-20,090109405097 V2=15,9678107386034 V3=0 T=0 M2=0 M3=-25,2968107756139 FrameElem=46-1 ElemStation=0,0917
Frame=46 Station=0,1834 OutputCase=STR086 CaseType=Combination P=-20,090109405097 V2=16,4629907386034 V3=0 T=0 M2=0 M3=-26,7837630233438 FrameElem=46-1 ElemStation=0,1834
Frame=46 Station=0 OutputCase=STR087 CaseType=Combination P=-33,283654470987 V2=-10,2796604002749 V3=0 T=0 M2=0 M3=-22,0115471688426 FrameElem=46-1 ElemStation=0
Frame=46 Station=0,0917 OutputCase=STR087 CaseType=Combination P=-33,283654470987 V2=-9,78448040027487 V3=0 T=0 M2=0 M3=-21,0916063131374 FrameElem=46-1 ElemStation=0,0917
Frame=46 Station=0,1834 OutputCase=STR087 CaseType=Combination P=-33,283654470987 V2=-9,28930040027487 V3=0 T=0 M2=0 M3=-20,2170734634322 FrameElem=46-1 ElemStation=0,1834
Frame=46 Station=0 OutputCase=STR088 CaseType=Combination P=-20,8651686874313 V2=24,3401528707593 V3=0 T=0 M2=0 M3=-1,63165398670795 FrameElem=46-1 ElemStation=0
Frame=46 Station=0,0917 OutputCase=STR088 CaseType=Combination P=-20,8651686874313 V2=24,7069528707593 V3=0 T=0 M2=0 M3=-3,88046378495657 FrameElem=46-1 ElemStation=0,0917
Frame=46 Station=0,1834 OutputCase=STR088 CaseType=Combination P=-20,8651686874313 V2=25,0737528707593 V3=0 T=0 M2=0 M3=-6,1629091432052 FrameElem=46-1 ElemStation=0,1834
Frame=46 Station=0 OutputCase=STR089 CaseType=Combination P=-34,0587137533214 V2=-1,412138268119 V3=0 T=0 M2=0 M3=0,212065378333358 FrameElem=46-1 ElemStation=0
Frame=46 Station=0,0917 OutputCase=STR089 CaseType=Combination P=-34,0587137533214 V2=-1,04533826811901 V3=0 T=0 M2=0 M3=0,324740677519871 FrameElem=46-1 ElemStation=0,0917
Frame=46 Station=0,1834 OutputCase=STR089 CaseType=Combination P=-34,0587137533214 V2=-0,678538268119004 V3=0 T=0 M2=0 M3=0,403780416706386 FrameElem=46-1 ElemStation=0,1834
Frame=46 Station=0 OutputCase=STR090 CaseType=Combination P=-15,0727372498468 V2=-2,1682731074831 V3=0 T=0 M2=0 M3=-4,53181670550635 FrameElem=46-1 ElemStation=0
Frame=46 Station=0,0917 OutputCase=STR090 CaseType=Combination P=-15,0727372498468 V2=-1,6730931074831 V3=0 T=0 M2=0 M3=-4,35569006455015 FrameElem=46-1 ElemStation=0,0917
Frame=46 Station=0,1834 OutputCase=STR090 CaseType=Combination P=-15,0727372498468 V2=-1,1779131074831 V3=0 T=0 M2=0 M3=-4,22497142959395 FrameElem=46-1 ElemStation=0,1834
Frame=46 Station=0 OutputCase=STR091 CaseType=Combination P=-7,31702937958601 V2=-2,16730247054767 V3=0 T=0 M2=0 M3=-5,46983250553659 FrameElem=46-1 ElemStation=0
Frame=46 Station=0,0917 OutputCase=STR091 CaseType=Combination P=-7,31702937958601 V2=-1,67212247054767 V3=0 T=0 M2=0 M3=-5,29379487198737 FrameElem=46-1 ElemStation=0,0917
Frame=46 Station=0,1834 OutputCase=STR091 CaseType=Combination P=-7,31702937958601 V2=-1,17694247054767 V3=0 T=0 M2=0 M3=-5,16316524443815 FrameElem=46-1 ElemStation=0,1834
Frame=46 Station=0 OutputCase=STR092 CaseType=Combination P=-6,34489023243832 V2=-10,2753718343822 V3=0 T=0 M2=0 M3=-26,1559830665813 FrameElem=46-1 ElemStation=0
Frame=46 Station=0,0917 OutputCase=STR092 CaseType=Combination P=-6,34489023243832 V2=-9,78019183438219 V3=0 T=0 M2=0 M3=-25,2364354723685 FrameElem=46-1 ElemStation=0,0917
Frame=46 Station=0,1834 OutputCase=STR092 CaseType=Combination P=-6,34489023243832 V2=-9,28501183438218 V3=0 T=0 M2=0 M3=-24,3622958841556 FrameElem=46-1 ElemStation=0,1834
Frame=46 Station=0 OutputCase=STR093 CaseType=Combination P=-19,5384353018674 V2=15,4731036286449 V3=0 T=0 M2=0 M3=-24,3122637010093 FrameElem=46-1 ElemStation=0
Frame=46 Station=0,0917 OutputCase=STR093 CaseType=Combination P=-19,5384353018674 V2=15,9682836286449 V3=0 T=0 M2=0 M3=-25,7538513067561 FrameElem=46-1 ElemStation=0,0917
Frame=46 Station=0,1834 OutputCase=STR093 CaseType=Combination P=-19,5384353018674 V2=16,4634636286449 V3=0 T=0 M2=0 M3=-27,2408469185028 FrameElem=46-1 ElemStation=0,1834
Frame=46 Station=0 OutputCase=STR094 CaseType=Combination P=-32,7319803677575 V2=-10,2791875102334 V3=0 T=0 M2=0 M3=-22,468544335968 FrameElem=46-1 ElemStation=0
Frame=46 Station=0,0917 OutputCase=STR094 CaseType=Combination P=-32,7319803677575 V2=-9,78400751023341 V3=0 T=0 M2=0 M3=-21,5486468442796 FrameElem=46-1 ElemStation=0,0917
Frame=46 Station=0,1834 OutputCase=STR094 CaseType=Combination P=-32,7319803677575 V2=-9,28882751023341 V3=0 T=0 M2=0 M3=-20,6741573585912 FrameElem=46-1 ElemStation=0,1834
Frame=46 Station=0 OutputCase=STR095 CaseType=Combination P=-20,3134945842018 V2=24,3406257608007 V3=0 T=0 M2=0 M3=-2,08865115383335 FrameElem=46-1 ElemStation=0
Frame=46 Station=0,0917 OutputCase=STR095 CaseType=Combination P=-20,3134945842018 V2=24,7074257608007 V3=0 T=0 M2=0 M3=-4,33750431609878 FrameElem=46-1 ElemStation=0,0917
Frame=46 Station=0,1834 OutputCase=STR095 CaseType=Combination P=-20,3134945842018 V2=25,0742257608007 V3=0 T=0 M2=0 M3=-6,6199930383642 FrameElem=46-1 ElemStation=0,1834
Frame=46 Station=0 OutputCase=STR096 CaseType=Combination P=-33,5070396500918 V2=-1,41166537807755 V3=0 T=0 M2=0 M3=-0,244931788792044 FrameElem=46-1 ElemStation=0
Frame=46 Station=0,0917 OutputCase=STR096 CaseType=Combination P=-33,5070396500918 V2=-1,04486537807755 V3=0 T=0 M2=0 M3=0,132299853622332 FrameElem=46-1 ElemStation=0,0917
Frame=46 Station=0,1834 OutputCase=STR096 CaseType=Combination P=-33,5070396500918 V2=-0,678065378077547 V3=0 T=0 M2=0 M3=-5,33034784526196E-02 FrameElem=46-1 ElemStation=0,1834
Frame=46 Station=0 OutputCase=STR097 CaseType=Combination P=-16,1760854563059 V2=-2,16921888756601 V3=0 T=0 M2=0 M3=-3,61782237125554 FrameElem=46-1 ElemStation=0
Frame=46 Station=0,0917 OutputCase=STR097 CaseType=Combination P=-16,1760854563059 V2=-1,67403888756601 V3=0 T=0 M2=0 M3=-3,44160900226574 FrameElem=46-1 ElemStation=0,0917
Frame=46 Station=0,1834 OutputCase=STR097 CaseType=Combination P=-16,1760854563059 V2=-1,1788588756601 V3=0 T=0 M2=0 M3=-3,31080363927593 FrameElem=46-1 ElemStation=0,1834
Frame=46 Station=0 OutputCase=STR098 CaseType=Combination P=-8,4203775860451 V2=-2,16824825063059 V3=0 T=0 M2=0 M3=-4,55583817128579 FrameElem=46-1 ElemStation=0
Frame=46 Station=0,0917 OutputCase=STR098 CaseType=Combination P=-8,4203775860451 V2=-1,67306825063059 V3=0 T=0 M2=0 M3=-4,37971380970296 FrameElem=46-1 ElemStation=0,0917
Frame=46 Station=0,1834 OutputCase=STR098 CaseType=Combination P=-8,4203775860451 V2=-1,17788825063059 V3=0 T=0 M2=0 M3=-4,24899745412014 FrameElem=46-1 ElemStation=0,1834
Frame=46 Station=0 OutputCase=STR099 CaseType=Combination P=-7,44823843889741 V2=-10,2763176144651 V3=0 T=0 M2=0 M3=-25,2419887323305 FrameElem=46-1 ElemStation=0
Frame=46 Station=0,0917 OutputCase=STR099 CaseType=Combination P=-7,44823843889741 V2=-9,7811376144651 V3=0 T=0 M2=0 M3=-24,3223544100841 FrameElem=46-1 ElemStation=0,0917
Frame=46 Station=0,1834 OutputCase=STR099 CaseType=Combination P=-7,44823843889741 V2=-9,2859576144651 V3=0 T=0 M2=0 M3=-23,4481280938376 FrameElem=46-1 ElemStation=0,1834
Frame=46 Station=0 OutputCase=STR100 CaseType=Combination P=-20,6417835083265 V2=15,4721578485619 V3=0 T=0 M2=0 M3=-23,3982693667585 FrameElem=46-1 ElemStation=0
Frame=46 Station=0,0917 OutputCase=STR100 CaseType=Combination P=-20,6417835083265 V2=15,9673378485619 V3=0 T=0 M2=0 M3=-24,8397702444717 FrameElem=46-1 ElemStation=0,0917
Frame=46 Station=0,1834 OutputCase=STR100 CaseType=Combination P=-20,6417835083265 V2=16,4625178485619 V3=0 T=0 M2=0 M3=-26,3266791281848 FrameElem=46-1 ElemStation=0,1834

Società di Progetto
Brebemi SpA



Doc. N.
60235-0000-A00.doc

CODIFICA DOCUMENTO
04RCDII10000000000300A00

REV.
00

FOGLIO
604 di 628

Frame=46 Station=0 OutputCase=STR101 CaseType=Combination P=-33,8353285742166 V2=-10,2801332903163 V3=0 T=0 M2=0 M3=-21,5545500017172 FrameElem=46-1 ElemStation=0
Frame=46 Station=0,0917 OutputCase=STR101 CaseType=Combination P=-33,8353285742166 V2=-9,78495329031633 V3=0 T=0 M2=0 M3=-20,6345657819952 FrameElem=46-1 ElemStation=0,0917
Frame=46 Station=0,1834 OutputCase=STR101 CaseType=Combination P=-33,8353285742166 V2=-9,28977329031633 V3=0 T=0 M2=0 M3=-19,7599895682732 FrameElem=46-1 ElemStation=0,1834
Frame=46 Station=0 OutputCase=STR102 CaseType=Combination P=-21,4168427906609 V2=24,3396799807178 V3=0 T=0 M2=0 M3=-1,17465681958255 FrameElem=46-1 ElemStation=0
Frame=46 Station=0,0917 OutputCase=STR102 CaseType=Combination P=-21,4168427906609 V2=24,7064799807178 V3=0 T=0 M2=0 M3=-3,42342325381437 FrameElem=46-1 ElemStation=0,0917
Frame=46 Station=0,1834 OutputCase=STR102 CaseType=Combination P=-21,4168427906609 V2=25,0732799807178 V3=0 T=0 M2=0 M3=-5,70582524804619 FrameElem=46-1 ElemStation=0,1834
Frame=46 Station=0 OutputCase=STR103 CaseType=Combination P=-34,6103878565509 V2=-1,41261115816046 V3=0 T=0 M2=0 M3=0,66906254545876 FrameElem=46-1 ElemStation=0
Frame=46 Station=0,0917 OutputCase=STR103 CaseType=Combination P=-34,6103878565509 V2=-1,04581115816046 V3=0 T=0 M2=0 M3=0,781781208662075 FrameElem=46-1 ElemStation=0,0917
Frame=46 Station=0,1834 OutputCase=STR103 CaseType=Combination P=-34,6103878565509 V2=-0,679011158160461 V3=0 T=0 M2=0 M3=0,860864311865391 FrameElem=46-1 ElemStation=0,1834
Frame=46 Station=0 OutputCase=STR104 CaseType=Combination P=-16,1760854563059 V2=-2,16921888756601 V3=0 T=0 M2=0 M3=-3,61782237125554 FrameElem=46-1 ElemStation=0
Frame=46 Station=0,0917 OutputCase=STR104 CaseType=Combination P=-16,1760854563059 V2=-1,67403888756601 V3=0 T=0 M2=0 M3=-3,44160900226574 FrameElem=46-1 ElemStation=0,0917
Frame=46 Station=0,1834 OutputCase=STR104 CaseType=Combination P=-16,1760854563059 V2=-1,17885888756601 V3=0 T=0 M2=0 M3=-3,31080363927593 FrameElem=46-1 ElemStation=0,1834
Frame=46 Station=0 OutputCase=STR105 CaseType=Combination P=-8,4203775860451 V2=-2,16824825063059 V3=0 T=0 M2=0 M3=-4,55583817128579 FrameElem=46-1 ElemStation=0
Frame=46 Station=0,0917 OutputCase=STR105 CaseType=Combination P=-8,4203775860451 V2=-1,67306825063059 V3=0 T=0 M2=0 M3=-4,37971380970296 FrameElem=46-1 ElemStation=0,0917
Frame=46 Station=0,1834 OutputCase=STR105 CaseType=Combination P=-8,4203775860451 V2=-1,17788825063059 V3=0 T=0 M2=0 M3=-4,24899745412014 FrameElem=46-1 ElemStation=0,1834
Frame=46 Station=0 OutputCase=STR106 CaseType=Combination P=-7,44823843889741 V2=-10,2763176144651 V3=0 T=0 M2=0 M3=-25,2419887323305 FrameElem=46-1 ElemStation=0
Frame=46 Station=0,0917 OutputCase=STR106 CaseType=Combination P=-7,44823843889741 V2=-9,7811376144651 V3=0 T=0 M2=0 M3=-24,3223544100841 FrameElem=46-1 ElemStation=0,0917
Frame=46 Station=0,1834 OutputCase=STR106 CaseType=Combination P=-7,44823843889741 V2=-9,2859576144651 V3=0 T=0 M2=0 M3=-23,4481280938376 FrameElem=46-1 ElemStation=0,1834
Frame=46 Station=0 OutputCase=STR107 CaseType=Combination P=-20,6417835083265 V2=15,4721578485619 V3=0 T=0 M2=0 M3=-23,3982693667585 FrameElem=46-1 ElemStation=0
Frame=46 Station=0,0917 OutputCase=STR107 CaseType=Combination P=-20,6417835083265 V2=15,9673378485619 V3=0 T=0 M2=0 M3=-24,8397702444717 FrameElem=46-1 ElemStation=0,0917
Frame=46 Station=0,1834 OutputCase=STR107 CaseType=Combination P=-20,6417835083265 V2=16,4625178485619 V3=0 T=0 M2=0 M3=-26,3266791281848 FrameElem=46-1 ElemStation=0,1834
Frame=46 Station=0 OutputCase=STR108 CaseType=Combination P=-33,8353285742166 V2=-10,2801332903163 V3=0 T=0 M2=0 M3=-21,5545500017172 FrameElem=46-1 ElemStation=0
Frame=46 Station=0,0917 OutputCase=STR108 CaseType=Combination P=-33,8353285742166 V2=-9,78495329031633 V3=0 T=0 M2=0 M3=-20,6345657819952 FrameElem=46-1 ElemStation=0,0917
Frame=46 Station=0,1834 OutputCase=STR108 CaseType=Combination P=-33,8353285742166 V2=-9,28977329031633 V3=0 T=0 M2=0 M3=-19,7599895682732 FrameElem=46-1 ElemStation=0,1834
Frame=46 Station=0 OutputCase=STR109 CaseType=Combination P=-21,4168427906609 V2=24,3396799807178 V3=0 T=0 M2=0 M3=-1,17465681958255 FrameElem=46-1 ElemStation=0
Frame=46 Station=0,0917 OutputCase=STR109 CaseType=Combination P=-21,4168427906609 V2=24,7064799807178 V3=0 T=0 M2=0 M3=-3,42342325381437 FrameElem=46-1 ElemStation=0,0917
Frame=46 Station=0,1834 OutputCase=STR109 CaseType=Combination P=-21,4168427906609 V2=25,0732799807178 V3=0 T=0 M2=0 M3=-5,70582524804619 FrameElem=46-1 ElemStation=0,1834
Frame=46 Station=0 OutputCase=STR110 CaseType=Combination P=-34,6103878565509 V2=-1,41261115816046 V3=0 T=0 M2=0 M3=0,66906254545876 FrameElem=46-1 ElemStation=0
Frame=46 Station=0,0917 OutputCase=STR110 CaseType=Combination P=-34,6103878565509 V2=-1,04581115816046 V3=0 T=0 M2=0 M3=0,781781208662075 FrameElem=46-1 ElemStation=0,0917
Frame=46 Station=0,1834 OutputCase=STR110 CaseType=Combination P=-34,6103878565509 V2=-0,679011158160461 V3=0 T=0 M2=0 M3=0,860864311865391 FrameElem=46-1 ElemStation=0,1834
Frame=46 Station=0 OutputCase=STR111 CaseType=Combination P=-14,8615057773876 V2=-3,69351534981687 V3=0 T=0 M2=0 M3=-4,28174810322288 FrameElem=46-1 ElemStation=0
Frame=46 Station=0,0917 OutputCase=STR111 CaseType=Combination P=-14,8615057773876 V2=-3,19833534981687 V3=0 T=0 M2=0 M3=-3,96575674864468 FrameElem=46-1 ElemStation=0,0917
Frame=46 Station=0,1834 OutputCase=STR111 CaseType=Combination P=-14,8615057773876 V2=-2,70315534981687 V3=0 T=0 M2=0 M3=-3,69517340006647 FrameElem=46-1 ElemStation=0,1834
Frame=46 Station=0 OutputCase=STR112 CaseType=Combination P=-7,10579790712682 V2=-3,69254471288144 V3=0 T=0 M2=0 M3=-5,21976390325313 FrameElem=46-1 ElemStation=0
Frame=46 Station=0,0917 OutputCase=STR112 CaseType=Combination P=-7,10579790712682 V2=-3,19736471288144 V3=0 T=0 M2=0 M3=-4,9038615560819 FrameElem=46-1 ElemStation=0,0917
Frame=46 Station=0,1834 OutputCase=STR112 CaseType=Combination P=-7,10579790712682 V2=-2,70218471288144 V3=0 T=0 M2=0 M3=-4,63336721491067 FrameElem=46-1 ElemStation=0,1834
Frame=46 Station=0 OutputCase=STR113 CaseType=Combination P=-5,96219349273431 V2=-14,1983499942023 V3=0 T=0 M2=0 M3=-32,7599122716777 FrameElem=46-1 ElemStation=0
Frame=46 Station=0,0917 OutputCase=STR113 CaseType=Combination P=-5,96219349273431 V2=-13,7031699942023 V3=0 T=0 M2=0 M3=-31,4806275802094 FrameElem=46-1 ElemStation=0,0917
Frame=46 Station=0,1834 OutputCase=STR113 CaseType=Combination P=-5,96219349273431 V2=-13,2079899942023 V3=0 T=0 M2=0 M3=-30,246750894741 FrameElem=46-1 ElemStation=0,1834
Frame=46 Station=0 OutputCase=STR114 CaseType=Combination P=-22,2609689399875 V2=18,4022845090522 V3=0 T=0 M2=0 M3=-30,4579557509419 FrameElem=46-1 ElemStation=0
Frame=46 Station=0,0917 OutputCase=STR114 CaseType=Combination P=-22,2609689399875 V2=18,8974645090522 V3=0 T=0 M2=0 M3=-32,168149243422 FrameElem=46-1 ElemStation=0,0917
Frame=46 Station=0,1834 OutputCase=STR114 CaseType=Combination P=-22,2609689399875 V2=19,3926445090522 V3=0 T=0 M2=0 M3=-33,9237507419021 FrameElem=46-1 ElemStation=0,1834
Frame=46 Station=0 OutputCase=STR115 CaseType=Combination P=-38,5597443830729 V2=-14,2031140163588 V3=0 T=0 M2=0 M3=-28,1559992308701 FrameElem=46-1 ElemStation=0
Frame=46 Station=0,0917 OutputCase=STR115 CaseType=Combination P=-38,5597443830729 V2=-13,7079340163588 V3=0 T=0 M2=0 M3=-26,87627767857 FrameElem=46-1 ElemStation=0,0917

APPROVATO S.D.P.
Società di Progetto
Brebemi SpA



Doc. N.
60235-0000-A00.doc

CODIFICA DOCUMENTO
04RCDII10000000000300A00

REV.
00

FOGLIO
605 di 628

Frame=46 Station=0,1834 OutputCase=STR115 CaseType=Combination P=-38,5597443830729 V2=-13,2127540163588 V3=0 T=0 M2=0 M3=-25,6419641322699
FrameElem=46-1 ElemStation=0,1834
Frame=46 Station=0 OutputCase=STR116 CaseType=Combination P=-23,3600746047044 V2=29,972464291529 V3=0 T=0 M2=0 M3=-1,33895968341772 FrameElem=46-1
ElemStation=0
Frame=46 Station=0,0917 OutputCase=STR116 CaseType=Combination P=-23,3600746047044 V2=30,3392964291529 V3=0 T=0 M2=0 M3=-4,10425358597104
FrameElem=46-1 ElemStation=0,0917
Frame=46 Station=0,1834 OutputCase=STR116 CaseType=Combination P=-23,3600746047044 V2=30,7060964291529 V3=0 T=0 M2=0 M3=-6,90318664852436
FrameElem=46-1 ElemStation=0,1834
Frame=46 Station=0 OutputCase=STR117 CaseType=Combination P=-39,6588500477898 V2=-2,63290209625812 V3=0 T=0 M2=0 M3=0,962996836654155 FrameElem=46-1
ElemStation=0
Frame=46 Station=0,0917 OutputCase=STR117 CaseType=Combination P=-39,6588500477898 V2=-2,26610209625812 V3=0 T=0 M2=0 M3=1,18761617888103
FrameElem=46-1 ElemStation=0,0917
Frame=46 Station=0,1834 OutputCase=STR117 CaseType=Combination P=-39,6588500477898 V2=-1,89930209625812 V3=0 T=0 M2=0 M3=1,3785999611079 FrameElem=46-1
ElemStation=0,1834
Frame=46 Station=0 OutputCase=STR118 CaseType=Combination P=-19,4797849470605 V2=46,0810320791589 V3=0 T=0 M2=0 M3=-24,0208093855831 FrameElem=46-1
ElemStation=0
Frame=46 Station=0,0917 OutputCase=STR118 CaseType=Combination P=-19,4797849470605 V2=46,5762120791589 V3=0 T=0 M2=0 M3=-28,269144030242 FrameElem=46-1
ElemStation=0,0917
Frame=46 Station=0,1834 OutputCase=STR118 CaseType=Combination P=-19,4797849470605 V2=47,0713920791589 V3=0 T=0 M2=0 M3=-32,5628866809009
FrameElem=46-1 ElemStation=0,1834
Frame=46 Station=0 OutputCase=STR119 CaseType=Combination P=-6,13365875997913 V2=-11,800614076716 V3=0 T=0 M2=0 M3=-25,9059144642979 FrameElem=46-1
ElemStation=0
Frame=46 Station=0,0917 OutputCase=STR119 CaseType=Combination P=-6,13365875997913 V2=-11,305434076716 V3=0 T=0 M2=0 M3=-24,846502156463 FrameElem=46-1
ElemStation=0,0917
Frame=46 Station=0,1834 OutputCase=STR119 CaseType=Combination P=-6,13365875997913 V2=-10,810254076716 V3=0 T=0 M2=0 M3=-23,8324978546281
FrameElem=46-1 ElemStation=0,1834
Frame=46 Station=0 OutputCase=STR120 CaseType=Combination P=-19,3272038294082 V2=13,9478613863111 V3=0 T=0 M2=0 M3=-24,0621950987259 FrameElem=46-1
ElemStation=0
Frame=46 Station=0,0917 OutputCase=STR120 CaseType=Combination P=-19,3272038294082 V2=14,4430413863111 V3=0 T=0 M2=0 M3=-25,3639179908506
FrameElem=46-1 ElemStation=0,0917
Frame=46 Station=0,1834 OutputCase=STR120 CaseType=Combination P=-19,3272038294082 V2=14,9382213863111 V3=0 T=0 M2=0 M3=-26,7110488889753
FrameElem=46-1 ElemStation=0,1834
Frame=46 Station=0 OutputCase=STR121 CaseType=Combination P=-32,5207488952983 V2=-11,8044297525672 V3=0 T=0 M2=0 M3=-22,2184757336846 FrameElem=46-1
ElemStation=0
Frame=46 Station=0,0917 OutputCase=STR121 CaseType=Combination P=-32,5207488952983 V2=-11,3092497525672 V3=0 T=0 M2=0 M3=-21,1587135283741
FrameElem=46-1 ElemStation=0,0917
Frame=46 Station=0,1834 OutputCase=STR121 CaseType=Combination P=-32,5207488952983 V2=-10,8140697525672 V3=0 T=0 M2=0 M3=-20,1443593290637
FrameElem=46-1 ElemStation=0,1834
Frame=46 Station=0 OutputCase=STR122 CaseType=Combination P=-20,1022631117426 V2=22,8153835184669 V3=0 T=0 M2=0 M3=-1,83858255154989 FrameElem=46-1
ElemStation=0
Frame=46 Station=0,0917 OutputCase=STR122 CaseType=Combination P=-20,1022631117426 V2=23,1821835184669 V3=0 T=0 M2=0 M3=-3,94757100019331
FrameElem=46-1 ElemStation=0,0917
Frame=46 Station=0,1834 OutputCase=STR122 CaseType=Combination P=-20,1022631117426 V2=23,5489835184669 V3=0 T=0 M2=0 M3=-6,09019500883672
FrameElem=46-1 ElemStation=0,1834
Frame=46 Station=0 OutputCase=STR123 CaseType=Combination P=-33,2958081776326 V2=-2,93690762041132 V3=0 T=0 M2=0 M3=5,13681349141822E-03 FrameElem=46-1
ElemStation=0
Frame=46 Station=0,0917 OutputCase=STR123 CaseType=Combination P=-33,2958081776326 V2=-2,57010762041132 V3=0 T=0 M2=0 M3=0,257633462283137
FrameElem=46-1 ElemStation=0,0917
Frame=46 Station=0,1834 OutputCase=STR123 CaseType=Combination P=-33,2958081776326 V2=-2,20330762041132 V3=0 T=0 M2=0 M3=0,476494551074856
FrameElem=46-1 ElemStation=0,1834
Frame=46 Station=0 OutputCase=STR124 CaseType=Combination P=-14,3098316741581 V2=-3,69304245977541 V3=0 T=0 M2=0 M3=-4,73874527034829 FrameElem=46-1
ElemStation=0
Frame=46 Station=0,0917 OutputCase=STR124 CaseType=Combination P=-14,3098316741581 V2=-3,19786245977541 V3=0 T=0 M2=0 M3=-4,4229727978688
FrameElem=46-1 ElemStation=0,0917
Frame=46 Station=0,1834 OutputCase=STR124 CaseType=Combination P=-14,3098316741581 V2=-2,70268245977541 V3=0 T=0 M2=0 M3=-4,15225729522547
FrameElem=46-1 ElemStation=0,1834
Frame=46 Station=0 OutputCase=STR125 CaseType=Combination P=-6,55412380389728 V2=-3,69207182283999 V3=0 T=0 M2=0 M3=-5,6767107037853 FrameElem=46-1
ElemStation=0
Frame=46 Station=0,0917 OutputCase=STR125 CaseType=Combination P=-6,55412380389728 V2=-3,19689182283999 V3=0 T=0 M2=0 M3=-5,3609020872241
FrameElem=46-1 ElemStation=0,0917
Frame=46 Station=0,1834 OutputCase=STR125 CaseType=Combination P=-6,55412380389728 V2=-2,70171182283999 V3=0 T=0 M2=0 M3=-5,09045111006968
FrameElem=46-1 ElemStation=0,1834
Frame=46 Station=0 OutputCase=STR126 CaseType=Combination P=-5,58198465674958 V2=-11,8001411866745 V3=0 T=0 M2=0 M3=-26,3629116314233 FrameElem=46-1
ElemStation=0
Frame=46 Station=0,0917 OutputCase=STR126 CaseType=Combination P=-5,58198465674958 V2=-11,3049611866745 V3=0 T=0 M2=0 M3=-25,3035426876052
FrameElem=46-1 ElemStation=0,0917
Frame=46 Station=0,1834 OutputCase=STR126 CaseType=Combination P=-5,58198465674958 V2=-10,8097811866745 V3=0 T=0 M2=0 M3=-24,2895817497872
FrameElem=46-1 ElemStation=0,1834
Frame=46 Station=0 OutputCase=STR127 CaseType=Combination P=-18,7755297261787 V2=13,9483342763525 V3=0 T=0 M2=0 M3=24,5191922658513 FrameElem=46-1
ElemStation=0
Frame=46 Station=0,0917 OutputCase=STR127 CaseType=Combination P=-18,7755297261787 V2=14,4435142763525 V3=0 T=0 M2=0 M3=-25,8209585219928
FrameElem=46-1 ElemStation=0,0917
Frame=46 Station=0,1834 OutputCase=STR127 CaseType=Combination P=-18,7755297261787 V2=14,9386942763525 V3=0 T=0 M2=0 M3=-27,1681327841343
FrameElem=46-1 ElemStation=0,1834
Frame=46 Station=0 OutputCase=STR128 CaseType=Combination P=-31,9690747920687 V2=-11,8039568625257 V3=0 T=0 M2=0 M3=-22,67547290081 FrameElem=46-1
ElemStation=0
Frame=46 Station=0,0917 OutputCase=STR128 CaseType=Combination P=-31,9690747920687 V2=-11,3087768625257 V3=0 T=0 M2=0 M3=-21,6157540595164
FrameElem=46-1 ElemStation=0,0917
Frame=46 Station=0,1834 OutputCase=STR128 CaseType=Combination P=-31,9690747920687 V2=-10,8135968625257 V3=0 T=0 M2=0 M3=-20,6014432242227
FrameElem=46-1 ElemStation=0,1834
Frame=46 Station=0 OutputCase=STR129 CaseType=Combination P=-19,550589008513 V2=22,8158564085084 V3=0 T=0 M2=0 M3=-2,29557971867529 FrameElem=46-1
ElemStation=0
Frame=46 Station=0,0917 OutputCase=STR129 CaseType=Combination P=-19,550589008513 V2=23,1826564085084 V3=0 T=0 M2=0 M3=-4,40461153133551 FrameElem=46-1
ElemStation=0,0917
Frame=46 Station=0,1834 OutputCase=STR129 CaseType=Combination P=-19,550589008513 V2=23,5494564085084 V3=0 T=0 M2=0 M3=-6,54727890399573 FrameElem=46-1
ElemStation=0,1834
Frame=46 Station=0 OutputCase=STR130 CaseType=Combination P=-32,7441340744031 V2=-2,93643473036986 V3=0 T=0 M2=0 M3=-0,451860353633984 FrameElem=46-1
ElemStation=0

Società di Progetto
Brebemi SpA



Doc. N.
60235-0000-A00.doc

CODIFICA DOCUMENTO
04RCDII10000000000300A00

REV.
00

FOGLIO
606 di 628

Frame=46 Station=0,0917 OutputCase=STR130 CaseType=Combination P=-32,7441340744031 V2=-2,56963473036986 V3=0 T=0 M2=0 M3=-0,199407068859067
FrameElem=46-1 ElemStation=0,0917
Frame=46 Station=0,1834 OutputCase=STR130 CaseType=Combination P=-32,7441340744031 V2=-2,20283473036986 V3=0 T=0 M2=0 M3=1,94106559158512E-02
FrameElem=46-1 ElemStation=0,1834
Frame=46 Station=0 OutputCase=STR131 CaseType=Combination P=-15,4131798806172 V2=-3,69398823985833 V3=0 T=0 M2=0 M3=-3,82475093609748 FrameElem=46-1
ElemStation=0
Frame=46 Station=0,0917 OutputCase=STR131 CaseType=Combination P=-15,4131798806172 V2=-3,19880823985833 V3=0 T=0 M2=0 M3=-3,50871621750247
FrameElem=46-1 ElemStation=0,0917
Frame=46 Station=0,1834 OutputCase=STR131 CaseType=Combination P=-15,4131798806172 V2=-2,70362823985833 V3=0 T=0 M2=0 M3=-3,23808950490746
FrameElem=46-1 ElemStation=0,1834
Frame=46 Station=0 OutputCase=STR132 CaseType=Combination P=-7,65747201035636 V2=-3,6930176029229 V3=0 T=0 M2=0 M3=-4,76276673612773 FrameElem=46-1
ElemStation=0
Frame=46 Station=0,0917 OutputCase=STR132 CaseType=Combination P=-7,65747201035636 V2=-3,1978376029229 V3=0 T=0 M2=0 M3=-4,4468210249397 FrameElem=46-1
ElemStation=0,0917
Frame=46 Station=0,1834 OutputCase=STR132 CaseType=Combination P=-7,65747201035636 V2=-2,7026576029229 V3=0 T=0 M2=0 M3=-4,17628331975167
FrameElem=46-1 ElemStation=0,1834
Frame=46 Station=0 OutputCase=STR133 CaseType=Combination P=-6,68533286320867 V2=-11,8010869667574 V3=0 T=0 M2=0 M3=-25,4489172971725 FrameElem=46-1
ElemStation=0
Frame=46 Station=0,0917 OutputCase=STR133 CaseType=Combination P=-6,68533286320867 V2=-11,3059069667574 V3=0 T=0 M2=0 M3=-24,3894616253208
FrameElem=46-1 ElemStation=0,0917
Frame=46 Station=0,1834 OutputCase=STR133 CaseType=Combination P=-6,68533286320867 V2=-10,8107269667574 V3=0 T=0 M2=0 M3=-23,3754139594691
FrameElem=46-1 ElemStation=0,1834
Frame=46 Station=0 OutputCase=STR134 CaseType=Combination P=-19,8788779326378 V2=13,9473884962696 V3=0 T=0 M2=0 M3=-23,6051979316005 FrameElem=46-1
ElemStation=0
Frame=46 Station=0,0917 OutputCase=STR134 CaseType=Combination P=-19,8788779326378 V2=14,4425684962696 V3=0 T=0 M2=0 M3=-24,9068774597084
FrameElem=46-1 ElemStation=0,0917
Frame=46 Station=0,1834 OutputCase=STR134 CaseType=Combination P=-19,8788779326378 V2=14,9377484962696 V3=0 T=0 M2=0 M3=-26,2539649938163
FrameElem=46-1 ElemStation=0,1834
Frame=46 Station=0 OutputCase=STR135 CaseType=Combination P=-33,0724229985278 V2=-11,8049026426086 V3=0 T=0 M2=0 M3=-21,7614785665592 FrameElem=46-1
ElemStation=0
Frame=46 Station=0,0917 OutputCase=STR135 CaseType=Combination P=-33,0724229985278 V2=-11,3097226426086 V3=0 T=0 M2=0 M3=-20,7016729972319
FrameElem=46-1 ElemStation=0,0917
Frame=46 Station=0,1834 OutputCase=STR135 CaseType=Combination P=-33,0724229985278 V2=-10,8145426426086 V3=0 T=0 M2=0 M3=-19,6872754339047
FrameElem=46-1 ElemStation=0,1834
Frame=46 Station=0 OutputCase=STR136 CaseType=Combination P=-20,6539372149721 V2=22,8149106284255 V3=0 T=0 M2=0 M3=-1,38158538442449 FrameElem=46-1
ElemStation=0
Frame=46 Station=0,0917 OutputCase=STR136 CaseType=Combination P=-20,6539372149721 V2=23,1817106284255 V3=0 T=0 M2=0 M3=-3,4905304690511 FrameElem=46-1
ElemStation=0,0917
Frame=46 Station=0,1834 OutputCase=STR136 CaseType=Combination P=-20,6539372149721 V2=23,5485106284255 V3=0 T=0 M2=0 M3=-5,63311111367772
FrameElem=46-1 ElemStation=0,1834
Frame=46 Station=0 OutputCase=STR137 CaseType=Combination P=-33,8474822808622 V2=-2,93738051045277 V3=0 T=0 M2=0 M3=0,46213398061682 FrameElem=46-1
ElemStation=0
Frame=46 Station=0,0917 OutputCase=STR137 CaseType=Combination P=-33,8474822808622 V2=-2,57058051045278 V3=0 T=0 M2=0 M3=0,71467399342534
FrameElem=46-1 ElemStation=0,0917
Frame=46 Station=0,1834 OutputCase=STR137 CaseType=Combination P=-33,8474822808622 V2=-2,20378051045278 V3=0 T=0 M2=0 M3=0,933578446233861
FrameElem=46-1 ElemStation=0,1834
Frame=46 Station=0 OutputCase=STR138 CaseType=Combination P=-15,4131798806172 V2=-3,69398823985833 V3=0 T=0 M2=0 M3=-3,82475093609748 FrameElem=46-1
ElemStation=0
Frame=46 Station=0,0917 OutputCase=STR138 CaseType=Combination P=-15,4131798806172 V2=-3,19880823985833 V3=0 T=0 M2=0 M3=-3,50871621750247
FrameElem=46-1 ElemStation=0,0917
Frame=46 Station=0,1834 OutputCase=STR138 CaseType=Combination P=-15,4131798806172 V2=-2,70362823985833 V3=0 T=0 M2=0 M3=-3,23808950490746
FrameElem=46-1 ElemStation=0,1834
Frame=46 Station=0 OutputCase=STR139 CaseType=Combination P=-7,65747201035636 V2=-3,6930176029229 V3=0 T=0 M2=0 M3=-4,76276673612773 FrameElem=46-1
ElemStation=0
Frame=46 Station=0,0917 OutputCase=STR139 CaseType=Combination P=-7,65747201035636 V2=-3,1978376029229 V3=0 T=0 M2=0 M3=-4,4468210249397 FrameElem=46-1
ElemStation=0,0917
Frame=46 Station=0,1834 OutputCase=STR139 CaseType=Combination P=-7,65747201035636 V2=-2,7026576029229 V3=0 T=0 M2=0 M3=-4,17628331975167
FrameElem=46-1 ElemStation=0,1834
Frame=46 Station=0 OutputCase=STR140 CaseType=Combination P=-6,68533286320867 V2=-11,8010869667574 V3=0 T=0 M2=0 M3=-25,4489172971725 FrameElem=46-1
ElemStation=0
Frame=46 Station=0,0917 OutputCase=STR140 CaseType=Combination P=-6,68533286320867 V2=-11,3059069667574 V3=0 T=0 M2=0 M3=-24,3894616253208
FrameElem=46-1 ElemStation=0,0917
Frame=46 Station=0,1834 OutputCase=STR140 CaseType=Combination P=-6,68533286320867 V2=-10,8107269667574 V3=0 T=0 M2=0 M3=-23,3754139594691
FrameElem=46-1 ElemStation=0,1834
Frame=46 Station=0 OutputCase=STR141 CaseType=Combination P=-19,8788779326378 V2=13,9473884962696 V3=0 T=0 M2=0 M3=-23,6051979316005 FrameElem=46-1
ElemStation=0
Frame=46 Station=0,0917 OutputCase=STR141 CaseType=Combination P=-19,8788779326378 V2=14,4425684962696 V3=0 T=0 M2=0 M3=-24,9068774597084
FrameElem=46-1 ElemStation=0,0917
Frame=46 Station=0,1834 OutputCase=STR141 CaseType=Combination P=-19,8788779326378 V2=14,9377484962696 V3=0 T=0 M2=0 M3=-26,2539649938163
FrameElem=46-1 ElemStation=0,1834
Frame=46 Station=0 OutputCase=STR142 CaseType=Combination P=-33,0724229985278 V2=-11,8049026426086 V3=0 T=0 M2=0 M3=-21,7614785665592 FrameElem=46-1
ElemStation=0
Frame=46 Station=0,0917 OutputCase=STR142 CaseType=Combination P=-33,0724229985278 V2=-11,3097226426086 V3=0 T=0 M2=0 M3=-20,7016729972319
FrameElem=46-1 ElemStation=0,0917
Frame=46 Station=0,1834 OutputCase=STR142 CaseType=Combination P=-33,0724229985278 V2=-10,8145426426086 V3=0 T=0 M2=0 M3=-19,6872754339047
FrameElem=46-1 ElemStation=0,1834
Frame=46 Station=0 OutputCase=STR143 CaseType=Combination P=-20,6539372149721 V2=22,8149106284255 V3=0 T=0 M2=0 M3=-1,38158538442449 FrameElem=46-1
ElemStation=0
Frame=46 Station=0,0917 OutputCase=STR143 CaseType=Combination P=-20,6539372149721 V2=23,1817106284255 V3=0 T=0 M2=0 M3=-3,4905304690511 FrameElem=46-1
ElemStation=0,0917
Frame=46 Station=0,1834 OutputCase=STR143 CaseType=Combination P=-20,6539372149721 V2=23,5485106284255 V3=0 T=0 M2=0 M3=-5,63311111367772
FrameElem=46-1 ElemStation=0,1834
Frame=46 Station=0 OutputCase=STR144 CaseType=Combination P=-33,8474822808622 V2=-2,93738051045277 V3=0 T=0 M2=0 M3=0,46213398061682 FrameElem=46-1
ElemStation=0
Frame=46 Station=0,0917 OutputCase=STR144 CaseType=Combination P=-33,8474822808622 V2=-2,57058051045278 V3=0 T=0 M2=0 M3=0,71467399342534
FrameElem=46-1 ElemStation=0,0917
Frame=46 Station=0,1834 OutputCase=STR144 CaseType=Combination P=-33,8474822808622 V2=-2,20378051045277 V3=0 T=0 M2=0 M3=0,933578446233861
FrameElem=46-1 ElemStation=0,1834

Società di Progetto
Brebemi SpA



Doc. N.
60235-00000-A00.doc

CODIFICA DOCUMENTO
04RCDII10000000000300A00

REV.
00

FOGLIO
607 di 628

Frame=46 Station=0 OutputCase=STR145 CaseType=Combination P=-16,1624154039479 V2=-2,93191882373981 V3=0 T=0 M2=0 M3=-3,41662187559291 FrameElem=46-1 ElemStation=0
Frame=46 Station=0,0917 OutputCase=STR145 CaseType=Combination P=-16,1624154039479 V2=-2,43673882373981 V3=0 T=0 M2=0 M3=-3,17046892245597 FrameElem=46-1 ElemStation=0,0917
Frame=46 Station=0,1834 OutputCase=STR145 CaseType=Combination P=-16,1624154039479 V2=-1,94155882373981 V3=0 T=0 M2=0 M3=-2,96972397531903 FrameElem=46-1 ElemStation=0,1834
Frame=46 Station=0 OutputCase=STR146 CaseType=Combination P=-8,4067075336871 V2=-2,93094818680438 V3=0 T=0 M2=0 M3=-4,35463767562316 FrameElem=46-1 ElemStation=0
Frame=46 Station=0,0917 OutputCase=STR146 CaseType=Combination P=-8,4067075336871 V2=-2,43576818680438 V3=0 T=0 M2=0 M3=-4,10857327989319 FrameElem=46-1 ElemStation=0,0917
Frame=46 Station=0,1834 OutputCase=STR146 CaseType=Combination P=-8,4067075336871 V2=-1,94058818680438 V3=0 T=0 M2=0 M3=-3,90791779016323 FrameElem=46-1 ElemStation=0,1834
Frame=46 Station=0 OutputCase=STR147 CaseType=Combination P=-6,74273926867048 V2=-13,7413920785561 V3=0 T=0 M2=0 M3=-32,2408365350997 FrameElem=46-1 ElemStation=0
Frame=46 Station=0,0917 OutputCase=STR147 CaseType=Combination P=-6,74273926867048 V2=-13,2462120785561 V3=0 T=0 M2=0 M3=-31,0034548844961 FrameElem=46-1 ElemStation=0,0917
Frame=46 Station=0,1834 OutputCase=STR147 CaseType=Combination P=-6,74273926867048 V2=-12,7510320785561 V3=0 T=0 M2=0 M3=-29,8114812398925 FrameElem=46-1 ElemStation=0,1834
Frame=46 Station=0 OutputCase=STR148 CaseType=Combination P=-23,0415147159236 V2=18,8592424246985 V3=0 T=0 M2=0 M3=-29,938880014364 FrameElem=46-1 ElemStation=0
Frame=46 Station=0,0917 OutputCase=STR148 CaseType=Combination P=-23,0415147159236 V2=19,3544224246985 V3=0 T=0 M2=0 M3=-31,690765477088 FrameElem=46-1 ElemStation=0,0917
Frame=46 Station=0,1834 OutputCase=STR148 CaseType=Combination P=-23,0415147159236 V2=19,8496024246985 V3=0 T=0 M2=0 M3=-33,4884810870537 FrameElem=46-1 ElemStation=0,1834
Frame=46 Station=0 OutputCase=STR149 CaseType=Combination P=-39,3402901590091 V2=-13,7461561007126 V3=0 T=0 M2=0 M3=-27,6369234942921 FrameElem=46-1 ElemStation=0
Frame=46 Station=0,0917 OutputCase=STR149 CaseType=Combination P=-39,3402901590091 V2=-13,2509761007126 V3=0 T=0 M2=0 M3=-26,3991049828567 FrameElem=46-1 ElemStation=0,0917
Frame=46 Station=0,1834 OutputCase=STR149 CaseType=Combination P=-39,3402901590091 V2=-12,7557961007126 V3=0 T=0 M2=0 M3=-25,2066944774214 FrameElem=46-1 ElemStation=0,1834
Frame=46 Station=0 OutputCase=STR150 CaseType=Combination P=-24,1406203806405 V2=30,4294543447992 V3=0 T=0 M2=0 M3=-0,819883946839733 FrameElem=46-1 ElemStation=0
Frame=46 Station=0,0917 OutputCase=STR150 CaseType=Combination P=-24,1406203806405 V2=30,7962543447992 V3=0 T=0 M2=0 M3=-3,62708269025782 FrameElem=46-1 ElemStation=0,0917
Frame=46 Station=0,1834 OutputCase=STR150 CaseType=Combination P=-24,1406203806405 V2=31,1630543447992 V3=0 T=0 M2=0 M3=-6,4679169936759 FrameElem=46-1 ElemStation=0,1834
Frame=46 Station=0 OutputCase=STR151 CaseType=Combination P=-40,439395823726 V2=-2,17594418061189 V3=0 T=0 M2=0 M3=1,48207257323214 FrameElem=46-1 ElemStation=0
Frame=46 Station=0,0917 OutputCase=STR151 CaseType=Combination P=-40,439395823726 V2=-1,80914418061189 V3=0 T=0 M2=0 M3=1,66478887459425 FrameElem=46-1 ElemStation=0,0917
Frame=46 Station=0,1834 OutputCase=STR151 CaseType=Combination P=-40,439395823726 V2=-1,44234418061189 V3=0 T=0 M2=0 M3=1,81386961595636 FrameElem=46-1 ElemStation=0,1834
Frame=46 Station=0 OutputCase=STR152 CaseType=Combination P=-20,2603307229967 V2=46,5379899948052 V3=0 T=0 M2=0 M3=-23,5017336490051 FrameElem=46-1 ElemStation=0
Frame=46 Station=0,0917 OutputCase=STR152 CaseType=Combination P=-20,2603307229967 V2=47,0331699948051 V3=0 T=0 M2=0 M3=-27,7919713345288 FrameElem=46-1 ElemStation=0,0917
Frame=46 Station=0,1834 OutputCase=STR152 CaseType=Combination P=-20,2603307229967 V2=47,5283499948051 V3=0 T=0 M2=0 M3=-32,1276170260524 FrameElem=46-1 ElemStation=0,1834
Frame=46 Station=0 OutputCase=STR153 CaseType=Combination P=-7,4345683865394 V2=-11,0390175506389 V3=0 T=0 M2=0 M3=-25,0407882366679 FrameElem=46-1 ElemStation=0
Frame=46 Station=0,0917 OutputCase=STR153 CaseType=Combination P=-7,4345683865394 V2=-10,5438375506389 V3=0 T=0 M2=0 M3=-24,0512143302743 FrameElem=46-1 ElemStation=0,0917
Frame=46 Station=0,1834 OutputCase=STR153 CaseType=Combination P=-7,4345683865394 V2=-10,0486575506389 V3=0 T=0 M2=0 M3=-23,1070484298807 FrameElem=46-1 ElemStation=0,1834
Frame=46 Station=0 OutputCase=STR154 CaseType=Combination P=-20,6281134559685 V2=14,7094579123881 V3=0 T=0 M2=0 M3=-23,1970688710959 FrameElem=46-1 ElemStation=0
Frame=46 Station=0,0917 OutputCase=STR154 CaseType=Combination P=-20,6281134559685 V2=15,2046379123881 V3=0 T=0 M2=0 M3=-24,5686301646619 FrameElem=46-1 ElemStation=0,0917
Frame=46 Station=0,1834 OutputCase=STR154 CaseType=Combination P=-20,6281134559685 V2=15,6998179123881 V3=0 T=0 M2=0 M3=-25,9855994642279 FrameElem=46-1 ElemStation=0,1834
Frame=46 Station=0 OutputCase=STR155 CaseType=Combination P=-33,8216585218586 V2=-11,042832264901 V3=0 T=0 M2=0 M3=-21,3533495060546 FrameElem=46-1 ElemStation=0
Frame=46 Station=0,0917 OutputCase=STR155 CaseType=Combination P=-33,8216585218586 V2=-10,5476532264901 V3=0 T=0 M2=0 M3=-20,3634257021854 FrameElem=46-1 ElemStation=0,0917
Frame=46 Station=0,1834 OutputCase=STR155 CaseType=Combination P=-33,8216585218586 V2=-10,0524732264901 V3=0 T=0 M2=0 M3=-19,4189099043163 FrameElem=46-1 ElemStation=0,1834
Frame=46 Station=0 OutputCase=STR156 CaseType=Combination P=-21,4031727383028 V2=23,576980044544 V3=0 T=0 M2=0 M3=-0,973456323919915 FrameElem=46-1 ElemStation=0
Frame=46 Station=0,0917 OutputCase=STR156 CaseType=Combination P=-21,4031727383028 V2=23,943780044544 V3=0 T=0 M2=0 M3=-3,1522831740046 FrameElem=46-1 ElemStation=0,0917
Frame=46 Station=0,1834 OutputCase=STR156 CaseType=Combination P=-21,4031727383028 V2=24,310580044544 V3=0 T=0 M2=0 M3=-5,36474558408929 FrameElem=46-1 ElemStation=0,1834
Frame=46 Station=0 OutputCase=STR157 CaseType=Combination P=-34,5967178041929 V2=-2,17531109433426 V3=0 T=0 M2=0 M3=0,870263041121391 FrameElem=46-1 ElemStation=0
Frame=46 Station=0,0917 OutputCase=STR157 CaseType=Combination P=-34,5967178041929 V2=-1,80851109433426 V3=0 T=0 M2=0 M3=1,05292128847184 FrameElem=46-1 ElemStation=0,0917
Frame=46 Station=0,1834 OutputCase=STR157 CaseType=Combination P=-34,5967178041929 V2=-1,44171109433426 V3=0 T=0 M2=0 M3=1,2019439758223 FrameElem=46-1 ElemStation=0,1834
Frame=46 Station=0 OutputCase=STR158 CaseType=Combination P=-15,6107413007184 V2=-2,93144593369835 V3=0 T=0 M2=0 M3=-3,87361904271831 FrameElem=46-1 ElemStation=0
Frame=46 Station=0,0917 OutputCase=STR158 CaseType=Combination P=-15,6107413007184 V2=-2,43626593369835 V3=0 T=0 M2=0 M3=-3,62750945359817 FrameElem=46-1 ElemStation=0,0917
Frame=46 Station=0,1834 OutputCase=STR158 CaseType=Combination P=-15,6107413007184 V2=-1,94108593369835 V3=0 T=0 M2=0 M3=-3,42680787047803 FrameElem=46-1 ElemStation=0,1834
Frame=46 Station=0 OutputCase=STR159 CaseType=Combination P=-7,85503343045755 V2=-2,93047529676293 V3=0 T=0 M2=0 M3=-4,81163484274856 FrameElem=46-1 ElemStation=0
Frame=46 Station=0,0917 OutputCase=STR159 CaseType=Combination P=-7,85503343045755 V2=-2,43529529676293 V3=0 T=0 M2=0 M3=-4,5656142610354 FrameElem=46-1 ElemStation=0,0917

Società di Progetto
Brebemi SpA



Doc. N.
60235-0000-A00.doc

CODIFICA DOCUMENTO
04RCDII10000000000300A00

REV.
00

FOGLIO
608 di 628

Frame=46 Station=0,1834 OutputCase=STR159 CaseType=Combination P=-7,85503343045755 V2=-1,94011529676293 V3=0 T=0 M2=0 M3=-4,36500168532224
FrameElem=46-1 ElemStation=0,1834
Frame=46 Station=0 OutputCase=STR160 CaseType=Combination P=-6,88289428330986 V2=-11,0385446605974 V3=0 T=0 M2=0 M3=-25,4977854037933 FrameElem=46-1
ElemStation=0
Frame=46 Station=0,0917 OutputCase=STR160 CaseType=Combination P=-6,88289428330986 V2=-10,5433646605974 V3=0 T=0 M2=0 M3=-24,5082548614165
FrameElem=46-1 ElemStation=0,0917
Frame=46 Station=0,1834 OutputCase=STR160 CaseType=Combination P=-6,88289428330986 V2=-10,0481846605974 V3=0 T=0 M2=0 M3=-23,5641323250397
FrameElem=46-1 ElemStation=0,1834
Frame=46 Station=0 OutputCase=STR161 CaseType=Combination P=-20,0764393527389 V2=14,7099308024296 V3=0 T=0 M2=0 M3=-23,6540660382213 FrameElem=46-1
ElemStation=0
Frame=46 Station=0,0917 OutputCase=STR161 CaseType=Combination P=-20,0764393527389 V2=15,2051108024296 V3=0 T=0 M2=0 M3=-25,0256706958041
FrameElem=46-1 ElemStation=0,0917
Frame=46 Station=0,1834 OutputCase=STR161 CaseType=Combination P=-20,0764393527389 V2=15,7002908024296 V3=0 T=0 M2=0 M3=-26,4426833593869
FrameElem=46-1 ElemStation=0,1834
Frame=46 Station=0 OutputCase=STR162 CaseType=Combination P=-33,269984418629 V2=-11,0423603364487 V3=0 T=0 M2=0 M3=-21,81034667318 FrameElem=46-1
ElemStation=0
Frame=46 Station=0,0917 OutputCase=STR162 CaseType=Combination P=-33,269984418629 V2=-10,5471803364487 V3=0 T=0 M2=0 M3=-20,8204662333276
FrameElem=46-1 ElemStation=0,0917
Frame=46 Station=0,1834 OutputCase=STR162 CaseType=Combination P=-33,269984418629 V2=-10,0520003364487 V3=0 T=0 M2=0 M3=-19,8759937994753
FrameElem=46-1 ElemStation=0,1834
Frame=46 Station=0 OutputCase=STR163 CaseType=Combination P=-20,8514986350733 V2=23,5774529345855 V3=0 T=0 M2=0 M3=-1,43045349104532 FrameElem=46-1
ElemStation=0
Frame=46 Station=0,0917 OutputCase=STR163 CaseType=Combination P=-20,8514986350733 V2=23,9442529345855 V3=0 T=0 M2=0 M3=-3,6093237051468 FrameElem=46-1
ElemStation=0,0917
Frame=46 Station=0,1834 OutputCase=STR163 CaseType=Combination P=-20,8514986350733 V2=24,3110529345855 V3=0 T=0 M2=0 M3=-5,82182947924829
FrameElem=46-1 ElemStation=0,1834
Frame=46 Station=0 OutputCase=STR164 CaseType=Combination P=-34,0450437009634 V2=-2,1748382042928 V3=0 T=0 M2=0 M3=0,413265873995989 FrameElem=46-1
ElemStation=0
Frame=46 Station=0,0917 OutputCase=STR164 CaseType=Combination P=-34,0450437009634 V2=-1,8080382042928 V3=0 T=0 M2=0 M3=0,59588075732964 FrameElem=46-1
ElemStation=0,0917
Frame=46 Station=0,1834 OutputCase=STR164 CaseType=Combination P=-34,0450437009634 V2=-1,4412382042928 V3=0 T=0 M2=0 M3=0,744860080663291
FrameElem=46-1 ElemStation=0,1834
Frame=46 Station=0 OutputCase=STR165 CaseType=Combination P=-16,7140895071775 V2=-2,93239171378127 V3=0 T=0 M2=0 M3=-2,95962470846751 FrameElem=46-1
ElemStation=0
Frame=46 Station=0,0917 OutputCase=STR165 CaseType=Combination P=-16,7140895071775 V2=-2,43721171378127 V3=0 T=0 M2=0 M3=-2,71342839131377
FrameElem=46-1 ElemStation=0,0917
Frame=46 Station=0,1834 OutputCase=STR165 CaseType=Combination P=-16,7140895071775 V2=-1,94203171378127 V3=0 T=0 M2=0 M3=-2,51264008016002
FrameElem=46-1 ElemStation=0,1834
Frame=46 Station=0 OutputCase=STR166 CaseType=Combination P=-8,95838163691664 V2=-2,93142107684584 V3=0 T=0 M2=0 M3=-3,89764050849776 FrameElem=46-1
ElemStation=0
Frame=46 Station=0,0917 OutputCase=STR166 CaseType=Combination P=-8,95838163691664 V2=-2,43624107684584 V3=0 T=0 M2=0 M3=-3,65153319875099
FrameElem=46-1 ElemStation=0,0917
Frame=46 Station=0,1834 OutputCase=STR166 CaseType=Combination P=-8,95838163691664 V2=-1,94106107684584 V3=0 T=0 M2=0 M3=-3,45083389500423
FrameElem=46-1 ElemStation=0,1834
Frame=46 Station=0 OutputCase=STR167 CaseType=Combination P=-7,98624248976895 V2=-11,0394904406804 V3=0 T=0 M2=0 M3=-24,5837910695425 FrameElem=46-1
ElemStation=0
Frame=46 Station=0,0917 OutputCase=STR167 CaseType=Combination P=-7,98624248976895 V2=-10,5443104406804 V3=0 T=0 M2=0 M3=-23,5941737991321
FrameElem=46-1 ElemStation=0,0917
Frame=46 Station=0,1834 OutputCase=STR167 CaseType=Combination P=-7,98624248976895 V2=-10,0491304406804 V3=0 T=0 M2=0 M3=-22,6499645347217
FrameElem=46-1 ElemStation=0,1834
Frame=46 Station=0 OutputCase=STR168 CaseType=Combination P=-21,179787559198 V2=14,7089850223467 V3=0 T=0 M2=0 M3=-22,7400717039705 FrameElem=46-1
ElemStation=0
Frame=46 Station=0,0917 OutputCase=STR168 CaseType=Combination P=-21,179787559198 V2=15,2041650223467 V3=0 T=0 M2=0 M3=-24,1115896335197 FrameElem=46-1
ElemStation=0,0917
Frame=46 Station=0,1834 OutputCase=STR168 CaseType=Combination P=-21,179787559198 V2=15,6993450223467 V3=0 T=0 M2=0 M3=-25,5285155690689 FrameElem=46-1
ElemStation=0,1834
Frame=46 Station=0 OutputCase=STR169 CaseType=Combination P=-34,3733326250881 V2=-11,0433061165316 V3=0 T=0 M2=0 M3=-20,8963523389292 FrameElem=46-1
ElemStation=0
Frame=46 Station=0,0917 OutputCase=STR169 CaseType=Combination P=-34,3733326250881 V2=-10,5481261165316 V3=0 T=0 M2=0 M3=-19,9063851710432
FrameElem=46-1 ElemStation=0,0917
Frame=46 Station=0,1834 OutputCase=STR169 CaseType=Combination P=-34,3733326250881 V2=-10,0529461165316 V3=0 T=0 M2=0 M3=-18,9618260091573
FrameElem=46-1 ElemStation=0,1834
Frame=46 Station=0 OutputCase=STR170 CaseType=Combination P=-21,9548468415324 V2=23,5765071545025 V3=0 T=0 M2=0 M3=-0,516459156794513 FrameElem=46-1
ElemStation=0
Frame=46 Station=0,0917 OutputCase=STR170 CaseType=Combination P=-21,9548468415324 V2=23,9433071545025 V3=0 T=0 M2=0 M3=-2,6952426428624 FrameElem=46-1
ElemStation=0,0917
Frame=46 Station=0,1834 OutputCase=STR170 CaseType=Combination P=-21,9548468415324 V2=24,3101071545026 V3=0 T=0 M2=0 M3=-4,90766168893028
FrameElem=46-1 ElemStation=0,1834
Frame=46 Station=0 OutputCase=STR171 CaseType=Combination P=-35,1483919074225 V2=-2,17578398437571 V3=0 T=0 M2=0 M3=1,32726020824679 FrameElem=46-1
ElemStation=0
Frame=46 Station=0,0917 OutputCase=STR171 CaseType=Combination P=-35,1483919074225 V2=-1,80898398437572 V3=0 T=0 M2=0 M3=1,50996181961405
FrameElem=46-1 ElemStation=0,0917
Frame=46 Station=0,1834 OutputCase=STR171 CaseType=Combination P=-35,1483919074225 V2=-1,44218398437571 V3=0 T=0 M2=0 M3=1,6590278709813 FrameElem=46-1
ElemStation=0,1834
Frame=46 Station=0 OutputCase=STR172 CaseType=Combination P=-16,3912870766545 V2=-2,47448801805212 V3=0 T=0 M2=0 M3=-3,35454330614033 FrameElem=46-1
ElemStation=0
Frame=46 Station=0,0917 OutputCase=STR172 CaseType=Combination P=-16,3912870766545 V2=-1,97930801805212 V3=0 T=0 M2=0 M3=-3,15033675788495
FrameElem=46-1 ElemStation=0,0917
Frame=46 Station=0,1834 OutputCase=STR172 CaseType=Combination P=-16,3912870766545 V2=-1,48412801805212 V3=0 T=0 M2=0 M3=-2,99153821562957
FrameElem=46-1 ElemStation=0,1834
Frame=46 Station=0 OutputCase=STR173 CaseType=Combination P=-8,63557920639372 V2=-2,47351738111669 V3=0 T=0 M2=0 M3=-4,29255910617058 FrameElem=46-1
ElemStation=0
Frame=46 Station=0,0917 OutputCase=STR173 CaseType=Combination P=-8,63557920639372 V2=-1,97833738111669 V3=0 T=0 M2=0 M3=-4,08844156532217
FrameElem=46-1 ElemStation=0,0917
Frame=46 Station=0,1834 OutputCase=STR173 CaseType=Combination P=-8,63557920639372 V2=-1,48315738111669 V3=0 T=0 M2=0 M3=-3,92973203047377
FrameElem=46-1 ElemStation=0,1834
Frame=46 Station=0 OutputCase=STR174 CaseType=Combination P=-7,66344005924602 V2=-10,5815867449512 V3=0 T=0 M2=0 M3=-24,9787096672153 FrameElem=46-1
ElemStation=0

APPROVATO S.D.P.

Società di Progetto
Brebemi SpA

	Doc. N. 60235-0000-A00.doc	CODIFICA DOCUMENTO 04RCDII10000000000300A00	REV. 00	FOGLIO 609 di 628
--	-------------------------------	--	------------	----------------------

Frame=46 Station=0,0917 OutputCase=STR174 CaseType=Combination P=-7,66344005924602 V2=-10,0864067449512 V3=0 T=0 M2=0 M3=-24,0310821657033
 FrameElem=46-1 ElemStation=0,0917
 Frame=46 Station=0,1834 OutputCase=STR174 CaseType=Combination P=-7,66344005924602 V2=-9,5912267449512 V3=0 T=0 M2=0 M3=-23,1288626701912
 FrameElem=46-1 ElemStation=0,1834
 Frame=46 Station=0 OutputCase=STR175 CaseType=Combination P=-20,8569851286751 V2=15,1668887180758 V3=0 T=0 M2=0 M3=-23,1349903016433 FrameElem=46-1
 ElemStation=0
 Frame=46 Station=0,0917 OutputCase=STR175 CaseType=Combination P=-20,8569851286751 V2=15,6620687180758 V3=0 T=0 M2=0 M3=-24,5484980000909
 FrameElem=46-1 ElemStation=0,0917
 Frame=46 Station=0,1834 OutputCase=STR175 CaseType=Combination P=-20,8569851286751 V2=16,1572487180758 V3=0 T=0 M2=0 M3=-26,0074137045384
 FrameElem=46-1 ElemStation=0,1834
 Frame=46 Station=0 OutputCase=STR176 CaseType=Combination P=-34,0505301945652 V2=-10,5854024208024 V3=0 T=0 M2=0 M3=-21,291270936602 FrameElem=46-1
 ElemStation=0
 Frame=46 Station=0,0917 OutputCase=STR176 CaseType=Combination P=-34,0505301945652 V2=-10,0902224208024 V3=0 T=0 M2=0 M3=-20,3432935376144
 FrameElem=46-1 ElemStation=0,0917
 Frame=46 Station=0,1834 OutputCase=STR176 CaseType=Combination P=-34,0505301945652 V2=-9,59504242080243 V3=0 T=0 M2=0 M3=-19,4407241446268
 FrameElem=46-1 ElemStation=0,1834
 Frame=46 Station=0 OutputCase=STR177 CaseType=Combination P=-21,6320444110095 V2=24,0344108502317 V3=0 T=0 M2=0 M3=-0,911377754467333 FrameElem=46-1
 ElemStation=0
 Frame=46 Station=0,0917 OutputCase=STR177 CaseType=Combination P=-21,6320444110095 V2=24,4012108502317 V3=0 T=0 M2=0 M3=-3,13215100943358
 FrameElem=46-1 ElemStation=0,0917
 Frame=46 Station=0,1834 OutputCase=STR177 CaseType=Combination P=-21,6320444110095 V2=24,7680108502317 V3=0 T=0 M2=0 M3=-5,38655982439983
 FrameElem=46-1 ElemStation=0,1834
 Frame=46 Station=0 OutputCase=STR178 CaseType=Combination P=-34,8255894768995 V2=-1,71788028864656 V3=0 T=0 M2=0 M3=0,932341610573973 FrameElem=46-1
 ElemStation=0
 Frame=46 Station=0,0917 OutputCase=STR178 CaseType=Combination P=-34,8255894768995 V2=-1,35108028864656 V3=0 T=0 M2=0 M3=1,07305345304286
 FrameElem=46-1 ElemStation=0,0917
 Frame=46 Station=0,1834 OutputCase=STR178 CaseType=Combination P=-34,8255894768995 V2=-0,984280288646562 V3=0 T=0 M2=0 M3=1,18012973551175
 FrameElem=46-1 ElemStation=0,1834
 Frame=46 Station=0 OutputCase=STR179 CaseType=Combination P=-16,3912870766545 V2=-2,47448801805212 V3=0 T=0 M2=0 M3=-3,35454330614033 FrameElem=46-1
 ElemStation=0
 Frame=46 Station=0,0917 OutputCase=STR179 CaseType=Combination P=-16,3912870766545 V2=-1,97930801805212 V3=0 T=0 M2=0 M3=-3,15033675788495
 FrameElem=46-1 ElemStation=0,0917
 Frame=46 Station=0,1834 OutputCase=STR179 CaseType=Combination P=-16,3912870766545 V2=-1,48412801805212 V3=0 T=0 M2=0 M3=-2,99153821562957
 FrameElem=46-1 ElemStation=0,1834
 Frame=46 Station=0 OutputCase=STR180 CaseType=Combination P=-15,9335437312413 V2=-3,3893496294275 V3=0 T=0 M2=0 M3=-3,47870044504549 FrameElem=46-1
 ElemStation=0
 Frame=46 Station=0,0917 OutputCase=STR180 CaseType=Combination P=-15,9335437312413 V2=-2,8941696294275 V3=0 T=0 M2=0 M3=-3,19060108702699
 FrameElem=46-1 ElemStation=0,0917
 Frame=46 Station=0,1834 OutputCase=STR180 CaseType=Combination P=-15,9335437312413 V2=-2,3989896294275 V3=0 T=0 M2=0 M3=-2,94790973500849
 FrameElem=46-1 ElemStation=0,1834
 Frame=46 Station=0 OutputCase=STR181 CaseType=Combination P=-8,17783586098047 V2=-3,38837899249208 V3=0 T=0 M2=0 M3=-4,41671624507574 FrameElem=46-1
 ElemStation=0
 Frame=46 Station=0,0917 OutputCase=STR181 CaseType=Combination P=-8,17783586098047 V2=-2,89319899249208 V3=0 T=0 M2=0 M3=-4,12870589446421
 FrameElem=46-1 ElemStation=0,0917
 Frame=46 Station=0,1834 OutputCase=STR181 CaseType=Combination P=-8,17783586098047 V2=-2,39801899249208 V3=0 T=0 M2=0 M3=-3,88610354985269
 FrameElem=46-1 ElemStation=0,1834
 Frame=46 Station=0 OutputCase=STR182 CaseType=Combination P=-7,20569671383278 V2=-11,4964483563266 V3=0 T=0 M2=0 M3=-25,1028668061205 FrameElem=46-1
 ElemStation=0
 Frame=46 Station=0,0917 OutputCase=STR182 CaseType=Combination P=-7,20569671383278 V2=-11,0012683563266 V3=0 T=0 M2=0 M3=-24,0713464948453
 FrameElem=46-1 ElemStation=0,0917
 Frame=46 Station=0,1834 OutputCase=STR182 CaseType=Combination P=-7,20569671383278 V2=-10,5060883563266 V3=0 T=0 M2=0 M3=-23,0852341895702
 FrameElem=46-1 ElemStation=0,1834
 Frame=46 Station=0 OutputCase=STR183 CaseType=Combination P=-20,3992417832619 V2=14,2520271067004 V3=0 T=0 M2=0 M3=-23,2591474405485 FrameElem=46-1
 ElemStation=0
 Frame=46 Station=0,0917 OutputCase=STR183 CaseType=Combination P=-20,3992417832619 V2=14,7472071067004 V3=0 T=0 M2=0 M3=-24,5887623292329
 FrameElem=46-1 ElemStation=0,0917
 Frame=46 Station=0,1834 OutputCase=STR183 CaseType=Combination P=-20,3992417832619 V2=15,2423871067004 V3=0 T=0 M2=0 M3=-25,9637852239173
 FrameElem=46-1 ElemStation=0,1834
 Frame=46 Station=0 OutputCase=STR184 CaseType=Combination P=-33,5927868491519 V2=-11,5002640321778 V3=0 T=0 M2=0 M3=-21,4154280735072 FrameElem=46-1
 ElemStation=0
 Frame=46 Station=0,0917 OutputCase=STR184 CaseType=Combination P=-33,5927868491519 V2=-11,0050840321778 V3=0 T=0 M2=0 M3=-20,3835578667565
 FrameElem=46-1 ElemStation=0,0917
 Frame=46 Station=0,1834 OutputCase=STR184 CaseType=Combination P=-33,5927868491519 V2=-10,5099040321778 V3=0 T=0 M2=0 M3=-19,3970956640058
 FrameElem=46-1 ElemStation=0,1834
 Frame=46 Station=0 OutputCase=STR185 CaseType=Combination P=-21,1743010655962 V2=23,1195492388563 V3=0 T=0 M2=0 M3=-1,0355348933725 FrameElem=46-1
 ElemStation=0
 Frame=46 Station=0,0917 OutputCase=STR185 CaseType=Combination P=-21,1743010655962 V2=23,4863492388563 V3=0 T=0 M2=0 M3=-3,17241533857562
 FrameElem=46-1 ElemStation=0,0917
 Frame=46 Station=0,1834 OutputCase=STR185 CaseType=Combination P=-21,1743010655962 V2=23,8531492388563 V3=0 T=0 M2=0 M3=-5,34293134377874
 FrameElem=46-1 ElemStation=0,1834
 Frame=46 Station=0 OutputCase=STR186 CaseType=Combination P=-34,3678461314863 V2=-2,63274190002195 V3=0 T=0 M2=0 M3=0,808184471668809 FrameElem=46-1
 ElemStation=0
 Frame=46 Station=0,0917 OutputCase=STR186 CaseType=Combination P=-34,3678461314863 V2=-2,26594190002195 V3=0 T=0 M2=0 M3=1,03278912390082
 FrameElem=46-1 ElemStation=0,0917
 Frame=46 Station=0,1834 OutputCase=STR186 CaseType=Combination P=-34,3678461314863 V2=-1,89914190002195 V3=0 T=0 M2=0 M3=1,22375821613284
 FrameElem=46-1 ElemStation=0,1834
 Frame=46 Station=0 OutputCase=STR187 CaseType=Combination P=-15,9335437312413 V2=-3,3893496294275 V3=0 T=0 M2=0 M3=-3,47870044504549 FrameElem=46-1
 ElemStation=0
 Frame=46 Station=0,0917 OutputCase=STR187 CaseType=Combination P=-15,9335437312413 V2=-2,8941696294275 V3=0 T=0 M2=0 M3=-3,19060108702699
 FrameElem=46-1 ElemStation=0,0917
 Frame=46 Station=0,1834 OutputCase=STR187 CaseType=Combination P=-15,9335437312413 V2=-2,3989896294275 V3=0 T=0 M2=0 M3=-2,94790973500849
 FrameElem=46-1 ElemStation=0,1834
 Frame=46 Station=0 OutputCase=INVSTR CaseType=Combination StepType=Max P=-5,36678303640097 V2=46,9958936905343 V3=0 T=0 M2=0 M3=1,48207257323214
 FrameElem=46-1 ElemStation=0
 Frame=46 Station=0,0917 OutputCase=INVSTR CaseType=Combination StepType=Max P=-5,36678303640097 V2=47,4910736905343 V3=0 T=0 M2=0
 M3=1,66478887459425 FrameElem=46-1 ElemStation=0,0917
 Frame=46 Station=0,1834 OutputCase=INVSTR CaseType=Combination StepType=Max P=-5,36678303640097 V2=47,9862536905343 V3=0 T=0 M2=0
 M3=1,81386961595636 FrameElem=46-1 ElemStation=0,1834

Società di Progetto
Brebemi SpA

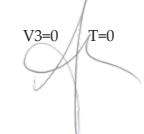



Doc. N.
60235-0000-A00.doc

CODIFICA DOCUMENTO
04RCDII10000000000300A00

REV.
00

FOGLIO
610 di 628

Frame=46 Station=0 OutputCase=INVSTR CaseType=Combination StepType=Min P=-40,439395823726 V2=-14,2031140163588 V3=0 T=0 M2=0 M3=-33,1548308693505
FrameElem=46-1 ElemStation=0
Frame=46 Station=0,0917 OutputCase=INVSTR CaseType=Combination StepType=Min P=-40,439395823726 V2=-13,7079340163588 V3=0 T=0 M2=0 M3=-
32,605076099932 FrameElem=46-1 ElemStation=0,0917
Frame=46 Station=0,1834 OutputCase=INVSTR CaseType=Combination StepType=Min P=-40,439395823726 V2=-13,2127540163588 V3=0 T=0 M2=0 M3=-
34,4026488773717 FrameElem=46-1 ElemStation=0,1834
Frame=46 Station=0 OutputCase=SIS01 CaseType=Combination P=-13,549203811234 V2=9,38021478364317 V3=0 T=0 M2=0 M3=-2,59639765629411 FrameElem=46-1
ElemStation=0
Frame=46 Station=0,0917 OutputCase=SIS01 CaseType=Combination P=-13,549203811234 V2=9,74701478364317 V3=0 T=0 M2=0 M3=-3,47338113195419 FrameElem=46-1
ElemStation=0,0917
Frame=46 Station=0,1834 OutputCase=SIS01 CaseType=Combination P=-13,549203811234 V2=10,1138147836432 V3=0 T=0 M2=0 M3=-4,38400016761426 FrameElem=46-1
ElemStation=0,1834
Frame=46 Station=0 OutputCase=SIS02 CaseType=Combination P=-13,1660967951024 V2=9,38054317950529 V3=0 T=0 M2=0 M3=-2,91375680013119 FrameElem=46-1
ElemStation=0
Frame=46 Station=0,0917 OutputCase=SIS02 CaseType=Combination P=-13,1660967951024 V2=9,74734317950529 V3=0 T=0 M2=0 M3=-3,79077038969183 FrameElem=46-1
ElemStation=0,0917
Frame=46 Station=0,1834 OutputCase=SIS02 CaseType=Combination P=-13,1660967951024 V2=10,1141431795053 V3=0 T=0 M2=0 M3=-4,70141953925246 FrameElem=46-1
ElemStation=0,1834
Frame=46 Station=0 OutputCase=SIS03 CaseType=Combination P=-13,9323108273656 V2=9,37988638778105 V3=0 T=0 M2=0 M3=-2,27903851245702 FrameElem=46-1
ElemStation=0
Frame=46 Station=0,0917 OutputCase=SIS03 CaseType=Combination P=-13,9323108273656 V2=9,74668638778105 V3=0 T=0 M2=0 M3=-3,15599187421654 FrameElem=46-1
ElemStation=0,0917
Frame=46 Station=0,1834 OutputCase=SIS03 CaseType=Combination P=-13,9323108273656 V2=10,113486387781 V3=0 T=0 M2=0 M3=-4,06658079597607 FrameElem=46-1
ElemStation=0,1834
Frame=46 Station=0 OutputCase=SIS04 CaseType=Combination P=-13,7081424728358 V2=9,69787506537073 V3=0 T=0 M2=0 M3=-2,5532875386187 FrameElem=46-1
ElemStation=0
Frame=46 Station=0,0917 OutputCase=SIS04 CaseType=Combination P=-13,7081424728358 V2=10,0646750653707 V3=0 T=0 M2=0 M3=-3,4594004621132 FrameElem=46-1
ElemStation=0,0917
Frame=46 Station=0,1834 OutputCase=SIS04 CaseType=Combination P=-13,7081424728358 V2=10,4314750653707 V3=0 T=0 M2=0 M3=-4,3991489456077 FrameElem=46-1
ElemStation=0,1834
Frame=46 Station=0 OutputCase=SIS05 CaseType=Combination P=-13,3902651496322 V2=9,0625545019156 V3=0 T=0 M2=0 M3=-2,63950777396951 FrameElem=46-1
ElemStation=0
Frame=46 Station=0,0917 OutputCase=SIS05 CaseType=Combination P=-13,3902651496322 V2=9,4293545019156 V3=0 T=0 M2=0 M3=-3,48736180179517 FrameElem=46-1
ElemStation=0,0917
Frame=46 Station=0,1834 OutputCase=SIS05 CaseType=Combination P=-13,3902651496322 V2=9,7961545019156 V3=0 T=0 M2=0 M3=-4,36885138962083 FrameElem=46-1
ElemStation=0,1834
Frame=46 Station=0 OutputCase=SIS06 CaseType=Combination P=-13,9323108273656 V2=9,37988638778105 V3=0 T=0 M2=0 M3=-2,27903851245702 FrameElem=46-1
ElemStation=0
Frame=46 Station=0,0917 OutputCase=SIS06 CaseType=Combination P=-13,9323108273656 V2=9,74668638778105 V3=0 T=0 M2=0 M3=-3,15599187421654 FrameElem=46-1
ElemStation=0,0917
Frame=46 Station=0,1834 OutputCase=SIS06 CaseType=Combination P=-13,9323108273656 V2=10,113486387781 V3=0 T=0 M2=0 M3=-4,06658079597607 FrameElem=46-1
ElemStation=0,1834
Frame=46 Station=0 OutputCase=SIS07 CaseType=Combination P=-13,3250354567042 V2=9,69820346123286 V3=0 T=0 M2=0 M3=-2,87064668245579 FrameElem=46-1
ElemStation=0
Frame=46 Station=0,0917 OutputCase=SIS07 CaseType=Combination P=-13,3250354567042 V2=10,0650034612329 V3=0 T=0 M2=0 M3=-3,77678971985084 FrameElem=46-1
ElemStation=0,0917
Frame=46 Station=0,1834 OutputCase=SIS07 CaseType=Combination P=-13,3250354567042 V2=10,4318034612329 V3=0 T=0 M2=0 M3=-4,71656831724589 FrameElem=46-1
ElemStation=0,1834
Frame=46 Station=0 OutputCase=SIS08 CaseType=Combination P=-13,0071581335006 V2=9,06288289777773 V3=0 T=0 M2=0 M3=-2,9568669178066 FrameElem=46-1
ElemStation=0
Frame=46 Station=0,0917 OutputCase=SIS08 CaseType=Combination P=-13,0071581335006 V2=9,42968289777773 V3=0 T=0 M2=0 M3=-3,80475105953281 FrameElem=46-1
ElemStation=0,0917
Frame=46 Station=0,1834 OutputCase=SIS08 CaseType=Combination P=-13,0071581335006 V2=9,79648289777773 V3=0 T=0 M2=0 M3=-4,68627076125903 FrameElem=46-1
ElemStation=0,1834
Frame=46 Station=0 OutputCase=SIS09 CaseType=Combination P=-13,549203811234 V2=9,38021478364317 V3=0 T=0 M2=0 M3=-2,59639765629411 FrameElem=46-1
ElemStation=0
Frame=46 Station=0,0917 OutputCase=SIS09 CaseType=Combination P=-13,549203811234 V2=9,74701478364317 V3=0 T=0 M2=0 M3=-3,47338113195419 FrameElem=46-1
ElemStation=0,0917
Frame=46 Station=0,1834 OutputCase=SIS09 CaseType=Combination P=-13,549203811234 V2=10,1138147836432 V3=0 T=0 M2=0 M3=-4,38400016761426 FrameElem=46-1
ElemStation=0,1834
Frame=46 Station=0 OutputCase=SIS10 CaseType=Combination P=-13,5899746444713 V2=9,25707666241578 V3=0 T=0 M2=0 M3=-2,8954580684722 FrameElem=46-1
ElemStation=0
Frame=46 Station=0,0917 OutputCase=SIS10 CaseType=Combination P=-13,5899746444713 V2=9,62387666241578 V3=0 T=0 M2=0 M3=-3,76114977841573 FrameElem=46-1
ElemStation=0,0917
Frame=46 Station=0,1834 OutputCase=SIS10 CaseType=Combination P=-13,5899746444713 V2=9,99067666241578 V3=0 T=0 M2=0 M3=-4,66047704835926 FrameElem=46-1
ElemStation=0,1834
Frame=46 Station=0 OutputCase=SIS11 CaseType=Combination P=-13,2068676283397 V2=9,25740505827791 V3=0 T=0 M2=0 M3=-3,21281721230929 FrameElem=46-1
ElemStation=0
Frame=46 Station=0,0917 OutputCase=SIS11 CaseType=Combination P=-13,2068676283397 V2=9,62420505827791 V3=0 T=0 M2=0 M3=-4,07853903615337 FrameElem=46-1
ElemStation=0,0917
Frame=46 Station=0,1834 OutputCase=SIS11 CaseType=Combination P=-13,2068676283397 V2=9,99100505827791 V3=0 T=0 M2=0 M3=-4,97789641999746 FrameElem=46-1
ElemStation=0,1834
Frame=46 Station=0 OutputCase=SIS12 CaseType=Combination P=-13,973081660603 V2=9,25674826655366 V3=0 T=0 M2=0 M3=-2,57809892463512 FrameElem=46-1
ElemStation=0
Frame=46 Station=0,0917 OutputCase=SIS12 CaseType=Combination P=-13,973081660603 V2=9,62354826655366 V3=0 T=0 M2=0 M3=-3,44376052067809 FrameElem=46-1
ElemStation=0,0917
Frame=46 Station=0,1834 OutputCase=SIS12 CaseType=Combination P=-13,973081660603 V2=9,99034826655366 V3=0 T=0 M2=0 M3=-4,34305767672106 FrameElem=46-1
ElemStation=0,1834
Frame=46 Station=0 OutputCase=SIS13 CaseType=Combination P=-13,7489133060732 V2=9,57473694414335 V3=0 T=0 M2=0 M3=-2,8523479507968 FrameElem=46-1
ElemStation=0
Frame=46 Station=0,0917 OutputCase=SIS13 CaseType=Combination P=-13,7489133060732 V2=9,94153694414335 V3=0 T=0 M2=0 M3=-3,74716910857474 FrameElem=46-1
ElemStation=0,0917
Frame=46 Station=0,1834 OutputCase=SIS13 CaseType=Combination P=-13,7489133060732 V2=10,3083369441433 V3=0 T=0 M2=0 M3=-4,67562582635269 FrameElem=46-1
ElemStation=0,1834
Frame=46 Station=0 OutputCase=SIS14 CaseType=Combination P=-13,4310359828695 V2=8,93941638068822 V3=0 T=0 M2=0 M3=-2,93856818614761 FrameElem=46-1
ElemStation=0
Frame=46 Station=0,0917 OutputCase=SIS14 CaseType=Combination P=-13,4310359828695 V2=9,30621638068822 V3=0 T=0 M2=0 M3=-3,77513044825672 FrameElem=46-1
ElemStation=0,0917

Società di Progetto
Brebemi SpA



Doc. N.
60235-0000-A00.doc

CODIFICA DOCUMENTO
04RCDII10000000000300A00

REV.
00

FOGLIO
611 di 628

Frame=46 Station=0,1834 OutputCase=SIS14 CaseType=Combination P=-13,4310359828695 V2=9,67301638068822 V3=0 T=0 M2=0 M3=-4,64532827036583 FrameElem=46-1
ElemStation=0,1834
Frame=46 Station=0 OutputCase=SIS15 CaseType=Combination P=-13,973081660603 V2=9,25674826655366 V3=0 T=0 M2=0 M3=-2,57809892463512 FrameElem=46-1
ElemStation=0
Frame=46 Station=0,0917 OutputCase=SIS15 CaseType=Combination P=-13,973081660603 V2=9,62354826655366 V3=0 T=0 M2=0 M3=-3,44376052067809 FrameElem=46-1
ElemStation=0,0917
Frame=46 Station=0,1834 OutputCase=SIS15 CaseType=Combination P=-13,973081660603 V2=9,99034826655366 V3=0 T=0 M2=0 M3=-4,34305767672106 FrameElem=46-1
ElemStation=0,1834
Frame=46 Station=0 OutputCase=SIS16 CaseType=Combination P=-13,3658062899415 V2=9,57506534000547 V3=0 T=0 M2=0 M3=-3,16970709463388 FrameElem=46-1
ElemStation=0
Frame=46 Station=0,0917 OutputCase=SIS16 CaseType=Combination P=-13,3658062899415 V2=9,94186534000547 V3=0 T=0 M2=0 M3=-4,06455836631239 FrameElem=46-1
ElemStation=0,0917
Frame=46 Station=0,1834 OutputCase=SIS16 CaseType=Combination P=-13,3658062899415 V2=10,3086653400055 V3=0 T=0 M2=0 M3=-4,99304519799089 FrameElem=46-1
ElemStation=0,1834
Frame=46 Station=0 OutputCase=SIS17 CaseType=Combination P=-13,0479289667379 V2=8,93974477655034 V3=0 T=0 M2=0 M3=-3,25592732998469 FrameElem=46-1
ElemStation=0
Frame=46 Station=0,0917 OutputCase=SIS17 CaseType=Combination P=-13,0479289667379 V2=9,30654477655034 V3=0 T=0 M2=0 M3=-4,09251970599436 FrameElem=46-1
ElemStation=0,0917
Frame=46 Station=0,1834 OutputCase=SIS17 CaseType=Combination P=-13,0479289667379 V2=9,67334477655034 V3=0 T=0 M2=0 M3=-4,96274764200403 FrameElem=46-1
ElemStation=0,1834
Frame=46 Station=0 OutputCase=SIS18 CaseType=Combination P=-13,5899746444713 V2=9,25707666241578 V3=0 T=0 M2=0 M3=-2,8954580684722 FrameElem=46-1
ElemStation=0
Frame=46 Station=0,0917 OutputCase=SIS18 CaseType=Combination P=-13,5899746444713 V2=9,62387666241578 V3=0 T=0 M2=0 M3=-3,76114977841573 FrameElem=46-1
ElemStation=0,0917
Frame=46 Station=0,1834 OutputCase=SIS18 CaseType=Combination P=-13,5899746444713 V2=9,99067666241578 V3=0 T=0 M2=0 M3=-4,66047704835926 FrameElem=46-1
ElemStation=0,1834
Frame=46 Station=0 OutputCase=SIS19 CaseType=Combination P=-13,5016378391238 V2=5,44286941889259 V3=0 T=0 M2=0 M3=-2,24749384211307 FrameElem=46-1
ElemStation=0
Frame=46 Station=0,0917 OutputCase=SIS19 CaseType=Combination P=-13,5016378391238 V2=5,80966941889259 V3=0 T=0 M2=0 M3=-2,76342274782552 FrameElem=46-1
ElemStation=0,0917
Frame=46 Station=0,1834 OutputCase=SIS19 CaseType=Combination P=-13,5016378391238 V2=6,17646941889259 V3=0 T=0 M2=0 M3=-3,31298721353797 FrameElem=46-1
ElemStation=0,1834
Frame=46 Station=0 OutputCase=SIS20 CaseType=Combination P=-13,1185308229922 V2=5,44319781475471 V3=0 T=0 M2=0 M3=-2,56485298595015 FrameElem=46-1
ElemStation=0
Frame=46 Station=0,0917 OutputCase=SIS20 CaseType=Combination P=-13,1185308229922 V2=5,80999781475471 V3=0 T=0 M2=0 M3=-3,08081200556316 FrameElem=46-1
ElemStation=0,0917
Frame=46 Station=0,1834 OutputCase=SIS20 CaseType=Combination P=-13,1185308229922 V2=6,17679781475471 V3=0 T=0 M2=0 M3=-3,63040658517617 FrameElem=46-1
ElemStation=0,1834
Frame=46 Station=0 OutputCase=SIS21 CaseType=Combination P=-13,884744852554 V2=5,44254102303046 V3=0 T=0 M2=0 M3=-1,93013469827598 FrameElem=46-1
ElemStation=0
Frame=46 Station=0,0917 OutputCase=SIS21 CaseType=Combination P=-13,884744852554 V2=5,80934102303046 V3=0 T=0 M2=0 M3=-2,44603349008788 FrameElem=46-1
ElemStation=0,0917
Frame=46 Station=0,1834 OutputCase=SIS21 CaseType=Combination P=-13,884744852554 V2=6,17614102303046 V3=0 T=0 M2=0 M3=-2,99556784189977 FrameElem=46-1
ElemStation=0,1834
Frame=46 Station=0 OutputCase=SIS22 CaseType=Combination P=-13,6605765007256 V2=5,76052970062015 V3=0 T=0 M2=0 M3=-2,20438372443766 FrameElem=46-1
ElemStation=0
Frame=46 Station=0,0917 OutputCase=SIS22 CaseType=Combination P=-13,6605765007256 V2=6,12732970062015 V3=0 T=0 M2=0 M3=-2,74944207798453 FrameElem=46-1
ElemStation=0,0917
Frame=46 Station=0,1834 OutputCase=SIS22 CaseType=Combination P=-13,6605765007256 V2=6,49412970062015 V3=0 T=0 M2=0 M3=-3,3281359915314 FrameElem=46-1
ElemStation=0,1834
Frame=46 Station=0 OutputCase=SIS23 CaseType=Combination P=-13,342699177522 V2=5,12520913716502 V3=0 T=0 M2=0 M3=-2,29060395978847 FrameElem=46-1
ElemStation=0
Frame=46 Station=0,0917 OutputCase=SIS23 CaseType=Combination P=-13,342699177522 V2=5,49200913716502 V3=0 T=0 M2=0 M3=-2,7774034176665 FrameElem=46-1
ElemStation=0,0917
Frame=46 Station=0,1834 OutputCase=SIS23 CaseType=Combination P=-13,342699177522 V2=5,85880913716502 V3=0 T=0 M2=0 M3=-3,29783843554454 FrameElem=46-1
ElemStation=0,1834
Frame=46 Station=0 OutputCase=SIS24 CaseType=Combination P=-13,884744852554 V2=5,44254102303046 V3=0 T=0 M2=0 M3=-1,93013469827598 FrameElem=46-1
ElemStation=0
Frame=46 Station=0,0917 OutputCase=SIS24 CaseType=Combination P=-13,884744852554 V2=5,80934102303046 V3=0 T=0 M2=0 M3=-2,44603349008788 FrameElem=46-1
ElemStation=0,0917
Frame=46 Station=0,1834 OutputCase=SIS24 CaseType=Combination P=-13,884744852554 V2=6,17614102303046 V3=0 T=0 M2=0 M3=-2,99556784189977 FrameElem=46-1
ElemStation=0,1834
Frame=46 Station=0 OutputCase=SIS25 CaseType=Combination P=-13,277469484594 V2=5,76085809648228 V3=0 T=0 M2=0 M3=-2,52174286827475 FrameElem=46-1
ElemStation=0
Frame=46 Station=0,0917 OutputCase=SIS25 CaseType=Combination P=-13,277469484594 V2=6,12765809648228 V3=0 T=0 M2=0 M3=-3,06683133572217 FrameElem=46-1
ElemStation=0,0917
Frame=46 Station=0,1834 OutputCase=SIS25 CaseType=Combination P=-13,277469484594 V2=6,49445809648228 V3=0 T=0 M2=0 M3=-3,6455553631696 FrameElem=46-1
ElemStation=0,1834
Frame=46 Station=0 OutputCase=SIS26 CaseType=Combination P=-12,9595921613903 V2=5,12553753302714 V3=0 T=0 M2=0 M3=-2,60796310362556 FrameElem=46-1
ElemStation=0
Frame=46 Station=0,0917 OutputCase=SIS26 CaseType=Combination P=-12,9595921613903 V2=5,49233753302714 V3=0 T=0 M2=0 M3=-3,09479267540415 FrameElem=46-1
ElemStation=0,0917
Frame=46 Station=0,1834 OutputCase=SIS26 CaseType=Combination P=-12,9595921613903 V2=5,85913753302715 V3=0 T=0 M2=0 M3=-3,61525780718273 FrameElem=46-1
ElemStation=0,1834
Frame=46 Station=0 OutputCase=SIS27 CaseType=Combination P=-13,5016378391238 V2=5,44286941889259 V3=0 T=0 M2=0 M3=-2,24749384211307 FrameElem=46-1
ElemStation=0
Frame=46 Station=0,0917 OutputCase=SIS27 CaseType=Combination P=-13,5016378391238 V2=5,80966941889259 V3=0 T=0 M2=0 M3=-2,76342274782552 FrameElem=46-1
ElemStation=0,0917
Frame=46 Station=0,1834 OutputCase=SIS27 CaseType=Combination P=-13,5016378391238 V2=6,17646941889259 V3=0 T=0 M2=0 M3=-3,31298721353797 FrameElem=46-1
ElemStation=0,1834
Frame=46 Station=0 OutputCase=SIS28 CaseType=Combination P=-13,6375406165816 V2=5,03240901480131 V3=0 T=0 M2=0 M3=-3,24436188270672 FrameElem=46-1
ElemStation=0
Frame=46 Station=0,0917 OutputCase=SIS28 CaseType=Combination P=-13,6375406165816 V2=5,39920901480131 V3=0 T=0 M2=0 M3=-3,722651569364 FrameElem=46-1
ElemStation=0,0917
Frame=46 Station=0,1834 OutputCase=SIS28 CaseType=Combination P=-13,6375406165816 V2=5,76600901480131 V3=0 T=0 M2=0 M3=-4,23457681602128 FrameElem=46-1
ElemStation=0,1834
Frame=46 Station=0 OutputCase=SIS29 CaseType=Combination P=-13,2544336004499 V2=5,03273741066343 V3=0 T=0 M2=0 M3=-3,56172102654381 FrameElem=46-1
ElemStation=0

Società di Progetto
Brebemi SpA



Doc. N.
60235-0000-A00.doc

CODIFICA DOCUMENTO
04RCDII10000000000300A00

REV.
00

FOGLIO
612 di 628

Frame=46 Station=0,0917 OutputCase=SIS29 CaseType=Combination P=-13,2544336004499 V2=5,39953741066343 V3=0 T=0 M2=0 M3=-4,04004082710164 FrameElem=46-1 ElemStation=0,0917
Frame=46 Station=0,1834 OutputCase=SIS29 CaseType=Combination P=-13,2544336004499 V2=5,76633741066343 V3=0 T=0 M2=0 M3=-4,55199618765948 FrameElem=46-1 ElemStation=0,1834
Frame=46 Station=0 OutputCase=SIS30 CaseType=Combination P=-14,0206476327132 V2=5,03208061893918 V3=0 T=0 M2=0 M3=-2,92700273886964 FrameElem=46-1 ElemStation=0
Frame=46 Station=0,0917 OutputCase=SIS30 CaseType=Combination P=-14,0206476327132 V2=5,39888061893918 V3=0 T=0 M2=0 M3=-3,40526231162636 FrameElem=46-1 ElemStation=0,0917
Frame=46 Station=0,1834 OutputCase=SIS30 CaseType=Combination P=-14,0206476327132 V2=5,76568061893918 V3=0 T=0 M2=0 M3=-3,91715744438308 FrameElem=46-1 ElemStation=0,1834
Frame=46 Station=0 OutputCase=SIS31 CaseType=Combination P=-13,7964792781834 V2=5,35006929652887 V3=0 T=0 M2=0 M3=-3,20125176503132 FrameElem=46-1 ElemStation=0
Frame=46 Station=0,0917 OutputCase=SIS31 CaseType=Combination P=-13,7964792781834 V2=5,71686929652887 V3=0 T=0 M2=0 M3=-3,70867089952301 FrameElem=46-1 ElemStation=0,0917
Frame=46 Station=0,1834 OutputCase=SIS31 CaseType=Combination P=-13,7964792781834 V2=6,0836929652887 V3=0 T=0 M2=0 M3=-4,2497255904171 FrameElem=46-1 ElemStation=0,1834
Frame=46 Station=0 OutputCase=SIS32 CaseType=Combination P=-13,4786019549797 V2=4,71474873307374 V3=0 T=0 M2=0 M3=-3,28747200038213 FrameElem=46-1 ElemStation=0
Frame=46 Station=0,0917 OutputCase=SIS32 CaseType=Combination P=-13,4786019549797 V2=5,08154873307374 V3=0 T=0 M2=0 M3=-3,73663223920499 FrameElem=46-1 ElemStation=0,0917
Frame=46 Station=0,1834 OutputCase=SIS32 CaseType=Combination P=-13,4786019549797 V2=5,44834873307374 V3=0 T=0 M2=0 M3=-4,21942803802785 FrameElem=46-1 ElemStation=0,1834
Frame=46 Station=0 OutputCase=SIS33 CaseType=Combination P=-14,0206476327132 V2=5,03208061893918 V3=0 T=0 M2=0 M3=-2,92700273886964 FrameElem=46-1 ElemStation=0
Frame=46 Station=0,0917 OutputCase=SIS33 CaseType=Combination P=-14,0206476327132 V2=5,39888061893918 V3=0 T=0 M2=0 M3=-3,40526231162636 FrameElem=46-1 ElemStation=0,0917
Frame=46 Station=0,1834 OutputCase=SIS33 CaseType=Combination P=-14,0206476327132 V2=5,76568061893918 V3=0 T=0 M2=0 M3=-3,91715744438308 FrameElem=46-1 ElemStation=0,1834
Frame=46 Station=0 OutputCase=SIS34 CaseType=Combination P=-13,4133722620517 V2=5,35039769239099 V3=0 T=0 M2=0 M3=-3,5186109088684 FrameElem=46-1 ElemStation=0
Frame=46 Station=0,0917 OutputCase=SIS34 CaseType=Combination P=-13,4133722620517 V2=5,71719769239099 V3=0 T=0 M2=0 M3=-4,02606015726066 FrameElem=46-1 ElemStation=0,0917
Frame=46 Station=0,1834 OutputCase=SIS34 CaseType=Combination P=-13,4133722620517 V2=6,08399769239099 V3=0 T=0 M2=0 M3=-4,56714496565291 FrameElem=46-1 ElemStation=0,1834
Frame=46 Station=0 OutputCase=SIS35 CaseType=Combination P=-13,0954949388481 V2=4,71507712893586 V3=0 T=0 M2=0 M3=-3,60483114421921 FrameElem=46-1 ElemStation=0
Frame=46 Station=0,0917 OutputCase=SIS35 CaseType=Combination P=-13,0954949388481 V2=5,08187712893586 V3=0 T=0 M2=0 M3=-4,05402149694263 FrameElem=46-1 ElemStation=0,0917
Frame=46 Station=0,1834 OutputCase=SIS35 CaseType=Combination P=-13,0954949388481 V2=5,44867712893586 V3=0 T=0 M2=0 M3=-4,53684740966605 FrameElem=46-1 ElemStation=0,1834
Frame=46 Station=0 OutputCase=SIS36 CaseType=Combination P=-13,6375406165816 V2=5,03240901480131 V3=0 T=0 M2=0 M3=-3,24436188270672 FrameElem=46-1 ElemStation=0
Frame=46 Station=0,0917 OutputCase=SIS36 CaseType=Combination P=-13,6375406165816 V2=5,39920901480131 V3=0 T=0 M2=0 M3=-3,722651569364 FrameElem=46-1 ElemStation=0,0917
Frame=46 Station=0,1834 OutputCase=SIS36 CaseType=Combination P=-13,6375406165816 V2=5,76600901480131 V3=0 T=0 M2=0 M3=-4,23457681602128 FrameElem=46-1 ElemStation=0,1834
Frame=46 Station=0 OutputCase=INVSIS CaseType=Combination StepType=Max P=-12,9595921613903 V2=9,69820346123286 V3=0 T=0 M2=0 M3=-1,93013469827598 FrameElem=46-1 ElemStation=0
Frame=46 Station=0,0917 OutputCase=INVSIS CaseType=Combination StepType=Max P=-12,9595921613903 V2=10,0650034612329 V3=0 T=0 M2=0 M3=-2,44603349008788 FrameElem=46-1 ElemStation=0,0917
Frame=46 Station=0,1834 OutputCase=INVSIS CaseType=Combination StepType=Max P=-12,9595921613903 V2=10,4318034612329 V3=0 T=0 M2=0 M3=-2,99556784189977 FrameElem=46-1 ElemStation=0,1834
Frame=46 Station=0 OutputCase=INVSIS CaseType=Combination StepType=Min P=-14,0206476327132 V2=4,71474873307374 V3=0 T=0 M2=0 M3=-3,60483114421921 FrameElem=46-1 ElemStation=0
Frame=46 Station=0,0917 OutputCase=INVSIS CaseType=Combination StepType=Min P=-14,0206476327132 V2=5,08154873307374 V3=0 T=0 M2=0 M3=-4,09251970599436 FrameElem=46-1 ElemStation=0,0917
Frame=46 Station=0,1834 OutputCase=INVSIS CaseType=Combination StepType=Min P=-14,0206476327132 V2=5,44834873307374 V3=0 T=0 M2=0 M3=-4,99304519799089 FrameElem=46-1 ElemStation=0,1834
Frame=46 Station=0 OutputCase=RAR001 CaseType=Combination P=-11,2910804186904 V2=-2,17120790642275 V3=0 T=0 M2=0 M3=-3,09502505244586 FrameElem=46-1 ElemStation=0
Frame=46 Station=0,0917 OutputCase=RAR001 CaseType=Combination P=-11,2910804186904 V2=-1,80440790642275 V3=0 T=0 M2=0 M3=-2,9127430674269 FrameElem=46-1 ElemStation=0,0917
Frame=46 Station=0,1834 OutputCase=RAR001 CaseType=Combination P=-11,2910804186904 V2=-1,43760790642275 V3=0 T=0 M2=0 M3=-2,76409664240793 FrameElem=46-1 ElemStation=0,1834
Frame=46 Station=0 OutputCase=RAR002 CaseType=Combination P=-6,33003340087618 V2=-10,1786770104727 V3=0 T=0 M2=0 M3=-24,0096036209179 FrameElem=46-1 ElemStation=0
Frame=46 Station=0,0917 OutputCase=RAR002 CaseType=Combination P=-6,33003340087618 V2=-9,81187701047271 V3=0 T=0 M2=0 M3=-23,0930367190576 FrameElem=46-1 ElemStation=0,0917
Frame=46 Station=0,1834 OutputCase=RAR002 CaseType=Combination P=-6,33003340087618 V2=-9,44507701047271 V3=0 T=0 M2=0 M3=-22,2101053771972 FrameElem=46-1 ElemStation=0,1834
Frame=46 Station=0 OutputCase=RAR003 CaseType=Combination P=-17,5311707966847 V2=12,8008961639298 V3=0 T=0 M2=0 M3=-22,4099576107527 FrameElem=46-1 ElemStation=0
Frame=46 Station=0,0917 OutputCase=RAR003 CaseType=Combination P=-17,5311707966847 V2=13,1676961639298 V3=0 T=0 M2=0 M3=-23,6006175689851 FrameElem=46-1 ElemStation=0,0917
Frame=46 Station=0,1834 OutputCase=RAR003 CaseType=Combination P=-17,5311707966847 V2=13,5344961639298 V3=0 T=0 M2=0 M3=-24,8249130872174 FrameElem=46-1 ElemStation=0,1834
Frame=46 Station=0 OutputCase=RAR004 CaseType=Combination P=-28,7323081894663 V2=-10,1819875634601 V3=0 T=0 M2=0 M3=-20,81031160105 FrameElem=46-1 ElemStation=0
Frame=46 Station=0,0917 OutputCase=RAR004 CaseType=Combination P=-28,7323081894663 V2=-9,8151875634601 V3=0 T=0 M2=0 M3=-19,8934411214807 FrameElem=46-1 ElemStation=0,0917
Frame=46 Station=0,1834 OutputCase=RAR004 CaseType=Combination P=-28,7323081894663 V2=-9,4483875634601 V3=0 T=0 M2=0 M3=-19,0102062019114 FrameElem=46-1 ElemStation=0,1834
Frame=46 Station=0 OutputCase=RAR005 CaseType=Combination P=-18,4913082259663 V2=20,8088659059886 V3=0 T=0 M2=0 M3=-1,9791916245357 FrameElem=46-1 ElemStation=0
Frame=46 Station=0,0917 OutputCase=RAR005 CaseType=Combination P=-18,4913082259663 V2=21,1756659059886 V3=0 T=0 M2=0 M3=-3,90418240811485 FrameElem=46-1 ElemStation=0,0917
Frame=46 Station=0,1834 OutputCase=RAR005 CaseType=Combination P=-18,4913082259663 V2=21,5424659059886 V3=0 T=0 M2=0 M3=-5,862808751694 FrameElem=46-1 ElemStation=0,1834

Società di Progetto
Brebemi SpA

	Doc. N. 60235-0000-A00.doc	CODIFICA DOCUMENTO 04RCDII10000000000300A00	REV. 00	FOGLIO 613 di 628
--	-------------------------------	--	------------	----------------------

Frame=46 Station=0 OutputCase=RAR006 CaseType=Combination P=-29,692445618748 V2=-2,17401782140132 V3=0 T=0 M2=0 M3=-0,379545614832978 FrameElem=46-1 ElemStation=0

Frame=46 Station=0,0917 OutputCase=RAR006 CaseType=Combination P=-29,692445618748 V2=-1,80721782140132 V3=0 T=0 M2=0 M3=-0,197005960610476 FrameElem=46-1 ElemStation=0,0917

Frame=46 Station=0,1834 OutputCase=RAR006 CaseType=Combination P=-29,692445618748 V2=-1,44041782140132 V3=0 T=0 M2=0 M3=-4,81018663879746E-02 FrameElem=46-1 ElemStation=0,1834

Frame=46 Station=0 OutputCase=RAR007 CaseType=Combination P=-15,4710345056277 V2=33,3036721417866 V3=0 T=0 M2=0 M3=-17,6417010438203 FrameElem=46-1 ElemStation=0

Frame=46 Station=0,0917 OutputCase=RAR007 CaseType=Combination P=-15,4710345056277 V2=33,6704721417866 V3=0 T=0 M2=0 M3=-20,7124655592221 FrameElem=46-1 ElemStation=0,0917

Frame=46 Station=0,1834 OutputCase=RAR007 CaseType=Combination P=-15,4710345056277 V2=34,0372721417866 V3=0 T=0 M2=0 M3=-23,8168656346239 FrameElem=46-1 ElemStation=0,1834

Frame=46 Station=0 OutputCase=RAR008 CaseType=Combination P=-6,52395679789459 V2=-2,17005047668969 V3=0 T=0 M2=0 M3=-4,21355592237507 FrameElem=46-1 ElemStation=0

Frame=46 Station=0,0917 OutputCase=RAR008 CaseType=Combination P=-6,52395679789459 V2=-1,80325047668969 V3=0 T=0 M2=0 M3=-4,03138007366263 FrameElem=46-1 ElemStation=0,0917

Frame=46 Station=0,1834 OutputCase=RAR008 CaseType=Combination P=-6,52395679789459 V2=-1,43645047668969 V3=0 T=0 M2=0 M3=-3,88283978495018 FrameElem=46-1 ElemStation=0,1834

Frame=46 Station=0 OutputCase=RAR009 CaseType=Combination P=-5,87030498151822 V2=-10,1782829354382 V3=0 T=0 M2=0 M3=-24,3904345935224 FrameElem=46-1 ElemStation=0

Frame=46 Station=0,0917 OutputCase=RAR009 CaseType=Combination P=-5,87030498151822 V2=-9,81148293543816 V3=0 T=0 M2=0 M3=-23,4793038283427 FrameElem=46-1 ElemStation=0,0917

Frame=46 Station=0,1834 OutputCase=RAR009 CaseType=Combination P=-5,87030498151822 V2=-9,44468293543816 V3=0 T=0 M2=0 M3=-22,5910086231631 FrameElem=46-1 ElemStation=0,1834

Frame=46 Station=0 OutputCase=RAR010 CaseType=Combination P=-17,0714423773267 V2=12,8012902389643 V3=0 T=0 M2=0 M3=-22,7907885833572 FrameElem=46-1 ElemStation=0

Frame=46 Station=0,0917 OutputCase=RAR010 CaseType=Combination P=-17,0714423773267 V2=13,1680902389643 V3=0 T=0 M2=0 M3=-23,9814846782702 FrameElem=46-1 ElemStation=0,0917

Frame=46 Station=0,1834 OutputCase=RAR010 CaseType=Combination P=-17,0714423773267 V2=13,5348902389643 V3=0 T=0 M2=0 M3=-25,2058163331833 FrameElem=46-1 ElemStation=0,1834

Frame=46 Station=0 OutputCase=RAR011 CaseType=Combination P=-28,2725797701084 V2=-10,1815934884256 V3=0 T=0 M2=0 M3=-21,1911425736545 FrameElem=46-1 ElemStation=0

Frame=46 Station=0,0917 OutputCase=RAR011 CaseType=Combination P=-28,2725797701084 V2=-9,81479348842555 V3=0 T=0 M2=0 M3=-20,2743082307659 FrameElem=46-1 ElemStation=0,0917

Frame=46 Station=0,1834 OutputCase=RAR011 CaseType=Combination P=-28,2725797701084 V2=-9,44799348842555 V3=0 T=0 M2=0 M3=-19,3911094478772 FrameElem=46-1 ElemStation=0,1834

Frame=46 Station=0 OutputCase=RAR012 CaseType=Combination P=-18,0315798066084 V2=20,8092599810231 V3=0 T=0 M2=0 M3=-2,3600225971402 FrameElem=46-1 ElemStation=0

Frame=46 Station=0,0917 OutputCase=RAR012 CaseType=Combination P=-18,0315798066084 V2=21,1760599810231 V3=0 T=0 M2=0 M3=-4,28504951740002 FrameElem=46-1 ElemStation=0,0917

Frame=46 Station=0,1834 OutputCase=RAR012 CaseType=Combination P=-18,0315798066084 V2=21,5428599810231 V3=0 T=0 M2=0 M3=-6,24371199765984 FrameElem=46-1 ElemStation=0,1834

Frame=46 Station=0 OutputCase=RAR013 CaseType=Combination P=-29,23271719939 V2=-2,17362374636677 V3=0 T=0 M2=0 M3=-0,760376587437479 FrameElem=46-1 ElemStation=0

Frame=46 Station=0,0917 OutputCase=RAR013 CaseType=Combination P=-29,23271719939 V2=-1,80682374636678 V3=0 T=0 M2=0 M3=-0,577873069895646 FrameElem=46-1 ElemStation=0,0917

Frame=46 Station=0,1834 OutputCase=RAR013 CaseType=Combination P=-29,23271719939 V2=-1,44002374636677 V3=0 T=0 M2=0 M3=-0,429005112353812 FrameElem=46-1 ElemStation=0,1834

Frame=46 Station=0 OutputCase=RAR014 CaseType=Combination P=-15,0113060862697 V2=33,3040662168211 V3=0 T=0 M2=0 M3=-18,0225320164248 FrameElem=46-1 ElemStation=0

Frame=46 Station=0,0917 OutputCase=RAR014 CaseType=Combination P=-15,0113060862697 V2=33,6708662168211 V3=0 T=0 M2=0 M3=-21,0933326685073 FrameElem=46-1 ElemStation=0,0917

Frame=46 Station=0,1834 OutputCase=RAR014 CaseType=Combination P=-15,0113060862697 V2=34,0376662168211 V3=0 T=0 M2=0 M3=-24,1977688805898 FrameElem=46-1 ElemStation=0,1834

Frame=46 Station=0 OutputCase=RAR015 CaseType=Combination P=-5,80385372593334 V2=-8,17602778323377 V3=0 T=0 M2=0 M3=-19,5366304120378 FrameElem=46-1 ElemStation=0

Frame=46 Station=0,0917 OutputCase=RAR015 CaseType=Combination P=-5,80385372593334 V2=-7,80922778323377 V3=0 T=0 M2=0 M3=-18,8037064443153 FrameElem=46-1 ElemStation=0,0917

Frame=46 Station=0,1834 OutputCase=RAR015 CaseType=Combination P=-5,80385372593334 V2=-7,44242778323377 V3=0 T=0 M2=0 M3=-18,1044180365928 FrameElem=46-1 ElemStation=0,1834

Frame=46 Station=0 OutputCase=RAR016 CaseType=Combination P=-14,7048204715018 V2=9,72787202803723 V3=0 T=0 M2=0 M3=-18,2764193316236 FrameElem=46-1 ElemStation=0

Frame=46 Station=0,0917 OutputCase=RAR016 CaseType=Combination P=-14,7048204715018 V2=10,0946720280372 V3=0 T=0 M2=0 M3=-19,1852829765946 FrameElem=46-1 ElemStation=0,0917

Frame=46 Station=0,1834 OutputCase=RAR016 CaseType=Combination P=-14,7048204715018 V2=10,4614720280372 V3=0 T=0 M2=0 M3=-20,1277821815656 FrameElem=46-1 ElemStation=0,1834

Frame=46 Station=0 OutputCase=RAR017 CaseType=Combination P=-23,6057872145091 V2=-8,17863585747651 V3=0 T=0 M2=0 M3=-17,0162082515731 FrameElem=46-1 ElemStation=0

Frame=46 Station=0,0917 OutputCase=RAR017 CaseType=Combination P=-23,6057872145091 V2=-7,81183585747652 V3=0 T=0 M2=0 M3=-16,2830451234425 FrameElem=46-1 ElemStation=0,0917

Frame=46 Station=0,1834 OutputCase=RAR017 CaseType=Combination P=-23,6057872145091 V2=-7,44503585747651 V3=0 T=0 M2=0 M3=-15,5835175553119 FrameElem=46-1 ElemStation=0,1834

Frame=46 Station=0 OutputCase=RAR018 CaseType=Combination P=-15,424923543463 V2=15,7338493345813 V3=0 T=0 M2=0 M3=-2,95334484196082 FrameElem=46-1 ElemStation=0

Frame=46 Station=0,0917 OutputCase=RAR018 CaseType=Combination P=-15,424923543463 V2=16,1006493345813 V3=0 T=0 M2=0 M3=-4,41295660594193 FrameElem=46-1 ElemStation=0,0917

Frame=46 Station=0,1834 OutputCase=RAR018 CaseType=Combination P=-15,424923543463 V2=16,4674493345813 V3=0 T=0 M2=0 M3=-5,90620392992303 FrameElem=46-1 ElemStation=0,1834

Frame=46 Station=0 OutputCase=RAR019 CaseType=Combination P=-24,3258902864703 V2=-2,17265855093243 V3=0 T=0 M2=0 M3=-1,69313376191037 FrameElem=46-1 ElemStation=0

Frame=46 Station=0,0917 OutputCase=RAR019 CaseType=Combination P=-24,3258902864703 V2=-1,80585855093243 V3=0 T=0 M2=0 M3=-1,51071875278986 FrameElem=46-1 ElemStation=0,0917

Frame=46 Station=0,1834 OutputCase=RAR019 CaseType=Combination P=-24,3258902864703 V2=-1,43905855093243 V3=0 T=0 M2=0 M3=-1,36193938366936 FrameElem=46-1 ElemStation=0,1834

Frame=46 Station=0 OutputCase=RAR020 CaseType=Combination P=-6,71468319181678 V2=-1,78885813861661 V3=0 T=0 M2=0 M3=-4,16182378116459 FrameElem=46-1 ElemStation=0

Frame=46 Station=0,0917 OutputCase=RAR020 CaseType=Combination P=-6,71468319181678 V2=-1,42205813861661 V3=0 T=0 M2=0 M3=-4,01460326985344 FrameElem=46-1 ElemStation=0,0917

Società di Progetto
Brebemi SpA

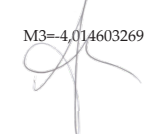



Doc. N.
60235-0000-A00.doc

CODIFICA DOCUMENTO
04RCDII10000000000300A00

REV.
00

FOGLIO
614 di 628

Frame=46 Station=0,1834 OutputCase=RAR020 CaseType=Combination P=-6,71468319181678 V2=-1,05525813861661 V3=0 T=0 M2=0 M3=-3,9010183185423
FrameElem=46-1 ElemStation=0,1834
Frame=46 Station=0 OutputCase=RAR021 CaseType=Combination P=-5,99458011985552 V2=-7,79483544516069 V3=0 T=0 M2=0 M3=-19,4848982708273 FrameElem=46-1
ElemStation=0
Frame=46 Station=0,0917 OutputCase=RAR021 CaseType=Combination P=-5,99458011985552 V2=-7,42803544516069 V3=0 T=0 M2=0 M3=-18,7869296405061
FrameElem=46-1 ElemStation=0,0917
Frame=46 Station=0,1834 OutputCase=RAR021 CaseType=Combination P=-5,99458011985552 V2=-7,06123544516069 V3=0 T=0 M2=0 M3=-18,1225965701849
FrameElem=46-1 ElemStation=0,1834
Frame=46 Station=0 OutputCase=RAR022 CaseType=Combination P=-14,895546865424 V2=-10,1090643661103 V3=0 T=0 M2=0 M3=-18,2246871904131 FrameElem=46-1
ElemStation=0
Frame=46 Station=0,0917 OutputCase=RAR022 CaseType=Combination P=-14,895546865424 V2=10,4758643661103 V3=0 T=0 M2=0 M3=-19,1685061727854
FrameElem=46-1 ElemStation=0,0917
Frame=46 Station=0,1834 OutputCase=RAR022 CaseType=Combination P=-14,895546865424 V2=10,8426643661103 V3=0 T=0 M2=0 M3=-20,1459607151577
FrameElem=46-1 ElemStation=0,1834
Frame=46 Station=0 OutputCase=RAR023 CaseType=Combination P=-23,7965136084313 V2=-7,79744351940344 V3=0 T=0 M2=0 M3=-16,9644761103626 FrameElem=46-1
ElemStation=0
Frame=46 Station=0,0917 OutputCase=RAR023 CaseType=Combination P=-23,7965136084313 V2=-7,43064351940344 V3=0 T=0 M2=0 M3=-16,2662683196333
FrameElem=46-1 ElemStation=0,0917
Frame=46 Station=0,1834 OutputCase=RAR023 CaseType=Combination P=-23,7965136084313 V2=-7,06384351940344 V3=0 T=0 M2=0 M3=-15,601696088904
FrameElem=46-1 ElemStation=0,1834
Frame=46 Station=0 OutputCase=RAR024 CaseType=Combination P=-15,6156499373852 V2=16,1150416726544 V3=0 T=0 M2=0 M3=-2,90161270075034 FrameElem=46-1
ElemStation=0
Frame=46 Station=0,0917 OutputCase=RAR024 CaseType=Combination P=-15,6156499373852 V2=16,4818416726544 V3=0 T=0 M2=0 M3=-4,39617980213274
FrameElem=46-1 ElemStation=0,0917
Frame=46 Station=0,1834 OutputCase=RAR024 CaseType=Combination P=-15,6156499373852 V2=16,8486416726544 V3=0 T=0 M2=0 M3=-5,92438246351515
FrameElem=46-1 ElemStation=0,1834
Frame=46 Station=0 OutputCase=RAR025 CaseType=Combination P=-24,5166166803925 V2=-1,79146621285935 V3=0 T=0 M2=0 M3=-1,64140162069988 FrameElem=46-1
ElemStation=0
Frame=46 Station=0,0917 OutputCase=RAR025 CaseType=Combination P=-24,5166166803925 V2=-1,42466621285935 V3=0 T=0 M2=0 M3=-1,49394194898068
FrameElem=46-1 ElemStation=0,0917
Frame=46 Station=0,1834 OutputCase=RAR025 CaseType=Combination P=-24,5166166803925 V2=-1,05786621285935 V3=0 T=0 M2=0 M3=-1,38011783726148
FrameElem=46-1 ElemStation=0,1834
Frame=46 Station=0 OutputCase=RAR026 CaseType=Combination P=-6,33323040397241 V2=-2,55124281476277 V3=0 T=0 M2=0 M3=-4,26528806358556 FrameElem=46-1
ElemStation=0
Frame=46 Station=0,0917 OutputCase=RAR026 CaseType=Combination P=-6,33323040397241 V2=-2,18444281476277 V3=0 T=0 M2=0 M3=-4,04815687747181
FrameElem=46-1 ElemStation=0,0917
Frame=46 Station=0,1834 OutputCase=RAR026 CaseType=Combination P=-6,33323040397241 V2=-1,81764281476277 V3=0 T=0 M2=0 M3=-3,86466125135807
FrameElem=46-1 ElemStation=0,1834
Frame=46 Station=0 OutputCase=RAR027 CaseType=Combination P=-5,61312733201115 V2=-8,55722012130685 V3=0 T=0 M2=0 M3=-19,5883625532483 FrameElem=46-1
ElemStation=0
Frame=46 Station=0,0917 OutputCase=RAR027 CaseType=Combination P=-5,61312733201115 V2=-8,19042012130685 V3=0 T=0 M2=0 M3=-18,8204832481245
FrameElem=46-1 ElemStation=0,0917
Frame=46 Station=0,1834 OutputCase=RAR027 CaseType=Combination P=-5,61312733201115 V2=-7,82362012130685 V3=0 T=0 M2=0 M3=-18,0862395030006
FrameElem=46-1 ElemStation=0,1834
Frame=46 Station=0 OutputCase=RAR028 CaseType=Combination P=-14,5140940775796 V2=9,34667968996416 V3=0 T=0 M2=0 M3=-18,3281514728341 FrameElem=46-1
ElemStation=0
Frame=46 Station=0,0917 OutputCase=RAR028 CaseType=Combination P=-14,5140940775796 V2=9,71347968996415 V3=0 T=0 M2=0 M3=-19,2020597804038
FrameElem=46-1 ElemStation=0,0917
Frame=46 Station=0,1834 OutputCase=RAR028 CaseType=Combination P=-14,5140940775796 V2=10,0802796899642 V3=0 T=0 M2=0 M3=-20,1096036479735
FrameElem=46-1 ElemStation=0,1834
Frame=46 Station=0 OutputCase=RAR029 CaseType=Combination P=-23,4150608205869 V2=-8,55982819554959 V3=0 T=0 M2=0 M3=-17,0679403927836 FrameElem=46-1
ElemStation=0
Frame=46 Station=0,0917 OutputCase=RAR029 CaseType=Combination P=-23,4150608205869 V2=-8,19302819554959 V3=0 T=0 M2=0 M3=-16,2998219272517
FrameElem=46-1 ElemStation=0,0917
Frame=46 Station=0,1834 OutputCase=RAR029 CaseType=Combination P=-23,4150608205869 V2=-7,82622819554959 V3=0 T=0 M2=0 M3=-15,565390217198
FrameElem=46-1 ElemStation=0,1834
Frame=46 Station=0 OutputCase=RAR030 CaseType=Combination P=-15,2341971495408 V2=15,3526569965082 V3=0 T=0 M2=0 M3=-3,00507698317131 FrameElem=46-1
ElemStation=0
Frame=46 Station=0,0917 OutputCase=RAR030 CaseType=Combination P=-15,2341971495408 V2=15,7194569965082 V3=0 T=0 M2=0 M3=-4,42973340975111
FrameElem=46-1 ElemStation=0,0917
Frame=46 Station=0,1834 OutputCase=RAR030 CaseType=Combination P=-15,2341971495408 V2=16,0862569965082 V3=0 T=0 M2=0 M3=-5,88802539633092
FrameElem=46-1 ElemStation=0,1834
Frame=46 Station=0 OutputCase=RAR031 CaseType=Combination P=-24,1351638925482 V2=-2,55385088900551 V3=0 T=0 M2=0 M3=-1,74486590312085 FrameElem=46-1
ElemStation=0
Frame=46 Station=0,0917 OutputCase=RAR031 CaseType=Combination P=-24,1351638925482 V2=-2,18705088900551 V3=0 T=0 M2=0 M3=-1,52749555659905
FrameElem=46-1 ElemStation=0,0917
Frame=46 Station=0,1834 OutputCase=RAR031 CaseType=Combination P=-24,1351638925482 V2=-1,82025088900551 V3=0 T=0 M2=0 M3=-1,34376077007724
FrameElem=46-1 ElemStation=0,1834
Frame=46 Station=0 OutputCase=RAR032 CaseType=Combination P=-6,98368521725255 V2=-2,17044455172424 V3=0 T=0 M2=0 M3=-3,83272494977057 FrameElem=46-1
ElemStation=0
Frame=46 Station=0,0917 OutputCase=RAR032 CaseType=Combination P=-6,98368521725255 V2=-1,80364455172424 V3=0 T=0 M2=0 M3=-3,65051296437746
FrameElem=46-1 ElemStation=0,0917
Frame=46 Station=0,1834 OutputCase=RAR032 CaseType=Combination P=-6,98368521725255 V2=-1,43684455172424 V3=0 T=0 M2=0 M3=-3,50193653898435
FrameElem=46-1 ElemStation=0,1834
Frame=46 Station=0 OutputCase=RAR033 CaseType=Combination P=-6,26358214529129 V2=-8,17642185826832 V3=0 T=0 M2=0 M3=-19,1557994394333 FrameElem=46-1
ElemStation=0
Frame=46 Station=0,0917 OutputCase=RAR033 CaseType=Combination P=-6,26358214529129 V2=-7,80962185826832 V3=0 T=0 M2=0 M3=-18,4228393350301
FrameElem=46-1 ElemStation=0,0917
Frame=46 Station=0,1834 OutputCase=RAR033 CaseType=Combination P=-6,26358214529129 V2=-7,44282185826832 V3=0 T=0 M2=0 M3=-17,7235147906269
FrameElem=46-1 ElemStation=0,1834
Frame=46 Station=0 OutputCase=RAR034 CaseType=Combination P=-15,1645488908597 V2=9,72747795300269 V3=0 T=0 M2=0 M3=-17,8955883590191 FrameElem=46-1
ElemStation=0
Frame=46 Station=0,0917 OutputCase=RAR034 CaseType=Combination P=-15,1645488908597 V2=10,0942779530027 V3=0 T=0 M2=0 M3=-18,8044138673094
FrameElem=46-1 ElemStation=0,0917
Frame=46 Station=0,1834 OutputCase=RAR034 CaseType=Combination P=-15,1645488908597 V2=10,4610779530027 V3=0 T=0 M2=0 M3=-19,74687893355998
FrameElem=46-1 ElemStation=0,1834
Frame=46 Station=0 OutputCase=RAR035 CaseType=Combination P=-24,065515633867 V2=-8,17902993251106 V3=0 T=0 M2=0 M3=-16,6353772789686 FrameElem=46-1
ElemStation=0

APPROVATO S.D.P.
Società di Progetto
Brebemi SpA



Doc. N.
60235-0000-A00.doc

CODIFICA DOCUMENTO
04RCDII10000000000300A00

REV.
00

FOGLIO
615 di 628

Frame=46 Station=0,0917 OutputCase=RAR035 CaseType=Combination P=-24,065515633867 V2=-7,81222993251106 V3=0 T=0 M2=0 M3=-15,9021780141574
FrameElem=46-1 ElemStation=0,0917
Frame=46 Station=0,1834 OutputCase=RAR035 CaseType=Combination P=-24,065515633867 V2=-7,44542993251106 V3=0 T=0 M2=0 M3=-15,2026143093461
FrameElem=46-1 ElemStation=0,1834
Frame=46 Station=0 OutputCase=RAR036 CaseType=Combination P=-15,884651962821 V2=15,7334552595468 V3=0 T=0 M2=0 M3=-2,57251386935632 FrameElem=46-1
ElemStation=0
Frame=46 Station=0,0917 OutputCase=RAR036 CaseType=Combination P=-15,884651962821 V2=16,1002552595468 V3=0 T=0 M2=0 M3=-4,03208949665676
FrameElem=46-1 ElemStation=0,0917
Frame=46 Station=0,1834 OutputCase=RAR036 CaseType=Combination P=-15,884651962821 V2=16,4670552595468 V3=0 T=0 M2=0 M3=-5,5253006839572 FrameElem=46-1
ElemStation=0,1834
Frame=46 Station=0 OutputCase=RAR037 CaseType=Combination P=-24,7856187058283 V2=-2,17305262596698 V3=0 T=0 M2=0 M3=-1,31230278930587 FrameElem=46-1
ElemStation=0
Frame=46 Station=0,0917 OutputCase=RAR037 CaseType=Combination P=-24,7856187058283 V2=-1,80625262596698 V3=0 T=0 M2=0 M3=-1,12985164350469
FrameElem=46-1 ElemStation=0,0917
Frame=46 Station=0,1834 OutputCase=RAR037 CaseType=Combination P=-24,7856187058283 V2=-1,43945262596698 V3=0 T=0 M2=0 M3=-0,981036057703522
FrameElem=46-1 ElemStation=0,1834
Frame=46 Station=0 OutputCase=RAR038 CaseType=Combination P=-8,0563848624211 V2=-2,17136406013818 V3=0 T=0 M2=0 M3=-2,94411934702673 FrameElem=46-1
ElemStation=0
Frame=46 Station=0,0917 OutputCase=RAR038 CaseType=Combination P=-8,0563848624211 V2=-1,80456406013818 V3=0 T=0 M2=0 M3=-2,76182304271206
FrameElem=46-1 ElemStation=0,0917
Frame=46 Station=0,1834 OutputCase=RAR038 CaseType=Combination P=-8,0563848624211 V2=-1,43776406013818 V3=0 T=0 M2=0 M3=-2,61316229839739
FrameElem=46-1 ElemStation=0,1834
Frame=46 Station=0 OutputCase=RAR039 CaseType=Combination P=-6,78976182023413 V2=-10,1790710855073 V3=0 T=0 M2=0 M3=-23,6287726483134 FrameElem=46-1
ElemStation=0
Frame=46 Station=0,0917 OutputCase=RAR039 CaseType=Combination P=-6,78976182023413 V2=-9,81227108550726 V3=0 T=0 M2=0 M3=-22,7121696097724
FrameElem=46-1 ElemStation=0,0917
Frame=46 Station=0,1834 OutputCase=RAR039 CaseType=Combination P=-6,78976182023413 V2=-9,44547108550726 V3=0 T=0 M2=0 M3=-21,8292021312314
FrameElem=46-1 ElemStation=0,1834
Frame=46 Station=0 OutputCase=RAR040 CaseType=Combination P=-17,9908992160426 V2=12,8005020888952 V3=0 T=0 M2=0 M3=-22,0291266381482 FrameElem=46-1
ElemStation=0
Frame=46 Station=0,0917 OutputCase=RAR040 CaseType=Combination P=-17,9908992160426 V2=13,1673020888952 V3=0 T=0 M2=0 M3=-23,2197504596999
FrameElem=46-1 ElemStation=0,0917
Frame=46 Station=0,1834 OutputCase=RAR040 CaseType=Combination P=-17,9908992160426 V2=13,5341020888952 V3=0 T=0 M2=0 M3=-24,4440098412516
FrameElem=46-1 ElemStation=0,1834
Frame=46 Station=0 OutputCase=RAR041 CaseType=Combination P=-29,1920366088243 V2=-10,1823816384946 V3=0 T=0 M2=0 M3=-20,4294806284455 FrameElem=46-1
ElemStation=0
Frame=46 Station=0,0917 OutputCase=RAR041 CaseType=Combination P=-29,1920366088243 V2=-9,81558163849465 V3=0 T=0 M2=0 M3=-19,5125740121955
FrameElem=46-1 ElemStation=0,0917
Frame=46 Station=0,1834 OutputCase=RAR041 CaseType=Combination P=-29,1920366088243 V2=-9,44878163849465 V3=0 T=0 M2=0 M3=-18,6293029559456
FrameElem=46-1 ElemStation=0,1834
Frame=46 Station=0 OutputCase=RAR042 CaseType=Combination P=-18,9510366453243 V2=20,808471830954 V3=0 T=0 M2=0 M3=-1,5983606519312 FrameElem=46-1
ElemStation=0
Frame=46 Station=0,0917 OutputCase=RAR042 CaseType=Combination P=-18,9510366453243 V2=21,175271830954 V3=0 T=0 M2=0 M3=-3,52331529882968
FrameElem=46-1 ElemStation=0,0917
Frame=46 Station=0,1834 OutputCase=RAR042 CaseType=Combination P=-18,9510366453243 V2=21,542071830954 V3=0 T=0 M2=0 M3=-5,48190550572817
FrameElem=46-1 ElemStation=0,1834
Frame=46 Station=0 OutputCase=RAR043 CaseType=Combination P=-30,152174038106 V2=-2,17441189643587 V3=0 T=0 M2=0 M3=1,28535777152389E-03 FrameElem=46-1
ElemStation=0
Frame=46 Station=0,0917 OutputCase=RAR043 CaseType=Combination P=-30,152174038106 V2=-1,80761189643587 V3=0 T=0 M2=0 M3=0,183861148674693
FrameElem=46-1 ElemStation=0,0917
Frame=46 Station=0,1834 OutputCase=RAR043 CaseType=Combination P=-30,152174038106 V2=-1,44081189643587 V3=0 T=0 M2=0 M3=0,332801379577863
FrameElem=46-1 ElemStation=0,1834
Frame=46 Station=0 OutputCase=RAR044 CaseType=Combination P=-15,9307629249856 V2=33,303278066752 V3=0 T=0 M2=0 M3=-17,2608700712158 FrameElem=46-1
ElemStation=0
Frame=46 Station=0,0917 OutputCase=RAR044 CaseType=Combination P=-15,9307629249856 V2=33,670078066752 V3=0 T=0 M2=0 M3=-20,3315984499369
FrameElem=46-1 ElemStation=0,0917
Frame=46 Station=0,1834 OutputCase=RAR044 CaseType=Combination P=-15,9307629249856 V2=34,036878066752 V3=0 T=0 M2=0 M3=-23,4359623886581
FrameElem=46-1 ElemStation=0,1834
Frame=46 Station=0 OutputCase=RAR045 CaseType=Combination P=-7,33628179045985 V2=-8,17734136668226 V3=0 T=0 M2=0 M3=-18,2671938366895 FrameElem=46-1
ElemStation=0
Frame=46 Station=0,0917 OutputCase=RAR045 CaseType=Combination P=-7,33628179045985 V2=-7,81054136668226 V3=0 T=0 M2=0 M3=-17,5341494133647
FrameElem=46-1 ElemStation=0,0917
Frame=46 Station=0,1834 OutputCase=RAR045 CaseType=Combination P=-7,33628179045985 V2=-7,44374136668226 V3=0 T=0 M2=0 M3=-16,83474055004 FrameElem=46-1
ElemStation=0,1834
Frame=46 Station=0 OutputCase=RAR046 CaseType=Combination P=-16,2372485360283 V2=9,72655844458874 V3=0 T=0 M2=0 M3=-17,0069827562752 FrameElem=46-1
ElemStation=0
Frame=46 Station=0,0917 OutputCase=RAR046 CaseType=Combination P=-16,2372485360283 V2=10,0933584445887 V3=0 T=0 M2=0 M3=-17,915725945644
FrameElem=46-1 ElemStation=0,0917
Frame=46 Station=0,1834 OutputCase=RAR046 CaseType=Combination P=-16,2372485360283 V2=10,4601584445887 V3=0 T=0 M2=0 M3=-18,8581046950128
FrameElem=46-1 ElemStation=0,1834
Frame=46 Station=0 OutputCase=RAR047 CaseType=Combination P=-25,1382152790356 V2=-8,17994944092501 V3=0 T=0 M2=0 M3=-15,7467716762248 FrameElem=46-1
ElemStation=0
Frame=46 Station=0,0917 OutputCase=RAR047 CaseType=Combination P=-25,1382152790356 V2=-7,81314944092501 V3=0 T=0 M2=0 M3=-15,013488092492
FrameElem=46-1 ElemStation=0,0917
Frame=46 Station=0,1834 OutputCase=RAR047 CaseType=Combination P=-25,1382152790356 V2=-7,44634944092501 V3=0 T=0 M2=0 M3=-14,3138400687591
FrameElem=46-1 ElemStation=0,1834
Frame=46 Station=0 OutputCase=RAR048 CaseType=Combination P=-16,9573516079895 V2=15,7325357511328 V3=0 T=0 M2=0 M3=-1,68390826661248 FrameElem=46-1
ElemStation=0
Frame=46 Station=0,0917 OutputCase=RAR048 CaseType=Combination P=-16,9573516079895 V2=16,0993357511328 V3=0 T=0 M2=0 M3=-3,14339957499136
FrameElem=46-1 ElemStation=0,0917
Frame=46 Station=0,1834 OutputCase=RAR048 CaseType=Combination P=-16,9573516079895 V2=16,4661357511328 V3=0 T=0 M2=0 M3=-4,63652644337024
FrameElem=46-1 ElemStation=0,1834
Frame=46 Station=0 OutputCase=RAR049 CaseType=Combination P=-25,8583183509968 V2=-2,17397213438093 V3=0 T=0 M2=0 M3=-0,42369718656203 FrameElem=46-1
ElemStation=0
Frame=46 Station=0,0917 OutputCase=RAR049 CaseType=Combination P=-25,8583183509968 V2=-1,80717213438093 V3=0 T=0 M2=0 M3=-0,241161721839299
FrameElem=46-1 ElemStation=0,0917
Frame=46 Station=0,1834 OutputCase=RAR049 CaseType=Combination P=-25,8583183509968 V2=-1,44037213438093 V3=0 T=0 M2=0 M3=-9,22618171165677E-02
FrameElem=46-1 ElemStation=0,1834

Società di Progetto
Brebemi SpA



Doc. N.
60235-0000-A00.doc

CODIFICA DOCUMENTO
04RCDII10000000000300A00

REV.
00

FOGLIO
616 di 628

Frame=46 Station=0 OutputCase=RAR050 CaseType=Combination P=-8,24711125634329 V2=-1,7901717220651 V3=0 T=0 M2=0 M3=-2,89238720581625 FrameElem=46-1 ElemStation=0
Frame=46 Station=0,0917 OutputCase=RAR050 CaseType=Combination P=-8,24711125634329 V2=-1,4233717220651 V3=0 T=0 M2=0 M3=-2,74504623890288 FrameElem=46-1 ElemStation=0,0917
Frame=46 Station=0,1834 OutputCase=RAR050 CaseType=Combination P=-8,24711125634329 V2=-1,0565717220651 V3=0 T=0 M2=0 M3=-2,63134083198951 FrameElem=46-1 ElemStation=0,1834
Frame=46 Station=0 OutputCase=RAR051 CaseType=Combination P=-7,52700818438203 V2=-7,79614902860919 V3=0 T=0 M2=0 M3=-18,215461695479 FrameElem=46-1 ElemStation=0
Frame=46 Station=0,0917 OutputCase=RAR051 CaseType=Combination P=-7,52700818438203 V2=-7,42934902860919 V3=0 T=0 M2=0 M3=-17,5173726095555 FrameElem=46-1 ElemStation=0,0917
Frame=46 Station=0,1834 OutputCase=RAR051 CaseType=Combination P=-7,52700818438203 V2=-7,06254902860919 V3=0 T=0 M2=0 M3=-16,8529190836321 FrameElem=46-1 ElemStation=0,1834
Frame=46 Station=0 OutputCase=RAR052 CaseType=Combination P=-16,4279749299505 V2=10,1077507826618 V3=0 T=0 M2=0 M3=-16,9552506150648 FrameElem=46-1 ElemStation=0
Frame=46 Station=0,0917 OutputCase=RAR052 CaseType=Combination P=-16,4279749299505 V2=10,4745507826618 V3=0 T=0 M2=0 M3=-17,8989491418348 FrameElem=46-1 ElemStation=0,0917
Frame=46 Station=0,1834 OutputCase=RAR052 CaseType=Combination P=-16,4279749299505 V2=10,8413507826618 V3=0 T=0 M2=0 M3=-18,8762832286049 FrameElem=46-1 ElemStation=0,1834
Frame=46 Station=0 OutputCase=RAR053 CaseType=Combination P=-25,3289416729578 V2=-7,79875710285193 V3=0 T=0 M2=0 M3=-15,6950395350143 FrameElem=46-1 ElemStation=0
Frame=46 Station=0,0917 OutputCase=RAR053 CaseType=Combination P=-25,3289416729578 V2=-7,43195710285193 V3=0 T=0 M2=0 M3=-14,9967112886828 FrameElem=46-1 ElemStation=0,0917
Frame=46 Station=0,1834 OutputCase=RAR053 CaseType=Combination P=-25,3289416729578 V2=-7,06515710285193 V3=0 T=0 M2=0 M3=-14,3320186023513 FrameElem=46-1 ElemStation=0,1834
Frame=46 Station=0 OutputCase=RAR054 CaseType=Combination P=-17,1480780019117 V2=16,1137280892059 V3=0 T=0 M2=0 M3=-1,632176125402 FrameElem=46-1 ElemStation=0
Frame=46 Station=0,0917 OutputCase=RAR054 CaseType=Combination P=-17,1480780019117 V2=16,4805280892059 V3=0 T=0 M2=0 M3=-3,12662277118218 FrameElem=46-1 ElemStation=0,0917
Frame=46 Station=0,1834 OutputCase=RAR054 CaseType=Combination P=-17,1480780019117 V2=16,8473280892059 V3=0 T=0 M2=0 M3=-4,65470497696236 FrameElem=46-1 ElemStation=0,1834
Frame=46 Station=0 OutputCase=RAR055 CaseType=Combination P=-26,049044744919 V2=-1,79277979630785 V3=0 T=0 M2=0 M3=-0,371965045351545 FrameElem=46-1 ElemStation=0
Frame=46 Station=0,0917 OutputCase=RAR055 CaseType=Combination P=-26,049044744919 V2=-1,42597979630785 V3=0 T=0 M2=0 M3=-0,224384918030115 FrameElem=46-1 ElemStation=0,0917
Frame=46 Station=0,1834 OutputCase=RAR055 CaseType=Combination P=-26,049044744919 V2=-1,05917979630785 V3=0 T=0 M2=0 M3=-0,110440350708685 FrameElem=46-1 ElemStation=0,1834
Frame=46 Station=0 OutputCase=RAR056 CaseType=Combination P=-7,86565846849892 V2=-2,55255639821126 V3=0 T=0 M2=0 M3=-2,99585148823722 FrameElem=46-1 ElemStation=0
Frame=46 Station=0,0917 OutputCase=RAR056 CaseType=Combination P=-7,86565846849892 V2=-2,18575639821126 V3=0 T=0 M2=0 M3=-2,77859984652125 FrameElem=46-1 ElemStation=0,0917
Frame=46 Station=0,1834 OutputCase=RAR056 CaseType=Combination P=-7,86565846849892 V2=-1,81895639821126 V3=0 T=0 M2=0 M3=-2,59498376480527 FrameElem=46-1 ElemStation=0,1834
Frame=46 Station=0 OutputCase=RAR057 CaseType=Combination P=-7,1455539653767 V2=-8,55853370475534 V3=0 T=0 M2=0 M3=-18,3189259779 FrameElem=46-1 ElemStation=0
Frame=46 Station=0,0917 OutputCase=RAR057 CaseType=Combination P=-7,1455539653767 V2=-8,19173370475534 V3=0 T=0 M2=0 M3=-17,5509262171739 FrameElem=46-1 ElemStation=0,0917
Frame=46 Station=0,1834 OutputCase=RAR057 CaseType=Combination P=-7,1455539653767 V2=-7,82493370475534 V3=0 T=0 M2=0 M3=-16,8165620164478 FrameElem=46-1 ElemStation=0,1834
Frame=46 Station=0 OutputCase=RAR058 CaseType=Combination P=-16,0465221421061 V2=9,34536610651566 V3=0 T=0 M2=0 M3=-17,0587148974857 FrameElem=46-1 ElemStation=0
Frame=46 Station=0,0917 OutputCase=RAR058 CaseType=Combination P=-16,0465221421061 V2=9,71216610651566 V3=0 T=0 M2=0 M3=-17,9325027494532 FrameElem=46-1 ElemStation=0,0917
Frame=46 Station=0,1834 OutputCase=RAR058 CaseType=Combination P=-16,0465221421061 V2=10,0789661065157 V3=0 T=0 M2=0 M3=-18,8399261614207 FrameElem=46-1 ElemStation=0,1834
Frame=46 Station=0 OutputCase=RAR059 CaseType=Combination P=-24,9474888851134 V2=-8,56114177899808 V3=0 T=0 M2=0 M3=-15,7985038174353 FrameElem=46-1 ElemStation=0
Frame=46 Station=0,0917 OutputCase=RAR059 CaseType=Combination P=-24,9474888851134 V2=-8,19434177899809 V3=0 T=0 M2=0 M3=-15,0302648963011 FrameElem=46-1 ElemStation=0,0917
Frame=46 Station=0,1834 OutputCase=RAR059 CaseType=Combination P=-24,9474888851134 V2=-7,82754177899809 V3=0 T=0 M2=0 M3=-14,295661535167 FrameElem=46-1 ElemStation=0,1834
Frame=46 Station=0 OutputCase=RAR060 CaseType=Combination P=-16,7666252140674 V2=15,3513434130597 V3=0 T=0 M2=0 M3=-1,73564040782297 FrameElem=46-1 ElemStation=0
Frame=46 Station=0,0917 OutputCase=RAR060 CaseType=Combination P=-16,7666252140674 V2=15,7181434130597 V3=0 T=0 M2=0 M3=-3,16017637880055 FrameElem=46-1 ElemStation=0,0917
Frame=46 Station=0,1834 OutputCase=RAR060 CaseType=Combination P=-16,7666252140674 V2=16,0849434130597 V3=0 T=0 M2=0 M3=-4,61834790977812 FrameElem=46-1 ElemStation=0,1834
Frame=46 Station=0 OutputCase=RAR061 CaseType=Combination P=-25,6675919570747 V2=-2,555164472454 V3=0 T=0 M2=0 M3=-0,475429327772514 FrameElem=46-1 ElemStation=0
Frame=46 Station=0,0917 OutputCase=RAR061 CaseType=Combination P=-25,6675919570747 V2=-2,188364472454 V3=0 T=0 M2=0 M3=-0,257938525648482 FrameElem=46-1 ElemStation=0,0917
Frame=46 Station=0,1834 OutputCase=RAR061 CaseType=Combination P=-25,6675919570747 V2=-1,821564472454 V3=0 T=0 M2=0 M3=-0,07408328352445 FrameElem=46-1 ElemStation=0,1834
Frame=46 Station=0 OutputCase=RAR062 CaseType=Combination P=-8,51611328177906 V2=-2,17175813517273 V3=0 T=0 M2=0 M3=-2,56328837442223 FrameElem=46-1 ElemStation=0
Frame=46 Station=0,0917 OutputCase=RAR062 CaseType=Combination P=-8,51611328177906 V2=-1,80495813517273 V3=0 T=0 M2=0 M3=-2,38095593342689 FrameElem=46-1 ElemStation=0,0917
Frame=46 Station=0,1834 OutputCase=RAR062 CaseType=Combination P=-8,51611328177906 V2=-1,43815813517273 V3=0 T=0 M2=0 M3=-2,23225905243155 FrameElem=46-1 ElemStation=0,1834
Frame=46 Station=0 OutputCase=RAR063 CaseType=Combination P=-7,7960102098178 V2=-8,17773544171681 V3=0 T=0 M2=0 M3=-17,886362864085 FrameElem=46-1 ElemStation=0
Frame=46 Station=0,0917 OutputCase=RAR063 CaseType=Combination P=-7,7960102098178 V2=-7,81093544171681 V3=0 T=0 M2=0 M3=-17,1532823040796 FrameElem=46-1 ElemStation=0,0917
Frame=46 Station=0,1834 OutputCase=RAR063 CaseType=Combination P=-7,7960102098178 V2=-7,44413544171681 V3=0 T=0 M2=0 M3=-16,4538373040741 FrameElem=46-1 ElemStation=0,1834
Frame=46 Station=0 OutputCase=RAR064 CaseType=Combination P=-16,6969769553862 V2=9,72616436955419 V3=0 T=0 M2=0 M3=-16,6261517836707 FrameElem=46-1 ElemStation=0
Frame=46 Station=0,0917 OutputCase=RAR064 CaseType=Combination P=-16,6969769553862 V2=10,0929643695542 V3=0 T=0 M2=0 M3=-17,5348588363589 FrameElem=46-1 ElemStation=0,0917

Società di Progetto
Brebemi SpA

	Doc. N. 60235-0000-A00.doc	CODIFICA DOCUMENTO 04RCDII10000000000300A00	REV. 00	FOGLIO 617 di 628
--	-------------------------------	--	------------	----------------------

Frame=46 Station=0,1834 OutputCase=RAR064 CaseType=Combination P=-16,6969769553862 V2=10,4597643695542 V3=0 T=0 M2=0 M3=-18,477201449047
 FrameElem=46-1 ElemStation=0,1834
 Frame=46 Station=0 OutputCase=RAR065 CaseType=Combination P=-25,5979436983935 V2=-8,18034351595955 V3=0 T=0 M2=0 M3=-15,3659407036203 FrameElem=46-1
 ElemStation=0
 Frame=46 Station=0,0917 OutputCase=RAR065 CaseType=Combination P=-25,5979436983935 V2=-7,81354351595956 V3=0 T=0 M2=0 M3=-14,6326209832068
 FrameElem=46-1 ElemStation=0,0917
 Frame=46 Station=0,1834 OutputCase=RAR065 CaseType=Combination P=-25,5979436983935 V2=-7,44674351595955 V3=0 T=0 M2=0 M3=-13,9329368227933
 FrameElem=46-1 ElemStation=0,1834
 Frame=46 Station=0 OutputCase=RAR066 CaseType=Combination P=-17,4170800273475 V2=15,7321416760983 V3=0 T=0 M2=0 M3=-1,30307729400798 FrameElem=46-1
 ElemStation=0
 Frame=46 Station=0,0917 OutputCase=RAR066 CaseType=Combination P=-17,4170800273475 V2=16,0989416760983 V3=0 T=0 M2=0 M3=-2,76253246570619
 FrameElem=46-1 ElemStation=0,0917
 Frame=46 Station=0,1834 OutputCase=RAR066 CaseType=Combination P=-17,4170800273475 V2=16,4657416760983 V3=0 T=0 M2=0 M3=-4,2556231974044
 FrameElem=46-1 ElemStation=0,1834
 Frame=46 Station=0 OutputCase=RAR067 CaseType=Combination P=-26,3180467703548 V2=-2,17436620941547 V3=0 T=0 M2=0 M3=-0,042866213957528 FrameElem=46-1
 ElemStation=0
 Frame=46 Station=0,0917 OutputCase=RAR067 CaseType=Combination P=-26,3180467703548 V2=-1,80756620941547 V3=0 T=0 M2=0 M3=0,139705387445871
 FrameElem=46-1 ElemStation=0,0917
 Frame=46 Station=0,1834 OutputCase=RAR067 CaseType=Combination P=-26,3180467703548 V2=-1,44076620941547 V3=0 T=0 M2=0 M3=0,28864142884927
 FrameElem=46-1 ElemStation=0,1834
 Frame=46 Station=0 OutputCase=RAR068 CaseType=Combination P=-7,60804815336149 V2=-1,5353867049588 V3=0 T=0 M2=0 M3=-3,4926173993501 FrameElem=46-1
 ElemStation=0
 Frame=46 Station=0,0917 OutputCase=RAR068 CaseType=Combination P=-7,60804815336149 V2=-1,1685867049588 V3=0 T=0 M2=0 M3=-3,36864021850537
 FrameElem=46-1 ElemStation=0,0917
 Frame=46 Station=0,1834 OutputCase=RAR068 CaseType=Combination P=-7,60804815336149 V2=-0,801786704958804 V3=0 T=0 M2=0 M3=-3,27829859766065
 FrameElem=46-1 ElemStation=0,1834
 Frame=46 Station=0 OutputCase=RAR069 CaseType=Combination P=-6,52075979479836 V2=-9,79748462739963 V3=0 T=0 M2=0 M3=-23,9578714797074 FrameElem=46-1
 ElemStation=0
 Frame=46 Station=0,0917 OutputCase=RAR069 CaseType=Combination P=-6,52075979479836 V2=-9,43068467239963 V3=0 T=0 M2=0 M3=-23,0762599152484
 FrameElem=46-1 ElemStation=0,0917
 Frame=46 Station=0,1834 OutputCase=RAR069 CaseType=Combination P=-6,52075979479836 V2=-9,06388467239963 V3=0 T=0 M2=0 M3=-22,2282839107893
 FrameElem=46-1 ElemStation=0,1834
 Frame=46 Station=0 OutputCase=RAR070 CaseType=Combination P=-17,7218971906068 V2=13,1820885020029 V3=0 T=0 M2=0 M3=-22,3582254695422 FrameElem=46-1
 ElemStation=0
 Frame=46 Station=0,0917 OutputCase=RAR070 CaseType=Combination P=-17,7218971906068 V2=13,5488885020029 V3=0 T=0 M2=0 M3=-23,5838407651759
 FrameElem=46-1 ElemStation=0,0917
 Frame=46 Station=0,1834 OutputCase=RAR070 CaseType=Combination P=-17,7218971906068 V2=13,9156885020029 V3=0 T=0 M2=0 M3=-24,8430916208096
 FrameElem=46-1 ElemStation=0,1834
 Frame=46 Station=0 OutputCase=RAR071 CaseType=Combination P=-28,9230345833885 V2=-9,80079522538702 V3=0 T=0 M2=0 M3=-20,7585794598395 FrameElem=46-1
 ElemStation=0
 Frame=46 Station=0,0917 OutputCase=RAR071 CaseType=Combination P=-28,9230345833885 V2=-9,43399522538702 V3=0 T=0 M2=0 M3=-19,8766643176715
 FrameElem=46-1 ElemStation=0,0917
 Frame=46 Station=0,1834 OutputCase=RAR071 CaseType=Combination P=-28,9230345833885 V2=-9,06719522538702 V3=0 T=0 M2=0 M3=-19,0283847355035
 FrameElem=46-1 ElemStation=0,1834
 Frame=46 Station=0 OutputCase=RAR072 CaseType=Combination P=-18,6820346198885 V2=21,1900582440616 V3=0 T=0 M2=0 M3=-1,92745948332522 FrameElem=46-1
 ElemStation=0
 Frame=46 Station=0,0917 OutputCase=RAR072 CaseType=Combination P=-18,6820346198885 V2=21,5568582440616 V3=0 T=0 M2=0 M3=-3,88740560430567
 FrameElem=46-1 ElemStation=0,0917
 Frame=46 Station=0,1834 OutputCase=RAR072 CaseType=Combination P=-18,6820346198885 V2=21,9236582440616 V3=0 T=0 M2=0 M3=-5,88098728528612
 FrameElem=46-1 ElemStation=0,1834
 Frame=46 Station=0 OutputCase=RAR073 CaseType=Combination P=-29,8831720126702 V2=-1,79282548332824 V3=0 T=0 M2=0 M3=-0,327813473622493 FrameElem=46-1
 ElemStation=0
 Frame=46 Station=0,0917 OutputCase=RAR073 CaseType=Combination P=-29,8831720126702 V2=-1,42602548332825 V3=0 T=0 M2=0 M3=-0,180229156801293
 FrameElem=46-1 ElemStation=0,0917
 Frame=46 Station=0,1834 OutputCase=RAR073 CaseType=Combination P=-29,8831720126702 V2=-1,05922548332824 V3=0 T=0 M2=0 M3=-6,6280399800923E-02
 FrameElem=46-1 ElemStation=0,1834
 Frame=46 Station=0 OutputCase=RAR074 CaseType=Combination P=-15,6617608995499 V2=33,6848644798597 V3=0 T=0 M2=0 M3=-17,5899689026098 FrameElem=46-1
 ElemStation=0
 Frame=46 Station=0,0917 OutputCase=RAR074 CaseType=Combination P=-15,6617608995499 V2=34,0516644798597 V3=0 T=0 M2=0 M3=-20,6956887554129
 FrameElem=46-1 ElemStation=0,0917
 Frame=46 Station=0,1834 OutputCase=RAR074 CaseType=Combination P=-15,6617608995499 V2=34,4184644798597 V3=0 T=0 M2=0 M3=-23,835044168216
 FrameElem=46-1 ElemStation=0,1834
 Frame=46 Station=0 OutputCase=RAR075 CaseType=Combination P=-6,88794508140024 V2=-7,54136401150289 V3=0 T=0 M2=0 M3=-18,8156918890129 FrameElem=46-1
 ElemStation=0
 Frame=46 Station=0,0917 OutputCase=RAR075 CaseType=Combination P=-6,88794508140024 V2=-7,17456401150289 V3=0 T=0 M2=0 M3=-18,140966589158
 FrameElem=46-1 ElemStation=0,0917
 Frame=46 Station=0,1834 OutputCase=RAR075 CaseType=Combination P=-6,88794508140024 V2=-6,80776401150289 V3=0 T=0 M2=0 M3=-17,4998768493032
 FrameElem=46-1 ElemStation=0,1834
 Frame=46 Station=0 OutputCase=RAR076 CaseType=Combination P=-15,7889118269687 V2=10,3625357997681 V3=0 T=0 M2=0 M3=-17,5554808085986 FrameElem=46-1
 ElemStation=0
 Frame=46 Station=0,0917 OutputCase=RAR076 CaseType=Combination P=-15,7889118269687 V2=10,7293357997681 V3=0 T=0 M2=0 M3=-18,5225431214373
 FrameElem=46-1 ElemStation=0,0917
 Frame=46 Station=0,1834 OutputCase=RAR076 CaseType=Combination P=-15,7889118269687 V2=11,0961357997681 V3=0 T=0 M2=0 M3=-19,5232409942761
 FrameElem=46-1 ElemStation=0,1834
 Frame=46 Station=0 OutputCase=RAR077 CaseType=Combination P=-24,689878569976 V2=-7,54397208574563 V3=0 T=0 M2=0 M3=-16,2952697285481 FrameElem=46-1
 ElemStation=0
 Frame=46 Station=0,0917 OutputCase=RAR077 CaseType=Combination P=-24,689878569976 V2=-7,17717208574563 V3=0 T=0 M2=0 M3=-15,6203052682853
 FrameElem=46-1 ElemStation=0,0917
 Frame=46 Station=0,1834 OutputCase=RAR077 CaseType=Combination P=-24,689878569976 V2=-6,81037208574563 V3=0 T=0 M2=0 M3=-14,9789763680224
 FrameElem=46-1 ElemStation=0,1834
 Frame=46 Station=0 OutputCase=RAR078 CaseType=Combination P=-16,5090148989299 V2=16,3685131063122 V3=0 T=0 M2=0 M3=-2,23240631893584 FrameElem=46-1
 ElemStation=0
 Frame=46 Station=0,0917 OutputCase=RAR078 CaseType=Combination P=-16,5090148989299 V2=16,7353131063122 V3=0 T=0 M2=0 M3=-3,75021678078467
 FrameElem=46-1 ElemStation=0,0917
 Frame=46 Station=0,1834 OutputCase=RAR078 CaseType=Combination P=-16,5090148989299 V2=17,1021131063122 V3=0 T=0 M2=0 M3=-5,3016627426335
 FrameElem=46-1 ElemStation=0,1834
 Frame=46 Station=0 OutputCase=RAR079 CaseType=Combination P=-25,4099816419372 V2=-1,53799477920155 V3=0 T=0 M2=0 M3=-0,972195238885391 FrameElem=46-1
 ElemStation=0

Società di Progetto
Brebemi SpA

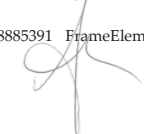



Doc. N.
60235-0000-A00.doc

CODIFICA DOCUMENTO
04RCDII10000000000300A00

REV.
00

FOGLIO
618 di 628

Frame=46 Station=0,0917 OutputCase=RAR079 CaseType=Combination P=-25,4099816419372 V2=-1,17119477920155 V3=0 T=0 M2=0 M3=-0,847978897632609
FrameElem=46-1 ElemStation=0,0917
Frame=46 Station=0,1834 OutputCase=RAR079 CaseType=Combination P=-25,4099816419372 V2=-0,804394779201549 V3=0 T=0 M2=0 M3=-0,757398116379826
FrameElem=46-1 ElemStation=0,1834
Frame=46 Station=0 OutputCase=RAR080 CaseType=Combination P=-7,14831973400354 V2=-1,53499262992426 V3=0 T=0 M2=0 M3=-3,8734483719546
FrameElem=46-1 ElemStation=0
Frame=46 Station=0,0917 OutputCase=RAR080 CaseType=Combination P=-7,14831973400354 V2=-1,16819262992426 V3=0 T=0 M2=0 M3=-3,74950732779054
FrameElem=46-1 ElemStation=0,0917
Frame=46 Station=0,1834 OutputCase=RAR080 CaseType=Combination P=-7,14831973400354 V2=-0,801392629924256 V3=0 T=0 M2=0 M3=-3,65920184362649
FrameElem=46-1 ElemStation=0,1834
Frame=46 Station=0 OutputCase=RAR081 CaseType=Combination P=-6,42821666204228 V2=-7,54096993646834 V3=0 T=0 M2=0 M3=-19,1965228616174
FrameElem=46-1 ElemStation=0
Frame=46 Station=0,0917 OutputCase=RAR081 CaseType=Combination P=-6,42821666204228 V2=-7,17416993646834 V3=0 T=0 M2=0 M3=-18,5218336984432
FrameElem=46-1 ElemStation=0,0917
Frame=46 Station=0,1834 OutputCase=RAR081 CaseType=Combination P=-6,42821666204228 V2=-6,80736993646834 V3=0 T=0 M2=0 M3=-17,8807800952691
FrameElem=46-1 ElemStation=0,1834
Frame=46 Station=0 OutputCase=RAR082 CaseType=Combination P=-15,3291834076107 V2=10,3629298748027 V3=0 T=0 M2=0 M3=-17,9363117812031
FrameElem=46-1 ElemStation=0
Frame=46 Station=0,0917 OutputCase=RAR082 CaseType=Combination P=-15,3291834076107 V2=10,7297298748027 V3=0 T=0 M2=0 M3=-18,9034102307225
FrameElem=46-1 ElemStation=0,0917
Frame=46 Station=0,1834 OutputCase=RAR082 CaseType=Combination P=-15,3291834076107 V2=11,0965298748027 V3=0 T=0 M2=0 M3=-19,9041442402419
FrameElem=46-1 ElemStation=0,1834
Frame=46 Station=0 OutputCase=RAR083 CaseType=Combination P=-24,230150150618 V2=-7,54357801071108 V3=0 T=0 M2=0 M3=-16,6761007011527
FrameElem=46-1 ElemStation=0
Frame=46 Station=0,0917 OutputCase=RAR083 CaseType=Combination P=-24,230150150618 V2=-7,17677801071108 V3=0 T=0 M2=0 M3=-16,0011723775704
FrameElem=46-1 ElemStation=0,0917
Frame=46 Station=0,1834 OutputCase=RAR083 CaseType=Combination P=-24,230150150618 V2=-6,80997801071108 V3=0 T=0 M2=0 M3=-15,3598796139882
FrameElem=46-1 ElemStation=0,1834
Frame=46 Station=0 OutputCase=RAR084 CaseType=Combination P=-16,049286479572 V2=16,3689071813467 V3=0 T=0 M2=0 M3=-2,61323729154035
FrameElem=46-1 ElemStation=0
Frame=46 Station=0,0917 OutputCase=RAR084 CaseType=Combination P=-16,049286479572 V2=16,7357071813467 V3=0 T=0 M2=0 M3=-4,13108386006984
FrameElem=46-1 ElemStation=0,0917
Frame=46 Station=0,1834 OutputCase=RAR084 CaseType=Combination P=-16,049286479572 V2=17,1025071813467 V3=0 T=0 M2=0 M3=-5,68256598859934
FrameElem=46-1 ElemStation=0,1834
Frame=46 Station=0 OutputCase=RAR085 CaseType=Combination P=-24,9502532225793 V2=-1,537600704167 V3=0 T=0 M2=0 M3=-1,35302621148989
FrameElem=46-1 ElemStation=0
Frame=46 Station=0,0917 OutputCase=RAR085 CaseType=Combination P=-24,9502532225793 V2=-1,170800704167 V3=0 T=0 M2=0 M3=-1,22884600691778
FrameElem=46-1 ElemStation=0,0917
Frame=46 Station=0,1834 OutputCase=RAR085 CaseType=Combination P=-24,9502532225793 V2=-0,804000704167001 V3=0 T=0 M2=0 M3=-1,13830136234566
FrameElem=46-1 ElemStation=0,1834
Frame=46 Station=0 OutputCase=RAR086 CaseType=Combination P=-8,06777657271944 V2=-1,53578077999335 V3=0 T=0 M2=0 M3=-3,11178642674559
FrameElem=46-1 ElemStation=0
Frame=46 Station=0,0917 OutputCase=RAR086 CaseType=Combination P=-8,06777657271944 V2=-1,16898077999335 V3=0 T=0 M2=0 M3=-2,9877731092202
FrameElem=46-1 ElemStation=0,0917
Frame=46 Station=0,1834 OutputCase=RAR086 CaseType=Combination P=-8,06777657271944 V2=-0,802180779993352 V3=0 T=0 M2=0 M3=-2,89739535169481
FrameElem=46-1 ElemStation=0,1834
Frame=46 Station=0 OutputCase=RAR087 CaseType=Combination P=-7,34767350075819 V2=-7,54175808653743 V3=0 T=0 M2=0 M3=-18,4348609164084
FrameElem=46-1 ElemStation=0
Frame=46 Station=0,0917 OutputCase=RAR087 CaseType=Combination P=-7,34767350075819 V2=-7,17495808653743 V3=0 T=0 M2=0 M3=-17,7600994798729
FrameElem=46-1 ElemStation=0,0917
Frame=46 Station=0,1834 OutputCase=RAR087 CaseType=Combination P=-7,34767350075819 V2=-6,80815808653743 V3=0 T=0 M2=0 M3=-17,1189736033374
FrameElem=46-1 ElemStation=0,1834
Frame=46 Station=0 OutputCase=RAR088 CaseType=Combination P=-16,2486402463266 V2=10,3621417247336 V3=0 T=0 M2=0 M3=-17,1746498359941
FrameElem=46-1 ElemStation=0
Frame=46 Station=0,0917 OutputCase=RAR088 CaseType=Combination P=-16,2486402463266 V2=10,7289417247336 V3=0 T=0 M2=0 M3=-18,1416760121522
FrameElem=46-1 ElemStation=0,0917
Frame=46 Station=0,1834 OutputCase=RAR088 CaseType=Combination P=-16,2486402463266 V2=11,0957417247336 V3=0 T=0 M2=0 M3=-19,1423377483102
FrameElem=46-1 ElemStation=0,1834
Frame=46 Station=0 OutputCase=RAR089 CaseType=Combination P=-25,1496069893339 V2=-7,54436616078018 V3=0 T=0 M2=0 M3=-15,9144387559436
FrameElem=46-1 ElemStation=0
Frame=46 Station=0,0917 OutputCase=RAR089 CaseType=Combination P=-25,1496069893339 V2=-7,17756616078018 V3=0 T=0 M2=0 M3=-15,2394381590001
FrameElem=46-1 ElemStation=0,0917
Frame=46 Station=0,1834 OutputCase=RAR089 CaseType=Combination P=-25,1496069893339 V2=-6,81076616078018 V3=0 T=0 M2=0 M3=-14,5980731220566
FrameElem=46-1 ElemStation=0,1834
Frame=46 Station=0 OutputCase=RAR090 CaseType=Combination P=-16,9687433182879 V2=16,3681190312777 V3=0 T=0 M2=0 M3=-1,85157534633134
FrameElem=46-1 ElemStation=0
Frame=46 Station=0,0917 OutputCase=RAR090 CaseType=Combination P=-16,9687433182879 V2=16,7349190312776 V3=0 T=0 M2=0 M3=-3,3693496414995
FrameElem=46-1 ElemStation=0,0917
Frame=46 Station=0,1834 OutputCase=RAR090 CaseType=Combination P=-16,9687433182879 V2=17,1017190312777 V3=0 T=0 M2=0 M3=-4,92075949666766
FrameElem=46-1 ElemStation=0,1834
Frame=46 Station=0 OutputCase=RAR091 CaseType=Combination P=-25,8697100612952 V2=-1,5383888542361 V3=0 T=0 M2=0 M3=-0,591364266280889
FrameElem=46-1 ElemStation=0
Frame=46 Station=0,0917 OutputCase=RAR091 CaseType=Combination P=-25,8697100612952 V2=-1,1715888542361 V3=0 T=0 M2=0 M3=-0,467111788347439
FrameElem=46-1 ElemStation=0,0917
Frame=46 Station=0,1834 OutputCase=RAR091 CaseType=Combination P=-25,8697100612952 V2=-0,804788854236097 V3=0 T=0 M2=0 M3=-0,376494870413989
FrameElem=46-1 ElemStation=0,1834
Frame=46 Station=0 OutputCase=RAR092 CaseType=Combination P=-8,06777657271944 V2=-1,53578077999335 V3=0 T=0 M2=0 M3=-3,11178642674559
FrameElem=46-1 ElemStation=0
Frame=46 Station=0,0917 OutputCase=RAR092 CaseType=Combination P=-8,06777657271944 V2=-1,16898077999335 V3=0 T=0 M2=0 M3=-2,9877731092202
FrameElem=46-1 ElemStation=0,0917
Frame=46 Station=0,1834 OutputCase=RAR092 CaseType=Combination P=-8,06777657271944 V2=-0,802180779993352 V3=0 T=0 M2=0 M3=-2,89739535169481
FrameElem=46-1 ElemStation=0,1834
Frame=46 Station=0 OutputCase=RAR093 CaseType=Combination P=-7,34767350075819 V2=-7,54175808653743 V3=0 T=0 M2=0 M3=-18,4348609164084
FrameElem=46-1 ElemStation=0
Frame=46 Station=0,0917 OutputCase=RAR093 CaseType=Combination P=-7,34767350075819 V2=-7,17495808653743 V3=0 T=0 M2=0 M3=-17,7600994798729
FrameElem=46-1 ElemStation=0,0917
Frame=46 Station=0,1834 OutputCase=RAR093 CaseType=Combination P=-7,34767350075819 V2=-6,80815808653743 V3=0 T=0 M2=0 M3=-17,1189736033374
FrameElem=46-1 ElemStation=0,1834

Società di Progetto
Brebemi SpA

	Doc. N. 60235-0000-A00.doc	CODIFICA DOCUMENTO 04RCDII10000000000300A00	REV. 00	FOGLIO 619 di 628
--	-------------------------------	--	------------	----------------------

Frame=46 Station=0 OutputCase=RAR094 CaseType=Combination P=-16,2486402463266 V2=10,3621417247336 V3=0 T=0 M2=0 M3=-17,1746498359941 FrameElem=46-1 ElemStation=0

Frame=46 Station=0,0917 OutputCase=RAR094 CaseType=Combination P=-16,2486402463266 V2=10,7289417247336 V3=0 T=0 M2=0 M3=-18,1416760121522 FrameElem=46-1 ElemStation=0,0917

Frame=46 Station=0,1834 OutputCase=RAR094 CaseType=Combination P=-16,2486402463266 V2=11,0957417247336 V3=0 T=0 M2=0 M3=-19,1423377483102 FrameElem=46-1 ElemStation=0,1834

Frame=46 Station=0 OutputCase=RAR095 CaseType=Combination P=-25,1496069893339 V2=-7,54436616078018 V3=0 T=0 M2=0 M3=-15,9144387559436 FrameElem=46-1 ElemStation=0

Frame=46 Station=0,0917 OutputCase=RAR095 CaseType=Combination P=-25,1496069893339 V2=-7,17756616078018 V3=0 T=0 M2=0 M3=-15,2394381590001 FrameElem=46-1 ElemStation=0,0917

Frame=46 Station=0,1834 OutputCase=RAR095 CaseType=Combination P=-25,1496069893339 V2=-6,81076616078018 V3=0 T=0 M2=0 M3=-14,5980731220566 FrameElem=46-1 ElemStation=0,1834

Frame=46 Station=0 OutputCase=RAR096 CaseType=Combination P=-16,9687433182879 V2=16,3681190312777 V3=0 T=0 M2=0 M3=-1,85157534633134 FrameElem=46-1 ElemStation=0

Frame=46 Station=0,0917 OutputCase=RAR096 CaseType=Combination P=-16,9687433182879 V2=16,7349190312776 V3=0 T=0 M2=0 M3=-3,3693496414995 FrameElem=46-1 ElemStation=0,0917

Frame=46 Station=0,1834 OutputCase=RAR096 CaseType=Combination P=-16,9687433182879 V2=17,1017190312777 V3=0 T=0 M2=0 M3=-4,92075949666766 FrameElem=46-1 ElemStation=0,1834

Frame=46 Station=0 OutputCase=RAR097 CaseType=Combination P=-25,8697100612952 V2=-1,5383888542361 V3=0 T=0 M2=0 M3=-0,591364266280889 FrameElem=46-1 ElemStation=0

Frame=46 Station=0,0917 OutputCase=RAR097 CaseType=Combination P=-25,8697100612952 V2=-1,1715888542361 V3=0 T=0 M2=0 M3=-0,467111788347439 FrameElem=46-1 ElemStation=0,0917

Frame=46 Station=0,1834 OutputCase=RAR097 CaseType=Combination P=-25,8697100612952 V2=-0,804788854236097 V3=0 T=0 M2=0 M3=-0,376494870413989 FrameElem=46-1 ElemStation=0,1834

Frame=46 Station=0 OutputCase=RAR098 CaseType=Combination P=-6,97229350695421 V2=-2,80602783186907 V3=0 T=0 M2=0 M3=-3,66505787005171 FrameElem=46-1 ElemStation=0

Frame=46 Station=0,0917 OutputCase=RAR098 CaseType=Combination P=-6,97229350695421 V2=-2,43922783186907 V3=0 T=0 M2=0 M3=-3,42456289786932 FrameElem=46-1 ElemStation=0,0917

Frame=46 Station=0,1834 OutputCase=RAR098 CaseType=Combination P=-6,97229350695421 V2=-2,07242783186907 V3=0 T=0 M2=0 M3=-3,21770348568692 FrameElem=46-1 ElemStation=0,1834

Frame=46 Station=0 OutputCase=RAR099 CaseType=Combination P=-6,13930700695399 V2=-10,5598693485458 V3=0 T=0 M2=0 M3=-24,0613357621284 FrameElem=46-1 ElemStation=0

Frame=46 Station=0,0917 OutputCase=RAR099 CaseType=Combination P=-6,13930700695399 V2=-10,1930693485458 V3=0 T=0 M2=0 M3=-23,1098135228667 FrameElem=46-1 ElemStation=0,0917

Frame=46 Station=0,1834 OutputCase=RAR099 CaseType=Combination P=-6,13930700695399 V2=-9,82626934854579 V3=0 T=0 M2=0 M3=-22,1919268436051 FrameElem=46-1 ElemStation=0,1834

Frame=46 Station=0 OutputCase=RAR100 CaseType=Combination P=-17,3404444027625 V2=12,4197038258567 V3=0 T=0 M2=0 M3=-22,4616897519632 FrameElem=46-1 ElemStation=0

Frame=46 Station=0,0917 OutputCase=RAR100 CaseType=Combination P=-17,3404444027625 V2=12,7865038258567 V3=0 T=0 M2=0 M3=-23,6173943727943 FrameElem=46-1 ElemStation=0,0917

Frame=46 Station=0,1834 OutputCase=RAR100 CaseType=Combination P=-17,3404444027625 V2=13,1533038258567 V3=0 T=0 M2=0 M3=-24,8067345536253 FrameElem=46-1 ElemStation=0,1834

Frame=46 Station=0 OutputCase=RAR101 CaseType=Combination P=-28,5415817955441 V2=-10,5631799015332 V3=0 T=0 M2=0 M3=-20,8620437422605 FrameElem=46-1 ElemStation=0

Frame=46 Station=0,0917 OutputCase=RAR101 CaseType=Combination P=-28,5415817955441 V2=-10,1963799015332 V3=0 T=0 M2=0 M3=-19,9102179252899 FrameElem=46-1 ElemStation=0,0917

Frame=46 Station=0,1834 OutputCase=RAR101 CaseType=Combination P=-28,5415817955441 V2=-9,82957990153318 V3=0 T=0 M2=0 M3=-18,9920276683193 FrameElem=46-1 ElemStation=0,1834

Frame=46 Station=0 OutputCase=RAR102 CaseType=Combination P=-18,3005818320441 V2=20,4276735679155 V3=0 T=0 M2=0 M3=-2,03092376574619 FrameElem=46-1 ElemStation=0

Frame=46 Station=0,0917 OutputCase=RAR102 CaseType=Combination P=-18,3005818320441 V2=20,7944735679155 V3=0 T=0 M2=0 M3=-3,92095921192404 FrameElem=46-1 ElemStation=0,0917

Frame=46 Station=0,1834 OutputCase=RAR102 CaseType=Combination P=-18,3005818320441 V2=21,1612735679155 V3=0 T=0 M2=0 M3=-5,84463021810189 FrameElem=46-1 ElemStation=0,1834

Frame=46 Station=0 OutputCase=RAR103 CaseType=Combination P=-29,5017192248258 V2=-2,5552101594744 V3=0 T=0 M2=0 M3=-0,431277756043463 FrameElem=46-1 ElemStation=0

Frame=46 Station=0,0917 OutputCase=RAR103 CaseType=Combination P=-29,5017192248258 V2=-2,1884101594744 V3=0 T=0 M2=0 M3=-0,21378276441966 FrameElem=46-1 ElemStation=0,0917

Frame=46 Station=0,1834 OutputCase=RAR103 CaseType=Combination P=-29,5017192248258 V2=-1,8216101594744 V3=0 T=0 M2=0 M3=-2,99233327958569E-02 FrameElem=46-1 ElemStation=0,1834

Frame=46 Station=0 OutputCase=RAR104 CaseType=Combination P=-15,2803081117055 V2=32,9224798037135 V3=0 T=0 M2=0 M3=-17,6934331850307 FrameElem=46-1 ElemStation=0

Frame=46 Station=0,0917 OutputCase=RAR104 CaseType=Combination P=-15,2803081117055 V2=33,2892798037135 V3=0 T=0 M2=0 M3=-20,7292423630313 FrameElem=46-1 ElemStation=0,0917

Frame=46 Station=0,1834 OutputCase=RAR104 CaseType=Combination P=-15,2803081117055 V2=33,6560798037135 V3=0 T=0 M2=0 M3=-23,7986871010318 FrameElem=46-1 ElemStation=0,1834

Frame=46 Station=0 OutputCase=RAR105 CaseType=Combination P=-6,25219043499295 V2=-8,81200513841315 V3=0 T=0 M2=0 M3=-18,9881323597145 FrameElem=46-1 ElemStation=0

Frame=46 Station=0,0917 OutputCase=RAR105 CaseType=Combination P=-6,25219043499295 V2=-8,44520513841315 V3=0 T=0 M2=0 M3=-18,196889268522 FrameElem=46-1 ElemStation=0,0917

Frame=46 Station=0,1834 OutputCase=RAR105 CaseType=Combination P=-6,25219043499295 V2=-8,07840513841315 V3=0 T=0 M2=0 M3=-17,4392817373295 FrameElem=46-1 ElemStation=0,1834

Frame=46 Station=0 OutputCase=RAR106 CaseType=Combination P=-15,1531571805614 V2=9,09189467285785 V3=0 T=0 M2=0 M3=-17,7279212793002 FrameElem=46-1 ElemStation=0

Frame=46 Station=0,0917 OutputCase=RAR106 CaseType=Combination P=-15,1531571805614 V2=9,45869467285786 V3=0 T=0 M2=0 M3=-18,5784658008013 FrameElem=46-1 ElemStation=0,0917

Frame=46 Station=0,1834 OutputCase=RAR106 CaseType=Combination P=-15,1531571805614 V2=9,82549467285785 V3=0 T=0 M2=0 M3=-19,4626458823023 FrameElem=46-1 ElemStation=0,1834

Frame=46 Station=0 OutputCase=RAR107 CaseType=Combination P=-24,0541239235687 V2=-8,81461321265589 V3=0 T=0 M2=0 M3=-16,4677101992498 FrameElem=46-1 ElemStation=0

Frame=46 Station=0,0917 OutputCase=RAR107 CaseType=Combination P=-24,0541239235687 V2=-8,44781321265589 V3=0 T=0 M2=0 M3=-15,6762279476492 FrameElem=46-1 ElemStation=0,0917

Frame=46 Station=0,1834 OutputCase=RAR107 CaseType=Combination P=-24,0541239235687 V2=-8,08101321265589 V3=0 T=0 M2=0 M3=-14,9183812560487 FrameElem=46-1 ElemStation=0,1834

Frame=46 Station=0 OutputCase=RAR108 CaseType=Combination P=-15,8732602525226 V2=15,0978719794019 V3=0 T=0 M2=0 M3=-2,40484678963746 FrameElem=46-1 ElemStation=0

Frame=46 Station=0,0917 OutputCase=RAR108 CaseType=Combination P=-15,8732602525226 V2=15,4646719794019 V3=0 T=0 M2=0 M3=-3,80613943014862 FrameElem=46-1 ElemStation=0,0917

APPROVATO S.D.P.

Società di Progetto
Brebemi SpA



	Doc. N. 60235-0000-A00.doc	CODIFICA DOCUMENTO 04RCDII10000000000300A00	REV. 00	FOGLIO 620 di 628
--	-------------------------------	--	------------	----------------------

Frame=46 Station=0,1834 OutputCase=RAR108 CaseType=Combination P=-15,8732602525226 V2=15,8314719794019 V3=0 T=0 M2=0 M3=-5,24106763065978
 FrameElem=46-1 ElemStation=0,1834
 Frame=46 Station=0 OutputCase=RAR109 CaseType=Combination P=-24,77422699553 V2=-2,80863590611181 V3=0 T=0 M2=0 M3=-1,14463570958701 FrameElem=46-1
 ElemStation=0
 Frame=46 Station=0,0917 OutputCase=RAR109 CaseType=Combination P=-24,77422699553 V2=-2,44183590611181 V3=0 T=0 M2=0 M3=-0,903901576996554
 FrameElem=46-1 ElemStation=0,0917
 Frame=46 Station=0,1834 OutputCase=RAR109 CaseType=Combination P=-24,77422699553 V2=-2,07503590611181 V3=0 T=0 M2=0 M3=-0,696803004406101
 FrameElem=46-1 ElemStation=0,1834
 Frame=46 Station=0 OutputCase=RAR110 CaseType=Combination P=-6,51256508759625 V2=-2,80563375683452 V3=0 T=0 M2=0 M3=-4,04588884265621 FrameElem=46-1
 ElemStation=0
 Frame=46 Station=0,0917 OutputCase=RAR110 CaseType=Combination P=-6,51256508759625 V2=-2,43883375683452 V3=0 T=0 M2=0 M3=-3,80543000715449
 FrameElem=46-1 ElemStation=0,0917
 Frame=46 Station=0,1834 OutputCase=RAR110 CaseType=Combination P=-6,51256508759625 V2=-2,07203375683452 V3=0 T=0 M2=0 M3=-3,59860673165276
 FrameElem=46-1 ElemStation=0,1834
 Frame=46 Station=0 OutputCase=RAR111 CaseType=Combination P=-5,792462015635 V2=-8,8116110633786 V3=0 T=0 M2=0 M3=-19,368963332319 FrameElem=46-1
 ElemStation=0
 Frame=46 Station=0,0917 OutputCase=RAR111 CaseType=Combination P=-5,792462015635 V2=-8,4448110633786 V3=0 T=0 M2=0 M3=-18,5777563778072 FrameElem=46-1
 ElemStation=0,0917
 Frame=46 Station=0,1834 OutputCase=RAR111 CaseType=Combination P=-5,792462015635 V2=-8,0780110633786 V3=0 T=0 M2=0 M3=-17,8201849832953 FrameElem=46-1
 ElemStation=0,1834
 Frame=46 Station=0 OutputCase=RAR112 CaseType=Combination P=-14,6934287612034 V2=9,0922887478924 V3=0 T=0 M2=0 M3=-18,1087522519047 FrameElem=46-1
 ElemStation=0
 Frame=46 Station=0,0917 OutputCase=RAR112 CaseType=Combination P=-14,6934287612034 V2=9,4590887478924 V3=0 T=0 M2=0 M3=-18,9593329100865
 FrameElem=46-1 ElemStation=0,0917
 Frame=46 Station=0,1834 OutputCase=RAR112 CaseType=Combination P=-14,6934287612034 V2=9,8258887478924 V3=0 T=0 M2=0 M3=-19,8435491282682
 FrameElem=46-1 ElemStation=0,1834
 Frame=46 Station=0 OutputCase=RAR113 CaseType=Combination P=-23,594395042107 V2=-8,81421913762134 V3=0 T=0 M2=0 M3=-16,8485411718543 FrameElem=46-1
 ElemStation=0
 Frame=46 Station=0,0917 OutputCase=RAR113 CaseType=Combination P=-23,594395042107 V2=-8,44741913762135 V3=0 T=0 M2=0 M3=-16,0570950569344
 FrameElem=46-1 ElemStation=0,0917
 Frame=46 Station=0,1834 OutputCase=RAR113 CaseType=Combination P=-23,594395042107 V2=-8,08061913762134 V3=0 T=0 M2=0 M3=-15,2992845020145
 FrameElem=46-1 ElemStation=0,1834
 Frame=46 Station=0 OutputCase=RAR114 CaseType=Combination P=-15,4135318331647 V2=15,0982660544365 V3=0 T=0 M2=0 M3=-2,78567776224196 FrameElem=46-1
 ElemStation=0
 Frame=46 Station=0,0917 OutputCase=RAR114 CaseType=Combination P=-15,4135318331647 V2=15,4650660544365 V3=0 T=0 M2=0 M3=-4,18700653943379
 FrameElem=46-1 ElemStation=0,0917
 Frame=46 Station=0,1834 OutputCase=RAR114 CaseType=Combination P=-15,4135318331647 V2=15,8318660544365 V3=0 T=0 M2=0 M3=-5,62197087662561
 FrameElem=46-1 ElemStation=0,1834
 Frame=46 Station=0 OutputCase=RAR115 CaseType=Combination P=-24,314498576172 V2=-2,80824183107726 V3=0 T=0 M2=0 M3=-1,52546668219151 FrameElem=46-1
 ElemStation=0
 Frame=46 Station=0,0917 OutputCase=RAR115 CaseType=Combination P=-24,314498576172 V2=-2,44144183107726 V3=0 T=0 M2=0 M3=-1,2847686828172
 FrameElem=46-1 ElemStation=0,0917
 Frame=46 Station=0,1834 OutputCase=RAR115 CaseType=Combination P=-24,314498576172 V2=-2,07464183107726 V3=0 T=0 M2=0 M3=-1,07770625037194
 FrameElem=46-1 ElemStation=0,1834
 Frame=46 Station=0 OutputCase=RAR116 CaseType=Combination P=-7,43202192631216 V2=-2,80642190690361 V3=0 T=0 M2=0 M3=-3,28422689744721 FrameElem=46-1
 ElemStation=0
 Frame=46 Station=0,0917 OutputCase=RAR116 CaseType=Combination P=-7,43202192631216 V2=-2,43962190690361 V3=0 T=0 M2=0 M3=-3,04369578858415
 FrameElem=46-1 ElemStation=0,0917
 Frame=46 Station=0,1834 OutputCase=RAR116 CaseType=Combination P=-7,43202192631216 V2=-2,07282190690361 V3=0 T=0 M2=0 M3=-2,83680023972109
 FrameElem=46-1 ElemStation=0,1834
 Frame=46 Station=0 OutputCase=RAR117 CaseType=Combination P=-6,71191885435091 V2=-8,81239921344769 V3=0 T=0 M2=0 M3=-18,60730138711 FrameElem=46-1
 ElemStation=0
 Frame=46 Station=0,0917 OutputCase=RAR117 CaseType=Combination P=-6,71191885435091 V2=-8,4455992134477 V3=0 T=0 M2=0 M3=-17,8160221592368
 FrameElem=46-1 ElemStation=0,0917
 Frame=46 Station=0,1834 OutputCase=RAR117 CaseType=Combination P=-6,71191885435091 V2=-8,0787992134477 V3=0 T=0 M2=0 M3=-17,0583784913637
 FrameElem=46-1 ElemStation=0,1834
 Frame=46 Station=0 OutputCase=RAR118 CaseType=Combination P=-15,6128855999193 V2=9,09150059782331 V3=0 T=0 M2=0 M3=-17,3470903066957 FrameElem=46-1
 ElemStation=0
 Frame=46 Station=0,0917 OutputCase=RAR118 CaseType=Combination P=-15,6128855999193 V2=9,45830059782331 V3=0 T=0 M2=0 M3=-18,1975986915161
 FrameElem=46-1 ElemStation=0,0917
 Frame=46 Station=0,1834 OutputCase=RAR118 CaseType=Combination P=-15,6128855999193 V2=9,82510059782331 V3=0 T=0 M2=0 M3=-19,0817426363365
 FrameElem=46-1 ElemStation=0,1834
 Frame=46 Station=0 OutputCase=RAR119 CaseType=Combination P=-24,5138523429267 V2=-8,81500728769044 V3=0 T=0 M2=0 M3=-16,0868792266453 FrameElem=46-1
 ElemStation=0
 Frame=46 Station=0,0917 OutputCase=RAR119 CaseType=Combination P=-24,5138523429267 V2=-8,44820728769044 V3=0 T=0 M2=0 M3=-15,2953608383641
 FrameElem=46-1 ElemStation=0,0917
 Frame=46 Station=0,1834 OutputCase=RAR119 CaseType=Combination P=-24,5138523429267 V2=-8,08140728769044 V3=0 T=0 M2=0 M3=-14,5374780100828
 FrameElem=46-1 ElemStation=0,1834
 Frame=46 Station=0 OutputCase=RAR120 CaseType=Combination P=-16,3329886718806 V2=15,0974779043674 V3=0 T=0 M2=0 M3=-2,02401581703296 FrameElem=46-1
 ElemStation=0
 Frame=46 Station=0,0917 OutputCase=RAR120 CaseType=Combination P=-16,3329886718806 V2=15,4642779043674 V3=0 T=0 M2=0 M3=-3,42527232086345
 FrameElem=46-1 ElemStation=0,0917
 Frame=46 Station=0,1834 OutputCase=RAR120 CaseType=Combination P=-16,3329886718806 V2=15,8310779043674 V3=0 T=0 M2=0 M3=-4,86016438469394
 FrameElem=46-1 ElemStation=0,1834
 Frame=46 Station=0 OutputCase=RAR121 CaseType=Combination P=-25,2339554148879 V2=-2,80902998114636 V3=0 T=0 M2=0 M3=-0,763804736982505 FrameElem=46-1
 ElemStation=0
 Frame=46 Station=0,0917 OutputCase=RAR121 CaseType=Combination P=-25,2339554148879 V2=-2,4422998114636 V3=0 T=0 M2=0 M3=-0,523034467711384
 FrameElem=46-1 ElemStation=0,0917
 Frame=46 Station=0,1834 OutputCase=RAR121 CaseType=Combination P=-25,2339554148879 V2=-2,07542998114636 V3=0 T=0 M2=0 M3=-0,315899758440263
 FrameElem=46-1 ElemStation=0,1834
 Frame=46 Station=0 OutputCase=RAR122 CaseType=Combination P=-7,43202192631216 V2=-2,80642190690361 V3=0 T=0 M2=0 M3=-3,28422689744721 FrameElem=46-1
 ElemStation=0
 Frame=46 Station=0,0917 OutputCase=RAR122 CaseType=Combination P=-7,43202192631216 V2=-2,43962190690361 V3=0 T=0 M2=0 M3=-3,04369578858415
 FrameElem=46-1 ElemStation=0,0917
 Frame=46 Station=0,1834 OutputCase=RAR122 CaseType=Combination P=-7,43202192631216 V2=-2,07282190690361 V3=0 T=0 M2=0 M3=-2,83680023972109
 FrameElem=46-1 ElemStation=0,1834
 Frame=46 Station=0 OutputCase=RAR123 CaseType=Combination P=-6,71191885435091 V2=-8,8123992134477 V3=0 T=0 M2=0 M3=-18,60730138711 FrameElem=46-1
 ElemStation=0

Società di Progetto
Brebemi SpA



Doc. N.
60235-0000-A00.doc

CODIFICA DOCUMENTO
04RCDII10000000000300A00

REV.
00

FOGLIO
621 di 628

Frame=46 Station=0,0917 OutputCase=RAR123 CaseType=Combination P=-6,71191885435091 V2=-8,44559921344769 V3=0 T=0 M2=0 M3=-17,8160221592368
FrameElem=46-1 ElemStation=0,0917
Frame=46 Station=0,1834 OutputCase=RAR123 CaseType=Combination P=-6,71191885435091 V2=-8,0787992134477 V3=0 T=0 M2=0 M3=-17,0583784913637
FrameElem=46-1 ElemStation=0,1834
Frame=46 Station=0 OutputCase=RAR124 CaseType=Combination P=-15,6128855999193 V2=9,09150059782331 V3=0 T=0 M2=0 M3=-17,3470903066957
FrameElem=46-1 ElemStation=0
Frame=46 Station=0,0917 OutputCase=RAR124 CaseType=Combination P=-15,6128855999193 V2=9,45830059782331 V3=0 T=0 M2=0 M3=-18,1975986915161
FrameElem=46-1 ElemStation=0,0917
Frame=46 Station=0,1834 OutputCase=RAR124 CaseType=Combination P=-15,6128855999193 V2=9,82510059782331 V3=0 T=0 M2=0 M3=-19,0817426336365
FrameElem=46-1 ElemStation=0,1834
Frame=46 Station=0 OutputCase=RAR125 CaseType=Combination P=-24,5138523429267 V2=-8,81500728769044 V3=0 T=0 M2=0 M3=-16,0868792266453
FrameElem=46-1 ElemStation=0
Frame=46 Station=0,0917 OutputCase=RAR125 CaseType=Combination P=-24,5138523429267 V2=-8,44820728769044 V3=0 T=0 M2=0 M3=-15,2953608383641
FrameElem=46-1 ElemStation=0,0917
Frame=46 Station=0,1834 OutputCase=RAR125 CaseType=Combination P=-24,5138523429267 V2=-8,08140728769044 V3=0 T=0 M2=0 M3=-14,5374780100828
FrameElem=46-1 ElemStation=0,1834
Frame=46 Station=0 OutputCase=RAR126 CaseType=Combination P=-16,3329886718806 V2=15,0974779043674 V3=0 T=0 M2=0 M3=-2,02401581703296
FrameElem=46-1 ElemStation=0
Frame=46 Station=0,0917 OutputCase=RAR126 CaseType=Combination P=-16,3329886718806 V2=15,4642779043674 V3=0 T=0 M2=0 M3=-3,42527232086345
FrameElem=46-1 ElemStation=0,0917
Frame=46 Station=0,1834 OutputCase=RAR126 CaseType=Combination P=-16,3329886718806 V2=15,8310779043674 V3=0 T=0 M2=0 M3=-4,86016438469394
FrameElem=46-1 ElemStation=0,1834
Frame=46 Station=0 OutputCase=RAR127 CaseType=Combination P=-25,2339554148879 V2=-2,80902998114636 V3=0 T=0 M2=0 M3=-0,763804736982505
FrameElem=46-1 ElemStation=0
Frame=46 Station=0,0917 OutputCase=RAR127 CaseType=Combination P=-25,2339554148879 V2=-2,4422998114636 V3=0 T=0 M2=0 M3=-0,523034467711384
FrameElem=46-1 ElemStation=0,0917
Frame=46 Station=0,1834 OutputCase=RAR127 CaseType=Combination P=-25,2339554148879 V2=-2,07542998114636 V3=0 T=0 M2=0 M3=-0,315899758440263
FrameElem=46-1 ElemStation=0,1834
Frame=46 Station=0 OutputCase=RAR128 CaseType=Combination P=-8,0563848624211 V2=-2,17136406013818 V3=0 T=0 M2=0 M3=-2,94411934702673
FrameElem=46-1 ElemStation=0
Frame=46 Station=0,0917 OutputCase=RAR128 CaseType=Combination P=-8,0563848624211 V2=-1,80456406013818 V3=0 T=0 M2=0 M3=-2,76182304271206
FrameElem=46-1 ElemStation=0,0917
Frame=46 Station=0,1834 OutputCase=RAR128 CaseType=Combination P=-8,0563848624211 V2=-1,43776406013818 V3=0 T=0 M2=0 M3=-2,61316229839739
FrameElem=46-1 ElemStation=0,1834
Frame=46 Station=0 OutputCase=RAR129 CaseType=Combination P=-6,78976182023413 V2=-10,1790710855073 V3=0 T=0 M2=0 M3=-23,6287726483134
FrameElem=46-1 ElemStation=0
Frame=46 Station=0,0917 OutputCase=RAR129 CaseType=Combination P=-6,78976182023413 V2=-9,81227108550726 V3=0 T=0 M2=0 M3=-22,7121696097724
FrameElem=46-1 ElemStation=0,0917
Frame=46 Station=0,1834 OutputCase=RAR129 CaseType=Combination P=-6,78976182023413 V2=-9,44547108550726 V3=0 T=0 M2=0 M3=-21,8292021312314
FrameElem=46-1 ElemStation=0,1834
Frame=46 Station=0 OutputCase=RAR130 CaseType=Combination P=-17,9908992160426 V2=12,8005020888952 V3=0 T=0 M2=0 M3=-22,0291266381482
FrameElem=46-1 ElemStation=0
Frame=46 Station=0,0917 OutputCase=RAR130 CaseType=Combination P=-17,9908992160426 V2=13,1673020888952 V3=0 T=0 M2=0 M3=-23,2197504596999
FrameElem=46-1 ElemStation=0,0917
Frame=46 Station=0,1834 OutputCase=RAR130 CaseType=Combination P=-17,9908992160426 V2=13,5341020888952 V3=0 T=0 M2=0 M3=-24,4440098412516
FrameElem=46-1 ElemStation=0,1834
Frame=46 Station=0 OutputCase=RAR131 CaseType=Combination P=-29,1920366088243 V2=-10,1823816384946 V3=0 T=0 M2=0 M3=-20,4294806284455
FrameElem=46-1 ElemStation=0
Frame=46 Station=0,0917 OutputCase=RAR131 CaseType=Combination P=-29,1920366088243 V2=-9,81558163849465 V3=0 T=0 M2=0 M3=-19,5125740121955
FrameElem=46-1 ElemStation=0,0917
Frame=46 Station=0,1834 OutputCase=RAR131 CaseType=Combination P=-29,1920366088243 V2=-9,44878163849465 V3=0 T=0 M2=0 M3=-18,6293029559456
FrameElem=46-1 ElemStation=0,1834
Frame=46 Station=0 OutputCase=RAR132 CaseType=Combination P=-18,9510366453243 V2=20,808471830954 V3=0 T=0 M2=0 M3=-1,5983606519312
FrameElem=46-1 ElemStation=0
Frame=46 Station=0,0917 OutputCase=RAR132 CaseType=Combination P=-18,9510366453243 V2=21,175271830954 V3=0 T=0 M2=0 M3=-3,52331529882968
FrameElem=46-1 ElemStation=0,0917
Frame=46 Station=0,1834 OutputCase=RAR132 CaseType=Combination P=-18,9510366453243 V2=21,542071830954 V3=0 T=0 M2=0 M3=-5,48190550572817
FrameElem=46-1 ElemStation=0,1834
Frame=46 Station=0 OutputCase=RAR133 CaseType=Combination P=-30,152174038106 V2=-2,17441189643587 V3=0 T=0 M2=0 M3=1,2853777152389E-03
FrameElem=46-1 ElemStation=0
Frame=46 Station=0,0917 OutputCase=RAR133 CaseType=Combination P=-30,152174038106 V2=-1,80761189643587 V3=0 T=0 M2=0 M3=0,183861148674693
FrameElem=46-1 ElemStation=0,0917
Frame=46 Station=0,1834 OutputCase=RAR133 CaseType=Combination P=-30,152174038106 V2=-1,44081189643587 V3=0 T=0 M2=0 M3=0,332801379577863
FrameElem=46-1 ElemStation=0,1834
Frame=46 Station=0 OutputCase=RAR134 CaseType=Combination P=-15,9307629249856 V2=33,303278066752 V3=0 T=0 M2=0 M3=-17,2608700712158
FrameElem=46-1 ElemStation=0
Frame=46 Station=0,0917 OutputCase=RAR134 CaseType=Combination P=-15,9307629249856 V2=33,670078066752 V3=0 T=0 M2=0 M3=-20,3315984499369
FrameElem=46-1 ElemStation=0,0917
Frame=46 Station=0,1834 OutputCase=RAR134 CaseType=Combination P=-15,9307629249856 V2=34,036878066752 V3=0 T=0 M2=0 M3=-23,4359623886581
FrameElem=46-1 ElemStation=0,1834
Frame=46 Station=0 OutputCase=RAR135 CaseType=Combination P=-7,33628179045985 V2=-8,17734136668226 V3=0 T=0 M2=0 M3=-18,2671938366895
FrameElem=46-1 ElemStation=0
Frame=46 Station=0,0917 OutputCase=RAR135 CaseType=Combination P=-7,33628179045985 V2=-7,81054136668226 V3=0 T=0 M2=0 M3=-17,5341494133647
FrameElem=46-1 ElemStation=0,0917
Frame=46 Station=0,1834 OutputCase=RAR135 CaseType=Combination P=-7,33628179045985 V2=-7,44374136668226 V3=0 T=0 M2=0 M3=-16,83474055004
FrameElem=46-1 ElemStation=0,1834
Frame=46 Station=0 OutputCase=RAR136 CaseType=Combination P=-16,2372485360283 V2=9,72655844458874 V3=0 T=0 M2=0 M3=-17,0069827562752
FrameElem=46-1 ElemStation=0
Frame=46 Station=0,0917 OutputCase=RAR136 CaseType=Combination P=-16,2372485360283 V2=10,0933584445887 V3=0 T=0 M2=0 M3=-17,915725945644
FrameElem=46-1 ElemStation=0,0917
Frame=46 Station=0,1834 OutputCase=RAR136 CaseType=Combination P=-16,2372485360283 V2=10,4601584445887 V3=0 T=0 M2=0 M3=-18,8581046950128
FrameElem=46-1 ElemStation=0,1834
Frame=46 Station=0 OutputCase=RAR137 CaseType=Combination P=-25,1382152790356 V2=-8,17994944092501 V3=0 T=0 M2=0 M3=-15,7467716762248
FrameElem=46-1 ElemStation=0
Frame=46 Station=0,0917 OutputCase=RAR137 CaseType=Combination P=-25,1382152790356 V2=-7,81314944092501 V3=0 T=0 M2=0 M3=-15,013488092492
FrameElem=46-1 ElemStation=0,0917
Frame=46 Station=0,1834 OutputCase=RAR137 CaseType=Combination P=-25,1382152790356 V2=-7,44634944092501 V3=0 T=0 M2=0 M3=-14,3138400687591
FrameElem=46-1 ElemStation=0,1834

Società di Progetto
Brebemi SpA

	Doc. N. 60235-0000-A00.doc	CODIFICA DOCUMENTO 04RCDII10000000000300A00	REV. 00	FOGLIO 622 di 628
--	-------------------------------	--	------------	----------------------

Frame=46 Station=0 OutputCase=RAR138 CaseType=Combination P=-16,9573516079895 V2=15,7325357511328 V3=0 T=0 M2=0 M3=-1,68390826661248 FrameElem=46-1 ElemStation=0

Frame=46 Station=0,0917 OutputCase=RAR138 CaseType=Combination P=-16,9573516079895 V2=16,0993357511328 V3=0 T=0 M2=0 M3=-3,14339957499136 FrameElem=46-1 ElemStation=0,0917

Frame=46 Station=0,1834 OutputCase=RAR138 CaseType=Combination P=-16,9573516079895 V2=16,4661357511328 V3=0 T=0 M2=0 M3=-4,63652644337024 FrameElem=46-1 ElemStation=0,1834

Frame=46 Station=0 OutputCase=RAR139 CaseType=Combination P=-25,8583183509968 V2=-2,17397213438093 V3=0 T=0 M2=0 M3=-0,42369718656203 FrameElem=46-1 ElemStation=0

Frame=46 Station=0,0917 OutputCase=RAR139 CaseType=Combination P=-25,8583183509968 V2=-1,80717213438093 V3=0 T=0 M2=0 M3=-0,241161721839299 FrameElem=46-1 ElemStation=0,0917

Frame=46 Station=0,1834 OutputCase=RAR139 CaseType=Combination P=-25,8583183509968 V2=-1,44037213438093 V3=0 T=0 M2=0 M3=-9,22618171165677E-02 FrameElem=46-1 ElemStation=0,1834

Frame=46 Station=0 OutputCase=RAR140 CaseType=Combination P=-7,59665644306315 V2=-2,17096998510363 V3=0 T=0 M2=0 M3=-3,32495031963124 FrameElem=46-1 ElemStation=0

Frame=46 Station=0,0917 OutputCase=RAR140 CaseType=Combination P=-7,59665644306315 V2=-1,80416998510363 V3=0 T=0 M2=0 M3=-3,14269015199723 FrameElem=46-1 ElemStation=0,0917

Frame=46 Station=0,1834 OutputCase=RAR140 CaseType=Combination P=-7,59665644306315 V2=-1,43736998510363 V3=0 T=0 M2=0 M3=-2,99406554436323 FrameElem=46-1 ElemStation=0,1834

Frame=46 Station=0 OutputCase=RAR141 CaseType=Combination P=-6,8765533711019 V2=-8,17694729164772 V3=0 T=0 M2=0 M3=-18,648024809294 FrameElem=46-1 ElemStation=0

Frame=46 Station=0,0917 OutputCase=RAR141 CaseType=Combination P=-6,8765533711019 V2=-7,81014729164772 V3=0 T=0 M2=0 M3=-17,9150165226499 FrameElem=46-1 ElemStation=0,0917

Frame=46 Station=0,1834 OutputCase=RAR141 CaseType=Combination P=-6,8765533711019 V2=-7,44334729164772 V3=0 T=0 M2=0 M3=-17,2156437960058 FrameElem=46-1 ElemStation=0,1834

Frame=46 Station=0 OutputCase=RAR142 CaseType=Combination P=-15,7775201166703 V2=9,72695251962329 V3=0 T=0 M2=0 M3=-17,3878137288797 FrameElem=46-1 ElemStation=0

Frame=46 Station=0,0917 OutputCase=RAR142 CaseType=Combination P=-15,7775201166703 V2=10,0937525196233 V3=0 T=0 M2=0 M3=-18,2965930549292 FrameElem=46-1 ElemStation=0,0917

Frame=46 Station=0,1834 OutputCase=RAR142 CaseType=Combination P=-15,7775201166703 V2=10,4605525196233 V3=0 T=0 M2=0 M3=-19,2390079409786 FrameElem=46-1 ElemStation=0,1834

Frame=46 Station=0 OutputCase=RAR143 CaseType=Combination P=-24,6784868596776 V2=-8,17955536589046 V3=0 T=0 M2=0 M3=-16,1276026488293 FrameElem=46-1 ElemStation=0

Frame=46 Station=0,0917 OutputCase=RAR143 CaseType=Combination P=-24,6784868596776 V2=-7,81275536589046 V3=0 T=0 M2=0 M3=-15,3943552017771 FrameElem=46-1 ElemStation=0,0917

Frame=46 Station=0,1834 OutputCase=RAR143 CaseType=Combination P=-24,6784868596776 V2=-7,44595536589046 V3=0 T=0 M2=0 M3=-14,694743314725 FrameElem=46-1 ElemStation=0,1834

Frame=46 Station=0 OutputCase=RAR144 CaseType=Combination P=-16,4976231886316 V2=15,7329298261674 V3=0 T=0 M2=0 M3=-2,06473923921698 FrameElem=46-1 ElemStation=0

Frame=46 Station=0,0917 OutputCase=RAR144 CaseType=Combination P=-16,4976231886316 V2=16,0997298261674 V3=0 T=0 M2=0 M3=-3,5242668427653 FrameElem=46-1 ElemStation=0,0917

Frame=46 Station=0,1834 OutputCase=RAR144 CaseType=Combination P=-16,4976231886316 V2=16,4665298261674 V3=0 T=0 M2=0 M3=-5,01742968933608 FrameElem=46-1 ElemStation=0,1834

Frame=46 Station=0 OutputCase=RAR145 CaseType=Combination P=-25,3985899316389 V2=-2,17357805934638 V3=0 T=0 M2=0 M3=-0,804528159166531 FrameElem=46-1 ElemStation=0

Frame=46 Station=0,0917 OutputCase=RAR145 CaseType=Combination P=-25,3985899316389 V2=-1,80677805934638 V3=0 T=0 M2=0 M3=-0,622028831124468 FrameElem=46-1 ElemStation=0,0917

Frame=46 Station=0,1834 OutputCase=RAR145 CaseType=Combination P=-25,3985899316389 V2=-1,43997805934638 V3=0 T=0 M2=0 M3=-0,473165063082405 FrameElem=46-1 ElemStation=0,1834

Frame=46 Station=0 OutputCase=RAR146 CaseType=Combination P=-8,51611328177906 V2=-2,17175813517273 V3=0 T=0 M2=0 M3=-2,56328837442223 FrameElem=46-1 ElemStation=0

Frame=46 Station=0,0917 OutputCase=RAR146 CaseType=Combination P=-8,51611328177906 V2=-1,80495813517273 V3=0 T=0 M2=0 M3=-2,38095593342689 FrameElem=46-1 ElemStation=0,0917

Frame=46 Station=0,1834 OutputCase=RAR146 CaseType=Combination P=-8,51611328177906 V2=-1,43815813517273 V3=0 T=0 M2=0 M3=-2,23225905243155 FrameElem=46-1 ElemStation=0,1834

Frame=46 Station=0 OutputCase=RAR147 CaseType=Combination P=-7,7960102098178 V2=-8,17773544171681 V3=0 T=0 M2=0 M3=-17,886362864085 FrameElem=46-1 ElemStation=0

Frame=46 Station=0,0917 OutputCase=RAR147 CaseType=Combination P=-7,7960102098178 V2=-7,81093544171681 V3=0 T=0 M2=0 M3=-17,1532823040796 FrameElem=46-1 ElemStation=0,0917

Frame=46 Station=0,1834 OutputCase=RAR147 CaseType=Combination P=-7,7960102098178 V2=-7,44413544171681 V3=0 T=0 M2=0 M3=-16,4538373040741 FrameElem=46-1 ElemStation=0,1834

Frame=46 Station=0 OutputCase=RAR148 CaseType=Combination P=-16,6969769553862 V2=9,72616436955419 V3=0 T=0 M2=0 M3=-16,6261517836707 FrameElem=46-1 ElemStation=0

Frame=46 Station=0,0917 OutputCase=RAR148 CaseType=Combination P=-16,6969769553862 V2=10,0929643695542 V3=0 T=0 M2=0 M3=-17,5348588363589 FrameElem=46-1 ElemStation=0,0917

Frame=46 Station=0,1834 OutputCase=RAR148 CaseType=Combination P=-16,6969769553862 V2=10,4597643695542 V3=0 T=0 M2=0 M3=-18,477201449047 FrameElem=46-1 ElemStation=0,1834

Frame=46 Station=0 OutputCase=RAR149 CaseType=Combination P=-25,5979436983935 V2=-8,18034351595955 V3=0 T=0 M2=0 M3=-15,3659407036203 FrameElem=46-1 ElemStation=0

Frame=46 Station=0,0917 OutputCase=RAR149 CaseType=Combination P=-25,5979436983935 V2=-7,81354351595956 V3=0 T=0 M2=0 M3=-14,6326209832068 FrameElem=46-1 ElemStation=0,0917

Frame=46 Station=0,1834 OutputCase=RAR149 CaseType=Combination P=-25,5979436983935 V2=-7,44674351595955 V3=0 T=0 M2=0 M3=-13,9329368227933 FrameElem=46-1 ElemStation=0,1834

Frame=46 Station=0 OutputCase=RAR150 CaseType=Combination P=-17,4170800273475 V2=15,7321416760983 V3=0 T=0 M2=0 M3=-1,30307729400798 FrameElem=46-1 ElemStation=0

Frame=46 Station=0,0917 OutputCase=RAR150 CaseType=Combination P=-17,4170800273475 V2=16,0989416760983 V3=0 T=0 M2=0 M3=-2,76253246570619 FrameElem=46-1 ElemStation=0,0917

Frame=46 Station=0,1834 OutputCase=RAR150 CaseType=Combination P=-17,4170800273475 V2=16,4654716760983 V3=0 T=0 M2=0 M3=-4,2556231974044 FrameElem=46-1 ElemStation=0,1834

Frame=46 Station=0 OutputCase=RAR151 CaseType=Combination P=-26,3180467703548 V2=-2,17436620941547 V3=0 T=0 M2=0 M3=-0,042866213957528 FrameElem=46-1 ElemStation=0

Frame=46 Station=0,0917 OutputCase=RAR151 CaseType=Combination P=-26,3180467703548 V2=-1,80756620941547 V3=0 T=0 M2=0 M3=0,139705387445871 FrameElem=46-1 ElemStation=0,0917

Frame=46 Station=0,1834 OutputCase=RAR151 CaseType=Combination P=-26,3180467703548 V2=-1,44076620941547 V3=0 T=0 M2=0 M3=0,28864142884927 FrameElem=46-1 ElemStation=0,1834

Frame=46 Station=0 OutputCase=RAR152 CaseType=Combination P=-8,24711125634329 V2=-1,790171220651 V3=0 T=0 M2=0 M3=-2,89238720581625 FrameElem=46-1 ElemStation=0

Frame=46 Station=0,0917 OutputCase=RAR152 CaseType=Combination P=-8,24711125634329 V2=-1,4233717220651 V3=0 T=0 M2=0 M3=-2,74504623890288 FrameElem=46-1 ElemStation=0,0917

APPROVATO S.D.P.

Società di Progetto
Brebemi SpA





Doc. N.
60235-0000-A00.doc

CODIFICA DOCUMENTO
04RCDII10000000000300A00

REV.
00

FOGLIO
623 di 628

Frame=46 Station=0,1834 OutputCase=RAR152 CaseType=Combination P=-8,24711125634329 V2=-1,0565717220651 V3=0 T=0 M2=0 M3=-2,63134083198951
FrameElem=46-1 ElemStation=0,1834
Frame=46 Station=0 OutputCase=RAR153 CaseType=Combination P=-7,52700818438203 V2=-7,79614902860919 V3=0 T=0 M2=0 M3=-18,215461695479 FrameElem=46-1
ElemStation=0
Frame=46 Station=0,0917 OutputCase=RAR153 CaseType=Combination P=-7,52700818438203 V2=-7,42934902860919 V3=0 T=0 M2=0 M3=-17,5173726095555
FrameElem=46-1 ElemStation=0,0917
Frame=46 Station=0,1834 OutputCase=RAR153 CaseType=Combination P=-7,52700818438203 V2=-7,06254902860919 V3=0 T=0 M2=0 M3=-16,8529190836321
FrameElem=46-1 ElemStation=0,1834
Frame=46 Station=0 OutputCase=RAR154 CaseType=Combination P=-16,4279749299505 V2=10,1077507826618 V3=0 T=0 M2=0 M3=-16,9552506150648 FrameElem=46-1
ElemStation=0
Frame=46 Station=0,0917 OutputCase=RAR154 CaseType=Combination P=-16,4279749299505 V2=10,4745507826618 V3=0 T=0 M2=0 M3=-17,8989491418348
FrameElem=46-1 ElemStation=0,0917
Frame=46 Station=0,1834 OutputCase=RAR154 CaseType=Combination P=-16,4279749299505 V2=10,8413507826618 V3=0 T=0 M2=0 M3=-18,8762832286049
FrameElem=46-1 ElemStation=0,1834
Frame=46 Station=0 OutputCase=RAR155 CaseType=Combination P=-25,3289416729578 V2=-7,79875710285193 V3=0 T=0 M2=0 M3=-15,6950395350143 FrameElem=46-1
ElemStation=0
Frame=46 Station=0,0917 OutputCase=RAR155 CaseType=Combination P=-25,3289416729578 V2=-7,43195710285193 V3=0 T=0 M2=0 M3=-14,9967112886828
FrameElem=46-1 ElemStation=0,0917
Frame=46 Station=0,1834 OutputCase=RAR155 CaseType=Combination P=-25,3289416729578 V2=-7,06515710285193 V3=0 T=0 M2=0 M3=-14,3320186023513
FrameElem=46-1 ElemStation=0,1834
Frame=46 Station=0 OutputCase=RAR156 CaseType=Combination P=-17,1480780019117 V2=16,1137280892059 V3=0 T=0 M2=0 M3=-1,632176125402 FrameElem=46-1
ElemStation=0
Frame=46 Station=0,0917 OutputCase=RAR156 CaseType=Combination P=-17,1480780019117 V2=16,4805280892059 V3=0 T=0 M2=0 M3=-3,12662277118218
FrameElem=46-1 ElemStation=0,0917
Frame=46 Station=0,1834 OutputCase=RAR156 CaseType=Combination P=-17,1480780019117 V2=16,8473280892059 V3=0 T=0 M2=0 M3=-4,65470497696236
FrameElem=46-1 ElemStation=0,1834
Frame=46 Station=0 OutputCase=RAR157 CaseType=Combination P=-26,049044744919 V2=-1,79277979630785 V3=0 T=0 M2=0 M3=-0,371965045351545 FrameElem=46-1
ElemStation=0
Frame=46 Station=0,0917 OutputCase=RAR157 CaseType=Combination P=-26,049044744919 V2=-1,42597979630785 V3=0 T=0 M2=0 M3=-0,224384918030115
FrameElem=46-1 ElemStation=0,0917
Frame=46 Station=0,1834 OutputCase=RAR157 CaseType=Combination P=-26,049044744919 V2=-1,05917979630785 V3=0 T=0 M2=0 M3=-0,110440350708685
FrameElem=46-1 ElemStation=0,1834
Frame=46 Station=0 OutputCase=RAR158 CaseType=Combination P=-7,86565846849892 V2=-2,55255639821126 V3=0 T=0 M2=0 M3=-2,99585148823722 FrameElem=46-1
ElemStation=0
Frame=46 Station=0,0917 OutputCase=RAR158 CaseType=Combination P=-7,86565846849892 V2=-2,18575639821126 V3=0 T=0 M2=0 M3=-2,77859984652125
FrameElem=46-1 ElemStation=0,0917
Frame=46 Station=0,1834 OutputCase=RAR158 CaseType=Combination P=-7,86565846849892 V2=-1,81895639821126 V3=0 T=0 M2=0 M3=-2,59498376480527
FrameElem=46-1 ElemStation=0,1834
Frame=46 Station=0 OutputCase=RAR159 CaseType=Combination P=-7,1455539653767 V2=-8,55853370475534 V3=0 T=0 M2=0 M3=-18,3189259779 FrameElem=46-1
ElemStation=0
Frame=46 Station=0,0917 OutputCase=RAR159 CaseType=Combination P=-7,1455539653767 V2=-8,19173370475534 V3=0 T=0 M2=0 M3=-17,5509262171739
FrameElem=46-1 ElemStation=0,0917
Frame=46 Station=0,1834 OutputCase=RAR159 CaseType=Combination P=-7,1455539653767 V2=-7,82493370475534 V3=0 T=0 M2=0 M3=-16,8165620164478
FrameElem=46-1 ElemStation=0,1834
Frame=46 Station=0 OutputCase=RAR160 CaseType=Combination P=-16,0465221421061 V2=9,34536610651566 V3=0 T=0 M2=0 M3=-17,0587148974857 FrameElem=46-1
ElemStation=0
Frame=46 Station=0,0917 OutputCase=RAR160 CaseType=Combination P=-16,0465221421061 V2=9,71216610651566 V3=0 T=0 M2=0 M3=-17,9325027494532
FrameElem=46-1 ElemStation=0,0917
Frame=46 Station=0,1834 OutputCase=RAR160 CaseType=Combination P=-16,0465221421061 V2=10,0789661065157 V3=0 T=0 M2=0 M3=-18,8399261614207
FrameElem=46-1 ElemStation=0,1834
Frame=46 Station=0 OutputCase=RAR161 CaseType=Combination P=-24,9474888851134 V2=-8,56114177899808 V3=0 T=0 M2=0 M3=-15,7985038174353 FrameElem=46-1
ElemStation=0
Frame=46 Station=0,0917 OutputCase=RAR161 CaseType=Combination P=-24,9474888851134 V2=-8,19434177899809 V3=0 T=0 M2=0 M3=-15,0302648963011
FrameElem=46-1 ElemStation=0,0917
Frame=46 Station=0,1834 OutputCase=RAR161 CaseType=Combination P=-24,9474888851134 V2=-7,82754177899809 V3=0 T=0 M2=0 M3=-14,295661535167
FrameElem=46-1 ElemStation=0,1834
Frame=46 Station=0 OutputCase=RAR162 CaseType=Combination P=-16,7666252140674 V2=15,3513434130597 V3=0 T=0 M2=0 M3=-1,73564040782297 FrameElem=46-1
ElemStation=0
Frame=46 Station=0,0917 OutputCase=RAR162 CaseType=Combination P=-16,7666252140674 V2=15,7181434130597 V3=0 T=0 M2=0 M3=-3,16017637880055
FrameElem=46-1 ElemStation=0,0917
Frame=46 Station=0,1834 OutputCase=RAR162 CaseType=Combination P=-16,7666252140674 V2=16,0849434130597 V3=0 T=0 M2=0 M3=-4,61834790977812
FrameElem=46-1 ElemStation=0,1834
Frame=46 Station=0 OutputCase=RAR163 CaseType=Combination P=-25,6675919570747 V2=-2,555164472454 V3=0 T=0 M2=0 M3=-0,475429327772515 FrameElem=46-1
ElemStation=0
Frame=46 Station=0,0917 OutputCase=RAR163 CaseType=Combination P=-25,6675919570747 V2=-2,188364472454 V3=0 T=0 M2=0 M3=-0,257938525648482
FrameElem=46-1 ElemStation=0,0917
Frame=46 Station=0,1834 OutputCase=RAR163 CaseType=Combination P=-25,6675919570747 V2=-1,821564472454 V3=0 T=0 M2=0 M3=-7,40832835244499E-02
FrameElem=46-1 ElemStation=0,1834
Frame=46 Station=0 OutputCase=INVRAR CaseType=Combination StepType=Max P=-5,61312733201115 V2=33,6848644798597 V3=0 T=0 M2=0 M3=1,28535777152389E-03
FrameElem=46-1 ElemStation=0
Frame=46 Station=0,0917 OutputCase=INVRAR CaseType=Combination StepType=Max P=-5,61312733201115 V2=34,0516644798597 V3=0 T=0 M2=0
M3=0,183861148674693 FrameElem=46-1 ElemStation=0,0917
Frame=46 Station=0,1834 OutputCase=INVRAR CaseType=Combination StepType=Max P=-5,61312733201115 V2=34,4184644798597 V3=0 T=0 M2=0
M3=0,332801379577863 FrameElem=46-1 ElemStation=0,1834
Frame=46 Station=0 OutputCase=INVRAR CaseType=Combination StepType=Min P=-30,152174038106 V2=-10,5631799015332 V3=0 T=0 M2=0 M3=-24,3904345935224
FrameElem=46-1 ElemStation=0
Frame=46 Station=0,0917 OutputCase=INVRAR CaseType=Combination StepType=Min P=-30,152174038106 V2=-10,1963799015332 V3=0 T=0 M2=0 M3=-
23,9814846782702 FrameElem=46-1 ElemStation=0,0917
Frame=46 Station=0,1834 OutputCase=INVRAR CaseType=Combination StepType=Min P=-30,152174038106 V2=-9,82957990153318 V3=0 T=0 M2=0 M3=-
25,2058163331833 FrameElem=46-1 ElemStation=0,1834
Frame=46 Station=0 OutputCase=FRE01 CaseType=Combination P=-11,2910804186904 V2=-2,17120790642275 V3=0 T=0 M2=0 M3=-3,09502505244586 FrameElem=46-1
ElemStation=0
Frame=46 Station=0,0917 OutputCase=FRE01 CaseType=Combination P=-11,2910804186904 V2=-1,80440790642275 V3=0 T=0 M2=0 M3=-2,9127430674269 FrameElem=46-
1 ElemStation=0,0917
Frame=46 Station=0,1834 OutputCase=FRE01 CaseType=Combination P=-11,2910804186904 V2=-1,43760790642275 V3=0 T=0 M2=0 M3=-2,76409664240793
FrameElem=46-1 ElemStation=0,1834
Frame=46 Station=0 OutputCase=FRE02 CaseType=Combination P=-6,57006775819659 V2=-8,17668457495802 V3=0 T=0 M2=0 M3=-18,9019121243637 FrameElem=46-1
ElemStation=0

Società di Progetto
Brebemi SpA



Doc. N.
60235-0000-A00.doc

CODIFICA DOCUMENTO
04RCDII10000000000300A00

REV.
00

FOGLIO
624 di 628

Frame=46 Station=0,0917 OutputCase=FRE02 CaseType=Combination P=-6,57006775819659 V2=-7,80988457495802 V3=0 T=0 M2=0 M3=-18,16892792884 FrameElem=46-1 ElemStation=0,0917
Frame=46 Station=0,1834 OutputCase=FRE02 CaseType=Combination P=-6,57006775819659 V2=-7,44308457495802 V3=0 T=0 M2=0 M3=-17,4695792933164 FrameElem=46-1 ElemStation=0,1834
Frame=46 Station=0 OutputCase=FRE03 CaseType=Combination P=-15,471034503765 V2=9,72721523631299 V3=0 T=0 M2=0 M3=-17,6417010439494 FrameElem=46-1 ElemStation=0
Frame=46 Station=0,0917 OutputCase=FRE03 CaseType=Combination P=-15,471034503765 V2=10,094015236313 V3=0 T=0 M2=0 M3=-18,5505044611193 FrameElem=46-1 ElemStation=0,0917
Frame=46 Station=0,1834 OutputCase=FRE03 CaseType=Combination P=-15,471034503765 V2=10,460815236313 V3=0 T=0 M2=0 M3=-19,4929434382892 FrameElem=46-1 ElemStation=0,1834
Frame=46 Station=0 OutputCase=FRE04 CaseType=Combination P=-24,3720012467723 V2=-8,17929264920076 V3=0 T=0 M2=0 M3=-16,381489963899 FrameElem=46-1 ElemStation=0
Frame=46 Station=0,0917 OutputCase=FRE04 CaseType=Combination P=-24,3720012467723 V2=-7,81249264920076 V3=0 T=0 M2=0 M3=-15,6482666079672 FrameElem=46-1 ElemStation=0,0917
Frame=46 Station=0,1834 OutputCase=FRE04 CaseType=Combination P=-24,3720012467723 V2=-7,44569264920076 V3=0 T=0 M2=0 M3=-14,9486788120355 FrameElem=46-1 ElemStation=0,1834
Frame=46 Station=0 OutputCase=FRE05 CaseType=Combination P=-16,1911375757263 V2=15,7331925428571 V3=0 T=0 M2=0 M3=-2,31862655428665 FrameElem=46-1 ElemStation=0
Frame=46 Station=0,0917 OutputCase=FRE05 CaseType=Combination P=-16,1911375757263 V2=16,0999925428571 V3=0 T=0 M2=0 M3=-3,77817809046664 FrameElem=46-1 ElemStation=0,0917
Frame=46 Station=0,1834 OutputCase=FRE05 CaseType=Combination P=-16,1911375757263 V2=16,4667925428571 V3=0 T=0 M2=0 M3=-5,27136518664664 FrameElem=46-1 ElemStation=0,1834
Frame=46 Station=0 OutputCase=FRE06 CaseType=Combination P=-25,0921043187336 V2=-2,17331534265668 V3=0 T=0 M2=0 M3=-1,0584154742362 FrameElem=46-1 ElemStation=0
Frame=46 Station=0,0917 OutputCase=FRE06 CaseType=Combination P=-25,0921043187336 V2=-1,80651534265668 V3=0 T=0 M2=0 M3=-0,875940237314581 FrameElem=46-1 ElemStation=0,0917
Frame=46 Station=0,1834 OutputCase=FRE06 CaseType=Combination P=-25,0921043187336 V2=-1,43971534265668 V3=0 T=0 M2=0 M3=-0,727100560392964 FrameElem=46-1 ElemStation=0,1834
Frame=46 Station=0 OutputCase=FRE07 CaseType=Combination P=-6,8304424107999 V2=-2,17031319337939 V3=0 T=0 M2=0 M3=-3,9596686073054 FrameElem=46-1 ElemStation=0
Frame=46 Station=0,0917 OutputCase=FRE07 CaseType=Combination P=-6,8304424107999 V2=-1,80351319337939 V3=0 T=0 M2=0 M3=-3,77746866747251 FrameElem=46-1 ElemStation=0,0917
Frame=46 Station=0,1834 OutputCase=FRE07 CaseType=Combination P=-6,8304424107999 V2=-1,43671319337939 V3=0 T=0 M2=0 M3=-3,62890428763962 FrameElem=46-1 ElemStation=0,1834
Frame=46 Station=0 OutputCase=FRE08 CaseType=Combination P=-6,18696074206497 V2=-8,17635617909589 V3=0 T=0 M2=0 M3=-19,2192712682007 FrameElem=46-1 ElemStation=0
Frame=46 Station=0,0917 OutputCase=FRE08 CaseType=Combination P=-6,18696074206497 V2=-7,80955617909589 V3=0 T=0 M2=0 M3=-18,4863171865777 FrameElem=46-1 ElemStation=0,0917
Frame=46 Station=0,1834 OutputCase=FRE08 CaseType=Combination P=-6,18696074206497 V2=-7,44275617909589 V3=0 T=0 M2=0 M3=-17,7869986649546 FrameElem=46-1 ElemStation=0,1834
Frame=46 Station=0 OutputCase=FRE09 CaseType=Combination P=-15,0879274876334 V2=9,72754363217511 V3=0 T=0 M2=0 M3=-17,9590601877865 FrameElem=46-1 ElemStation=0
Frame=46 Station=0,0917 OutputCase=FRE09 CaseType=Combination P=-15,0879274876334 V2=10,0943436321751 V3=0 T=0 M2=0 M3=-18,867893718857 FrameElem=46-1 ElemStation=0,0917
Frame=46 Station=0,1834 OutputCase=FRE09 CaseType=Combination P=-15,0879274876334 V2=10,4611436321751 V3=0 T=0 M2=0 M3=-19,8103628099274 FrameElem=46-1 ElemStation=0,1834
Frame=46 Station=0 OutputCase=FRE10 CaseType=Combination P=-23,9888942306407 V2=-8,17896425333864 V3=0 T=0 M2=0 M3=-16,698849107736 FrameElem=46-1 ElemStation=0
Frame=46 Station=0,0917 OutputCase=FRE10 CaseType=Combination P=-23,9888942306407 V2=-7,81216425333864 V3=0 T=0 M2=0 M3=-15,965658657049 FrameElem=46-1 ElemStation=0,0917
Frame=46 Station=0,1834 OutputCase=FRE10 CaseType=Combination P=-23,9888942306407 V2=-7,44536425333864 V3=0 T=0 M2=0 M3=-15,2660981836737 FrameElem=46-1 ElemStation=0,1834
Frame=46 Station=0 OutputCase=FRE11 CaseType=Combination P=-15,8080305595947 V2=15,7335209387192 V3=0 T=0 M2=0 M3=-2,63598569812374 FrameElem=46-1 ElemStation=0
Frame=46 Station=0,0917 OutputCase=FRE11 CaseType=Combination P=-15,8080305595947 V2=16,1003209387192 V3=0 T=0 M2=0 M3=-4,09556734820429 FrameElem=46-1 ElemStation=0,0917
Frame=46 Station=0,1834 OutputCase=FRE11 CaseType=Combination P=-15,8080305595947 V2=16,4671209387192 V3=0 T=0 M2=0 M3=-5,58878455828484 FrameElem=46-1 ElemStation=0,1834
Frame=46 Station=0 OutputCase=FRE12 CaseType=Combination P=-24,708997302602 V2=-2,17298694679456 V3=0 T=0 M2=0 M3=-1,37577461807328 FrameElem=46-1 ElemStation=0
Frame=46 Station=0,0917 OutputCase=FRE12 CaseType=Combination P=-24,708997302602 V2=-1,80618694679456 V3=0 T=0 M2=0 M3=-1,19332949505222 FrameElem=46-1 ElemStation=0,0917
Frame=46 Station=0,1834 OutputCase=FRE12 CaseType=Combination P=-24,708997302602 V2=-1,43938694679456 V3=0 T=0 M2=0 M3=-1,04451993203116 FrameElem=46-1 ElemStation=0,1834
Frame=46 Station=0 OutputCase=FRE13 CaseType=Combination P=-6,98938107240172 V2=-1,85265291165182 V3=0 T=0 M2=0 M3=-3,91655848963 FrameElem=46-1 ElemStation=0
Frame=46 Station=0,0917 OutputCase=FRE13 CaseType=Combination P=-6,98938107240172 V2=-1,48585291165182 V3=0 T=0 M2=0 M3=-3,76348799763153 FrameElem=46-1 ElemStation=0,0917
Frame=46 Station=0,1834 OutputCase=FRE13 CaseType=Combination P=-6,98938107240172 V2=-1,11905291165182 V3=0 T=0 M2=0 M3=-3,64405306563306 FrameElem=46-1 ElemStation=0,1834
Frame=46 Station=0 OutputCase=FRE14 CaseType=Combination P=-6,67150374919807 V2=-2,4879347510695 V3=0 T=0 M2=0 M3=-4,00277872498081 FrameElem=46-1 ElemStation=0
Frame=46 Station=0,0917 OutputCase=FRE14 CaseType=Combination P=-6,67150374919807 V2=-2,12117347510695 V3=0 T=0 M2=0 M3=-3,7914493373135 FrameElem=46-1 ElemStation=0,0917
Frame=46 Station=0,1834 OutputCase=FRE14 CaseType=Combination P=-6,67150374919807 V2=-1,75437347510695 V3=0 T=0 M2=0 M3=-3,61375550964619 FrameElem=46-1 ElemStation=0,1834
Frame=46 Station=0 OutputCase=FRE15 CaseType=Combination P=-7,21354942693152 V2=-2,17064158924151 V3=0 T=0 M2=0 M3=-3,64230946346832 FrameElem=46-1 ElemStation=0
Frame=46 Station=0,0917 OutputCase=FRE15 CaseType=Combination P=-7,21354942693152 V2=-1,80384158924151 V3=0 T=0 M2=0 M3=-3,46007940973487 FrameElem=46-1 ElemStation=0,0917
Frame=46 Station=0,1834 OutputCase=FRE15 CaseType=Combination P=-7,21354942693152 V2=-1,43704158924151 V3=0 T=0 M2=0 M3=-3,31148491600143 FrameElem=46-1 ElemStation=0,1834
Frame=46 Station=0 OutputCase=FRE16 CaseType=Combination P=-7,7498992495158 V2=-2,17110134344848 V3=0 T=0 M2=0 M3=-3,198006620964 FrameElem=46-1 ElemStation=0
Frame=46 Station=0,0917 OutputCase=FRE16 CaseType=Combination P=-7,7498992495158 V2=-1,80430134344848 V3=0 T=0 M2=0 M3=-3,01573444890218 FrameElem=46-1 ElemStation=0,0917
Frame=46 Station=0,1834 OutputCase=FRE16 CaseType=Combination P=-7,7498992495158 V2=-1,43750134344848 V3=0 T=0 M2=0 M3=-2,86709779570795 FrameElem=46-1 ElemStation=0,1834

Società di Progetto
Brebemi SpA



Doc. N.
60235-0000-A00.doc

CODIFICA DOCUMENTO
04RCDII10000000000300A00

REV.
00

FOGLIO
625 di 628

Frame=46 Station=0 OutputCase=FRE17 CaseType=Combination P=-6,95317477432822 V2=-8,17701297082014 V3=0 T=0 M2=0 M3=-18,5845529805266 FrameElem=46-1 ElemStation=0
Frame=46 Station=0,0917 OutputCase=FRE17 CaseType=Combination P=-6,95317477432822 V2=-7,81021297082014 V3=0 T=0 M2=0 M3=-17,8515386711024 FrameElem=46-1 ElemStation=0,0917
Frame=46 Station=0,1834 OutputCase=FRE17 CaseType=Combination P=-6,95317477432822 V2=-7,44341297082014 V3=0 T=0 M2=0 M3=-17,1521599216782 FrameElem=46-1 ElemStation=0,1834
Frame=46 Station=0 OutputCase=FRE18 CaseType=Combination P=-15,8541415198967 V2=9,72688684045086 V3=0 T=0 M2=0 M3=-17,3243419001123 FrameElem=46-1 ElemStation=0
Frame=46 Station=0,0917 OutputCase=FRE18 CaseType=Combination P=-15,8541415198967 V2=10,0936868404509 V3=0 T=0 M2=0 M3=-18,2331152033817 FrameElem=46-1 ElemStation=0,0917
Frame=46 Station=0,1834 OutputCase=FRE18 CaseType=Combination P=-15,8541415198967 V2=10,4604868404509 V3=0 T=0 M2=0 M3=-19,175524066651 FrameElem=46-1 ElemStation=0,1834
Frame=46 Station=0 OutputCase=FRE19 CaseType=Combination P=-24,755108262904 V2=-8,17962104506288 V3=0 T=0 M2=0 M3=-16,0641308200619 FrameElem=46-1 ElemStation=0
Frame=46 Station=0,0917 OutputCase=FRE19 CaseType=Combination P=-24,755108262904 V2=-7,81282104506288 V3=0 T=0 M2=0 M3=-15,3308773502296 FrameElem=46-1 ElemStation=0,0917
Frame=46 Station=0,1834 OutputCase=FRE19 CaseType=Combination P=-24,755108262904 V2=-7,44602104506288 V3=0 T=0 M2=0 M3=-14,6312594403973 FrameElem=46-1 ElemStation=0,1834
Frame=46 Station=0 OutputCase=FRE20 CaseType=Combination P=-16,5742445918579 V2=15,7328641469949 V3=0 T=0 M2=0 M3=-2,00126741044957 FrameElem=46-1 ElemStation=0
Frame=46 Station=0,0917 OutputCase=FRE20 CaseType=Combination P=-16,5742445918579 V2=16,0996641469949 V3=0 T=0 M2=0 M3=-3,46078832729 FrameElem=46-1 ElemStation=0,0917
Frame=46 Station=0,1834 OutputCase=FRE20 CaseType=Combination P=-16,5742445918579 V2=16,4664641469949 V3=0 T=0 M2=0 M3=-4,95394581500844 FrameElem=46-1 ElemStation=0,1834
Frame=46 Station=0 OutputCase=FRE21 CaseType=Combination P=-25,4752113348652 V2=-2,1736437385188 V3=0 T=0 M2=0 M3=-0,741056330399114 FrameElem=46-1 ElemStation=0
Frame=46 Station=0,0917 OutputCase=FRE21 CaseType=Combination P=-25,4752113348652 V2=-1,8068437385188 V3=0 T=0 M2=0 M3=-0,55855097957694 FrameElem=46-1 ElemStation=0,0917
Frame=46 Station=0,1834 OutputCase=FRE21 CaseType=Combination P=-25,4752113348652 V2=-1,4400437385188 V3=0 T=0 M2=0 M3=-0,409681188754766 FrameElem=46-1 ElemStation=0,1834
Frame=46 Station=0 OutputCase=FRE22 CaseType=Combination P=-7,90883791111762 V2=-1,85344106172092 V3=0 T=0 M2=0 M3=-3,154896544421 FrameElem=46-1 ElemStation=0
Frame=46 Station=0,0917 OutputCase=FRE22 CaseType=Combination P=-7,90883791111762 V2=-1,48664106172092 V3=0 T=0 M2=0 M3=-3,00175377906119 FrameElem=46-1 ElemStation=0,0917
Frame=46 Station=0,1834 OutputCase=FRE22 CaseType=Combination P=-7,90883791111762 V2=-1,11984106172092 V3=0 T=0 M2=0 M3=-2,88224657370138 FrameElem=46-1 ElemStation=0,1834
Frame=46 Station=0 OutputCase=FRE23 CaseType=Combination P=-7,59096058791398 V2=-2,48876162517605 V3=0 T=0 M2=0 M3=-3,24111677977181 FrameElem=46-1 ElemStation=0
Frame=46 Station=0,0917 OutputCase=FRE23 CaseType=Combination P=-7,59096058791398 V2=-2,12196162517605 V3=0 T=0 M2=0 M3=-3,02971511874316 FrameElem=46-1 ElemStation=0,0917
Frame=46 Station=0,1834 OutputCase=FRE23 CaseType=Combination P=-7,59096058791398 V2=-1,75516162517605 V3=0 T=0 M2=0 M3=-2,85194901771452 FrameElem=46-1 ElemStation=0,1834
Frame=46 Station=0 OutputCase=FRE24 CaseType=Combination P=-8,13300626564743 V2=-2,17142973931061 V3=0 T=0 M2=0 M3=-2,88064751825932 FrameElem=46-1 ElemStation=0
Frame=46 Station=0,0917 OutputCase=FRE24 CaseType=Combination P=-8,13300626564743 V2=-1,80462973931061 V3=0 T=0 M2=0 M3=-2,69834519116453 FrameElem=46-1 ElemStation=0,0917
Frame=46 Station=0,1834 OutputCase=FRE24 CaseType=Combination P=-8,13300626564743 V2=-1,43782973931061 V3=0 T=0 M2=0 M3=-2,54967842406975 FrameElem=46-1 ElemStation=0,1834
Frame=46 Station=0 OutputCase=FRE25 CaseType=Combination P=-7,48089722408003 V2=-1,78951493034086 V3=0 T=0 M2=0 M3=-3,52710549349042 FrameElem=46-1 ElemStation=0
Frame=46 Station=0,0917 OutputCase=FRE25 CaseType=Combination P=-7,48089722408003 V2=-1,42271493034086 V3=0 T=0 M2=0 M3=-3,37982475437816 FrameElem=46-1 ElemStation=0,0917
Frame=46 Station=0,1834 OutputCase=FRE25 CaseType=Combination P=-7,48089722408003 V2=-1,05591493034086 V3=0 T=0 M2=0 M3=-3,26617957526591 FrameElem=46-1 ElemStation=0,1834
Frame=46 Station=0 OutputCase=FRE26 CaseType=Combination P=-6,72900641979841 V2=-7,85902429323045 V3=0 T=0 M2=0 M3=-18,8588020066883 FrameElem=46-1 ElemStation=0
Frame=46 Station=0,0917 OutputCase=FRE26 CaseType=Combination P=-6,72900641979841 V2=-7,49222429323045 V3=0 T=0 M2=0 M3=-18,154947258999 FrameElem=46-1 ElemStation=0,0917
Frame=46 Station=0,1834 OutputCase=FRE26 CaseType=Combination P=-6,72900641979841 V2=-7,12542429323045 V3=0 T=0 M2=0 M3=-17,4847280713098 FrameElem=46-1 ElemStation=0,1834
Frame=46 Station=0 OutputCase=FRE27 CaseType=Combination P=-15,6299731653669 V2=10,0448755180406 V3=0 T=0 M2=0 M3=-17,598590926274 FrameElem=46-1 ElemStation=0
Frame=46 Station=0,0917 OutputCase=FRE27 CaseType=Combination P=-15,6299731653669 V2=10,4116755180406 V3=0 T=0 M2=0 M3=-18,5365237912783 FrameElem=46-1 ElemStation=0,0917
Frame=46 Station=0,1834 OutputCase=FRE27 CaseType=Combination P=-15,6299731653669 V2=10,7784755180406 V3=0 T=0 M2=0 M3=-19,5080922162826 FrameElem=46-1 ElemStation=0,1834
Frame=46 Station=0 OutputCase=FRE28 CaseType=Combination P=-24,5309399083742 V2=-7,8616323674732 V3=0 T=0 M2=0 M3=-16,3383798462236 FrameElem=46-1 ElemStation=0
Frame=46 Station=0,0917 OutputCase=FRE28 CaseType=Combination P=-24,5309399083742 V2=-7,4948323674732 V3=0 T=0 M2=0 M3=-15,6342859381263 FrameElem=46-1 ElemStation=0,0917
Frame=46 Station=0,1834 OutputCase=FRE28 CaseType=Combination P=-24,5309399083742 V2=-7,1280323674732 V3=0 T=0 M2=0 M3=-14,963827590029 FrameElem=46-1 ElemStation=0,1834
Frame=46 Station=0 OutputCase=FRE29 CaseType=Combination P=-16,3500762373281 V2=16,0508528245846 V3=0 T=0 M2=0 M3=-2,27551643661125 FrameElem=46-1 ElemStation=0
Frame=46 Station=0,0917 OutputCase=FRE29 CaseType=Combination P=-16,3500762373281 V2=16,4176528245846 V3=0 T=0 M2=0 M3=-3,76419742062566 FrameElem=46-1 ElemStation=0,0917
Frame=46 Station=0,1834 OutputCase=FRE29 CaseType=Combination P=-16,3500762373281 V2=16,7844528245846 V3=0 T=0 M2=0 M3=-5,28651396464007 FrameElem=46-1 ElemStation=0,1834
Frame=46 Station=0 OutputCase=FRE30 CaseType=Combination P=-25,2510429803354 V2=-1,85565506092911 V3=0 T=0 M2=0 M3=-1,01530535656079 FrameElem=46-1 ElemStation=0
Frame=46 Station=0,0917 OutputCase=FRE30 CaseType=Combination P=-25,2510429803354 V2=-1,48885506092911 V3=0 T=0 M2=0 M3=-0,861959567473595 FrameElem=46-1 ElemStation=0,0917
Frame=46 Station=0,1834 OutputCase=FRE30 CaseType=Combination P=-25,2510429803354 V2=-1,12205506092911 V3=0 T=0 M2=0 M3=-0,742249338386395 FrameElem=46-1 ElemStation=0,1834
Frame=46 Station=0 OutputCase=FRE31 CaseType=Combination P=-7,09779020794841 V2=-1,78918653447873 V3=0 T=0 M2=0 M3=-3,8444646373275 FrameElem=46-1 ElemStation=0
Frame=46 Station=0,0917 OutputCase=FRE31 CaseType=Combination P=-7,09779020794841 V2=-1,42238653447873 V3=0 T=0 M2=0 M3=-3,6972140121158 FrameElem=46-1 ElemStation=0,0917

Società di Progetto
Brebemi SpA



Doc. N.
60235-00000-A00.doc

CODIFICA DOCUMENTO
04RCDII10000000000300A00

REV.
00

FOGLIO
626 di 628

Frame=46 Station=0,1834 OutputCase=FRE31 CaseType=Combination P=-7,09779020794841 V2=-1,05558653447873 V3=0 T=0 M2=0 M3=-3,5835989469041 FrameElem=46-1 ElemStation=0,1834

Frame=46 Station=0 OutputCase=FRE32 CaseType=Combination P=-7,86400424021166 V2=-1,78984332620298 V3=0 T=0 M2=0 M3=-3,20974634965333 FrameElem=46-1 ElemStation=0

Frame=46 Station=0,0917 OutputCase=FRE32 CaseType=Combination P=-7,86400424021166 V2=-1,42304332620298 V3=0 T=0 M2=0 M3=-3,06243549664052 FrameElem=46-1 ElemStation=0,0917

Frame=46 Station=0,1834 OutputCase=FRE32 CaseType=Combination P=-7,86400424021166 V2=-1,05624332620298 V3=0 T=0 M2=0 M3=-2,94876020362771 FrameElem=46-1 ElemStation=0,1834

Frame=46 Station=0 OutputCase=FRE33 CaseType=Combination P=-7,86400424021166 V2=-1,78984332620298 V3=0 T=0 M2=0 M3=-3,20974634965333 FrameElem=46-1 ElemStation=0

Frame=46 Station=0,0917 OutputCase=FRE33 CaseType=Combination P=-7,86400424021166 V2=-1,42304332620298 V3=0 T=0 M2=0 M3=-3,06243549664052 FrameElem=46-1 ElemStation=0,0917

Frame=46 Station=0,1834 OutputCase=FRE33 CaseType=Combination P=-7,86400424021166 V2=-1,05624332620298 V3=0 T=0 M2=0 M3=-2,94876020362771 FrameElem=46-1 ElemStation=0,1834

Frame=46 Station=0 OutputCase=FRE34 CaseType=Combination P=-7,09944443623566 V2=-2,55189960648701 V3=0 T=0 M2=0 M3=-3,63056977591139 FrameElem=46-1 ElemStation=0

Frame=46 Station=0,0917 OutputCase=FRE34 CaseType=Combination P=-7,09944443623566 V2=-2,18509960648701 V3=0 T=0 M2=0 M3=-3,41337836199653 FrameElem=46-1 ElemStation=0,0917

Frame=46 Station=0,1834 OutputCase=FRE34 CaseType=Combination P=-7,09944443623566 V2=-1,81829960648701 V3=0 T=0 M2=0 M3=-3,22982250808167 FrameElem=46-1 ElemStation=0,1834

Frame=46 Station=0 OutputCase=FRE35 CaseType=Combination P=-6,41112909659477 V2=-8,49434485668558 V3=0 T=0 M2=0 M3=-18,9450222420391 FrameElem=46-1 ElemStation=0

Frame=46 Station=0,0917 OutputCase=FRE35 CaseType=Combination P=-6,41112909659477 V2=-8,12754485668558 V3=0 T=0 M2=0 M3=-18,182908598681 FrameElem=46-1 ElemStation=0,0917

Frame=46 Station=0,1834 OutputCase=FRE35 CaseType=Combination P=-6,41112909659477 V2=-7,76074485668558 V3=0 T=0 M2=0 M3=-17,4544305153229 FrameElem=46-1 ElemStation=0,1834

Frame=46 Station=0 OutputCase=FRE36 CaseType=Combination P=-15,3120958421632 V2=9,40955495458542 V3=0 T=0 M2=0 M3=-17,6848111616248 FrameElem=46-1 ElemStation=0

Frame=46 Station=0,0917 OutputCase=FRE36 CaseType=Combination P=-15,3120958421632 V2=9,77635495458542 V3=0 T=0 M2=0 M3=-18,5644851309603 FrameElem=46-1 ElemStation=0,0917

Frame=46 Station=0,1834 OutputCase=FRE36 CaseType=Combination P=-15,3120958421632 V2=10,1431549545854 V3=0 T=0 M2=0 M3=-19,4777946602958 FrameElem=46-1 ElemStation=0,1834

Frame=46 Station=0 OutputCase=FRE37 CaseType=Combination P=-24,2130625851705 V2=-8,49695293092833 V3=0 T=0 M2=0 M3=-16,4246000815744 FrameElem=46-1 ElemStation=0

Frame=46 Station=0,0917 OutputCase=FRE37 CaseType=Combination P=-24,2130625851705 V2=-8,13015293092833 V3=0 T=0 M2=0 M3=-15,6622472778082 FrameElem=46-1 ElemStation=0,0917

Frame=46 Station=0,1834 OutputCase=FRE37 CaseType=Combination P=-24,2130625851705 V2=-7,76335293092833 V3=0 T=0 M2=0 M3=-14,9335300340421 FrameElem=46-1 ElemStation=0,1834

Frame=46 Station=0 OutputCase=FRE38 CaseType=Combination P=-16,0321989141245 V2=15,4155322611295 V3=0 T=0 M2=0 M3=-2,36173667196206 FrameElem=46-1 ElemStation=0

Frame=46 Station=0,0917 OutputCase=FRE38 CaseType=Combination P=-16,0321989141245 V2=15,7823322611295 V3=0 T=0 M2=0 M3=-3,79215876030763 FrameElem=46-1 ElemStation=0,0917

Frame=46 Station=0,1834 OutputCase=FRE38 CaseType=Combination P=-16,0321989141245 V2=16,1491322611295 V3=0 T=0 M2=0 M3=-5,25621640865321 FrameElem=46-1 ElemStation=0,1834

Frame=46 Station=0 OutputCase=FRE39 CaseType=Combination P=-24,9331656571318 V2=-2,49097562438424 V3=0 T=0 M2=0 M3=-1,1015255919116 FrameElem=46-1 ElemStation=0

Frame=46 Station=0,0917 OutputCase=FRE39 CaseType=Combination P=-24,9331656571318 V2=-2,12417562438424 V3=0 T=0 M2=0 M3=-0,889920907155568 FrameElem=46-1 ElemStation=0,0917

Frame=46 Station=0,1834 OutputCase=FRE39 CaseType=Combination P=-24,9331656571318 V2=-1,75737562438424 V3=0 T=0 M2=0 M3=-0,711951782399532 FrameElem=46-1 ElemStation=0,1834

Frame=46 Station=0 OutputCase=FRE40 CaseType=Combination P=-6,71633742010404 V2=-2,55157121062489 V3=0 T=0 M2=0 M3=-3,94792891974847 FrameElem=46-1 ElemStation=0

Frame=46 Station=0,0917 OutputCase=FRE40 CaseType=Combination P=-6,71633742010404 V2=-2,18477121062489 V3=0 T=0 M2=0 M3=-3,73076761973417 FrameElem=46-1 ElemStation=0,0917

Frame=46 Station=0,1834 OutputCase=FRE40 CaseType=Combination P=-6,71633742010404 V2=-1,81797121062489 V3=0 T=0 M2=0 M3=-3,54724187971987 FrameElem=46-1 ElemStation=0,1834

Frame=46 Station=0 OutputCase=FRE41 CaseType=Combination P=-7,48255145236729 V2=-2,5522800234914 V3=0 T=0 M2=0 M3=-3,3132106320743 FrameElem=46-1 ElemStation=0

Frame=46 Station=0,0917 OutputCase=FRE41 CaseType=Combination P=-7,48255145236729 V2=-2,18542800234914 V3=0 T=0 M2=0 M3=-3,09598910425889 FrameElem=46-1 ElemStation=0,0917

Frame=46 Station=0,1834 OutputCase=FRE41 CaseType=Combination P=-7,48255145236729 V2=-1,81862800234914 V3=0 T=0 M2=0 M3=-2,91240313644347 FrameElem=46-1 ElemStation=0,1834

Frame=46 Station=0 OutputCase=FRE42 CaseType=Combination P=-7,48255145236729 V2=-2,5522800234914 V3=0 T=0 M2=0 M3=-3,3132106320743 FrameElem=46-1 ElemStation=0

Frame=46 Station=0,0917 OutputCase=FRE42 CaseType=Combination P=-7,48255145236729 V2=-2,18542800234914 V3=0 T=0 M2=0 M3=-3,09598910425889 FrameElem=46-1 ElemStation=0,0917

Frame=46 Station=0,1834 OutputCase=FRE42 CaseType=Combination P=-7,48255145236729 V2=-1,81862800234914 V3=0 T=0 M2=0 M3=-2,91240313644347 FrameElem=46-1 ElemStation=0,1834

Frame=46 Station=0 OutputCase=FRE43 CaseType=Combination P=-7,7498992495158 V2=-2,17110134344848 V3=0 T=0 M2=0 M3=-3,1980066620964 FrameElem=46-1 ElemStation=0

Frame=46 Station=0,0917 OutputCase=FRE43 CaseType=Combination P=-7,7498992495158 V2=-1,80430134344848 V3=0 T=0 M2=0 M3=-3,01573444890218 FrameElem=46-1 ElemStation=0,0917

Frame=46 Station=0,1834 OutputCase=FRE43 CaseType=Combination P=-7,7498992495158 V2=-1,43750134344848 V3=0 T=0 M2=0 M3=-2,86709797570795 FrameElem=46-1 ElemStation=0,1834

Frame=46 Station=0 OutputCase=FRE44 CaseType=Combination P=-6,95317477432822 V2=-8,17701297082014 V3=0 T=0 M2=0 M3=-18,5845529805266 FrameElem=46-1 ElemStation=0

Frame=46 Station=0,0917 OutputCase=FRE44 CaseType=Combination P=-6,95317477432822 V2=-7,81021297082014 V3=0 T=0 M2=0 M3=-17,8515386711024 FrameElem=46-1 ElemStation=0,0917

Frame=46 Station=0,1834 OutputCase=FRE44 CaseType=Combination P=-6,95317477432822 V2=-7,44341297082014 V3=0 T=0 M2=0 M3=-17,1521599216782 FrameElem=46-1 ElemStation=0,1834

Frame=46 Station=0 OutputCase=FRE45 CaseType=Combination P=-15,8541415198967 V2=9,7268868405086 V3=0 T=0 M2=0 M3=-17,3243419001123 FrameElem=46-1 ElemStation=0

Frame=46 Station=0,0917 OutputCase=FRE45 CaseType=Combination P=-15,8541415198967 V2=10,093686840509 V3=0 T=0 M2=0 M3=-18,2331152033817 FrameElem=46-1 ElemStation=0,0917

Frame=46 Station=0,1834 OutputCase=FRE45 CaseType=Combination P=-15,8541415198967 V2=10,460486840509 V3=0 T=0 M2=0 M3=-19,175524066651 FrameElem=46-1 ElemStation=0,1834

Frame=46 Station=0 OutputCase=FRE46 CaseType=Combination P=-24,755108262904 V2=-8,17962104506288 V3=0 T=0 M2=0 M3=-16,0641308200619 FrameElem=46-1 ElemStation=0

Società di Progetto
Brebemi SpA



Doc. N.
60235-0000-A00.doc

CODIFICA DOCUMENTO
04RCDII10000000000300A00

REV.
00

FOGLIO
627 di 628

Frame=46 Station=0,0917 OutputCase=FRE46 CaseType=Combination P=-24,755108262904 V2=-7,81282104506288 V3=0 T=0 M2=0 M3=-15,3308773502296 FrameElem=46-1 ElemStation=0,0917
Frame=46 Station=0,1834 OutputCase=FRE46 CaseType=Combination P=-24,755108262904 V2=-7,44602104506288 V3=0 T=0 M2=0 M3=-14,6312594403973 FrameElem=46-1 ElemStation=0,1834
Frame=46 Station=0 OutputCase=FRE47 CaseType=Combination P=-16,5742445918579 V2=15,7328641469949 V3=0 T=0 M2=0 M3=-2,00126741044957 FrameElem=46-1 ElemStation=0
Frame=46 Station=0,0917 OutputCase=FRE47 CaseType=Combination P=-16,5742445918579 V2=16,0996641469949 V3=0 T=0 M2=0 M3=-3,460788832729 FrameElem=46-1 ElemStation=0,0917
Frame=46 Station=0,1834 OutputCase=FRE47 CaseType=Combination P=-16,5742445918579 V2=16,4664641469949 V3=0 T=0 M2=0 M3=-4,95394581500844 FrameElem=46-1 ElemStation=0,1834
Frame=46 Station=0 OutputCase=FRE48 CaseType=Combination P=-25,4752113348652 V2=-2,1736437385188 V3=0 T=0 M2=0 M3=-0,741056330399114 FrameElem=46-1 ElemStation=0
Frame=46 Station=0,0917 OutputCase=FRE48 CaseType=Combination P=-25,4752113348652 V2=-1,8068437385188 V3=0 T=0 M2=0 M3=-0,55855097957694 FrameElem=46-1 ElemStation=0,0917
Frame=46 Station=0,1834 OutputCase=FRE48 CaseType=Combination P=-25,4752113348652 V2=-1,4400437385188 V3=0 T=0 M2=0 M3=-0,409681188754766 FrameElem=46-1 ElemStation=0,1834
Frame=46 Station=0 OutputCase=FRE49 CaseType=Combination P=-8,13300626564743 V2=-2,17142973931061 V3=0 T=0 M2=0 M3=-2,88064751825932 FrameElem=46-1 ElemStation=0
Frame=46 Station=0,0917 OutputCase=FRE49 CaseType=Combination P=-8,13300626564743 V2=-1,80462973931061 V3=0 T=0 M2=0 M3=-2,69834519116453 FrameElem=46-1 ElemStation=0,0917
Frame=46 Station=0,1834 OutputCase=FRE49 CaseType=Combination P=-8,13300626564743 V2=-1,43782973931061 V3=0 T=0 M2=0 M3=-2,54967842406975 FrameElem=46-1 ElemStation=0,1834
Frame=46 Station=0 OutputCase=FRE50 CaseType=Combination P=-7,90883791111762 V2=-1,85344106172092 V3=0 T=0 M2=0 M3=-3,154896544421 FrameElem=46-1 ElemStation=0
Frame=46 Station=0,0917 OutputCase=FRE50 CaseType=Combination P=-7,90883791111762 V2=-1,48664106172092 V3=0 T=0 M2=0 M3=-3,00175377906119 FrameElem=46-1 ElemStation=0,0917
Frame=46 Station=0,1834 OutputCase=FRE50 CaseType=Combination P=-7,90883791111762 V2=-1,11984106172092 V3=0 T=0 M2=0 M3=-2,88224657370138 FrameElem=46-1 ElemStation=0,1834
Frame=46 Station=0 OutputCase=FRE51 CaseType=Combination P=-7,59096058791398 V2=-2,48876162517605 V3=0 T=0 M2=0 M3=-3,24111677977181 FrameElem=46-1 ElemStation=0
Frame=46 Station=0,0917 OutputCase=FRE51 CaseType=Combination P=-7,59096058791398 V2=-2,12196162517605 V3=0 T=0 M2=0 M3=-3,02971511874316 FrameElem=46-1 ElemStation=0,0917
Frame=46 Station=0,1834 OutputCase=FRE51 CaseType=Combination P=-7,59096058791398 V2=-1,75516162517605 V3=0 T=0 M2=0 M3=-2,85194901771452 FrameElem=46-1 ElemStation=0,1834
Frame=46 Station=0 OutputCase=INVFRE CaseType=Combination StepType=Max P=-6,18696074206497 V2=16,0508528245846 V3=0 T=0 M2=0 M3=-0,741056330399114 FrameElem=46-1 ElemStation=0
Frame=46 Station=0,0917 OutputCase=INVFRE CaseType=Combination StepType=Max P=-6,18696074206497 V2=16,4176528245846 V3=0 T=0 M2=0 M3=-0,55855097957694 FrameElem=46-1 ElemStation=0,0917
Frame=46 Station=0,1834 OutputCase=INVFRE CaseType=Combination StepType=Max P=-6,18696074206497 V2=16,7844528245846 V3=0 T=0 M2=0 M3=-0,409681188754766 FrameElem=46-1 ElemStation=0,1834
Frame=46 Station=0 OutputCase=INVFRE CaseType=Combination StepType=Min P=-25,4752113348652 V2=-8,49695293092833 V3=0 T=0 M2=0 M3=-19,2192712682007 FrameElem=46-1 ElemStation=0
Frame=46 Station=0,0917 OutputCase=INVFRE CaseType=Combination StepType=Min P=-25,4752113348652 V2=-8,13015293092833 V3=0 T=0 M2=0 M3=-18,867893718857 FrameElem=46-1 ElemStation=0,0917
Frame=46 Station=0,1834 OutputCase=INVFRE CaseType=Combination StepType=Min P=-25,4752113348652 V2=-7,76335293092833 V3=0 T=0 M2=0 M3=-19,8103628099274 FrameElem=46-1 ElemStation=0,1834
Frame=46 Station=0 OutputCase=QPE01 CaseType=Combination P=-9,29062562384203 V2=-4,84808762829925 V3=0 T=0 M2=0 M3=-3,33693134360726 FrameElem=46-1 ElemStation=0
Frame=46 Station=0,0917 OutputCase=QPE01 CaseType=Combination P=-9,29062562384203 V2=-4,48128762829925 V3=0 T=0 M2=0 M3=-2,90917948809222 FrameElem=46-1 ElemStation=0,0917
Frame=46 Station=0,1834 OutputCase=QPE01 CaseType=Combination P=-9,29062562384203 V2=-4,11448762829925 V3=0 T=0 M2=0 M3=-2,51506319257718 FrameElem=46-1 ElemStation=0,1834
Frame=46 Station=0 OutputCase=QPE02 CaseType=Combination P=-8,9075186077104 V2=-4,84775923243713 V3=0 T=0 M2=0 M3=-3,65429048744435 FrameElem=46-1 ElemStation=0
Frame=46 Station=0,0917 OutputCase=QPE02 CaseType=Combination P=-8,9075186077104 V2=-4,4805923243713 V3=0 T=0 M2=0 M3=-3,22656874582986 FrameElem=46-1 ElemStation=0,0917
Frame=46 Station=0,1834 OutputCase=QPE02 CaseType=Combination P=-8,9075186077104 V2=-4,11415923243713 V3=0 T=0 M2=0 M3=-2,83248256421538 FrameElem=46-1 ElemStation=0,1834
Frame=46 Station=0 OutputCase=QPE03 CaseType=Combination P=-9,67373263997366 V2=-4,84841602416138 V3=0 T=0 M2=0 M3=-3,01957219977018 FrameElem=46-1 ElemStation=0
Frame=46 Station=0,0917 OutputCase=QPE03 CaseType=Combination P=-9,67373263997366 V2=-4,48161602416138 V3=0 T=0 M2=0 M3=-2,59179023035458 FrameElem=46-1 ElemStation=0,0917
Frame=46 Station=0,1834 OutputCase=QPE03 CaseType=Combination P=-9,67373263997366 V2=-4,11481602416138 V3=0 T=0 M2=0 M3=-2,19764382093898 FrameElem=46-1 ElemStation=0,1834
Frame=46 Station=0 OutputCase=QPE04 CaseType=Combination P=-9,44956428544385 V2=-4,53042734657169 V3=0 T=0 M2=0 M3=-3,29382122593186 FrameElem=46-1 ElemStation=0
Frame=46 Station=0,0917 OutputCase=QPE04 CaseType=Combination P=-9,44956428544385 V2=-4,16362734657169 V3=0 T=0 M2=0 M3=-2,89519881825123 FrameElem=46-1 ElemStation=0,0917
Frame=46 Station=0,1834 OutputCase=QPE04 CaseType=Combination P=-9,44956428544385 V2=-3,79682734657169 V3=0 T=0 M2=0 M3=-2,53021197057061 FrameElem=46-1 ElemStation=0,1834
Frame=46 Station=0 OutputCase=QPE05 CaseType=Combination P=-9,13168696224021 V2=-5,16574791002682 V3=0 T=0 M2=0 M3=-3,38004146128267 FrameElem=46-1 ElemStation=0
Frame=46 Station=0,0917 OutputCase=QPE05 CaseType=Combination P=-9,13168696224021 V2=-4,7989791002682 V3=0 T=0 M2=0 M3=-2,92316015793321 FrameElem=46-1 ElemStation=0,0917
Frame=46 Station=0,1834 OutputCase=QPE05 CaseType=Combination P=-9,13168696224021 V2=-4,43214791002682 V3=0 T=0 M2=0 M3=-2,49991441458375 FrameElem=46-1 ElemStation=0,1834
Frame=46 Station=0 OutputCase=QPE06 CaseType=Combination P=-9,67373263997366 V2=-4,84841602416138 V3=0 T=0 M2=0 M3=-3,01957219977018 FrameElem=46-1 ElemStation=0
Frame=46 Station=0,0917 OutputCase=QPE06 CaseType=Combination P=-9,67373263997366 V2=-4,48161602416138 V3=0 T=0 M2=0 M3=-2,59179023035458 FrameElem=46-1 ElemStation=0,0917
Frame=46 Station=0,1834 OutputCase=QPE06 CaseType=Combination P=-9,67373263997366 V2=-4,11481602416138 V3=0 T=0 M2=0 M3=-2,19764382093898 FrameElem=46-1 ElemStation=0,1834
Frame=46 Station=0 OutputCase=QPE07 CaseType=Combination P=-9,06645726931222 V2=-4,53009895070957 V3=0 T=0 M2=0 M3=-3,61118036976894 FrameElem=46-1 ElemStation=0
Frame=46 Station=0,0917 OutputCase=QPE07 CaseType=Combination P=-9,06645726931222 V2=-4,16329895070957 V3=0 T=0 M2=0 M3=-3,21258807598888 FrameElem=46-1 ElemStation=0,0917
Frame=46 Station=0,1834 OutputCase=QPE07 CaseType=Combination P=-9,06645726931222 V2=-3,79649895070957 V3=0 T=0 M2=0 M3=-2,84763134220881 FrameElem=46-1 ElemStation=0,1834

Società di Progetto
Brebemi SpA



Doc. N.
60235-0000-A00.doc

CODIFICA DOCUMENTO
04RCDII10000000000300A00

REV.
00

FOGLIO
628 di 628

Frame=46 Station=0 OutputCase=QPE08 CaseType=Combination P=-8,74857994610858 V2=-5,1654195141647 V3=0 T=0 M2=0 M3=-3,69740060511975 FrameElem=46-1 ElemStation=0
Frame=46 Station=0,0917 OutputCase=QPE08 CaseType=Combination P=-8,74857994610858 V2=-4,7986195141647 V3=0 T=0 M2=0 M3=-3,24054941567085 FrameElem=46-1 ElemStation=0,0917
Frame=46 Station=0,1834 OutputCase=QPE08 CaseType=Combination P=-8,74857994610858 V2=-4,4318195141647 V3=0 T=0 M2=0 M3=-2,81733378622195 FrameElem=46-1 ElemStation=0,1834
Frame=46 Station=0 OutputCase=QPE09 CaseType=Combination P=-9,29062562384203 V2=-4,84808762829925 V3=0 T=0 M2=0 M3=-3,33693134360726 FrameElem=46-1 ElemStation=0
Frame=46 Station=0,0917 OutputCase=QPE09 CaseType=Combination P=-9,29062562384203 V2=-4,48128762829925 V3=0 T=0 M2=0 M3=-2,90917948809222 FrameElem=46-1 ElemStation=0,0917
Frame=46 Station=0,1834 OutputCase=QPE09 CaseType=Combination P=-9,29062562384203 V2=-4,11448762829925 V3=0 T=0 M2=0 M3=-2,51506319257718 FrameElem=46-1 ElemStation=0,1834
Frame=46 Station=0 OutputCase=QPE10 CaseType=Combination P=-9,29062562500619 V2=0,506172453462568 V3=0 T=0 M2=0 M3=-3,3369313435395 FrameElem=46-1 ElemStation=0
Frame=46 Station=0,0917 OutputCase=QPE10 CaseType=Combination P=-9,29062562500619 V2=0,872972453462568 V3=0 T=0 M2=0 M3=-3,40016513752202 FrameElem=46-1 ElemStation=0,0917
Frame=46 Station=0,1834 OutputCase=QPE10 CaseType=Combination P=-9,29062562500619 V2=1,23977245346257 V3=0 T=0 M2=0 M3=-3,49703449150454 FrameElem=46-1 ElemStation=0,1834
Frame=46 Station=0 OutputCase=QPE11 CaseType=Combination P=-8,90751860887456 V2=0,506500849324691 V3=0 T=0 M2=0 M3=-3,65429048737659 FrameElem=46-1 ElemStation=0
Frame=46 Station=0,0917 OutputCase=QPE11 CaseType=Combination P=-8,90751860887456 V2=0,873300849324691 V3=0 T=0 M2=0 M3=-3,71755439525966 FrameElem=46-1 ElemStation=0,0917
Frame=46 Station=0,1834 OutputCase=QPE11 CaseType=Combination P=-8,90751860887456 V2=1,24010084932469 V3=0 T=0 M2=0 M3=-3,81445386314274 FrameElem=46-1 ElemStation=0,1834
Frame=46 Station=0 OutputCase=QPE12 CaseType=Combination P=-9,67373264113781 V2=0,505844057600445 V3=0 T=0 M2=0 M3=-3,01957219970242 FrameElem=46-1 ElemStation=0
Frame=46 Station=0,0917 OutputCase=QPE12 CaseType=Combination P=-9,67373264113781 V2=0,872644057600445 V3=0 T=0 M2=0 M3=-3,08277587978438 FrameElem=46-1 ElemStation=0,0917
Frame=46 Station=0,1834 OutputCase=QPE12 CaseType=Combination P=-9,67373264113781 V2=1,23944405760045 V3=0 T=0 M2=0 M3=-3,17961511986634 FrameElem=46-1 ElemStation=0,1834
Frame=46 Station=0 OutputCase=QPE13 CaseType=Combination P=-9,44956428660801 V2=0,823832735190134 V3=0 T=0 M2=0 M3=-3,2938212258641 FrameElem=46-1 ElemStation=0
Frame=46 Station=0,0917 OutputCase=QPE13 CaseType=Combination P=-9,44956428660801 V2=1,19063273519013 V3=0 T=0 M2=0 M3=-3,38618446768103 FrameElem=46-1 ElemStation=0,0917
Frame=46 Station=0,1834 OutputCase=QPE13 CaseType=Combination P=-9,44956428660801 V2=1,55743273519013 V3=0 T=0 M2=0 M3=-3,51218326949797 FrameElem=46-1 ElemStation=0,1834
Frame=46 Station=0 OutputCase=QPE14 CaseType=Combination P=-9,13168696340437 V2=0,188512171735003 V3=0 T=0 M2=0 M3=-3,38004146121491 FrameElem=46-1 ElemStation=0
Frame=46 Station=0,0917 OutputCase=QPE14 CaseType=Combination P=-9,13168696340437 V2=0,555312171735002 V3=0 T=0 M2=0 M3=-3,41414580736301 FrameElem=46-1 ElemStation=0,0917
Frame=46 Station=0,1834 OutputCase=QPE14 CaseType=Combination P=-9,13168696340437 V2=0,922112171735003 V3=0 T=0 M2=0 M3=-3,48188571351111 FrameElem=46-1 ElemStation=0,1834
Frame=46 Station=0 OutputCase=QPE15 CaseType=Combination P=-9,67373264113781 V2=0,505844057600445 V3=0 T=0 M2=0 M3=-3,01957219970242 FrameElem=46-1 ElemStation=0
Frame=46 Station=0,0917 OutputCase=QPE15 CaseType=Combination P=-9,67373264113781 V2=0,872644057600445 V3=0 T=0 M2=0 M3=-3,08277587978438 FrameElem=46-1 ElemStation=0,0917
Frame=46 Station=0,1834 OutputCase=QPE15 CaseType=Combination P=-9,67373264113781 V2=1,23944405760045 V3=0 T=0 M2=0 M3=-3,17961511986634 FrameElem=46-1 ElemStation=0,1834
Frame=46 Station=0 OutputCase=QPE16 CaseType=Combination P=-9,06645727047638 V2=0,824161131052257 V3=0 T=0 M2=0 M3=-3,61118036970118 FrameElem=46-1 ElemStation=0
Frame=46 Station=0,0917 OutputCase=QPE16 CaseType=Combination P=-9,06645727047638 V2=1,19096113105226 V3=0 T=0 M2=0 M3=-3,70357372541868 FrameElem=46-1 ElemStation=0,0917
Frame=46 Station=0,1834 OutputCase=QPE16 CaseType=Combination P=-9,06645727047638 V2=1,55776113105226 V3=0 T=0 M2=0 M3=-3,82960264113617 FrameElem=46-1 ElemStation=0,1834
Frame=46 Station=0 OutputCase=QPE17 CaseType=Combination P=-8,74857994727274 V2=0,188840567597126 V3=0 T=0 M2=0 M3=-3,69740060505199 FrameElem=46-1 ElemStation=0
Frame=46 Station=0,0917 OutputCase=QPE17 CaseType=Combination P=-8,74857994727274 V2=0,555640567597126 V3=0 T=0 M2=0 M3=-3,73153506510065 FrameElem=46-1 ElemStation=0,0917
Frame=46 Station=0,1834 OutputCase=QPE17 CaseType=Combination P=-8,74857994727274 V2=0,922440567597126 V3=0 T=0 M2=0 M3=-3,79930508514931 FrameElem=46-1 ElemStation=0,1834
Frame=46 Station=0 OutputCase=QPE18 CaseType=Combination P=-9,29062562500619 V2=0,506172453462568 V3=0 T=0 M2=0 M3=-3,3369313435395 FrameElem=46-1 ElemStation=0
Frame=46 Station=0,0917 OutputCase=QPE18 CaseType=Combination P=-9,29062562500619 V2=0,872972453462568 V3=0 T=0 M2=0 M3=-3,40016513752202 FrameElem=46-1 ElemStation=0,0917
Frame=46 Station=0,1834 OutputCase=QPE18 CaseType=Combination P=-9,29062562500619 V2=1,23977245346257 V3=0 T=0 M2=0 M3=-3,49703449150454 FrameElem=46-1 ElemStation=0,1834
Frame=46 Station=0 OutputCase=INVQPE CaseType=Combination StepType=Max P=-8,74857994610858 V2=0,824161131052257 V3=0 T=0 M2=0 M3=-3,01957219970242 FrameElem=46-1 ElemStation=0
Frame=46 Station=0,0917 OutputCase=INVQPE CaseType=Combination StepType=Max P=-8,74857994610858 V2=1,19096113105226 V3=0 T=0 M2=0 M3=-2,59179023035458 FrameElem=46-1 ElemStation=0,0917
Frame=46 Station=0,1834 OutputCase=INVQPE CaseType=Combination StepType=Max P=-8,74857994610858 V2=1,55776113105226 V3=0 T=0 M2=0 M3=-2,19764382093898 FrameElem=46-1 ElemStation=0,1834
Frame=46 Station=0 OutputCase=INVQPE CaseType=Combination StepType=Min P=-9,67373264113781 V2=-5,16574791002682 V3=0 T=0 M2=0 M3=-3,69740060511975 FrameElem=46-1 ElemStation=0
Frame=46 Station=0,0917 OutputCase=INVQPE CaseType=Combination StepType=Min P=-9,67373264113781 V2=-4,79894791002682 V3=0 T=0 M2=0 M3=-3,73153506510065 FrameElem=46-1 ElemStation=0,0917
Frame=46 Station=0,1834 OutputCase=INVQPE CaseType=Combination StepType=Min P=-9,67373264113781 V2=-4,43214791002682 V3=0 T=0 M2=0 M3=-3,82960264113617 FrameElem=46-1 ElemStation=0,1834

END TABLE DATA

Società di Progetto
Brebemi SpA