

PLANIMETRIA

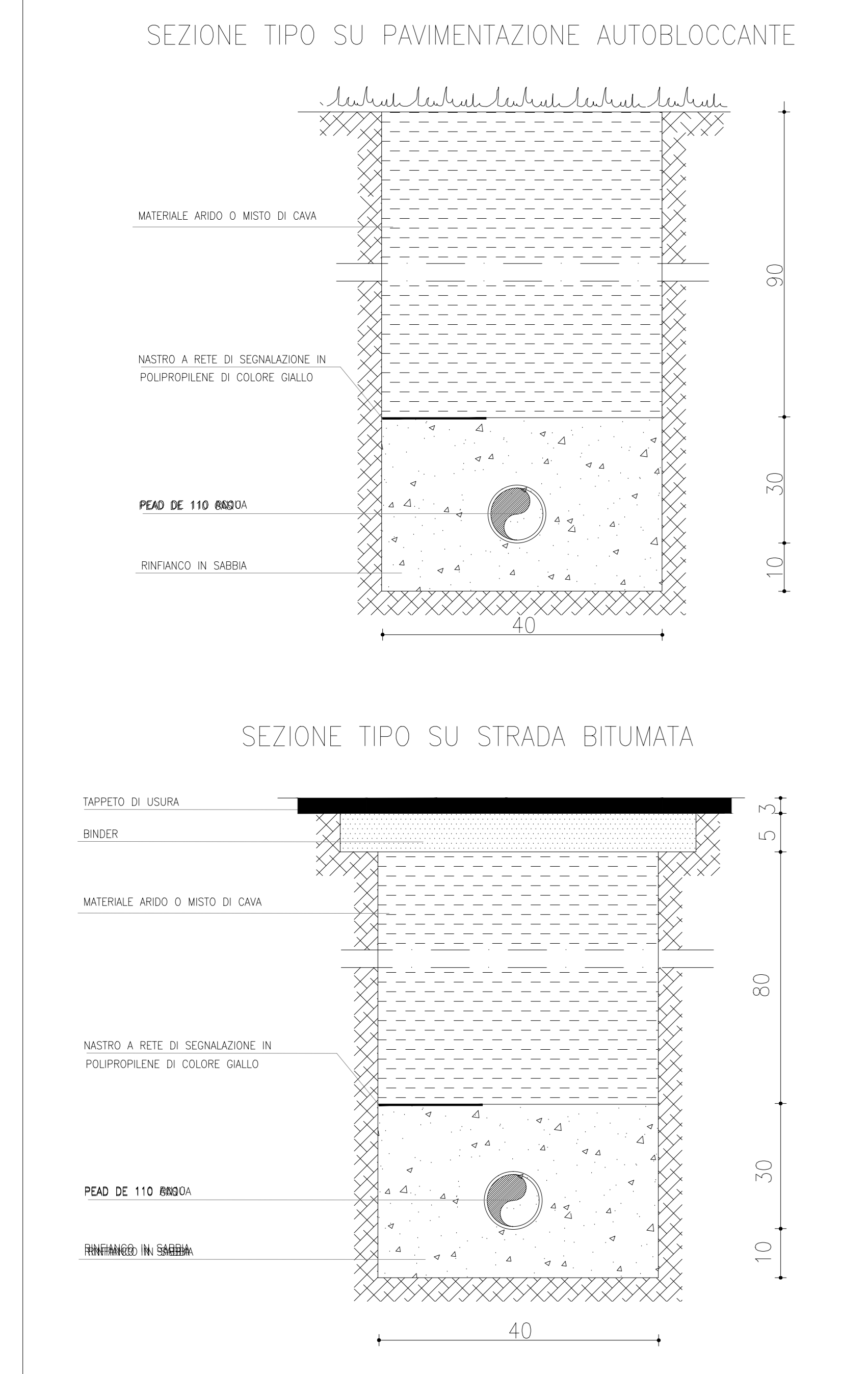
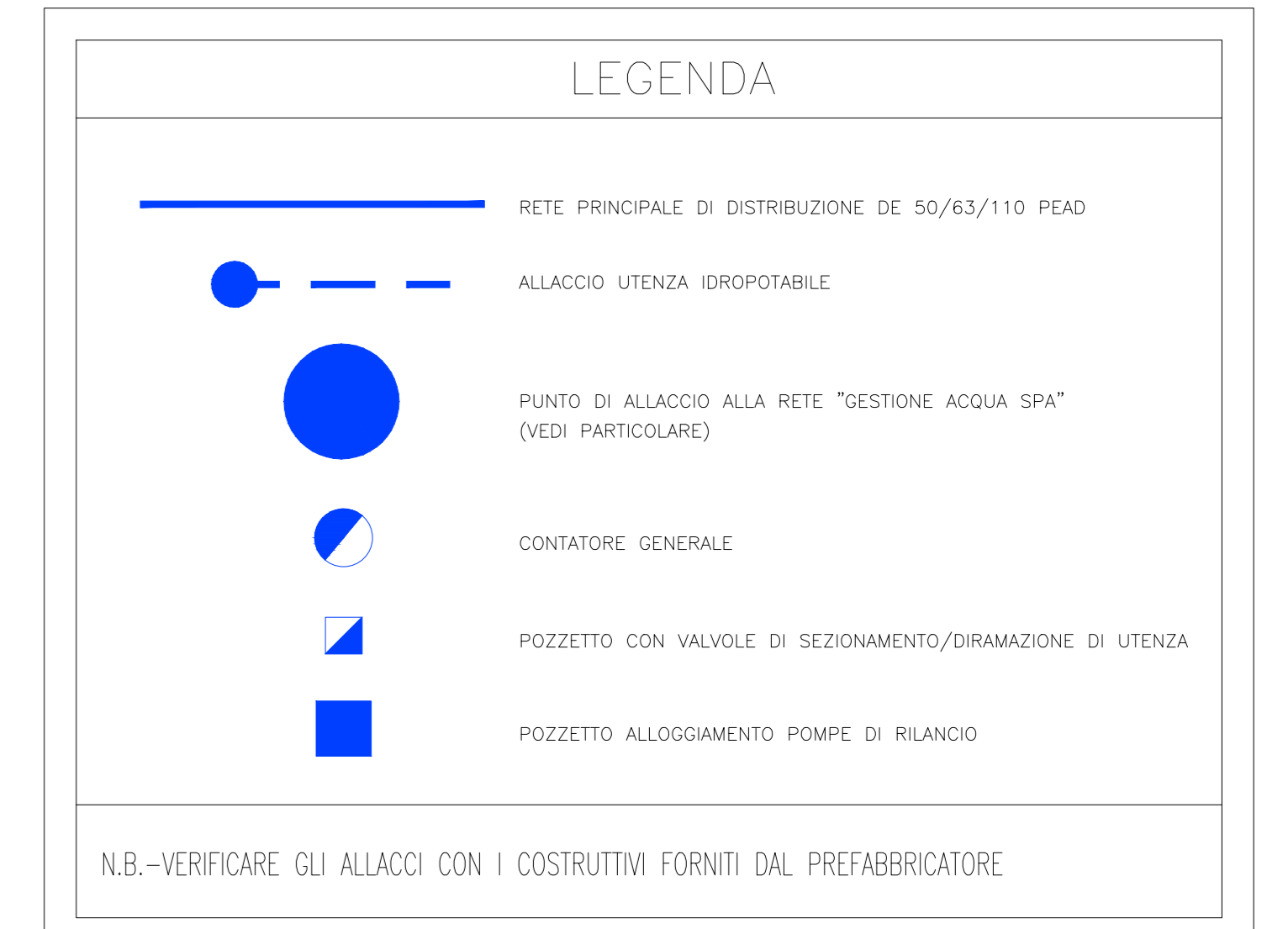
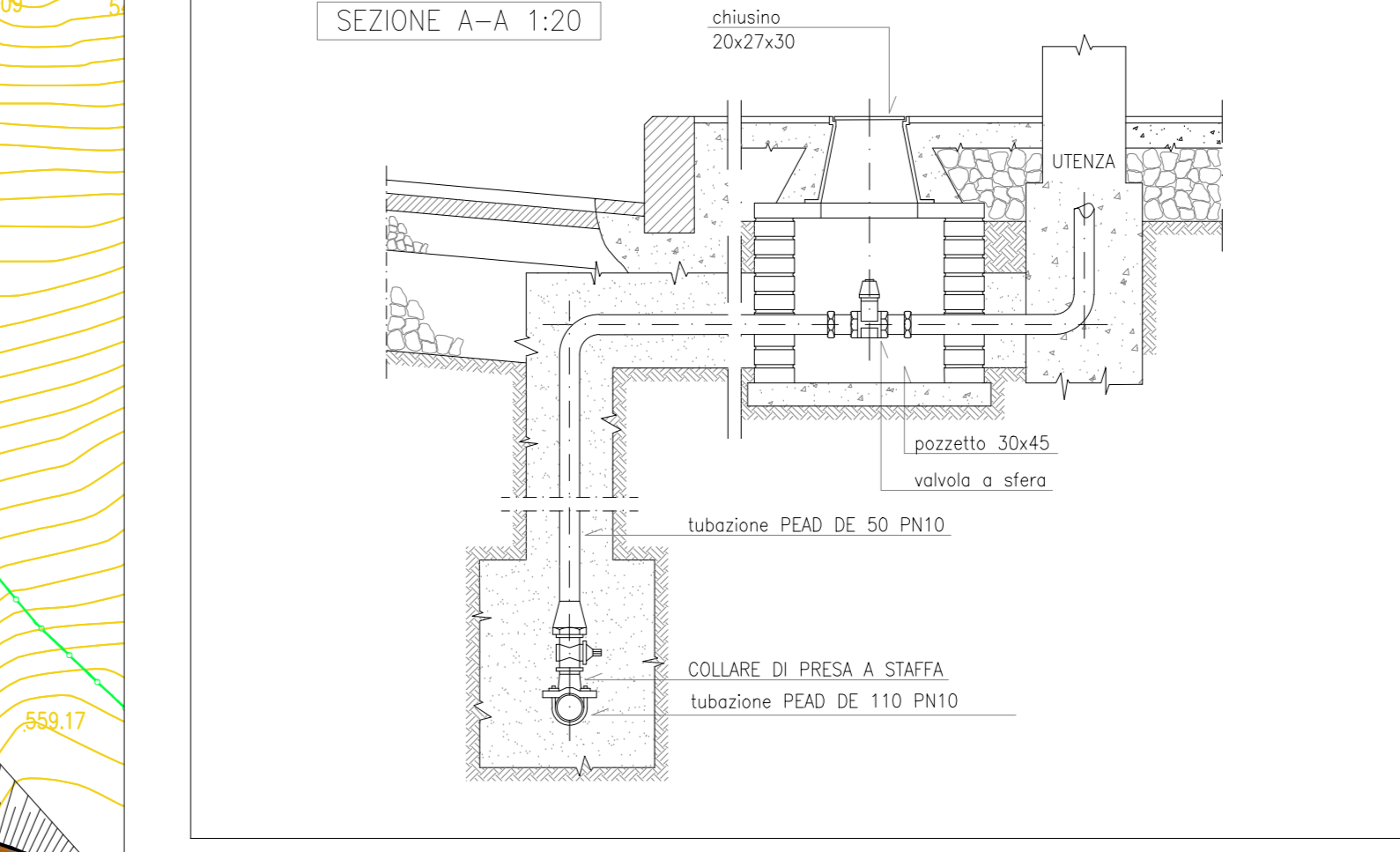
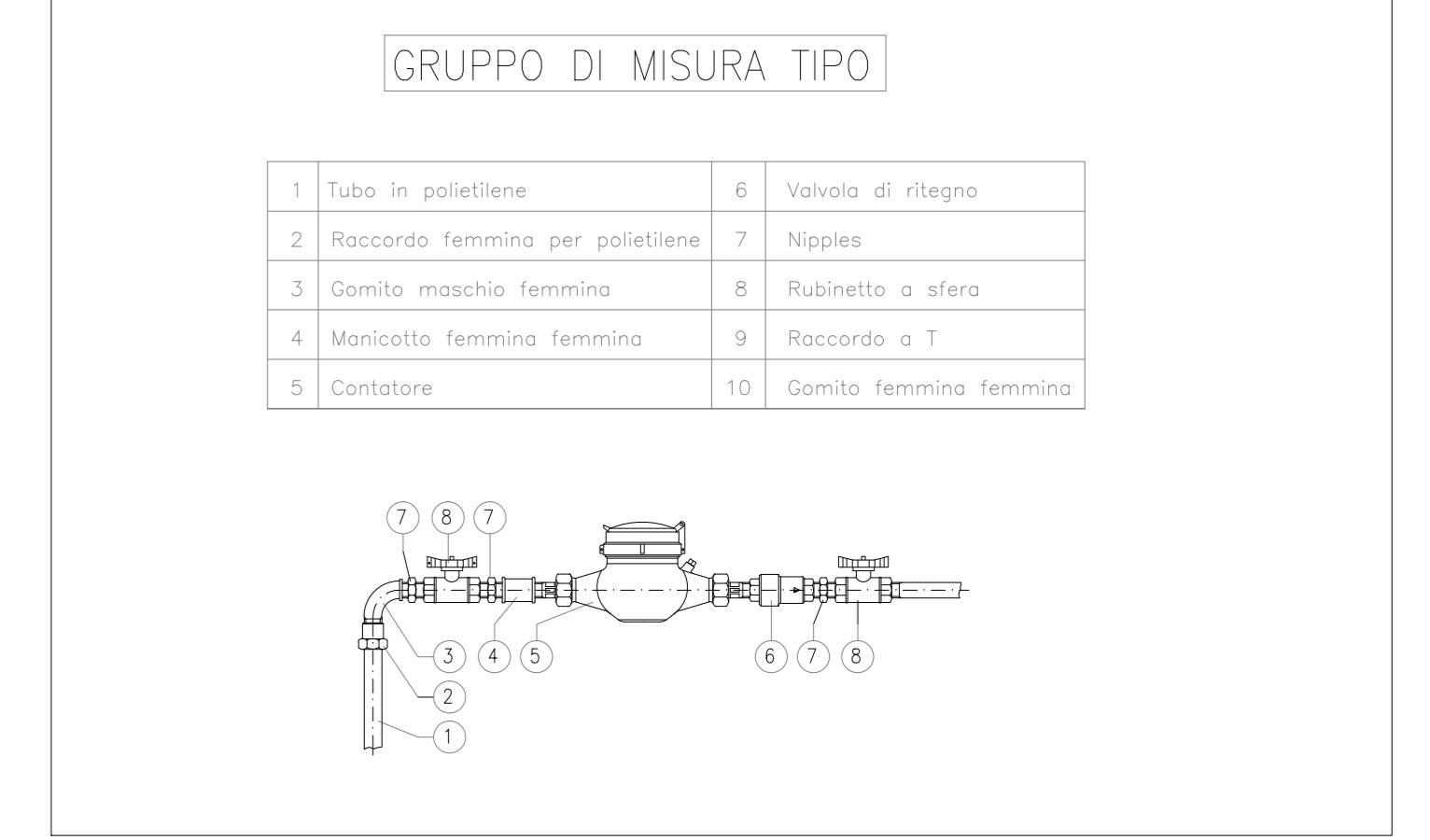
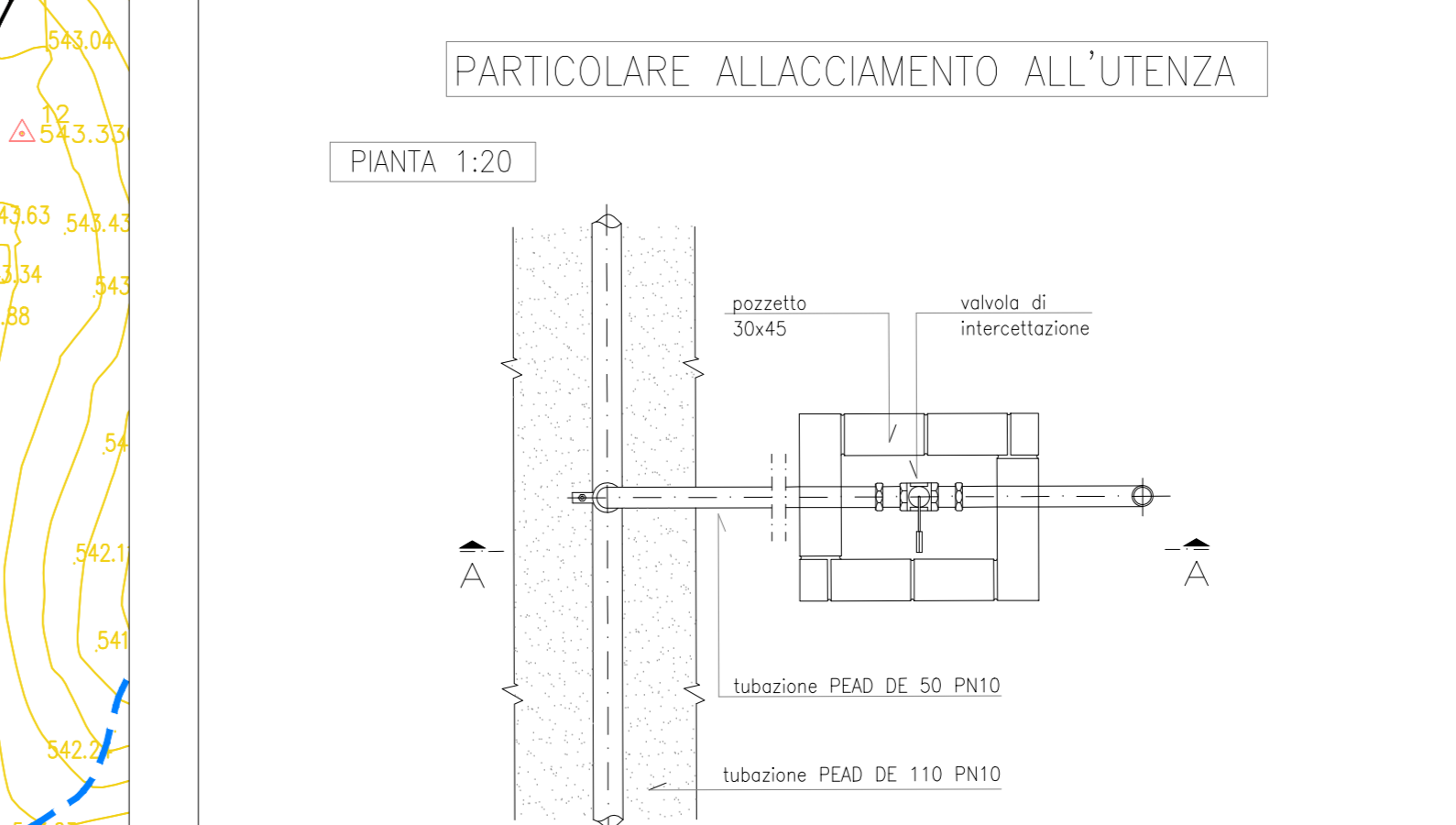
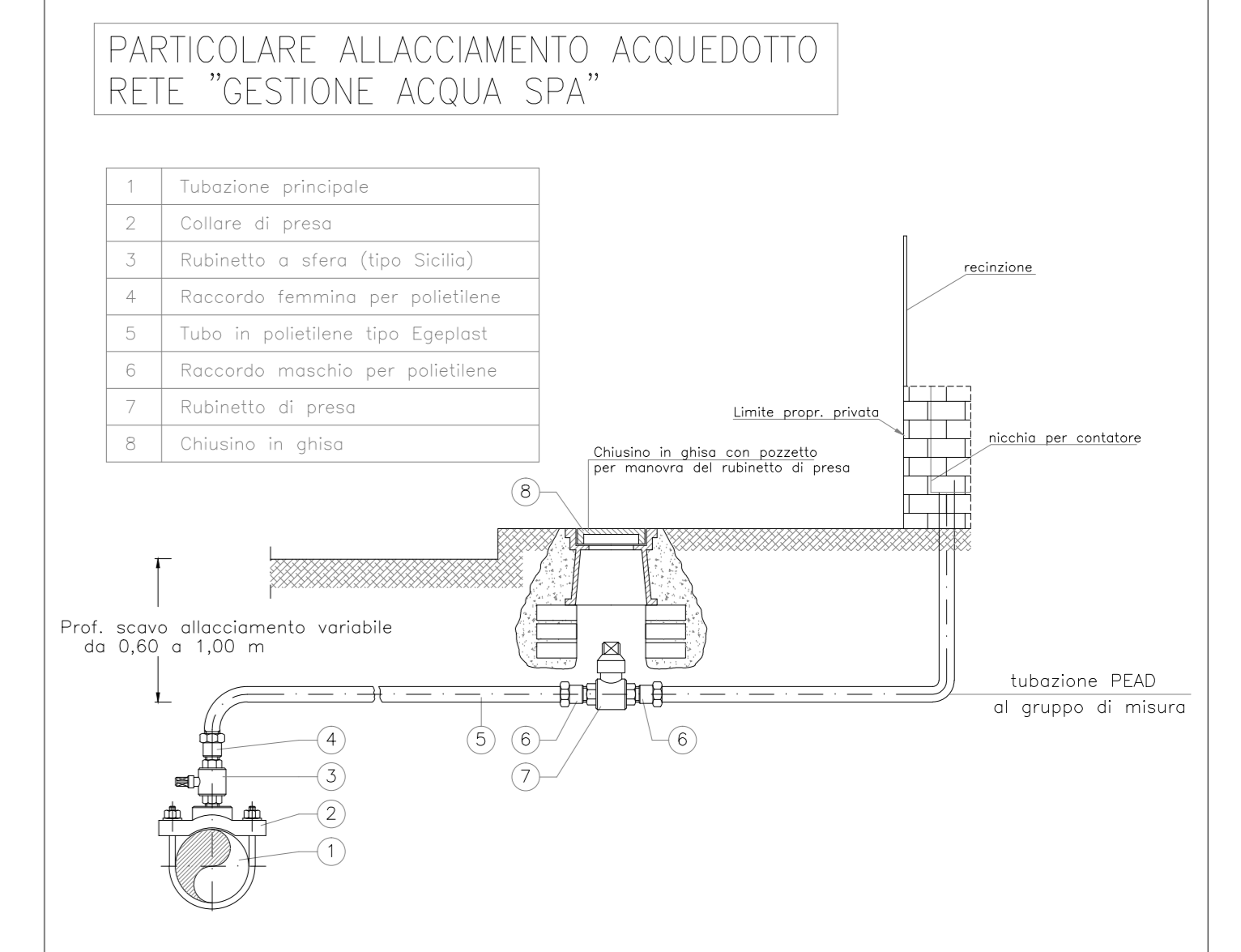
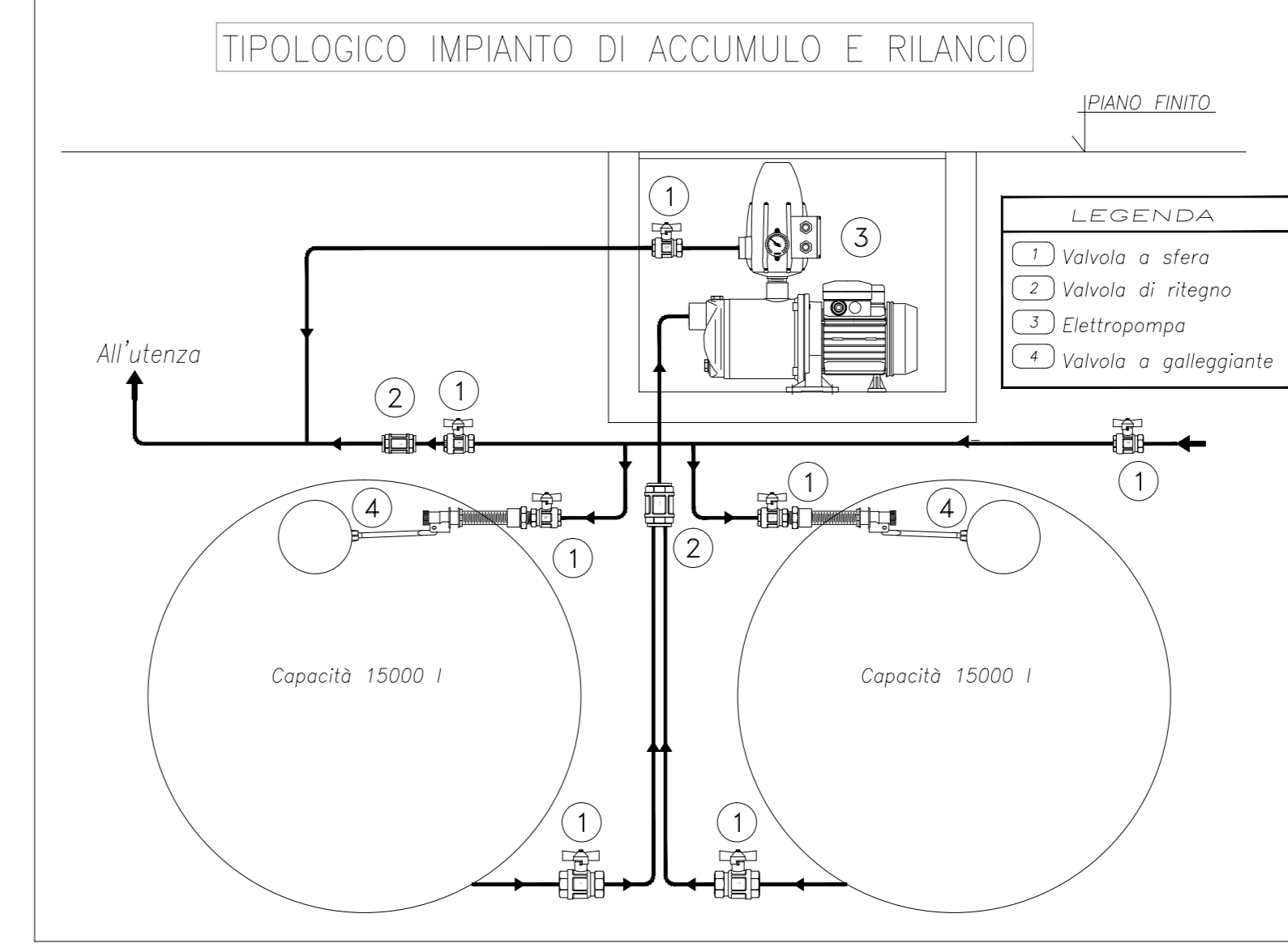
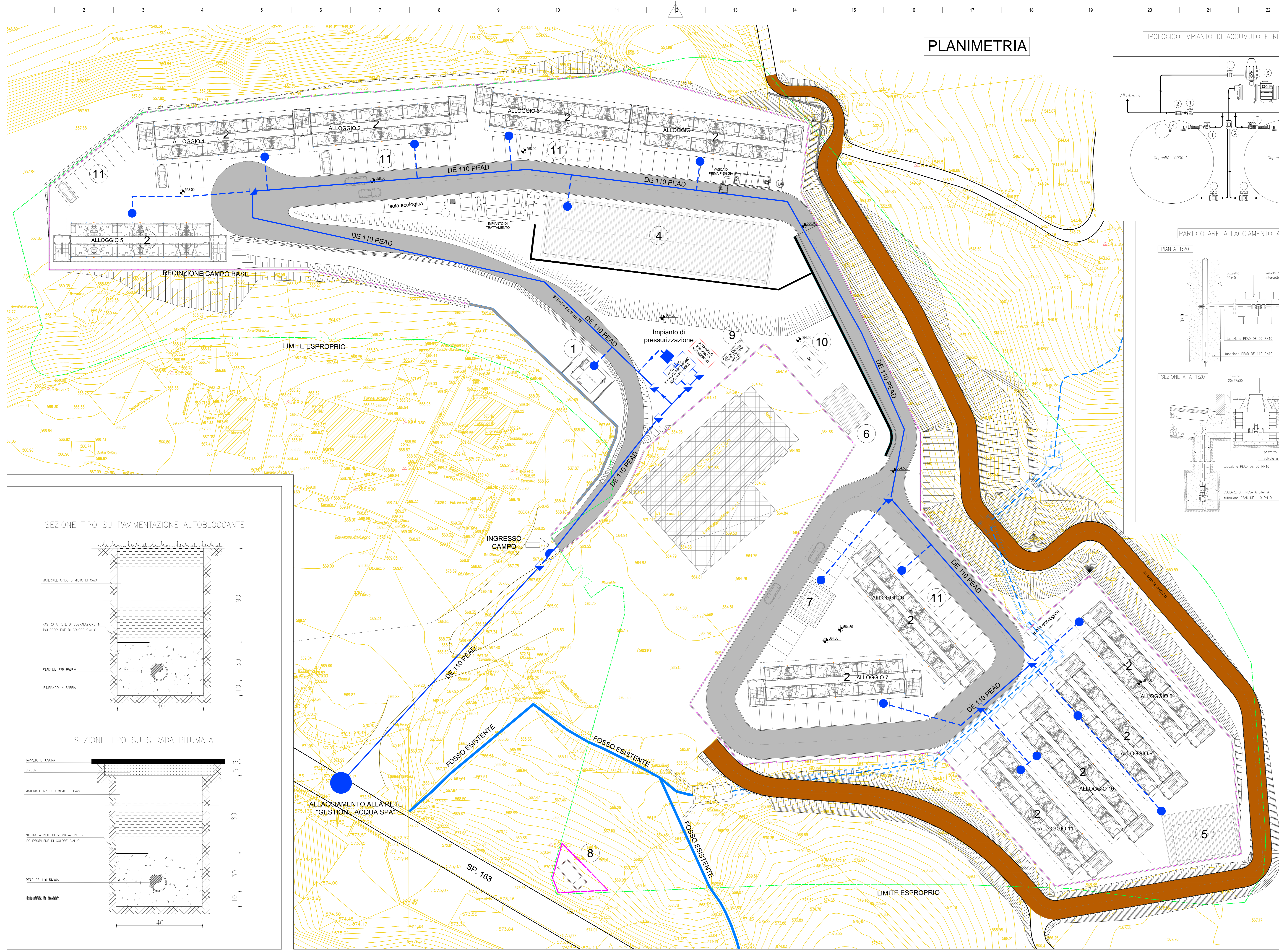

COMMITTENTE: **RFI** RETE FERROVIARIA ITALIANA GRUPPO FERROVIE DELLO STATO ITALIANO

ALTA Sorveglianza: **ITALFERR**

GENERAL CONTRACTOR: **COCIV**

INFRASTRUTTURE FERROVIARIE STRATEGICHE DEFINITE DALLA LEGGE OBIETTIVO N.443/01

TRATTA A.V.J.A.C. TERZO VALICO DEI GIOVI PROGETTO ESECUTIVO

Campo Base Pian dei Grilli CBP2
Planimetria rete idroportabile

GENERAL CONTRACTOR	DIRETTORE LAVORI	SCALA
Cociv Ing. E. Pignatelli		1:500
COMISSA: 1 G 5 1	LOTTO: 0 0	PAGE: E
ENTE: CIV	PROG. DOC.: P 18	OPERAZIONE/OPERA: C A 0 7 0 1
PROGETTAZIONE	REDAZIONE	DATA
Aut. Piana Esecutiva	Aut. Piana Esecutiva	31/01/2014
Aut. Piana Generale	Aut. Piana Generale	11/11/2014
Aut. Piana Generale	Aut. Piana Generale	05/05/2015

In Elaborazione