

**SEZIONE A-A**  
SCALA 1:50

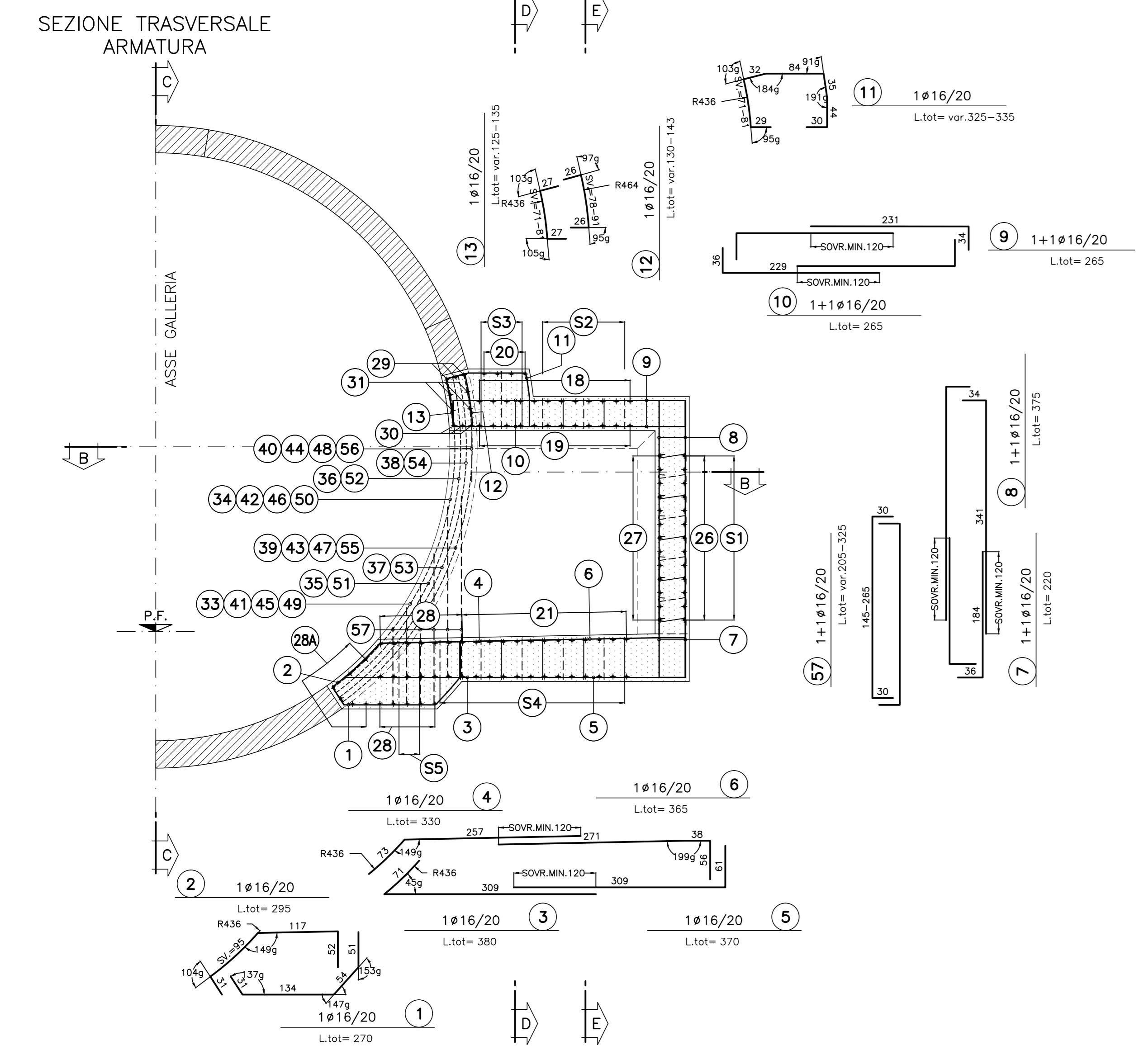

**SEZIONE C-C**  
SCALA 1:50

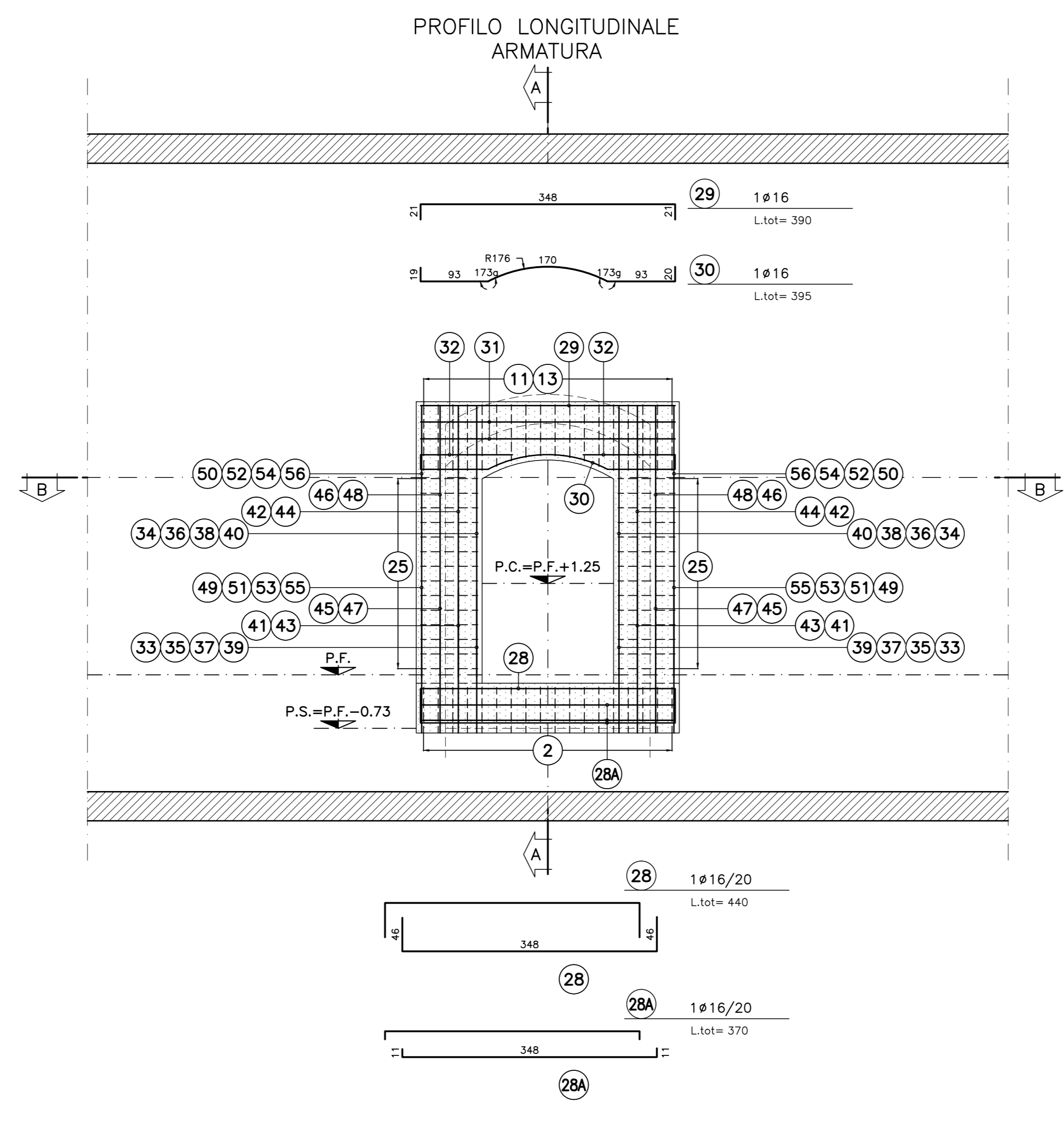

**SEZIONE D-D**  
SCALA 1:50

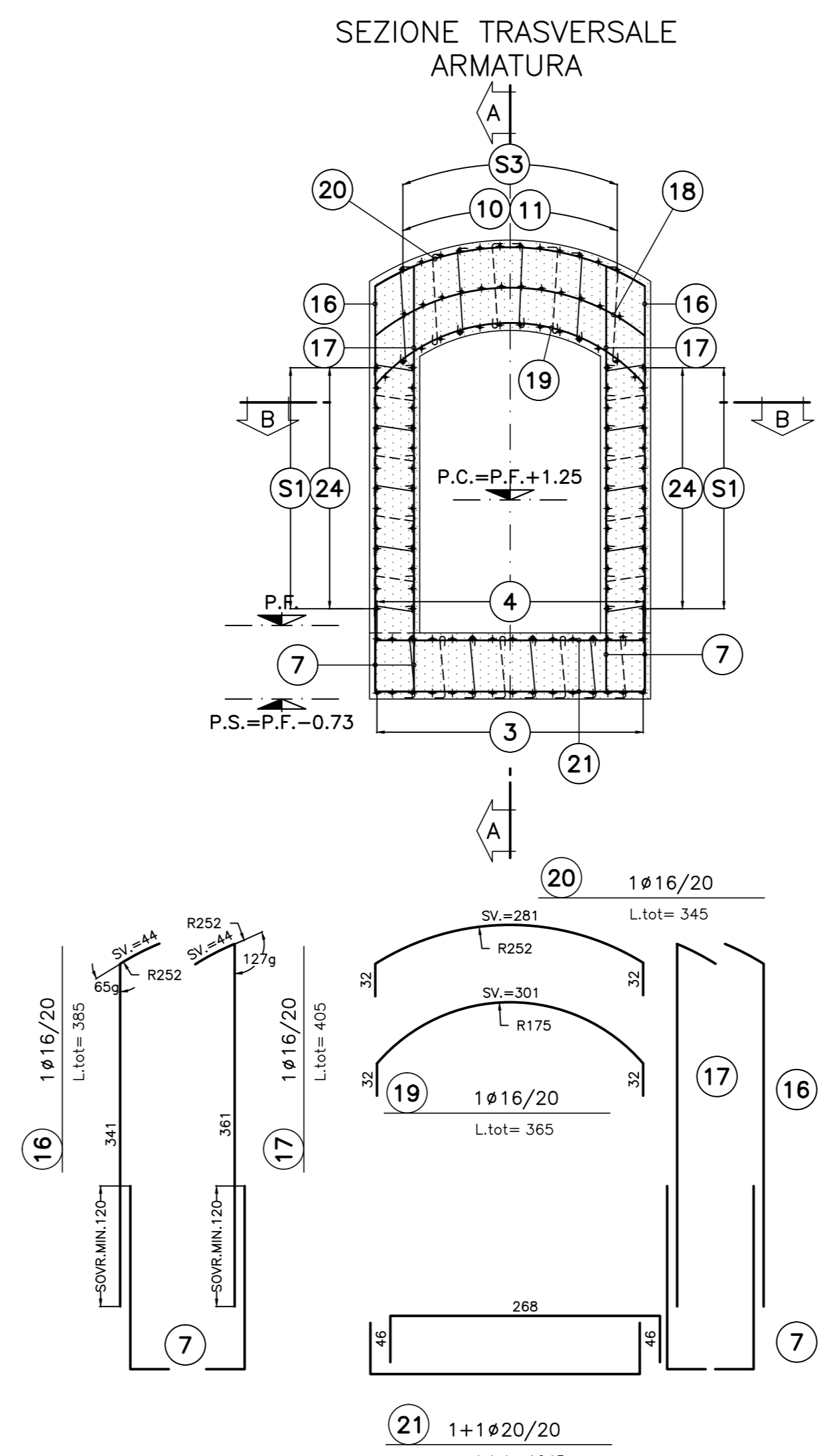

**SEZIONE E-E**  
SCALA 1:50

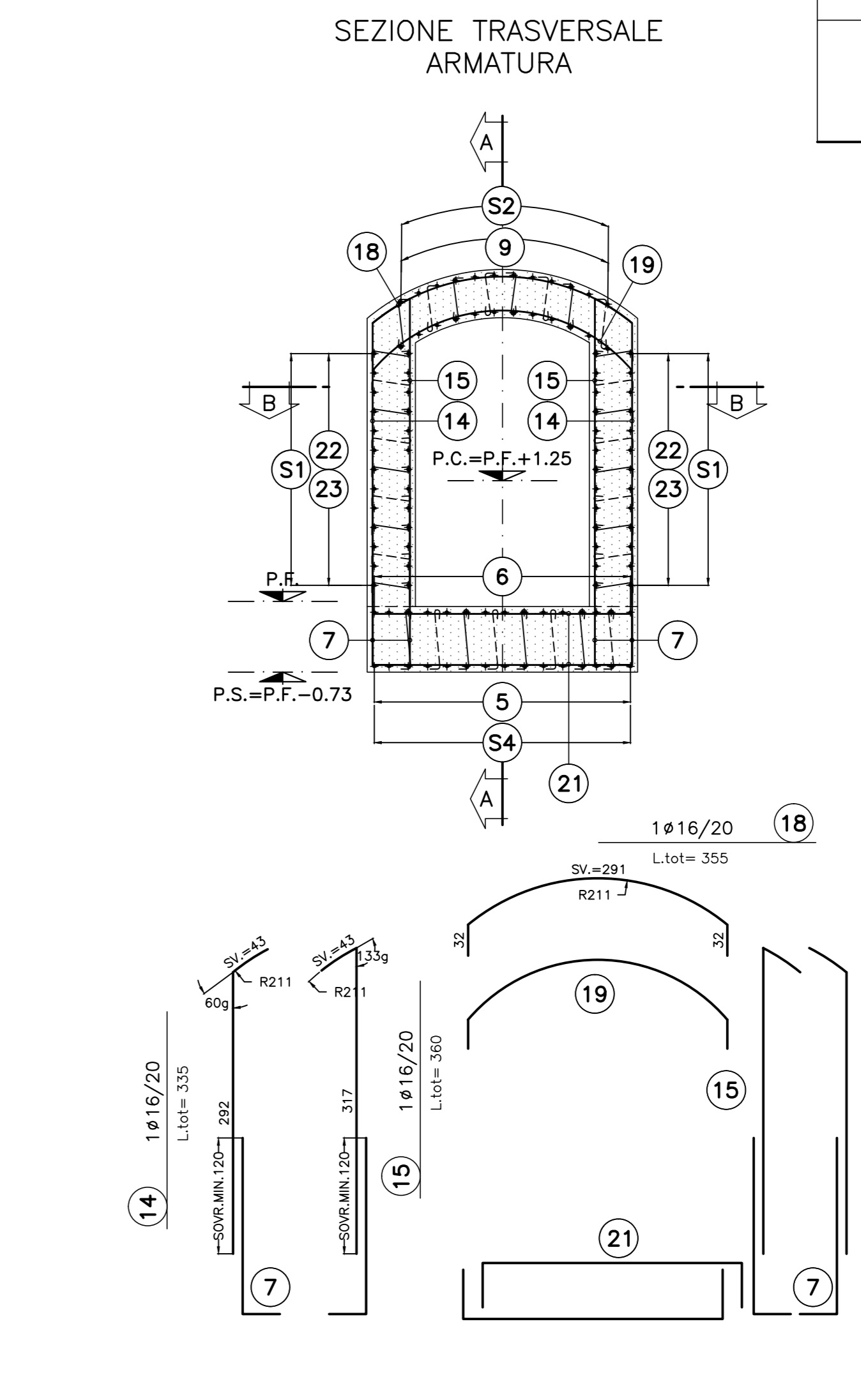

**SEZIONE B-B**  
SCALA 1:50

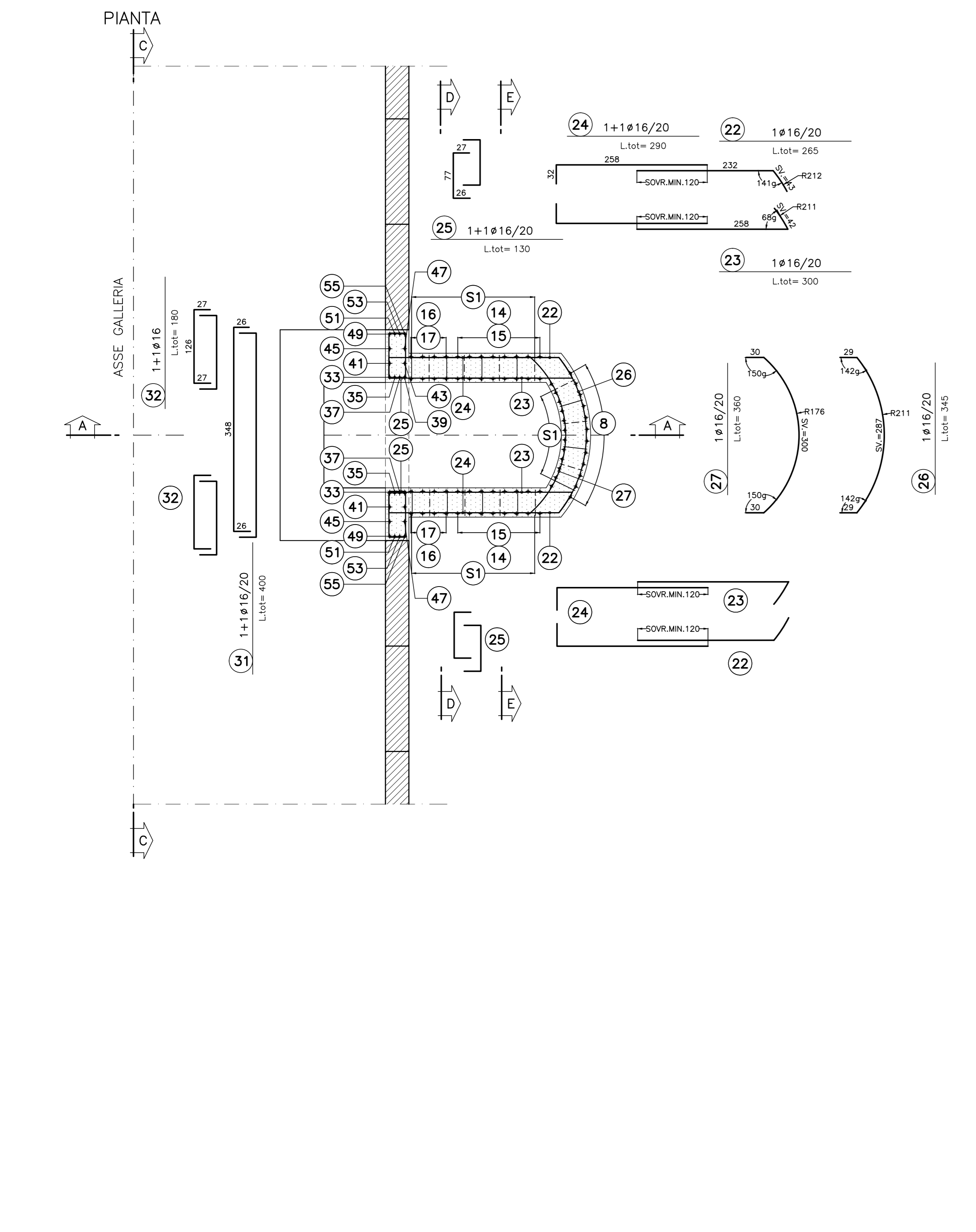

VISTA LATERALE

VISTA FRONTALE

VISTA LATERALE

VISTA FRONTALE



TABELLA MATERIALI	
ACCIAIO ARMATURE	B450C
COPRIFERRO	5cm
NOTA: - PER TUTTO QUANTO NON INDICATO SI FACCIA RIFERIMENTO AL CAPITOLATO OPERE CIVILI	
- ELABORATO DI RIFERIMENTO: "OPERE DI LINEA-CARATTERISTICHE DEI MATERIALI E NOTE" (cod.IG51-00-E-CV-TT-000000-002)	
LEGGENDA	
- P.C.	PIANO DEI CENTRI
- P.F.	PIANO FERRO
- P.I.M.	PIANO IMPOSTA MURETTE

- S1 SPILLI Ø8 60x60  
L.tot= 65
- S2 SPILLI Ø8 60x60  
L.tot= vor.76-68
- S3 SPILLI Ø8 60x60  
L.tot= vor.108-121
- S4 SPILLI Ø8 60x60  
L.tot= vor.88-92
- S5 SPILLI Ø8 60x60  
L.tot= 128

COMMITTENTE: **RFI** RETE FERROVIARIA ITALIANA GRUPPO FERROVIE DELLO STATO ITALIANO

ALTA SORVEGLIANZA: **ITALFERR** GRUPPO FERROVIE DELLO STATO ITALIANO

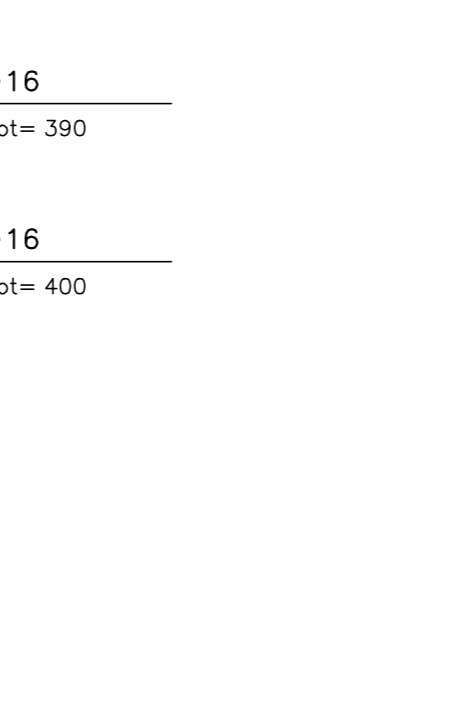
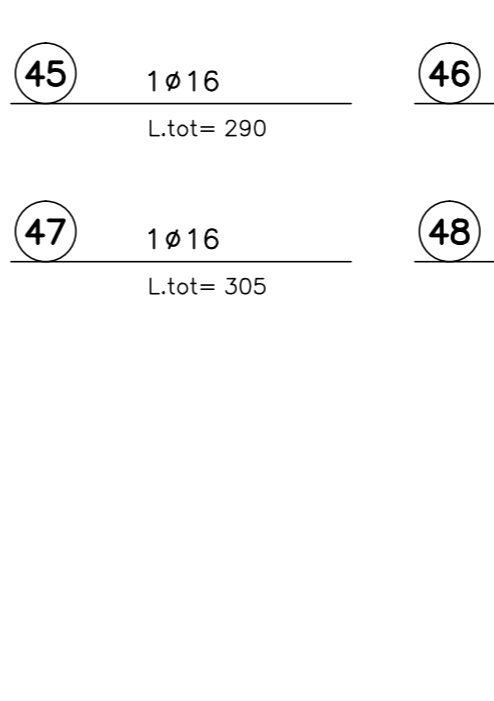
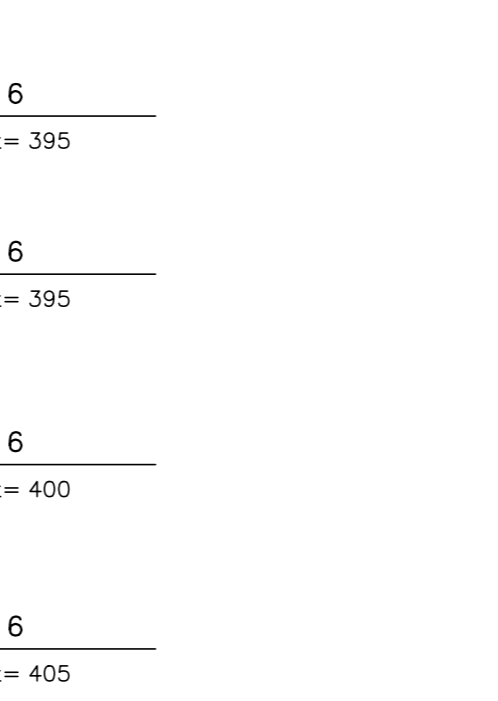
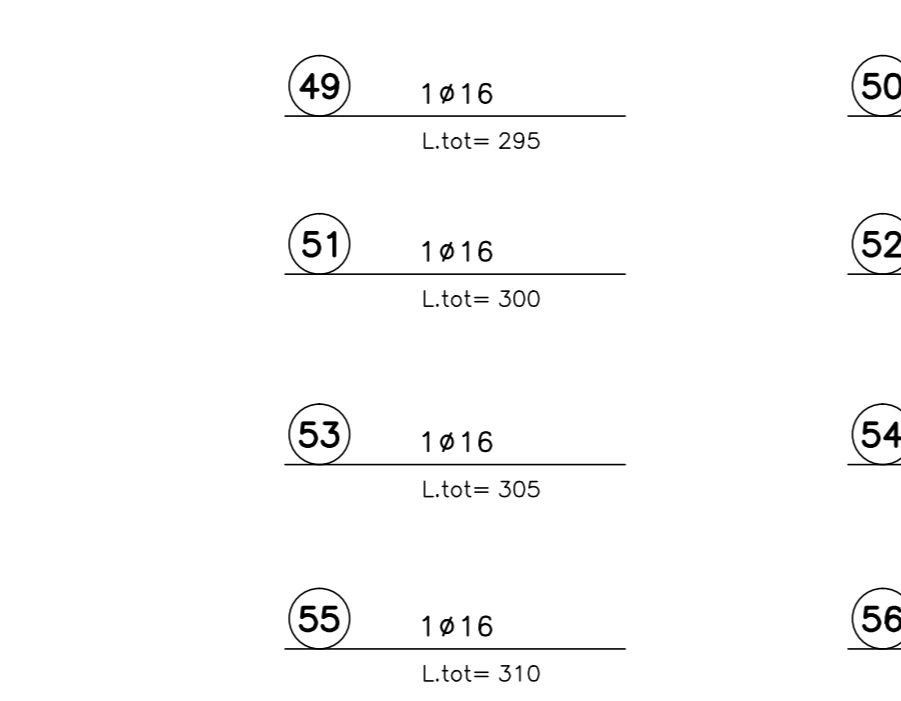
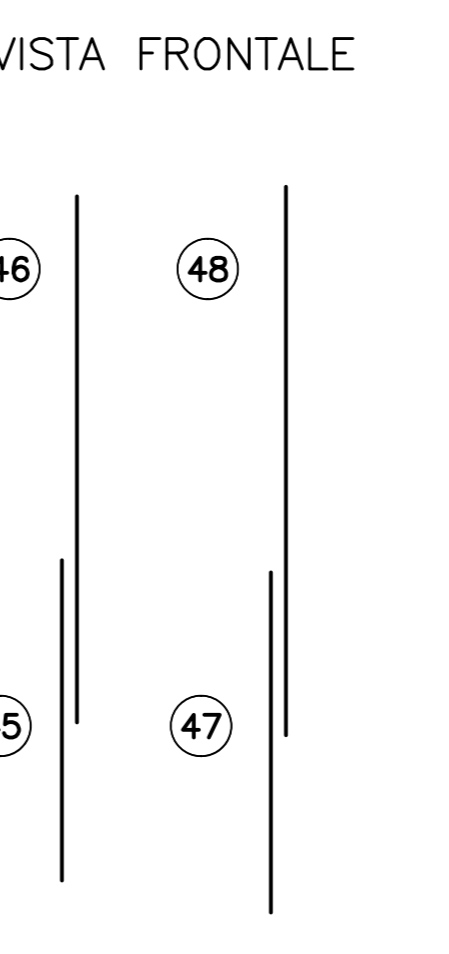
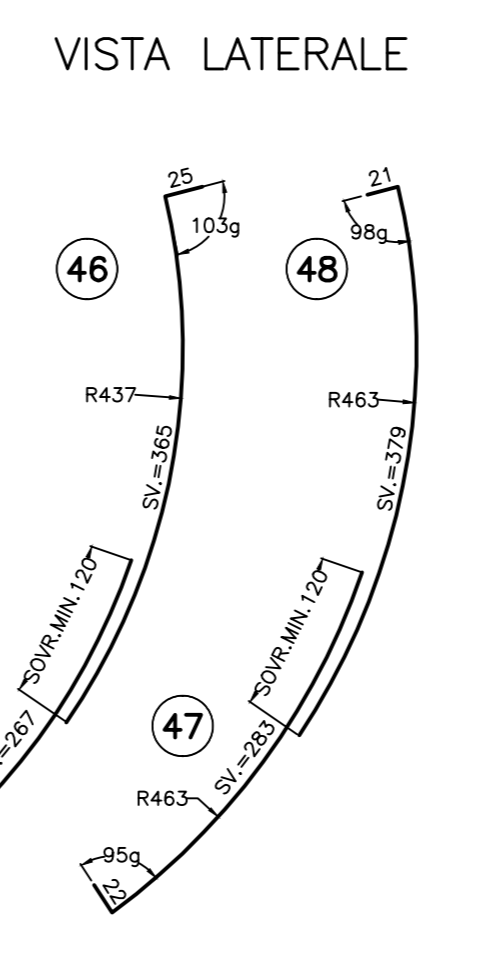
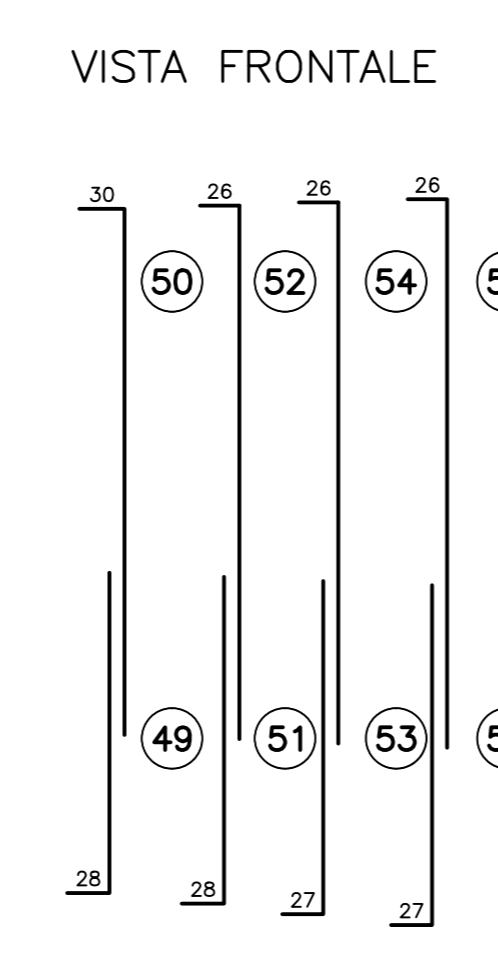
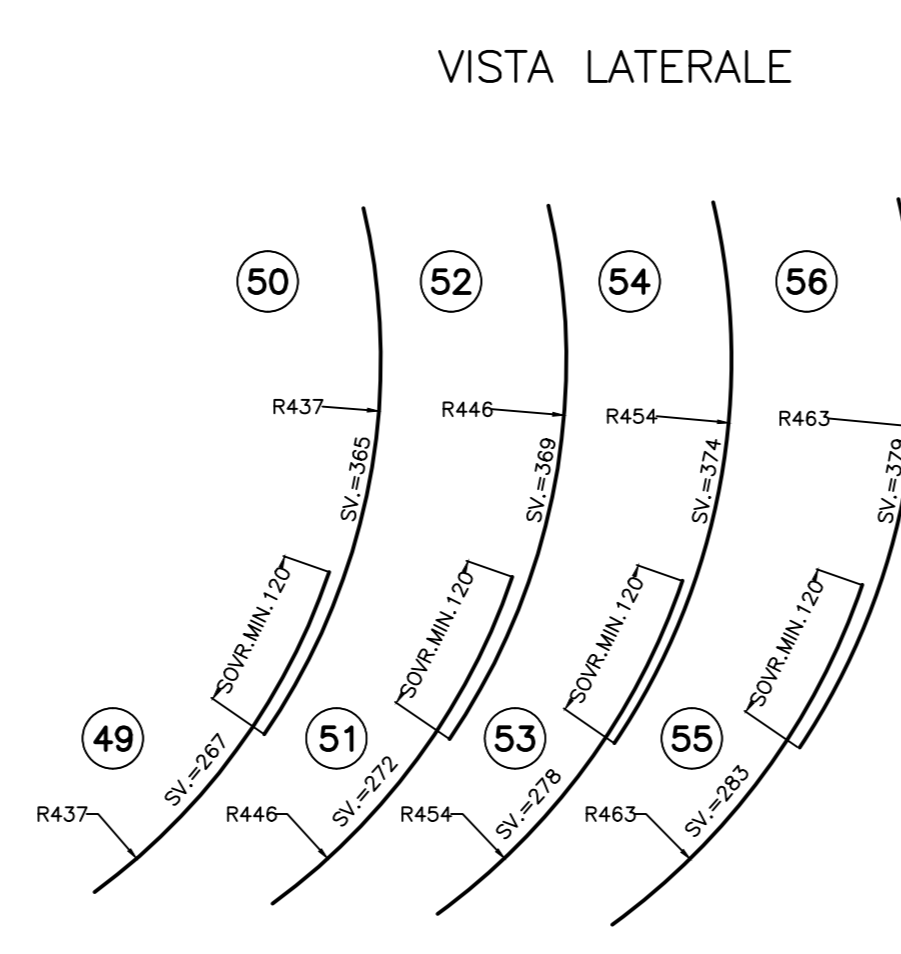
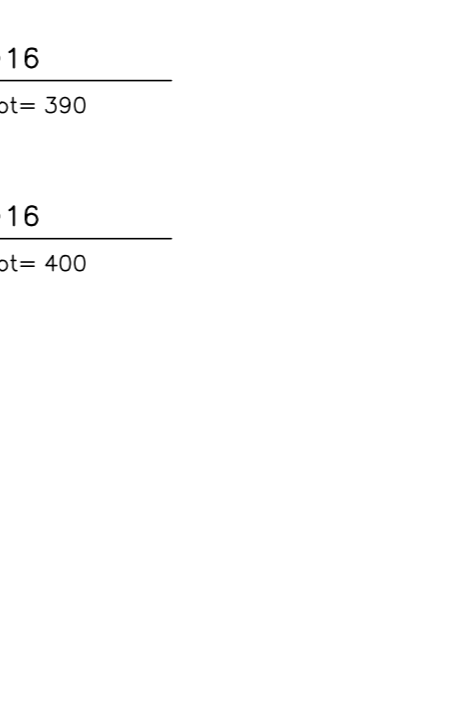
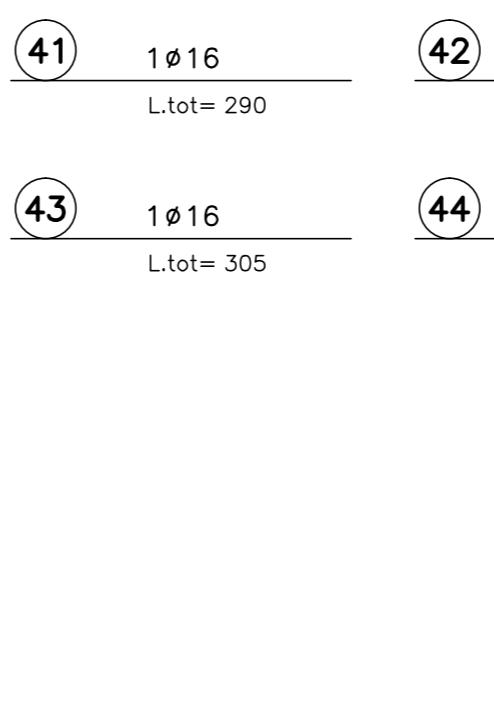
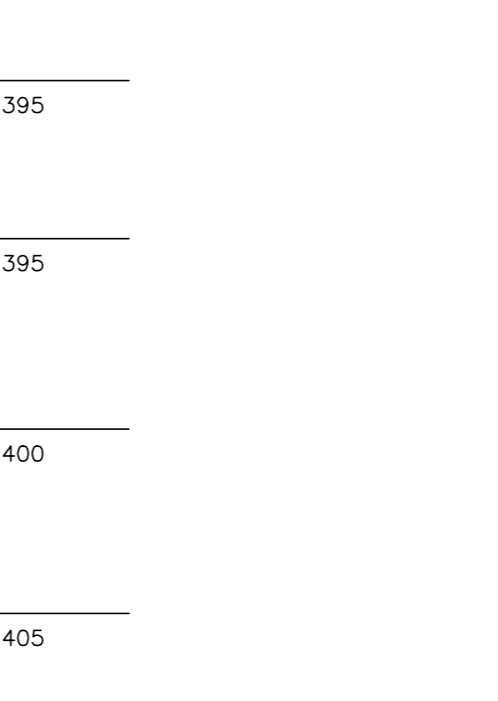
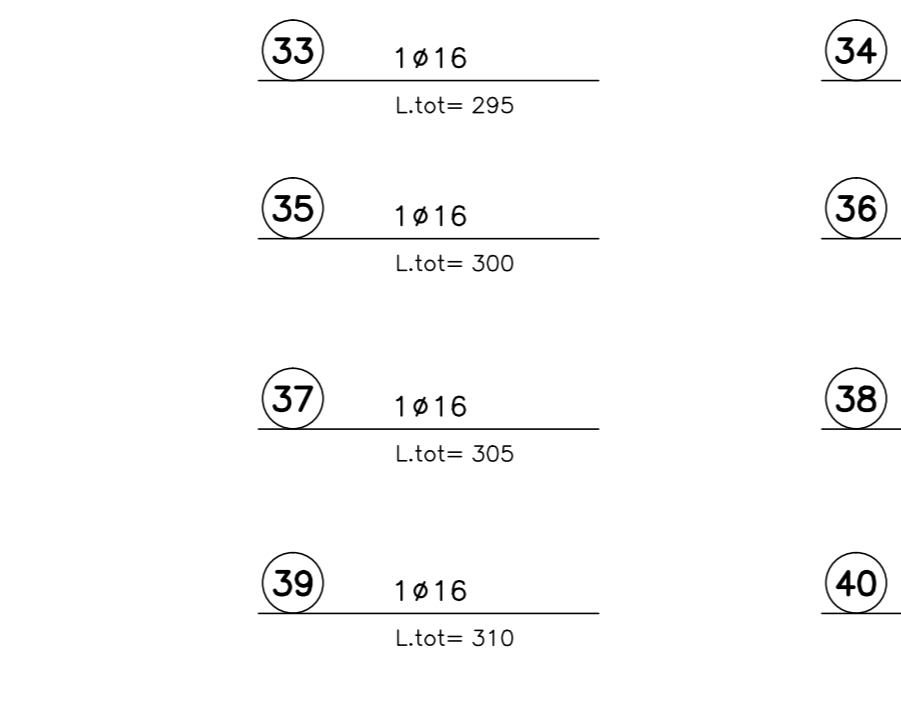
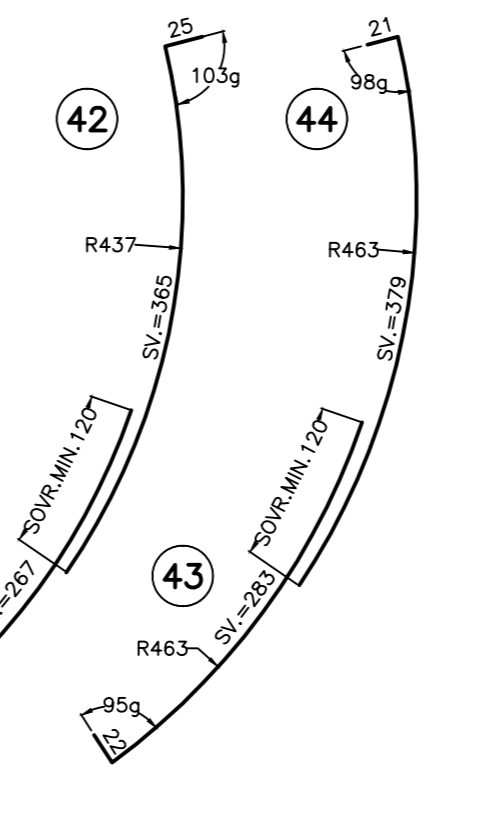
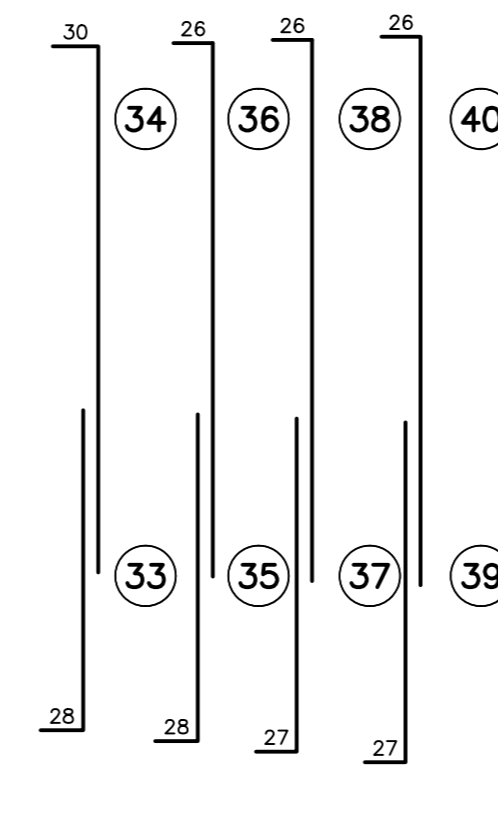
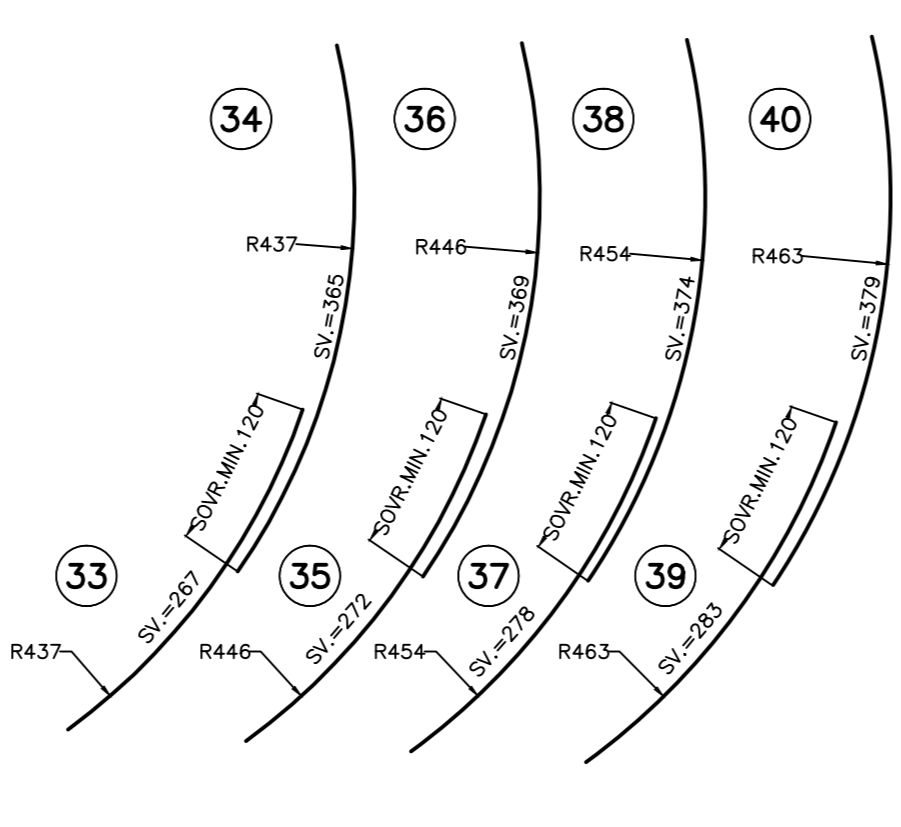
GENERAL CONTRACTOR: **COCIV** Consorzio Collaamenti Integrati Valchi

INFRASTRUTTURE FERROVIARIE STRATEGICHE DEFINITE DALLA LEGGE OBIETTIVO N.443/01

TRATTA A.V./A.C. TERZO VALICO DEI GIOVI PROGETTO ESECUTIVO

Galleria naturale di Serravalle  
Scavo in meccanizzato da PK 29+958.49 a PK 33+959.95 - Binario Pari

Nichia UAD  
Armatura

GENERAL CONTRACTOR: **Cociv** Ing. E. Pagan

DIRETTORE LAVORI: \_\_\_\_\_

SCALA: 1:50

COMMESSA	LOTTO	FASE	ENTE	TIPO DOC	OPERADISCIPLINA	PROGE	REV.
IG51	03	E	CV	BB	GN1BA X	004	A

PROGETTAZIONE

Rev.	Descrizione emissione	Redatto	Data	Verificato	Data	Firma	Data	IL PROGETTISTA
A00	Prima emissione	[Firma]	16/12/2013	[Firma]	18/12/2013	A. Palomba	20/12/2013	[Firma]
A01	Revisione generale	[Firma]	01/10/2015	[Firma]	02/10/2015	A. Marzante	06/10/2015	[Firma]

Nome File: 1501-03-CV-00-B-0013-AK-001-A01  
CUP: F5H0500000000