

GALLERIA IC VOLTRI

GALLERIA CAMPASSO

GALLERIA III VALICO

GALLERIA SERRAVALLE

Binario Pari

Binario Dispari

Da PK 0+437,45 (imbocco sud)  
a PK 1+153,50 (imbocco nord)

da PK 1+214,50 (imbocco sud)  
a PK 1+675

Da PK 29+491,39 (imbocco sud)  
a PK -29+950

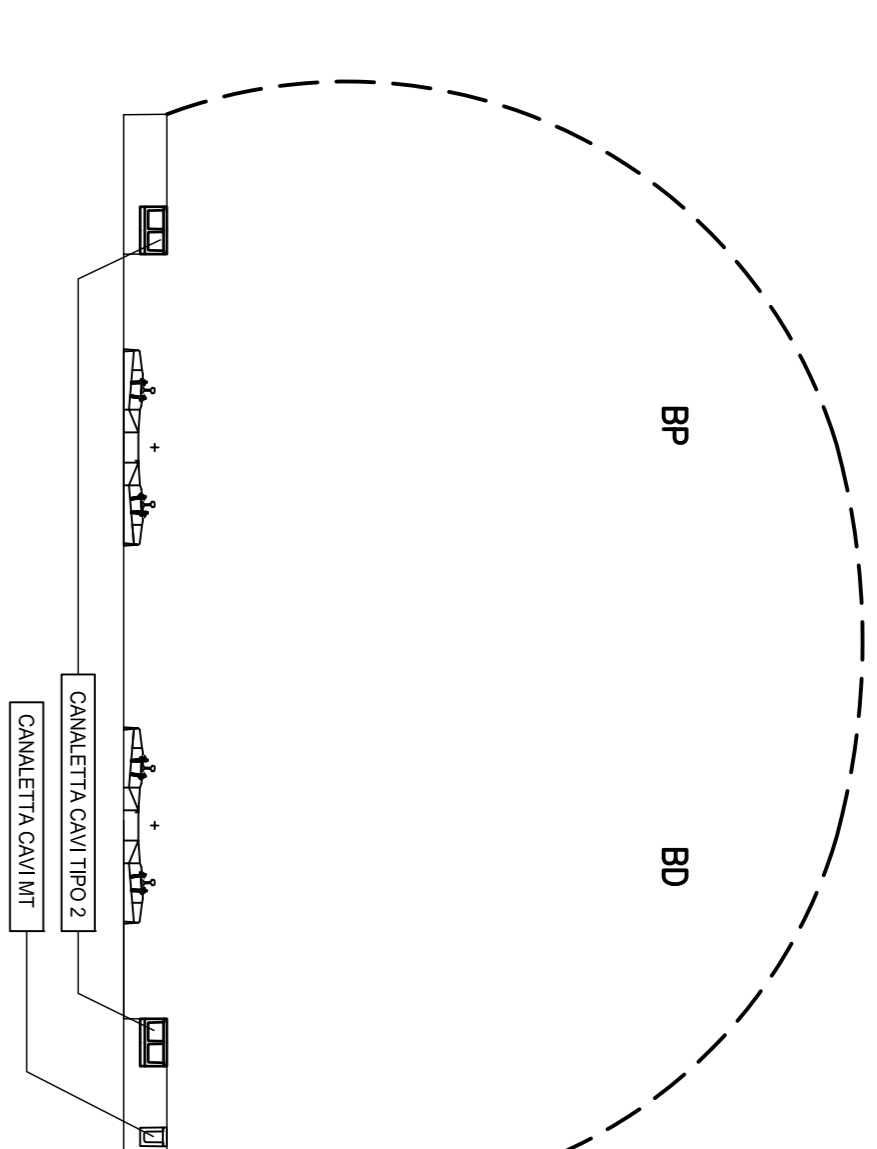
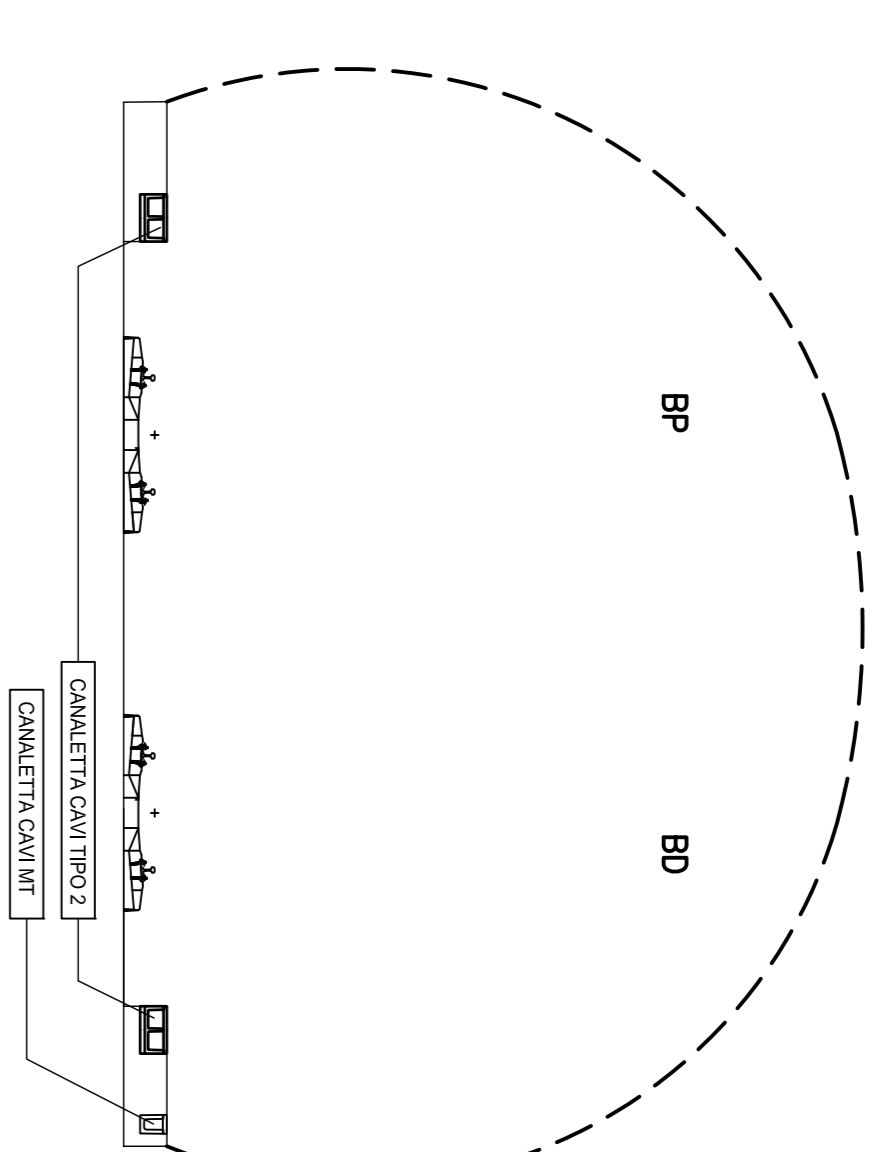
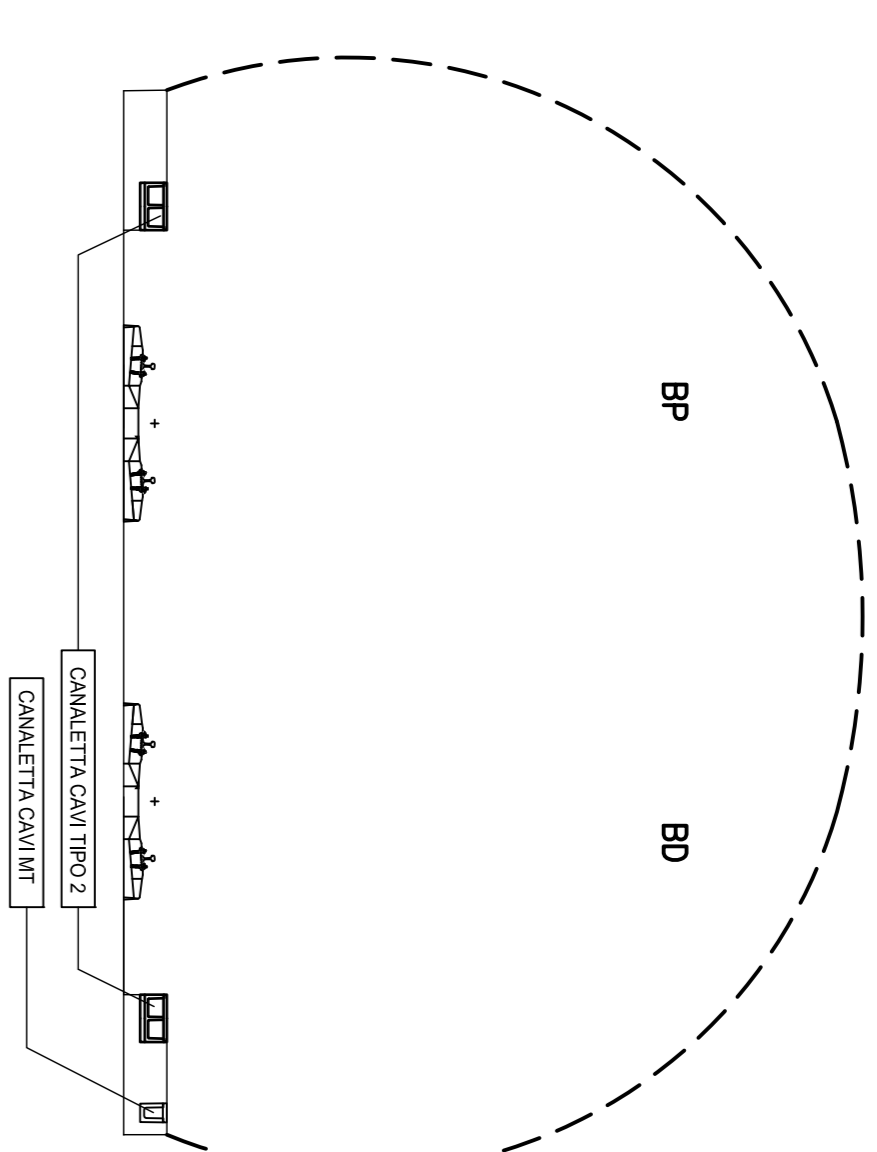
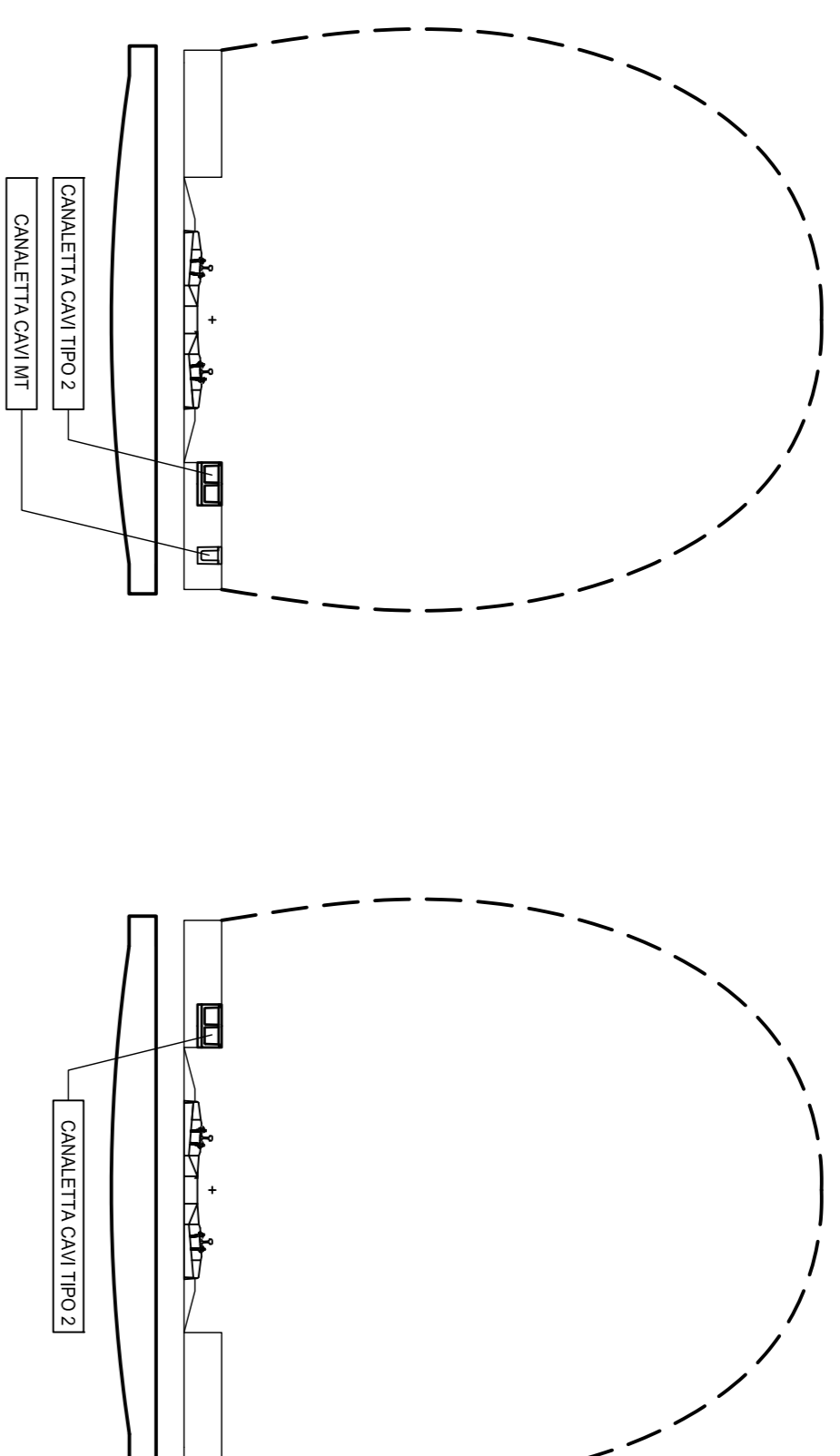

Da PK 1+675  
a PK -27+500

Da PK -29+950 a PK 36+316,304 (B.D.)

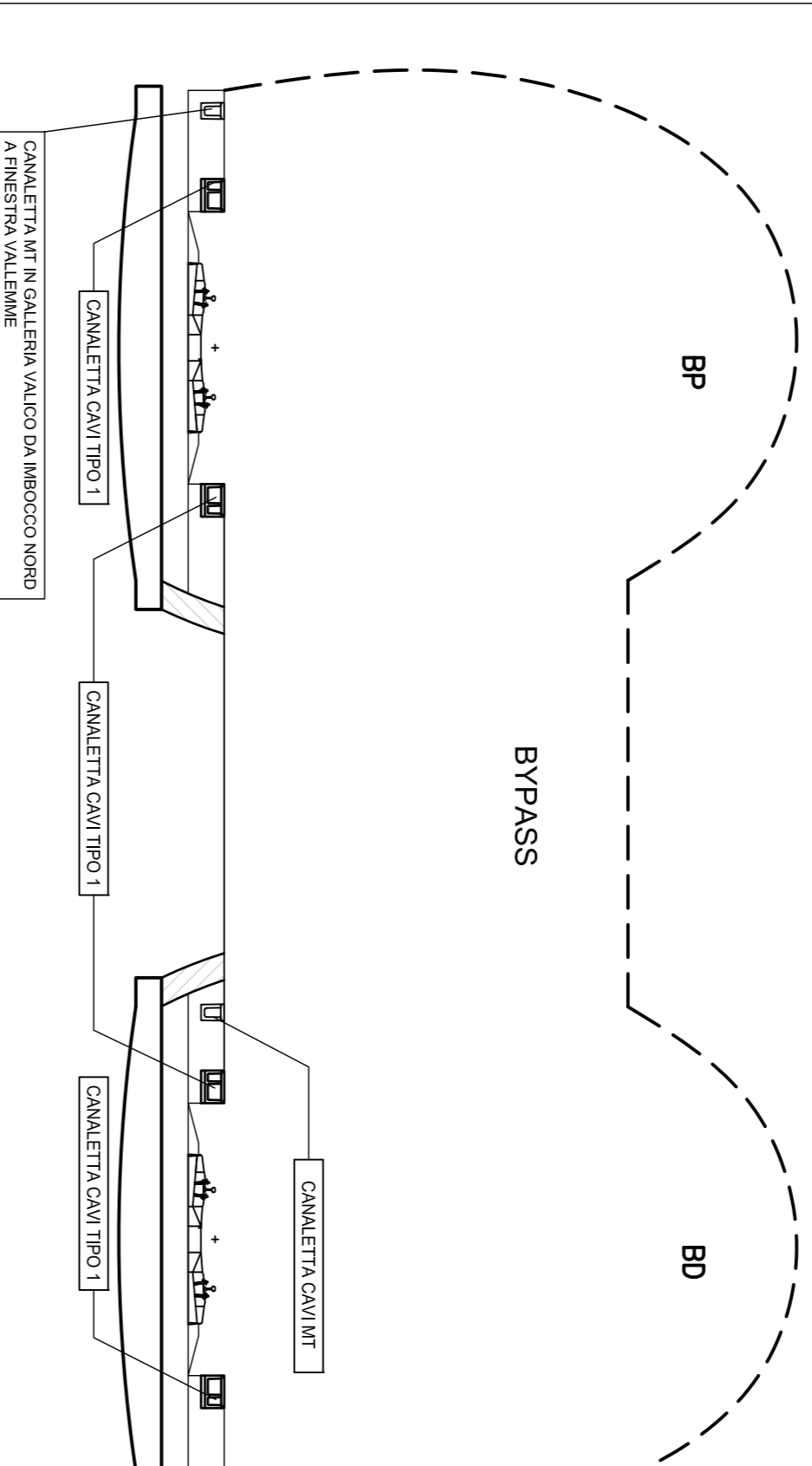

Da PK -27+500  
a PK -27+660

Da PK 36+316,304 (B.D.)  
a PK 36+585,205 (B.P.)

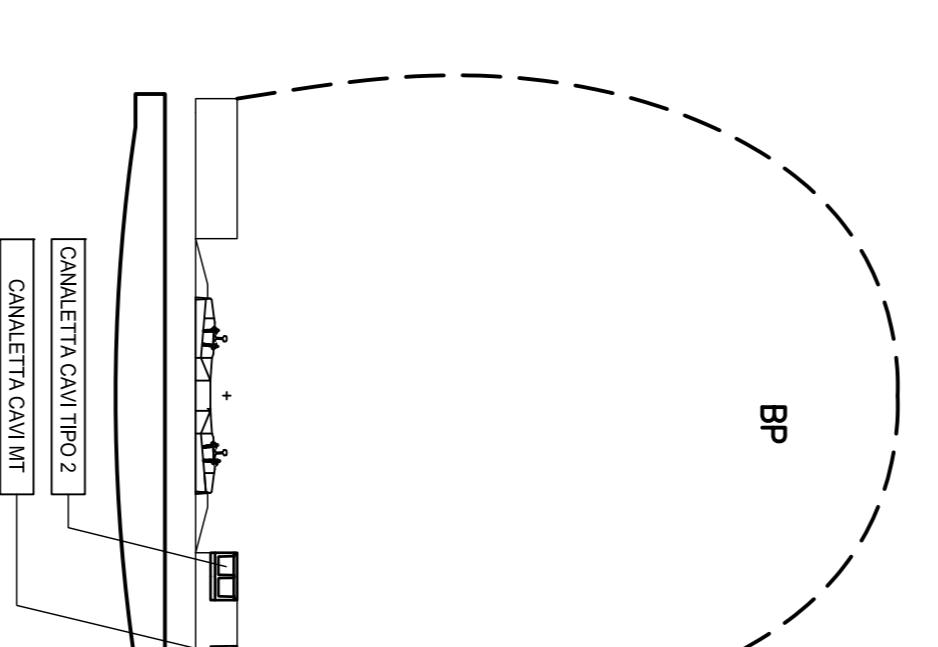
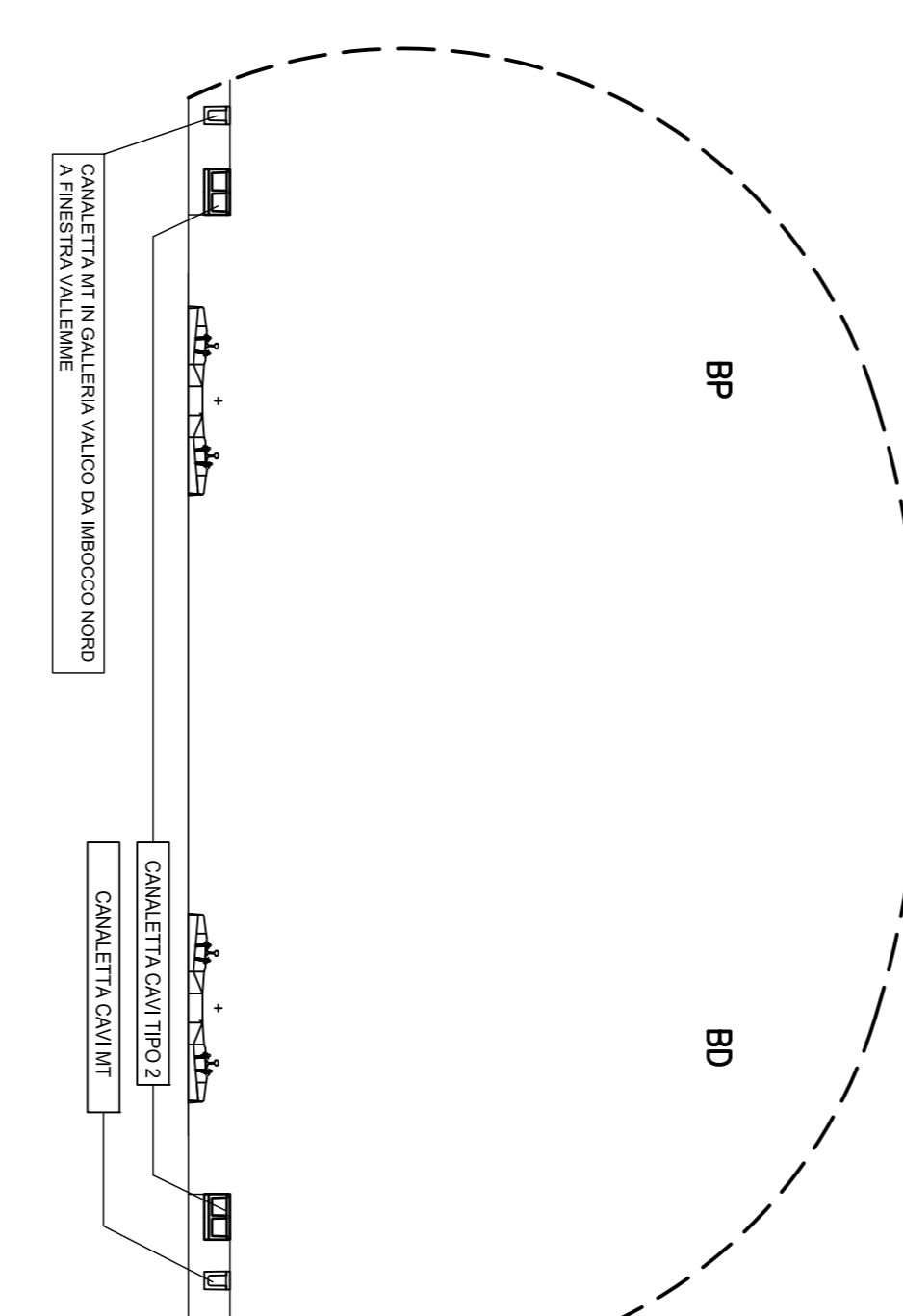

Da PK -27+660  
a PK 28+467,23 (imbocco nord)

CANALETTA PORTACAVI A 2 GOLE  
TIPO 1

CANALETTA PORTACAVI A 2 GOLE  
(SEZIONE MAGGIORATA PER GOLA CAVI 1KV E BT)  
TIPO 2

CANALETTA PORTACAVI A 1 GOLA  
(PER CAVI MT)

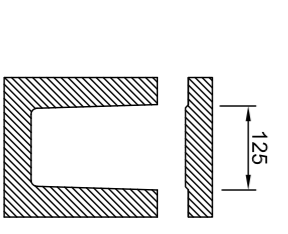
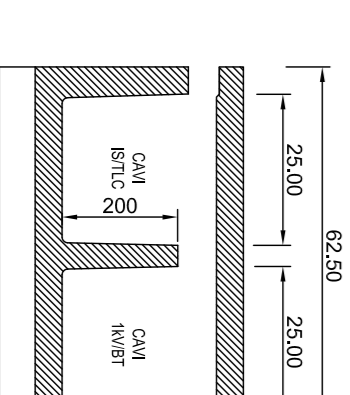
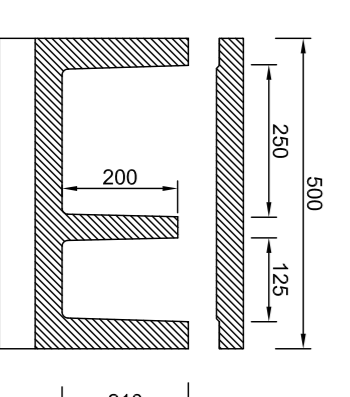

DA PRESSIONE: LUNGO ENTRAMBI I BINARI IC VOLTRI CAMPASSO  
LUNGO ENTRAMBI I BINARI GALLERIA VALICO  
LUNGO ENTRAMBI I BINARI GALLERIA SERRAVALLE  
DA PK 1+214 A PK 1+675  
DA PK 1+214 A PK 1+675  
LUNGO ENTRAMBI I BINARI AVAC PC ASSIQUATA/ALVAERTIO  
LUNGO ENTRAMBI I BINARI GALLERIA SERRAVALLE

COMITENTE:



ALTA SORVEGLIANZA



GENERAL CONTRACTOR:



INFRASTRUTTURE FERROVIARIE STRATEGICHE DEFINITE DALLA  
LEGGE OBBIETTIVO N.443/01  
TRATTA A.V./A.C. TERZO VALICO DEI GIOVI  
PROGETTO DEFINITIVO

GALLERIA NATURALE

DISPOSIZIONE CANALETTE PORTACAVI

GENERAL CONTRACTOR: ITALFERRO S.p.A.

CONTRATTO	LOTTO	FASE	ENTE	PROG. DOC.	PROF./DESCRIZIONE	FOREGG.	REV.
A3011	00	D	CVI	PX	GN000X	012	E

Rev.	Descrizione emissione	Modello	Data	Versione	Data	Progettista	Disegn.	Verificatore	Aut.
000	Assegnamento elaborato in generale	000	16/02/12	001	20/10/12	Ing. E. Pappalardo	Ing. E. Pappalardo	Ing. E. Pappalardo	Ing. E. Pappalardo

GENERAL CONTRACTOR: ITALFERRO S.p.A.									
SCALE: 1:100									
DATA: 16/02/12									
PROGETTO: 000X									
FOREGG.: 012									
REV.: E									
AUT.: Ing. E. Pappalardo									
VERIFICATORE: Ing. E. Pappalardo									
AUT. VERIFICAZIONE: Ing. E. Pappalardo									