

PROGRESSIVA 54+042.00

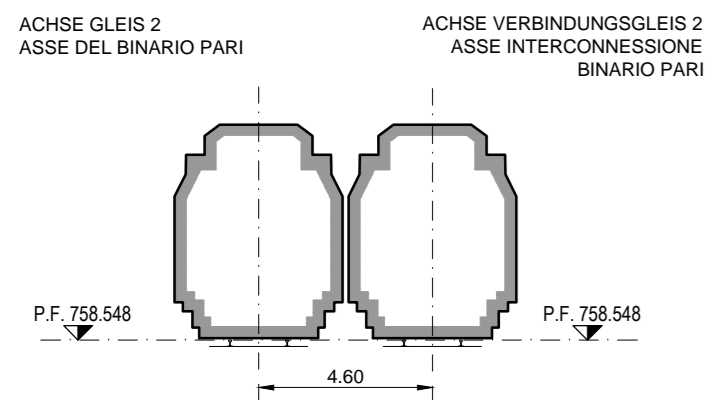

DA Progr. 54+042.00 A Progr. 54+185.00

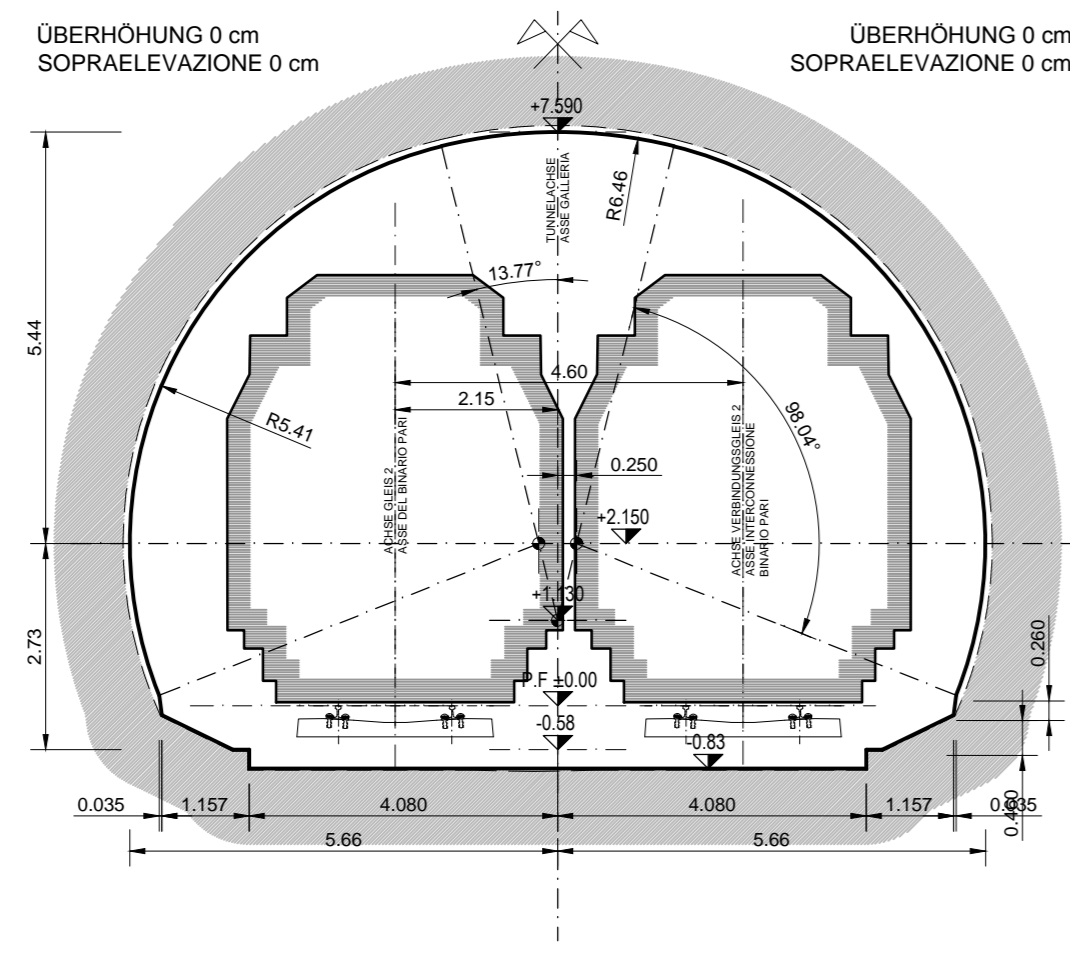

GALLERIA PRINCIPALE A DOPPIO BINARIO
INTERASSE BINARI 4,60m
SISTEMA A MASSE FLOTTANTI
(Tipo "N2 - DR - SMF - 4,6")

PROGRESSIVA 54+185.00

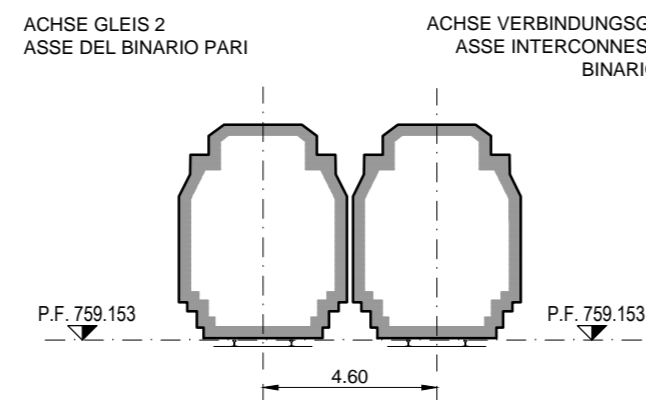

DA Progr. 54+185.00 A Progr. 54+247.50

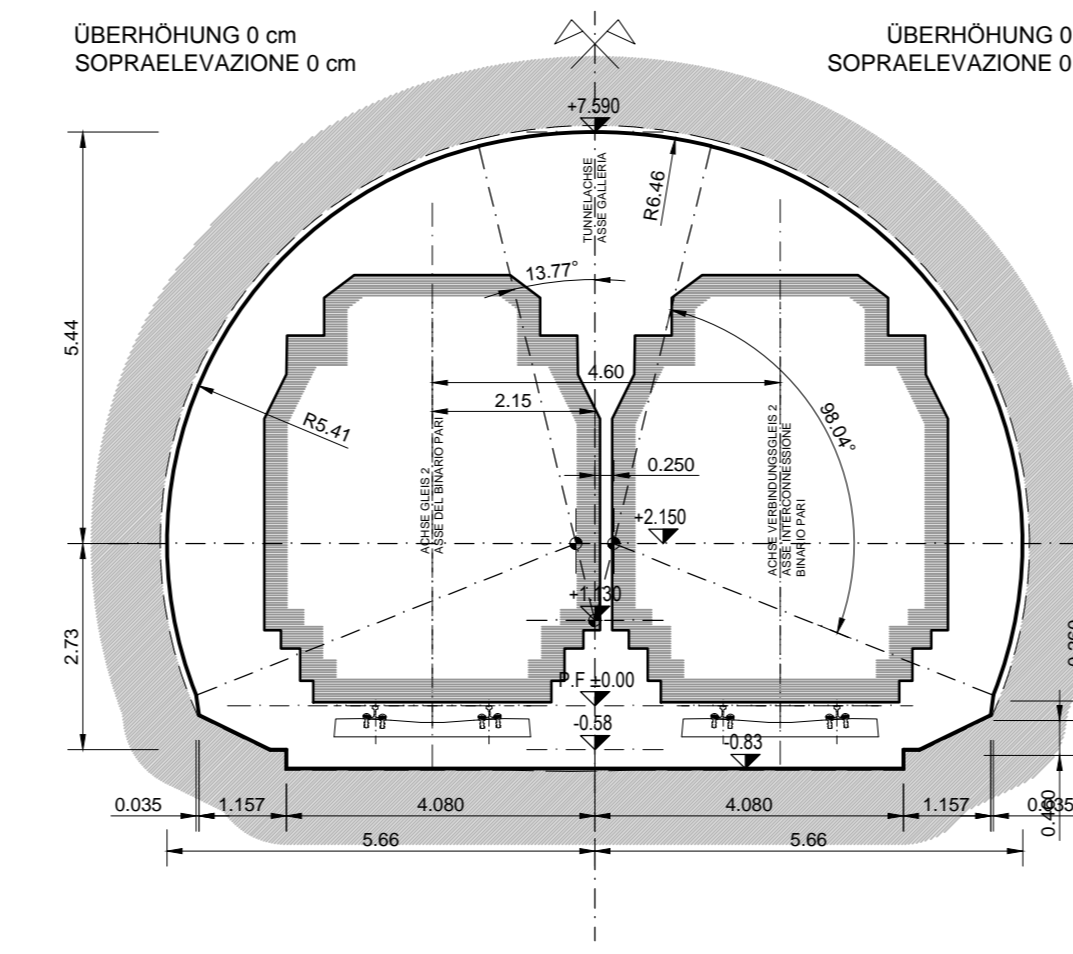

GALLERIA PRINCIPALE A DOPPIO BINARIO
INTERASSE BINARI 4,60m
SISTEMA A MASSE FLOTTANTI
(Tipo "N2-TP-SMF-4.6")

PROGRESSIVA 54+247.50

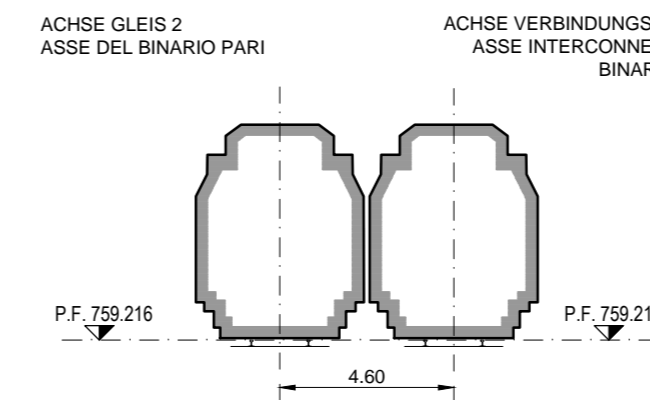

DA Progr. 54+247.50 A Progr. 54+348.00

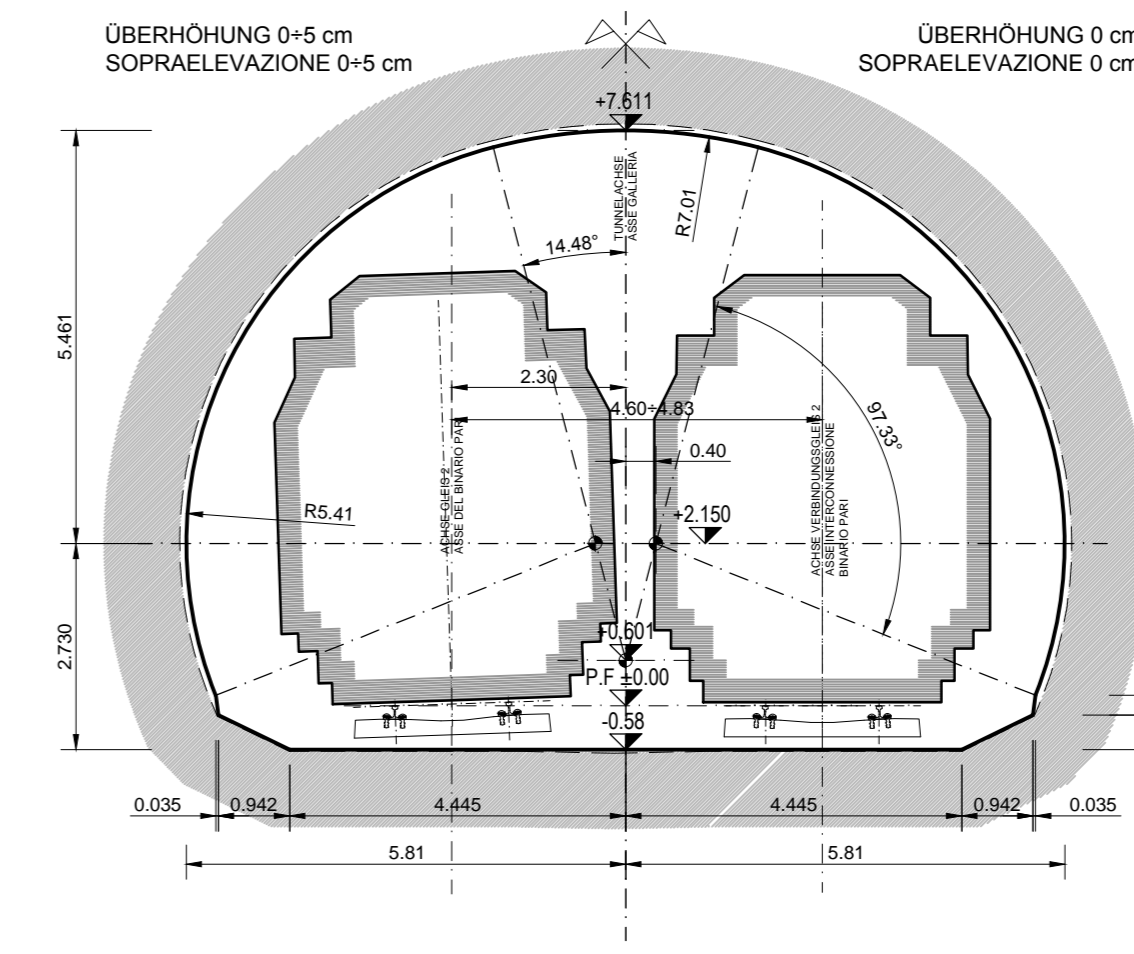

GALLERIA PRINCIPALE A DOPPIO BINARIO
INTERASSE BINARI 4,60+4,83m
(Tipo "N2-TP-4.9")

PROGRESSIVA 54+348.00

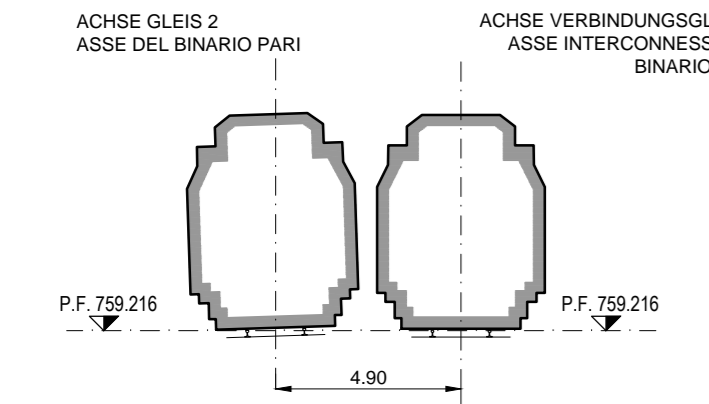

DA Progr. 54+348.00 A Progr. 54+440.00

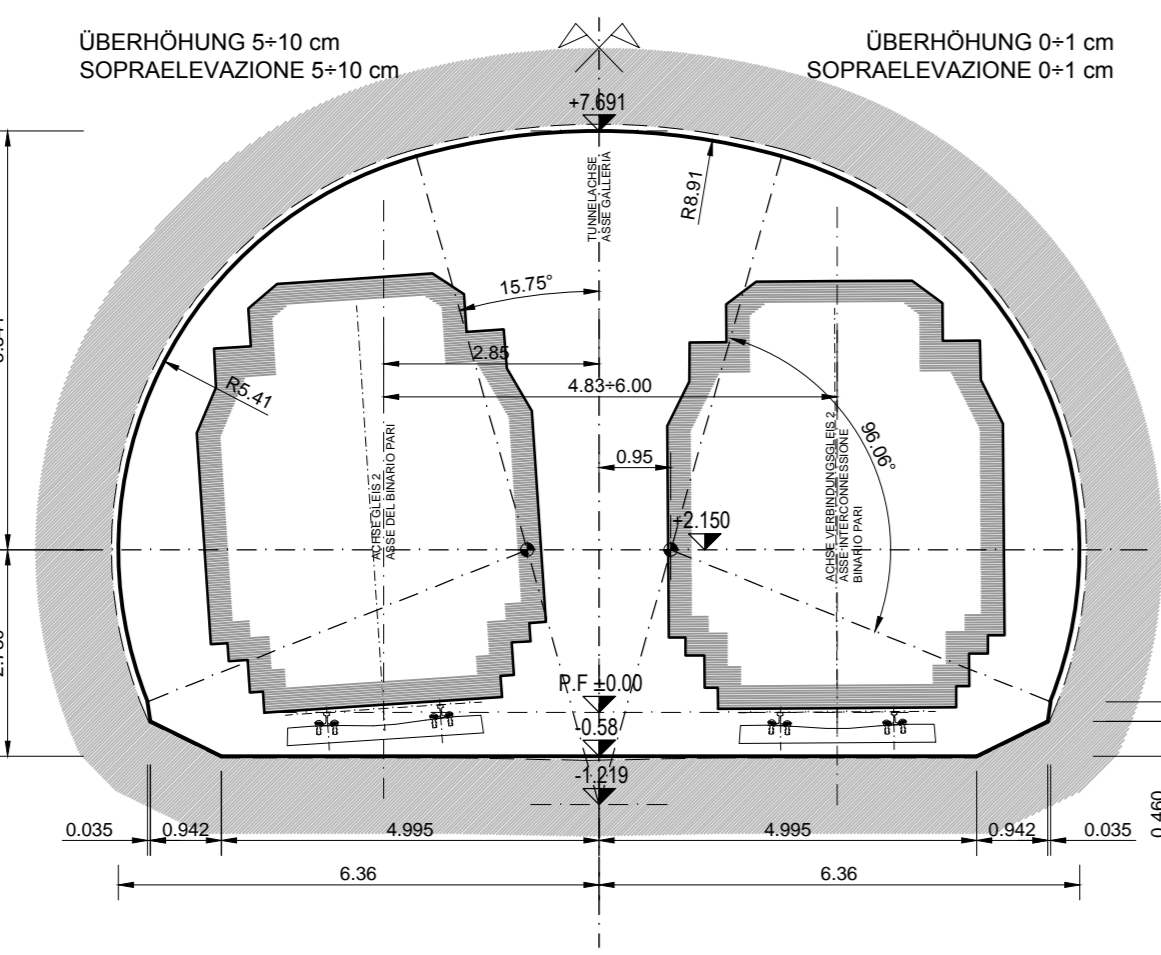

GALLERIA PRINCIPALE A DOPPIO BINARIO
INTERASSE BINARI 4,83+6,00m
(Tipo "N2-TP-6.0")

PROGRESSIVA 54+440.00

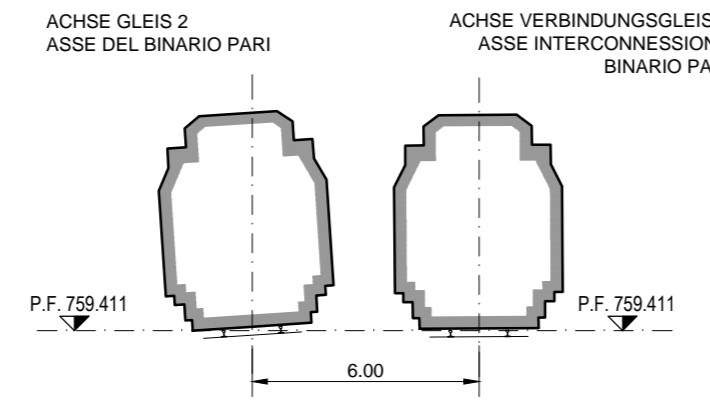

DA Progr. 54+440.00 A Progr. 54+473.00

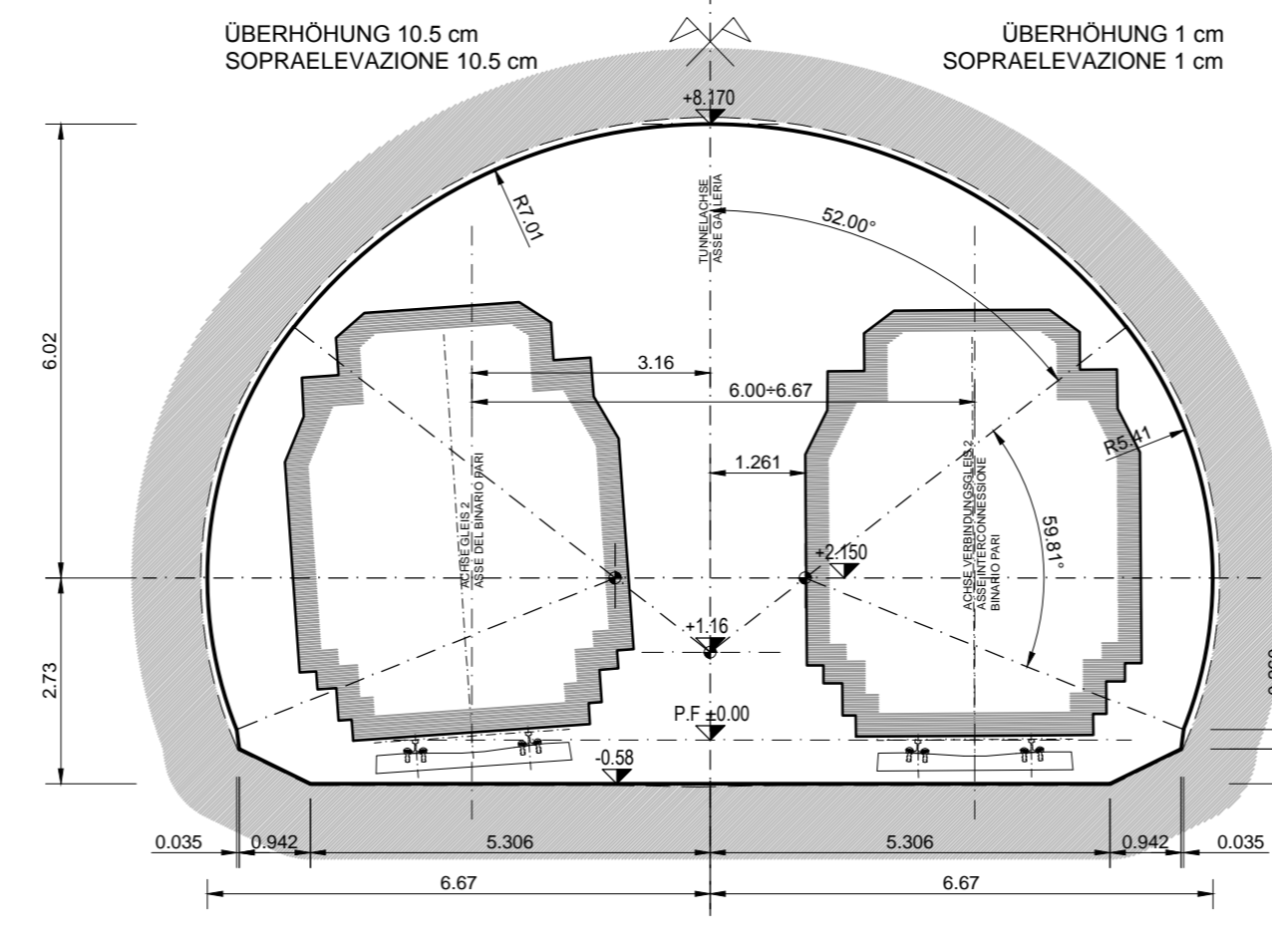

GALLERIA PRINCIPALE A DOPPIO BINARIO
INTERASSE BINARI 6,00+6,67m
(Tipo "N2 - TP-PC2")

PROGRESSIVA 54+473.00

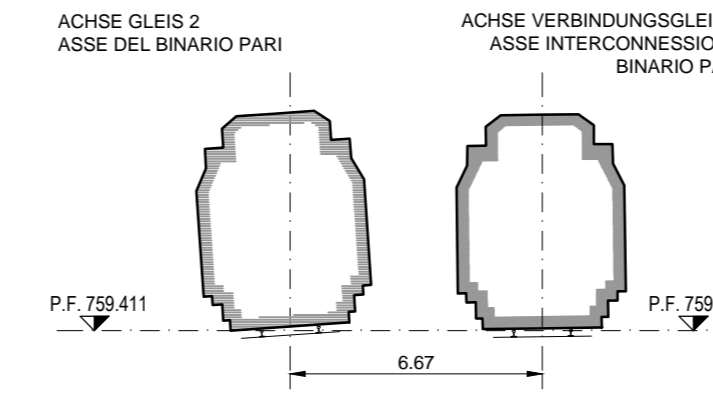

DA Progr. 54+473.00 A Progr. 54+553.00

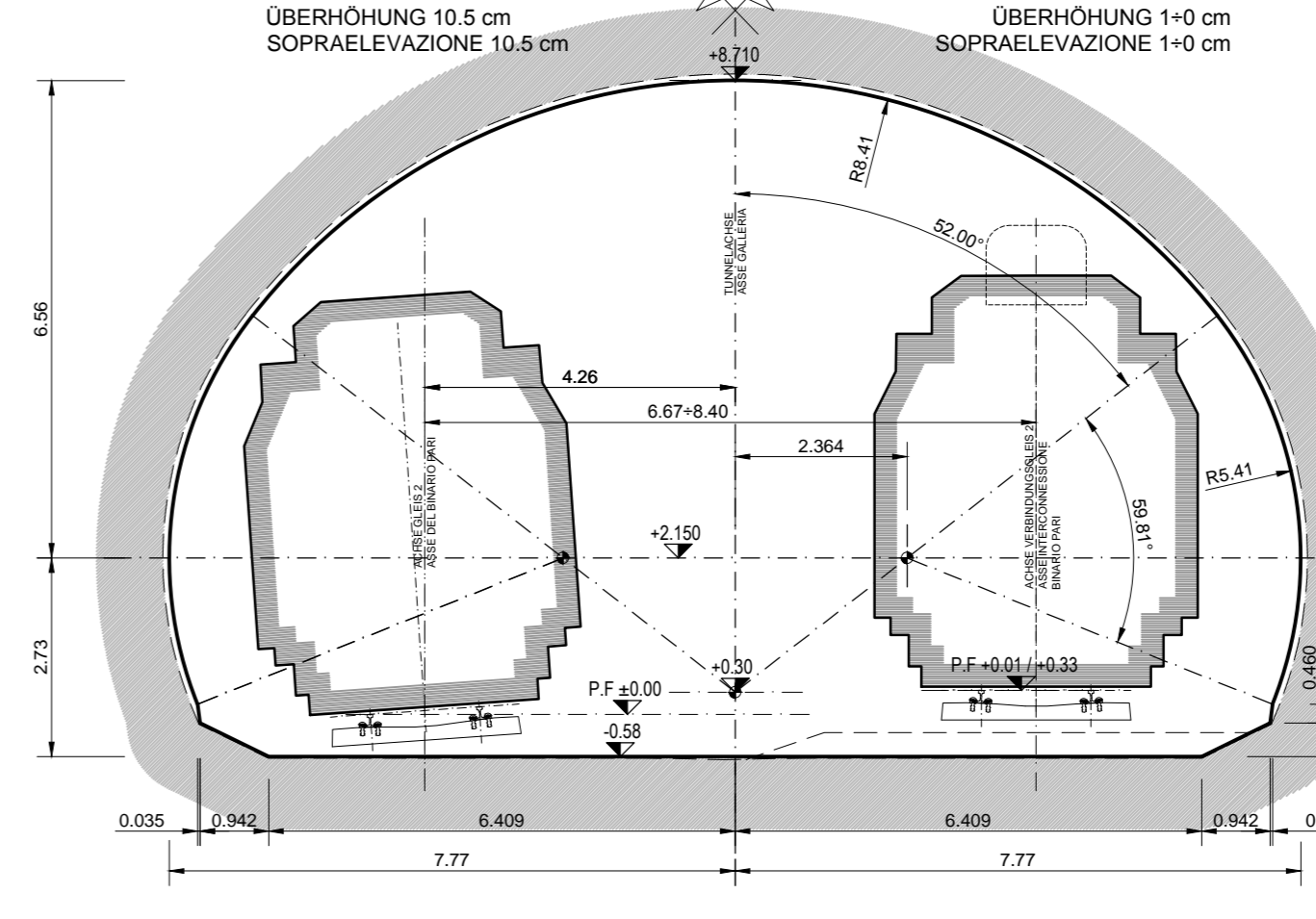

GALLERIA PRINCIPALE A DOPPIO BINARIO
INTERASSE BINARI 6,67+8,40m
(Tipo "N2 - TP-PC3")

PROGRESSIVA 54+553.00

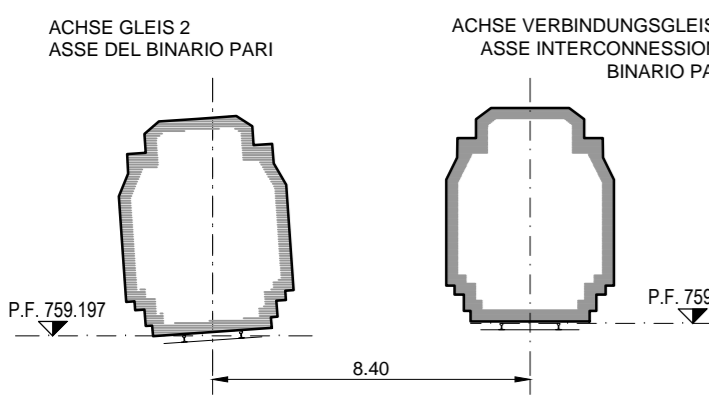

DA Progr. 54+553.00 A Progr. 54+588.00

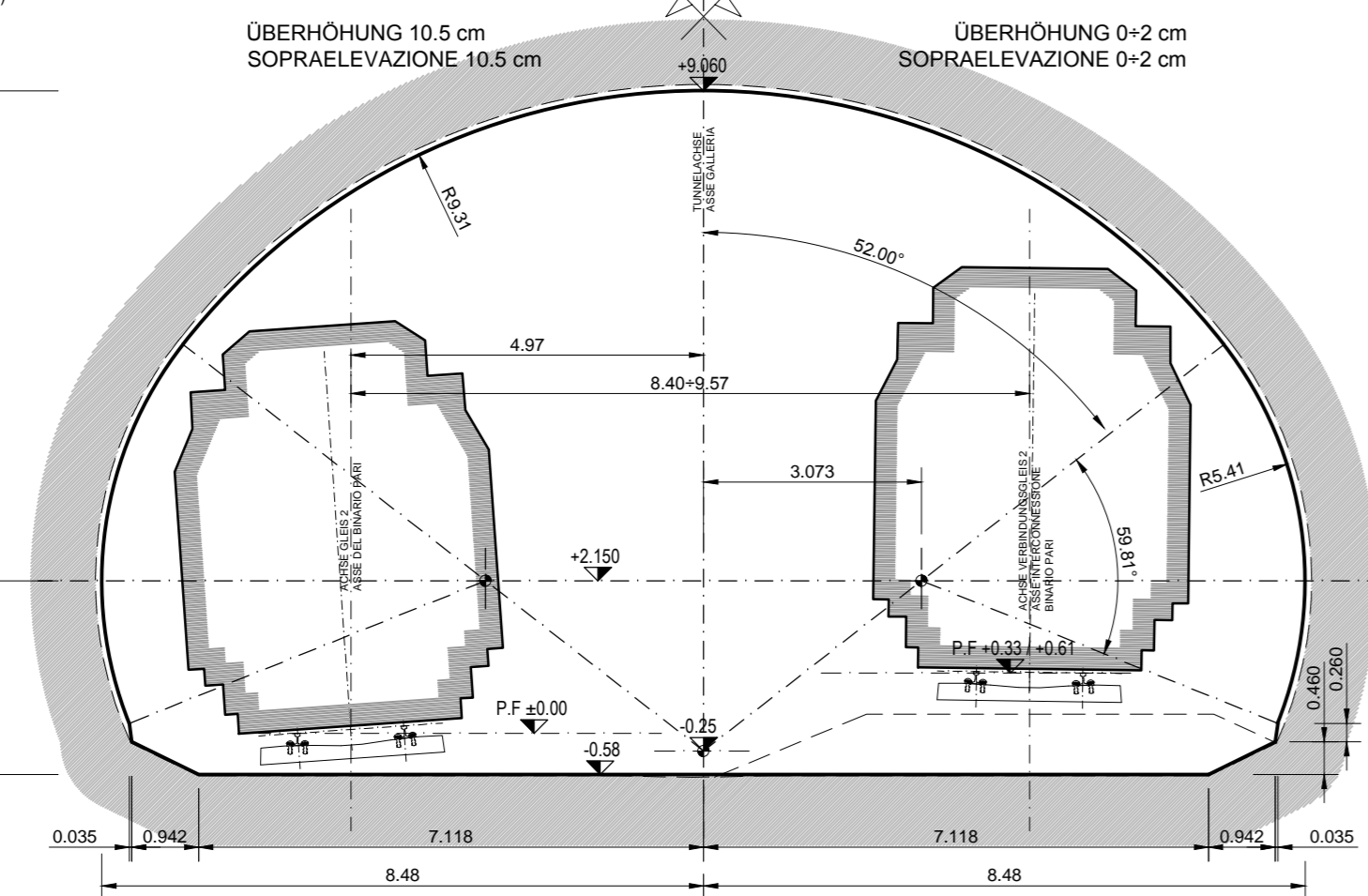

GALLERIA PRINCIPALE A DOPPIO BINARIO
INTERASSE BINARI 8,40+9,57m
(Tipo "N2 - TP-PC4")

PROGRESSIVA 54+588.00

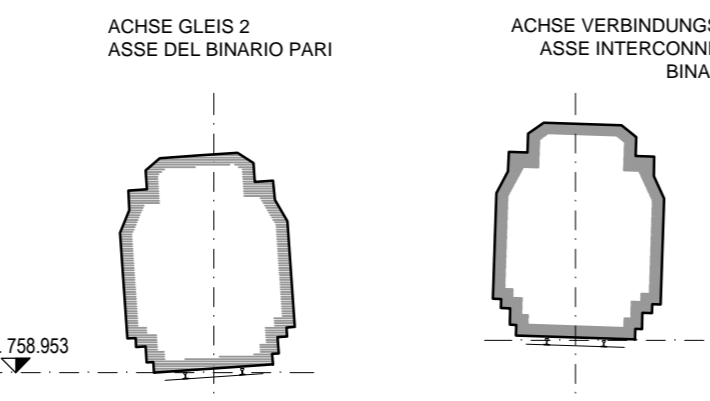

DA Progr. 54+588.00 A Progr. 54+598.85

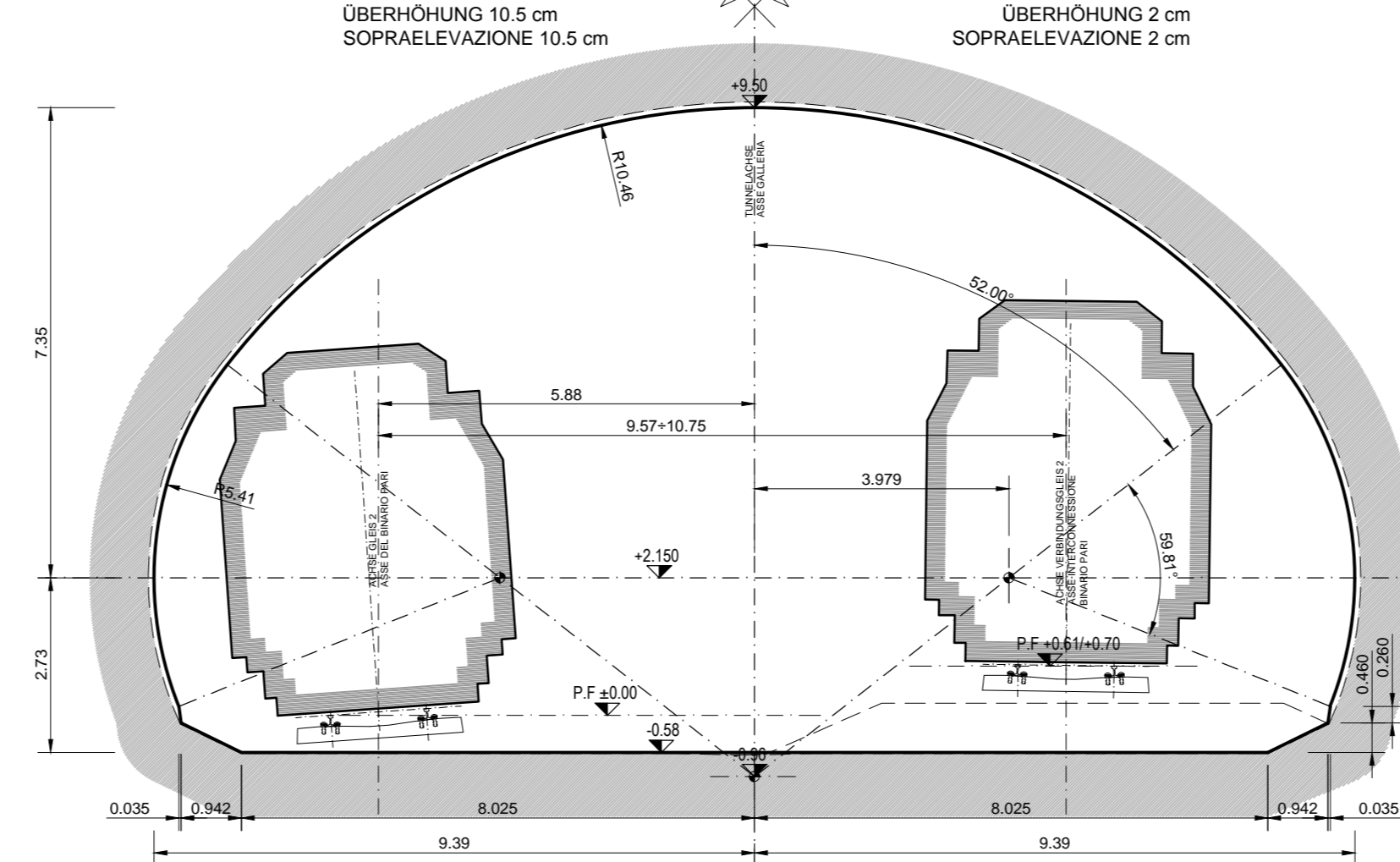

GALLERIA PRINCIPALE A DOPPIO BINARIO
INTERASSE BINARI 9,57+10,75m
(Tipo "N2 - TP-PC5")

PROGRESSIVA 54+598.85

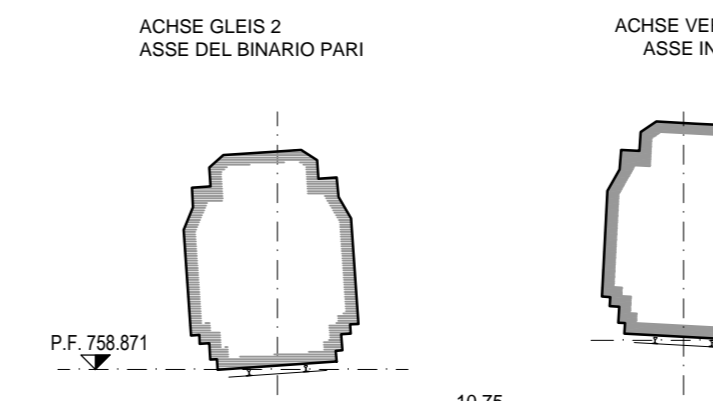

DA Progr. 54+598.85 A Progr. 54+711.07

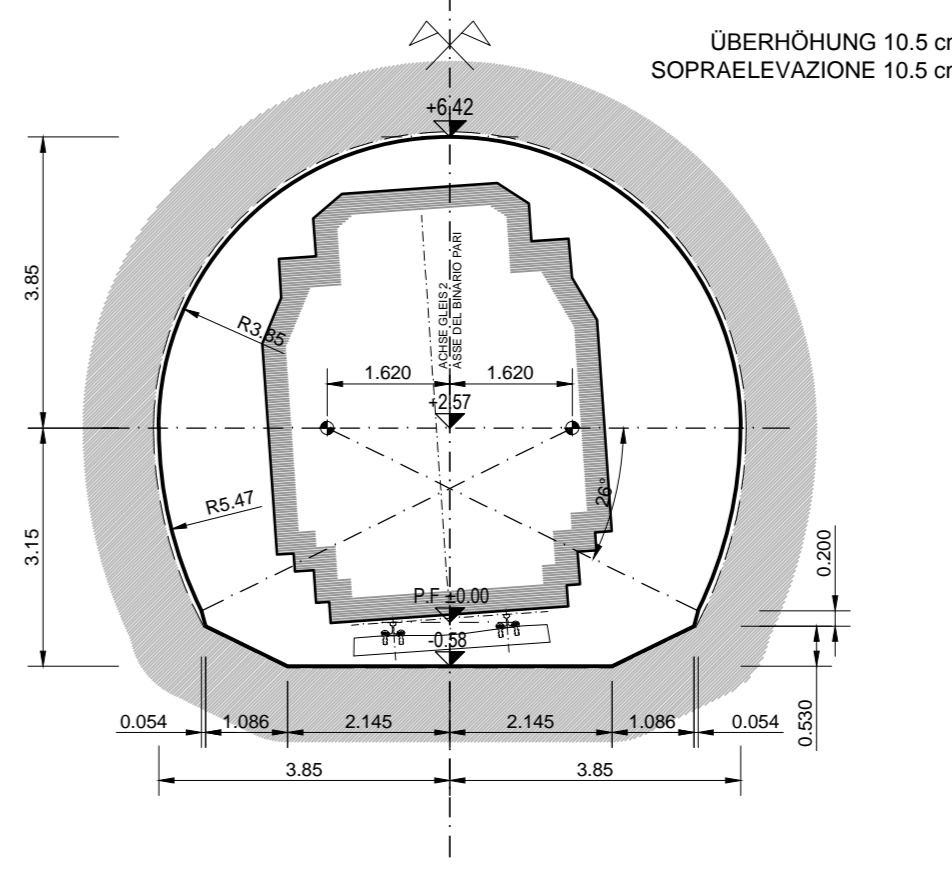

GALLERIA PRINCIPALE A SINGOLO BINARIO
(Tipo "S1 - TP - IS")

SAGOMA DETERMINANTE
MAßGEBENDER LICHTRAUM

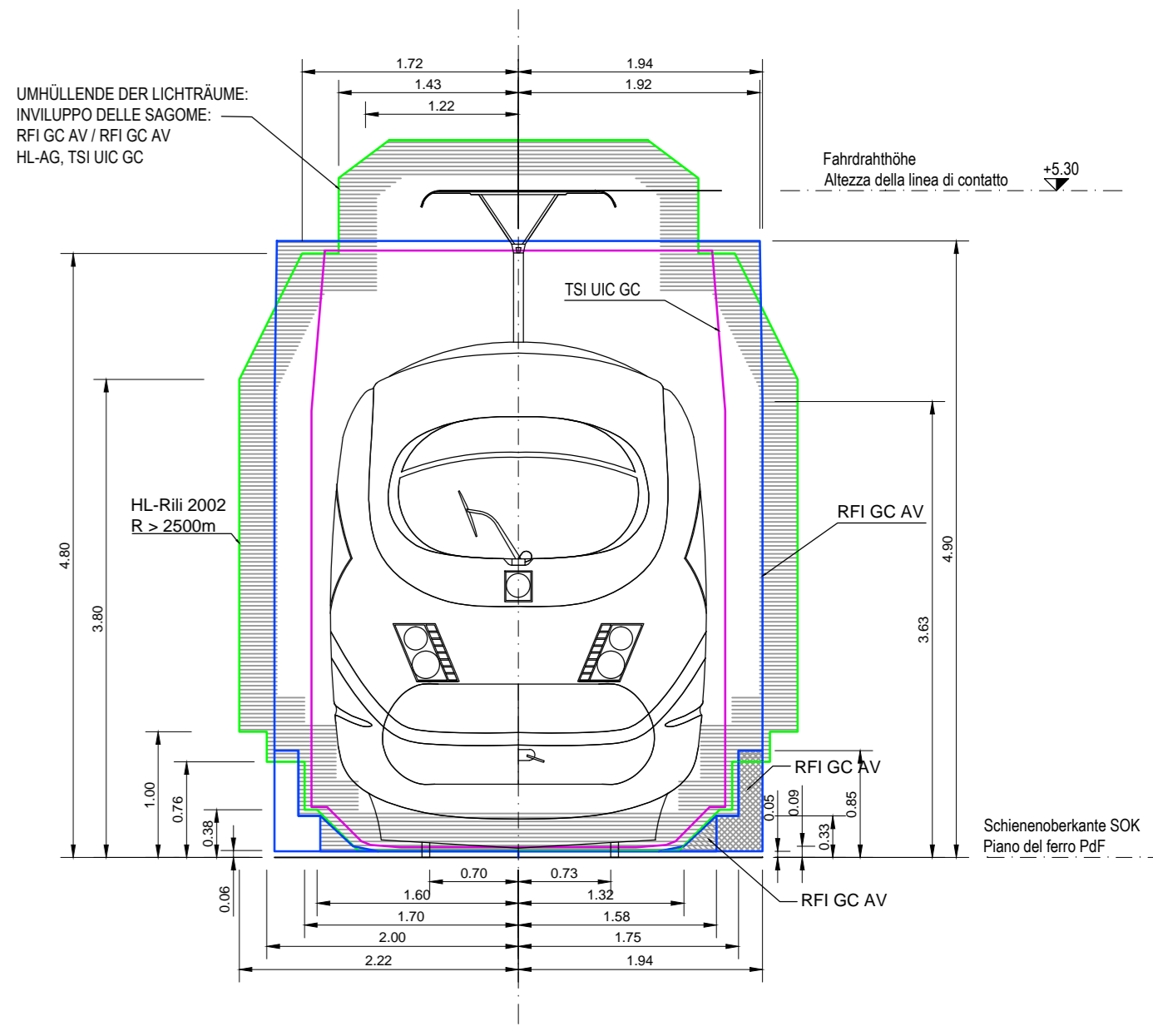

QUADRO DI UNIONE



BEZUGSSYSTEM / SISTEMA DI RIFERIMENTO:
BBT_TM_WGS84



| Bearbeitungsstand Stato di elaborazione | | | |
|--|--------------------------------|--|------------|
| Revision | Änderungen / Modifiche | Verantwortliche Änderung / Responsabile modifica | Datum |
| 00 | Ersterfassung / Prima Versione | M. Rasnelli | 31.07.2015 |
| 01 | Aktualisierung / Aggiornamento | M. Rasnelli | 06.08.2015 |
| 02 | | | |
| 03 | | | |
| 04 | | | |
| 05 | | | |

**Ausbau Eisenbahnstrecke München-Verona
BRENNER BASISTUNNEL**
Ausführungsprojekt

Potenziamento asse ferroviario Monaco - Verona
GALLERIA DI BASE DEL BRENNERO
Progetto esecutivo

Sub-Bauleos Hauptbauwerke Eisackunterquerung
Sublotto di costruzione Opere Principali Sottoattraversamento Isarco

Fachbereich: 05 - Streckenplanung Settore: 05 - Progettazione del tracciato
Thema: Haupttunnelsystem Thema: Sistema della galleria principale
Dokumententyp: Regelprofil Tipo documento: Sezioni tipo
Titel: Gleis 2 Regelquerschnitte - Blatt 1 Titolo: Sezioni tipo binario pari - Tav. 1

| | | | |
|--|--|--|----------------------------|
| | Bearbeiter / Elaborato: M. Rasnelli Geprüft / Verificato: D. Bonadies Freigegeben / Autorizzato: M. Mastor Gegeben BBT / Vista BBT_RUP: A. Lombardi | Datum / Data: 06.08.2015 Datum / Data: 06.08.2015 | rpa rpa GPingegneria |
|--|--|--|----------------------------|

| | | |
|--------------------------------|--------------------------------|--------------------------------------|
| Projekt / Progetto: v01 / da | Bau / Costruzione: v01 / da | Status / Stato: In Arbeit / In corso |
| Zeichner / Disegnatore: ba / a | Zeichner / Disegnatore: ba / a | Gezeichnet / Disegnato: ba / a |
| Proj. / Progetto: ba / a | Proj. / Progetto: ba / a | Proj. / Progetto: ba / a |
| Blatt / Foglio: 02 | Blatt / Foglio: 02 | Blatt / Foglio: 02 |
| Rev. / Revisione: 02 | Rev. / Revisione: 02 | Rev. / Revisione: 02 |