

TIPICO	DESCRIZIONE	RIELEVATO	DISCARICAZIONE	TRINCEA
9	PAV. ASP. IN CEMENTO PORT. S. 200	PAV. ASP. IN CEMENTO PORT. S. 200	PAV. ASP. IN CEMENTO PORT. S. 200	PAV. ASP. IN CEMENTO PORT. S. 200
12	PAV. ASP. IN CEMENTO PORT. S. 200	PAV. ASP. IN CEMENTO PORT. S. 200	PAV. ASP. IN CEMENTO PORT. S. 200	PAV. ASP. IN CEMENTO PORT. S. 200
14	PAV. ASP. IN CEMENTO PORT. S. 200	PAV. ASP. IN CEMENTO PORT. S. 200	PAV. ASP. IN CEMENTO PORT. S. 200	PAV. ASP. IN CEMENTO PORT. S. 200
24	PAV. ASP. IN CEMENTO PORT. S. 200	PAV. ASP. IN CEMENTO PORT. S. 200	PAV. ASP. IN CEMENTO PORT. S. 200	PAV. ASP. IN CEMENTO PORT. S. 200
34	PAV. ASP. IN CEMENTO PORT. S. 200	PAV. ASP. IN CEMENTO PORT. S. 200	PAV. ASP. IN CEMENTO PORT. S. 200	PAV. ASP. IN CEMENTO PORT. S. 200

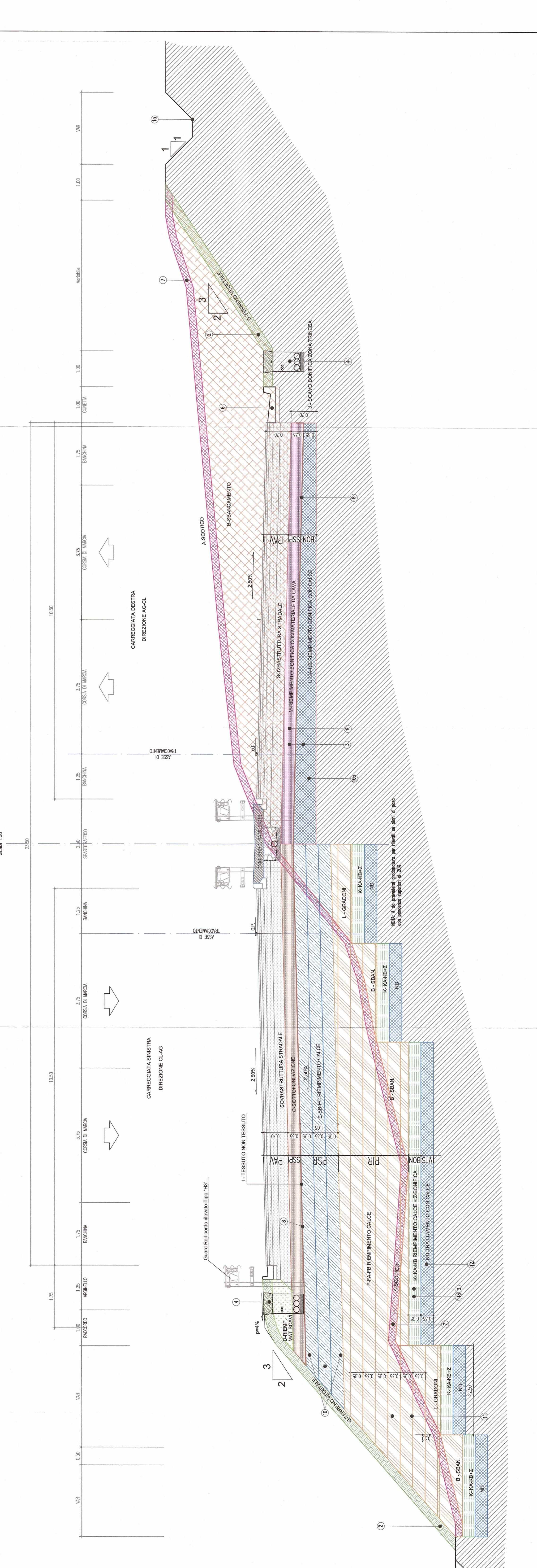
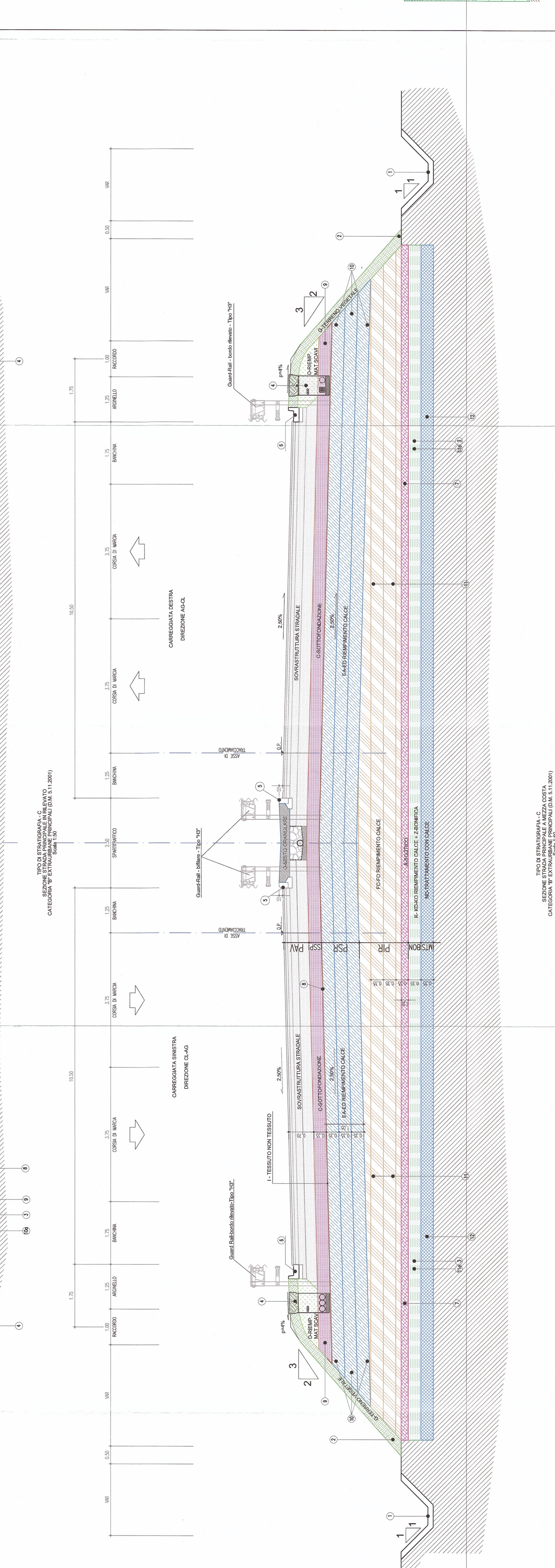
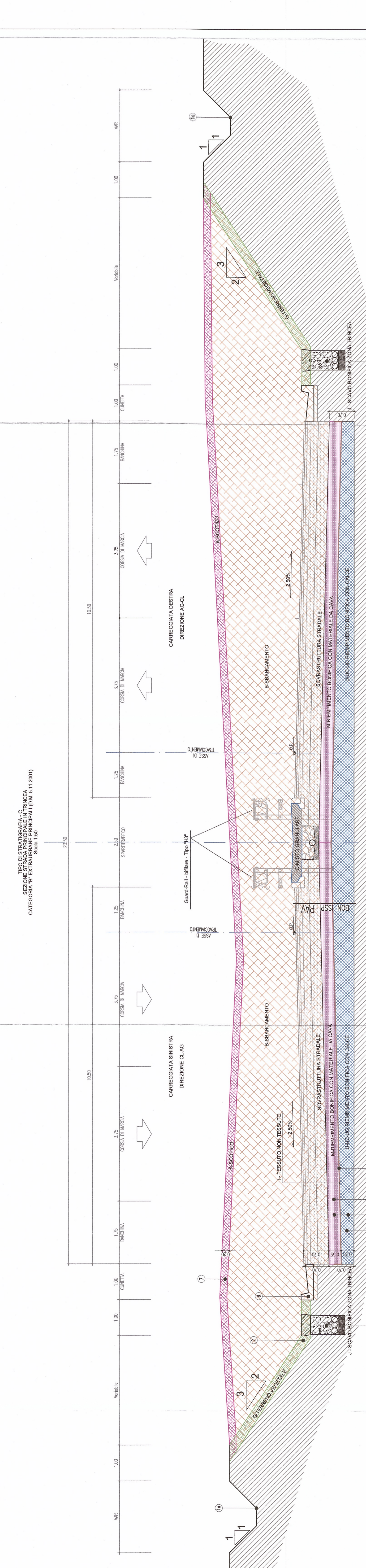
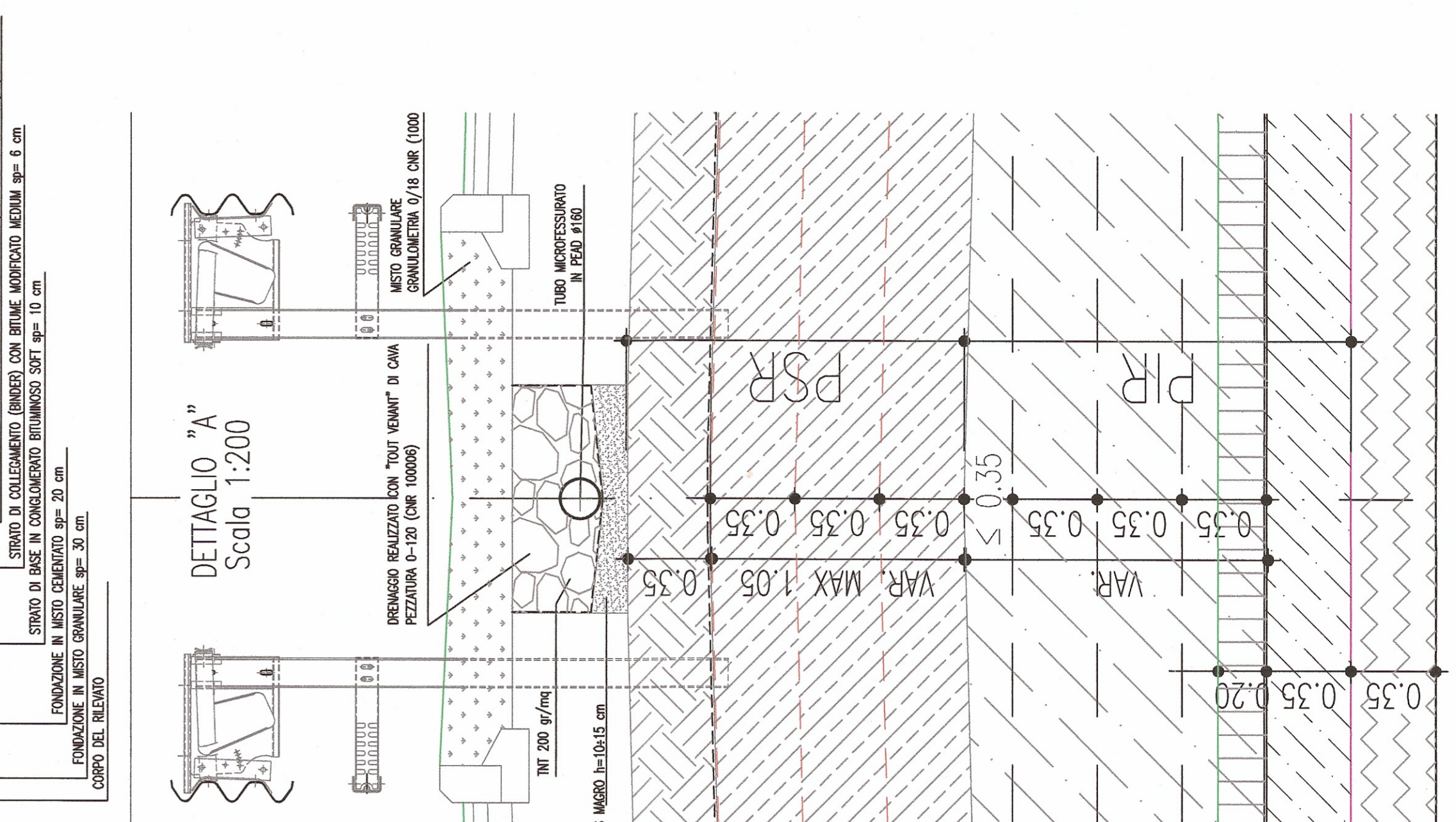
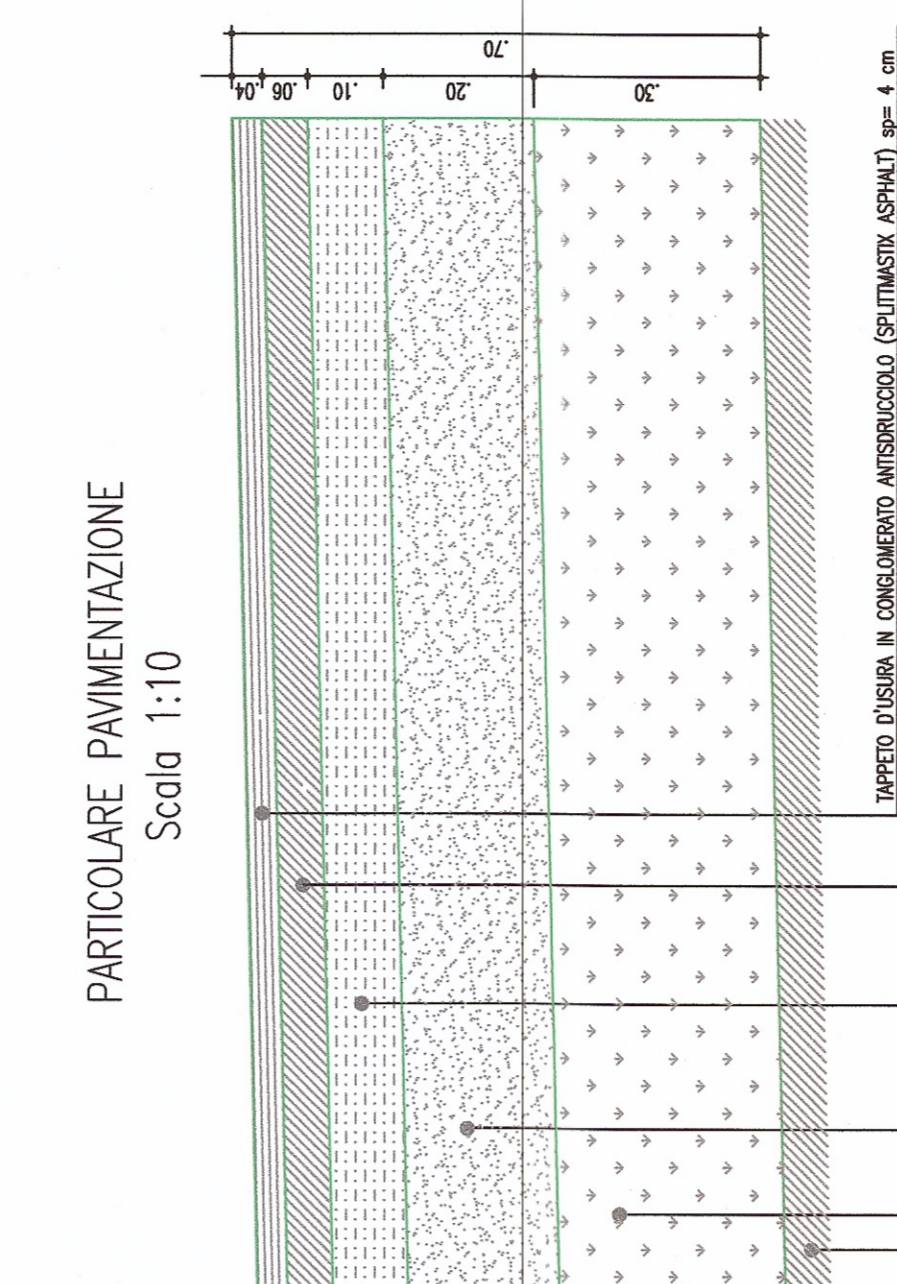
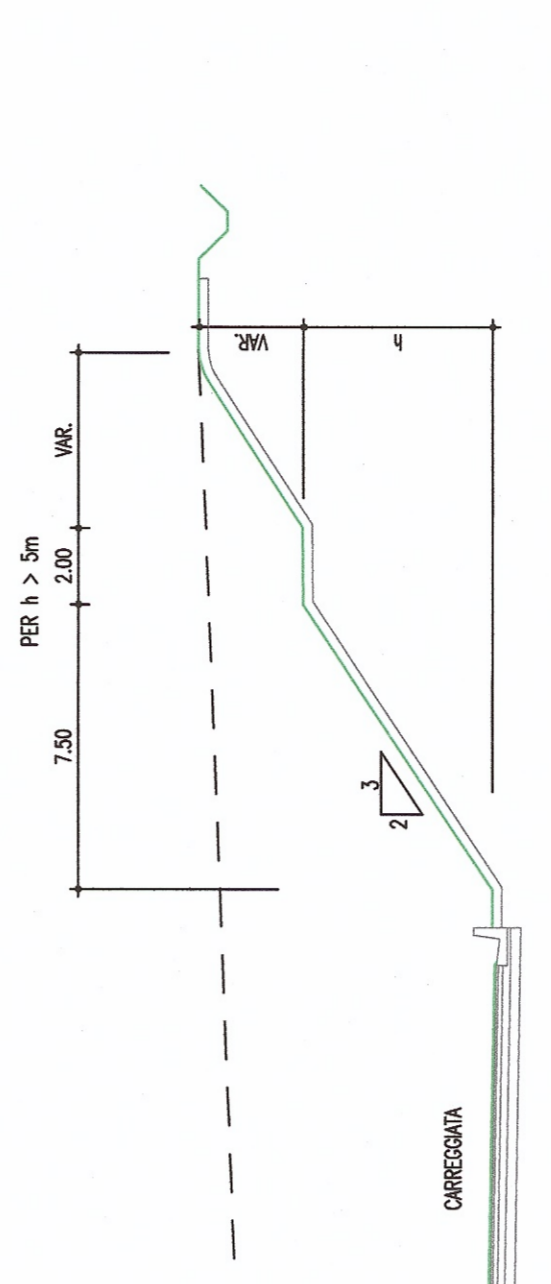
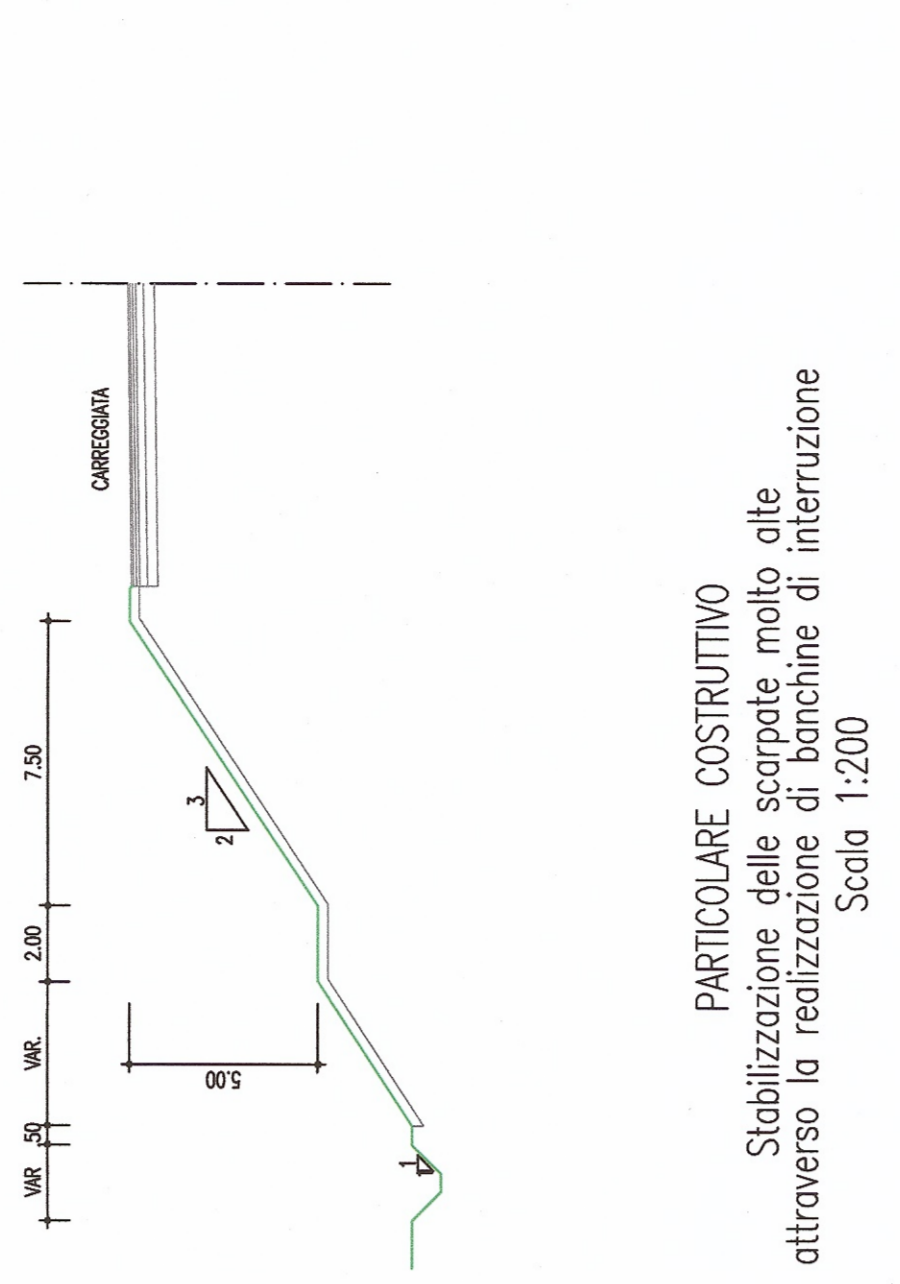
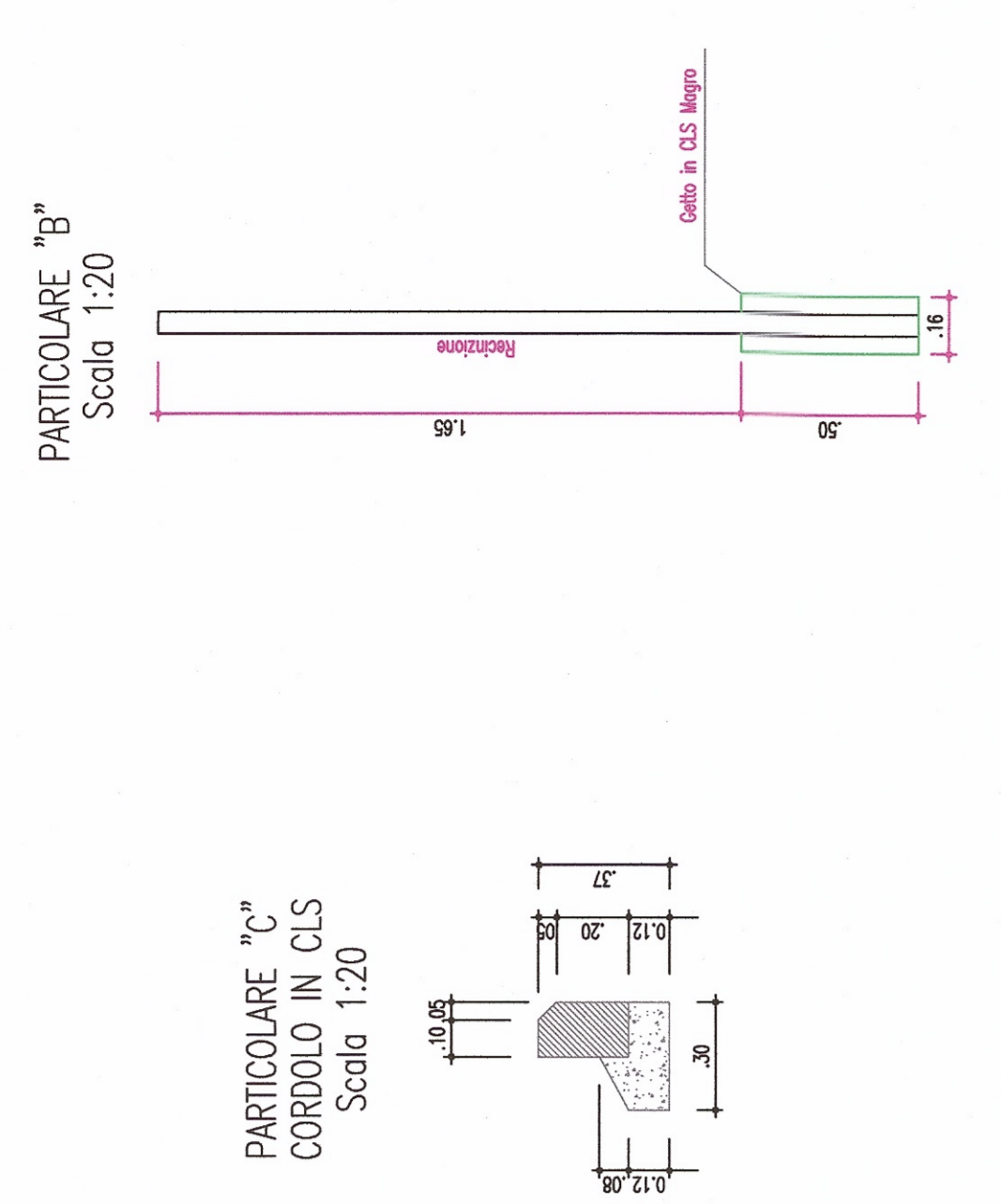

LEGENDA

1. PAV. ASP. IN CEMENTO PORT. S. 200
2. PAV. ASP. IN CEMENTO PORT. S. 200
3. PAV. ASP. IN CEMENTO PORT. S. 200
4. PAV. ASP. IN CEMENTO PORT. S. 200
5. PAV. ASP. IN CEMENTO PORT. S. 200
6. PAV. ASP. IN CEMENTO PORT. S. 200
7. PAV. ASP. IN CEMENTO PORT. S. 200
8. PAV. ASP. IN CEMENTO PORT. S. 200
9. PAV. ASP. IN CEMENTO PORT. S. 200
10. PAV. ASP. IN CEMENTO PORT. S. 200
11. PAV. ASP. IN CEMENTO PORT. S. 200
12. PAV. ASP. IN CEMENTO PORT. S. 200

PAV. PAVIMENTAZIONE

S.200: S.200 con C.200 (Riutilizzo)

S.150: S.150 con C.150 (Riutilizzo)

S.100: S.100 con C.100 (Riutilizzo)

S.50: S.50 con C.50 (Riutilizzo)

S.25: S.25 con C.25 (Riutilizzo)

S.12.5: S.12.5 con C.12.5 (Riutilizzo)

S.6.25: S.6.25 con C.6.25 (Riutilizzo)

S.3.125: S.3.125 con C.3.125 (Riutilizzo)

S.1.5625: S.1.5625 con C.1.5625 (Riutilizzo)

S.0.78125: S.0.78125 con C.0.78125 (Riutilizzo)

S.0.390625: S.0.390625 con C.0.390625 (Riutilizzo)

S.0.1953125: S.0.1953125 con C.0.1953125 (Riutilizzo)

S.0.09765625: S.0.09765625 con C.0.09765625 (Riutilizzo)

S.0.048828125: S.0.048828125 con C.0.048828125 (Riutilizzo)

S.0.0244140625: S.0.0244140625 con C.0.0244140625 (Riutilizzo)

S.0.01220703125: S.0.01220703125 con C.0.01220703125 (Riutilizzo)

S.0.006103515625: S.0.006103515625 con C.0.006103515625 (Riutilizzo)

S.0.0030517578125: S.0.0030517578125 con C.0.0030517578125 (Riutilizzo)

S.0.00152587890625: S.0.00152587890625 con C.0.00152587890625 (Riutilizzo)

S.0.000762939453125: S.0.000762939453125 con C.0.000762939453125 (Riutilizzo)

S.0.0003814697265625: S.0.0003814697265625 con C.0.0003814697265625 (Riutilizzo)

S.0.00019073486328125: S.0.00019073486328125 con C.0.00019073486328125 (Riutilizzo)

S.0.000095367431640625: S.0.000095367431640625 con C.0.000095367431640625 (Riutilizzo)

S.0.0000476837158203125: S.0.0000476837158203125 con C.0.0000476837158203125 (Riutilizzo)

S.0.0000238418591015625: S.0.0000238418591015625 con C.0.0000238418591015625 (Riutilizzo)

S.0.00001192092955078125: S.0.00001192092955078125 con C.0.00001192092955078125 (Riutilizzo)

S.0.000005960464775390625: S.0.000005960464775390625 con C.0.000005960464775390625 (Riutilizzo)

S.0.0000029802323876953125: S.0.0000029802323876953125 con C.0.0000029802323876953125 (Riutilizzo)

S.0.00000149011619384765625: S.0.00000149011619384765625 con C.0.00000149011619384765625 (Riutilizzo)

S.0.000000745058096923828125: S.0.000000745058096923828125 con C.0.000000745058096923828125 (Riutilizzo)

S.0.0000003725290484619140625: S.0.0000003725290484619140625 con C.0.0000003725290484619140625 (Riutilizzo)

S.0.00000018626452423095703125: S.0.00000018626452423095703125 con C.0.00000018626452423095703125 (Riutilizzo)

S.0.000000093132262115478515625: S.0.000000093132262115478515625 con C.0.000000093132262115478515625 (Riutilizzo)

S.0.00000004656613107739428125: S.0.00000004656613107739428125 con C.0.00000004656613107739428125 (Riutilizzo)

S.0.000000023283065538697140625: S.0.000000023283065538697140625 con C.0.000000023283065538697140625 (Riutilizzo)

S.0.0000000116415277693470703125: S.0.0000000116415277693470703125 con C.0.0000000116415277693470703125 (Riutilizzo)

S.0.00000000582076388467353515625: S.0.00000000582076388467353515625 con C.0.00000000582076388467353515625 (Riutilizzo)

S.0.0000000029103819423367678125: S.0.0000000029103819423367678125 con C.0.0000000029103819423367678125 (Riutilizzo)

S.0.00000000145519097116838390625: S.0.00000000145519097116838390625 con C.0.00000000145519097116838390625 (Riutilizzo)

S.0.000000000727595485584191953125: S.0.000000000727595485584191953125 con C.0.000000000727595485584191953125 (Riutilizzo)

S.0.0000000003637977427920959765625: S.0.0000000003637977427920959765625 con C.0.0000000003637977427920959765625 (Riutilizzo)

S.0.000000000181898871391047988125: S.0.000000000181898871391047988125 con C.0.000000000181898871391047988125 (Riutilizzo)

S.0.0000000000909494355470994040625: S.0.0000000000909494355470994040625 con C.0.0000000000909494355470994040625 (Riutilizzo)

S.0.0000000000454747177735497020703125: S.0.0000000000454747177735497020703125 con C.0.0000000000454747177735497020703125 (Riutilizzo)

S.0.00000000002273735888677485103515625: S.0.00000000002273735888677485103515625 con C.0.00000000002273735888677485103515625 (Riutilizzo)

S.0.0000000000113686794433874242678125: S.0.0000000000113686794433874242678125 con C.0.0000000000113686794433874242678125 (Riutilizzo)

S.0.00000000000568433972169371213390625: S.0.00000000000568433972169371213390625 con C.0.00000000000568433972169371213390625 (Riutilizzo)

S.0.00000000000284216986084685606703125: S.0.00000000000284216986084685606703125 con C.0.00000000000284216986084685606703125 (Riutilizzo)

S.0.000000000001421084930423428033515625: S.0.000000000001421084930423428033515625 con C.0.000000000001421084930423428033515625 (Riutilizzo)

S.0.00000000000071054246521171401678125: S.0.00000000000071054246521171401678125 con C.0.00000000000071054246521171401678125 (Riutilizzo)

S.0.000000000000355271232605857008390625: S.0.000000000000355271232605857008390625 con C.0.000000000000355271232605857008390625 (Riutilizzo)

S.0.0000000000001776356163029285341953125: S.0.0000000000001776356163029285341953125 con C.0.0000000000001776356163029285341953125 (Riutilizzo)

S.0.00000000000008881780815146426719765625: S.0.00000000000008881780815146426719765625 con C.0.00000000000008881780815146426719765625 (Riutilizzo)

S.0.0000000000000444089040757321335938125: S.0.0000000000000444089040757321335938125 con C.0.0000000000000444089040757321335938125 (Riutilizzo)

S.0.00000000000002220445203786606719703125: S.0.00000000000002220445203786606719703125 con C.0.00000000000002220445203786606719703125 (Riutilizzo)

S.0.0000000000000111022260189330308515625: S.0.0000000000000111022260189330308515625 con C.0.0000000000000111022260189330308515625 (Riutilizzo)

S.0.00000000000000555111300946651542678125: S.0.00000000000000555111300946651542678125 con C.0.00000000000000555111300946651542678125 (Riutilizzo)

S.0.000000000000002775556504733271335938125: S.0.000000000000002775556504733271335938125 con C.0.000000000000002775556504733271335938125 (Riutilizzo)

S.0.0000000000000013877782523666366719703125: S.0.0000000000000013877782523666366719703125 con C.0.0000000000000013877782523666366719703125 (Riutilizzo)

S.0.000000000000000693889126183318335938125: S.0.000000000000000693889126183318335938125 con C.0.000000000000000693889126183318335938125 (Riutilizzo)

S.0.0000000000000003469445630916667938125: S.0.0000000000000003469445630916667938125 con C.0.0000000000000003469445630916667938125 (Riutilizzo)

S.0.00000000000000017347228154583339691953125: S.0.00000000000000017347228154583339691953125 con C.0.00000000000000017347228154583339691953125 (Riutilizzo)

S.0.000000000000000086736140772791693470703125: S.0.000000000000000086736140772791693470703125 con C.0.000000000000000086736140772791693470703125 (Riutilizzo)

S.0.0000000000000000433680703863958467353515625: S.0.0000000000000000433680703863958467353515625 con C.0.0000000000000000433680703863958467353515625 (Riutilizzo)

S.0.000000000000000021684035193197923367678125: S.0.000000000000000021684035193197923367678125 con C.0.000000000000000021684035193197923367678125 (Riutilizzo)

S.0.0000000000000000108420175965989616838390625: S.0.0000000000000000108420175965989616838390625 con C.0.0000000000000000108420175965989616838390625 (Riutilizzo)

S.0.000000000000000005421008798299484191953125: S.0.000000000000000005421008798299484191953125 con C.0.000000000000000005421008798299484191953125 (Riutilizzo)

S.0.0000000000000000027105043991492420959765625: S.0.0000000000000000027105043991492420959765625 con C.0.0000000000000000027105043991492420959765625 (Riutilizzo)

S.0.00000000000000000135525021957471047988125: S.0.00000000000000000135525021957471047988125 con C.0.00000000000000000135525021957471047988125 (Riutilizzo)

S.0.000000000000000000677625107873557008390625: S.0.000000000000000000677625107873557008390625 con C.0.000000000000000000677625107873557008390625 (Riutilizzo)

S.0.0000000000000000003388125389386851542678125: S.0.0000000000000000003388125389386851542678125 con C.0.0000000000000000003388125389386851542678125 (Riutilizzo)

S.0.0000000000000000001694062694694271335938125: S.0.0000000000000000001694062694694271335938125 con C.0.0000000000000000001694062694694271335938125 (Riutilizzo)

S.0.00000000000000000008470313473471047988125: S.0.00000000000000000008470313473471047988125 con C.0.00000000000000000008470313473471047988125 (Riutilizzo)

S.0.000000000000000000042351567173557008390625: S.0.000000000000000000042351567173557008390625 con C.0.000000000000000000042351567173557008390625 (Riutilizzo)

S.0.000000000000000000021175783863958467353515625: S.0.000000000000000000021175783863958467353515625 con C.0.000000000000000000021175783863958467353515625 (Riutilizzo)

S.0.00000000000000000001058789193197923367678125: S.0.00000000000000000001058789193197923367678125 con C.0.00000000000000000001058789193197923367678125 (Riutilizzo)

S.0.000000000000000000005293945965989616838390625: S.0.000000000000000000005293945965989616838390625 con C.0.000000000000000000005293945965989616838390625 (Riutilizzo)

S.0.00000000000000000000264697298299484191953125: S.0.00000000000000000000264697298299484191953125 con C.0.00000000000000000000264697298299484191953125 (Riutilizzo)

S.0.000000000000000000001323486491492420959765625: S.0.000000000000000000001323486491492420959765625 con C.0.000000000000000000001323486491492420959765625 (Riutilizzo)

S.0.0000000000000000000006617432457471047988125: S.0.0000000000000000000006617432457471047988125 con C.0.0000000000000000000006617432457471047988125 (Riutilizzo)

S.0.00000000000000000000033087162386851542678125: S.0.00000000000000000000033087162386851542678125 con C.0.00000000000000000000033087162386851542678125 (Riutilizzo)

S.0.00000000000000000000016543581193197923367678125: S.0.00000000000000000000016543581193197923367678125 con C.0.00000000000000000000016543581193197923367678125 (Riutilizzo)

S.0.000000000000000000000082717905965989616838390625: S.0.000000000000000000000082717905965989616838390625 con C.0.000000000000000000000082717905965989616838390625 (Riutilizzo)

S.0.0000000000000000000000413589298299484191953125: S.0.0000000000000000000000413589298299484191953125 con C.0.0000000000000000000000413589298299484191953125 (Riutilizzo)

S.0.00000000000000000000002067946491492420959765625: S.0.00000000000000000000002067946491492420959765625 con C.0.00000000000000000000002067946491492420959765625 (Riutilizzo)

S.0.000000000000000000000010339732457471047988125: S.0.000000000000000000000010339732457471047988125 con C.0.000000000000000000000010339732457471047988125 (Riutilizzo)

S.0.0000000000000000000000051698662386851542678125: S.0.0000000000000000000000051698662386851542678125 con C.0.0000000000000000000000051698662386851542678125 (Riutilizzo)

S.0.000000000000000000000002584933193197923367678125: S.0.000000000000000000000002584933193197923367678125 con C.0.000000000000000000000002584933193197923367678125 (Riutilizzo)

S.0.0000000000000000000000012924665965989616838390625: S.0.0000000000000000000000012924665965989616838390625 con C.0.0000000000000000000000012924665965989616838390625 (Riutilizzo)

S.0.000000000000000000000000646233298299484191953125: S.0.000000000000000000000000646233298299484191953125 con C.0.000000000000000000000000646233298299484191953125 (Riutilizzo)

S.0.0000000000000000000000003231166491492420959765625: S.0.0000000000000000000000003231166491492420959765625 con C.0.0000000000000000000000003231166491492420959765625 (Riutilizzo)

S.0.00000000000000000000000016155832457471047988125: S.0.00000000000000000000000016155832457471047988125 con C.0.00000000000000000000000016155832457471047988125 (Riutilizzo)

S.0.000000000000000000000000080779162386851542678125: S.0.000000000000000000000000080779162386851542678125 con C.0.000000000000000000000000080779162386851542678125 (Riutilizzo)

S.0.000000000000000000000000040389581193197923367678125: S.0.000000000000000000000000040389