



ANAS S.p.A.



Commissario Governativo Delegato
OPCM n. 3869 del 23 aprile 2010
OPCM n. 3895 del 20/08/2010



REGIONE SARDEGNA

O.P.C.M. n. 3869 del 23/04/2010. Disposizioni urgenti di protezione civile per fronteggiare l'emergenza determinatasi nel settore del traffico e della mobilità nelle province di Sassari ed Olbia – Tempio, in relazione alla strada statale Sassari – Olbia

SOGGETTO ATTUATORE ANAS S.p.A.

ADEGUAMENTO AL TIPO B DELL'ITINERARIO SASSARI – OLBIA

LOTTO 4

DAL km 36+100 AL km 45+610

CIG: 4658037DB8

PROGETTO ESECUTIVO

VISTO IL RESPONSABILE DEL PROCEDIMENTO Ing. Francesco Ruggieri	VISTO: IL RESPONSABILE DEL SERVIZIO PROGETTAZIONE	VISTO: IL DIRETTORE DEI LAVORI
IMPRESA ESECUTRICE ATI:  GRANDI LAVORI FINCOSIT SPA Direttore Divisione Infrastrutture Ing. Vincenzo Costantino	PROGETTAZIONE: PROGETTAZIONE GRANDI INFRASTRUTTURE PROGIN S.p.A. (Il Progettista) Ing. Raffaele Piccirillo	Prof. Ing. Antonio Grimaldi (Responsabile integrazione delle Attività Specialistiche) Ing. Gianluca Pandolfi Elmi (Geologo) Ing. Michele Curiale (Coordinatore della Sicurezza in fase di Progettazione)

Elaborato:

**IDROLOGIA ED IDRAULICA
ATTRAVERSAMENTI ED INALVEAZIONI SECONDARIE**

RELAZIONE IDRAULICA RETICOLO SECONDARIO

CODICE PROGETTO		NOME FILE DPCA03E1004ID02IDRRE01D.DOCX		REVISIONE	FOGLIO	SCALA:
PROGETTO DPCA03	LIV.PROG. E	N. PROG. 1004	CODICE ELAB. ID02 IDR RE01	E	di	
E	OTTEMPERANZA PRESCRIZIONI GENIO CIVILE		Gennaio 2016	R. Malcotti	P. Iorio	R. Piccirillo
C	OTTEMPERANZA PRESCRIZIONI GENIO CIVILE E ISTRUTTORIA ANAS DEL 10-11-2014 E 01-12-2014		Dicembre 2014	R. Malcotti	P. Iorio	R. Piccirillo
B	REVISIONE A SEGUITO ISTRUTTORIA ANAS DEL 24-09-2014		Ottobre 2014	R. Malcotti	P. Iorio	R. Piccirillo
A	EMISSIONE		Maggio 2014	R. Malcotti	P. Iorio	R. Piccirillo
REV.	DESCRIZIONE		DATA	REDATTO	VERIFICATO	APPROVATO

INDICE

1. PREMESSA	4
2. INQUADRAMENTO NORMATIVO	5
3. INTERFERENZE IDRAULICHE PICCOLI BACINI.....	6
MODELLI DI SIMULAZIONE.....	7
PORTATE DI RIFERIMENTO	7
ALLESTIMENTO E CALIBRAZIONE DEI MODELLI.....	8
Assetto geometrico delle aste	8
Condizioni al contorno e definizione della scabrezza	8
RISULTATI DELLE SIMULAZIONI IDRAULICHE IN MOTO PERMANENTE	9
RISULTATI DELLE SIMULAZIONI ANTE-POST OPERAM IN MOTO VARIO	14
PONTI: VERIFICA ALLO SCALZAMENTO	15
INALVEAZIONI.....	23
Verifica a trascinamento dei rivestimenti.....	23
Verifica dei rivestimenti presso le curve.....	29
4. INTERFERENZE IDRAULICHE COMPLUVI.....	45
VERIFICA E DIMENSIONAMENTO	46
5. PIANO DI MANUTENZIONE	47
MANUALE D'USO	47
MANUALE DI MANUTENZIONE.....	48
PROGRAMMA DI MANUTENZIONE.....	49
Sottoprogramma delle prestazioni	49
Sottoprogramma dei controlli	49
Sottoprogramma degli interventi.....	50

ALLEGATI

ALLEGATO 1 – DESCRIZIONE DEL CODICE DI CALCOLO

ALLEGATO 2 – RISULTATI SIMULAZIONI MOTO PERMANENTE DELLE INTERFERENZE IDRAULICHE E DELLE INALVEAZIONI:

- 2.1 Interferenza idraulica - TO01: Tabella riassuntiva dei risultati, profilo idrico e sezioni trasversali con i livelli idrici (TR 200/500 anni)
- 2.2 Interferenza idraulica - TO02: Tabella riassuntiva dei risultati, profilo idrico e sezioni trasversali con i livelli idrici (TR 200/500 anni)
- 2.3 Interferenza idraulica - TO03: Tabella riassuntiva dei risultati, profilo idrico e sezioni trasversali con i livelli idrici (TR 200/500 anni)
- 2.4 Interferenza idraulica - TO04: Tabella riassuntiva dei risultati, profilo idrico e sezioni trasversali con i livelli idrici (TR 200/500 anni)
- 2.5 Interferenza idraulica - TO05: Tabella riassuntiva dei risultati, profilo idrico e sezioni trasversali con i livelli idrici (TR 200/500 anni)
- 2.6 Interferenza idraulica - TO06: Tabella riassuntiva dei risultati, profilo idrico e sezioni trasversali con i livelli idrici (TR 200/500 anni)
- 2.7 Interferenza idraulica - TO07: Tabella riassuntiva dei risultati, profilo idrico e sezioni trasversali con i livelli idrici (TR 200/500 anni)
- 2.8 Interferenza idraulica - TO08: Tabella riassuntiva dei risultati, profilo idrico e sezioni trasversali con i livelli idrici (TR 200/500 anni)
- 2.9 Interferenza idraulica - TO09: Tabella riassuntiva dei risultati, profilo idrico e sezioni trasversali con i livelli idrici (TR 200/500 anni)
- 2.10 Interferenza idraulica - TO10: Tabella riassuntiva dei risultati, profilo idrico e sezioni trasversali con i livelli idrici (TR 200/500 anni)
- 2.11 Interferenza idraulica - TO11: Tabella riassuntiva dei risultati, profilo idrico e sezioni trasversali con i livelli idrici (TR 200/500 anni)
- 2.12 Interferenza idraulica - TO12: Tabella riassuntiva dei risultati, profilo idrico e sezioni trasversali con i livelli idrici (TR 200/500 anni)
- 2.13 Inalveazione - CA01: Tabella riassuntiva dei risultati, profilo idrico e sezioni trasversali con i livelli idrici (TR 200 anni/500)
- 2.14 Inalveazione - CA02: Tabella riassuntiva dei risultati, profilo idrico e sezioni trasversali con i livelli idrici (TR 50, 100, 200 e 500 anni)

ALLEGATO 3 – RISULTATI SIMULAZIONI MOTO VARIO PER LE VERIFICHE ANTE-POST OPERAM DELLE INALVEAZIONI CRITICHE:

- 3.1 Interferenza idraulica - TO01: Tabella riassuntiva dei risultati, profilo idrico e sezioni trasversali con i livelli idrici (TR 200 anni)
- 3.2 Interferenza idraulica - TO02-TO03-CA02-TO07: Tabella riassuntiva dei risultati, profilo idrico e sezioni trasversali con i livelli idrici (TR 200 anni)
- 3.3 Interferenza idraulica - TO10: Tabella riassuntiva dei risultati, profilo idrico e sezioni trasversali con i livelli idrici (TR 200 anni)
- 3.4 Interferenza idraulica - TO11-TO12: Tabella riassuntiva dei risultati, profilo idrico e sezioni trasversali con i livelli idrici (TR 200 anni)

ALLEGATO 4 – INTERFERENZE IDRAULICHE COMPLUVI: RISULTATI INLET-OUTLET CONTROL

1. PREMESSA

La presente relazione inquadra le interferenze idrauliche col tracciato in progetto indicate nell'elaborato "Corografia dei piccoli bacini", e ne descrive la verifica e il dimensionamento delle opere risolutive.

Il reticolo idrografico è stato mappato mediante diversi livelli cartografici, che comprendono la carta IGM 25.000, la CTR 10.000, il rilievo aerofotogrammetrico 1:1000 appositamente realizzato per il presente progetto e il celerimetrico di campagna.

Oltre al rio Mannu di Oschiri, per il quale sono prodotti elaborati specifici, le interferenze principali con la strada di progetto del reticolo idrografico individuato da mappatura IGM e CTR, prendono la codifica TOxx o CAxx, rispettivamente nel caso siano previsti nuovi attraversamenti oppure esclusivamente canalizzazioni/inalveazioni. I bacini sottesi delle interferenze principali hanno usualmente una superficie di diversi decine di chilometri quadrati. I criteri di verifica e dimensionamento delle interferenze TO fanno riferimento alla normativa vigente regionale e nazionale.

Le interferenze secondarie con la strada di progetto del reticolo idrografico individuato da mappatura di dettaglio (scoline, incisioni, compluvi, fossi di guardia) prendono la codifica COxx, ed hanno superfici inferiori a 1 km². I criteri di verifica e dimensionamento delle interferenze CO sono analoghi a quanto previsto per il sistema di piattaforma, essendone parte integrante.

L'elaborato "Planimetria delle interferenze idrauliche" esplicita le classi di suddivisione del reticolo idraulico e gli elaborati di pertinenza.

Le interferenze dei fossi di guardia esistenti e futuri, nonché della rete di collettori di piattaforma saranno infine analizzati con codifica dedicata nella attività "Idraulica di piattaforma e presidi".

Le opere di attraversamento sono corredate da opportune opere di imbocco e sbocco di lunghezza tale da consentirne il rilascio al recapito a quota compatibile. Per tale motivo, associata alla esigenza di livelletta idraulica e stradale, spesso si sono resi necessari lunghi interventi di inalveazione: risonamento dei canali a sezione trasversale artificializzata, riprofilatura longitudinale, salti di fondo.

Di tutte le interferenze TO e CA è stata eseguita una modellazione di dettaglio col codice di calcolo HEC-RAS. Di ogni opera sono descritti profili, planimetrie e sezioni, sia in termini di verifica idraulica sia come restituzione progettuale a scala di dettaglio (1:500, 1:200).

In base alle verifiche idrauliche effettuate, i tombini esistenti sono risultati inadeguati, e se ne prevede, di conseguenza, la sistematica sostituzione.

Le dimensioni dei tombini, in taluni casi assolutamente sovrabbondanti rispetto alle portate di progetto calcolate, sono state determinate tenendo in conto la situazione attuale dell'attraversamento, ove esistente, e comunque assicurando in ogni caso la facilità di intervento in sicurezza per le future operazioni manutentive.

Per le interferenze idrauliche principali TOxx, la tipologia dei tombini utilizzata è quella scatolare. In ogni caso, il manufatto più piccolo sarà di dimensione minima 2,00 x 2,00.

Il sistema di riferimento topografico adottato in tutto il progetto è Coordinate Rettilinee; rispetto al sistema ufficiale regionale Gauss-Boaga, lo scostamento è nell'ordine metrico.

Revisione Ottobre 2014 per ottemperanza prescrizioni Genio Civile - A seguito delle prescrizioni richieste dal Genio Civile prot. 33219 del 30.09.2014, sono state apportate delle modifiche alle opere di rivestimento delle inalveazioni e dei rilevati stradali, e inserite nuove opere di attraversamento.

2. INQUADRAMENTO NORMATIVO

Le analisi sono state svolte nel rispetto della seguente normativa regionale e nazionale:

- R.D. n°523 del 1904 e ss.mm.ii.
- D.lgs. n°152 del 2006
- D.M. 11.03.1988 e Circolare 9.1.1996 n.218/24/3 del Ministero LL.PP.
- Decreto del Presidente della Repubblica n. 380 del 06/06/2001 - "Testo unico delle disposizioni legislative e regolamentari in materia edilizia"
- D.M. 14.01.2008 - Norme Tecniche per le Costruzioni
- Circolare 2 febbraio 2009 n. 617. C.S.LL.PP.
- N.T.A. e Linee Guida del Piano Stralcio per l'Assetto Idrologico
- Direttive per la manutenzione degli alvei e la gestione dei sedimenti approvate dal Comitato Istituzionale dell'Autorità di Bacino regionale della Sardegna con Delibera n°22 del 1° Agosto 2012
- Piano Stralcio fasce fluviali

3. INTERFERENZE IDRAULICHE PICCOLI BACINI

Le interferenze idrauliche principali, individuabili mediante mappatura cartografica su IGM 25000 e CTR 10000 sono:

Tabella 1 – Elenco interferenze piccoli bacini

ID Interferenza idraulica	Reticolo idrico	ID Intervento progettuale	Asse stradale	Progr. Asse stradale	Tipologia di intervento
TO01	Naturale	TO01.A	SV.Oschiri - Rampa F	0+139.45	Tombino
		TO01.B	AP	36+900	Tombino
		TO01.C	SV.Oschiri - Rampa P	0+232.44	Tombino
		TO01.D	SV.Oschiri - Rampa A	0+220.43	Tombino
		TO01.E	Viab. L4SV1-SV2	0+920.00	Tombino
TO01BIS	Naturale	TO01.F	Viab. Comunale esistente	-	Tombino*
TO01TRIS	Naturale	TO01.G	SV.Oschiri - Rampa P	0+038	Tombino*
TO02	Naturale	TO02	AP	38+343.30	Tombino
TO03	Naturale	TO03.A	Viab. L4SR3 BIS	0+036	Tombino
		TO03.B	AP	689.9	Tombino
		TO03.C	Accesso privato DX	38+682	Tombino
TO04	Naturale	TO04.A	Viab. L4SV5 BIS	0+044	Tombino
		TO04.B	AP	39+139.60	Tombino
		TO04.C	Viab. L4SR6	0+365	Tombino
TO05	Naturale	TO05.A	Viab. L4SR6	0+575	Tombino
		TO05.B	AP	39+425	Tombino
TO06	Naturale	TO06	Viab. L4SR6	0+894	Tombino
TO07	Naturale	TO07.A	AP	40+390.50	Tombino
		TO07.B	Viab. L4SV5 BIS	0+322	Tombino
TO08	Naturale	TO08.A	Viab. SV9	0+090	Tombino
		TO08.B	AP	42+129.80	Tombino
		TO08.C	Viab. SV8	0+393.20	Tombino
TO09	Naturale	TO09.A	Viab. SV9	0+750	Tombino
		TO09.B	AP	42+777.90	Tombino
		TO09.C	Viab. SV8 BIS	0+751	Tombino
TO10	Naturale	TO10.A	AP	43+475	Ponte
		TO10.B	Viab. SV10	0+262	Ponte
		TO10.C	Viab. SV9	1+461	Ponte*
TO11	Naturale	TO11.A	Viab. L4SV13	0+325	Tombino
		TO11.B	AP	45+145.80	Tombino
		TO11.C	SV.Berchidda - Ret.SS199	Lato SX	Tombino*
TO12	Naturale	TO12	AP	45+350	Ponte
TO12bis	Naturale	TO12.B	SS199	0+107	Ponte*
CA01	Naturale	CA01	-	41+900	Inalveazione
CA02	Naturale	CA02	-	39+250	Inalveazione

*Opere aggiunte/eliminate a seguito prescrizioni Genio Civile e/o revisioni stradali ANAS

Modelli di simulazione

Per la verifica della compatibilità idraulica delle interferenze principali TOxx e CAxx è stato utilizzato il codice di calcolo HEC-RAS ver. 4.1.0, sviluppato dalla Hydrologic Engineering Center della U.S. Army, che consente il calcolo dell'andamento dei profili di corrente in moto gradualmente variato oppure in moto vario in alvei naturali o canali artificiali includendo anche la valutazione degli effetti sulla corrente dovuti all'interazione con ponti, tombinature, briglie, stramazzi, aree golenali ecc.. Per i dettagli del metodo utilizzato si rimanda all'Allegato specifico.

Portate di riferimento

Le verifiche idrauliche effettuate nel seguente studio relativamente al reticolo secondario vertono sulla compatibilità idraulica delle opere in progetto. L'evento **duecentennale** è stato considerato di riferimento per la verifica e la progettazione delle opere oggetto di studio.

Le simulazioni sono state effettuate sia in moto permanente (per la verifica dei tombini), sia in moto vario (per valutare l'effetto ANTE-POST OPERAM)

Come descritto nella relazione idrologica, a cui si rimanda per le specifiche metodologiche, di seguito si riportano i valori delle portate di progetto per ciascuna opera in progetto, calcolate mediante il metodo razionale considerando come parametro di assorbimento CN (Curve Number) sia quello ricavato secondo la metodologia elaborata dal CIMA (Centro di Ricerca Interuniversitario in Monitoraggio Ambientale, Savona) per conto e in coordinamento della Protezione Civile Nazionale (applicato anche nel PSFF), sia quello indicato nel progetto preliminare e pari a 91 per ciascun bacino afferente al reticolo secondario indagato.

Tabella 2 – Portate di progetto del reticolo secondario interferente

Codifica interferenza	CN metodo CIMA-PSFF	CN 91
	Q (m³/s)	Q (m³/s)
TO01	8.3	10.4
TO01bis	14.9	17.7
TO01tris	4.7	5.5
TO02	7.4	8.7
TO03	21.8	25.9
TO04	6.4	7.7
TO05	3.9	4.9
TO06	2.7	3.4
TO07	82.2	102.1
TO08	18.9	27.9
TO09	9.9	14.0
TO10	126.3	145.7
TO11	11.1	15.7
TO12	95.1	103.9
TO12bis	107.8	121.8
CA01	26.8	36.1
CA02	53.1	59.6

Laddove presenti confluenze di rilievo, sono stati infittiti i bacini e ripartite le portate ai rii di pertinenza.

La portata di riferimento progettuale è stata scelta, in coerenza col Progetto Preliminare, applicando il cautelativo valore di $CN=91$.

Allestimento e calibrazione dei modelli

Assetto geometrico delle aste

La schematizzazione geometrica delle varie aste studiate è stata effettuata in modo da ottenere una buona e realistica rappresentazione del deflusso di piena basandosi sul rilievo 3D di dettaglio a disposizione integrato con la modellazione tridimensionale delle opere in progetto.

Di ogni opera viene rappresentato l'andamento planimetrico, il profilo longitudinale e l'andamento geometrico delle sezioni trasversali indagate.

La schematizzazione dei tombini idraulici in ciascun modello di calcolo numerico è stata effettuata mediante la funzione "Bridge and culverts" del codice di calcolo in questione. In particolare tali strutture sono state schematizzate utilizzando 4 sezioni trasversali consecutive, due a monte e due a valle dell'opera; la distanza tra le sezioni è stata definita in modo da rappresentare correttamente la larghezza della struttura e il restringimento geometrico indotto dalla medesima.

Per il calcolo del profilo di corrente in corrispondenza delle strutture, tra le diverse opzioni offerte dal codice di calcolo, sono state selezionate le equazioni di bilancio dell'energia ed il metodo dei momenti, tra le quali il software seleziona in automatico la formulazione caratterizzata dalla maggiore dissipazione energetica. Per il deflusso al di sotto dell'impalcato (low flow); viene invece assunta la schematizzazione con deflusso in pressione e stramazzo al di sopra dell'impalcato (pressure and weir), per le situazioni con livello della corrente tale da interessare l'intradosso del ponte (high flow). Le condizioni limite per il deflusso in pressione sono definite dal programma in base al livello di corrente registrato a monte.

Condizioni al contorno e definizione della scabrezza

Le simulazioni idrodinamiche sono state effettuate sia in moto permanente (per la verifica dei tombini), sia in moto vario (per valutare l'effetto ANTE-POST OPERAM). Nello specifico per ciascun modello numerico è stata stabilita una condizione al contorno di monte imponendo la portata di progetto relativa in ingresso (costante o mediante idrogramma), mentre come condizione al contorno di valle è stata imposto normalmente il deflusso in moto uniforme "Normal Depth", fatto salvo specifici casi di passaggio in corrente critica (confluenze con salti di fondo).



Figura 1 – Esempio di idrogramma (bacino TO01) per simulazione in moto vario

Per quanto concerne la scabrezza, la valutazione dei coefficienti da inserire in ciascun modello è stata basata su dati di letteratura, sull'esperienza acquisita nel campo della modellistica idraulica e sulle indicazioni rilevate durante i sopralluoghi lungo il tratto oggetto di studio.

Tutte le aste presentano connotati di scabrezza pressoché omogenei: ampie golene a pascolo, incisioni appena marcate, fondo in terra e sponde in pietrisco, densità vegetativa scarsa. Sulla scorta di tale analisi si è assunto un valore del coefficiente di Strickler pari a $33 \text{ m}^{1/3}/\text{s}$, omogeneo su tutta la sezione di deflusso.

Risultati delle simulazioni idrauliche in moto permanente

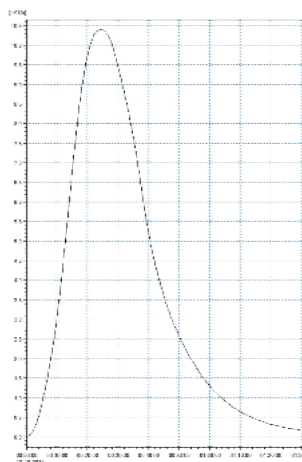
Sono stati definiti due differenti scenari per la verifica della compatibilità idraulica e al contempo per dimensionare dal punto di vista idraulico le opere oggetto di studio, come anticipato nel paragrafo precedente le simulazioni vertono su due differenti valori di portata di progetto per ognuna delle aste analizzate.

In particolare lo studio del funzionamento idraulico di ciascun opera verte sulla verifica del franco idraulico secondo le modalità indicate dalla Delibera n.23 del 01.08.2012 adottata dall'Autorità di Bacino Regionale della Regione Autonoma della Sardegna, "Modifica e integrazione dell'art.21, comma 2 lettera d. delle Norme di Attuazione del Piano di Stralcio per l'Assetto Idrogeologico della Regione Sardegna, a seguito della "Analisi modellistica per la definizione del franco idraulico da utilizzare nella progettazione, realizzazione e manutenzione delle infrastrutture a rete o puntuali" condotta dal Dipartimento di Ingegneria del Territorio dell'Università degli Studi di Cagliari nell'ambito dell'accordo di collaborazione scientifica con la Direzione generale Agenzia Regionale del distretto Idrografico della Sardegna".

Secondo tali indicazioni, il franco calcolato sul livello della portata di progetto e per velocità medie della corrente inferiori a 8 m/s deve corrispondere al massimo tra i seguenti valori:

$0.7 * v^2 / 2g$	"v" indica la velocità media della corrente
1m	
$0.87 * \sqrt{y} + \alpha y'$	y indica la profondità media della corrente, y' è l'altezza della corrente areata, e α è un coefficiente che varia linearmente tra 0 e 1 quando la velocità varia tra 5 m/s, con le limitazioni che il valore $0.87\sqrt{y}$ sarà assunto al massimo pari a 1.5 ed y' viene assunto pari a 2 metri o alla profondità media y, se questa risulta minore di 2.

Per velocità superiori a 8 m/s il franco sarà almeno pari all'intera altezza cinetica $v^2/2g$.

Per il reticolo secondario sono state analizzate tre differenti tipologie di strutture di diverse dimensioni:

- Scatolari tipo "Tensiter", per i quali il franco idraulico geometrico è stato preliminarmente verificato secondo la circolare 2 febbraio 2009 n. 617. C.S.LL.PP., in cui viene indicato che il valore del franco deve essere assicurato per almeno 2/3 della luce quando l'intradosso del ponte non sia rettilineo, e poi successivamente in risposta a prescrizioni di maggior cautela richieste dal Genio Civile, definito sul piedritto delle opere (escludendo in tal modo dal calcolo del franco tutta l'altezza compresa negli obliqui sommitali);
- Scatolari tipo rettangolari "Musilli";
- Ponti ad unica campata.

Nella tabella seguente si riportano i risultati delle simulazioni idrauliche effettuate per la verifica della compatibilità idraulica di ciascun opera, si evidenzia quindi il valore del franco idraulico

calcolato secondo la delibera n.23 del 01.08.2013 adottata dall'Autorità di Bacino della Regione Sardegna e quella geometrica calcolata come confronto tra l'altezza utile dell'opera e il tirante idrico registrato nella sezione idraulica immediatamente a monte del manufatto indagato.

Tabella 3 – Tombini TO: codifica, ubicazione, tipologia, franchi

ID Interferenza idraulica	ID Intervento progettuale	Asse stradale	Progr. Asse stradale	Tipologico adottato (base x altezza)		Tipologic o verificato	Num. tipologic i	Geometria tipologico verificato					TR200_CN91							
								b	h piedritto	h utile ai 2/3	L	i	Q	h _{media}	h _{max}	V	Livello	Franco (da PAI)	Franco (Calcolato sui 2/3)	Franco (Calcolato sul piedritto)
								(m)	(m)	(m)	(m)	(%)	(m ² /s)	(m)	(m)	(m/s)	(m s.l.m.)	(m)	(m)	(m)
TO01	TO01.A	SV. Oschiri - Rampa F	0+139.45	Tensiter	3X2.25	3X2.25	1	3.0	2.25	2.71	20.00	1.0	10.4	0.84	0.87	3.9	204.81	1.00	1.84	1.38
	TO01.B	AP	36+900	Tensiter	3X2.25	3X2.25	1	3.0	2.25	2.71	47.50	1.0	10.4	1.18	1.22	2.7	204.41	1.00	1.49	1.03
	TO01.C	SV. Oschiri - Rampa P	0+232.44	Tensiter	3X2.60	3X2.60	1	3.0	2.60	3.06	22.50	1.0	10.4	0.70	0.71	4.7	198.06	1.00	2.35	1.89
	TO01.D	SV. Oschiri - Rampa A	0+220.43	Tensiter	3X2.25	3X2.25	1	3.0	2.25	2.71	30.00	1.0	10.4	1.18	1.22	2.7	197.95	1.00	1.49	1.03
	TO01.E	Viab. L4SV2	0+920.00	Tensiter	3X2.60	3X2.60	1	3.0	2.60	3.06	12.50	1.3	10.4	0.80	0.82	4.1	195.70	1.00	2.24	1.78
TO01BIS	TO01.F	Strada comunale sud	-	Musilli	2X2.5	2X2.5	2	2.0	2.5	2.5	24	1.0	17.7	0.86	0.86	4.7	190.53	1.00	-	1.64
TO01TRIS	TO01.G	SV. Oschiri - Rampa P	0+038	Musilli	2X2	2X2	1	2.0	2.0	2.0	9.95	2	5.5	0.60	0.62	4.3	198.92	1.00	-	1.38
TO02	TO02	AP	38+343.30	Tensiter	3x3	3x2	1	3.0	3.00	3.19	27.50	1.0	8.7	1.05	1.08	2.6	205.84	1.00	2.11	1.92
TO03	TO03.A	Viab. L4SR3 BIS	0+036	Tensiter	8x2.25	8X2.25	1	8.0	2.25	2.67	7.50	0.1	25.9	0.45	0.45	7.1	199.53	1.80	2.22	1.80
	TO03.B	AP	38+651.9	Tensiter	8x2.25	8X2.25	1	8.0	2.25	2.67	28.75	1.0	25.9	1.10	1.12	2.9	196.94	1.00	1.55	1.13
	TO03.C	Accesso privato DX	38+682	Tensiter	8x2.25	8X2.25	1	8.0	2.25	2.67	7.50	1.0	25.9	0.60	0.61	5.3	193.95	1.00	2.06	1.64
TO04	TO04.A	Viab. L4SV5 BIS	0+044	Tensiter	5X2.52	5X2.52	1	5.0	2.52	2.78	11.25	1.0	7.7	1.14	1.17	1.3	184.97	1.00	1.63	1.35
	TO04.B	AP	39+139.60	Tensiter	5X3.5	5X4	1	4.0	4.00	4.28	26.25	1.0	7.7	0.98	1.00	1.5	184.56	1.00	3.43	3.00
	TO04.C	Viab. L4SR6	0+365	Tensiter	5X2.52	5X2.5	1	5.0	2.50	2.78	11.25	1.0	7.7	1.11	1.13	1.3	184.28	1.00	1.67	1.39
TO05	TO05.A	Viab. L4SR6	0+575	Tensiter	3X3	3X3	1	3.0	3.00	3.19	10.00	0.7	4.9	1.30	1.38	1.1	181.40	1.00	1.81	1.62
	TO05.B	AP	39+425	Tensiter	3X3.52	3X3.52	1	3.0	3.52	3.80	27.50	0.6	8.4	1.26	1.31	2.0	181.17	1.00	2.49	2.21
TO06	TO06	Viab. L4SR6	0+894	Musilli	2X1.5	2X1.5	1	2.0	1.50	1.50	10.00	0.4	3.4	0.45	0.46	3.6	183.11	1.00	-	1.04
TO07	TO07.A	AP	40+390.50	Tensiter	12X4.5	12X3	1	12.0	3.00	3.56	32.50	1.0	102.1	1.72	1.74	4.8	167.81	1.15	1.82	1.26
	TO07.B	Viab. L4SV5 BIS	0+322	Tensiter	12X3	4X3	3	4.0	3.00	3.29	15.00	1.0	102.1	1.21	1.22	6.1	166.22	1.33	2.07	1.78
TO08	TO08.A	Viab. SV9	0+090	Tensiter	8X2.70	8X2.70	1	8.0	2.70	3.12	7.50	0.5	27.9	1.53	1.56	2.2	165.98	1.08	1.56	1.14
	TO08.B	AP	42+129.80	Tensiter	8X2.70	8X2.70	1	8.0	2.70	3.12	30.00	0.5	27.9	1.51	1.54	2.2	165.83	1.07	1.58	1.16
	TO08.C	Viab. SV8	0+393.20	Tensiter	8X2.70	8X2.70	1	8.0	2.70	3.12	7.50	1.0	27.9	1.18	1.20	2.8	165.33	1.00	1.92	1.50
TO09	TO09.A	Viab. SV9	0+750	Tensiter	5X3	4X3	1	4.0	3.00	3.29	7.50	0.6	14	0.60	0.61	5.6	170.88	1.12	2.68	2.39
	TO09.B	AP	42+777.90	Tensiter	5X3	4X3	1	4.0	3.00	3.29	25.00	0.6	14	1.66	1.73	1.9	171.87	1.13	1.56	1.27
	TO09.C	Viab. SV8 BIS	0+751	Tensiter	5X3	4X3	1	4.0	3.00	3.29	7.50	0.6	14	1.61	1.68	2.0	171.64	1.11	1.61	1.32
TO10	TO10.A	AP	43+475	-	-	PONTE	1	35.0	179.41*	4.88	25.40	-	145.7	1.07	2.34	3.8	177.25	1.00	-	2.16
	TO10.B	Viab. SV10	0+262	-	-	PONTE	1	35.0	179.41*	5.20	12.00	-	145.7	1.48	2.79	2.7	177.28	1.06	-	2.13
	TO10.C	Viab. SV09	1+461	-	-	PONTE	1	35.0	179.76*	5.50	12.00	-	145.7	1.26	2.84	2.4	177.98	1.00	-	1.78
TO11	TO11.A	Viab. L4SV13	0+325	Tensiter	6X3	6X3	1	6.0	3.00	3.28	7.50	1.0	15.7	0.31	0.31	8.4	179.42	2.52	2.97	2.69
	TO11.B	AP	45+145.80	Tensiter	6X3	6X3	1	6.0	3.00	3.28	51.25	1.0	15.7	1.34	1.37	1.9	180.20	1.01	1.91	1.63
TO12	TO12	AP	45+350	-	-	PONTE	1	35.0	183.70*	4.00	29.15	-	103.9	1.62	2.71	1.7	182.38	1.11	-	1.32

ID Interferenza idraulica	ID Intervento progettuale	Asse stradale	Progr. Asse stradale	Tipologico adottato (base x altezza)		Tipologico verificato	Num. tipologici	Geometria tipologico verificato					TR200_CN91							
								b	h piedritto	h utile ai 2/3	L	i	Q	h _{media}	h _{max}	V	Livello	Franco (da PAI)	Franco (Calcolato sui 2/3)	Franco (Calcolato sul piedritto)
								(m)	(m)	(m)	(m)	(%)	(m ³ /s)	(m)	(m)	(m/s)	(m s.l.m.)	(m)	(m)	(m)
TO12bis	TO12.B	SS199	0+107	-	-	PONTE	1	35.0	179.02*	4.00	29.15	-	121.8	1.25	2.87	1.9	177.93	1.00	-	1.09

*Per i ponti è fornita direttamente la quota di verifica di intradosso

Si evidenzia che, come prescritto dal Genio Civile, le verifiche idrauliche dei tombini sono state effettuate al fine di garantire il franco idraulico rispetto alla differenza tra quota scorrimento e:

- quota di intradosso nel caso di impalcato orizzontale;
- altezza piedritto (quota di imposta del simil-arco) nel caso di impalcato non-orizzontale.

A seguire una tabella che illustra le altezze utili per i tombini tipo "Tensiter" utilizzati.

Tabella 4 – Tipologici Tensiter: altezze di verifica sui piedritti e in imposta

Tipologico	Altezza piedritto H	Altezza utile ai 2/3 dell'arco teorico sotteso all'imposta
	m	m
Tensiter - G 430e mod	2.00	2.19
Tensiter - G 330e	2.25	2.71
Tensiter - G 430e	3.00	3.19
Tensiter - S 508e mod	2.25	2.67
Tensiter - S 350e mod	3.00	3.29
Tensiter - S 350e	2.50	2.78
Tensiter - G 360e mod	3.00	3.28
Tensiter - S 508e mod	2.25	2.67
Tensiter - S 512e mod	3.00	3.56
Tensiter - G 330e mod	2.60	3.06
Tensiter - S 308e mod	2.70	3.12

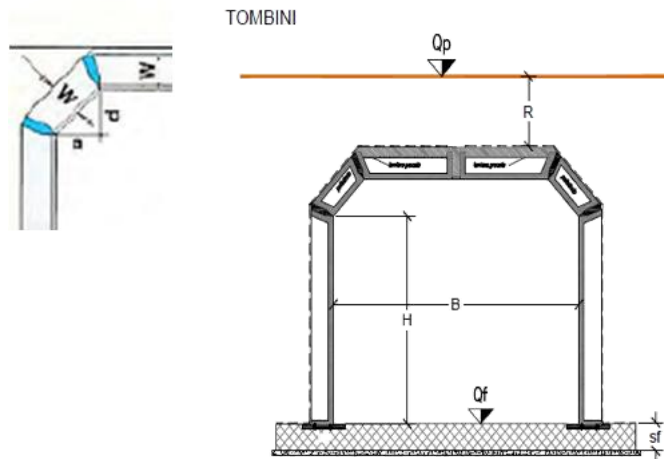

La sezione minima di verifica può essere stata successivamente sostituita in corso di progettazione, per esigenze strutturali, stradali o faunistiche, con sezioni ad officiosità idraulica maggiorata (vedasi colonna Tipologico Adottato). Per officiosità idraulica maggiorata si intende un aumento di geometria dell'opera in termini di altezza e di larghezza, ma imponendo la stessa geometria d'alveo tanto a monte quanto a valle, stessa scabrezza, stesso profilo longitudinale di fondo scorrevole.

Risultati delle simulazioni ANTE-POST OPERAM in moto vario

Le verifiche in moto vario sono state condotte al fine di verificare gli effetti in termini di allagamenti e/o laminazione (e quindi aumento/riduzione della portata al colmo) dei nuovi interventi.

La configurazione attuale del reticolo idrografico è già alterata rispetto ad uno scenario "naturale", in quanto la strada esistente già interferisce in maniera significativa sul sistema di drenaggio del versante e sui corpi idrici interferiti.

Gli interventi di progetto intendono sì migliorare l'attuale capacità di deflusso di tutte le opere di attraversamento, ma così facendo spesso si ottiene come effetto indotto un aumento delle portate verso valle: le opere esistenti risultano tutte inadeguate alle portate di progetto, funzionando, a rischio per l'infrastruttura, da barriera laminante il colmo di piena. Inserendo le nuove opere si migliora la sicurezza dell'infrastruttura, ma si elimina di contro l'effetto di laminazione, generando potenzialmente a valle un aggravio della pericolosità.

Gli interventi previsti in progetto (con particolare riferimento all'estensione degli interventi inalveazioni-attraersamenti anche oltre le fasce di rispetto espropriativo) intendono annullare tale aggravio di pericolosità.

A tale fine, in contraddittorio con l'ufficio del Genio Civile di Sassari, sono stati anche inseriti n.3 nuovi attraversamenti (TO01.F, TO10.B e TO12.B), ed eliminato il tombino TO11.C.

L'attività di verifica ha necessitato l'estensione e/o accorpamento dei modelli di moto permanente precedentemente allestiti.

I risultati sono descritti in termini di tabelle, profili e sezioni negli allegati alla relazione, mentre il tracciamento delle aree allagabili ANTE-POST OPERAM è descritto in planimetrie dedicate.

Ponti: verifica allo scalzamento

Nel presente capitolo sono condotte le verifiche allo scalzamento dei seguenti ponti:

- TO10 – Ponte progr. 43+477 (sia il TO10.A dell'asse principale che il TO10.C posto a monte del precedente sulla viabilità secondaria SV09, che il TO10.B posto a valle sulla viabilità secondaria SV09);
- TO12 – Ponte progr. 45+335;
- TO12-bis – Ponte SS199 (presso lo svincolo di Berchidda) progr. 0+107.

Tutti gli attraversamenti analizzati non hanno pile, mentre le spalle sono ben raccordate con le sponde dell'alveo sia a monte che a valle.

Lo scalzamento totale relativo a tali attraversamenti sarà costituito da tre componenti:

- abbassamento generalizzato dell'alveo;
- scalzamento da contrazione della sezione trasversale;
- scalzamento locale per effetto della spalla.

In generale le tre componenti devono essere sommate per ottenere il valore complessivo sulle fondazioni della struttura; questo equivale ad assumere che ciascuna componente si manifesti in modo indipendente rispetto alle altre, costituendo un criterio in qualche misura cautelativo.

Nel caso specifico l'abbassamento generalizzato dell'alveo è da escludersi essendo i rii geomorfologicamente stabili, senza evidenze alcune che indichino tale tendenza.

E' invece da prevedersi in corso di piena una possibile migrazione planimetrica del thalweg (parte più incisa) con ri-orientamento della direzione di deflusso della corrente; questo fenomeno può influenzare la stabilità delle fondazioni delle spalle, provocare erosioni attorno ai muri d'ala e dei rilevati di approccio o modificare il valore dello scalzamento locale variando la direzione della corrente in rapporto all'orientamento delle spalle.

Dal punto di vista geologico il profilo individua per entrambi i ponti un substrato di depositi alluvionali con successione di sabbie grossolane per minimo 2.5 m di profondità.

Idraulicamente si è assunto, come configurazione di progetto per la stima dell'erosione, l'evento di progetto con tempo di ritorno di 200 anni.

Le formule di scalzamento adottate sono quelle classiche di letteratura: Hire, Froehlich, CSU.

Come si evince dai risultati analitici delle tabelle a seguire, il valore totale di scalzamento atteso è sempre inferiore alla profondità di intradosso della platea di fondazione rispetto al piano campagna finale definito dalle future inalveazioni: i pali di fondazione non risultano essere interessati dal fenomeno. Particolare attenzione sarà posta invece nei confronti di sponda, rilevato e spalle, necessariamente oggetto di rivestimento con difese.

Tabella 5 – Sintesi dei risultati

Opera	Quota minima piano campagna presso le spalle (post operam) (A)	Quota intradosso plinto (B)	Dislivello A-B	Scalzamento atteso		Verifica
	<i>m s.m.</i>	<i>m s.m.</i>		Spalla SX	Spalla DX	
			<i>m</i>	<i>m</i>	<i>m</i>	
TO10.C	176.82	172.00	4.82	2.62	3.68	OK
TO10.A	176.68	172.00	4.68	2.06	2.42	OK
TO10.B	176.26	172.00	4.26	3.18	3.36	OK
TO12	180.98	177.74	3.24	3.07	3.07	OK
TO12-bis	176.80	173.17	3.63	2.00	2.74	OK

Tabella 6 – Risultati del calcolo dell'erosione per il ponte TO10.C, viab. Secondaria SV09 progr. 1+461

Contraction Scour			
	Left	Channel	Right
Input Data			
Average Depth (m):	0.57	1.50	0.10
Approach Velocity (m/s):	2.53	4.72	0.84
Br Average Depth (m):	0.56	1.76	0.84
BR Opening Flow (m3/s):	3.31	114.32	28.06
BR Top WD (m):	3.34	17.70	13.96
Grain Size D50 (mm):	100.00	100.00	100.00
Approach Flow (m3/s):	22.39	122.98	0.33
Approach Top WD (m):	15.60	17.35	3.79
K1 Coefficient:	0.590	0.640	0.590
Results			
Scour Depth Ys (m):	0.00	0.10	0.00
Critical Velocity (m/s):			
Equation:	Clear	Clear	Clear
Abutment Scour			
	Left	Right	
Input Data			
Station at Toe (m):	12.50	47.50	
Toe Sta at appr (m):	12.26	46.91	
Abutment Length (m):	12.26	0.00	
Depth at Toe (m):	0.88	1.17	
K1 Shape Coef:	0.55 - Spill-through abutment		
Degree of Skew (degrees):	60.00	120.00	
K2 Skew Coef:	0.95	1.04	
Projected Length L' (m):	10.62	0.00	
Avg Depth Obstructed Ya (m):	0.59		
Flow Obstructed Qe (m3/s):	18.60		
Area Obstructed Ae (m2):	7.17		
Results			
Scour Depth Ys (m):	2.62	3.68	
Froude #:	0.48	0.43	
Equation:	HIRE	HIRE	
Combined Scour Depths			
Left abutment scour + contraction scour (m):	2.62		
Right abutment scour + contraction scour (m):		3.68	

Tabella 7 –Risultati del calcolo dell'erosione per il ponte TO10.A progr. 43+477

Contraction Scour			
	Left	Channel	Right
Input Data			
Average Depth (m):		1.03	
Approach Velocity (m/s):		3.87	
Br Average Depth (m):		1.11	
BR Opening Flow (m3/s):		145.69	
BR Top WD (m):		35.00	
Grain Size D50 (mm):	100.00	100.00	100.00
Approach Flow (m3/s):		145.69	
Approach Top WD (m):		36.44	
K1 Coefficient:		0.590	
Results			
Scour Depth Ys (m):		0.16	
Critical Velocity (m/s):			
Equation:		Clear	
Abutment Scour			
	Left	Right	
Input Data			
Station at Toe (m):	12.50	47.50	
Toe Sta at appr (m):	12.42	47.53	
Abutment Length (m):	0.45	1.34	
Depth at Toe (m):	0.57	0.57	
K1 Shape Coef:	0.55 - Spill-through abutment		
Degree of Skew (degrees):	90.00	90.00	
K2 Skew Coef:	1.00	1.00	
Projected Length L' (m):	0.45	1.34	
Avg Depth Obstructed Ya (m):	0.35	0.54	
Flow Obstructed Qe (m3/s):	0.21	1.67	
Area Obstructed Ae (m2):	0.16	0.73	
Results			
Scour Depth Ys (m):	1.91	2.26	
Froude #:	0.59	0.97	
Equation:	HIRE	HIRE	
Combined Scour Depths			
Left abutment scour + contraction scour (m):	2.08		
Right abutment scour + contraction scour (m):		2.42	

Tabella 8 – Risultati del calcolo dell'erosione per il ponte TO10.B, viab. Secondaria SV10 progr. 0+262

Contraction Scour			
	Left	Channel	Right
Input Data			
Average Depth (m):		1.43	
Approach Velocity (m/s):		2.84	
Br Average Depth (m):		1.51	
BR Opening Flow (m3/s):		145.69	
BR Top WD (m):		35.00	
Grain Size D50 (mm):	100.00	100.00	100.00
Approach Flow (m3/s):		145.69	
Approach Top WD (m):		35.78	
K1 Coefficient:		0.590	
Results			
Scour Depth Ys (m):		0.00	
Critical Velocity (m/s):			
Equation:		Clear	
Abutment Scour			
	Left	Right	
Input Data			
Station at Toe (m):	12.50	47.50	
Toe Sta at appr (m):	12.11	47.54	
Abutment Length (m):	0.85	0.93	
Depth at Toe (m):	1.02	1.02	
K1 Shape Coef:	0.55 - Spill-through abutment		
Degree of Skew (degrees):	90.00	90.00	
K2 Skew Coef:	1.00	1.00	
Projected Length L' (m):	0.85	0.93	
Avg Depth Obstructed Ya (m):	0.72	0.96	
Flow Obstructed Qe (m3/s):	0.83	1.66	
Area Obstructed Ae (m2):	0.61	0.89	
Results			
Scour Depth Ys (m):	3.18	3.36	
Froude #:	0.47	0.55	
Equation:	HIRE	HIRE	

Figura 2 – Scalzamento atteso per il ponte TO10.C viab. Secondaria SV09 progr. 1+461



Figura 3 – Scalzamento atteso per il ponte TO10.A progr. 43+477



Figura 4 – Scalzamento atteso per il ponte TO10.B viab. Secondaria SV10 progr. 0+262

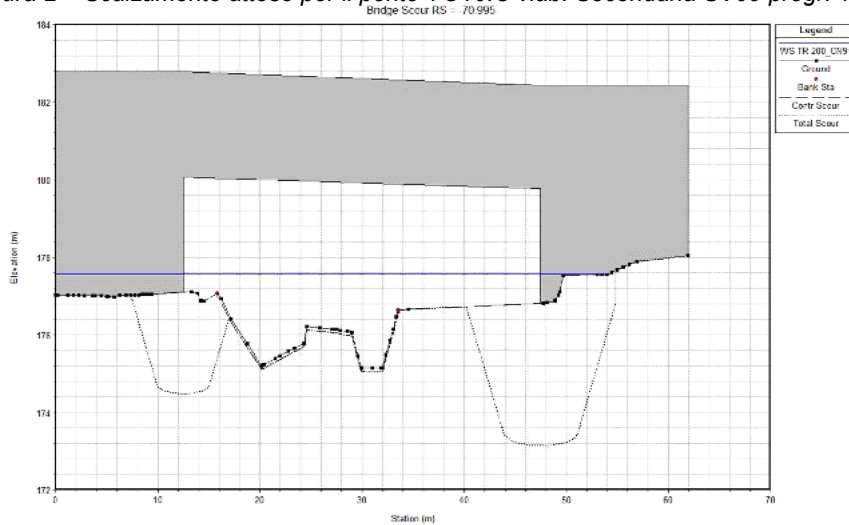

Tabella 9 –Risultati del calcolo dell'erosione per il ponte TO12 progr. 45+335

Contraction Scour			
	Left	Channel	Right
Input Data			
Average Depth (m):	0.48	1.80	0.67
Approach Velocity (m/s):	3.04	6.69	3.78
Br Average Depth (m):	1.55	2.42	1.55
BR Opening Flow (m3/s):	41.19	20.99	41.72
BR Top WD (m):	15.31	4.19	15.50
Grain Size D50 (mm):	100.00	100.00	100.00
Approach Flow (m3/s):	12.39	70.46	21.06
Approach Top WD (m):	8.43	5.86	8.36
K1 Coefficient:	0.640	0.640	0.640
Results			
Scour Depth Ys (m):	0.00	0.00	0.00
Critical Velocity (m/s):			
Equation:	Clear	Clear	Clear
Abutment Scour			
	Left	Right	
Input Data			
Station at Toe (m):	12.50	47.50	
Toe Sta at appr (m):	12.69	47.50	
Abutment Length (m):	8.79	0.00	
Depth at Toe (m):	1.40	1.40	
K1 Shape Coef:	0.55 - Spill-through abutment		
Degree of Skew (degrees):	90.00	90.00	
K2 Skew Coef:	1.00	1.00	
Projected Length L' (m):	8.79	0.00	
Avg Depth Obstructed Ya (m):	0.51		
Flow Obstructed Qe (m3/s):	13.81		
Area Obstructed Ae (m2):	4.46		
Results			
Scour Depth Ys (m):	3.07	3.07	
Froude #:	0.16	0.16	
Equation:	HIRE	HIRE	

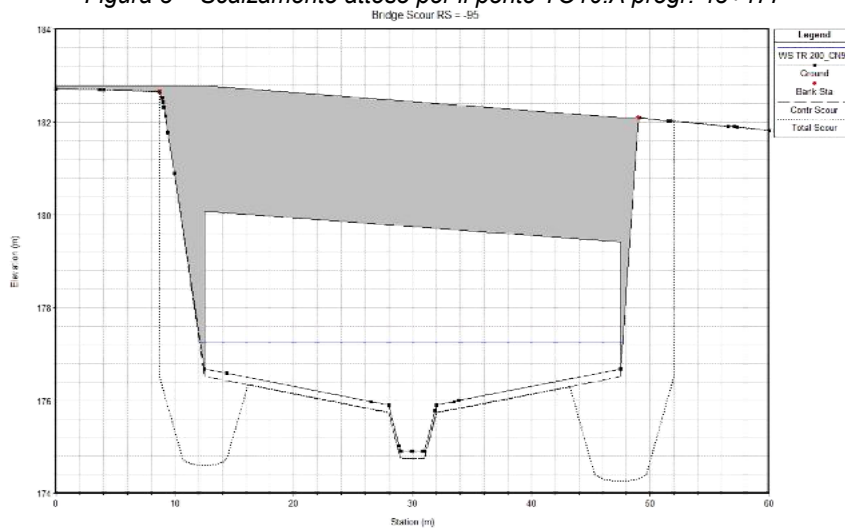
Tabella 10 – Risultati del calcolo dell'erosione per il ponte TO12-bis, SS199 progr. 0+107

Contraction Scour			
	Left	Channel	Right
Input Data			
Average Depth (m):	0.84	1.16	
Approach Velocity (m/s):	0.98	1.39	
Br Average Depth (m):	0.37	1.51	0.40
BR Opening Flow (m3/s):	5.01	115.31	1.51
BR Top WD (m):	9.89	22.59	2.52
Grain Size D50 (mm):	100.00	100.00	100.00
Approach Flow (m3/s):	2.70	119.13	
Approach Top WD (m):	3.28	73.83	
K1 Coefficient:	0.590	0.590	
Results			
Scour Depth Ys (m):	0.00	0.01	
Critical Velocity (m/s):			
Equation:	Clear	Clear	
Abutment Scour			
	Left	Right	
Input Data			
Station at Toe (m):	14.05	50.00	
Toe Sta at appr (m):	-7.56	82.22	
Abutment Length (m):	0.00	0.00	
Depth at Toe (m):	0.71	0.89	
K1 Shape Coef:	0.55 - Spill-through abutment		
Degree of Skew (degrees):	60.00	120.00	
K2 Skew Coef:	0.95	1.04	
Projected Length L' (m):	0.00	0.00	
Avg Depth Obstructed Ya (m):			
Flow Obstructed Qe (m3/s):			
Area Obstructed Ae (m2):			
Results			
Scour Depth Ys (m):	2.00	2.74	
Froude #:	0.40	0.40	
Equation:	HIRE	HIRE	
Combined Scour Depths			
Left abutment scour + contraction scour (m):	2.00		
Right abutment scour + contraction scour (m):		2.74	

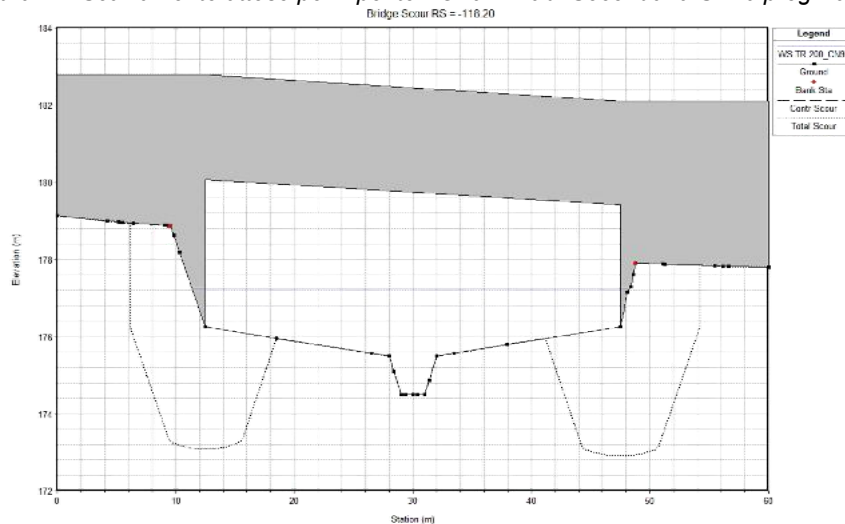

Figura 5 – Scalzamento atteso per il ponte TO12 progr. 45+335



Figura 6 – Scalzamento atteso per il ponte TO12-bis, SS199 progr. 0+107

Inalveazioni

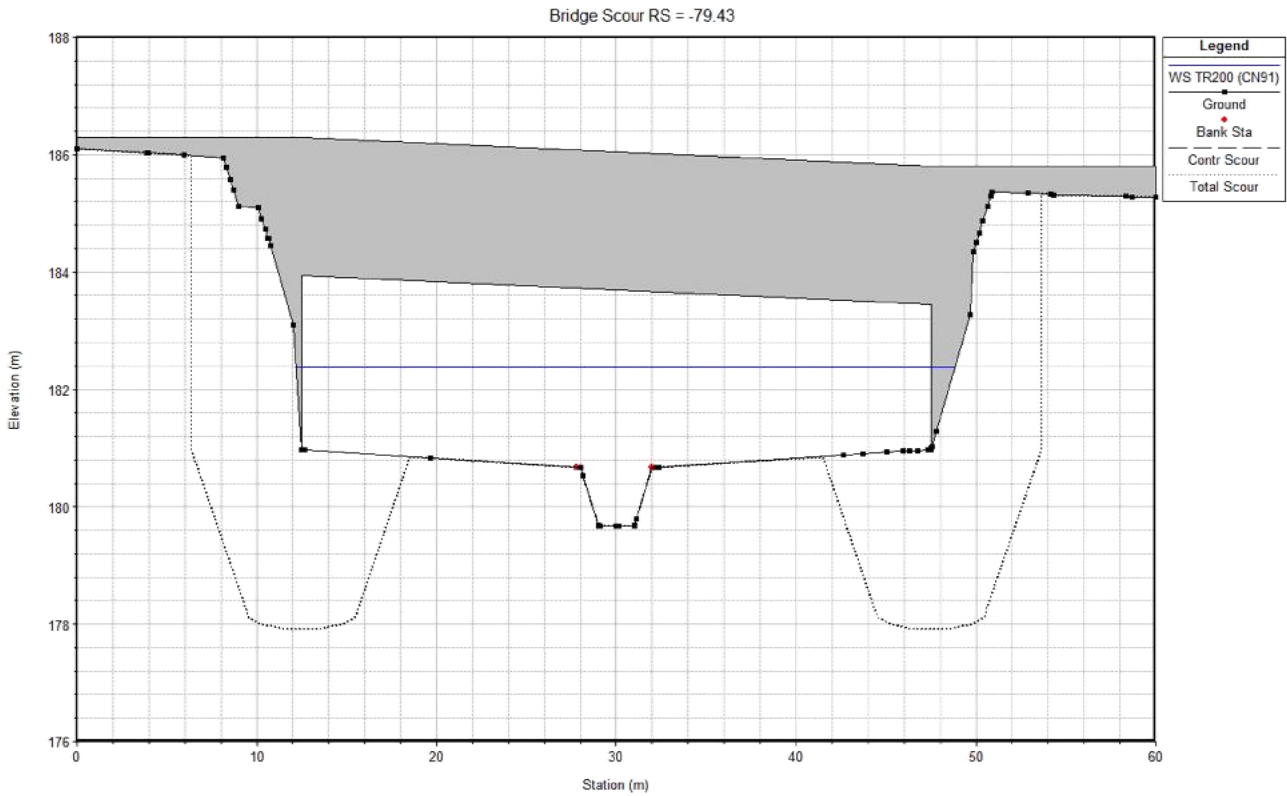
Per interferenze col tracciato o con gli svincoli, nonché in alcuni casi per ben raccordare i nuovi tombini della strada oggetto della progettazione, è prevista una deviazione locale dei rii.

Gli interventi di inalveazione sono altresì necessari anche in quei casi critici dove le nuove opere (che ricordiamo essere sempre più ampie rispetto le esistenti) possono produrre verso valle un peggioramento del deflusso, inteso come maggiori portate e allagamenti.

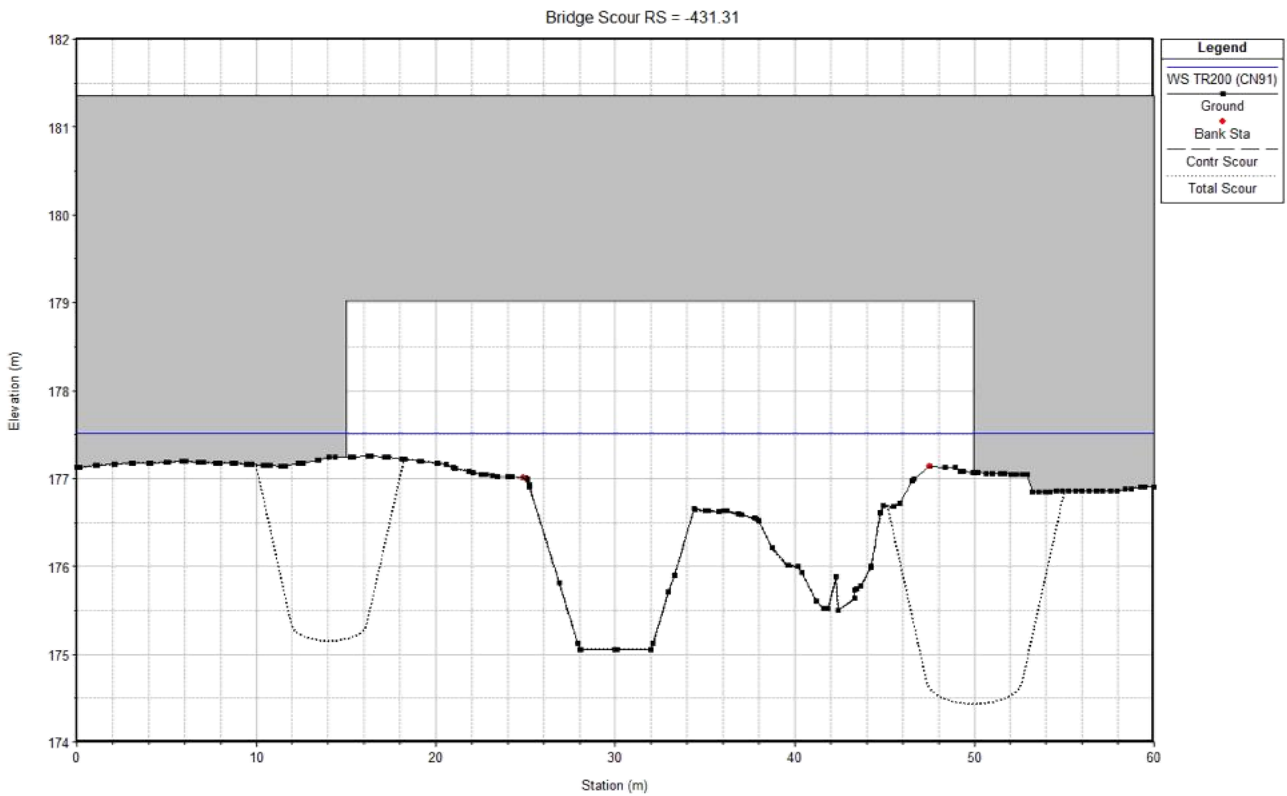
Le inalveazioni sono state verificate negli stessi modelli idraulici contestualmente alle opere di attraversamento, ma in condizioni di verifica ANTE-POST OPERAM in moto vario.

La portata al colmo dell'idrogramma è sempre quella di progetto duecentennale, mentre la forma degli idrogrammi è definita col metodo dell'idrogramma unitario.

Per la determinazione di dette portate si è proceduto con gli stessi criteri esposti nella relazione idrologica del presente progetto, a cui si rimanda per ulteriori dettagli.

Le sezioni di verifica idraulica delle inalveazioni sono del tipo trapezio; i dettagli tipologici presenti negli elaborati dedicati ne descrivono puntualmente la geometria, la presenza di rivestimenti, savanella etc.

In taluni casi, non potendo agire diversamente mediante rialzo stradale, si interviene sul profilo del corso d'acqua introducendo un certo numero di briglie al fine di ridurre la naturale pendenza del nuovo canale risultata eccessiva: tale accorgimento garantisce di conseguenza la diminuzione delle velocità di deflusso in occorrenza di piene significative.

Verifica a trascinamento dei rivestimenti

Gli interventi di protezione hanno lo scopo di evitare o minimizzare i problemi di stabilità dell'alveo e delle strutture su di esso localizzate (pile, spalle e rilevati di accesso all'impalcato).

In recepimento alle prescrizioni del Genio Civile, si prevede la sostituzione dei rivestimenti materassi metallici con pietrame (previsti peraltro nel Progetto Preliminare affidato) con difese in massi a secco o, ma solo puntualmente nei casi più critici, anche intasati con calcestruzzo. L'estensione delle difese viene inoltre ridotta ai soli tratti critici, individuati secondo i seguenti criteri:

- verifica dei tratti in cui le azioni di trascinamento della corrente (per evento di progetto TR 200) sono superiori alla resistenza critica del materiale naturale di sponda e fondo alveo;
- in corrispondenza dei salti di fondo;
- in corrispondenza di curva accentuate;
- in corrispondenza di confluenze ed immissioni laterali;
- a monte e a valle delle nuove opere;
- in rivestimento dei rilevati laddove questi siano potenzialmente esposti alla corrente;
- lungo i tratti di inalveazioni adiacenti i corpi stradali (asse principale).

Sono numerose le formule empiriche di calcolo disponibili in letteratura per la valutazione della stabilità di materiali soggetti all'azione di trascinamento della corrente. Questi procedimenti empirici si basano sulla determinazione dei valori critici (desunti da dati sperimentali) delle velocità

o delle tensioni tangenziali (intesi come valori che corrispondono alle condizioni di moto incipiente per il materiale considerato).

Nel caso specifico l'analisi delle condizioni critiche di moto incipiente è effettuata mediante l'utilizzo di formule basate sul confronto delle tensioni di trascinamento. Tale criterio si basa sulla definizione dello sforzo tangenziale esercitato dalla corrente sul materiale costituente il letto fluviale, secondo la formula:

$$\tau_0 = \gamma R i \quad (\text{N/m}^2)$$

dove

γ (N/m³) è il peso specifico dell'acqua,

R (m) è il raggio idraulico della sezione,

i (m/m) è la pendenza di fondo.

La tensione tangenziale di trascinamento della corrente è stata calcolata dal modello numerico monodimensionale HEC-RAS per ogni inalveazione, così come riportato nella colonna Shear Chn delle tabelle presenti in allegato.

Sulle sponde il valore di tensione si riduce linearmente dal fondo alla sommità. E' consuetudine applicare sulle sponde il 75% di quella calcolata in alveo.

Figure 8-7 Lateral distribution of shear stress in a trapezoidal channel

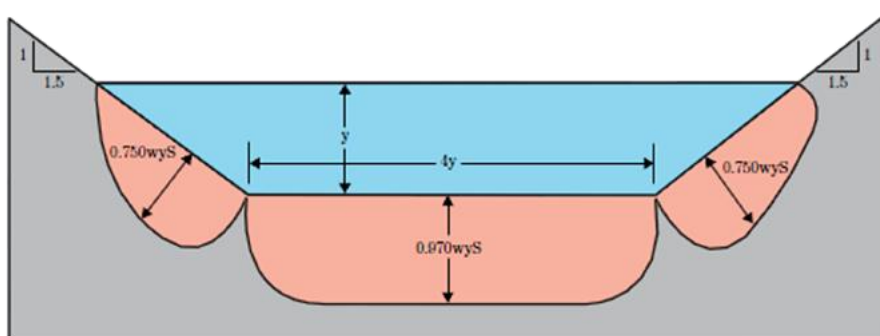

w=specific weight of water, y=depth, and S=slope

(210-VI-NEH, August 2007)

Figura 7 – Confronto ambito di test sperimentale (sinistra) e foto rio TO03 (destra)

La condizione di stabilità del fondo risulta quando $\tau_{cr} > \tau_0$, ossia quando la tensione tangenziale critica del materiale di rivestimento del canale è maggiore o uguale a quella di moto incipiente esercitata dalla corrente.

La seguente analisi di stabilità è riferita alla teoria della tensione tangenziale critica (Shields - 1936 - la cui formula base è stata ricavata da esperimenti su letti a granulometria uniforme di forte scabrezza), attraverso la valutazione della forza che determina il moto incipiente dei granuli, esprimibile in termini generali con la seguente relazione che esprime una condizione di equilibrio:

$$\frac{\tau_{cr}}{(\gamma_s - \gamma)d} = \Phi(Re^*)$$

dove:

- τ_{cr} = tensione tangenziale critica (N/m²);
- γ_s = peso specifico materiale d'alveo (N/m³);
- γ = peso specifico dell'acqua (N/m³);
- d = diametro del granulo (m);
- ϕ = parametro adimensionale dipendente dalle caratteristiche dei granuli, del letto fluviale e dal numero di Reynolds (Re^*) relativo alla velocità di attrito ($u^* = \sqrt{\tau_{cr}/\rho}$).

Per la traduzione della condizione di equilibrio suddetta in termini empirici ed ingegneristici sono state proposte varie formulazioni, derivanti da osservazioni sperimentali, ciascuna caratterizzata da limiti e campi di applicabilità specifici che ne condizionano l'utilizzo alla preventiva definizione della tipologia dei substrati naturali o artificiali e del comportamento idraulico dell'alveo.

In particolare alcuni autori hanno individuato valori empirici specifici del parametro di Shields:

- $\phi = 0,058 \div 0,060$ nell'espressione originale di Shields, valida in moto turbolento $Re^* > 1000$ e con diametro medio del materiale molto inferiore del tirante idrico (materiale naturale sciolto non vegetato);
- $\phi = 0,116$ nell'espressione di Kalinske, che considera un fattore di compattezza del materiale rappresentante l'effetto di mutuo incastro delle particelle (ideale per rappresentare i massi di grande pezzatura);
- $\phi = 0,06 \left[1 + 0,67 \left(\frac{d}{h} \right)^{0,5} \right]$ nella formulazione di Armanini, valida per diametri comparabili con il tirante idrico h (pietrame e massi).

L'elemento più delicato da definire è pertanto la tensione tangenziale critica del materiale di rivestimento del rio.

Il progetto preliminare prevedeva il rivestimento in materassi tipo Reno per l'intera estensione di tutte le inalveazioni. Su prescrizione di ANAS e Genio Civile, è stato cambiato tipologico di rivestimento e discretizzato l'utilizzo solo dove necessario. Dove infatti il materiale naturale di rivestimento del rio (nella configurazione consolidata di rinaturazione di fondo e sponde) garantisce la verifica a trascinamento rispetto allo scenario TR200 anni, allora non sono previste opere di rivestimento; viceversa si procede al rivestimento con massi di adeguata pezzatura, sciolti o intasati. In ogni modo è previsto il rivestimento nei punti critici: salti di fondo, curve accentuate, confluenze, presso i nuovi attraversamenti.

Rivestimento naturale: coltre erbosa e sabbia grossolana

Analizzando i campioni più superficiali dei sondaggi geotecnici si evince che in tutti i casi delle inalveazioni il materiale costituente il primo substrato rientra nella categoria delle sabbie grossolane, o come depositi alluvionali o come formazione di Oppia Nuova (depositi conglomeratici grossolani poco cementati). Il peso specifico dei grani si aggira mediamente attorno a 2600 kg/m³ (=25 kN/m³), con angolo d'attrito pari a circa 27° e resistenza a taglio (senza carico) nell'ordine dei 20 kN/m² (confrontabile con velocità critiche di 0.8-1 m/s).

Tuttavia in tutti i casi analizzati nel Lotto, i rii hanno una piccola incisione (massimo 2-3 m di larghezza per massimo 1 m di profondità) all'interno di fondovalle naturale pascolato densamente inerbito. Per la realizzazione delle inalveazioni il primo strato inerbito sarà sicuramente rimosso, ma è prevedibile un ripristino della coltre erbosa. Per tale motivo si ritiene che l'ipotesi semplificativa di partenza sia considerare la verifica idraulica di progetto TR200 anni condotta su materiale già inerbito e coeso, il che dovrebbe realisticamente avvenire nel giro di alcune stagioni.

La presenza di apparati radicali incide significativamente sulla coesione e la resistenza al trascinarsi del materiale costituente il fondo alveo. Esistono numerose ricerche in merito (SHEWBRIDGE e SITAR [1989], GRAY e OHASHI [1983], POLLEN e SIMON [2004], SCHWARZ et al. [2010], United States Department of Agriculture, National Engineering Handbook [2007]) e tutte confermano che l'apparato radicale nel suolo modifica notevolmente le caratteristiche strutturali e di resistenza a taglio: in sintesi, nel momento in cui nel terreno crescono delle radici, la situazione può essere assimilata a quella di una matrice in cui siano immerse delle fibre sulle quali vengono distribuiti gli sforzi. Gli stessi dati sperimentali definiscono nello strato apicale di terreni sabbiosi grossolani un incremento, in caso di apparato radicale consolidato, di almeno 15-20 kN/m² la tensione a taglio, indifferentemente dalla azione di carico di consolidazione. Tale condizione è tempo variante, decrescendo la resistenza al perdurare dell'azione di piena idraulica, ma è sicuramente massima nelle prime decine di minuti, come nel caso dei piccoli bacini in esame.

Per quanto detto, nel caso in esame la tensione tangenziale critica del fondo alveo inerbito viene assunta pari a 40-50 kN/m² (confrontabile con velocità critiche di 1.5-2.0 m/s).



Figura 8 – Confronto ambito di test sperimentale (sinistra) e foto rio TO03 (destra)



Figura 9 – Tabella velocità critiche sperimentali

Table 8-6 Allowable velocities for channels lined with grass

Cover	Slope range percent	Allowable velocity (ft/s)	
		Erosion-resistant soils	Easily eroded soils
Bermudagrass	0-5	8	6
	5-10	7	5
	>10	6	4
Buffalograss, Kentucky bluegrass, smooth brome, blue grama	0-5	7	5
	5-10	6	4
	>10	5	3
Grass mixture	0-5	5	4
	5-10	4	3
Not recommended on slopes greater than 10%			
Lespedeza sericea, weeping lovegrass, ischaemum (yellow bluestem), kudzu, alfalfa, crabgrass	0-5	3.5	2.5
	Not recommended on slopes greater than 5%, except for side slopes in a compound channel		
Annuals—used on mild slopes or as temporary protection until permanent covers are established, common lespedeza, Sudangrass	0-5	3.5	2.5
	Not recommended for slopes greater than 5%		

(210-VI-NEH, August 2007)

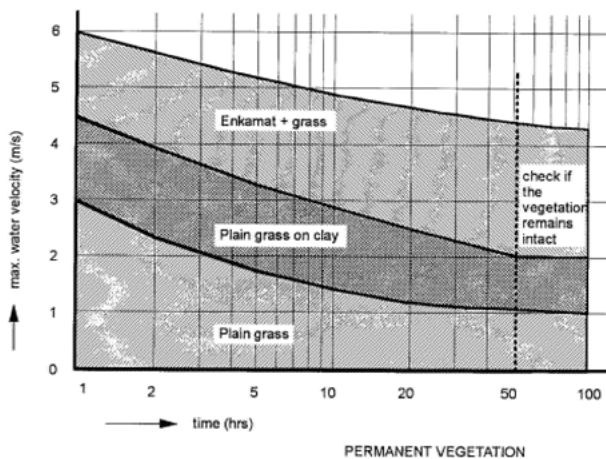
8-27

Figura 10 – Tabella velocità critiche sperimentali (1ft/s = 0.305m/s)

Rivestimento con massi a secco

Per le verifiche di stabilità dei massi sciolti costituenti le opere di difesa in progetto verrà fatto riferimento, nel caso specifico, all'espressione di Shields nella formulazione di Kalinske.

Per le verifiche di stabilità del paramento inclinato, la condizione di moto incipiente va espressa considerando le componenti attive del peso e della spinta idrodinamica in relazione alla pendenza (α) della sponda rispetto all'orizzontale. A tal scopo è normalmente utilizzata la seguente espressione (E. Lane, 1953):

$$\tau_{cr}(\alpha) = \tau_{cr}(0) \left[\cos \alpha \sqrt{1 - \frac{tg^2 \alpha}{tg^2 \varphi}} \right]$$

dove

- $\tau_{cr}(0)$ = tensione critica sul fondo,
- φ = angolo d'attrito interno del materiale.

Dal confronto fra le tensioni tangenziali esercitate dalla corrente sul fondo e la corrispondente tensione tangenziale critica legata alla pezzatura del materiale utilizzato per il rivestimento, è possibile verificarne la stabilità in alveo identificando le dimensioni dei massi impiegati attraverso il diametro medio di calcolo D_{50} .

Volendo esprimere l'ordine di grandezza dei massi tramite il loro peso, si consideri che, in generale, il volume di elementi di forma abbastanza regolare è compreso tra quello di un cubo di lato pari alla dimensione caratteristica calcolata D_{50} e quello di una sfera di tale diametro.

Il rapporto tra questi due volumi è 0,52, mentre il volume del masso caratteristico sarà circa pari a 0,8 volte il volume del cubo.

Quindi, per calcolare il volume del masso caratteristico si può utilizzare la seguente semplice formula:

$$V = 0,80 (D_{50})^3$$

Il volume per il peso specifico del materiale utilizzato (che nel caso in esame è stato assunto pari a 2600 kg/m³) fornisce il peso corrispondente del materiale impiegato.

Tabella 11 – Valori di tensione critica di trascinamento per massi sciolti

Formula	Caratteristiche minime del masso			Tensione critica di trascinamento al fondo	Tensione critica di trascinamento sulla sponda (angolo attrito dei massi incastrati assunto 70°, sponda 45°)
	D50 [m]	Volume [m ³]	Peso [kg]	[N/m ²]	[N/m ²]
Shields-Kalinske	0.3	0.02	55	540	360
Shields-Kalinske	0.4	0.05	130	730	480
Shields-Kalinske	0.5	0.10	260	910	600
Shields-Kalinske	0.6	0.17	450	1090	720
Shields-Kalinske	0.7	0.27	710	1270	840
Shields-Kalinske	0.8	0.41	1060	1450	960
Shields-Kalinske	0.9	0.58	1510	1630	1080
Shields-Kalinske	1.0	0.80	2080	1820	1200

Rivestimento con massi intasati mediante calcestruzzo

Per la tipologia di massi intasati mediante calcestruzzo non è prevista una specifica verifica a trascinamento, tuttavia si prescrive:

- utilizzo di massi aventi diametro medio $D_{med} = 0.3$ m per tratti senza salti di fondo;
- utilizzo di massi aventi diametro minimo $D_{min} = 0.6$ m per tratti con salti di fondo.

Verifica dei rivestimenti presso le curve

Come premesso nel capitolo precedente, tutte le curve delle inalveazioni, a maggior ragione quelle più “brusche”, sono previste rivestite in massi trasversalmente su fondo e sponde. Anche in corrispondenza degli imbocchi alle opere i rii sono rivestiti su fondo e sponde, mentre i muri d'ala dei tombini sono sempre perpendicolari al deflusso e intestati dietro le sponde stesse. Dove potenzialmente esposti alla corrente, anche i rilevati stradali sono rivestiti al piede.

Si procede ugualmente in una stima di correttezza dei raccordi curvilinei di tracciato delle inalveazioni andando a quantificare il rialzo trasversale della superficie liquida. Tale fenomeno avviene nelle correnti subcritiche per azione della forza centrifuga. Il dislivello totale tra la sopraelevazione sulla sponda esterna e la depressione su quella interna è così calcolato:

$$\Delta Y = \frac{V^2 b}{g r_m}$$

dove

V è la velocità media (m/s);

b è la larghezza della superficie libera (m);

r_m è il raggio medio della curvatura (in asse tracciato) (m)

g è la forza di gravità (m/s²).

Rispetto all'altezza idrica calcolata nei modelli idraulici è possibile calcolare un incremento lato esterno curva pari a $\Delta Y/2$.

Nella tabella a seguire sono riassunti, per ogni inalveazione, le curve più critiche poste a monte dell'infrastruttura e la sopraelevazione teorica attesa.

Tabella 12 – Valori di sovrizzo teorico atteso nelle curve più critiche delle inalveazioni

Inalveazione	Progr. inalveazione	Sovralzo atteso lato esterno curva (m)
TO01	177	0.19
TO02	-	-
TO03	789	0.2
TO04	68.09	0.13
TO05	123.98	0.08
TO06	63.4	0.07
TO07	151	0.9
TO08	-	-
TO09	-	-
TO10	-	-
TO11	59	0.3
TO12	-	-

Presso le curve critiche (in rosso nella tabella) si procederà, se necessario, nel posizionare i rivestimenti anche sui rilevati stradali esposti al deflusso.

In taluni casi il rivestimento al piede del rilevato era già previsto in quanto i livelli idrici risultano superiori alle sponde dell'inalveazione o del rio (v. ponti TO10, TO12, tombino TO07 etc).

Tabella 13 – Verifica dei tratti da rivestire: TO01

Ponte	Reach	River Sta	Tensione tangenziale al fondo	Tensione tangenziale sulle sponde	Tensione critica ammissibile	Inalveazione	Curve - Ponti - Salti di fondo - Confluenze	Carta geologica: formazione superficiale	Osservazioni	Rivestimento fondo	Rivestimento sponde
			(N/m ²)	(N/m ²)	(N/m ²)					-	-
	TO01	0	172	129	50	X		Depositi (1)	Alveo naturale	SI	SI
	TO01	-25	167	125	50	X		Depositi (1)	Alveo naturale	SI	SI
	TO01	-50	203	152	50	X		Depositi (1)	Alveo naturale	SI	SI
	TO01	-62	204	153	50	X	Imbocco	Depositi (1)	Alveo naturale	SI	SI
TO01.A	TO01	-71.35	161	121	50	X	Ponte	Depositi (1)	Area di svincolo		
	TO01	-81.77	Bridge		50	X	Ponte	Depositi (1)	Area di svincolo	SI	NO
	TO01	-91.35	141	106	50	X	Ponte	Depositi (1)	Area di svincolo	SI	SI
	TO01	-98	83	63	50	X	Sbocco	Depositi (1)	Area di svincolo	SI	SI
	TO01	-126	3	2	50	X	Curva	Depositi (1)	Area di svincolo	NO	NO
	TO01	-155	2	2	50	X	Confluenza	Depositi (1)	Area di svincolo	NO	NO
	TO01	-177	54	40	50	X	Imbocco	Depositi (1)	Area di svincolo	SI	NO
TO01.B	TO01	- 185.47	73	55	50	X	Ponte	Depositi (1)	Area di svincolo	SI	SI
	TO01	- 207.67	Bridge		50	X	Ponte	Depositi (1)	Area di svincolo		
	TO01	- 232.97	141	106	50	X	Ponte	Depositi (1)	Area di svincolo	SI	SI
	TO01	- 240.25	138	104	50	X	Sbocco	Depositi (1)	Area di svincolo	SI	SI
	TO01	-260	741	556	50	X	Curva	Depositi (1)	Area di svincolo	SI	SI
	TO01	-285.5	336	252	50	X	Curva	Depositi (1)	Area di svincolo	SI	SI
	TO01	-295	302	227	50	X	Imbocco	Depositi (1)	Area di svincolo	SI	SI
TO01.C	TO01	- 301.02	250	188	50	X	Ponte	Depositi (1)	Area di svincolo	SI	SI
	TO01	-312.5	Bridge		50	X	Ponte	Depositi (1)	Area di svincolo		
	TO01	- 323.52	61	45	50	X	Ponte	Depositi (1)	Area di svincolo	SI	NO
	TO01	-327	51	38	50	X	Sbocco	Depositi (1)	Area di svincolo	SI	NO
	TO01	-344	49	37	50	X	Curva	Depositi (1)	Area di svincolo	NO	NO
	TO01	-369	51	38	50	X		Depositi (1)	Area di svincolo	SI	NO
	TO01	-378	54	40	50	X	Imbocco	Depositi (1)	Area di svincolo	SI	NO
TO01.D	TO01	- 384.49	73	55	50	X	Ponte	Depositi (1)	Area di svincolo	SI	SI
	TO01	-398.8	Bridge		50	X	Ponte	Depositi (1)	Area di svincolo		

Ponte	Reach	River Sta	Tensione tangenziale al fondo	Tensione tangenziale sulle sponde	Tensione critica ammissibile	Inalveazione	Curve - Ponti - Salti di fondo - Confluenze	Carta geologica: formazione superficiale	Osservazioni	Rivestimento fondo	Rivestimento sponde
			(N/m ²)	(N/m ²)	(N/m ²)					-	-
	TO01	- 414.49	141	106	50	X	Ponte	Depositi (1)	Area di svincolo	SI	SI
	TO01	-420	104	78	50	X	Sbocco	Depositi (1)	Area di svincolo	SI	SI
	TO01	-443	185	139	50	X		Depositi (1)	Area di svincolo	SI	SI
	TO01	-458	171	128	50	X	Imbocco	Depositi (1)	Area di svincolo	SI	SI
TO01.E	TO01	- 469.07	183	137	50	X	Ponte	Depositi (1)	Area di svincolo	SI	SI
	TO01	- 475.18	Bridge		50	X	Ponte	Depositi (1)	Area di svincolo		
	TO01	- 481.36	166	125	50	X	Ponte	Depositi (1)	Area di svincolo	SI	SI
	TO01	-493.6	187	140	50	X	Sbocco	Depositi (1)	Area antropizzata	SI	SI
	TO01	- 507.71	159	119	50	X	Confluenza	Depositi (1)	Area antropizzata	SI	SI
	TO01	-522	263	198	50	X		Depositi (1)	Area antropizzata	SI	SI
	TO01	-532.8	217	163	50	X		Depositi (1)	Area antropizzata	SI	SI
	TO01	-557.8	173	130	50	X	Curva	Depositi (1)	Area antropizzata	SI	SI
	TO01	- 585.29	167	125	50	X	Salto di fondo	Depositi (1)	Area antropizzata	SI	SI
	TO01	- 587.33	527	395	50	X	Salto di fondo	Depositi (1)	Area antropizzata	SI	SI
	TO01	-599	290	217	50	X		Depositi (1)	Area antropizzata	SI	SI
	TO01	-612.8	188	141	50	X	Imbocco	Depositi (1)	Area antropizzata	SI	SI
TO01.F	TO01	- 616.32	199	149	50	X	Ponte	Depositi (1)	Area antropizzata	SI	SI
	TO01	- 628.25	Bridge		50	X	Ponte	Depositi (1)	Area antropizzata		
	TO01	- 640.18	162	122	50	X	Ponte	Depositi (1)	Area antropizzata	SI	SI
	TO01	-645	111	83	50	X	Sbocco	Depositi (1)	Area antropizzata	SI	SI
	TO01	-662.8	81	61	50	X		Depositi (1)	Area antropizzata	SI	SI
	TO01	-687.8	99	74	50	X		Depositi (1)	Area antropizzata	SI	SI

Tabella 14 – Verifica dei tratti da rivestire: TO02

Ponte	Reach	River Sta	Tensione tangenziale al fondo	Tensione tangenziale sulle sponde	Tensione critica ammissibile	Inalveazione	Curve - Ponti - Salti di fondo - Confluenze	Carta geologica: formazione superficiale	Osservazioni	Rivestimento fondo	Rivestimento sponde
			(N/m ²)	(N/m ²)	(N/m ²)					-	-
	TO02	0	42	32	50			Depositi (1)	Alveo naturale	NO	NO
	TO02	-25	41	31	50		Imbocco	Depositi (1)		SI	SI
TO02	TO02	-34.09	68	51	50	X	Ponte	Depositi (1)		SI	SI
	TO02	-47.76	Bridge			X	Ponte	Depositi (1)			
	TO02	-64.42	126	95	50	X	Ponte	Depositi (1)		SI	SI
	TO02	-68.65	205	154	50	X	Sbocco	Formazione (7)		SI	SI
	TO02	-71.55	199	150	50	X		Formazione (7)	confluenza	SI	SI

Tabella 15 – Verifica dei tratti da rivestire: TO03

Ponte	Reach	River Sta	Tensione tangenziale al fondo	Tensione tangenziale sulle sponde	Tensione critica ammissibile	Inalveazione	Curve - Ponti - Salti di fondo - Confluenze	Carta geologica: formazione superficiale	Osservazioni	Rivestimento fondo	Rivestimento sponde
			(N/m ²)	(N/m ²)	(N/m ²)					-	-
	TO03	0	27	20	50			Formazione (7)		NO	NO
	TO03	-16.6	607	455	50	X	Imbocco	Formazione (7)		SI	SI
CO05A	TO03	-23.77	164	123	50	X	Ponte	Formazione (7)		SI	SI
	TO03	-41.27	Bridge			X	Ponte	Formazione (7)			
	TO03	-58.77	91	68	50	X	Ponte	Formazione (7)		SI	SI
	TO03	-63.1	103	77	50	X	Sbocco/Imbocco/Salto	Depositi (1)		SI	SI
CO05B	TO03	-83.69	354	265	50	X	Ponte	Depositi (1)		SI	SI
	TO03	-87.37	Bridge			X	Ponte	Formazione (7)			
	TO03	-91.05	154	115	50	X	Ponte	Formazione (7)		SI	SI
	TO03	-100	115	86	50	X	Sbocco	Formazione (7)		SI	SI
	TO03	-125	18	14	50	X		Formazione (7)	Scava a lato stazione pompaggio	SI	SI
	TO03	-150	62	46	50	X	Curva	Formazione (7)	Scava a lato stazione pompaggio	SI	SI
	TO03	-175	83	62	50	X	Curva	Formazione (7)	Scava a lato stazione pompaggio	SI	SI
	TO03	-200	3	2	50	X	Curva	Formazione (7)		SI	SI
	TO03	-225	68	51	50	X	Confluenza	Formazione (7)		SI	SI
	TO03	-250	124	93	50	X	Confluenza	Formazione (7)		SI	SI

Ponte	Reach	River Sta	Tensione tangenziale al fondo	Tensione tangenziale sulle sponde	Tensione critica ammissibile	Inalveazione	Curve - Ponti - Salti di fondo - Confluenze	Carta geologica: formazione superficiale	Osservazioni	Rivestimento fondo	Rivestimento sponde
			(N/m ²)	(N/m ²)	(N/m ²)					-	-
	TO03	-275	96	72	50	X		Depositi (1)	Altezza scavo < 1.0	NO	NO
	TO03	-300	106	80	50	X		Depositi (1)	Altezza scavo < 1.0	NO	NO
	TO03	-325	105	79	50	X		Depositi (1)	Altezza scavo < 1.0	NO	NO
	TO03	-350	104	78	50	X		Depositi (1)	Altezza scavo < 1.0	NO	NO
	TO03	-375	104	78	50	X	Confluenza	Depositi (1)		SI	SI
	TO03	-400	68	51	50	X	Confluenza	Depositi (1)		SI	SI
	TO03	-425	70	53	50	X		Depositi (1)	Altezza scavo < 1.0	NO	NO
	TO03	-450	63	47	50	X	Confluenza	Depositi (1)		SI	SI
	TO03	-475	23	17	50	X	Confluenza	Depositi (1)		SI	SI
	TO03	-500	83	62	50	X	Salto	Depositi (1)		SI	SI
	TO03	-523.35	991	743	50	X	Imbocco	Depositi (1)		SI	SI
TO03.A	TO03	-527.89	595	446	50	X	Ponte	Depositi (1)		SI	SI
	TO03	-531.64	Bridge			X	Ponte	Depositi (1)			
	TO03	-535.39	330	247	50	X	Ponte	Depositi (1)		SI	SI
	TO03	-541.22	233	175	50	X	Sbocco	Depositi (1)		SI	SI
	TO03	-550	136	102	50	X		Depositi (1)	Protezione lato strada	NO	SI
	TO03	-575	83	62	50	X		Depositi (1)	Protezione lato strada	NO	SI
	TO03	-600	97	73	50	X		Depositi (1)	Protezione lato strada	NO	SI
	TO03	-625	83	62	50	X		Depositi (1)	Protezione lato strada	NO	SI
	TO03	-650	97	73	50	X		Depositi (1)	Protezione lato strada	NO	SI
	TO03	-675	83	62	50	X		Depositi (1)		SI	SI
	TO03	-700	97	72	50	X		Depositi (1)		SI	SI
	TO03	-725	86	64	50	X		Depositi (1)		SI	SI
	TO03	-750	96	72	50	X		Depositi (1)		SI	SI
	TO03	-772.6	92	69	50	X	curva	Depositi (1)		SI	SI
	TO03	-789.51	53	39	50	X	curva	Depositi (1)		SI	SI
	TO03	-801.32	41	30	50	X	Imbocco	Depositi (1)		SI	SI
TO03.B	TO03	-806.61	75	56	50	X	Ponte	Depositi (1)		SI	SI
	TO03	-820.99	Bridge			X	Ponte	Depositi (1)			

Ponte	Reach	River Sta	Tensione tangenziale al fondo	Tensione tangenziale sulle sponde	Tensione critica ammissibile	Inalveazione	Curve - Ponti - Salti di fondo - Confluenze	Carta geologica: formazione superficiale	Osservazioni	Rivestimento fondo	Rivestimento sponde
			(N/m ²)	(N/m ²)	(N/m ²)					-	-
	TO03	-835.36	113	85	50	X	Ponte	Depositi (1)		SI	SI
	TO03	-842.96	149	111	50	X	Sbocco	Depositi (1)		SI	SI
	TO03	-849	119	89	50	X	curva	Depositi (1)		SI	SI
	TO03	-851.72	88	66	50	X	salto	Depositi (1)		SI	SI
	TO03	-872.81	476	357	50	X	Imbocco	Depositi (1)		SI	SI
TO03.C	TO03	-877.6	305	229	50	X	Ponte	Depositi (1)		SI	SI
	TO03	-881.34	Bridge			X	Ponte	Depositi (1)			
	TO03	-885.08	204	153	50	X	Ponte	Depositi (1)		SI	SI
	TO03	-890.74	163	122	50	X	Sbocco	Depositi (1)		SI	SI
	TO03	-900	89	67	50	X		Depositi (1)	Tratto di raccordo con alveo naturale		
	TO03	-925	89	67	50	X		Depositi (1)			
	TO03	-950	81	61	50	X		Depositi (1)			
	TO03	-975	73	55	50	X		Depositi (1)			
	TO03	-1000	82	62	50	X		Depositi (1)			
	TO03	-1035	122	92	50			Depositi (1)		Alveo naturale	

Tabella 16 – Verifica dei tratti da rivestire: TO04

Ponte	Reach	River Sta	Tensione tangenziale al fondo (N/m ²)	Tensione tangenziale sulle sponde (N/m ²)	Tensione critica ammissibile (N/m ²)	Inalveazione	Curve - Ponti - Salti di fondo - Confluenze	Carta geologica: formazione superficiale	Osservazioni	Rivestimento fondo	Rivestimento sponde
										-	-
	TO04	0	70	52	50			Depositi (1)	Alveo naturale		
	TO04	-25	62	47	50	X		Depositi (1)	Altezza scavo < 1.0	NO	NO
	TO04	-50	231	173	50	X	Curva	Depositi (1)		SI	SI
	TO04	-65.09	214	161	50	X	Curva	Depositi (1)		SI	SI
TO04.A	TO04	-71.77	15	11	50	X	Ponte	Depositi (1)		SI	SI
	TO04	-77.45	Bridge			X	Ponte	Depositi (1)			
	TO04	-83.12	13	10	50	X	Ponte	Depositi (1)		SI	SI
	TO04	-87.53	75	56	50	X	Sbocco/Imbocco	Depositi (1)		SI	SI
TO04.B	TO04	-96.53	22	17	50	X	Ponte	Depositi (1)		SI	SI
	TO04	-109.65	Bridge			X	Ponte	Depositi (1)			
	TO04	-122.78	14	11	50	X	Ponte	Depositi (1)		SI	SI
	TO04	-132.18	75	57	50	X	Sbocco/Imbocco	Depositi (1)		SI	SI
TO04.C	TO04	-137.34	16	12	50	X	Ponte	Depositi (1)		SI	SI
	TO04	-143.02	Bridge			X	Ponte	Depositi (1)			
	TO04	-148.69	13	10	50	X	Ponte	Depositi (1)		SI	SI
	TO04	-157	58	44	50	X	Sbocco	Depositi (1)		SI	SI
	TO04	-182	60	45	50	X	curva	Depositi (1)		SI	SI
	TO04	-207	60	45	50	X		Depositi (1)	Eventuale posa di massi sciolti D300 al fondo: da verificare in fase di scavo.	NO	NO
	TO04	-232	60	45	50	X		Depositi (1)		NO	NO
	TO04	-257	54	41	50	X		Depositi (1)		NO	NO
	TO04	-282	72	54	50	X		Depositi (1)		NO	SI
	TO04	-300	56	42	50	X	confluenza	Depositi (1)		SI	SI

Tabella 17 – Verifica dei tratti da rivestire: TO05

Ponte	Reach	River Sta	Tensione tangenziale al fondo	Tensione tangenziale sulle sponde	Tensione critica ammissibile	Inalveazione	Curve - Ponti - Salti di fondo - Confluenze	Carta geologica: formazione superficiale	Osservazioni	Rivestimento fondo	Rivestimento sponde
			(N/m ²)	(N/m ²)	(N/m ²)					-	-
	TO05	-10	210	158	50	X		Depositi (1)	Alveo naturale		
	TO05	-23.86	93	70	50	X		Depositi (1)	Eventuale posa di massi sciolti D300: da verificare in fase di scavo.	NO	NO
	TO05	-48.98	101	75	50	X		Depositi (1)		NO	NO
	TO05	-73.98	99	74	50	X		Depositi (1)		NO	NO
	TO05	-98.98	101	76	50	X		Depositi (1)		NO	NO
	TO05	-123.98	98	73	50	X	Imbocco	Depositi (1)		NO	NO
TO05.A	TO05	-145.45	12	9	50	X	Ponte	Depositi (1)		SI	SI
	TO05	-150.53	Bridge			X	Ponte	Depositi (1)			
	TO05	-155.61	11	8	50	X	Ponte	Depositi (1)		SI	SI
	TO05	-159.85	24	18	50	X	Sbocco/Imbocco	Depositi (1)		SI	SI
TO05.B	TO05	-167.52	41	30	50	X	Ponte	Depositi (1)		SI	SI
	TO05	-181.2	Bridge			X	Ponte	Depositi (1)		SI	SI
	TO05	-194.88	47	35	50	X	Ponte	Depositi (1)		SI	SI
	TO05	-203.43	43	32	50	X	Sbocco /Confluenza	Depositi (1)		SI	SI

Tabella 18 – Verifica dei tratti da rivestire: TO06

Ponte	Reach	River Sta	Tensione tangenziale al fondo	Tensione tangenziale sulle sponde	Tensione critica ammissibile	Inalveazione	Curve - Ponti - Salti di fondo - Confluenze	Carta geologica: formazione superficiale	Osservazioni	Rivestimento fondo	Rivestimento sponde
			(N/m ²)	(N/m ²)	(N/m ²)					-	-
	TO06	0	31	23	50			Depositi (1)		NO	NO
	TO06	-25	0	0	50			Depositi (1)		NO	NO
	TO06	-45	0	0	50			Depositi (1)		SI	SI
	TO06	-49.4	33	25	50		Imbocco	Depositi (1)		NO	NO
TO06	TO06	-53.4	149	112			Ponte	Depositi (1)			
	TO06	-58.4	Bridge		50		Ponte	Depositi (1)		SI	NO
	TO06	-63.4	82	61	50		Ponte	Depositi (1)		SI	SI
	TO06	-77.68	34	26	50		Sbocco	Formazione (7)		SI	SI
	TO06	-94.51	34	26	50		curva	Formazione (7)		NO	NO
	TO06	-119.51	33	24	50			Depositi (1)		NO	NO
	TO06	-144.51	38	29	50			Depositi (1)		NO	NO
	TO06	-169.51	31	23	50			Depositi (1)		NO	NO

Ponte	Reach	River Sta	Tensione tangenziale al fondo	Tensione tangenziale sulle sponde	Tensione critica ammissibile	Inalveazione	Curve - Ponti - Salti di fondo - Confluenze	Carta geologica: formazione superficiale	Osservazioni	Rivestimento fondo	Rivestimento sponde
			(N/m ²)	(N/m ²)	(N/m ²)					-	-
	TO06	-194.51	32	24	50		confluenza	Depositi (1)		NO	NO

Tabella 19 – Verifica dei tratti da rivestire: TO07

Ponte	Reach	River Sta	Tensione tangenziale al fondo	Tensione tangenziale sulle sponde	Tensione critica ammissibile	Inalveazione	Curve - Ponti - Salti di fondo - Confluenze	Carta geologica: formazione superficiale	Osservazioni	Rivestimento fondo	Rivestimento sponde
			(N/m ²)	(N/m ²)	(N/m ²)					-	-
	TO07	0	194	145	50			Depositi (1)	alveo naturale		
	TO07	-25	124	93	50	X		Depositi (1)	Tratto di raccordo con alveo naturale	NO	NO
	TO07	-38.49	163	122	50	X		Depositi (1)	Tratto di raccordo con alveo naturale	NO	NO
	TO07	-55.01	234	175	50	X	Imbocco	Depositi (1)		SI	SI
TO07.A	TO07	-66.79	185	139	50	X	Ponte	Depositi (1)		SI	SI
	TO07	-83.04	Bridge			X	Ponte	Depositi (1)			
	TO07	-99.29	205	154	50	X	Ponte	Depositi (1)		SI	SI
	TO07	-116.36	273	204	50	X	Sbocco/Imbocco	Depositi (1)		SI	SI
TO07.B	TO07	-126.41	300	225	50	X	Ponte	Depositi (1)		SI	SI
	TO07	-133.88	Bridge			X	Ponte	Depositi (1)			
	TO07	-141.35	256	192	50	X	Ponte	Depositi (1)		SI	SI
	TO07	-150.82	192	144	50	X	Sbocco	Depositi (1)		SI	SI
	TO07	-159.09	78	59	50	X	curva	Depositi (1)		SI	SI
	TO07	-200	76	57	50	X		Depositi (1)	Eventuale posa di massi sciolti D300: da verificare in fase di scavo.	NO	NO
	TO07	-225	67	50	50	X		Depositi (1)		NO	NO
	TO07	-250	63	47	50	X		Depositi (1)		NO	NO
	TO07	-275	89	66	50	X		Depositi (1)	Altezza scavo < 1.0	NO	NO
	TO07	-300	151	113	50	X		Depositi (1)	Altezza scavo < 1.0	NO	NO
	TO07	-325	58	43	50	X		Depositi (1)	Altezza scavo < 1.0	NO	NO
	TO07	-350	46	34	50	X		Depositi (1)	Altezza scavo < 1.0	NO	NO
	TO07	-375	53	40	50	X		Depositi (1)	Altezza scavo < 1.0	NO	NO
	TO07	-400	68	51	50	X		Depositi (1)	Altezza scavo < 1.0	NO	NO

Ponte	Reach	River Sta	Tensione tangenziale al fondo	Tensione tangenziale sulle sponde	Tensione critica ammissibile	Inalveazione	Curve - Ponti - Salti di fondo - Confluenze	Carta geologica: formazione superficiale	Osservazioni	Rivestimento fondo	Rivestimento sponde
			(N/m ²)	(N/m ²)	(N/m ²)					-	-
	TO07	-425	43	32	50	X		Depositi (1)	Altezza scavo < 1.0	NO	NO
	TO07	-450	98	73	50	X		Depositi (1)	Altezza scavo < 1.0	NO	NO
	TO07	-475	59	44	50			Depositi (1)	Tratto di raccordo con alveo naturale	NO	NO

Tabella 20 – Verifica dei tratti da rivestire: TO08

Ponte	Reach	River Sta	Tensione tangenziale al fondo	Tensione tangenziale sulle sponde	Tensione critica ammissibile	Inalveazione	Curve - Ponti - Salti di fondo - Confluenze	Carta geologica: formazione superficiale	Osservazioni	Rivestimento fondo	Rivestimento sponde
			(N/m ²)	(N/m ²)	(N/m ²)					-	-
	TO08	0	252	189	50			Depositi (1)	Alveo naturale		
	TO08	-46.59	20	15	50	X		Depositi (1)		NO	NO
	TO08	-50.04	14	11	50	X	Imbocco	Depositi (1)		SI	SI
TO08.A	TO08	-53.29	40	30	50	X	Ponte	Depositi (1)		SI	SI
	TO08	-56.94	Bridge			X	Ponte	Depositi (1)			
	TO08	-60.59	42	32	50	X	Ponte	Depositi (1)		SI	SI
	TO08	-64.65	12	9	50	X	Sbocco	Depositi (1)	canalizzazione	SI	SI
	TO08	-69.54	11	8	50	X		Depositi (1)	canalizzazione	SI	SI
	TO08	-72.03	11	8	50	X	Imbocco	Depositi (1)	canalizzazione	SI	SI
TO08.B	TO08	-78.71	42	31	50	X	Ponte	Depositi (1)		SI	SI
	TO08	-93.61	Bridge			X	Ponte	Depositi (1)			
	TO08	-108.51	179	134	50	X	Ponte	Depositi (1)		SI	SI
TO08.C	TO08	-119.78	72	54	50	X	Ponte	Depositi (1)		SI	SI
	TO08	-123.5	Bridge			X	Ponte	Depositi (1)			
	TO08	-127.21	118	88	50	X	Ponte	Depositi (1)		SI	SI
	TO08	-132	215	161	50	X	Sbocco	Depositi (1)		SI	SI
	TO08	-142.48	38	29	50	X		Depositi (1)		NO	NO
	TO08	-161.1	38	29	50	X		Depositi (1)		NO	NO
	TO08	-193.82	38	29	50	X		Depositi (1)		NO	NO
	TO08	-223	39	29	50	X		Depositi (1)		NO	NO

Ponte	Reach	River Sta	Tensione tangenziale al fondo	Tensione tangenziale sulle sponde	Tensione critica ammissibile	Inalveazione	Curve - Ponti - Salti di fondo - Confluenze	Carta geologica: formazione superficiale	Osservazioni	Rivestimento fondo	Rivestimento sponde
			(N/m ²)	(N/m ²)	(N/m ²)					-	-
	TO08	-248	40	30	50	X		Depositi (1)		NO	NO
	TO08	-273	41	31	50	X		Depositi (1)		NO	NO
	TO08	-298	51	38	50	X		Depositi (1)		NO	NO
	TO08	-323	35	27	50	X		Depositi (1)		NO	NO

Tabella 21 – Verifica dei tratti da rivestire: TO09

Ponte	Reach	River Sta	Tensione tangenziale al fondo	Tensione tangenziale sulle sponde	Tensione critica ammissibile	Inalveazione	Curve - Ponti - Salti di fondo - Confluenze	Carta geologica: formazione superficiale	Osservazioni	Rivestimento fondo	Rivestimento sponde
			(N/m ²)	(N/m ²)	(N/m ²)					-	-
	TO09	0	251	188	50	X	salto	Depositi (1)		SI	SI
	TO09	-24.44	366	274	50	X	salto	Depositi (1)		SI	SI
	TO09	-28.38	830	623	50	X	salto	Depositi (1)		SI	SI
	TO09	-35.16	476	357	50	X	curva	Depositi (1)		SI	SI
	TO09	-37.95	377	283	50	X		Depositi (1)		SI	SI
	TO09	-40.37	311	233	50	X	Imbocco	Depositi (1)		SI	SI
TO09.A	TO09	-42.78	359	269	50	X	Ponte	Depositi (1)		SI	SI
	TO09	-46.53	Bridge			X	Ponte	Depositi (1)			
	TO09	-50.28	36	27	50	X	Ponte	Depositi (1)		SI	SI
	TO09	-56	35	26	50	X	Sbocco/Imbocco	Depositi (1)		SI	SI
TO09.B	TO09	-65.28	34	25	50	X	Ponte	Depositi (1)		SI	SI
	TO09	-77.78	Bridge			X	Ponte	Depositi (1)			
	TO09	-90.28	37	27	50	X	Sbocco/Imbocco	Depositi (1)		SI	SI
TO09.C	TO09	-95.28	36	27	50	X	Ponte	Depositi (1)		SI	SI
	TO09	-99.05	Bridge			X	Ponte	Depositi (1)			
	TO09	-102.81	37	28	50	X	Ponte	Depositi (1)		SI	SI
	TO09	-104.89	70	52	50	X	Sbocco	Depositi (1)		SI	SI
	TO09	-106.97	69	52	50	X		Depositi (1)		SI	SI
	TO09	-115.64	71	53	50	X		Depositi (1)		SI	SI
	TO09	-124.54	71	53	50	X		Depositi (1)	Tratto di raccordo con alveo naturale	NO	NO

Ponte	Reach	River Sta	Tensione tangenziale al fondo	Tensione tangenziale sulle sponde	Tensione critica ammissibile	Inalveazione	Curve - Ponti - Salti di fondo - Confluenze	Carta geologica: formazione superficiale	Osservazioni	Rivestimento fondo	Rivestimento sponde
			(N/m ²)	(N/m ²)	(N/m ²)					-	-
	TO09	-146.32	81	60	50	X		Depositi (1)	Tratto di raccordo con alveo naturale	NO	NO
	TO09	-161	68	51	50	X		Depositi (1)	Tratto di raccordo con alveo naturale	NO	NO
	TO09	-178.31	147	110	50	X		Depositi (1)	Altezza scavo < 1.0	NO	NO
	TO09	-187.28	50	38	50			Depositi (1)	Altezza scavo < 1.0	NO	NO
	TO09	-191.84	98	74	50			Depositi (1)	alveo naturale		
	TO09	-205.43	247	185	50			Depositi (1)	alveo naturale		

Tabella 22 – Verifica dei tratti da rivestire: TO10

Ponte	Reach	River Sta	Tensione tangenziale al fondo	Tensione tangenziale sulle sponde	Tensione critica ammissibile	Inalveazione	Curve - Ponti - Salti di fondo - Confluenze	Carta geologica: formazione superficiale	Osservazioni	Rivestimento fondo	Rivestimento sponde
			(N/m ²)	(N/m ²)	(N/m ²)					-	-
	TO10	0	85	64	50			Depositi (1)	alveo naturale		
	TO10	-25	41	31	50			Depositi (1)	Non è presente inalveazione ma solo spostamento alveo di magra		
	TO10	-47.29	107	80	50			Depositi (1)	"		
	TO10	-60	178	133	50			Depositi (1)	"		
TO10.C	TO10	-65	42	31	50		Imbocco	Depositi (1)	"		
	TO10	-70.995	Bridge		50		Ponte	Depositi (1)	Verifica allo scalzamento "		
	TO10	-76.99	133	99	50		Ponte	Depositi (1)	"		
TO10.A	TO10	-81.88	127	96	50		Ponte	Depositi (1)	"		
	TO10	-95	Bridge		50		Ponte	Depositi (1)	"		
	TO10	-107.26	64	48	50		Ponte	Depositi (1)	"		
TO10.B	TO10	-112.39	56	42	50		Ponte	Depositi (1)	"		
	TO10	-118.2	Bridge		50		Ponte	Depositi (1)	"		
	TO10	-124	46	34	50		Sbocco	Depositi (1)	"		
	TO10	-140	109	82	50			Depositi (1)	"		
	TO10	-160	388	291	50			Depositi (1)	alveo naturale		
	TO10	-180	185	139	50			Depositi (1)	alveo naturale		

Tabella 23 – Verifica dei tratti da rivestire: TO11

Ponte	Reach	River Sta	Tensione tangenziale al fondo	Tensione tangenziale sulle sponde	Tensione critica ammissibile	Inalveazione	Curve - Ponti - Salti di fondo - Confluenze	Carta geologica: formazione superficiale	Osservazioni	Rivestimento fondo	Rivestimento sponde
			(N/m ²)	(N/m ²)	(N/m ²)					-	-
	TO11	0	227	171	50			Evento deposizionale (1ci)	Alveo naturale		
	TO11	-25	241	181	50			Evento deposizionale (1ci)	Alveo naturale		
	TO11	-43.37	148	111	50	X	curva	Evento deposizionale (1ci)	Da valutare durante fase di scavo consistenza materiale	SI	SI
	TO11	-50	211	158	50	X	salto	Evento deposizionale (1ci)	Da valutare durante fase di scavo consistenza materiale	SI	SI
	TO11	-59.31	501	376	50	X	Imbocco	Depositi (1)		SI	SI
TO11.A	TO11	-66.94	942	707	50	X	Ponte	Depositi (1)		SI	SI
	TO11	-70.6	Bridge			X	Ponte	Depositi (1)			
	TO11	-74.25	442	331	50	X	Ponte	Depositi (1)		SI	SI
TO11.B	TO11	-95.45	31	23	50	X	Sbocco/Imbocco	Depositi (1)		SI	SI
	TO11	-121.04	Bridge			X	Ponte	Depositi (1)			
	TO11	-146.62	54	40	50	X	Ponte	Depositi (1)		SI	SI
	TO11	-175	94	71	50	X	Ponte	Depositi (1)		SI	SI
	TO11	-200	249	187	50	X	Sbocco	Depositi (1)		SI	SI
	TO11	-225	29	22	50	X		Depositi (1)		NO	NO
	TO11	-250	8	6	50	X		Depositi (1)		NO	NO
	TO11	-275	3	2	50	X		Depositi (1)		NO	NO
	TO11	-310	4	3	50	X		Depositi (1)		NO	NO
	TO11	-335	3	2	50	X		Depositi (1)		NO	NO

Tabella 24 – Verifica dei tratti da rivestire: TO012

Ponte	Reach	River Sta	Tensione tangenziale al fondo	Tensione tangenziale sulle sponde	Tensione critica ammissibile	Inalveazione	Curve - Ponti - Salti di fondo - Confluenze	Carta geologica: formazione superficiale	Osservazioni	Rivestimento fondo	Rivestimento sponde
			(N/m ²)	(N/m ²)	(N/m ²)					-	-
	TO12	0	276	207	50			Depositi (1)	alveo naturale		
	TO12	-25	341	256	50			Depositi (1)	Non è presente inalveazione ma solo spostamento alveo di magra	NO	NO
	TO12	-50	631	473	50		Imbocco	Depositi (1)	"	SI	SI
TO12	TO12	-64.99	23	18	50		Ponte	Depositi (1)	"	NO	NO
	TO12	-79.43	Bridge				Ponte	Depositi (1)	Verifica allo scalzamento "		
	TO12	-93.96	26	20	50		Ponte	Depositi (1)	"	NO	NO
	TO12	-103.59	22	17	50		Sbocco	Depositi (1)	"	NO	NO
	TO12	-125	114	86	50			Depositi (1)	"	NO	NO
	TO12	-145	301	226	50			Depositi (1)	alveo naturale		
	TO12	-200	116	87	50			Depositi (1)	alveo naturale		
	TO12	-225	112	84	50			Depositi (1)	alveo naturale		
	TO12	-250	139	104	50			Depositi (1)	alveo naturale		
	TO12	-275	97	72	50			Depositi (1)	alveo naturale		
	TO12	-300	122	92	50			Depositi (1)	alveo naturale		
	TO12	-325	36	27	50			Depositi (1)	alveo naturale		
	TO12	-350	23	18	50			Depositi (1)	alveo naturale		
	TO12	-375	26	20	50	X		Depositi (1)		NO	NO
	TO12	-400	31	23	50	X	curva	Depositi (1)		SI	SI
	TO12	-414.43	17	13	50	X	Imbocco	Depositi (1)		SI	SI
TO12.B	TO12	-425.54	27	20	50	X	Ponte	Depositi (1)		SI	SI
	TO12	-431.31	Bridge			X	Ponte	Depositi (1)	Verifica allo scalzamento		
	TO12	-437.08	200	150	50	X	Ponte	Depositi (1)		SI	SI
	TO12	-450	246	184	50	X	Sbocco	Depositi (1)		SI	SI
	TO12	-475	42	32	50	X		Depositi (1)		NO	NO
	TO12	-500	74	55	50	X		Depositi (1)	Tratto di raccordo con alveo naturale	NO	NO
	TO12	-530	88	66	50	X		Depositi (1)	Tratto di raccordo con alveo naturale	NO	NO

Tabella 25 – Verifica dei tratti da rivestire: CA01

Ponte	Reach	River Sta	Tensione tangenziale al fondo	Tensione tangenziale sulle sponde	Tensione critica ammissibile	Inalveazione	Curve - Ponti - Salti di fondo - Confluenze	Carta geologica: formazione superficiale	Osservazioni	Rivestimento fondo	Rivestimento sponde
			(N/m ²)	(N/m ²)	(N/m ²)					-	-
	CA01	0	54	41	50	X		Depositi (1)	Canale di gronda non rivestito soggetto ad oscillazioni del lago. Coghinas.	NO	NO
	CA01	-25	55	41	50	X		Depositi (1)	"	NO	NO
	CA01	-50	56	42	50	X		Depositi (1)	"	NO	NO
	CA01	-75	54	41	50	X		Depositi (1)	"	NO	NO
	CA01	-100	54	41	50	X		Depositi (1)	"	NO	NO
	CA01	-125	54	41	50	X		Depositi (1)	"	NO	NO
	CA01	-150	55	41	50	X		Depositi (1)	"	NO	NO
	CA01	-175	56	42	50	X		Depositi (1)	"	NO	NO
	CA01	-200	54	41	50	X		Depositi (1)	"	NO	NO
	CA01	-225	55	41	50	X		Depositi (1)	"	NO	NO
	CA01	-250	55	41	50	X		Depositi (1)	"	NO	NO
	CA01	-275	49	37	50	X		Depositi (1)	"	NO	NO
	CA01	-300	56	42	50	X		Depositi (1)	"	NO	NO
	CA01	-325	49	37	50	X		Depositi (1)	"	NO	NO
	CA01	-350	54	41	50	X		Depositi (1)	"	NO	NO
	CA01	-375	55	41	50	X		Depositi (1)	"	NO	NO
	CA01	-400	56	42	50	X		Depositi (1)	"	NO	NO
	CA01	-425	54	41	50	X		Depositi (1)	"	NO	NO
	CA01	-450	54	41	50	X		Depositi (1)	"	NO	NO
	CA01	-475	54	41	50	X		Depositi (1)	"	NO	NO
	CA01	-500	55	41	50	X		Depositi (1)	"	NO	NO
	CA01	-525	56	42	50	X		Depositi (1)	"	NO	NO
	CA01	-550	55	41	50	X		Depositi (1)	"	NO	NO
	CA01	-575	56	42	50	X		Depositi (1)	"	NO	NO
	CA01	-600	61	45	50	X		Depositi (1)	"	NO	NO
	CA01	-625	81	61	50	X		Depositi (1)	"	NO	NO
	CA01	-650	278	208	50	X		Depositi (1)	"	NO	NO
	CA01	-675	495	371	50	X		Depositi (1)	"	NO	NO
	CA01	-677.74	430	322	50	X		Depositi (1)	"	NO	NO

Tabella 26 – Verifica dei tratti da rivestire: CA02

Ponte	Reach	River Sta	Tensione tangenziale al fondo	Tensione tangenziale sulle sponde	Tensione critica ammissibile	Inalveazione	Curve - Ponti - Salti di fondo - Confluenze	Carta geologica: formazione superficiale	Osservazioni	Rivestimento fondo	Rivestimento sponde
			(N/m ²)	(N/m ²)	(N/m ²)					-	-
	CA02	0	74	56	50			Depositi (1)	alveo naturale		
	CA02	-25	353	265	50	X		Depositi (1)	Protezione lato strada	NO	SI
	CA02	-50	122	91	50	X		Depositi (1)	Protezione lato strada	NO	SI
	CA02	-75	85	63	50	X		Depositi (1)	Protezione lato strada	NO	SI
	CA02	-100	92	69	50	X		Depositi (1)	Protezione lato strada	NO	SI
	CA02	-125	85	64	50	X		Depositi (1)	Protezione lato strada	NO	SI
	CA02	-150	108	81	50	X		Depositi (1)	Protezione lato strada	NO	SI
	CA02	-175	57	43	50	X	confluenza	Depositi (1)		SI	SI
	CA02	-200	78	59	50	X		Depositi (1)	Protezione lato strada	NO	SI
	CA02	-225	115	86	50	X		Depositi (1)	Protezione lato strada	NO	SI
	CA02	-250	83	62	50	X		Depositi (1)	Protezione lato strada	NO	SI
	CA02	-275	88	66	50	X		Depositi (1)	Protezione lato strada	NO	SI
	CA02	-300	60	45	50	X		Depositi (1)	Protezione lato strada	NO	SI
	CA02	-325	71	53	50	X		Depositi (1)	Altezza di scavo < 1m	NO	NO
	CA02	-350	133	99	50	X		Depositi (1)	Altezza di scavo < 1m	NO	NO
	CA02	-375	93	70	50	X		Depositi (1)	Altezza di scavo < 1m	NO	NO
	CA02	-400	77	57	50	X		Depositi (1)	Tratto di raccordo con alveo naturale	NO	NO
	CA02	-425	99	74	50			Depositi (1)	Tratto di raccordo con alveo naturale	NO	NO

4. INTERFERENZE IDRAULICHE COMPLUVI

Il capitolo affronta la risoluzione delle interferenze individuate come COxx, reticolo che rientra nella classificazione di compluvi non oggetto di autorizzazione secondo R.D. n°523 del 1904 e ss.mm.ii.

Nel caso specifico i bacini sottesi risultano essere sempre inferiori a 1 km².

Le interferenze "compluvi", individuabili mediante mappatura cartografica su aerofotogrammetrico 1.000 e celerimetrico di campagna, sono:

Tabella 27 – Elenco interferenze "compluvi"

ID Interferenza idraulica	Reticolo idrico	ID Intervento progettuale	Asse stradale	Progr. Asse stradale	Tipologia di intervento
CO01	Naturale	CO01	Viab. SV1 BIS	0+140	Riprofilatura
CO02	Naturale	CO02	SV. Oschiri - Rampa E	0+100	Tombino
CO03	Naturale	CO03	AP	37+256.30	Tombino
CO04	Naturale	CO04	AP	37+739.30	Tombino
CO05.A	Naturale	CO05.A	AP	37+928.50	Tombino
CO05.B	Naturale	CO05.B	Viab. L4SR3	0+015	Tombino
CO06	Naturale	CO06	AP	38+096.3	Tombino
CO07.A	Naturale	CO07.A	Viab. SV4 BIS	0+228.37	Tombino
CO07.B	Naturale	CO07.B	AP	38+847	Tombino
CO07.C	Naturale	CO07.C	Viab. SR6	0+066.40	Tombino
CO08	Naturale	CO08	AP	39+925	Inalveazione
CO09	Naturale	CO09	AP	40+850	Riprofilatura
CO09bis	Naturale	CO09bis	Accesso privato Viab. SV9	0+726.9	Tombino
CO10	Naturale	CO10	AP	43+927	Tombino
CO11	Naturale	CO11	AP	45+570	Tombino

*Opera eliminata a seguito di modifiche stradali recepite in ottemperanza all'istruttoria ANAS di luglio 2015

La verifica è stata condotta rispetto alla portata duecentennale.

La verifica delle opere è stata condotta mediante l'applicazione del metodo della Federal Highway Administration (FHWA) denominato "Inlet/Outlet Control".

Le leggi che regolano il deflusso di una corrente attraverso un tombino si rifanno all'idraulica dei canali a pelo libero sino a quando la corrente non è a sezione piena. In letteratura sono disponibili numerosi studi effettuati da diversi autori (Marnell, Nagler, Woodward, Mavis, Straub, Morris, Anderson, Bowers, Shoemaker, Clayton) che hanno investigato casi particolari. Un'indagine sperimentale completa sul comportamento idraulico delle più comuni tipologie di tombini è stata eseguita dal U.S. Bureau of Standard come riportato da French in più pubblicazioni. Sulla base di queste esperienze è stato verificato che l'imbocco di un tombino risulta libero qualora il carico idraulico a monte sia inferiore ad un valore critico definito in funzione delle caratteristiche geometriche dell'imbocco del tombino stesso.

Le dimensioni dei tombini, in taluni casi assolutamente sovrabbondanti rispetto alle portate di progetto calcolate, sono state determinate tenendo in conto la situazione attuale dell'attraversamento, ove esistente, e comunque assicurando in ogni caso la facilità di intervento in sicurezza per le future operazioni manutentive. A tal fine sotto l'asse principale della statale e sotto le rampe di svincolo è stato adottato uno scatolare minimo rettangolare 2.0x1.5 m (base per altezza).

Di ogni interferenze sono descritti negli elaborati specifici (v. sintesi in "Planimetria delle interferenze- DPCA03E1004ID00IDRCCO03A), planimetria, profili e sezioni, nonché elementi caratteristici.

La verifica dei fossi integrati con i compluvi è stata condotta in analogia col sistema delle acqua di piattaforma (metodo dell'invaso), essendo le interferenze "compluvi" pienamente integrate con esse. Si rimanda alla relazione idraulica di piattaforma per l'analisi di tale sistema.

Verifica e dimensionamento

Le portate dei bacini sottesi sono state individuate con la stessa metodologia applicata alle interferenze TO (v. Relazione Idrologica).

I dati analitici di calcolo sono descritti in Allegato 4.

Di seguito la tabella riepilogativa del dimensionamento dei compluvi CO:

Tabella 28 – Tombini CO

ID INTERFERE NZA	ID OPERA	Geometria			Portata bacino TR200
		b (m)	h (m)	D (m)	Q _b (m ³ /s)
CO01	TF01			1.20	1.03
CO02	CO02	3.0	2.25		2.7
CO03	CO03			1.20	0.6
CO04	CO04	2.0	1.5		1.7
CO05	CO05.A	3.0	2.25		2.9
CO05*	CO05.B	2.0	2.0		2.9
CO06	CO06	2.0	1.5		0.4
CO07	CO07.A	2.0	2.0		4.0
CO07	CO07.B	2.0	2.0		4.0
CO07	CO07.C	2.0	2.0		4.0
CO08	TF28			1.20	2.67
CO09	TF30			1.00	2.25
CO09	TF31			1.20	2.25
CO10	CO10	2.0	1.5		4.5
CO10	TF38	2.0	1.5		4.5
CO11	CO11	2.0	1.5		2.7

*Opera eliminata a seguito di modifiche stradali recepite in ottemperanza all'istruttoria ANAS di luglio 2015

5. PIANO DI MANUTENZIONE

Il presente capitolo ha la funzione di esplicitare nel dettaglio le pratiche da eseguire per l'esecuzione degli interventi di ripristino e/o di manutenzione delle opere idrauliche in progetto.

In generale gli obiettivi cui si deve fare riferimento nella predisposizione del piano di manutenzione sono:

- prevedere gli interventi di manutenzione necessari, con particolare riferimento alle opere realizzate, alle modalità di realizzazione delle stesse ed ai materiali impiegati;
- pianificare gli interventi di manutenzione, dando indicazione delle scadenze temporali da prevedersi per ciascun ambito manutentivo o manutenzione delle varie parti di opera realizzata;
- programmare le risorse necessarie al rispetto delle scadenze definite in fase di pianificazione per l'effettuazione degli interventi manutentivi.

Le azioni di cui sopra devono essere fissate per garantire non solo l'efficienza e la funzionalità dell'opera realizzata, ma anche il mantenimento del valore economico della stessa.

Così come previsto dal D.P.R. 554/99, il piano di manutenzione dell'opera è costituito dai seguenti documenti operativi:

- manuale d'uso;
- manuale di manutenzione;
- programma di manutenzione.

Nel caso specifico le opere da analizzare sono il rilevato stradale, i tombini, le difese in alveo.

Manuale d'uso

Per la dettagliata descrizione dei lavori, delle caratteristiche dell'opera in progetto, della geometria, del materiale, della funzionalità, nonché della collocazione delle opere nel contesto territoriale si rimanda alle relazioni specialistiche, agli elaborati grafici ed ai dettagli costruttivi facenti parte del progetto esecutivo, nonché agli eventuali elaborati di variante che saranno predisposti, in caso di necessità, a cura della Direzione dei Lavori.

Manuale di manutenzione

Parti d'opera a manutenzione omogenea	Materiali	Anomalie riscontrabili	Attività di manutenzione
Rilevati stradali	Terreno	Erosione al piede, erosione delle scarpate per azione della corrente	Ricarica e sistemazione mediante apporto di materiale terroso, riprofilatura scarpate e relativa semina, interventi di protezione attiva (materassini tipo "Reno", geotessiti, lastroni in calcestruzzo gettati in opera o prefabbricati)
		Fenomeni di instabilità locale e globale	Consolidamento delle scarpate mediante il ripristino delle scarpate mediante l'apporto di materiale terroso, formazione di banche lato campagna e lato fiume per aumentare il coefficiente di sicurezza allo scivolamento, diminuzione delle pendenze delle scarpate
		Erosione per ruscellamento delle acque superficiali e meteoriche	Sistemazione delle scarpate, inerbimento, idrosemina, utilizzo di geotessili (biostuoie)
		Cedimento	Adeguamento del rilevato in sagoma
		Crescita di arbusti lungo le scarpate	Sfalcio, disboscamento, decespugliamento
		Filtrazione nel corpo arginale	Interventi per diminuire il flusso attraverso il corpo arginale (formazione di nuclei con materiali impermeabili, rivestimenti in calcestruzzo, rivestimenti con geotessili)
		Fossi di guardia	Pulizia dei fossi, ripristino delle sezioni, sfalcio e decespugliamento
Muri	Pietrame, calcestruzzo, cemento armato	Crollo, scalzamento, dislocazione	Recupero delle parti di muratura ammorlate, consolidamento fondazioni, recupero delle parti in c.a. anche mediante resine
Drenaggio piattaforma (tubazioni, canalette etc)	Calcestruzzo, plastica, metallo	Rottura, corrosione, interrimento, ostruzione	Svuotamento, riparazione e/o sostituzione
Tombini	Calcestruzzo	Corrosione, ammoramento, danneggiamento, intasamento	Svuotamento, riparazione, recupero
Inalveazioni	Terreno/Materassi reno	Erosione al piede, erosione delle scarpate per azione della corrente	Ricarica e sistemazione mediante apporto di materiale terroso, riprofilatura scarpate e relativa semina, interventi di protezione attiva (materassini tipo "Reno", geotessiti, massi)
Difese sponda/briglie	Massi/materassi reno	Erosione al piede per azione della corrente	Ricarica e sistemazione mediante apporto di massi di caratteristiche uguali o superiori
		Fenomeni di instabilità locale e globale del paramento, cedimento	Ripristino mediante rifacimento di parte della difesa
		Formazione di buche nel terreno retrostante la difesa	Ricarica e costipamento con materiale naturale grossolano, tipo ciottolame e ghaia
		Crescita di arbusti lungo le scarpate	Sfalcio, disboscamento, decespugliamento

Programma di manutenzione

Il Programma di Manutenzione definisce i controlli e gli interventi e le scadenze alle quali devono essere eseguiti al fine di una corretta gestione dell'opera.

Per mantenere in buono stato di conservazione ed efficienza il patrimonio delle opere in progetto, è necessario provvedere alle attività di seguito riportate:

- definizione del livello prestazionale che l'opera realizzata può garantire secondo i dati progettuali, ed eventualmente quali accorgimenti siano stati introdotti per la loro verifica di campo;
- verifiche e controlli dello stato di manutenzione delle opere; tali operazioni devono essere svolte da personale competente, qualificato ed attrezzato, in relazione al tipo di opera e di intervento previsto;
- manutenzione ordinaria (o programmata) delle opere;
- manutenzione straordinaria delle opere.

Sottoprogramma delle prestazioni

La sezione del Programma di Manutenzione è subordinata a quanto previsto dagli enti gestori della strada in merito ai requisiti minimi prestazionali delle opere.

Il sistema oggetto di realizzazione potrà essere agevolmente monitorato visivamente dagli Addetti dell'Ente gestore indicato.

I lavori sono mirati alla difesa delle pile in alveo e delle pile/spalle in zona golenale dall'erosione al piede e alla regimazione del corso d'acqua in modo da garantire un buon regime idraulico all'intero sistema.

Gli obiettivi perseguiti sono:

- garantire la stabilità strutturale del rilevato stradale nei confronti di eventi alluvionali;
- mantenere efficiente il sistema di drenaggio e smaltimento idraulico.

Sottoprogramma dei controlli

Le verifiche e i controlli devono essere eseguiti da personale esperto, qualificato ed idoneamente attrezzato in relazione alla categoria di opera da mantenere, in grado di eseguire i controlli previsti ed in particolare quanto segue:

- ispezionare periodicamente le opere realizzate;
- verificare eventuali malfunzionamenti;
- verificare l'integrità dei paramenti spondali o dei muri in C.A., al corpo di fondazione e al corpo mantellata;
- verificare presenza di erosione/scavi;
- verificare presenza di assestamenti del terreno;
- verificare ostruzioni e/o interrimento dei tombini.

Ogni operazione deve essere svolta nel rigoroso rispetto di fondamentali norme atte a tutelare l'incolumità degli operatori addetti ad opere di manutenzione; per questo dovranno essere adottate tutte le precauzioni idonee ad evitare qualunque tipo di rischio per la circolazione veicolare.

Di seguito si riporta una scheda "tipo" di verifica e controllo che dovrà essere utilizzata dal personale tecnico responsabile della gestione manutentiva dell'opera.

Ad ogni ispezione diretta dovrà essere compilata da parte del personale preposto una dettagliata relazione di consistenza delle opere.

Si riporta una tabella ad indicare la frequenza delle verifiche per le opere in progetto:

PIANO DI MANUTENZIONE DELL'OPERA E DELLE SUE PARTI							Scheda n.
PROGRAMMA DI MANUTENZIONE - SOTTOPROGRAMMA DEI CONTROLLI							Data verifica
Scheda di verifica e controllo							
Tipo (compartimento)	Indispensabile		Cadenza	Ditta	Anomalie da verificare	% diminuzione	Osservazioni
	SI	NO		incaricata		livello prestazionale	
1	2	3	4	5	6	7	8
Rilevato - Corpo	<input checked="" type="checkbox"/>	<input type="checkbox"/>	Dopo evento alluvionale	Specializzata	Cedimento		
Rilevato - Paramenti	<input checked="" type="checkbox"/>	<input type="checkbox"/>	Dopo evento alluvionale	Specializzata	Erosione, infiltrazione cedimento		
Rilevato - Fondazioni	<input checked="" type="checkbox"/>	<input type="checkbox"/>	Dopo evento alluvionale	Specializzata	Cedimento/ scalzamento		
Muri	<input checked="" type="checkbox"/>	<input type="checkbox"/>	Dopo evento alluvionale	Specializzata	Cedimento strutturale/ dissesto/ scalzamento		
Drenaggio piattaforma	<input checked="" type="checkbox"/>	<input type="checkbox"/>	Dopo evento alluvionale	Specializzata	Otruzioni e/o interrimento		
Tombini	<input checked="" type="checkbox"/>	<input type="checkbox"/>	Dopo evento alluvionale	Specializzata	Otruzioni e/o interrimento		
Difese sponda	<input checked="" type="checkbox"/>	<input type="checkbox"/>	Dopo evento alluvionale	Specializzata	Cedimenti		

Sottoprogramma degli interventi

Per quanto riguarda il sottoprogramma degli interventi il presente piano non prevede specifiche manutenzioni programmate dedicate specificatamente alle opere di progetto; eventuali manutenzioni "specifiche", come già ricordato in precedenza, saranno effettuate "secondo condizione" ovvero "a guasto" e previste in seguito alle ispezioni realizzate in conformità con lo scadenziario predisposto.

L'attività di sfalcio vegetazionale sarà concordata con l'Ente gestore.

ALLEGATI

INDICE

1. ALLEGATO 1 – DESCRIZIONE DEL CODICE DI CALCOLO

2. ALLEGATO 2 – RISULTATI SIMULAZIONI DELLE INTERFERENZE IDRAULICHE E DELLE INALVEAZIONI
 - 2.1 Interferenza idraulica - TO01
Tabella riassuntiva dei risultati, profilo idrico e sezioni trasversali con i livelli idrici (TR 200 - 500 anni)

 - 2.2 Interferenza idraulica - TO02
Tabella riassuntiva dei risultati, profilo idrico e sezioni trasversali con i livelli idrici (TR 200 - 500 anni)

 - 2.3 Interferenza idraulica - TO03
Tabella riassuntiva dei risultati, profilo idrico e sezioni trasversali con i livelli idrici (TR 200 - 500 anni)

 - 2.4 Interferenza idraulica - TO04
Tabella riassuntiva dei risultati, profilo idrico e sezioni trasversali con i livelli idrici (TR 200 - 500 anni)

 - 2.5 Interferenza idraulica - TO05
Tabella riassuntiva dei risultati, profilo idrico e sezioni trasversali con i livelli idrici (TR 200 - 500 anni)

 - 2.6 Interferenza idraulica - TO06
Tabella riassuntiva dei risultati, profilo idrico e sezioni trasversali con i livelli idrici (TR 200 - 500 anni)

 - 2.7 Interferenza idraulica - TO07
Tabella riassuntiva dei risultati, profilo idrico e sezioni trasversali con i livelli idrici (TR 200 - 500 anni)

 - 2.8 Interferenza idraulica - TO08
Tabella riassuntiva dei risultati, profilo idrico e sezioni trasversali con i livelli idrici (TR 200 - 500 anni)

 - 2.9 Interferenza idraulica - TO09
Tabella riassuntiva dei risultati, profilo idrico e sezioni trasversali con i livelli idrici (TR 200 - 500 anni)

- 2.10 Interferenza idraulica – TO10
Tabella riassuntiva dei risultati, profilo idrico e sezioni trasversali con i livelli idrici (TR 200 - 500 anni)
- 2.11 Interferenza idraulica – TO11
Tabella riassuntiva dei risultati, profilo idrico e sezioni trasversali con i livelli idrici (TR 200 - 500 anni)
- 2.12 Interferenza idraulica – TO12
Tabella riassuntiva dei risultati, profilo idrico e sezioni trasversali con i livelli idrici (TR 200 - 500 anni)
- 2.13 Inalveazione – CA01
Tabella riassuntiva dei risultati, profilo idrico e sezioni trasversali con i livelli idrici (TR 200 anni)
- 2.14 Inalveazione – CA02
Tabella riassuntiva dei risultati, profilo idrico e sezioni trasversali con i livelli idrici (TR 50, 100 e 200 anni)

3. ALLEGATO 3 – RISULTATI SIMULAZIONI MOTO VARIO PER LE VERIFICHE ANTE-POST OPERAM DELLE INALVEAZIONI CRITICHE:

- 3.1. Interferenza idraulica - TO01: Tabella riassuntiva dei risultati, profilo idrico e sezioni trasversali con i livelli idrici (TR 200 anni)
- 3.2. Interferenza idraulica - TO02-TO03-CA02-TO07: Tabella riassuntiva dei risultati, profilo idrico e sezioni trasversali con i livelli idrici (TR 200 anni)
- 3.3. Interferenza idraulica - TO10: Tabella riassuntiva dei risultati, profilo idrico e sezioni trasversali con i livelli idrici (TR 200 anni)
- 3.4. Interferenza idraulica – TO11-TO12: Tabella riassuntiva dei risultati, profilo idrico e sezioni trasversali con i livelli idrici (TR 200 anni)

4. ALLEGATO 4 – INTERFERENZE IDRAULICHE COMPLUVI: RISULTATI INLET-OUTLET CONTROL

ALLEGATO 1

DESCRIZIONE DEL CODICE DI CALCOLO

1. DESCRIZIONE DEL CODICE DI CALCOLO

Il modello di simulazione implementato da HEC-RAS (River Analysis System) presso l'Hydrologic Engineering Center dell'United States Army Corps of Engineers, consente il calcolo dei profili idraulici di moto permanente gradualmente vario in reti di canali naturali o artificiali.

Con tale modello possono essere simulate condizioni di moto subcritico, supercritico e misto e possono essere valutati gli effetti di immissioni o emissioni laterali di portata, opere in alveo, ostacoli al flusso e costruzioni presenti lungo le sponde.

Come noto, le equazioni utilizzate per valutare le perdite di carico e quindi il profilo di rigurgito di una corrente variano a seconda del tipo di corrente. Per correnti che si mantengono o sempre lente o sempre veloci in un determinato tratto, si è utilizzata l'equazione della conservazione dell'energia totale.

1.1 CONSERVAZIONE DELL'ENERGIA TOTALE

Isolando un tratto di corrente e indicando con 1 e 2 le sezioni a monte e a valle del tratto, si è definita l'equazione dell'energia, in riferimento alla Figura 1, nel modo seguente:

$$Y_2 + Z_2 + \frac{\alpha_2 V_2^2}{2g} = Y_1 + Z_1 + \frac{\alpha_1 V_1^2}{2g} + h_e \quad (1)$$

dove

h_e , perdite di energia;

V_i , velocità media nella sezione, pari al rapporto tra portata totale ed area totale;

α_i , coefficienti legati alla distribuzione della velocità nella sezione



Figura 1 Schema di calcolo

La perdita di carico h_e presente tra due sezioni è causata prevalentemente dalla perdita per attrito o per le variazioni di velocità intrinseche nelle zone di espansione o contrazione della corrente. Indicando con J la cadente piezometrica e con C un coefficiente che tiene conto del fenomeno dell'espansione o contrazione, le perdite di pressione sono state pertanto calcolate nel modo seguente:

$$h_e = LJ + C \left| \frac{\alpha_2 V_2^2}{2g} - \frac{\alpha_1 V_1^2}{2g} \right| \quad (2)$$

Il coefficiente C di espansione o contrazione è stato valutato, in funzione del tipo di transizione che si determina, in accordo alla seguente tabella.

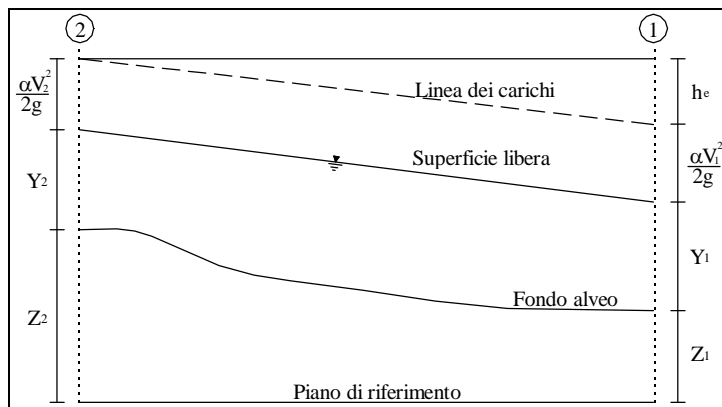
Tabella 1 - Coefficiente di contrazione o espansione

C	Contrazione	Espansione
Nessuna transizione	0,0	0,0
Transizione graduale	0,1	0,3
Sezione tipica di un ponte	0,3	0,5
Rapida transizione	0,6	0,8

La presenza di una espansione o di una contrazione è valutata confrontando la velocità a monte e a valle della sezione considerata. In particolare, se la velocità a monte risulta maggiore della velocità a valle, nella sezione si attesta un'espansione del canale; viceversa una contrazione.

La cadente piezometrica J e il coefficiente di ragguglio dell'energia cinetica adimensionale α_i , che compaiono nelle equazioni (1) e (2), vengono espresse in funzione delle caratteristiche idrodinamiche della corrente nel seguente modo.

La pendenza d'attrito J viene calcolata come rapporto tra la portata media Q ed il coefficiente medio di resistenza K .

$$J = \left(\frac{Q}{K} \right)^2 \quad \text{con} \quad K = \frac{1.486}{n} AR^{2/3} \quad (3)$$

dove

n , coefficiente di scabrezza di Manning;

A , area della sezione;

R , raggio idraulico.

Per portare adeguatamente in conto la frequente circostanza di sezione caratterizzata da zone a differente scabrezza (tipica in particolare degli alvei a banchina e savanella), i valori della conveyance per ciascuna area golendale sono ottenuti come somma dei rispettivi valori parziali (Figura 2). Il canale principale è invece trattato come un unico elemento dotato di un solo valore

di conveyance. Il valore finale ragguagliato di K per l'intera sezione è ottenuto come somma dei tre contributi parziali (sinistra, canale, destra).



Figura 2 Procedura di calcolo della conveyance

Per ciò che concerne invece il coefficiente di ragguaglio α , poiché coerentemente con la citata ipotesi di corrente monodimensionale, ad ogni sezione resterà associata una sola superficie libera e di conseguenza una sola altezza cinetica. In particolare, per un dato valore del tirante idrico nella sezione, l'altezza cinetica viene calcolata come valor medio pesato alla portata fra quelli associati alle tre sottosezioni: golena sinistra, canale, golena destra. Una semplice schematizzazione del modello, nel caso di assenza di golena sinistra è riportato in Figura 3. In pratica l'altezza cinetica è calcolata mediante la relazione:

$$\alpha \cdot \frac{\bar{V}^2}{2g} = \frac{\sum_{i=1}^n Q_i \cdot \left(\frac{V_i^2}{2g} \right)}{Q_{tot}} \quad (4)$$

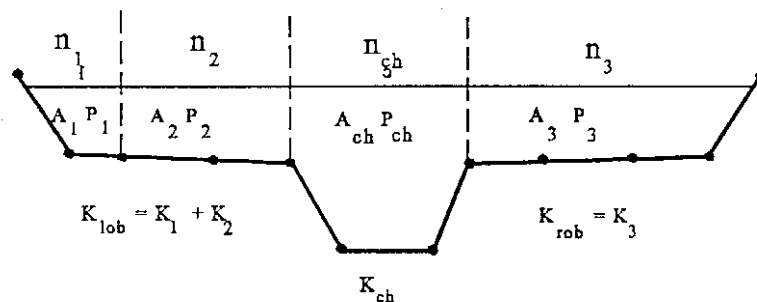

Figura 3 Suddivisione in sottosezione con eguale velocità della corrente

Dalla precedente relazione pertanto il coefficiente di ragguaglio risulta quindi:

$$\alpha = \frac{\sum_{i=1}^n Q_i \cdot V_i^2}{Q \cdot V^2} \quad (5)$$

L'incognita della (1) è la quota idrometrica (Y+Z), che il programma di calcolo determina con il metodo della secante applicato all'equazione del bilancio energetico.

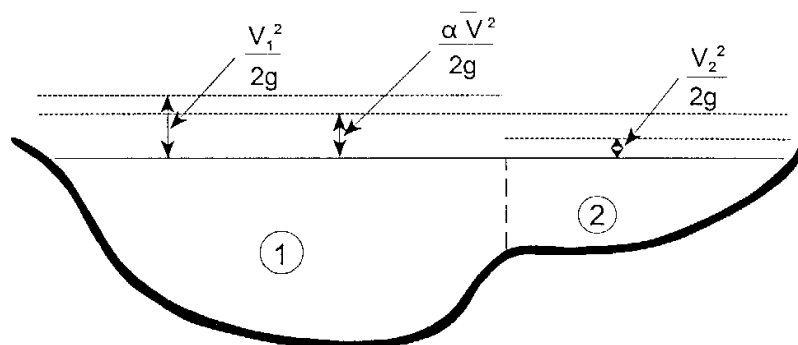
La procedura risulta iterativa e si svolge attraverso i seguenti passi:

- Si assume una quota idrica $(Y+Z)_{ass.2}^1$ di primo tentativo per la sezione incognita, di monte nel caso di moto lento o di valle per corrente rapida;
- Basandosi sull'assunzione della quota idrica si determinano i corrispondenti termini cinetici;
- Valutata la pendenza J, si risolve l'equazione per calcolare le perdite h_e nel tratto;
- Dai valori ottenuti viene effettuato il calcolo della corrispondente quota idrica da confrontare con la quota assunta all'inizio del processo iterativo determinando l'errore commesso.

Il programma ripeterà i passaggi descritti fino al momento in cui l'errore risulterà minore della tolleranza, imposta di default come 0.003 m.

Le equazioni utilizzate per i primi due tentativi sono:

$$(Y + Z)_{calc.2}^1 = E_1 + h_e - \left(\alpha \frac{V^2}{2g} \right)_2 \quad (6)$$

Equazione per la determinazione della quota calcolata:

$$err^1 = (Y + Z)_{ass.2}^1 - (Y + Z)_{calc.2}^1 = E_2 - (E_1 + h_e) \quad (7)$$

Errore della prima iterazione:

$$(Y + Z)_{ass.2}^2 = (Y + Z)_{ass.2}^1 - 0.70 \cdot err^1 \quad (8)$$

Valore assunto per la seconda iterazione:

$$err^2 = (Y + Z)_{ass.2}^2 - (Y + Z)_{calc.2}^2 = E_2 - (E_1 - h_e) \quad (9)$$

Errore della seconda iterazione.

Mentre per il calcolo dei tentativi successivi viene applicata la formula del metodo della secante, nella forma:

$$(Y+Z)_{ass.2}^I = (Y+Z)_{ass.2}^{I-1} - err^{I-1} \cdot \frac{(Y+Z)_{ass.2}^{I-1} - (Y+Z)_{ass.2}^{I-2}}{err^{I-1} - err^{I-2}} \quad (10)$$

Nel caso in cui il numero delle iterazioni necessarie raggiunga il valore massimo impostato (20 di default) senza soddisfare la tolleranza, si confronterà con la quota $(Y+Z)_{crit}$, corrispondente alle condizioni critiche della sezione, il valore della quota al quale nelle varie iterazioni compiute corrisponde il valore minimo di errore, $(Y+Z)_{min_err}$.

Se da tale confronto risulta un corretto posizionamento della quota rispetto la quota critica ($(Y+Z)_{min_err} > (Y+Z)_{crit}$ per profili in corrente lenta e $(Y+Z)_{min_err} < (Y+Z)_{crit}$ per profili in corrente veloce) e l'errore associato a $(Y+Z)_{min_err}$ sia inferiore ad una seconda tolleranza impostata maggiore della precedente (0.1 di default), il valore $(Y+Z)_{min_err}$ è assunto come soluzione; nel caso in cui, invece, l'errore corrispondente non soddisfi la seconda tolleranza oppure la posizione risulti non corretta rispetto alla quota critica, la soluzione assunta è l'altezza critica.

Si osserva dunque che indipendentemente dal tipo di condizione imposta per la risoluzione del moto del profilo, moto subcritico o moto supercritico, il profilo può risultare costituito da tratti validi con il pelo libero superiore alla quota critica, intervallati da altri tratti in cui il profilo coincide con quest'ultima.

1.2 EQUAZIONE DELLA CONSERVAZIONE DELLA QUANTITÀ DI MOTO

L'equazione della conservazione dell'energia totale (1) ha validità solo nel caso di correnti gradualmente variate all'interno del ramo in esame. In particolare viene applicata nel caso di corrente ovunque subcritiche o supercritiche. Qualora all'interno di un ramo si verificasse il passaggio da corrente veloce a lenta, con perdita della gradualità del movimento, è necessario impostare una risoluzione del codice di calcolo tramite un regime di corrente mista. Per tale metodo di calcolo è necessario assegnare due condizioni al contorno: una a monte ed una a valle. In tal caso la determinazione del profilo avviene secondo un procedimento nel quale si utilizza il teorema della quantità di moto per la localizzazione dell'eventuale risalto idraulico.

La grandezza che regola il regime di corrente mista è la spinta totale composta dalla spinta idrostatica (P_i) e idrodinamica della corrente ($Q\rho\Delta V$).

$$S_{tot} = \gamma \bar{A} Y \cos \theta + Q\rho V_x \quad (10)$$

Applicando l'equazione globale dell'equilibrio dinamico al volume di controllo compreso tra le sezioni 1-2, in cui la corrente si suppone gradualmente variata, (Figura 4) e proiettandola lungo l'asse x, si ottiene

$$P_2 - P_1 + W_x - F_f = Q\rho\Delta V_x \quad (11)$$

dove si è indicato con

P_i , spinta idrostatica sulla sezione i ;

W_x , componente della forza peso nella direzione del moto;

F_f , forza d'attrito lungo la superficie di contorno del volume di controllo;

Q , portata complessiva (supposta costante);

ρ , densità del fluido;

ΔV_x , variazione della velocità tra le due sezioni.



Figura 4 Schema di calcolo

I termini idrostatici per pendenze dell'ordine di 1 a 10 sono valutabili come

$$P = \gamma \bar{A} \bar{Y} \cos \theta \cong \gamma \bar{A} \bar{Y} \quad (12)$$

potendo porre, per le pendenze in esame, $\cos \theta = 1$.

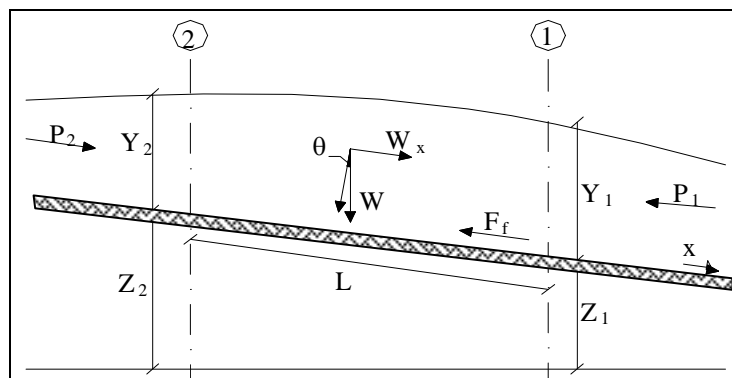
Nella relazione (12) γ corrisponde al peso specifico del fluido, A l'area della sezione ed \bar{Y} l'altezza del pelo libero nel baricentro della sezione.

La componente della forza peso, noto il peso specifico del fluido, la lunghezza L del tronco e l'area totale di fluido presente, è stata valutata nel modo seguente:

$$W = \gamma \left(\frac{A_1 + A_2}{2} \right) \cdot L \Rightarrow W_x = W \cdot \sin \theta \quad (13)$$

La forza d'attrito F_f è funzione delle caratteristiche del fluido come la densità dell'acqua, l'azione tangenziale che si esplica sul letto del fiume e la cadente piezometrica J .

In particolare:

$$F_f = \tau PL$$

$$\tau = \gamma RJ \Rightarrow F_f = \gamma \frac{A}{P} J PL = \gamma \left(\frac{A_1 + A_2}{2} \right) \cdot JL \quad (14)$$

dove P ed R sono rispettivamente il perimetro bagnato ed il raggio idraulico della sezione.

La soluzione dell'equazione (10) avviene per iterazioni successive. Vengono quindi calcolati tutti i profili sia in regime di corrente subcritica, partendo dalla sezione di valle e procedendo a ritroso fino alla sezione di monte, sia in regime supercritico partendo dalla sezione di monte con la condizione imposta, determinando nel primo caso $S_{tot,sub}$ e nel secondo $S_{tot,super}$. Le sezioni in cui la soluzione è posta uguale alla quota critica $(Y+Z)_{crit}$ vengono salvate in memoria.

Successivamente si controlla che $S_{tot,super}$ sia maggiore della $S_{tot,sub}$. Se risulta $S_{tot,super} > S_{tot,sub}$ allora è valida la condizione supercritica ed inizia il calcolo del profilo di corrente veloce verso valle controllando che in ogni sezione permanga verificata la disuguaglianza.

Se invece nella sezione di monte è $S_{tot,super} < S_{tot,sub}$, è valida la soluzione subcritica, e il programma ricerca la prima sezione verso valle, conservata in memoria, in cui la soluzione in regime subcritico era stata posta uguale alla quota critica. Da qui ha inizio il calcolo di un profilo di corrente rapida verso valle che è valido finché non si arriva ad una sezione con una soluzione subcritica alla quale corrisponde una $S_{tot,super} < S_{tot,sub}$.

Si assume quindi che, fra questa sezione e quella precedente si verifichi un risalto idraulico, con transizione da corrente veloce a corrente lenta e si prosegue con lo stesso criterio fino ad arrivare alla sezione di valle.

Nella Figura 5 è rappresentata una parte del profilo dove si verifica il passaggio dal regime supercritico a quello subcritico, che può verificarsi in regime di corrente mista.



Figura 5 Profilo calcolato in regime di corrente mista

Le equazioni (1) e (11) sono state applicate anche alle sezioni caratterizzate dalla presenza di un ponte. E' stato sufficiente suddividere il tratto interessato in più sezioni e ripetere per la successione di esse l'analisi svolta per il tratto delimitato da sole due sezioni.

Prendendo un tratto caratterizzato dalla presenza di un ponte, Figura 4 e Figura 5, si evidenziano 3 zone:

- una zona di contrazione;
- una zona intermedia interessata dalla presenza del ponte;
- una zona di espansione.

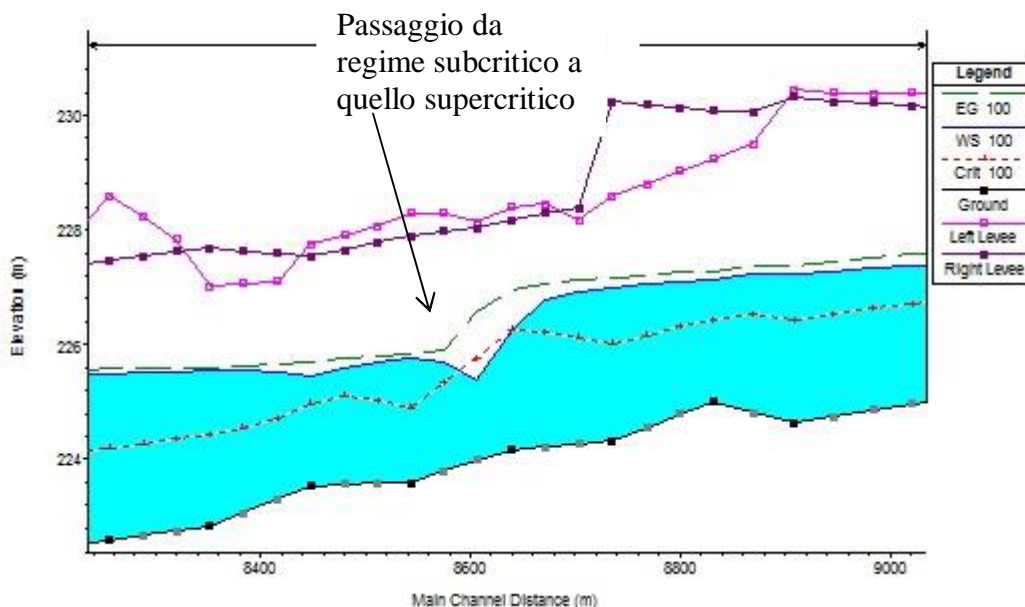

Figura 5 Pianta schematica di un attraversamento fluviale

L'applicazione dell'equazione della conservazione della quantità di moto tra le sezioni 1-2 e 3-4 è del tutto analoga alla situazione vista in precedenza mentre la presenza del ponte comporta termini nuovi nella valutazione dell'equilibrio tra le sezioni 2-BD (Step 1), BD-BU (Step 2) ed BU-3 (Step 3).

Step 1; definendo con A_{pi} l'area ostruita ed con Y_{pi} la distanza verticale che intercorre tra il baricentro delle pile e la superficie libera nella zona di valle, l'espressione del bilancio è la seguente:

$$\frac{Q_{BD}^2 \beta_{BD}}{g A_{BD}} + A_{BD} Y_{BD} = \frac{Q_2^2 \beta_2}{g A_2} + A_2 Y_2 - A_{p_{BD}} Y_{p_{BD}} + F_f - W_x \quad (15)$$

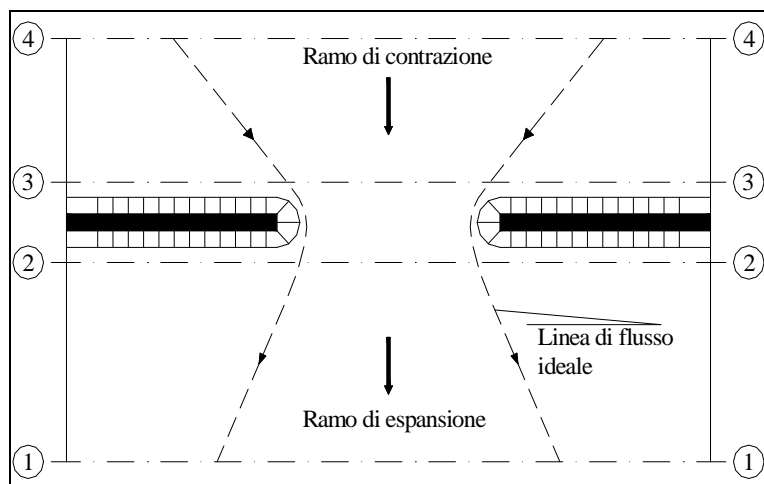
Step 2; equilibrio tra BU e BD:

$$\frac{Q_{BD}^2 \beta_{BD}}{g A_{BD}} + A_{BD} Y_{BD} + F_f - W_x = \frac{Q_{BU}^2 \beta_{BU}}{g A_{BU}} + A_{BU} Y_{BU} \quad (16)$$

Step 3 ; equilibrio tra BU e 3:

$$\frac{Q_3^2 \beta_3}{gA_3} + A_3 Y_3 = \frac{Q_{BU}^2 \beta_{BU}}{gA_{BU}} + A_{BU} Y_{BU} - A_{P_{BU}} Y_{P_{BU}} + F_f - W_x + \frac{1}{2} C_D \frac{A_{P_{BU}} Q_3^2}{gA_3^2} \quad (17)$$

con C_D coefficiente di resistenza idrodinamica intorno alla pila ricavabile dalla tab. 2 in funzione del tipo di pila presente.



Figura 6 Sezione schematica di un attraversamento fluviale

Tabella 2 - Coefficiente di resistenza idrodinamico C_D

TIPO DI PILA	C_D
Pila circolare	1.2
Pila allungata con punta semicircolare	1.33
Pila ellittica con rapporto assi 2 :1	0.6
Pila ellittica con rapporto assi 4 :1	0.32
Pila ellittica con rapporto assi 8 :1	0.29
Pila rettangolare	2.00
Pila triangolare con apertura $\alpha = 30^\circ$	1.00
Pila triangolare con apertura $\alpha = 60^\circ$	1.39
Pila triangolare con apertura $\alpha = 90^\circ$	1.60
Pila triangolare con apertura $\alpha = 120^\circ$	1.72

In alternativa all'equazione della conservazione della quantità di moto il software permette anche di utilizzare l'equazione di Yarnell (non utilizzata per i casi specifici) che permette di valutare le perdite di energia localizzate in corrispondenza di un ponte.

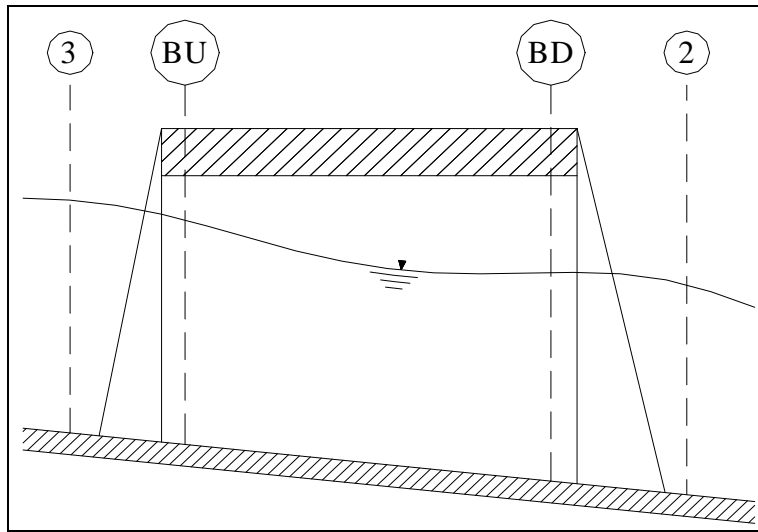
Con riferimento alle Figura 4 e Figura 5, le perdite di energia tra le sezioni 2 e 3 sono state valutate nel modo seguente:

$$H_{3-2} = 2K(K + 10\omega - 0.6) \cdot (\alpha + 15\alpha^4) \cdot \frac{V_2^2}{2g} \quad (18)$$

dove H_{i-j} rappresenta appunto la perdita di energia nel passaggio della corrente attraverso la sezione ostruita e K , coefficiente di Yarnell, tiene conto delle differenti sagome di pila esistenti, tabella 3;

Tabella 3 - Coefficiente di Yarnell

TIPO DI PILA	K
Pila semicircolare in punta	0.9
Pila cilindrica doppia collegata con diaframma	0.95
Pila cilindrica doppia senza diaframma	1.05
Pila con punta triangolare $\alpha = 90^\circ$	1.05
Pile rettangolari	1.25
Dieci pile a cavalletto inclinate	2.5

ω rappresenta il rapporto tra l'altezza ed il tirante della sezione 2; α il rapporto tra l'area ostruita dalle pile e l'area totale ed infine V_2 la velocità a valle della sezione.

Il modello elaborato prevede una corrente con un'altezza idrica minore dell'altezza di intradosso del ponte. Nel caso di correnti con altezza idrica superiore o eguale alla quota di intradosso dell'attraversamento fluviale, la valutazione delle perdite di energia è effettuata attraverso il calcolo della portata che attraversa la sezione. In particolare, in riferimento ad un caso generico, Figura 6, la portata è calcolata nel modo seguente:

$$Q = C_d A_1 \left[2g \left(Y_1 - \frac{Z}{2} + \frac{\alpha_1 V_1^2}{2g} \right) \right]^{1/2} \quad (19)$$

dove

C_d , coefficiente di deflusso il cui andamento è riportato nel grafico di Figura 7, assumendo valori tra 0,27 e 0,5;

A_1 , area della luce nella sezione di monte;

Y_1 , altezza idrica della sezione di monte;

α , coefficiente correttivo cinetico;

V_1 , velocità della corrente a monte.



Figura 7 Sezione schematica di un ponte – Schema di calcolo



Figura 8 Diagramma per la stima del coefficiente di deflusso Cd

Se il ponte è in pressione sia a monte che a valle l'equazione (19) è corretta nel modo seguente:

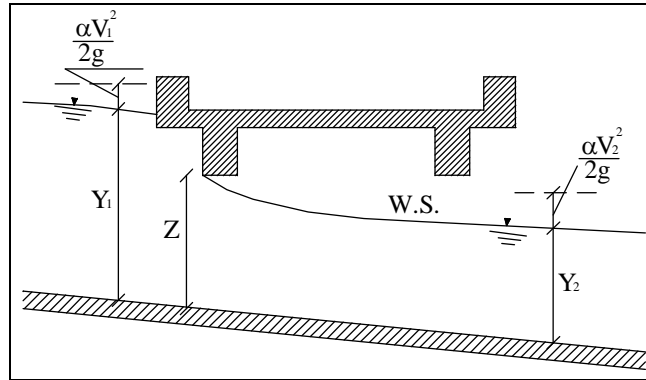
$$Q = CA\sqrt{2gH} \quad (20)$$

dove C assume il valore di 0.8 ed H coincide con la perdita di energia totale tra la sezione di monte e di valle del ponte come indicato in Figura 9.

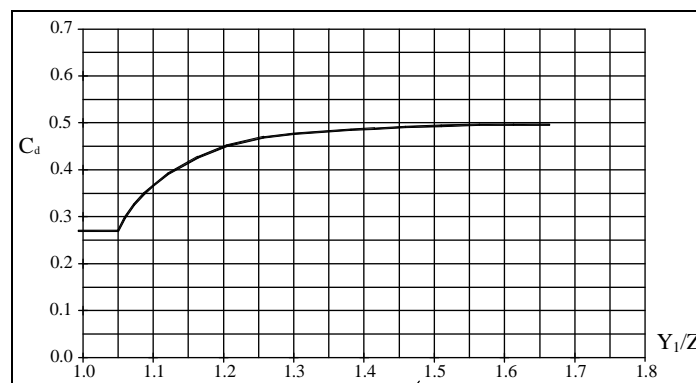

Figura 9 Sezione schematica di un ponte – Schema di calcolo

Infine se il ponte è superato dalla corrente di piena, Figura 10, la portata si calcola nel modo seguente:

$$Q = CLH^{2/3} \quad (21)$$

con C si indica un coefficiente correttivo della portata, L la lunghezza del ponte ed H la differenza di energia tra monte e valle.

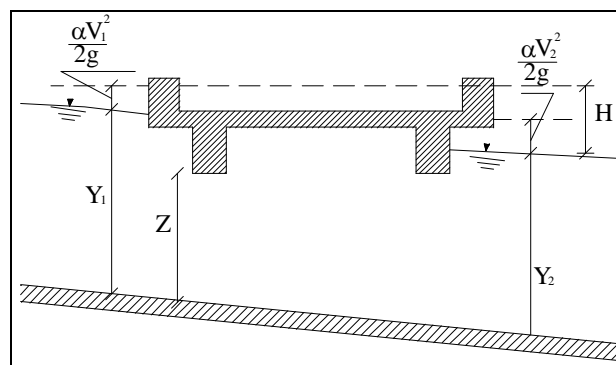

Figura 10 Sezione schematica di un ponte – Schema di calcolo

ALLEGATO 2

RISULTATI SIMULAZIONI DELLE INTERFERENZE
IDRAULICHE E DELLE INALVEAZIONI

ALLEGATO 2.1

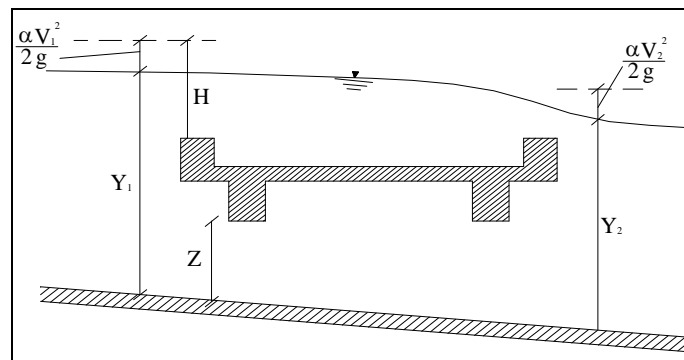
Interferenza idraulica - T001
Tabella riassuntiva dei risultati, profilo idrico e sezioni
trasversali con i livelli idrici (TR 200 - 500 anni)

HEC-RAS Plan: POST_agg River: TO01 Reach: TO01 Profile: TR 200 (CN 91)

Reach	River Sta	Profile	Q Total (m3/s)	Min Ch El (m)	Max Chl Dpth (m)	W.S. Elev (m)	Crit W.S. (m)	Diff	Froude # Chl	E.G. Elev (m)	Vel Chnl (m/s)	Vel Total (m/s)	Hydr Radius C (m)	Shear Chan (N/m2)	Hydr Depth (m)
TO01	0	TR 200 (CN 91)	10.4	206.80	0.64	207.44	207.62	-0.18	1.64	208.00	4.0	2.8	0.6	172.1	0.28
TO01	-25	TR 200 (CN 91)	10.4	205.73	0.81	206.54	206.75	-0.21	1.54	207.25	4.0	3.2	0.6	167.0	0.27
TO01	-50	TR 200 (CN 91)	10.4	204.65	0.82	205.47	205.78	-0.31	1.72	206.40	4.3	4.0	0.6	202.8	0.42
TO01	-62	TR 200 (CN 91)	10.4	204.14	0.84	204.98	205.31	-0.33	1.73	205.94	4.3	4.3	0.5	204.4	0.65
TO01	-71.35	TR 200 (CN 91)	10.4	203.94	0.87	204.81	204.99	-0.18	1.35	205.58	3.9	3.9	0.6	161.2	0.84
TO01	-81.77	Bridge													
TO01	-91.35	TR 200 (CN 91)	10.4	203.74	0.92	204.66	204.79	-0.13	1.24	205.34	3.7	3.7	0.6	141.3	0.89
TO01	-98	TR 200 (CN 91)	10.4	203.67	1.14	204.82	204.82	0.00	1.01	205.24	2.9	2.9	0.7	83.4	0.84
TO01	-126	TR 200 (CN 91)	10.4	203.36	1.51	204.87	204.18	0.69	0.16	204.88	0.6	0.5	1.1	2.8	0.74
TO01	-155	TR 200 (CN 91)	10.4	203.30	1.56	204.86	204.01	0.85	0.14	204.88	0.5	0.5	1.1	2.3	1.03
TO01	-177	TR 200 (CN 91)	10.4	203.26	1.32	204.58	204.40	0.18	0.77	204.86	2.4	2.3	0.8	53.7	0.75
TO01	-185.47	TR 200 (CN 91)	10.4	203.19	1.22	204.41	204.24	0.17	0.80	204.79	2.7	2.7	0.7	73.4	1.18
TO01	-207.67	Bridge													
TO01	-232.97	TR 200 (CN 91)	10.4	202.71	0.92	203.63	203.76	-0.13	1.24	204.31	3.7	3.7	0.6	141.4	0.89
TO01	-240.25	TR 200 (CN 91)	10.4	202.50	0.96	203.46	203.64	-0.18	1.36	204.14	3.6	3.6	0.6	138.4	0.73
TO01	-260	TR 200 (CN 91)	10.4	199.50	0.52	200.03	200.67	-0.64	3.78	203.11	7.8	7.7	0.4	741.1	0.40
TO01	-285.5	TR 200 (CN 91)	10.4	198.04	0.70	198.74	199.18	-0.44	2.33	200.26	5.5	5.5	0.5	335.5	0.56
TO01	-295	TR 200 (CN 91)	10.4	197.51	0.73	198.24	198.66	-0.42	2.18	199.62	5.2	5.2	0.5	302.3	0.58
TO01	-301.02	TR 200 (CN 91)	10.4	197.35	0.71	198.06	198.40	-0.34	1.81	199.21	4.7	4.7	0.5	250.1	0.70
TO01	-312.5	Bridge													
TO01	-323.52	TR 200 (CN 91)	10.4	197.13	1.33	198.46	198.18	0.28	0.70	198.78	2.5	2.5	0.7	60.5	1.28
TO01	-327	TR 200 (CN 91)	10.4	197.11	1.36	198.47	198.26	0.21	0.74	198.74	2.3	2.3	0.8	50.7	0.97
TO01	-344	TR 200 (CN 91)	10.4	197.00	1.36	198.36	198.14	0.22	0.73	198.62	2.3	2.3	0.8	49.2	0.97
TO01	-369	TR 200 (CN 91)	10.4	196.84	1.35	198.19	197.98	0.21	0.75	198.46	2.3	2.3	0.8	50.5	0.96
TO01	-378	TR 200 (CN 91)	10.4	196.79	1.32	198.11	197.93	0.18	0.78	198.40	2.4	2.4	0.8	53.8	0.95
TO01	-384.49	TR 200 (CN 91)	10.4	196.73	1.22	197.95	197.78	0.17	0.80	198.33	2.7	2.7	0.7	73.4	1.18
TO01	-398.8	Bridge													
TO01	-414.49	TR 200 (CN 91)	10.4	196.43	0.92	197.35	197.48	-0.13	1.24	198.03	3.7	3.7	0.6	141.4	0.89
TO01	-420	TR 200 (CN 91)	10.4	196.34	1.06	197.40	197.48	-0.08	1.15	197.92	3.2	3.2	0.7	103.7	0.79
TO01	-443	TR 200 (CN 91)	10.4	195.65	0.87	196.52	197.02	-0.50	1.62	197.40	4.2	4.2	0.6	184.7	0.67
TO01	-458	TR 200 (CN 91)	10.4	195.21	0.89	196.10	196.45	-0.35	1.55	196.92	4.0	4.0	0.6	170.5	0.68
TO01	-469.07	TR 200 (CN 91)	10.4	194.88	0.82	195.70	195.95	-0.25	1.47	196.56	4.1	4.1	0.5	183.3	0.80
TO01	-475.18	Bridge													
TO01	-481.36	TR 200 (CN 91)	10.4	194.71	0.86	195.57	195.77	-0.20	1.37	196.36	4.0	4.0	0.6	166.2	0.84
TO01	-493.6	TR 200 (CN 91)	10.4	194.42	0.68	195.10	195.40	-0.30	1.72	195.96	4.1	4.0	0.5	187.2	0.38
TO01	-507.71	TR 200 (CN 91)	10.4	194.08	0.70	194.78	195.01	-0.23	1.57	195.49	3.8	3.3	0.5	158.8	0.22
TO01	-522	TR 200 (CN 91)	17.7	192.76	0.90	193.66	194.06	-0.40	1.89	194.96	5.1	5.1	0.6	263.4	0.73
TO01	-532.8	TR 200 (CN 91)	17.7	192.50	0.96	193.46	193.80	-0.34	1.68	194.56	4.6	4.6	0.7	217.0	0.77
TO01	-557.8	TR 200 (CN 91)	17.7	191.91	1.04	192.95	193.21	-0.26	1.46	193.84	4.2	4.2	0.7	172.7	0.83
TO01	-585.29	TR 200 (CN 91)	17.7	191.26	1.06	192.32	192.56	-0.24	1.43	193.18	4.1	4.1	0.7	166.7	0.84
TO01	-587.33	TR 200 (CN 91)	17.7	189.96	0.69	190.65	191.26	-0.61	2.89	193.09	6.9	6.9	0.5	526.9	0.58
TO01	-599	TR 200 (CN 91)	17.7	189.84	0.82	190.66	191.14	-0.48	2.18	192.27	5.6	5.6	0.6	289.9	0.68
TO01	-612.8	TR 200 (CN 91)	17.7	189.71	0.96	190.67	191.01	-0.34	1.67	191.76	4.6	4.6	0.7	187.7	0.77
TO01	-616.32	TR 200 (CN 91)	17.7	189.67	0.86	190.53	190.85	-0.32	1.61	191.65	4.7	4.7	0.6	198.6	0.86
TO01	-628.25	Bridge													
TO01	-640.18	TR 200 (CN 91)	17.7	189.43	0.94	190.37	190.61	-0.24	1.41	191.31	4.3	4.3	0.7	162.4	0.94
TO01	-645	TR 200 (CN 91)	17.7	189.38	1.16	190.54	190.68	-0.14	1.22	191.22	3.6	3.6	0.8	111.3	0.91
TO01	-662.8	TR 200 (CN 91)	17.7	189.20	1.30	190.50	190.51	-0.01	1.01	191.01	3.2	3.2	0.8	81.4	0.93
TO01	-687.8	TR 200 (CN 91)	17.7	188.95	1.25	190.20	190.36	-0.16	1.03	190.74	3.3	3.1	0.9	99.3	0.61
TO01	-712.8	TR 200 (CN 91)	17.7	188.70	0.87	189.57	189.79	-0.22	1.52	190.31	4.2	3.1	0.7	176.4	0.31

HEC-RAS Plan: TO01-TRIS River: TO01-TRIS Reach: TO01-TRIS Profile: TR 200

Reach	River Sta	Profile	Q Total (m3/s)	Min Ch El (m)	Max Chl Dpth (m)	W.S. Elev (m)	Crit W.S. (m)	Diff	Froude # Chl	E.G. Elev (m)	Vel Chnl (m/s)	Vel Total (m/s)	Hydr Radius C (m)	Shear Chan (N/m2)	Hydr Depth (m)
TO01-TRIS	-10	TR 200	5.5	200.55	0.30	200.85	200.85	0.00	1.00	200.95	1.4	1.4	0.2	29.3	0.19
TO01-TRIS	-25	TR 200	5.5	199.22	0.56	199.78	200.01	-0.23	1.80	200.52	3.8	3.8	0.4	174.3	0.46
TO01-TRIS	-32	TR 200	5.5	198.43	0.46	198.89	199.22	-0.33	2.44	200.06	4.8	4.8	0.3	287.7	0.39
TO01-TRIS	-34	TR 200	5.5	198.30	0.62	198.92	199.20	-0.28	1.76	199.85	4.3	4.3	0.4	220.5	0.60
TO01-TRIS	-39	Bridge													
TO01-TRIS	-44	TR 200	5.5	198.09	0.67	198.76	198.99	-0.23	1.58	199.56	4.0	4.0	0.4	187.3	0.64
TO01-TRIS	-48	TR 200	5.5	197.75	0.48	198.23	198.54	-0.31	2.31	199.30	4.6	4.6	0.4	261.7	0.40
TO01-TRIS	-75	TR 200	5.5	195.98	0.51	196.49	196.84	-0.35	2.10	197.42	4.3	4.3	0.4	224.9	0.42
TO01-TRIS	-100	TR 200	5.5	194.81	0.57	195.38	195.69	-0.31	1.75	196.09	3.7	3.7	0.4	167.2	0.47
TO01-TRIS	-125	TR 200	5.5	194.02	0.64	194.66	194.82	-0.16	1.43	195.19	3.2	3.2	0.4	120.5	0.52

HEC-RAS Plan: POST_agg River: TO01 Reach: TO01 Profile: TR 500 (CN 91)

Reach	River Sta	Profile	Q Total (m3/s)	Min Ch El (m)	Max Chl Dpth (m)	W.S. Elev (m)	Crit W.S. (m)	Diff	Froude # Chl	E.G. Elev (m)	Vel Chnl (m/s)	Vel Total (m/s)	Hydr Radius C (m)	Shear Chan (N/m2)	Hydr Depth (m)
TO01	0	TR 500 (CN 91)	12.3	206.80	0.68	207.48	207.66	-0.18	1.65	208.07	4.2	2.9	0.6	183.0	0.29
TO01	-25	TR 500 (CN 91)	12.3	205.73	0.85	206.58	206.81	-0.23	1.55	207.32	4.2	3.2	0.6	177.6	0.29
TO01	-50	TR 500 (CN 91)	12.3	204.65	0.89	205.54	205.87	-0.33	1.68	206.50	4.5	4.0	0.6	207.3	0.45
TO01	-62	TR 500 (CN 91)	12.3	204.14	1.57	205.71	205.37	0.34	0.41	205.79	1.5	1.1	1.1	18.3	0.58
TO01	-71.35	TR 500 (CN 91)	12.3	203.94	1.38	205.32	205.11	0.21	0.79	205.73	2.8	2.8	0.7	78.4	1.32
TO01	-81.77	Bridge													
TO01	-91.35	TR 500 (CN 91)	12.3	203.74	1.02	204.76	204.92	-0.16	1.25	205.53	3.9	3.9	0.6	156.6	0.98
TO01	-98	TR 500 (CN 91)	12.3	203.67	1.26	204.93	204.93	0.00	1.01	205.39	3.0	3.0	0.7	88.1	0.91
TO01	-126	TR 500 (CN 91)	12.3	203.36	1.68	205.04	204.22	0.82	0.14	205.05	0.6	0.5	1.3	2.5	0.90
TO01	-155	TR 500 (CN 91)	12.3	203.30	1.73	205.03	204.05	0.98	0.14	205.05	0.5	0.5	1.3	2.3	1.11
TO01	-177	TR 500 (CN 91)	12.3	203.26	1.56	204.82	204.53	0.29	0.64	205.04	2.1	1.9	0.9	41.1	0.63
TO01	-185.47	TR 500 (CN 91)	12.3	203.19	1.38	204.57	204.36	0.21	0.79	204.98	2.8	2.8	0.7	78.4	1.32
TO01	-207.67	Bridge													
TO01	-232.97	TR 500 (CN 91)	12.3	202.71	1.02	203.73	203.88	-0.15	1.25	204.50	3.9	3.9	0.6	156.6	0.98
TO01	-240.25	TR 500 (CN 91)	12.3	202.50	1.03	203.53	203.75	-0.22	1.42	204.31	3.9	3.9	0.6	156.9	0.77
TO01	-260	TR 500 (CN 91)	12.3	199.50	0.59	200.09	200.74	-0.65	3.64	203.26	7.9	7.8	0.4	740.7	0.43
TO01	-285.5	TR 500 (CN 91)	12.3	198.04	0.77	198.81	199.29	-0.48	2.36	200.49	5.7	5.7	0.5	362.6	0.60
TO01	-295	TR 500 (CN 91)	12.3	197.51	0.80	198.31	198.77	-0.46	2.22	199.84	5.5	5.5	0.5	328.0	0.62
TO01	-301.02	TR 500 (CN 91)	12.3	197.35	0.80	198.15	198.52	-0.37	1.81	199.42	5.0	5.0	0.5	270.8	0.78
TO01	-312.5	Bridge													
TO01	-323.52	TR 500 (CN 91)	12.3	197.13	1.44	198.57	198.30	0.27	0.73	198.95	2.7	2.7	0.8	70.4	1.38
TO01	-327	TR 500 (CN 91)	12.3	197.11	1.50	198.61	198.37	0.24	0.74	198.89	2.4	2.4	0.8	52.5	1.05
TO01	-344	TR 500 (CN 91)	12.3	197.00	1.51	198.51	198.26	0.25	0.72	198.78	2.3	2.3	0.8	49.9	1.06
TO01	-369	TR 500 (CN 91)	12.3	196.84	1.53	198.37	198.10	0.27	0.70	198.63	2.3	2.3	0.9	48.0	1.07
TO01	-378	TR 500 (CN 91)	12.3	196.79	1.53	198.32	198.05	0.27	0.70	198.58	2.3	2.3	0.9	48.2	1.07
TO01	-384.49	TR 500 (CN 91)	12.3	196.73	1.38	198.11	197.91	0.20	0.79	198.52	2.8	2.8	0.7	78.4	1.32
TO01	-398.8	Bridge													
TO01	-414.49	TR 500 (CN 91)	12.3	196.43	1.02	197.45	197.60	-0.15	1.25	198.22	3.9	3.9	0.6	156.6	0.98
TO01	-420	TR 500 (CN 91)	12.3	196.34	1.11	197.45	197.77	-0.32	1.26	198.10	3.6	3.6	0.7	128.6	0.82
TO01	-443	TR 500 (CN 91)	12.3	195.65	0.98	196.63	197.06	-0.43	1.57	197.54	4.2	4.2	0.6	185.6	0.74
TO01	-458	TR 500 (CN 91)	12.3	195.21	0.98	196.19	196.50	-0.31	1.55	197.08	4.2	4.1	0.6	182.4	0.48
TO01	-469.07	TR 500 (CN 91)	12.3	194.88	1.77	196.65	196.06	0.59	0.18	196.67	0.7	0.5	1.2	4.7	0.77
TO01	-475.18	Bridge													
TO01	-481.36	TR 500 (CN 91)	12.3	194.71	0.97	195.68	195.89	-0.21	1.33	196.54	4.1	4.1	0.6	172.7	0.95
TO01	-493.6	TR 500 (CN 91)	12.3	194.42	0.72	195.14	195.45	-0.31	1.80	196.14	4.5	4.2	0.6	214.5	0.38
TO01	-507.71	TR 500 (CN 91)	12.3	194.08	0.73	194.81	195.06	-0.25	1.67	195.63	4.2	3.4	0.6	185.0	0.21
TO01	-522	TR 500 (CN 91)	20.9	192.76	1.02	193.78	194.19	-0.41	1.81	195.11	5.1	5.1	0.7	259.4	0.81
TO01	-532.8	TR 500 (CN 91)	20.9	192.50	1.08	193.58	193.94	-0.36	1.65	194.73	4.8	4.8	0.7	223.3	0.85
TO01	-557.8	TR 500 (CN 91)	20.9	191.91	1.15	193.06	193.35	-0.29	1.48	194.04	4.4	4.4	0.8	186.0	0.90
TO01	-585.29	TR 500 (CN 91)	20.9	191.26	1.16	192.42	192.70	-0.28	1.45	193.37	4.3	4.3	0.8	179.6	0.91
TO01	-587.33	TR 500 (CN 91)	20.9	189.96	0.78	190.74	191.40	-0.66	2.80	193.28	7.1	7.1	0.6	531.9	0.65
TO01	-599	TR 500 (CN 91)	20.9	189.84	0.91	190.75	191.28	-0.53	2.18	192.51	5.9	5.9	0.6	307.6	0.74
TO01	-612.8	TR 500 (CN 91)	20.9	189.71	1.05	190.76	191.15	-0.39	1.72	191.99	4.9	4.9	0.7	207.5	0.83
TO01	-616.32	TR 500 (CN 91)	20.9	189.67	0.97	190.64	191.00	-0.36	1.59	191.88	4.9	4.9	0.7	212.1	0.97
TO01	-628.25	Bridge													
TO01	-640.18	TR 500 (CN 91)	20.9	189.43	1.06	190.49	190.75	-0.26	1.41	191.54	4.5	4.5	0.7	177.1	1.06
TO01	-645	TR 500 (CN 91)	20.9	189.38	1.22	190.60	190.82	-0.22	1.32	191.44	4.0	4.0	0.8	135.2	0.95
TO01	-662.8	TR 500 (CN 91)	20.9	189.20	1.37	190.57	190.67	-0.10	1.09	191.19	3.5	3.5	0.9	98.5	0.90
TO01	-687.8	TR 500 (CN 91)	20.9	188.95	1.33	190.28	190.49	-0.21	1.07	190.90	3.5	3.2	0.9	113.0	0.58
TO01	-712.8	TR 500 (CN 91)	20.9	188.70	0.91	189.61	189.84	-0.23	1.60	190.43	4.5	3.4	0.7	202.1	0.35

HEC-RAS Plan: TO01-TRIS River: TO01-TRIS Reach: TO01-TRIS Profile: TR 500

Reach	River Sta	Profile	Q Total (m3/s)	Min Ch El (m)	Max Chl Dpth (m)	W.S. Elev (m)	Crit W.S. (m)	Diff	Froude # Chl	E.G. Elev (m)	Vel Chnl (m/s)	Vel Total (m/s)	Hydr Radius C (m)	Shear Chan (N/m2)	Hydr Depth (m)
TO01-TRIS	-10	TR 500	6.4	200.55	0.32	200.87	200.87	0.00	1.00	200.98	1.5	1.4	0.2	31.1	0.21
TO01-TRIS	-25	TR 500	6.4	199.22	0.64	199.86	200.09	-0.23	1.67	200.59	3.8	3.8	0.4	163.8	0.52
TO01-TRIS	-32	TR 500	6.4	198.43	0.52	198.95	199.30	-0.35	2.38	200.17	4.9	4.9	0.4	292.7	0.43
TO01-TRIS	-34	TR 500	6.4	198.30	0.72	199.02	199.29	-0.27	1.65	199.96	4.3	4.3	0.4	216.7	0.69
TO01-TRIS	-39	Bridge													
TO01-TRIS	-44	TR 500	6.4	198.09	0.74	198.83	199.08	-0.25	1.58	199.72	4.2	4.2	0.4	202.8	0.71
TO01-TRIS	-48	TR 500	6.4	197.75	0.53	198.28	198.62	-0.34	2.32	199.46	4.8	4.8	0.4	281.5	0.44
TO01-TRIS	-75	TR 500	6.4	195.98	0.56	196.54	196.90	-0.36	2.12	197.57	4.5	4.5	0.4	243.0	0.46
TO01-TRIS	-100	TR 500	6.4	194.81	0.62	195.43	195.76	-0.33	1.77	196.22	3.9	3.9	0.4	181.0	0.50
TO01-TRIS	-125	TR 500	6.4	194.02	0.70	194.72	195.04	-0.32	1.45	195.31	3.4	3.4	0.5	130.1	0.56

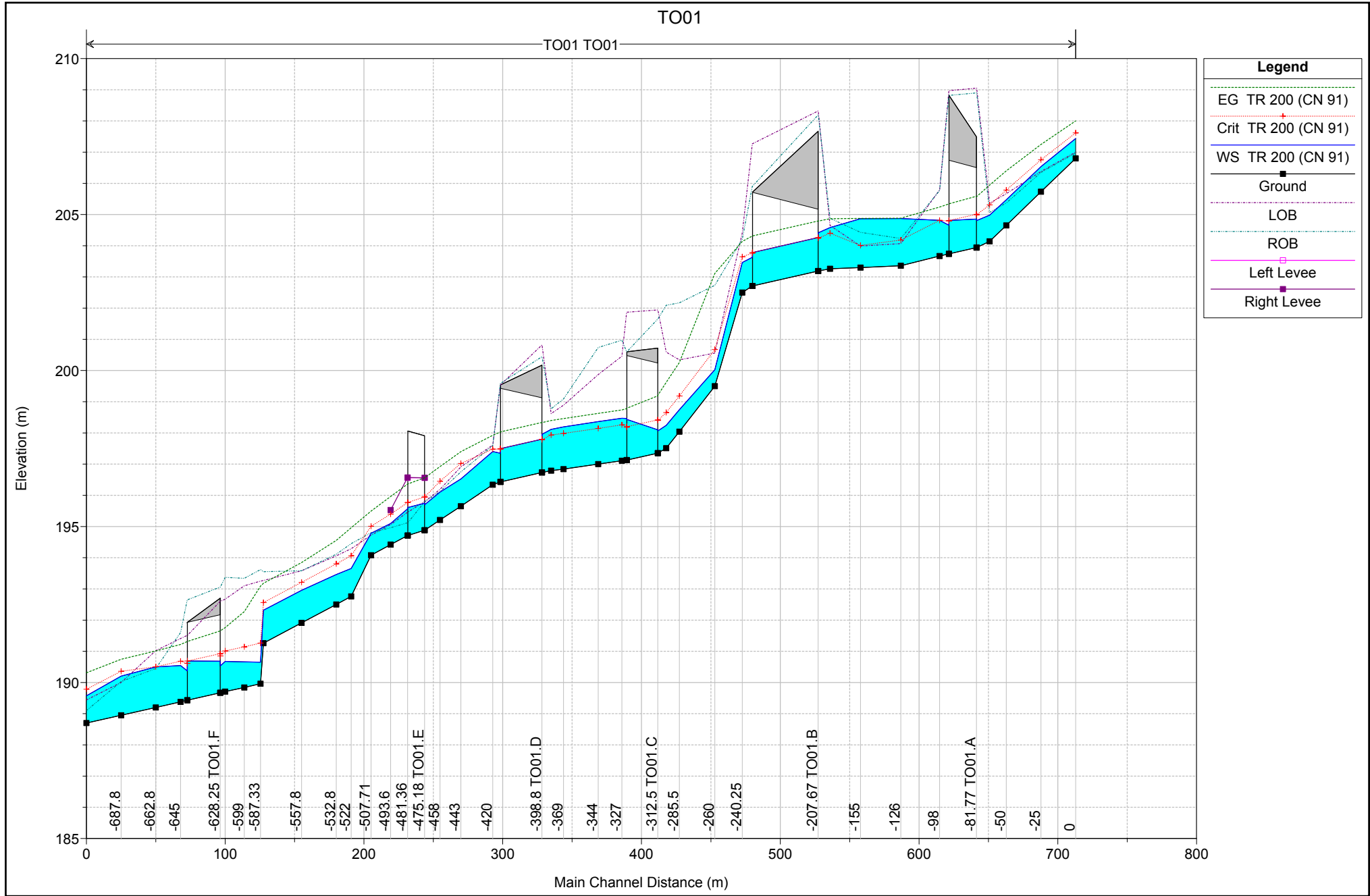

TO01-TRIS

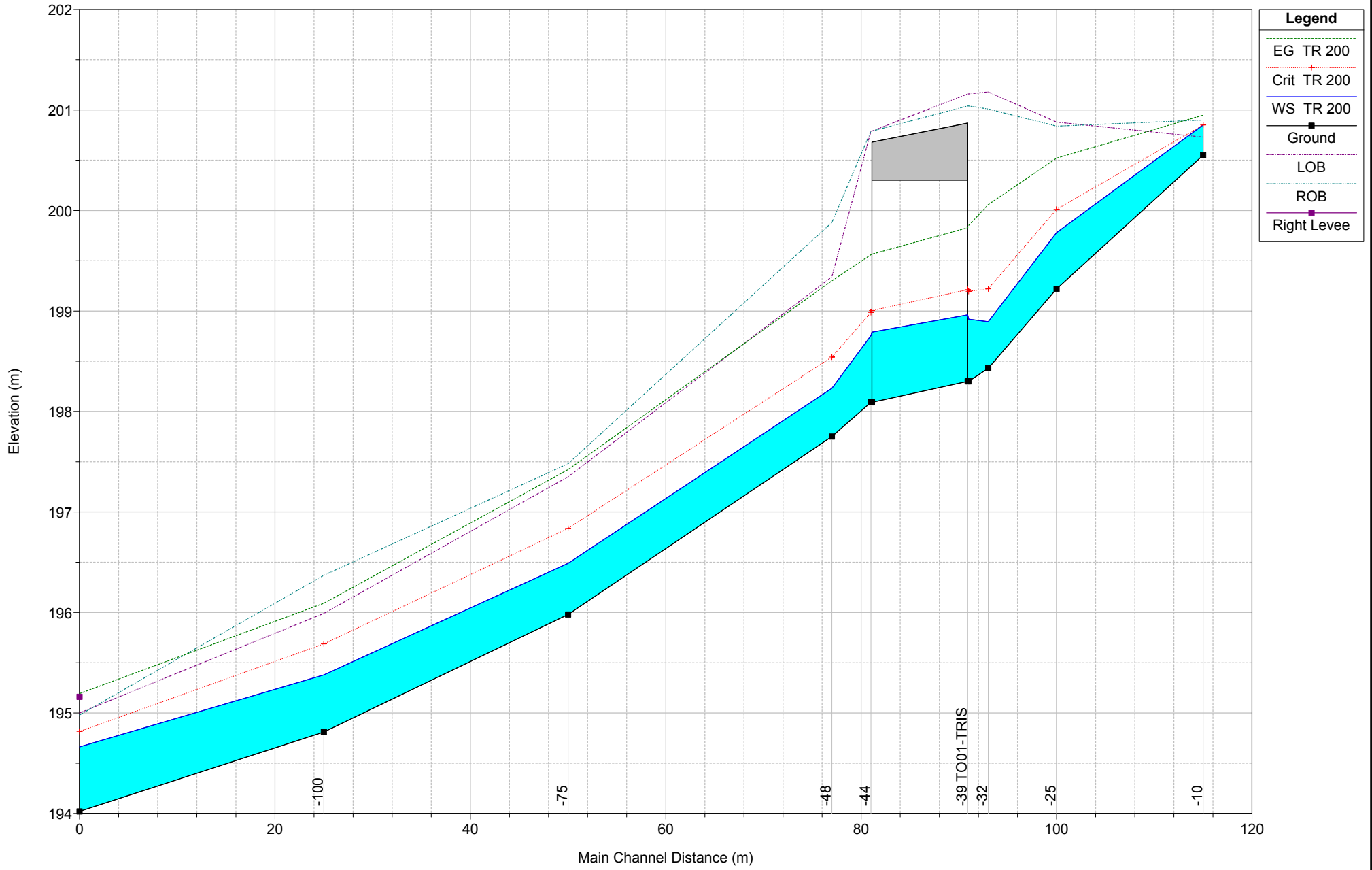

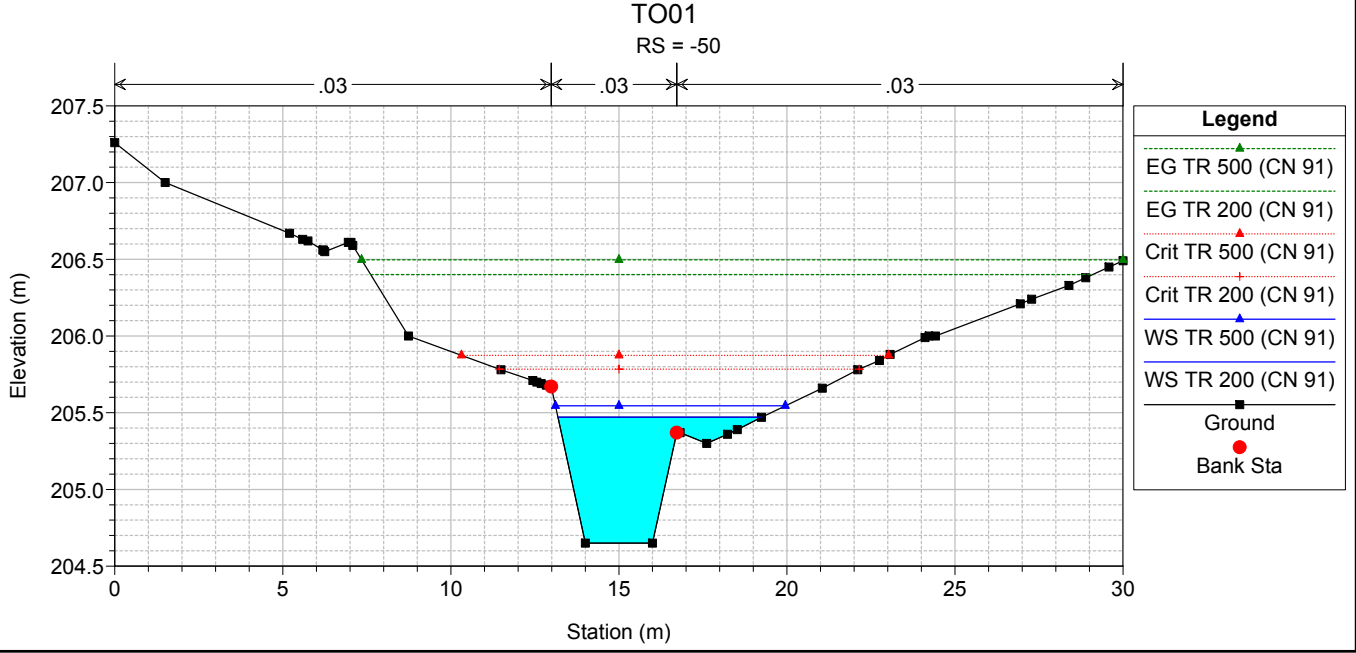
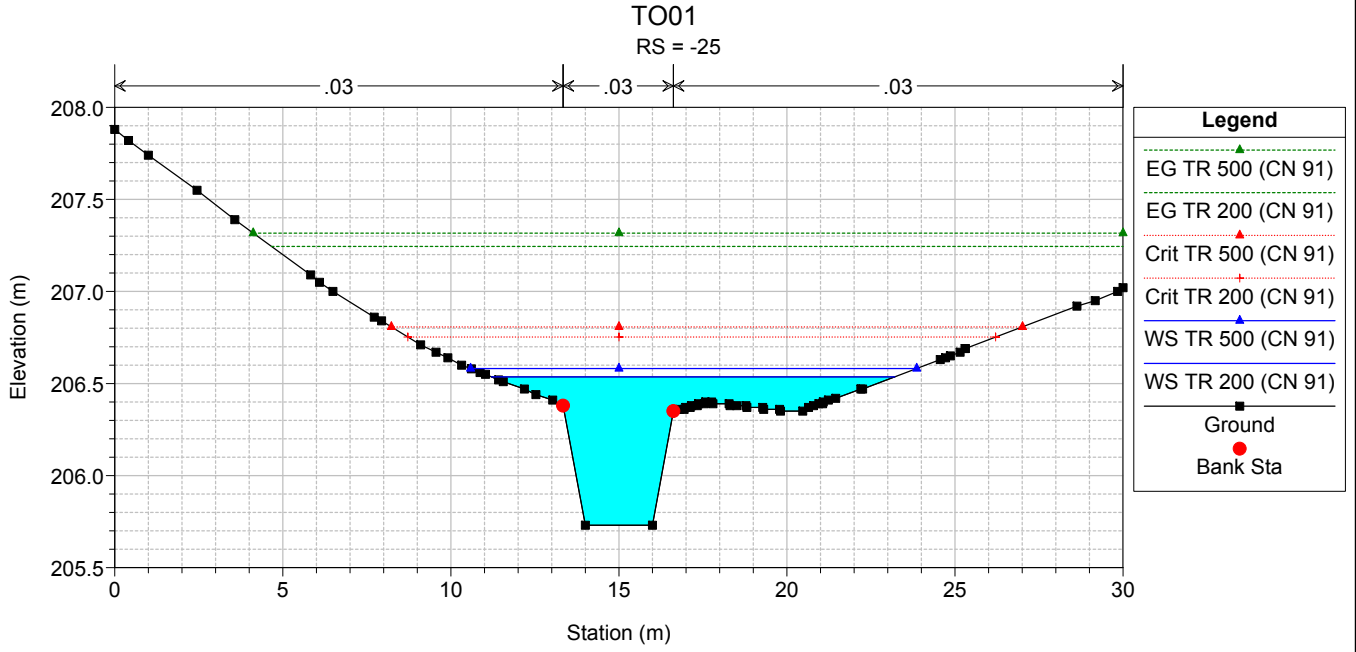
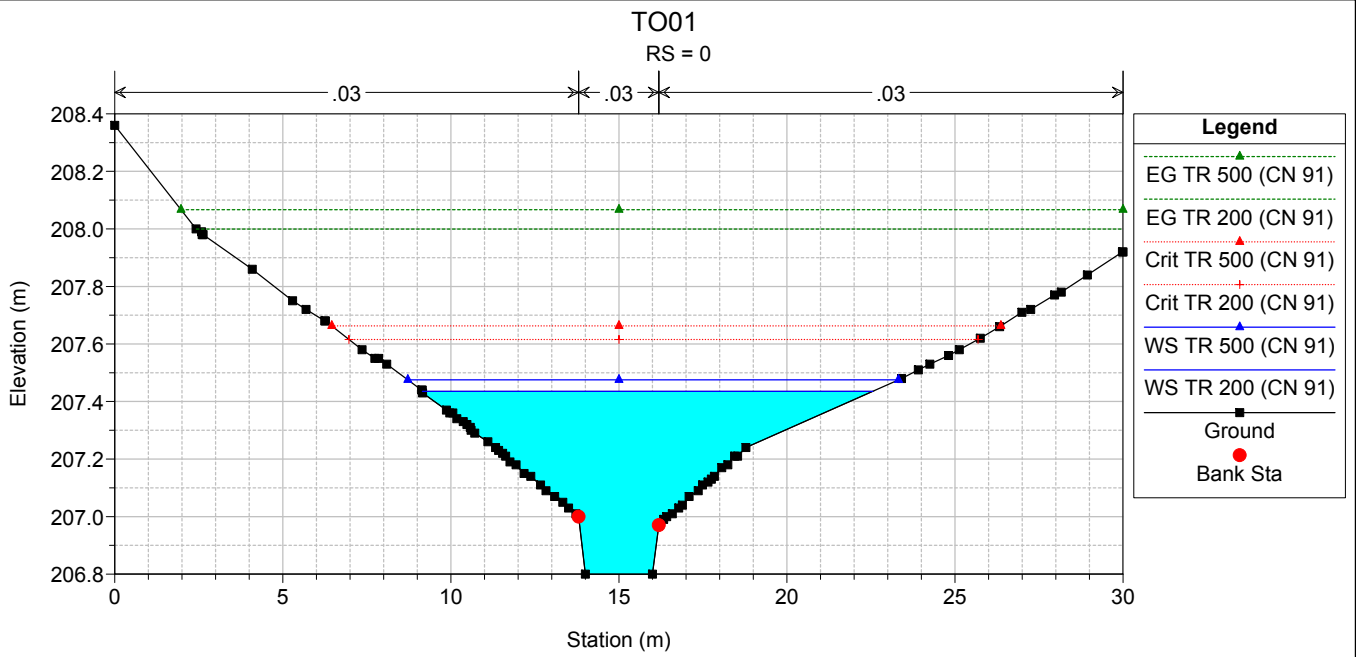

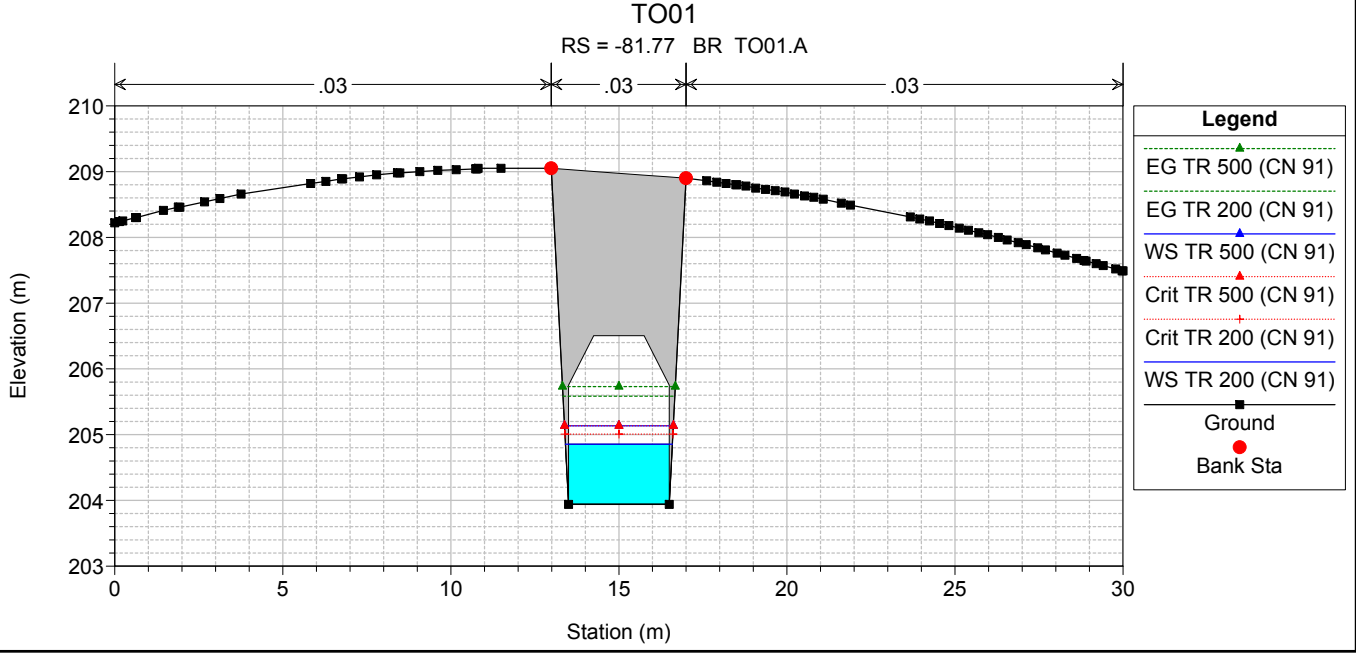
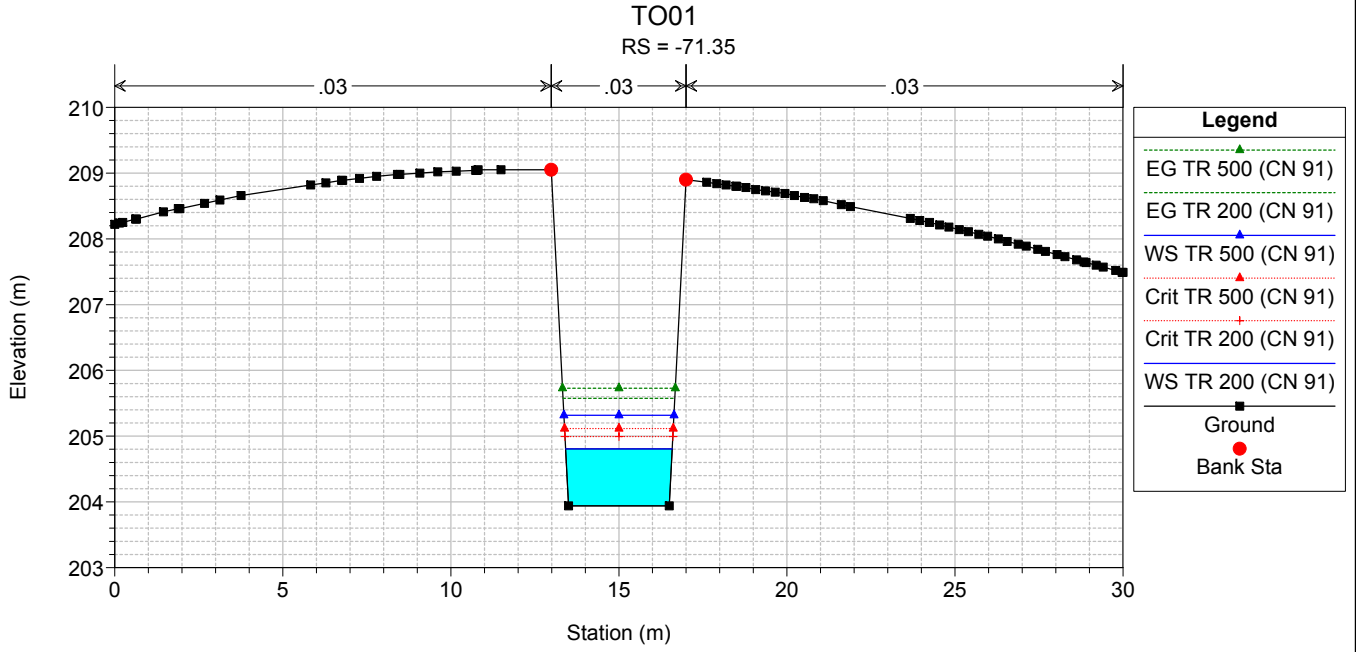
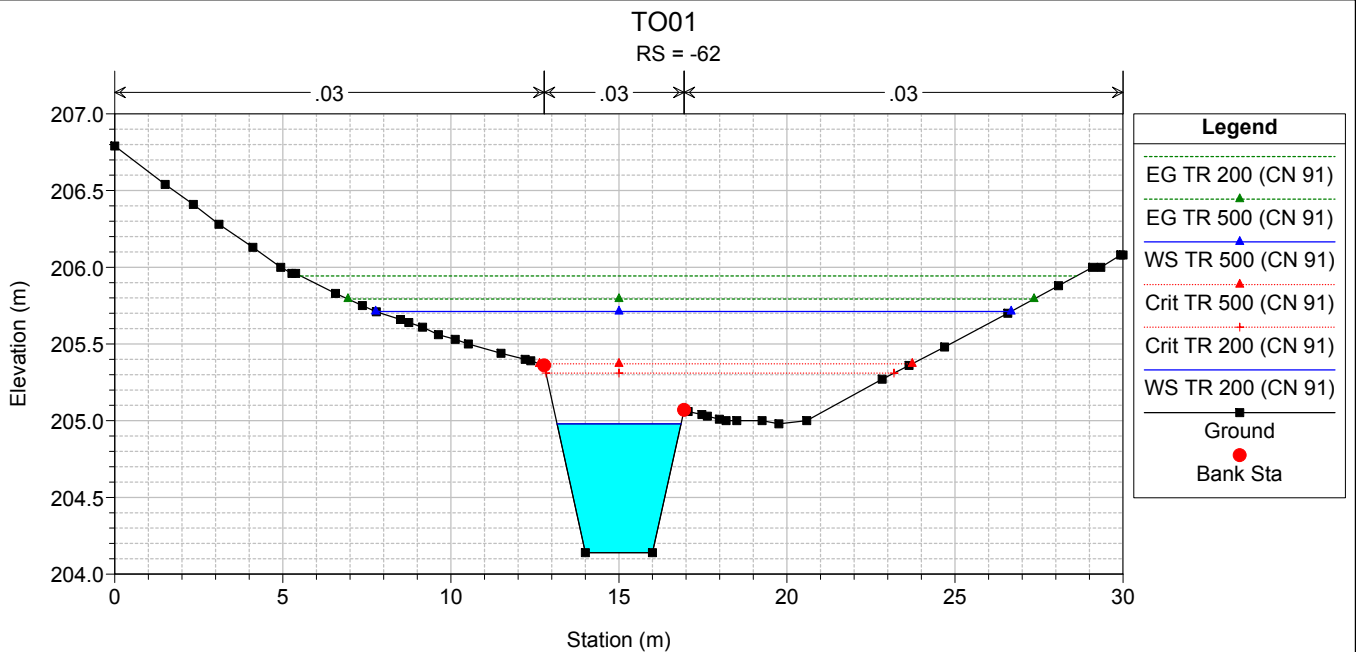

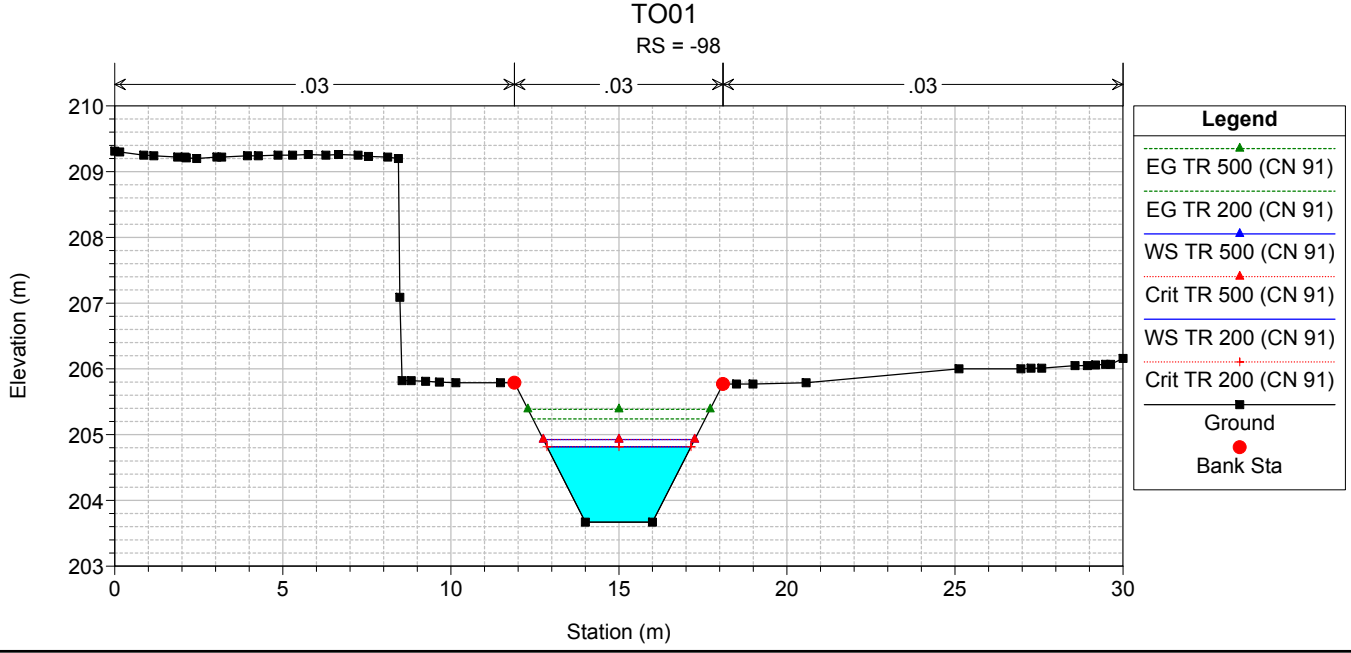
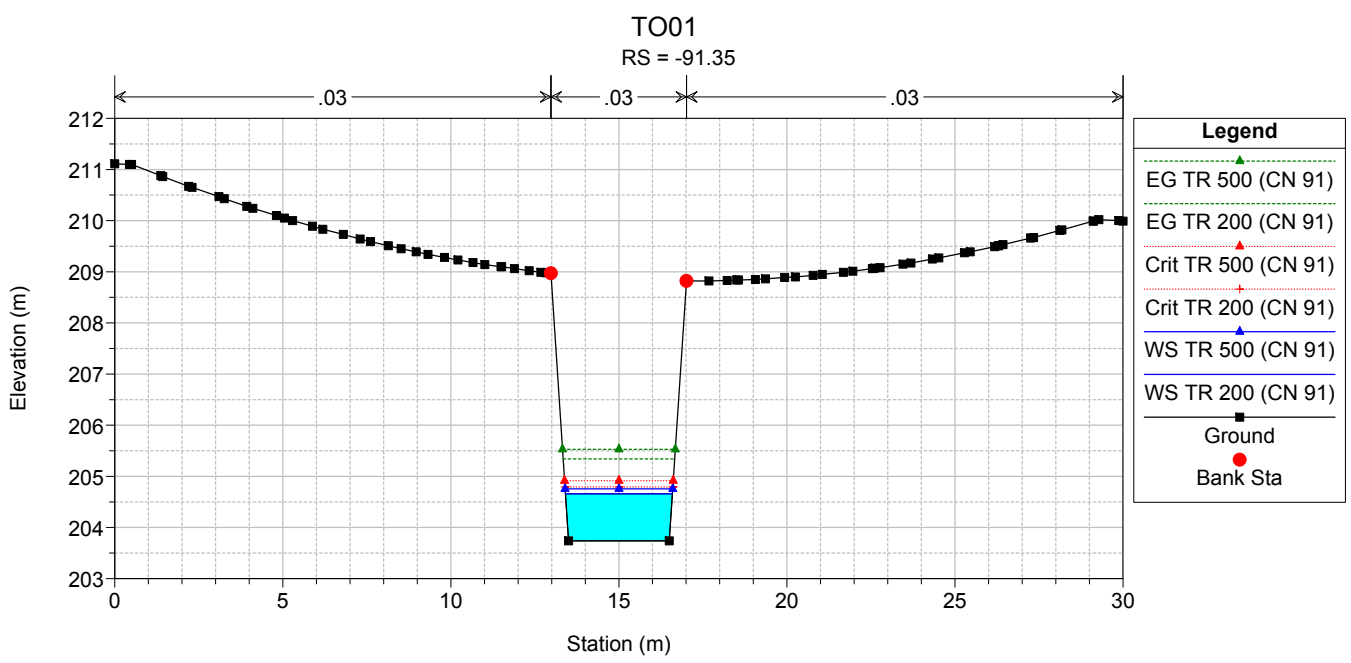
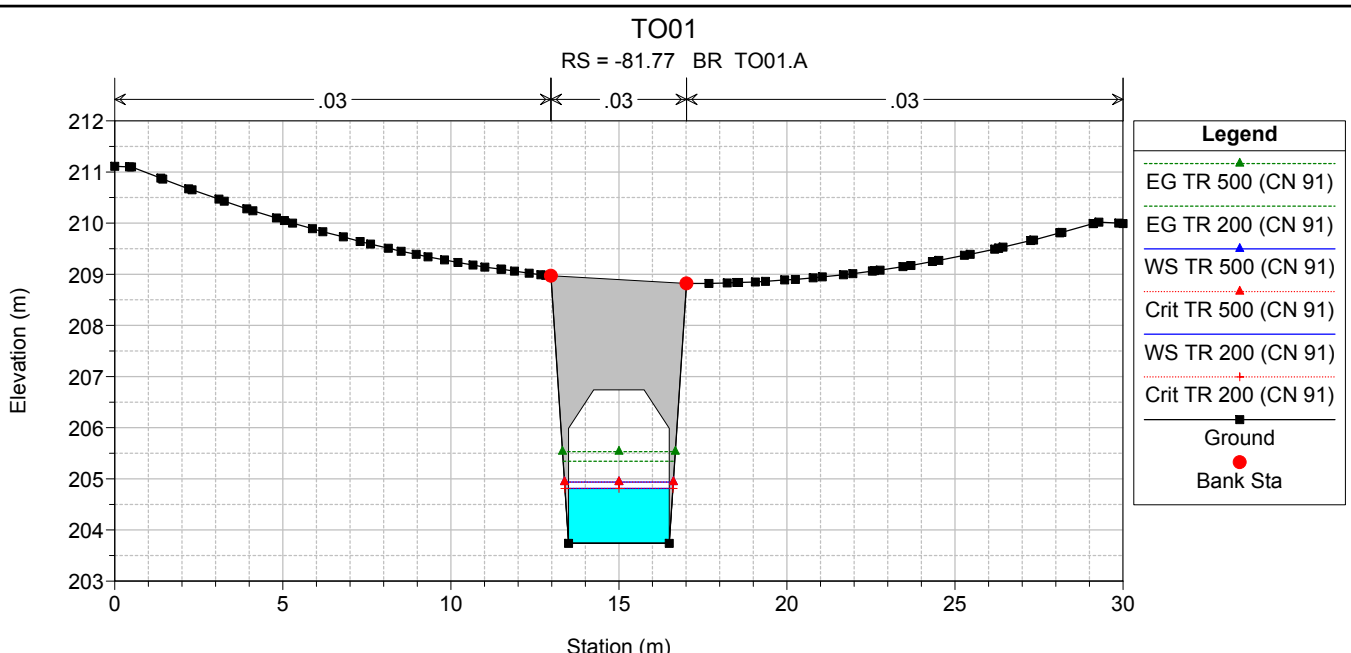

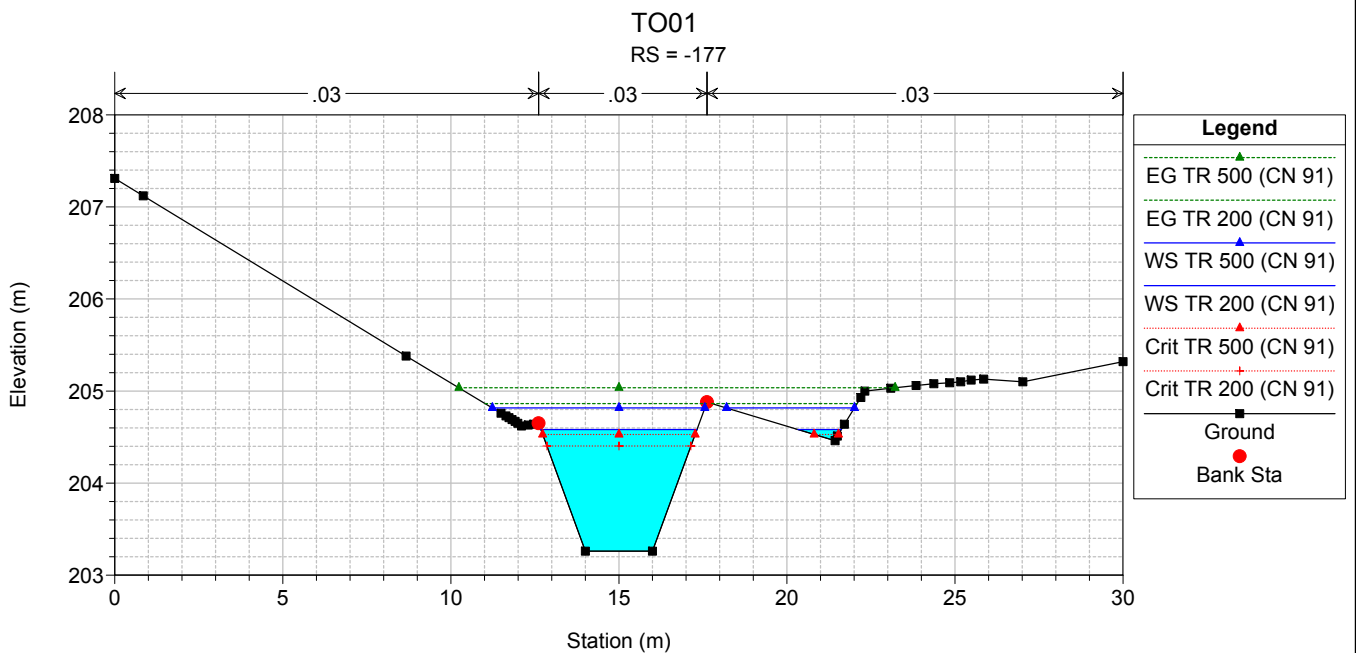
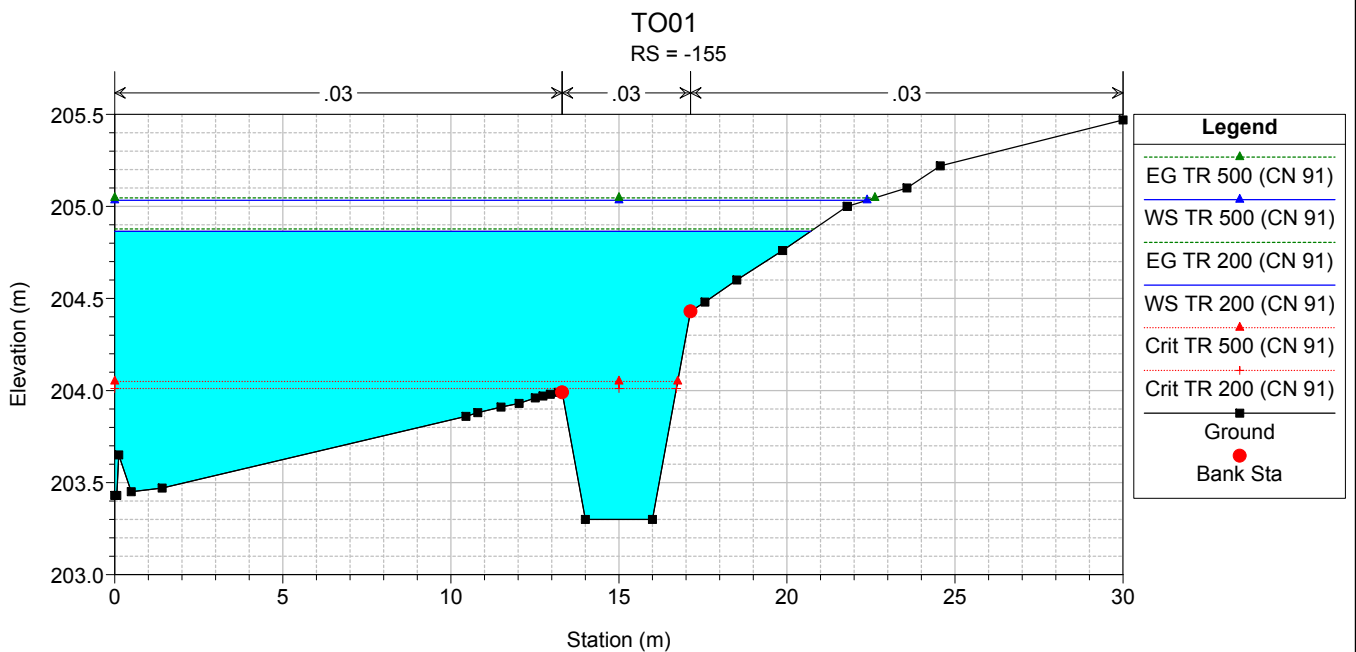
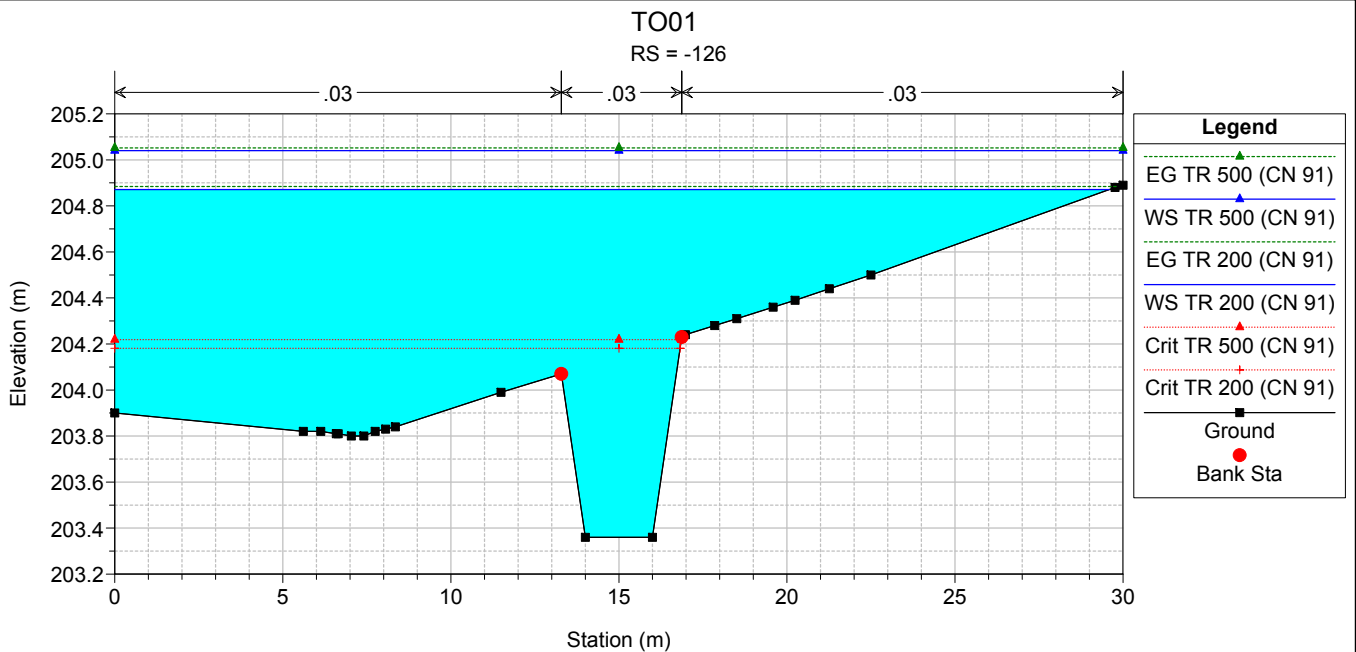

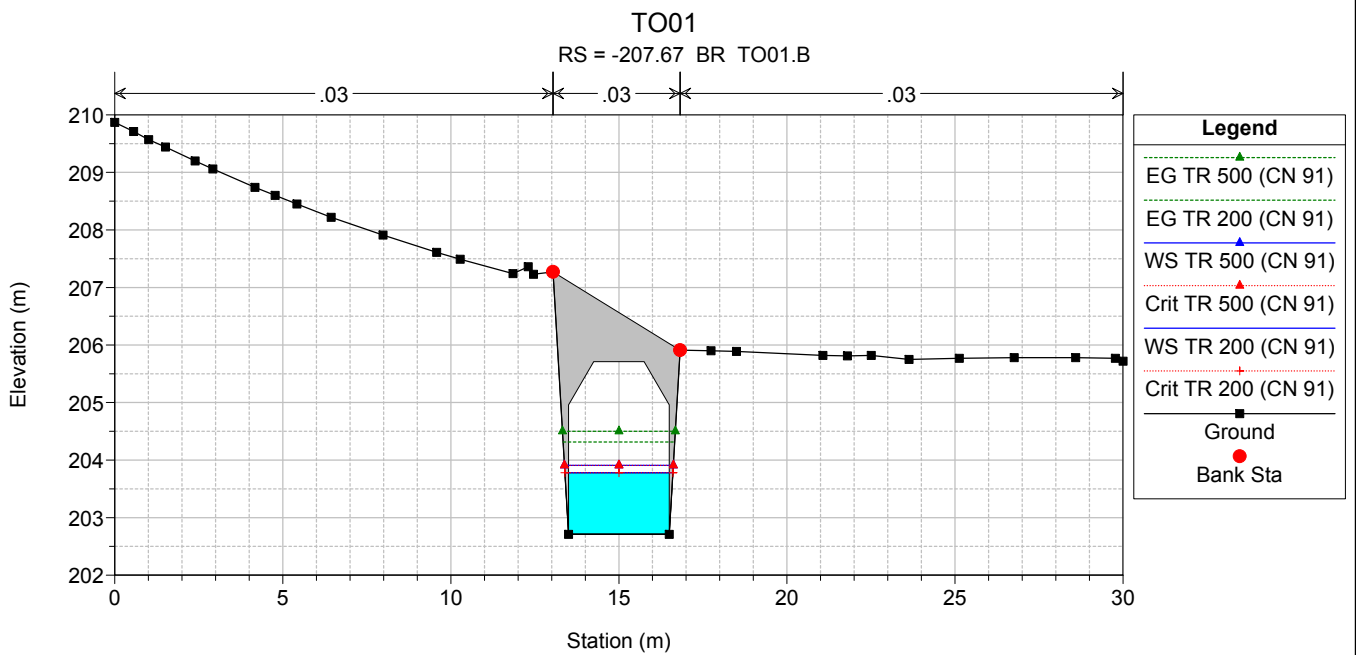
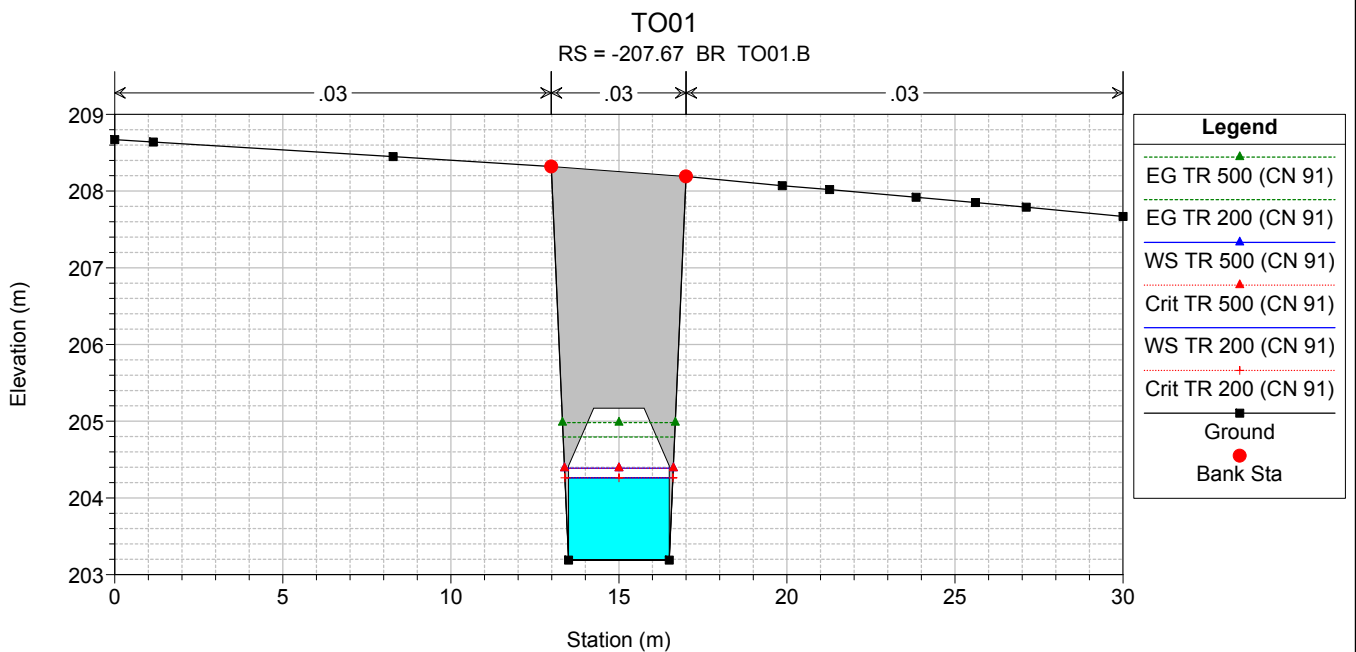
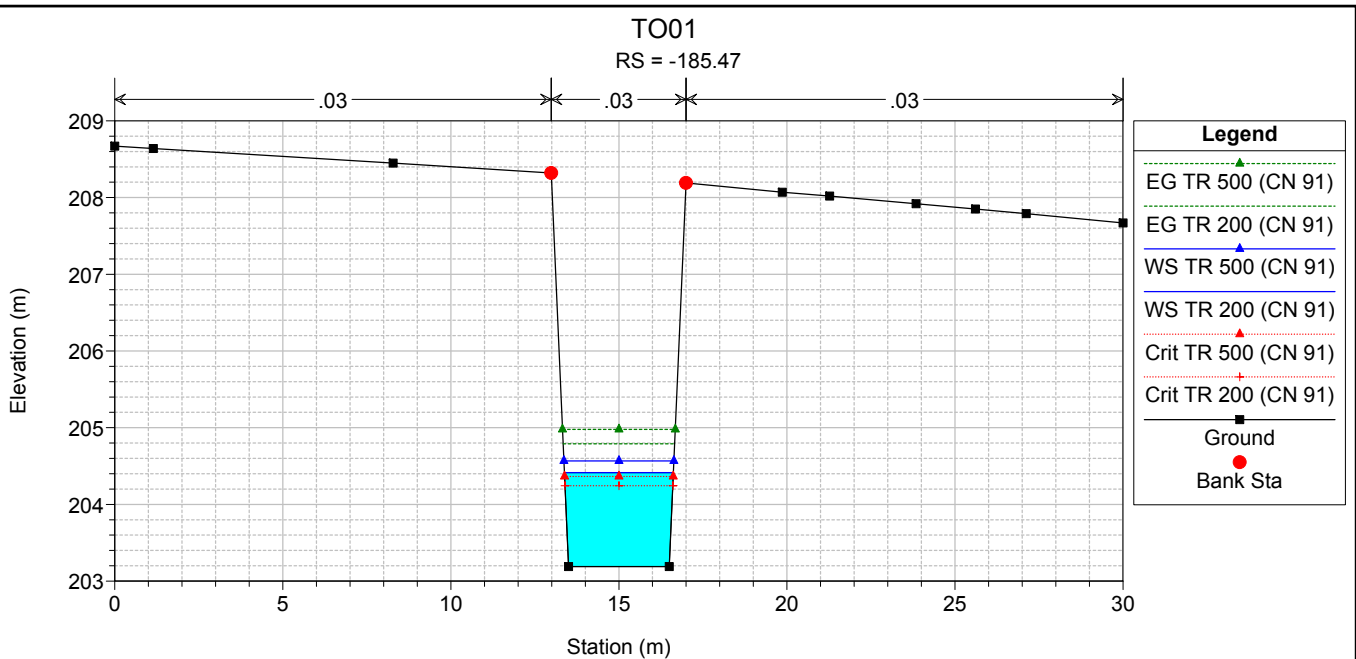

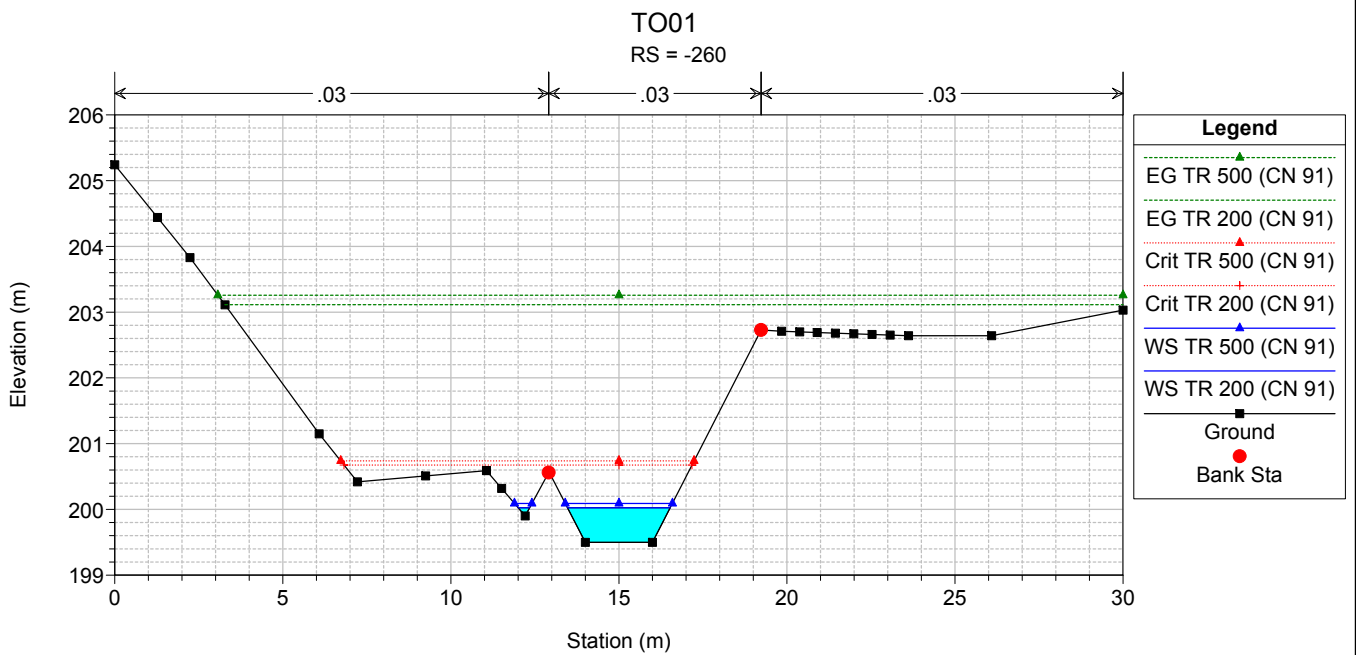
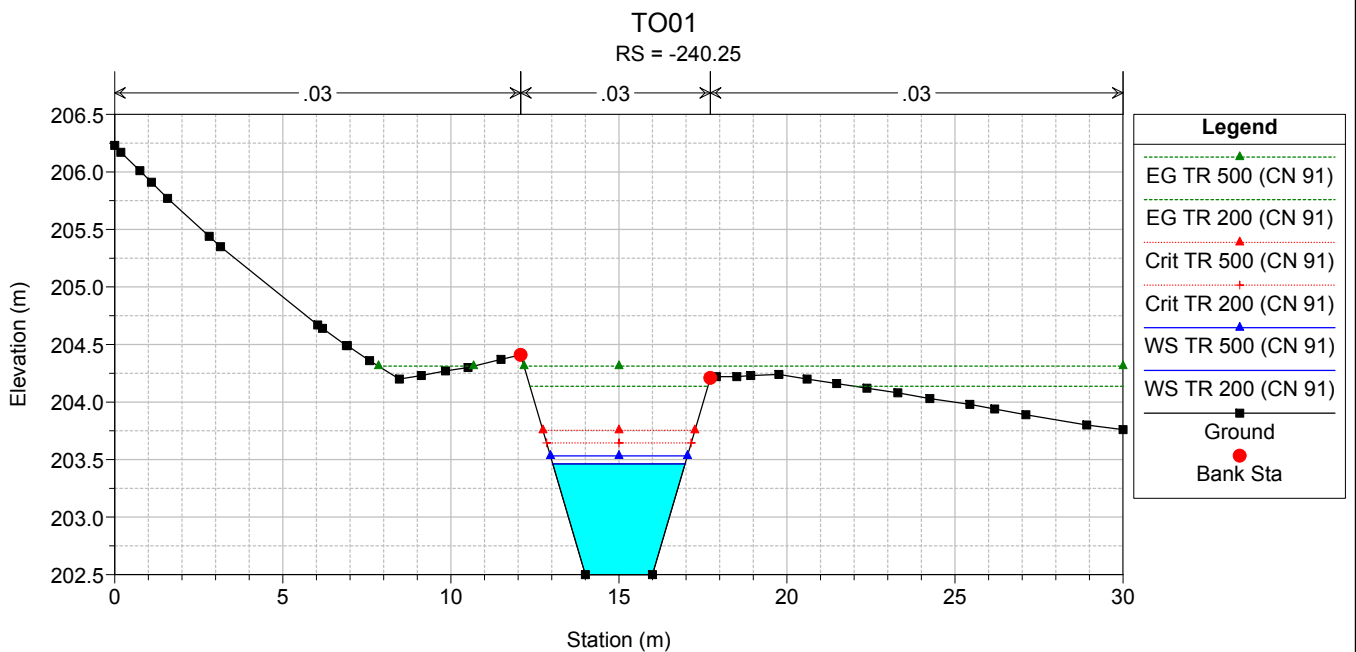
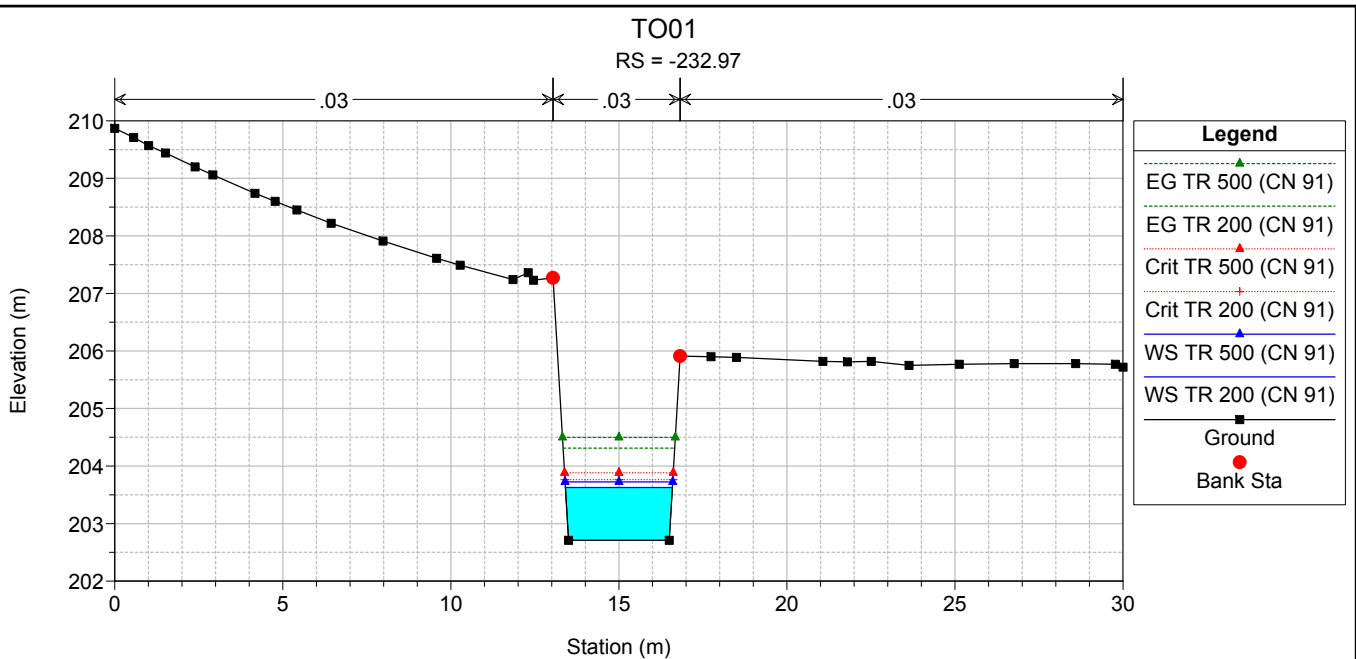

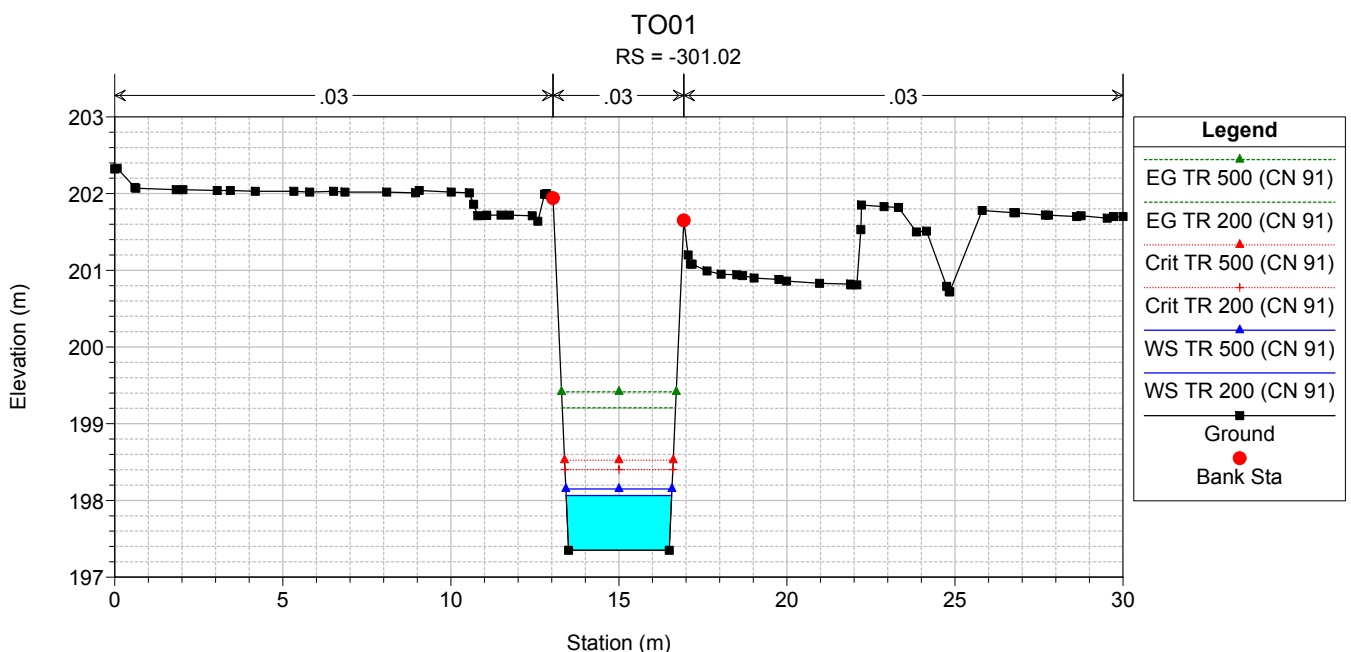
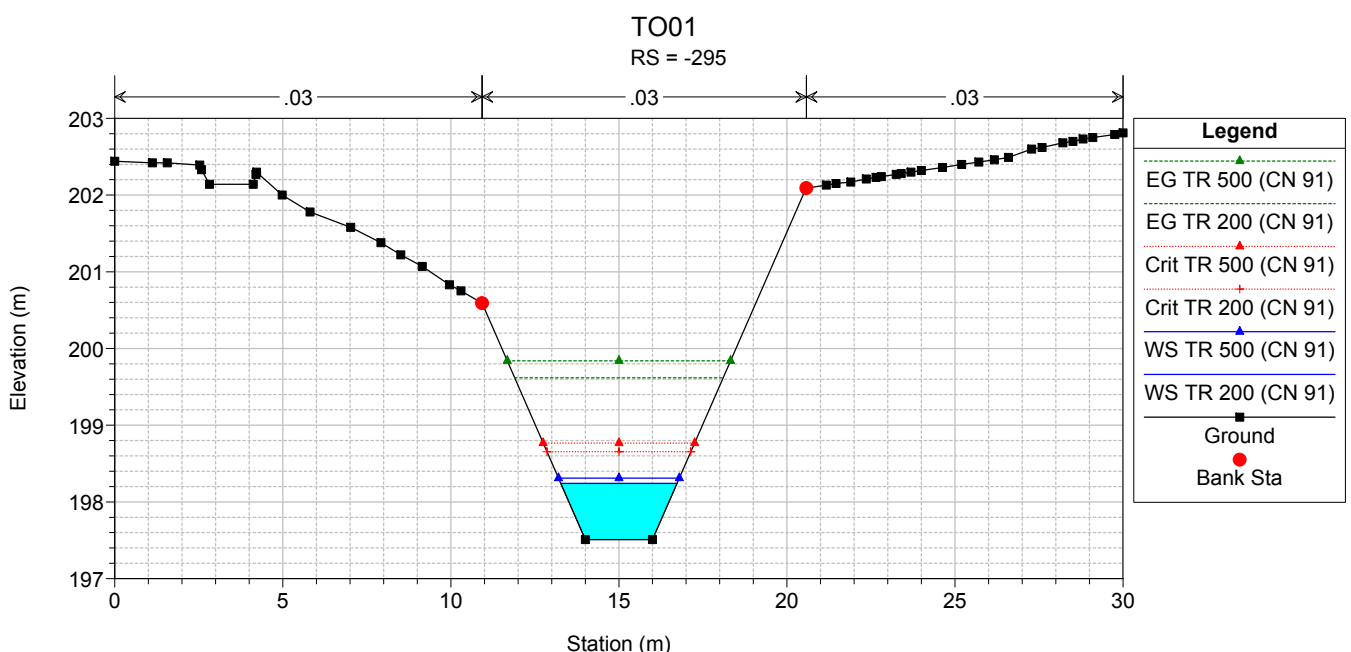
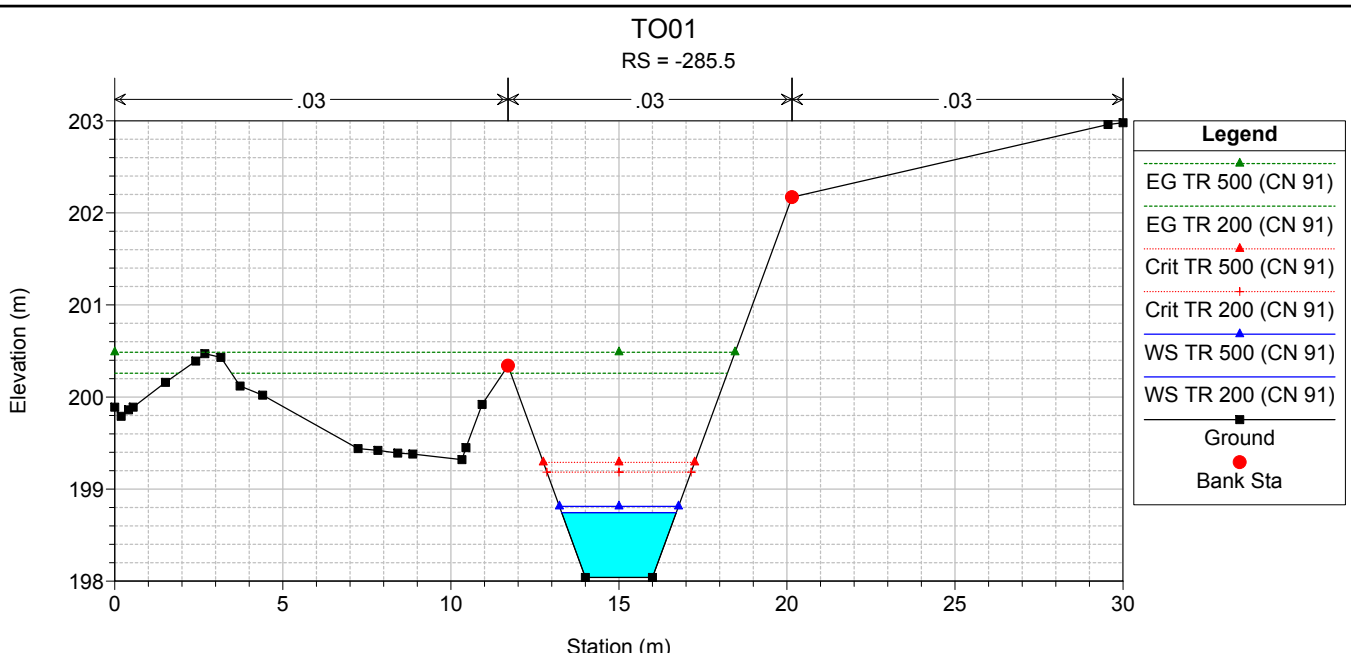

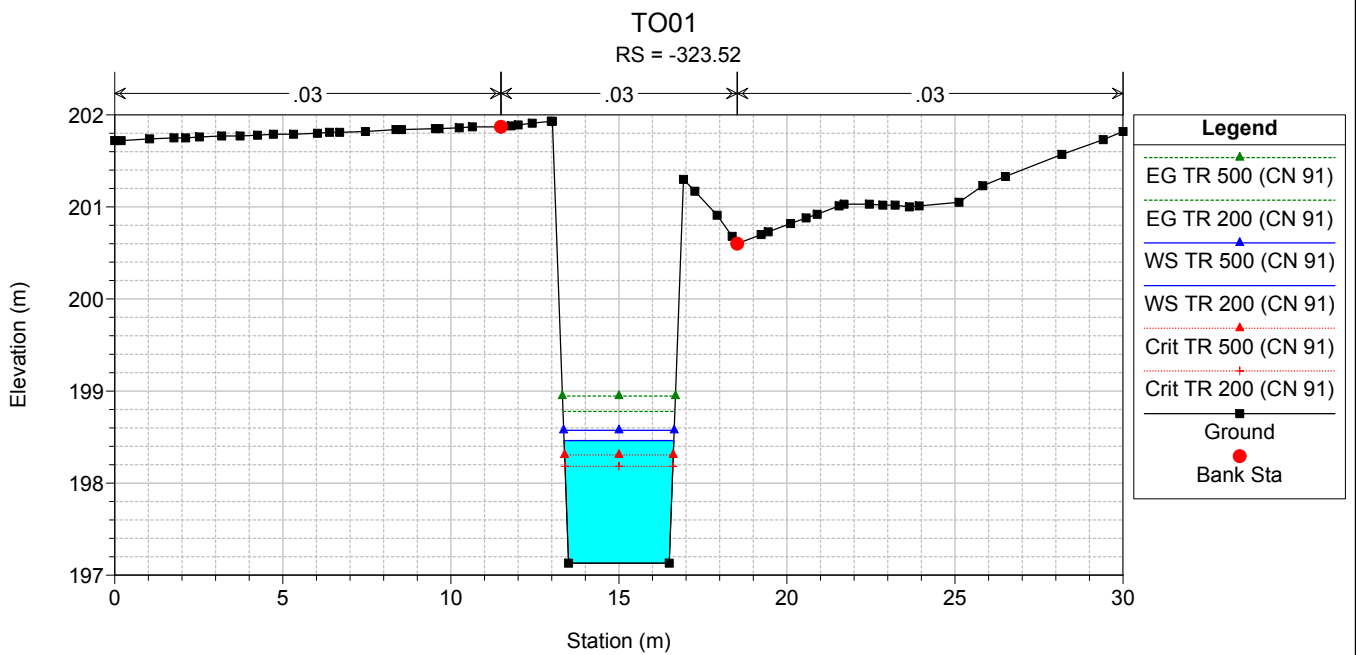
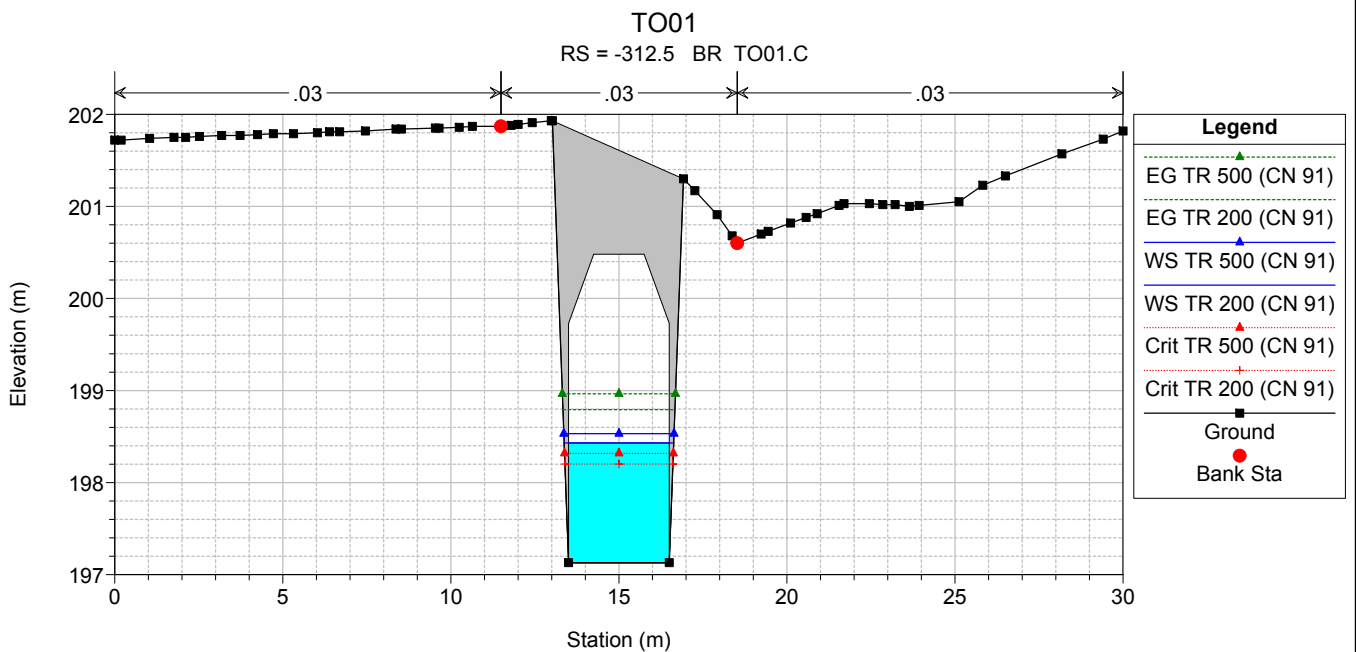
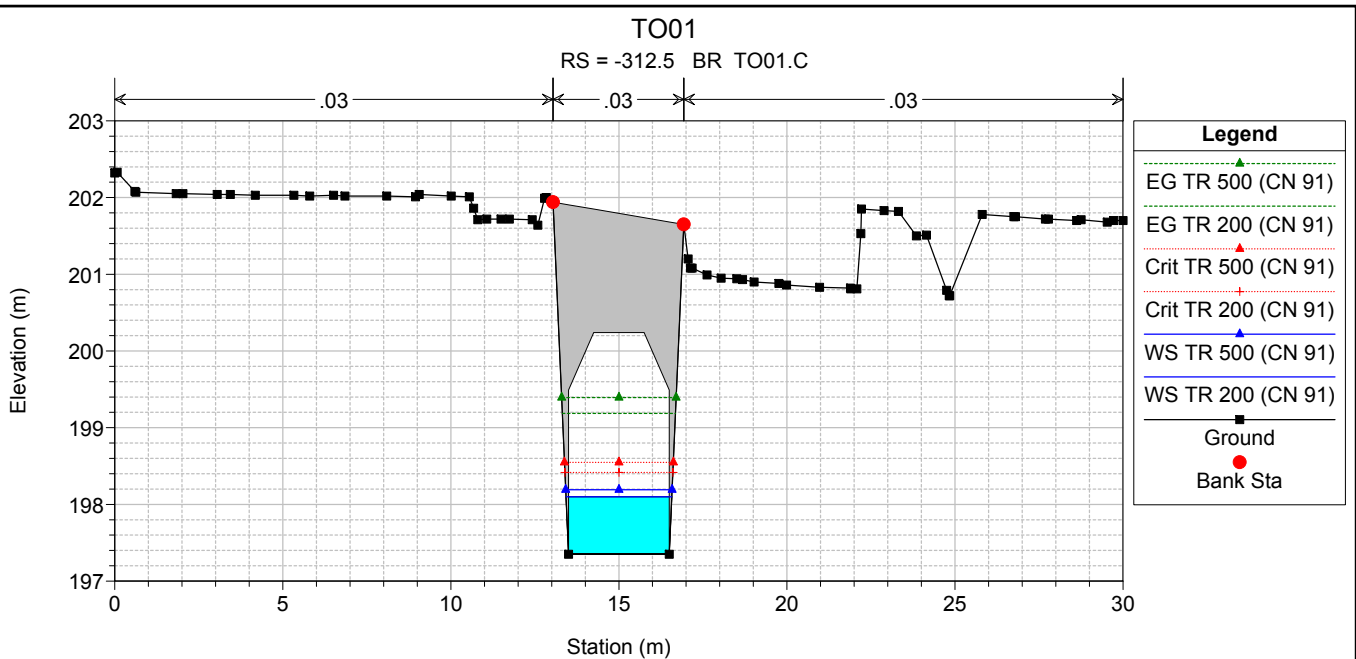

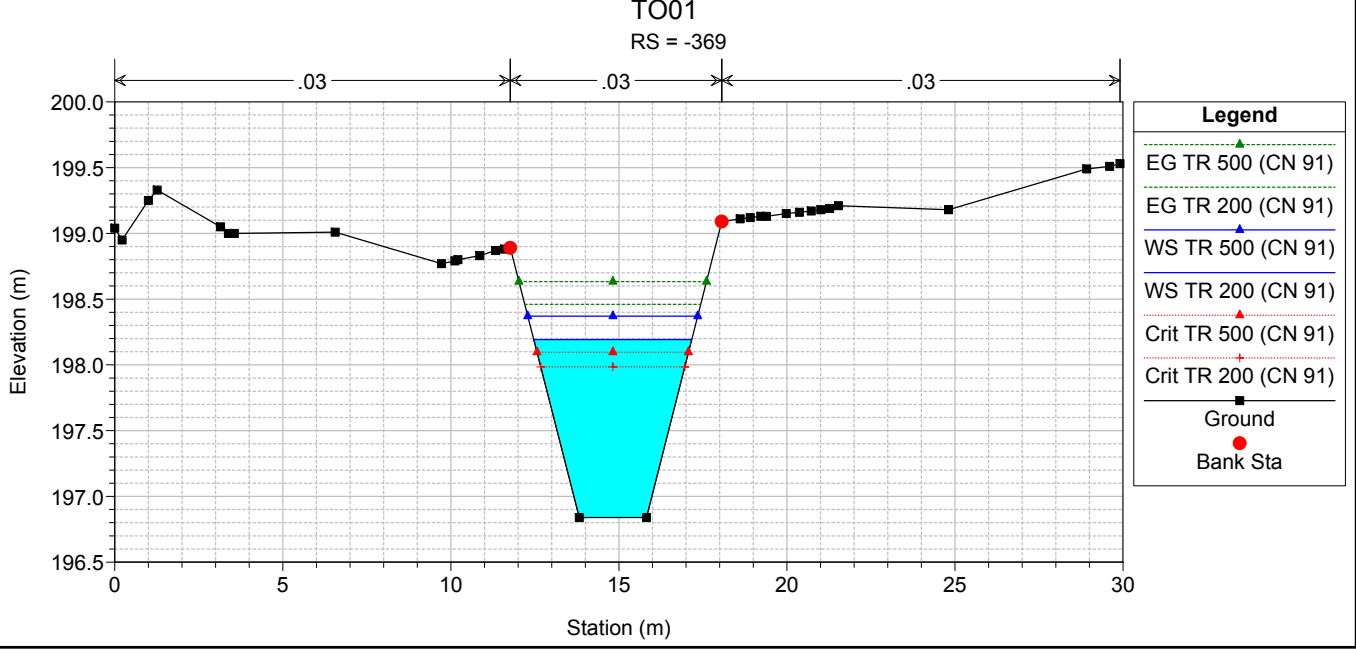
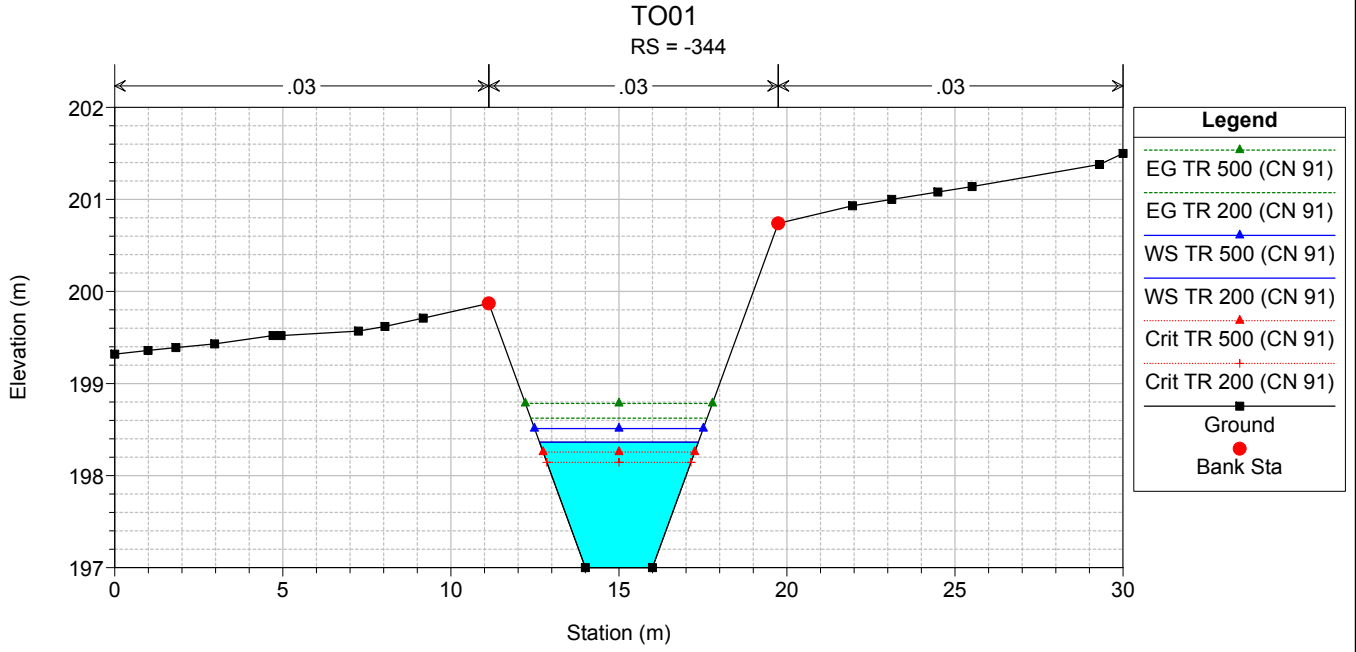
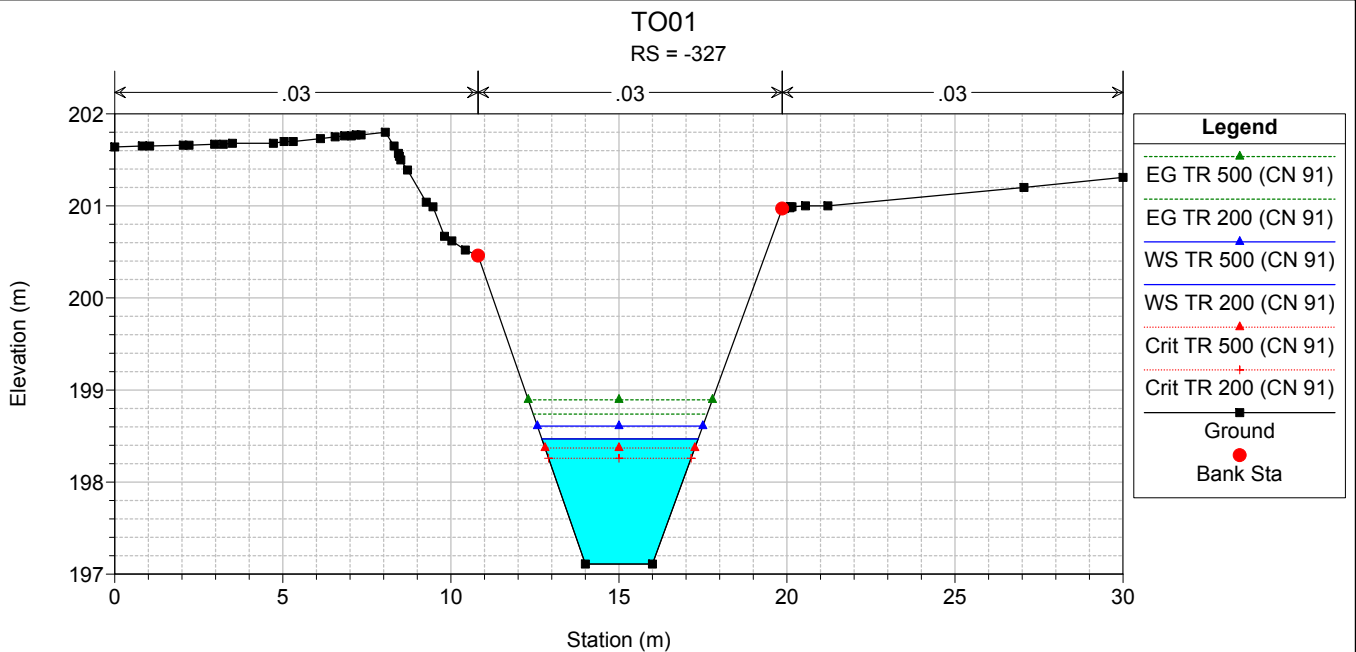

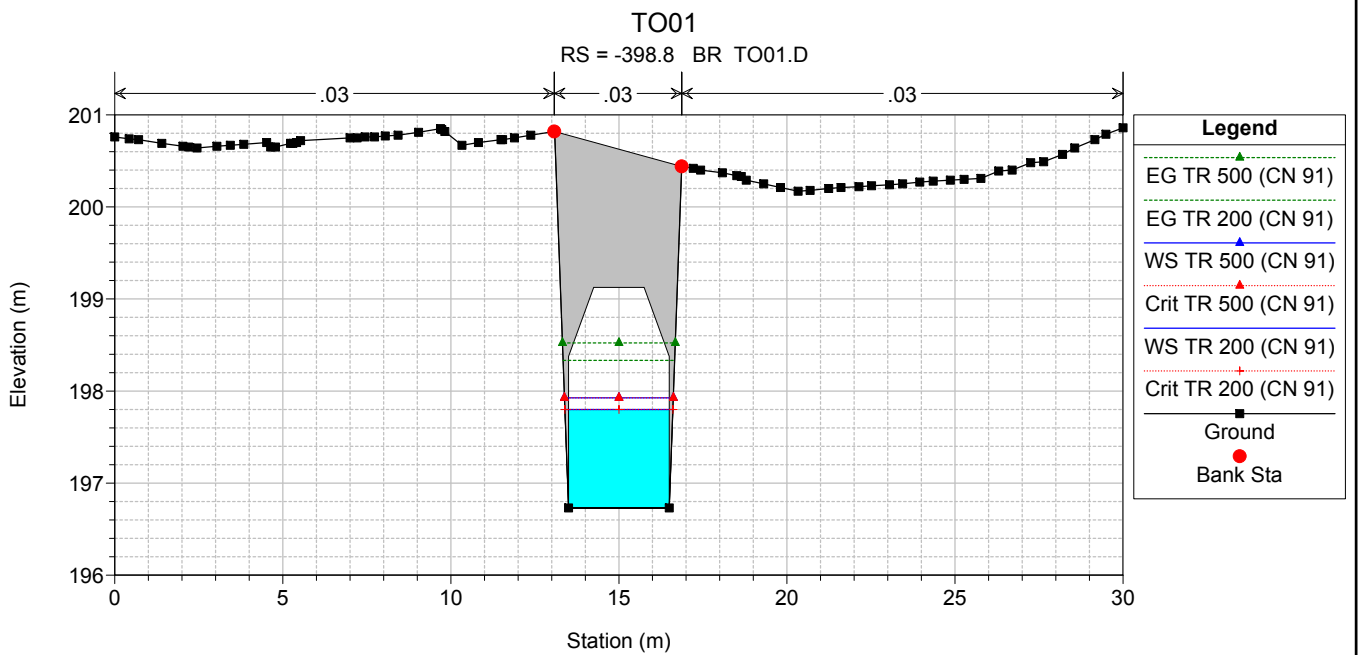
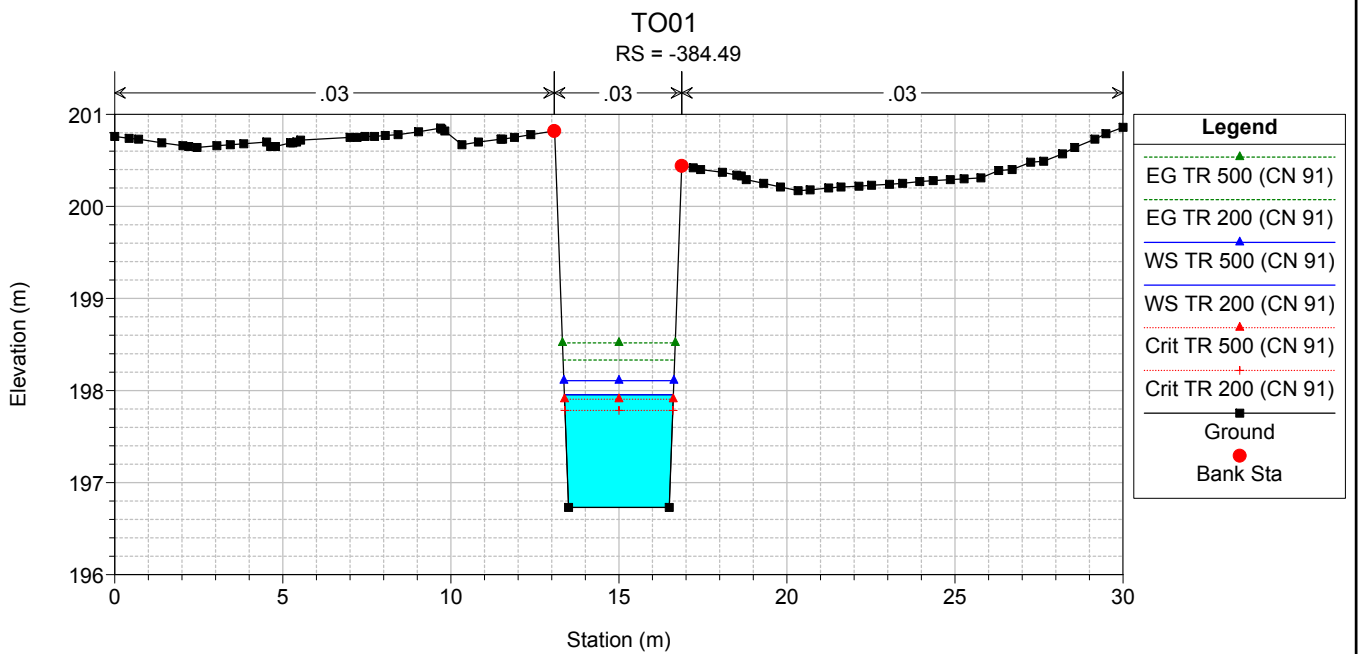
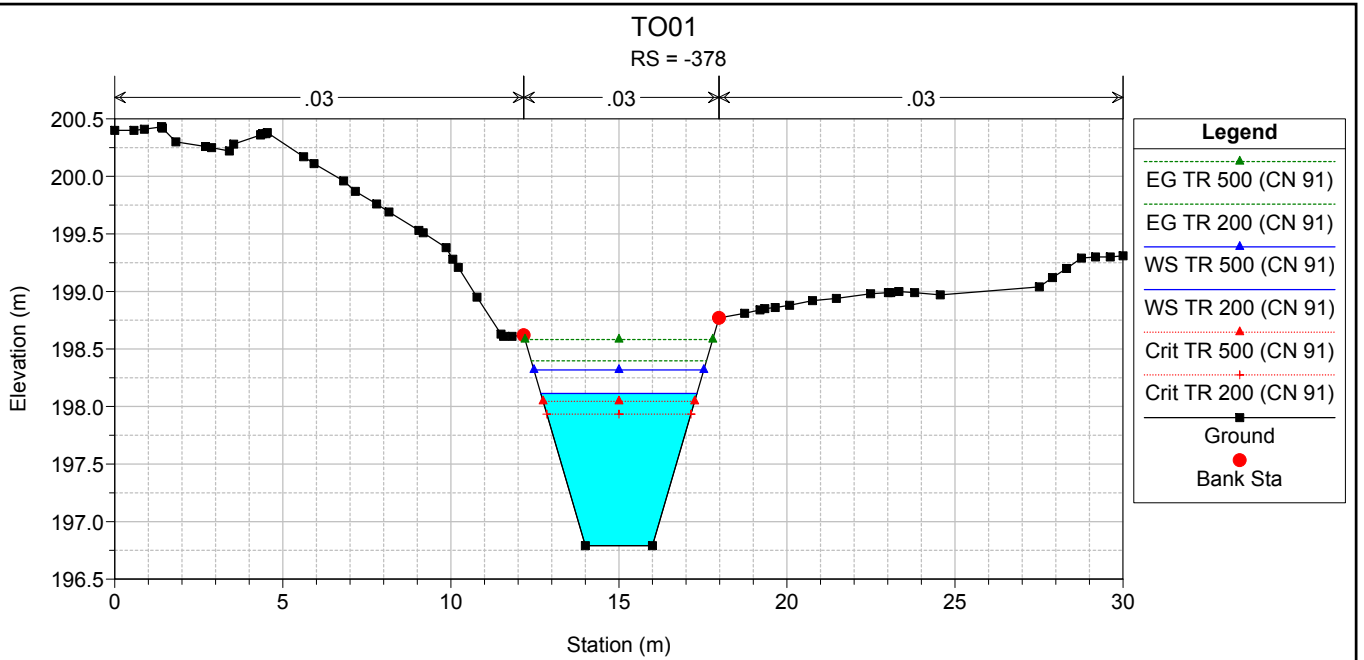

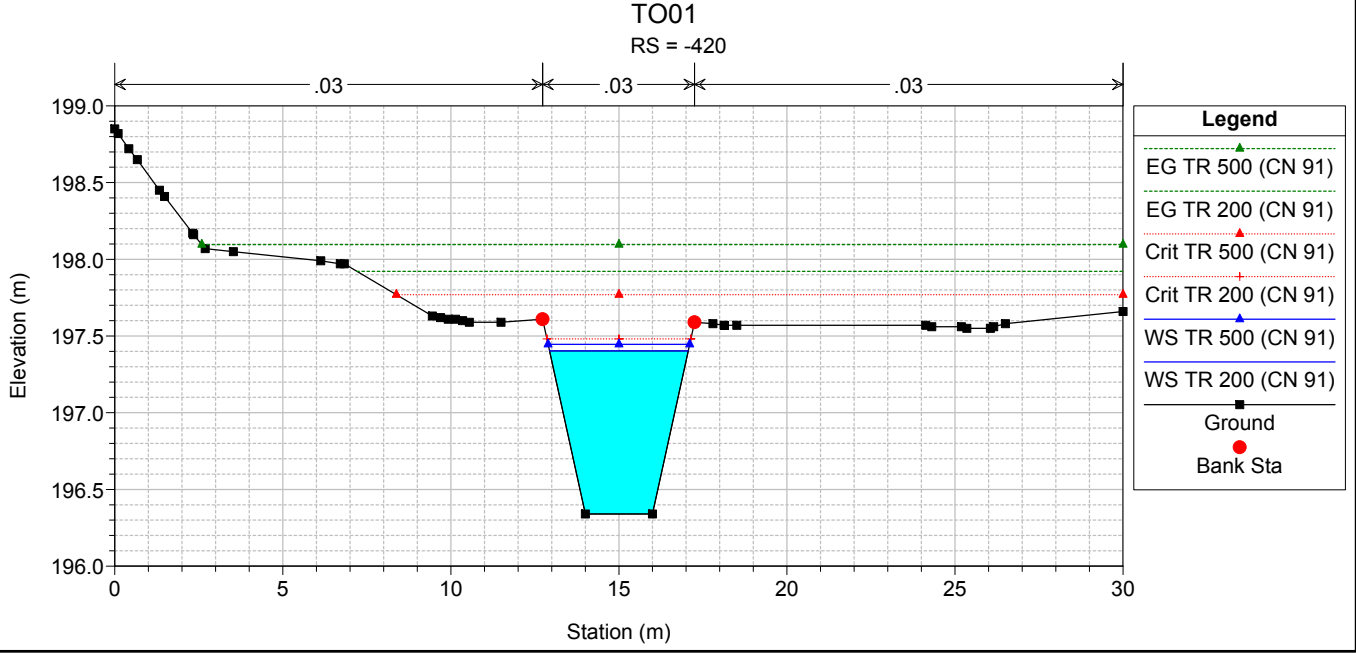
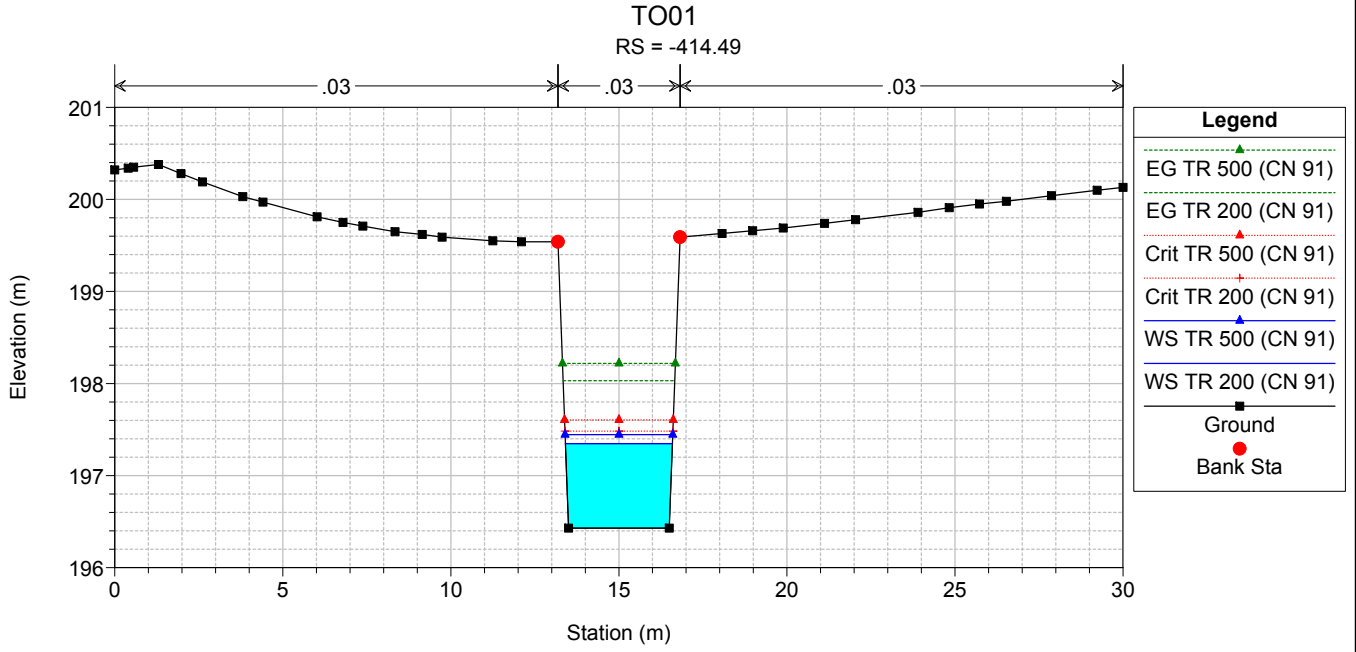
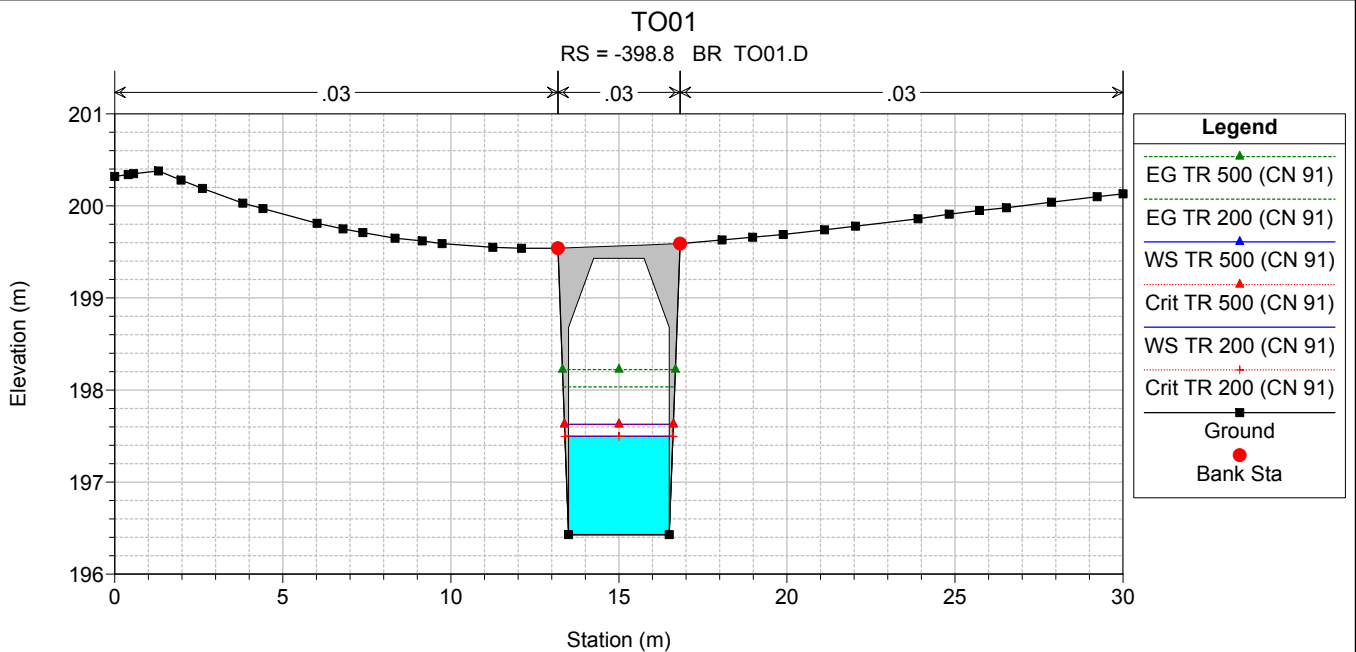

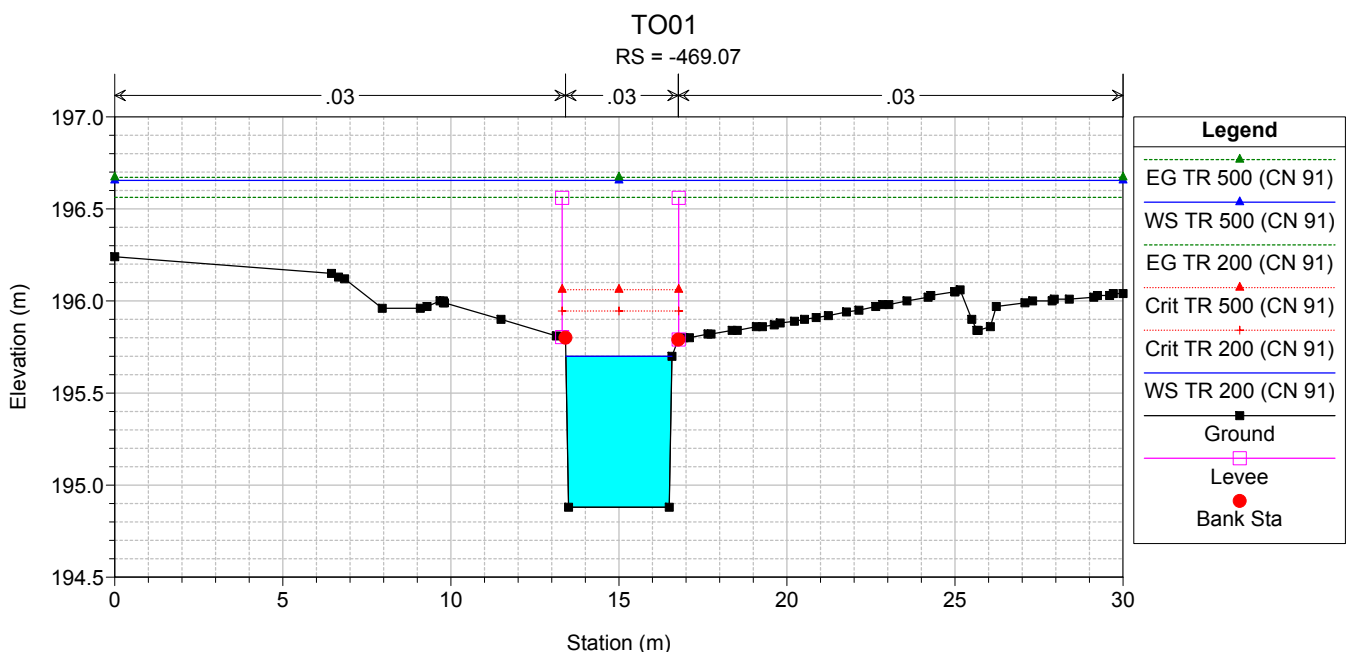
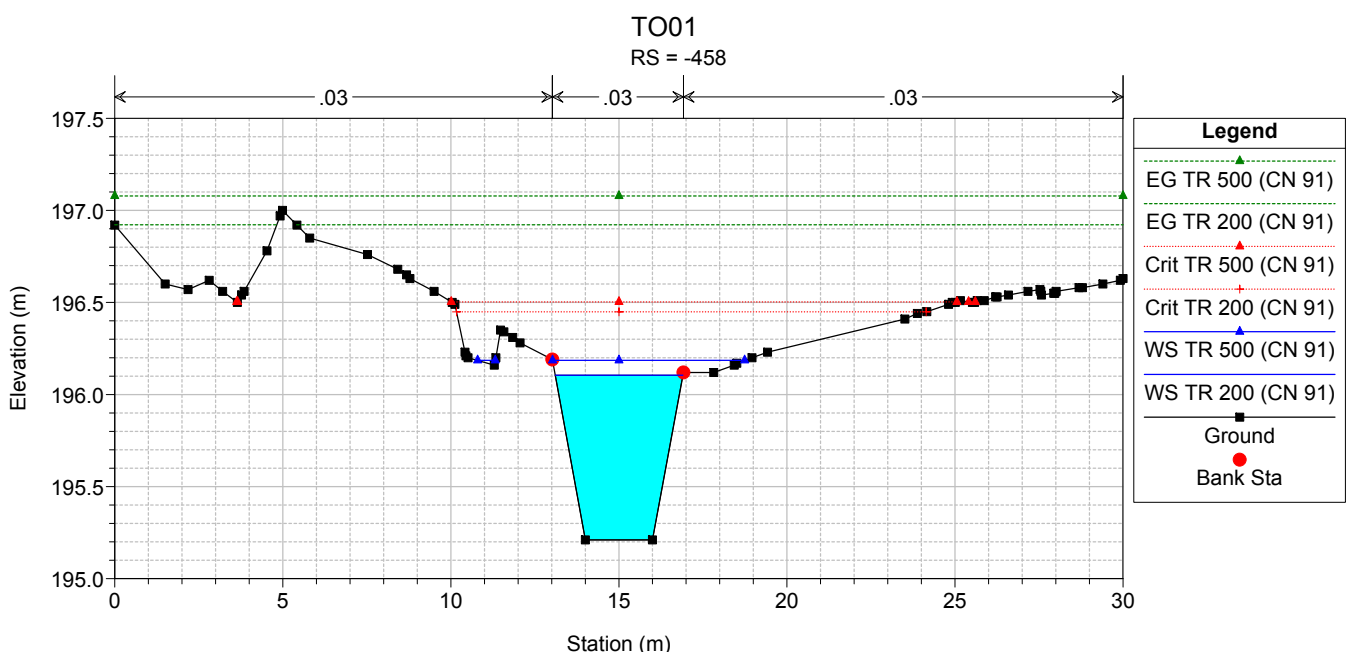
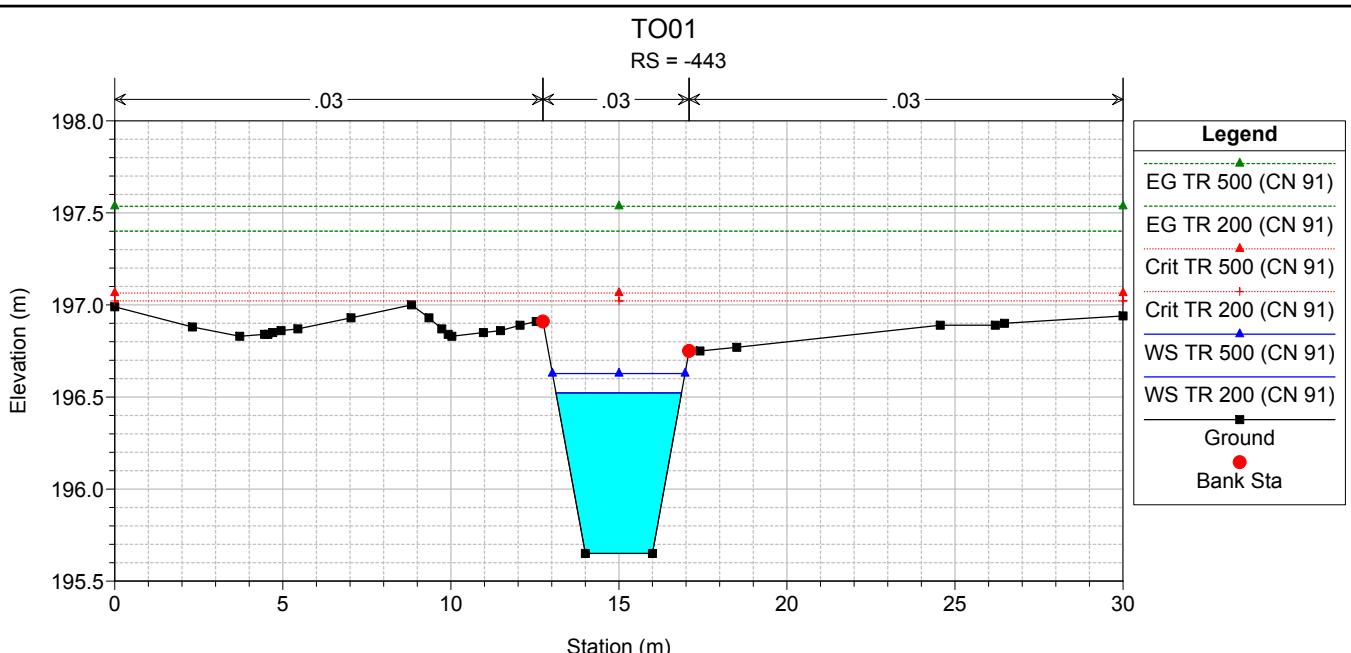

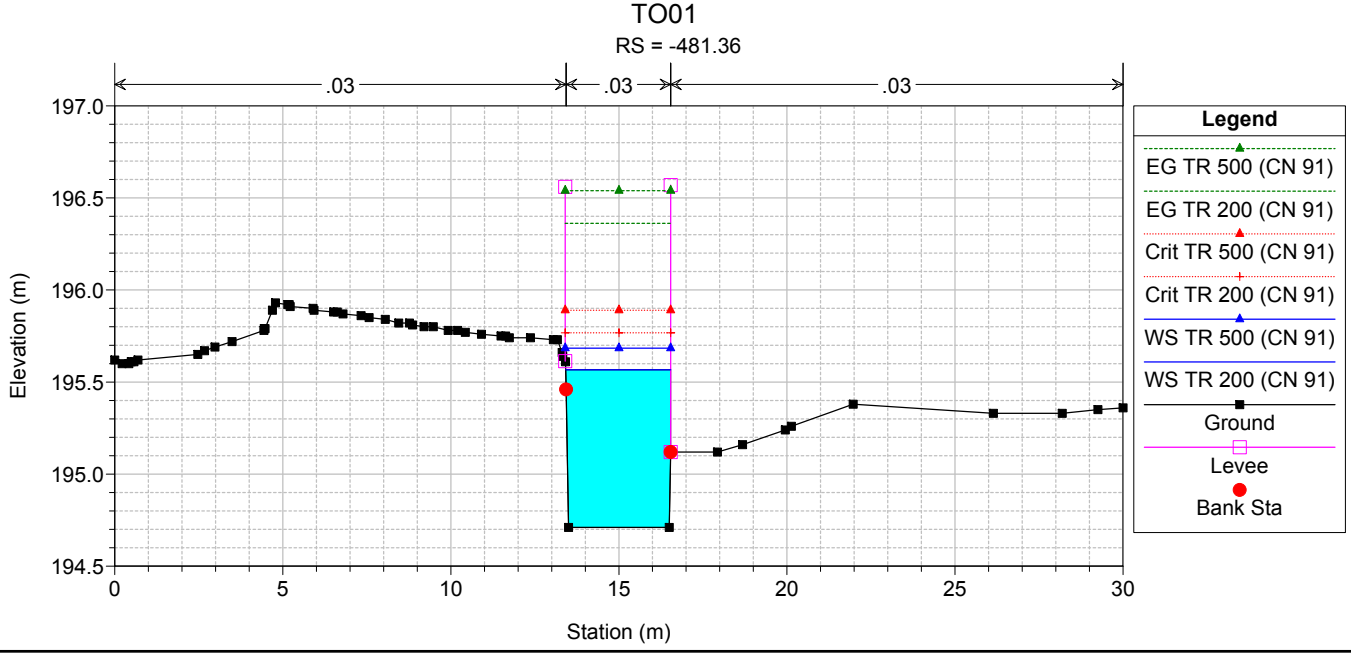
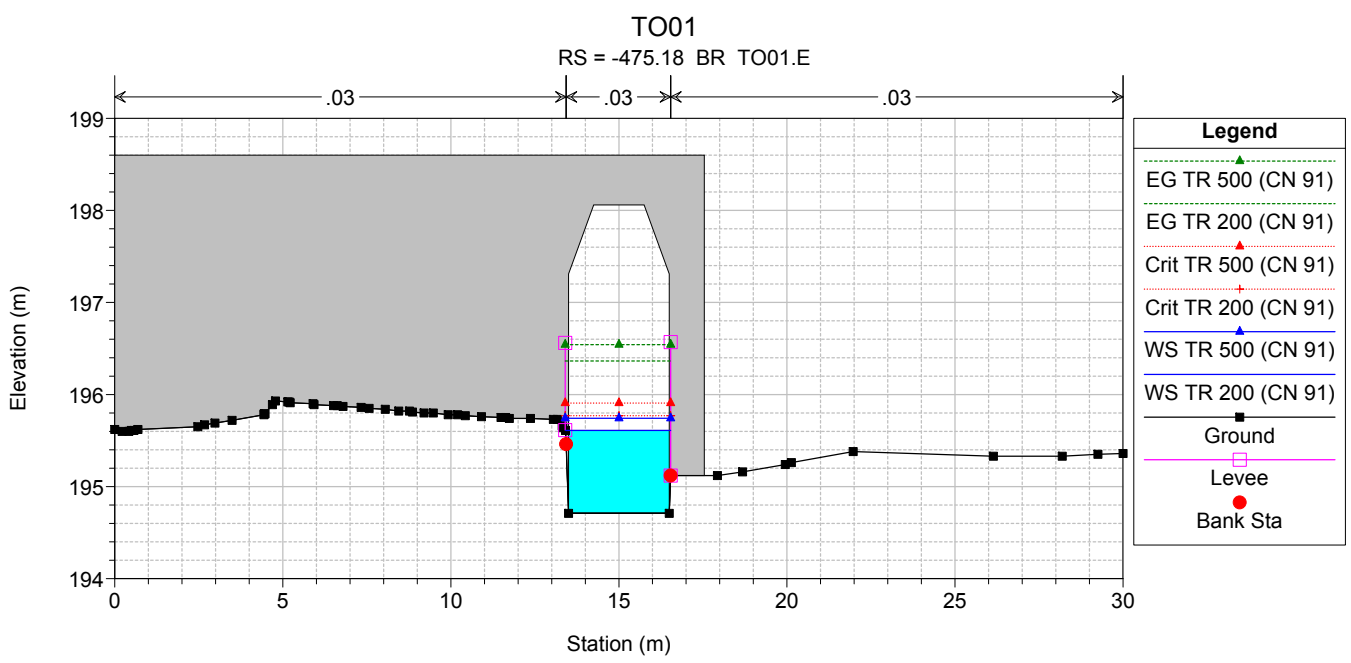
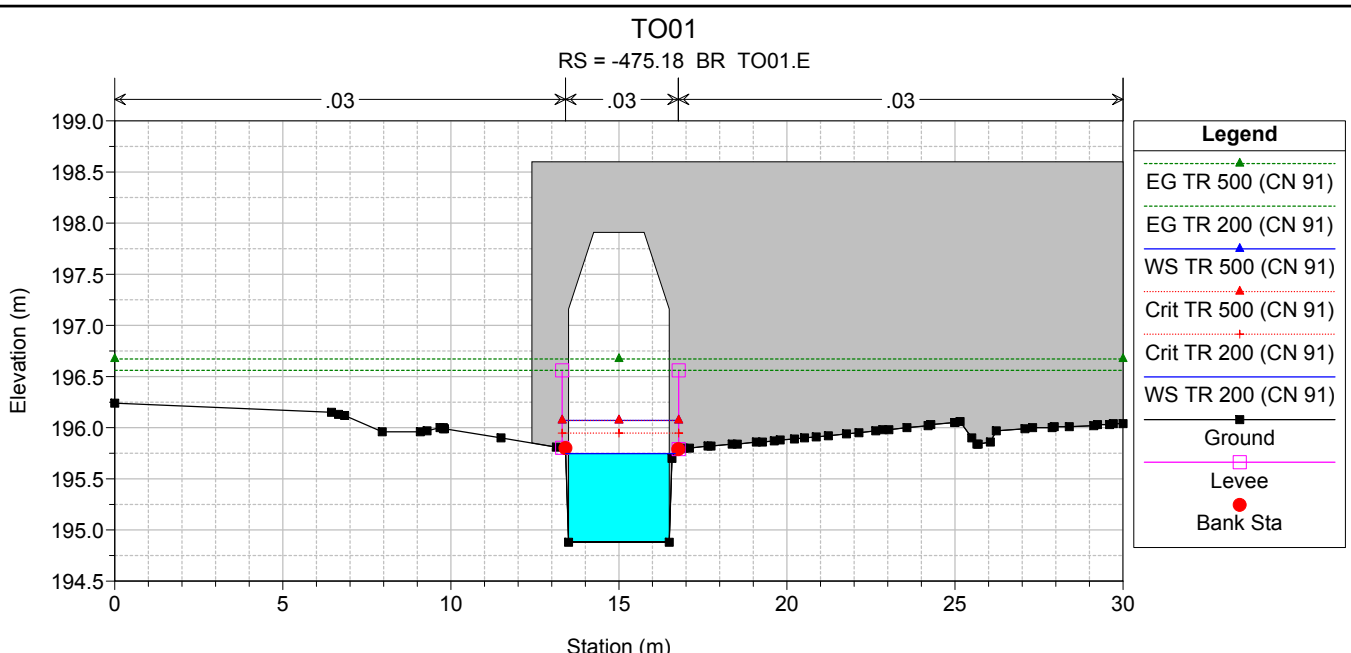

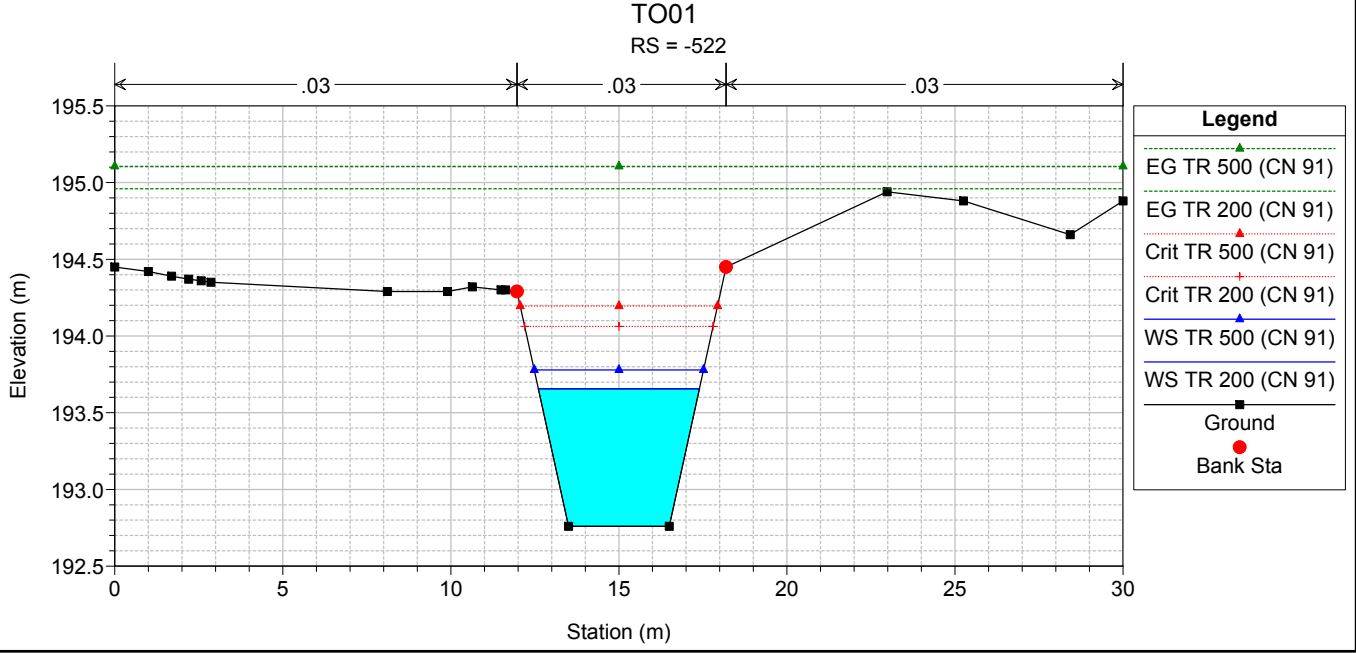
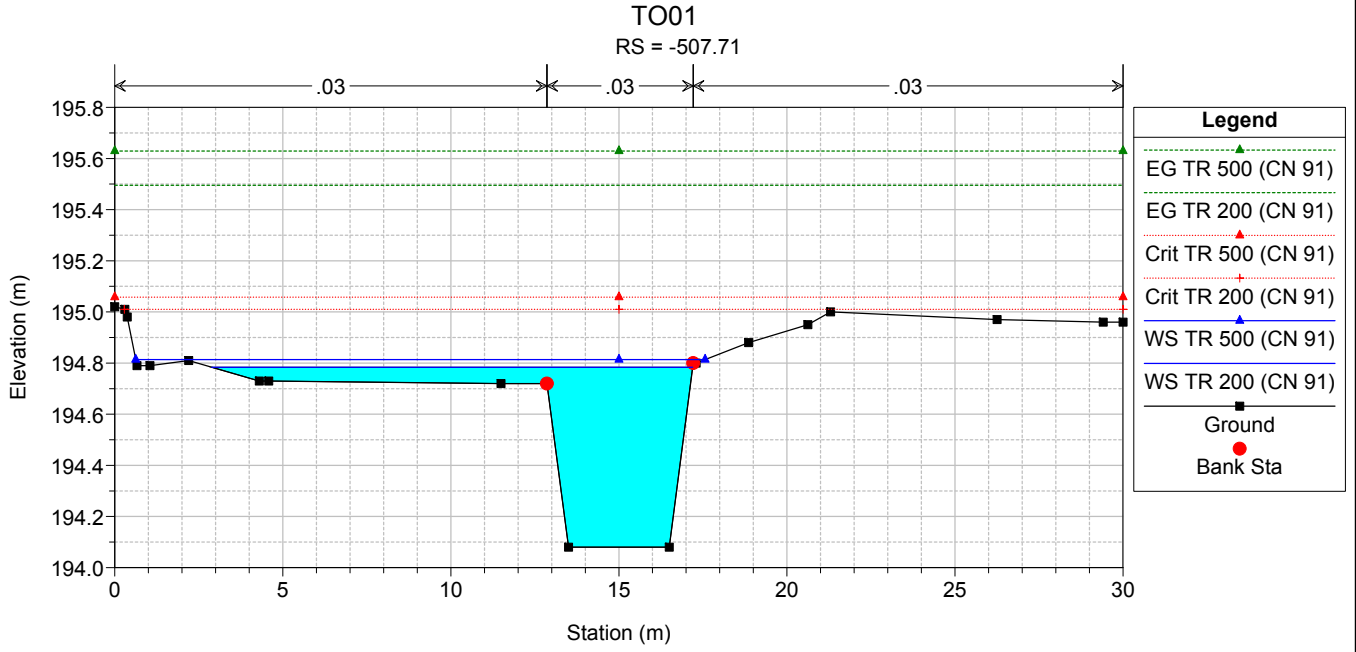
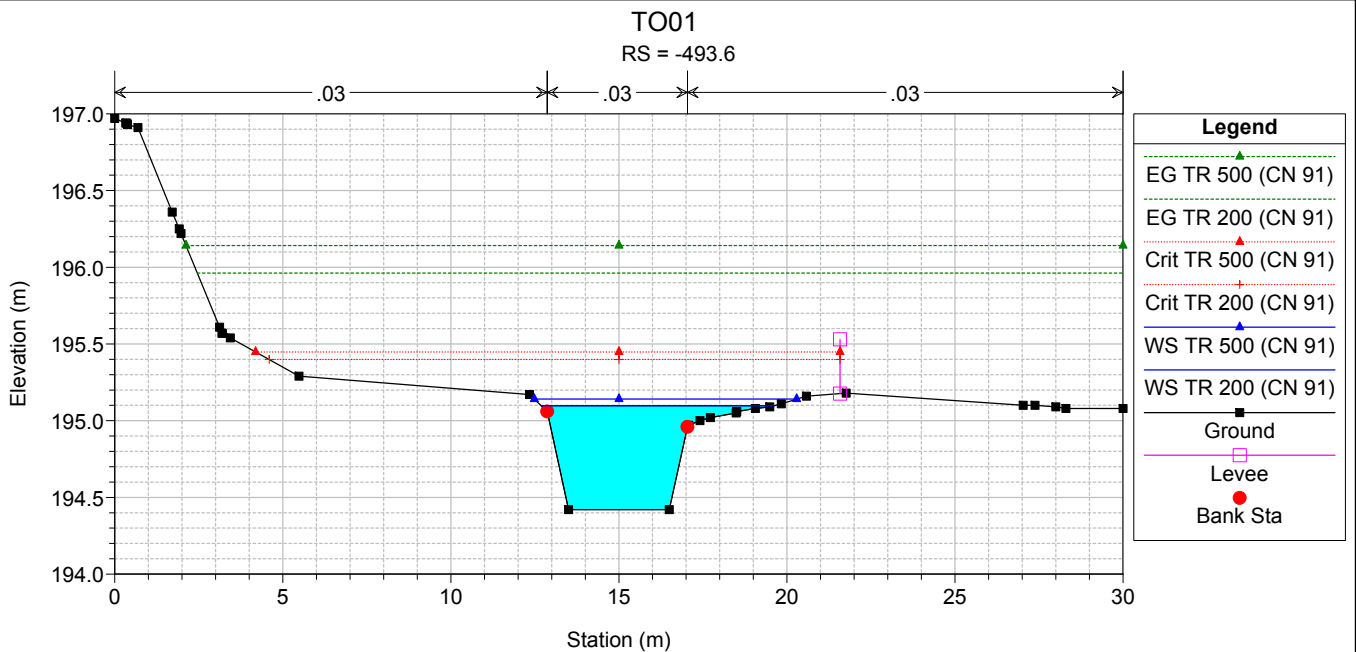

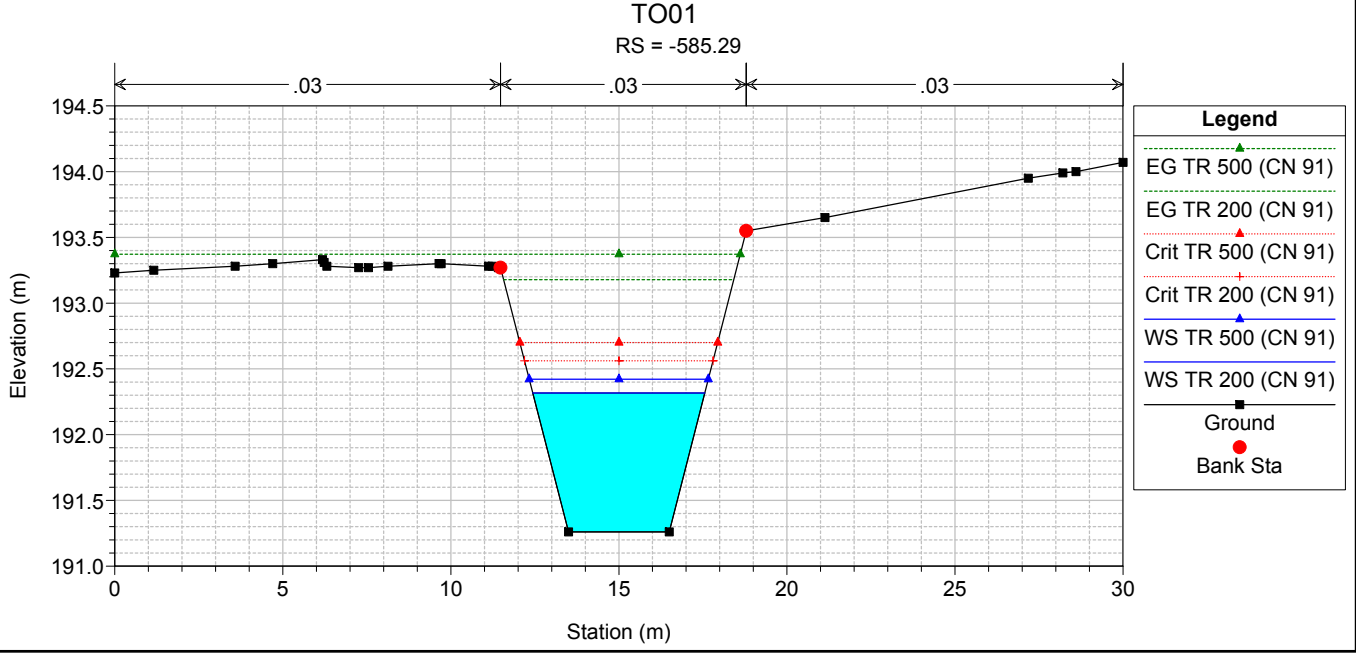
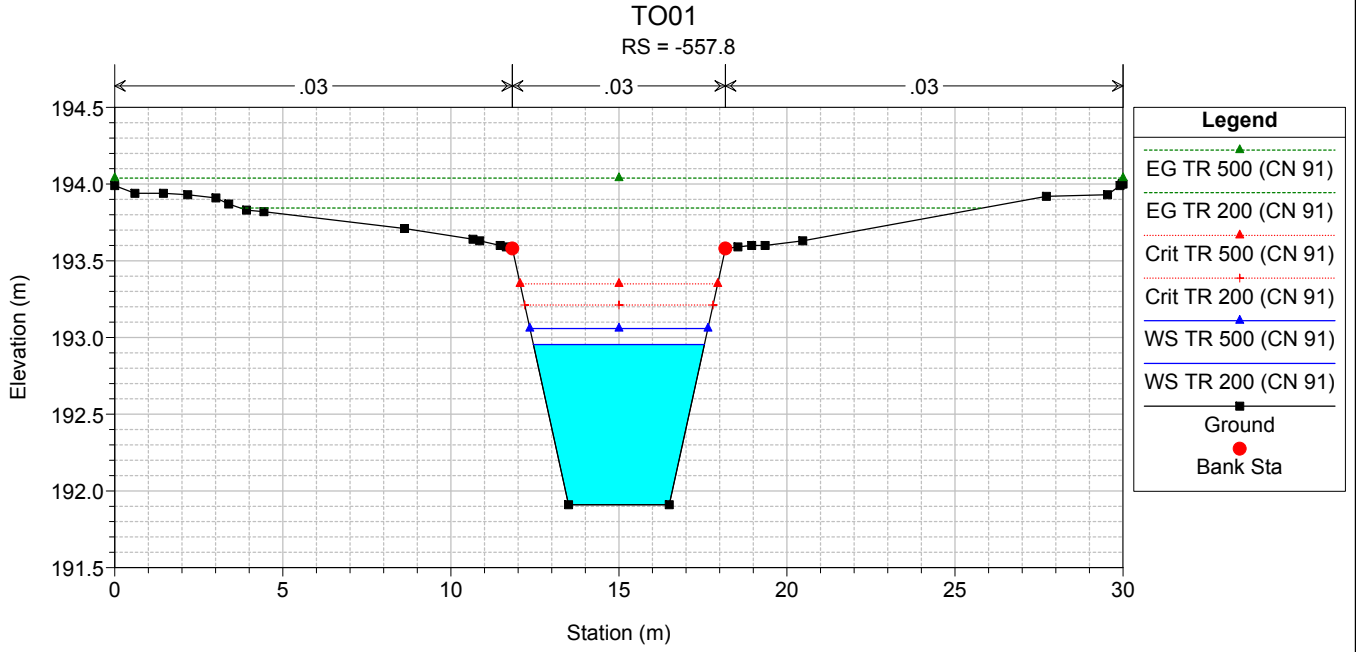
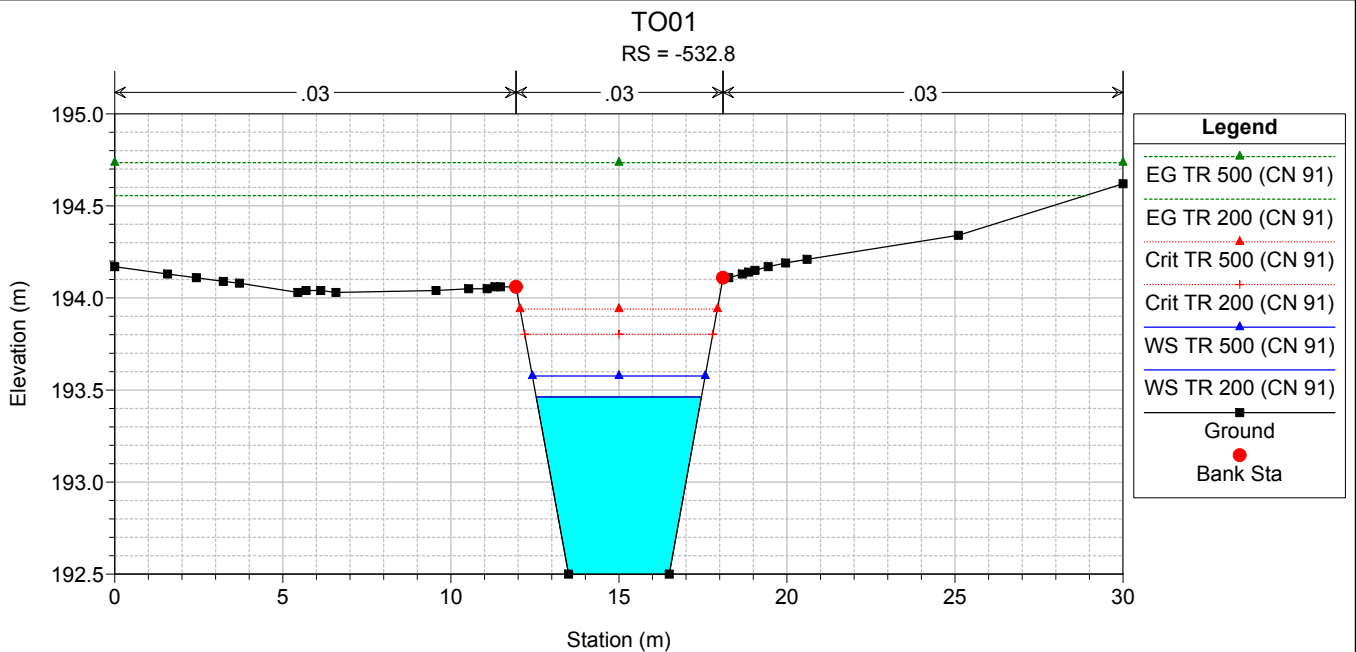

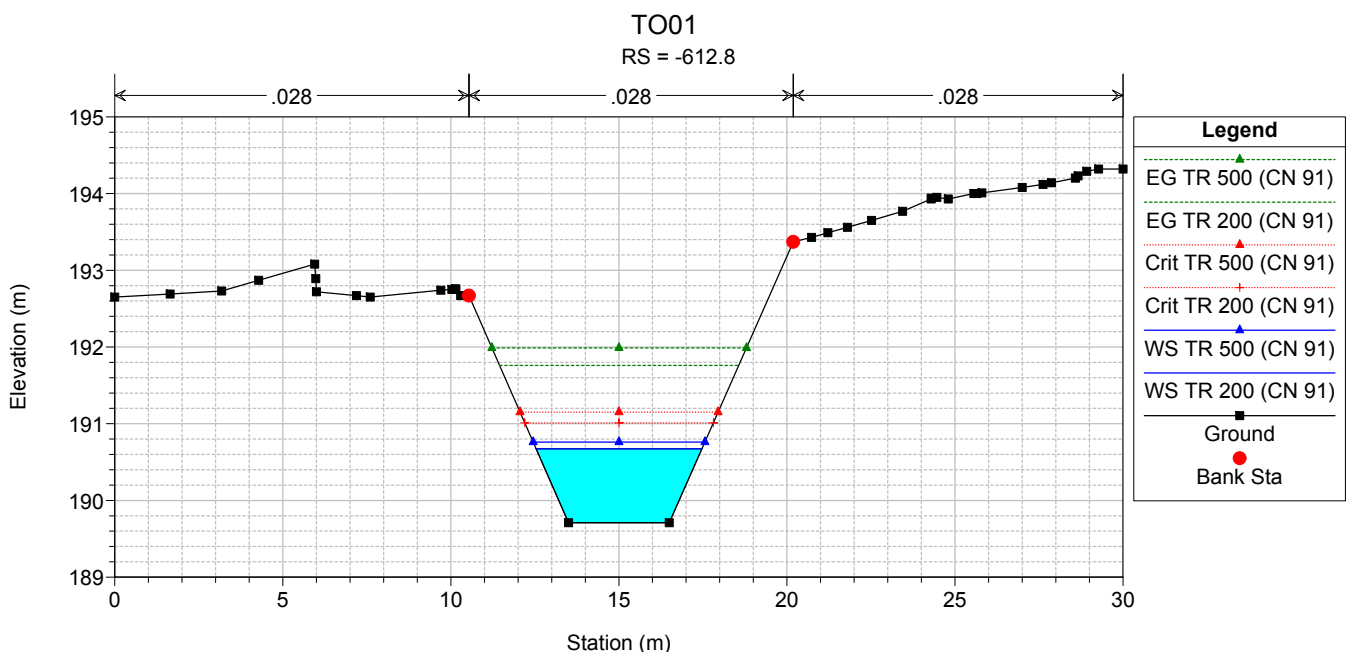
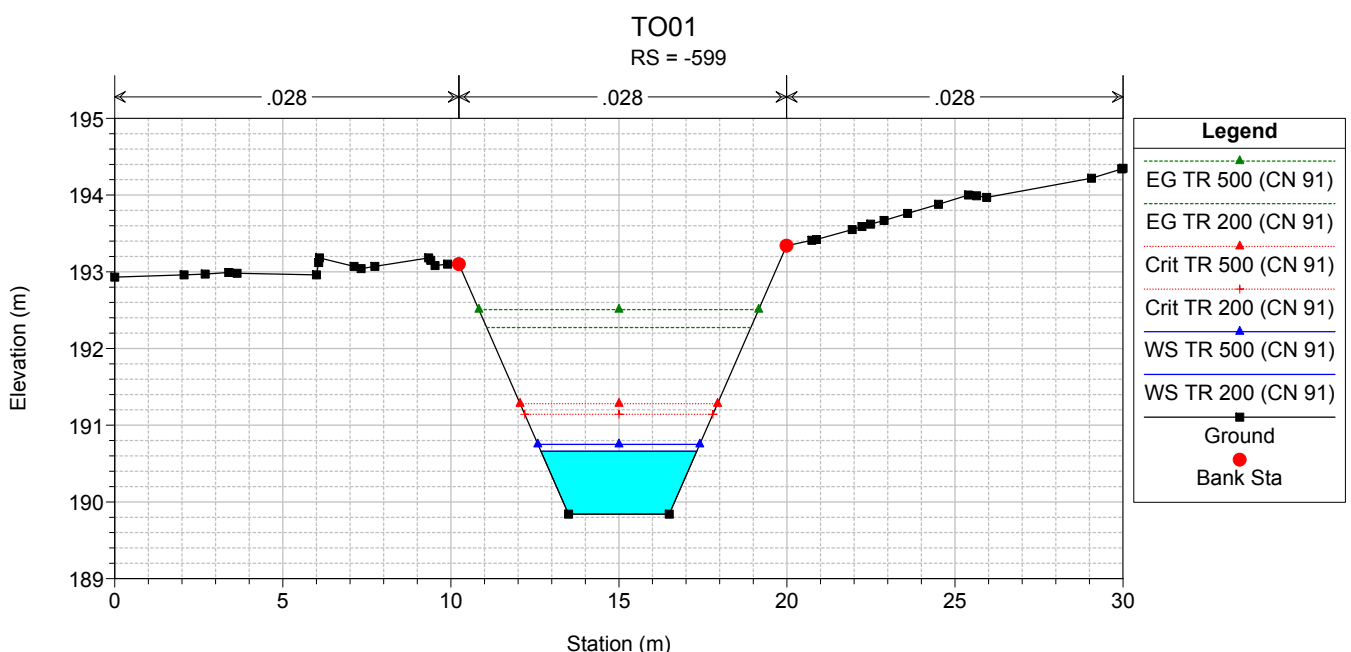
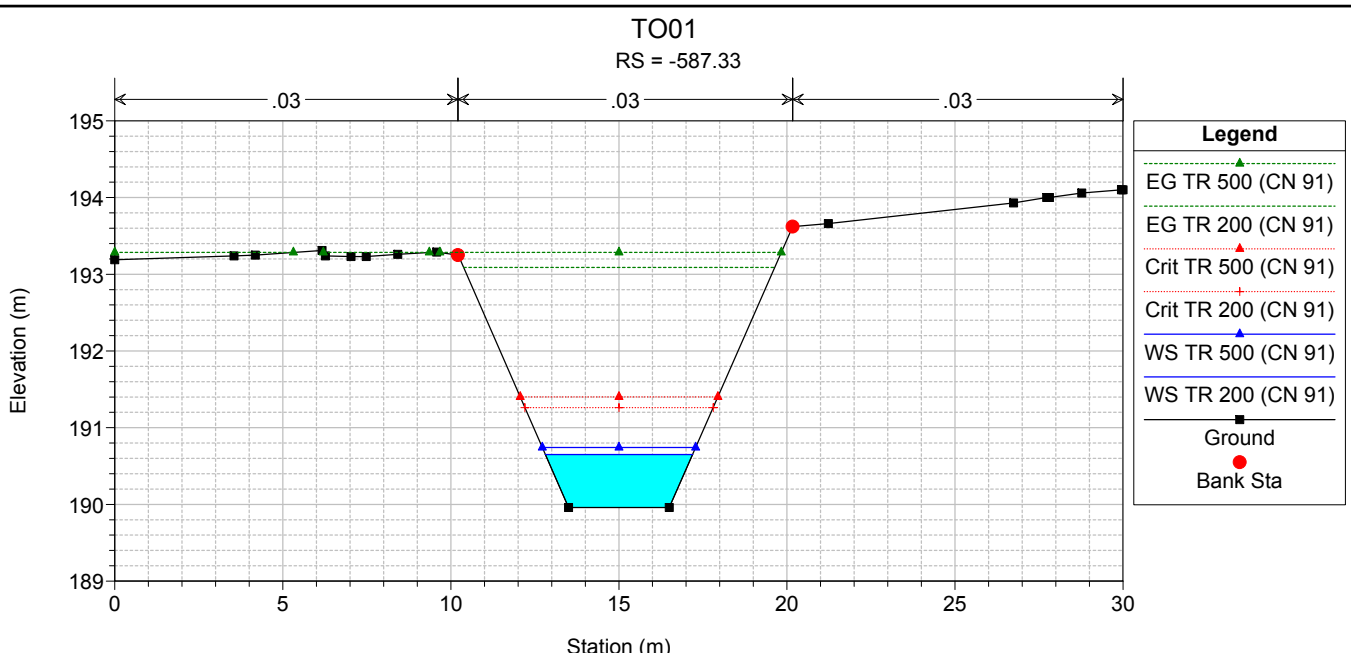

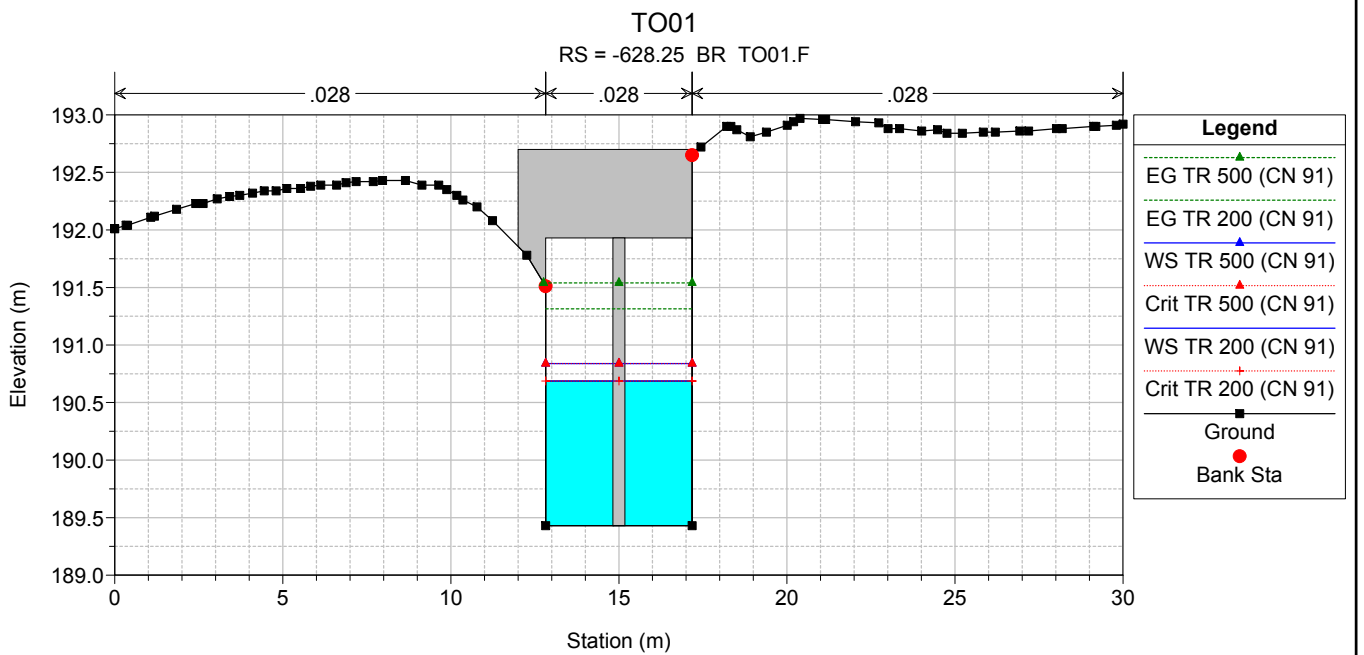
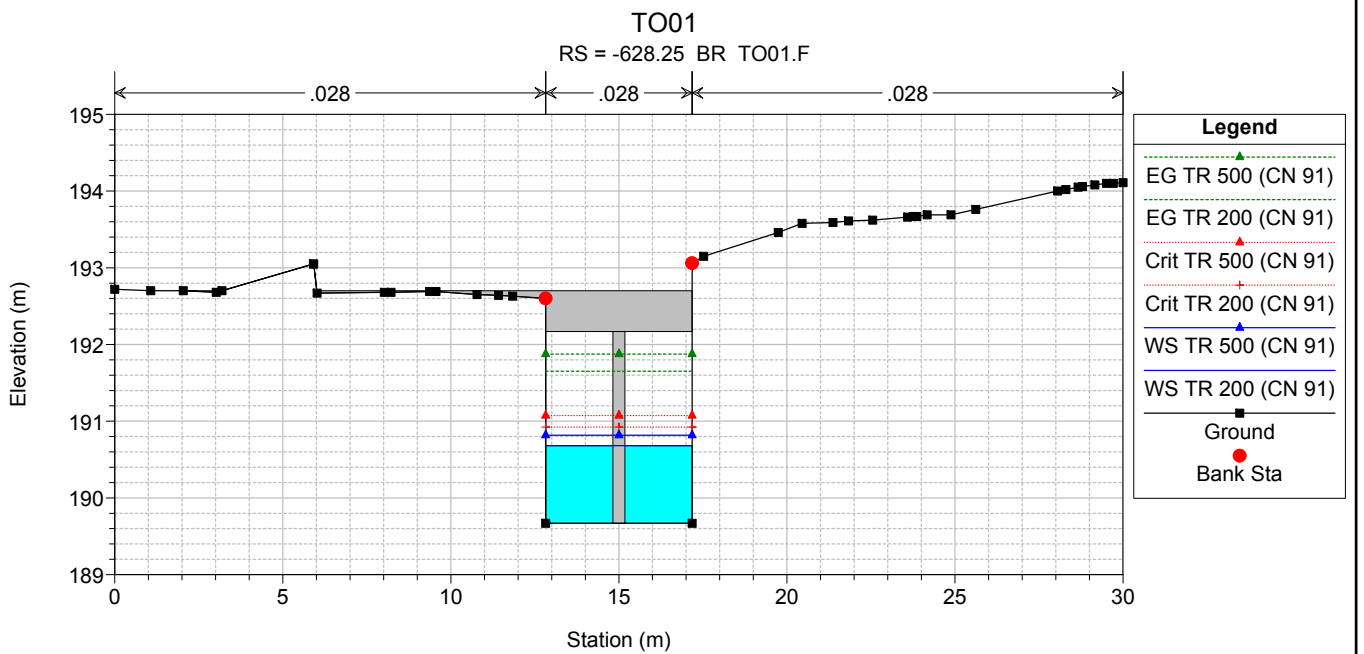
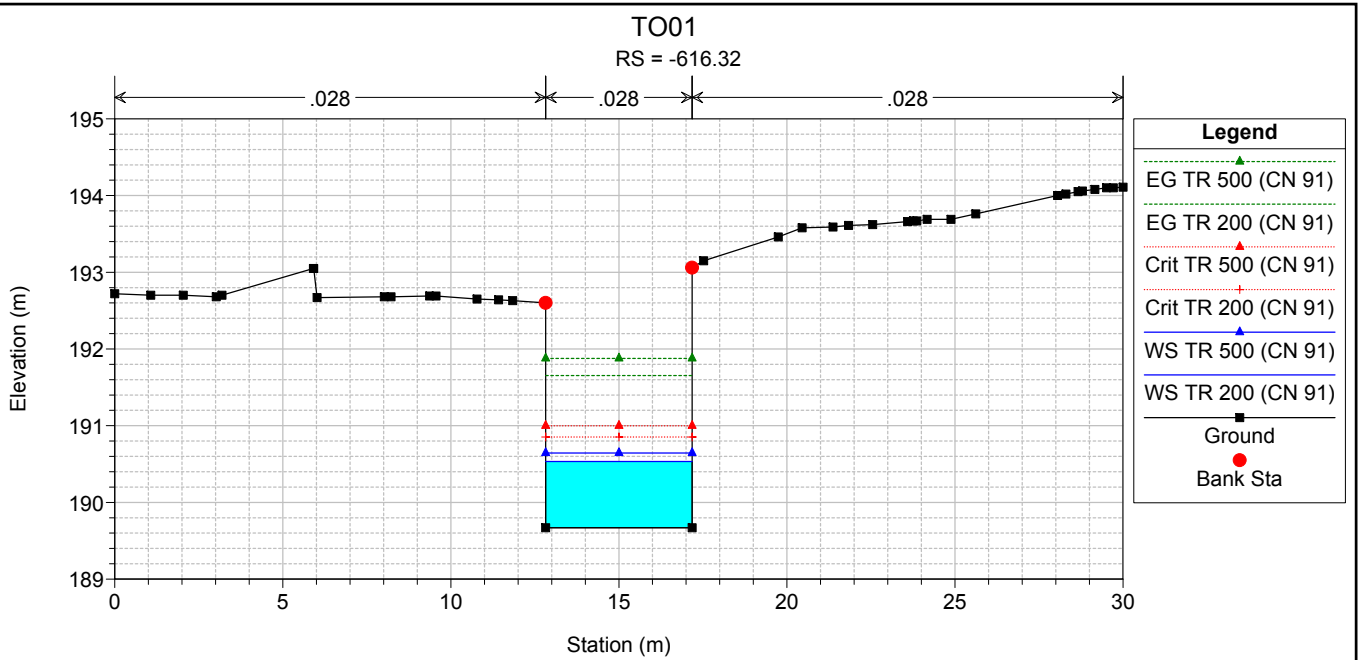

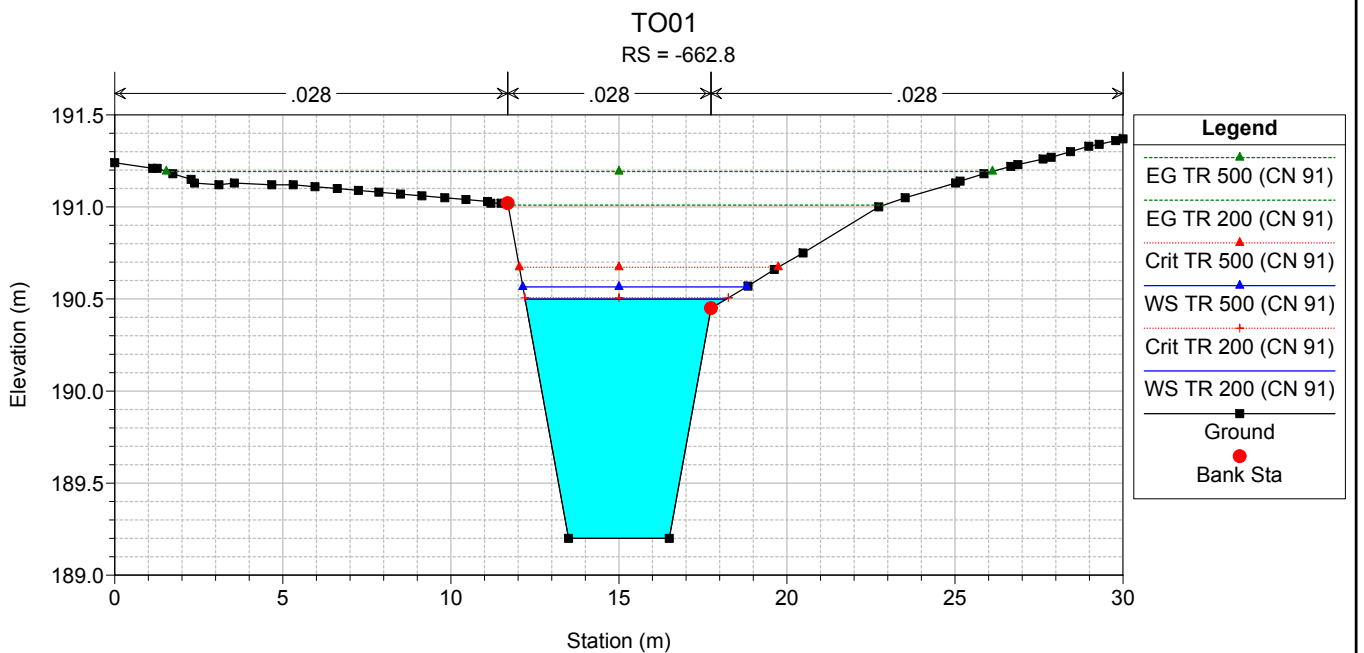
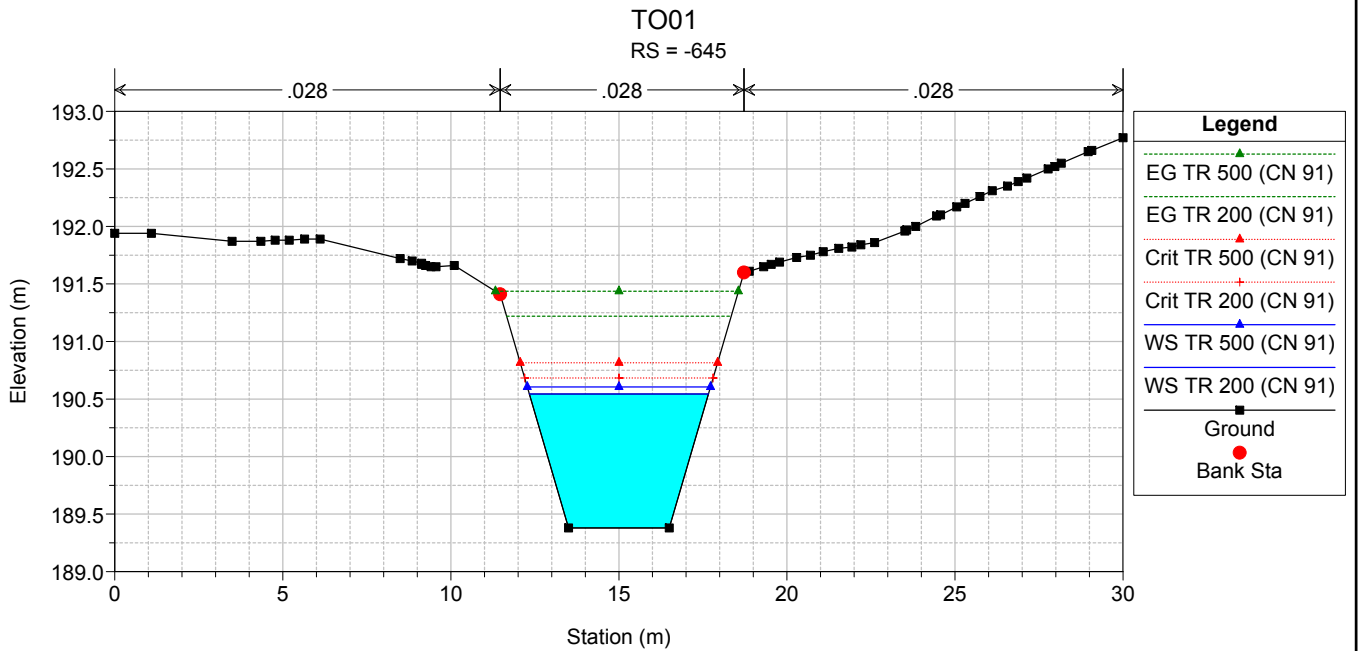
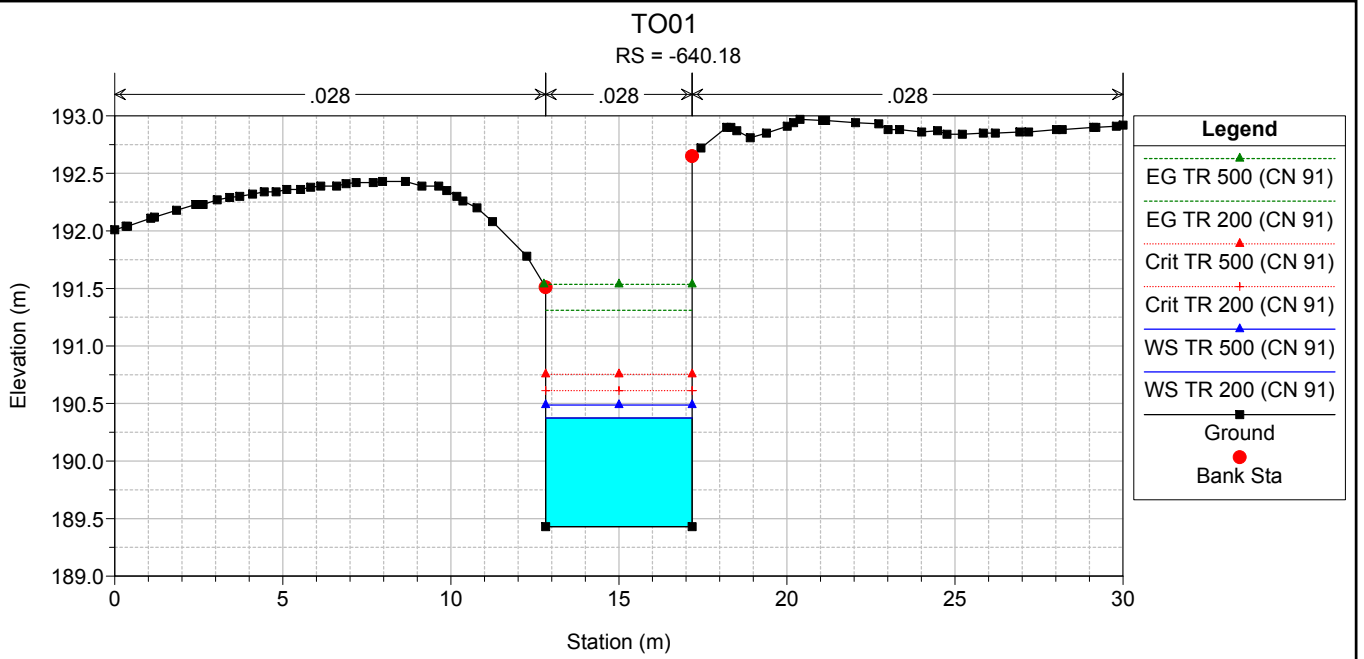

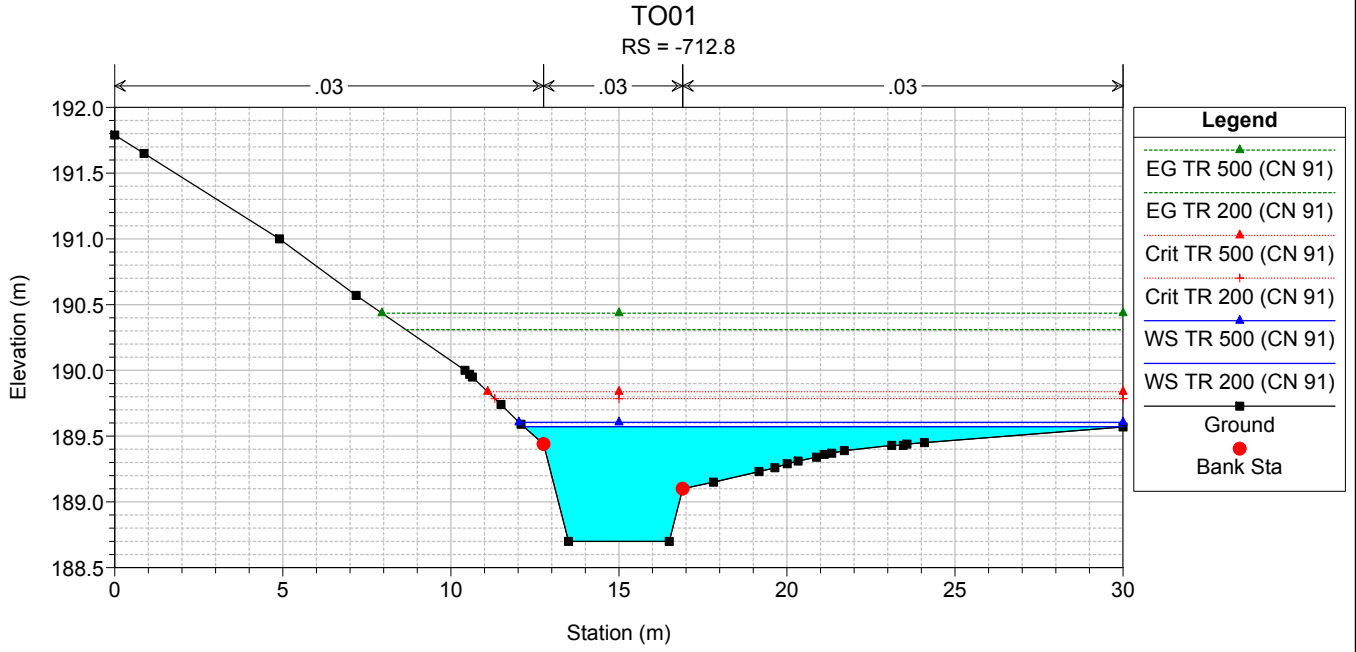
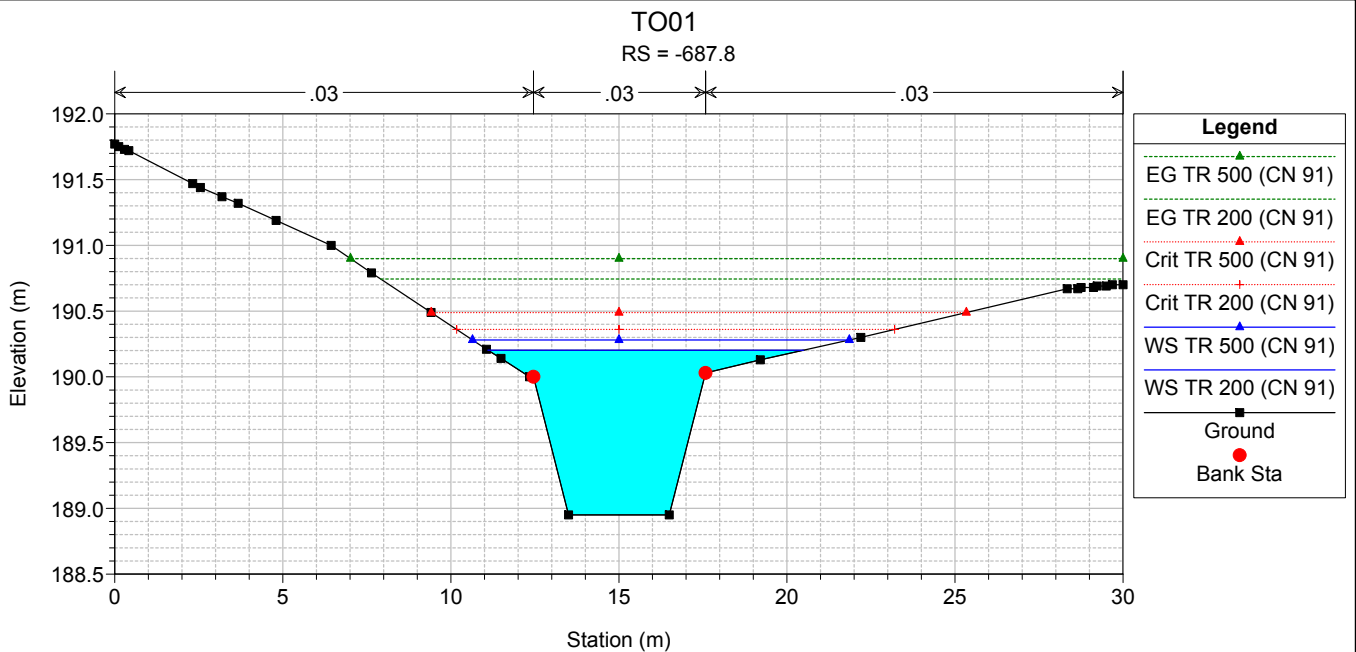

TO01-TRIS

RS = -10

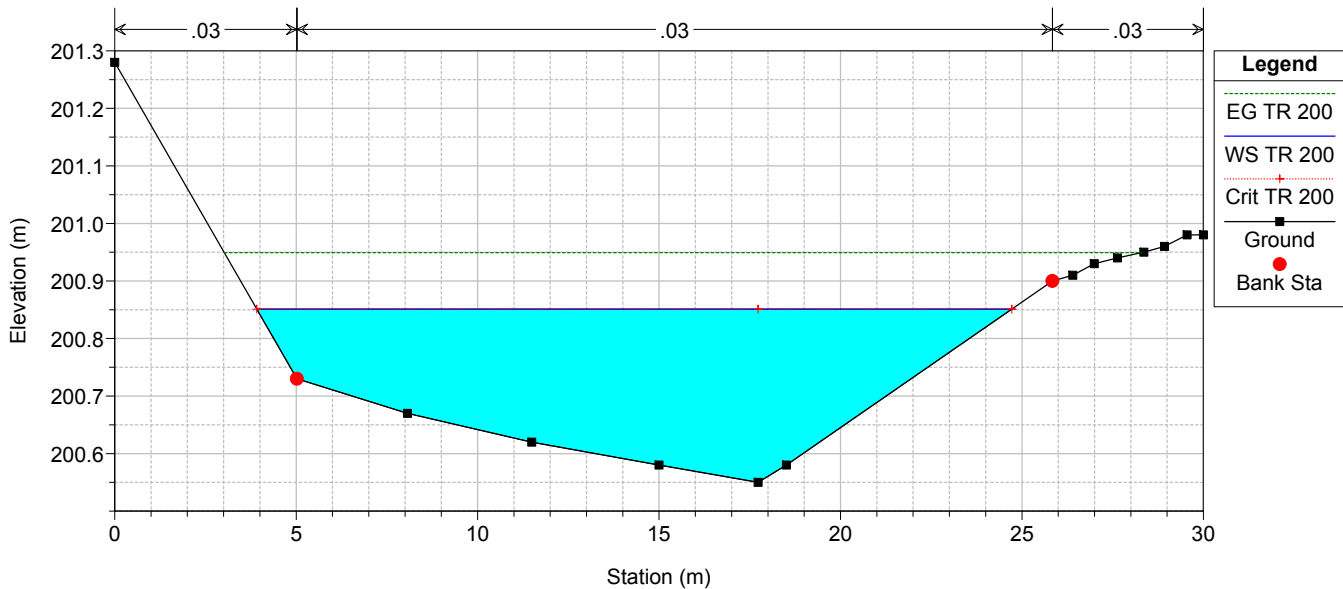

TO01-TRIS

RS = -25

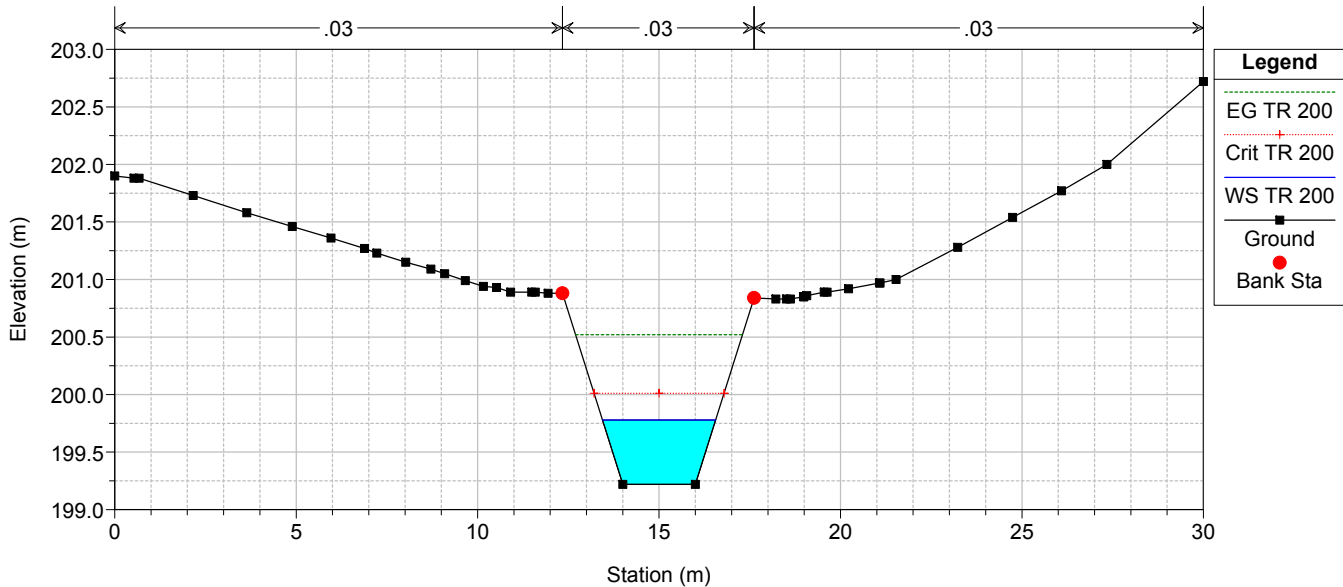

TO01-TRIS

RS = -32

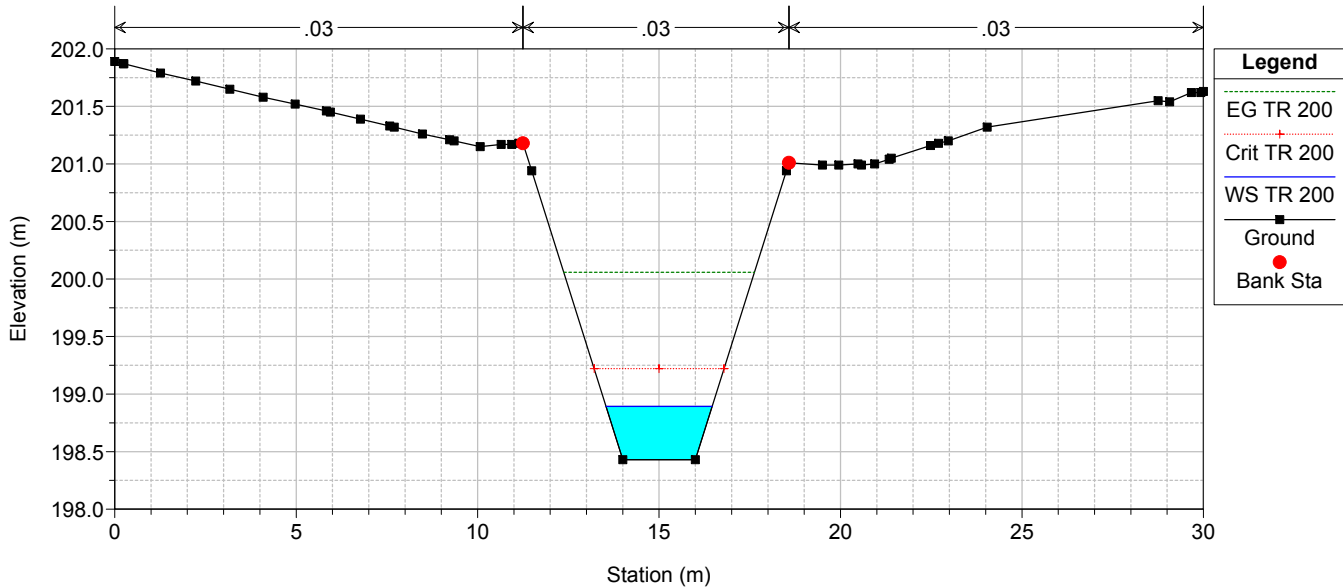

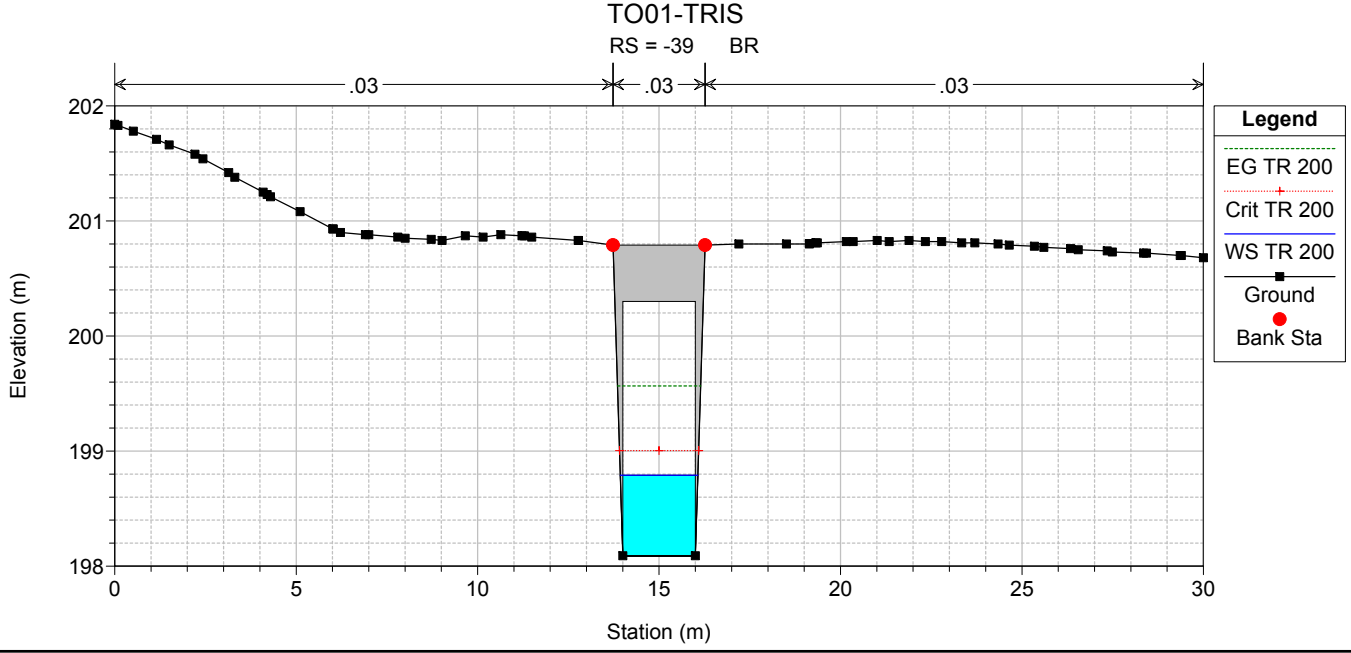
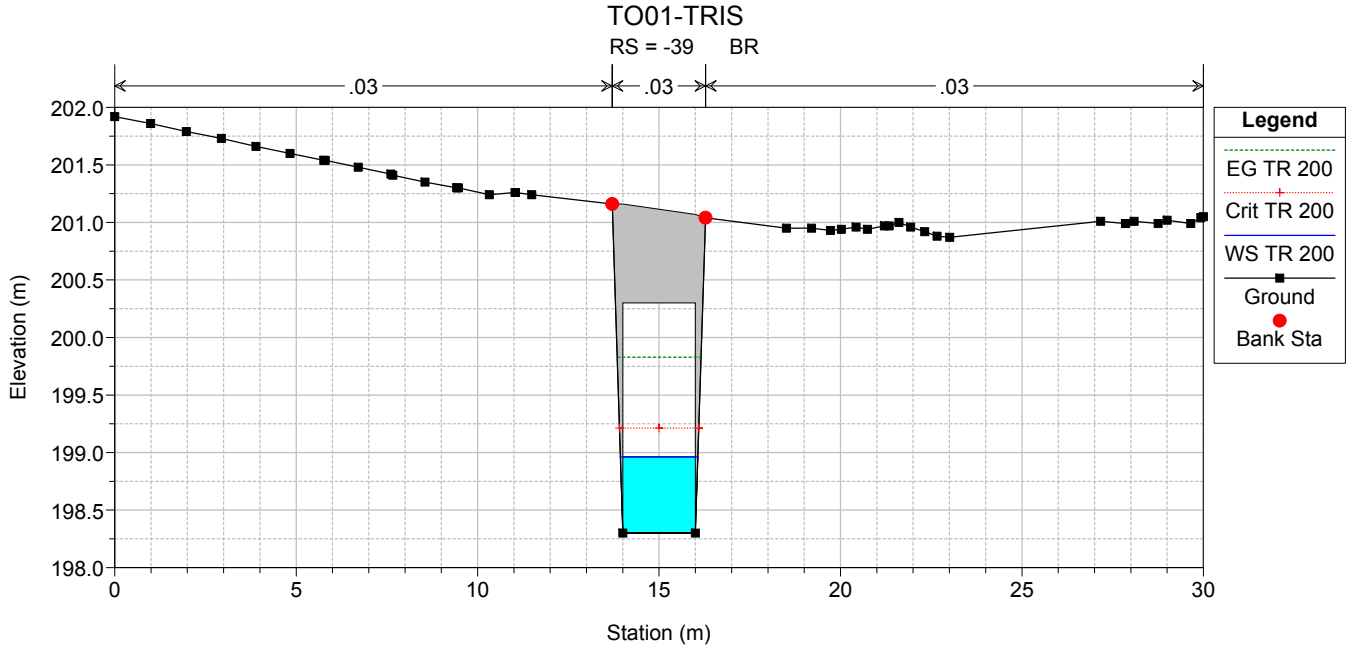
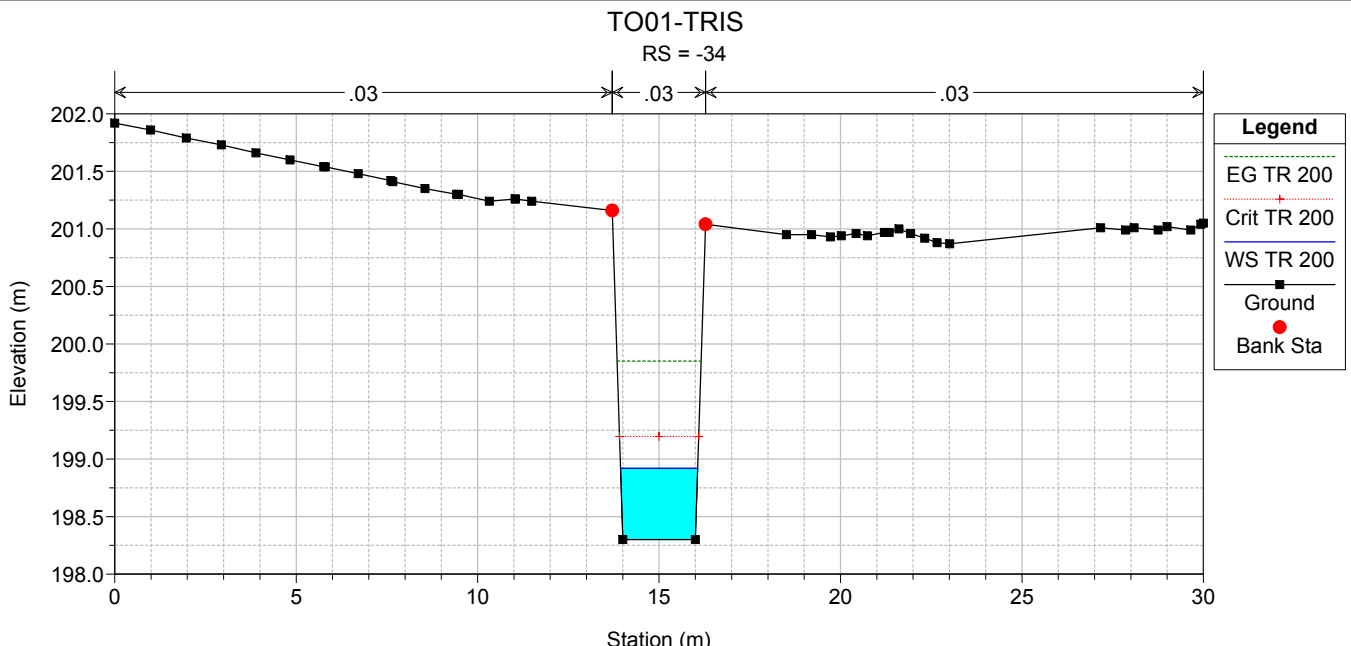

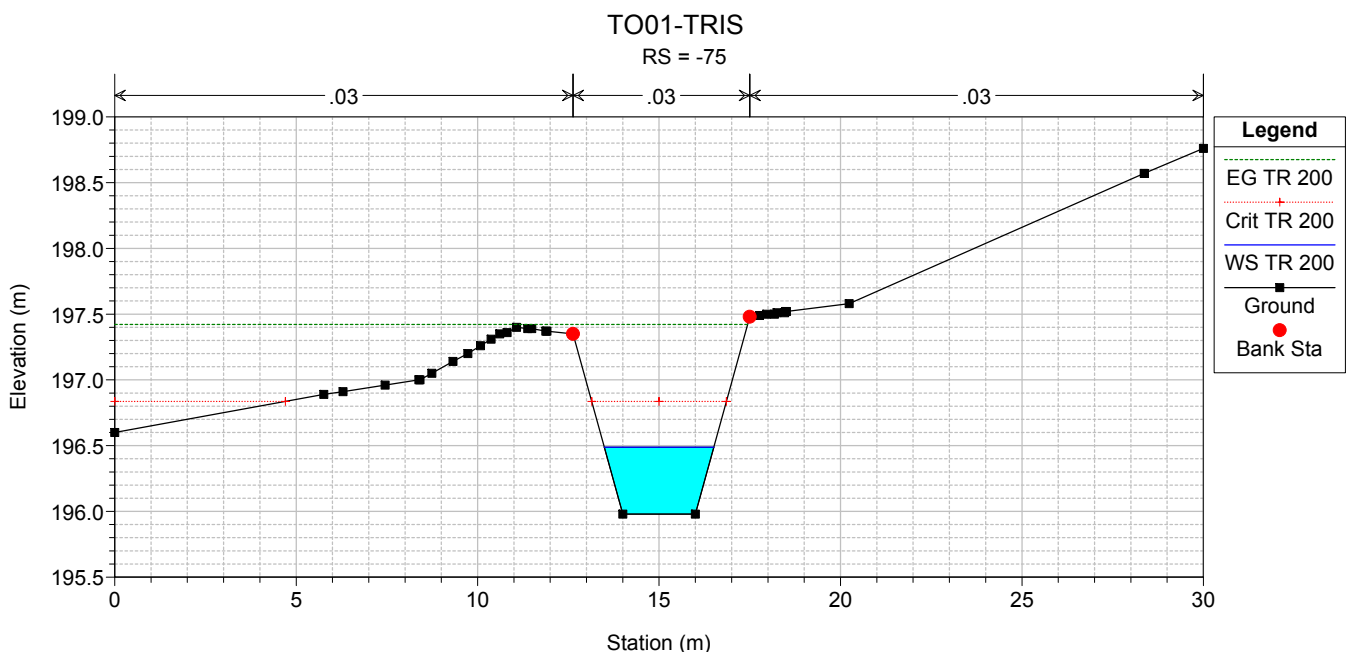
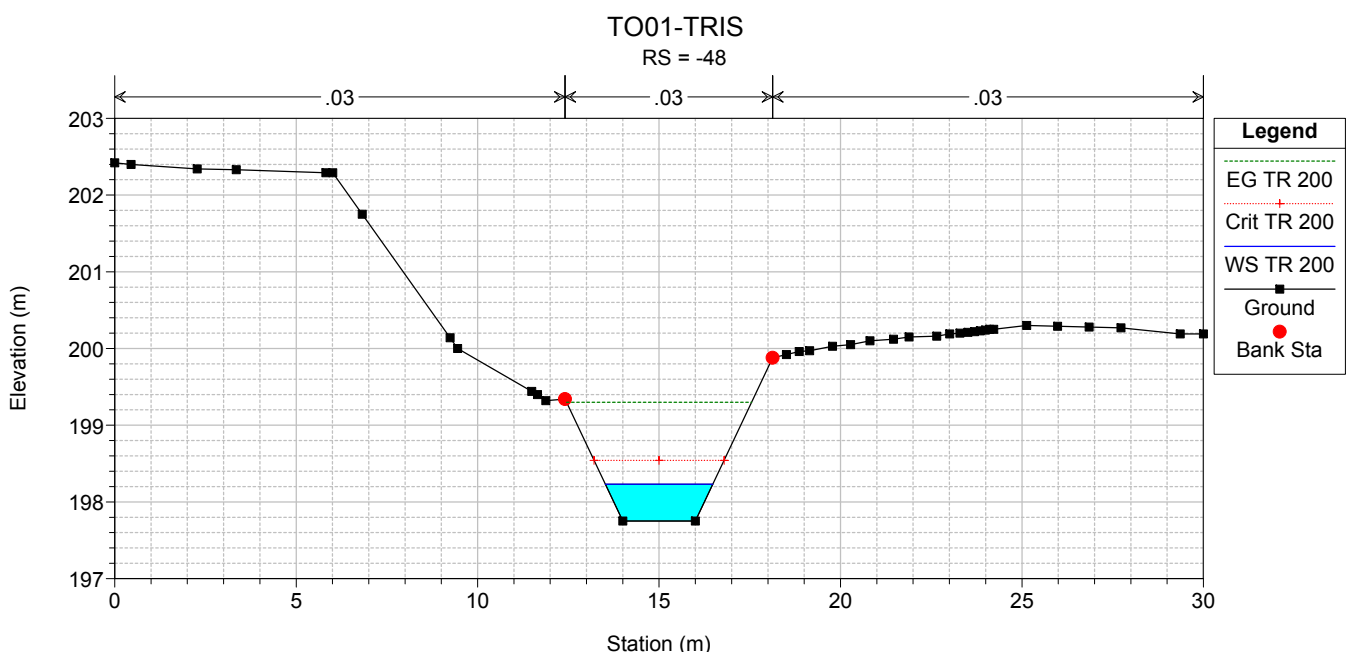
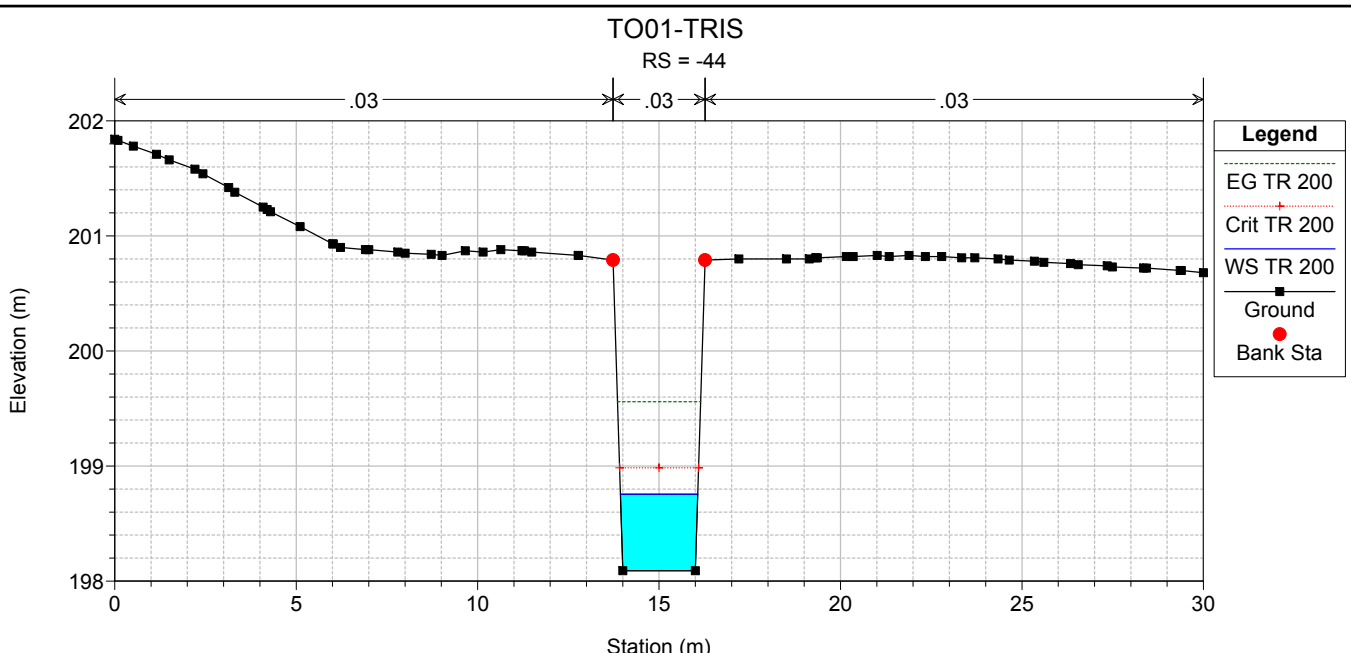

TO01-TRIS

RS = -100

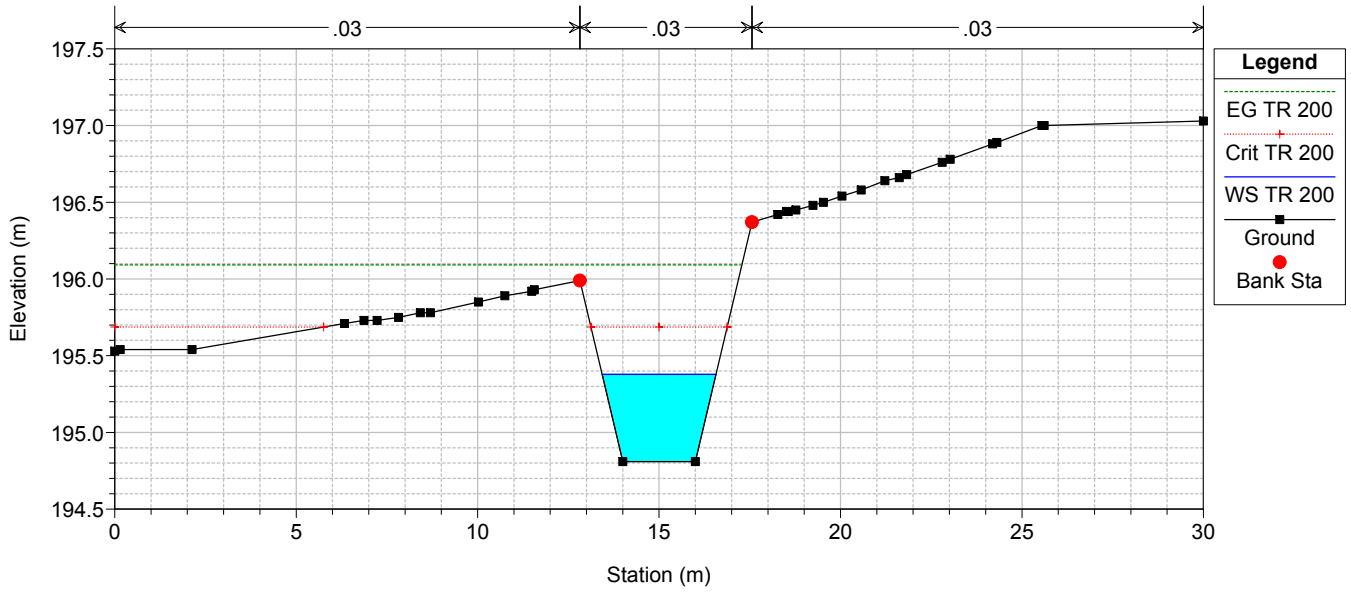

TO01-TRIS

RS = -125

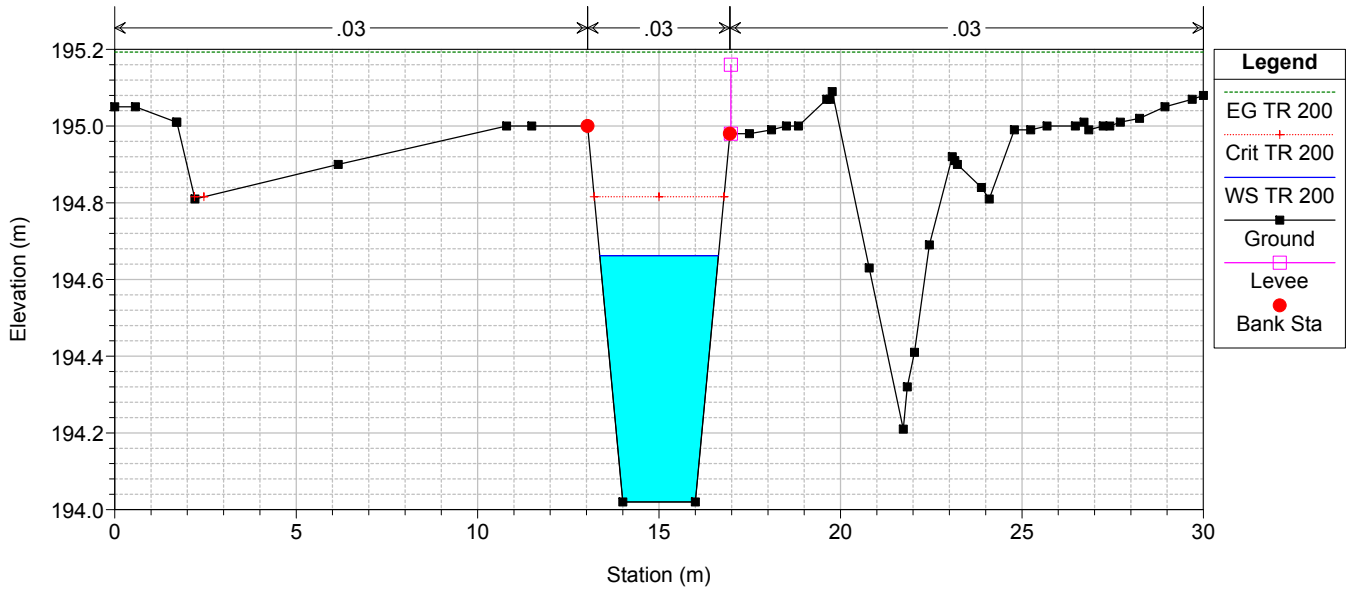

ALLEGATO 2.2

Interferenza idraulica - T002
Tabella riassuntiva dei risultati, profilo idrico e sezioni
trasversali con i livelli idrici (TR 200 -500 anni)

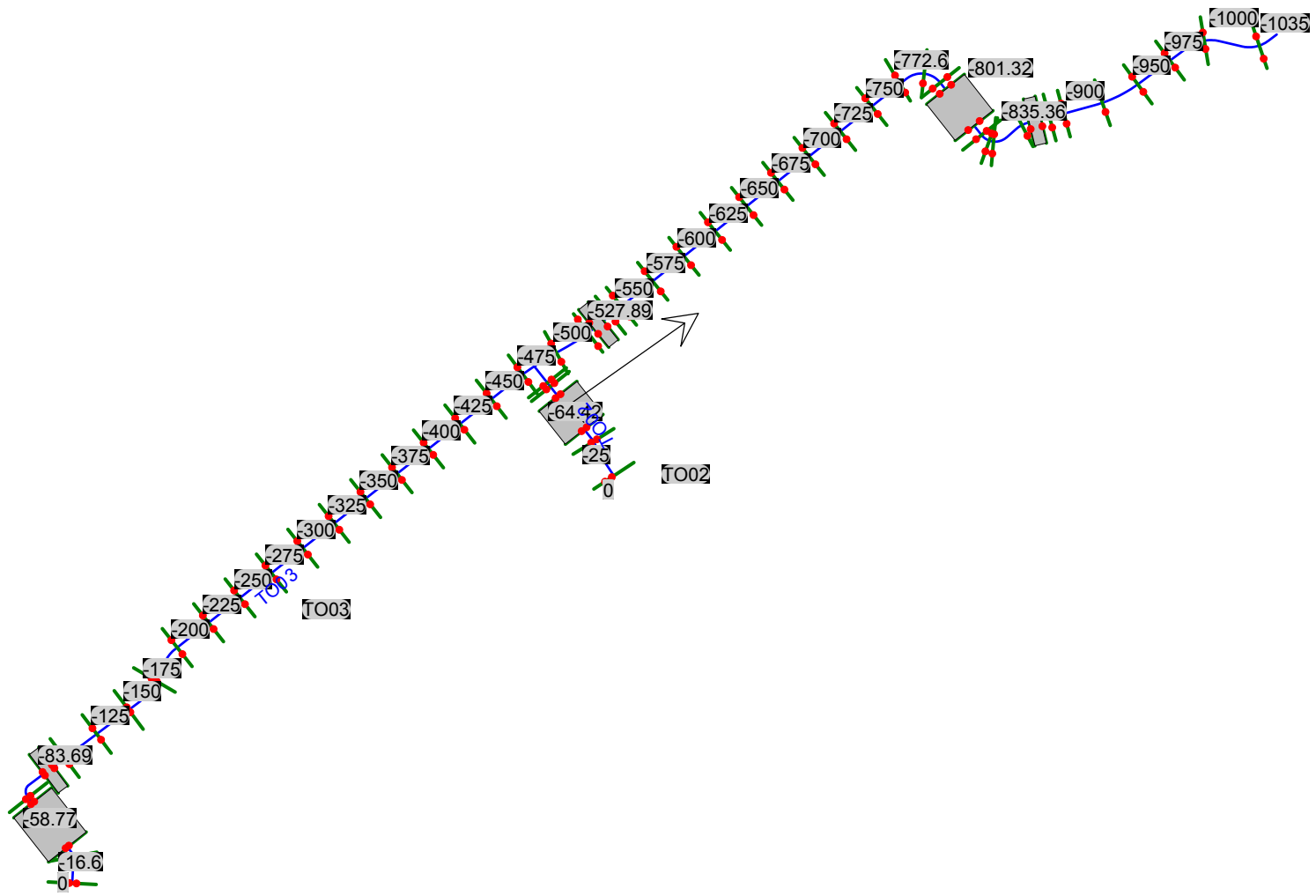

HEC-RAS Plan: TO02-TO03_PO River: TO02 Reach: TO02 Profile: TR 200_CN91

Reach	River Sta	Profile	Q Total (m ³ /s)	Min Ch El (m)	Max Chl Dpth (m)	W.S. Elev (m)	Crit W.S. (m)	Diff	Froude # Chl	E.G. Elev (m)	Vel Chnl (m/s)	Vel Total (m/s)	Hydr Radius C (m)	Shear Chan (N/m ²)	Hydr Depth (m)
TO02	0	TR 200_CN91	8.7	206.00	0.52	206.52	206.51	0.01	0.96	206.66	1.9	1.6	0.4	42.4	0.27
TO02	-25	TR 200_CN91	8.7	205.77	0.54	206.24	206.24	0.00	0.95	206.37	1.8	1.5	0.4	41.3	0.25
TO02	-34.09	TR 200_CN91	8.7	204.76	1.08	205.84	205.70	0.14	0.81	206.18	2.6	2.6	0.7	68.1	1.05
TO02	-47.76	Bridge													
TO02	-64.42	TR 200_CN91	8.7	204.50	0.83	205.33	205.44	-0.11	1.22	205.92	3.4	3.4	0.5	126.4	0.81
TO02	-68.65	TR 200_CN91	8.7	204.31	0.47	204.78	205.04	-0.26	2.02	205.65	4.1	4.1	0.4	205.1	0.43
TO02	-71.55	TR 200_CN91	8.7	204.17	0.48	204.65	204.90	-0.25	1.98	205.49	4.1	4.1	0.4	199.4	0.43

HEC-RAS Plan: TO02-TO03_PO River: TO02 Reach: TO02 Profile: TR 500_CN91

Reach	River Sta	Profile	Q Total (m ³ /s)	Min Ch El (m)	Max Chl Dpth (m)	W.S. Elev (m)	Crit W.S. (m)	Diff	Froude # Chl	E.G. Elev (m)	Vel Chnl (m/s)	Vel Total (m/s)	Hydr Radius C (m)	Shear Chan (N/m ²)	Hydr Depth (m)
TO02	0	TR 500_CN91	10.2	206.00	0.55	206.55	206.55	0.00	0.98	206.70	2.0	1.6	0.4	46.6	0.29
TO02	-25	TR 500_CN91	10.2	205.77	0.66	206.36	206.27	0.09	0.63	206.44	1.4	1.2	0.5	21.9	0.34
TO02	-34.09	TR 500_CN91	10.2	204.76	1.21	205.97	205.80	0.17	0.80	206.34	2.7	2.7	0.7	72.8	1.17
TO02	-47.76	Bridge													
TO02	-64.42	TR 500_CN91	10.2	204.50	0.91	205.41	205.54	-0.13	1.23	206.08	3.6	3.6	0.6	139.1	0.89
TO02	-68.65	TR 500_CN91	10.2	204.31	0.52	204.83	205.12	-0.29	2.05	205.80	4.4	4.4	0.4	223.9	0.46
TO02	-71.55	TR 500_CN91	10.2	204.17	0.52	204.69	204.98	-0.29	2.01	205.64	4.3	4.3	0.4	217.6	0.47

TO02-TO03

TO02 TO02

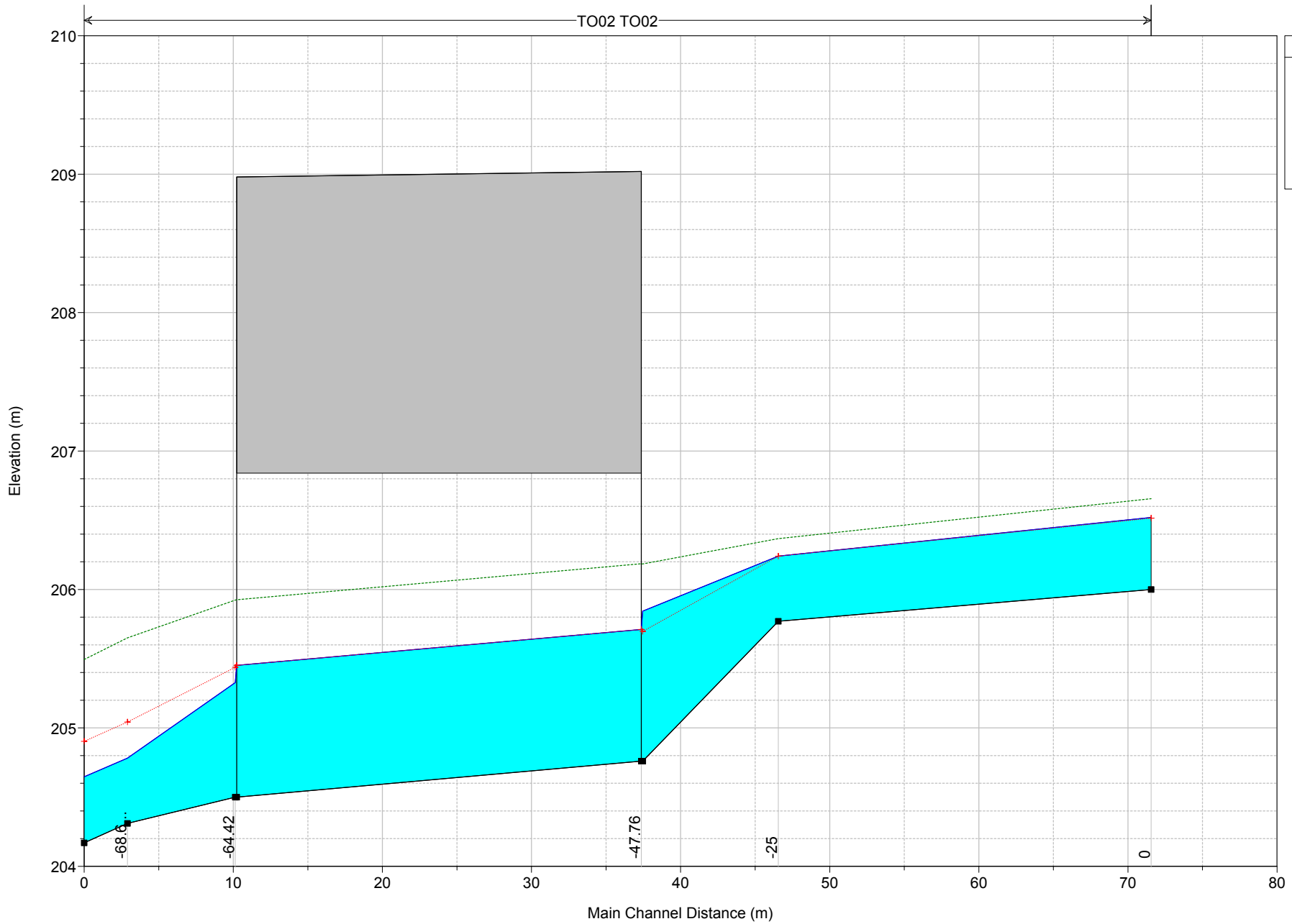

Legend

- EG TR 200_CN91 (Green dashed line)
- Crit TR 200_CN91 (Red dotted line)
- WS TR 200_CN91 (Blue solid line)
- Ground (Black line with square marker)

TO02-TO03

RS = 0

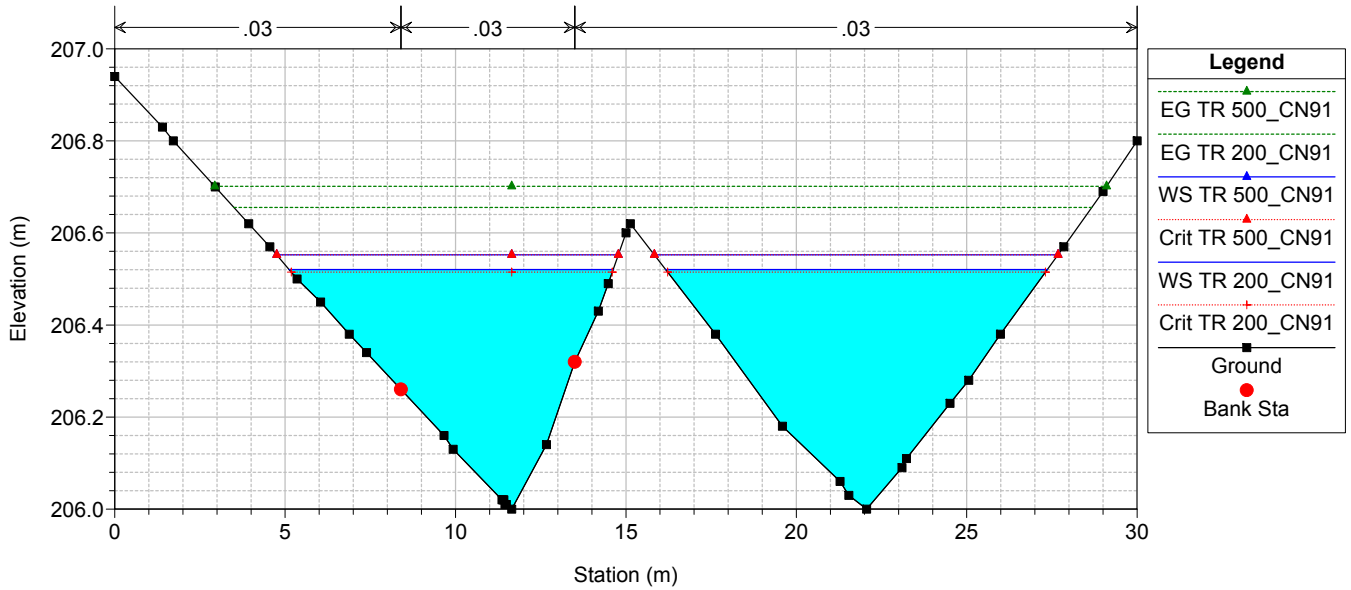

TO02-TO03

RS = -25

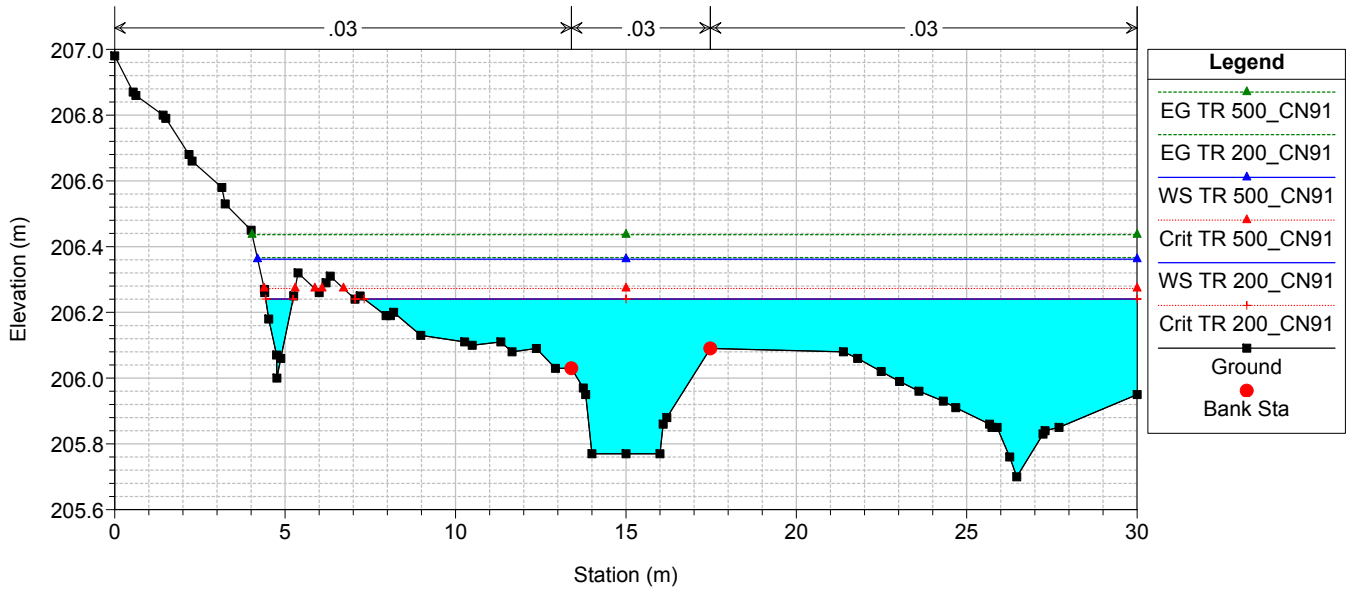

TO02-TO03

RS = -34.09

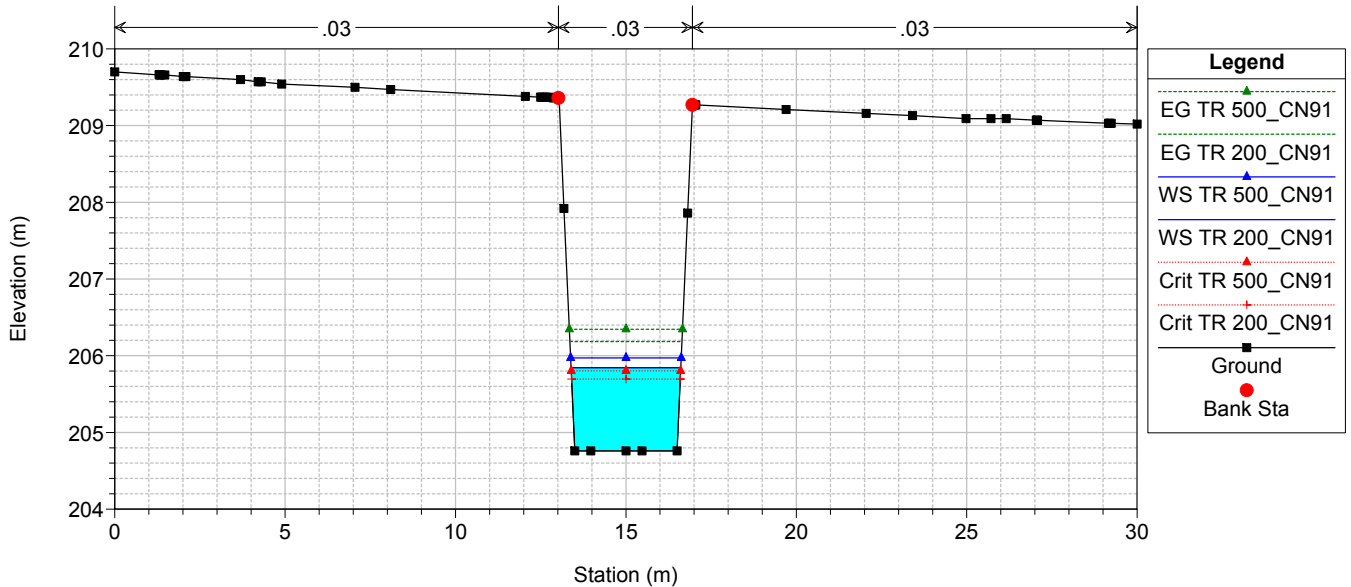

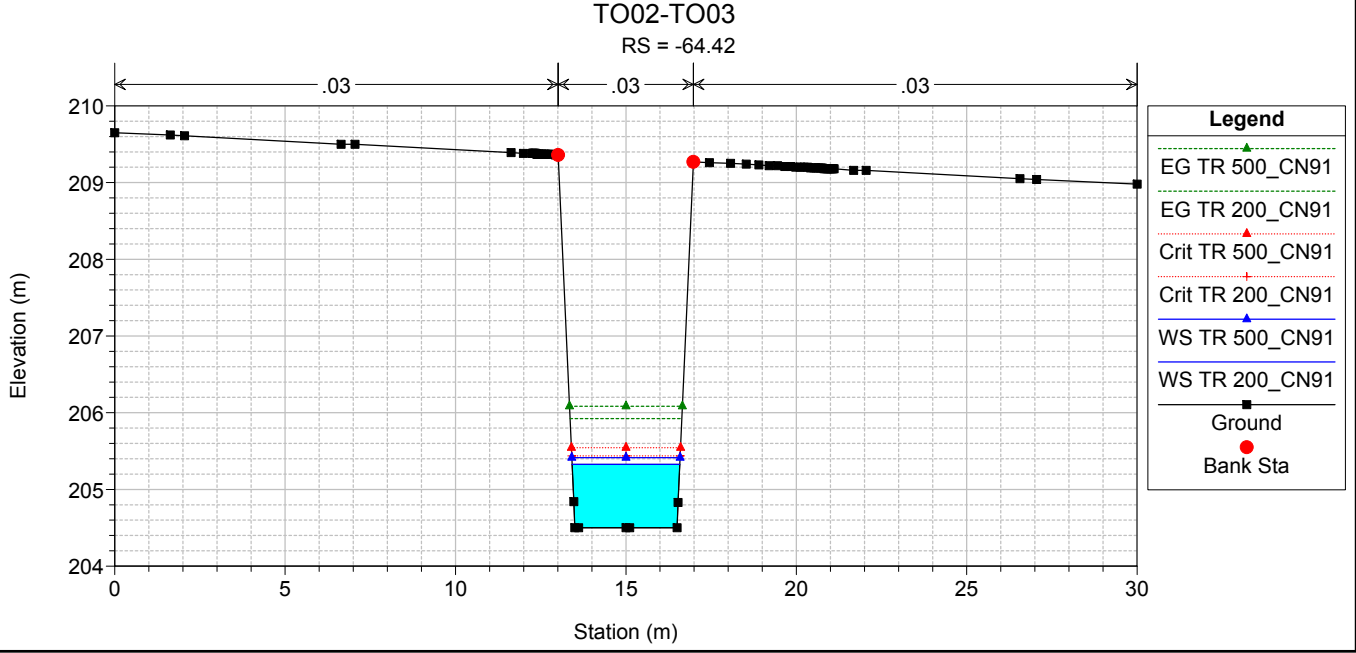
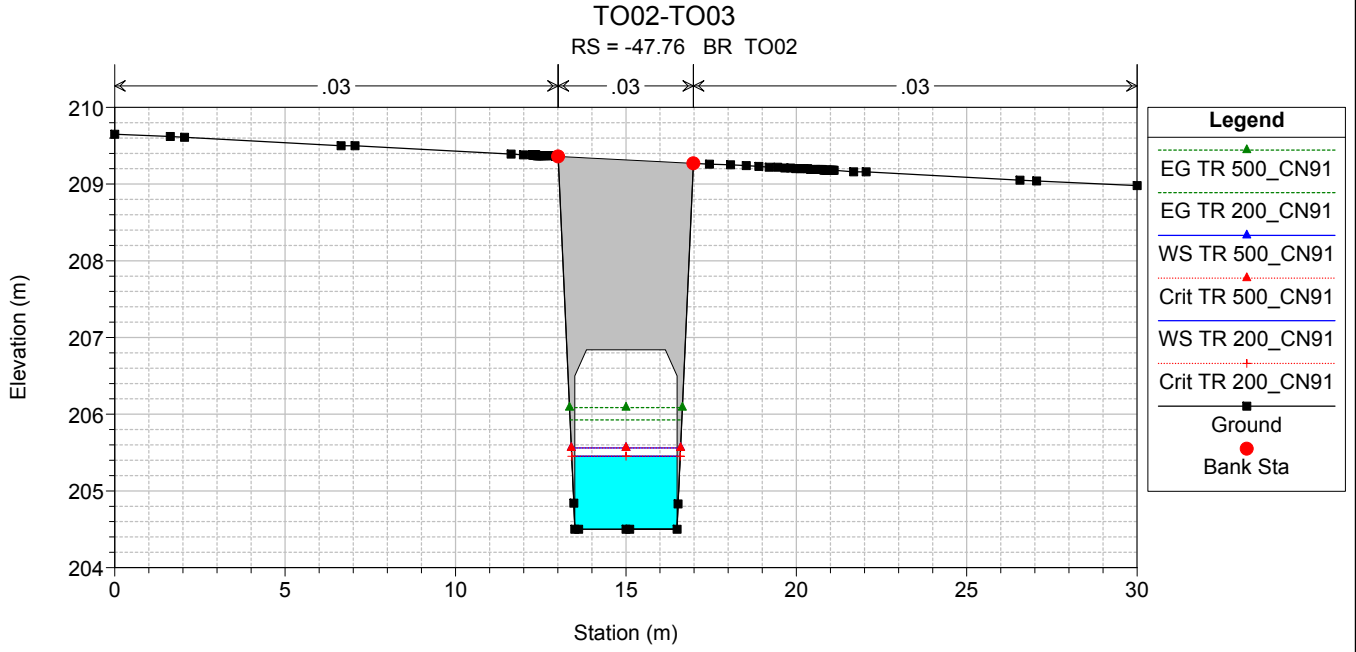
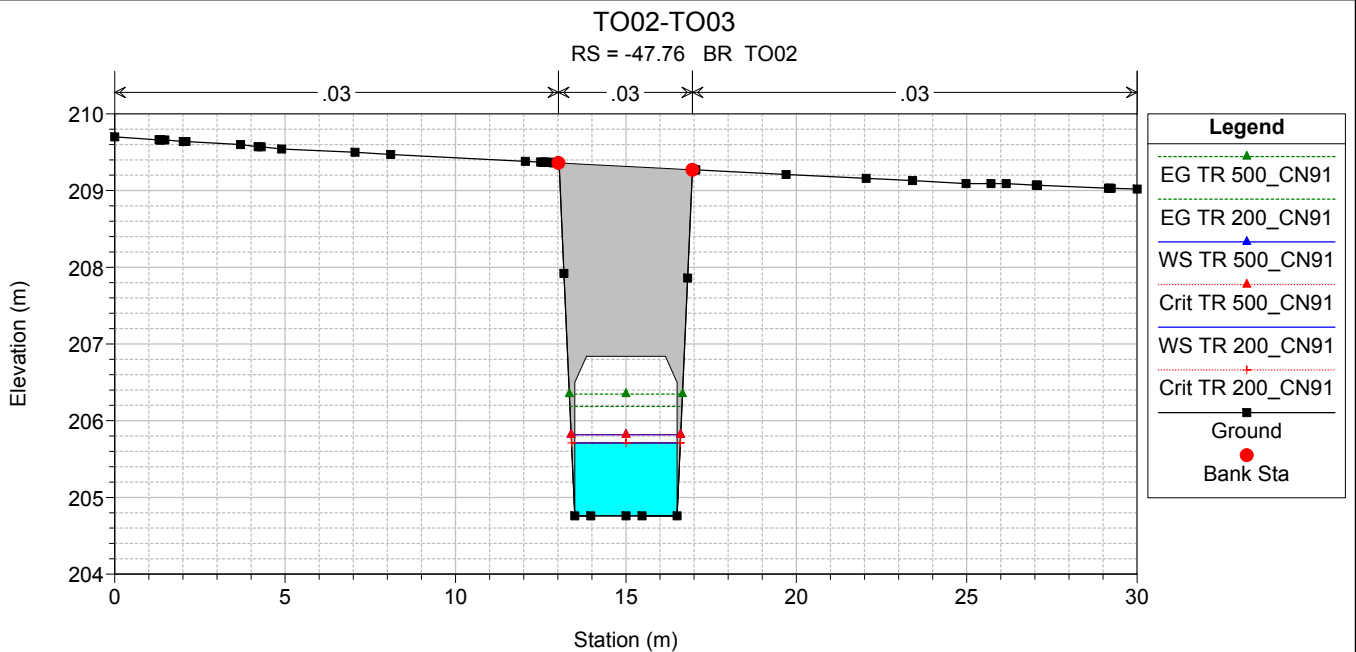

TO02-TO03

RS = -68.65

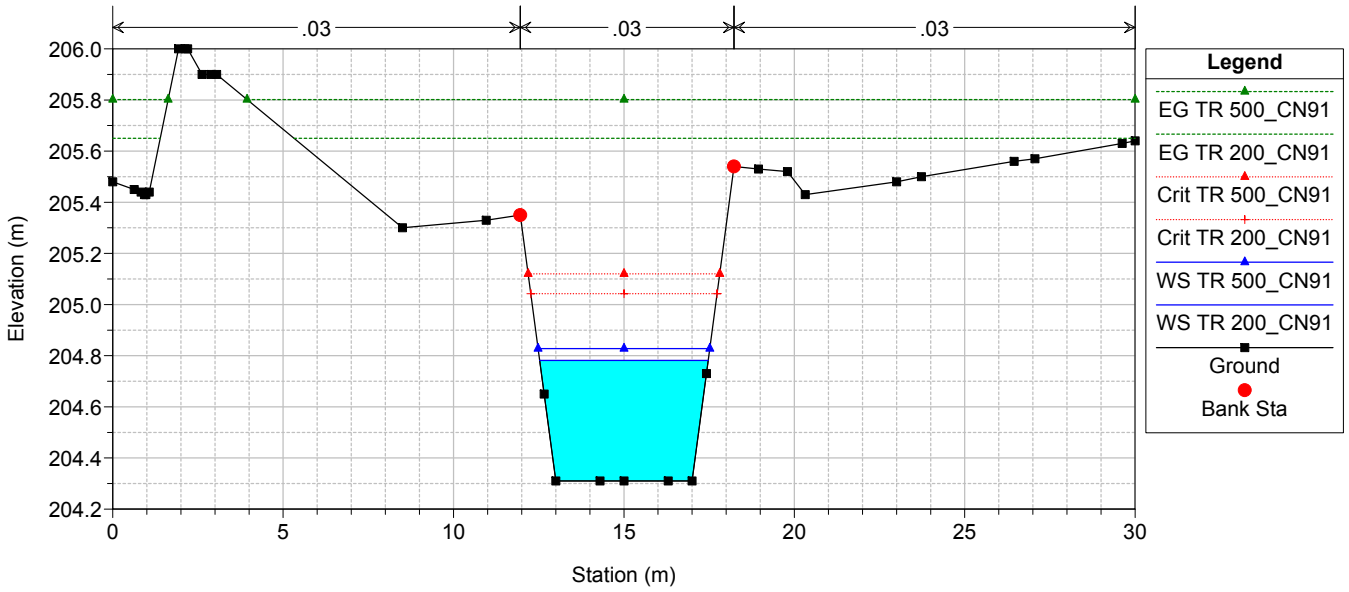

TO02-TO03

RS = -71.55

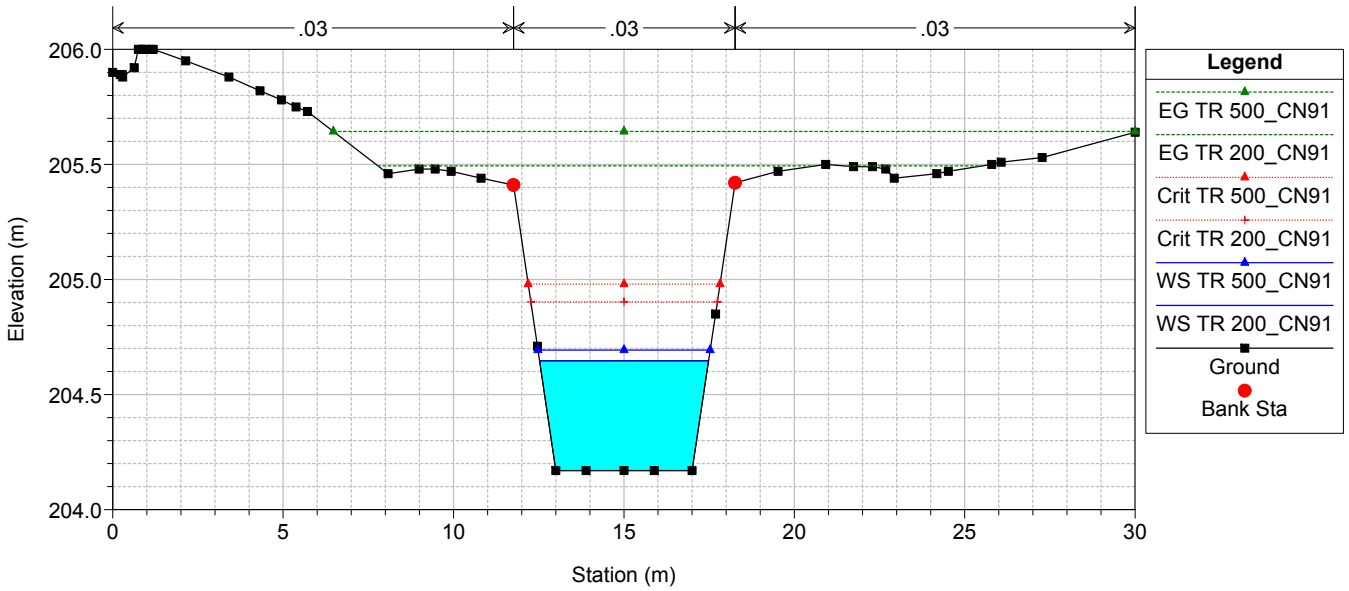

ALLEGATO 2.3

Interferenza idraulica - TO03
Tabella riassuntiva dei risultati, profilo idrico e sezioni
trasversali con i livelli idrici (TR 200 - 500 anni)

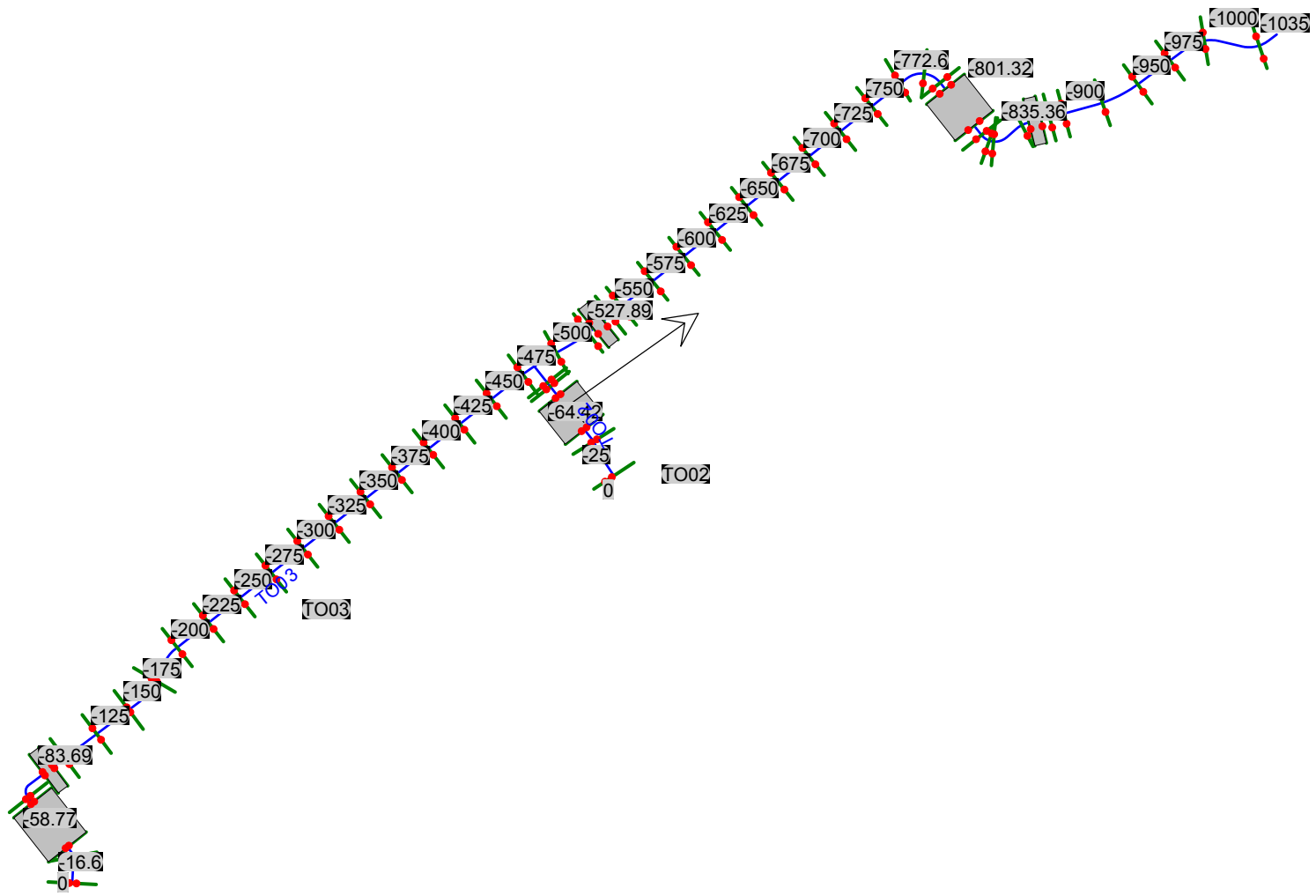

Reach	River Sta	Profile	Q Total (m ³ /s)	Min Ch El (m)	Max Chl Dpth (m)	W.S. Elev (m)	Crit W.S. (m)	Diff	Froude # Chl	E.G. Elev (m)	Vel Chnl (m/s)	Vel Total (m/s)	Hydr Radius C (m)	Shear Chan (N/m ²)	Hydr Depth (m)
TO03	0	TR 200_CN91	2.9	215.16	0.56	215.72	215.72	0.00	0.74	215.82	1.5	1.1	0.4	26.5	0.15
TO03	-16.6	TR 200_CN91	2.9	213.08	0.21	213.29	213.59	-0.30	4.55	215.26	6.2	6.2	0.2	607.1	0.19
TO03	-23.77	TR 200_CN91	2.9	213.00	0.40	213.40	213.59	-0.19	1.79	214.03	3.5	3.5	0.3	163.5	0.39
TO03	-41.27	Bridge													
TO03	-58.77	TR 200_CN91	2.9	212.65	0.52	213.17	213.24	-0.07	1.21	213.54	2.7	2.7	0.3	91.1	0.51
TO03	-63.1	TR 200_CN91	2.9	212.58	0.42	213.00	213.18	-0.18	1.50	213.41	2.8	2.8	0.3	102.7	0.31
TO03	-83.69	TR 200_CN91	2.9	210.51	0.29	210.80	211.10	-0.30	2.97	212.04	4.9	4.9	0.2	353.7	0.28
TO03	-87.37	Bridge													
TO03	-91.05	TR 200_CN91	2.9	210.43	0.41	210.84	211.02	-0.18	1.71	211.43	3.4	3.4	0.3	153.5	0.40
TO03	-100	TR 200_CN91	2.9	210.26	0.24	210.50	210.62	-0.12	1.87	210.90	2.8	2.8	0.2	115.0	0.23
TO03	-125	TR 200_CN91	2.9	209.81	0.51	210.32	210.17	0.15	0.59	210.40	1.2	1.2	0.4	18.4	0.46
TO03	-150	TR 200_CN91	2.9	209.36	0.57	209.93	209.93	0.00	1.01	210.19	2.3	2.3	0.4	61.9	0.52
TO03	-175	TR 200_CN91	2.9	208.90	0.45	209.35	209.43	-0.08	1.33	209.69	2.6	2.6	0.3	83.3	0.38
TO03	-200	TR 200_CN91	2.9	208.40	0.67	209.07	208.63	0.44	0.20	209.08	0.5	0.5	0.6	2.6	0.62
TO03	-225	TR 200_CN91	16.0	207.89	0.72	208.61	208.61	0.00	1.01	208.94	2.6	2.6	0.6	67.9	0.66
TO03	-250	TR 200_CN91	16.0	207.39	0.56	207.95	208.11	-0.16	1.47	208.52	3.3	3.3	0.5	123.5	0.53
TO03	-275	TR 200_CN91	16.0	206.88	0.62	207.50	207.60	-0.10	1.25	207.96	3.0	3.0	0.5	96.4	0.58
TO03	-300	TR 200_CN91	16.0	206.38	0.60	206.98	207.10	-0.12	1.34	207.47	3.1	3.1	0.5	106.4	0.56
TO03	-325	TR 200_CN91	16.0	205.87	0.60	206.47	206.59	-0.12	1.33	206.96	3.1	3.1	0.5	105.3	0.56
TO03	-350	TR 200_CN91	16.0	205.37	0.60	205.97	206.12	-0.15	1.32	206.46	3.1	3.1	0.5	104.4	0.56
TO03	-375	TR 200_CN91	16.0	204.87	0.60	205.47	205.59	-0.12	1.32	205.96	3.1	3.1	0.5	104.2	0.56
TO03	-400	TR 200_CN91	16.0	204.36	0.72	205.34	205.34	0.00	1.01	205.67	2.6	2.6	0.6	67.9	0.66
TO03	-425	TR 200_CN91	16.0	204.36	0.69	205.05	205.15	-0.10	1.03	205.39	2.6	2.4	0.6	70.2	0.31
TO03	-450	TR 200_CN91	16.0	204.11	0.70	204.81	204.87	-0.06	0.97	205.10	2.5	2.2	0.6	62.8	0.37
TO03	-475	TR 200_CN91	16.0	203.59	0.96	204.55	204.33	0.22	0.54	204.66	1.6	1.4	0.8	23.2	0.67
TO03	-500	TR 200_CN91	25.9	203.06	0.98	204.04	204.04	0.00	1.01	204.48	3.0	3.0	0.8	82.5	0.88
TO03	-523.35	TR 200_CN91	25.9	199.15	0.35	199.50	200.13	-0.63	4.83	203.44	8.8	8.8	0.3	990.5	0.34
TO03	-527.89	TR 200_CN91	25.9	199.08	0.45	199.53	200.09	-0.56	3.36	202.09	7.1	7.1	0.4	595.1	0.45
TO03	-531.64	Bridge													
TO03	-535.39	TR 200_CN91	25.9	199.07	0.59	199.66	200.08	-0.42	2.29	201.18	5.5	5.5	0.5	329.5	0.58
TO03	-541.22	TR 200_CN91	25.9	199.00	0.64	199.64	199.98	-0.34	1.93	200.75	4.7	4.7	0.6	233.1	0.60
TO03	-550	TR 200_CN91	25.9	198.89	0.80	199.69	199.87	-0.18	1.37	200.38	3.7	3.7	0.7	135.6	0.73
TO03	-575	TR 200_CN91	25.9	198.59	0.98	199.57	199.57	0.00	1.01	200.01	3.0	3.0	0.8	82.5	0.88
TO03	-600	TR 200_CN91	25.9	198.29	0.91	199.20	199.27	-0.07	1.12	199.72	3.2	3.2	0.8	97.4	0.83
TO03	-625	TR 200_CN91	25.9	197.99	0.98	198.97	198.97	0.00	1.01	199.41	3.0	3.0	0.8	82.5	0.88
TO03	-650	TR 200_CN91	25.9	197.69	0.91	198.60	198.67	-0.07	1.11	199.12	3.2	3.2	0.8	96.8	0.83
TO03	-675	TR 200_CN91	25.9	197.39	0.97	198.36	198.37	-0.01	1.01	198.81	3.0	3.0	0.8	83.1	0.88
TO03	-700	TR 200_CN91	25.9	197.09	0.92	198.01	198.07	-0.06	1.11	198.52	3.2	3.2	0.8	96.5	0.83
TO03	-725	TR 200_CN91	25.9	196.79	0.96	197.75	197.77	-0.02	1.03	198.21	3.0	3.0	0.8	85.6	0.87
TO03	-750	TR 200_CN91	25.9	196.49	0.92	197.41	197.47	-0.06	1.10	197.92	3.2	3.2	0.8	95.7	0.83
TO03	-772.6	TR 200_CN91	25.9	196.21	0.93	197.14	197.19	-0.05	1.08	197.63	3.1	3.1	0.8	92.0	0.84
TO03	-789.51	TR 200_CN91	25.9	196.01	1.17	197.18	196.98	0.20	0.76	197.47	2.4	2.4	0.9	52.6	1.03
TO03	-801.32	TR 200_CN91	25.9	195.87	1.29	197.16			0.65	197.40	2.2	2.2	1.0	40.5	1.13
TO03	-806.61	TR 200_CN91	25.9	195.82	1.12	196.94	196.83	0.11	0.87	197.35	2.9	2.9	0.9	75.2	1.10
TO03	-820.99	Bridge													
TO03	-835.36	TR 200_CN91	25.9	195.53	0.93	196.46	196.54	-0.08	1.14	197.06	3.4	3.4	0.8	112.9	0.92
TO03	-842.96	TR 200_CN91	25.9	195.45	0.77	196.22	196.43	-0.21	1.40	196.91	3.8	3.4	0.7	148.6	0.45
TO03	-849	TR 200_CN91	25.9	195.39	0.79	196.18	196.35	-0.17	1.28	196.76	3.5	3.1	0.7	119.1	0.49
TO03	-851.72	TR 200_CN91	25.9	195.37	0.87	196.25	196.34	-0.09	1.07	196.68	3.0	2.7	0.8	88.3	0.56
TO03	-872.81	TR 200_CN91	25.9	193.39	0.48	193.87	194.37	-0.50	3.03	195.95	6.4	6.4	0.4	476.0	0.45
TO03	-877.6	TR 200_CN91	25.9	193.34	0.61	193.95	194.35	-0.40	2.18	195.37	5.3	5.3	0.5	305.1	0.60
TO03	-881.34	Bridge													
TO03	-885.08	TR 200_CN91	25.9	193.26	0.72	193.98	194.27	-0.29	1.67	194.98	4.4	4.4	0.6	203.9	0.72
TO03	-890.74	TR 200_CN91	25.9	193.21	0.74	193.95	194.19	-0.24	1.54	194.76	4.0	4.0	0.6	163.3	0.68
TO03	-900	TR 200_CN91	25.9	193.12	0.94	194.06	194.10	-0.04	1.06	194.54	3.1	3.1	0.8	89.4	0.85
TO03	-925	TR 200_CN91	25.9	192.87	0.94	193.81	193.85	-0.04	1.06	194.29	3.1	3.1	0.8	89.4	0.85
TO03	-950	TR 200_CN91	25.9	192.63	0.98	193.61	193.61	0.00	0.99	194.05	2.9	2.9	0.8	81.0	0.89
TO03	-975	TR 200_CN91	25.9	192.38	1.02	193.40	193.36	0.04	0.93	193.80	2.8	2.8	0.8	73.1	0.92
TO03	-1000	TR 200_CN91	25.9	192.14	0.98	193.12	193.12	0.00	1.00	193.56	3.0	3.0	0.8	82.4	0.88
TO03	-1035	TR 200_CN91	25.9	191.98	0.52	192.50	192.67	-0.17	1.53	193.00	3.3	3.0	0.5	122.4	0.36

Reach	River Sta	Profile	Q Total (m ³ /s)	Min Ch El (m)	Max Chl Dpth (m)	W.S. Elev (m)	Crit W.S. (m)	Diff	Froude # Chl	E.G. Elev (m)	Vel Chnl (m/s)	Vel Total (m/s)	Hydr Radius C (m)	Shear Chan (N/m ²)	Hydr Depth (m)
TO03	0	TR 500_CN91	3.3	215.16	0.60	215.76	215.76	0.00	0.69	215.84	1.4	1.0	0.4	24.1	0.15
TO03	-16.6	TR 500_CN91	3.3	213.08	0.24	213.32	213.63	-0.31	4.34	215.33	6.3	6.3	0.2	598.6	0.21
TO03	-23.77	TR 500_CN91	3.3	213.00	0.44	213.44	213.65	-0.21	1.79	214.13	3.7	3.7	0.3	176.2	0.43
TO03	-41.27	Bridge													
TO03	-58.77	TR 500_CN91	3.3	212.65	0.57	213.22	213.30	-0.08	1.22	213.63	2.9	2.9	0.4	99.8	0.55
TO03	-63.1	TR 500_CN91	3.3	212.58	0.45	213.03	213.19	-0.16	1.57	213.49	3.0	2.9	0.3	116.8	0.22
TO03	-83.69	TR 500_CN91	3.3	210.51	0.33	210.84	211.16	-0.32	2.81	212.11	5.0	5.0	0.3	350.1	0.32
TO03	-87.37	Bridge													
TO03	-91.05	TR 500_CN91	3.3	210.43	0.45	210.88	211.08	-0.20	1.73	211.55	3.6	3.6	0.3	168.3	0.44
TO03	-100	TR 500_CN91	3.3	210.26	0.26	210.52	210.66	-0.14	1.96	210.99	3.0	3.0	0.2	131.7	0.24
TO03	-125	TR 500_CN91	3.3	209.81	0.58	210.39	210.21	0.18	0.56	210.47	1.3	1.3	0.5	18.0	0.51
TO03	-150	TR 500_CN91	3.3	209.36	0.63	209.99	209.99	0.00	1.01	210.27	2.4	2.4	0.4	66.1	0.57
TO03	-175	TR 500_CN91	3.3	208.90	0.49	209.39	209.49	-0.10	1.36	209.76	2.7	2.7	0.4	91.3	0.40
TO03	-200	TR 500_CN91	3.3	208.40	0.78	209.18	208.66	0.52	0.19	209.19	0.5	0.5	0.7	2.5	0.71
TO03	-225	TR 500_CN91	18.8	207.89	0.80	208.69	208.69	0.00	1.01	209.05	2.7	2.7	0.7	72.8	0.73
TO03	-250	TR 500_CN91	18.8	207.39	0.62	208.01	208.21	-0.20	1.46	208.64	3.5	3.5	0.6	131.9	0.58
TO03	-275	TR 500_CN91	18.8	206.88	0.68	207.56	207.68	-0.12	1.28	208.08	3.2	3.2	0.6	106.8	0.63
TO03	-300	TR 500_CN91	18.8	206.38	0.66	207.04	207.17	-0.13	1.35	207.59	3.3	3.3	0.6	115.2	0.61
TO03	-325	TR 500_CN91	18.8	205.87	0.66	206.53	206.67	-0.14	1.35	207.08	3.3	3.3	0.6	115.3	0.61
TO03	-350	TR 500_CN91	18.8	205.37	0.66	206.03	206.21	-0.18	1.34	206.58	3.3	3.3	0.6	113.9	0.62
TO03	-375	TR 500_CN91	18.8	204.87	0.66	205.53	205.67	-0.14	1.33	206.08	3.3	3.3	0.6	113.7	0.62
TO03	-400	TR 500_CN91	18.8	204.62	0.89	205.51	205.51	0.00	0.80	205.77	2.3	2.0	0.8	49.7	0.42
TO03	-425	TR 500_CN91	18.8	204.36	0.70	205.06	205.21	-0.15	1.19	205.51	3.0	2.7	0.6	94.0	0.31
TO03	-450	TR 500_CN91	18.8	204.11	0.78	204.89	204.93	-0.04	0.92	205.17	2.4	2.1	0.7	60.0	0.45
TO03	-475	TR 500_CN91	18.8	203.59	1.11	204.70	204.39	0.31	0.48	204.80	1.5	1.4	0.9	20.4	0.79
TO03	-500	TR 500_CN91	30.5	203.06	1.08	204.14	204.14	0.00	1.01	204.63	3.1	3.1	0.9	88.2	0.97
TO03	-523.35	TR 500_CN91	30.5	199.15	0.41	199.56	200.23	-0.67	4.58	203.62	8.9	8.9	0.4	977.0	0.39
TO03	-527.89	TR 500_CN91	30.5	199.08	0.51	199.59	200.22	-0.63	3.31	202.38	7.4	7.4	0.5	627.4	0.51
TO03	-531.64	Bridge													
TO03	-535.39	TR 500_CN91	30.5	199.07	0.64	199.71	200.20	-0.49	2.37	201.49	5.9	5.9	0.6	374.4	0.64
TO03	-541.22	TR 500_CN91	30.5	199.00	0.68	199.68	200.08	-0.40	2.06	201.03	5.1	5.1	0.6	276.8	0.63
TO03	-550	TR 500_CN91	30.5	198.89	0.83	199.72	199.97	-0.25	1.52	200.60	4.2	4.2	0.7	171.0	0.76
TO03	-575	TR 500_CN91	30.5	198.59	1.08	199.67	199.67	0.00	1.01	200.16	3.1	3.1	0.9	88.2	0.97
TO03	-600	TR 500_CN91	30.5	198.29	1.01	199.30	199.37	-0.07	1.12	199.87	3.3	3.3	0.8	104.7	0.91
TO03	-625	TR 500_CN91	30.5	197.99	1.06	199.05	199.07	-0.02	1.04	199.56	3.2	3.2	0.9	93.7	0.95
TO03	-650	TR 500_CN91	30.5	197.69	1.02	198.71	198.77	-0.06	1.10	199.27	3.3	3.3	0.8	102.2	0.92
TO03	-675	TR 500_CN91	30.5	197.39	1.04	198.43	198.47	-0.04	1.07	198.97	3.3	3.3	0.9	98.1	0.93
TO03	-700	TR 500_CN91	30.5	197.09	1.03	198.12	198.17	-0.05	1.09	198.67	3.3	3.3	0.9	100.8	0.92
TO03	-725	TR 500_CN91	30.5	196.79	1.03	197.82	197.87	-0.05	1.09	198.37	3.3	3.3	0.9	99.9	0.93
TO03	-750	TR 500_CN91	30.5	196.49	1.03	197.52	197.57	-0.05	1.09	198.07	3.3	3.3	0.9	99.9	0.93
TO03	-772.6	TR 500_CN91	30.5	196.21	1.02	197.23	197.30	-0.07	1.11	197.79	3.3	3.3	0.8	102.3	0.91
TO03	-789.51	TR 500_CN91	30.5	196.01	1.33	197.34	197.09	0.25	0.73	197.65	2.5	2.5	1.1	52.4	1.16
TO03	-801.32	TR 500_CN91	30.5	195.87	1.46	197.33			0.63	197.58	2.2	2.2	1.1	41.3	1.23
TO03	-806.61	TR 500_CN91	30.5	195.82	1.25	197.07	196.95	0.12	0.86	197.53	3.0	3.0	1.0	80.4	1.23
TO03	-820.99	Bridge													
TO03	-835.36	TR 500_CN91	30.5	195.53	1.04	196.57	196.66	-0.09	1.14	197.24	3.6	3.6	0.8	123.5	1.03
TO03	-842.96	TR 500_CN91	30.5	195.45	0.81	196.26	196.51	-0.25	1.49	197.07	4.2	3.7	0.7	175.0	0.49
TO03	-849	TR 500_CN91	30.5	195.39	0.84	196.23	196.43	-0.20	1.36	196.90	3.8	3.4	0.7	139.1	0.53
TO03	-851.72	TR 500_CN91	30.5	195.37	0.90	196.27	196.41	-0.14	1.18	196.81	3.4	3.0	0.8	110.4	0.58
TO03	-872.81	TR 500_CN91	30.5	193.39	0.56	193.95	194.47	-0.52	2.83	196.04	6.4	6.4	0.5	457.8	0.52
TO03	-877.6	TR 500_CN91	30.5	193.34	0.70	194.04	194.48	-0.44	2.08	195.53	5.4	5.4	0.6	306.8	0.69
TO03	-881.34	Bridge													
TO03	-885.08	TR 500_CN91	30.5	193.26	0.81	194.07	194.39	-0.32	1.66	195.18	4.7	4.7	0.7	217.6	0.80
TO03	-890.74	TR 500_CN91	30.5	193.21	0.81	194.02	194.29	-0.27	1.60	194.96	4.3	4.3	0.7	185.0	0.74
TO03	-900	TR 500_CN91	30.5	193.12	1.07	194.19	194.20	-0.01	1.03	194.69	3.1	3.1	0.9	91.3	0.96
TO03	-925	TR 500_CN91	30.5	192.87	1.12	193.99	193.95	0.04	0.96	194.44	3.0	3.0	0.9	82.0	0.99
TO03	-950	TR 500_CN91	30.5	192.63	1.09	193.72	193.71	0.01	1.00	194.20	3.1	3.1	0.9	87.8	0.97
TO03	-975	TR 500_CN91	30.5	192.38	1.13	193.51	193.47	0.04	0.94	193.96	3.0	3.0	0.9	79.5	1.01
TO03	-1000	TR 500_CN91	30.5	192.14	1.08	193.22	193.22	0.00	1.01	193.71	3.1	3.1	0.9	88.9	0.96
TO03	-1035	TR 500_CN91	30.5	191.98	0.54	192.52	192.72	-0.20	1.64	193.14	3.6	3.3	0.5	146.5	0.38

TO02-TO03

TO03 TO03

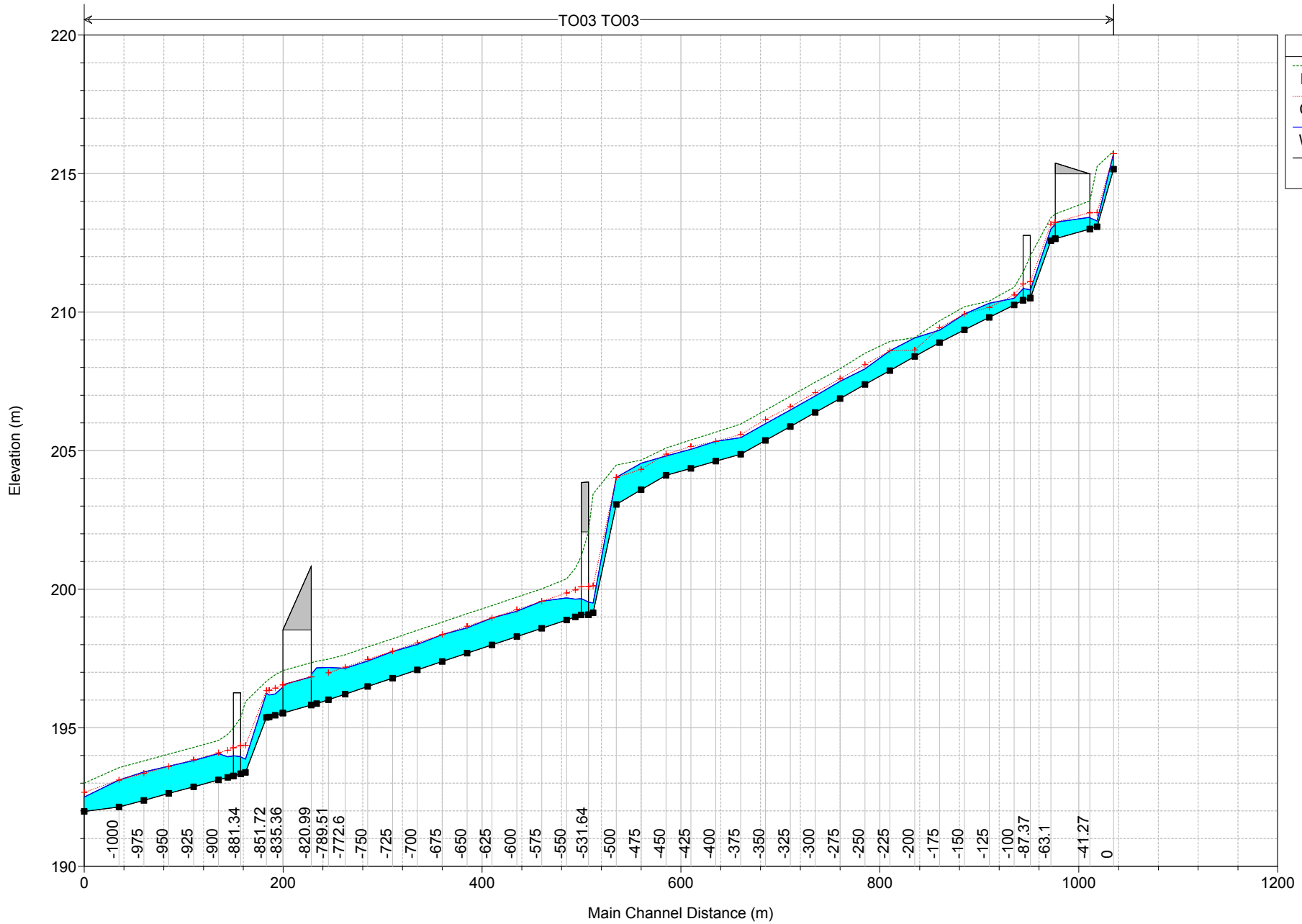

Legend

- EG TR 200_CN91 (Green dashed line)
- Crit TR 200_CN91 (Red dashed line with '+' markers)
- WS TR 200_CN91 (Blue dashed line)
- Ground (Black solid line with square markers)

-1000
-975
-950
-925
-900
-881.34
-851.72
-835.36
-820.99
-789.51
-772.6
-750
-725
-700
-675
-650
-625
-600
-575
-550
-531.64
-500
-475
-450
-425
-400
-375
-350
-325
-300
-275
-250
-225
-200
-175
-150
-125
-100
-87.37
-63.1
-41.27
0

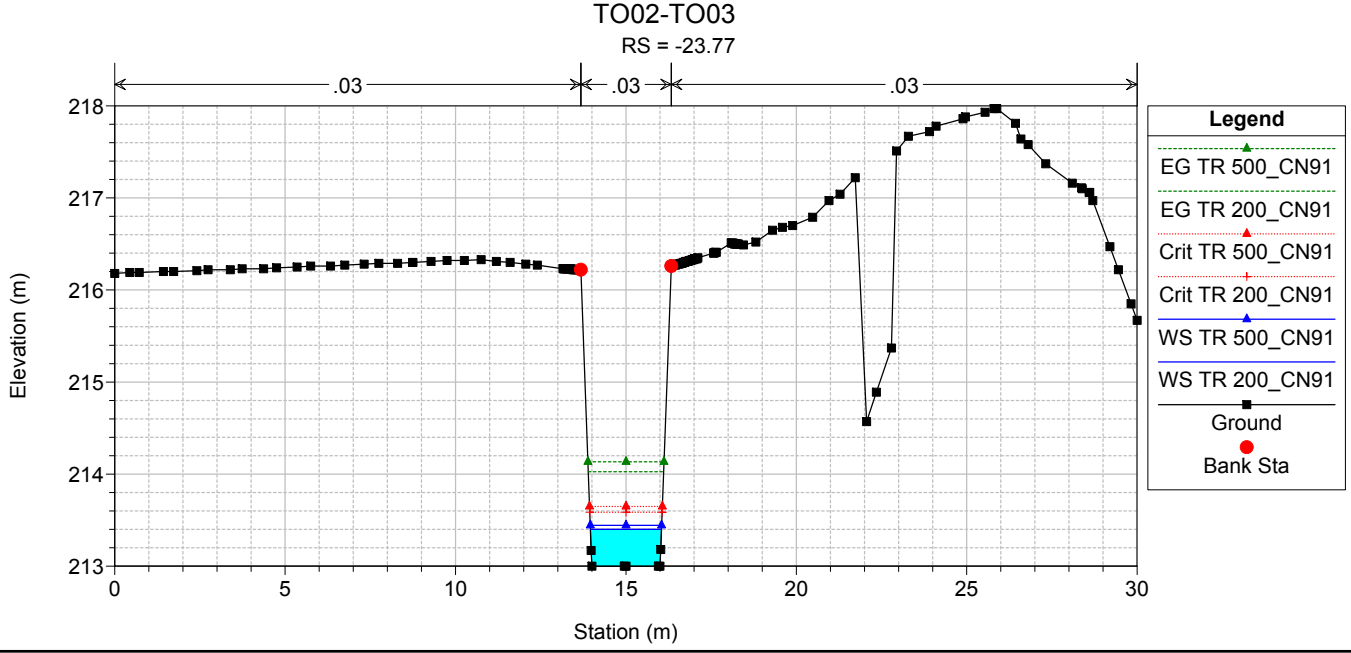
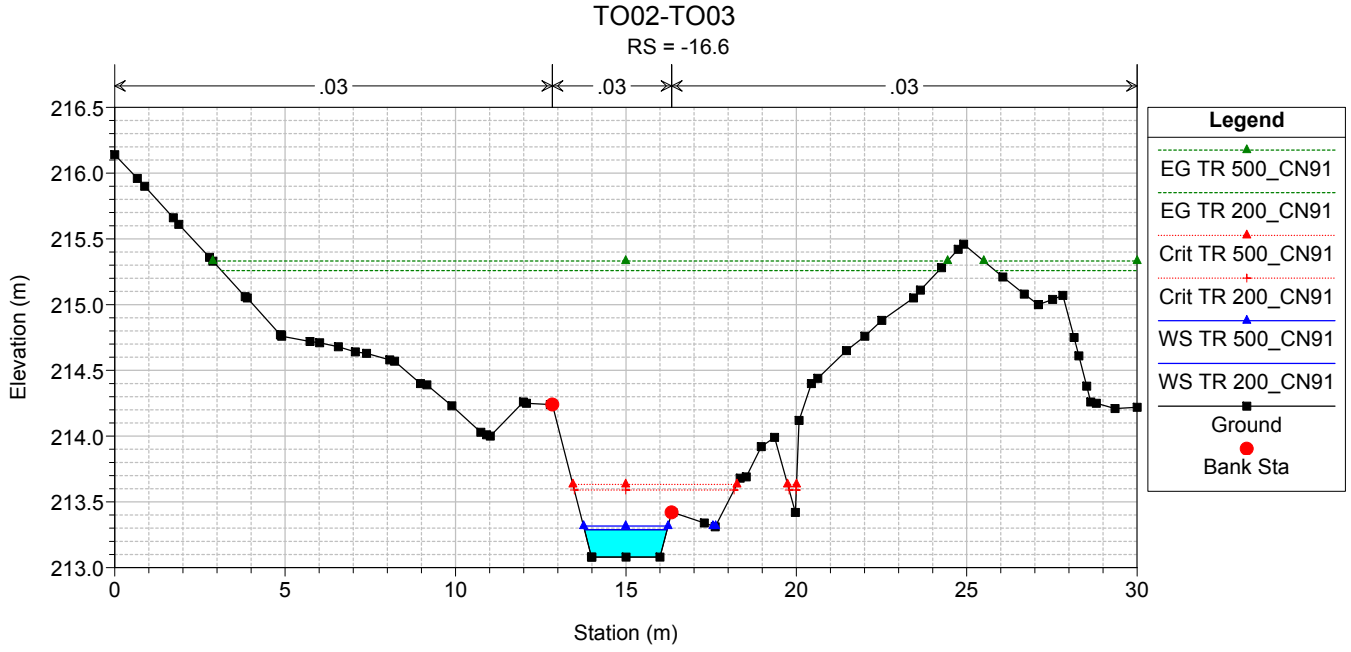
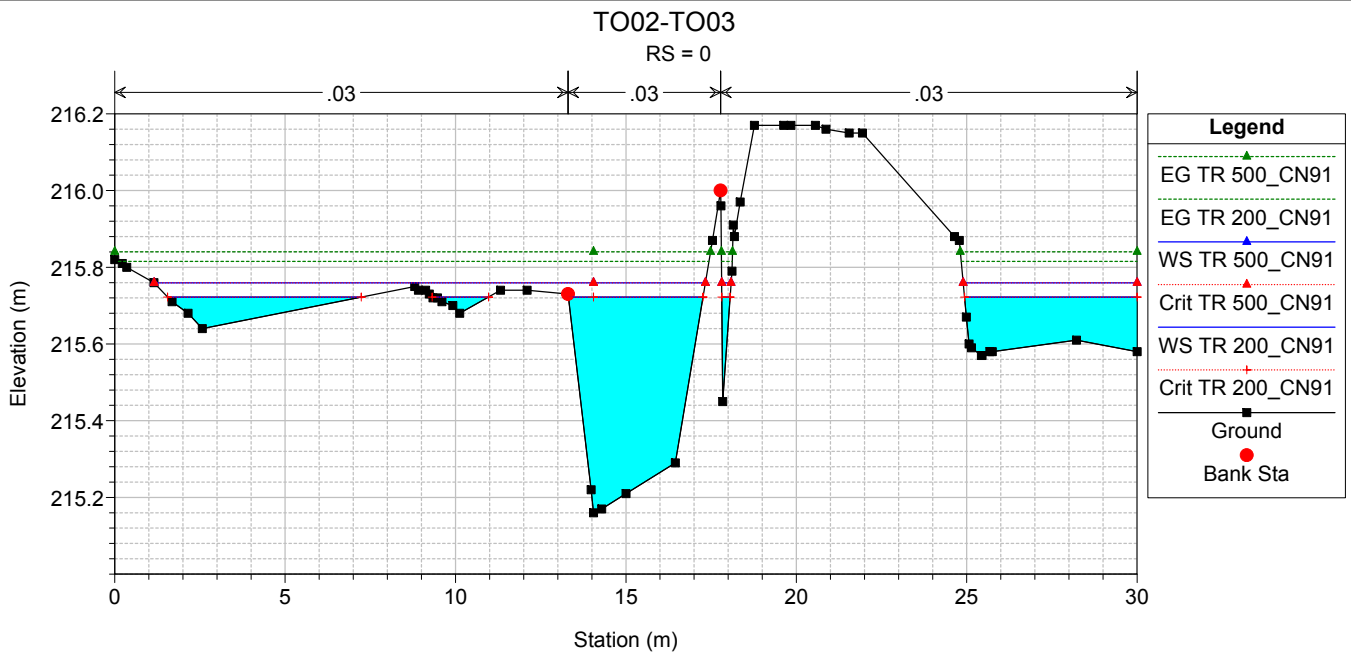

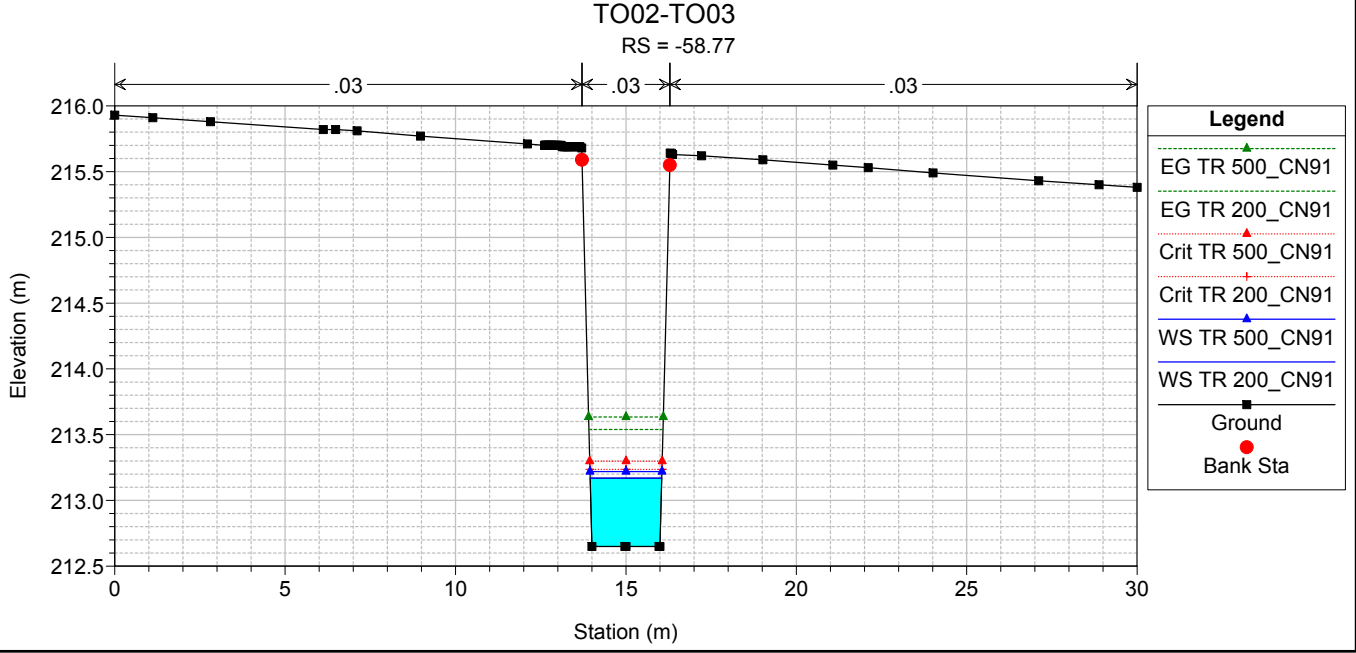
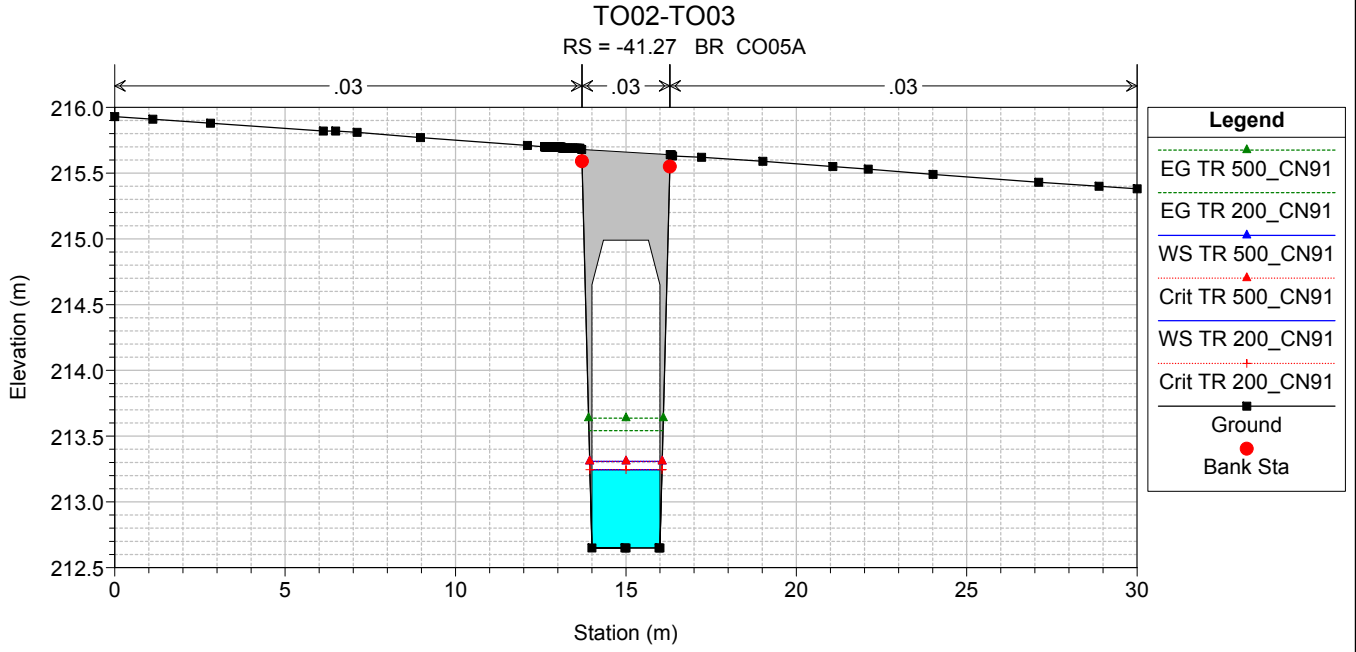
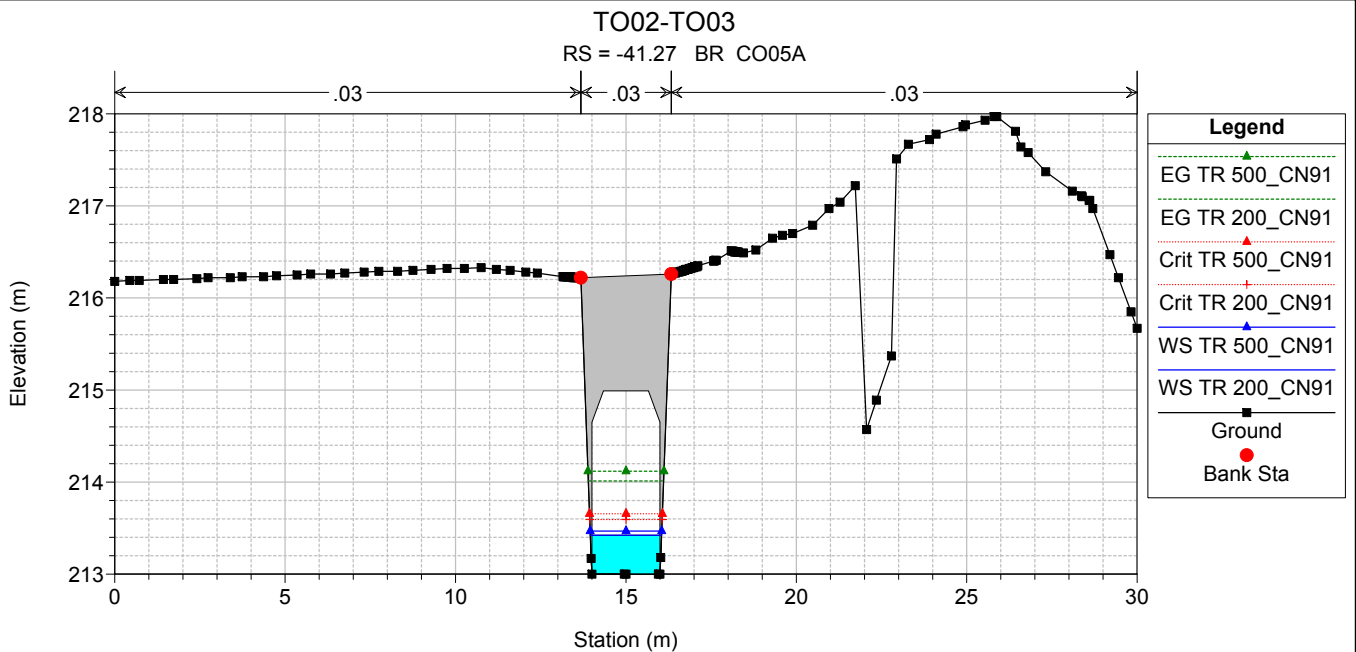

TO02-TO03

RS = -63.1

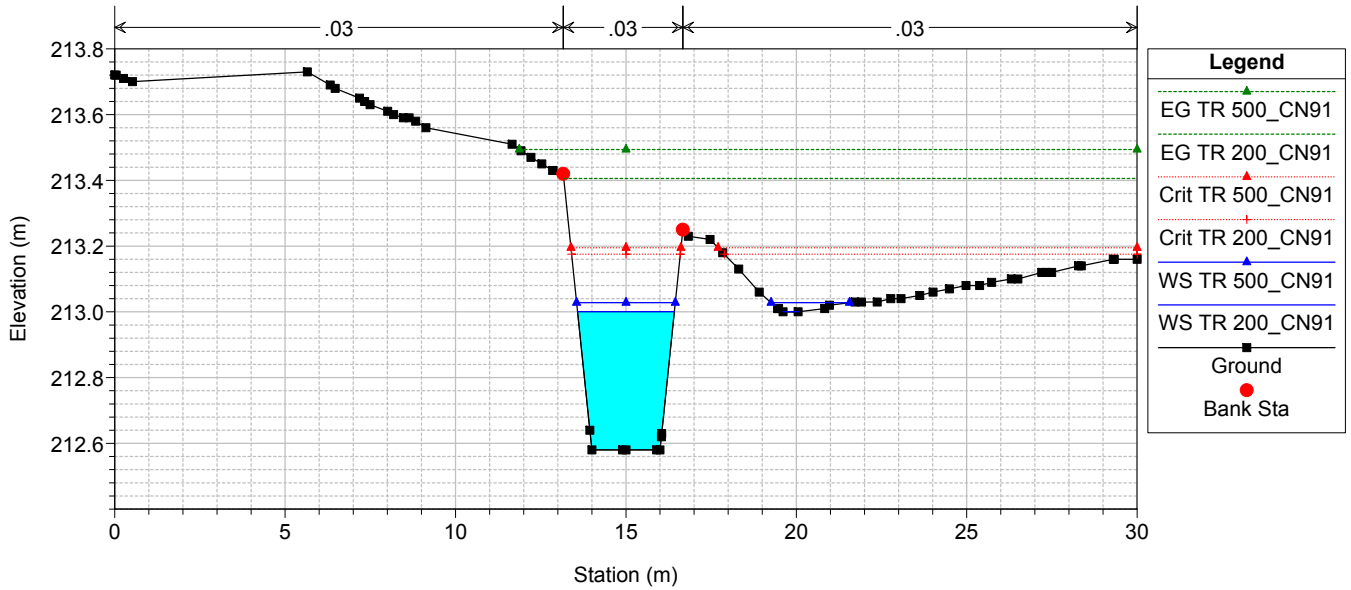

TO02-TO03

RS = -83.69

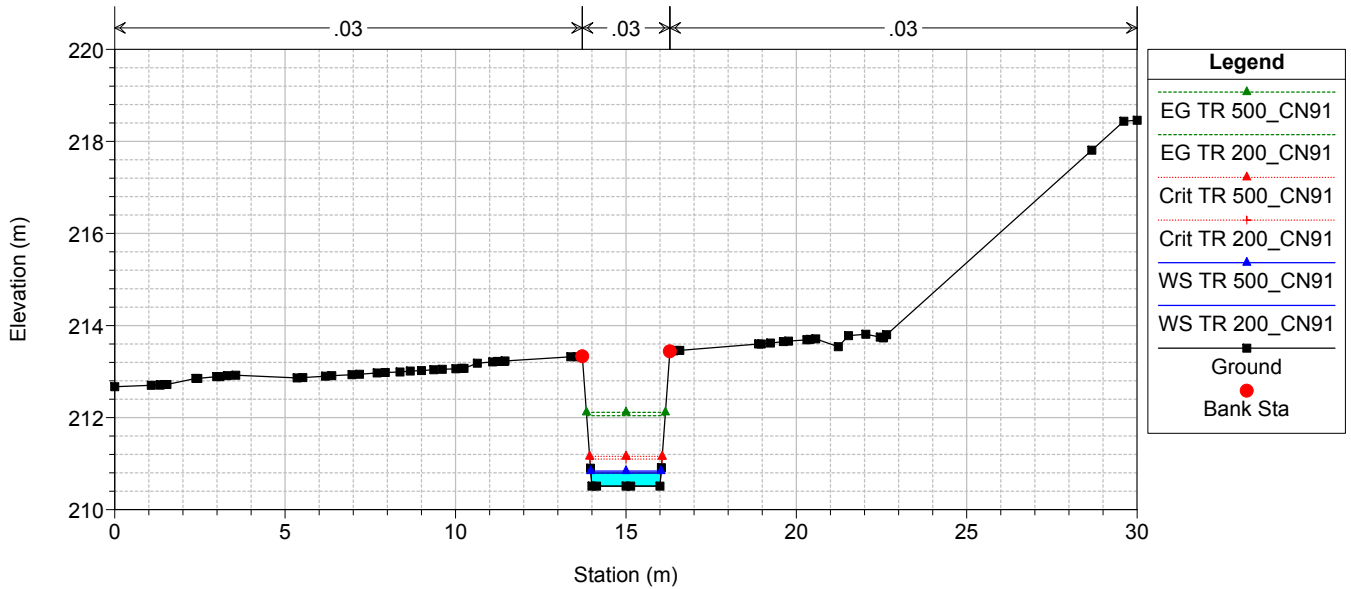

TO02-TO03

RS = -87.37 BR CO05B

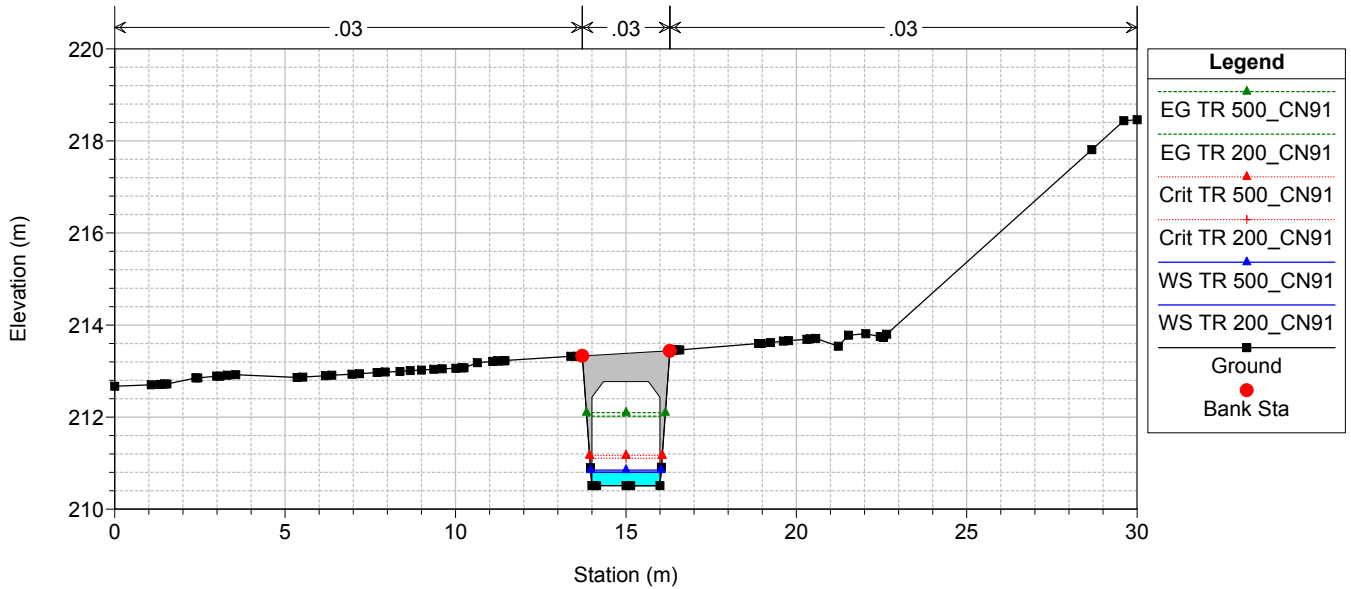

TO02-TO03

RS = -87.37 BR CO05B

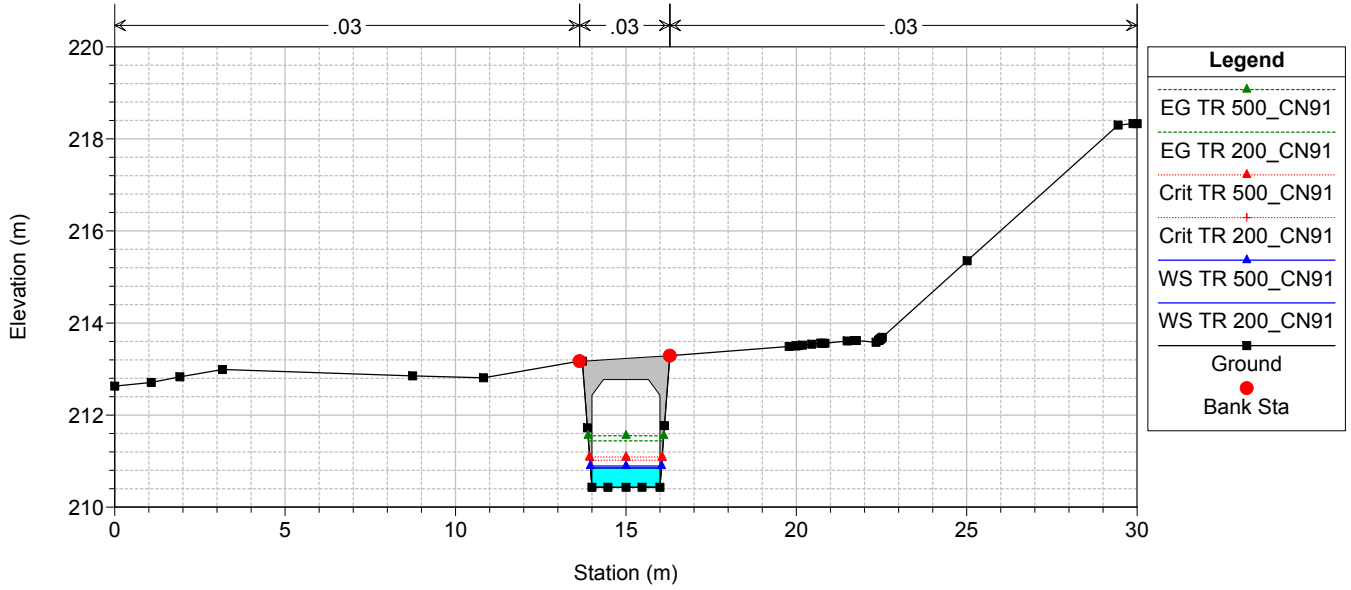

TO02-TO03

RS = -91.05

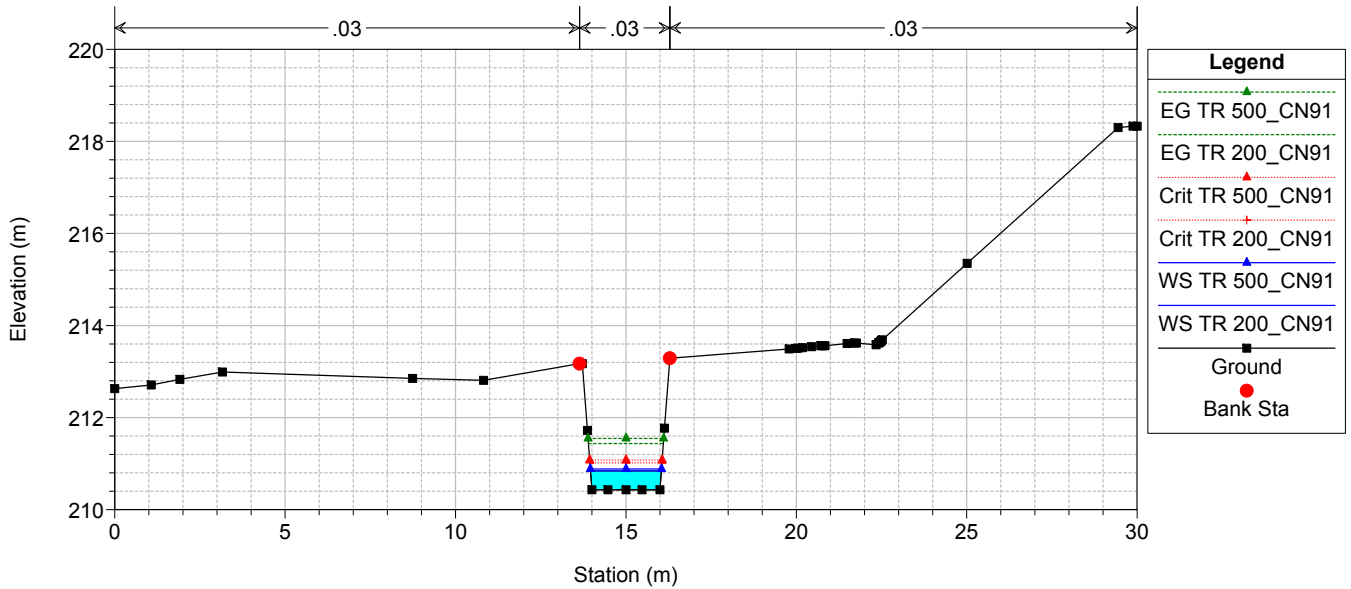

TO02-TO03

RS = -100

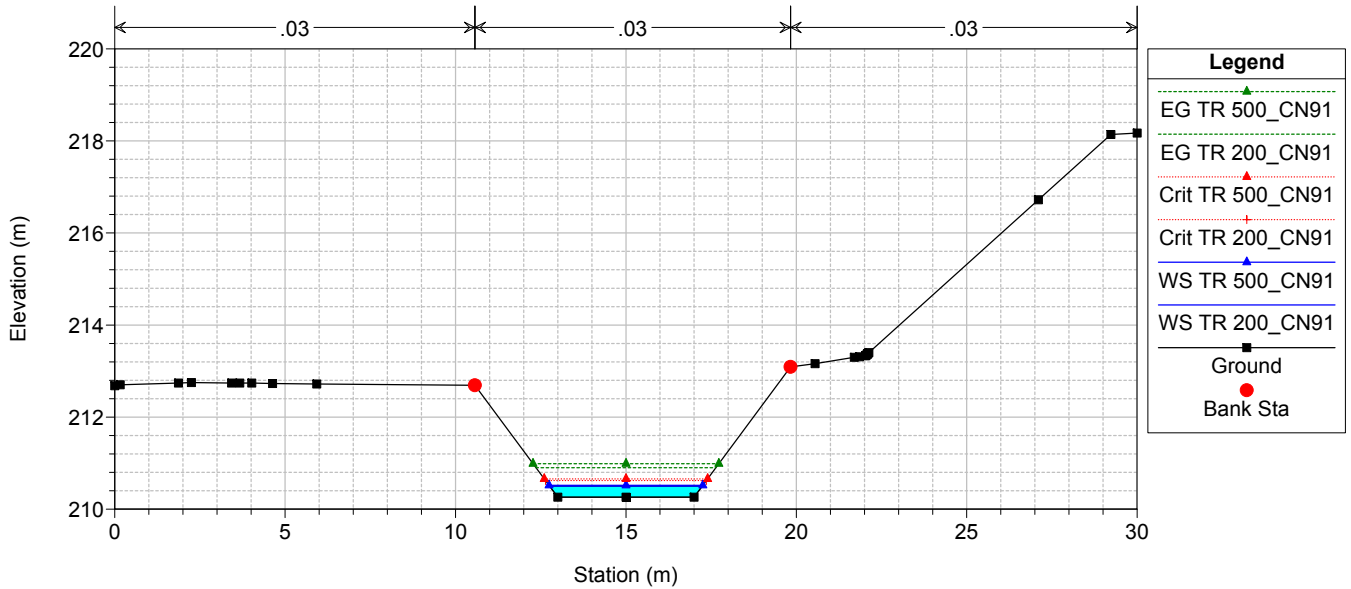

TO02-TO03

RS = -125

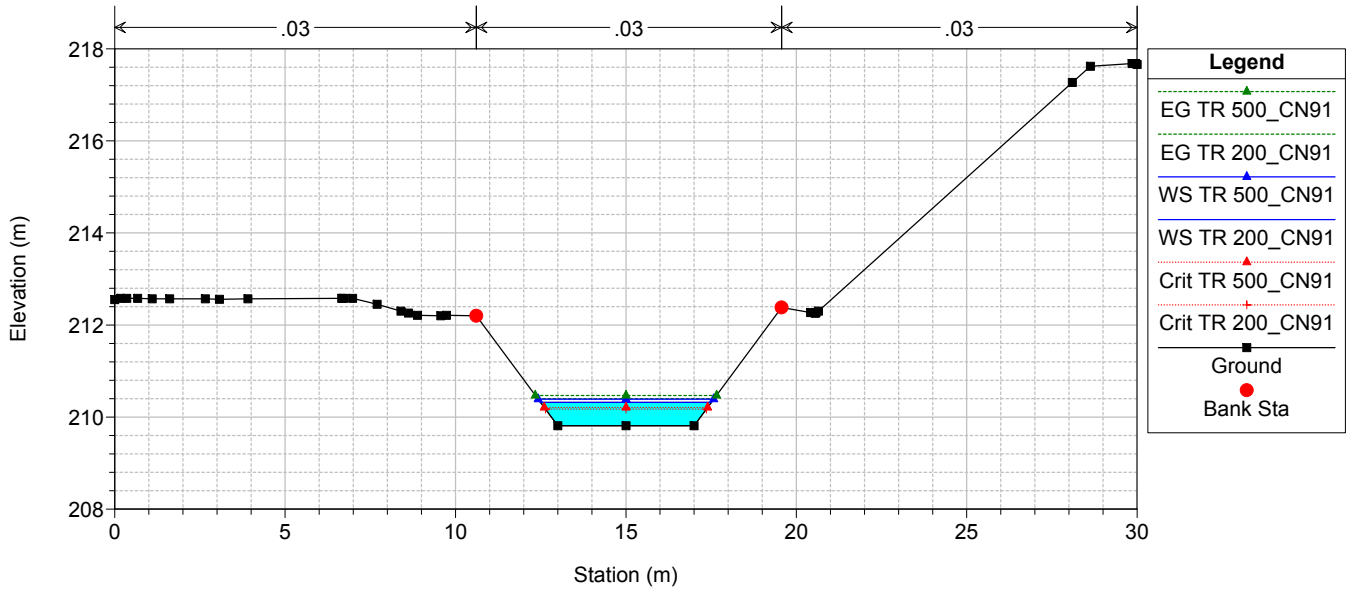

TO02-TO03

RS = -150

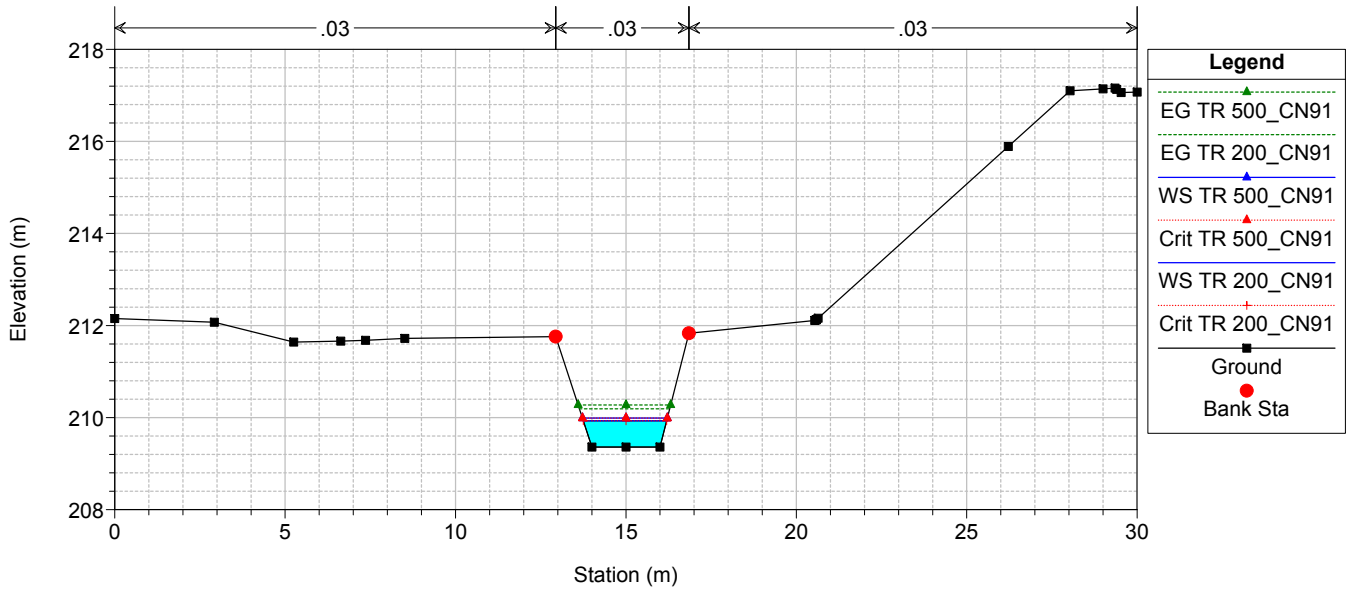

TO02-TO03

RS = -175

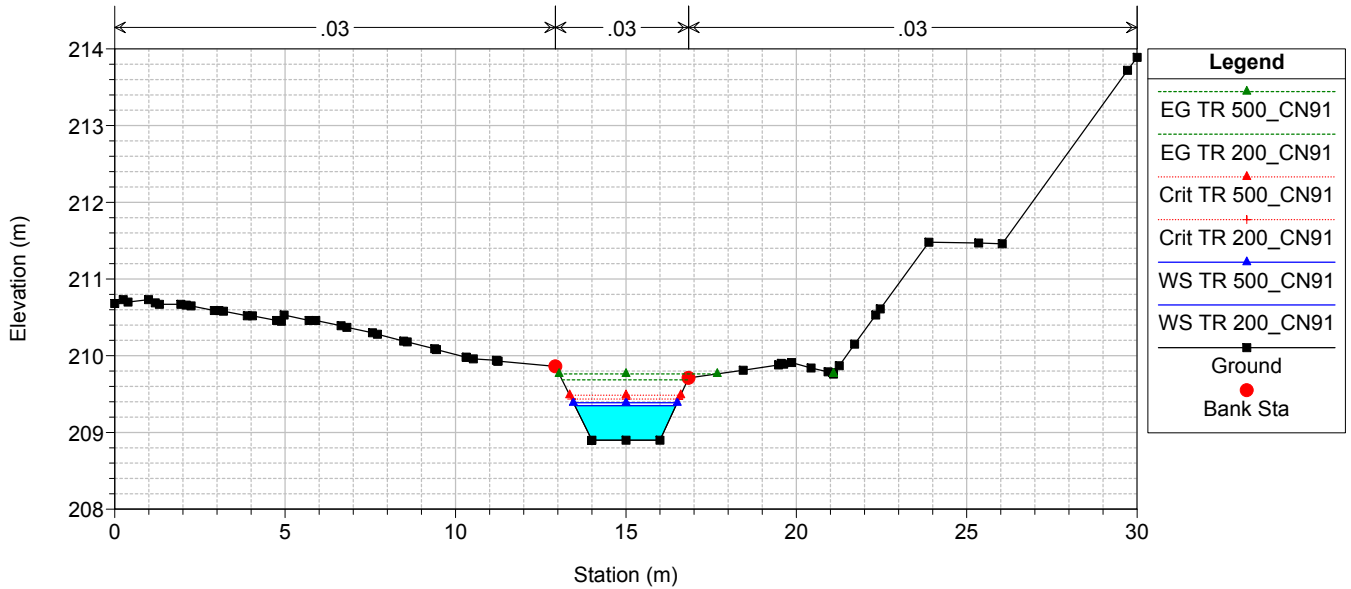

TO02-TO03

RS = -200

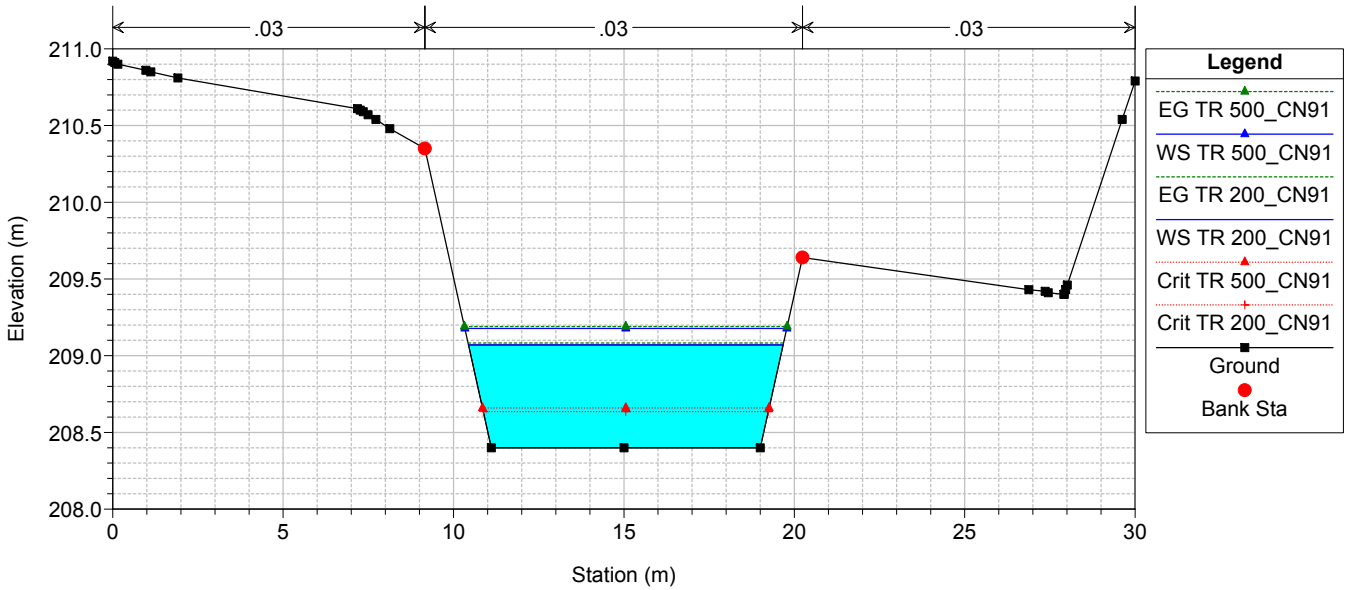

TO02-TO03

RS = -225

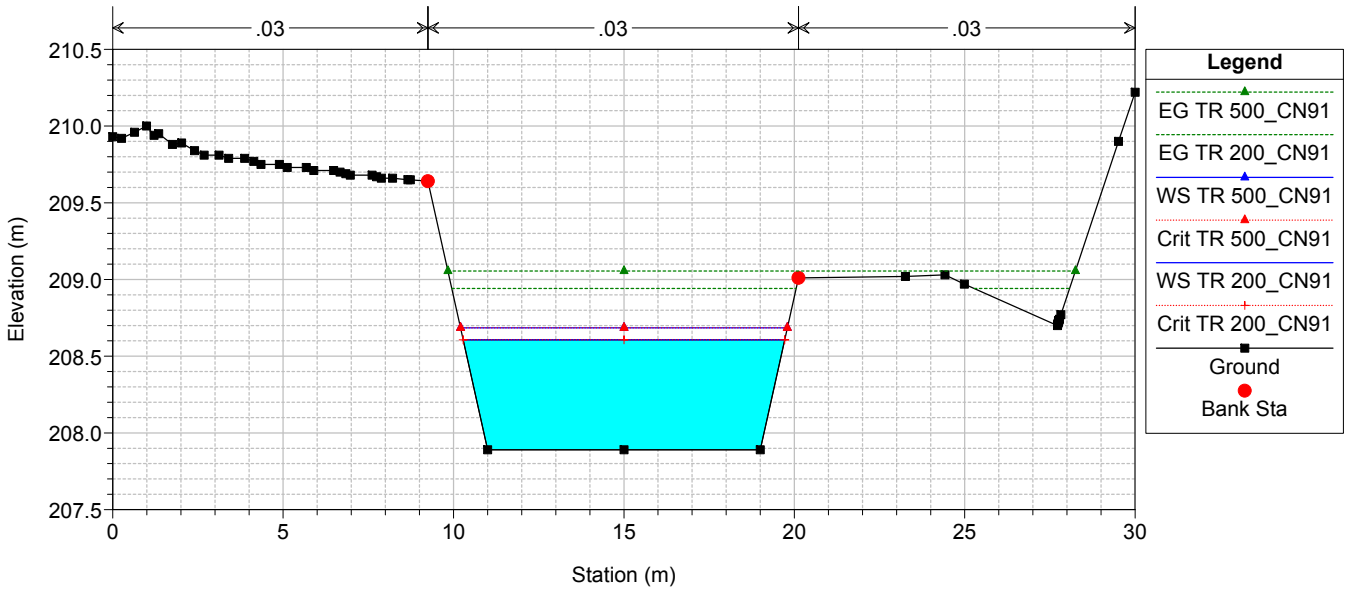

TO02-TO03

RS = -250

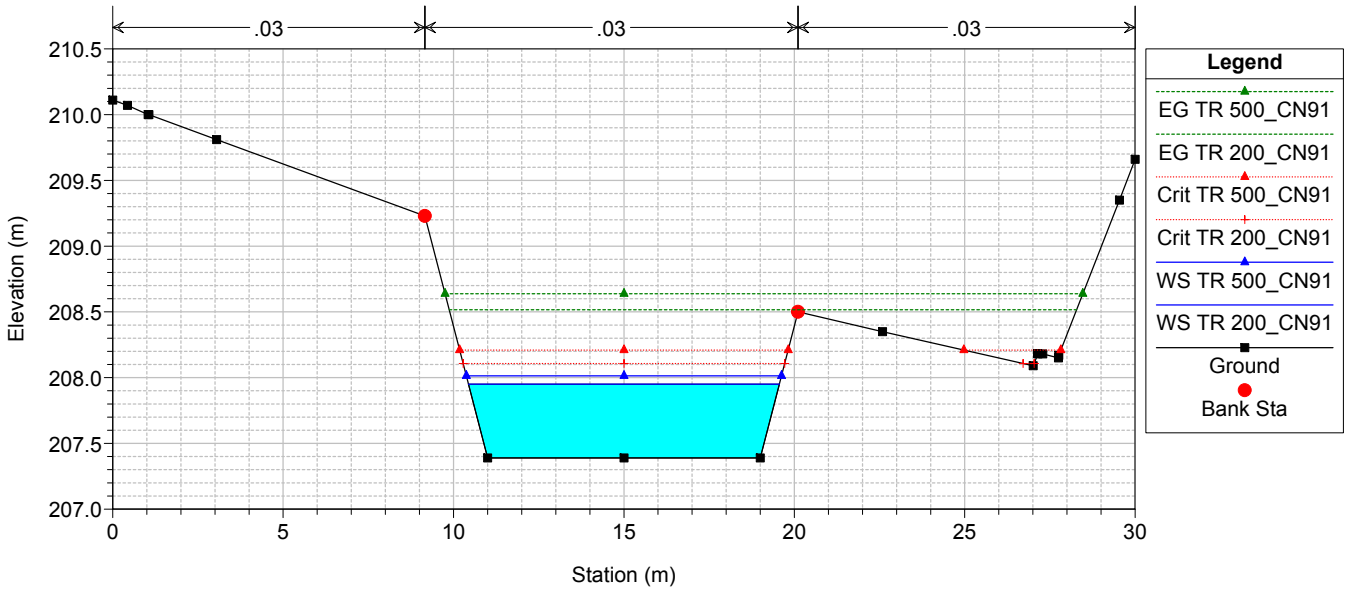

TO02-TO03

RS = -275

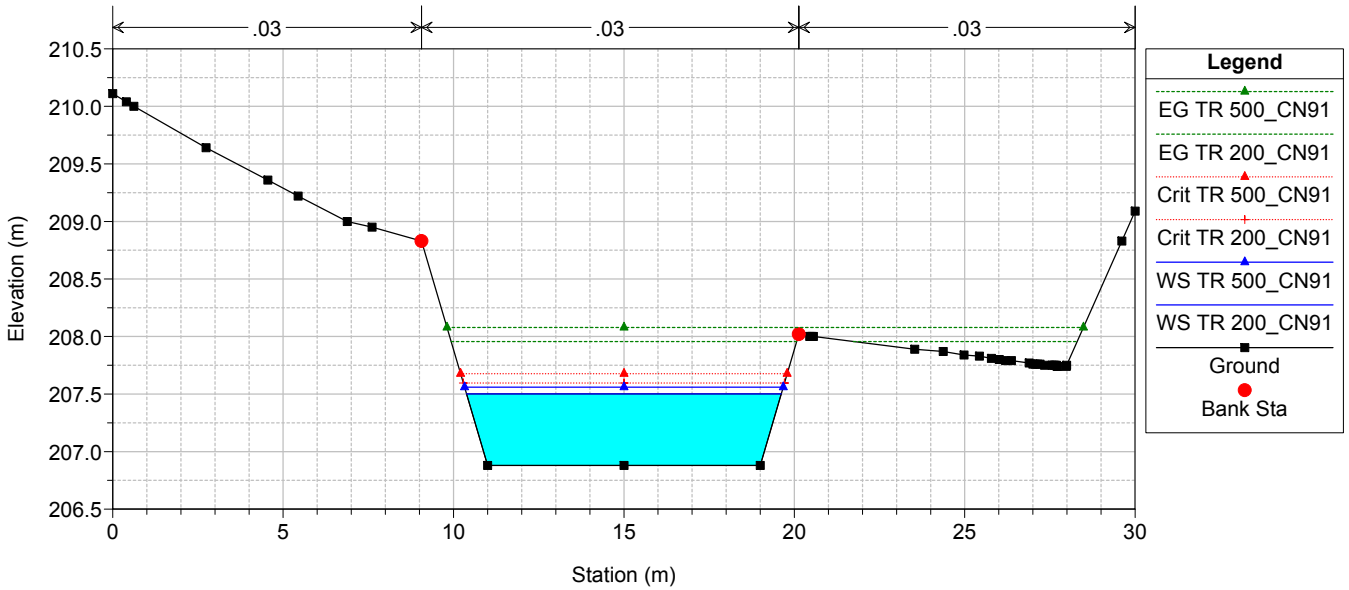

TO02-TO03

RS = -300

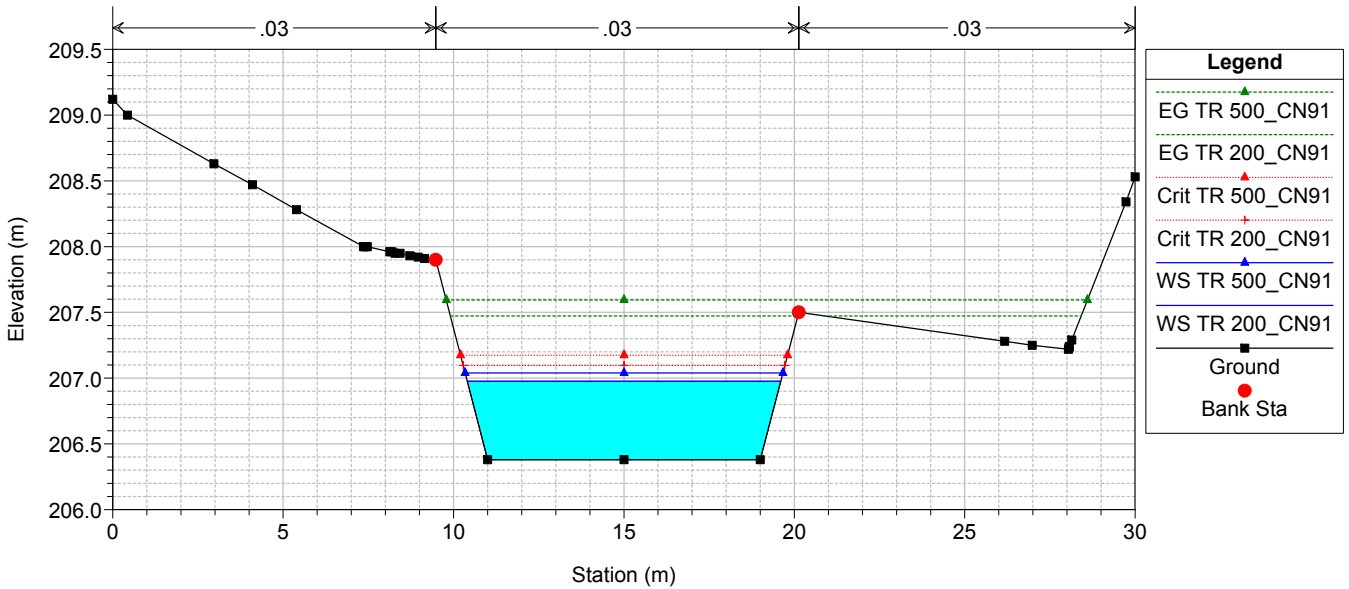

TO02-TO03

RS = -325

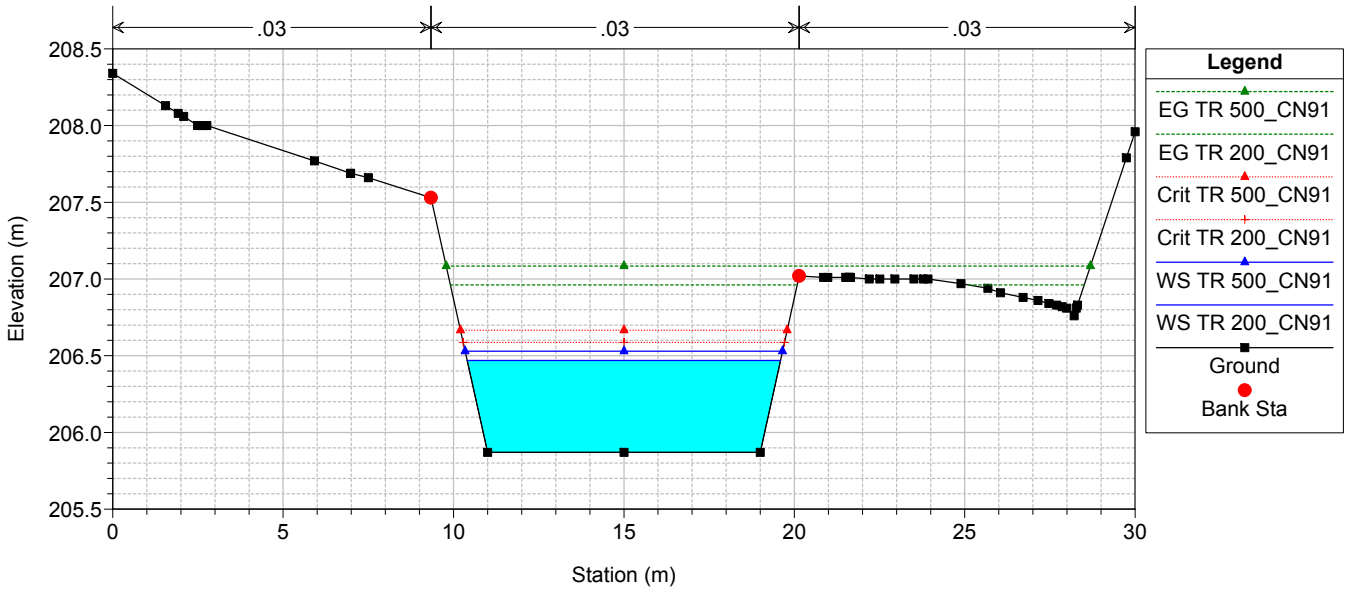

TO02-TO03

RS = -350

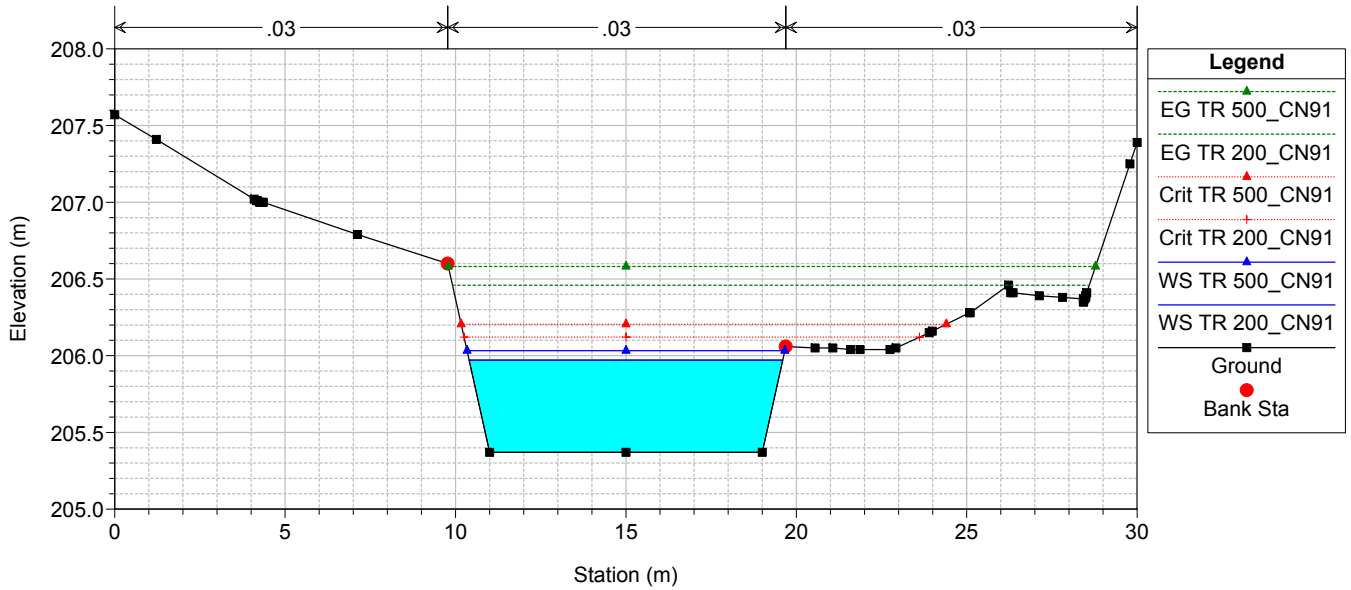

TO02-TO03

RS = -375

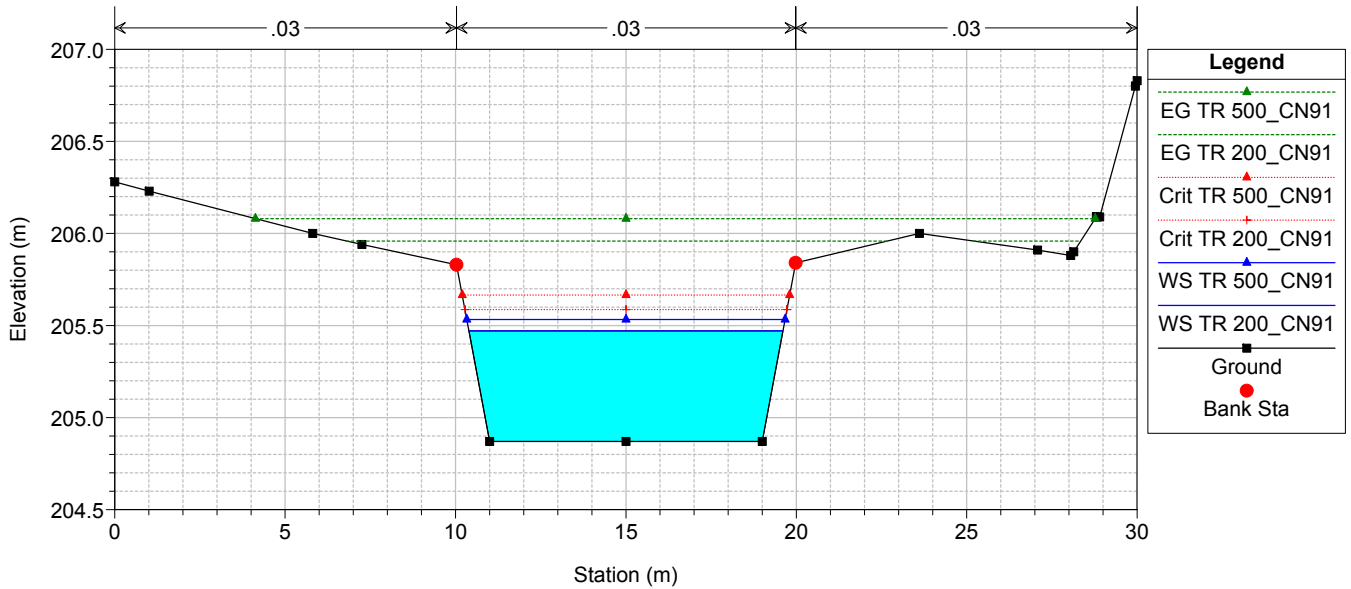

TO02-TO03

RS = -400

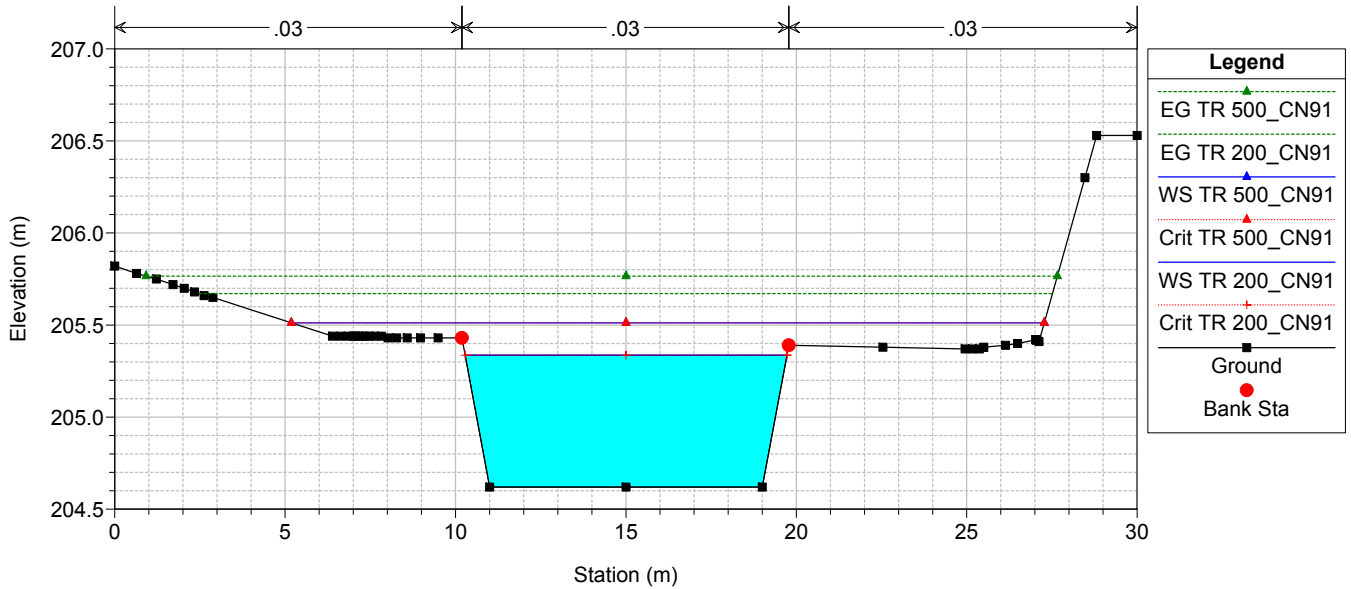

TO02-TO03

RS = -425

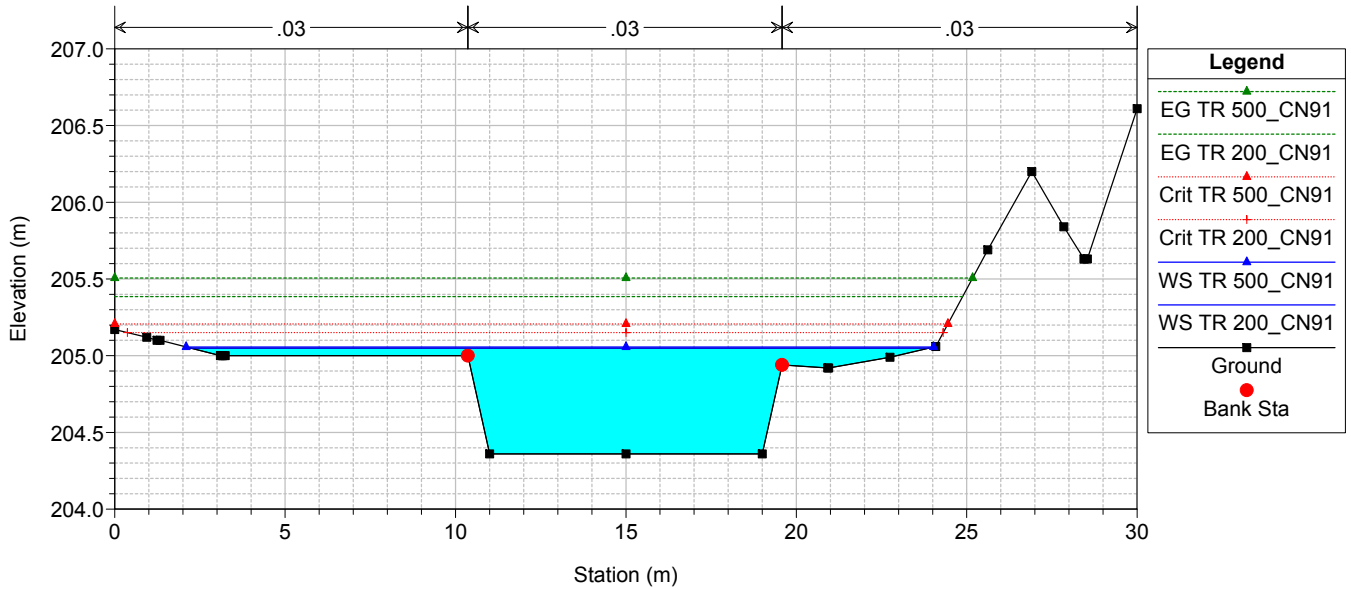

TO02-TO03

RS = -450

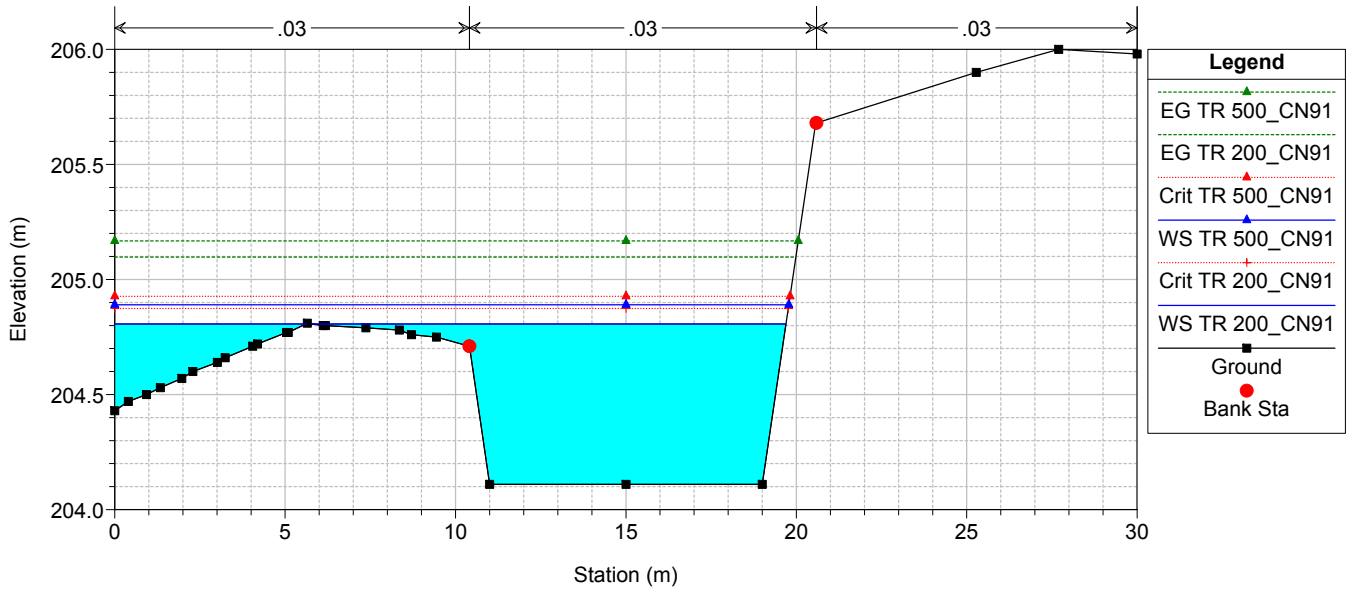

TO02-TO03

RS = -475

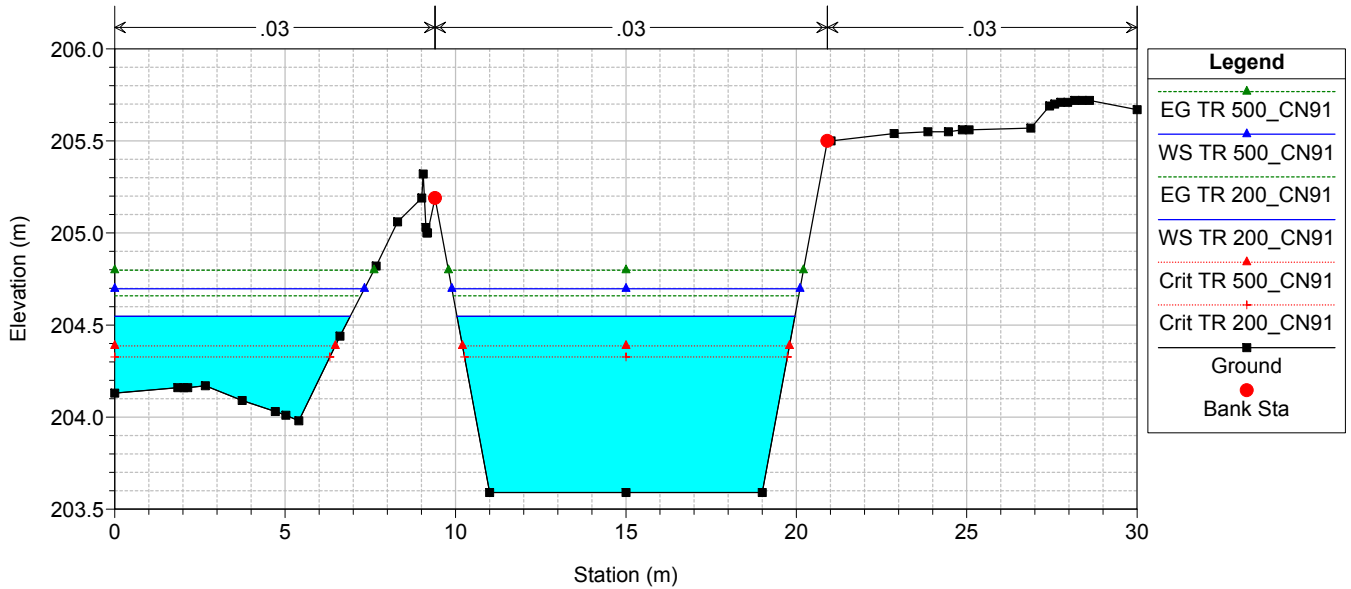

TO02-TO03

RS = -500

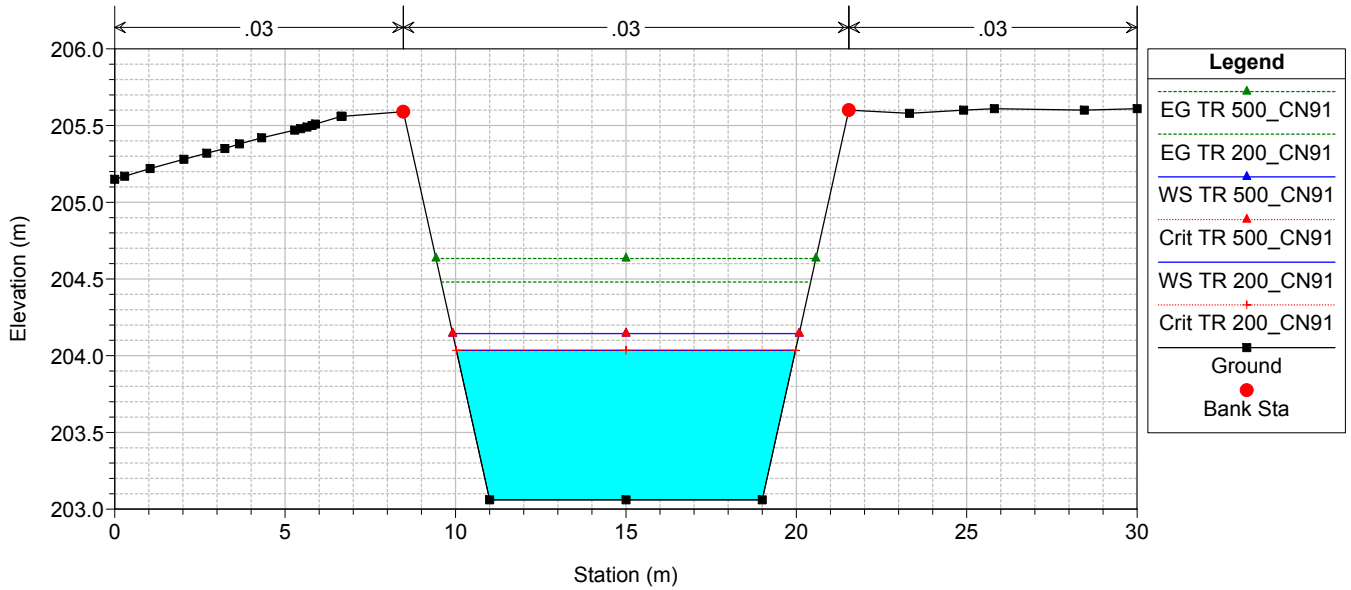

TO02-TO03

RS = -523.35

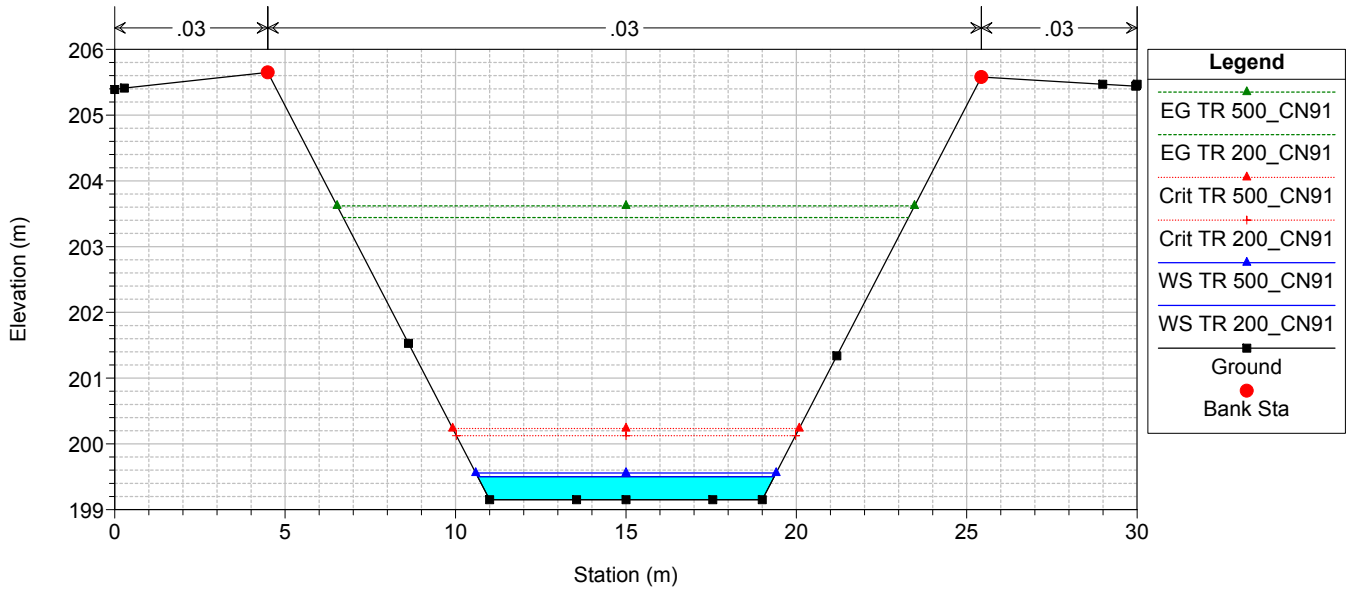

TO02-TO03

RS = -527.89

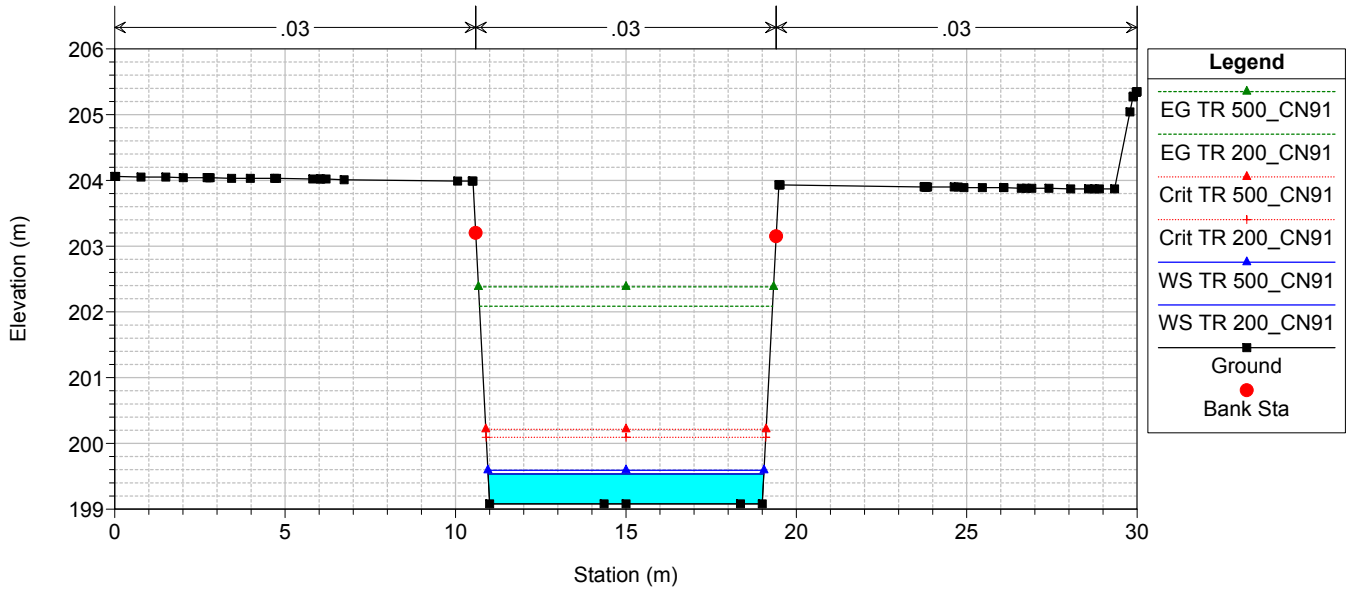

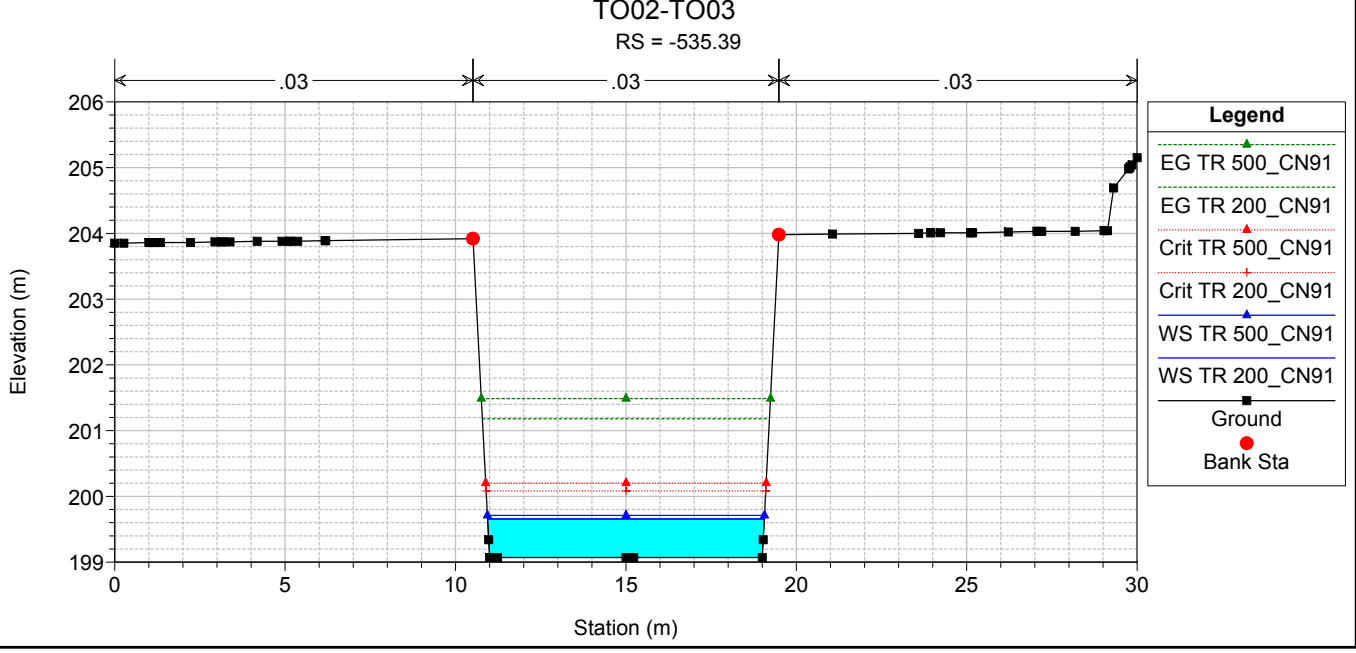
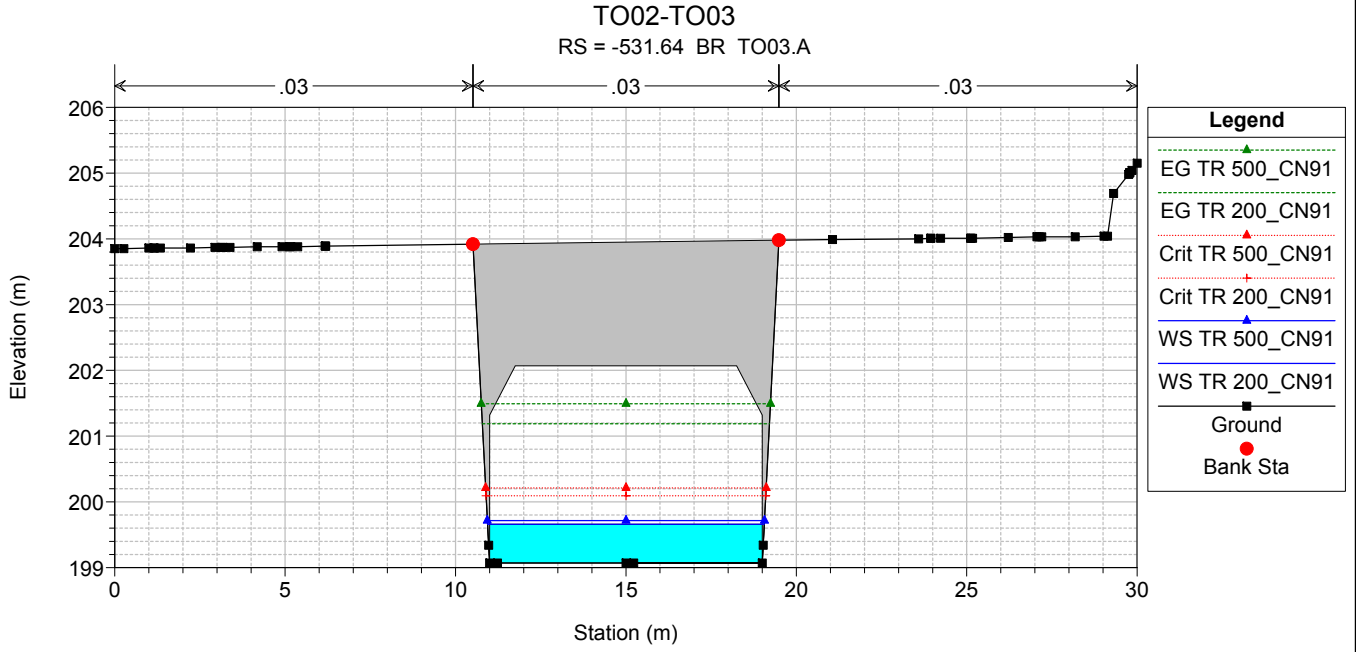
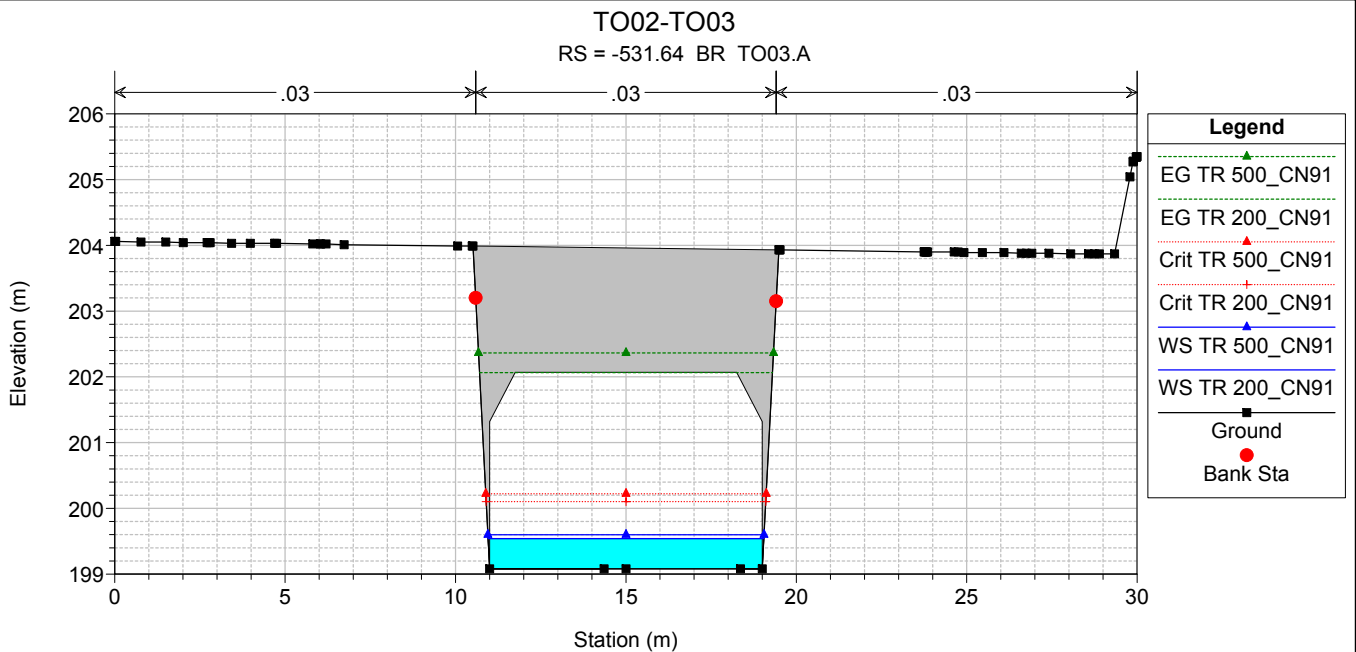

TO02-TO03

RS = -541.22

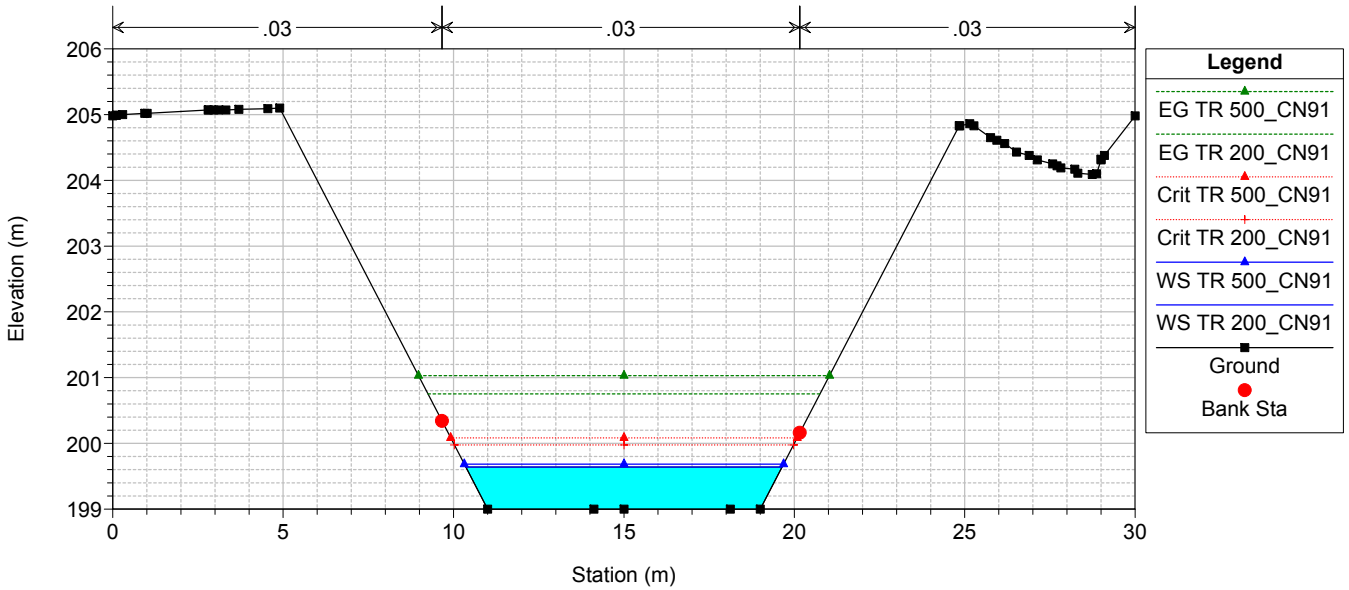

TO02-TO03

RS = -550

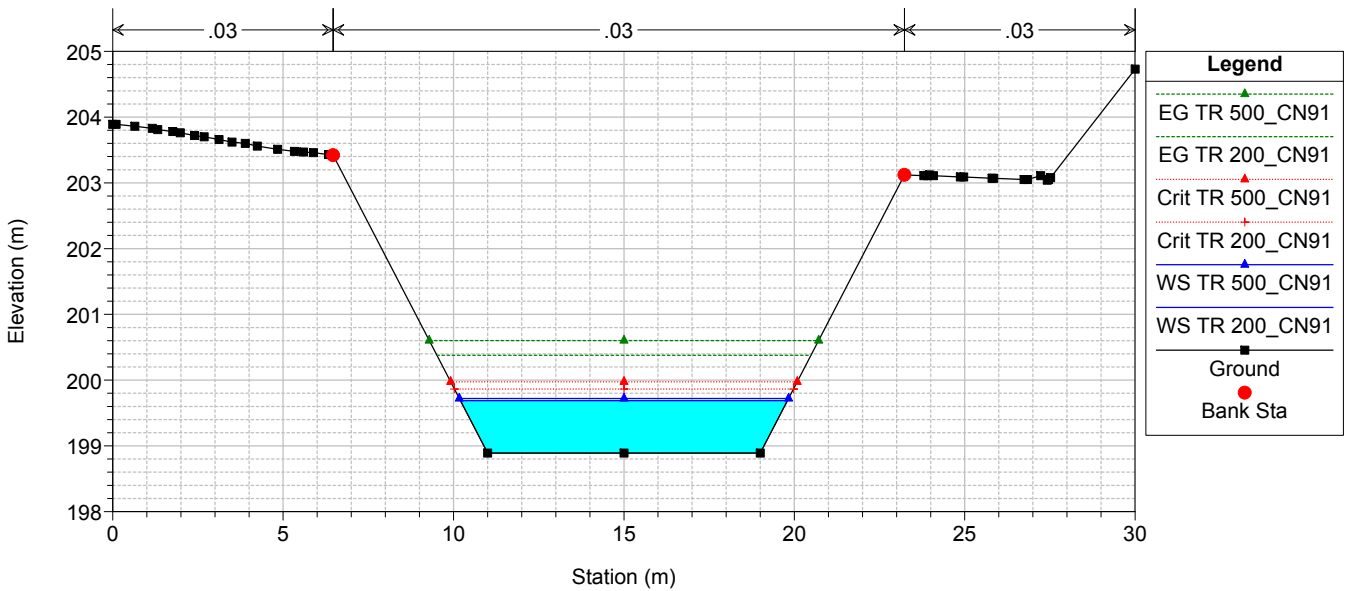

TO02-TO03

RS = -575

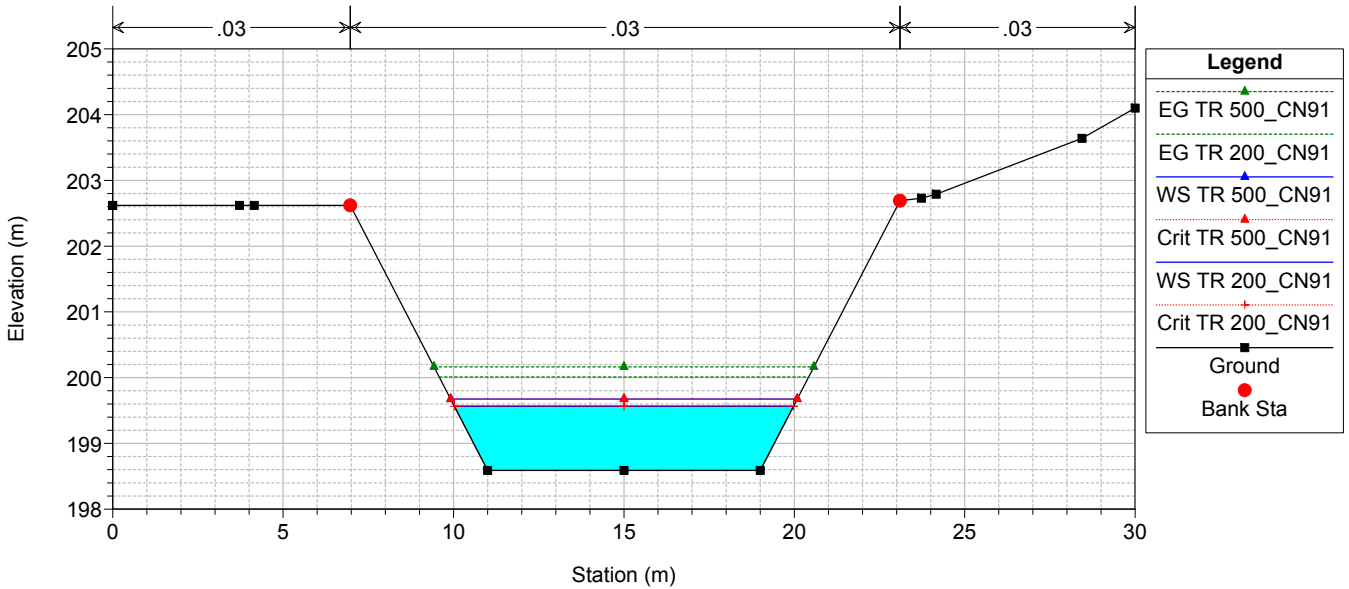

TO02-TO03

RS = -600

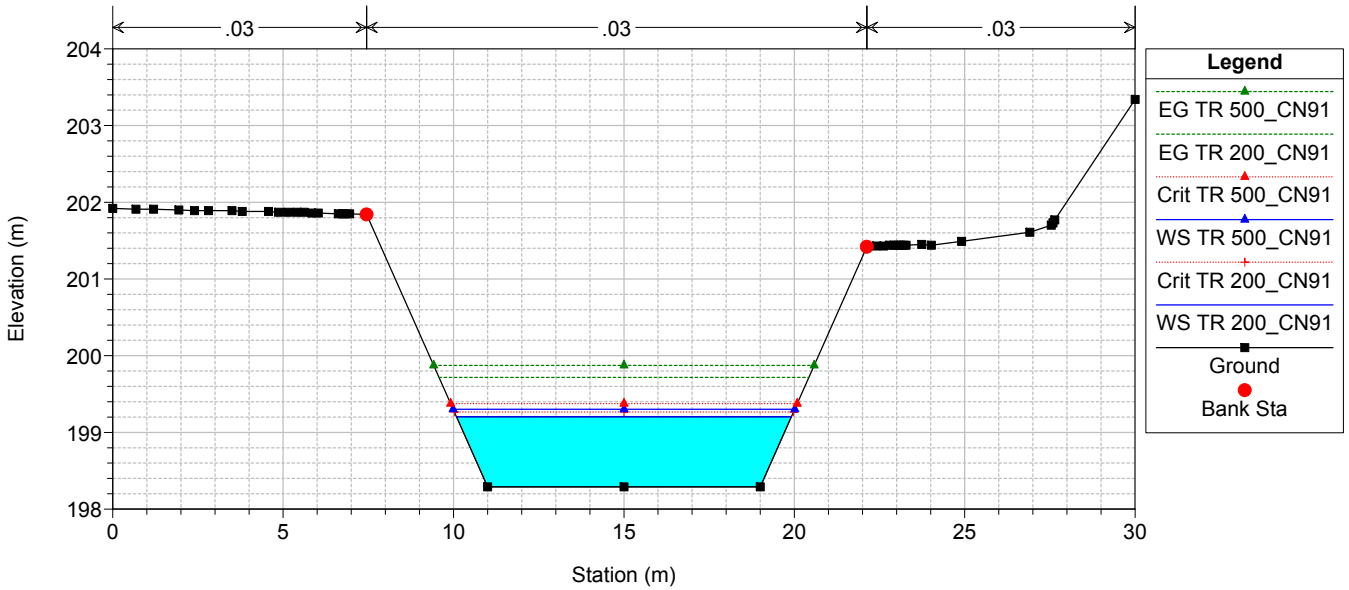

TO02-TO03

RS = -625

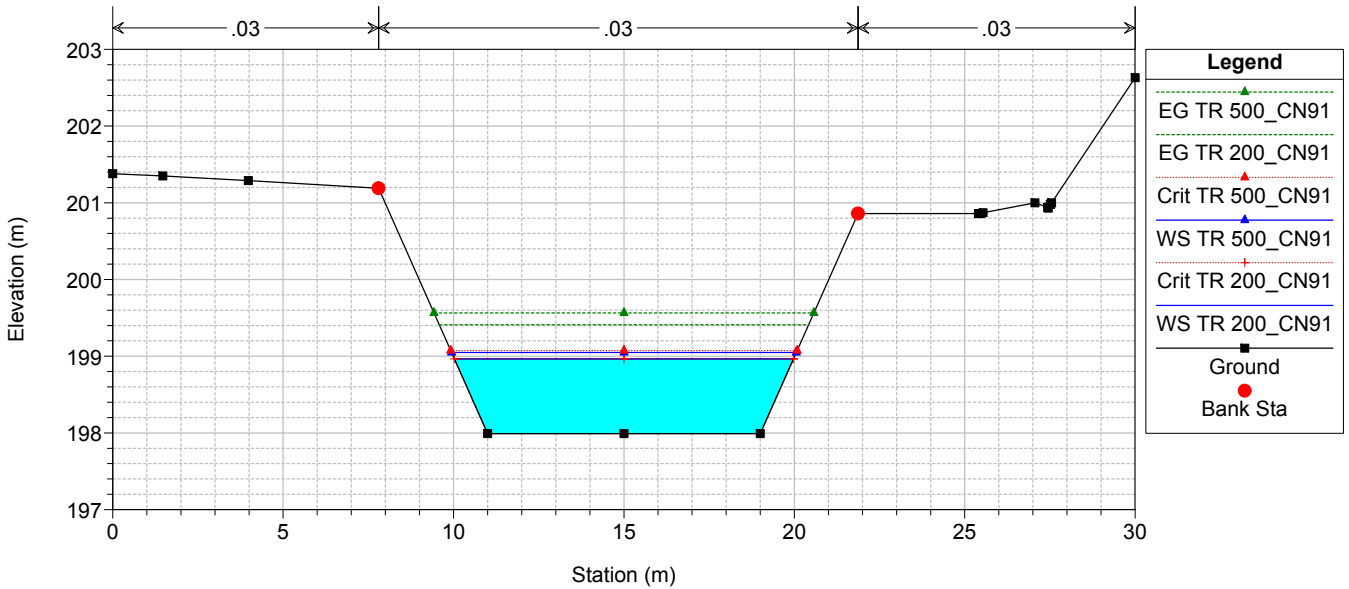

TO02-TO03

RS = -650

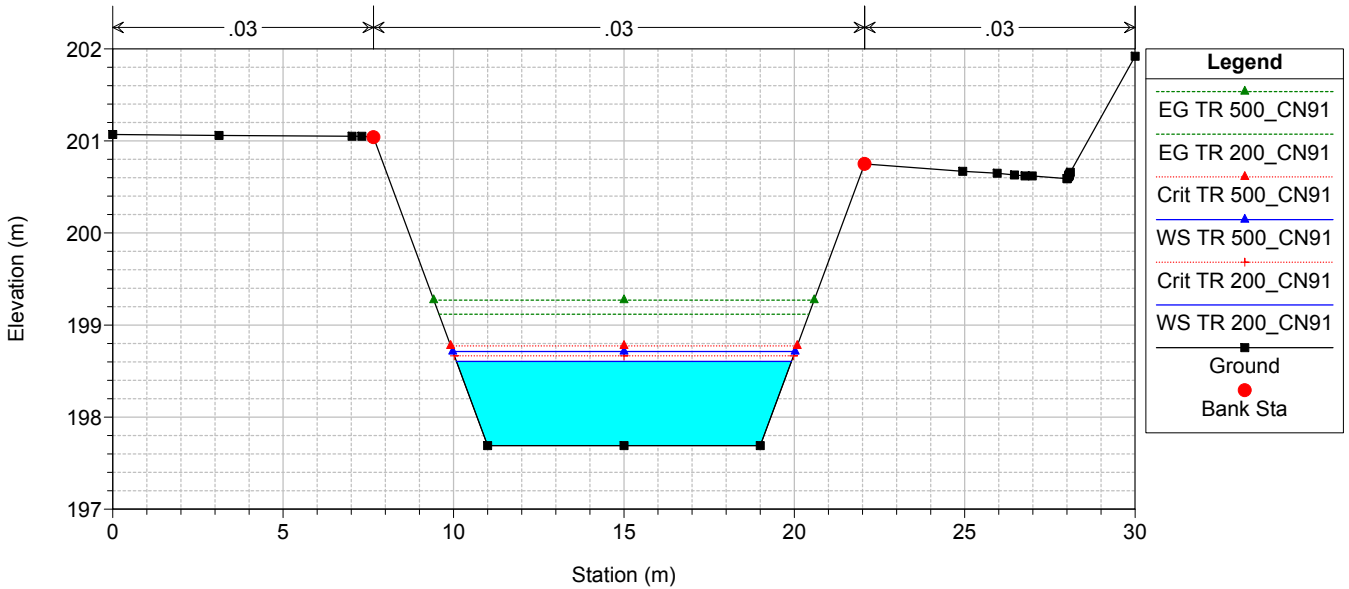

TO02-TO03

RS = -675

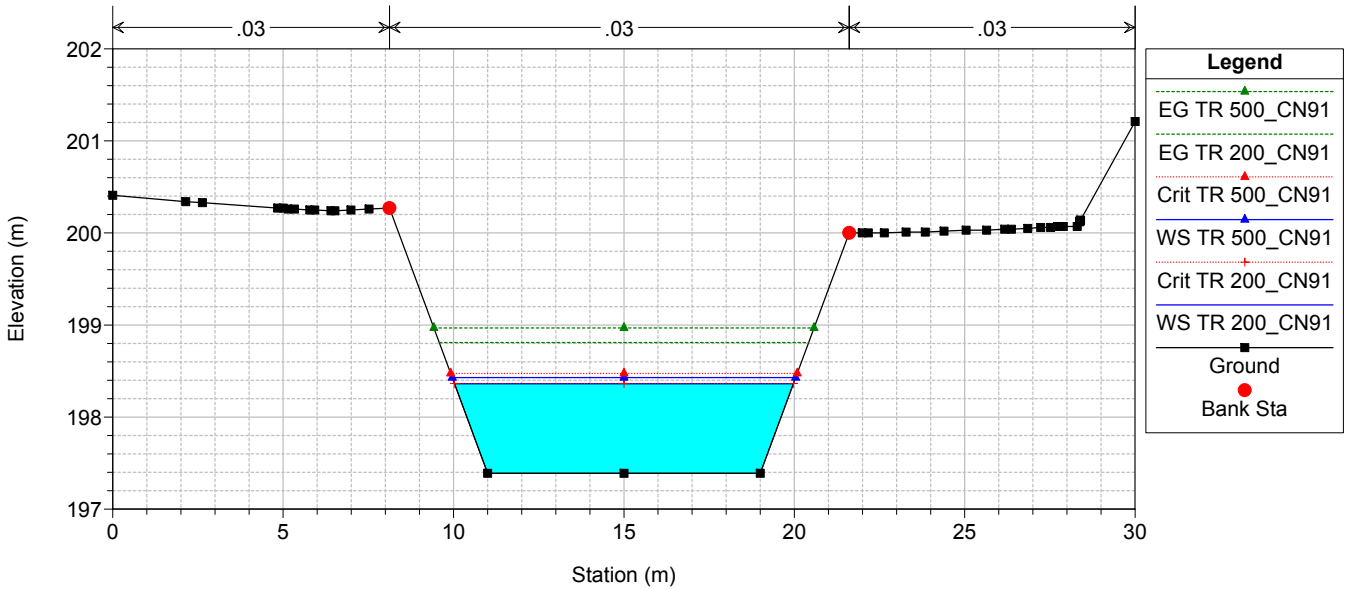

TO02-TO03

RS = -700

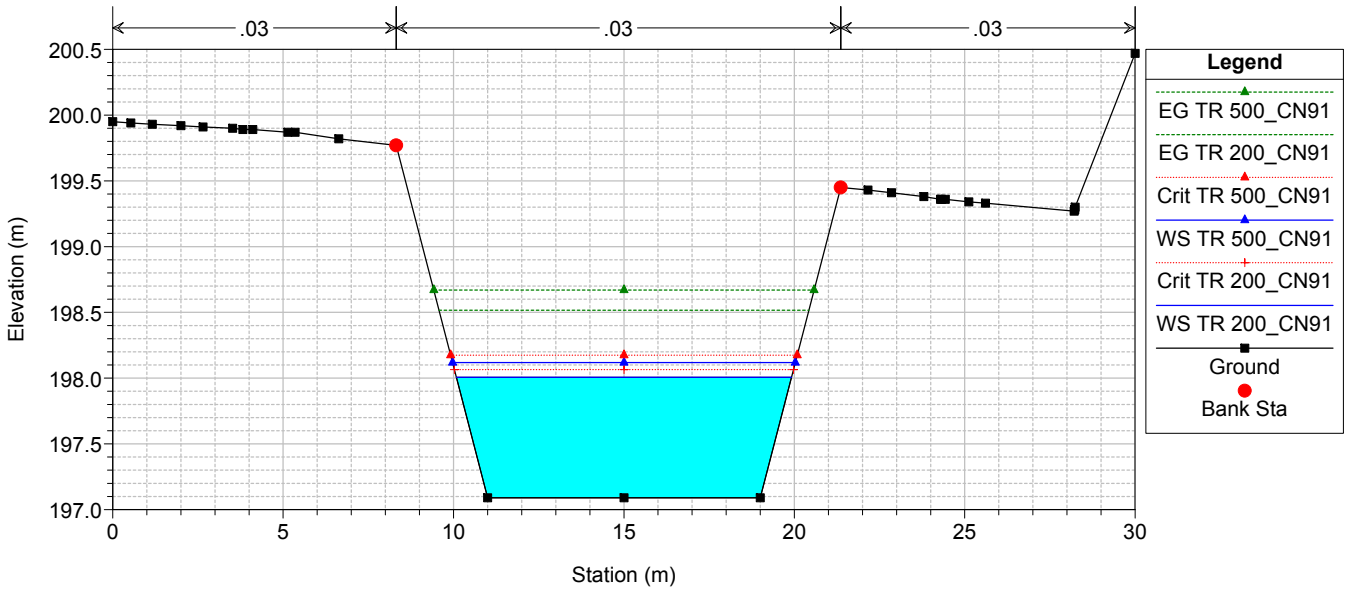

TO02-TO03

RS = -725

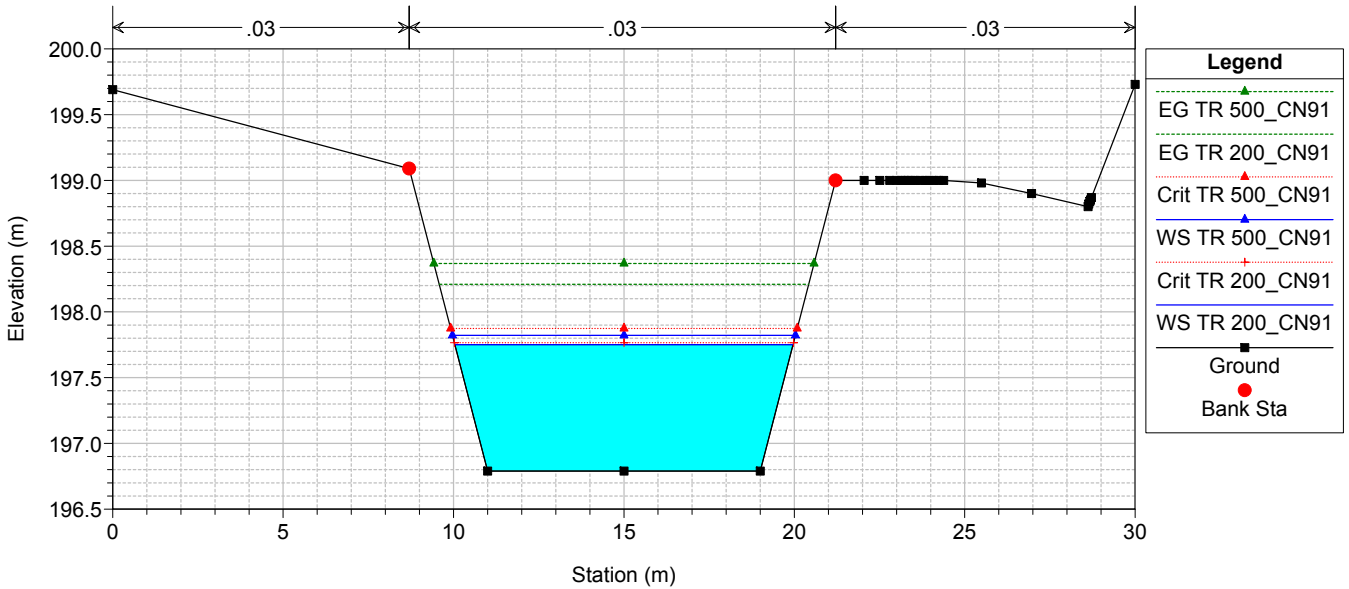

TO02-TO03

RS = -750

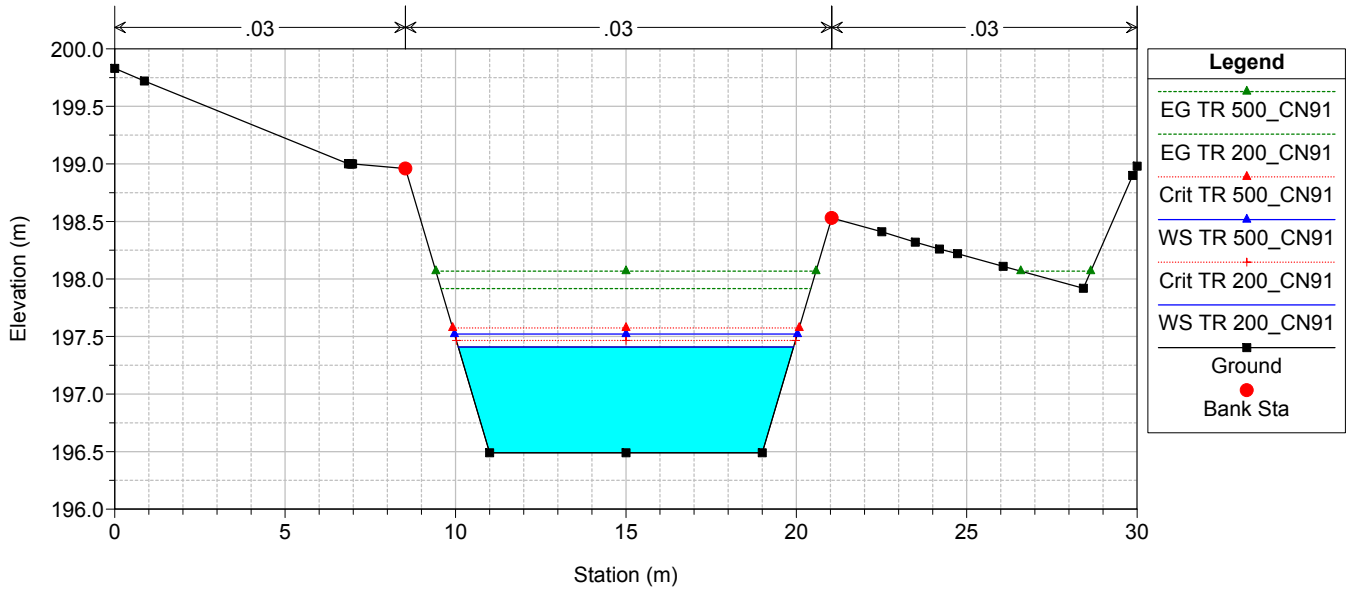

TO02-TO03

RS = -772.6

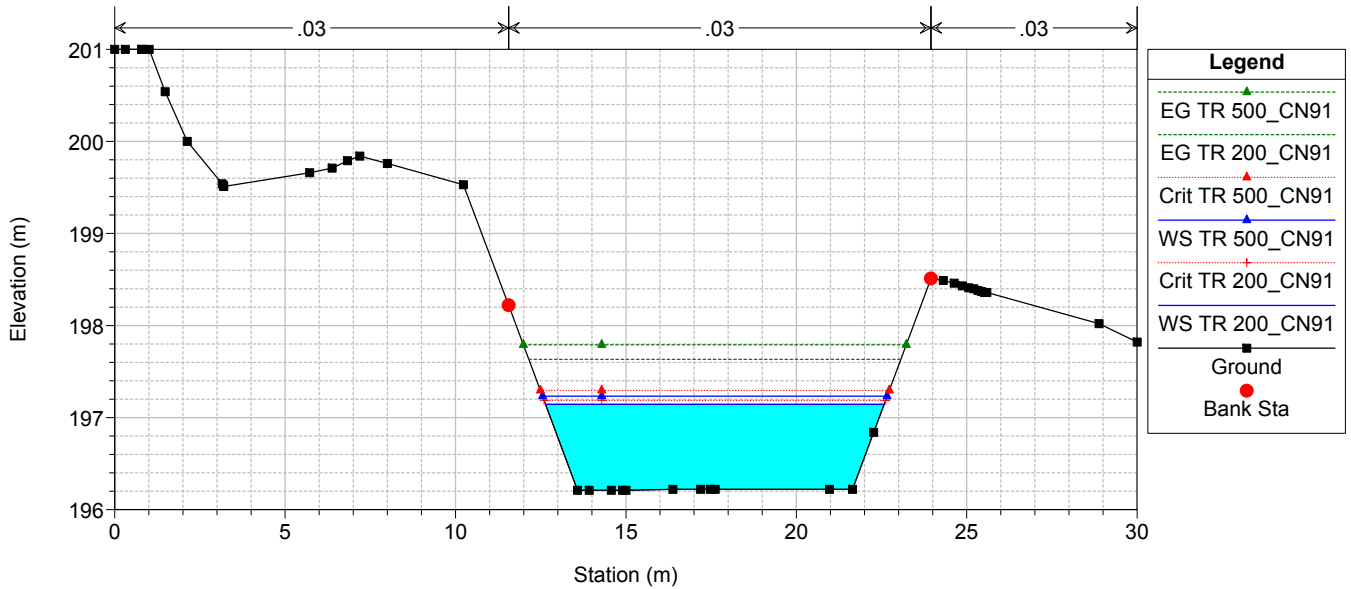

TO02-TO03

RS = -789.51

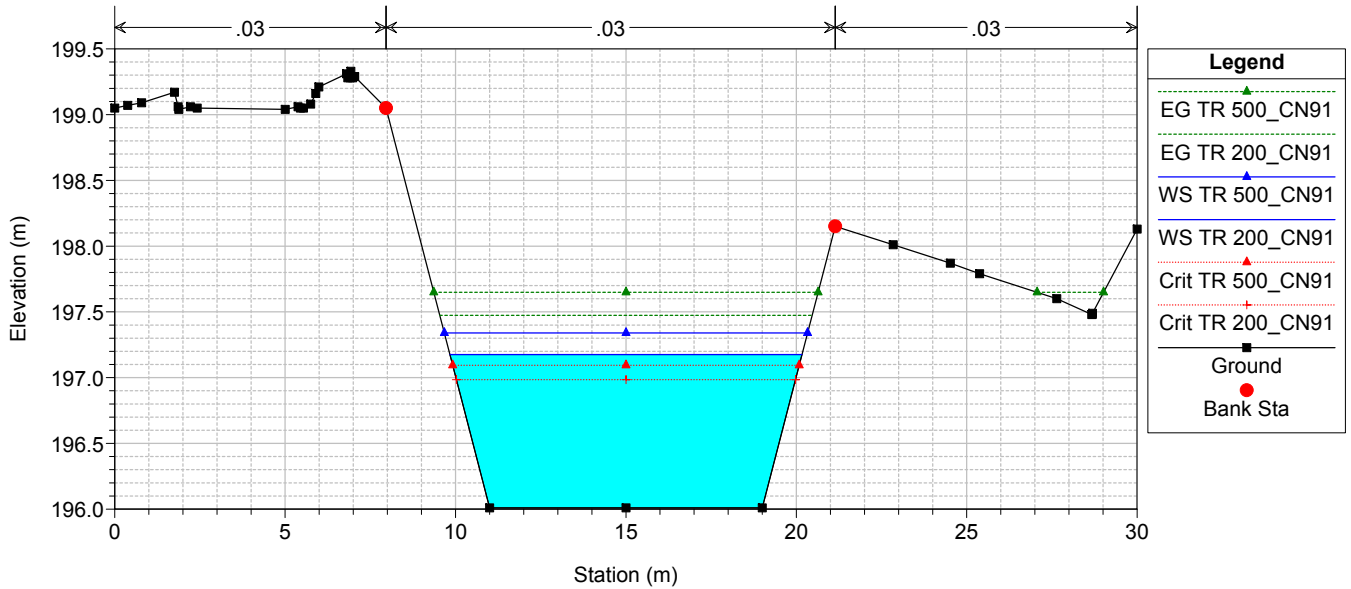

TO02-TO03

RS = -801.32

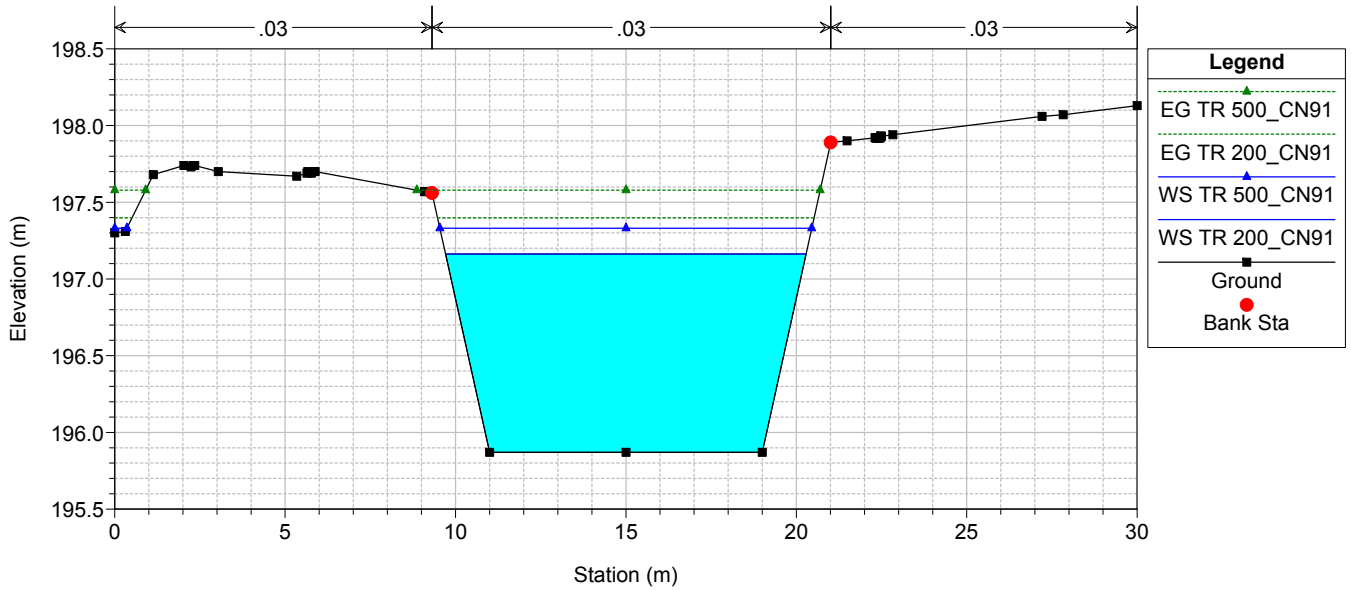

TO02-TO03

RS = -806.61

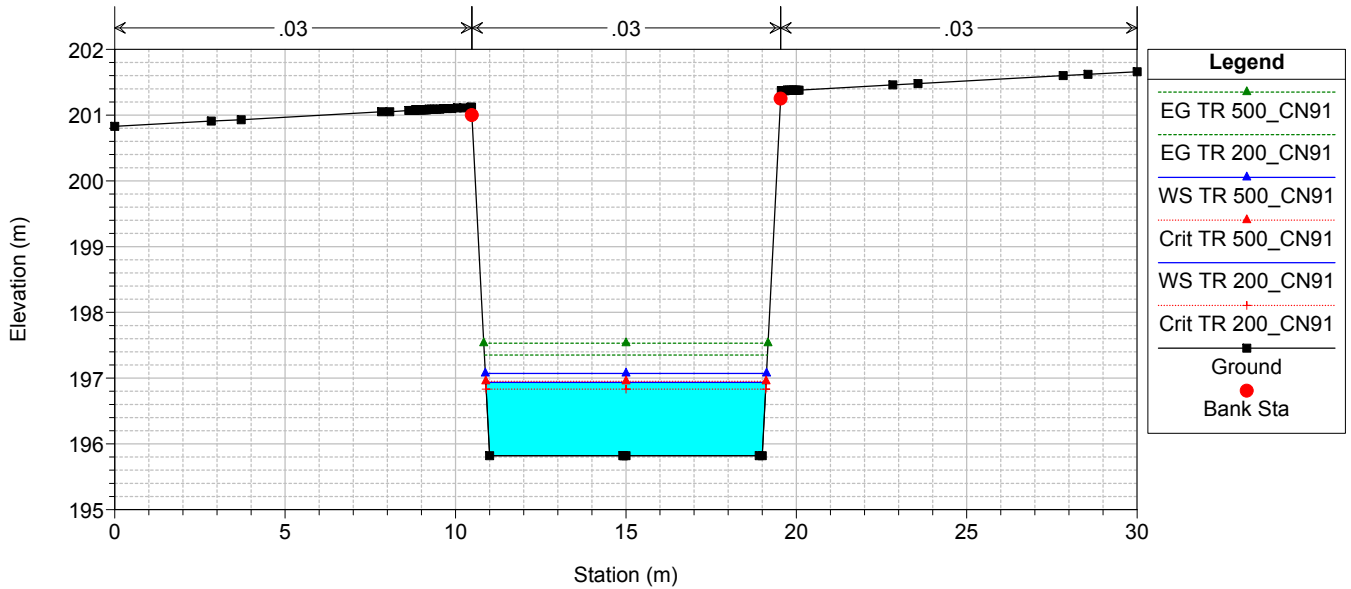

TO02-TO03

RS = -820.99 BR TO03.B

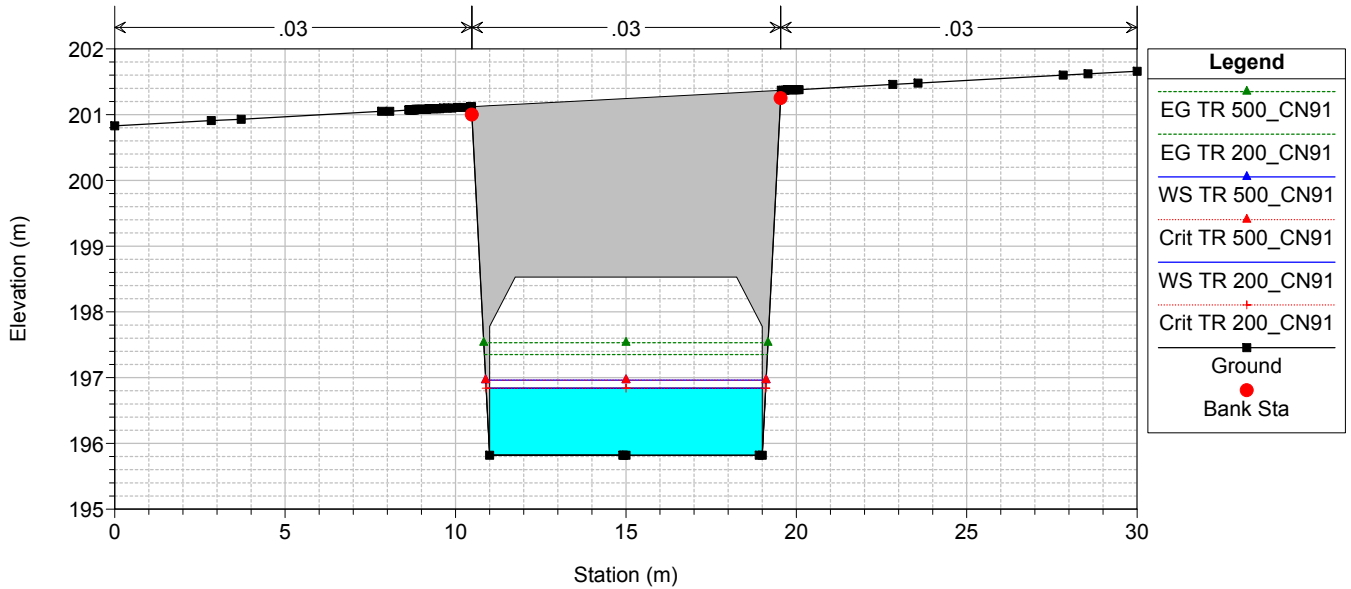

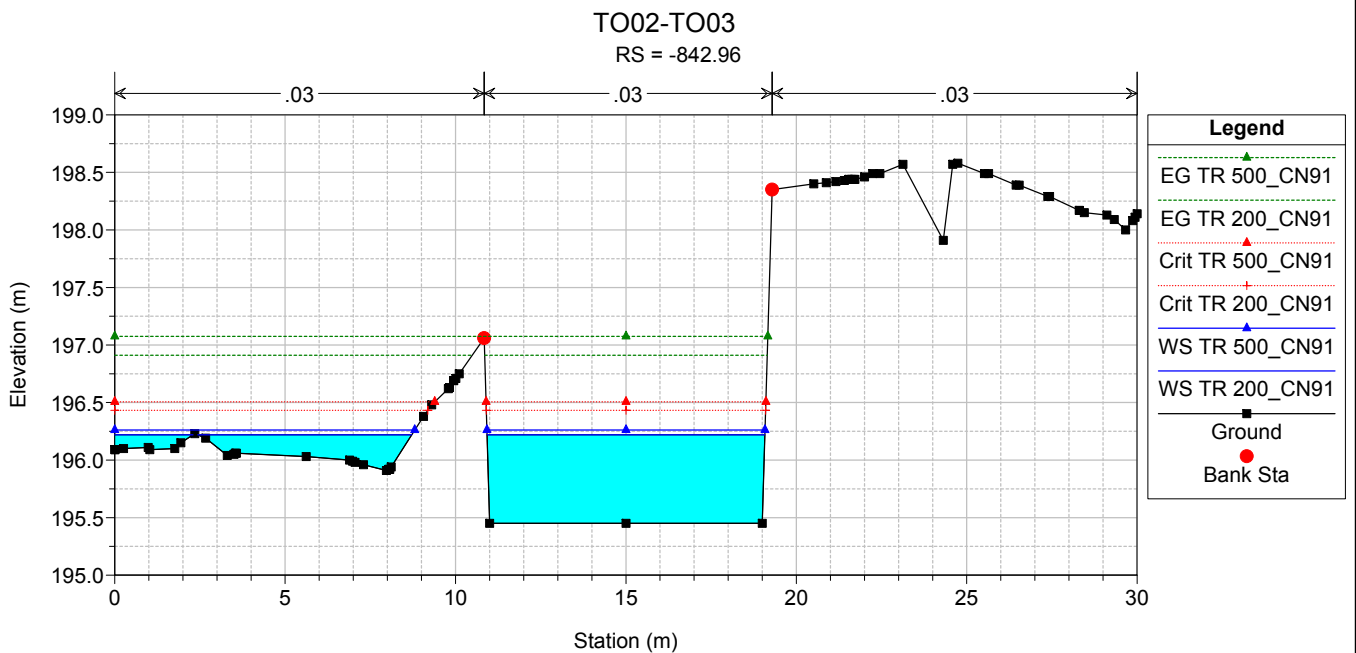
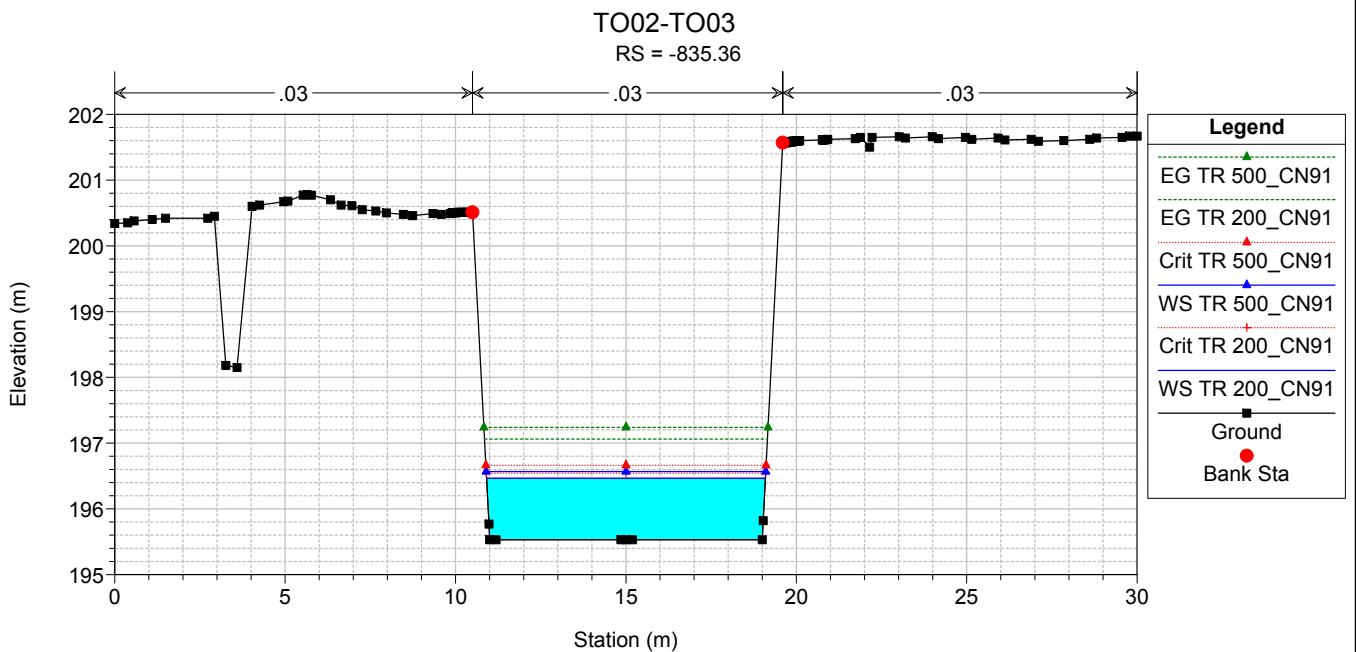
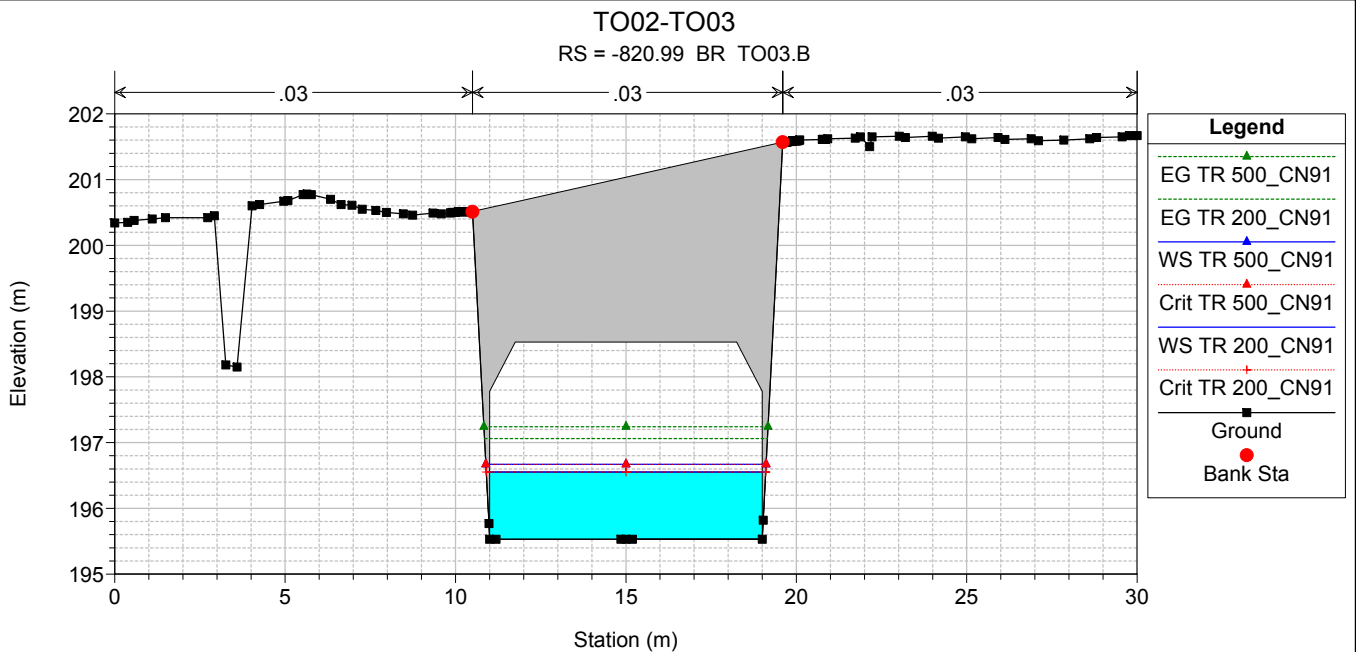

TO02-TO03

RS = -849

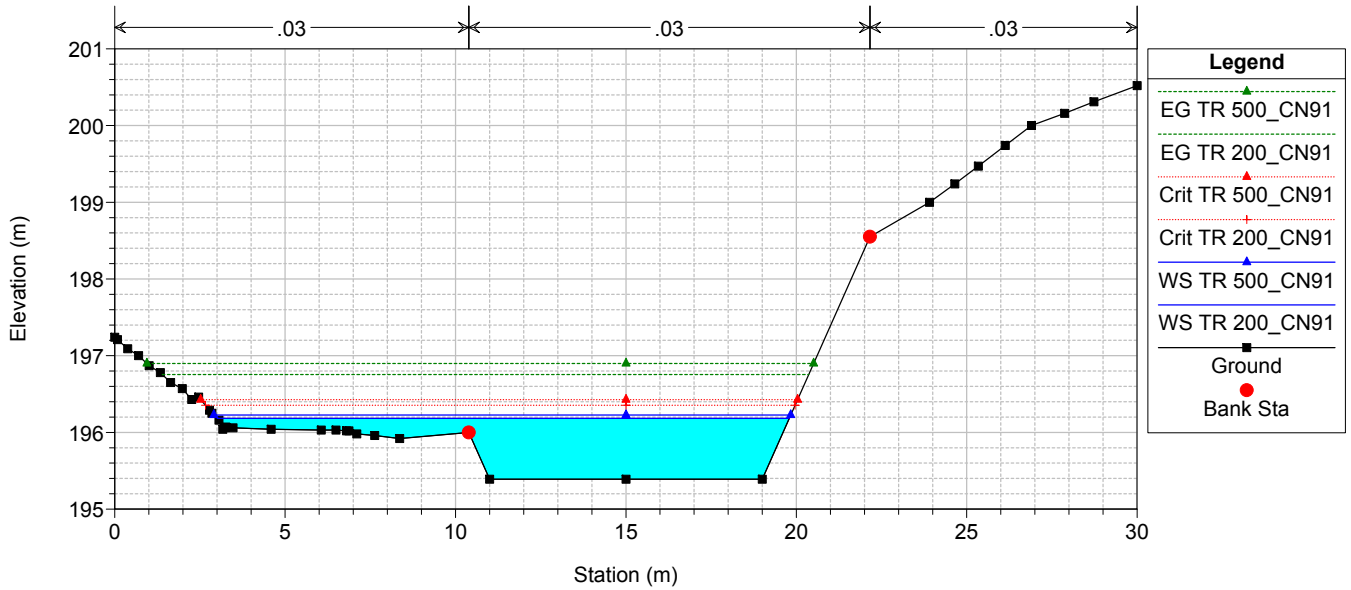

TO02-TO03

RS = -851.72

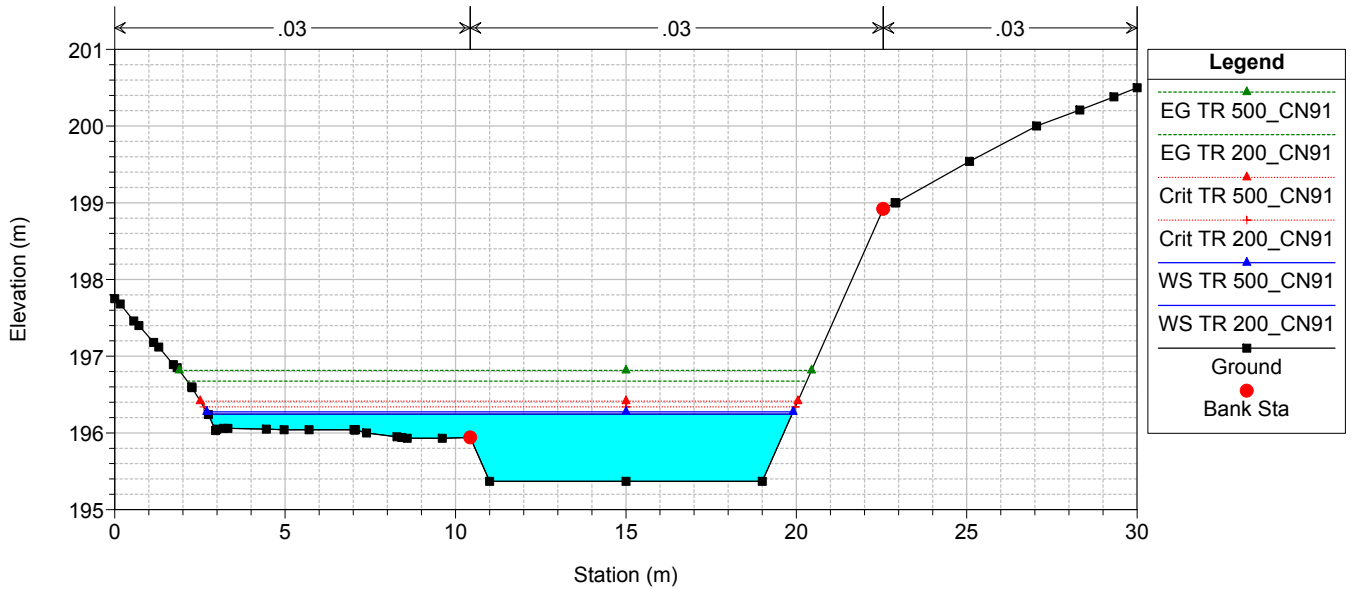

TO02-TO03

RS = -872.81

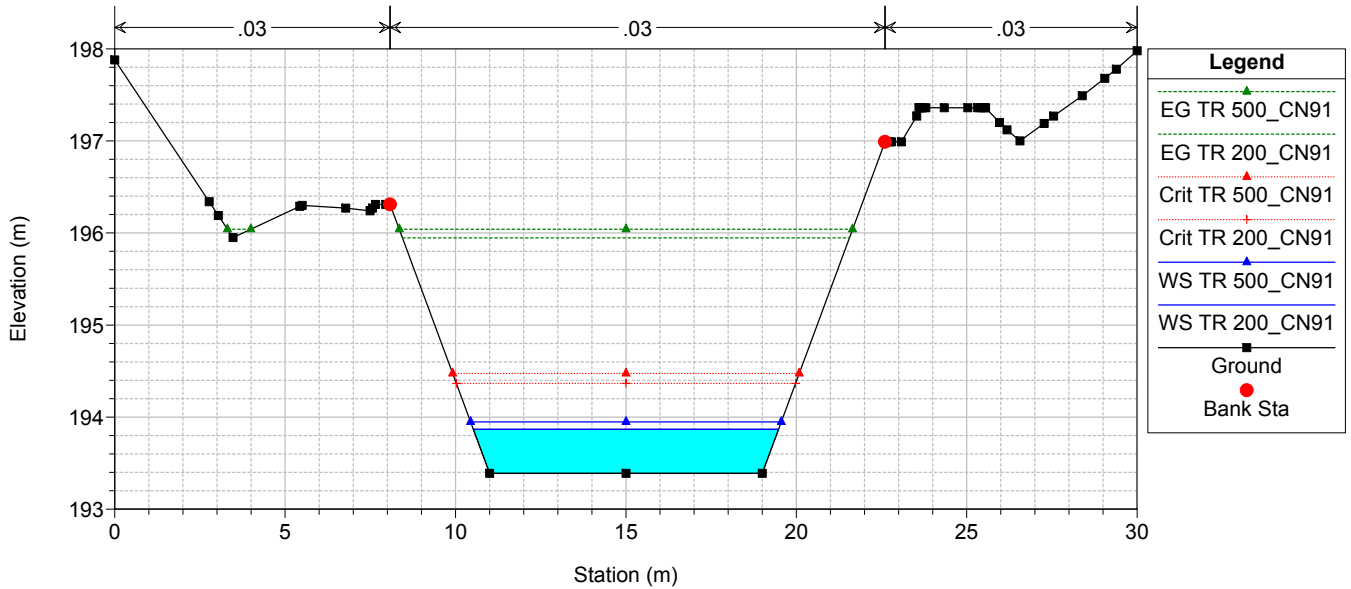

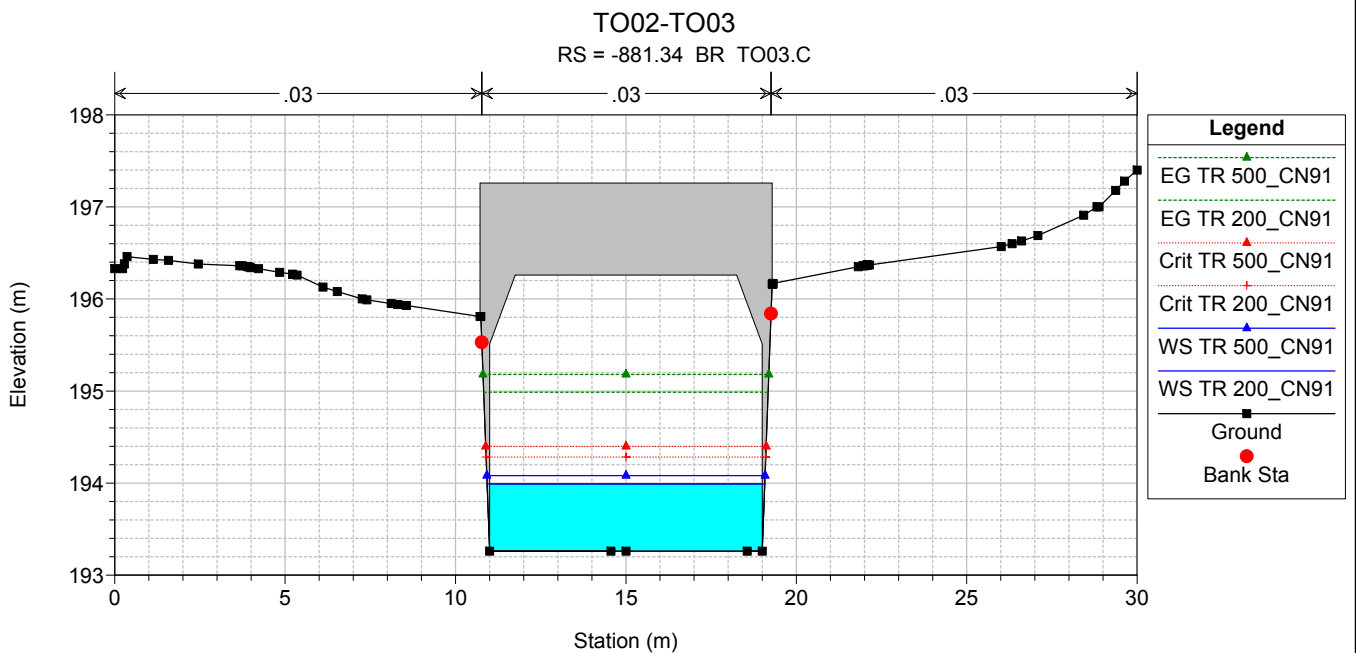
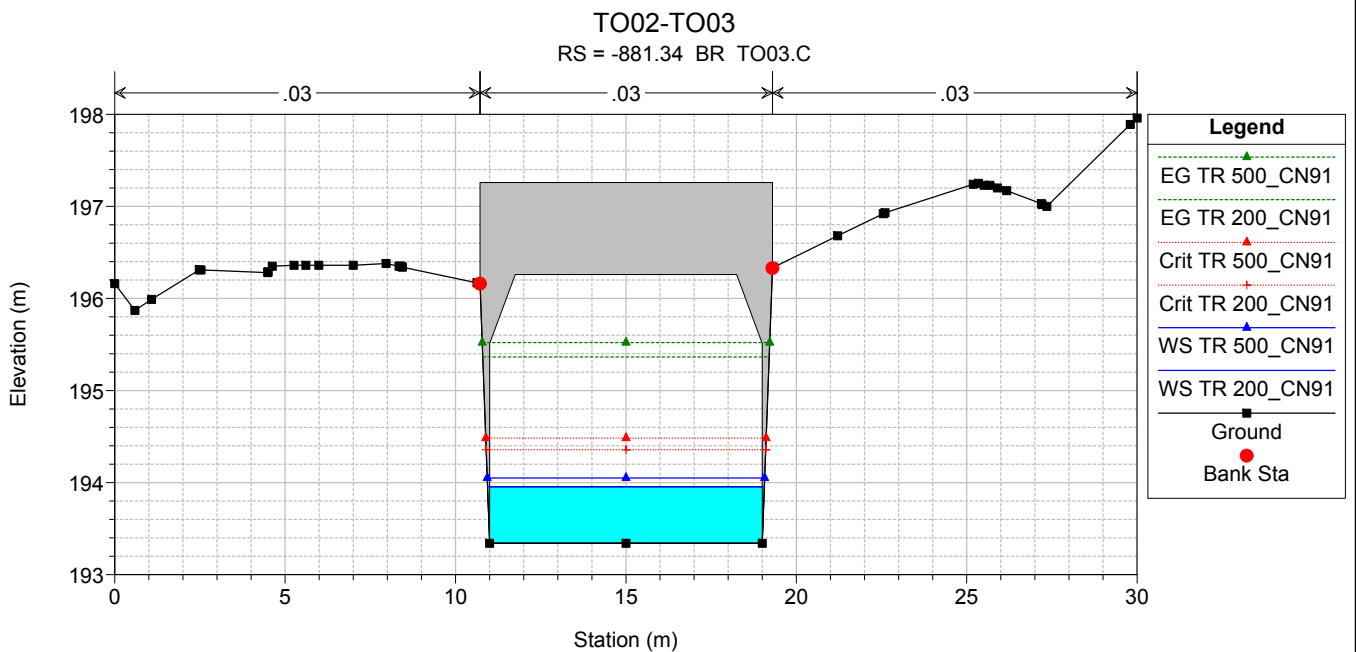
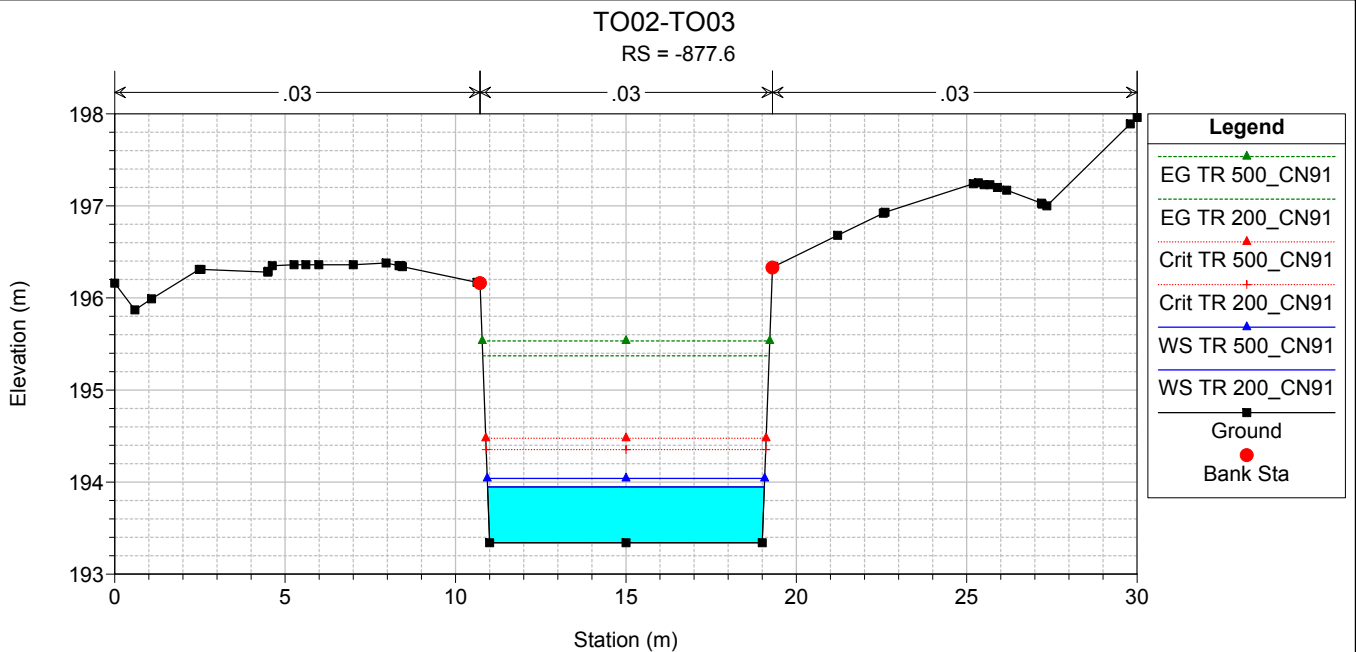

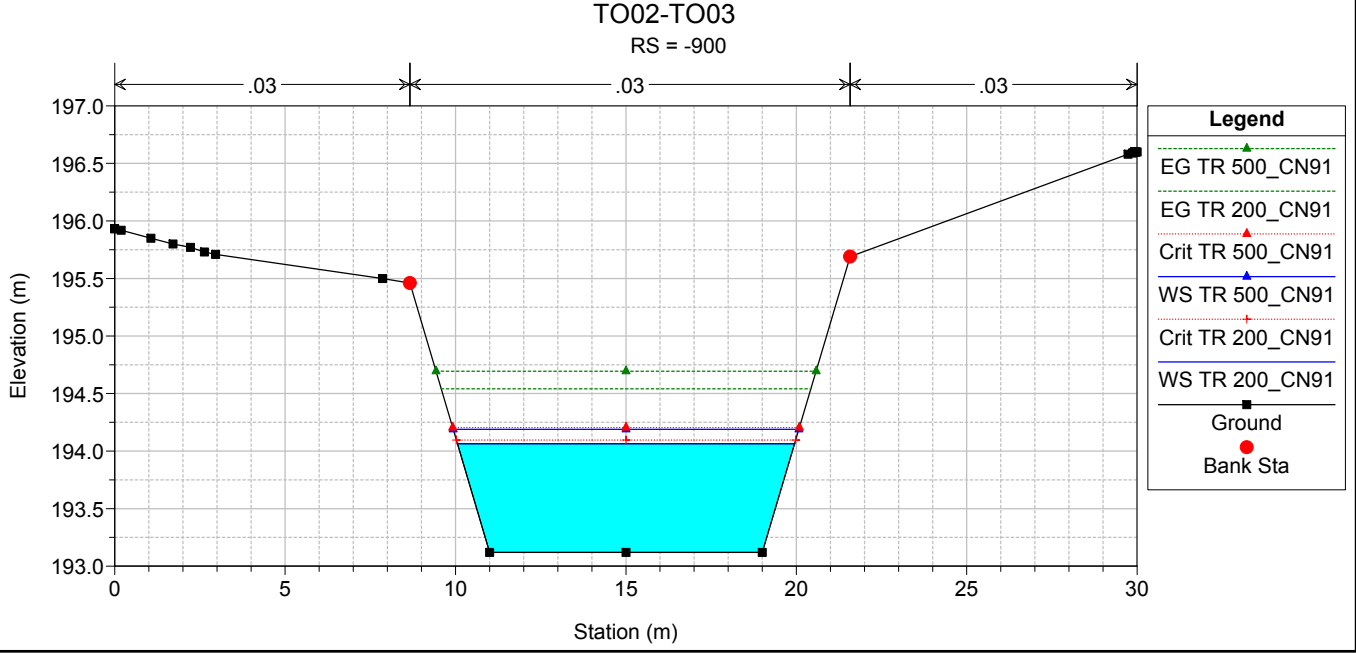
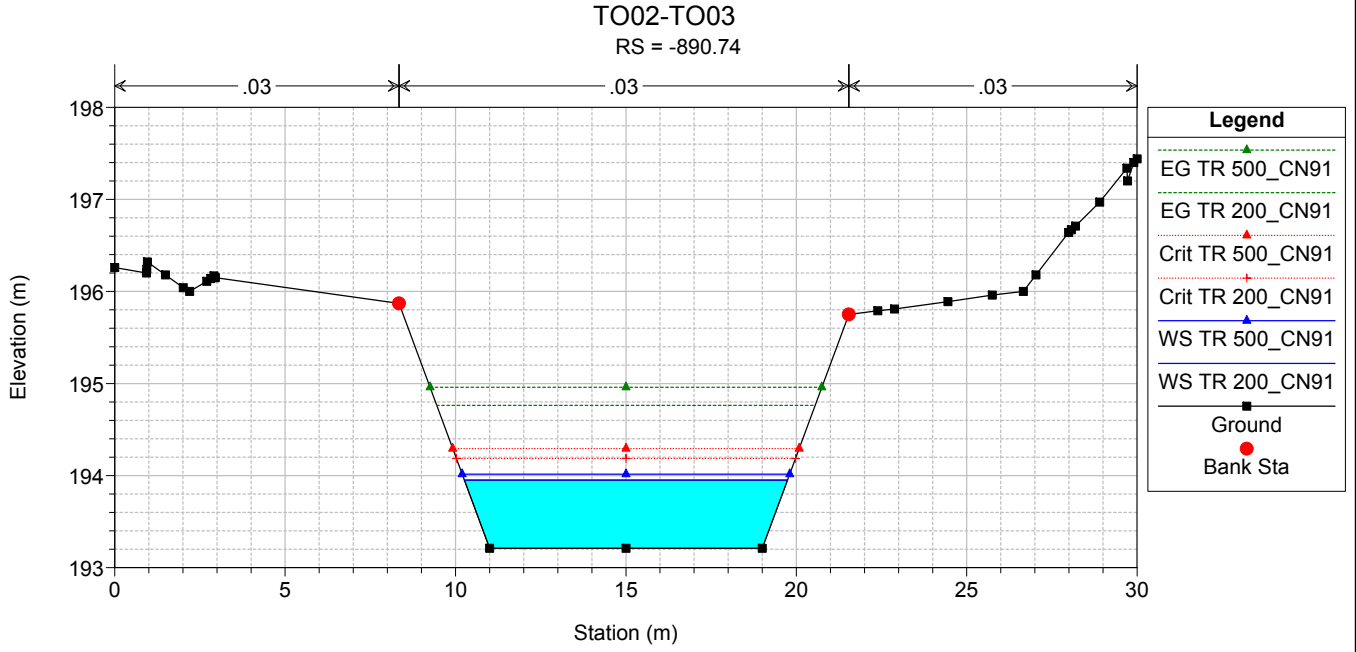
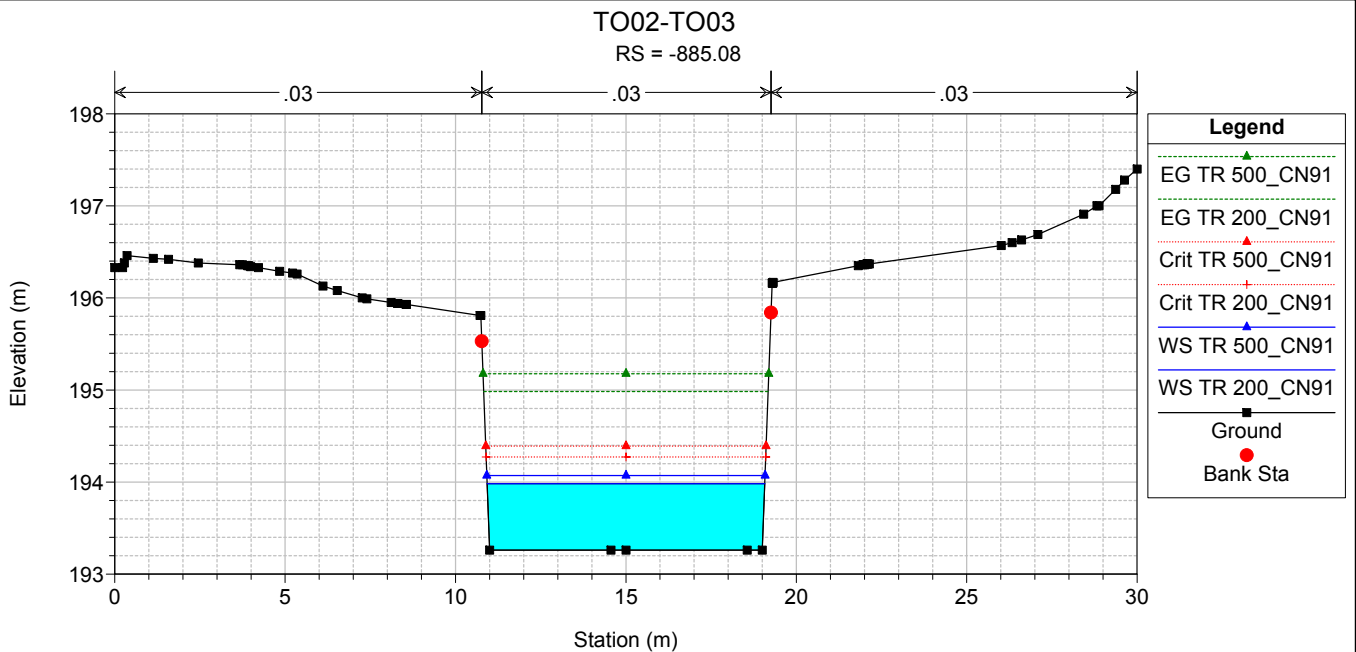

TO02-TO03

RS = -925

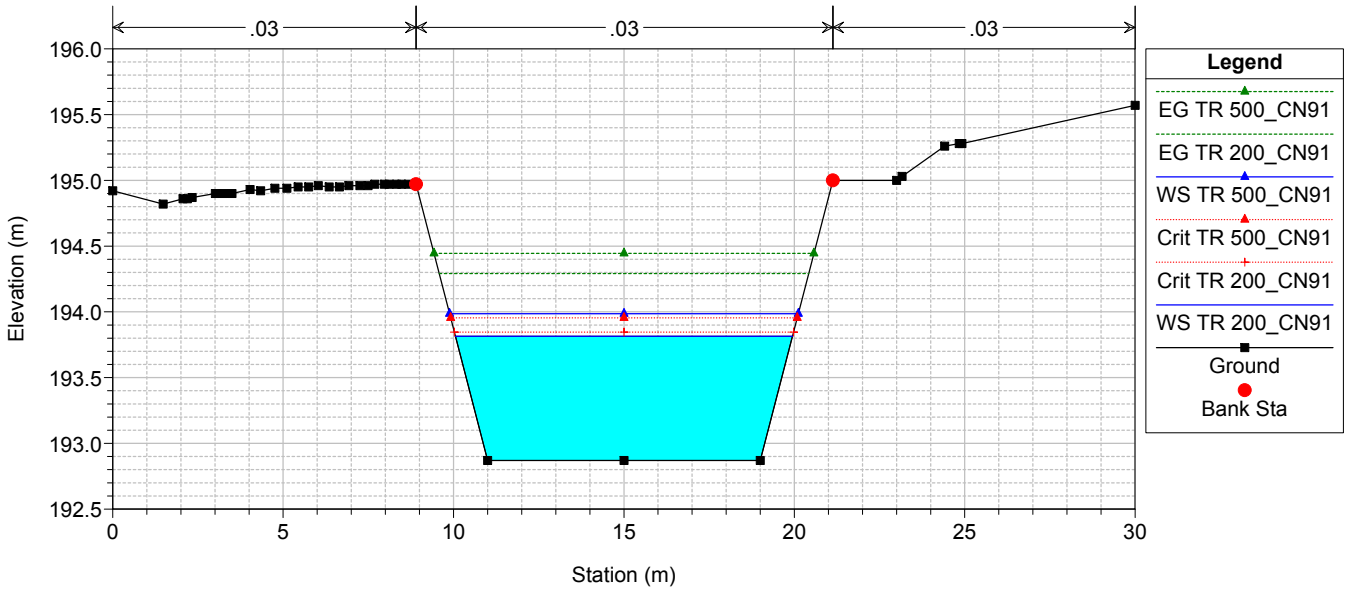

TO02-TO03

RS = -950

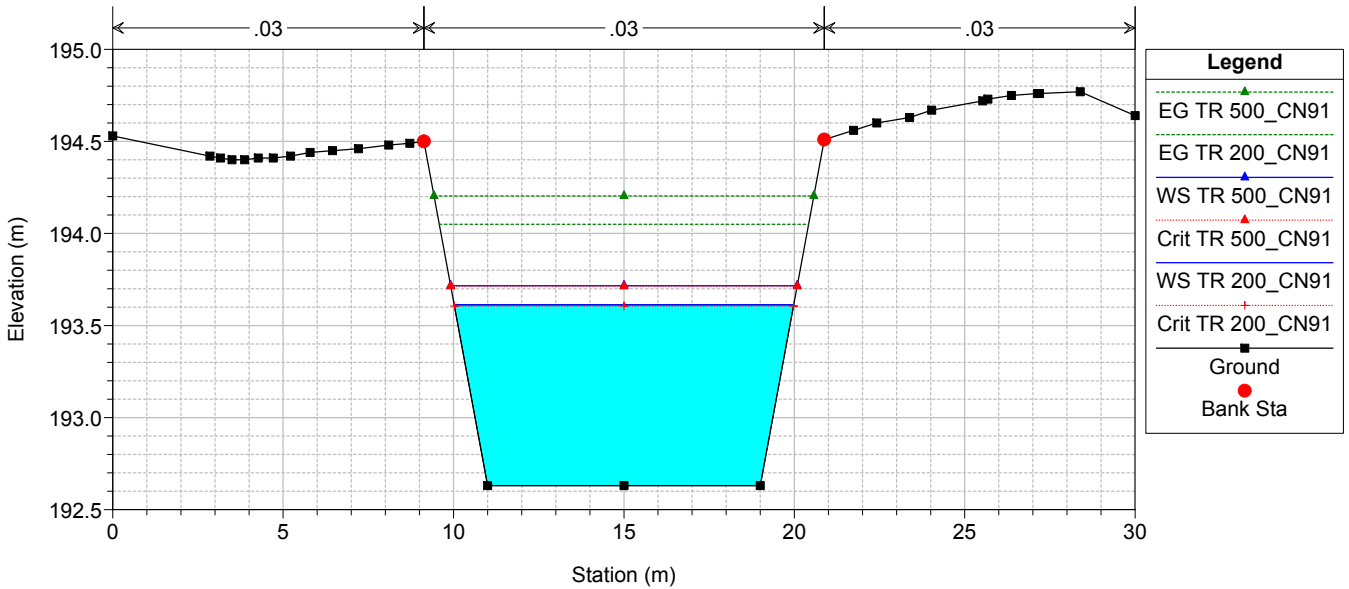

TO02-TO03

RS = -975

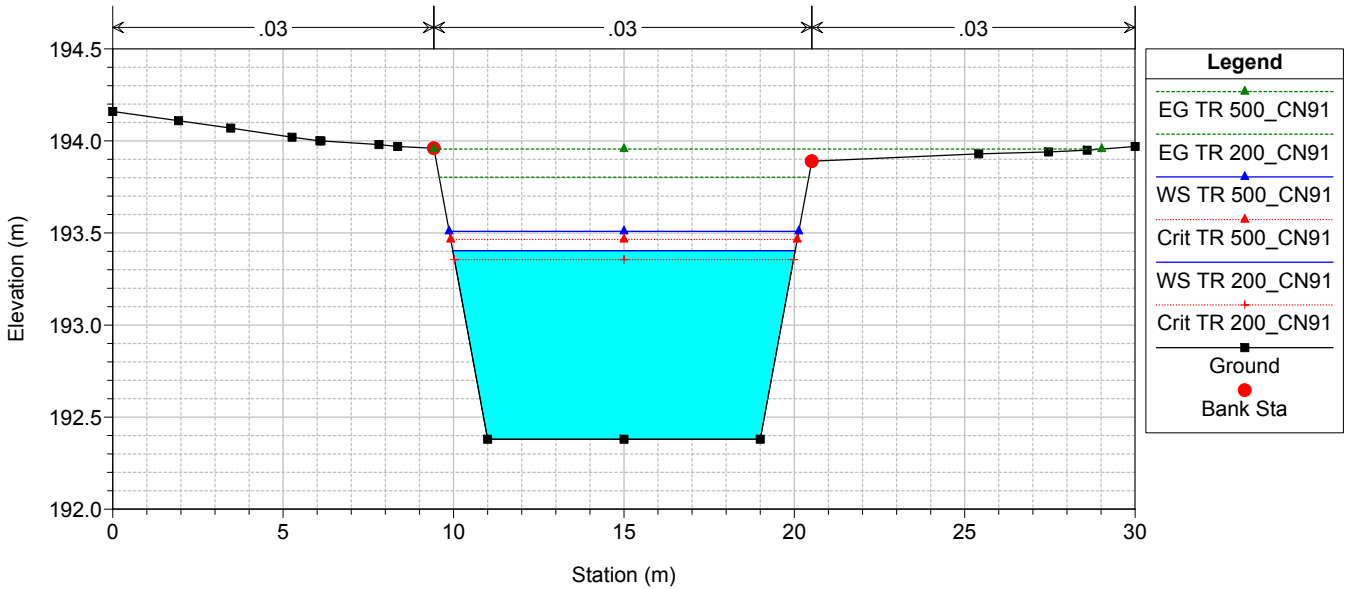

TO02-TO03

RS = -1000

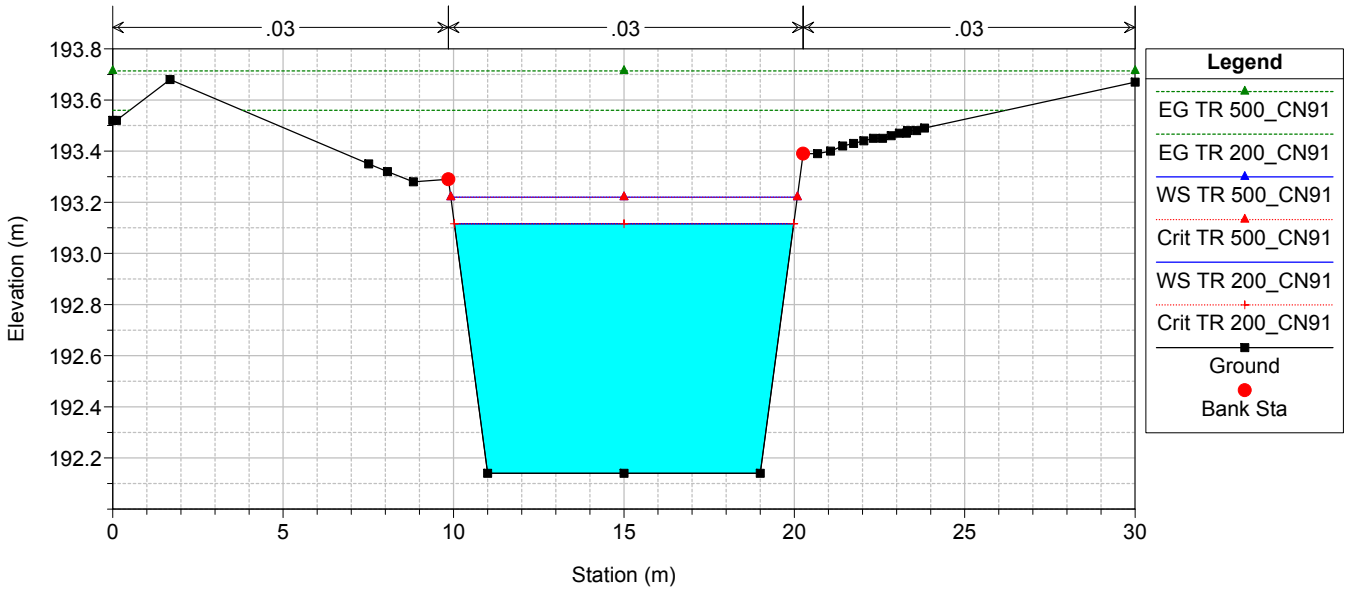

TO02-TO03

RS = -1035

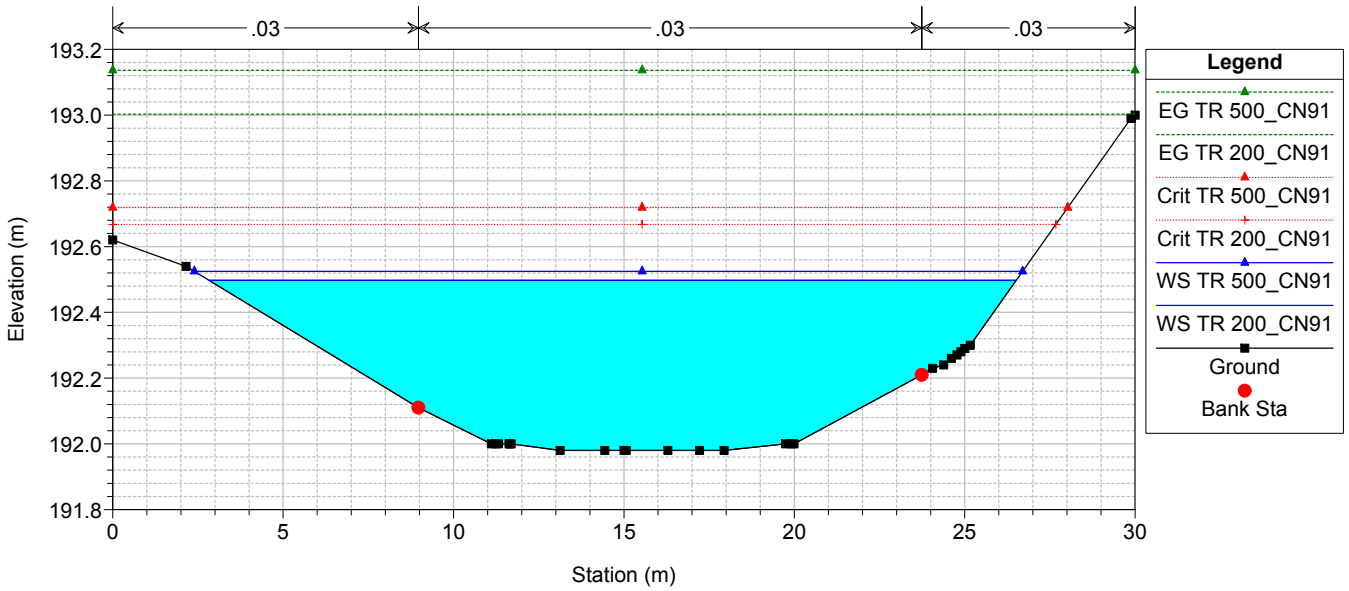

ALLEGATO 2.4

Interferenza idraulica - TO04
Tabella riassuntiva dei risultati, profilo idrico e sezioni
trasversali con i livelli idrici (TR 200 -500 anni)

HEC-RAS Plan: TO04_post River: TO04 Reach: TO04 Profile: TR 200_CN91

Reach	River Sta	Profile	Q Total (m ³ /s)	Min Ch El (m)	Max Chl Dpth (m)	W.S. Elev (m)	Crit W.S. (m)	Diff	Froude # Chl	E.G. Elev (m)	Vel Chnl (m/s)	Vel Total (m/s)	Hydr Radius C (m)	Shear Chan (N/m ²)	Hydr Depth (m)
TO04	0	TR 200_CN91	7.7	187.00	0.28	187.28	187.35	-0.07	1.50	187.52	2.2	2.2	0.2	69.7	0.22
TO04	-25	TR 200_CN91	7.7	186.07	0.80	186.87	186.94	-0.07	0.93	187.10	2.5	1.7	0.6	62.3	0.24
TO04	-50	TR 200_CN91	7.7	184.86	0.65	185.51	185.82	-0.31	1.98	186.53	4.5	4.5	0.4	231.3	0.52
TO04	-65.09	TR 200_CN91	7.7	184.13	0.66	184.79	185.09	-0.30	1.89	185.75	4.3	4.3	0.5	214.4	0.53
TO04	-71.77	TR 200_CN91	7.7	183.80	1.17	184.97	184.41	0.56	0.38	185.05	1.3	1.3	0.8	15.3	1.14
TO04	-77.45	Bridge													
TO04	-83.12	TR 200_CN91	7.7	183.69	1.26	184.95	184.31	0.64	0.34	185.02	1.2	1.2	0.9	13.0	1.23
TO04	-87.53	TR 200_CN91	7.7	183.65	0.96	184.61	184.61	0.00	1.01	184.98	2.7	2.7	0.6	75.1	0.73
TO04	-96.53	TR 200_CN91	7.7	183.56	1.00	184.56	184.18	0.38	0.49	184.67	1.5	1.5	0.7	22.2	0.98
TO04	-109.65	Bridge													
TO04	-122.78	TR 200_CN91	7.7	183.30	1.22	184.52	183.92	0.60	0.36	184.59	1.2	1.2	0.8	14.1	1.19
TO04	-132.18	TR 200_CN91	7.7	183.20	0.96	184.16	184.16	0.00	1.01	184.53	2.7	2.7	0.6	75.4	0.73
TO04	-137.34	TR 200_CN91	7.7	183.15	1.13	184.28	183.76	0.52	0.40	184.37	1.3	1.3	0.8	16.4	1.11
TO04	-143.02	Bridge													
TO04	-148.69	TR 200_CN91	7.7	183.03	1.24	184.27	183.64	0.63	0.35	184.34	1.2	1.2	0.9	13.3	1.20
TO04	-157	TR 200_CN91	7.7	182.95	1.05	184.00	183.91	0.09	0.86	184.29	2.4	2.4	0.6	58.1	0.78
TO04	-182	TR 200_CN91	7.7	182.72	1.04	183.76	183.68	0.08	0.88	184.06	2.4	2.4	0.6	60.0	0.77
TO04	-207	TR 200_CN91	7.7	182.48	1.04	183.52	183.44	0.08	0.88	183.82	2.4	2.4	0.6	60.4	0.77
TO04	-232	TR 200_CN91	7.7	182.24	1.04	183.28	183.20	0.08	0.88	183.58	2.4	2.4	0.6	60.1	0.77
TO04	-257	TR 200_CN91	7.7	182.00	1.04	183.04	182.96	0.08	0.88	183.34	2.4	2.4	0.6	59.9	0.77
TO04	-282	TR 200_CN91	7.7	181.76	1.05	182.81	182.73	0.08	0.86	183.10	2.4	2.4	0.6	58.4	0.78
TO04	-300	TR 200_CN91	7.7	181.59	1.03	182.62	182.56	0.06	0.90	182.93	2.5	2.5	0.6	62.2	0.77

HEC-RAS Plan: TO04_post River: TO04 Reach: TO04 Profile: TR 500_CN91

Reach	River Sta	Profile	Q Total (m ³ /s)	Min Ch El (m)	Max Chl Dpth (m)	W.S. Elev (m)	Crit W.S. (m)	Diff	Froude # Chl	E.G. Elev (m)	Vel Chnl (m/s)	Vel Total (m/s)	Hydr Radius C (m)	Shear Chan (N/m ²)	Hydr Depth (m)
TO04	0	TR 500_CN91	9.1	187.00	0.31	187.31	187.38	-0.07	1.52	187.58	2.3	2.3	0.2	76.2	0.23
TO04	-25	TR 500_CN91	9.1	186.07	0.84	186.91	186.98	-0.07	0.94	187.14	2.6	1.7	0.7	66.5	0.26
TO04	-50	TR 500_CN91	9.1	184.86	0.75	185.61	185.92	-0.31	1.83	186.60	4.4	4.4	0.5	216.1	0.59
TO04	-65.09	TR 500_CN91	9.1	184.13	0.74	184.87	185.20	-0.33	1.89	185.91	4.5	4.5	0.5	228.0	0.58
TO04	-71.77	TR 500_CN91	9.1	183.80	1.29	185.09	184.49	0.60	0.39	185.19	1.4	1.4	0.9	17.1	1.25
TO04	-77.45	Bridge													
TO04	-83.12	TR 500_CN91	9.1	183.69	1.38	185.07	184.38	0.69	0.35	185.16	1.3	1.3	0.9	14.9	1.35
TO04	-87.53	TR 500_CN91	9.1	183.65	1.06	184.71	184.71	0.00	1.00	185.11	2.8	2.8	0.7	79.4	0.79
TO04	-96.53	TR 500_CN91	9.1	183.56	1.12	184.68	184.25	0.43	0.48	184.81	1.6	1.6	0.8	23.9	1.10
TO04	-109.65	Bridge													
TO04	-122.78	TR 500_CN91	9.1	183.30	1.34	184.64	183.99	0.65	0.37	184.73	1.3	1.3	0.9	16.0	1.31
TO04	-132.18	TR 500_CN91	9.1	183.20	1.06	184.26	184.26	0.00	1.01	184.66	2.8	2.8	0.6	79.8	0.79
TO04	-137.34	TR 500_CN91	9.1	183.15	1.26	184.41	183.84	0.57	0.40	184.51	1.4	1.4	0.9	18.3	1.23
TO04	-143.02	Bridge													
TO04	-148.69	TR 500_CN91	9.1	183.03	1.36	184.39	183.72	0.67	0.36	184.47	1.3	1.3	0.9	15.2	1.31
TO04	-157	TR 500_CN91	9.1	182.95	1.15	184.10	184.01	0.09	0.87	184.42	2.5	2.5	0.7	62.4	0.85
TO04	-182	TR 500_CN91	9.1	182.72	1.14	183.86	183.78	0.08	0.88	184.19	2.5	2.5	0.7	64.2	0.84
TO04	-207	TR 500_CN91	9.1	182.48	1.14	183.62	183.54	0.08	0.88	183.95	2.5	2.5	0.7	63.8	0.84
TO04	-232	TR 500_CN91	9.1	182.24	1.19	183.43	183.30	0.13	0.83	183.72	2.4	2.4	0.7	57.2	0.86
TO04	-257	TR 500_CN91	9.1	182.00	1.06	183.06	183.06	0.00	1.00	183.46	2.8	2.8	0.7	79.2	0.79
TO04	-282	TR 500_CN91	9.1	181.76	1.07	182.83	182.83	0.00	1.00	183.22	2.8	2.8	0.7	78.4	0.79
TO04	-300	TR 500_CN91	9.1	181.59	1.13	182.72	182.66	0.06	0.90	183.06	2.6	2.6	0.7	66.7	0.83

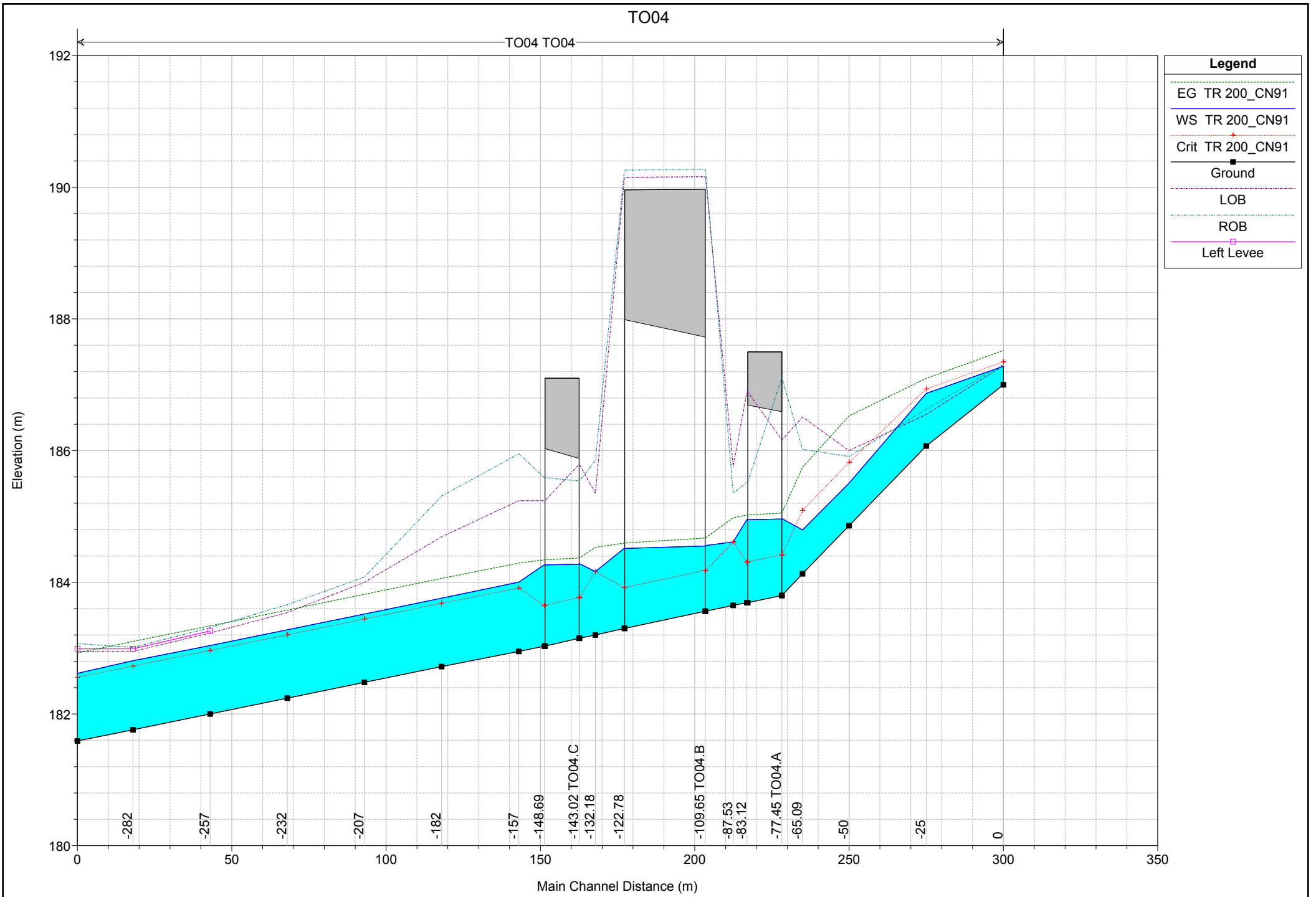

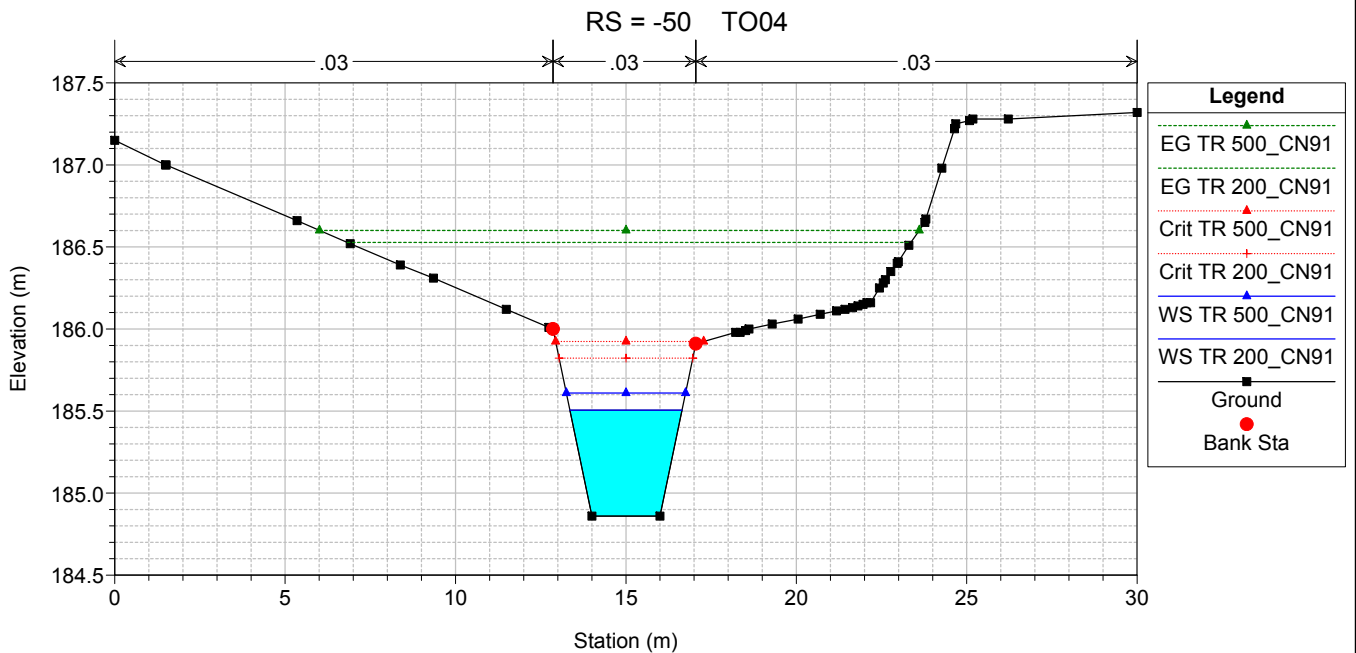
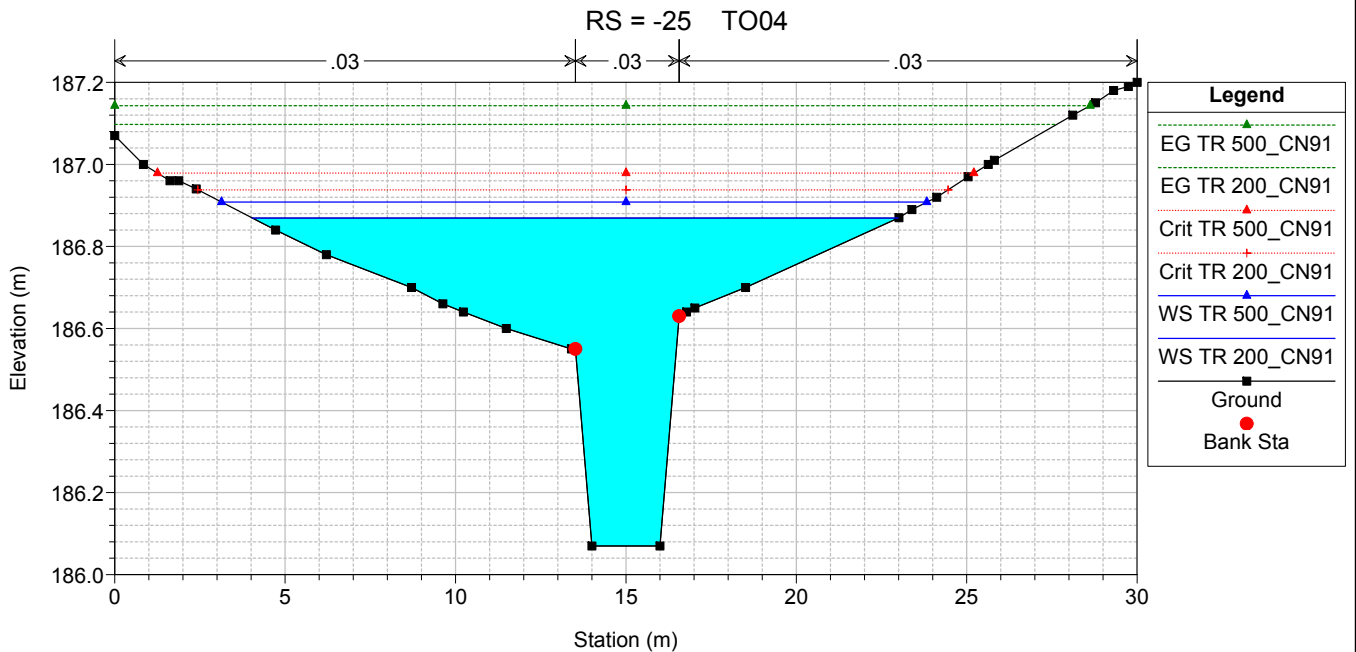
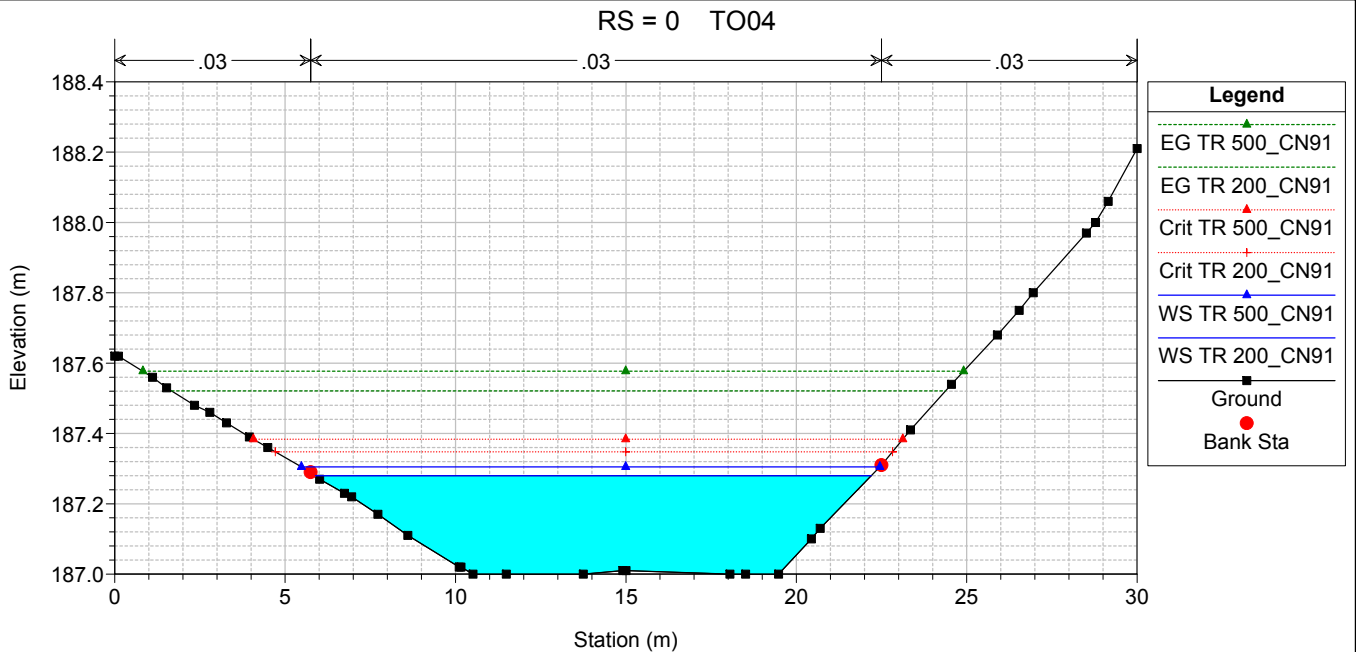

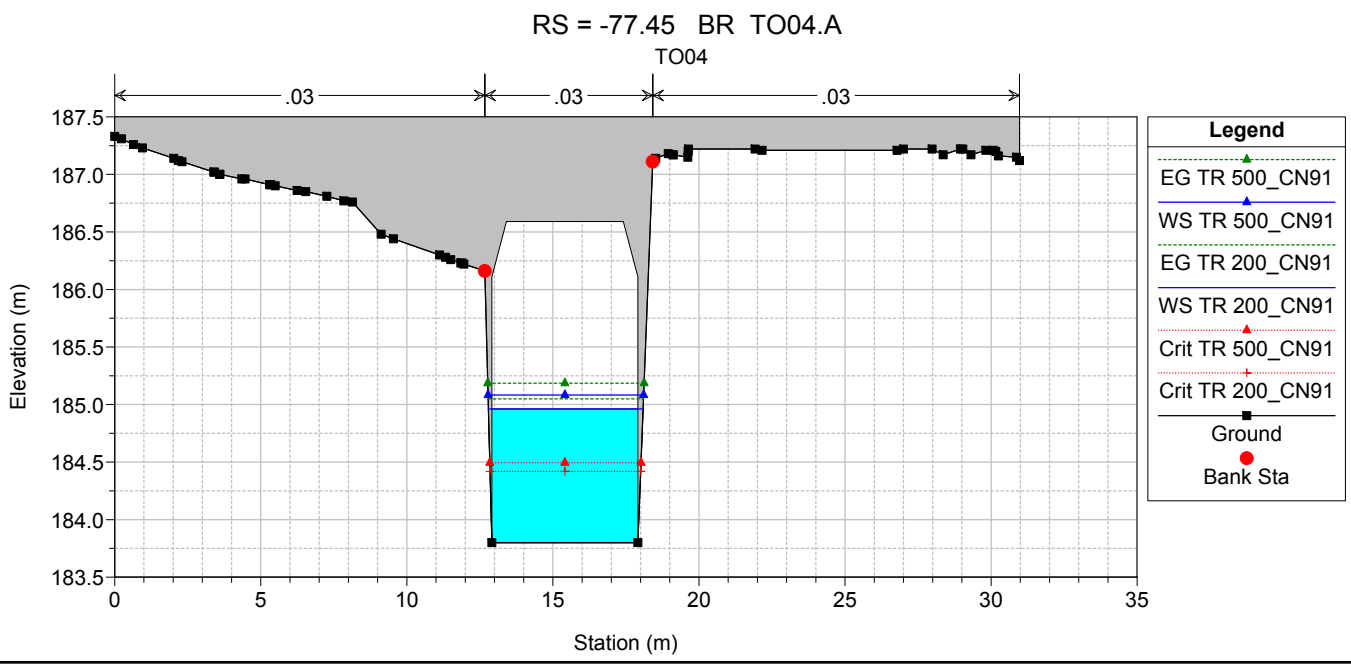
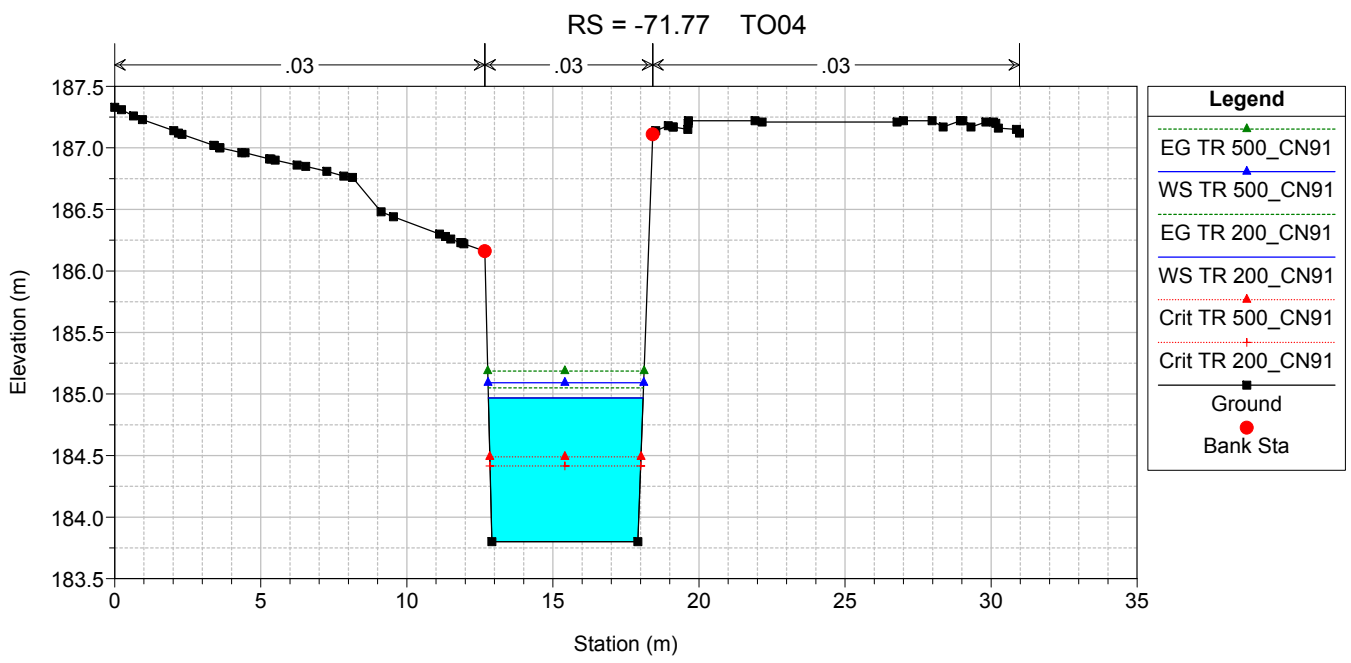
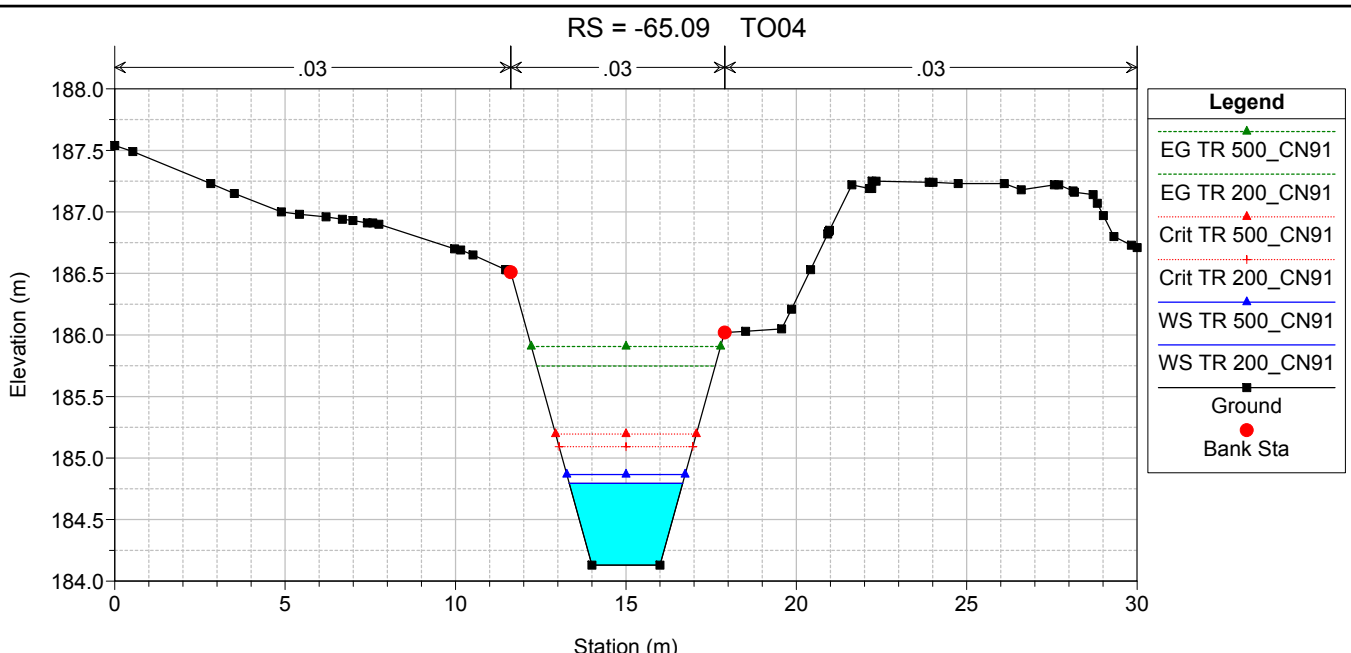

RS = -77.45 BR TO04.A

TO04

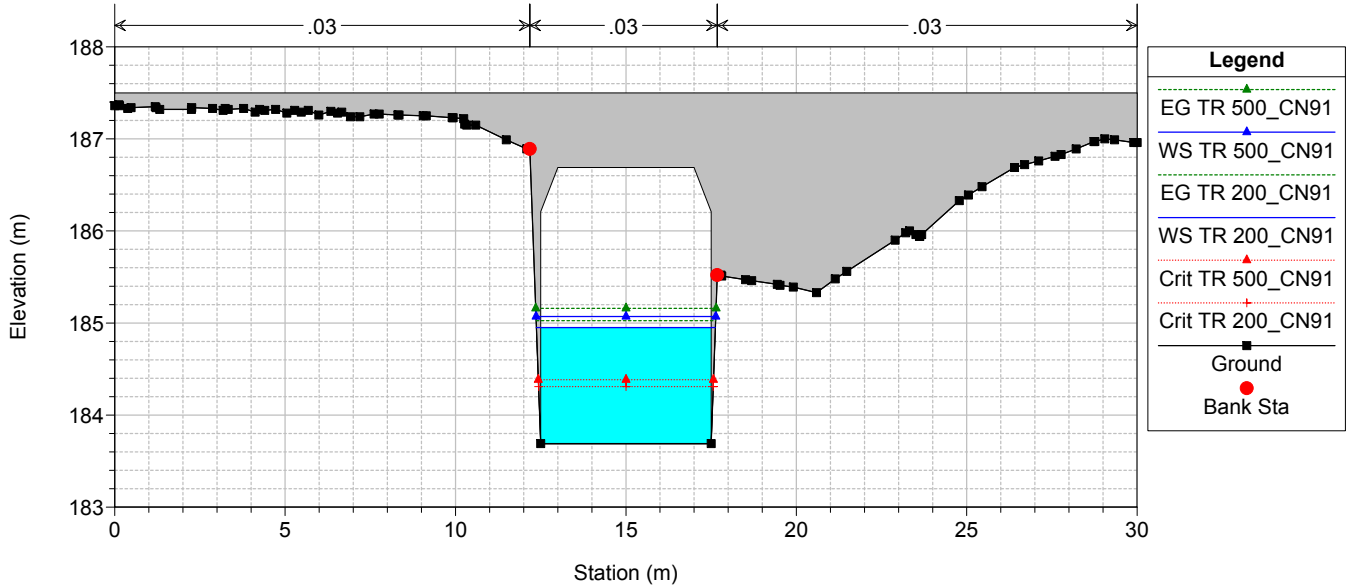

RS = -83.12 TO04

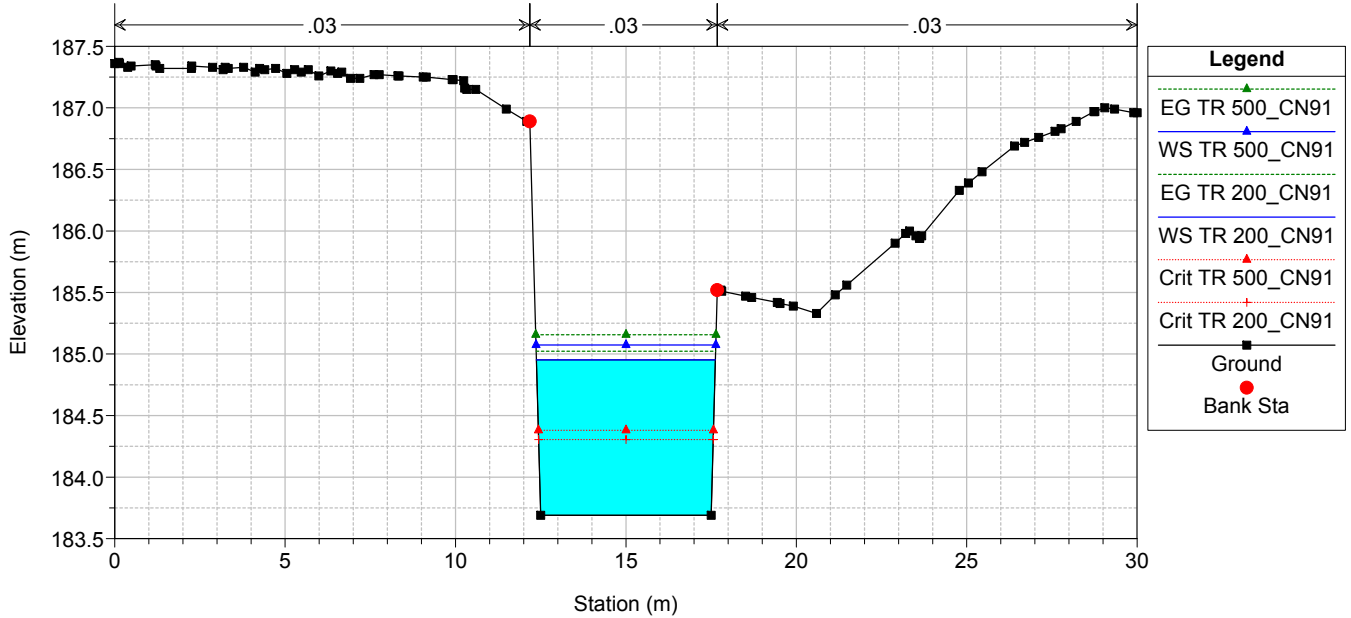

RS = -87.53 TO04

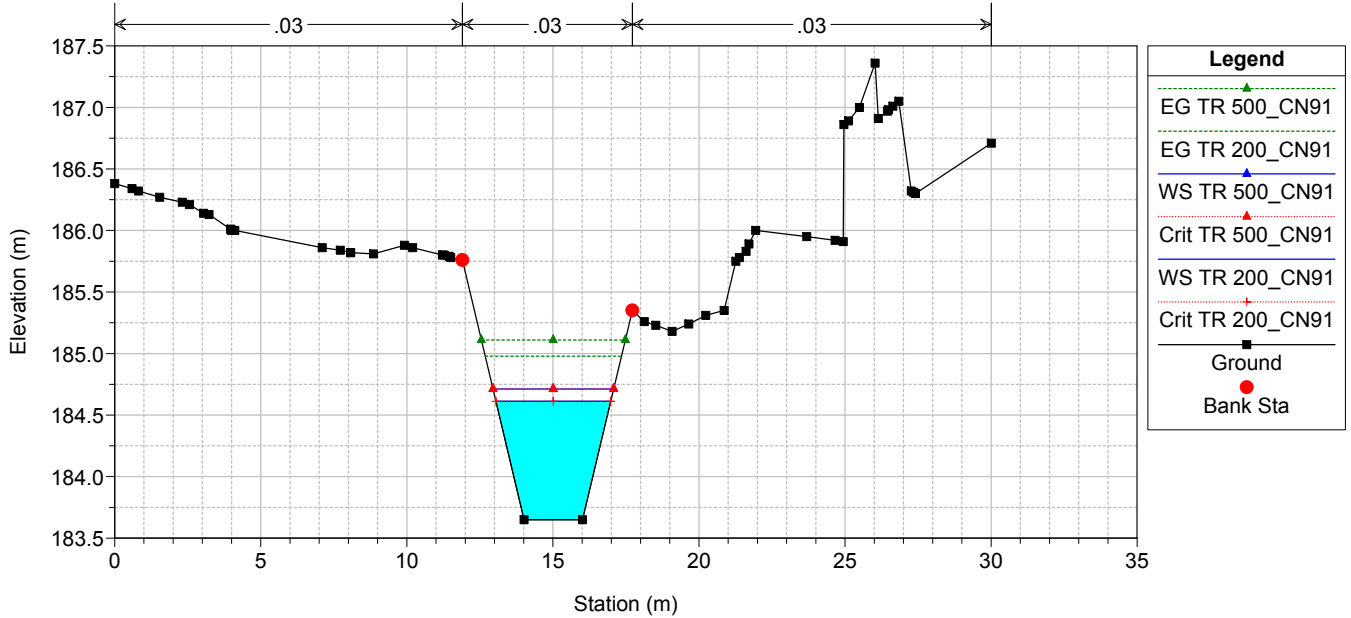

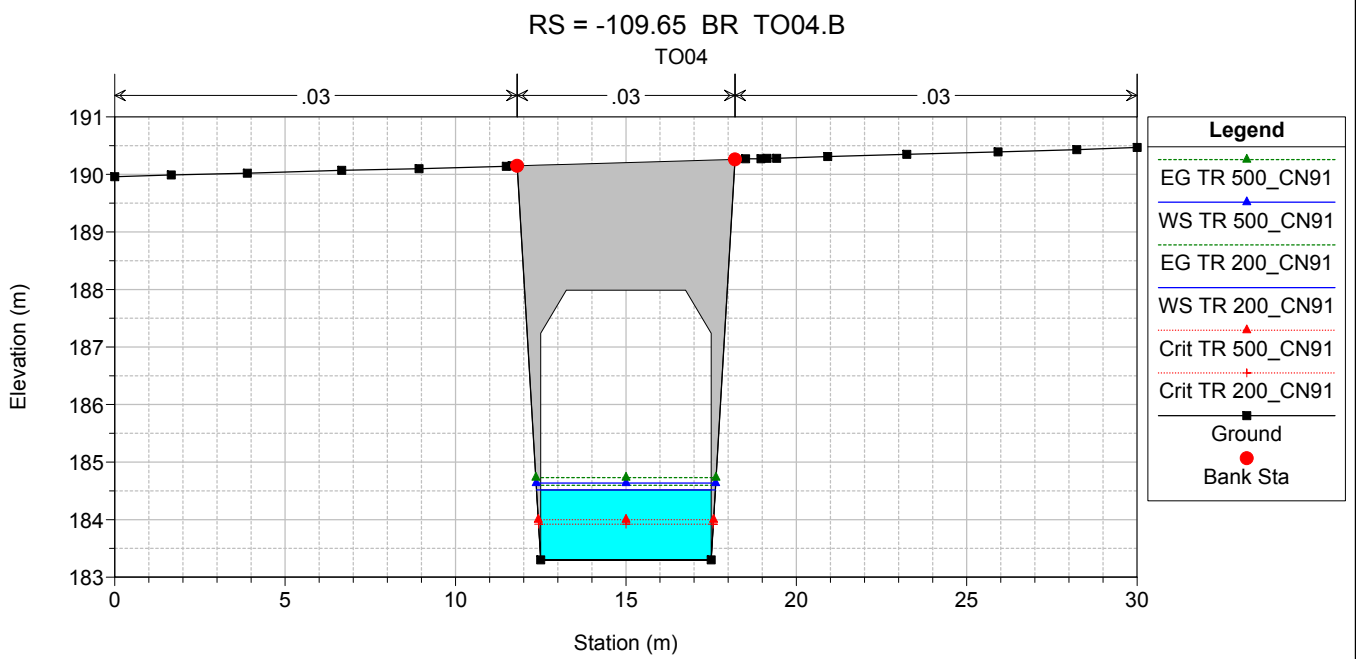
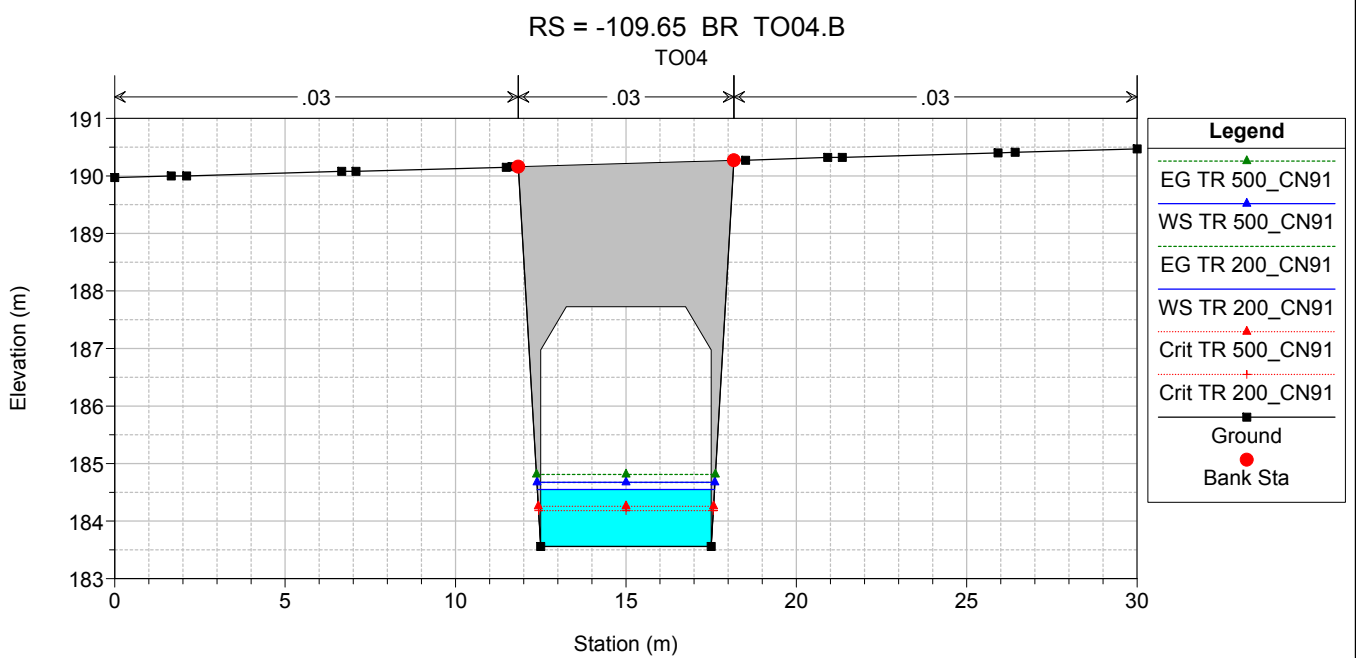
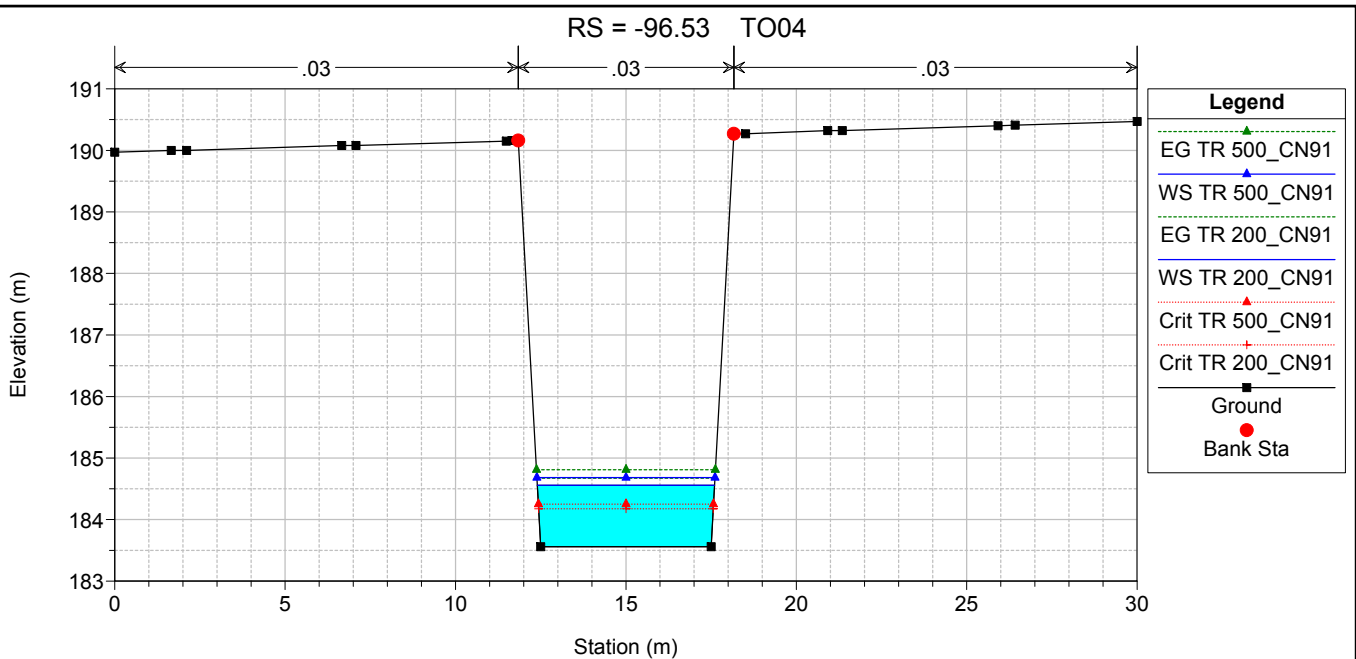

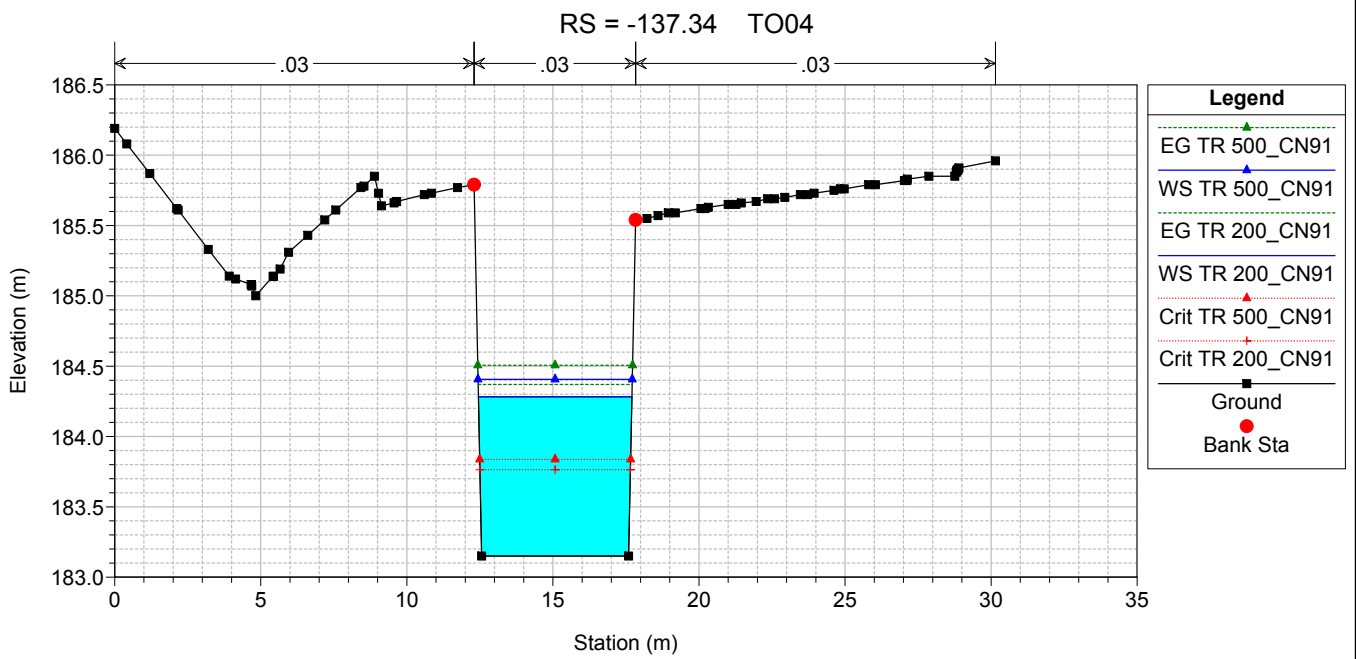
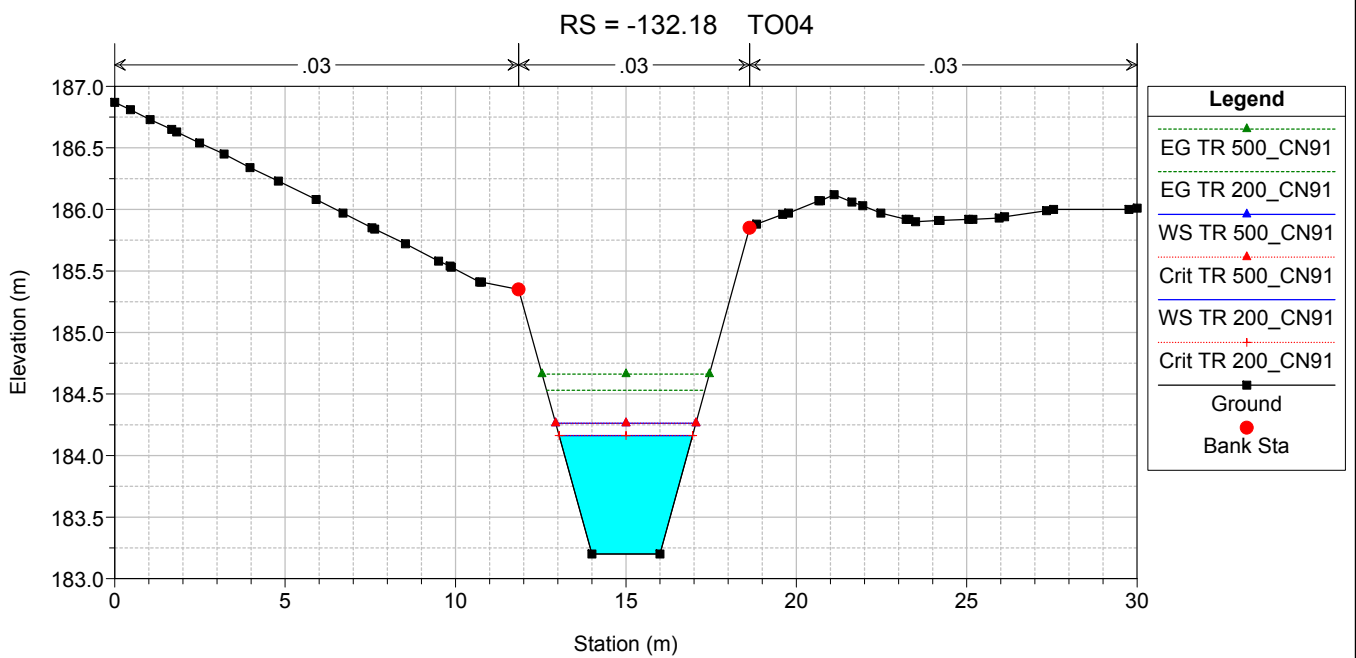
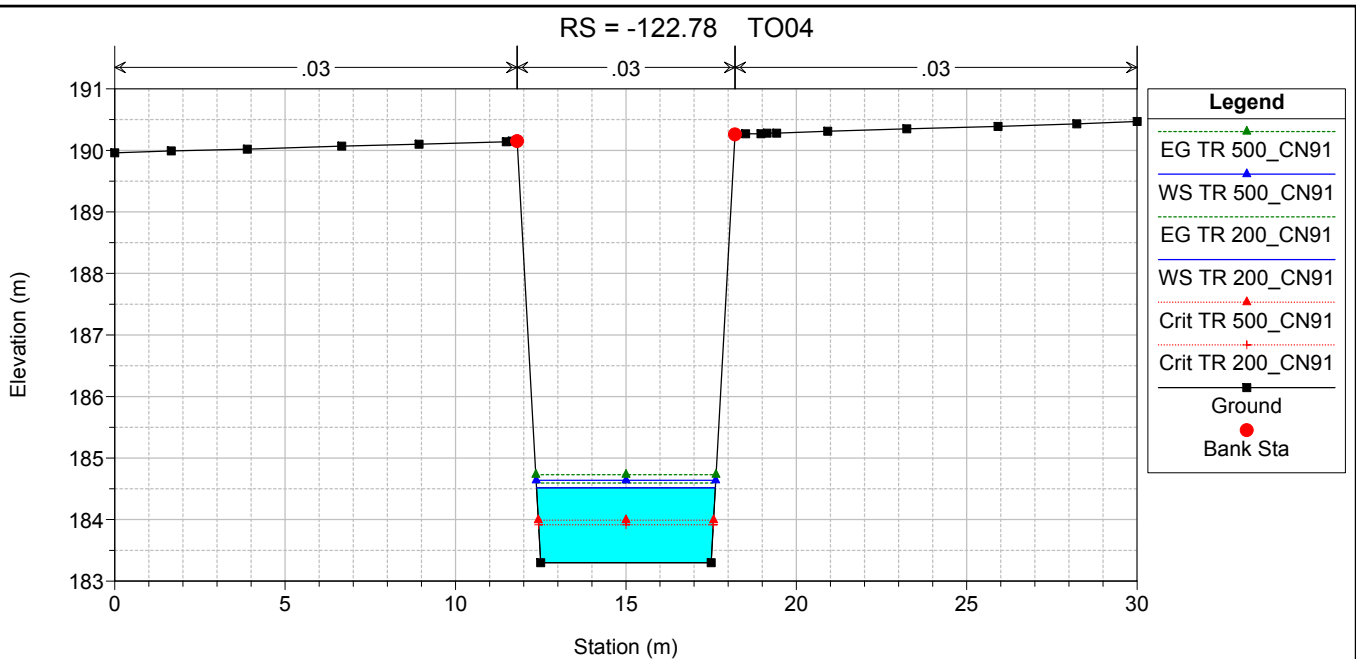

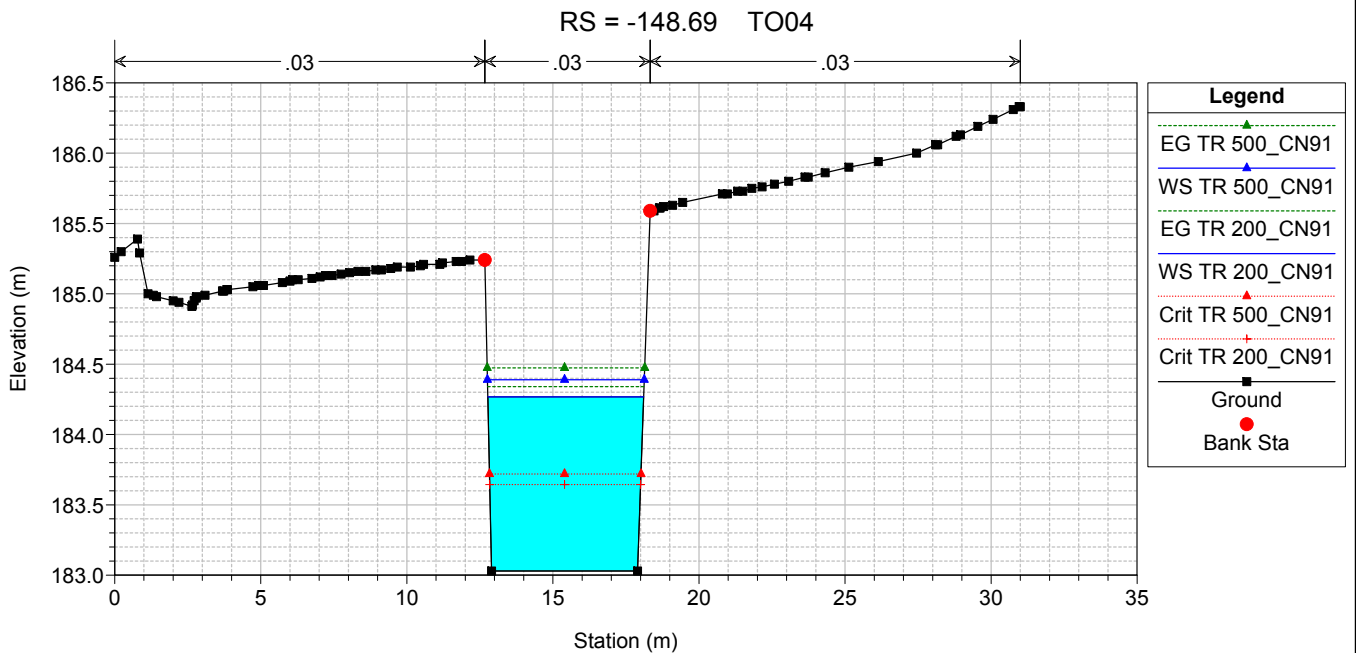
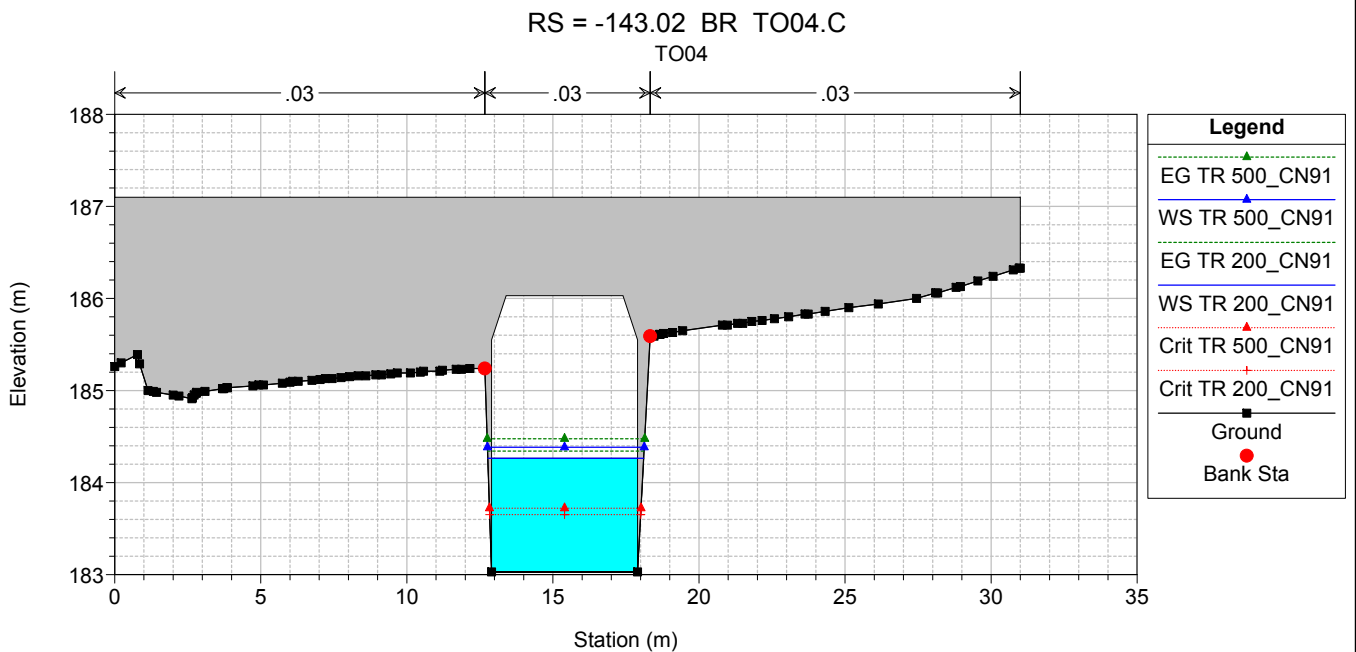
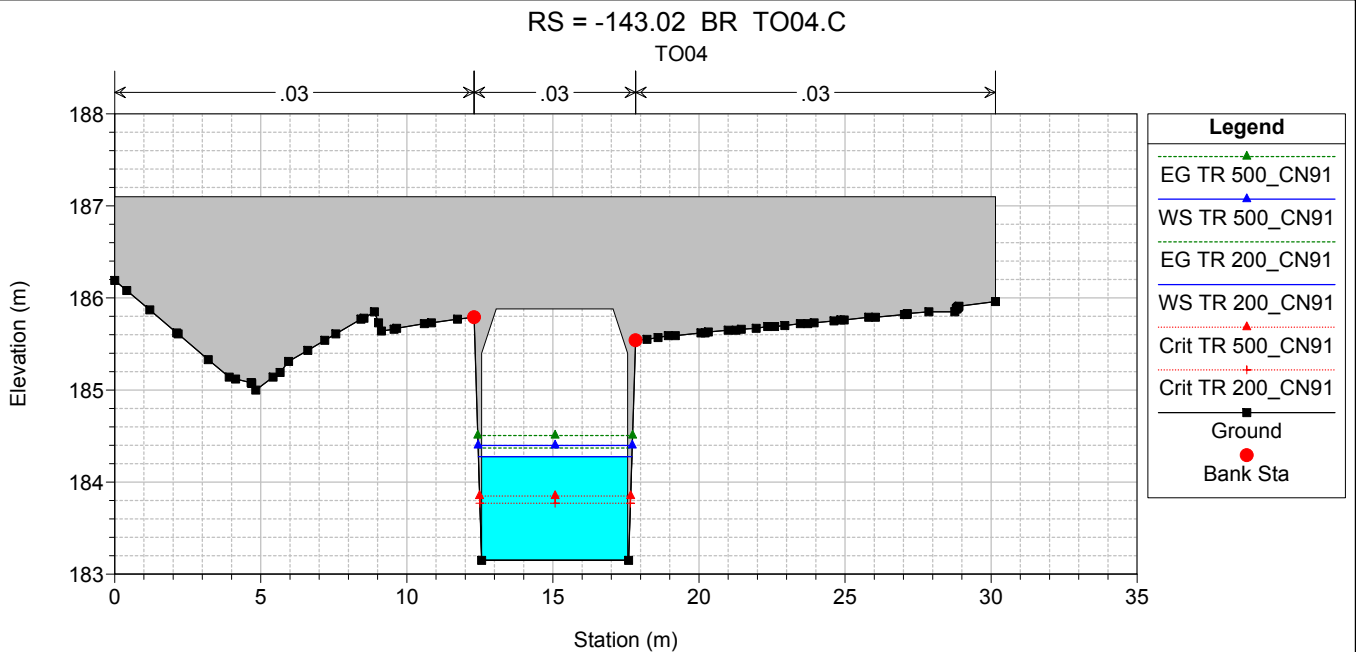

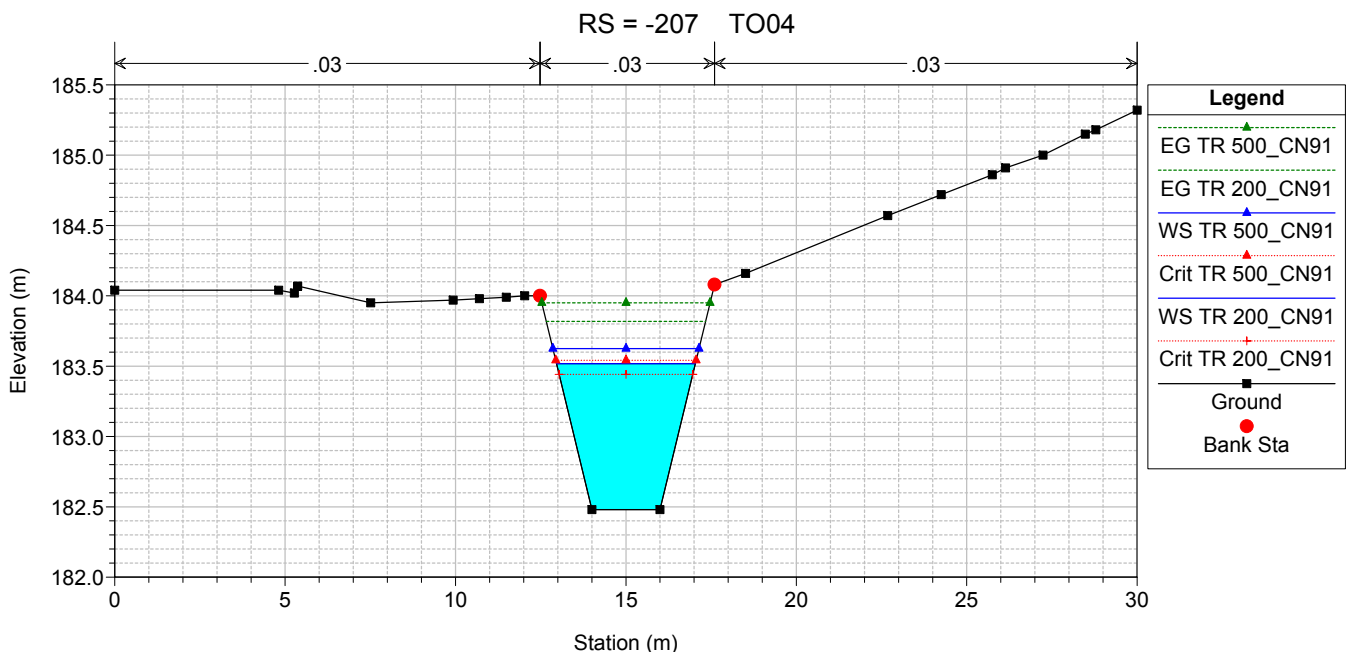
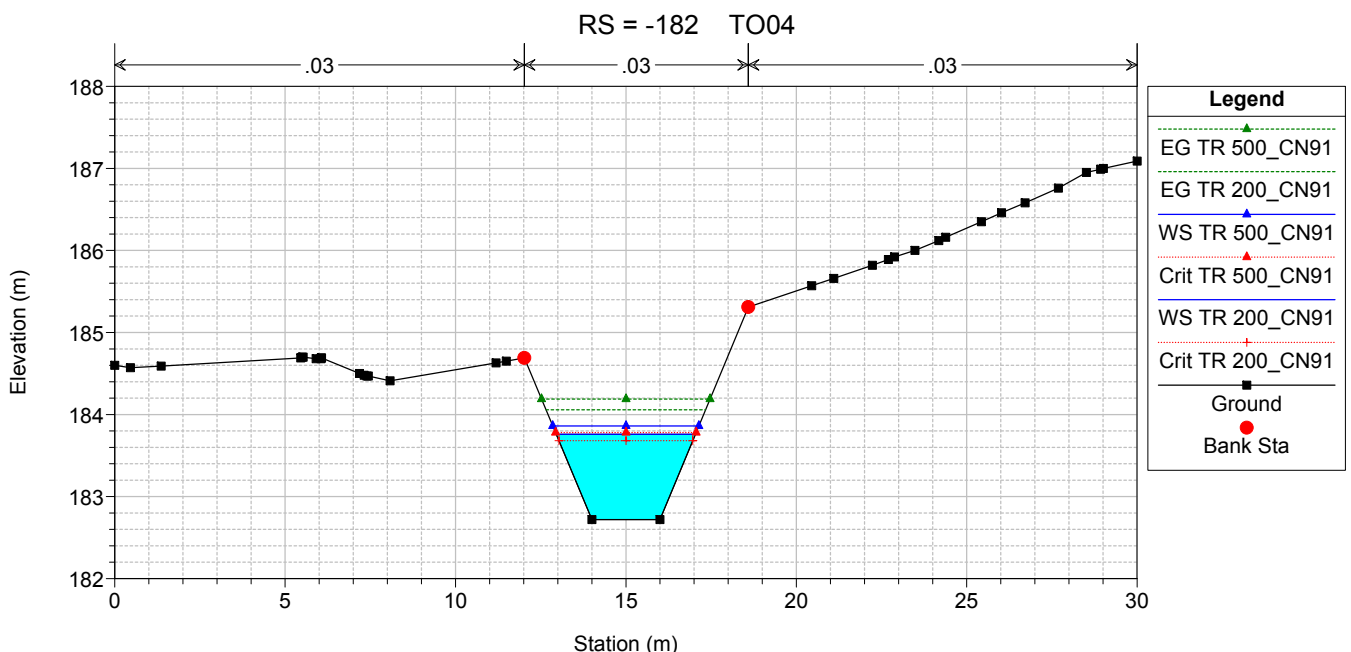
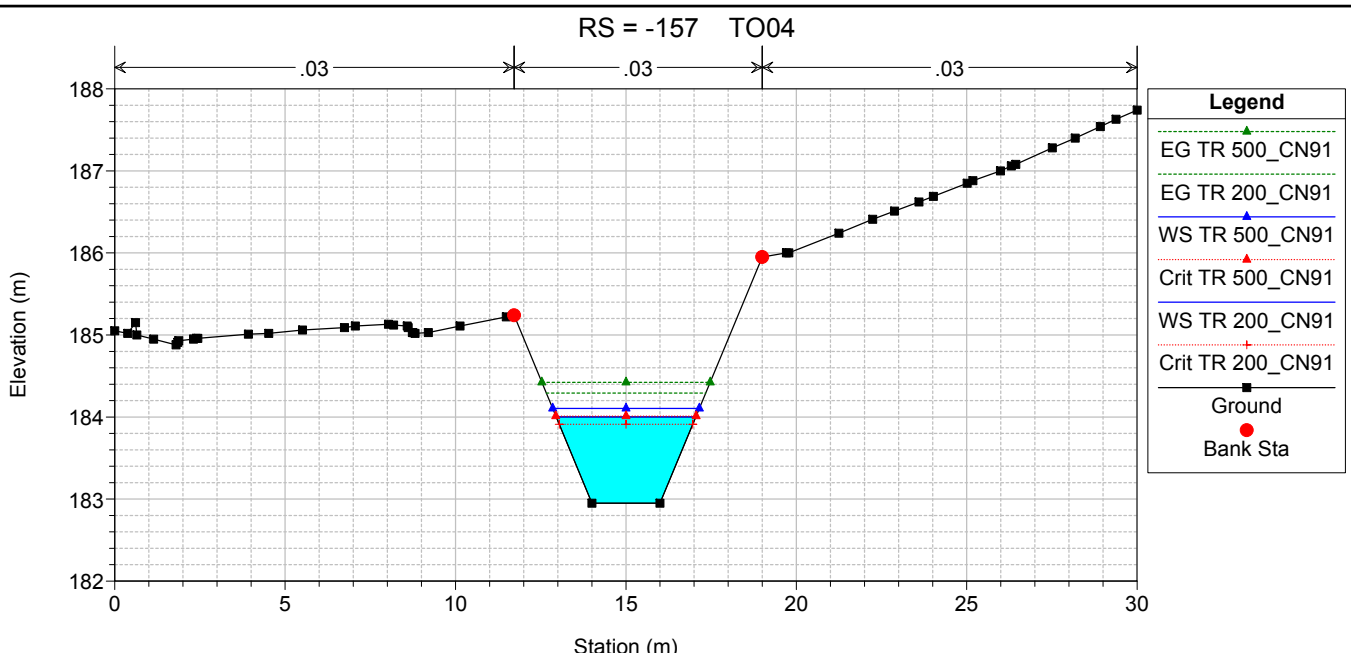

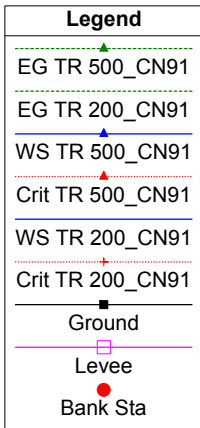
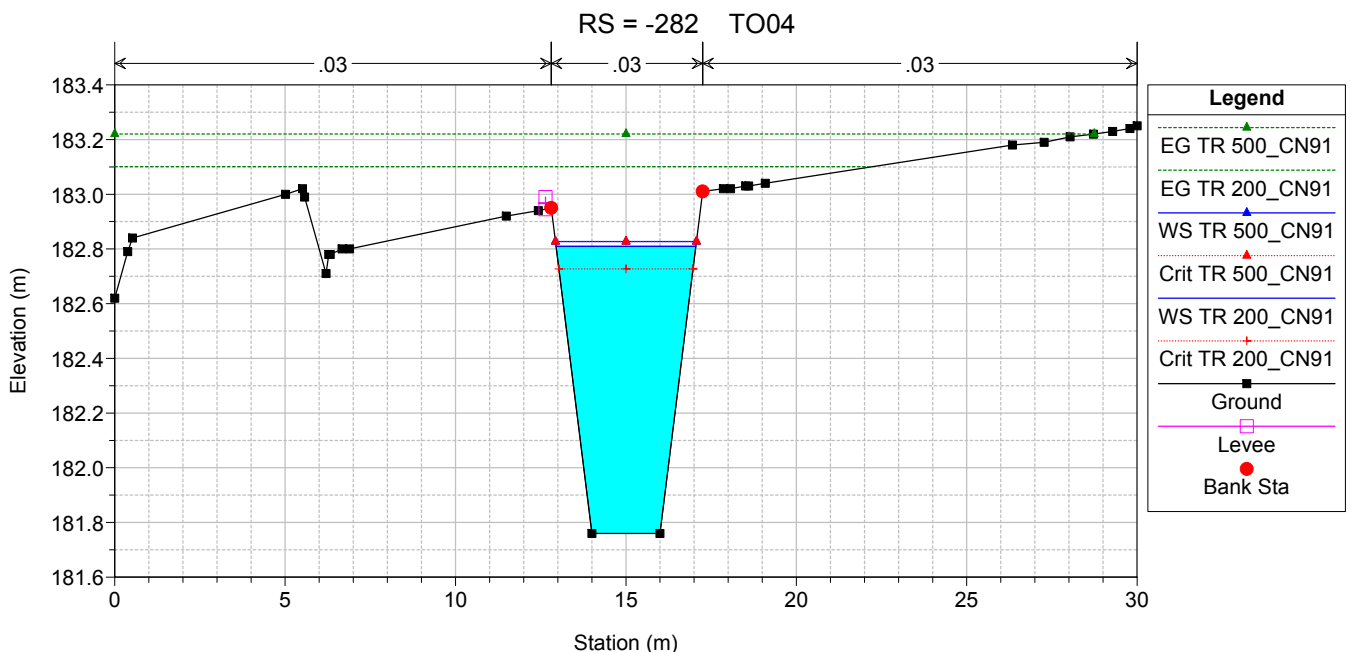
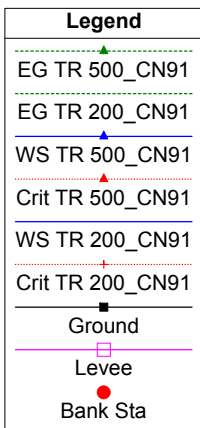
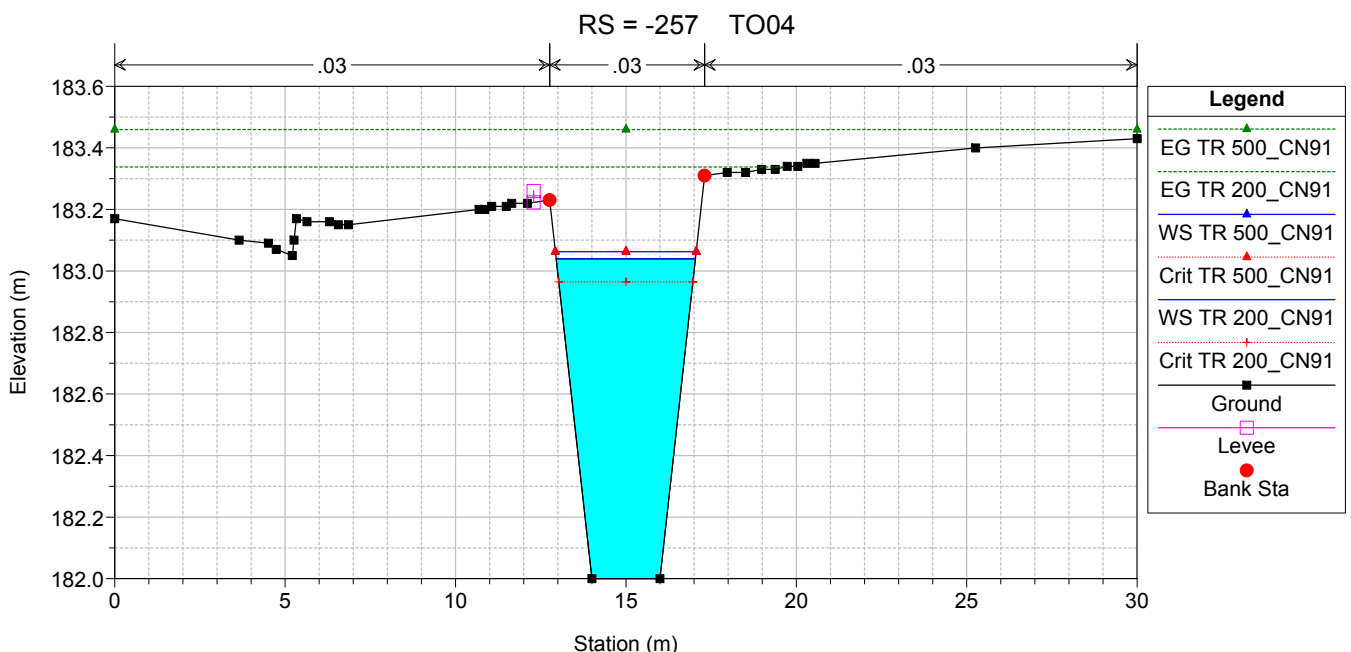
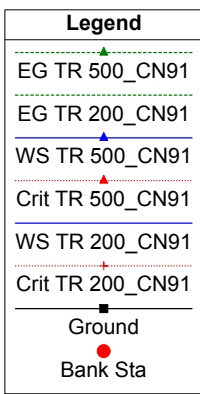
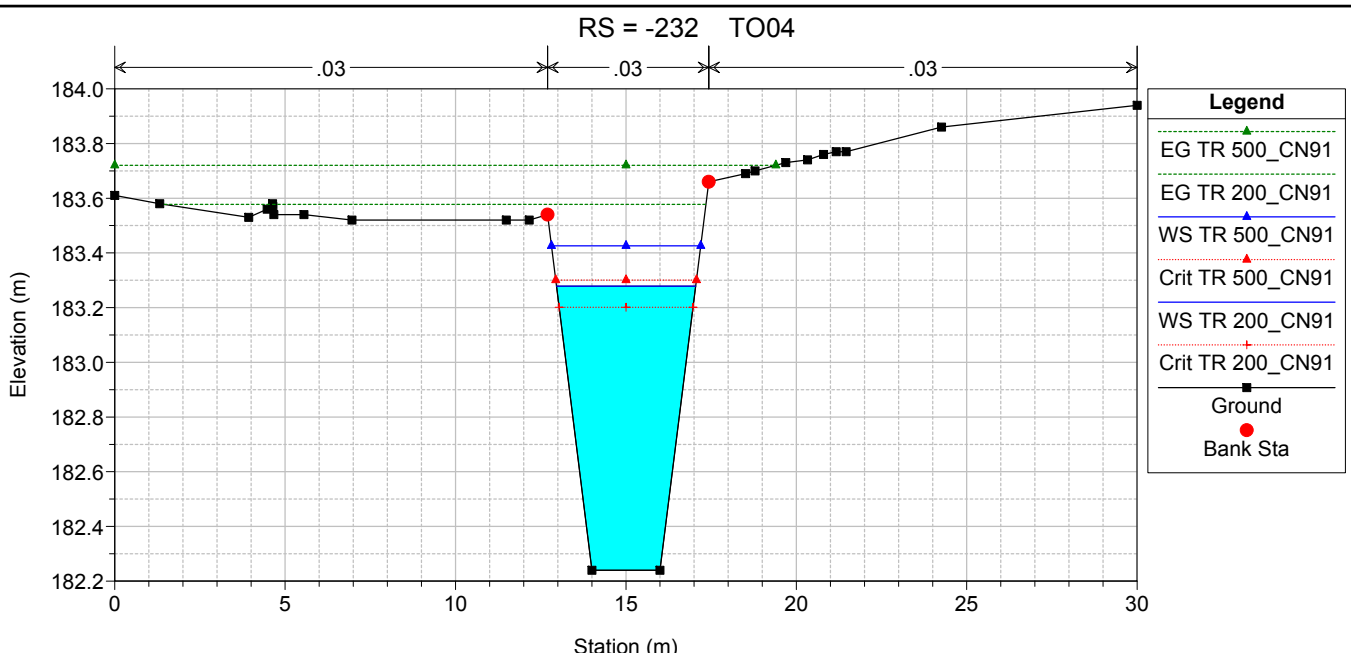

RS = -300 TO04

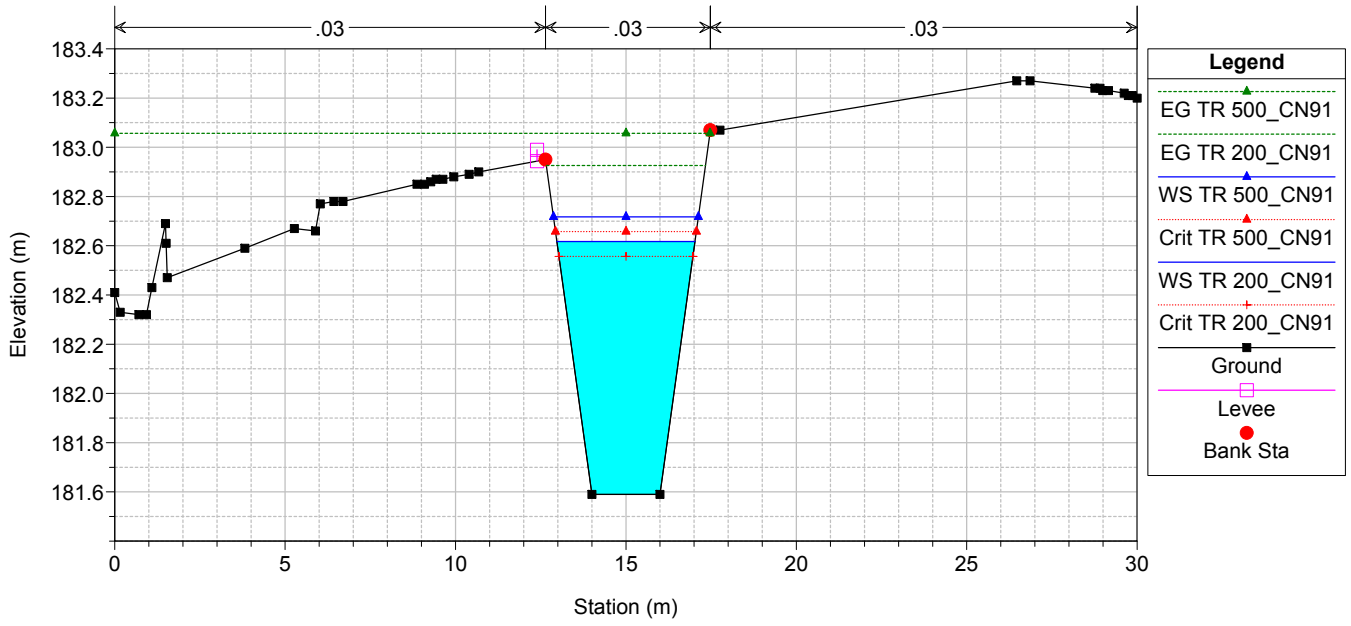

ALLEGATO 2.5

Interferenza idraulica - TO05
Tabella riassuntiva dei risultati, profilo idrico e sezioni
trasversali con i livelli idrici (TR 200 - 500 anni)

HEC-RAS Plan: TO05-TO06 River: TO05 Reach: TO05 Profile: TR 200_CN91

Reach	River Sta	Profile	Q Total (m ³ /s)	Min Ch El (m)	Max Chl Dpth (m)	W.S. Elev (m)	Crit W.S. (m)	Diff	Froude # Chl	E.G. Elev (m)	Vel Chnl (m/s)	Vel Total (m/s)	Hydr Radius C (m)	Shear Chan (N/m ²)	Hydr Depth (m)
TO05	-10	TR 200_CN91	4.9	183.12	0.48	183.60	183.82	-0.22	2.06	184.46	4.1	4.0	0.4	210.0	0.21
TO05	-23.86	TR 200_CN91	4.9	182.80	1.03	183.45	183.64	-0.19	1.25	183.87	2.8	2.8	0.5	93.3	0.53
TO05	-48.98	TR 200_CN91	4.9	182.23	0.64	182.87	182.98	-0.11	1.31	183.31	2.9	2.9	0.4	100.5	0.51
TO05	-73.98	TR 200_CN91	4.9	181.66	0.64	182.30	182.41	-0.11	1.30	182.73	2.9	2.9	0.4	98.5	0.52
TO05	-98.98	TR 200_CN91	4.9	181.08	0.64	181.72	181.83	-0.11	1.32	182.16	3.0	3.0	0.4	101.0	0.51
TO05	-123.98	TR 200_CN91	4.9	180.51	0.64	181.15	181.26	-0.11	1.29	181.58	2.9	2.9	0.4	97.9	0.52
TO05	-145.45	TR 200_CN91	4.9	180.02	1.38	181.40	180.66	0.74	0.31	181.46	1.1	1.1	0.8	12.2	1.30
TO05	-150.53	Bridge													
TO05	-155.61	TR 200_CN91	4.9	179.95	1.43	181.38	180.59	0.79	0.30	181.44	1.1	1.1	0.8	11.3	1.35
TO05	-159.85	TR 200_CN91	8.4	179.91	1.38	181.29	180.88	0.41	0.53	181.42	1.6	1.6	0.8	24.3	0.94
TO05	-167.52	TR 200_CN91	8.4	179.86	1.31	181.17	180.77	0.40	0.58	181.38	2.0	2.0	0.7	40.6	1.26
TO05	-181.20	Bridge													
TO05	-194.88	TR 200_CN91	8.4	179.69	1.23	180.92	180.60	0.32	0.64	181.16	2.2	2.2	0.7	47.1	1.18
TO05	-203.43	TR 200_CN91	8.4	179.64	1.24	180.88	180.65	0.23	0.71	181.10	2.1	2.1	0.7	42.8	0.90

HEC-RAS Plan: TO05-TO06 River: TO05 Reach: TO05 Profile: TR 500_CN91

Reach	River Sta	Profile	Q Total (m ³ /s)	Min Ch El (m)	Max Chl Dpth (m)	W.S. Elev (m)	Crit W.S. (m)	Diff	Froude # Chl	E.G. Elev (m)	Vel Chnl (m/s)	Vel Total (m/s)	Hydr Radius C (m)	Shear Chan (N/m ²)	Hydr Depth (m)
TO05	-10	TR 500_CN91	5.8	183.12	0.52	183.64	183.84	-0.20	2.08	184.55	4.3	3.8	0.4	223.3	0.16
TO05	-23.86	TR 500_CN91	5.8	182.80	1.12	183.54	183.72	-0.18	1.22	183.97	2.9	2.9	0.5	94.6	0.58
TO05	-48.98	TR 500_CN91	5.8	182.23	0.70	182.93	183.06	-0.13	1.34	183.42	3.1	3.1	0.5	110.1	0.55
TO05	-73.98	TR 500_CN91	5.8	181.66	0.71	182.37	182.49	-0.12	1.29	182.84	3.0	3.0	0.5	104.0	0.56
TO05	-98.98	TR 500_CN91	5.8	181.08	0.70	181.78	181.90	-0.12	1.33	182.27	3.1	3.1	0.5	108.9	0.55
TO05	-123.98	TR 500_CN91	5.8	180.51	1.03	181.54	181.33	0.21	0.68	181.72	1.9	1.9	0.6	35.9	0.77
TO05	-145.45	TR 500_CN91	5.8	180.02	1.53	181.55	180.74	0.81	0.32	181.63	1.2	1.2	0.8	13.3	1.44
TO05	-150.53	Bridge													
TO05	-155.61	TR 500_CN91	5.8	179.95	1.58	181.53	180.67	0.86	0.30	181.60	1.2	1.2	0.8	12.5	1.49
TO05	-159.85	TR 500_CN91	9.8	179.91	1.56	181.47	180.97	0.50	0.46	181.59	1.5	1.3	0.9	20.6	0.42
TO05	-167.52	TR 500_CN91	9.8	179.86	1.45	181.31	180.87	0.44	0.58	181.55	2.1	2.1	0.8	44.5	1.39
TO05	-181.20	Bridge													
TO05	-194.88	TR 500_CN91	9.8	179.69	1.32	181.01	180.70	0.31	0.67	181.30	2.4	2.4	0.7	54.7	1.27
TO05	-203.43	TR 500_CN91	9.8	179.64	1.35	180.99	180.75	0.24	0.71	181.23	2.2	2.2	0.8	45.6	0.96

TO05-TO06

TO05 TO05

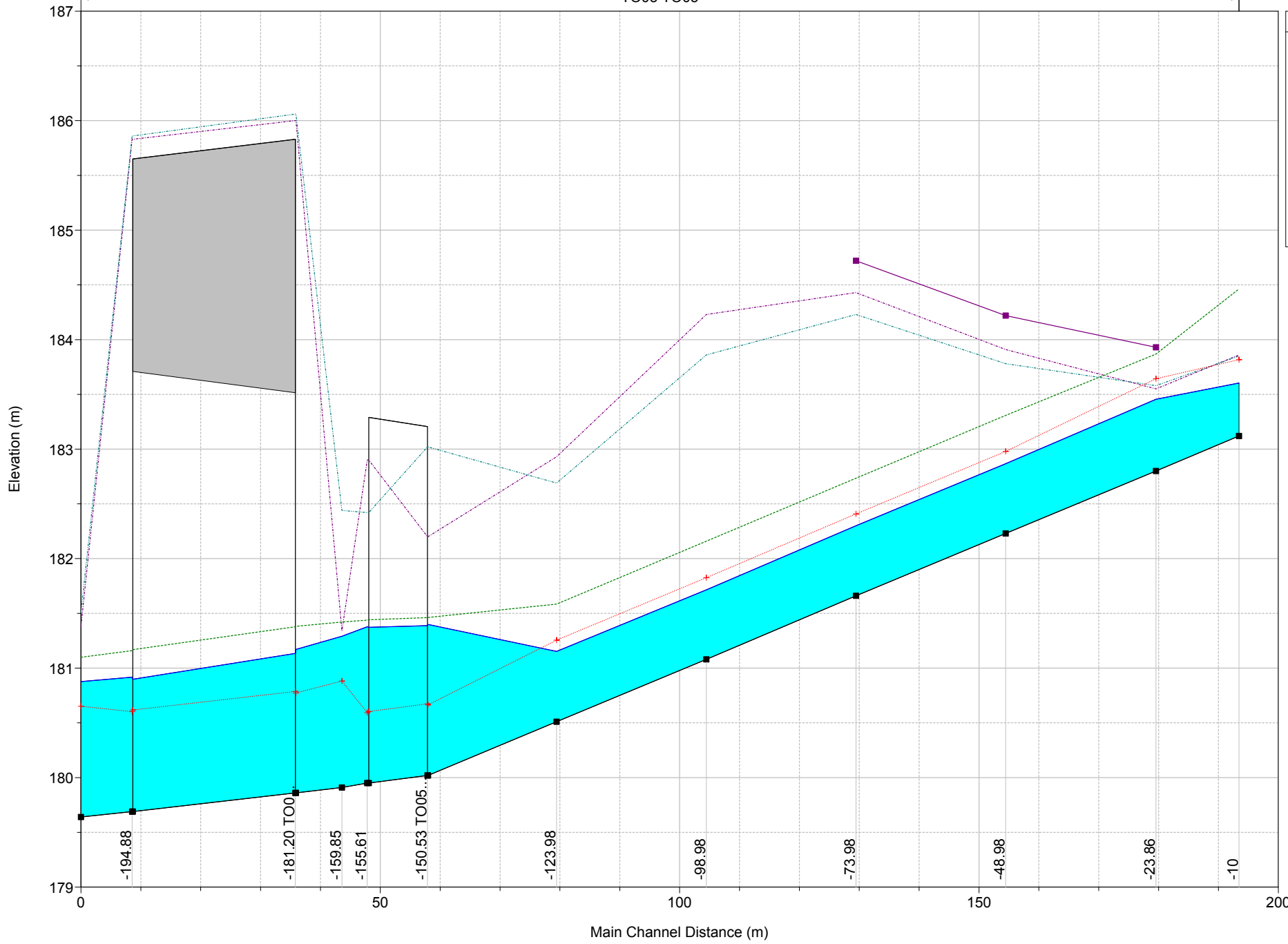

Legend

- EG TR 200_CN91
- WS TR 200_CN91
- Crit TR 200_CN91
- Ground
- LOB
- ROB
- Right Levee

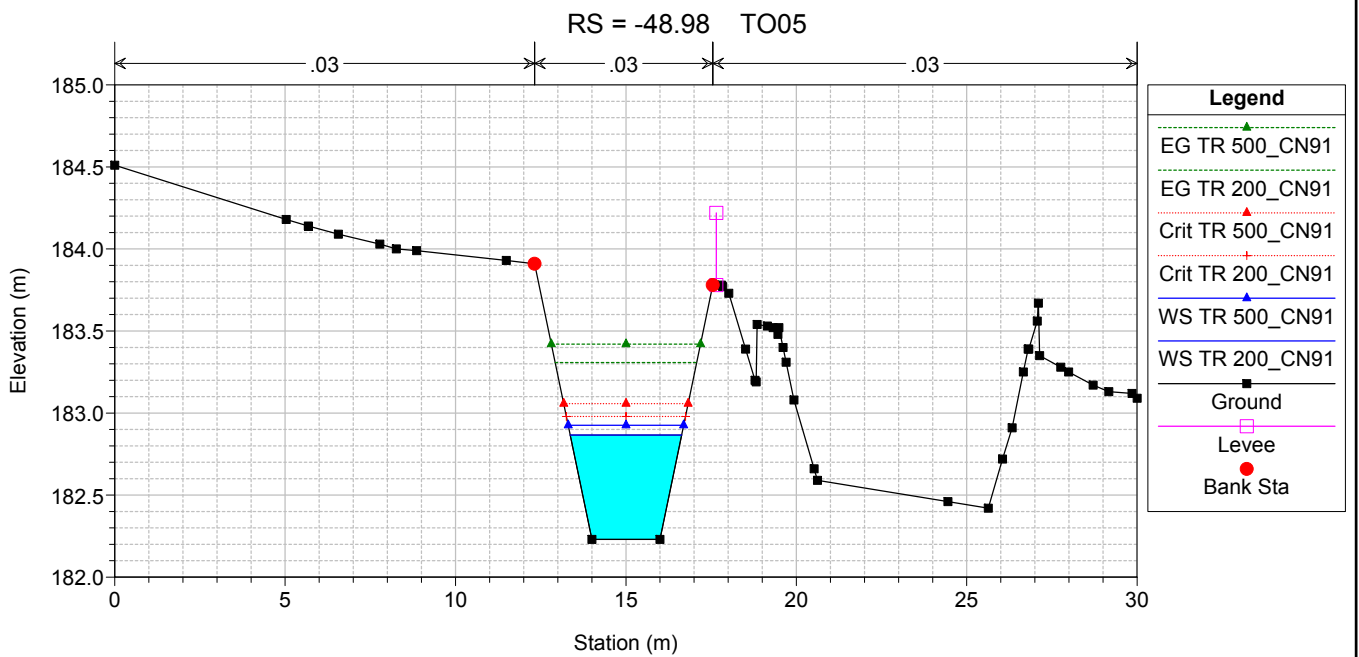
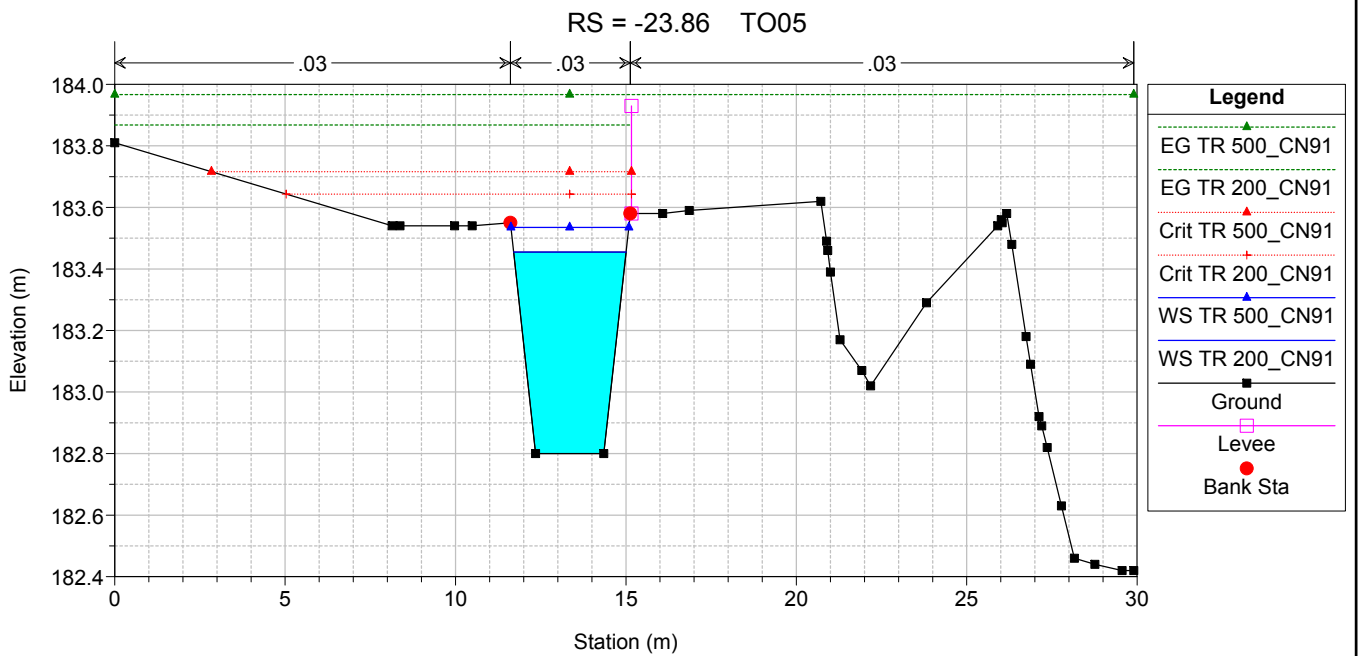
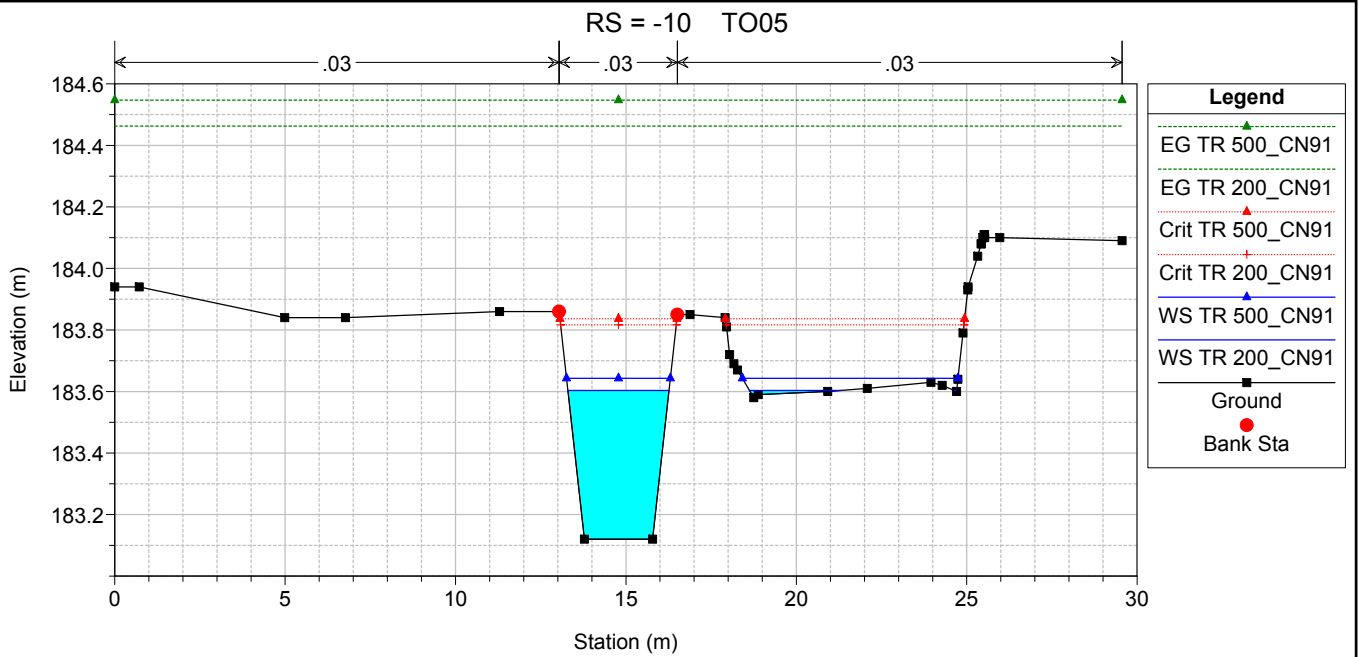

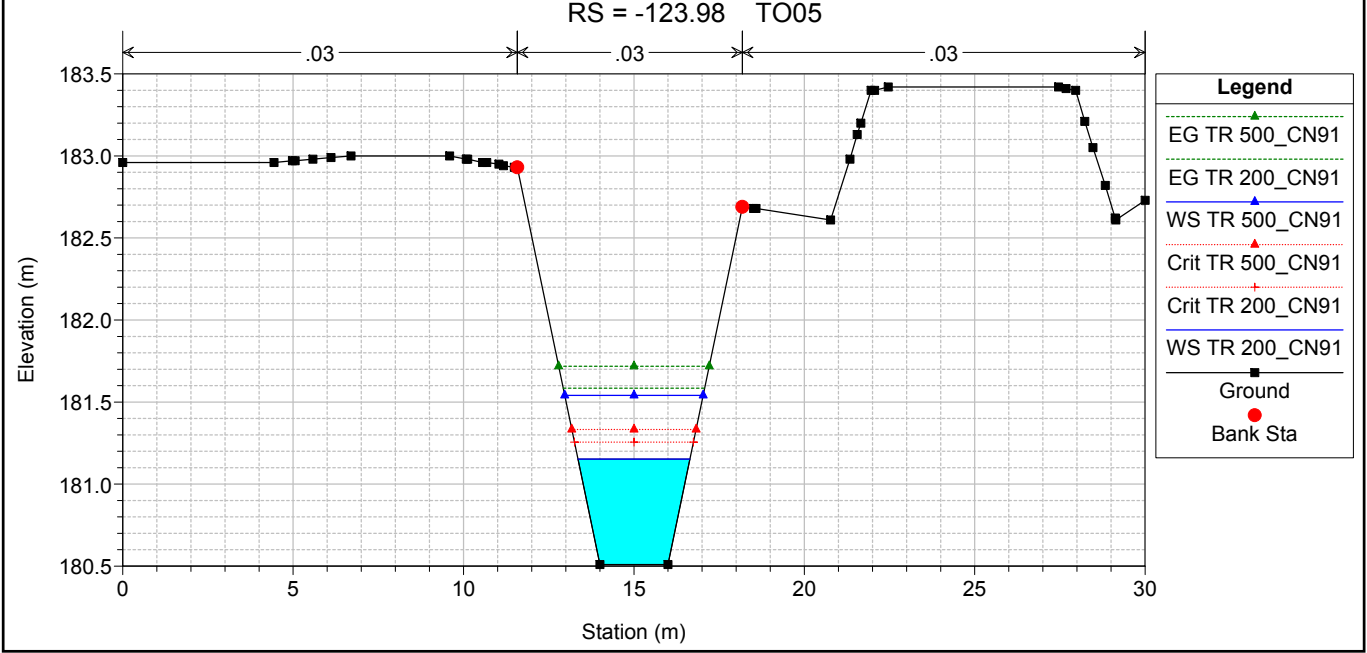
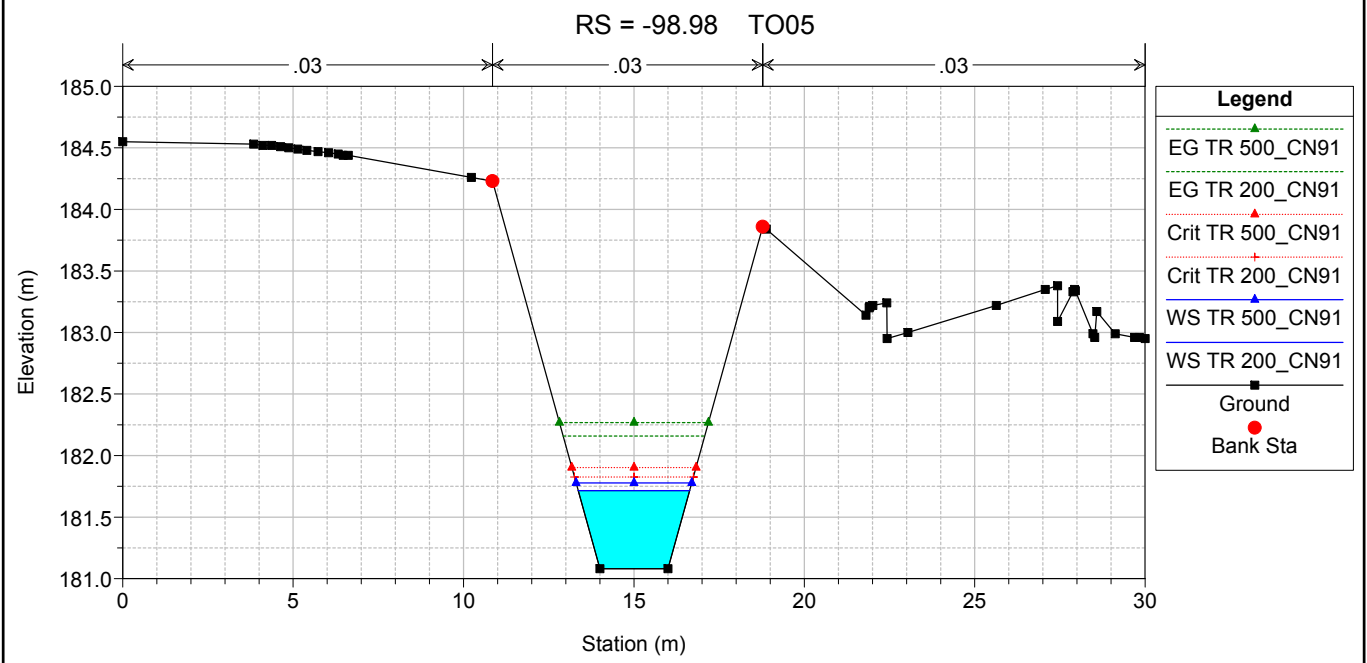
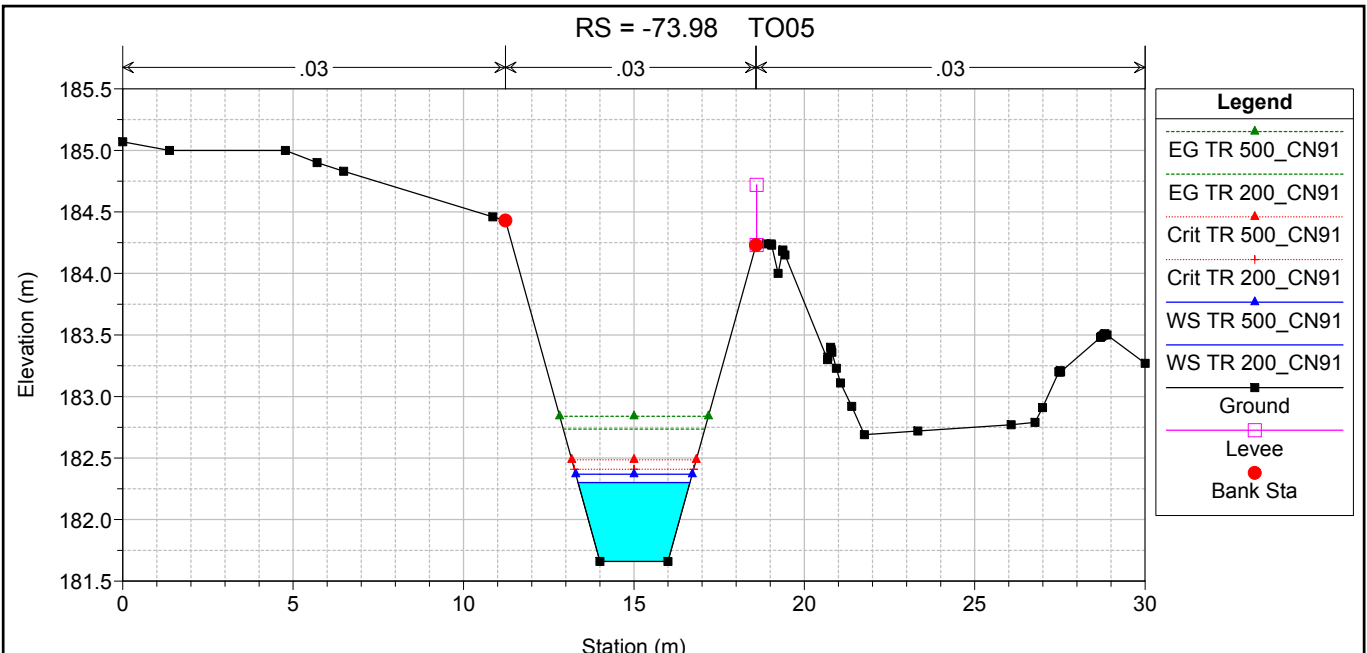

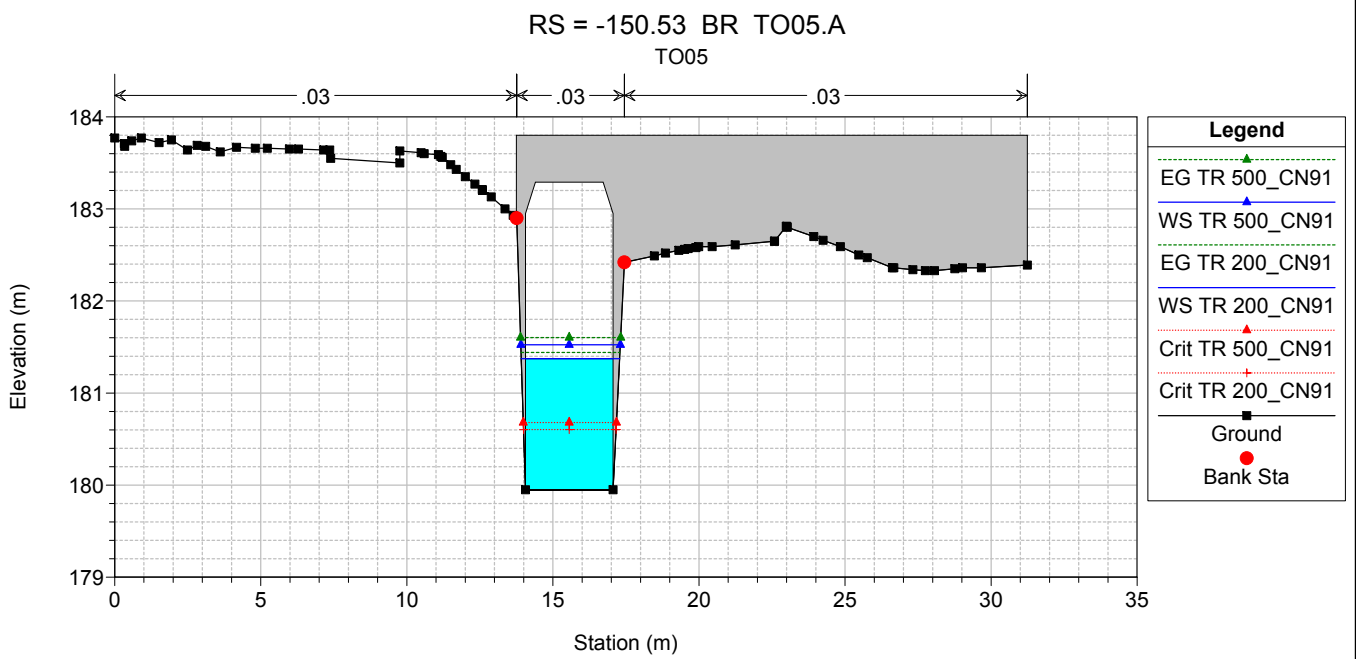
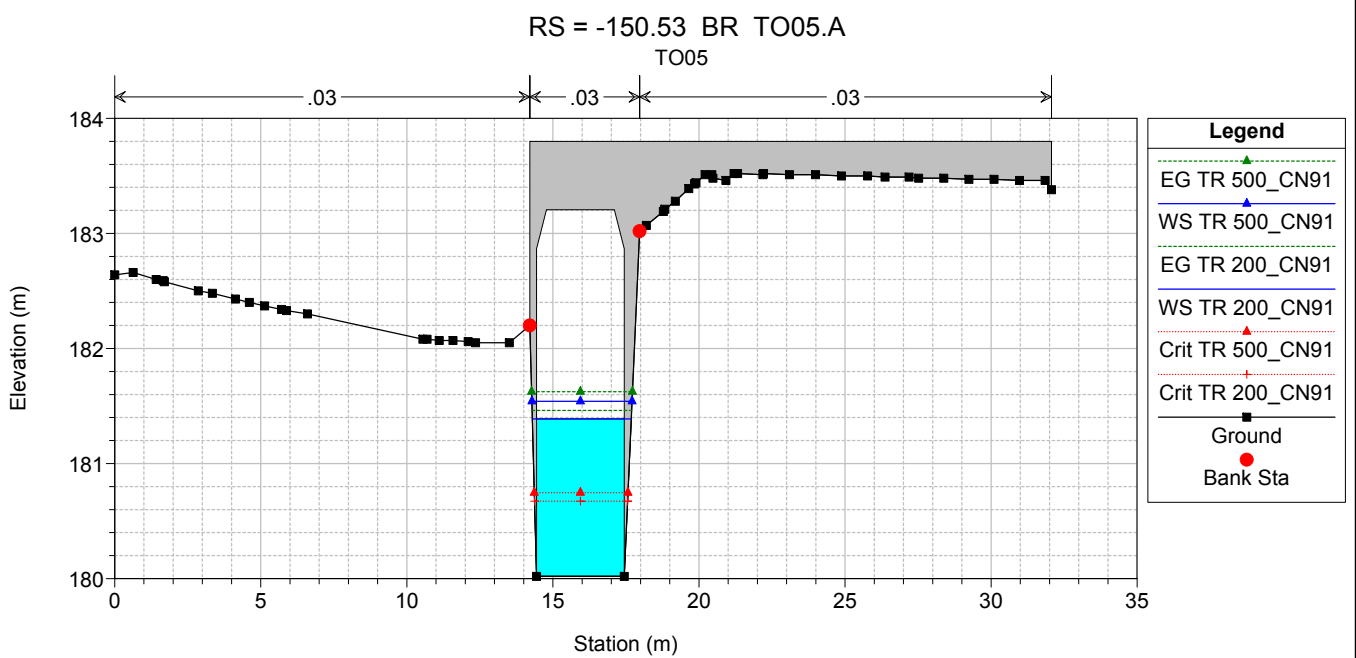
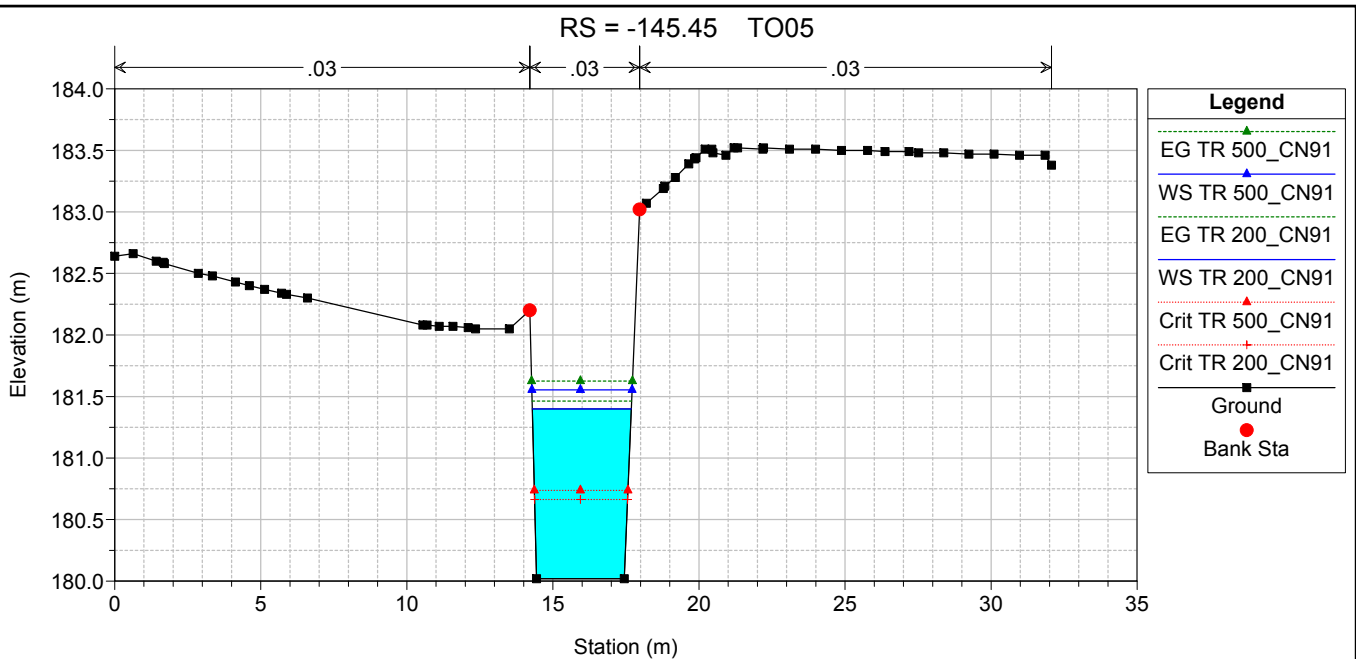

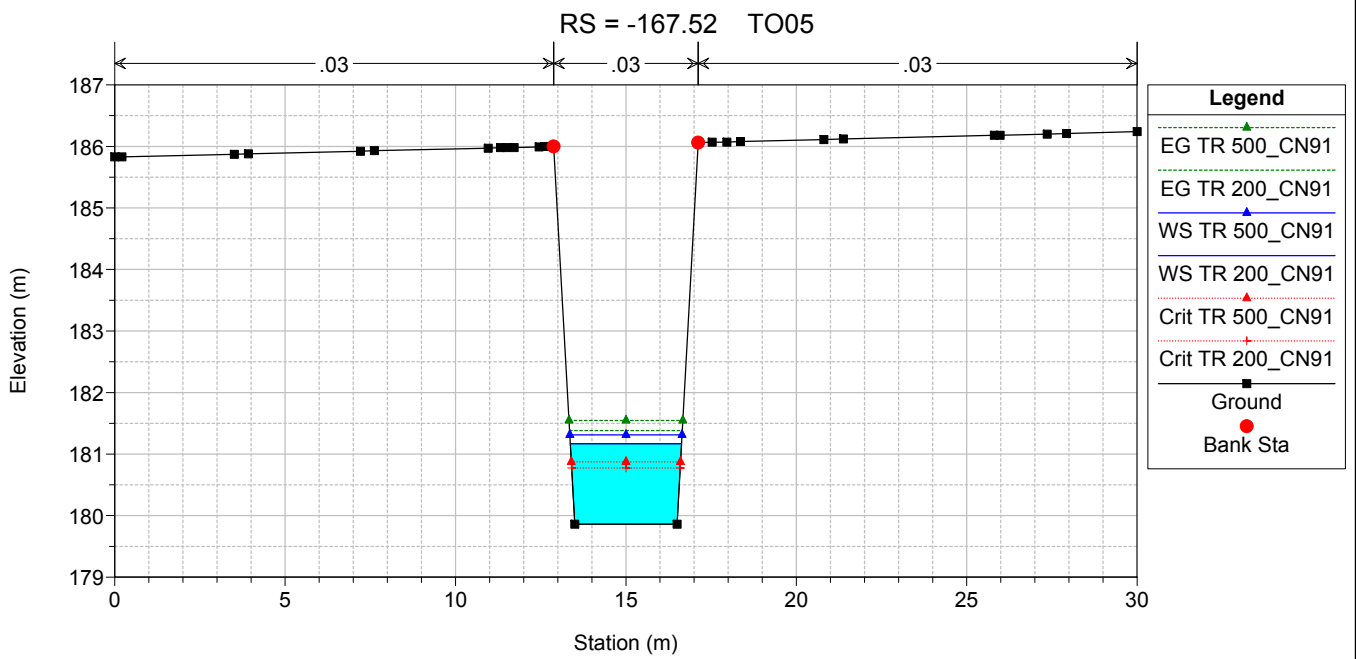
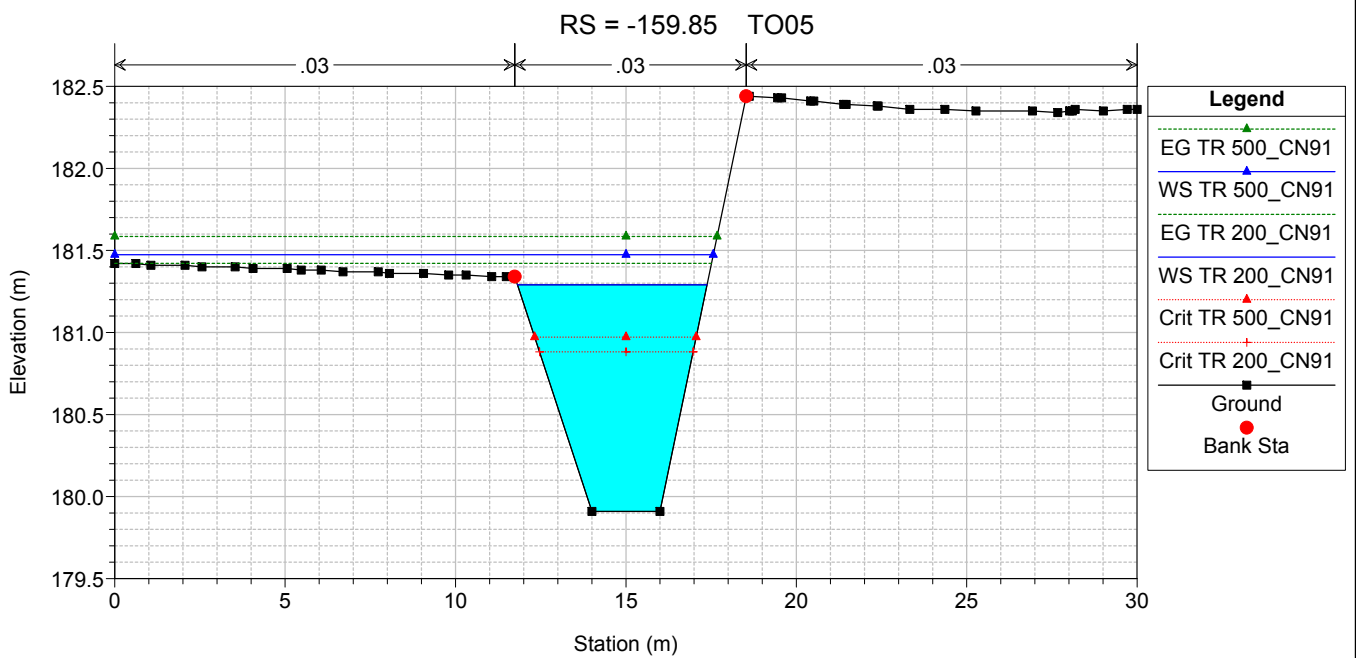
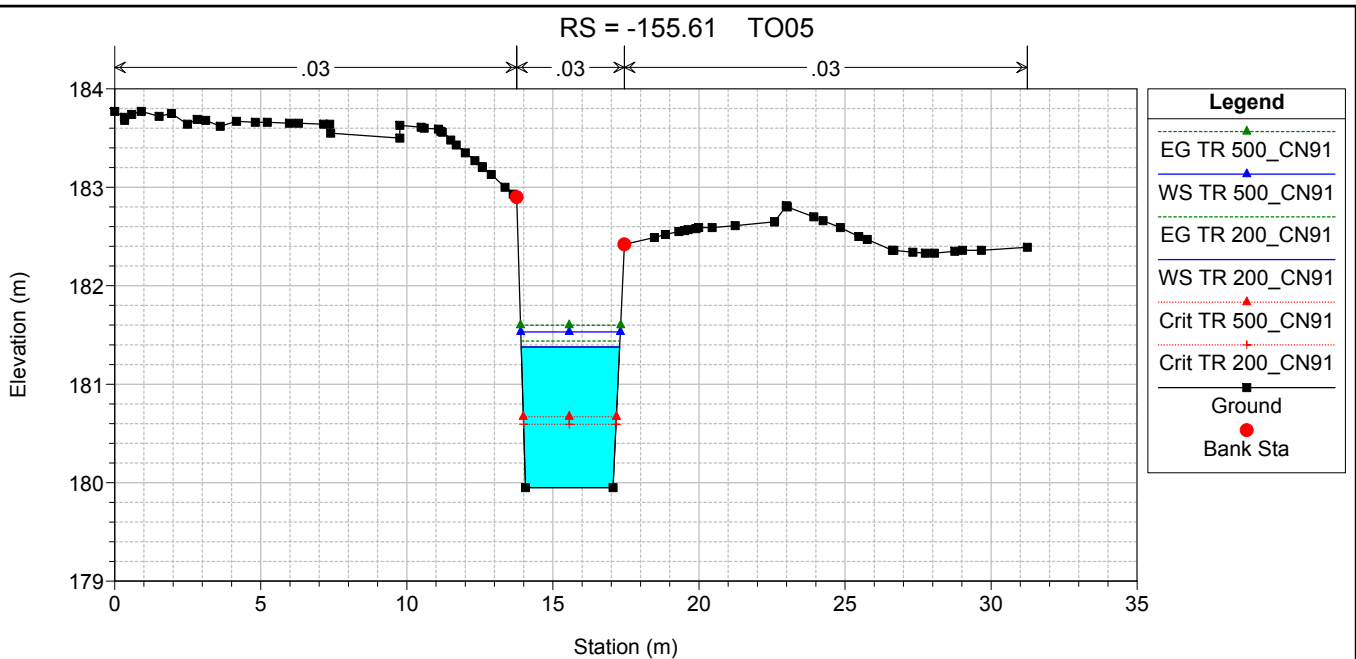

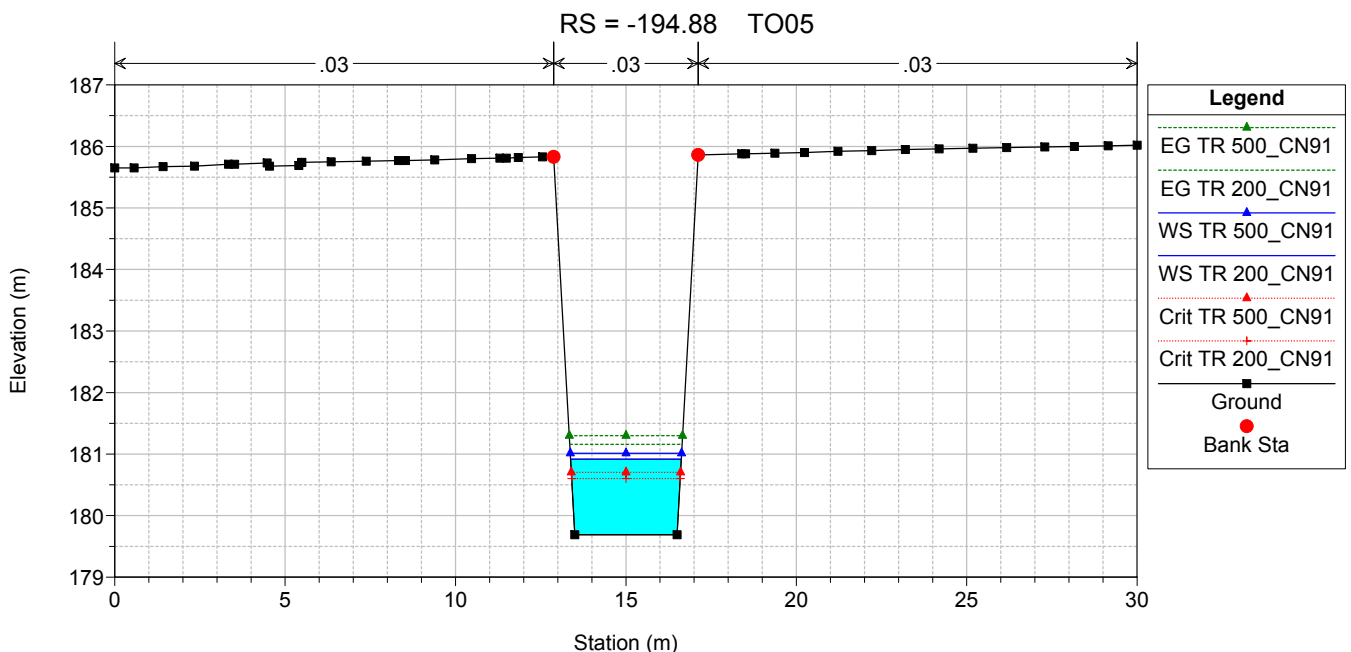
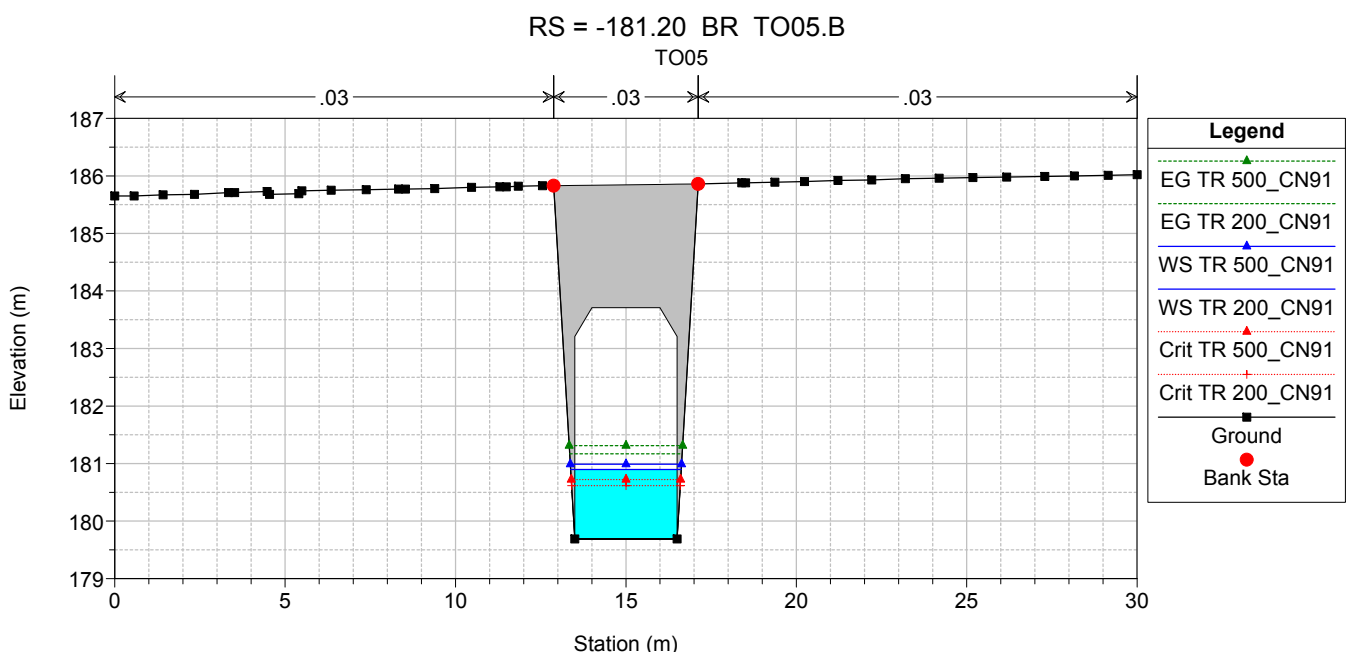
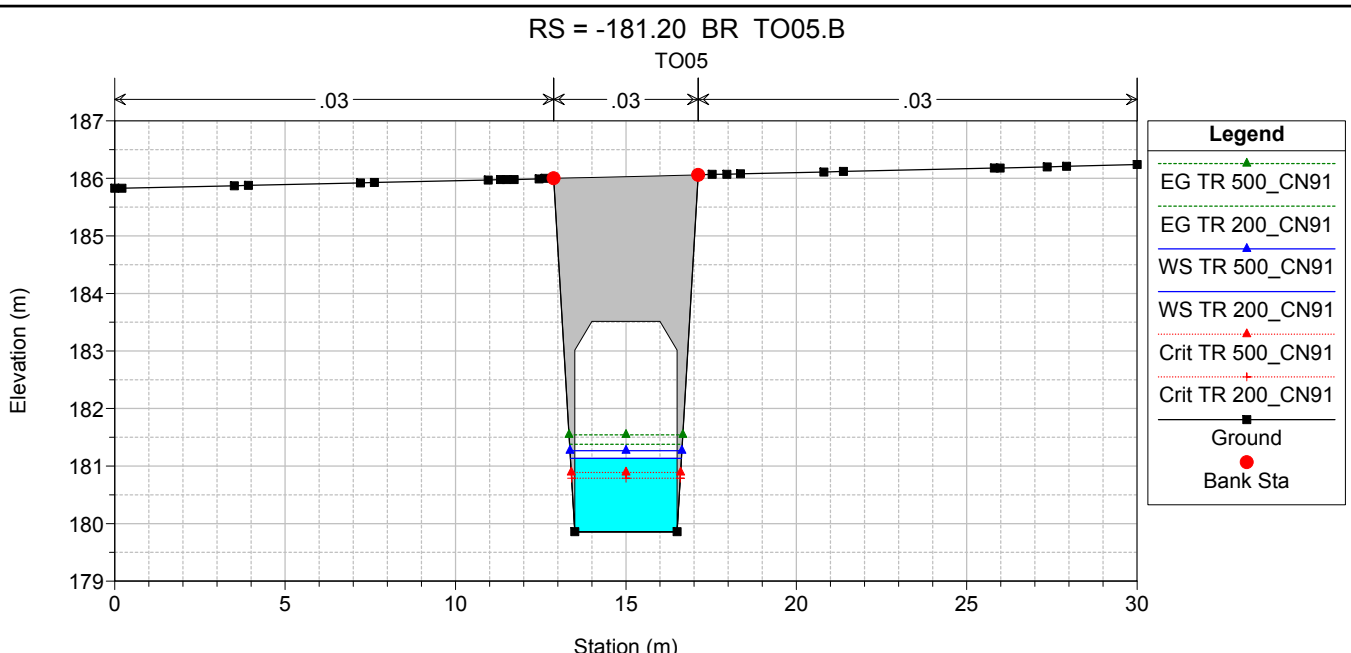

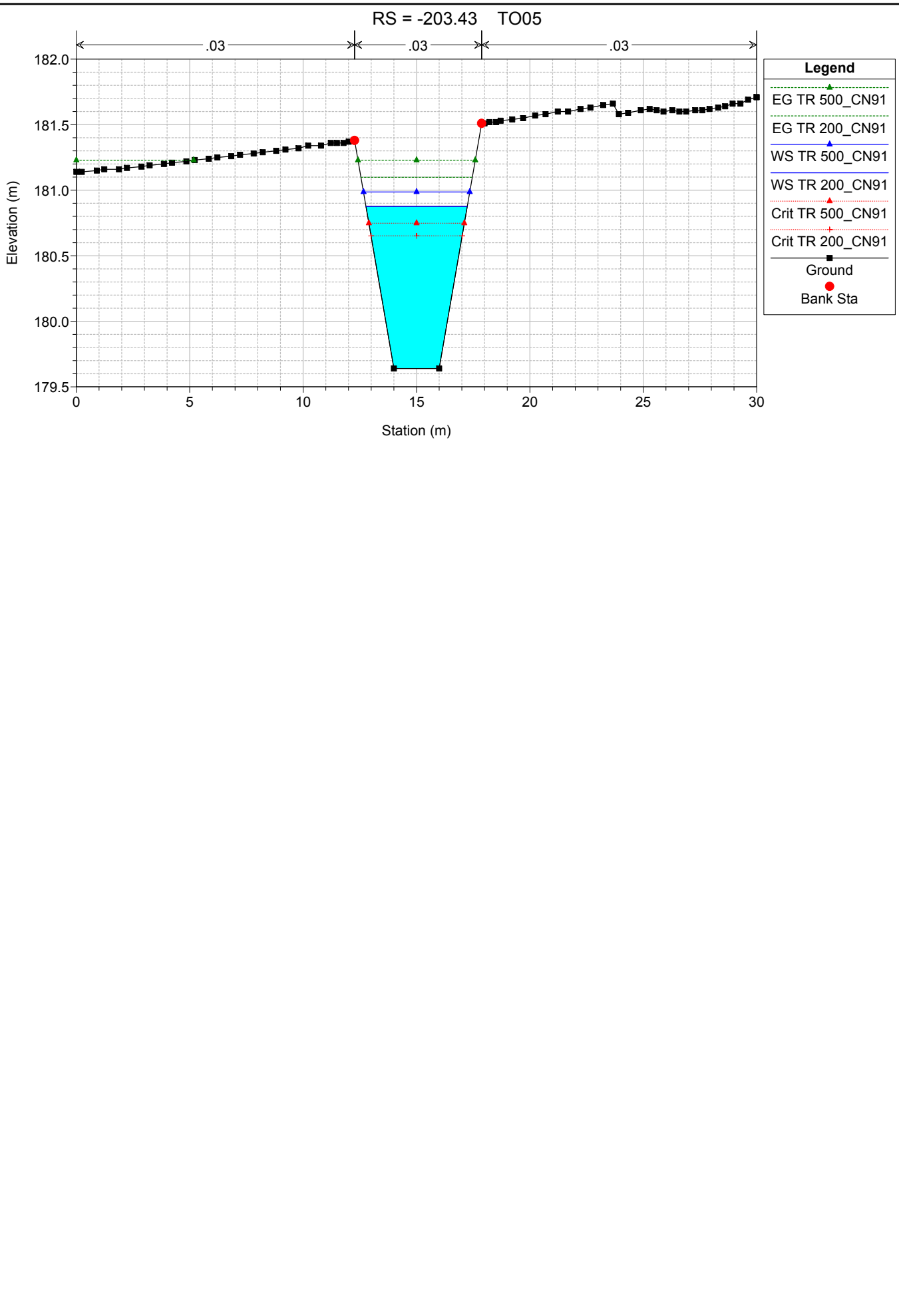

ALLEGATO 2.6

Interferenza idraulica - TO06
Tabella riassuntiva dei risultati, profilo idrico e sezioni
trasversali con i livelli idrici (TR 200 - 500 anni)

HEC-RAS Plan: TO05-TO06 River: TO06 Reach: TO06 Profile: TR 200_CN91

Reach	River Sta	Profile	Q Total (m ³ /s)	Min Ch El (m)	Max Chl Dpth (m)	W.S. Elev (m)	Crit W.S. (m)	Diff	Froude # Chl	E.G. Elev (m)	Vel Chnl (m/s)	Vel Total (m/s)	Hydr Radius C (m)	Shear Chan (N/m ²)	Hydr Depth (m)
TO06	0	TR 200_CN91	3.4	184.00	0.09	184.09	184.14	-0.05	2.09	184.26	1.8	1.8	0.1	30.9	0.08
TO06	-25	TR 200_CN91	3.4	182.81	1.06	183.87	183.07	0.80	0.05	183.87	0.2	0.2	0.8	0.1	0.89
TO06	-45	TR 200_CN91	3.4	182.08	1.79	183.87	182.31	1.56	0.03	183.87	0.1	0.1	1.4	0.0	1.43
TO06	-49.4	TR 200_CN91	3.4	183.41	0.42	183.75	183.75	0.00	0.99	183.87	1.7	1.5	0.3	33.1	0.23
TO06	-53.4	TR 200_CN91	3.4	182.65	0.46	183.11	183.31	-0.20	1.74	183.78	3.6	3.6	0.3	149.0	0.45
TO06	-58.40	Bridge													
TO06	-63.4	TR 200_CN91	3.4	182.61	0.60	183.21	183.27	-0.06	1.17	183.60	2.8	2.8	0.4	81.7	0.58
TO06	-77.68	TR 200_CN91	3.4	182.50	0.72	183.22	183.10	0.12	0.74	183.38	1.7	1.7	0.5	34.1	0.57
TO06	-94.51	TR 200_CN91	3.4	182.38	0.72	183.10	182.98	0.12	0.74	183.25	1.7	1.7	0.5	34.2	0.57
TO06	-119.51	TR 200_CN91	3.4	182.20	0.73	182.93	182.80	0.13	0.72	183.08	1.7	1.7	0.5	32.6	0.58
TO06	-144.51	TR 200_CN91	3.4	182.03	0.69	182.72	182.63	0.09	0.79	182.89	1.8	1.8	0.5	38.2	0.55
TO06	-169.51	TR 200_CN91	3.4	181.85	0.71	182.56	182.45	0.11	0.70	182.70	1.7	1.6	0.5	31.3	0.50
TO06	-194.51	TR 200_CN91	3.4	181.67	0.73	182.40	182.28	0.12	0.71	182.54	1.7	1.6	0.5	32.1	0.46
TO06	-219.51	TR 200_CN91	3.4	181.49	0.61	182.10	182.10	0.00	0.95	182.32	2.1	2.0	0.4	51.4	0.43

HEC-RAS Plan: TO05-TO06 River: TO06 Reach: TO06 Profile: TR 500_CN91

Reach	River Sta	Profile	Q Total (m ³ /s)	Min Ch El (m)	Max Chl Dpth (m)	W.S. Elev (m)	Crit W.S. (m)	Diff	Froude # Chl	E.G. Elev (m)	Vel Chnl (m/s)	Vel Total (m/s)	Hydr Radius C (m)	Shear Chan (N/m ²)	Hydr Depth (m)
TO06	0	TR 500_CN91	4.0	184.00	0.10	184.10	184.15	-0.05	2.12	184.29	2.0	2.0	0.1	33.8	0.09
TO06	-25	TR 500_CN91	4.0	182.81	1.09	183.90	183.08	0.82	0.06	183.90	0.2	0.2	0.9	0.1	0.91
TO06	-45	TR 500_CN91	4.0	182.08	1.82	183.90	182.33	1.57	0.03	183.90	0.1	0.1	1.4	0.1	1.43
TO06	-49.4	TR 500_CN91	4.0	183.41	0.46	183.79	183.79	0.00	0.94	183.90	1.7	1.5	0.3	32.3	0.21
TO06	-53.4	TR 500_CN91	4.0	182.65	0.55	183.20	183.38	-0.18	1.54	183.83	3.5	3.5	0.4	134.0	0.53
TO06	-58.40														
		Bridge													
TO06	-63.4	TR 500_CN91	4.0	182.61	0.66	183.27	183.34	-0.07	1.16	183.70	2.9	2.9	0.4	87.3	0.64
TO06	-77.68	TR 500_CN91	4.0	182.50	0.78	183.28	183.15	0.13	0.74	183.45	1.8	1.8	0.5	36.3	0.61
TO06	-94.51	TR 500_CN91	4.0	182.38	0.78	183.16	183.04	0.12	0.74	183.33	1.8	1.8	0.5	36.5	0.61
TO06	-119.51	TR 500_CN91	4.0	182.20	0.80	183.00	182.86	0.14	0.72	183.16	1.8	1.8	0.5	34.7	0.62
TO06	-144.51	TR 500_CN91	4.0	182.03	0.74	182.77	182.68	0.09	0.81	182.97	1.9	1.9	0.5	41.9	0.57
TO06	-169.51	TR 500_CN91	4.0	181.85	0.77	182.62	182.51	0.11	0.71	182.77	1.8	1.7	0.5	33.6	0.54
TO06	-194.51	TR 500_CN91	4.0	181.67	0.78	182.45	182.34	0.11	0.72	182.61	1.8	1.7	0.5	34.6	0.44
TO06	-219.51	TR 500_CN91	4.0	181.49	0.66	182.15	182.15	0.00	0.95	182.38	2.2	2.1	0.5	54.5	0.46

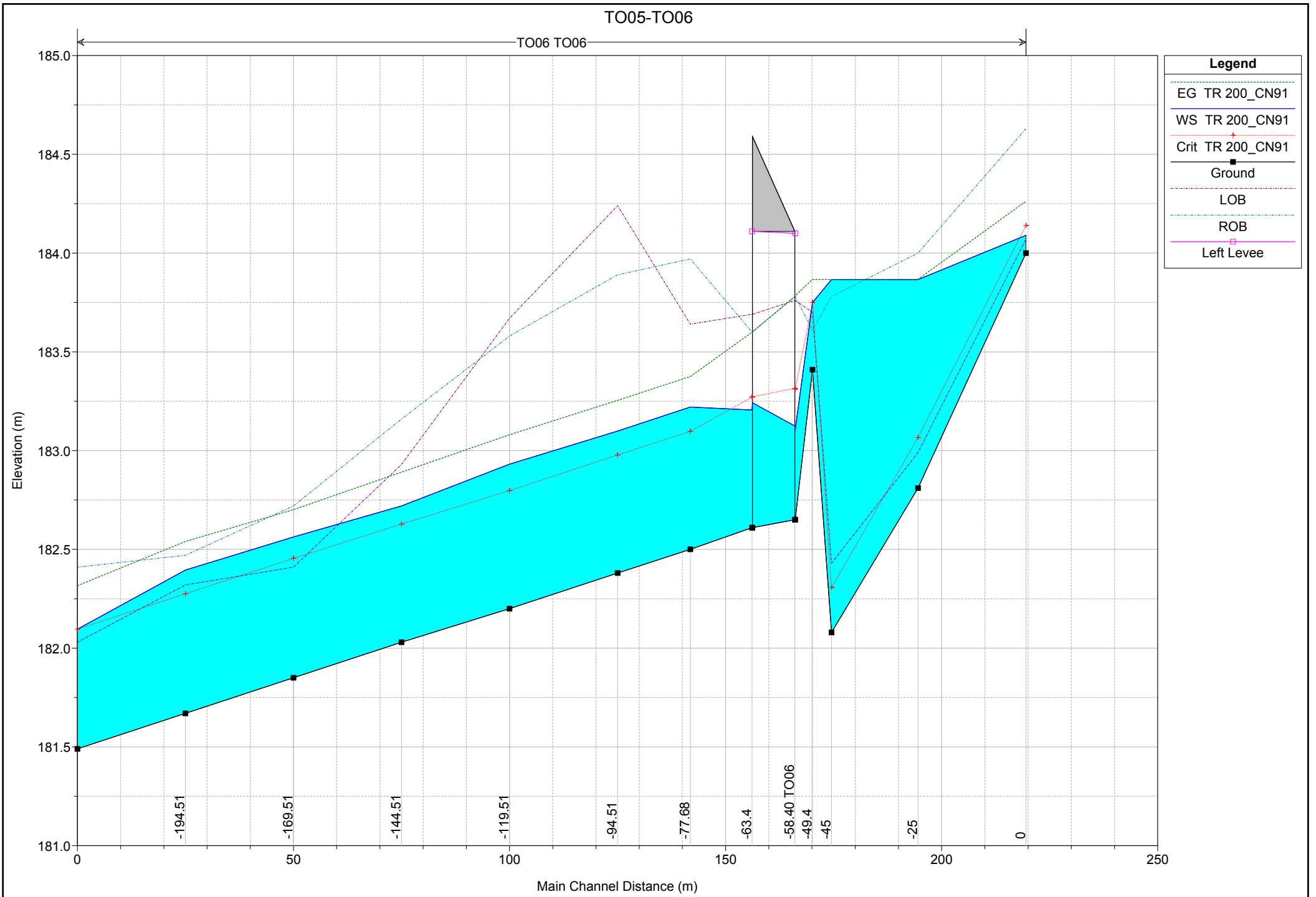

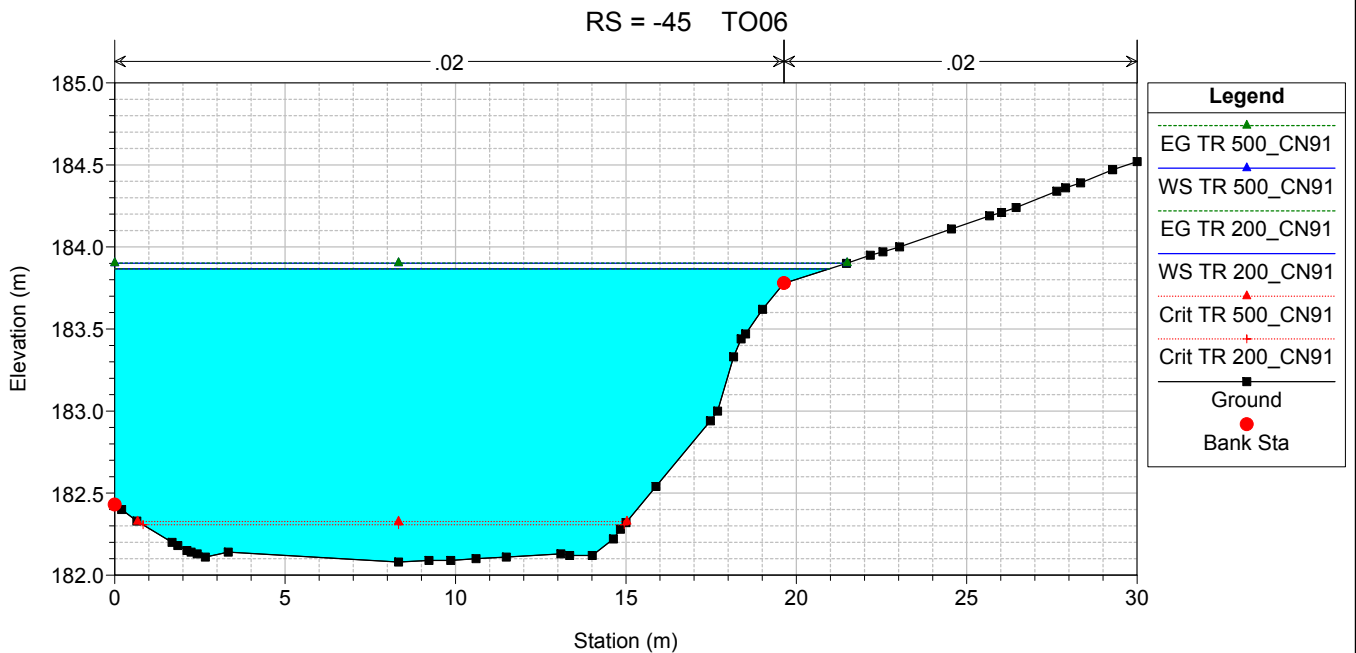
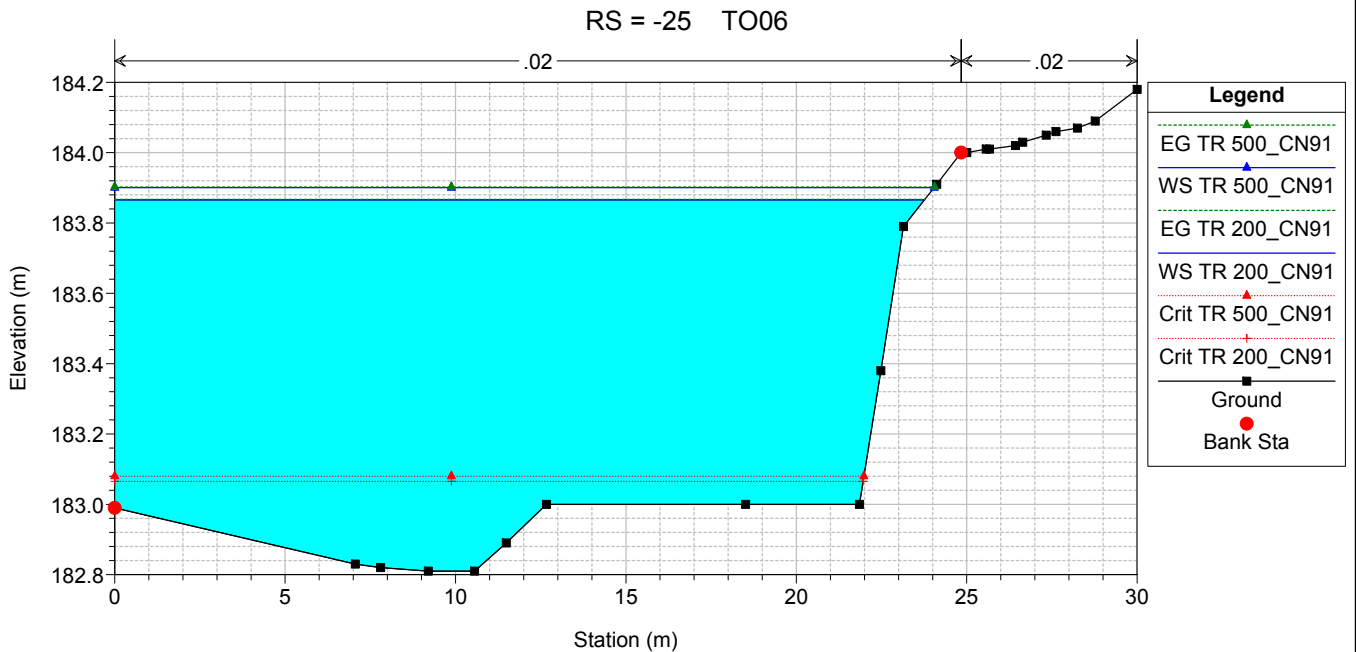
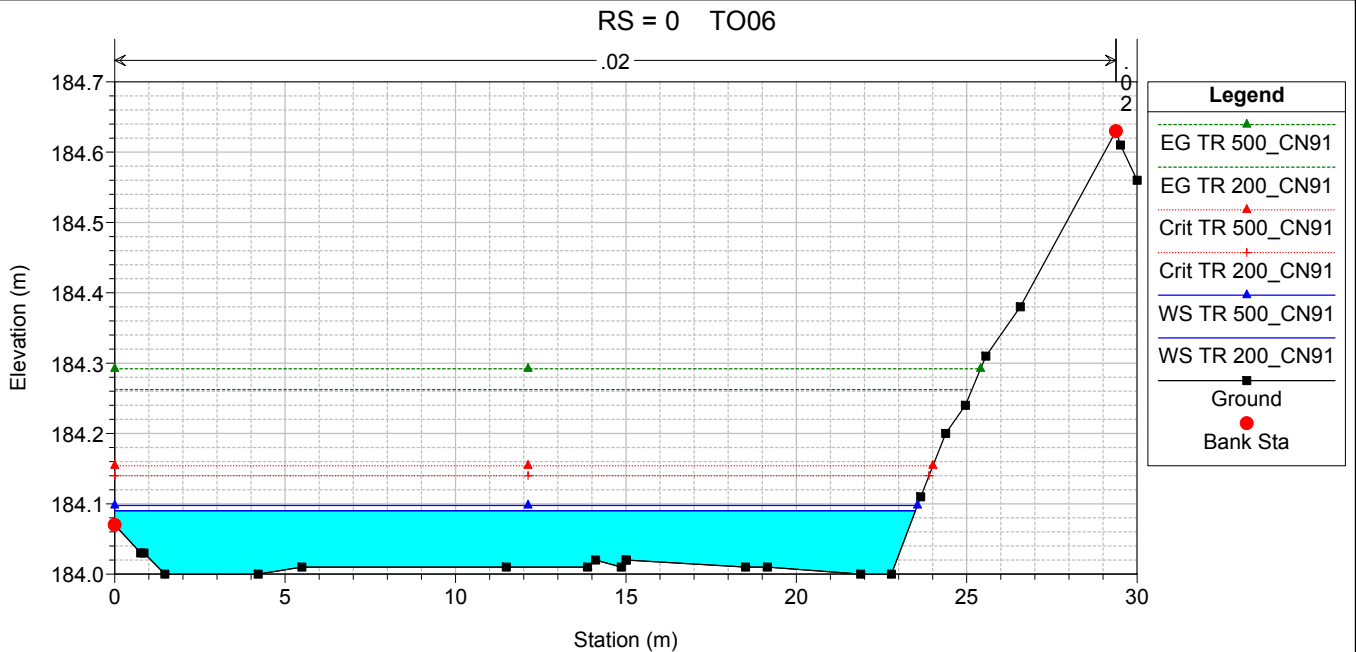

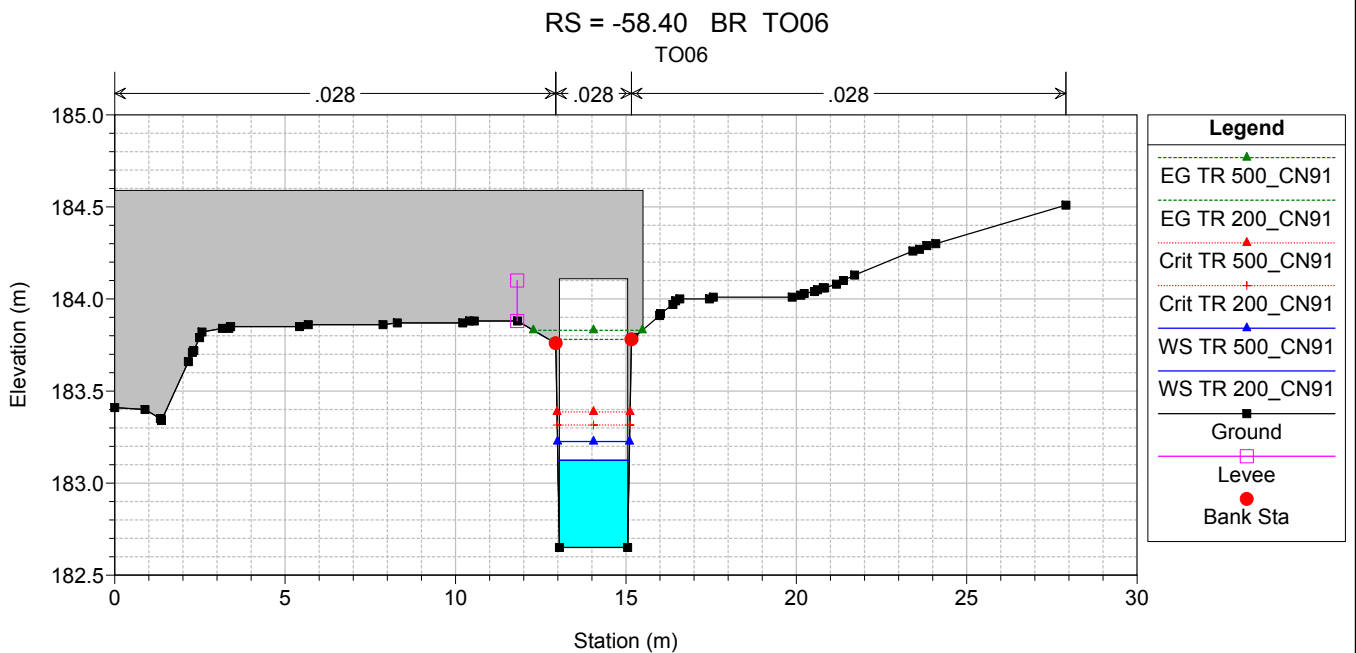
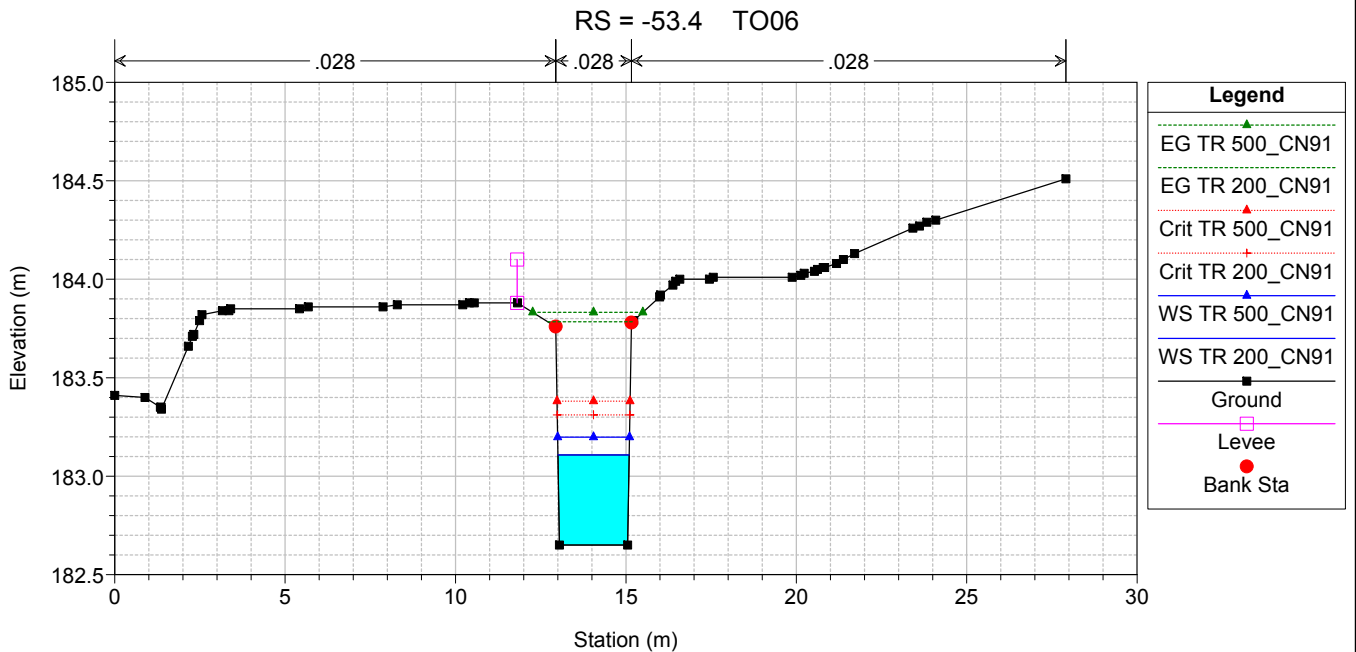
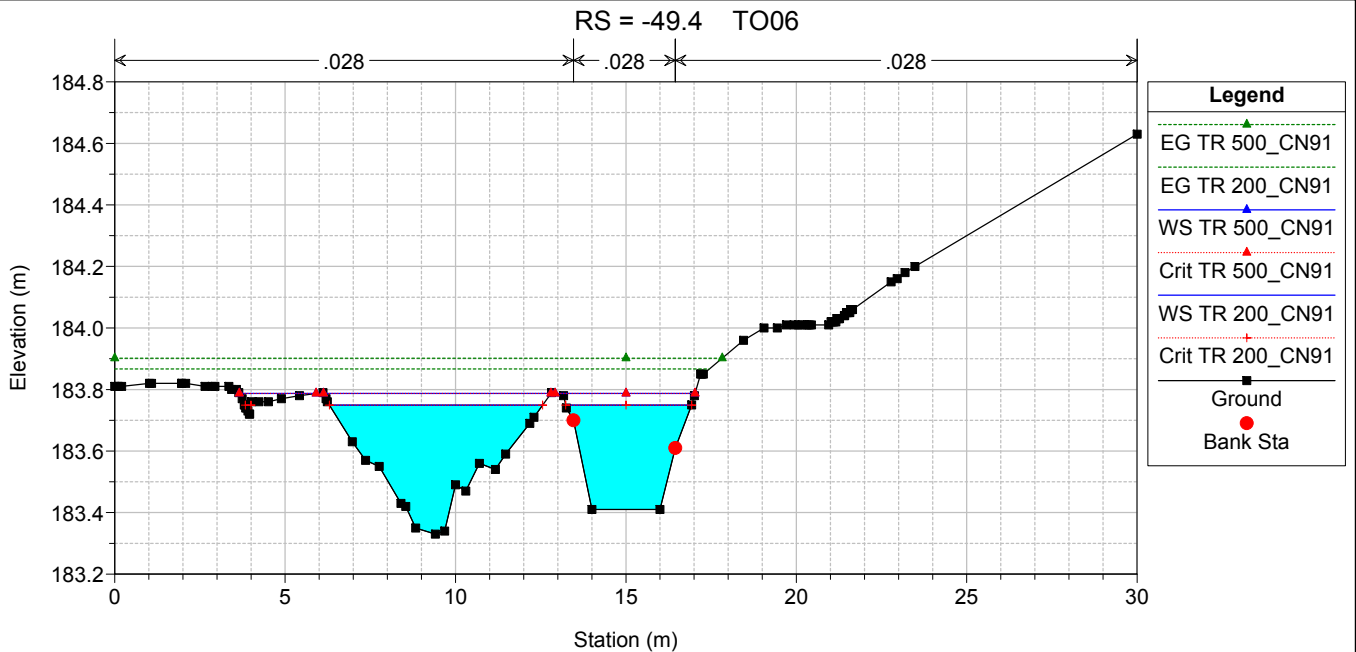

RS = -58.40 BR TO06

TO06

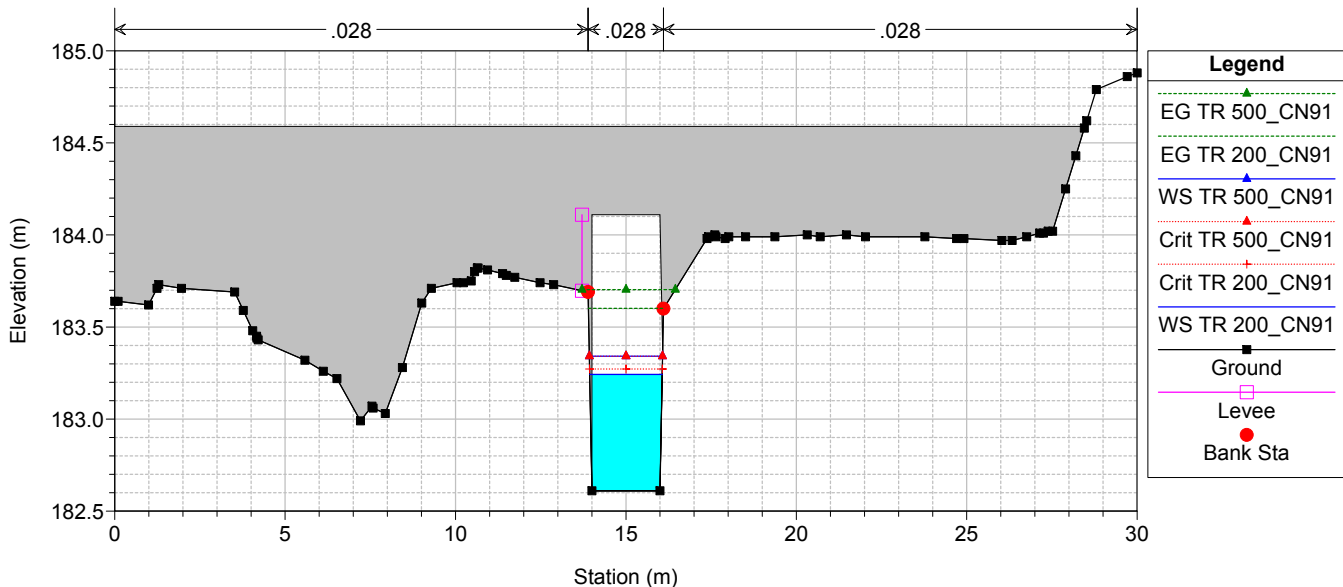

Station (m)

RS = -63.4 TO06

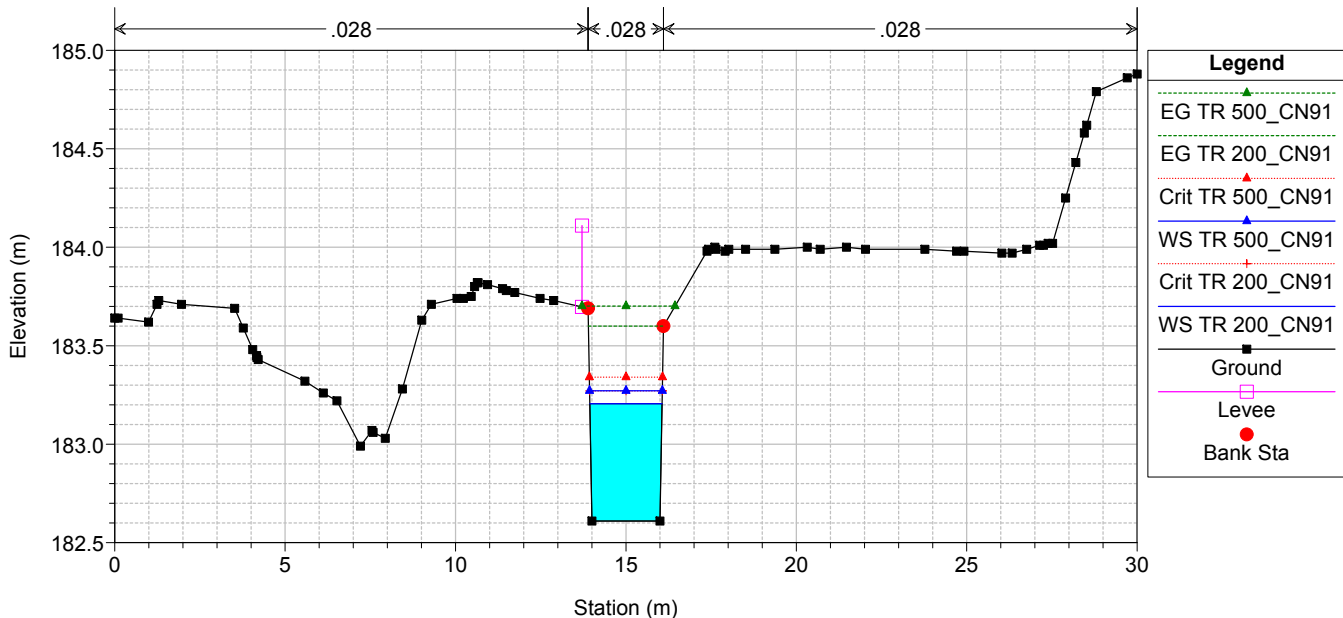

Station (m)

RS = -77.68 TO06

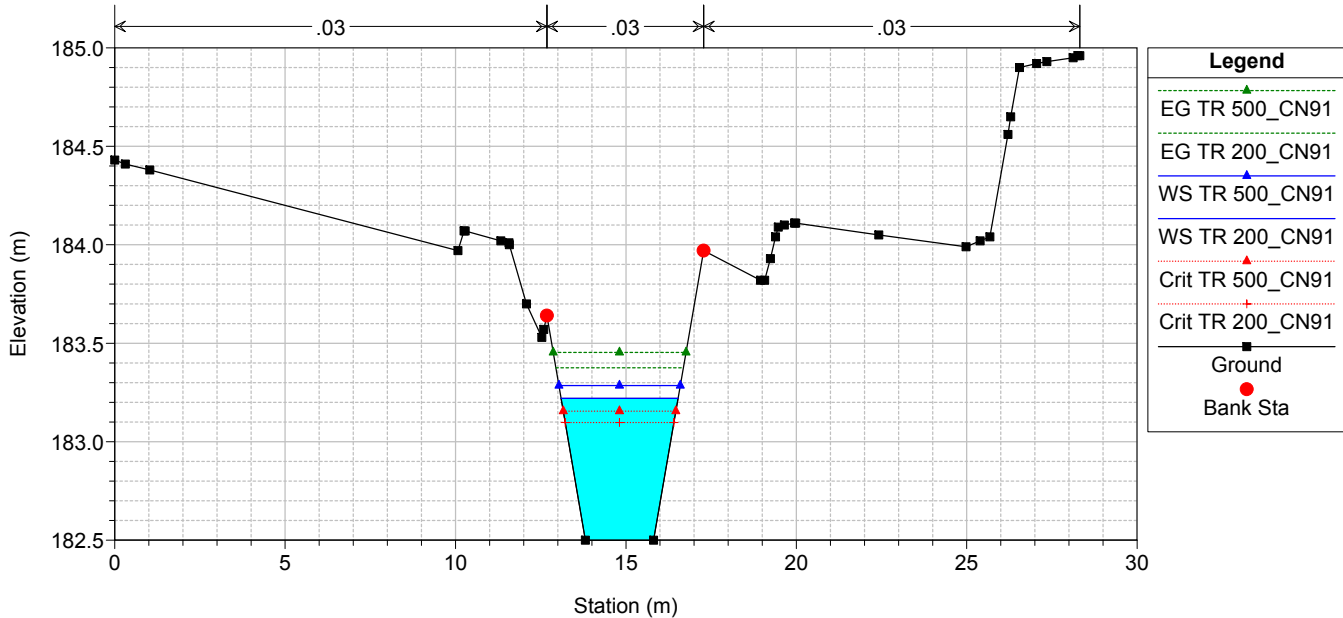

Station (m)

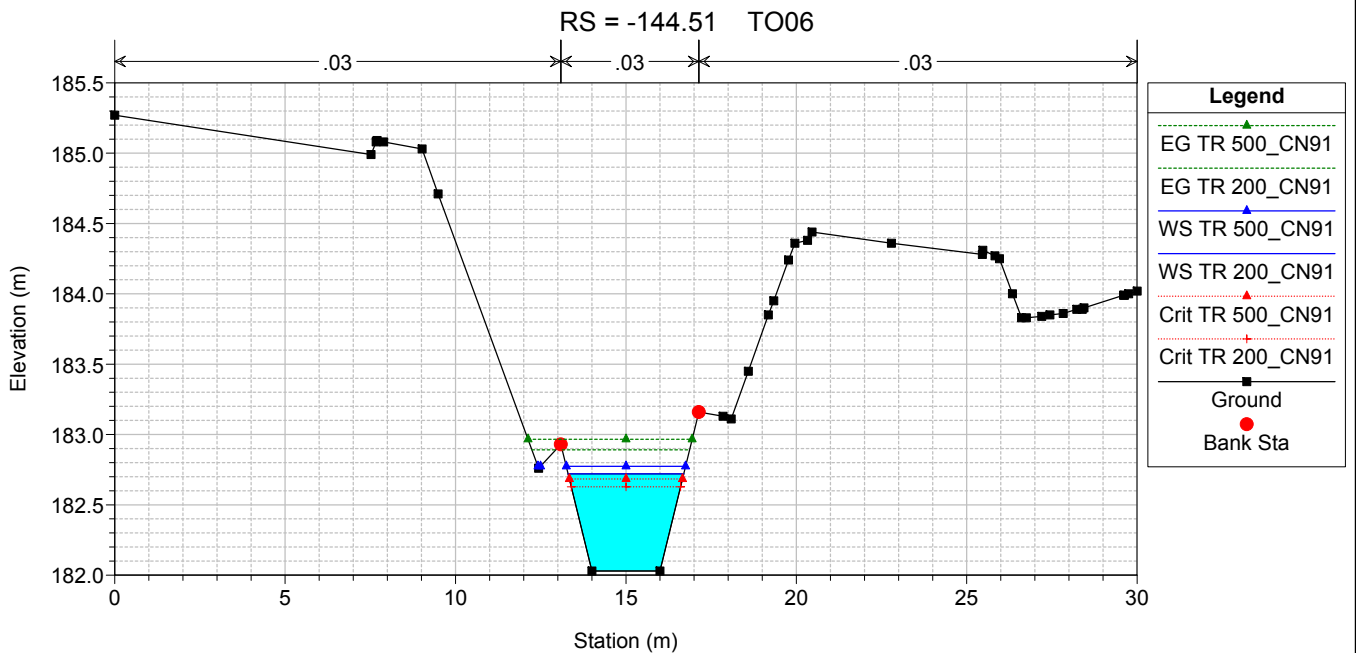
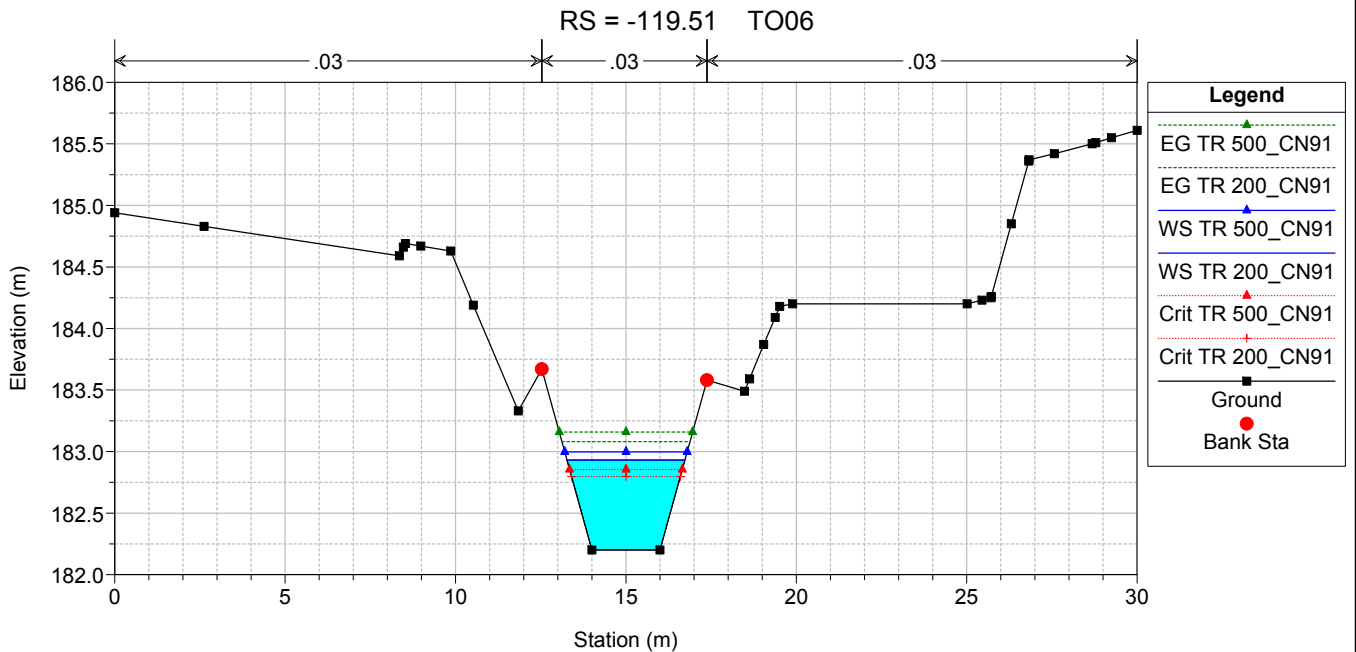
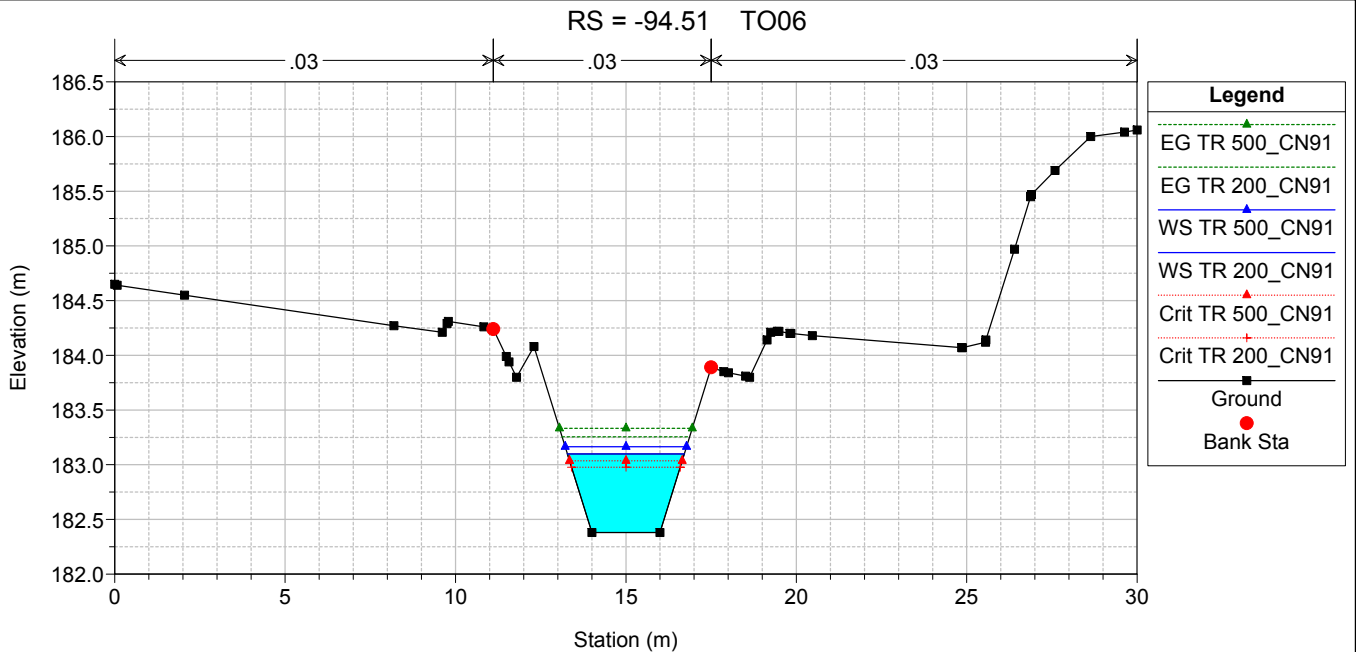

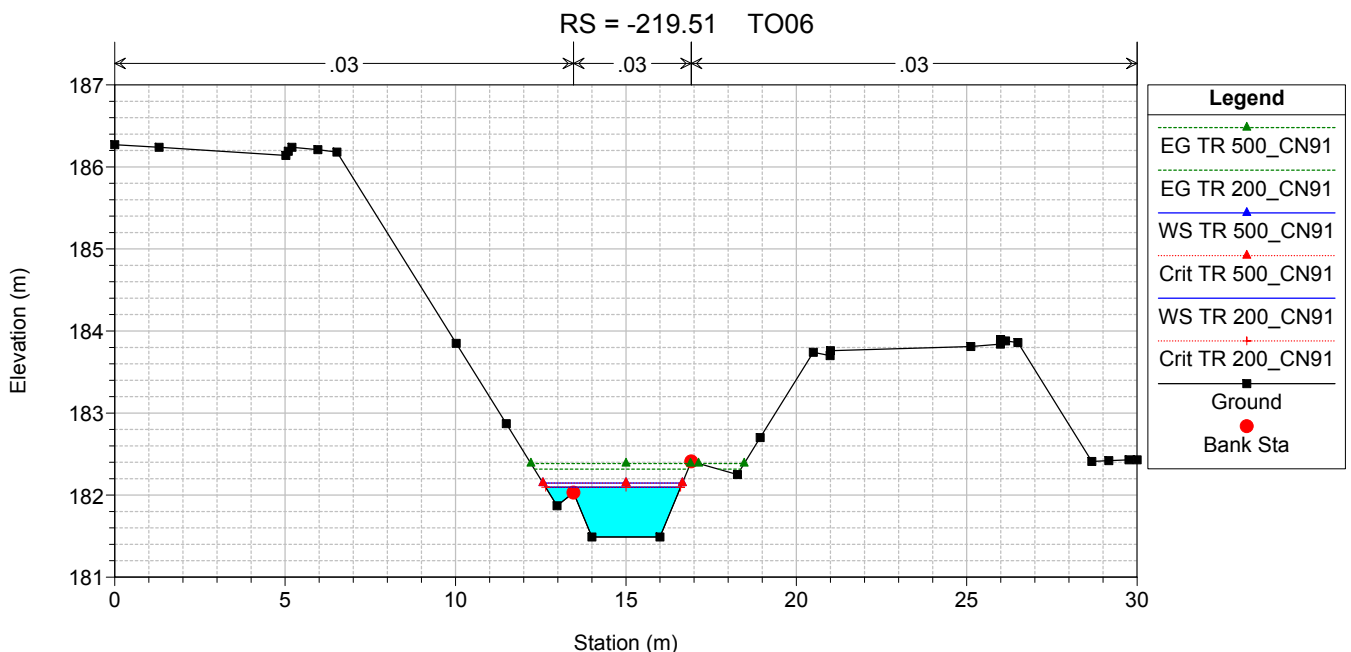
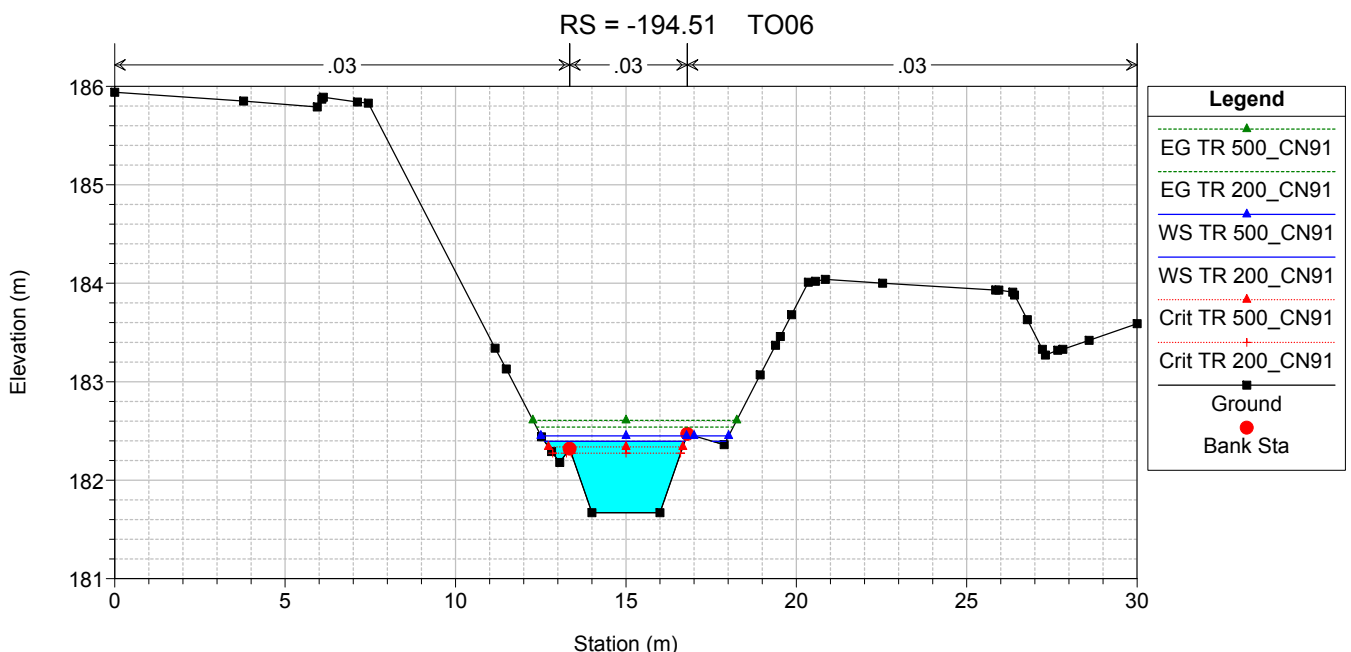
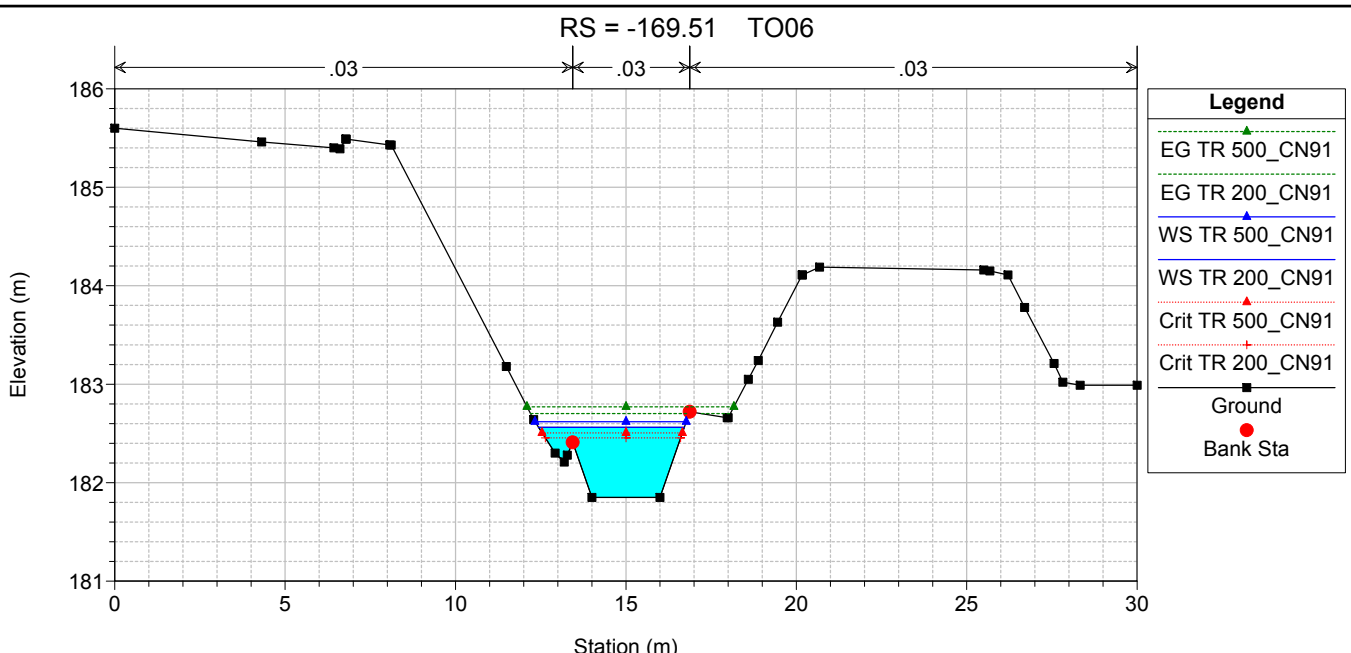

ALLEGATO 2.7

Interferenza idraulica - T007
Tabella riassuntiva dei risultati, profilo idrico e sezioni
trasversali con i livelli idrici (TR 200 - 500 anni)

HEC-RAS Plan: TO07_POST River: TO07 Reach: TO07 Profile: TR 200_CN91

Reach	River Sta	Profile	Q Total (m ³ /s)	Min Ch El (m)	Max Chl Dpth (m)	W.S. Elev (m)	Crit W.S. (m)	Diff	Froude # Chl	E.G. Elev (m)	Vel Chnl (m/s)	Vel Total (m/s)	Hydr Radius C (m)	Shear Chan (N/m ²)	Hydr Depth (m)
TO07	0	TR 200_CN91	102.1	168.02	1.05	168.88	169.18	-0.30	1.69	169.92	4.4	4.5	0.7	193.7	0.75
TO07	-25	TR 200_CN91	102.1	167.21	1.94	169.15	169.15	0.00	0.96	169.67	4.0	3.1	1.5	124.4	1.10
TO07	-38.49	TR 200_CN91	102.1	166.81	1.81	168.62	168.86	-0.24	1.16	169.49	4.5	3.8	1.4	162.7	0.92
TO07	-55.01	TR 200_CN91	102.1	166.32	1.43	167.75	168.25	-0.50	1.49	169.19	5.3	5.3	1.2	233.9	1.29
TO07	-66.79	TR 200_CN91	102.1	166.07	1.74	167.81	168.00	-0.19	1.17	168.99	4.8	4.8	1.4	184.8	1.72
TO07	-83.04	Bridge													
TO07	-99.29	TR 200_CN91	102.1	165.74	1.66	167.40	167.67	-0.27	1.26	168.70	5.0	5.0	1.3	205.2	1.64
TO07	-116.36	TR 200_CN91	102.1	165.31	1.31	166.62	167.15	-0.53	1.71	168.37	5.9	5.9	1.1	272.6	1.19
TO07	-126.41	TR 200_CN91	102.1	165.00	1.22	166.22	166.77	-0.55	1.76	168.09	6.1	6.1	1.0	299.6	1.21
TO07	-133.88	Bridge													
TO07	-141.35	TR 200_CN91	102.1	164.86	1.30	166.16	166.63	-0.47	1.59	167.80	5.7	5.7	1.1	256.0	1.29
TO07	-150.82	TR 200_CN91	102.1	164.83	1.51	166.34	166.67	-0.33	1.37	167.62	5.0	5.0	1.3	192.4	1.36
TO07	-159.09	TR 200_CN91	102.1	164.80	2.18	166.98	166.65	0.33	0.75	167.51	3.3	3.1	1.7	78.1	1.41
TO07	-200	TR 200_CN91	102.1	164.68	2.13	166.81	166.63	0.18	0.74	167.32	3.2	3.0	1.7	76.0	1.23
TO07	-225	TR 200_CN91	102.1	164.61	2.15	166.76	166.59	0.17	0.69	167.19	3.0	2.7	1.8	66.8	1.27
TO07	-260	TR 200_CN91	102.1	164.54	2.15	166.69	166.49	0.20	0.67	167.10	3.0	2.6	1.8	63.3	1.31
TO07	-275	TR 200_CN91	102.1	164.46	1.95	166.41	166.41	0.00	0.82	166.97	3.4	3.0	1.7	88.5	1.12
TO07	-300	TR 200_CN91	102.1	164.39	1.50	165.89	166.12	-0.23	1.17	166.75	4.3	3.8	1.3	151.1	0.90
TO07	-325	TR 200_CN91	102.1	164.31	1.83	166.14	165.86	0.28	0.67	166.47	2.8	2.4	1.7	57.9	1.40
TO07	-350	TR 200_CN91	102.1	164.24	1.88	166.12	165.66	0.46	0.59	166.38	2.5	2.2	1.8	45.5	1.55
TO07	-375	TR 200_CN91	102.1	164.17	1.83	166.00	165.65	0.35	0.64	166.30	2.7	2.3	1.7	53.1	1.46
TO07	-400	TR 200_CN91	102.1	164.09	1.72	165.81	165.62	0.19	0.74	166.20	3.0	2.6	1.7	68.3	1.30
TO07	-425	TR 200_CN91	102.1	164.02	1.81	165.83	165.34	0.49	0.58	166.08	2.4	2.2	1.7	42.9	1.58
TO07	-450	TR 200_CN91	102.1	163.95	1.46	165.41	165.41	0.00	0.94	165.95	3.5	3.1	1.3	97.9	1.09
TO07	-475	TR 200_CN91	102.1	163.83	1.72	165.42	165.15	0.27	0.72	165.75	2.8	2.5	1.5	59.1	1.36

HEC-RAS Plan: TO07_POST River: TO07 Reach: TO07 Profile: TR 500_CN91

Reach	River Sta	Profile	Q Total (m ³ /s)	Min Ch El (m)	Max Chl Dpth (m)	W.S. Elev (m)	Crit W.S. (m)	Diff	Froude # Chl	E.G. Elev (m)	Vel Chnl (m/s)	Vel Total (m/s)	Hydr Radius C (m)	Shear Chan (N/m ²)	Hydr Depth (m)
TO07	0	TR 500_CN91	121.5	168.02	1.13	168.96	169.31	-0.35	1.72	170.15	4.7	4.8	0.7	217.6	0.84
TO07	-25	TR 500_CN91	121.5	167.21	2.07	169.28	169.28	0.00	0.97	169.86	4.2	3.3	1.6	132.9	1.23
TO07	-38.49	TR 500_CN91	121.5	166.81	1.93	168.74	168.99	-0.25	1.18	169.69	4.7	3.9	1.5	174.8	1.03
TO07	-55.01	TR 500_CN91	121.5	166.32	2.70	169.02	168.47	0.55	0.58	169.39	2.8	2.5	2.2	53.8	1.60
TO07	-66.79	TR 500_CN91	121.5	166.07	2.42	168.49	168.24	0.25	0.85	169.35	4.1	4.1	1.8	123.0	2.37
TO07	-83.04	Bridge													
TO07	-99.29	TR 500_CN91	121.5	165.74	1.96	167.70	167.91	-0.21	1.17	169.02	5.1	5.1	1.5	199.6	1.93
TO07	-116.36	TR 500_CN91	121.5	165.31	1.46	166.77	167.37	-0.60	1.71	166.71	6.2	6.2	1.2	293.8	1.32
TO07	-126.41	TR 500_CN91	121.5	165.00	2.86	167.86	166.99	0.87	0.56	168.28	2.9	2.7	2.1	54.9	1.50
TO07	-133.88	Bridge													
TO07	-141.35	TR 500_CN91	121.5	164.86	2.19	167.05	166.85	0.20	0.86	167.85	4.0	3.9	1.7	109.0	1.41
TO07	-150.82	TR 500_CN91	121.5	164.83	2.30	167.13	166.97	0.16	0.82	167.80	3.6	3.5	1.8	89.2	1.38
TO07	-159.09	TR 500_CN91	121.5	164.80	2.33	167.13	166.96	0.17	0.79	167.75	3.5	3.4	1.8	90.7	1.49
TO07	-200	TR 500_CN91	121.5	164.68	2.29	166.97	166.85	0.12	0.77	167.54	3.5	3.1	1.9	85.6	1.38
TO07	-225	TR 500_CN91	121.5	164.61	2.32	166.93	166.75	0.18	0.70	167.40	3.2	2.8	2.0	73.3	1.44
TO07	-250	TR 500_CN91	121.5	164.54	2.32	166.86	166.65	0.21	0.68	167.30	3.1	2.7	2.0	69.5	1.48
TO07	-275	TR 500_CN91	121.5	164.46	2.10	166.56	166.56	0.00	0.84	167.18	3.7	3.2	1.8	97.5	1.26
TO07	-300	TR 500_CN91	121.5	164.39	1.63	166.02	166.26	-0.24	1.18	166.95	4.6	4.0	1.4	163.2	1.02
TO07	-325	TR 500_CN91	121.5	164.31	2.00	166.31	165.99	0.32	0.68	166.68	3.0	2.6	1.9	63.1	1.57
TO07	-350	TR 500_CN91	121.5	164.24	2.04	166.28	165.80	0.48	0.60	166.58	2.7	2.4	1.9	50.8	1.72
TO07	-375	TR 500_CN91	121.5	164.17	1.99	166.16	165.78	0.38	0.65	166.51	2.9	2.5	1.9	58.7	1.62
TO07	-400	TR 500_CN91	121.5	164.09	1.88	165.97	165.76	0.21	0.75	166.40	3.2	2.8	1.8	75.0	1.46
TO07	-425	TR 500_CN91	121.5	164.02	1.97	165.99	165.46	0.53	0.60	166.28	2.6	2.3	1.9	48.8	1.73
TO07	-450	TR 500_CN91	121.5	163.95	1.61	165.56	165.54	0.02	0.94	166.14	3.7	3.3	1.5	103.7	1.25
TO07	-475	TR 500_CN91	121.5	163.83	1.88	165.58	165.27	0.31	0.73	165.95	3.0	2.7	1.7	65.2	1.51

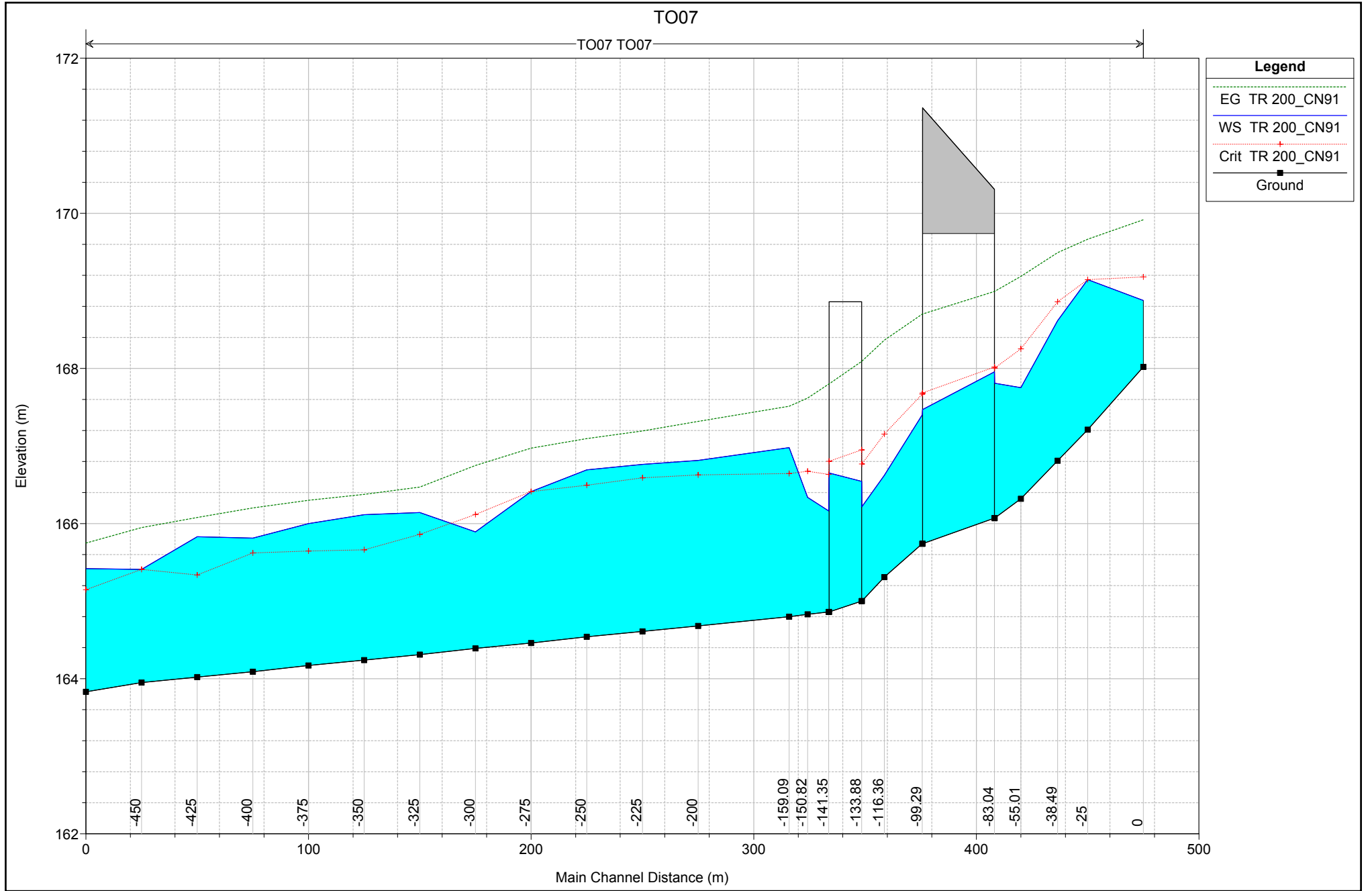

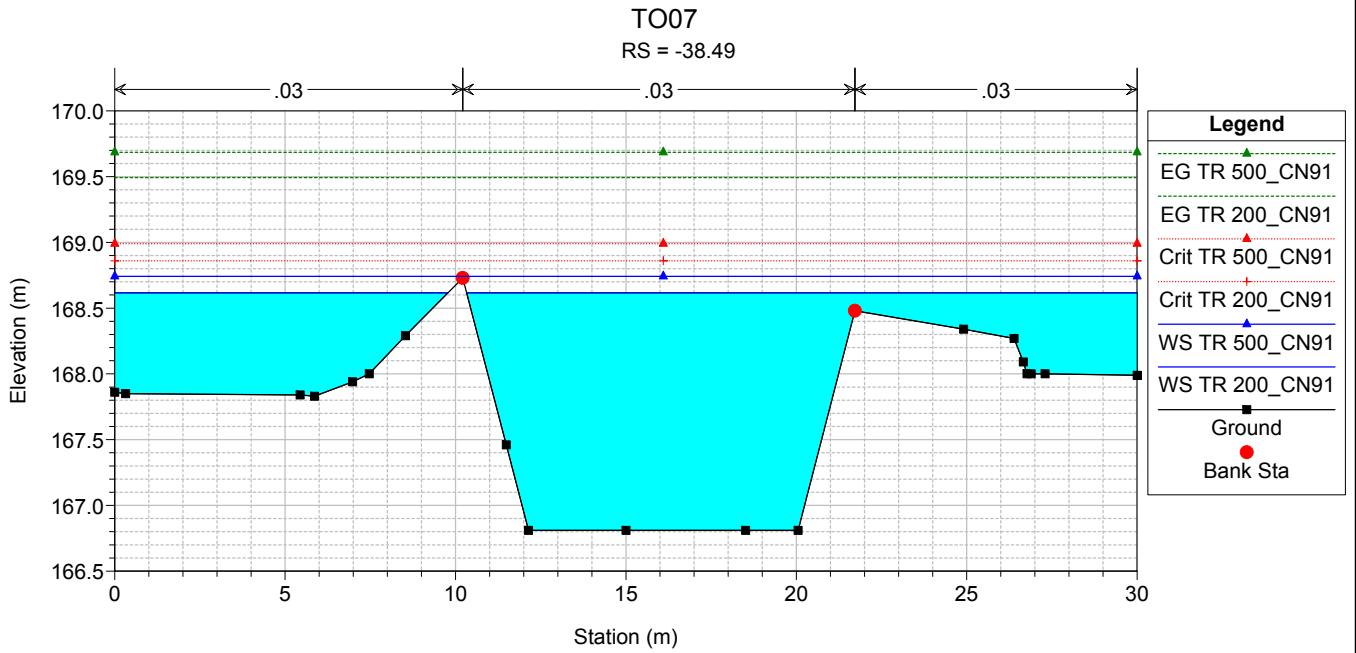
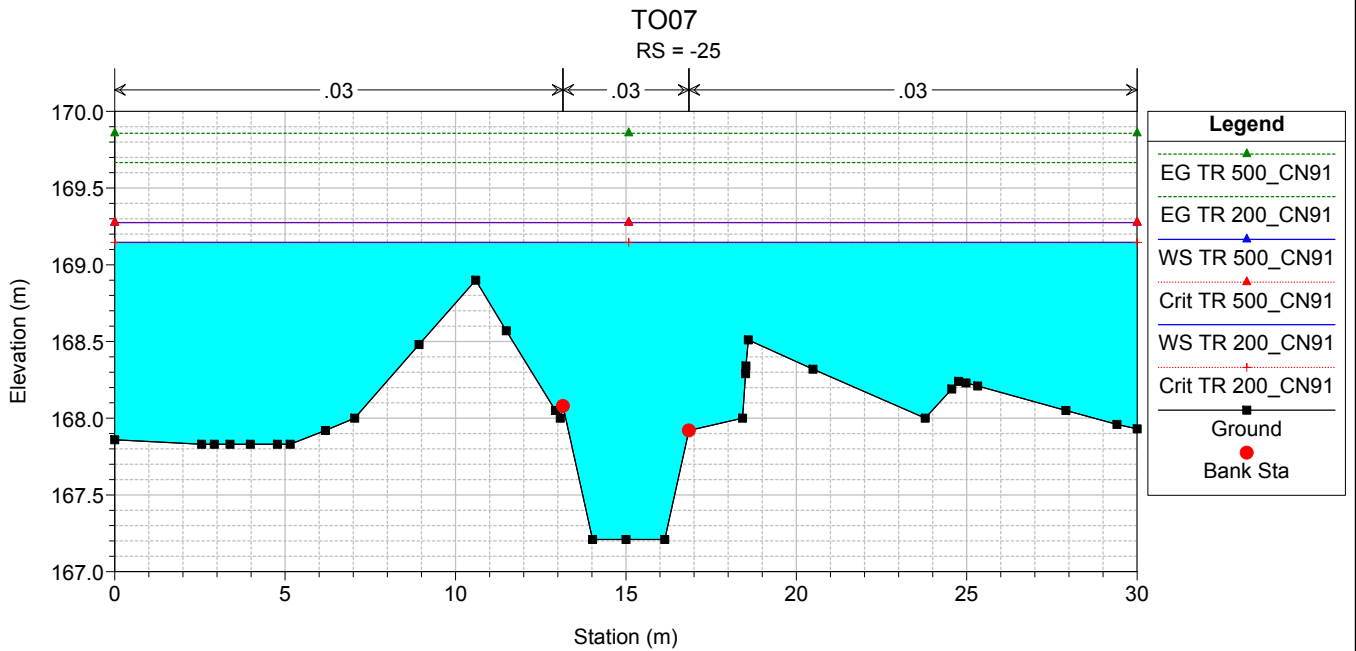
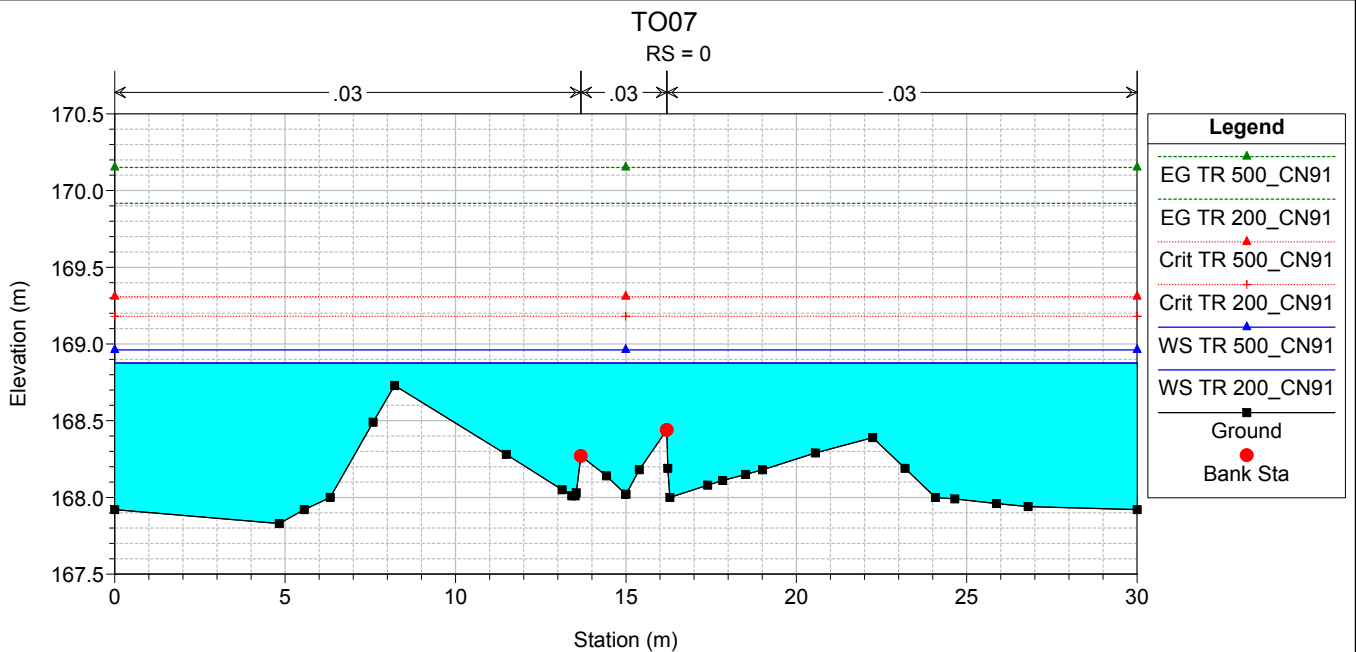

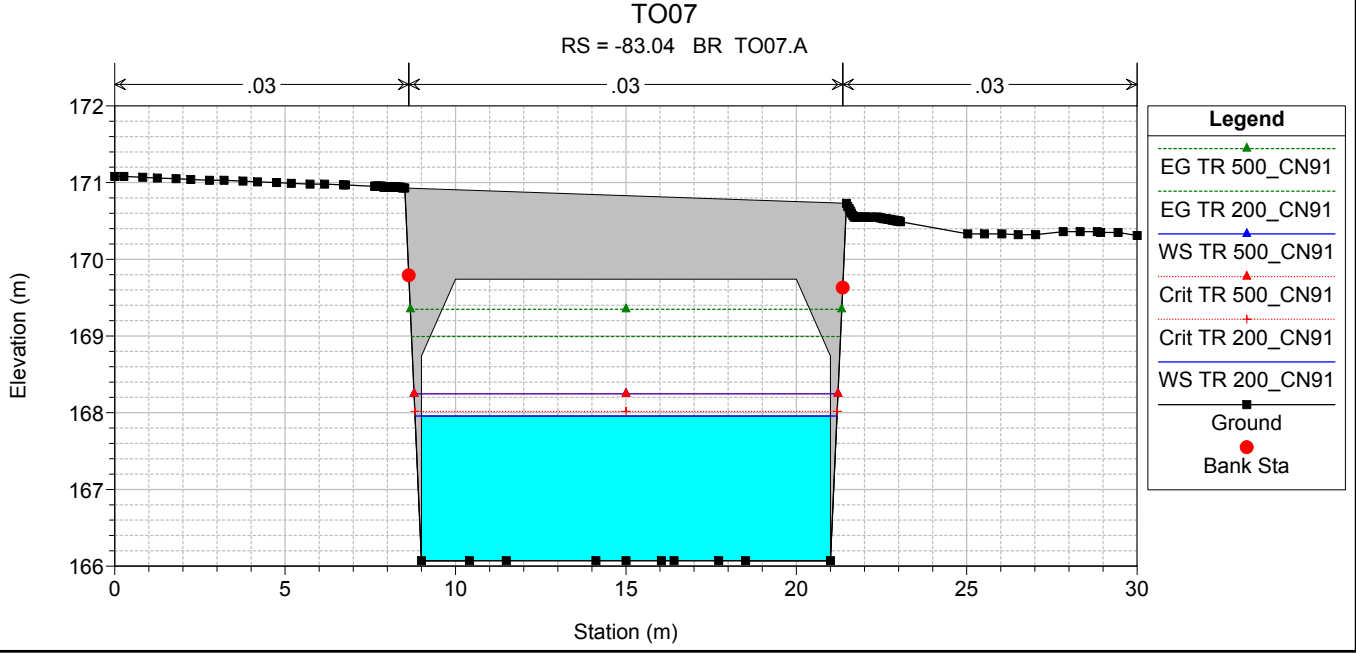
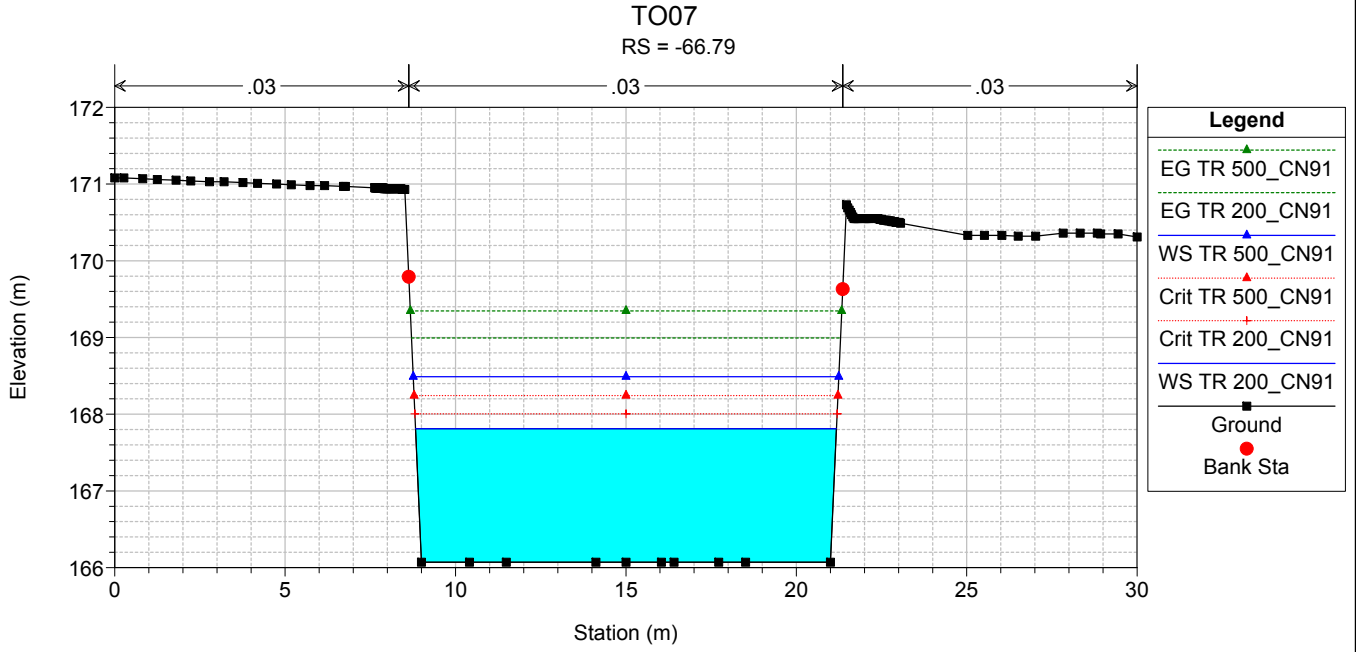
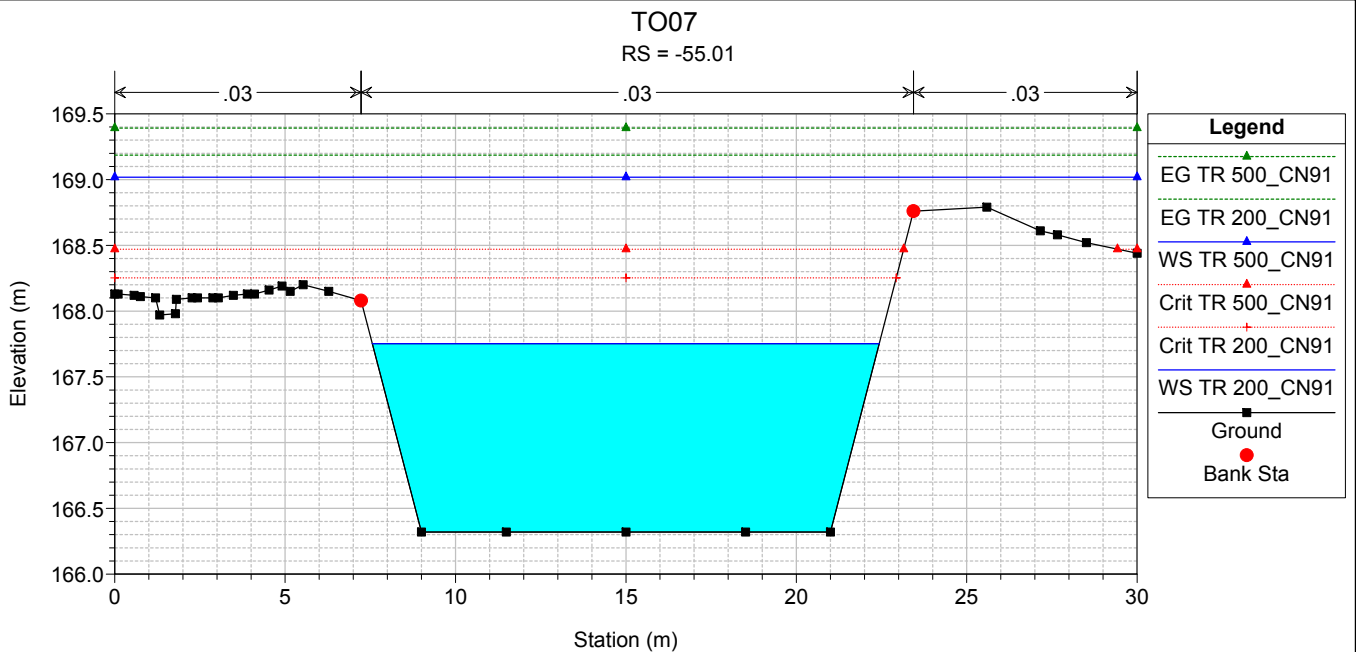

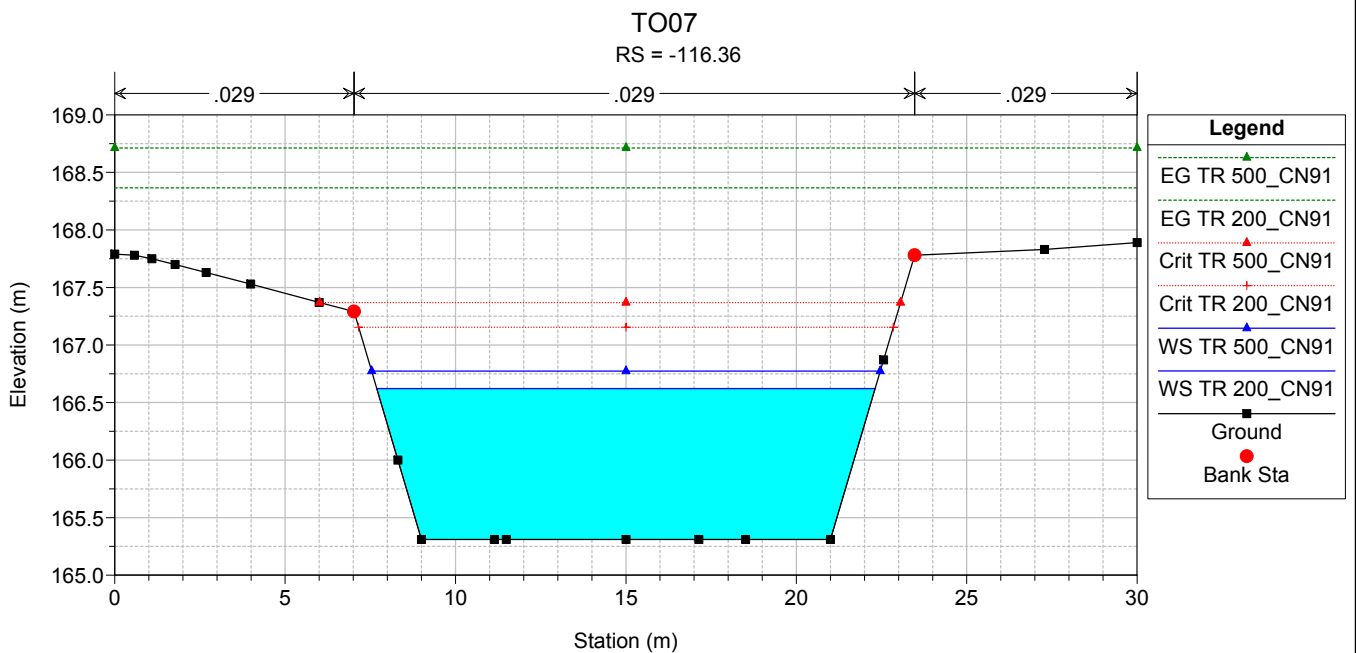
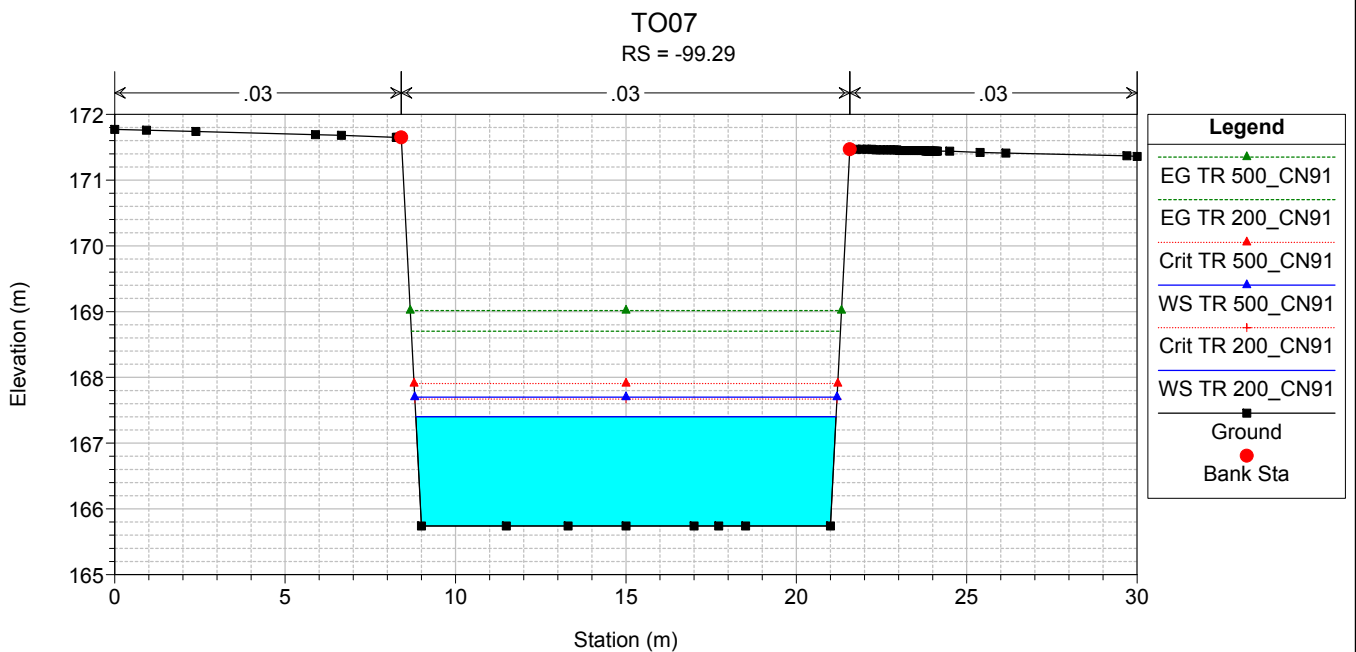
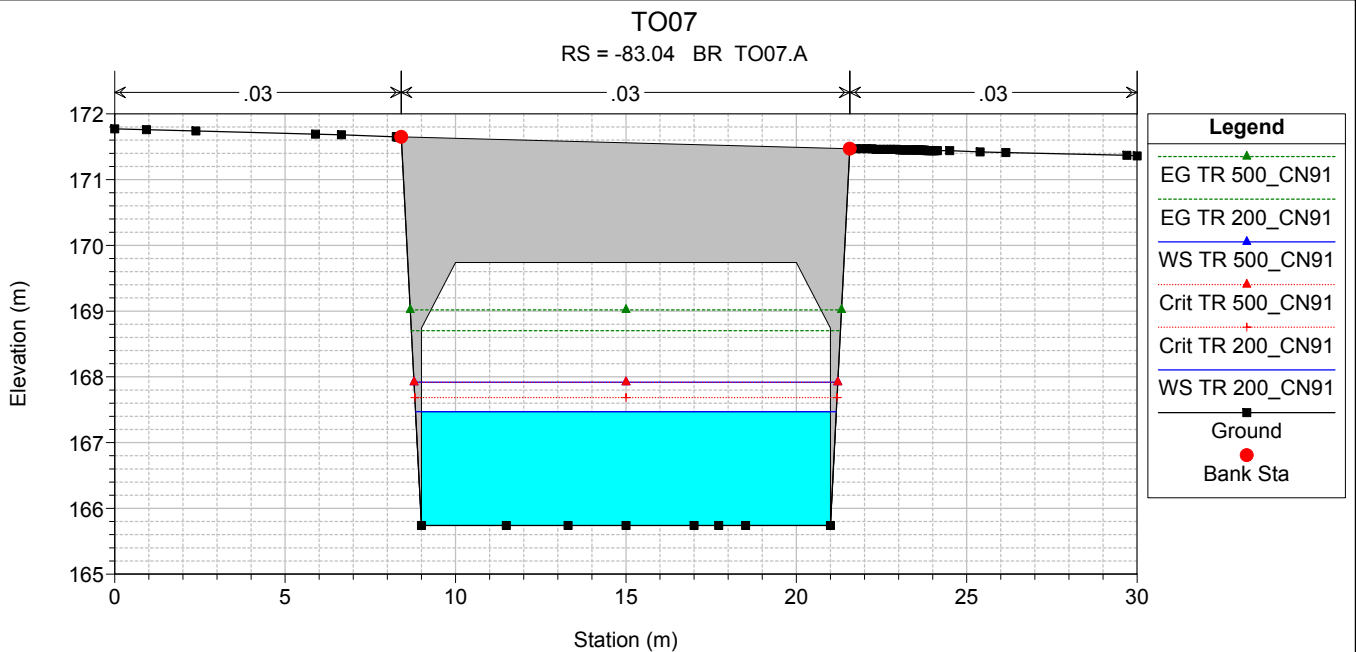

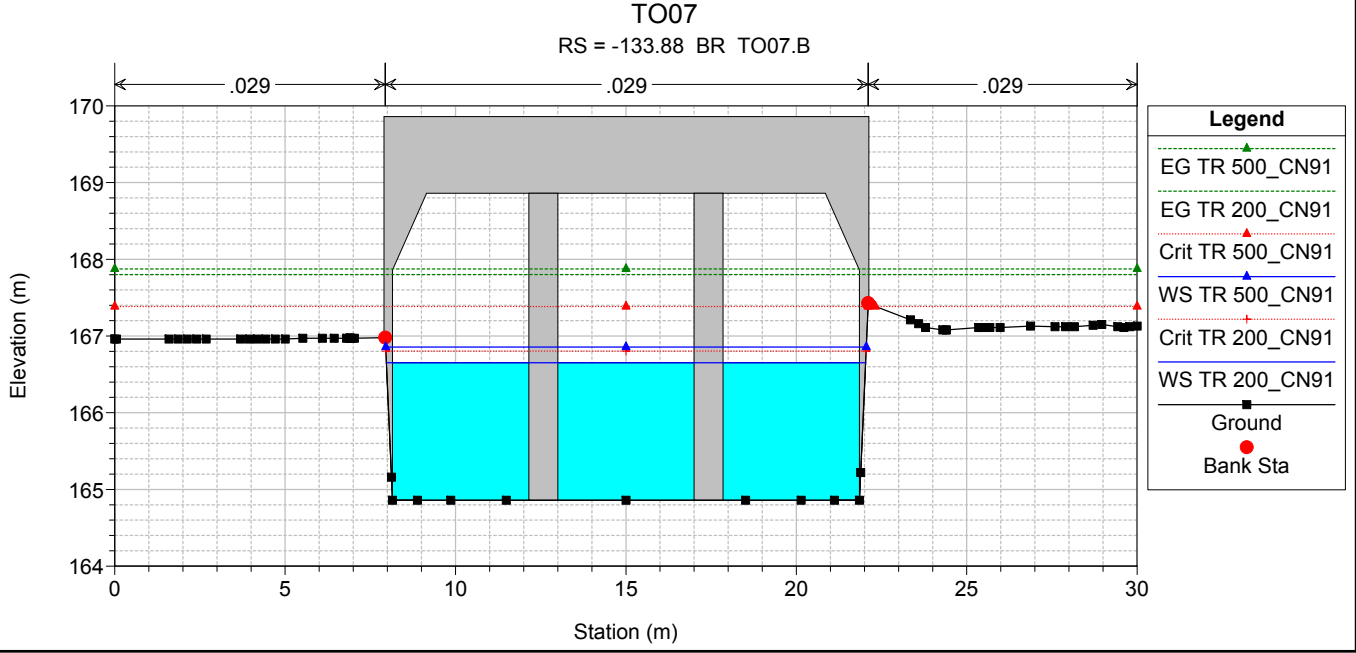
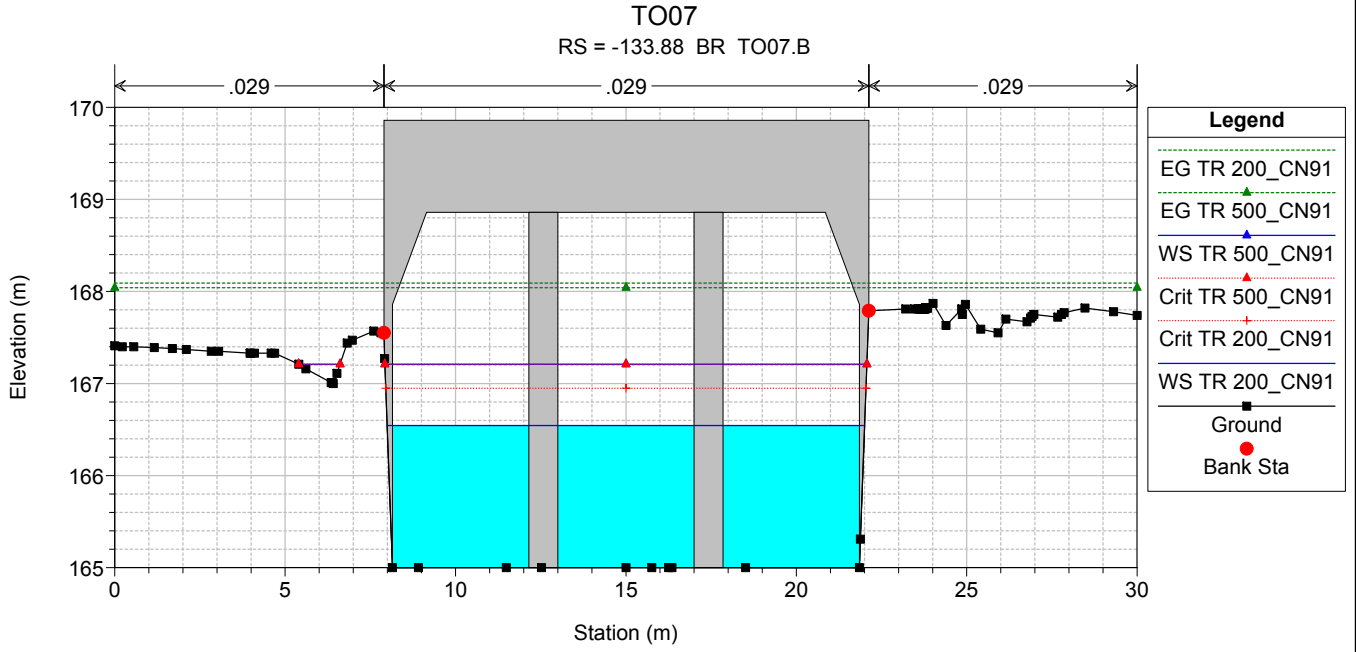
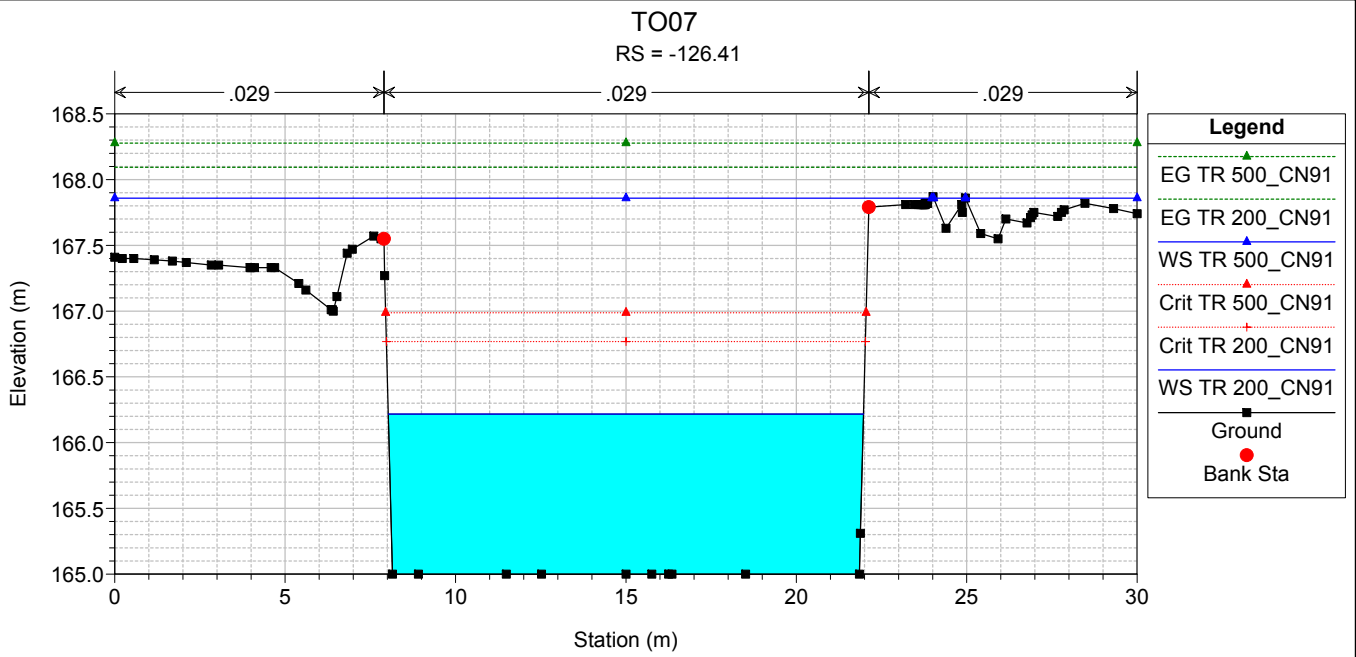

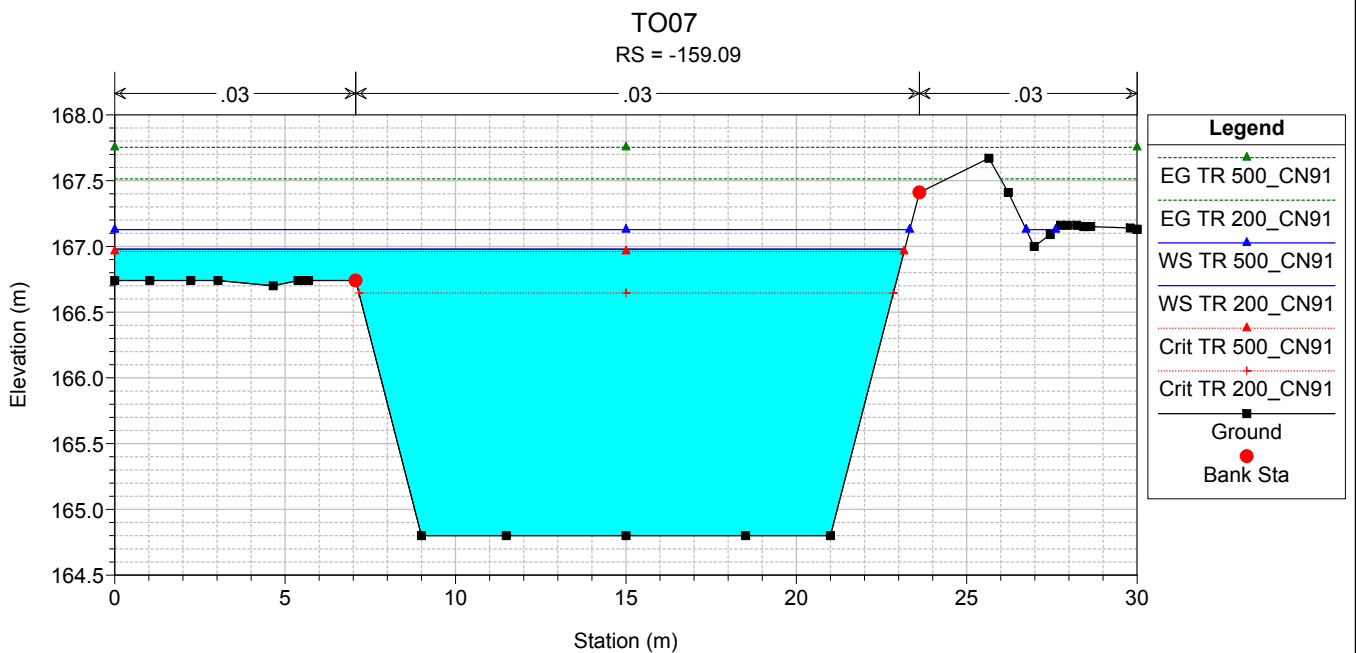
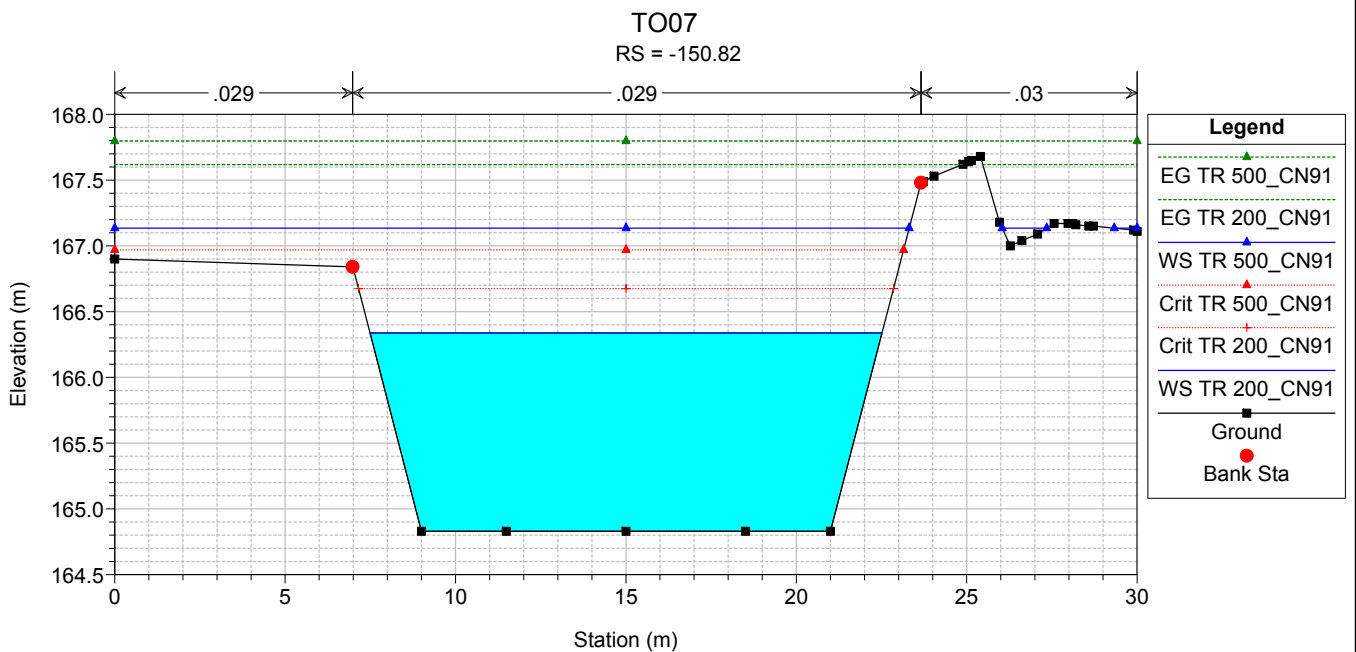
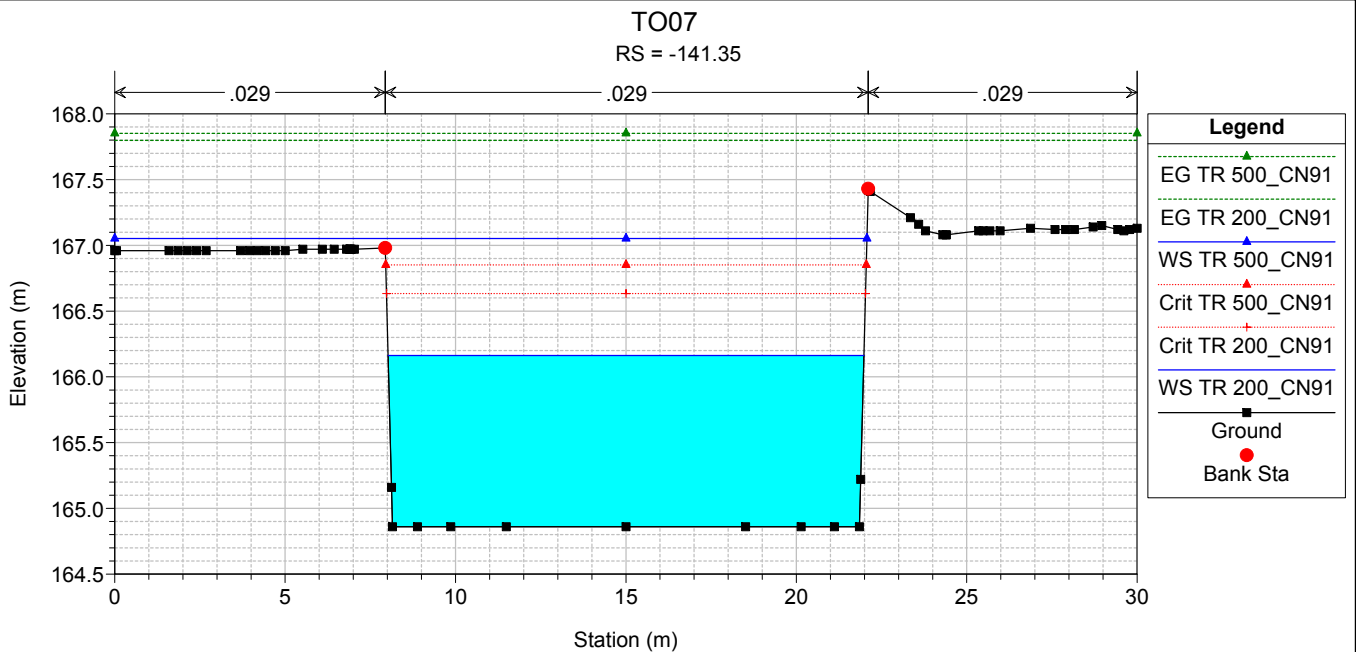

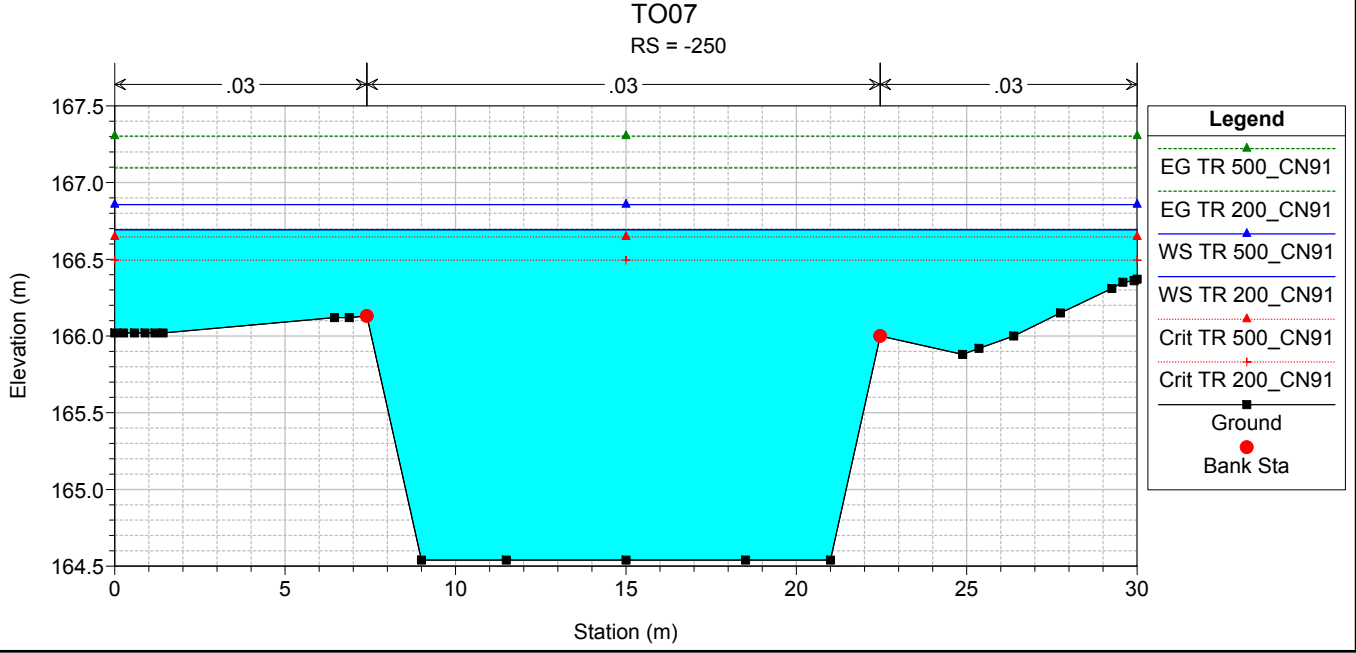
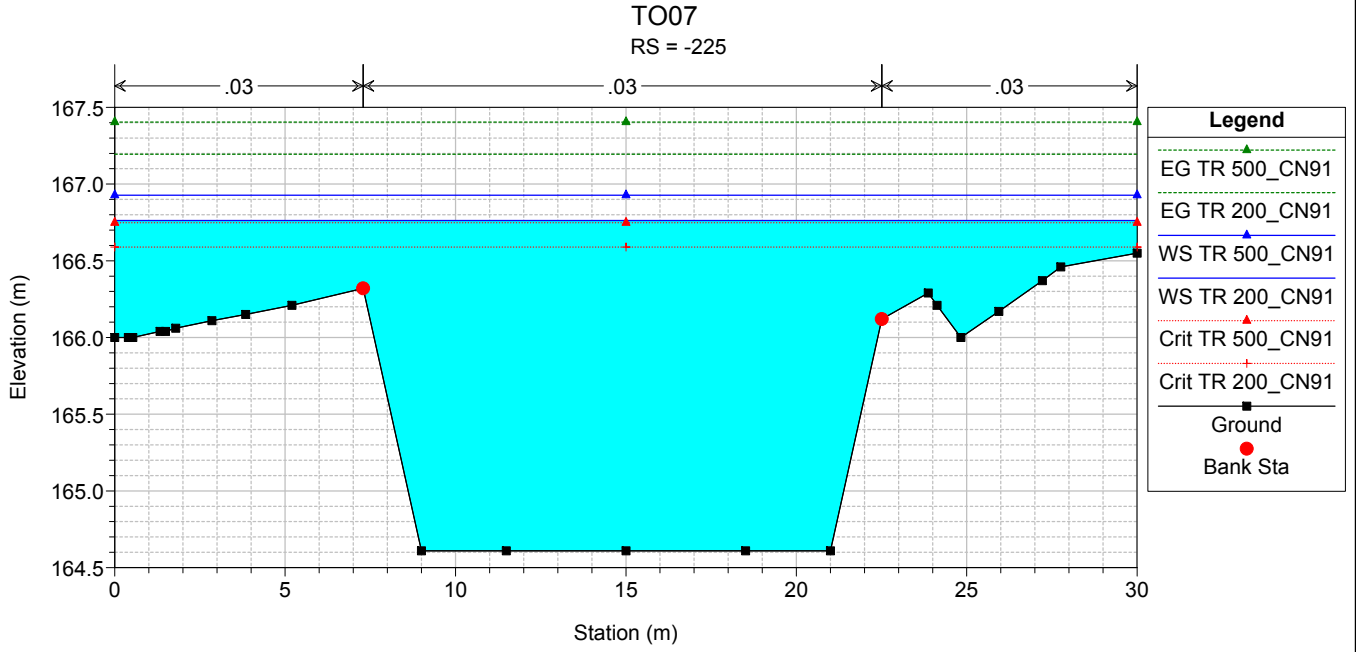
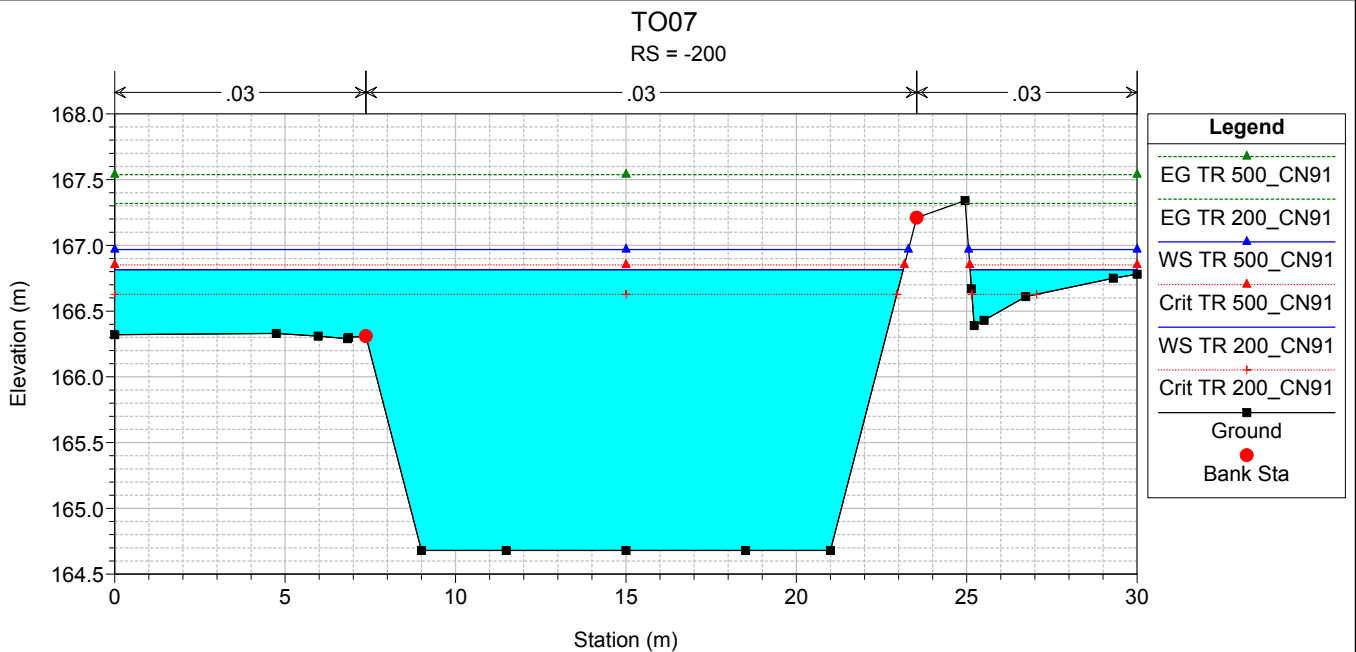

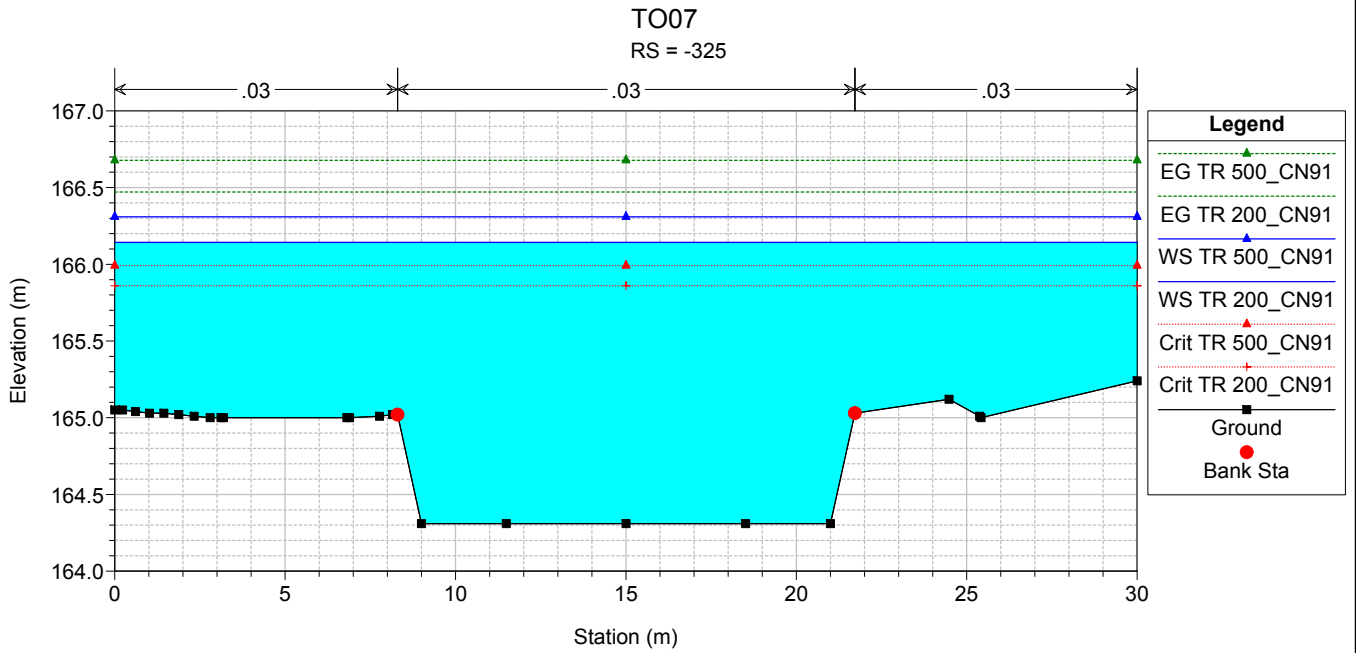
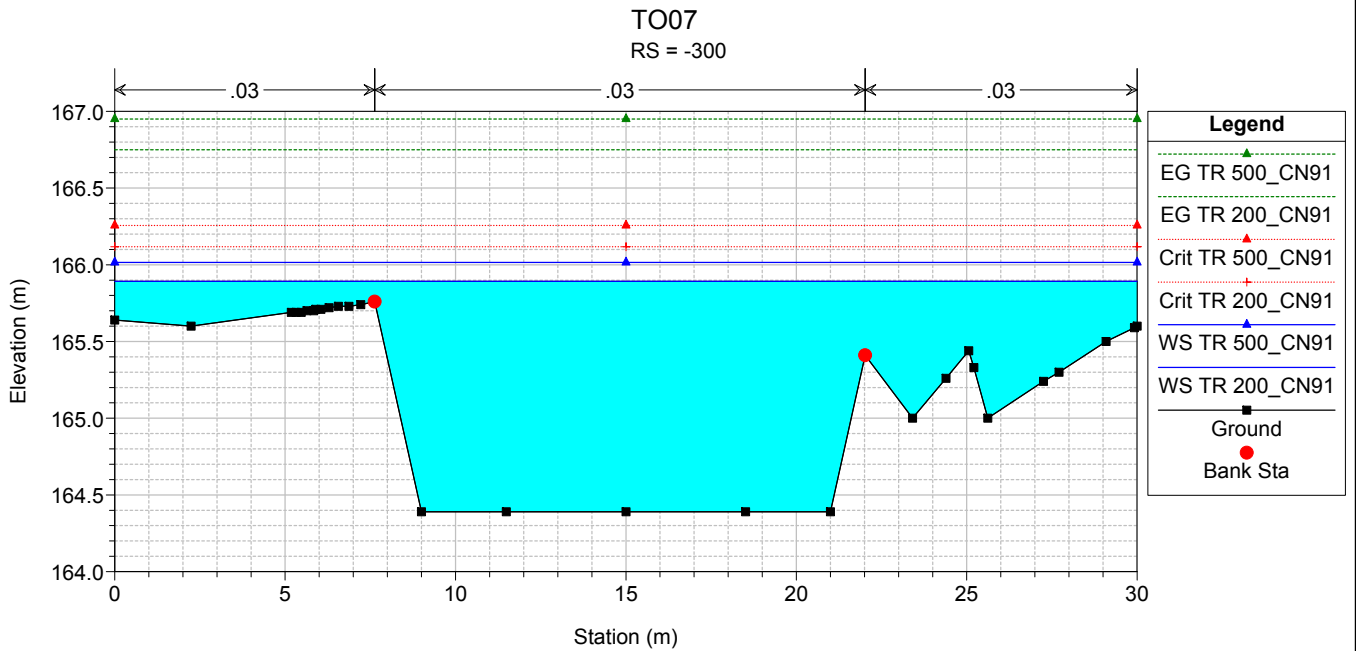
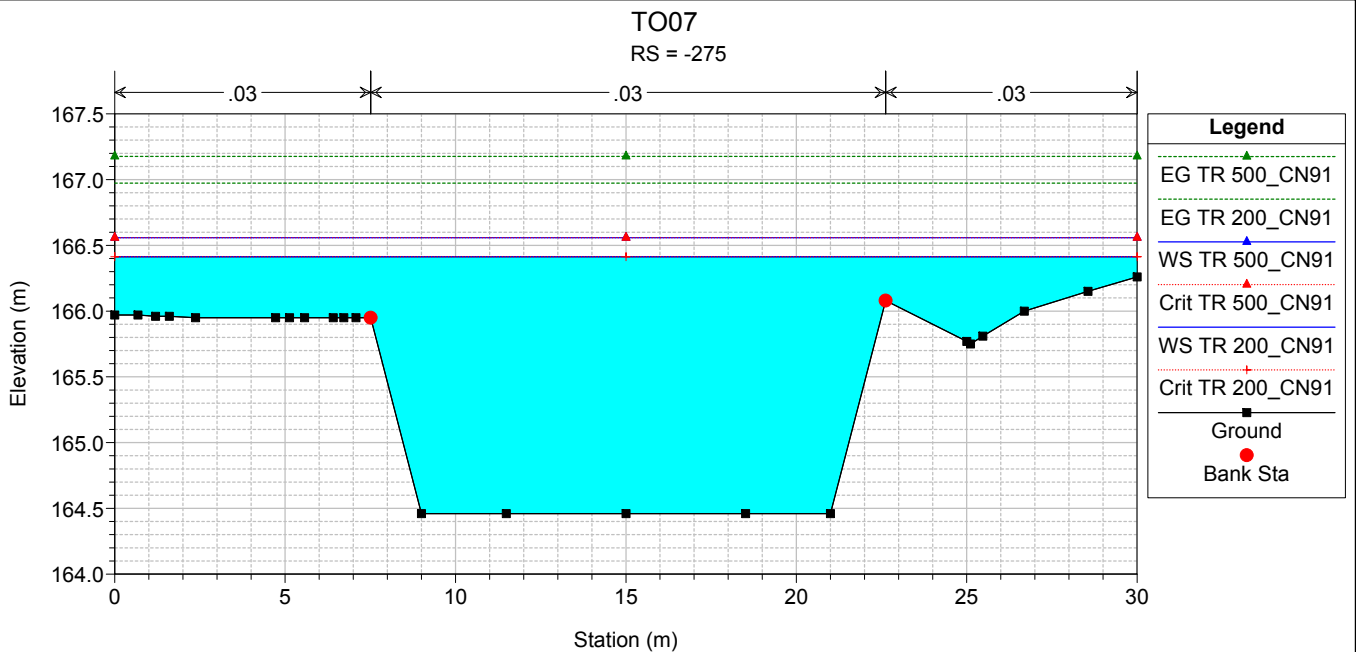

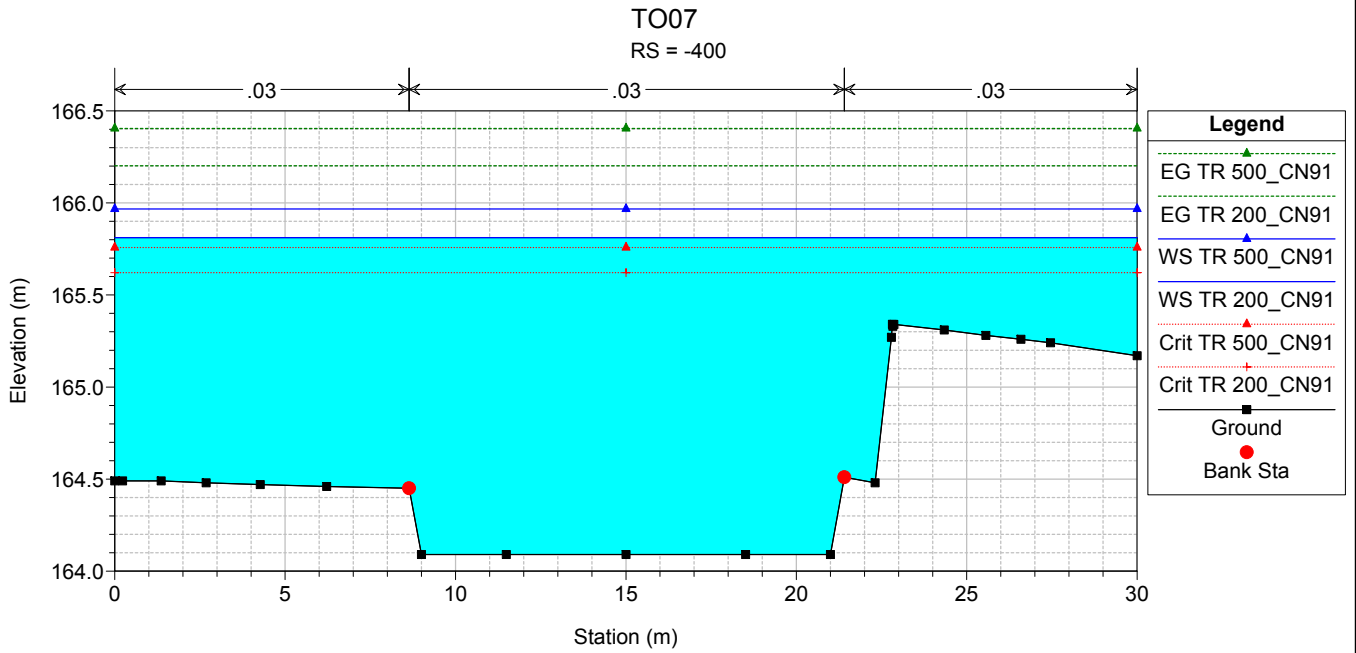
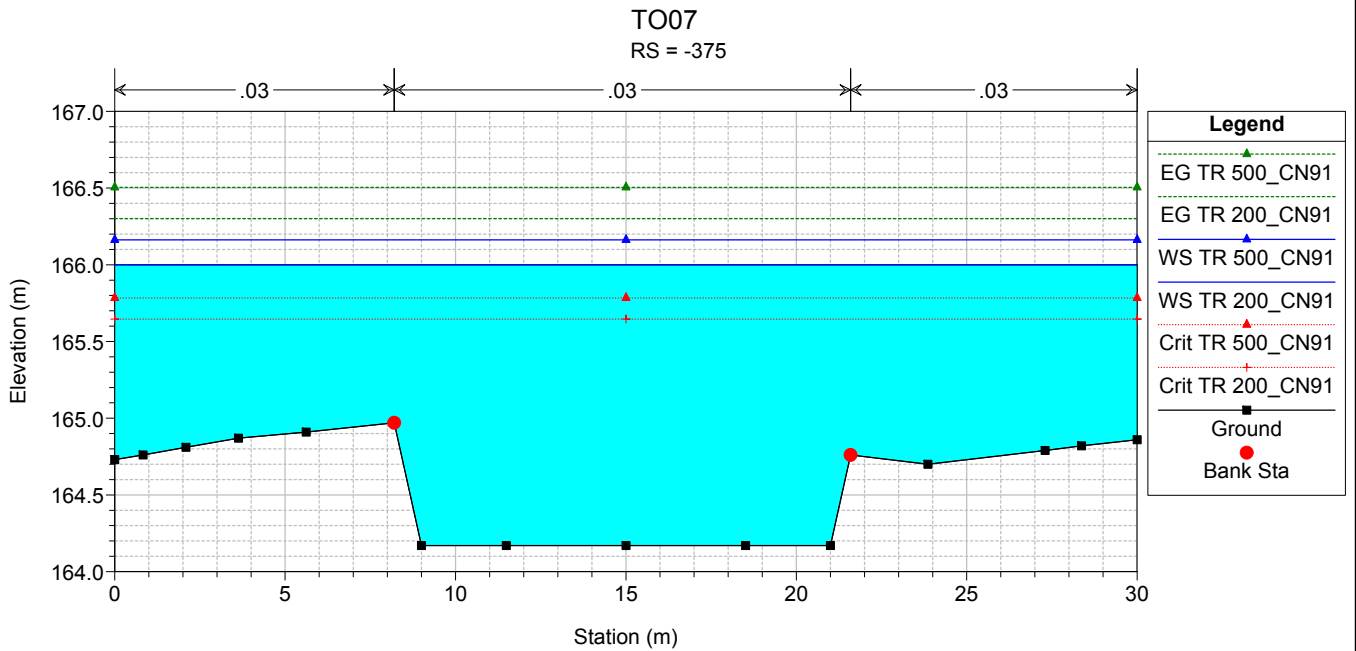
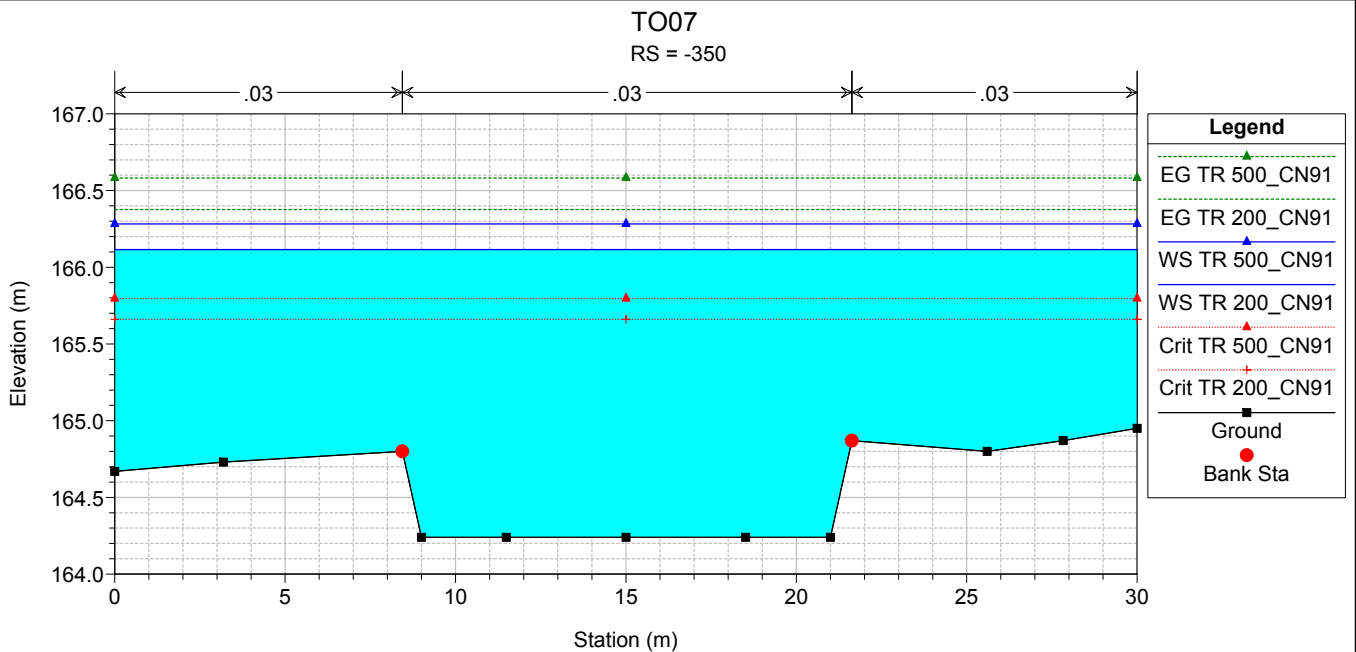

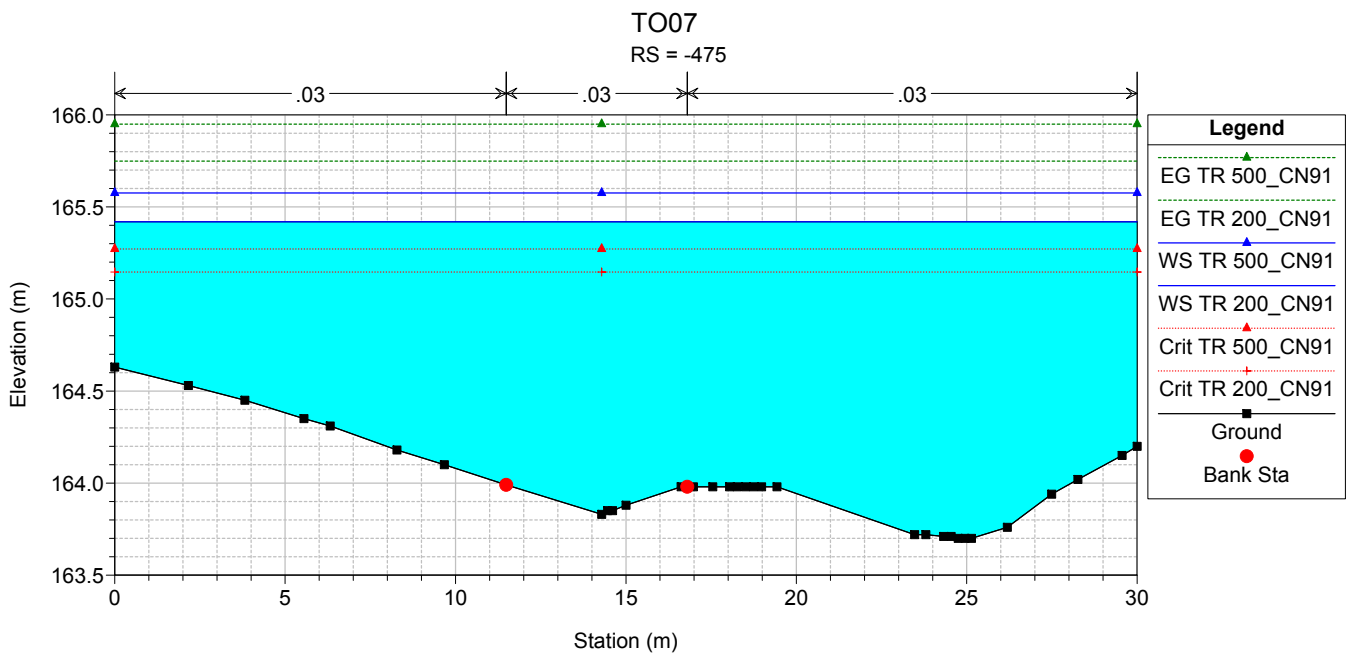
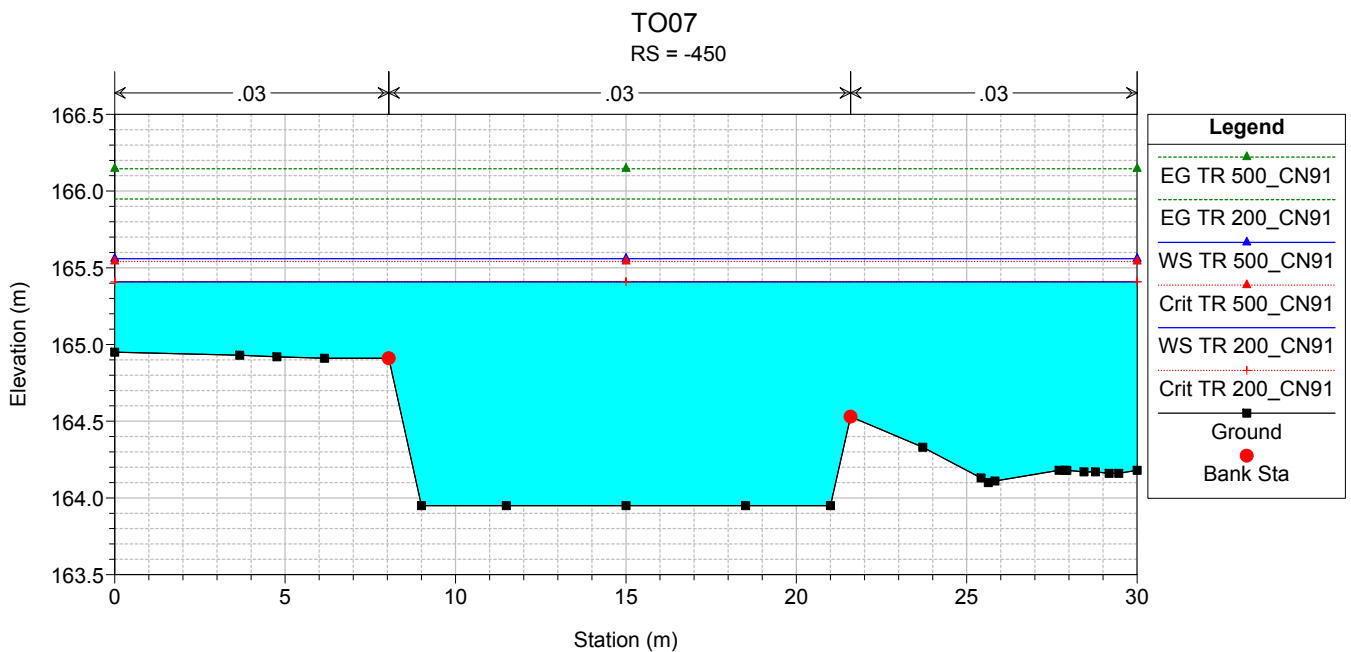
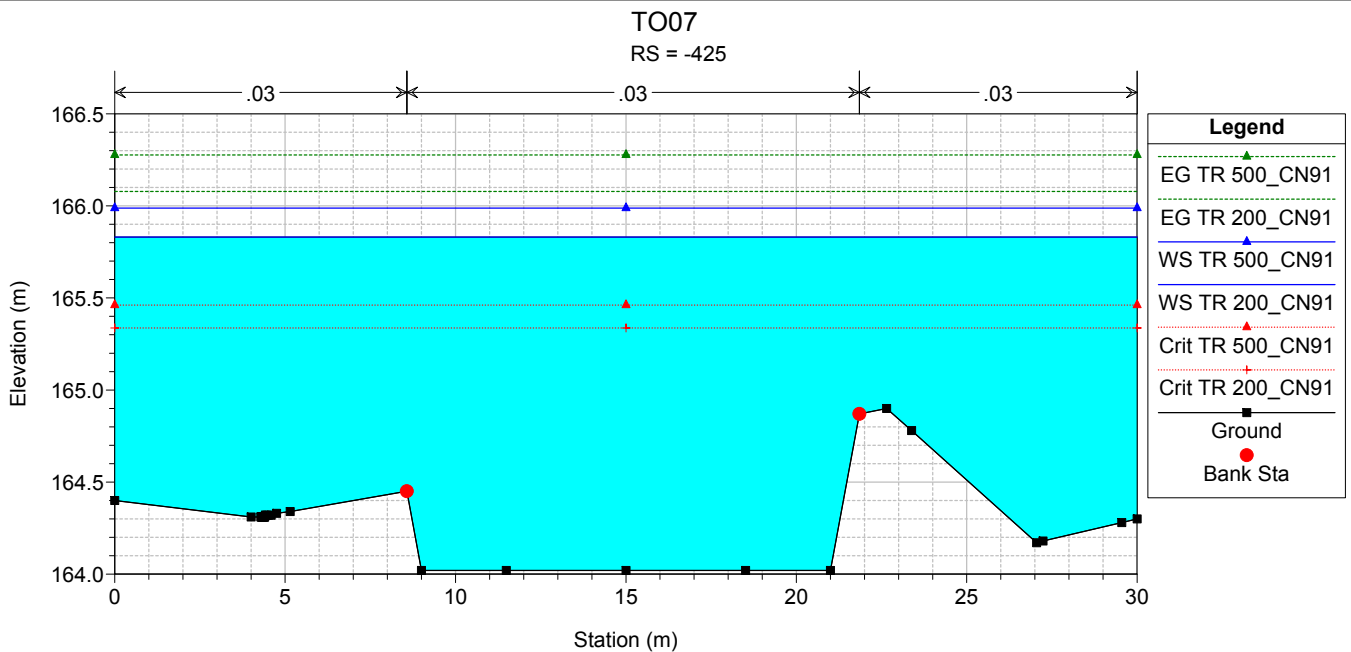

ALLEGATO 2.8

Interferenza idraulica - TO08
Tabella riassuntiva dei risultati, profilo idrico e sezioni
trasversali con i livelli idrici (TR 200 - 500 anni)

Reach	River Sta	Profile	Q Total (m ³ /s)	Min Ch El (m)	Max Chl Dpth (m)	W.S. Elev (m)	Crit W.S. (m)	Diff	Froude # Chl	E.G. Elev (m)	Vel Chnl (m/s)	Vel Total (m/s)	Hydr Radius C (m)	Shear Chan (N/m ²)	Hydr Depth (m)
TO08	0	TR 200_CN91	27.9	167.55	0.54	168.09	168.30	-0.21	2.26	168.91	4.6	3.6	0.4	252.4	0.26
TO08	-46.59	TR 200_CN91	27.9	164.79	1.35	166.14	165.59	0.55	0.44	166.27	1.5	1.5	1.1	20.1	1.23
TO08	-50.04	TR 200_CN91	27.9	164.60	1.56	166.16	165.40	0.76	0.36	166.25	1.3	1.3	1.3	14.1	1.40
TO08	-53.29	TR 200_CN91	27.9	164.42	1.56	165.98	165.49	0.49	0.56	166.23	2.2	2.2	1.1	40.4	1.53
TO08	-56.94	Bridge													
TO08	-60.59	TR 200_CN91	27.9	164.39	1.54	165.93	165.46	0.47	0.58	166.18	2.2	2.2	1.1	42.0	1.51
TO08	-64.65	TR 200_CN91	27.9	164.37	1.67	166.04	165.17	0.87	0.32	166.12	1.2	1.2	1.4	11.8	1.49
TO08	-69.54	TR 200_CN91	27.9	164.34	1.70	166.04	165.14	0.90	0.31	166.11	1.2	1.2	1.4	11.3	1.51
TO08	-72.03	TR 200_CN91	27.9	164.33	1.71	166.04	165.13	0.91	0.31	166.11	1.2	1.2	1.4	11.2	1.52
TO08	-78.71	TR 200_CN91	27.9	164.29	1.54	165.83	165.36	0.47	0.57	166.08	2.2	2.2	1.1	41.6	1.51
TO08	-93.61	Bridge													
TO08	-108.51	TR 200_CN91	27.9	164.15	0.82	164.97	165.22	-0.25	1.50	165.88	4.2	4.2	0.7	179.2	0.81
TO08	-119.78	TR 200_CN91	27.9	164.13	1.20	165.33	165.19	0.14	0.83	165.74	2.8	2.8	0.9	72.3	1.18
TO08	-123.5	Bridge													
TO08	-127.21	TR 200_CN91	27.9	164.05	0.98	165.03	165.12	-0.09	1.14	165.66	3.5	3.5	0.8	117.8	0.97
TO08	-132	TR 200_CN91	27.9	164.03	0.51	164.54	164.83	-0.29	1.98	165.51	4.4	4.4	0.5	214.6	0.49
TO08	-142.48	TR 200_CN91	27.9	163.99	1.04	165.03	164.79	0.24	0.66	165.25	2.0	2.0	0.9	38.2	0.97
TO08	-161.1	TR 200_CN91	27.9	163.91	1.05	164.96	164.71	0.25	0.66	165.17	2.0	2.0	0.9	38.1	0.97
TO08	-193.82	TR 200_CN91	27.9	163.77	1.04	164.81	164.57	0.24	0.66	165.03	2.0	2.0	0.9	38.1	0.97
TO08	-223	TR 200_CN91	27.9	163.65	1.03	164.68	164.45	0.23	0.68	164.90	2.1	2.1	0.9	39.3	0.96
TO08	-248	TR 200_CN91	27.9	163.54	1.03	164.57	164.34	0.23	0.68	164.79	2.1	2.1	0.9	39.7	0.95
TO08	-273	TR 200_CN91	27.9	163.43	1.02	164.45	164.23	0.22	0.69	164.67	2.1	2.1	0.9	40.7	0.94
TO08	-298	TR 200_CN91	27.9	163.33	0.93	164.26	164.13	0.13	0.80	164.53	2.3	2.3	0.8	50.9	0.87
TO08	-323	TR 200_CN91	27.9	163.22	0.98	164.20	164.11	0.09	0.65	164.38	2.0	1.7	0.9	35.4	0.55

HEC-RAS Plan: TO08_POST River: TO08 Reach: TO08 Profile: TR 500_CN91

Reach	River Sta	Profile	Q Total (m ³ /s)	Min Ch El (m)	Max Chl Dpth (m)	W.S. Elev (m)	Crit W.S. (m)	Diff	Froude # Chl	E.G. Elev (m)	Vel Chnl (m/s)	Vel Total (m/s)	Hydr Radius C (m)	Shear Chan (N/m ²)	Hydr Depth (m)
TO08	0	TR 500_CN91	33.2	167.55	0.57	168.12	168.35	-0.23	2.29	169.02	4.9	3.8	0.5	271.8	0.29
TO08	-46.59	TR 500_CN91	33.2	164.79	1.58	166.37	165.69	0.68	0.42	166.49	1.5	1.5	1.3	19.4	1.42
TO08	-50.04	TR 500_CN91	33.2	164.60	1.79	166.39	165.49	0.90	0.34	166.48	1.3	1.3	1.4	14.2	1.58
TO08	-53.29	TR 500_CN91	33.2	164.42	1.77	166.19	165.62	0.57	0.56	166.46	2.3	2.3	1.2	43.4	1.73
TO08	-56.94	Bridge													
TO08	-60.59	TR 500_CN91	33.2	164.39	1.74	166.13	165.59	0.54	0.57	166.41	2.3	2.3	1.2	44.7	1.70
TO08	-64.65	TR 500_CN91	33.2	164.37	1.89	166.26	165.26	1.00	0.31	166.34	1.3	1.3	1.5	12.3	1.66
TO08	-69.54	TR 500_CN91	33.2	164.34	1.92	166.26	165.23	1.03	0.31	166.34	1.2	1.2	1.5	11.8	1.69
TO08	-72.03	TR 500_CN91	33.2	164.33	1.93	166.26	165.22	1.04	0.30	166.34	1.2	1.2	1.5	11.7	1.69
TO08	-78.71	TR 500_CN91	33.2	164.29	1.74	166.03	165.49	0.54	0.57	166.31	2.3	2.3	1.2	45.0	1.70
TO08	-93.61	Bridge													
TO08	-108.51	TR 500_CN91	33.2	164.15	0.91	165.06	165.35	-0.29	1.51	166.09	4.5	4.5	0.8	195.6	0.90
TO08	-119.78	TR 500_CN91	33.2	164.13	1.35	165.48	165.32	0.16	0.83	165.94	3.0	3.0	1.0	78.2	1.33
TO08	-123.5	Bridge													
TO08	-127.21	TR 500_CN91	33.2	164.05	1.09	165.14	165.25	-0.11	1.15	165.86	3.7	3.7	0.9	129.6	1.08
TO08	-132	TR 500_CN91	33.2	164.03	0.57	164.60	164.92	-0.32	2.02	165.70	4.7	4.7	0.5	237.1	0.54
TO08	-142.48	TR 500_CN91	33.2	163.99	1.16	165.15	164.88	0.27	0.67	165.39	2.2	2.2	1.0	41.9	1.07
TO08	-161.1	TR 500_CN91	33.2	163.91	1.16	165.07	164.80	0.27	0.67	165.31	2.2	2.2	1.0	41.8	1.07
TO08	-193.82	TR 500_CN91	33.2	163.77	1.16	164.93	164.66	0.27	0.67	165.17	2.2	2.2	1.0	42.0	1.06
TO08	-223	TR 500_CN91	33.2	163.65	1.14	164.79	164.54	0.25	0.69	165.04	2.2	2.2	1.0	43.2	1.05
TO08	-248	TR 500_CN91	33.2	163.54	1.14	164.68	164.43	0.25	0.69	164.93	2.2	2.2	1.0	43.8	1.05
TO08	-273	TR 500_CN91	33.2	163.43	1.13	164.56	164.32	0.24	0.70	164.81	2.2	2.2	1.0	45.0	1.04
TO08	-298	TR 500_CN91	33.2	163.33	0.97	164.30	164.22	0.08	0.88	164.66	2.6	2.6	0.9	64.4	0.90
TO08	-323	TR 500_CN91	33.2	163.22	1.06	164.28	164.19	0.09	0.66	164.47	2.1	1.8	1.0	38.4	0.63

TO08

TO08 TO08

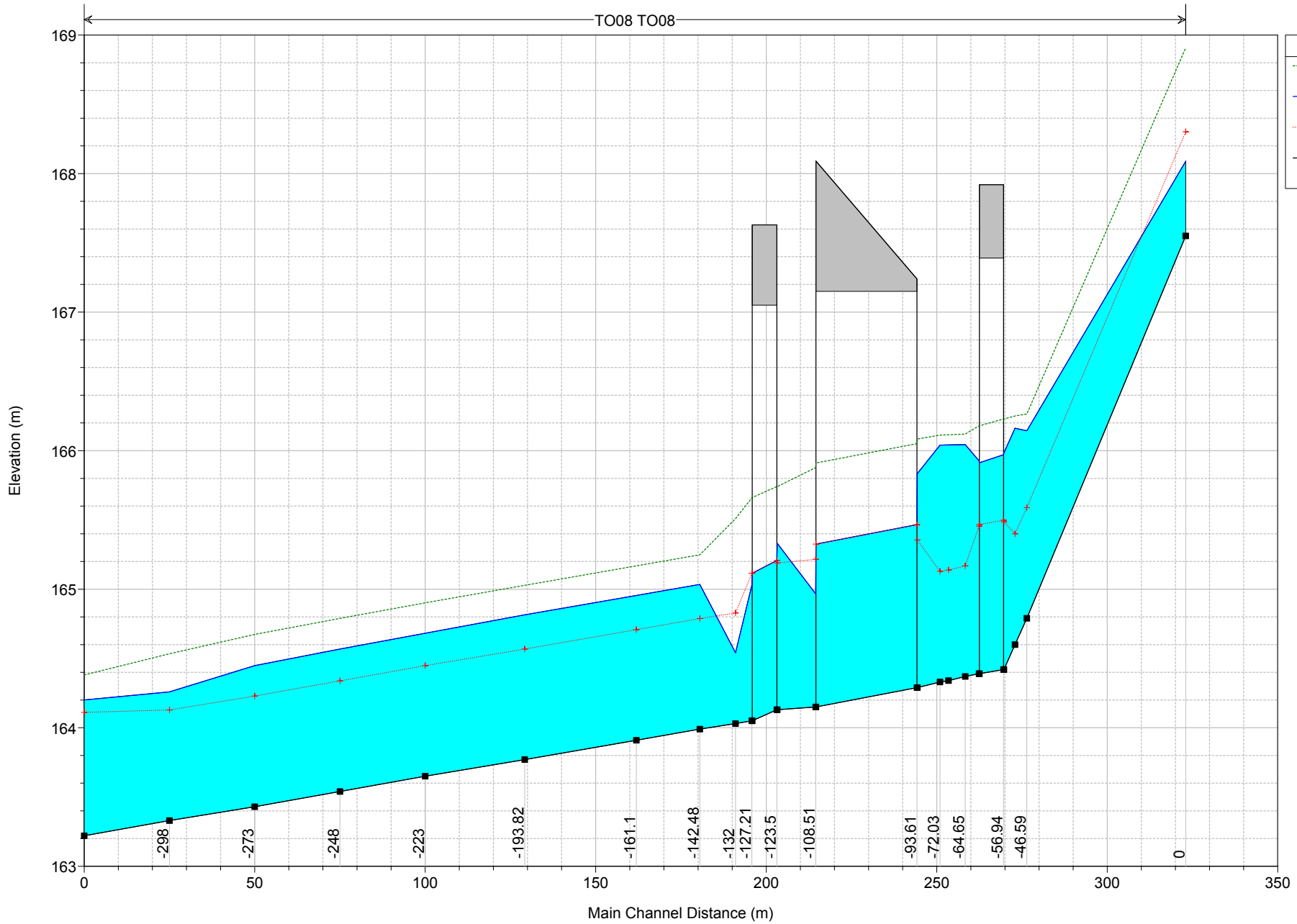

Legend

- EG TR 200_CN91
- WS TR 200_CN91
- Crit TR 200_CN91
- Ground

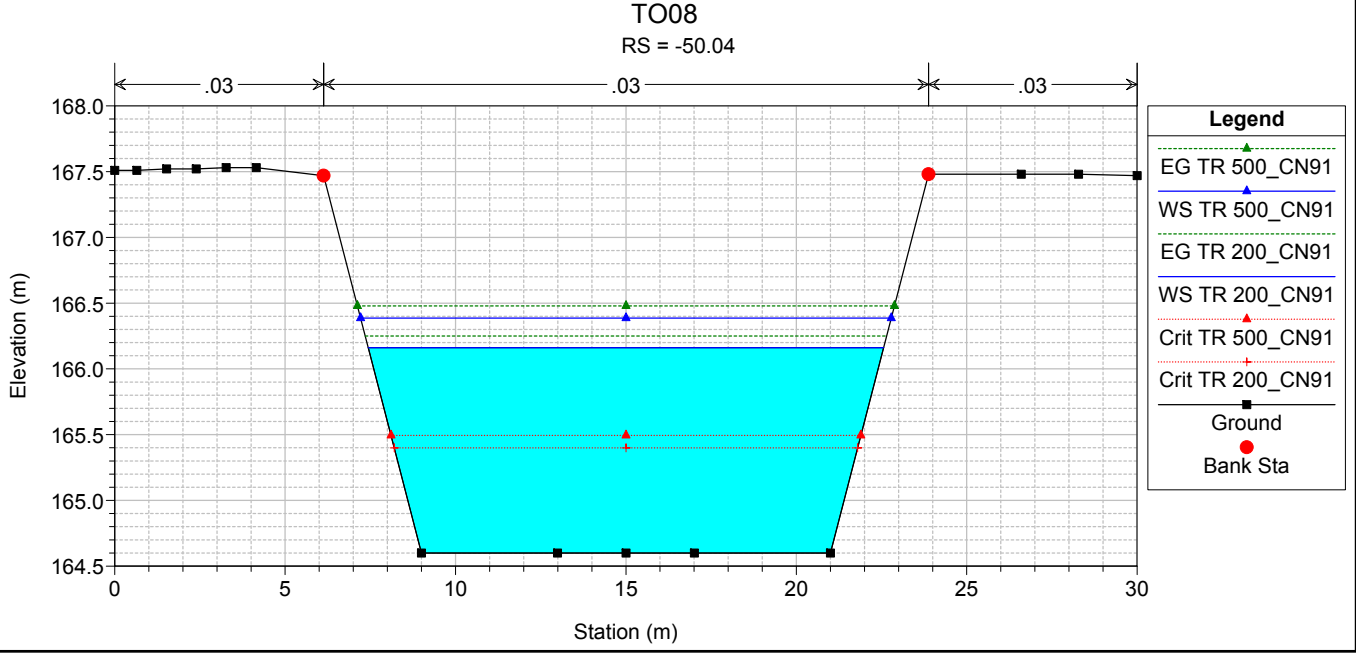
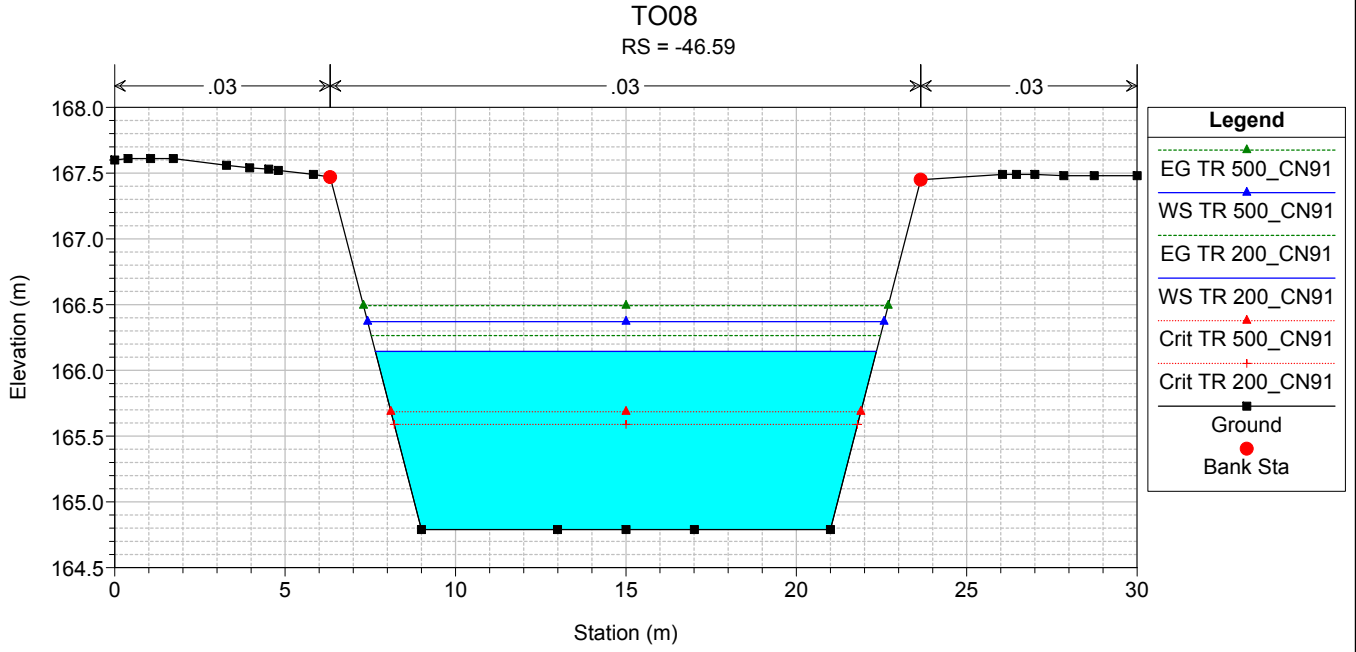
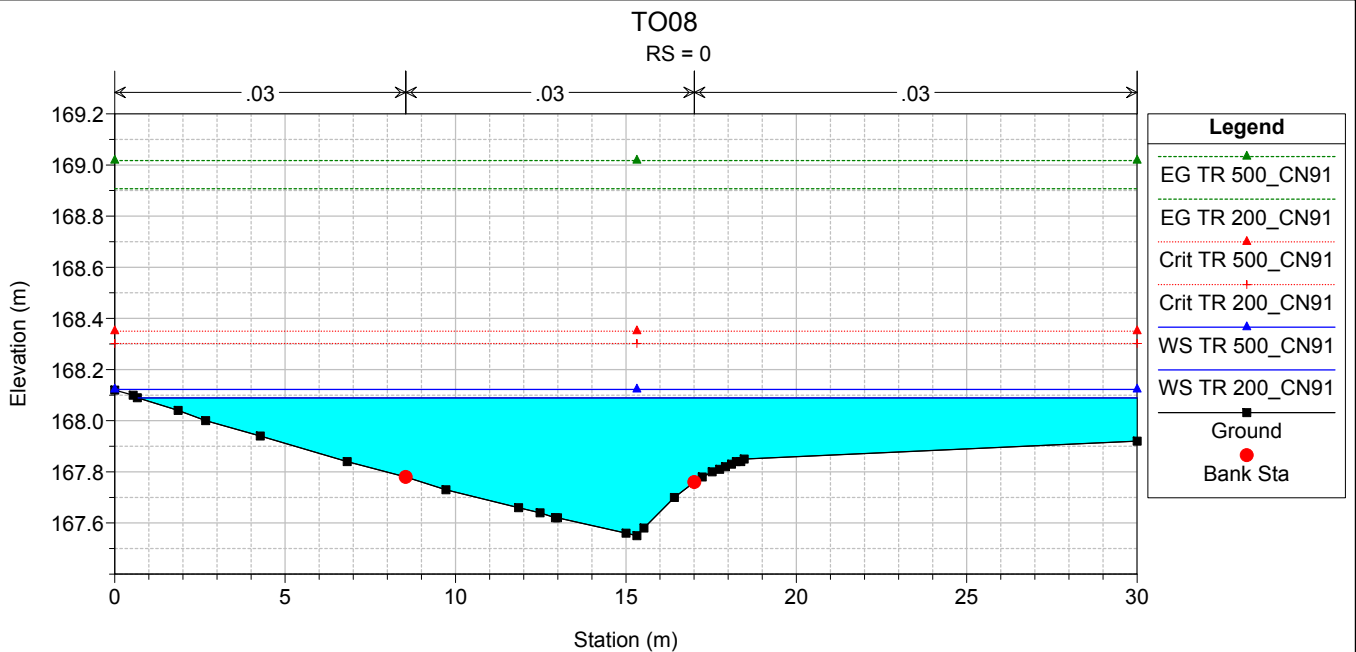

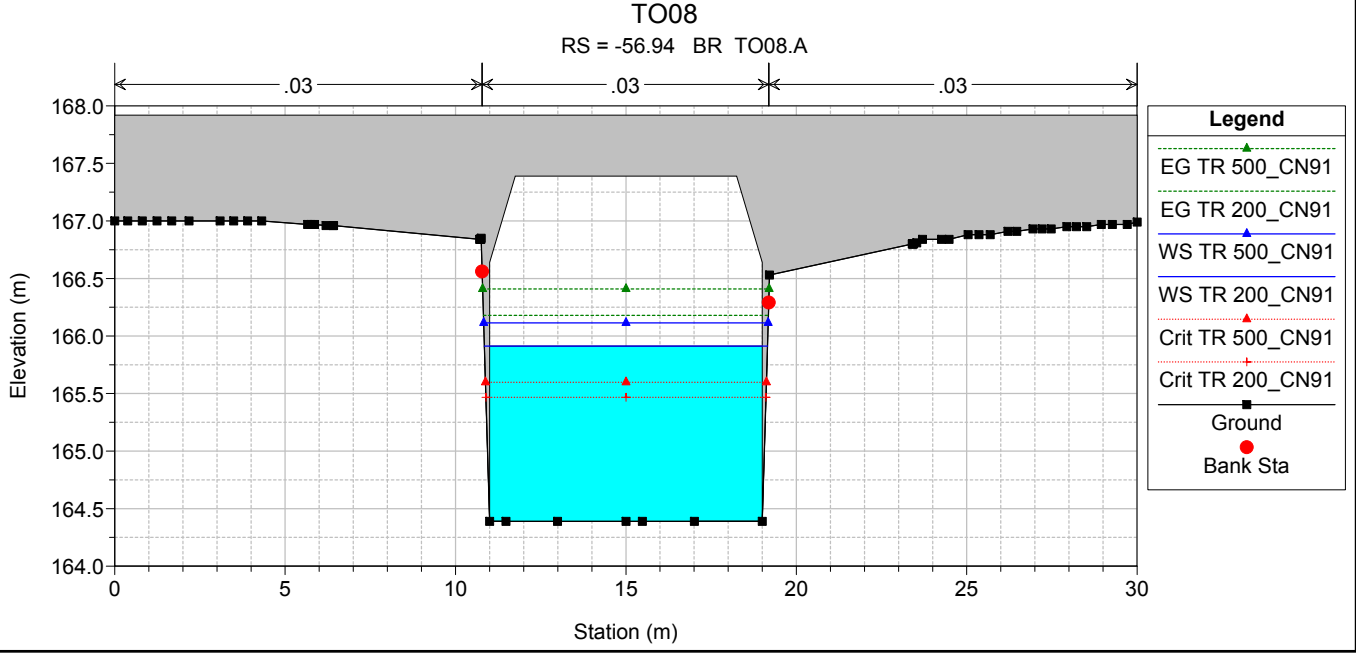
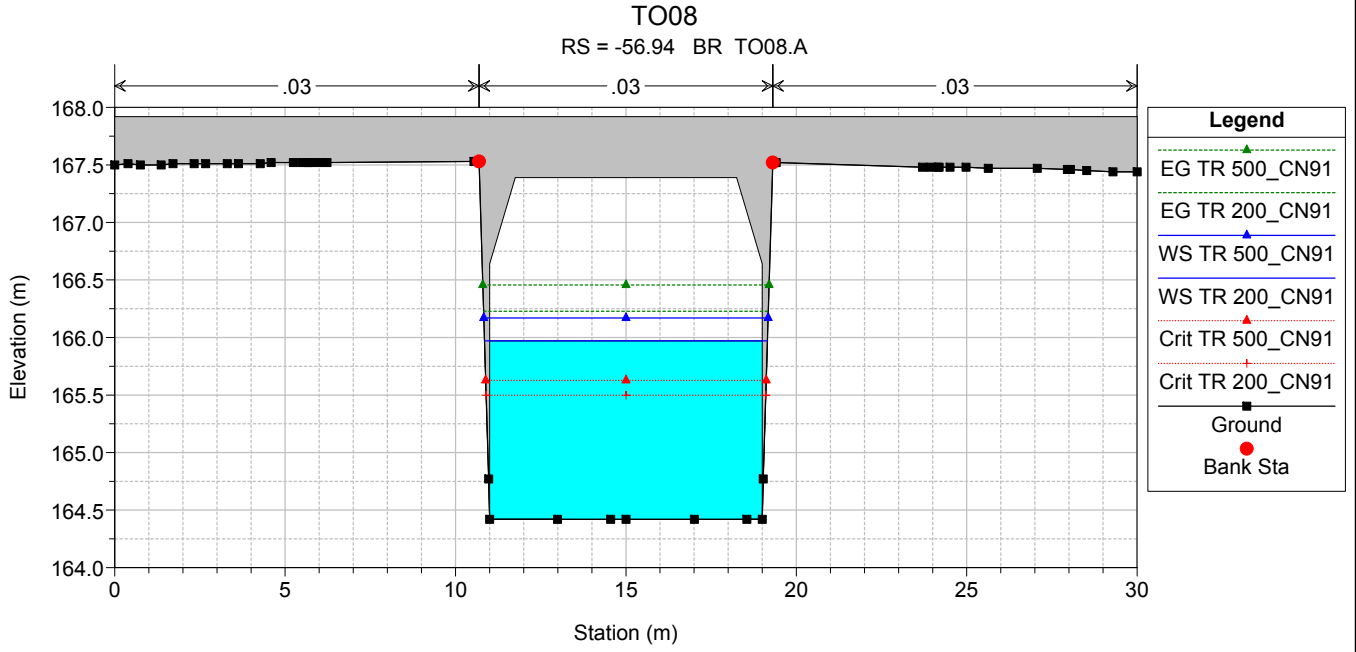
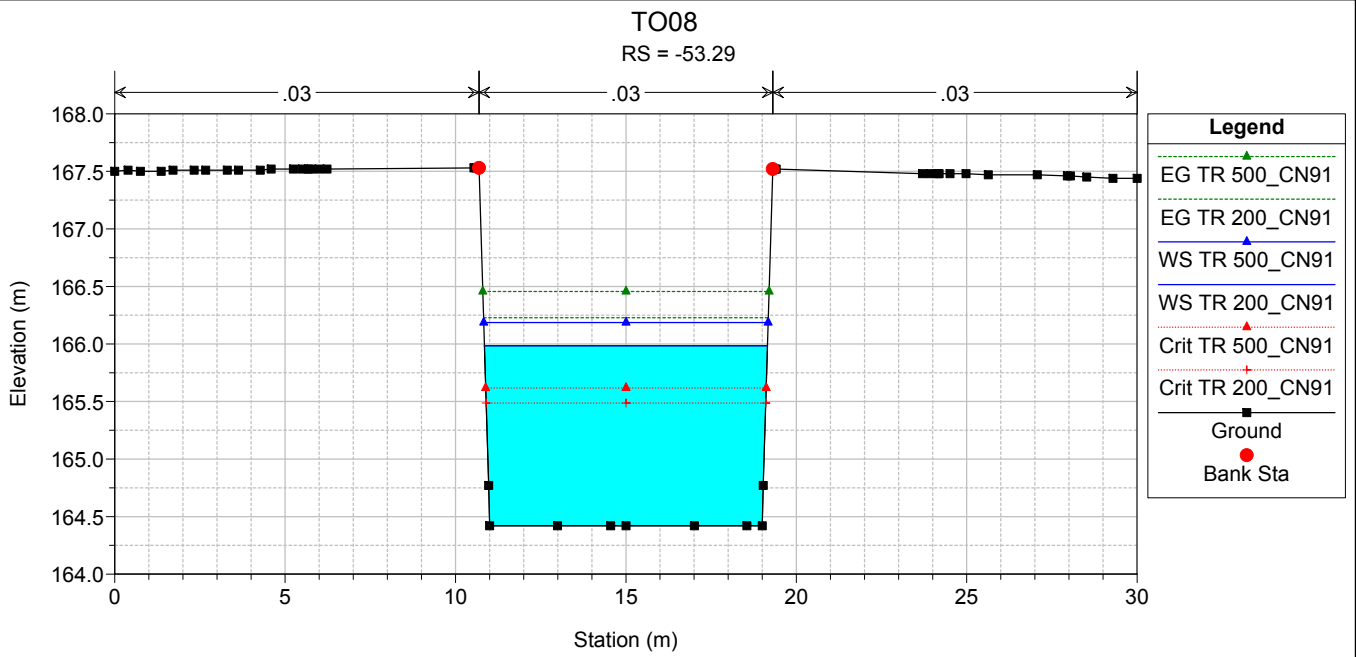

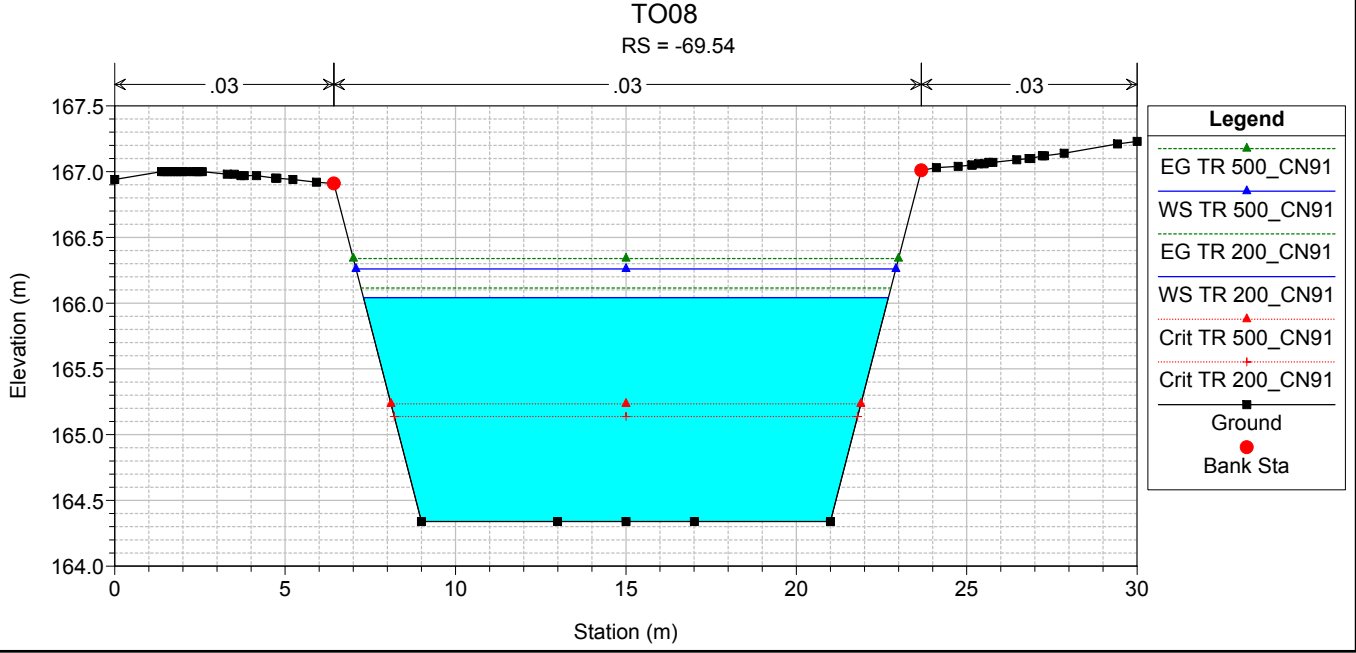
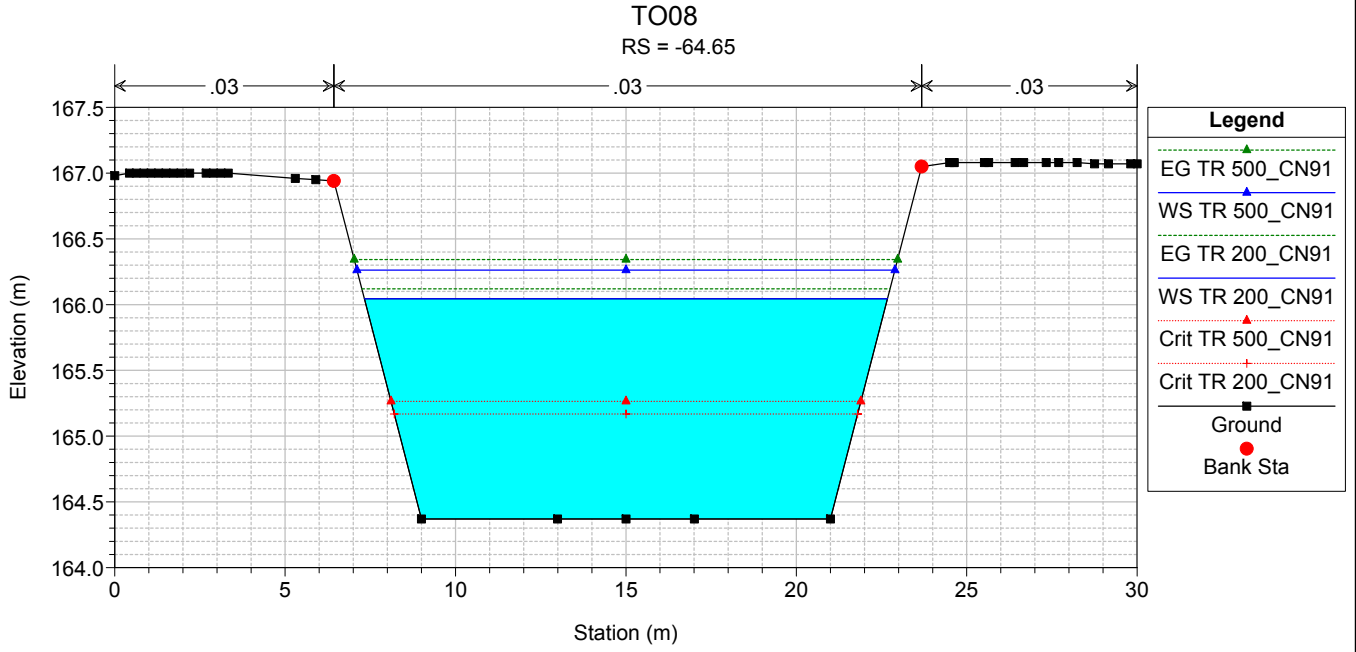
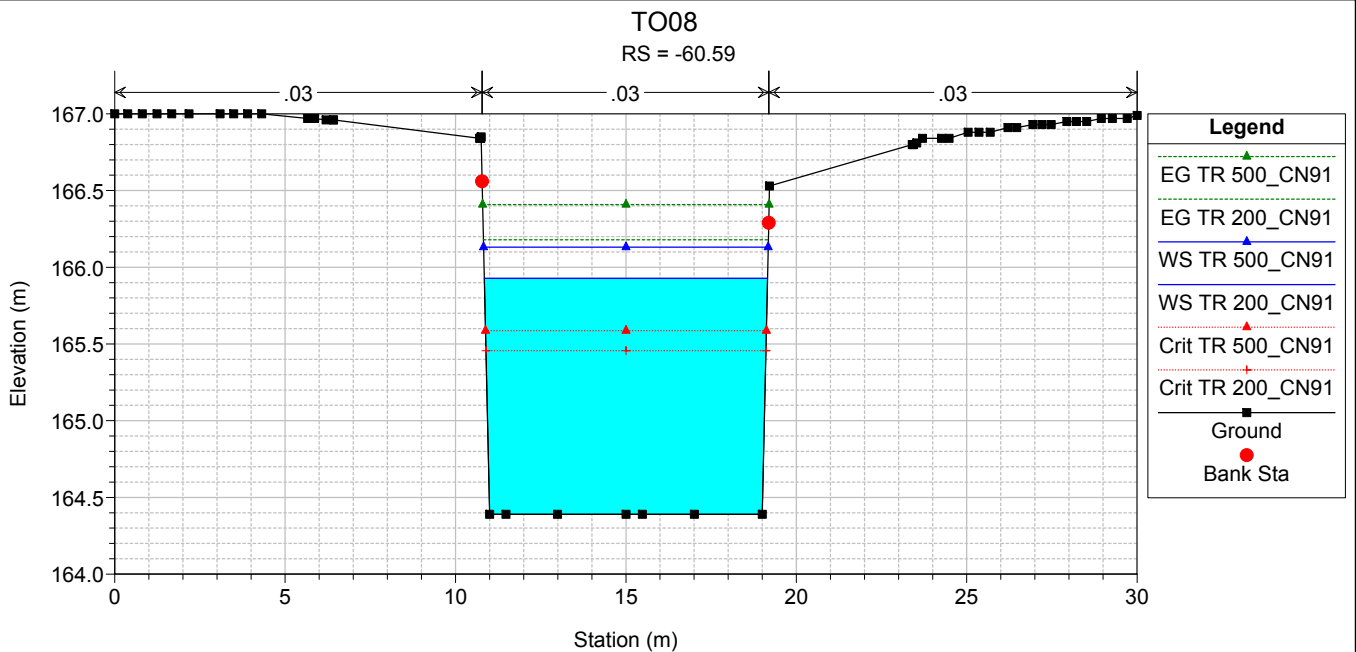

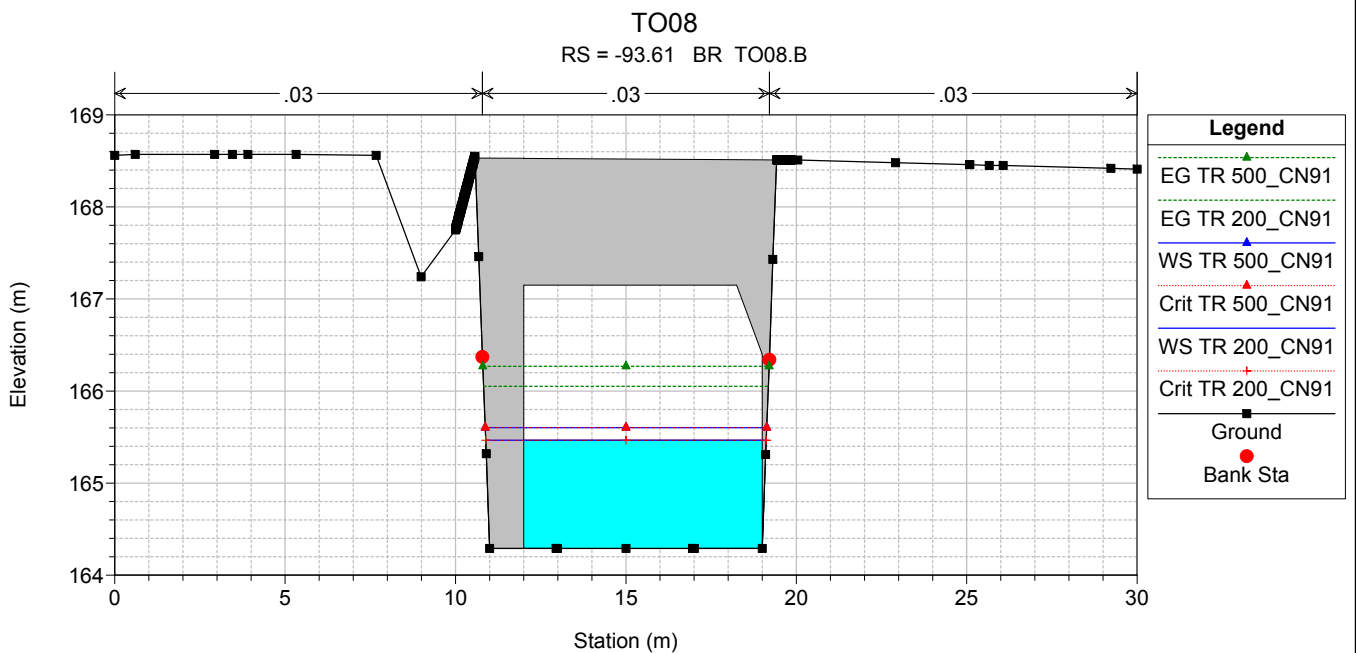
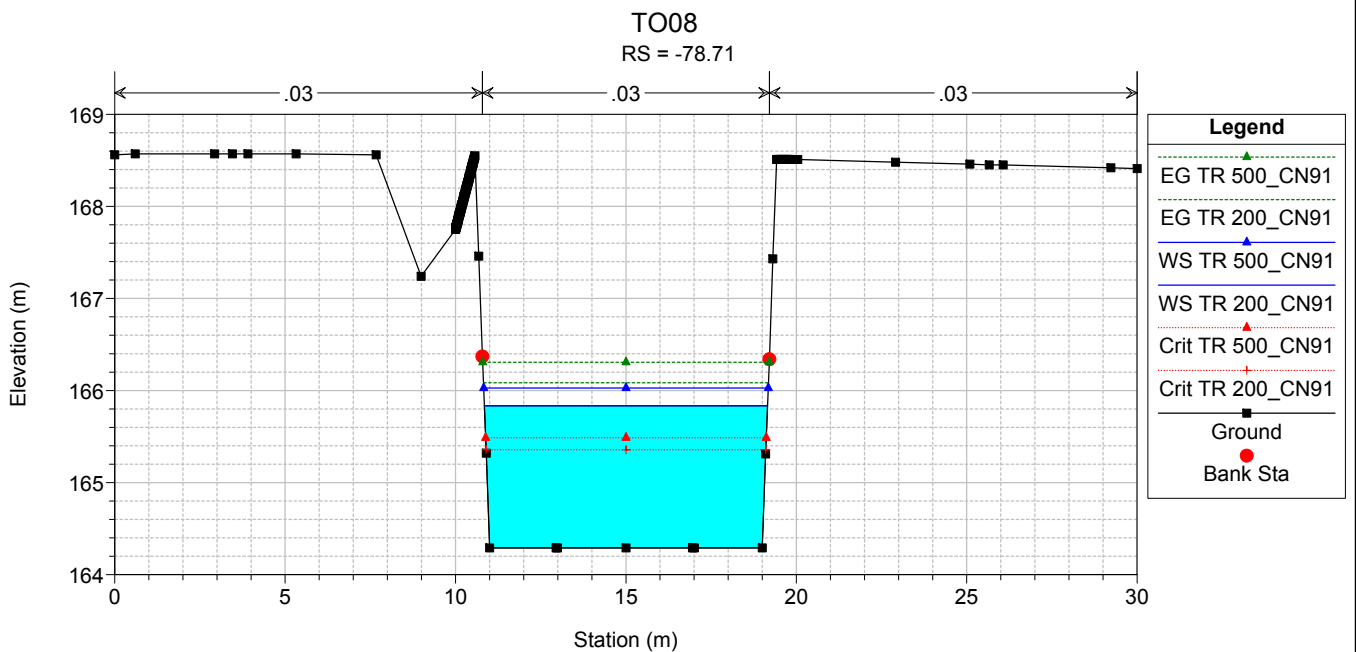
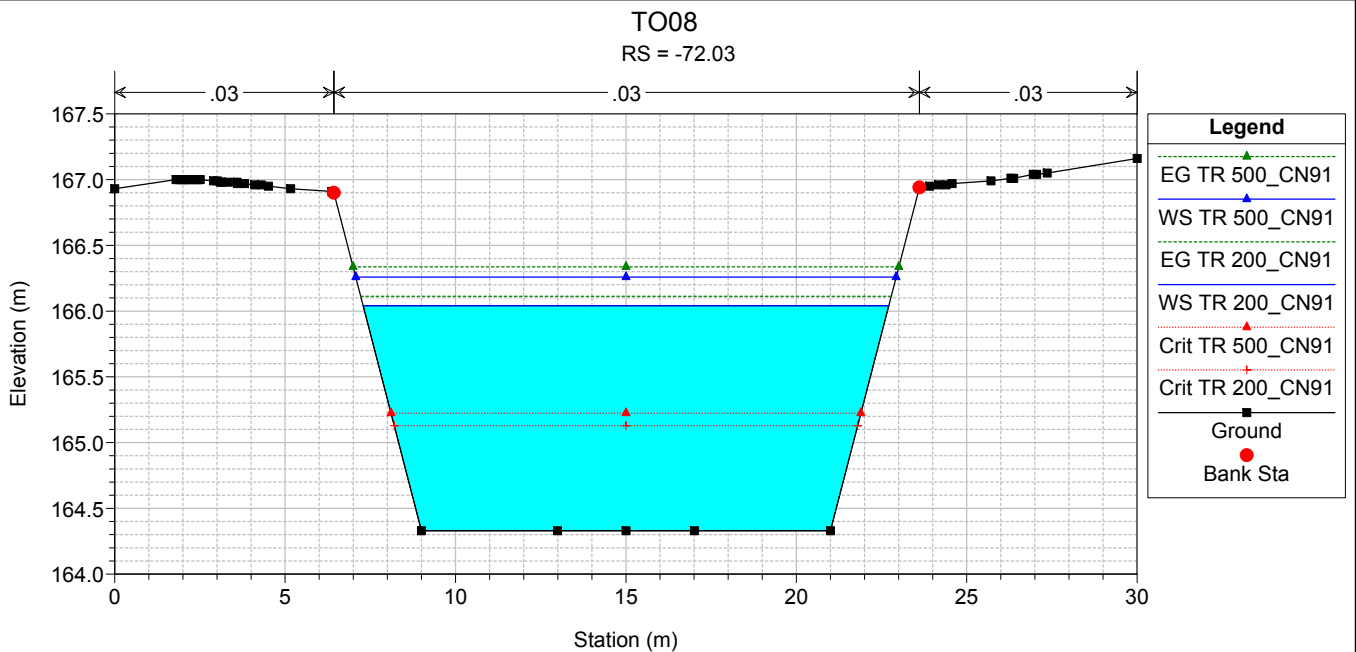

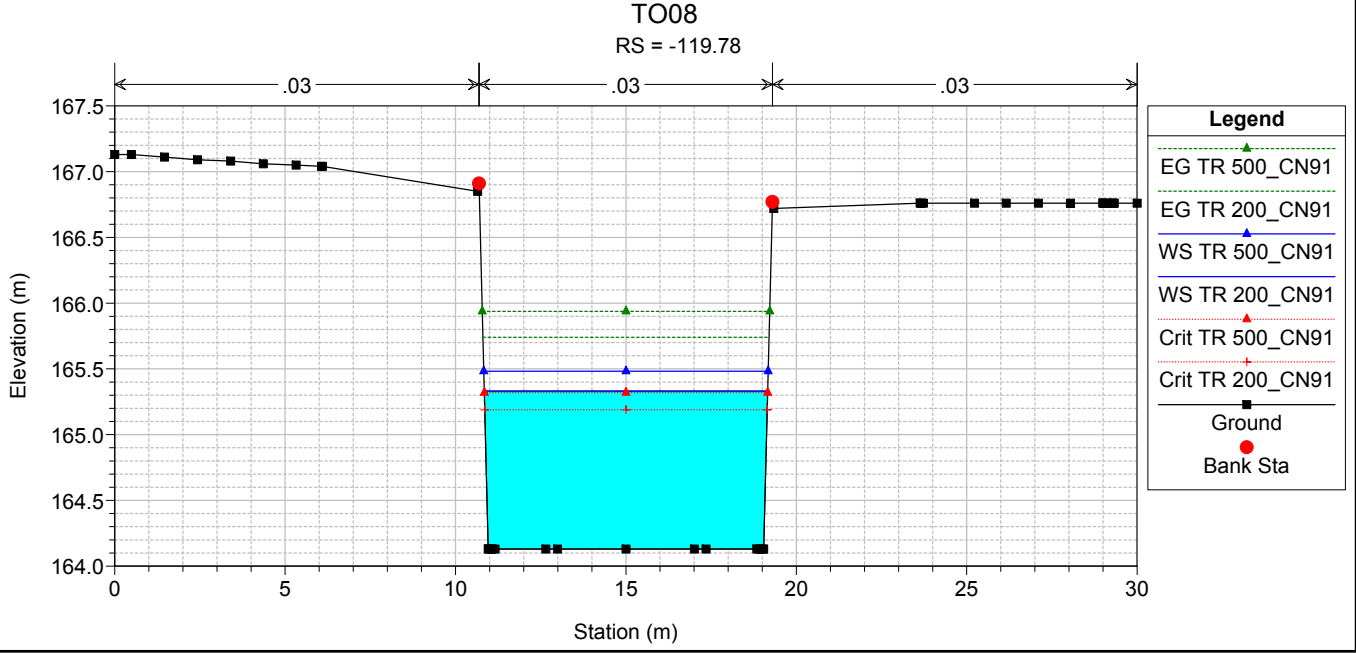
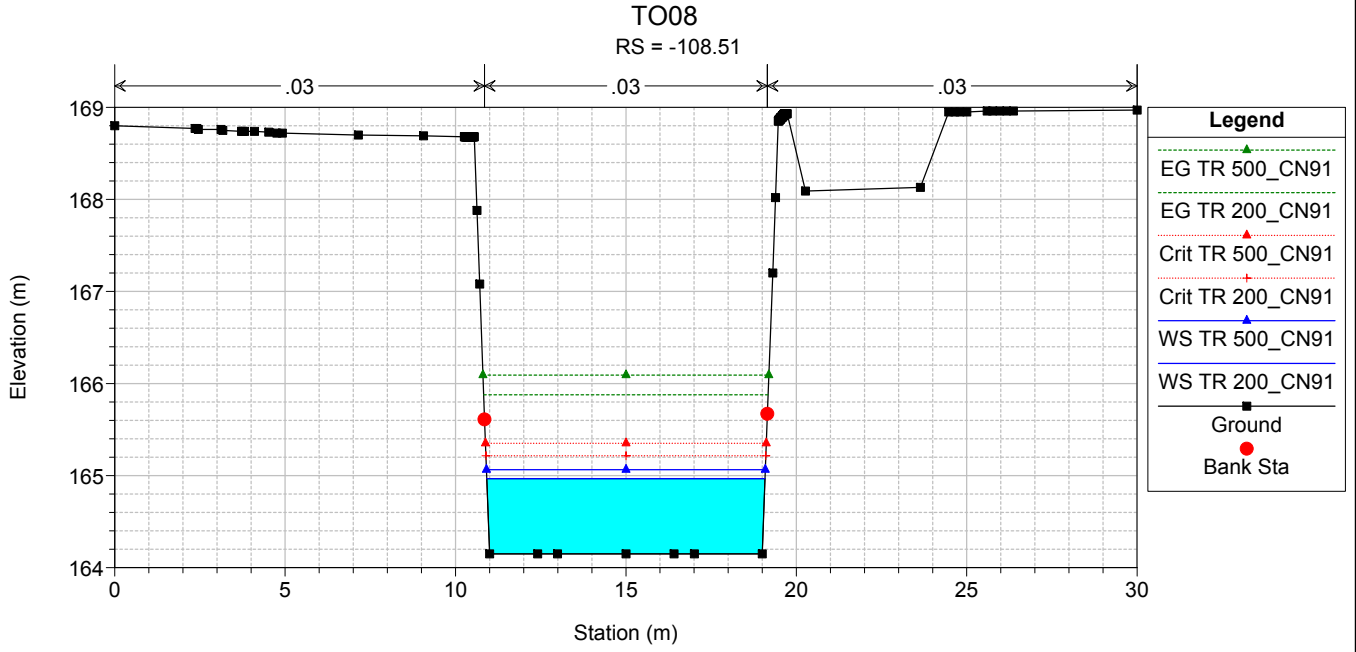
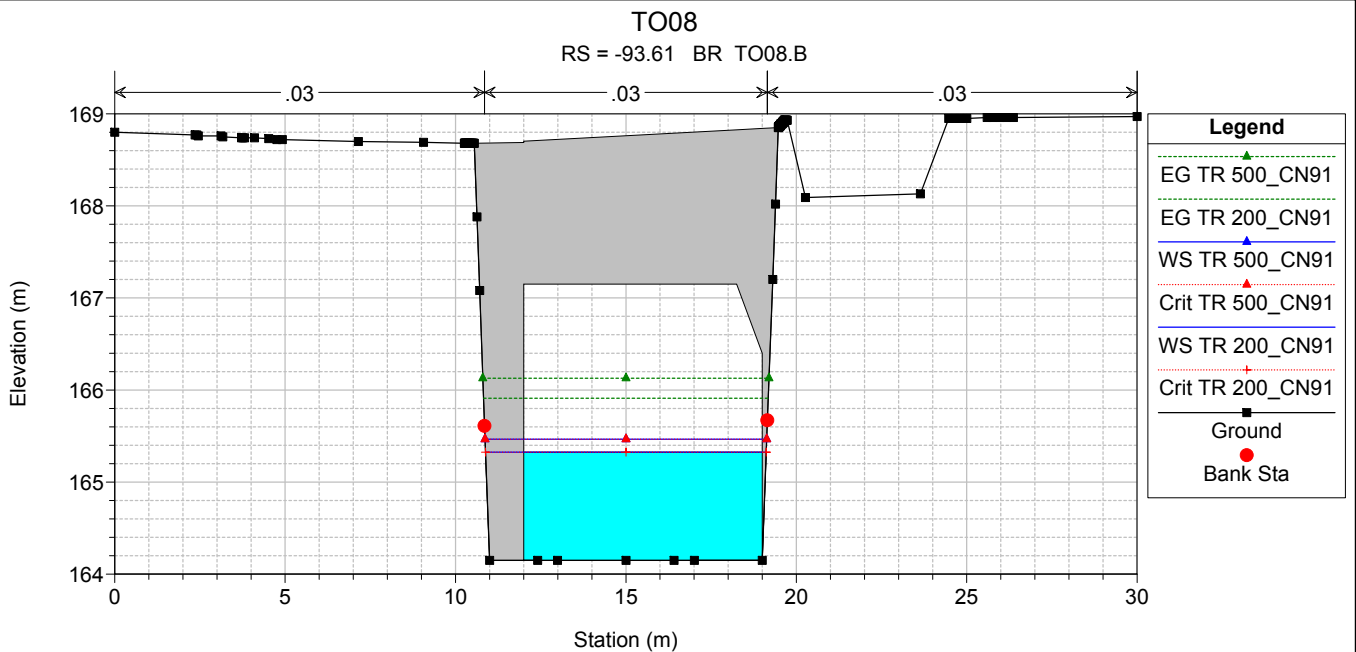

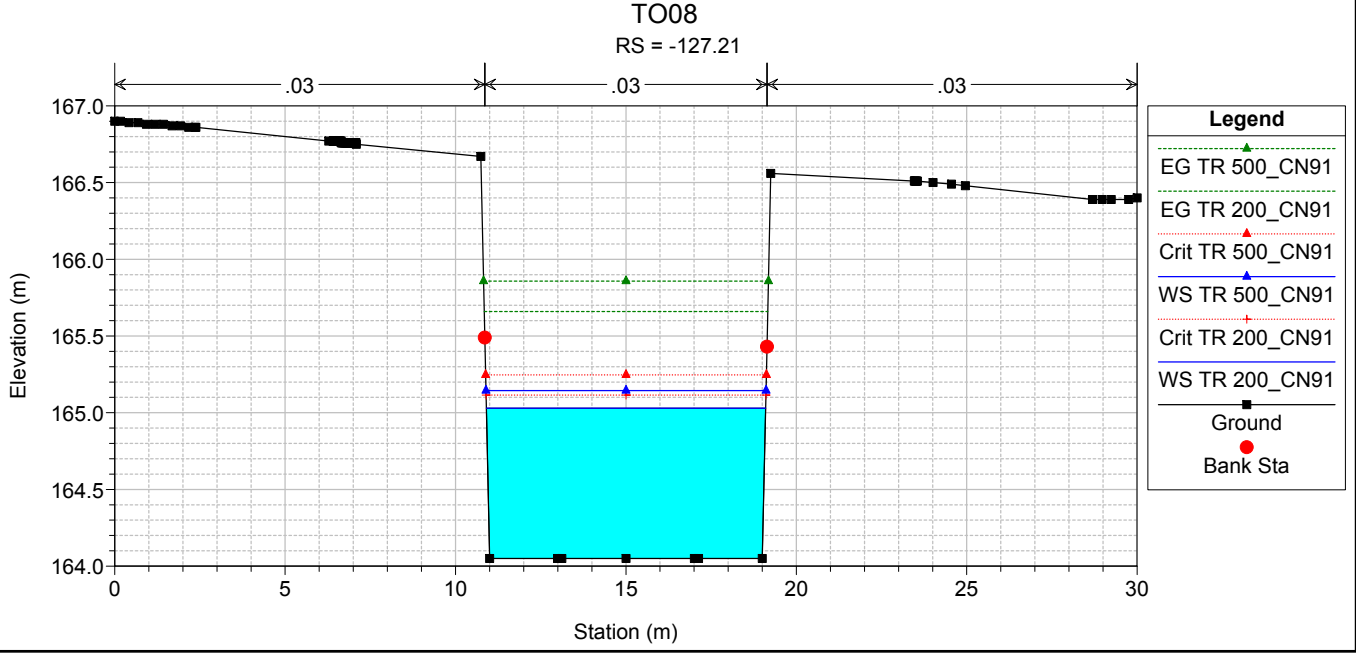
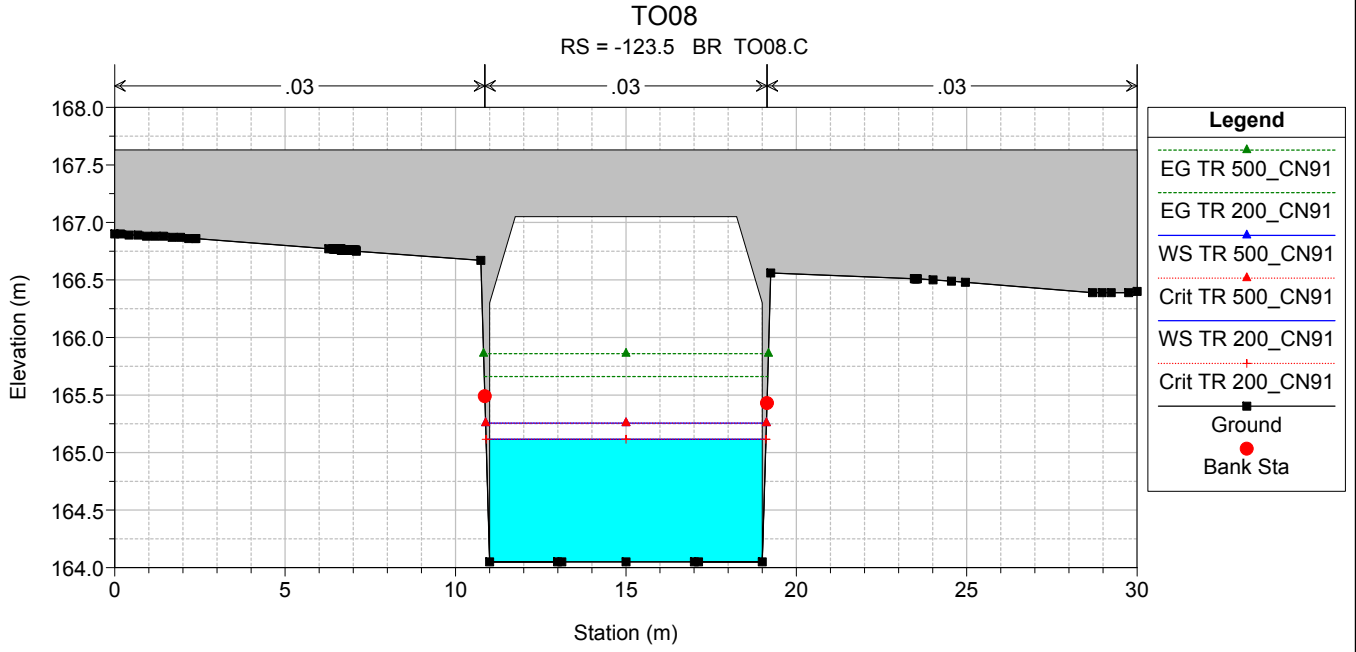
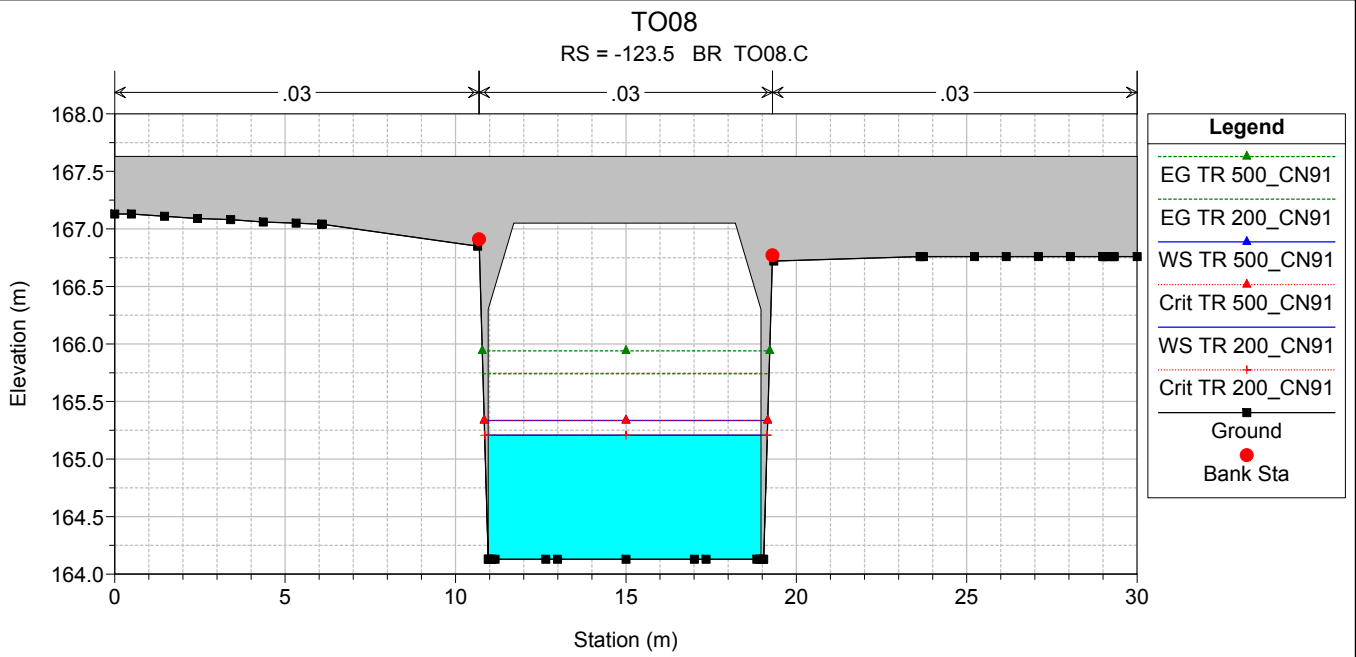

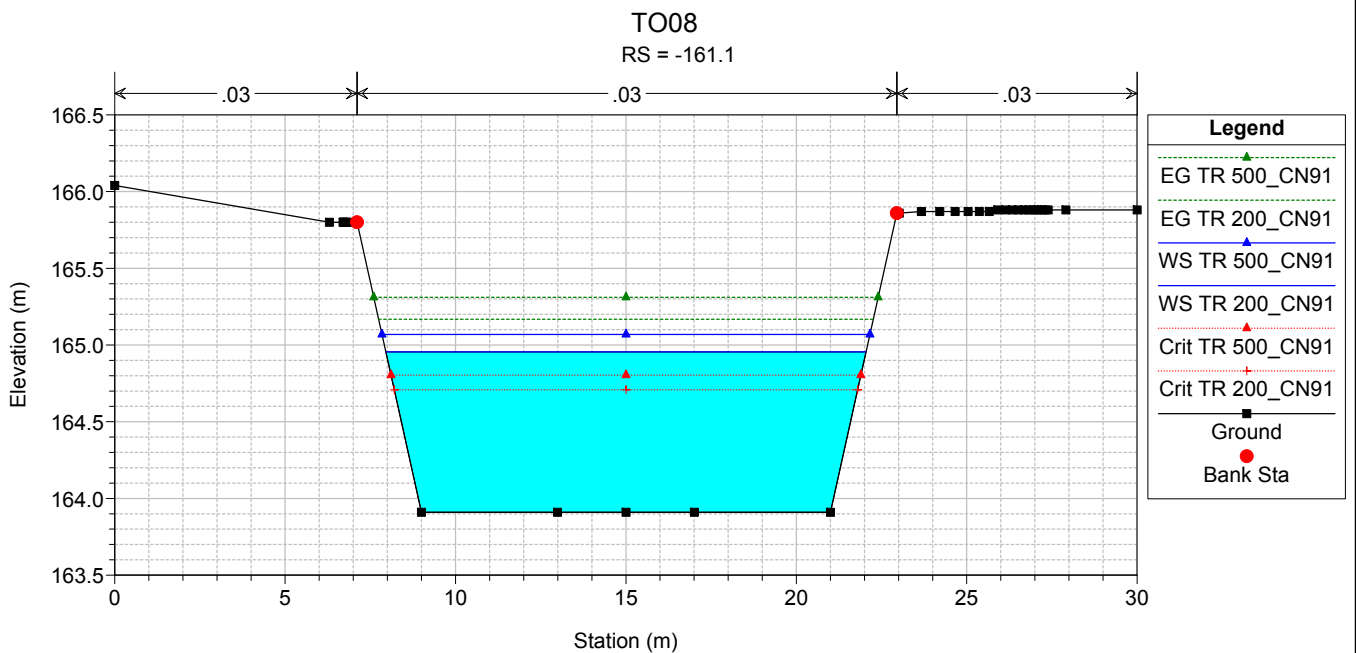
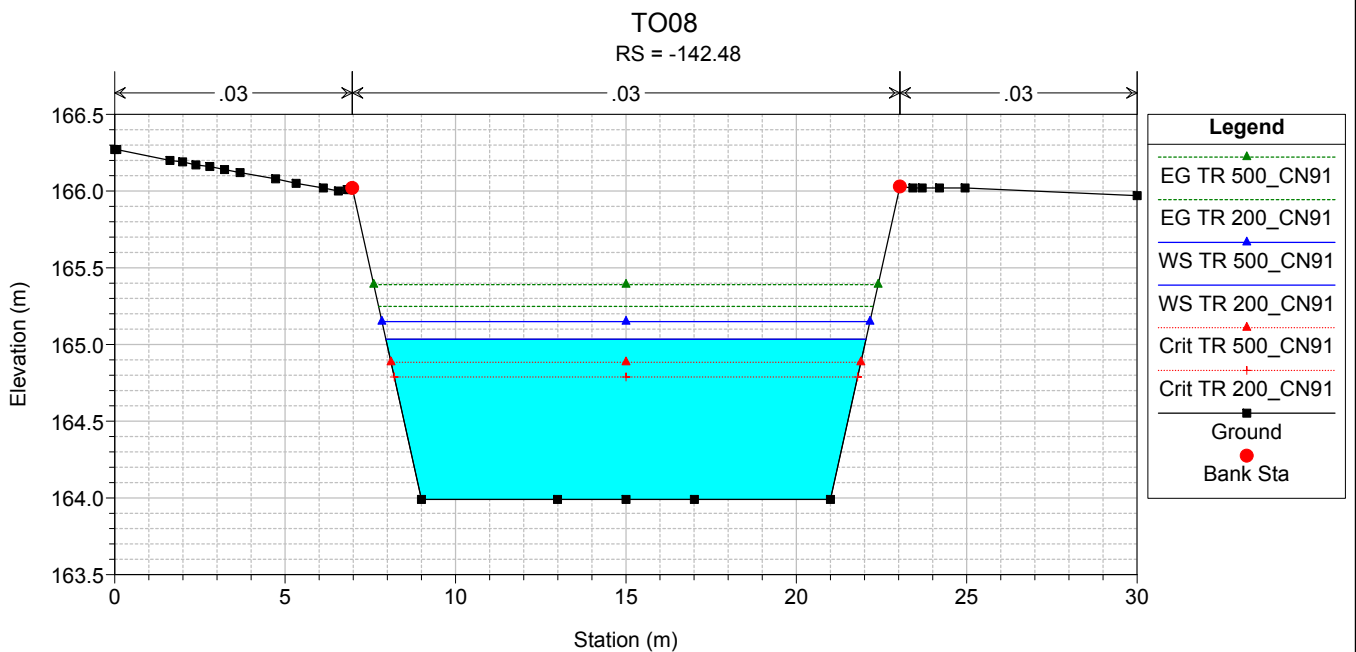
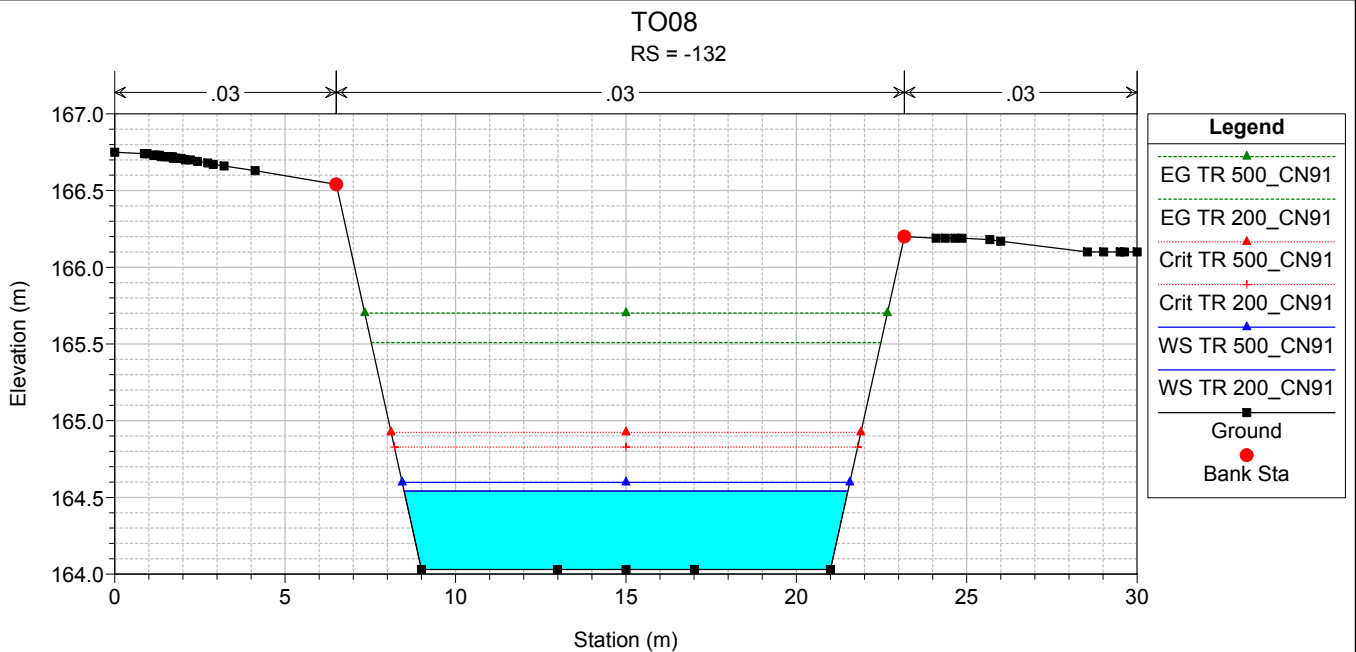

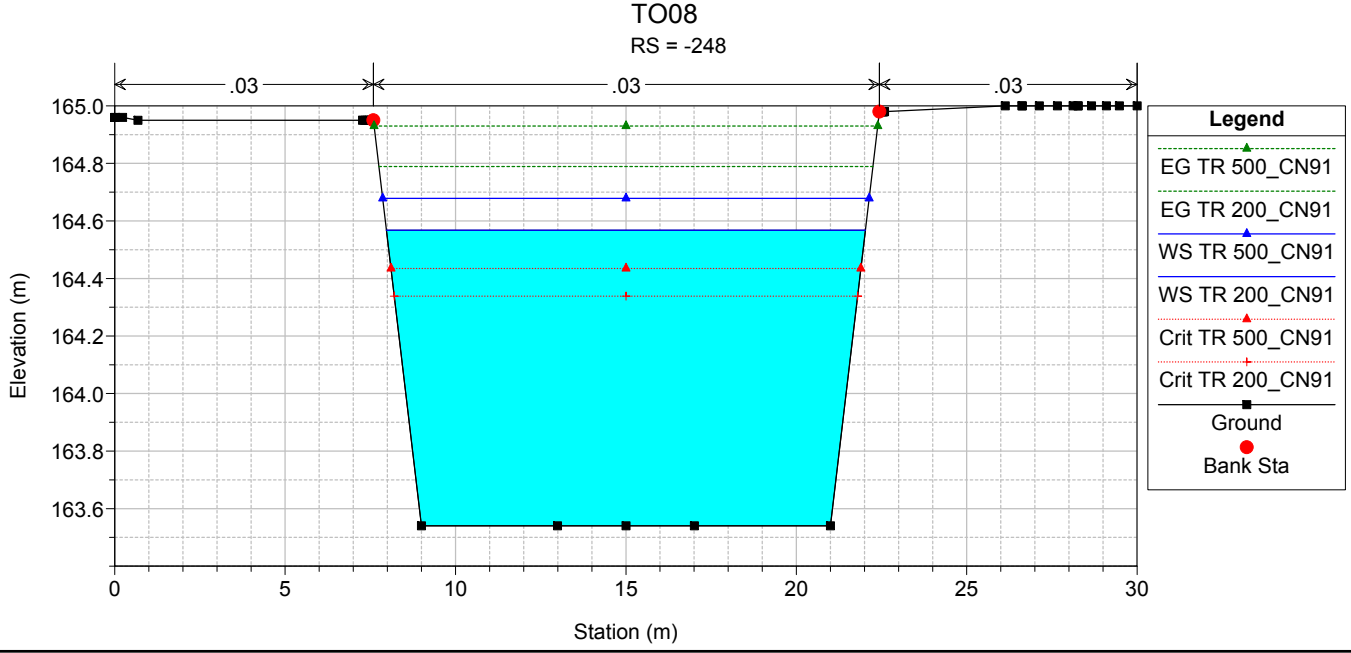
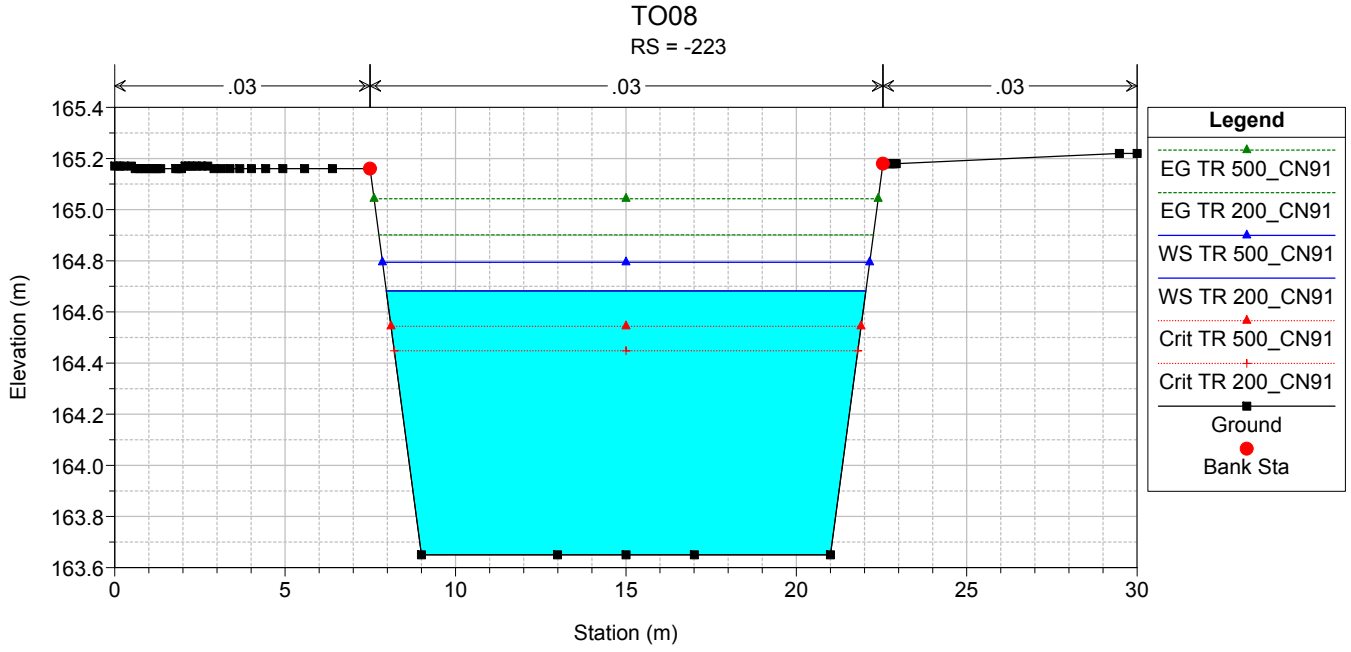
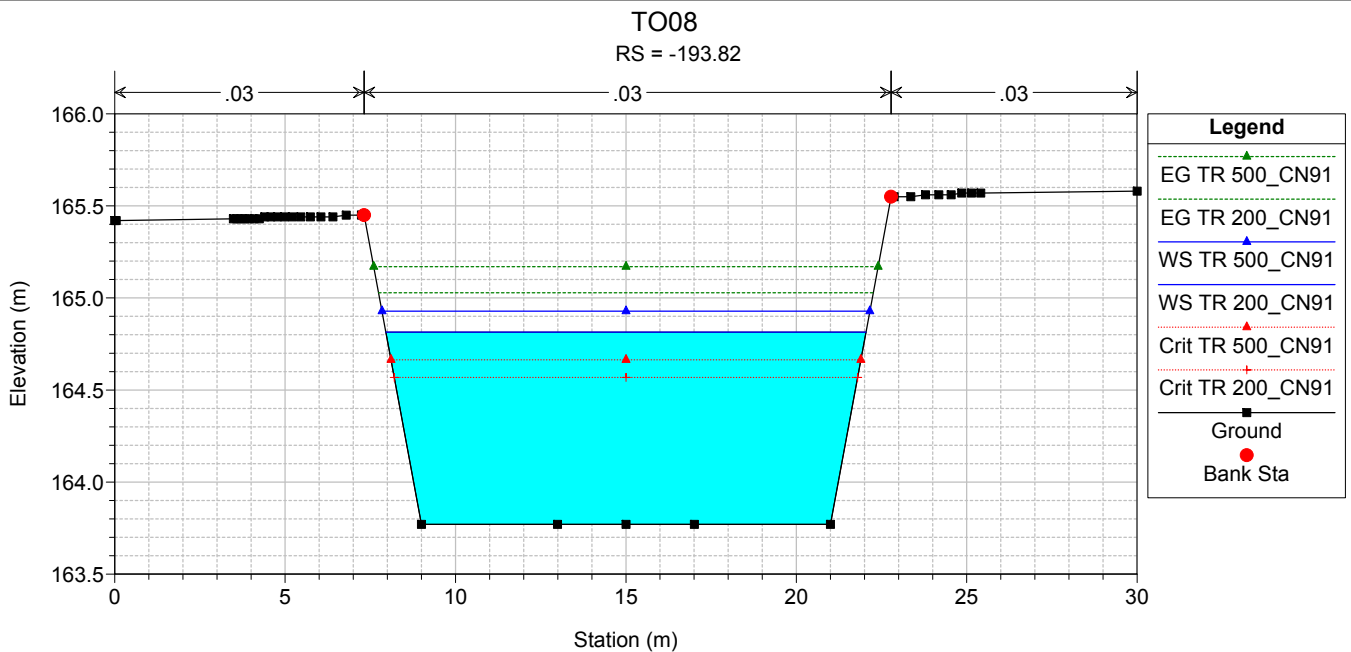

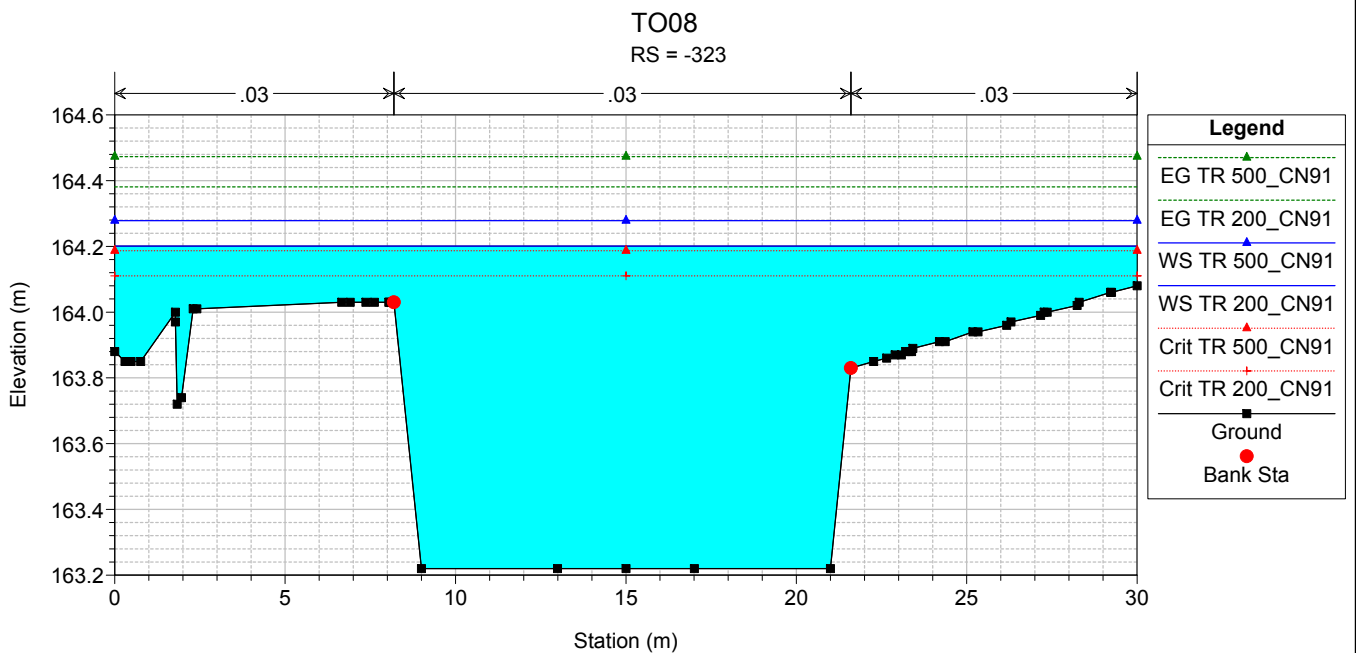
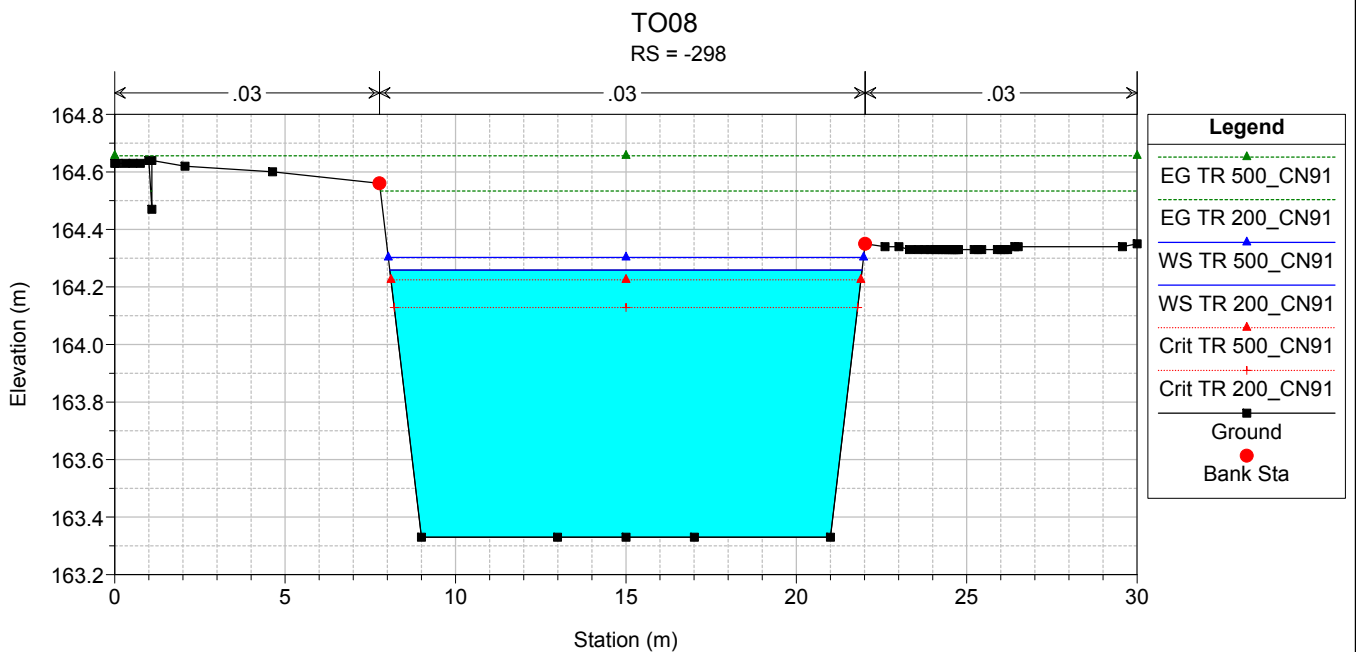
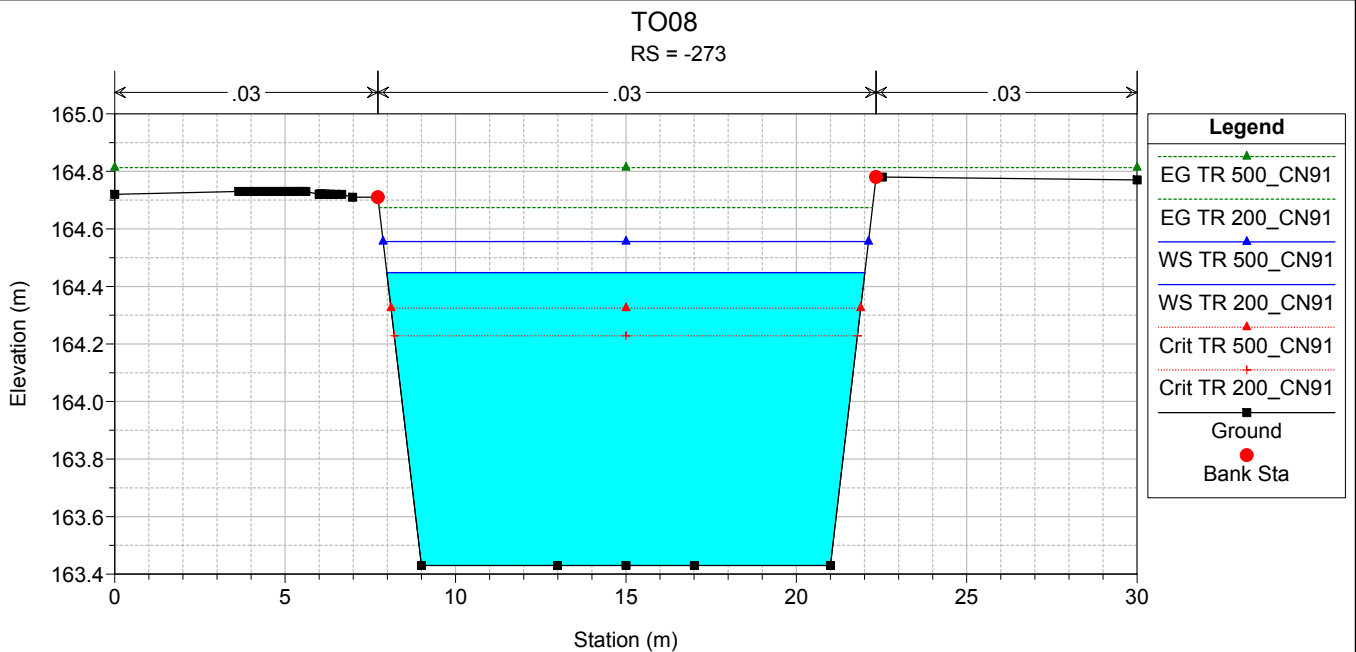

ALLEGATO 2.9

Interferenza idraulica - TO09
Tabella riassuntiva dei risultati, profilo idrico e sezioni
trasversali con i livelli idrici (TR 200 - 500 anni)

HEC-RAS Plan: TO09_POST River: TO09 Reach: TO09 Profile: TR 200_CN91

Reach	River Sta	Profile	Q Total (m ³ /s)	Min Ch El (m)	Max Chl Dpth (m)	W.S. Elev (m)	Crit W.S. (m)	Diff	Froude # Chl	E.G. Elev (m)	Vel Chnl (m/s)	Vel Total (m/s)	Hydr Radius C (m)	Shear Chan (N/m ²)	Hydr Depth (m)
TO09	0	TR 200_CN91	14.0	176.00	0.48	176.48	176.69	-0.21	2.67	177.28	4.3	3.9	0.3	251.3	0.21
TO09	-24.44	TR 200_CN91	14.0	172.62	0.85	173.47	173.96	-0.49	2.30	175.19	5.8	5.8	0.5	365.8	0.65
TO09	-28.38	TR 200_CN91	14.0	170.31	0.63	170.94	171.66	-0.72	3.78	174.58	8.5	8.5	0.4	830.0	0.51
TO09	-35.16	TR 200_CN91	14.0	170.29	0.77	171.06	171.64	-0.58	2.70	173.26	6.6	6.6	0.5	475.8	0.60
TO09	-37.95	TR 200_CN91	14.0	170.29	0.84	171.13	171.64	-0.51	2.35	172.90	5.9	5.9	0.5	377.0	0.65
TO09	-40.37	TR 200_CN91	14.0	170.28	0.89	171.17	171.63	-0.46	2.09	172.66	5.4	5.4	0.6	311.1	0.68
TO09	-42.78	TR 200_CN91	14.0	170.27	0.61	170.88	171.33	-0.45	2.31	172.50	5.6	5.6	0.5	358.7	0.60
TO09	-46.53	Bridge													
TO09	-50.28	TR 200_CN91	14.0	170.23	1.68	171.91	171.29	0.62	0.50	172.12	2.0	2.0	1.0	35.7	1.62
TO09	-56	TR 200_CN91	14.0	170.20	1.69	171.89	171.26	0.63	0.50	172.09	2.0	2.0	1.0	35.2	1.63
TO09	-65.28	TR 200_CN91	14.0	170.14	1.73	171.87	171.20	0.67	0.48	172.06	1.9	1.9	1.0	33.7	1.66
TO09	-77.78	Bridge													
TO09	-90.28	TR 200_CN91	14.0	169.99	1.66	171.65			0.51	171.86	2.0	2.0	0.9	36.6	1.60
TO09	-95.28	TR 200_CN91	14.0	169.96	1.68	171.64	171.02	0.62	0.50	171.84	2.0	2.0	0.9	36.0	1.61
TO09	-99.05	Bridge													
TO09	-102.81	TR 200_CN91	14.0	169.92	1.65	171.57			0.51	171.78	2.0	2.0	0.9	37.2	1.59
TO09	-104.89	TR 200_CN91	14.0	169.90	1.48	171.38	171.25	0.13	0.85	171.76	2.7	2.7	0.8	69.6	1.04
TO09	-106.97	TR 200_CN91	14.0	169.88	1.48	171.36			0.85	171.74	2.7	2.7	0.8	69.4	1.04
TO09	-115.64	TR 200_CN91	14.0	169.81	1.47	171.28	171.16	0.12	0.86	171.66	2.7	2.7	0.8	71.0	1.03
TO09	-124.54	TR 200_CN91	14.0	169.73	1.47	171.20	171.08	0.12	0.86	171.58	2.7	2.7	0.8	70.8	1.03
TO09	-146.32	TR 200_CN91	14.0	169.53	1.41	170.94	170.88	0.06	0.93	171.37	2.9	2.9	0.8	80.6	1.00
TO09	-161	TR 200_CN91	14.0	169.40	1.46	170.86	170.86	0.00	0.84	171.21	2.7	2.5	0.8	67.7	0.62
TO09	-178.31	TR 200_CN91	14.0	169.25	1.06	170.31	170.53	-0.22	1.43	170.96	3.7	3.3	0.6	147.3	0.40
TO09	-187.28	TR 200_CN91	14.0	169.17	1.29	170.46	170.46	0.00	0.73	170.67	2.3	1.7	0.8	50.4	0.43
TO09	-191.84	TR 200_CN91	14.0	169.02	1.05	170.07	170.23	-0.16	1.18	170.56	3.1	3.0	0.6	98.4	0.49
TO09	-205.43	TR 200_CN91	14.0	168.00	1.02	169.02	169.33	-0.31	1.98	170.15	4.8	4.4	0.5	246.7	0.33

HEC-RAS Plan: TO09_POST River: TO09 Reach: TO09 Profile: TR 500_CN91

Reach	River Sta	Profile	Q Total (m ³ /s)	Min Ch El (m)	Max Chl Dpth (m)	W.S. Elev (m)	Crit W.S. (m)	Diff	Froude # Chl	E.G. Elev (m)	Vel Chnl (m/s)	Vel Total (m/s)	Hydr Radius C (m)	Shear Chan (N/m ²)	Hydr Depth (m)
TO09	0	TR 500_CN91	16.4	176.00	0.50	176.50	176.73	-0.23	2.71	177.40	4.5	4.1	0.3	274.5	0.22
TO09	-24.44	TR 500_CN91	16.4	172.62	0.94	173.56	174.09	-0.53	2.26	175.37	6.0	6.0	0.6	373.9	0.71
TO09	-28.38	TR 500_CN91	16.4	170.31	0.71	171.02	171.78	-0.76	3.67	174.78	8.6	8.6	0.5	833.7	0.56
TO09	-35.16	TR 500_CN91	16.4	170.29	0.84	171.13	171.76	-0.63	2.70	173.51	6.8	6.8	0.5	502.6	0.65
TO09	-37.95	TR 500_CN91	16.4	170.29	0.91	171.20	171.76	-0.56	2.38	173.15	6.2	6.2	0.6	406.4	0.69
TO09	-40.37	TR 500_CN91	16.4	170.28	0.97	171.25	171.75	-0.50	2.14	172.91	5.7	5.7	0.6	341.2	0.73
TO09	-42.78	TR 500_CN91	16.4	170.27	0.68	170.95	171.45	-0.50	2.32	172.74	5.9	5.9	0.5	387.2	0.67
TO09	-46.53	Bridge													
TO09	-50.28	TR 500_CN91	16.4	170.23	1.83	172.06	171.41	0.65	0.52	172.29	2.1	2.1	1.0	40.6	1.75
TO09	-56	TR 500_CN91	16.4	170.20	1.83	172.03	171.38	0.65	0.51	172.27	2.1	2.1	1.0	40.3	1.76
TO09	-65.28	TR 500_CN91	16.4	170.14	1.86	172.00	171.32	0.68	0.50	172.23	2.1	2.1	1.0	38.9	1.79
TO09	-77.78	Bridge													
TO09	-90.28	TR 500_CN91	16.4	169.99	1.79	171.78			0.53	172.02	2.2	2.2	1.0	42.5	1.72
TO09	-95.28	TR 500_CN91	16.4	169.96	1.80	171.76	171.14	0.62	0.53	172.00	2.2	2.2	1.0	42.0	1.73
TO09	-99.05	Bridge													
TO09	-102.81	TR 500_CN91	16.4	169.92	1.78	171.70			0.54	171.94	2.2	2.2	1.0	43.4	1.70
TO09	-104.89	TR 500_CN91	16.4	169.90	1.61	171.51			0.85	171.92	2.8	2.8	0.9	72.6	1.12
TO09	-106.97	TR 500_CN91	16.4	169.88	1.62	171.50			0.85	171.90	2.8	2.8	0.9	72.4	1.12
TO09	-115.64	TR 500_CN91	16.4	169.81	1.61	171.42			0.85	171.83	2.8	2.8	0.9	72.6	1.12
TO09	-124.54	TR 500_CN91	16.4	169.73	1.63	171.36	171.20	0.16	0.84	171.75	2.8	2.8	0.9	70.7	1.12
TO09	-146.32	TR 500_CN91	16.4	169.53	1.47	171.00	171.00	0.00	1.01	171.53	3.2	3.2	0.8	96.6	1.01
TO09	-161	TR 500_CN91	16.4	169.40	1.45	170.85	170.97	-0.12	0.99	171.35	3.2	2.9	0.8	93.7	0.62
TO09	-178.31	TR 500_CN91	16.4	169.25	1.12	170.37	170.59	-0.22	1.44	171.05	3.9	3.3	0.6	156.2	0.41
TO09	-187.28	TR 500_CN91	16.4	169.17	1.35	170.52	170.52	0.00	0.74	170.73	2.4	1.8	0.9	53.1	0.46
TO09	-191.84	TR 500_CN91	16.4	169.02	1.17	170.19	170.31	-0.12	1.05	170.63	3.0	2.7	0.8	86.7	0.46
TO09	-205.43	TR 500_CN91	16.4	168.00	1.07	169.07	169.41	-0.34	1.97	170.26	5.0	4.5	0.6	258.4	0.37

TO09

TO09 TO09

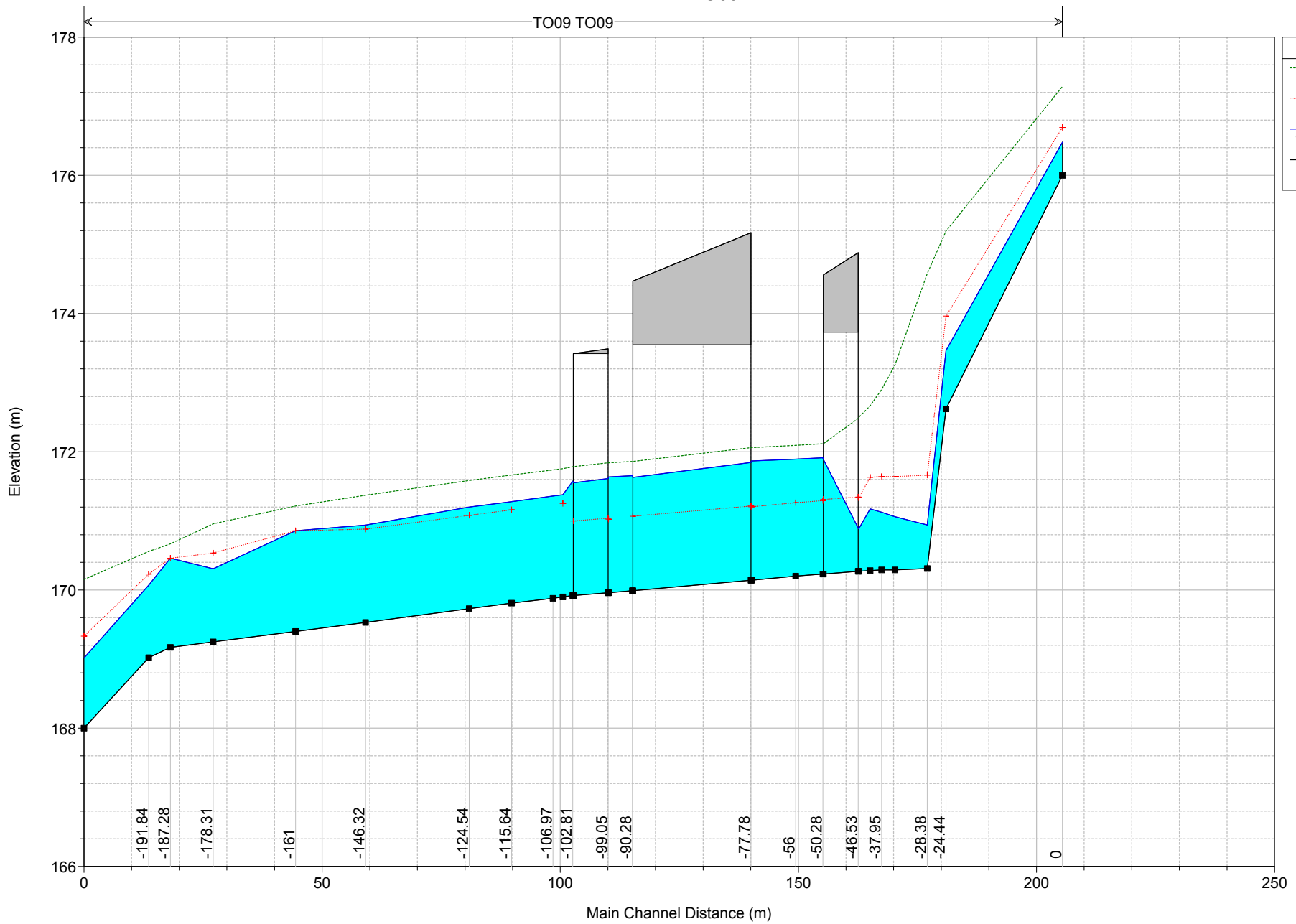

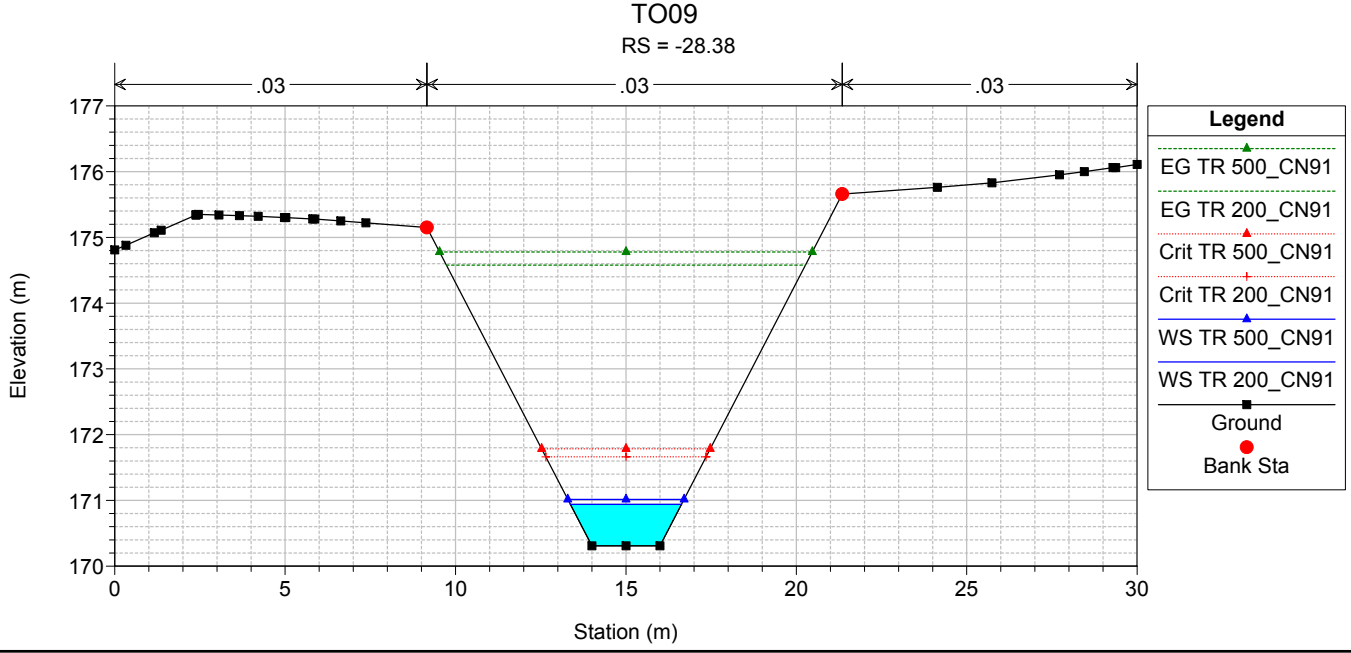
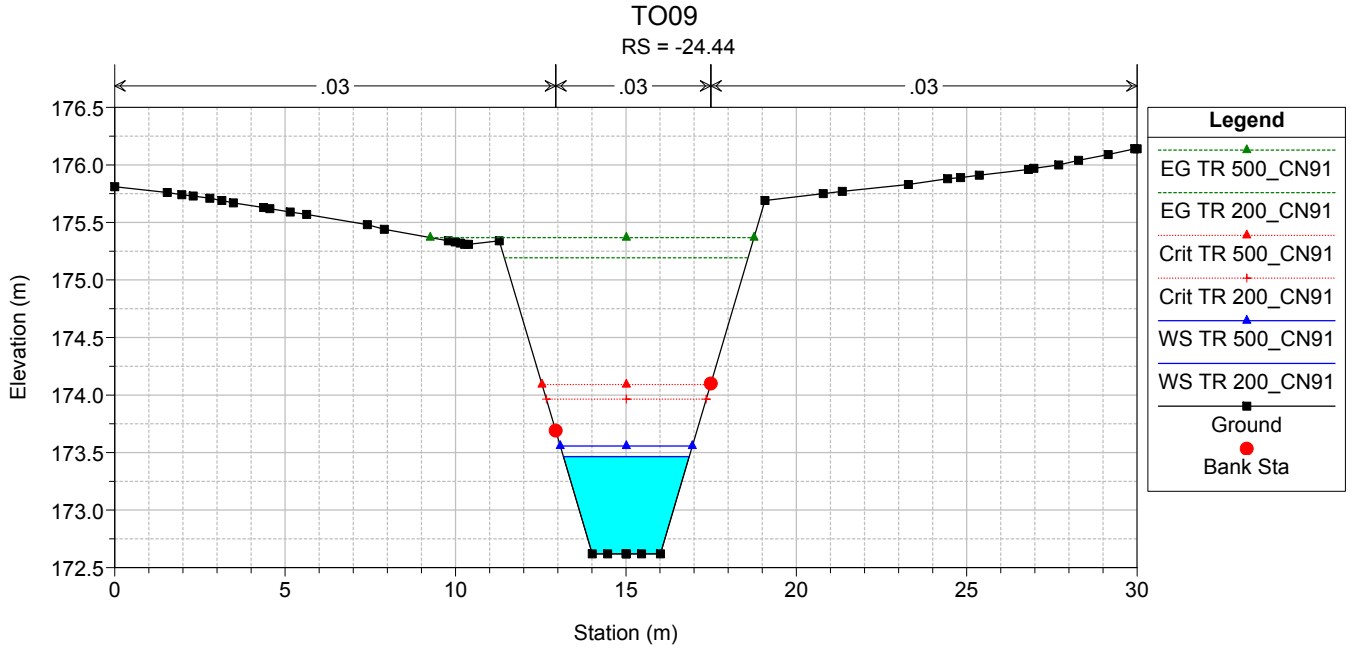
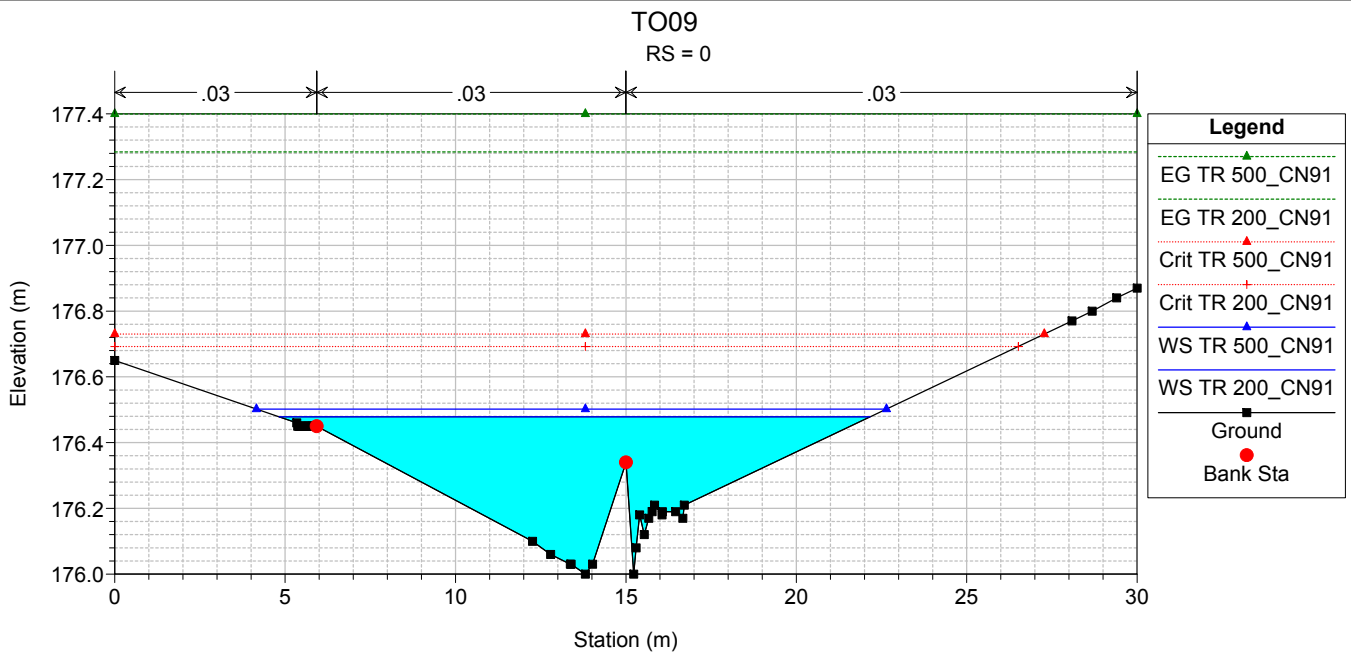

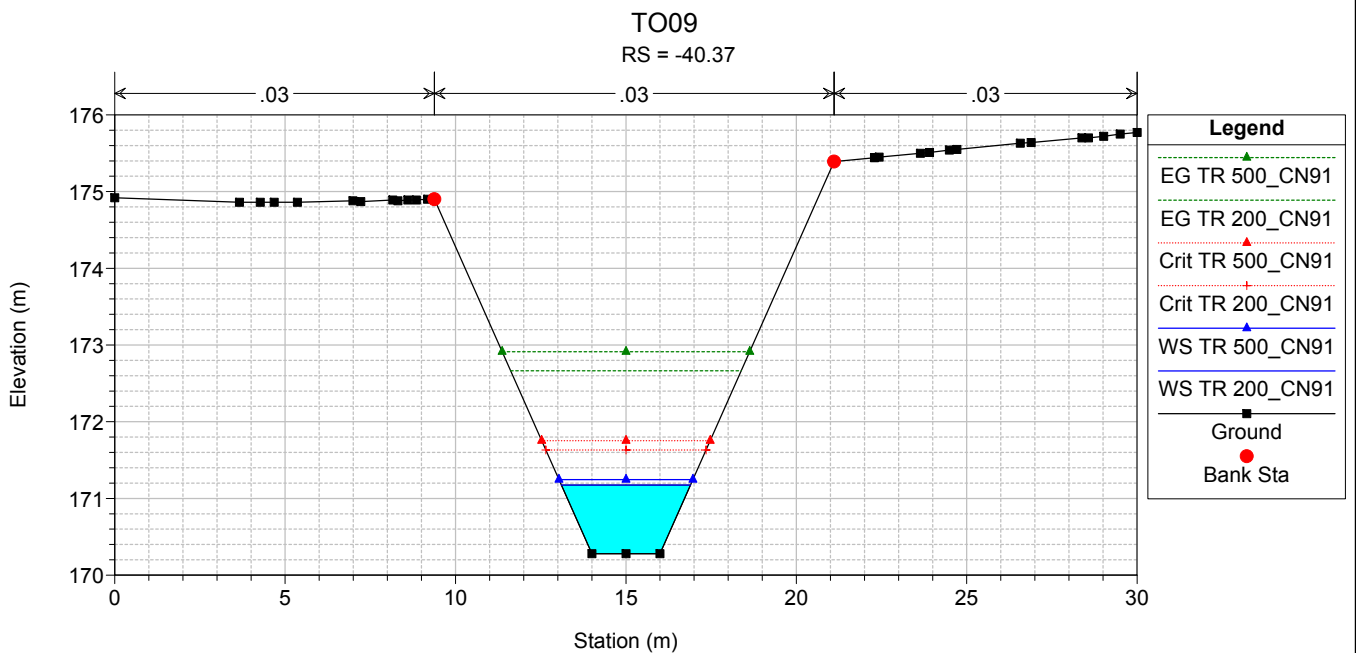
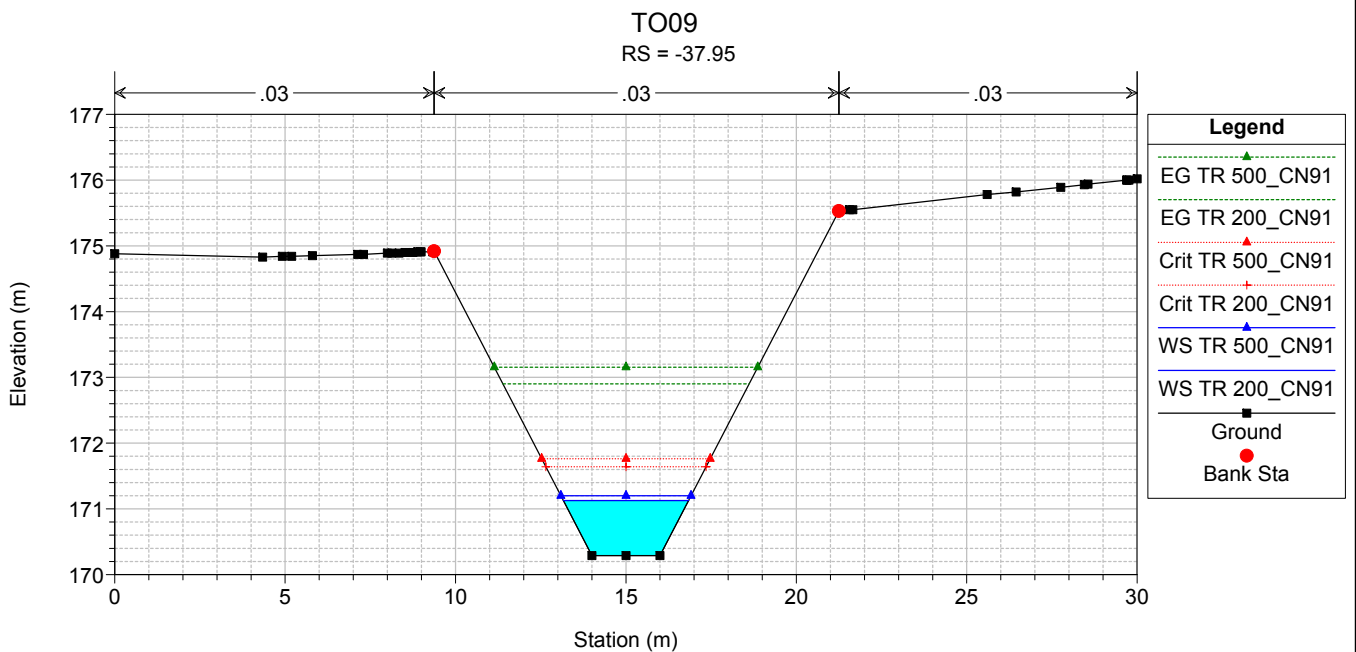
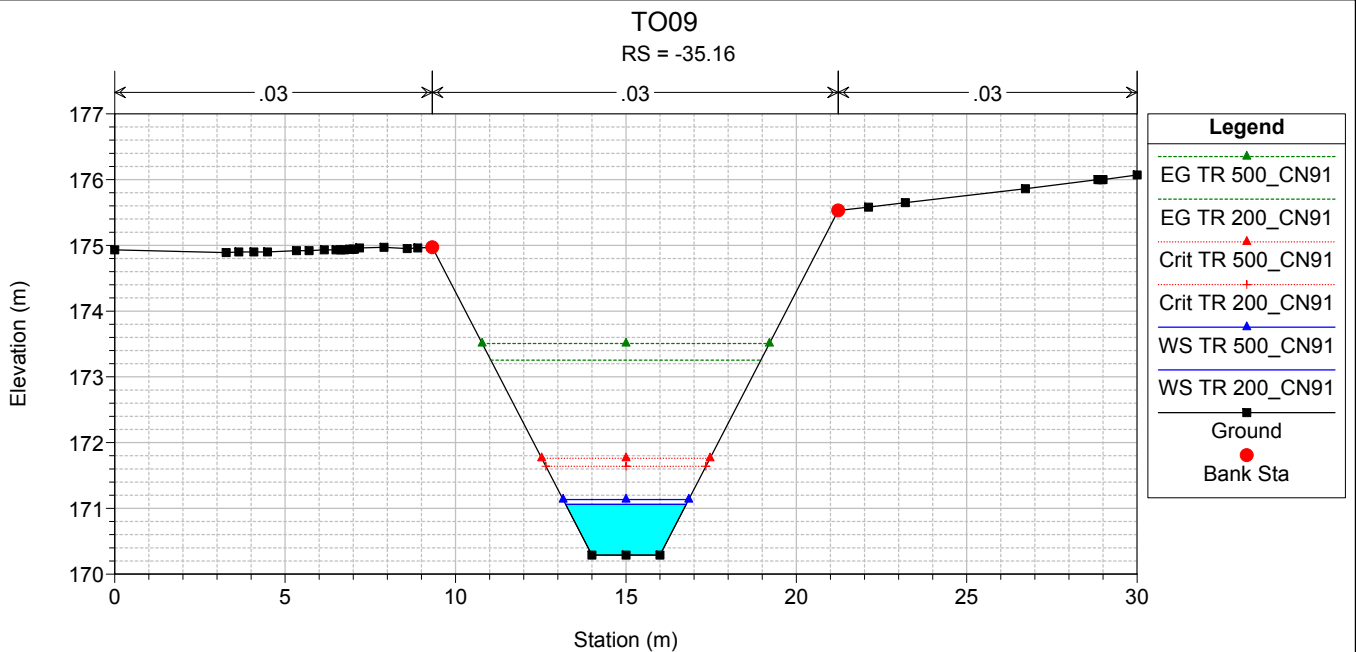

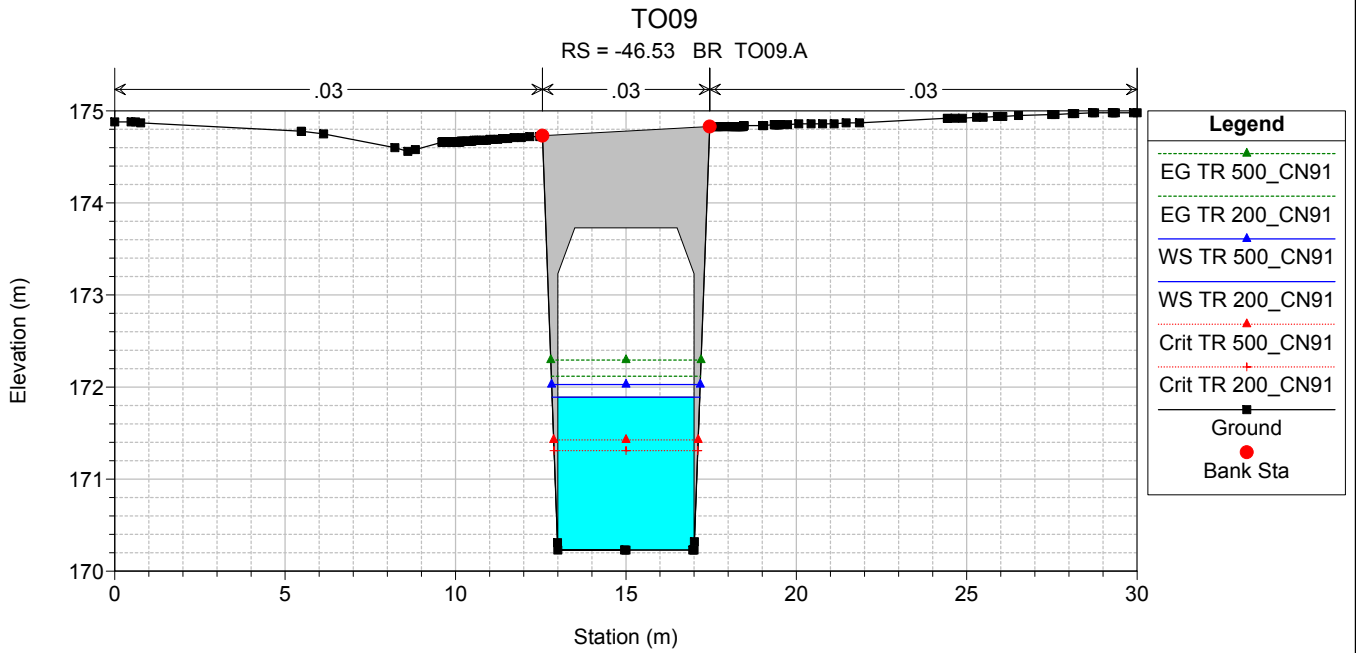
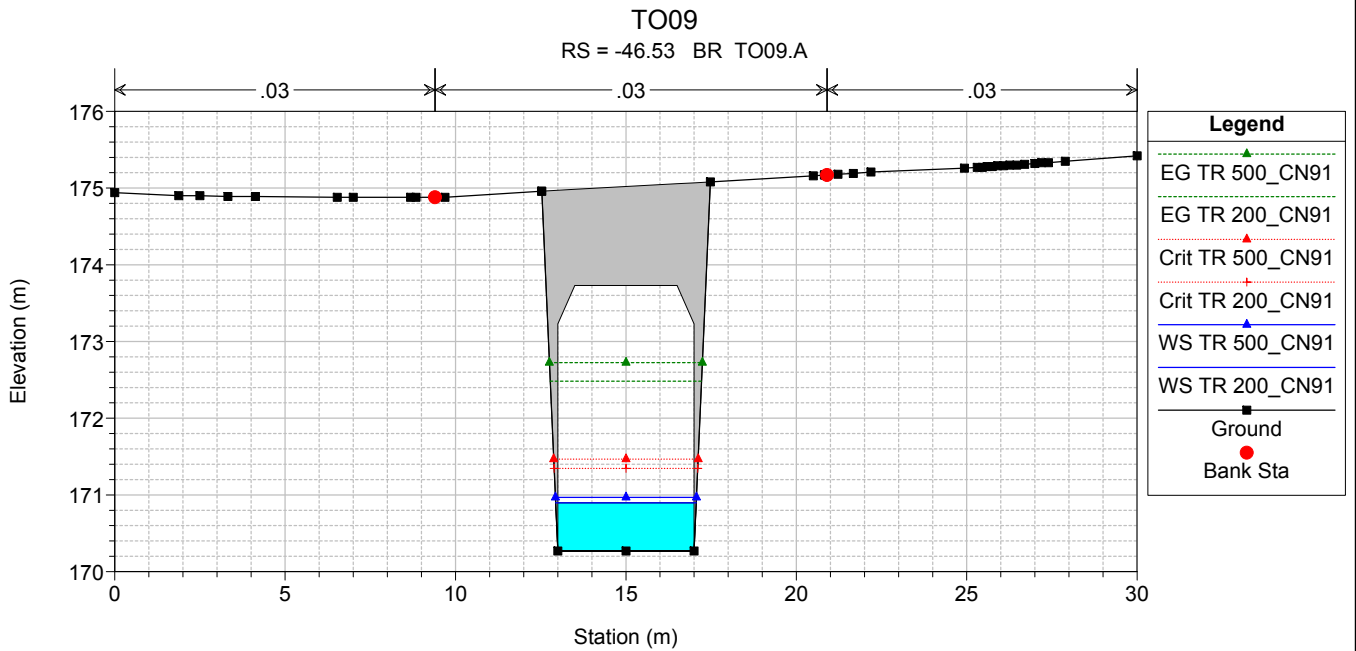
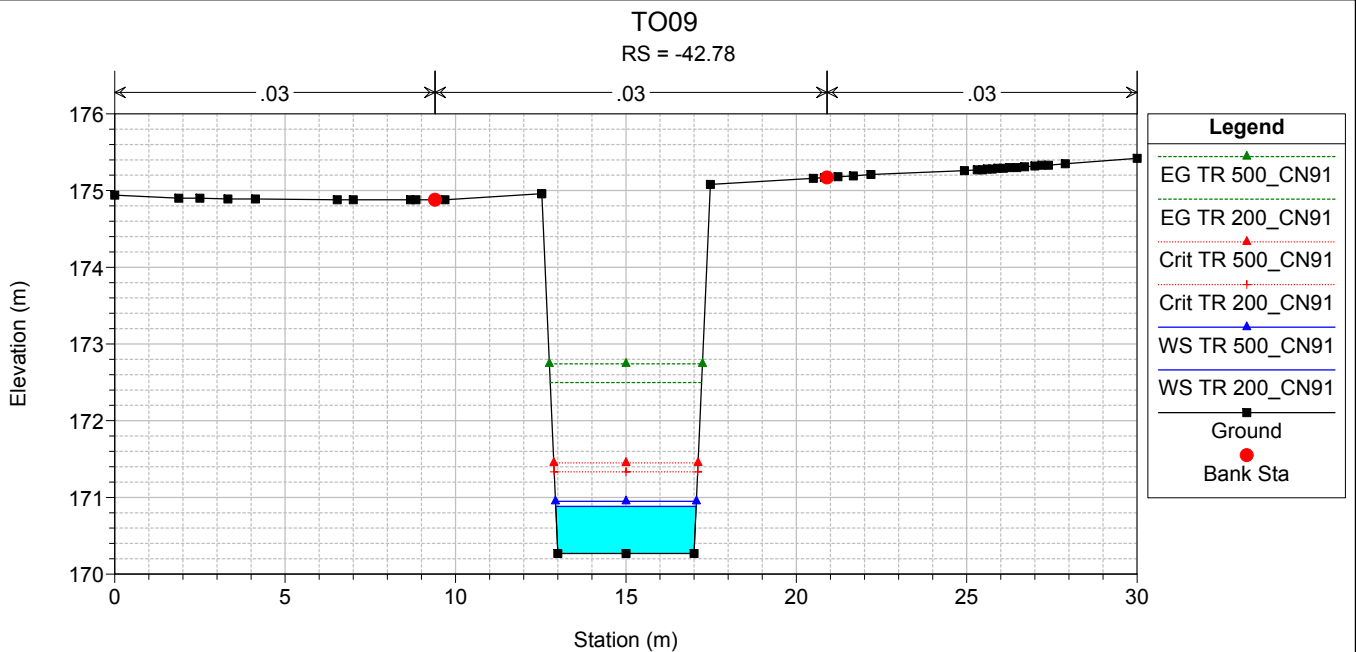

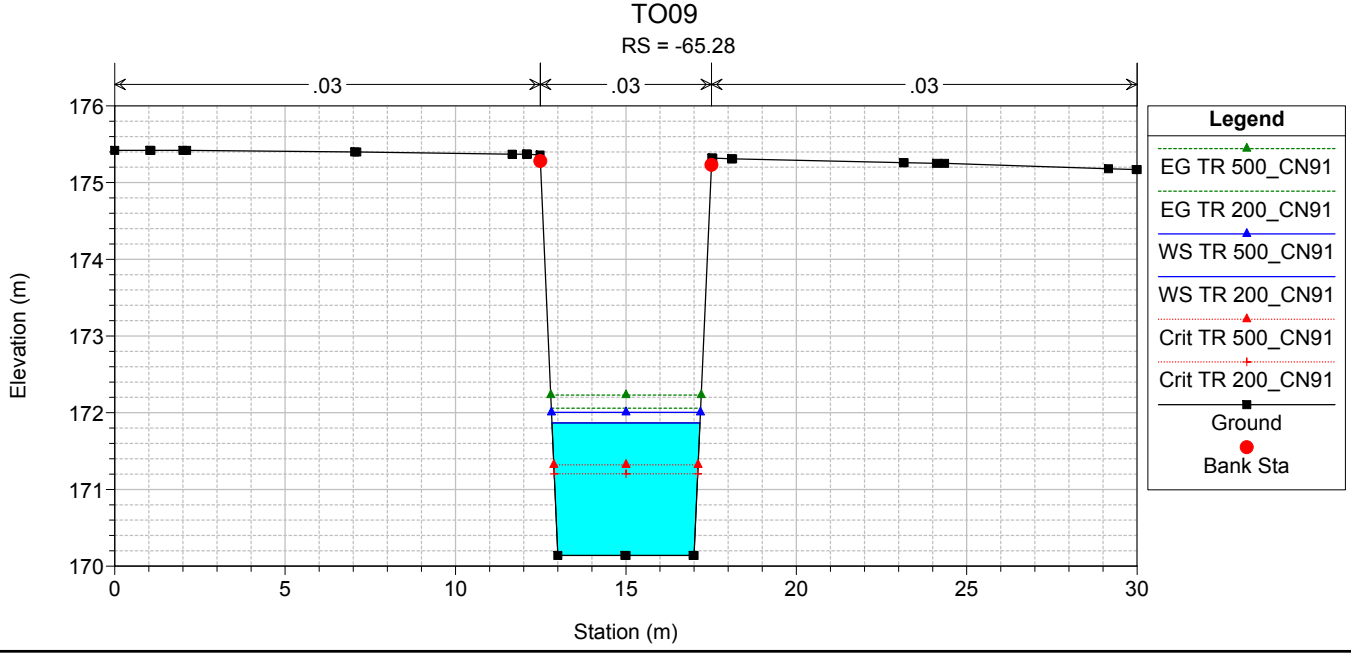
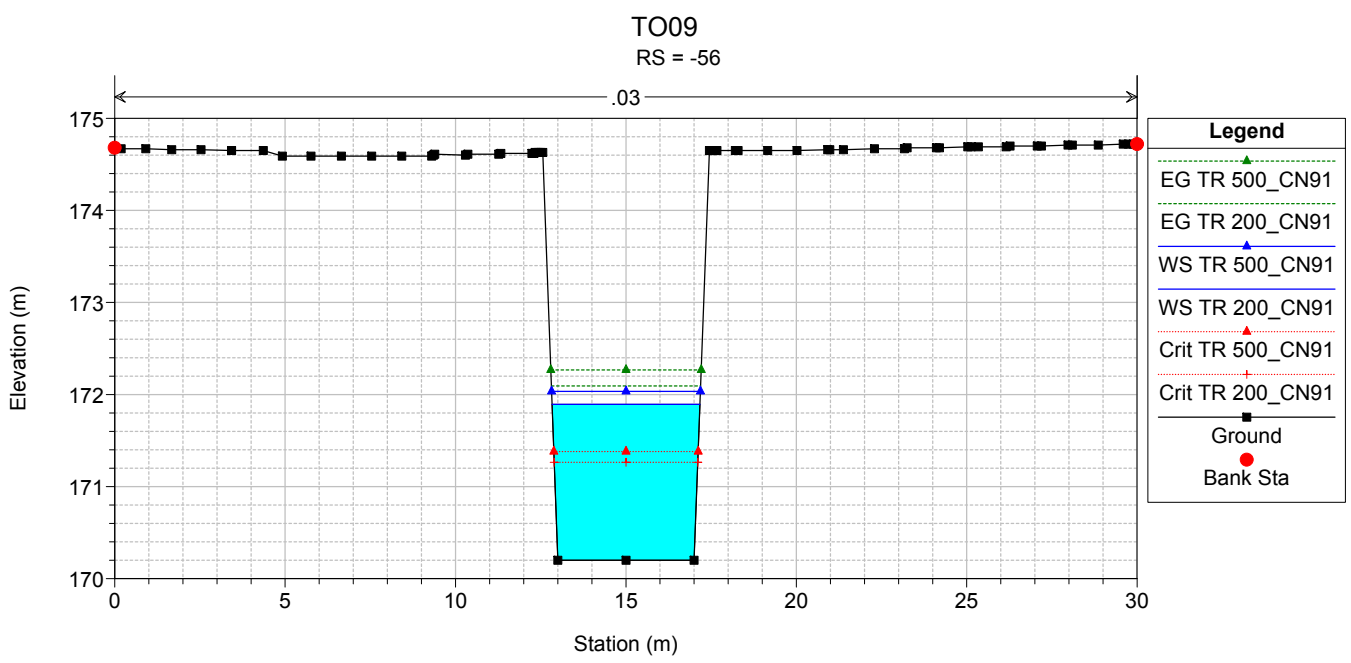
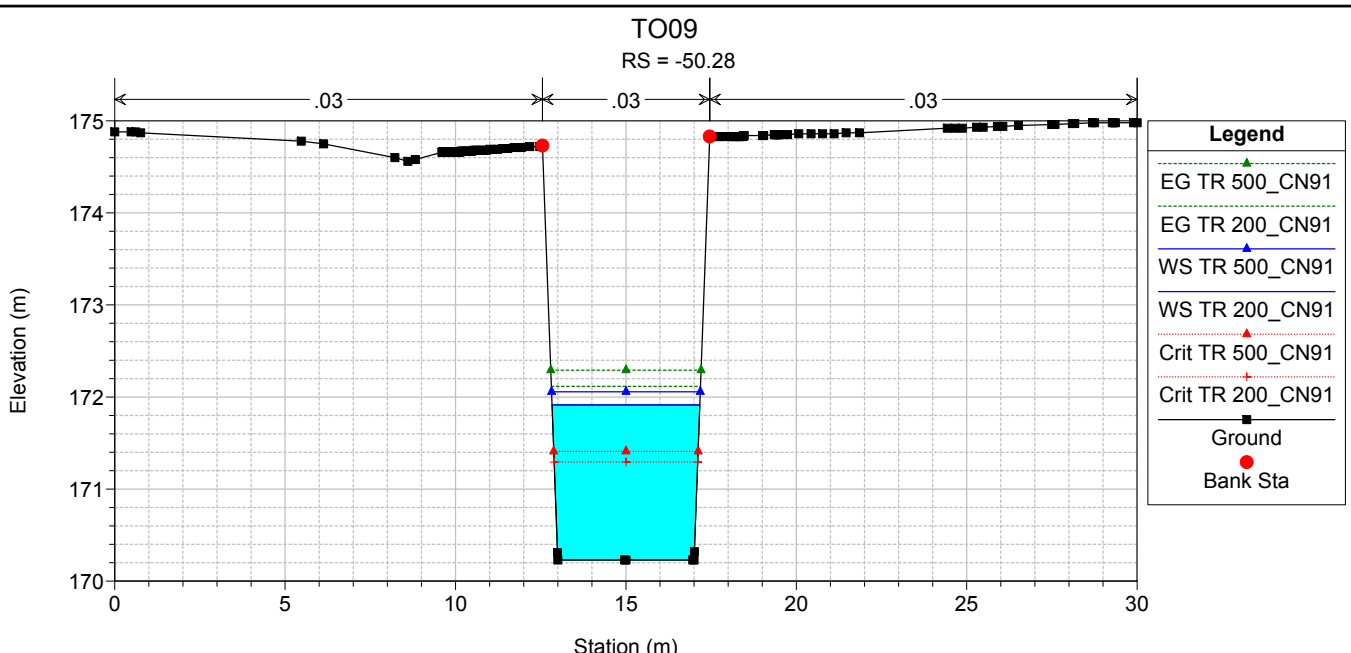

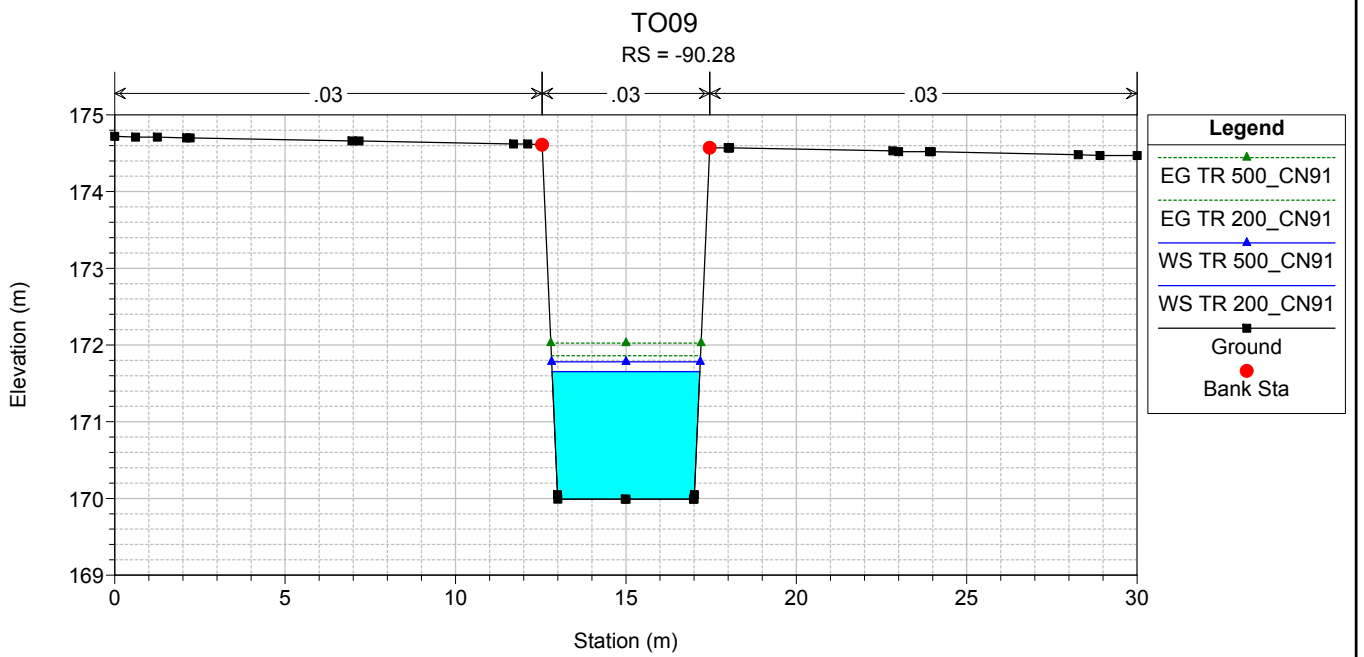
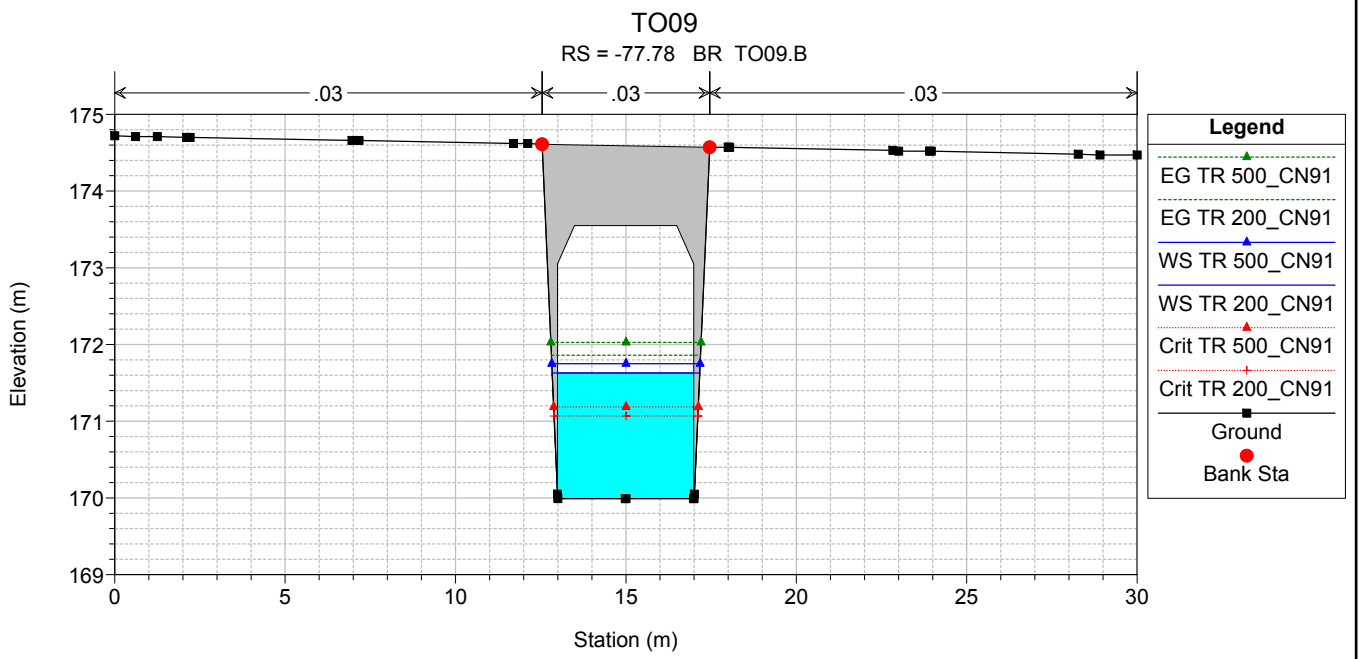
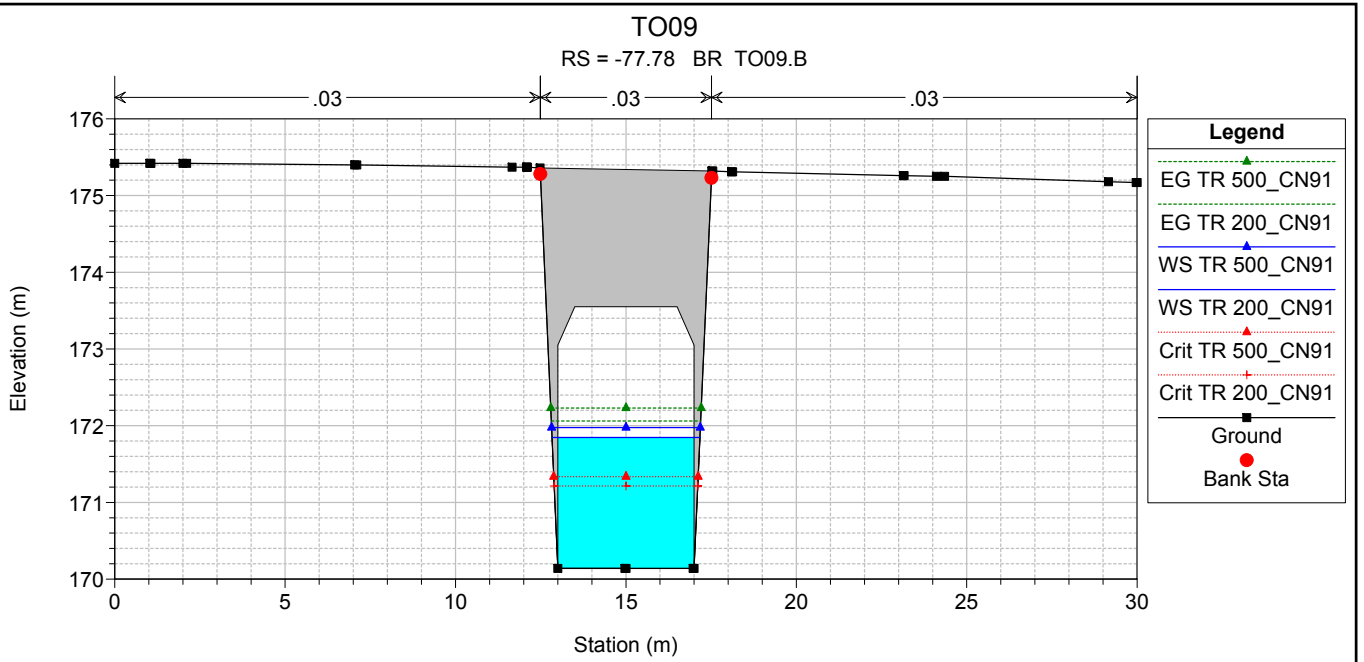

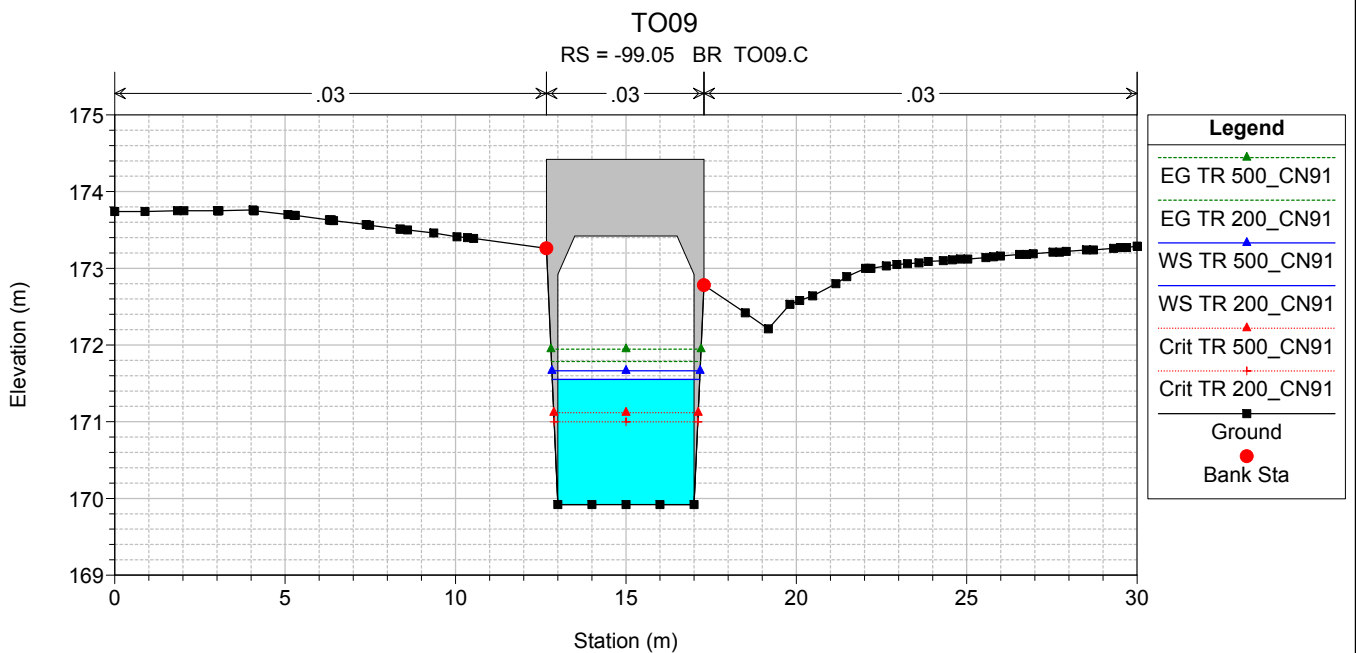
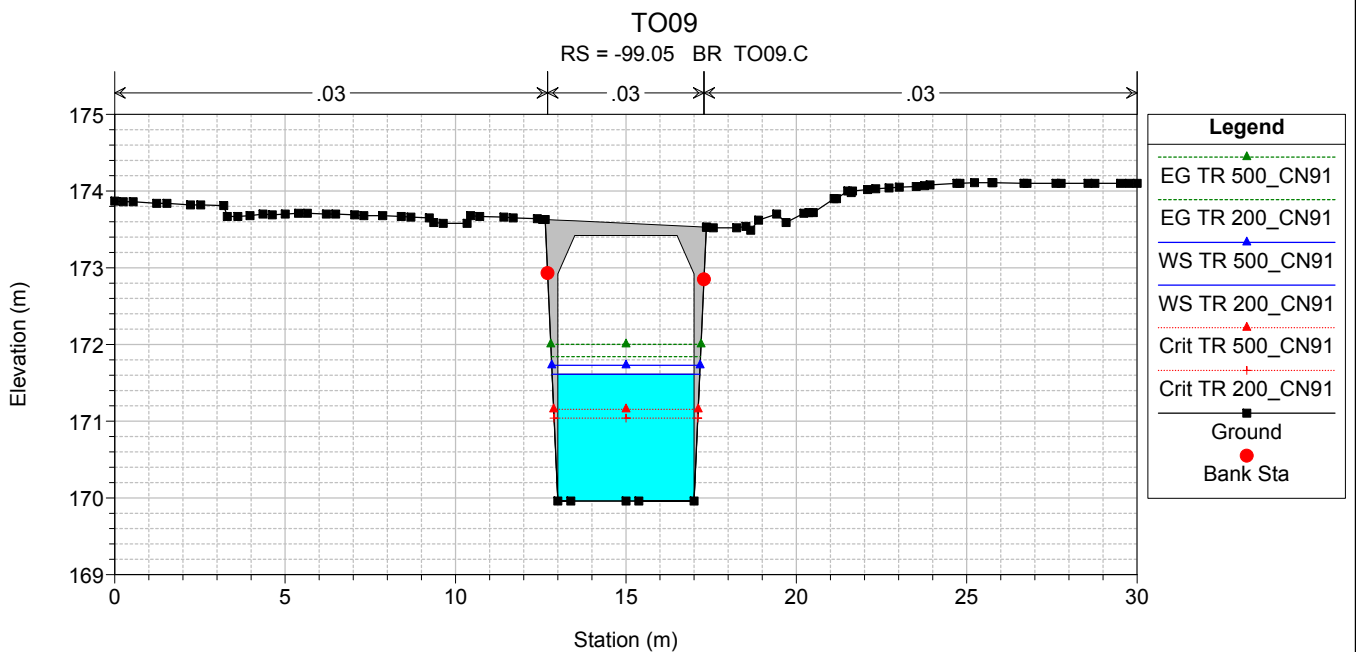
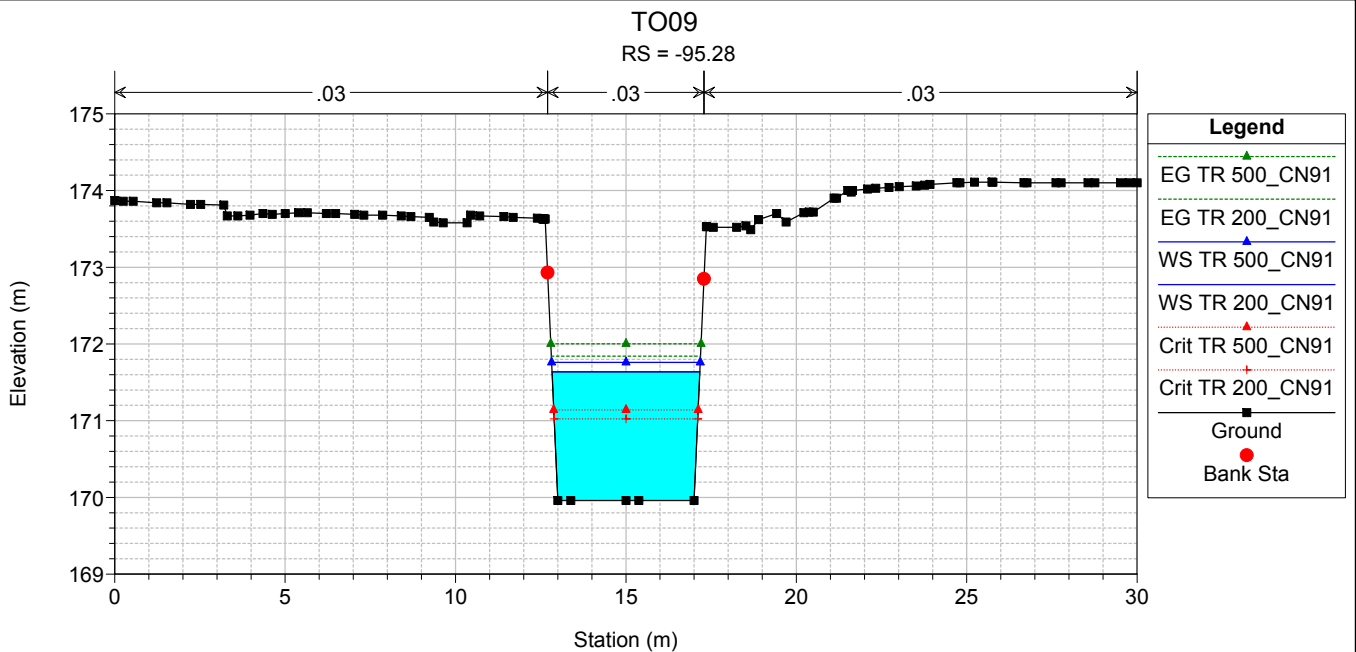

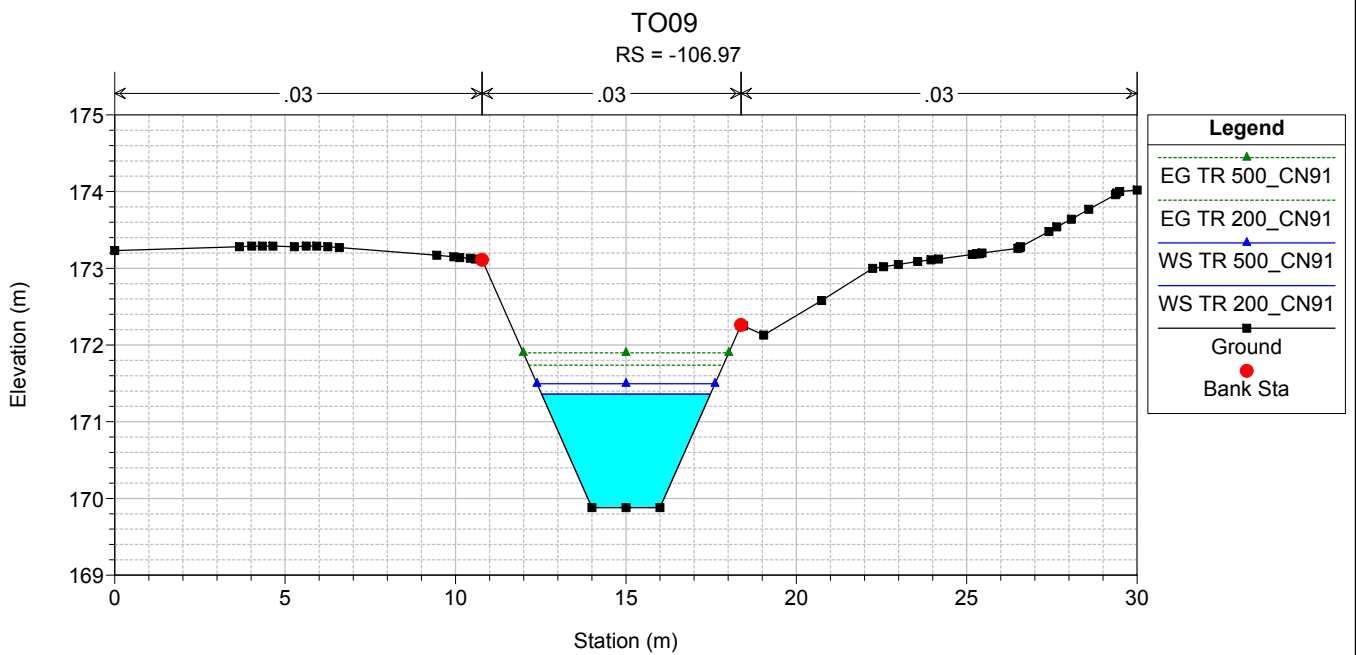
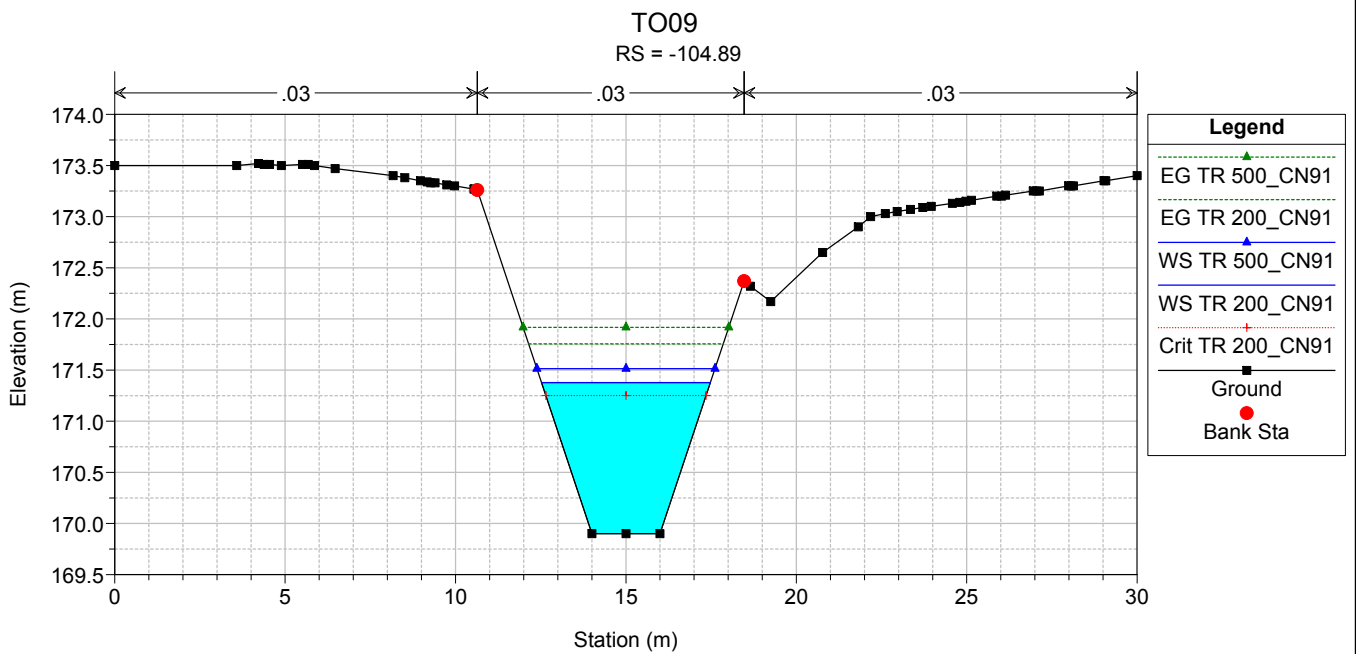
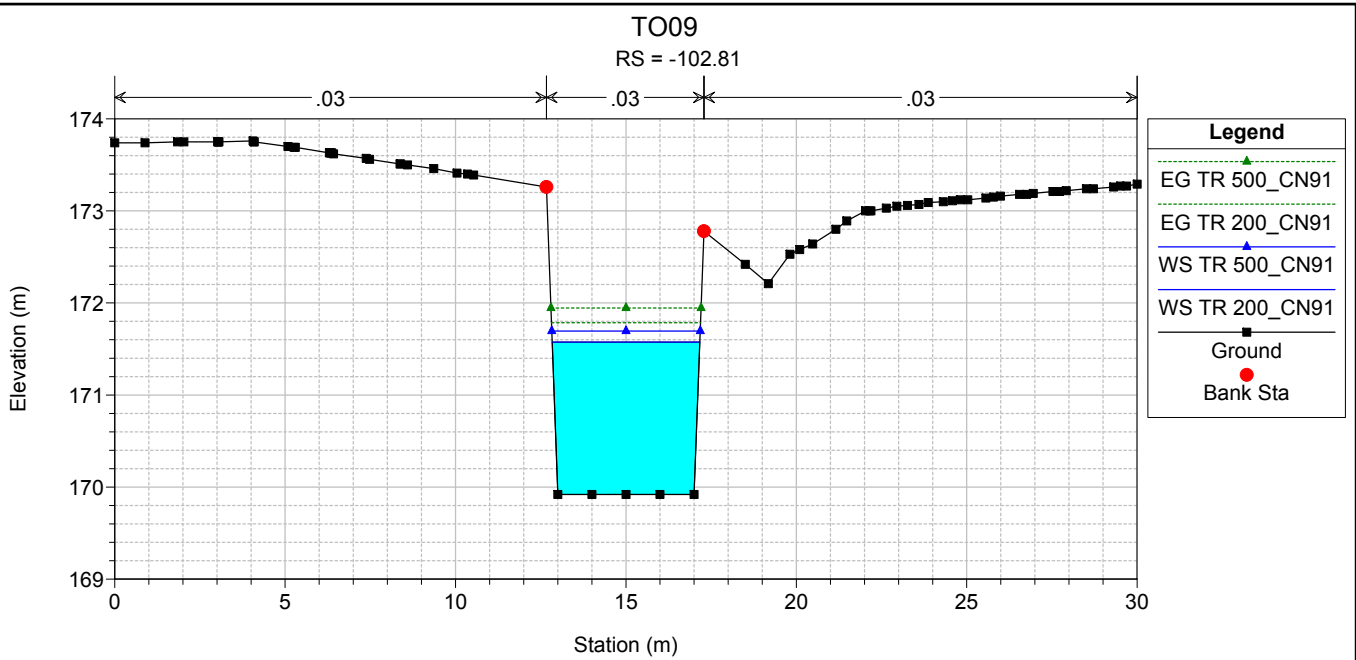

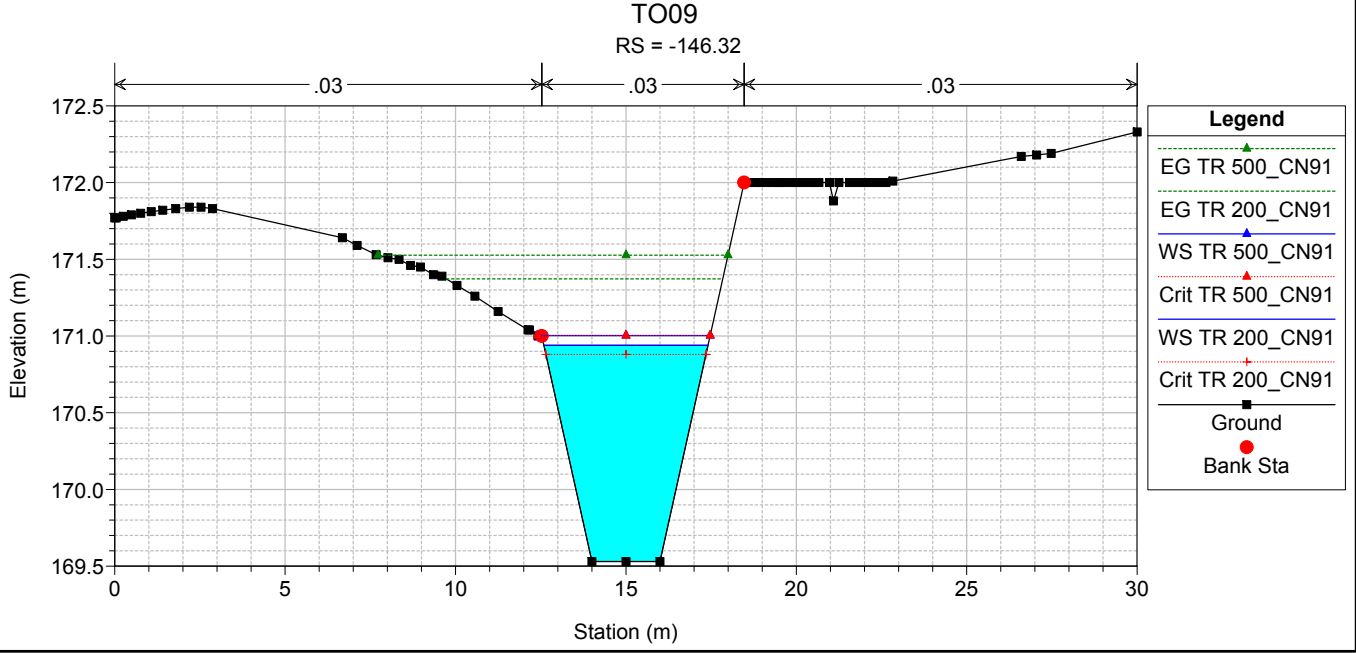
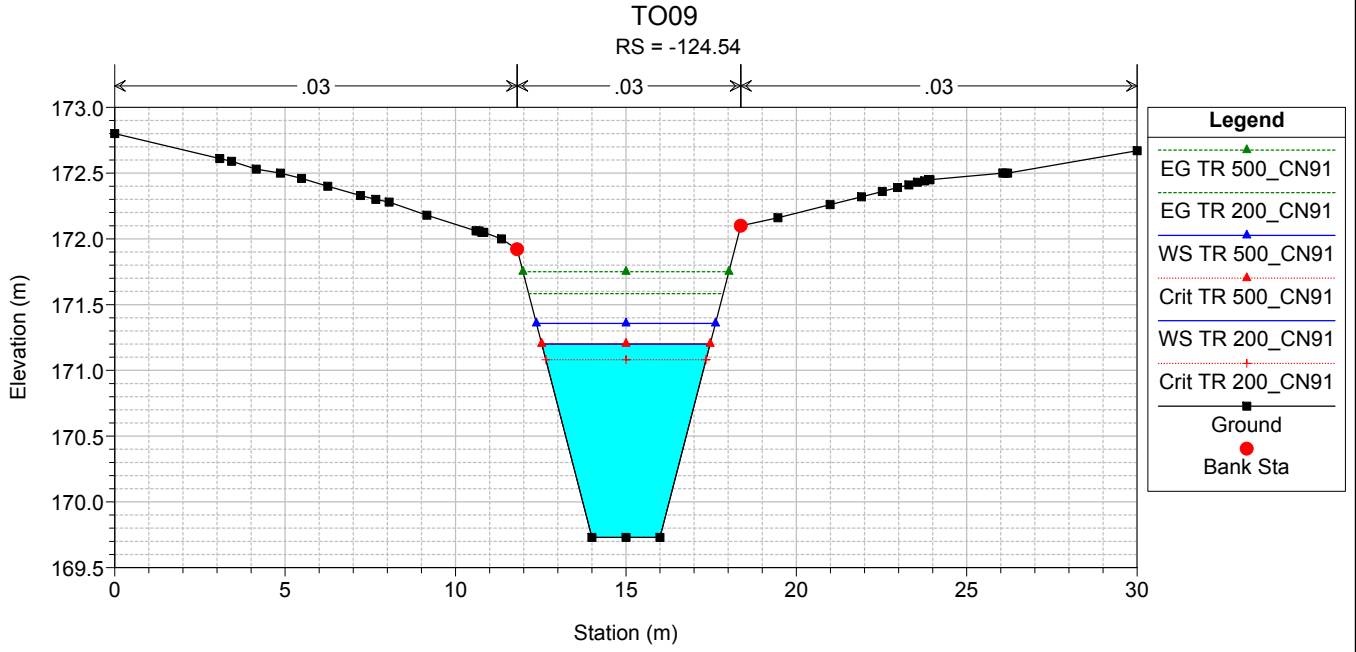
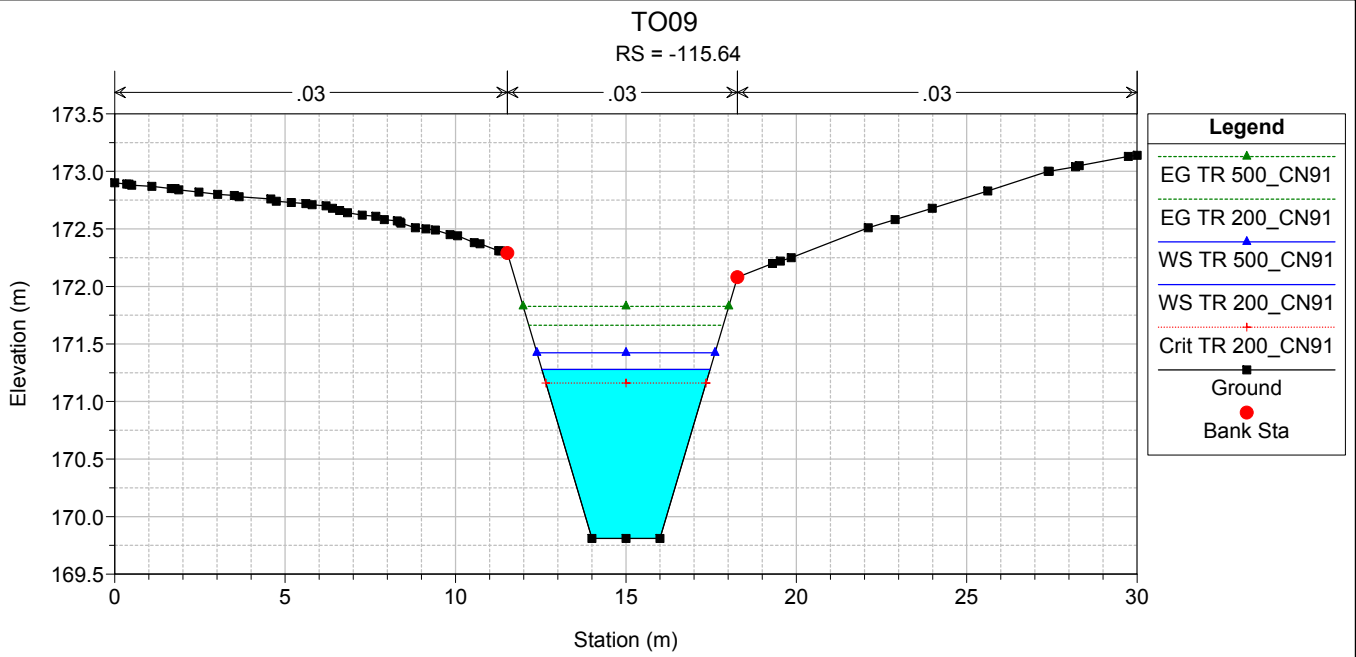

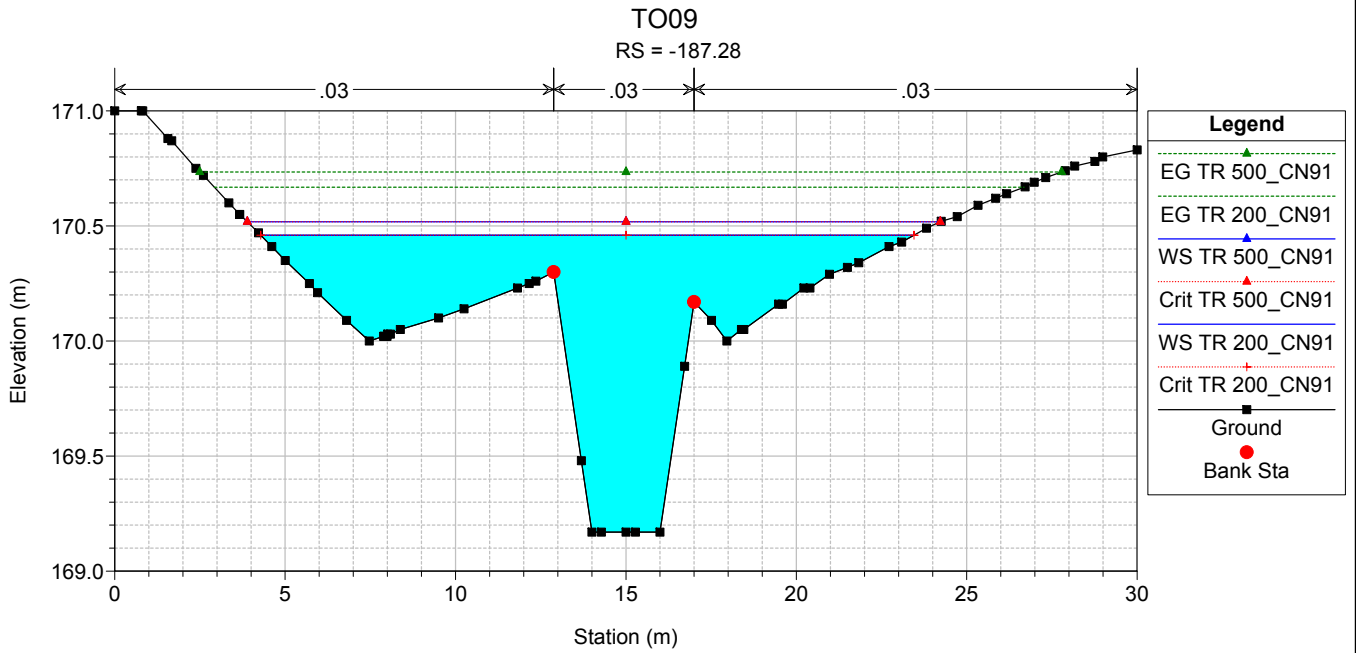
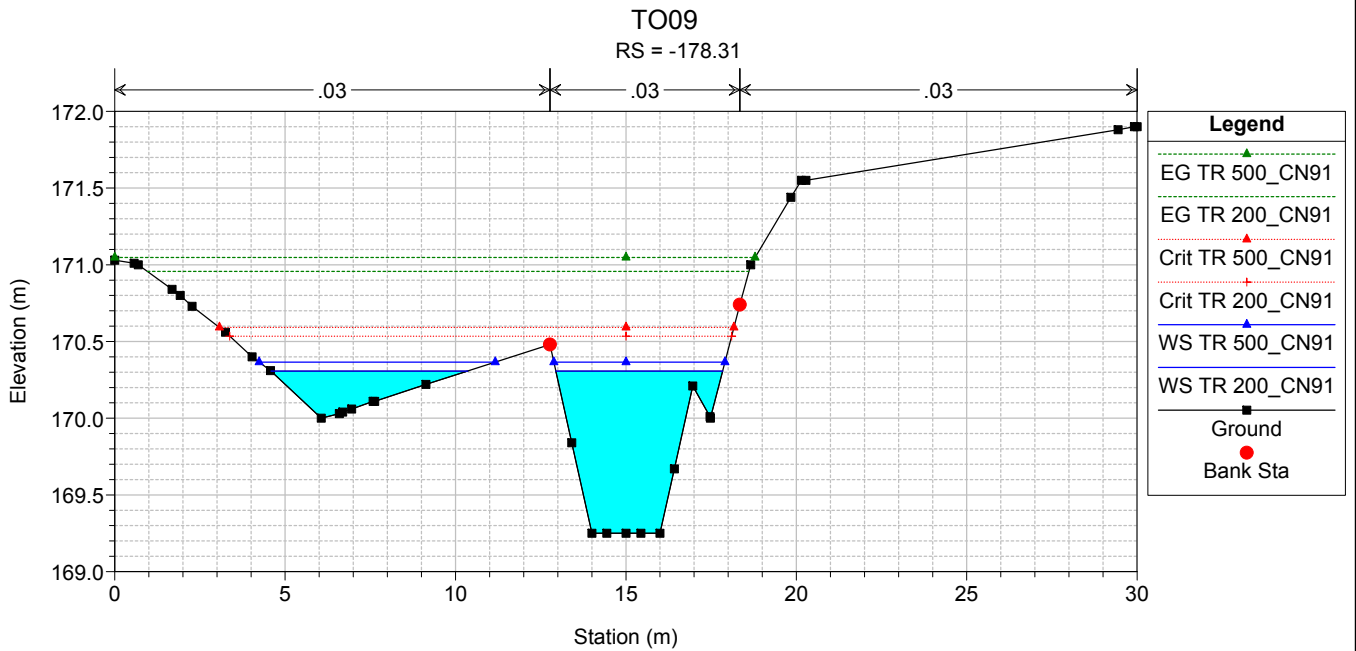
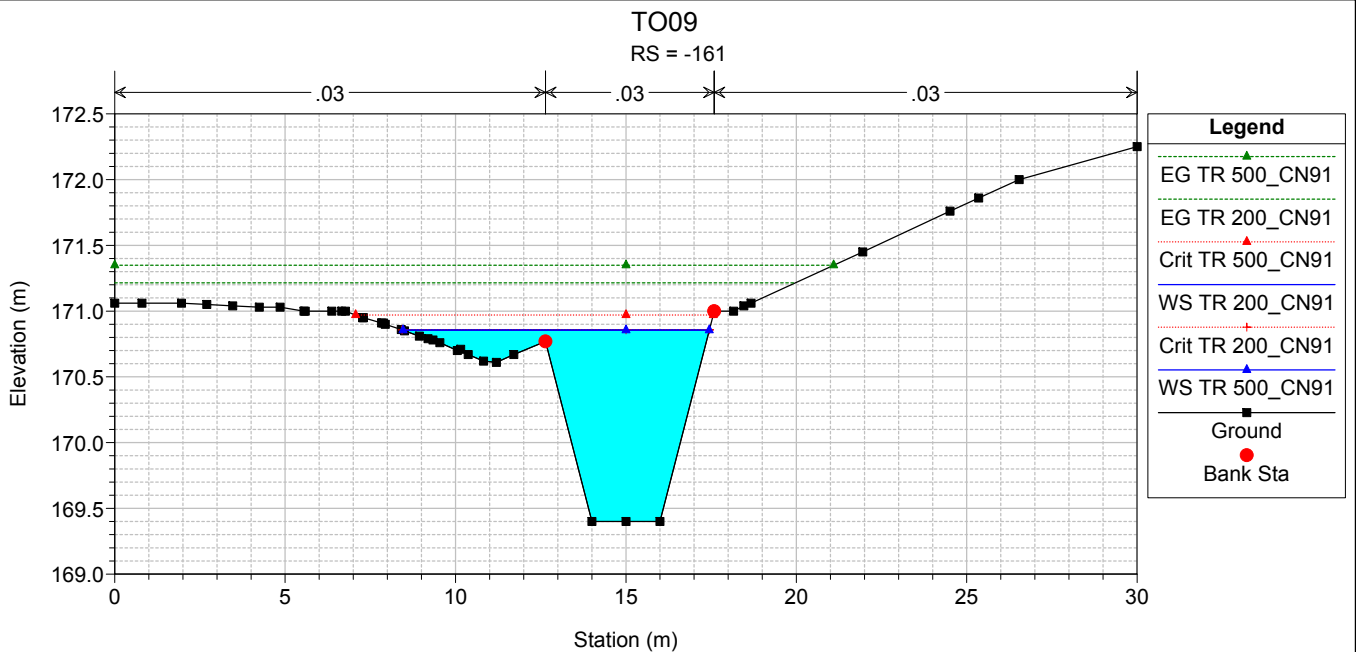

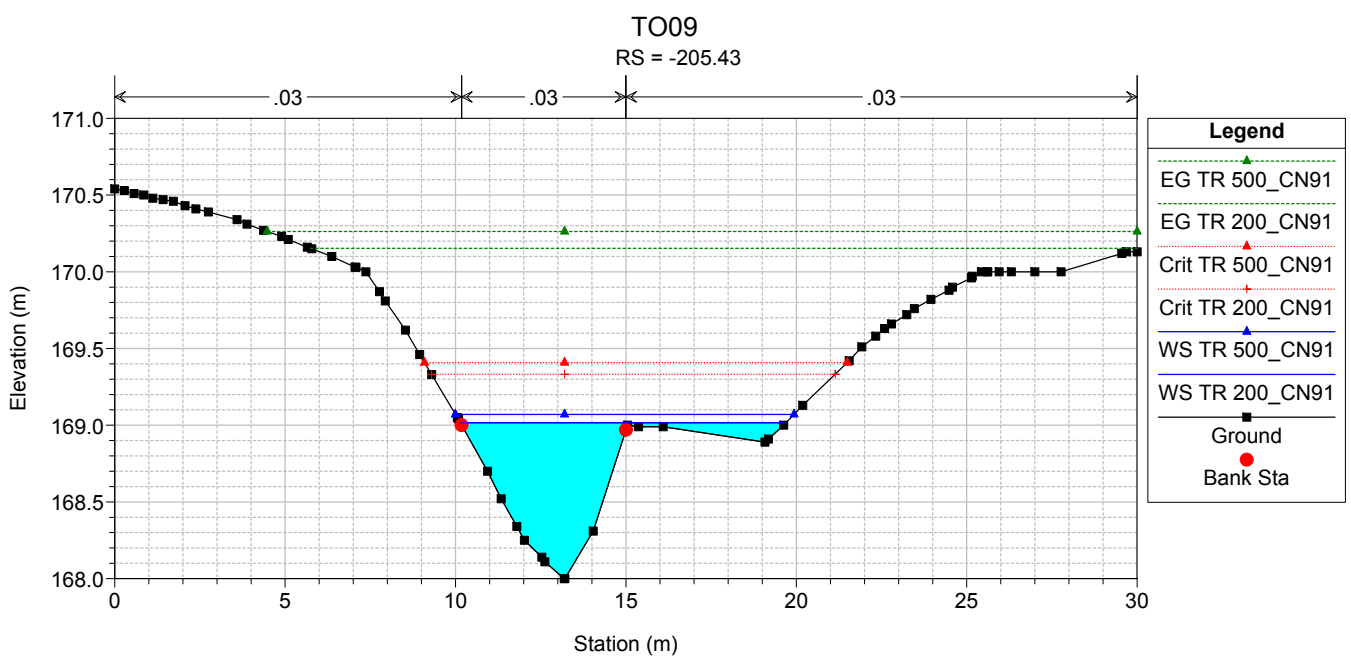
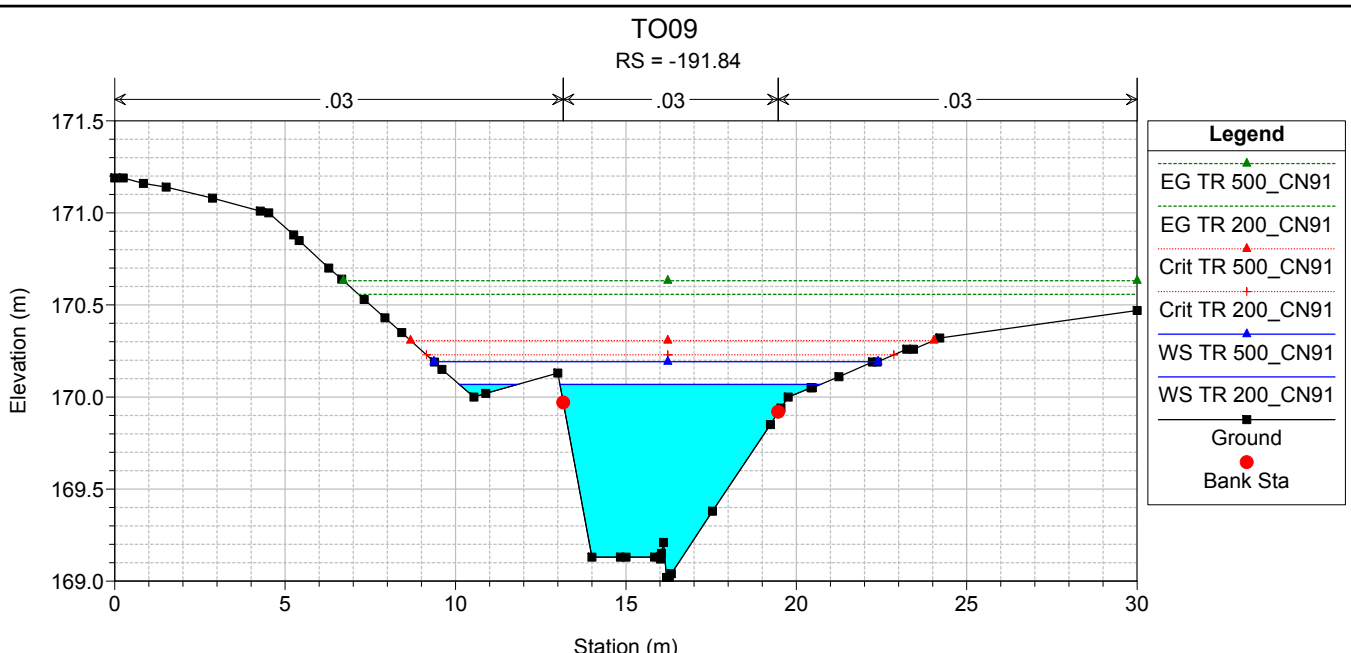

ALLEGATO 2.10

Interferenza idraulica – TO10
Tabella riassuntiva dei risultati, profilo idrico e sezioni
trasversali con i livelli idrici (TR 200 - 500 anni)

HEC-RAS Plan: POST_PERM_DEF River: TO10 Reach: TO10 Profile: TR 200_CN91

Reach	River Sta	Profile	Q Total (m ³ /s)	Min Ch El (m)	Max Chl Dpth (m)	W.S. Elev (m)	Crit W.S. (m)	Diff	Froude # Chl	E.G. Elev (m)	Vel Chnl (m/s)	Vel Total (m/s)	Hydr Radius C (m)	Shear Chan (N/m ²)	Hydr Depth (m)
TO10	0	TR 200_CN91	145.7	175.96	2.44	178.40	178.29	0.11	0.81	178.75	3.4	2.5	1.6	84.9	0.99
TO10	-25	TR 200_CN91	145.7	175.66	2.75	178.41	178.01	0.40	0.53	178.63	2.4	1.9	2.0	40.8	1.27
TO10	-47.29	TR 200_CN91	145.7	175.39	2.51	177.90	177.90	0.00	0.89	178.52	3.8	3.3	1.7	106.5	1.20
TO10	-60	TR 200_CN91	145.7	175.21	2.14	177.35	177.67	-0.32	1.23	178.36	4.7	4.1	1.4	177.8	0.96
TO10	-65	TR 200_CN91	145.7	175.14	2.84	177.98	177.50	0.48	0.53	178.21	2.4	1.9	2.0	41.5	1.26
TO10	-70.995	Bridge													
TO10	-76.99	TR 200_CN91	145.7	174.98	2.31	177.29	177.43	-0.14	1.22	178.06	3.9	3.9	1.0	132.6	1.03
TO10	-81.88	TR 200_CN91	145.7	174.91	2.34	177.25	177.37	-0.12	1.18	177.99	3.8	3.8	1.0	127.4	1.07
TO10	-95	Bridge													
TO10	-107.26	TR 200_CN91	145.7	174.56	2.71	177.27	177.02	0.25	0.76	177.68	2.8	2.8	1.4	64.3	1.43
TO10	-112.39	TR 200_CN91	145.7	174.49	2.79	177.28	176.95	0.33	0.70	177.64	2.7	2.7	1.4	55.6	1.48
TO10	-118.20	Bridge													
TO10	-124	TR 200_CN91	145.7	174.33	2.94	177.27	176.78	0.49	0.60	177.57	2.4	2.4	1.5	45.6	1.67
TO10	-140	TR 200_CN91	145.7	174.11	2.72	176.83	176.83	0.00	0.92	177.47	3.8	3.4	1.5	109.3	1.33
TO10	-160	TR 200_CN91	145.7	173.84	1.61	175.45	175.89	-0.44	2.22	177.06	6.4	5.3	0.8	388.2	0.57
TO10	-180	TR 200_CN91	145.7	173.51	2.05	175.56	175.78	-0.22	1.29	176.35	4.8	3.7	1.3	184.9	0.83

HEC-RAS Plan: POST_PERM_DEF River: TO10 Reach: TO10 Profile: TR 500_CN91

Reach	River Sta	Profile	Q Total (m ³ /s)	Min Ch El (m)	Max Chl Dpth (m)	W.S. Elev (m)	Crit W.S. (m)	Diff	Froude # Chl	E.G. Elev (m)	Vel Chnl (m/s)	Vel Total (m/s)	Hydr Radius C (m)	Shear Chan (N/m ²)	Hydr Depth (m)
TO10	0	TR 500_CN91	172.5	175.96	2.60	178.56	178.41	0.15	0.77	178.91	3.3	2.5	1.8	80.9	1.14
TO10	-25	TR 500_CN91	172.5	175.66	2.90	178.56	178.12	0.44	0.54	178.81	2.5	2.0	2.1	43.8	1.42
TO10	-47.29	TR 500_CN91	172.5	175.39	2.78	178.17	178.17	0.00	0.79	178.71	3.6	2.9	1.9	91.5	0.98
TO10	-60	TR 500_CN91	172.5	175.21	2.91	178.12	177.82	0.30	0.63	178.48	3.0	2.4	2.1	61.3	1.20
TO10	-65	TR 500_CN91	172.5	175.14	3.07	178.21	177.71	0.50	0.50	178.43	2.4	1.9	2.2	39.9	1.45
TO10	-70.995	Bridge													
TO10	-76.99	TR 500_CN91	172.5	174.98	2.44	177.42	177.57	-0.15	1.21	178.27	4.1	4.1	1.1	141.8	1.16
TO10	-81.88	TR 500_CN91	172.5	174.91	2.75	177.66	177.51	0.15	0.86	178.21	3.3	3.3	1.4	83.9	1.48
TO10	-95	Bridge													
TO10	-107.26	TR 500_CN91	172.5	174.56	2.90	177.46	177.16	0.30	0.74	177.91	3.0	3.0	1.5	67.2	1.62
TO10	-112.39	TR 500_CN91	172.5	174.49	2.99	177.48	177.08	0.40	0.69	177.87	2.8	2.8	1.6	58.3	1.66
TO10	-118.20	Bridge													
TO10	-124	TR 500_CN91	172.5	174.33	3.13	177.46	176.93	0.53	0.61	177.80	2.6	2.6	1.7	50.0	1.86
TO10	-140	TR 500_CN91	172.5	174.11	2.87	176.98	176.98	0.00	0.93	177.69	4.0	3.6	1.6	119.5	1.48
TO10	-160	TR 500_CN91	172.5	173.84	1.68	175.52	176.02	-0.50	2.23	177.28	6.7	5.6	0.9	412.0	0.62
TO10	-180	TR 500_CN91	172.5	173.51	2.14	175.65	175.89	-0.24	1.33	176.55	5.1	3.9	1.4	205.9	0.89

TO10

TO10 TO10

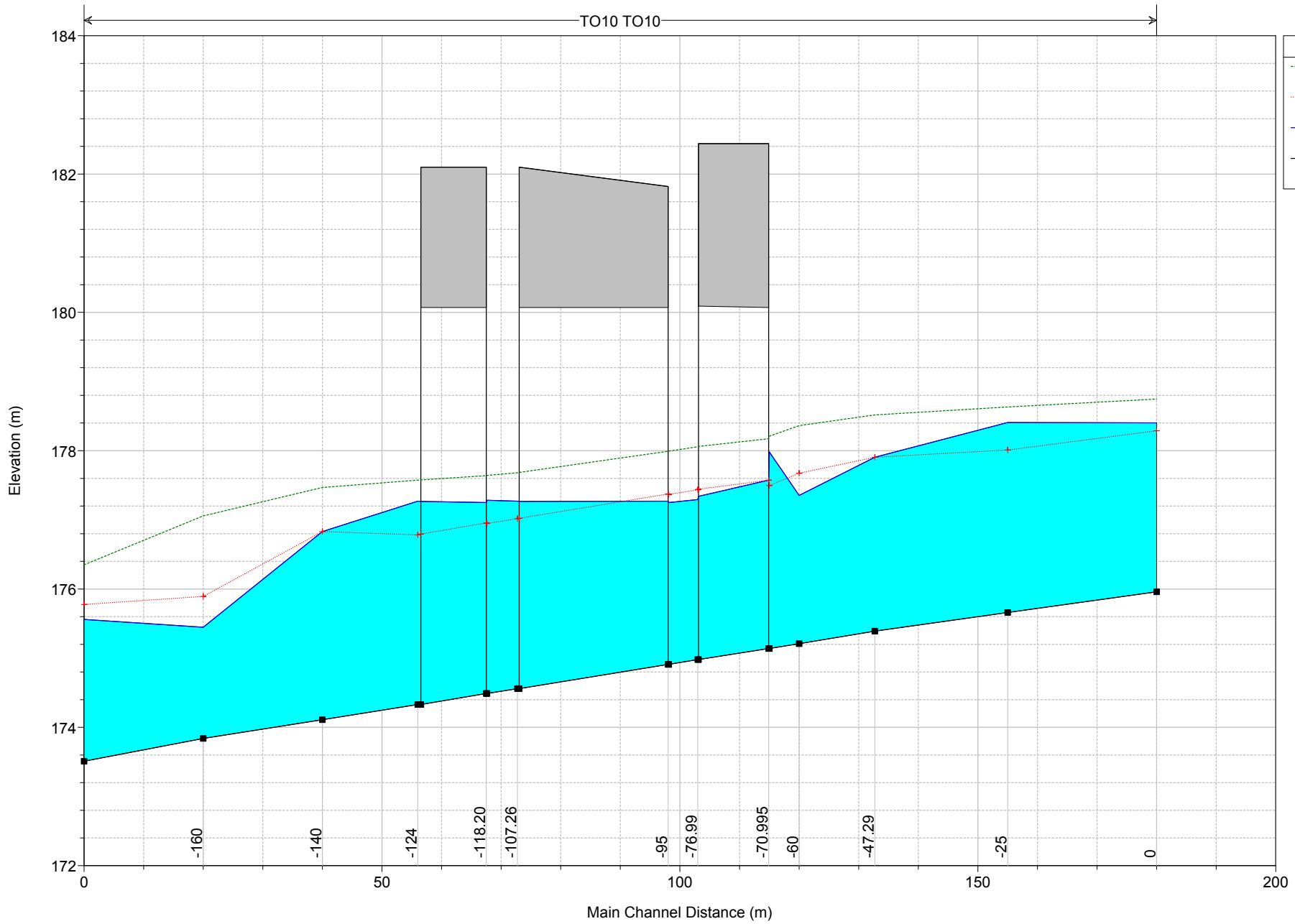

Legend

- EG TR 200_CN91
- Crit TR 200_CN91
- WS TR 200_CN91
- Ground

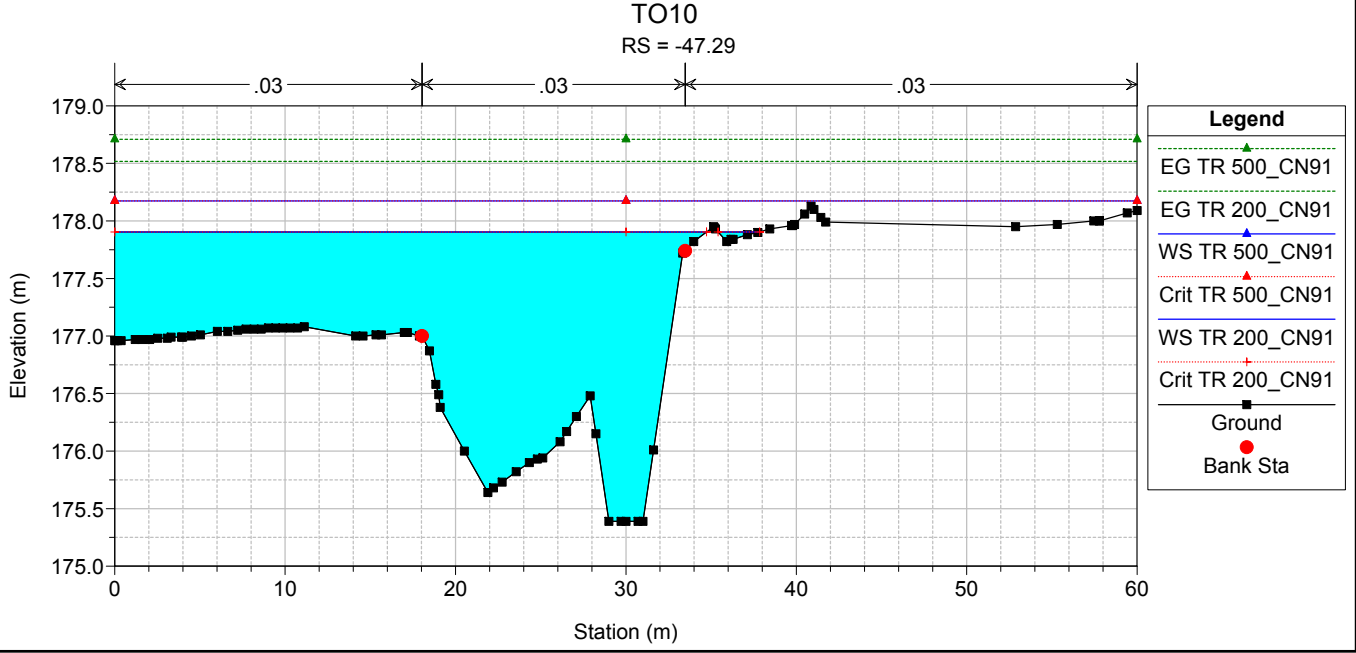
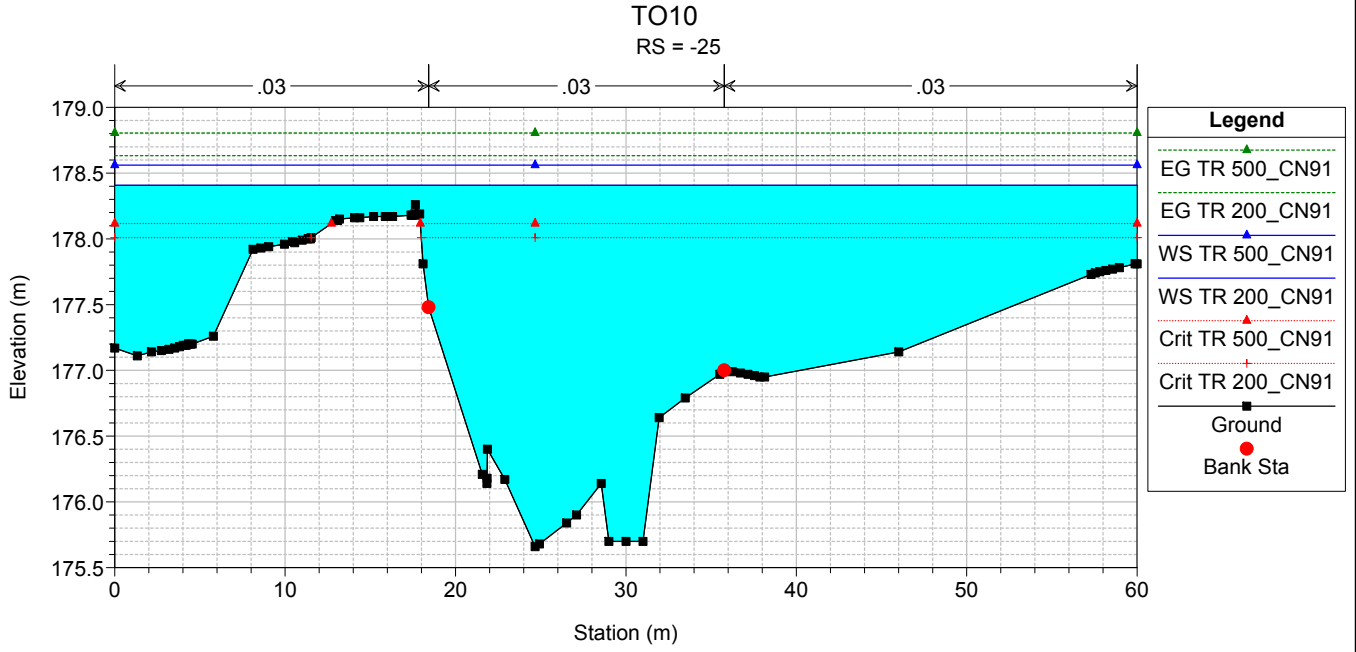
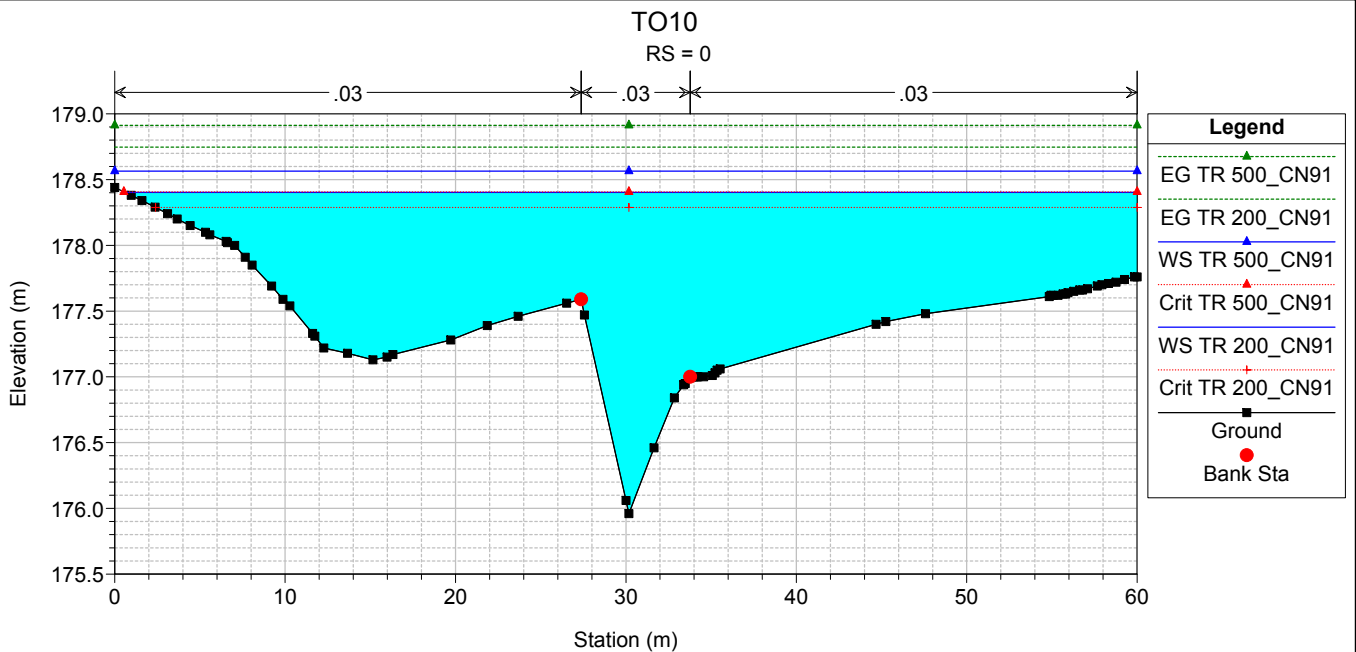

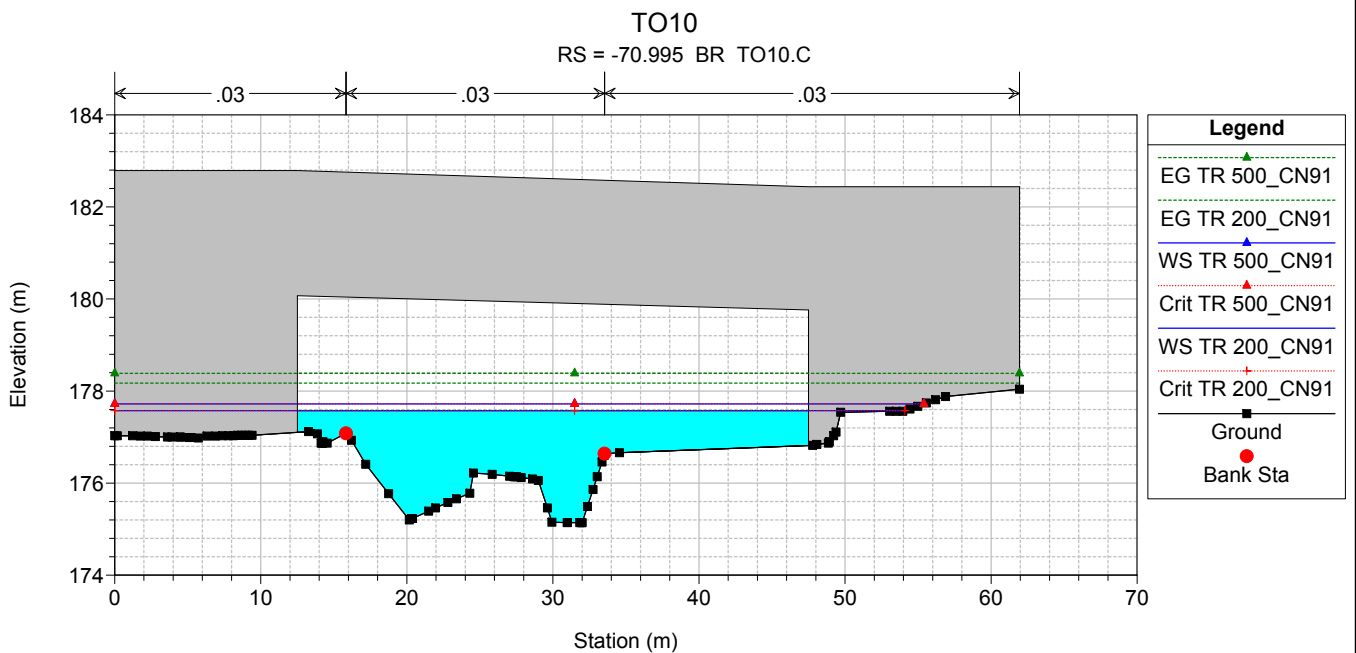
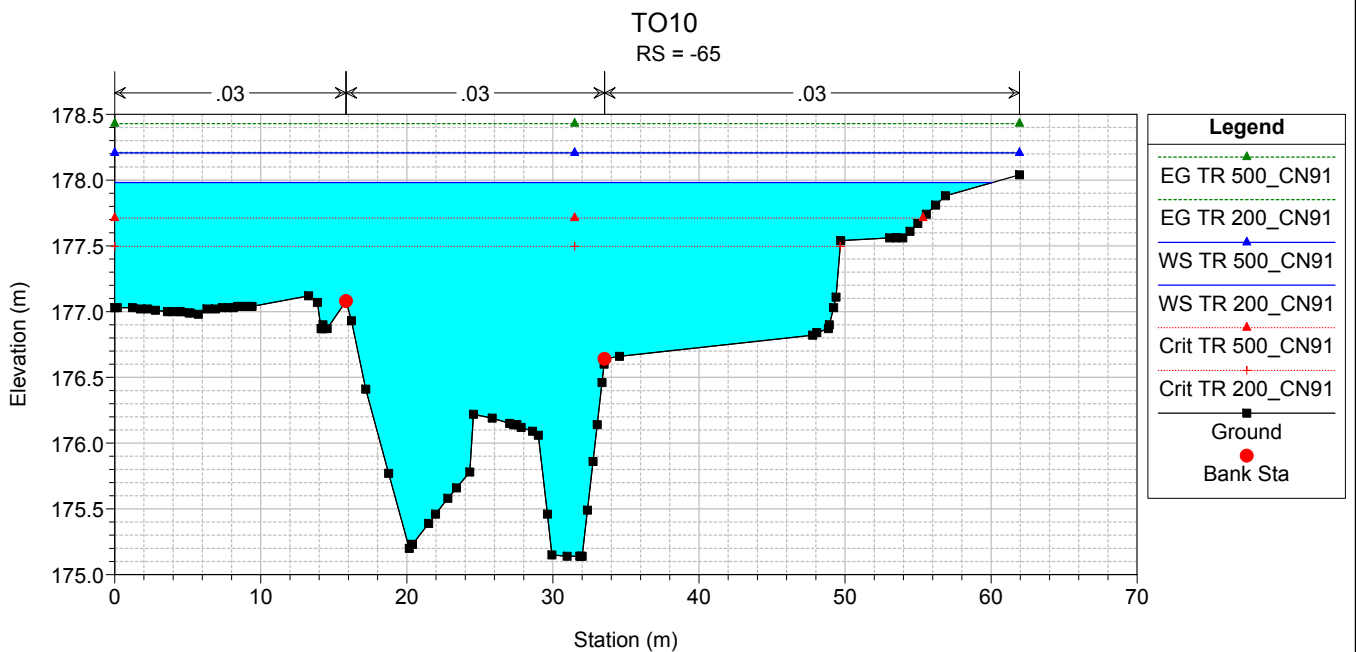
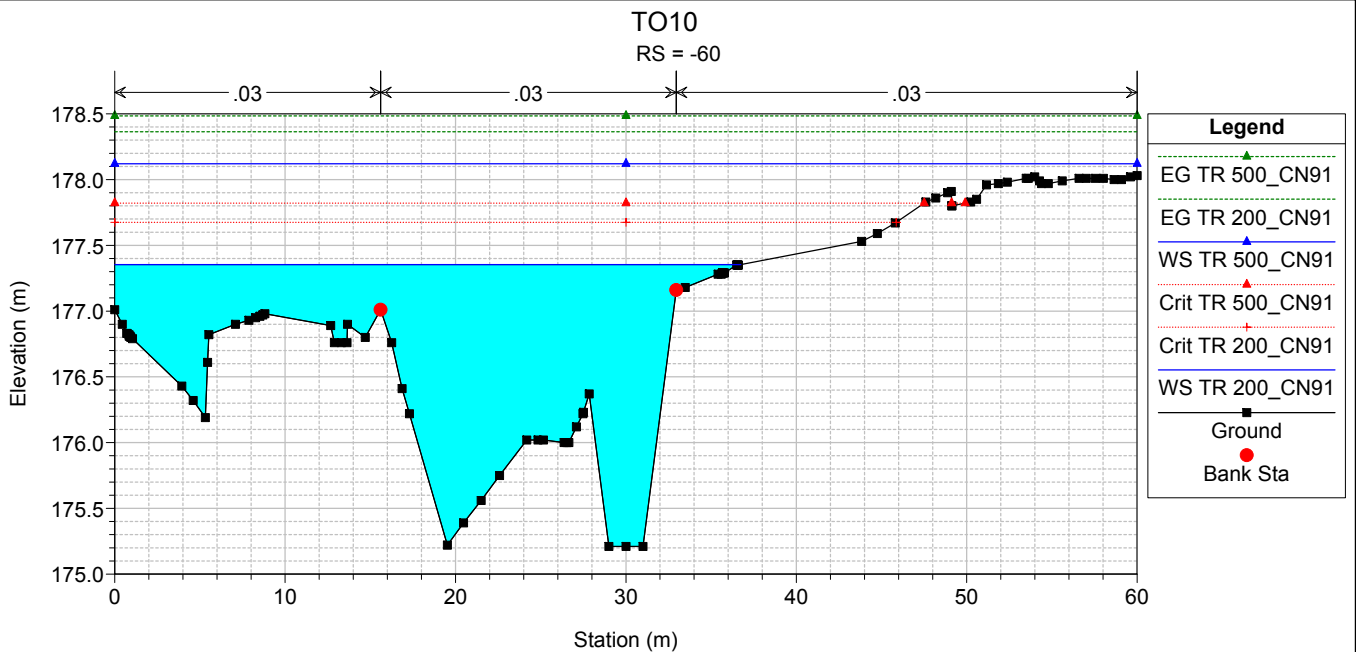

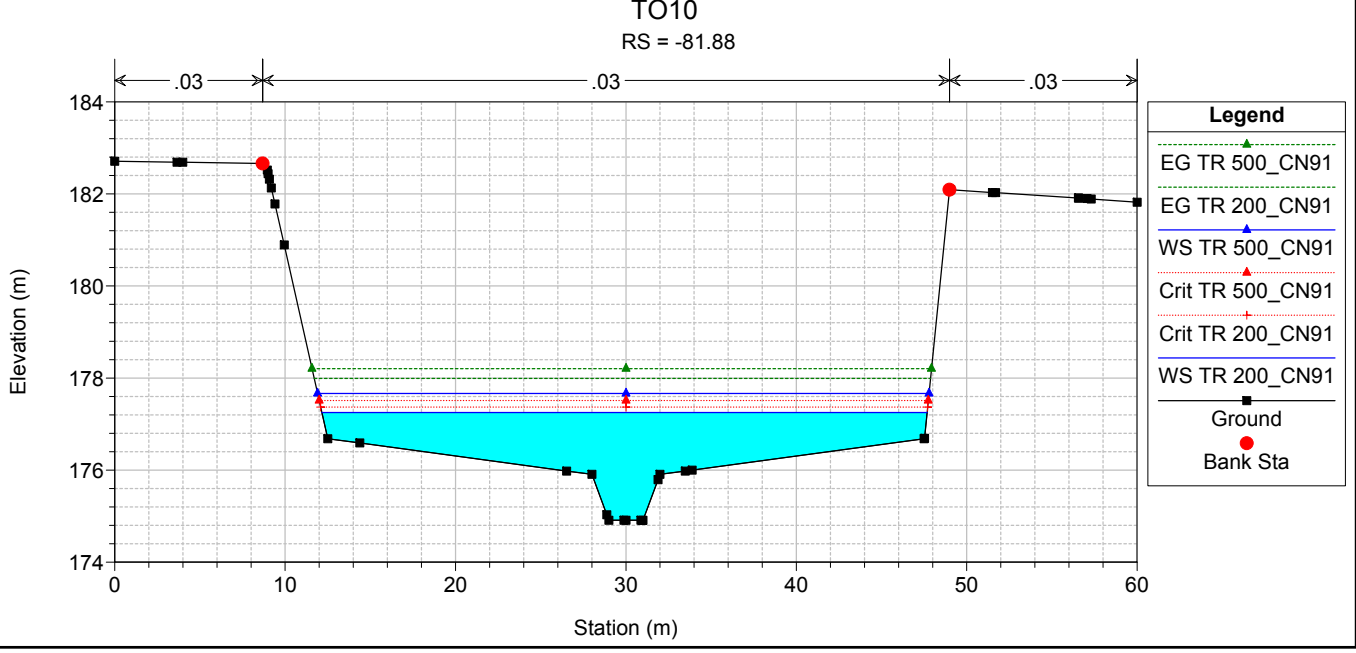
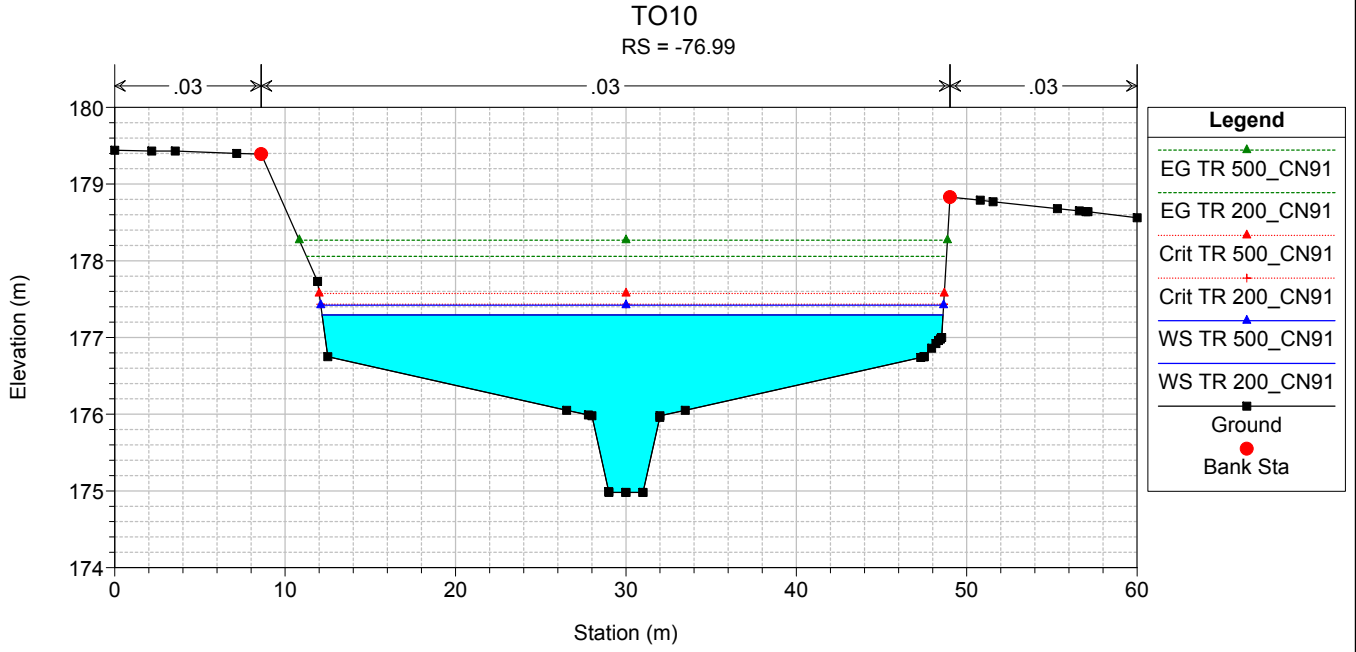
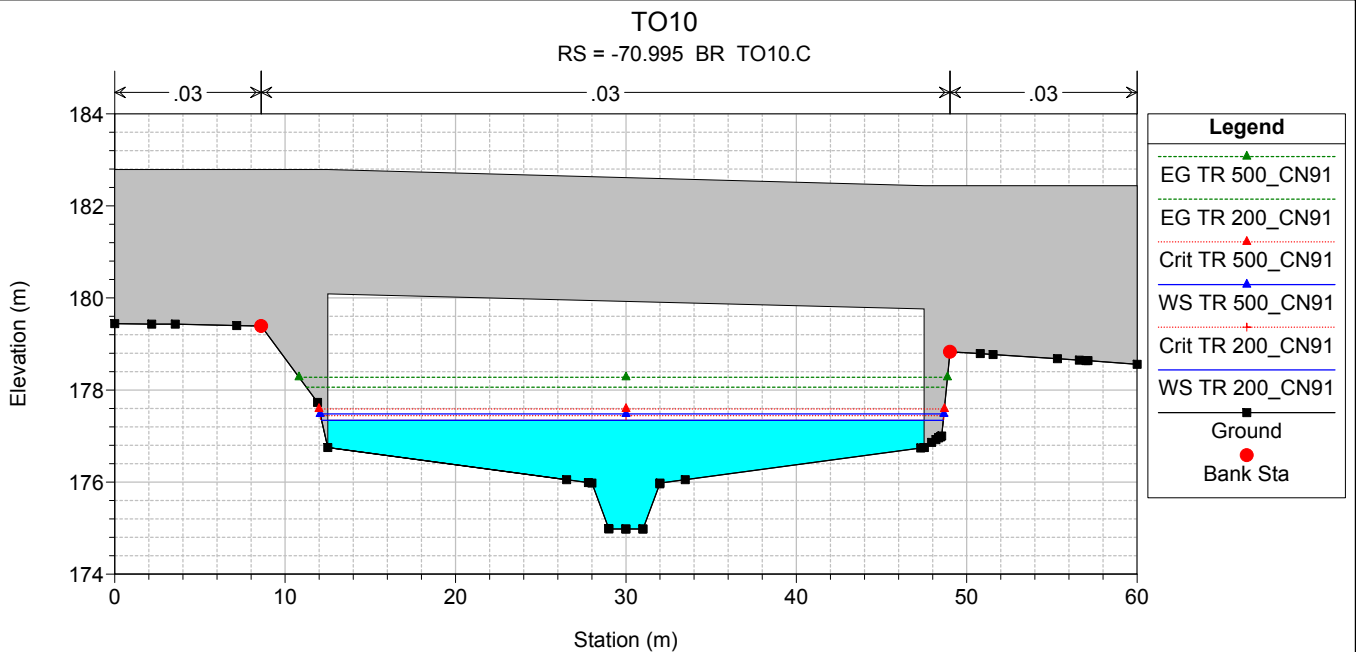

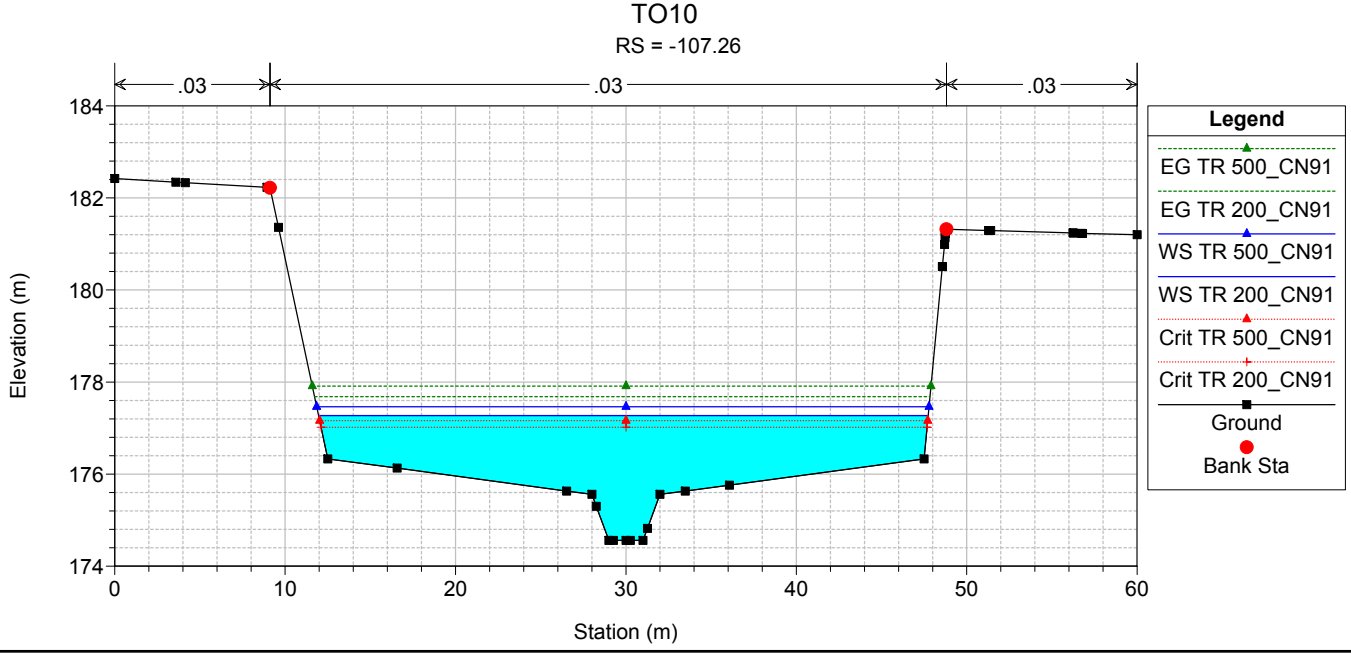
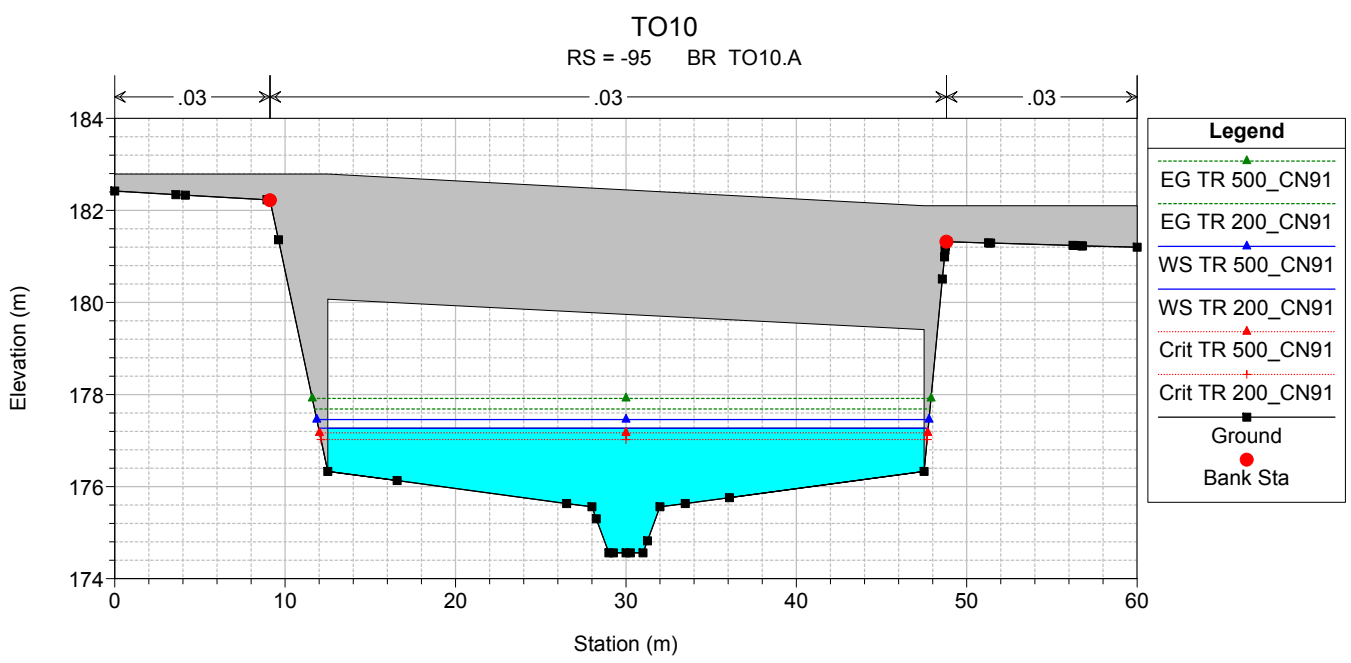
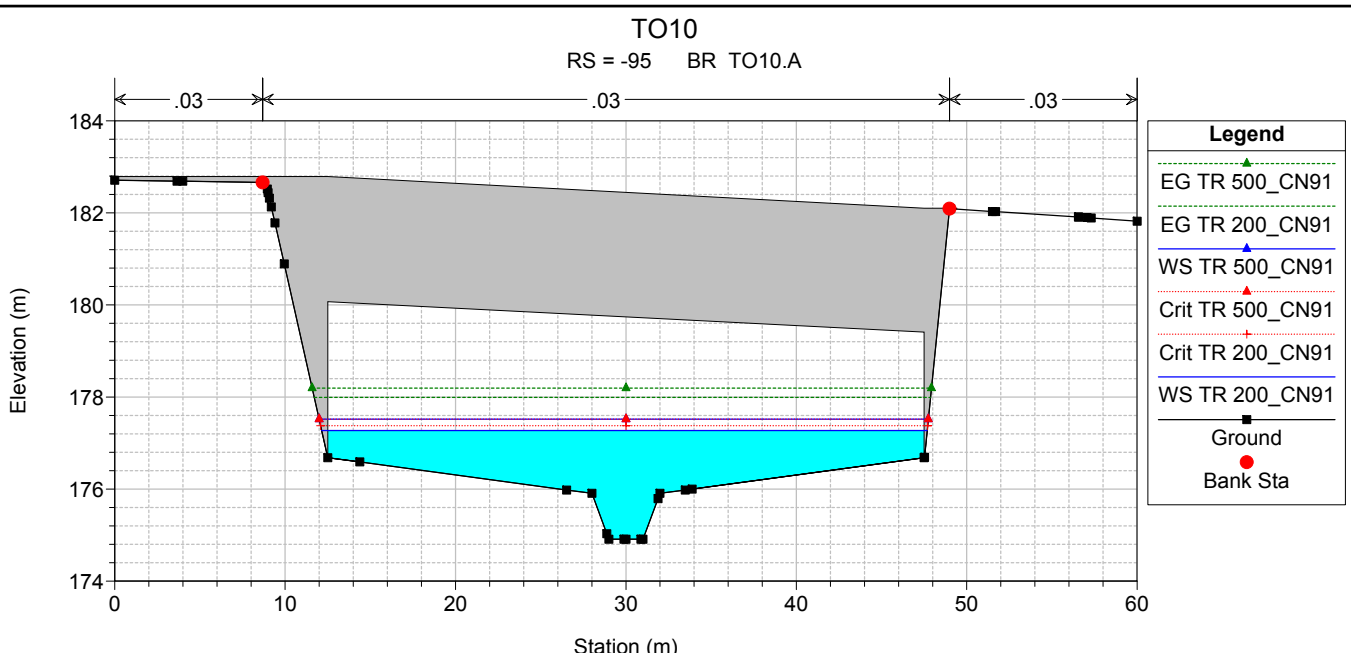

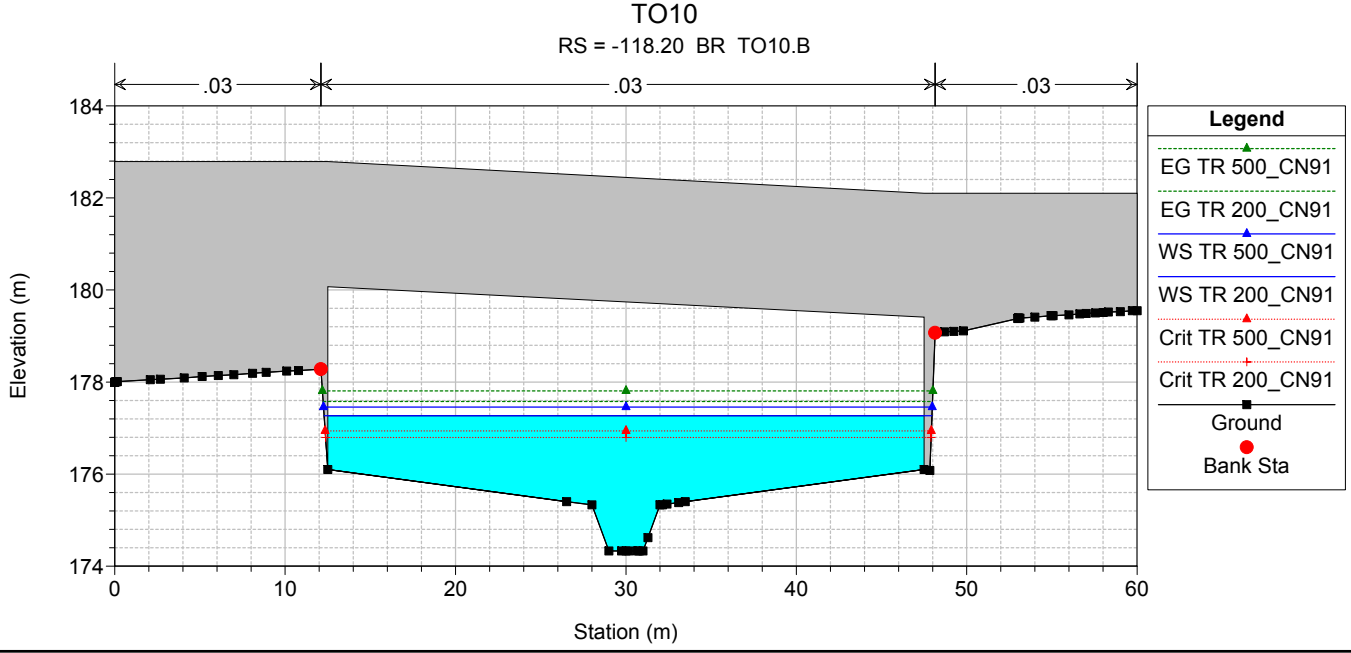
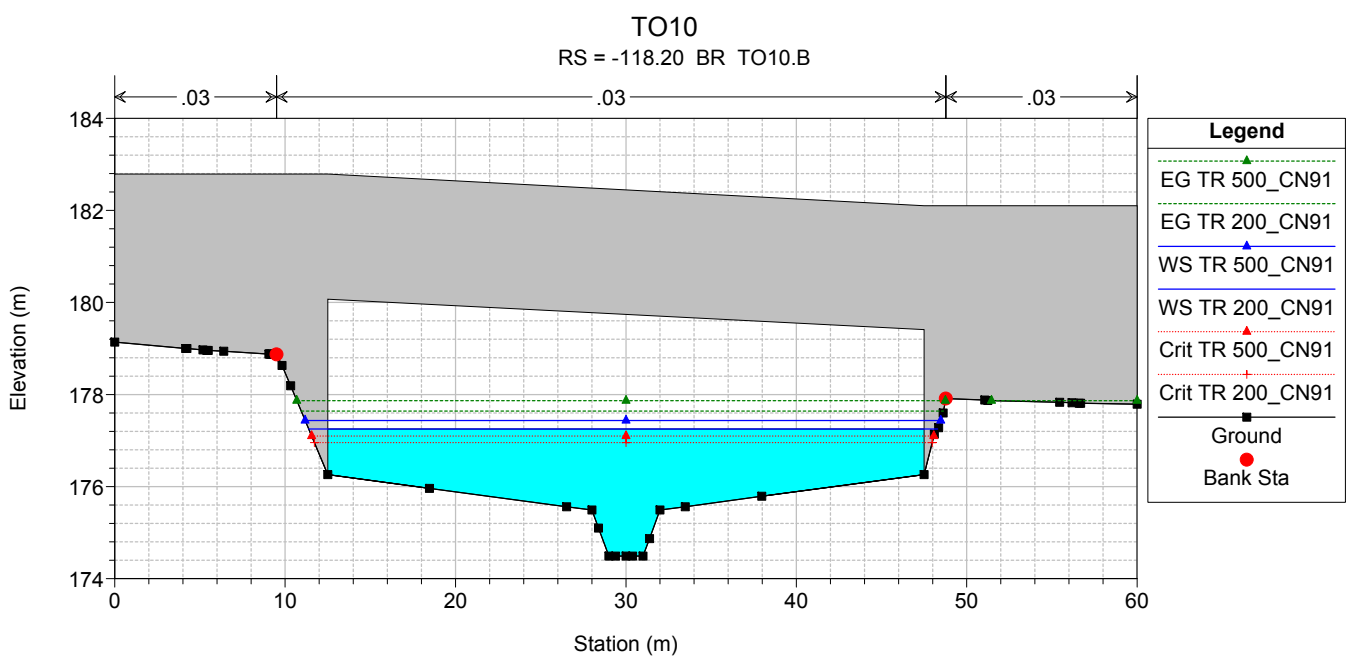
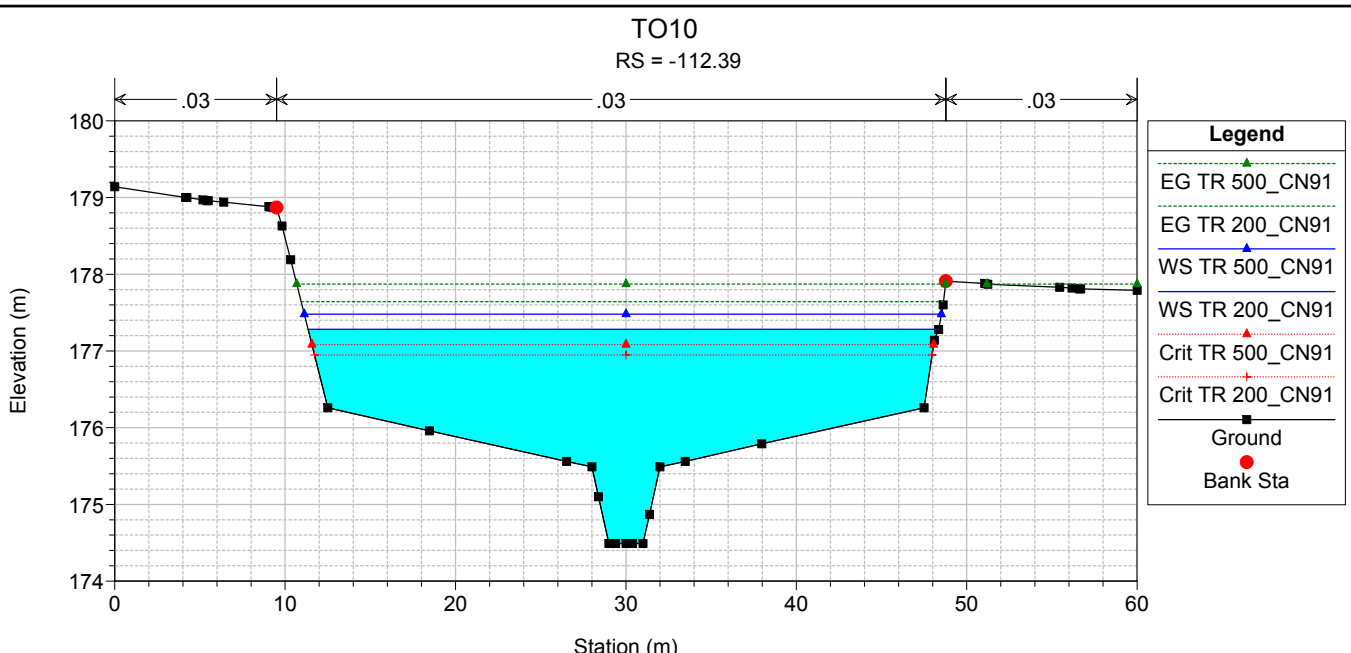

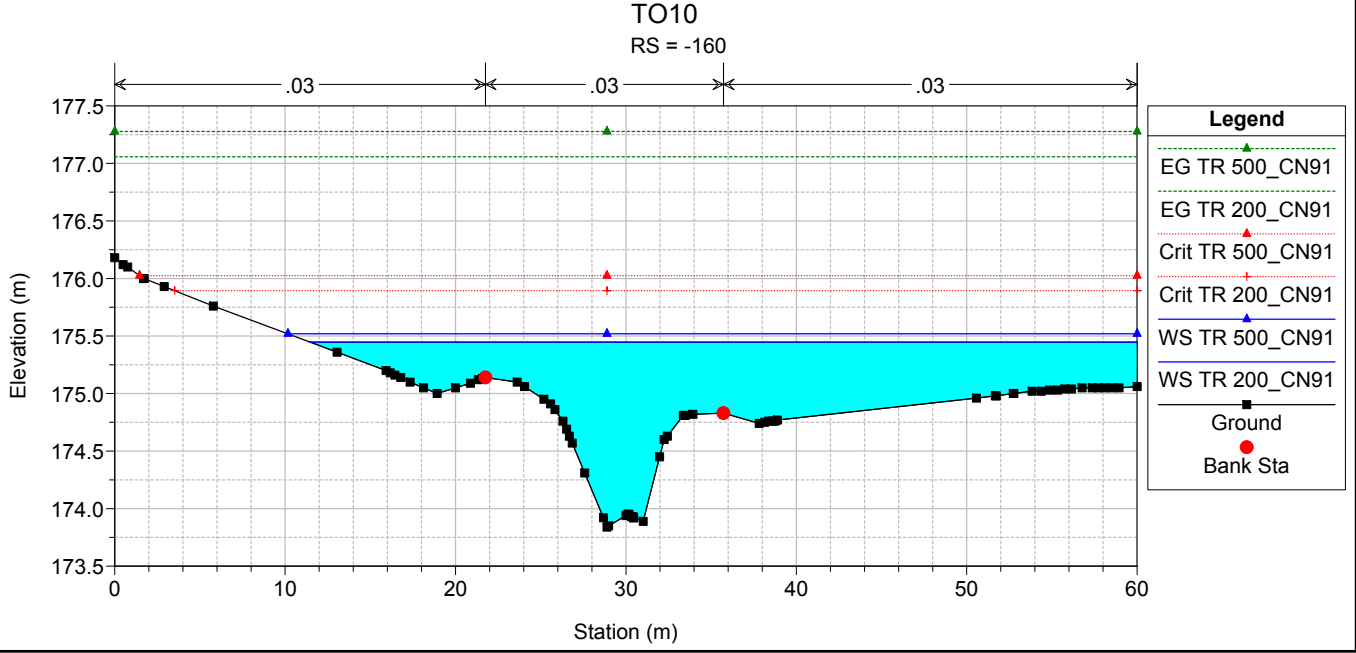
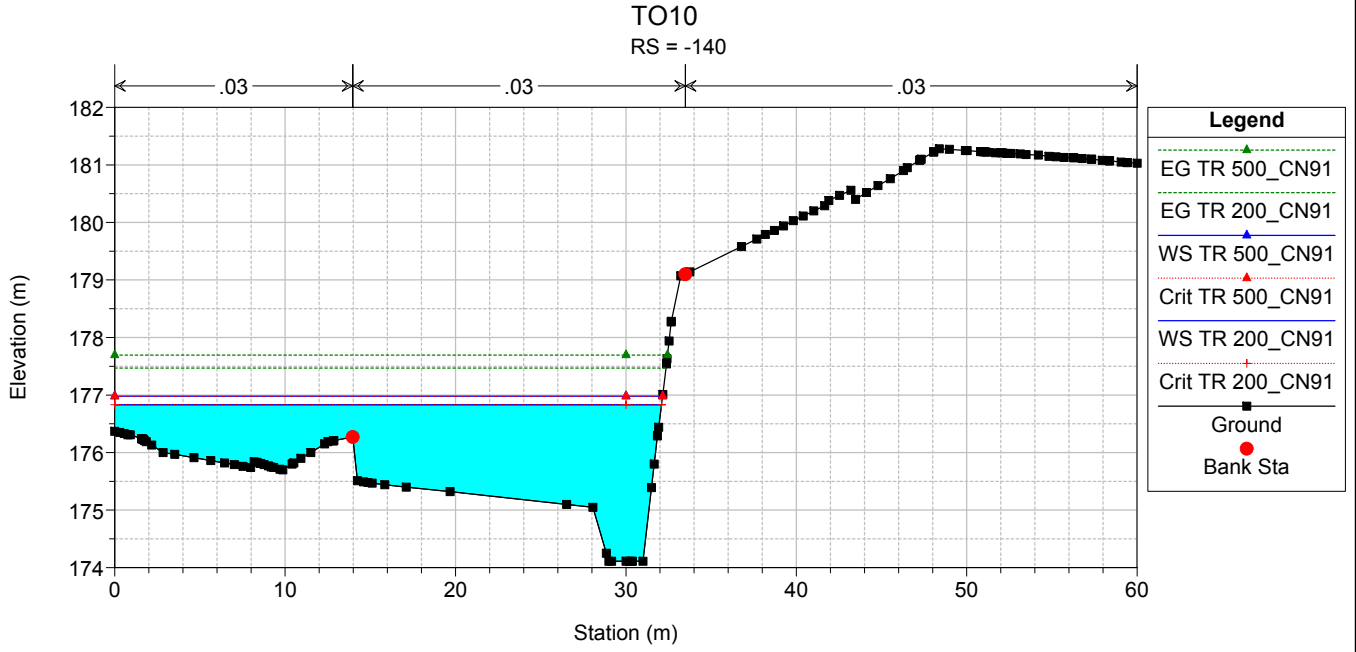
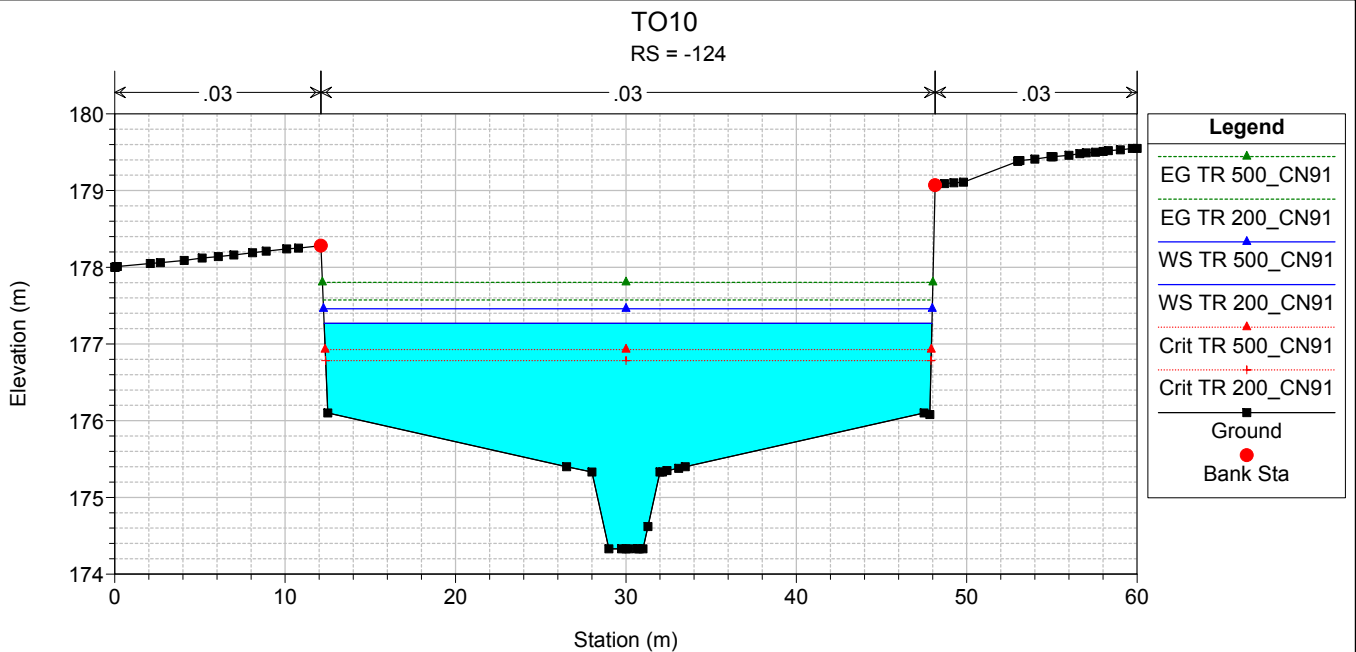

TO10
RS = -180

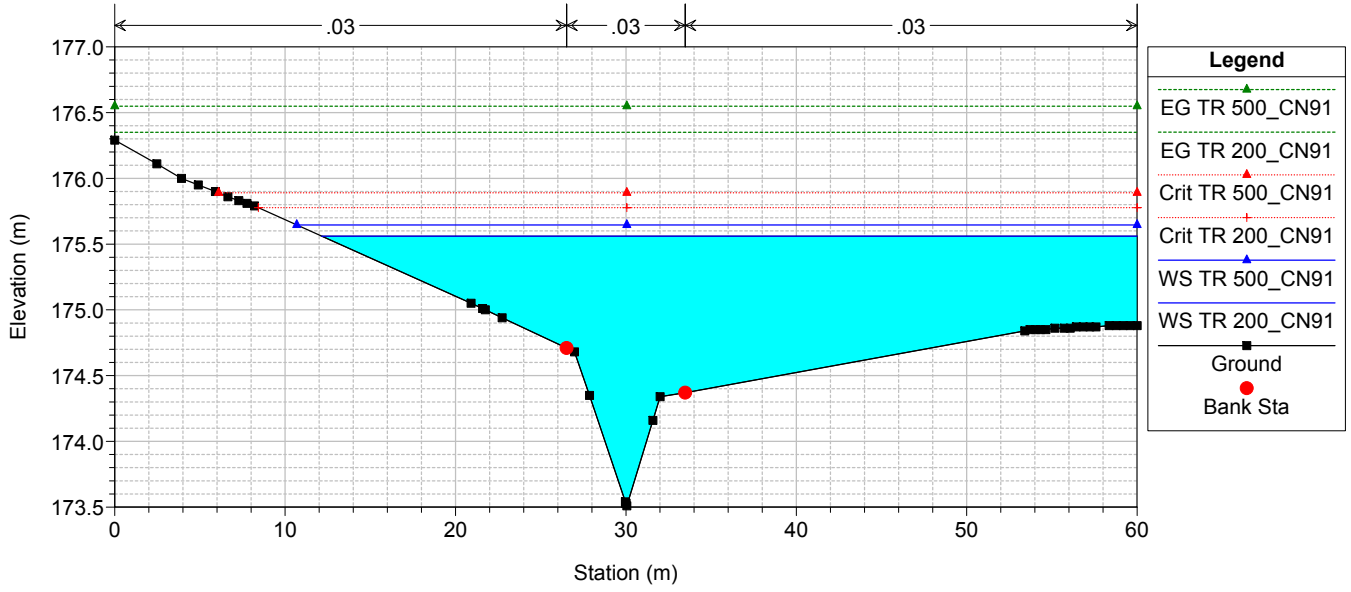

ALLEGATO 2.11

Interferenza idraulica – TO11
Tabella riassuntiva dei risultati, profilo idrico e sezioni
trasversali con i livelli idrici (TR 200 - 500 anni)

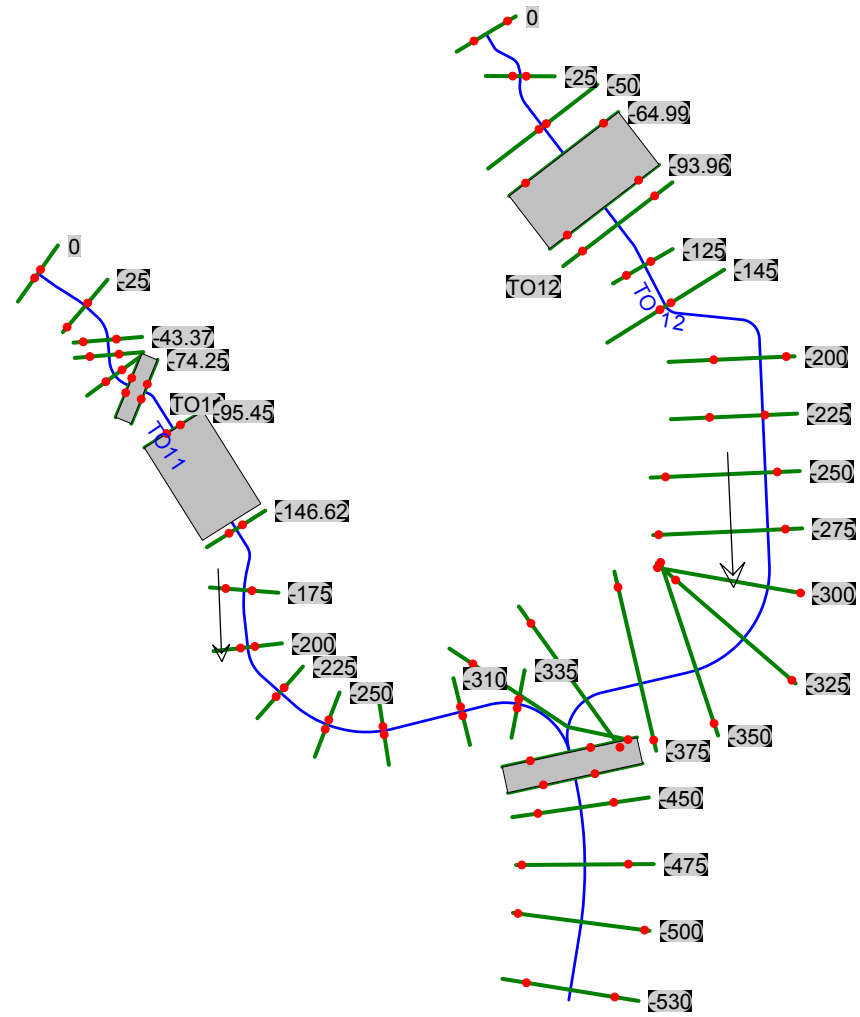

HEC-RAS Plan: POST_PERM River: TO11 Reach: TO11 Profile: TR200 (CN91)

Reach	River Sta	Profile	Q Total (m3/s)	Min Ch El (m)	Max Chl Dpth (m)	W.S. Elev (m)	Crit W.S. (m)	Diff	Froude # Chl	E.G. Elev (m)	Vel Chnl (m/s)	Vel Total (m/s)	Hydr Radius C (m)	Shear Chan (N/m2)	Hydr Depth (m)
TO11	0	TR200 (CN91)	15.7	186.00	0.93	186.93	187.17	-0.24	1.90	187.83	4.6	3.5	0.6	227.4	0.26
TO11	-25	TR200 (CN91)	15.7	185.00	0.51	185.51	185.77	-0.26	2.44	186.46	4.3	4.3	0.3	240.9	0.32
TO11	-43.37	TR200 (CN91)	15.7	183.78	0.99	184.77	185.02	-0.25	1.72	185.41	3.5	3.5	0.4	148.2	0.43
TO11	-50	TR200 (CN91)	15.7	183.46	0.82	184.28	184.52	-0.24	1.95	185.11	4.3	3.7	0.5	211.3	0.30
TO11	-59.31	TR200 (CN91)	15.7	181.19	0.82	182.01	182.63	-0.62	2.72	184.36	6.8	6.8	0.5	501.4	0.64
TO11	-66.94	TR200 (CN91)	15.7	179.11	0.31	179.42	179.99	-0.57	4.81	182.99	8.4	8.4	0.3	942.4	0.31
TO11	-70.6	Bridge													
TO11	-74.25	TR200 (CN91)	15.7	179.04	0.43	179.47	179.91	-0.44	2.95	181.31	6.0	6.0	0.4	441.6	0.42
TO11	-95.45	TR200 (CN91)	15.7	178.83	1.37	180.20	179.71	0.49	0.52	180.38	1.9	1.9	1.0	31.3	1.34
TO11	-121.04	Bridge													
TO11	-146.62	TR200 (CN91)	15.7	178.32	1.08	179.40	179.20	0.20	0.74	179.69	2.4	2.4	0.8	53.6	1.06
TO11	-175	TR200 (CN91)	15.7	177.50	1.44	178.94	178.94	0.00	1.00	179.45	3.2	3.2	0.8	94.1	1.02
TO11	-200	TR200 (CN91)	15.7	176.60	1.05	177.65	178.04	-0.39	1.78	178.88	4.9	4.9	0.6	248.8	0.78
TO11	-225	TR200 (CN91)	15.7	176.26	1.72	177.98	177.85	0.13	0.53	178.11	1.8	1.4	1.0	29.4	0.42
TO11	-250	TR200 (CN91)	15.7	176.20	1.82	178.02	177.64	0.38	0.26	178.05	1.0	0.7	1.2	8.0	0.74
TO11	-275	TR200 (CN91)	15.7	176.15	1.87	178.02	177.24	0.78	0.15	178.04	0.6	0.5	1.4	3.0	1.05
TO11	-310	TR200 (CN91)	15.7	176.07	1.94	178.01	177.22	0.79	0.17	178.03	0.7	0.6	1.4	3.8	0.95
TO11	-335	TR200 (CN91)	15.7	176.01	2.00	178.01	177.22	0.79	0.14	178.02	0.6	0.5	1.5	2.7	1.10

HEC-RAS Plan: POST_PERM River: TO11 Reach: TO11 Profile: TR500 (CN91)

Reach	River Sta	Profile	Q Total (m3/s)	Min Ch El (m)	Max Chl Dpth (m)	W.S. Elev (m)	Crit W.S. (m)	Diff	Froude # Chl	E.G. Elev (m)	Vel Chnl (m/s)	Vel Total (m/s)	Hydr Radius C (m)	Shear Chan (N/m2)	Hydr Depth (m)
TO11	0	TR500 (CN91)	18.6	186.00	0.97	186.97	187.21	-0.24	1.93	187.91	4.8	3.5	0.6	242.9	0.27
TO11	-25	TR500 (CN91)	18.6	185.00	0.56	185.56	185.84	-0.28	2.41	186.57	4.5	4.5	0.3	250.2	0.35
TO11	-43.37	TR500 (CN91)	18.6	183.78	1.05	184.83	185.08	-0.25	1.77	185.52	3.7	3.7	0.4	158.7	0.44
TO11	-50	TR500 (CN91)	18.6	183.46	0.86	184.32	184.58	-0.26	1.99	185.21	4.5	3.8	0.5	227.5	0.32
TO11	-59.31	TR500 (CN91)	18.6	181.19	0.93	182.12	182.77	-0.65	2.59	184.49	6.8	6.8	0.6	488.9	0.71
TO11	-66.94	TR500 (CN91)	18.6	179.11	0.36	179.47	180.09	-0.62	4.61	183.24	8.6	8.6	0.3	954.2	0.36
TO11	-70.6	Bridge													
TO11	-74.25	TR500 (CN91)	18.6	179.04	0.47	179.51	180.02	-0.51	3.02	181.63	6.5	6.5	0.4	495.5	0.47
TO11	-95.45	TR500 (CN91)	18.6	178.83	1.51	180.34	179.81	0.53	0.53	180.54	2.0	2.0	1.0	35.1	1.47
TO11	-121.04	Bridge													
TO11	-146.62	TR500 (CN91)	18.6	178.32	1.23	179.55	179.30	0.25	0.72	179.86	2.5	2.5	0.9	55.8	1.21
TO11	-175	TR500 (CN91)	18.6	177.50	1.58	179.08	179.08	0.00	1.00	179.63	3.3	3.3	0.9	99.3	1.10
TO11	-200	TR500 (CN91)	18.6	176.60	1.16	177.76	178.18	-0.42	1.76	179.07	5.1	5.1	0.7	256.9	0.85
TO11	-225	TR500 (CN91)	18.6	176.26	1.96	178.22	177.92	0.30	0.37	178.29	1.4	1.0	1.2	16.3	0.62
TO11	-250	TR500 (CN91)	18.6	176.20	2.03	178.23	177.70	0.53	0.21	178.25	0.9	0.7	1.4	6.0	0.95
TO11	-275	TR500 (CN91)	18.6	176.15	2.08	178.23	177.28	0.95	0.14	178.24	0.6	0.5	1.6	2.7	1.26
TO11	-310	TR500 (CN91)	18.6	176.07	2.15	178.22	177.27	0.95	0.15	178.24	0.7	0.5	1.6	3.3	1.16
TO11	-335	TR500 (CN91)	18.6	176.01	2.21	178.22	177.26	0.96	0.13	178.23	0.6	0.5	1.7	2.5	1.31

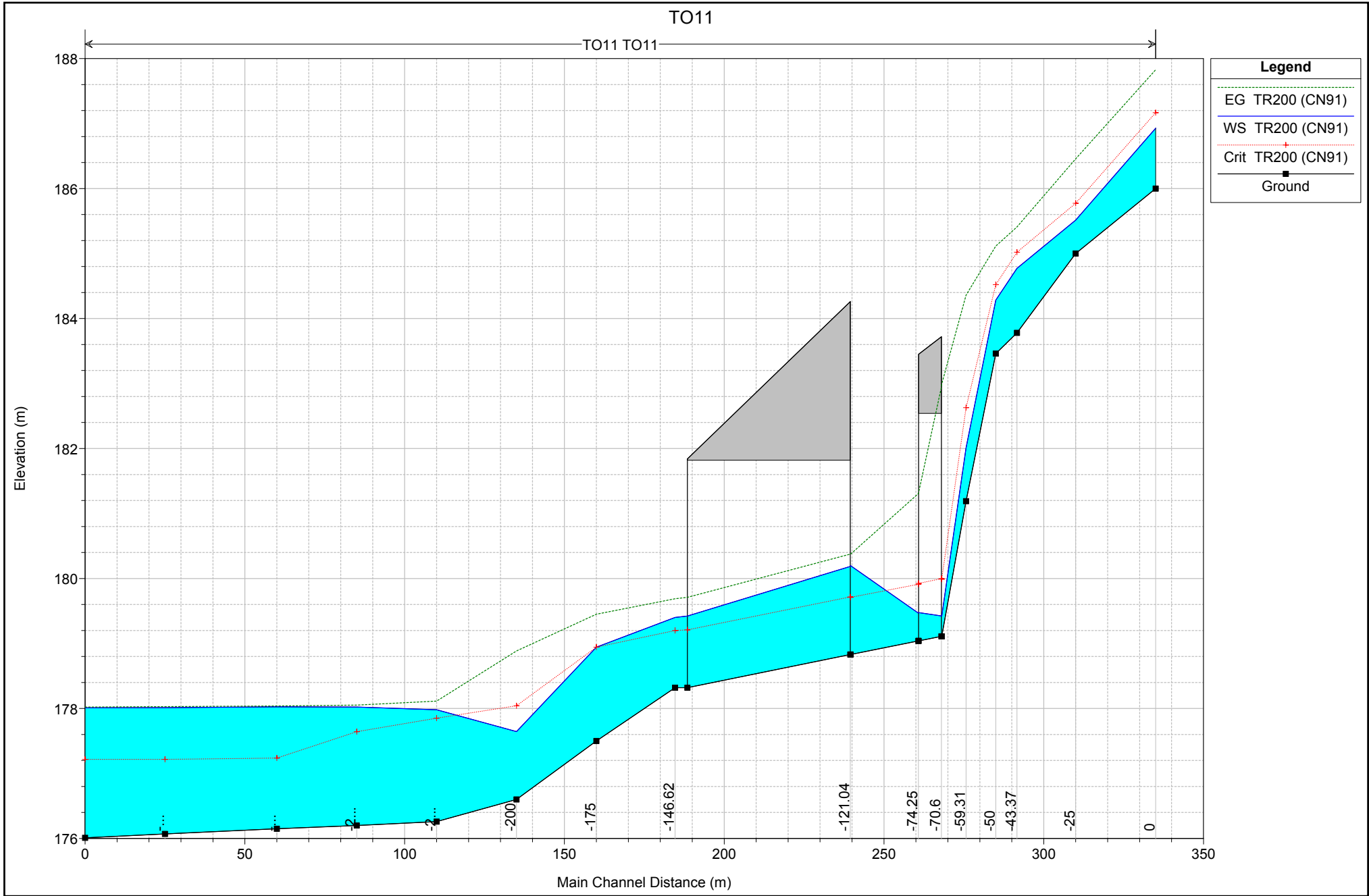

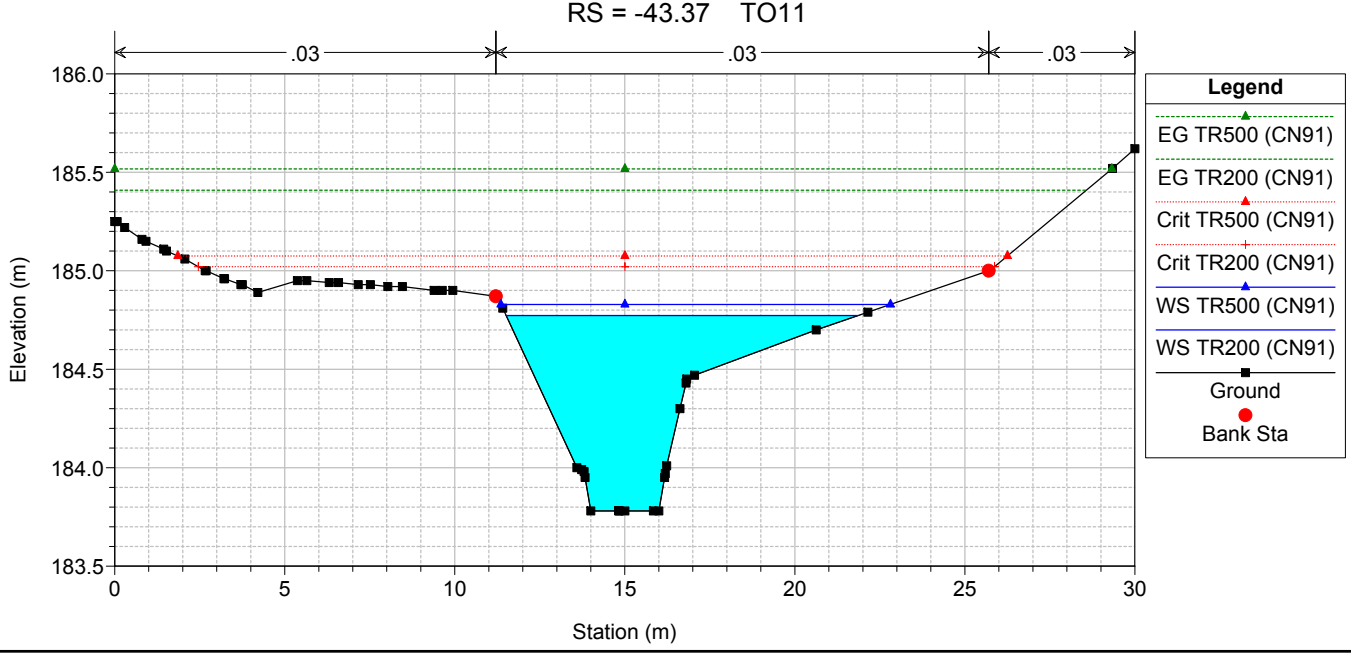
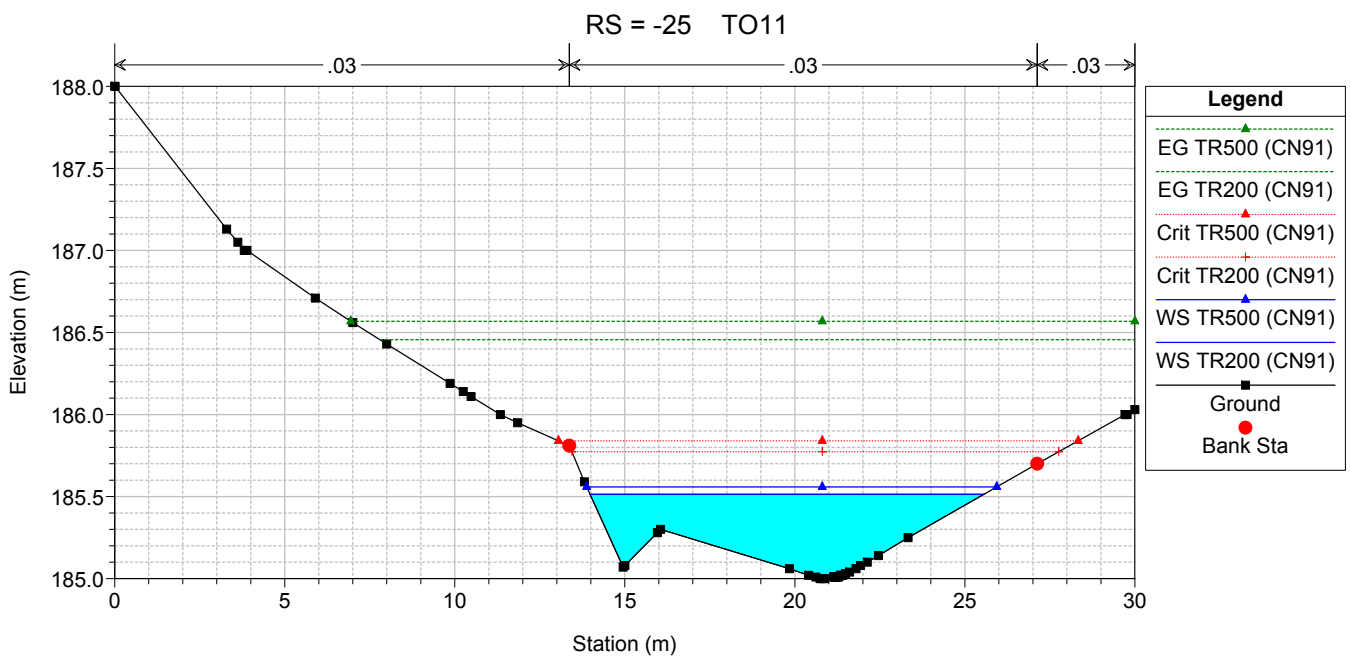
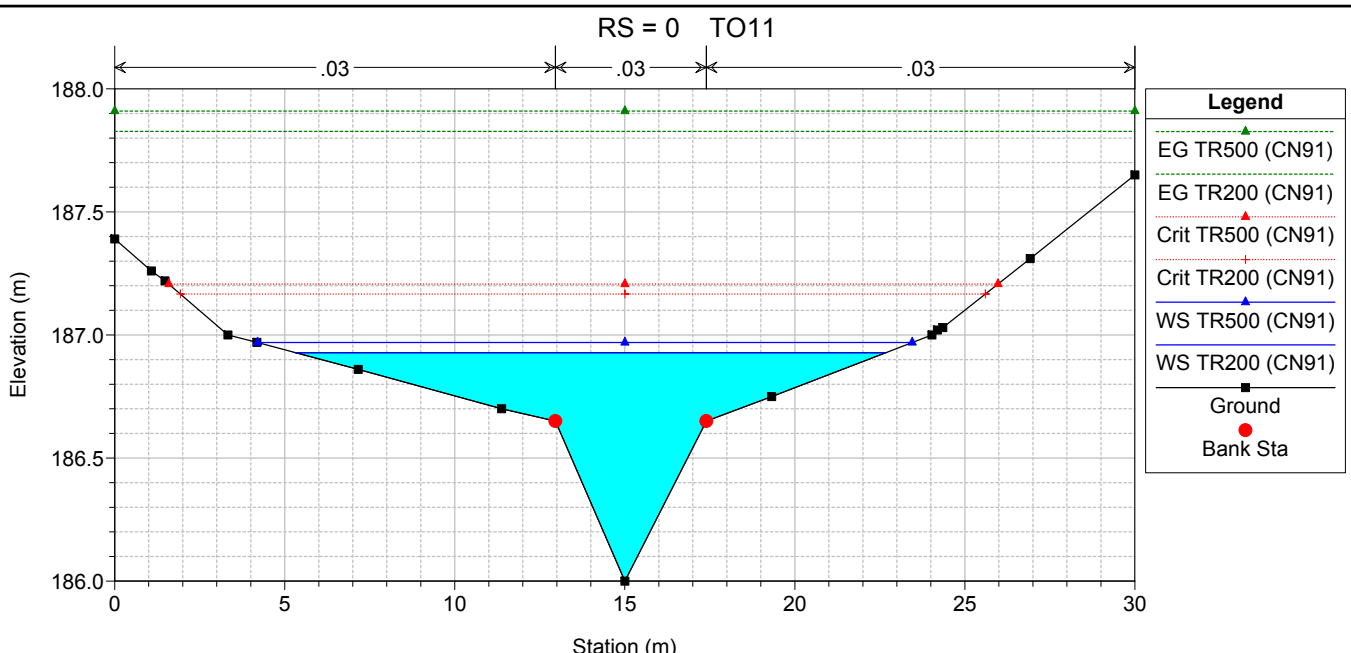

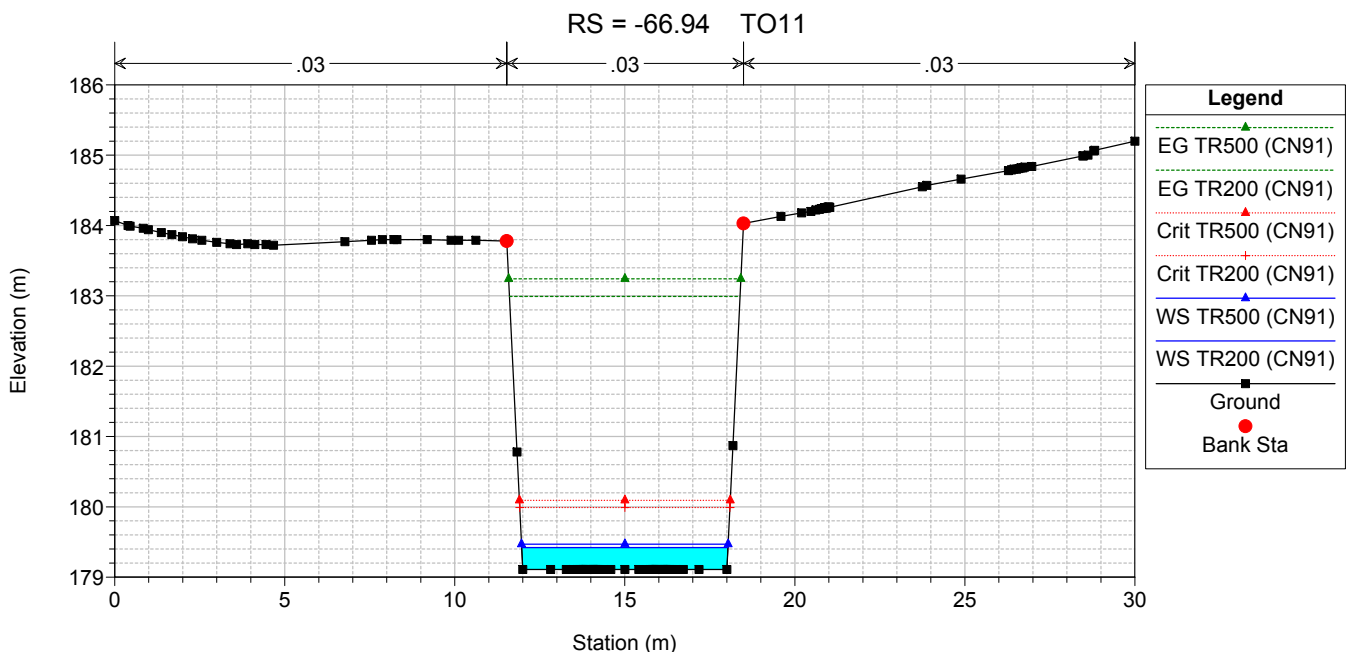
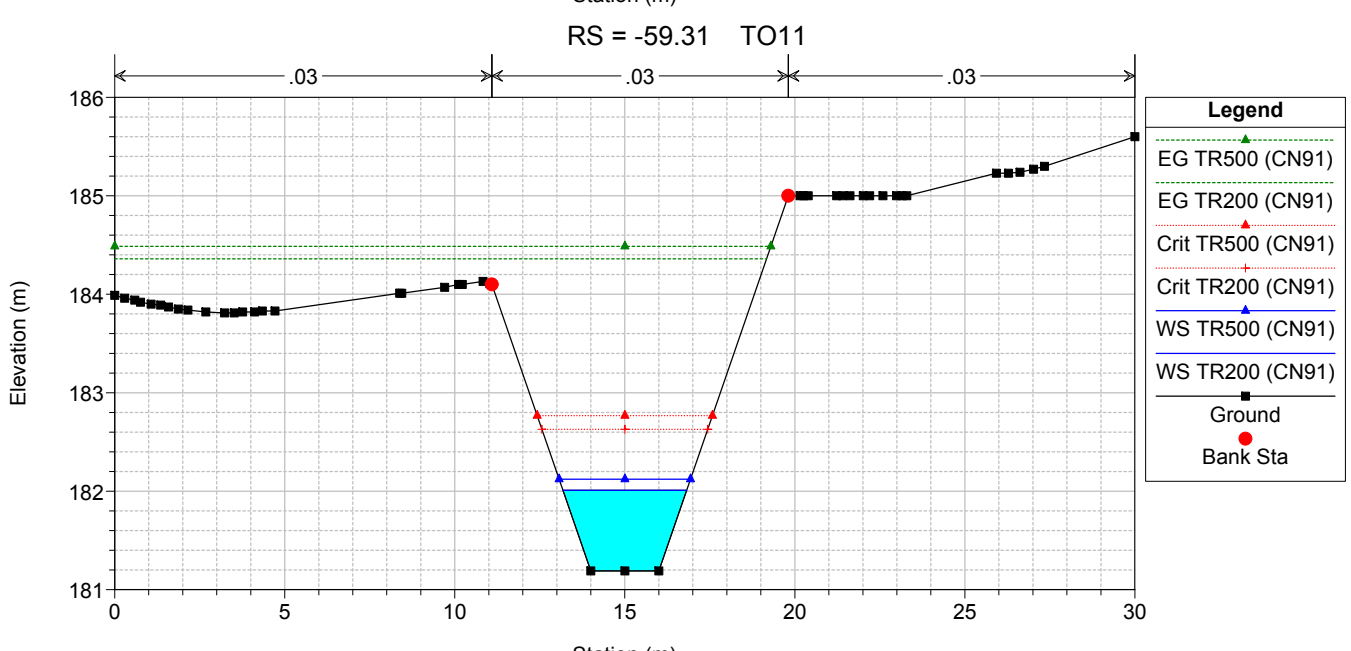
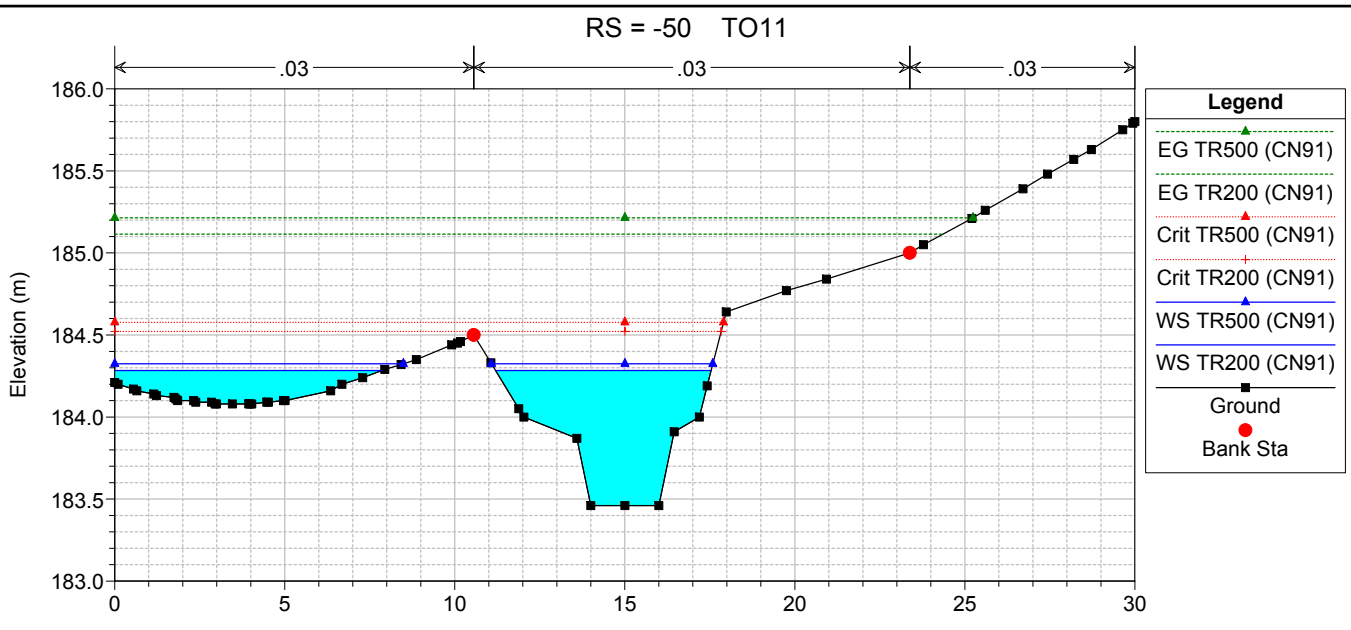

RS = -70.6 BR TO11.A
TO11

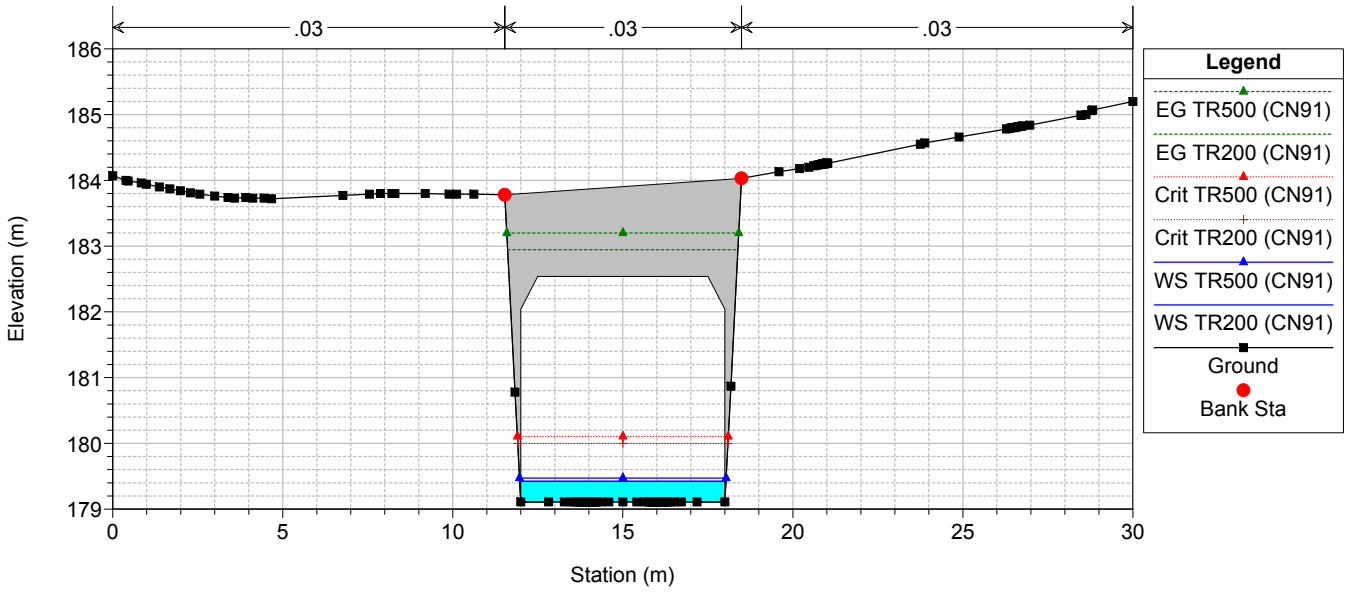

RS = -70.6 BR TO11.A
TO11

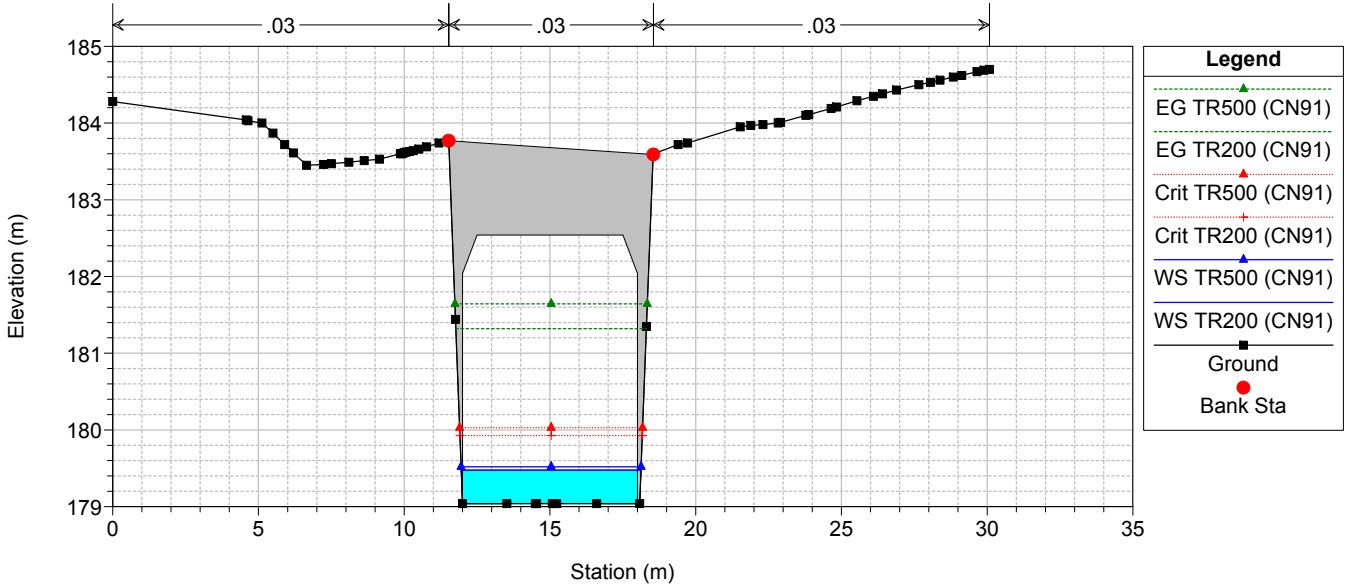

RS = -74.25 TO11

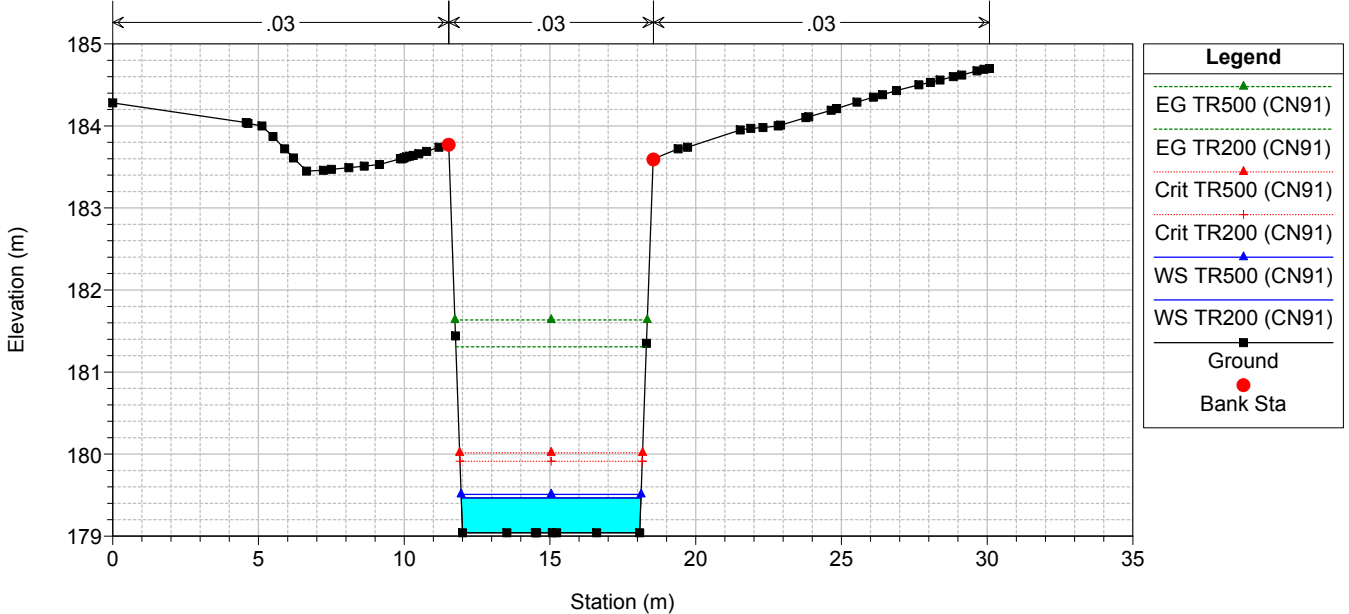

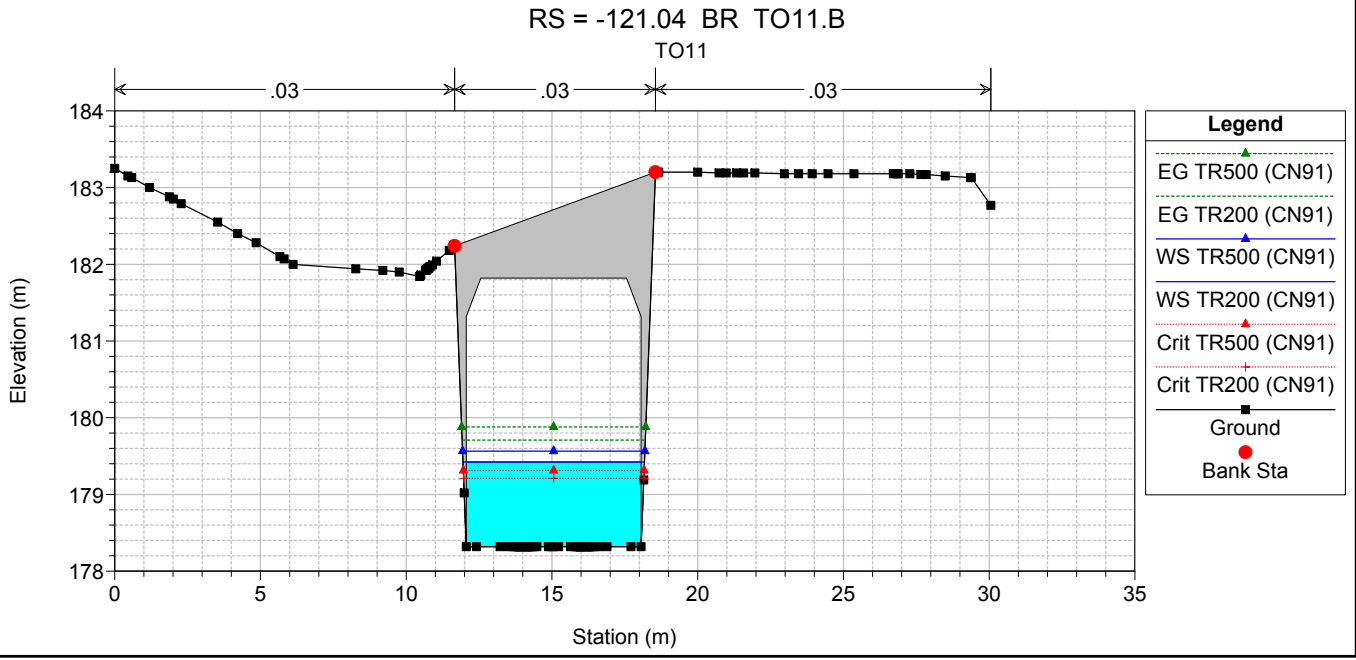
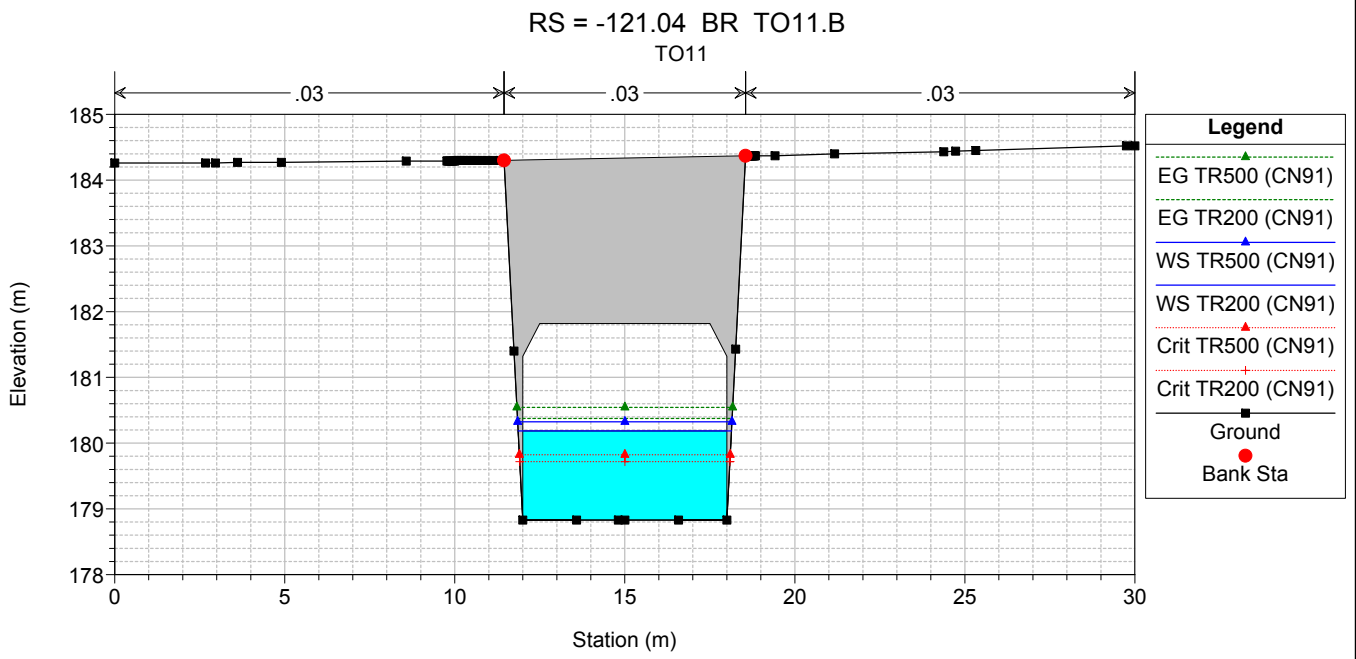
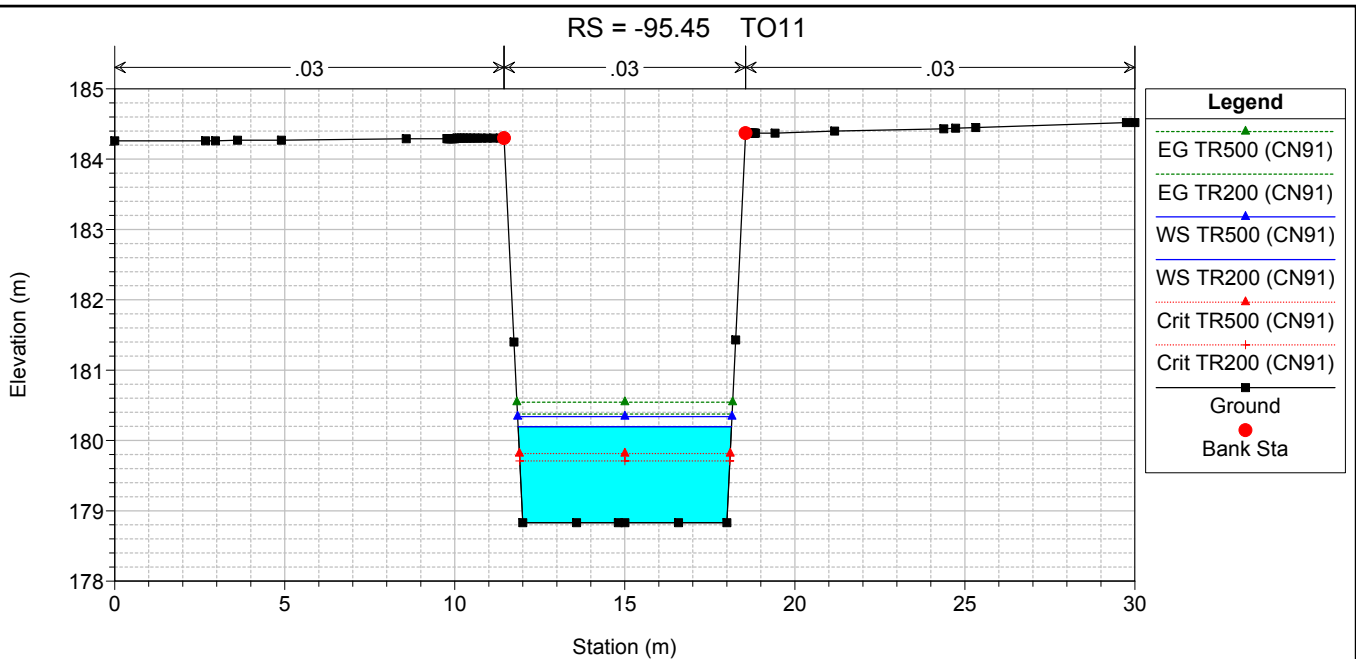

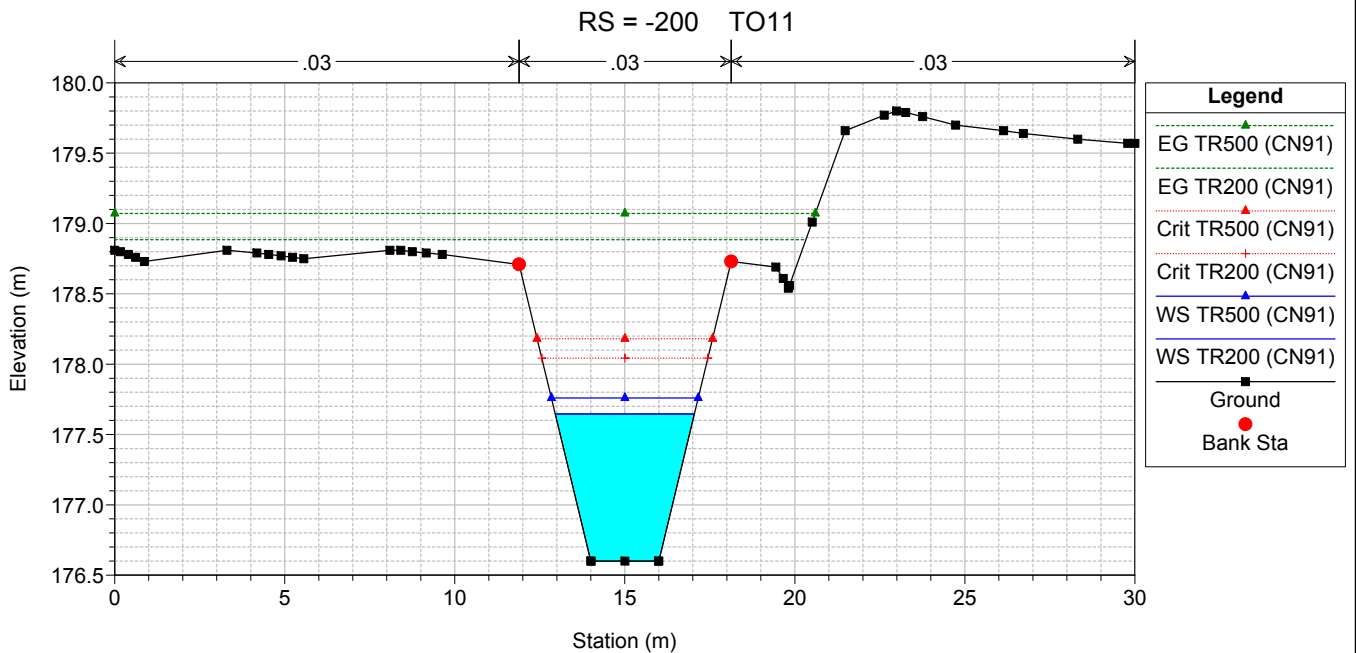
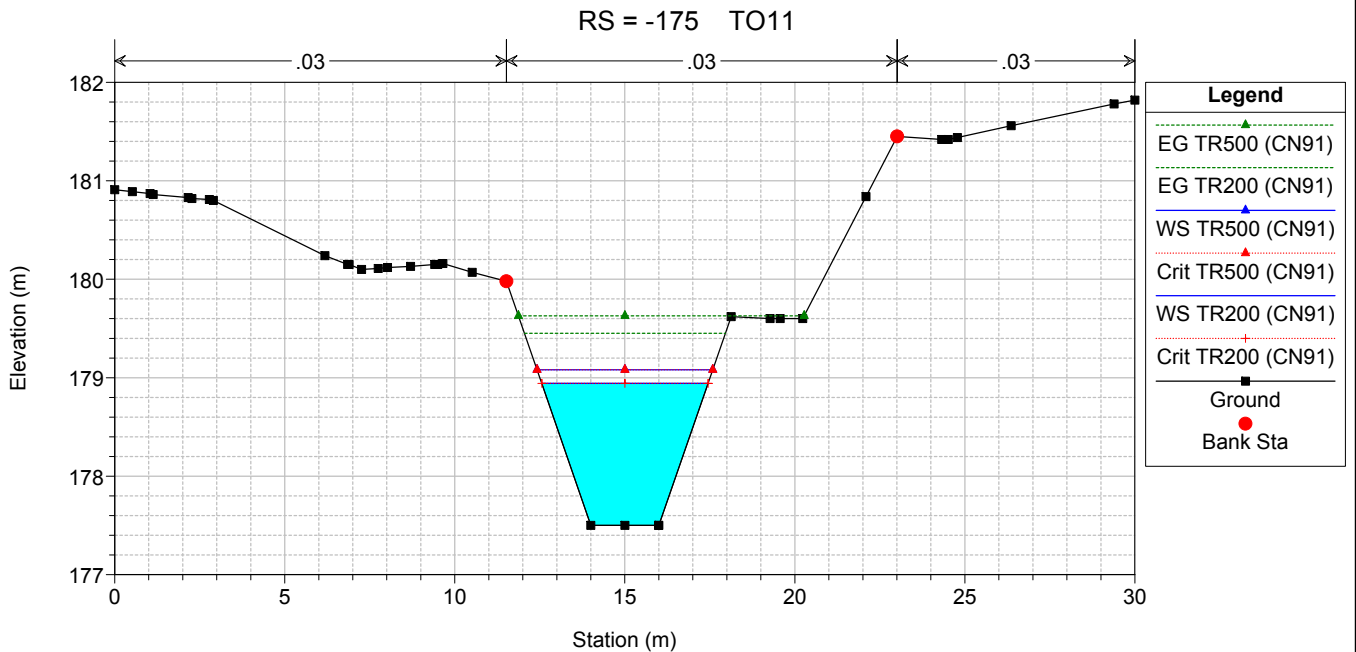
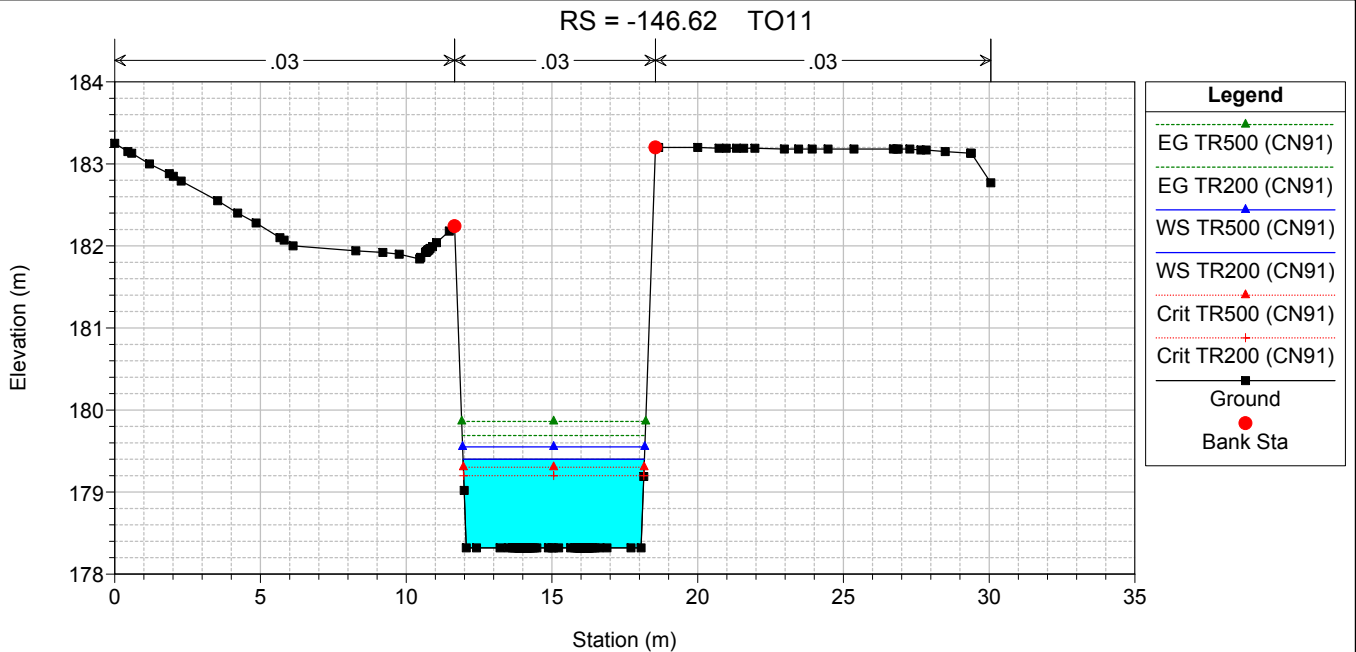

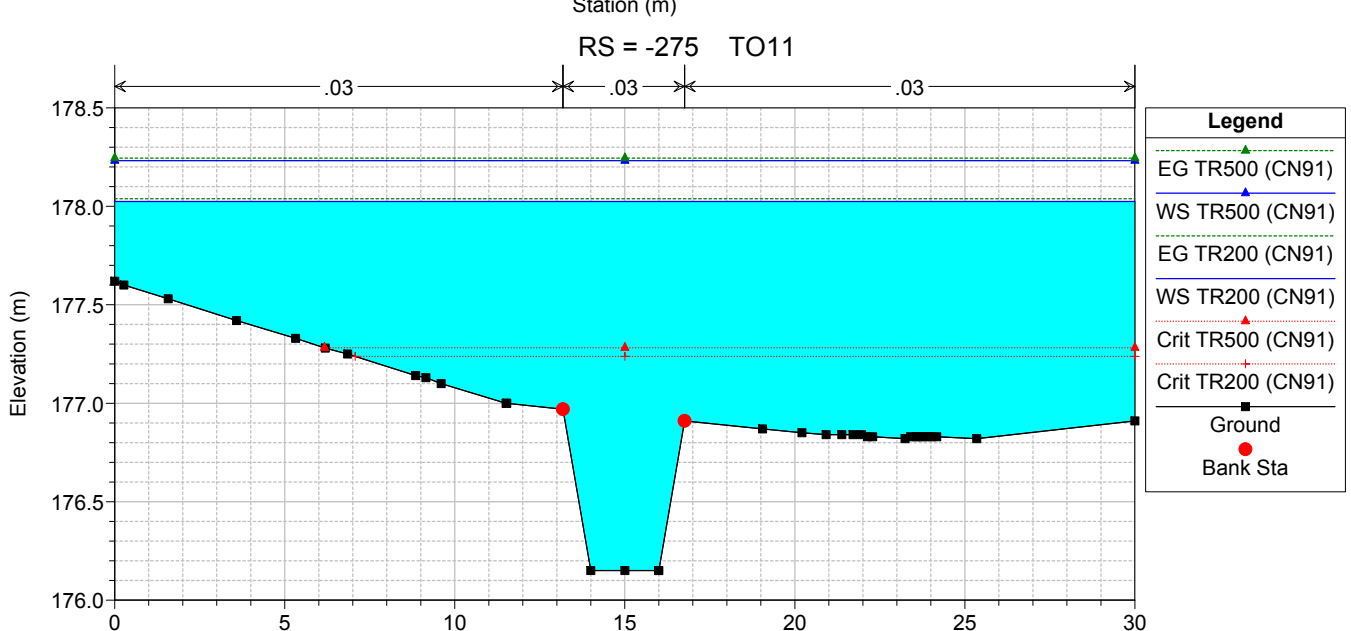
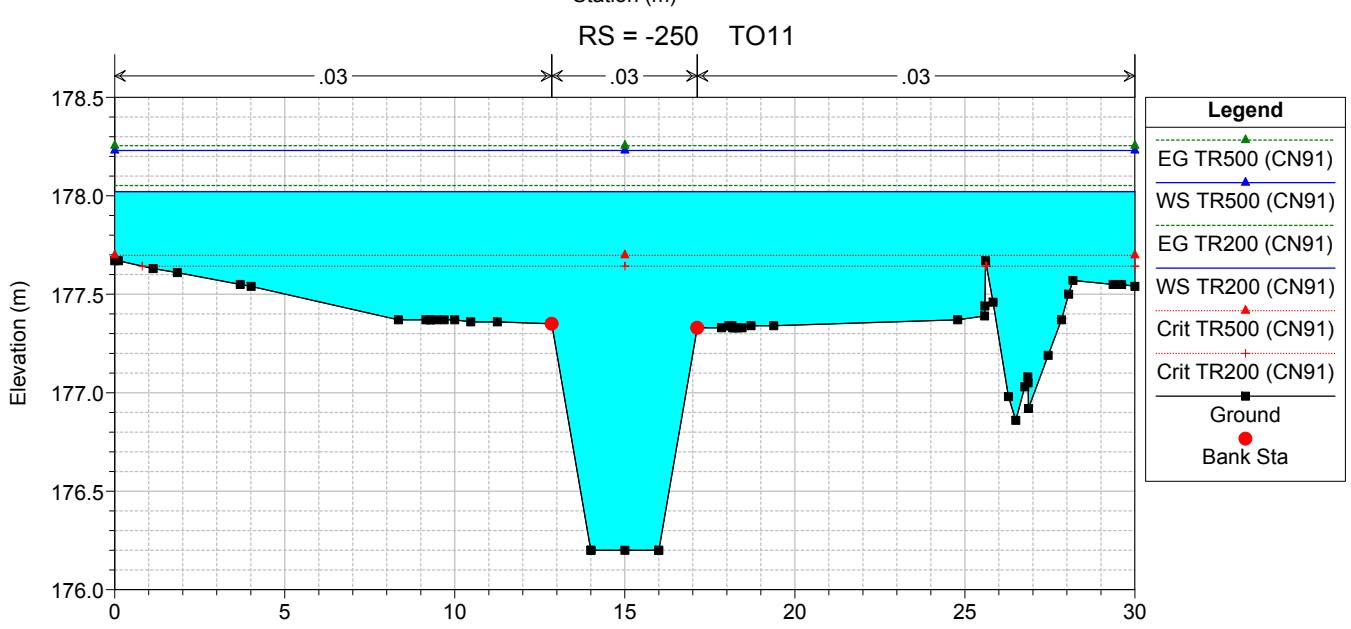
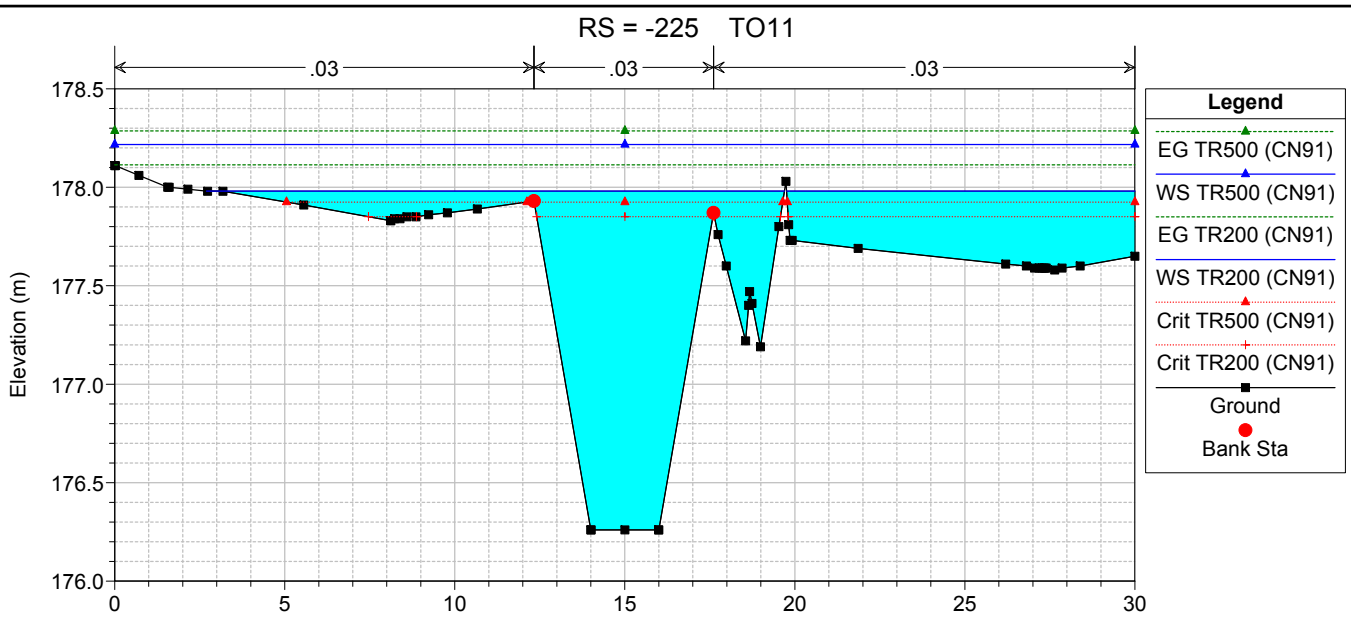

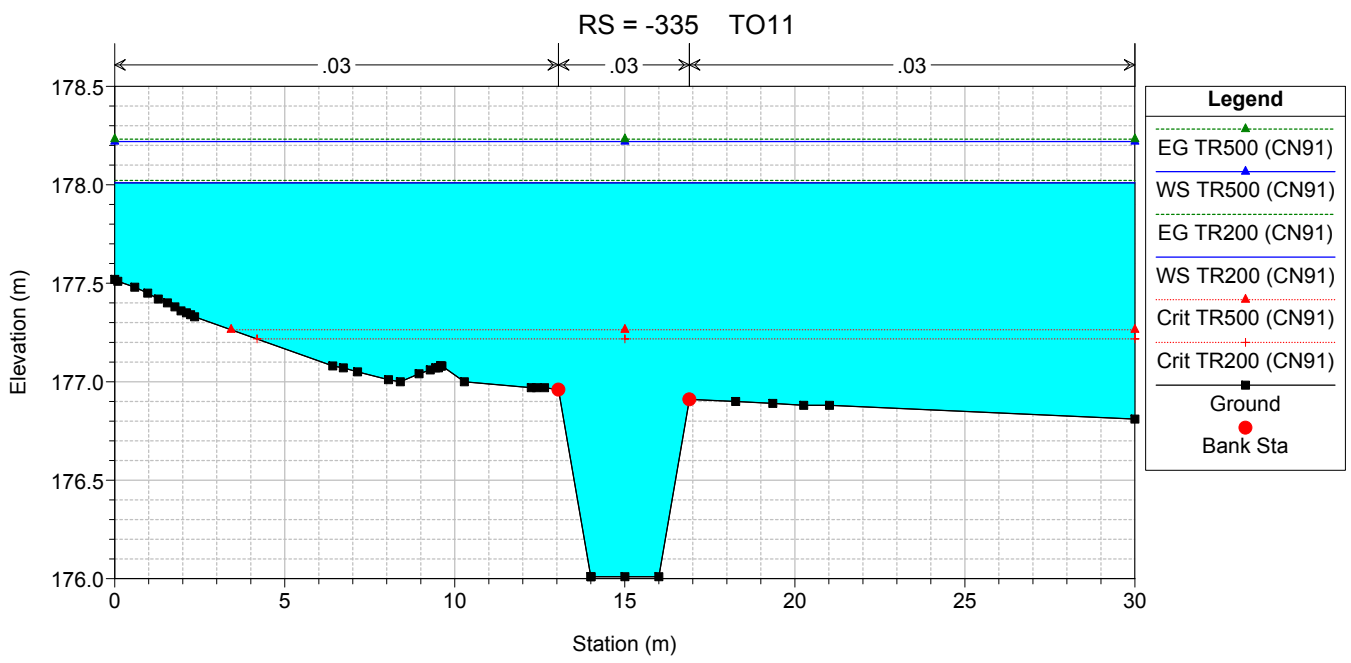
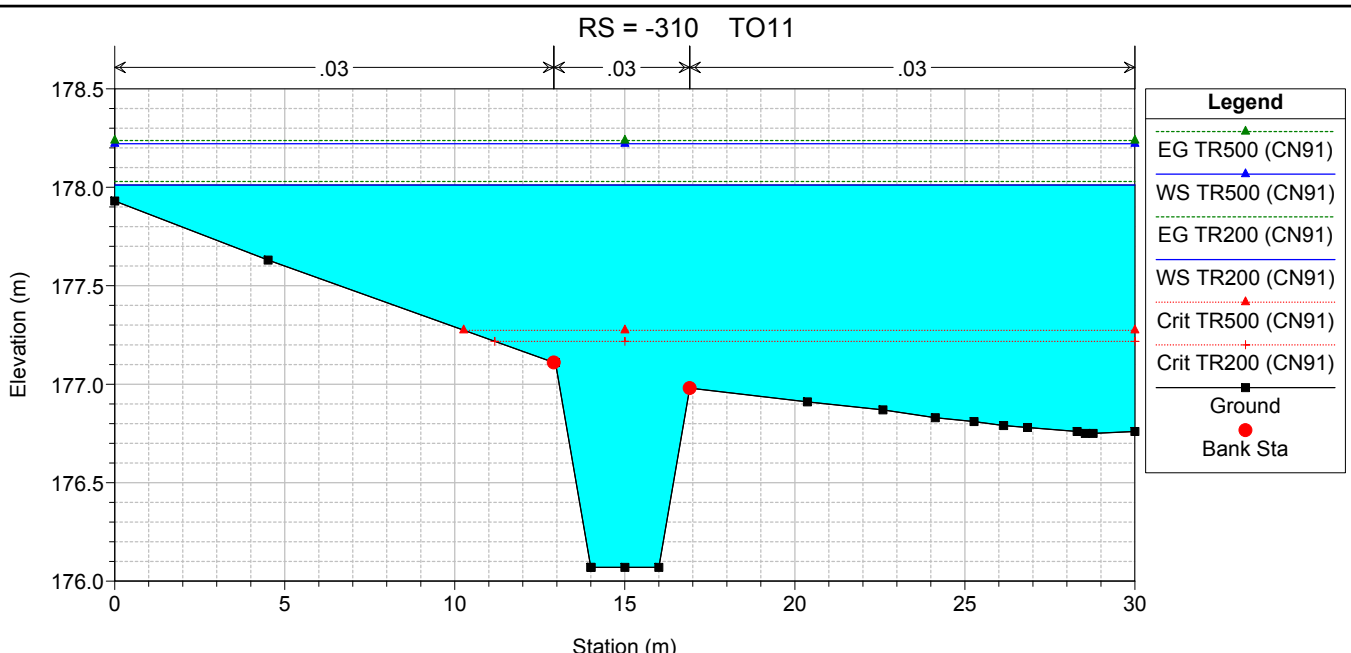

ALLEGATO 2.12

Interferenza idraulica – TO12
Tabella riassuntiva dei risultati, profilo idrico e sezioni
trasversali con i livelli idrici (TR 200 - 500 anni)

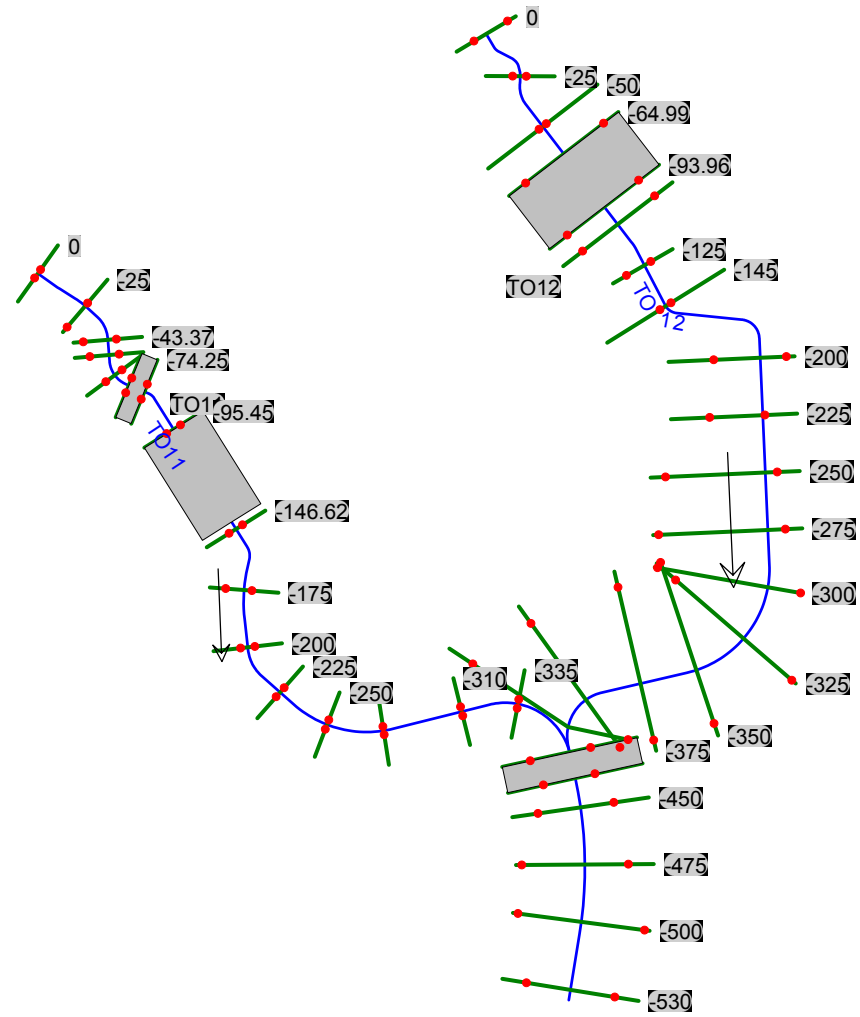

HEC-RAS Plan: POST_PERM River: TO12 Reach: TO12 Profile: TR200 (CN91)

Reach	River Sta	Profile	Q Total (m3/s)	Min Ch El (m)	Max Chl Dpth (m)	W.S. Elev (m)	Crit W.S. (m)	Diff	Froude # Chl	E.G. Elev (m)	Vel Chnl (m/s)	Vel Total (m/s)	Hydr Radius C (m)	Shear Chan (N/m2)	Hydr Depth (m)
TO12	0	TR200 (CN91)	103.9	181.48	2.32	183.80	184.34	-0.54	1.70	185.43	5.7	5.7	1.1	276.4	1.09
TO12	-25	TR200 (CN91)	103.9	180.83	2.24	183.07	183.60	-0.53	1.59	184.82	6.7	5.1	1.5	341.4	0.89
TO12	-50	TR200 (CN91)	103.9	179.82	1.64	181.46	182.04	-0.58	2.34	183.90	8.7	6.2	1.2	631.3	0.64
TO12	-64.99	TR200 (CN91)	103.9	179.67	2.71	182.38	181.68	0.70	0.44	182.54	1.7	1.7	1.5	23.4	1.62
TO12	-79.43	Bridge													
TO12	-93.96	TR200 (CN91)	103.9	179.38	2.65	182.03	181.39	0.64	0.46	182.21	1.8	1.8	1.5	26.0	1.58
TO12	-103.59	TR200 (CN91)	103.9	179.28	2.76	182.04	181.30	0.74	0.43	182.19	1.7	1.7	1.5	22.1	1.54
TO12	-125	TR200 (CN91)	103.9	179.07	2.41	181.48	181.48	0.00	0.97	182.13	3.8	3.5	1.4	114.1	1.32
TO12	-145	TR200 (CN91)	103.9	178.90	1.75	180.65	181.00	-0.35	1.74	181.83	5.8	4.7	0.9	301.1	0.68
TO12	-200	TR200 (CN91)	103.9	178.11	1.81	179.92	180.07	-0.15	1.20	180.54	3.5	3.3	0.9	116.0	0.71
TO12	-225	TR200 (CN91)	103.9	178.09	1.55	179.64	179.79	-0.15	1.12	180.22	3.6	3.1	1.0	111.9	0.71
TO12	-250	TR200 (CN91)	103.9	177.31	1.83	179.14	179.33	-0.19	1.50	179.81	3.6	3.6	0.6	139.3	0.58
TO12	-275	TR200 (CN91)	103.9	177.40	1.39	178.79	178.88	-0.09	1.22	179.27	3.1	3.1	0.6	96.5	0.64
TO12	-300	TR200 (CN91)	103.9	176.92	1.30	178.22	178.37	-0.15	1.50	178.77	3.3	3.3	0.5	122.3	0.49
TO12	-325	TR200 (CN91)	103.9	176.54	1.79	178.33	178.19	0.14	0.70	178.51	1.9	1.8	0.7	35.7	0.70
TO12	-350	TR200 (CN91)	103.9	176.44	1.80	178.24	177.96	0.28	0.55	178.37	1.6	1.6	0.8	23.4	0.83
TO12	-375	TR200 (CN91)	121.8	175.56	2.56	178.12	177.71	0.41	0.54	178.27	1.7	1.7	1.0	26.1	1.04
TO12	-400	TR200 (CN91)	121.8	175.31	2.67	177.98	177.59	0.39	0.57	178.16	1.9	1.9	1.1	31.0	1.10
TO12	-414.43	TR200 (CN91)	121.8	175.17	2.84	178.01	177.45	0.56	0.43	178.11	1.4	1.4	1.1	17.4	1.12
TO12	-425.54	TR200 (CN91)	121.8	175.06	2.87	177.93	177.49	0.44	0.46	178.09	1.9	1.6	1.6	26.9	1.25
TO12	-431.31	Bridge													
TO12	-437.08	TR200 (CN91)	121.8	174.94	2.19	177.13	177.40	-0.27	1.54	178.02	4.6	3.8	0.8	199.9	0.53
TO12	-450	TR200 (CN91)	121.8	174.81	1.66	176.47	176.80	-0.33	1.93	177.60	4.9	4.5	0.6	245.6	0.45
TO12	-475	TR200 (CN91)	121.8	174.56	2.28	176.84	176.63	0.21	0.69	177.07	2.2	2.1	1.0	42.2	0.97
TO12	-500	TR200 (CN91)	121.8	174.31	2.21	176.52	176.52	0.00	1.00	176.90	2.8	2.7	0.7	73.6	0.75
TO12	-530	TR200 (CN91)	121.8	174.01	2.11	176.12	176.17	-0.05	1.03	176.59	3.1	3.0	0.9	88.1	0.77

HEC-RAS Plan: POST_PERM River: TO12 Reach: TO12 Profile: TR500 (CN91)

Reach	River Sta	Profile	Q Total (m3/s)	Min Ch El (m)	Max Chl Dpth (m)	W.S. Elev (m)	Crit W.S. (m)	Diff	Froude # Chl	E.G. Elev (m)	Vel Chnl (m/s)	Vel Total (m/s)	Hydr Radius C (m)	Shear Chan (N/m2)	Hydr Depth (m)
TO12	0	TR500 (CN91)	124.2	181.48	2.46	183.94	184.52	-0.58	1.72	185.77	6.0	5.9	1.2	300.3	1.15
TO12	-25	TR500 (CN91)	124.2	180.83	2.35	183.18	183.78	-0.60	1.65	185.13	7.2	5.5	1.6	382.8	0.97
TO12	-50	TR500 (CN91)	124.2	179.82	1.72	181.54	182.22	-0.68	2.38	184.18	9.0	6.6	1.2	672.7	0.72
TO12	-64.99	TR500 (CN91)	124.2	179.67	2.93	182.60	181.80	0.80	0.43	182.77	1.8	1.8	1.7	25.0	1.83
TO12	-79.43	Bridge													
TO12	-93.96	TR500 (CN91)	124.2	179.38	2.88	182.26	181.51	0.75	0.46	182.44	1.9	1.9	1.7	27.5	1.79
TO12	-103.59	TR500 (CN91)	124.2	179.28	2.99	182.27	181.43	0.84	0.42	182.43	1.8	1.7	1.7	23.1	1.72
TO12	-125	TR500 (CN91)	124.2	179.07	2.58	181.65	181.65	0.00	0.98	182.37	4.0	3.7	1.5	123.2	1.47
TO12	-145	TR500 (CN91)	124.2	178.90	1.83	180.73	181.11	-0.38	1.78	182.07	6.0	5.0	1.0	324.8	0.76
TO12	-200	TR500 (CN91)	124.2	178.11	1.89	180.00	180.18	-0.18	1.24	180.72	3.8	3.6	0.9	131.8	0.76
TO12	-225	TR500 (CN91)	124.2	178.09	1.65	179.74	179.89	-0.15	1.13	180.38	3.8	3.3	1.1	121.3	0.77
TO12	-250	TR500 (CN91)	124.2	177.31	1.90	179.21	179.43	-0.22	1.51	179.97	3.9	3.8	0.6	152.1	0.84
TO12	-275	TR500 (CN91)	124.2	177.40	1.45	178.85	178.97	-0.12	1.27	179.42	3.3	3.3	0.7	111.3	0.69
TO12	-300	TR500 (CN91)	124.2	176.92	1.35	178.27	178.45	-0.18	1.52	178.91	3.5	3.5	0.5	135.3	0.54
TO12	-325	TR500 (CN91)	124.2	176.54	1.95	178.49	178.26	0.23	0.62	178.66	1.9	1.8	0.9	31.8	0.86
TO12	-350	TR500 (CN91)	124.2	176.44	1.98	178.42	178.03	0.39	0.49	178.54	1.6	1.5	1.0	21.1	1.02
TO12	-375	TR500 (CN91)	145.6	175.56	2.75	178.31	177.83	0.48	0.50	178.46	1.7	1.7	1.2	25.2	1.20
TO12	-400	TR500 (CN91)	145.6	175.31	2.88	178.19	177.70	0.49	0.54	178.37	1.9	1.9	1.2	29.6	1.22
TO12	-414.43	TR500 (CN91)	145.6	175.17	3.05	178.22	177.55	0.67	0.40	178.32	1.4	1.4	1.3	16.7	1.30
TO12	-425.54	TR500 (CN91)	145.6	175.06	3.08	178.14	177.60	0.54	0.44	178.30	1.9	1.7	1.8	26.8	1.46
TO12	-431.31	Bridge													
TO12	-437.08	TR500 (CN91)	145.6	174.94	2.24	177.18	177.48	-0.30	1.63	178.22	5.0	4.1	0.8	230.2	0.59
TO12	-450	TR500 (CN91)	145.6	174.81	1.73	176.54	176.89	-0.35	1.94	177.78	5.2	4.7	0.7	265.9	0.52
TO12	-475	TR500 (CN91)	145.6	174.56	2.39	176.95	176.73	0.22	0.70	177.21	2.3	2.3	1.1	46.8	1.08
TO12	-500	TR500 (CN91)	145.6	174.31	2.30	176.61	176.61	0.00	1.01	177.04	2.9	2.9	0.8	81.0	0.84
TO12	-530	TR500 (CN91)	145.6	174.01	2.23	176.24	176.30	-0.06	1.04	176.74	3.2	3.1	0.9	91.0	0.79

HEC-RAS Plan: ALL_MIN(155) Locations: User Defined Profile: TR 50

River	Reach	River Sta	Profile	Q Total (m ³ /s)	Min Ch El (m)	Max Chl Dpth (m)	W.S. Elev (m)	Crit W.S. (m)	Diff	Froude # Chl	E.G. Elev (m)	Vel Chnl (m/s)	Vel Total (m/s)	Hydr Radius C (m)	Shear Chan (N/m ²)	Hydr Depth (m)
RIU MANNU	RIU MANNU	0	TR 50	718.0	180.00	1.59	181.59	180.82	0.77	0.29	181.64	1.0	1.0	1.1	21.7	1.11
RIU MANNU	RIU MANNU	-200	TR 50	718.0	180.00	1.23	181.23	180.54	0.69	0.27	181.26	0.8	0.8	1.0	17.1	1.01
RIU MANNU	RIU MANNU	-400	TR 50	718.0	179.28	0.92	180.20	180.15	0.05	0.87	180.39	2.0	2.0	0.5	117.9	0.52
RIU MANNU	RIU MANNU	-600	TR 50	718.0	176.14	2.23	178.37	177.83	0.54	0.46	178.48	1.5	1.5	1.0	51.4	1.04
RIU MANNU	RIU MANNU	-800	TR 50	718.0	173.38	3.02	176.40	176.28	0.12	0.85	176.68	2.4	2.4	0.8	150.0	0.79
RIU MANNU	RIU MANNU	-912.52	TR 50	718.0	172.06	4.00	176.06	174.96	1.10	0.29	176.12	1.1	1.1	1.4	26.8	1.45
RIU MANNU	RIU MANNU	-1000	TR 50	718.0	171.53	4.32	175.85	174.69	1.16	0.33	175.93	1.3	1.3	1.5	35.1	1.38
RIU MANNU	RIU MANNU	-1200	TR 50	718.0	170.89	4.78	175.67	173.57	2.10	0.18	175.71	0.8	0.8	2.3	13.3	2.28
RIU MANNU	RIU MANNU	-1399.84	TR 50	718.0	169.99	5.50	175.49	173.39	2.10	0.24	175.54	1.0	1.0	1.8	20.2	1.77
RIU MANNU	RIU MANNU	-1600	TR 50	718.0	169.40	5.88	175.28	173.34	1.94	0.22	175.32	0.9	0.9	1.8	17.1	1.77
RIU MANNU	RIU MANNU	-1800	TR 50	718.0	169.23	5.79	175.02	172.39	2.63	0.26	175.10	1.2	1.2	2.3	27.8	2.28

HEC-RAS Plan: ALL_MIN(155) Locations: User Defined Profile: TR 100

River	Reach	River Sta	Profile	Q Total (m ³ /s)	Min Ch El (m)	Max Chl Dpth (m)	W.S. Elev (m)	Crit W.S. (m)	Diff	Froude # Chl	E.G. Elev (m)	Vel Chnl (m/s)	Vel Total (m/s)	Hydr Radius C (m)	Shear Chan (N/m ²)	Hydr Depth (m)
RIU MANNU	RIU MANNU	0	TR 100	871.0	180.00	1.72	181.72	180.92	0.80	0.30	181.77	1.0	1.0	1.2	24.9	1.19
RIU MANNU	RIU MANNU	-200	TR 100	871.0	180.00	1.33	181.33	180.61	0.72	0.28	181.37	0.9	0.9	1.1	20.2	1.10
RIU MANNU	RIU MANNU	-400	TR 100	871.0	179.28	1.03	180.31	180.21	0.10	0.79	180.50	2.0	2.0	0.6	109.8	0.62
RIU MANNU	RIU MANNU	-600	TR 100	871.0	176.14	2.33	178.47	177.96	0.51	0.49	178.60	1.6	1.6	1.1	62.1	1.10
RIU MANNU	RIU MANNU	-800	TR 100	871.0	173.38	3.23	176.61	176.41	0.20	0.74	176.87	2.2	2.2	0.9	125.6	0.91
RIU MANNU	RIU MANNU	-912.52	TR 100	871.0	172.06	4.25	176.31	175.18	1.13	0.29	176.38	1.1	1.1	1.6	27.1	1.60
RIU MANNU	RIU MANNU	-1000	TR 100	871.0	171.53	4.60	176.13	174.94	1.19	0.31	176.22	1.3	1.3	1.8	33.6	1.52
RIU MANNU	RIU MANNU	-1200	TR 100	871.0	170.89	5.08	175.97	173.78	2.19	0.18	176.01	0.9	0.9	2.5	14.8	2.54
RIU MANNU	RIU MANNU	-1399.84	TR 100	871.0	169.99	5.80	175.79	173.86	1.93	0.23	175.85	1.0	1.0	2.0	20.7	1.96
RIU MANNU	RIU MANNU	-1600	TR 100	871.0	169.40	6.21	175.61	173.55	2.06	0.21	175.65	0.9	0.9	2.0	17.1	2.01
RIU MANNU	RIU MANNU	-1800	TR 100	871.0	169.23	6.13	175.36	172.69	2.67	0.26	175.44	1.3	1.3	2.5	30.0	2.50

HEC-RAS Plan: ALL_MIN(155) Locations: User Defined Profile: TR 200

River	Reach	River Sta	Profile	Q Total (m3/s)	Min Ch El (m)	Max Chl Dpth (m)	W.S. Elev (m)	Crit W.S. (m)	Diff	Froude # Chl	E.G. Elev (m)	Vel Chnl (m/s)	Vel Total (m/s)	Hydr Radius C (m)	Shear Chan (N/m2)	Hydr Depth (m)
RIU MANNU	RIU MANNU	0	TR 200	1024.0	180.00	1.84	181.84	181.00	0.84	0.32	181.90	1.1	1.1	1.3	27.9	1.26
RIU MANNU	RIU MANNU	-200	TR 200	1024.0	180.00	1.42	181.42	180.68	0.74	0.29	181.47	1.0	1.0	1.2	23.1	1.19
RIU MANNU	RIU MANNU	-400	TR 200	1024.0	179.28	1.14	180.42	180.28	0.14	0.73	180.61	2.0	2.0	0.7	103.8	0.73
RIU MANNU	RIU MANNU	-600	TR 200	1024.0	176.14	2.40	178.54	178.06	0.48	0.53	178.70	1.8	1.8	1.1	74.7	1.14
RIU MANNU	RIU MANNU	-800	TR 200	1024.0	173.38	3.46	176.84	176.52	0.32	0.65	177.06	2.1	2.1	1.1	105.1	1.06
RIU MANNU	RIU MANNU	-912.52	TR 200	1024.0	172.06	4.54	176.60	175.29	1.31	0.27	176.67	1.1	1.1	1.8	25.6	1.81
RIU MANNU	RIU MANNU	-1000	TR 200	1024.0	171.53	4.93	176.46	175.14	1.32	0.27	176.54	1.2	1.2	2.1	29.6	1.83
RIU MANNU	RIU MANNU	-1200	TR 200	1024.0	170.89	5.41	176.30	173.97	2.33	0.18	176.35	0.9	0.9	2.6	15.6	2.63
RIU MANNU	RIU MANNU	-1399.84	TR 200	1024.0	169.99	6.16	176.15	174.06	2.09	0.22	176.20	1.0	1.0	2.2	19.6	2.23
RIU MANNU	RIU MANNU	-1600	TR 200	1024.0	169.40	6.60	176.00	173.71	2.29	0.19	176.04	0.9	0.9	2.3	15.7	2.30
RIU MANNU	RIU MANNU	-1800	TR 200	1024.0	169.23	6.55	175.78	172.90	2.88	0.25	175.86	1.3	1.3	2.7	29.2	2.71

HEC-RAS Plan: ALL_MIN(155) Locations: User Defined Profile: TR 500

River	Reach	River Sta	Profile	Q Total (m ³ /s)	Min Ch El (m)	Max Chl Dpth (m)	W.S. Elev (m)	Crit W.S. (m)	Diff	Froude # Chl	E.G. Elev (m)	Vel Chnl (m/s)	Vel Total (m/s)	Hydr Radius C (m)	Shear Chan (N/m ²)	Hydr Depth (m)
RIU MANNU	RIU MANNU	0	TR 500	1224.0	180.00	1.98	181.98	181.09	0.89	0.33	182.05	1.2	1.2	1.3	31.4	1.34
RIU MANNU	RIU MANNU	-200	TR 500	1224.0	180.00	1.54	181.54	180.77	0.77	0.31	181.60	1.1	1.1	1.3	26.6	1.29
RIU MANNU	RIU MANNU	-400	TR 500	1224.0	179.28	1.27	180.55	180.35	0.20	0.69	180.75	2.0	2.0	0.9	101.9	0.85
RIU MANNU	RIU MANNU	-600	TR 500	1224.0	176.14	2.48	178.62	178.19	0.43	0.58	178.82	2.0	2.0	1.2	91.2	1.20
RIU MANNU	RIU MANNU	-800	TR 500	1224.0	173.38	3.70	177.08	176.64	0.44	0.57	177.29	2.0	2.0	1.3	92.0	1.26
RIU MANNU	RIU MANNU	-912.52	TR 500	1224.0	172.06	4.83	176.89	175.43	1.46	0.26	176.96	1.2	1.2	2.1	26.0	2.03
RIU MANNU	RIU MANNU	-1000	TR 500	1224.0	171.53	5.24	176.77	175.29	1.48	0.26	176.85	1.3	1.3	2.3	29.3	2.11
RIU MANNU	RIU MANNU	-1200	TR 500	1224.0	170.89	5.72	176.61	174.20	2.41	0.19	176.66	1.0	1.0	2.8	17.4	2.78
RIU MANNU	RIU MANNU	-1399.84	TR 500	1224.0	169.99	6.46	176.45	174.26	2.19	0.22	176.51	1.1	1.1	2.4	20.9	2.46
RIU MANNU	RIU MANNU	-1600	TR 500	1224.0	169.40	6.91	176.31	173.93	2.38	0.19	176.35	1.0	1.0	2.5	16.8	2.49
RIU MANNU	RIU MANNU	-1800	TR 500	1224.0	169.23	6.84	176.07	173.19	2.88	0.26	176.17	1.4	1.4	2.8	33.1	2.86

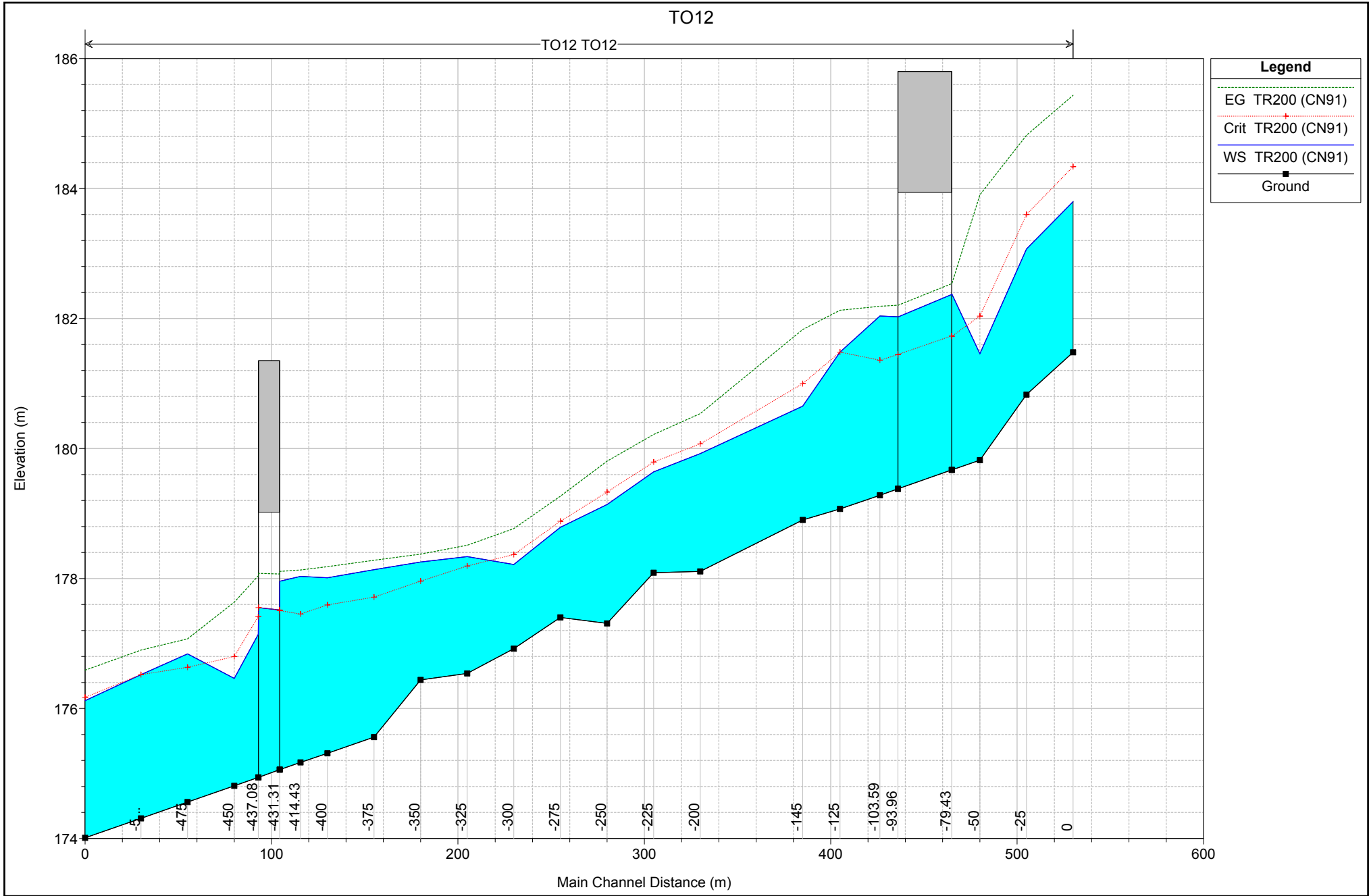

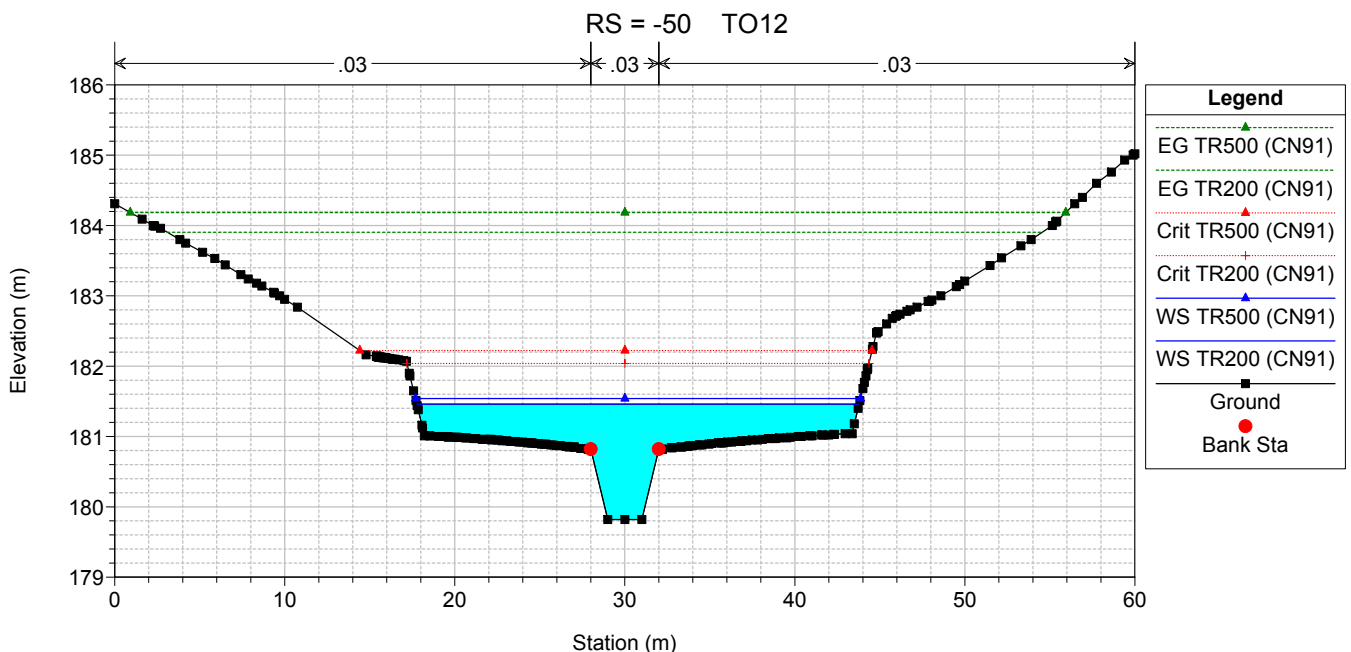
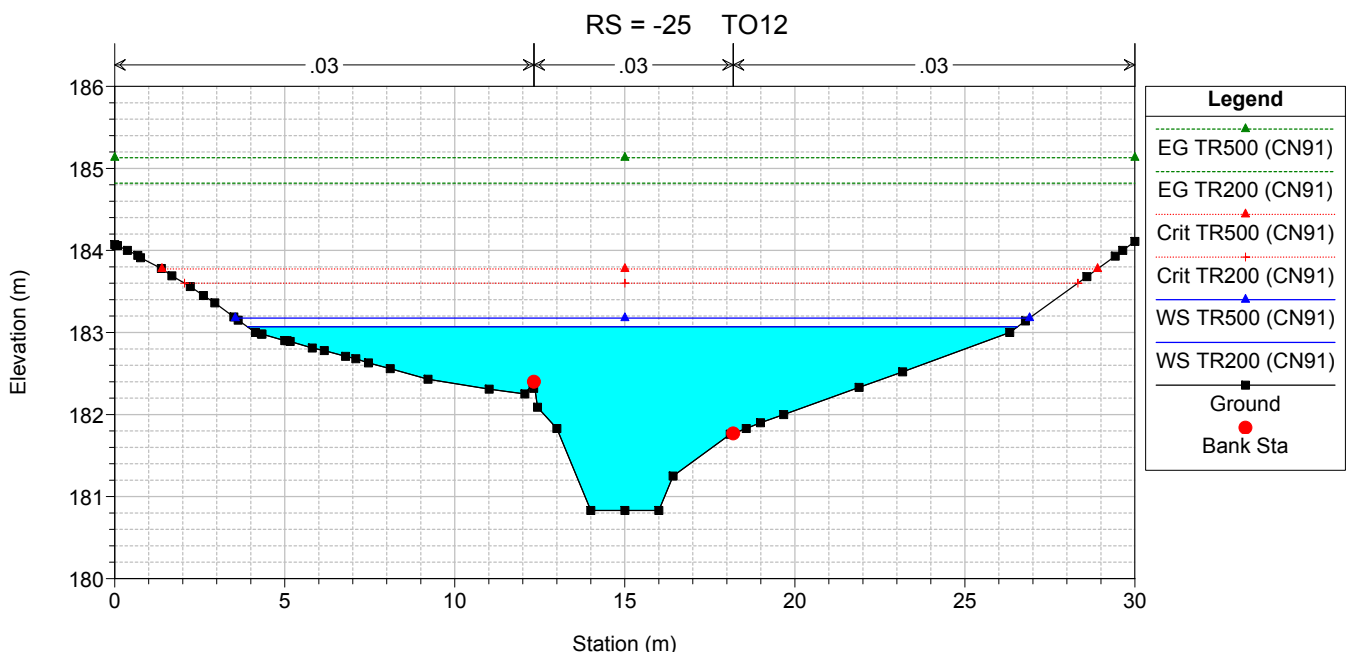
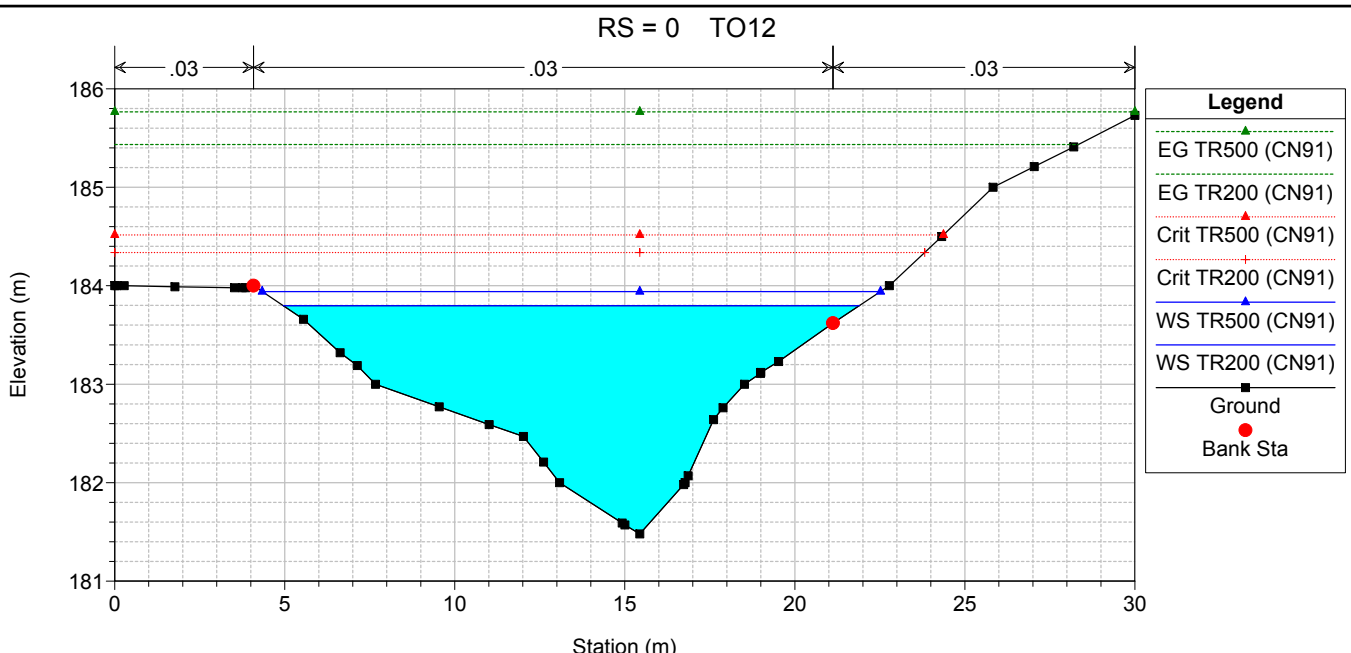

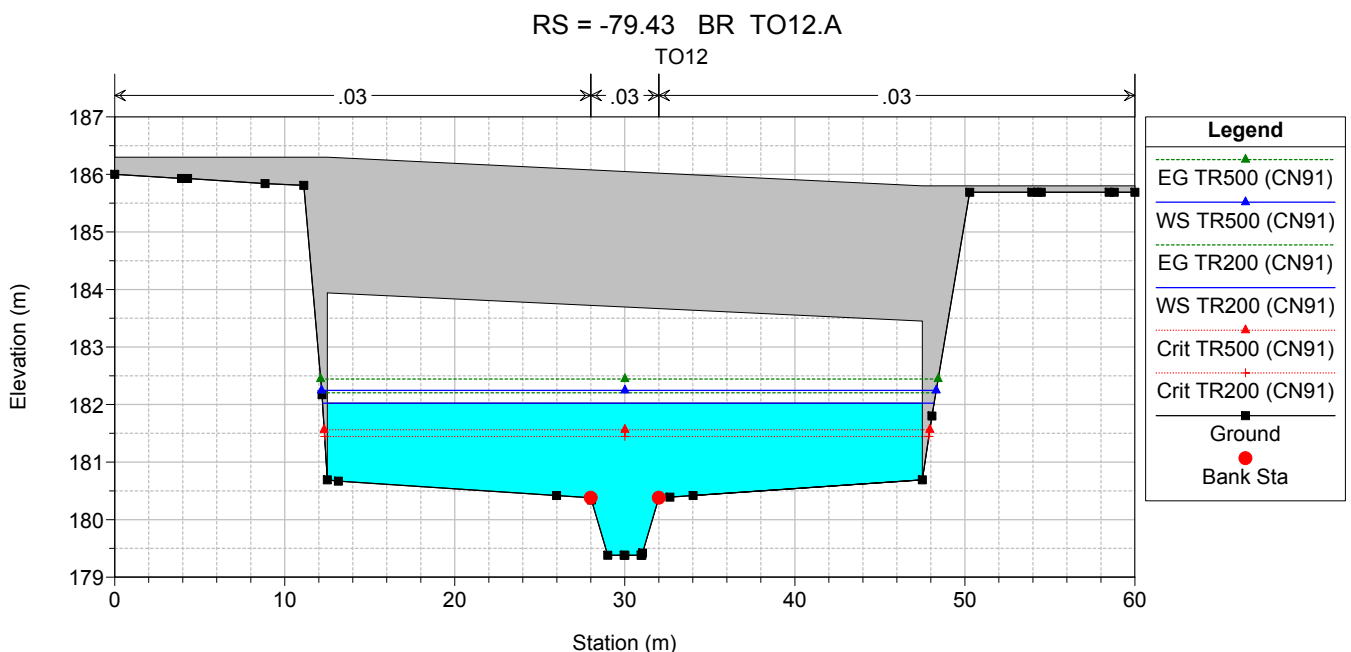
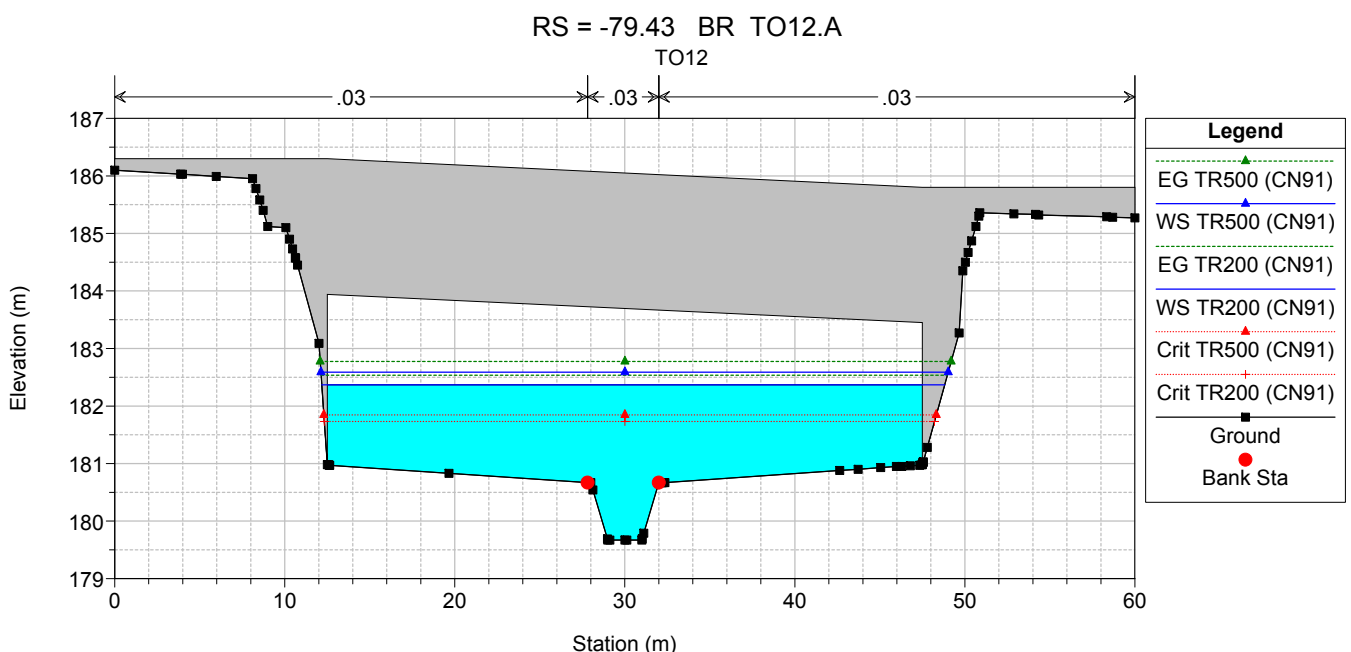
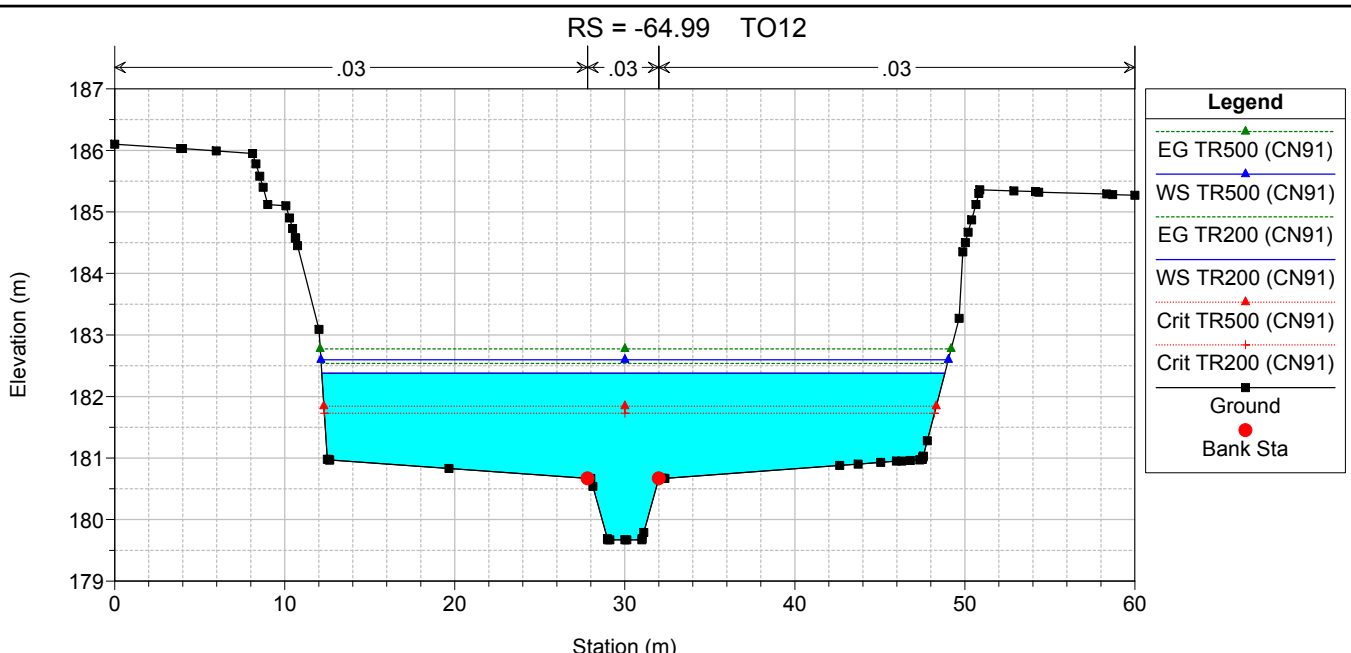

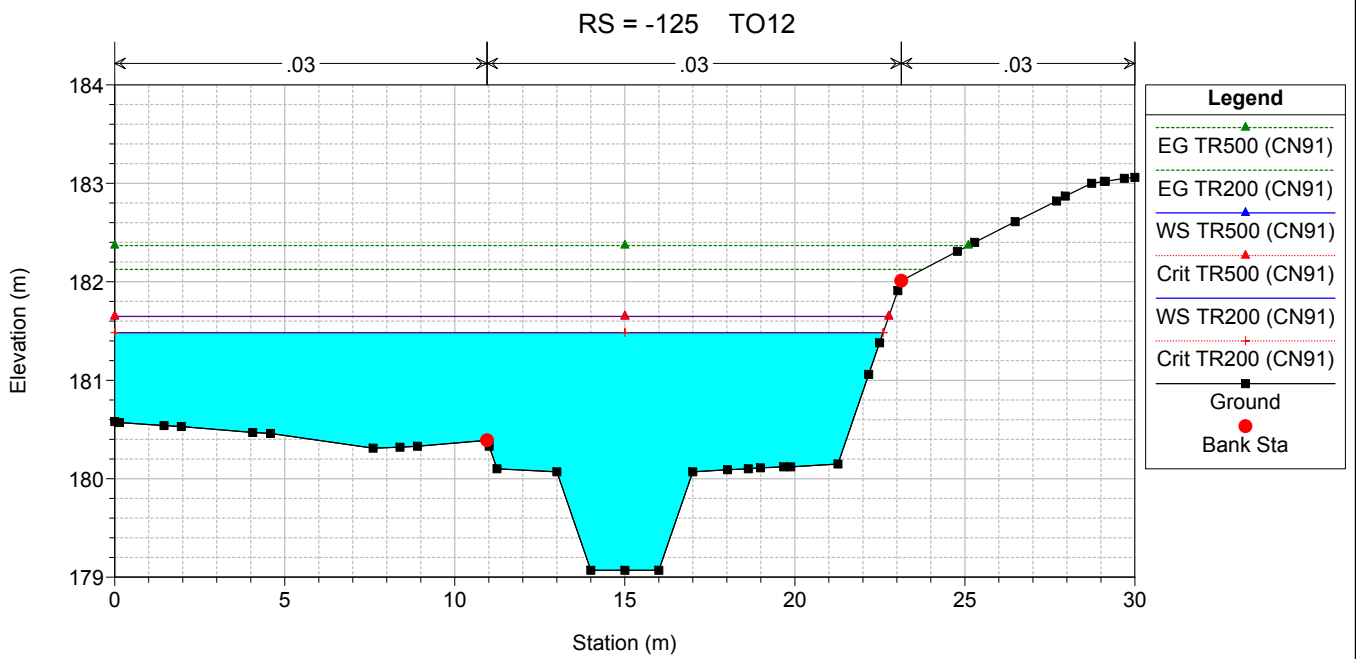
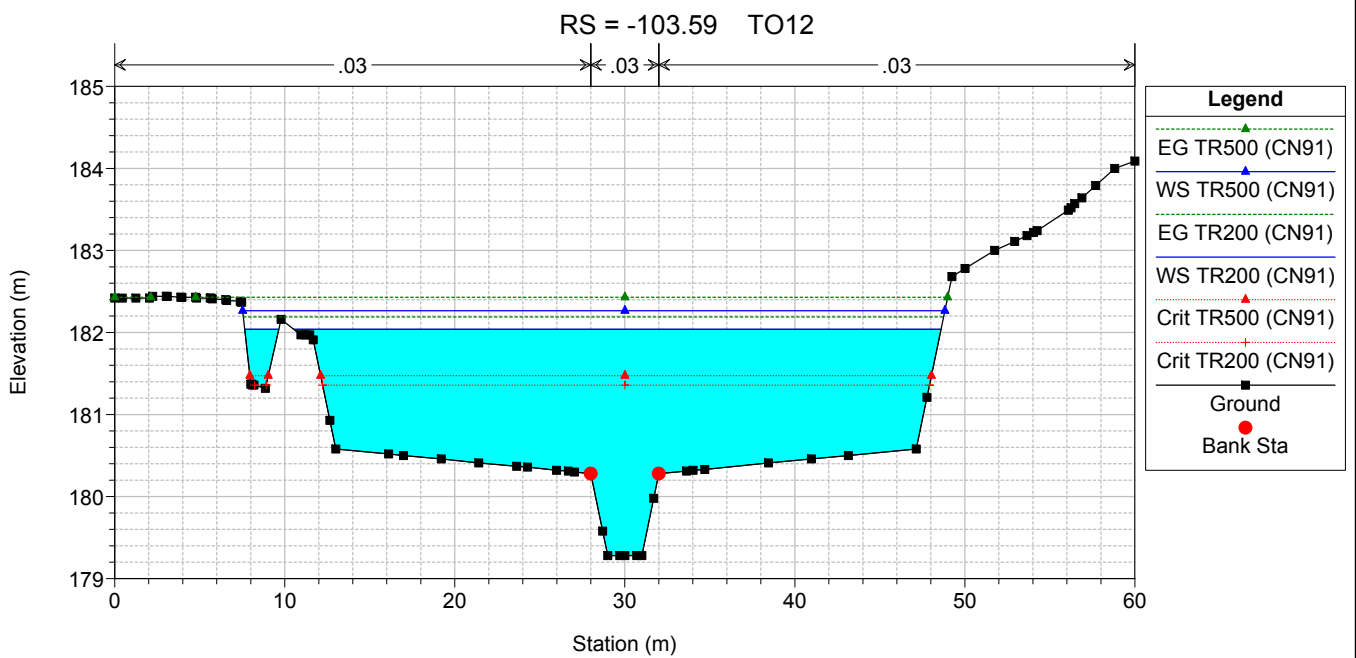
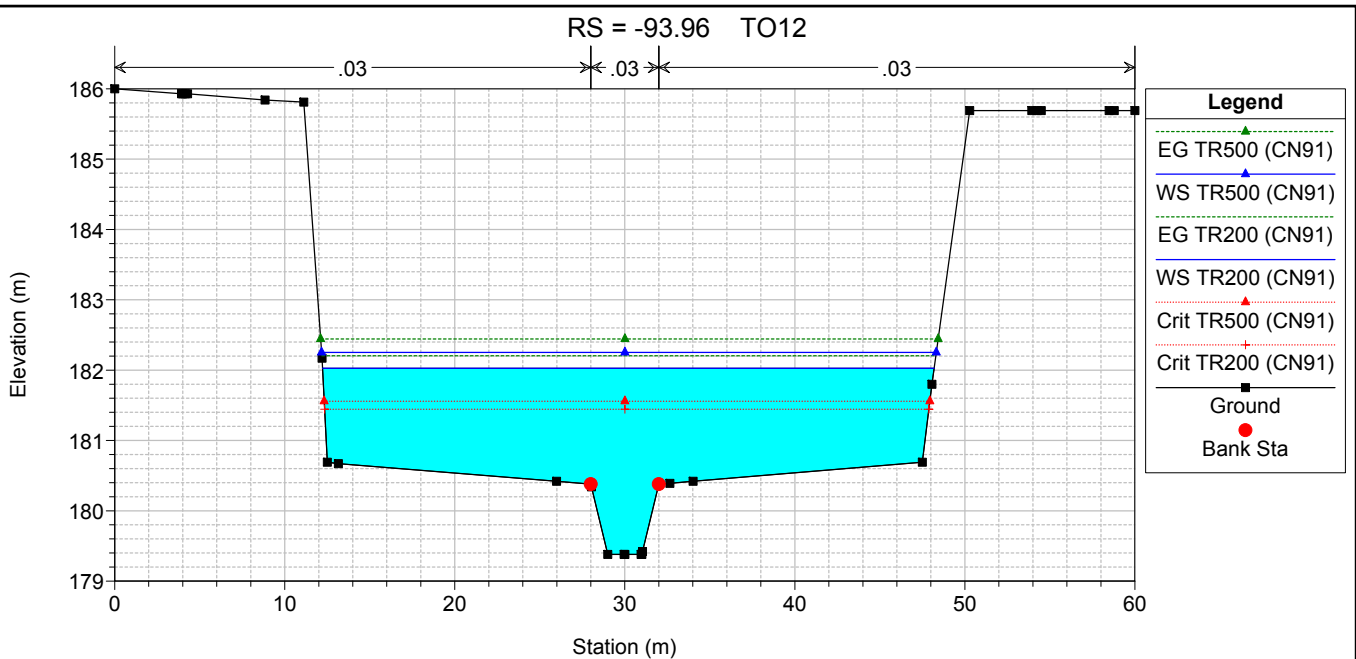

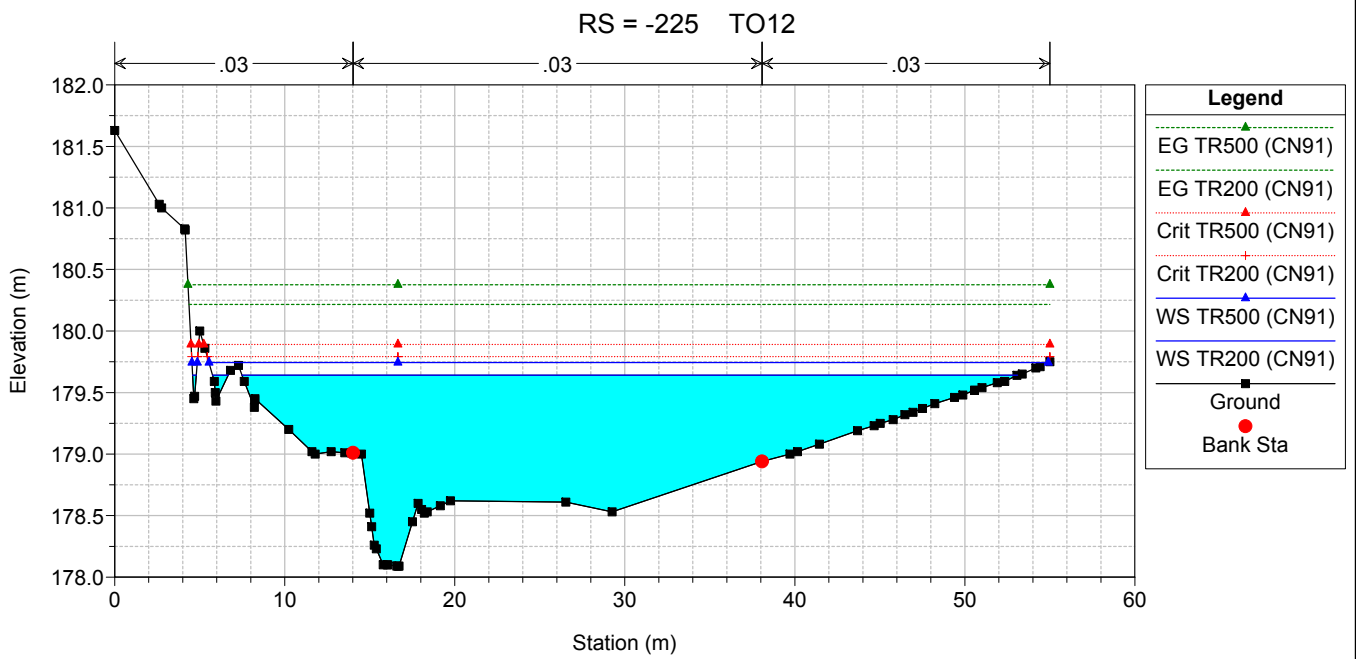
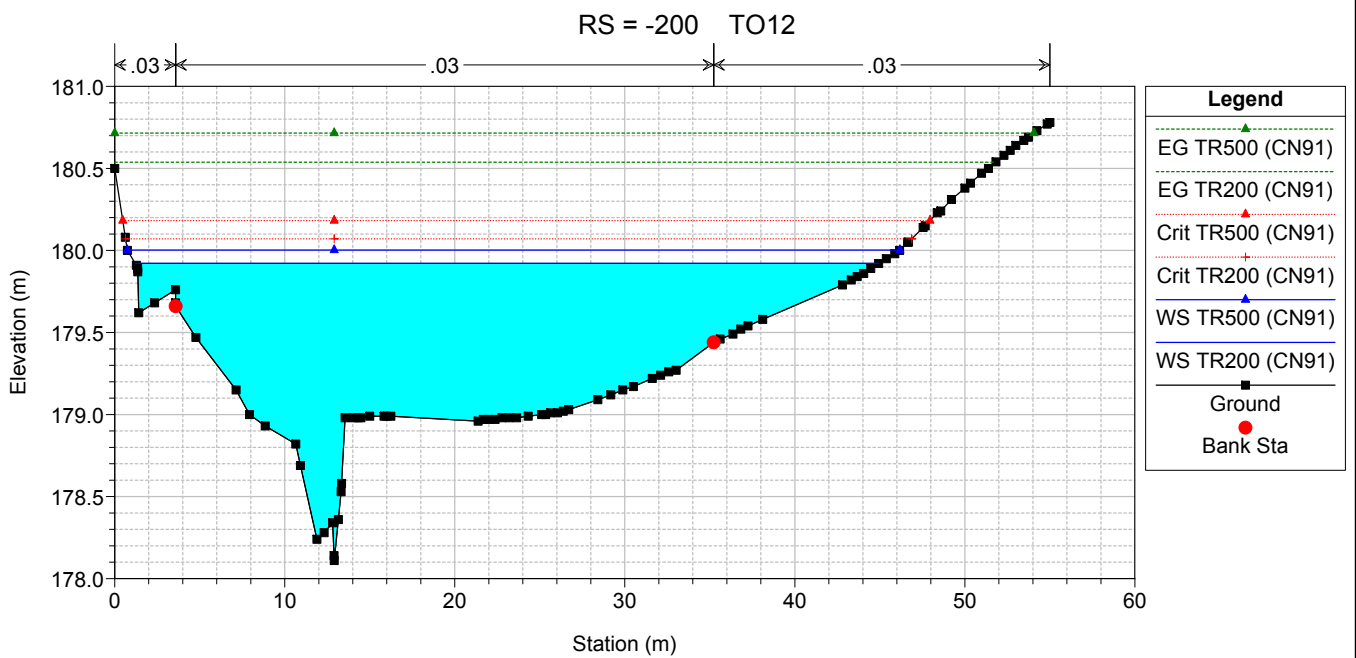
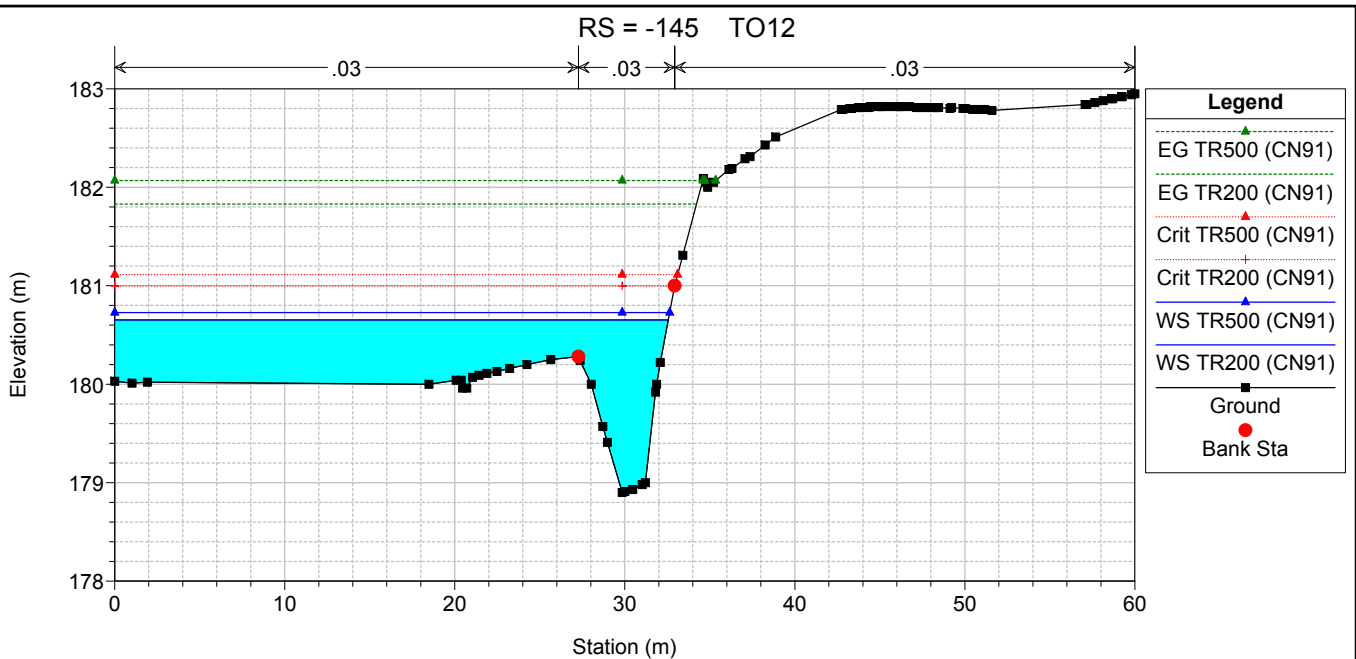

RS = -250 TO12

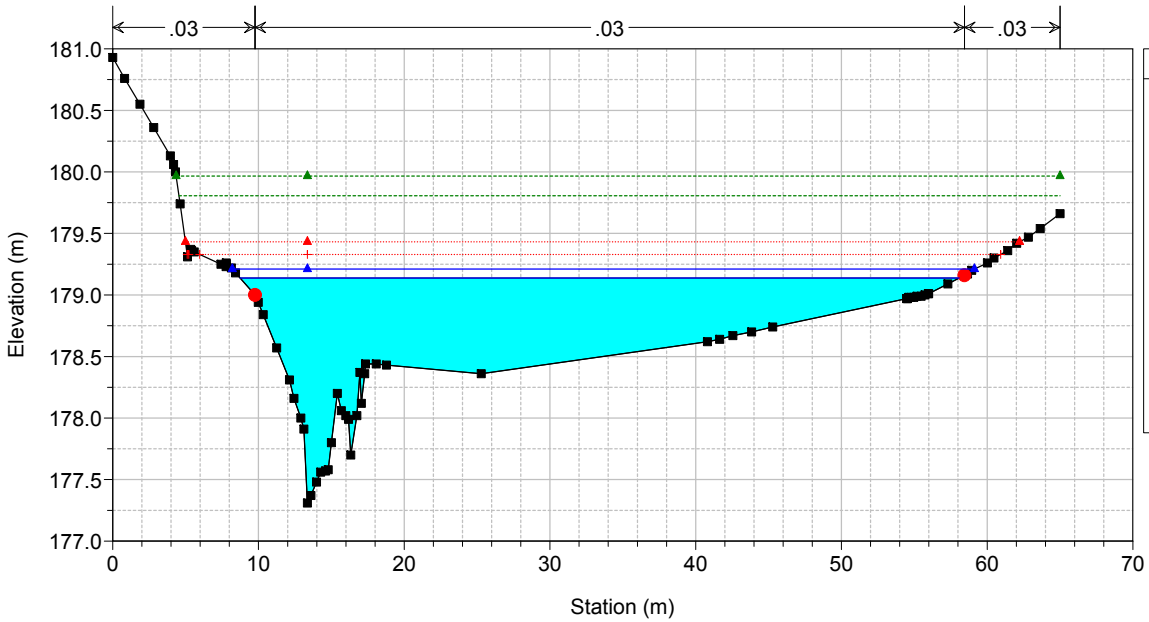

RS = -275 TO12

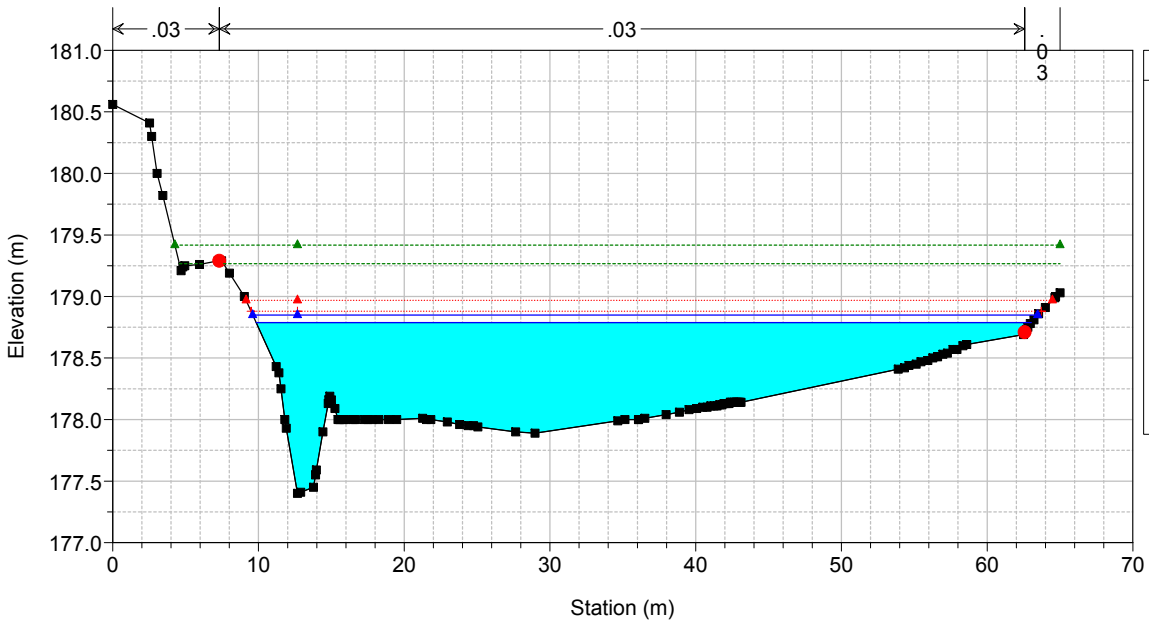

RS = -300 TO12

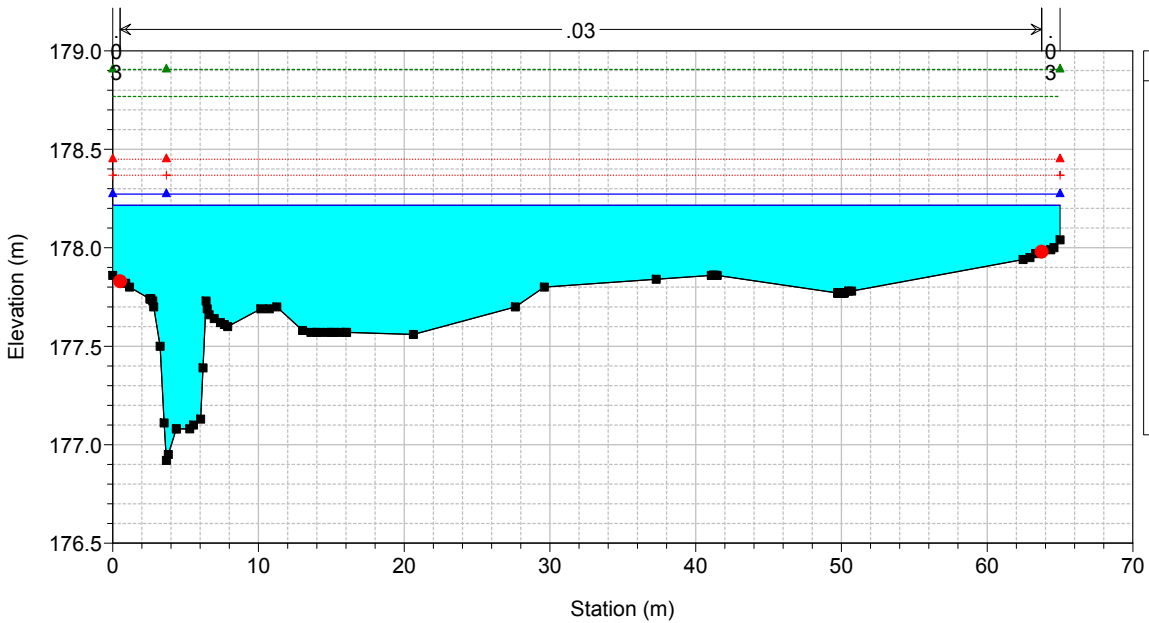

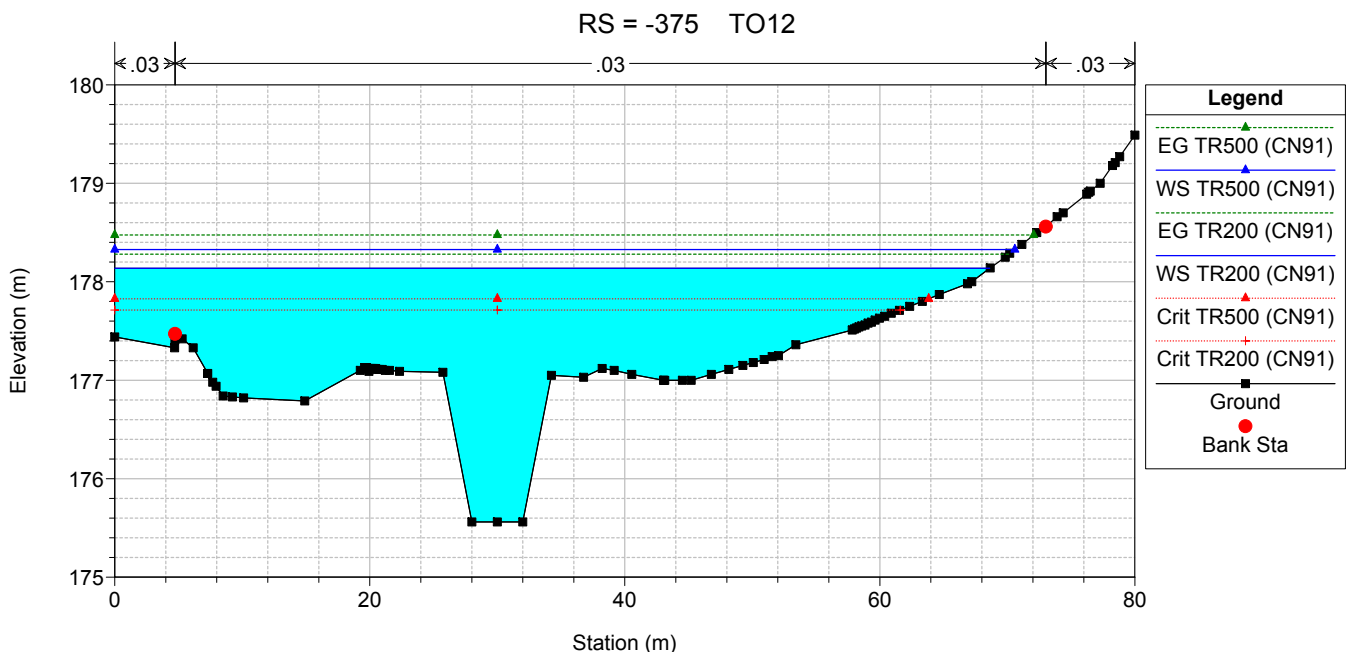
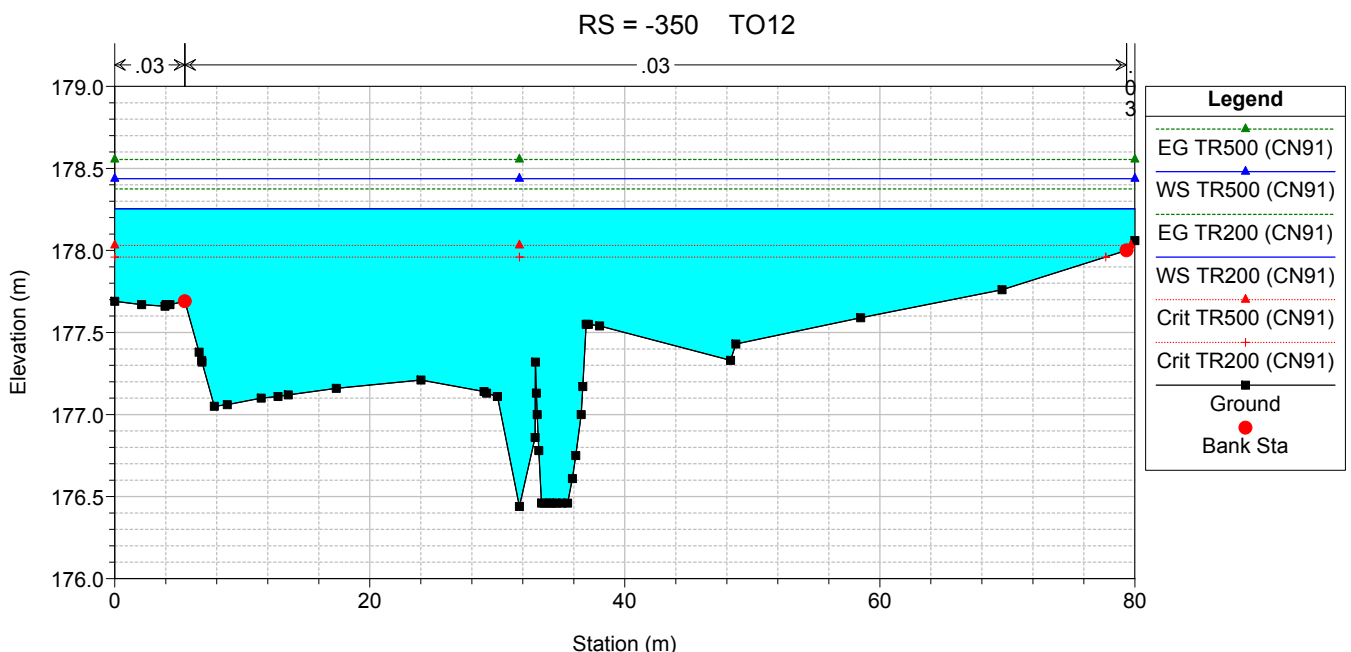
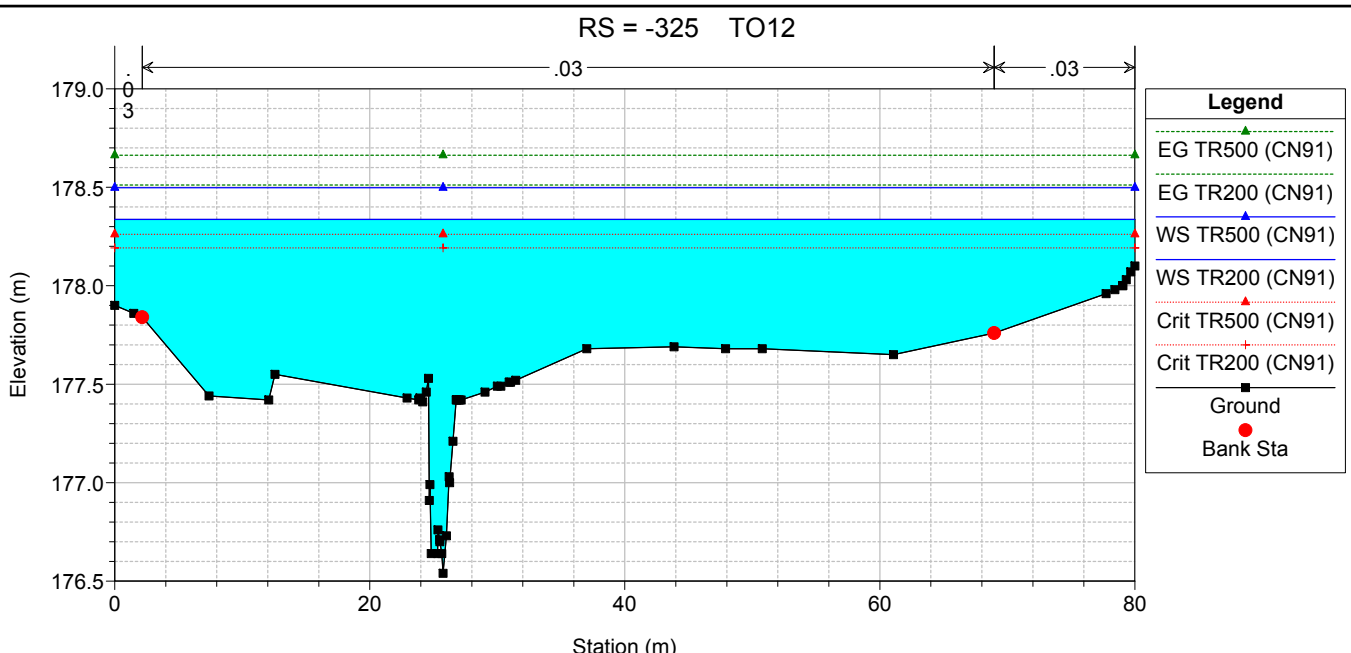

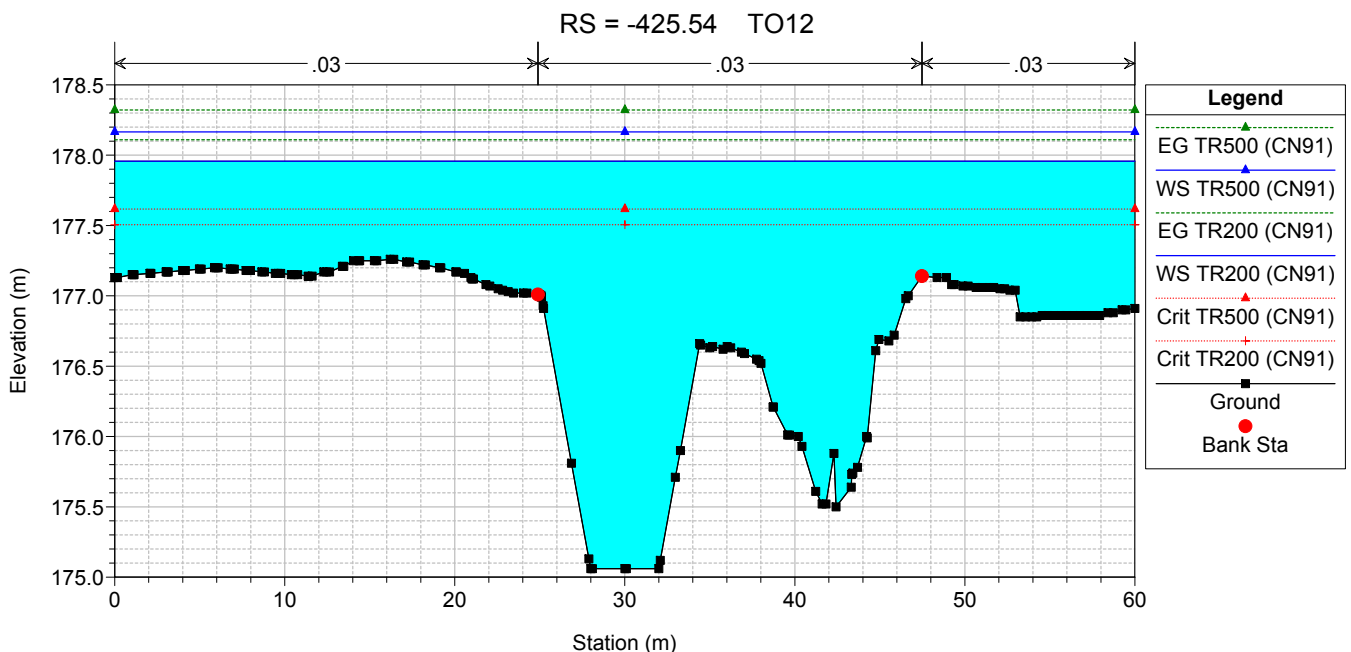
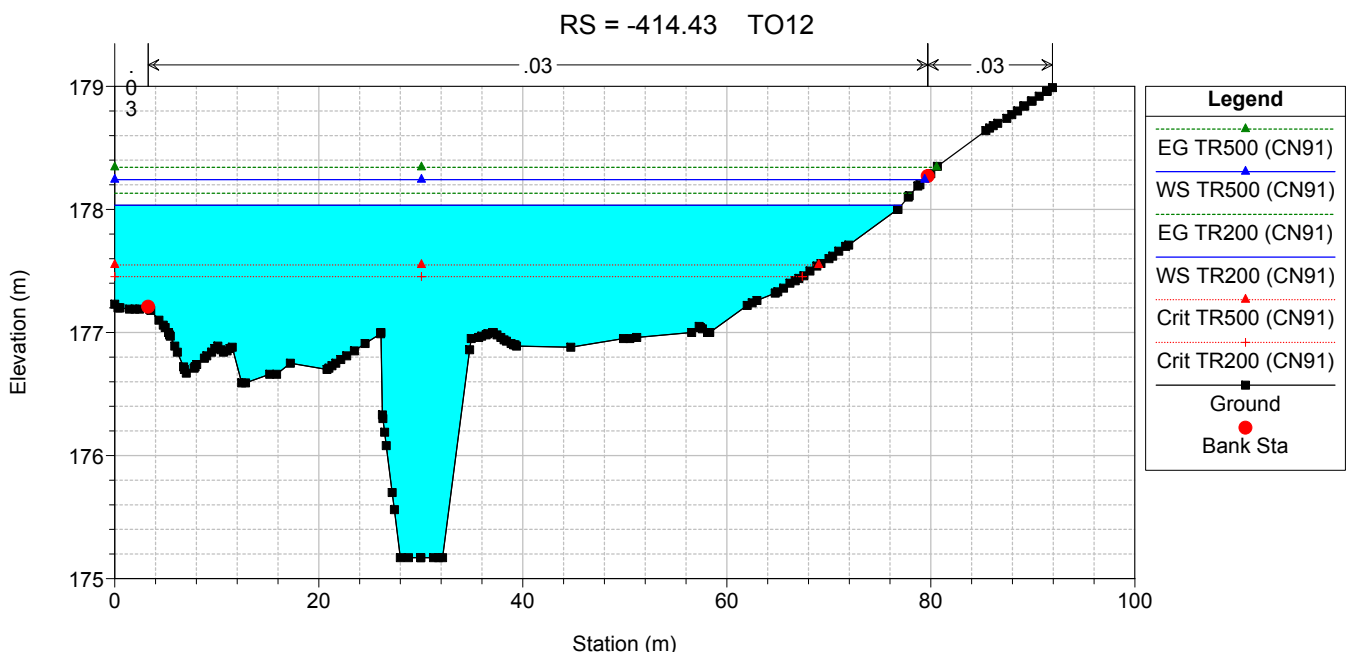
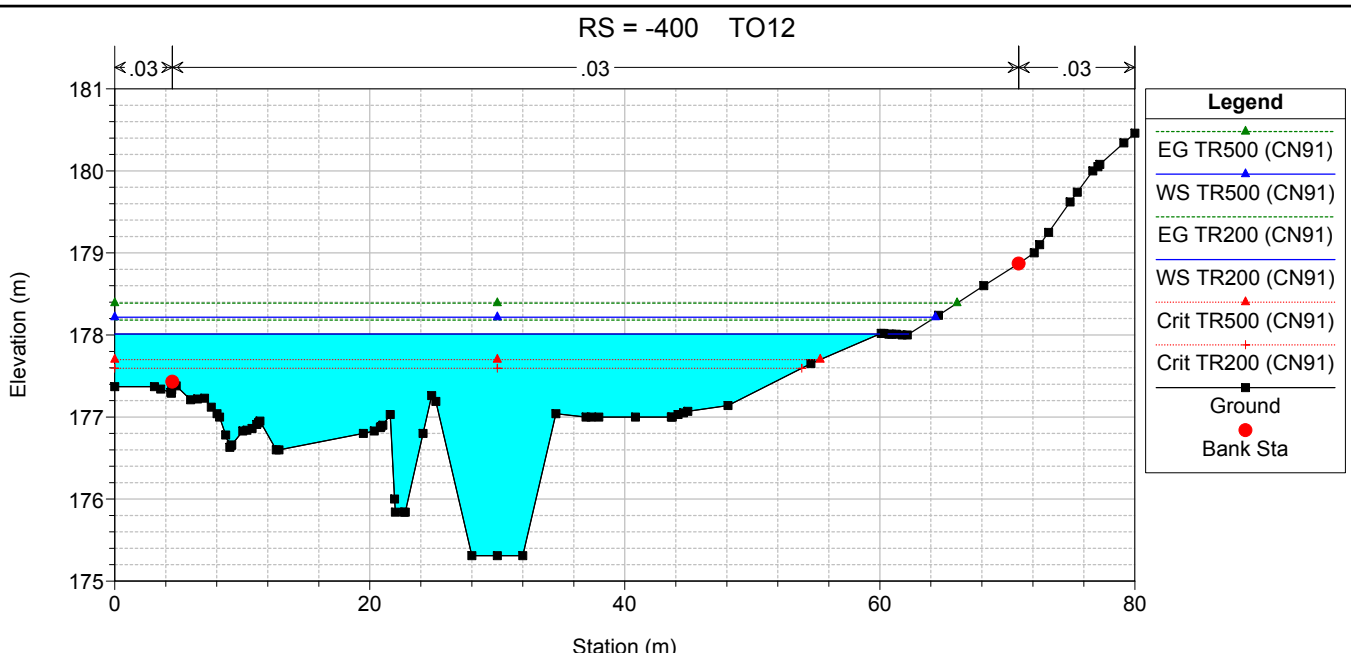

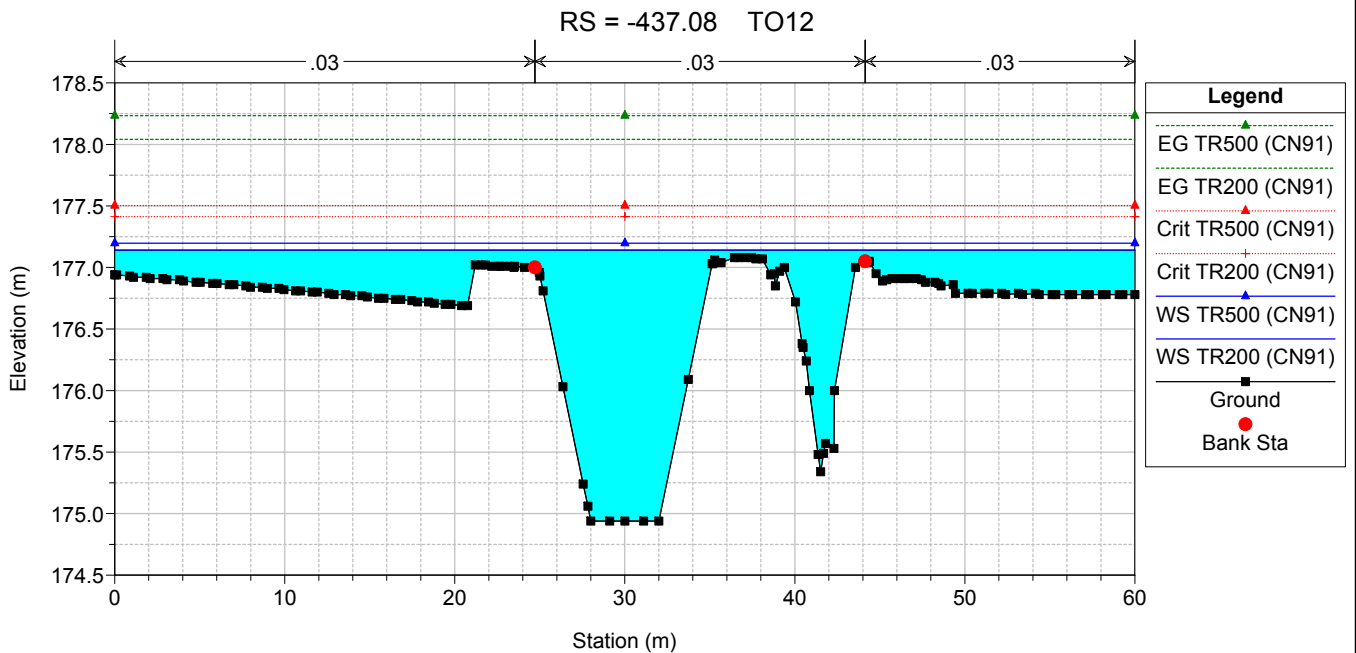
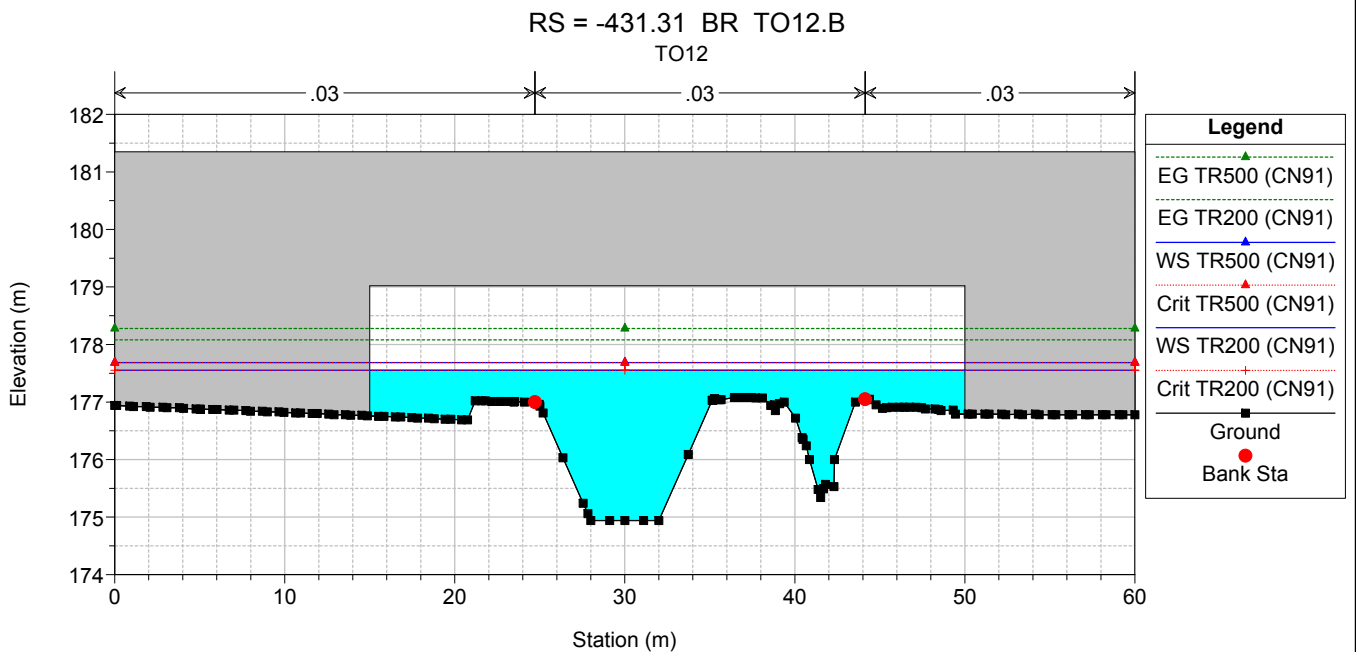
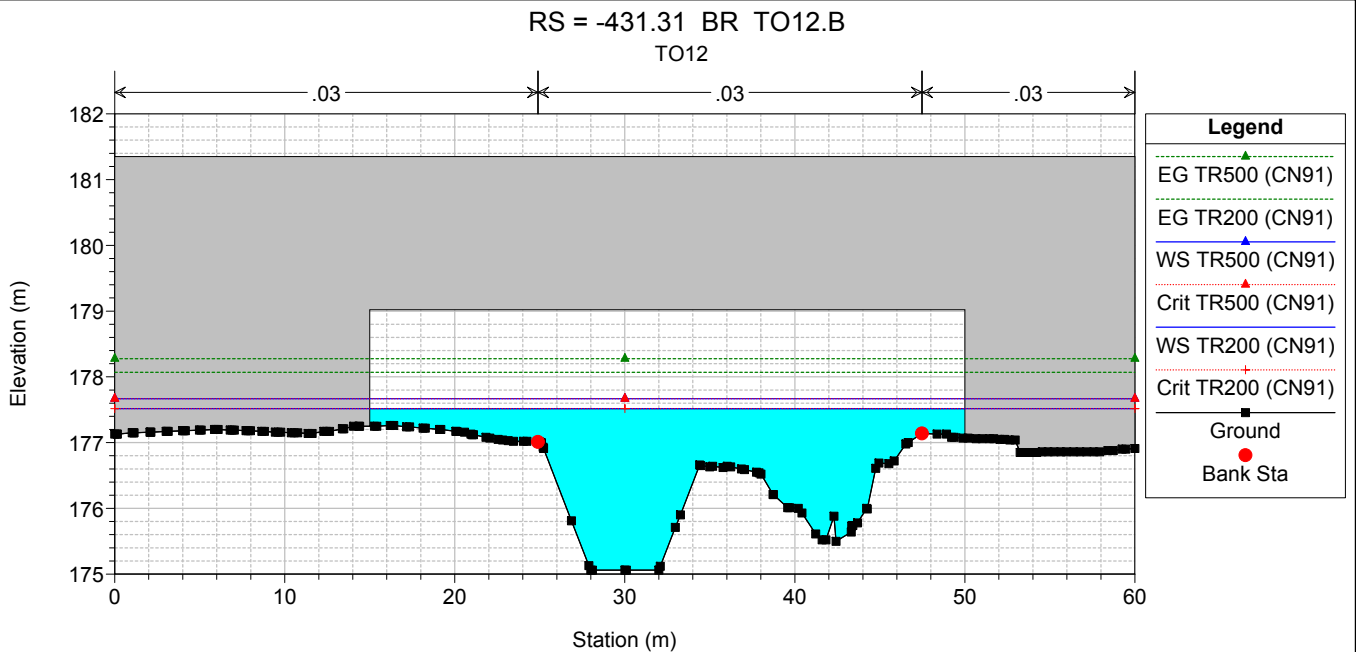

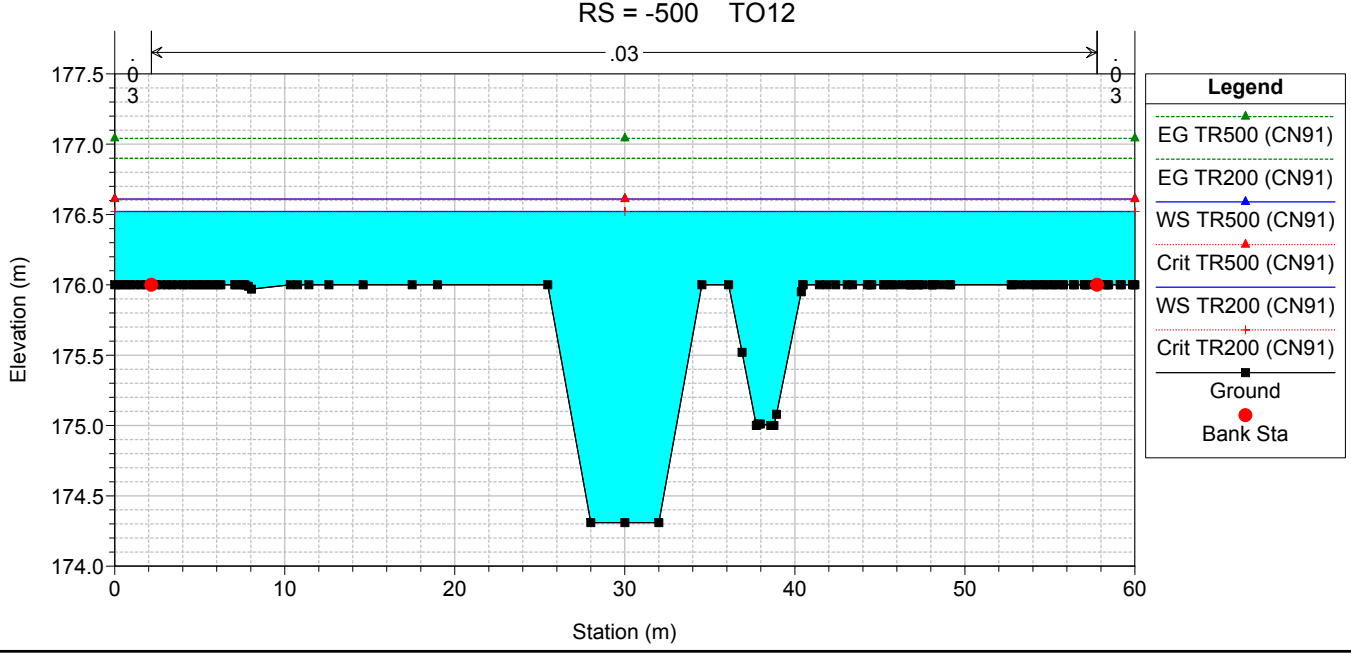
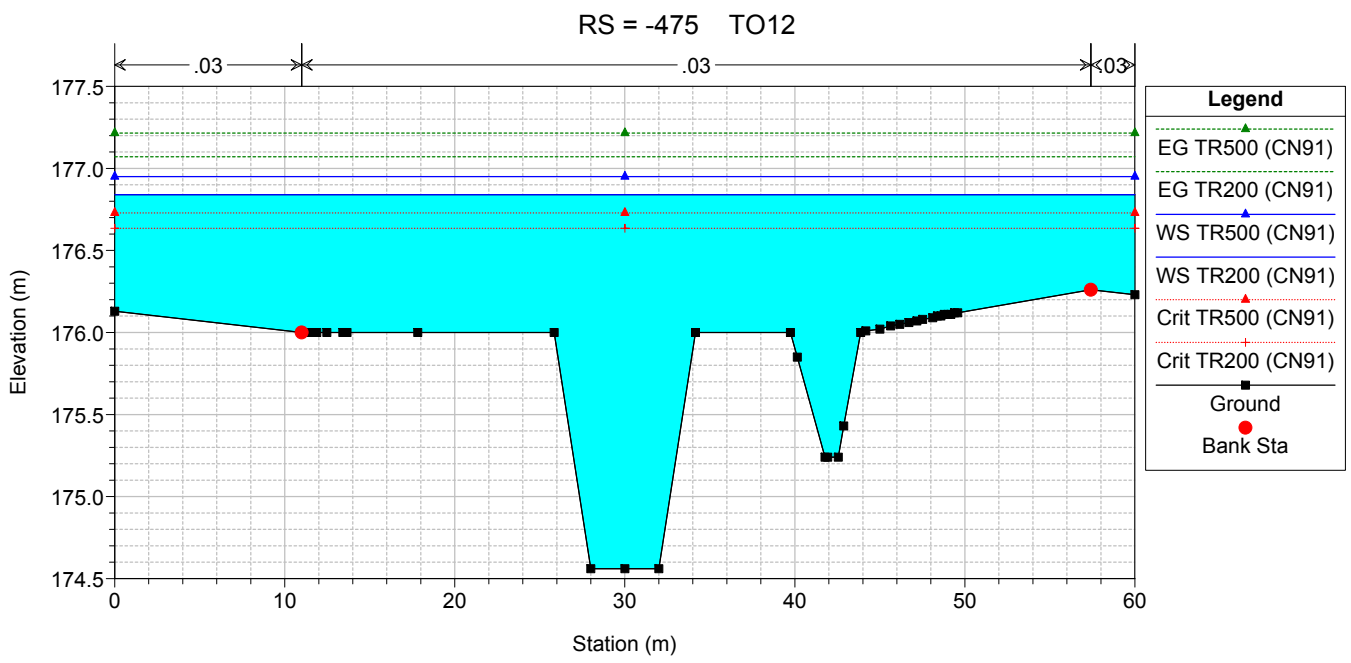
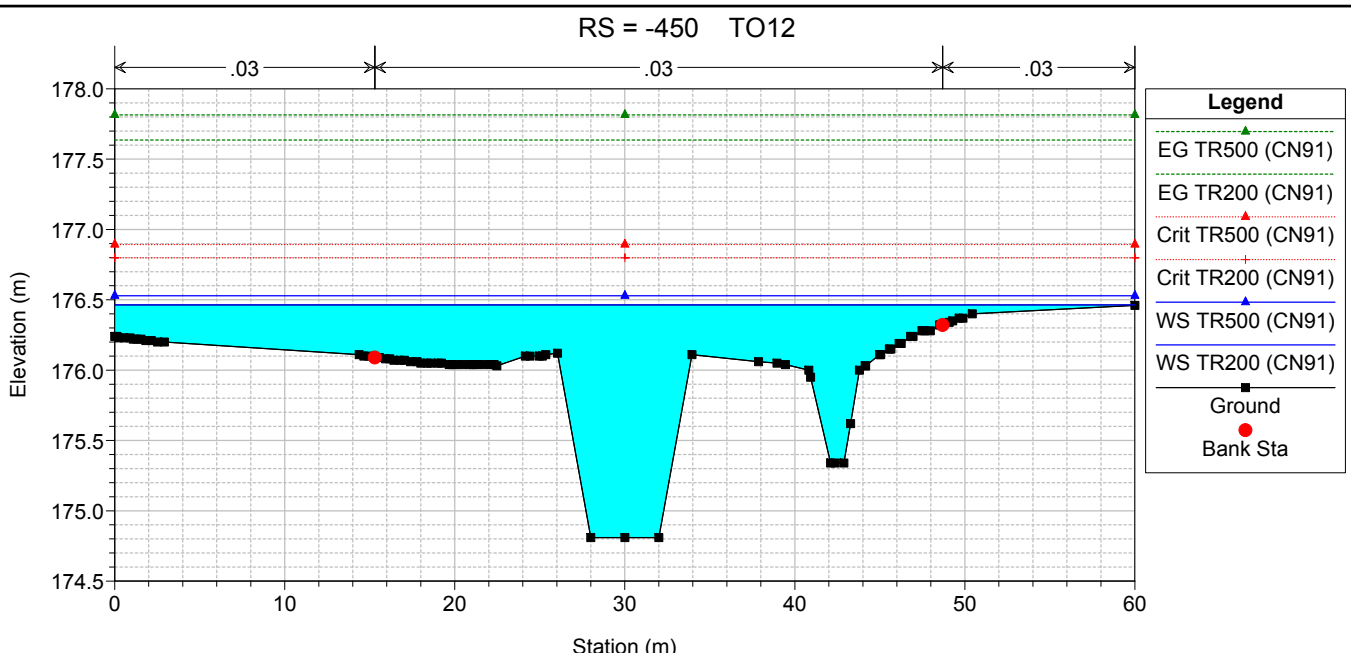

RS = -530 TO12

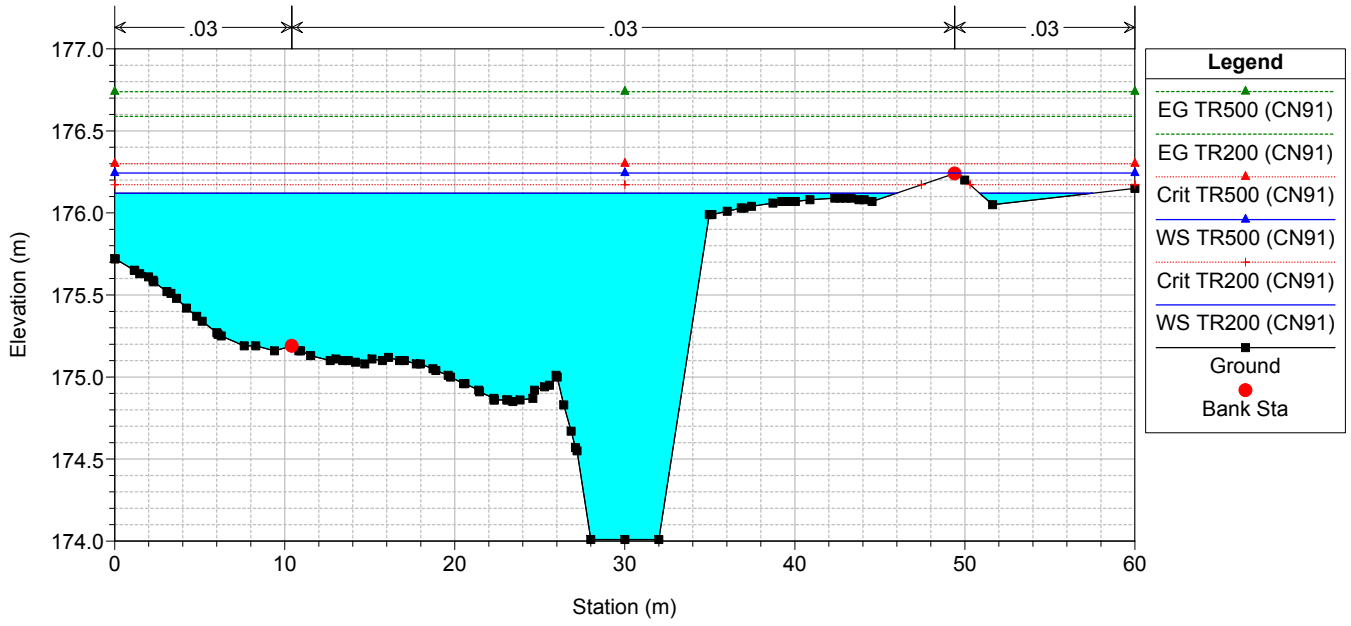

RIU MANNU

RIU MANNU RIU MANNU

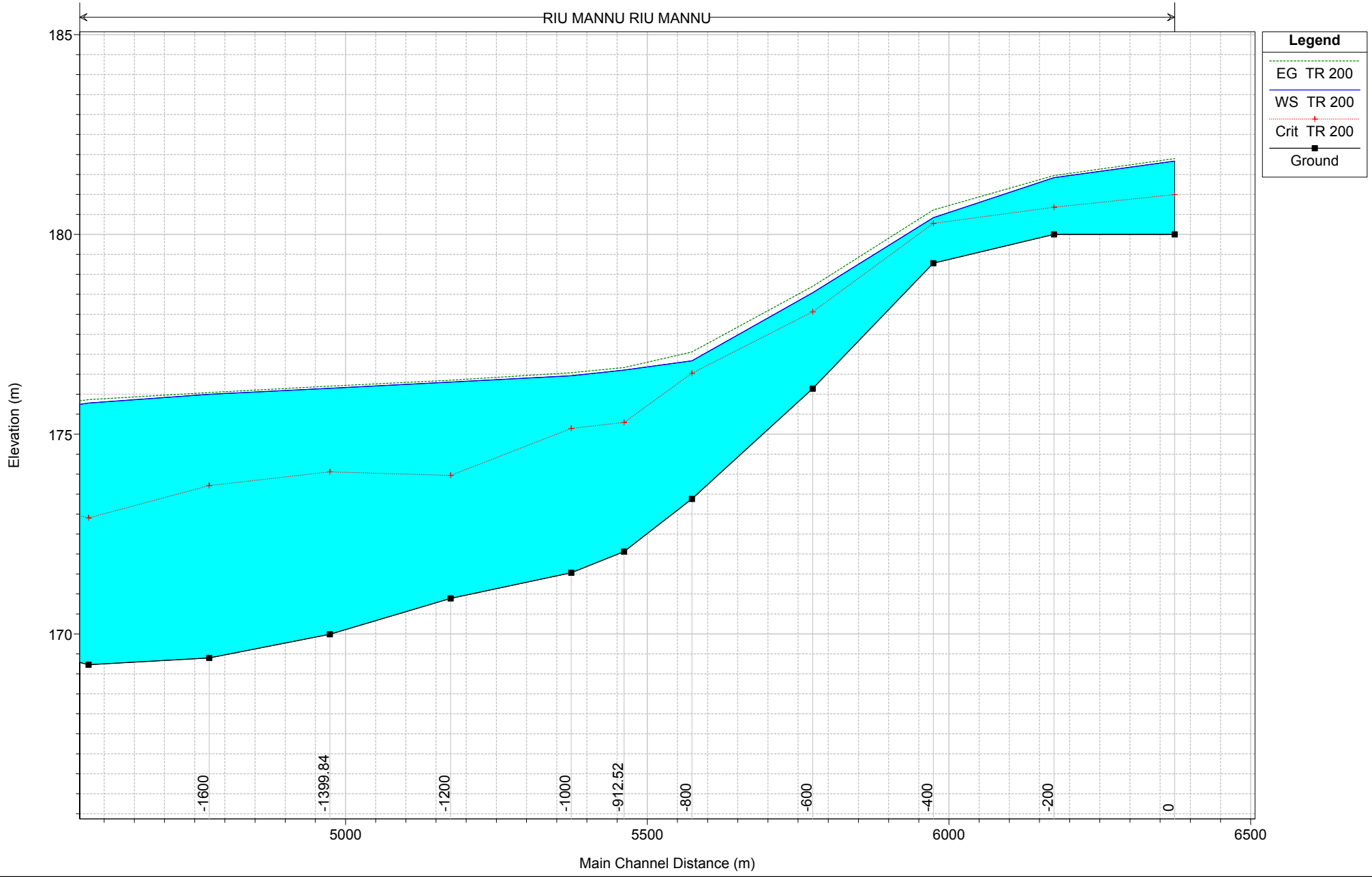

RIU MANNU

RS = 0

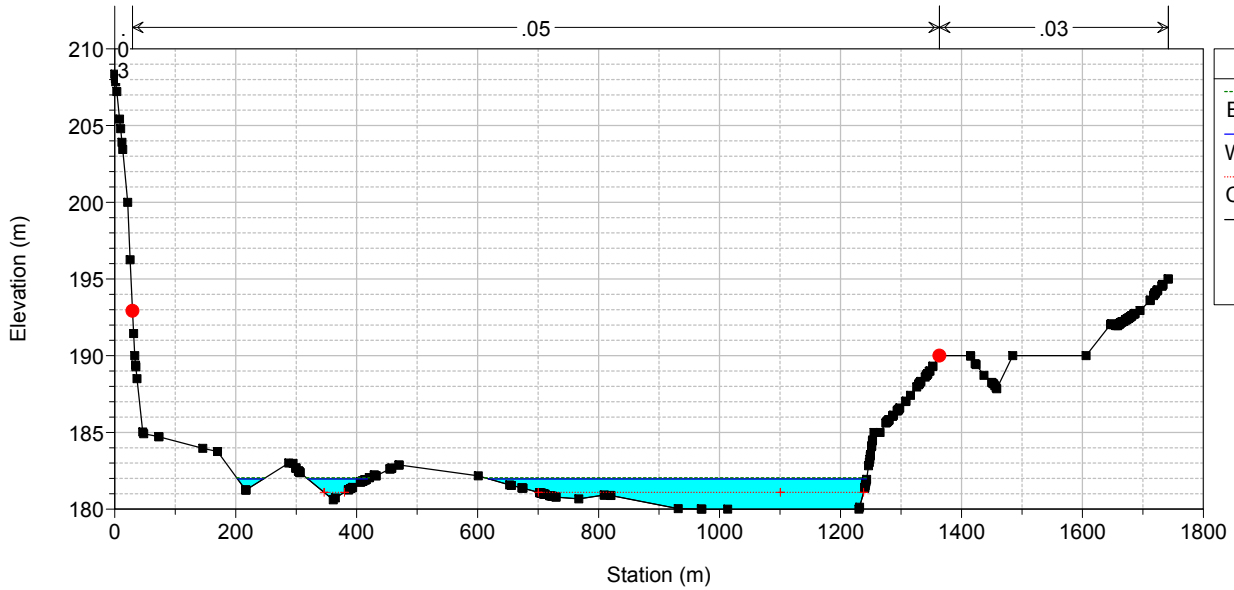

RIU MANNU

RS = -200

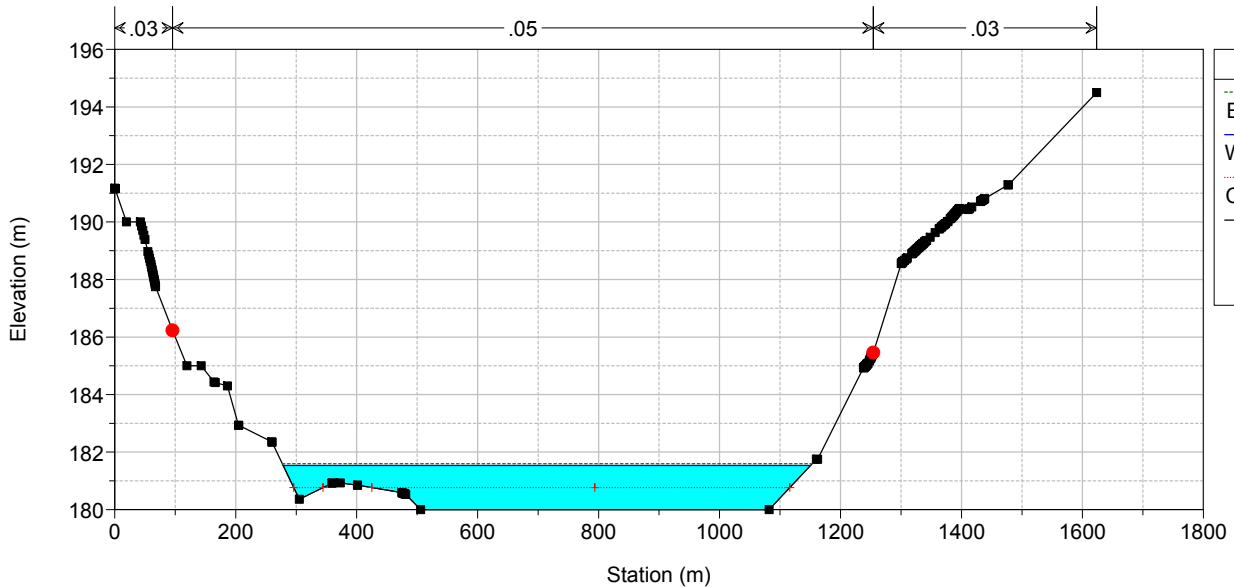

RIU MANNU

RS = -400

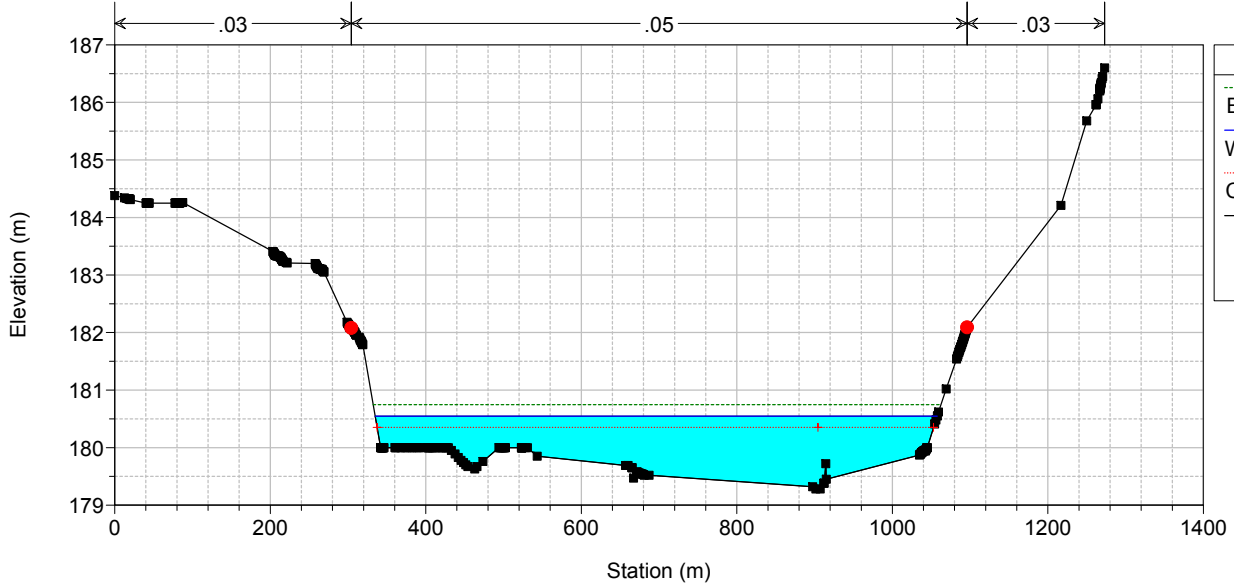

RIU MANNU

RS = -600

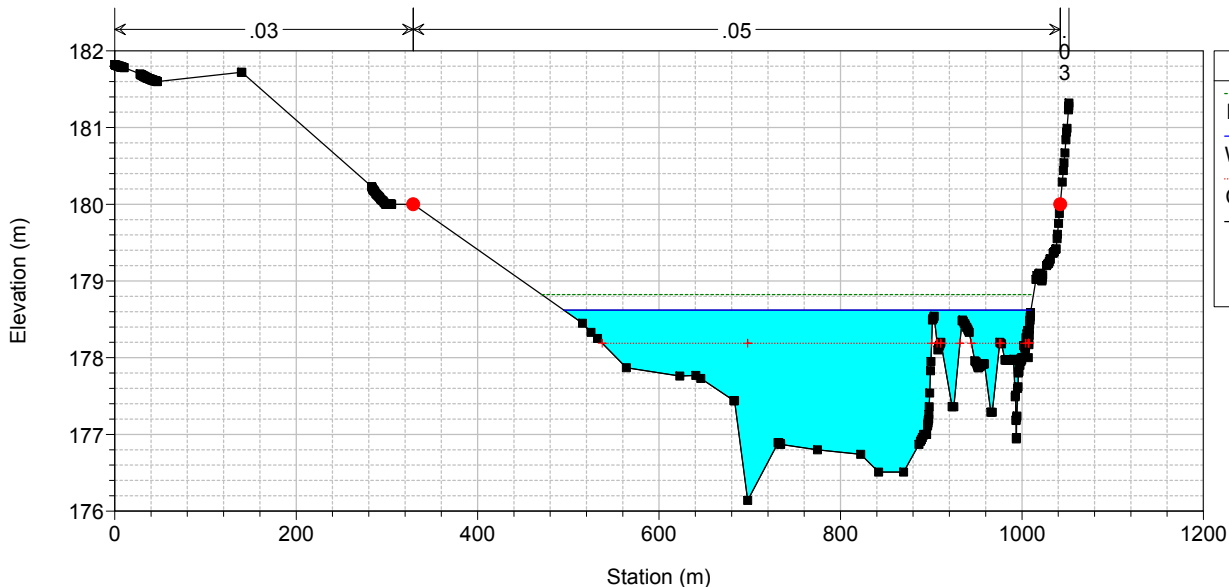

RIU MANNU

RS = -800

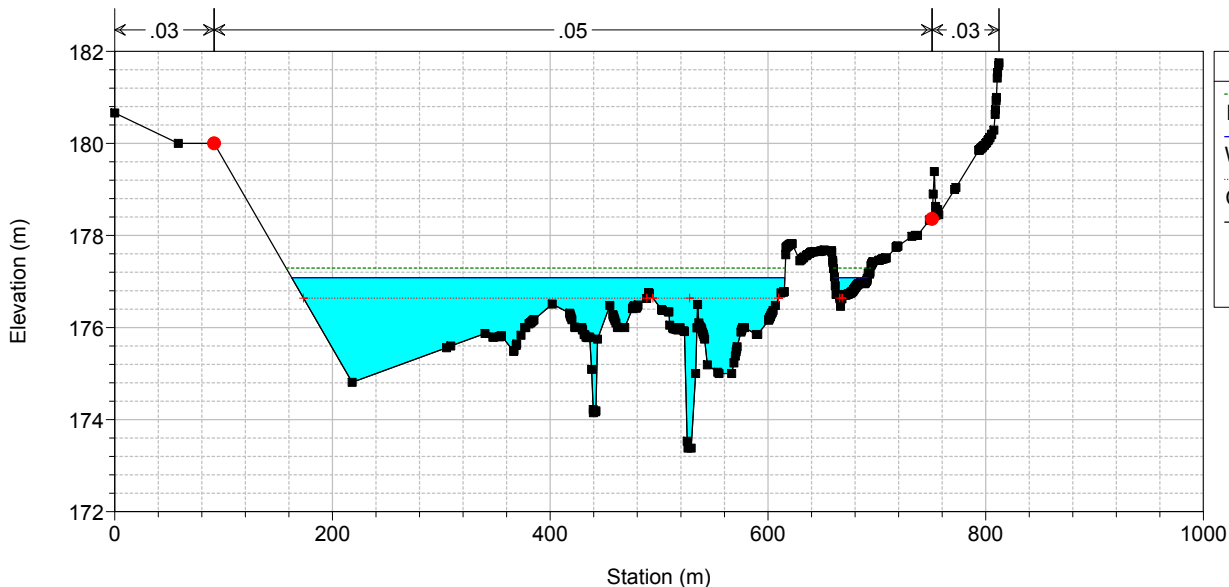

RIU MANNU

RS = -912.52

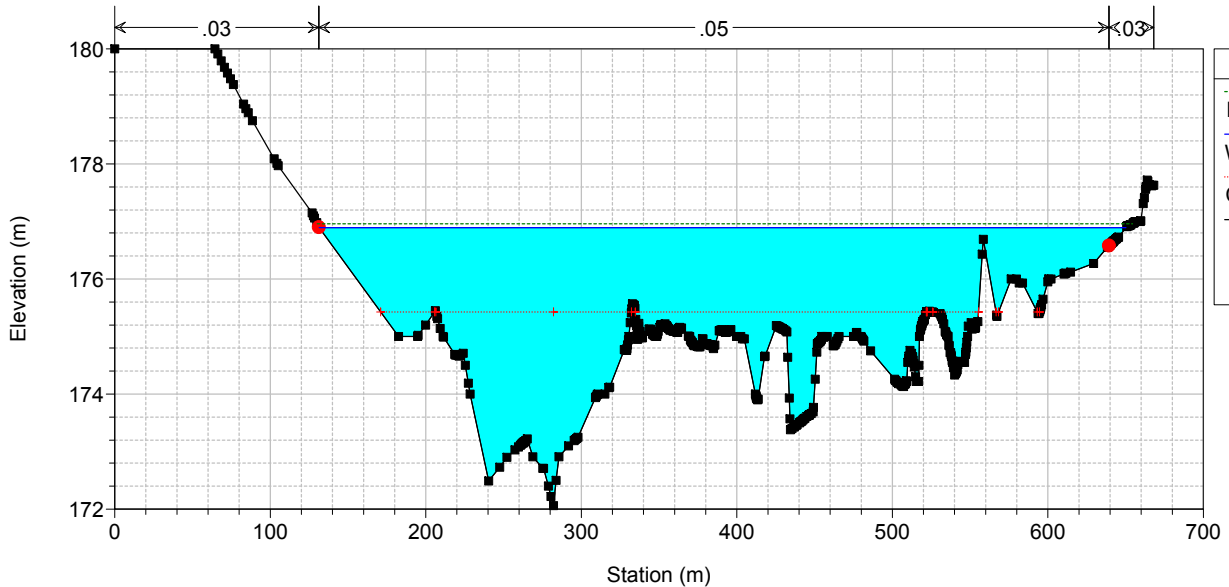

RIU MANNU

RS = -1000

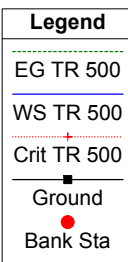
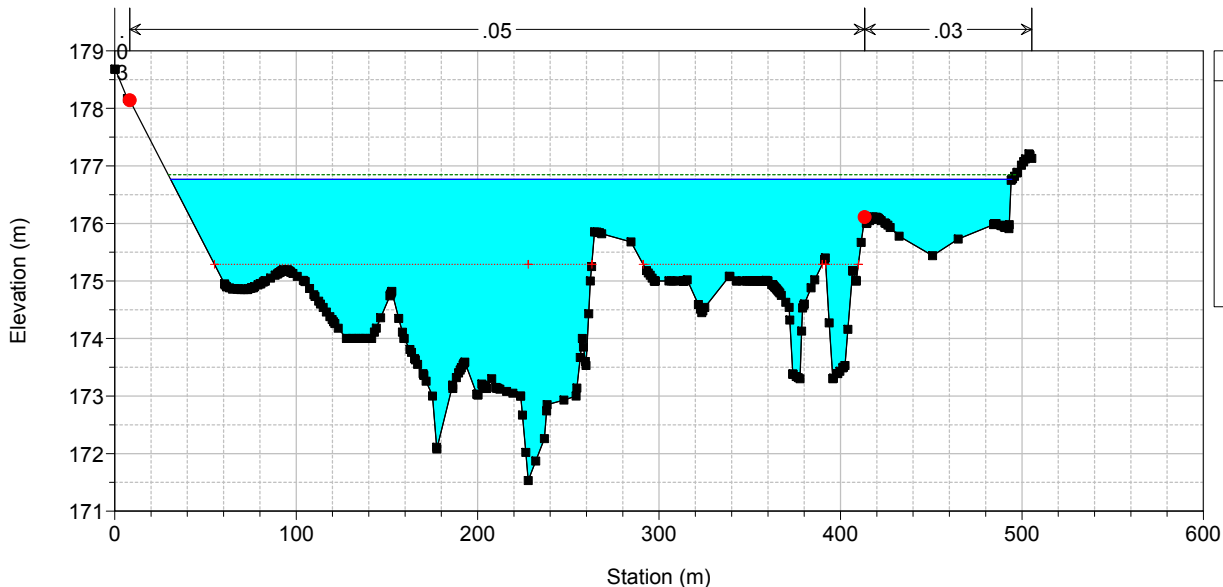

RIU MANNU

RS = -1200

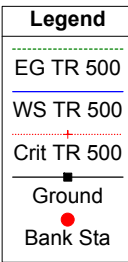
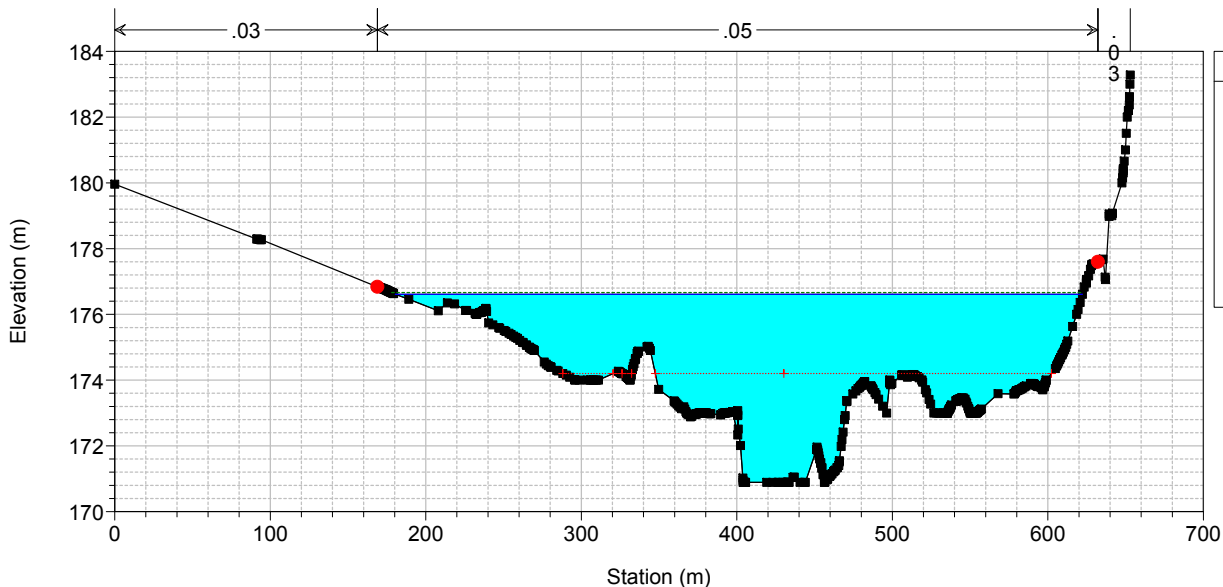

RIU MANNU

RS = -1399.84

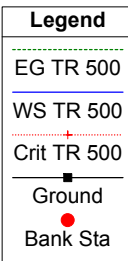
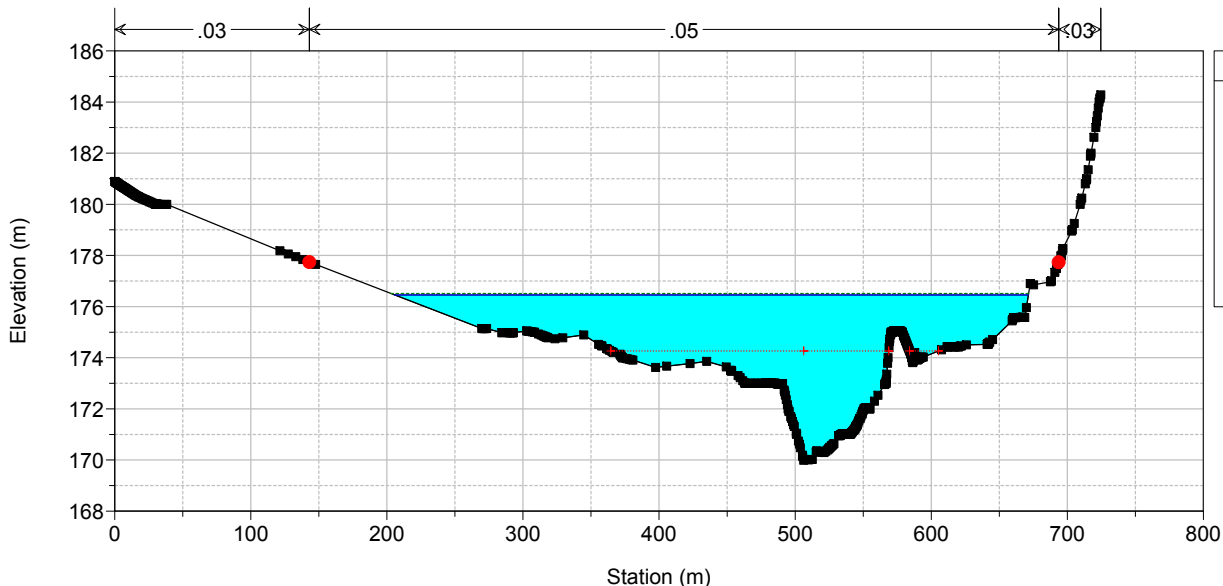

RIU MANNU

RS = -1600

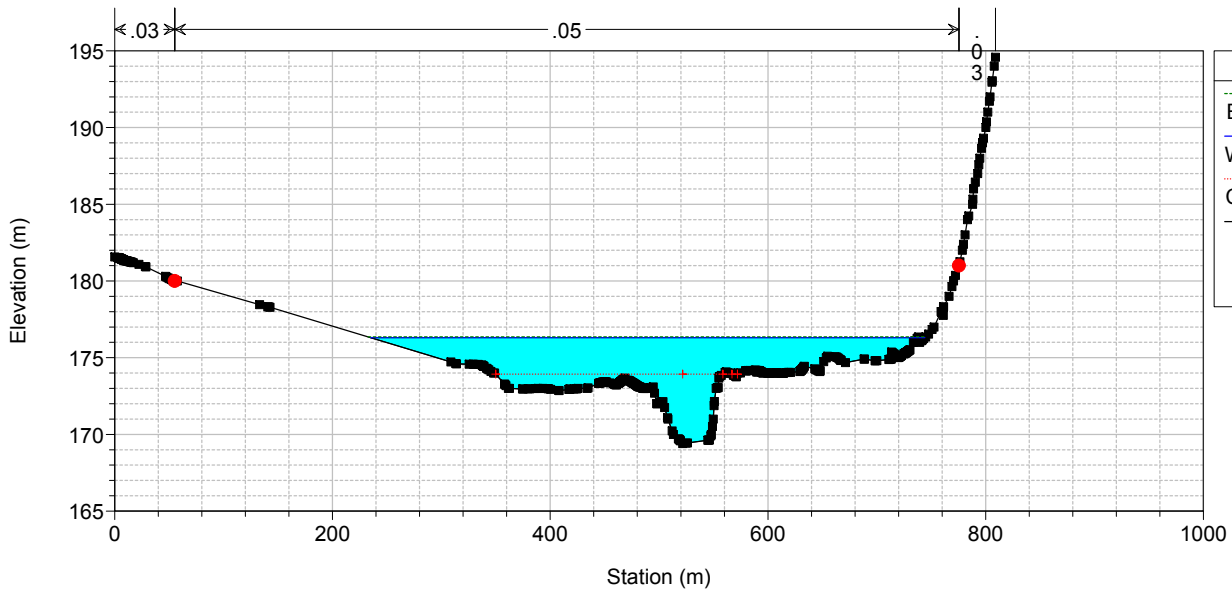

RIU MANNU

RS = -1800

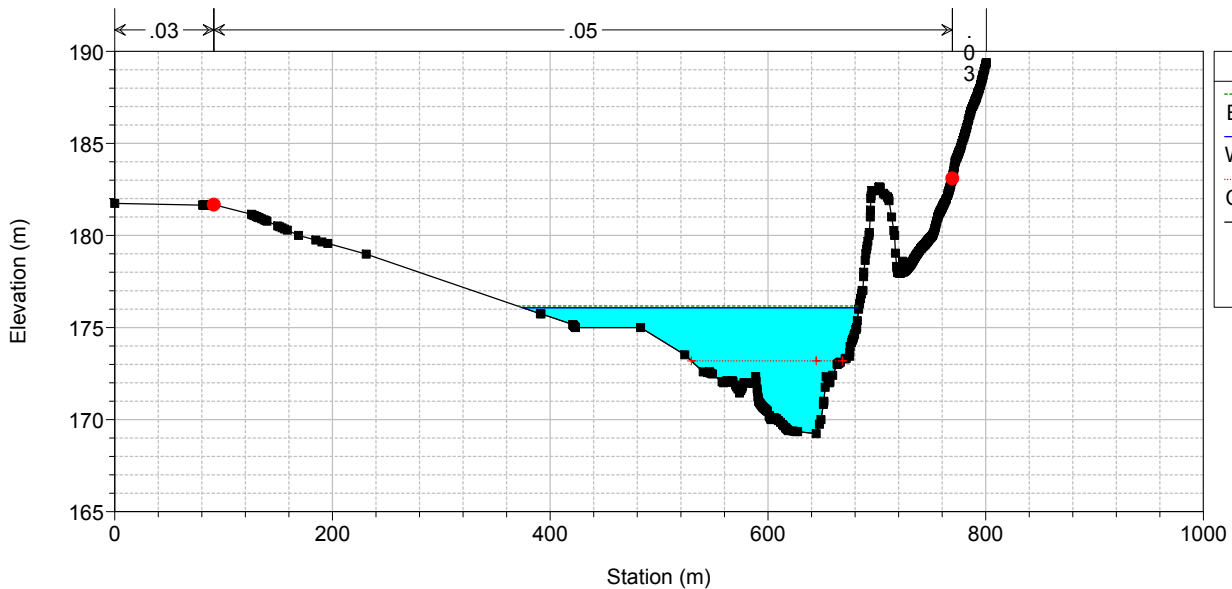

ALLEGATO 2.13

Inalveazione – CA01
Tabella riassuntiva dei risultati, profilo idrico e
sezioni trasversali con i livelli idrici (TR 200 anni)

HEC-RAS Plan: CA01 River: CA01 Reach: CA01 Profile: TR 200_CN91

Reach	River Sta	Profile	Q Total (m ³ /s)	Min Ch El (m)	Max Chl Dpth (m)	W.S. Elev (m)	Crit W.S. (m)	Diff	Froude # Chl	E.G. Elev (m)	Vel Chnl (m/s)	Vel Total (m/s)	Hydr Radius C (m)	Shear Chan (N/m ²)	Hydr Depth (m)
CA01	-20.68	TR 200_CN91	36.1	164.38	1.30	165.68	165.42	0.26	0.72	165.98	2.4	2.4	1.1	50.5	1.17
CA01	-25	TR 200_CN91	36.1	164.36	1.27	165.63	165.42	0.21	0.76	165.95	2.5	2.5	1.1	55.5	1.14
CA01	-50	TR 200_CN91	36.1	164.22	1.28	165.50	165.28	0.22	0.74	165.82	2.5	2.5	1.1	54.1	1.15
CA01	-75	TR 200_CN91	36.1	164.09	1.28	165.37	165.15	0.22	0.75	165.69	2.5	2.5	1.1	54.2	1.15
CA01	-100	TR 200_CN91	36.1	163.96	1.28	165.24	165.02	0.22	0.75	165.56	2.5	2.5	1.1	54.4	1.15
CA01	-125	TR 200_CN91	36.1	163.83	1.27	165.10	164.89	0.21	0.75	165.43	2.5	2.5	1.1	54.7	1.14
CA01	-150	TR 200_CN91	36.1	163.70	1.27	164.97	164.76	0.21	0.75	165.29	2.5	2.5	1.1	55.3	1.14
CA01	-175	TR 200_CN91	36.1	163.56	1.28	164.84	164.62	0.22	0.74	165.16	2.5	2.5	1.1	54.0	1.15
CA01	-200	TR 200_CN91	36.1	163.43	1.28	164.71	164.49	0.22	0.74	165.03	2.5	2.5	1.1	53.9	1.15
CA01	-225	TR 200_CN91	36.1	163.30	1.28	164.58	164.36	0.22	0.74	164.90	2.5	2.5	1.1	53.8	1.15
CA01	-250	TR 200_CN91	36.1	163.17	1.28	164.45	164.23	0.22	0.74	164.77	2.5	2.5	1.1	53.7	1.15
CA01	-275	TR 200_CN91	36.1	163.04	1.29	164.33	164.10	0.23	0.74	164.64	2.5	2.5	1.1	53.2	0.95
CA01	-300	TR 200_CN91	36.1	162.90	1.40	164.30	164.08	0.22	0.66	164.49	1.9	1.9	0.8	35.0	0.88
CA01	-325	TR 200_CN91	36.1	162.77	1.43	164.20	163.83	0.37	0.64	164.38	1.9	1.9	0.8	33.6	0.83
CA01	-350	TR 200_CN91	36.1	162.64	1.38	164.02	163.70	0.32	0.76	164.25	2.1	2.1	0.8	43.8	0.65
CA01	-375	TR 200_CN91	36.1	162.51	1.27	163.78	163.57	0.21	0.76	164.10	2.5	2.5	1.1	55.4	1.14
CA01	-400	TR 200_CN91	36.1	162.37	1.28	163.65	163.43	0.22	0.74	163.97	2.5	2.5	1.1	54.1	1.15
CA01	-425	TR 200_CN91	36.1	162.24	1.28	163.52	163.30	0.22	0.75	163.84	2.5	2.5	1.1	54.2	1.15
CA01	-450	TR 200_CN91	36.1	162.11	1.28	163.39	163.17	0.22	0.75	163.71	2.5	2.5	1.1	54.4	1.15
CA01	-475	TR 200_CN91	36.1	161.98	1.27	163.25	163.04	0.21	0.75	163.58	2.5	2.5	1.1	54.7	1.14
CA01	-500	TR 200_CN91	36.1	161.85	1.27	163.12	162.91	0.21	0.76	163.44	2.5	2.5	1.1	55.4	1.14
CA01	-525	TR 200_CN91	36.1	161.71	1.28	162.99	162.77	0.22	0.74	163.31	2.5	2.5	1.1	54.1	1.15
CA01	-550	TR 200_CN91	36.1	161.58	1.28	162.86	162.64	0.22	0.74	163.18	2.5	2.5	1.1	54.1	1.15
CA01	-575	TR 200_CN91	36.1	161.45	1.28	162.73	162.51	0.22	0.74	163.05	2.5	2.5	1.1	54.1	1.15
CA01	-600	TR 200_CN91	36.1	161.32	1.28	162.60	162.38	0.22	0.75	162.92	2.5	2.5	1.1	54.3	1.15
CA01	-625	TR 200_CN91	36.1	161.19	1.27	162.46	162.25	0.21	0.75	162.79	2.5	2.5	1.1	54.8	1.14
CA01	-650	TR 200_CN91	36.1	161.05	1.06	162.11	162.11	0.00	1.01	162.59	3.1	3.1	0.9	87.4	0.96
CA01	-675	TR 200_CN91	36.1	159.93	0.62	160.55	160.96	-0.41	2.25	162.00	5.4	5.2	0.6	311.7	0.46
CA01	-687.08	TR 200_CN91	36.1	158.17	0.42	158.58	158.99	-0.41	4.01	160.73	6.7	6.4	0.3	604.3	0.27

CA01

CA01 CA01

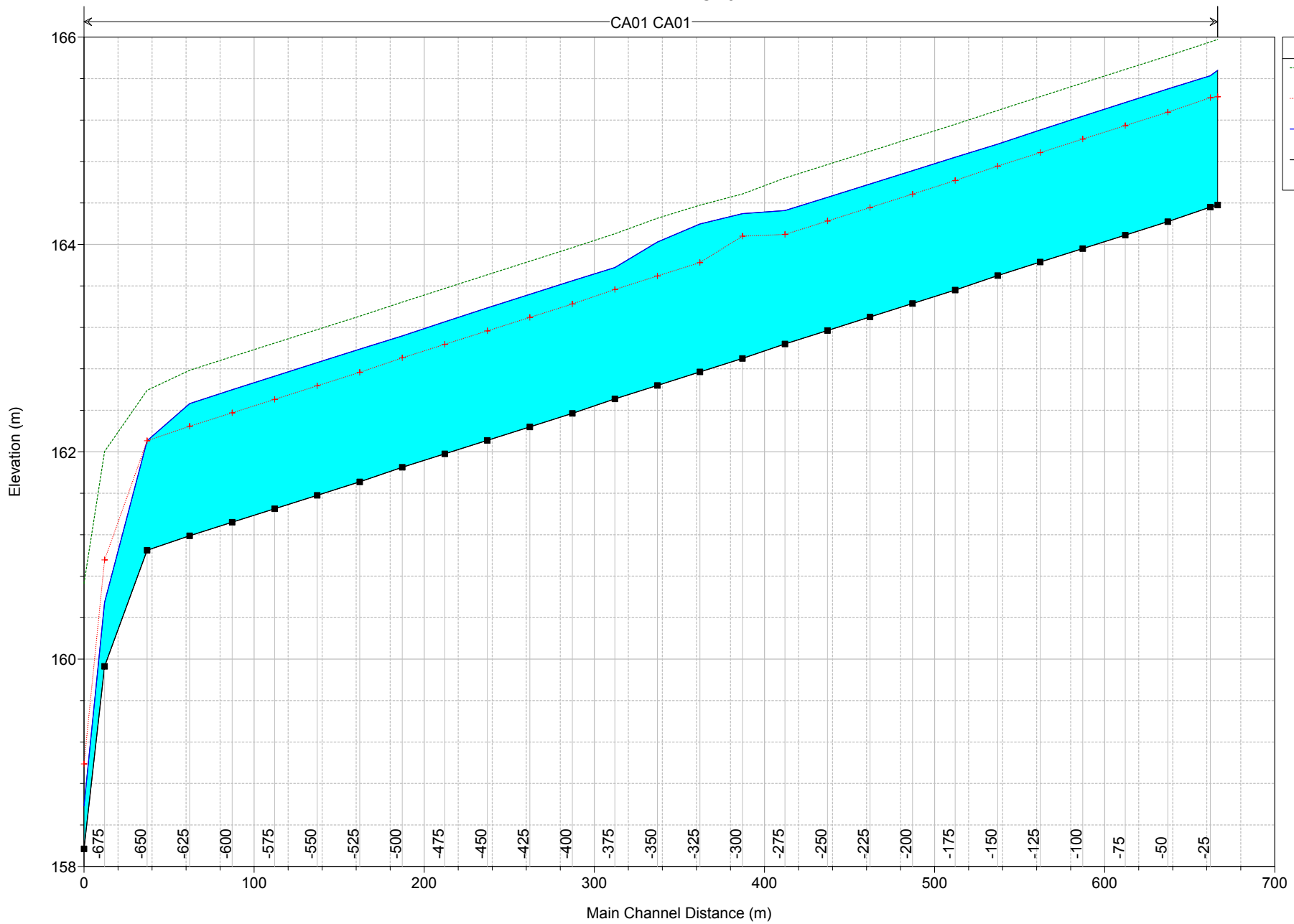

Legend

- EG TR 200_CN91
- Crit TR 200_CN91
- WS TR 200_CN91
- Ground

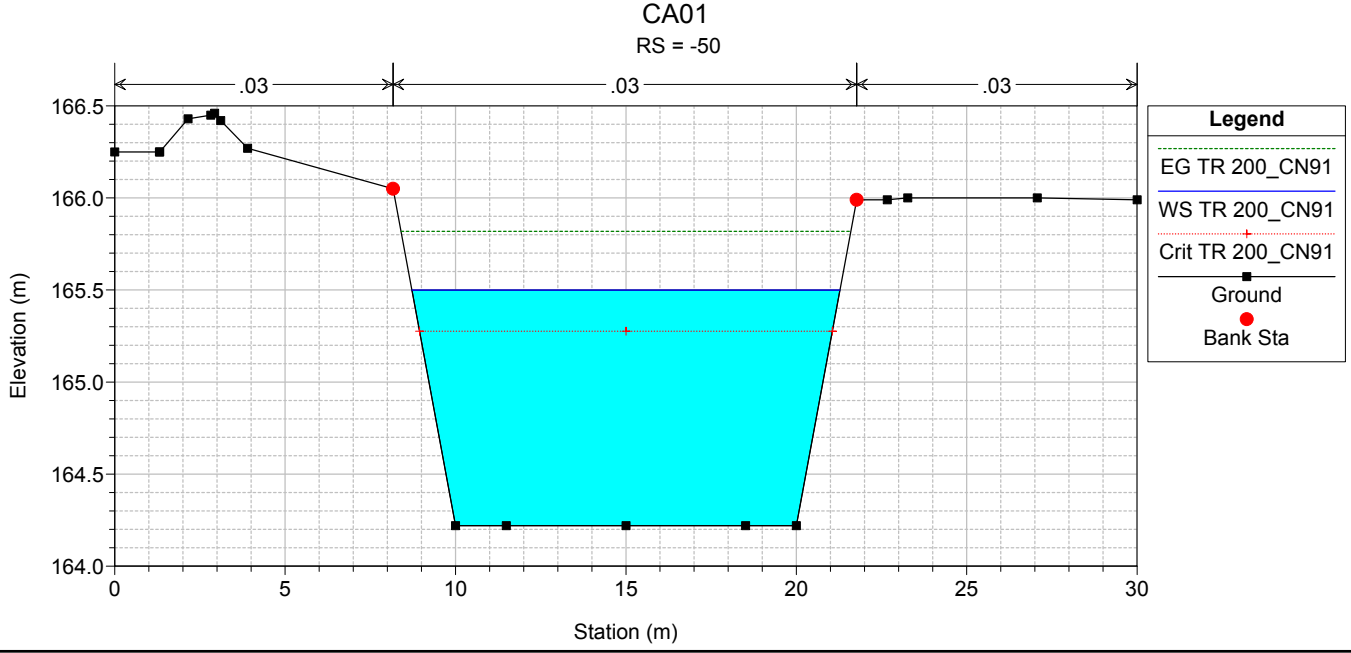
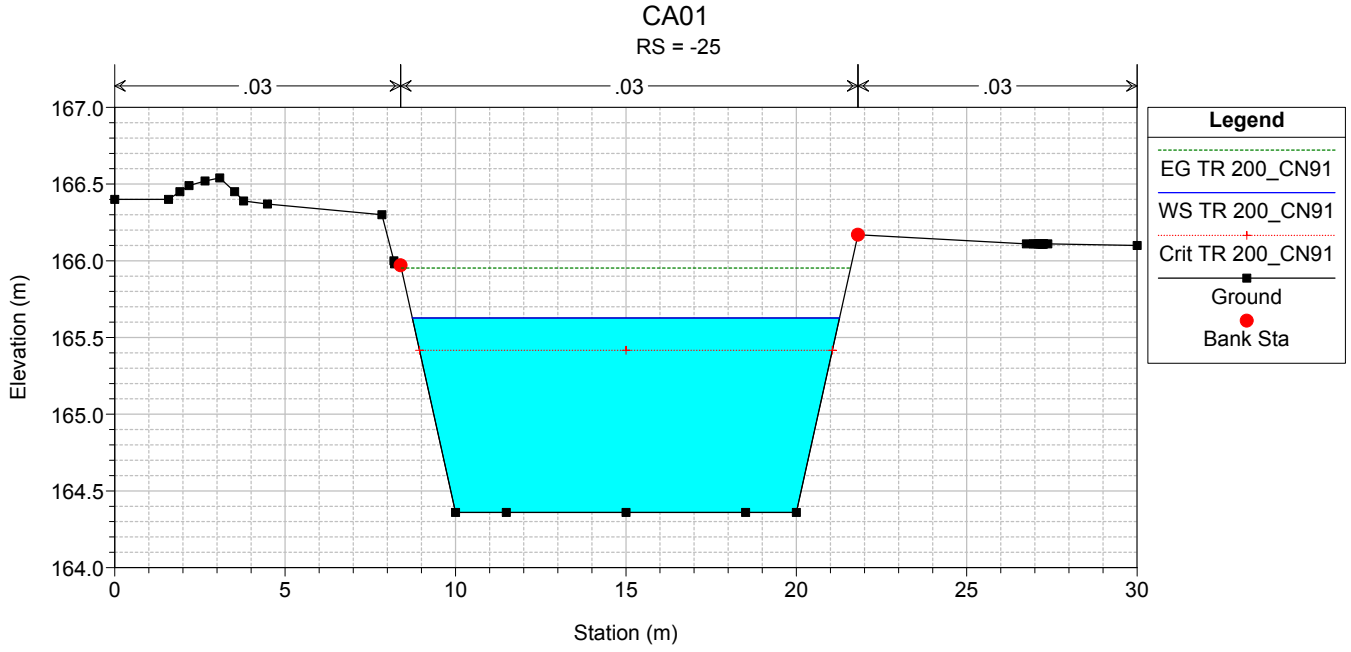
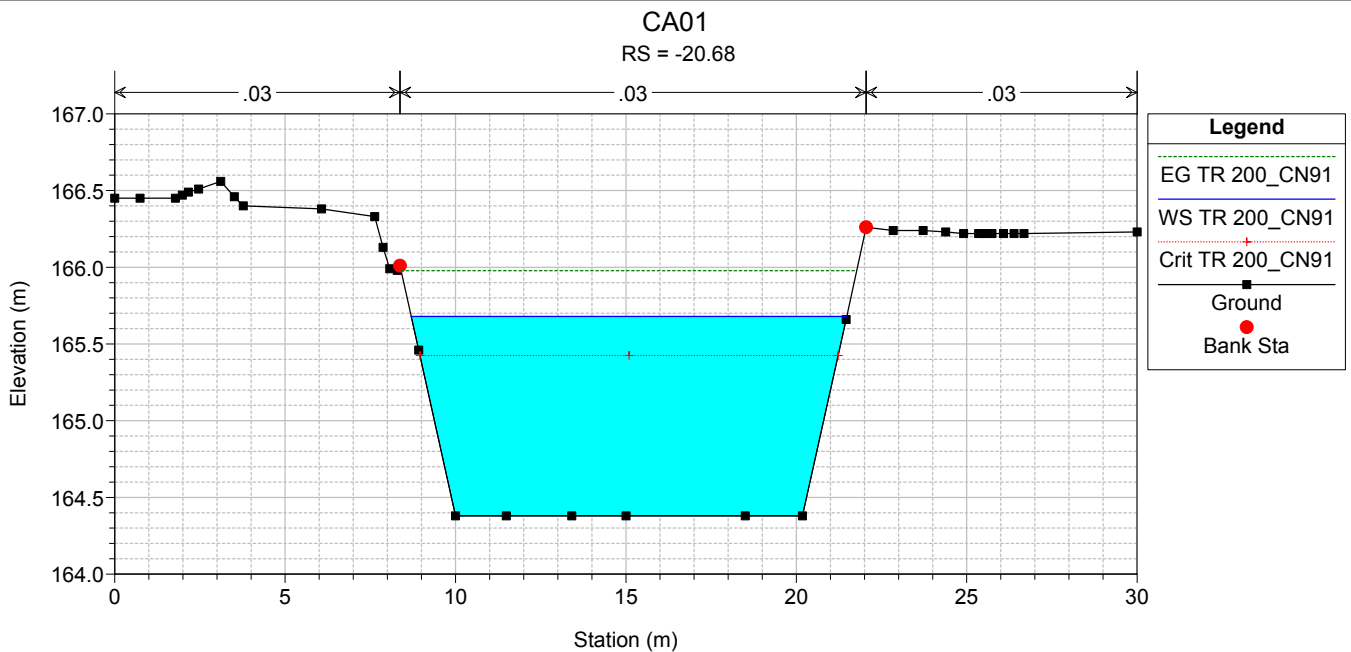

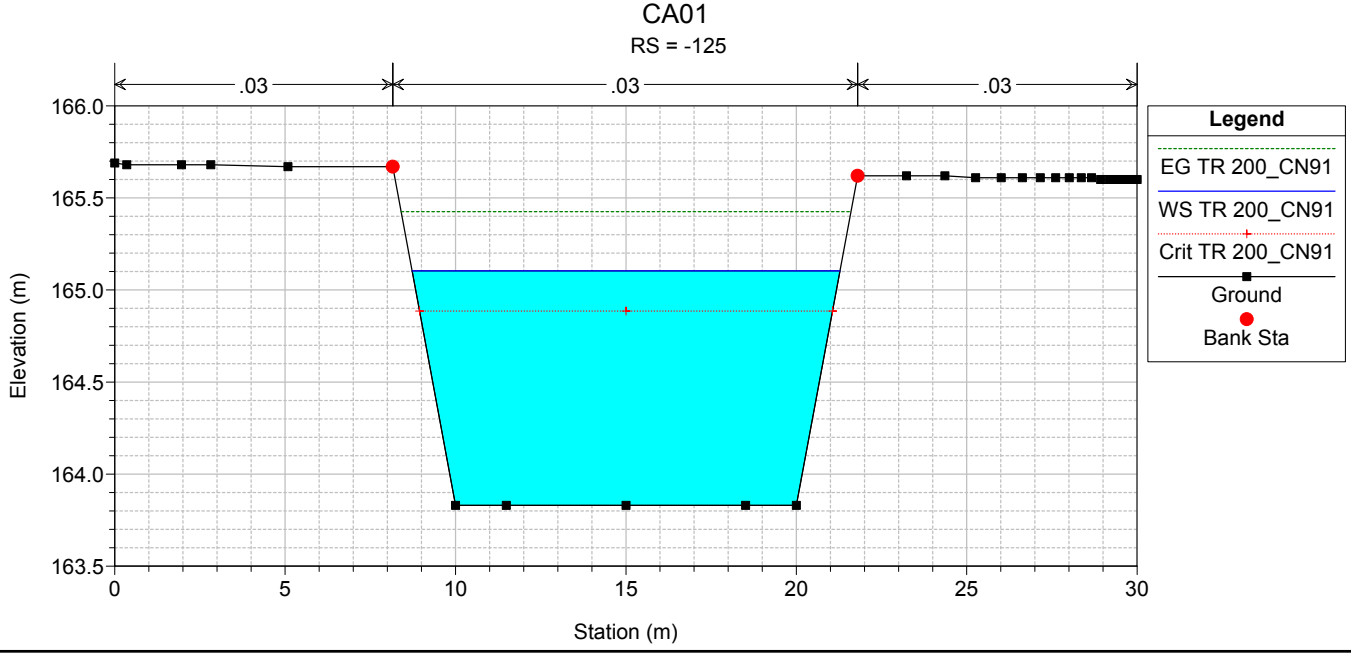
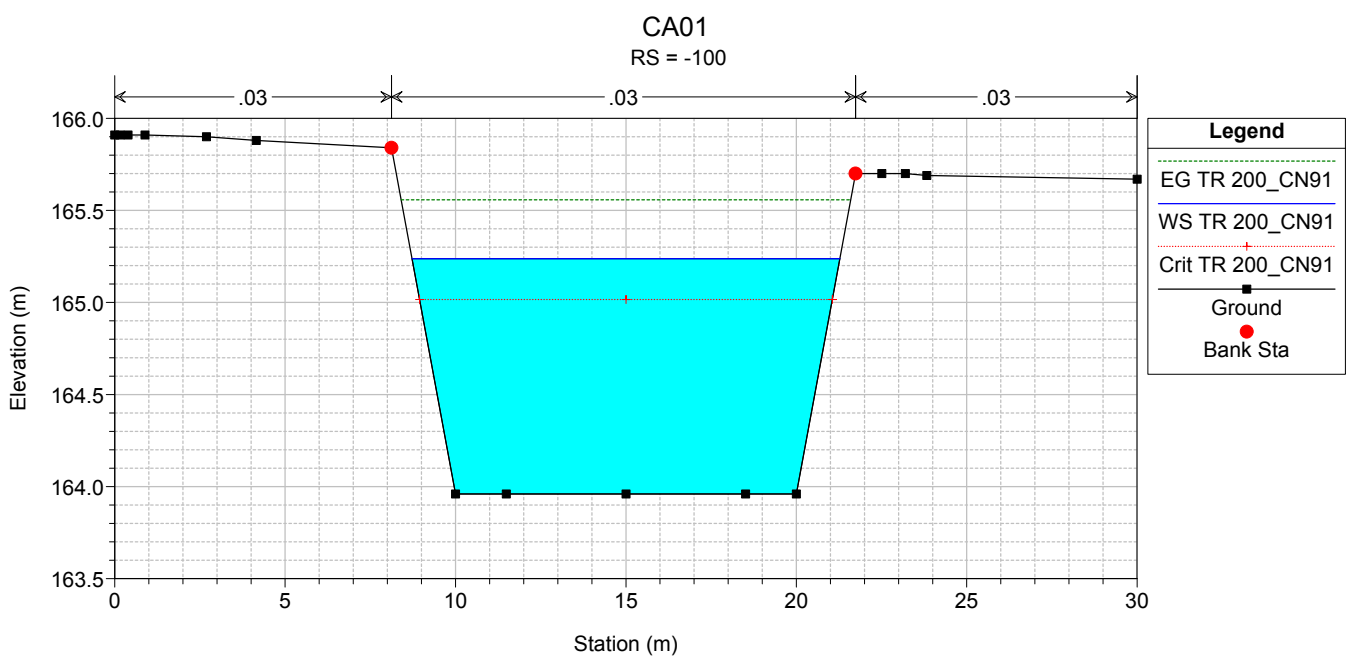
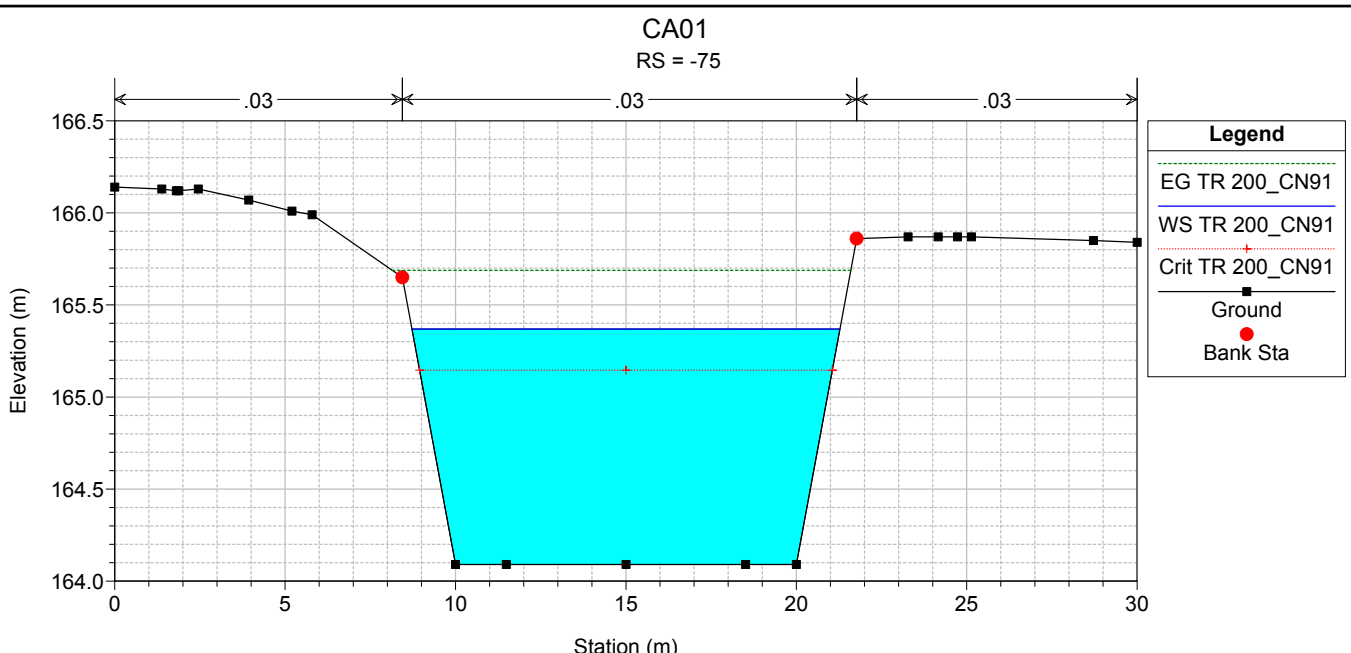

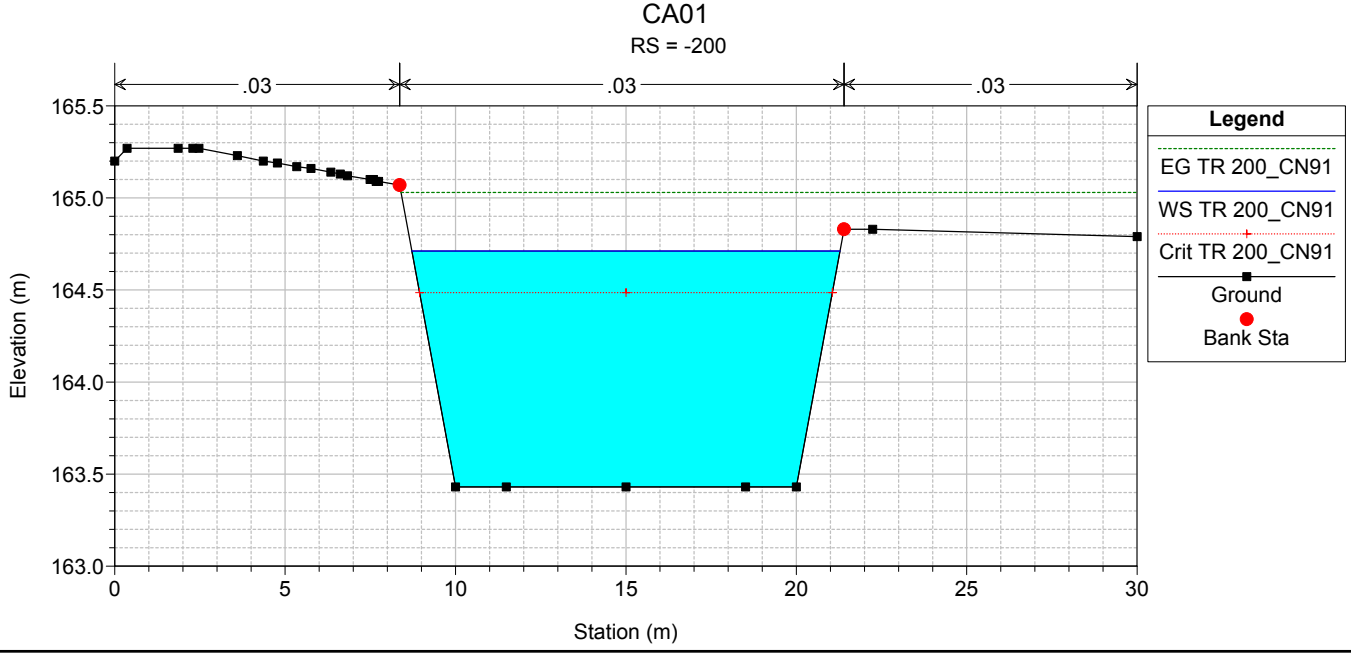
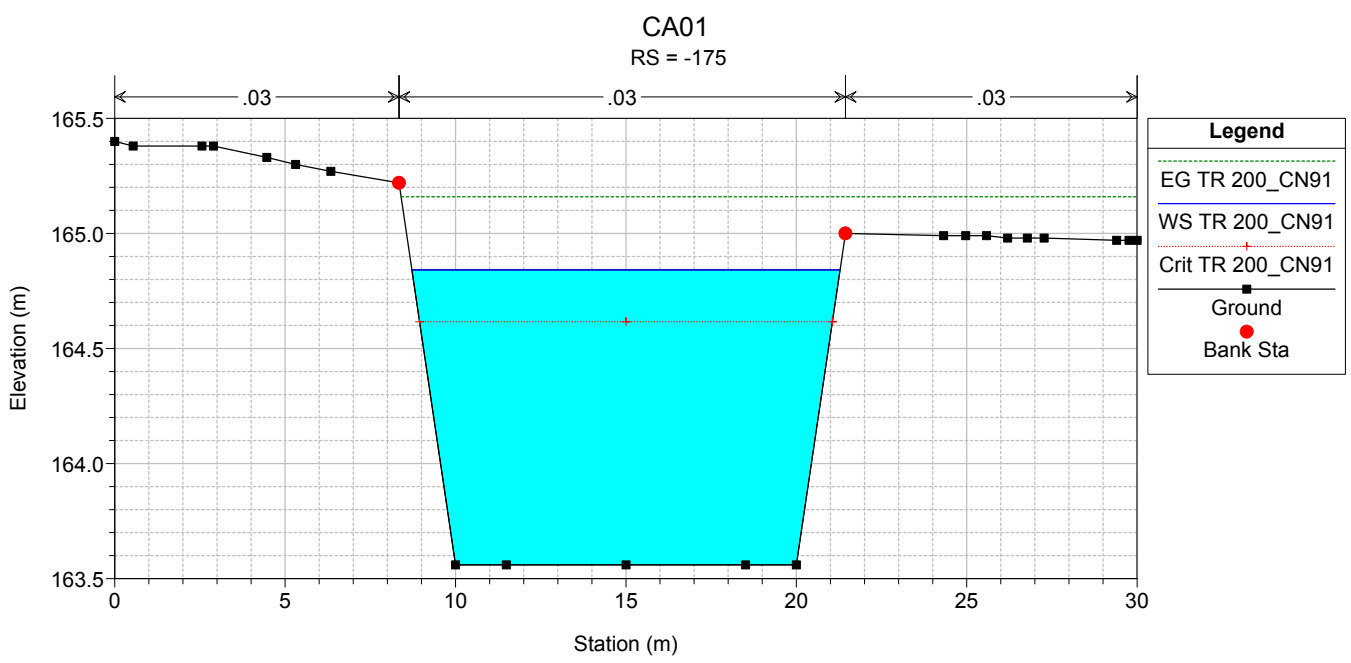
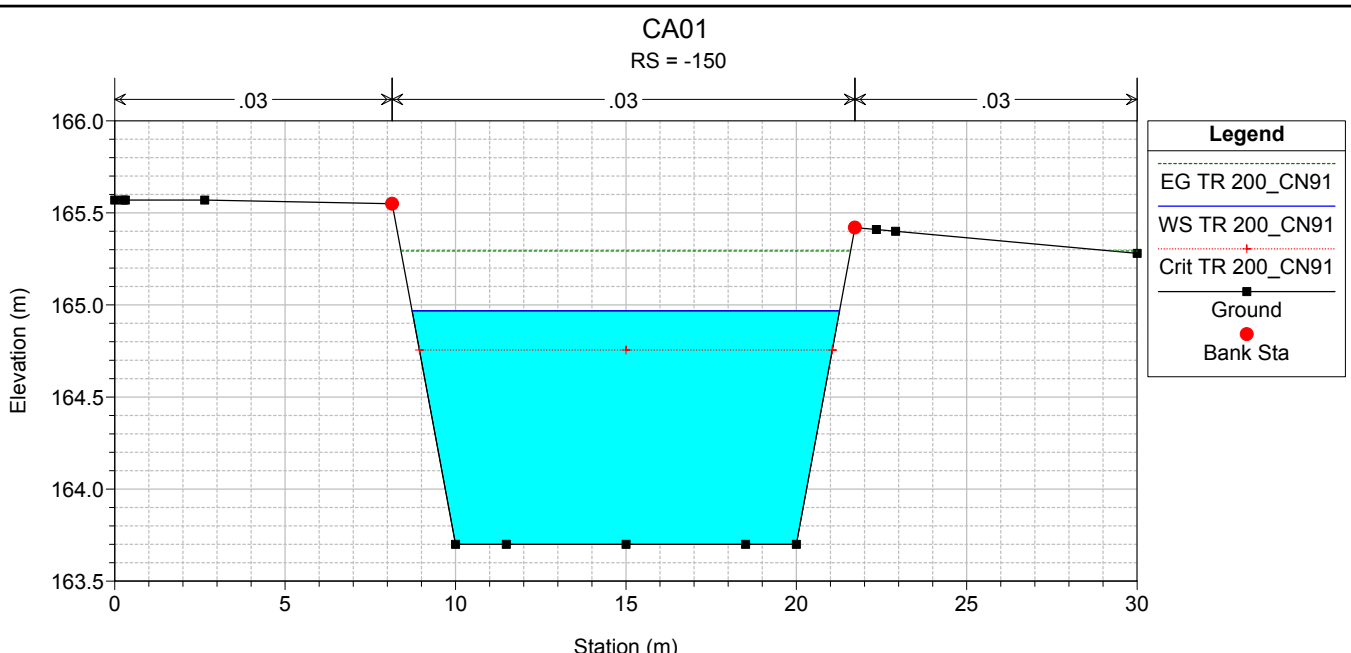

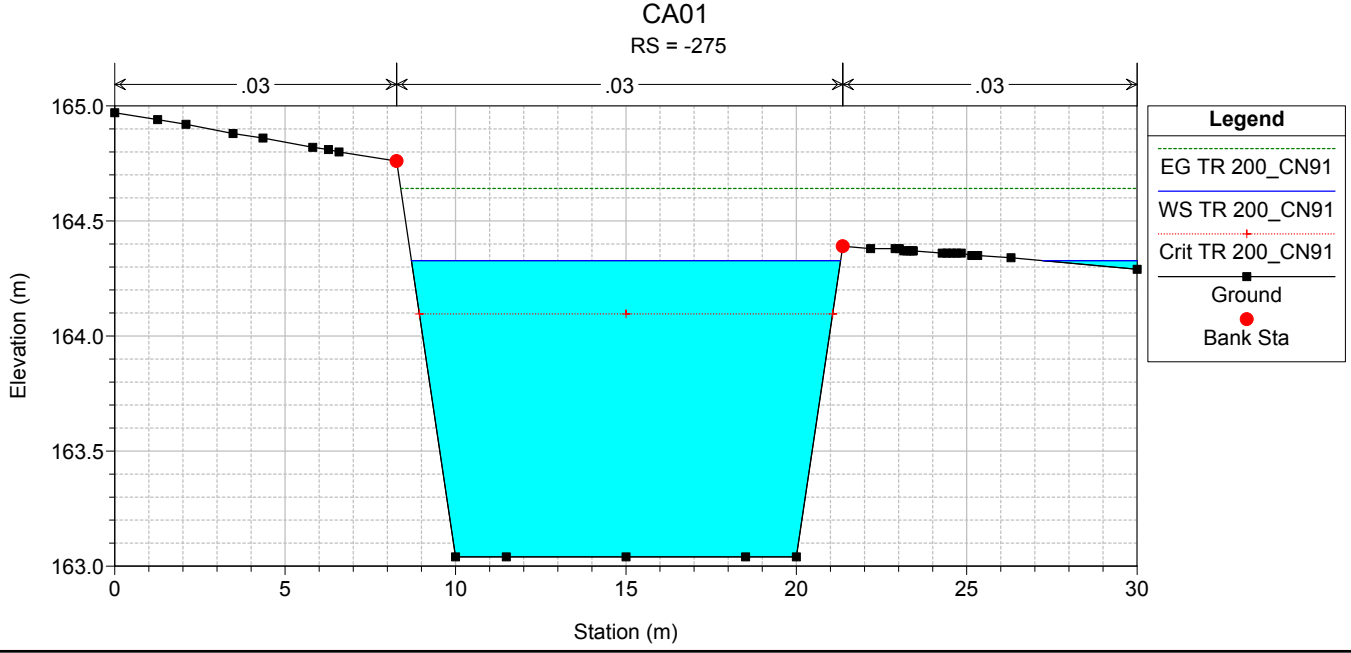
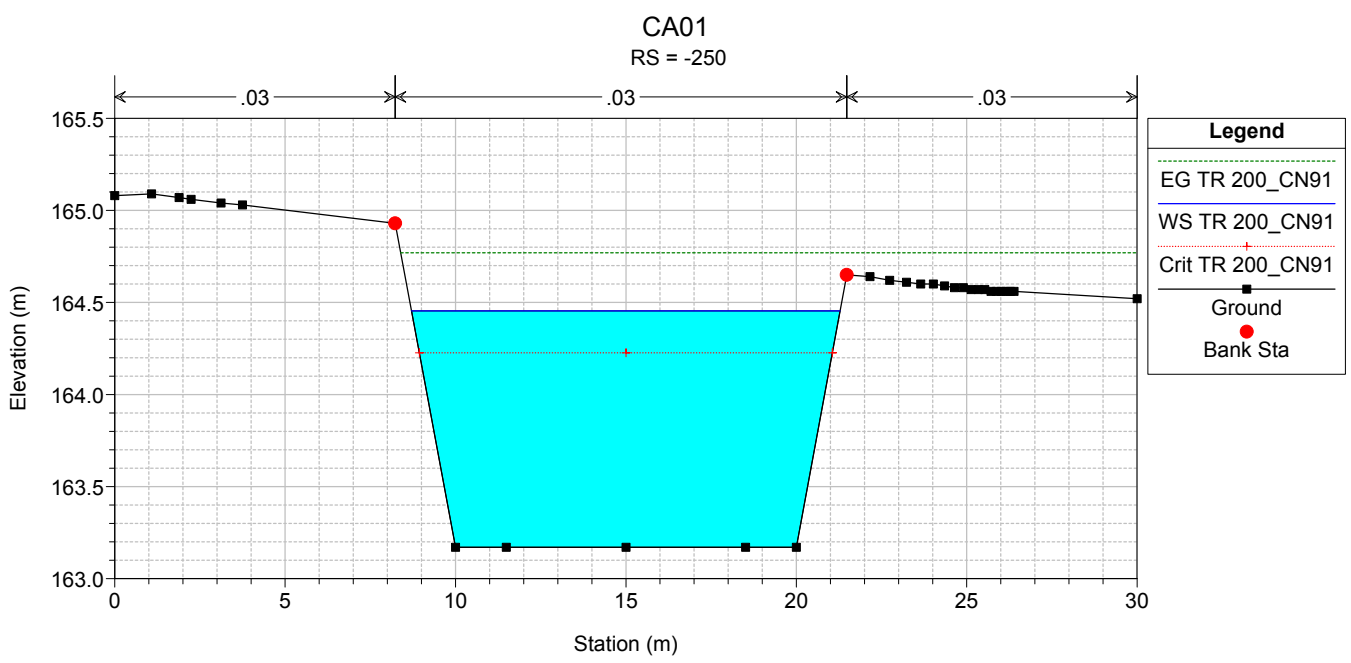
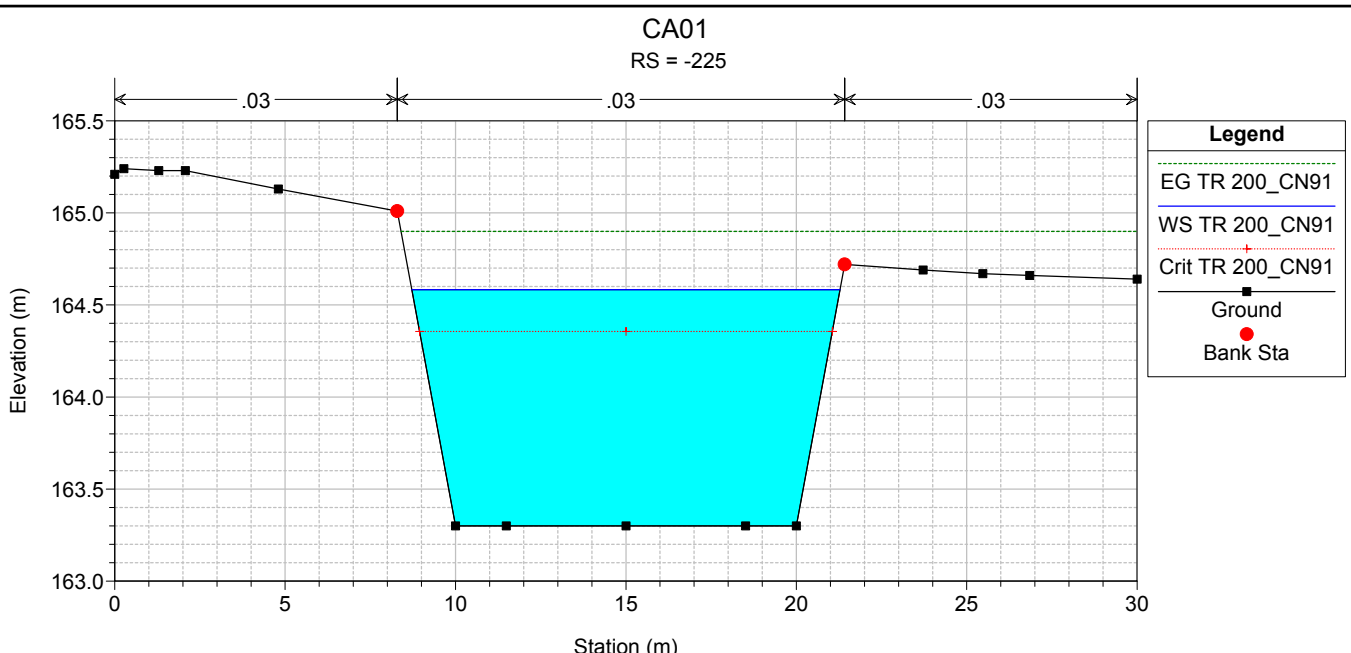

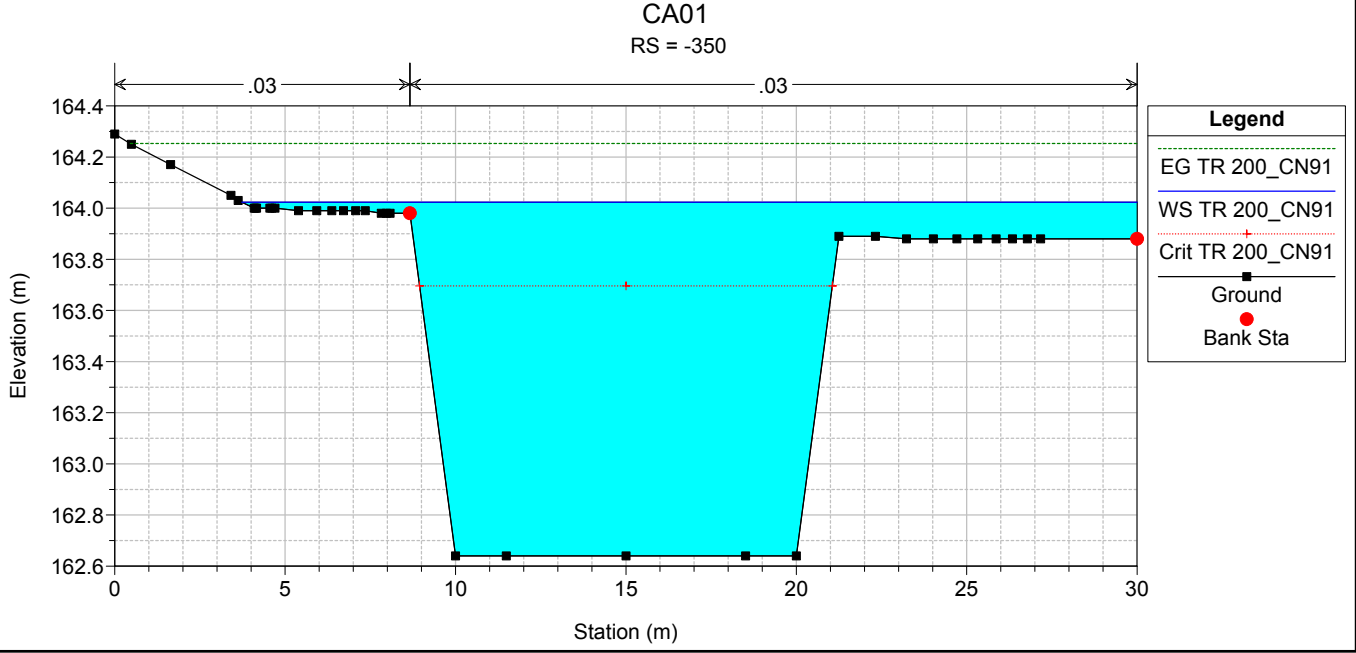
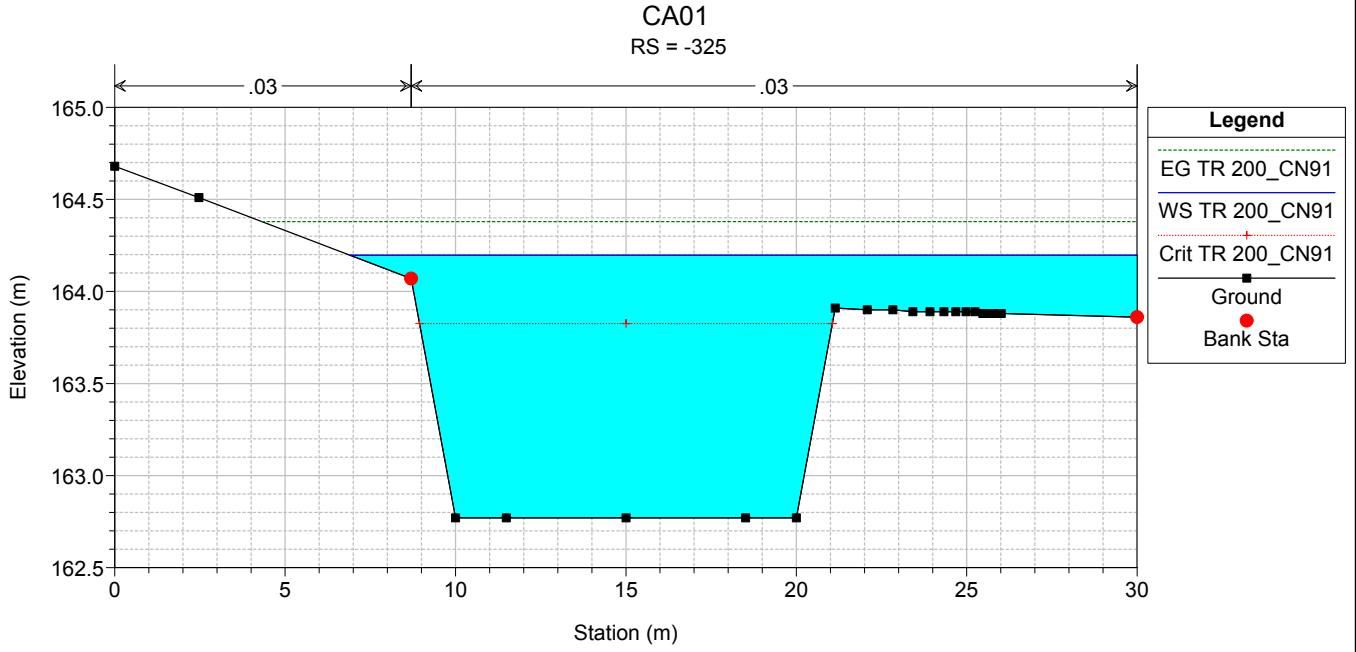
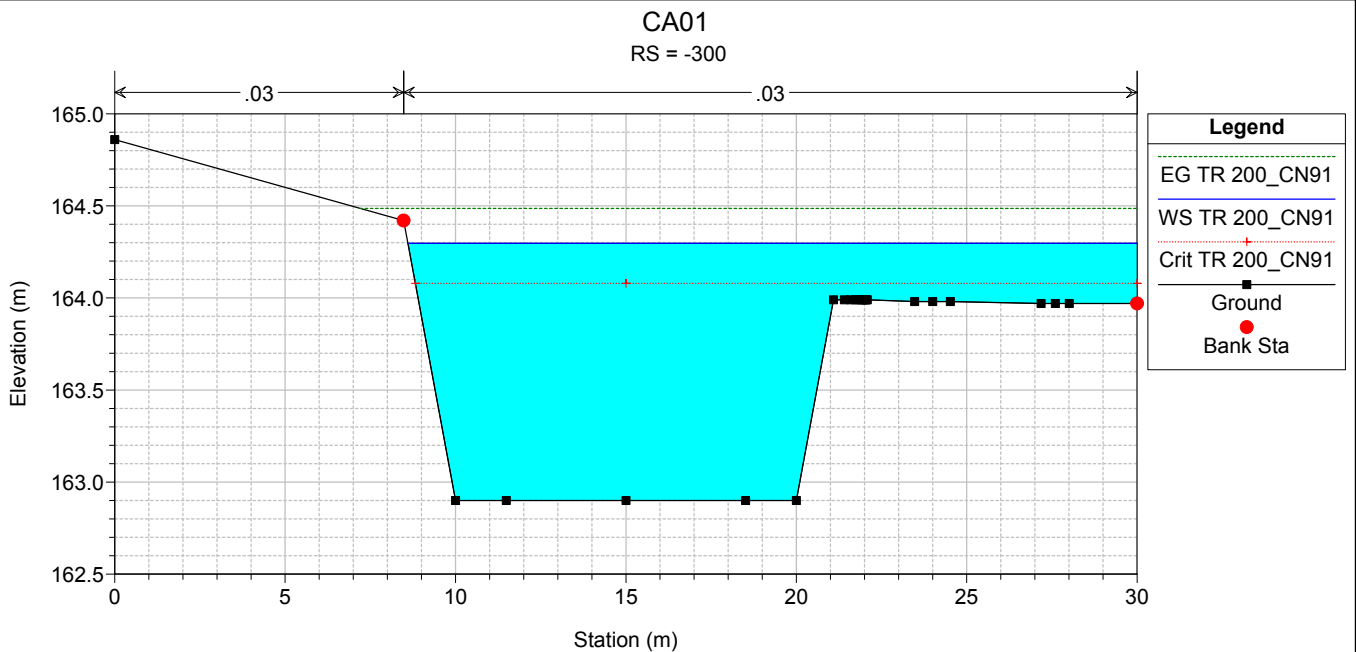

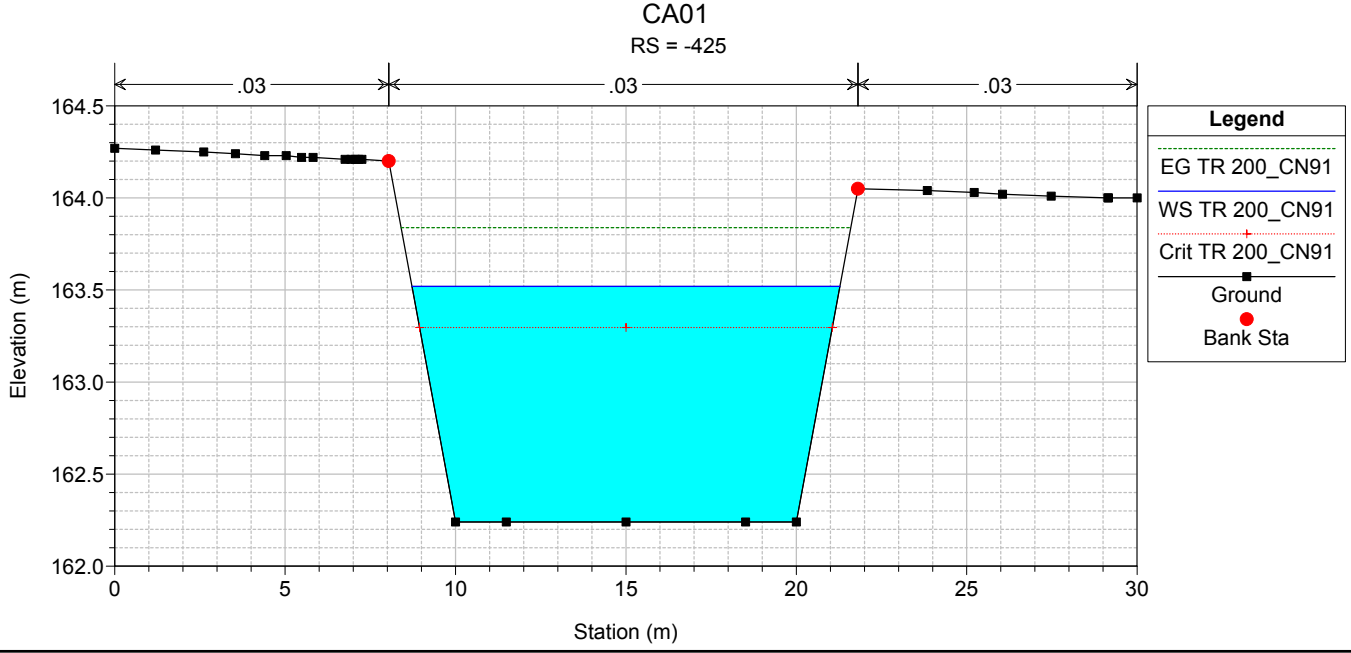
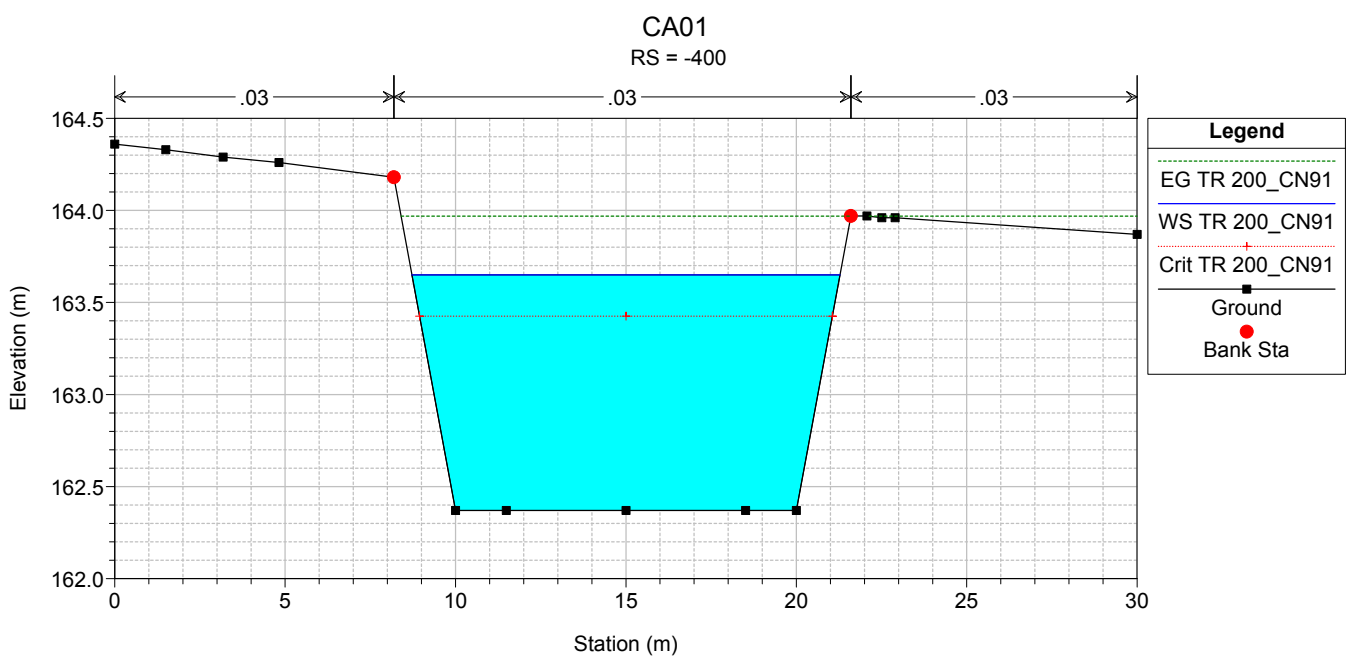
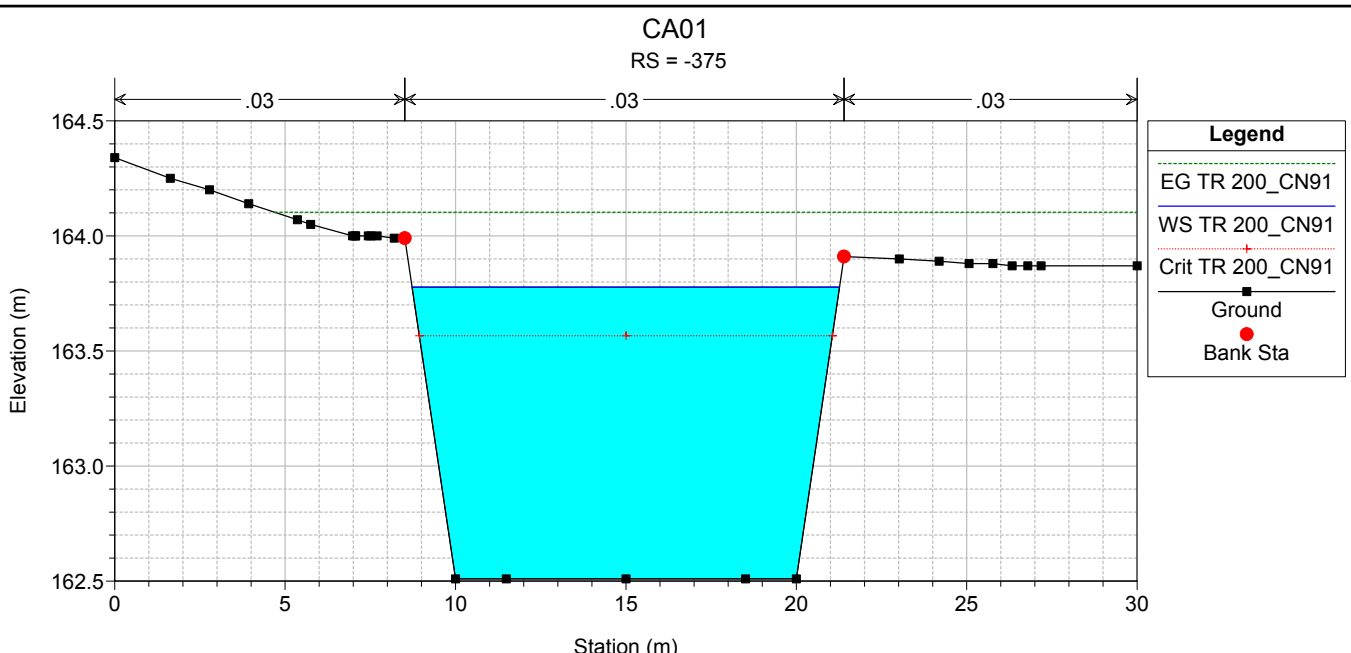

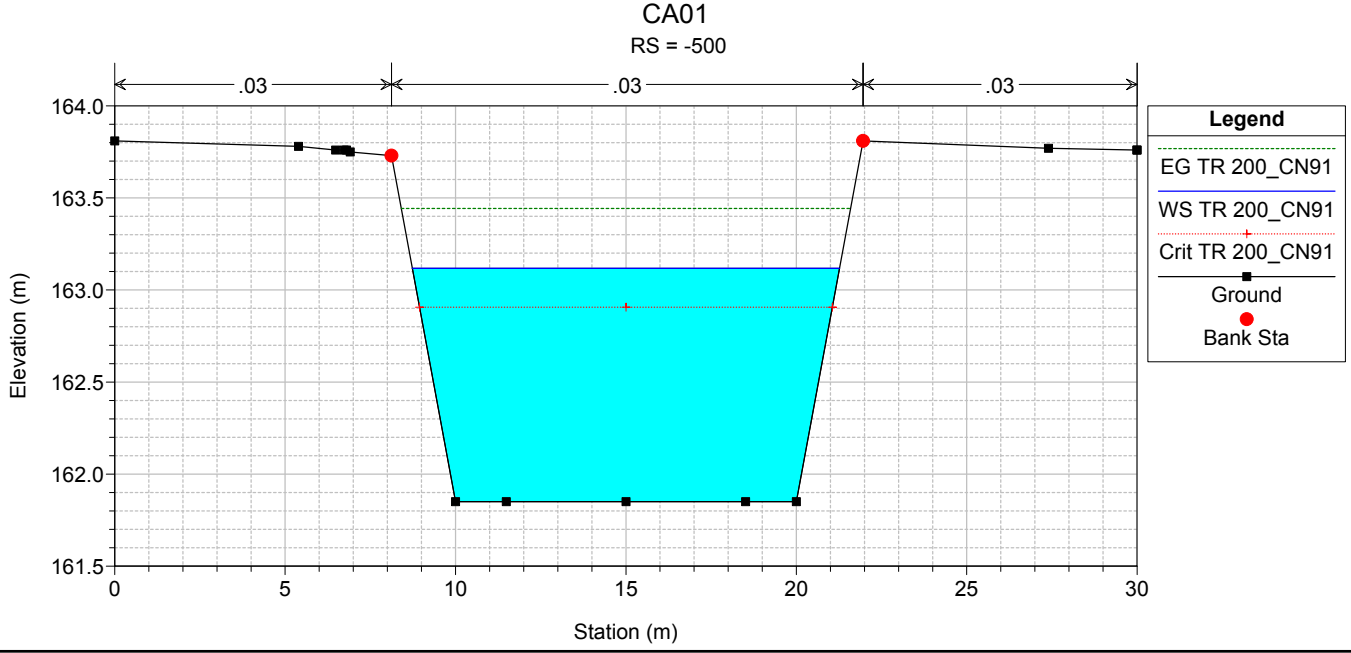
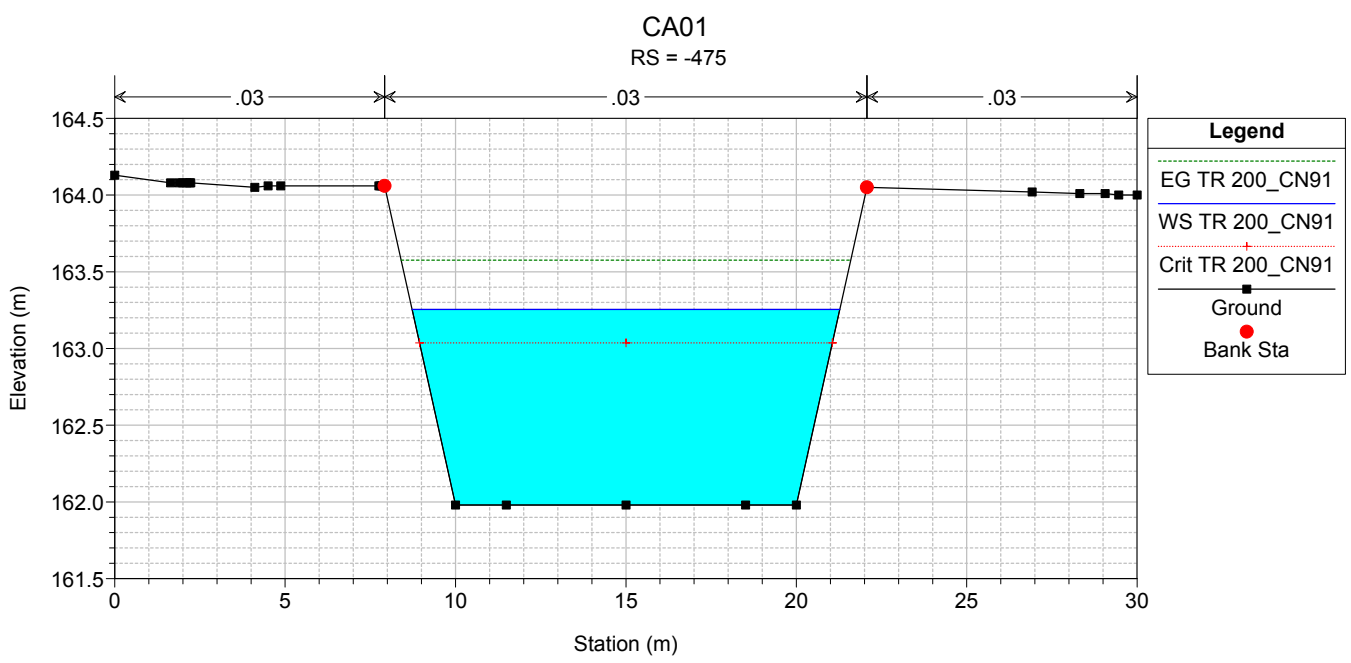
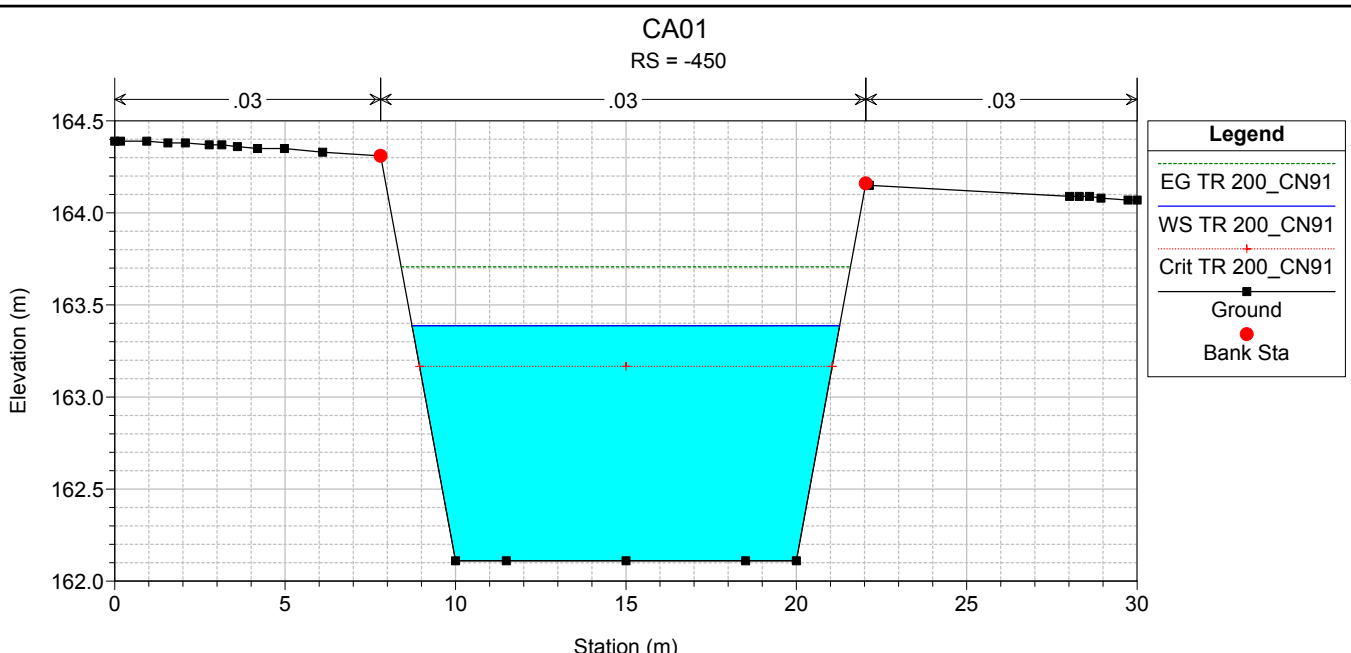

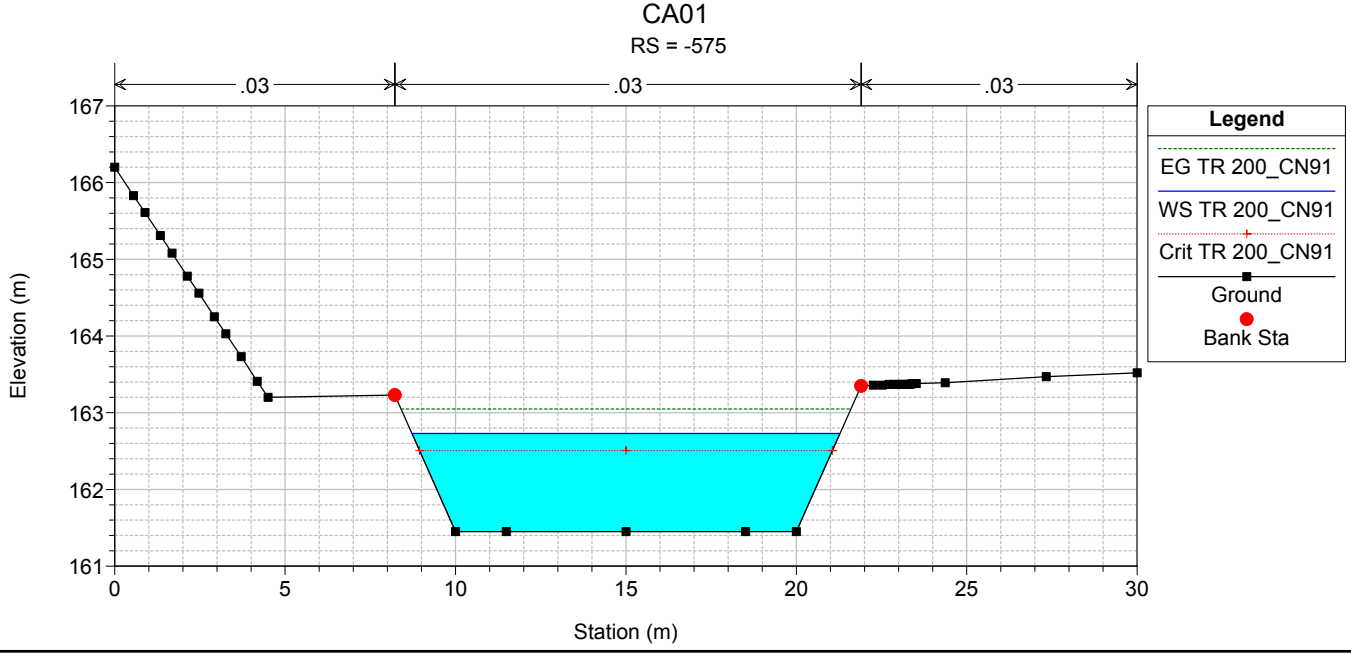
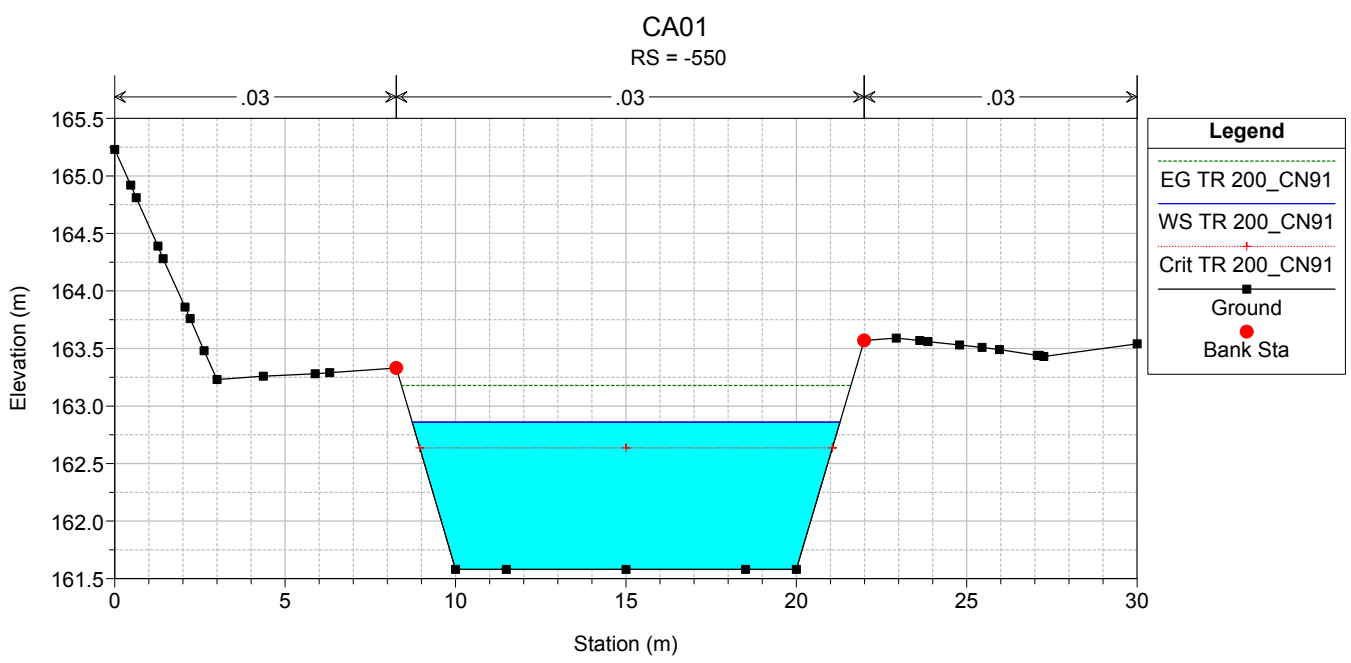
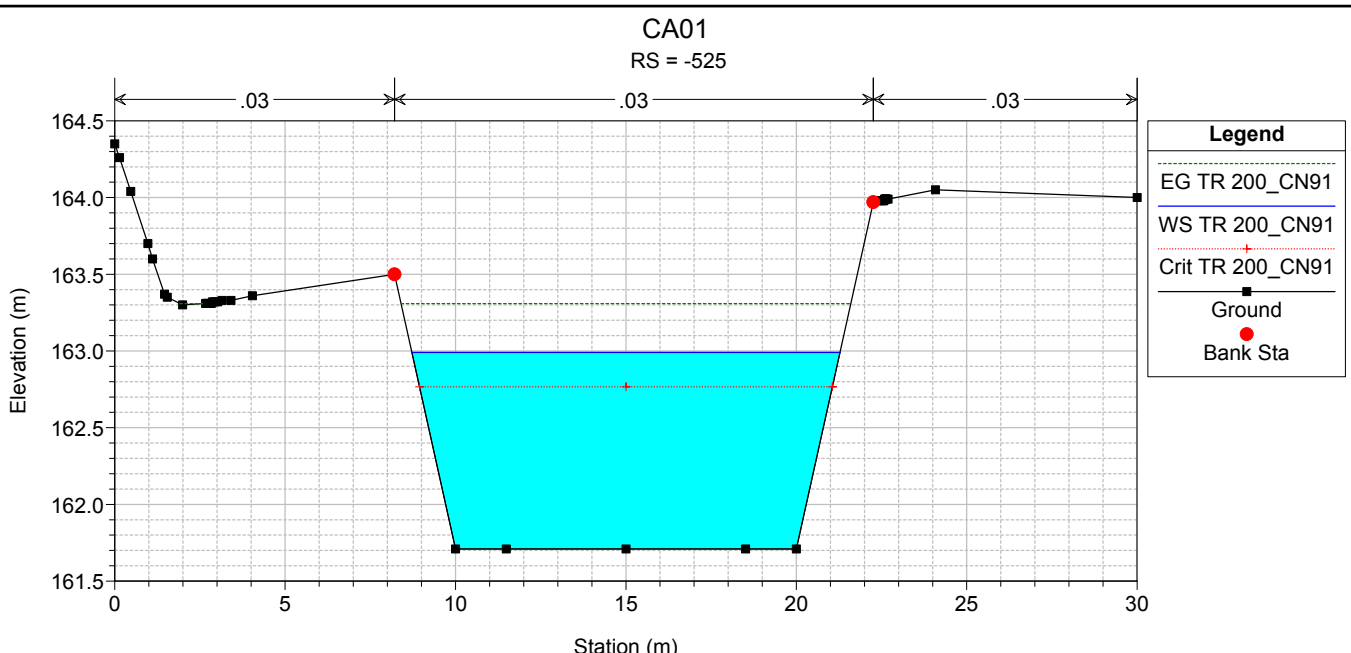

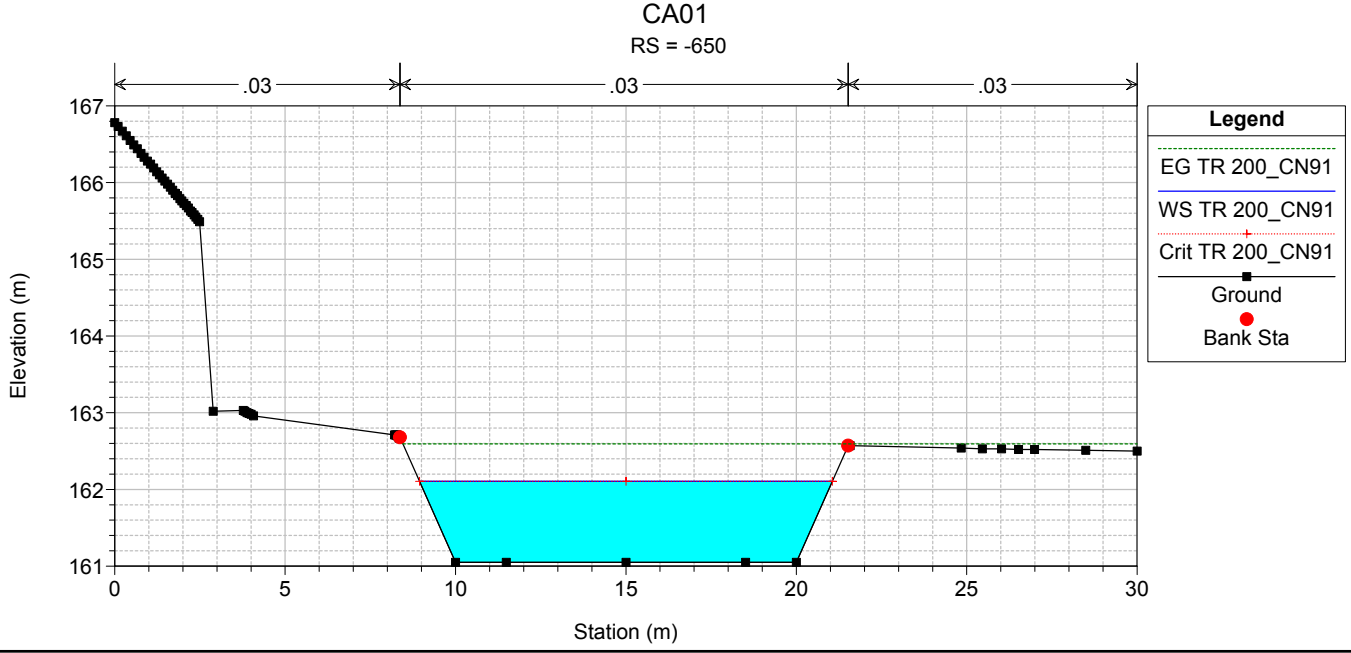
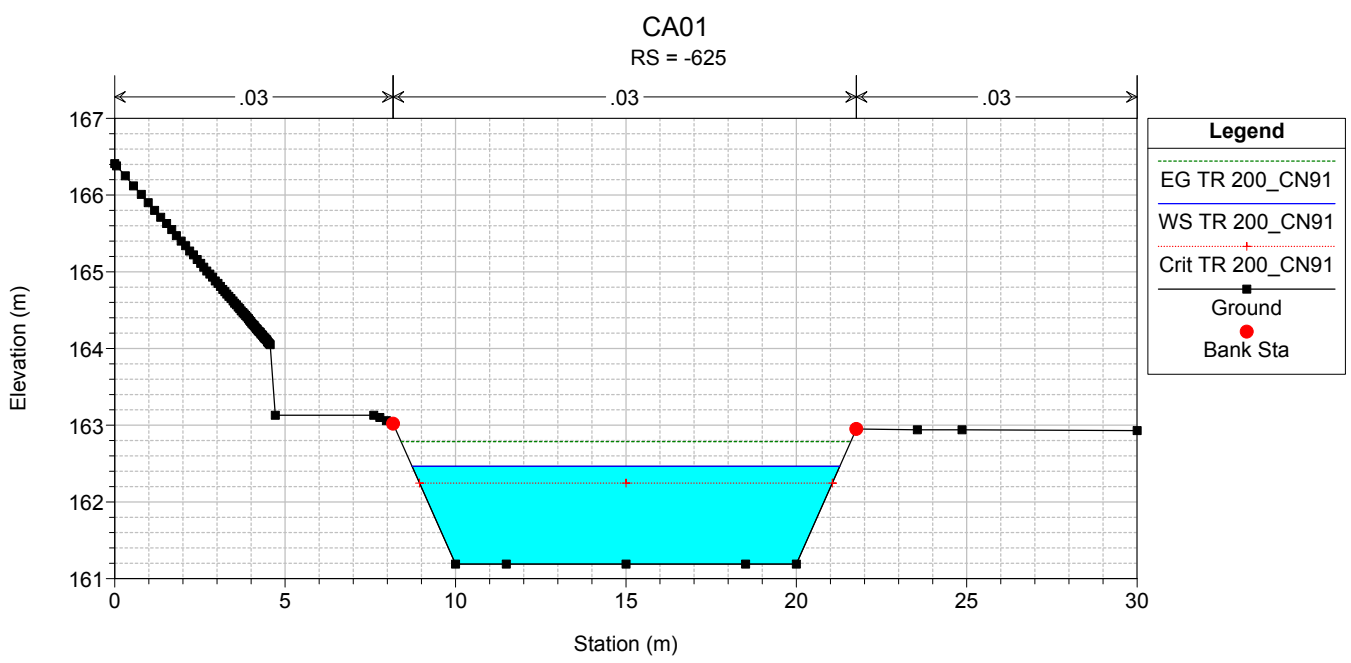
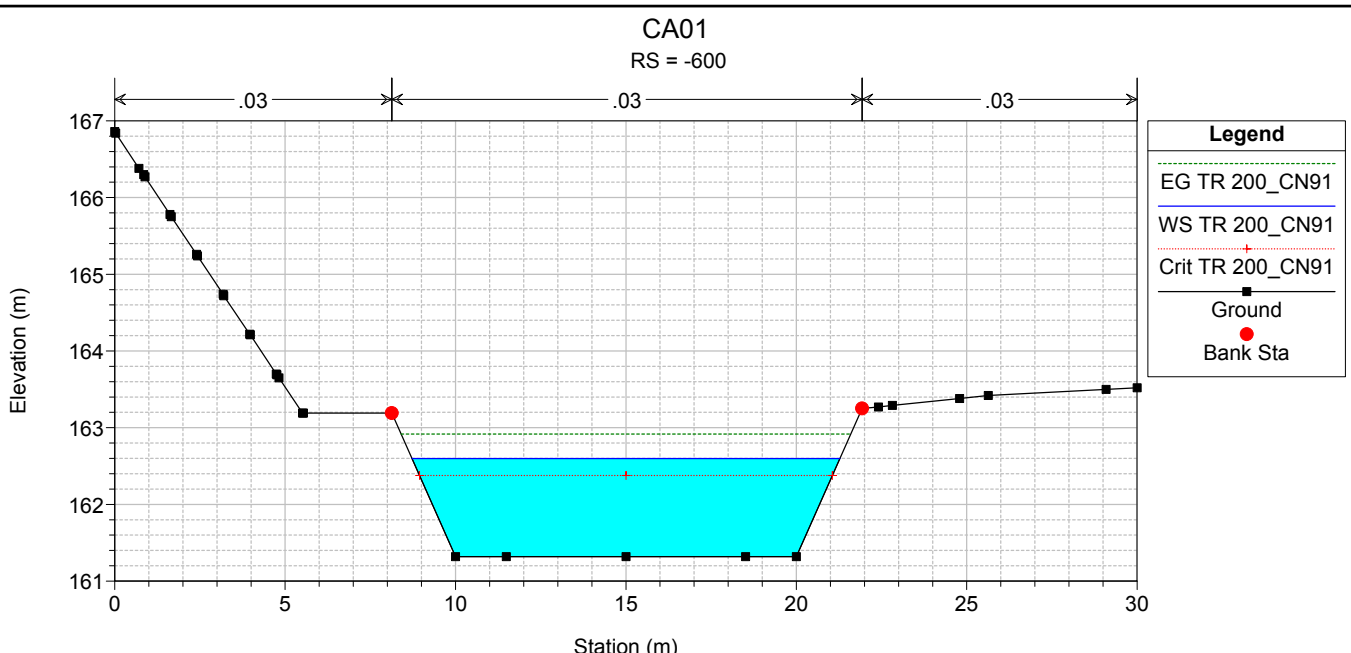

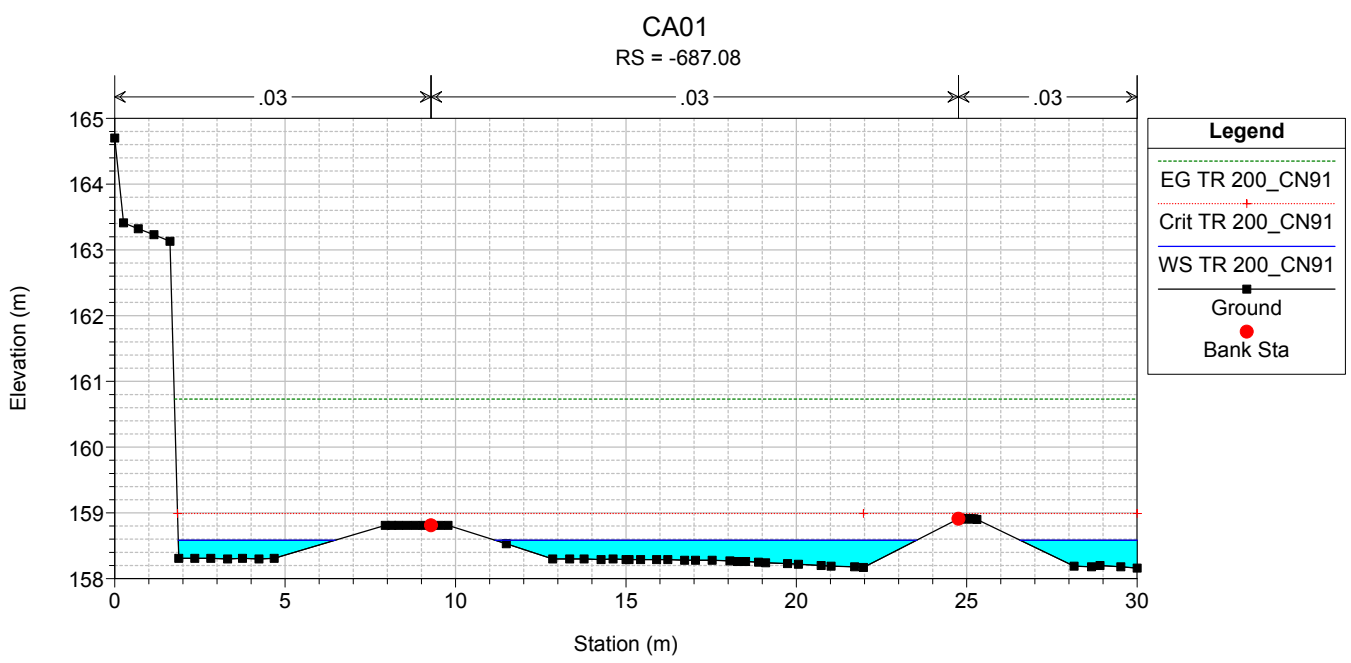
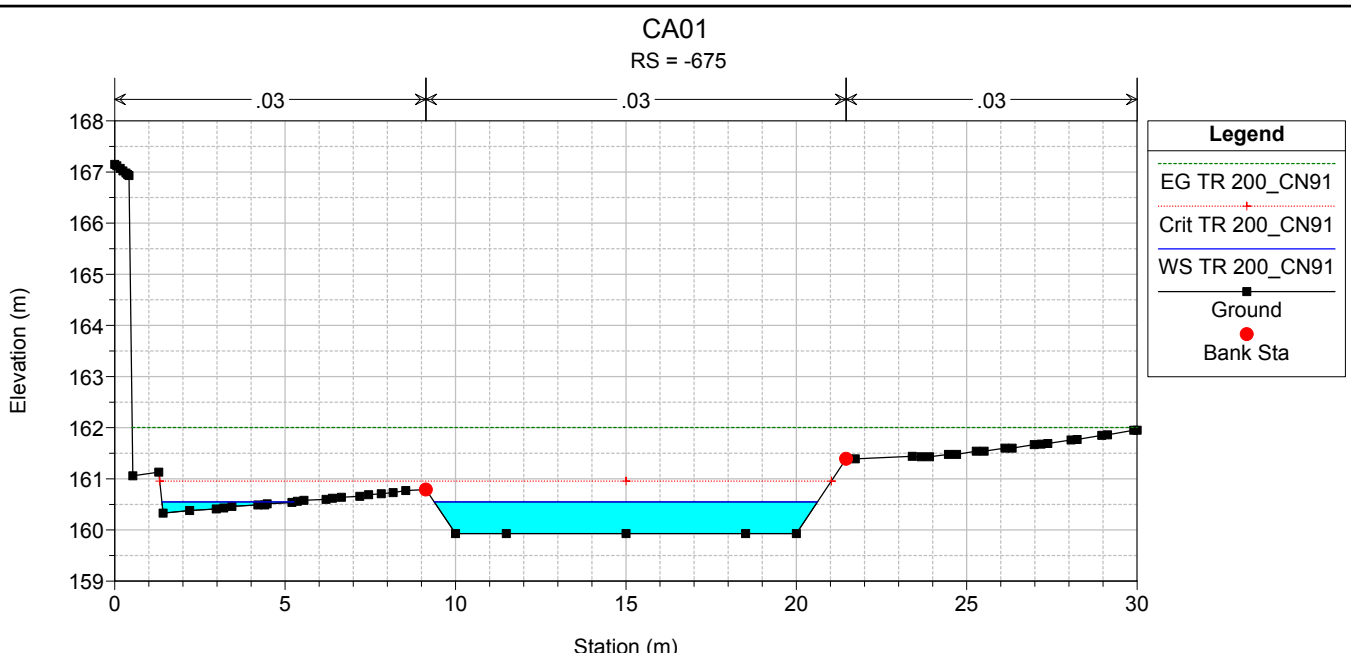

ALLEGATO 2.14

Inalveazione – CA02
Tabella riassuntiva dei risultati, profilo idrico e sezioni
trasversali con i livelli idrici (TR 50, 100 e 200 anni)

HEC-RAS Plan: CA02 River: CA02 Reach: CA02 Profile: TR 50_CN91

Reach	River Sta	Profile	Q Total (m3/s)	Min Ch El (m)	Max Chl Dpth (m)	W.S. Elev (m)	Crit W.S. (m)	Diff	Froude # Chl	E.G. Elev (m)	Vel Chnl (m/s)	Vel Total (m/s)	Hydr Radius C (m)	Shear Chan (N/m2)	Hydr Depth (m)
CA02	0	TR 50_CN91	42.5	182.96	0.99	183.95	183.95	0.00	0.99	184.33	2.9	2.7	0.8	76.6	0.73
CA02	-25	TR 50_CN91	42.5	181.48	0.59	182.07	182.53	-0.46	2.40	183.72	5.7	5.7	0.5	347.7	0.57
CA02	-50	TR 50_CN91	42.5	181.28	1.11	182.39	182.33	0.06	0.92	182.83	2.9	2.9	1.0	75.7	1.03
CA02	-75	TR 50_CN91	42.5	181.08	1.12	182.20	182.13	0.07	0.91	182.62	2.9	2.9	1.0	75.1	1.00
CA02	-100	TR 50_CN91	42.5	180.88	1.12	182.00	181.93	0.07	0.91	182.43	2.9	2.9	1.0	74.9	1.03
CA02	-125	TR 50_CN91	42.5	180.68	1.14	181.82	181.74	0.08	0.88	182.23	2.8	2.8	1.0	71.3	1.05
CA02	-150	TR 50_CN91	42.5	180.48	1.06	181.54	181.54	0.00	0.98	182.02	3.1	3.0	0.9	84.1	0.81
CA02	-175	TR 50_CN91	42.5	180.28	1.25	181.53	181.39	0.14	0.70	181.79	2.3	2.1	1.1	47.0	0.87
CA02	-200	TR 50_CN91	42.5	180.08	1.06	181.14	181.14	0.00	0.99	181.61	3.0	3.0	0.9	84.4	0.88
CA02	-225	TR 50_CN91	42.5	179.88	1.02	180.90	180.97	-0.07	1.01	181.36	3.0	2.9	0.9	85.9	0.64
CA02	-250	TR 50_CN91	42.5	179.68	1.08	180.76	180.77	-0.01	0.89	181.13	2.8	2.5	0.9	70.4	0.70
CA02	-275	TR 50_CN91	42.5	179.48	1.06	180.54	180.57	-0.03	0.91	180.94	2.9	2.6	1.0	73.9	0.67
CA02	-300	TR 50_CN91	42.5	179.28	1.17	180.45	180.42	0.03	0.76	180.75	2.5	2.2	1.1	54.2	0.65
CA02	-325	TR 50_CN91	42.5	179.08	1.12	180.20	180.20	0.00	0.87	180.58	2.8	2.6	1.0	69.1	0.68
CA02	-350	TR 50_CN91	42.5	178.88	0.90	179.78	179.95	-0.17	1.17	180.33	3.4	3.1	0.8	108.6	0.53
CA02	-375	TR 50_CN91	42.5	178.68	0.98	179.66	179.71	-0.05	0.92	180.02	2.8	2.4	0.9	71.7	0.59
CA02	-400	TR 50_CN91	42.5	178.48	1.01	179.49	179.52	-0.03	0.89	179.83	2.8	2.3	0.9	68.9	0.60
CA02	-425	TR 50_CN91	42.5	178.28	0.92	179.20	179.28	-0.08	1.02	179.61	3.0	2.6	0.9	84.4	0.55

HEC-RAS Plan: CA02 River: CA02 Reach: CA02 Profile: TR 100_CN91

Reach	River Sta	Profile	Q Total (m ³ /s)	Min Ch El (m)	Max Chl Dpth (m)	W.S. Elev (m)	Crit W.S. (m)	Diff	Froude # Chl	E.G. Elev (m)	Vel Chnl (m/s)	Vel Total (m/s)	Hydr Radius C (m)	Shear Chan (N/m ²)	Hydr Depth (m)
CA02	0	TR 100_CN91	51.0	182.96	1.03	183.99	183.99	0.00	1.11	184.48	3.3	3.0	0.9	98.3	0.76
CA02	-25	TR 100_CN91	51.0	181.48	0.71	182.19	182.66	-0.47	2.22	183.83	5.7	5.7	0.6	331.4	0.67
CA02	-50	TR 100_CN91	51.0	181.28	1.24	182.52	182.46	0.06	0.94	183.01	3.1	3.1	1.1	84.2	1.13
CA02	-75	TR 100_CN91	51.0	181.08	1.25	182.33	182.27	0.06	0.91	182.81	3.1	3.0	1.1	80.9	1.06
CA02	-100	TR 100_CN91	51.0	180.88	1.27	182.15	182.06	0.09	0.89	182.62	3.0	3.0	1.1	78.2	1.16
CA02	-125	TR 100_CN91	51.0	180.68	1.20	181.88	181.87	0.01	0.98	182.41	3.2	3.2	1.0	90.8	1.10
CA02	-150	TR 100_CN91	51.0	180.48	1.26	181.74	181.74	0.00	0.88	182.18	3.0	2.8	1.1	76.3	0.81
CA02	-175	TR 100_CN91	51.0	180.28	1.35	181.63	181.49	0.14	0.73	181.93	2.5	2.3	1.2	53.3	0.96
CA02	-200	TR 100_CN91	51.0	180.08	1.26	181.34	181.34	0.00	0.88	181.77	2.9	2.8	1.1	74.3	0.79
CA02	-225	TR 100_CN91	51.0	179.88	1.07	180.95	181.08	-0.13	1.10	181.53	3.4	3.2	0.9	106.2	0.70
CA02	-250	TR 100_CN91	51.0	179.68	1.18	180.86	180.88	-0.02	0.90	181.27	3.0	2.7	1.0	77.0	0.79
CA02	-275	TR 100_CN91	51.0	179.48	1.15	180.63	180.68	-0.05	0.93	181.07	3.1	2.7	1.1	81.0	0.76
CA02	-300	TR 100_CN91	51.0	179.28	1.28	180.56	180.52	0.04	0.76	180.87	2.6	2.3	1.2	57.9	0.75
CA02	-325	TR 100_CN91	51.0	179.08	1.27	180.35	180.35	0.00	0.82	180.72	2.8	2.5	1.1	66.5	0.68
CA02	-350	TR 100_CN91	51.0	178.88	0.96	179.85	180.04	-0.19	1.22	180.48	3.7	3.2	0.9	123.9	0.56
CA02	-375	TR 100_CN91	51.0	178.68	1.05	179.73	179.80	-0.07	0.97	180.14	3.1	2.6	1.0	83.3	0.65
CA02	-400	TR 100_CN91	51.0	178.48	1.12	179.60	179.60	0.00	0.86	179.94	2.8	2.4	1.0	68.6	0.72
CA02	-425	TR 100_CN91	51.0	178.28	0.99	179.27	179.36	-0.09	1.05	179.72	3.2	2.7	0.9	94.1	0.62

HEC-RAS Plan: CA02 River: CA02 Reach: CA02 Profile: TR 200_CN91

Reach	River Sta	Profile	Q Total (m3/s)	Min Ch El (m)	Max Chl Dpth (m)	W.S. Elev (m)	Crit W.S. (m)	Diff	Froude # Chl	E.G. Elev (m)	Vel Chnl (m/s)	Vel Total (m/s)	Hydr Radius C (m)	Shear Chan (N/m2)	Hydr Depth (m)
CA02	0	TR 200_CN91	59.6	182.96	1.24	184.20	184.20	0.00	0.90	184.59	2.9	2.6	1.1	74.3	0.77
CA02	-25	TR 200_CN91	59.6	181.48	0.78	182.26	182.79	-0.53	2.22	184.07	6.0	6.0	0.7	352.8	0.74
CA02	-50	TR 200_CN91	59.6	181.28	1.21	182.49	182.59	-0.10	1.13	183.20	3.7	3.7	1.0	121.7	1.11
CA02	-75	TR 200_CN91	59.6	181.08	1.39	182.47	182.40	0.07	0.90	182.98	3.2	3.1	1.2	84.5	1.18
CA02	-100	TR 200_CN91	59.6	180.88	1.35	182.23	182.19	0.04	0.95	182.79	3.3	3.3	1.1	92.4	1.23
CA02	-125	TR 200_CN91	59.6	180.68	1.38	182.06	182.06	0.00	0.91	182.58	3.2	3.1	1.2	85.0	0.86
CA02	-150	TR 200_CN91	59.6	180.48	1.24	181.72	181.85	-0.13	1.06	182.35	3.6	3.4	1.1	108.3	0.80
CA02	-175	TR 200_CN91	59.6	180.28	1.46	181.74	181.59	0.15	0.74	182.06	2.6	2.4	1.2	57.3	1.06
CA02	-200	TR 200_CN91	59.6	180.08	1.37	181.45	181.45	0.00	0.89	181.91	3.0	2.8	1.1	78.3	0.89
CA02	-225	TR 200_CN91	59.6	179.88	1.16	181.04	181.18	-0.14	1.12	181.67	3.6	3.3	1.0	114.5	0.78
CA02	-250	TR 200_CN91	59.6	179.68	1.27	180.95	180.96	-0.01	0.91	181.40	3.1	2.8	1.1	83.2	0.87
CA02	-275	TR 200_CN91	59.6	179.48	1.24	180.72	180.76	-0.04	0.94	181.20	3.2	2.9	1.1	87.5	0.85
CA02	-300	TR 200_CN91	59.6	179.28	1.38	180.66	180.60	0.06	0.75	180.99	2.7	2.3	1.3	59.7	0.86
CA02	-325	TR 200_CN91	59.6	179.08	1.36	180.44	180.44	0.00	0.82	180.84	2.9	2.6	1.2	71.2	0.77
CA02	-350	TR 200_CN91	59.6	178.88	1.04	179.92	180.12	-0.20	1.23	180.60	3.9	3.3	1.0	132.5	0.60
CA02	-375	TR 200_CN91	59.6	178.68	1.11	179.79	179.87	-0.08	1.00	180.26	3.3	2.8	1.0	92.8	0.71
CA02	-400	TR 200_CN91	59.6	178.48	1.18	179.66	179.68	-0.02	0.89	180.05	3.0	2.5	1.1	76.6	0.78
CA02	-425	TR 200_CN91	59.6	178.28	1.07	179.35	179.44	-0.09	1.05	179.83	3.4	2.8	1.0	99.0	0.70

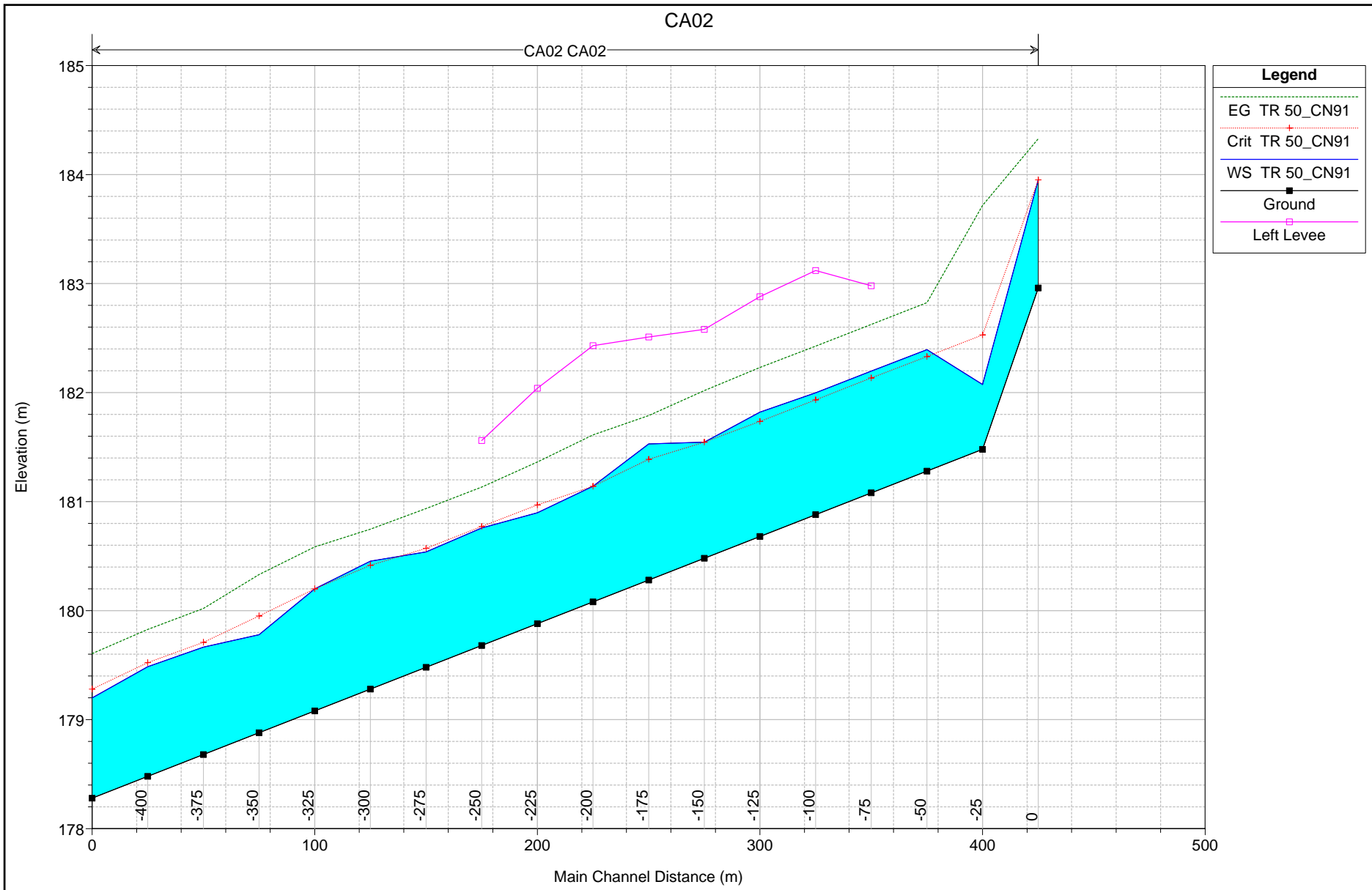

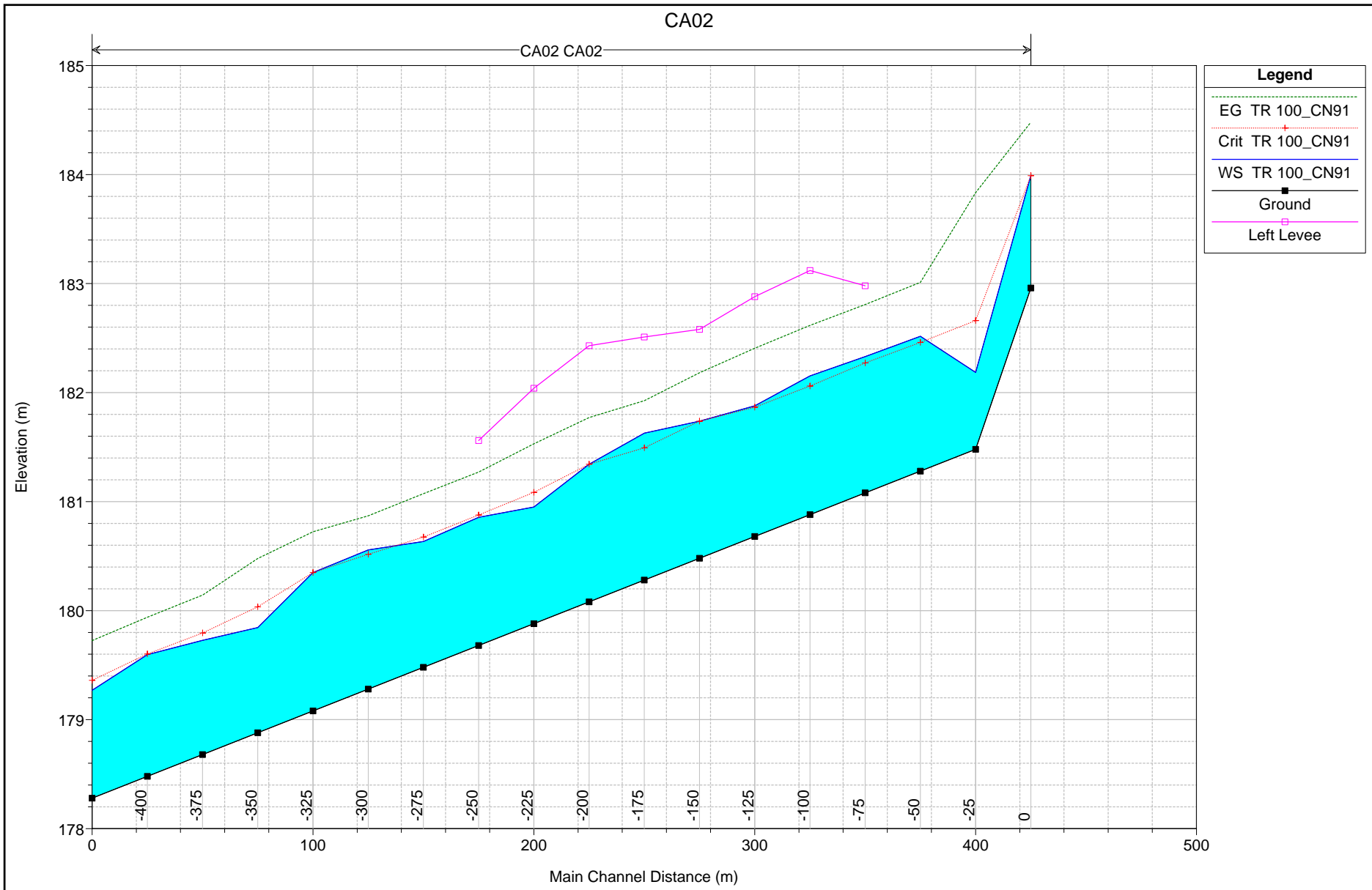

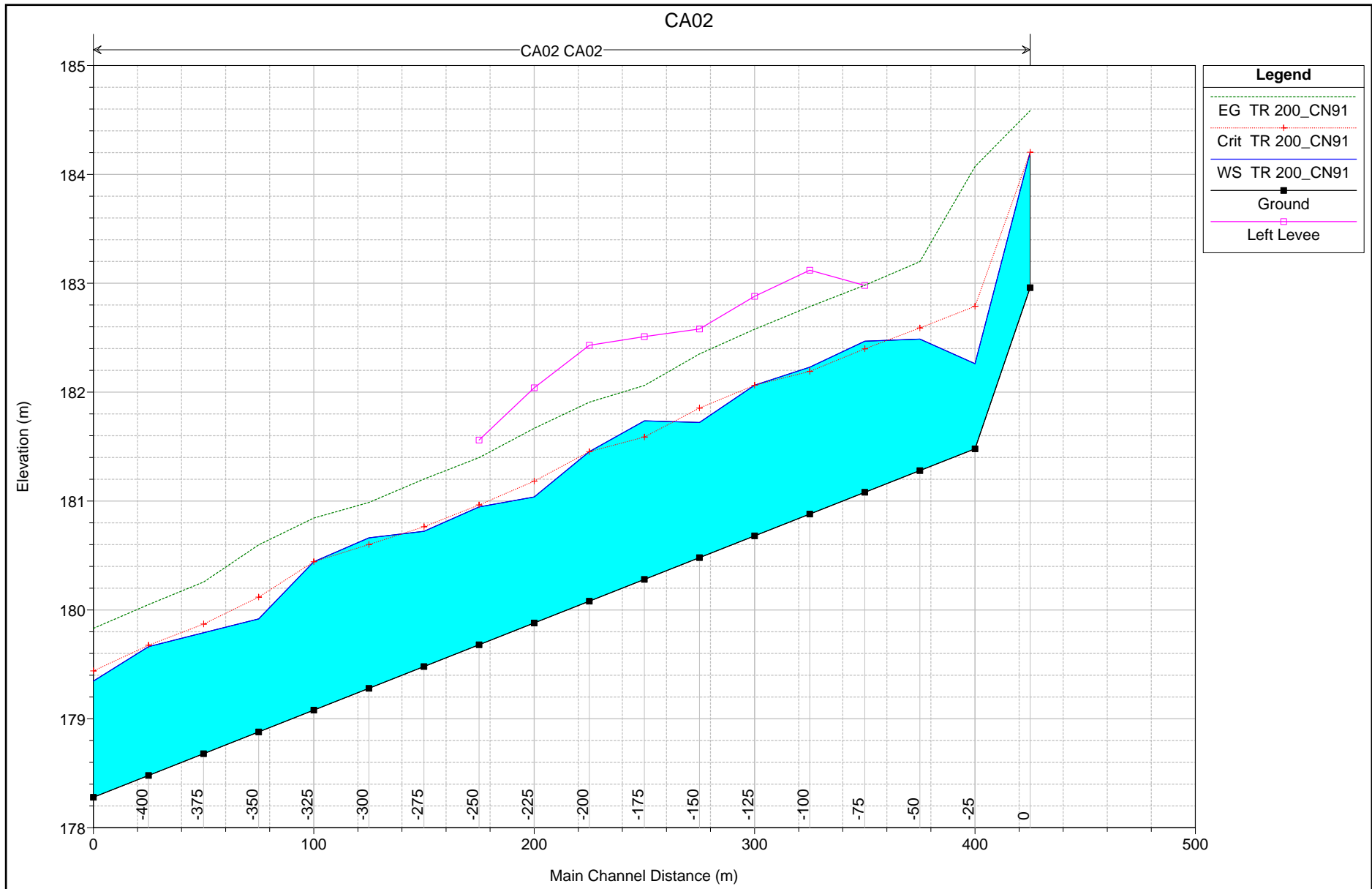

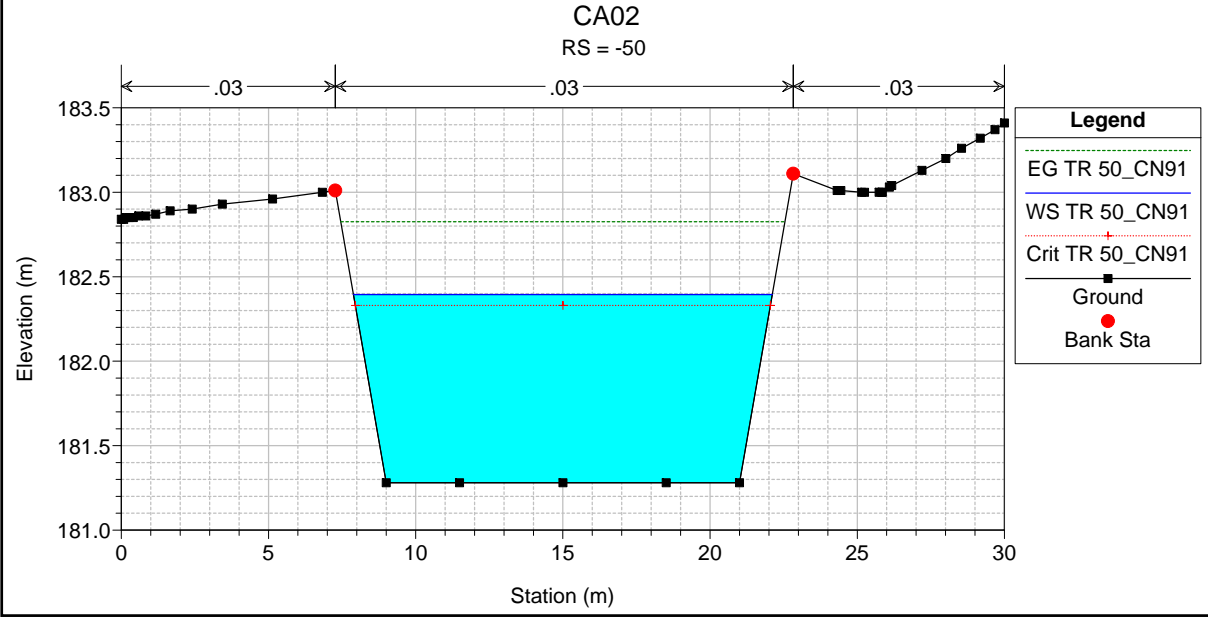
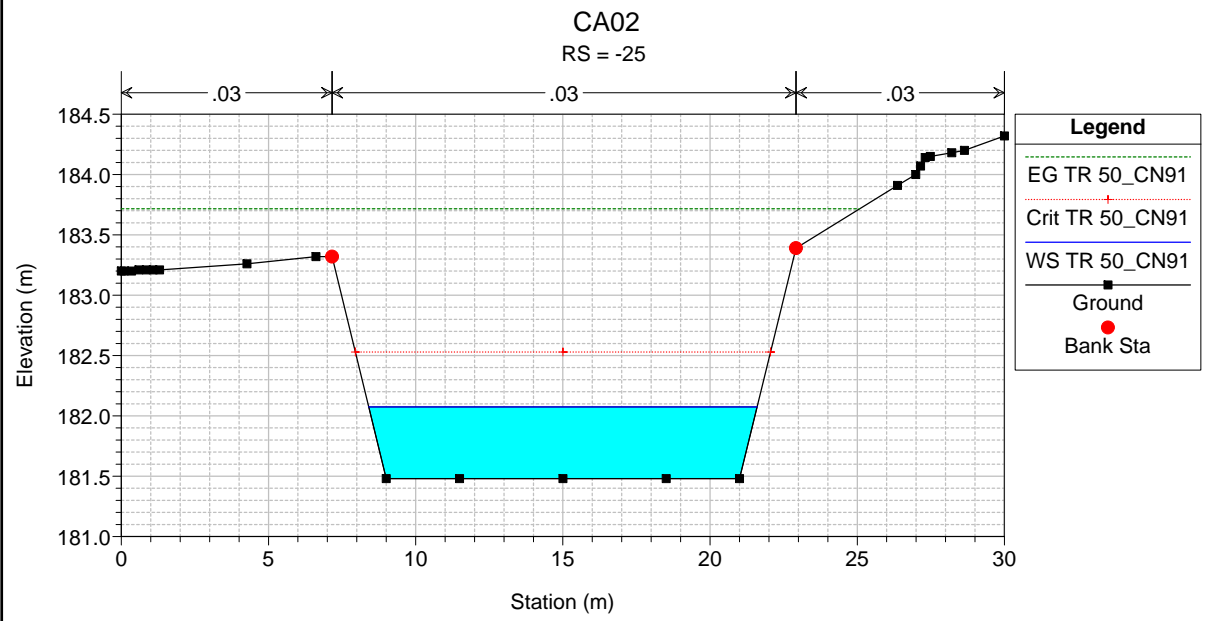
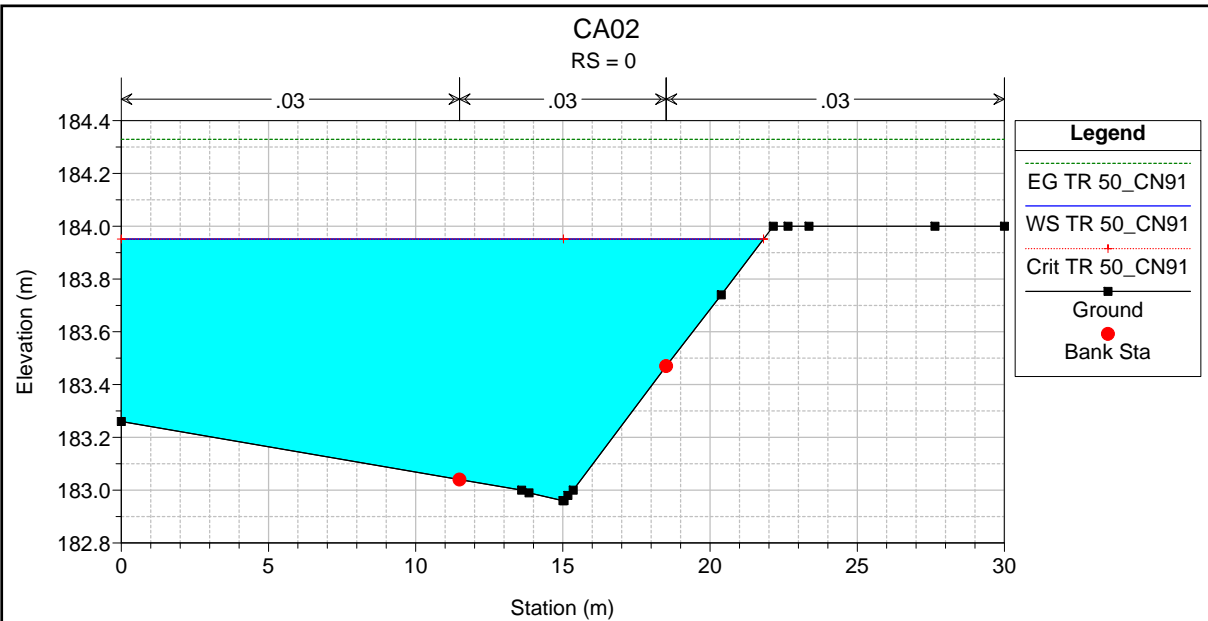

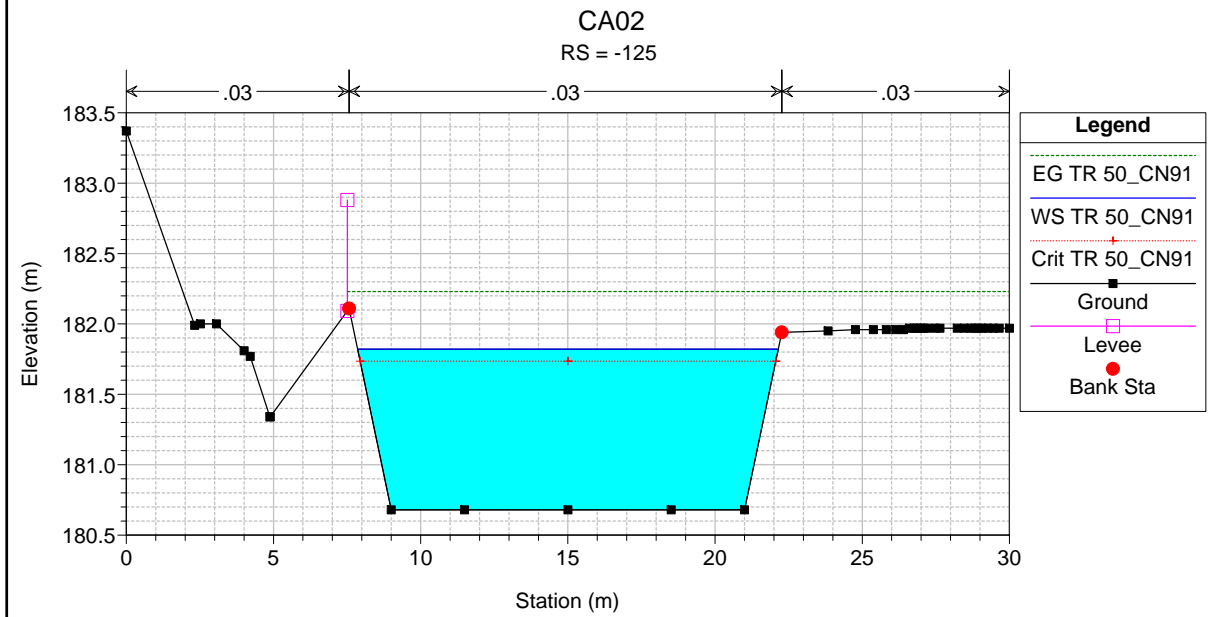
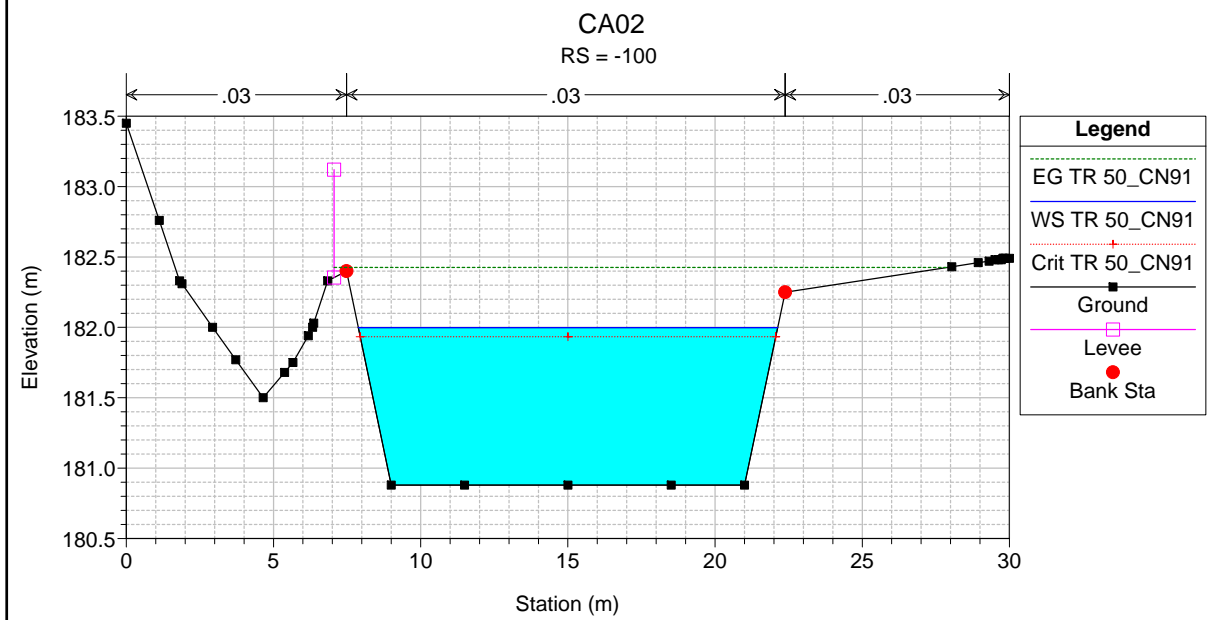
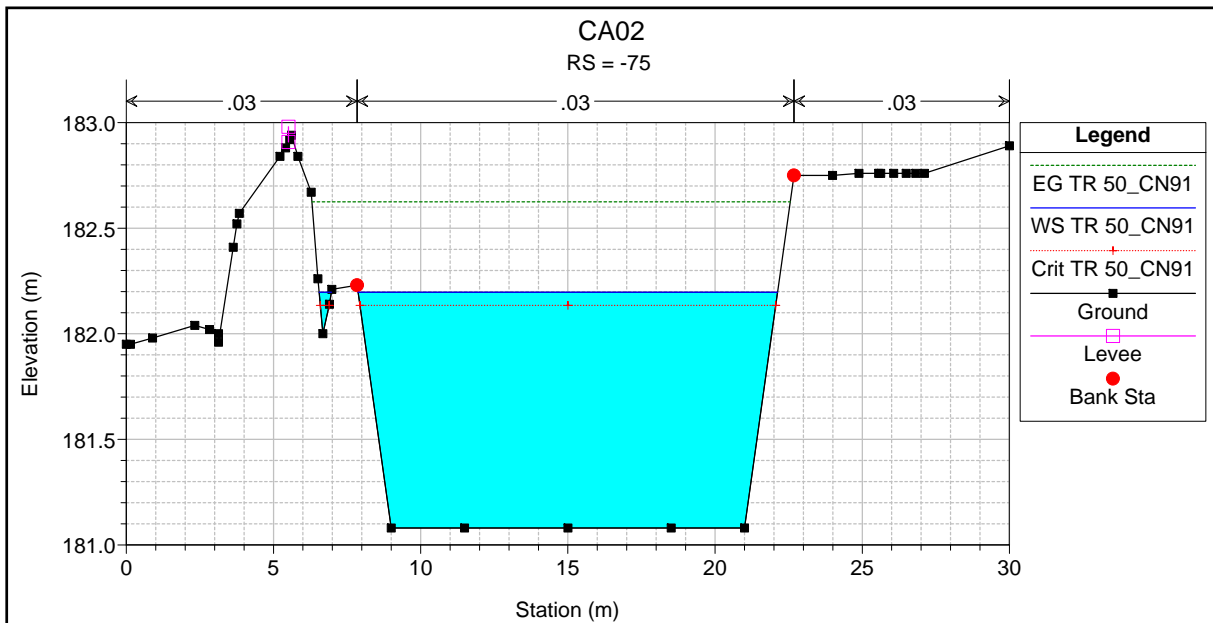

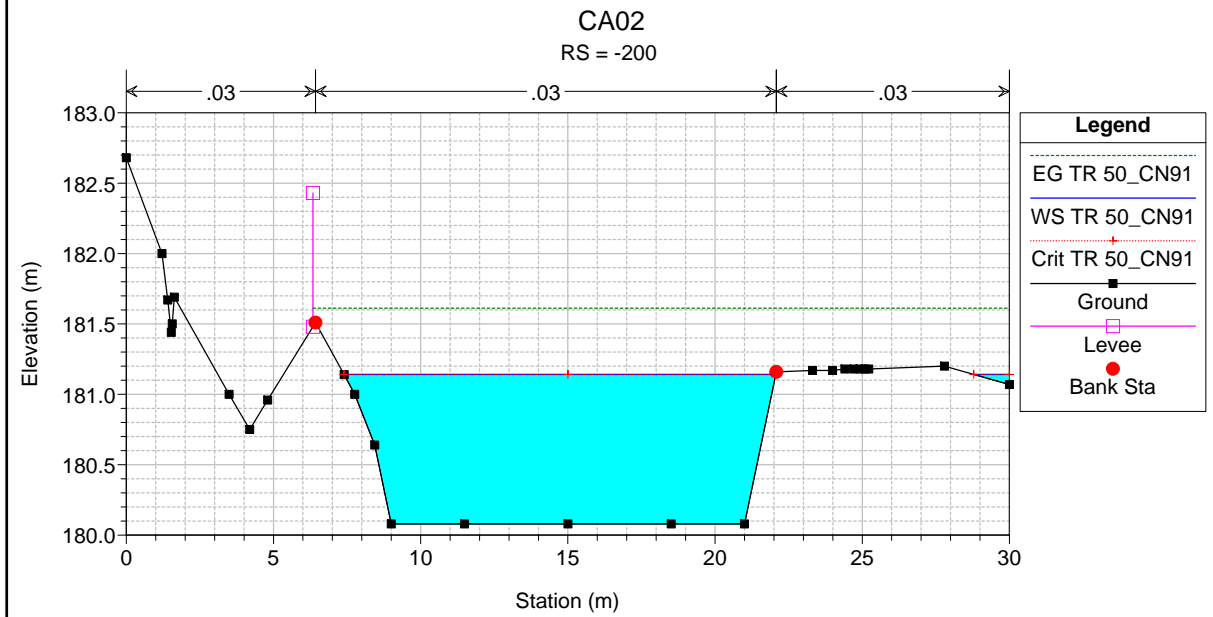
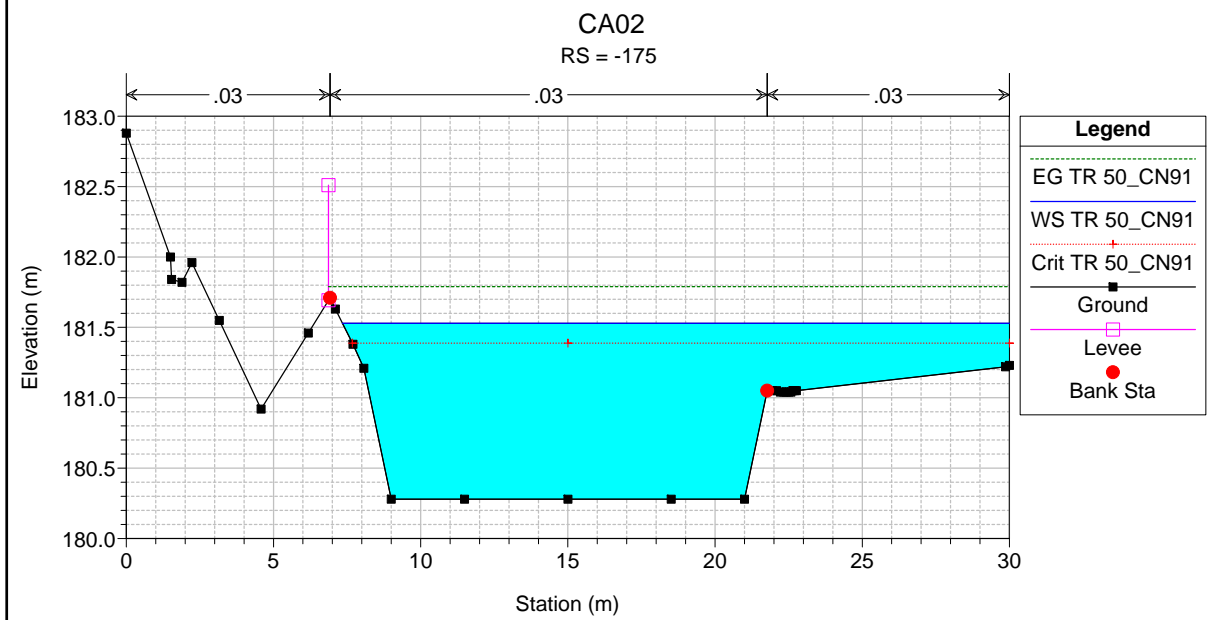
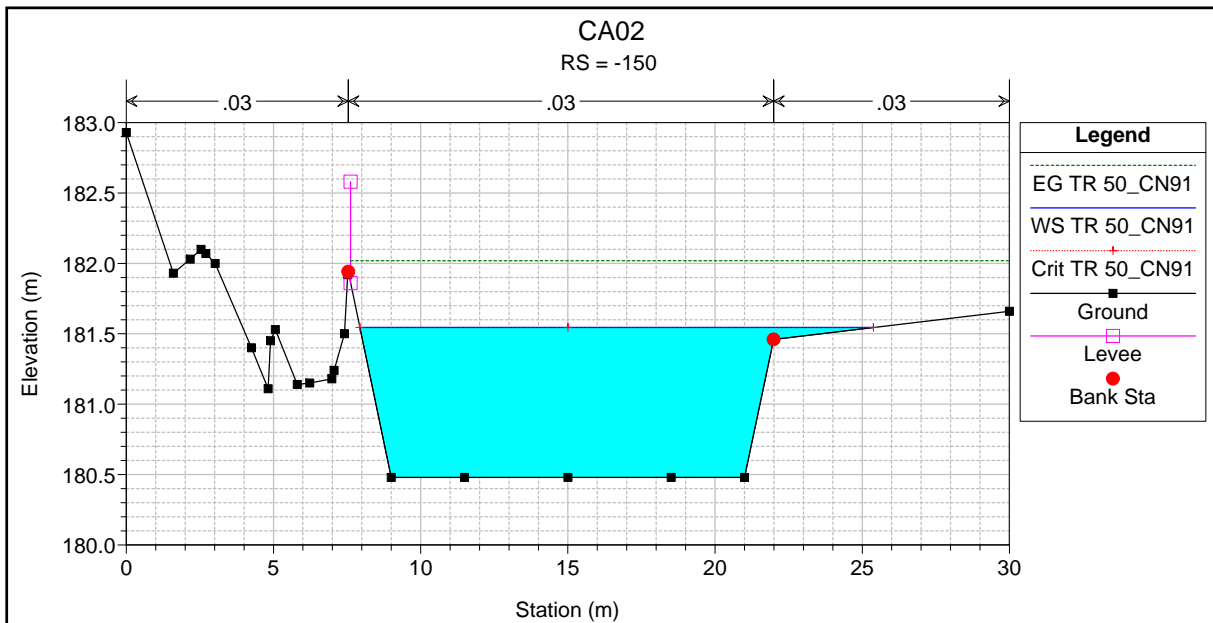

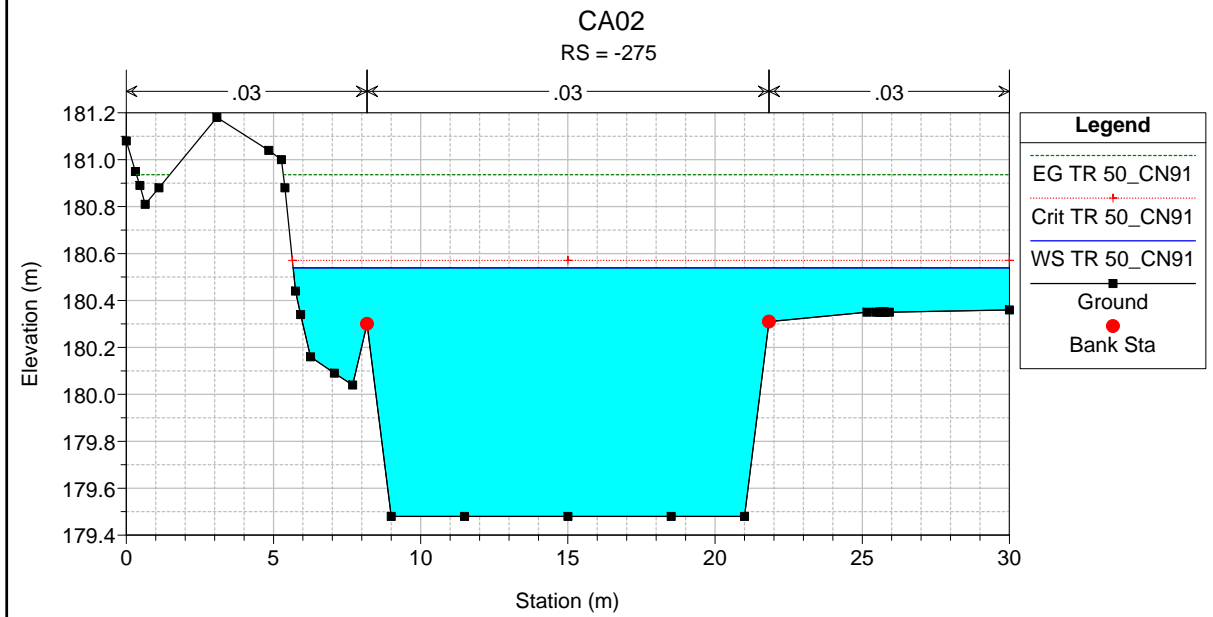
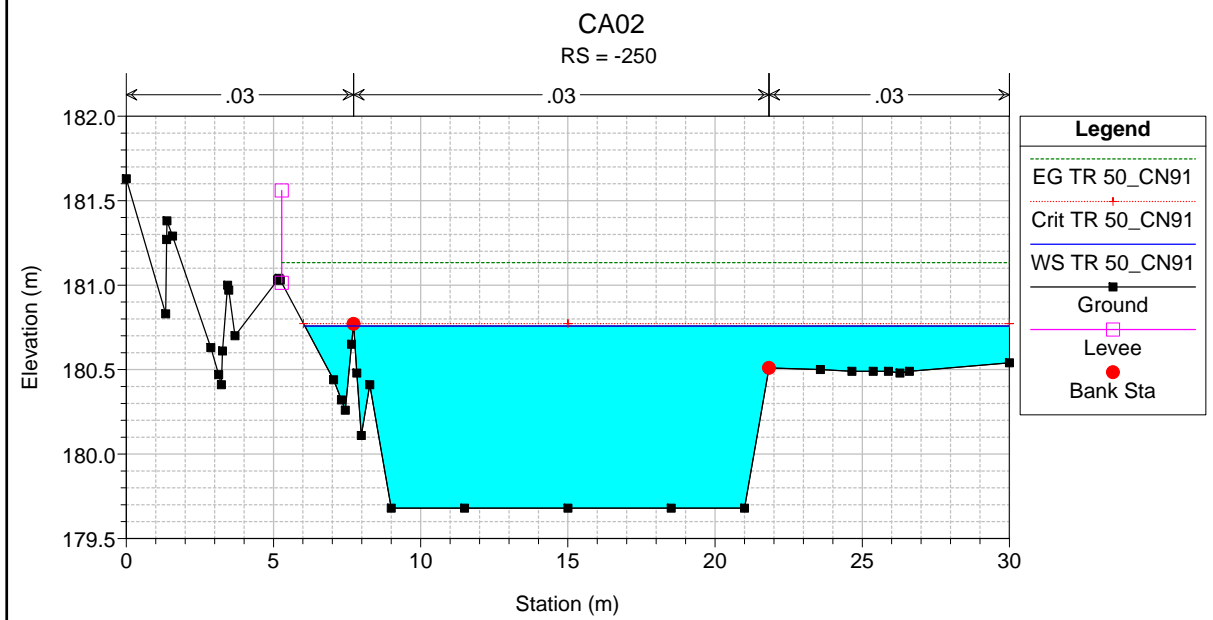
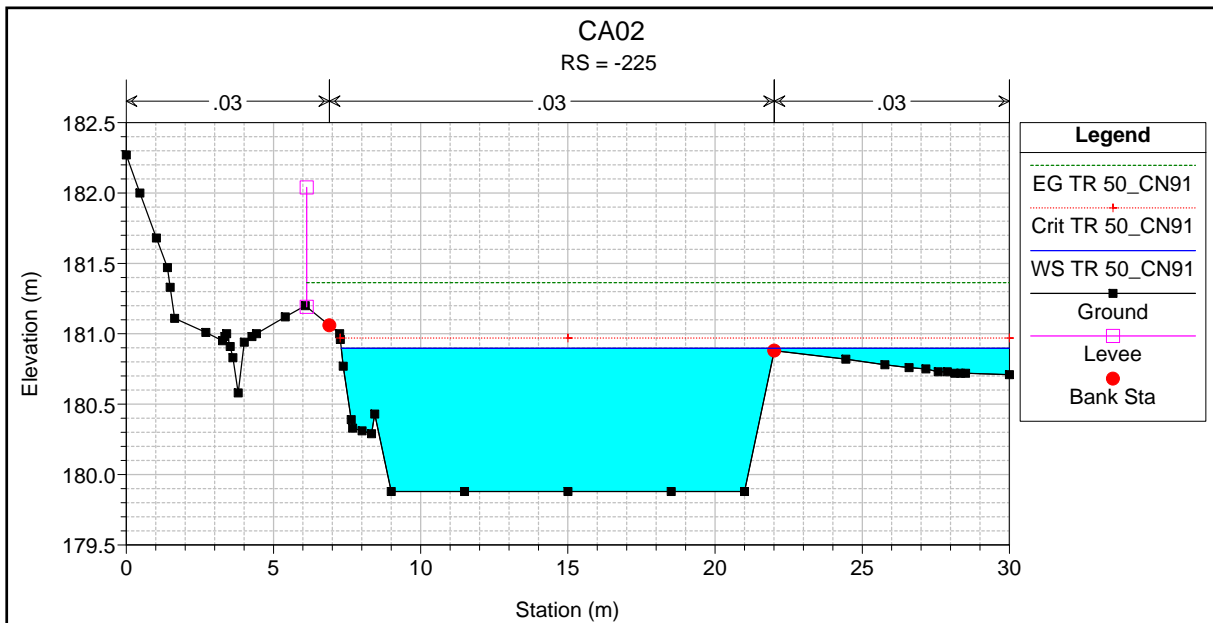

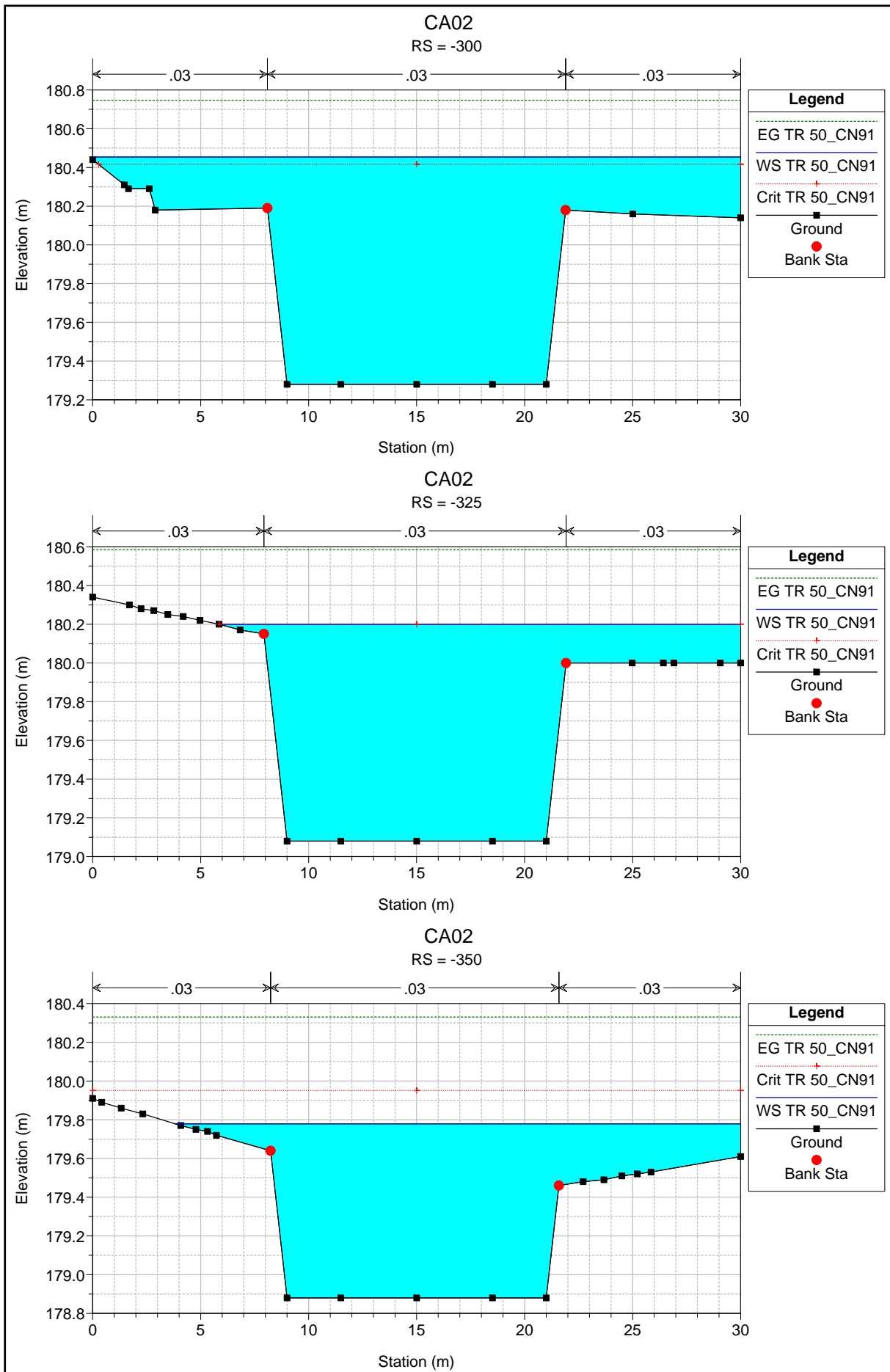

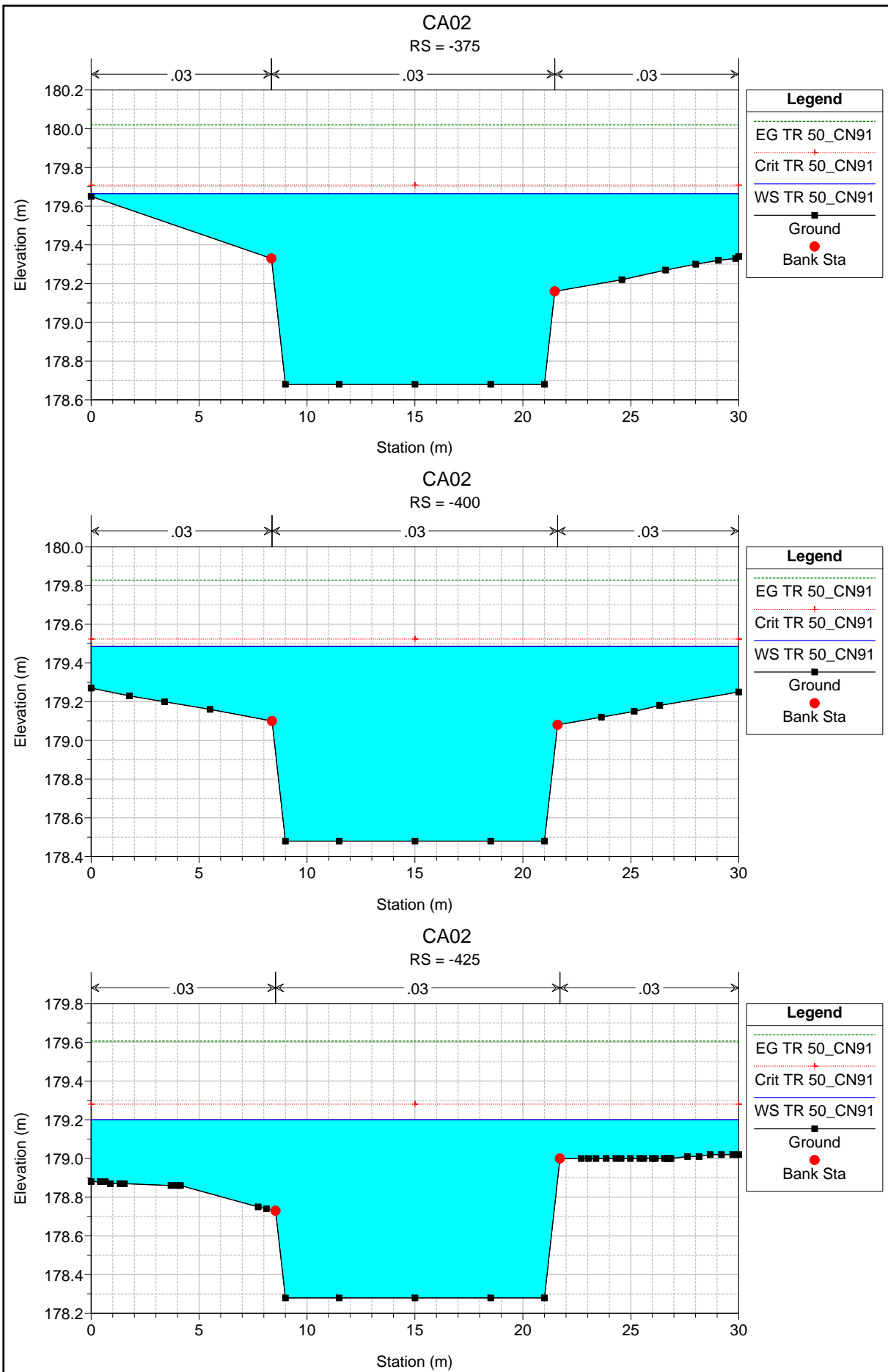

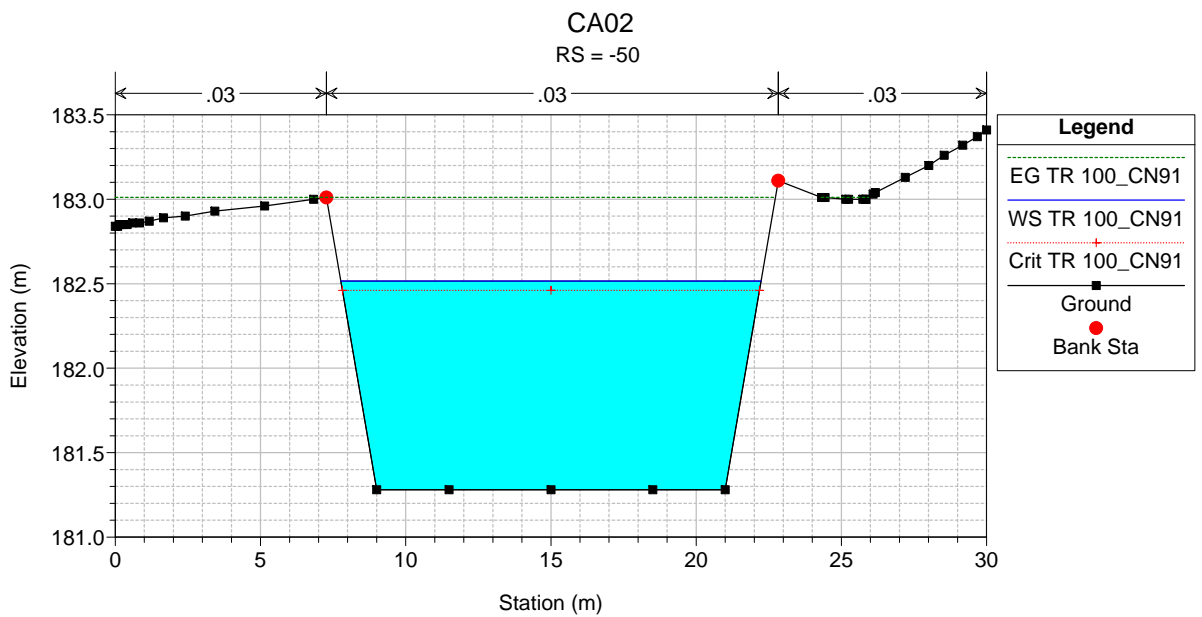
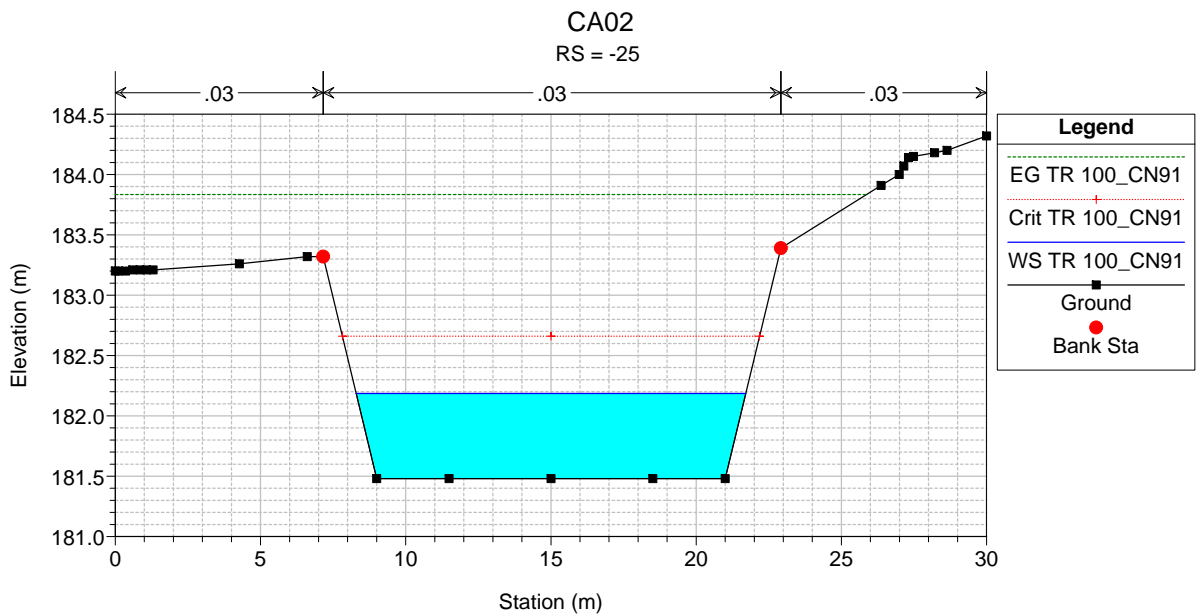
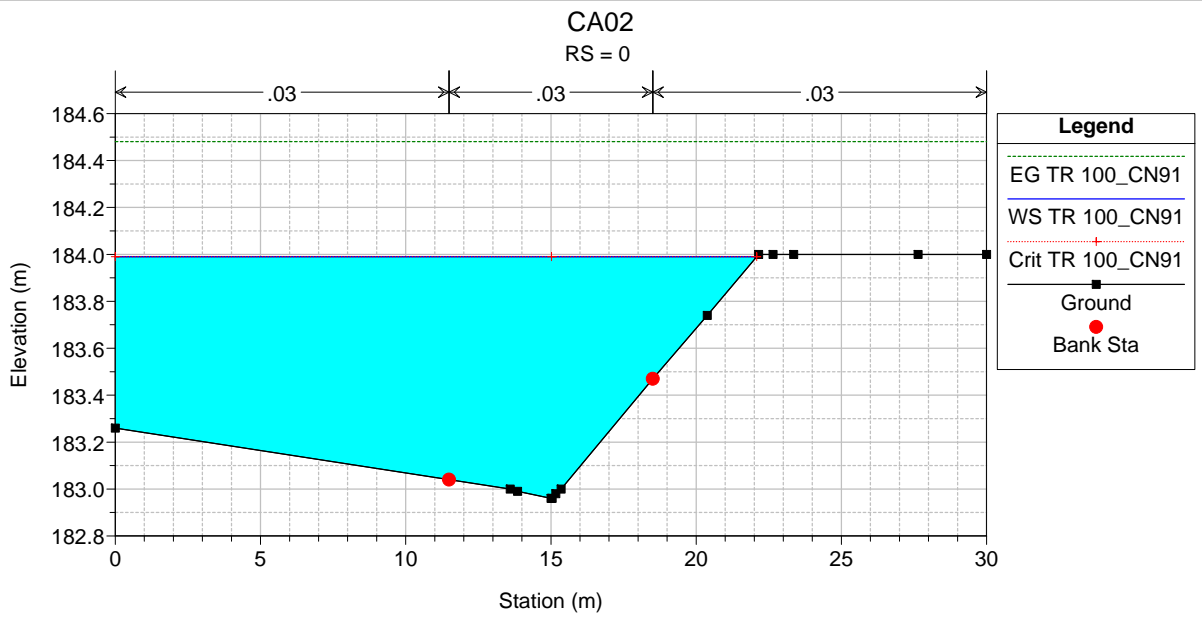

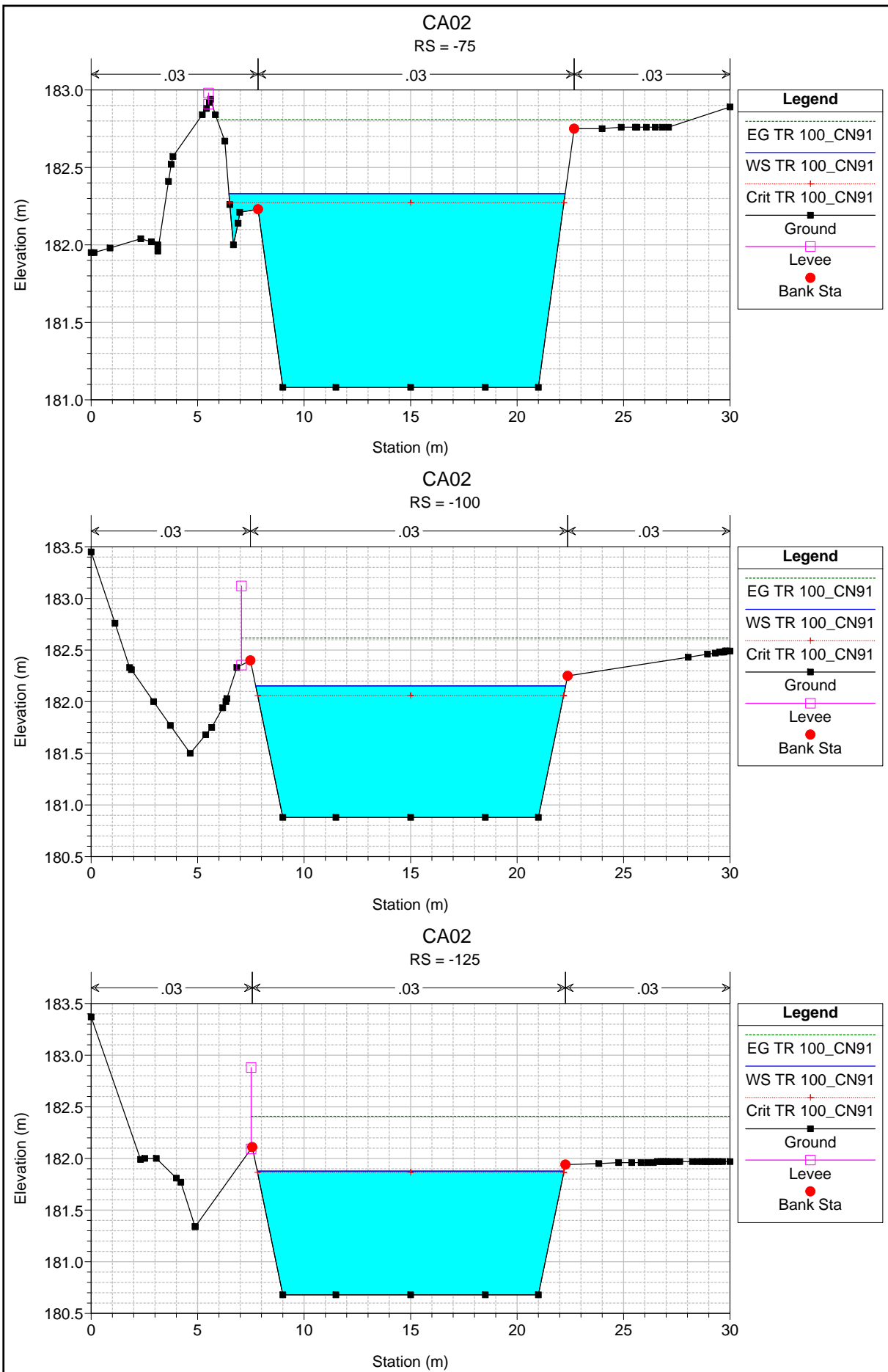

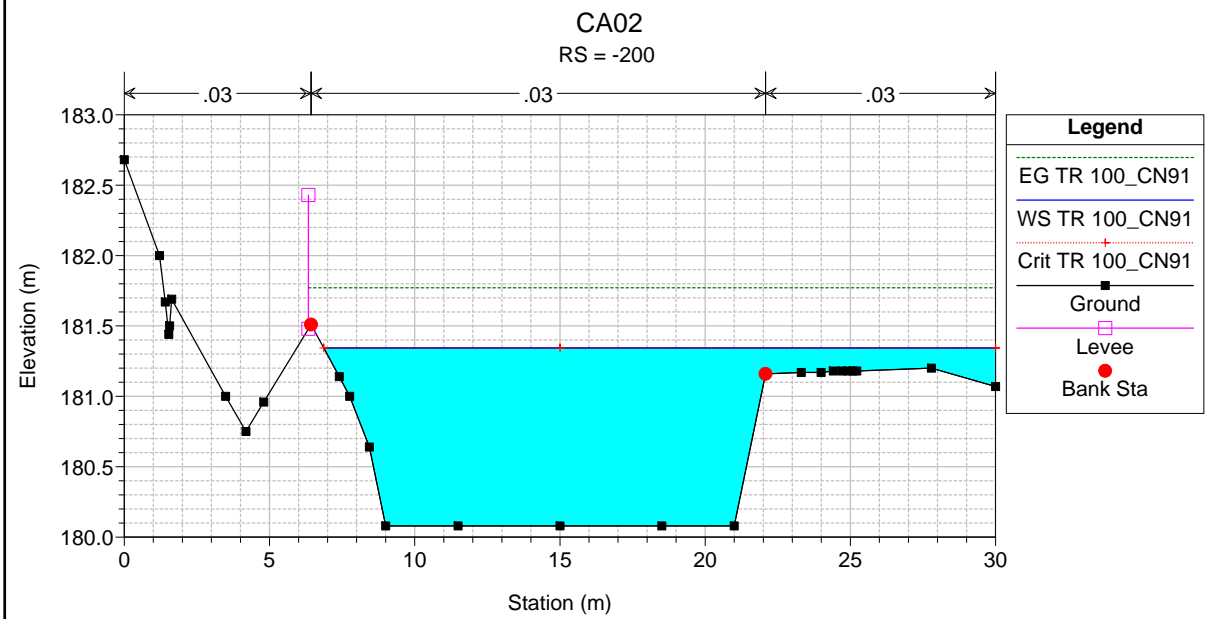
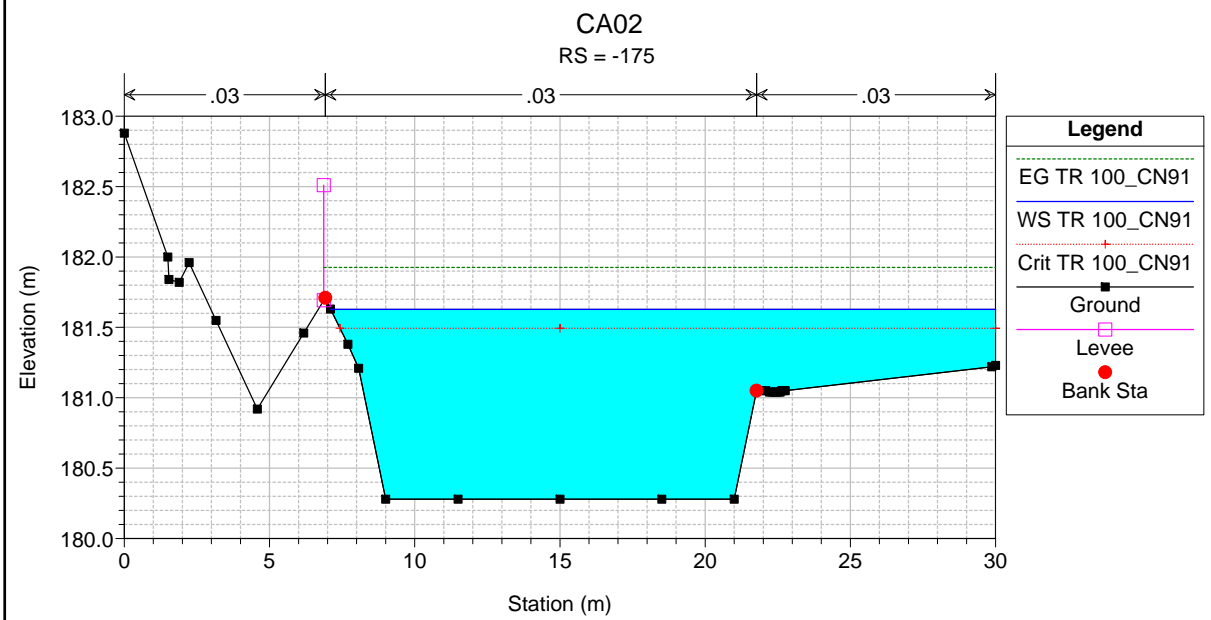
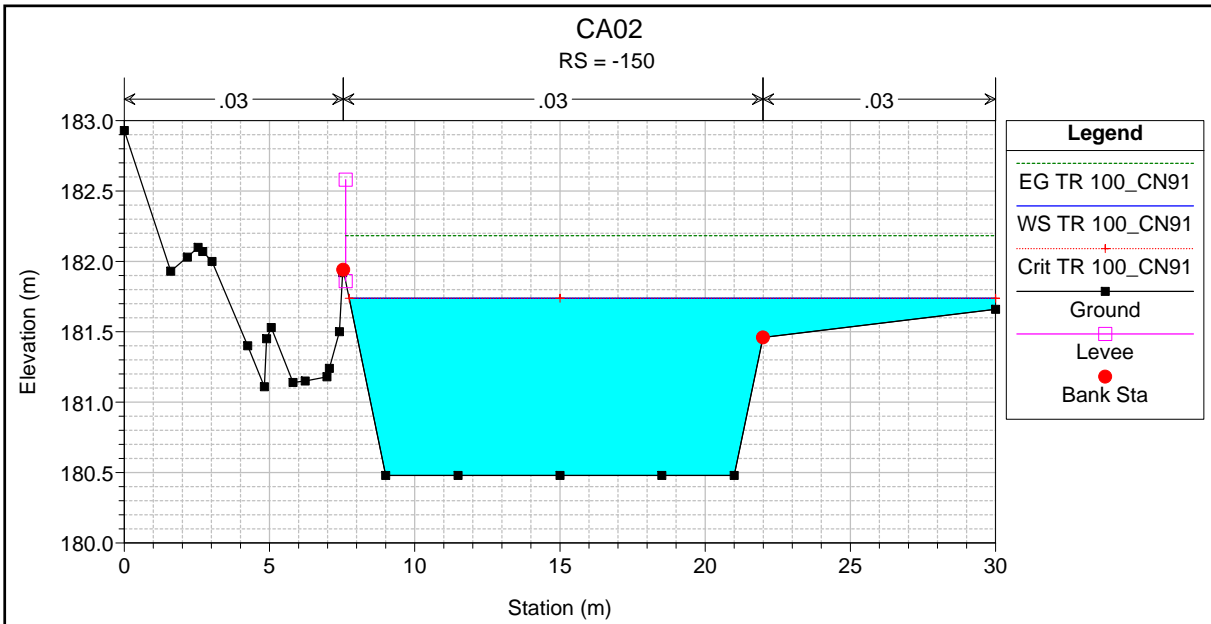

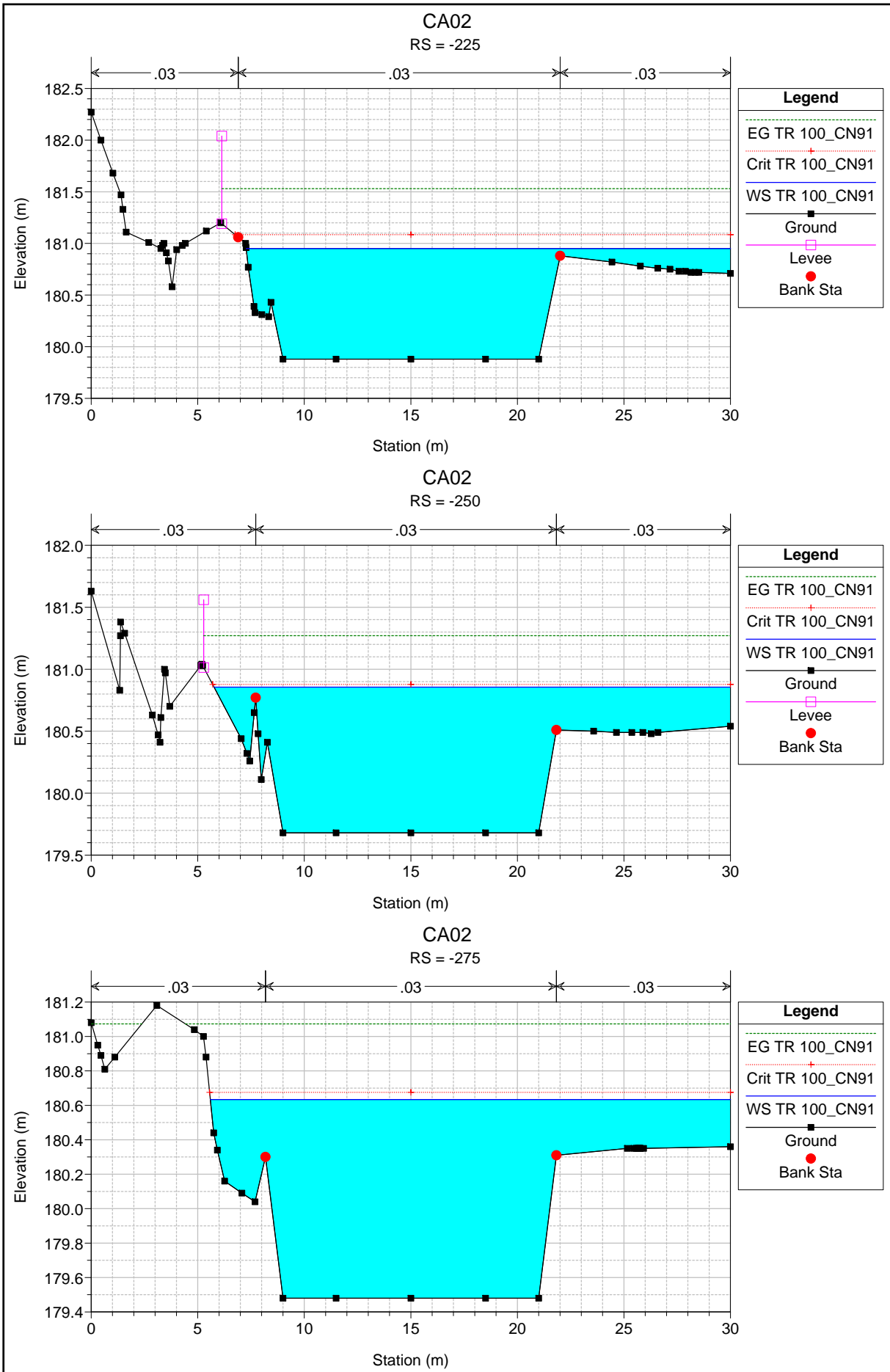

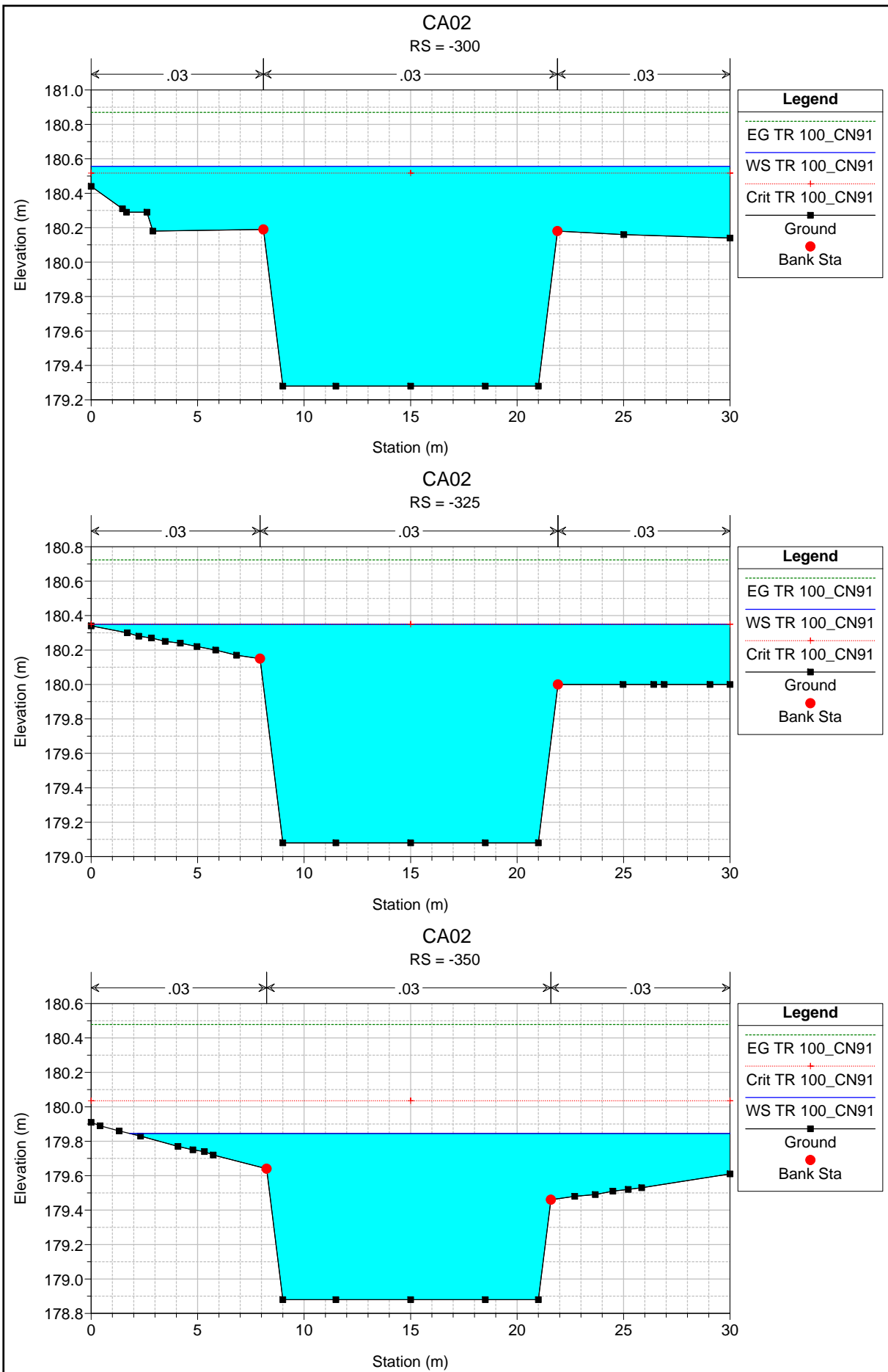

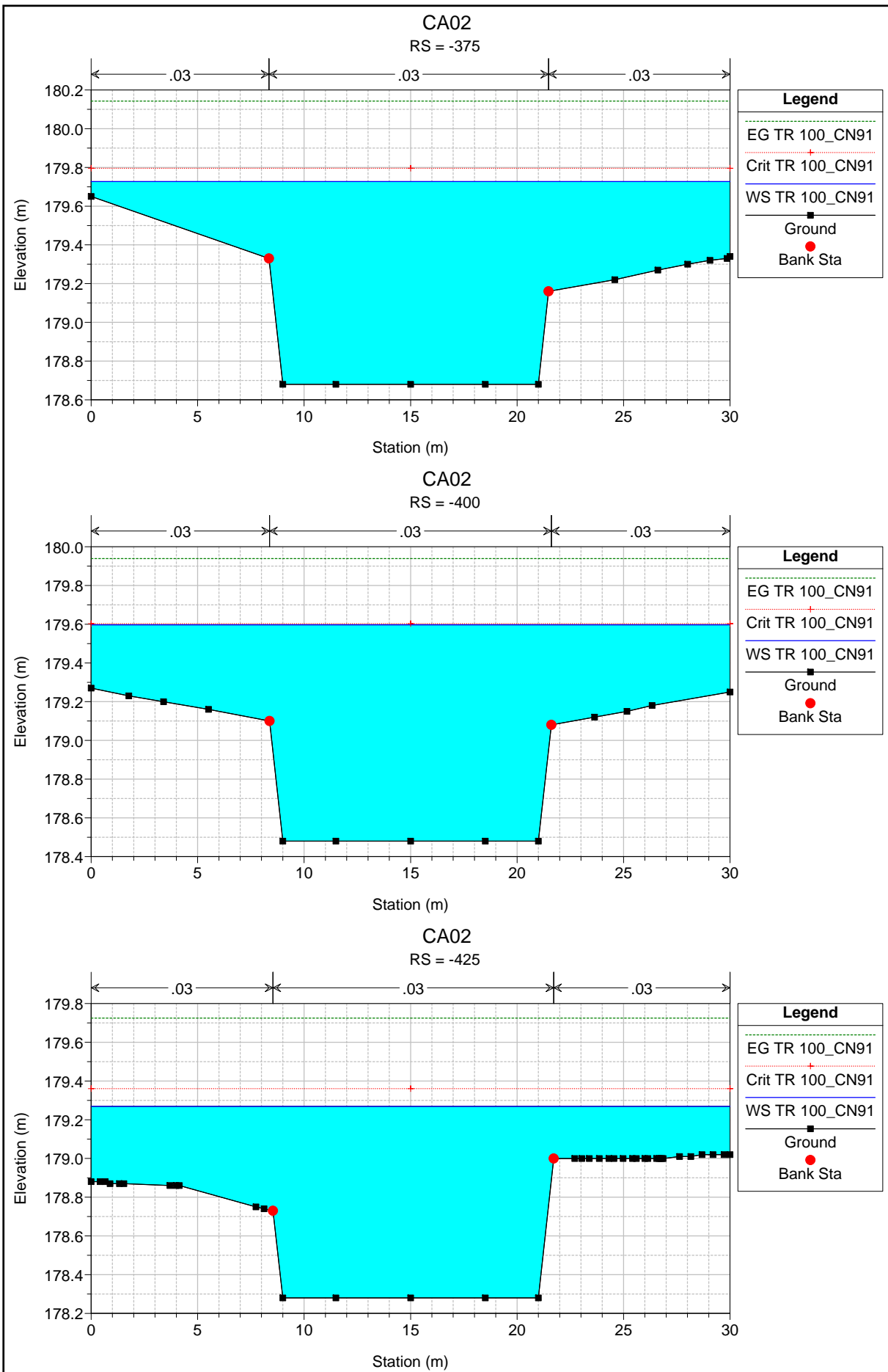

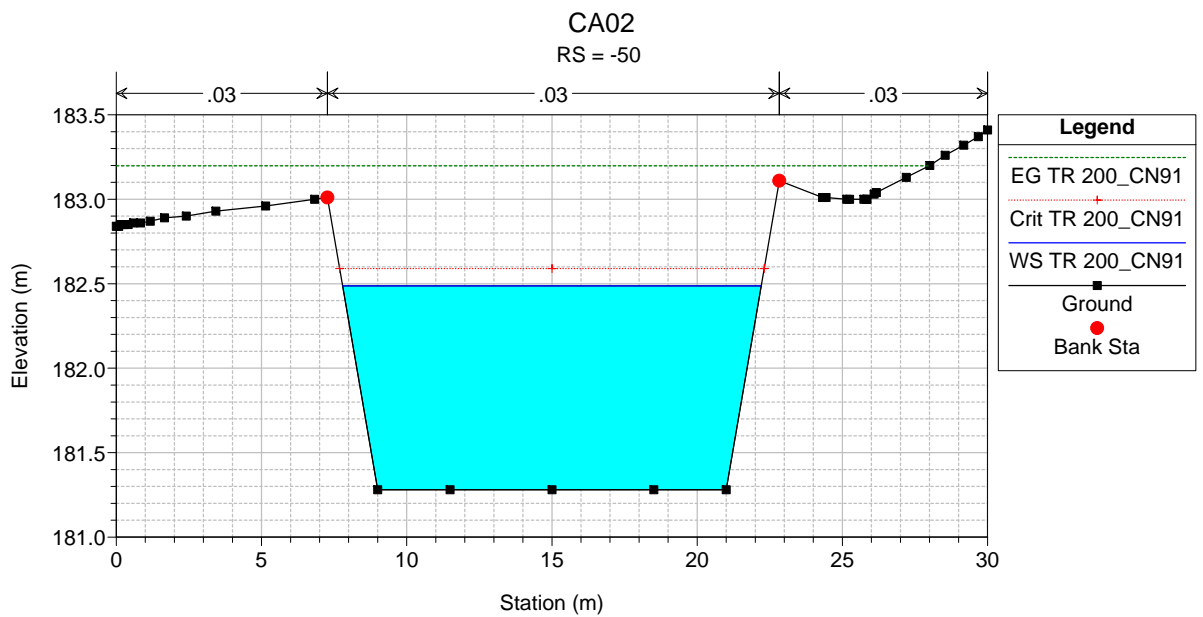
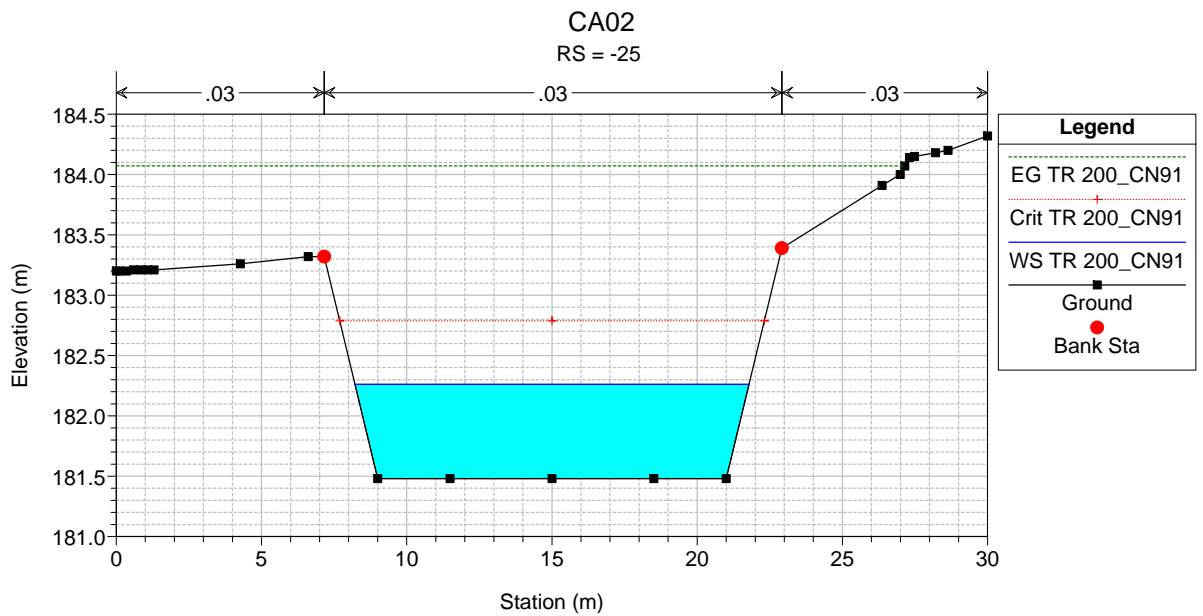
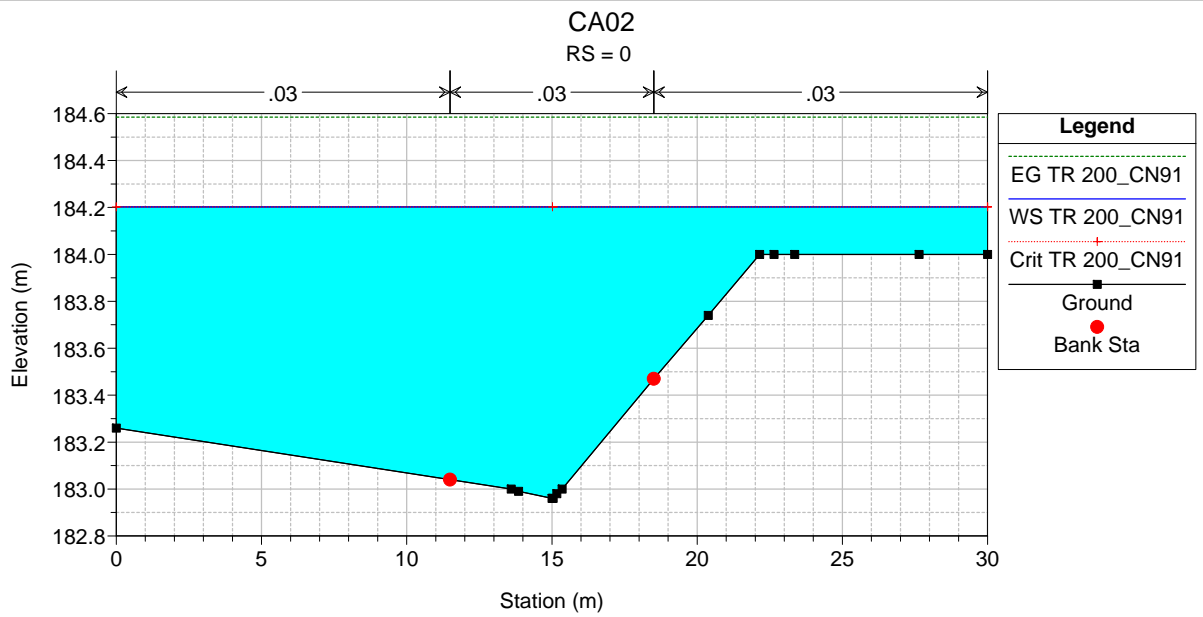

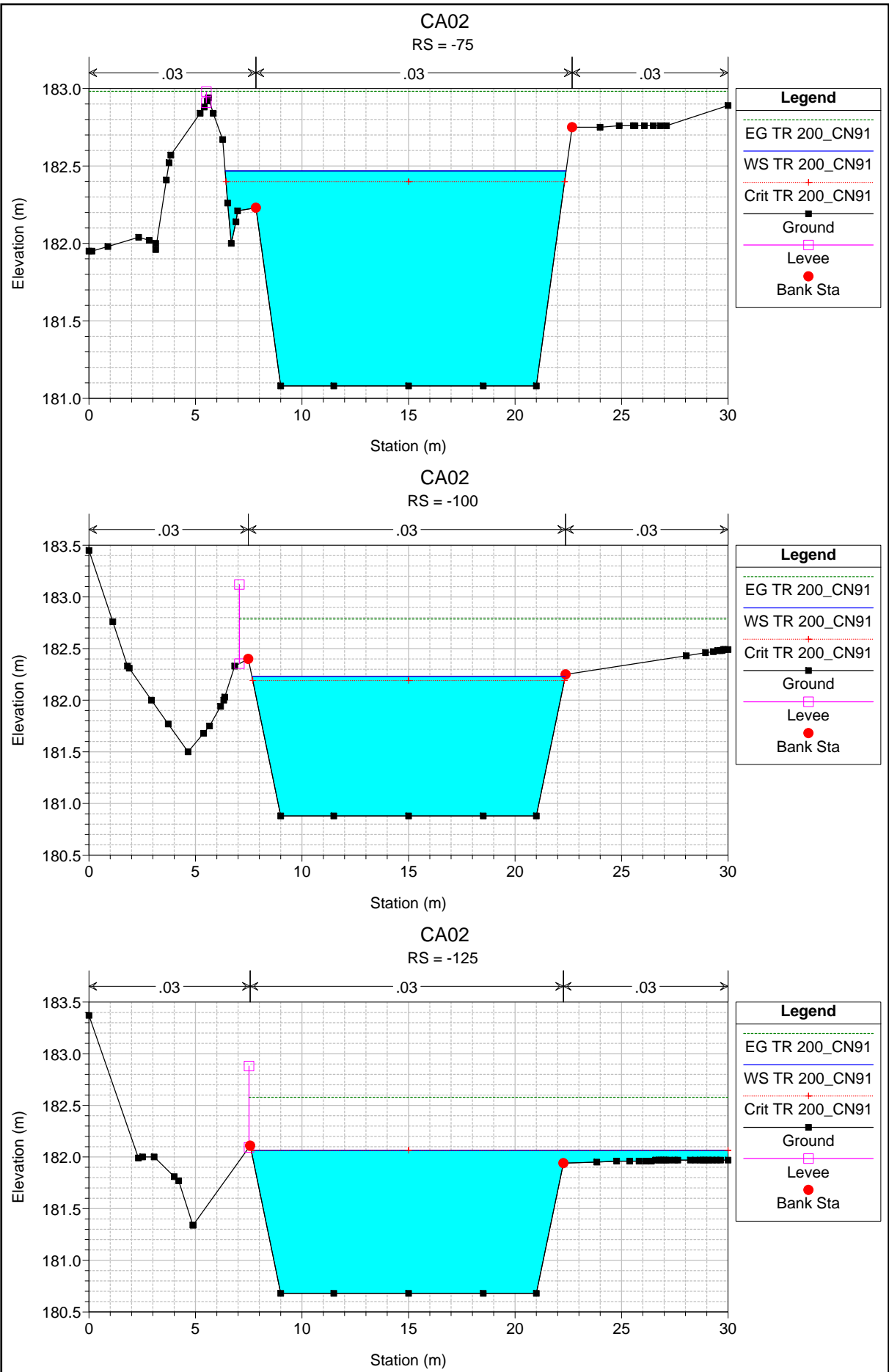

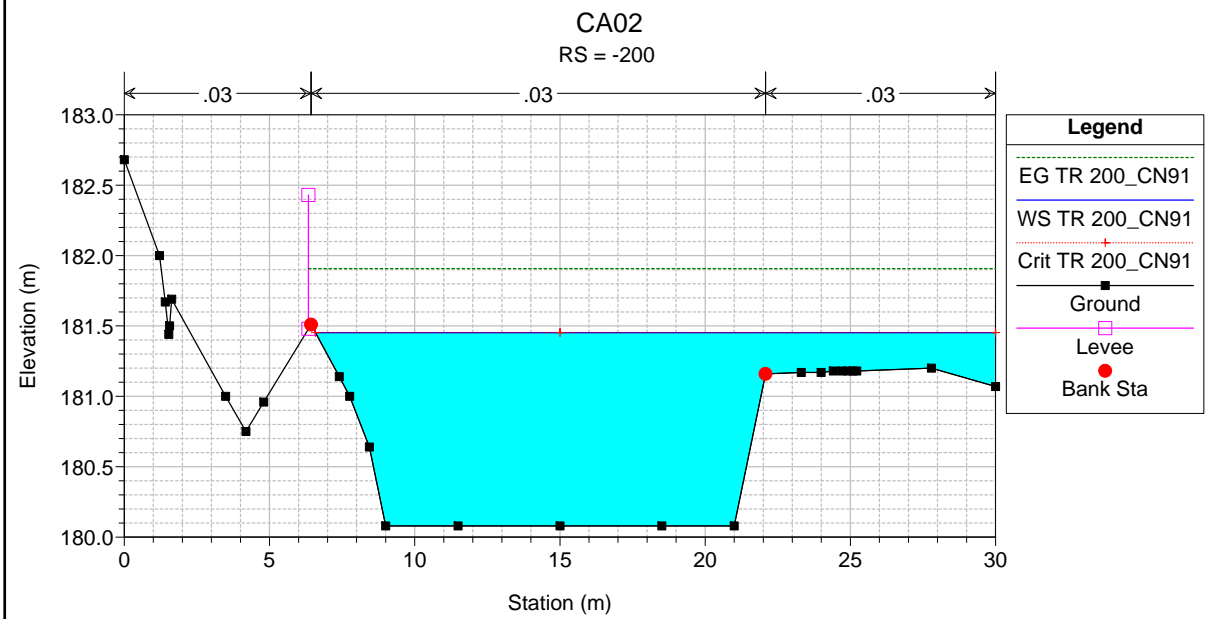
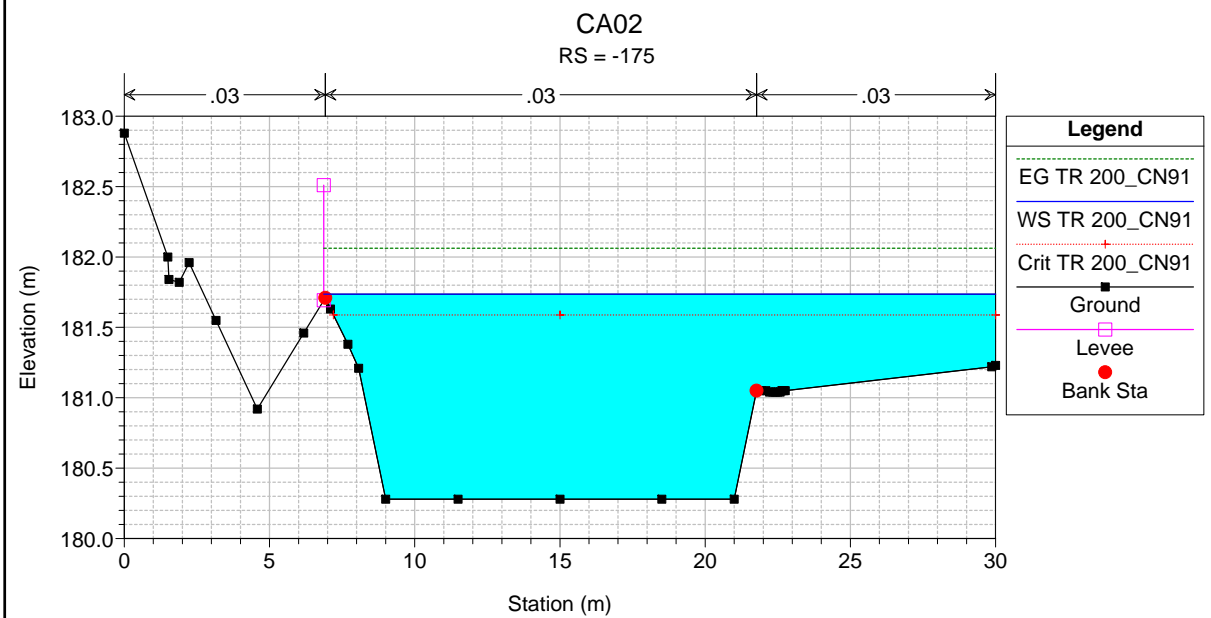
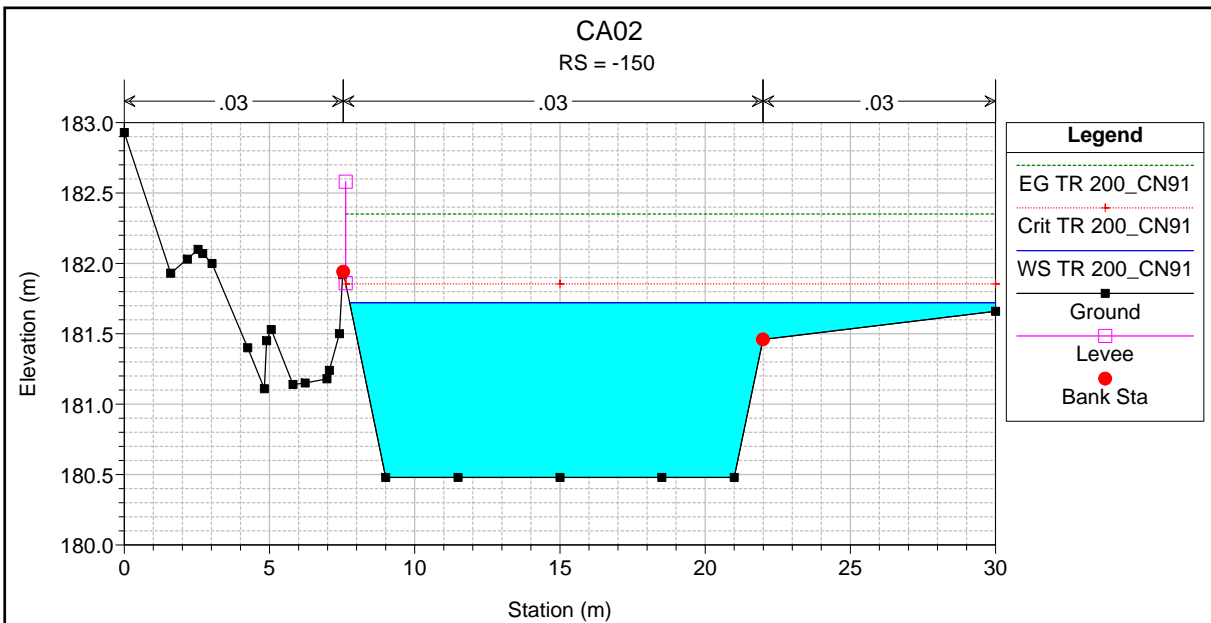

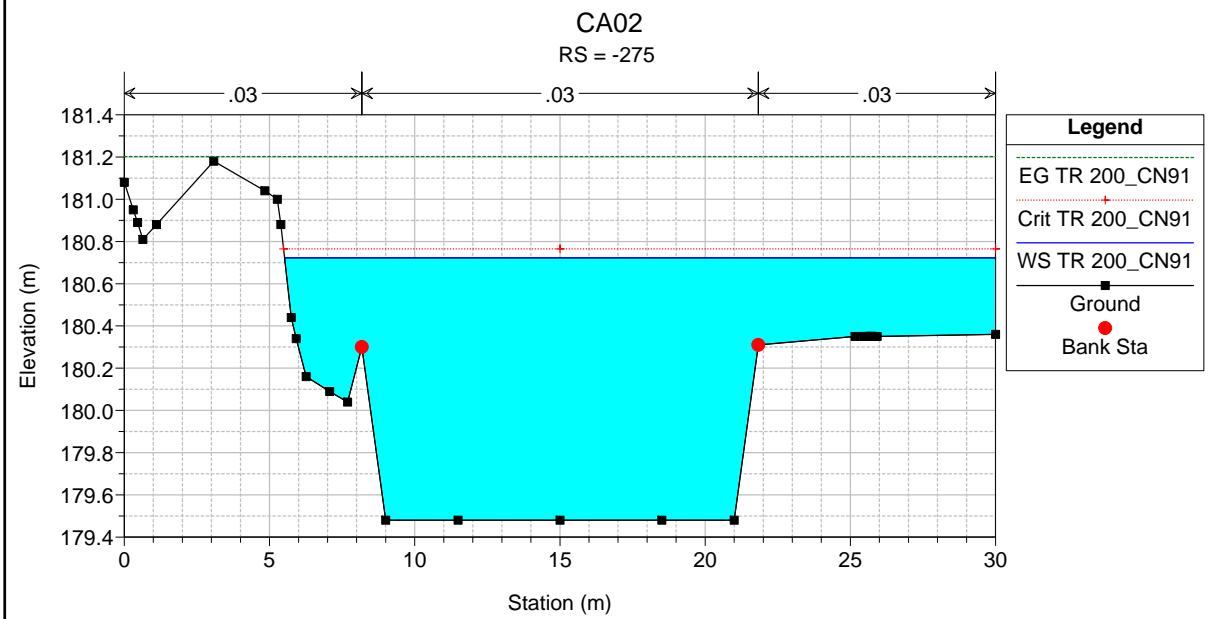
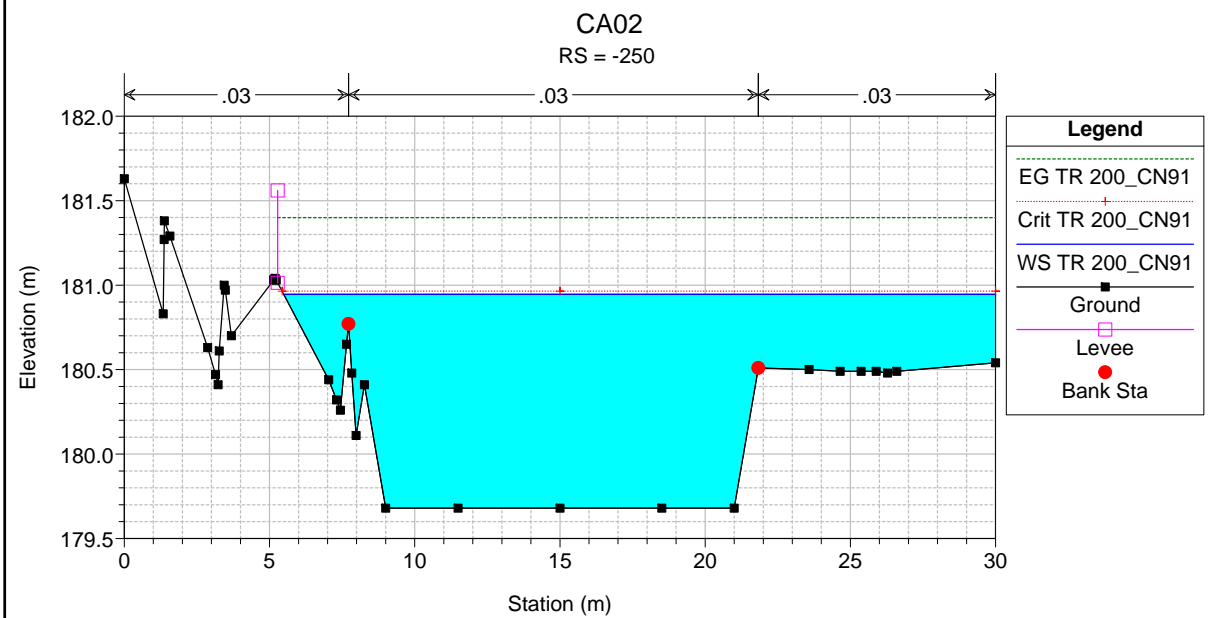
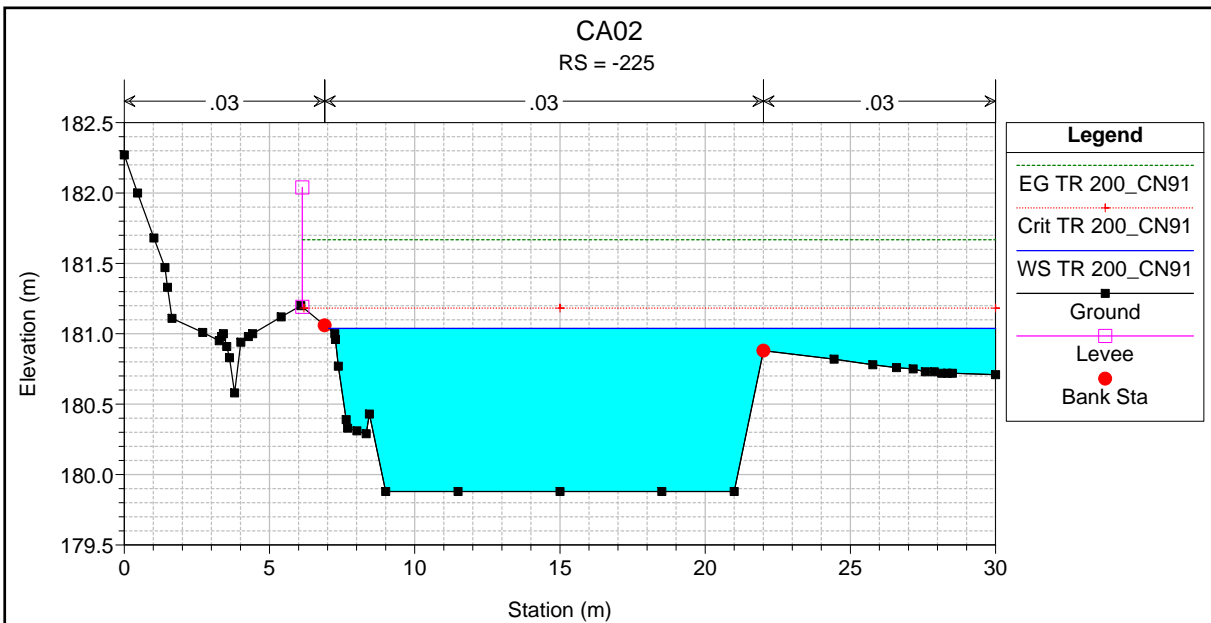

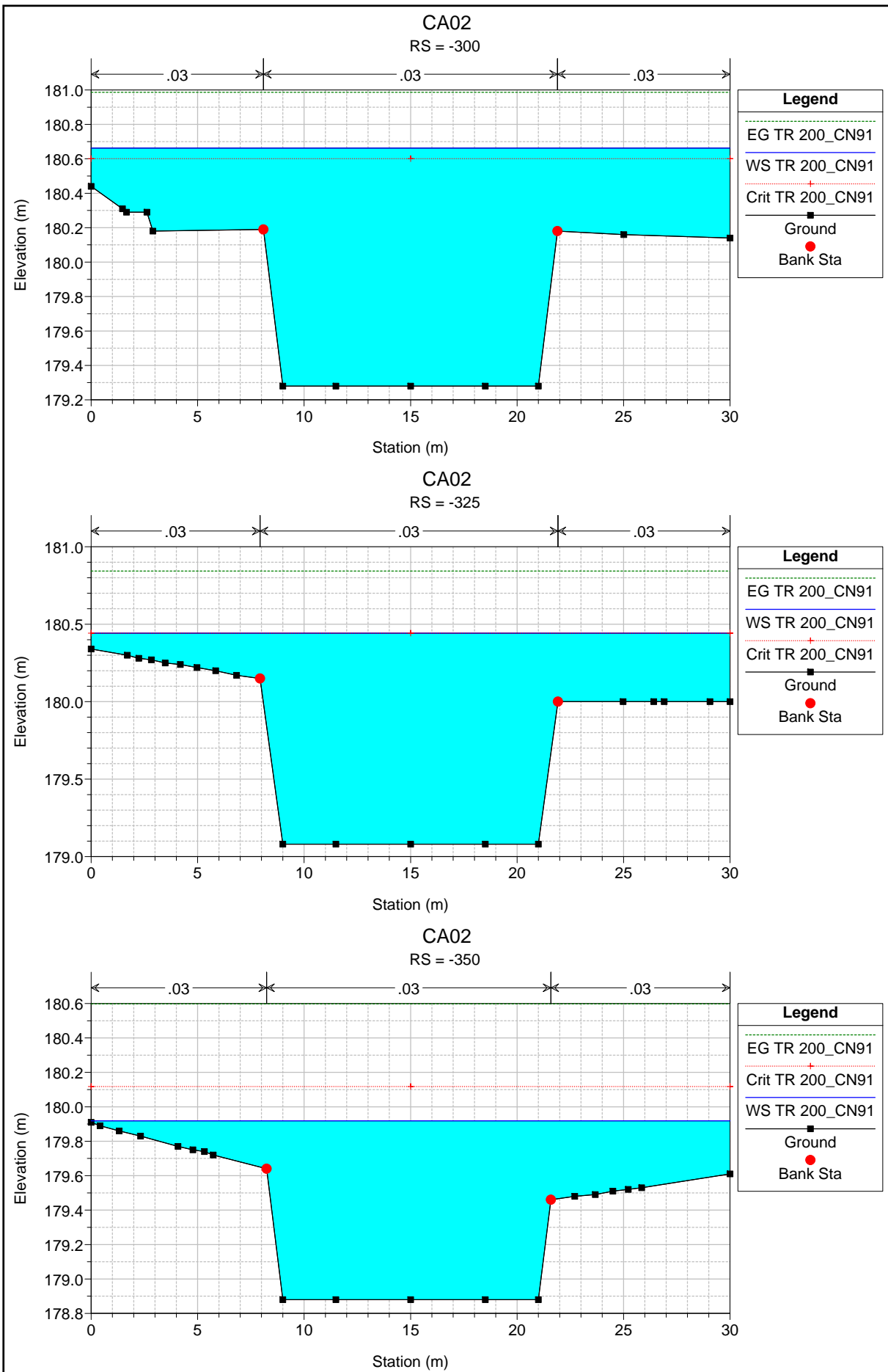

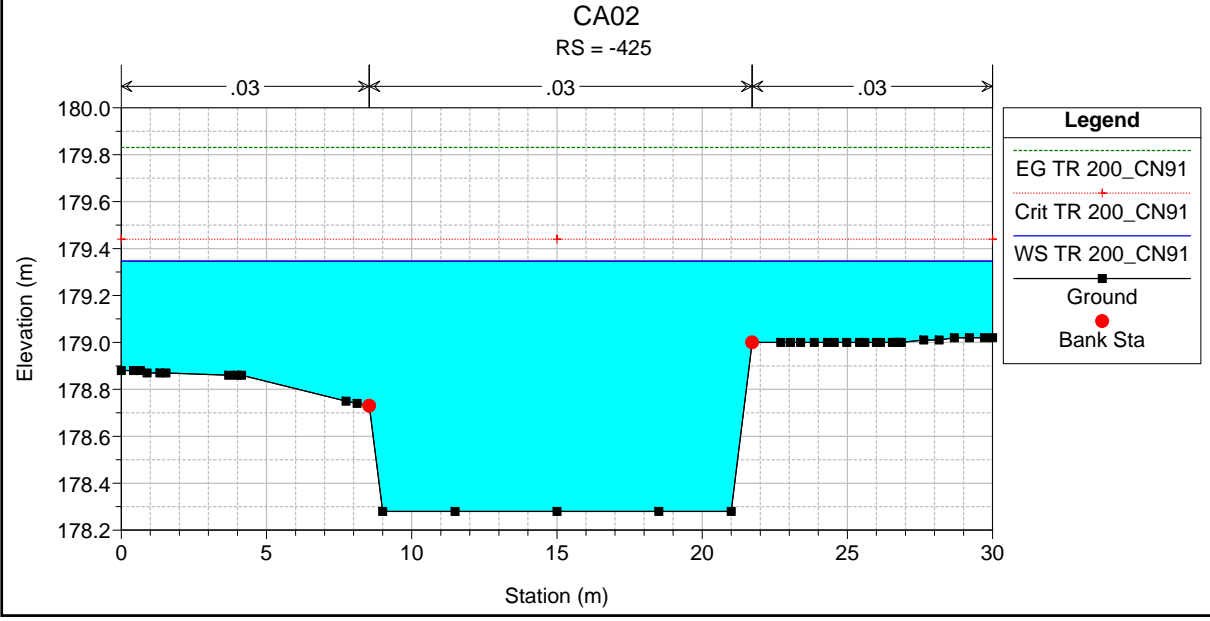
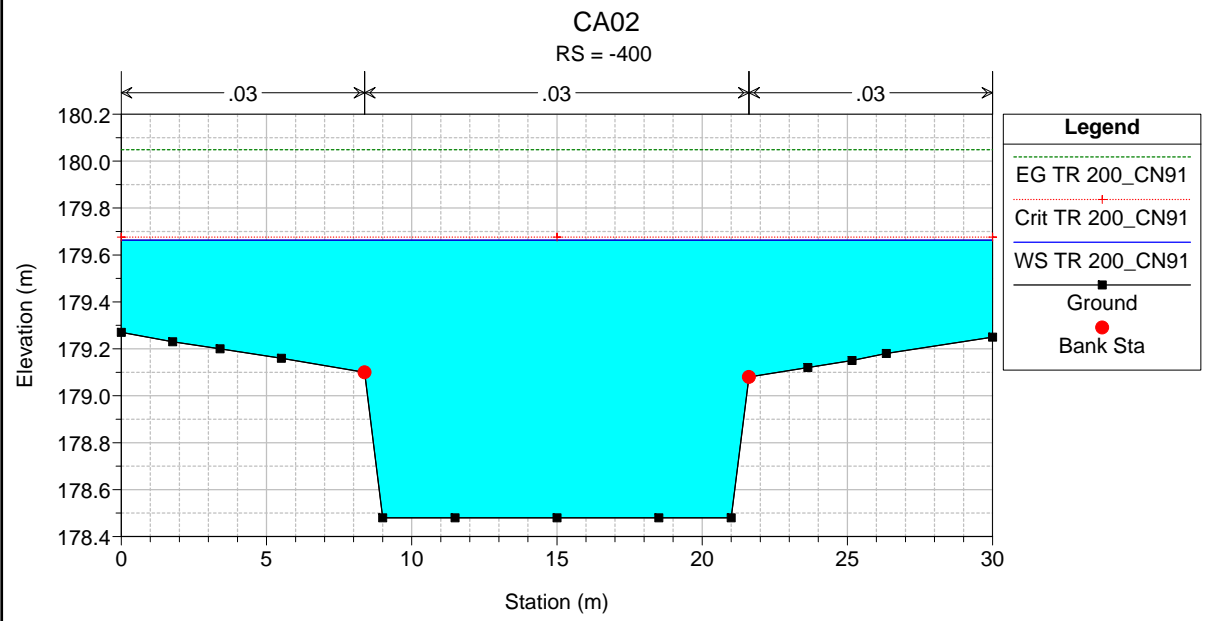
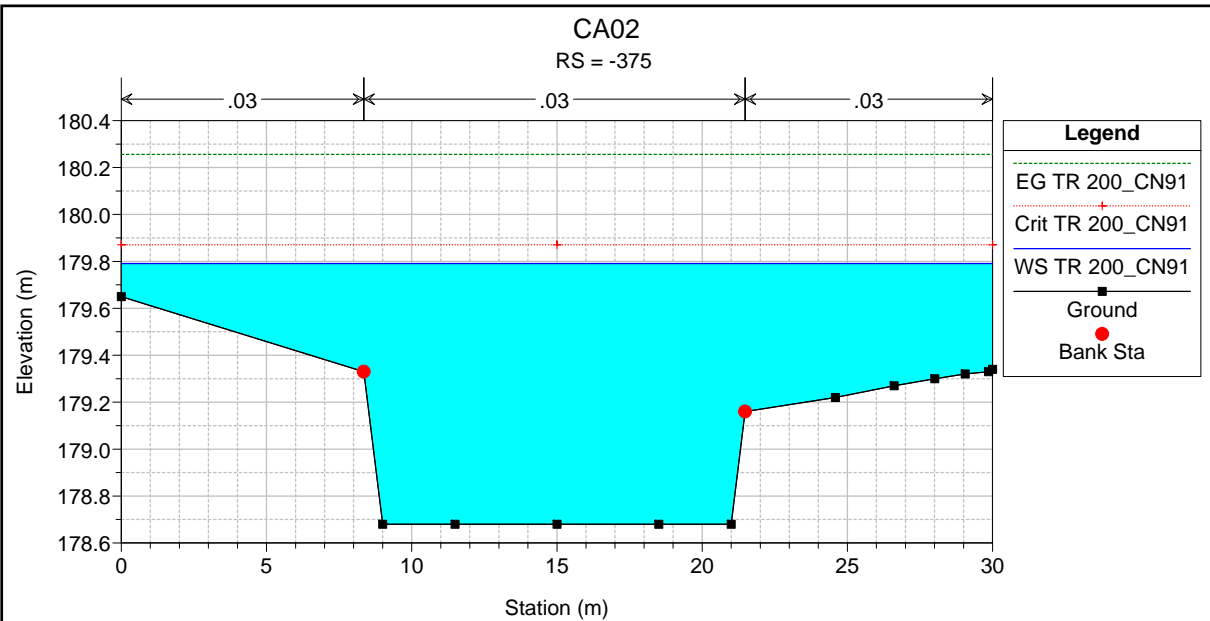

ALLEGATO 3

RISULTATI SIMULAZIONI MOTO VARIO PER LE VERIFICHE
ANTE-POST OPERAM DELLE INALVEAZIONI CRITICHE:

ALLEGATO 3.1

Interferenza idraulica - TO01:
Tabella riassuntiva dei risultati,
profilo idrico e sezioni trasversali con i livelli idrici (TR 200 anni)

ANTE

HEC-RAS Plan: T001_ANTE_VAR River: T001_ANTE Reach: T001_ANTE Profile: 13OCT2014 0031

Reach	River Sta	Profile	Q Total (m3/s)	Min Ch El (m)	Max Chl Dpth (m)	W.S. Elev (m)	Crit W.S. (m)	Diff	Froude # Chl	E.G. Elev (m)	Vel Chnl (m/s)	Vel Total (m/s)	Hydr Radius C (m)	Shear Chan (N/m2)	Hydr Depth (m)
T001_ANTE	-14.54	13OCT2014 0031	9.1	206.19	0.60	206.79	206.77	0.02	0.84	206.93	1.8	1.6	0.5	38.1	0.33
T001_ANTE	-25	13OCT2014 0031	8.8	205.93	0.91	206.85	206.44	0.41	0.28	206.87	0.8	0.7	0.9	6.3	0.53
T001_ANTE	-50	13OCT2014 0031	7.7	205.00	1.86	206.86	205.61	1.25	0.06	206.87	0.3	0.2	1.7	0.5	1.02
T001_ANTE	-75	13OCT2014 0031	6.5	204.79	2.08	206.87			0.02	206.87	0.1	0.1	1.2	0.1	1.41
T001_ANTE	-90			Culvert											
T001_ANTE	-105	13OCT2014 0031	6.5	204.64	2.21	206.86	205.17	1.69	0.04	206.86	0.2	0.2	2.0	0.3	1.32
T001_ANTE	-125	13OCT2014 0031	5.6	202.97	3.89	206.86	203.36	3.50	0.01	206.86	0.0	0.0	3.5	0.0	3.23
T001_ANTE	-156.8	13OCT2014 0031	4.1	202.62	4.24	206.86			0.01	206.86	0.0	0.0	4.1	0.0	3.25
T001_ANTE	-187.3			Culvert											
T001_ANTE	-217.8	13OCT2014 0031	4.1	201.17	0.58	201.74	201.81	-0.07	1.29	201.99	2.2	2.1	0.3	66.9	0.26
T001_ANTE	-250	13OCT2014 0031	4.1	200.16	1.44	201.61	200.97	0.64	0.20	201.62	0.6	0.6	0.8	3.1	0.84
T001_ANTE	-275	13OCT2014 0031	4.0	199.55	2.06	201.61	200.25	1.36	0.05	201.62	0.2	0.2	0.8	0.3	1.29
T001_ANTE	-295.8	13OCT2014 0031	4.0	199.92	1.69	201.61			0.06	201.62	0.3	0.2	1.6	0.5	0.91
T001_ANTE	-341.20			Culvert											
T001_ANTE	-386.6	13OCT2014 0031	4.0	198.02	0.68	198.71	198.92	-0.21	1.95	199.37	3.6	3.6	0.3	169.2	0.35
T001_ANTE	-400	13OCT2014 0031	4.0	197.69	0.47	198.05	198.13	-0.08	1.34	198.23	1.9	1.8	0.2	54.7	0.13
T001_ANTE	-425	13OCT2014 0031	4.0	197.13	0.21	197.21	197.24	-0.03	1.22	197.31	0.9	1.3	0.1	19.1	0.10
T001_ANTE	-450	13OCT2014 0031	4.0	195.84	0.33	196.18	196.20	-0.02	1.05	196.30	1.7	1.4	0.3	38.4	0.16
T001_ANTE	-475	13OCT2014 0031	11.3	195.00	0.69	195.69	195.82	-0.13	1.67	196.13	3.6	2.4	0.4	150.1	0.18
T001_ANTE	-500	13OCT2014 0031	11.3	194.28	0.51	194.79	194.90	-0.11	1.46	195.13	3.0	2.3	0.4	103.1	0.24
T001_ANTE	-525	13OCT2014 0031	11.3	193.58	0.61	194.19	194.27	-0.08	1.20	194.47	2.7	2.1	0.5	80.0	0.28
T001_ANTE	-550	13OCT2014 0031	11.3	193.23	0.55	193.78	193.83	-0.05	1.10	194.00	2.4	1.9	0.5	63.3	0.29
T001_ANTE	-575	13OCT2014 0031	11.3	192.66	0.74	193.40	193.43	-0.03	0.97	193.57	2.0	1.6	0.4	47.4	0.26
T001_ANTE	-602.6	13OCT2014 0031	11.2	192.21	1.13	193.33			0.37	193.37	1.0	0.8	0.8	10.2	0.53
T001_ANTE	-613.8			Culvert											
T001_ANTE	-625	13OCT2014 0031	11.2	191.69	0.77	192.46	192.76	-0.30	1.77	193.21	3.8	3.8	0.3	182.1	0.33
T001_ANTE	-650	13OCT2014 0031	11.2	190.02	0.91	190.94	191.01	-0.07	1.22	191.27	2.6	2.6	0.4	76.9	0.46
T001_ANTE	-675	13OCT2014 0031	11.2	189.88	0.50	190.38	190.55	-0.17	1.71	190.90	3.3	3.0	0.4	133.6	0.28
T001_ANTE	-700	13OCT2014 0031	11.2	189.00	0.58	189.58	189.70	-0.12	1.42	189.95	3.0	2.4	0.4	102.3	0.23
T001_ANTE	-725	13OCT2014 0031	11.2	188.67	0.39	189.06	189.10	-0.04	1.18	189.26	2.2	1.9	0.3	58.7	0.28
T001_ANTE	-750	13OCT2014 0031	11.2	188.00	0.69	188.68	188.59	0.09	1.32	188.96	3.0	2.0	0.5	97.4	0.25
T001_ANTE	-775	13OCT2014 0031	11.2	187.52	0.78	188.29	188.37	-0.08	1.23	188.55	2.6	2.0	0.4	76.9	0.25
T001_ANTE	-800	13OCT2014 0031	11.2	186.96	0.86	187.82	187.97	-0.15	1.20	188.22	2.9	2.6	0.6	87.2	0.40
T001_ANTE	-825	13OCT2014 0031	11.2	186.51	0.87	187.37	187.56	-0.19	1.49	187.94	3.6	3.0	0.6	137.5	0.37
T001_ANTE	-850	13OCT2014 0031	11.2	186.00	0.83	186.83	187.01	-0.18	1.37	187.26	2.9	2.8	0.4	101.7	0.30
T001_ANTE	-866.56	13OCT2014 0031	11.1	185.70	0.60	186.30	186.33	-0.03	1.19	186.45	2.1	1.6	0.3	56.5	0.19

TO01

TO01_ANTE TO01_ANTE

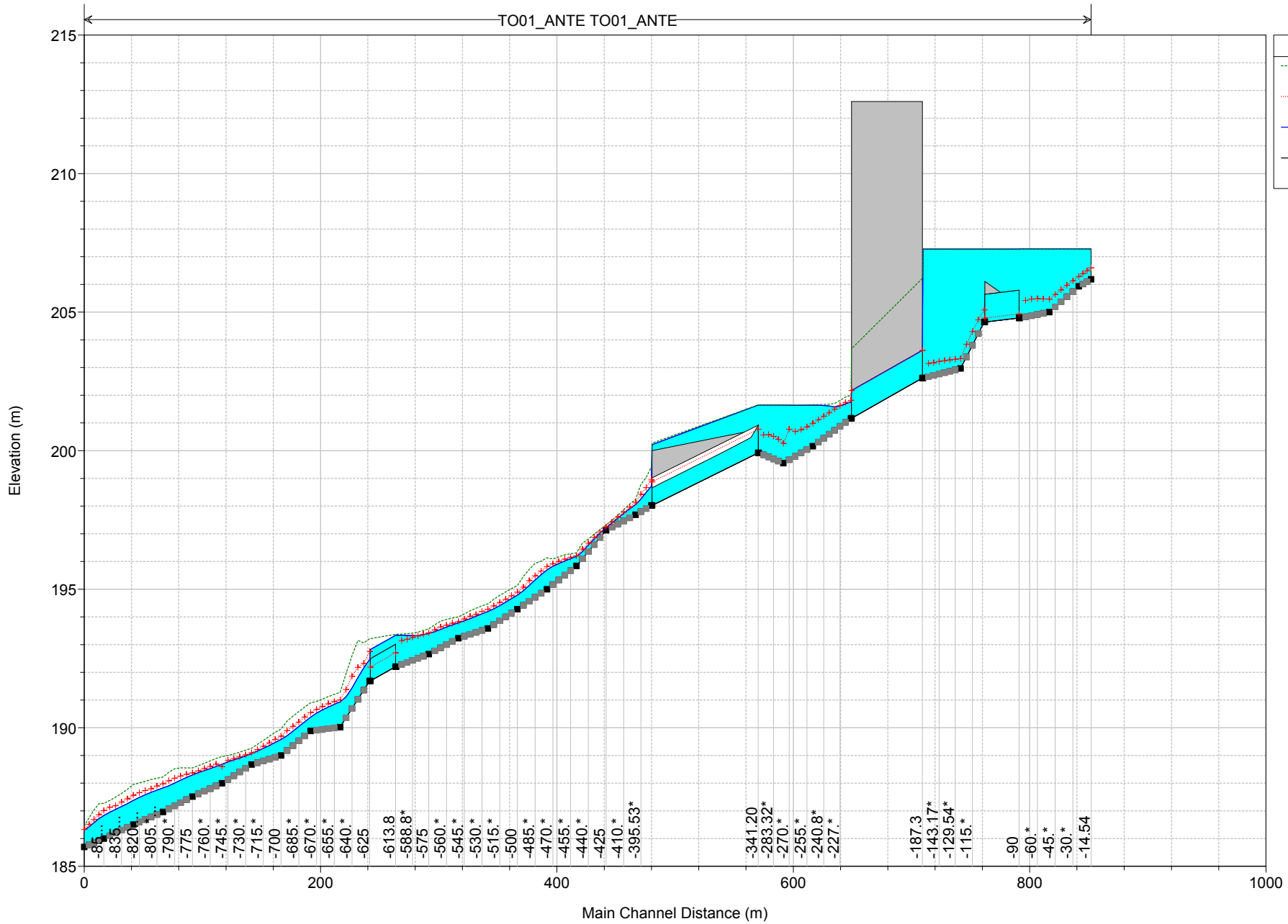

Legend	
EG Max WS	(Green dashed line)
Crit Max WS	(Red dotted line)
WS Max WS	(Blue solid line)
Ground	(Black solid line with square markers)

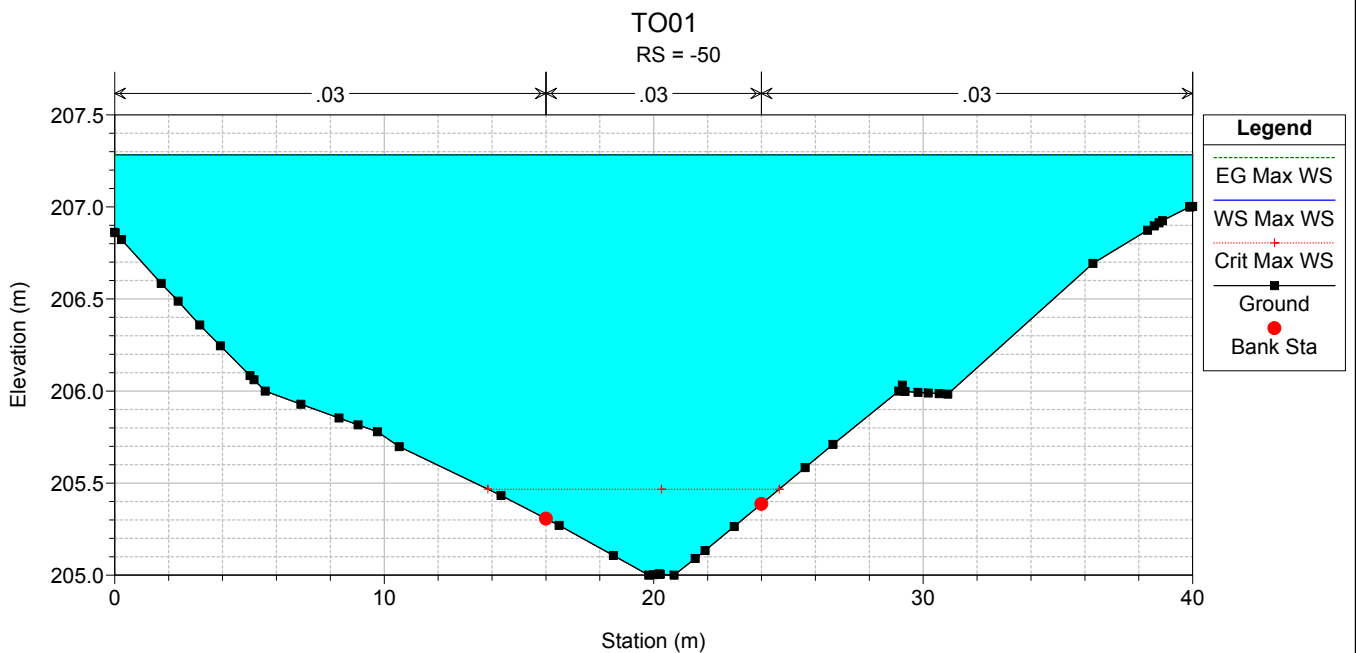
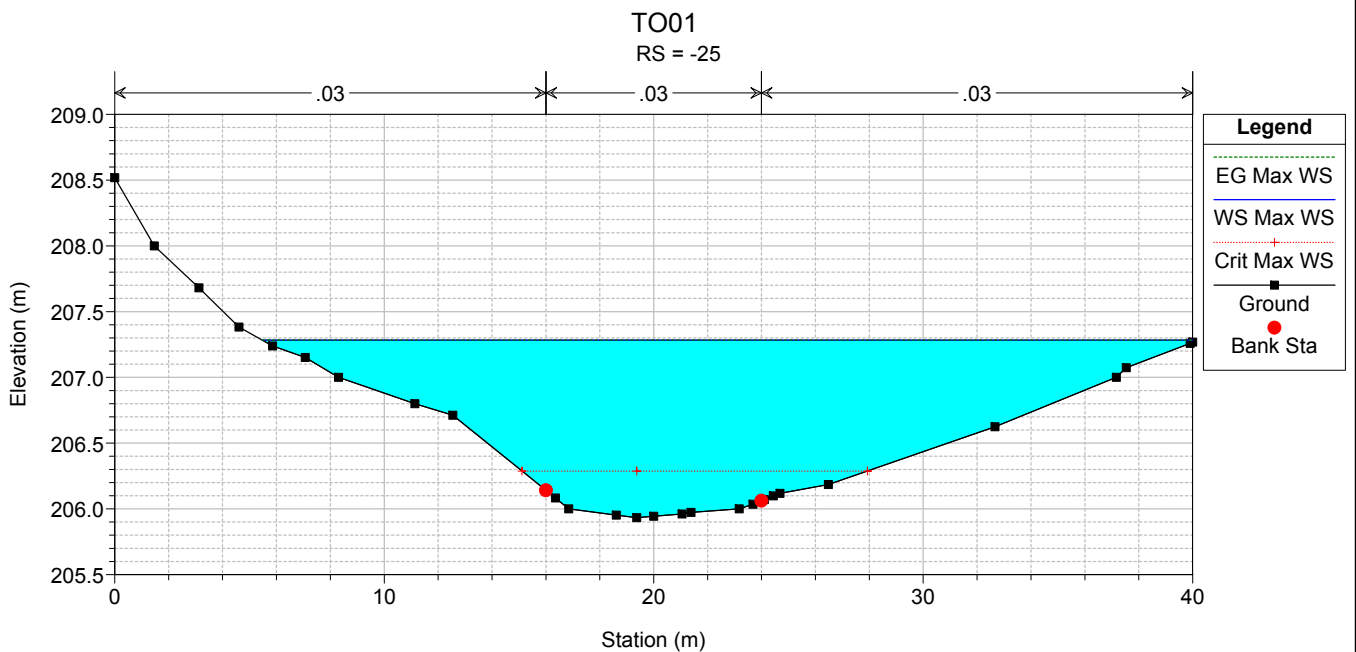
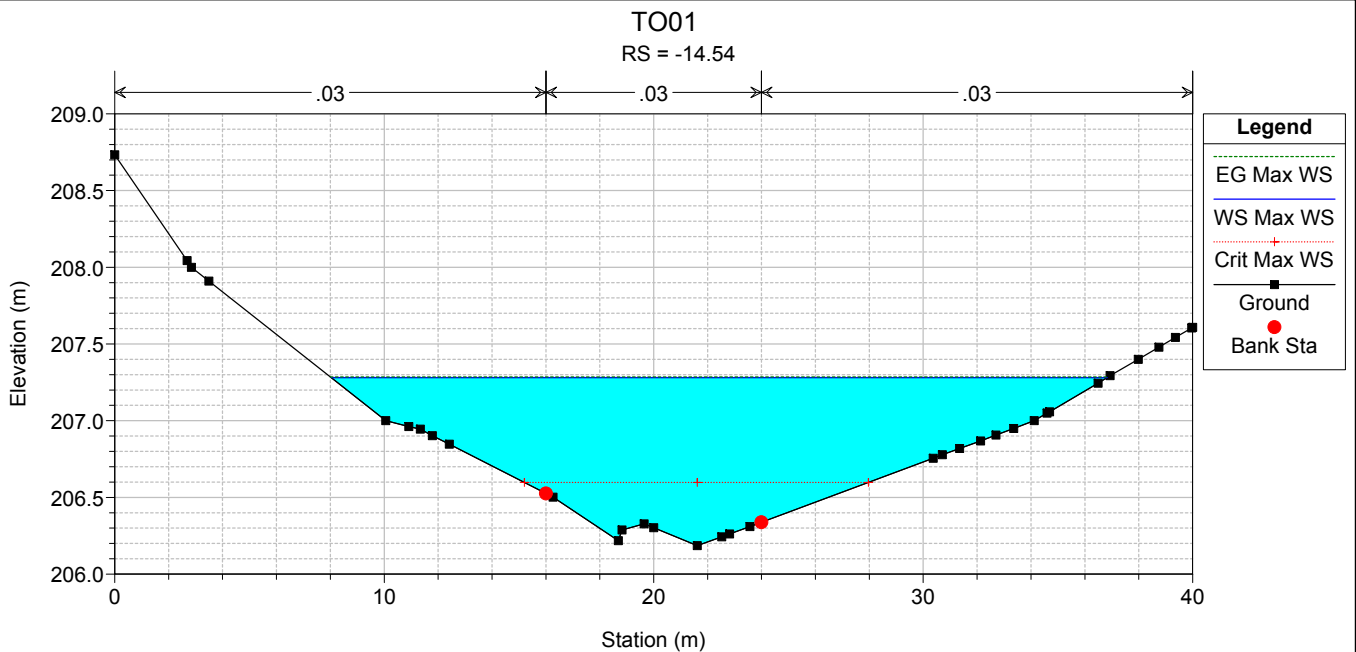

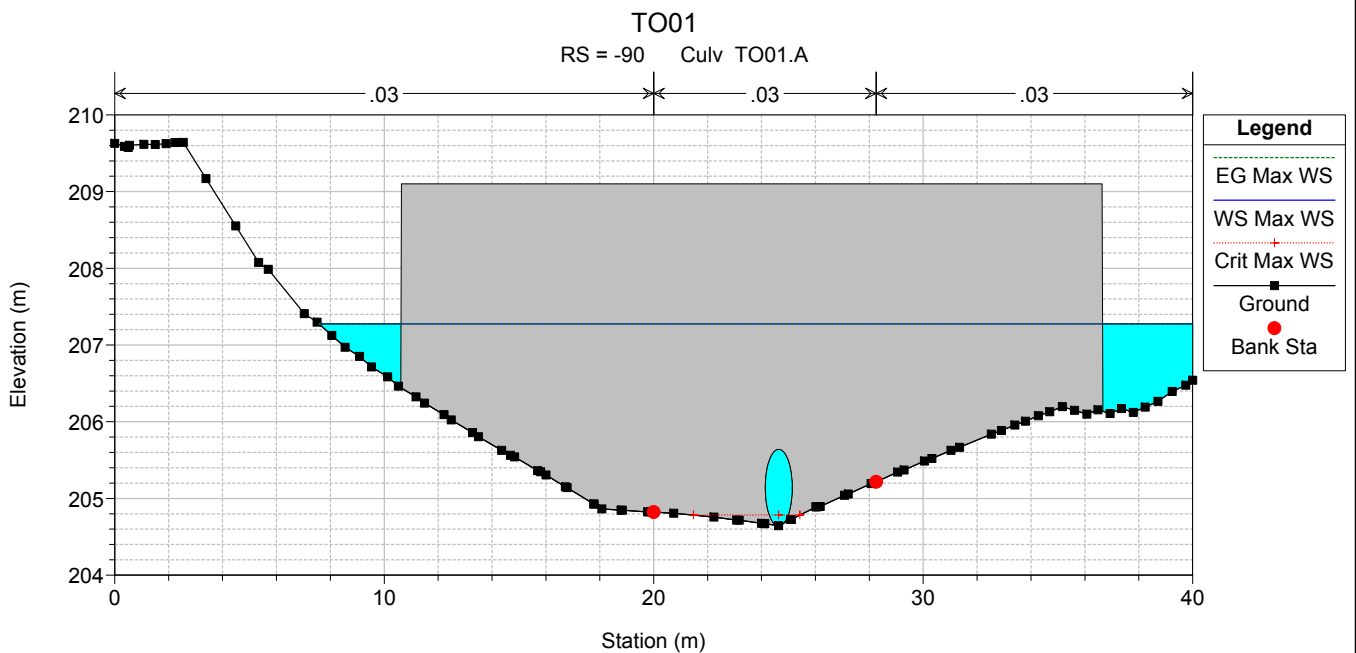
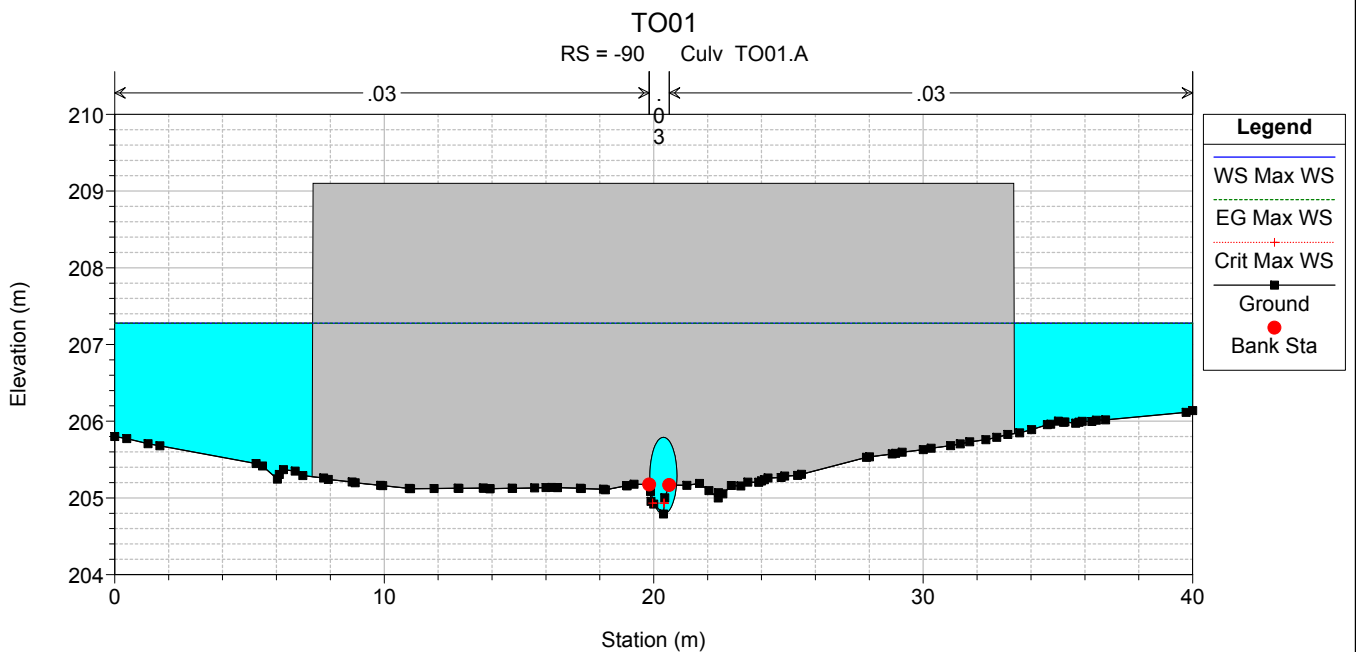
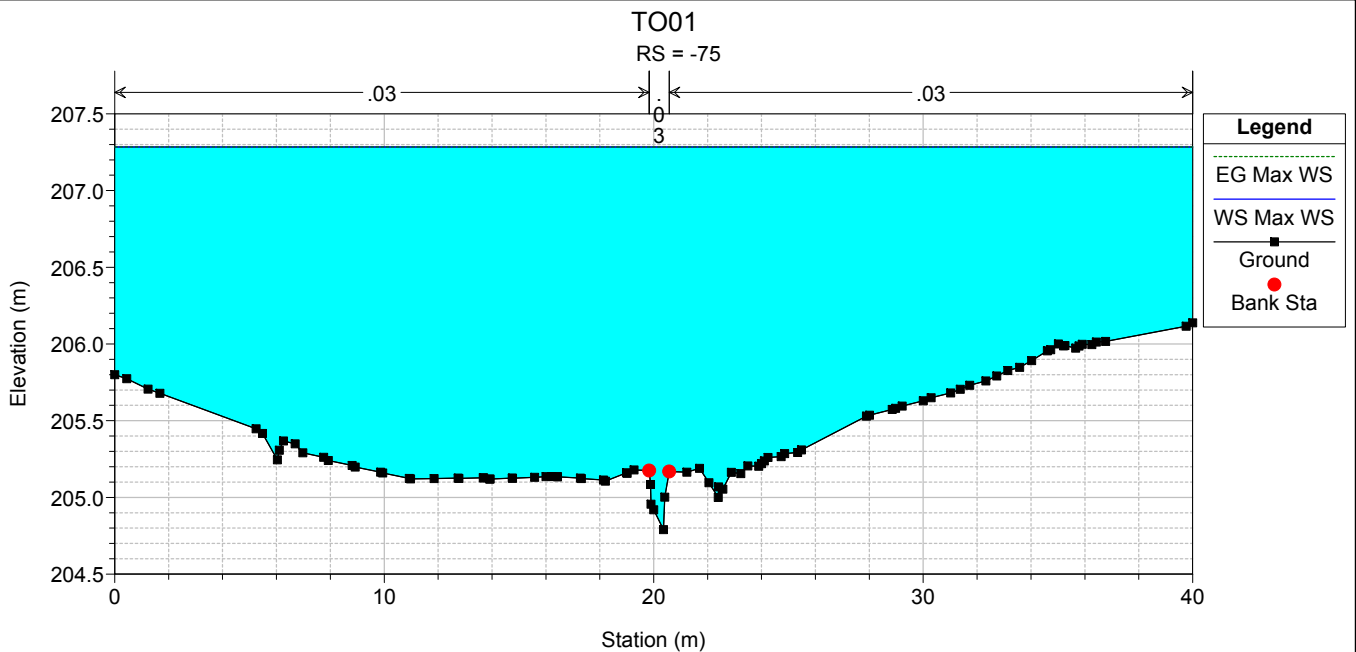

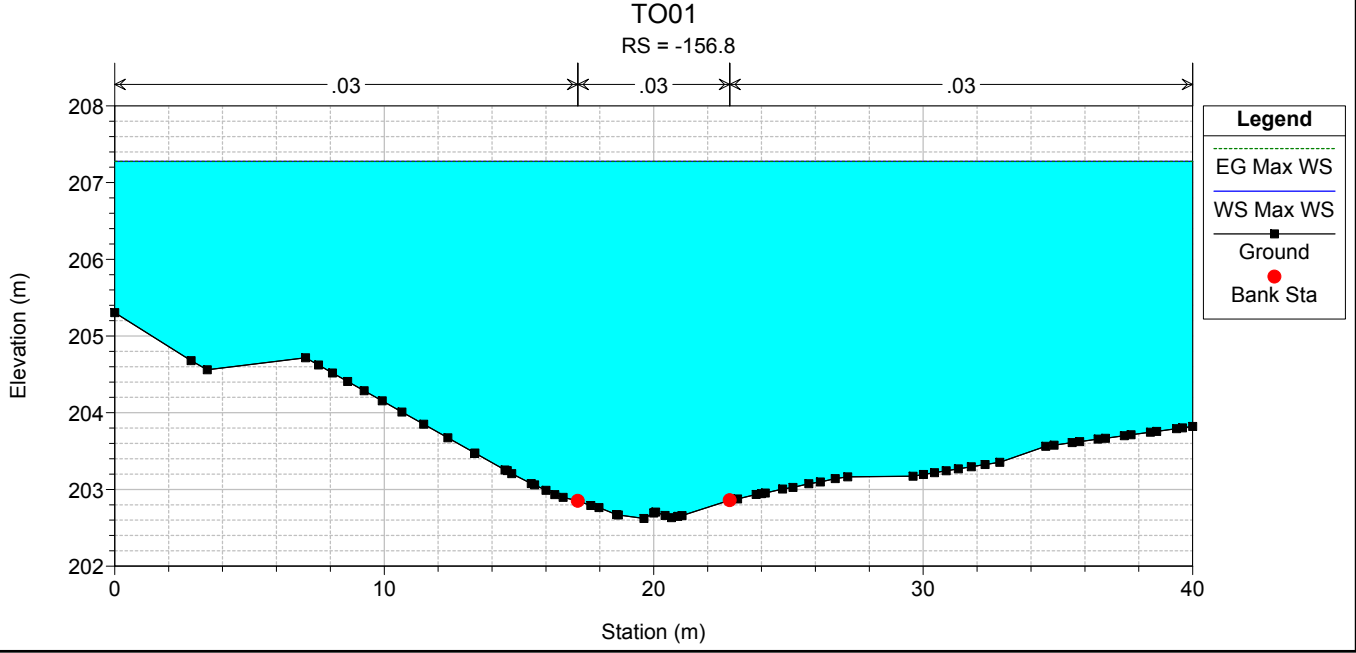
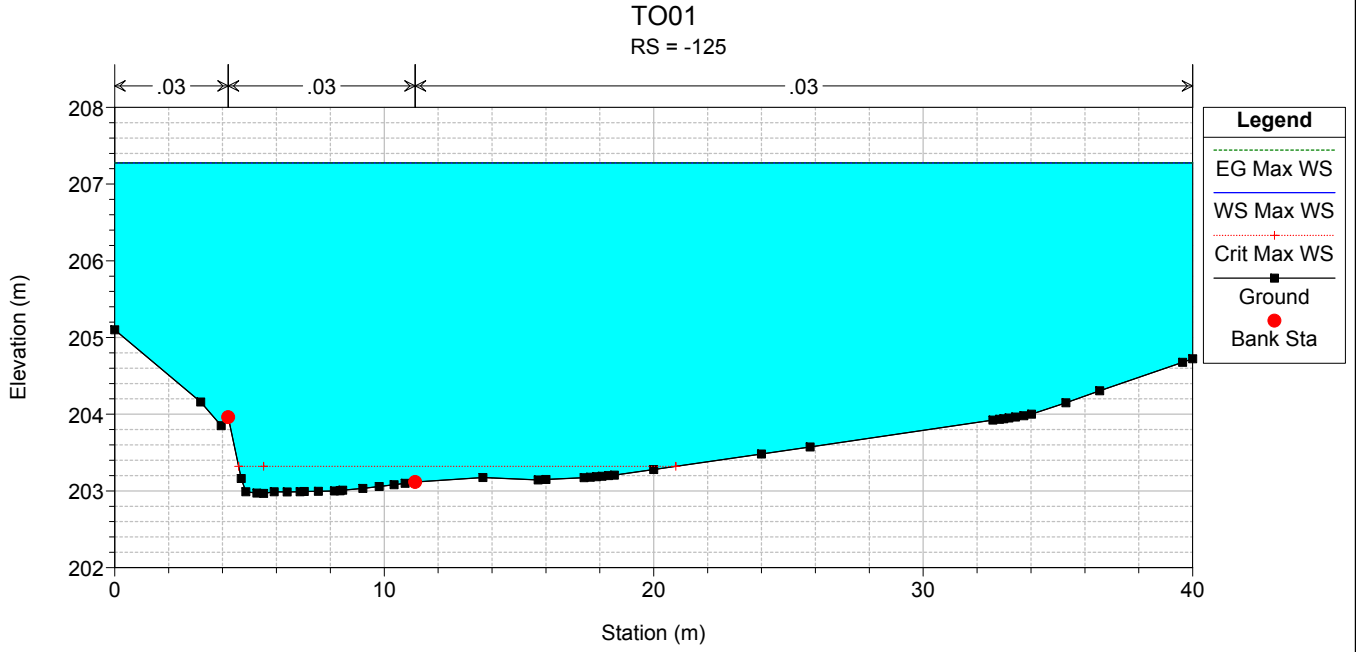
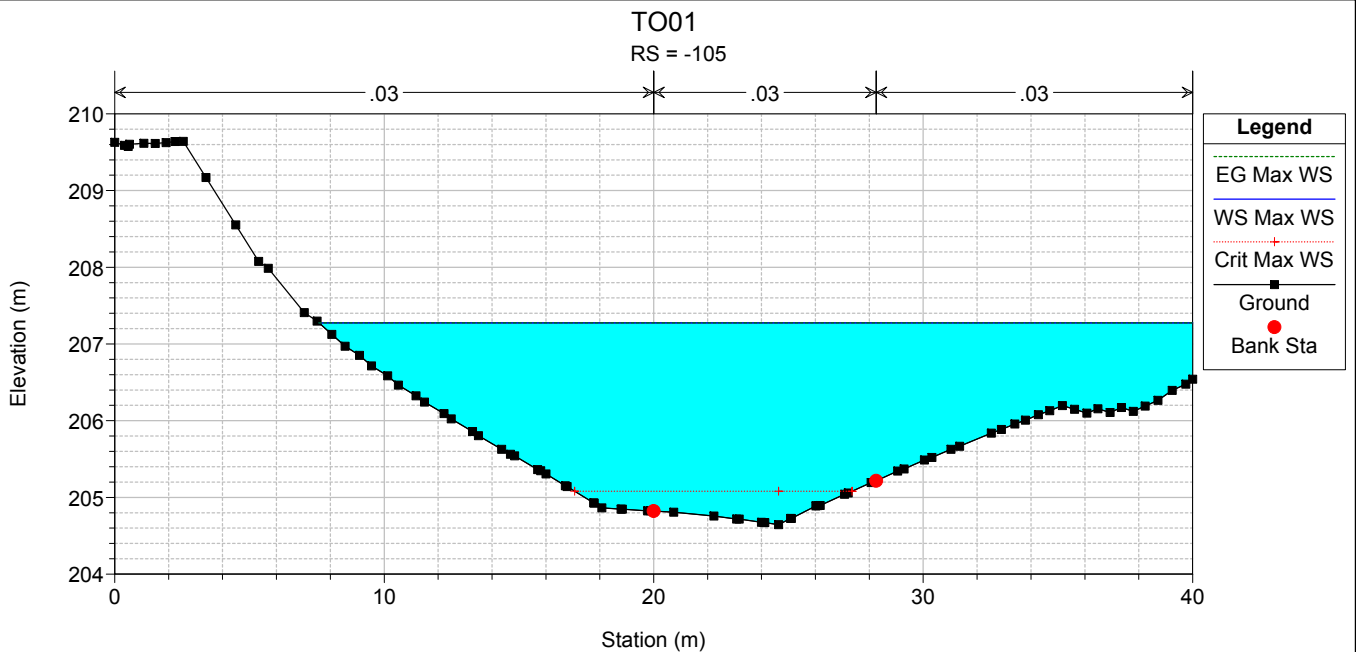

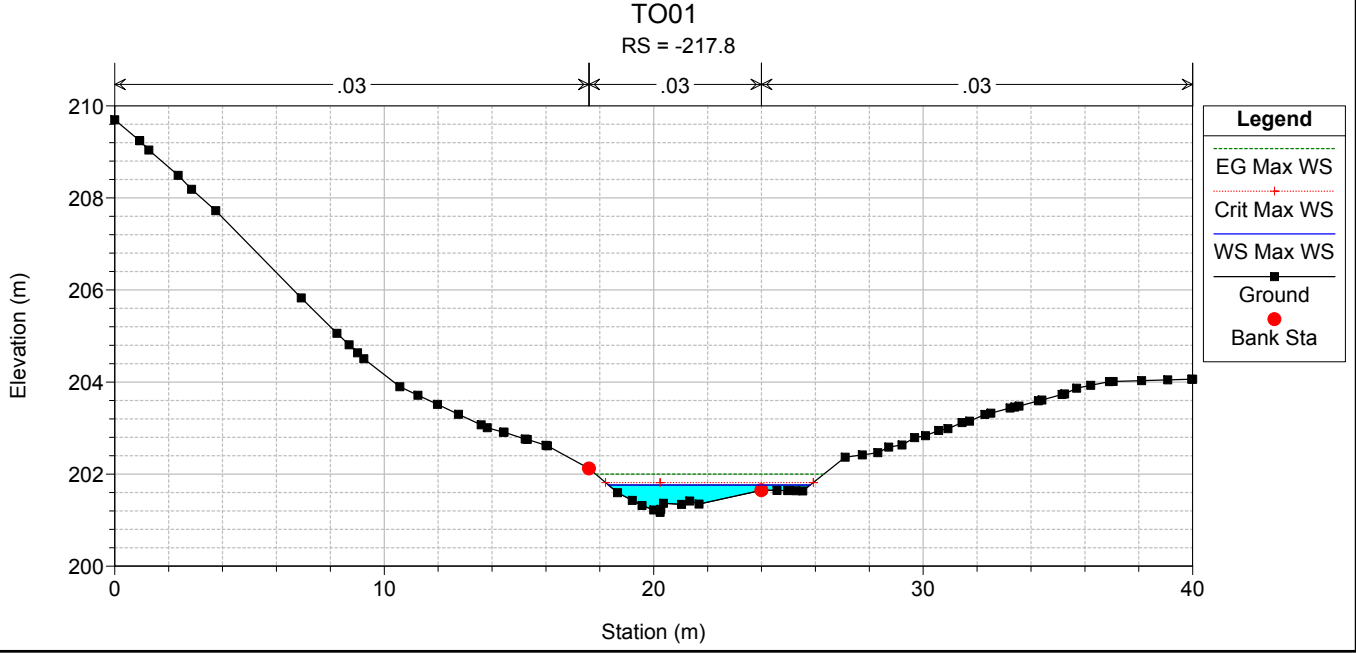
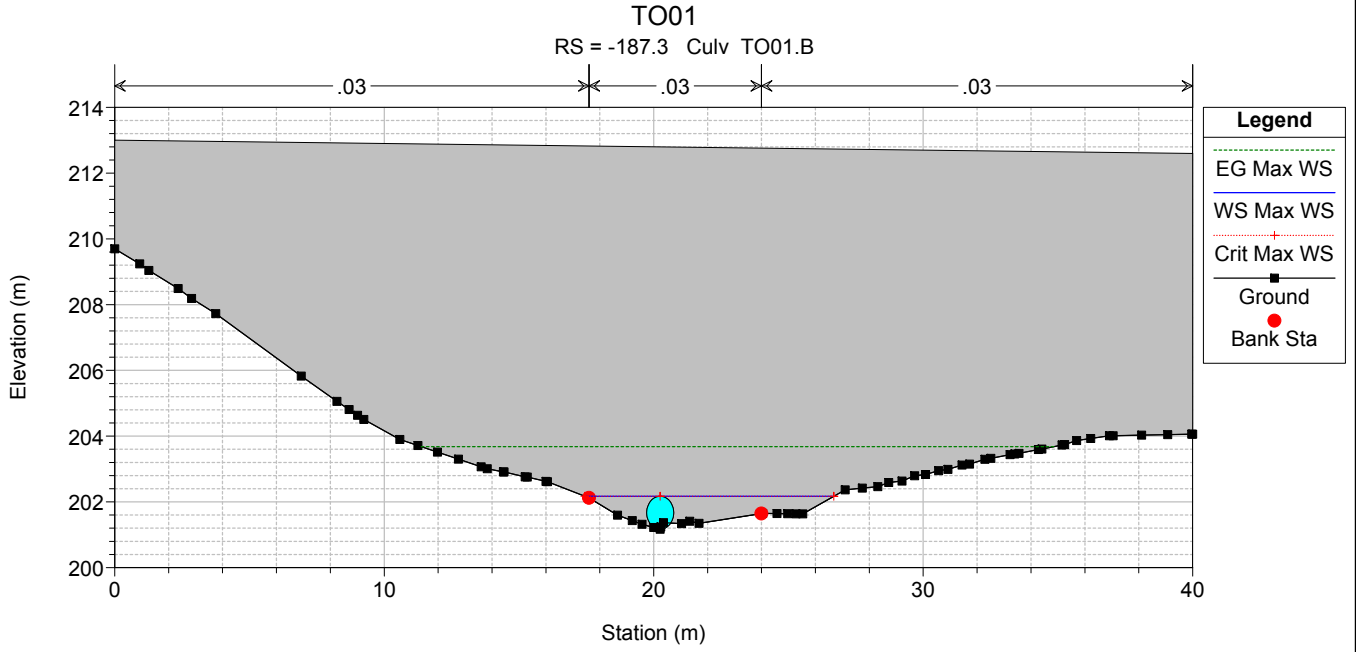
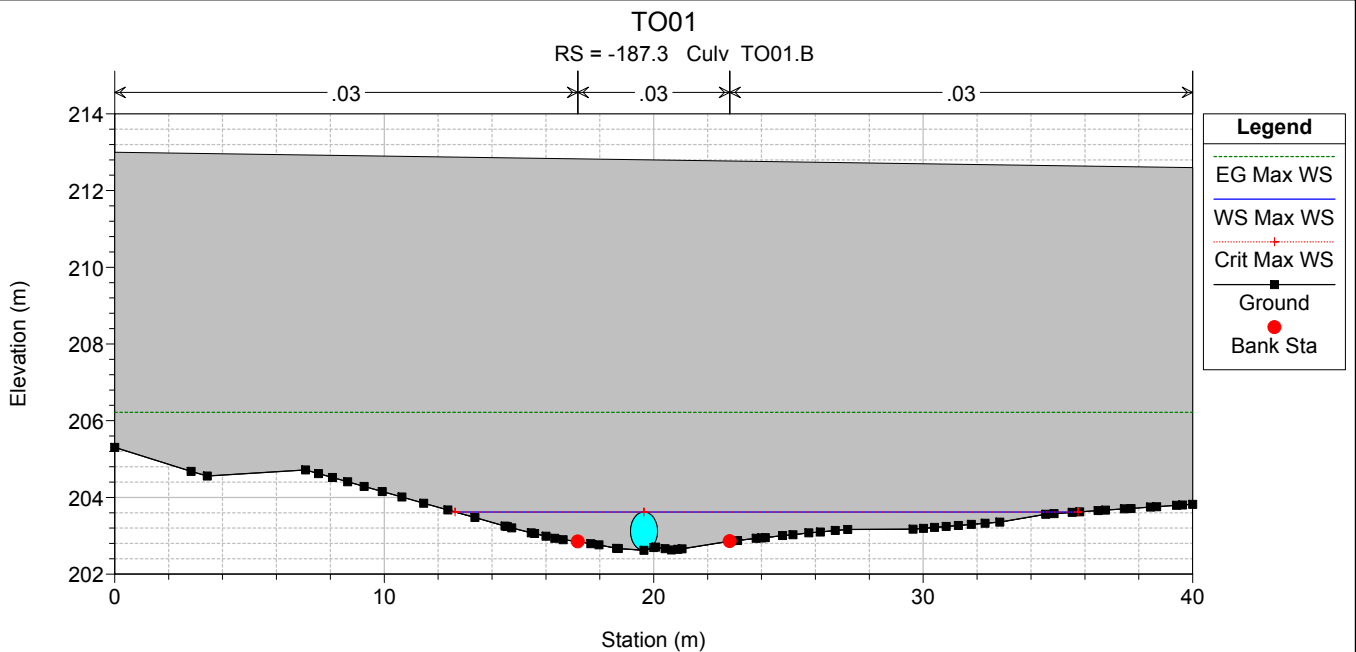

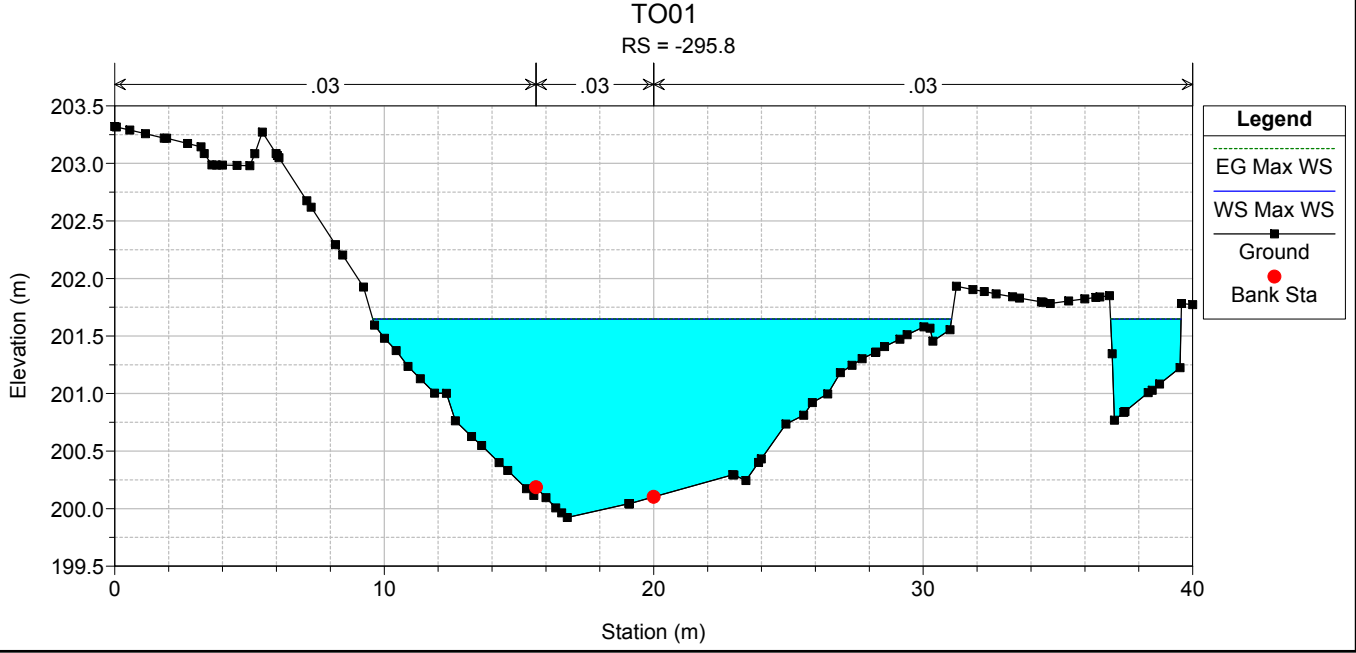
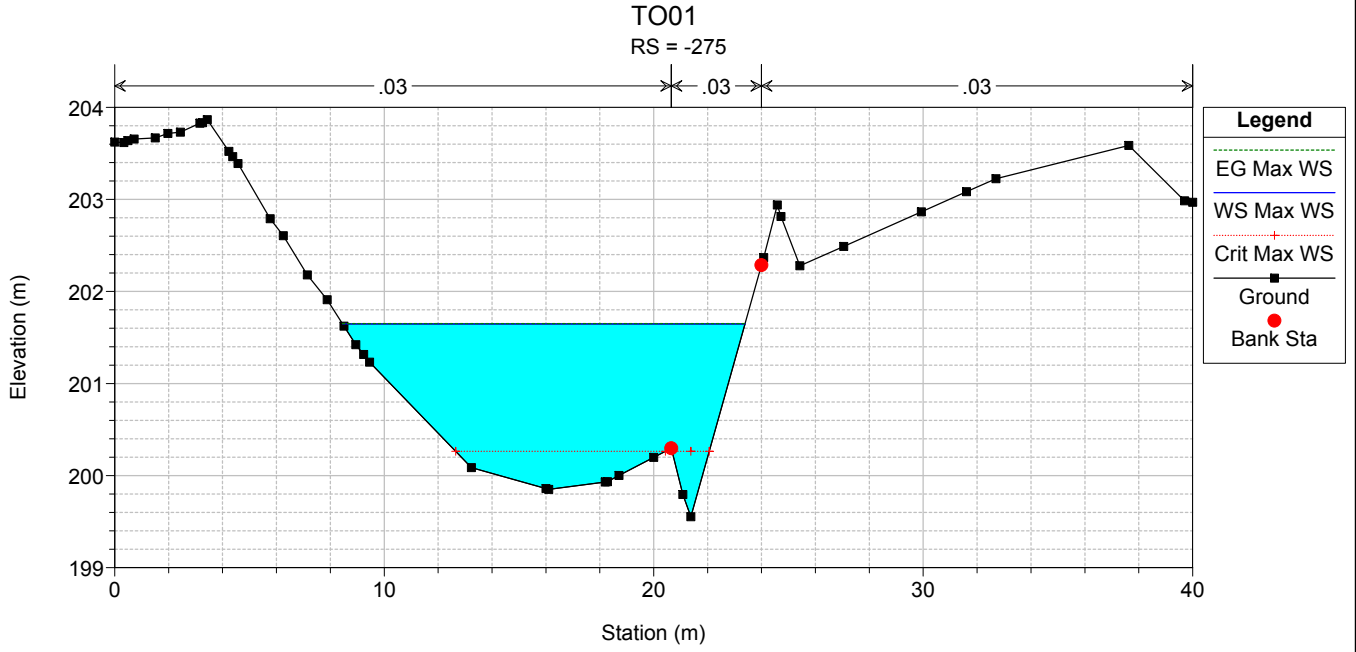
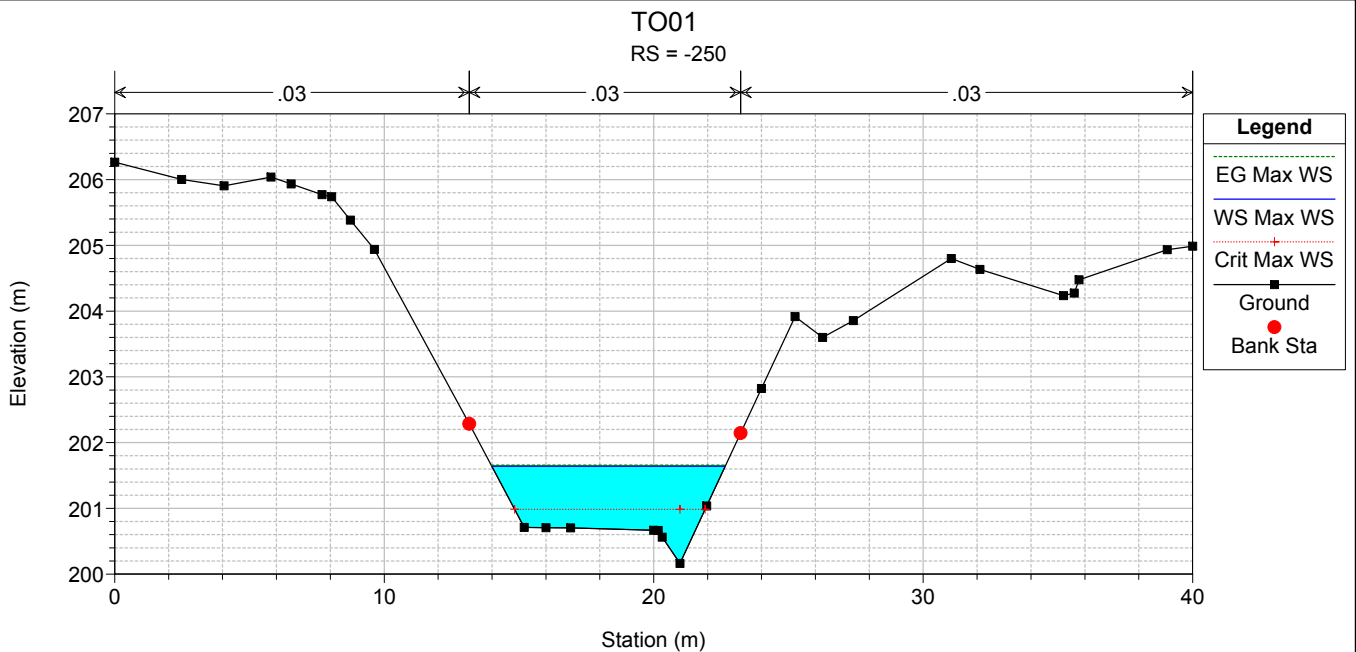

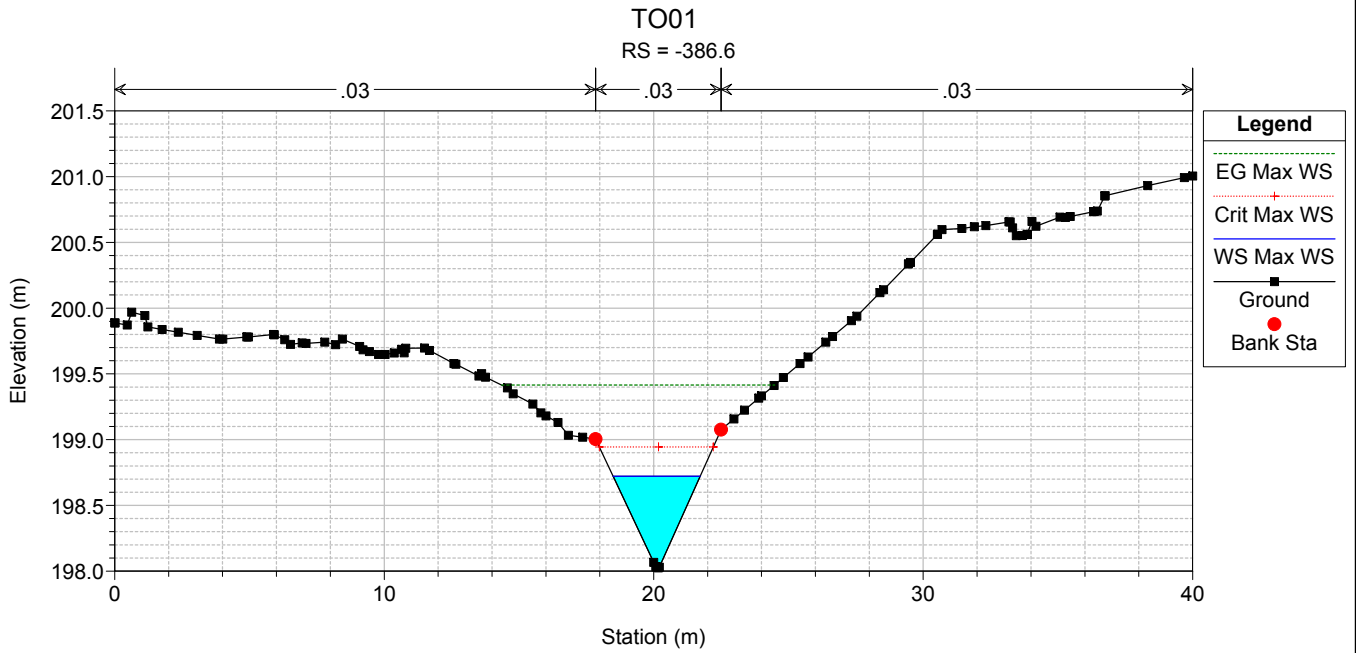
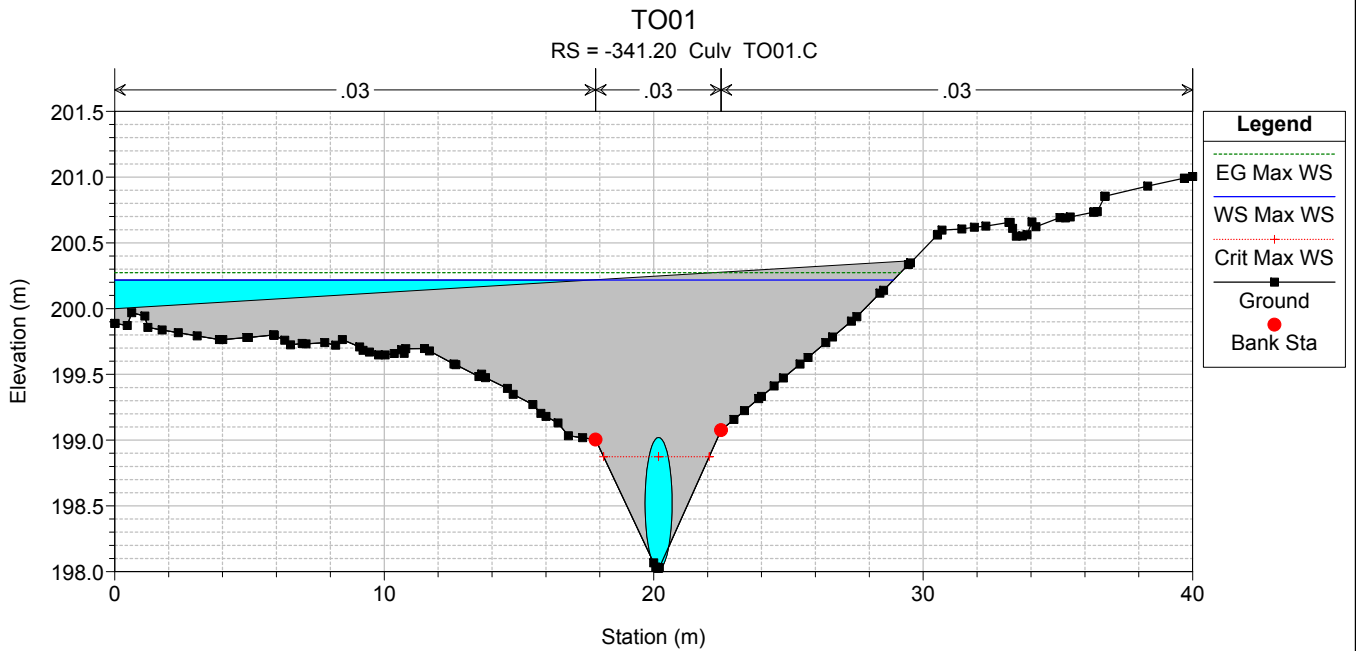
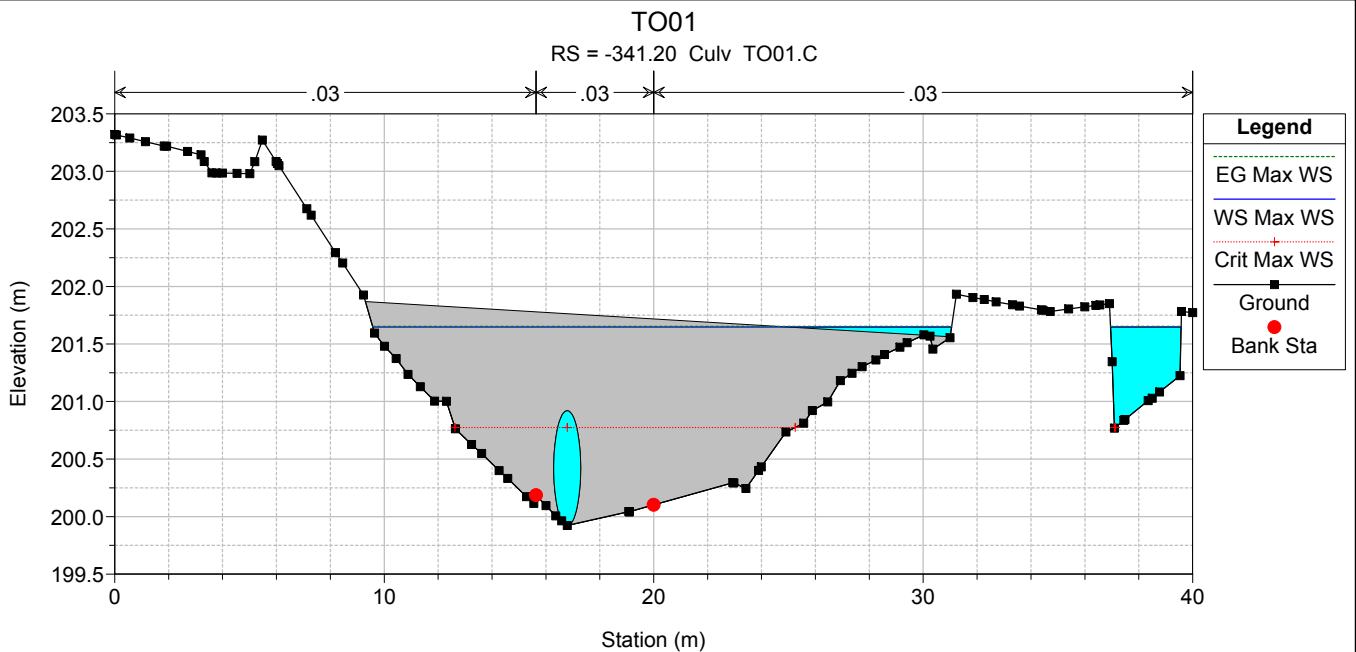

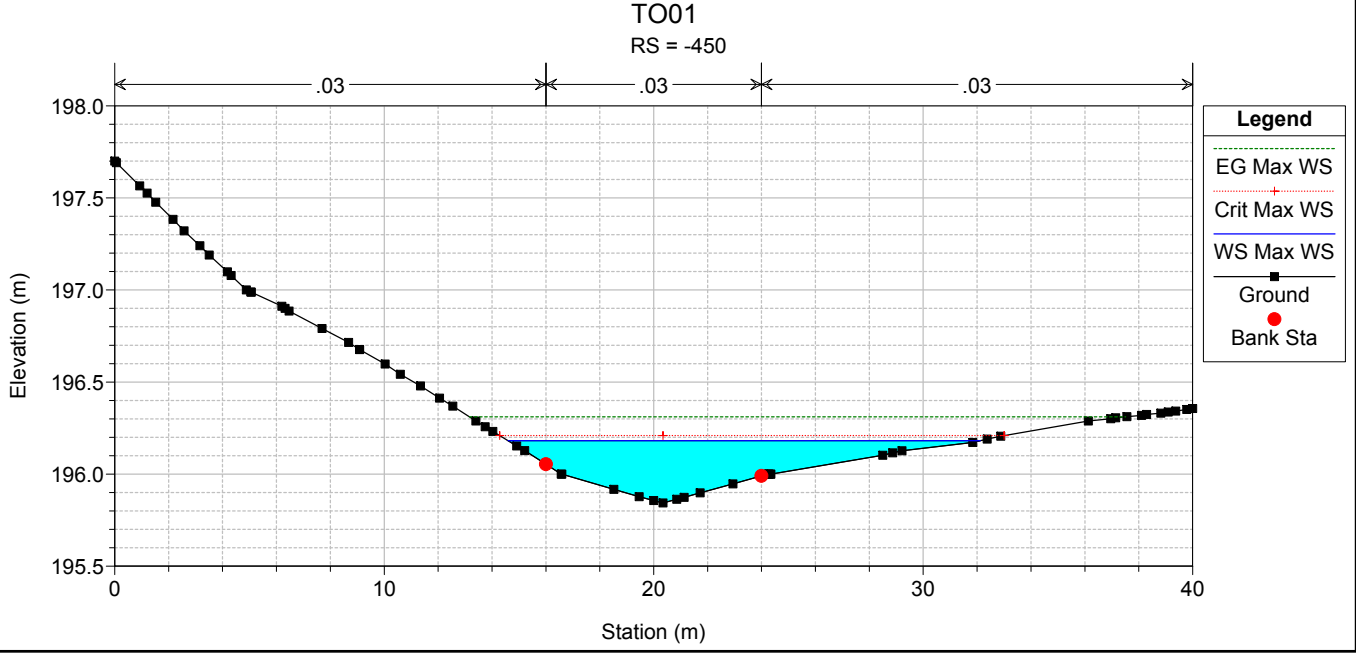
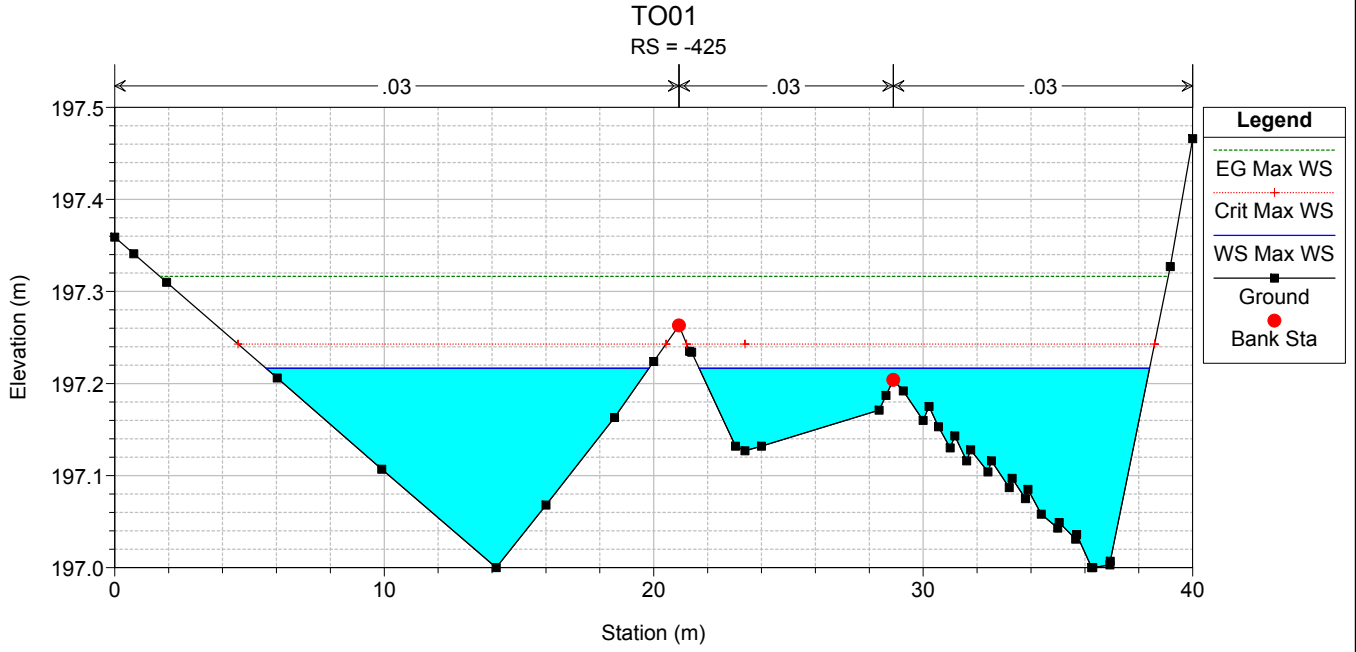
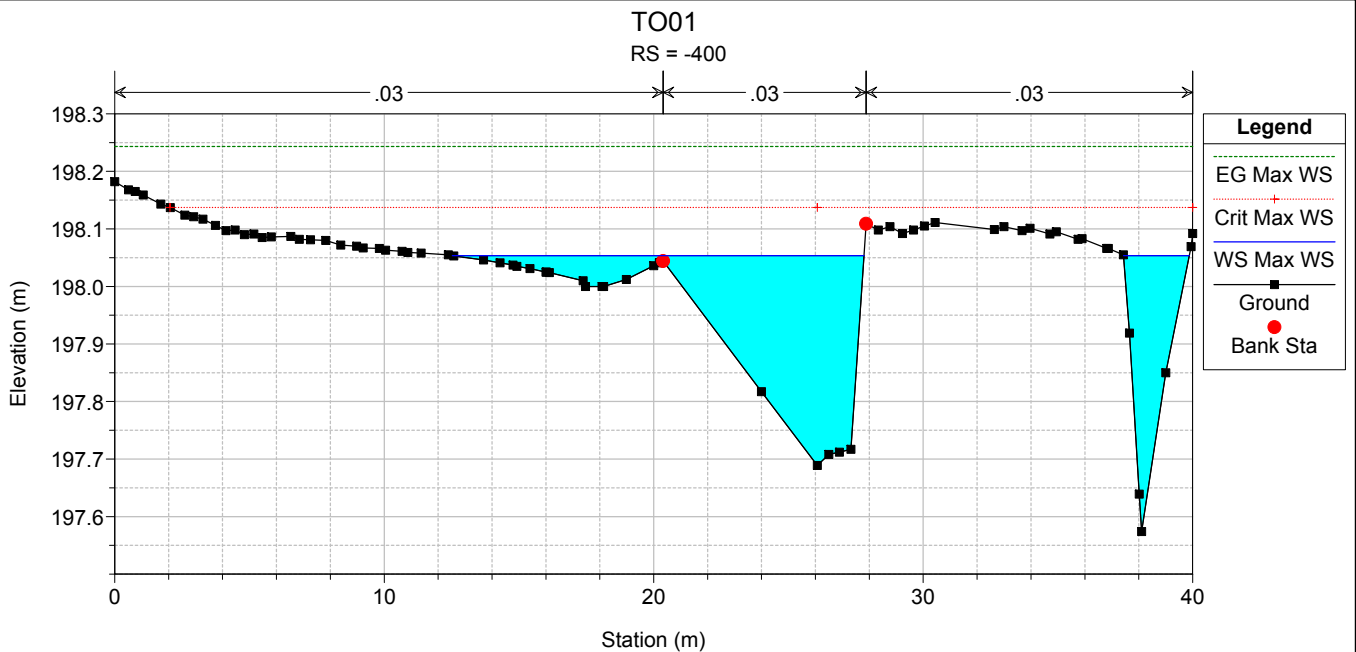

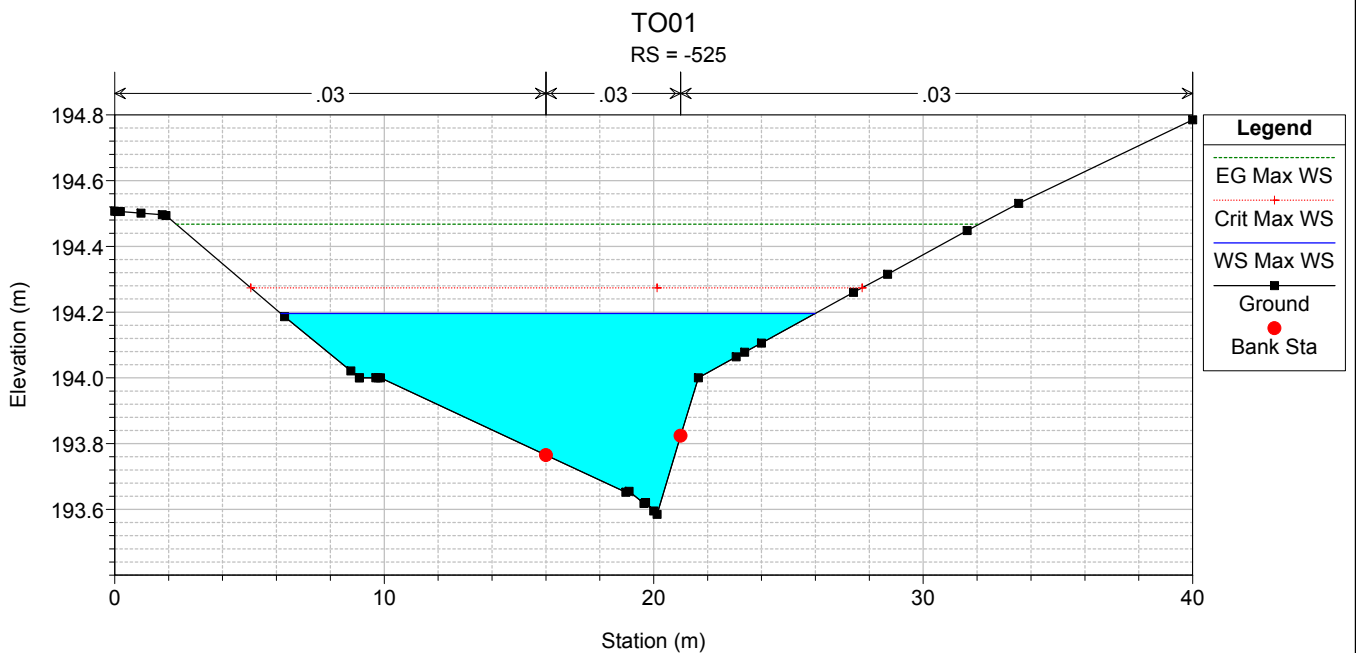
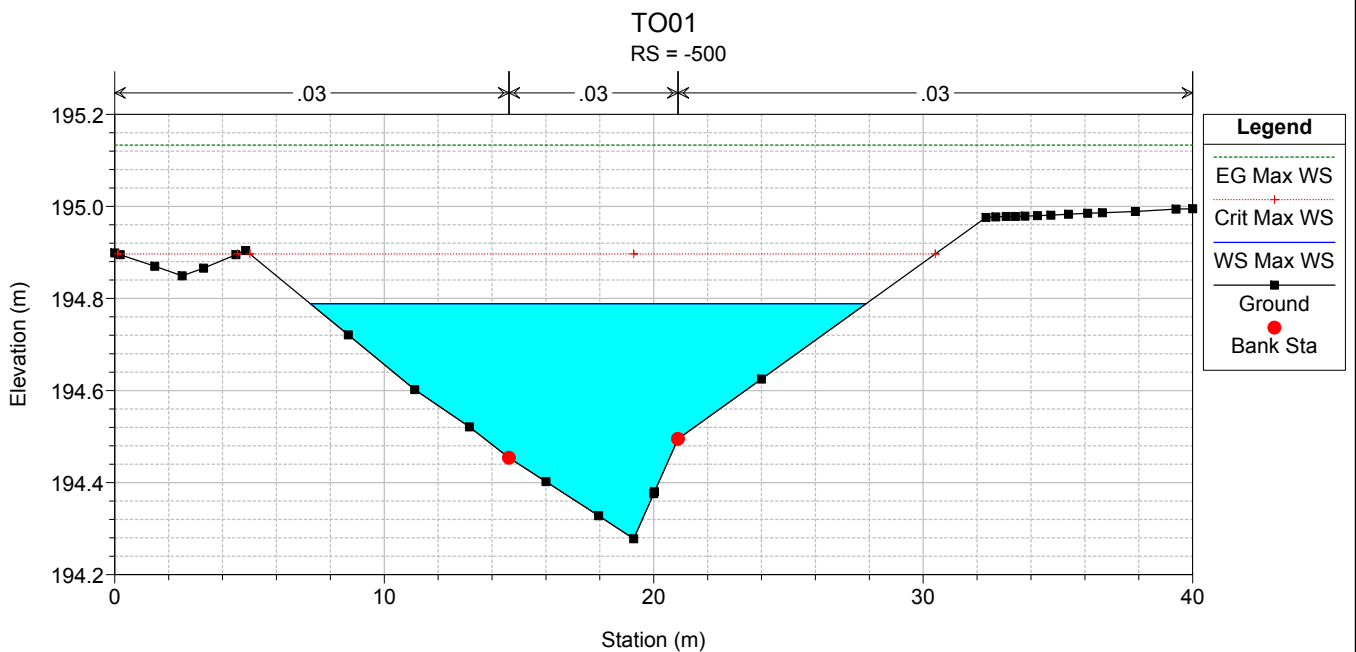
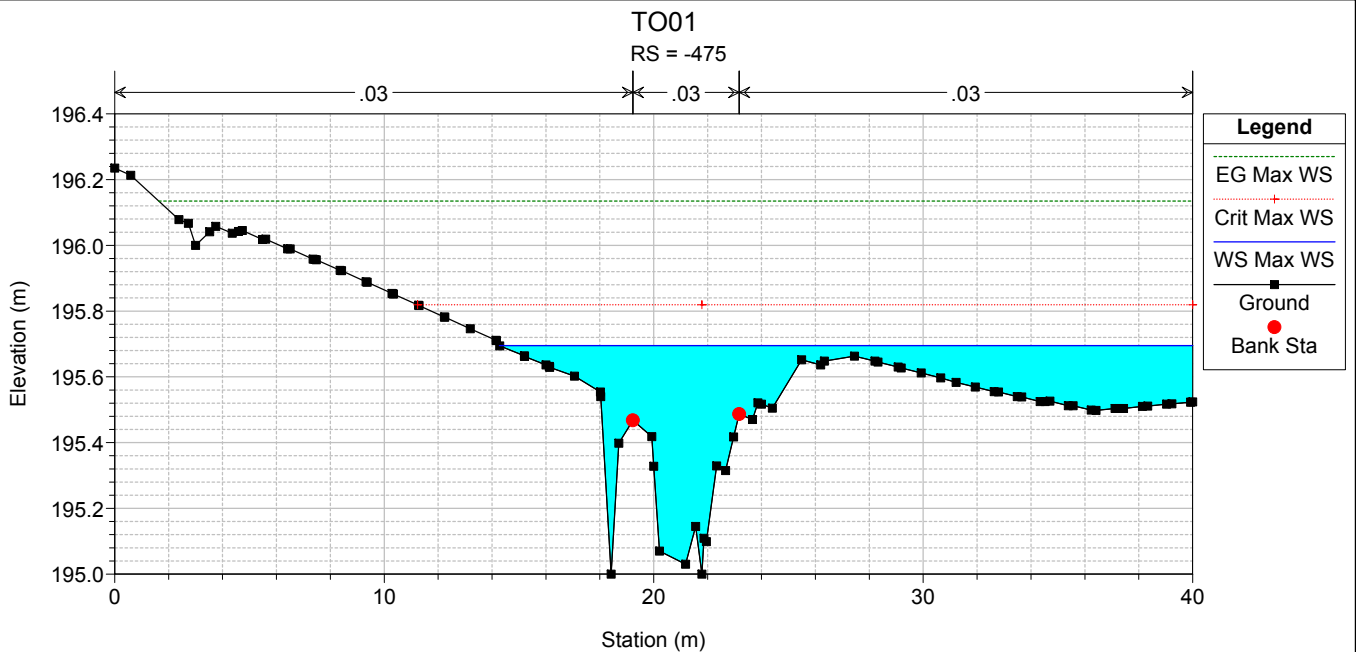

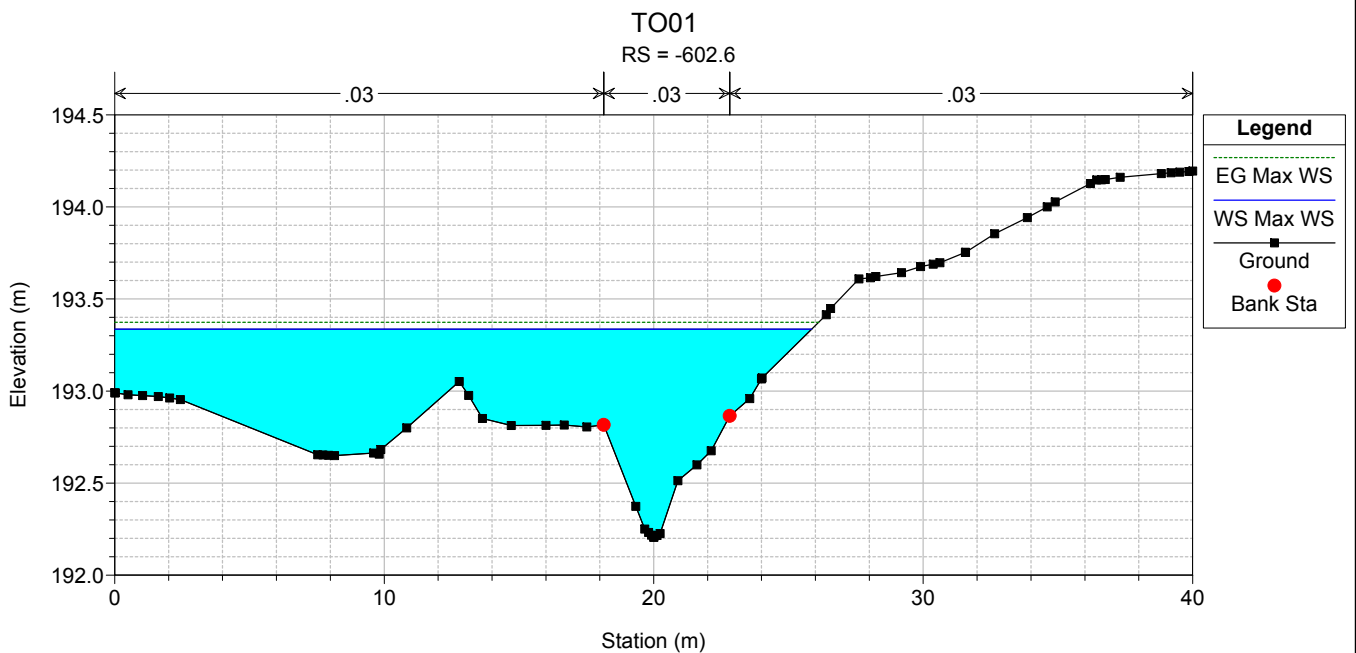
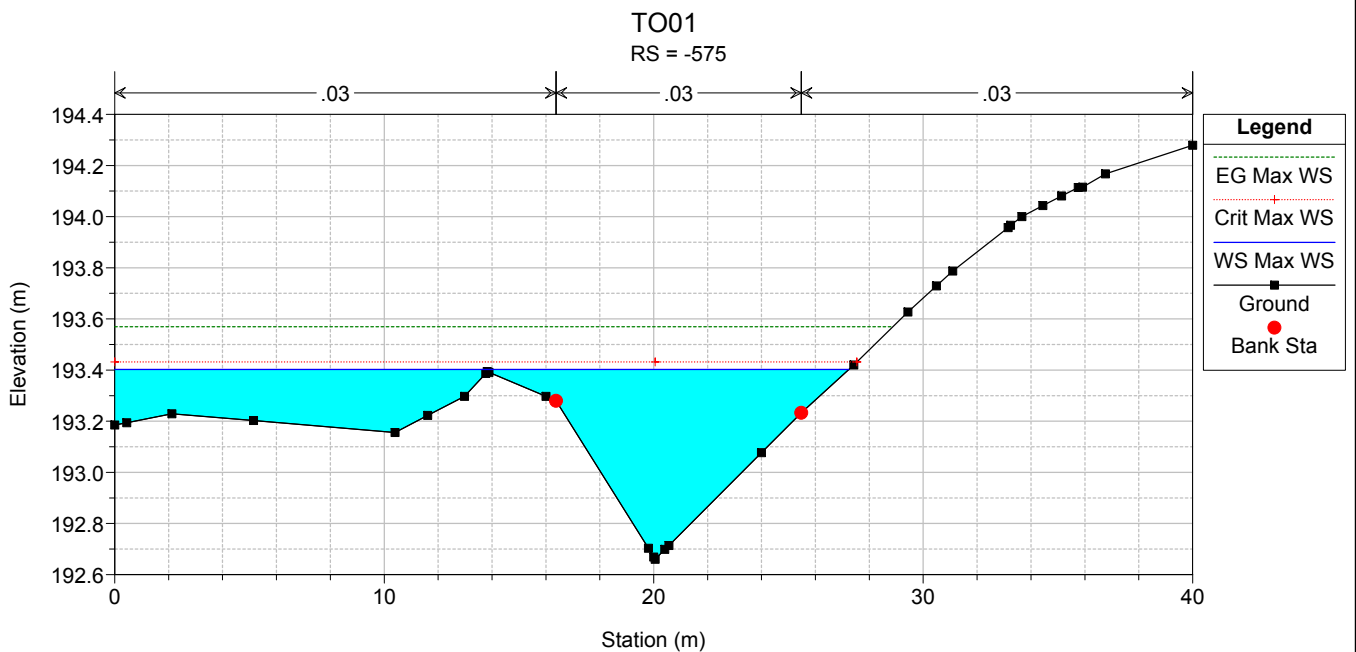
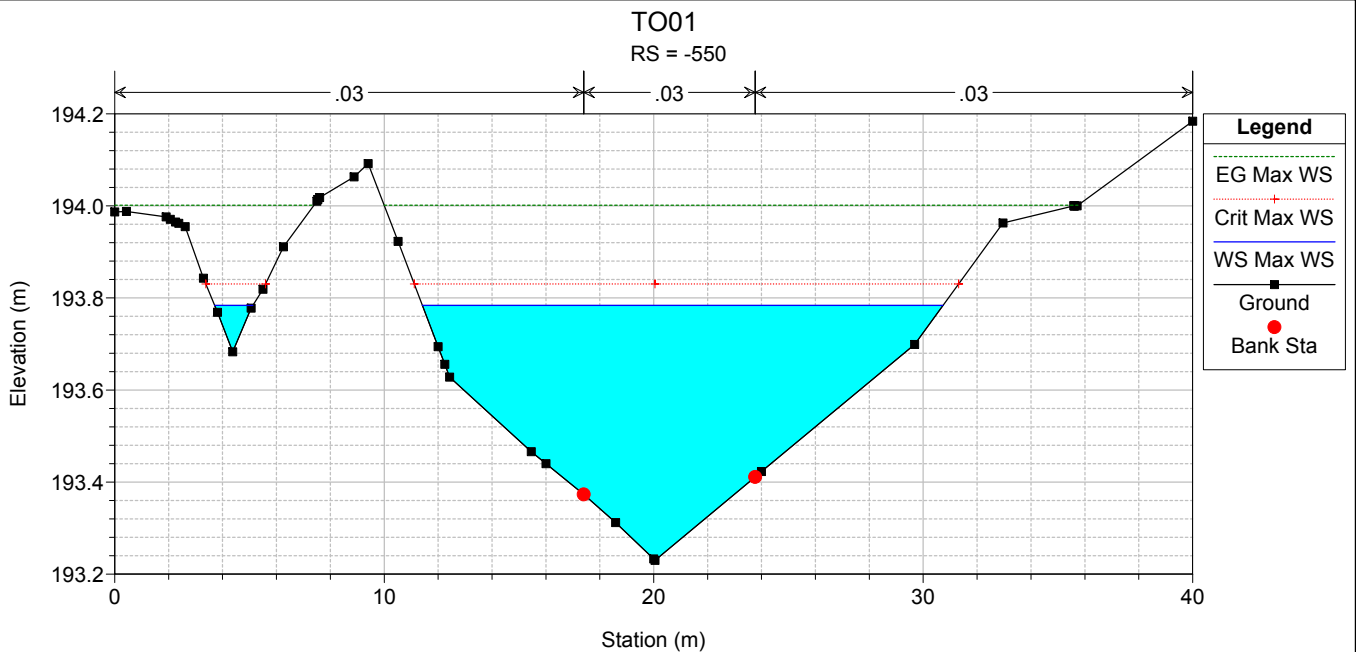

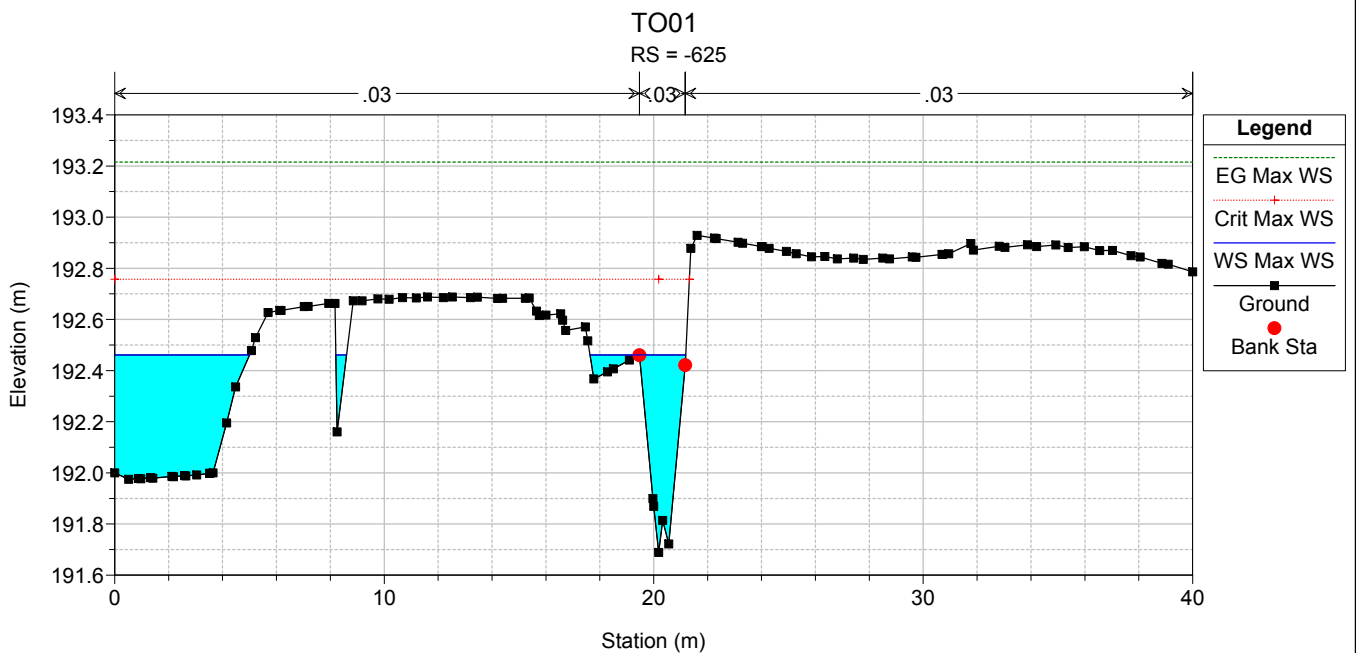
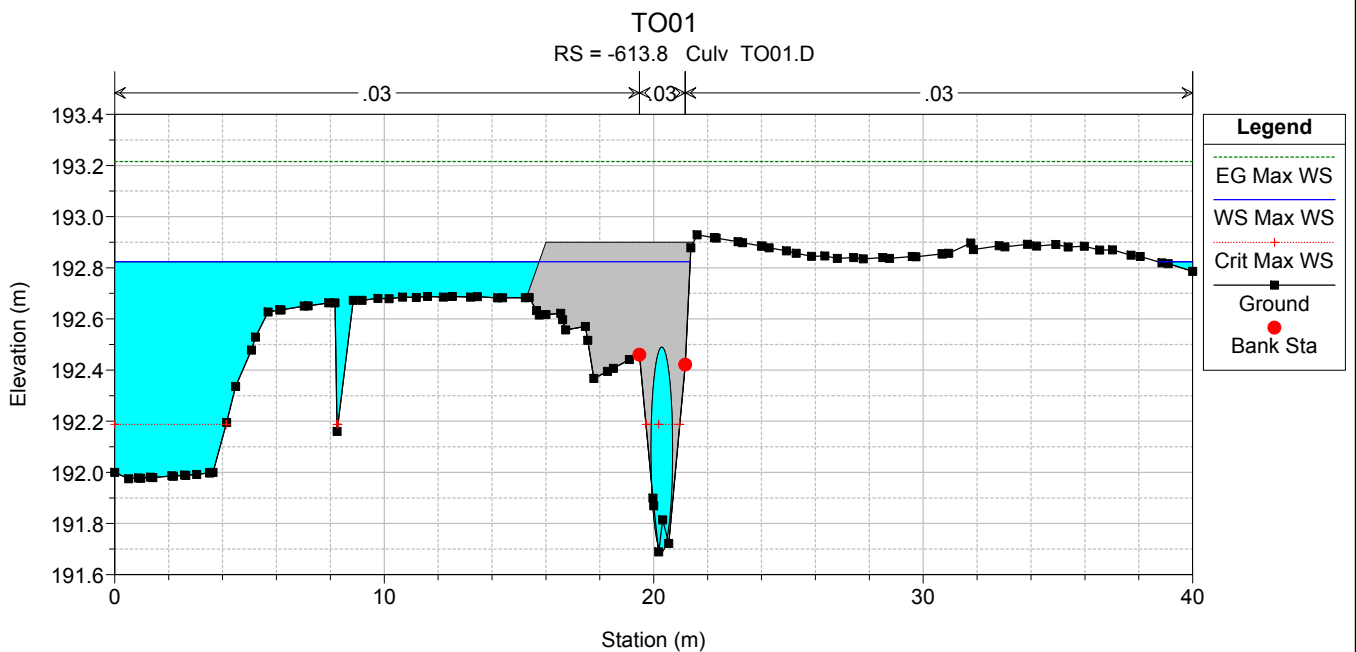
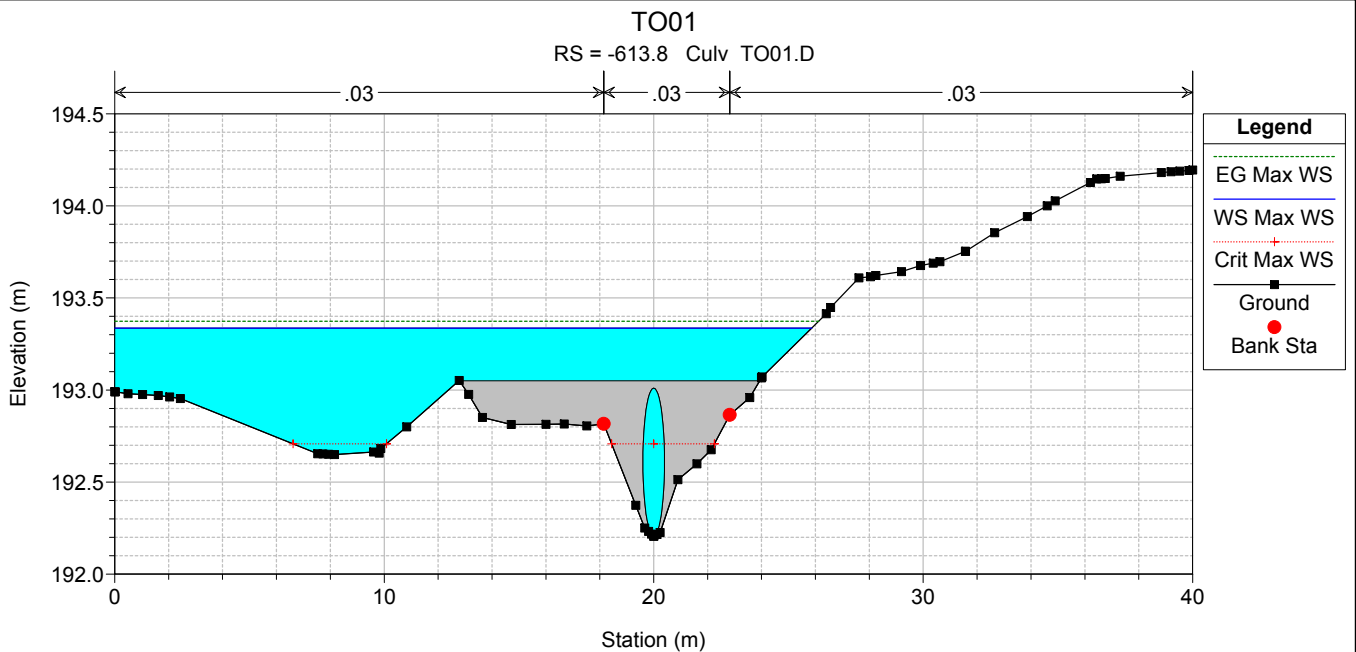

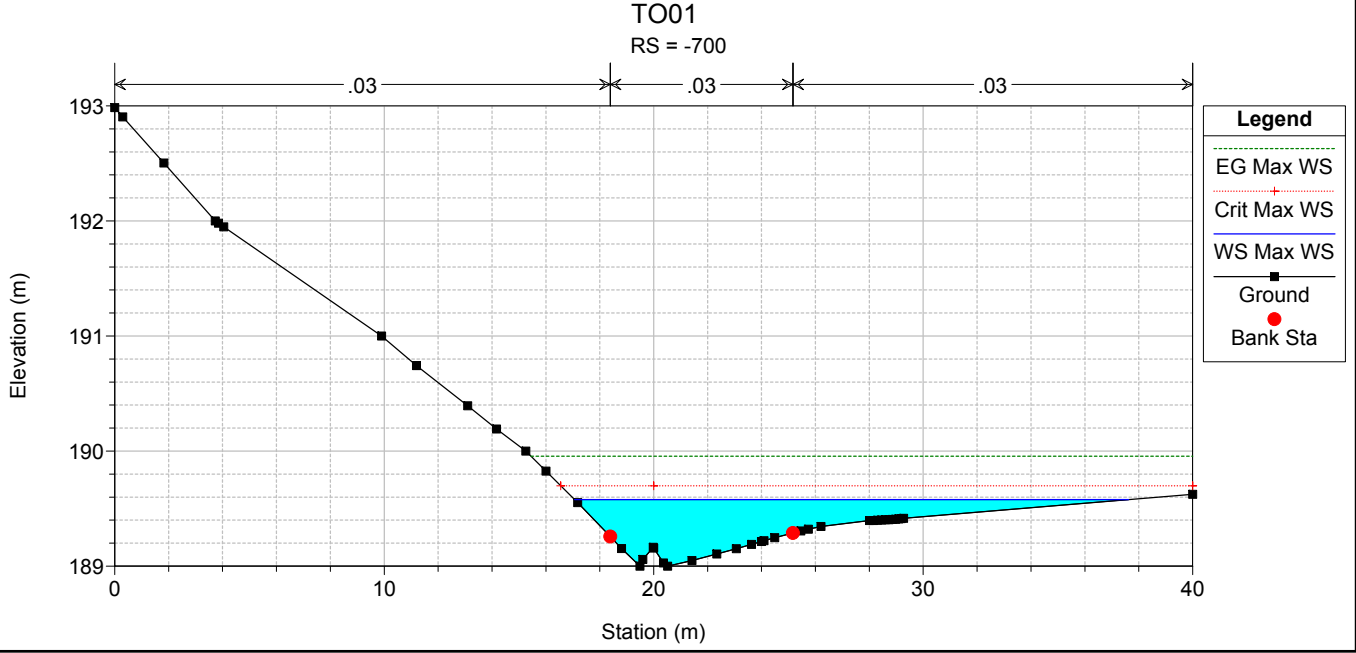
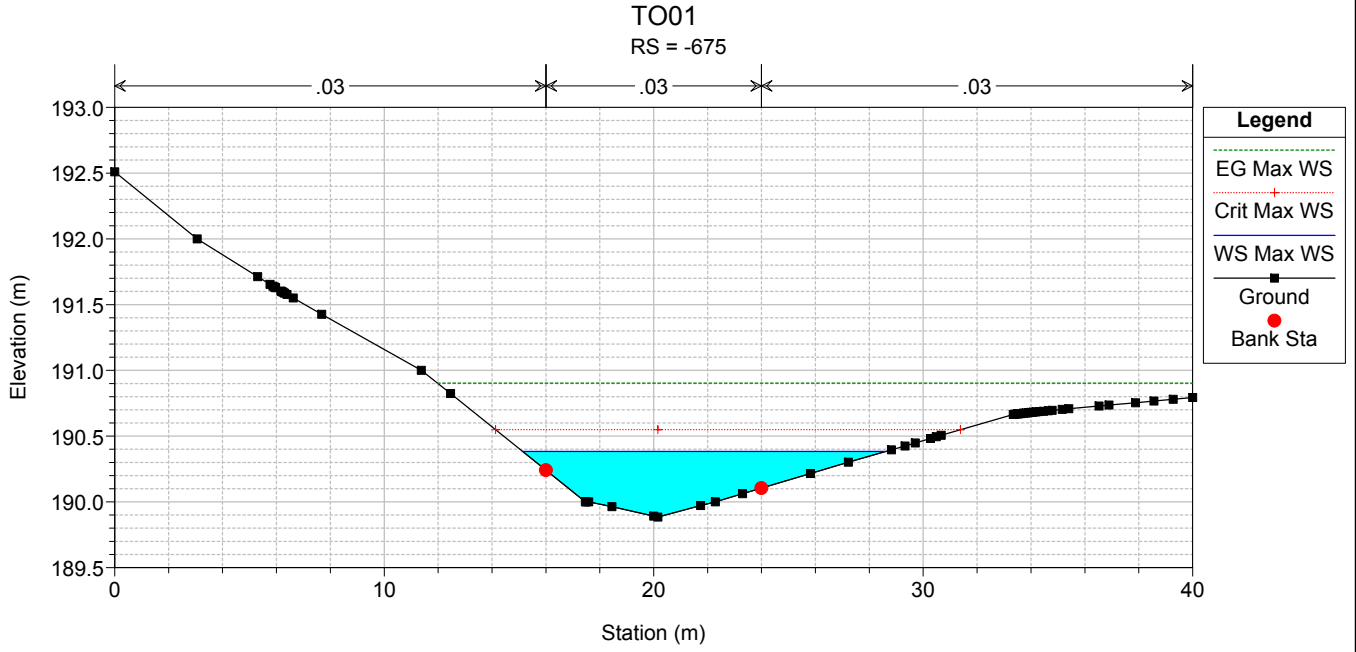
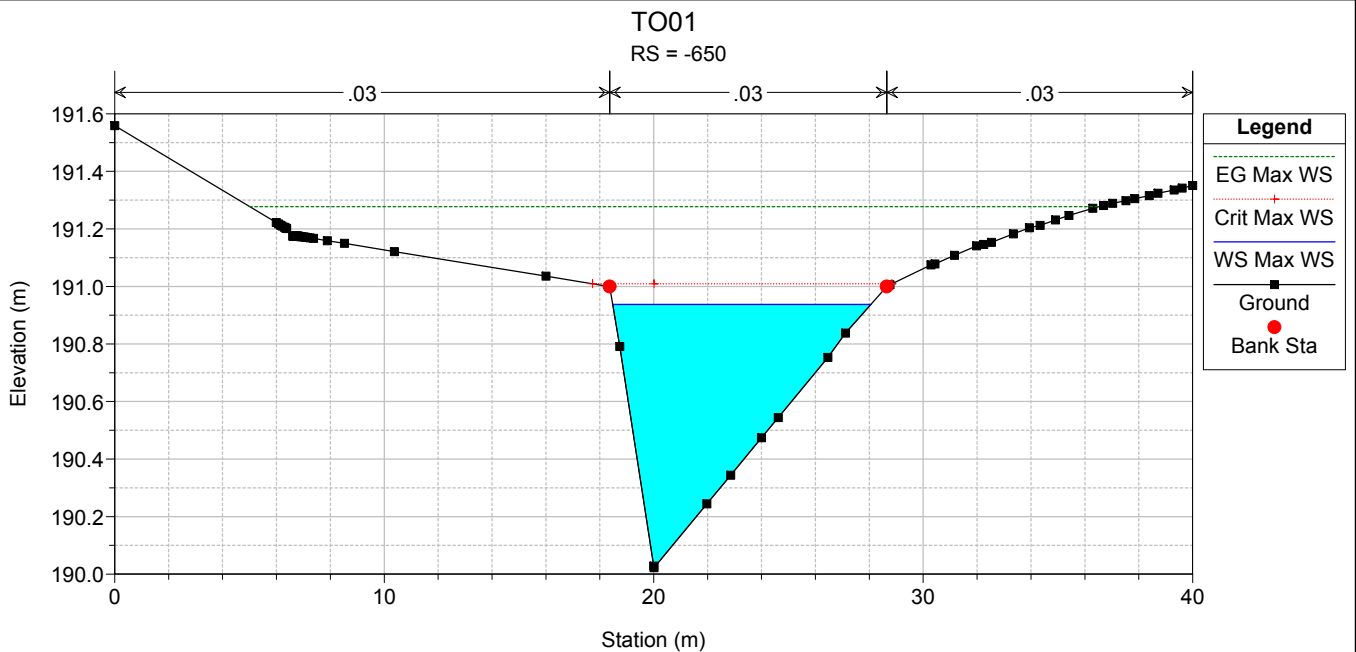

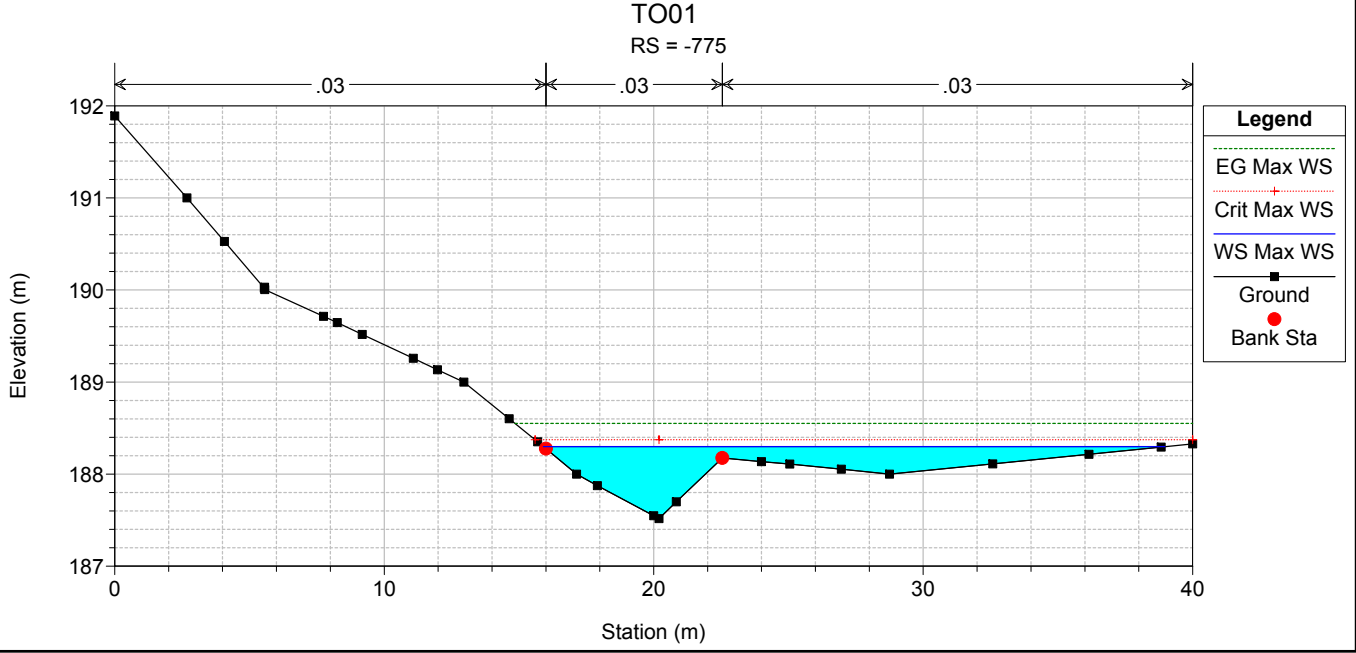
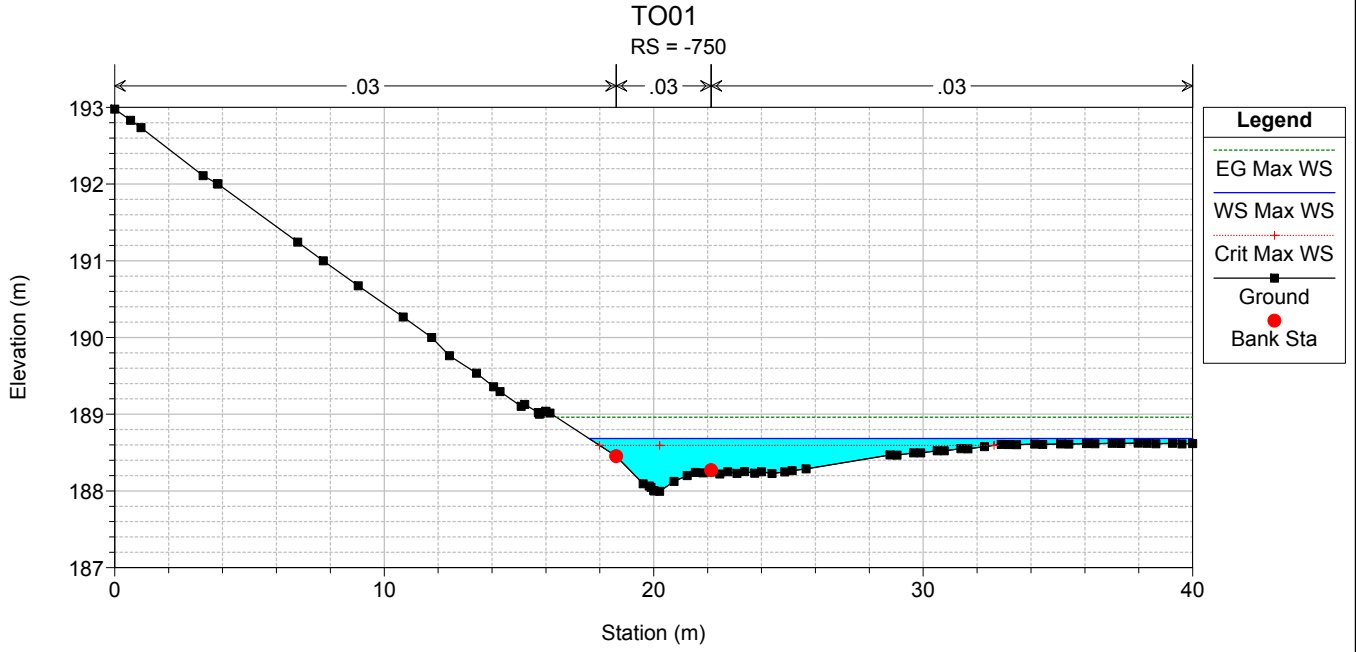
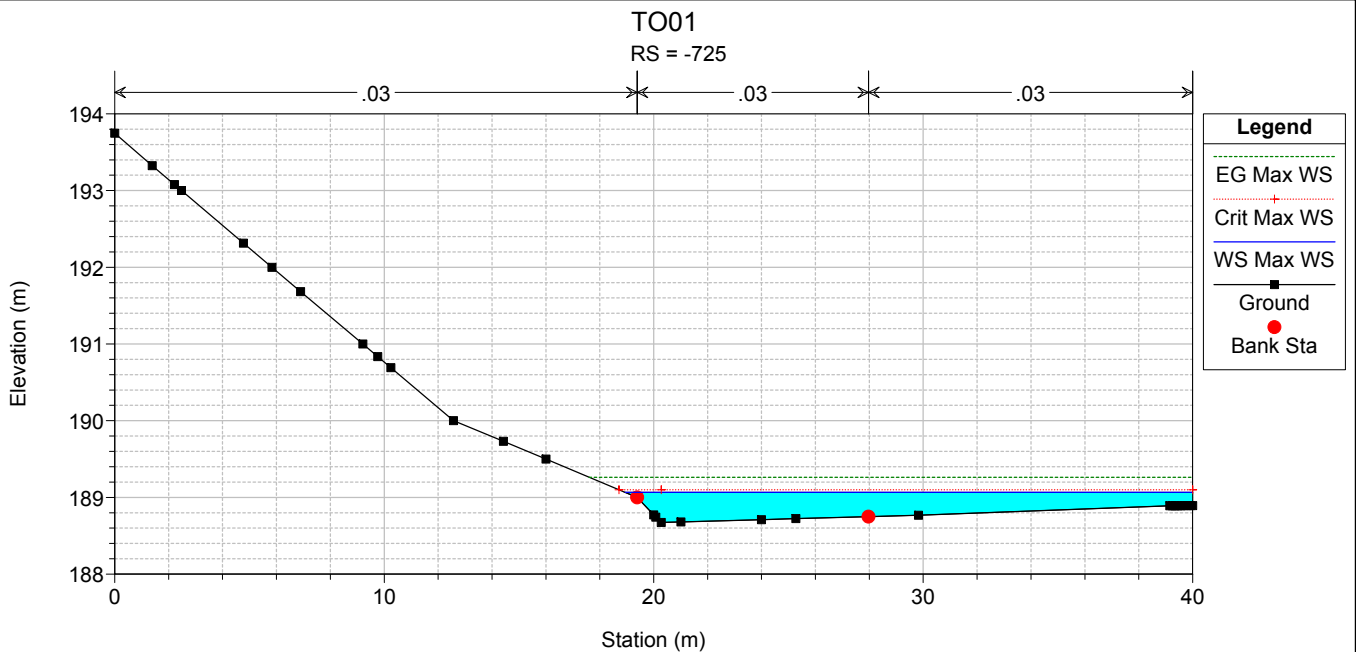

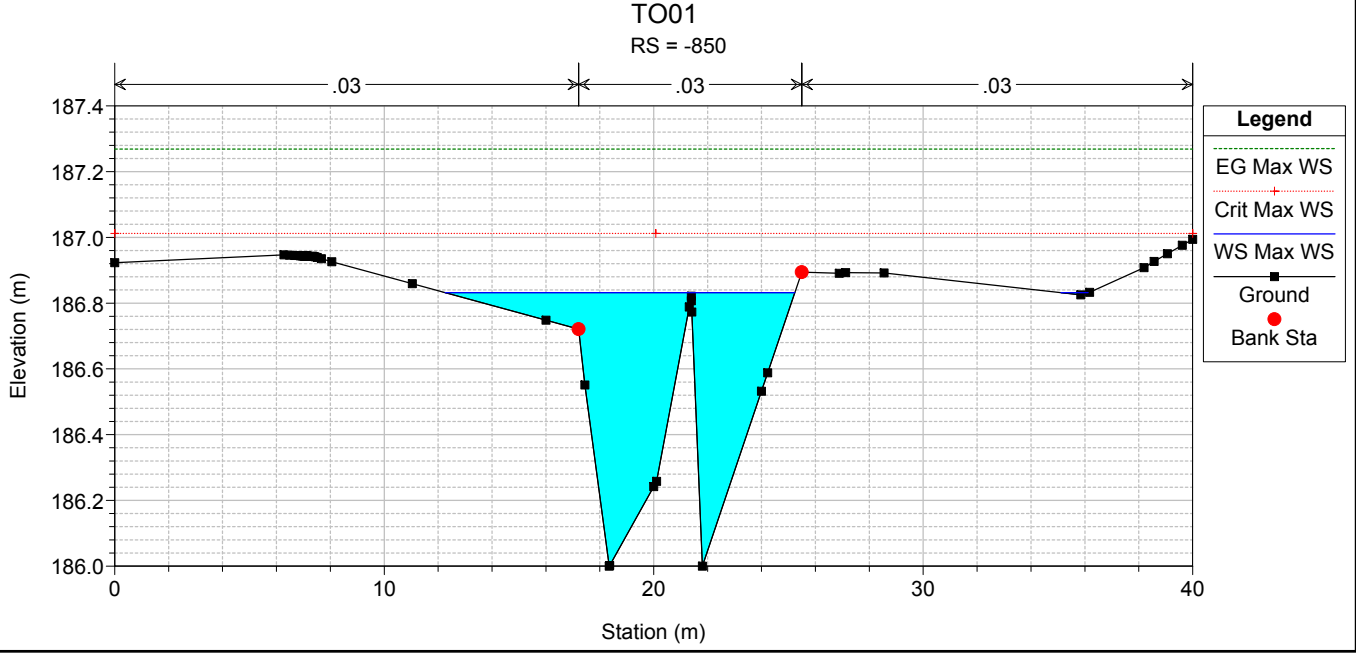
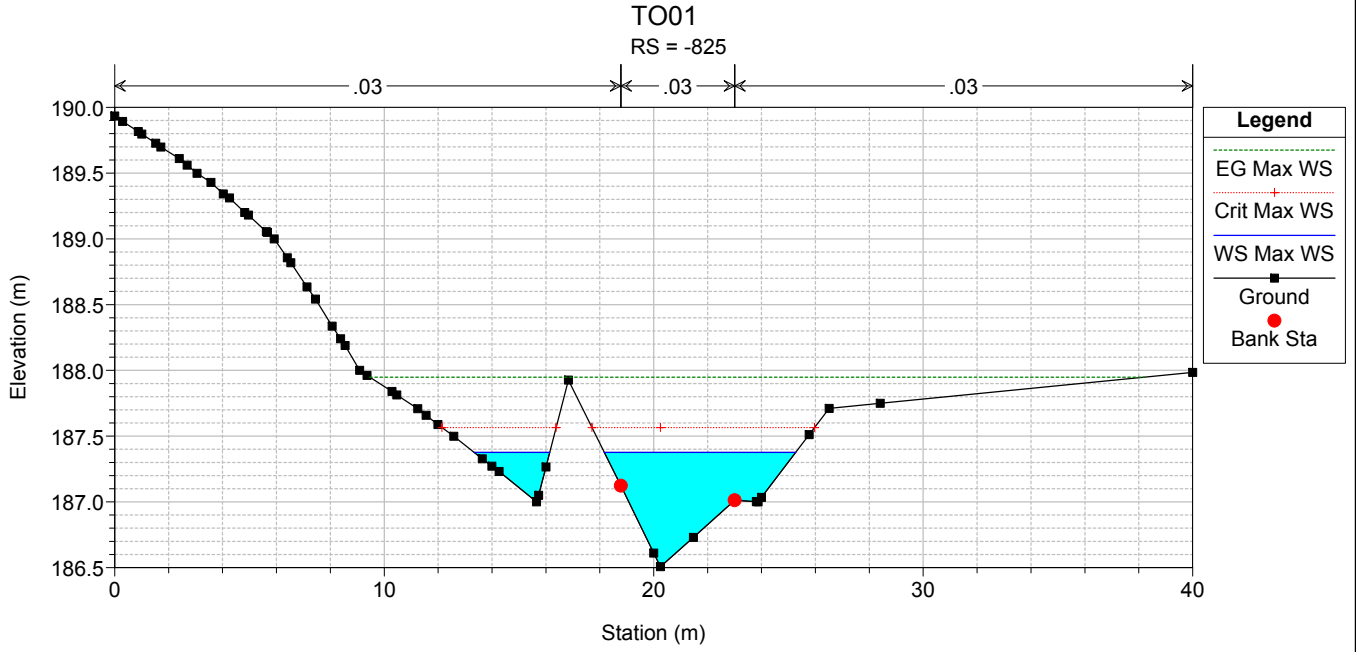
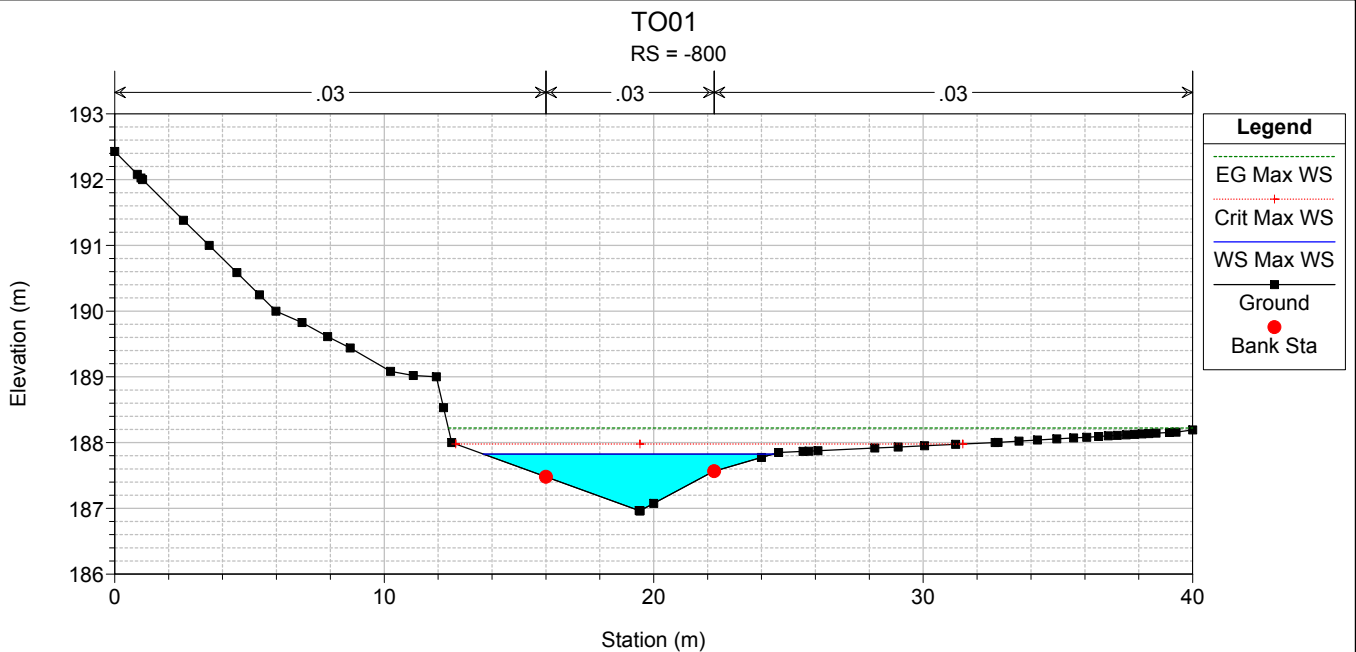

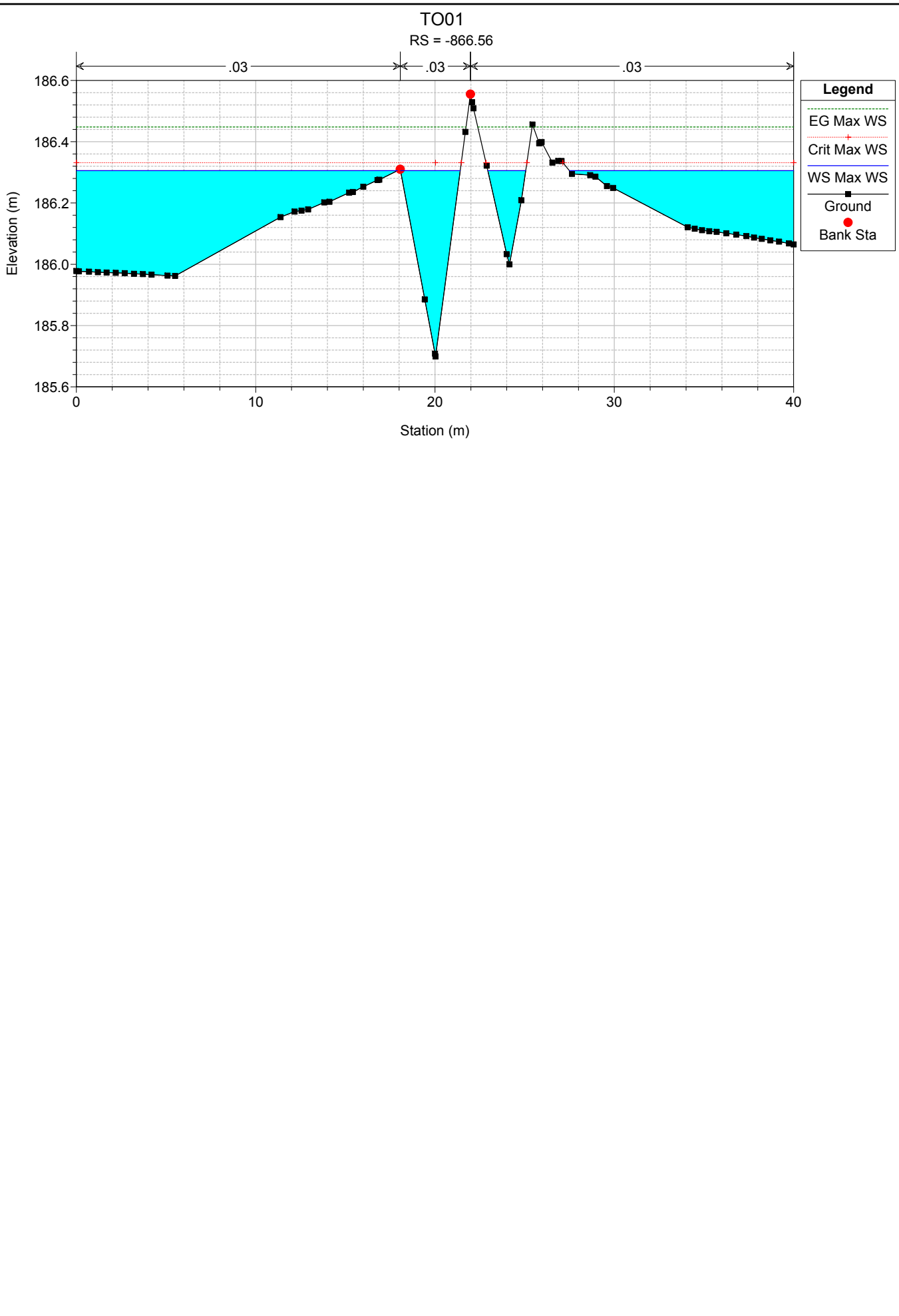

POST

HEC-RAS Plan: PERM-VARIO_agg River: TO01 Reach: TO01 Profile: Max WS

Reach	River Sta	Profile	Q Total (m3/s)	Min Ch El (m)	Max Chl Dpth (m)	W.S. Elev (m)	Crit W.S. (m)	Diff	Froude # Chl	E.G. Elev (m)	Vel Chnl (m/s)	Vel Total (m/s)	Hydr Radius C (m)	Shear Chan (N/m2)	Hydr Depth (m)
TO01	0	Max WS	10.4	206.80	0.61	207.41	207.62	-0.21	1.79	208.08	4.3	3.0	0.6	200.3	0.27
TO01	-25	Max WS	10.4	205.73	0.76	206.49	206.75	-0.26	1.80	207.44	4.5	3.7	0.5	219.2	0.26
TO01	-50	Max WS	10.4	204.65	0.93	205.58	205.78	-0.20	1.30	206.17	3.5	3.1	0.6	126.7	0.46
TO01	-62	Max WS	10.4	204.14	1.36	205.50	205.31	0.19	0.53	205.62	1.7	1.4	0.9	27.0	0.52
TO01	-71.35	Max WS	10.4	203.94	1.40	205.34	204.99	0.35	0.65	205.62	2.4	2.4	0.8	54.4	1.34
TO01	-81.77			Bridge											
TO01	-91.35	Max WS	10.4	203.74	1.21	204.95	204.79	0.16	0.81	205.34	2.7	2.7	0.7	75.0	1.17
TO01	-98	Max WS	10.4	203.67	1.21	204.88	204.82	0.06	0.91	205.25	2.7	2.7	0.7	70.5	0.88
TO01	-126	Max WS	10.3	203.36	1.52	204.88	204.18	0.70	0.16	204.89	0.6	0.5	1.1	2.7	0.75
TO01	-155	Max WS	10.0	203.30	1.57	204.87	204.00	0.87	0.14	204.88	0.5	0.5	1.1	2.1	1.03
TO01	-177	Max WS	10.4	203.26	1.37	204.63	204.41	0.22	0.73	204.88	2.2	2.2	0.8	48.2	0.71
TO01	-185.47	Max WS	10.4	203.19	1.44	204.63	204.24	0.39	0.62	204.90	2.3	2.3	0.8	50.6	1.38
TO01	-207.67			Bridge											
TO01	-232.97	Max WS	10.4	202.71	0.84	203.55	203.76	-0.21	1.42	204.37	4.0	4.0	0.6	173.7	0.82
TO01	-240.25	Max WS	10.4	202.50	0.57	203.07	203.64	-0.57	3.35	205.67	7.1	7.1	0.4	609.3	0.46
TO01	-260	Max WS	10.4	199.50	0.74	200.24	200.68	-0.44	2.09	201.47	5.0	4.8	0.5	276.7	0.49
TO01	-285.5	Max WS	10.4	198.04	0.90	198.94	199.18	-0.24	1.53	199.74	4.0	4.0	0.6	167.7	0.69
TO01	-295	Max WS	10.3	197.51	1.26	198.77	198.65	0.12	0.84	199.10	2.5	2.5	0.7	61.8	0.91
TO01	-301.02	Max WS	10.3	197.35	1.43	198.78	198.40	0.38	0.63	199.05	2.3	2.3	0.8	50.7	1.37
TO01	-312.5			Bridge											
TO01	-323.52	Max WS	10.4	197.13	1.33	198.46	198.19	0.27	0.71	198.78	2.5	2.5	0.7	61.3	1.28
TO01	-327	Max WS	10.4	197.11	1.38	198.49	198.26	0.23	0.72	198.75	2.3	2.3	0.8	48.4	0.98
TO01	-344	Max WS	10.4	197.00	1.41	198.41	198.14	0.27	0.69	198.65	2.2	2.2	0.8	44.6	1.00
TO01	-369	Max WS	10.4	196.84	1.45	198.29	197.98	0.31	0.65	198.51	2.1	2.1	0.8	40.4	1.02
TO01	-378	Max WS	10.4	196.79	1.46	198.25	197.93	0.32	0.64	198.47	2.0	2.0	0.8	39.3	1.03
TO01	-384.49	Max WS	10.4	196.73	1.42	198.15	197.78	0.37	0.64	198.43	2.3	2.3	0.8	52.1	1.36
TO01	-398.8			Bridge											
TO01	-414.49	Max WS	10.4	196.43	0.96	197.39	197.48	-0.09	1.16	198.01	3.5	3.5	0.6	128.0	0.93
TO01	-420	Max WS	10.4	196.34	0.90	197.24	197.48	-0.24	1.53	198.05	4.0	4.0	0.6	167.8	0.69
TO01	-443	Max WS	10.4	195.65	0.93	196.58	197.02	-0.44	1.44	197.32	3.8	3.8	0.6	151.0	0.71
TO01	-458	Max WS	10.4	195.21	1.05	196.26	196.45	-0.19	1.12	196.76	3.2	2.9	0.7	100.4	0.40
TO01	-469.07	Max WS	10.4	194.88	1.26	196.14	195.94	0.20	0.75	196.50	2.6	2.6	0.7	68.3	1.24
TO01	-475.18			Bridge											
TO01	-481.36	Max WS	10.4	194.71	0.79	195.50	195.97	-0.47	1.55	196.44	4.3	4.3	0.5	200.3	0.78
TO01	-493.6	Max WS	10.4	194.42	0.74	195.16	195.40	-0.24	1.45	195.82	3.7	3.4	0.6	142.6	0.38
TO01	-507.71	Max WS	10.4	194.08	0.52	194.60	195.01	-0.41	2.66	196.22	5.6	5.6	0.4	376.1	0.46
TO01	-522	Max WS	10.3	192.76	0.98	193.74	193.71	0.03	0.96	194.10	2.7	2.7	0.7	71.1	0.78
TO01	-532.8	Max WS	17.7	192.50	1.06	193.56	193.81	-0.25	1.44	194.43	4.1	4.1	0.7	167.6	0.84
TO01	-557.8	Max WS	17.7	191.91	1.04	192.95	193.21	-0.26	1.47	193.85	4.2	4.2	0.7	174.7	0.83
TO01	-585.29	Max WS	17.7	191.26	0.75	192.01	192.56	-0.55	2.55	194.03	6.3	6.3	0.5	428.2	0.62
TO01	-599	Max WS	18.3	189.84	1.87	191.71	191.17	0.54	0.55	191.91	2.0	2.0	1.1	30.3	1.35
TO01	-612.8	Max WS	17.8	189.71	1.99	191.70	191.02	0.68	0.48	191.86	1.8	1.8	1.1	23.6	1.42
TO01	-616.32	Max WS	17.8	189.67	1.96	191.63	190.86	0.77	0.47	191.85	2.1	2.1	1.0	32.9	1.96
TO01	-628.25			Bridge											
TO01	-640.18	Max WS	17.7	189.43	1.27	190.70	190.62	0.08	0.91	191.22	3.2	3.2	0.8	84.9	1.27
TO01	-645	Max WS	17.7	189.38	1.27	190.65	190.69	-0.04	1.06	191.20	3.3	3.3	0.8	88.3	0.98
TO01	-662.8	Max WS	17.7	189.20	1.25	190.45	190.51	-0.06	1.09	191.02	3.4	3.4	0.8	92.6	0.97
TO01	-687.8	Max WS	17.7	188.95	1.16	190.11	190.36	-0.25	1.21	190.79	3.7	3.6	0.8	127.9	0.68
TO01	-712.8	Max WS	17.7	188.70	1.03	189.72	189.79	-0.07	0.94	190.03	2.8	2.1	0.8	75.5	0.45

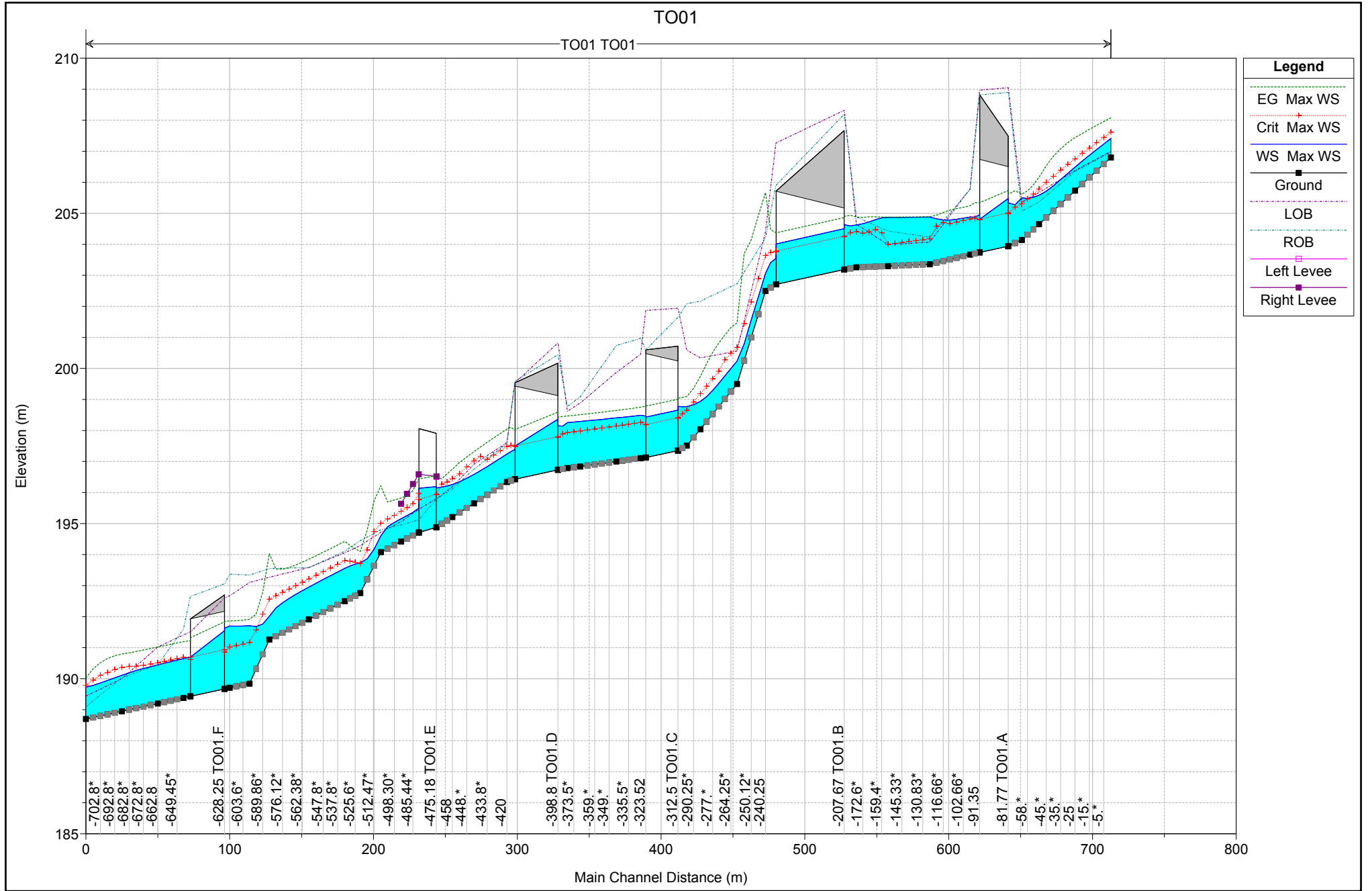

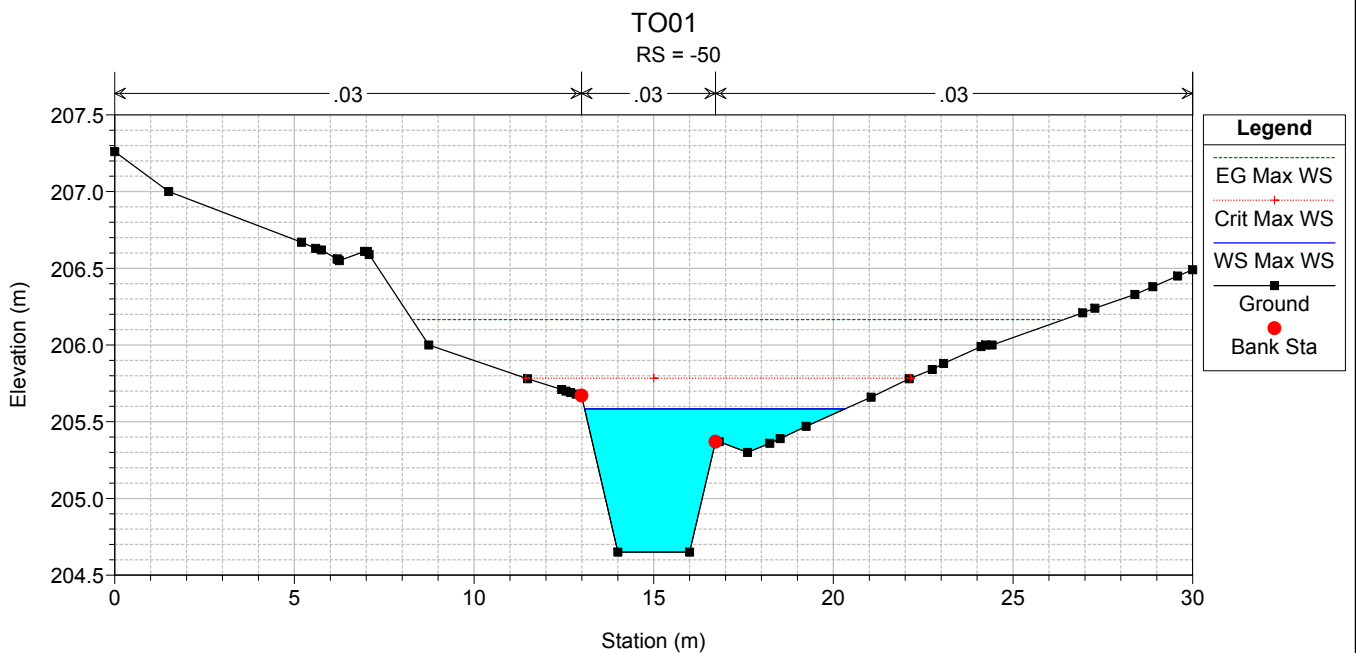
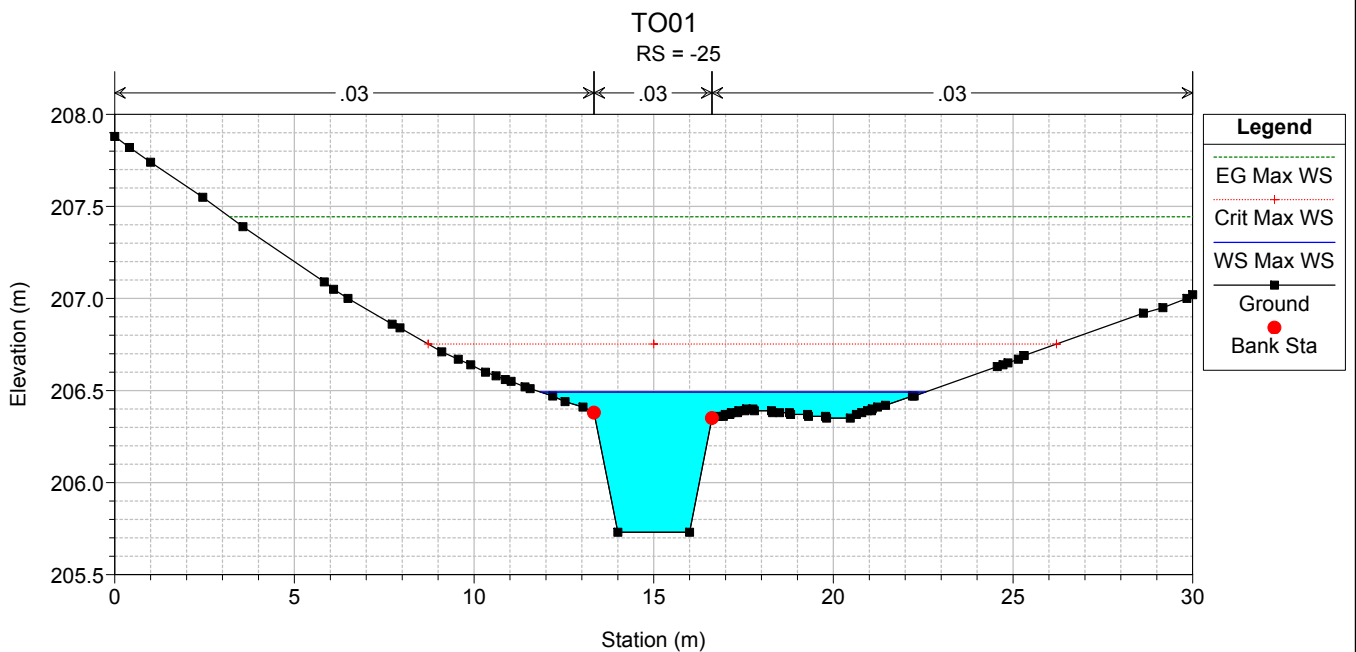
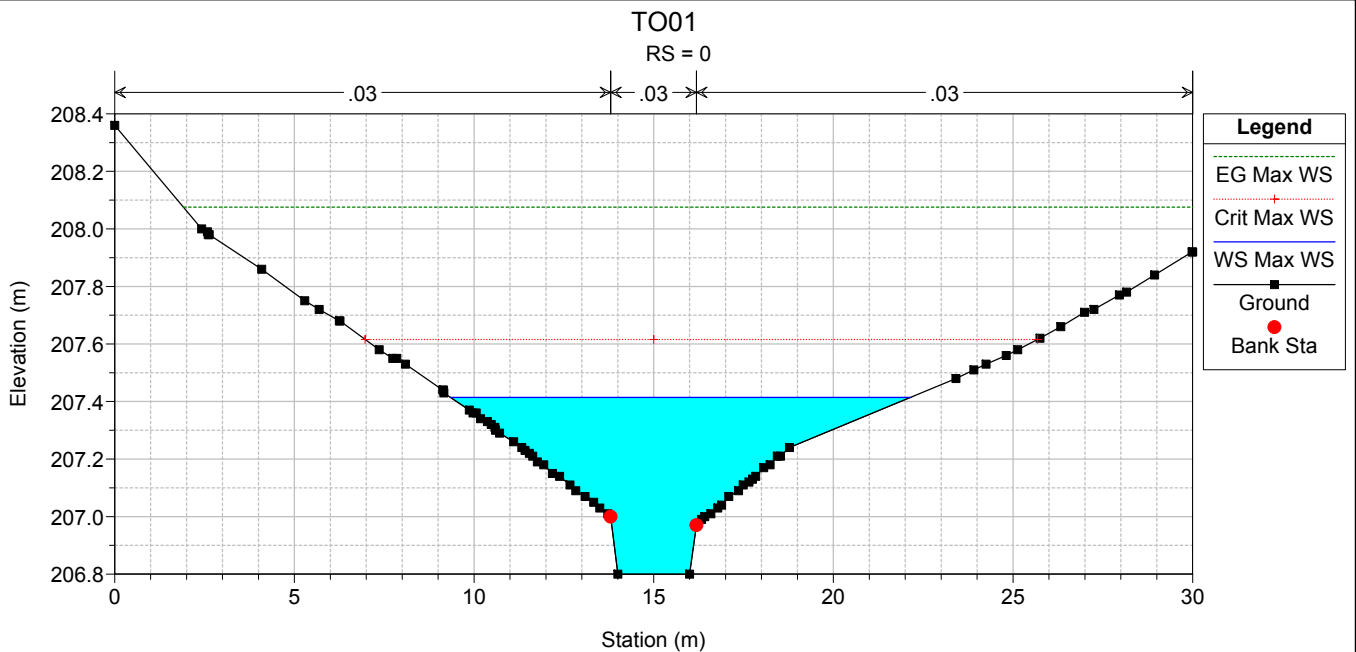

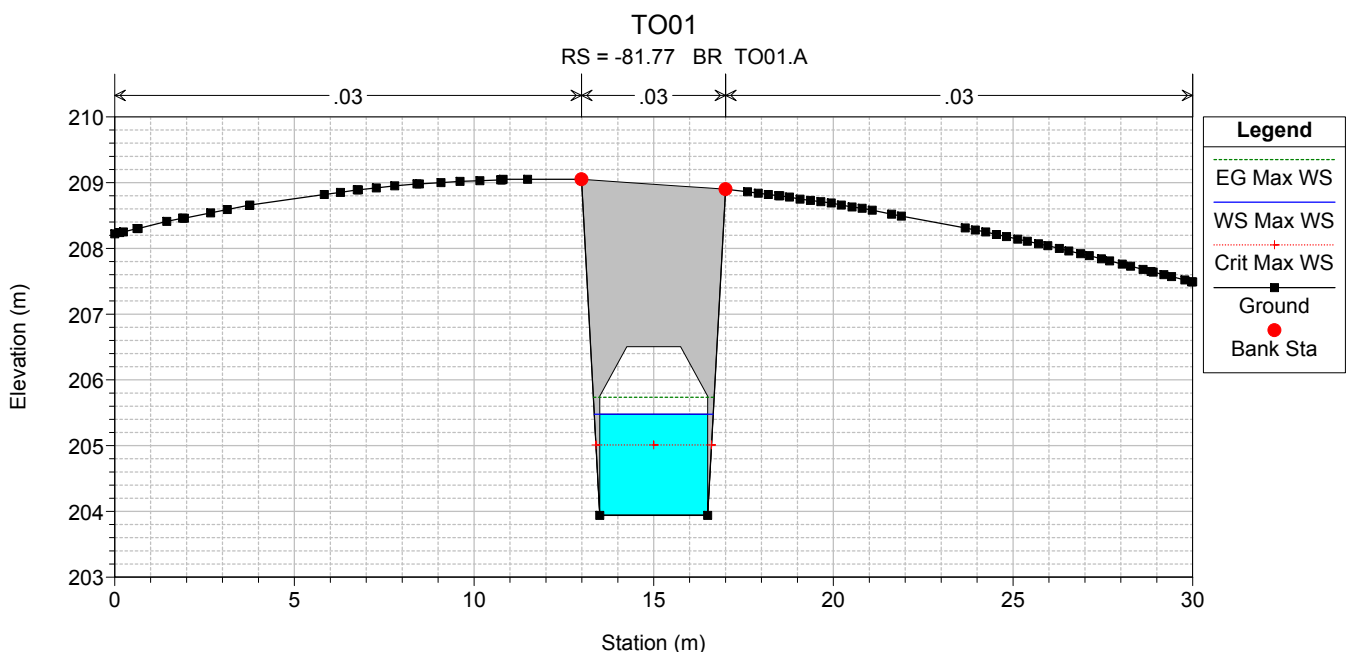
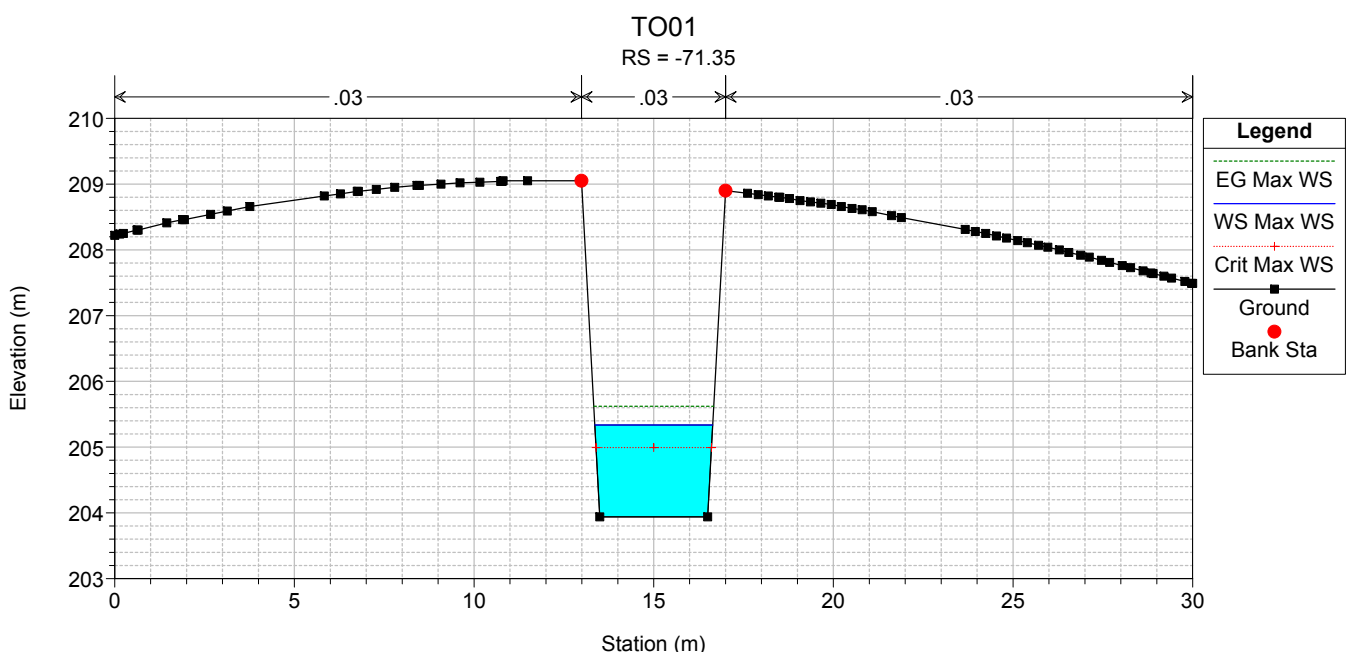
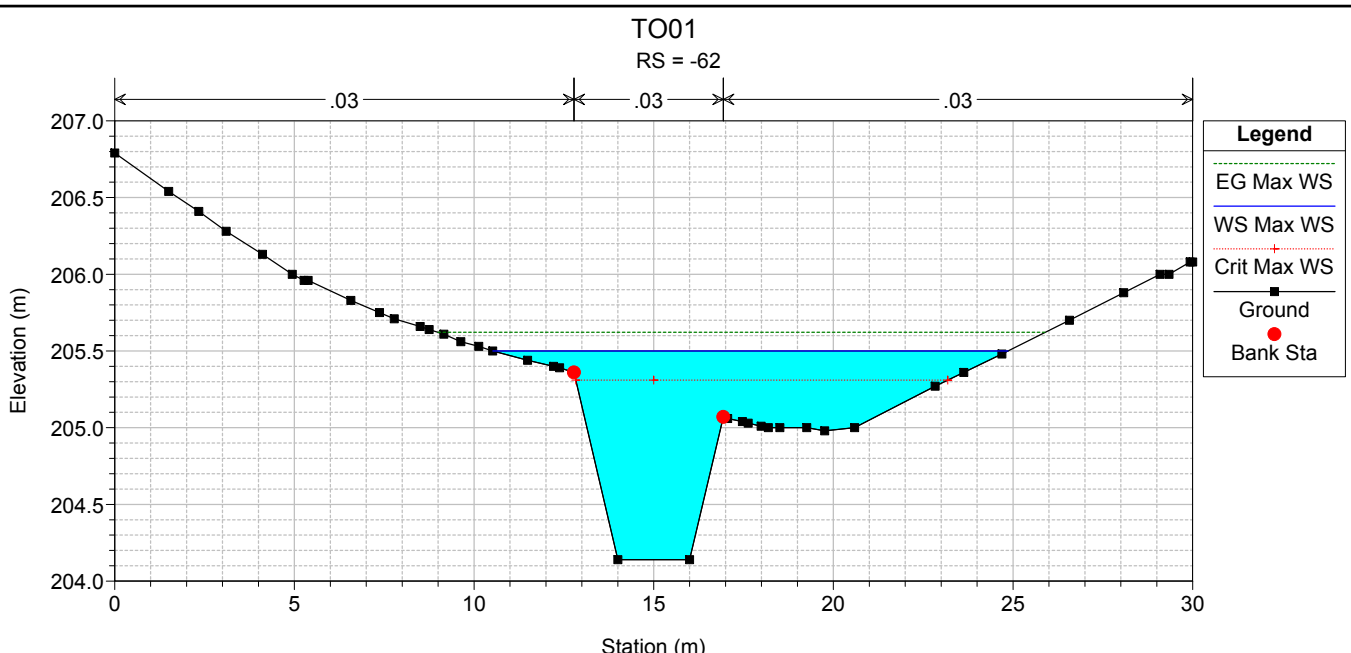

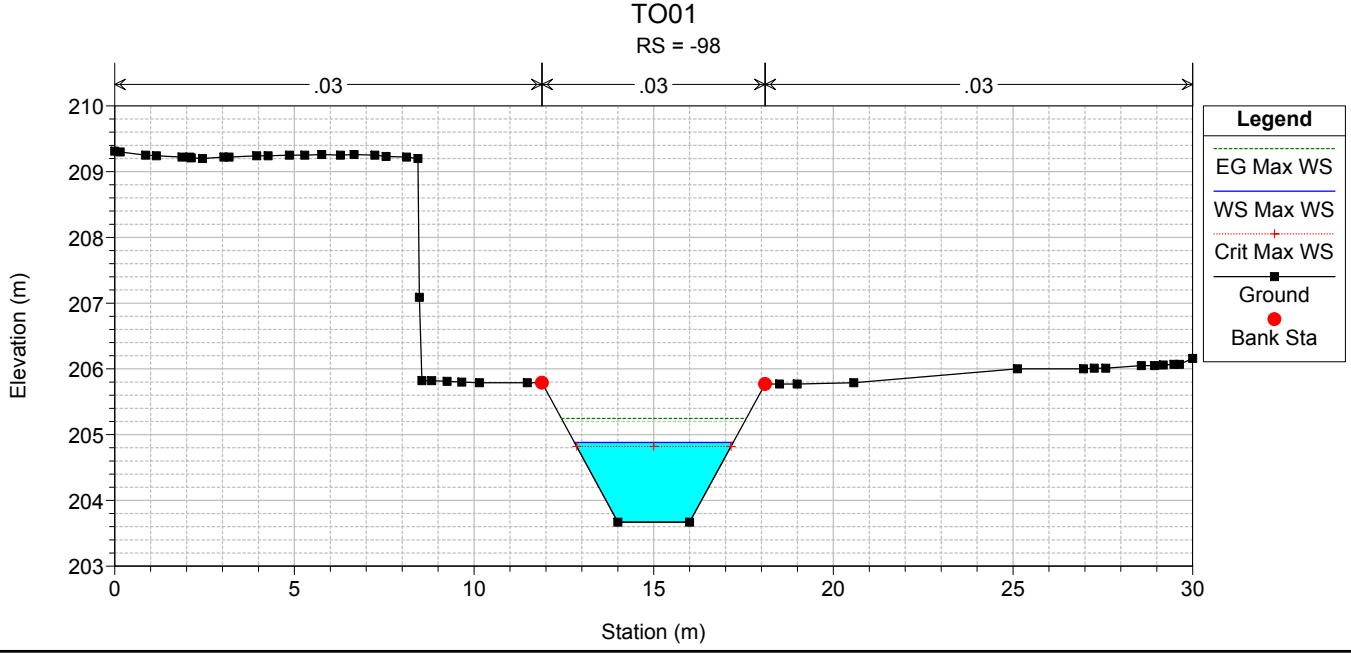
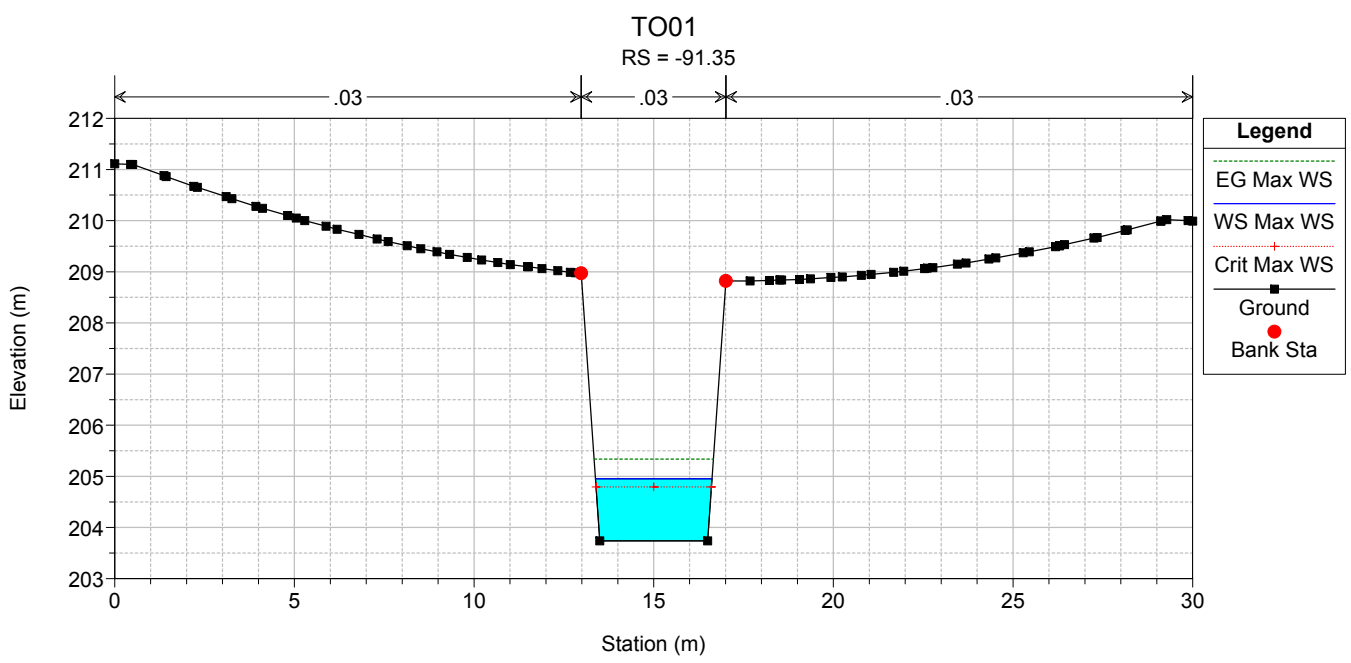
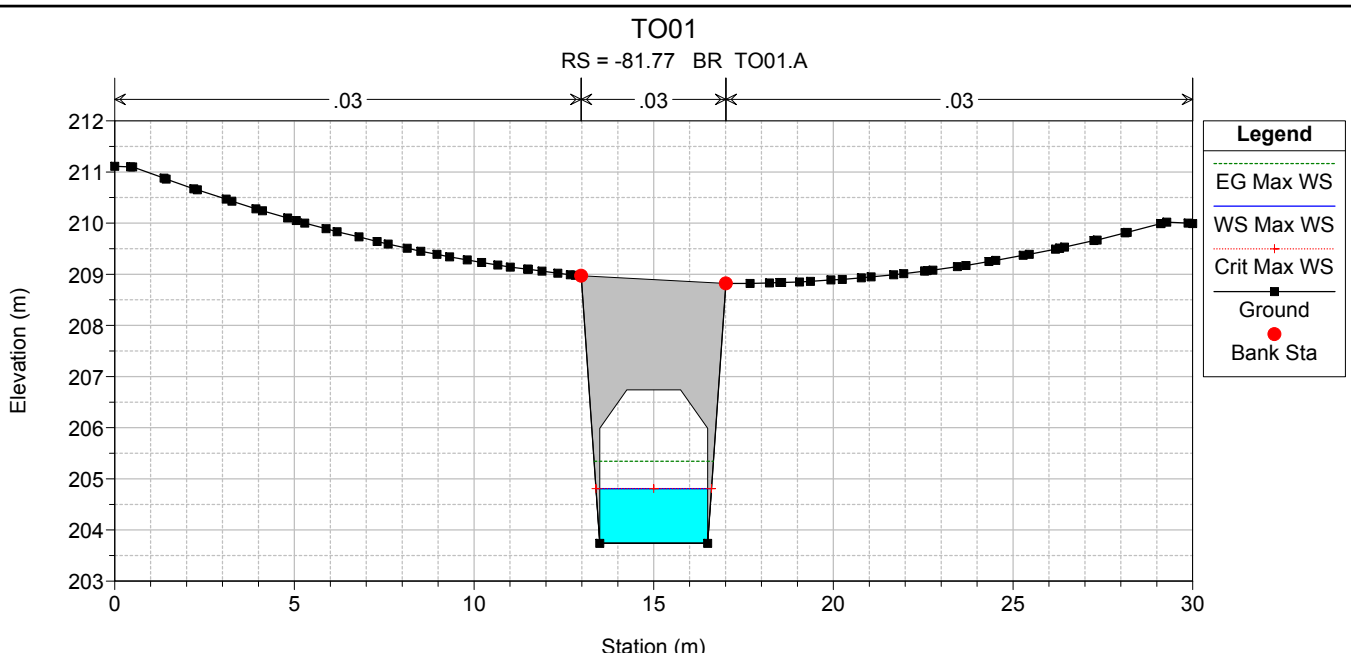

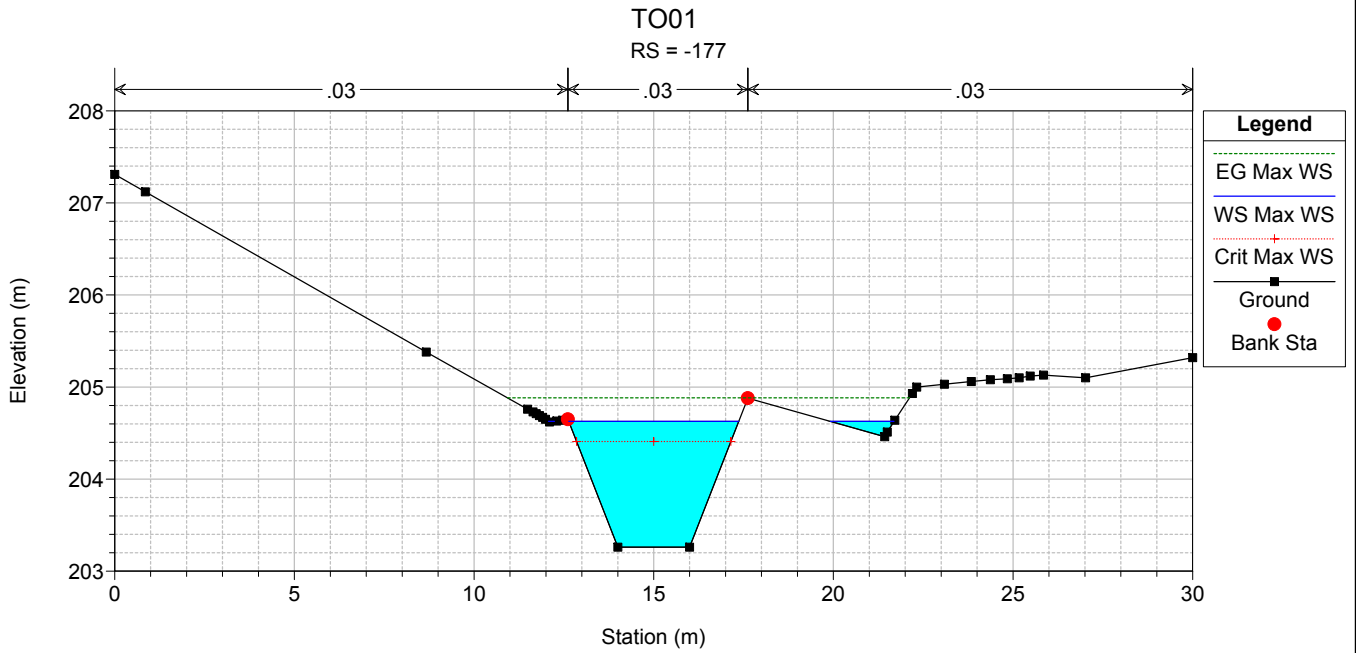
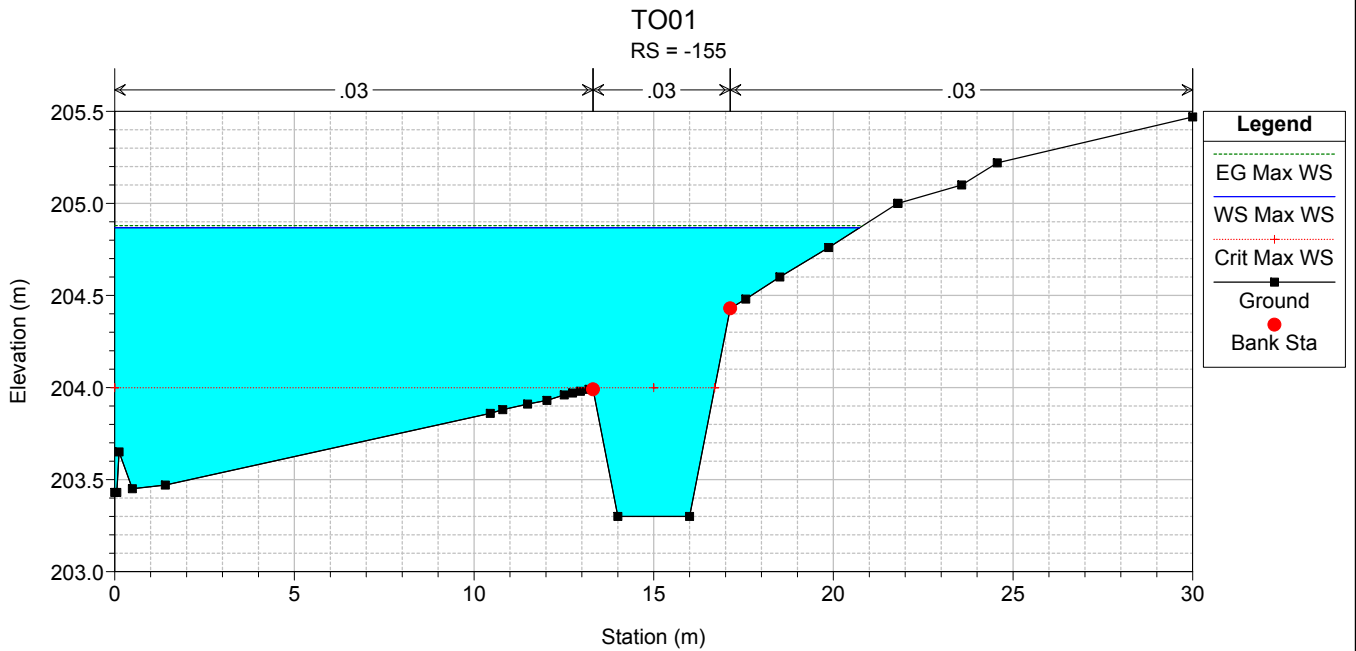
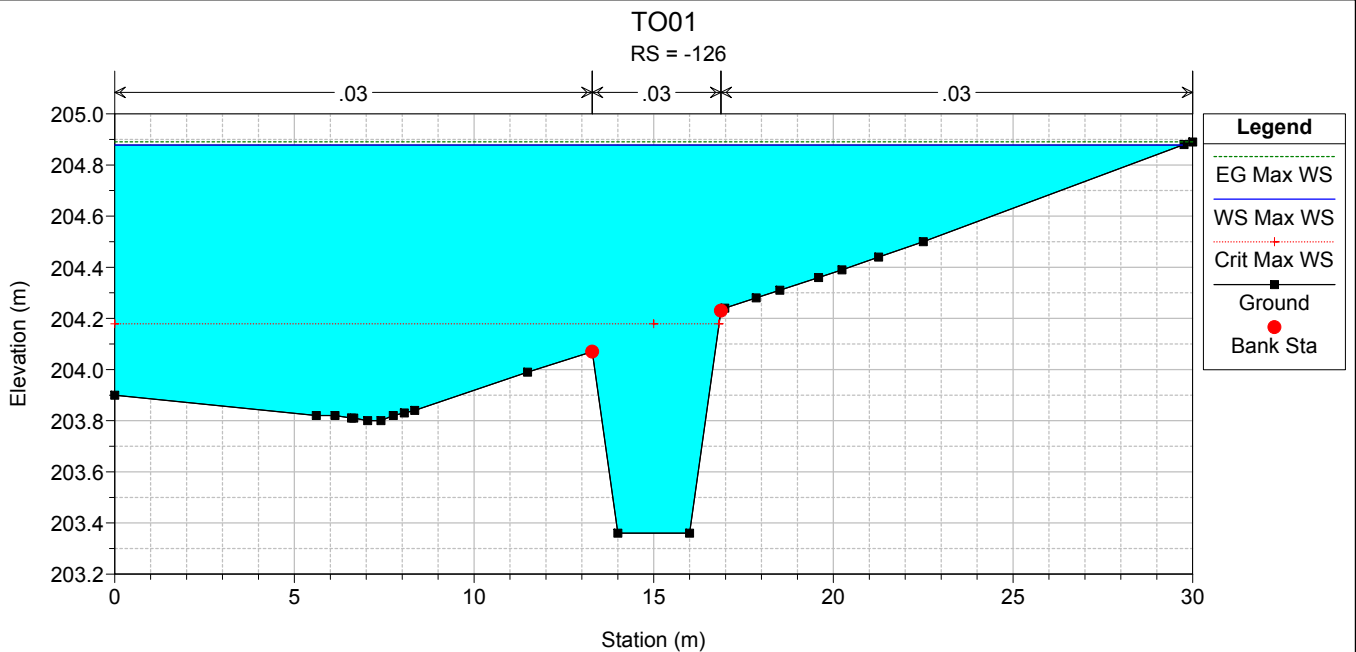

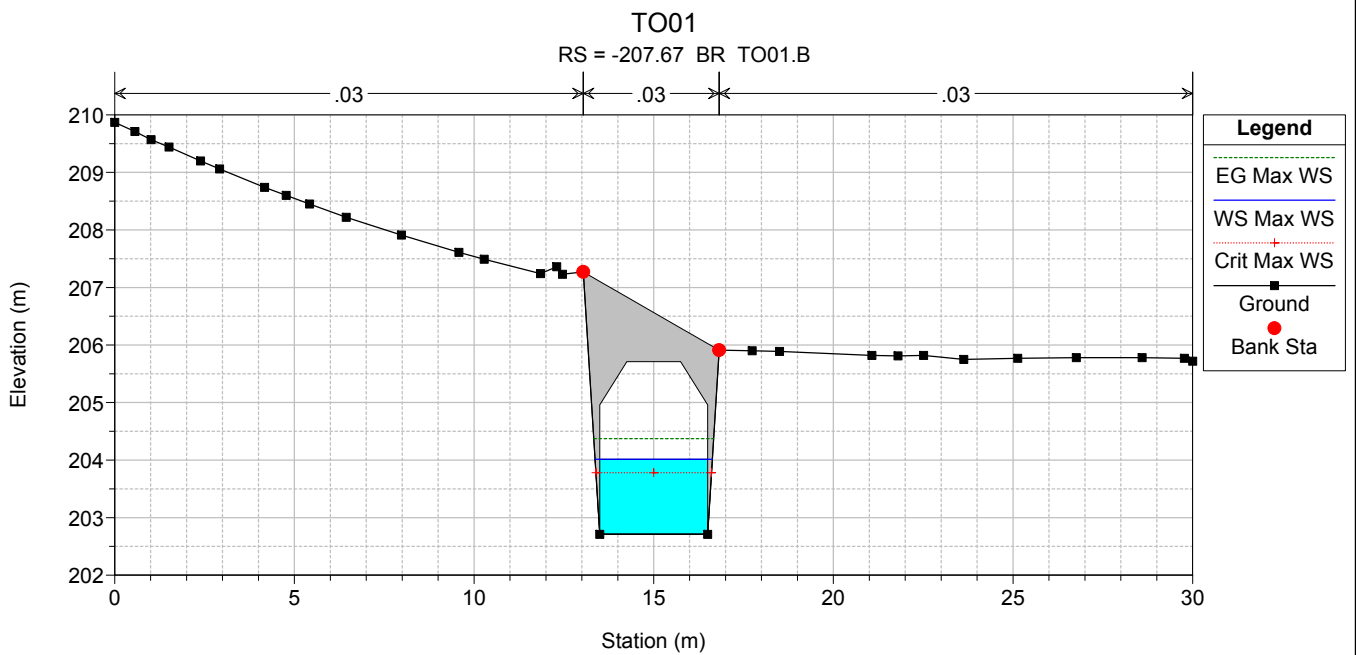
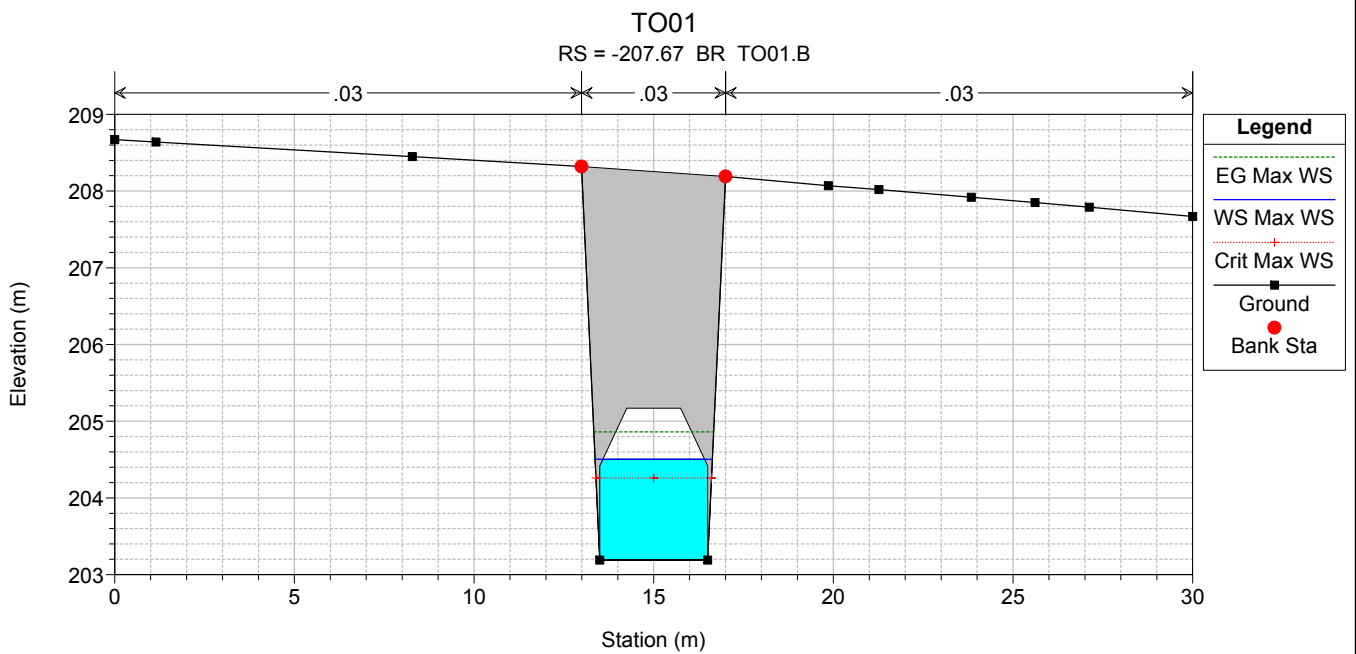
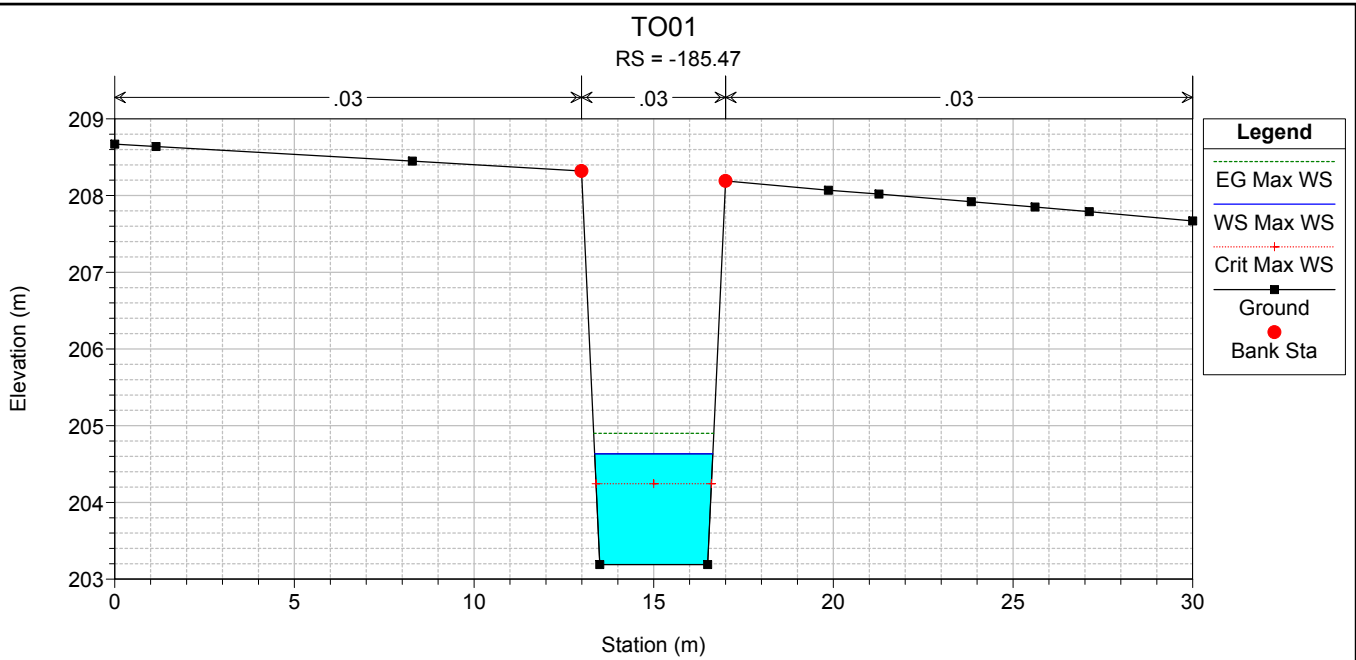

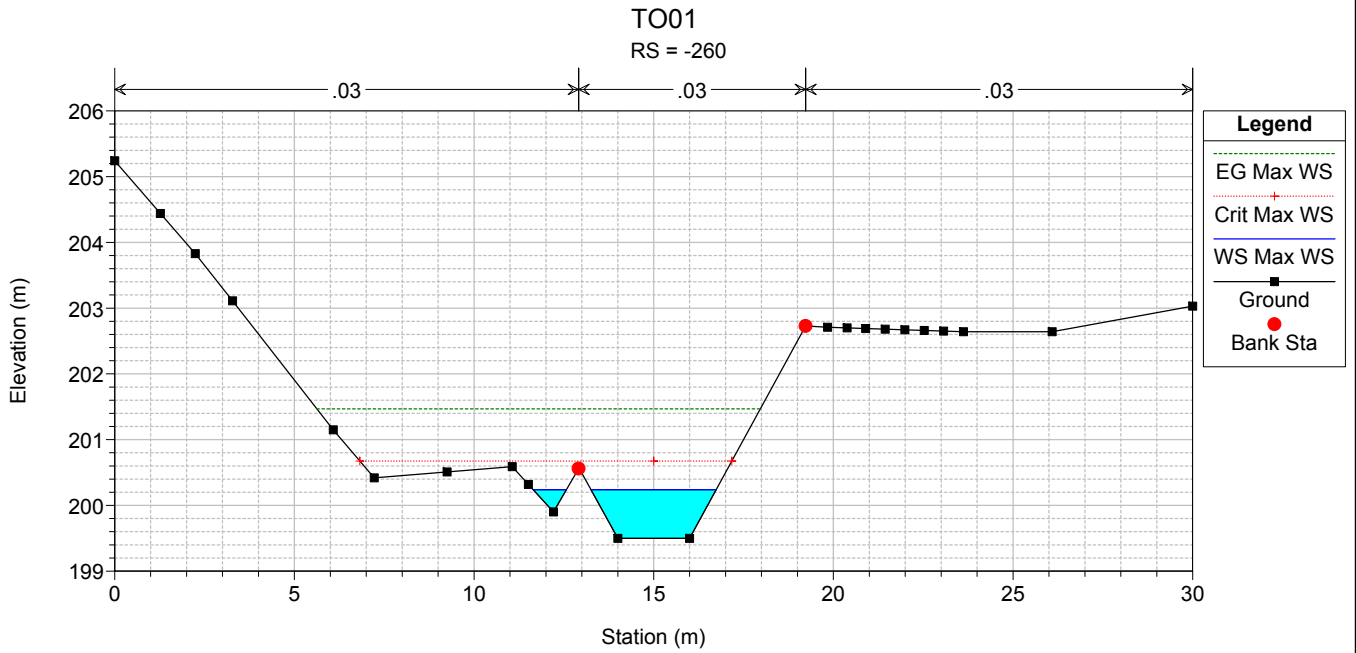
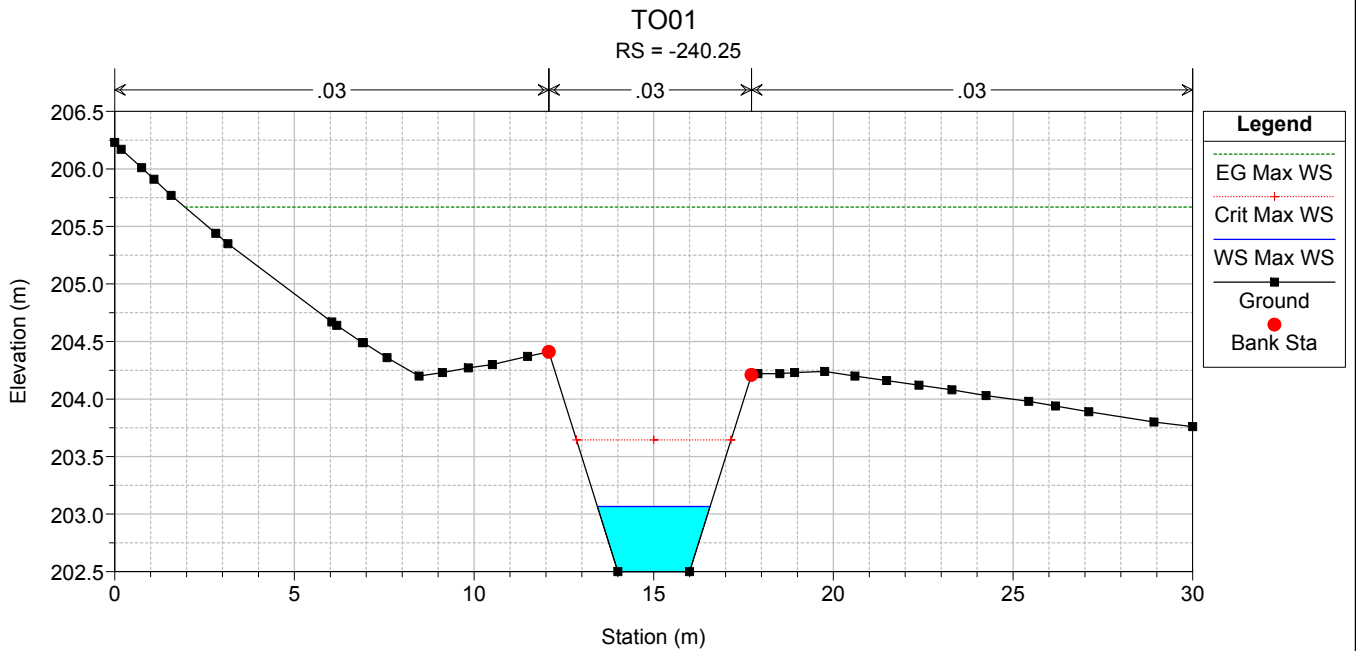
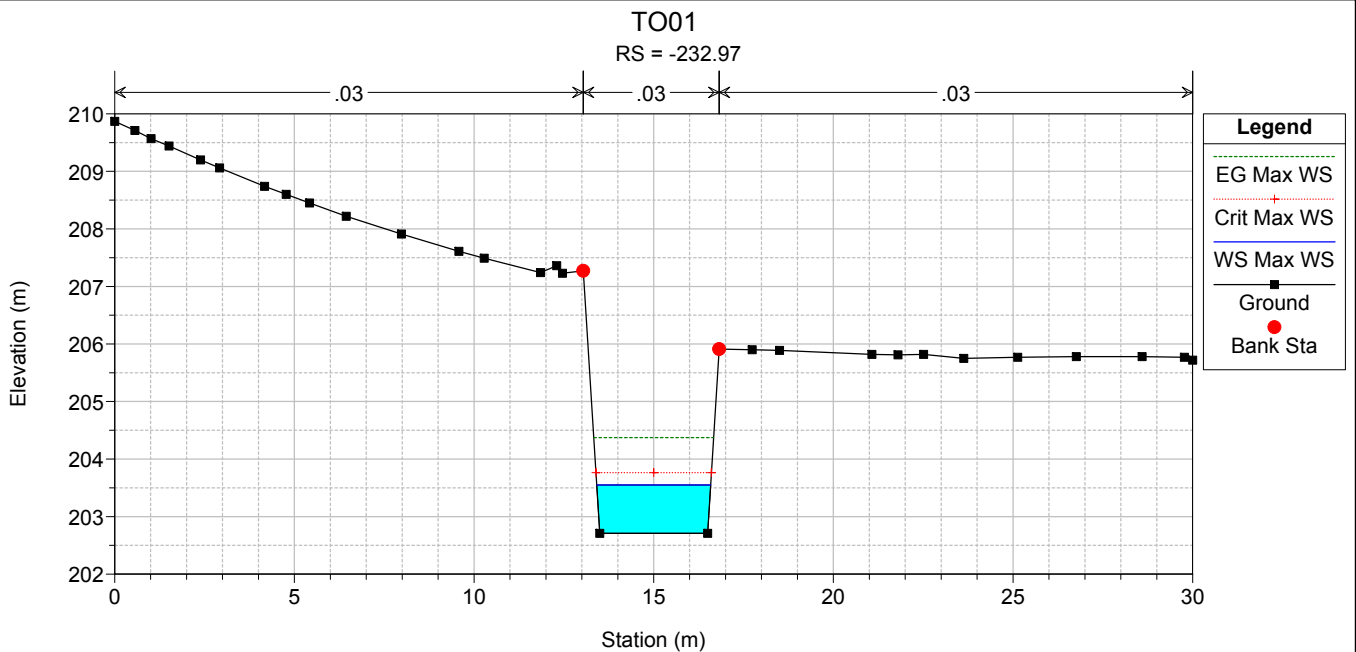

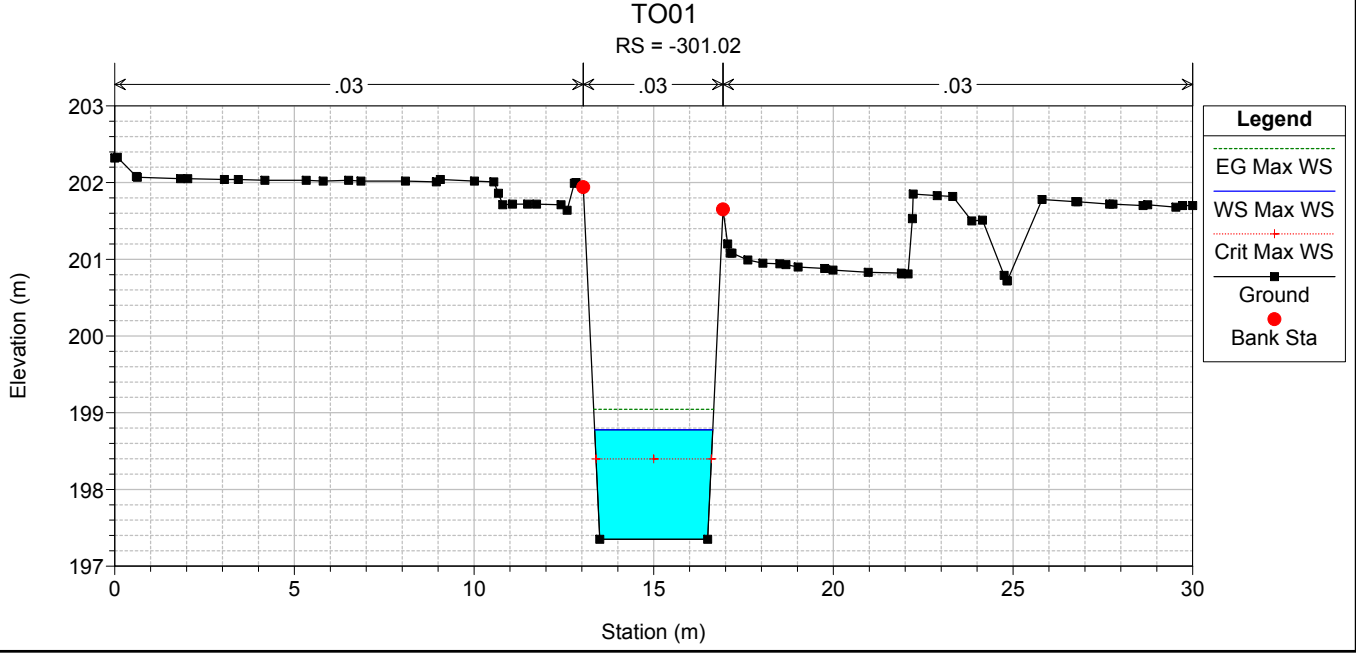
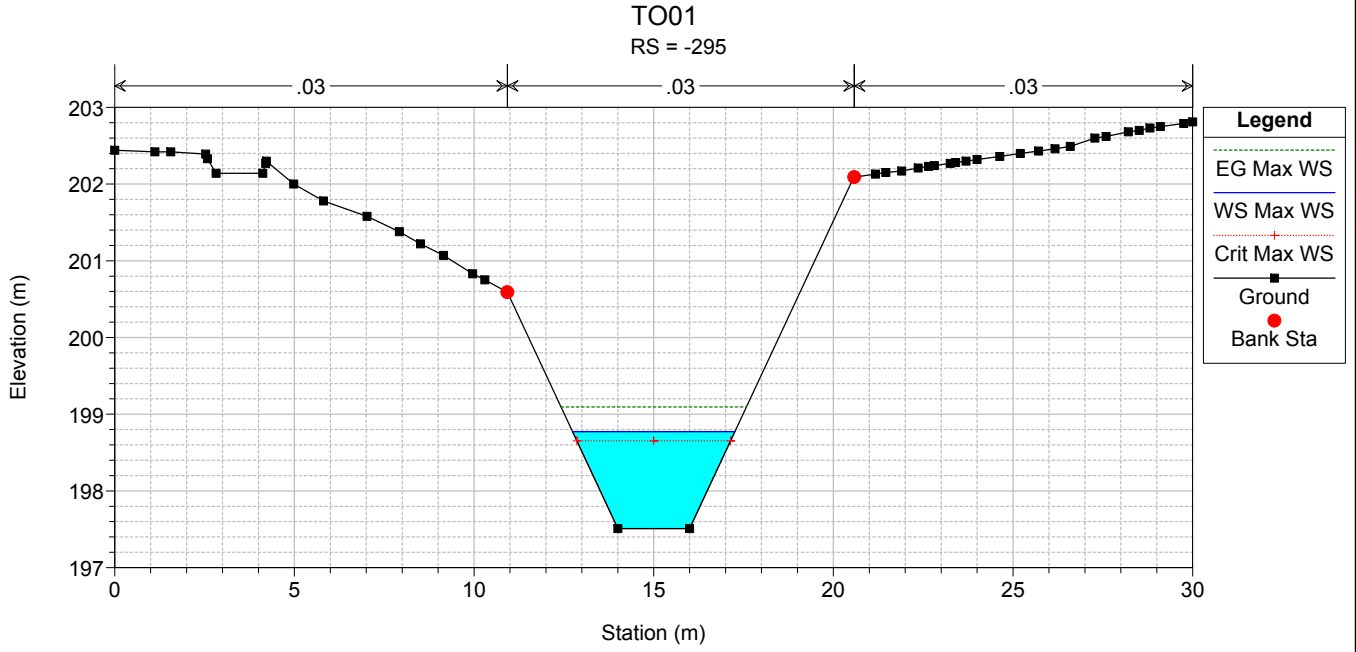
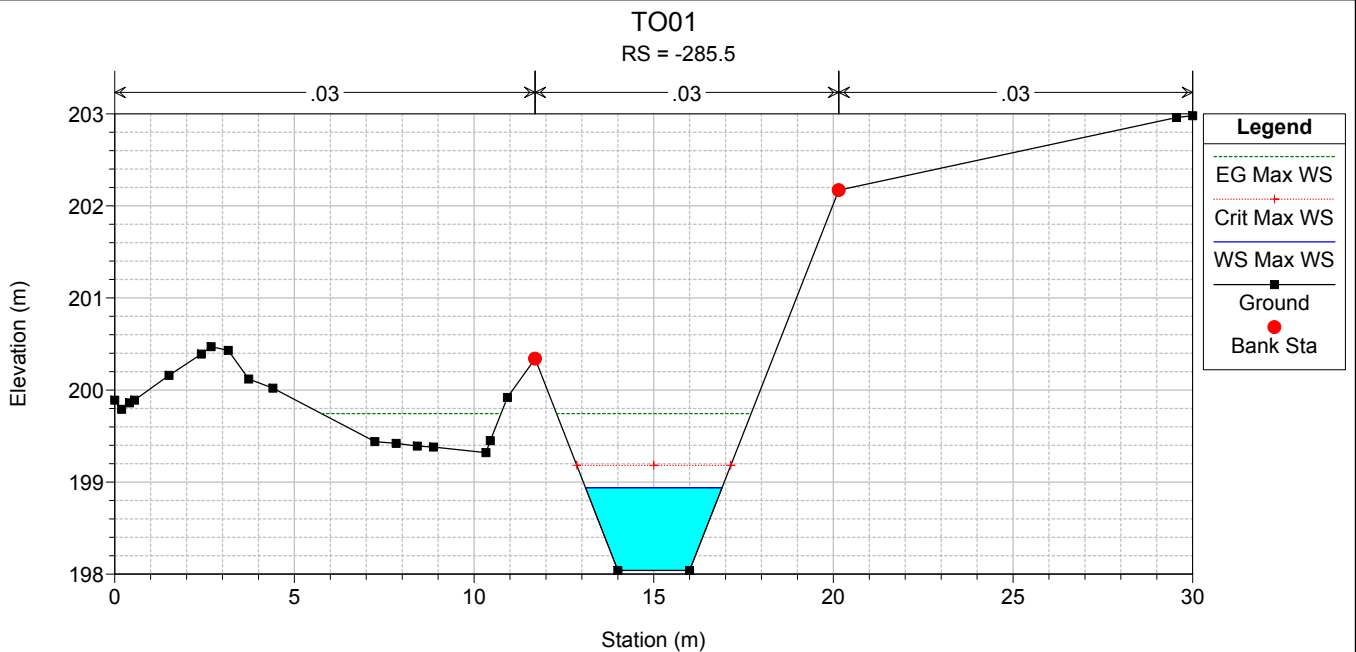

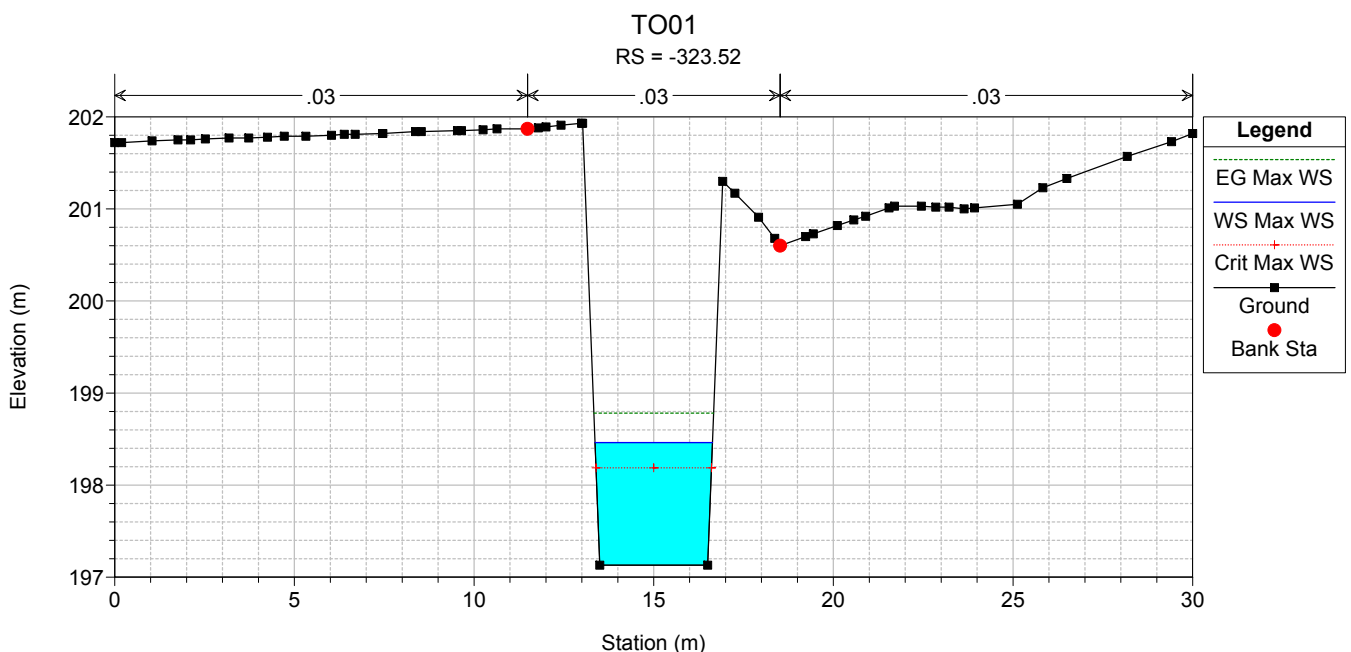
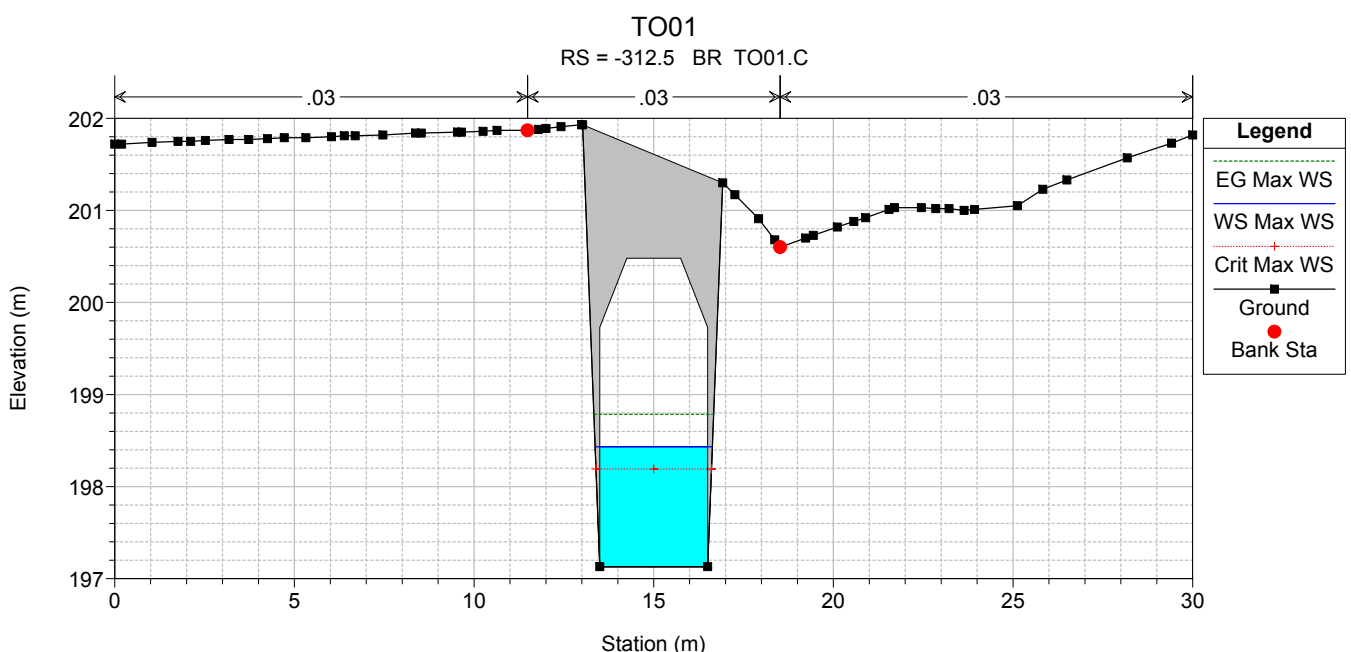
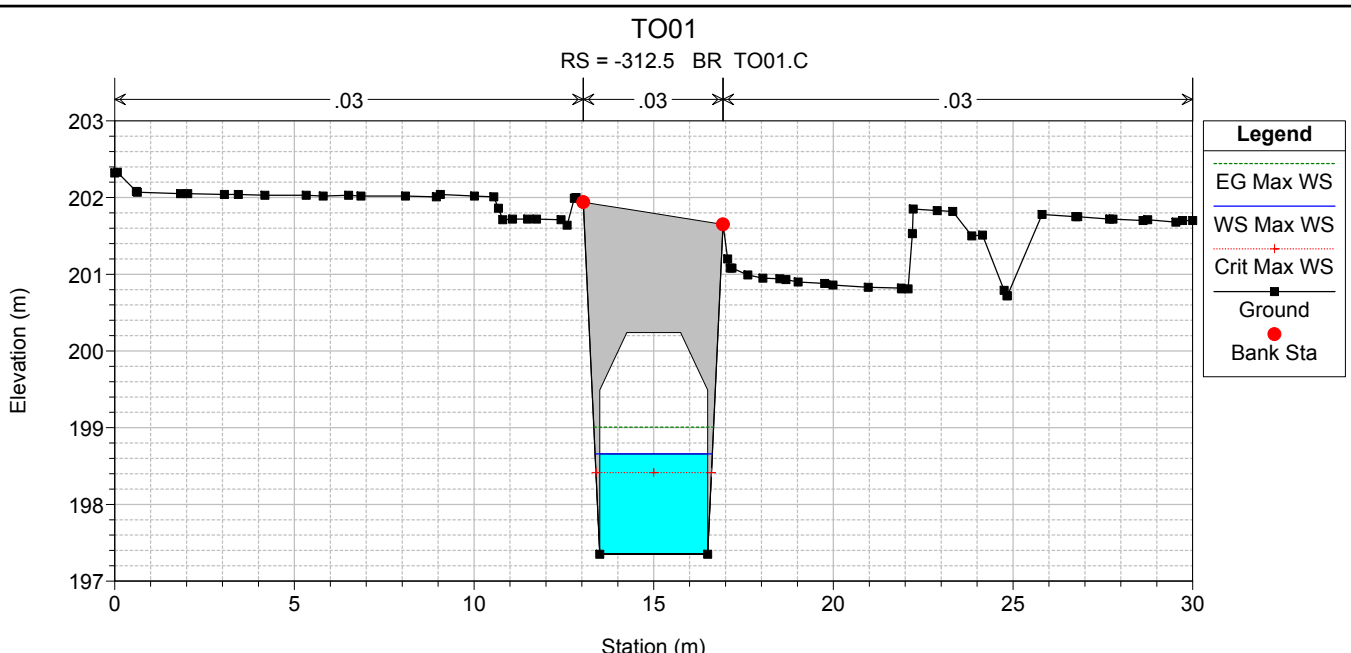

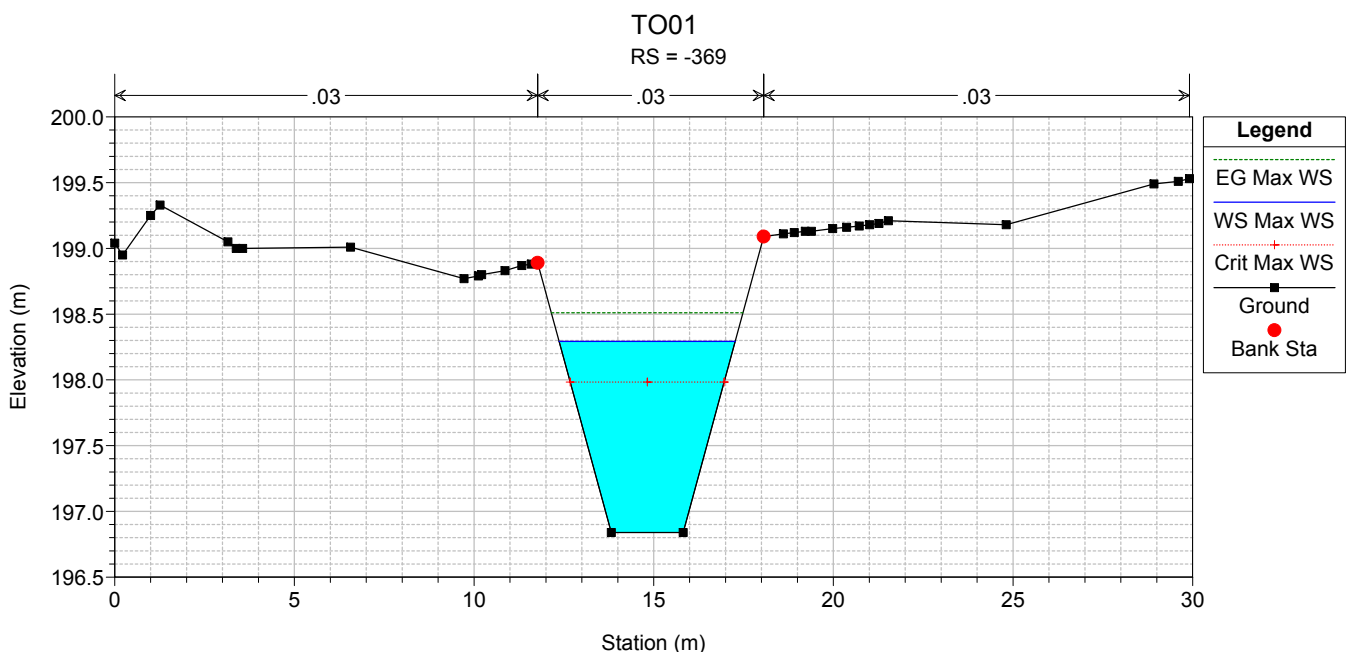
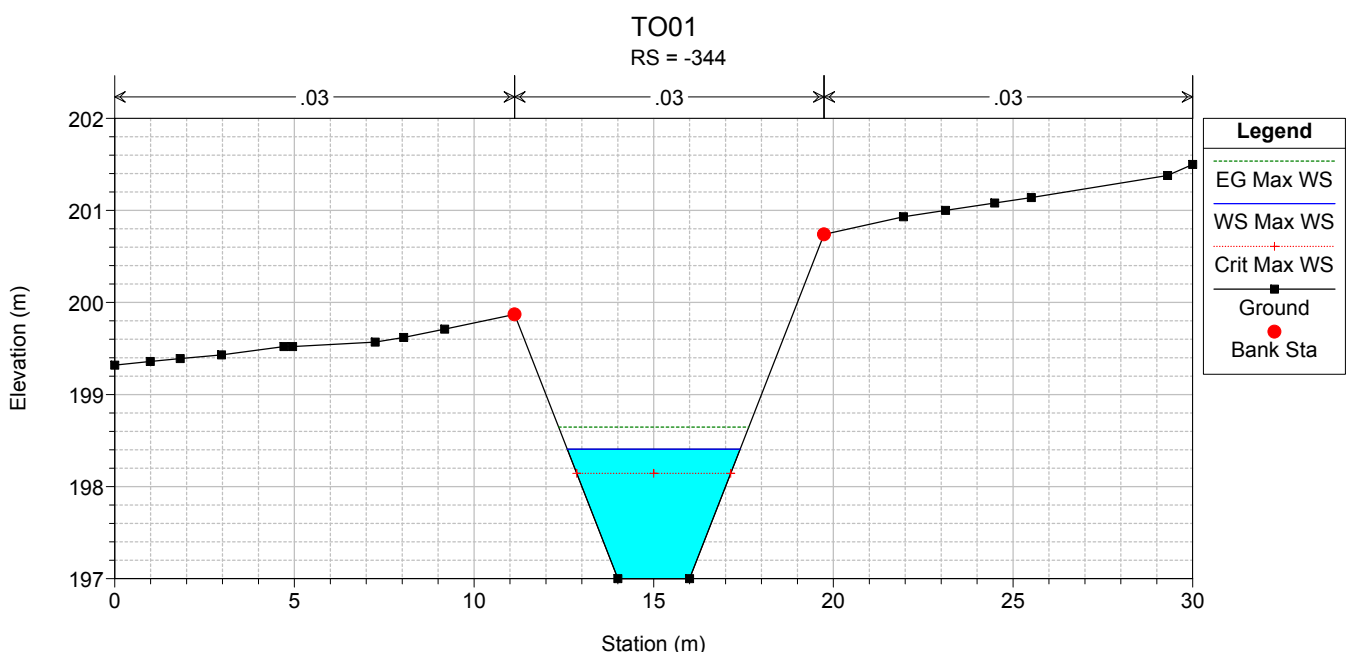
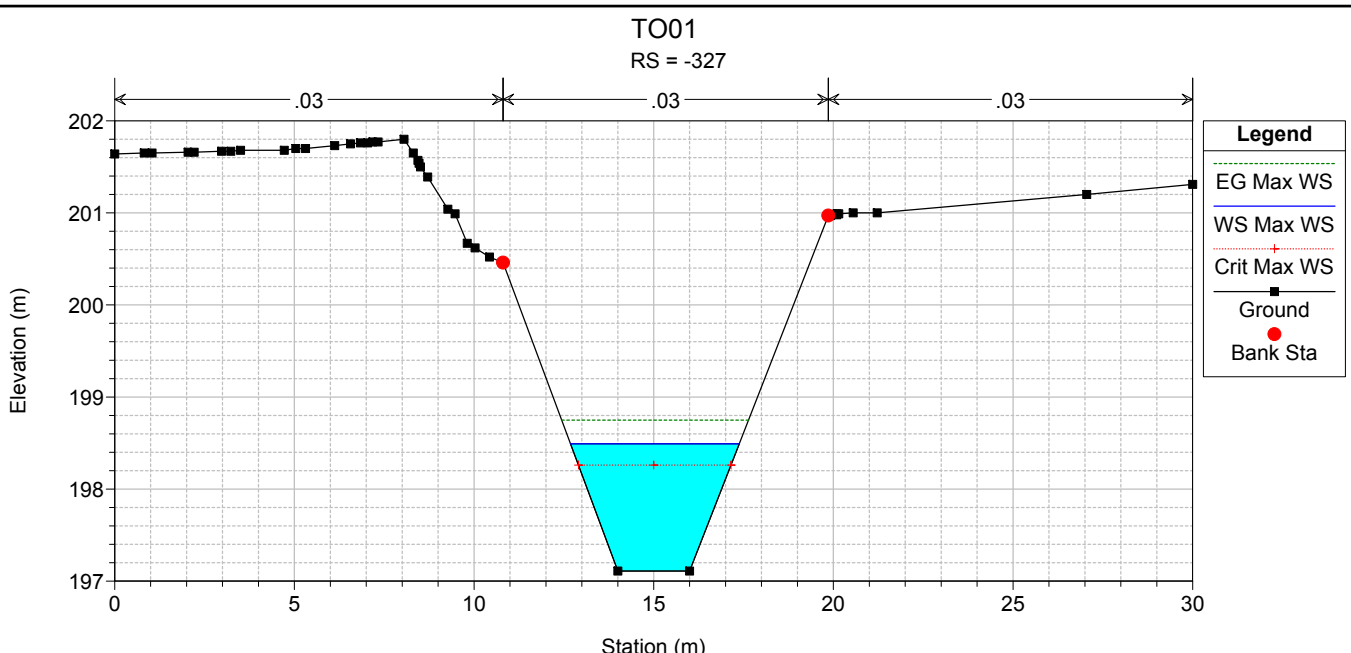

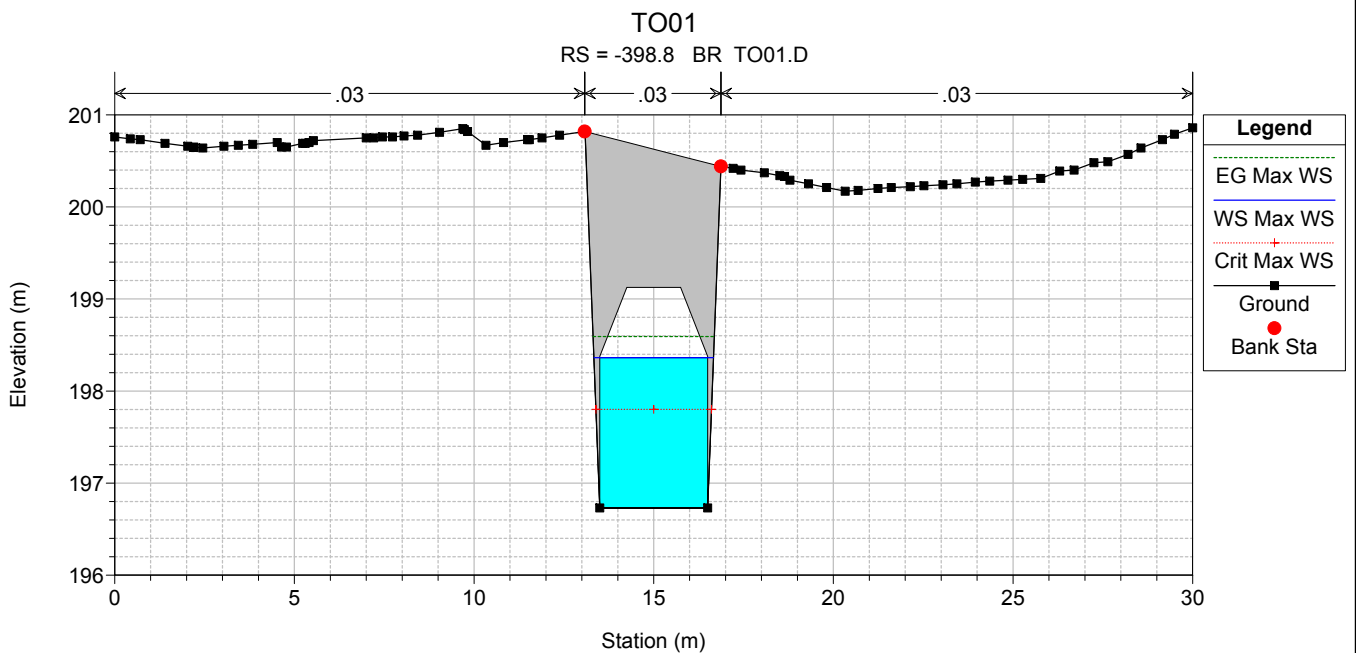
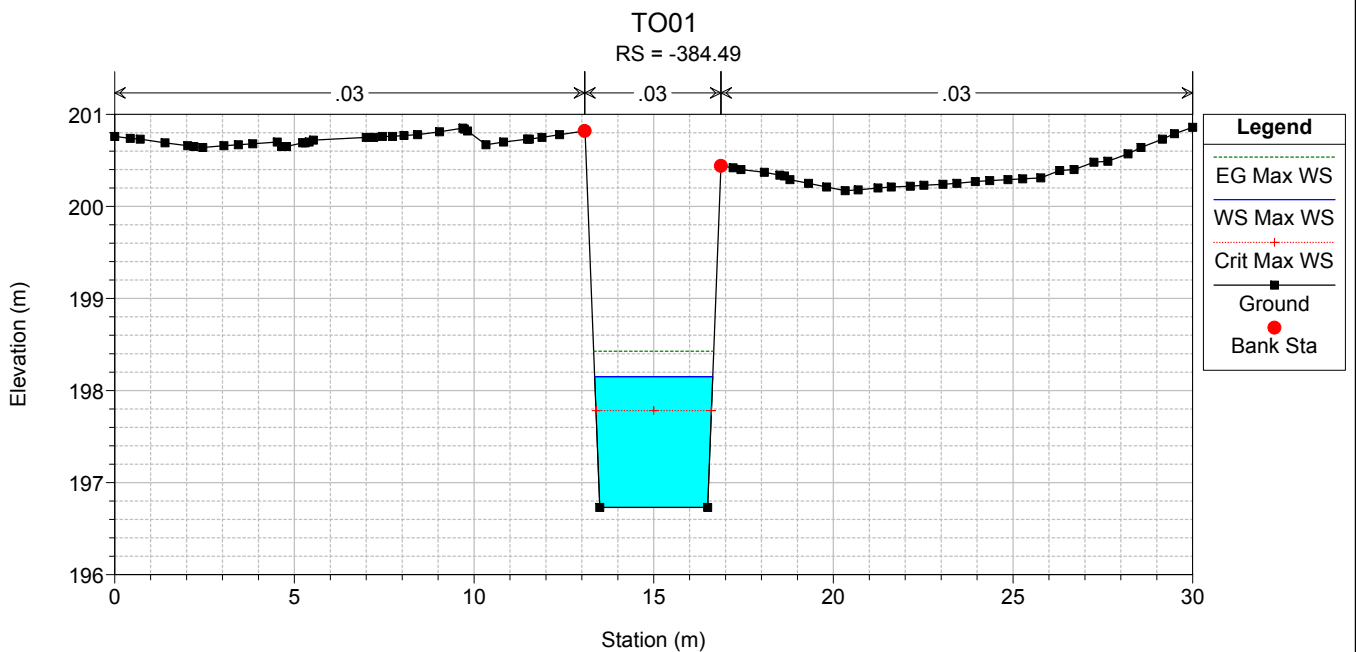
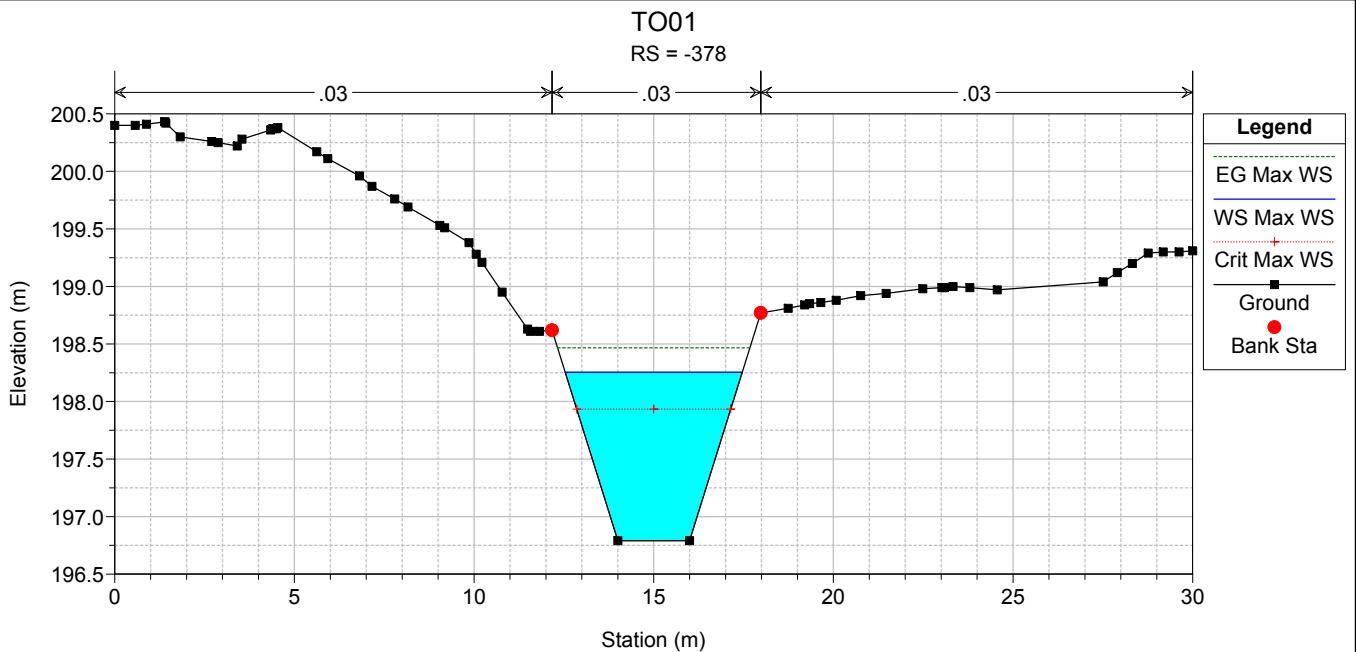

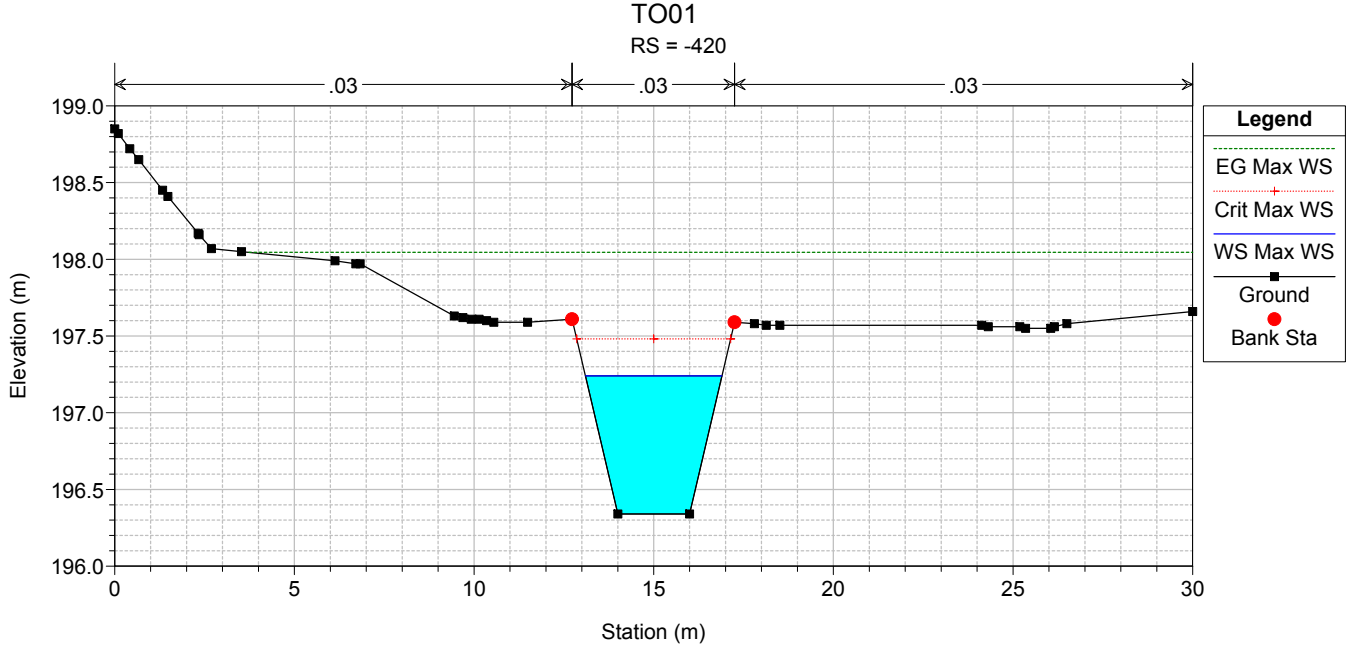
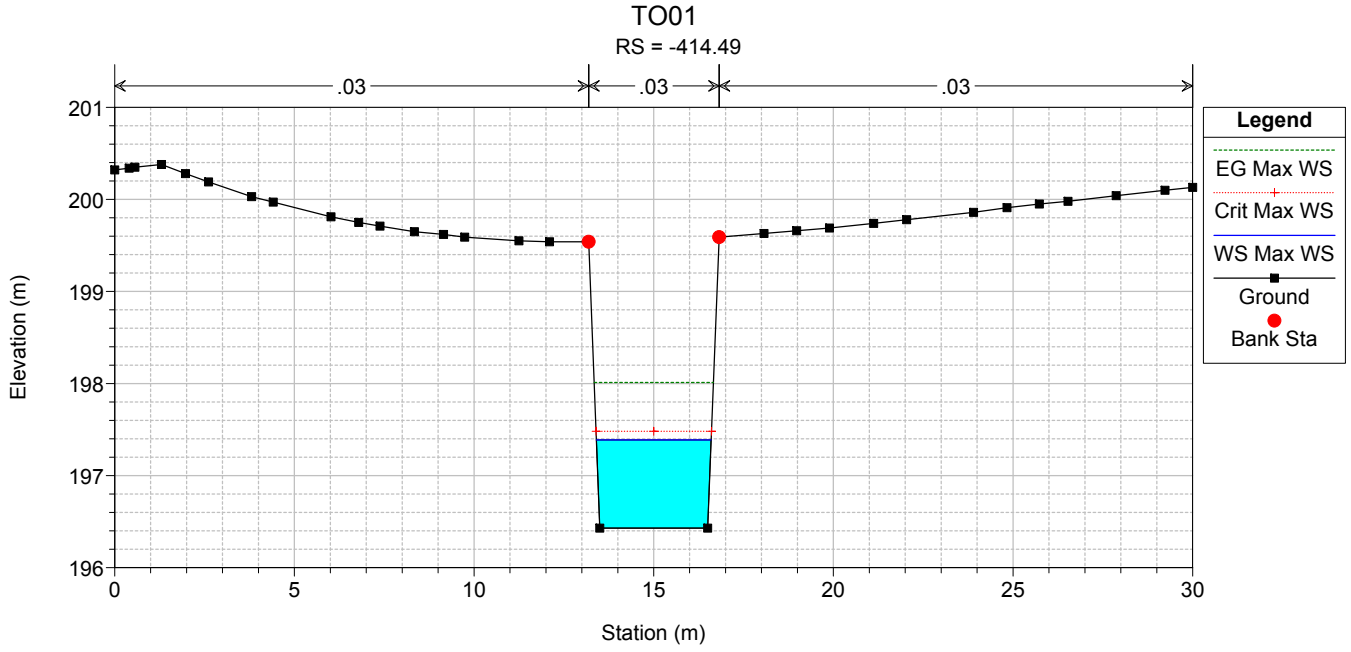
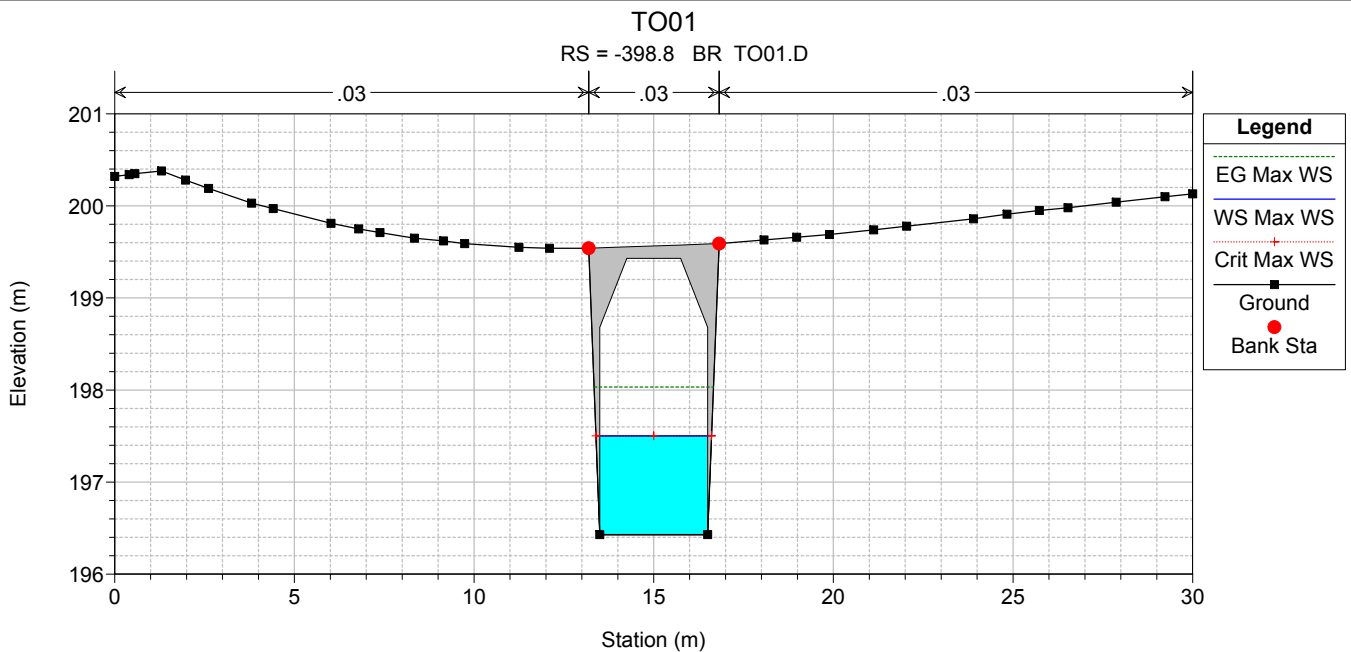

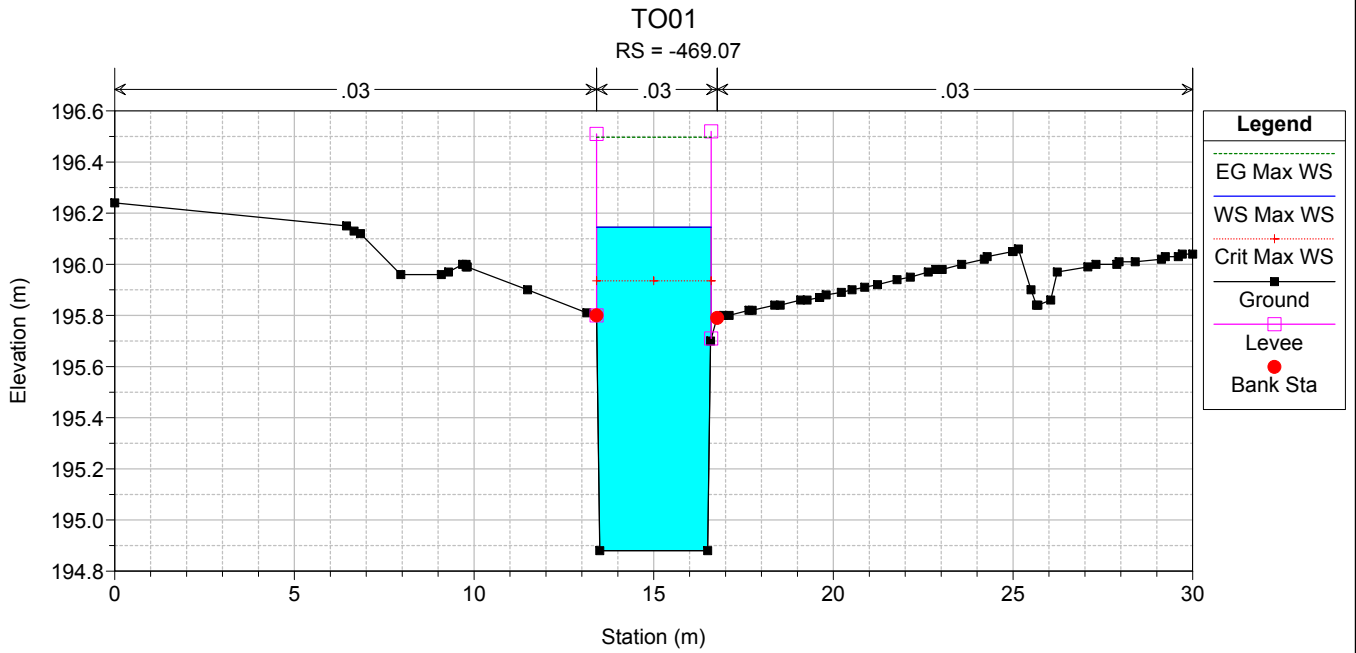
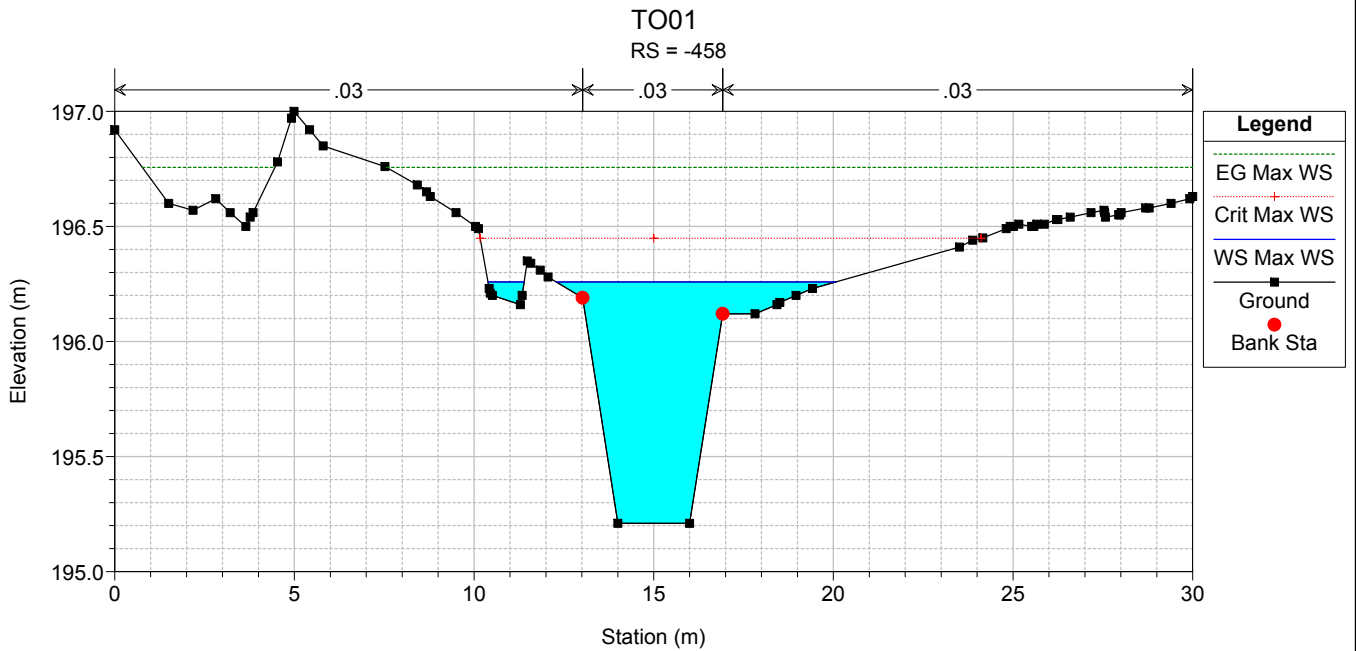
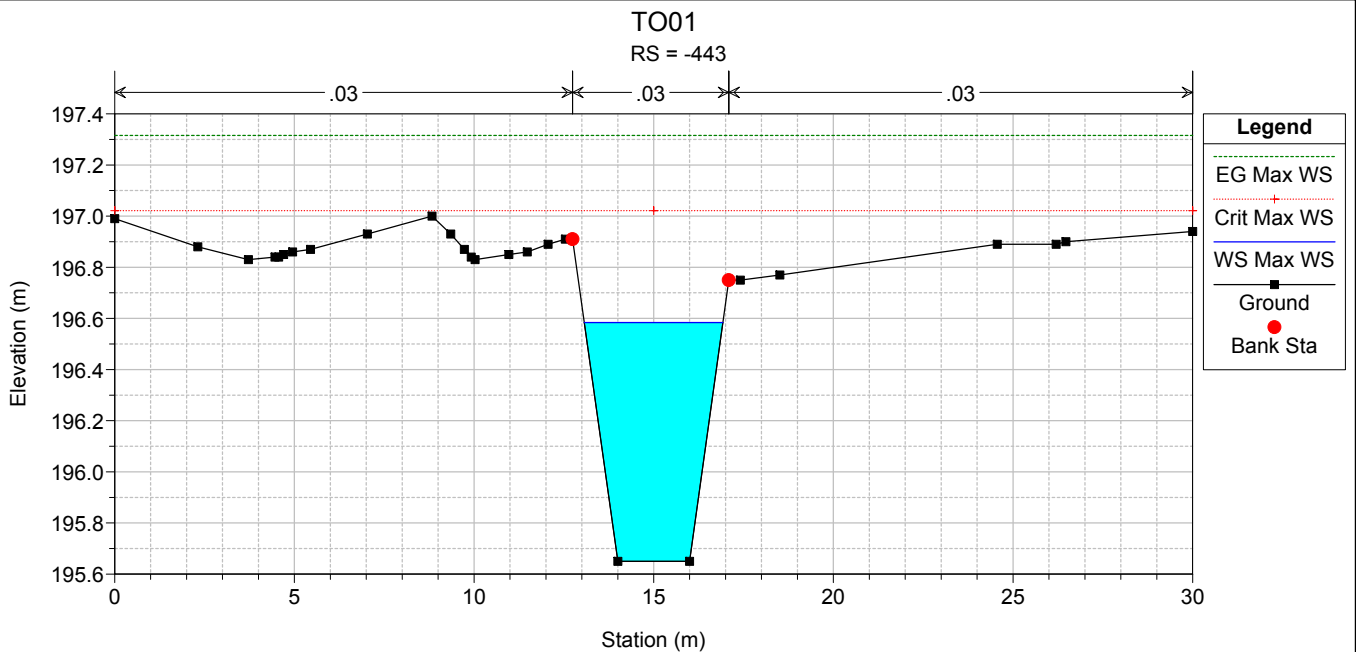

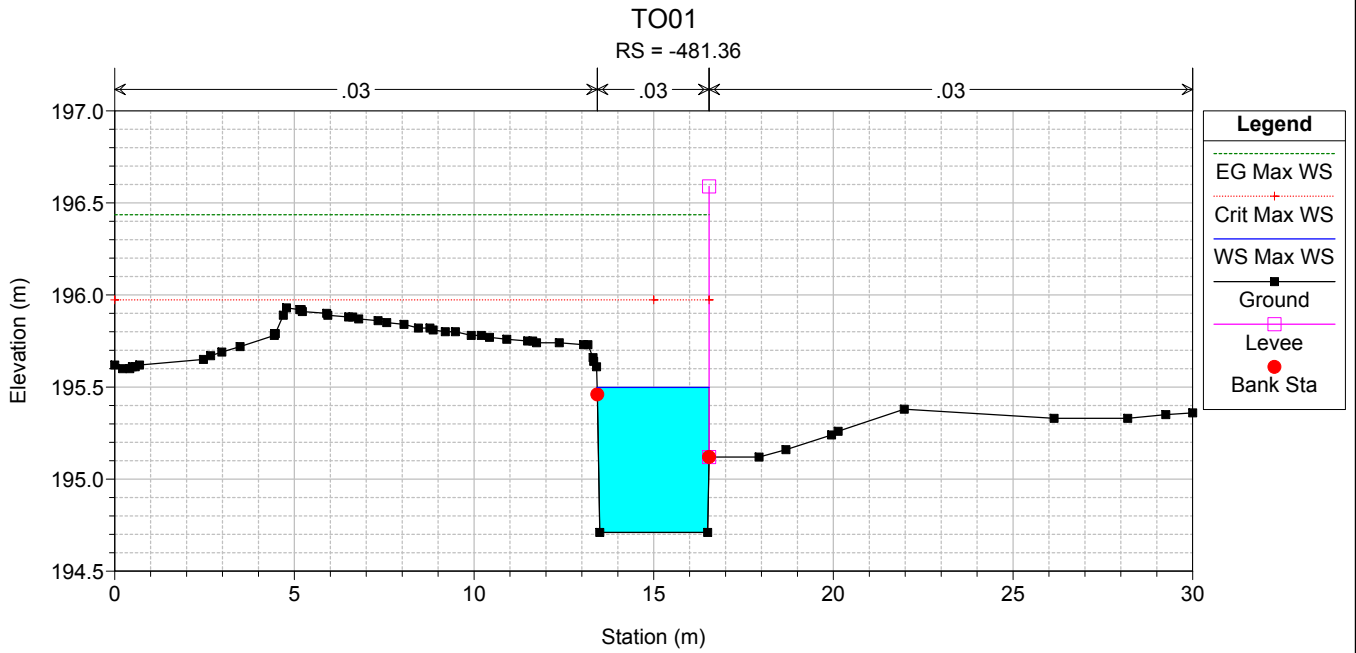
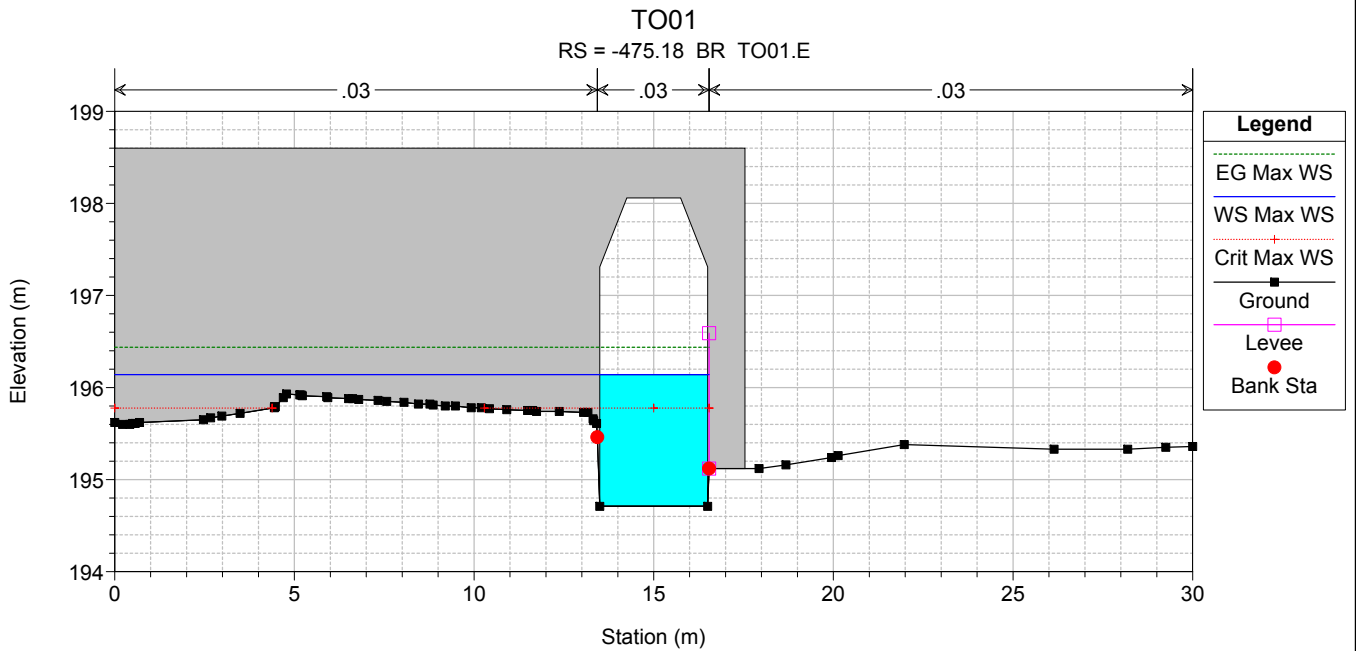
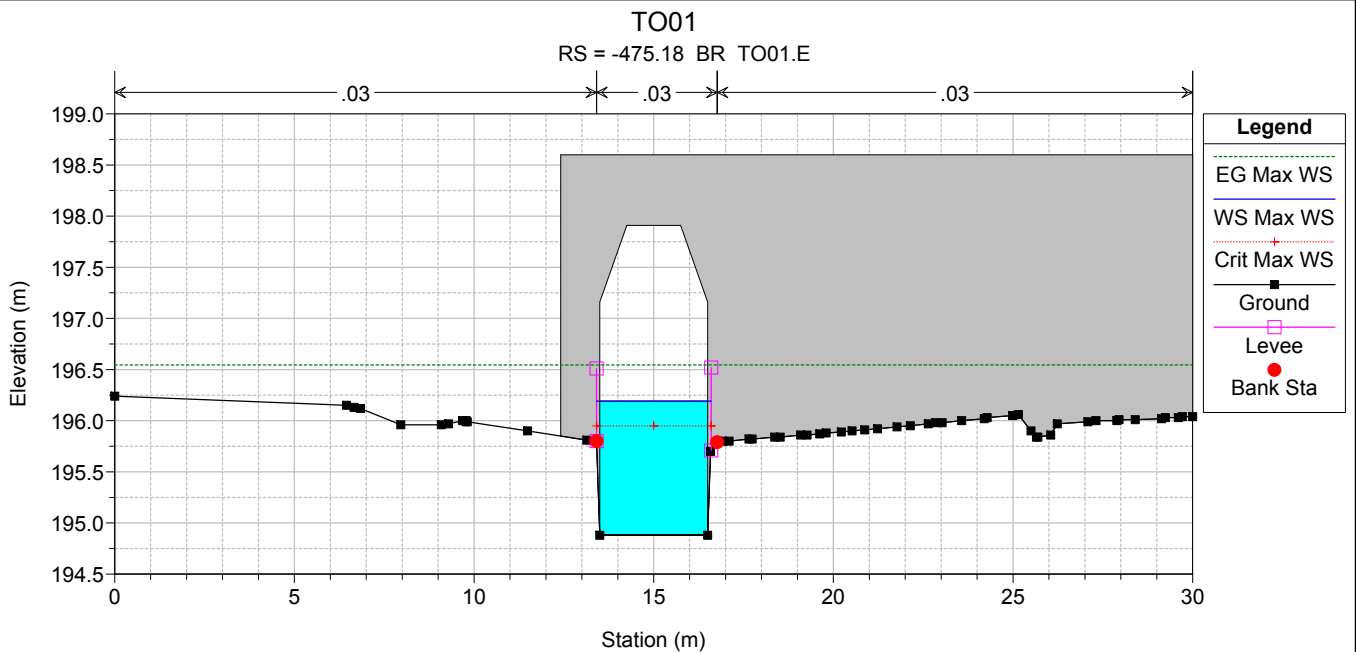

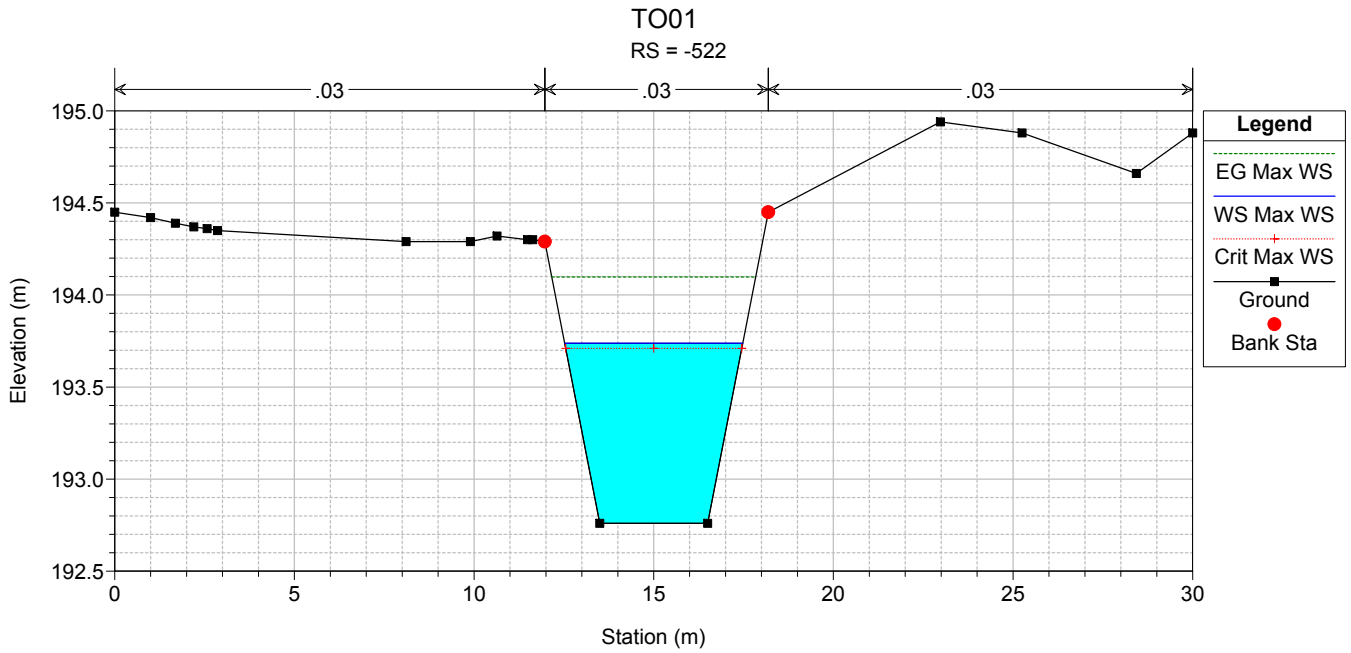
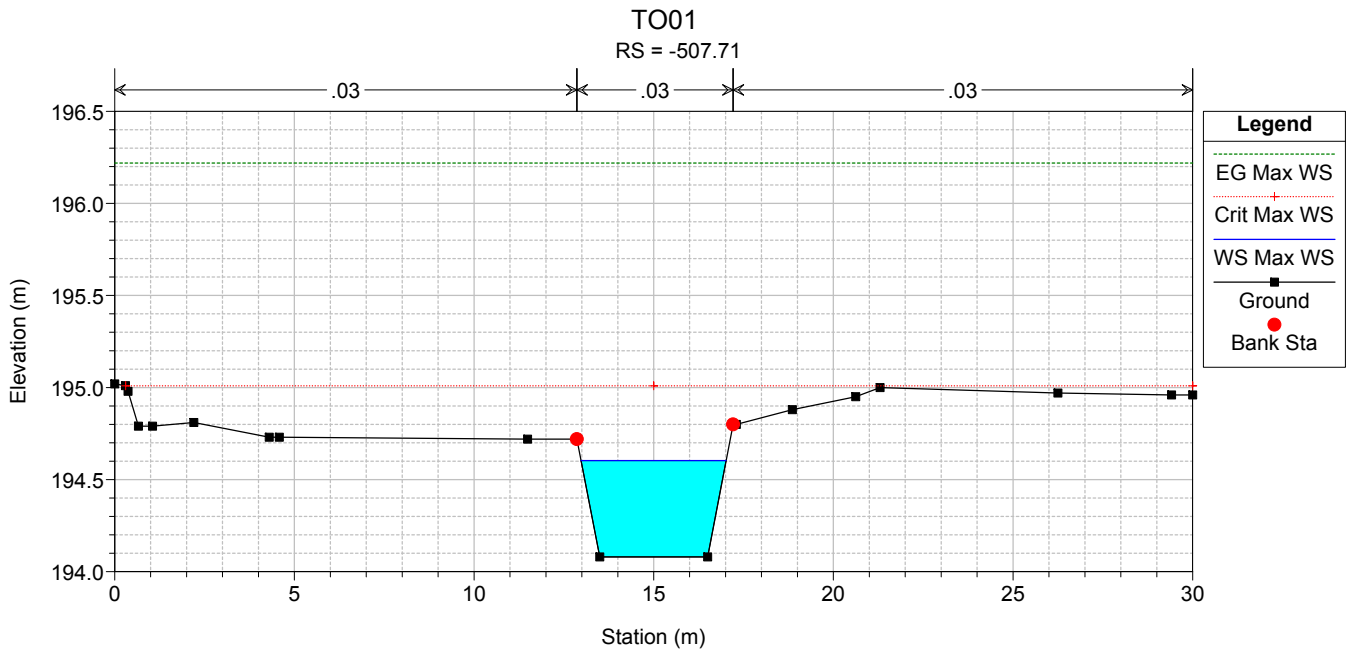
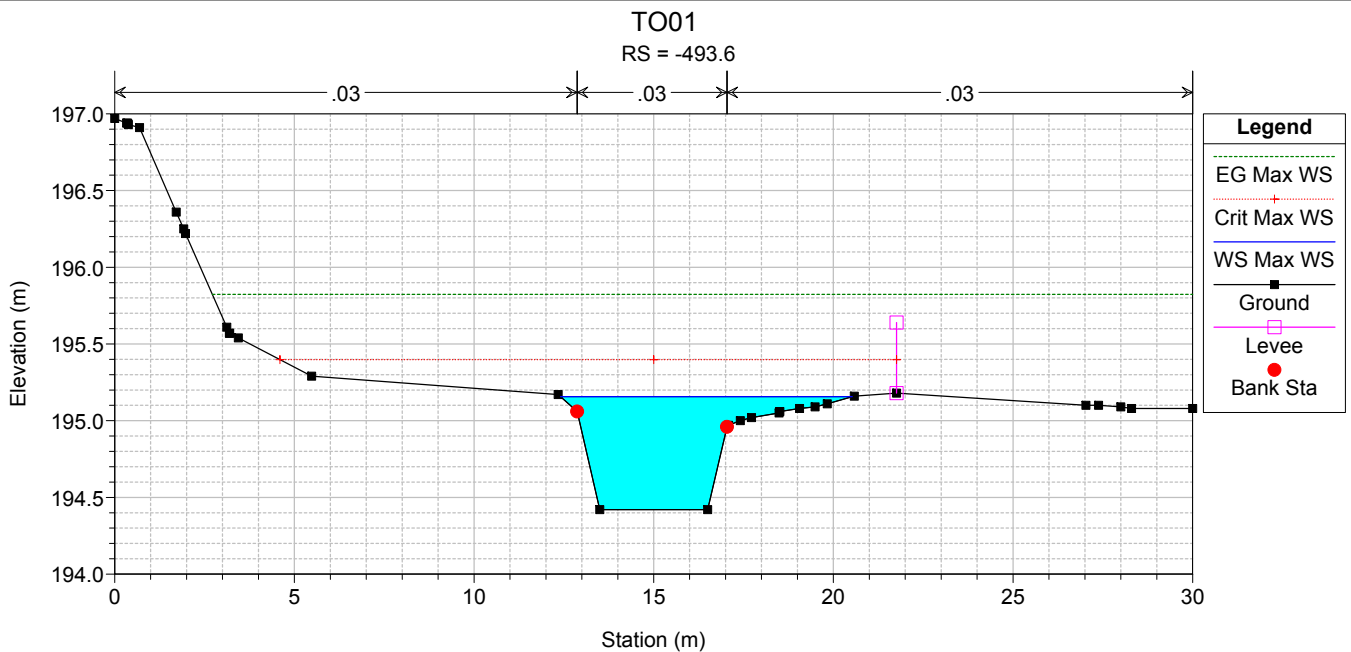

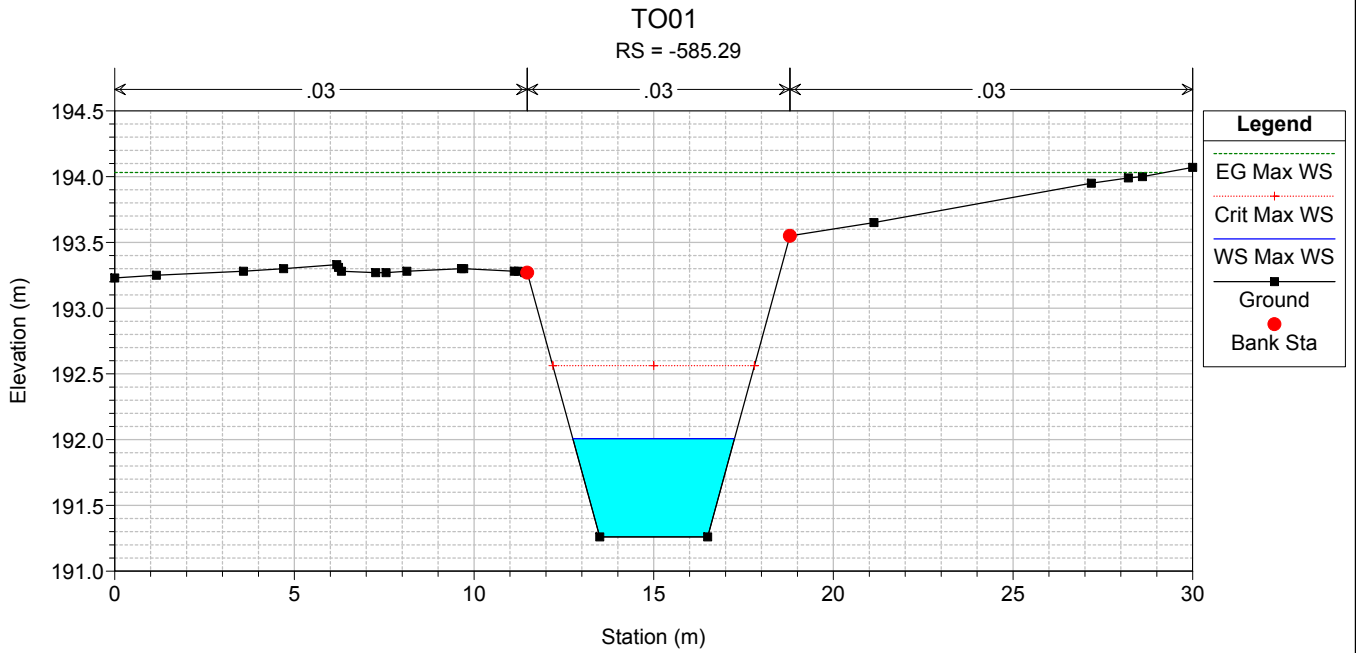
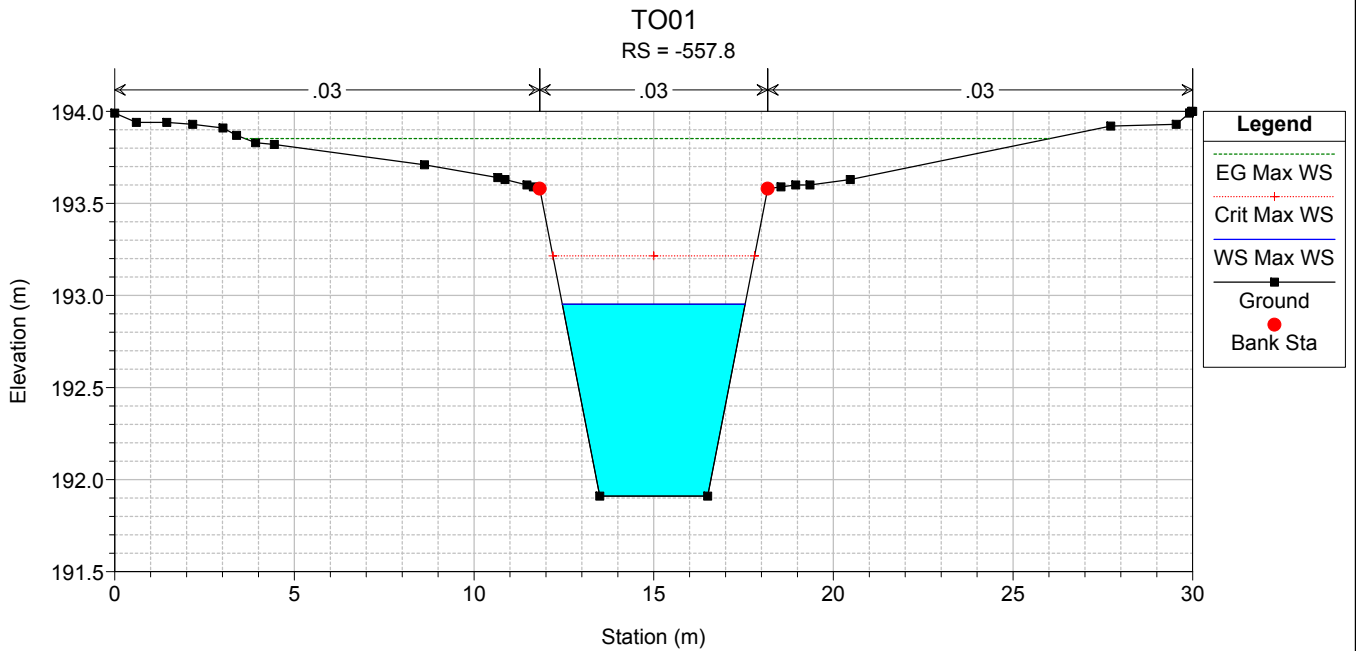
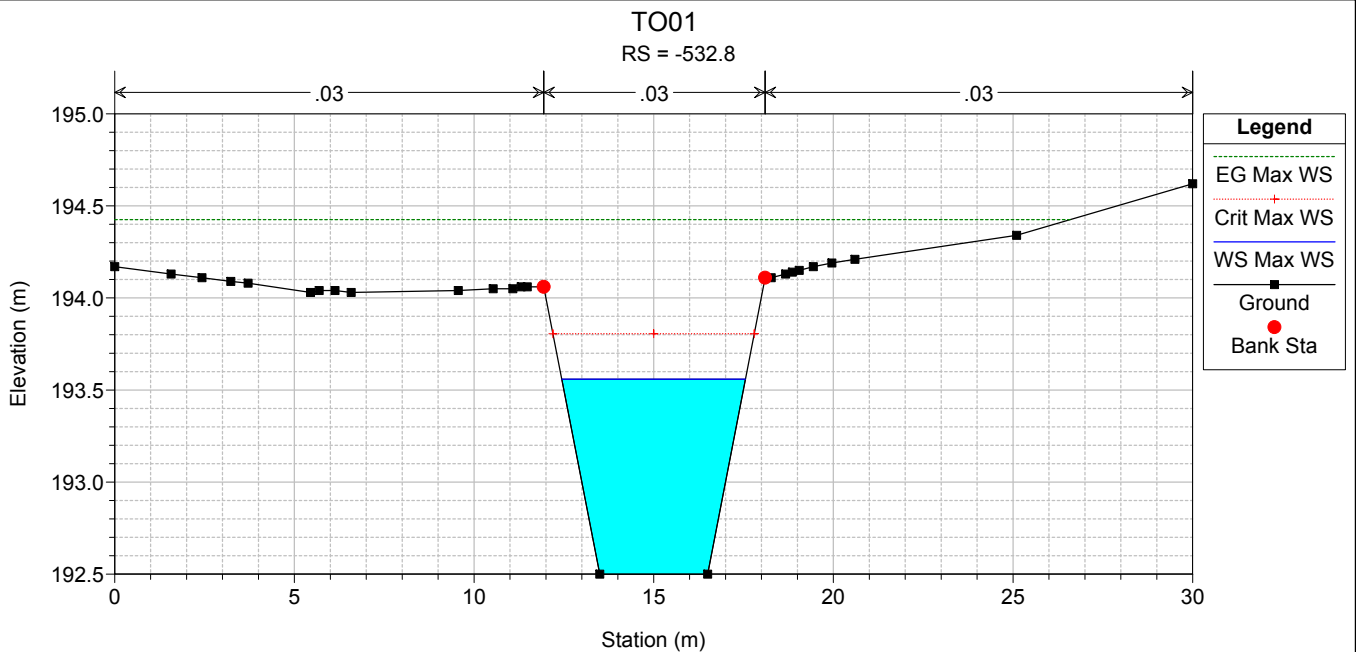

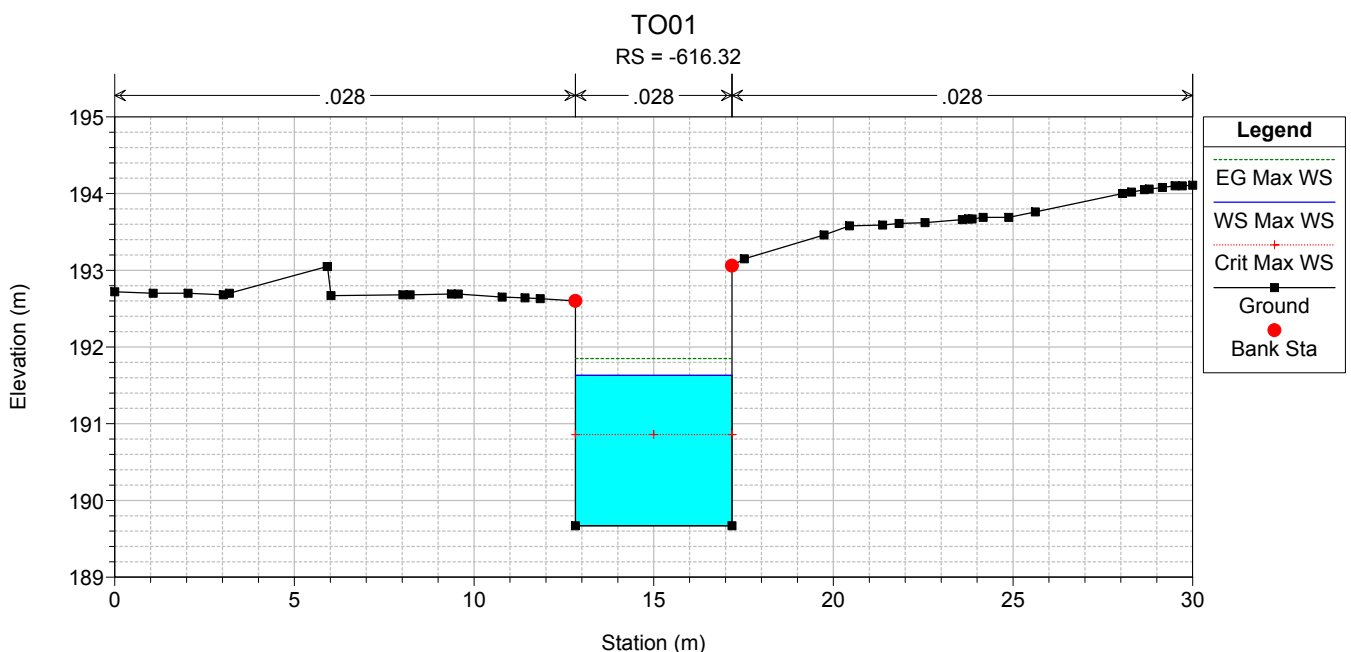
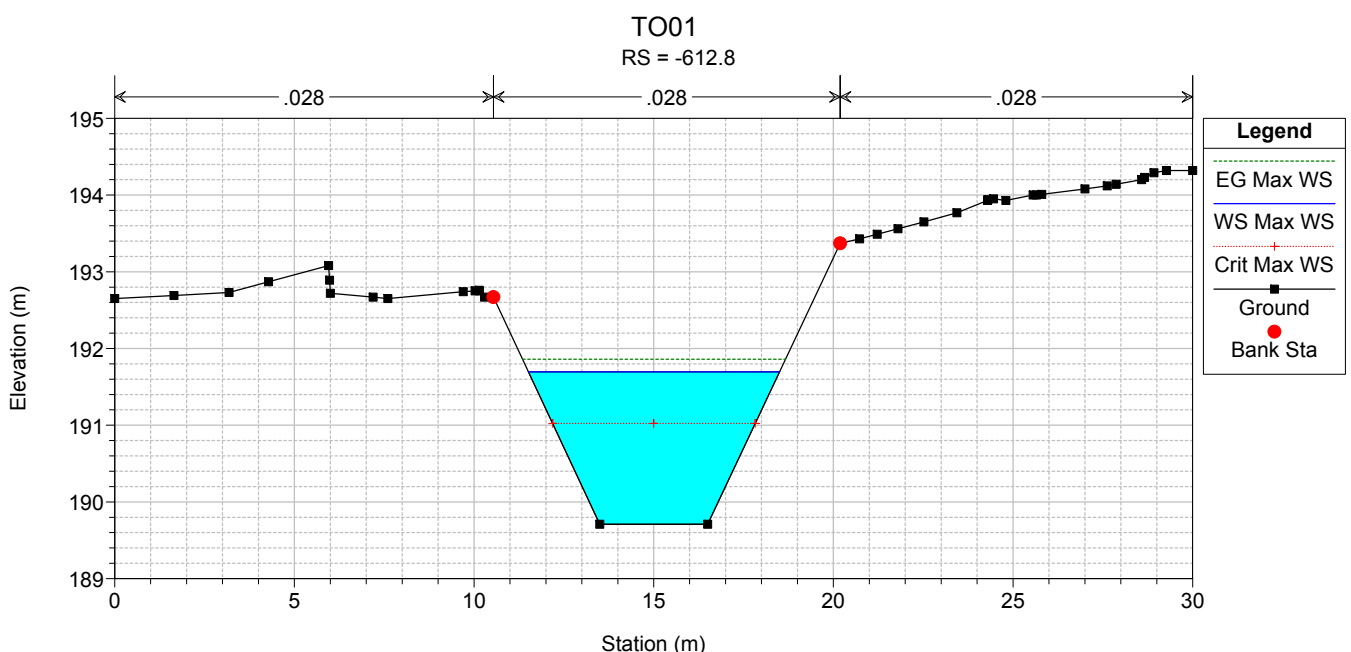
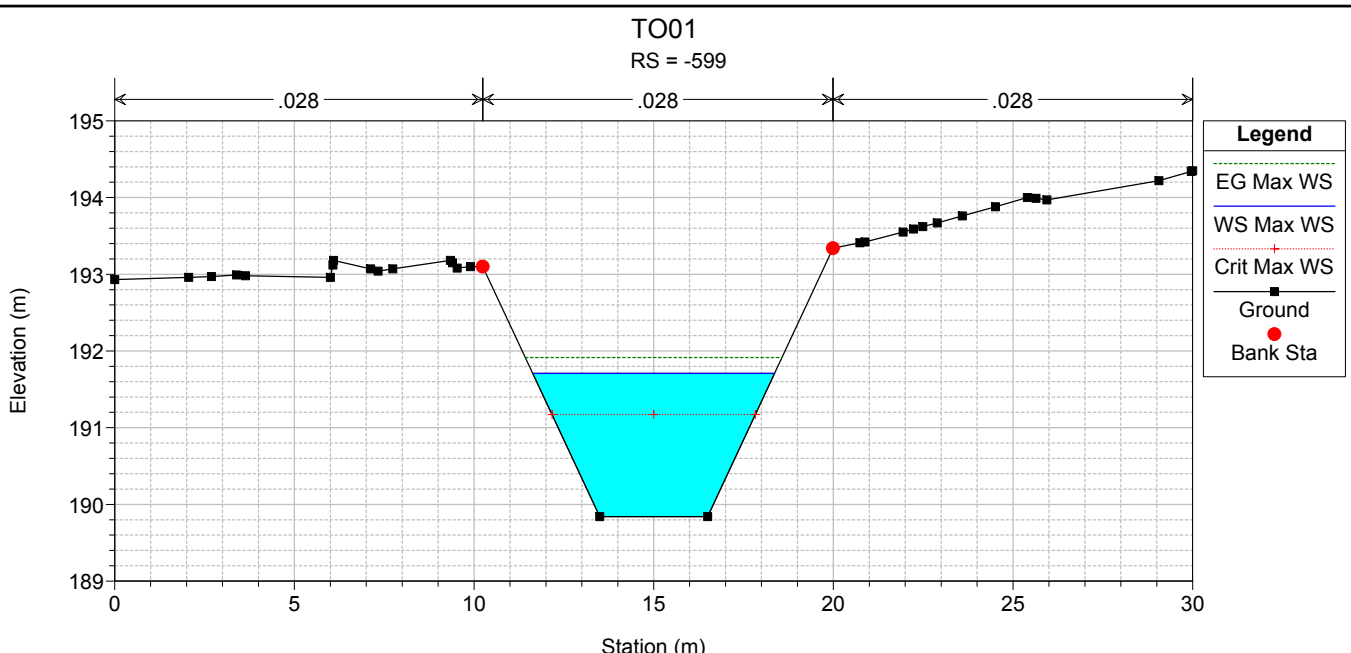

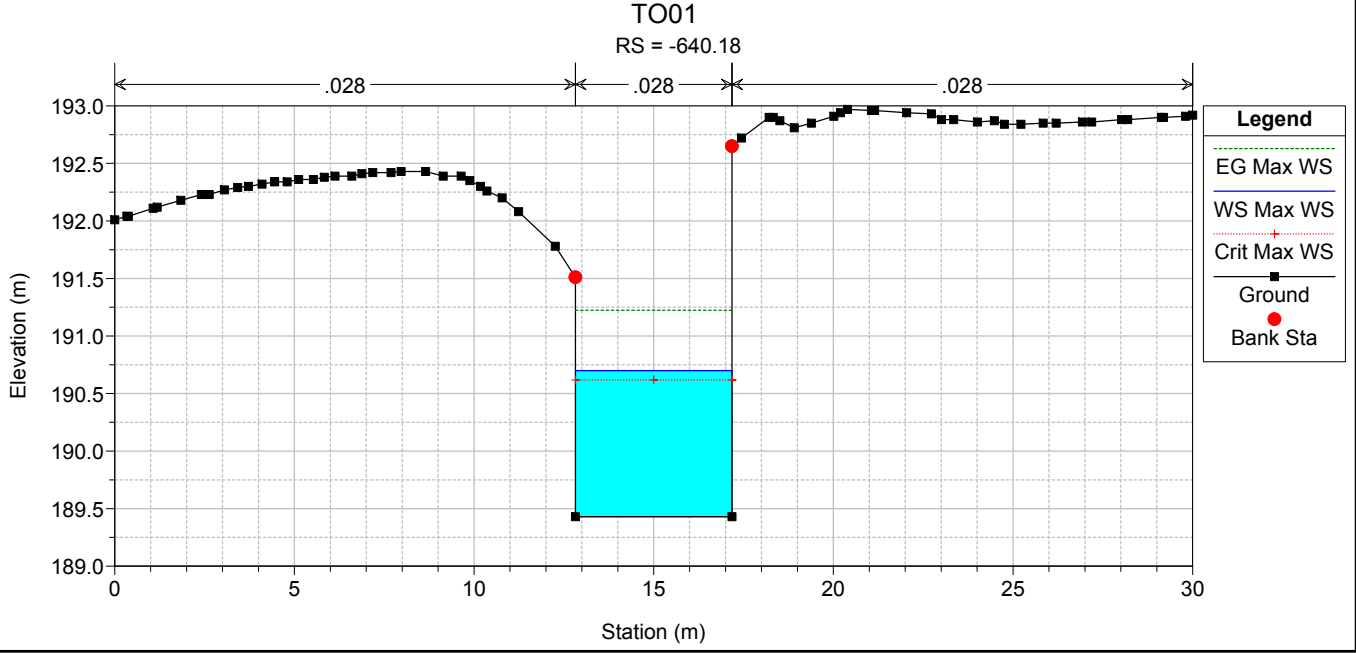
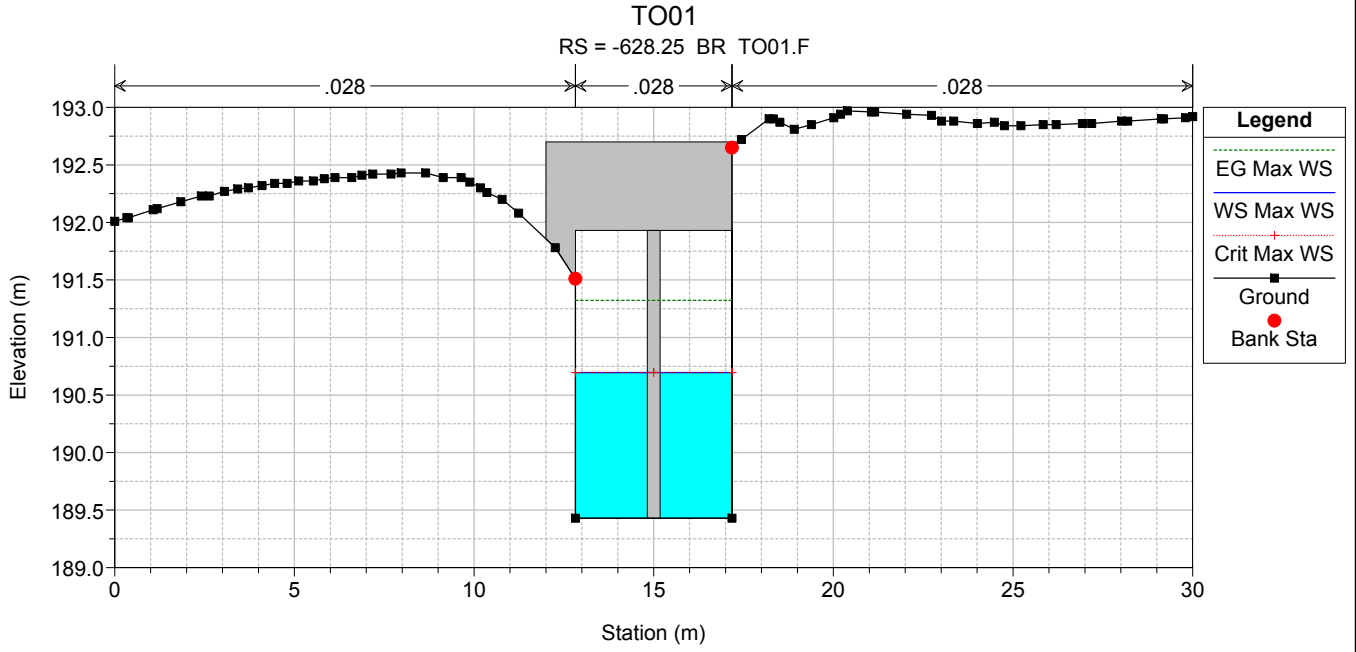
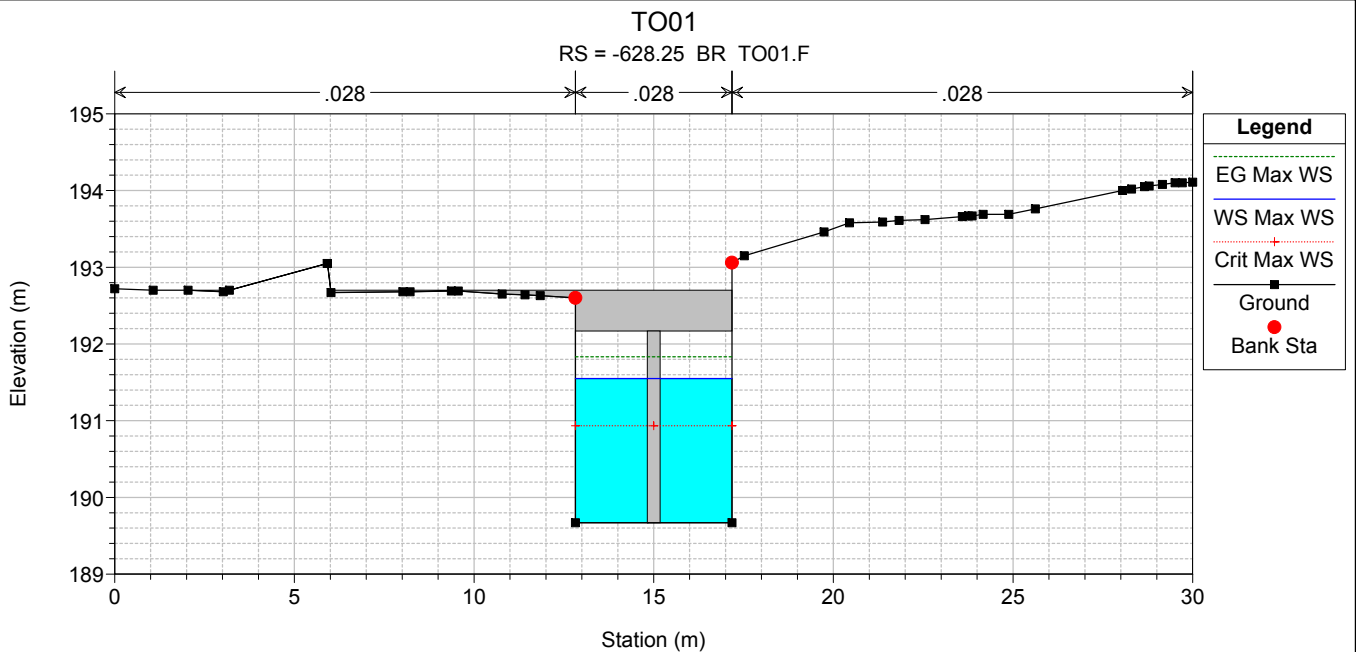

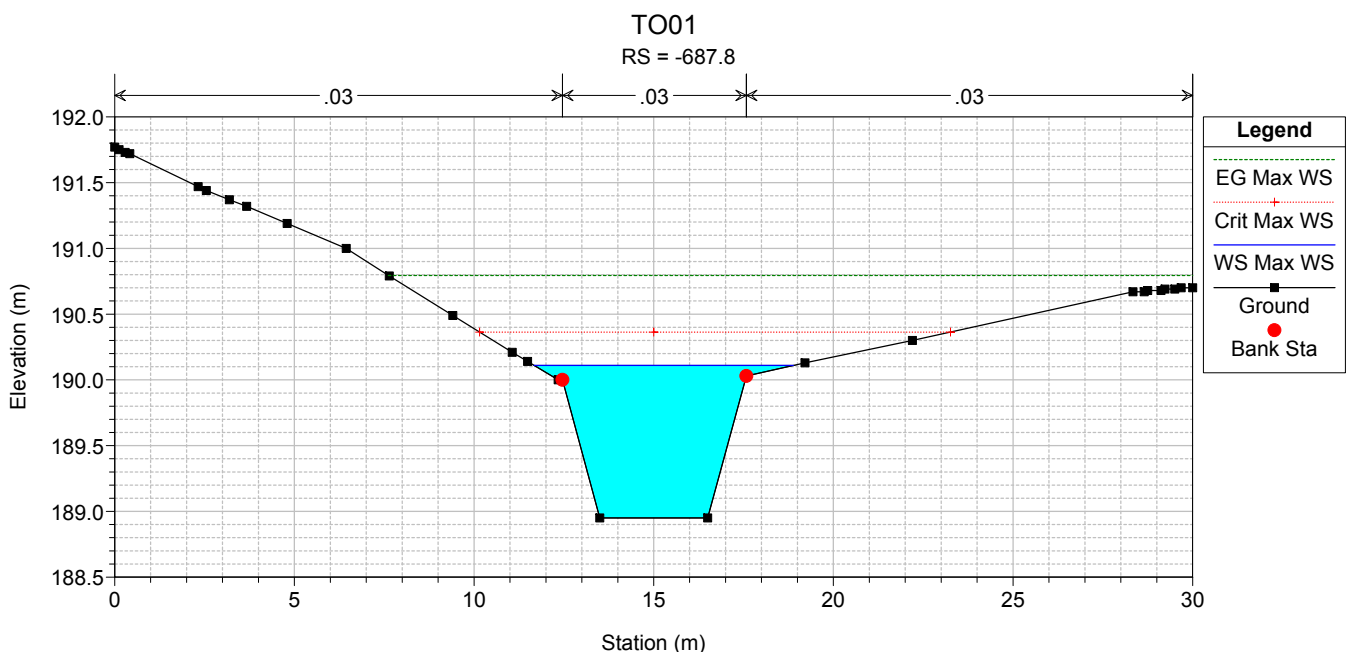
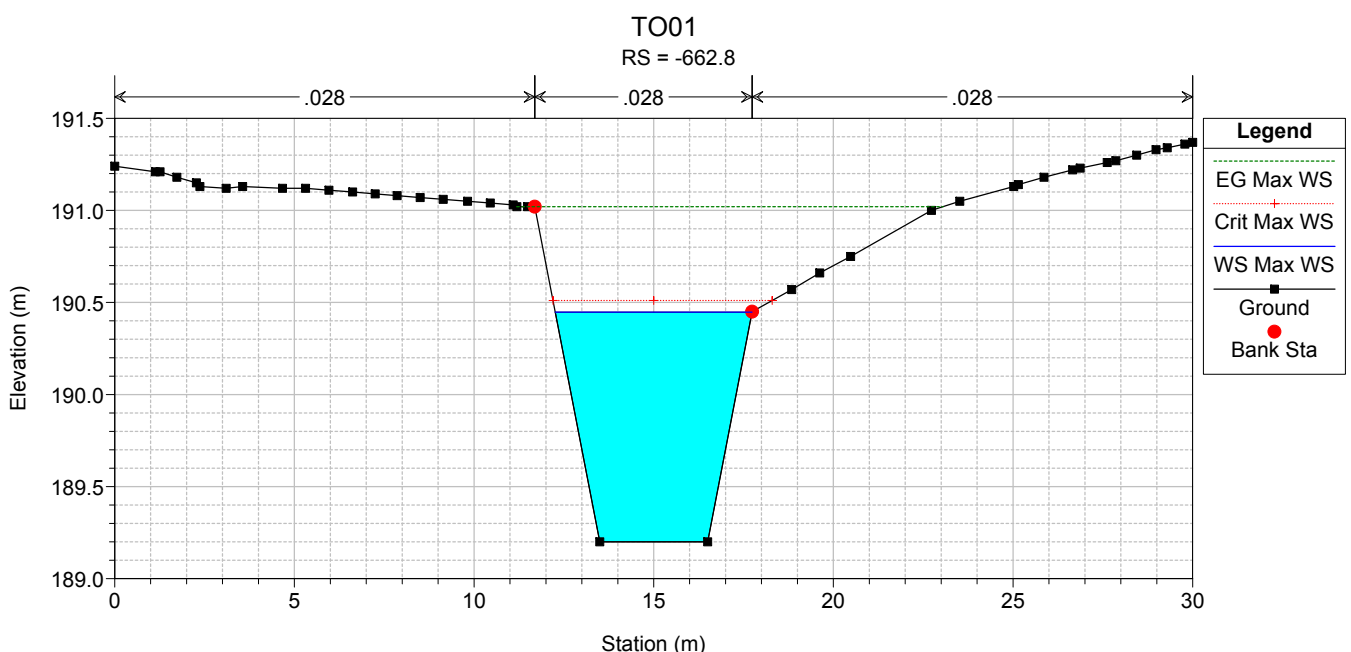
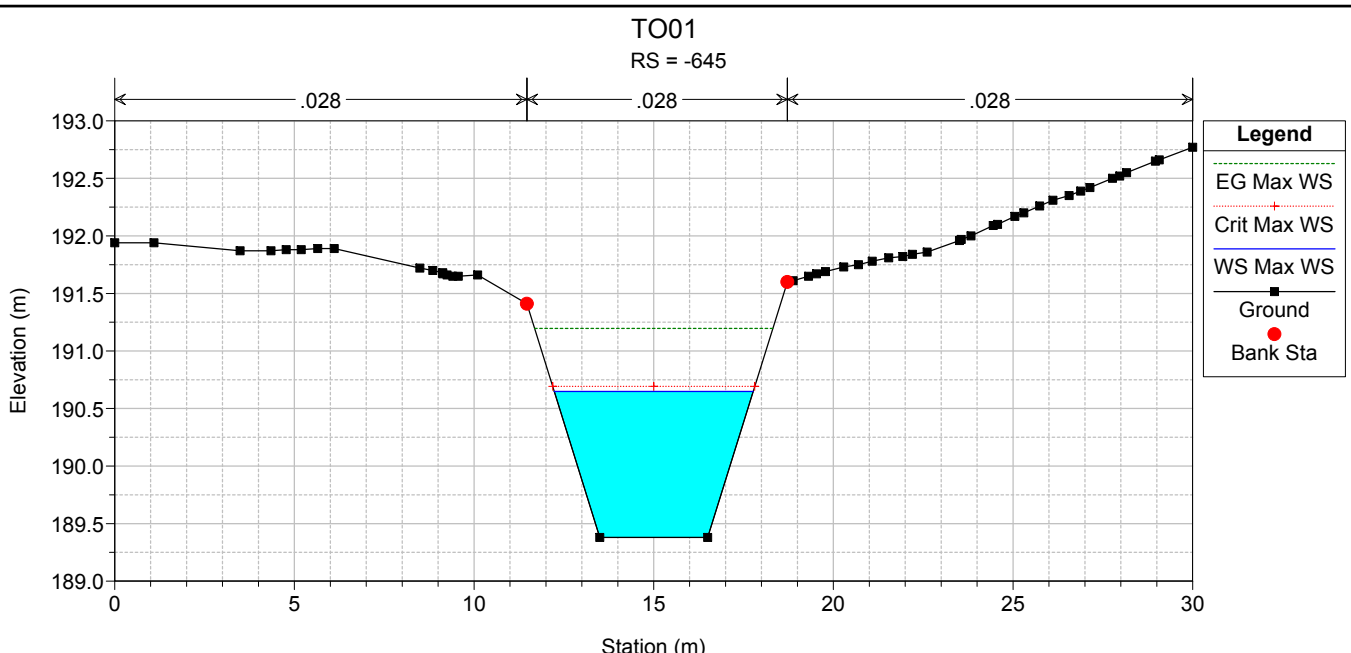

TO01
RS = -712.8

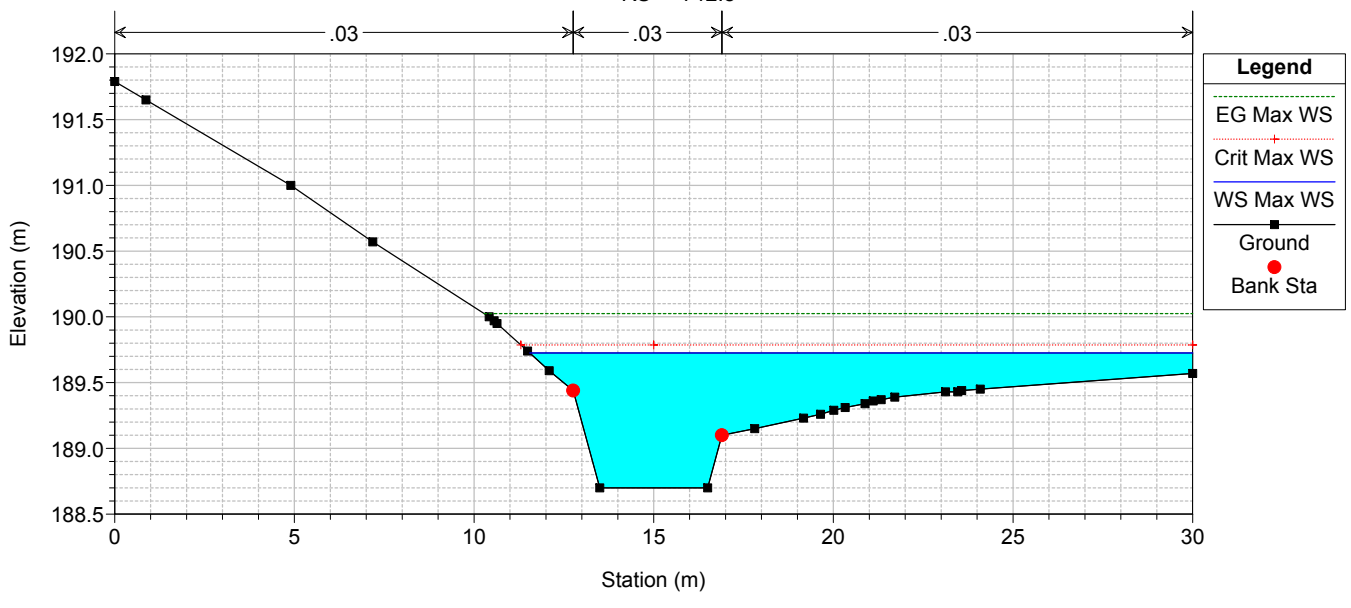

ALLEGATO 3.2

Interferenza idraulica - TO02-TO03-CA02-TO07:
Tabella riassuntiva dei risultati,
profilo idrico e sezioni trasversali con i livelli idrici (TR 200 anni)

ANTE

HEC-RAS Plan: ANTE River: TO02 Reach: TO02 Profile: 13OCT2014 0045

Reach	River Sta	Profile	Q Total (m3/s)	Min Ch El (m)	Max Chl Dpth (m)	W.S. Elev (m)	Crit W.S. (m)	Diff	Froude # Chl	E.G. Elev (m)	Vel Chnl (m/s)	Vel Total (m/s)	Hydr Radius C (m)	Shear Chan (N/m2)	Hydr Depth (m)
TO02	0	13OCT2014 0045	7.0	205.49	4.60	210.09	206.11	3.98	0.01	210.09	0.1	0.1	4.3	0.0	3.90
TO02	-25	13OCT2014 0045	7.3	205.49	4.60	210.09			0.01	210.09	0.1	0.1	4.3	0.0	3.90
TO02	-36.38		Culvert												
TO02	-61.42	13OCT2014 0045	7.3	205.31	1.48	206.79	205.65	1.14	0.05	206.79	0.2	0.2	1.4	0.3	1.30
TO02	-68.65	13OCT2014 0045	0.0	205.31	0.02	205.33	205.37	-0.04	10.93	206.03	3.7	3.7	0.0	533.3	0.01
TO02	-71.55	13OCT2014 0045	0.1	203.77	0.02	203.79	203.87	-0.08	16.82	205.93	6.5	6.5	0.0	1515.0	0.02

Reach	River Sta	Profile	Q Total (m3/s)	Min Ch El (m)	Max Chl Dpth (m)	W.S. Elev (m)	Crit W.S. (m)	Diff	Froude # Chl	E.G. Elev (m)	Vel Chnl (m/s)	Vel Total (m/s)	Hydr Radius C (m)	Shear Chan (N/m2)	Hydr Depth (m)
TO03	0	Max WS	2.7	215.16	0.40	215.56	215.76	-0.20	1.68	215.95	2.8	2.8	0.3	106.9	0.28
TO03	-16.6	Max WS	2.7	213.31	2.18	215.49			0.03	215.50	0.1	0.1	1.1	0.1	0.86
TO03	-70.8	Culvert													
TO03	-125	Max WS	2.7	211.99	0.24	212.23	212.28	-0.05	2.01	212.41	1.9	1.9	0.1	70.4	0.09
TO03	-150	Max WS	2.7	211.60	0.17	211.77	211.86	-0.09	3.05	212.13	2.7	2.7	0.1	148.4	0.08
TO03	-175	Max WS	2.7	209.56	0.40	209.96	209.98	-0.02	1.19	210.07	1.4	1.4	0.1	34.5	0.15
TO03	-200	Max WS	2.7	208.61	0.90	209.51	209.27	0.24	0.36	209.54	0.8	0.8	0.4	7.1	0.46
TO03	-225	Max WS	11.4	208.31	0.68	208.99	209.05	-0.06	1.13	209.20	2.0	2.0	0.3	53.2	0.33
TO03	-250	Max WS	24.5	207.54	1.02	208.56	208.53	0.03	0.95	208.76	2.0	2.0	0.4	46.6	0.45
TO03	-275	Max WS	24.5	207.30	0.90	208.20	208.30	-0.10	1.45	208.56	2.6	2.6	0.3	89.4	0.34
TO03	-300	Max WS	24.5	206.45	1.24	207.69	207.74	-0.05	1.20	207.98	2.4	2.4	0.4	68.5	0.40
TO03	-325	Max WS	24.5	206.12	1.13	207.25	207.36	-0.11	1.42	207.62	2.7	2.7	0.4	90.1	0.36
TO03	-350	Max WS	24.5	205.81	0.92	206.73	206.73	0.00	1.03	206.95	2.1	2.1	0.4	51.4	0.42
TO03	-375	Max WS	24.5	205.63	0.60	206.23	206.27	-0.04	1.14	206.46	2.1	2.1	0.3	56.4	0.35
TO03	-400	Max WS	24.5	205.37	0.46	205.83	205.88	-0.05	1.17	206.08	2.2	2.2	0.4	60.4	0.37
TO03	-425	Max WS	24.5	204.92	0.45	205.37	205.47	-0.10	1.45	205.72	2.6	2.6	0.3	86.7	0.33
TO03	-450	Max WS	24.5	204.07	0.76	204.83	204.86	-0.03	1.12	205.04	2.0	2.0	0.3	53.0	0.34
TO03	-475	Max WS	24.5	203.77	0.78	204.55	204.46	0.09	0.78	204.69	1.7	1.7	0.5	13.3	0.46
TO03	-500	Max WS	24.5	203.62	0.89	204.51	204.28	0.23	0.52	204.59	1.2	1.2	0.6	16.0	0.58
TO03	-516.82	Max WS	24.5	203.53	0.84	204.37	204.31	0.06	0.83	204.53	1.8	1.8	0.4	35.6	0.45
TO03	-525.8	Max WS	24.5	203.44	0.83	204.27	204.28	-0.01	1.04	204.49	2.1	2.1	0.4	51.0	0.40
TO03	-535.3	Max WS	24.5	203.31	0.80	204.12	204.23	-0.11	1.53	204.50	2.7	2.7	0.3	96.2	0.33
TO03	-550	Max WS	24.5	202.97	0.46	203.43	203.50	-0.07	1.34	203.71	2.4	2.3	0.3	73.9	0.30
TO03	-575	Max WS	26.2	202.48	0.42	202.90	202.96	-0.06	1.37	203.13	2.1	2.1	0.2	63.2	0.24
TO03	-600	Max WS	8.1	201.42	1.01	202.43	201.91	0.52	0.12	202.43	0.3	0.3	0.5	0.9	0.51
TO03	-625	Max WS	8.2	200.86	1.57	202.43	201.24	1.19	0.04	202.43	0.1	0.1	1.0	0.1	0.92
TO03	-650	Max WS	8.2	200.64	1.79	202.43	201.09	1.34	0.03	202.43	0.1	0.1	1.3	0.1	1.20
TO03	-675	Max WS	8.2	200.00	2.43	202.43	200.37	2.06	0.02	202.43	0.1	0.1	1.8	0.0	1.66
TO03	-700	Max WS	8.2	199.00	3.43	202.43	199.51	2.92	0.01	202.43	0.0	0.0	2.5	0.0	2.37
TO03	-725	Max WS	8.2	198.61	3.82	202.43	199.10	3.33	0.01	202.43	0.0	0.0	2.9	0.0	2.78
TO03	-750	Max WS	8.2	197.57	4.86	202.43	198.47	3.96	0.01	202.43	0.0	0.0	3.4	0.0	3.14
TO03	-772.6	Max WS	8.2	196.83	5.60	202.43	198.11	4.32	0.01	202.43	0.0	0.0	3.5	0.0	3.45
TO03	-806.61	Max WS	8.2	196.84	5.59	202.43			0.01	202.43	0.1	0.1	5.3	0.0	5.29
TO03	-824.785	Culvert													
TO03	-842.96	Max WS	8.2	195.91	0.72	196.63	196.51	0.12	0.70	196.76	1.6	1.6	0.5	28.6	0.53
TO03	-851.72	Max WS	8.2	195.93	0.69	196.62	196.38	0.24	0.48	196.69	1.1	1.1	0.6	14.0	0.56
TO03	-872.81	Max WS	7.9	195.75	0.71	196.46	196.42	0.04	0.85	196.57	1.5	1.5	0.3	28.8	0.31
TO03	-877.6	Max WS	7.0	195.83	0.60	196.43	196.40	0.03	0.88	196.53	1.4	1.4	0.2	26.8	0.25
TO03	-889.52	Max WS	3.2	195.57	0.80	196.37	195.89	0.48	0.10	196.38	0.2	0.2	0.5	0.6	0.46
TO03	-890.74	Max WS	3.0	195.50	0.87	196.37	195.83	0.54	0.09	196.37	0.2	0.2	0.5	0.4	0.47
TO03	-900	Max WS	45.9	195.34	0.78	196.12	196.25	-0.13	1.46	196.59	3.0	3.0	0.4	106.8	0.44
TO03	-950	Max WS	44.2	194.31	0.67	194.98	195.04	-0.06	1.28	195.27	2.4	2.4	0.4	71.5	0.36
TO03	-1000	Max WS	43.3	193.25	0.63	193.88	194.03	-0.15	1.73	194.35	3.1	3.1	0.3	121.0	0.32
TO03	-1035	Max WS	43.1	191.96	0.64	192.62	192.85	-0.23	1.76	193.30	3.6	3.6	0.4	154.0	0.43
TO03	-1085	Max WS	42.9	190.00	0.99	190.99	191.05	-0.06	1.15	191.35	2.7	2.7	0.5	76.5	0.55
TO03	-1185	Max WS	42.8	188.95	0.72	189.67	189.62	0.05	0.88	189.86	2.0	2.0	0.5	42.8	0.51
TO03	-1285	Max WS	42.8	187.61	0.69	188.30	188.35	-0.05	1.20	188.58	2.4	2.4	0.4	66.7	0.39
TO03	-1385	Max WS	42.8	186.00	0.82	186.82	186.92	-0.10	1.28	187.18	2.7	2.6	0.4	82.5	0.42
TO03	-1465	Max WS	42.8	184.70	0.62	185.32	185.37	-0.05	1.17	185.53	2.1	2.0	0.3	55.2	0.27
TO03	-1585	Max WS	42.6	182.81	1.34	184.15	183.65	0.50	0.22	184.17	0.6	0.6	0.8	3.7	0.76
TO03	-1614.19	Max WS	42.6	182.96	0.96	183.92	183.94	-0.02	1.03	184.32	2.8	2.8	0.7	76.8	0.71
TO03	-1639.19	Max WS	42.6	182.77	0.91	183.68	183.67	0.01	1.00	183.92	2.2	2.2	0.5	55.3	0.49
TO03	-1664.19	Max WS	42.6	182.37	1.41	183.45	183.29	0.16	0.61	183.55	1.5	1.4	0.6	22.5	0.54
TO03	-1689.19	Max WS	42.6	181.95	1.19	183.14	183.15	-0.01	1.05	183.41	2.3	2.3	0.5	60.3	0.50
TO03	-1714.19	Max WS	42.6	181.50	1.30	182.80	182.87	-0.07	1.21	183.17	2.7	2.7	0.5	89.9	0.48
TO03	-1739.19	Max WS	42.6	181.34	1.07	182.41	182.47	-0.06	1.18	182.74	2.5	2.5	0.5	73.6	0.47
TO03	-1764.19	Max WS	42.6	181.11	0.95	182.06	182.06	0.00	0.99	182.28	2.1	2.1	0.4	49.9	0.45
TO03	-1789.19	Max WS	42.6	180.81	1.01	181.82	181.74	0.08	0.84	182.01	1.9	1.9	0.5	40.4	0.54
TO03	-1814.19	Max WS	42.6	180.52	1.09	181.61	181.59	0.02	0.95	181.82	2.0	2.0	0.4	47.0	0.46
TO03	-1839.19	Max WS	42.6	180.29	1.06	181.35	181.36	-0.01	1.03	181.55	2.0	2.0	0.4	47.8	0.37
TO03	-1864.19	Max WS	42.6	180.11	0.94	181.05	181.03	0.02	0.95	181.21	1.8	1.8	0.4	40.3	0.36
TO03	-1889.19	Max WS	42.6	180.04	0.80	180.84	180.78	0.06	0.79	180.97	1.5	1.5	0.4	28.9	0.39
TO03	-1914.19	Max WS	42.6	179.93	0.72	180.65	180.58	0.07	0.77	180.77	1.5	1.5	0.4	28.4	0.41
TO03	-1939.19	Max WS	42.6	179.74	0.68	180.42	180.44	-0.02	1.10	180.61	1.9	1.9	0.3	47.5	0.30
TO03	-1964.19	Max WS	42.6	179.39	0.70	180.09	180.09	0.00	1.02	180.26	1.8	1.8	0.3	41.9	0.32
TO03	-1989.19	Max WS	42.6	179.04	0.81	179.85	179.77	0.08	0.78	179.95	1.5	1.5	0.4	26.4	0.35
TO03	-2014.19	Max WS	42.6	178.71	0.88	179.59	179.58	0.01	0.98	179.73	1.7	1.7	0.3	37.7	0.30
TO03	-2039.19	Max WS	42.6	178.54	0.70	179.24	179.28	-0.04	1.22	179.44	2.0	2.0	0.3	53.2	0.26
TO03	-2089.19	Max WS	42.6	177.29	1.23	178.52	178.56	-0.04	0.85	178.77	2.3	1.9	0.7	51.9	0.36
TO03	-2189.19	Max WS	42.6	176.84	0.70	177.55	177.55	0.00	1.02	177.80	2.3	2.3	0.5	56.8	0.49
TO03	-2289.19	Max WS	42.6	175.45	0.96	176.41	176.47	-0.06	1.22	176.71	2.4	2.4	0.4	70.5	0.41
TO03	-2389.19	Max WS	42.6	173.87	0.77	174.64	174.61	0.03	0.90	174.81	1.8	1.8	0.4	38.5	0.40
TO03	-2489.19	Max WS	11.9	172.78	1.18	173.96	173.18	0.78	0.07	173.96	0.2	0.2	0.7	0.3	0.53
TO03	-2589.19	Max WS	12.0	172.00	1.96	173.96	172.39	1.57	0.03	173.96	0.1	0.1	1.5	0.1	1.15
TO03	-2704.19	Max WS	12.1	171.00	2.96	173.96	171.47	2.49	0.01	173.96	0.1	0.0	2.6	0.0	1.83
TO03	-2804.19	Max WS	12.2	170.33	3.63	173.96	170.84	3.12	0.01	173.96	0.0	0.0	3.1	0.0	2.13
TO03	-3004.19	Max WS	12.2	168.87	5.09	173.96	169.27	4.69	0.00	173.96	0.0	0.0	4.8	0.0	3.89
TO03	-3130.19	Max WS	12.1	168.00	5.96	173.96	168.51	5.45	0.00	173.96	0.0	0.0	5.4	0.0	4.45
TO03	-3193.40	Max WS	12.1	168.00	6.13	173.96	168.16	5.80	0.00	173.96	0.0	0.0	5.4	0.0	5.73
TO03	-3218.40	Max WS	35.6	167.83	6.17	173.96	168.29	5.67	0.01	173.96	0.1	0.1	5.8	0.0	5.42
TO03	-3231.89	Max WS	35.6	167.33	6.63	173.96	168.36	5.60	0.01	173.96	0.1	0.1</			

TO02-TO03

← TO02 TO02 →

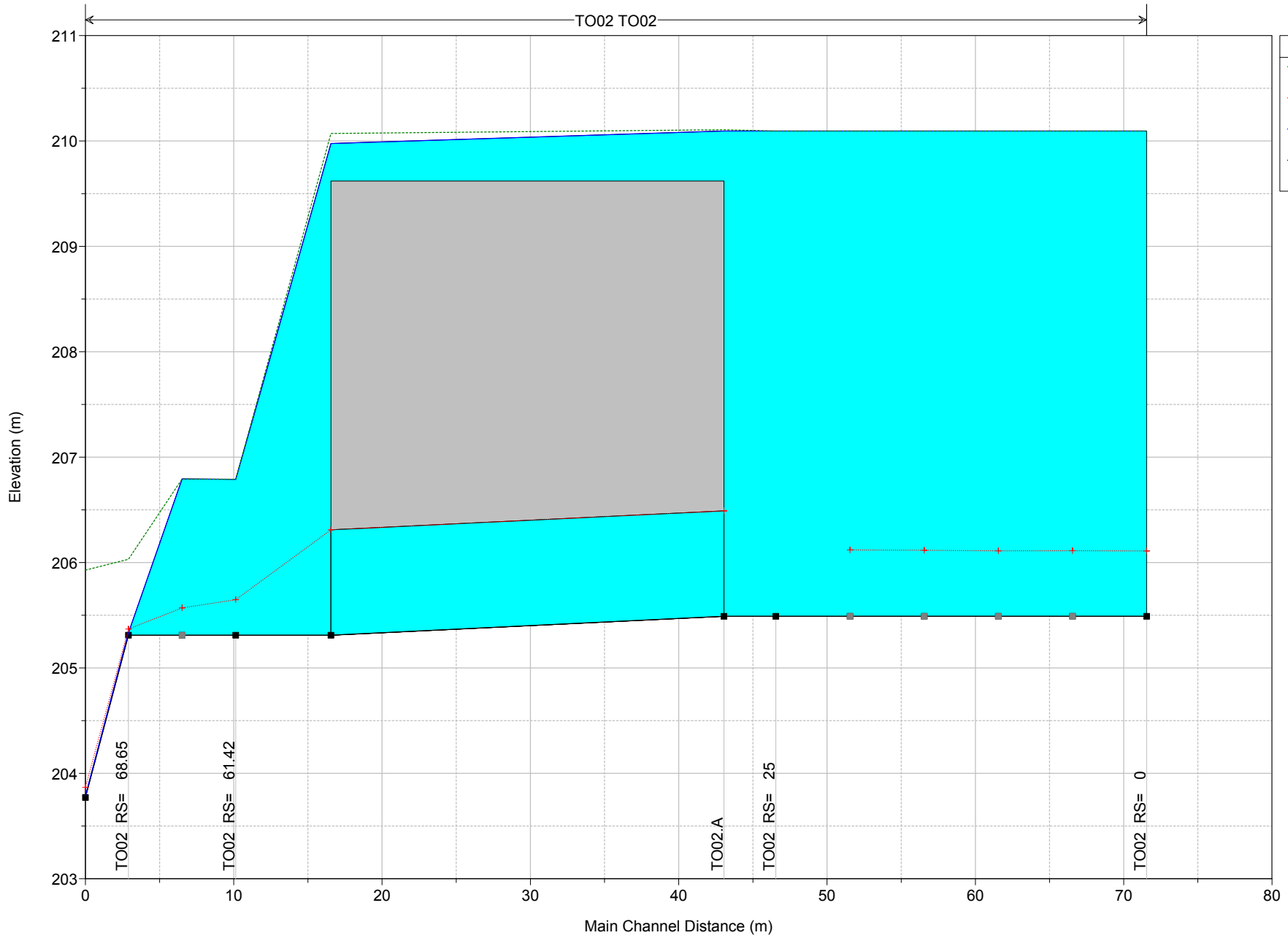

Legend	
EG 13OCT2014 0045	
Crit 13OCT2014 0045	
WS 13OCT2014 0045	
Ground	

TO02-TO03

TO03 TO03

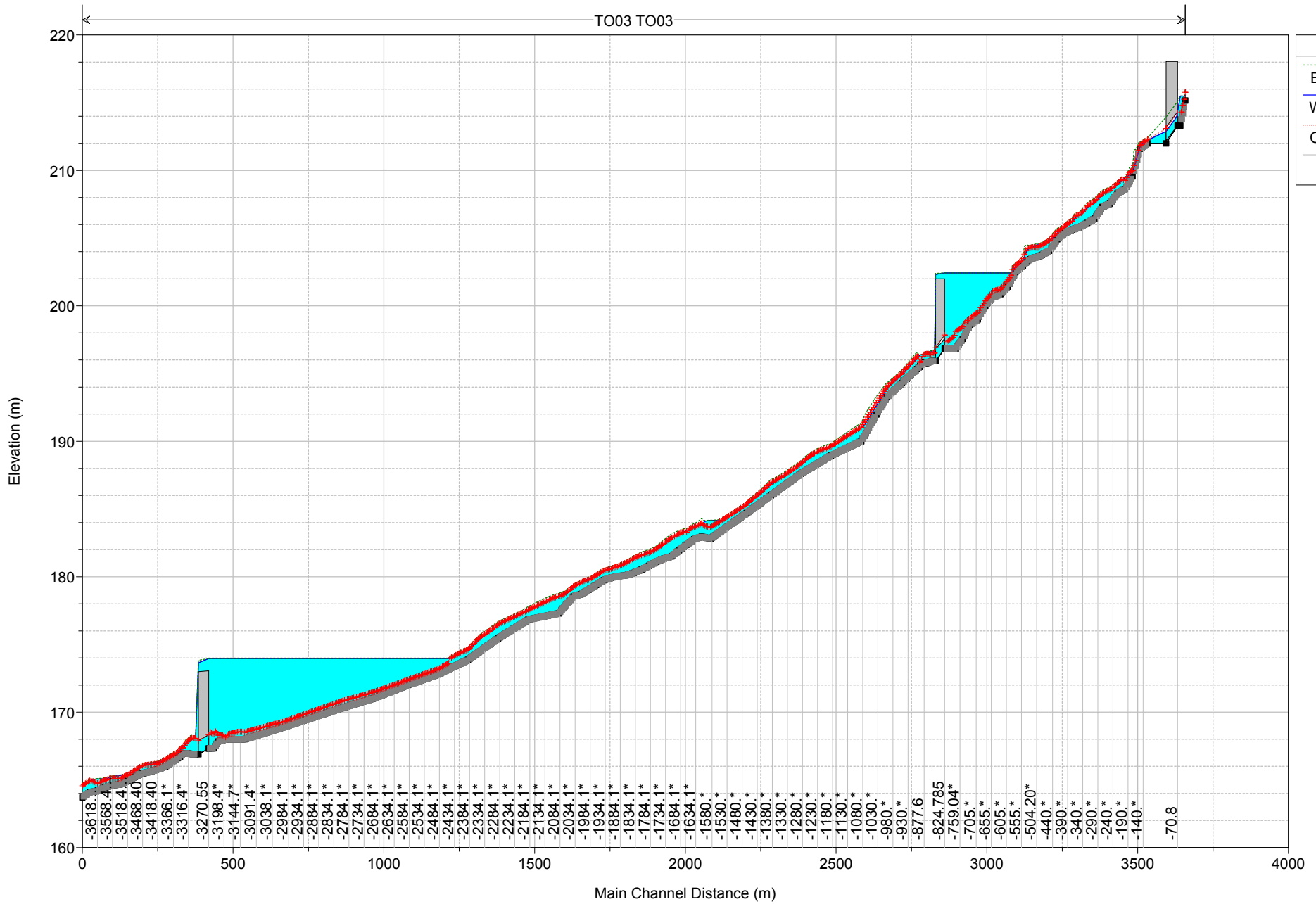

Legend

- EG Max WS
- WS Max WS
- Crit Max WS
- Ground

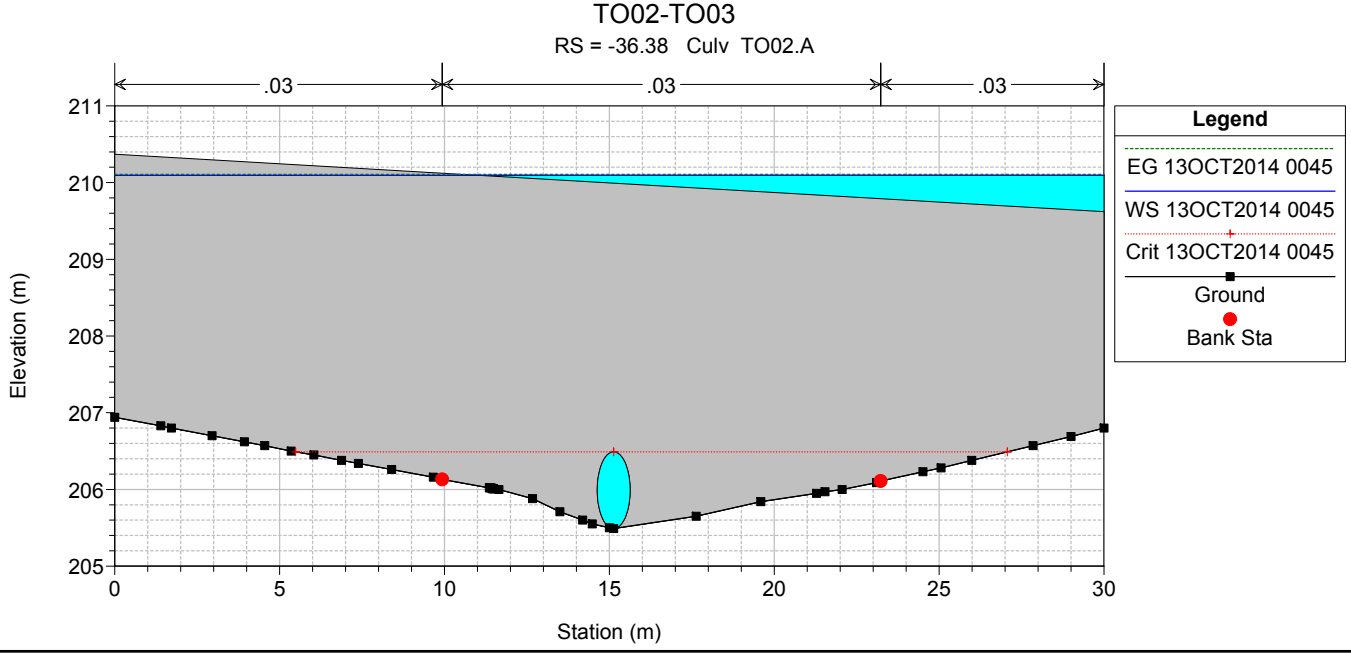
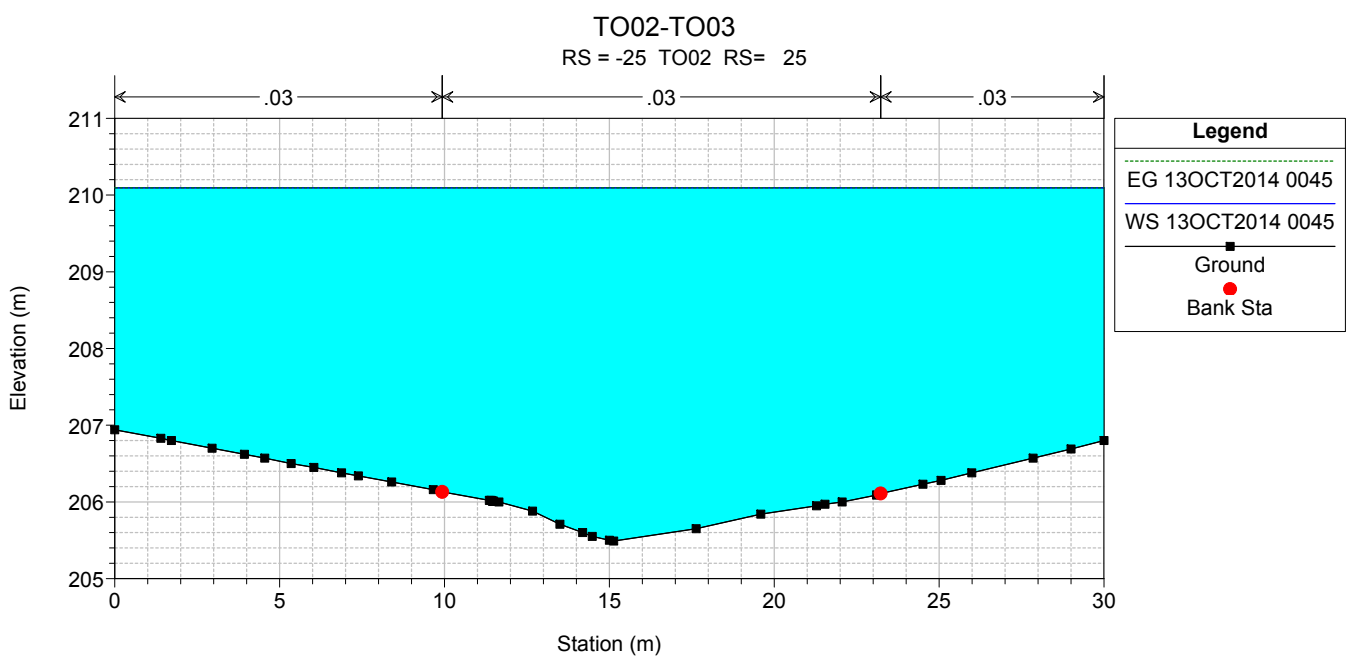
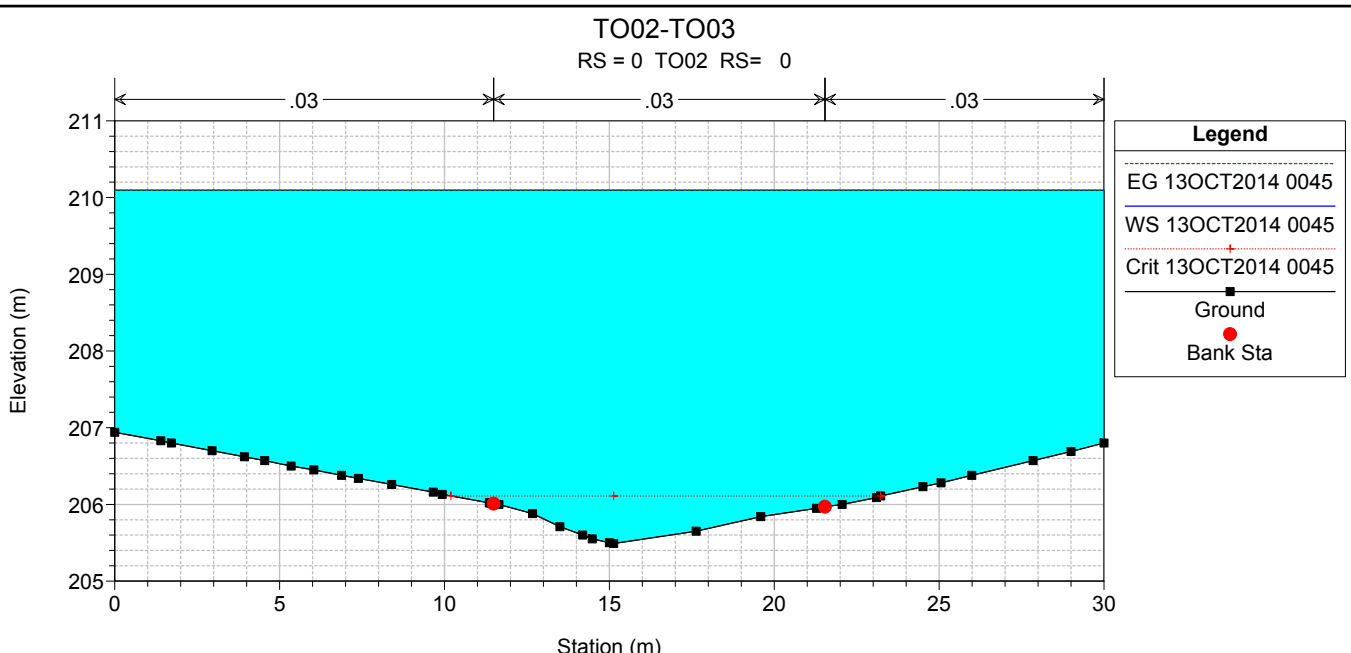

TO02-TO03

RS = -36.38 Culv TO02.A

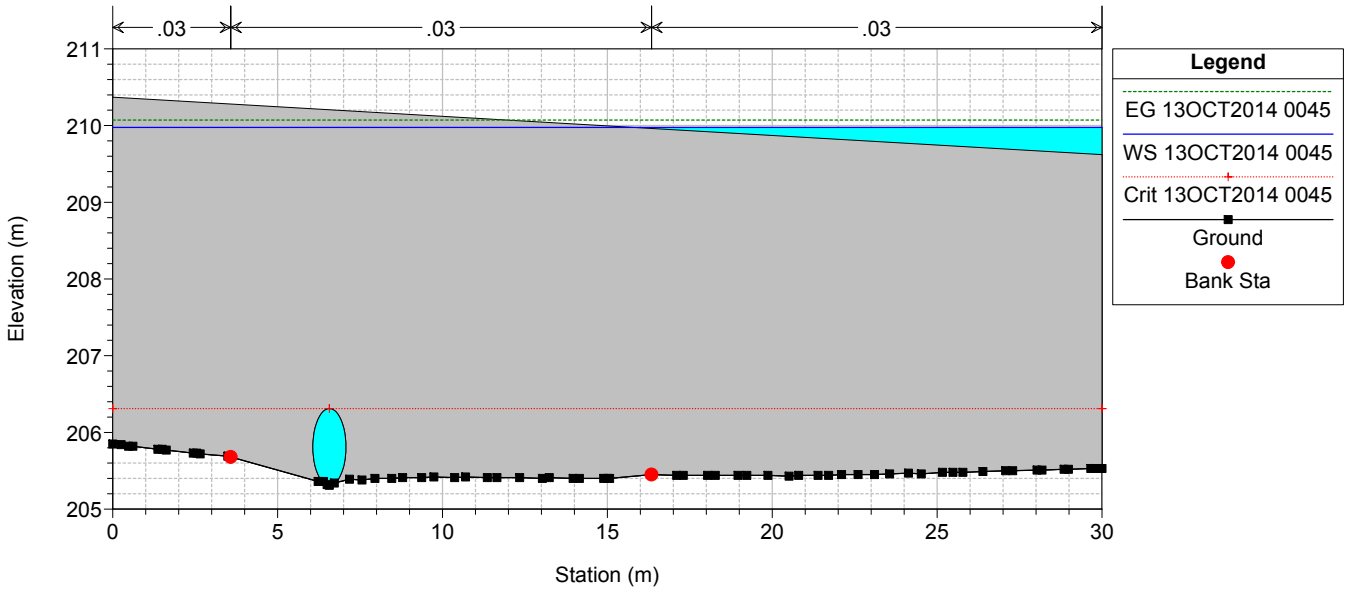

TO02-TO03

RS = -61.42 TO02 RS= 61.42

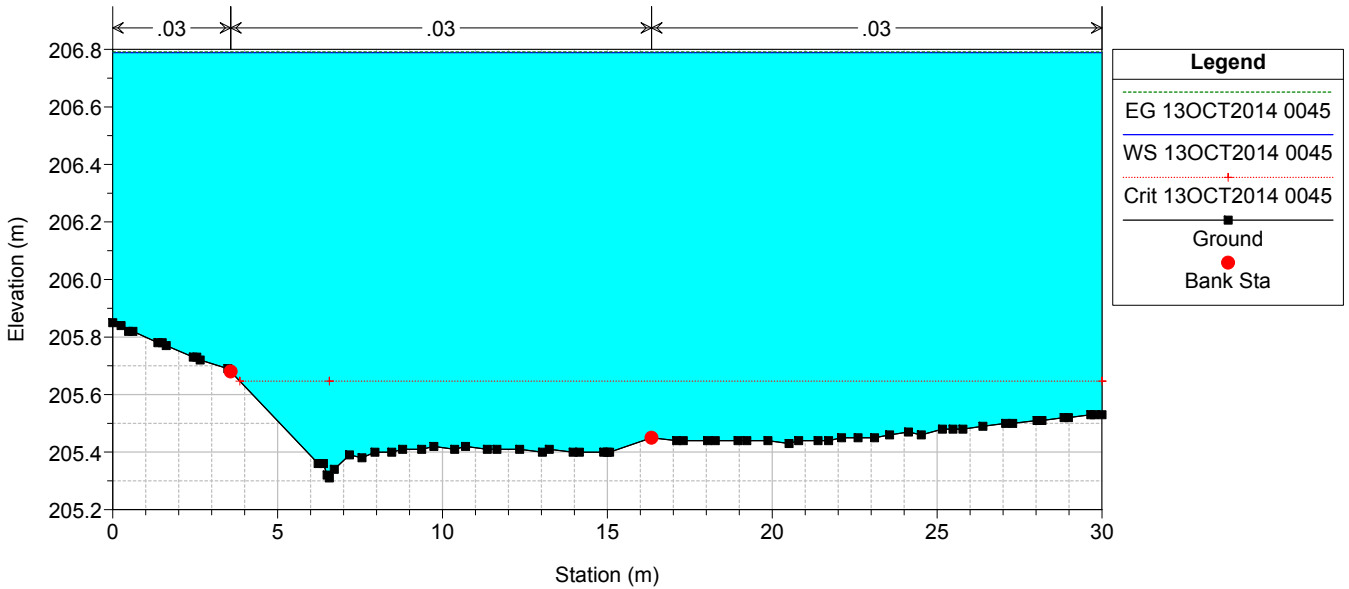

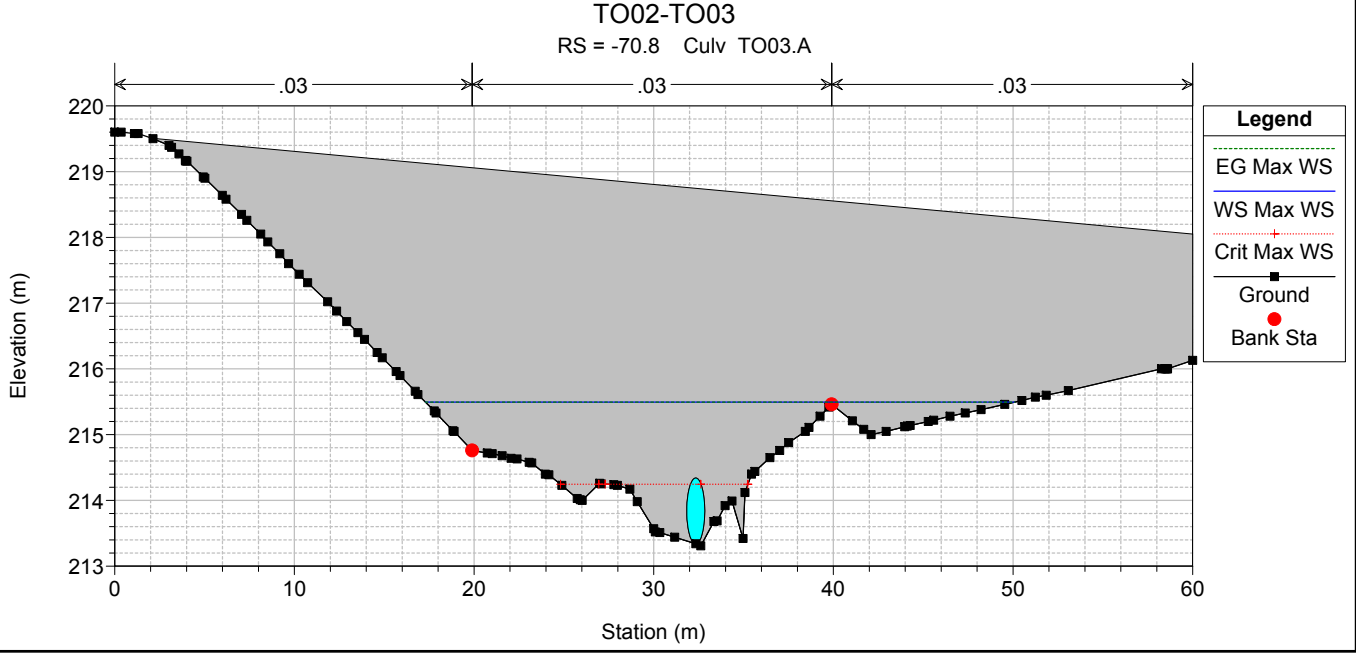
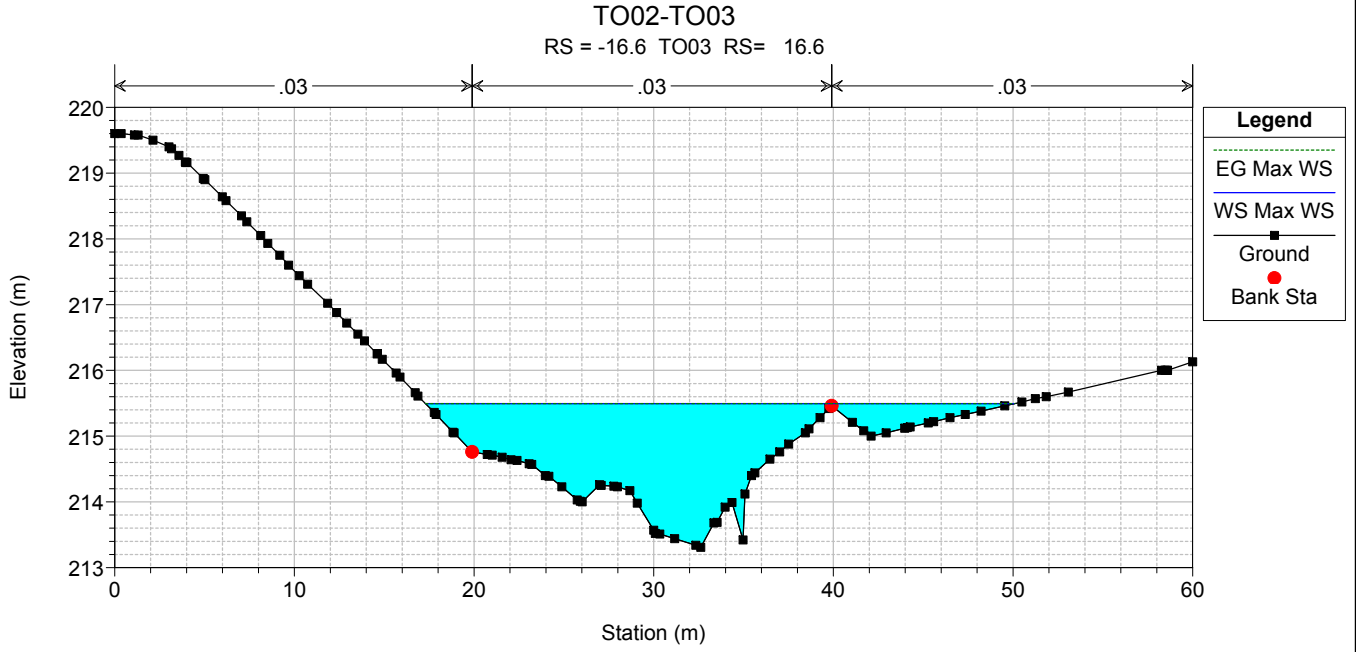
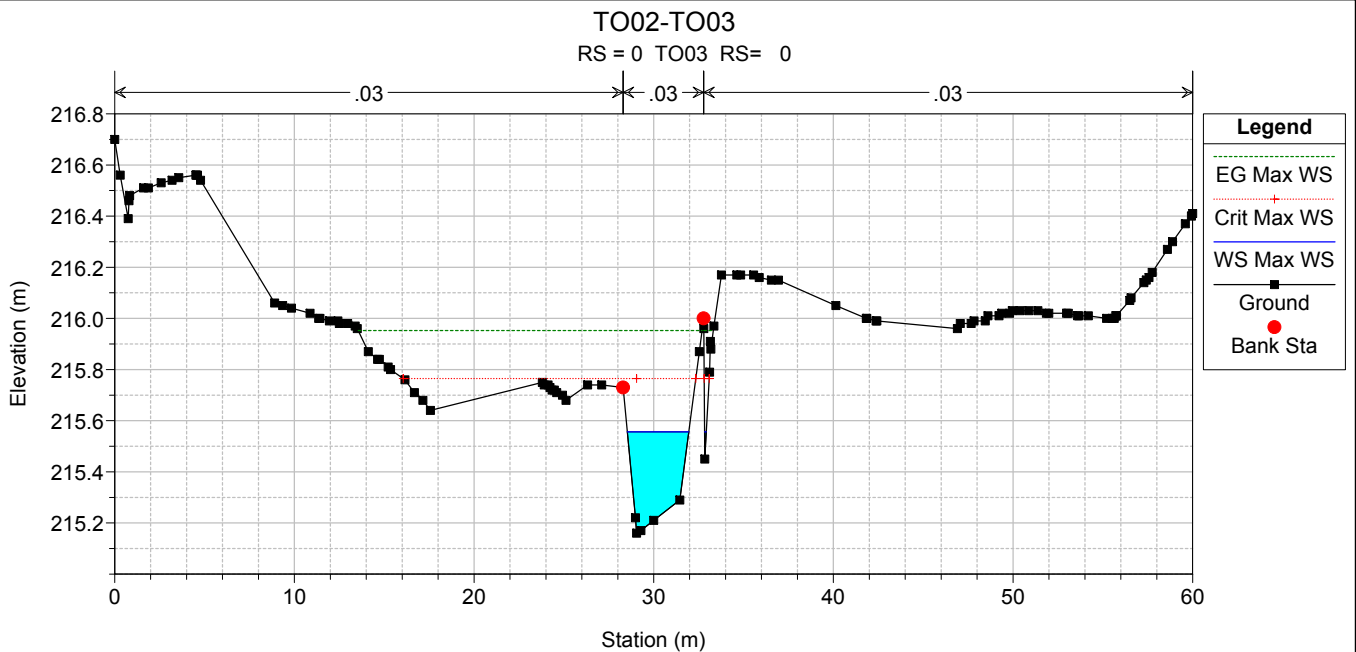

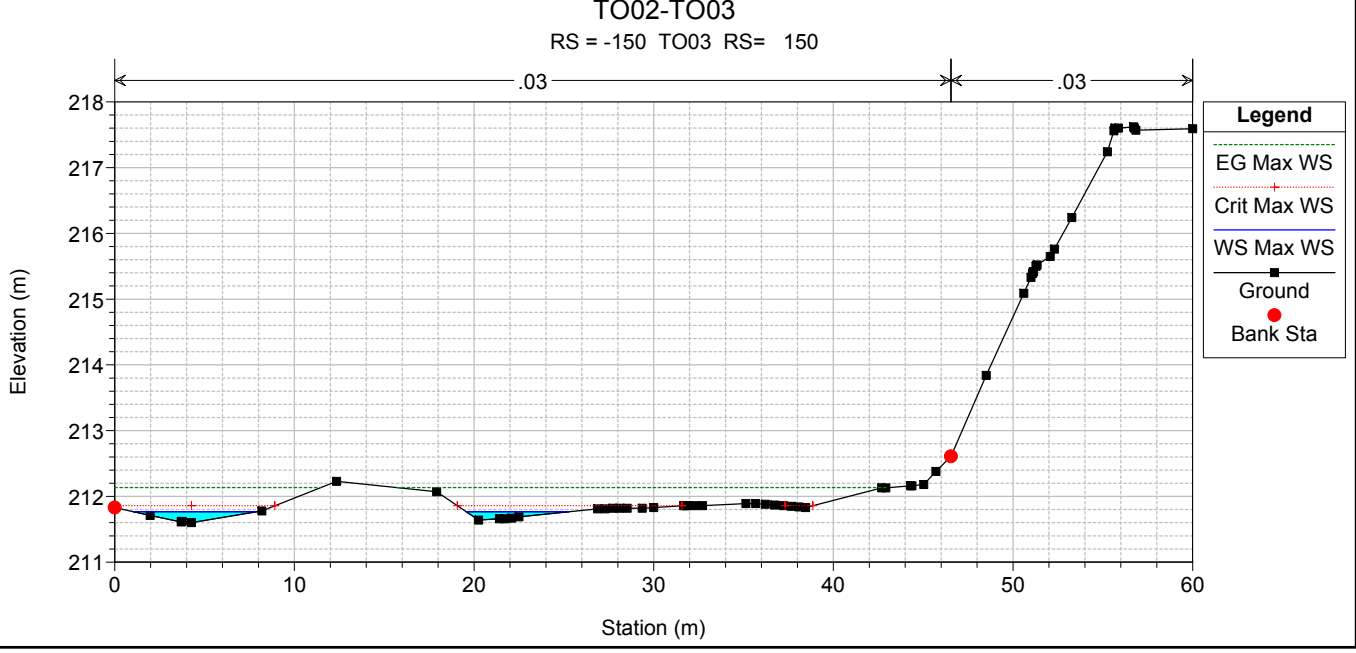
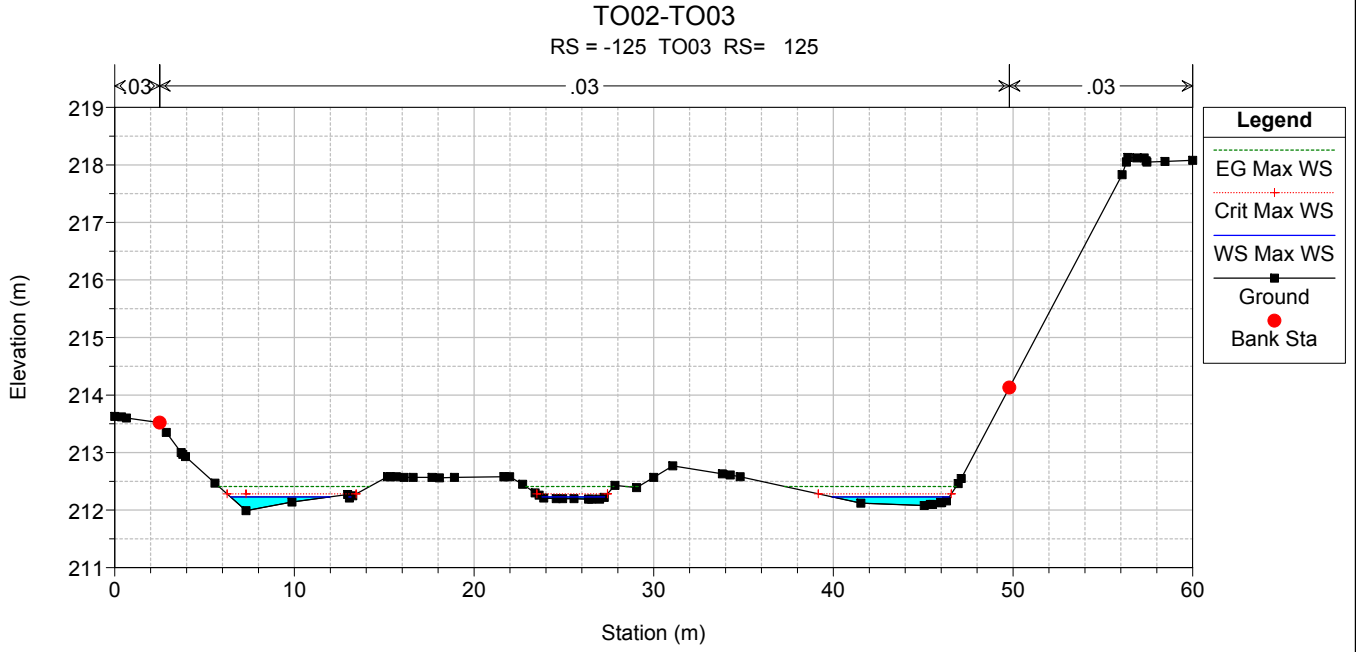
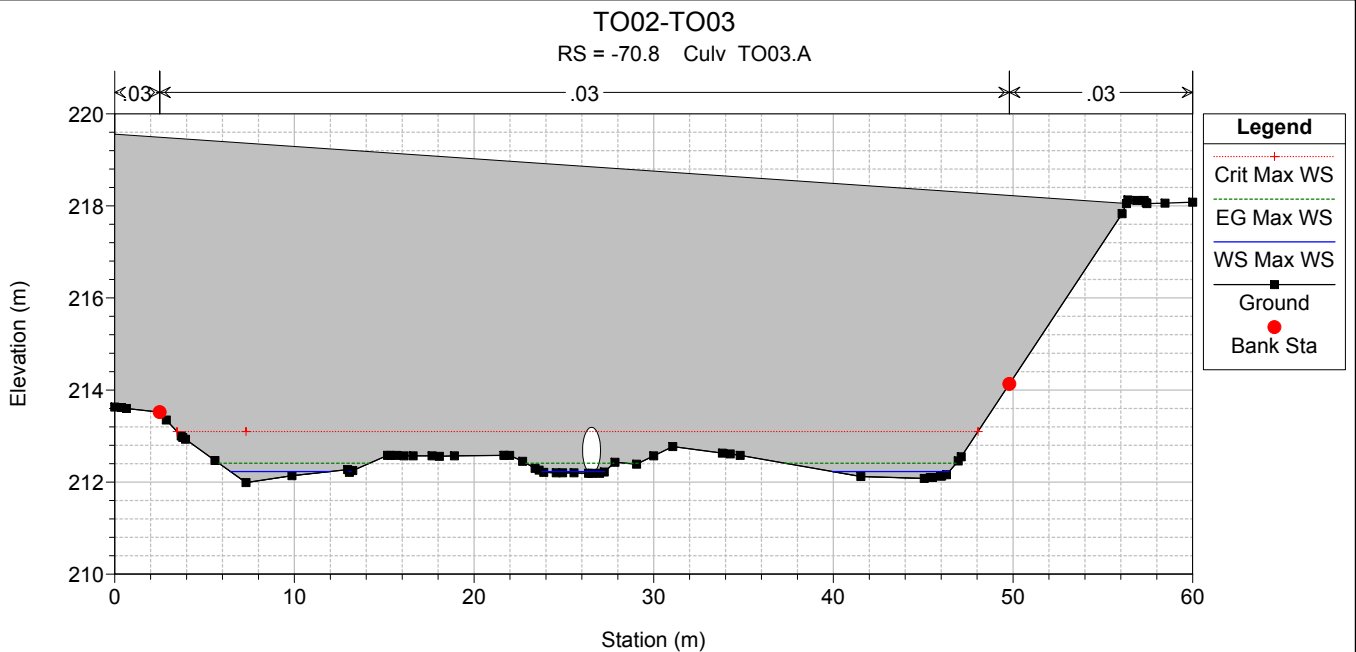

TO02-TO03

RS = -175 TO03 RS= 175

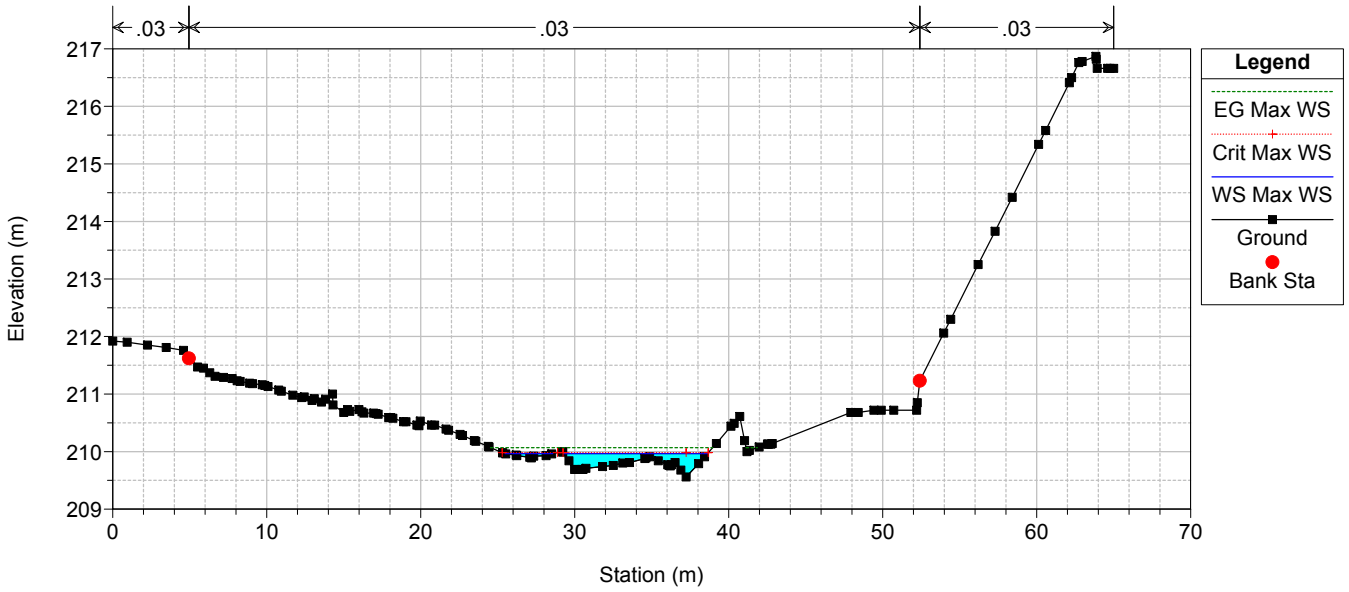

TO02-TO03

RS = -200 TO03 RS= 200

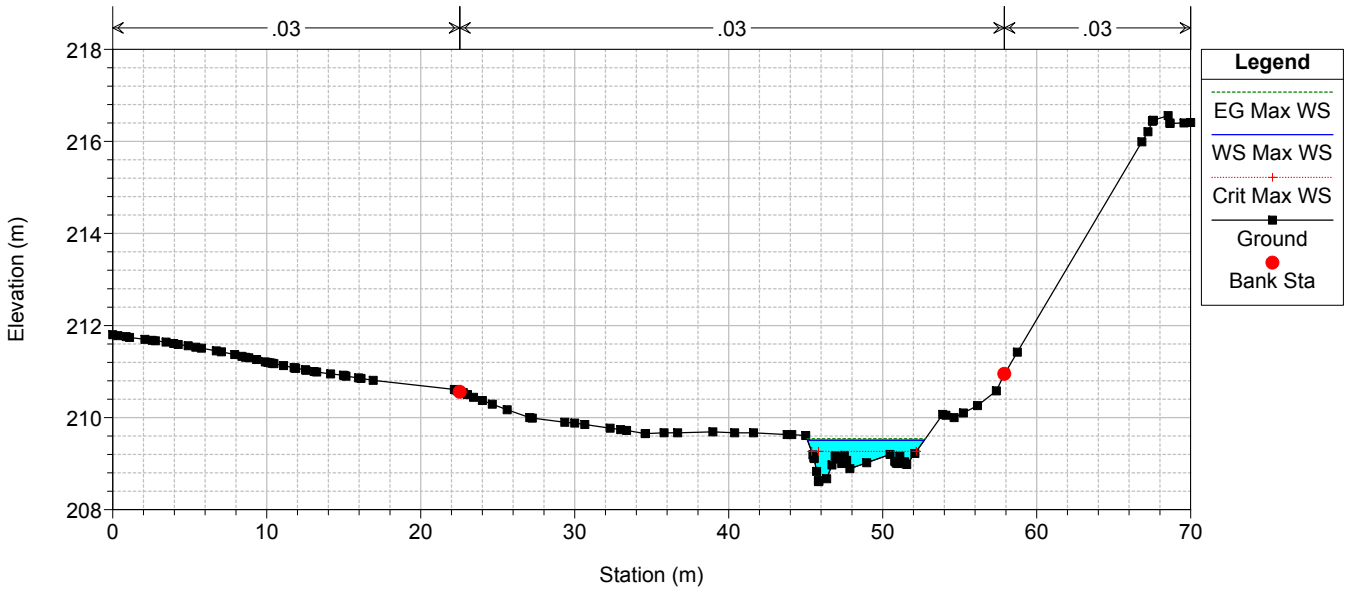

TO02-TO03

RS = -225 TO03 RS= 225

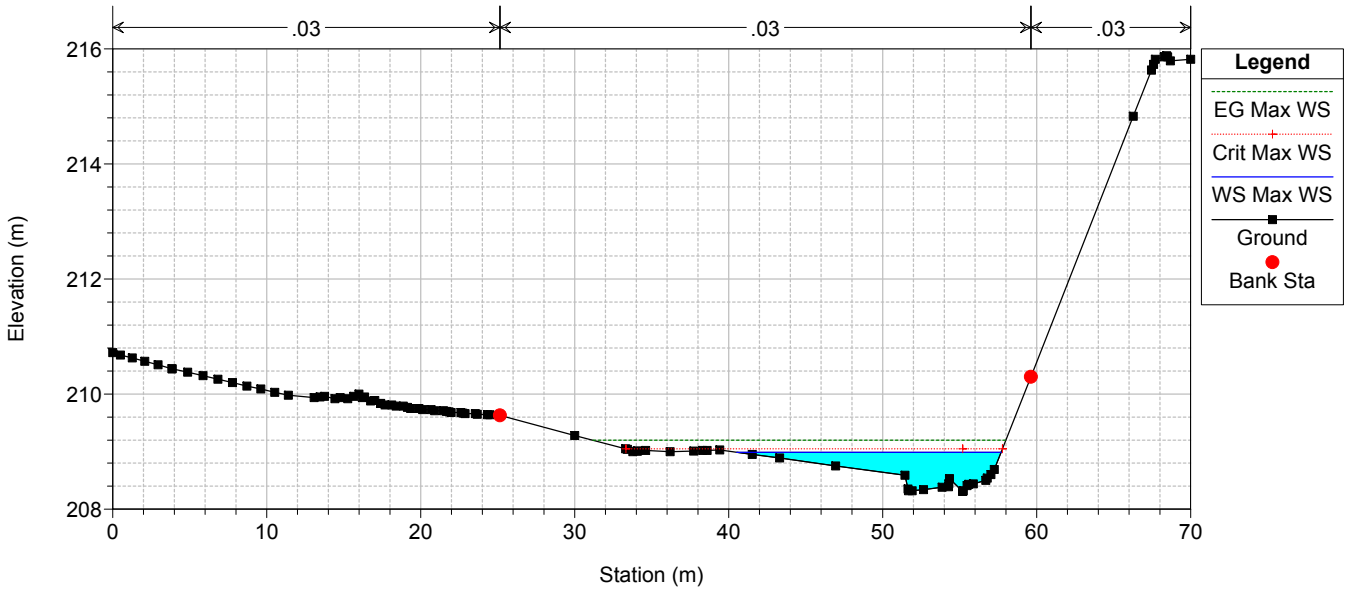

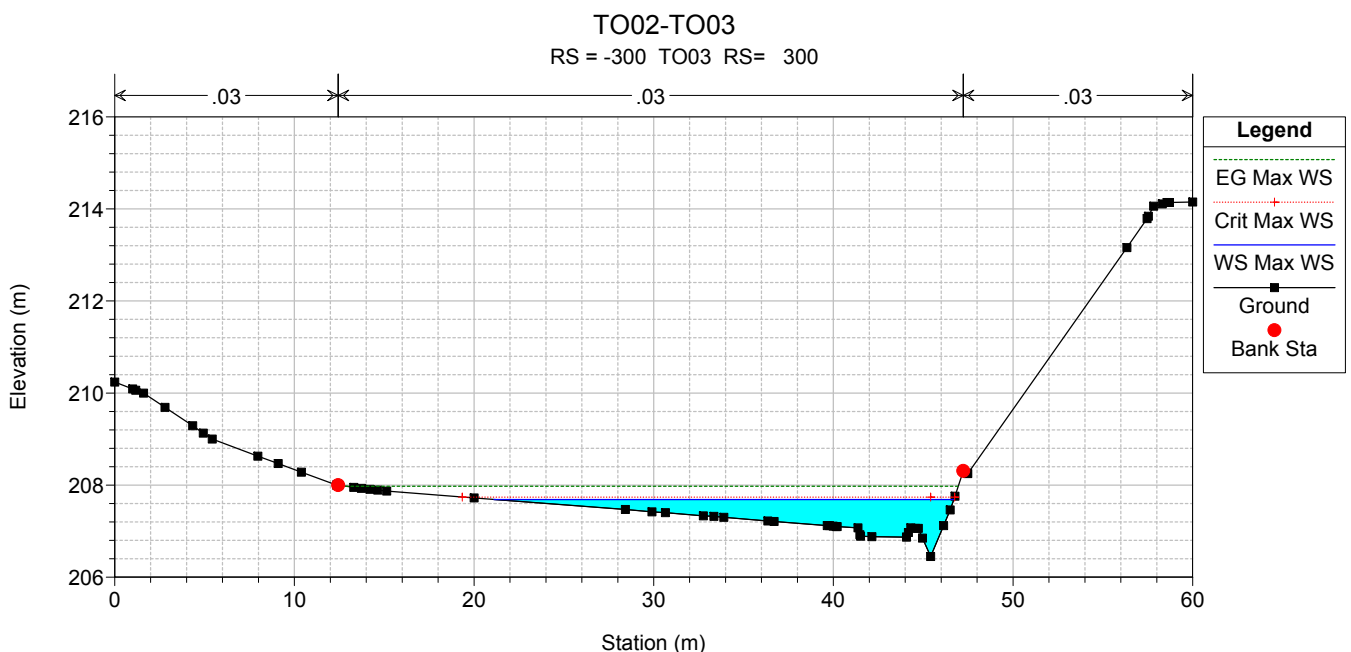
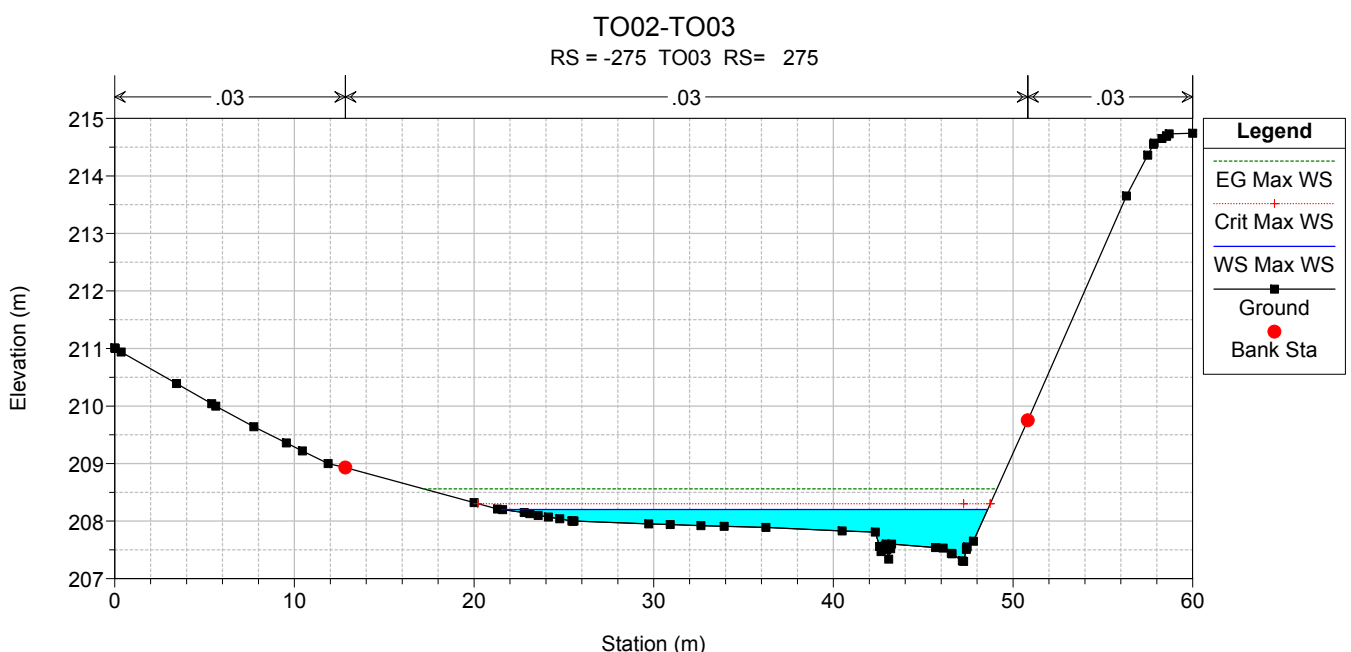
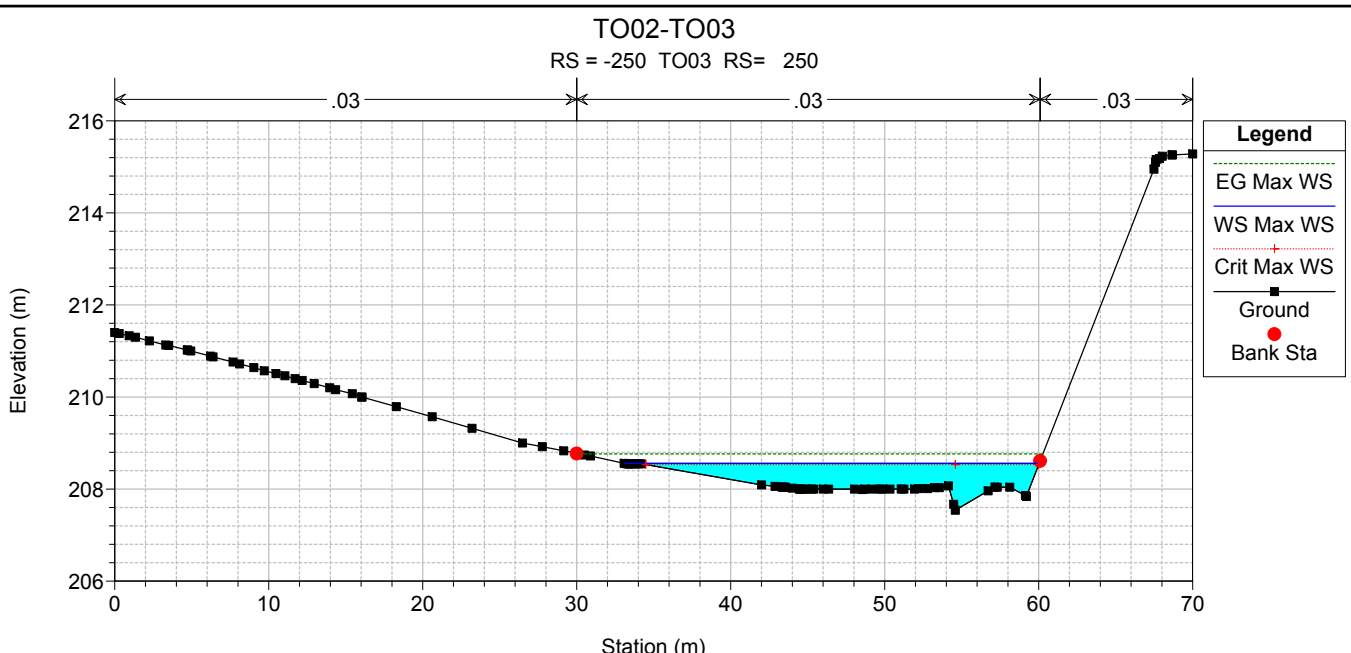

TO02-TO03

RS = -325 TO03 RS= 325

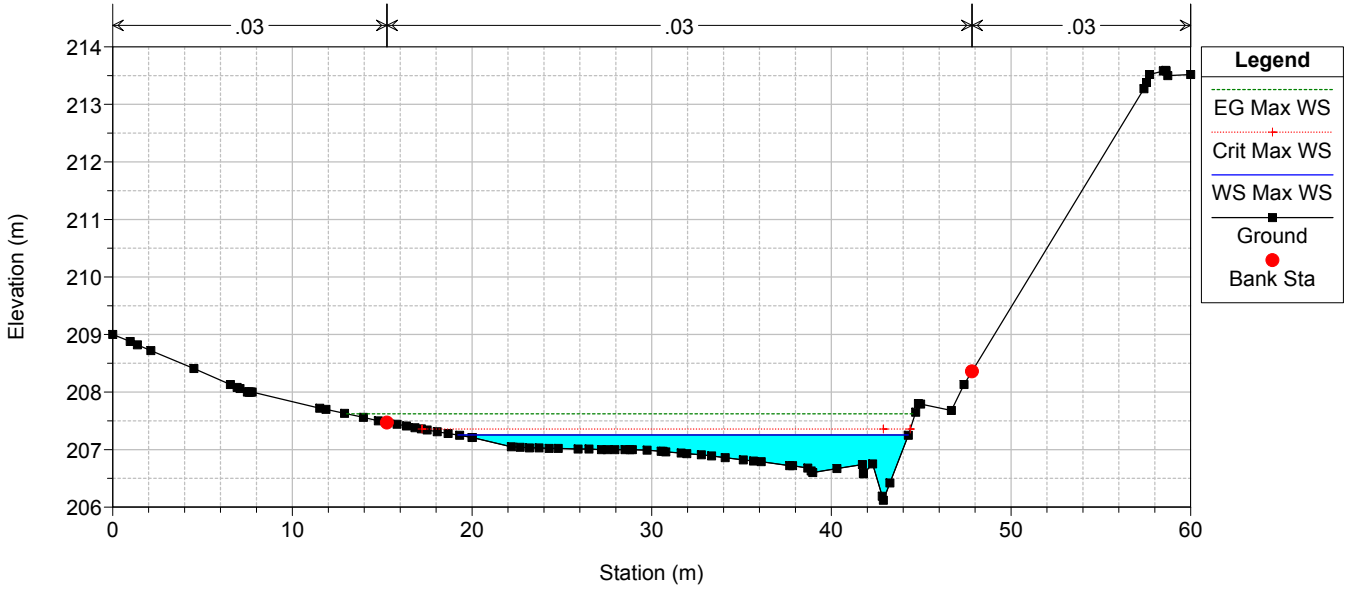

TO02-TO03

RS = -350 TO03 RS= 350

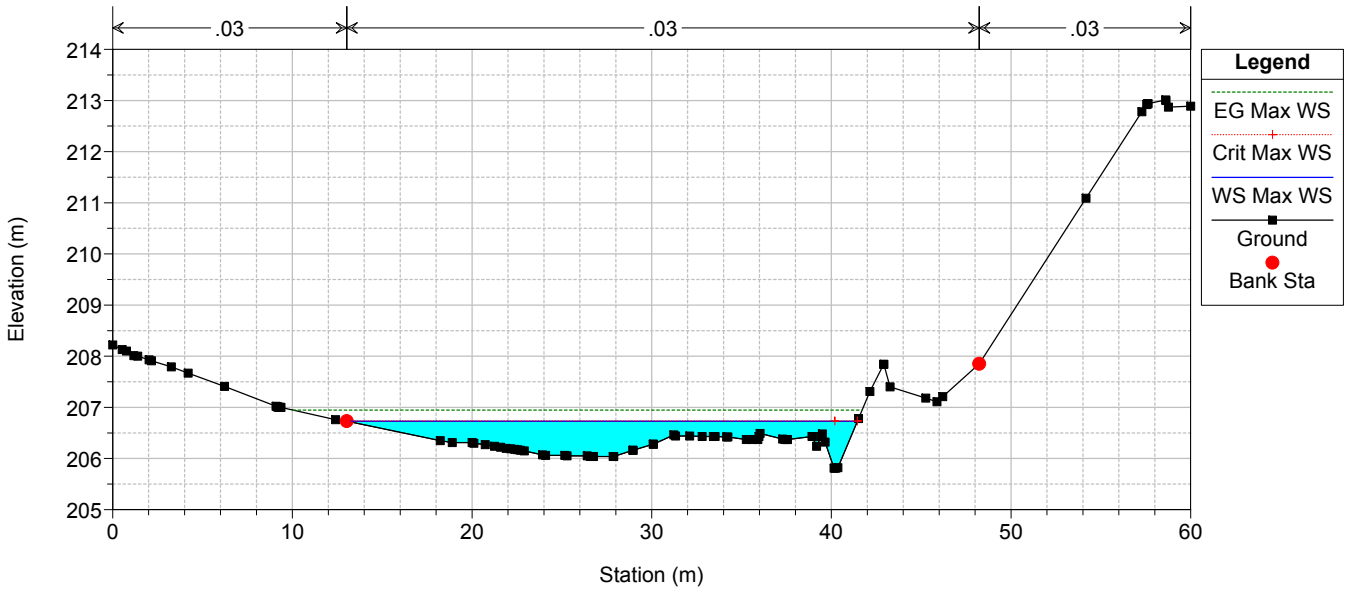

TO02-TO03

RS = -375 TO03 RS= 375

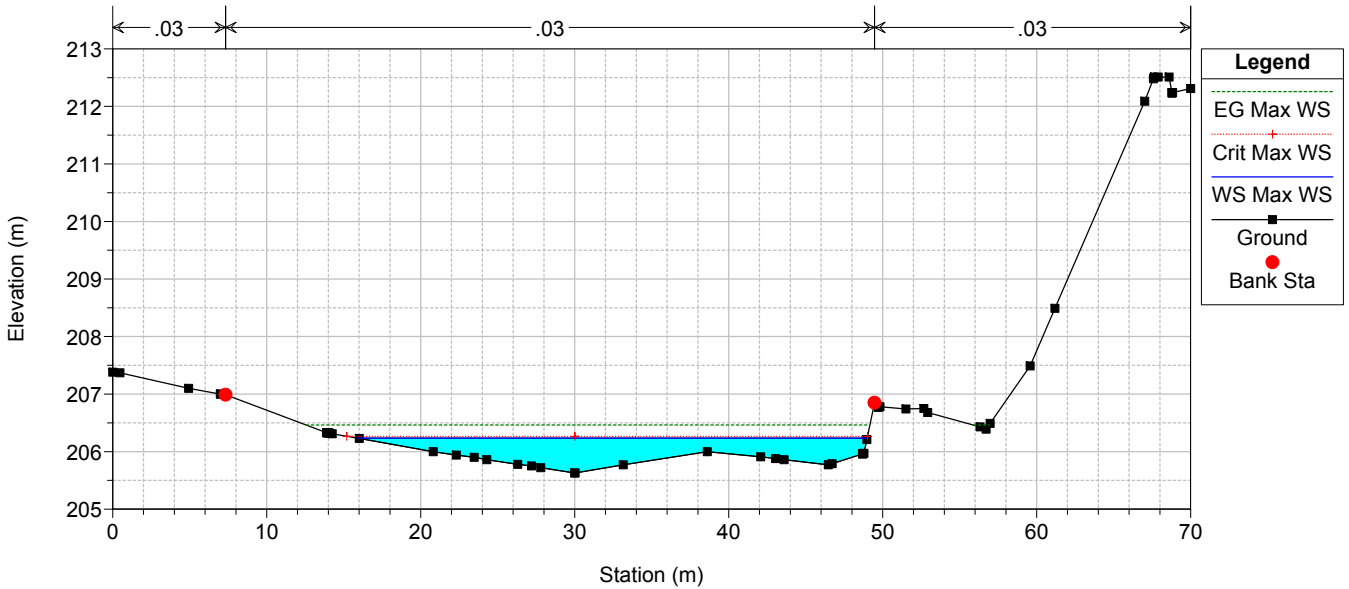

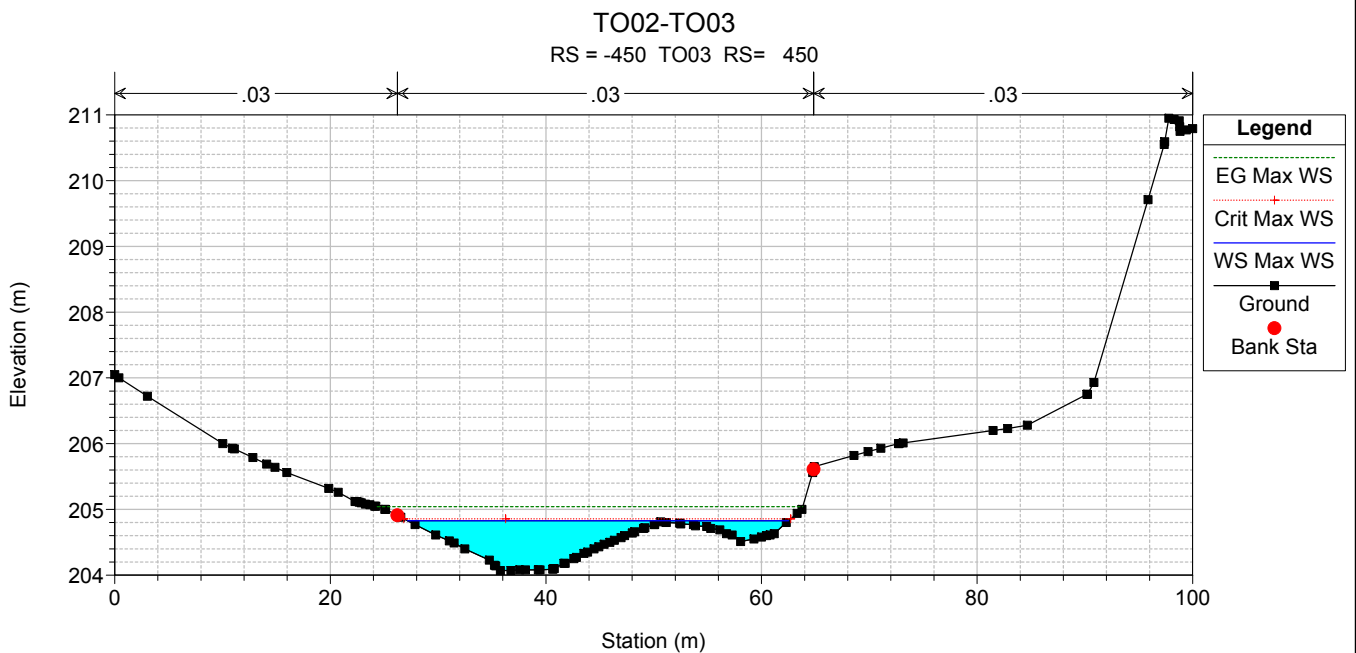
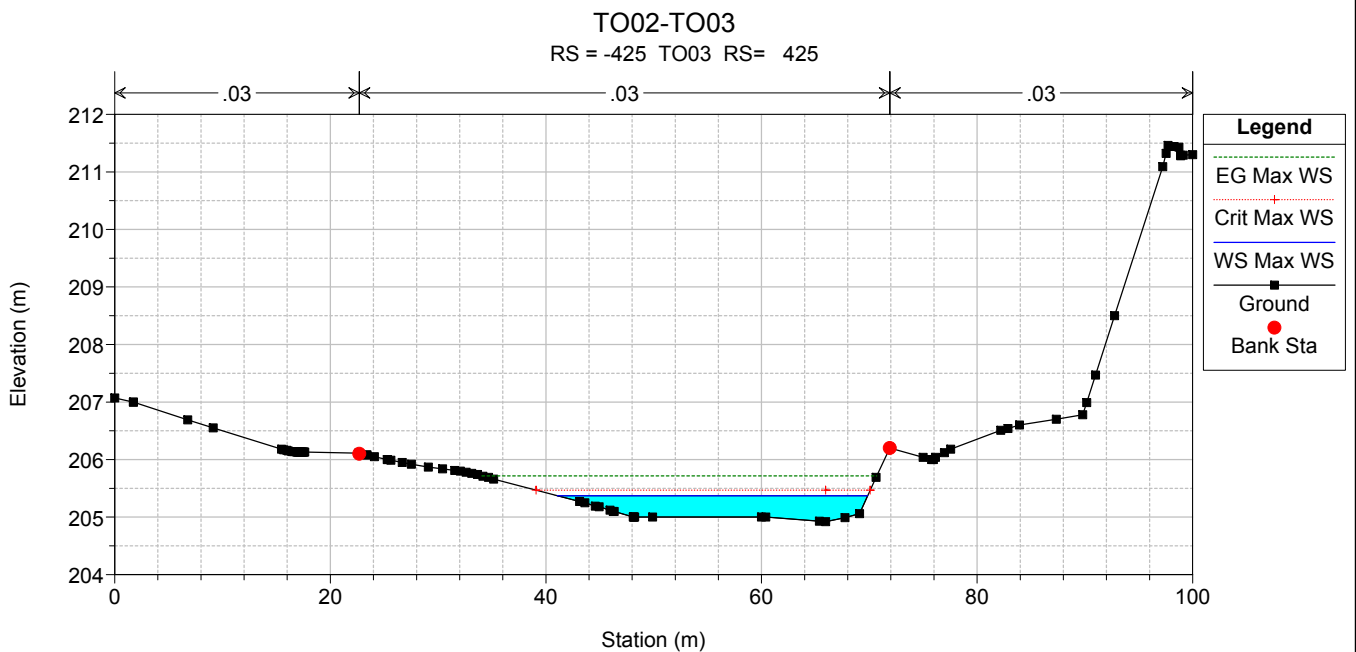
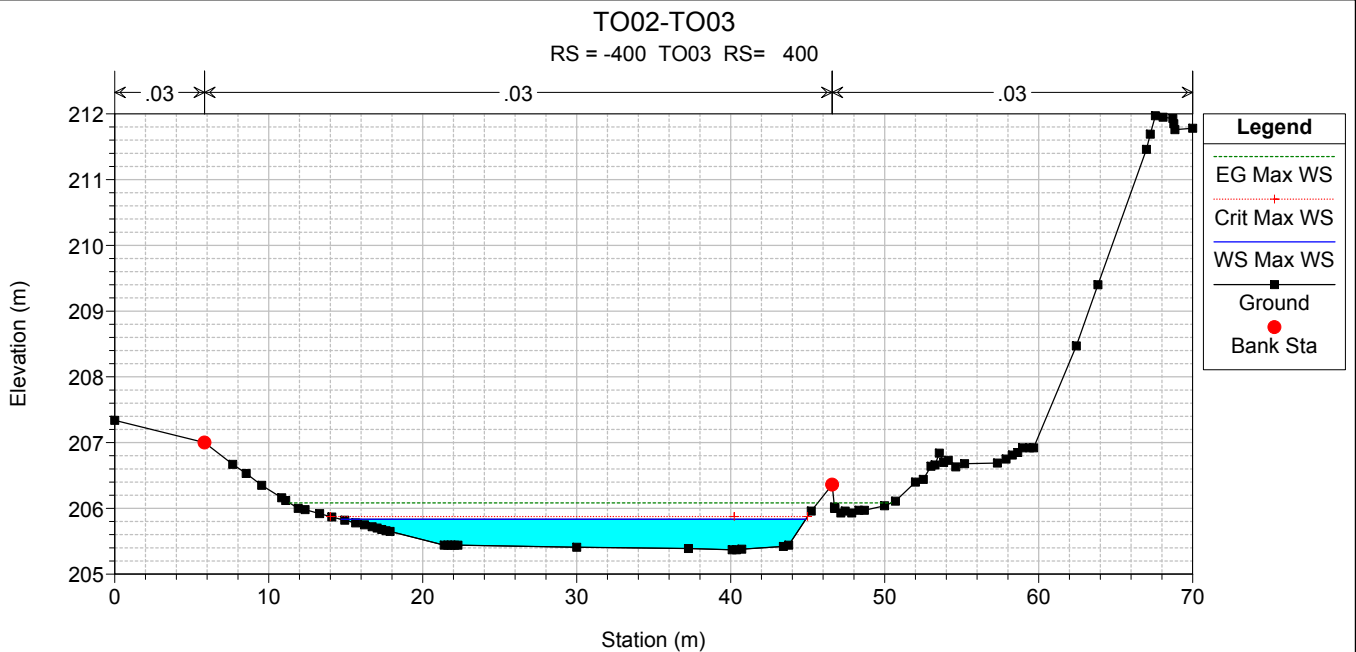

TO02-TO03

RS = -475 TO03 RS= 475

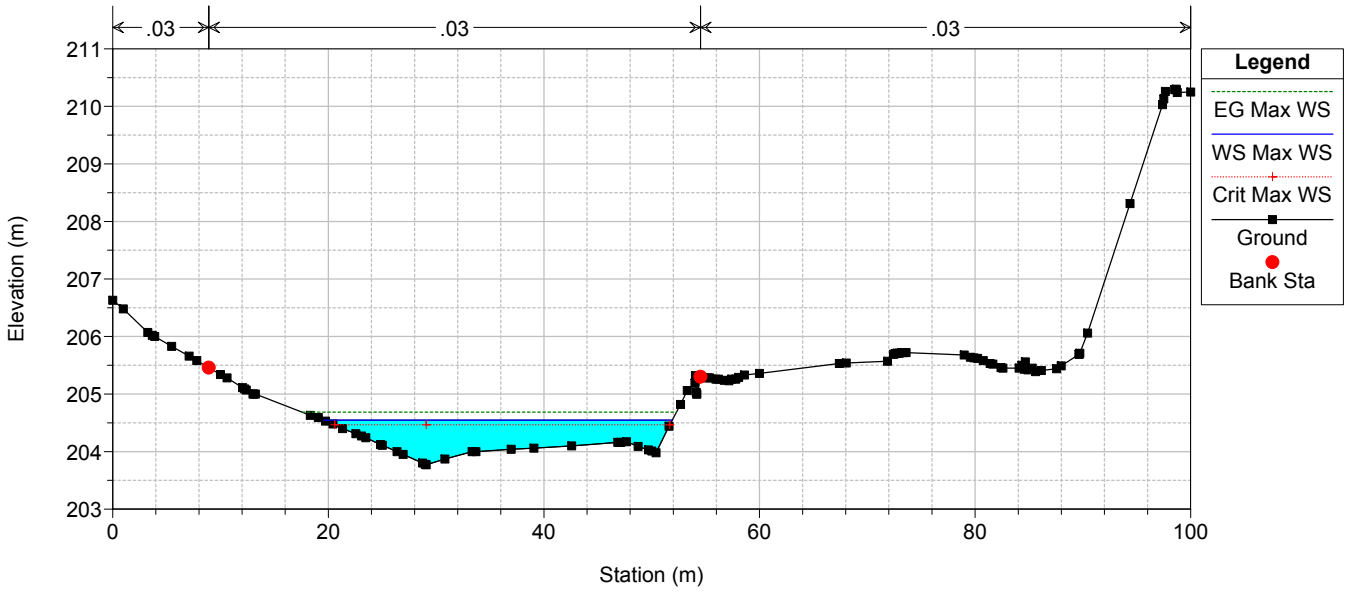

TO02-TO03

RS = -500 TO03 RS= 500

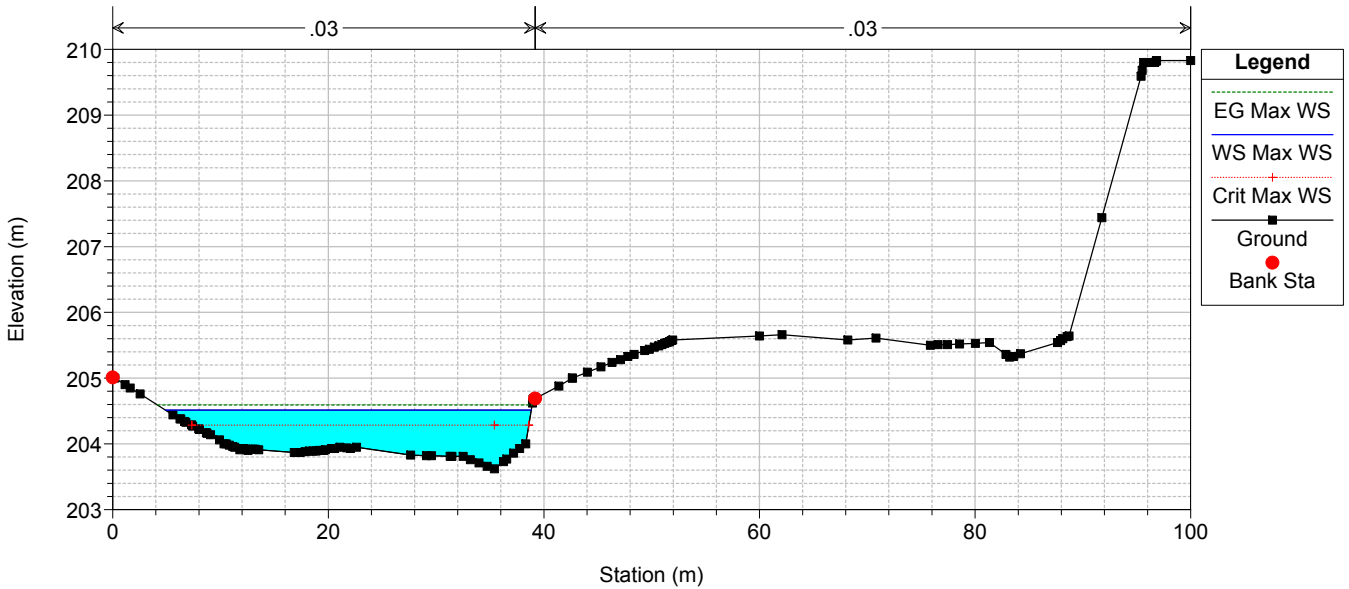

TO02-TO03

RS = -516.82

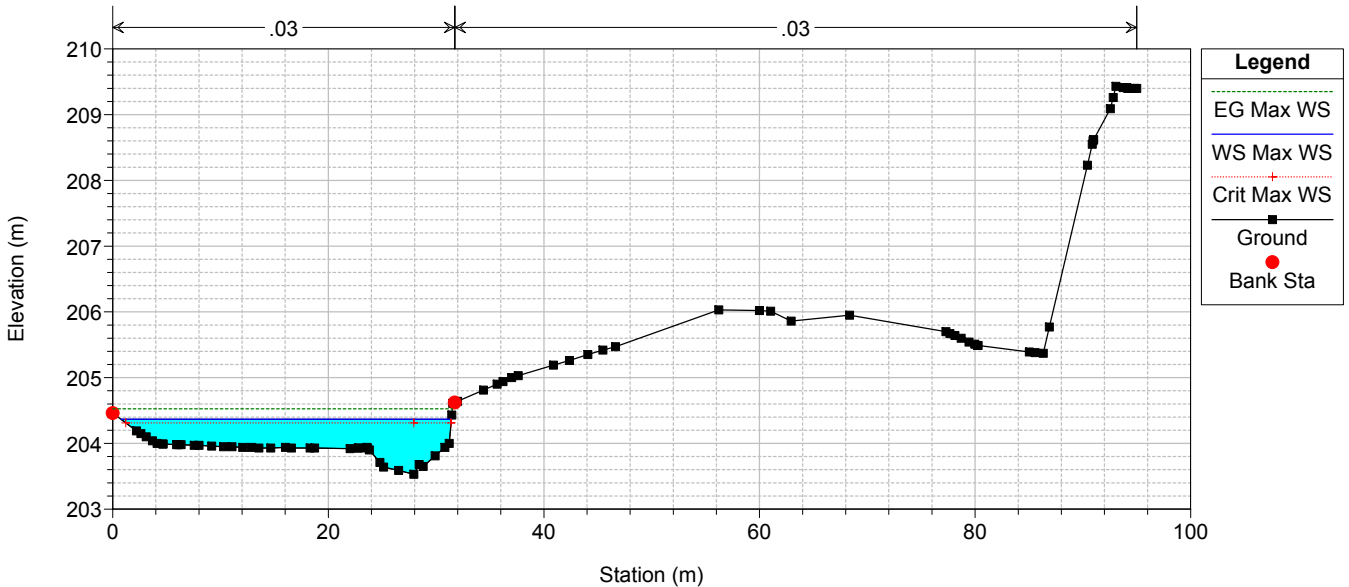

TO02-TO03

RS = -525.8

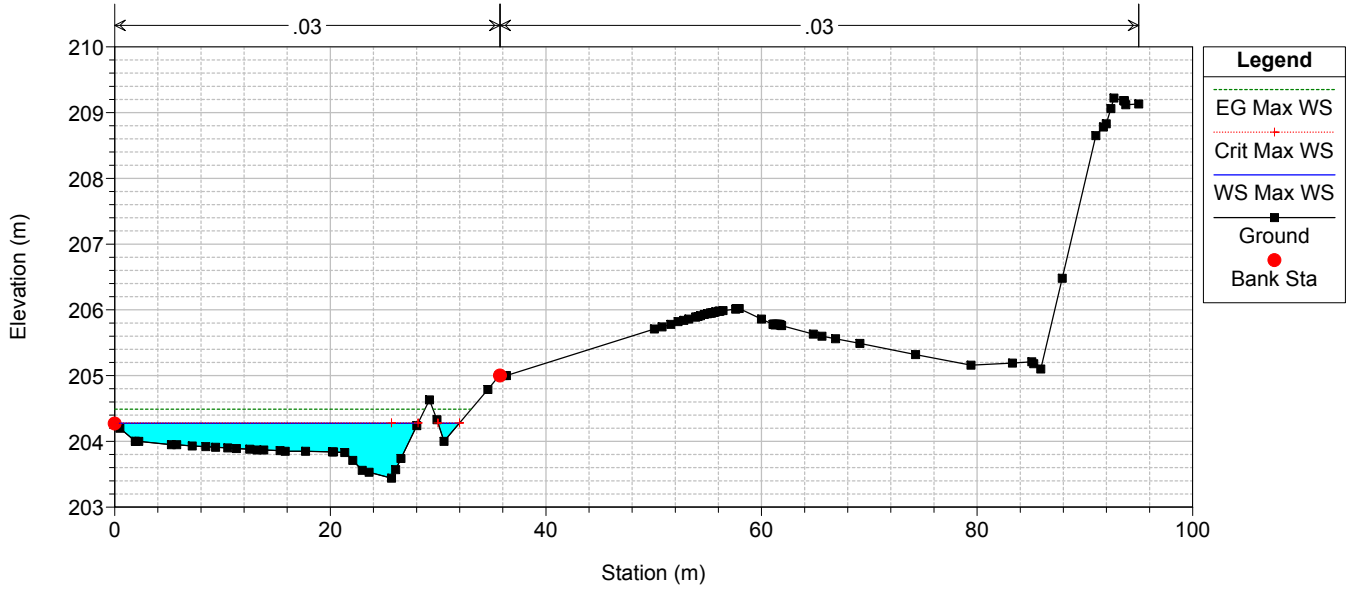

TO02-TO03

RS = -535.3

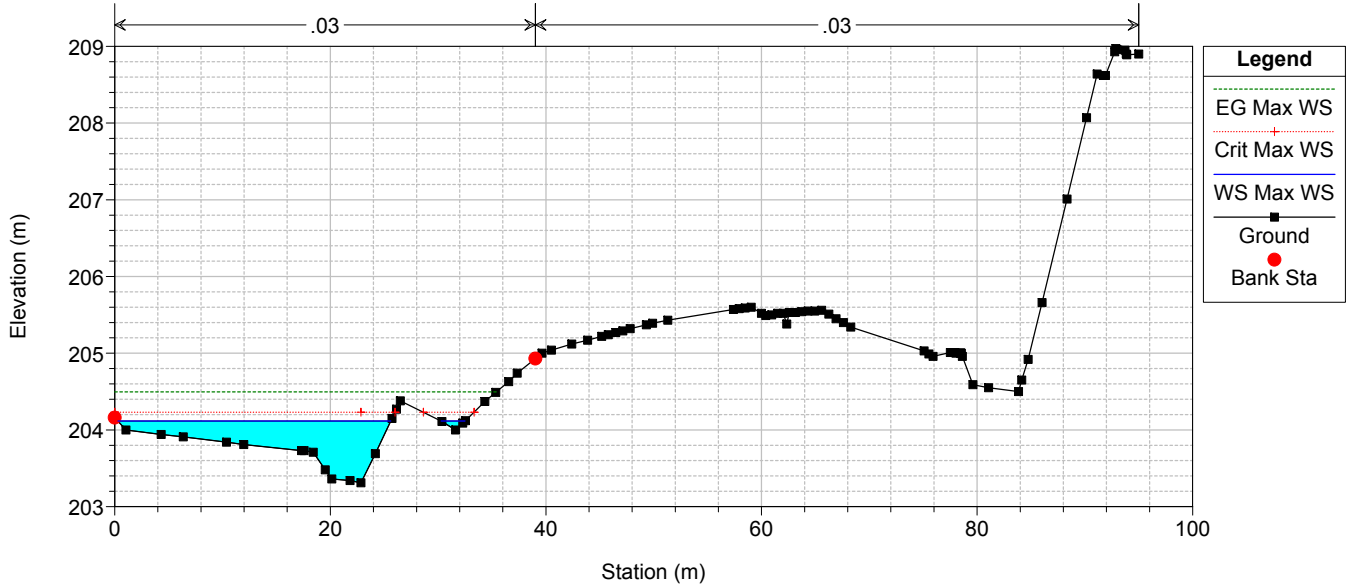

TO02-TO03

RS = -550 TO03 RS= 550

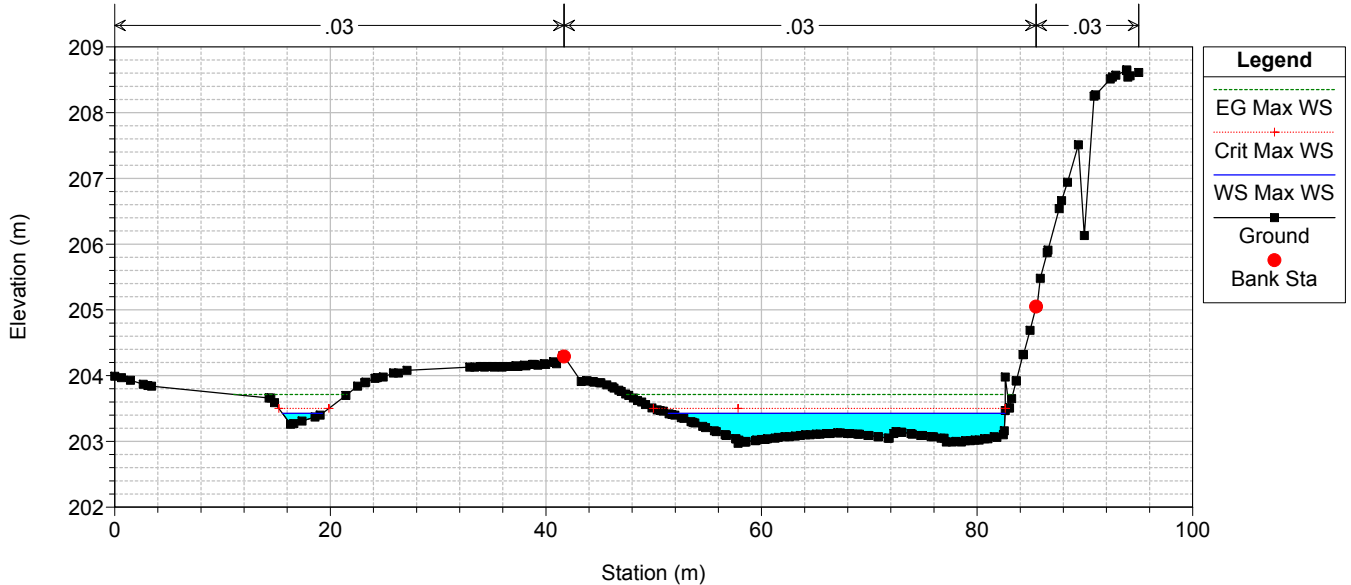

TO02-TO03

RS = -575 TO03 RS= 575

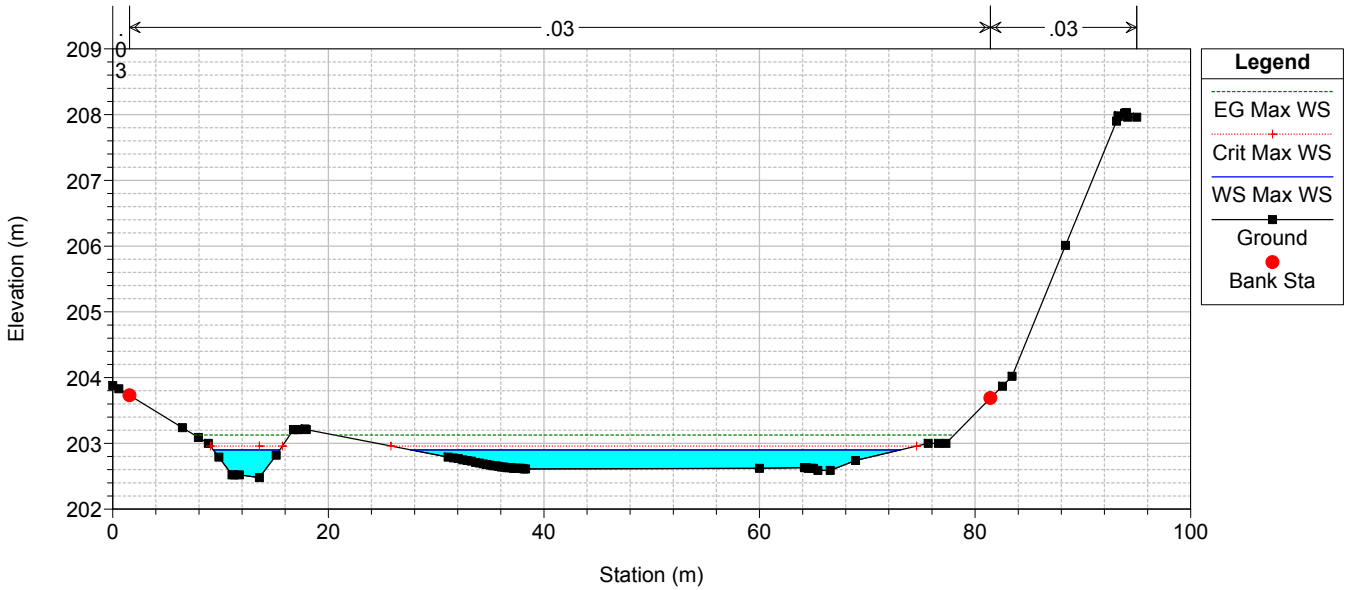

TO02-TO03

RS = -600 TO03 RS= 600

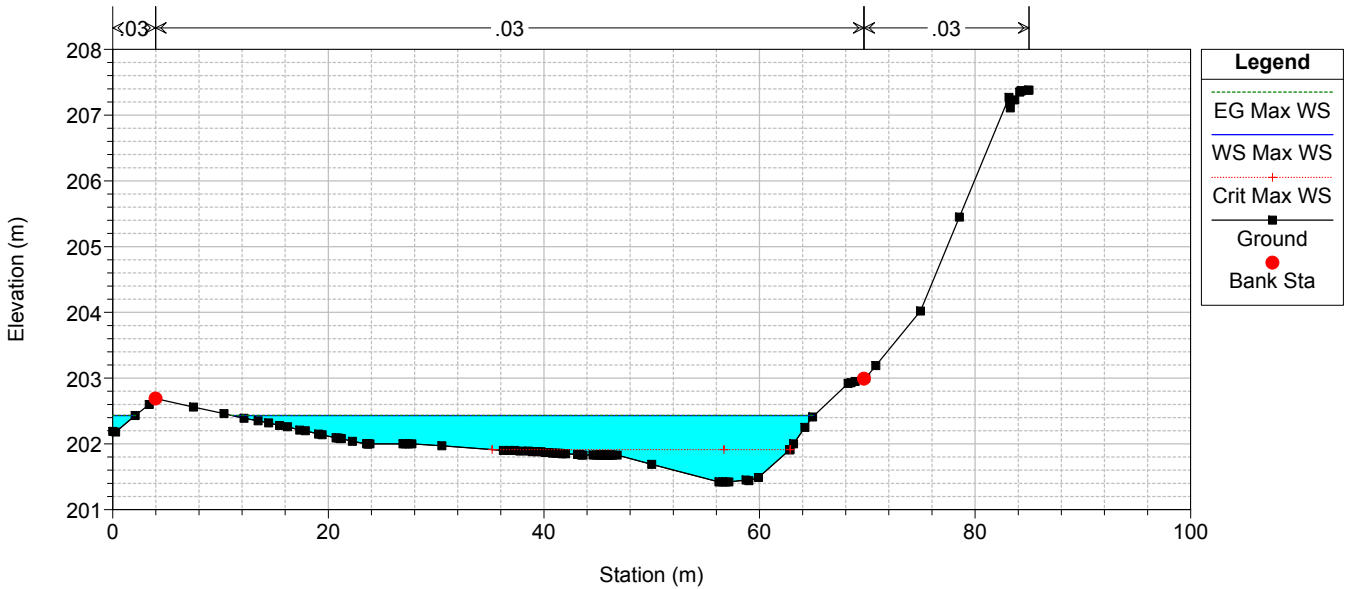

TO02-TO03

RS = -625 TO03 RS= 625

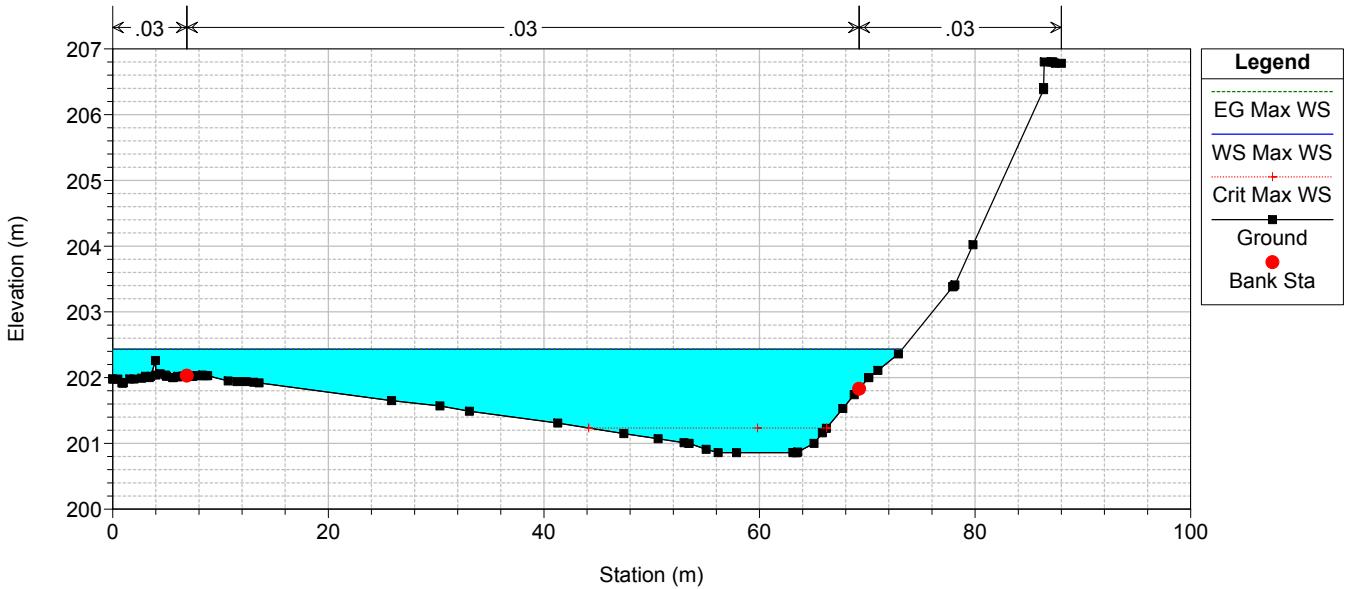

TO02-TO03

RS = -650 TO03 RS= 650

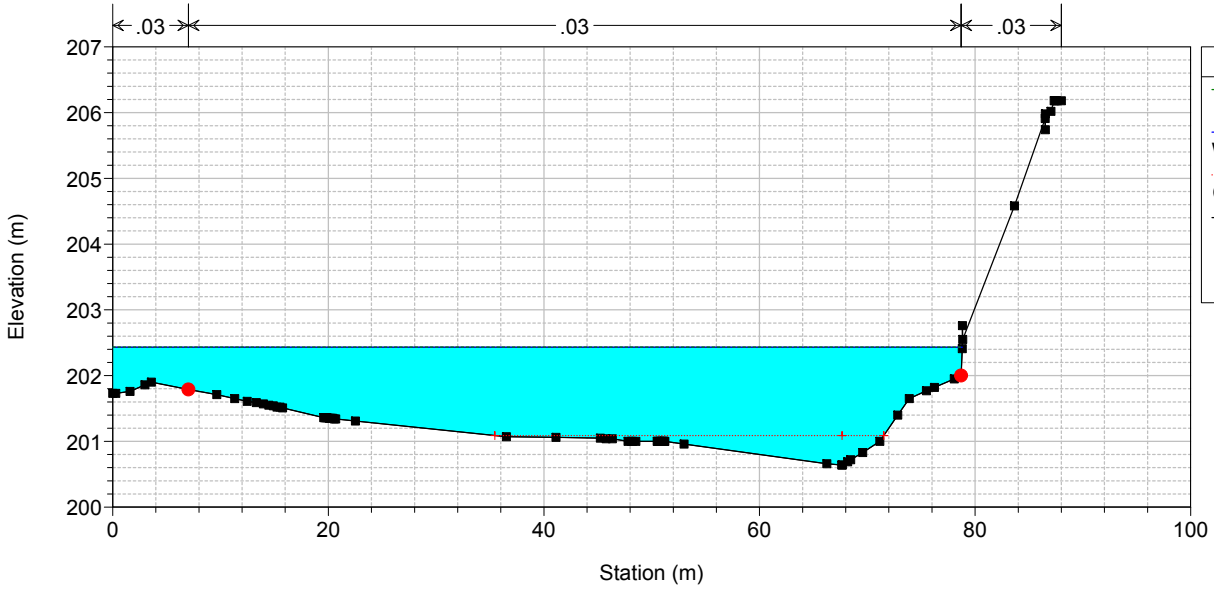

Legend

- EG Max WS
- WS Max WS
- Crit Max WS
- Ground
- Bank Sta

TO02-TO03

RS = -675 TO03 RS= 675

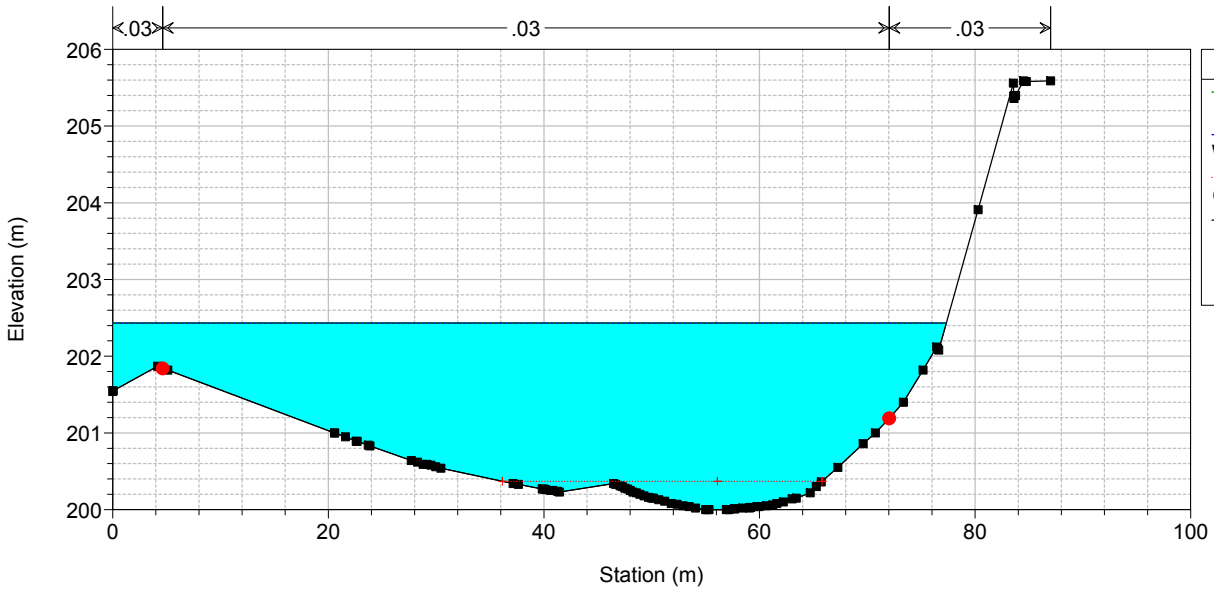

Legend

- EG Max WS
- WS Max WS
- Crit Max WS
- Ground
- Bank Sta

TO02-TO03

RS = -700 TO03 RS= 700

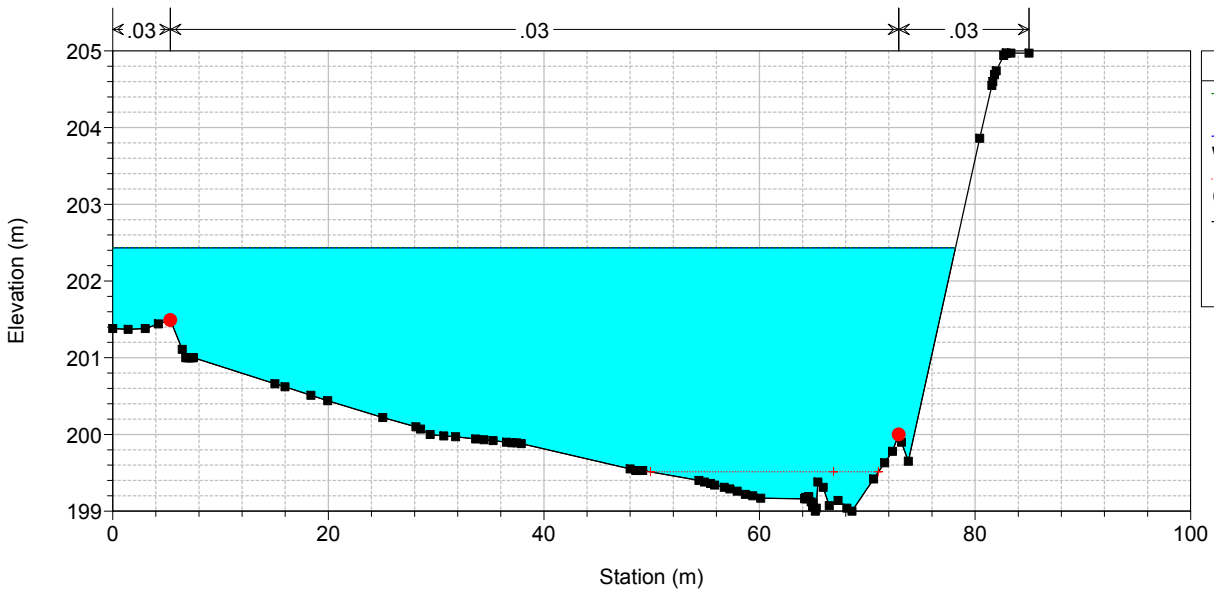

Legend

- EG Max WS
- WS Max WS
- Crit Max WS
- Ground
- Bank Sta

TO02-TO03

RS = -725 TO03 RS= 725

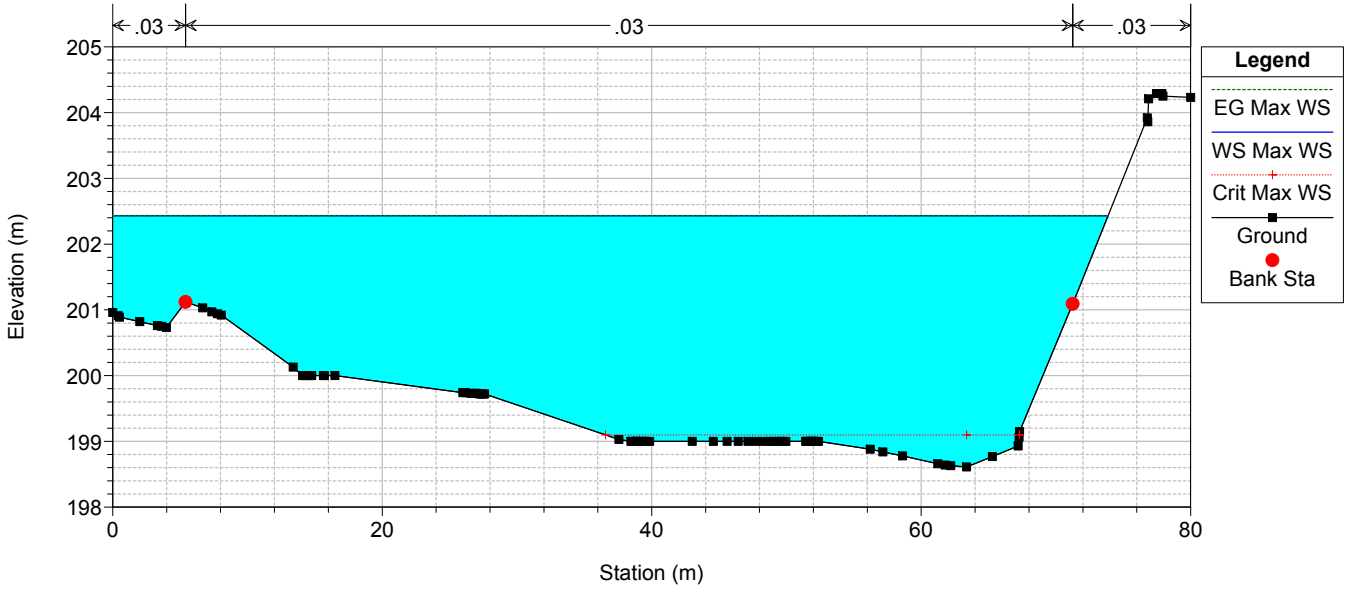

TO02-TO03

RS = -750 TO03 RS= 750

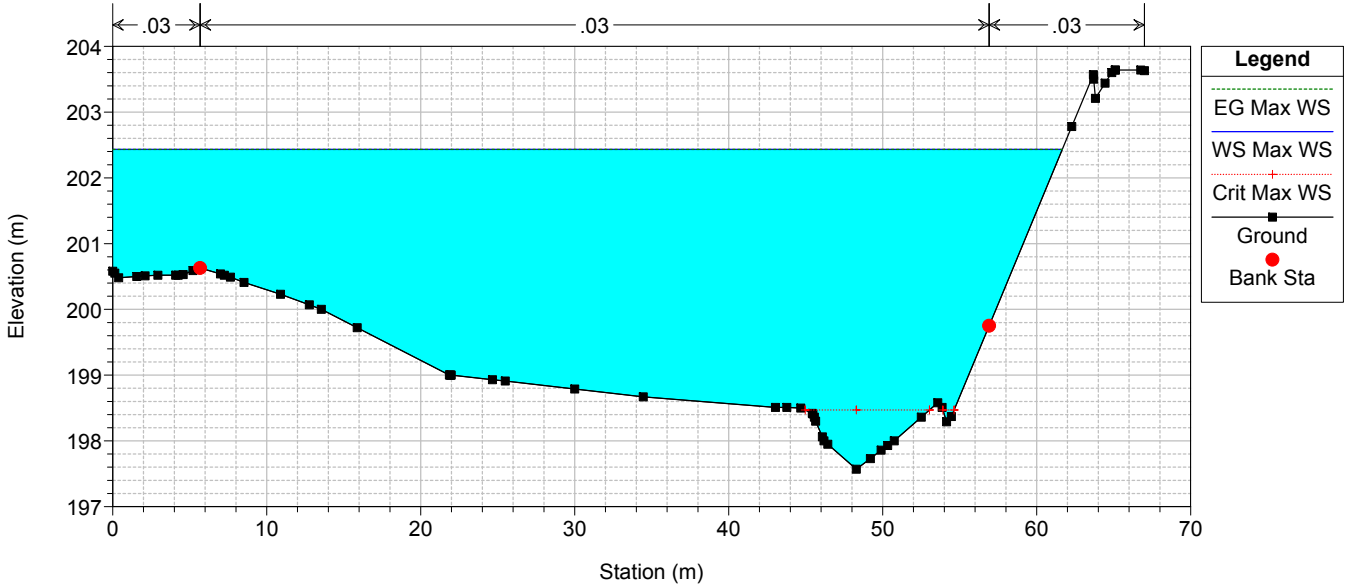

TO02-TO03

RS = -772.6 TO03 RS= 772.6

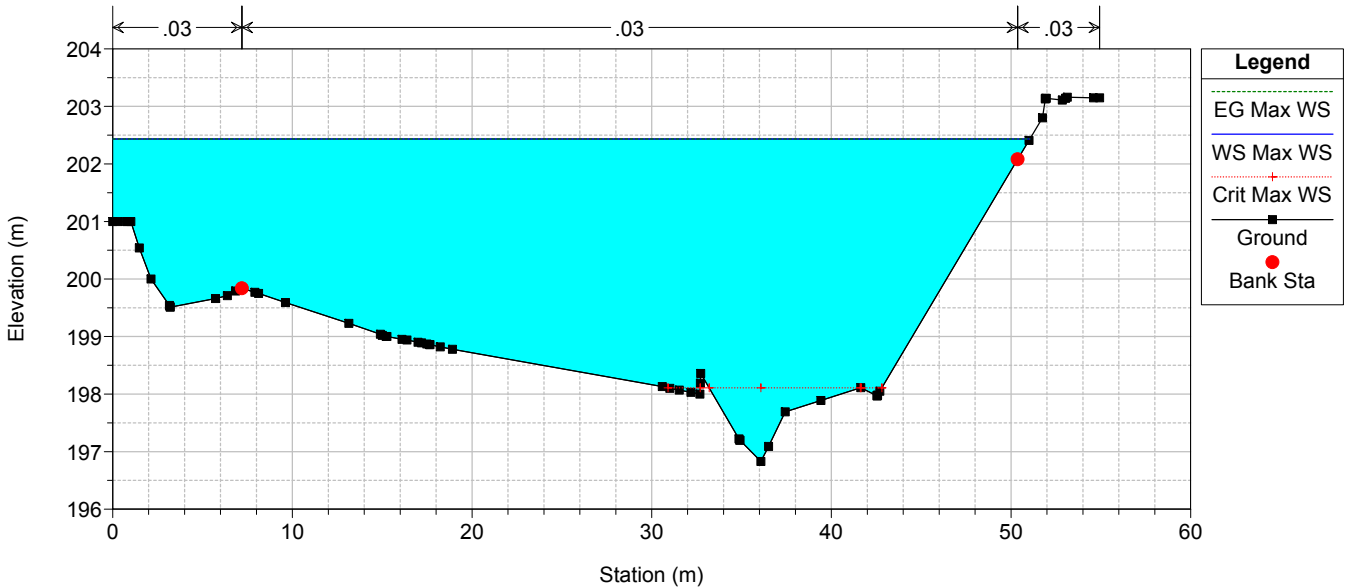

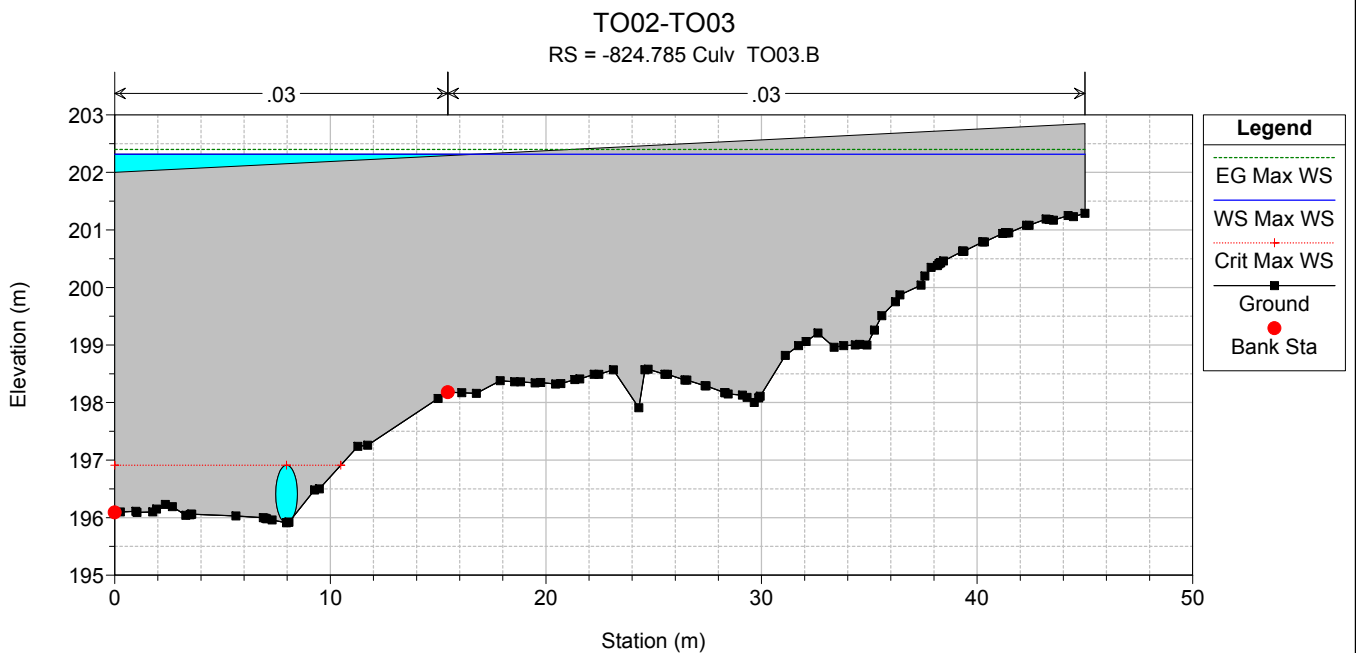
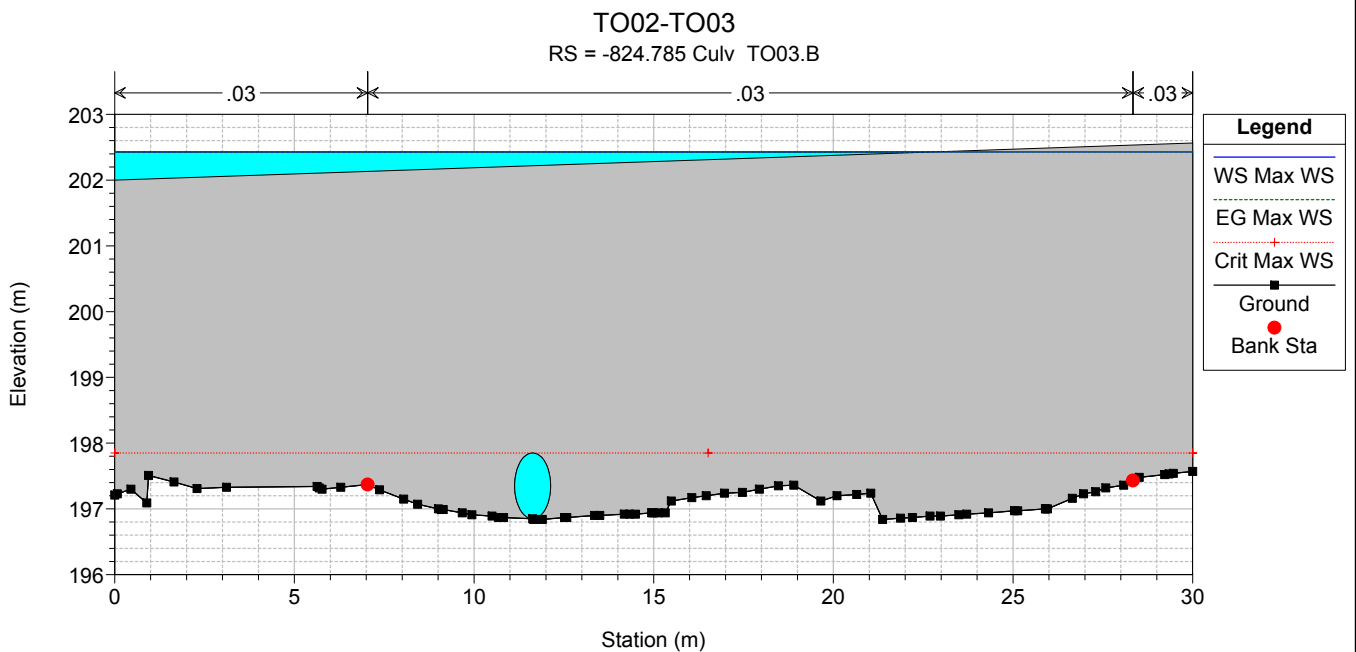
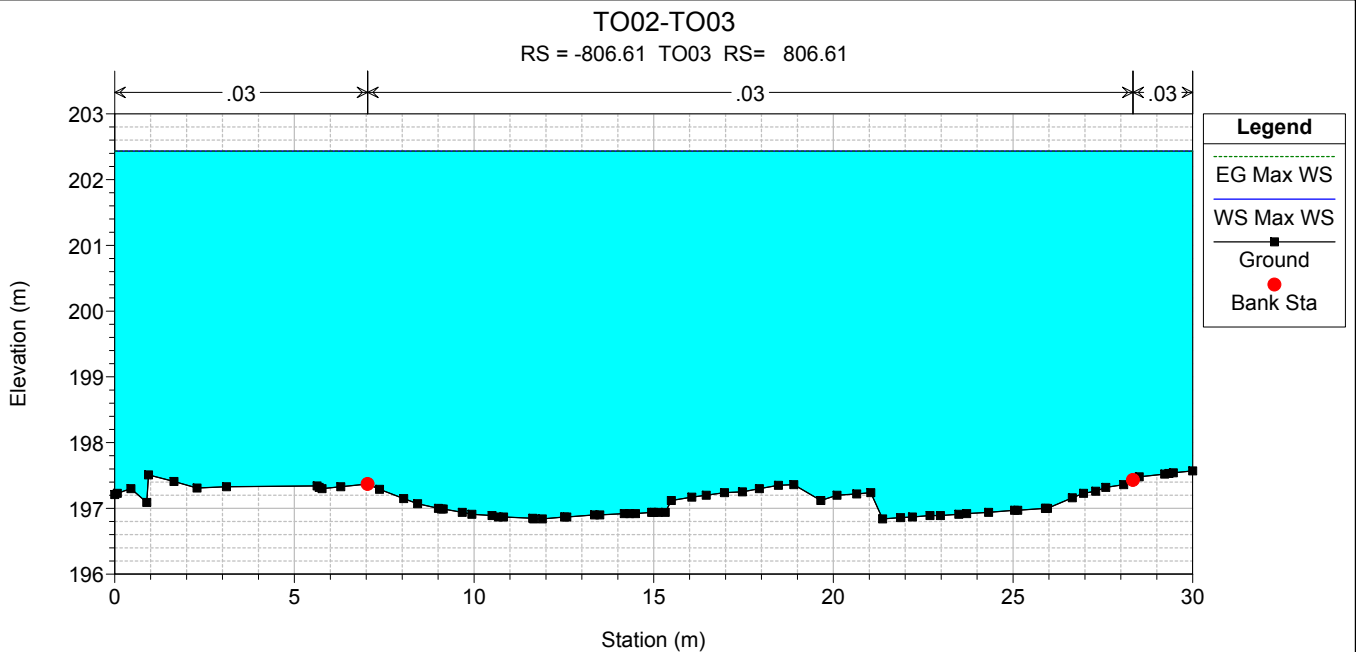

TO02-TO03

RS = -842.96 TO03 RS= 842.96

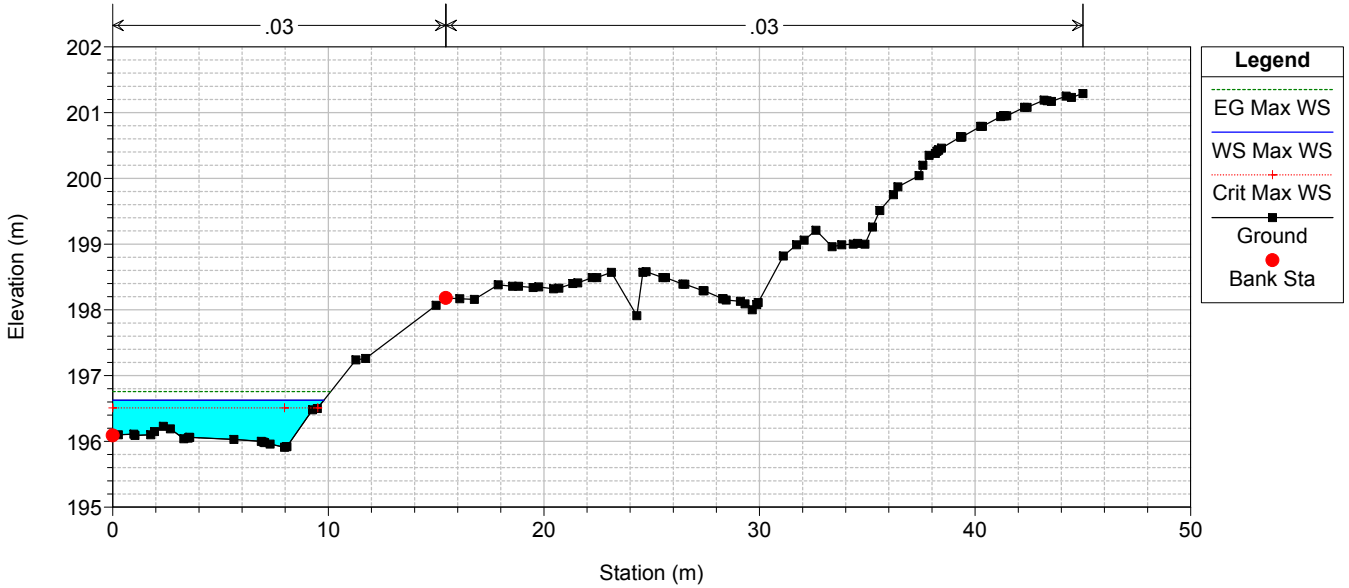

TO02-TO03

RS = -851.72 TO03 RS= 851.72

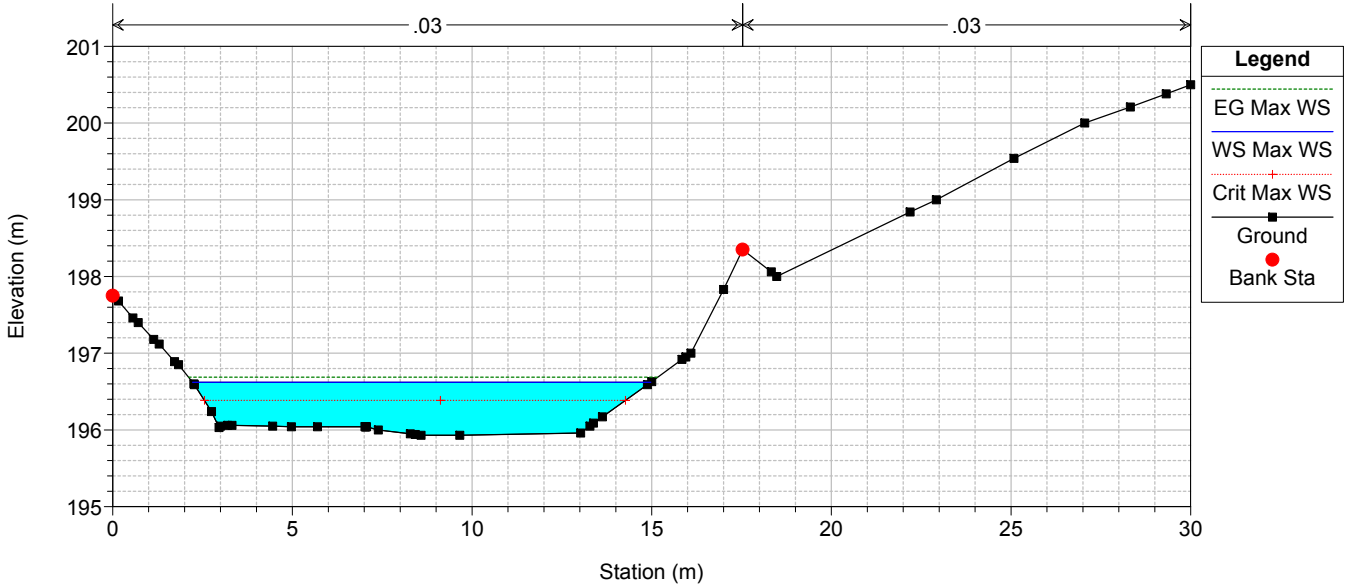

TO02-TO03

RS = -872.81 TO03 RS= 872.81

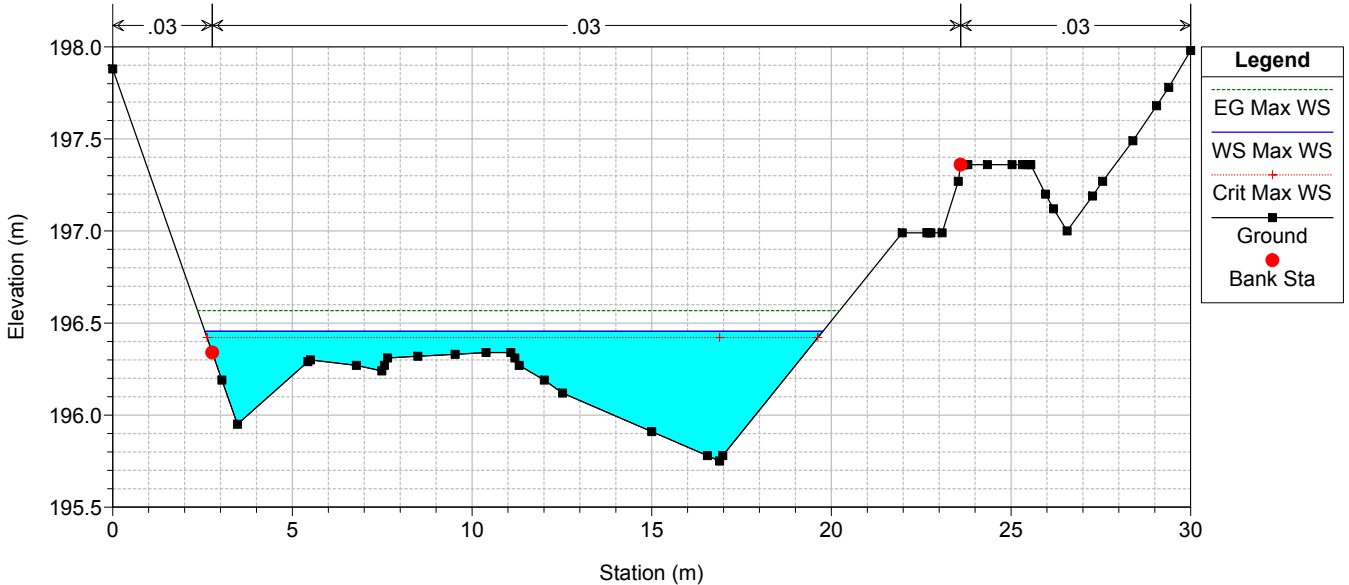

TO02-TO03

RS = -877.6 TO03 RS= 877.6

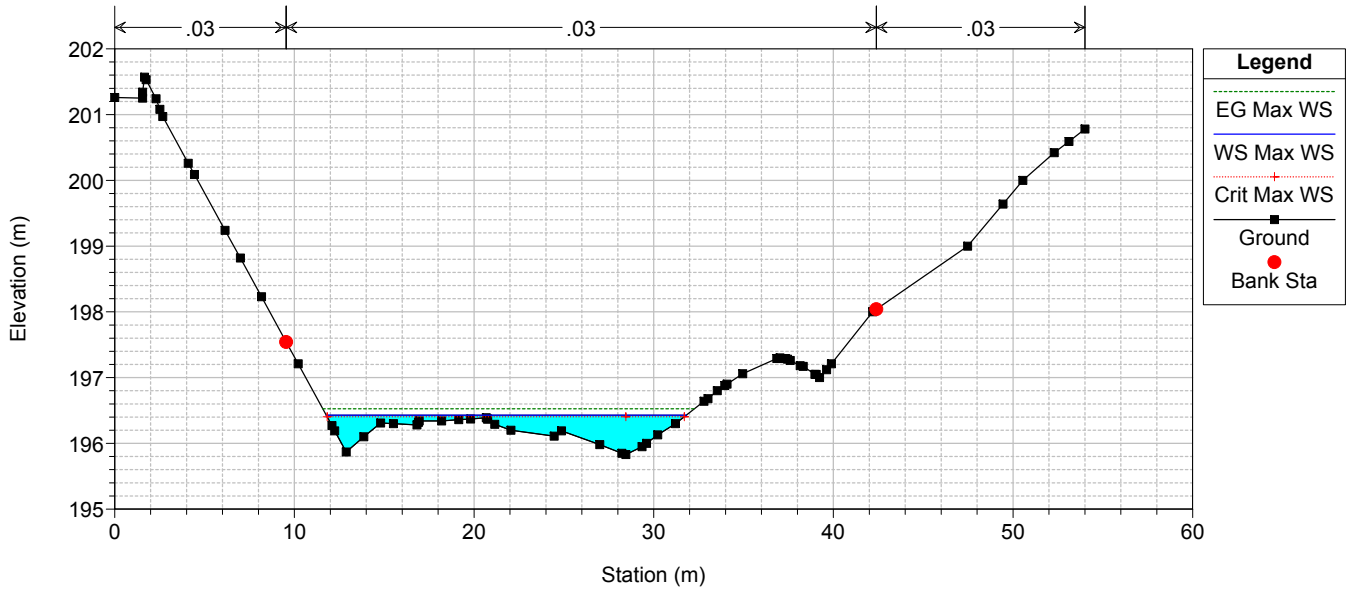

TO02-TO03

RS = -889.52

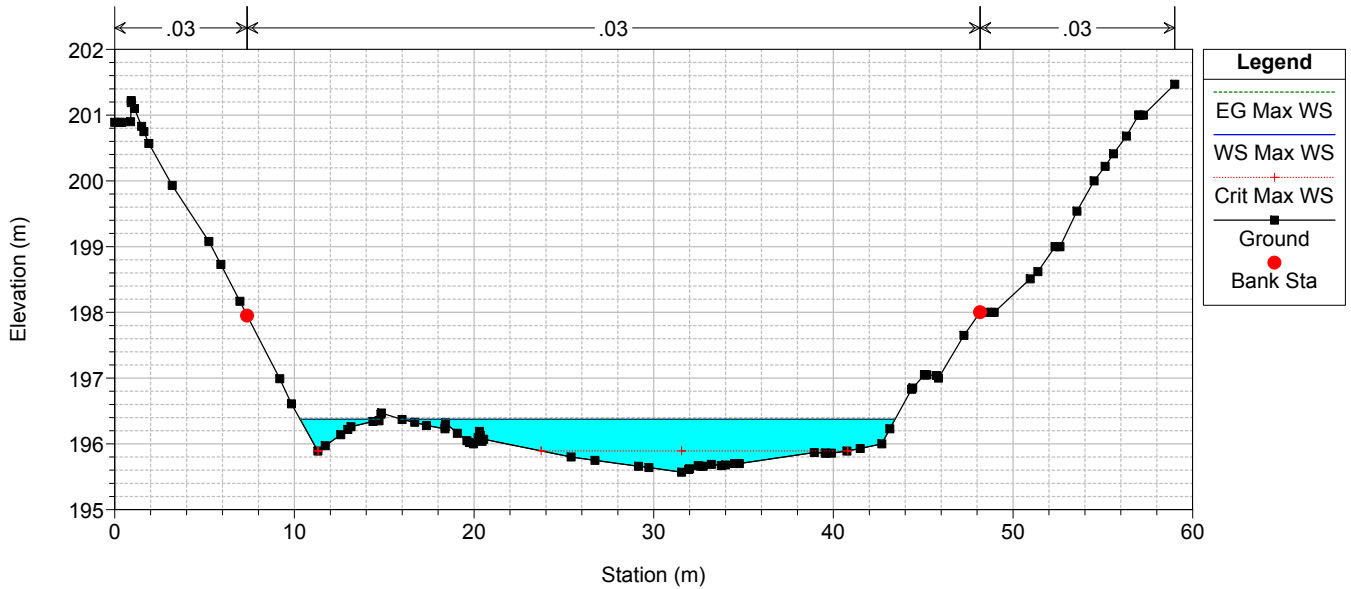

TO02-TO03

RS = -890.74 TO03 RS= 890.74

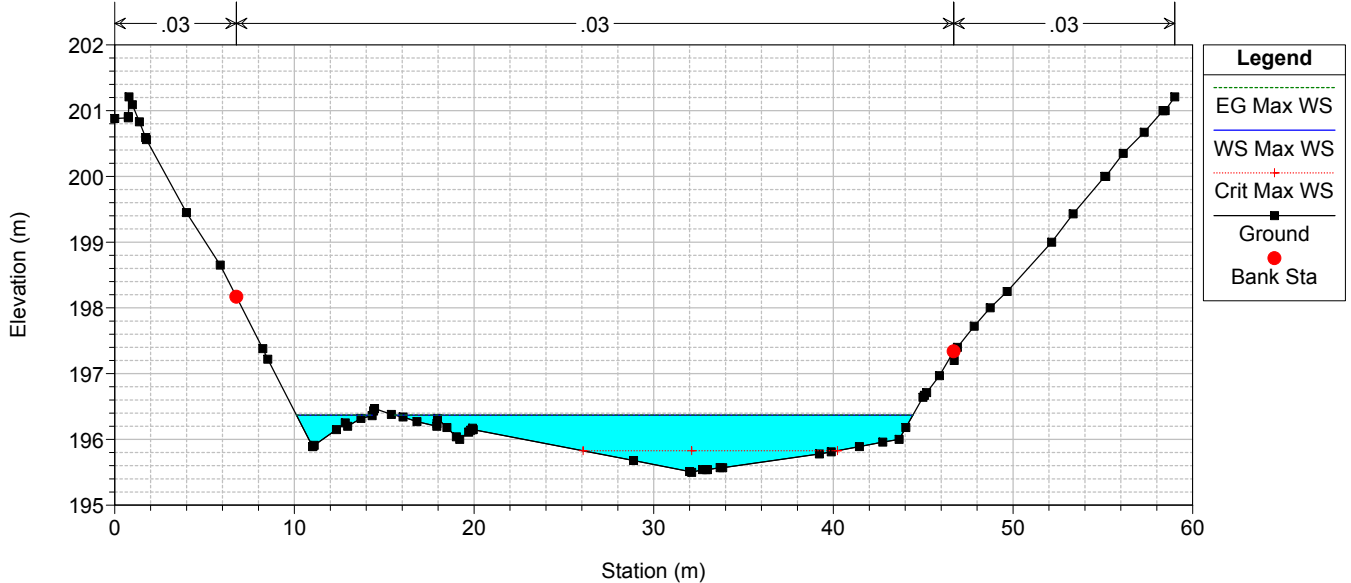

TO02-TO03

RS = -900 TO03 RS= 900

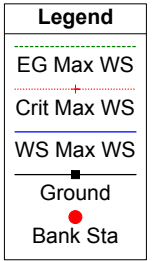
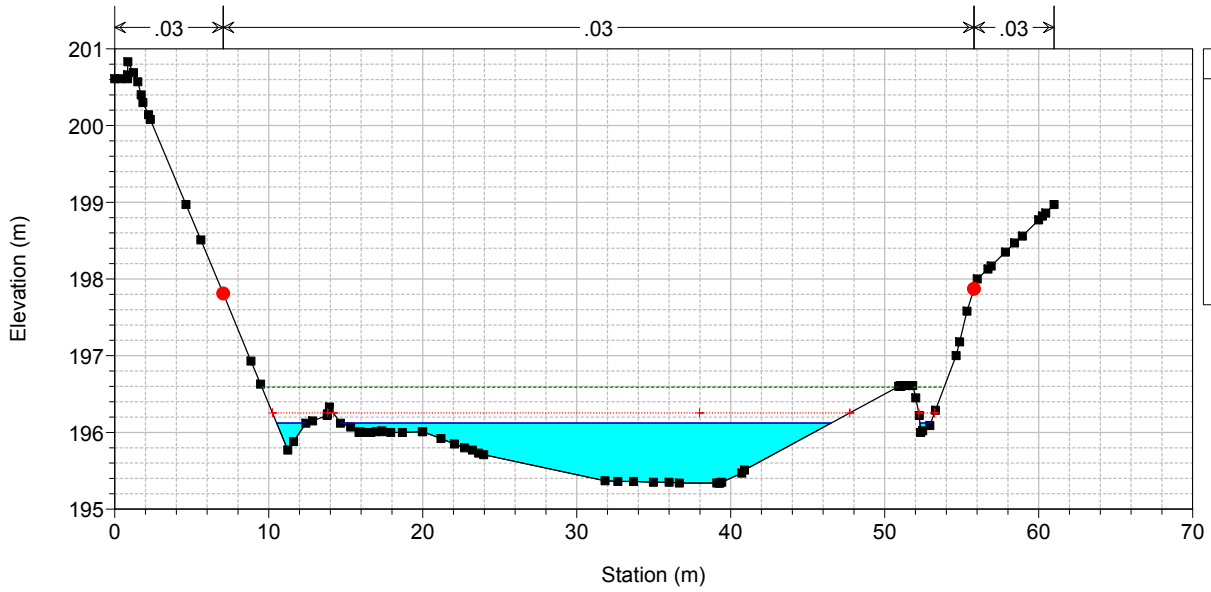

TO02-TO03

RS = -950 TO03 RS= 950

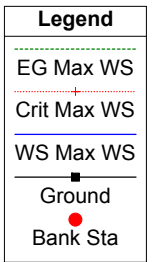
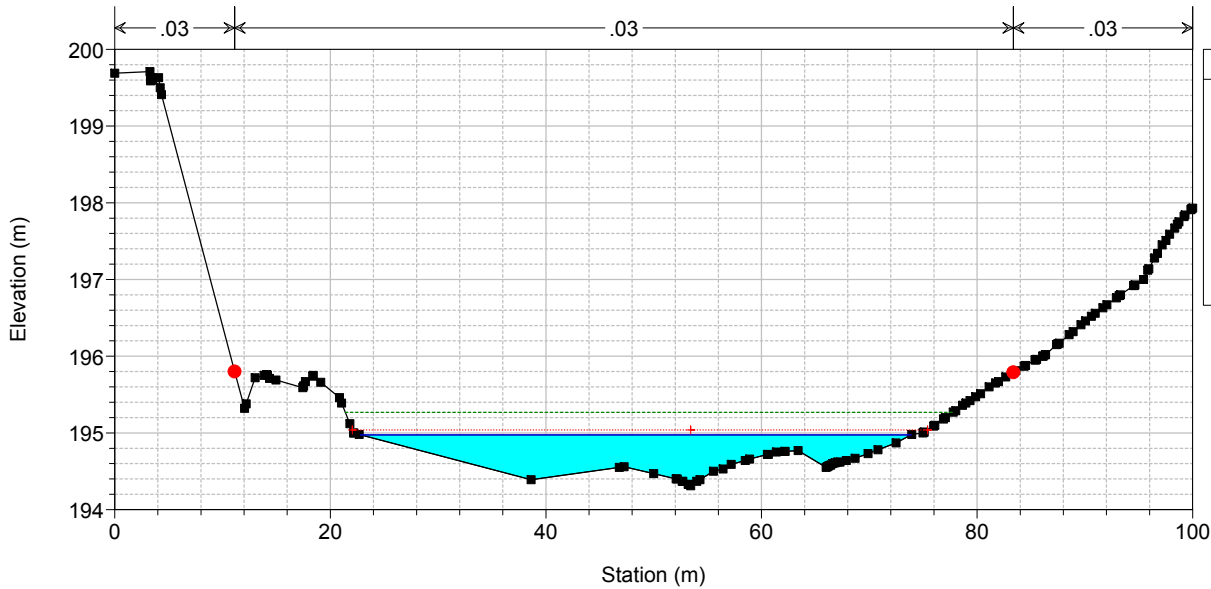

TO02-TO03

RS = -1000 TO03 RS= 1000

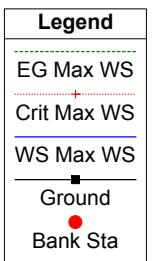
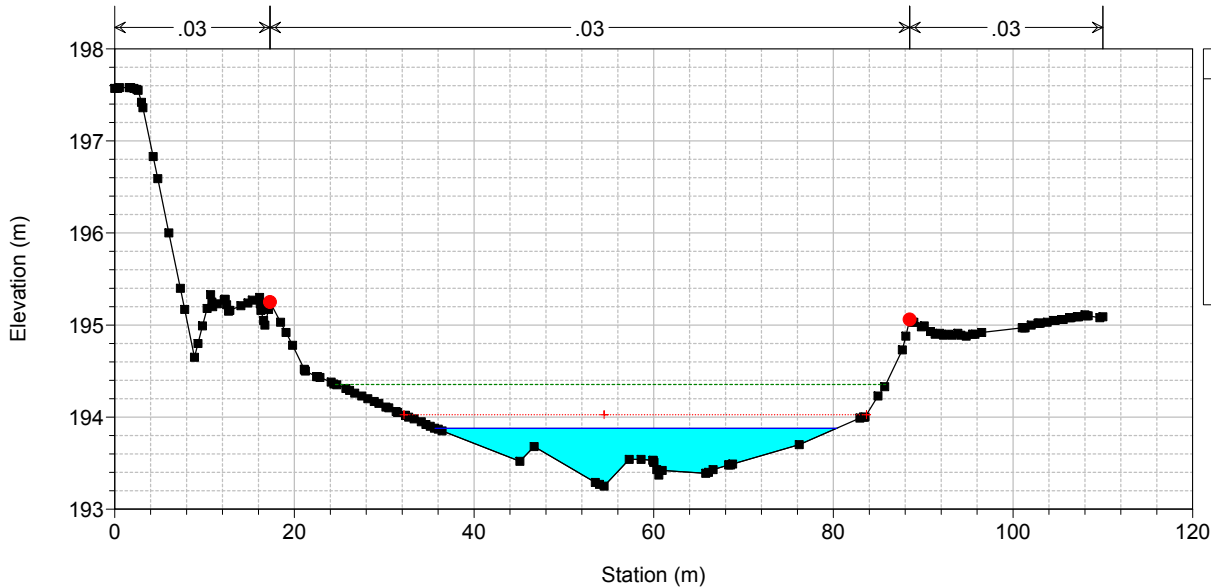

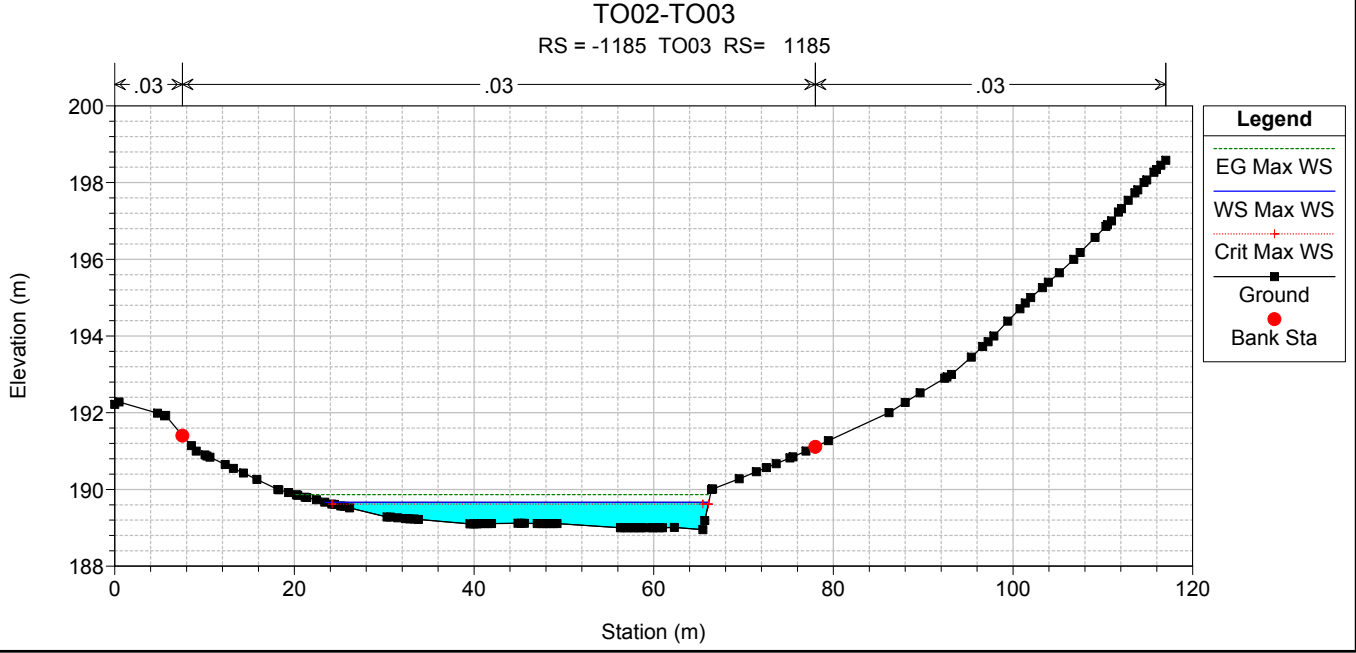
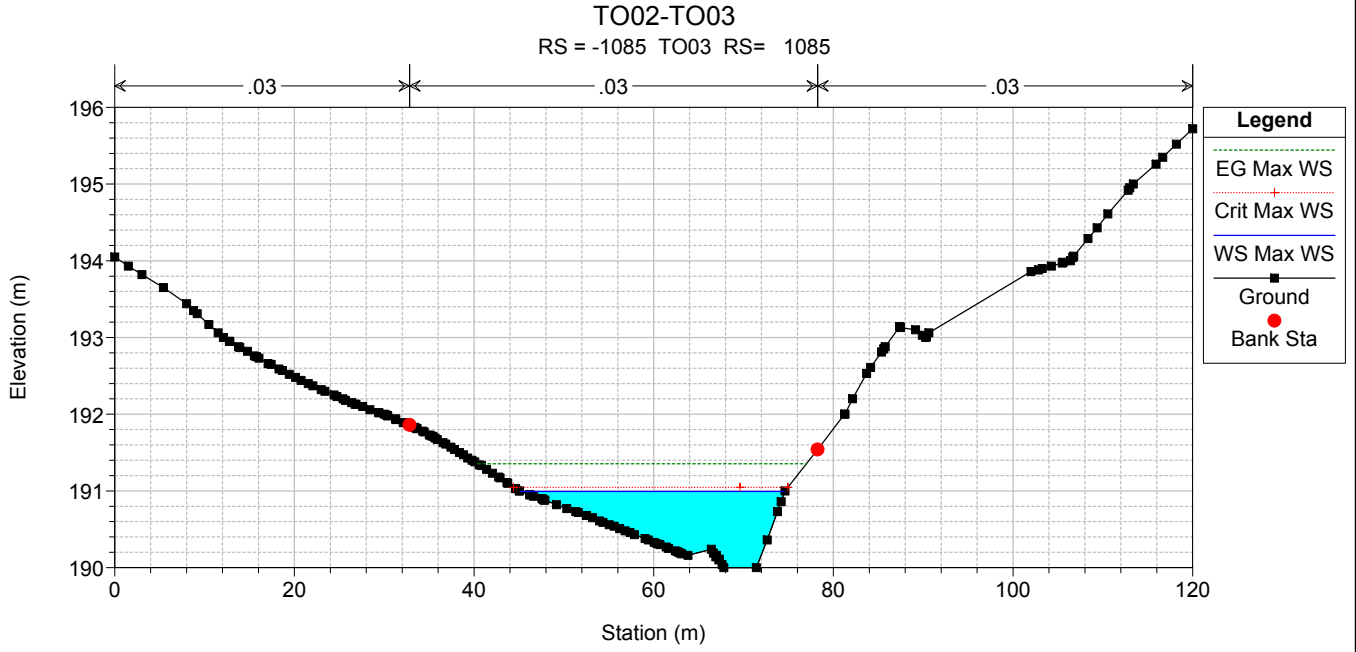
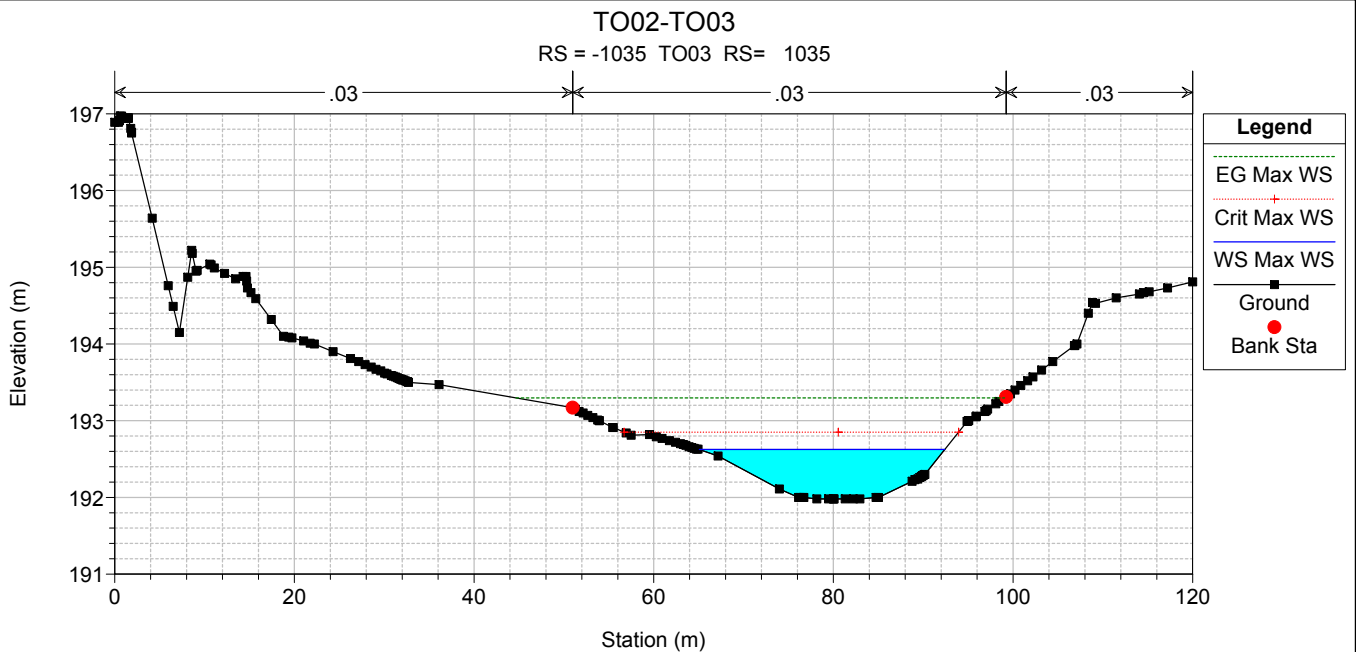

TO02-TO03

RS = -1285 TO03 RS= 1285

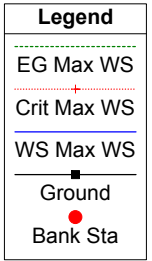
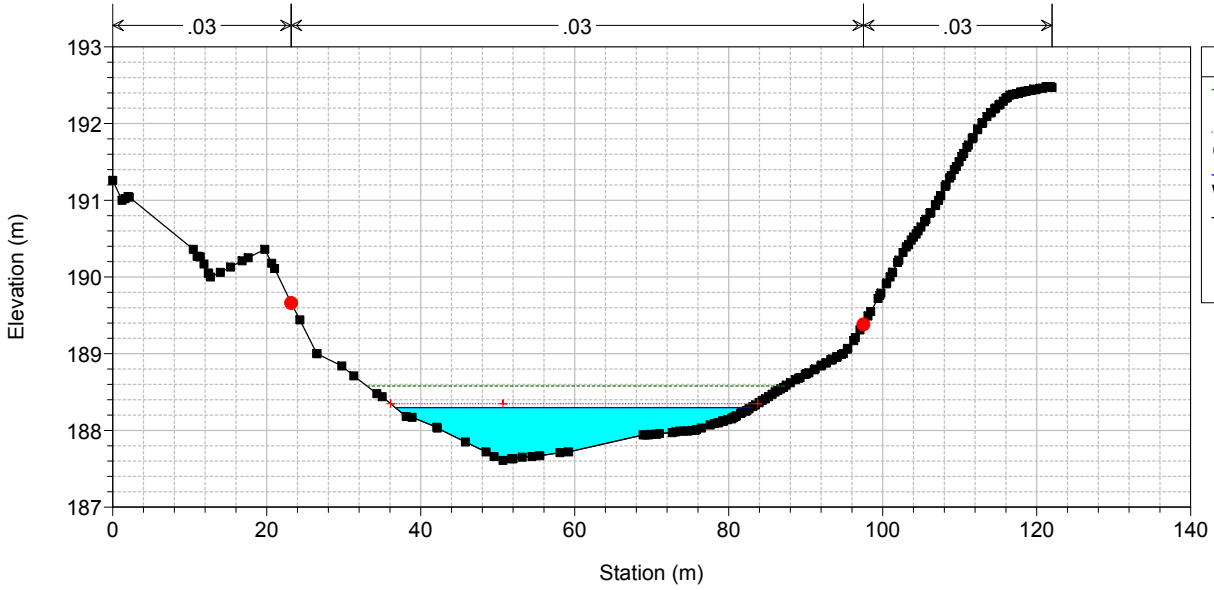

TO02-TO03

RS = -1385 TO03 RS= 1385

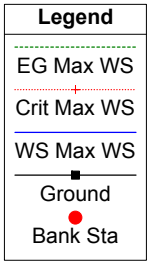
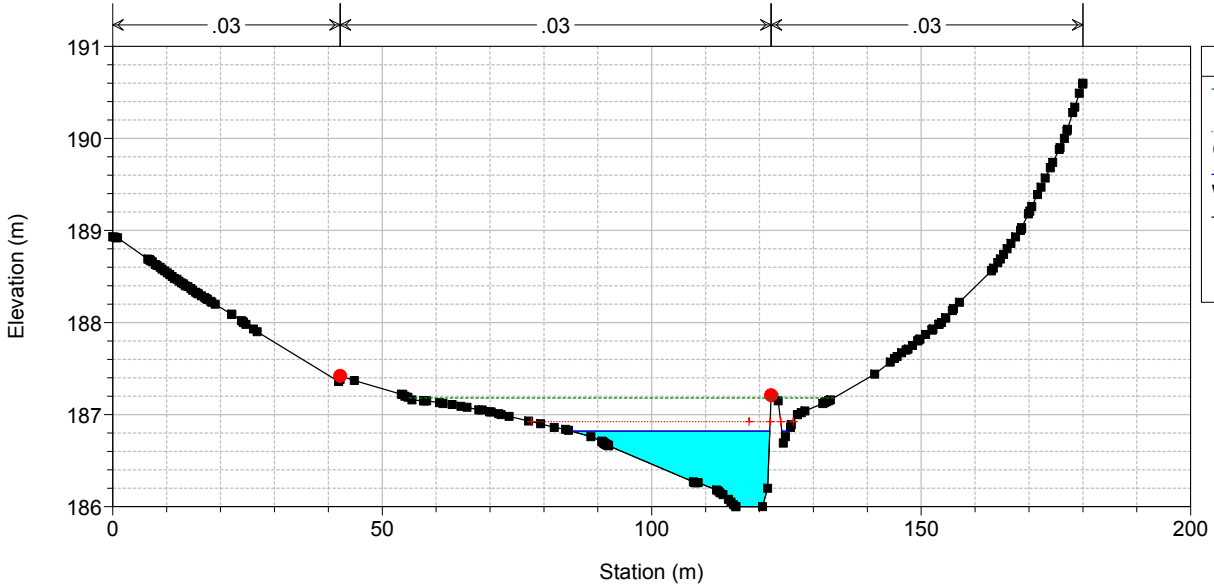

TO02-TO03

RS = -1465 TO03 RS= 1465

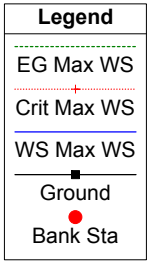
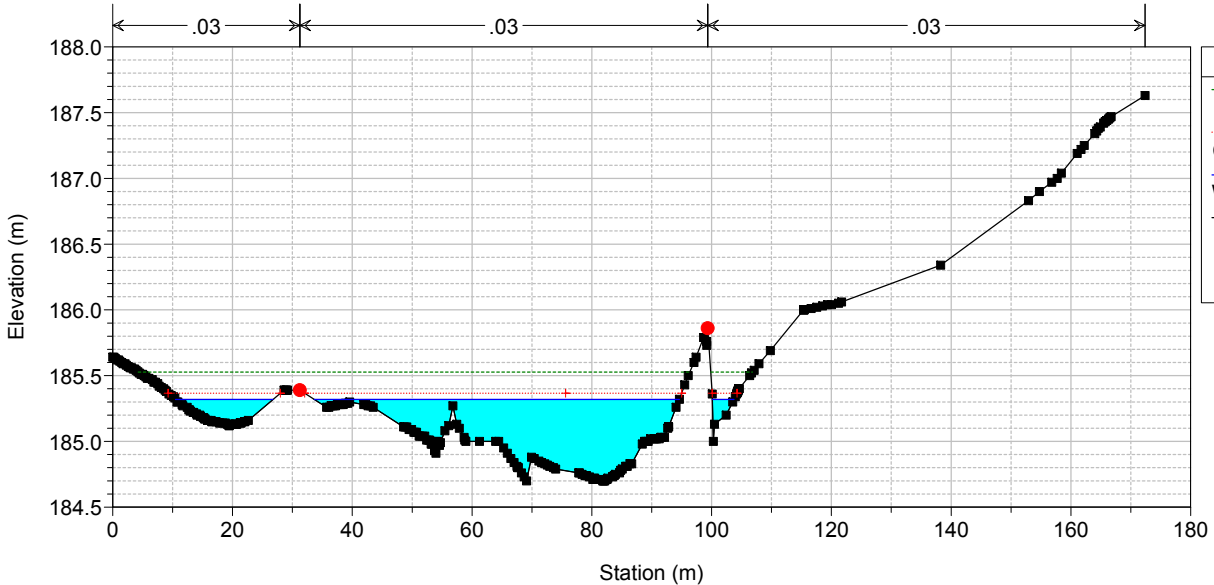

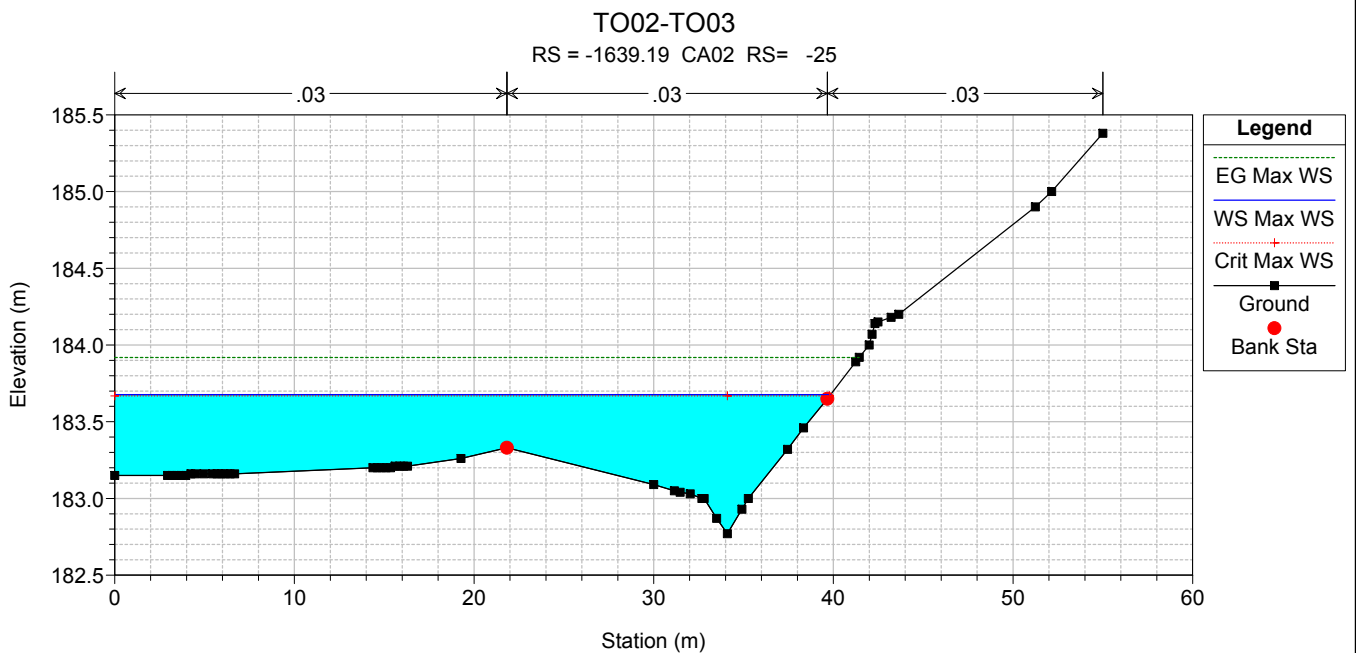
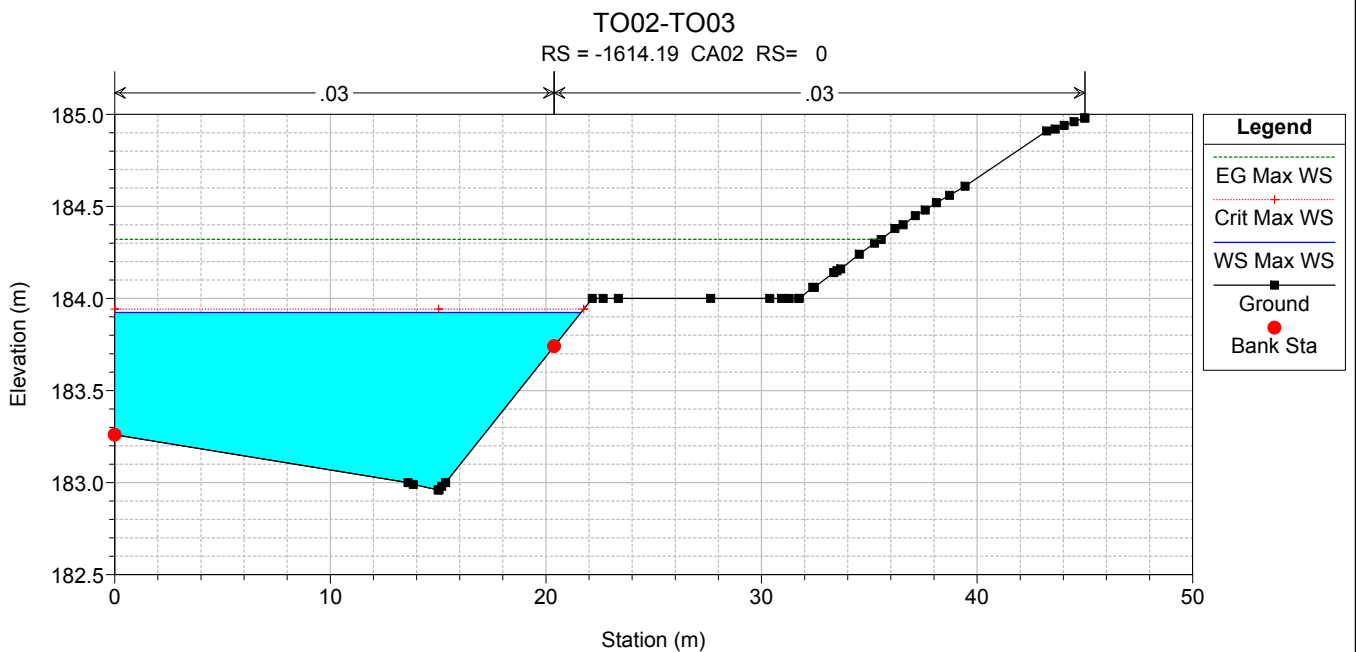
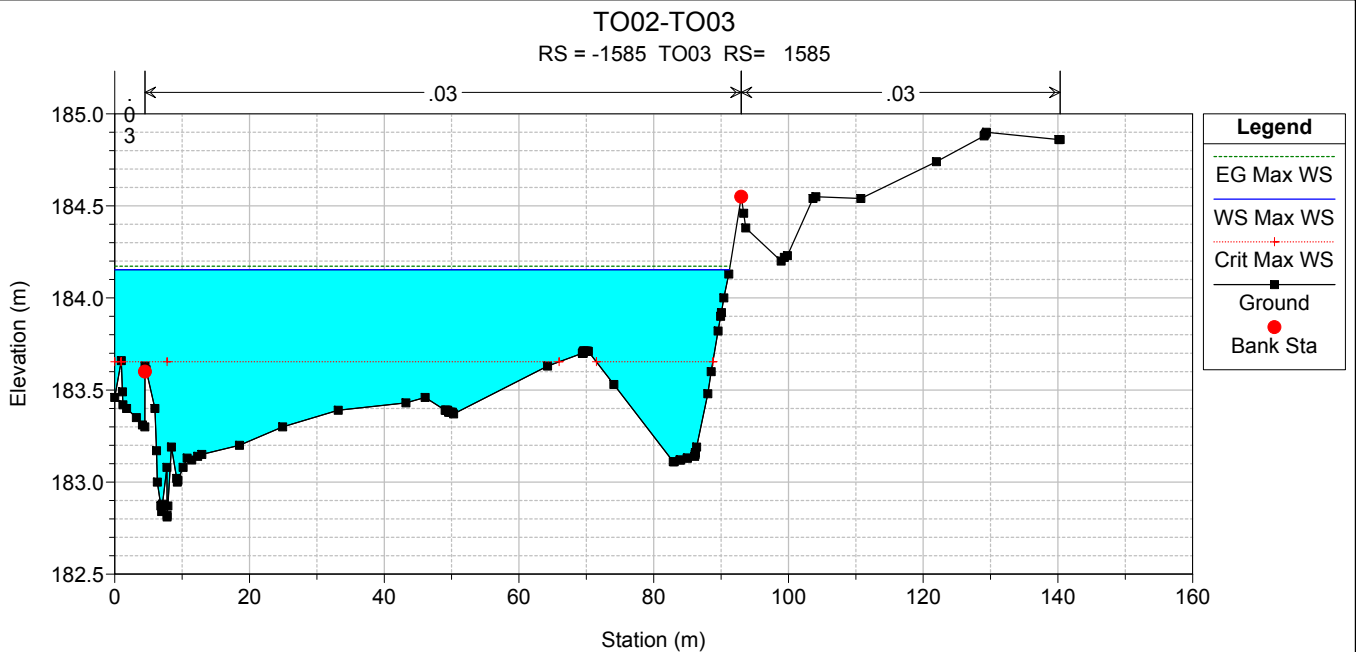

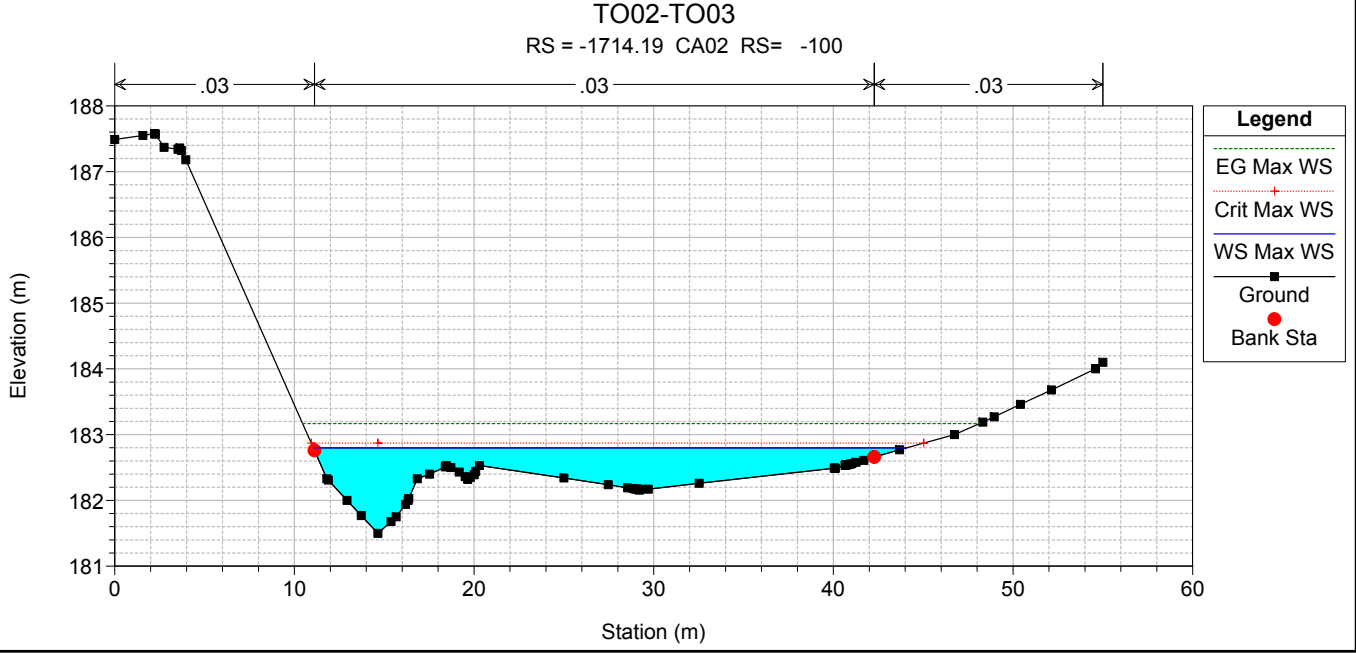
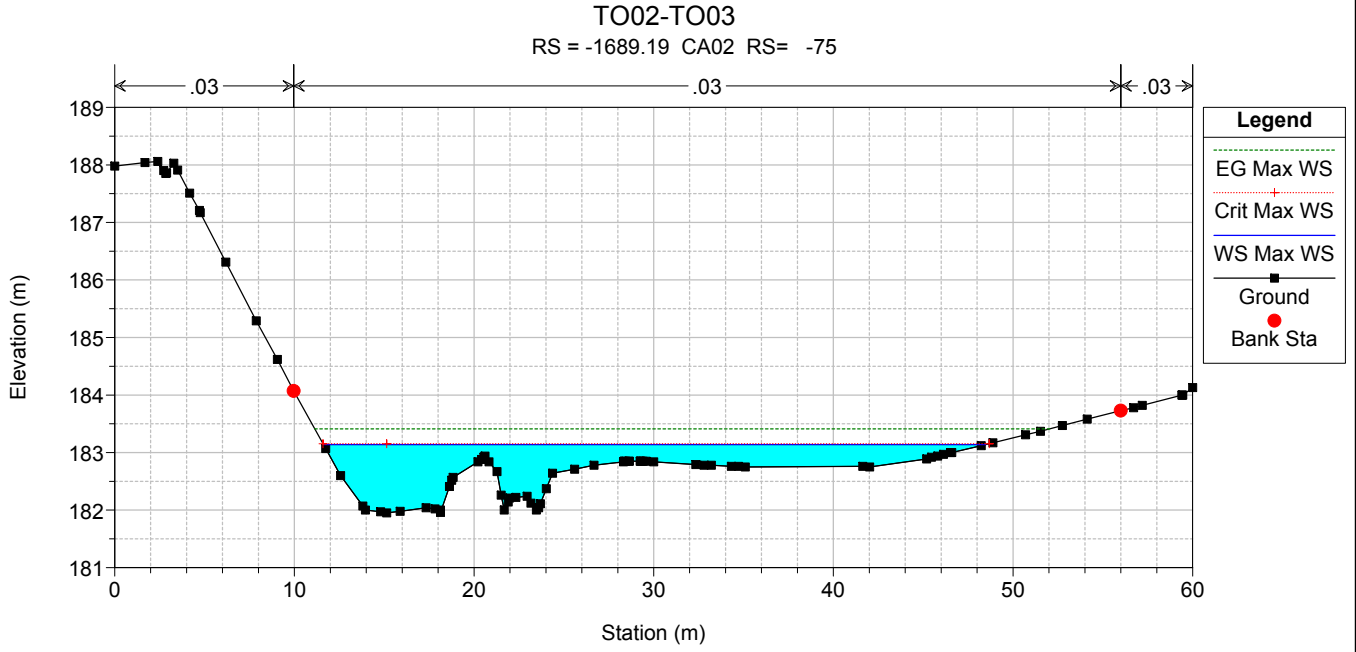
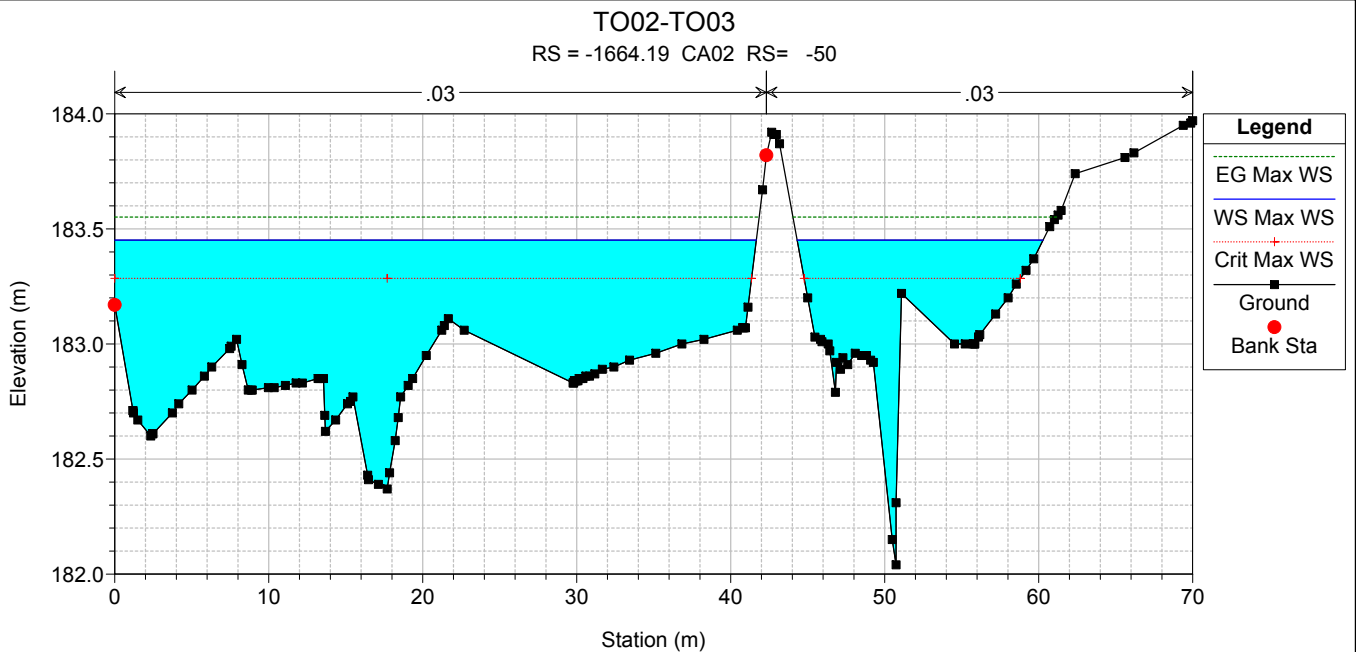

TO02-TO03

RS = -1739.19 CA02 RS= -125

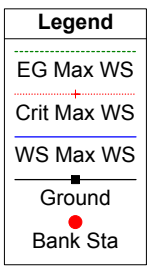
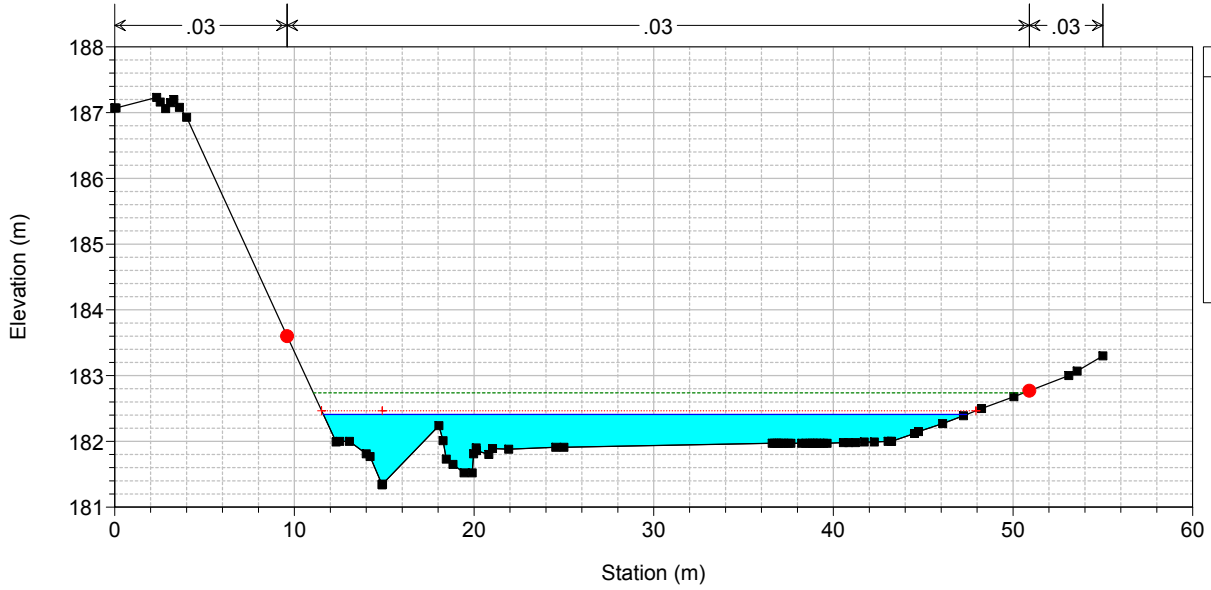

TO02-TO03

RS = -1764.19 CA02 RS= -150

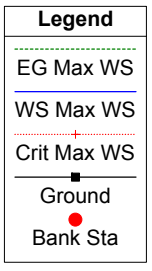
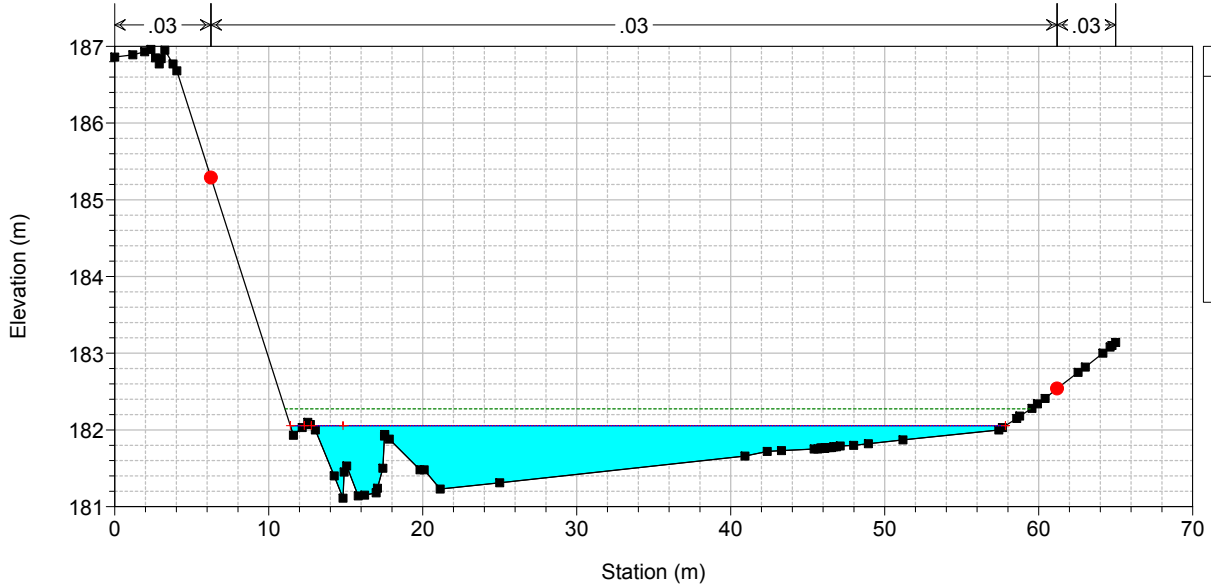

TO02-TO03

RS = -1789.19 CA02 RS= -175

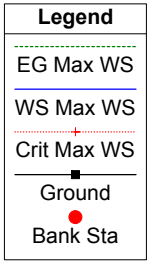
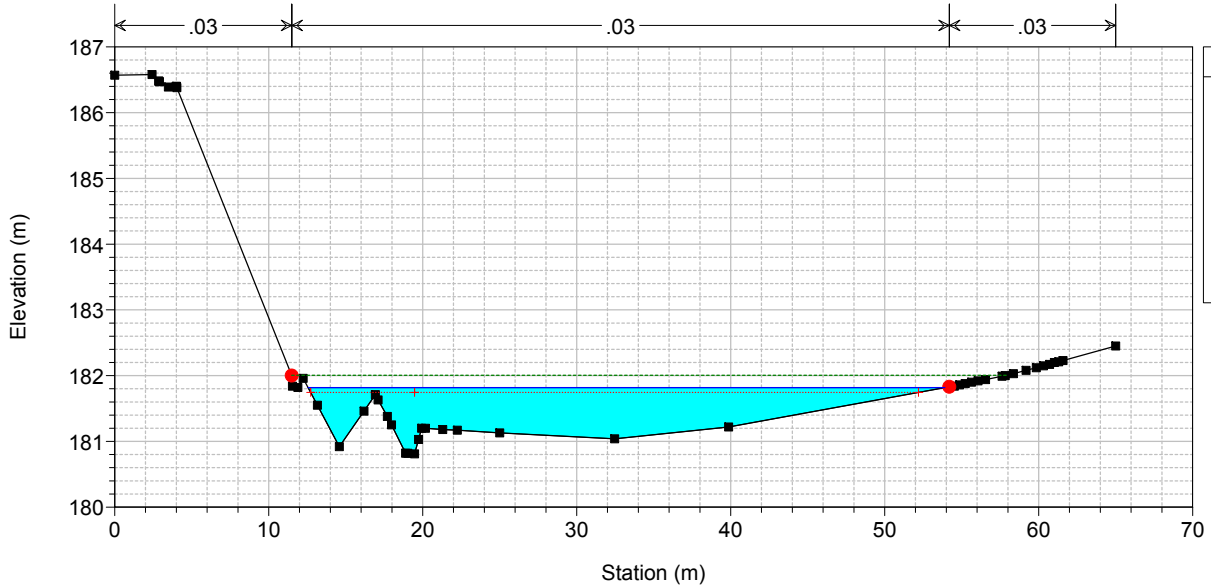

TO02-TO03

RS = -1814.19 CA02 RS= -200

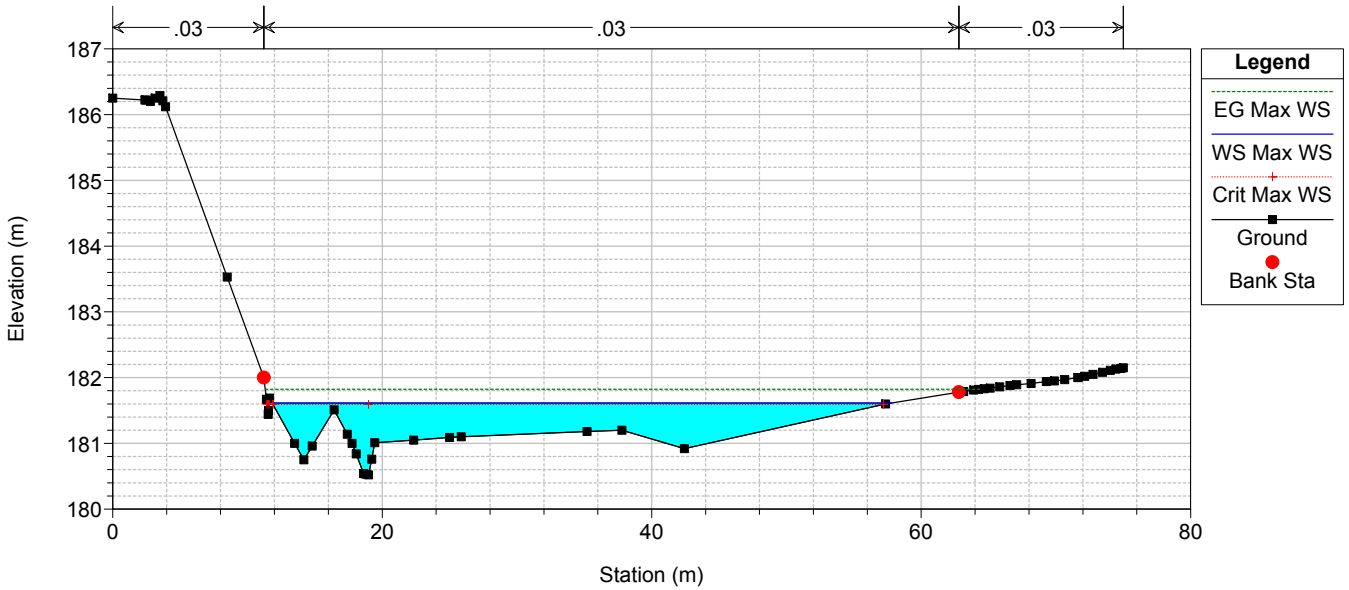

TO02-TO03

RS = -1839.19 CA02 RS= -225

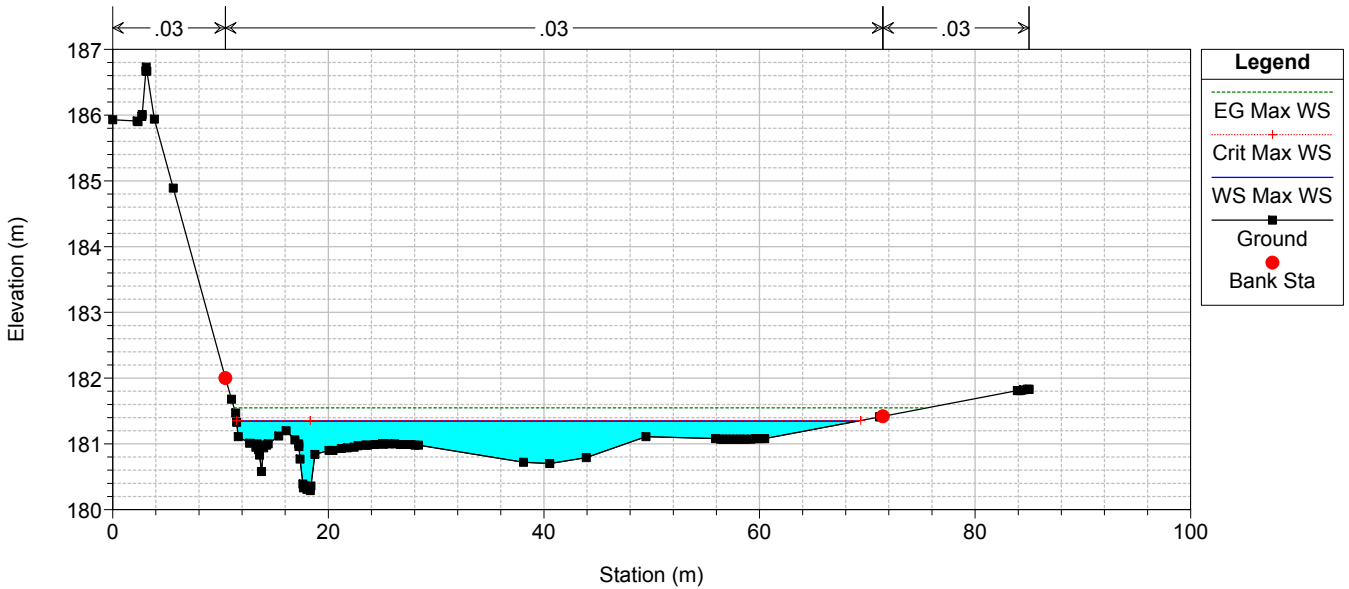

TO02-TO03

RS = -1864.19 CA02 RS= -250

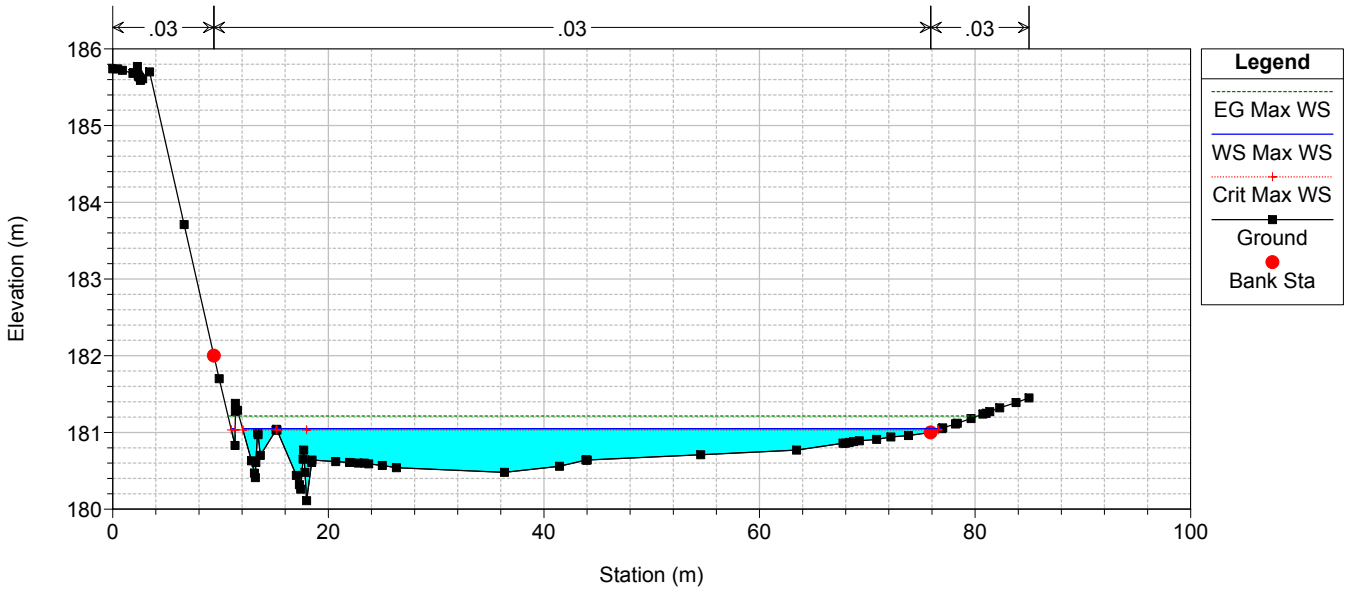

TO02-TO03

RS = -1889.19 CA02 RS= -275

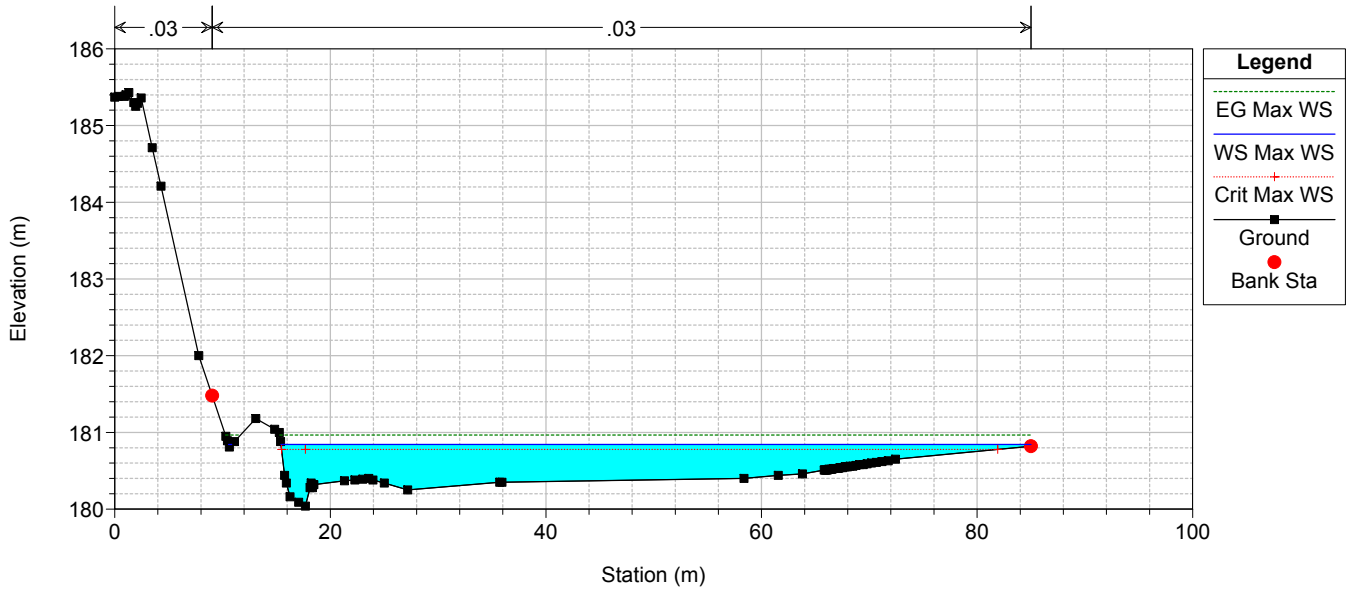

TO02-TO03

RS = -1914.19 CA02 RS= -300

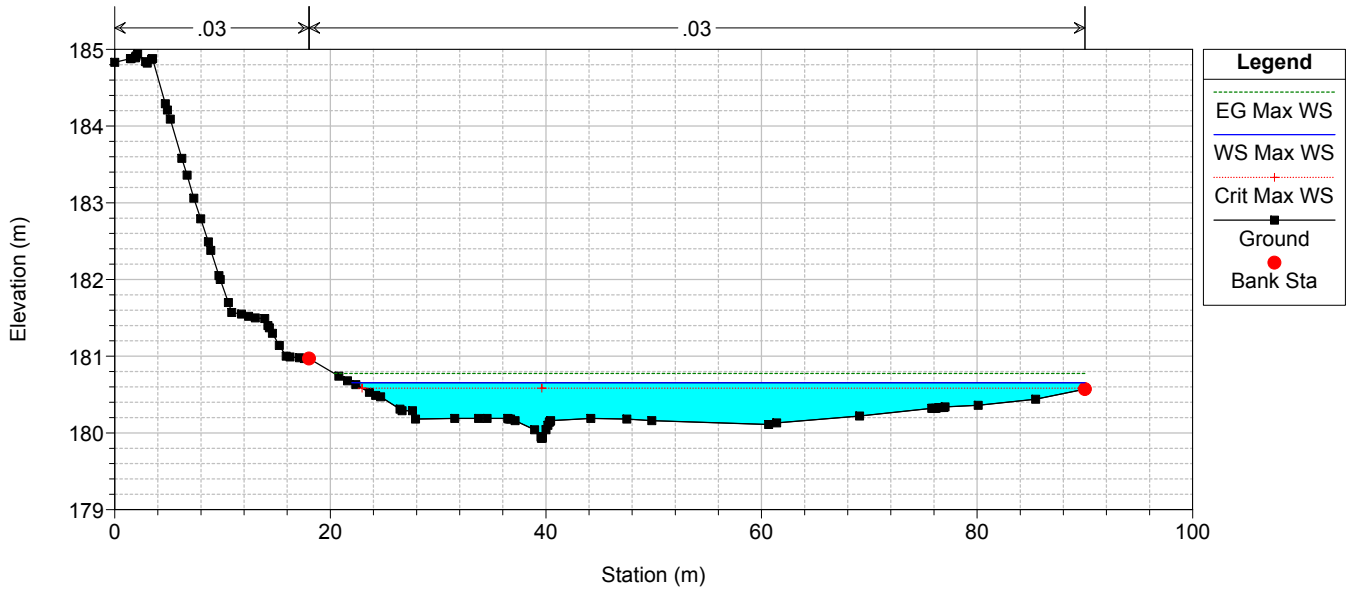

TO02-TO03

RS = -1939.19 CA02 RS= -325

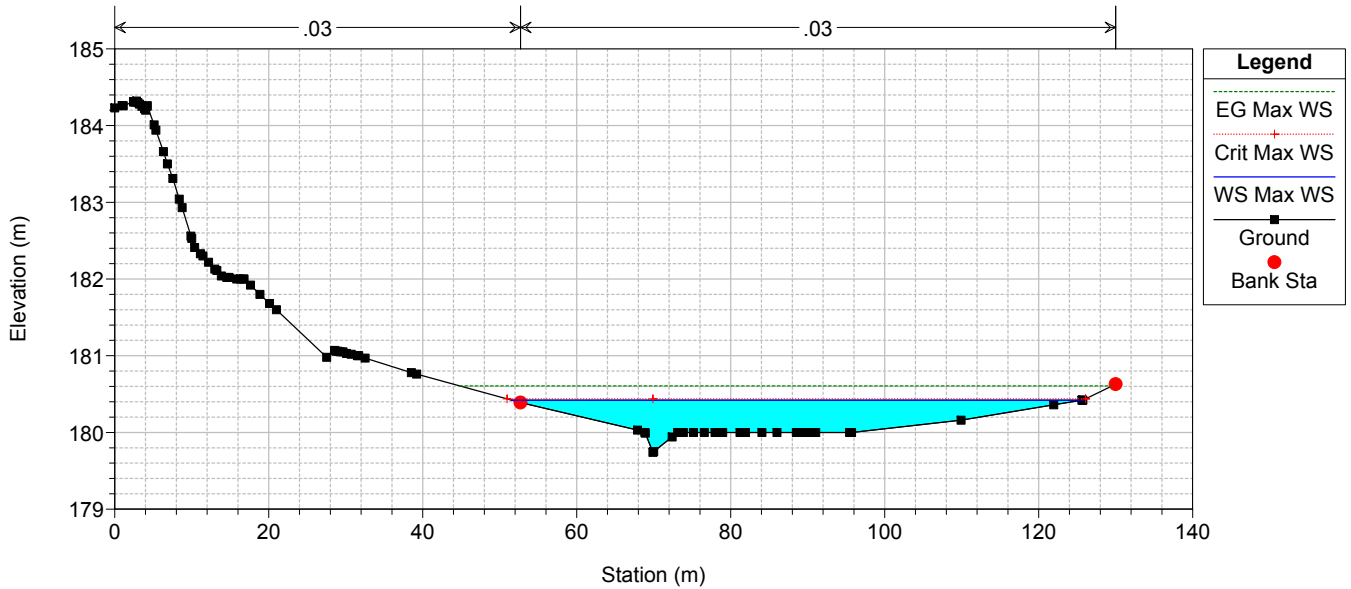

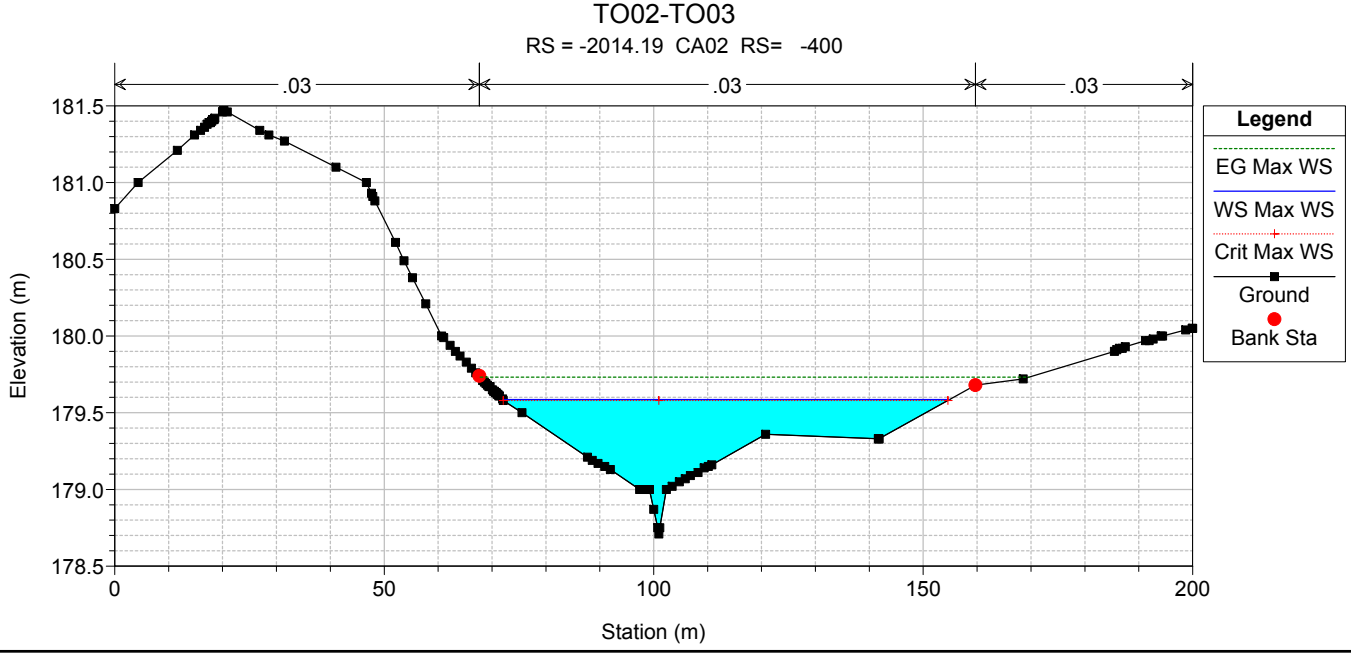
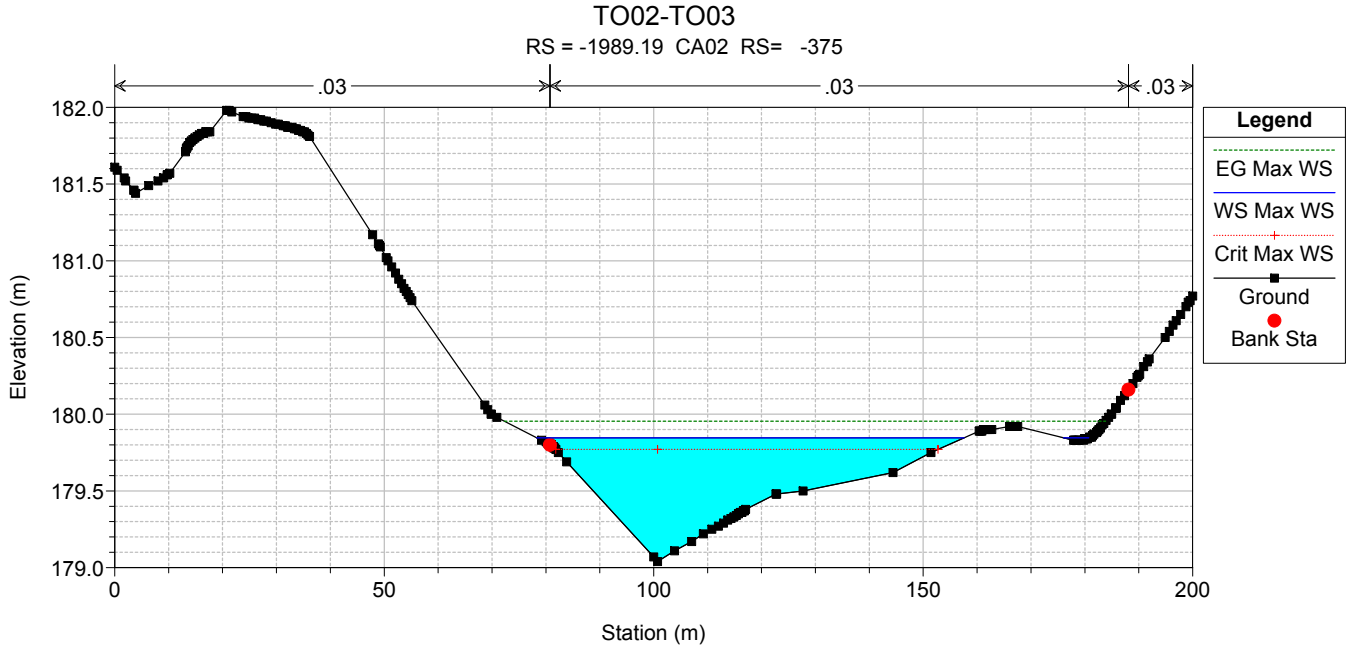
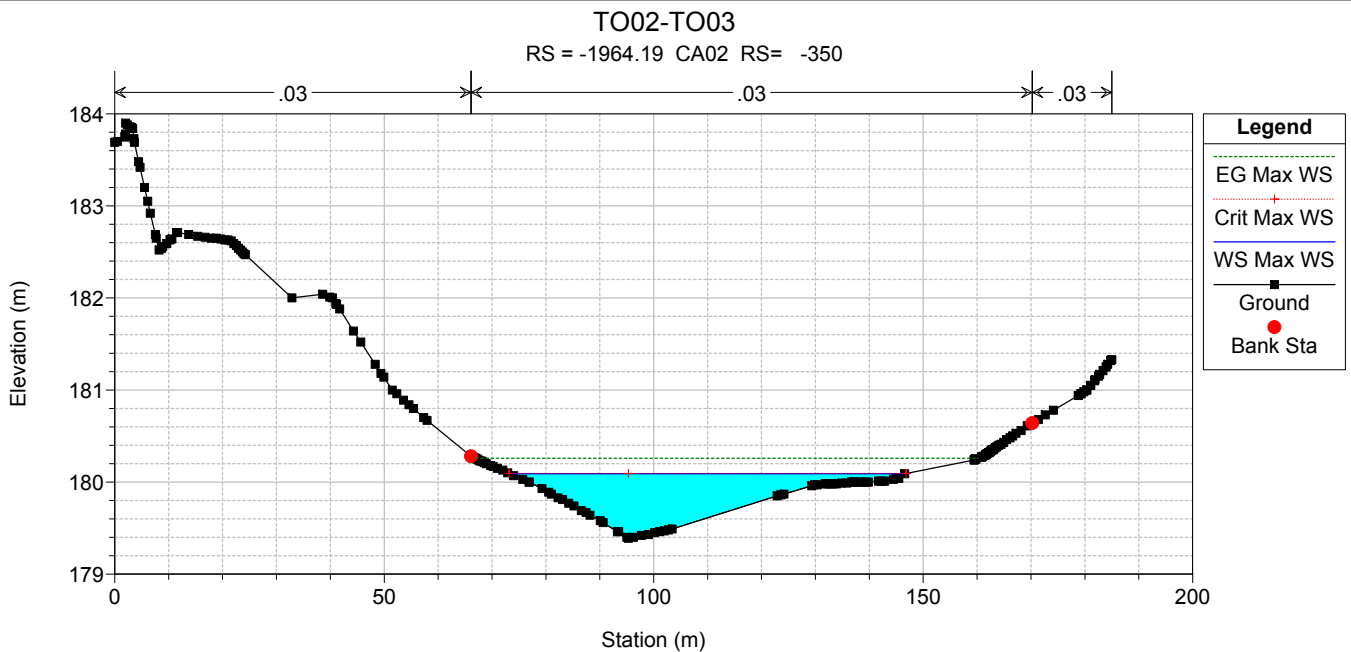

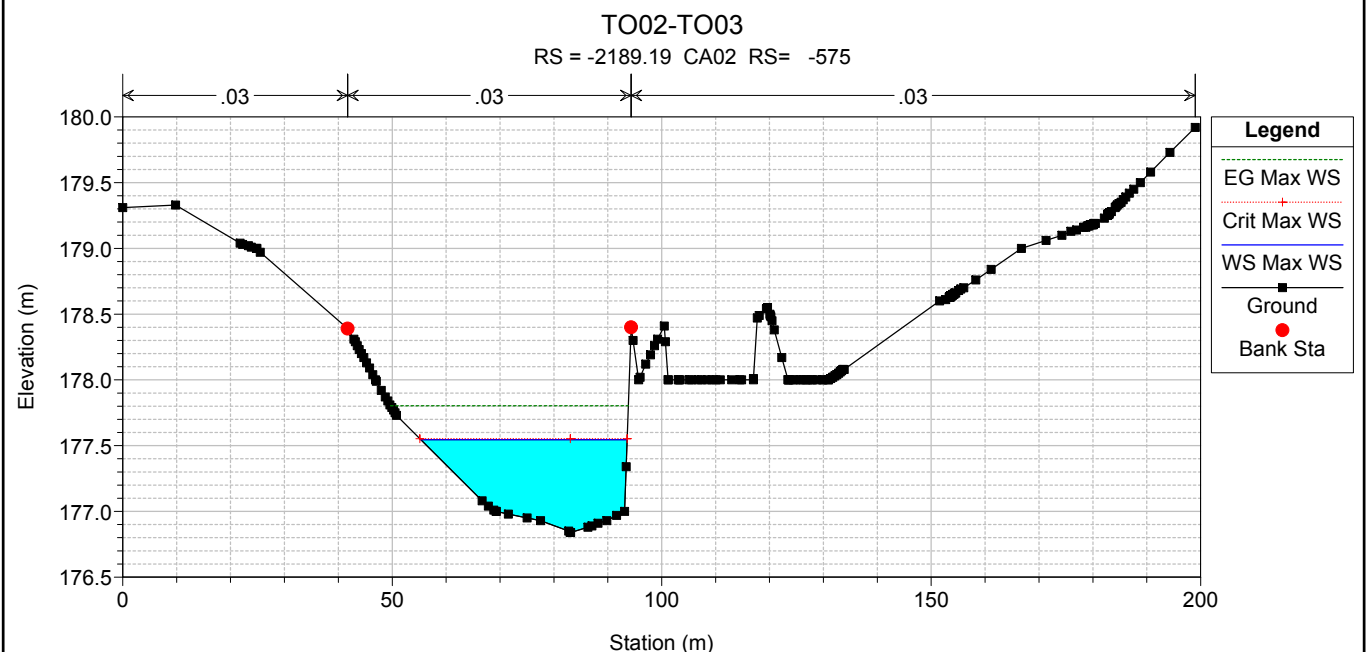
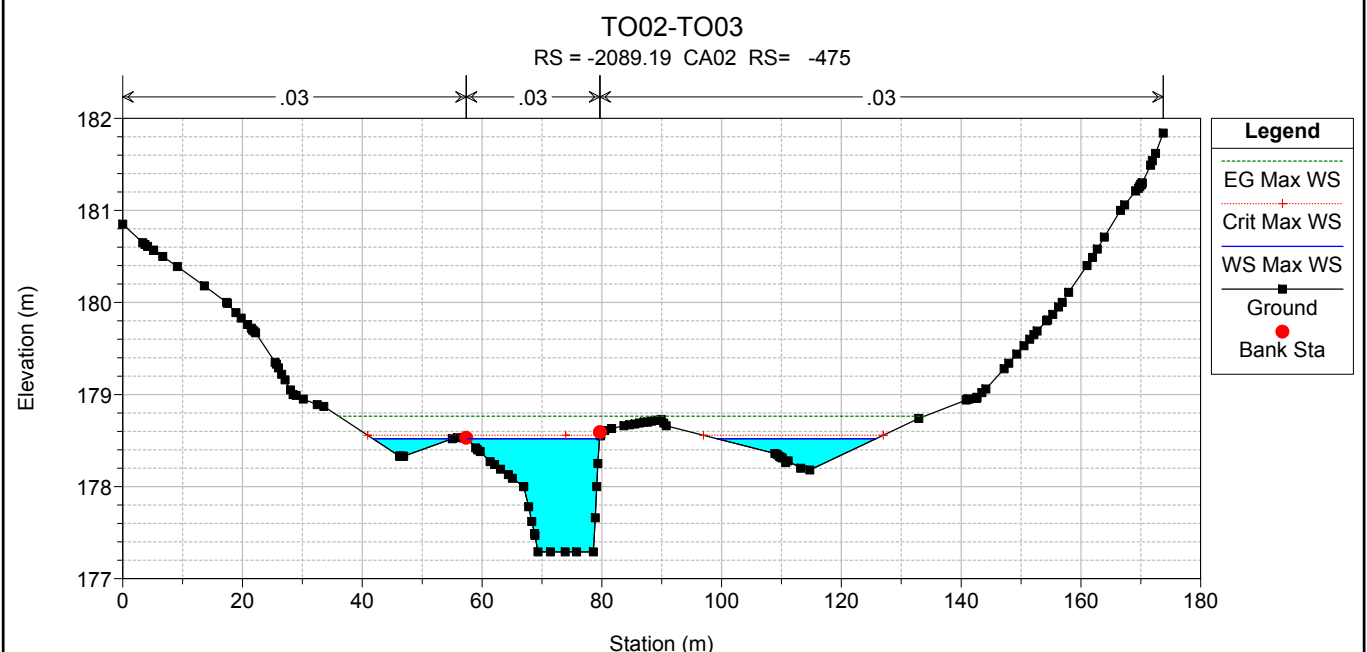
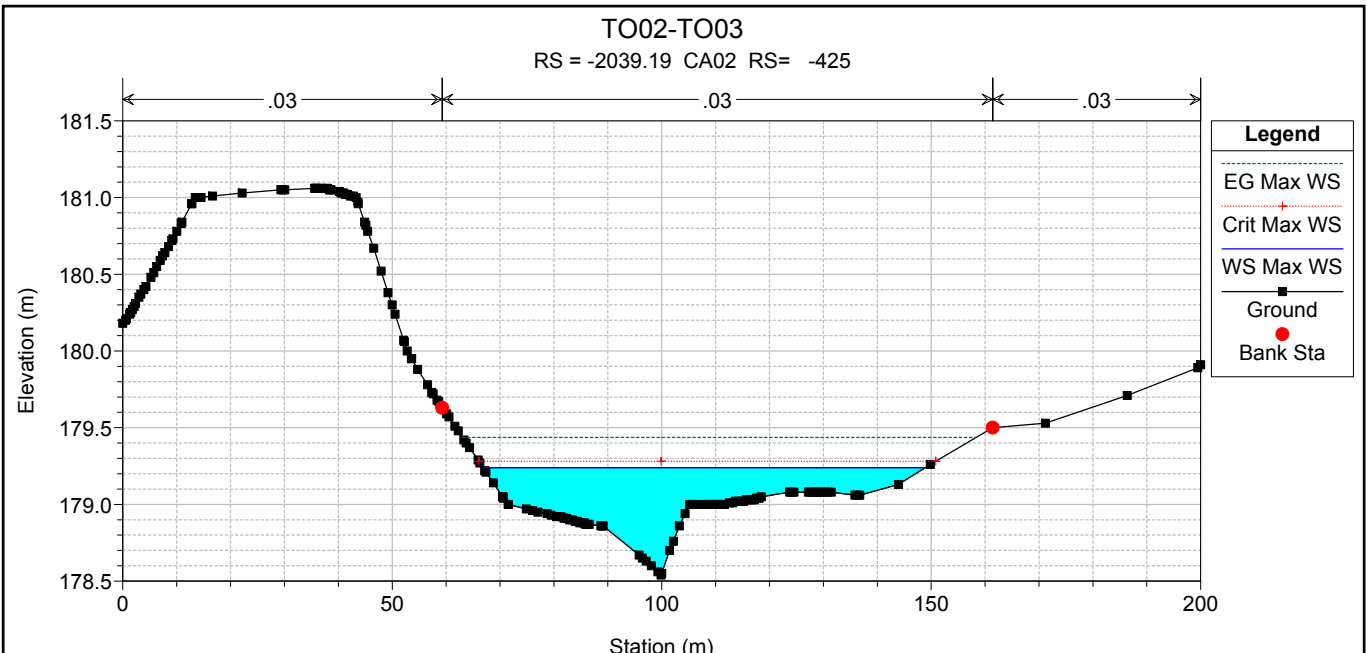

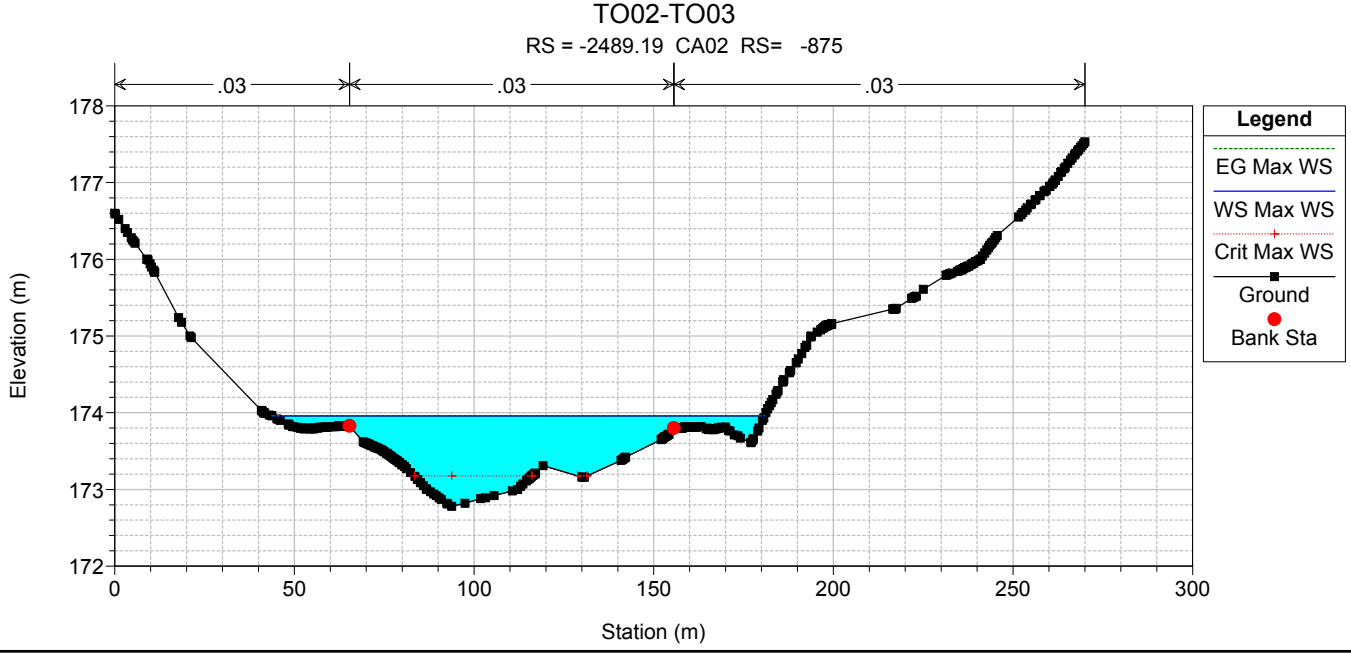
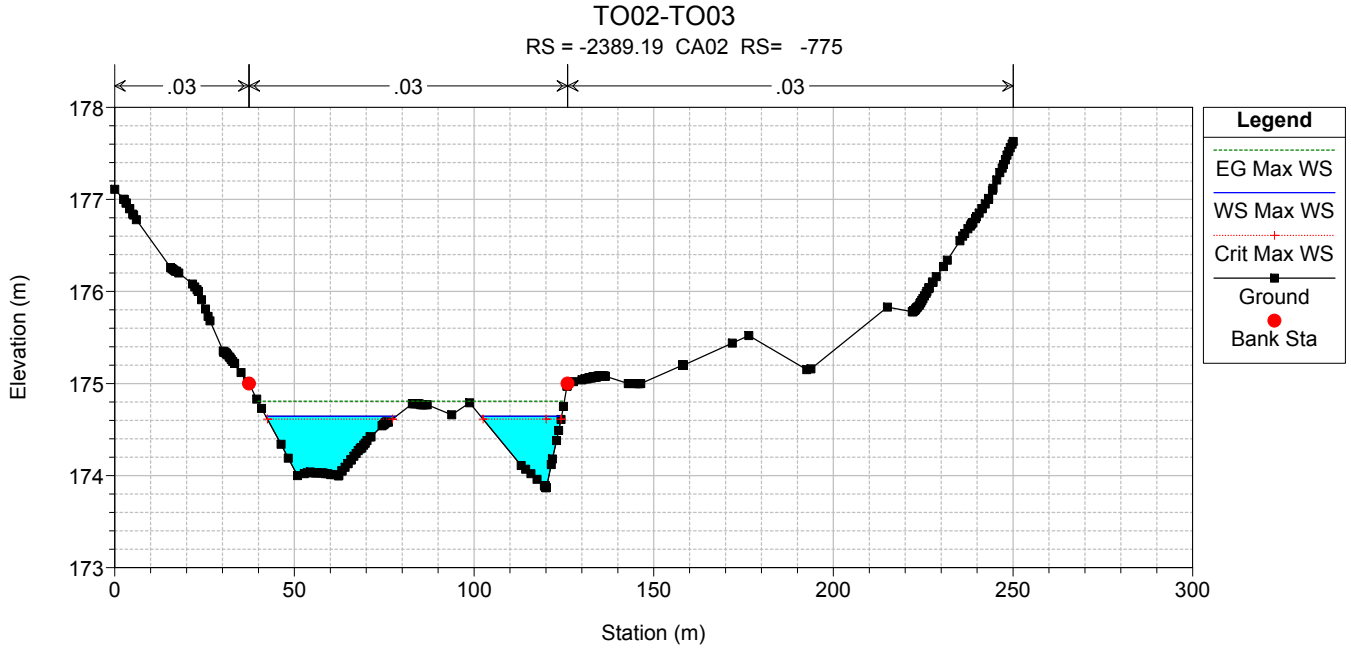
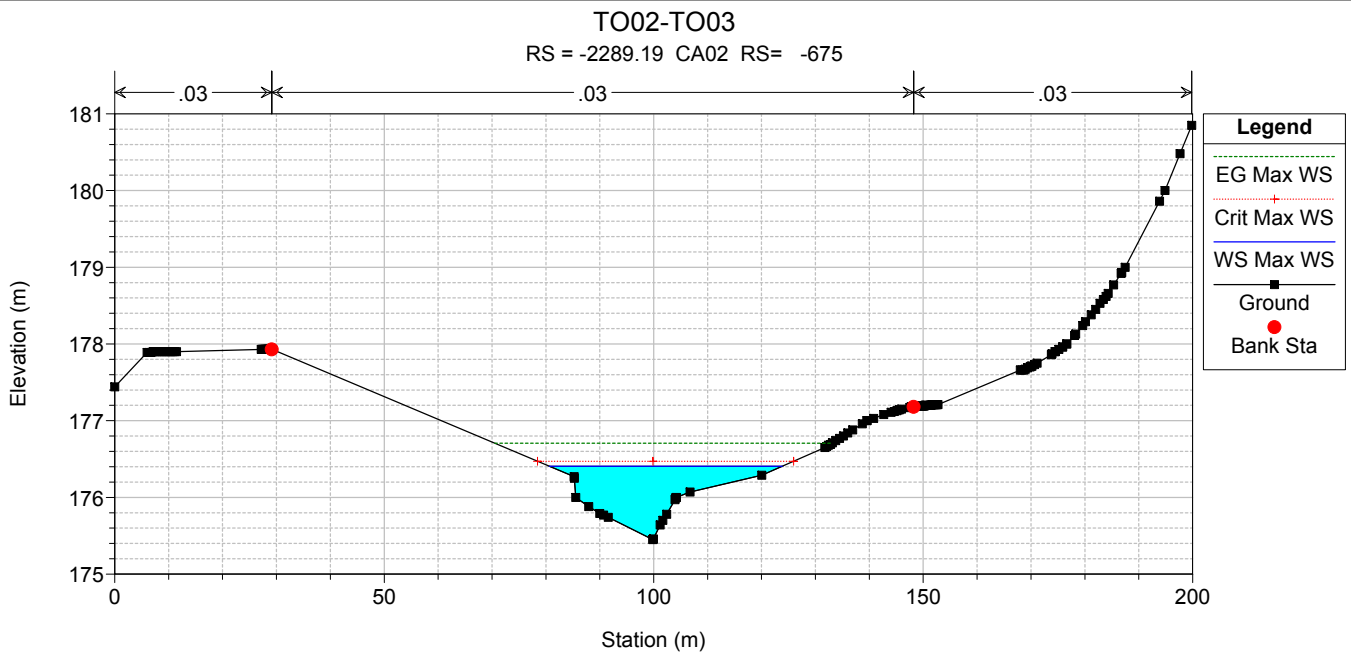

TO02-TO03

RS = -2589.19 CA02 RS= -975

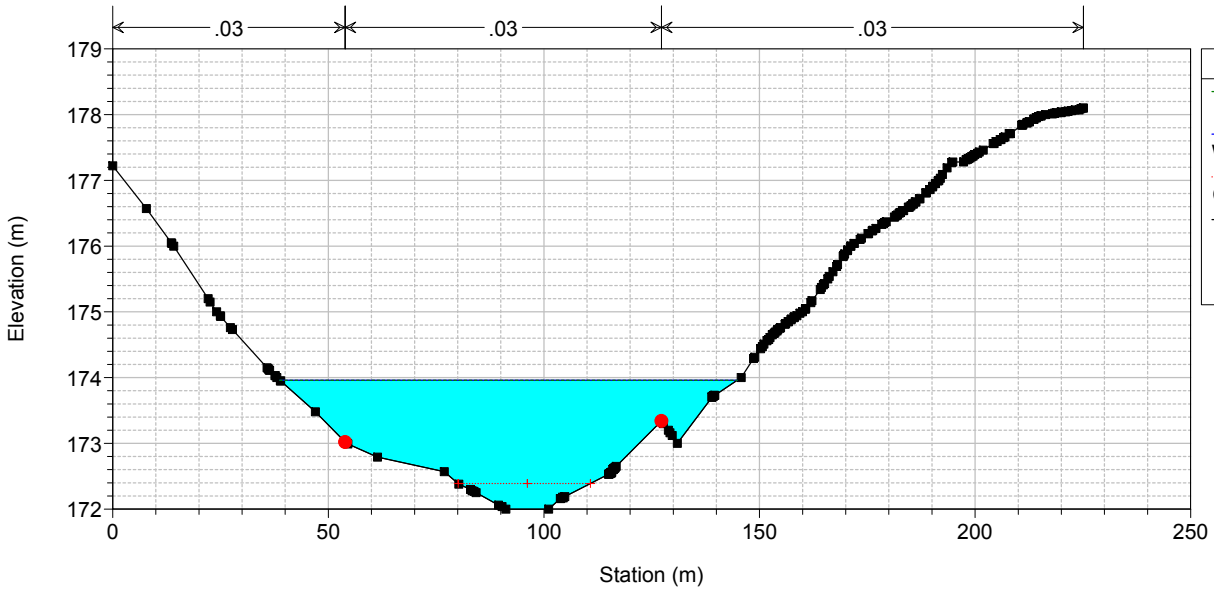

TO02-TO03

RS = -2704.19 CA02 RS= -1090

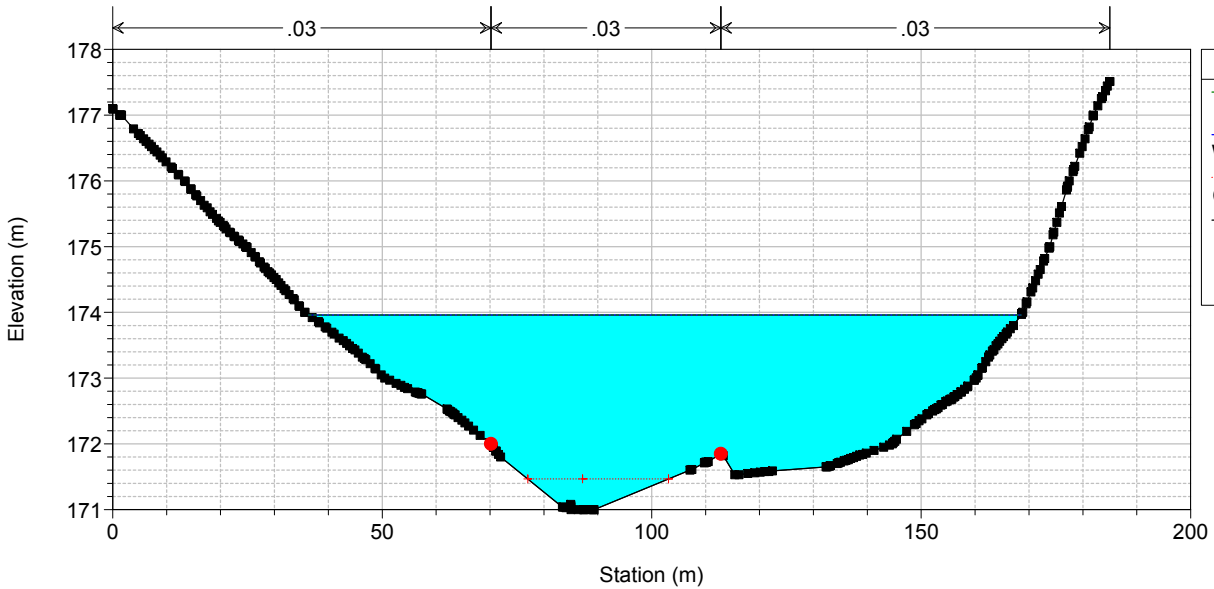

TO02-TO03

RS = -2804.19 CA02 RS= -1190

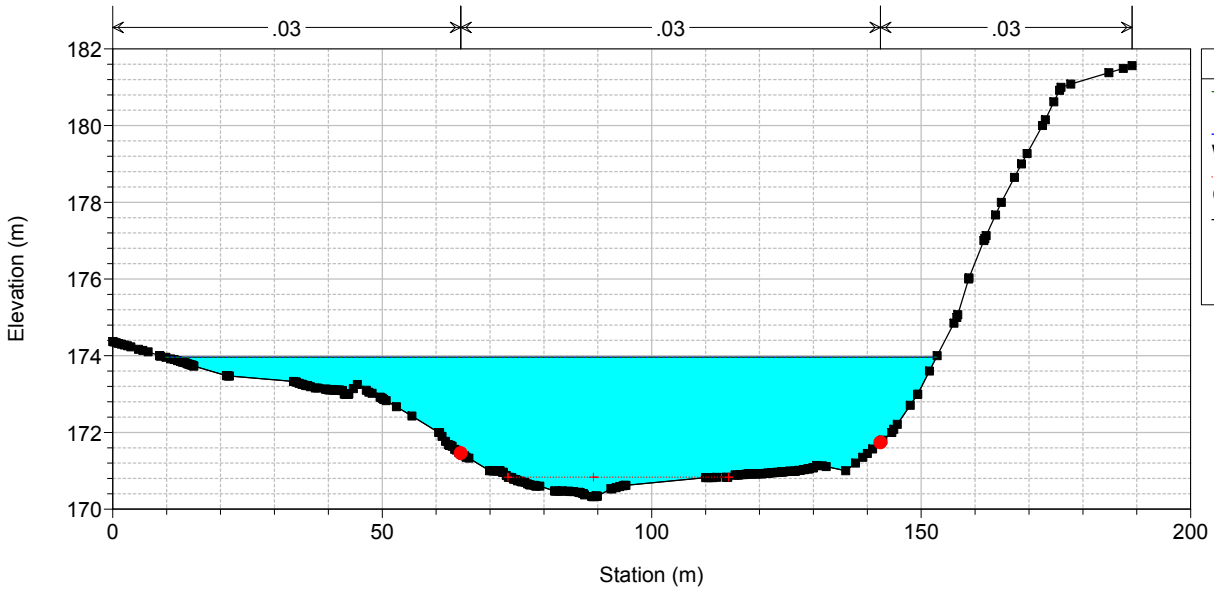

TO02-TO03

RS = -3004.19 CA02 RS= -1390

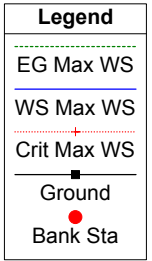
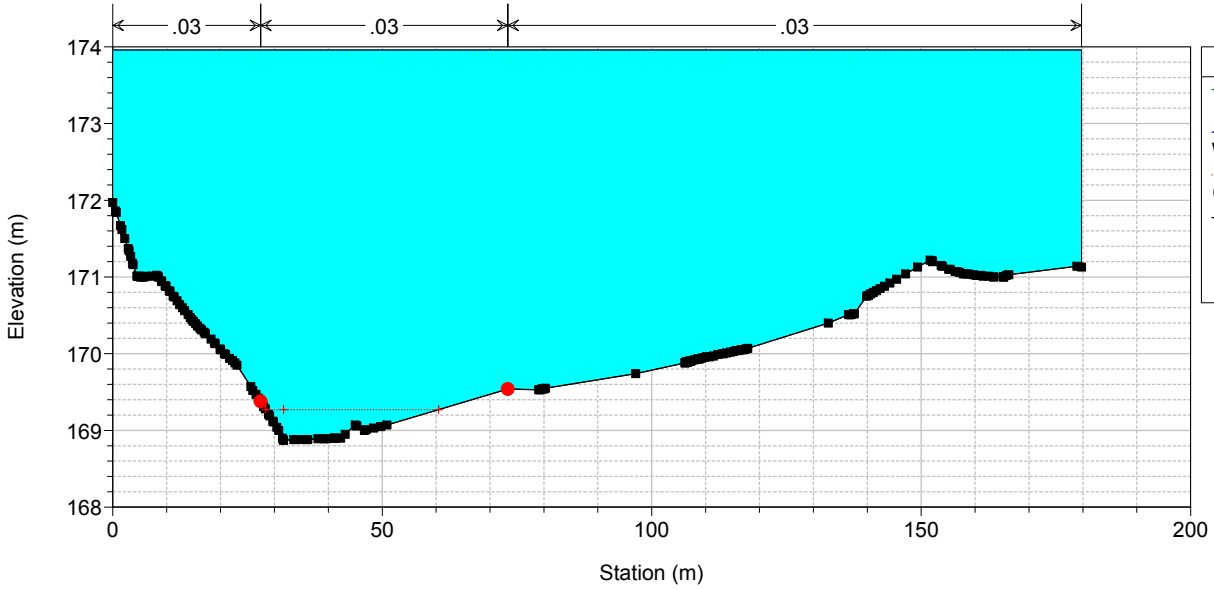

TO02-TO03

RS = -3130.19 CA02 RS= -1516

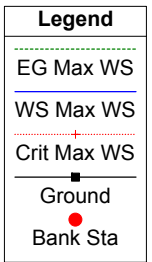
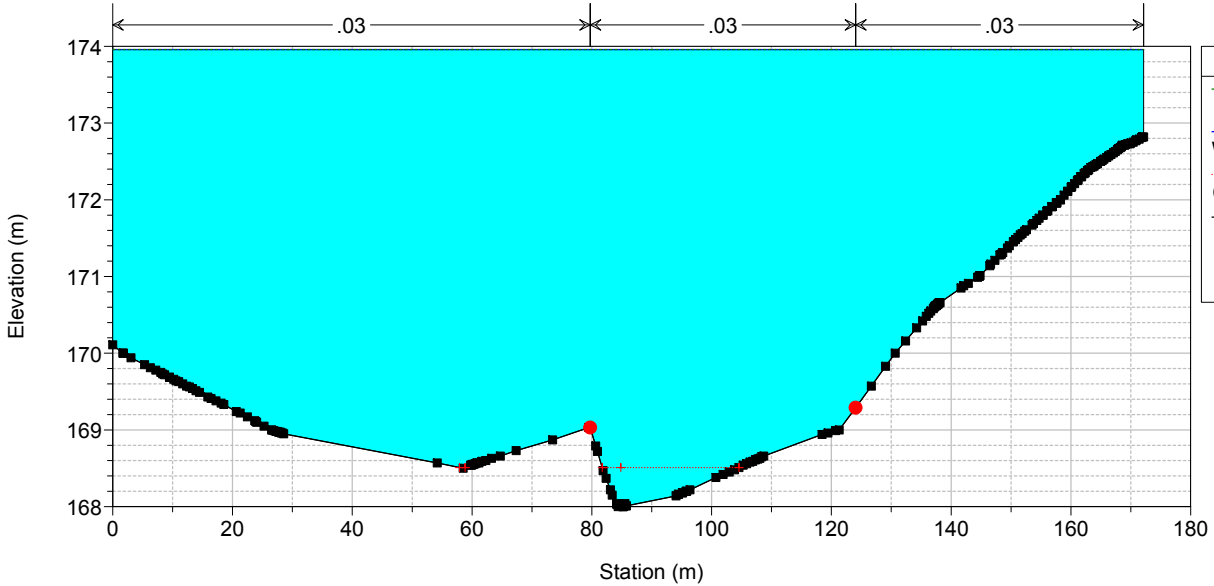

TO02-TO03

RS = -3193.40 TO07 RS= 0

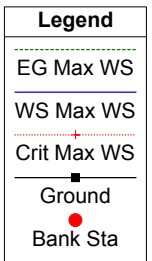
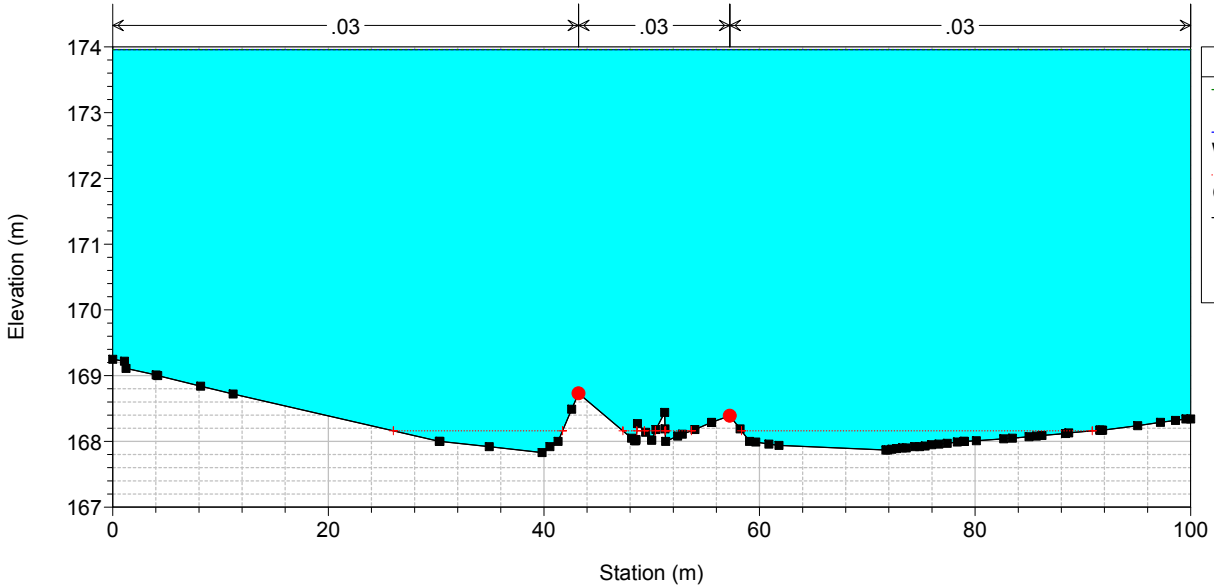

TO02-TO03

RS = -3218.40 TO07 RS= -25

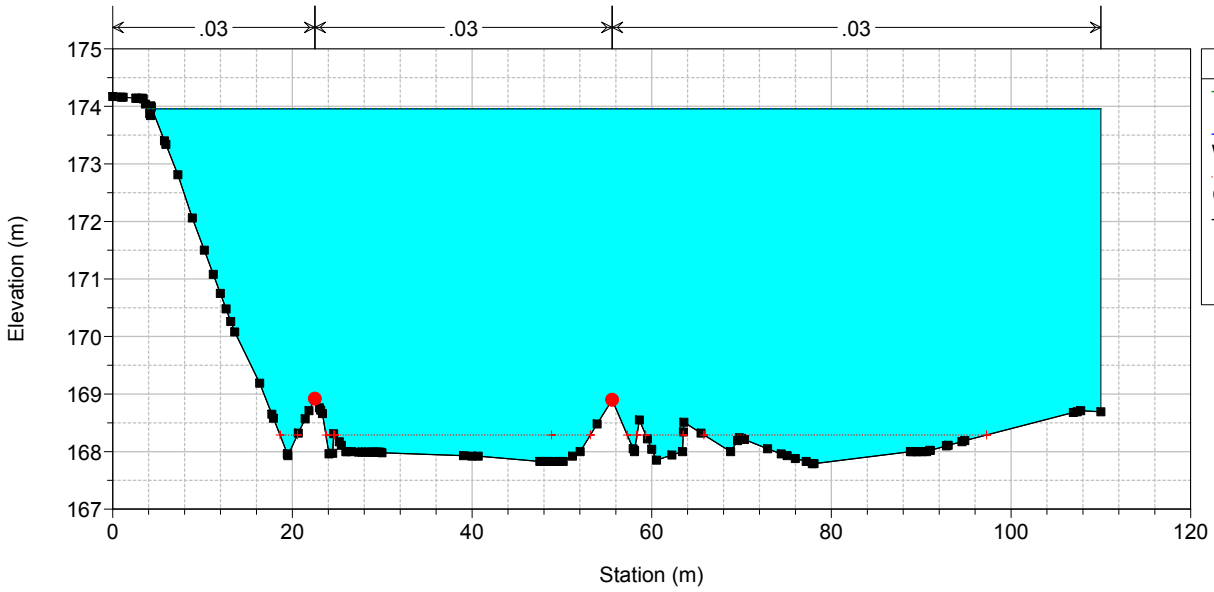

Legend

- EG Max WS
- WS Max WS
- Crit Max WS
- Ground
- Bank Sta

TO02-TO03

RS = -3231.89 TO07 RS= -38.49

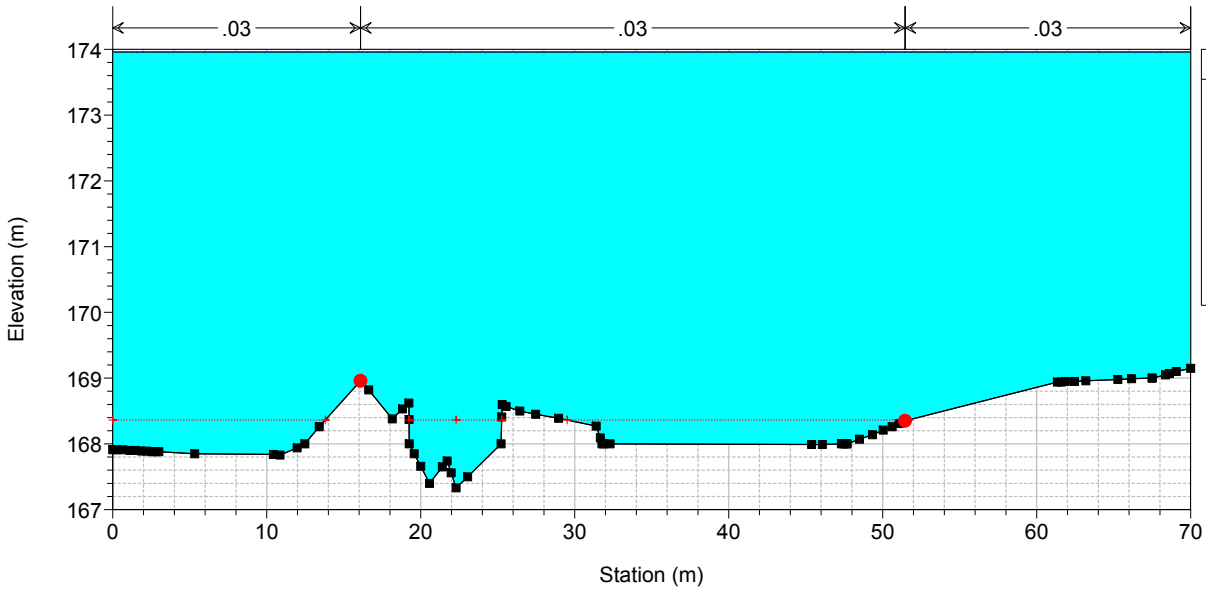

Legend

- EG Max WS
- WS Max WS
- Crit Max WS
- Ground
- Bank Sta

TO02-TO03

RS = -3248.41 TO07 RS= -61.4

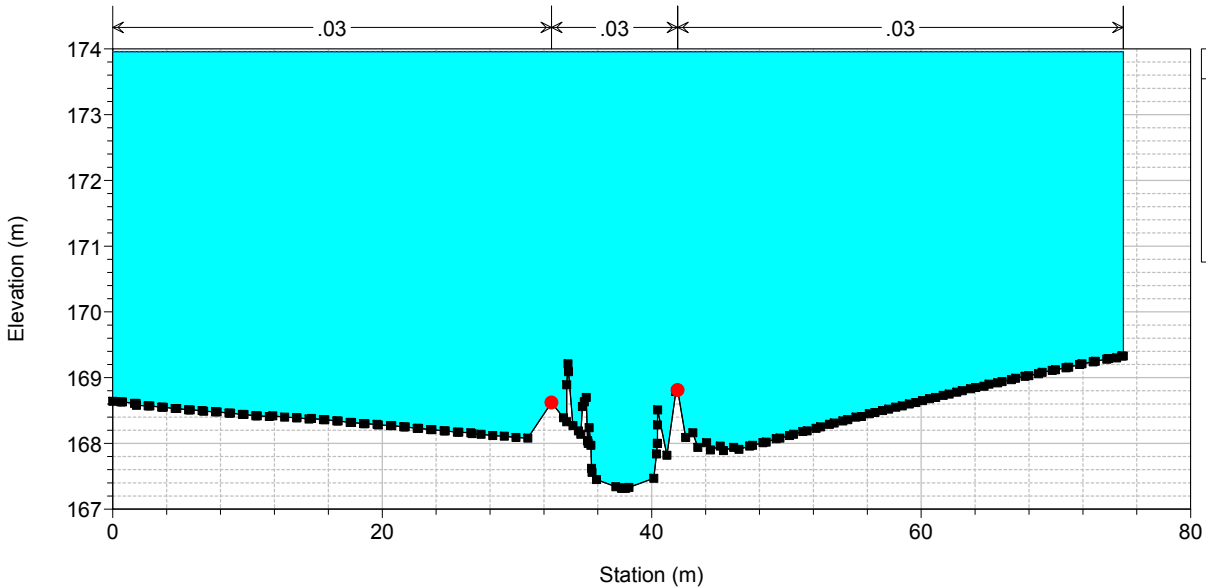

Legend

- EG Max WS
- WS Max WS
- Ground
- Bank Sta

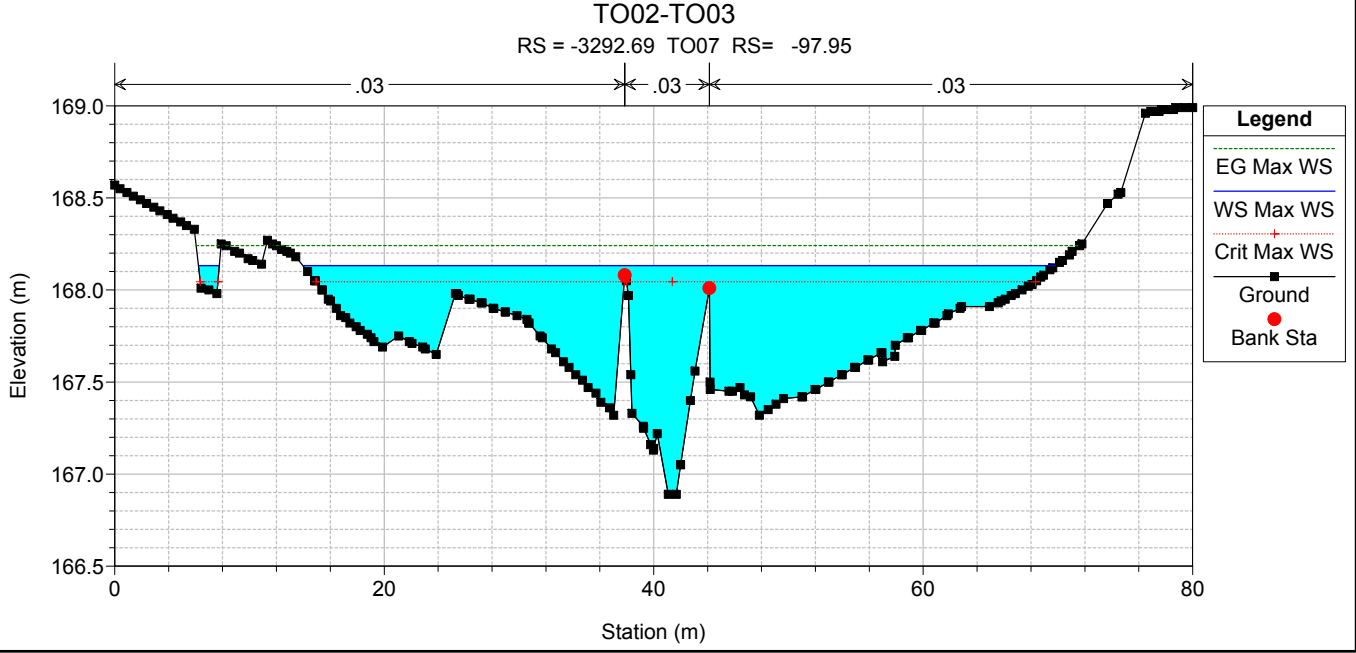
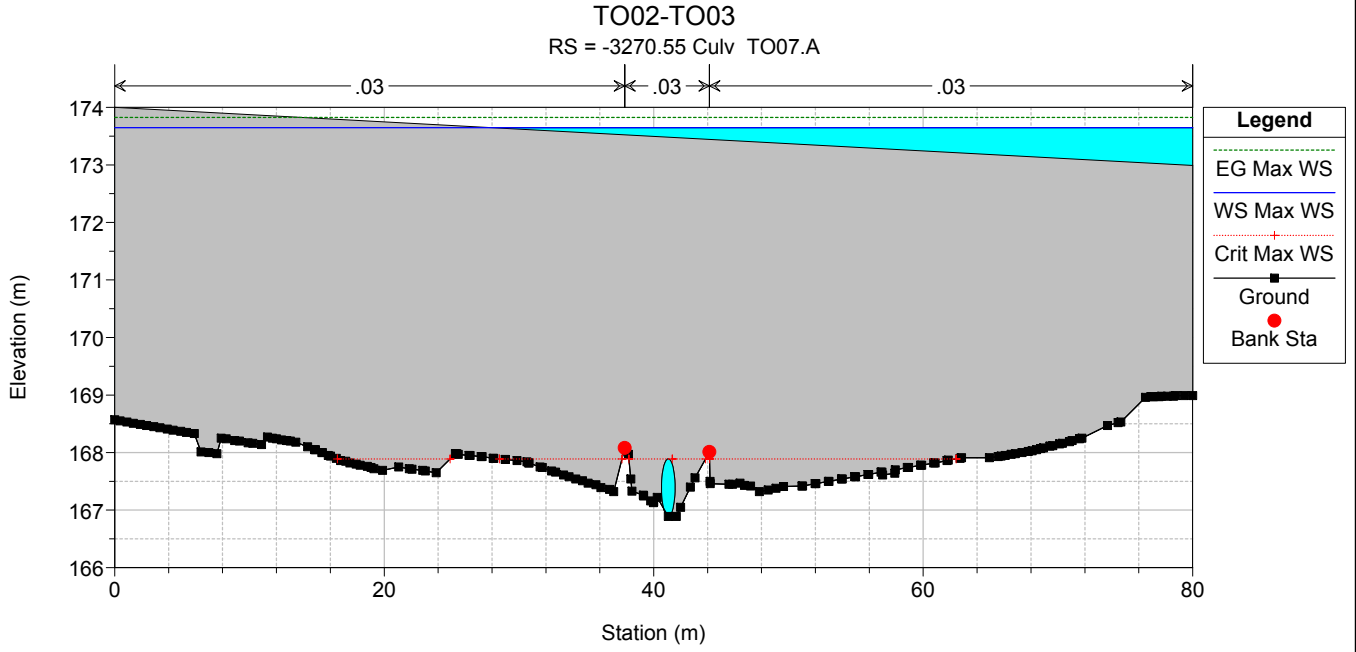
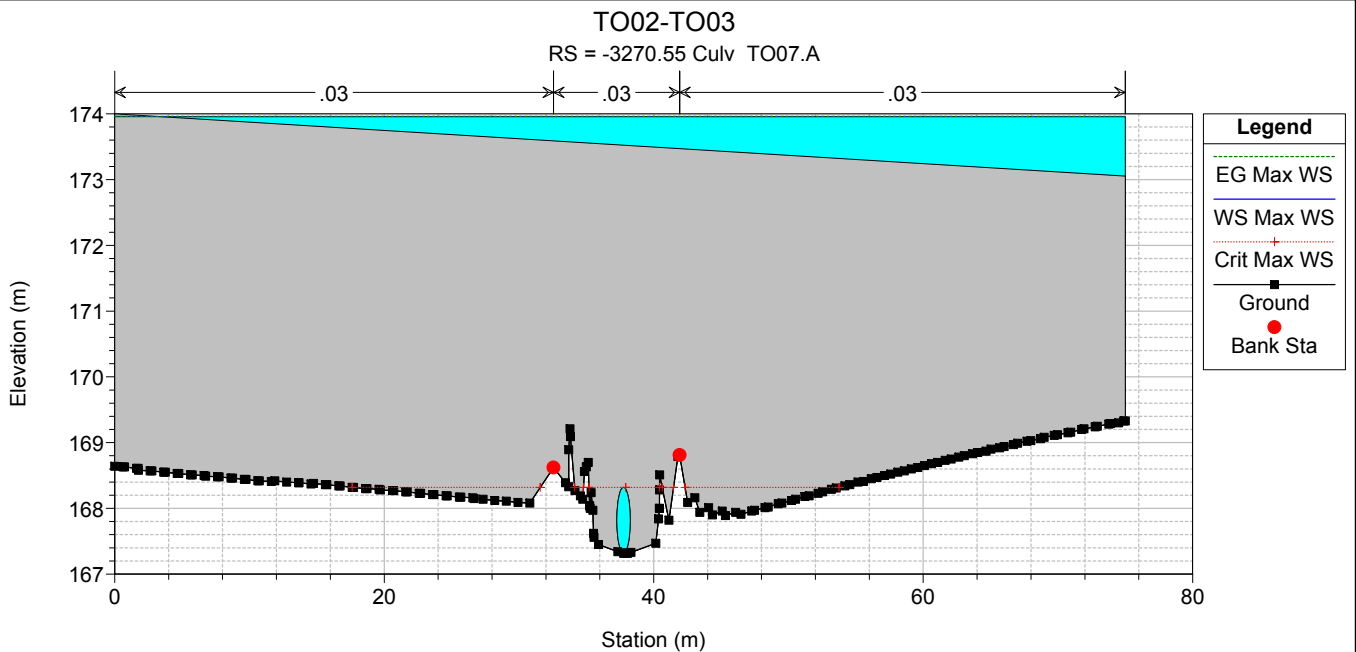

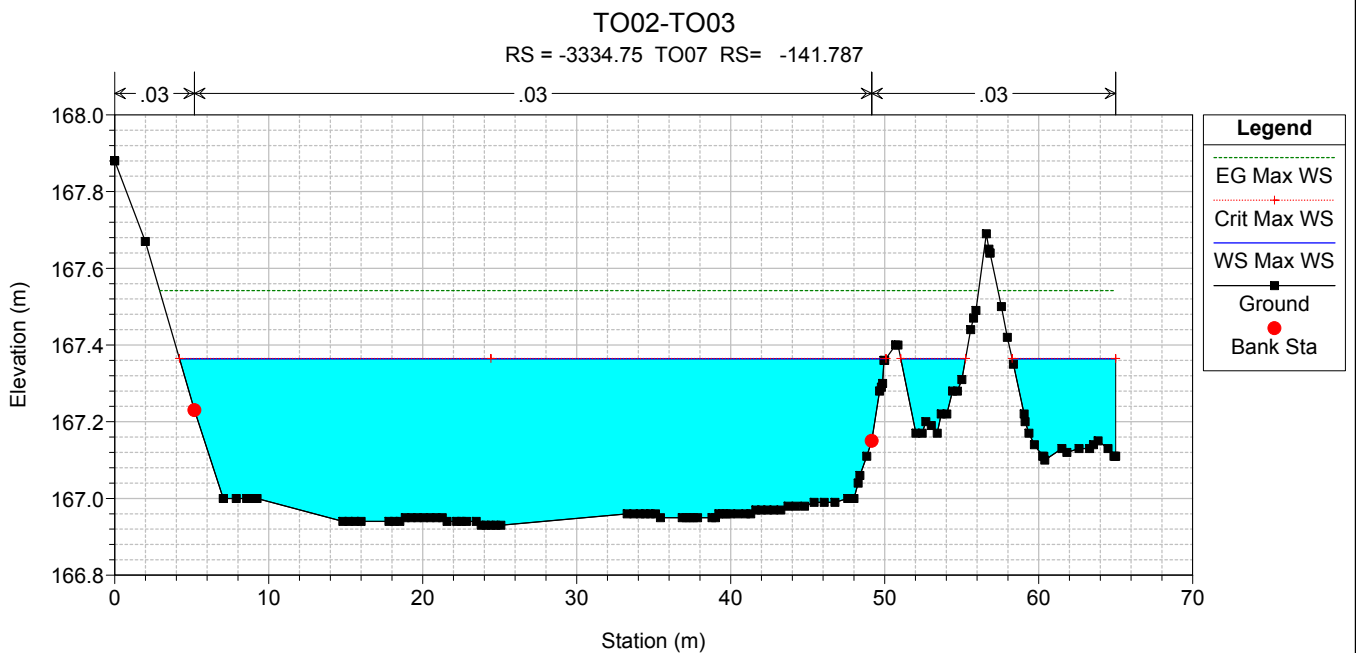
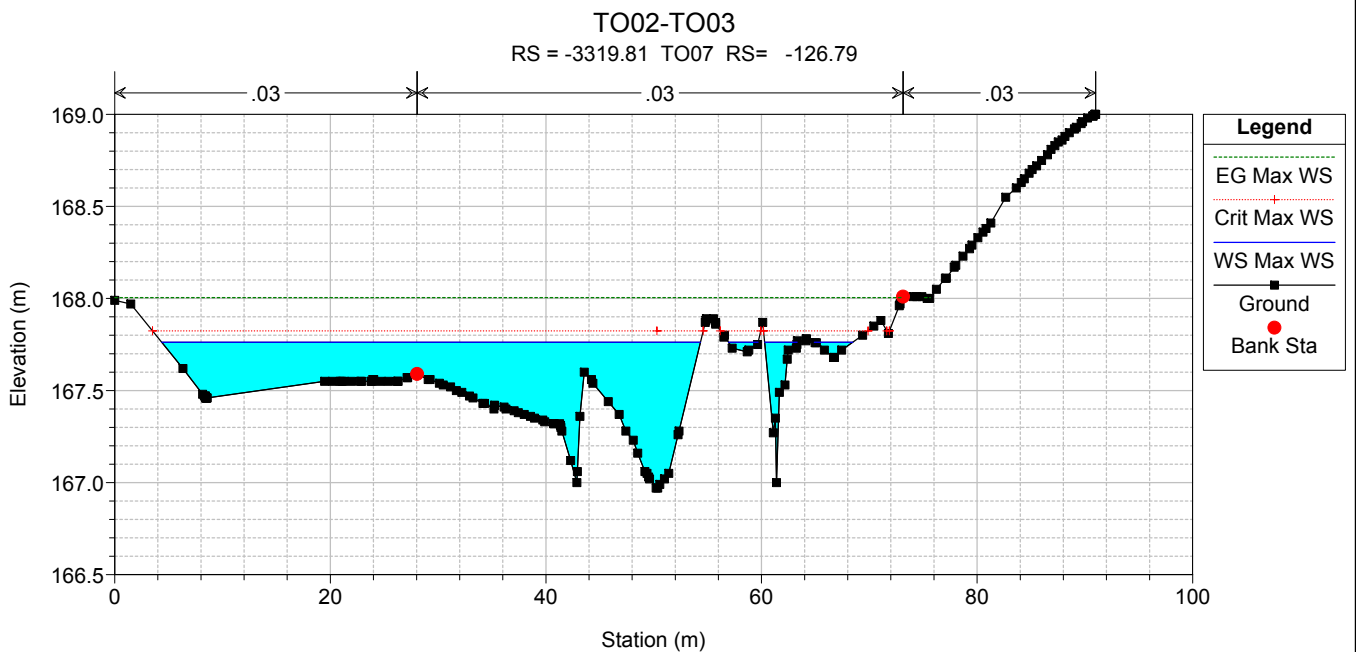
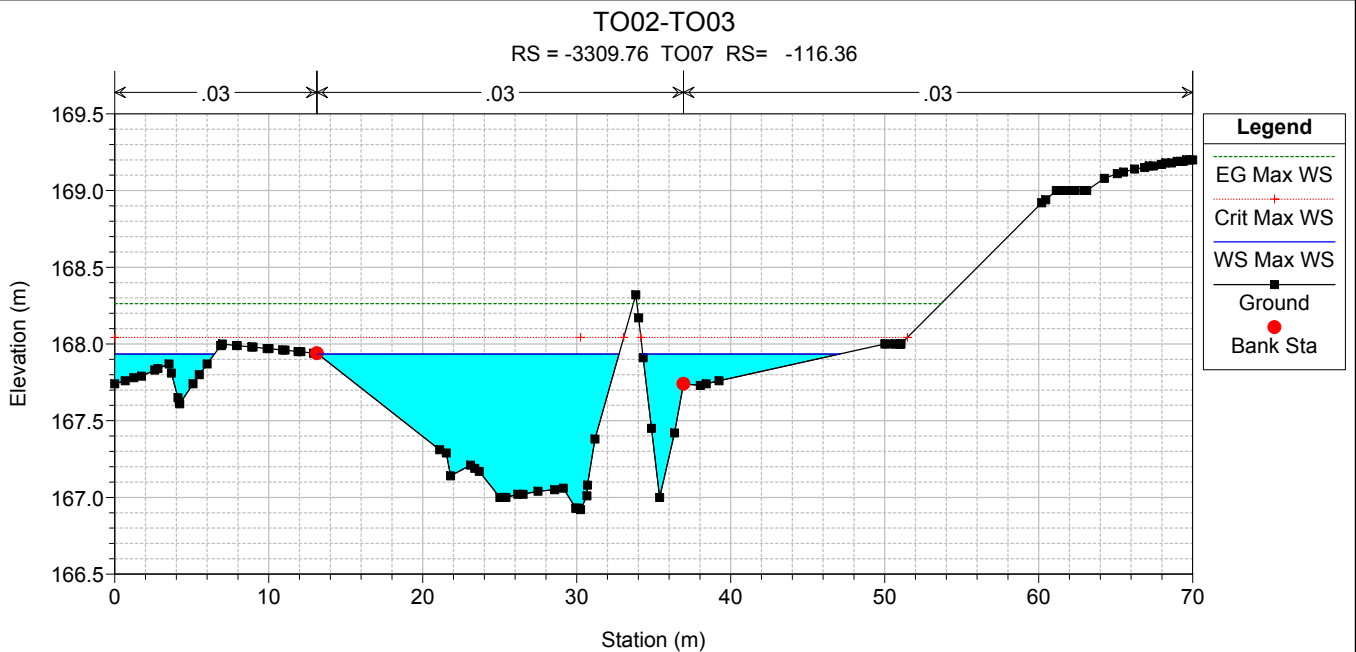

TO02-TO03

RS = -3344.22 TO07 RS= -150.818

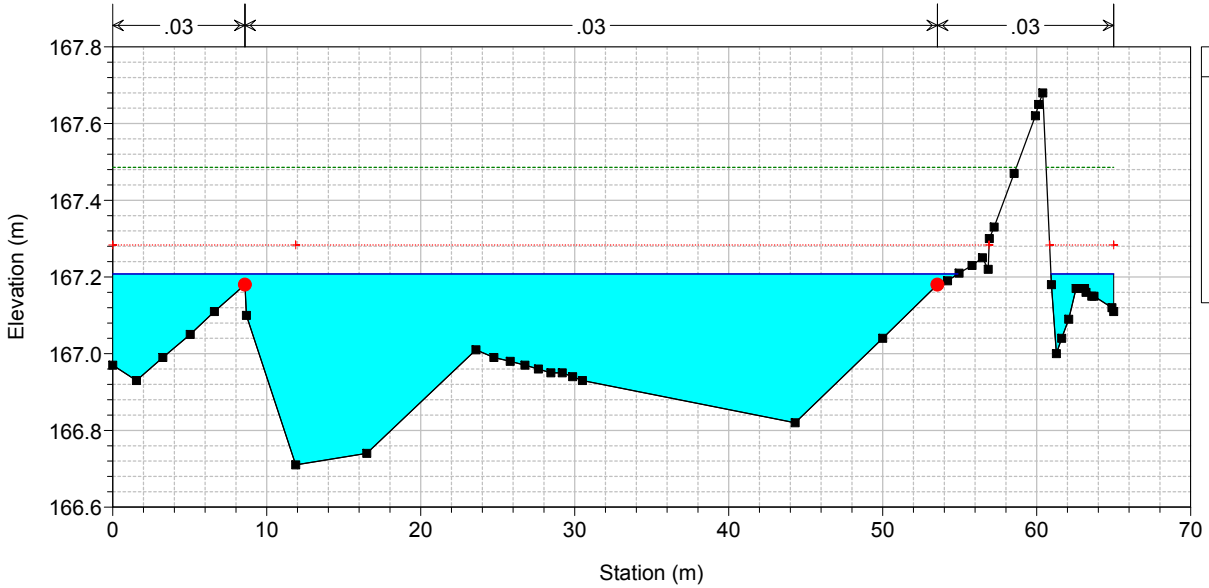

TO02-TO03

RS = -3352.49 TO07 RS= -159.09

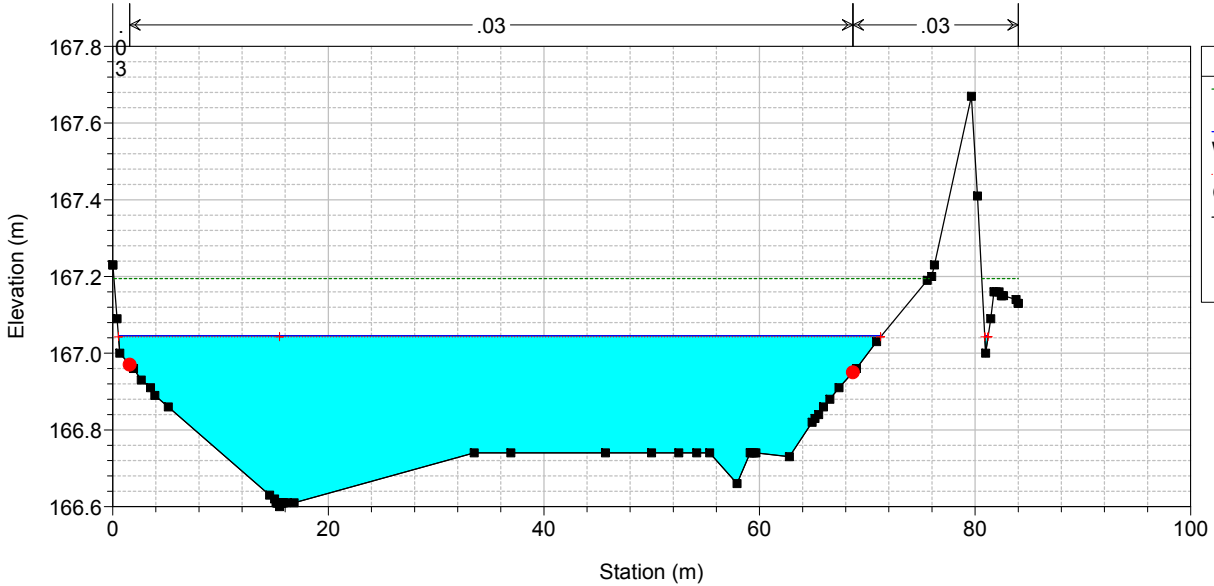

TO02-TO03

RS = -3393.40 TO07 RS= -200

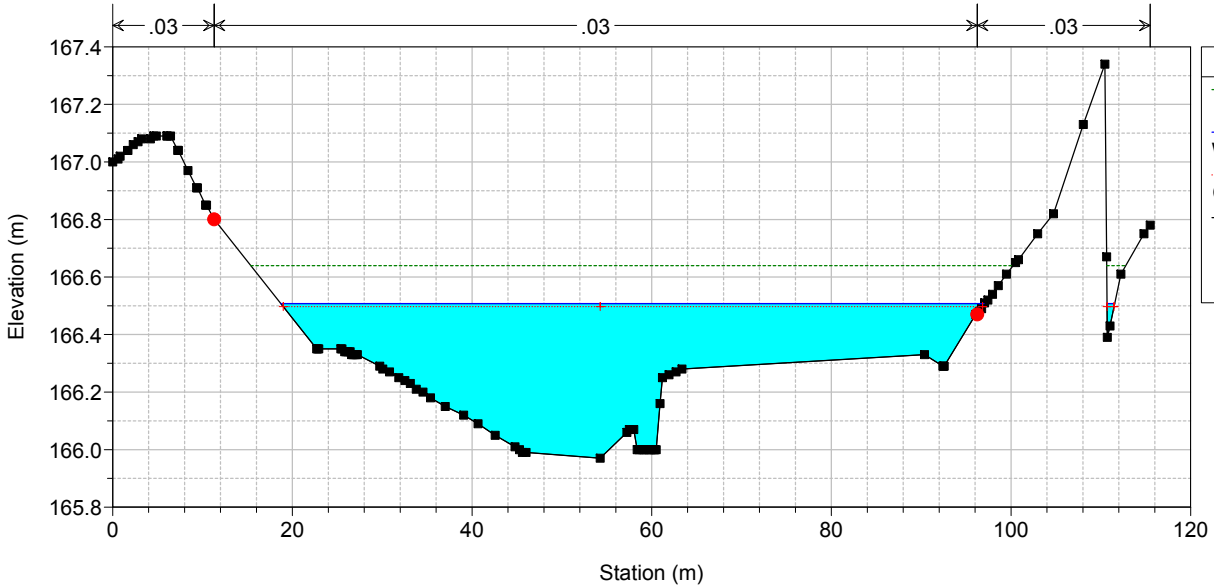

TO02-TO03

RS = -3418.40 TO07 RS= -225

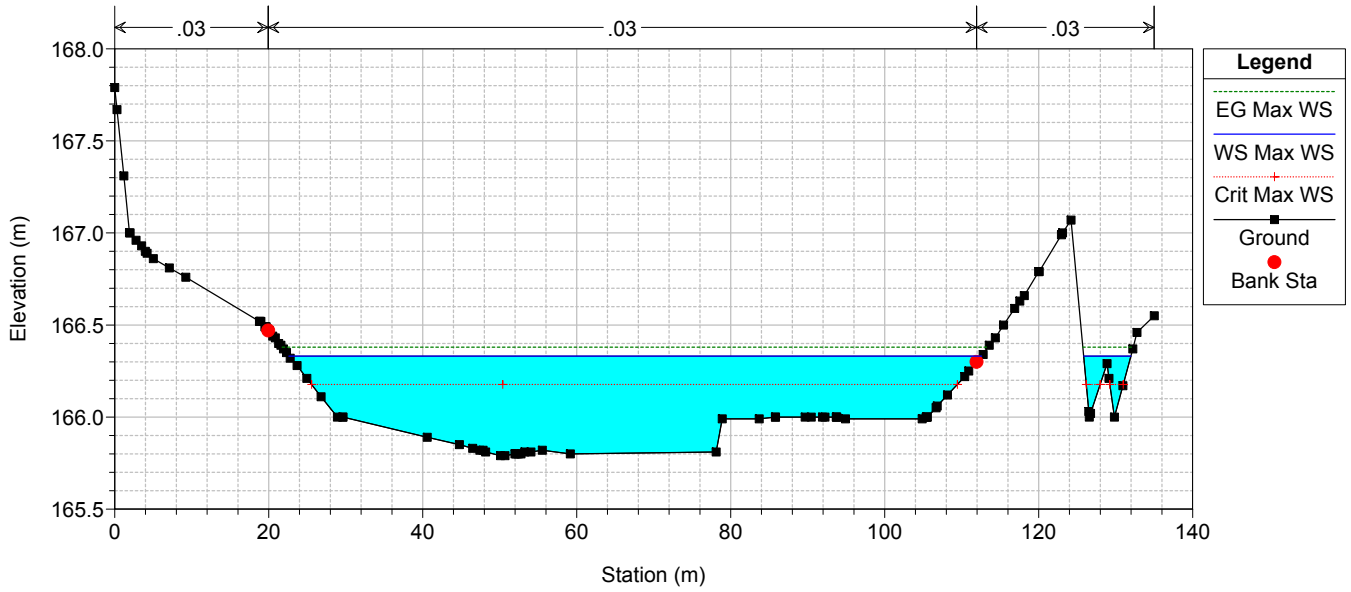

TO02-TO03

RS = -3443.40 TO07 RS= -250

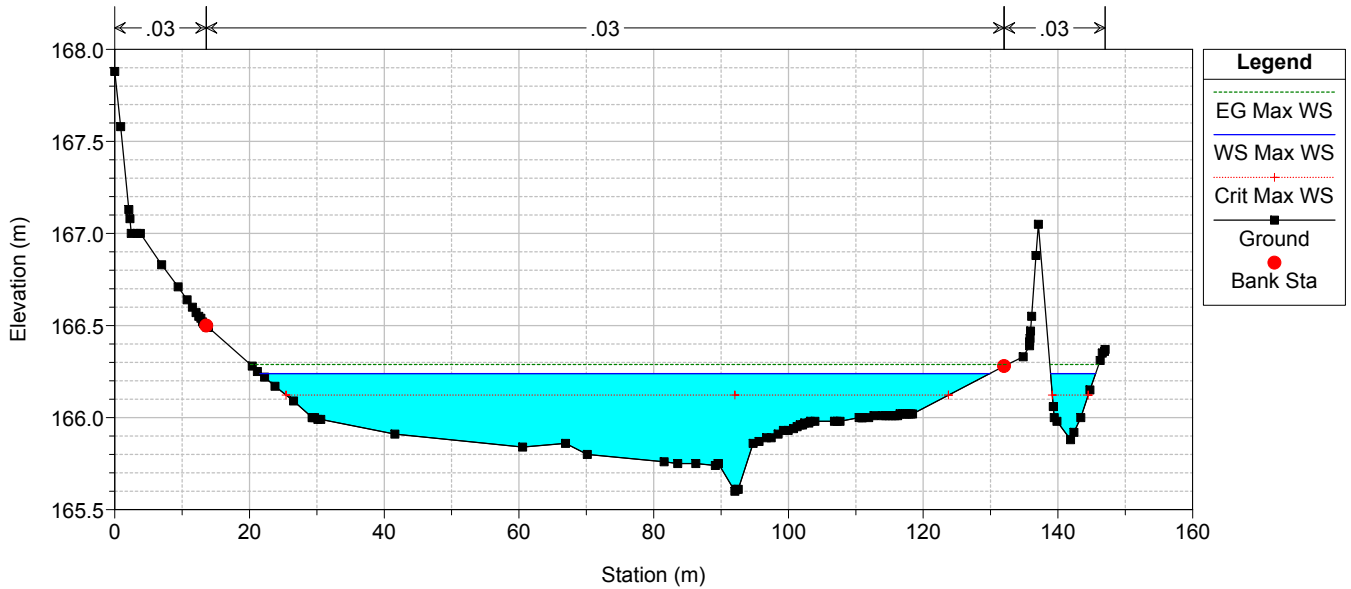

TO02-TO03

RS = -3468.40 TO07 RS= -275

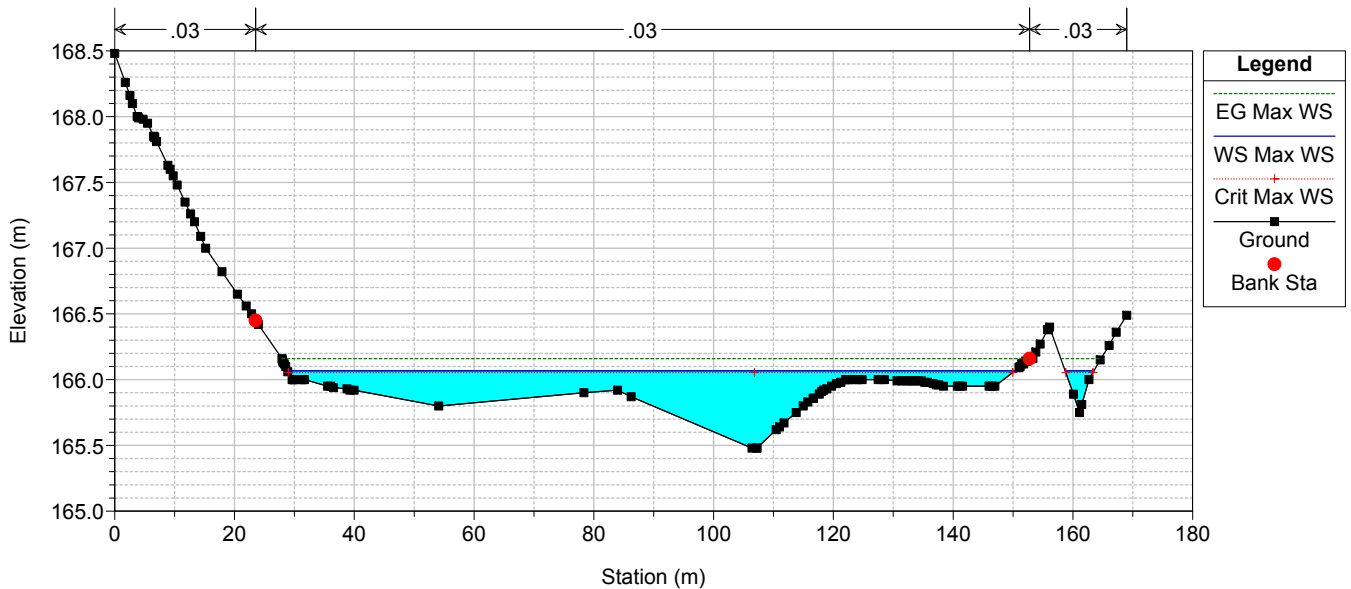

TO02-TO03

RS = -3493.40 TO07 RS= -300

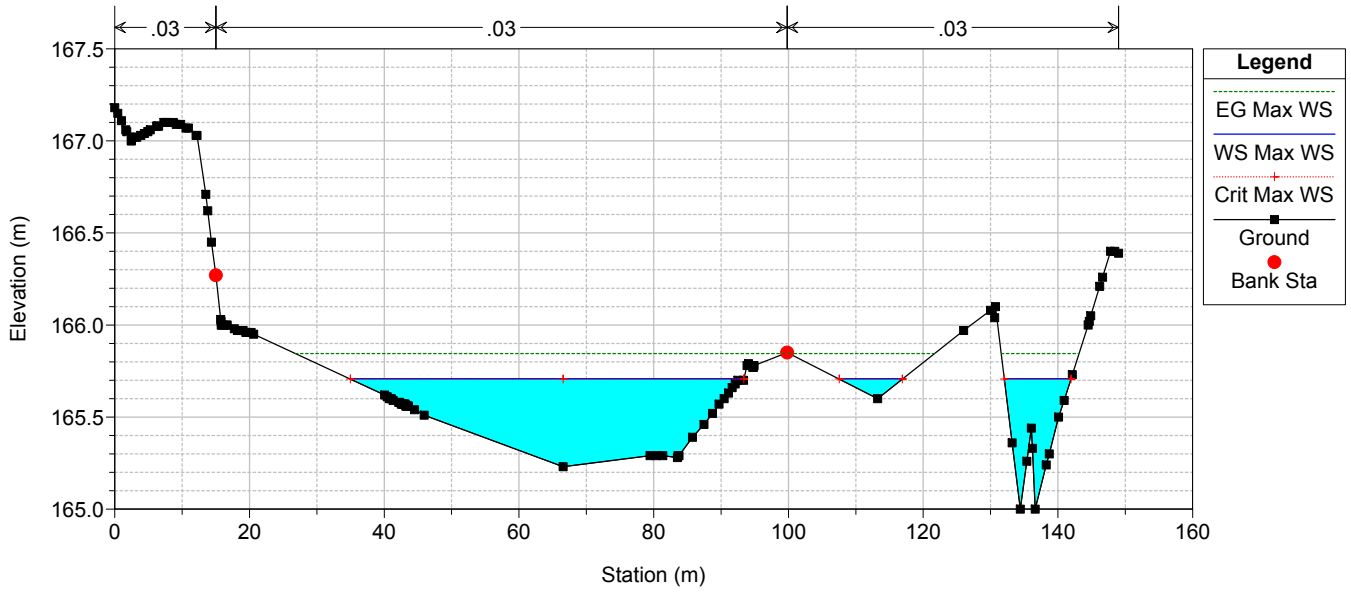

TO02-TO03

RS = -3518.40 TO07 RS= -325

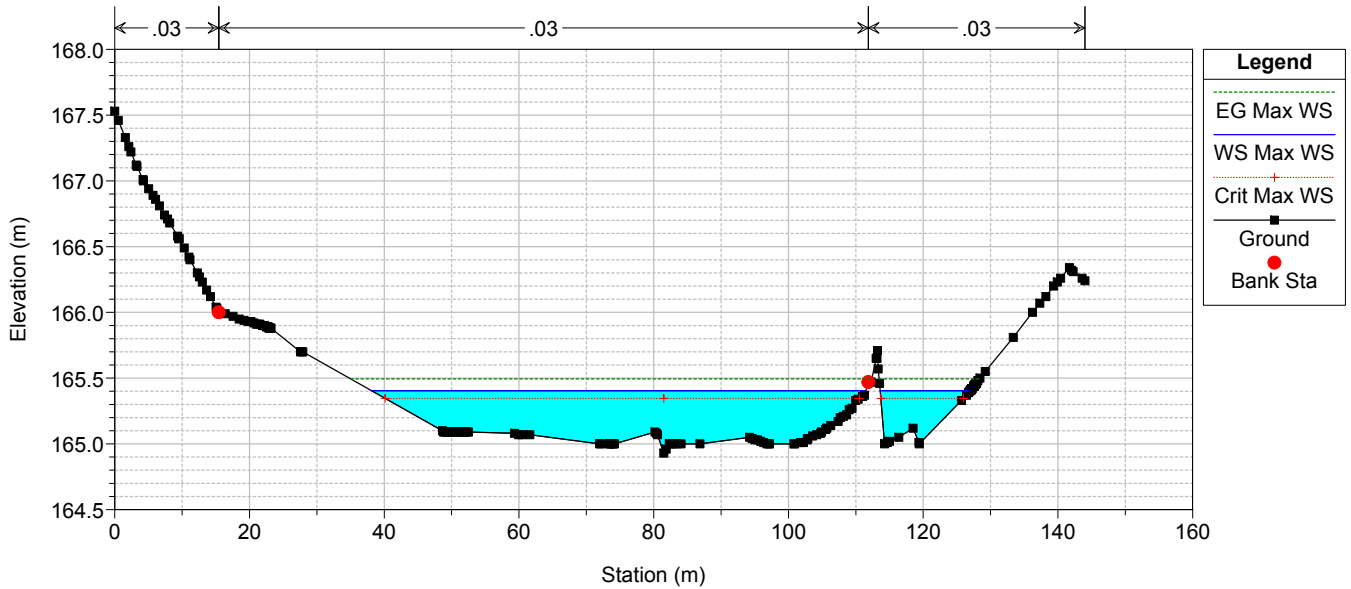

TO02-TO03

RS = -3543.40 TO07 RS= -350

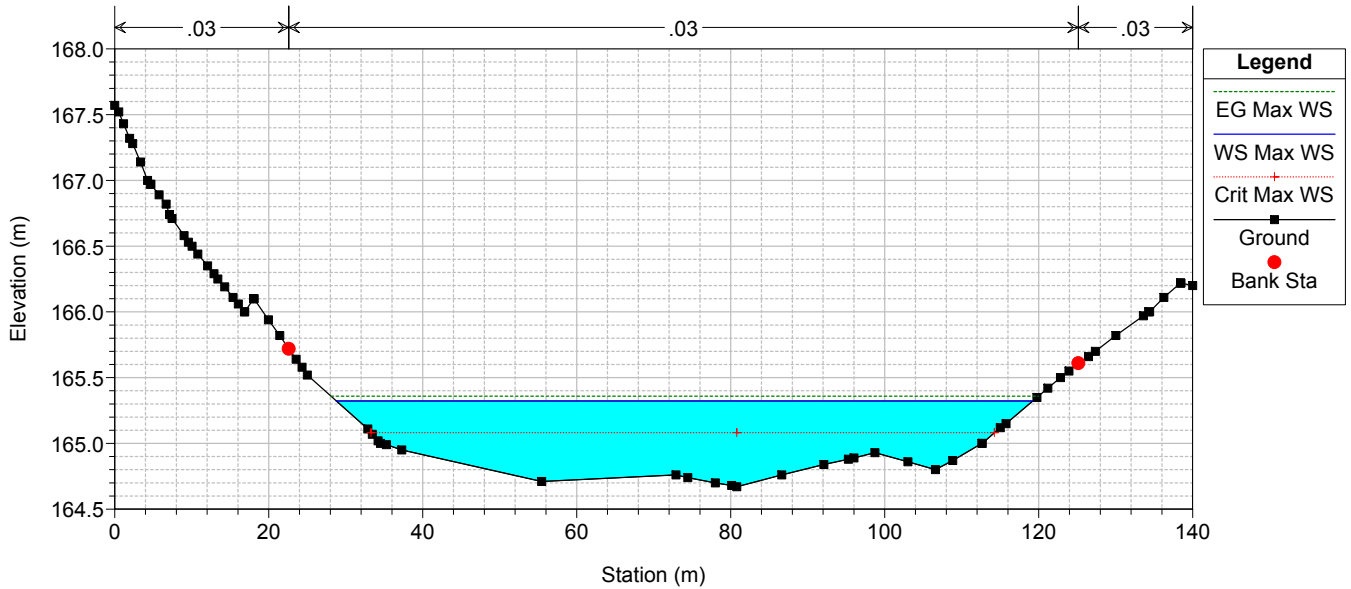

TO02-TO03

RS = -3568.40 TO07 RS= -375

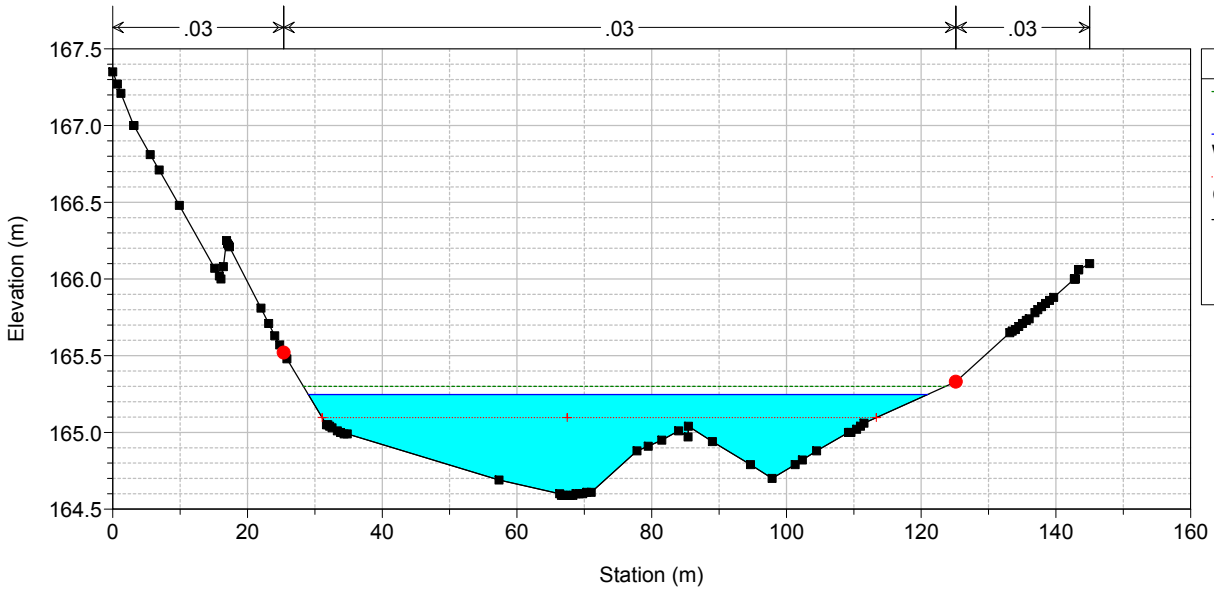

TO02-TO03

RS = -3593.40 TO07 RS= -400

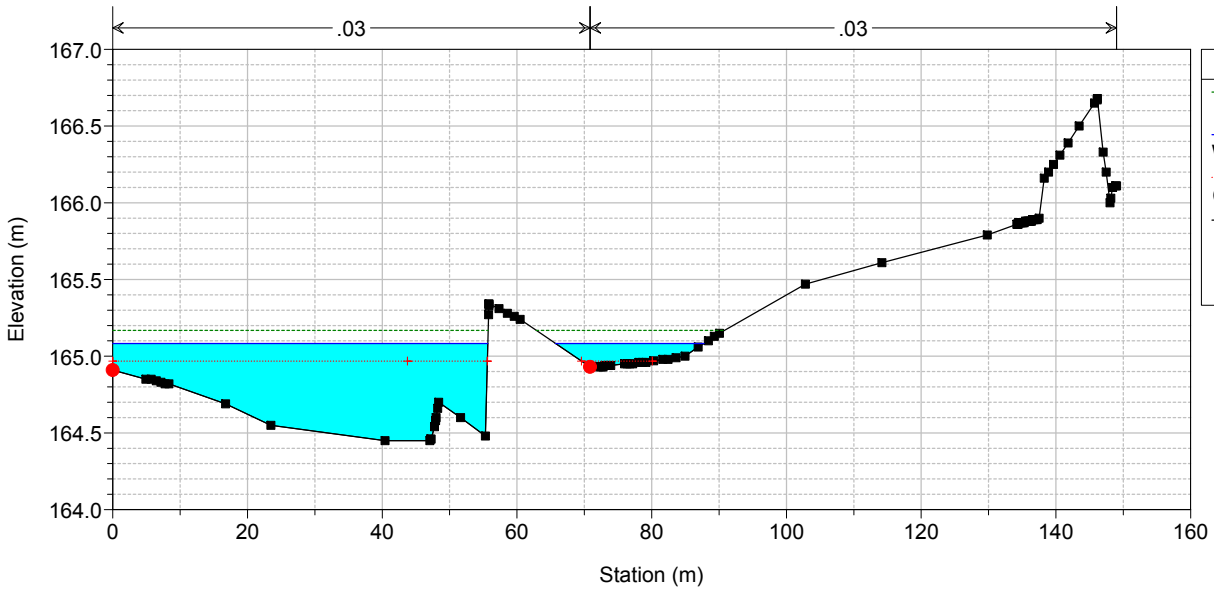

TO02-TO03

RS = -3618.40 TO07 RS= -425

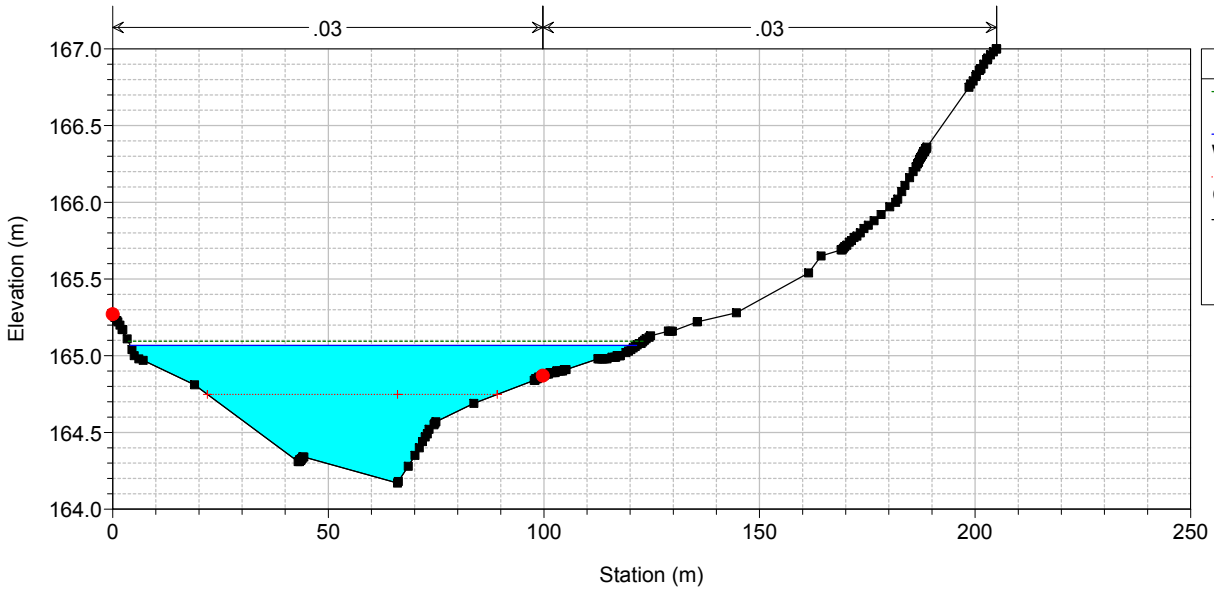

TO02-TO03

RS = -3643.40 TO07 RS= -450

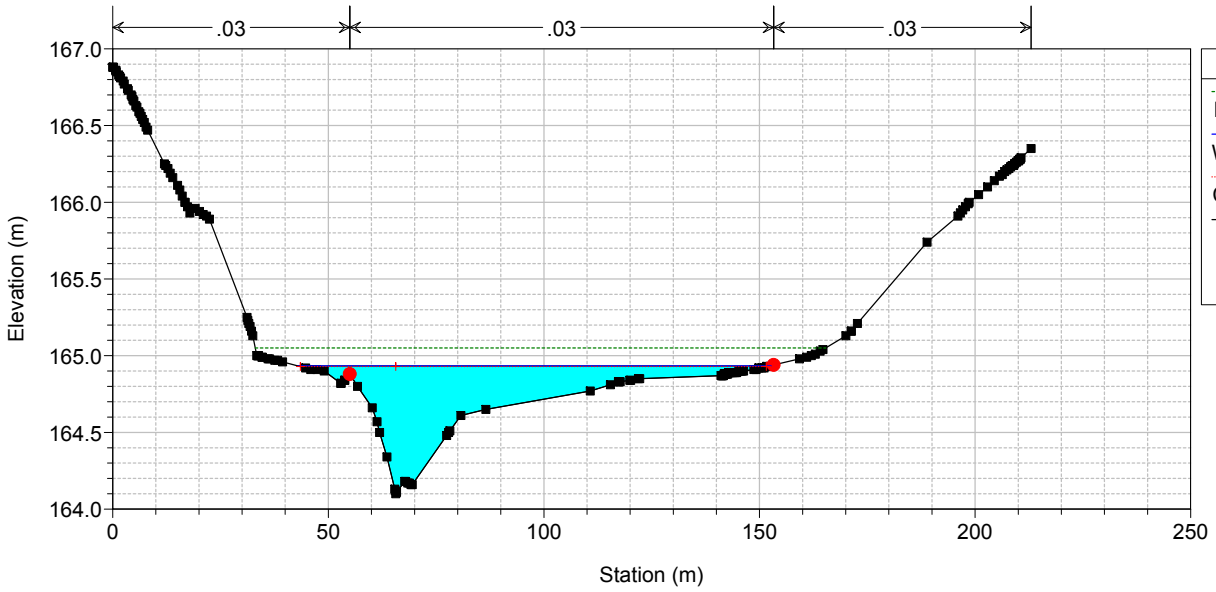

TO02-TO03

RS = -3668.40 TO07 RS= -475

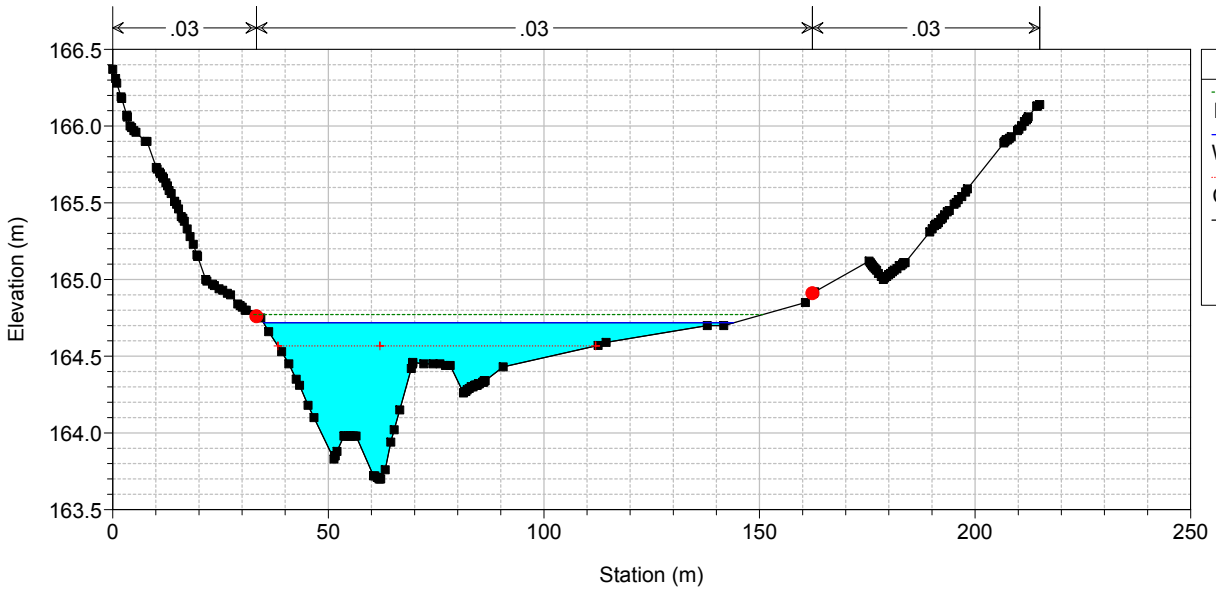

POST

HEC-RAS Plan: POST River: TO02 Reach: TO02 Profile: Max WS

Reach	River Sta	Profile	Q Total (m3/s)	Min Ch El (m)	Max Chl Dpth (m)	W.S. Elev (m)	Crit W.S. (m)	Diff	Froude # Chl	E.G. Elev (m)	Vel Chnl (m/s)	Vel Total (m/s)	Hydr Radius C (m)	Shear Chan (N/m2)	Hydr Depth (m)
TO02	0	Max WS	8.7	205.49	0.84	206.33	206.19	0.14	0.56	206.42	1.4	1.2	0.7	21.0	0.41
TO02	-25	Max WS	8.7	205.17	0.93	206.10	206.19	-0.09	0.98	206.39	2.6	1.9	0.6	71.5	0.24
TO02	-34.09	Max WS	8.7	204.76	1.33	206.09	205.70	0.39	0.59	206.31	2.1	2.1	0.7	42.3	1.28
TO02	-47.76	Bridge													
TO02	-61.42	Max WS	1.0	204.50	0.88	205.38	204.72	0.66	0.12	205.39	0.3	0.3	0.6	1.3	0.86
TO02	-68.65	Max WS	8.7	204.34	0.26	204.60	205.07	-0.47	5.01	207.69	7.8	7.8	0.2	867.9	0.25
TO02	-71.55	Max WS	8.6	203.38	0.66	204.04	204.14	-0.10	1.24	204.52	3.1	3.1	0.5	103.3	0.62

Reach	River Sta	Profile	Q Total (m3/s)	Min Ch El (m)	Max Chl Dpth (m)	W.S. Elev (m)	Crit W.S. (m)	Diff	Froude # Chl	E.G. Elev (m)	Vel Chnl (m/s)	Vel Total (m/s)	Hydr Radius C (m)	Shear Chan (N/m2)	Hydr Depth (m)
TO03	0	Max WS	2.9	215.16	0.31	215.47	215.72	-0.25	2.88	216.37	4.2	4.2	0.2	264.2	0.22
TO03	-16.6	Max WS	2.9	213.08	0.95	214.03	213.59	0.44	0.28	214.06	0.8	0.7	0.7	6.0	0.58
TO03	-23.77	Max WS	2.9	213.00	0.93	213.93	213.59	0.34	0.50	214.04	1.5	1.5	0.5	24.1	0.89
TO03	-41.27	Bridge													
TO03	-58.77	Max WS	2.9	212.65	0.51	213.16	213.24	-0.08	1.25	213.55	2.8	2.8	0.3	95.9	0.50
TO03	-63.1	Max WS	2.9	212.58	0.30	212.88	213.18	-0.30	2.53	213.74	4.1	4.1	0.2	237.8	0.27
TO03	-83.69	Max WS	2.9	210.51	0.78	211.29	211.10	0.19	0.66	211.45	1.8	1.8	0.5	36.5	0.75
TO03	-87.37	Bridge													
TO03	-91.05	Max WS	2.9	210.43	0.42	210.85	211.02	-0.17	1.66	211.42	3.3	3.3	0.3	147.1	0.41
TO03	-100	Max WS	2.9	210.26	0.31	210.57	210.62	-0.05	1.26	210.80	2.1	2.1	0.3	61.6	0.29
TO03	-125	Max WS	2.9	209.81	0.39	210.20	210.17	0.03	0.88	210.34	1.7	1.7	0.3	34.9	0.36
TO03	-150	Max WS	2.9	209.36	0.52	208.88	209.93	-0.05	1.15	210.20	2.5	2.5	0.4	76.1	0.48
TO03	-175	Max WS	2.9	208.90	0.39	209.29	209.44	-0.15	1.66	209.76	3.0	3.0	0.3	119.1	0.34
TO03	-200	Max WS	2.9	208.40	0.21	208.61	208.64	-0.03	1.18	208.76	1.7	1.7	0.2	42.6	0.21
TO03	-225	Max WS	2.9	207.89	0.55	208.44	208.12	0.32	0.27	208.46	0.6	0.6	0.5	4.1	0.52
TO03	-250	Max WS	16.1	207.39	0.60	207.99	208.11	-0.12	1.34	208.49	3.1	3.1	0.5	106.9	0.56
TO03	-275	Max WS	16.1	206.88	0.60	207.48	207.60	-0.12	1.32	207.97	3.1	3.1	0.5	105.3	0.56
TO03	-300	Max WS	16.1	206.38	0.60	206.98	207.10	-0.12	1.34	207.48	3.1	3.1	0.5	107.1	0.56
TO03	-325	Max WS	16.1	205.87	0.60	206.47	206.59	-0.12	1.32	206.96	3.1	3.1	0.5	104.8	0.56
TO03	-350	Max WS	16.1	205.37	0.61	205.98	206.12	-0.14	1.28	206.45	3.0	3.0	0.5	99.8	0.57
TO03	-375	Max WS	16.1	204.87	0.74	205.61	205.59	0.02	0.97	205.92	2.5	2.5	0.6	64.3	0.68
TO03	-400	Max WS	16.1	204.62	0.72	205.34	205.34	0.00	1.00	205.67	2.6	2.6	0.6	67.8	0.66
TO03	-425	Max WS	16.1	204.36	0.70	205.06	205.14	-0.08	1.01	205.39	2.6	2.4	0.6	67.8	0.36
TO03	-450	Max WS	16.1	204.11	0.60	204.71	204.88	-0.17	1.34	205.21	3.1	3.1	0.5	107.6	0.56
TO03	-475	Max WS	16.1	203.59	0.62	204.21	204.31	-0.10	1.28	204.67	3.0	3.0	0.5	99.4	0.57
TO03_V	-500	Max WS	24.7	203.06	0.41	203.47	204.01	-0.54	3.61	206.04	7.1	7.1	0.4	615.6	0.39
TO03_V	-523.35	Max WS	25.6	199.15	1.30	200.45	200.12	0.33	0.63	200.88	2.1	2.1	1.0	39.0	1.14
TO03_V	-527.89	Max WS	25.9	199.08	1.25	200.33	200.10	0.23	0.74	200.66	2.6	2.6	1.0	58.7	1.23
TO03_V	-531.64	Bridge													
TO03_V	-535.39	Max WS	25.9	199.07	0.94	200.01	200.09	-0.08	1.14	200.60	3.4	3.4	0.8	112.8	0.93
TO03_V	-541.22	Max WS	25.9	199.00	0.93	199.93	199.98	-0.05	1.09	200.43	3.1	3.1	0.8	94.5	0.84
TO03_V	-550	Max WS	25.9	198.89	0.93	199.82	199.87	-0.05	1.08	200.32	3.1	3.1	0.8	93.2	0.84
TO03_V	-575	Max WS	25.9	198.59	0.93	199.52	199.57	-0.05	1.08	200.02	3.1	3.1	0.8	92.8	0.84
TO03_V	-600	Max WS	25.9	198.29	0.93	199.22	199.27	-0.05	1.08	199.72	3.1	3.1	0.8	93.2	0.84
TO03_V	-625	Max WS	25.9	197.99	0.93	198.92	198.97	-0.05	1.08	199.42	3.1	3.1	0.8	92.9	0.84
TO03_V	-650	Max WS	25.9	197.69	0.93	198.62	198.67	-0.05	1.08	199.12	3.1	3.1	0.8	92.3	0.85
TO03_V	-675	Max WS	25.9	197.39	0.94	198.33	198.37	-0.04	1.07	198.82	3.1	3.1	0.8	91.5	0.85
TO03_V	-700	Max WS	25.9	197.09	0.95	198.04	198.07	-0.03	1.05	198.51	3.1	3.1	0.8	89.0	0.86
TO03_V	-725	Max WS	25.9	196.79	0.97	197.76	197.77	-0.01	1.01	198.21	3.0	3.0	0.8	83.1	0.88
TO03_V	-750	Max WS	25.9	196.49	1.07	197.56	197.47	0.09	0.87	197.92	2.7	2.7	0.9	65.7	0.96
TO03_V	-772.6	Max WS	25.9	196.21	1.18	197.39	197.19	0.20	0.75	197.68	2.4	2.4	0.9	51.7	1.04
TO03_V	-789.51	Max WS	25.9	196.01	1.30	197.31	196.99	0.32	0.64	197.55	2.1	2.1	1.0	39.9	1.14
TO03_V	-801.32	Max WS	25.9	195.87	1.46	197.33	196.85	0.48	0.53	197.51	1.9	1.9	1.1	30.0	1.22
TO03_V	-806.61	Max WS	25.9	195.82	1.41	197.23	196.84	0.39	0.61	197.49	2.3	2.3	1.1	44.2	1.38
TO03_V	-820.99	Bridge													
TO03_V	-835.36	Max WS	25.9	195.53	0.86	196.39	196.55	-0.16	1.29	197.10	3.7	3.7	0.7	137.8	0.85
TO03_V	-842.96	Max WS	25.9	195.45	0.77	196.22	196.43	-0.21	1.39	196.91	3.8	3.4	0.7	147.8	0.46
TO03_V	-849	Max WS	25.9	195.39	0.65	196.04	196.35	-0.31	1.86	197.08	4.5	4.3	0.6	218.5	0.39
TO03_V	-851.72	Max WS	25.9	195.37	0.49	195.86	196.34	-0.48	2.89	197.81	6.2	6.2	0.4	442.3	0.47
TO03_V	-872.81	Max WS	25.1	193.39	1.38	194.77	194.35	0.42	0.56	194.96	1.9	1.9	1.1	31.9	1.21
TO03_V	-877.6	Max WS	24.5	193.34	1.37	194.72	194.32	0.40	0.60	194.96	2.2	2.2	1.0	41.8	1.35
TO03_V	-881.34	Bridge													
TO03_V	-885.08	Max WS	26.7	193.26	1.03	194.29	194.29	0.00	1.01	194.81	3.2	3.2	0.8	95.1	1.02
TO03_V	-890.74	Max WS	26.5	193.21	1.04	194.25	194.20	0.05	0.94	194.66	2.8	2.8	0.9	74.6	0.93
TO03_V	-900	Max WS	26.7	193.12	1.04	194.16	194.12	0.04	0.94	194.57	2.9	2.9	0.9	75.5	0.93
TO03_V	-925	Max WS	27.3	192.87	1.05	193.92	193.89	0.03	0.94	194.34	2.9	2.9	0.9	75.9	0.94
TO03_V	-950	Max WS	27.9	192.63	1.04	193.67	193.66	0.01	0.98	194.12	3.0	3.0	0.9	81.1	0.94
TO03_V	-975	Max WS	28.6	192.38	1.05	193.43	193.42	0.01	1.00	193.89	3.0	3.0	0.9	85.0	0.94
TO03_V	-1000	Max WS	29.3	192.14	1.02	193.16	193.20	-0.04	1.06	193.68	3.2	3.2	0.8	94.8	0.92
TO03_V	-1035	Max WS	30.3	191.98	0.53	192.51	192.72	-0.21	1.72	193.16	3.7	3.4	0.5	158.3	0.37
TO03_V	-1085	Max WS	31.6	190.00	1.32	191.32	191.00	0.32	0.50	191.40	1.5	1.3	0.9	21.0	0.69
TO03_V	-1185	Max WS	48.2	189.00	0.77	189.72	189.71	0.01	0.97	189.97	2.5	2.2	0.7	63.0	0.53
TO03_V	-1285	Max WS	51.2	187.61	0.76	188.37	188.44	-0.07	1.14	188.70	2.9	2.4	0.7	86.9	0.45
TO03_V	-1385	Max WS	54.2	186.00	0.93	186.93	187.14	-0.21	1.51	187.51	4.1	3.0	0.8	164.4	0.40
TO03_V	-1465	Max WS	56.6	184.70	0.68	185.38	185.46	-0.08	1.18	185.66	2.8	2.1	0.6	82.0	0.31
TO03_V	-1585	Max WS	60.2	182.81	1.34	184.15	183.73	0.42	0.32	184.19	0.9	0.9	0.8	7.3	0.76
TO03_V	-1614.19	Max WS	60.2	182.96	0.88	183.84	184.21	-0.37	1.78	184.89	4.8	4.5	0.7	222.6	0.64
TO03_V	-1639.19	Max WS	60.2	181.48	1.36	182.84	182.79	0.05	0.95	183.40	3.3	3.3	1.1	91.8	1.24
TO03_V	-1664.19	Max WS	60.2	181.28	1.36	182.64	182.59	0.05	0.95	183.20	3.3	3.3	1.1	93.0	1.23
TO03_V	-1689.19	Max WS	60.2	181.08	1.35	182.43	182.41	0.02	0.95	182.99	3.3	3.3	1.2	92.5	1.15
TO03_V	-1714.19	Max WS	60.2	180.88	1.34	182.22	182.19	0.03	0.97	182.80	3.4	3.4	1.1	96.0	1.22
TO03_V	-1739.19	Max WS	60.2	180.68	1.32	182.00	182.08	-0.08	0.99	182.59	3.4	3.4	1.1	98.9	0.80
TO03_V	-1764.19	Max WS	60.2	180.48	1.30	181.78	181.86	-0.08	0.98	182.34	3.4	3.2	1.1	96.7	0.85
TO03_V	-1789.19	Max WS	60.2	180.28	1.29	181.57	181.59	-0.02	0.93	182.04	3.2	2.9	1.1	84.4	0.92
TO03_V	-1814.19	Max WS	60.2	180.08	1.28	181.36	181.46	-0.10	1.02	181.93	3.4	3.2	1.1	98.7	0.81
TO03_V	-1839.19	Max WS	60.2	179.88	1.26	181.14	181.19	-0.05	0.96	181.64	3.2	3.0	1.1	90.1	0.86
TO03_V	-1864.19	Max WS	60.1	179.68	1.25	180.93	180.97	-0.04	0.94	181.41	3.2	2.9	1.1	88.4	0.85
TO03_V	-1889.19	Max WS	60.1	179.48	1.25	180.73	180.77	-0.04	0.94	181.21	3.2	2.9	1.1	88.0	0.85
TO03_V	-1914.19	Max WS	60.1	179.28	1.25	180.53	180.61	-0.08	0.94	181.00	3.2	2.8	1.1	87.7	0.72
TO03_V	-1939.19	Max WS	60.1	179.08	1.23	180.31	180.45	-0.14	1.03	180.89	3.5	3.1	1.1	103.7	0.67
TO03_V	-1964.19	Max WS	60.1	178.88	1.20	180.08	180.12	-0.04	0.91	180.50	3.1	2.6	1.1	81.3	0.76
TO03_V	-1989.19	Max WS	60.1	178.68	1.26	179.94	179.87	0.07	0.78	180.26					

HEC-RAS Plan: POST Profile: Max WS (Continued)

Reach	River Sta	Profile	Q Total (m3/s)	Min Ch El (m)	Max Chl Dpth (m)	W.S. Elev (m)	Crit W.S. (m)	Diff	Froude # Chl	E.G. Elev (m)	Vel Chnl (m/s)	Vel Total (m/s)	Hydr Radius C (m)	Shear Chan (N/m2)	Hydr Depth (m)
TO03_V	-3352.49	Max WS	101.9	164.80	2.20	167.00	166.64	0.36	0.74	167.52	3.2	3.1	1.7	75.6	1.43
TO03_V	-3393.40	Max WS	101.9	164.68	2.20	166.88	166.63	0.25	0.70	167.34	3.1	2.8	1.8	68.2	1.30
TO03_V	-3418.40	Max WS	101.9	164.61	2.21	166.82	166.59	0.23	0.65	167.21	2.9	2.6	1.9	60.8	1.33
TO03_V	-3443.40	Max WS	101.8	164.54	2.19	166.73	166.49	0.24	0.64	167.11	2.9	2.5	1.9	59.2	1.35
TO03_V	-3468.40	Max WS	101.8	164.46	2.13	166.59	166.41	0.18	0.68	167.00	3.0	2.6	1.8	65.3	1.29
TO03_V	-3493.40	Max WS	101.8	164.39	2.20	166.59	166.12	0.47	0.54	166.85	2.4	2.1	2.0	42.2	1.60
TO03_V	-3518.40	Max WS	101.8	164.31	2.21	166.52	165.86	0.66	0.47	166.72	2.2	1.9	2.1	33.2	1.78
TO03_V	-3543.40	Max WS	101.8	164.24	2.19	166.43	165.66	0.77	0.45	166.61	2.1	1.8	2.1	29.4	1.87
TO03_V	-3568.40	Max WS	101.8	164.17	1.98	166.15	165.66	0.49	0.55	166.40	2.4	2.1	1.9	41.8	1.61
TO03_V	-3593.40	Max WS	101.8	164.09	2.02	166.11	165.62	0.49	0.55	166.37	2.5	2.1	2.0	42.5	1.60
TO03_V	-3618.40	Max WS	101.8	164.02	2.08	166.10	165.34	0.76	0.46	166.28	2.1	1.8	2.0	29.7	1.84
TO03_V	-3643.40	Max WS	101.8	163.95	1.84	165.79	165.41	0.38	0.62	166.08	2.6	2.3	1.7	49.6	1.48
TO03_V	-3668.40	Max WS	101.8	163.83	2.14	165.84	165.14	0.70	0.49	166.03	2.1	1.9	1.9	31.8	1.78

TO02-TO03

TO02 TO02

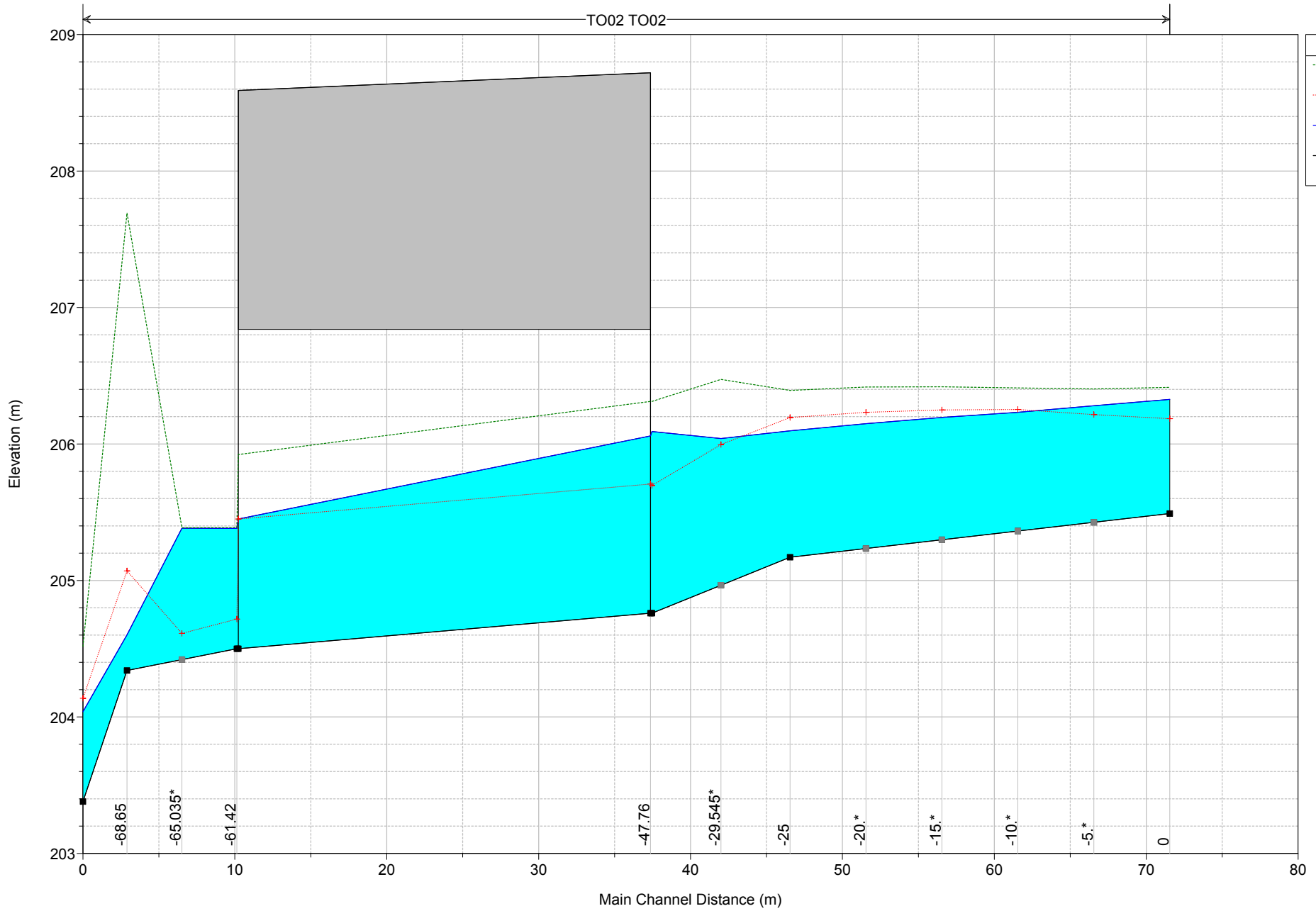

Legend

- EG Max WS
- Crit Max WS
- WS Max WS
- Ground

TO02-TO03

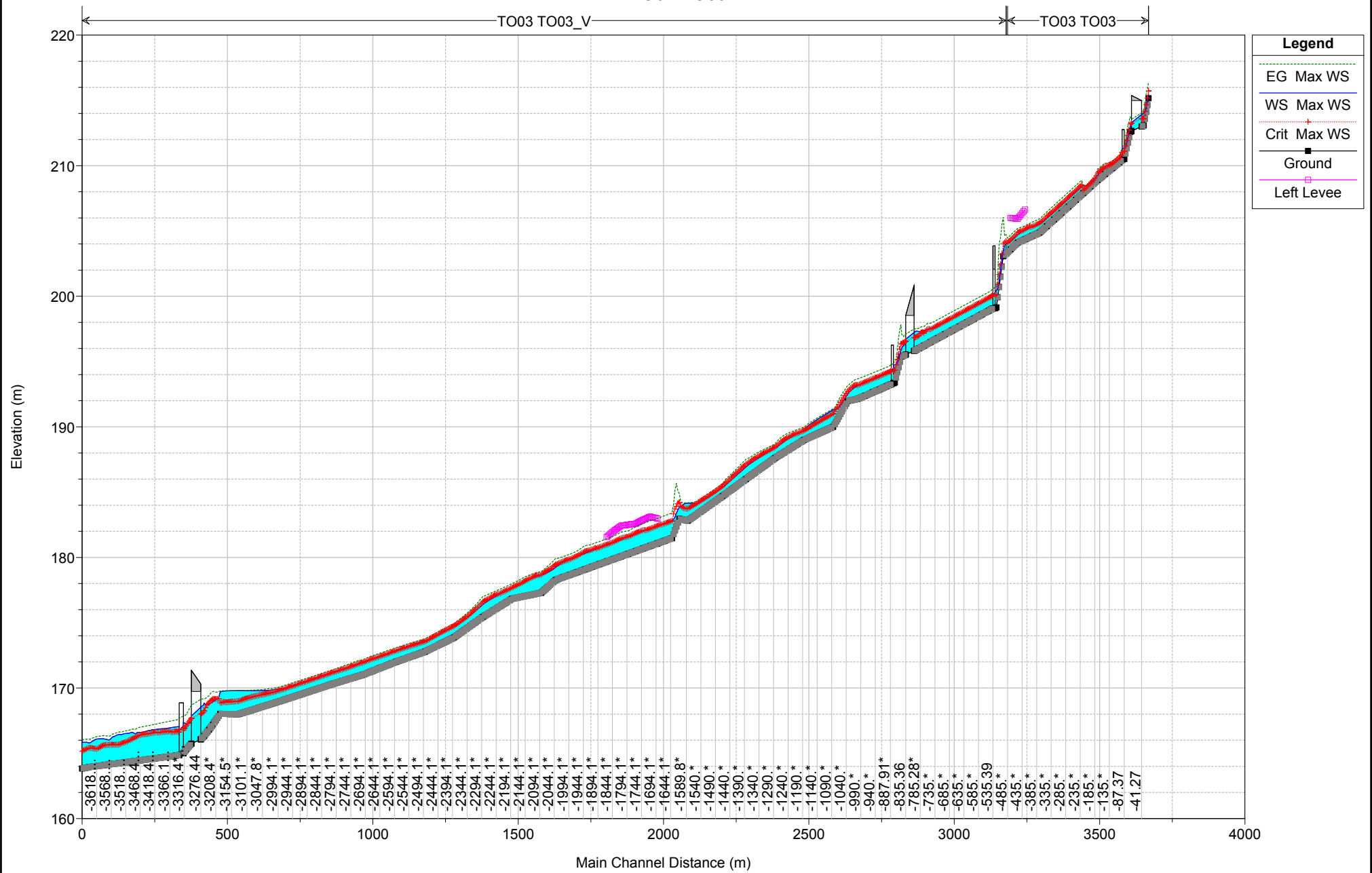

Legend	
EG Max WS	(Green dashed line)
WS Max WS	(Blue solid line)
Crit Max WS	(Red solid line with '+' markers)
Ground	(Black solid line with square markers)
Left Levee	(Magenta solid line with square markers)

Elevation (m)

Main Channel Distance (m)

TO03 TO03_V

TO03 TO03

-3618.1*
-3568.
-3518.
-3468.4*
-3418.4*
-3366.1*
-3316.4*
-3276.44
-3208.4*
-3154.5*
-3101.1*
-3047.8*
-2994.1*
-2944.1*
-2894.1*
-2844.1*
-2794.1*
-2744.1*
-2694.1*
-2644.1*
-2594.1*
-2544.1*
-2494.1*
-2444.1*
-2394.1*
-2344.1*
-2294.1*
-2244.1*
-2194.1*
-2144.1*
-2094.1*
-2044.1*
-1994.1*
-1944.1*
-1894.1*
-1844.1*
-1794.1*
-1744.1*
-1694.1*
-1644.1*
-1589.8*
-1540.*
-1490.*
-1440.*
-1390.*
-1340.*
-1290.*
-1240.*
-1190.*
-1140.*
-1090.*
-1040.*
-990.*
-940.*
-887.91*
-835.36
-785.28*
-735.*
-685.*
-635.*
-585.*
-535.39
-485.*
-435.*
-385.*
-335.*
-285.*
-235.*
-185.*
-135.*
-87.37
-41.27

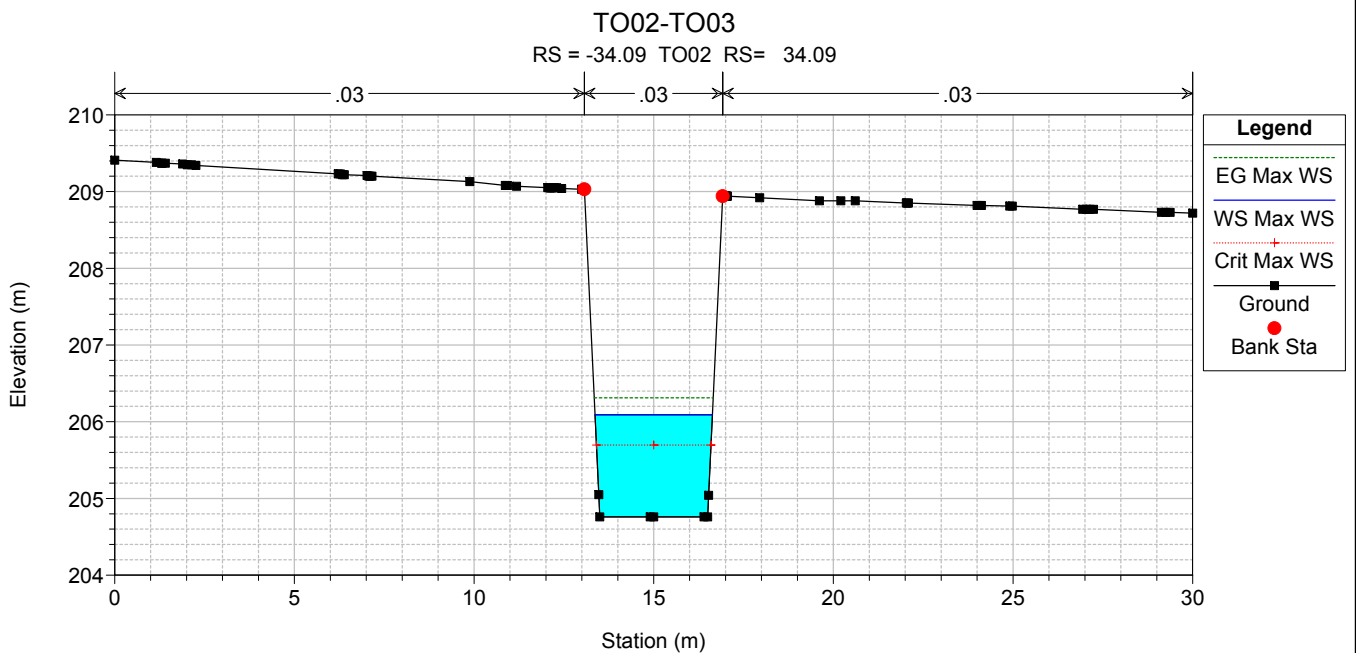
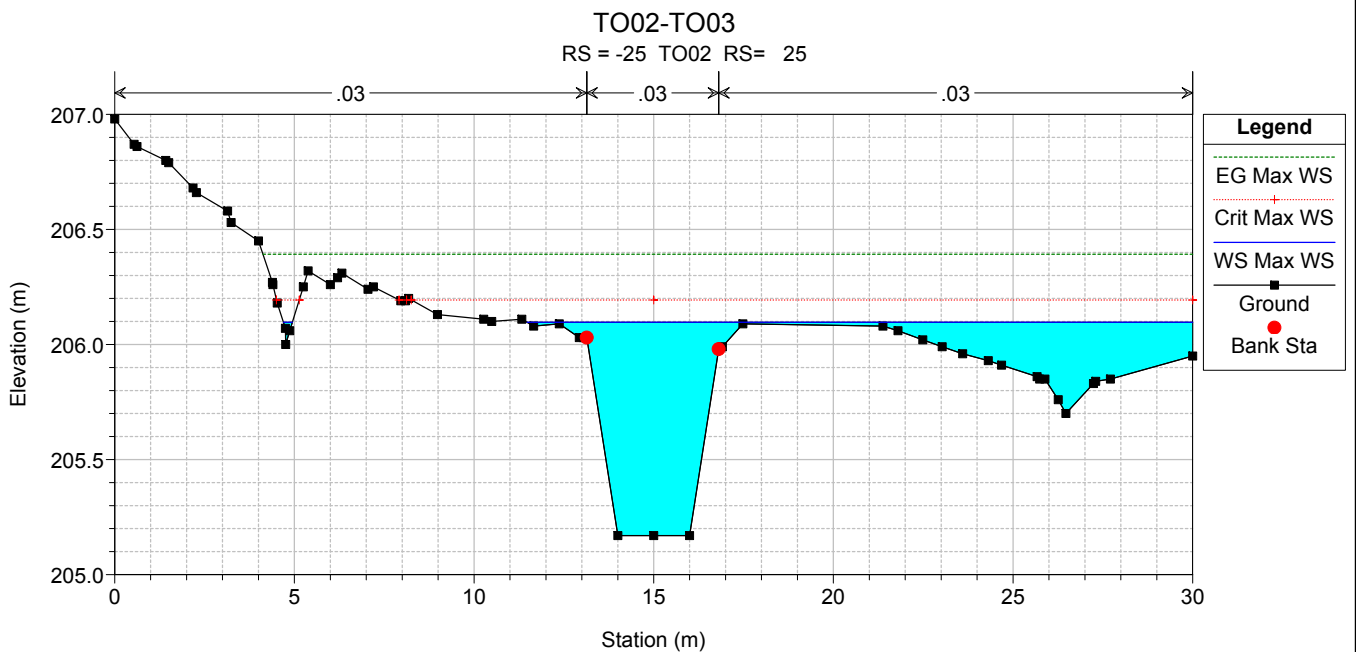
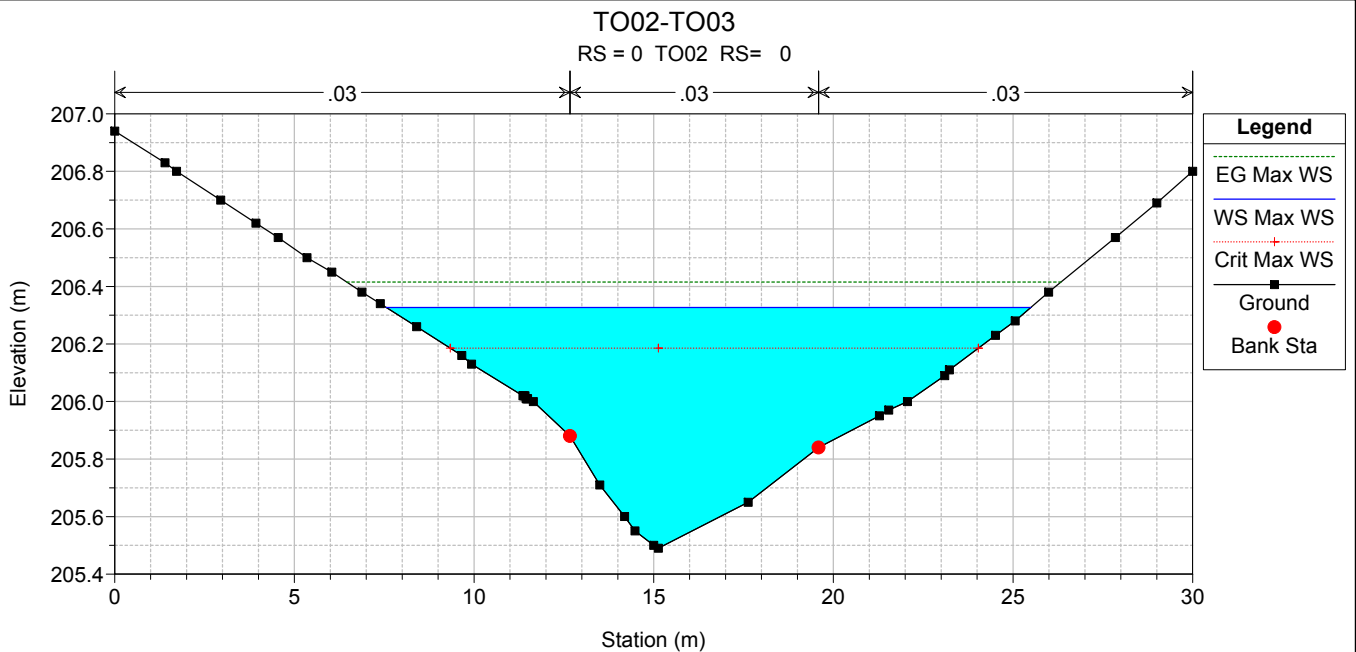

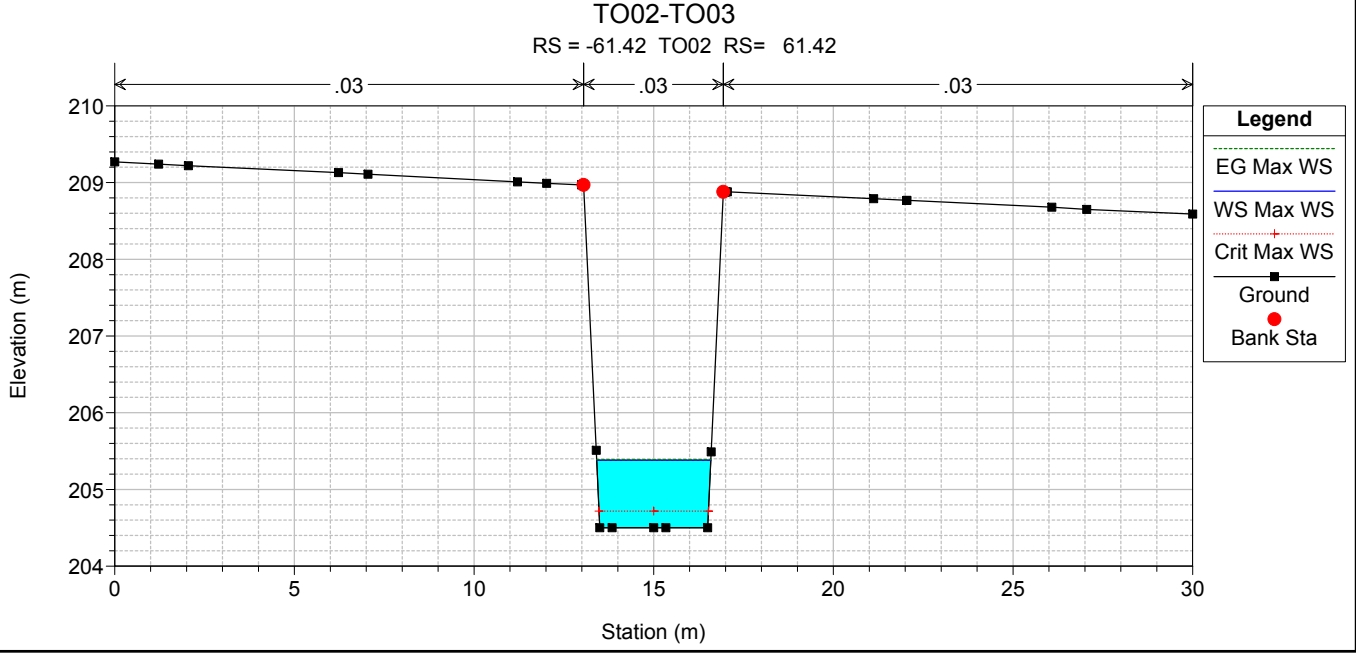
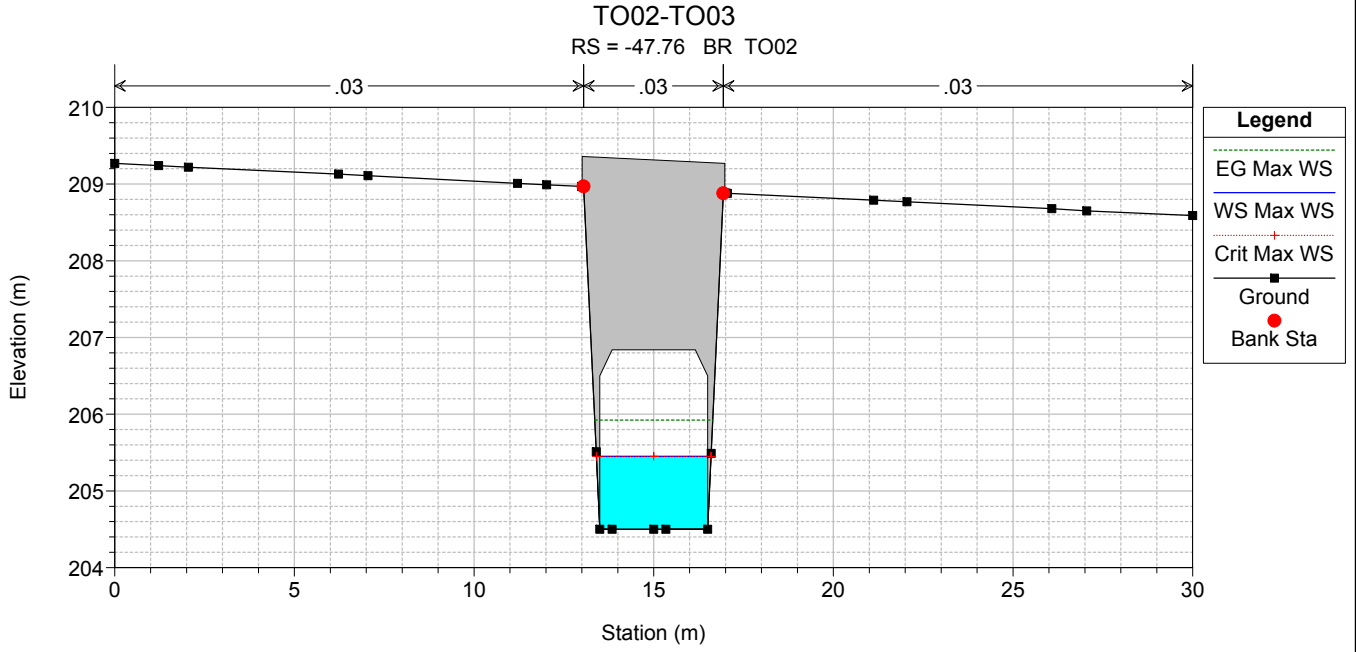
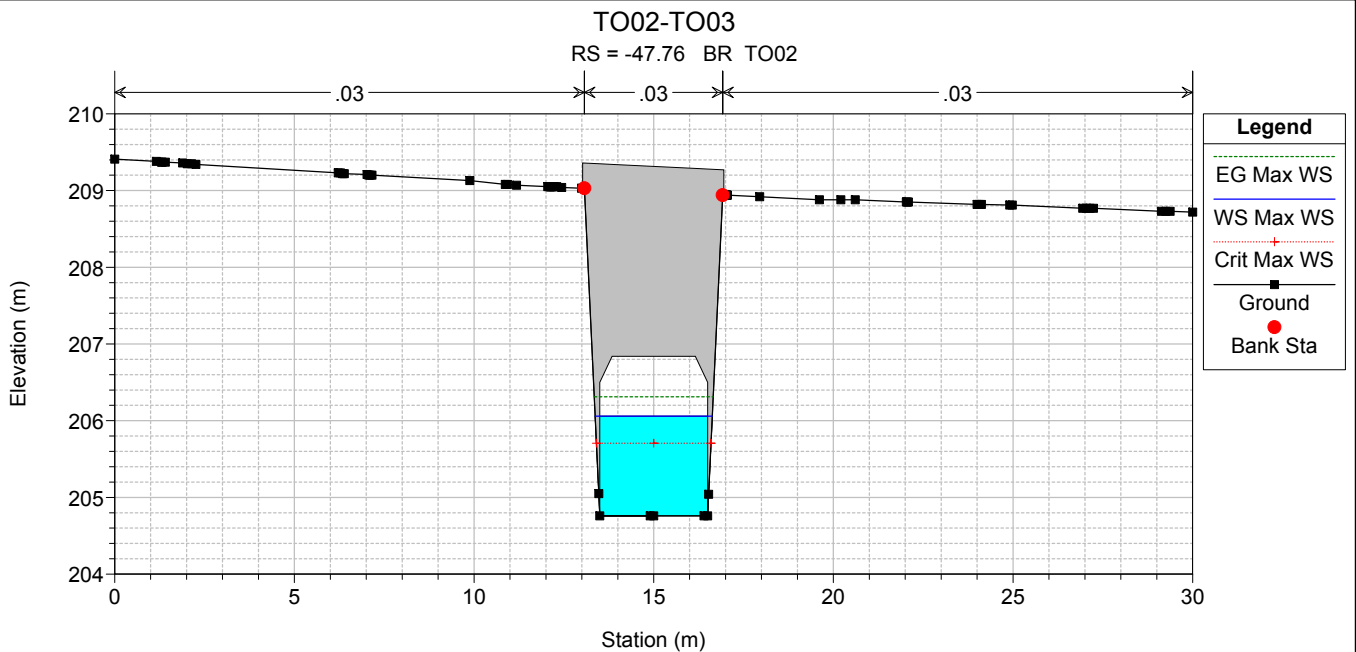

TO02-TO03

RS = -68.65 TO02 RS= 68.65

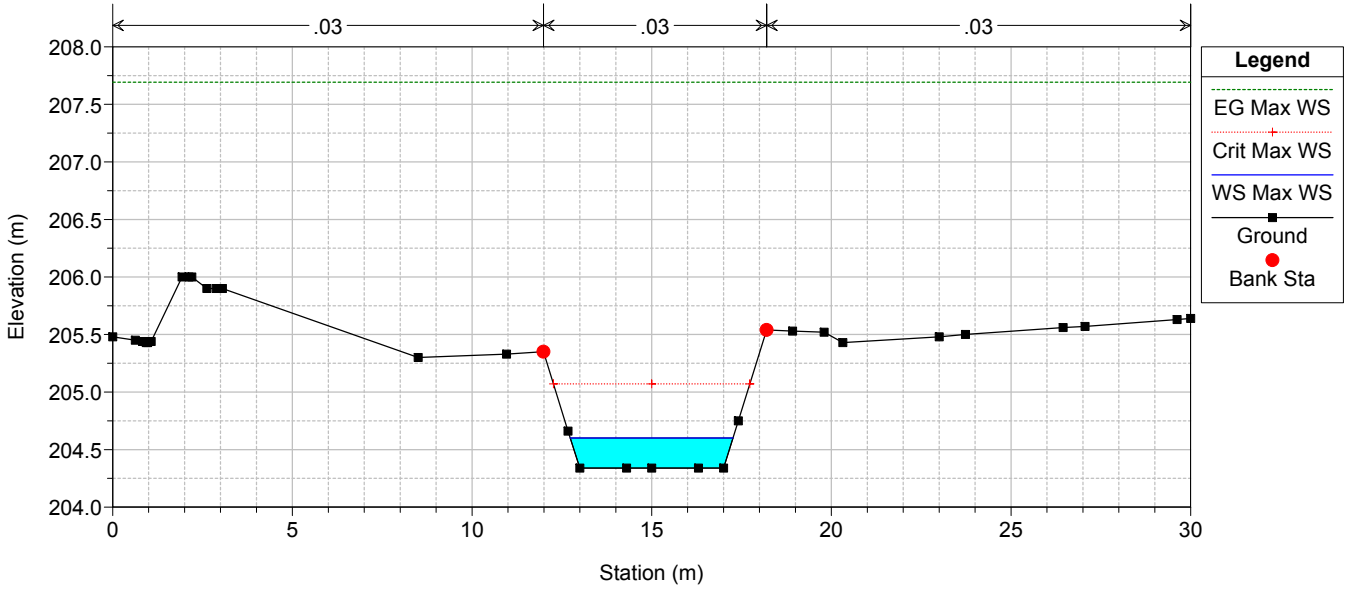

TO02-TO03

RS = -71.55 TO02 RS= 71.55

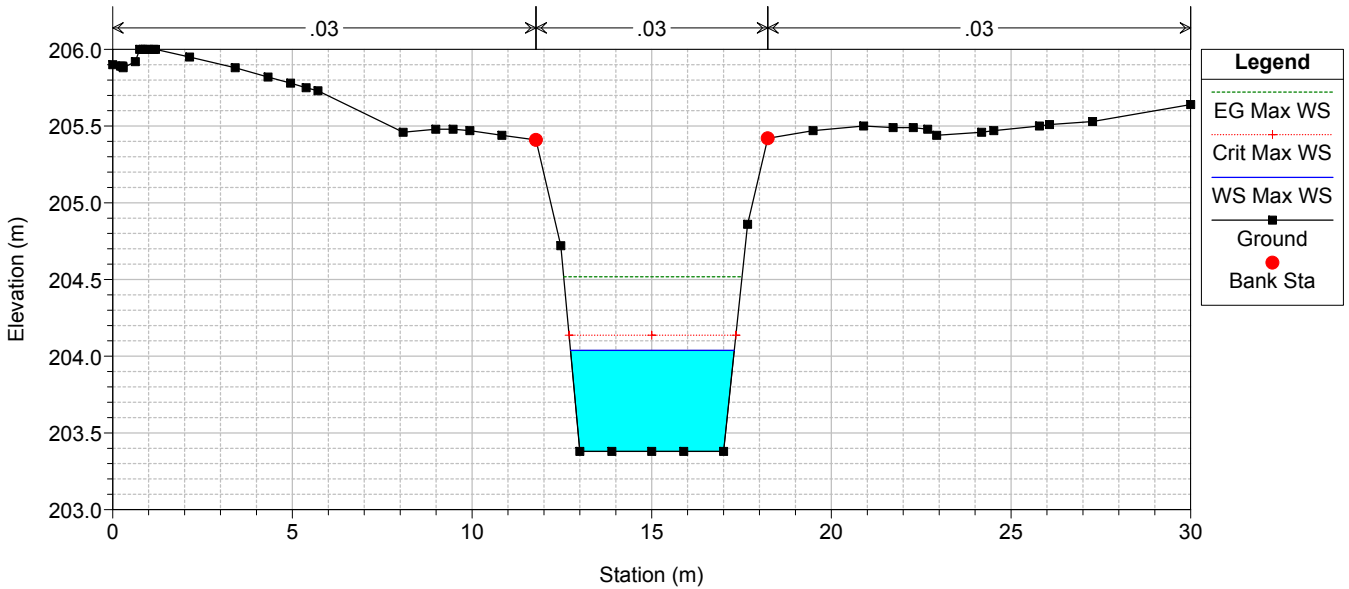

TO02-TO03-CA02-TO07_VARIO_POST

RS = 0 TO02 RS= 0

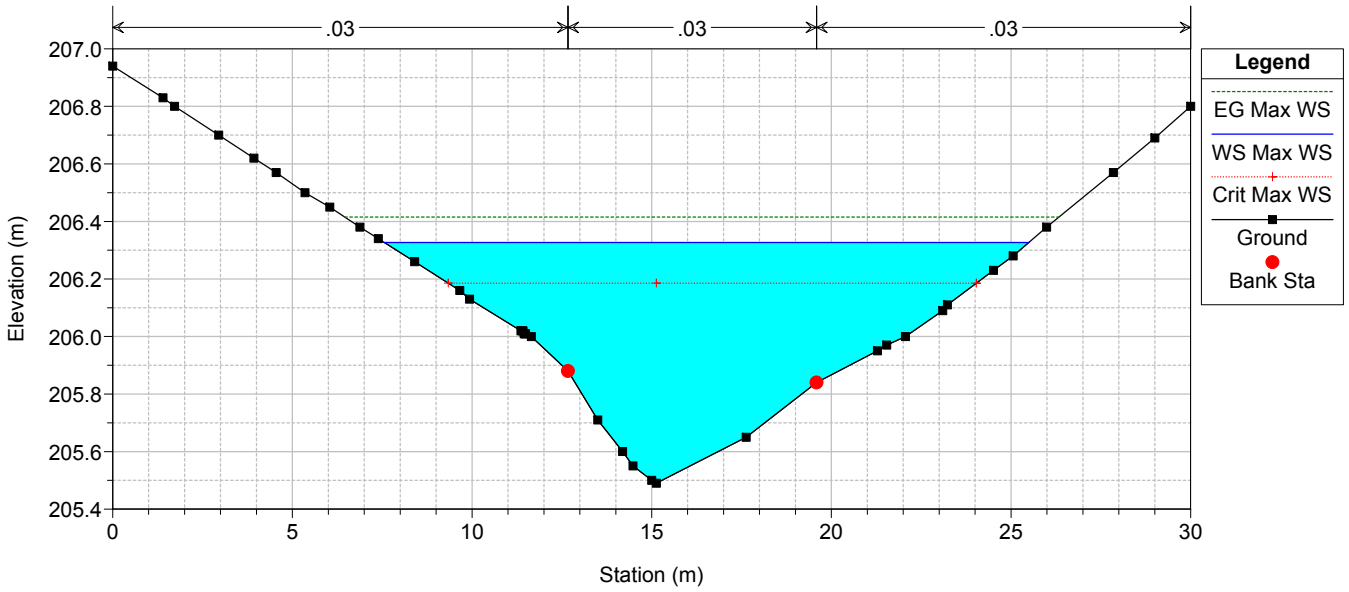

TO02-TO03-CA02-TO07_VARIO_POST

RS = -25 TO02 RS= 25

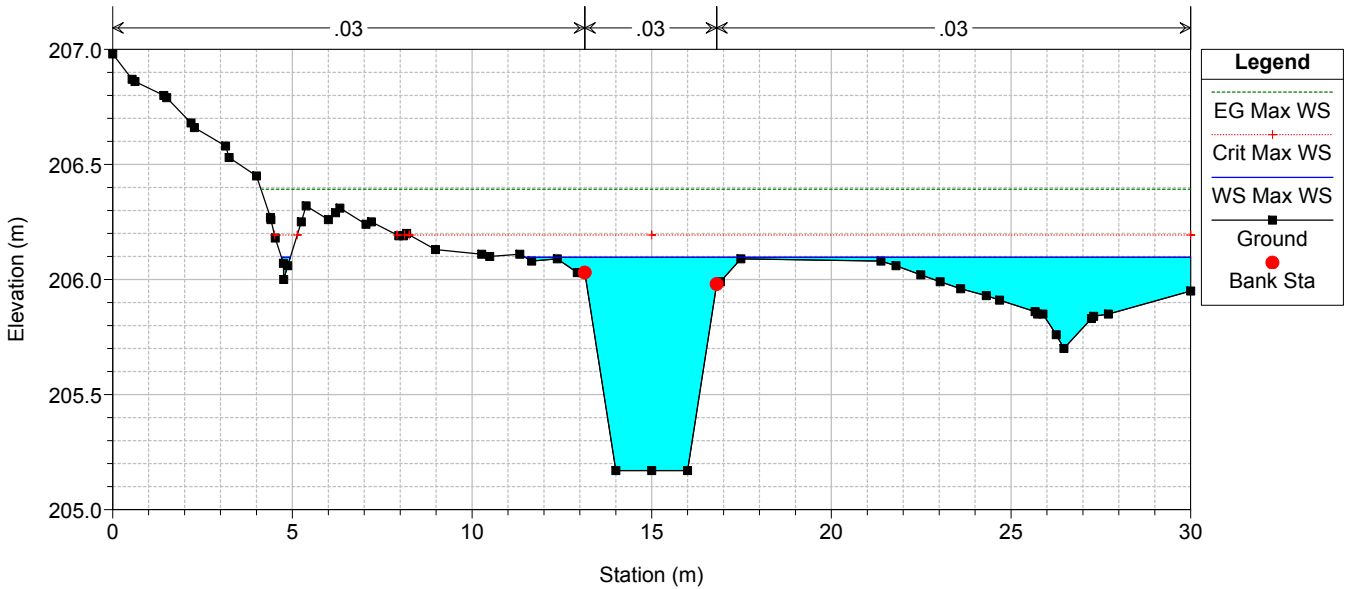

TO02-TO03-CA02-TO07_VARIO_POST

RS = -34.09 TO02 RS= 34.09

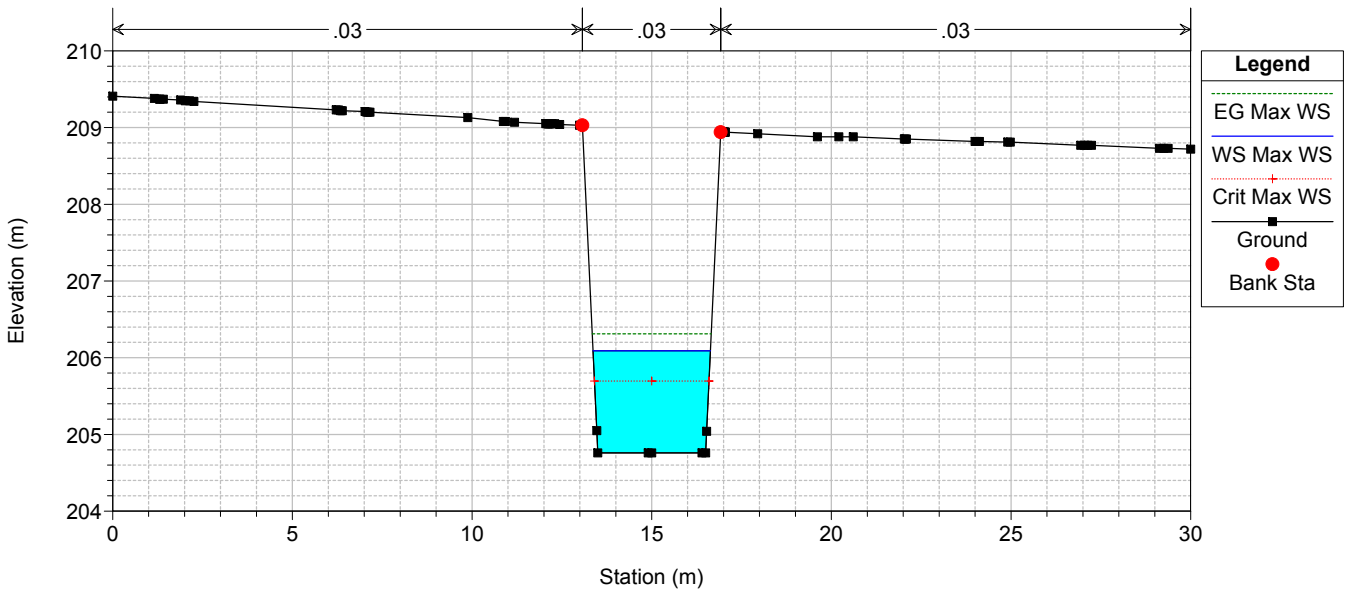

TO02-TO03-CA02-TO07_VARIO_POST

RS = -47.76 BR TO02

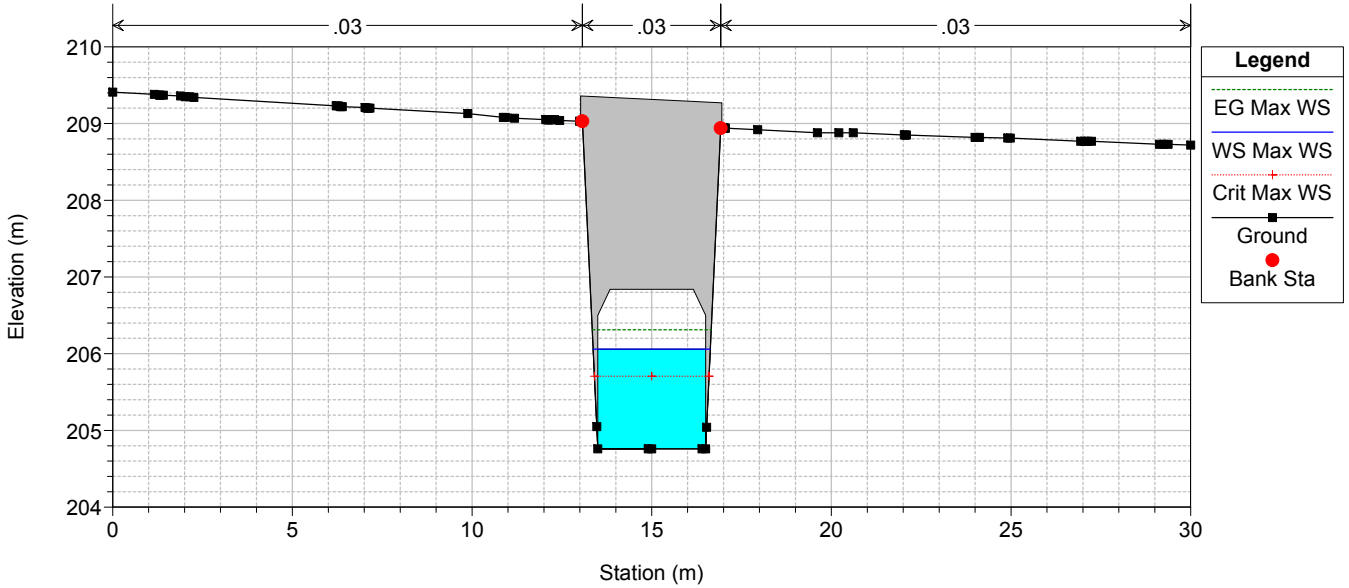

TO02-TO03-CA02-TO07_VARIO_POST

RS = -47.76 BR TO02

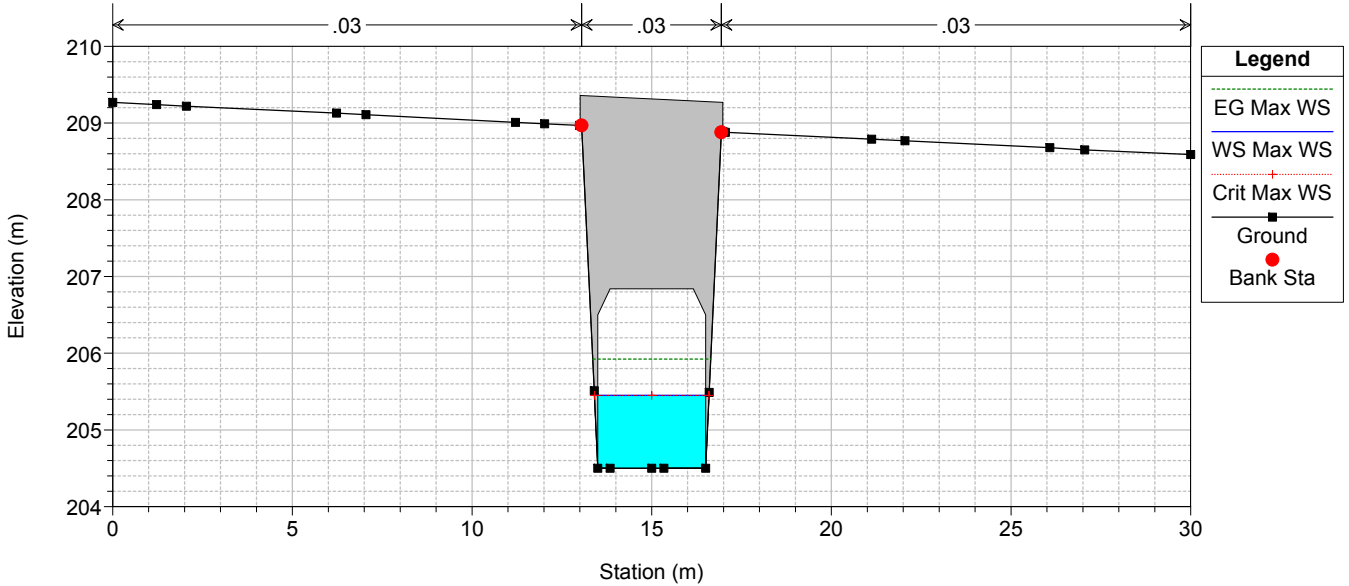

TO02-TO03-CA02-TO07_VARIO_POST

RS = -61.42 TO02 RS= 61.42

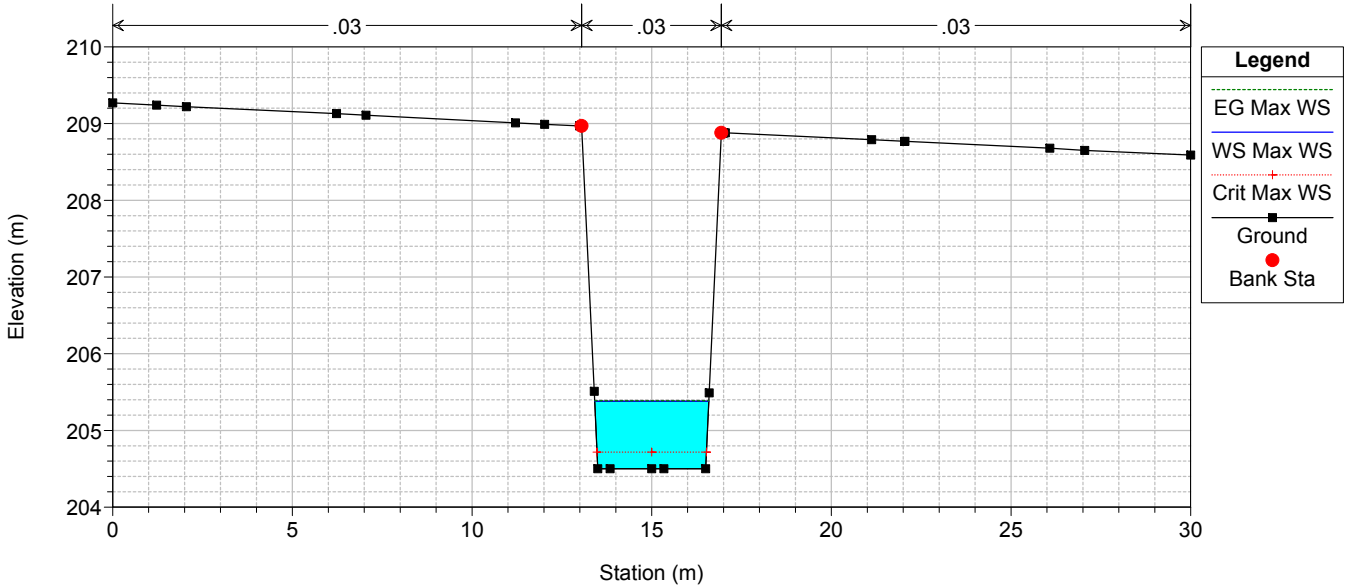

TO02-TO03-CA02-TO07_VARIO_POST

RS = -68.65 TO02 RS= 68.65

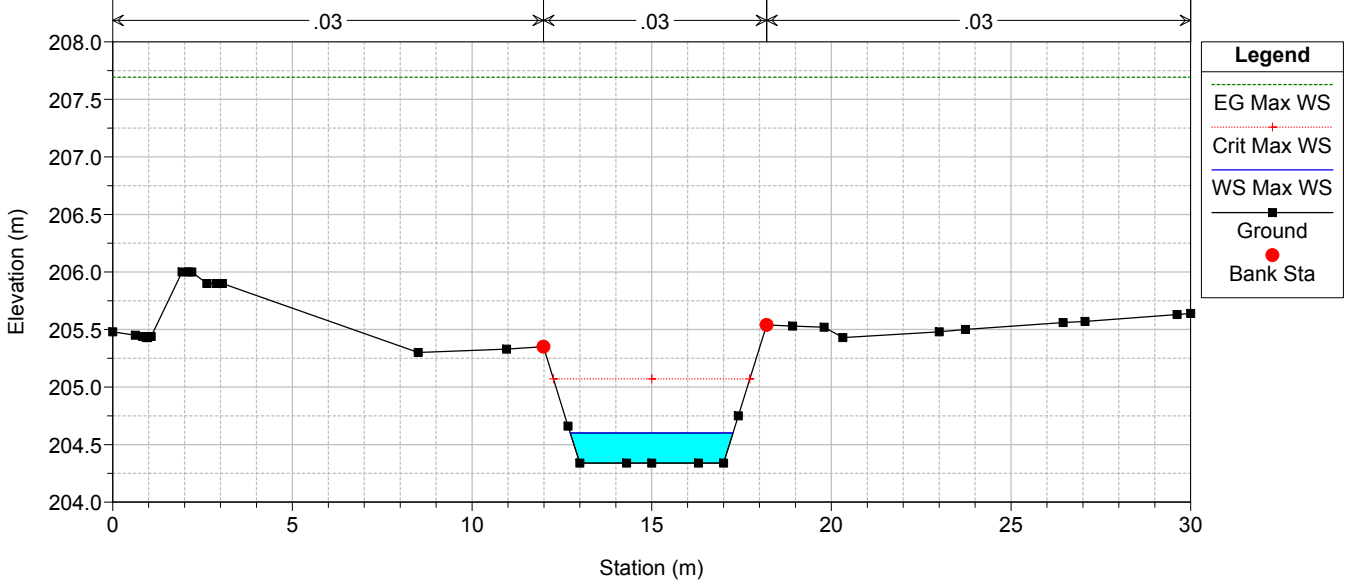

TO02-TO03-CA02-TO07_VARIO_POST

RS = -71.55 TO02 RS= 71.55

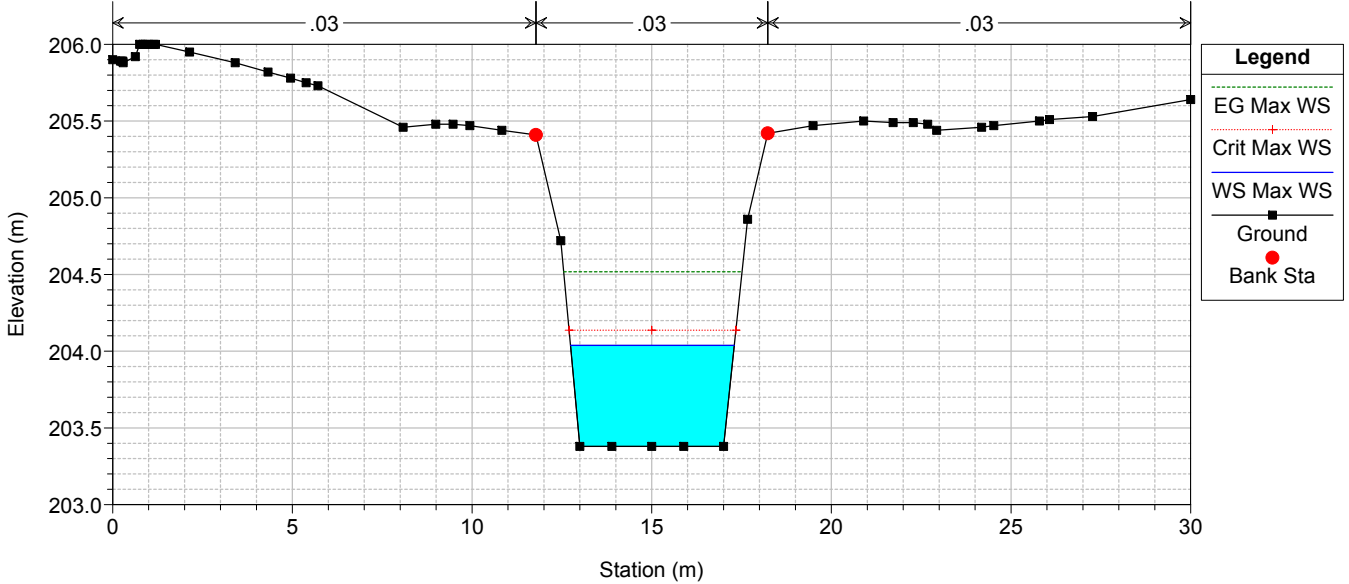

TO02-TO03-CA02-TO07_VARIO_POST

RS = 0 TO03 RS= 0

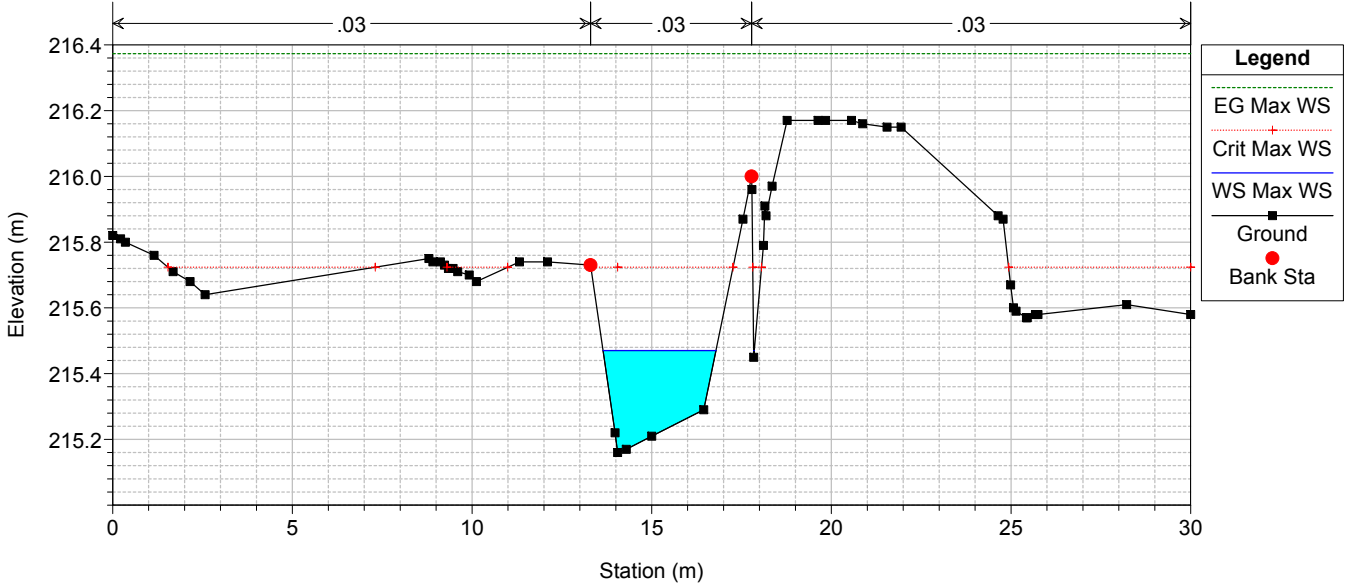

TO02-TO03-CA02-TO07_VARIO_POST

RS = -16.6 TO03 RS= 16.6

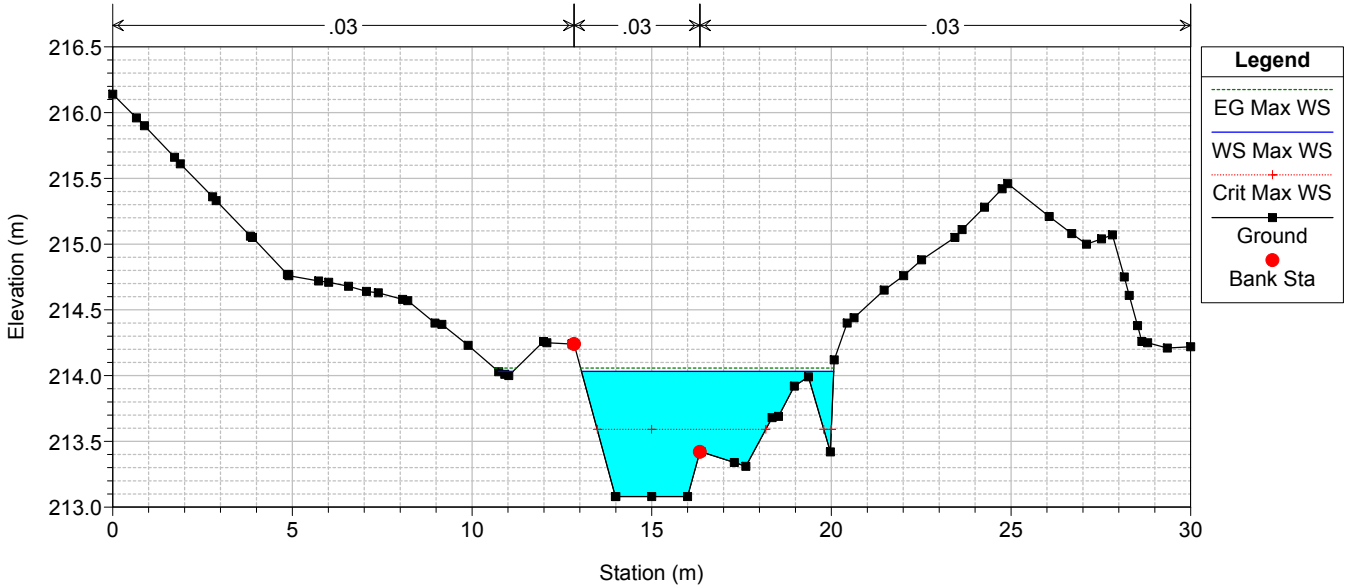

TO02-TO03-CA02-TO07_VARIO_POST

RS = -23.77 TO03 RS= 23.77

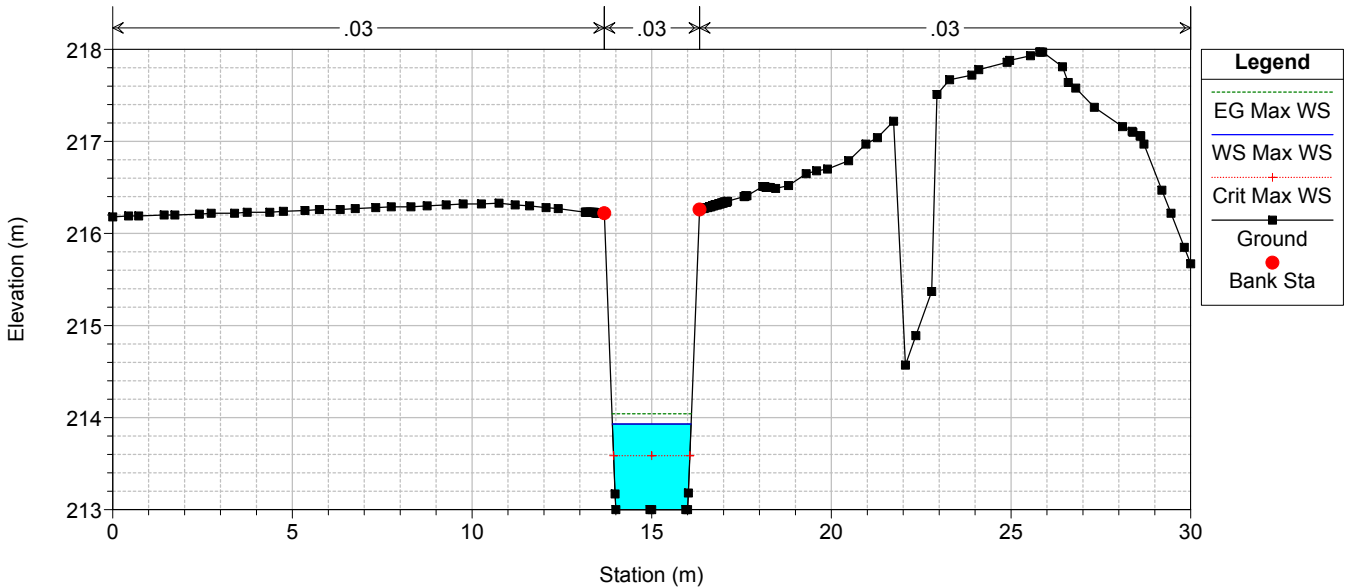

TO02-TO03-CA02-TO07_VARIO_POST

RS = -41.27 BR CO05A

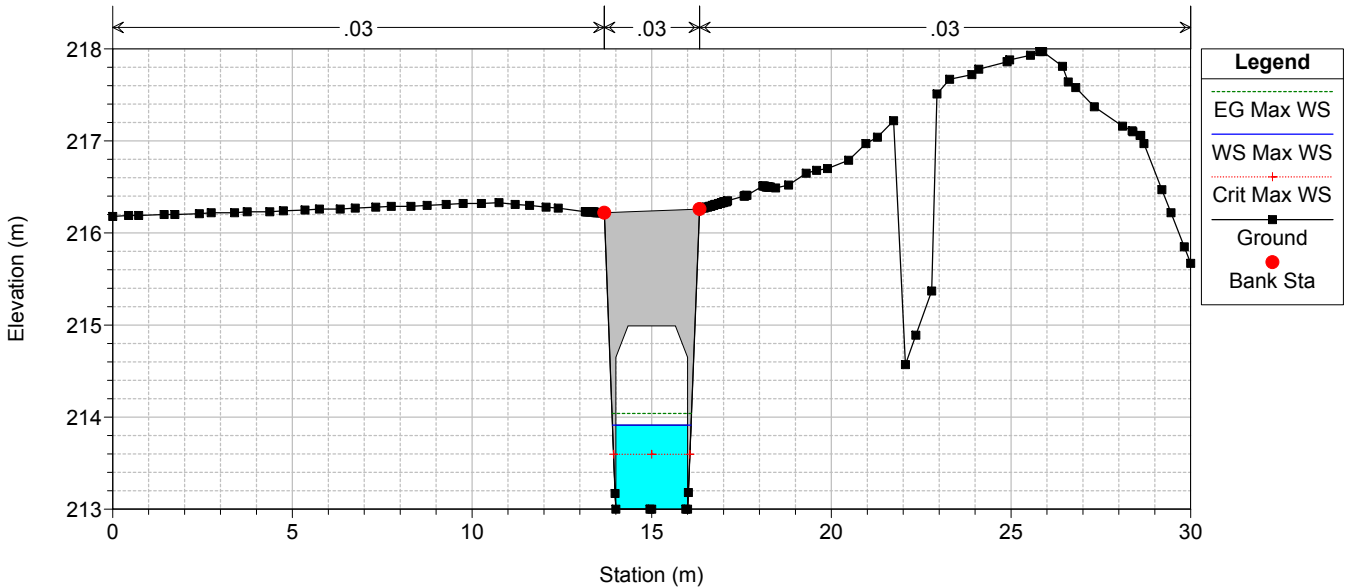

TO02-TO03-CA02-TO07_VARIO_POST

RS = -41.27 BR CO05A

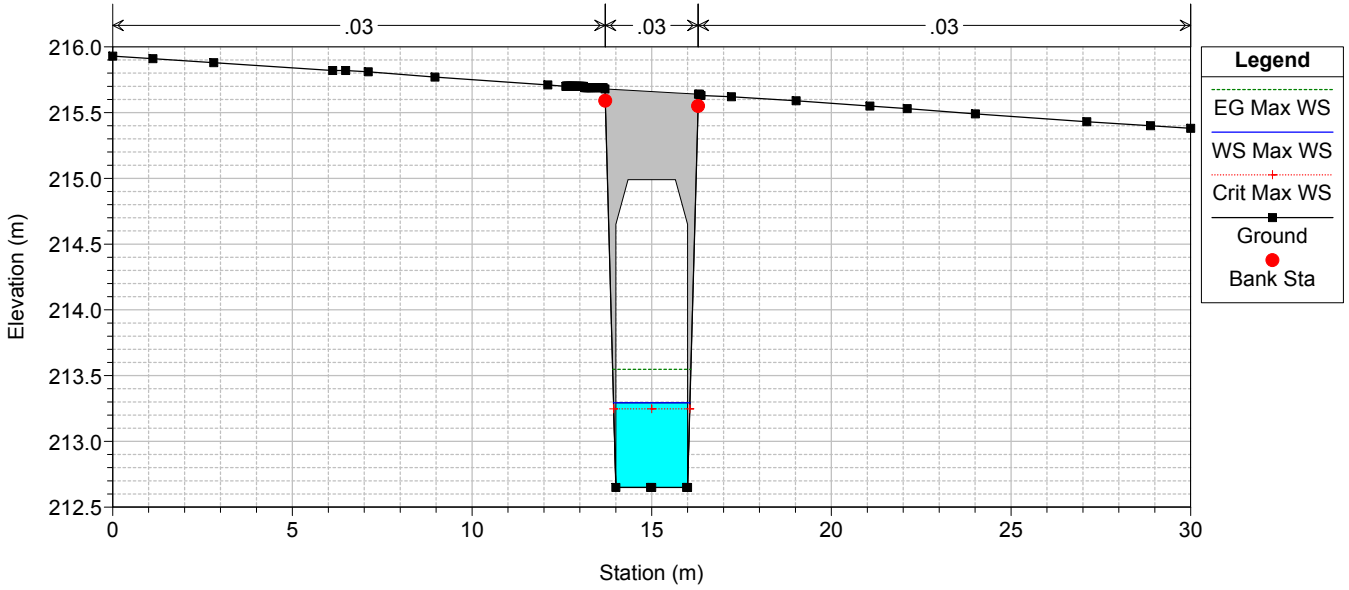

TO02-TO03-CA02-TO07_VARIO_POST

RS = -58.77 TO03 RS= 58.77

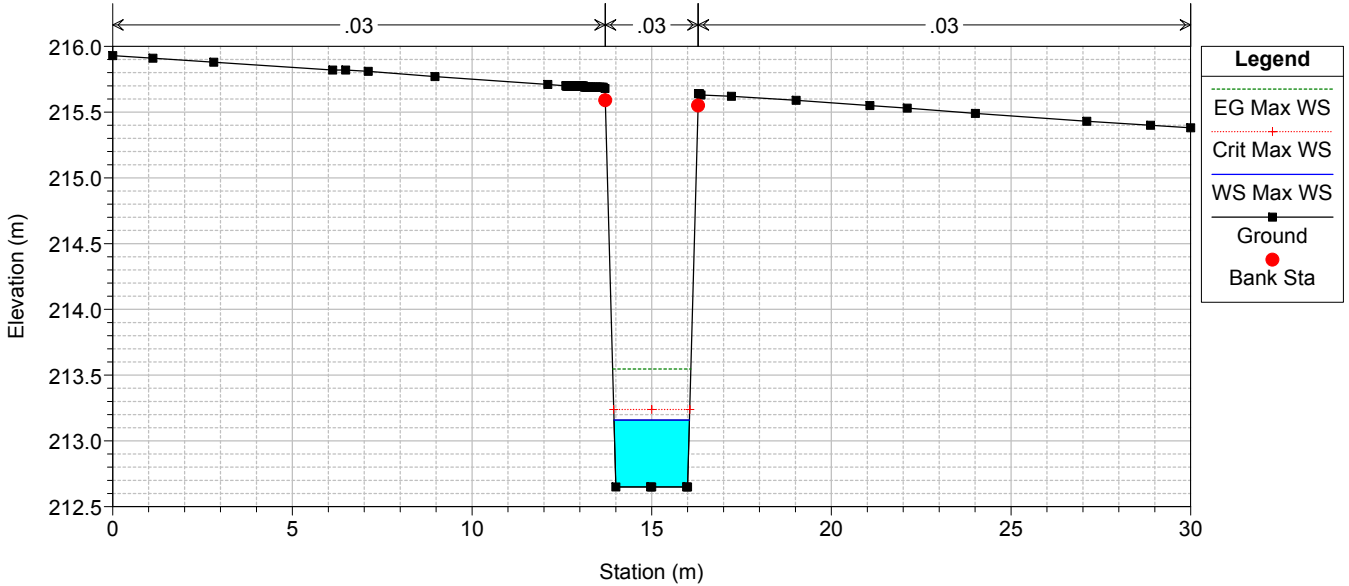

TO02-TO03-CA02-TO07_VARIO_POST

RS = -63.1 TO03 RS= 63.1

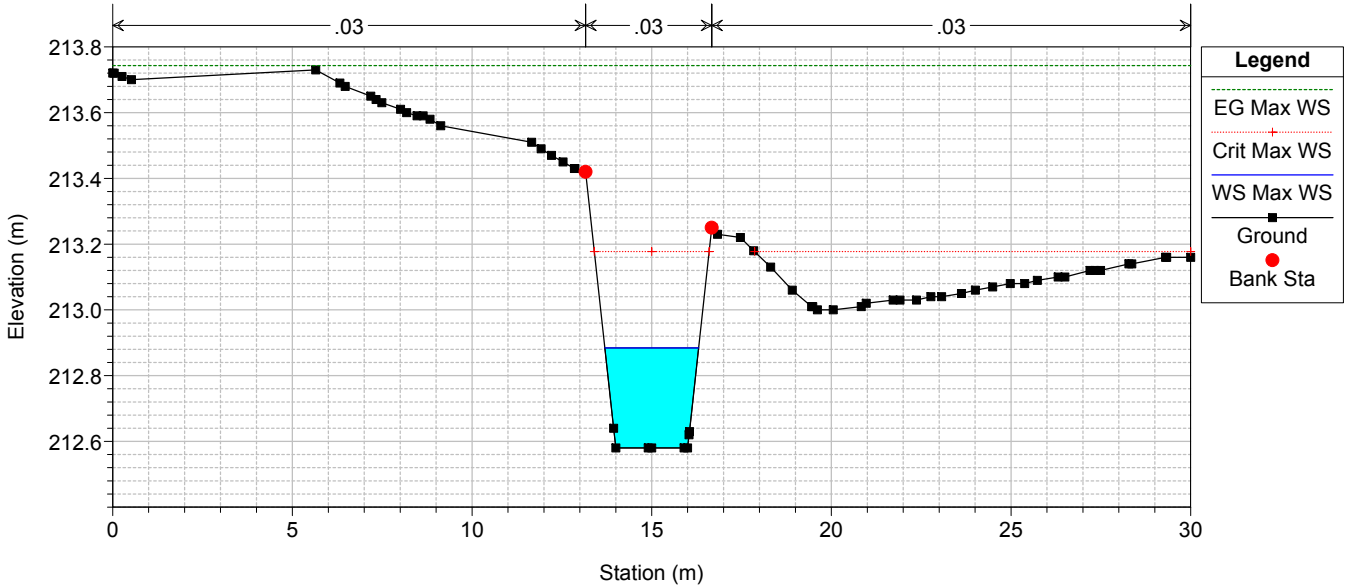

TO02-TO03-CA02-TO07_VARIO_POST

RS = -83.69 TO03 RS= 83.69

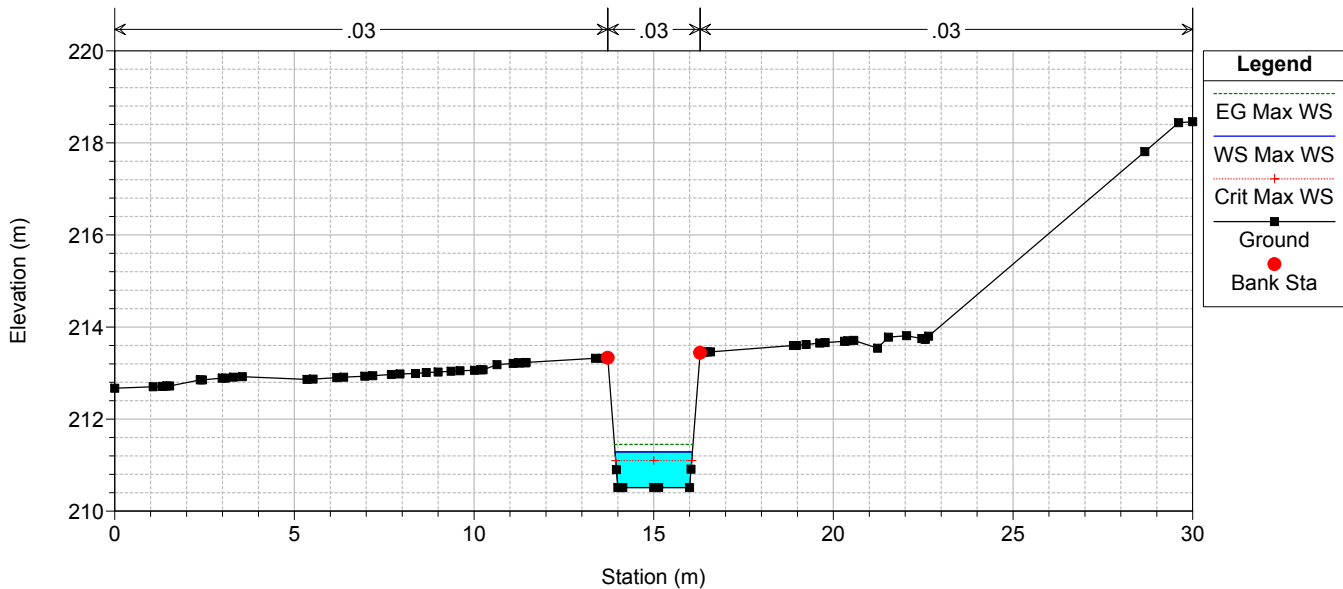

TO02-TO03-CA02-TO07_VARIO_POST

RS = -87.37 BR CO05B

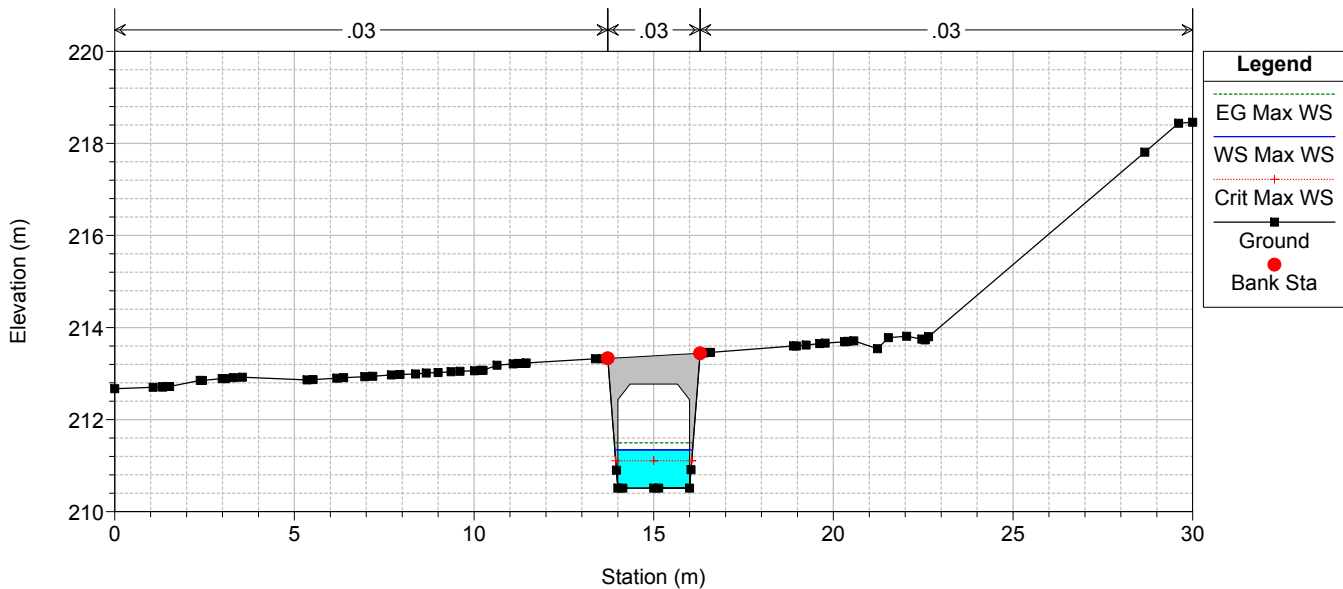

TO02-TO03-CA02-TO07_VARIO_POST

RS = -87.37 BR CO05B

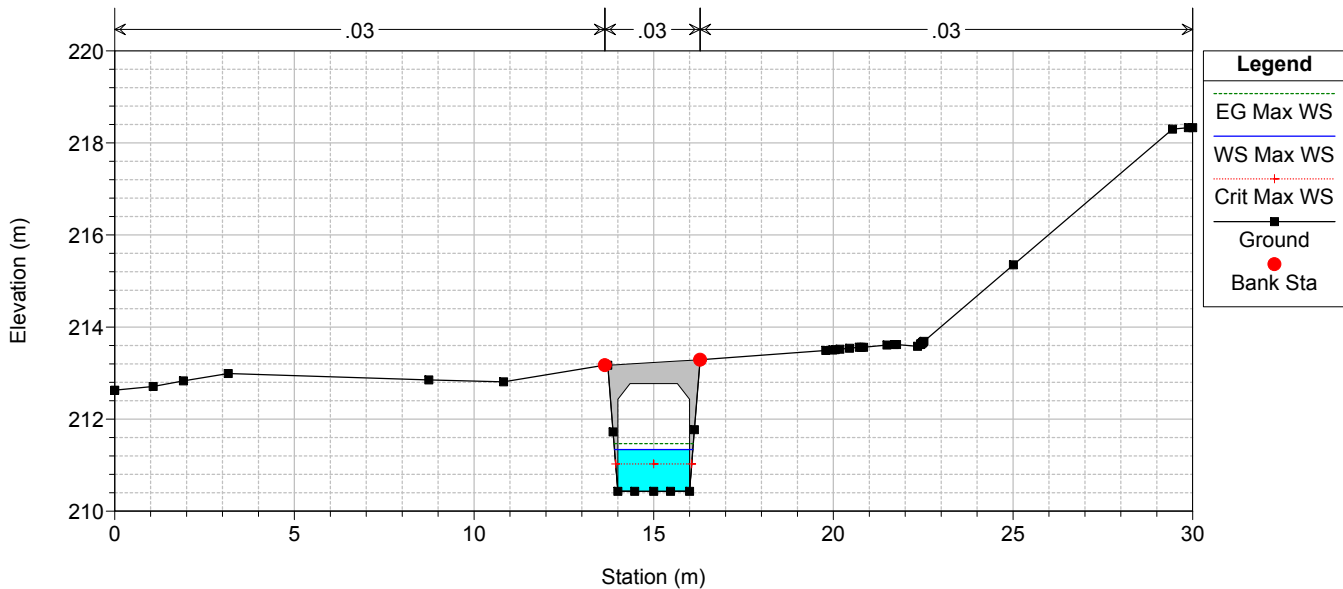

TO02-TO03-CA02-TO07_VARIO_POST

RS = -91.05 TO03 RS= 91.05

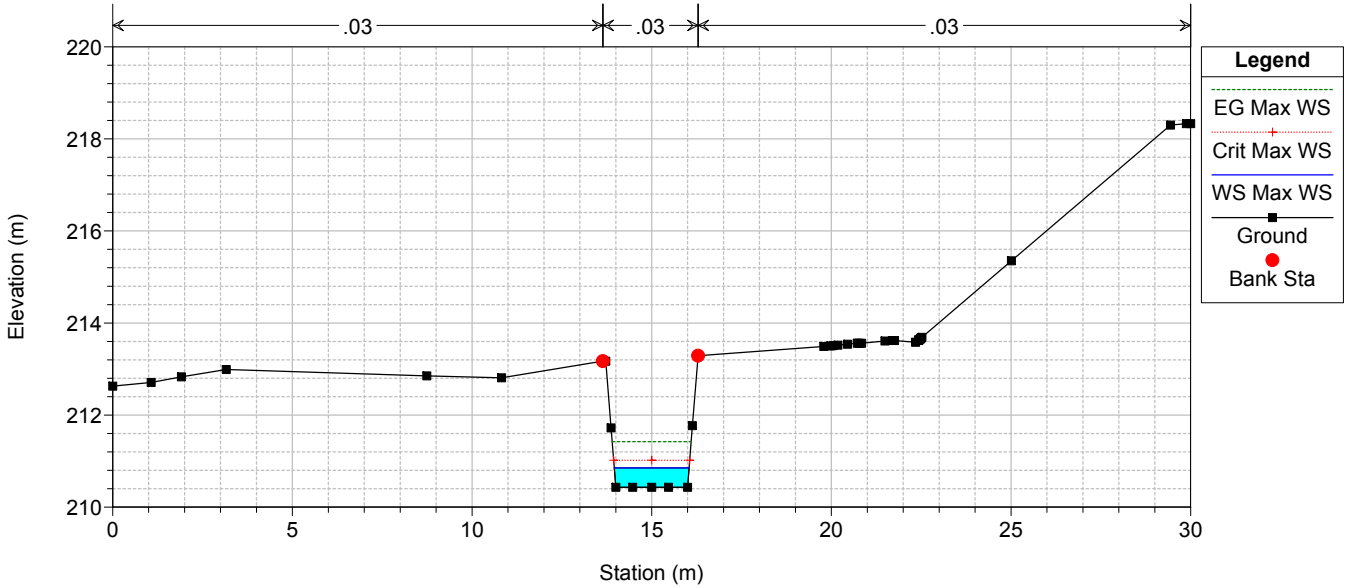

TO02-TO03-CA02-TO07_VARIO_POST

RS = -100 TO03 RS= 100

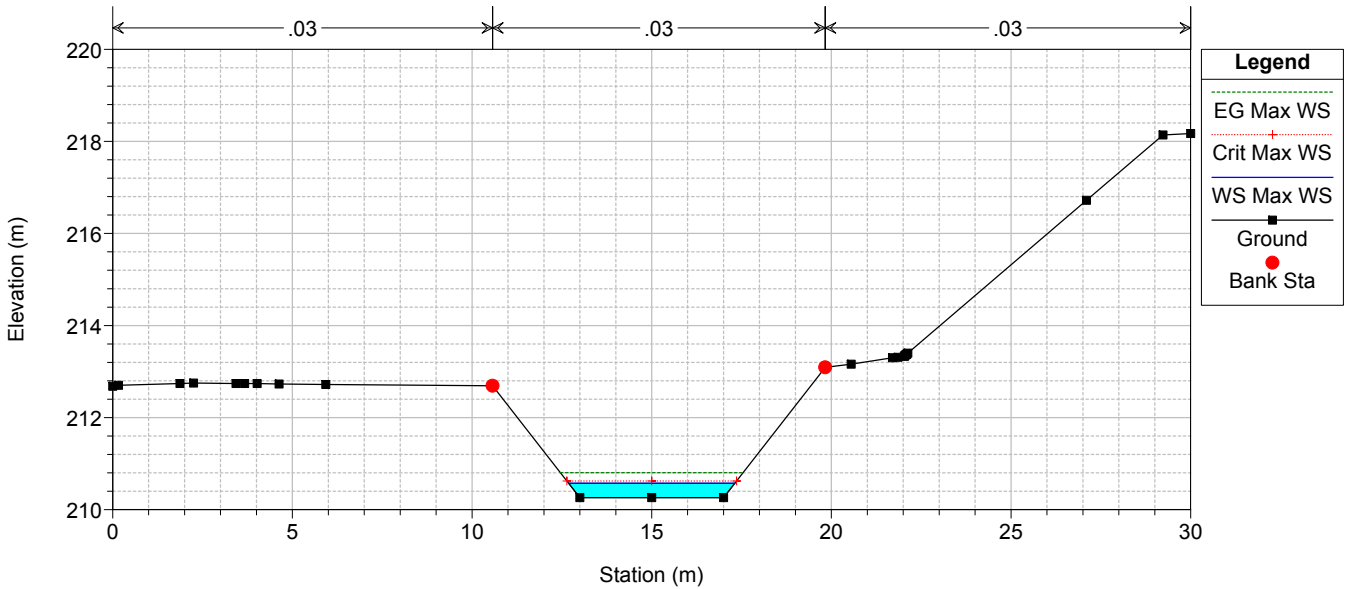

TO02-TO03-CA02-TO07_VARIO_POST

RS = -125 TO03 RS= 125

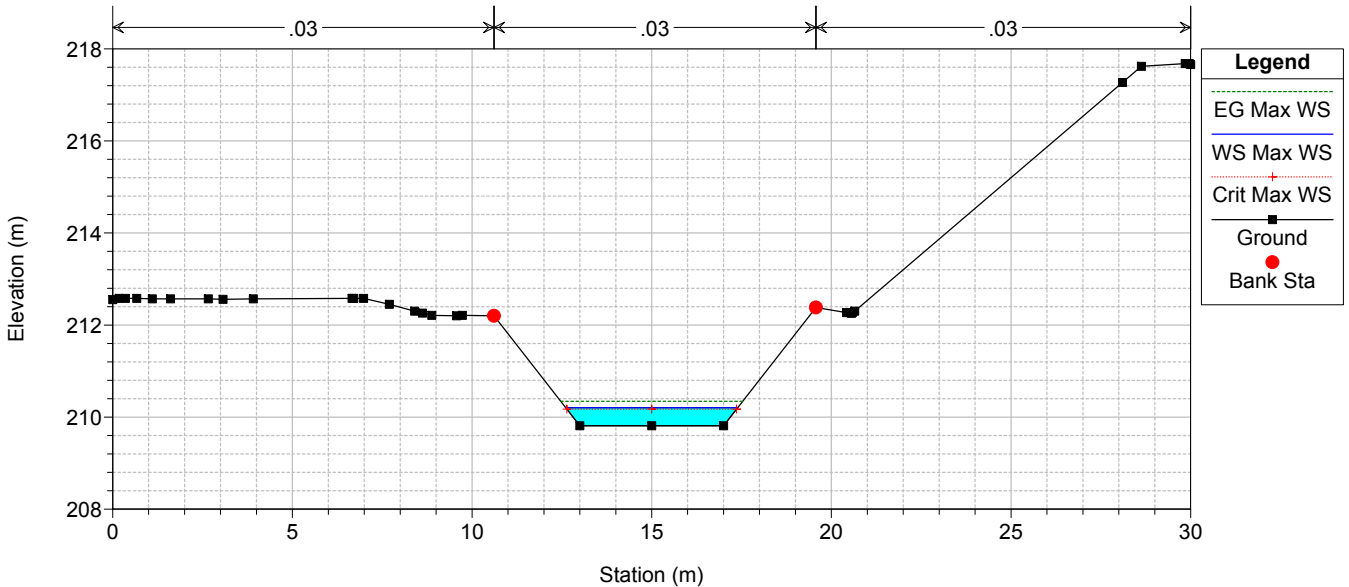

TO02-TO03-CA02-TO07_VARIO_POST

RS = -150 TO03 RS= 150

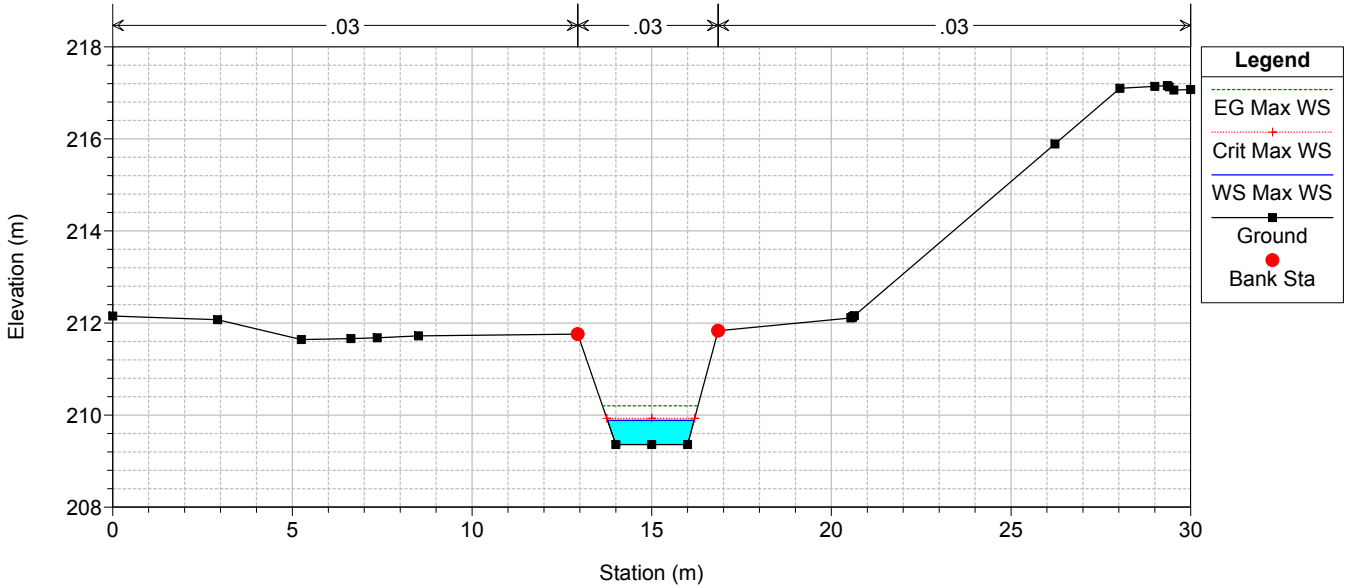

TO02-TO03-CA02-TO07_VARIO_POST

RS = -175 TO03 RS= 175

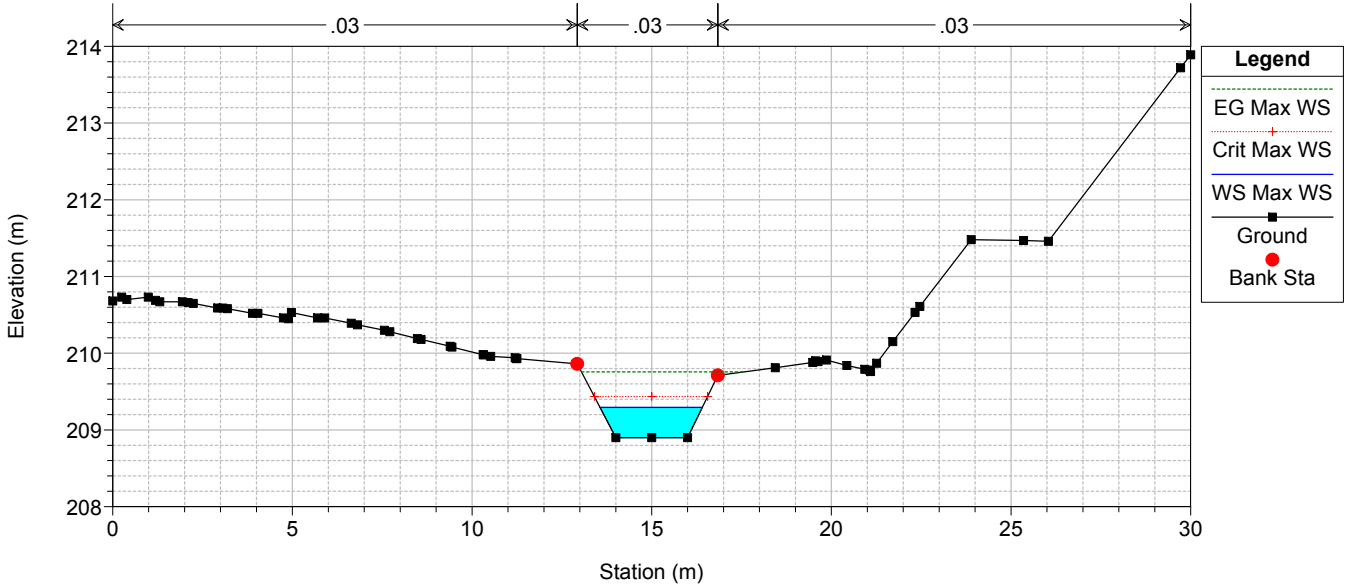

TO02-TO03-CA02-TO07_VARIO_POST

RS = -200 TO03 RS= 200

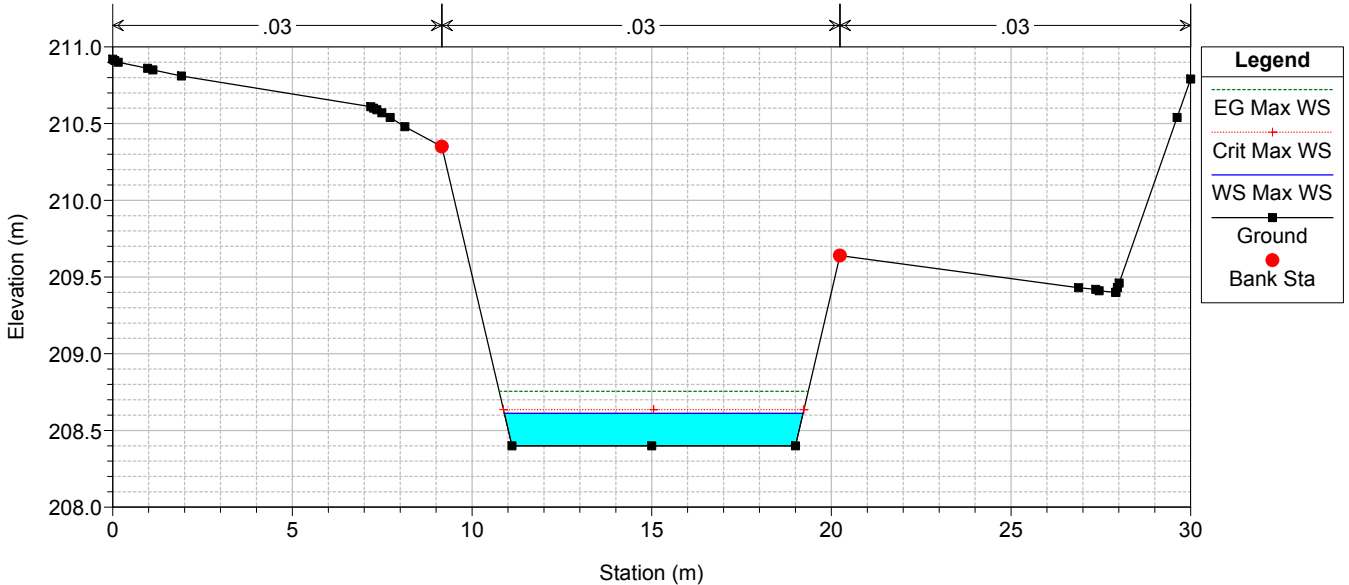

TO02-TO03-CA02-TO07_VARIO_POST

RS = -225 TO03 RS= 225

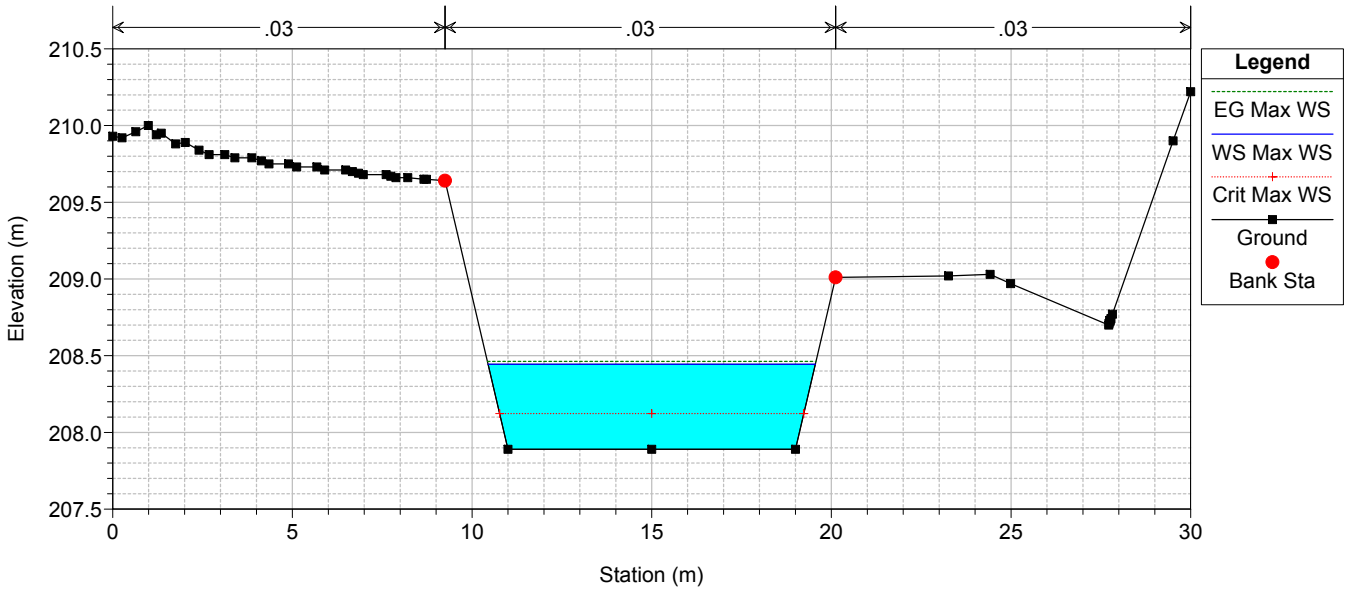

TO02-TO03-CA02-TO07_VARIO_POST

RS = -250 TO03 RS= 250

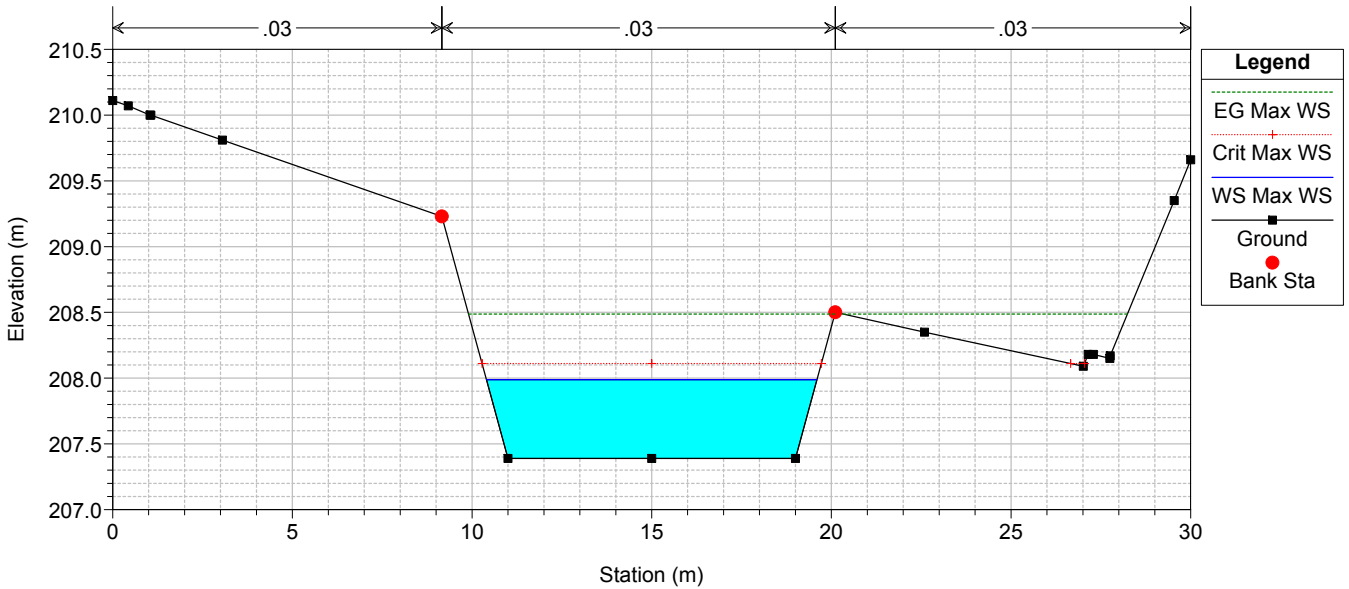

TO02-TO03-CA02-TO07_VARIO_POST

RS = -275 TO03 RS= 275

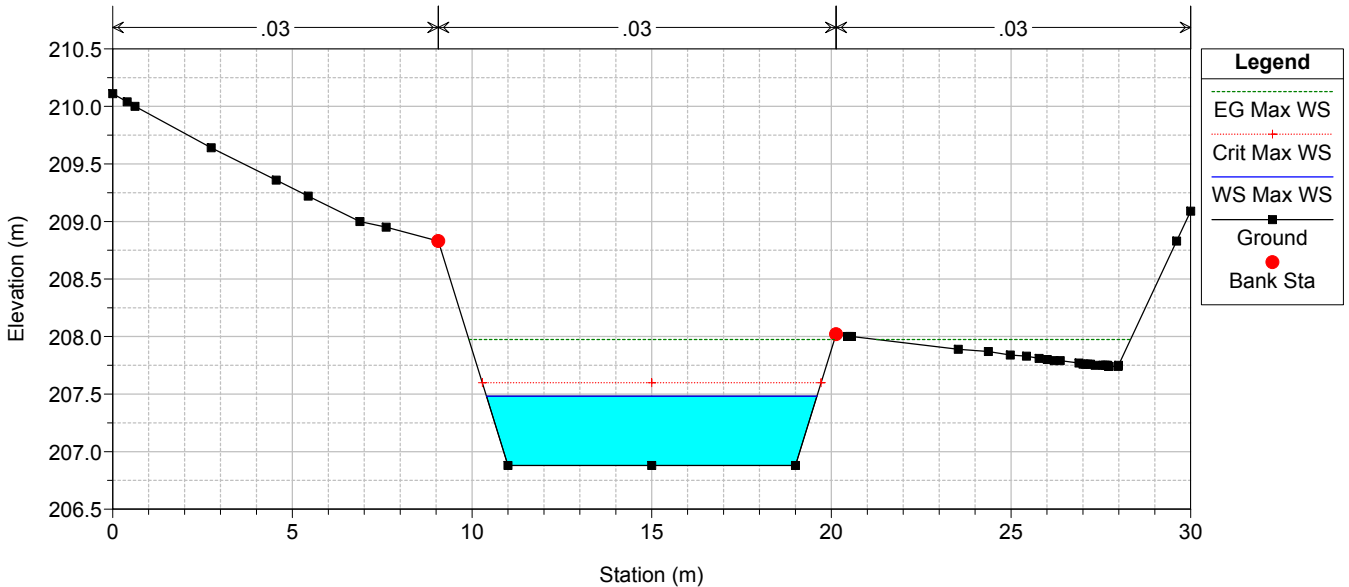

TO02-TO03-CA02-TO07_VARIO_POST

RS = -300 TO03 RS= 300

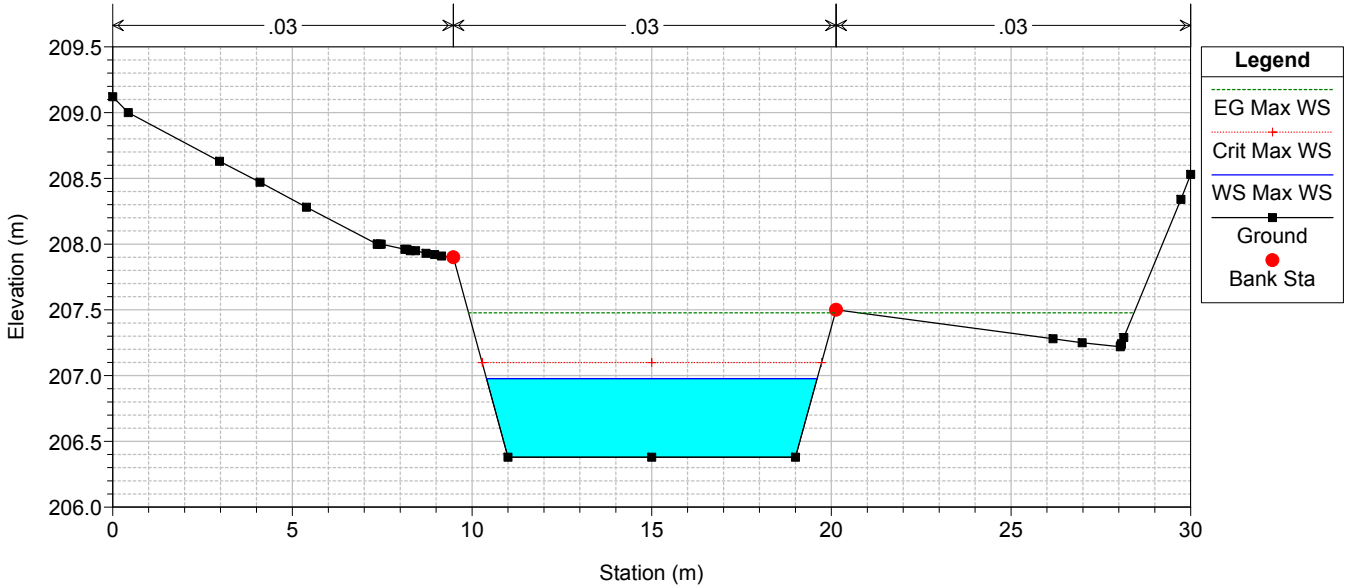

TO02-TO03-CA02-TO07_VARIO_POST

RS = -325 TO03 RS= 325

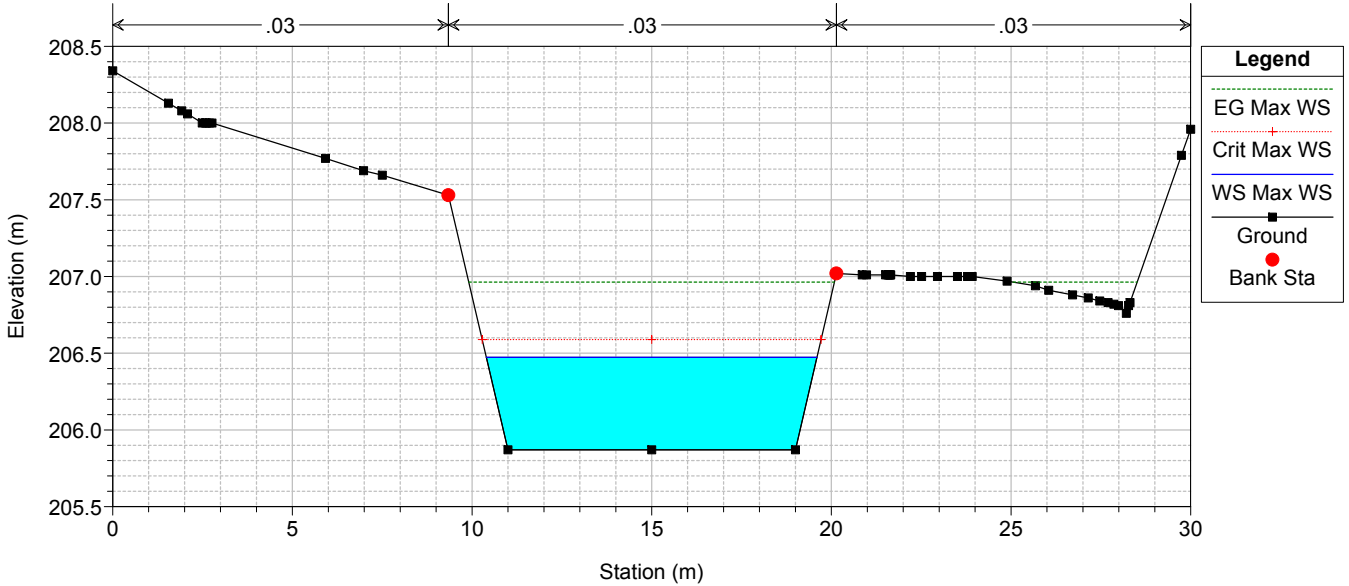

TO02-TO03-CA02-TO07_VARIO_POST

RS = -350 TO03 RS= 350

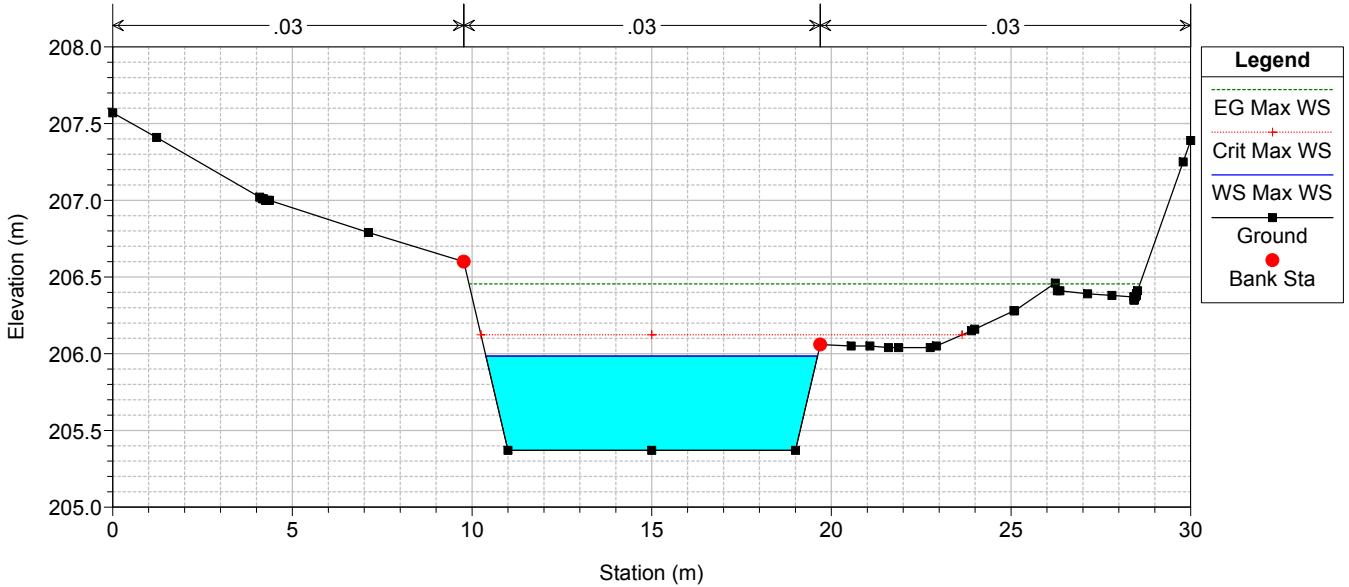

TO02-TO03-CA02-TO07_VARIO_POST

RS = -375 TO03 RS= 375

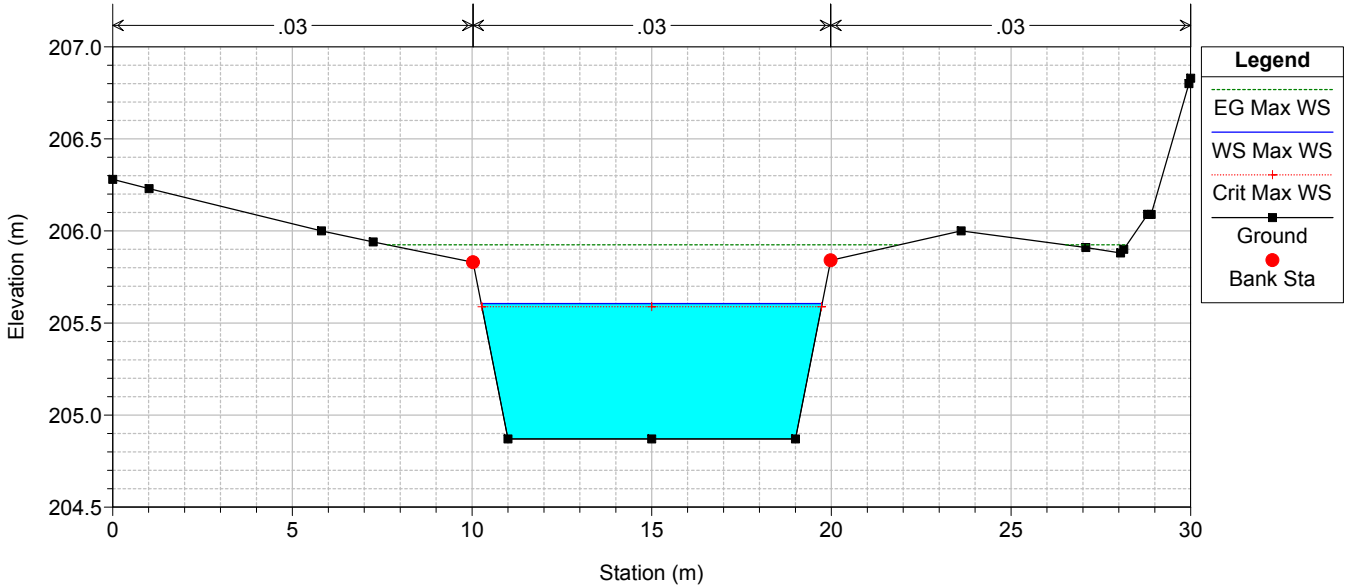

TO02-TO03-CA02-TO07_VARIO_POST

RS = -400 TO03 RS= 400

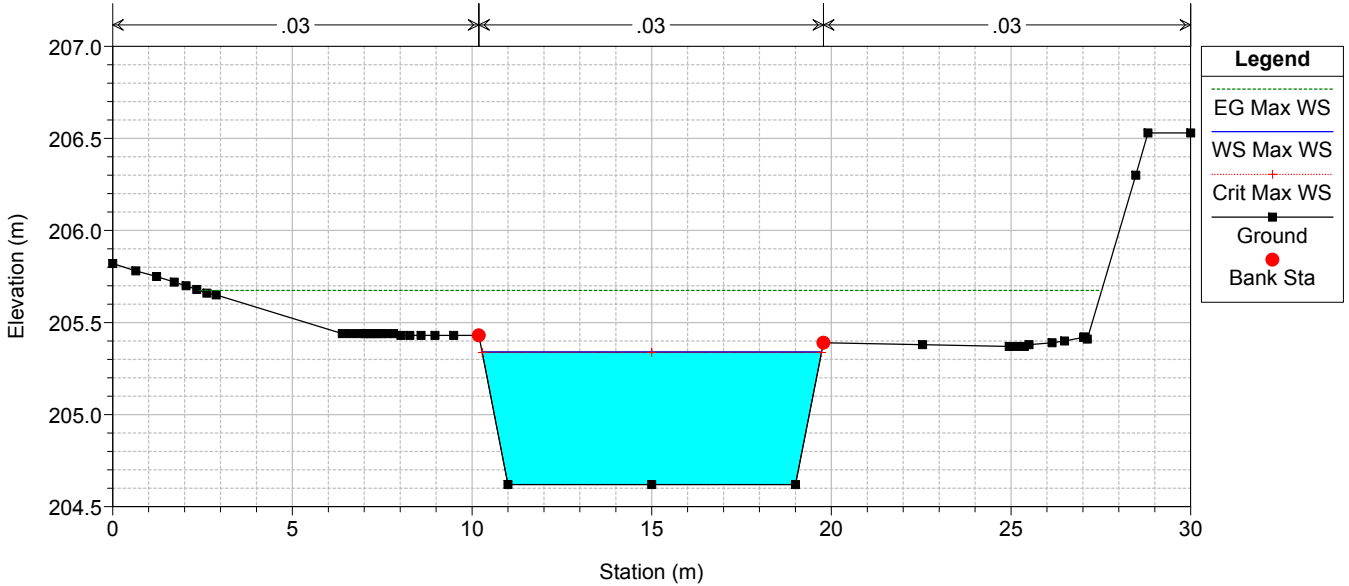

TO02-TO03-CA02-TO07_VARIO_POST

RS = -425 TO03 RS= 425

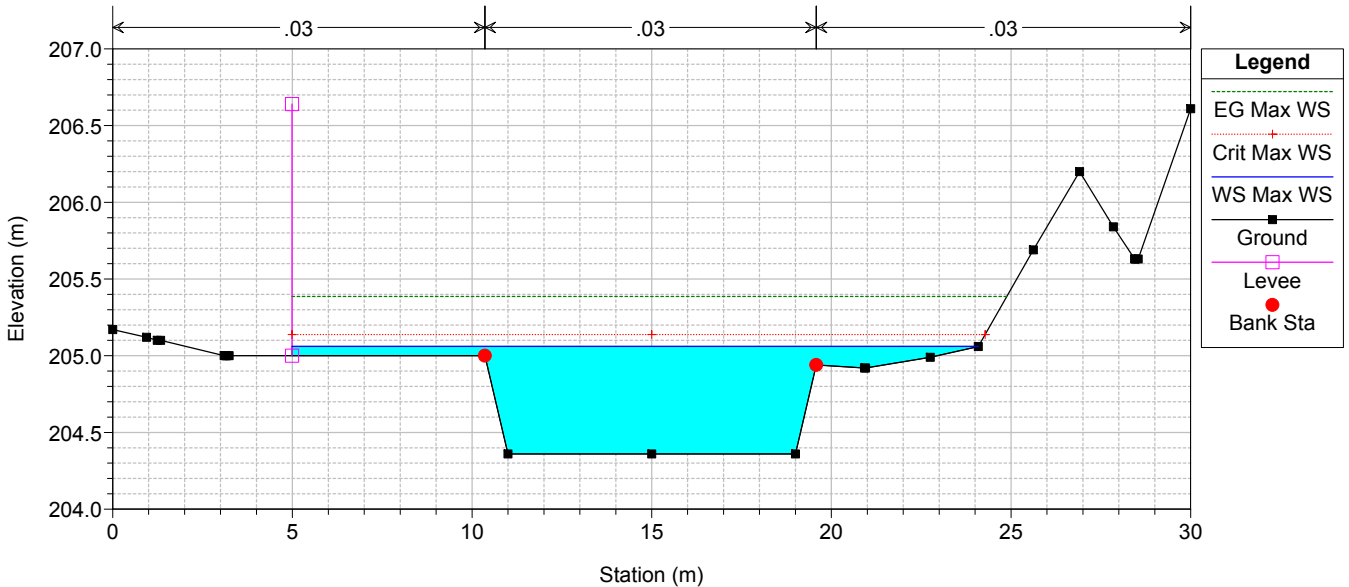

TO02-TO03-CA02-TO07_VARIO_POST

RS = -450 TO03 RS= 450

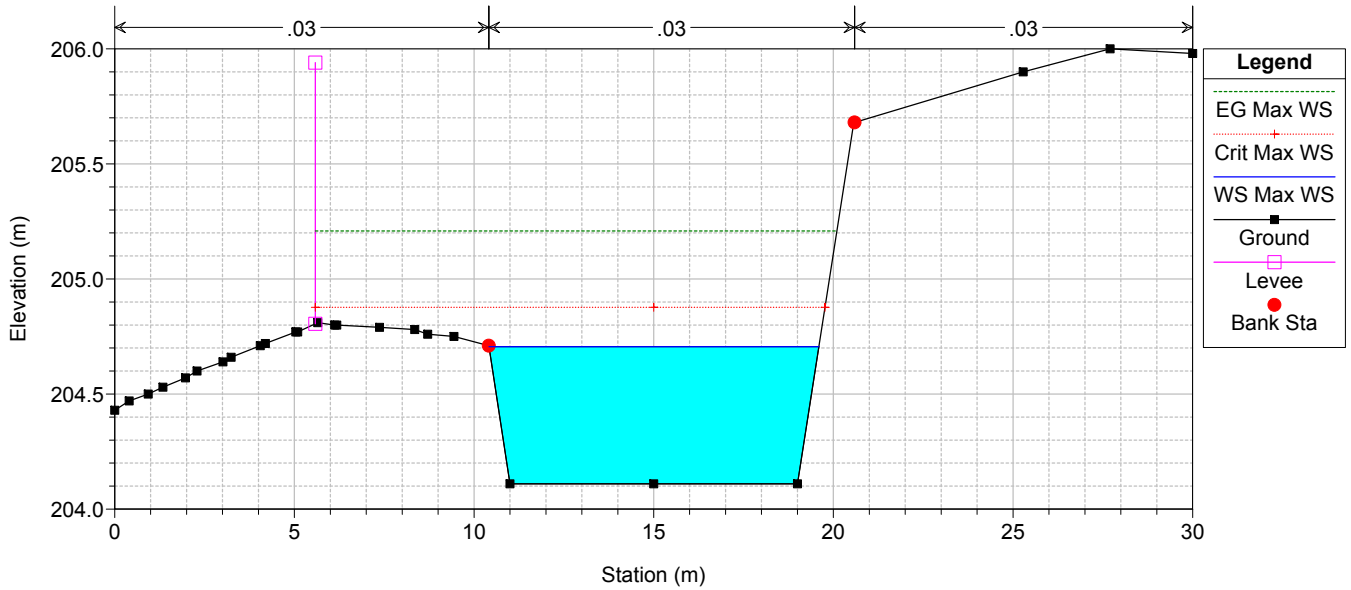

TO02-TO03-CA02-TO07_VARIO_POST

RS = -475 TO03 RS= 475

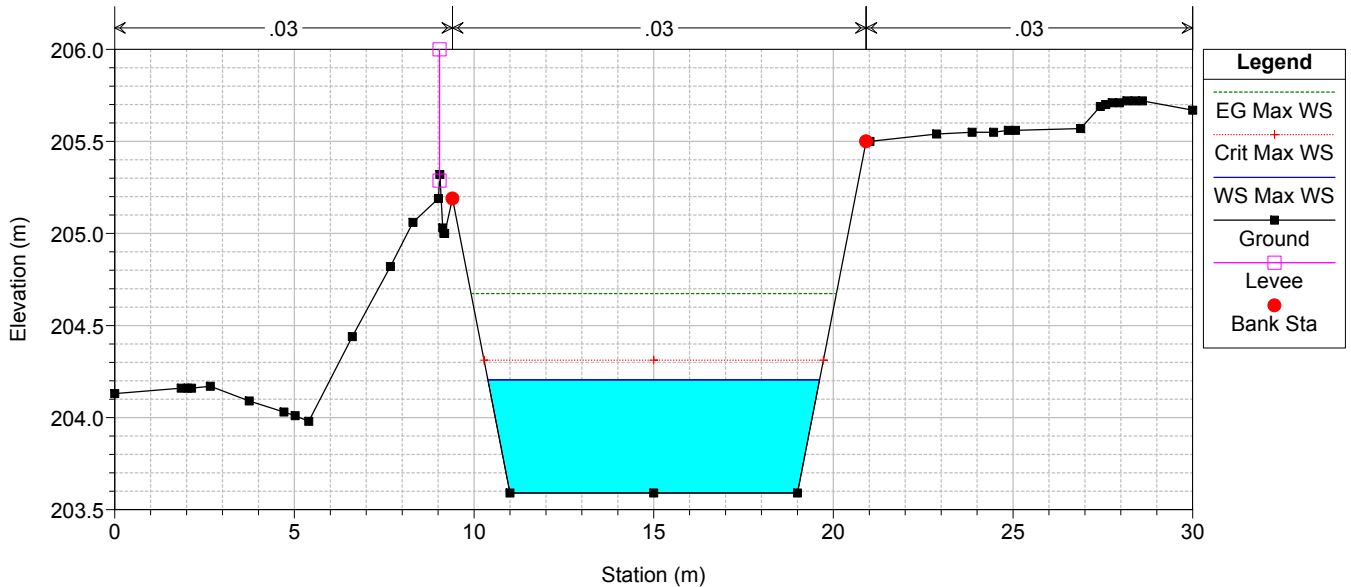

TO02-TO03-CA02-TO07_VARIO_POST

RS = -500 TO03 RS= 500

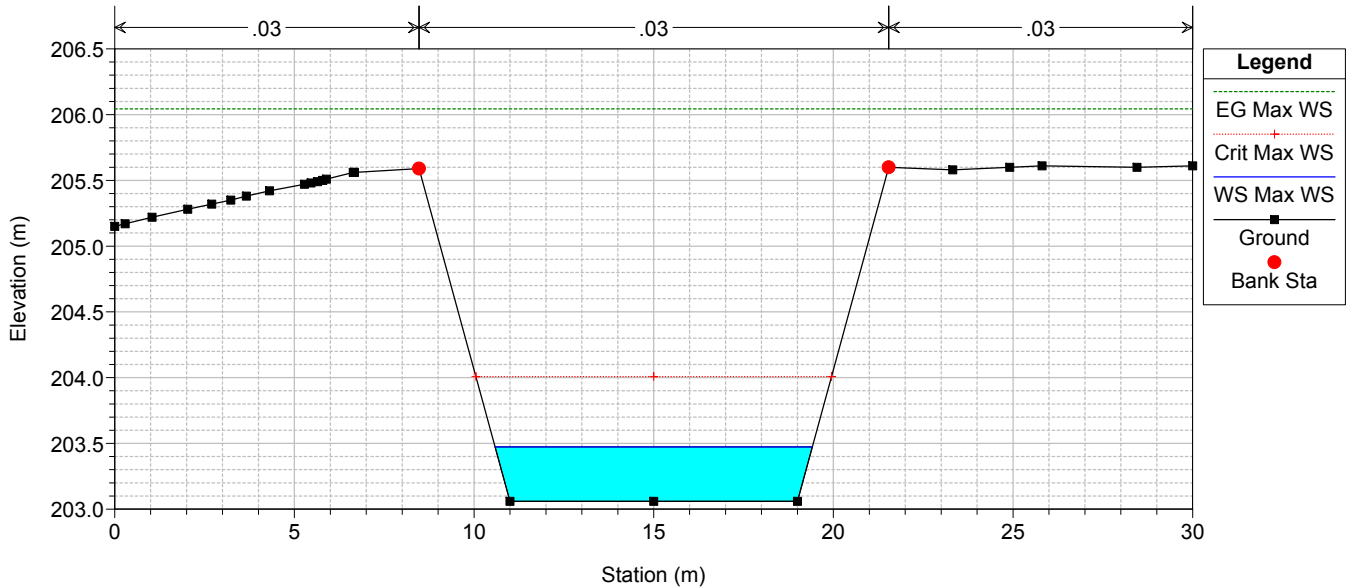

TO02-TO03-CA02-TO07_VARIO_POST

RS = -523.35 TO03 RS= 523.35

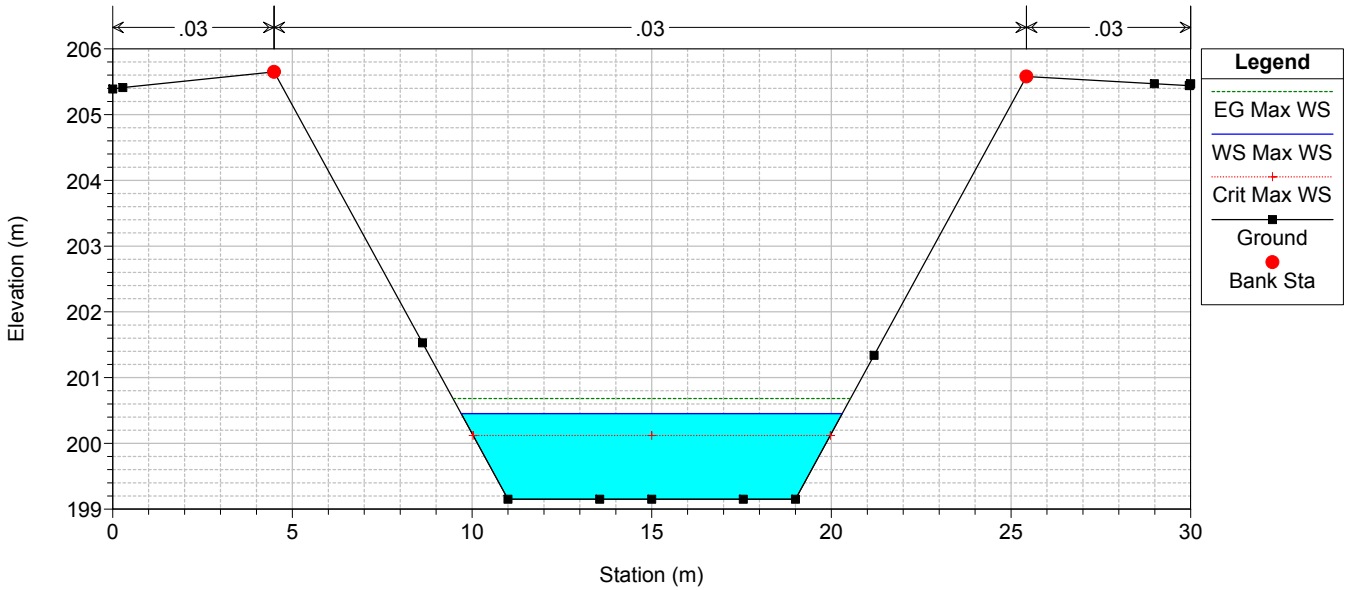

TO02-TO03-CA02-TO07_VARIO_POST

RS = -527.89 TO03 RS= 527.89

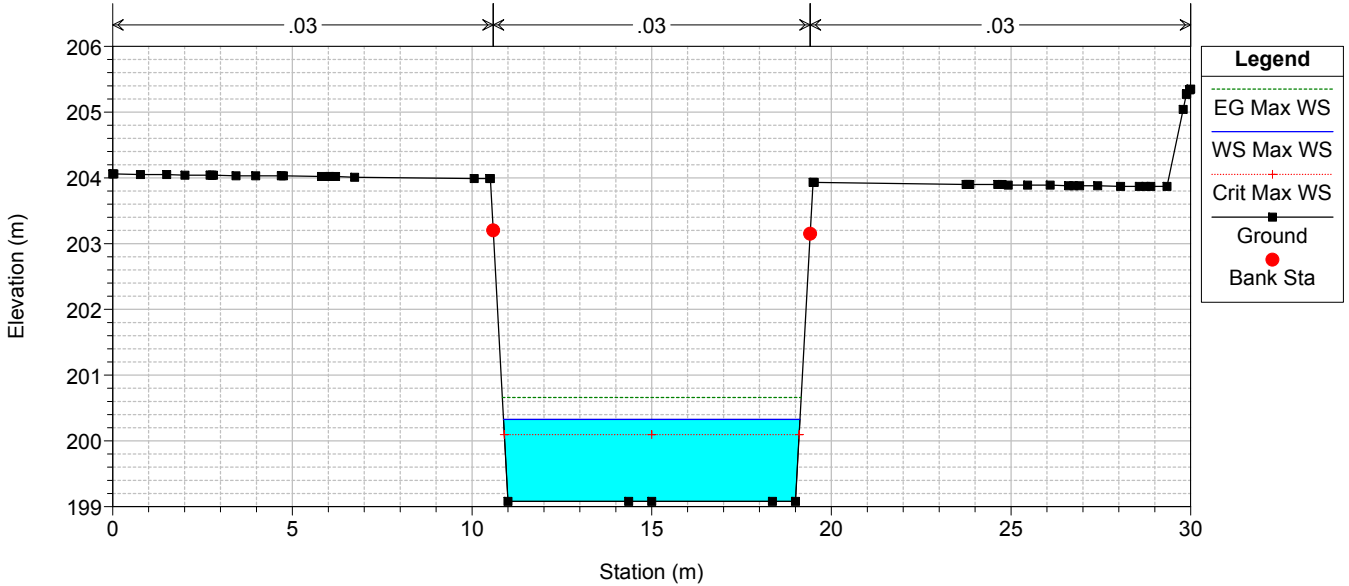

TO02-TO03-CA02-TO07_VARIO_POST

RS = -531.64 BR TO03.A

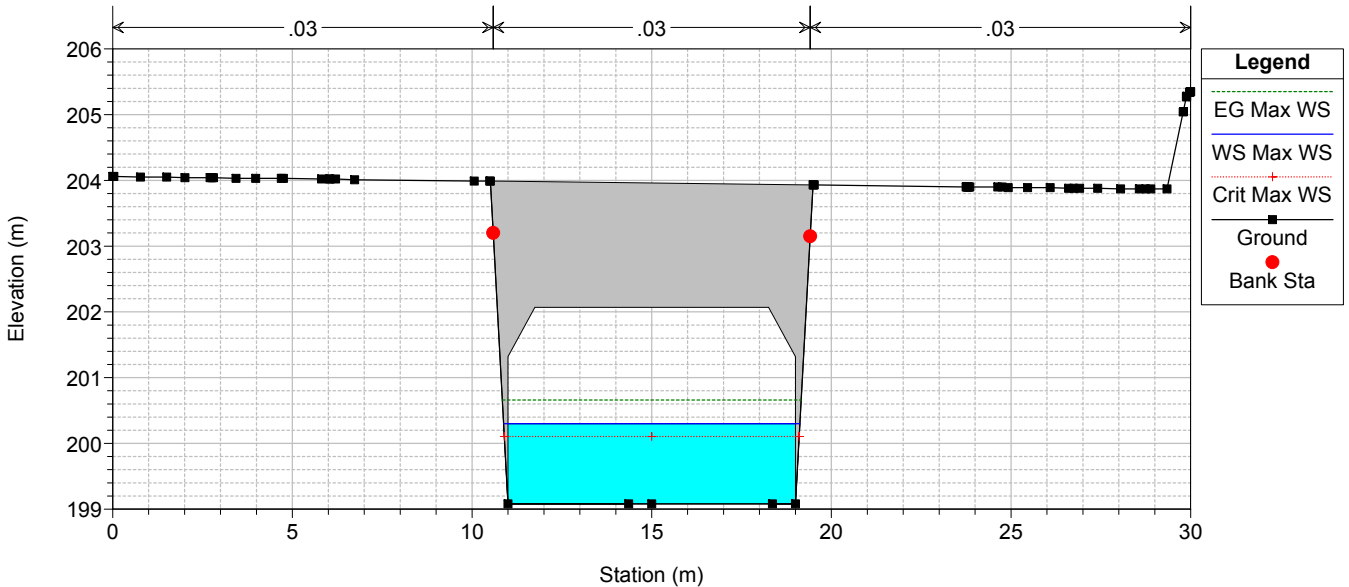

TO02-TO03-CA02-TO07_VARIO_POST

RS = -531.64 BR TO03.A

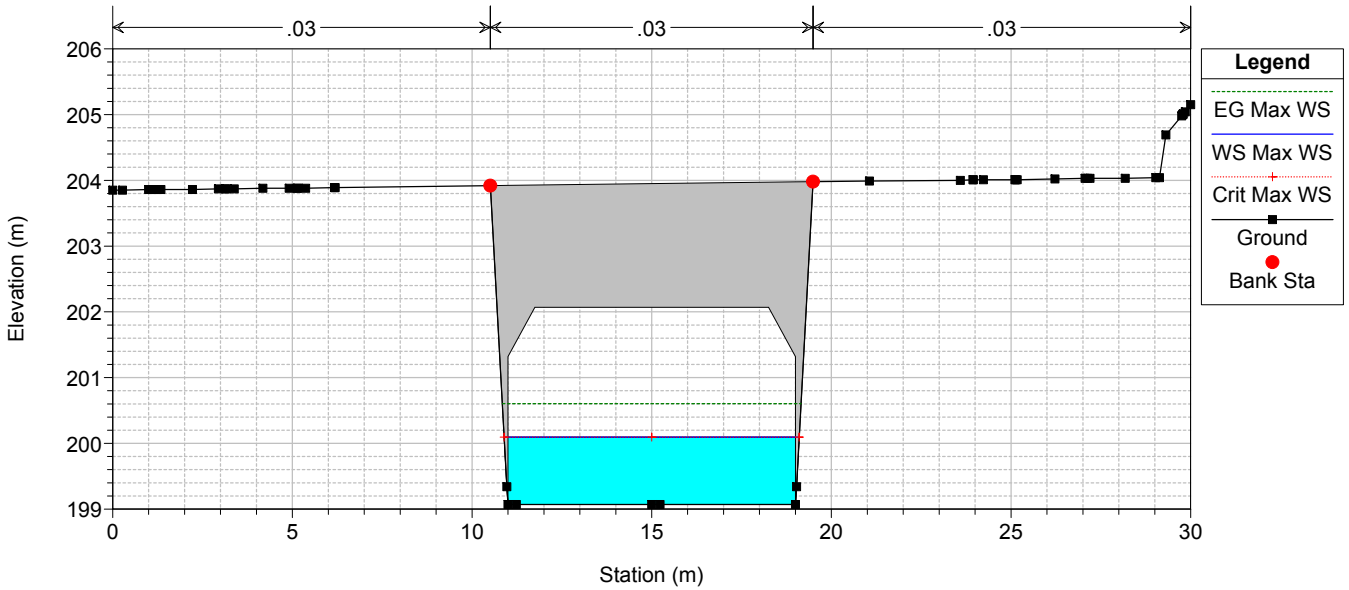

TO02-TO03-CA02-TO07_VARIO_POST

RS = -535.39 TO03 RS= 535.39

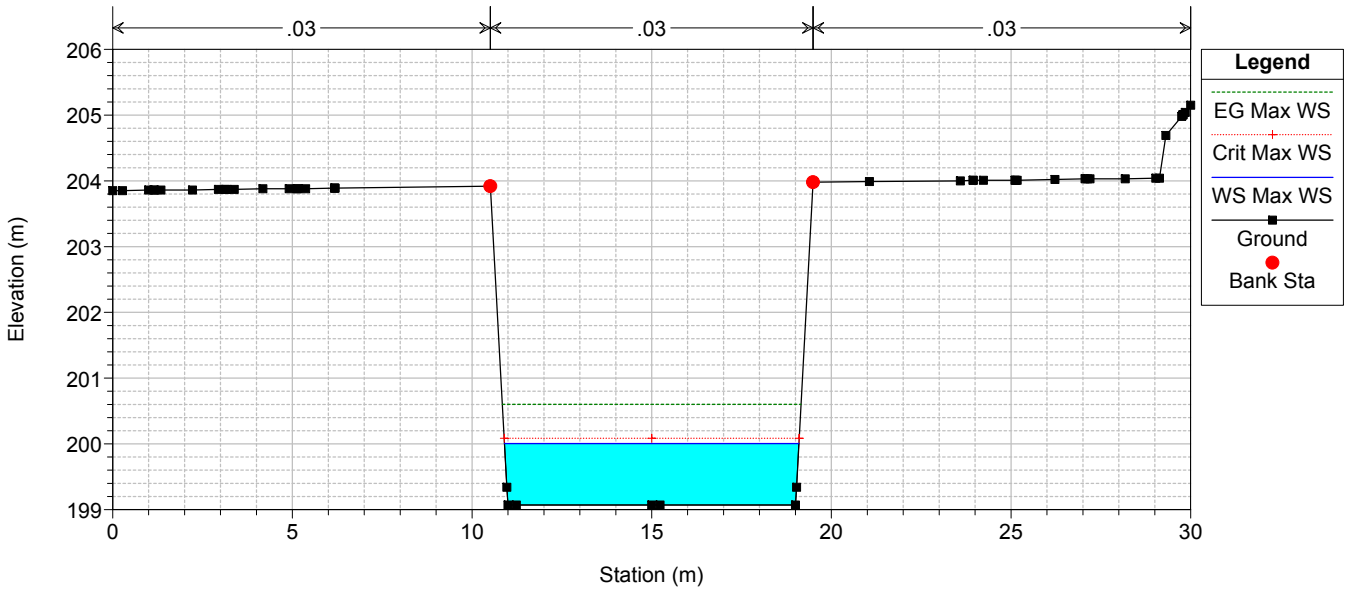

TO02-TO03-CA02-TO07_VARIO_POST

RS = -541.22 TO03 RS= 541.22

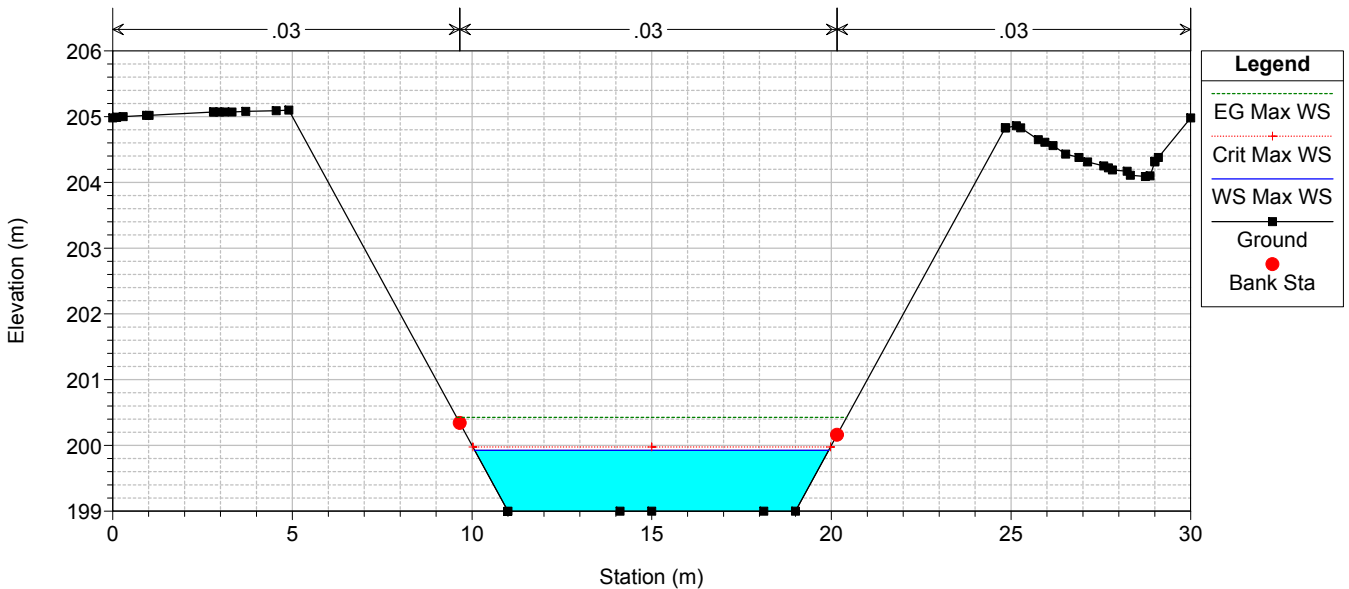

TO02-TO03-CA02-TO07_VARIO_POST

RS = -550 TO03 RS= 550

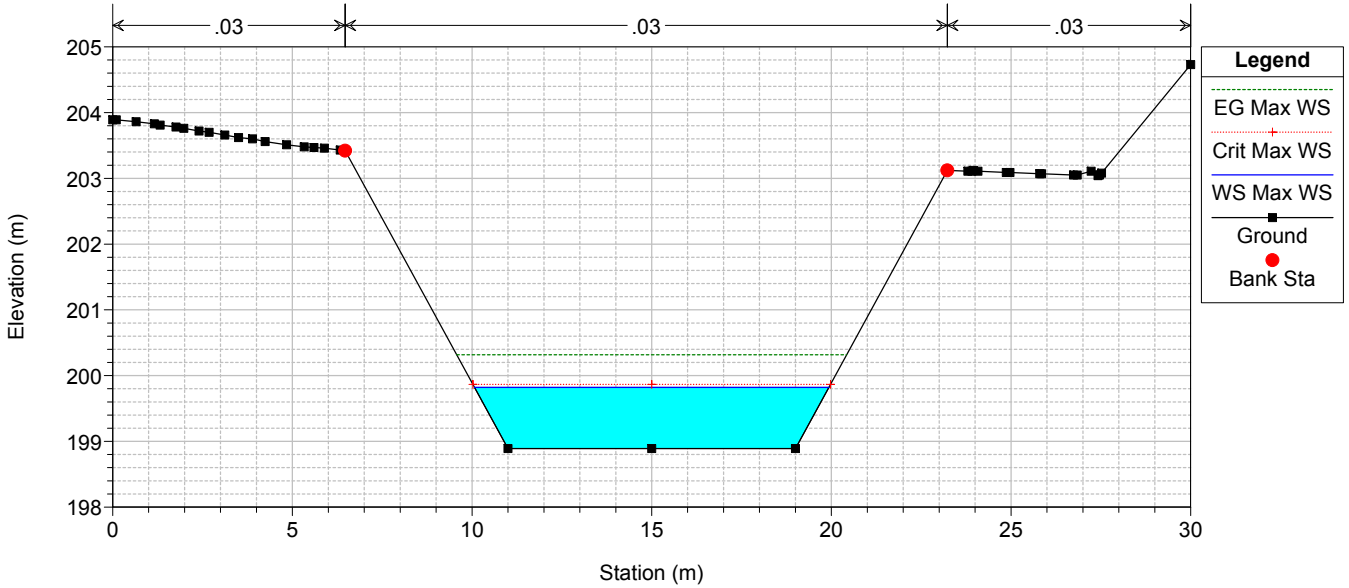

TO02-TO03-CA02-TO07_VARIO_POST

RS = -575 TO03 RS= 575

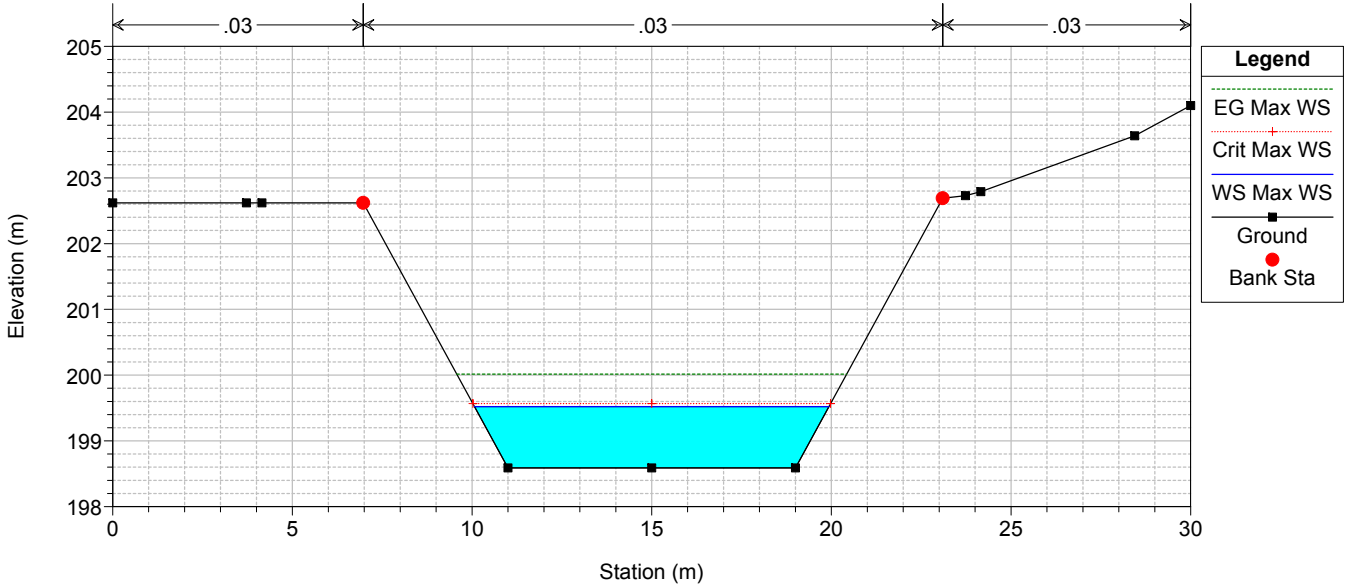

TO02-TO03-CA02-TO07_VARIO_POST

RS = -600 TO03 RS= 600

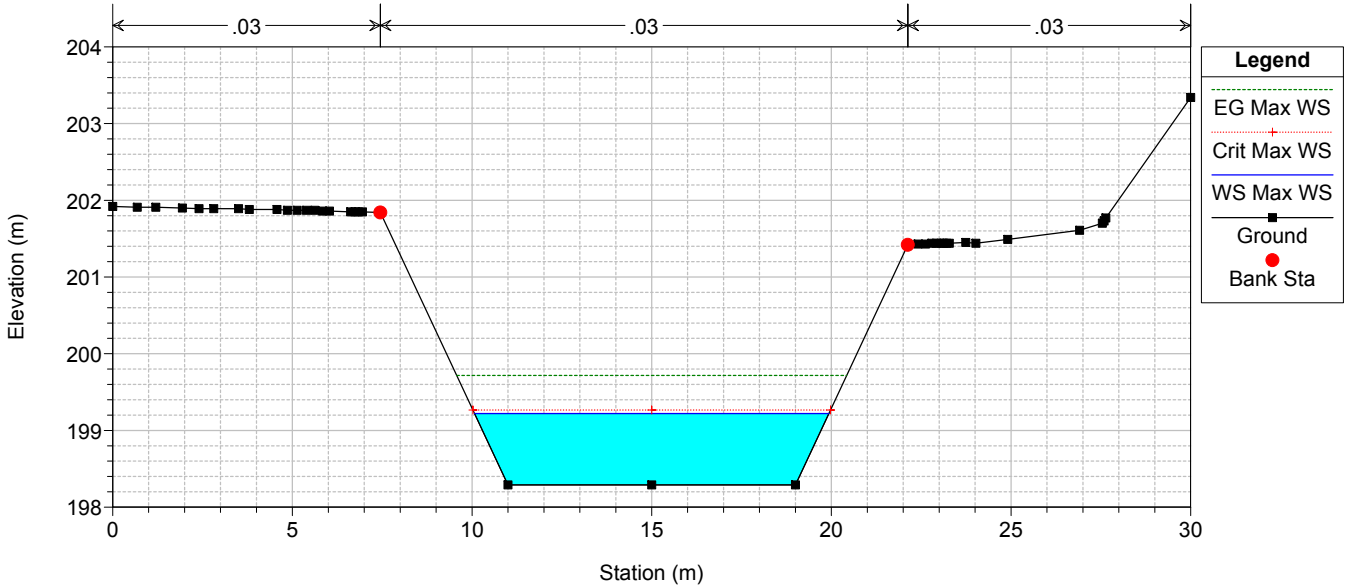

TO02-TO03-CA02-TO07_VARIO_POST

RS = -625 TO03 RS= 625

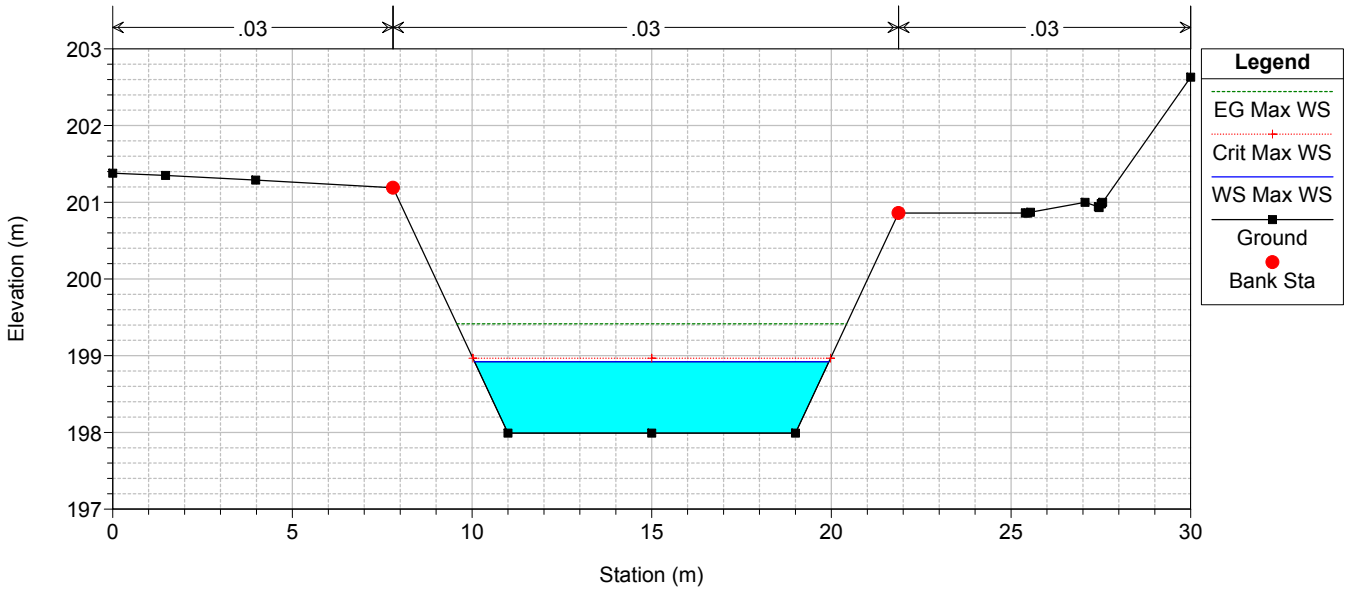

TO02-TO03-CA02-TO07_VARIO_POST

RS = -650 TO03 RS= 650

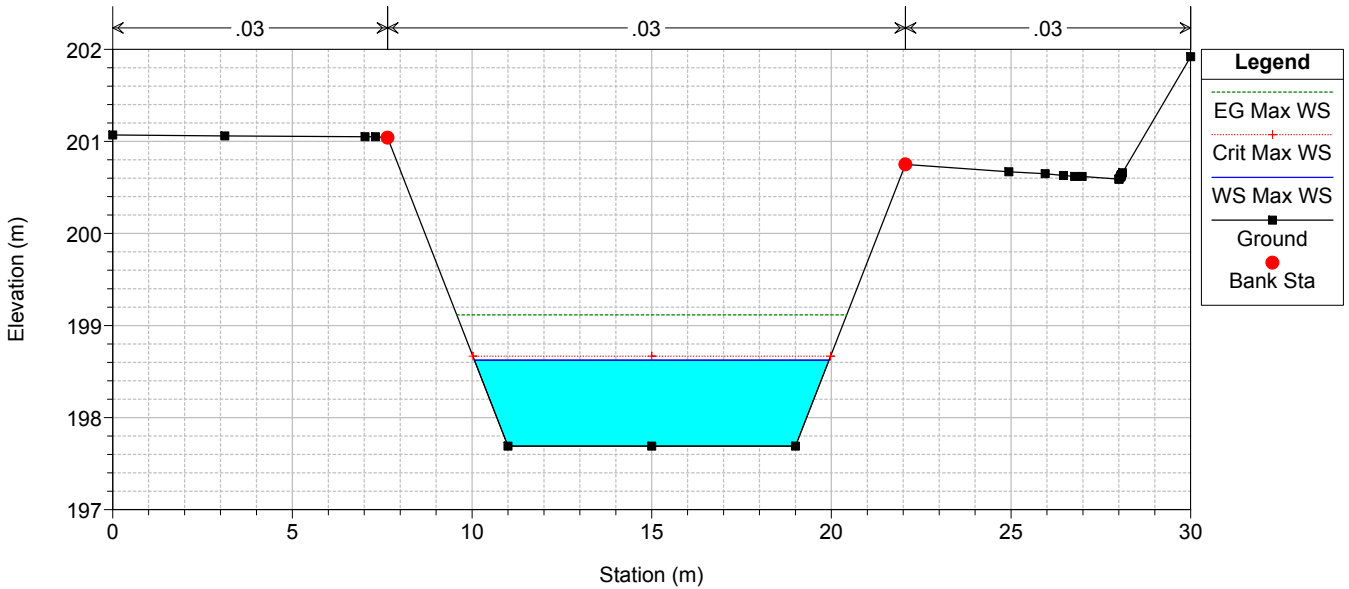

TO02-TO03-CA02-TO07_VARIO_POST

RS = -675 TO03 RS= 675

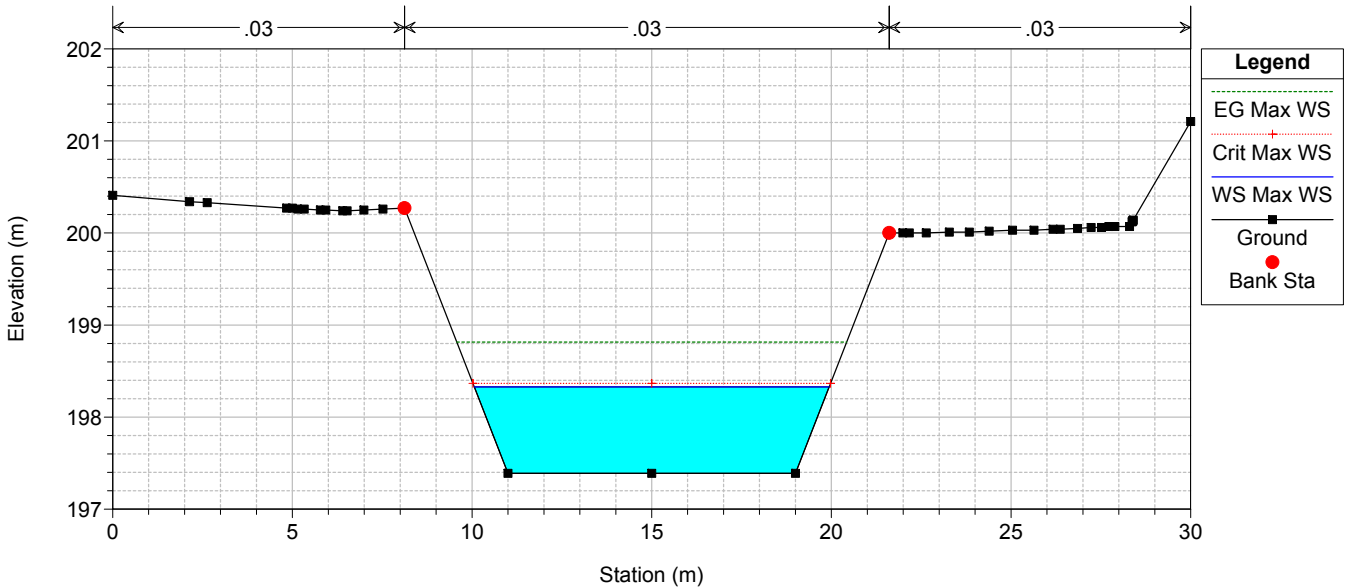

TO02-TO03-CA02-TO07_VARIO_POST

RS = -700 TO03 RS= 700

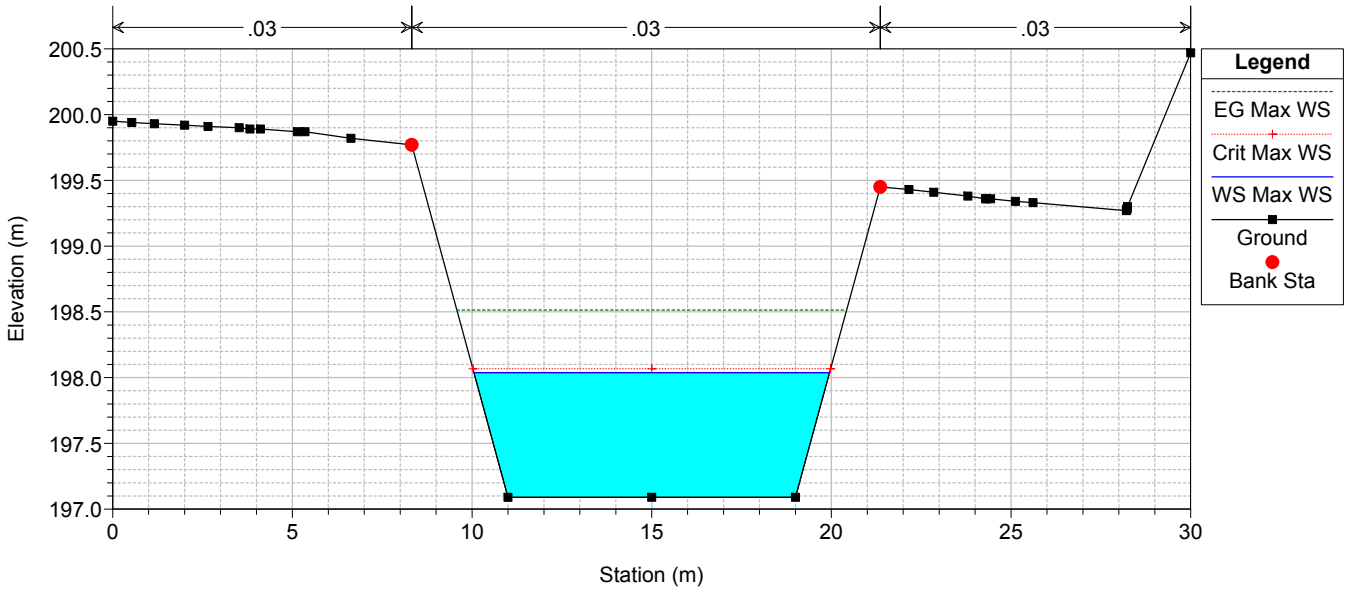

TO02-TO03-CA02-TO07_VARIO_POST

RS = -725 TO03 RS= 725

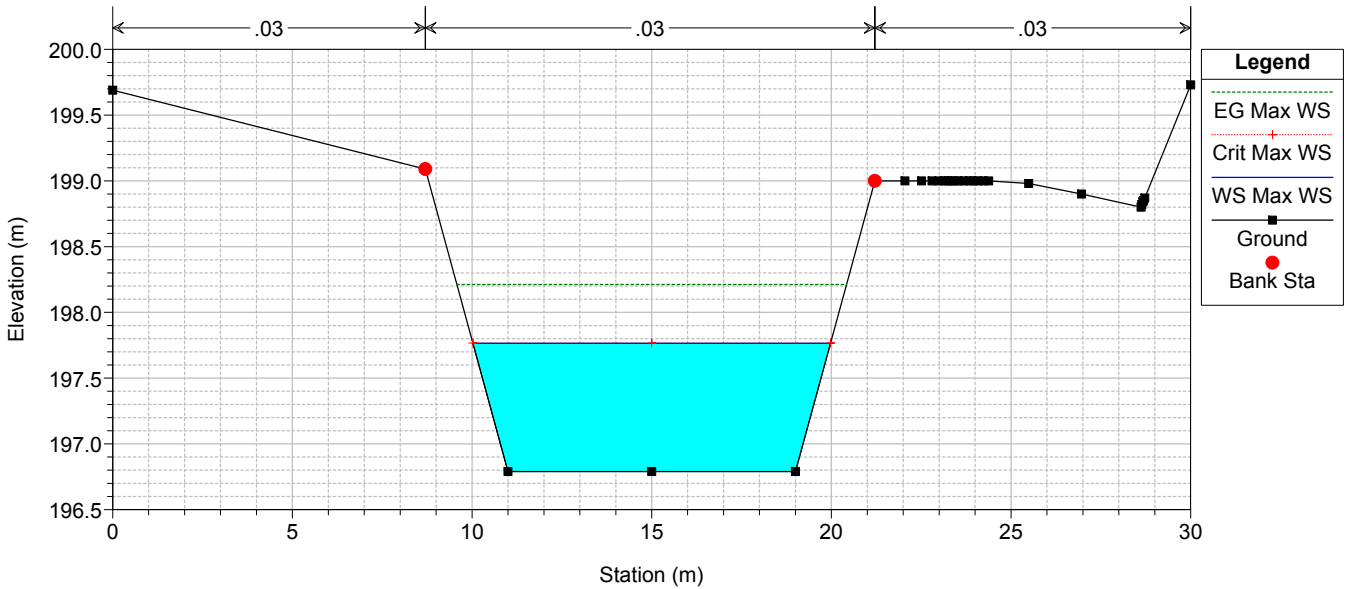

TO02-TO03-CA02-TO07_VARIO_POST

RS = -750 TO03 RS= 750

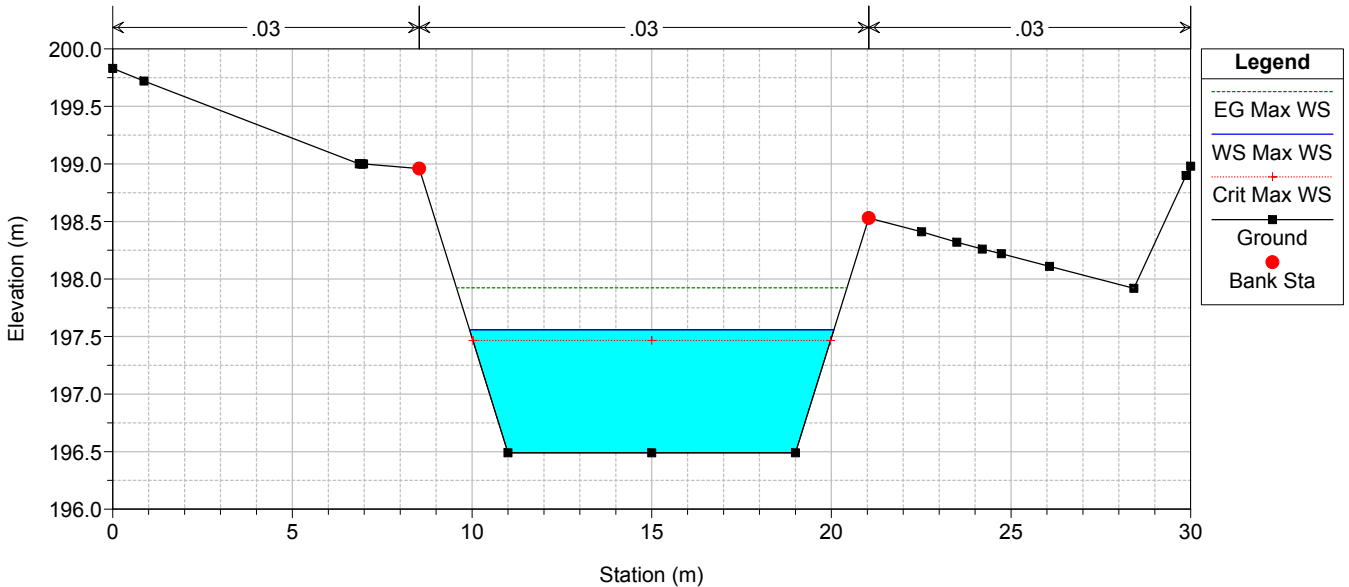

TO02-TO03-CA02-TO07_VARIO_POST

RS = -772.6 TO03 RS= 772.6

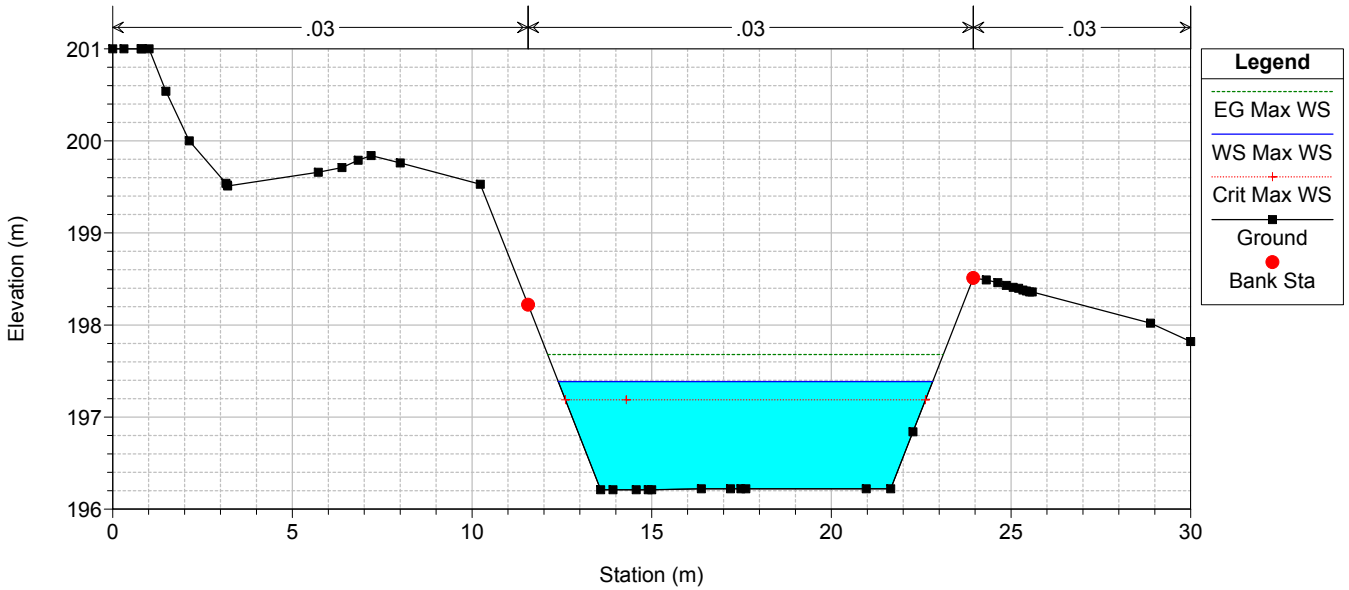

TO02-TO03-CA02-TO07_VARIO_POST

RS = -789.51 TO03 RS= 789.51

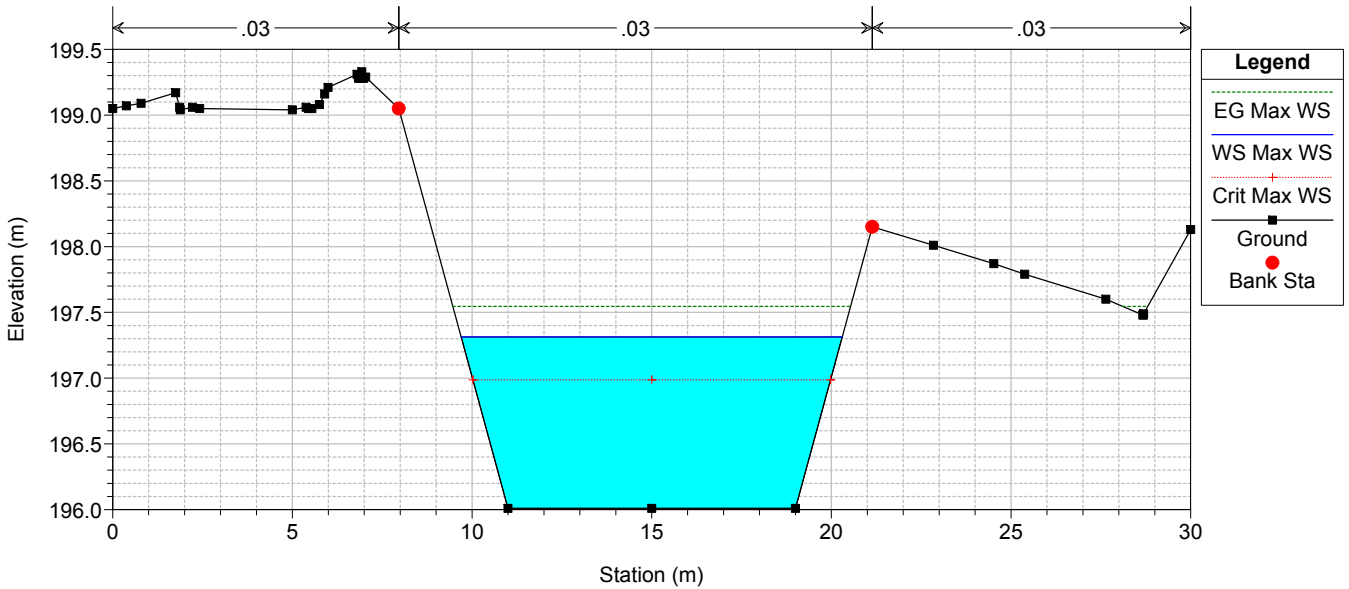

TO02-TO03-CA02-TO07_VARIO_POST

RS = -801.32 TO03 RS= 801.32

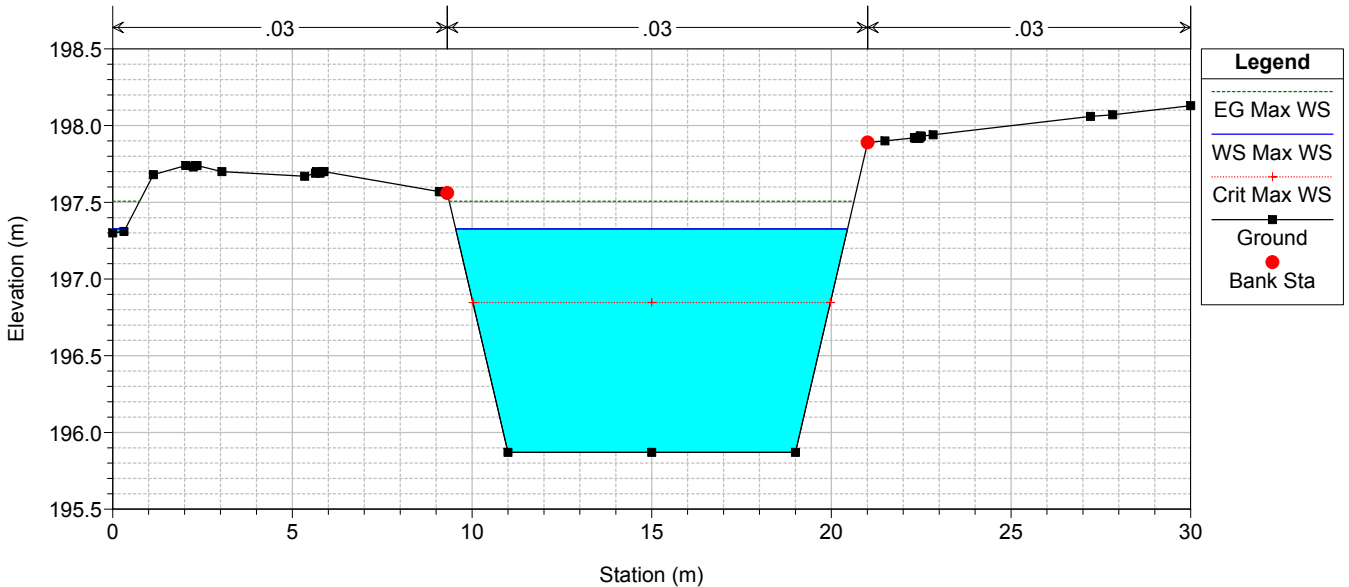

TO02-TO03-CA02-TO07_VARIO_POST

RS = -806.61 TO03 RS= 806.61

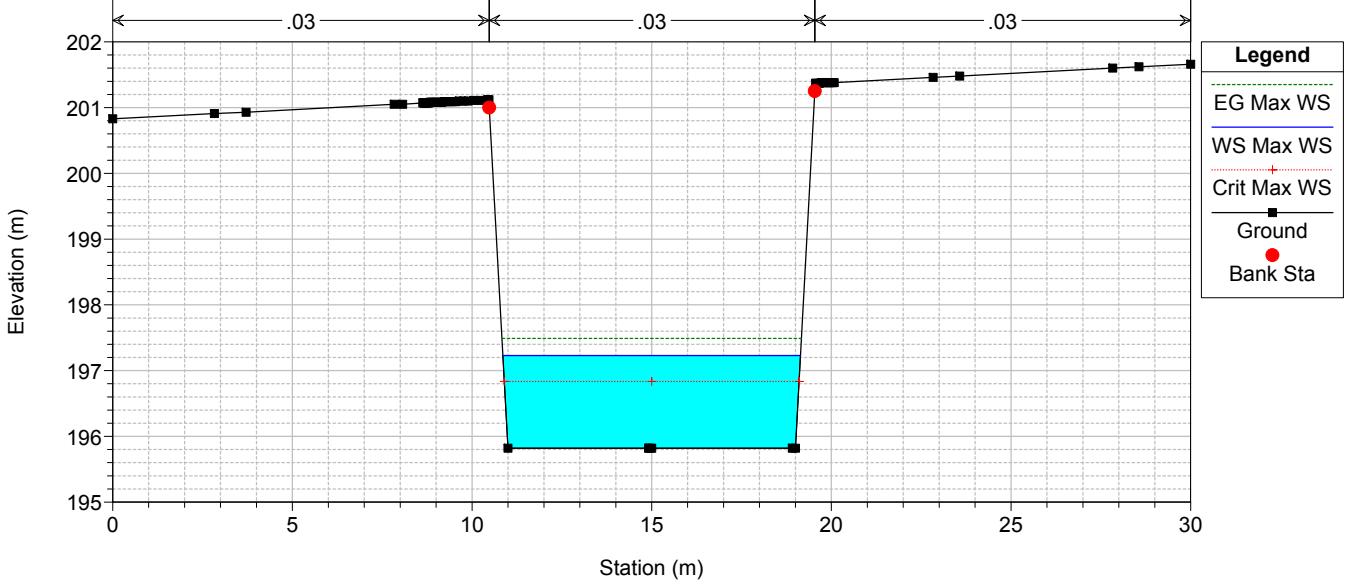

TO02-TO03-CA02-TO07_VARIO_POST

RS = -820.99 BR TO03.B

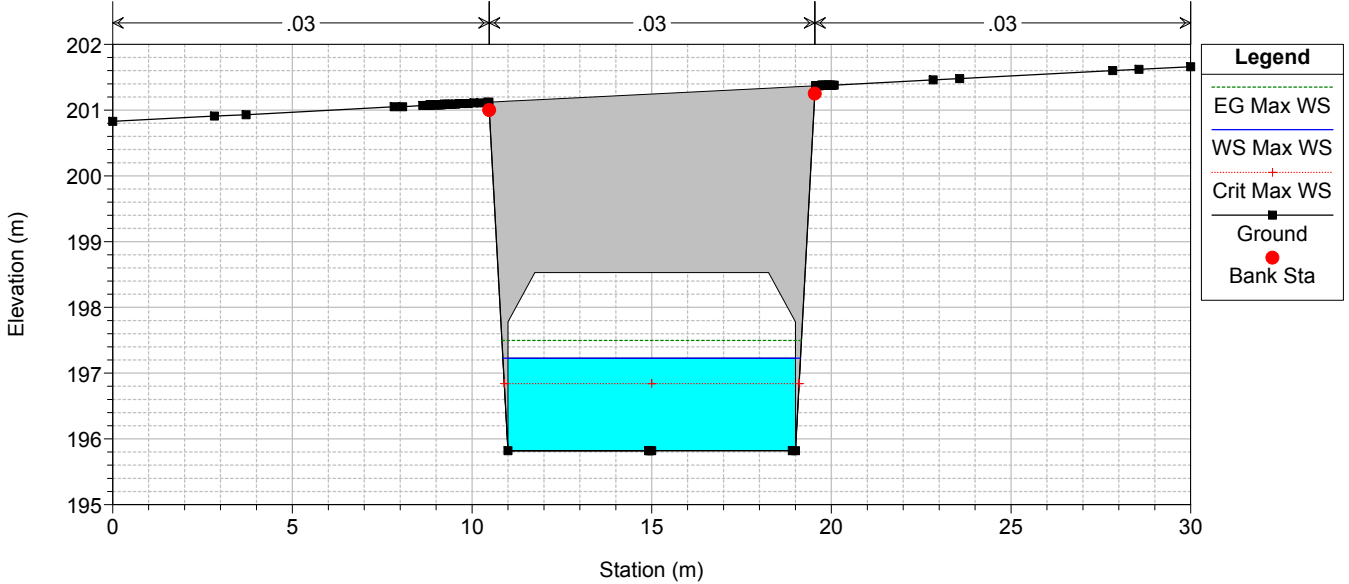

TO02-TO03-CA02-TO07_VARIO_POST

RS = -820.99 BR TO03.B

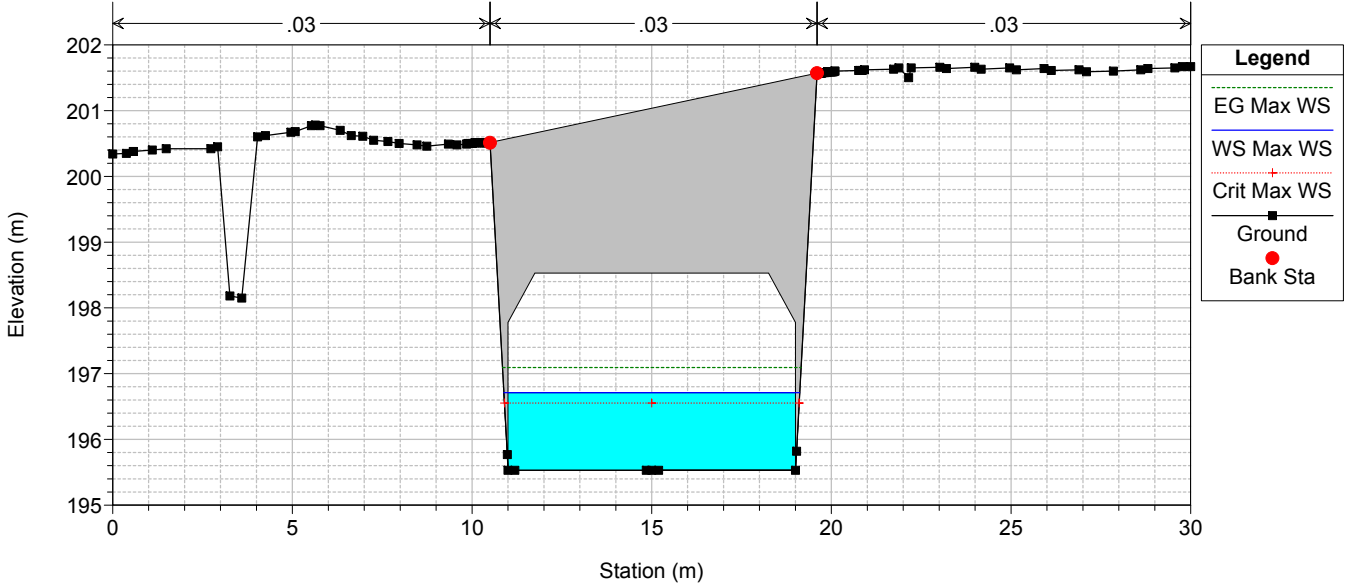

TO02-TO03-CA02-TO07_VARIO_POST

RS = -835.36 TO03 RS= 835.36

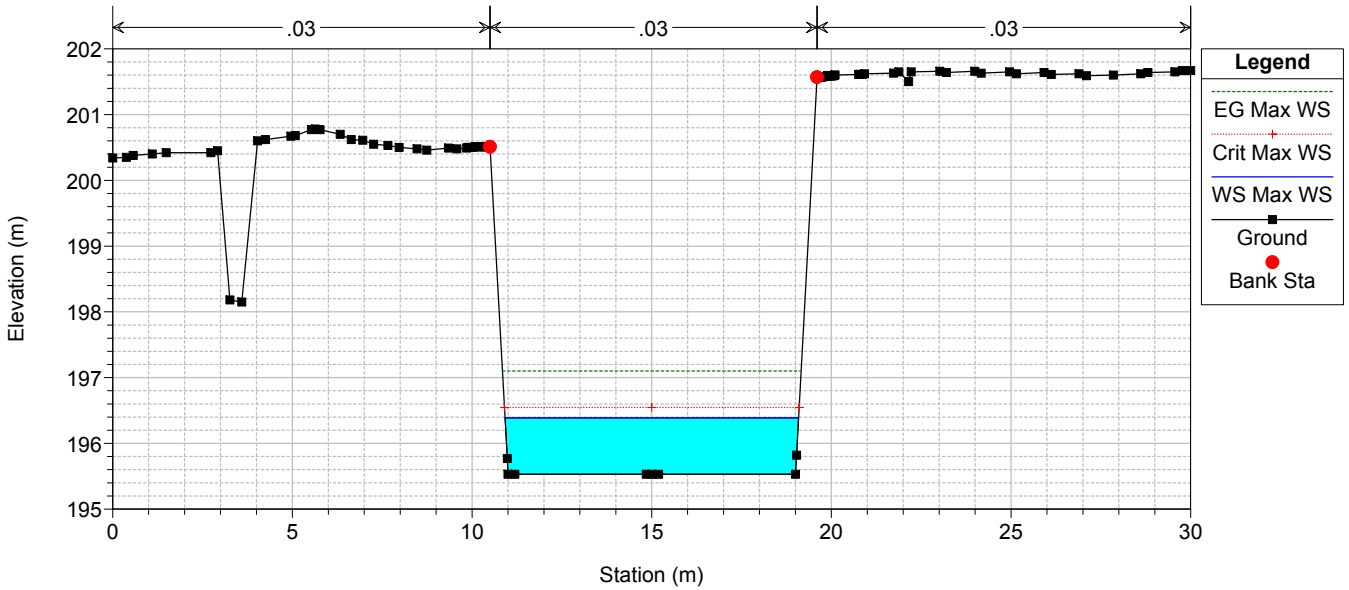

TO02-TO03-CA02-TO07_VARIO_POST

RS = -842.96 TO03 RS= 842.96

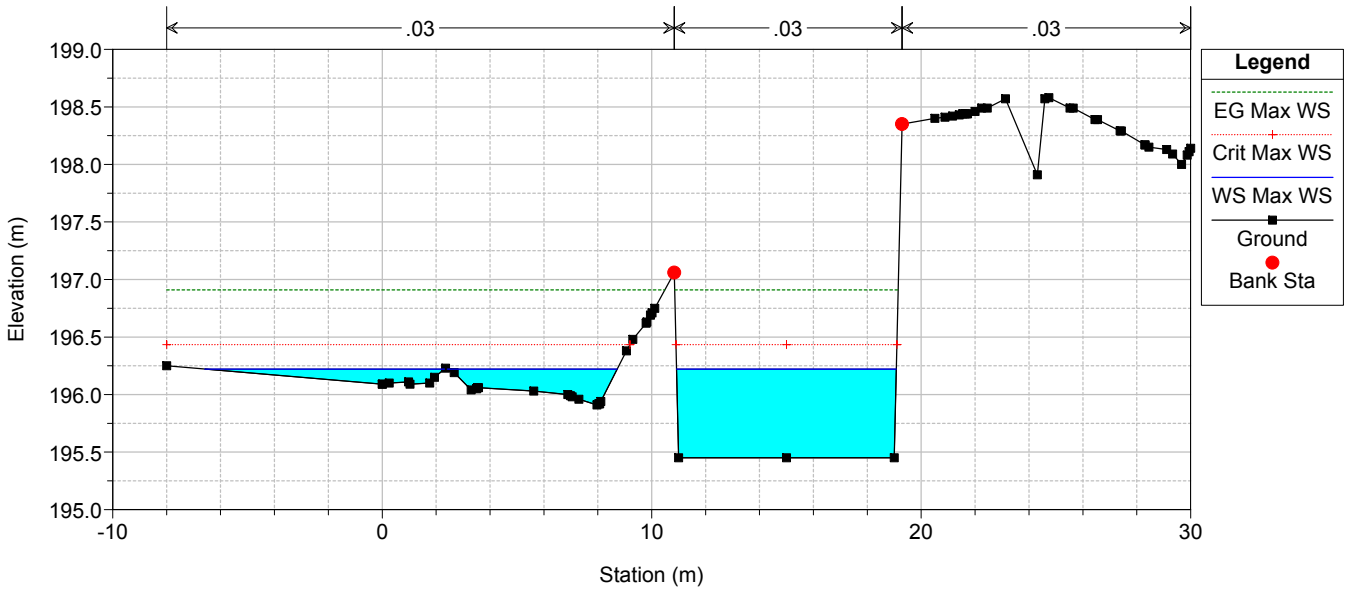

TO02-TO03-CA02-TO07_VARIO_POST

RS = -849 TO03 RS= 849

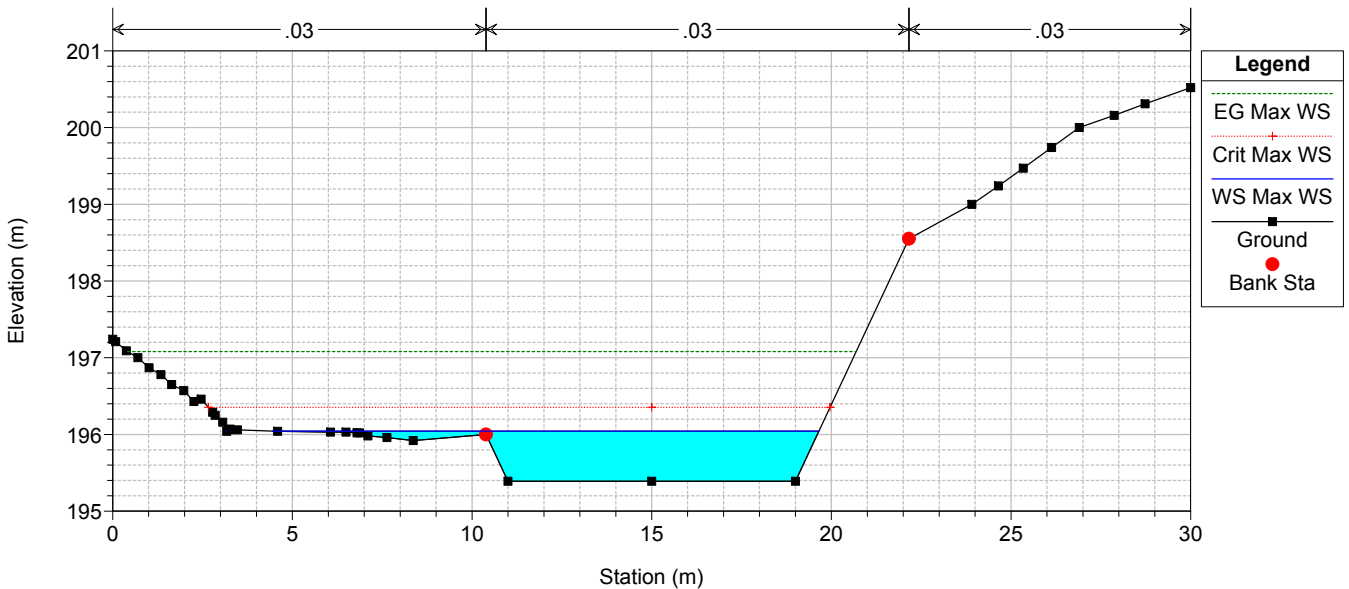

TO02-TO03-CA02-TO07_VARIO_POST

RS = -851.72 TO03 RS= 851.72

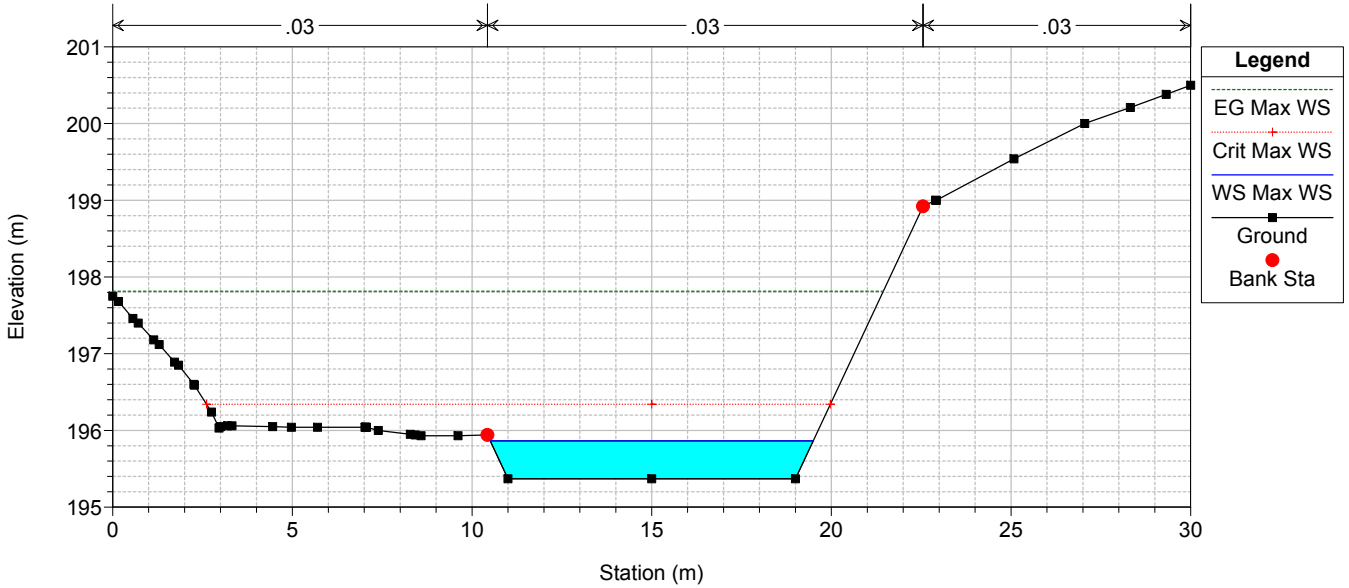

TO02-TO03-CA02-TO07_VARIO_POST

RS = -872.81 TO03 RS= 872.81

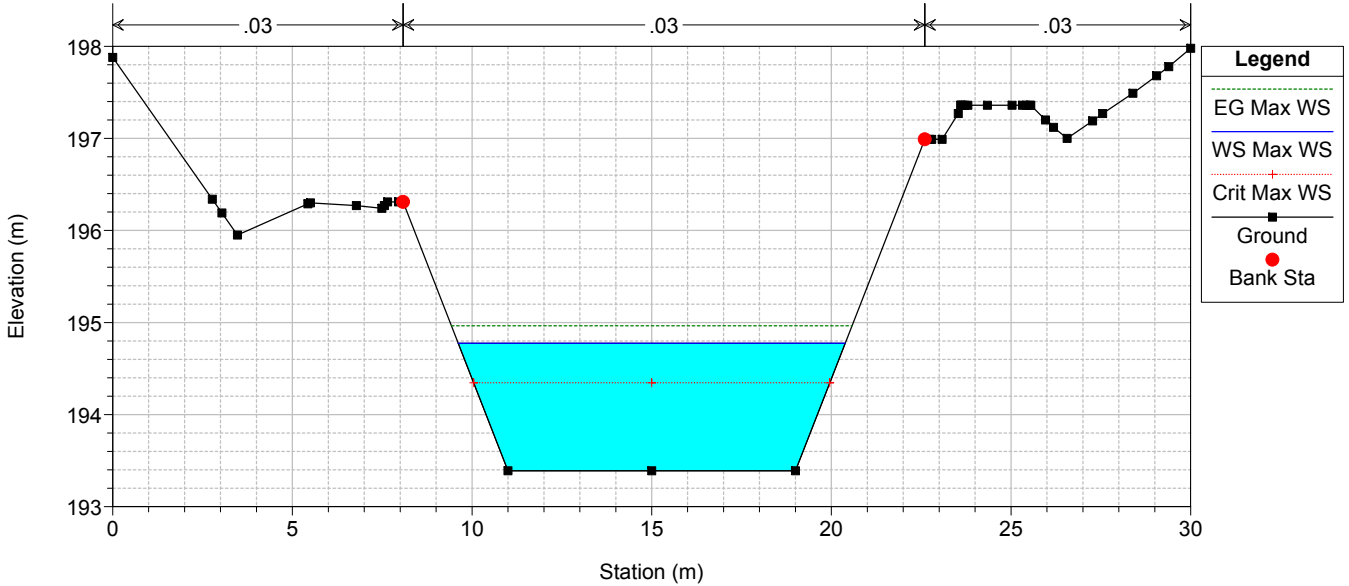

TO02-TO03-CA02-TO07_VARIO_POST

RS = -877.6 TO03 RS= 877.6

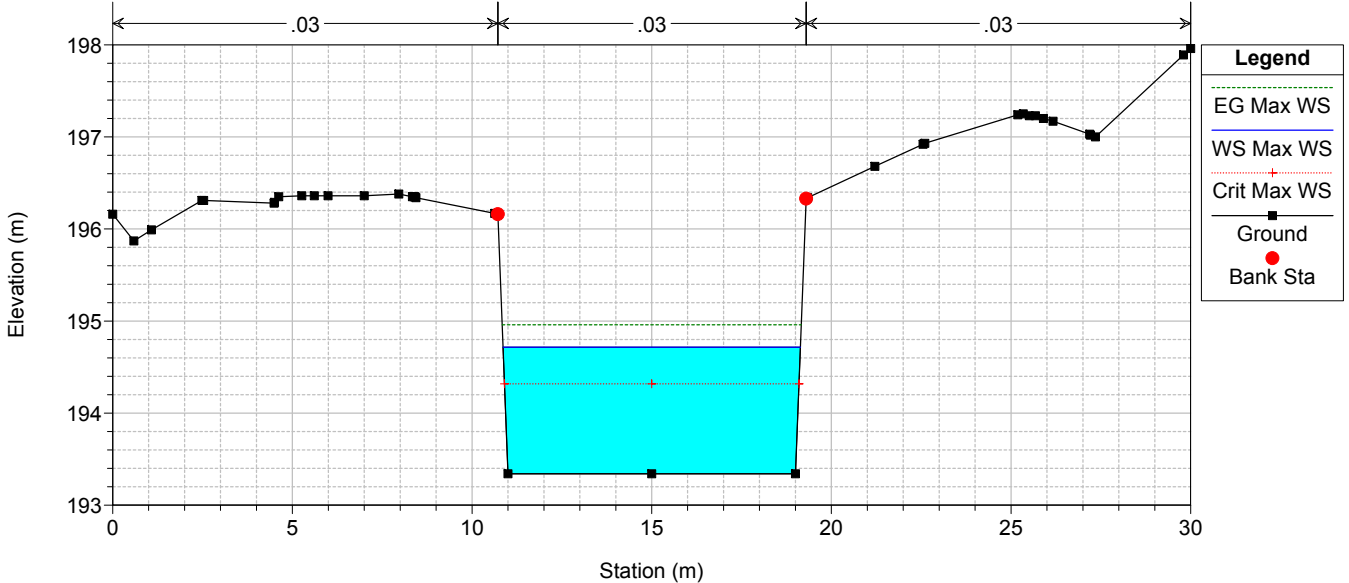

TO02-TO03-CA02-TO07_VARIO_POST

RS = -881.34 BR TO03.C

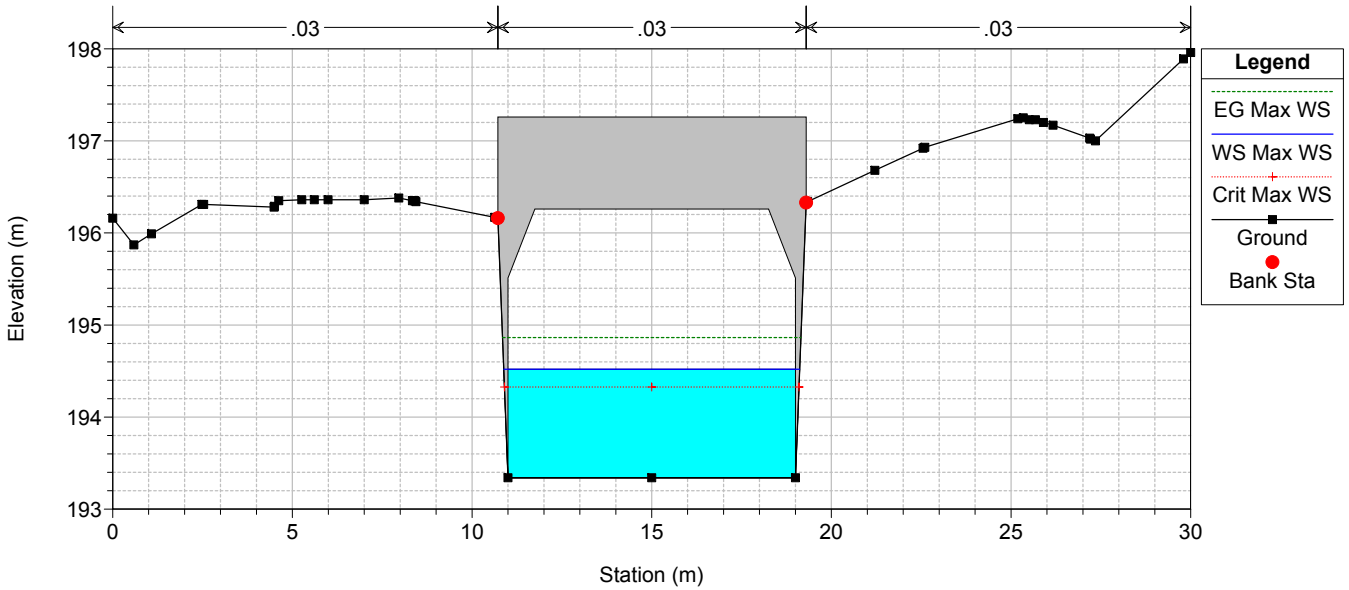

TO02-TO03-CA02-TO07_VARIO_POST

RS = -881.34 BR TO03.C

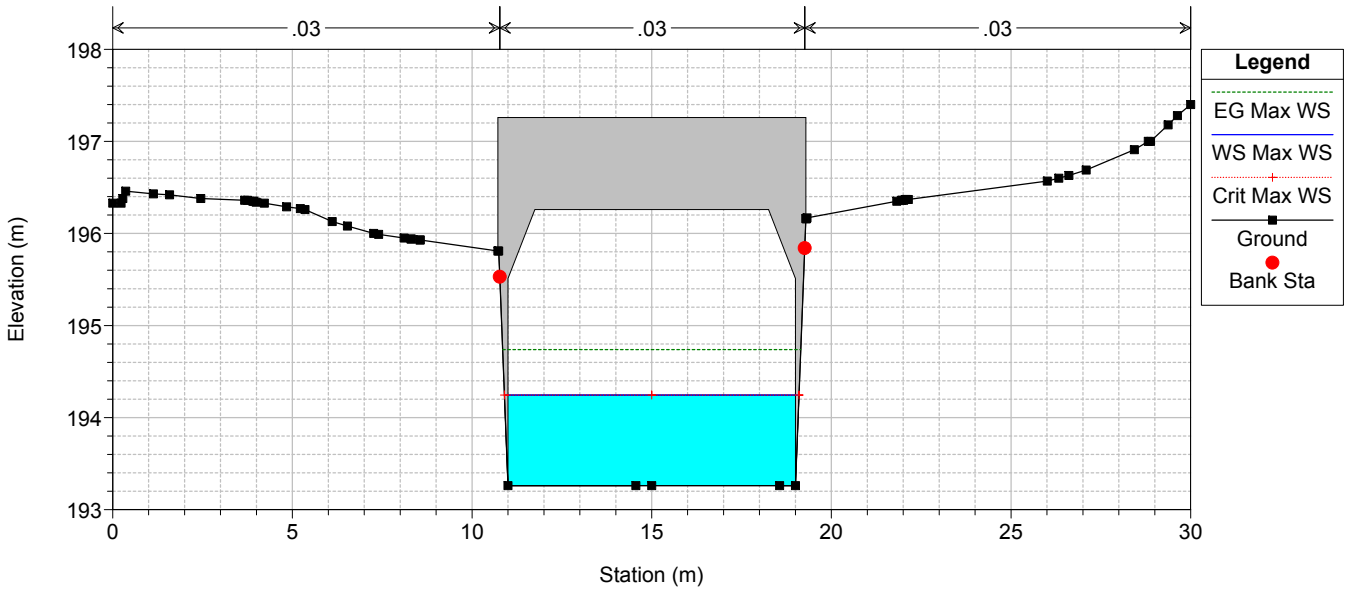

TO02-TO03-CA02-TO07_VARIO_POST

RS = -885.08 TO03 RS= 885.08

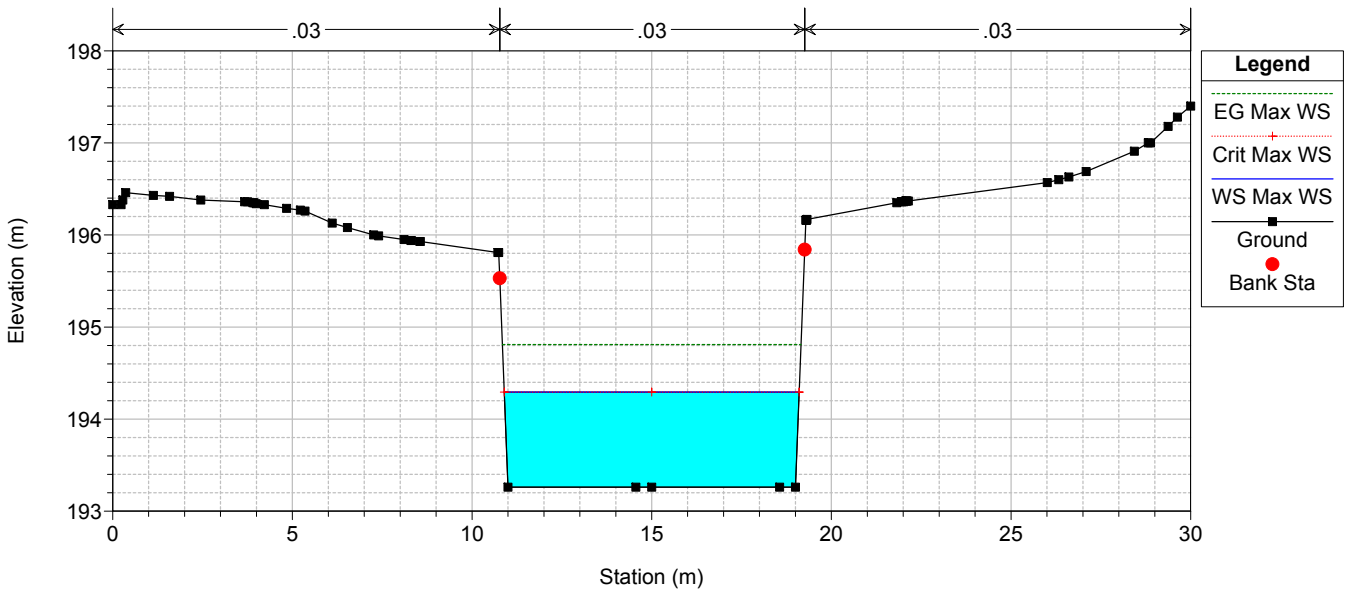

TO02-TO03-CA02-TO07_VARIO_POST

RS = -890.74 TO03 RS= 890.74

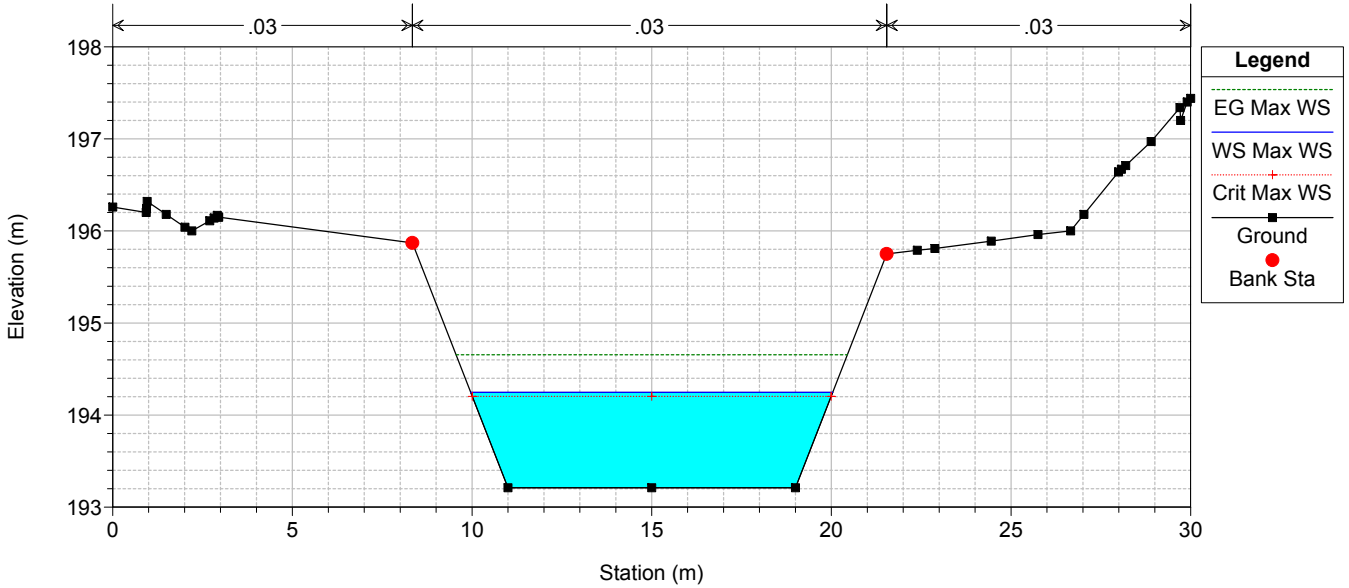

TO02-TO03-CA02-TO07_VARIO_POST

RS = -900 TO03 RS= 900

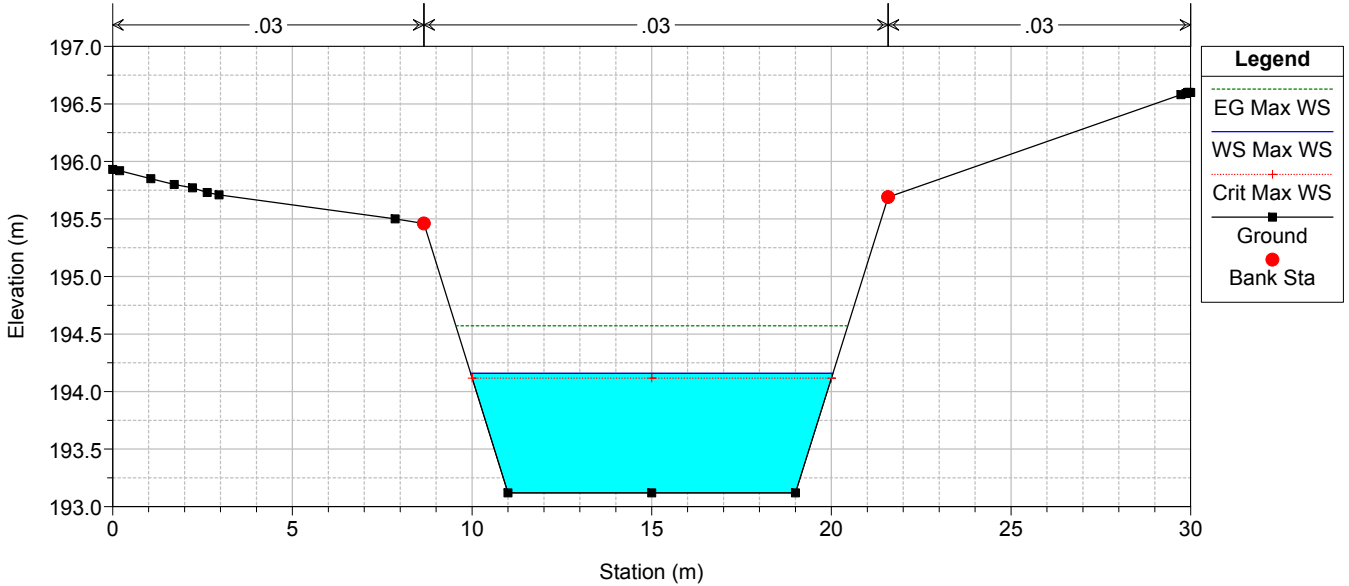

TO02-TO03-CA02-TO07_VARIO_POST

RS = -925 TO03 RS= 925

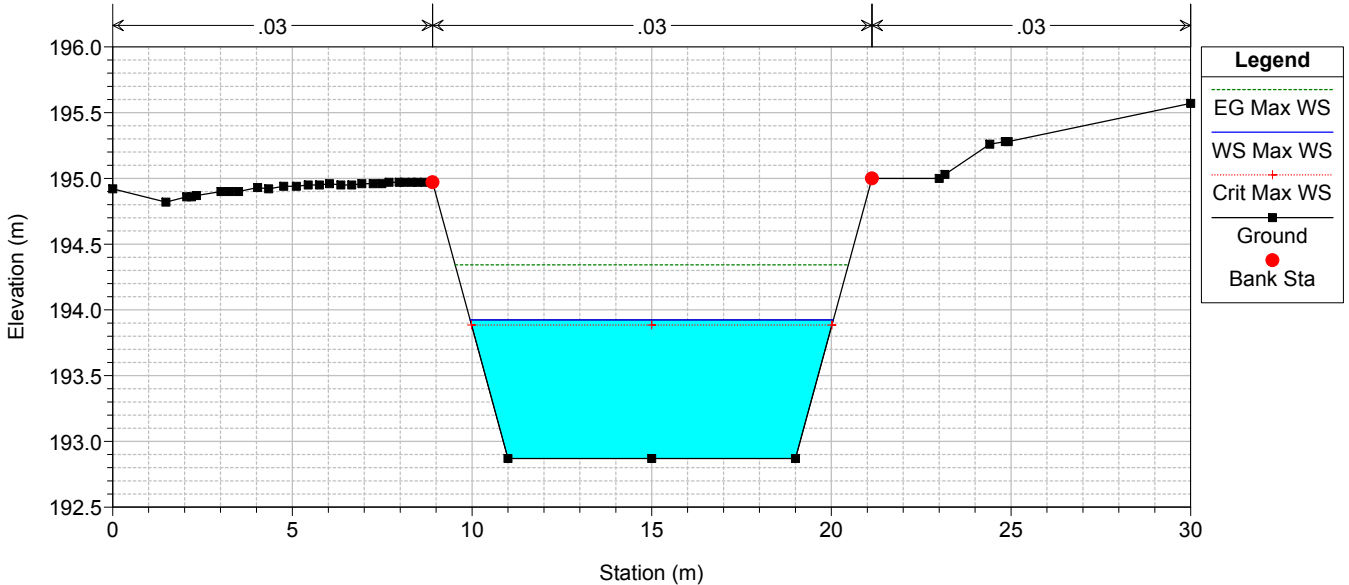

TO02-TO03-CA02-TO07_VARIO_POST

RS = -950 TO03 RS= 950

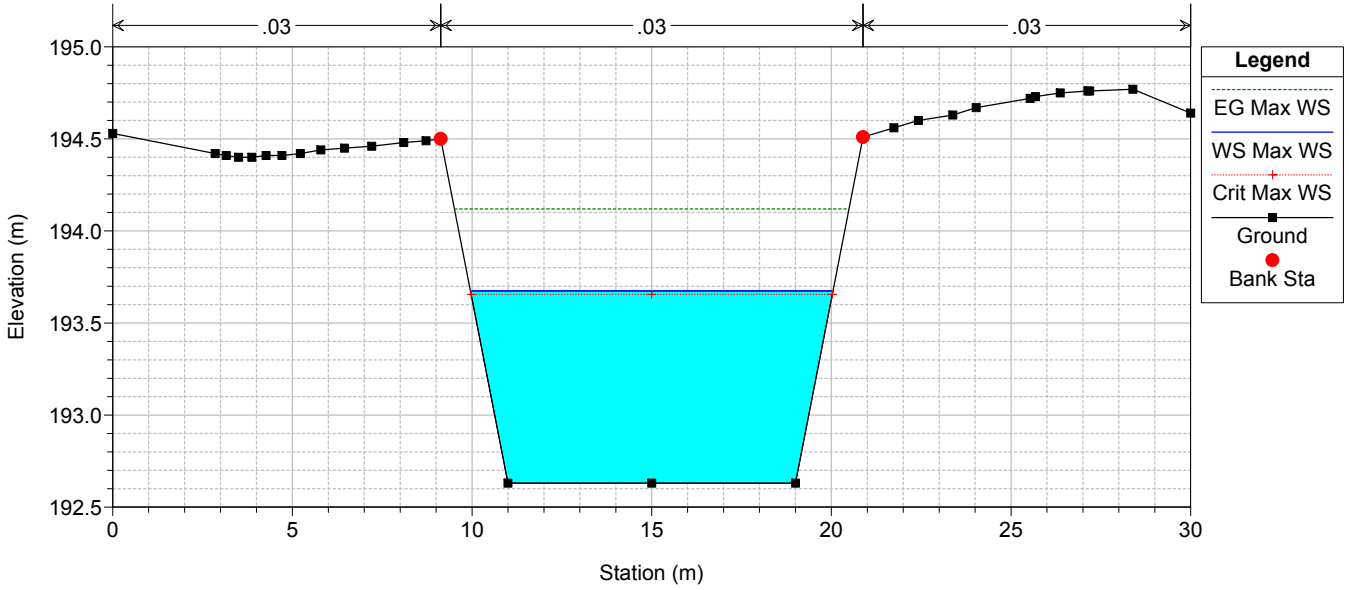

TO02-TO03-CA02-TO07_VARIO_POST

RS = -975 TO03 RS= 975

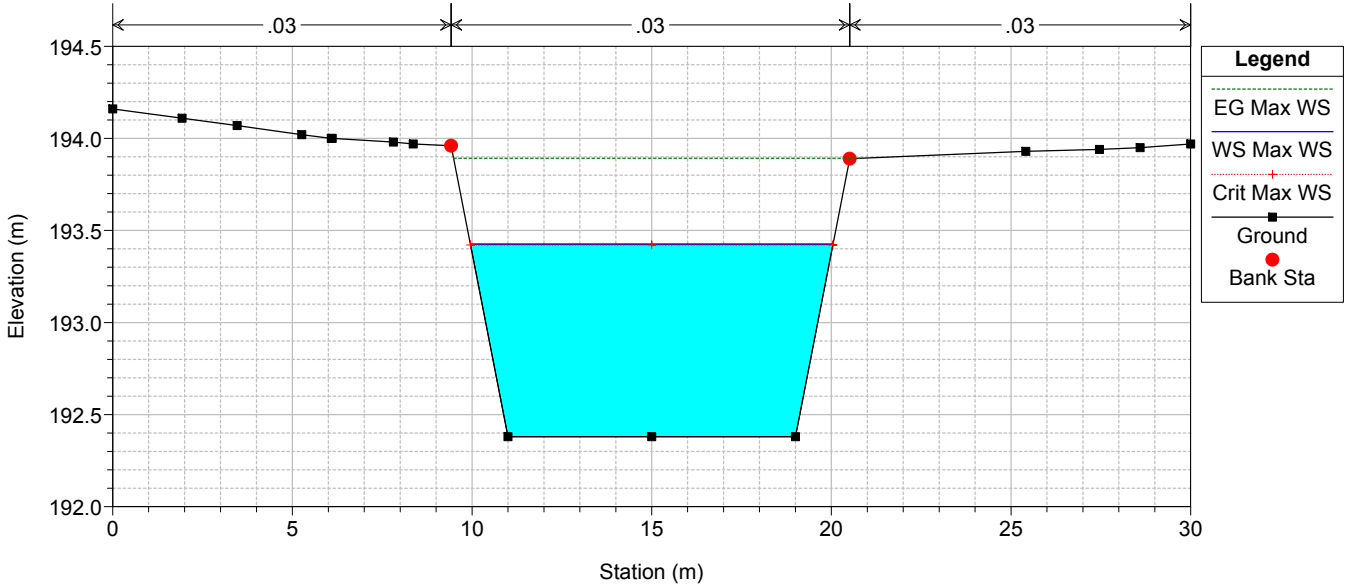

TO02-TO03-CA02-TO07_VARIO_POST

RS = -1000 TO03 RS= 1000

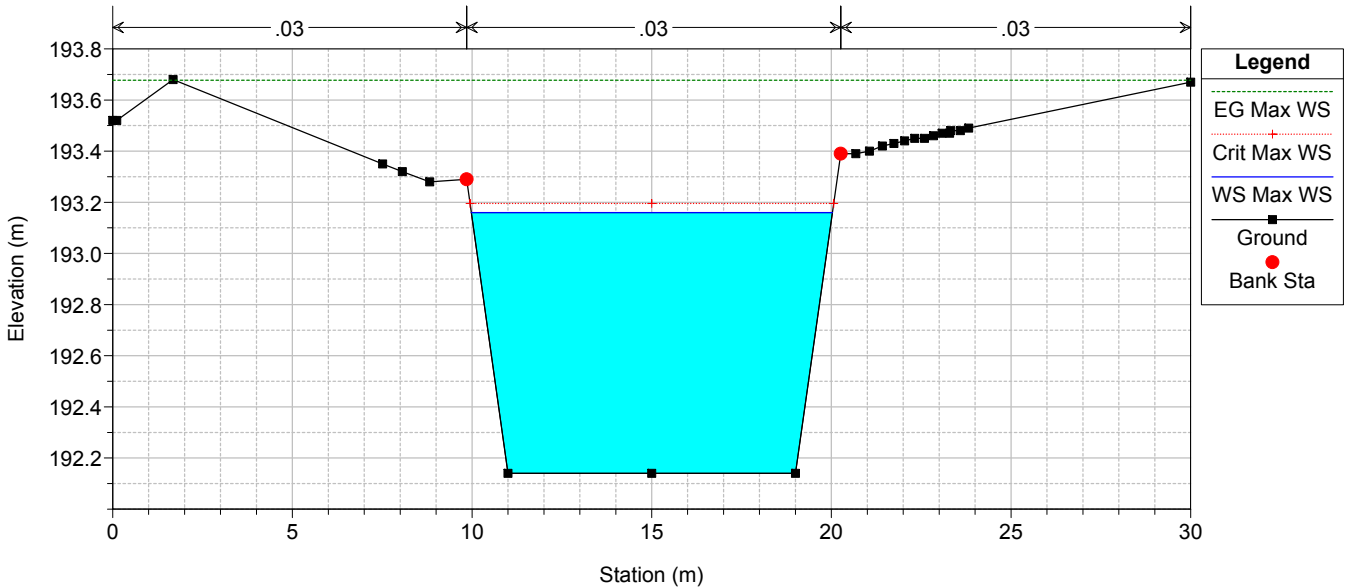

TO02-TO03-CA02-TO07_VARIO_POST

RS = -1035 TO03 RS= 1035

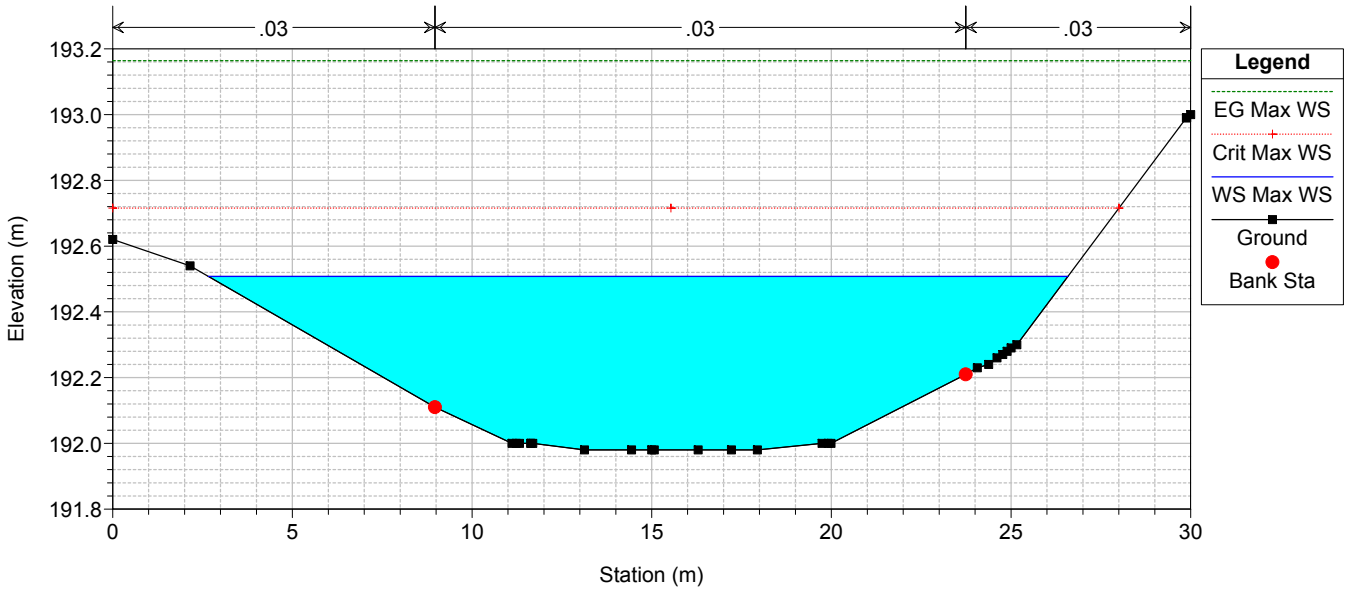

TO02-TO03-CA02-TO07_VARIO_POST

RS = -1085 TO03 RS= 1085

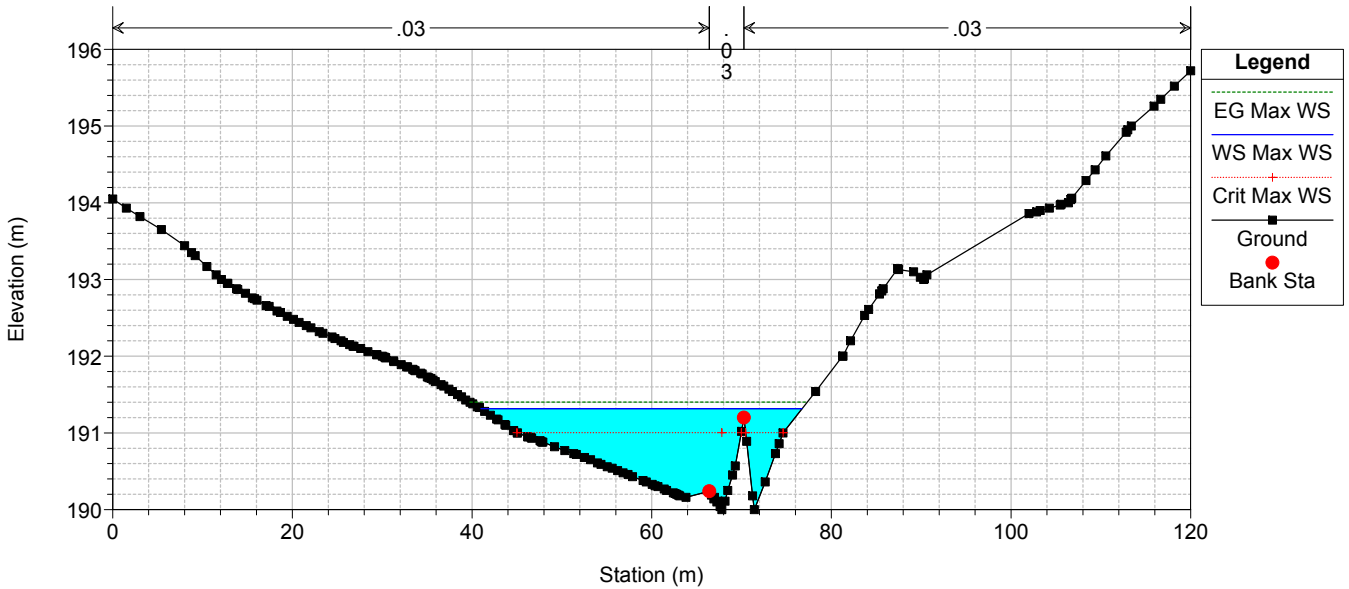

TO02-TO03-CA02-TO07_VARIO_POST

RS = -1185 TO03 RS= 1185

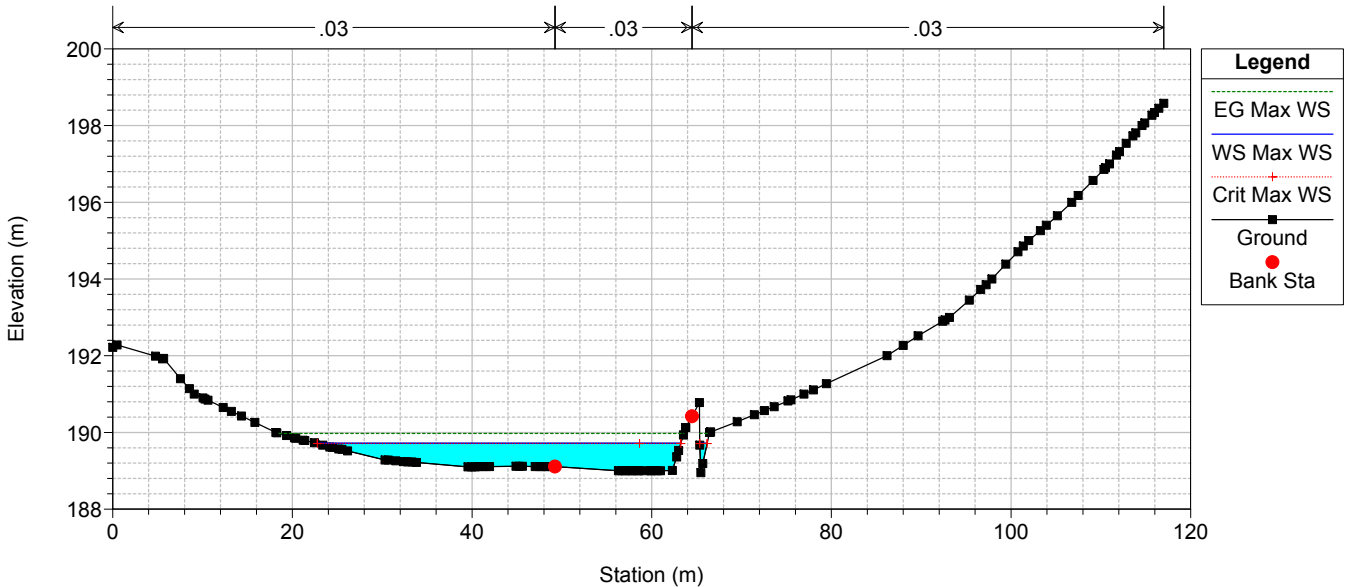

TO02-TO03-CA02-TO07_VARIO_POST

RS = -1285 TO03 RS= 1285

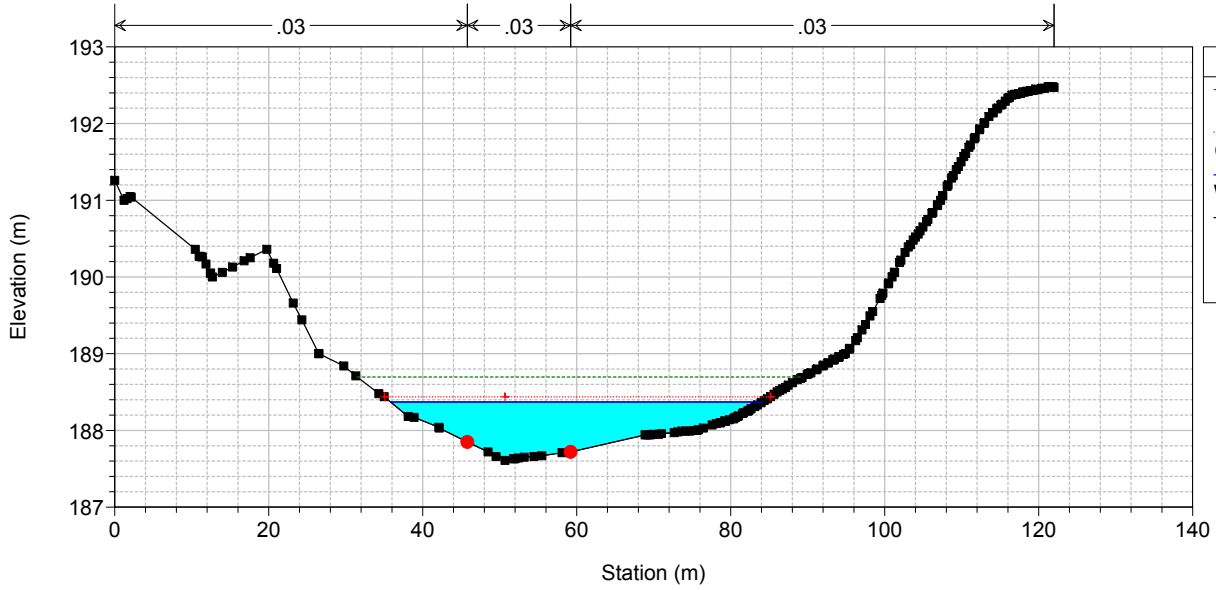

Legend

- EG Max WS
- Crit Max WS
- WS Max WS
- Ground
- Bank Sta

TO02-TO03-CA02-TO07_VARIO_POST

RS = -1385 TO03 RS= 1385

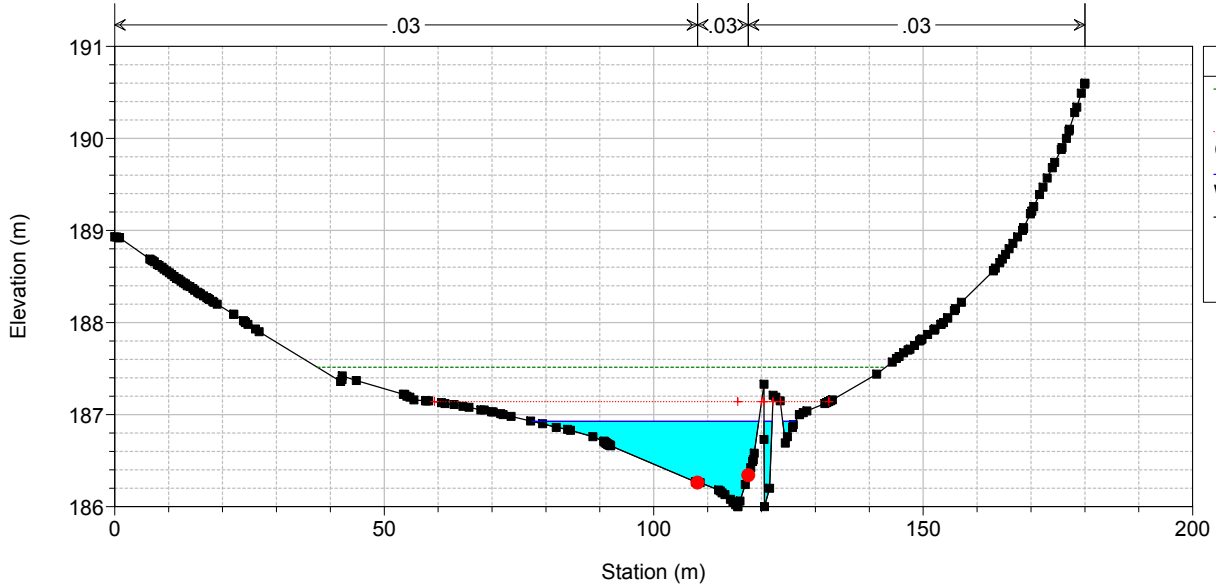

Legend

- EG Max WS
- Crit Max WS
- WS Max WS
- Ground
- Bank Sta

TO02-TO03-CA02-TO07_VARIO_POST

RS = -1465 TO03 RS= 1465

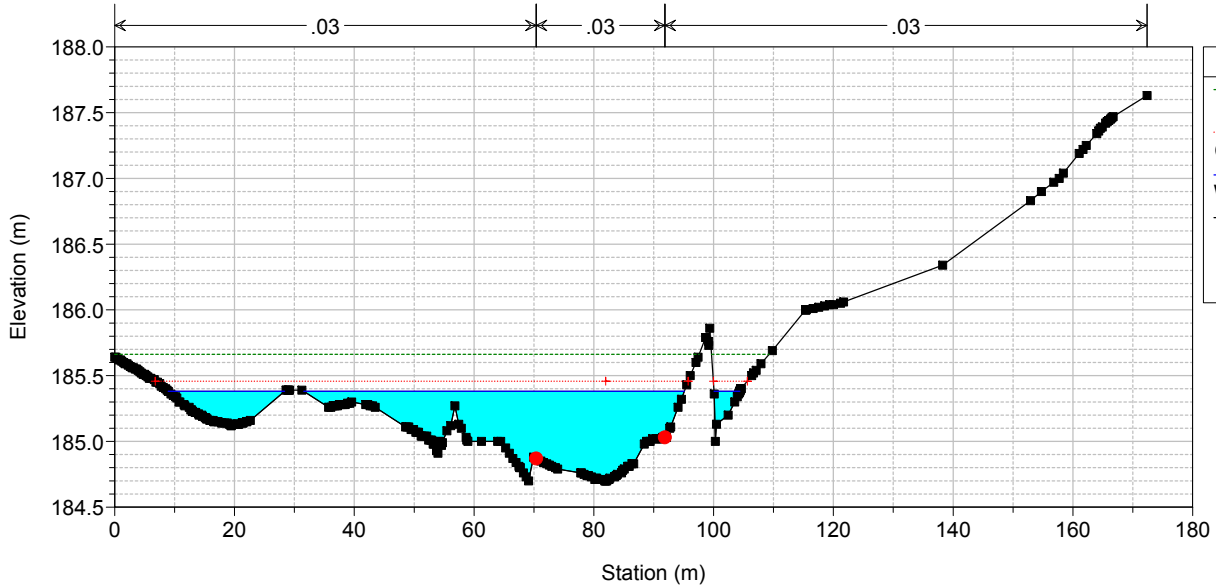

Legend

- EG Max WS
- Crit Max WS
- WS Max WS
- Ground
- Bank Sta

TO02-TO03-CA02-TO07_VARIO_POST

RS = -1585 TO03 RS= 1585

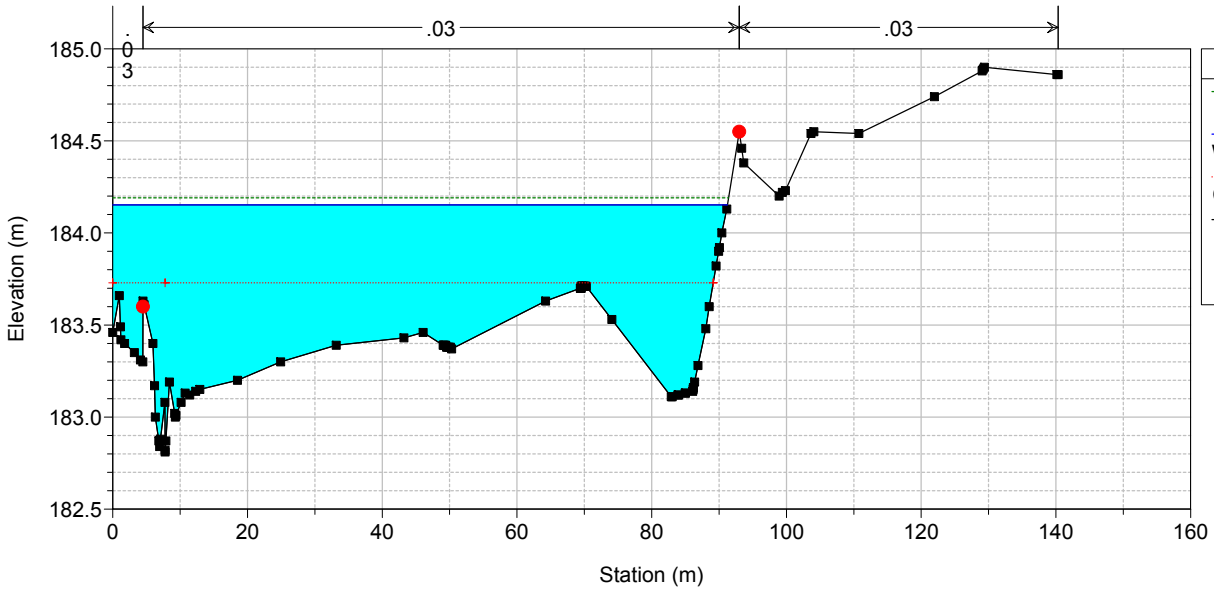

TO02-TO03-CA02-TO07_VARIO_POST

RS = -1614.19 CA02 RS= 0

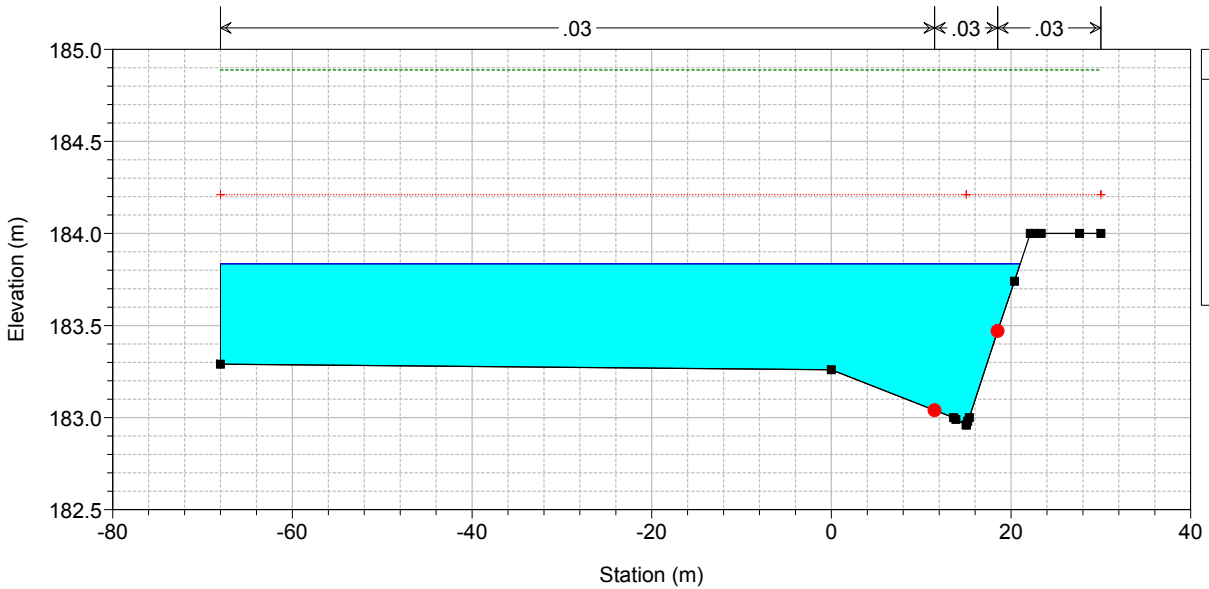

TO02-TO03-CA02-TO07_VARIO_POST

RS = -1639.19 CA02 RS= -25

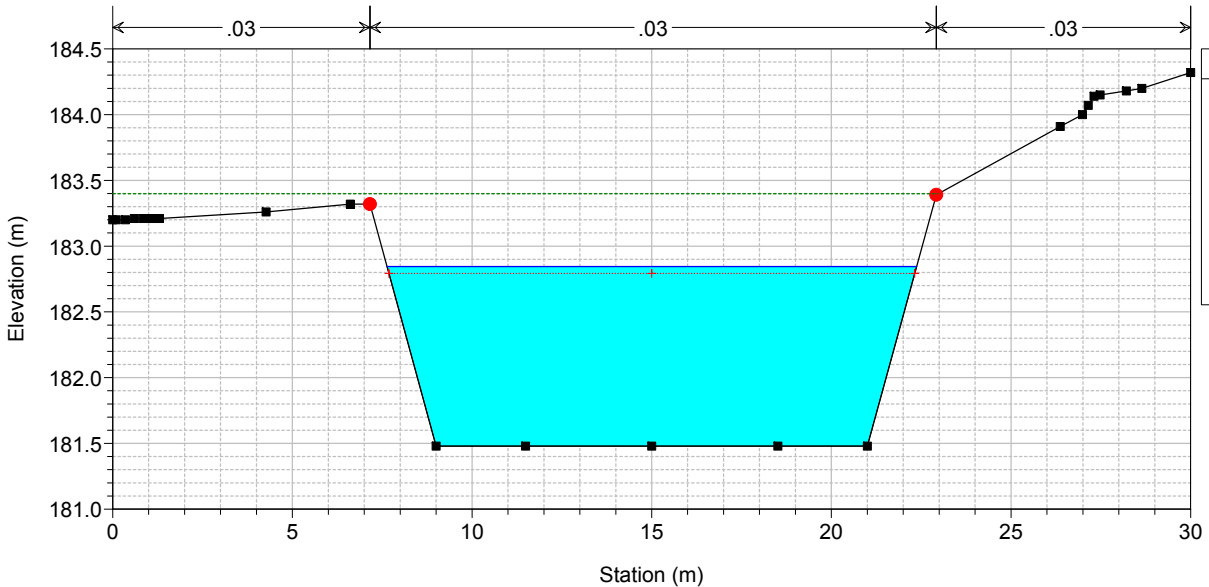

TO02-TO03-CA02-TO07_VARIO_POST

RS = -1664.19 CA02 RS= -50

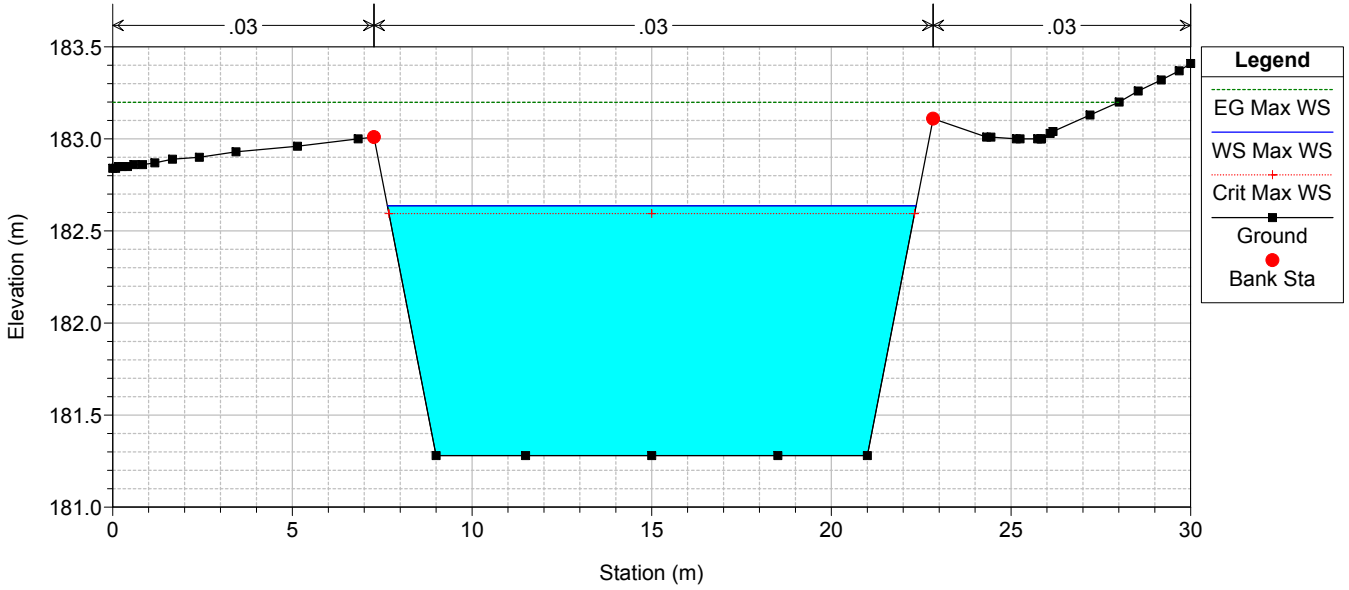

TO02-TO03-CA02-TO07_VARIO_POST

RS = -1689.19 CA02 RS= -75

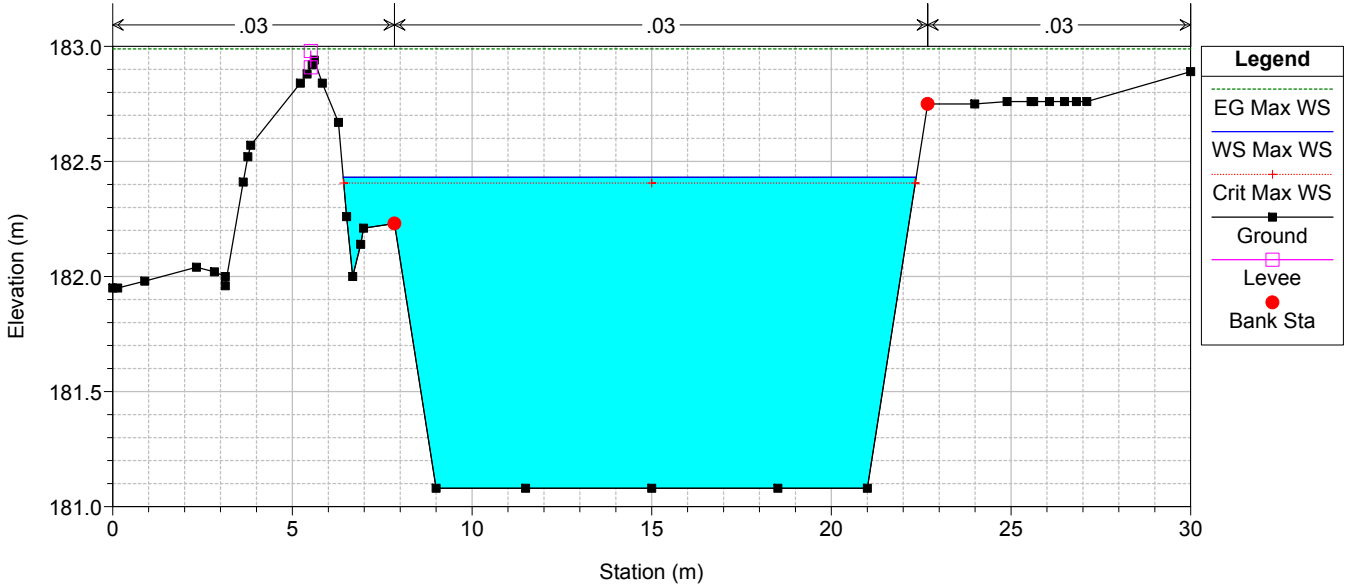

TO02-TO03-CA02-TO07_VARIO_POST

RS = -1714.19 CA02 RS= -100

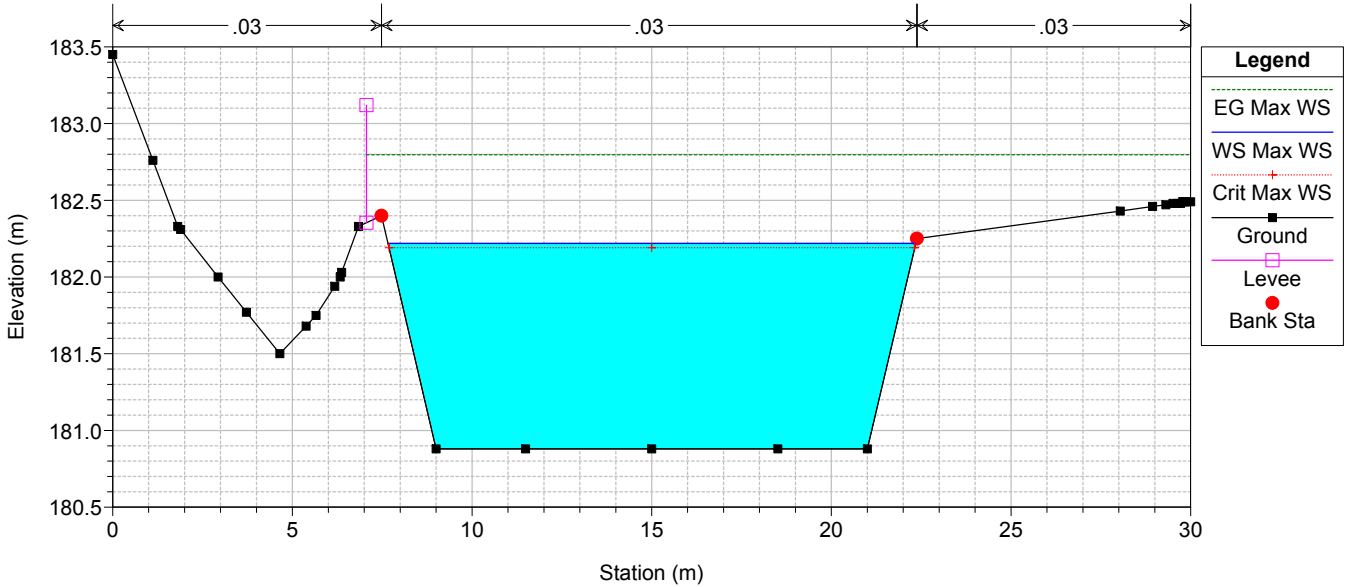

TO02-TO03-CA02-TO07_VARIO_POST

RS = -1739.19 CA02 RS= -125

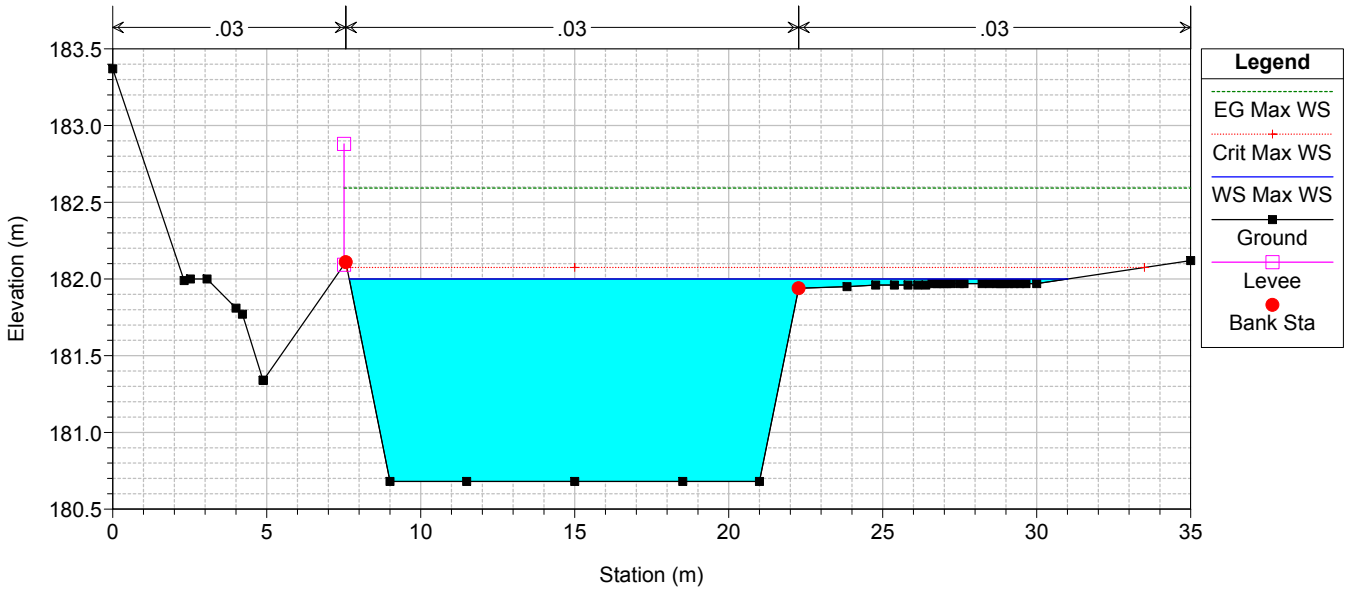

TO02-TO03-CA02-TO07_VARIO_POST

RS = -1764.19 CA02 RS= -150

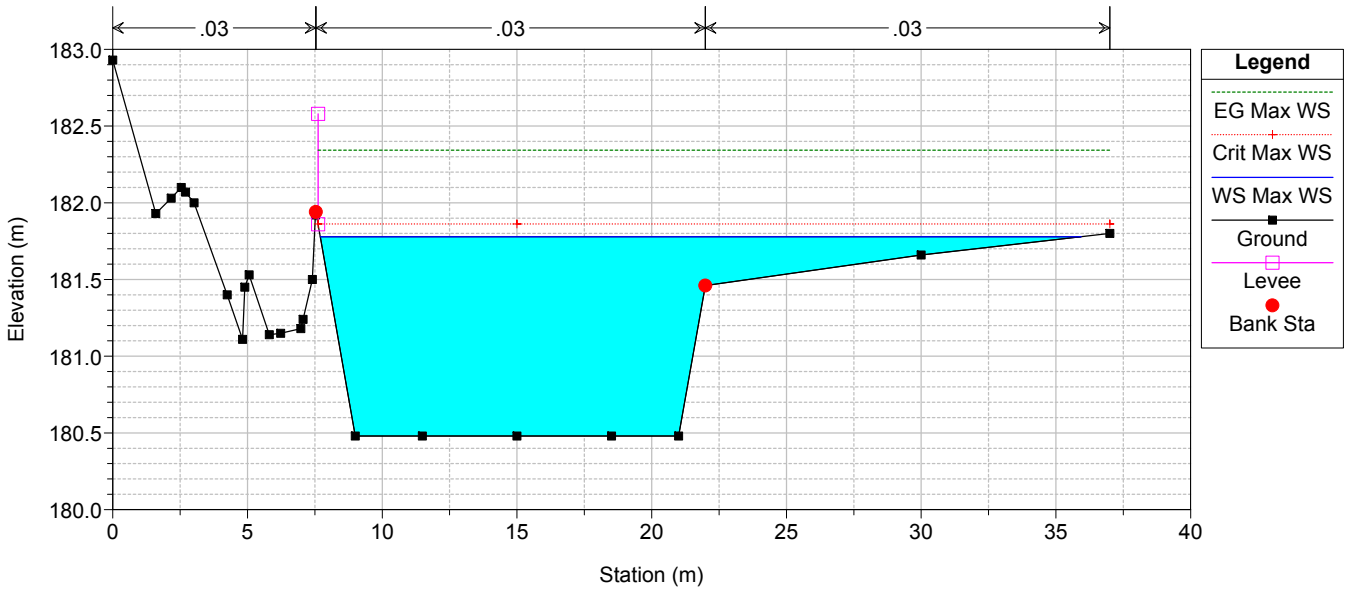

TO02-TO03-CA02-TO07_VARIO_POST

RS = -1789.19 CA02 RS= -175

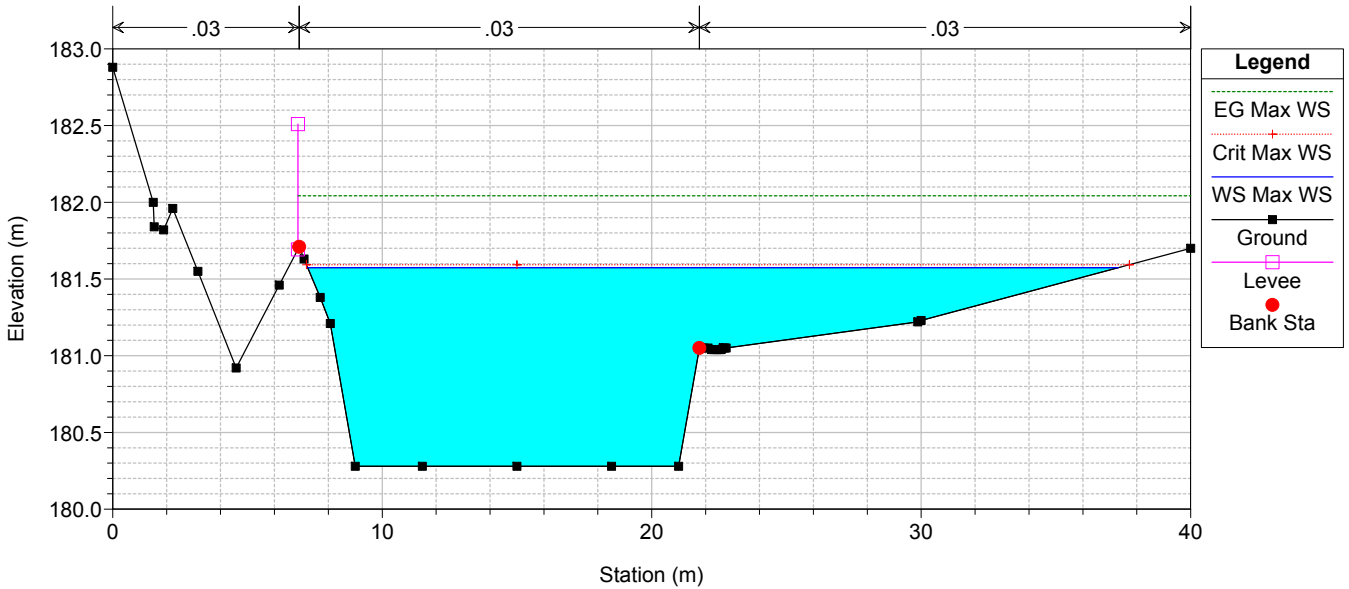

TO02-TO03-CA02-TO07_VARIO_POST

RS = -1814.19 CA02 RS= -200

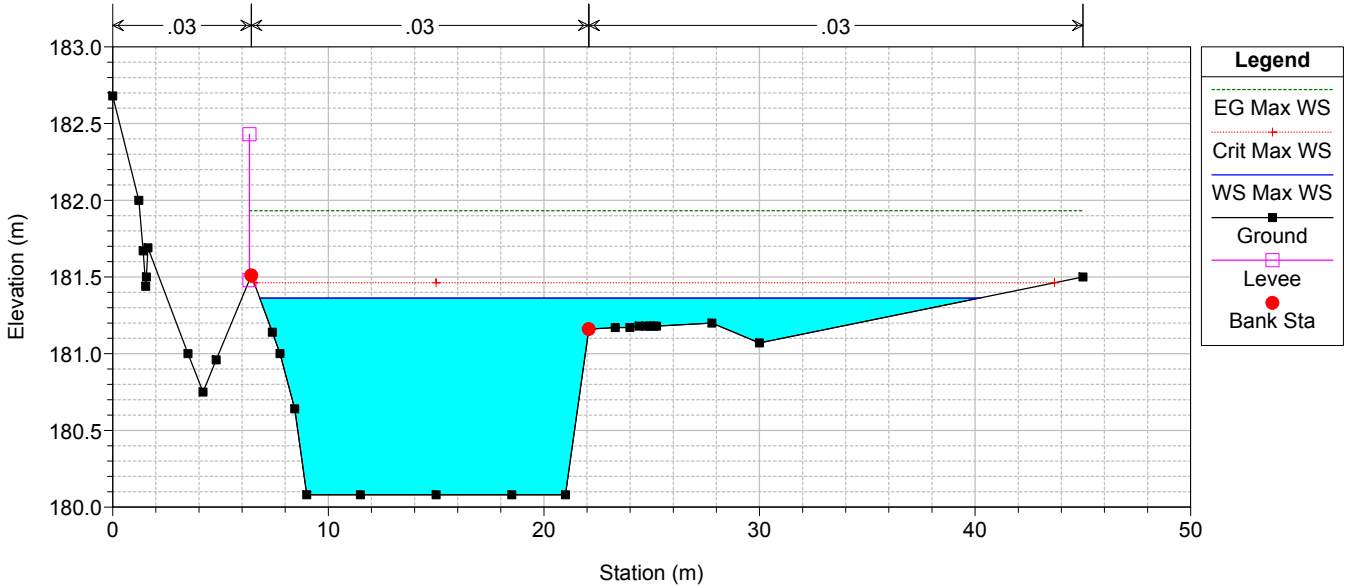

TO02-TO03-CA02-TO07_VARIO_POST

RS = -1839.19 CA02 RS= -225

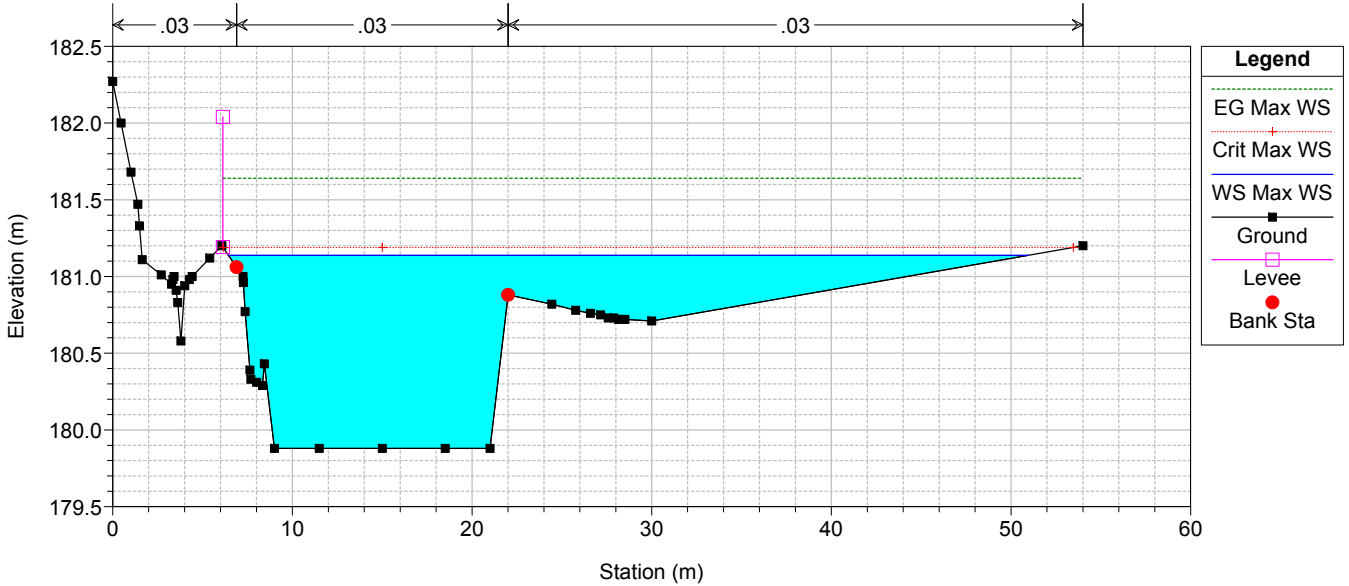

TO02-TO03-CA02-TO07_VARIO_POST

RS = -1864.19 CA02 RS= -250

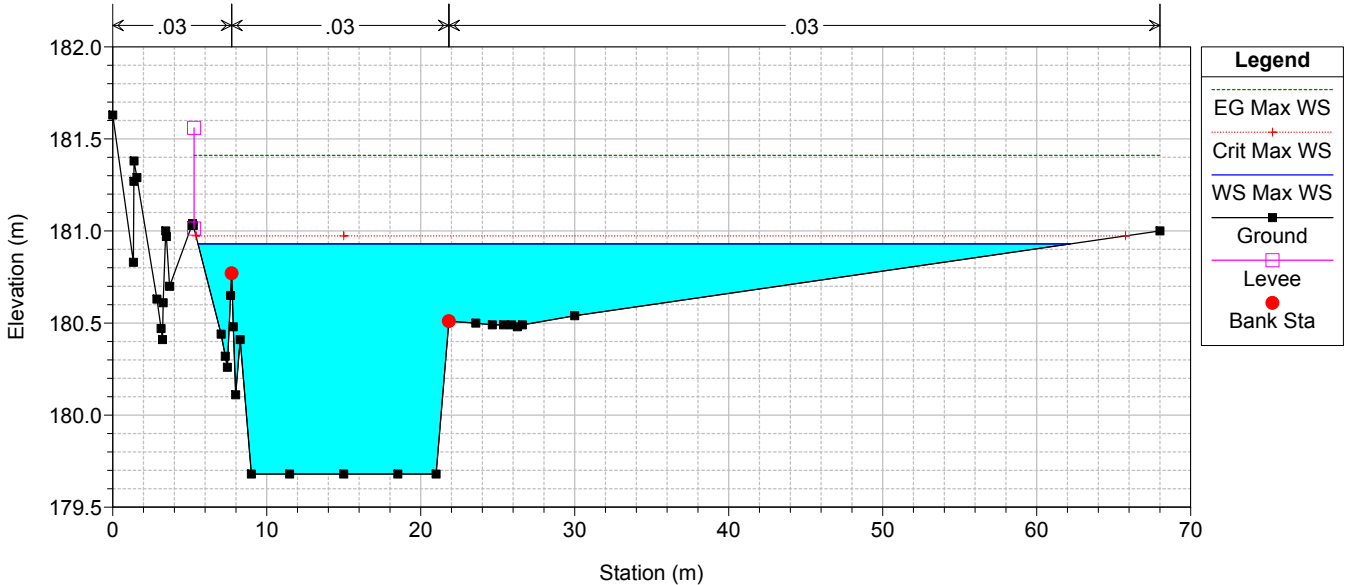

TO02-TO03-CA02-TO07_VARIO_POST

RS = -1889.19 CA02 RS= -275

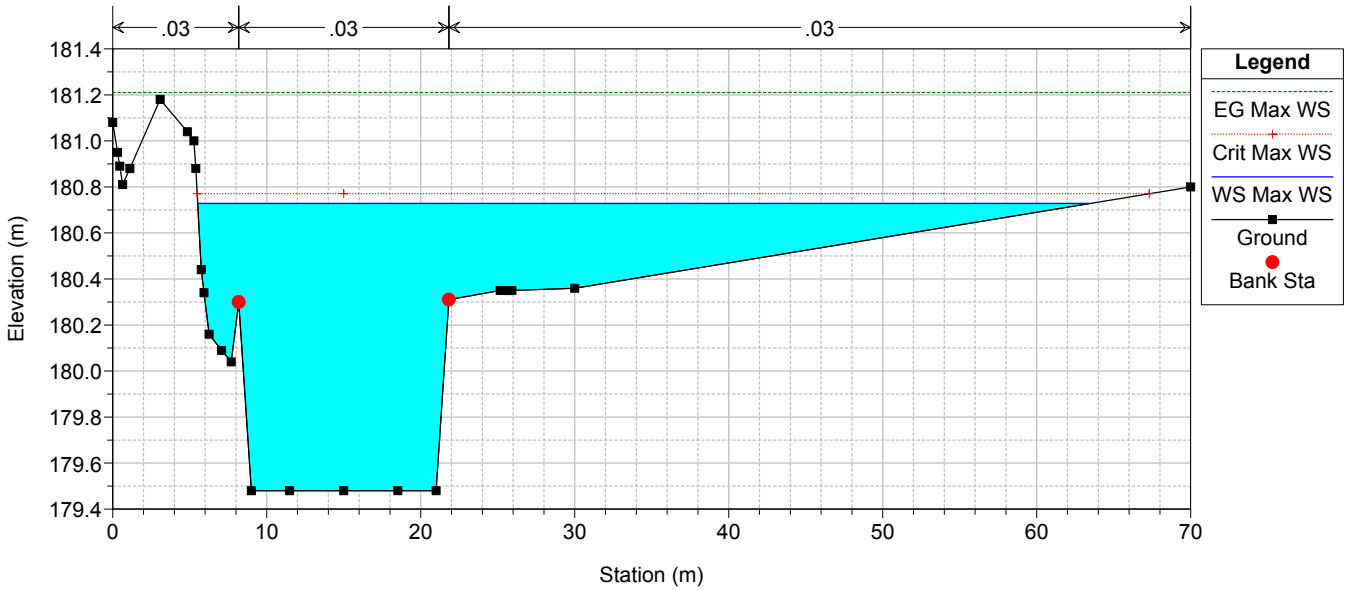

TO02-TO03-CA02-TO07_VARIO_POST

RS = -1914.19 CA02 RS= -300

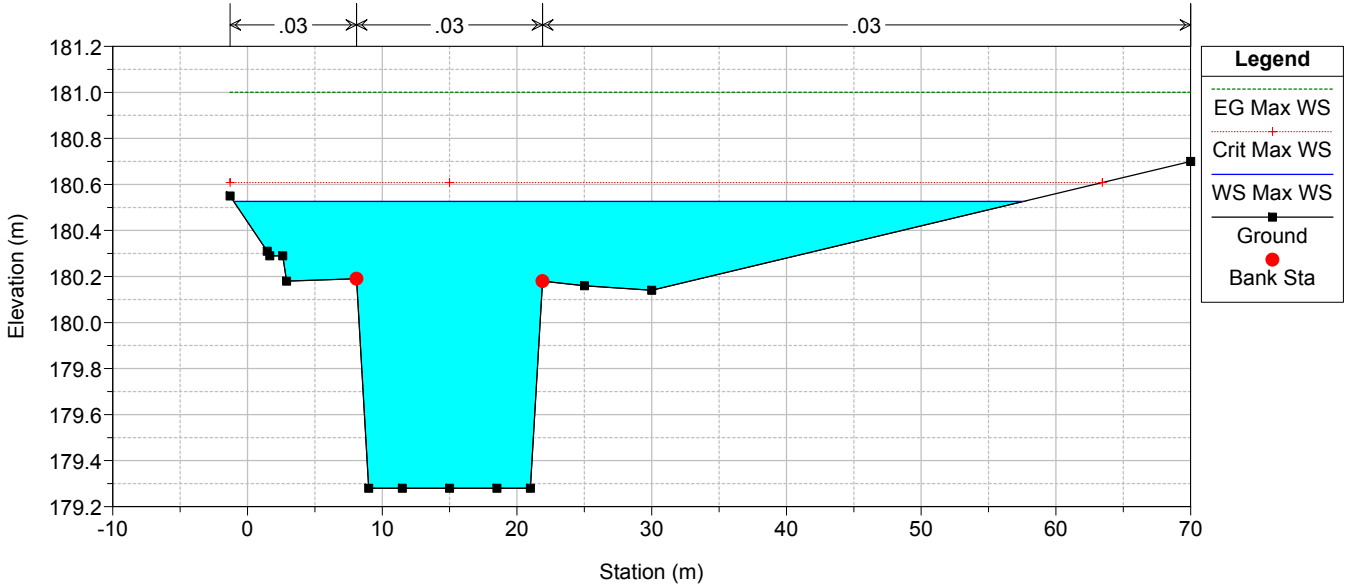

TO02-TO03-CA02-TO07_VARIO_POST

RS = -1939.19 CA02 RS= -325

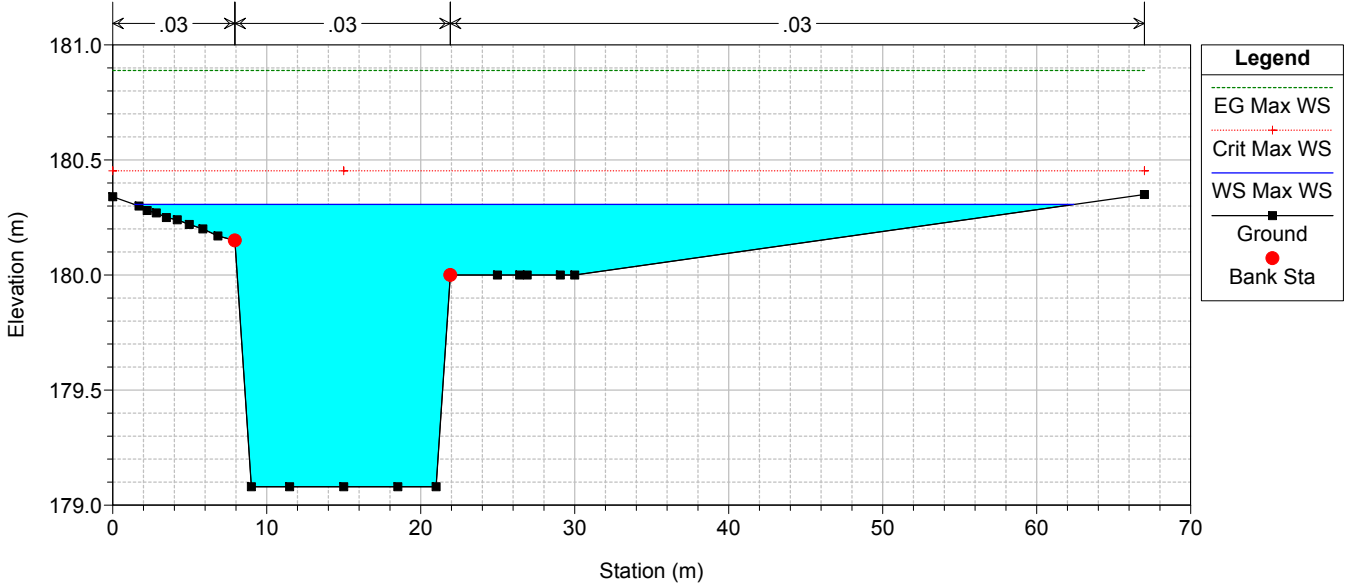

TO02-TO03-CA02-TO07_VARIO_POST

RS = -1964.19 CA02 RS= -350

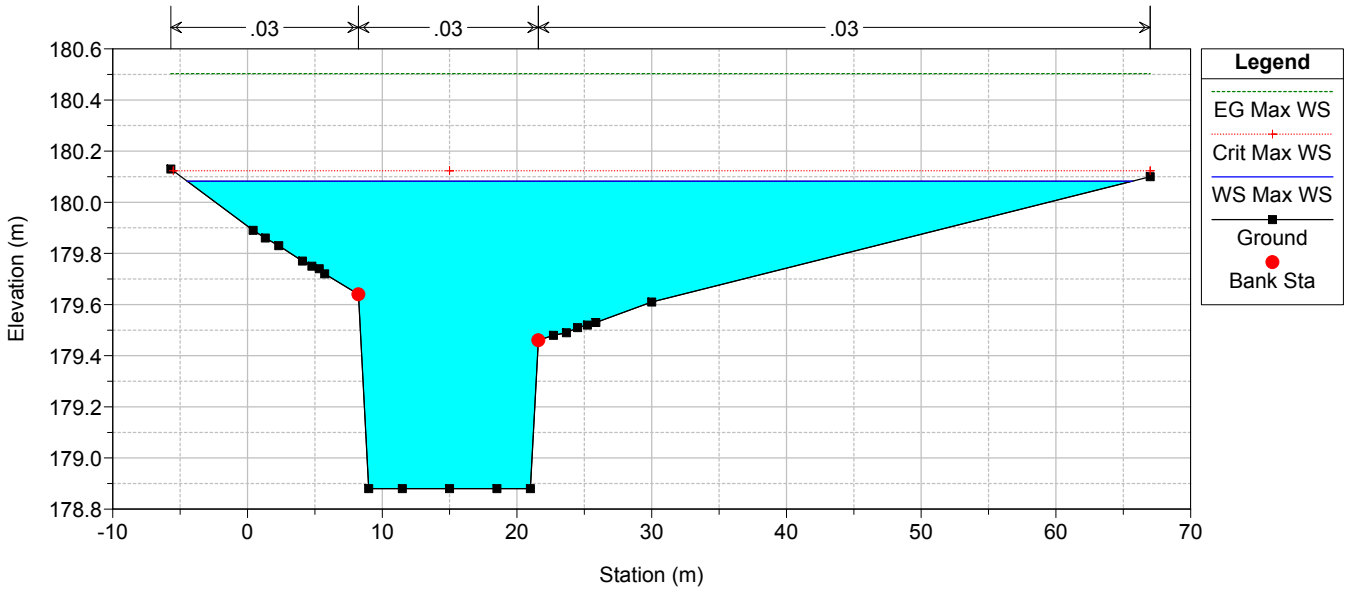

TO02-TO03-CA02-TO07_VARIO_POST

RS = -1989.19 CA02 RS= -375

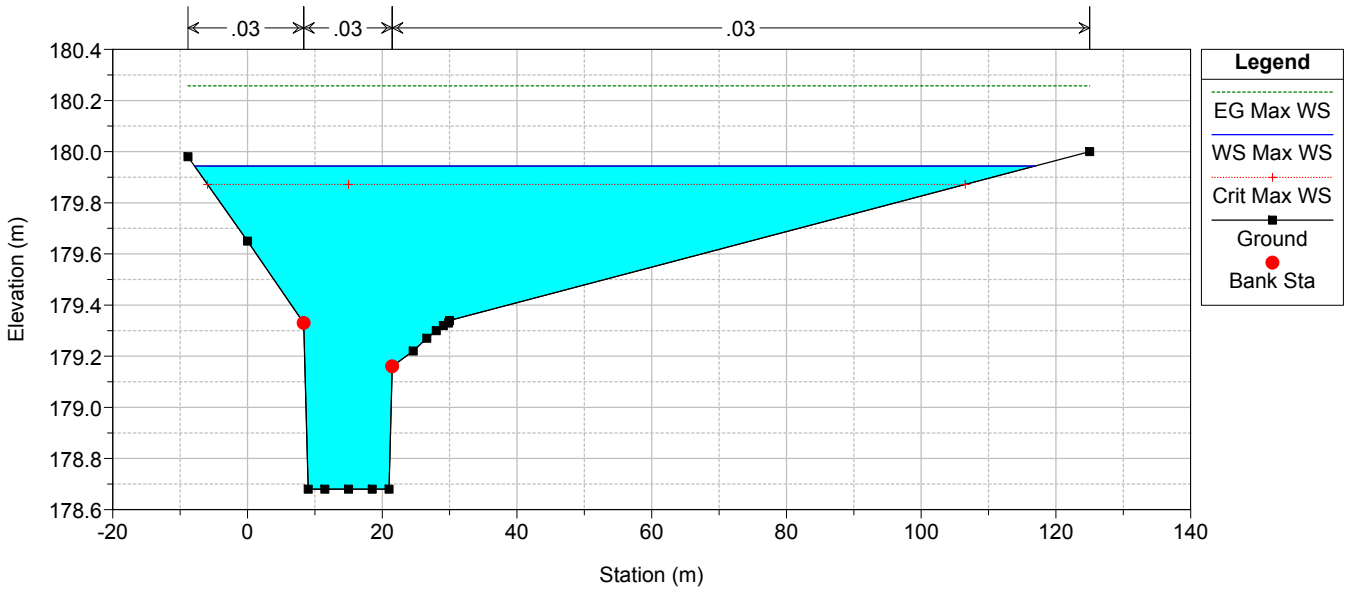

TO02-TO03-CA02-TO07_VARIO_POST

RS = -2014.19 CA02 RS= -400

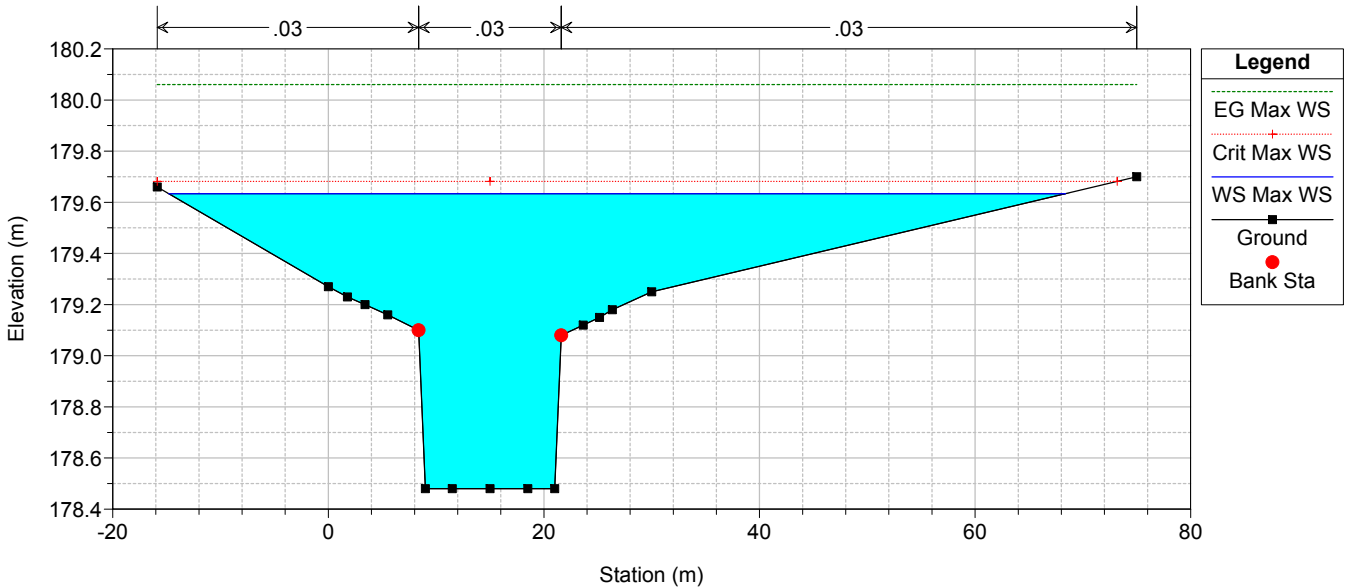

TO02-TO03-CA02-TO07_VARIO_POST

RS = -2039.19 CA02 RS= -425

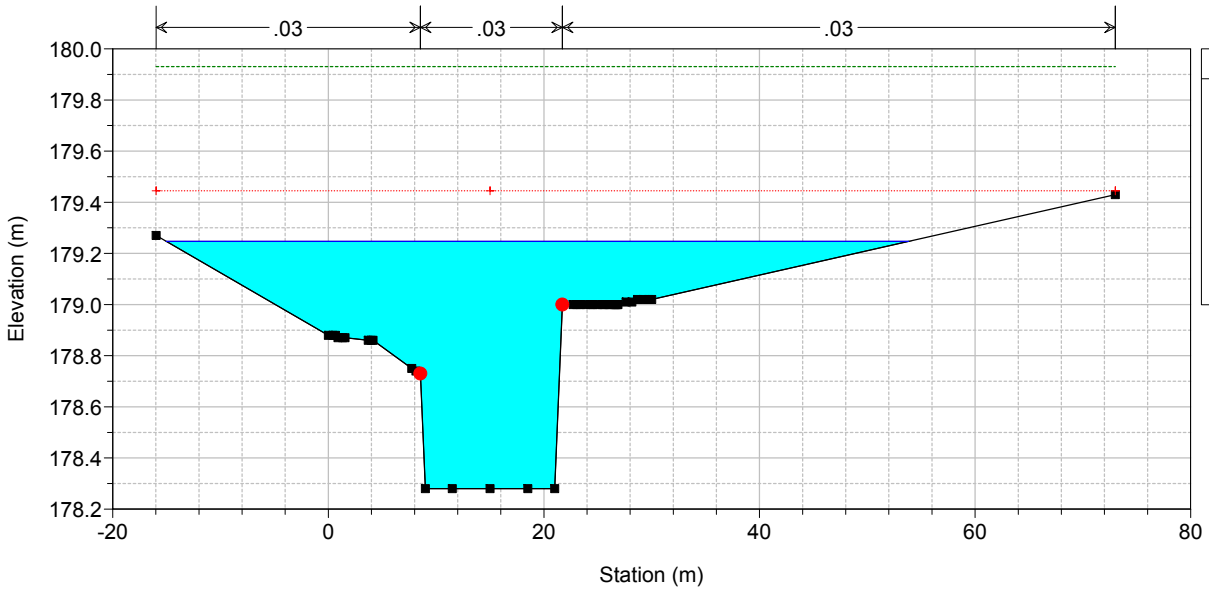

TO02-TO03-CA02-TO07_VARIO_POST

RS = -2089.19 CA02 RS= -475

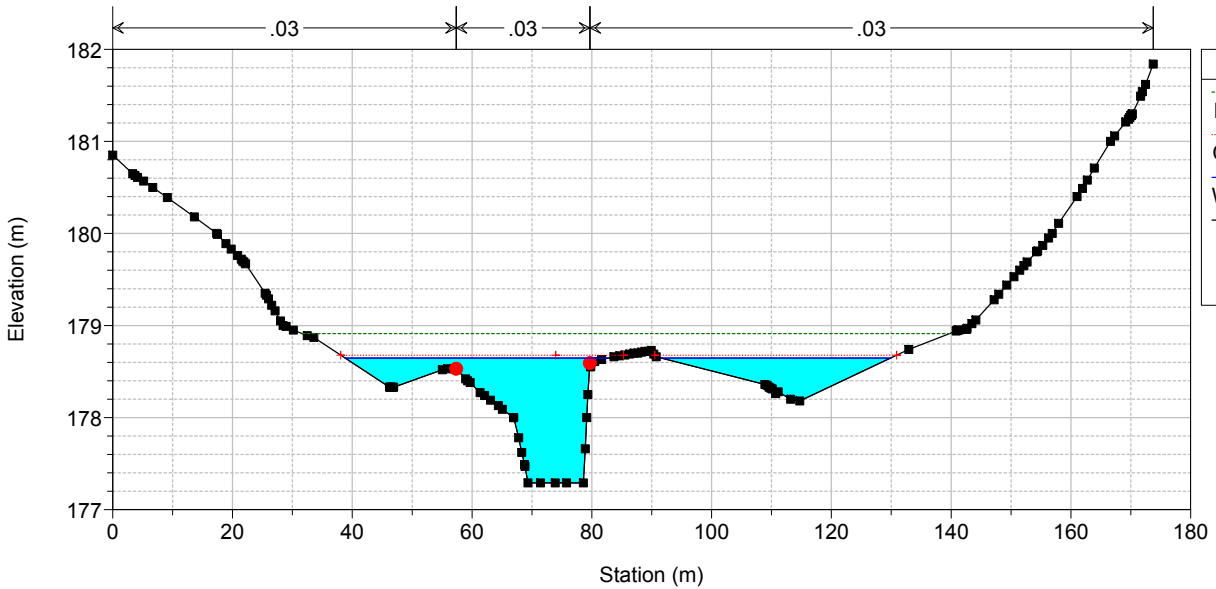

TO02-TO03-CA02-TO07_VARIO_POST

RS = -2189.19 CA02 RS= -575

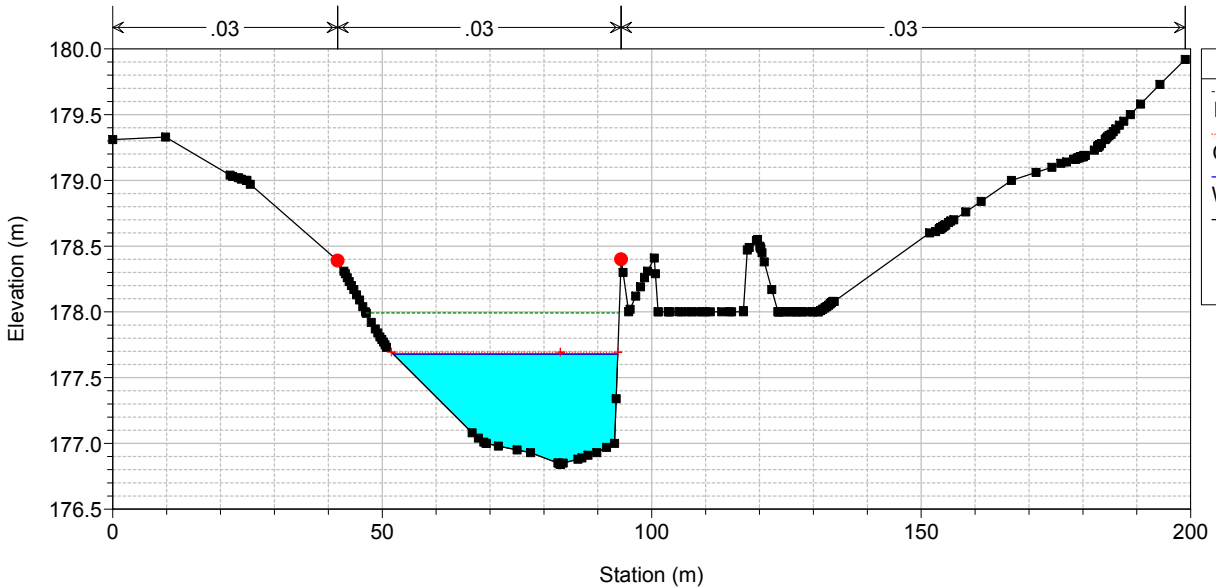

TO02-TO03-CA02-TO07_VARIO_POST

RS = -2289.19 CA02 RS= -675

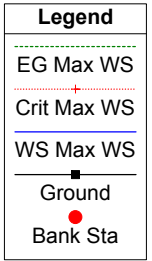
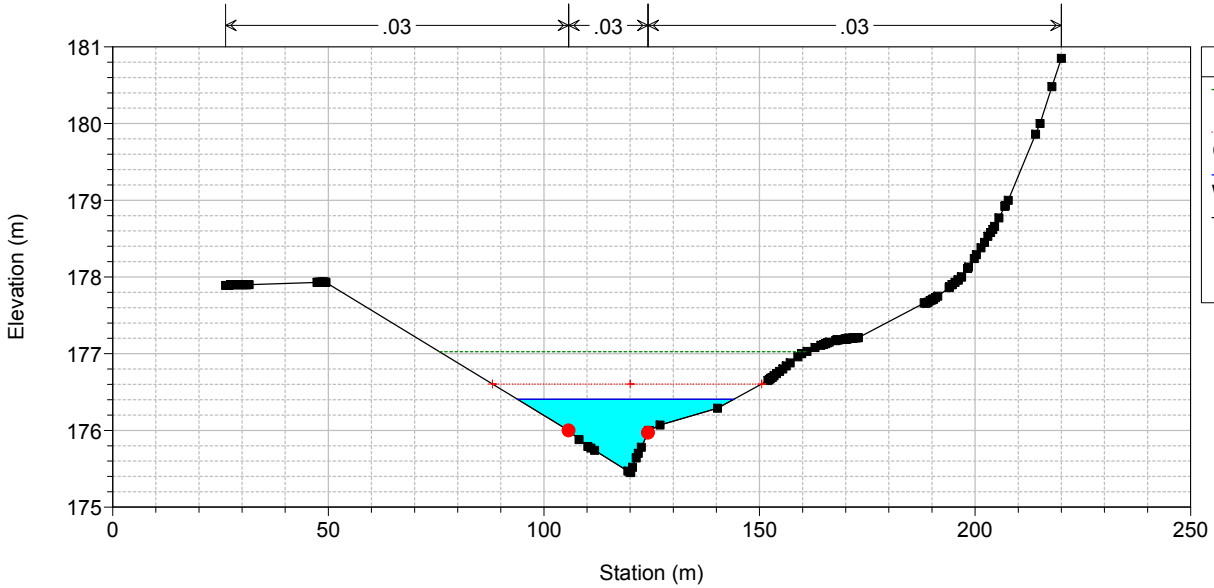

TO02-TO03-CA02-TO07_VARIO_POST

RS = -2389.19 CA02 RS= -775

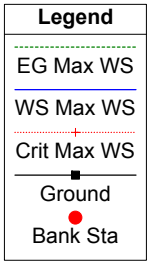
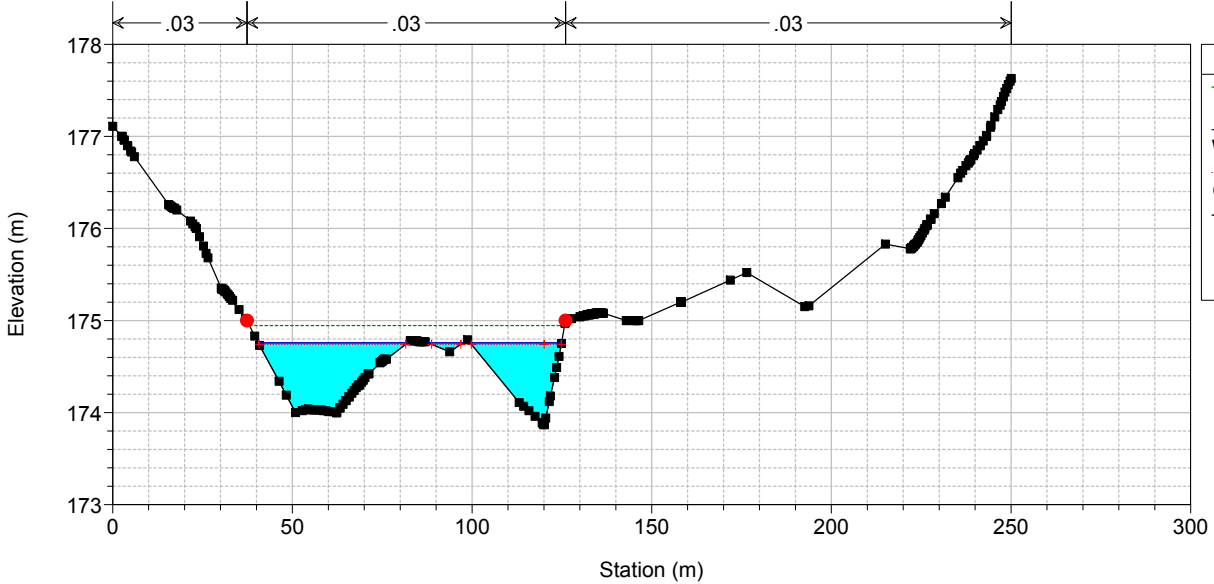

TO02-TO03-CA02-TO07_VARIO_POST

RS = -2489.19 CA02 RS= -875

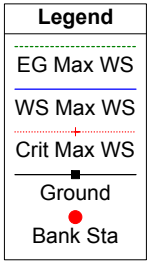
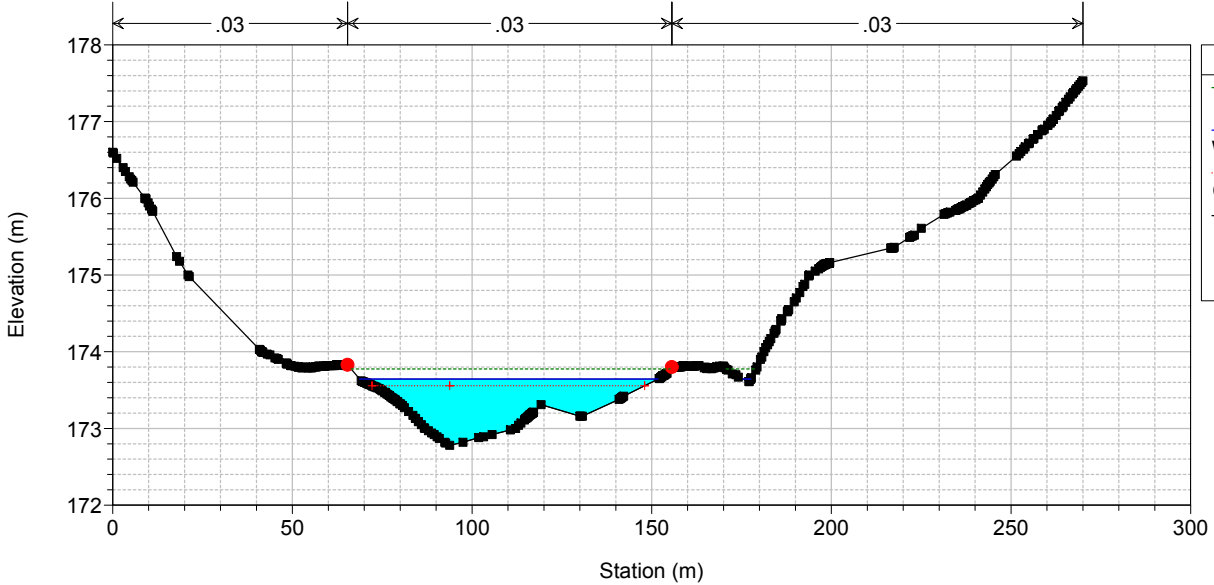

TO02-TO03-CA02-TO07_VARIO_POST

RS = -2589.19 CA02 RS= -975

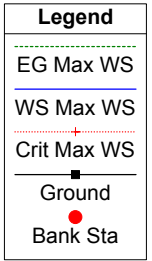
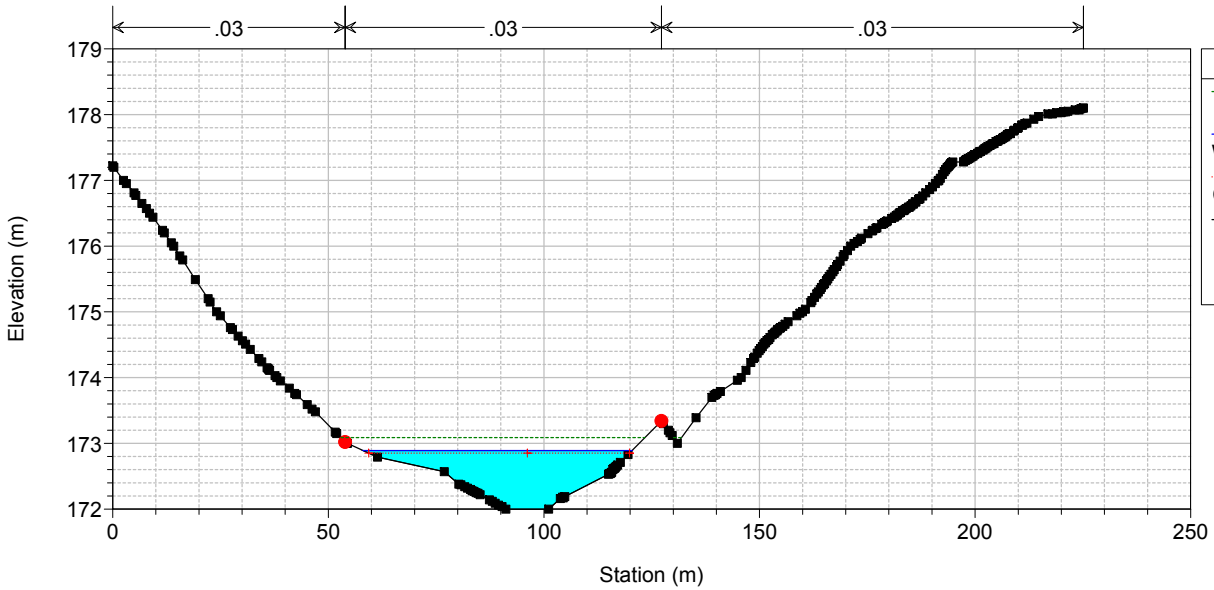

TO02-TO03-CA02-TO07_VARIO_POST

RS = -2704.19 CA02 RS= -1090

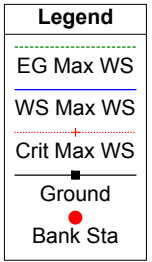
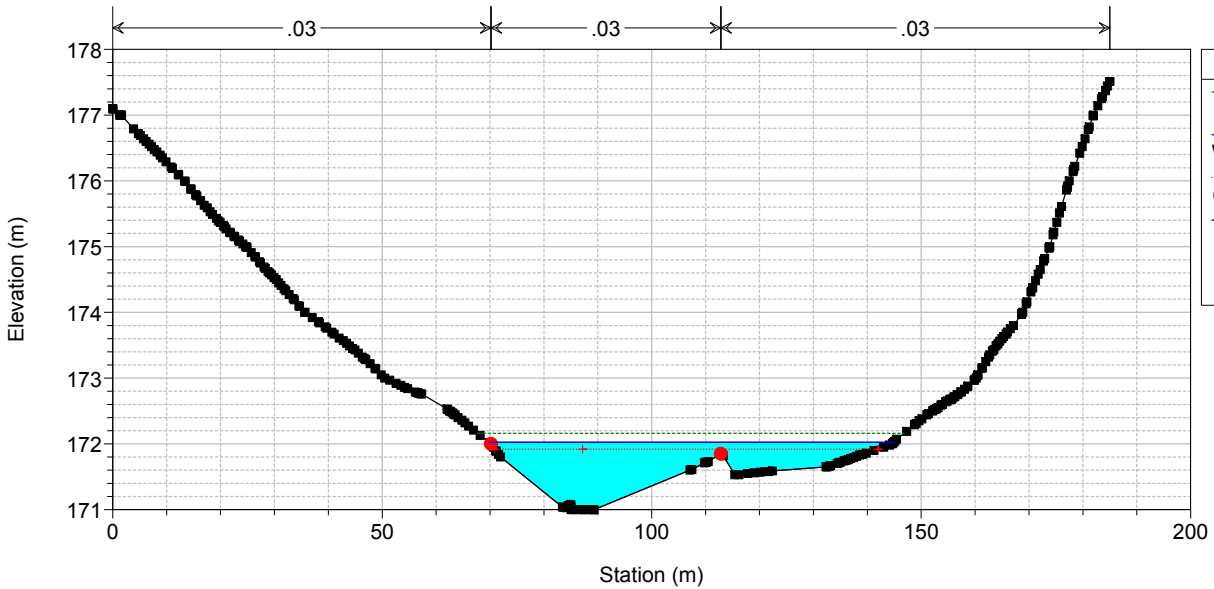

TO02-TO03-CA02-TO07_VARIO_POST

RS = -2804.19 CA02 RS= -1190

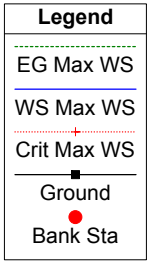
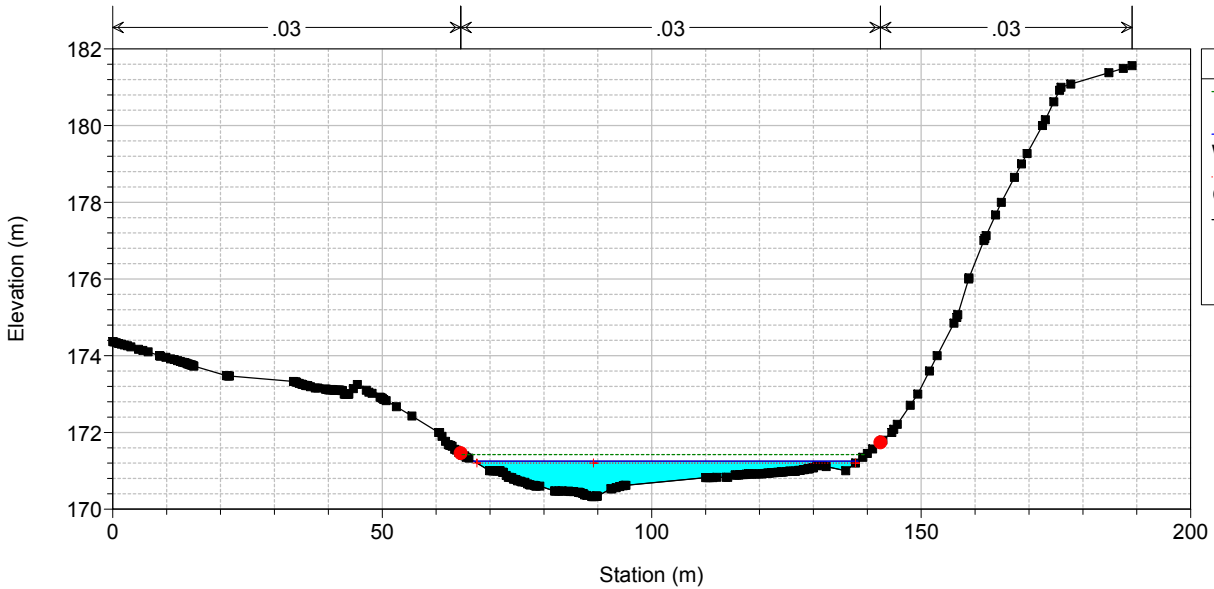

TO02-TO03-CA02-TO07_VARIO_POST

RS = -3004.19 CA02 RS= -1390

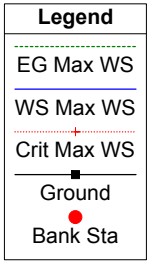
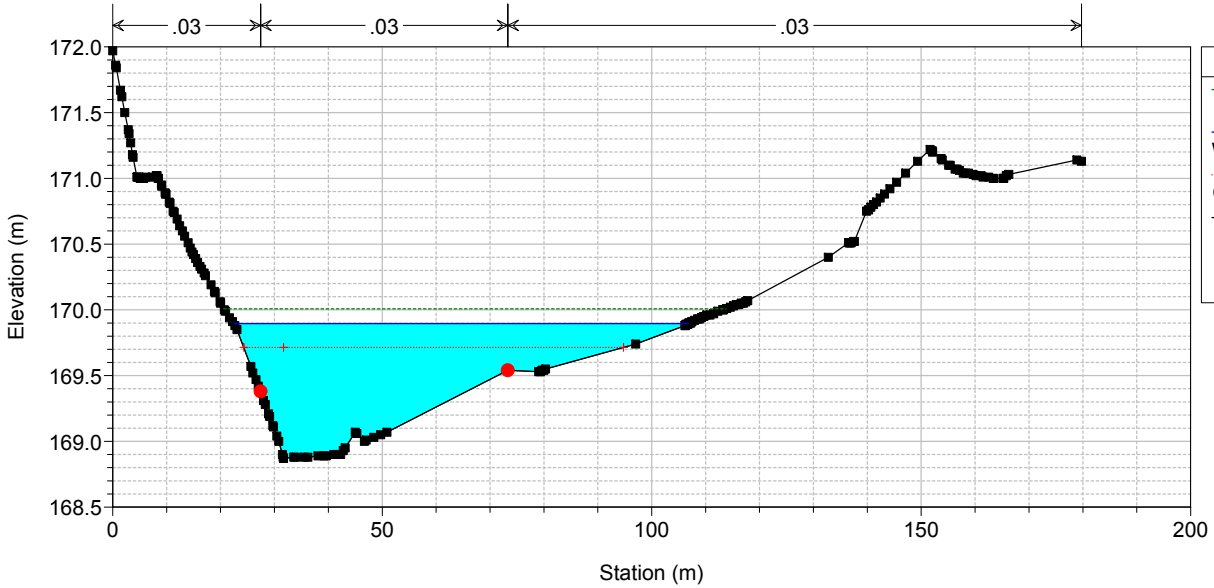

TO02-TO03-CA02-TO07_VARIO_POST

RS = -3130.19 CA02 RS= -1516

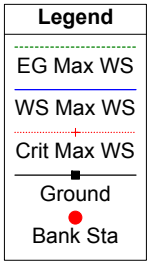
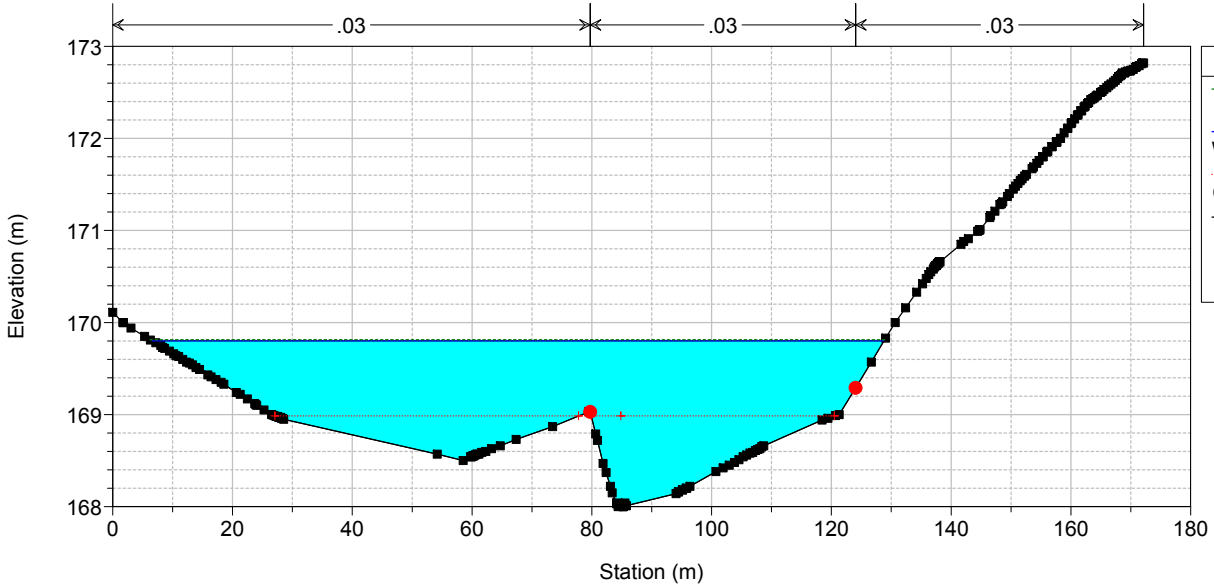

TO02-TO03-CA02-TO07_VARIO_POST

RS = -3193.40 TO07 RS= 0

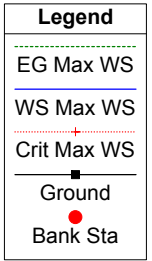
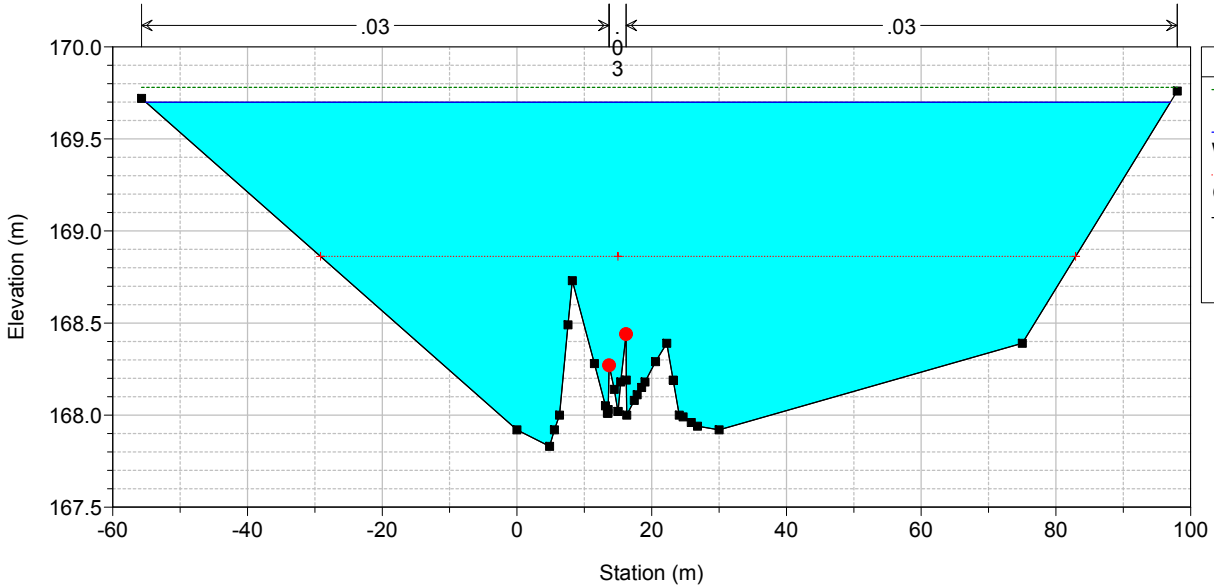

TO02-TO03-CA02-TO07_VARIO_POST

RS = -3218.40 TO07 RS= -25

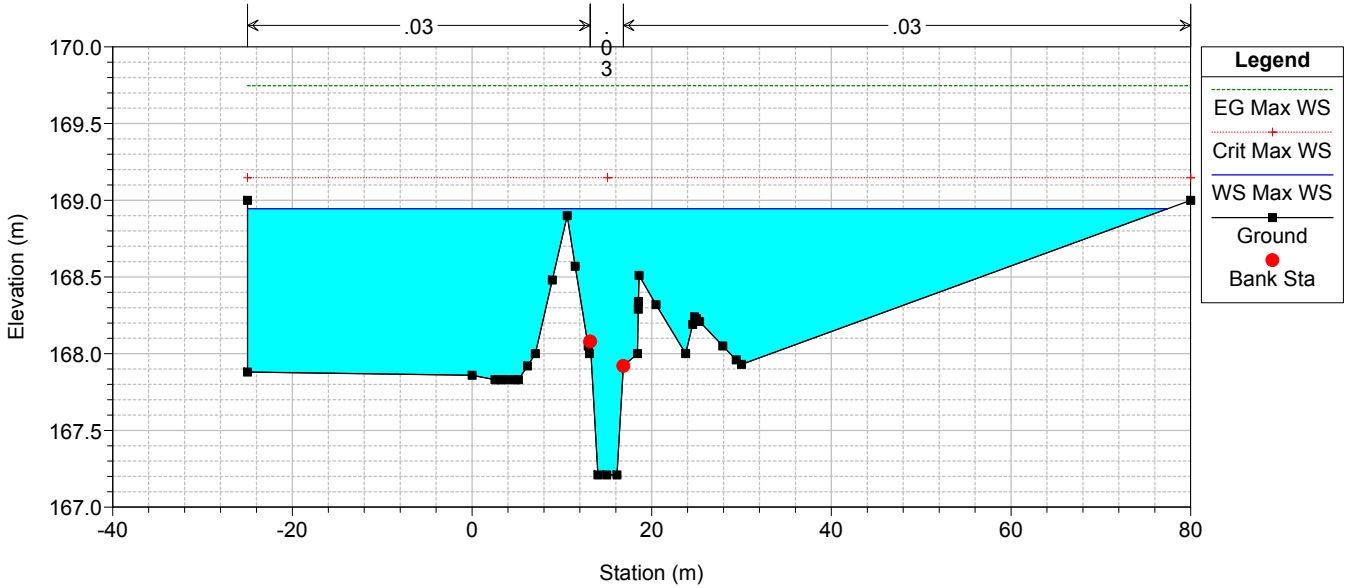

TO02-TO03-CA02-TO07_VARIO_POST

RS = -3231.89 TO07 RS= -38.49

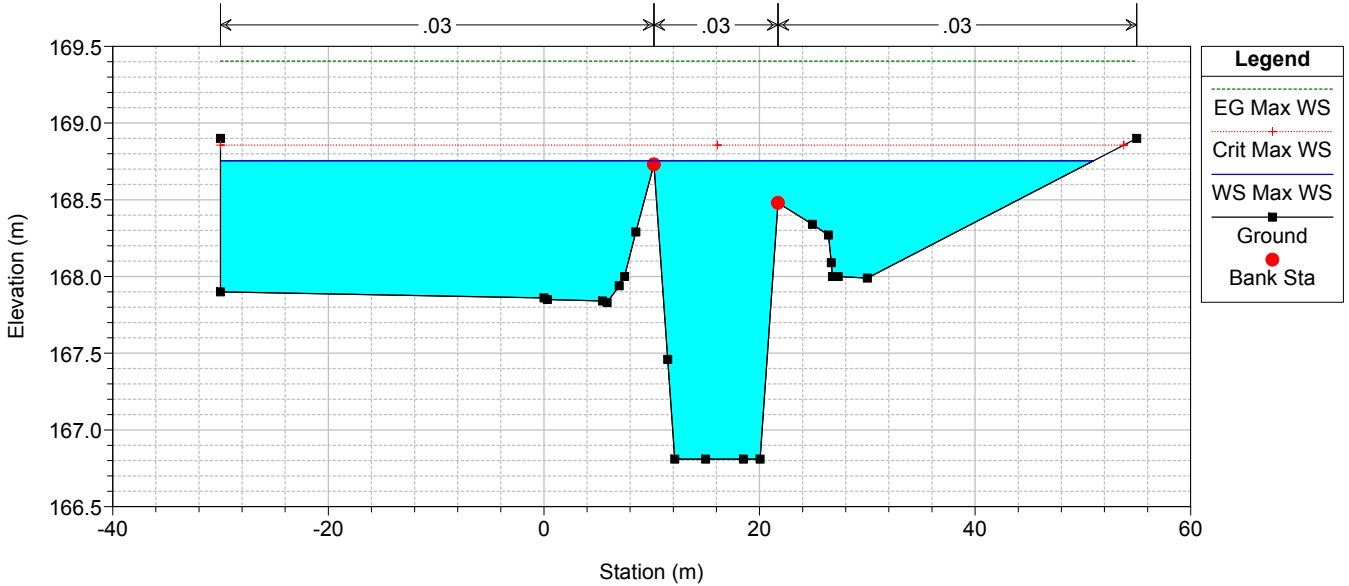

TO02-TO03-CA02-TO07_VARIO_POST

RS = -3248.41 TO07 RS= -61.4

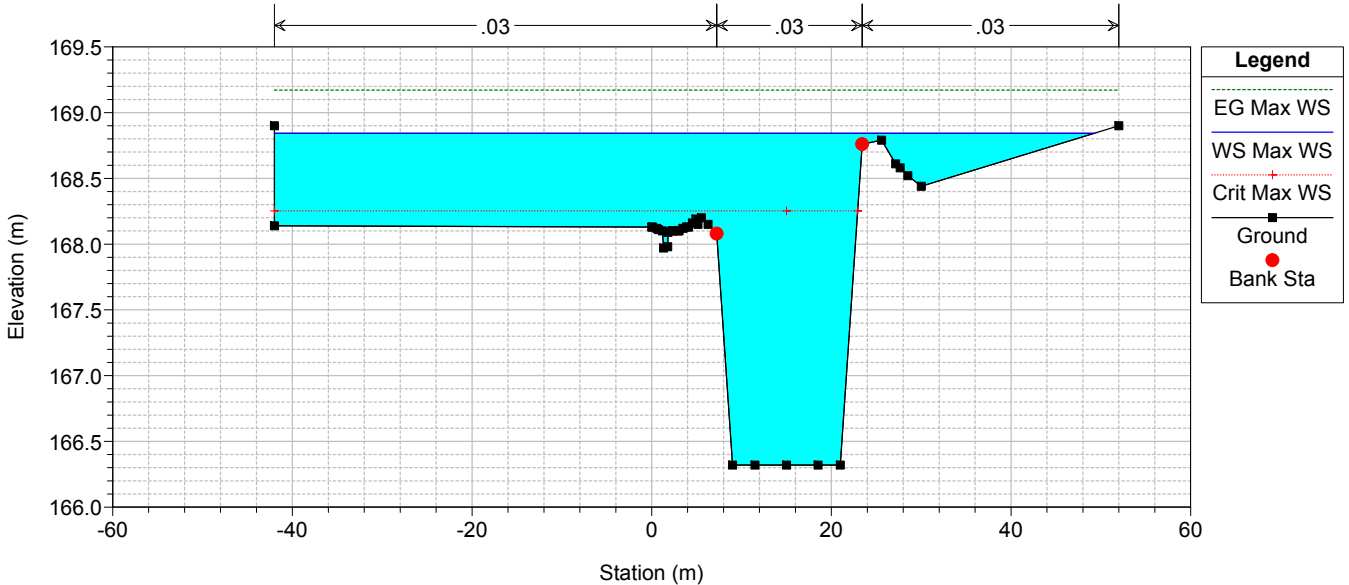

TO02-TO03-CA02-TO07_VARIO_POST

RS = -3260.19 TO07 RS= -68.09

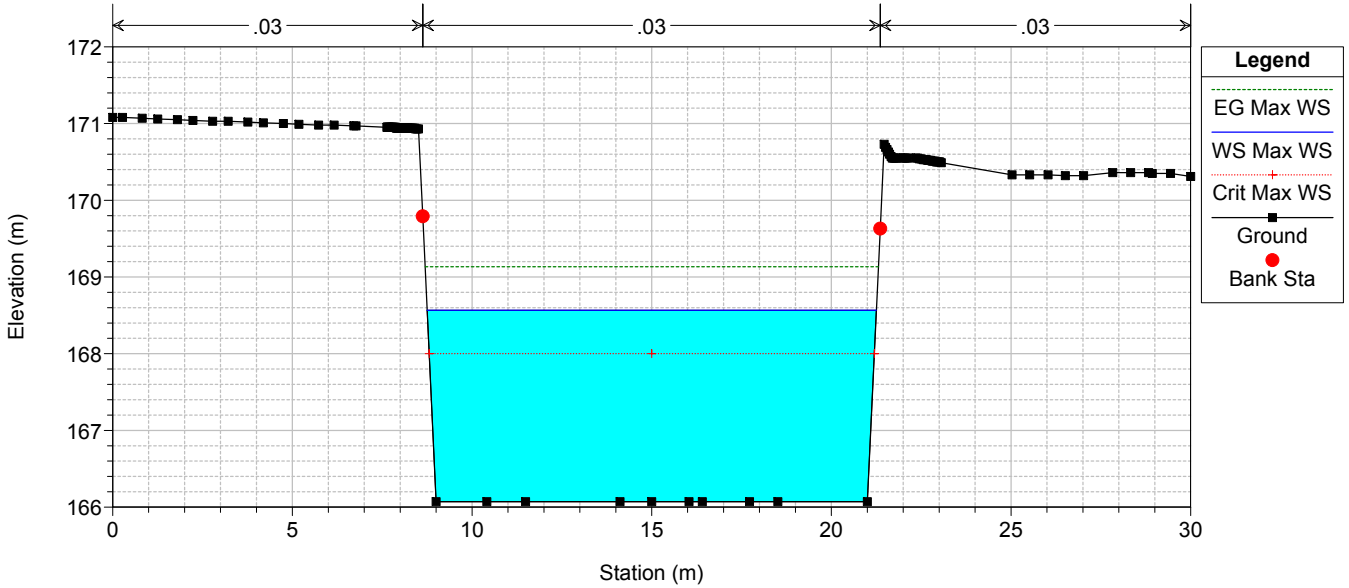

TO02-TO03-CA02-TO07_VARIO_POST

RS = -3276.44 BR TO07.A

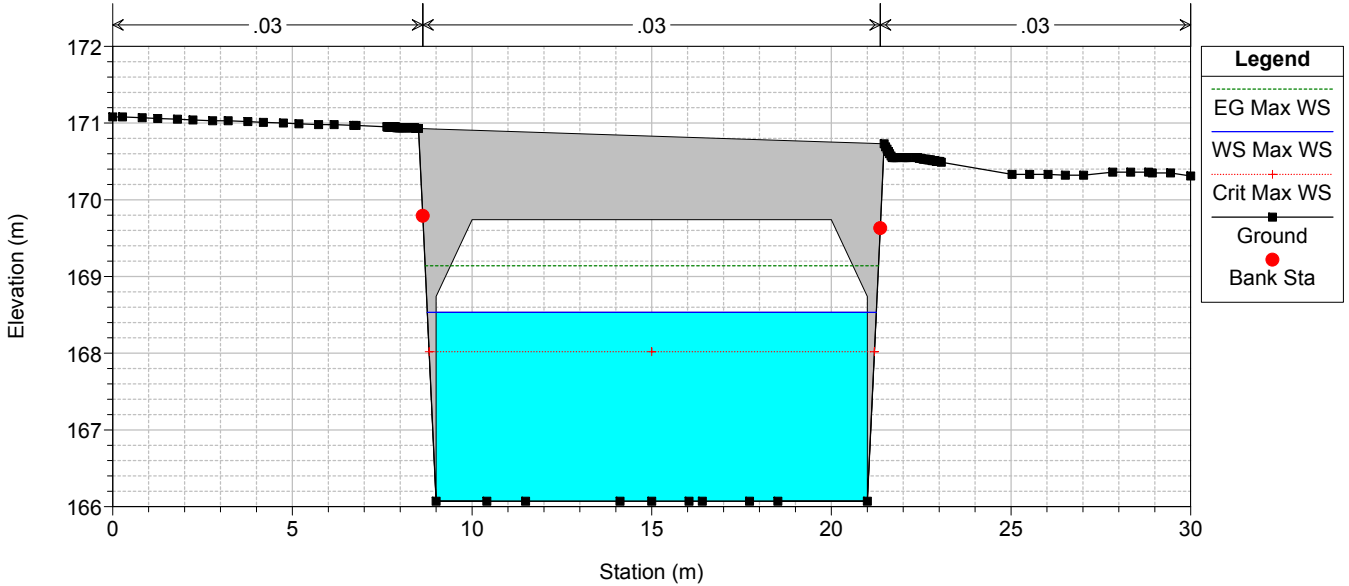

TO02-TO03-CA02-TO07_VARIO_POST

RS = -3276.44 BR TO07.A

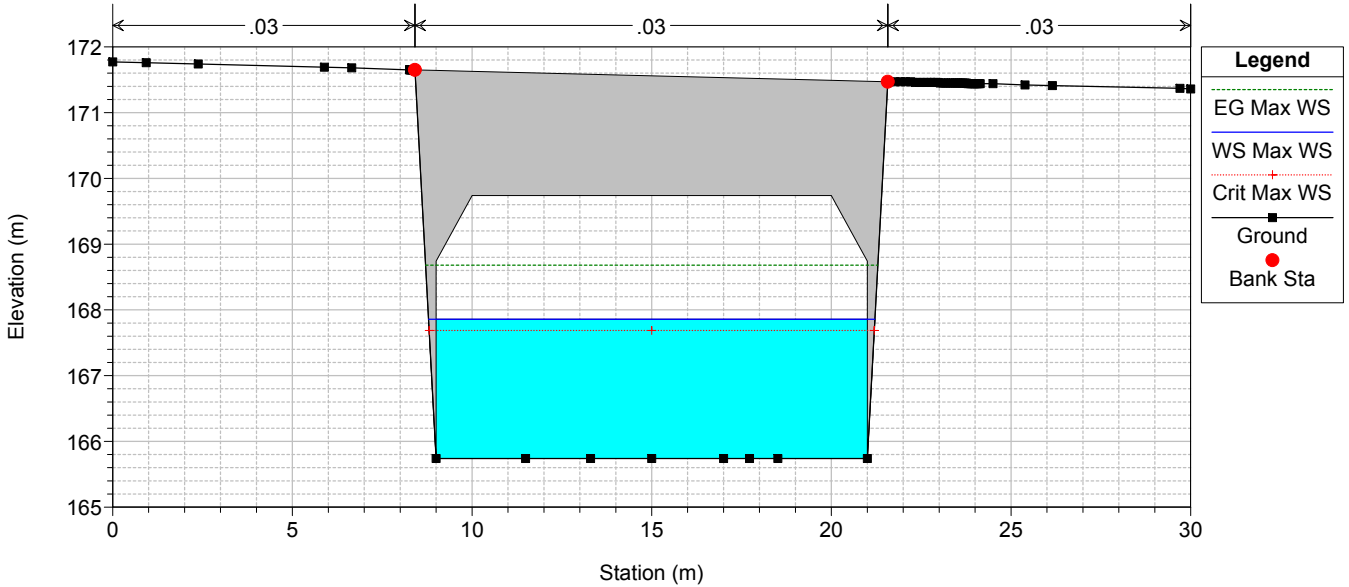

TO02-TO03-CA02-TO07_VARIO_POST

RS = -3292.69 TO07 RS= -97.95

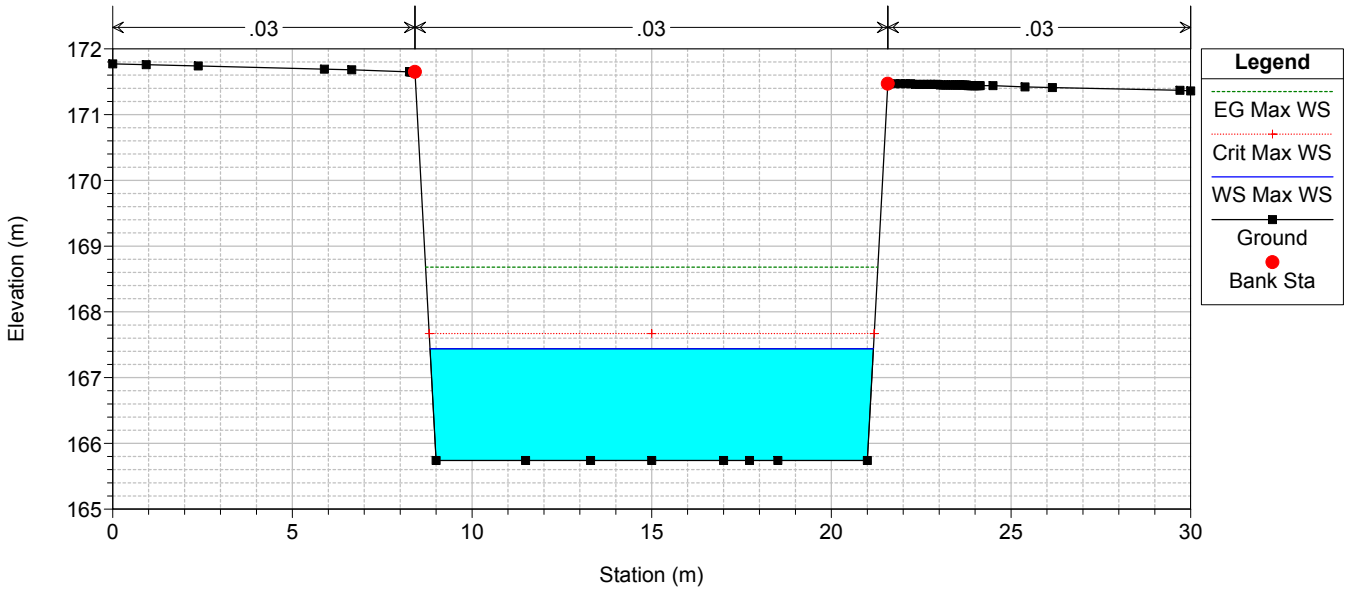

TO02-TO03-CA02-TO07_VARIO_POST

RS = -3309.76 TO07 RS= -116.36

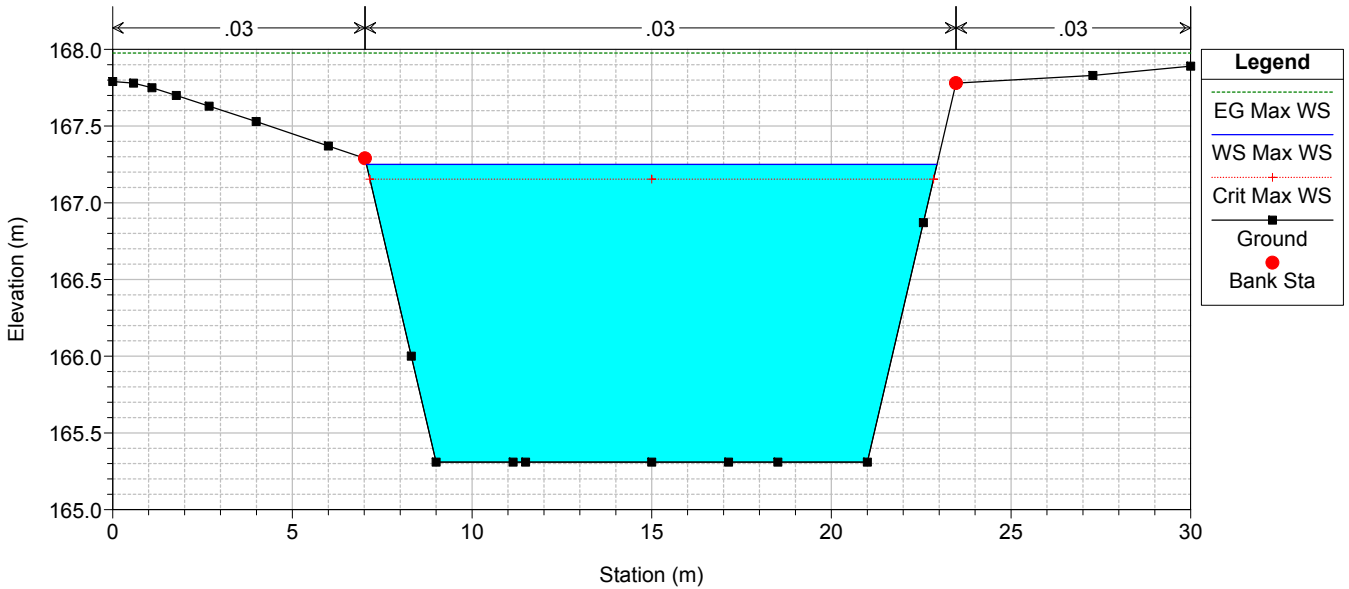

TO02-TO03-CA02-TO07_VARIO_POST

RS = -3319.81 TO07 RS= -126.79

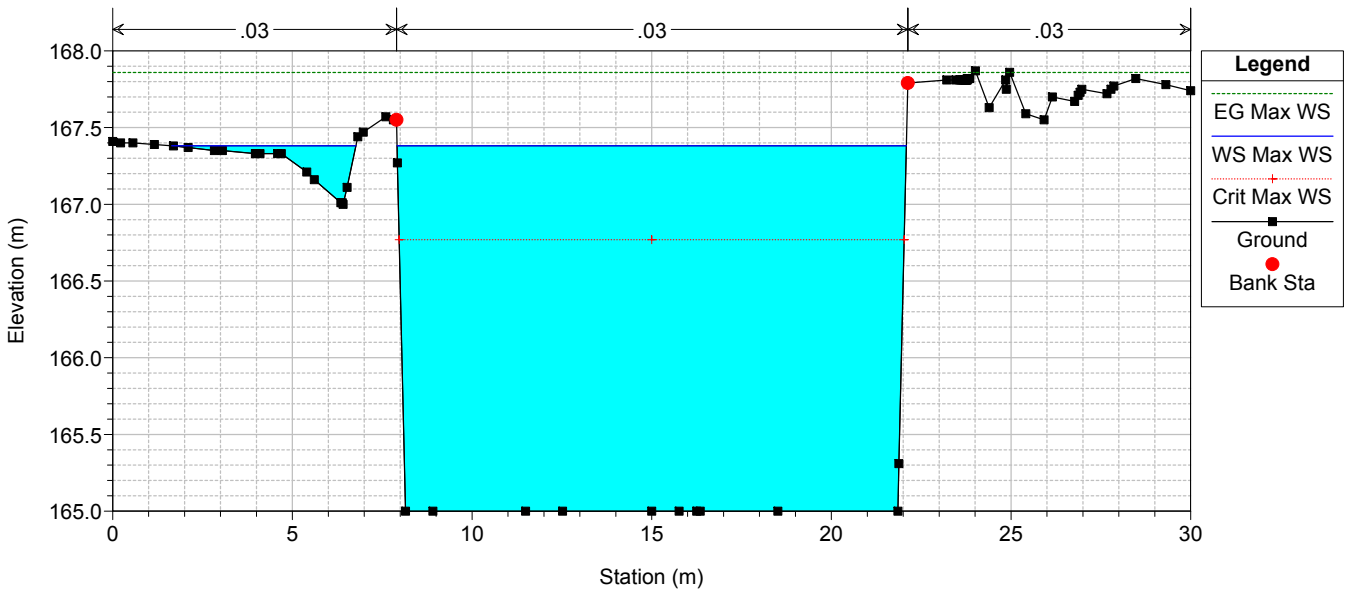

TO02-TO03-CA02-TO07_VARIO_POST

RS = -3327.28 BR TO07.B

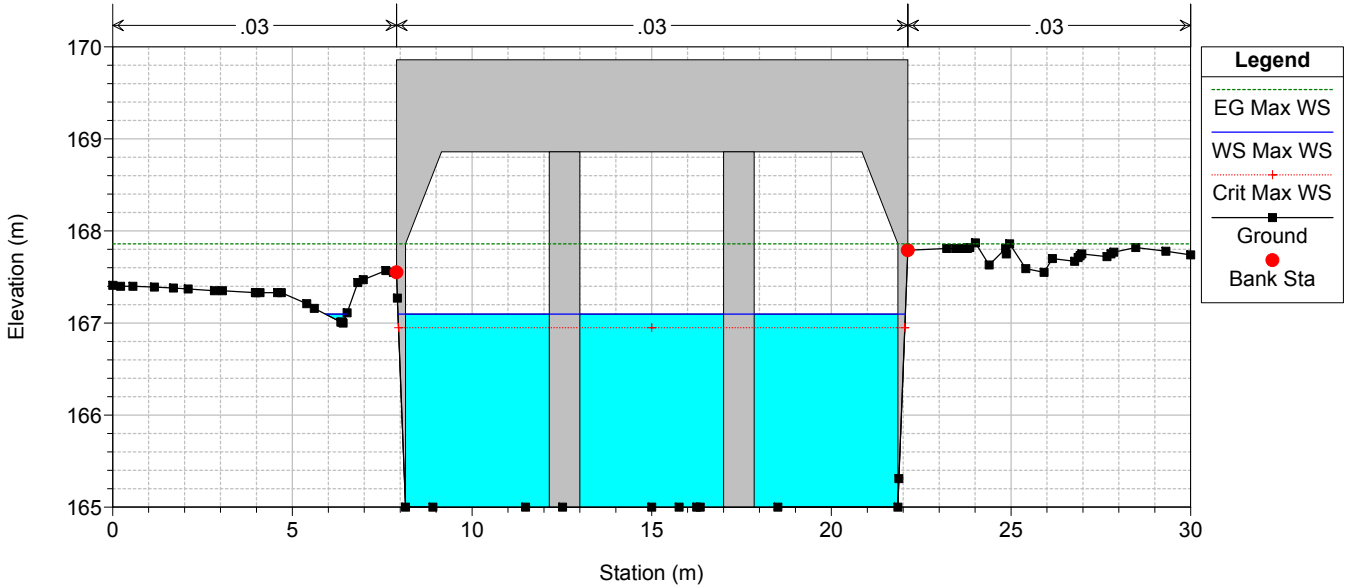

TO02-TO03-CA02-TO07_VARIO_POST

RS = -3327.28 BR TO07.B

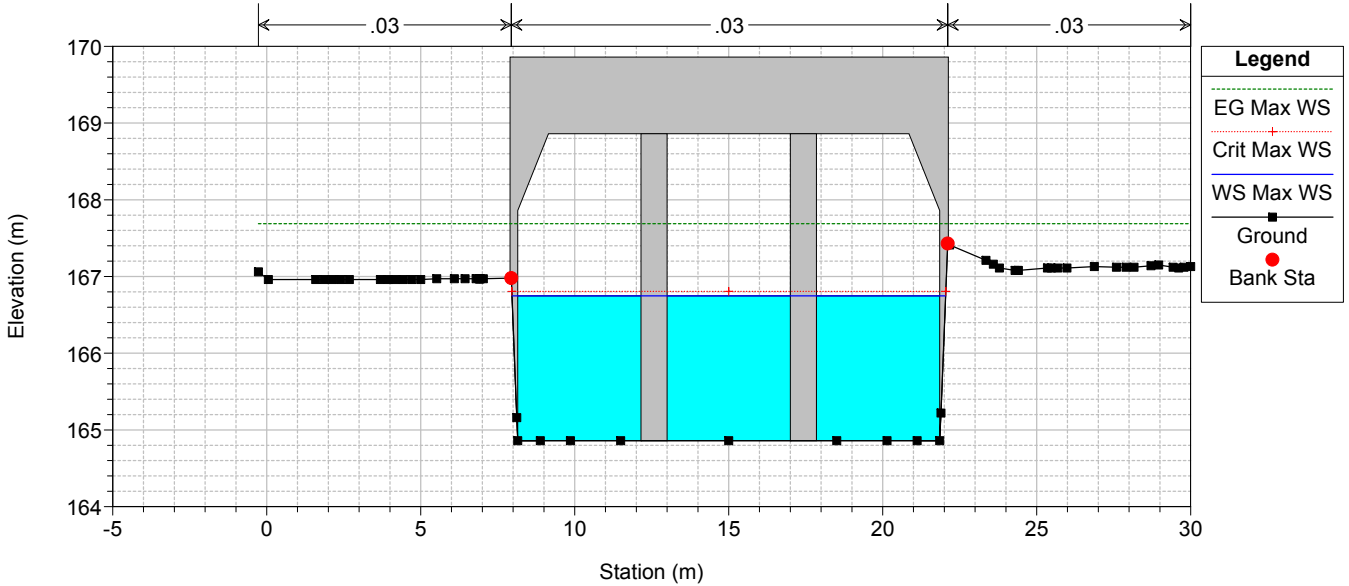

TO02-TO03-CA02-TO07_VARIO_POST

RS = -3334.75 TO07 RS= -141.787

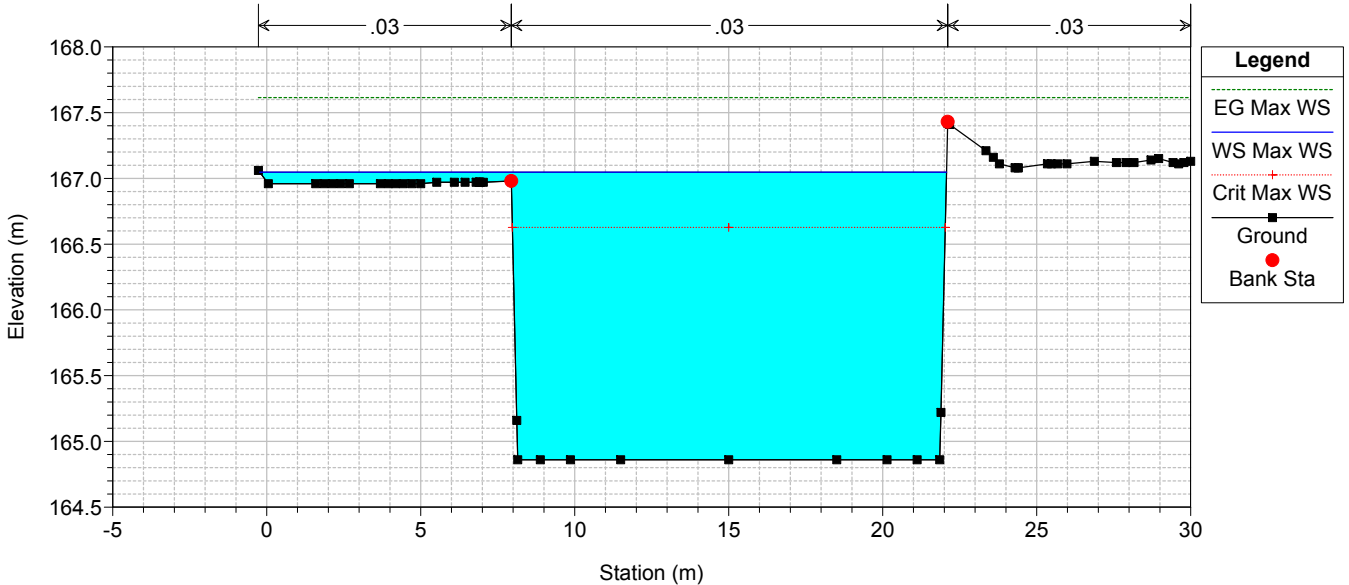

TO02-TO03-CA02-TO07_VARIO_POST

RS = -3344.22 TO07 RS= -150.818

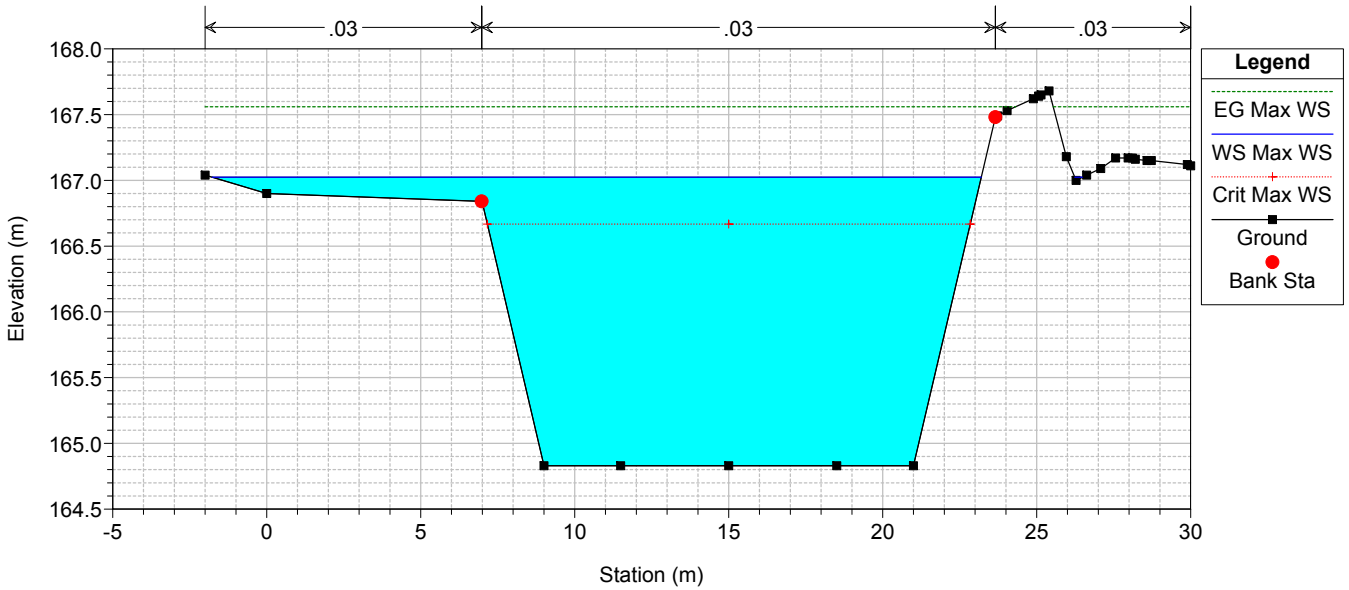

TO02-TO03-CA02-TO07_VARIO_POST

RS = -3352.49 TO07 RS= -159.09

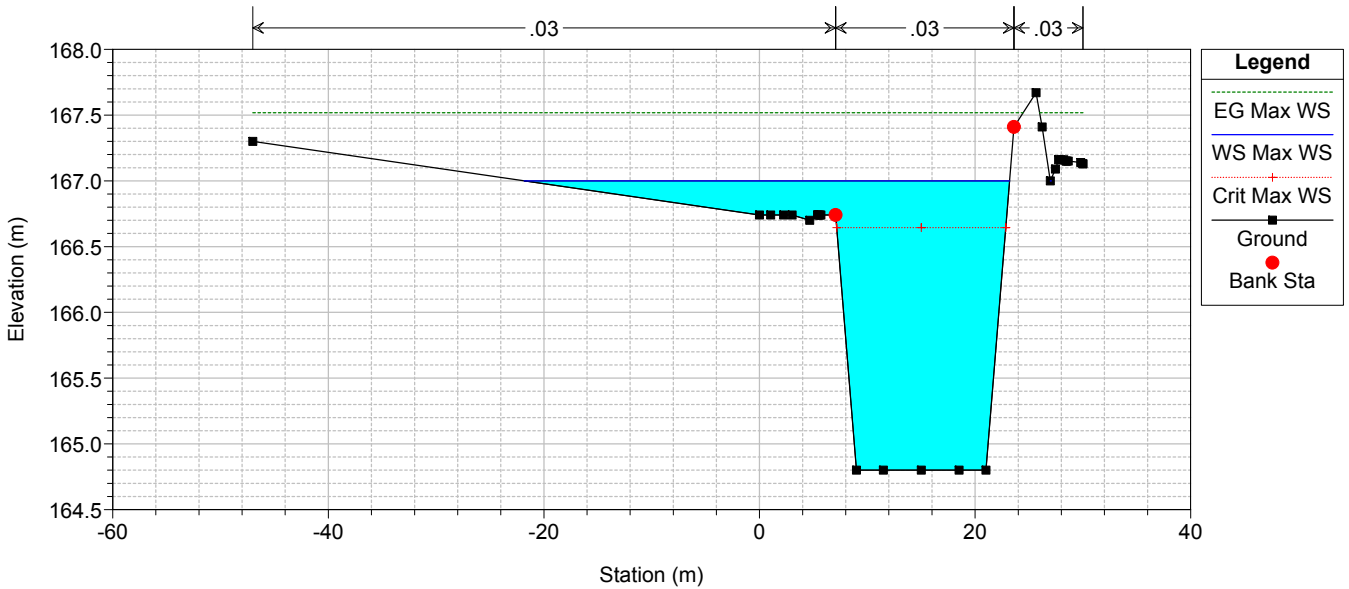

TO02-TO03-CA02-TO07_VARIO_POST

RS = -3393.40 TO07 RS= -200

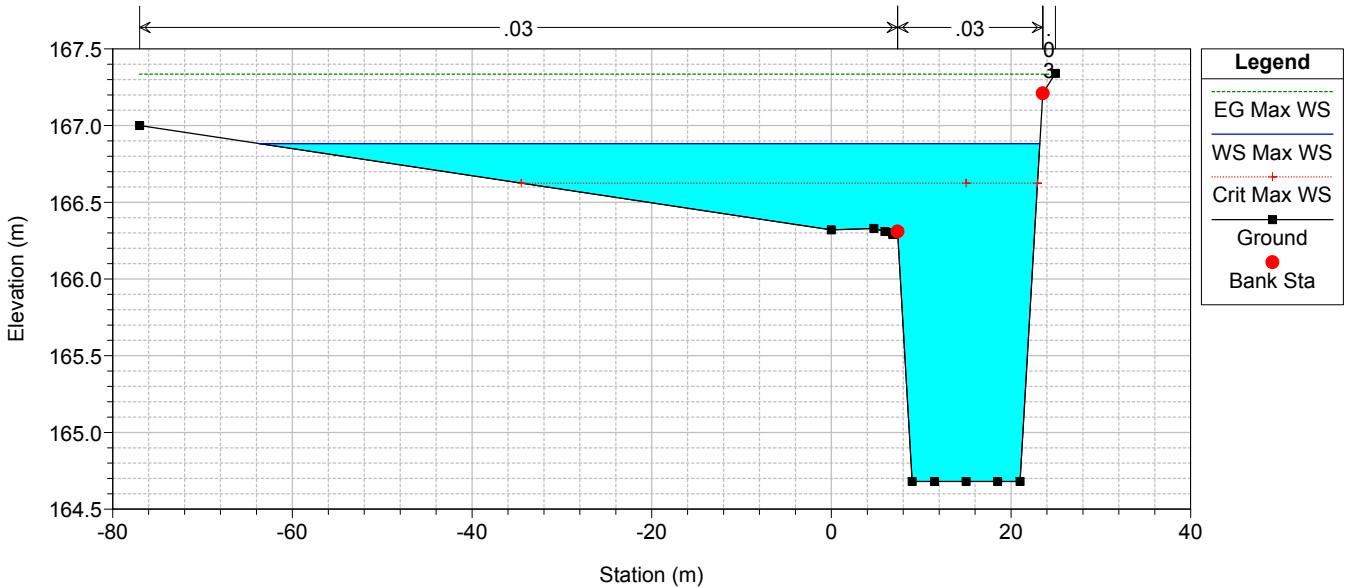

TO02-TO03-CA02-TO07_VARIO_POST

RS = -3418.40 TO07 RS= -225

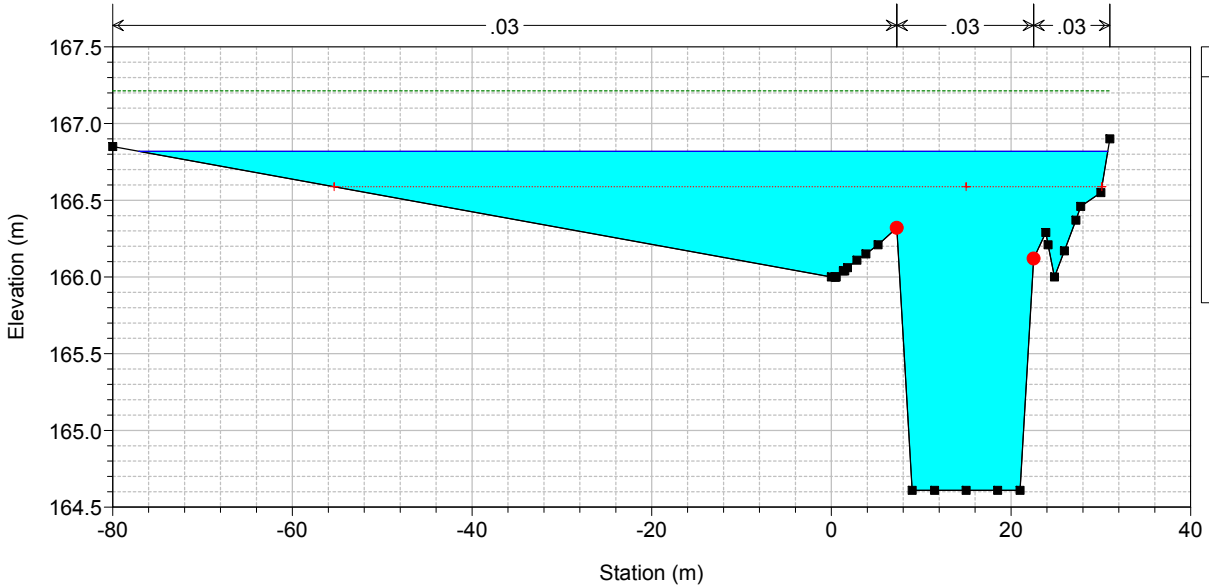

TO02-TO03-CA02-TO07_VARIO_POST

RS = -3443.40 TO07 RS= -250

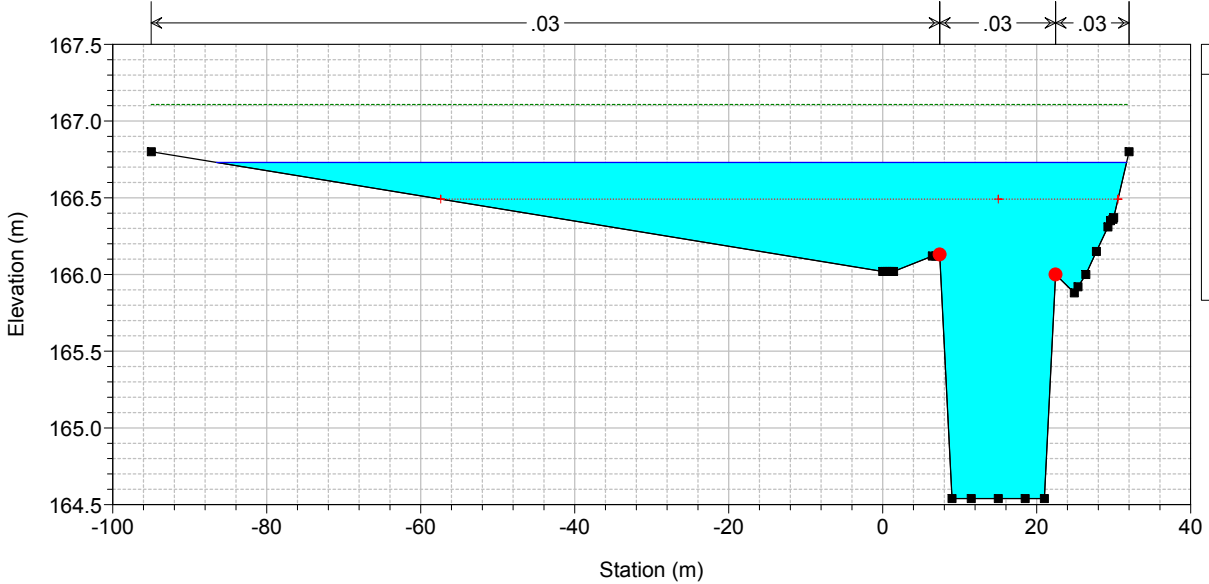

TO02-TO03-CA02-TO07_VARIO_POST

RS = -3468.40 TO07 RS= -275

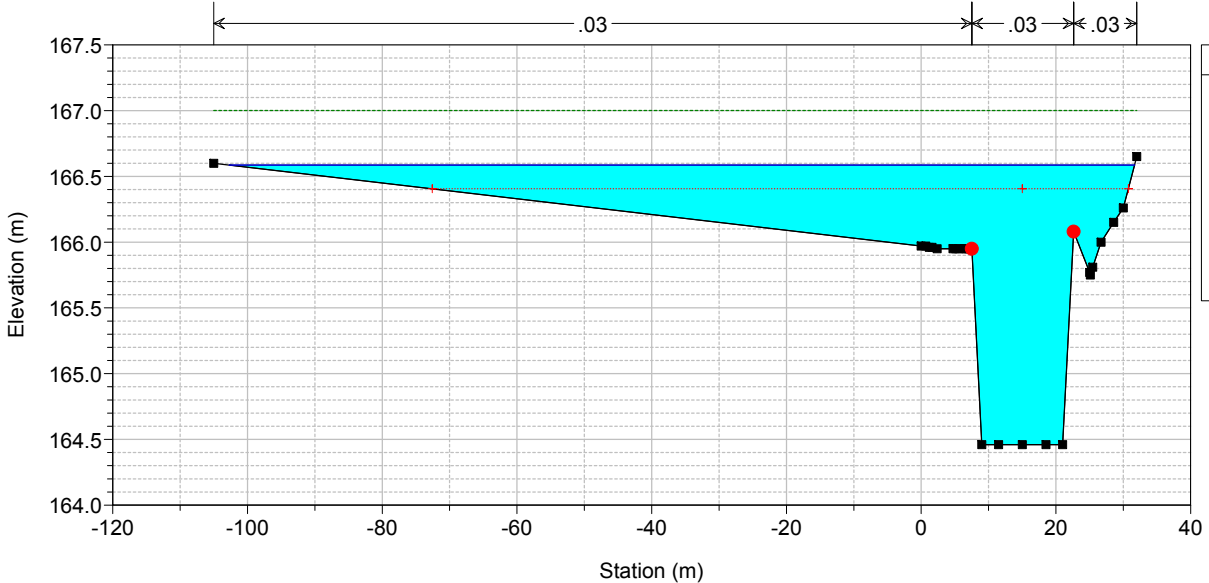

TO02-TO03-CA02-TO07_VARIO_POST

RS = -3493.40 TO07 RS= -300

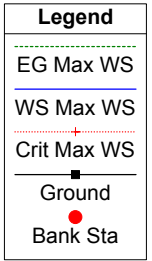
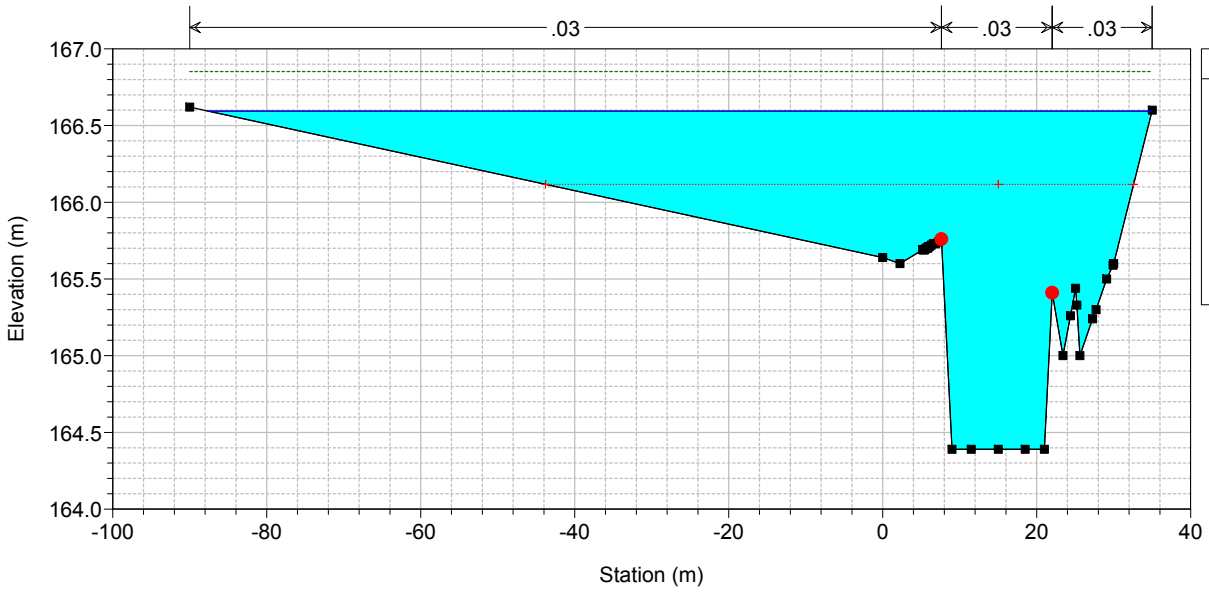

TO02-TO03-CA02-TO07_VARIO_POST

RS = -3518.40 TO07 RS= -325

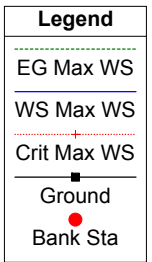
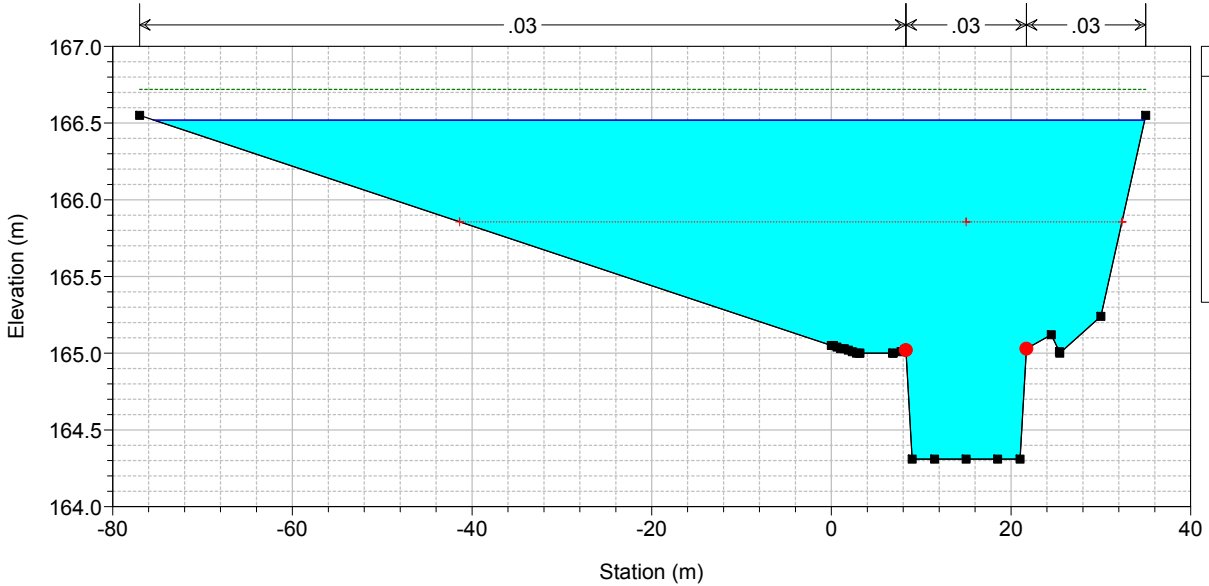

TO02-TO03-CA02-TO07_VARIO_POST

RS = -3543.40 TO07 RS= -350

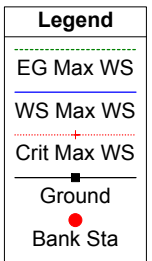
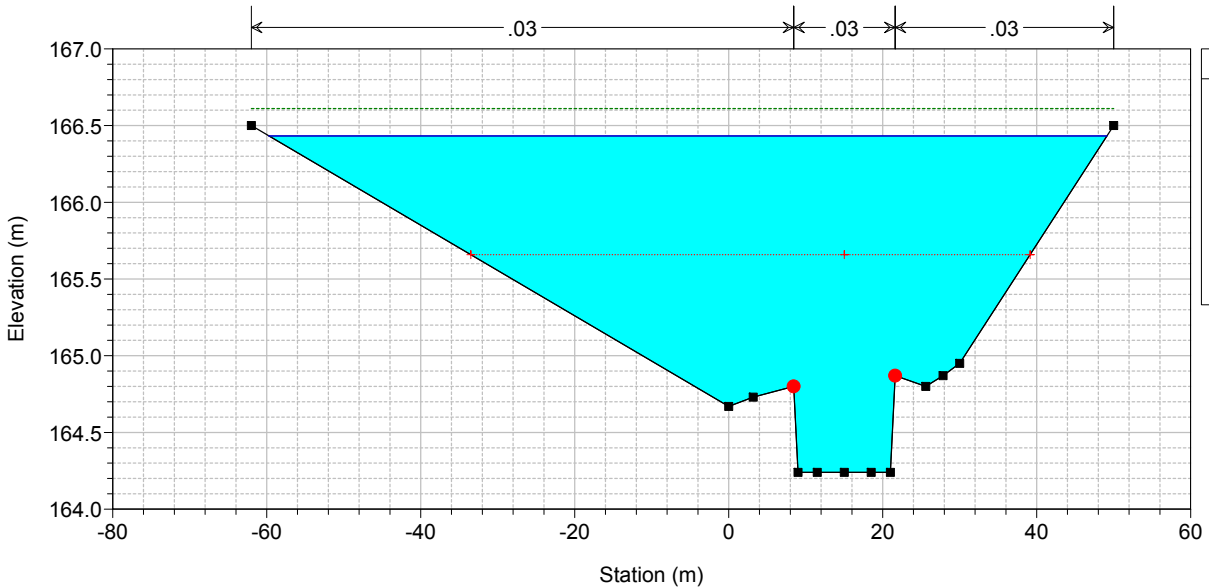

TO02-TO03-CA02-TO07_VARIO_POST

RS = -3568.40 TO07 RS= -375

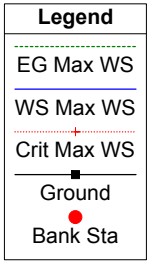
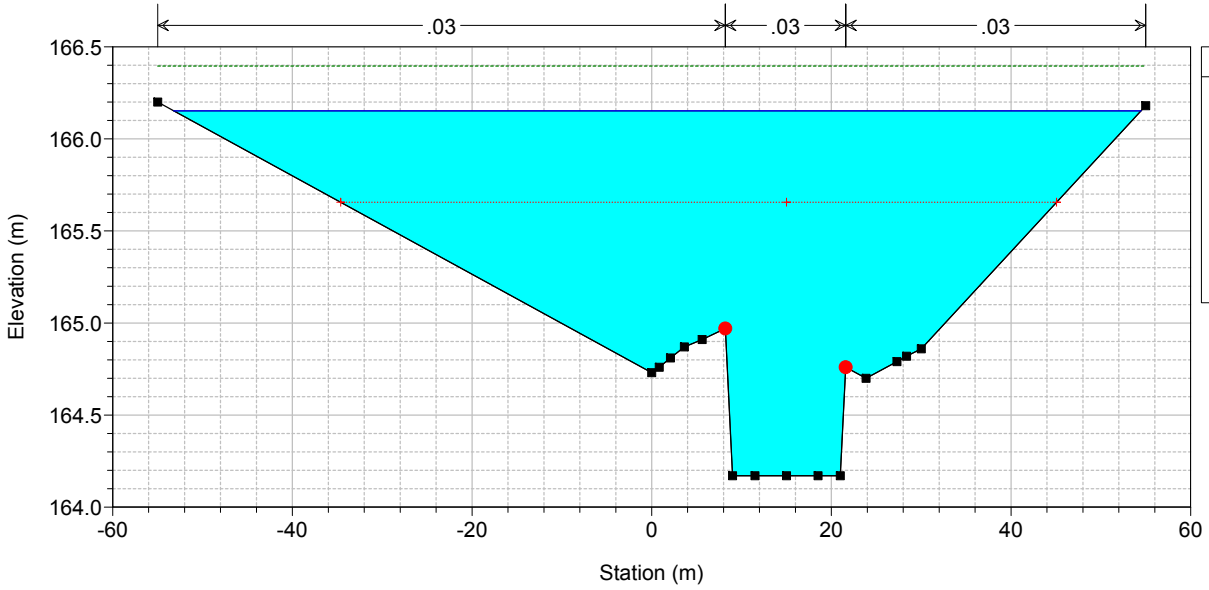

TO02-TO03-CA02-TO07_VARIO_POST

RS = -3593.40 TO07 RS= -400

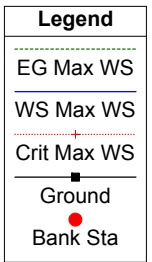
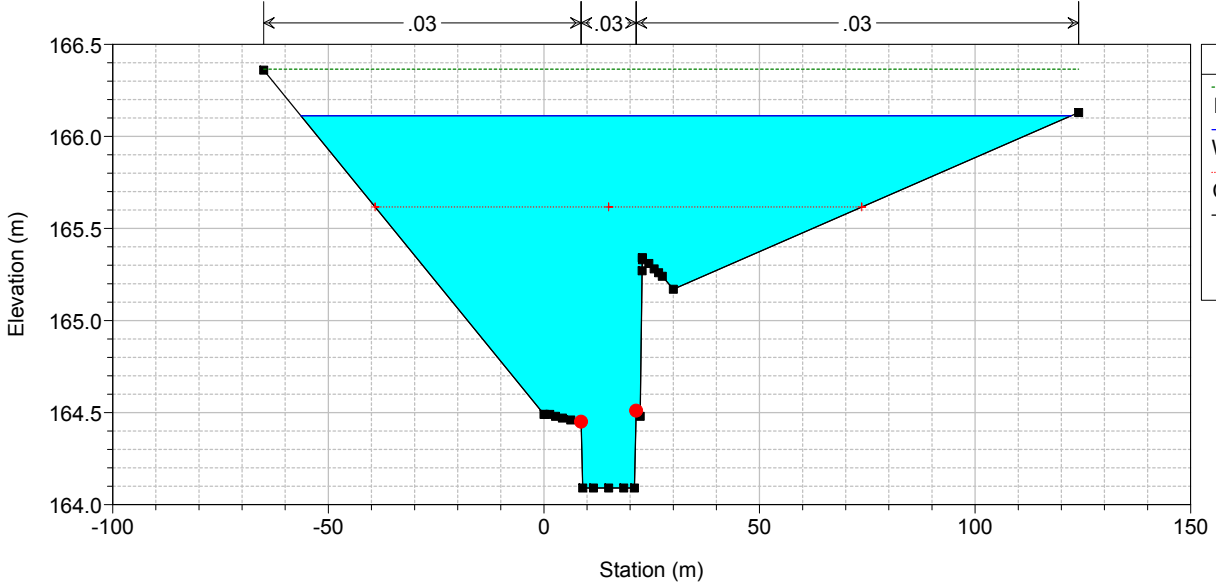

TO02-TO03-CA02-TO07_VARIO_POST

RS = -3618.40 TO07 RS= -425

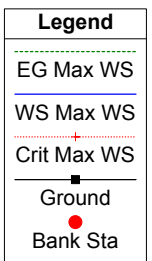
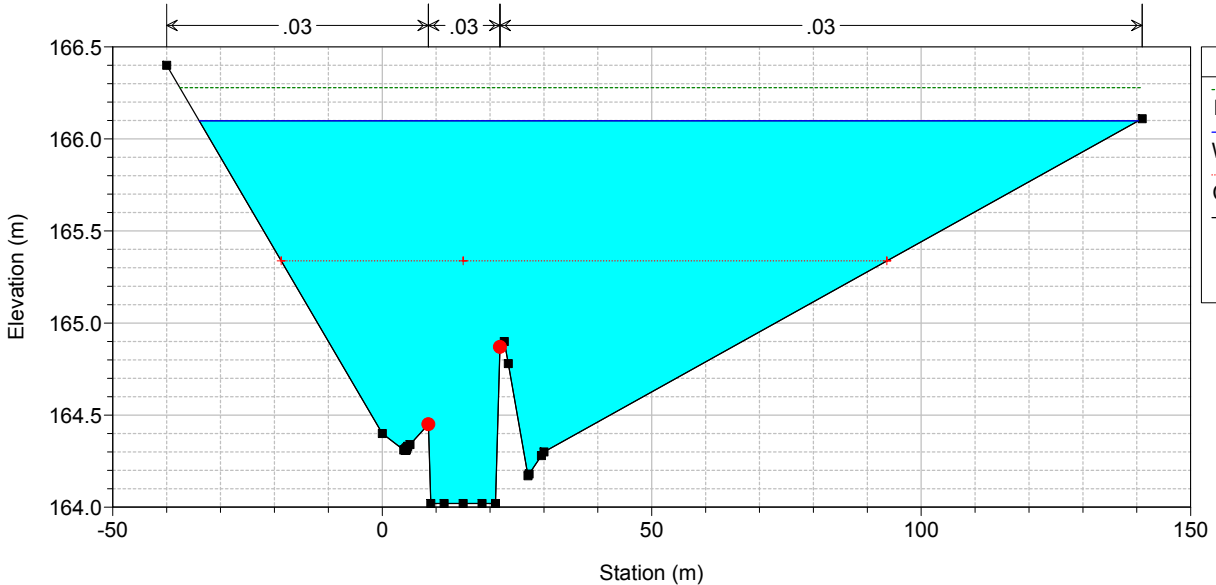

TO02-TO03-CA02-TO07_VARIO_POST

RS = -3643.40 TO07 RS= -450

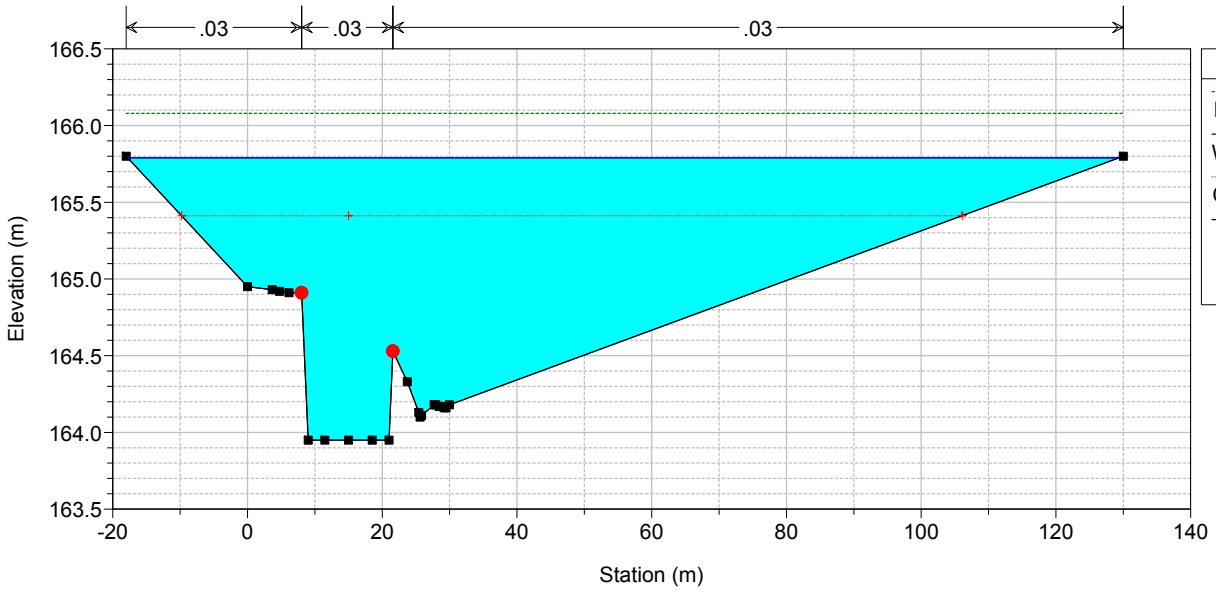

TO02-TO03-CA02-TO07_VARIO_POST

RS = -3668.40 TO07 RS= -475

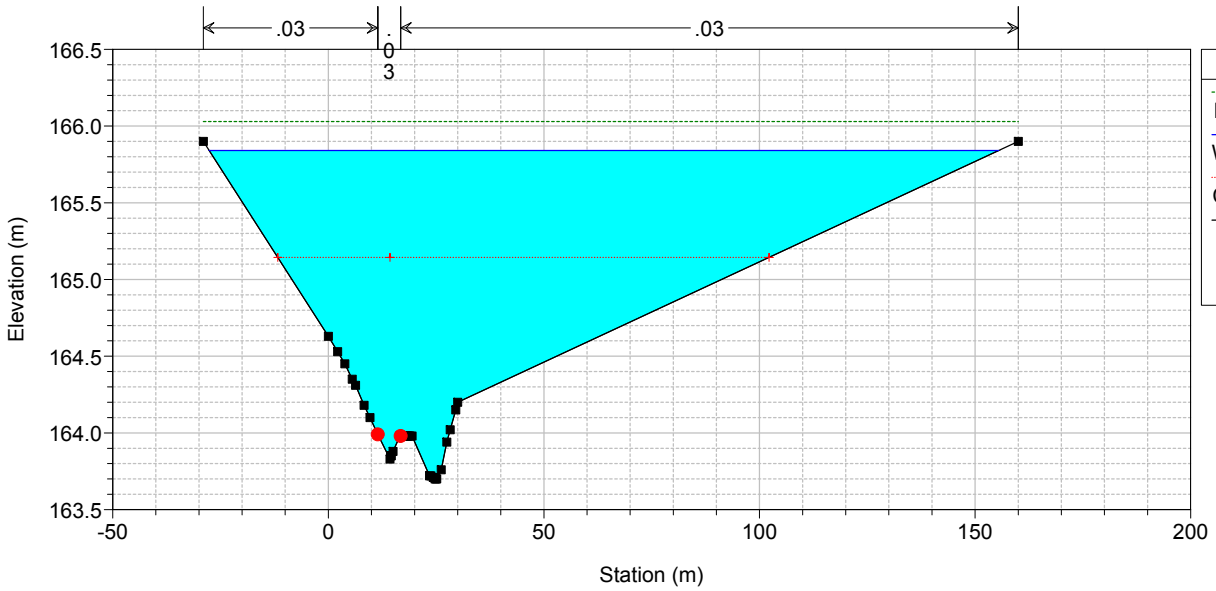

ALLEGATO 3.3

Interferenza idraulica – TO10
Tabella riassuntiva dei risultati,
profilo idrico e sezioni trasversali con i livelli idrici (TR 200 anni)

ANTE

HEC-RAS Plan: ANTE_VARIO River: TO10 Reach: TO10_SDF Profile: Max WS

Reach	River Sta	Profile	Q Total (m3/s)	Min Ch El (m)	Max Chl Dpth (m)	W.S. Elev (m)	Crit W.S. (m)	Diff	Froude # Chl	E.G. Elev (m)	Vel Chnl (m/s)	Vel Total (m/s)	Hydr Radius C (m)	Shear Chan (N/m2)	Hydr Depth (m)
TO10_SDF	0	Max WS	145.6	175.96	7.29	183.25	178.42	4.83	0.09	183.27	0.7	0.6	5.9	2.5	5.98
TO10_SDF	-25	Max WS	145.6	175.74	7.49	183.23	178.33	4.90	0.09	183.25	0.7	0.6	6.4	2.5	6.00
TO10_SDF	-33	Max WS	145.6	175.25	7.97	183.22	178.43	4.79	0.08	183.24	0.7	0.6	4.7	2.2	5.93
TO10_SDF	-36	Bridge													
TO10_SDF	-39	Max WS	145.6	175.21	8.02	183.23	178.55	4.68	0.09	183.25	0.7	0.6	5.7	2.6	5.89
TO10_SDF	-50	Max WS	145.6	175.47	7.77	183.23	178.01	5.22	0.08	183.25	0.7	0.6	6.8	2.2	6.43
TO10_SDF	-75	Max WS	145.6	175.11	8.11	183.23	177.48	5.75	0.07	183.24	0.6	0.5	6.7	1.8	6.92
TO10_SDF	-88	Max WS	145.6	175.01	8.13	183.14			0.10	183.18	0.9	0.9	3.1	4.4	4.26
TO10_SDF	-98.5	Culvert													
TO10_SDF	-109	Max WS	145.6	174.58	2.53	177.11	178.51	-1.40	2.00	181.82	9.6	9.6	1.4	726.8	2.35
TO10_SDF	-125	Max WS	145.6	173.92	2.46	176.38	176.59	-0.21	1.14	177.22	4.7	3.7	1.6	169.2	0.99
TO10_SDF	-150	Max WS	145.6	173.71	2.37	176.08	176.07	0.01	0.93	176.61	3.9	3.1	1.7	115.3	1.17
TO10_SDF	-165	Max WS	145.6	173.84	2.09	175.93	175.97	-0.04	1.01	176.52	4.0	3.3	1.6	123.5	1.12
TO10_SDF	-180.44	Max WS	145.6	173.51	2.28	175.79	175.91	-0.12	1.08	176.48	4.4	3.5	1.6	143.6	1.05

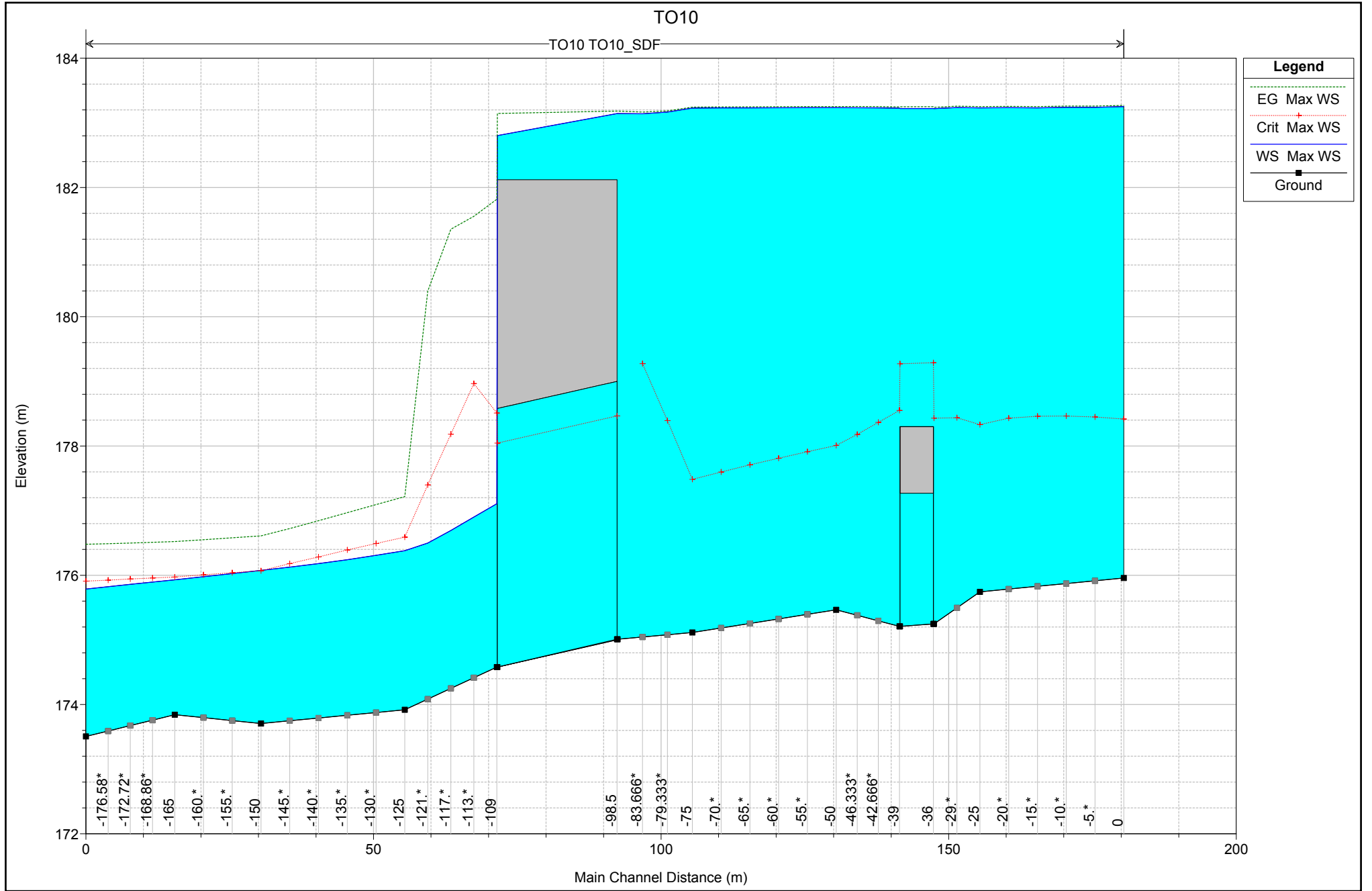

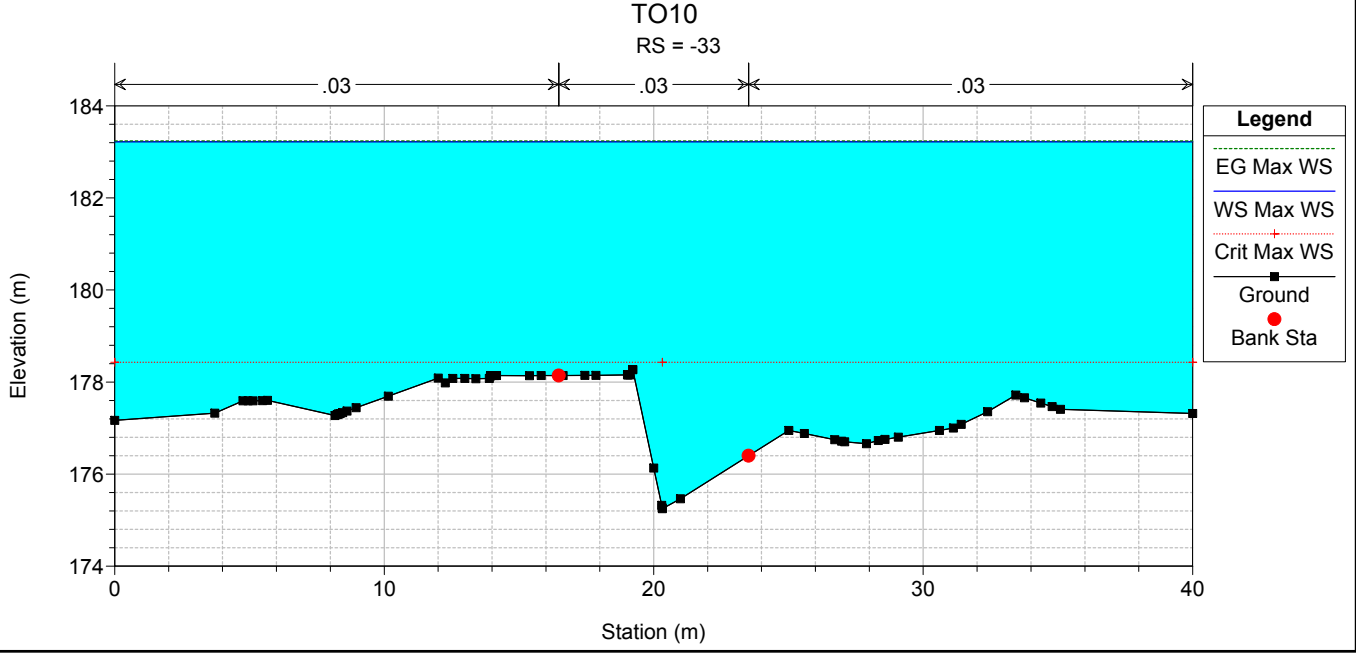
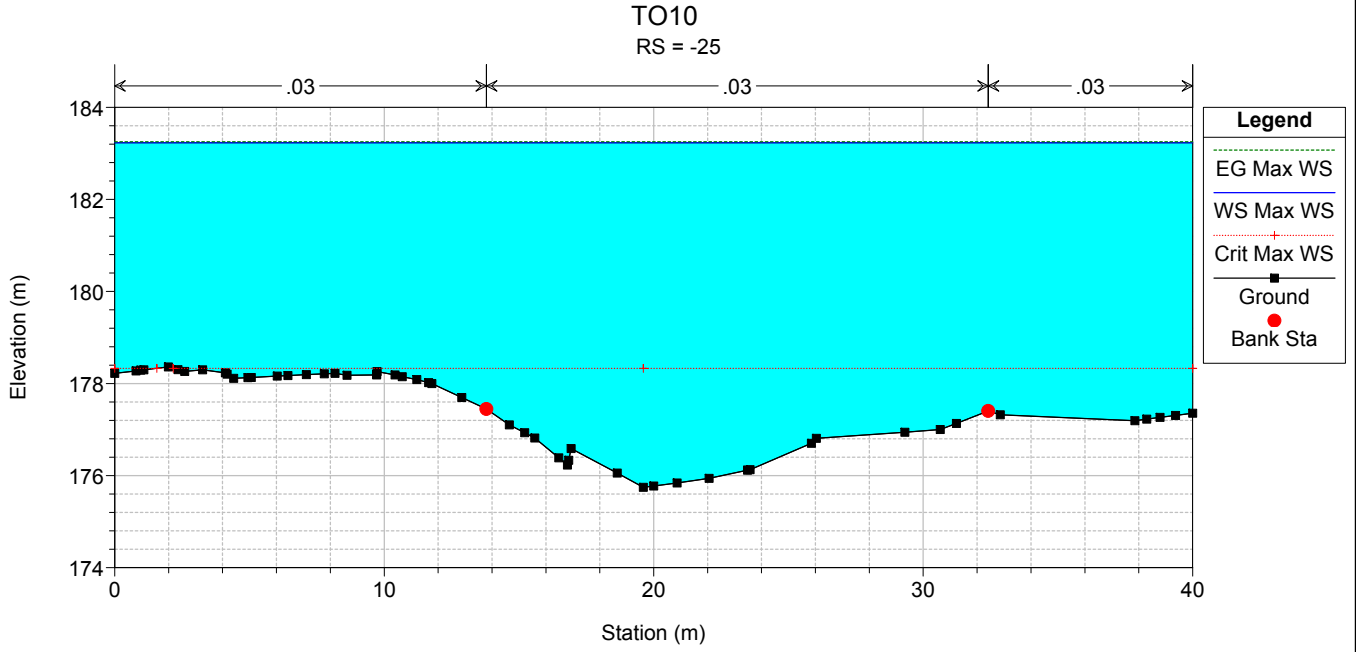
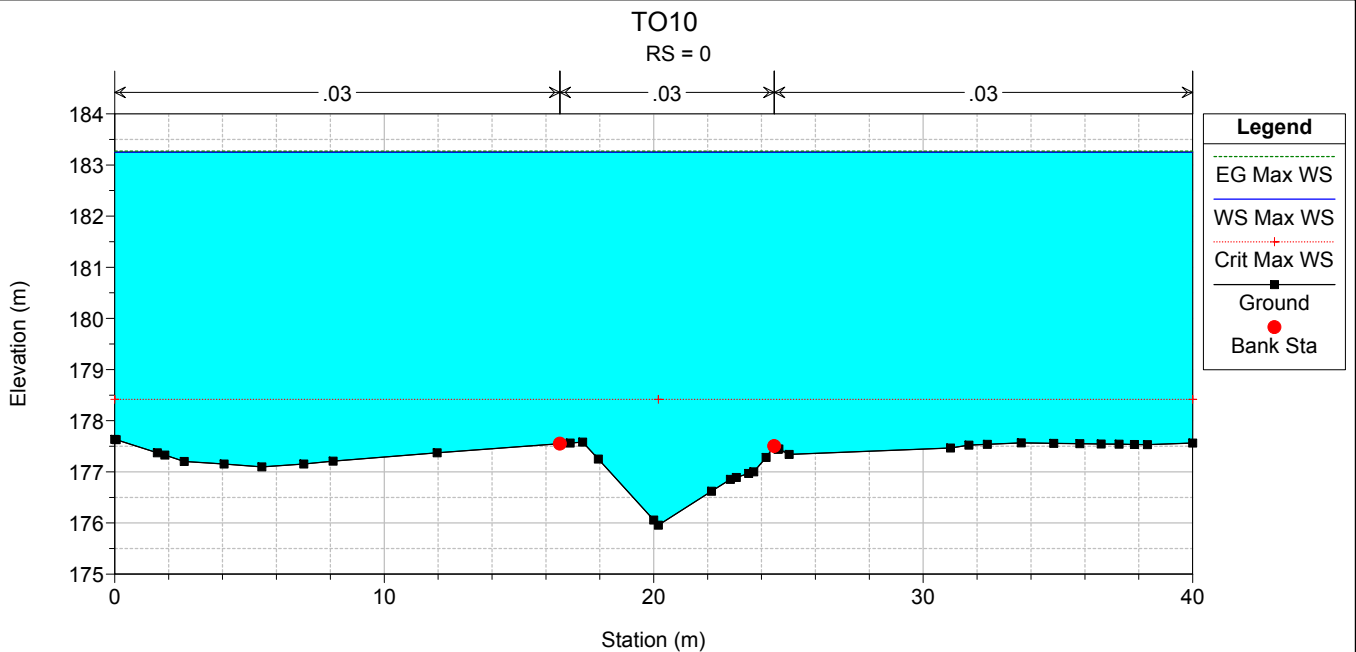

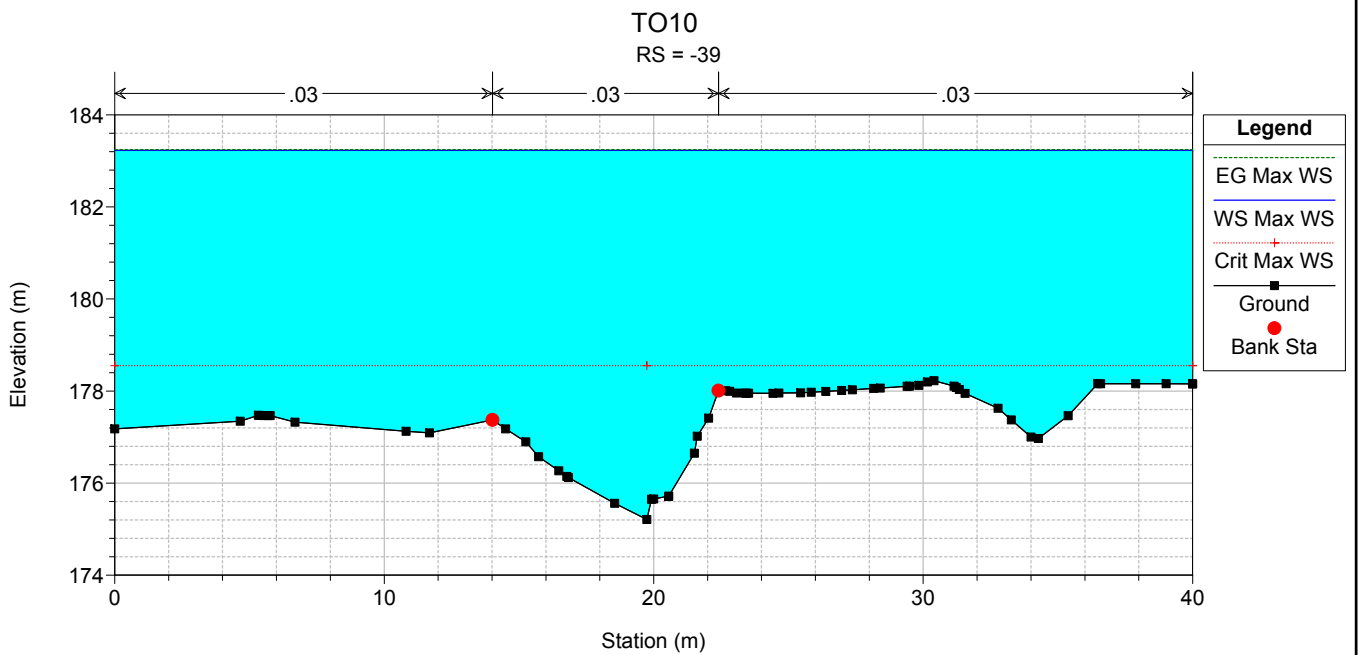
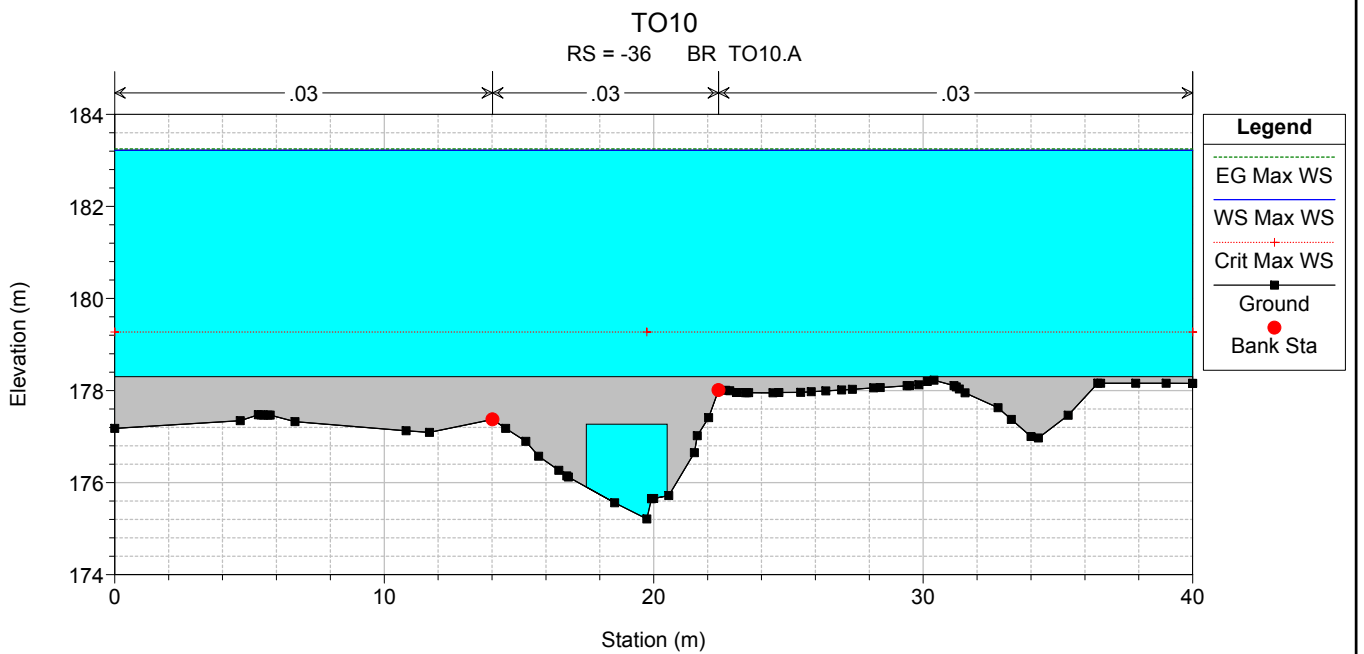
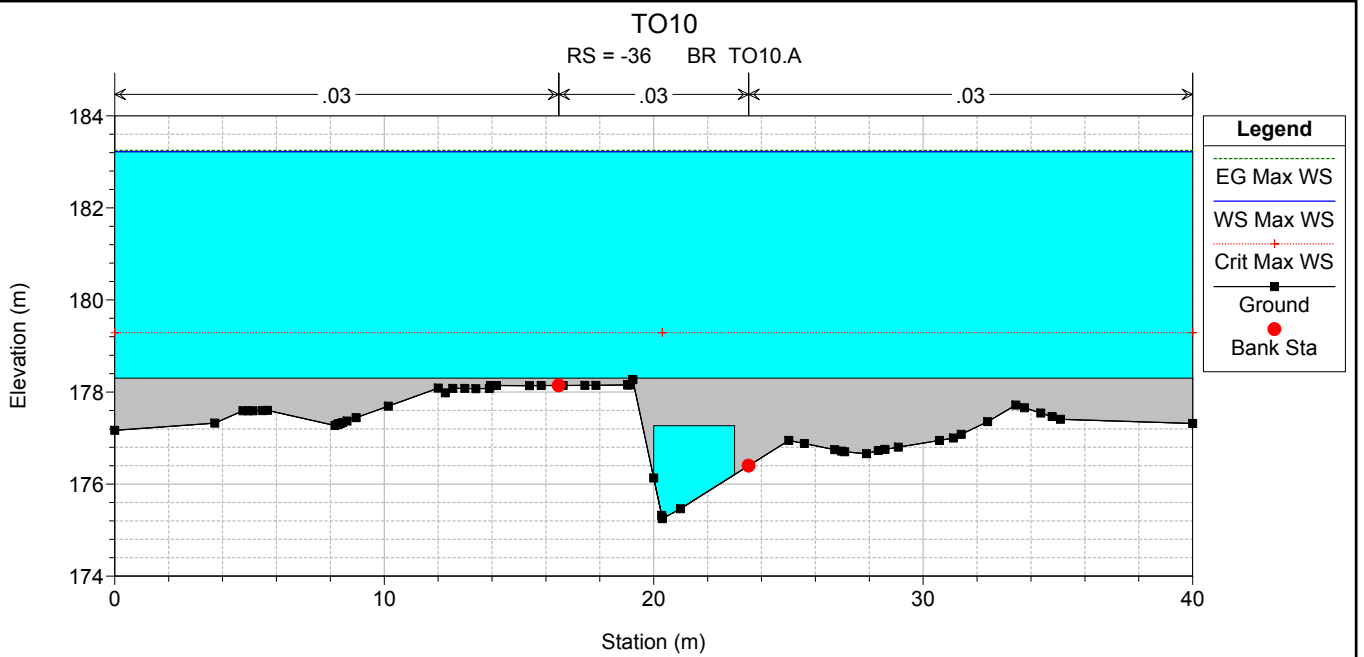

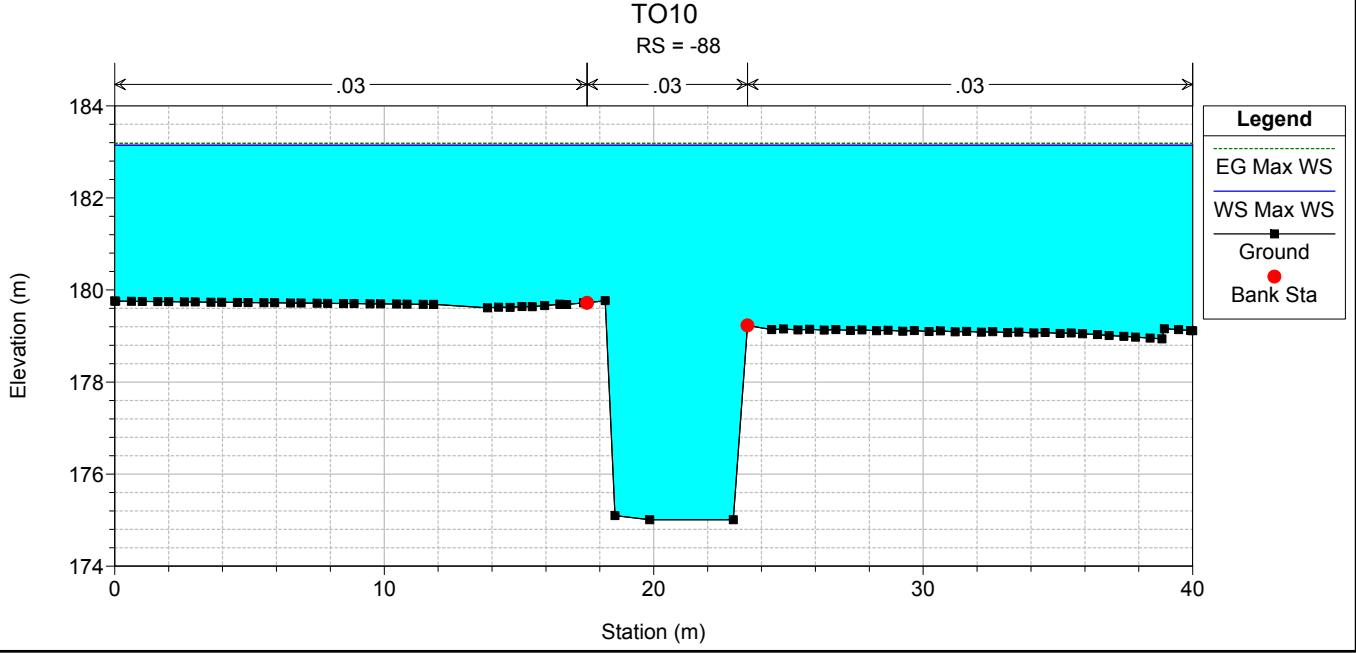
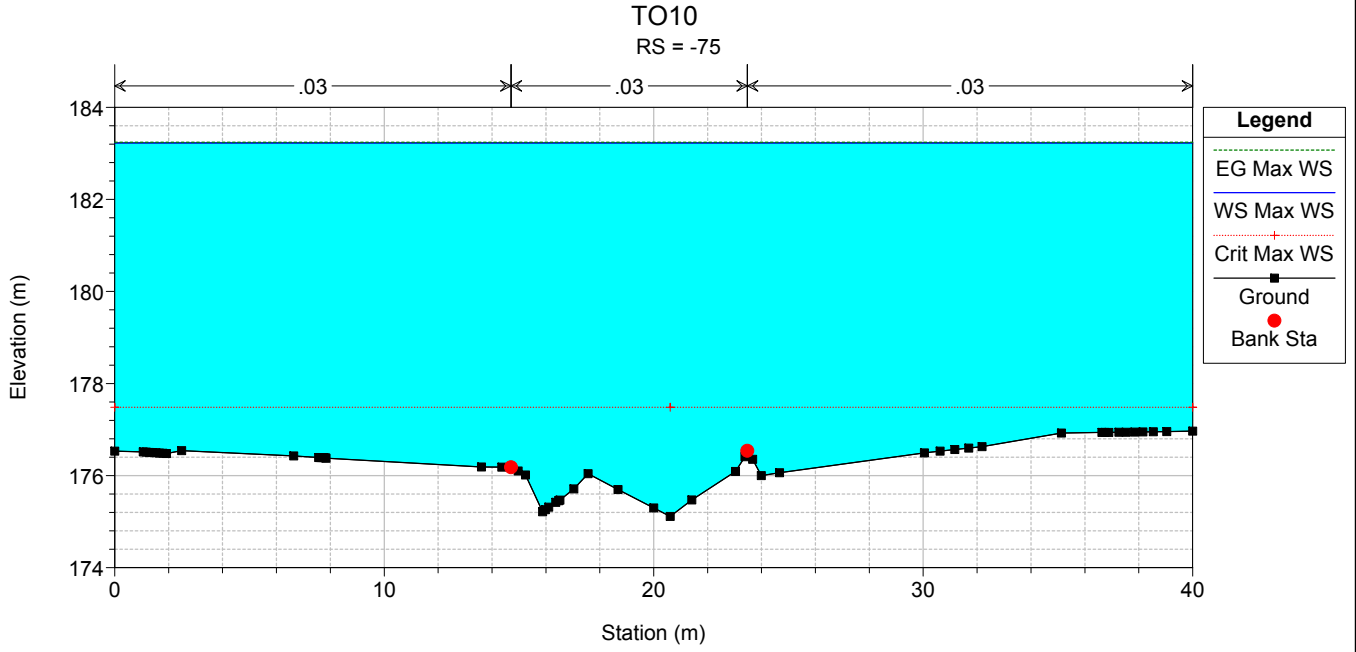
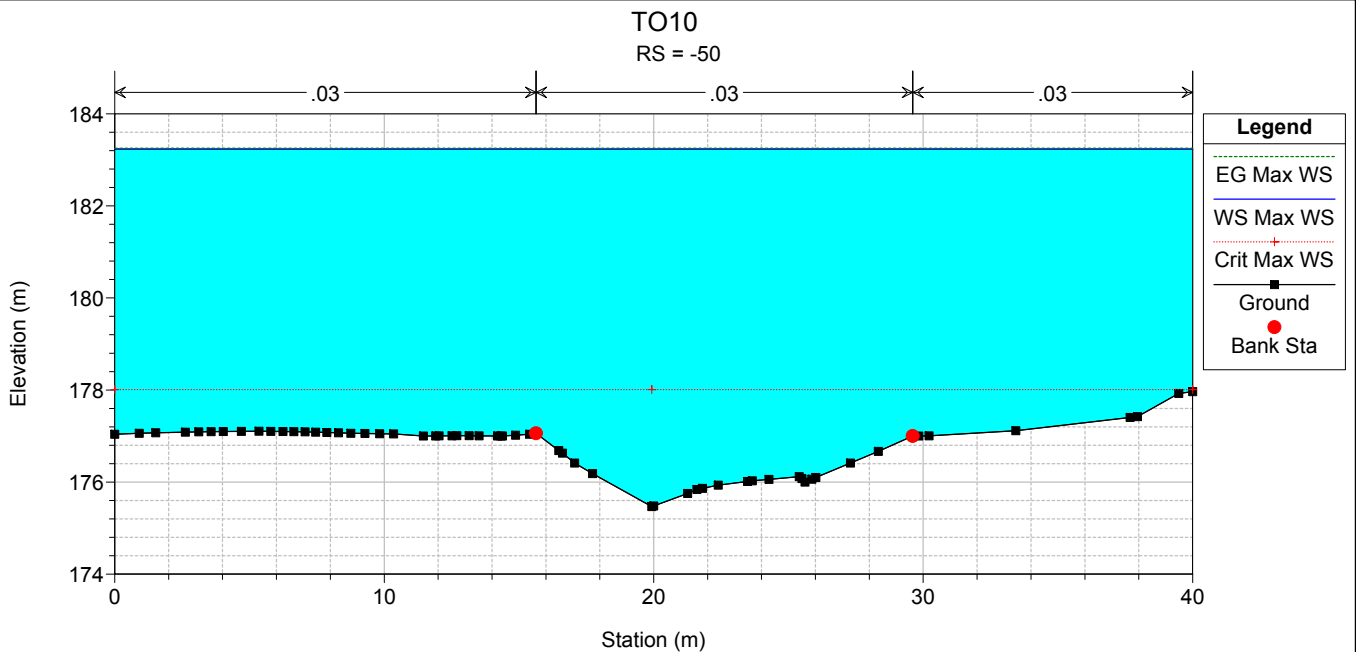

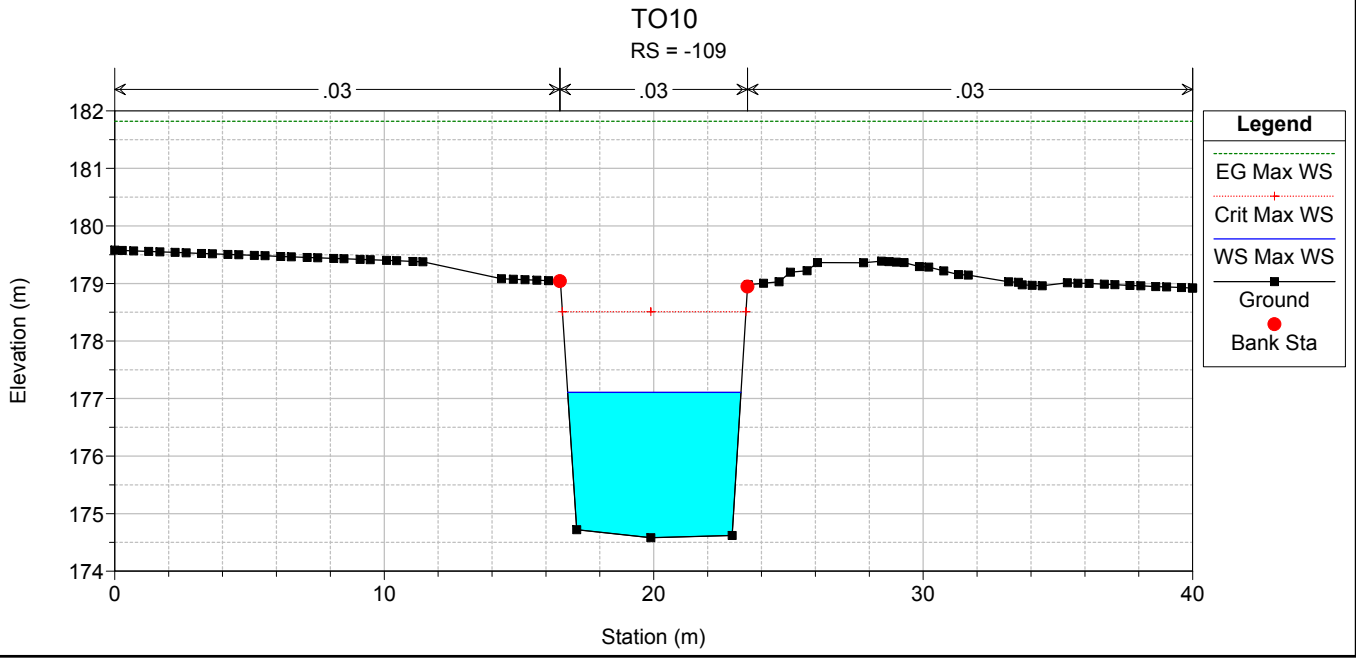
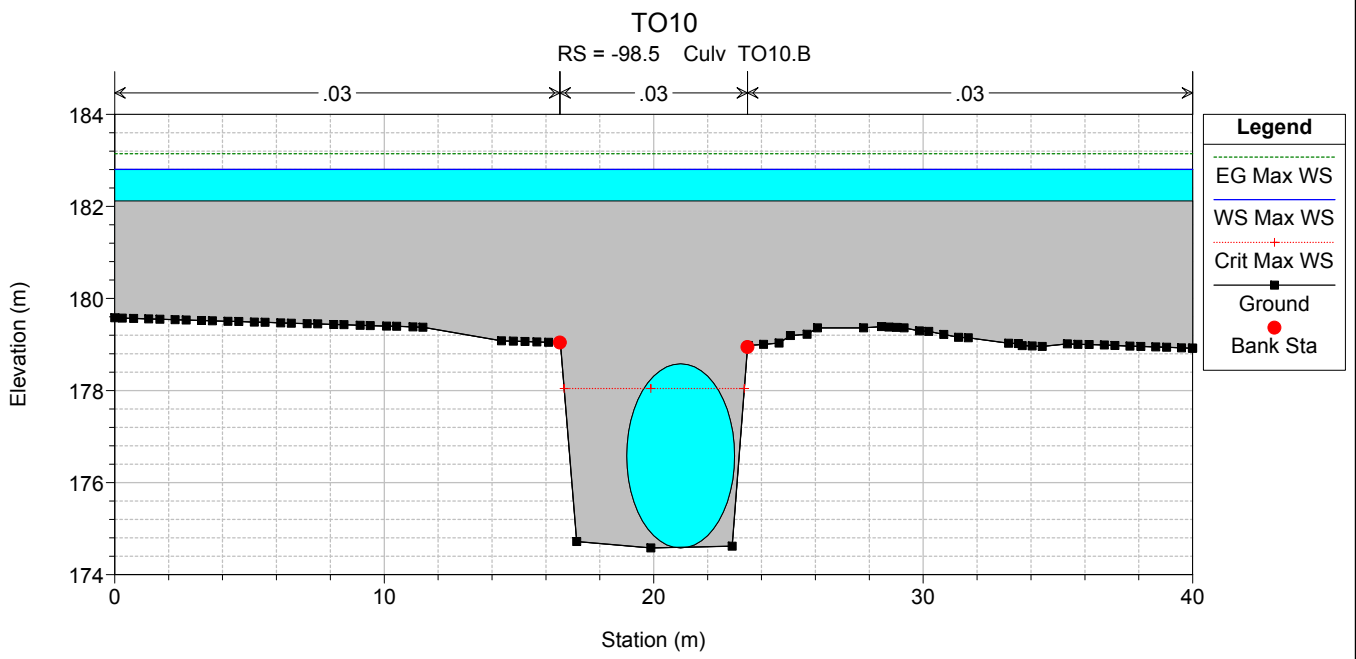
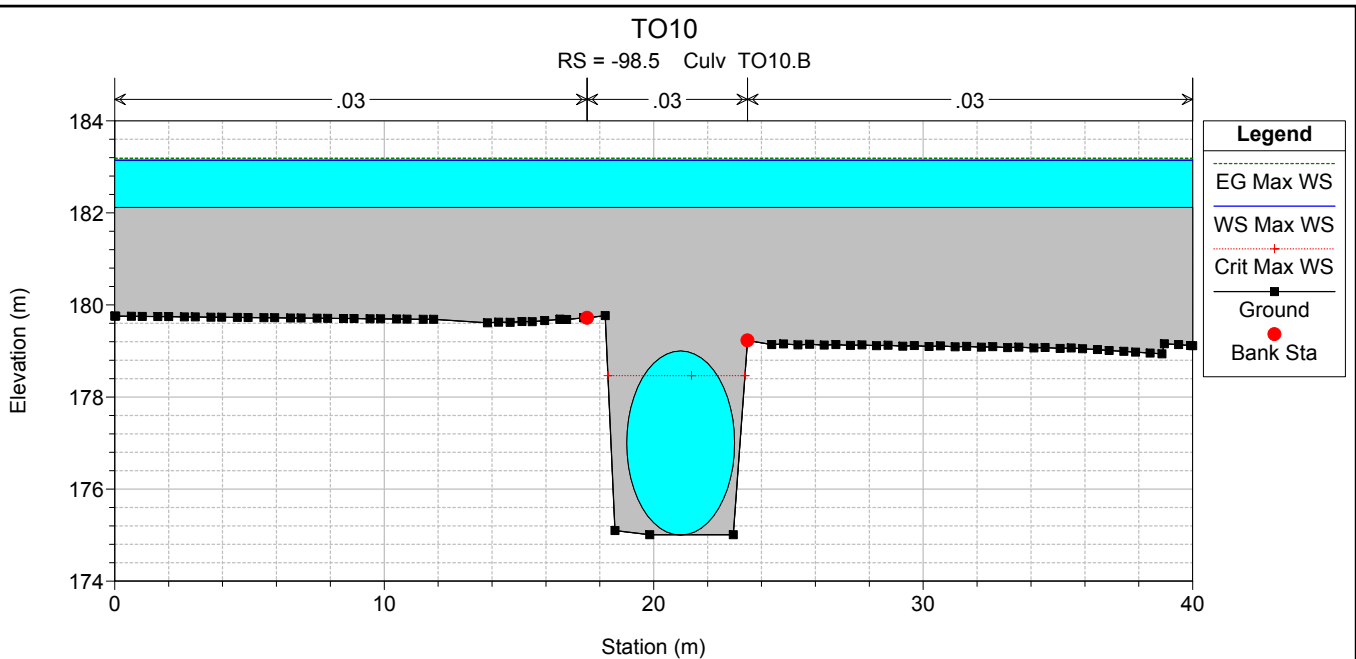

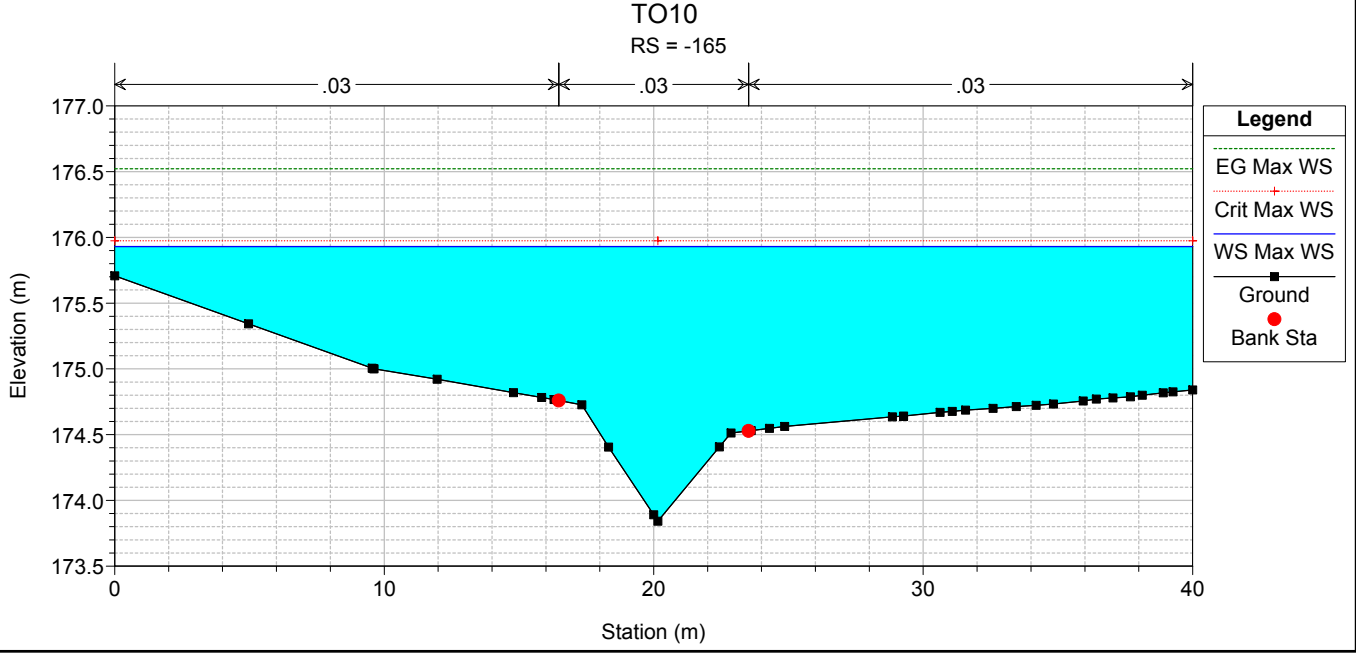
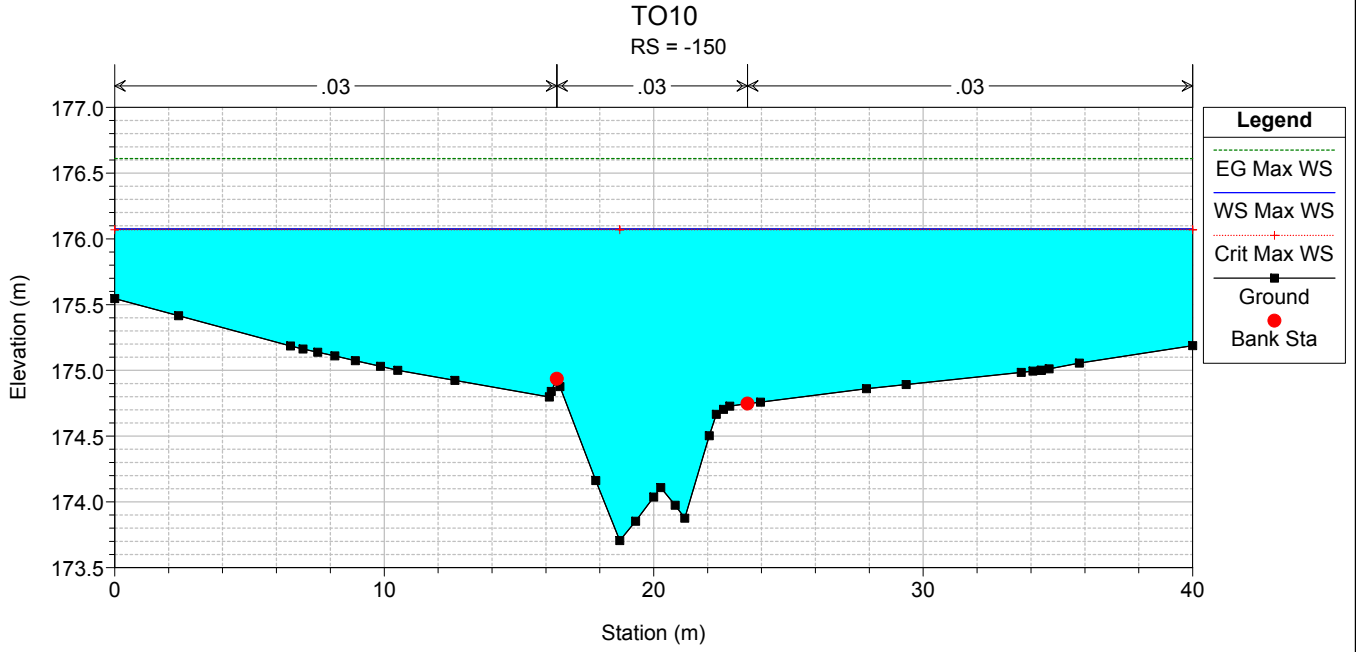
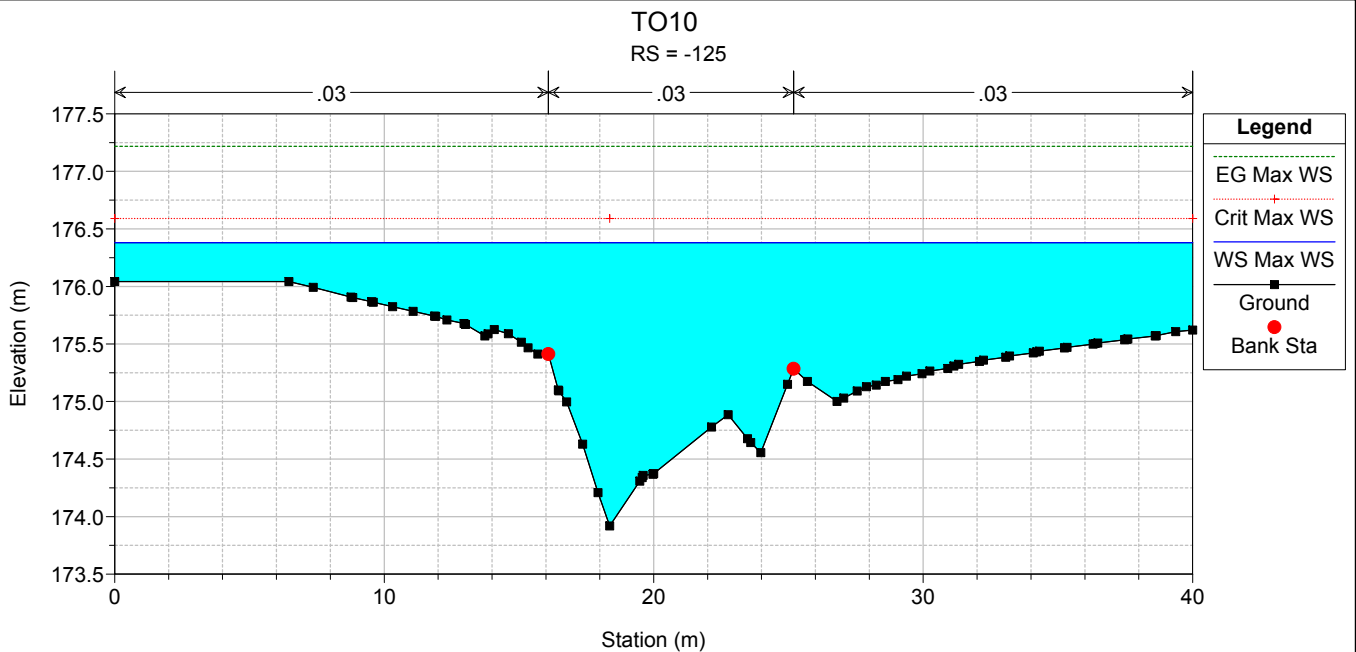

TO10
RS = -180.44

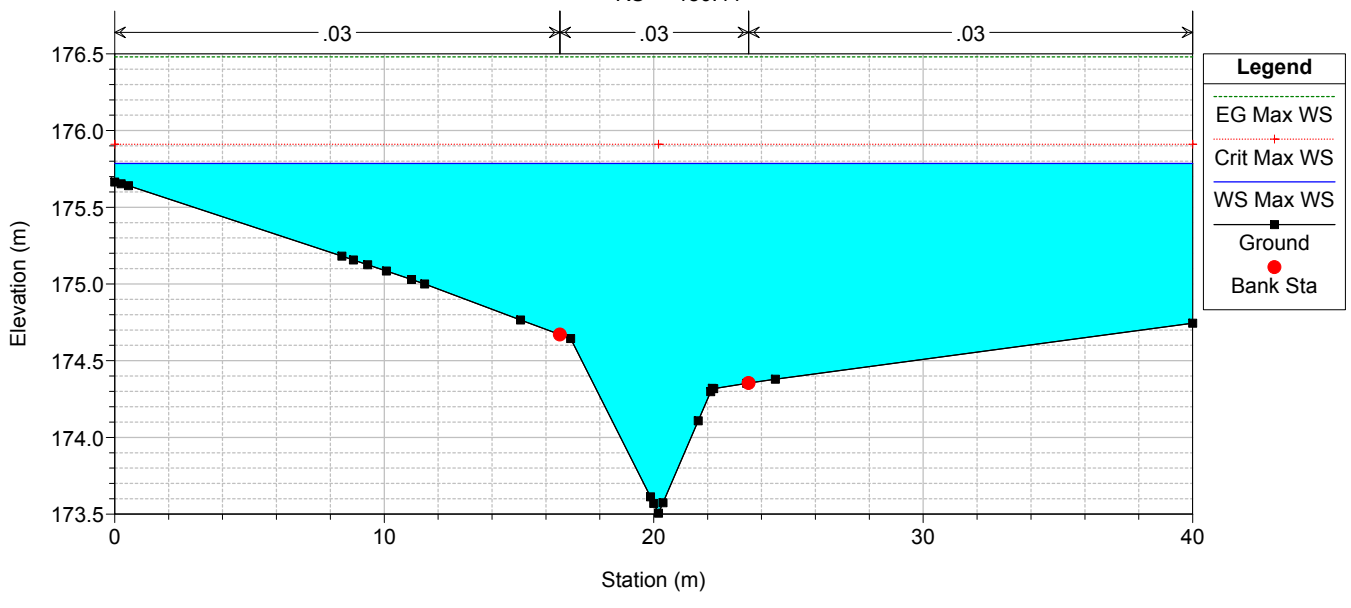

POST

HEC-RAS Plan: POST_VARIO_DEF River: TO10 Reach: TO10 Profile: 13OCT2014 0127

Reach	River Sta	Profile	Q Total (m ³ /s)	Min Ch El (m)	Max Chl Dpth (m)	W.S. Elev (m)	Crit W.S. (m)	Diff	Froude # Chl	E.G. Elev (m)	Vel Chnl (m/s)	Vel Total (m/s)	Hydr Radius C (m)	Shear Chan (N/m ²)	Hydr Depth (m)
TO10	0	13OCT2014 0127	145.6	175.96	2.28	178.24	178.29	-0.05	1.02	178.74	4.0	2.9	1.5	126.8	0.87
TO10	-25	13OCT2014 0127	145.6	175.66	2.39	178.05	178.01	0.04	0.79	178.49	3.3	2.6	1.7	80.4	1.03
TO10	-47.29	13OCT2014 0127	145.6	175.39	2.48	177.87	177.90	-0.03	0.92	178.52	3.9	3.4	1.6	112.2	1.21
TO10	-60	13OCT2014 0127	145.6	175.21	2.66	177.87	177.67	0.20	0.68	178.25	3.0	2.5	1.8	65.7	1.16
TO10	-65	13OCT2014 0127	145.6	175.14	2.84	177.98	177.50	0.48	0.53	178.21	2.4	1.9	2.0	41.7	1.26
TO10	-70.995	Bridge													
TO10	-76.99	13OCT2014 0127	145.6	174.98	2.53	177.51	177.43	0.08	0.91	178.03	3.2	3.2	1.2	84.5	1.25
TO10	-81.88	13OCT2014 0127	145.6	174.91	2.59	177.50	177.37	0.13	0.86	177.99	3.1	3.1	1.2	78.8	1.31
TO10	-95	Bridge													
TO10	-107.26	13OCT2014 0127	145.6	174.56	2.54	177.10	177.02	0.08	0.92	177.63	3.2	3.2	1.2	86.5	1.27
TO10	-112.39	13OCT2014 0127	145.6	174.49	2.62	177.11	176.94	0.17	0.84	177.57	3.0	3.0	1.3	73.9	1.32
TO10	-118.20	Bridge													
TO10	-124	13OCT2014 0127	145.6	174.33	2.40	176.73	176.78	-0.05	1.08	177.39	3.6	3.6	1.1	111.4	1.14
TO10	-140	13OCT2014 0127	145.6	174.11	2.31	176.42	176.83	-0.41	1.53	177.81	5.5	4.9	1.1	251.6	0.93
TO10	-160	13OCT2014 0127	145.6	173.84	1.94	175.78	175.89	-0.11	1.15	176.38	3.9	3.3	1.2	128.5	0.82
TO10	-180	13OCT2014 0127	145.6	173.51	2.01	175.52	175.76	-0.24	1.37	176.39	5.0	3.9	1.3	205.8	0.80

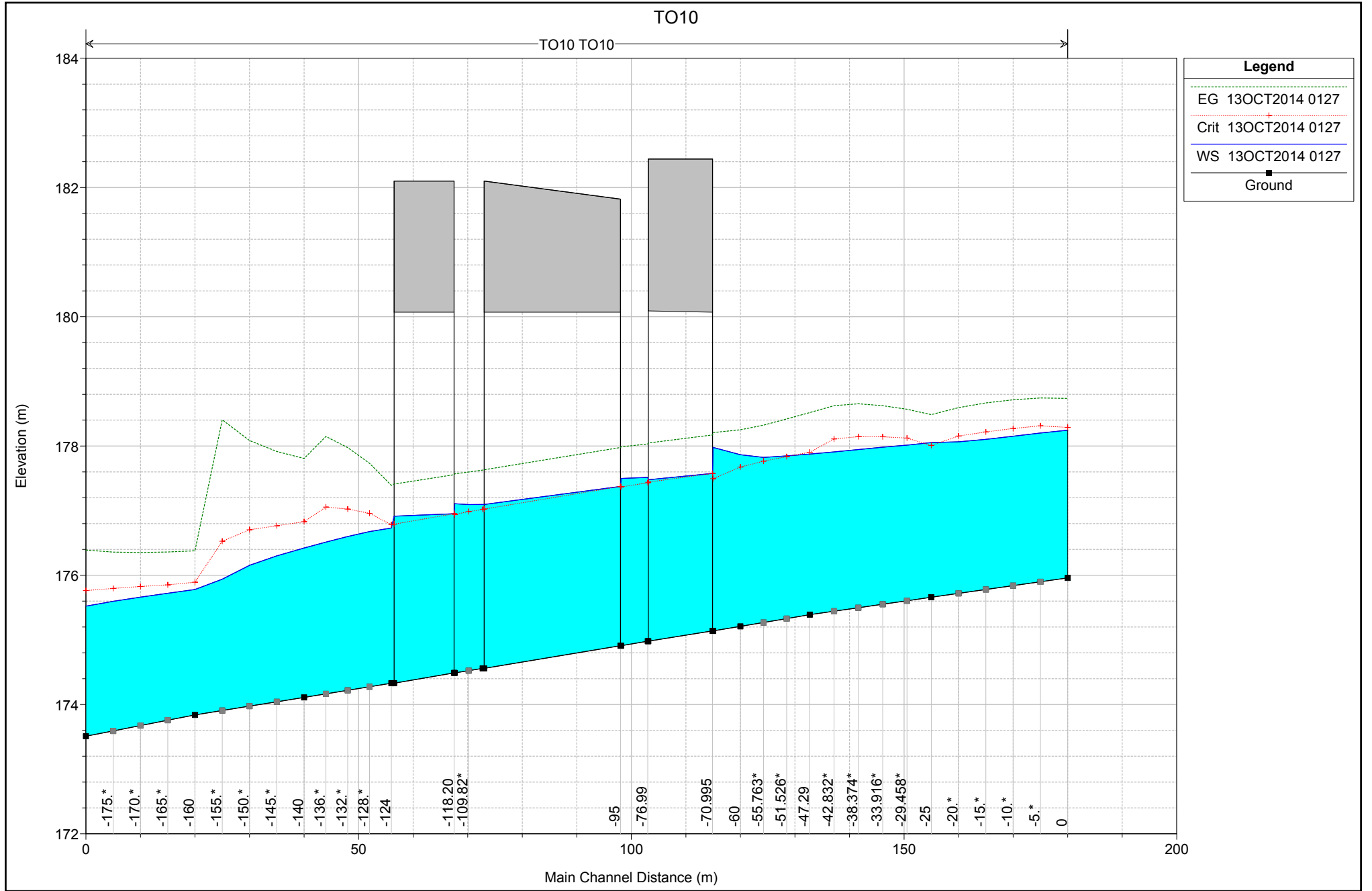

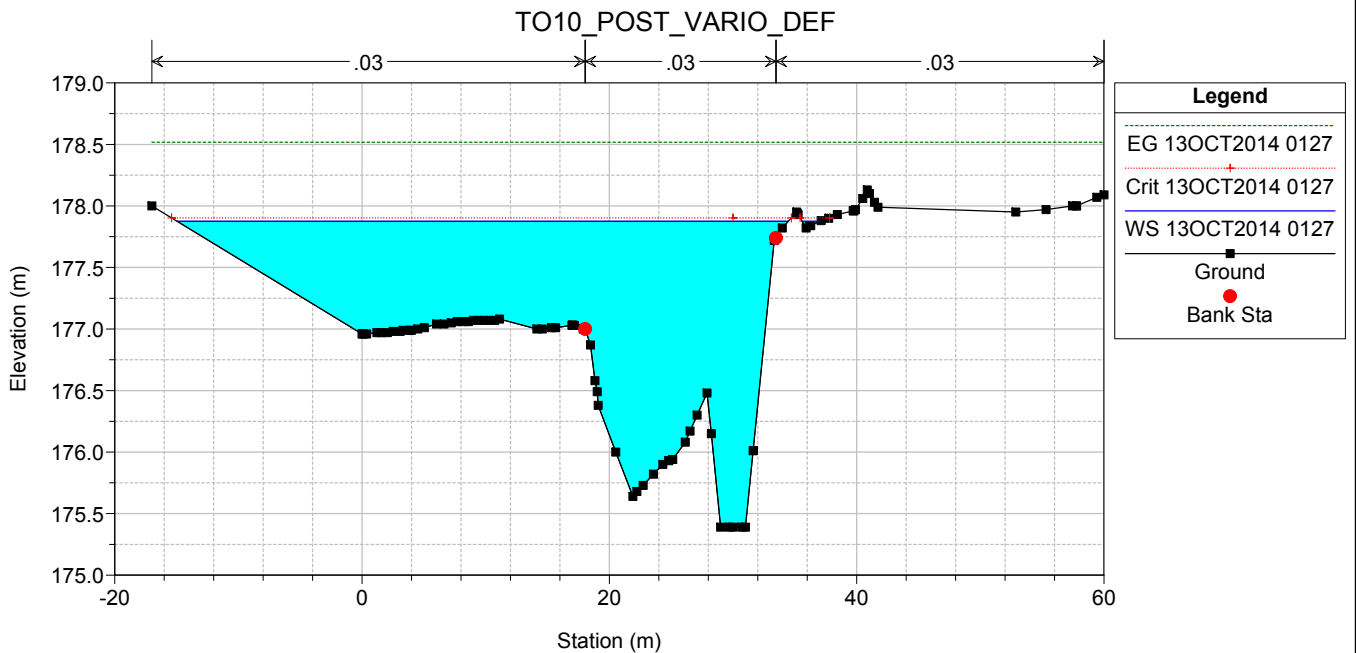
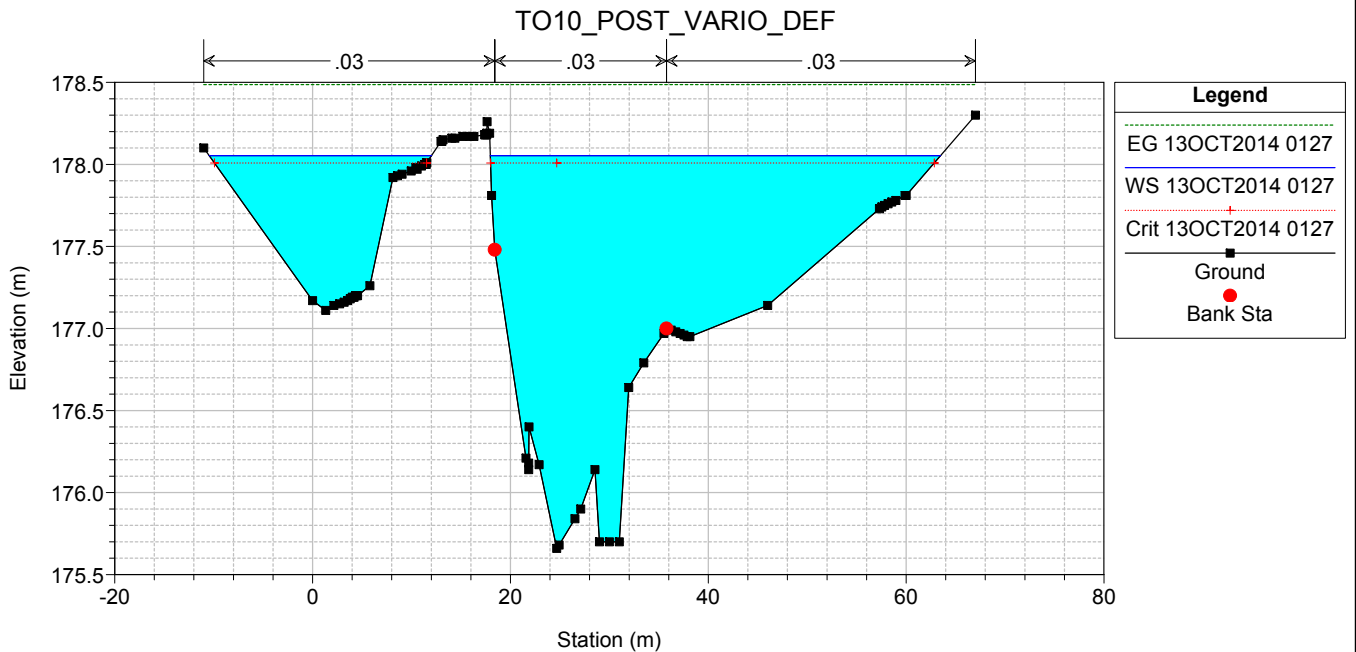
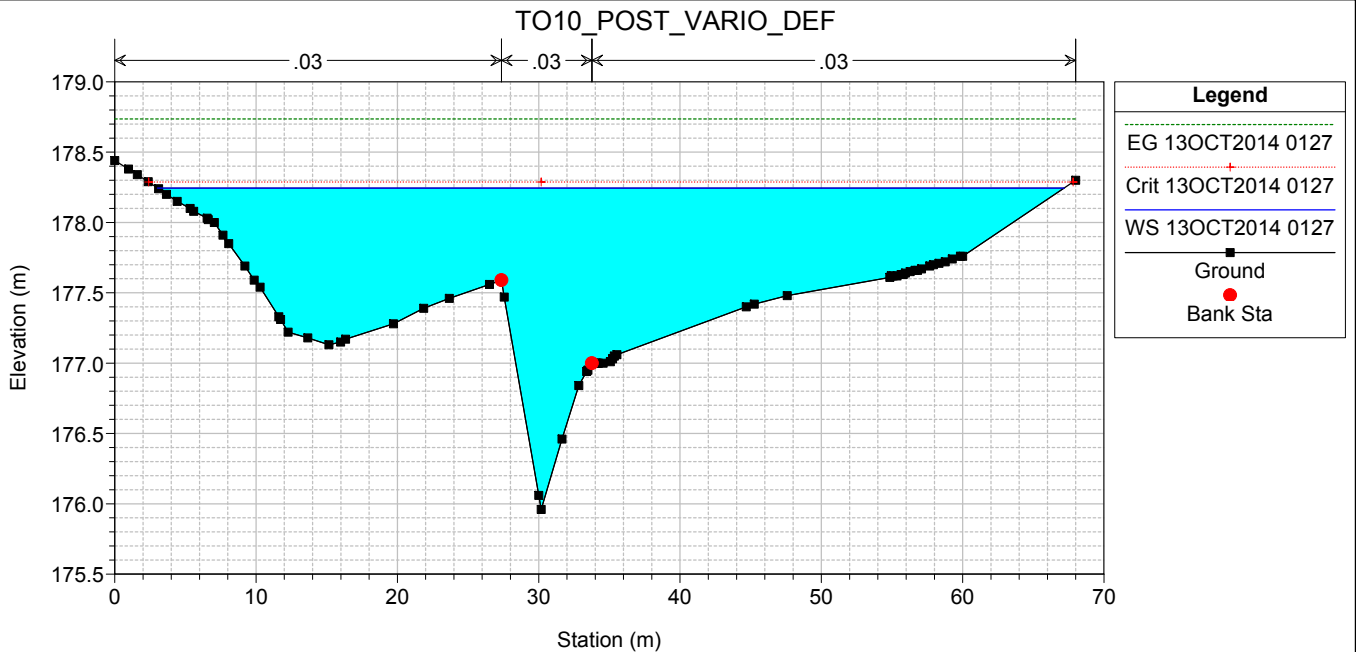

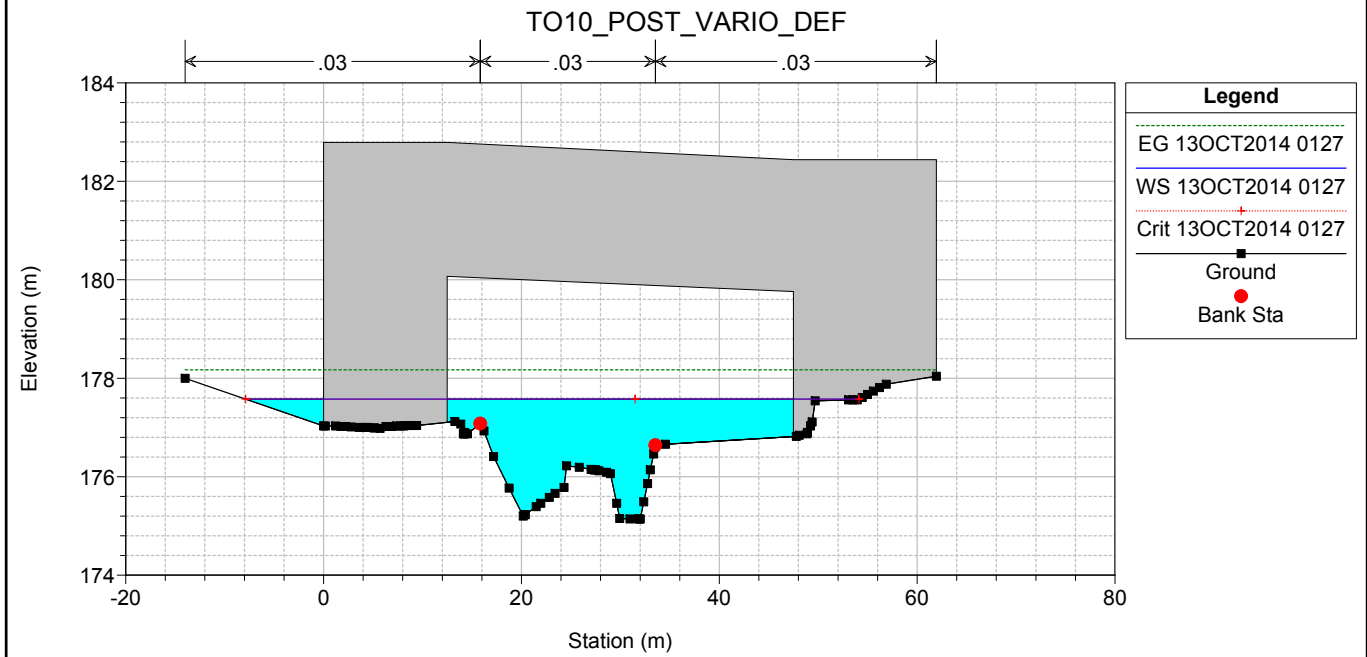
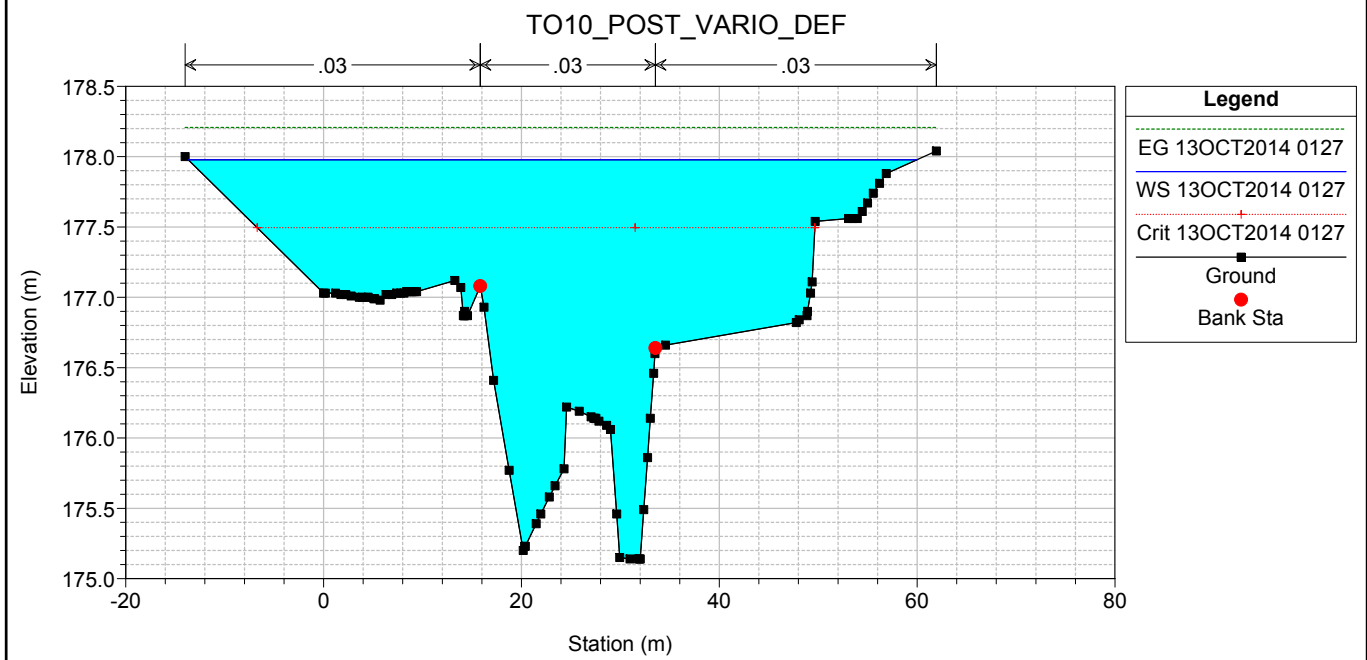
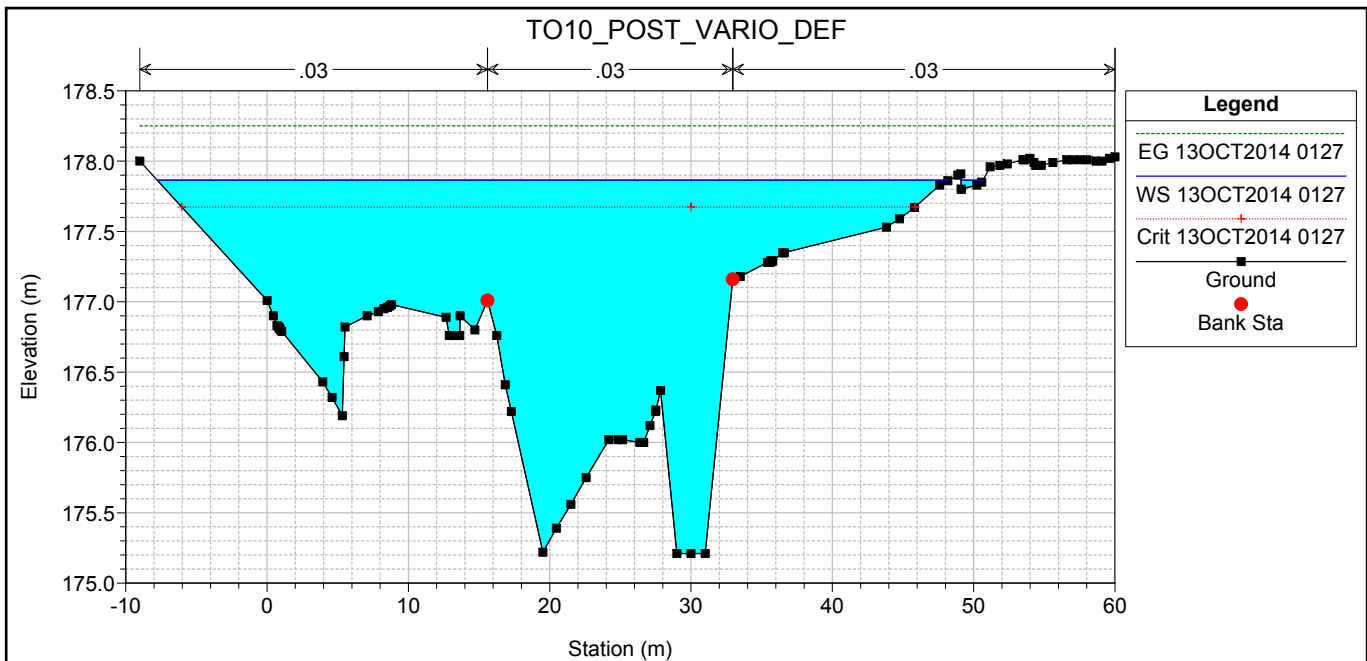

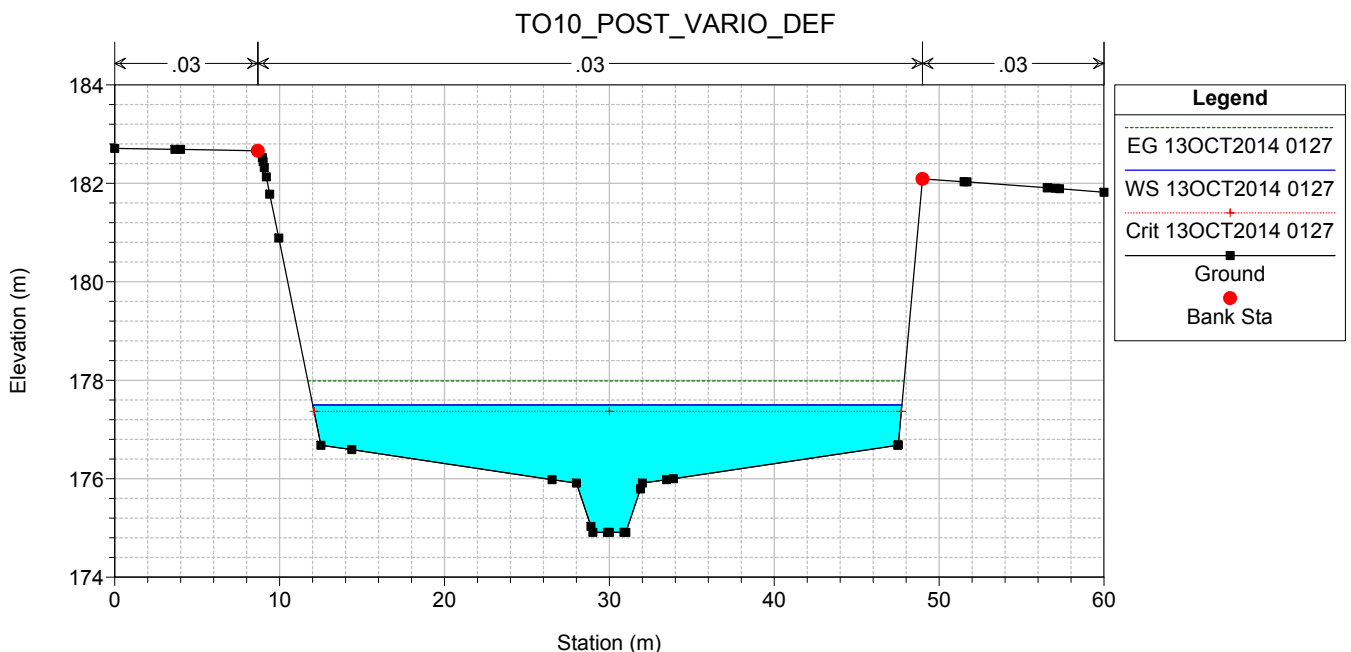
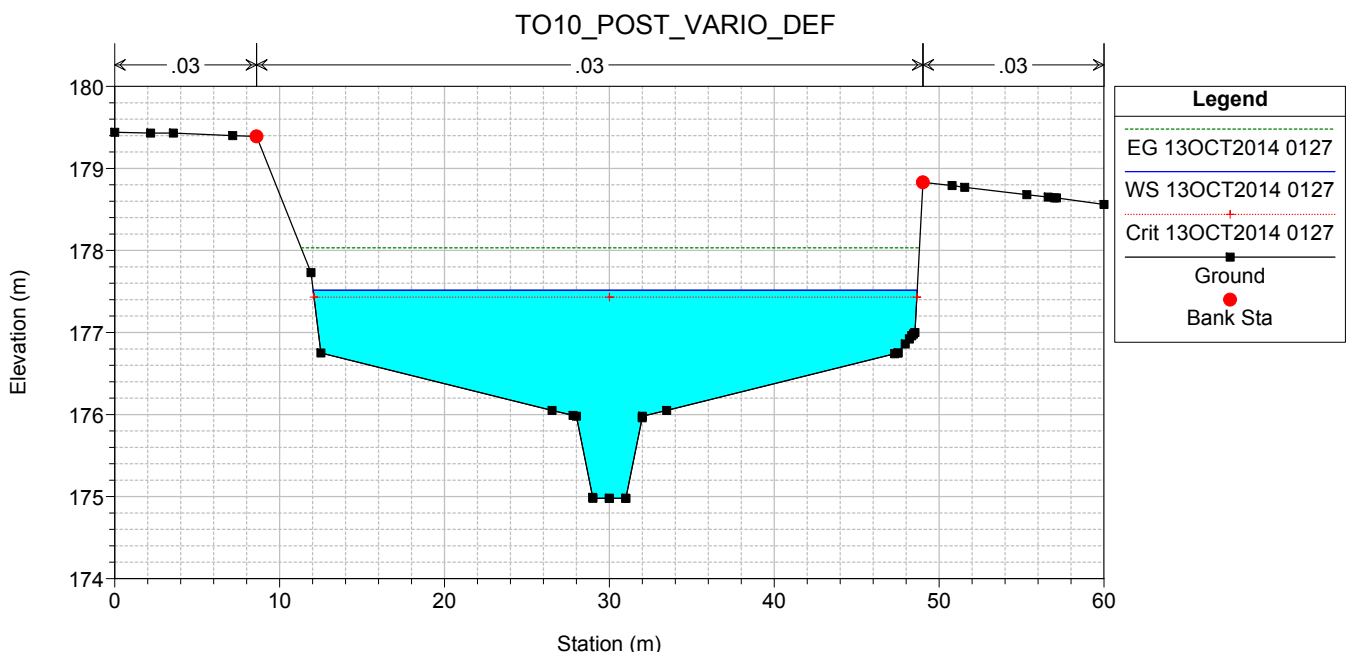
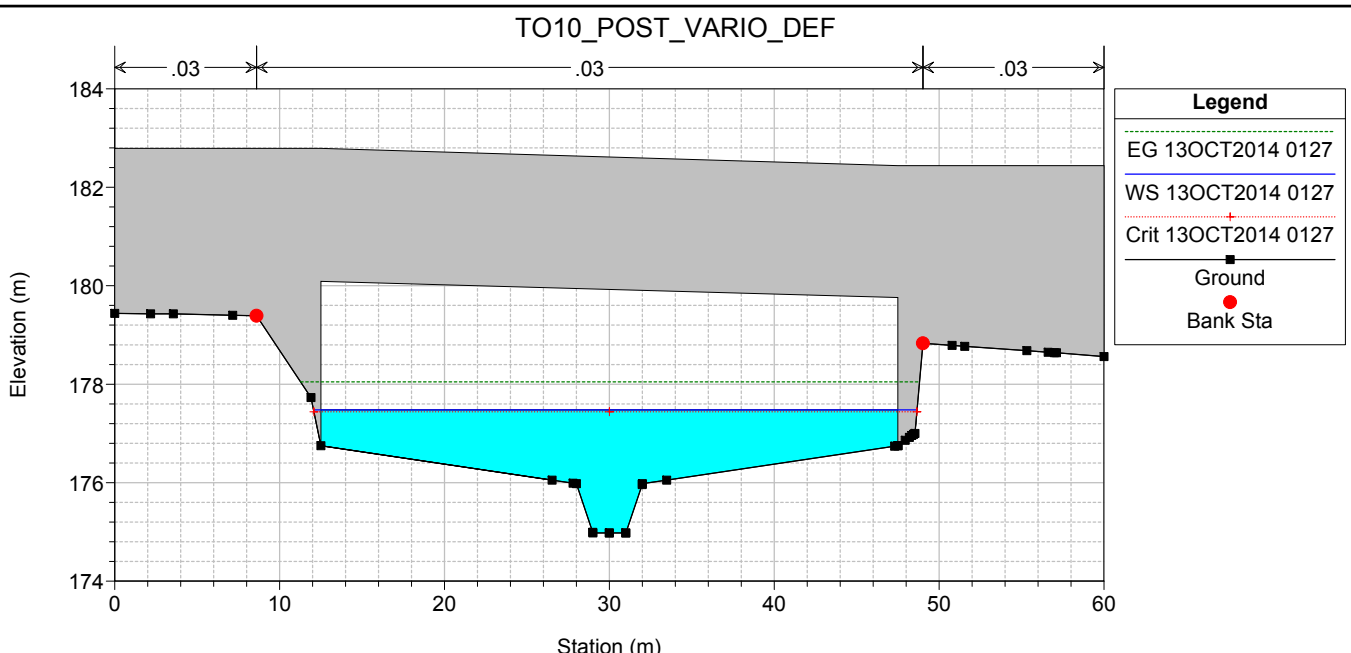

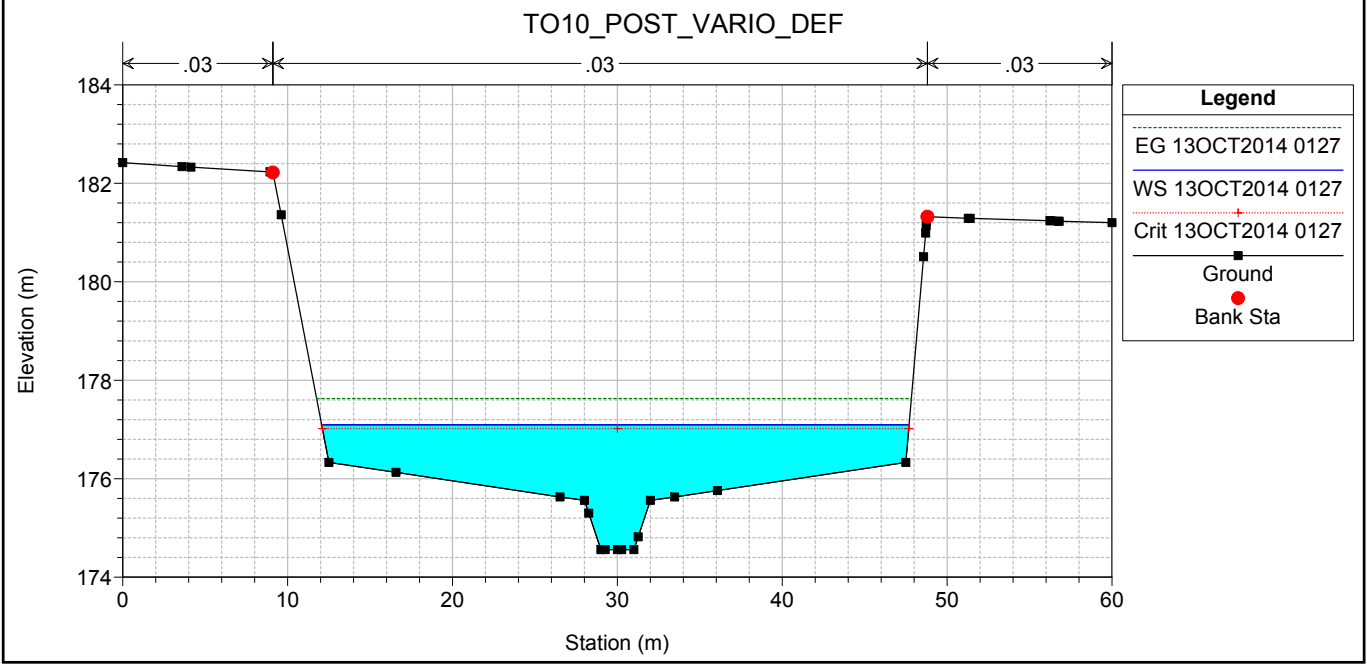
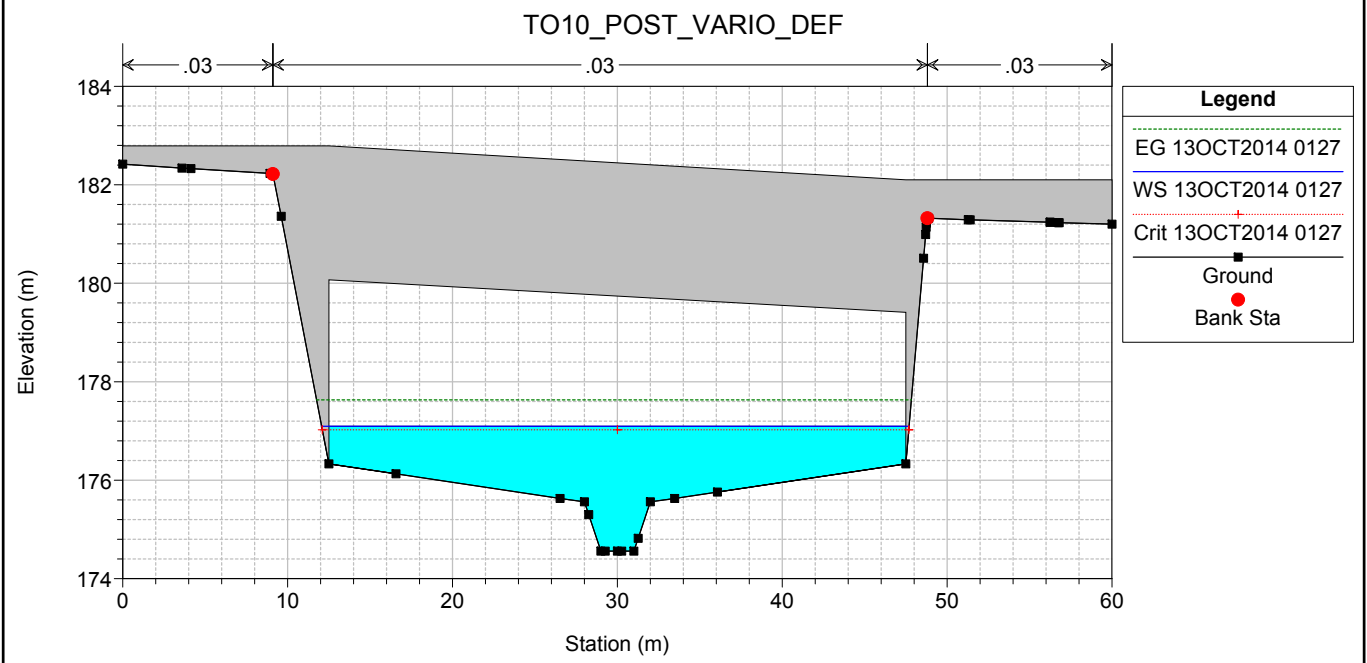
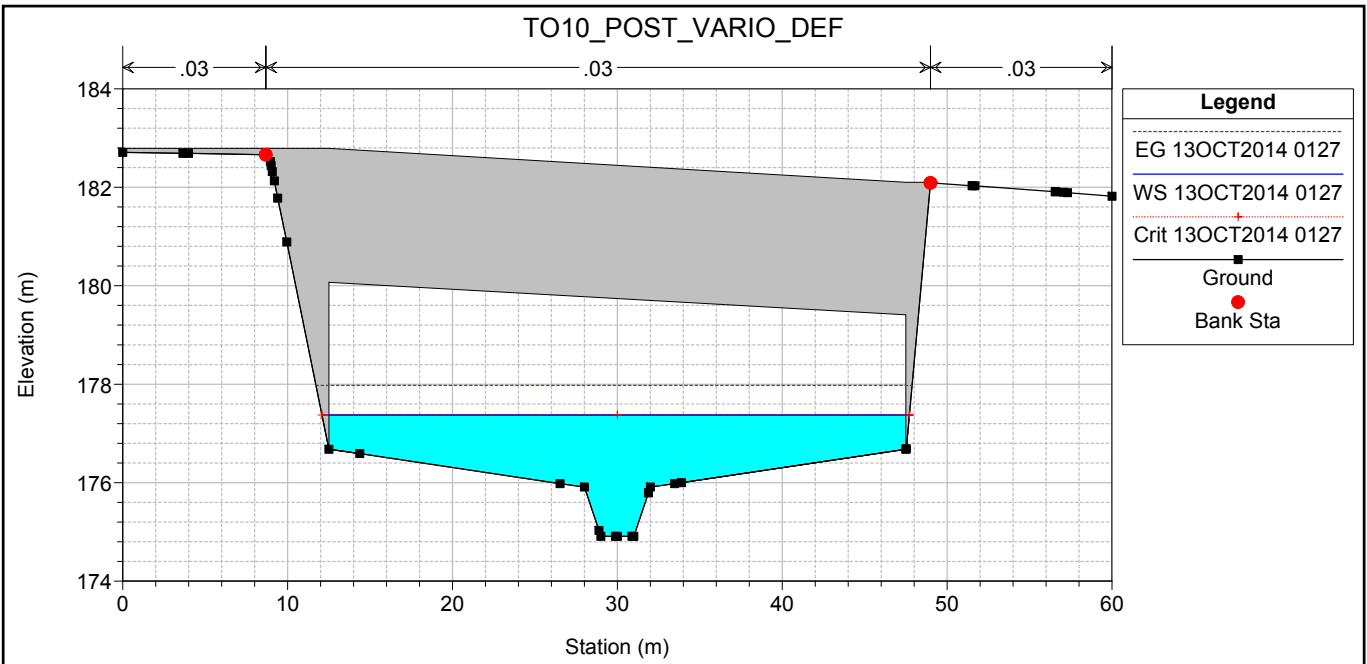

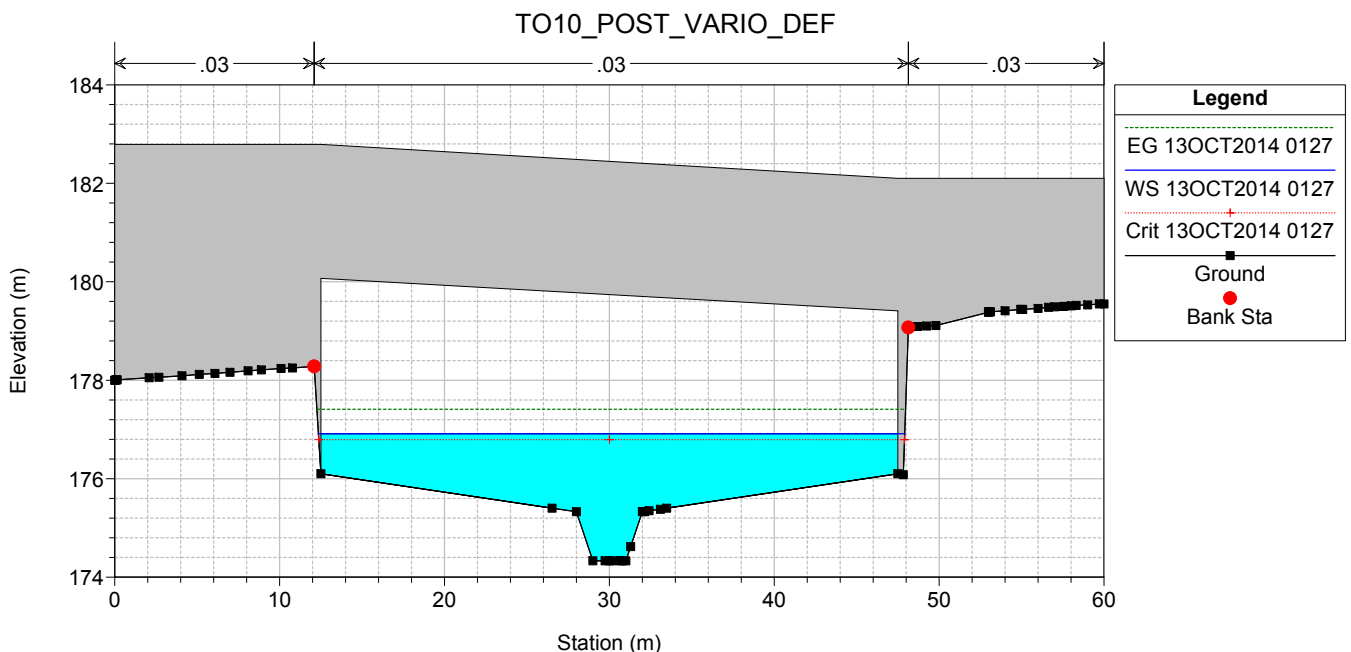
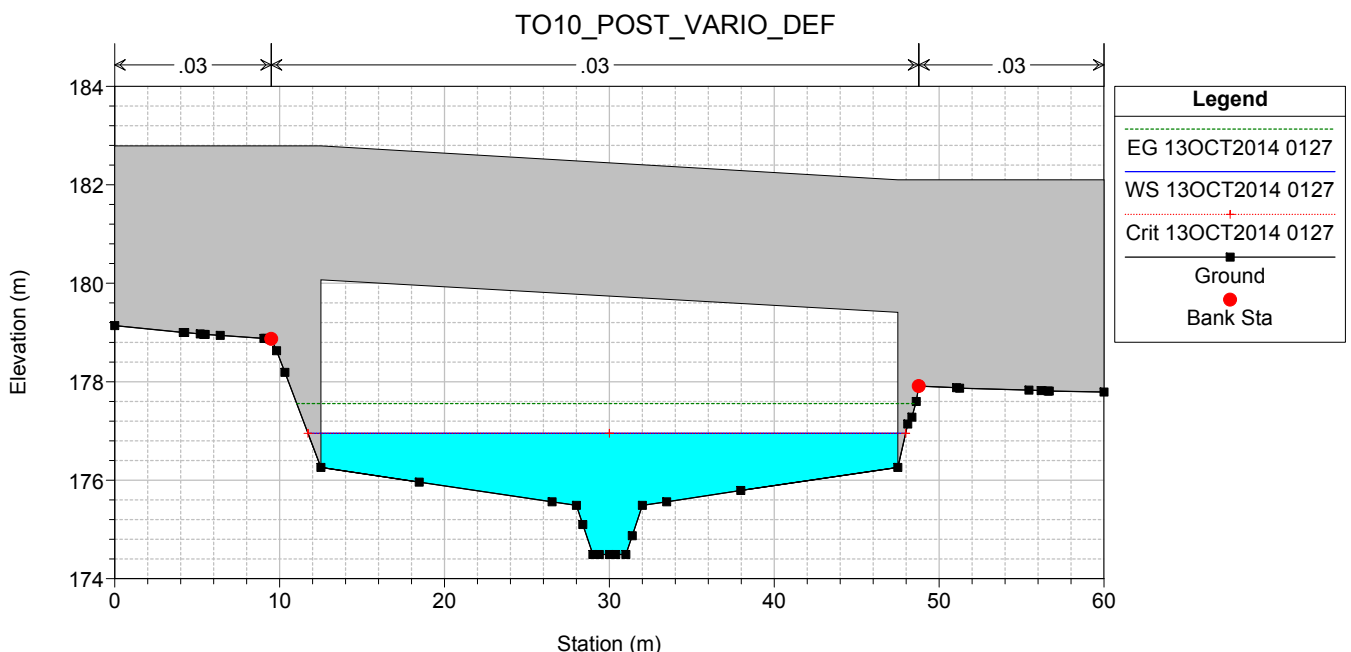
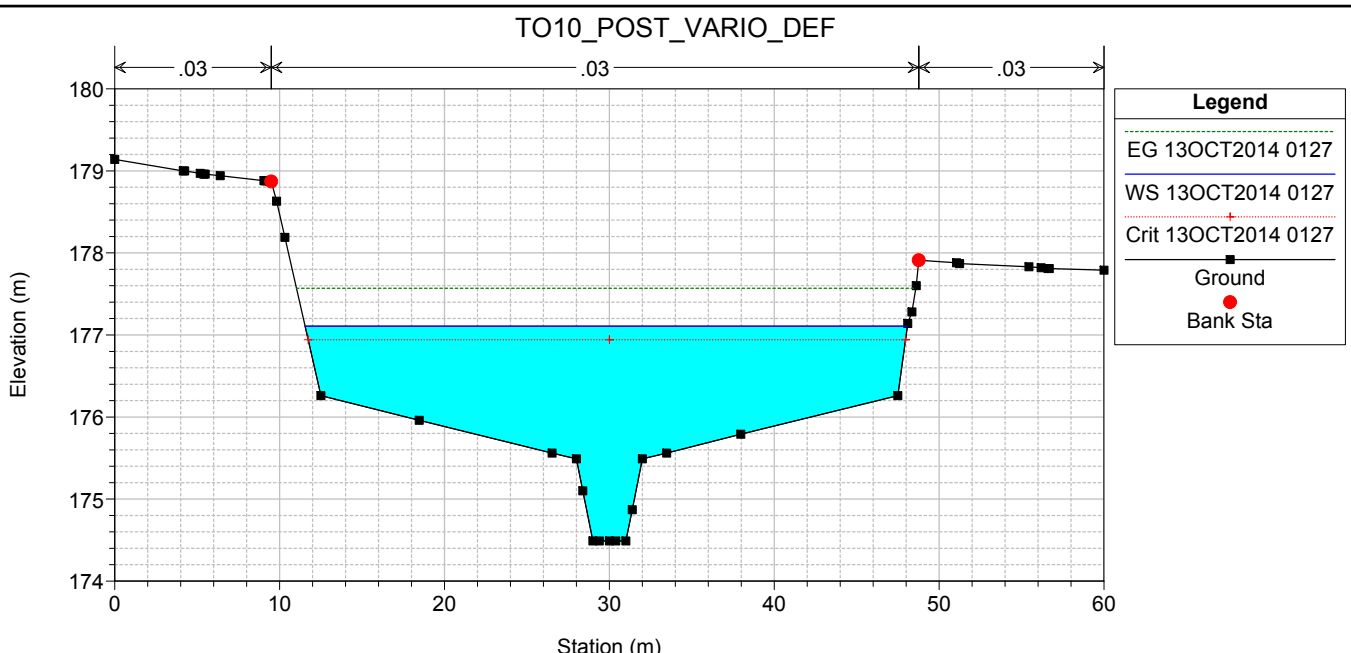

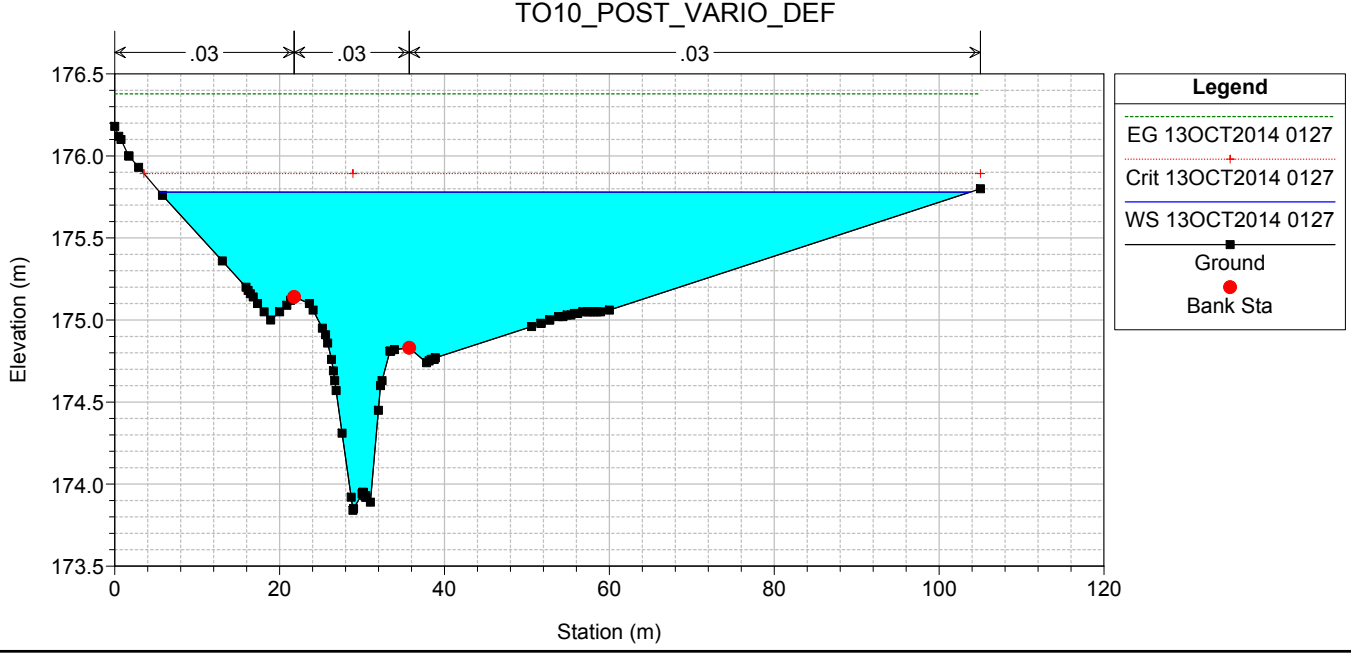
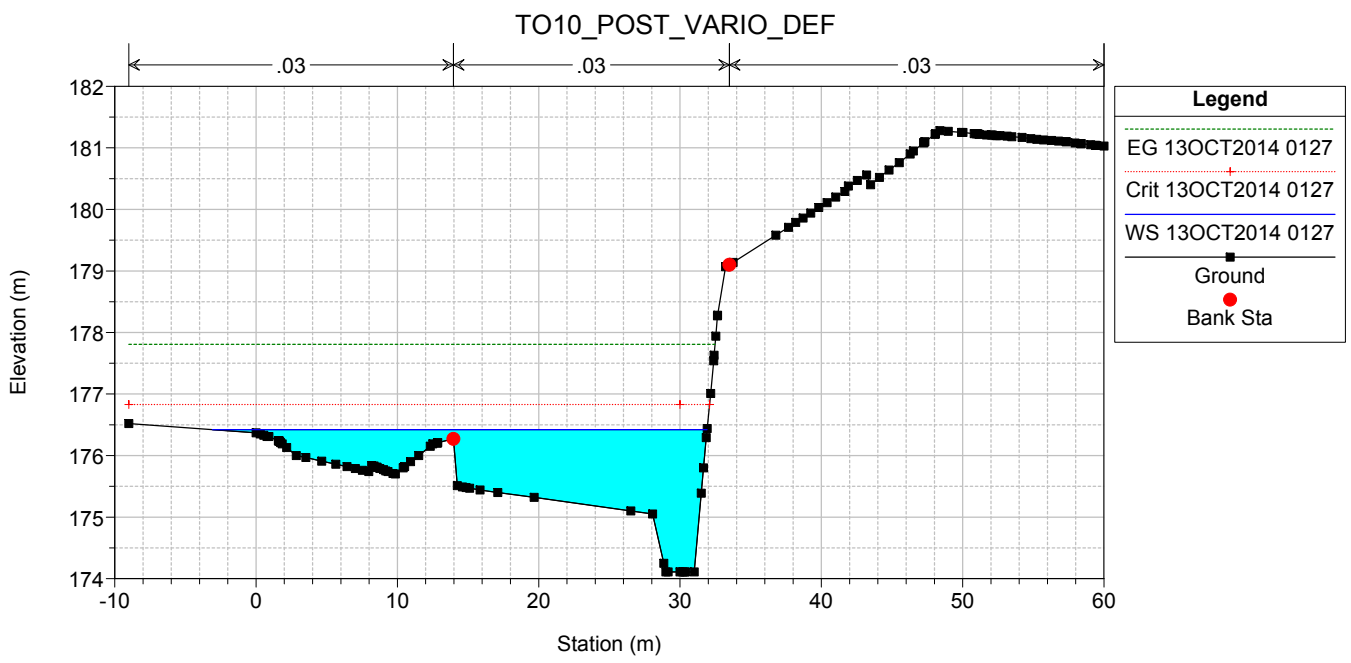
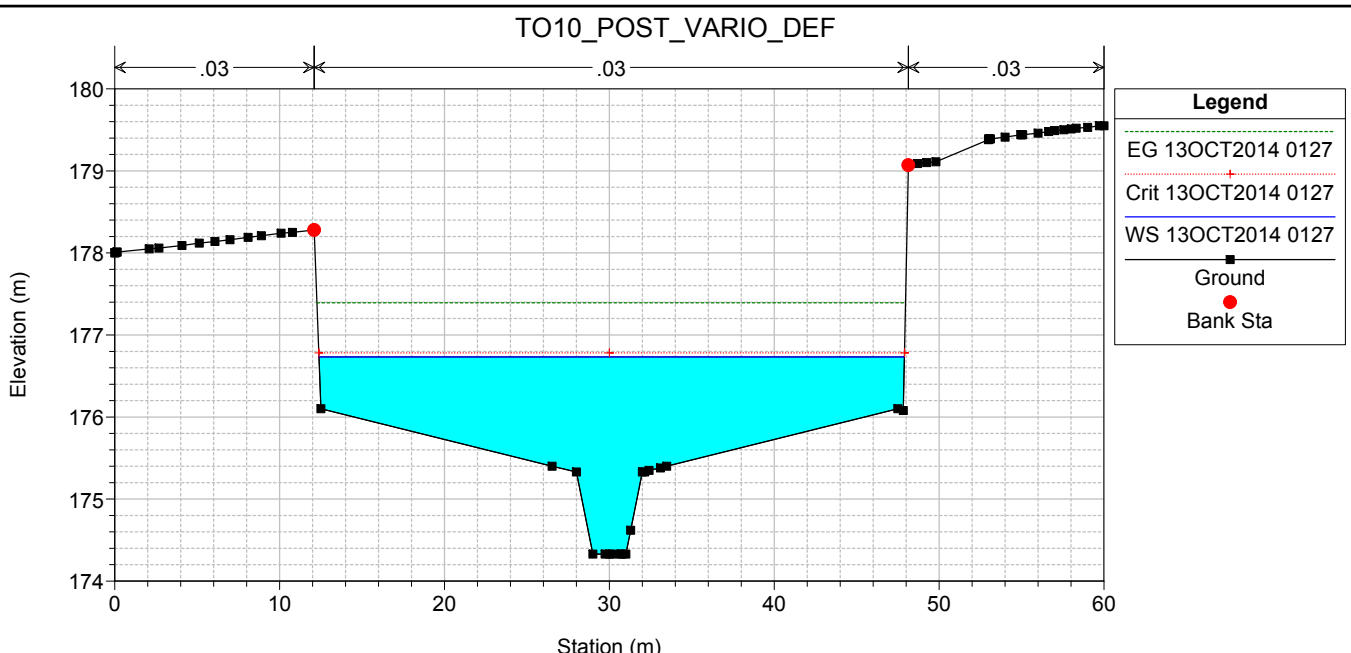

TO10_POST_VARIO_DEF

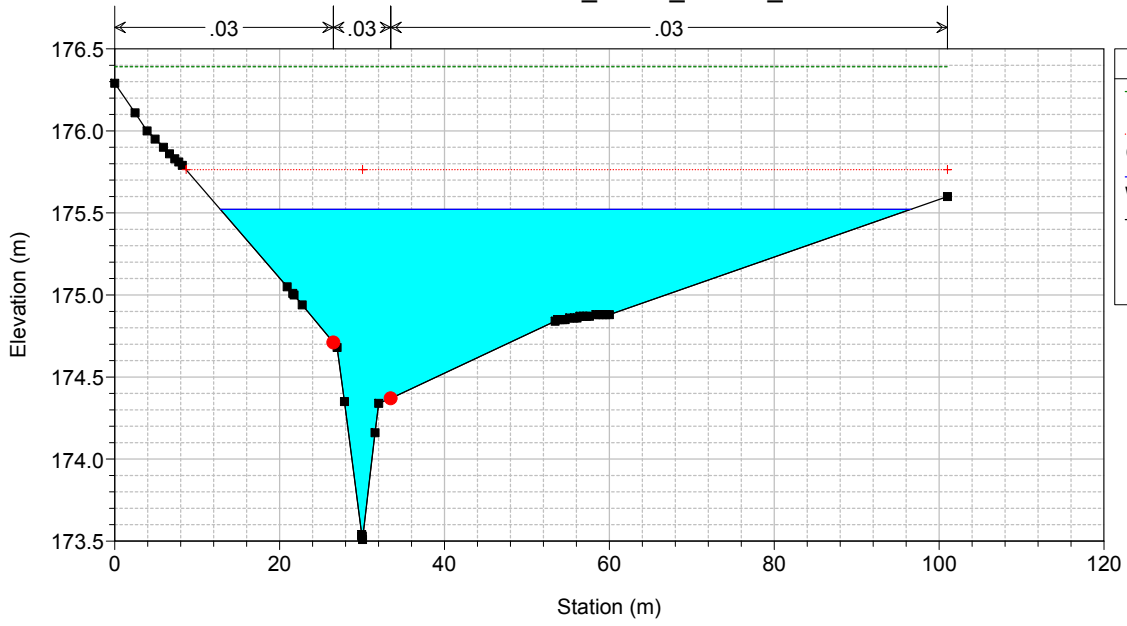

Legend	
EG 13OCT2014 0127	
Crit 13OCT2014 0127	
WS 13OCT2014 0127	
Ground	
Bank Sta	

ALLEGATO 3.4

Interferenza idraulica – TO11-TO12
Tabella riassuntiva dei risultati,
profilo idrico e sezioni trasversali con i livelli idrici (TR 200 anni)

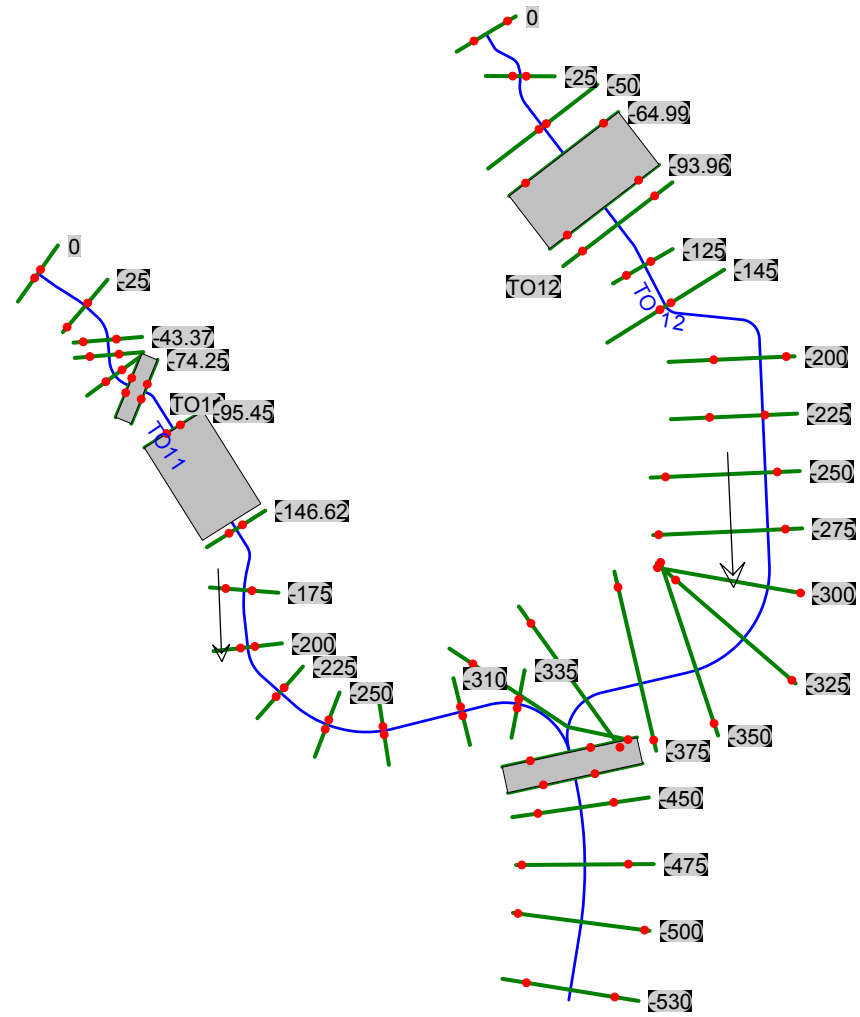

ANTE

HEC-RAS Plan: TR200_ANTE River: TO11_ANTE Reach: TO11_ANTE Profile: Max WS

Reach	River Sta	Profile	Q Total (m3/s)	Min Ch El (m)	Max Chl Dpth (m)	W.S. Elev (m)	Crit W.S. (m)	Diff	Froude # Chl	E.G. Elev (m)	Vel Chnl (m/s)	Vel Total (m/s)	Hydr Radius C (m)	Shear Chan (N/m2)	Hydr Depth (m)
TO11_ANTE	0	Max WS	15.7	183.94	1.06	185.00	185.17	-0.17	1.95	185.55	3.3	3.3	0.3	144.0	0.28
TO11_ANTE	-50	Max WS	15.6	182.00	1.54	183.54	182.95	0.59	0.29	183.58	0.8	0.8	0.8	6.3	0.82
TO11_ANTE	-64.88	Max WS	15.6	180.99	2.55	183.54	182.81	0.73	0.24	183.57	0.7	0.7	0.8	4.9	0.95
TO11_ANTE	-68.57	Max WS	15.6	180.99	2.55	183.54			0.24	183.57	0.7	0.7	0.8	4.9	0.95
TO11_ANTE	-77.995		Culvert												
TO11_ANTE	-87.42	Max WS	15.6	180.49	0.73	181.22	181.22	0.00	1.04	181.43	2.0	2.0	0.4	50.6	0.39
TO11_ANTE	-91.91	Max WS	15.6	180.49	0.65	181.14	181.22	-0.08	1.37	181.46	2.5	2.5	0.3	80.6	0.34
TO11_ANTE	-125	Max WS	15.6	179.34	0.91	180.25	180.45	-0.20	2.03	180.86	3.5	3.5	0.3	160.0	0.30
TO11_ANTE	-175	Max WS	15.6	177.14	0.71	177.85	177.89	-0.04	1.25	178.02	1.8	1.8	0.2	48.6	0.21
TO11_ANTE	-225	Max WS	15.6	176.96	0.41	177.37	177.27	0.10	0.55	177.41	0.9	0.9	0.3	10.6	0.26

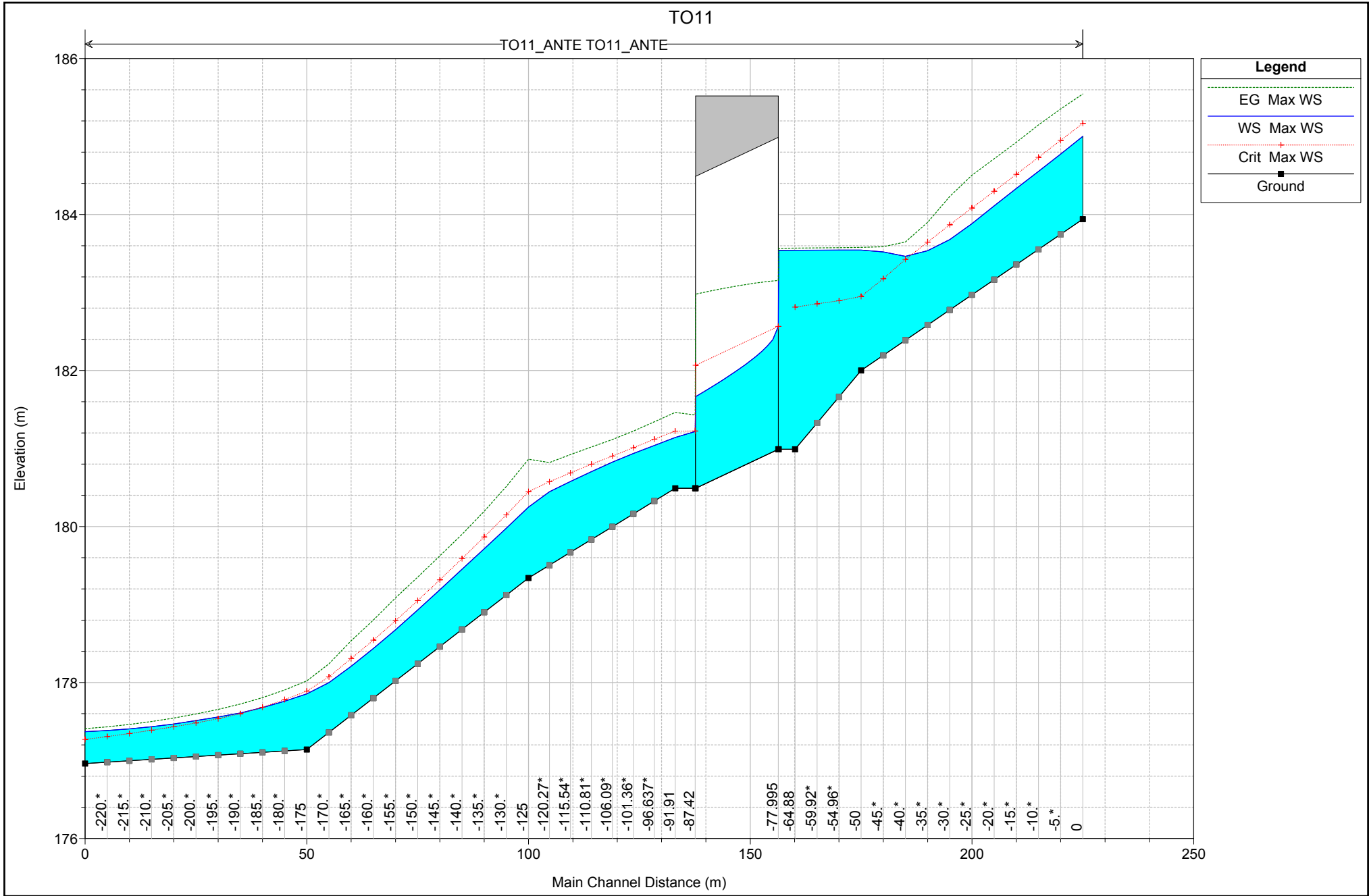

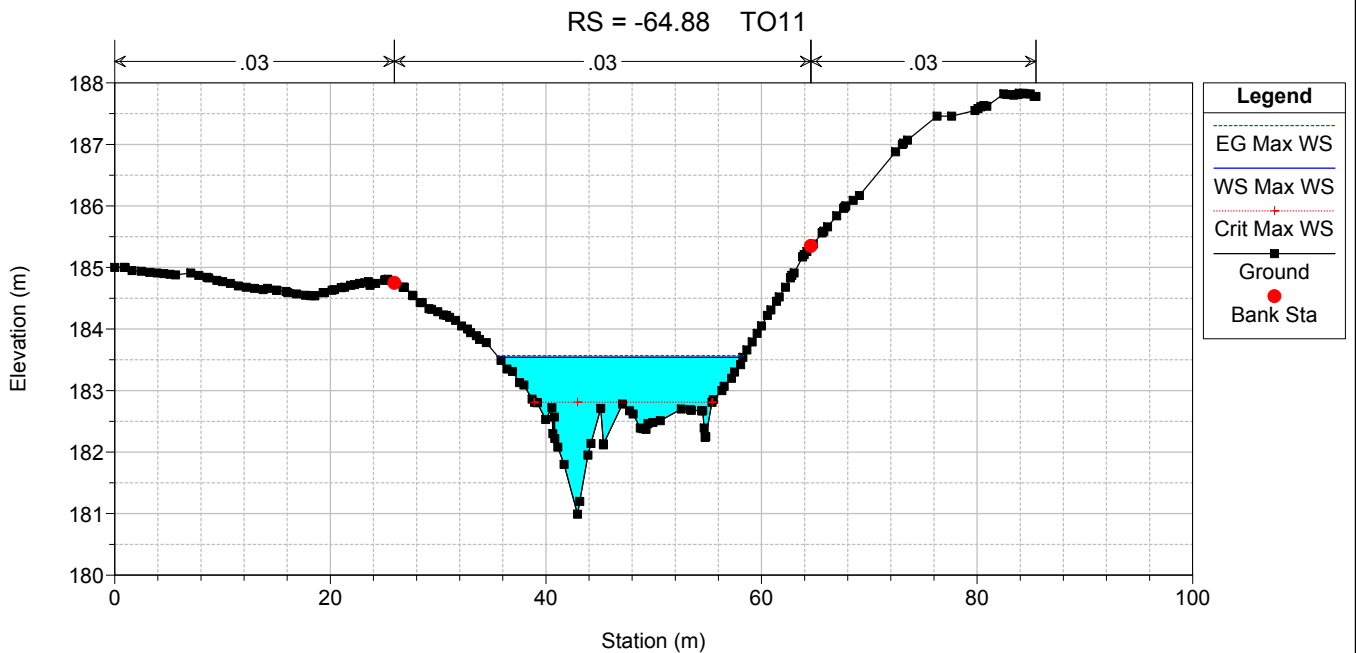
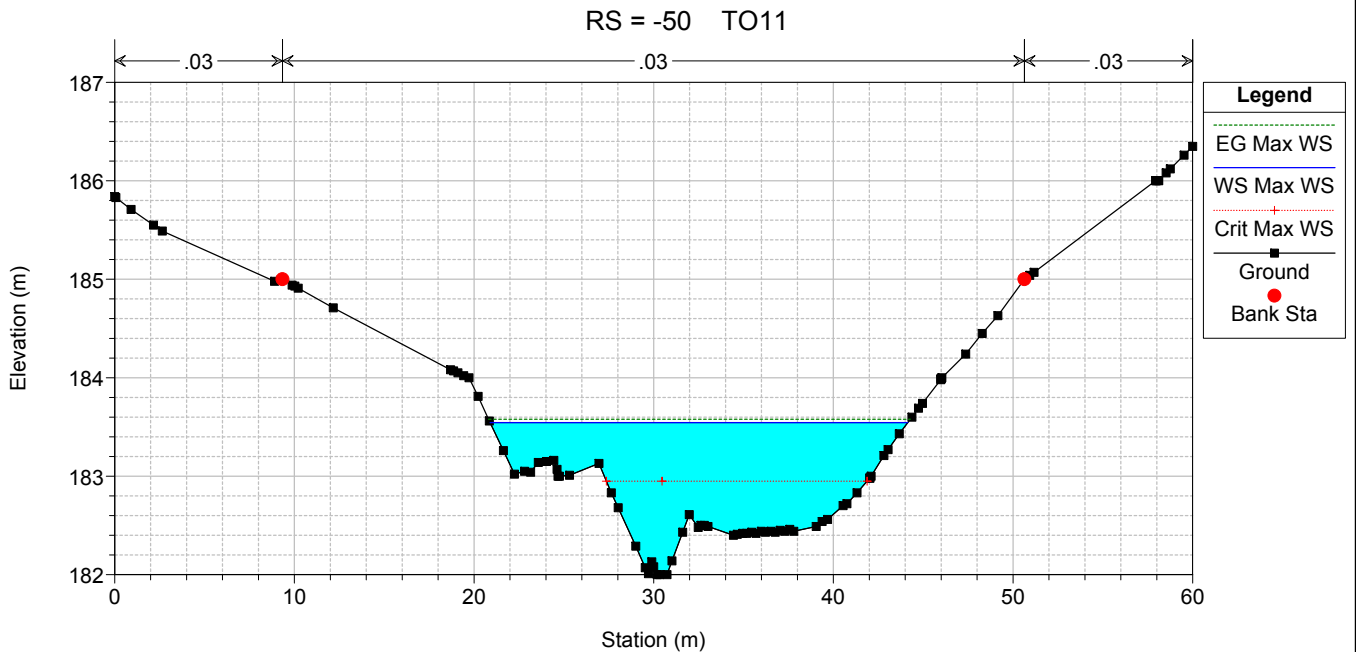
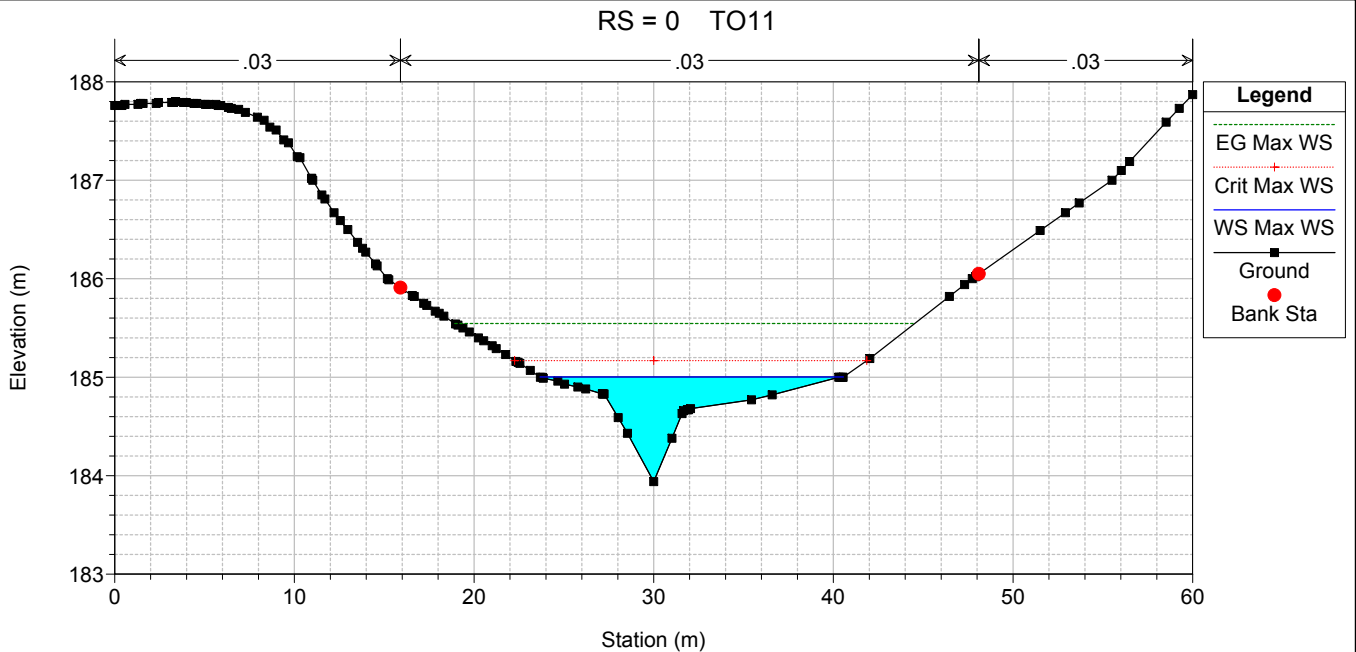

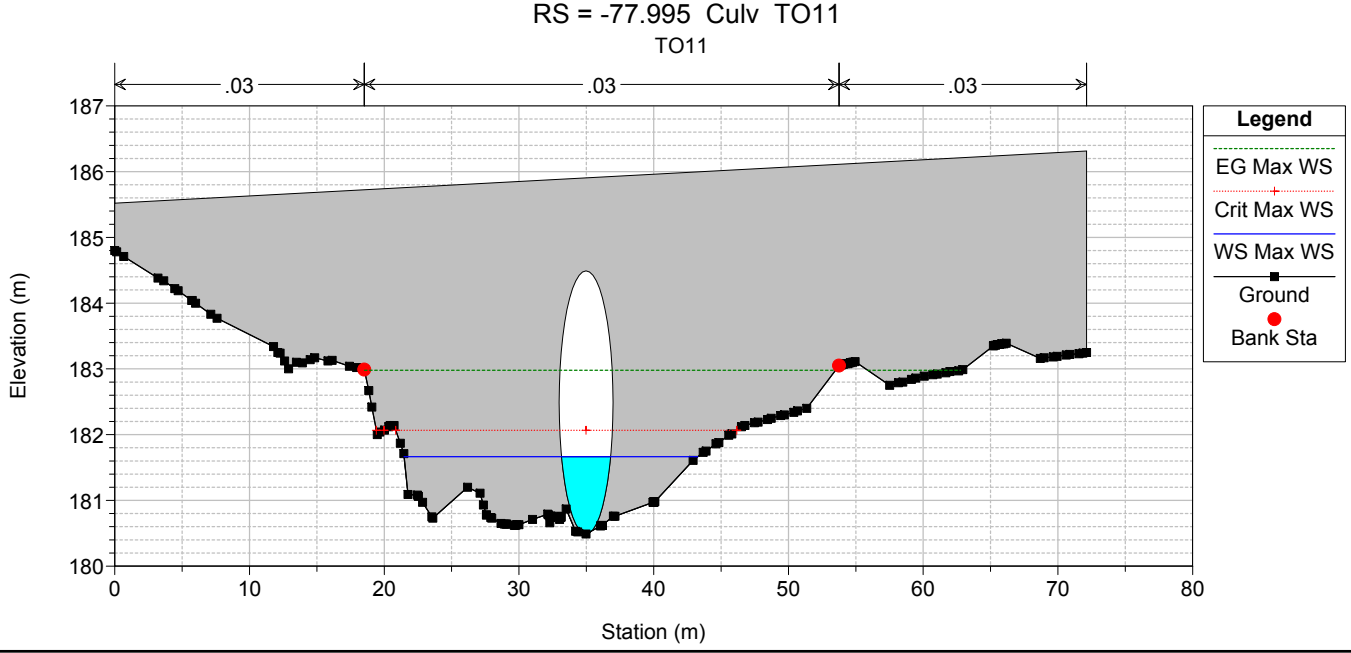
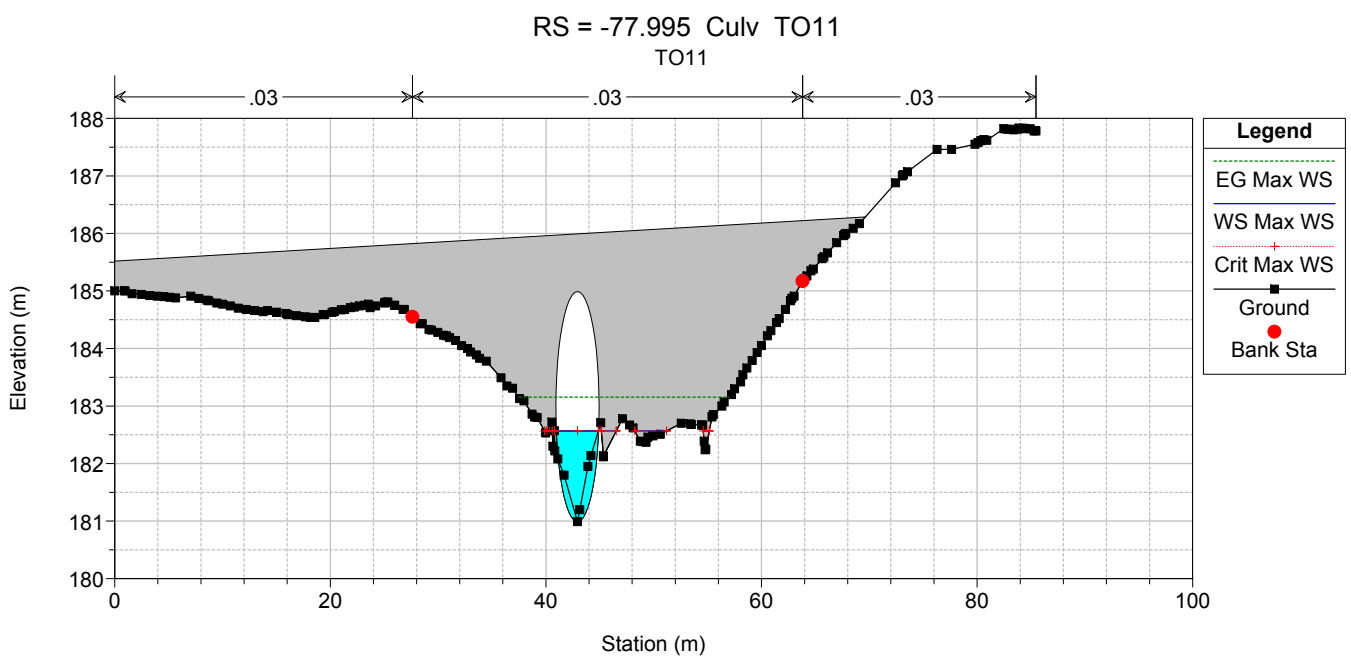
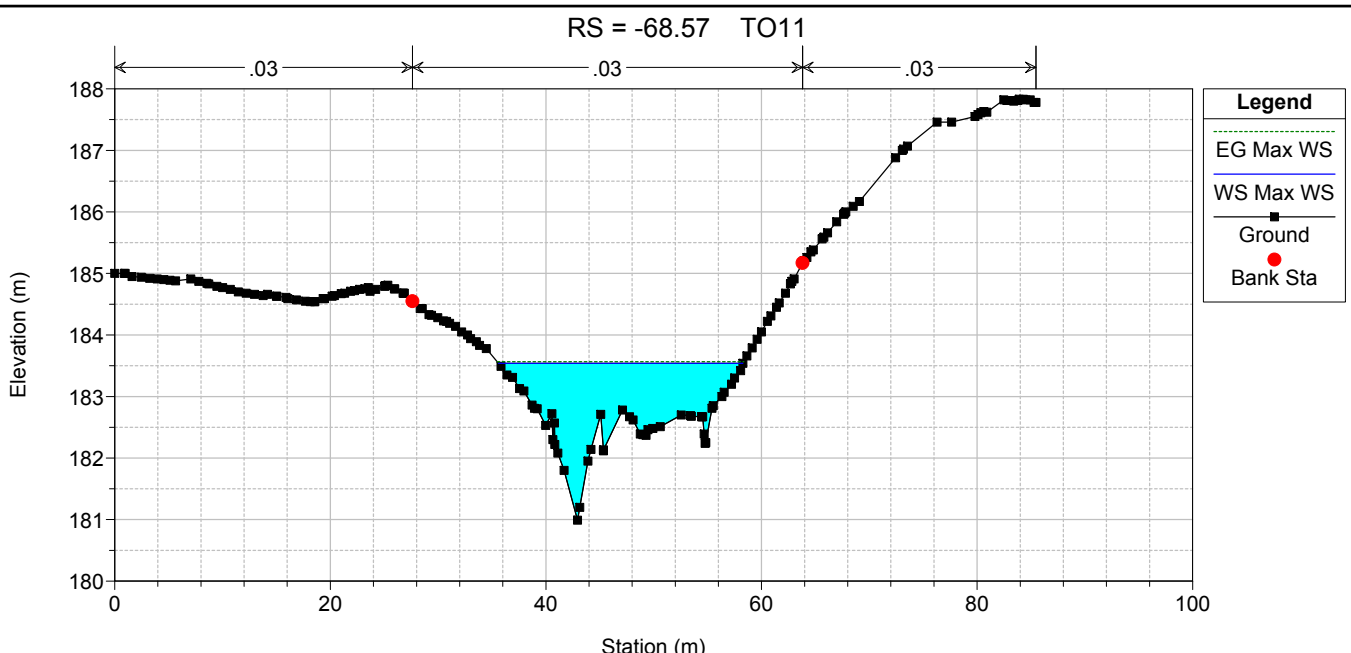

RS = -87.42 TO11

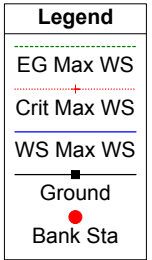
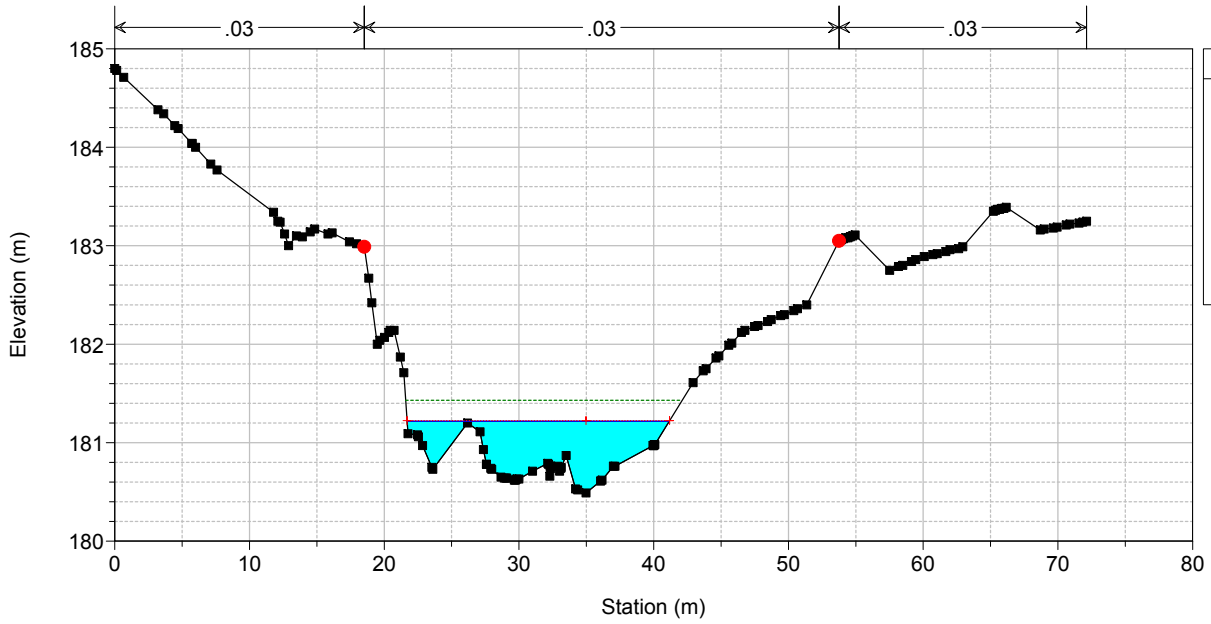

RS = -91.91 TO11

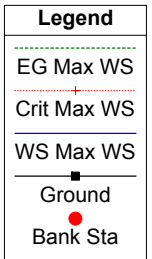
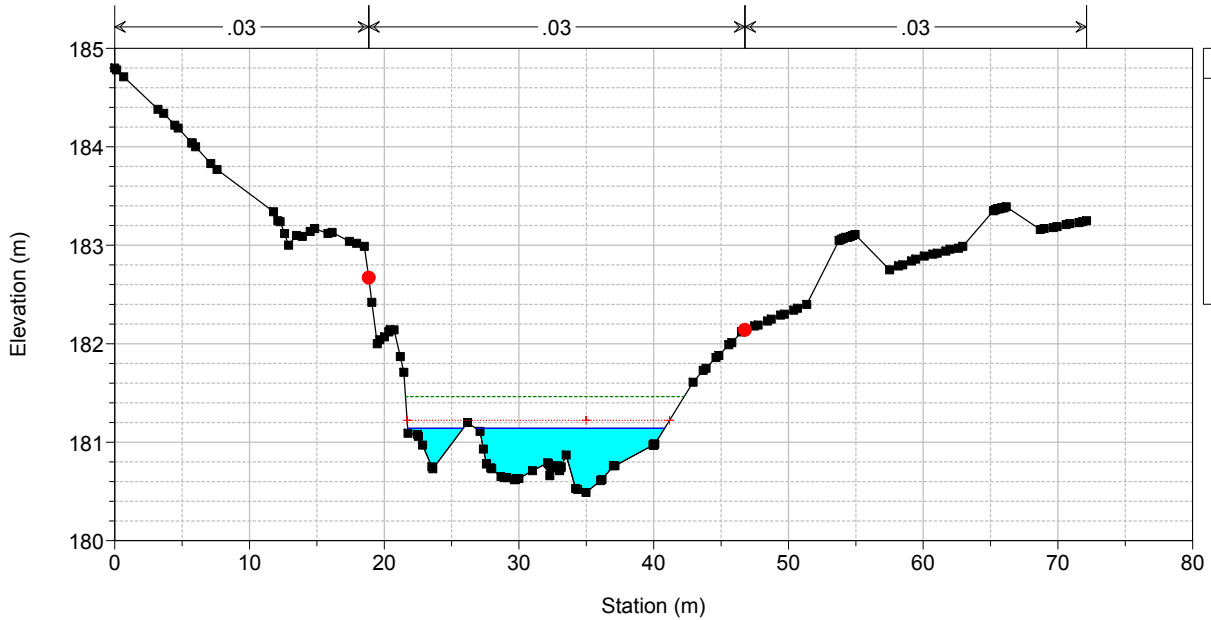

RS = -125 TO11

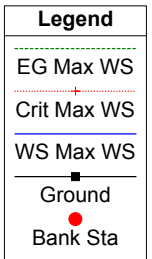
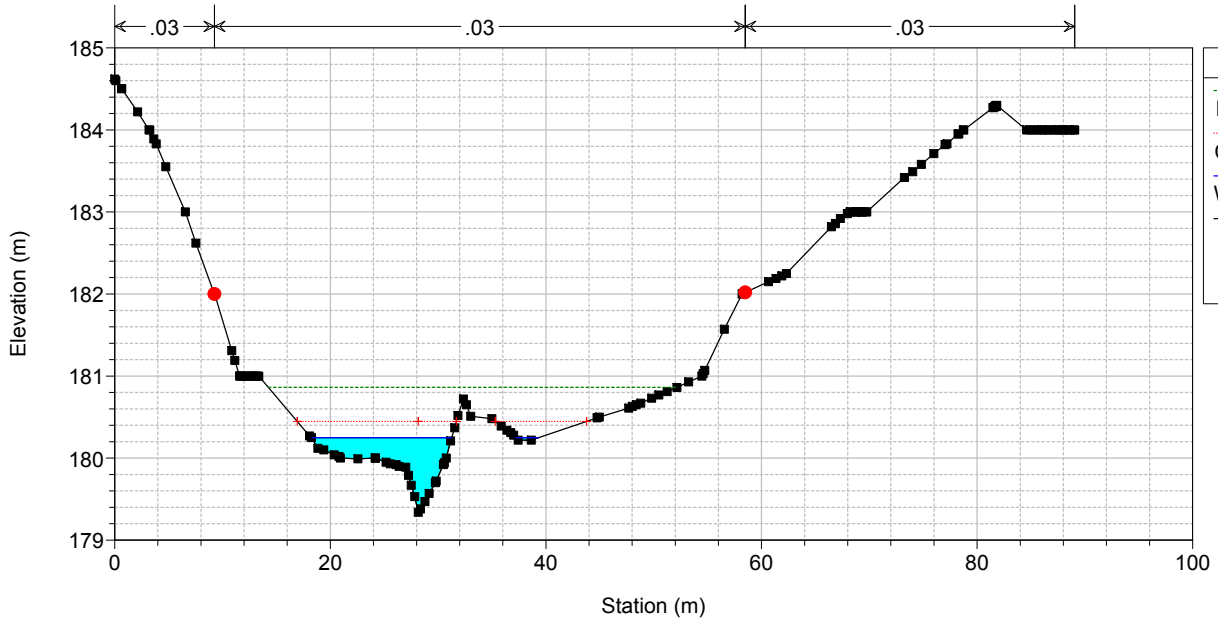

RS = -175 TO11

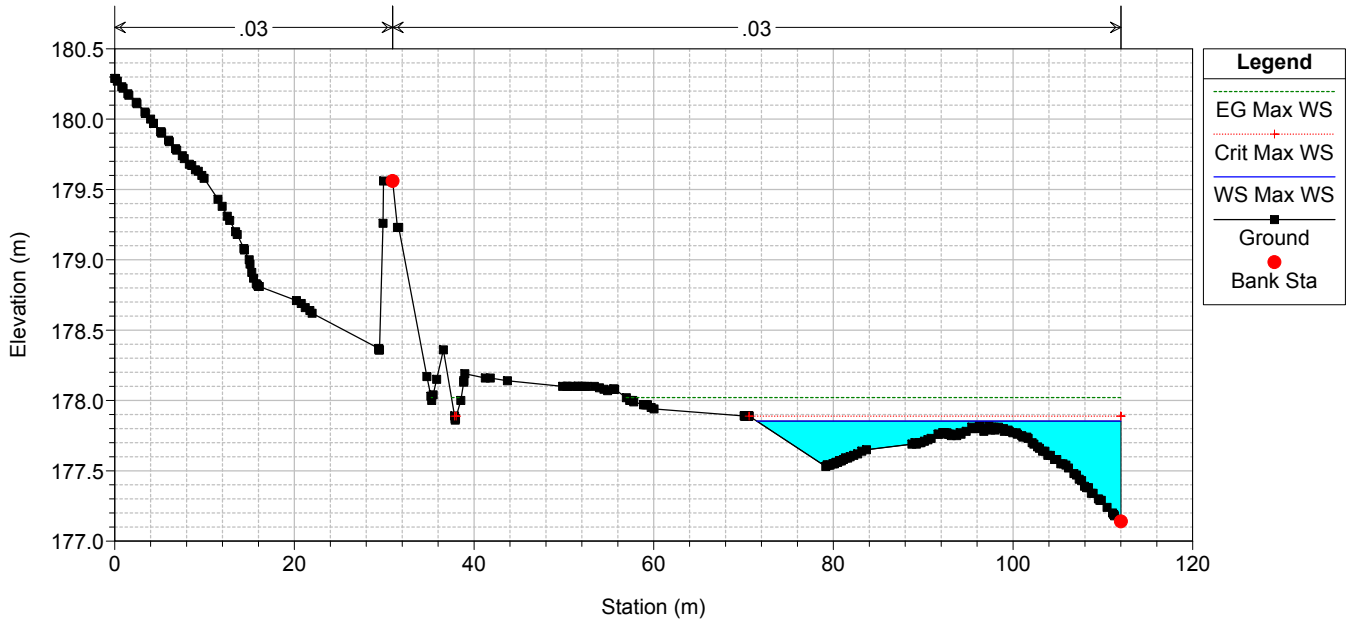

RS = -225 TO11

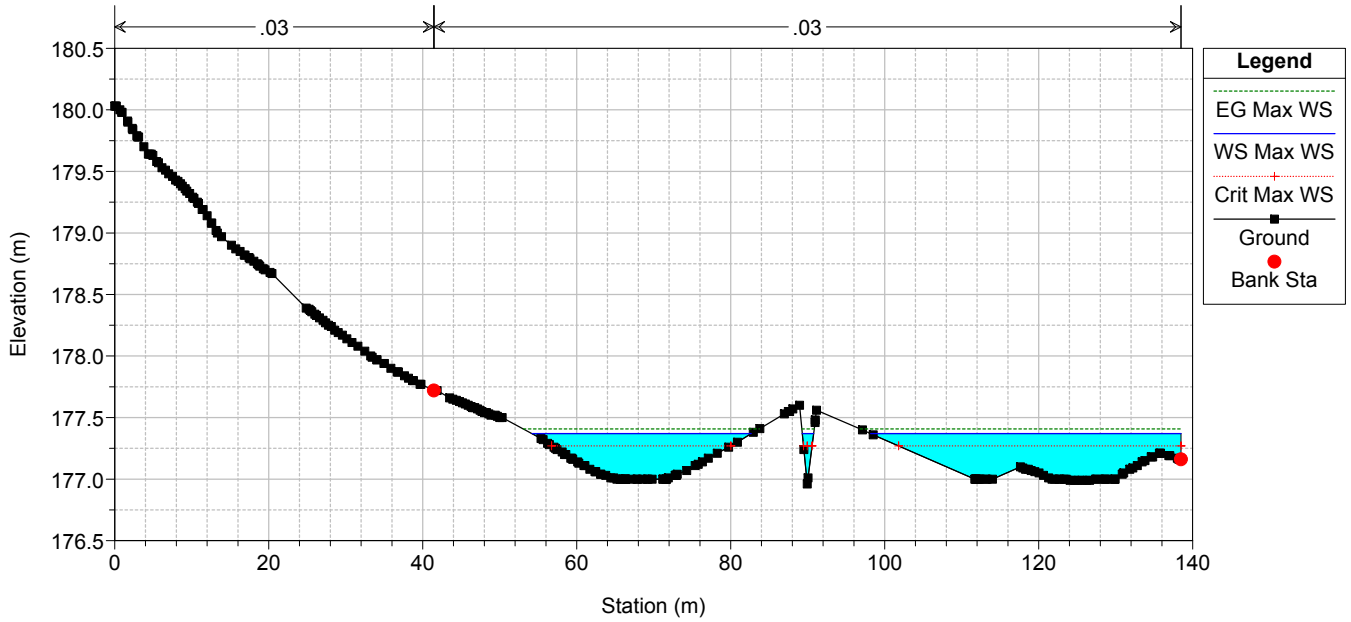

HEC-RAS Plan: TR200_ANTE River: TO12_ANTE Reach: TO12_ANTE Profile: 13OCT2014 0050

Reach	River Sta	Profile	Q Total (m3/s)	Min Ch El (m)	Max Chl Dpth (m)	W.S. Elev (m)	Crit W.S. (m)	Diff	Froude # Chl	E.G. Elev (m)	Vel Chnl (m/s)	Vel Total (m/s)	Hydr Radius C (m)	Shear Chan (N/m2)	Hydr Depth (m)
TO12_ANTE	0	13OCT2014 0050	103.9	181.48	4.99	186.47	184.32	2.15	0.19	186.52	1.0	1.0	2.8	6.4	2.25
TO12_ANTE	-50	13OCT2014 0050	103.9	180.61	5.89	186.50	182.82	3.68	0.07	186.51	0.5	0.5	4.5	1.5	3.81
TO12_ANTE	-70	13OCT2014 0050	103.9	180.59	5.91	186.50	182.56	3.94	0.06	186.51	0.4	0.4	4.8	1.0	4.31
TO12_ANTE	-78	13OCT2014 0050	103.9	180.59	5.91	186.50			0.06	186.51	0.4	0.4	4.7	1.0	4.31
TO12_ANTE	-85														
		Culvert													
TO12_ANTE	-92	13OCT2014 0050	103.9	180.17	1.38	181.55	181.65	-0.10	1.16	182.14	3.4	3.4	0.9	109.5	0.89
TO12_ANTE	-100	13OCT2014 0050	103.9	180.17	1.24	181.41	181.66	-0.25	1.45	182.23	4.0	4.0	0.8	156.2	0.78
TO12_ANTE	-150	13OCT2014 0050	103.9	178.87	1.84	180.71	180.52	0.19	0.65	180.86	1.7	1.7	0.7	29.7	0.72
TO12_ANTE	-200	13OCT2014 0050	103.8	178.55	1.62	180.17	180.16	0.01	0.99	180.53	2.7	2.7	0.7	69.4	0.74
TO12_ANTE	-250	13OCT2014 0050	103.8	178.03	1.56	179.59	179.69	-0.10	1.20	180.10	3.2	3.2	0.7	99.4	0.71
TO12_ANTE	-300	13OCT2014 0050	103.8	177.49	1.39	178.88	178.96	-0.08	1.19	179.33	3.0	3.0	0.6	91.9	0.65
TO12_ANTE	-350	13OCT2014 0050	103.8	176.92	1.67	178.59	178.18	0.41	0.46	178.69	1.4	1.4	0.9	17.7	0.95
TO12_ANTE	-400	13OCT2014 0050	103.7	176.46	1.82	178.28	178.25	0.03	0.93	178.54	2.3	2.2	0.6	53.7	0.58
TO12_ANTE	-450	13OCT2014 0050	104.3	176.04	1.75	177.79	177.79	0.00	1.01	178.13	2.6	2.6	0.6	68.4	0.66
TO12_ANTE	-490	13OCT2014 0050	103.8	175.59	2.28	177.87	176.97	0.90	0.10	177.87	0.3	0.3	1.0	0.8	0.97
TO12_ANTE	-494.5	13OCT2014 0050	121.5	175.59	2.27	177.66	176.99	0.67	0.11	177.87	0.4	0.4	1.0	1.2	0.97
TO12_ANTE	-498.75														
		Bridge													
TO12_ANTE	-503	13OCT2014 0050	121.5	175.34	1.10	176.44	176.30	0.14	0.63	176.52	1.3	1.3	0.4	19.4	0.42
TO12_ANTE	-506	13OCT2014 0050	121.5	175.34	1.08	176.42	176.30	0.12	0.68	176.51	1.4	1.4	0.4	22.1	0.41
TO12_ANTE	-550	13OCT2014 0050	121.7	175.09	1.17	176.26	175.96	0.30	0.38	176.29	0.8	0.8	0.4	7.1	0.48
TO12_ANTE	-626.63	13OCT2014 0050	121.9	174.22	1.84	176.06	175.82	0.24	0.46	176.13	0.8	1.0	0.3	8.4	0.41

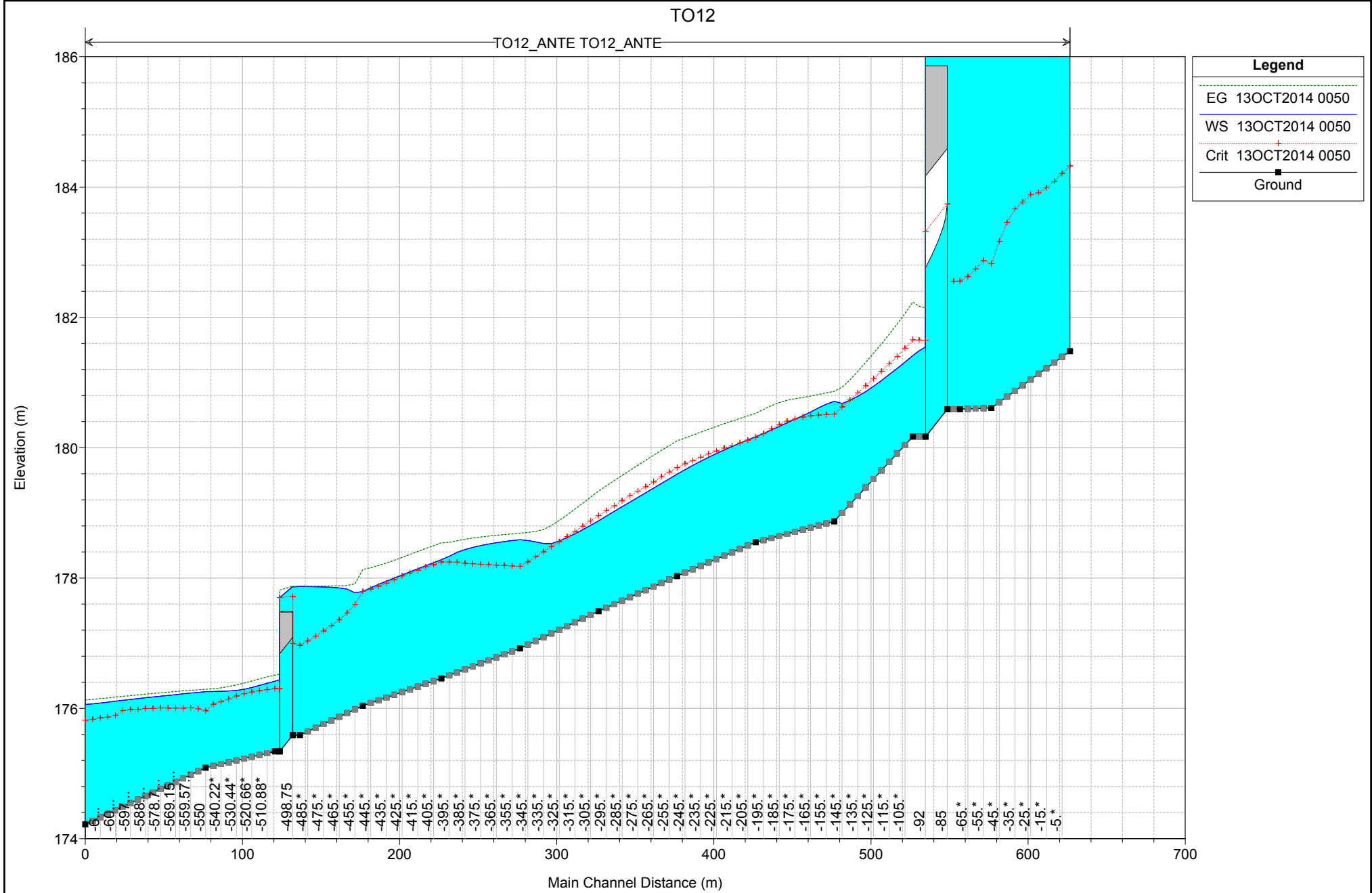

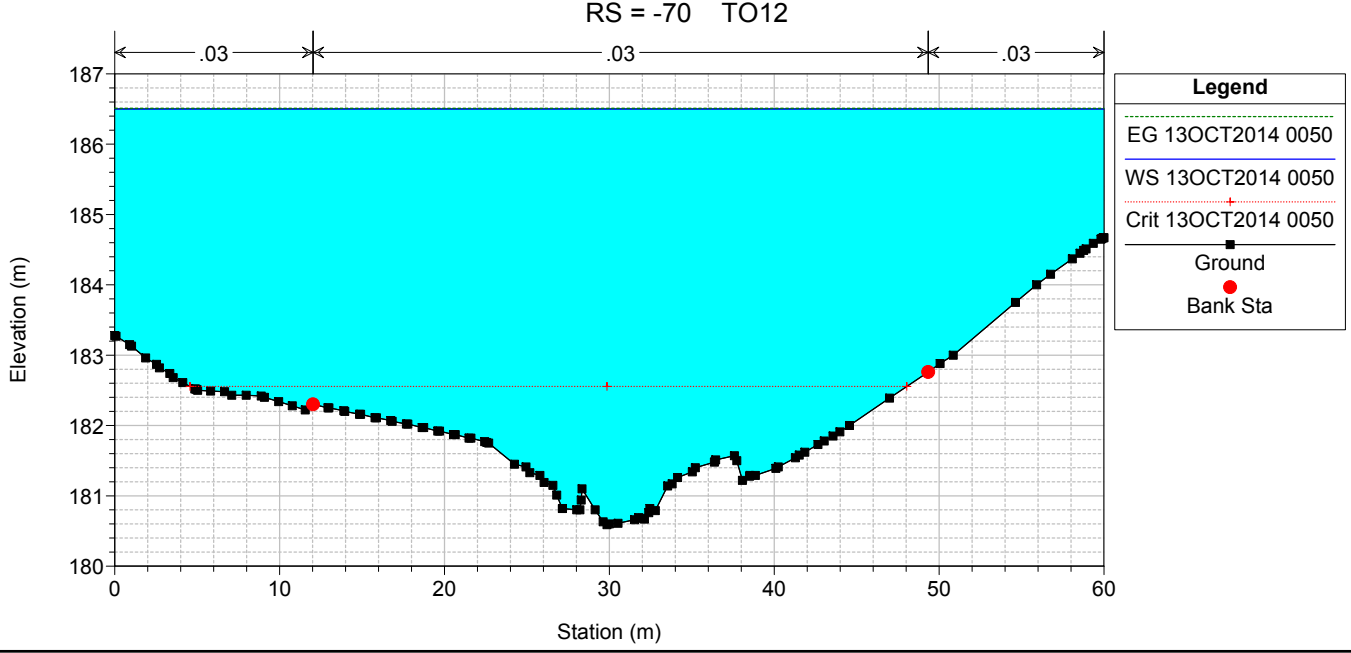
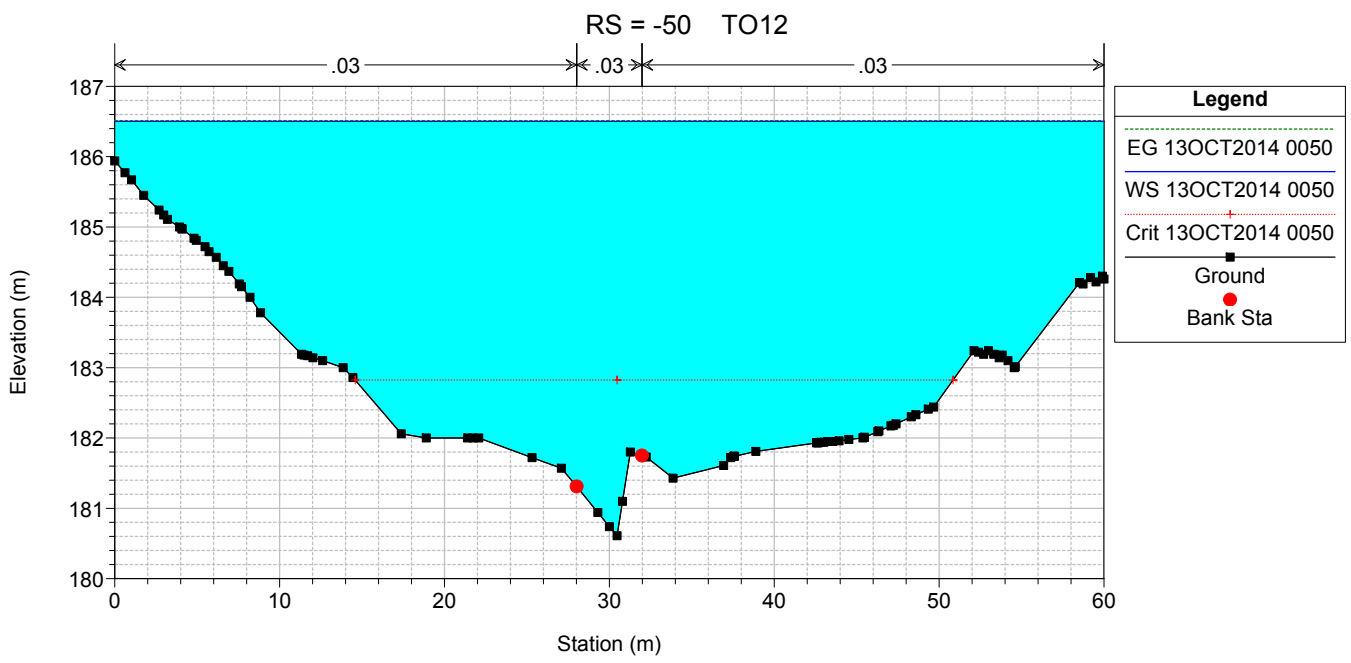
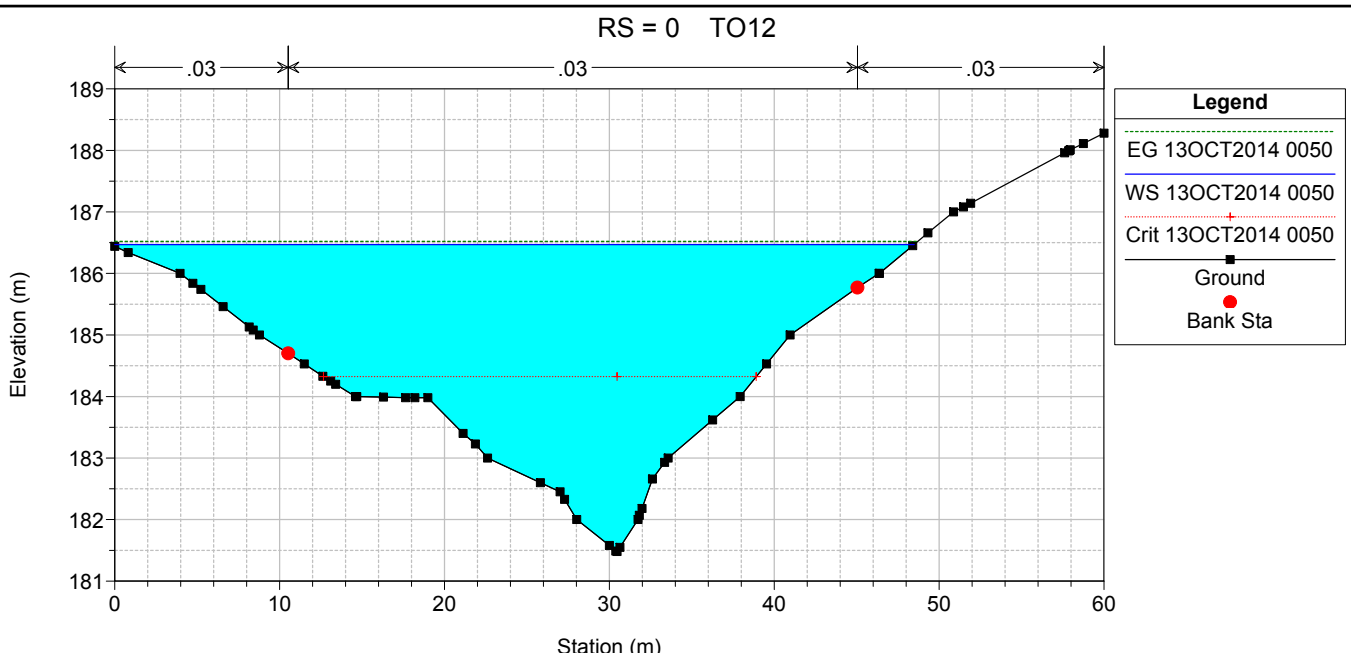

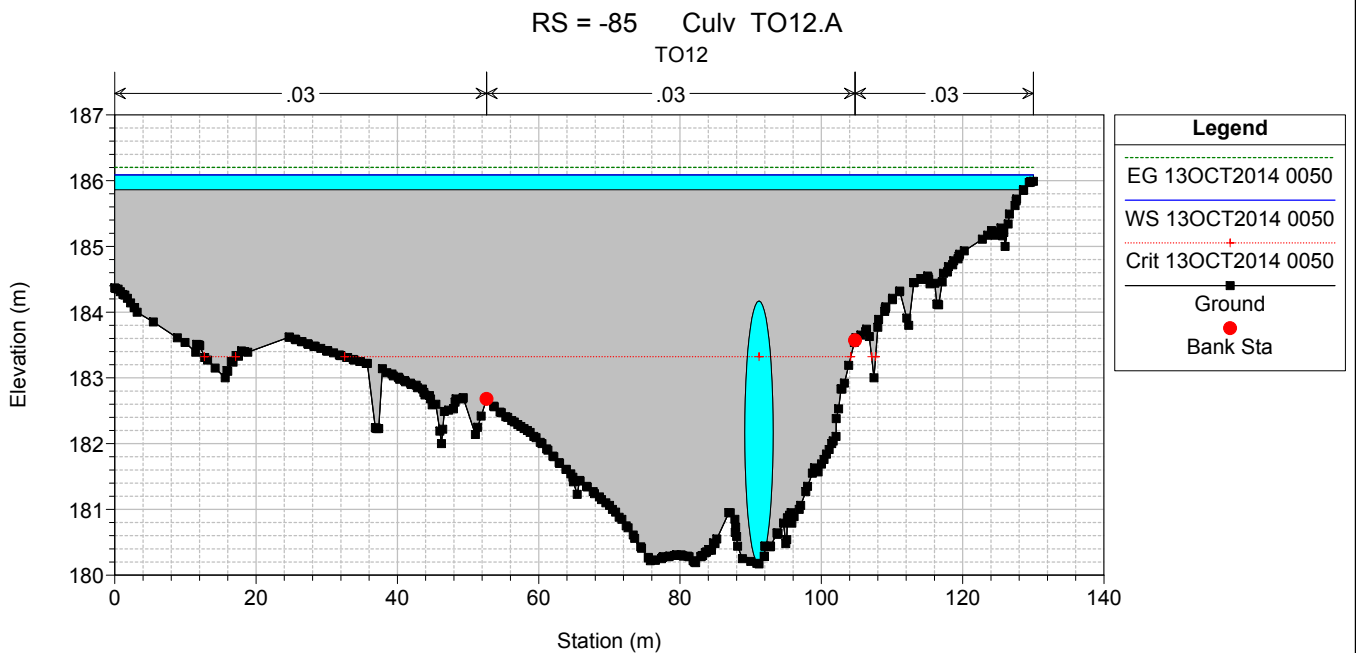
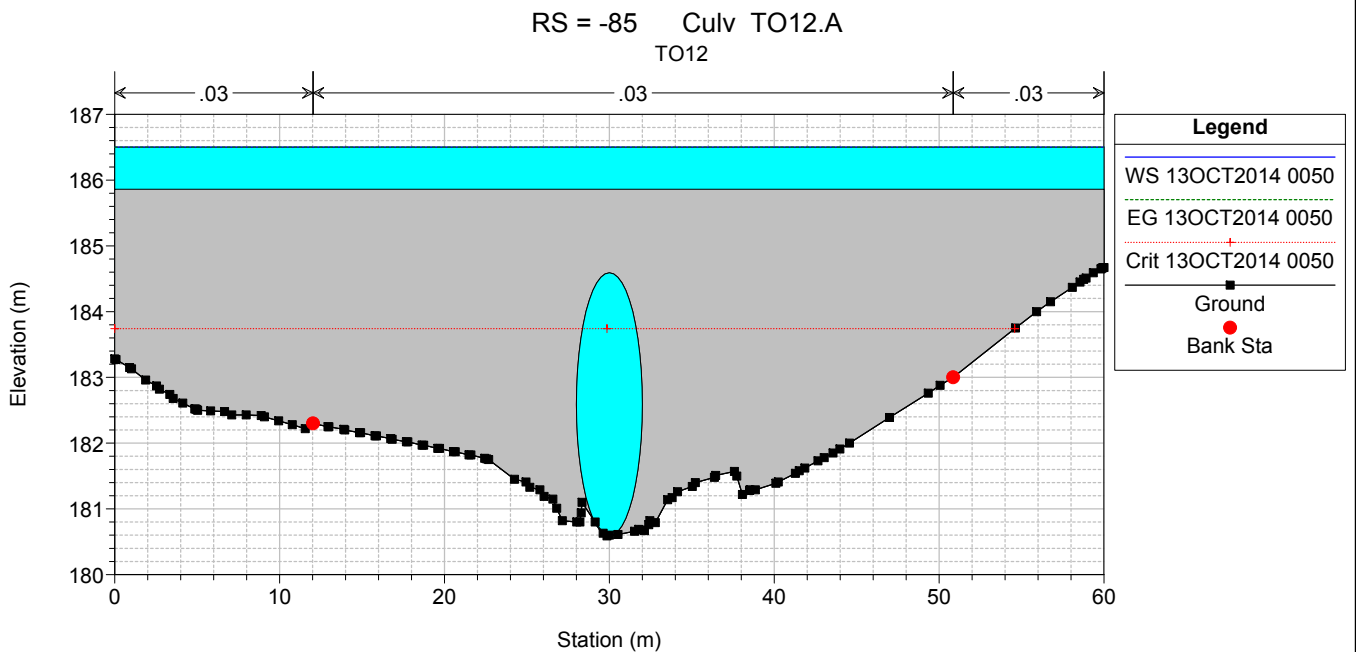
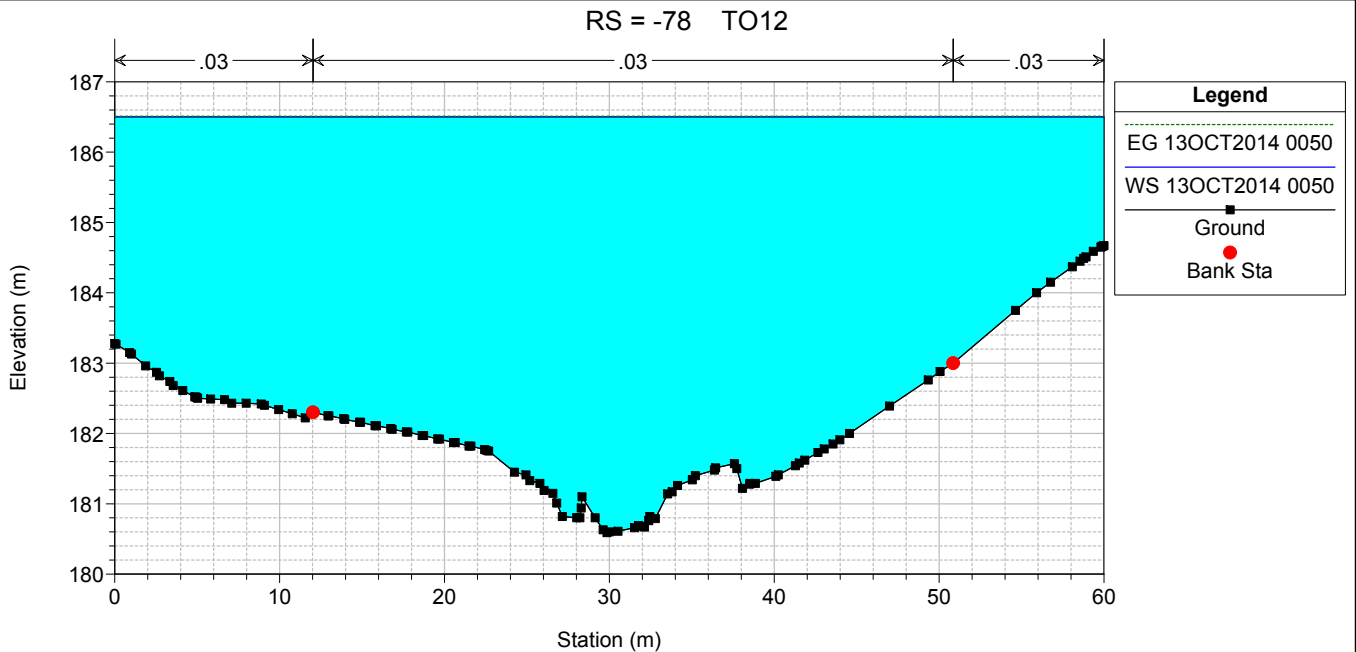

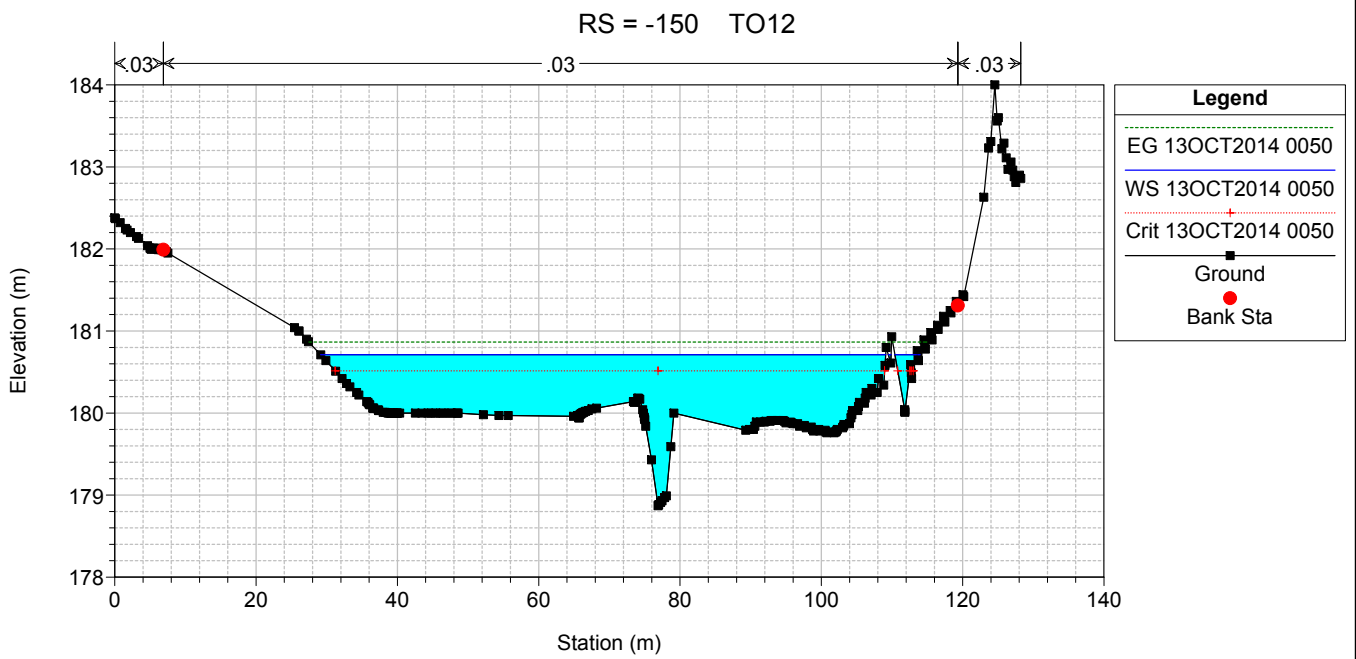
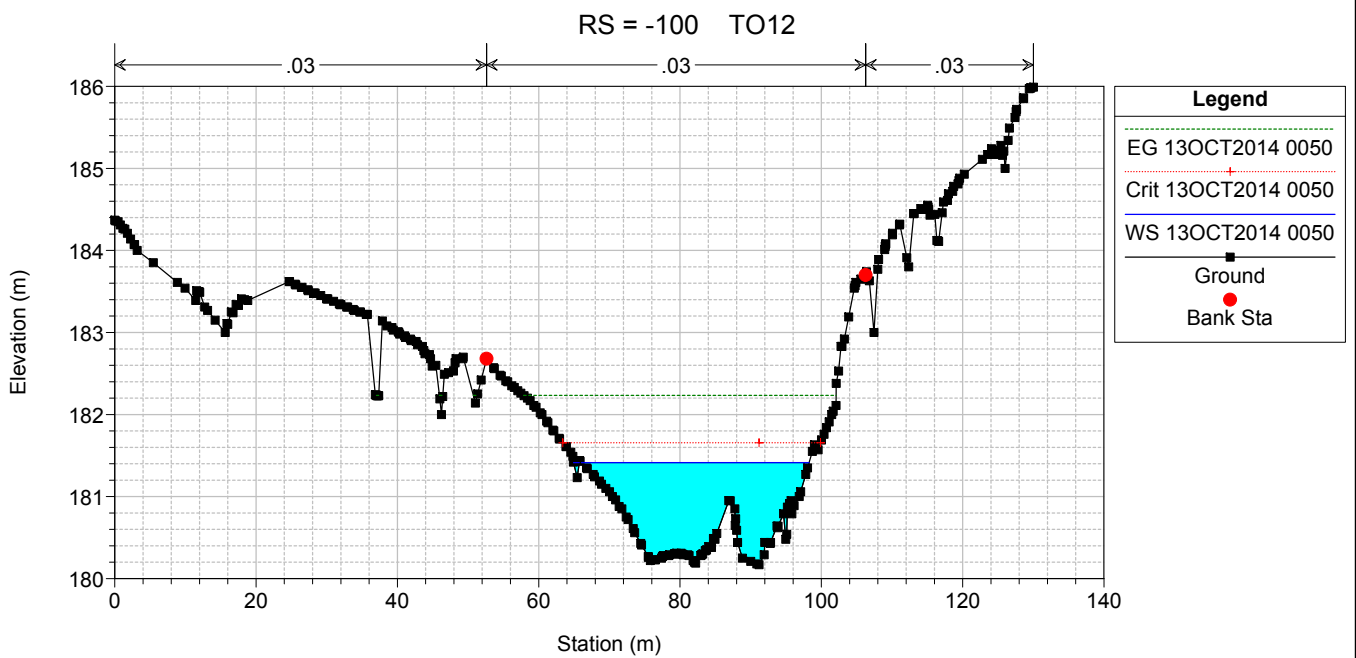
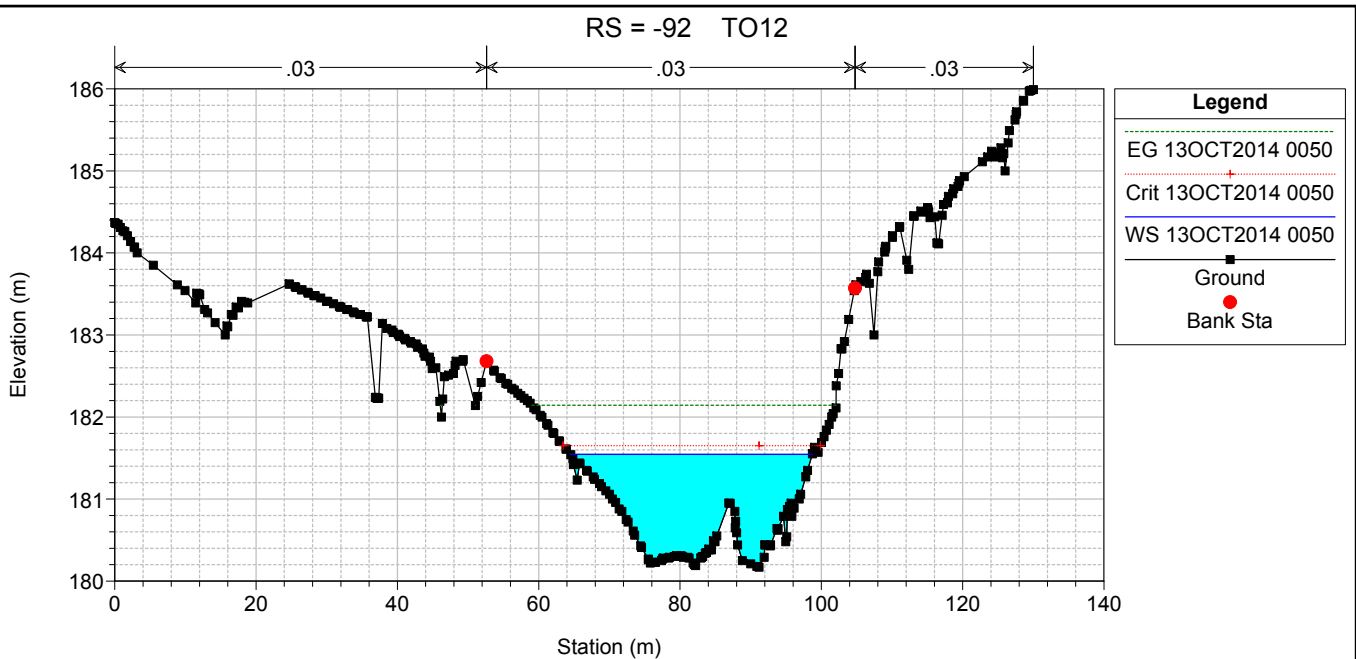

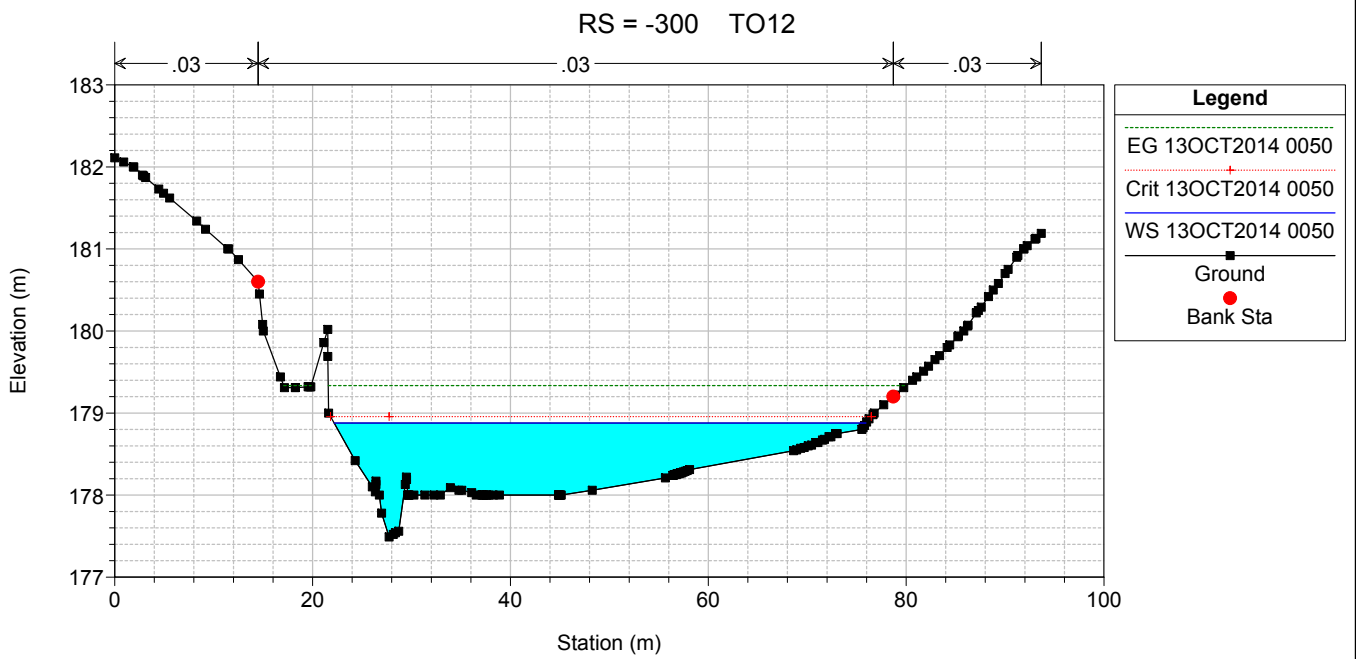
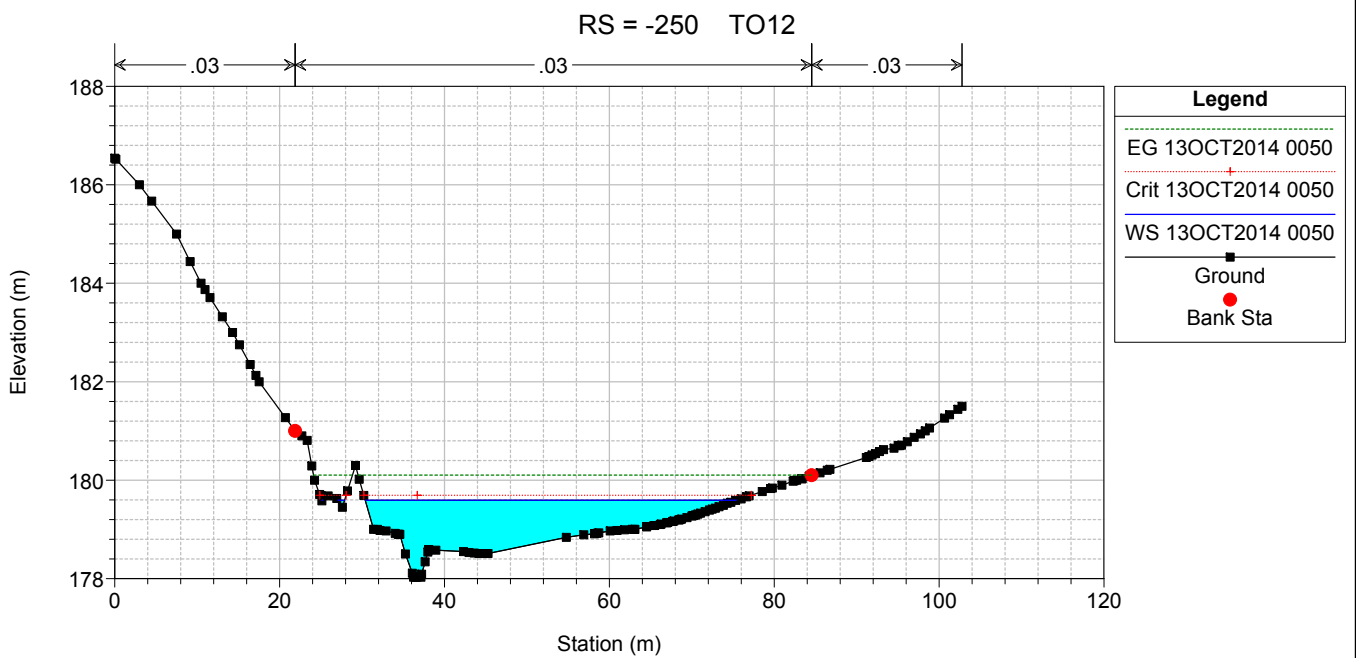
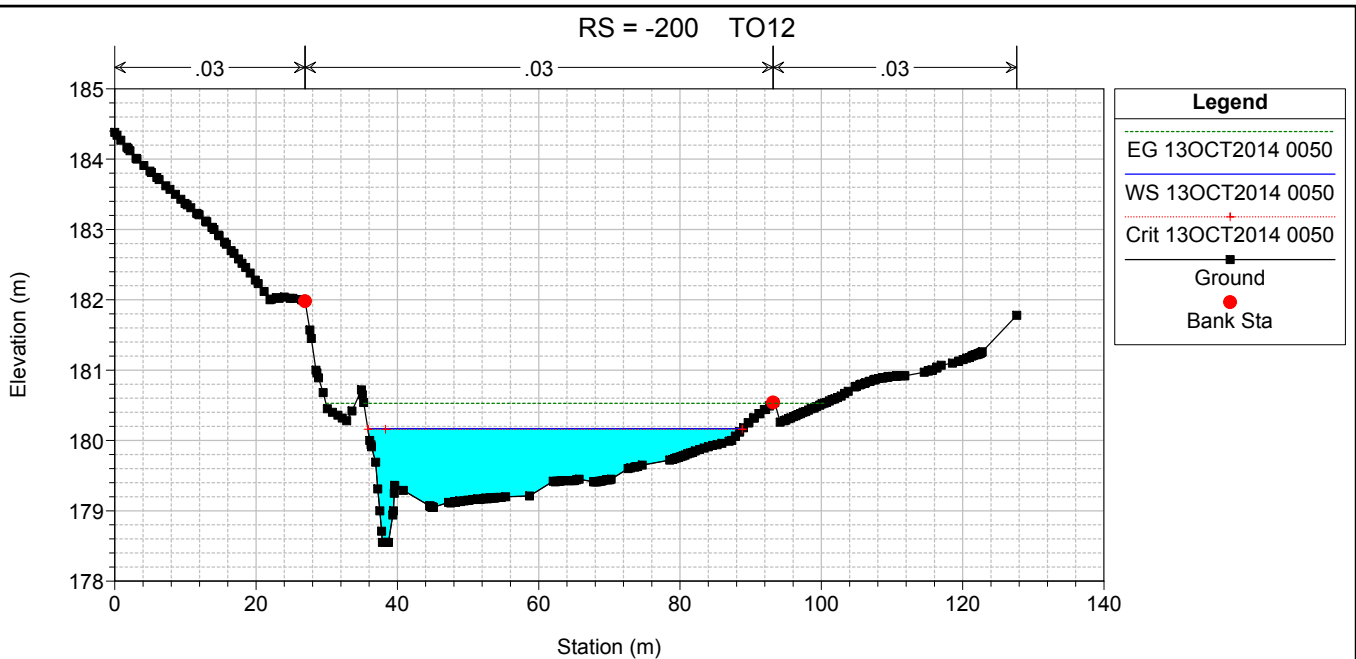

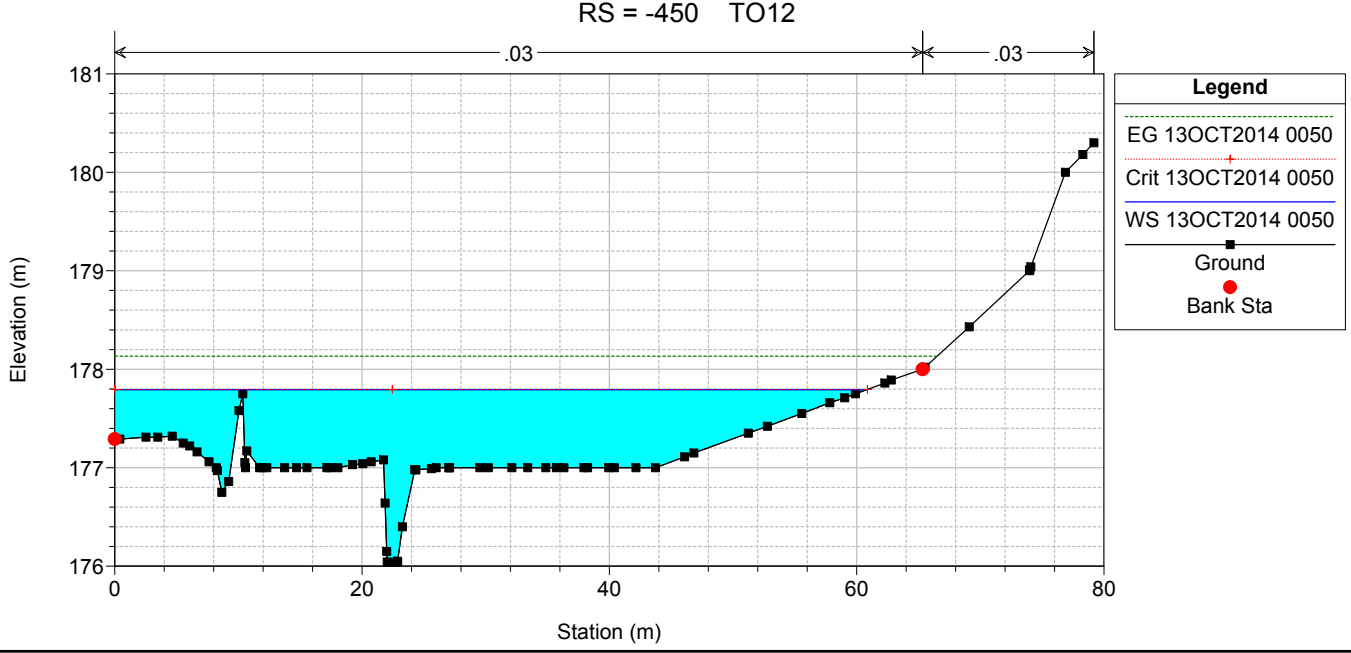
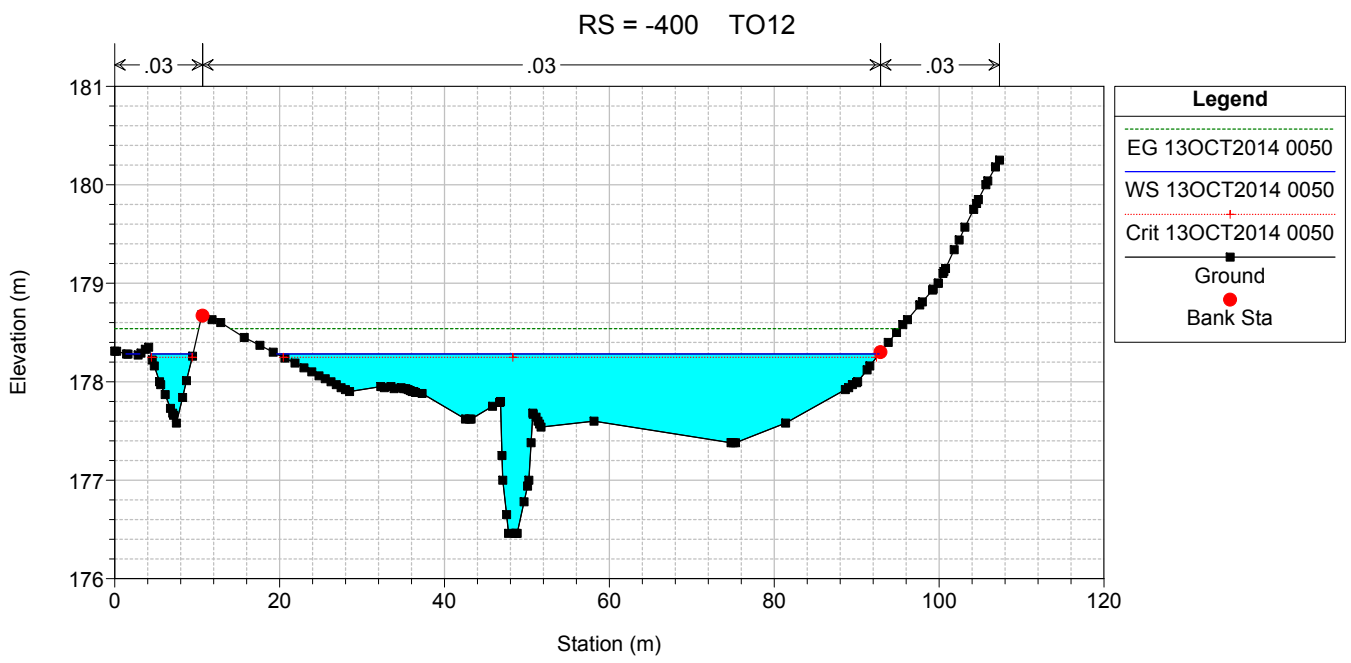
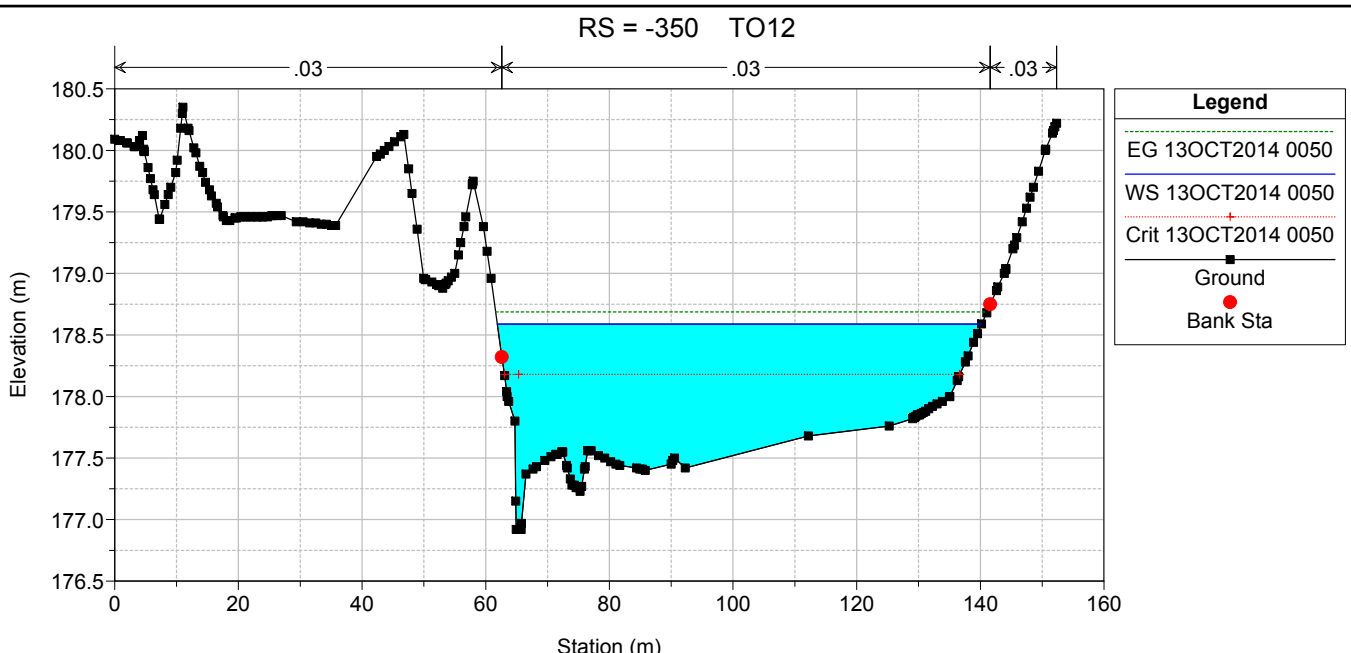

RS = -490 TO12

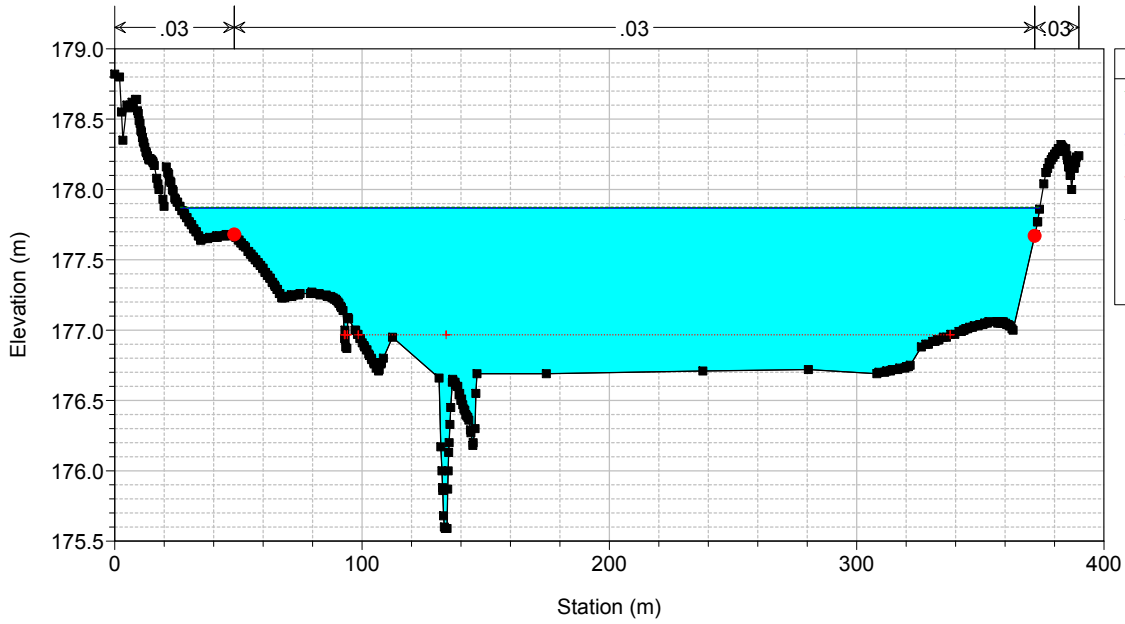

RS = -494.5 TO12

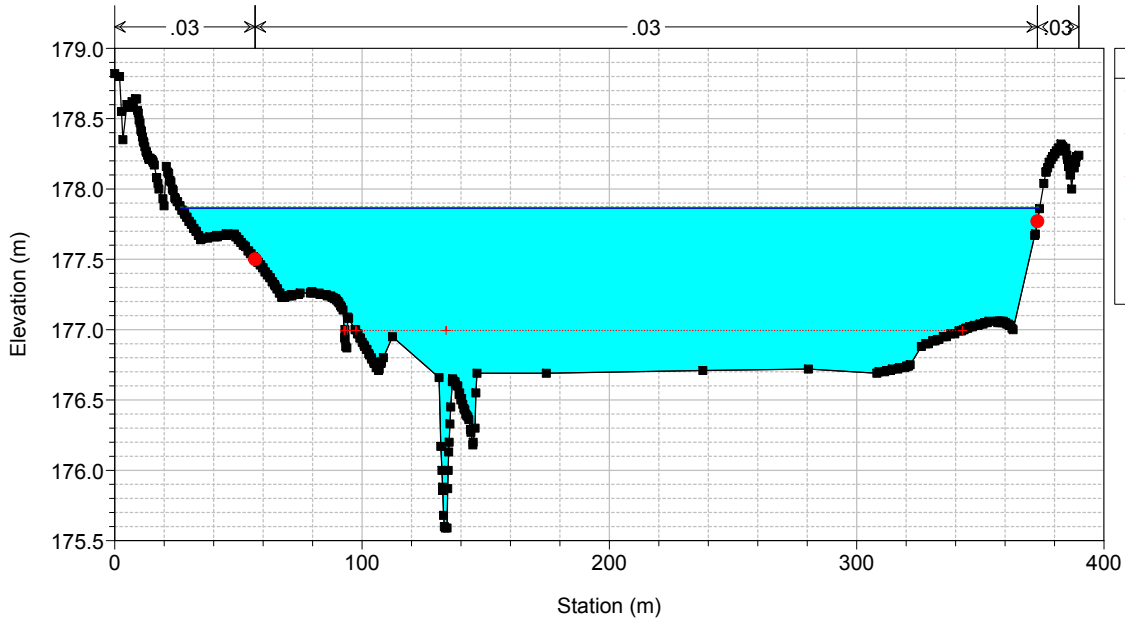

RS = -498.75 BR TO12.B
TO12

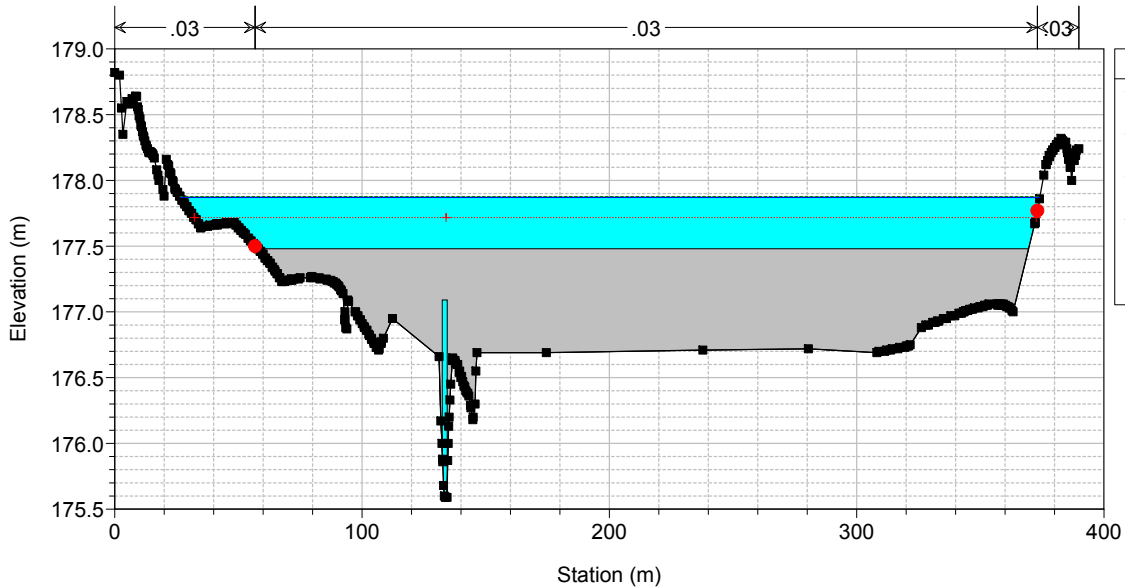

RS = -498.75 BR TO12.B

TO12

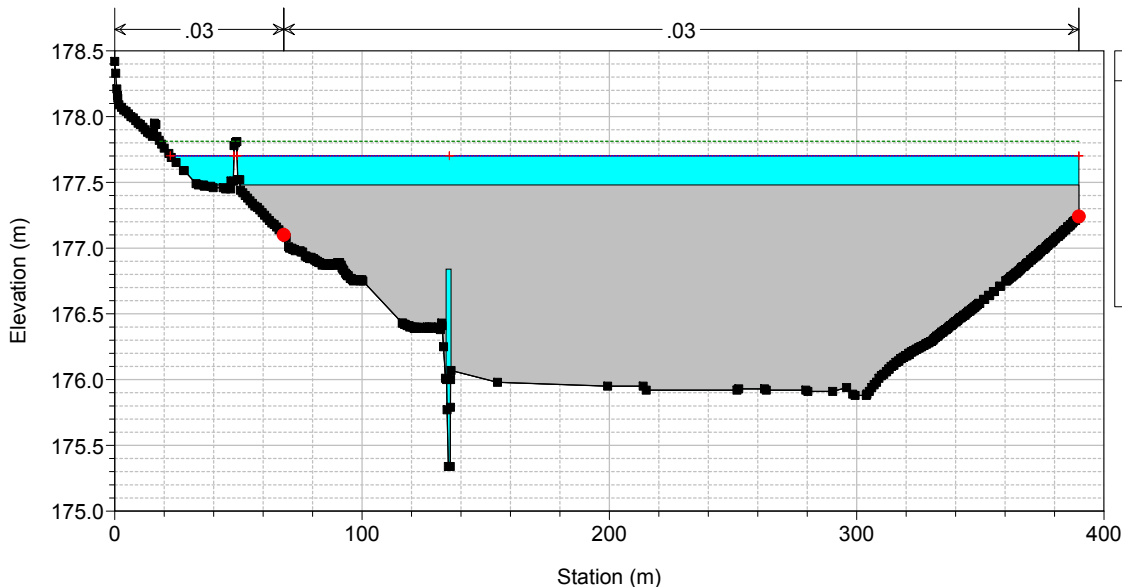

RS = -503 TO12

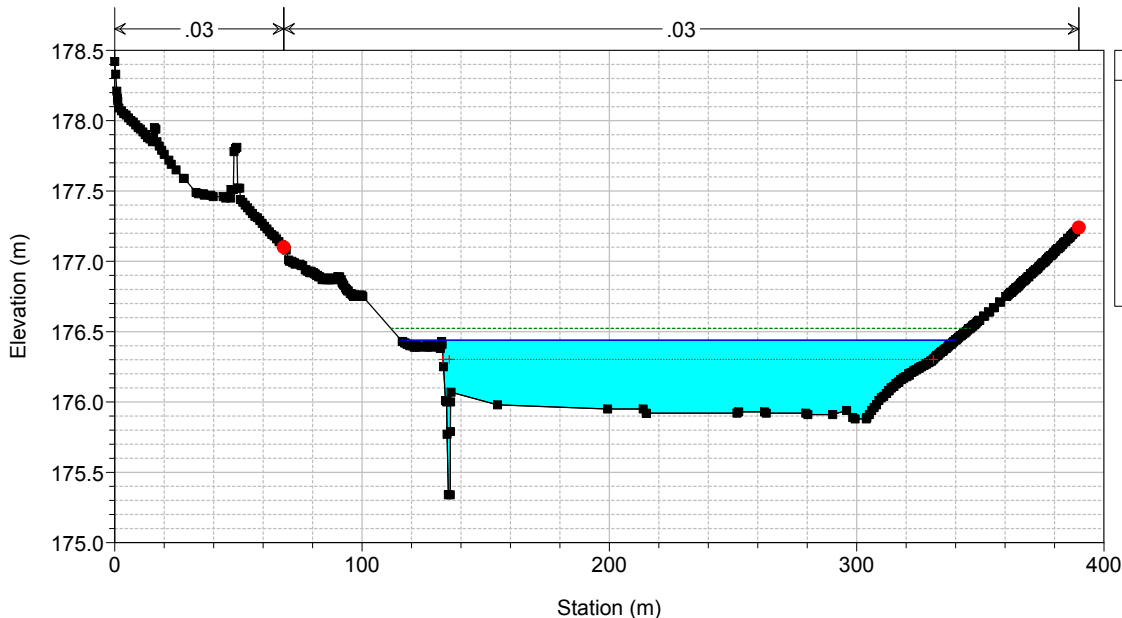

RS = -506 TO12

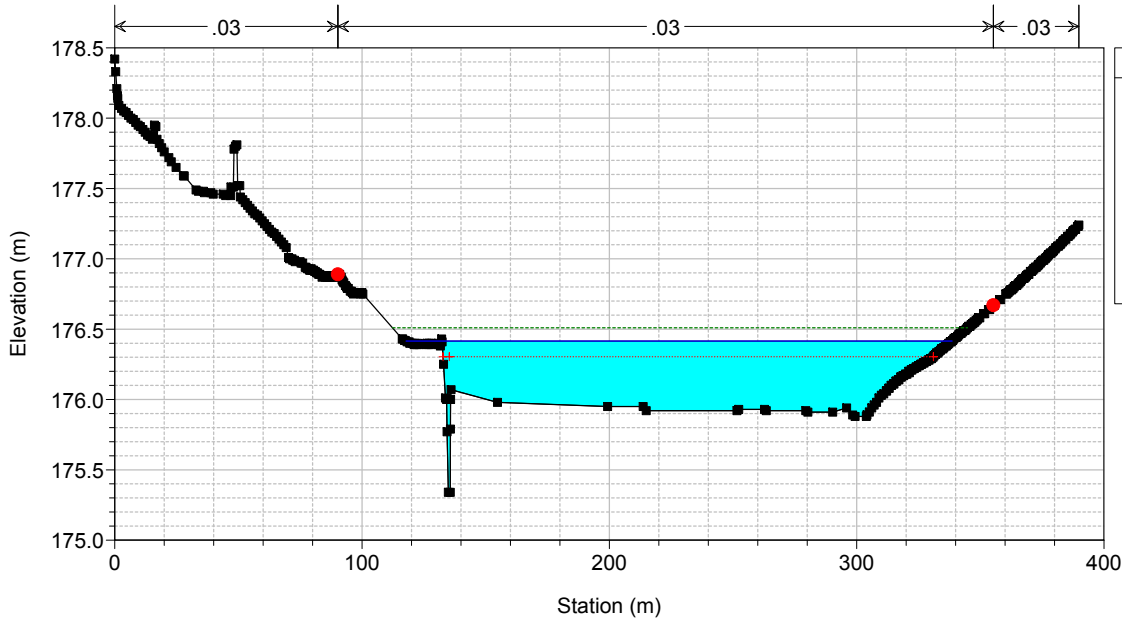

RS = -550 TO12

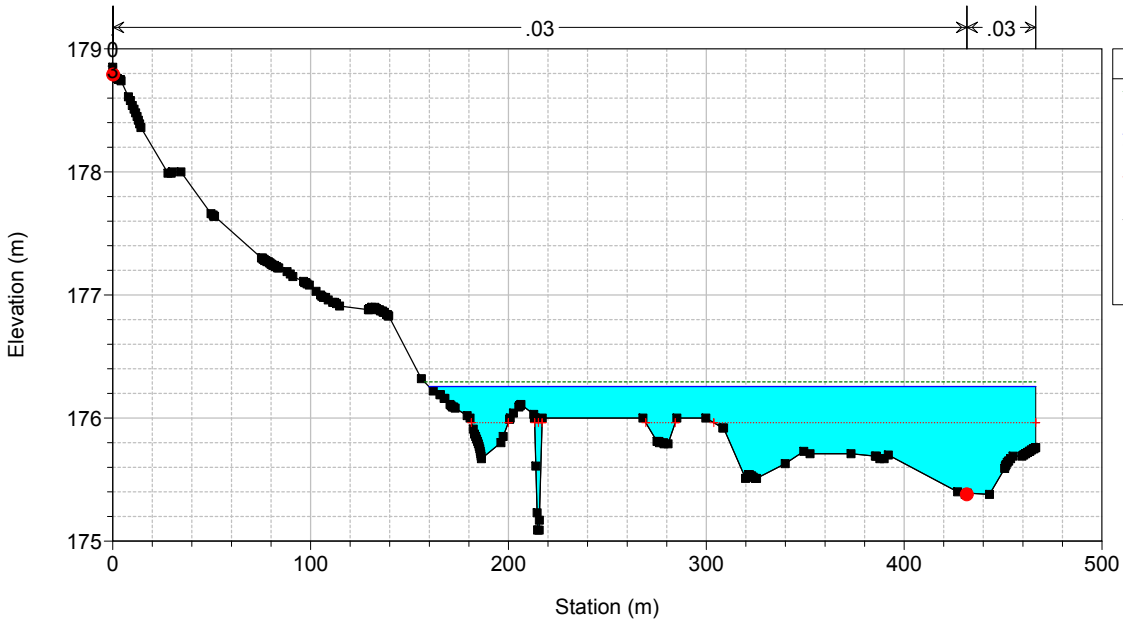

RS = -626.63 TO12

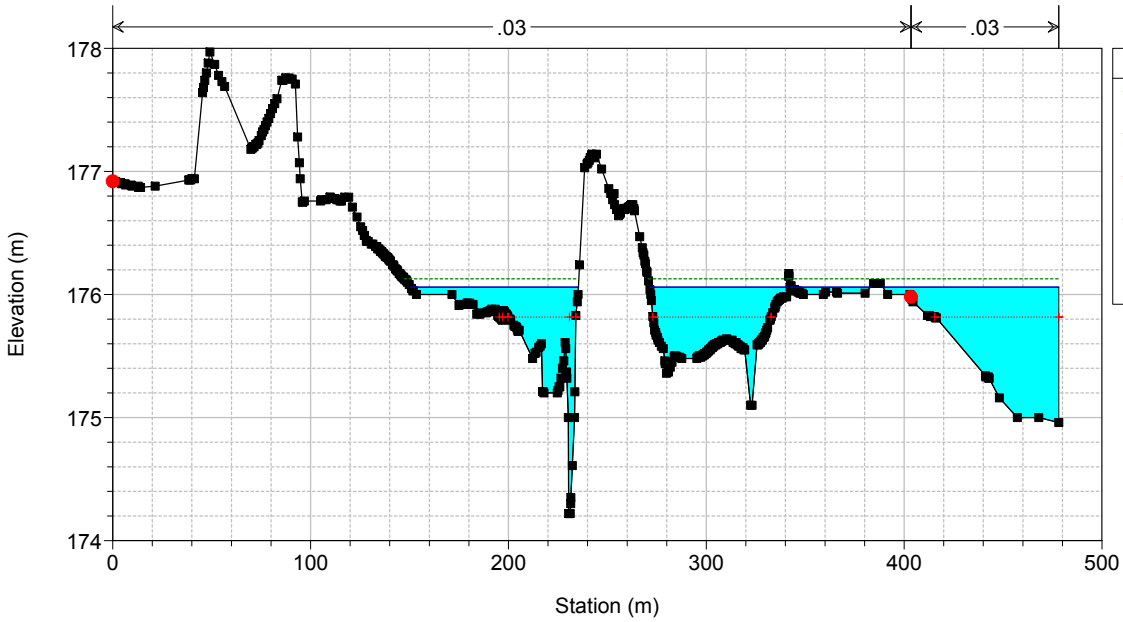

POST

HEC-RAS Plan: POST_VARIO River: TO11 Reach: TO11 Profile: Max WS

Reach	River Sta	Profile	Q Total (m3/s)	Min Ch El (m)	Max Chl Dpth (m)	W.S. Elev (m)	Crit W.S. (m)	Diff	Froude # Chl	E.G. Elev (m)	Vel Chnl (m/s)	Vel Total (m/s)	Hydr Radius C (m)	Shear Chan (N/m2)	Hydr Depth (m)
TO11	0	Max WS	15.7	186.00	0.89	186.89	187.17	-0.28	2.24	188.10	5.3	4.1	0.5	300.6	0.25
TO11	-25	Max WS	15.7	185.00	0.58	185.58	185.77	-0.19	1.87	186.22	3.5	3.5	0.4	155.1	0.36
TO11	-43.37	Max WS	15.7	183.78	0.95	184.73	185.02	-0.29	1.93	185.51	3.9	3.9	0.4	184.2	0.42
TO11	-50	Max WS	15.7	183.46	0.61	184.07	184.52	-0.45	4.66	187.75	8.5	8.5	0.3	938.0	0.34
TO11	-59.31	Max WS	15.7	181.19	0.54	181.73	182.63	-0.90	5.53	188.51	11.5	11.5	0.4	1612.1	0.44
TO11	-66.94	Max WS	15.7	179.11	1.23	180.34	179.99	0.35	0.61	180.56	2.1	2.1	0.9	40.2	1.20
TO11	-70.6	Bridge													
TO11	-74.25	Max WS	15.7	179.04	1.17	180.21	179.91	0.30	0.64	180.45	2.2	2.2	0.9	43.5	1.15
TO11	-95.45	Max WS	15.7	178.83	1.34	180.17	179.71	0.46	0.53	180.36	1.9	1.9	0.9	32.6	1.31
TO11	-121.04	Bridge													
TO11	-146.62	Max WS	15.7	178.32	0.78	179.10	179.20	-0.10	1.20	179.66	3.3	3.3	0.6	112.5	0.77
TO11	-175	Max WS	15.7	177.50	1.11	178.61	178.94	-0.33	1.60	179.66	4.5	4.5	0.7	207.9	0.82
TO11	-200	Max WS	15.7	176.60	1.47	178.07	178.04	0.03	0.97	178.55	3.1	3.1	0.8	89.6	1.03
TO11	-225	Max WS	0.9	176.26	1.76	178.02	176.51	1.51	0.03	178.02	0.1	0.1	1.0	0.1	0.44
TO11	-250	Max WS	14.5	176.20	1.82	178.02	177.57	0.45	0.24	178.05	0.9	0.7	1.2	6.8	0.74
TO11	-275	Max WS	15.6	176.15	1.88	178.03	177.24	0.79	0.15	178.04	0.6	0.5	1.4	3.0	1.05
TO11	-310	Max WS	15.6	176.07	1.94	178.01	177.22	0.79	0.17	178.03	0.7	0.5	1.4	3.8	0.95
TO11	-335	Max WS	2.0	176.01	2.00	178.01	176.44	1.57	0.02	178.01	0.1	0.1	1.5	0.0	1.10

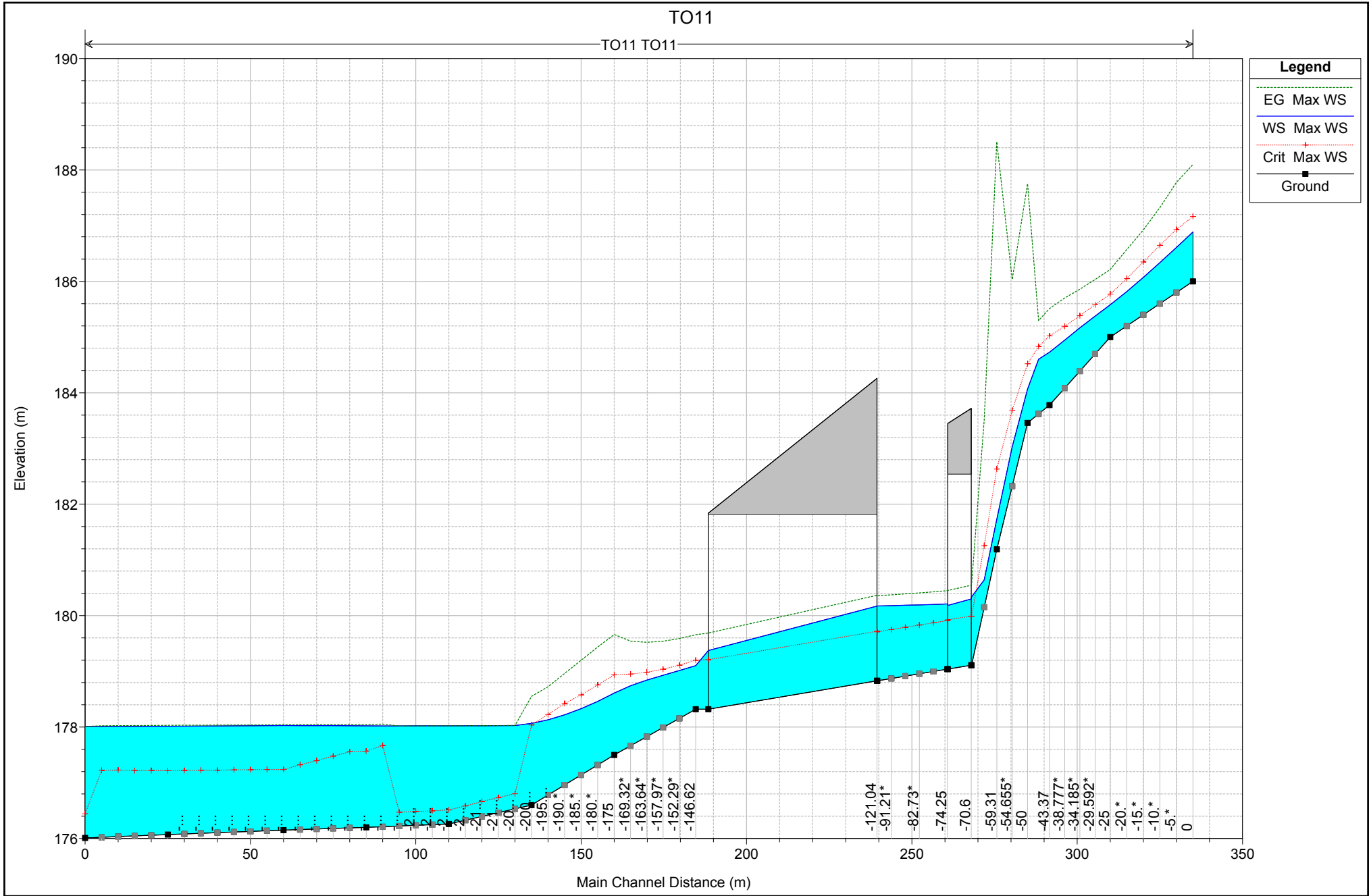

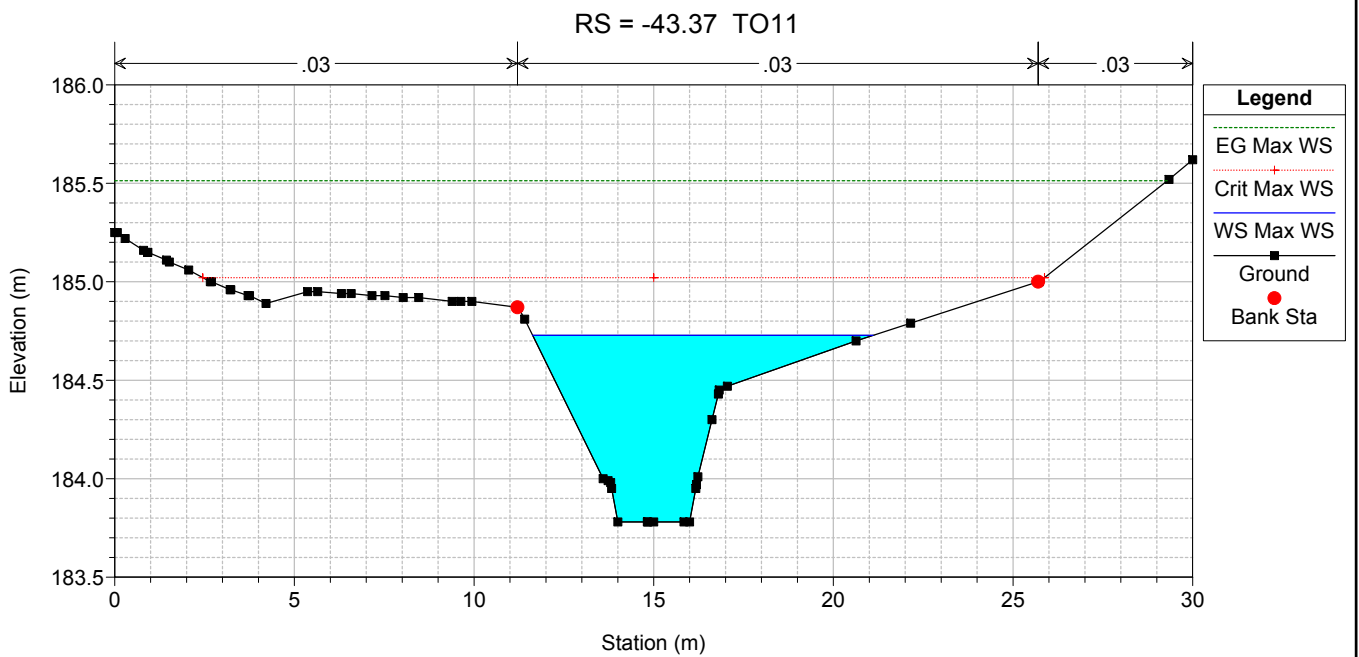
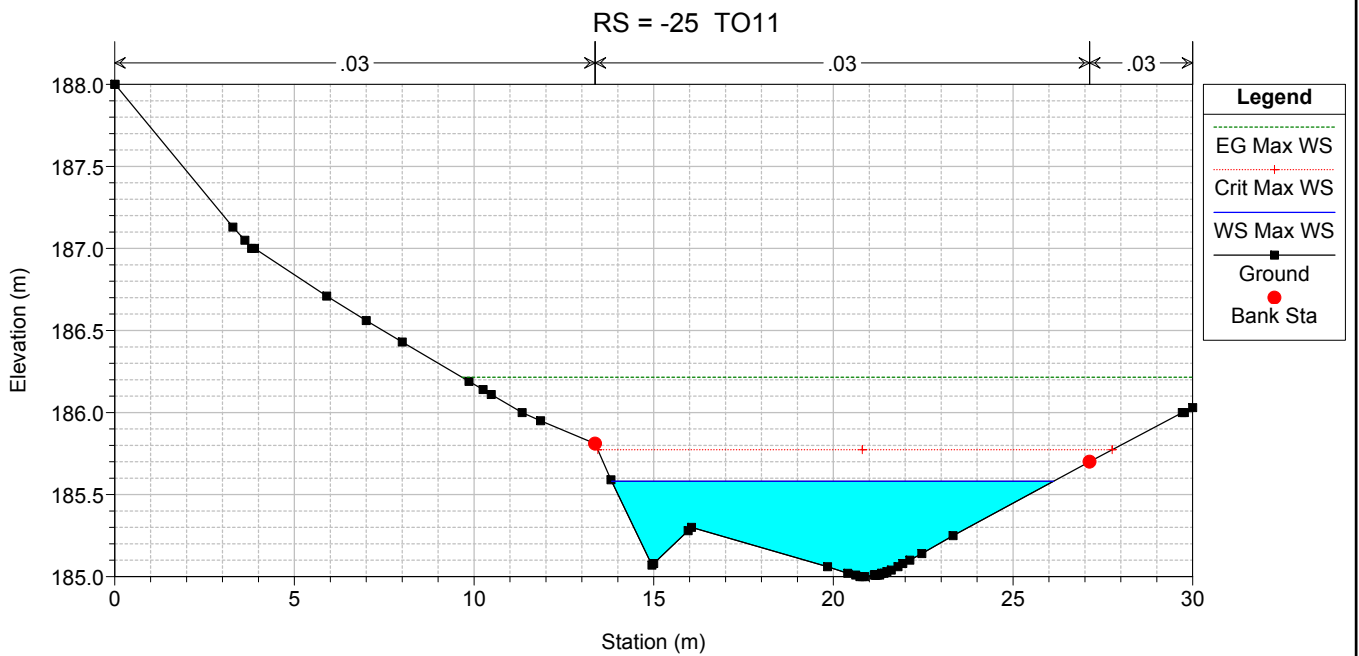
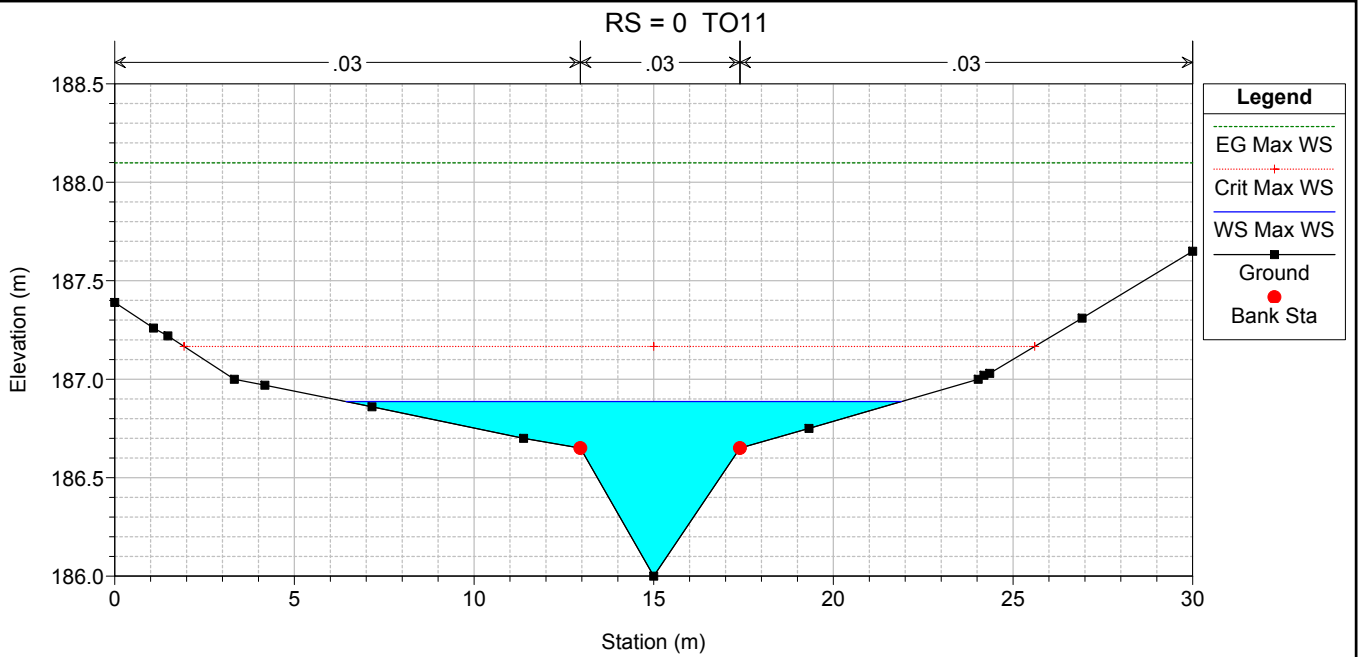

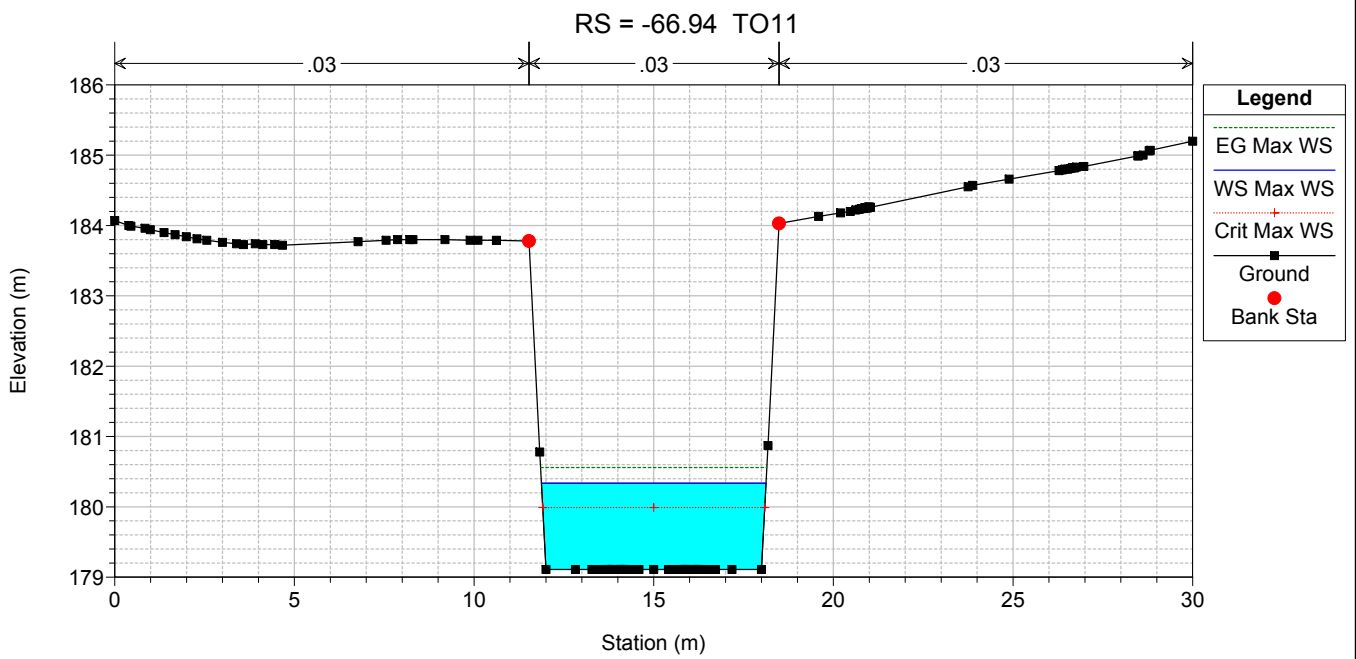
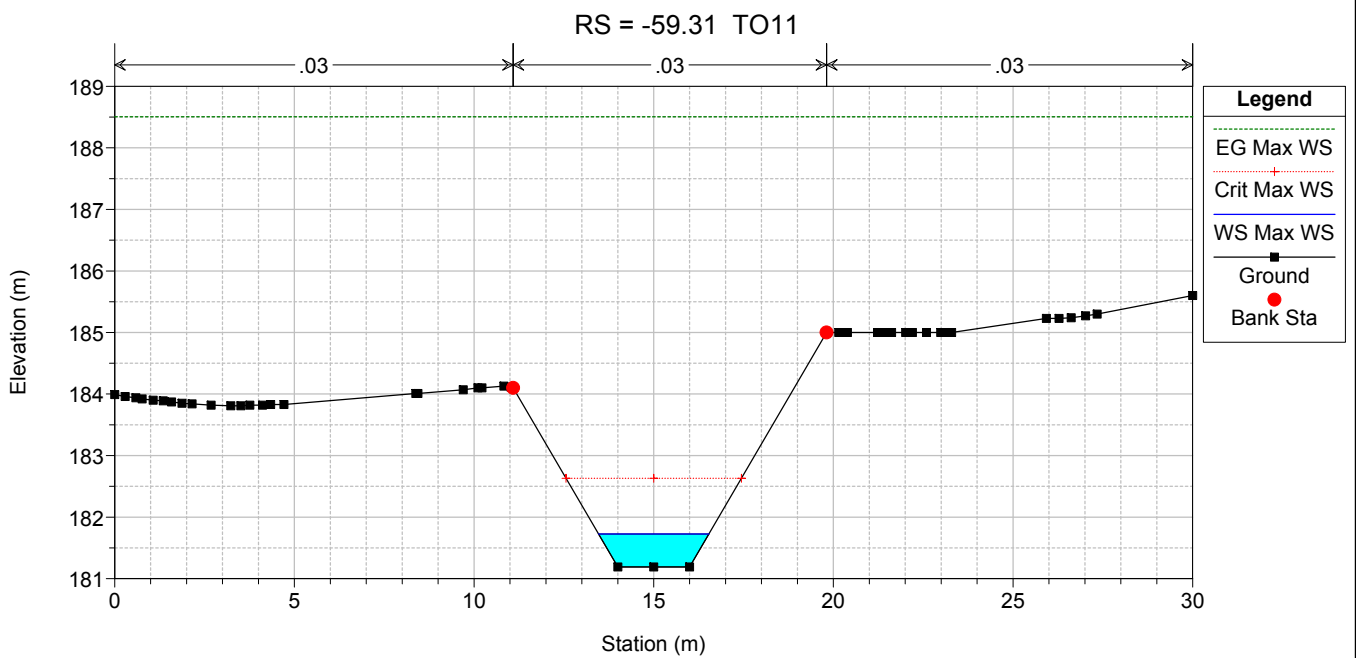
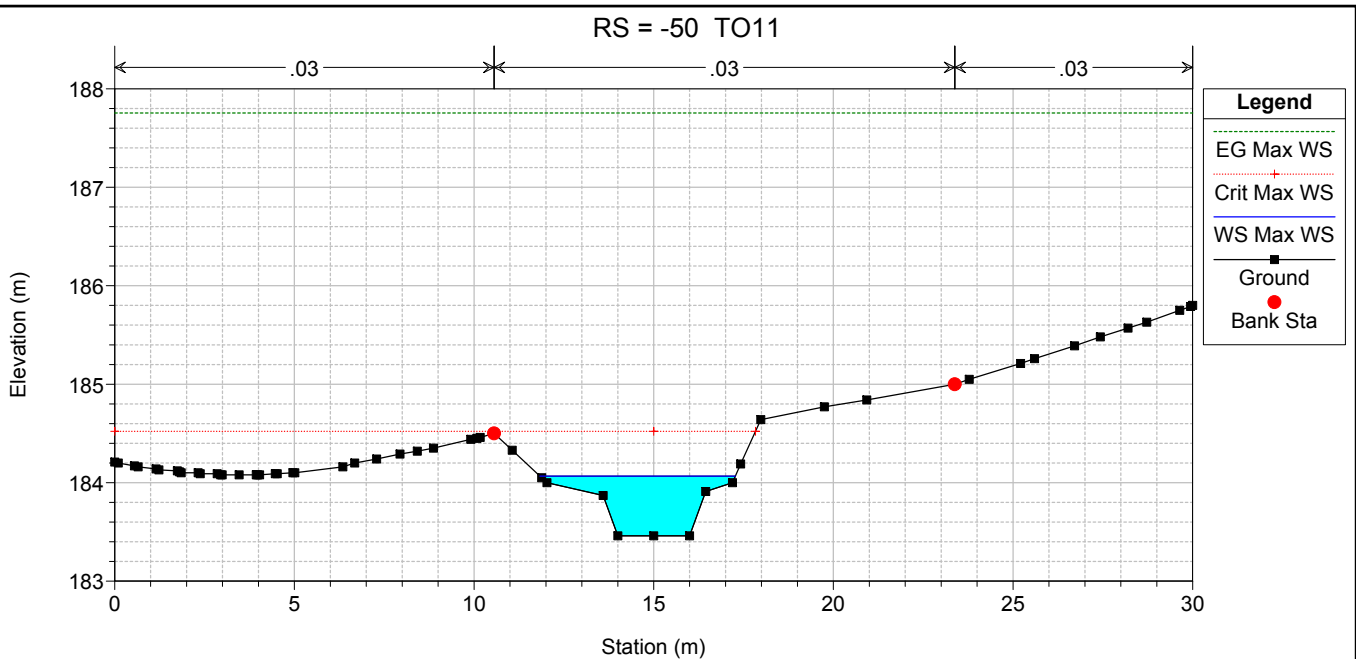

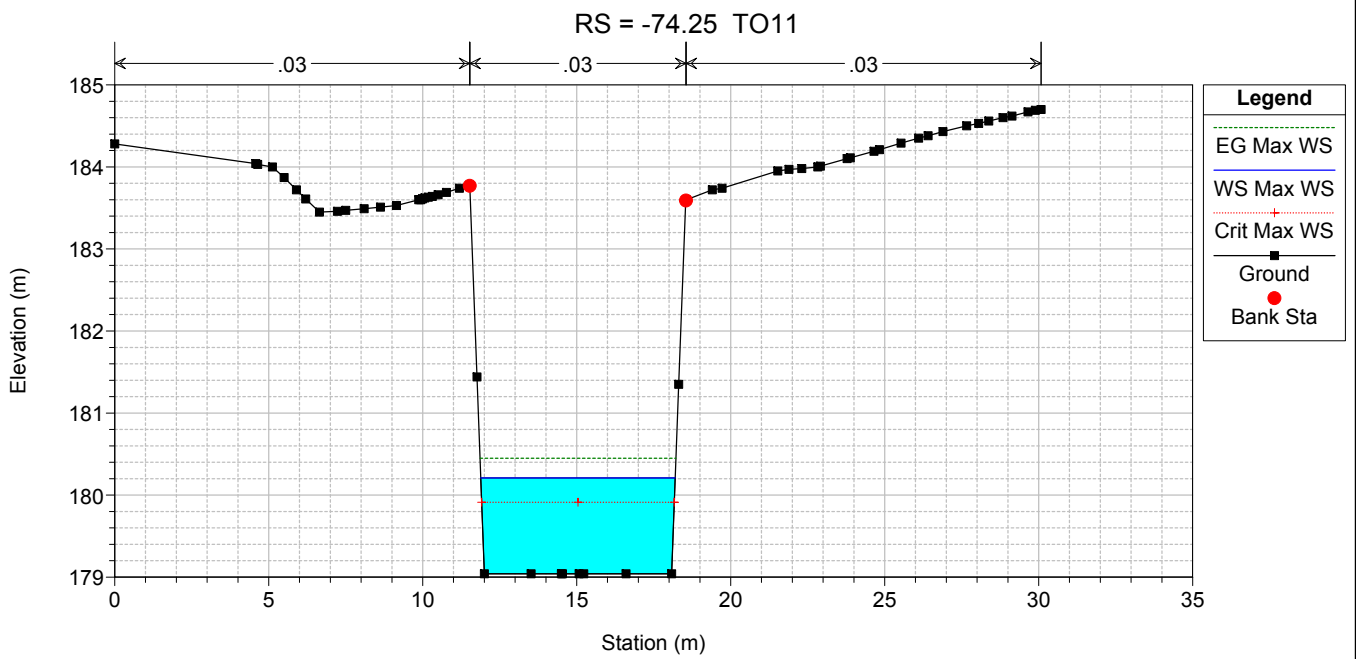
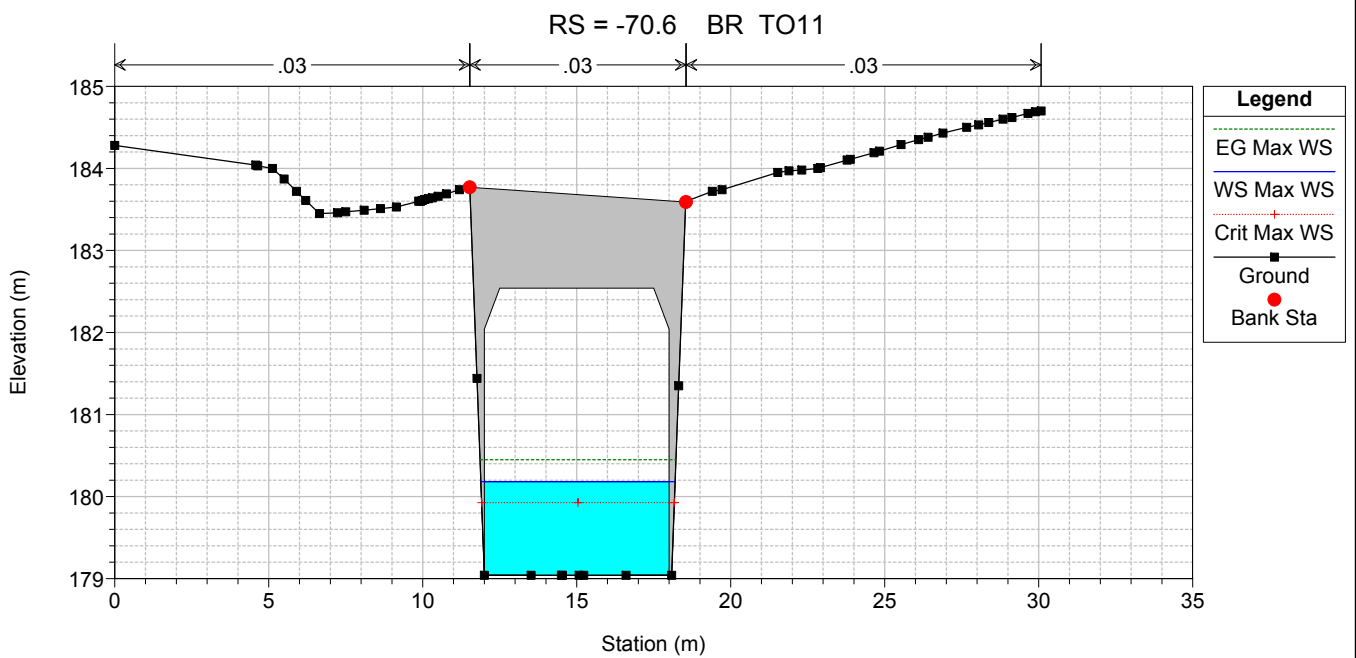
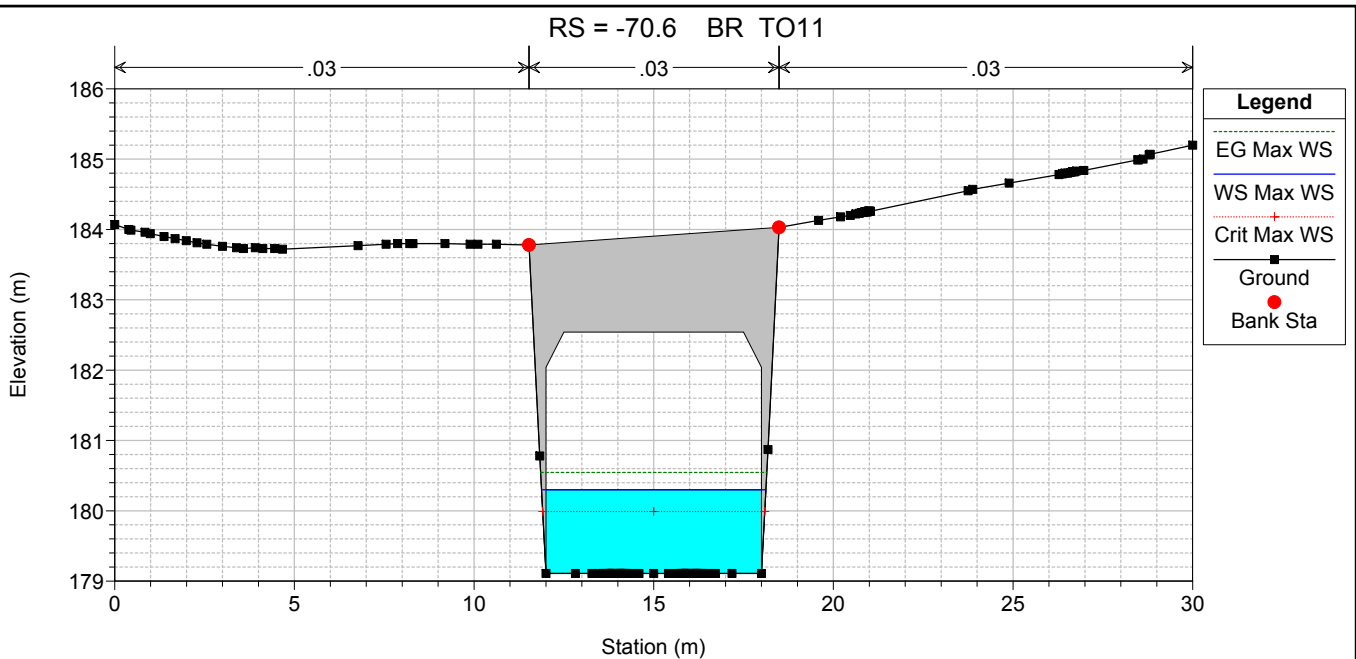

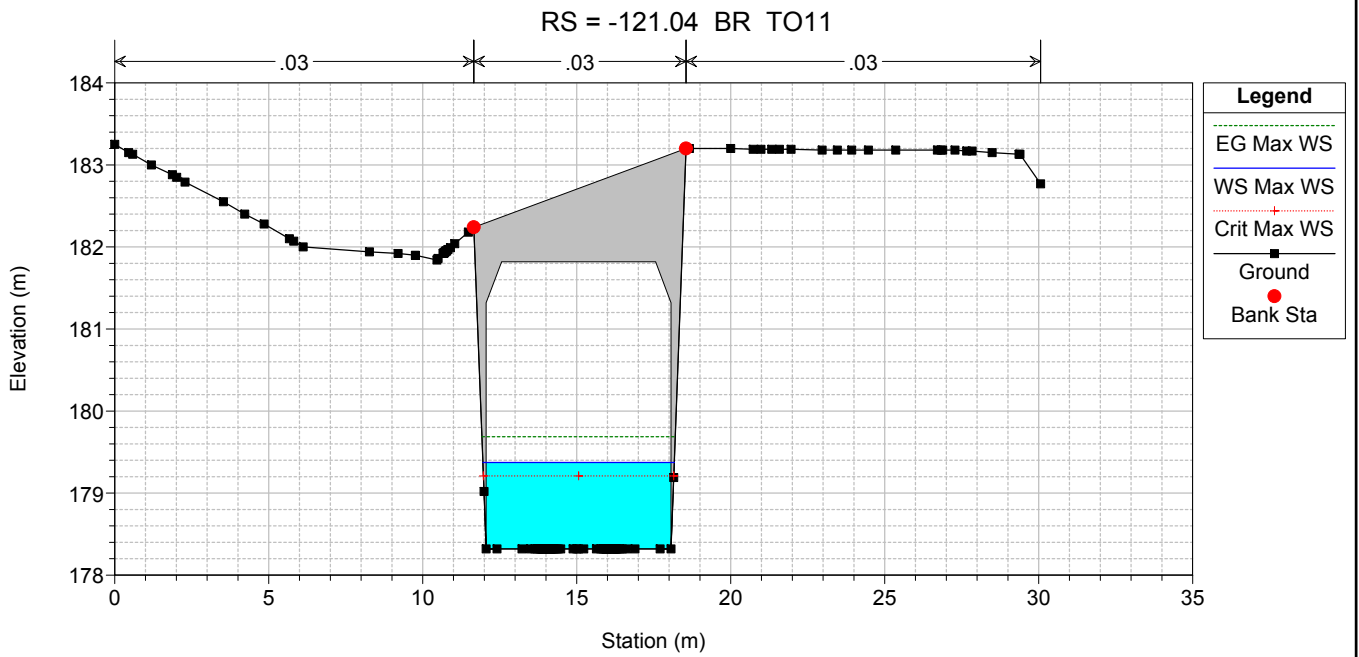
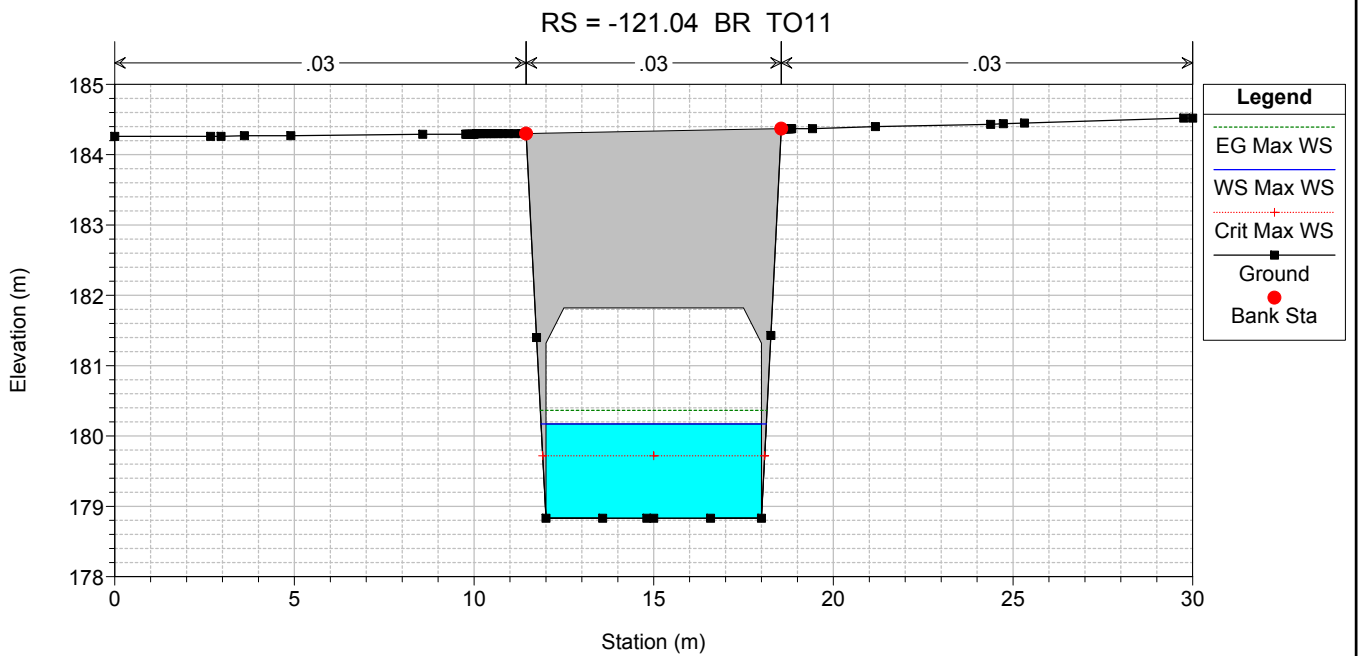
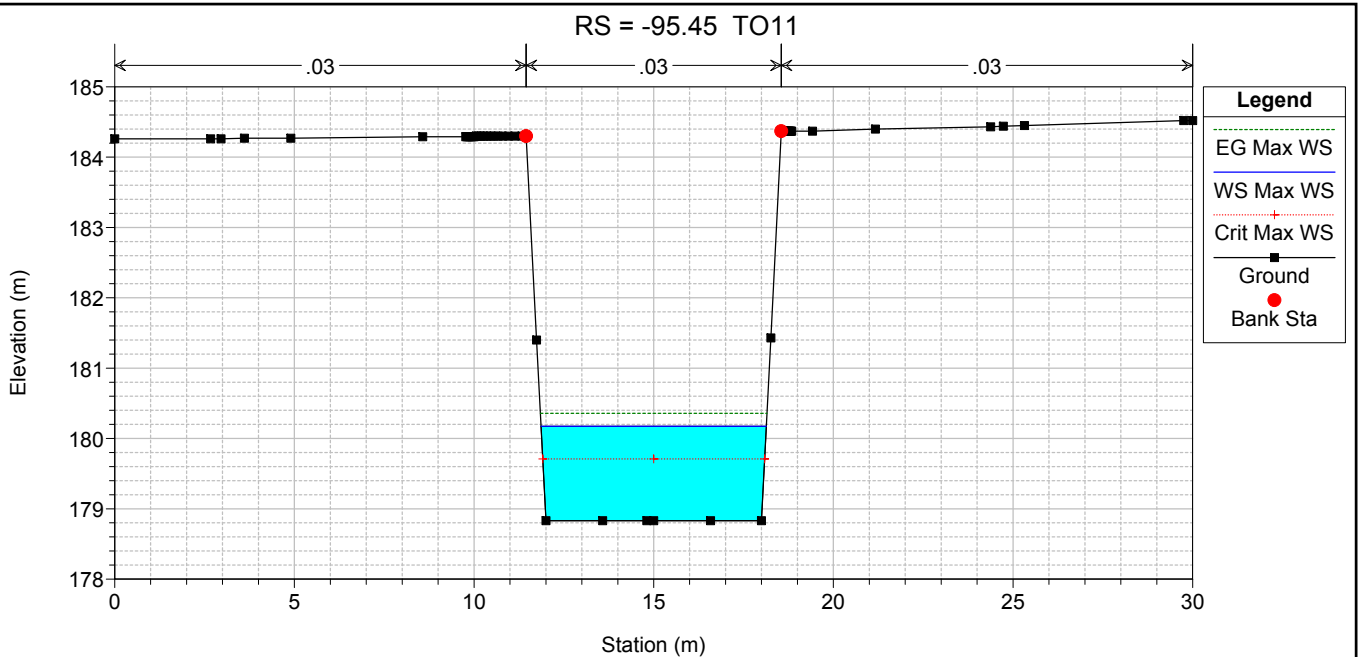

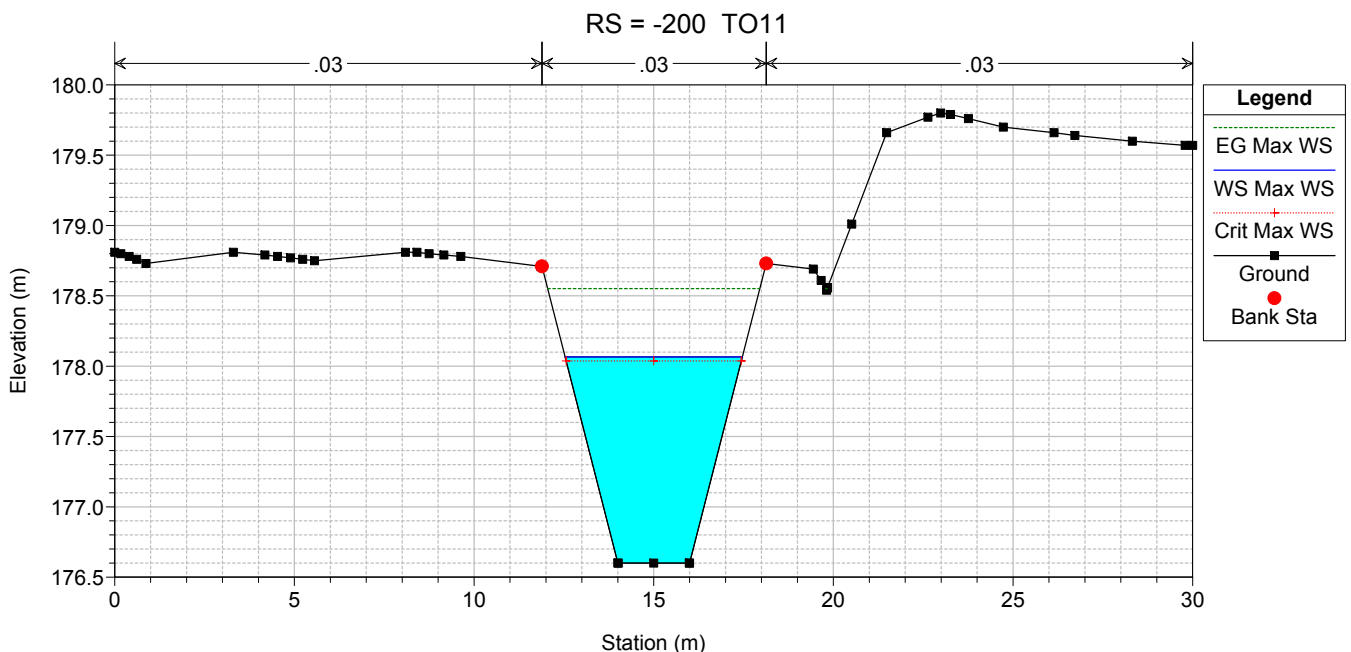
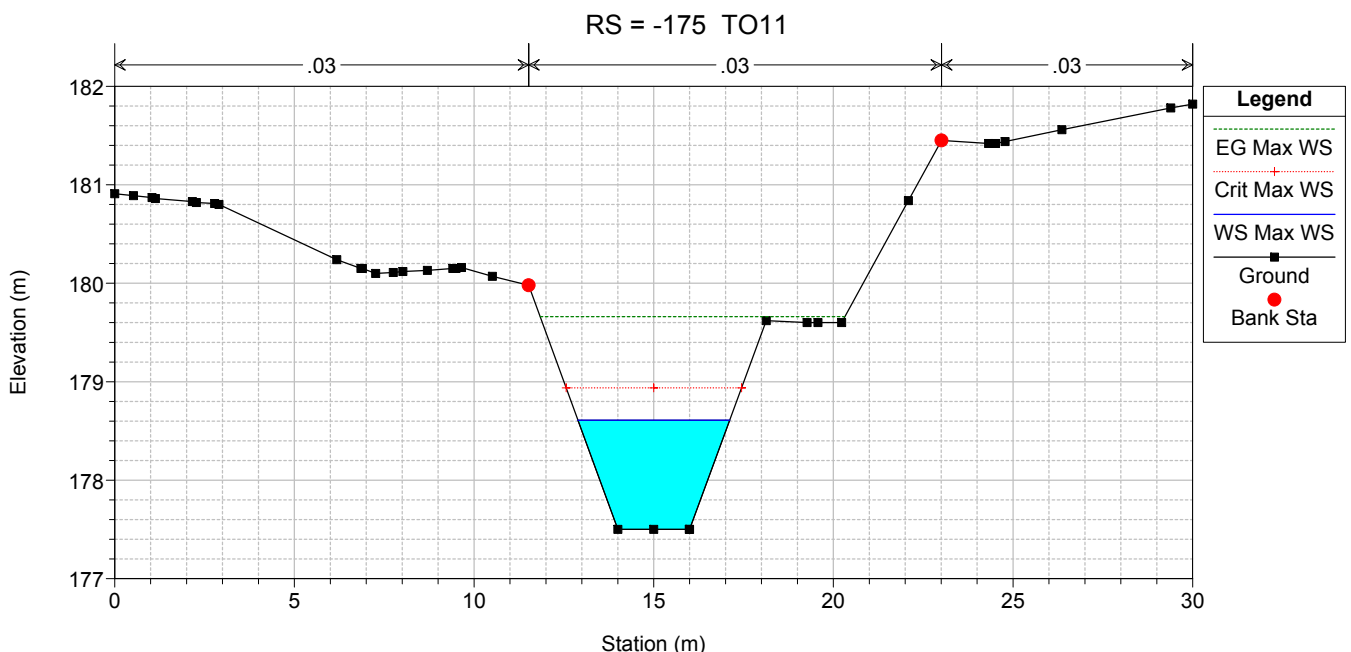
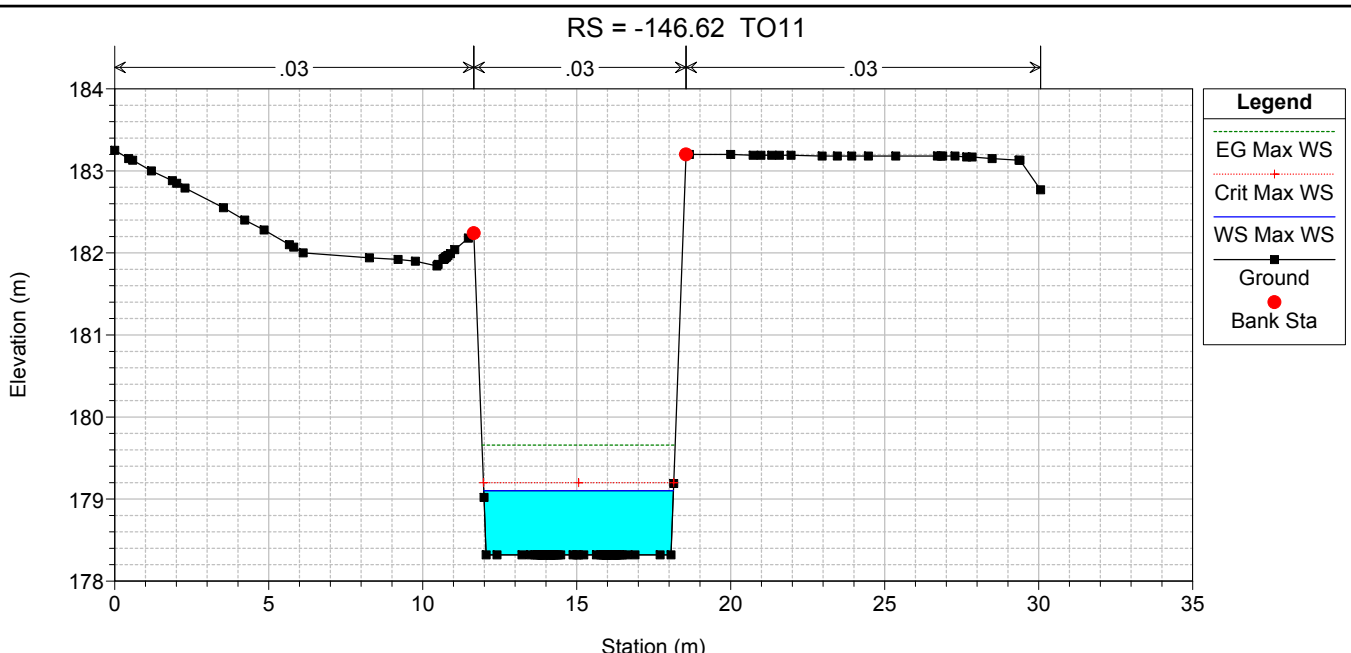

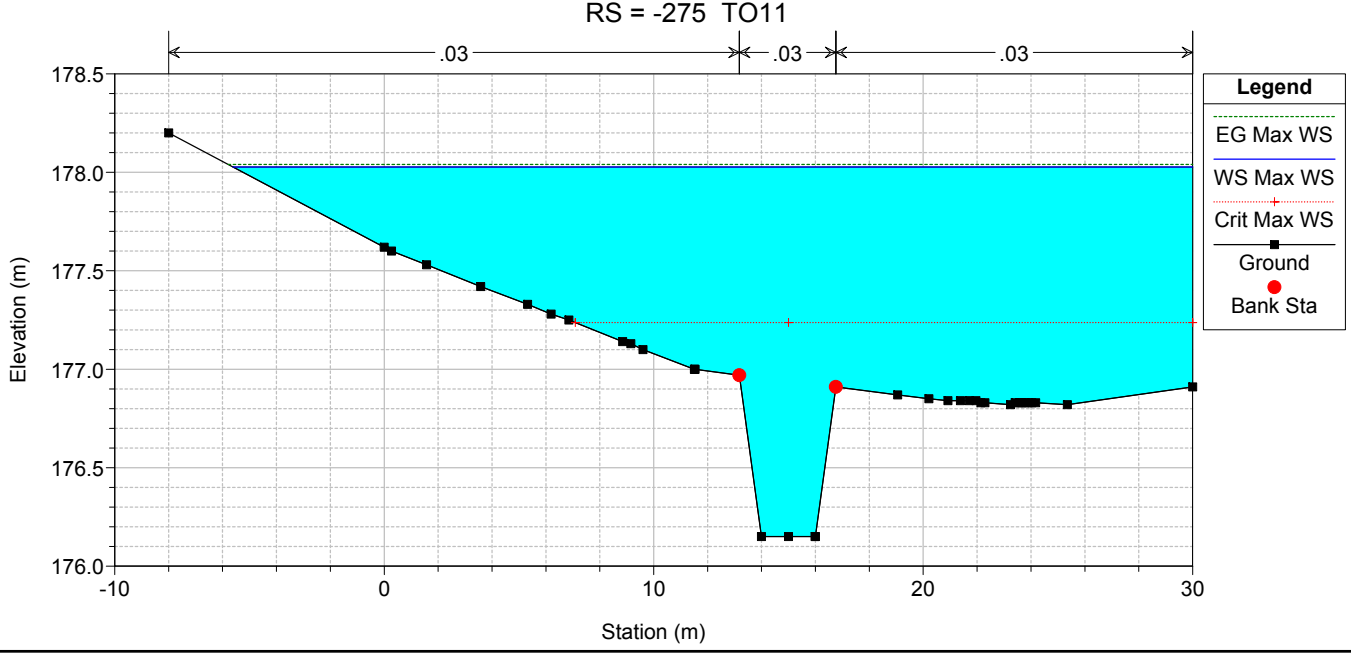
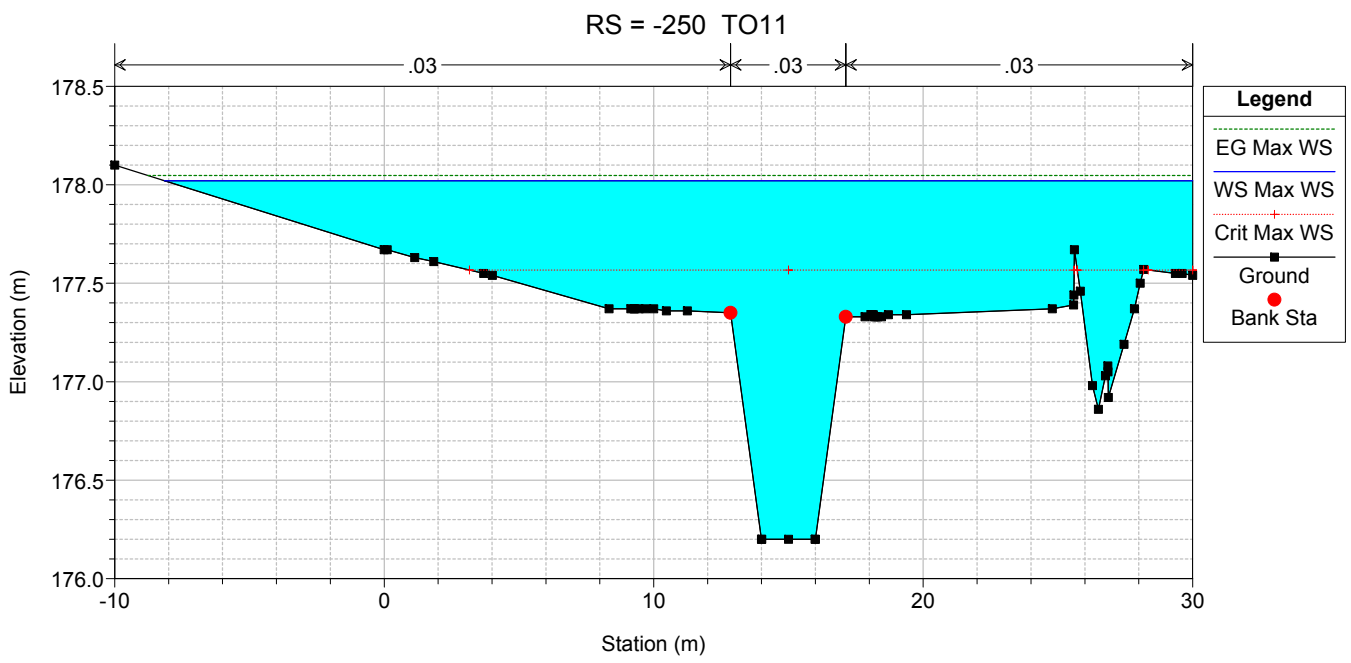
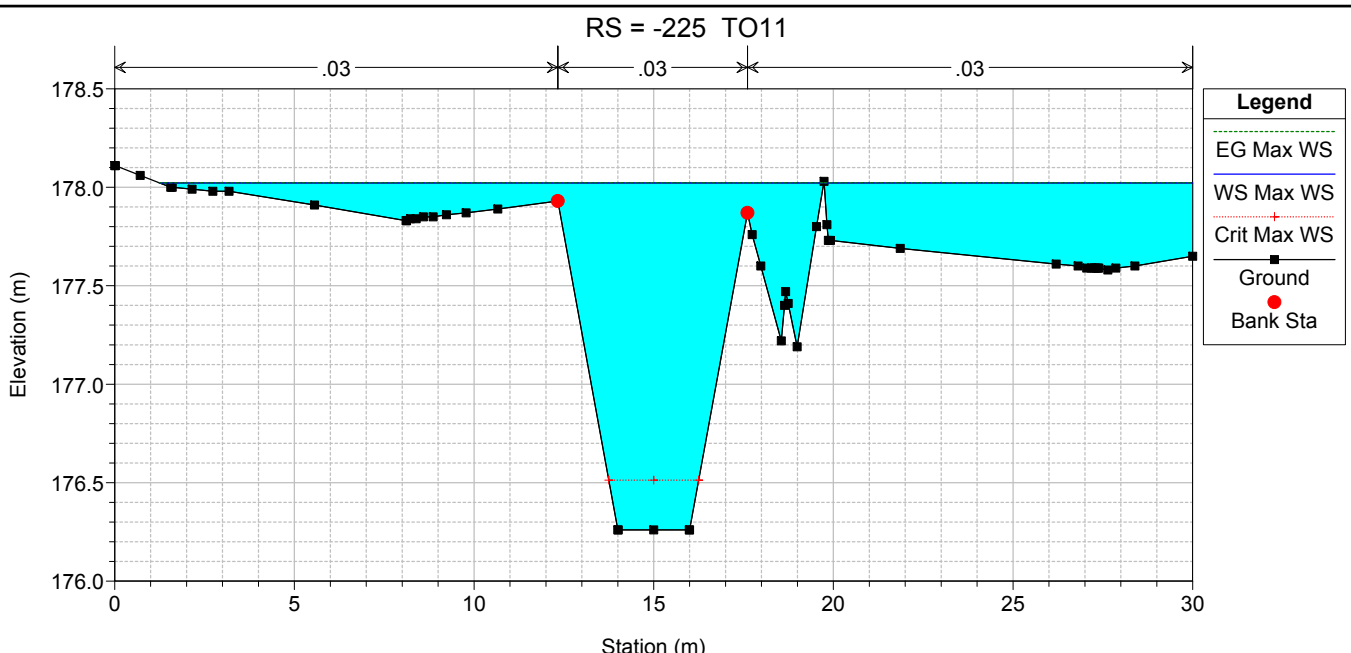

RS = -310 TO11

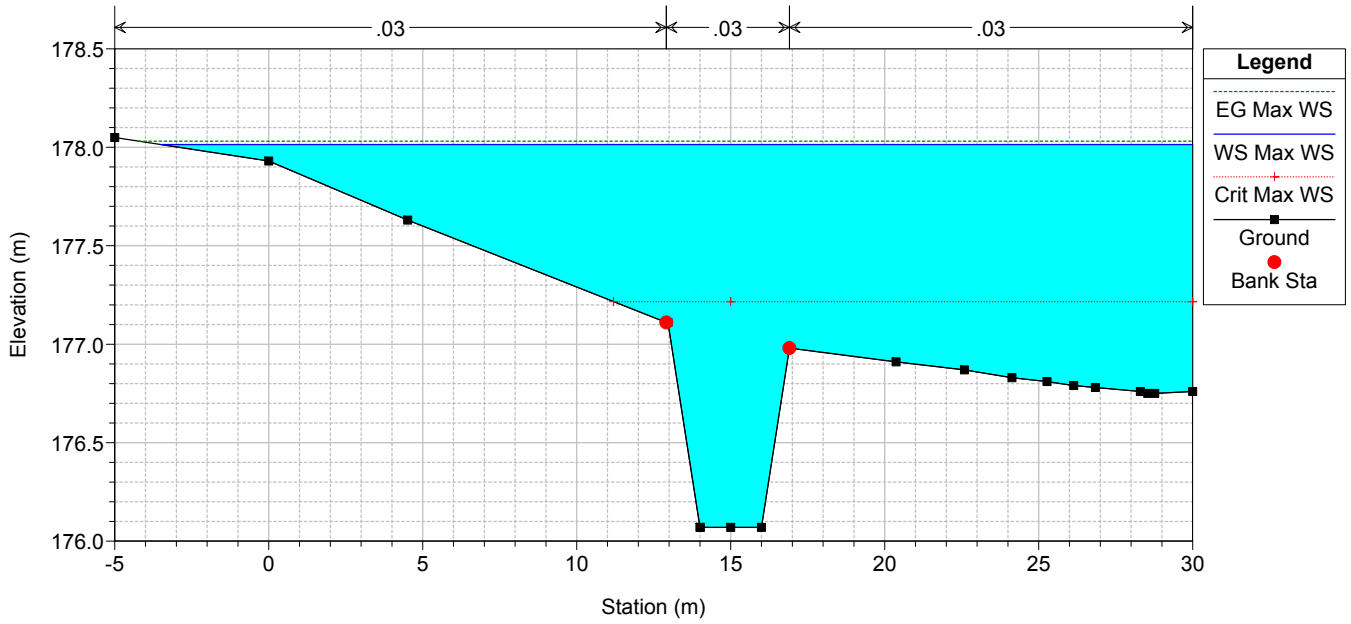

RS = -335 TO11

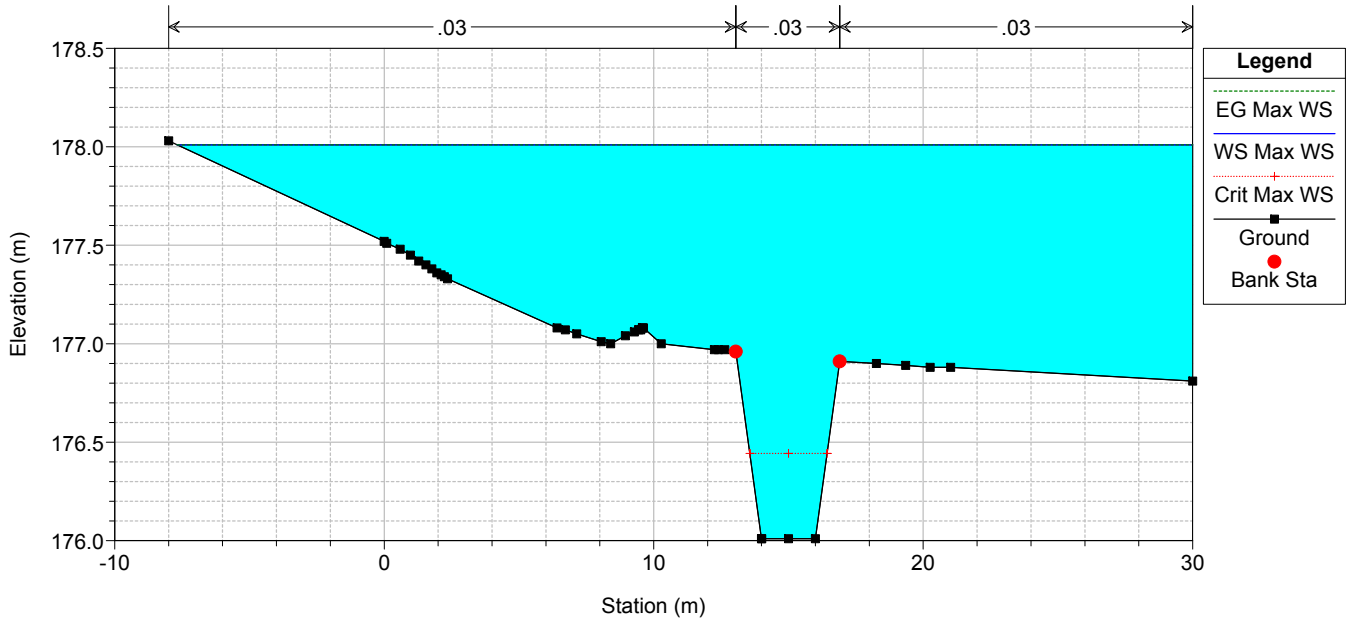

HEC-RAS Plan: POST_VARIO River: TO12 Reach: TO12 Profile: Max WS

Reach	River Sta	Profile	Q Total (m3/s)	Min Ch El (m)	Max Chl Dpth (m)	W.S. Elev (m)	Crit W.S. (m)	Diff	Froude # Chl	E.G. Elev (m)	Vel Chnl (m/s)	Vel Total (m/s)	Hydr Radius C (m)	Shear Chan (N/m2)	Hydr Depth (m)
TO12	0	Max WS	103.9	181.48	2.24	183.72	184.34	-0.62	1.88	185.61	6.1	6.1	1.0	325.1	1.05
TO12	-25	Max WS	102.9	180.83	1.98	182.81	183.59	-0.78	2.26	186.05	8.8	7.0	1.3	618.6	0.76
TO12	-50	Max WS	102.3	179.82	2.35	182.17	182.03	0.14	0.81	182.62	3.7	2.8	1.7	98.7	1.21
TO12	-64.99	Max WS	102.0	179.67	2.58	182.25	181.66	0.59	0.49	182.43	1.9	1.9	1.4	27.3	1.50
TO12	-79.43	Bridge													
TO12	-93.96	Max WS	116.1	179.38	2.18	181.56	181.47	0.09	0.88	181.99	2.9	2.9	1.1	74.1	1.11
TO12	-103.59	Max WS	105.2	179.28	2.22	181.50	181.31	0.19	0.77	181.83	2.6	2.6	1.1	56.7	1.11
TO12	-125	Max WS	110.8	179.07	2.14	181.21	181.54	-0.33	1.44	182.40	5.2	4.7	1.2	225.2	1.06
TO12	-145	Max WS	109.7	178.90	1.96	180.86	181.02	-0.16	1.23	181.60	4.3	3.8	1.0	164.1	0.89
TO12	-200	Max WS	107.8	178.11	1.83	179.94	180.09	-0.15	1.21	180.57	3.6	3.4	0.9	119.6	0.72
TO12	-225	Max WS	107.3	178.09	1.50	179.59	179.81	-0.22	1.28	180.30	4.0	3.5	1.0	140.3	0.68
TO12	-250	Max WS	106.9	177.31	1.90	179.21	179.35	-0.14	1.29	179.77	3.3	3.3	0.6	111.2	0.64
TO12	-275	Max WS	106.5	177.40	1.39	178.79	178.89	-0.10	1.25	179.29	3.1	3.1	0.6	101.7	0.64
TO12	-300	Max WS	106.1	176.92	1.62	178.54	178.38	0.16	0.71	178.75	2.0	2.0	0.8	38.5	0.82
TO12	-325	Max WS	103.9	176.54	1.85	178.39	178.19	0.20	0.62	178.54	1.7	1.7	0.8	29.0	0.77
TO12	-350	Max WS	103.9	176.44	1.86	178.30	177.96	0.34	0.49	178.41	1.5	1.4	0.9	19.8	0.90
TO12	-375	Max WS	103.8	175.56	2.71	178.27	177.64	0.63	0.37	178.35	1.3	1.3	1.2	13.7	1.17
TO12	-400	Max WS	103.5	175.31	2.91	178.22	177.50	0.72	0.37	178.30	1.3	1.3	1.2	14.2	1.24
TO12	-414.43	Max WS	122.4	175.17	3.01	178.18	177.46	0.72	0.35	178.26	1.2	1.2	1.3	12.5	1.27
TO12	-425.54	Max WS	122.3	175.06	2.97	178.03	177.49	0.54	0.41	178.16	1.8	1.5	1.7	22.7	1.35
TO12	-431.31	Bridge													
TO12	-437.08	Max WS	122.2	174.94	2.31	177.25	177.40	-0.15	1.16	177.82	3.7	3.1	0.9	123.6	0.66
TO12	-450	Max WS	122.1	174.81	2.45	177.26	176.80	0.46	0.47	177.41	1.8	1.6	1.4	25.1	1.24
TO12	-475	Max WS	122.1	174.56	2.61	177.17	176.64	0.53	0.45	177.29	1.6	1.6	1.3	21.6	1.29
TO12	-500	Max WS	122.1	174.31	2.33	176.64	176.52	0.12	0.81	176.92	2.4	2.3	0.9	52.5	0.87
TO12	-530	Max WS	2.0	174.01	2.05	176.06	174.29	1.77	0.02	176.06	0.1	0.1	1.0	0.0	0.95

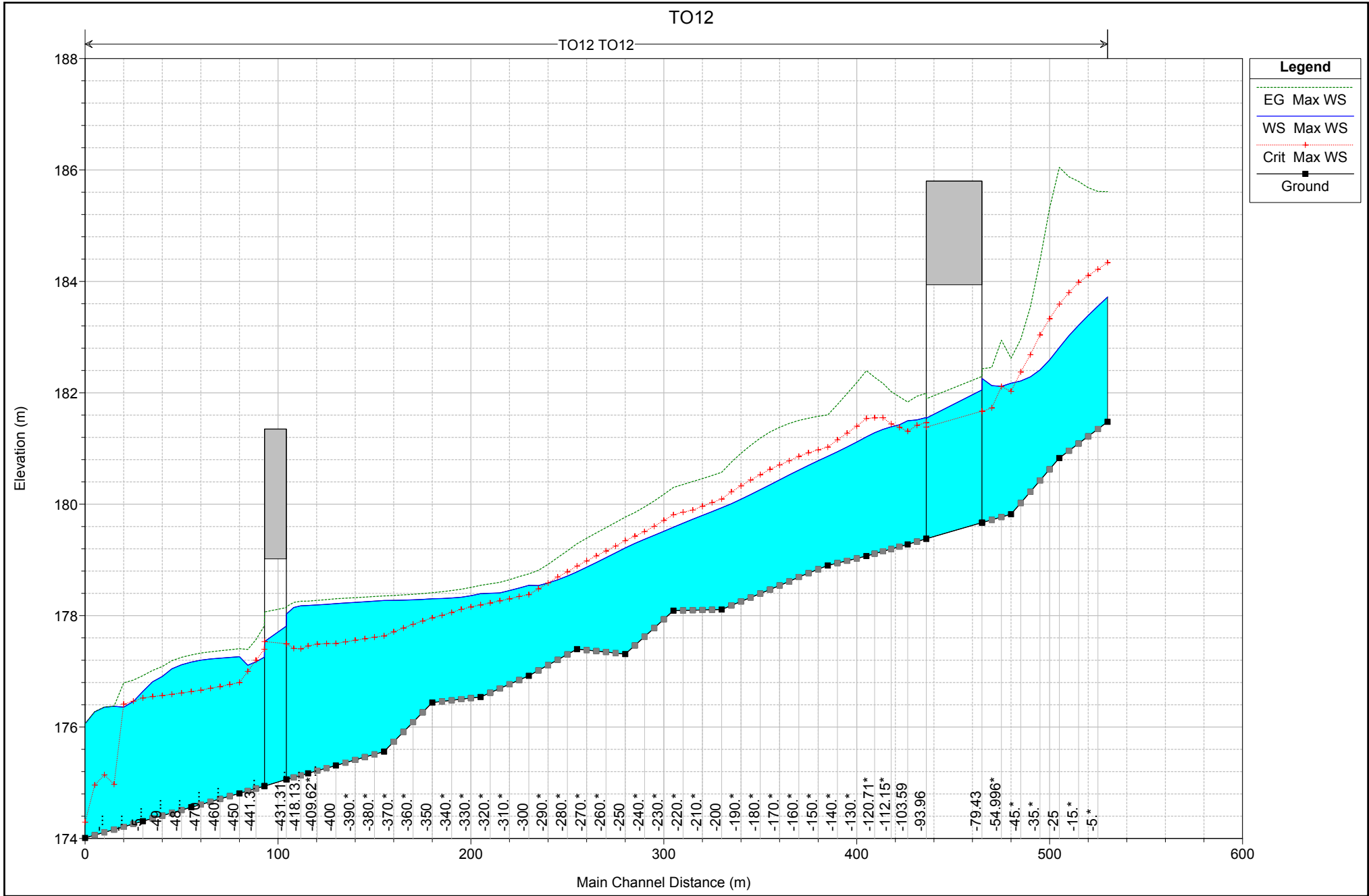

RS = 0 TO12

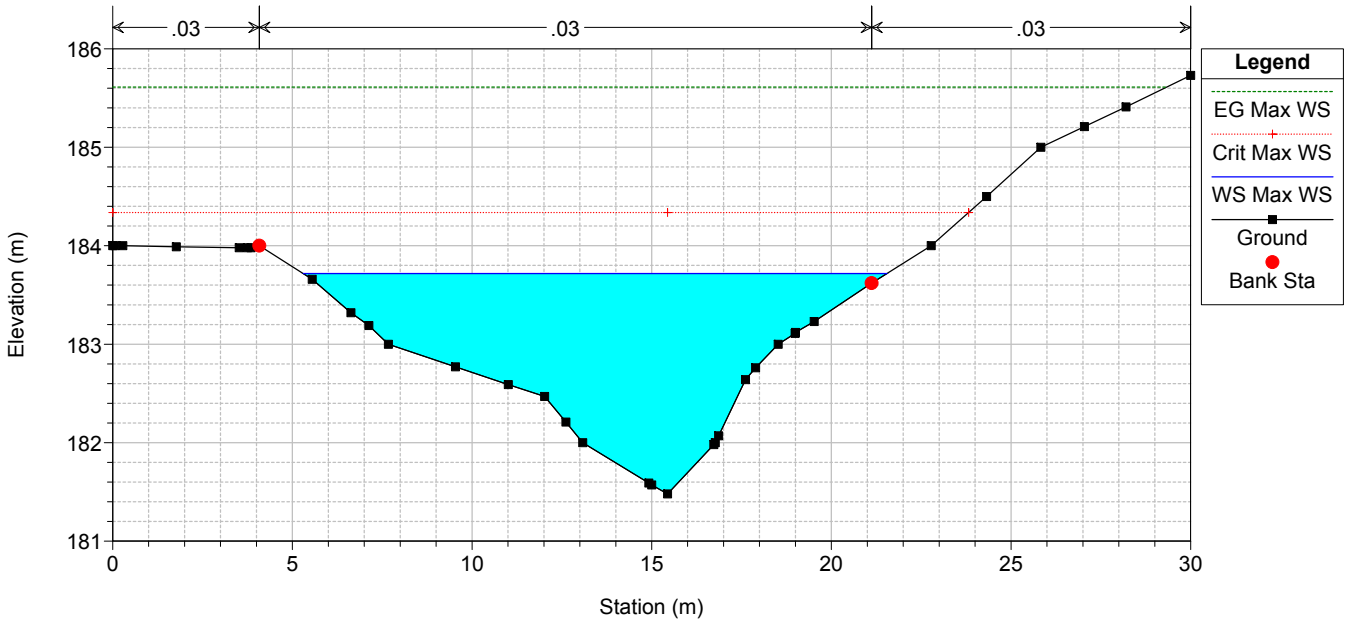

RS = -25 TO12

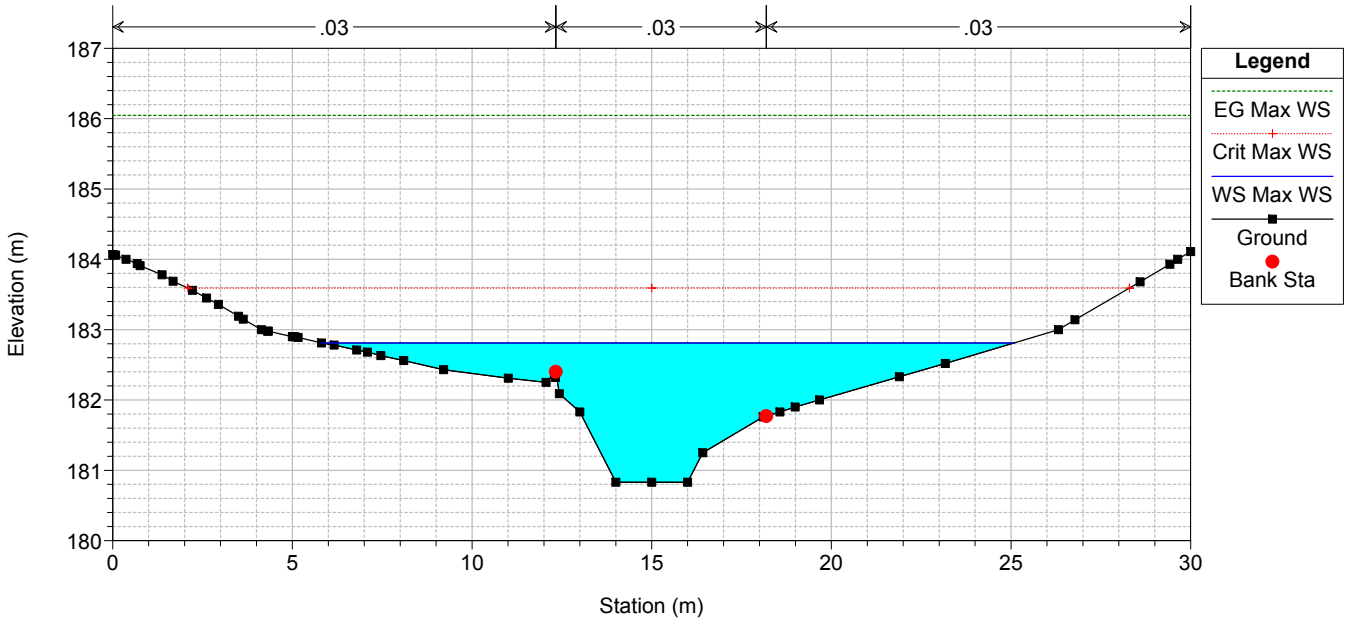

RS = -50 TO12

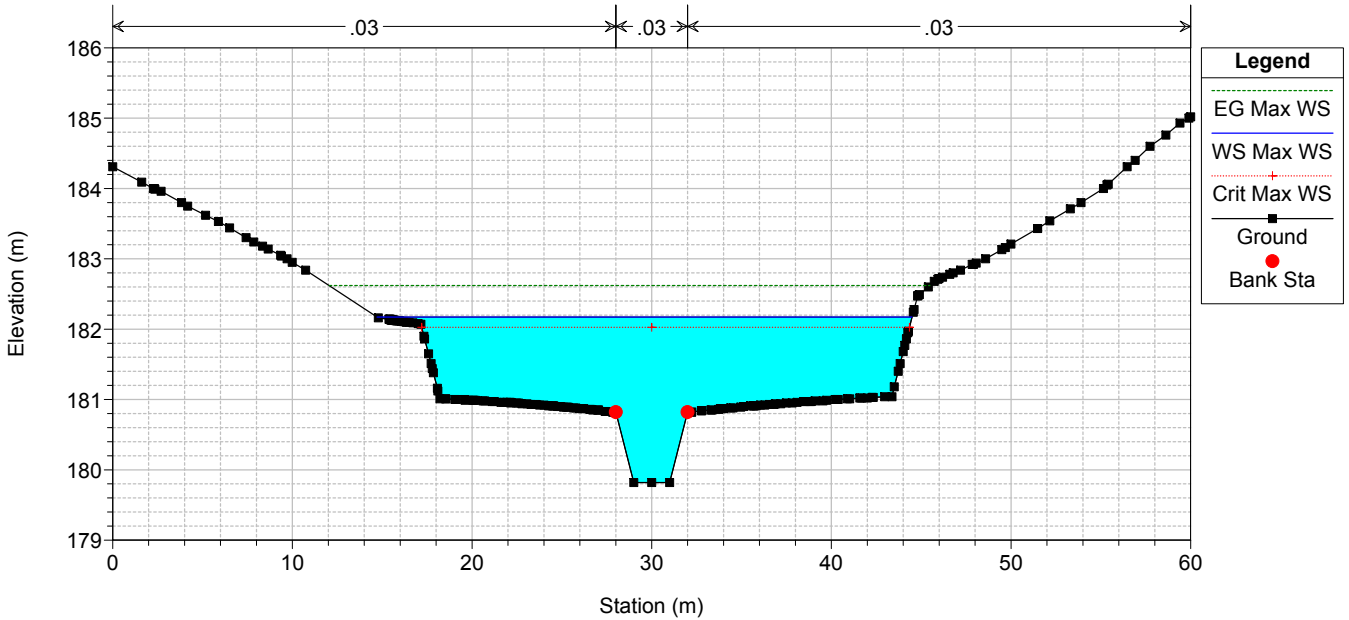

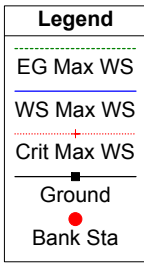
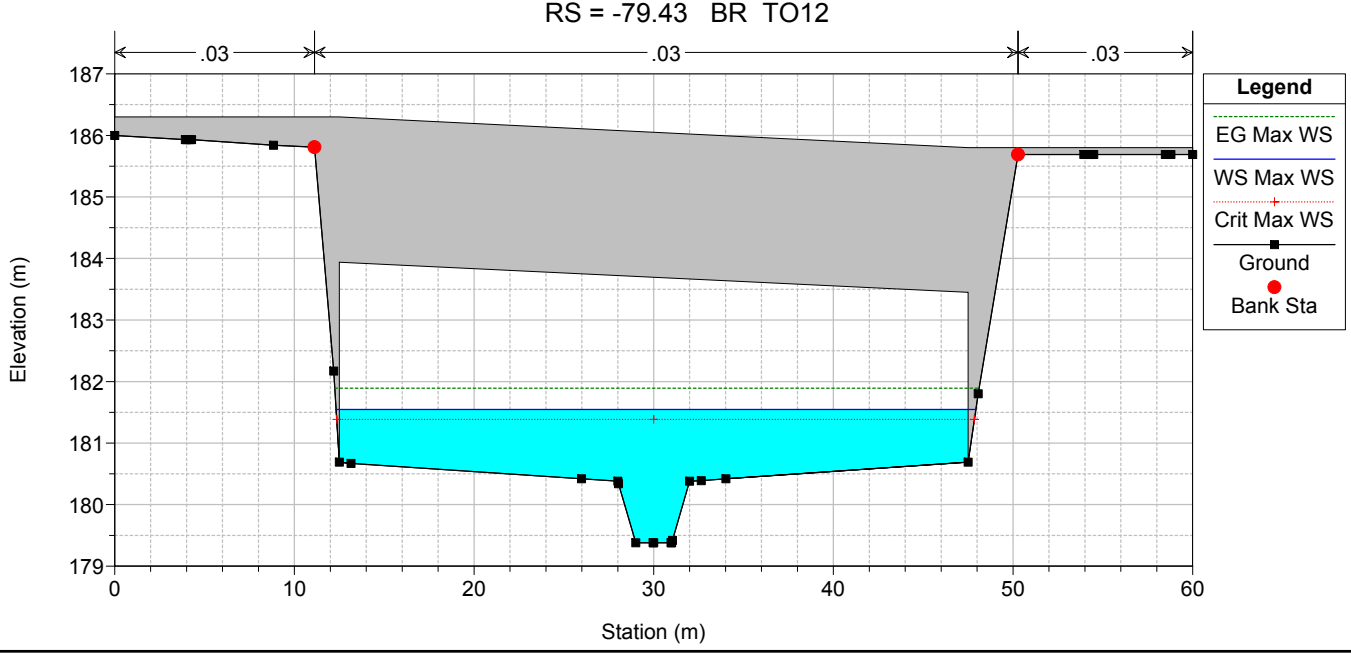
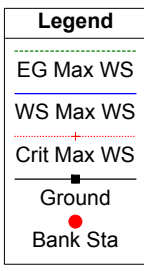
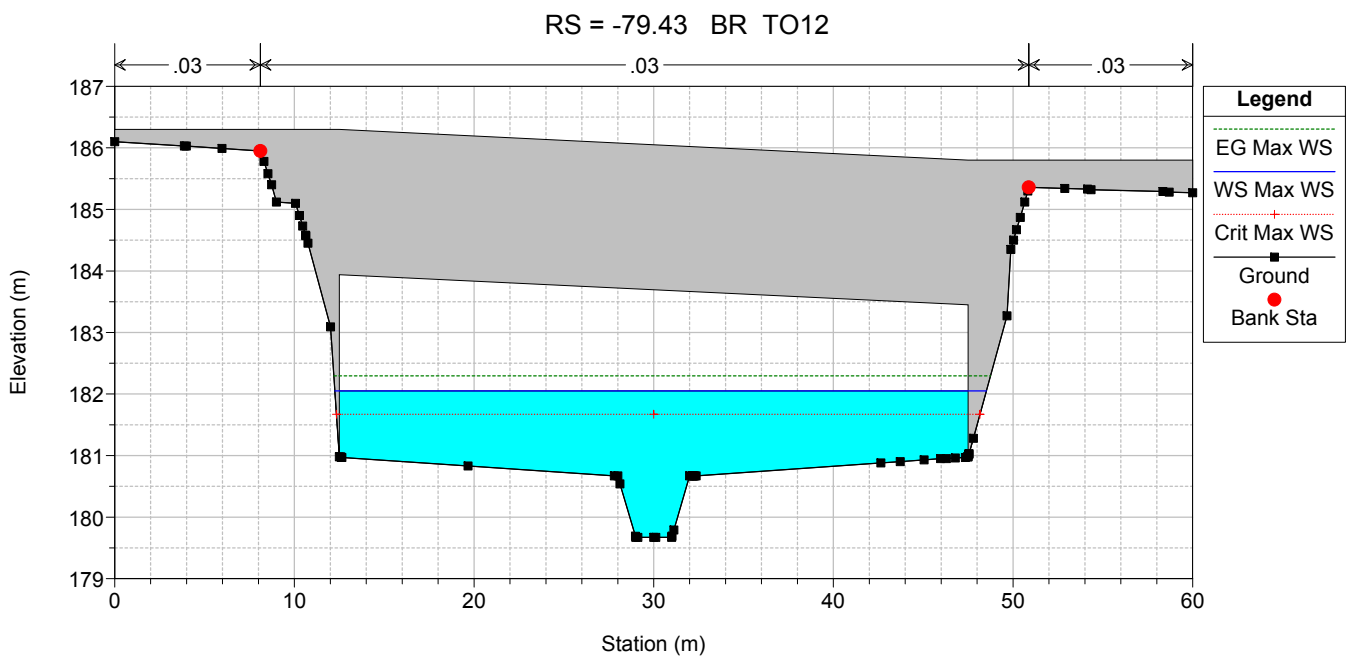
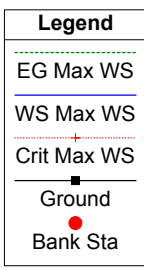
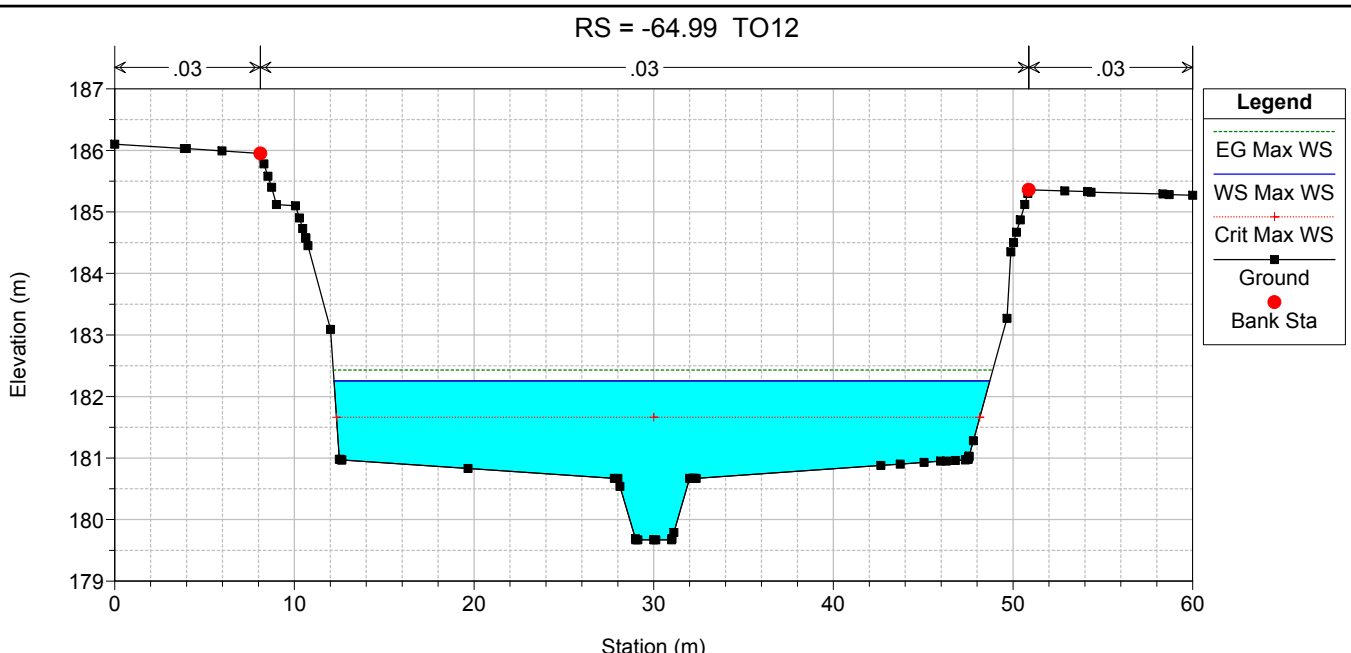

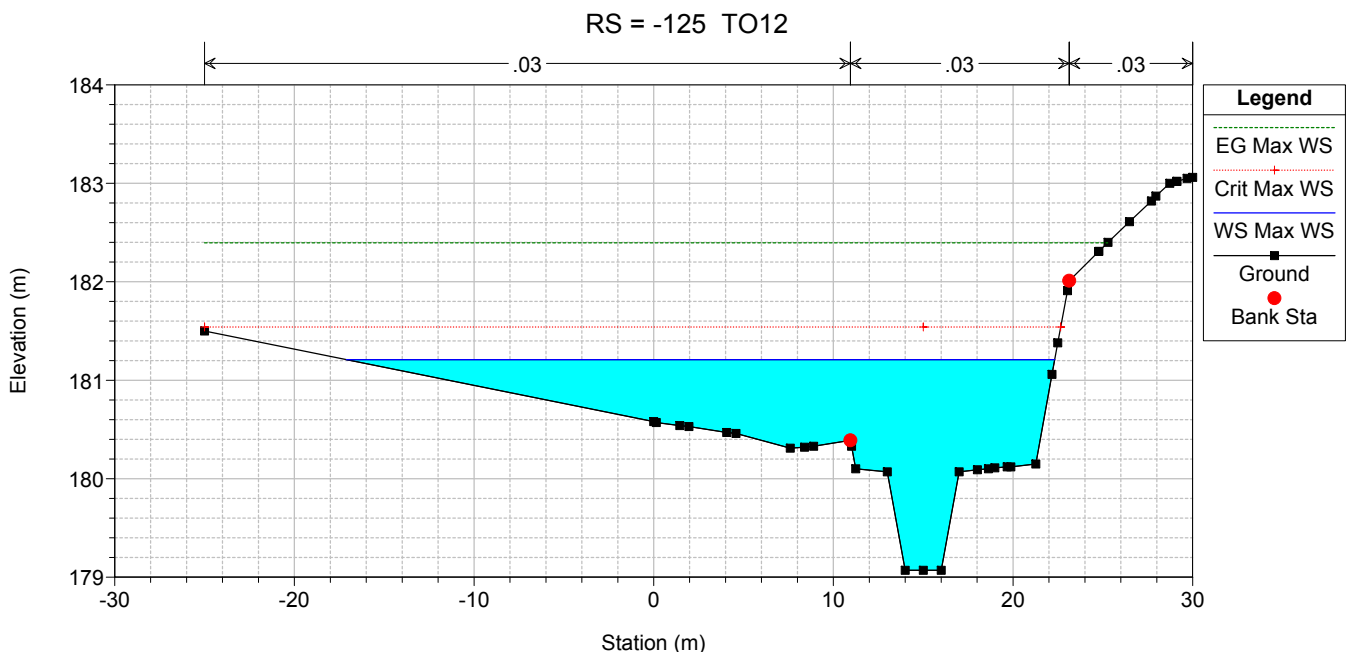
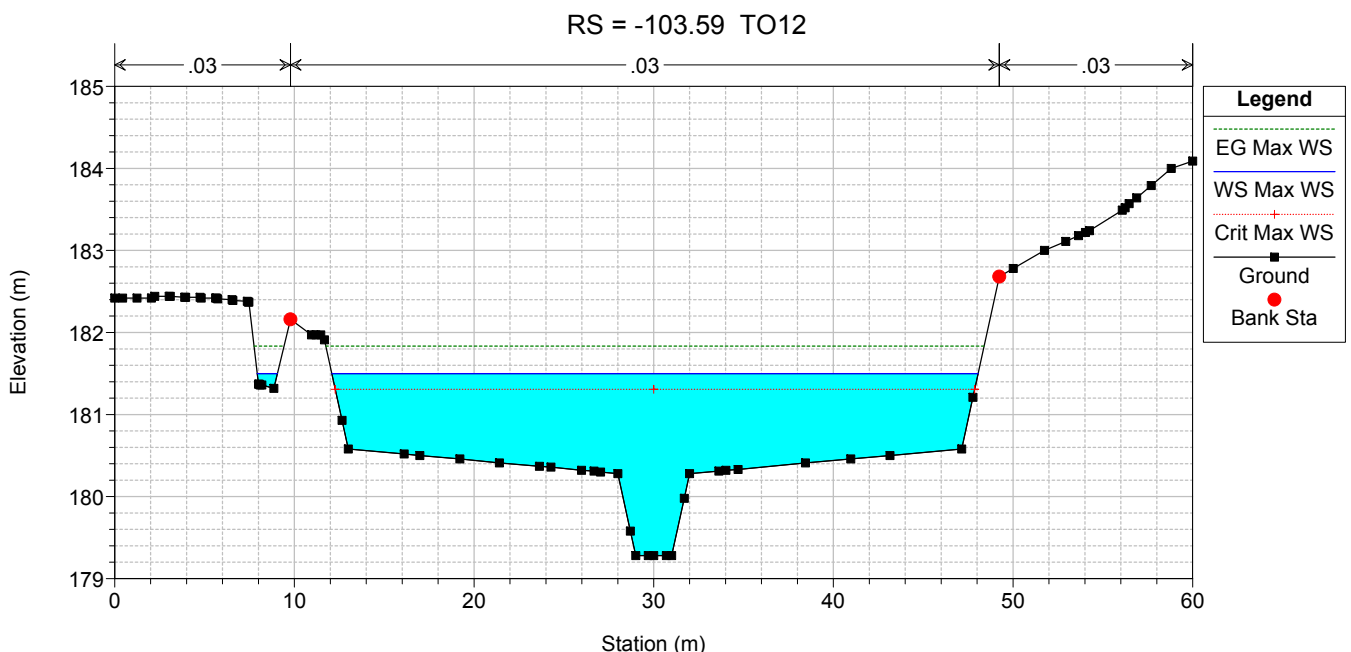
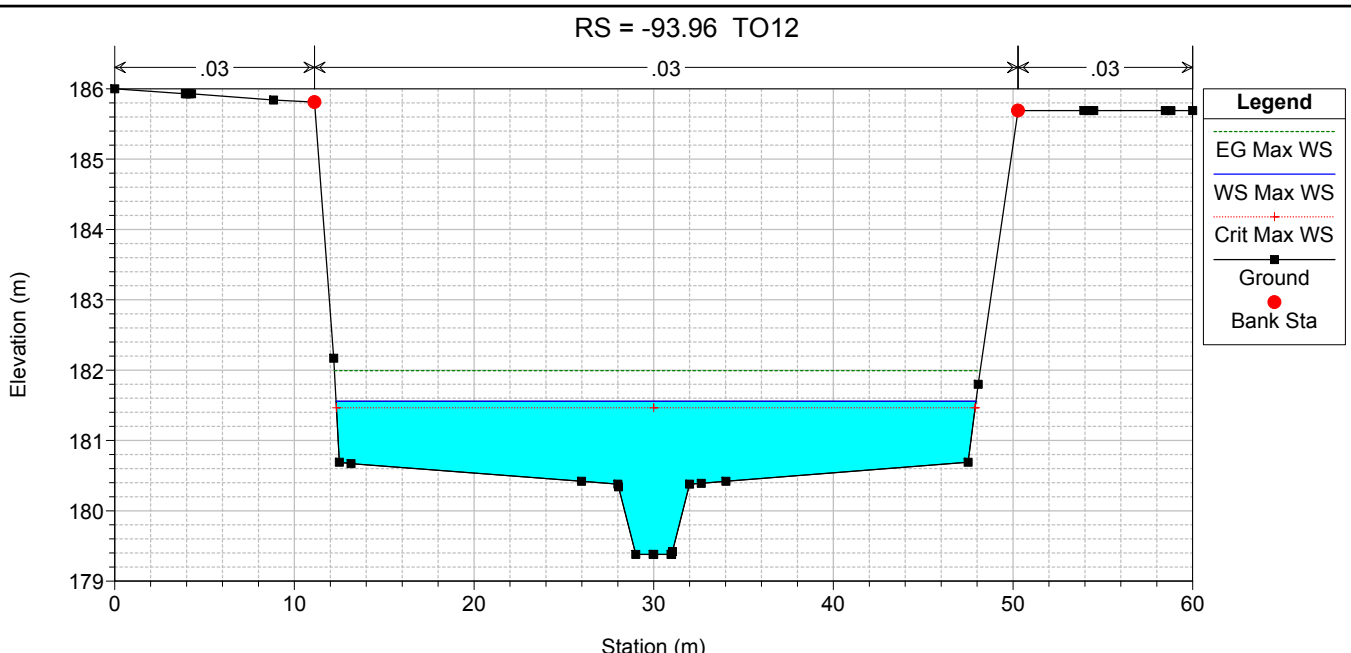

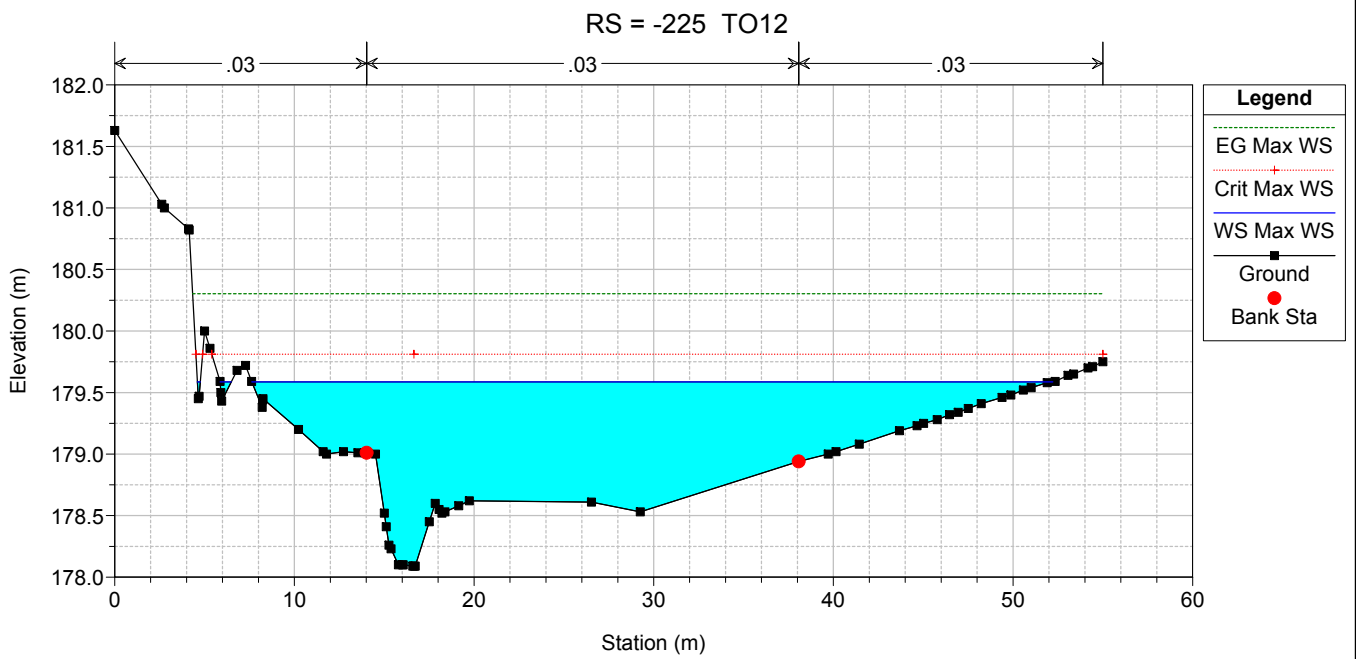
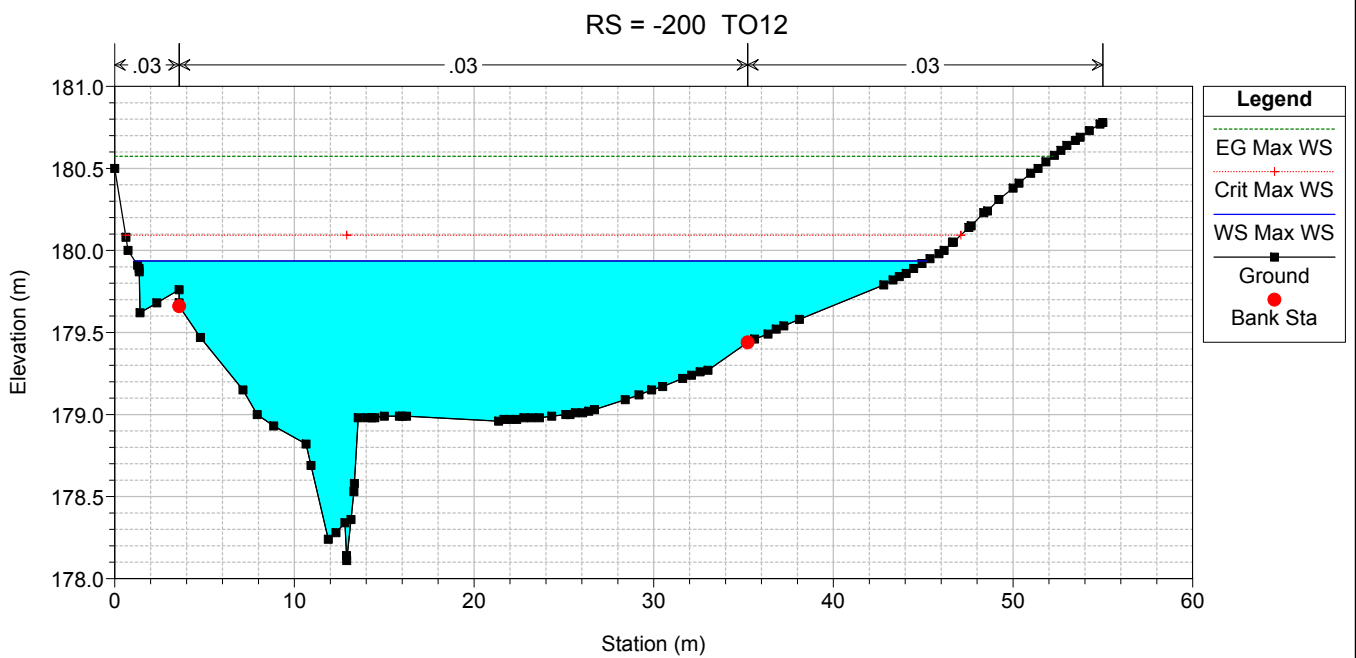
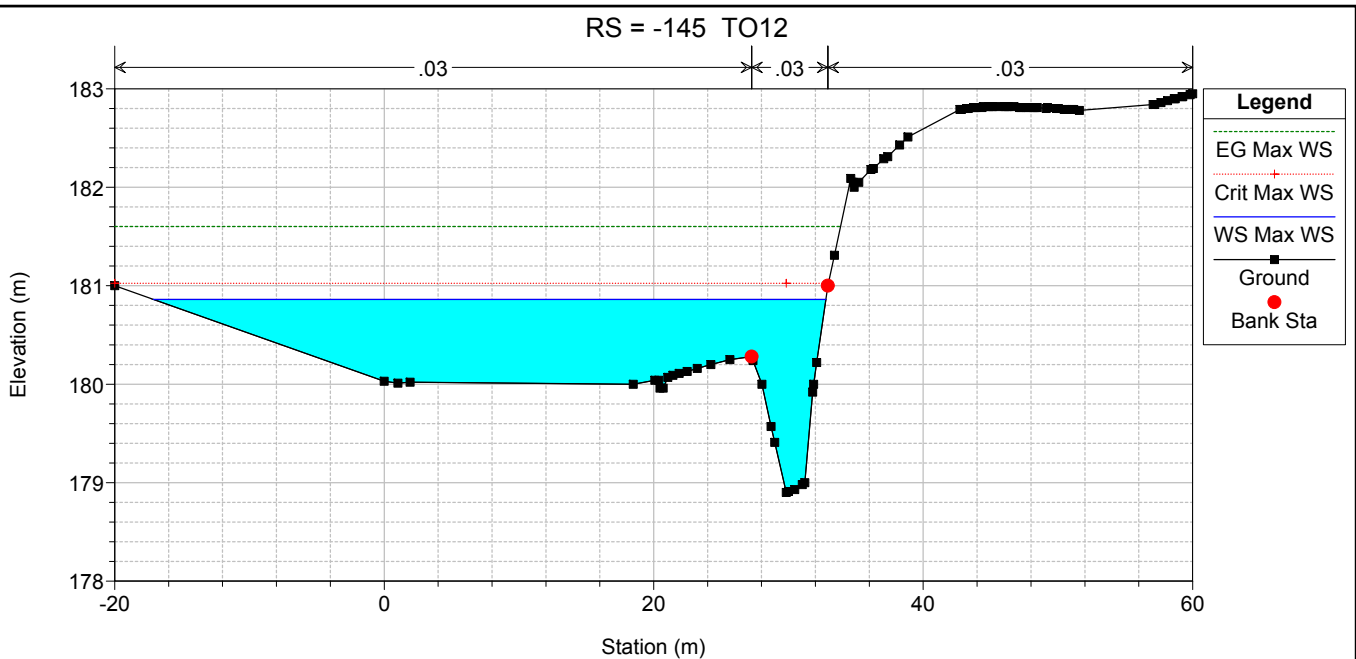

RS = -250 TO12

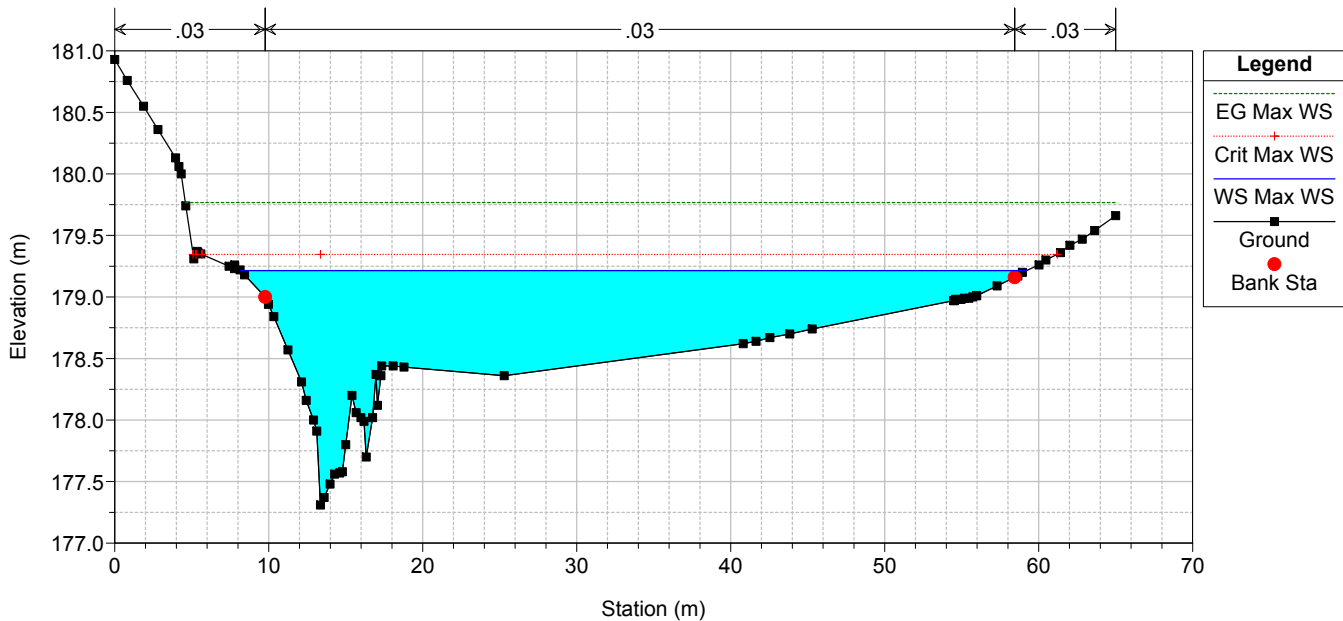

RS = -275 TO12

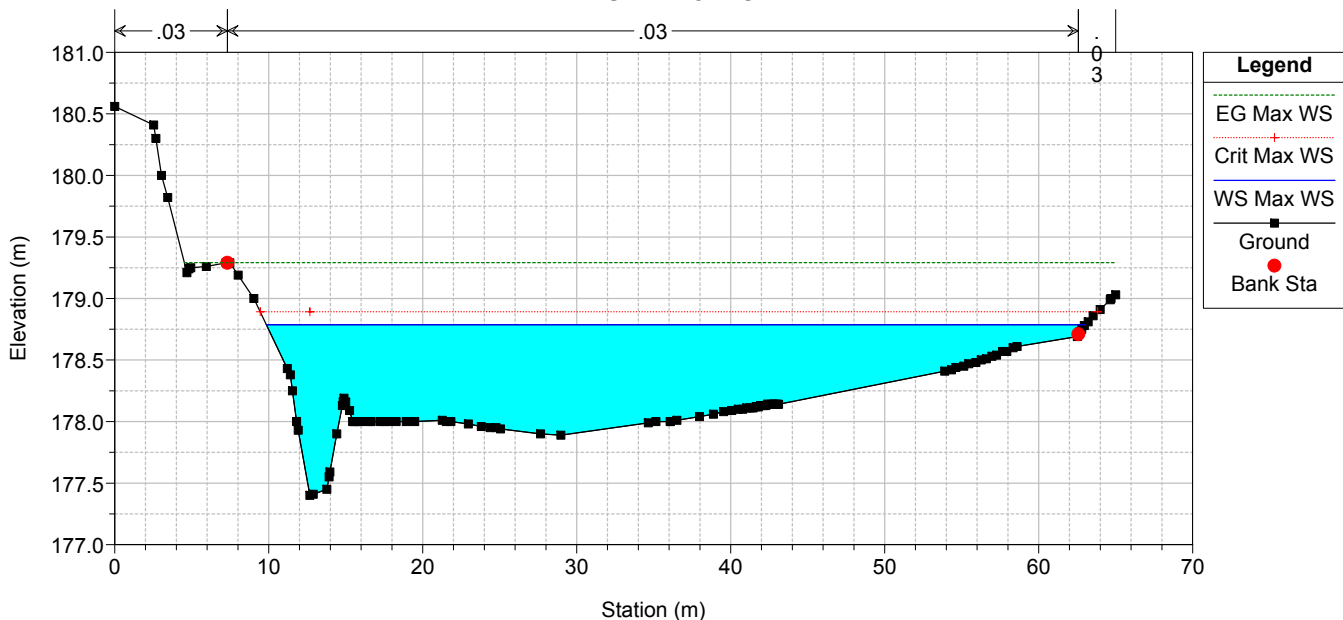

RS = -300 TO12

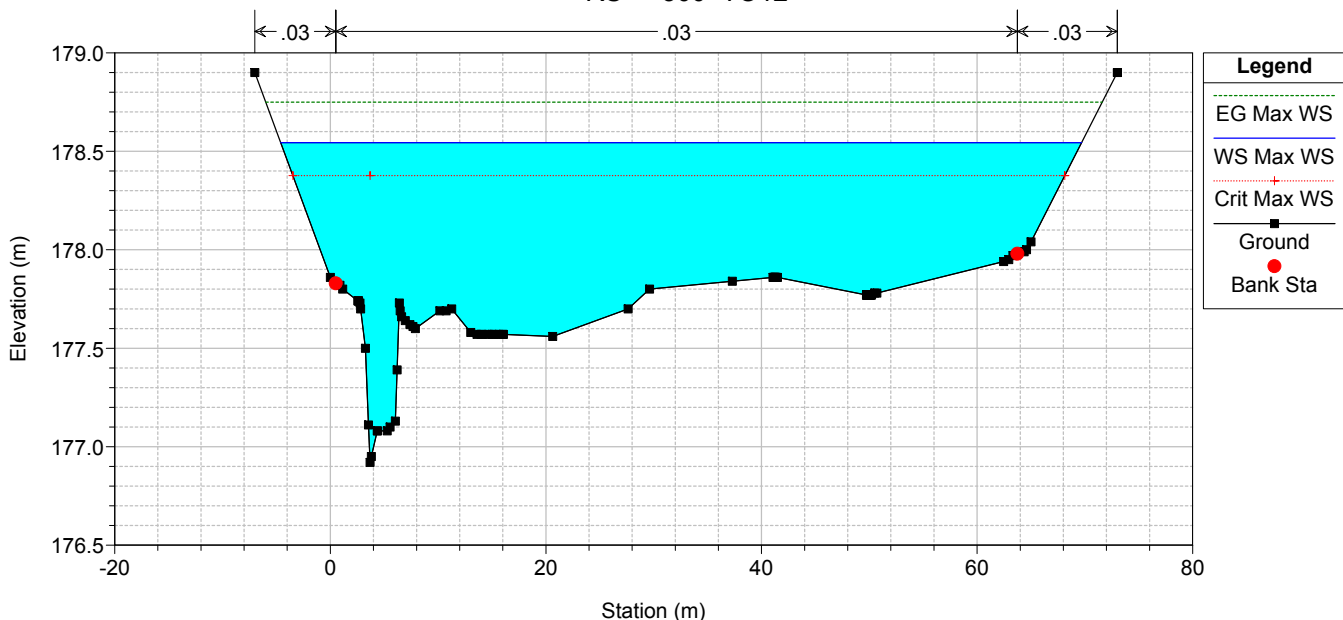

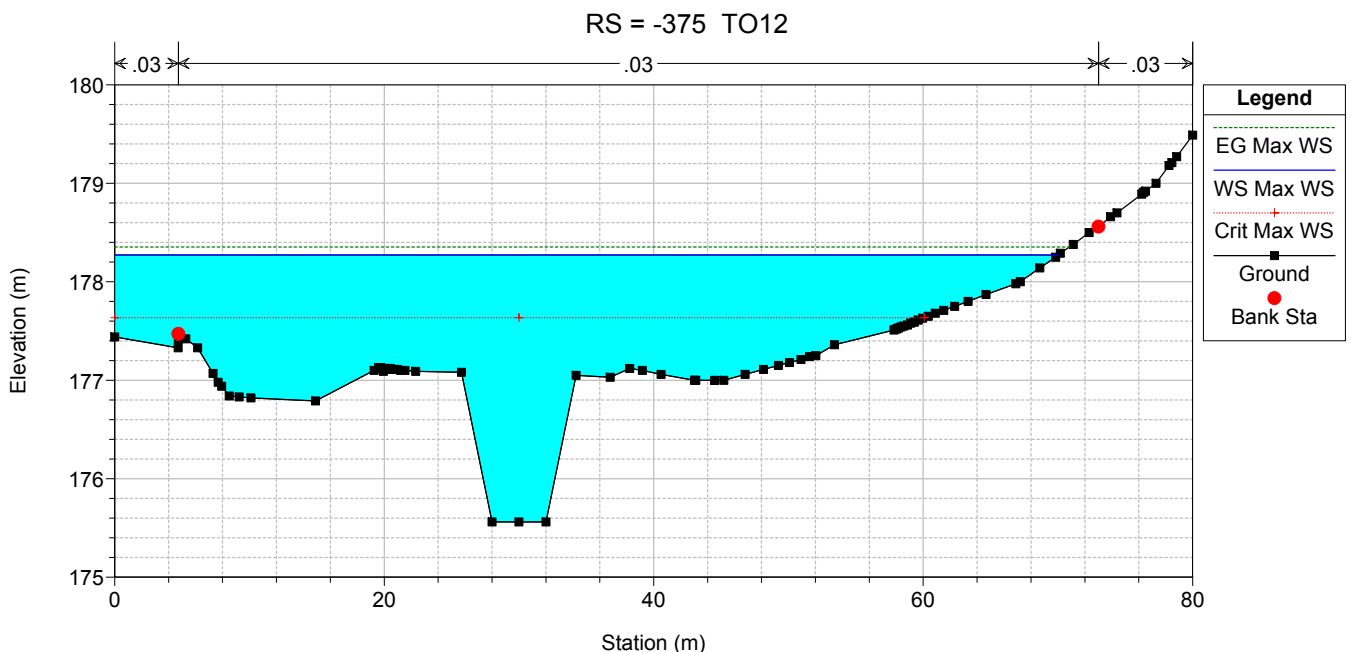
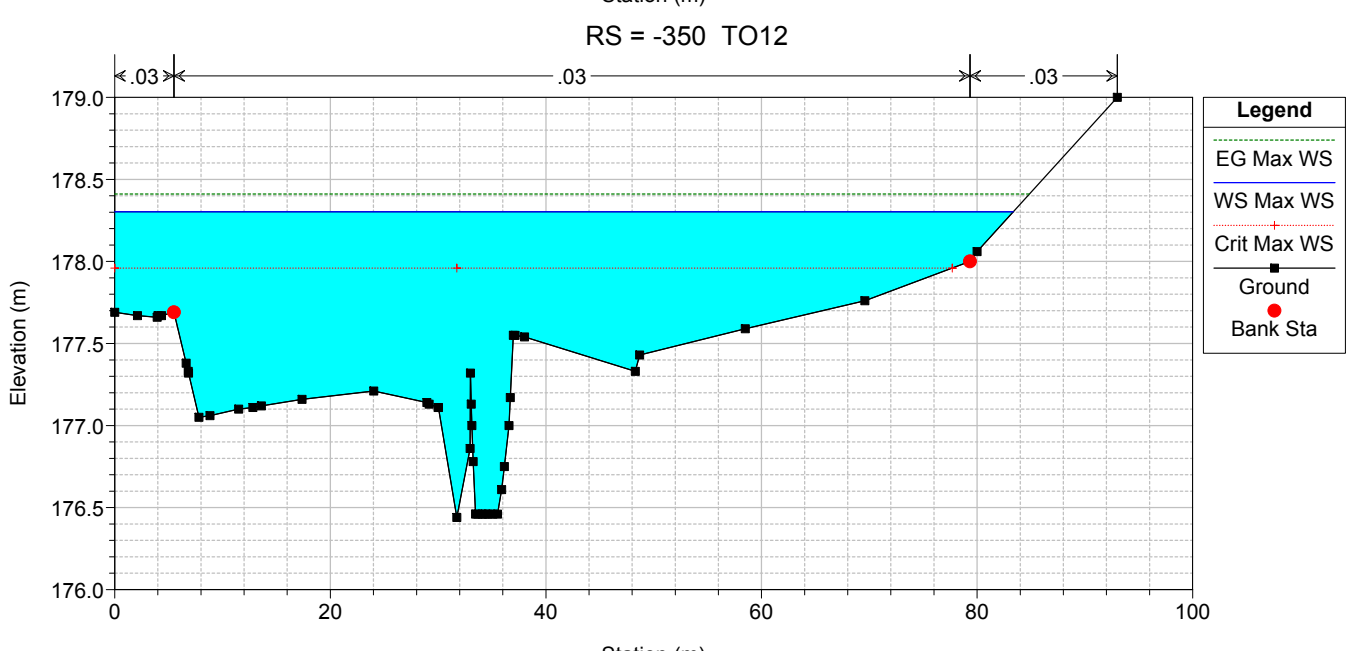
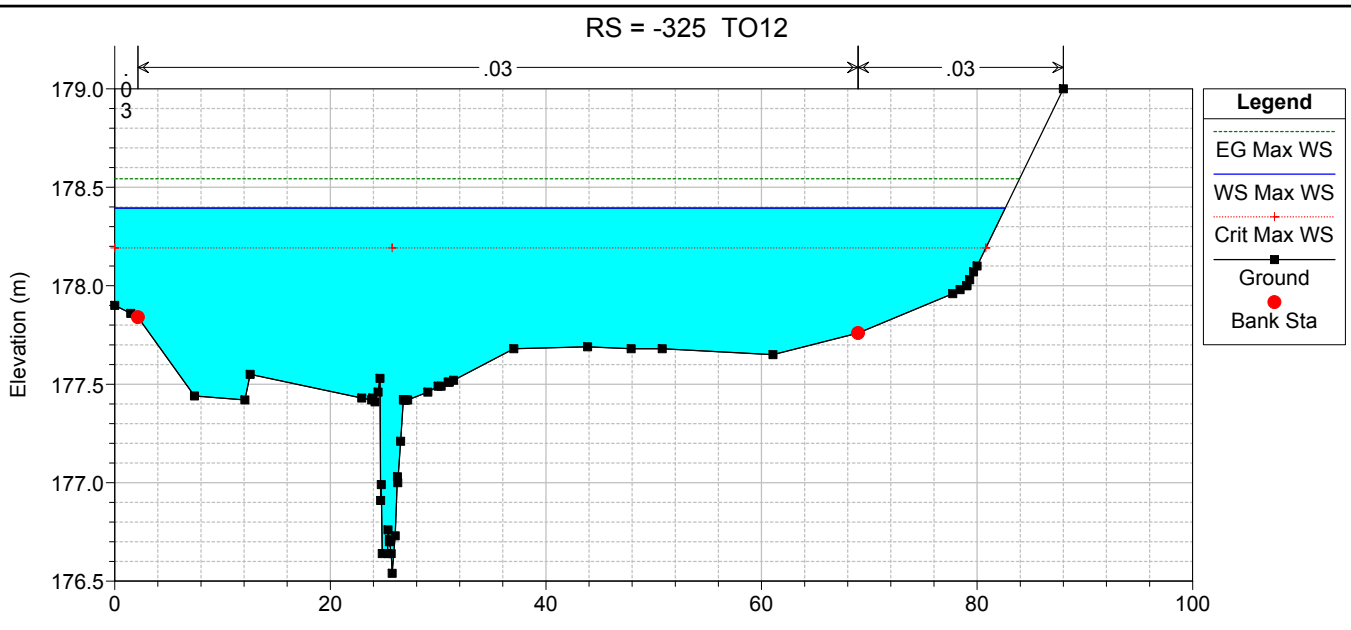

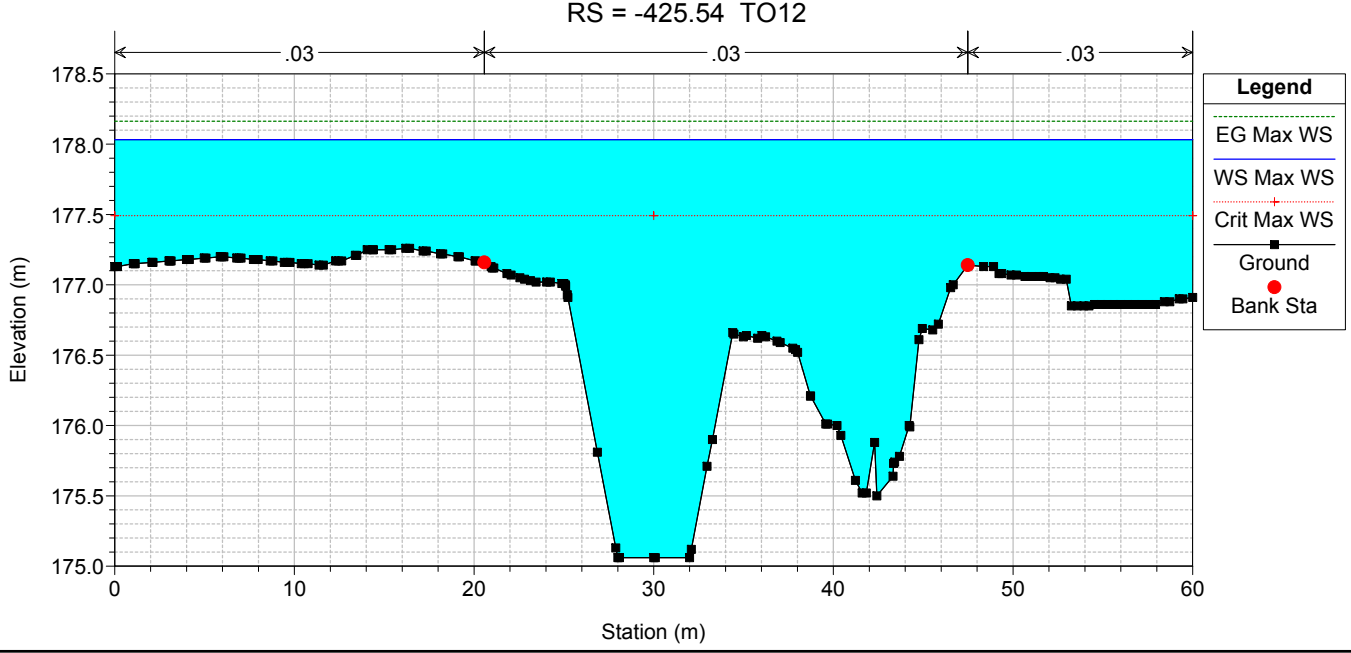
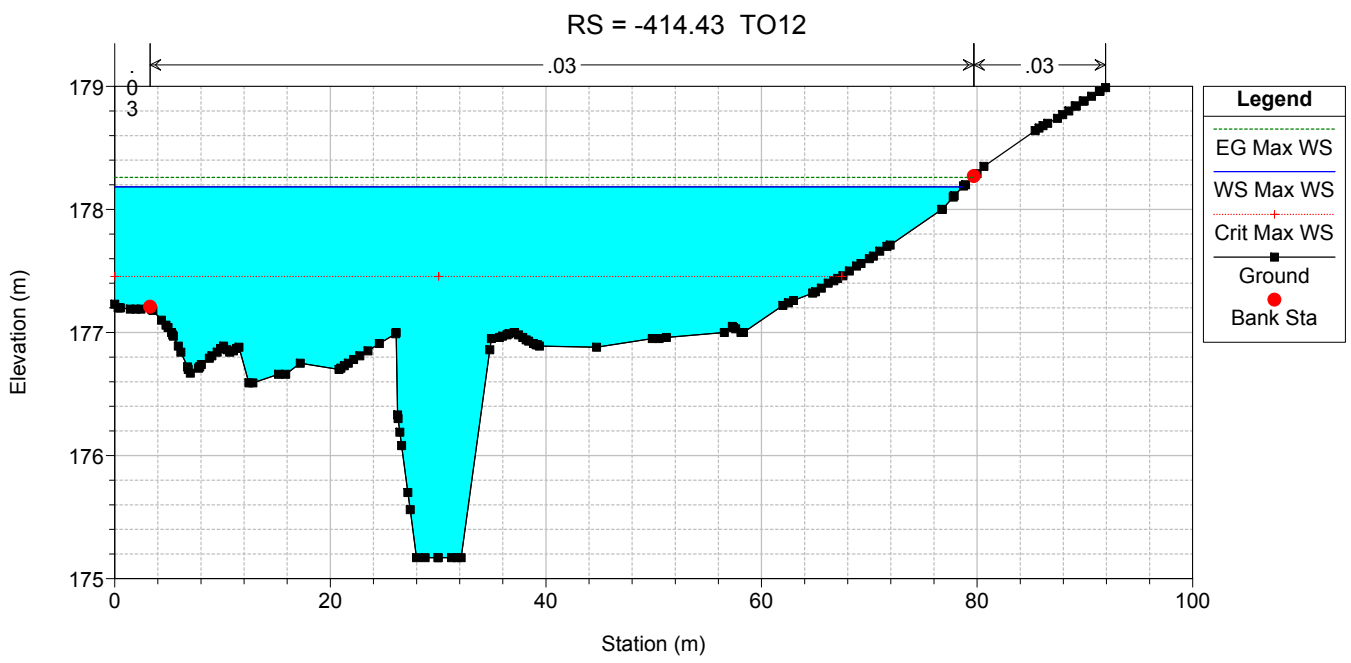
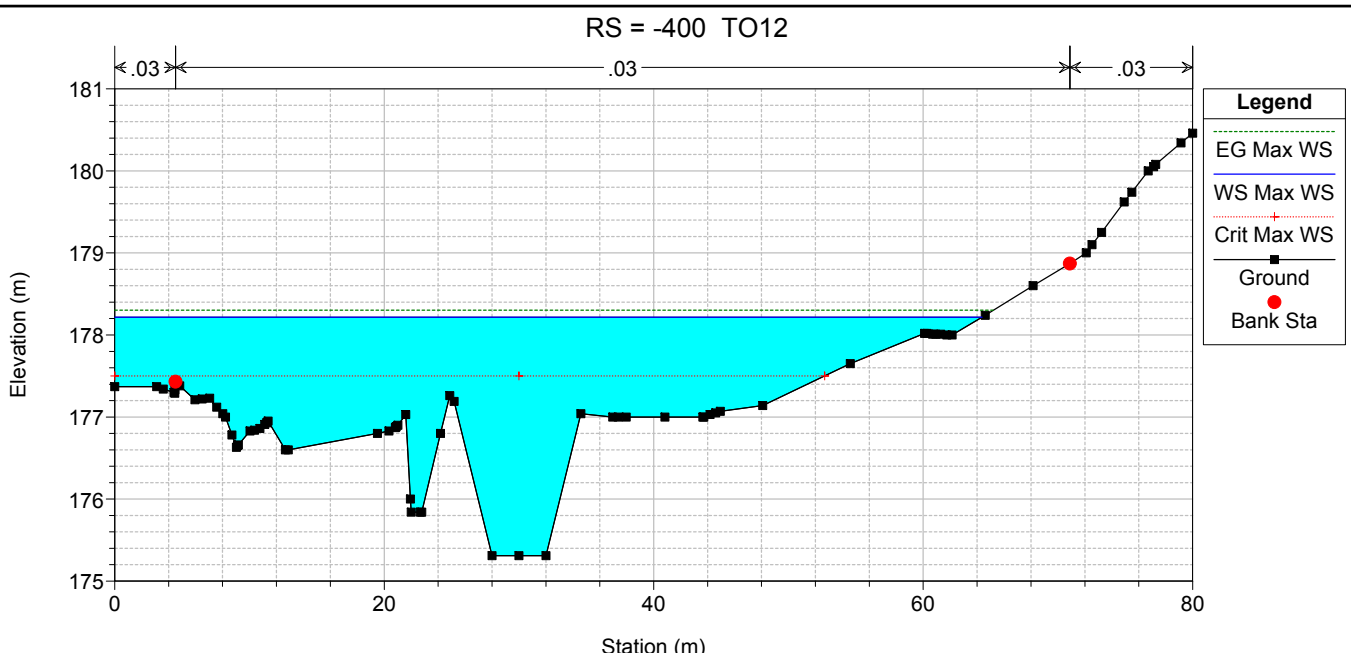

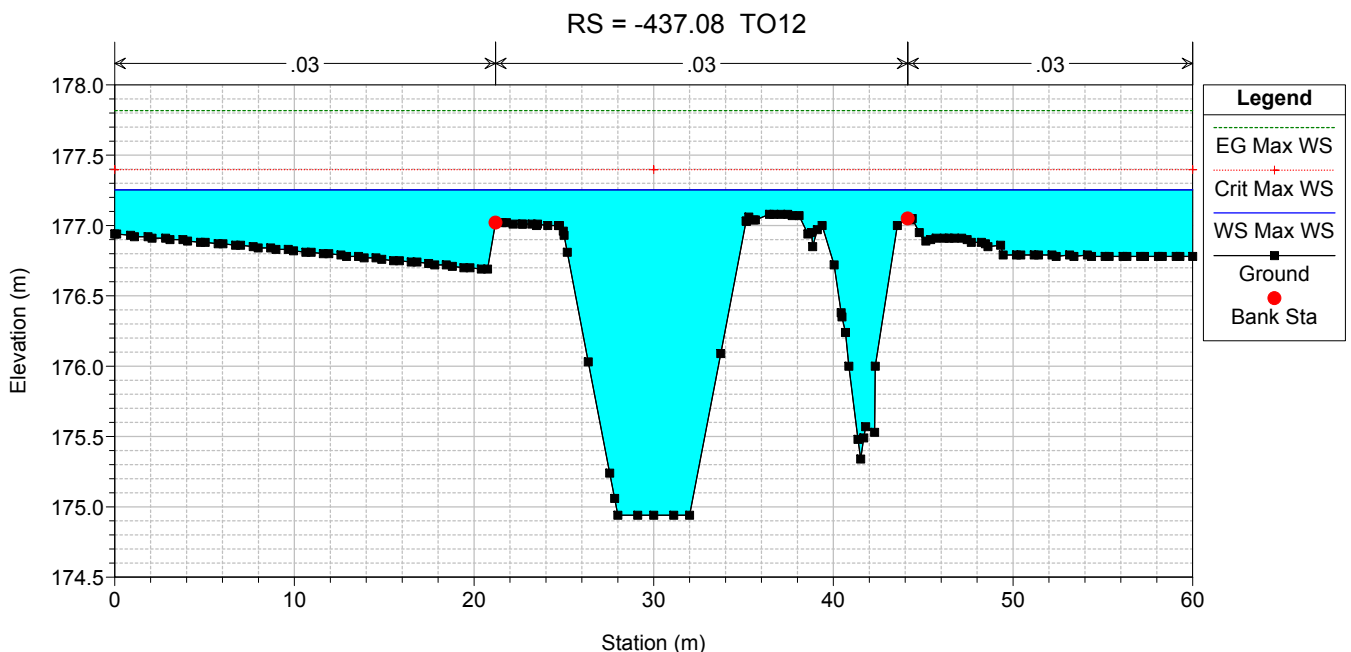
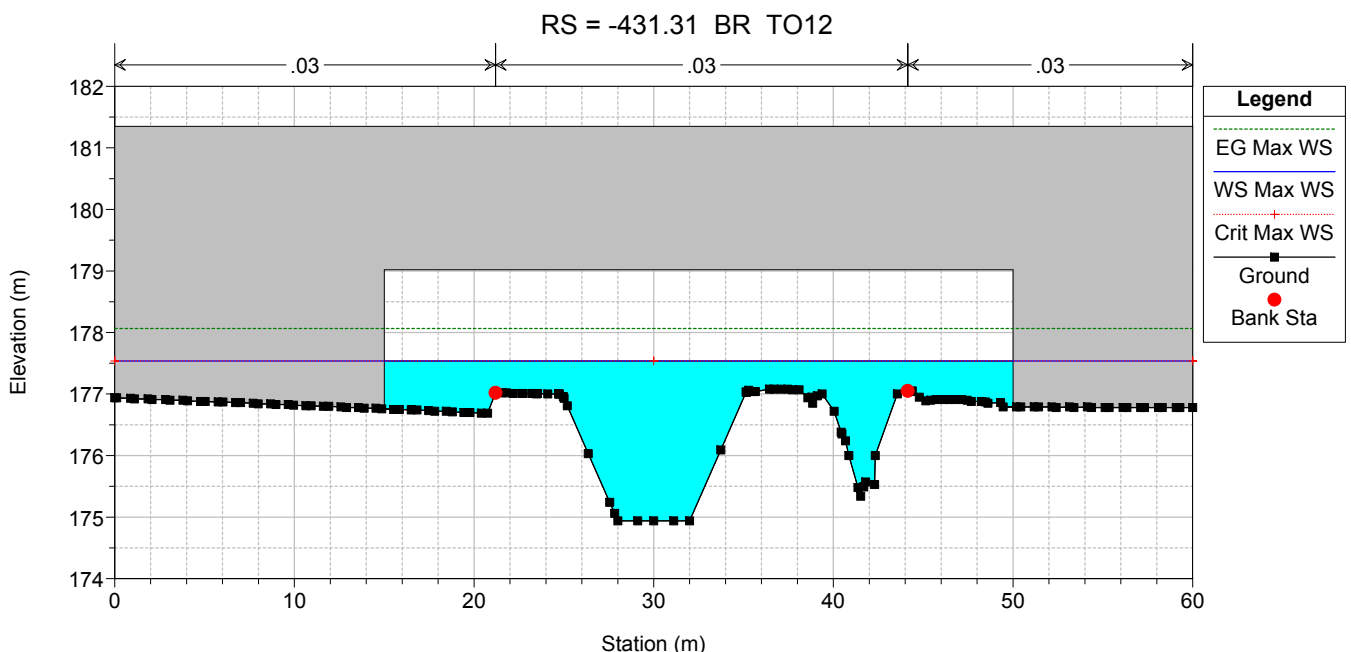
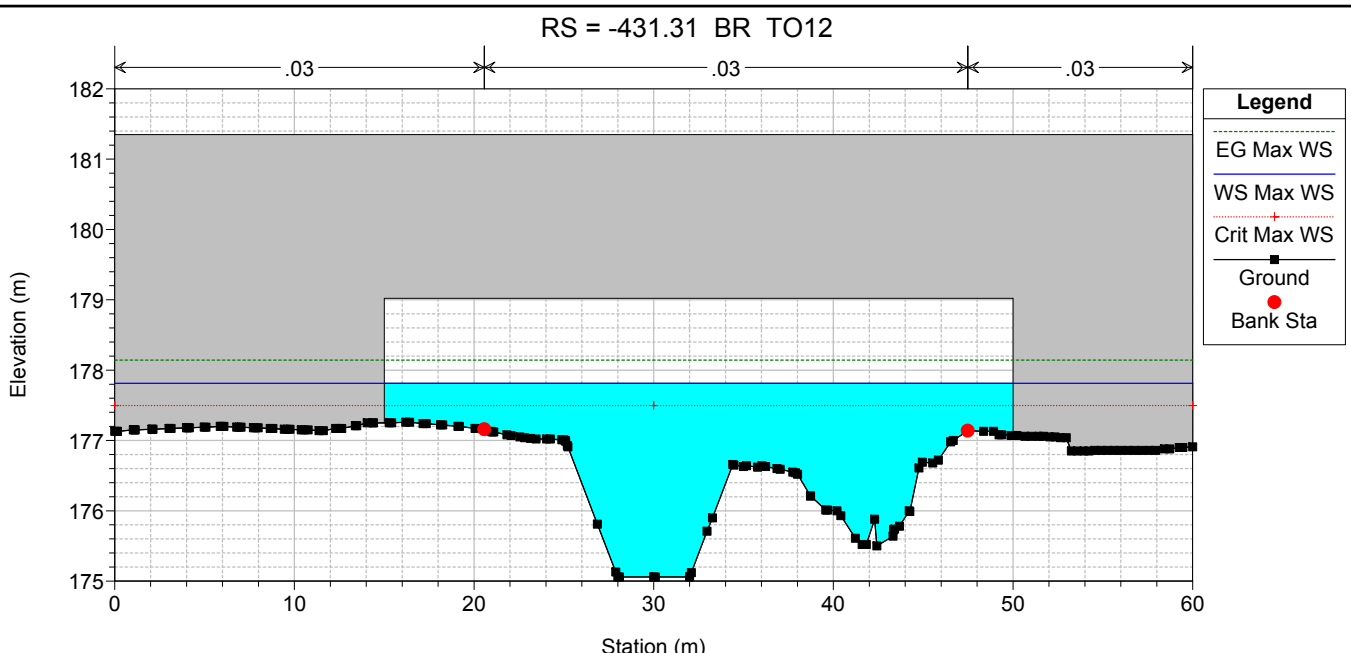

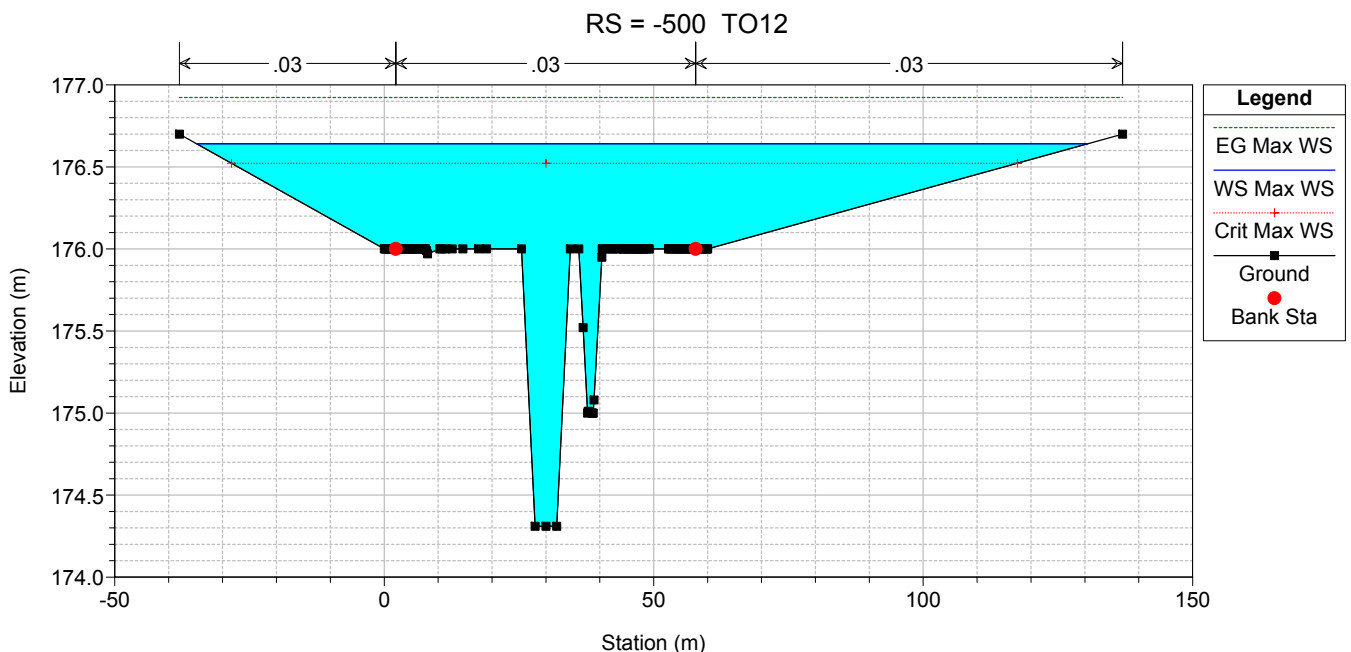
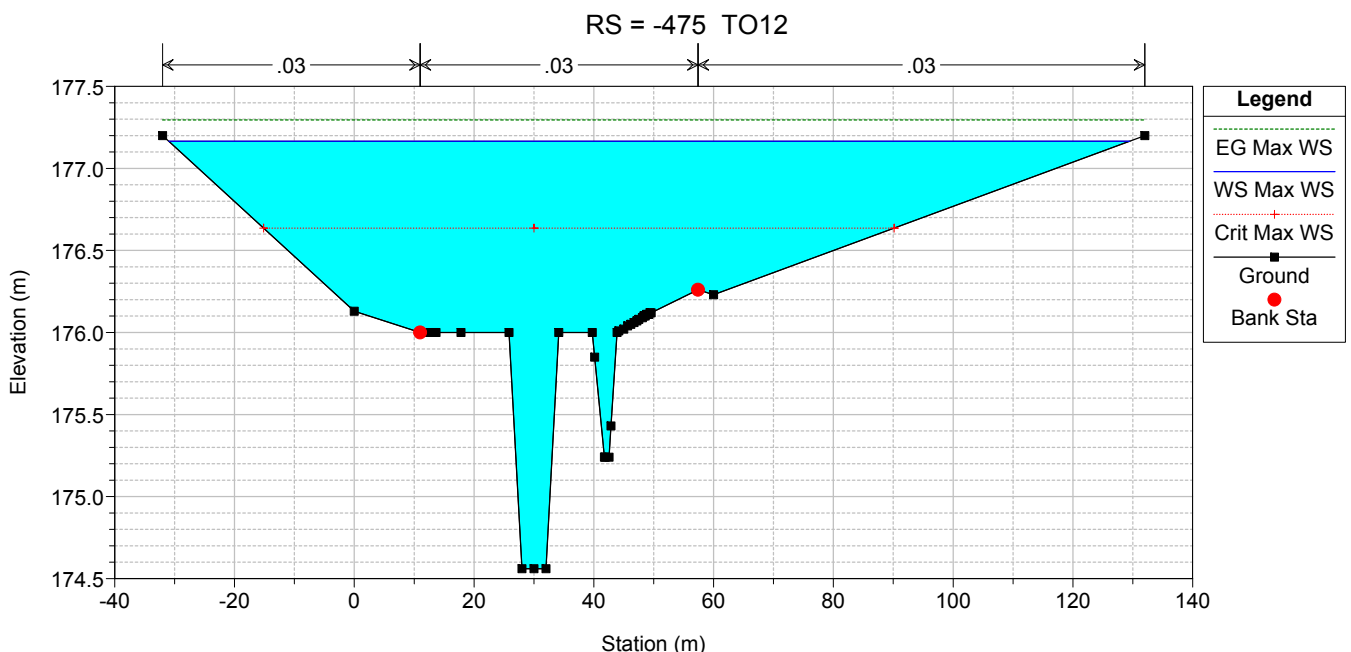
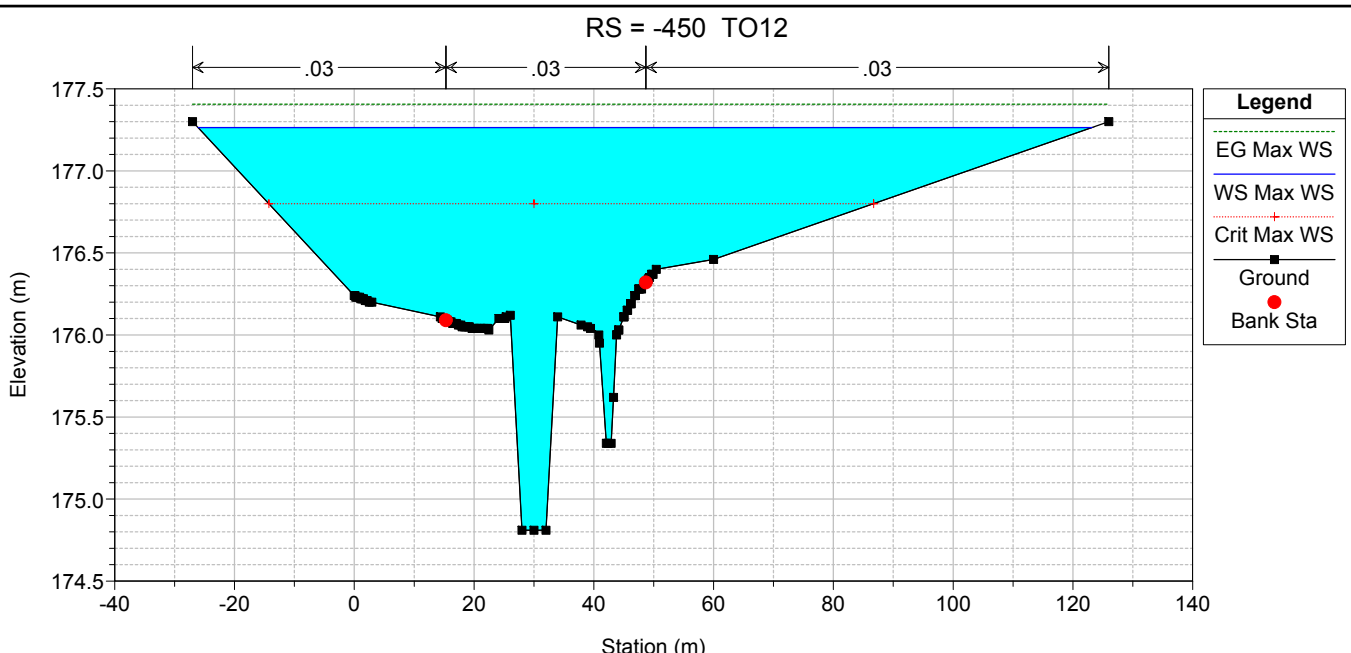

RS = -530 TO12

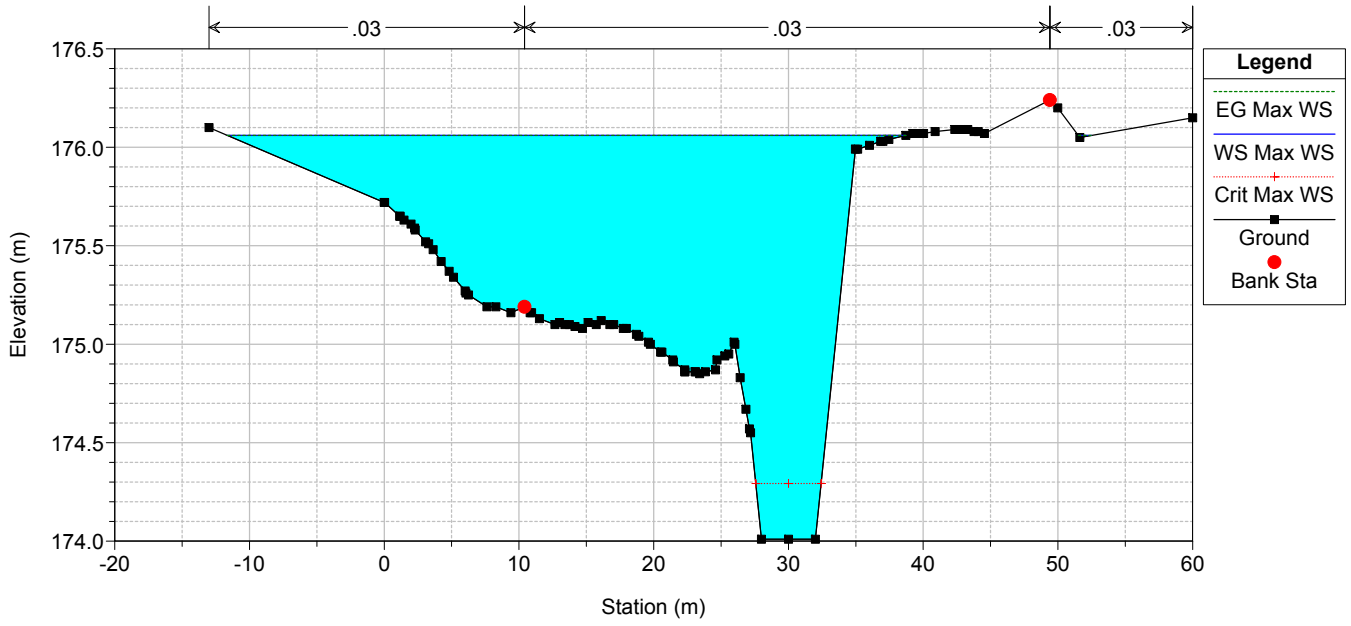

ALLEGATO 4

INTERFERENZE IDRAULICHE COMPLUVI:
RISULTATI INLET-OUTLET CONTROL

CO01

Crossing Front View (Roadway Profile): CO01

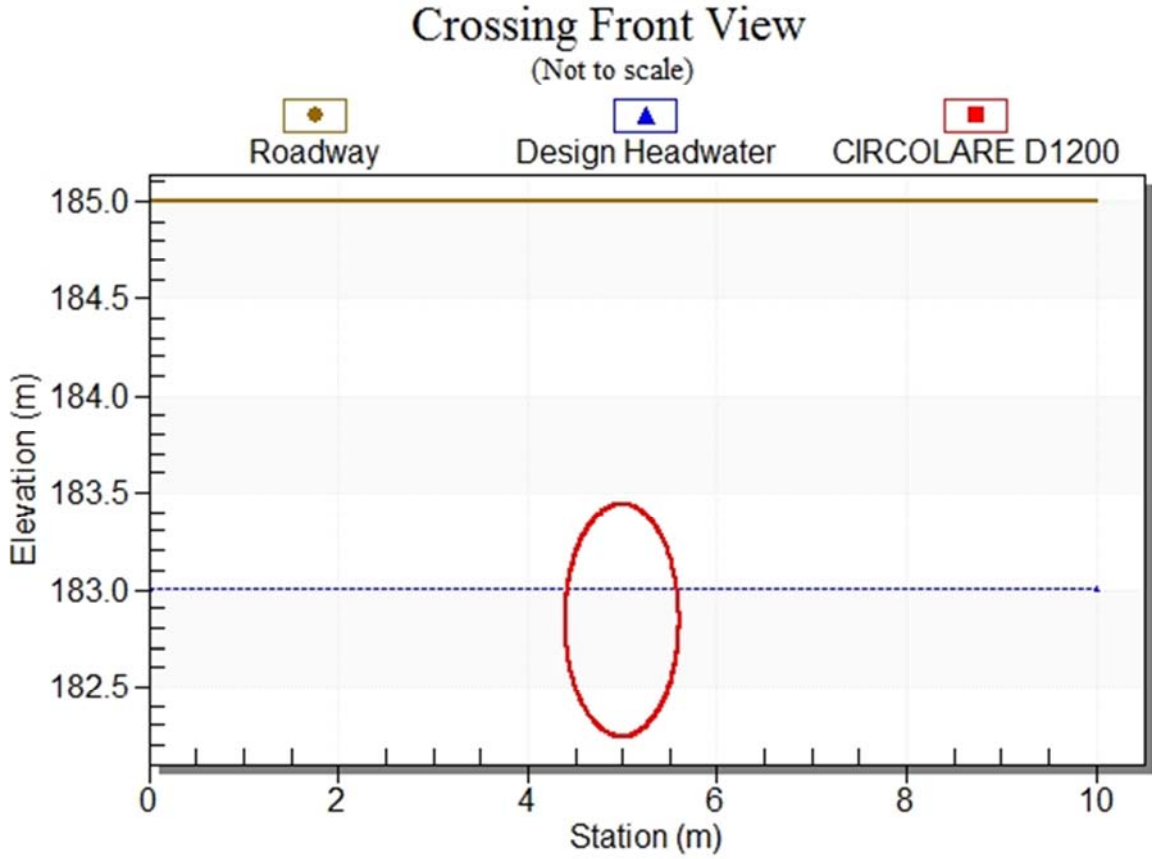

Culvert Performance Curve Plot: CIRCOLARE D1200

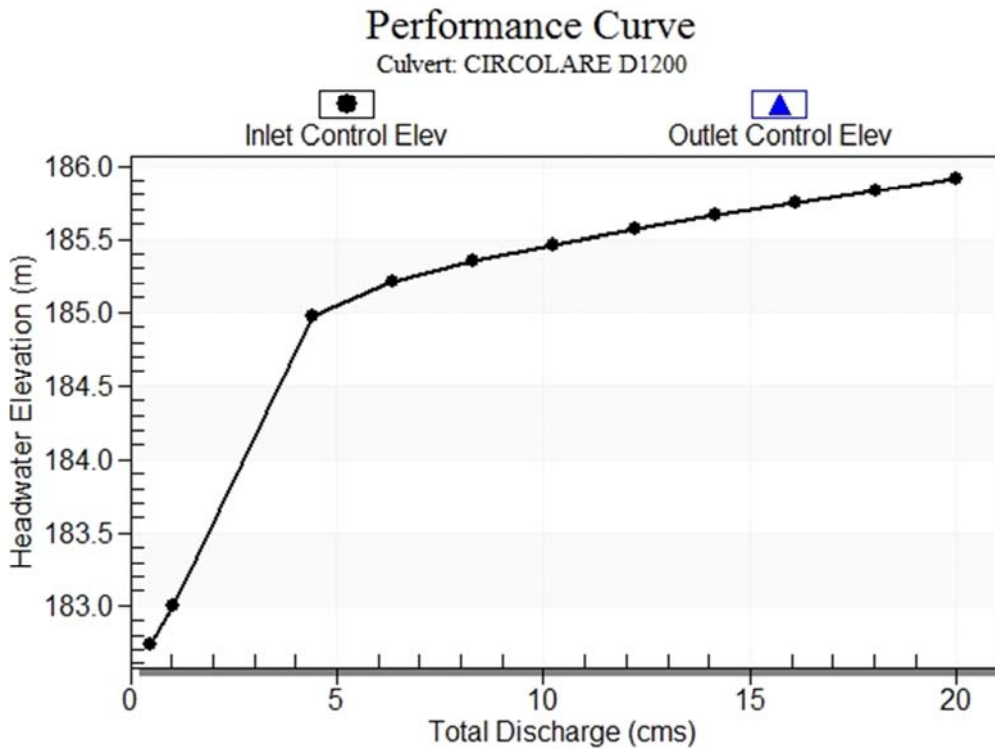

Water Surface Profile Plot for Culvert: CIRCOLARE D1200

Crossing - CO01, Design Discharge - 1.03 cms

Culvert - CIRCOLARE D1200, Culvert Discharge - 1.03 cms

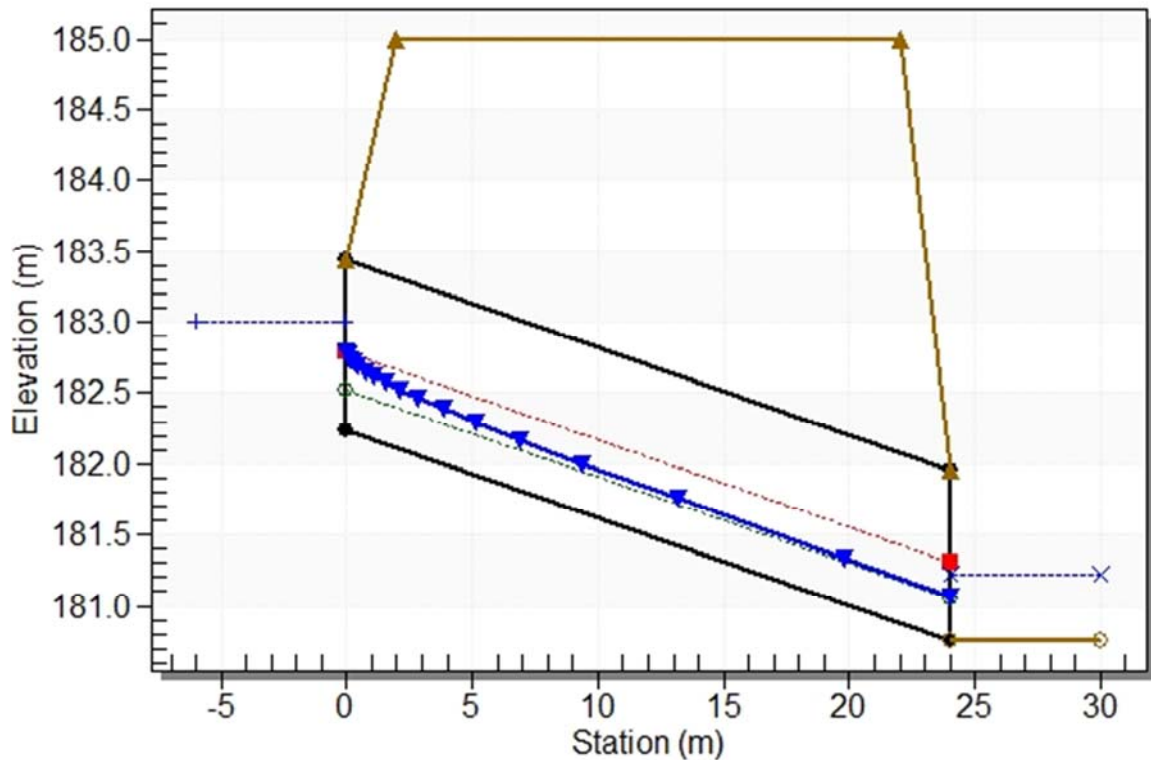

Site Data - CIRCOLARE D1200

Site Data Option: Culvert Invert Data

Inlet Station: 0.00 m

Inlet Elevation: 182.24 m

Outlet Station: 24.00 m

Outlet Elevation: 180.76 m

Number of Barrels: 1

Culvert Data Summary - CIRCOLARE D1200

Barrel Shape: Circular

Barrel Diameter: 1200.00 mm

Barrel Material: Concrete

Embedment: 0.00 mm

Barrel Manning's n: 0.0154

Culvert Type: Straight

Inlet Configuration: Square Edge with Headwall

Inlet Depression: NONE

CO02

Crossing Front View (Roadway Profile): CO02

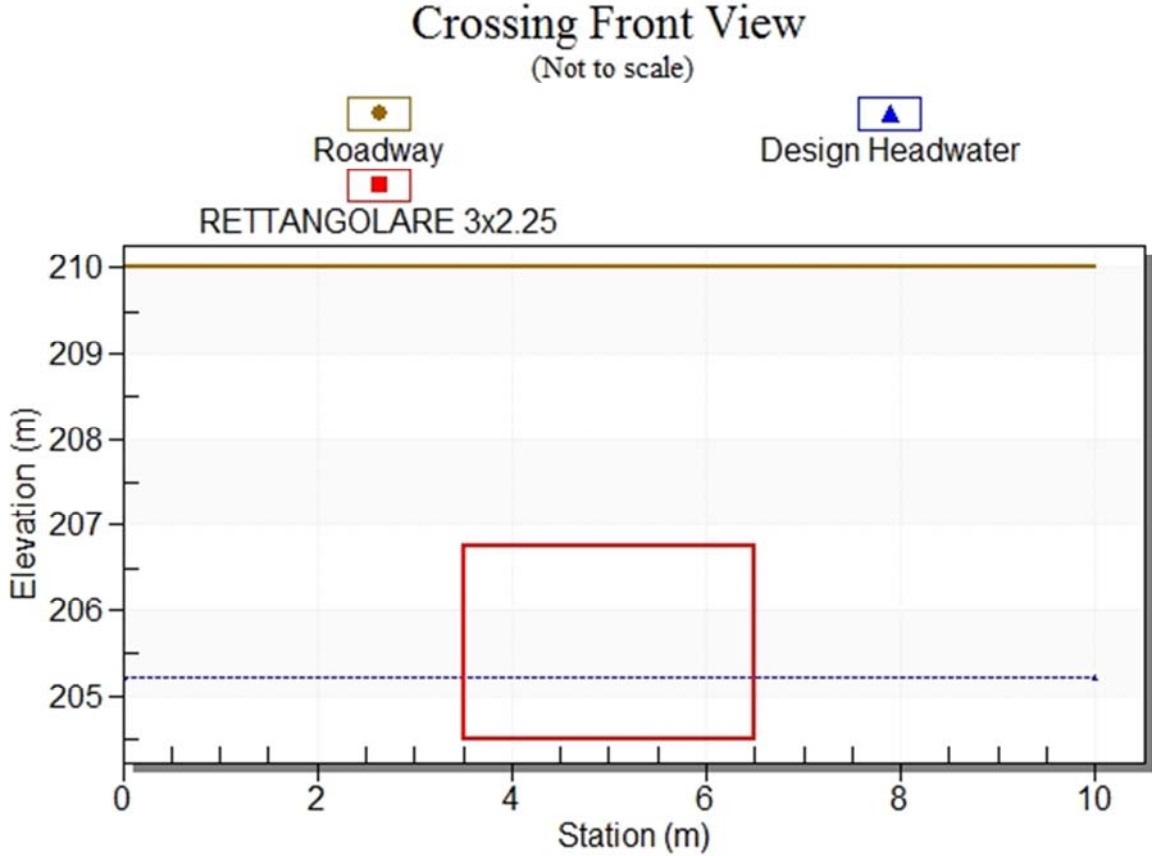

Culvert Performance Curve Plot: RETTANGOLARE 3x2.25

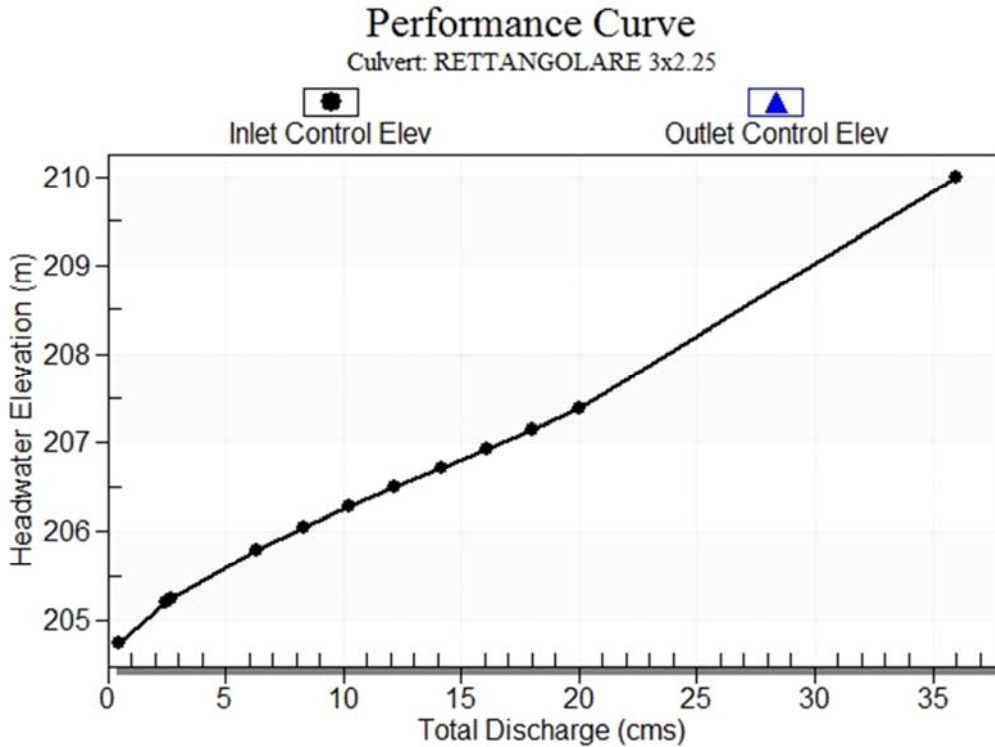

Water Surface Profile Plot for Culvert: RETTANGOLARE 3x2.25
Crossing - CO02, Design Discharge - 2.70 cms
 Culvert - RETTANGOLARE 3x2.25, Culvert Discharge - 2.70 cms

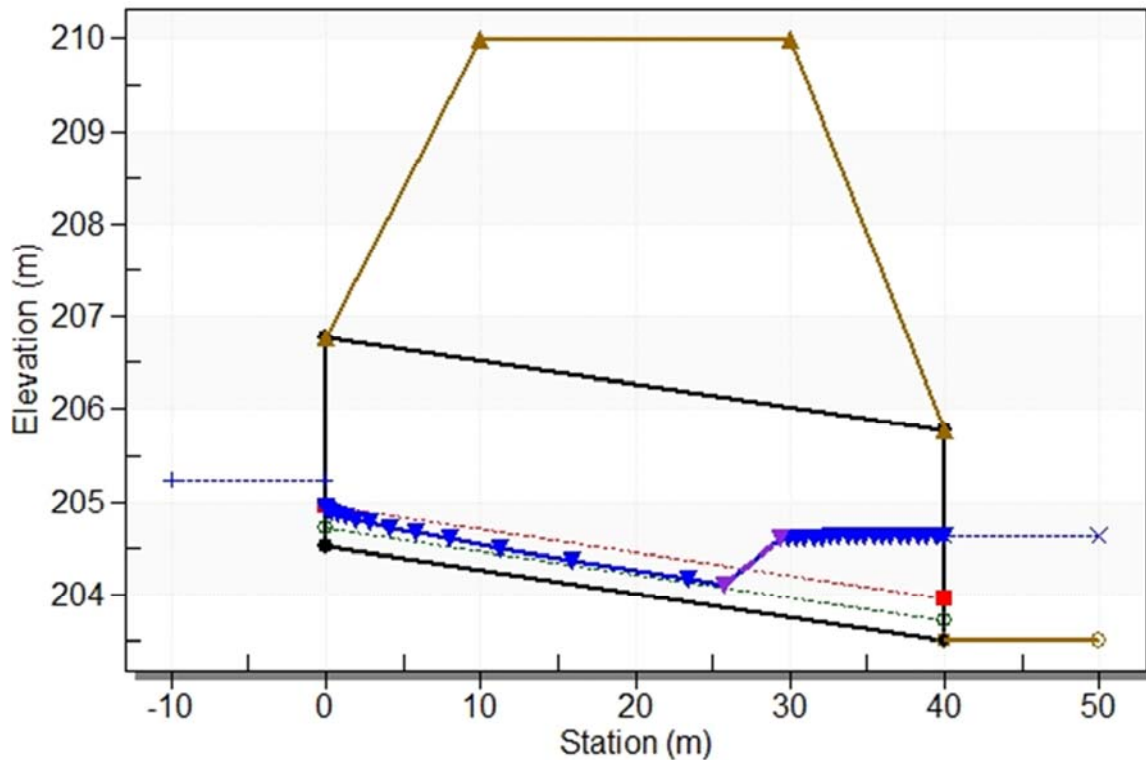

Site Data - RETTANGOLARE 3x2.25

Site Data Option: Culvert Invert Data

Inlet Station: 0.00 m

Inlet Elevation: 204.51 m

Outlet Station: 40.00 m

Outlet Elevation: 203.51 m

Number of Barrels: 1

Culvert Data Summary - RETTANGOLARE 3x2.25

Barrel Shape: Concrete Box

Barrel Span: 3000.00 mm

Barrel Rise: 2250.00 mm

Barrel Material: Concrete

Embedment: 0.00 mm

Barrel Manning's n: 0.0120

Culvert Type: Straight

Inlet Configuration: Square Edge (90°) Headwall

Inlet Depression: NONE

CO03

Crossing Front View (Roadway Profile): CO03

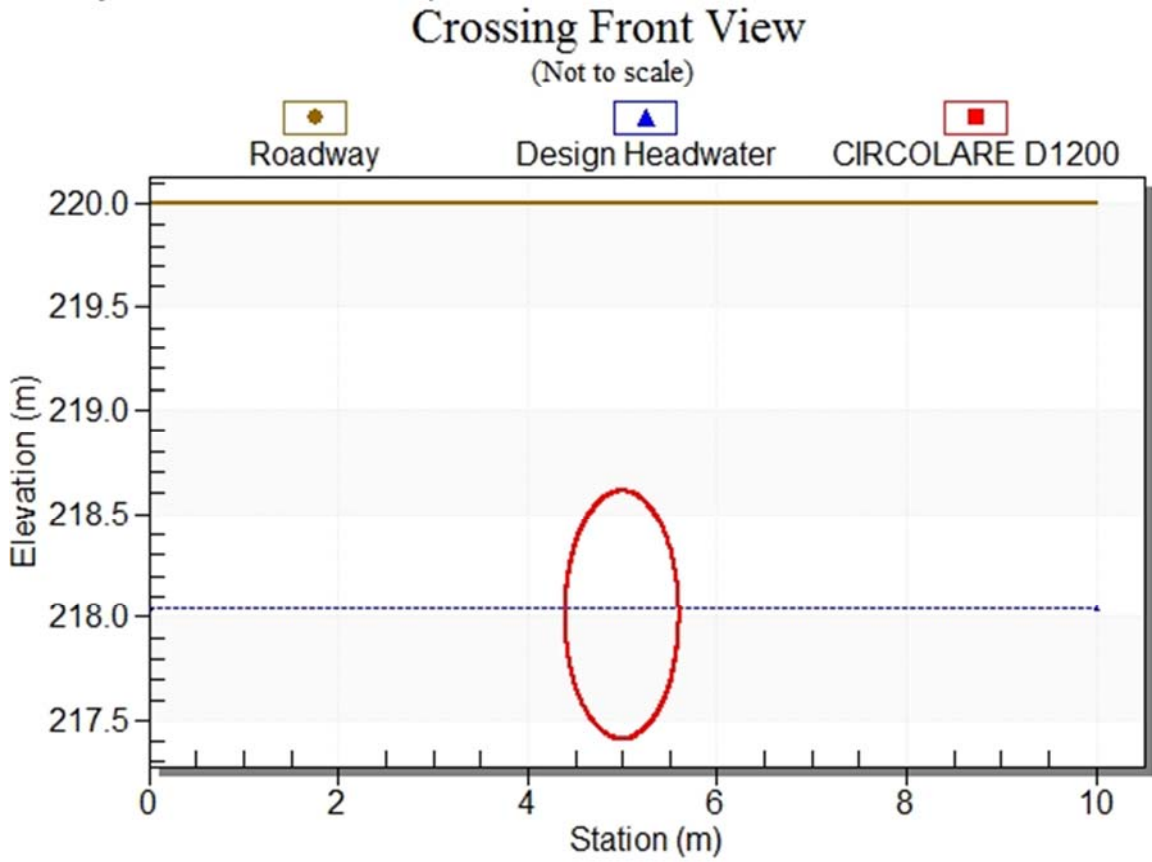

Culvert Performance Curve Plot: CIRCOLARE D1200

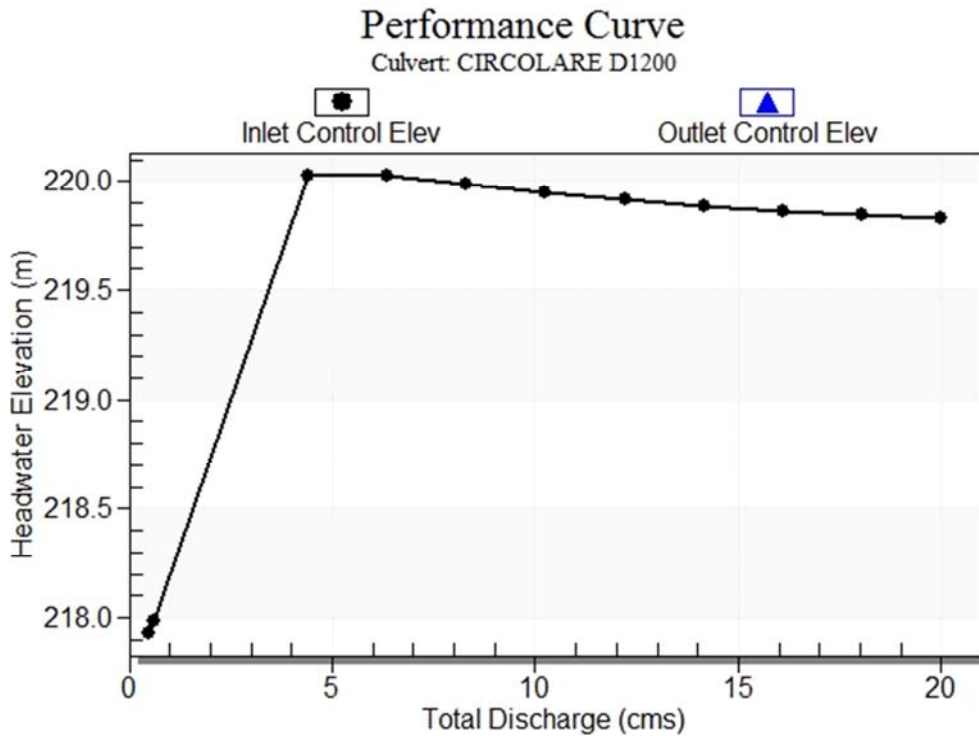

Water Surface Profile Plot for Culvert: CIRCOLARE D1200

Crossing - CO03, Design Discharge - 0.60 cms

Culvert - CIRCOLARE D1200, Culvert Discharge - 0.60 cms

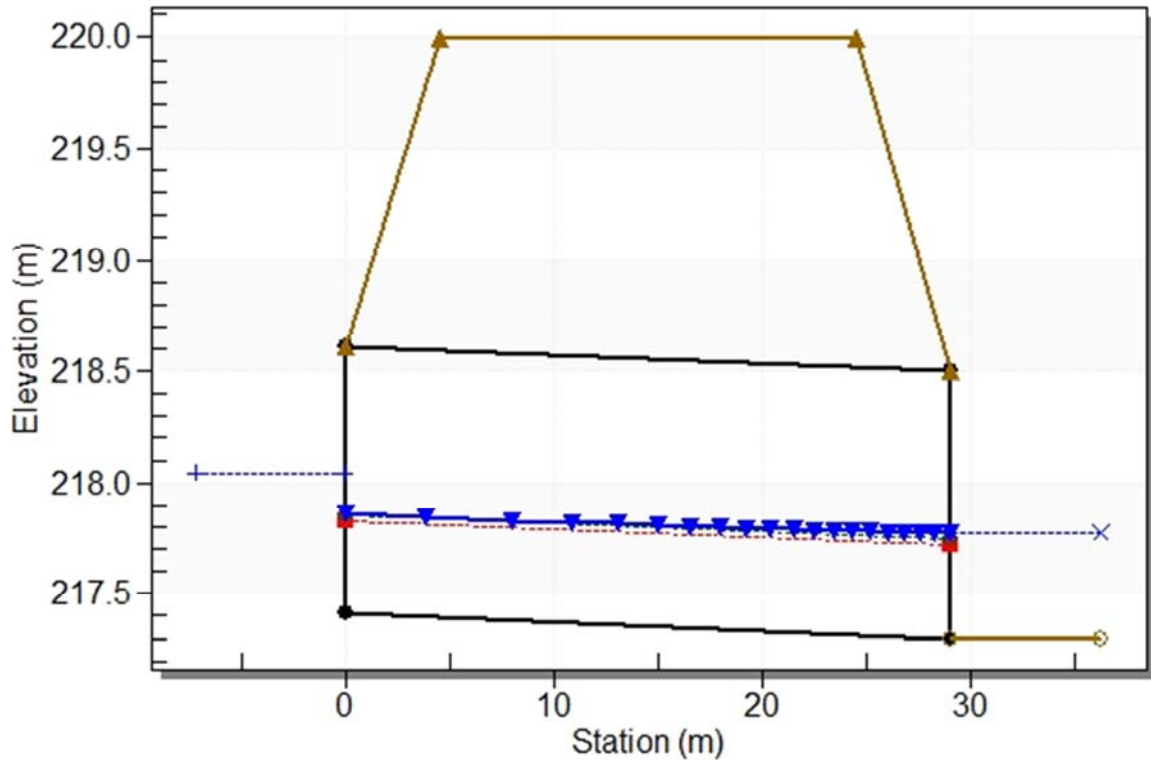

Site Data - CIRCOLARE D1200

Site Data Option: Culvert Invert Data

Inlet Station: 0.00 m

Inlet Elevation: 217.41 m

Outlet Station: 29.00 m

Outlet Elevation: 217.30 m

Number of Barrels: 1

Culvert Data Summary - CIRCOLARE D1200

Barrel Shape: Circular

Barrel Diameter: 1200.00 mm

Barrel Material: Concrete

Embedment: 0.00 mm

Barrel Manning's n: 0.0154

Culvert Type: Straight

Inlet Configuration: Square Edge with Headwall

Inlet Depression: NONE

CO04

Crossing Front View (Roadway Profile): CO04

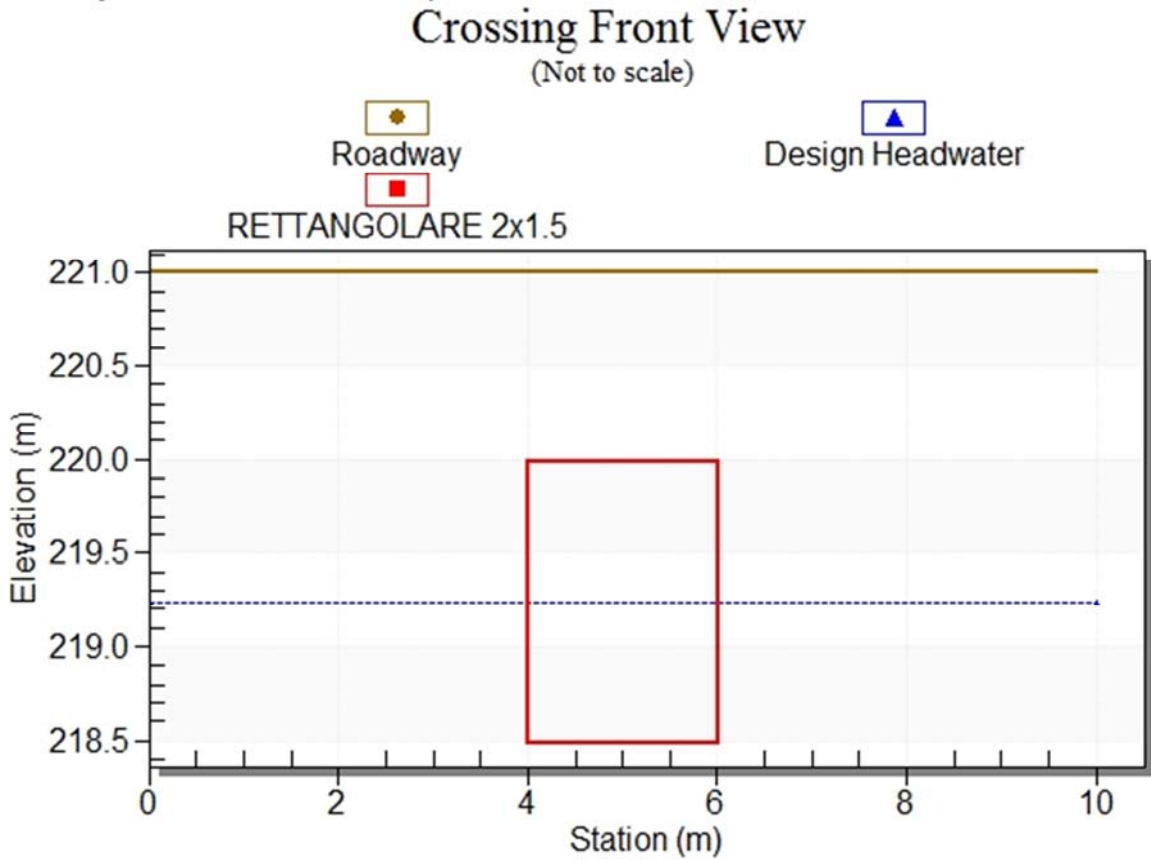

Culvert Performance Curve Plot: RETTANGOLARE 2x1.5

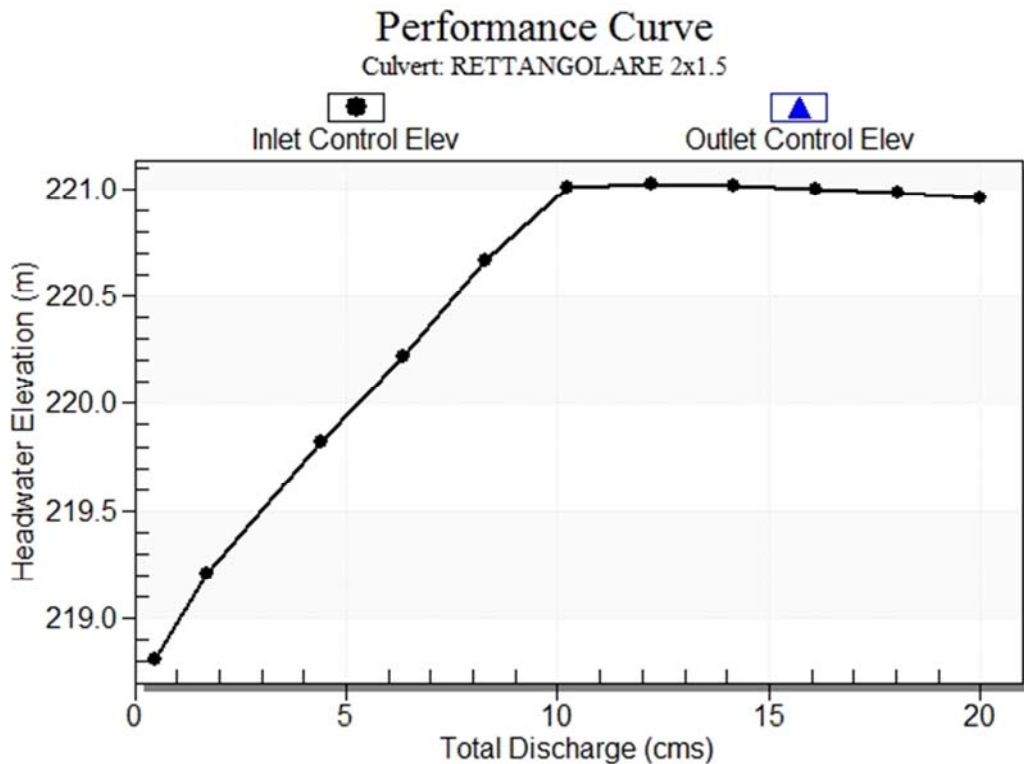

Water Surface Profile Plot for Culvert: RETTANGOLARE 2x1.5
Crossing - CO04, Design Discharge - 1.70 cms
 Culvert - RETTANGOLARE 2x1.5, Culvert Discharge - 1.70 cms

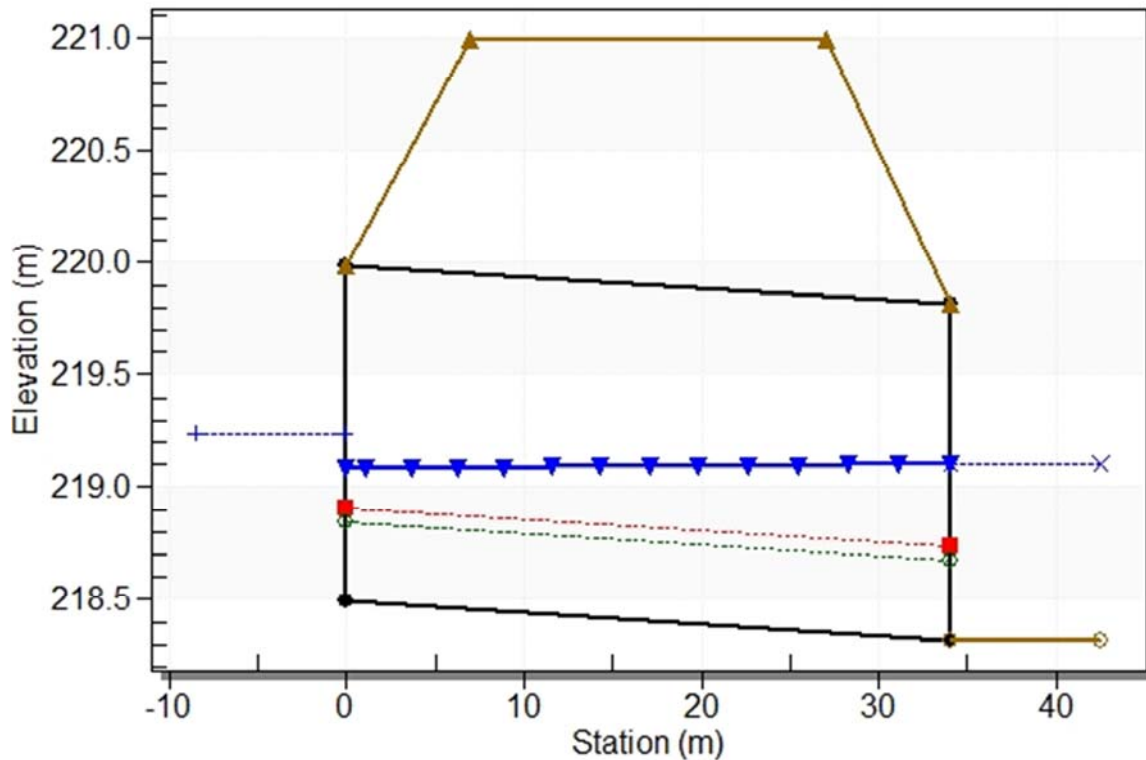

Site Data - RETTANGOLARE 2x1.5

Site Data Option: Culvert Invert Data

Inlet Station: 0.00 m

Inlet Elevation: 218.49 m

Outlet Station: 34.00 m

Outlet Elevation: 218.32 m

Number of Barrels: 1

Culvert Data Summary - RETTANGOLARE 2x1.5

Barrel Shape: Concrete Box

Barrel Span: 2000.00 mm

Barrel Rise: 1500.00 mm

Barrel Material: Concrete

Embedment: 0.00 mm

Barrel Manning's n: 0.0120

Culvert Type: Straight

Inlet Configuration: Square Edge (90°) Headwall

Inlet Depression: NONE

CO05

Crossing Front View (Roadway Profile): CO05

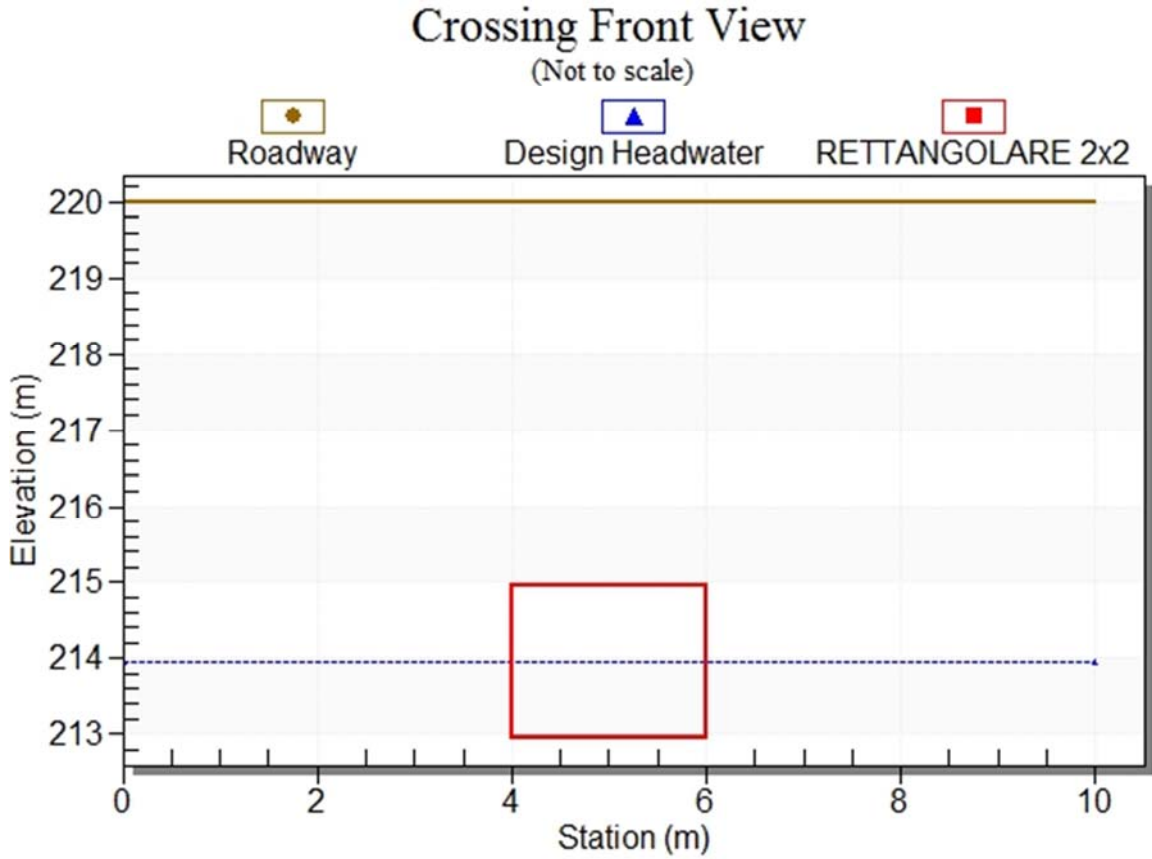

Culvert Performance Curve Plot: RETTANGOLARE 2x2

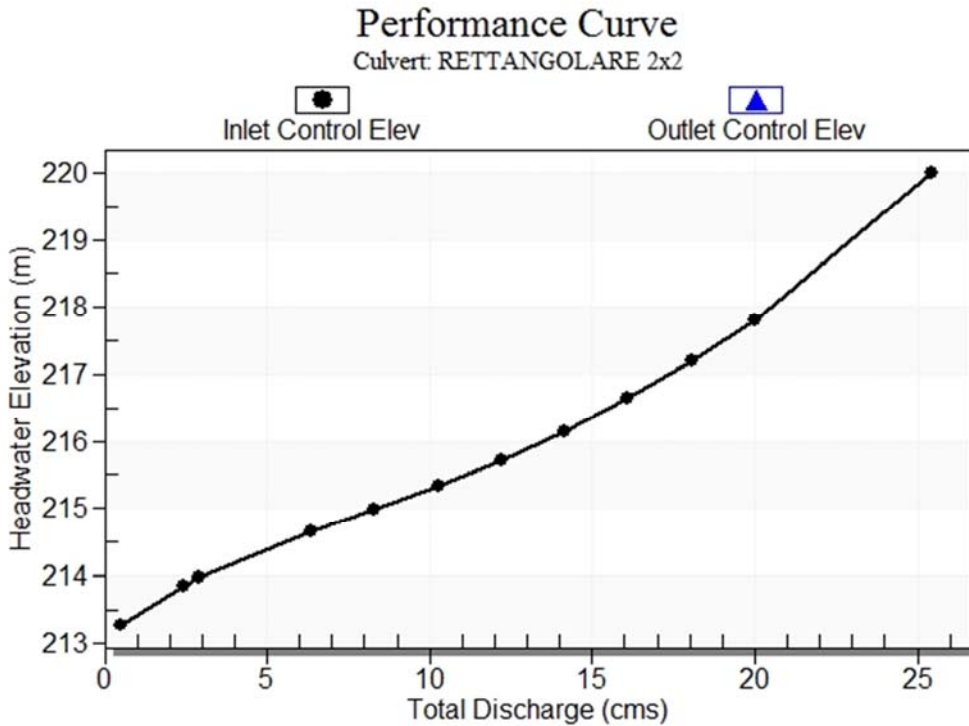

Water Surface Profile Plot for Culvert: RETTANGOLARE 2x2

Crossing - CO05, Design Discharge - 2.90 cms

Culvert - RETTANGOLARE 2x2, Culvert Discharge - 2.90 cms

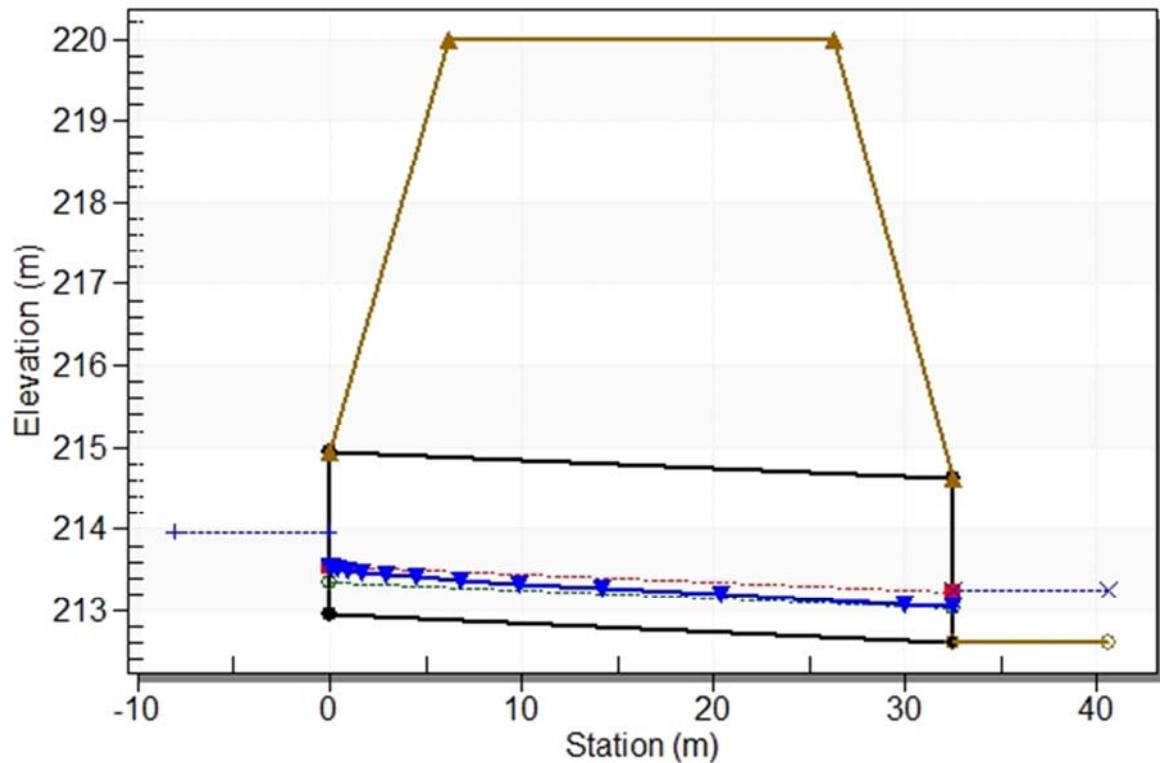

Site Data - RETTANGOLARE 2x2

Site Data Option: Culvert Invert Data

Inlet Station: 0.00 m

Inlet Elevation: 212.95 m

Outlet Station: 32.50 m

Outlet Elevation: 212.62 m

Number of Barrels: 1

Culvert Data Summary - RETTANGOLARE 2x2

Barrel Shape: Concrete Box

Barrel Span: 2000.00 mm

Barrel Rise: 2000.00 mm

Barrel Material: Concrete

Embedment: 0.00 mm

Barrel Manning's n: 0.0120

Culvert Type: Straight

Inlet Configuration: Square Edge (90°) Headwall

Inlet Depression: NONE

CO06

Crossing Front View (Roadway Profile): CO06

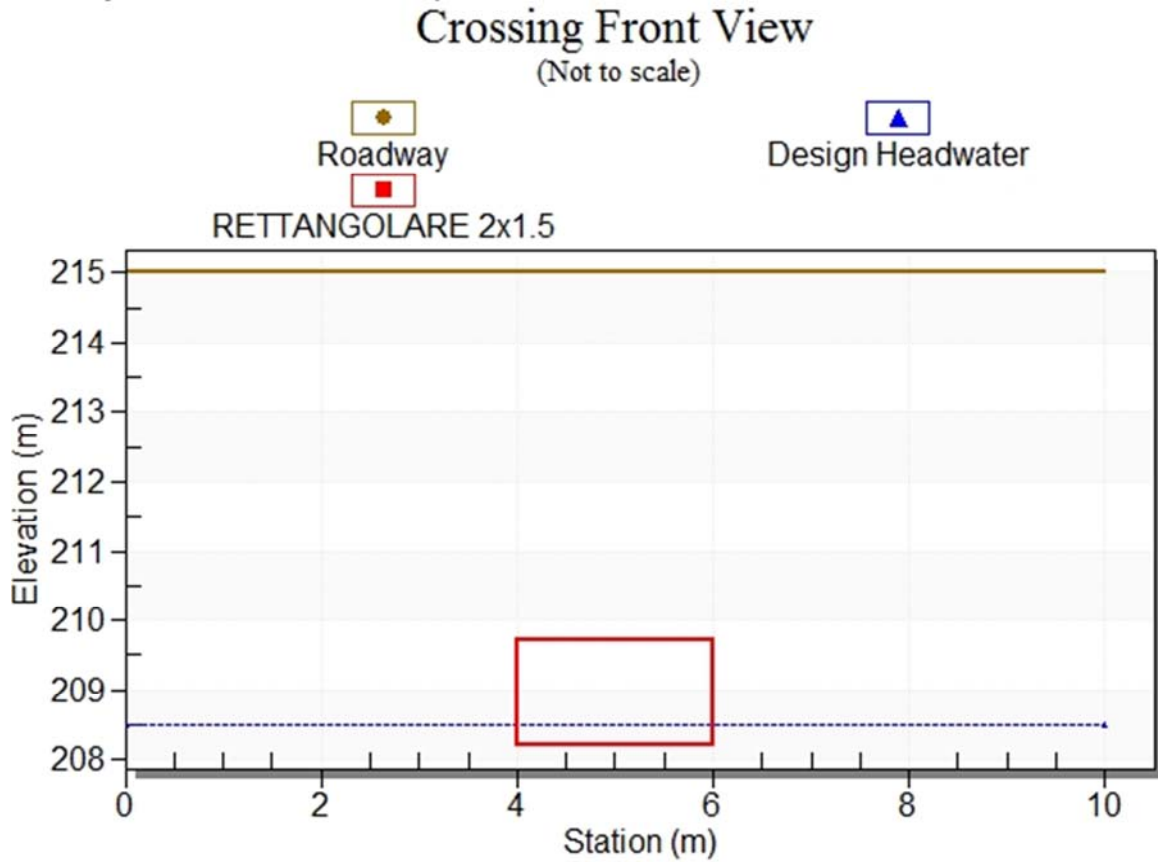

Culvert Performance Curve Plot: RETTANGOLARE 2x1.5

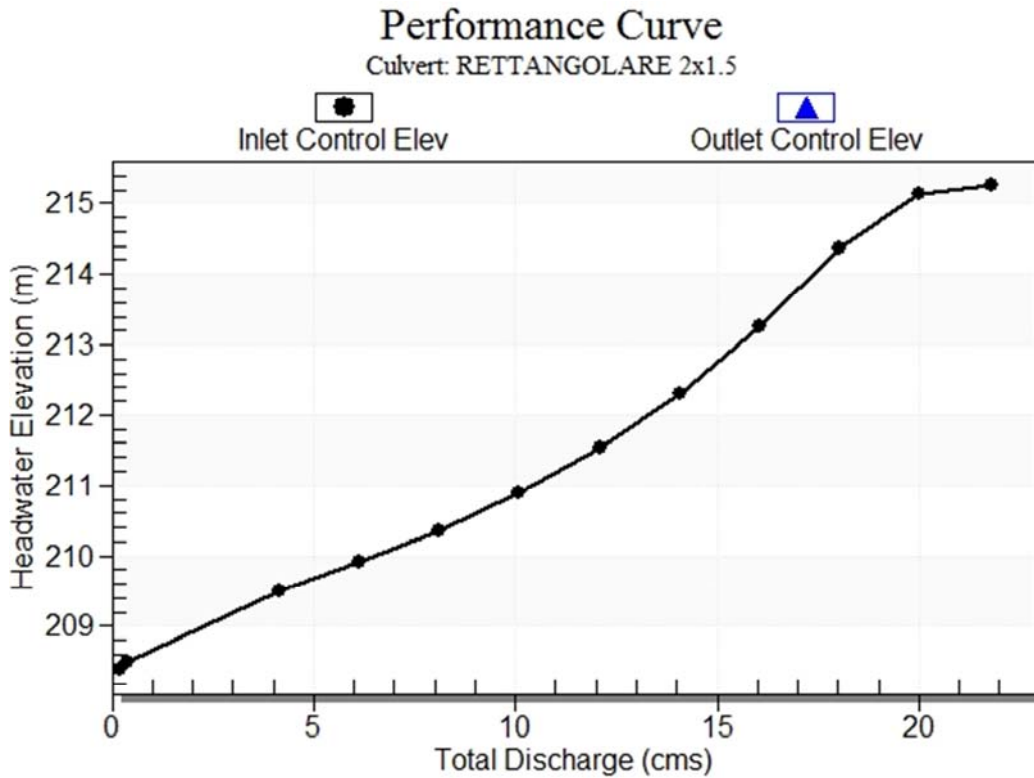

Water Surface Profile Plot for Culvert: RETTANGOLARE 2x1.5
Crossing - CO06, Design Discharge - 0.40 cms
 Culvert - RETTANGOLARE 2x1.5, Culvert Discharge - 0.40 cms

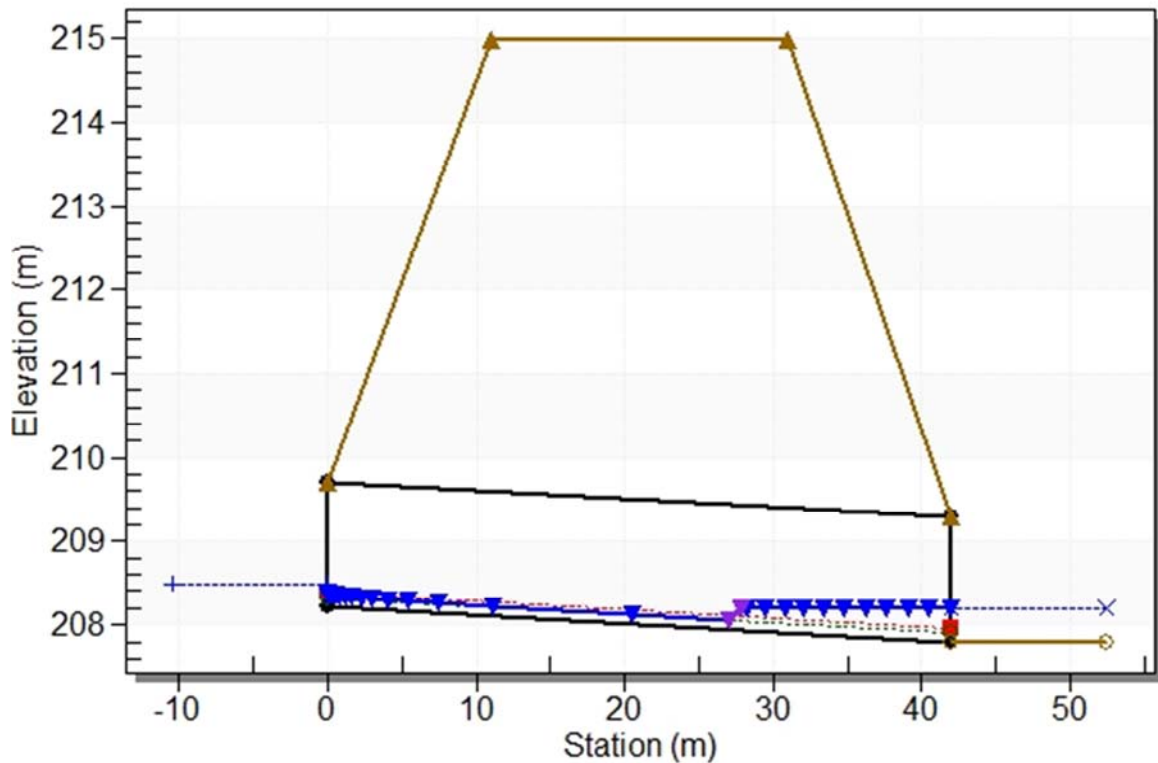

Site Data - RETTANGOLARE 2x1.5

Site Data Option: Culvert Invert Data

Inlet Station: 0.00 m

Inlet Elevation: 208.22 m

Outlet Station: 42.00 m

Outlet Elevation: 207.80 m

Number of Barrels: 1

Culvert Data Summary - RETTANGOLARE 2x1.5

Barrel Shape: Concrete Box

Barrel Span: 2000.00 mm

Barrel Rise: 1500.00 mm

Barrel Material: Concrete

Embedment: 0.00 mm

Barrel Manning's n: 0.0120

Culvert Type: Straight

Inlet Configuration: Square Edge (90°) Headwall

Inlet Depression: NONE

CO07

Crossing Front View (Roadway Profile): CO07

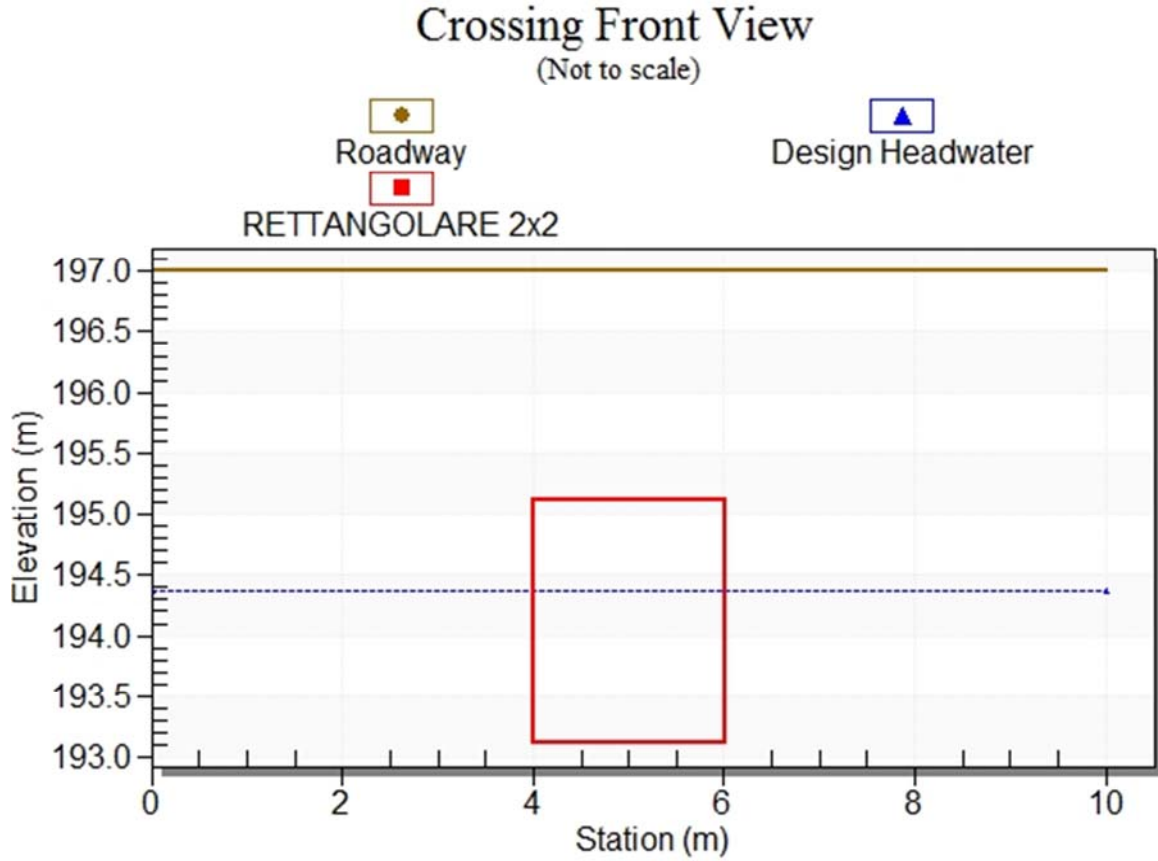

Culvert Performance Curve Plot: RETTANGOLARE 2x2

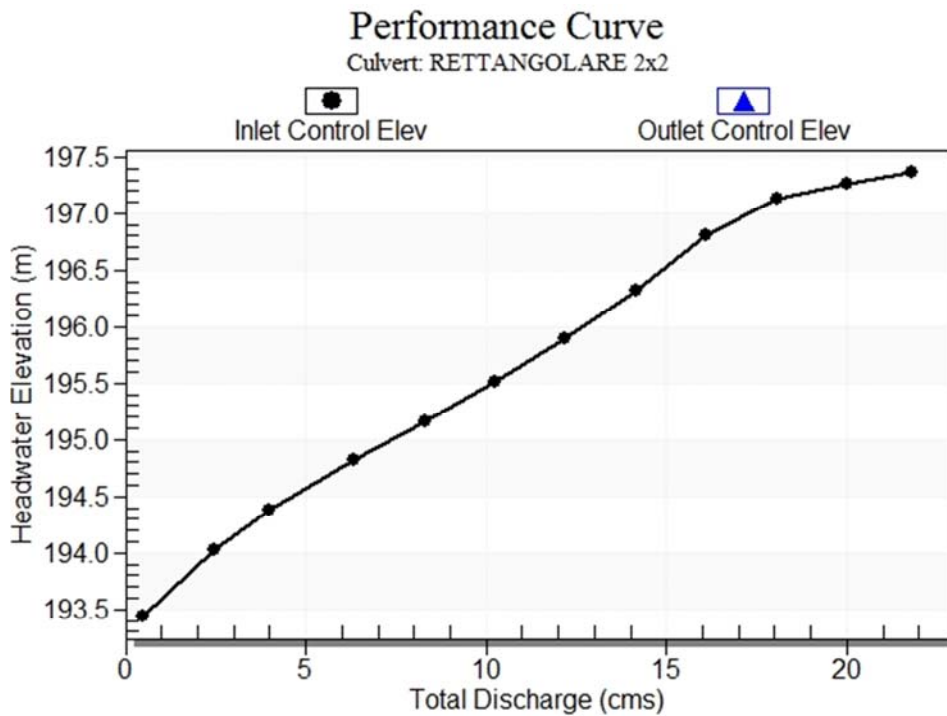

Water Surface Profile Plot for Culvert: RETTANGOLARE 2x2

Crossing - CO07, Design Discharge - 4.00 cms

Culvert - RETTANGOLARE 2x2, Culvert Discharge - 4.00 cms

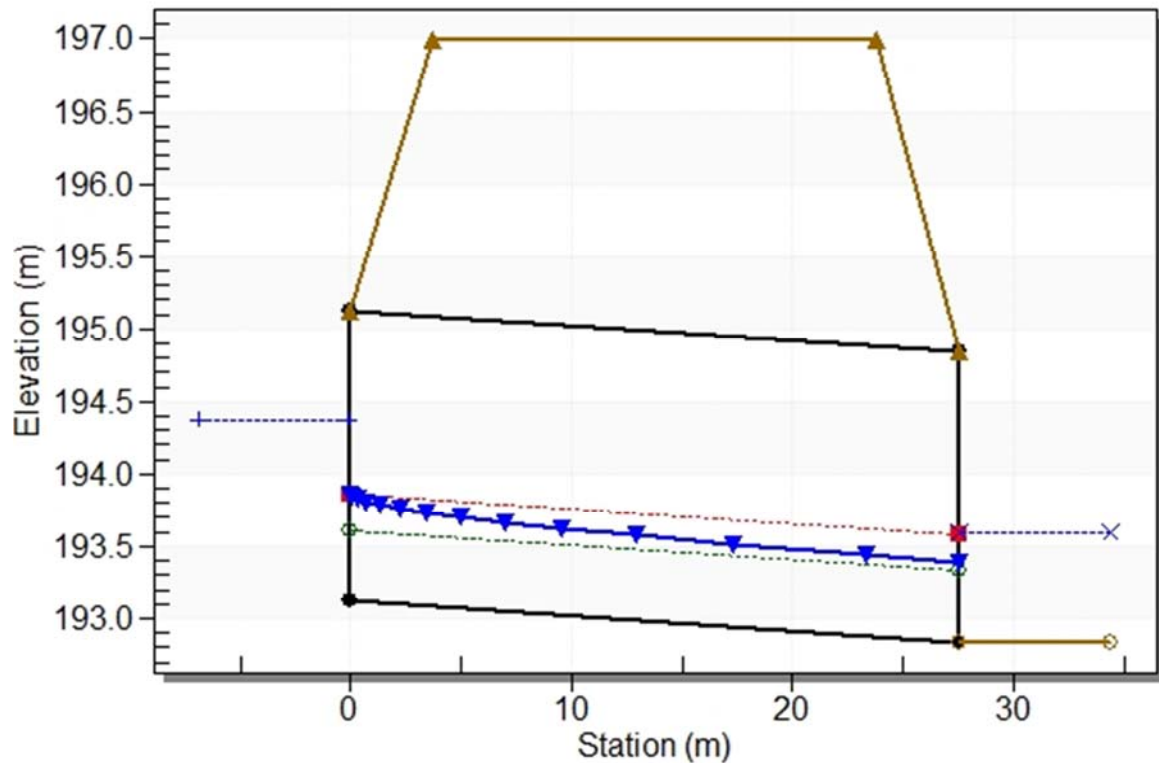

Site Data - RETTANGOLARE 2x2

Site Data Option: Culvert Invert Data

Inlet Station: 0.00 m

Inlet Elevation: 193.12 m

Outlet Station: 27.50 m

Outlet Elevation: 192.84 m

Number of Barrels: 1

Culvert Data Summary - RETTANGOLARE 2x2

Barrel Shape: Concrete Box

Barrel Span: 2000.00 mm

Barrel Rise: 2000.00 mm

Barrel Material: Concrete

Embedment: 0.00 mm

Barrel Manning's n: 0.0120

Culvert Type: Straight

Inlet Configuration: Square Edge (90°) Headwall

Inlet Depression: NONE

CO08

Crossing Front View (Roadway Profile): CO08

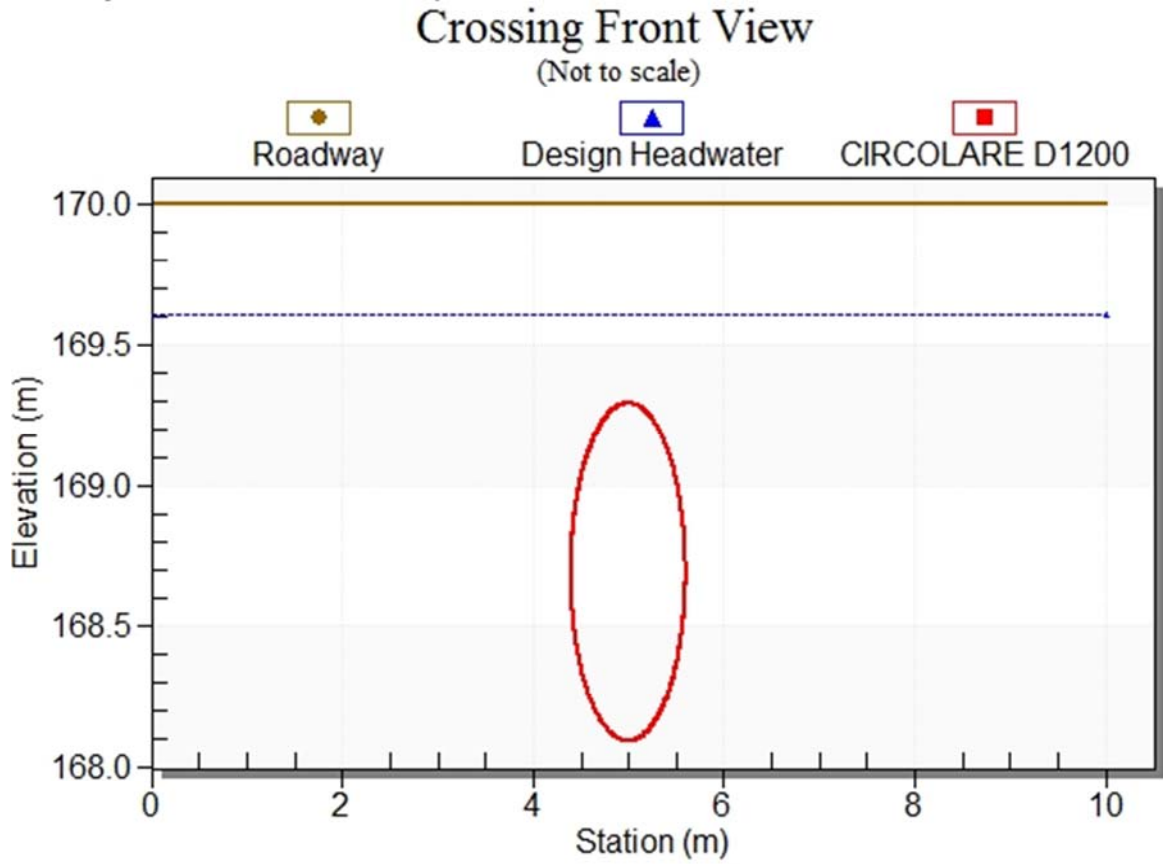

Culvert Performance Curve Plot: CIRCOLARE D1200

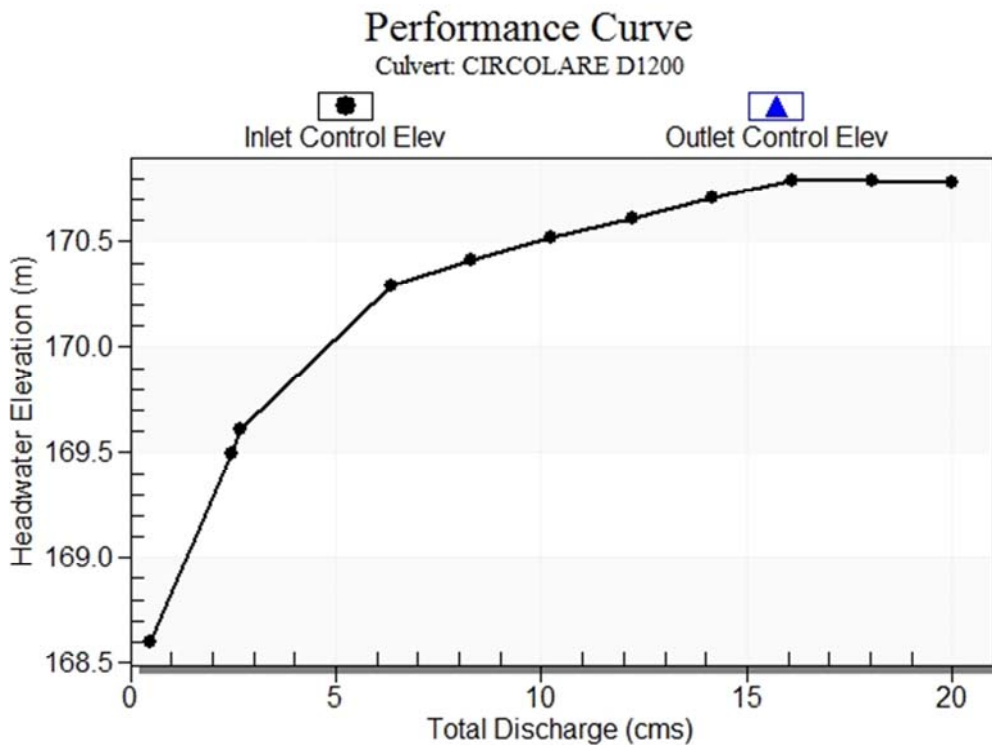

Water Surface Profile Plot for Culvert: CIRCOLARE D1200

Crossing - CO08, Design Discharge - 2.67 cms

Culvert - CIRCOLARE D1200, Culvert Discharge - 2.67 cms

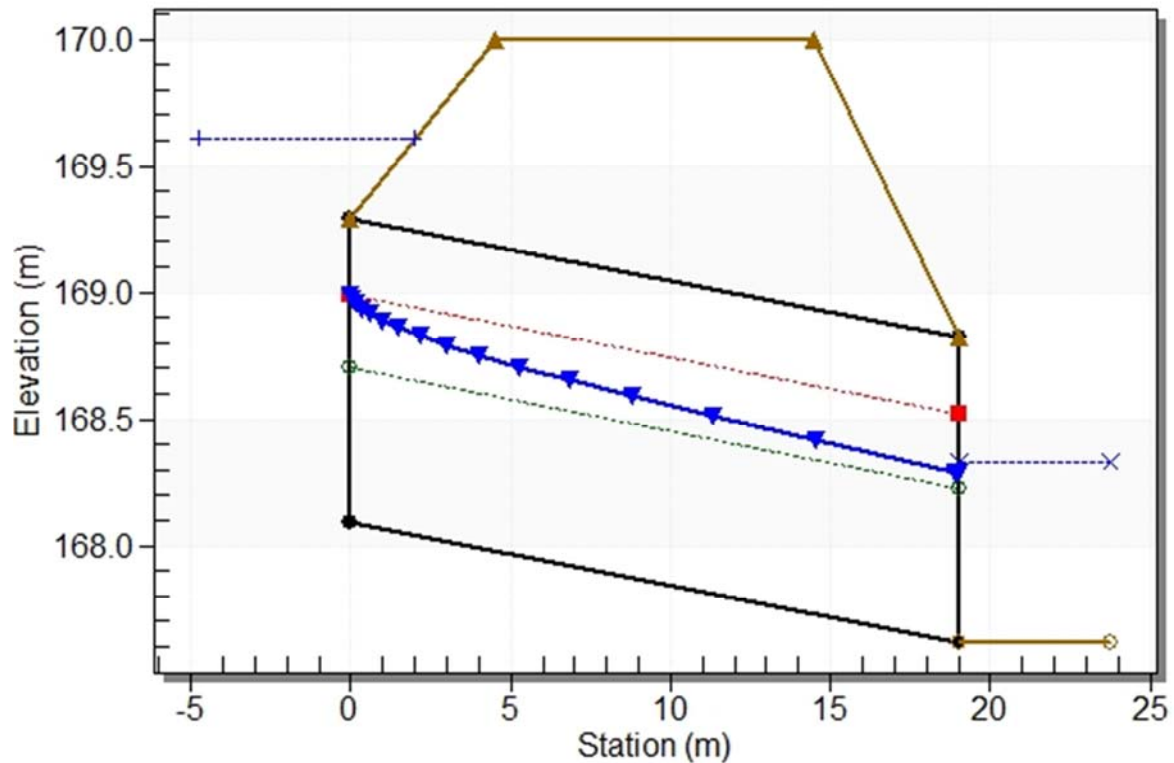

Site Data - CIRCOLARE D1200

Site Data Option: Culvert Invert Data

Inlet Station: 0.00 m

Inlet Elevation: 168.09 m

Outlet Station: 19.00 m

Outlet Elevation: 167.62 m

Number of Barrels: 1

Culvert Data Summary - CIRCOLARE D1200

Barrel Shape: Circular

Barrel Diameter: 1200.00 mm

Barrel Material: Concrete

Embedment: 0.00 mm

Barrel Manning's n: 0.0154

Culvert Type: Straight

Inlet Configuration: Square Edge with Headwall

Inlet Depression: NONE

CO09

Crossing Front View (Roadway Profile): CO09

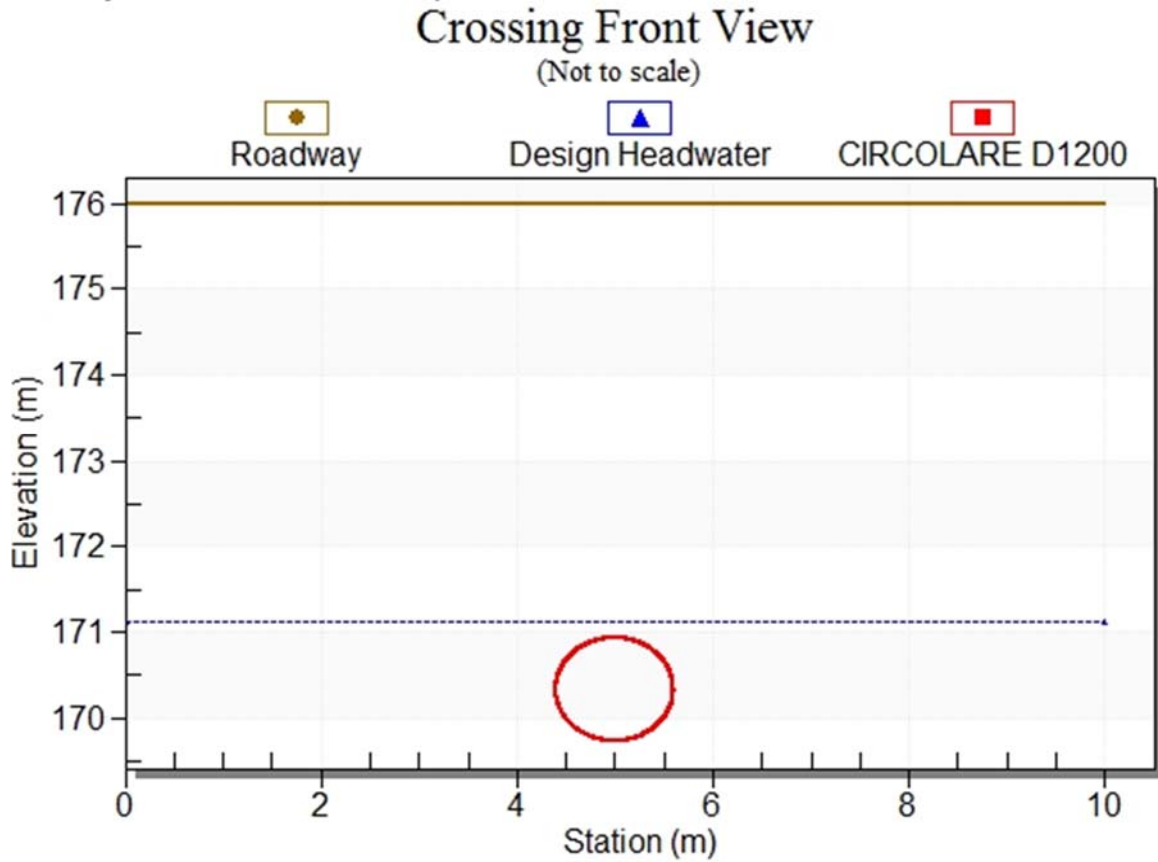

Culvert Performance Curve Plot: CIRCOLARE D1200

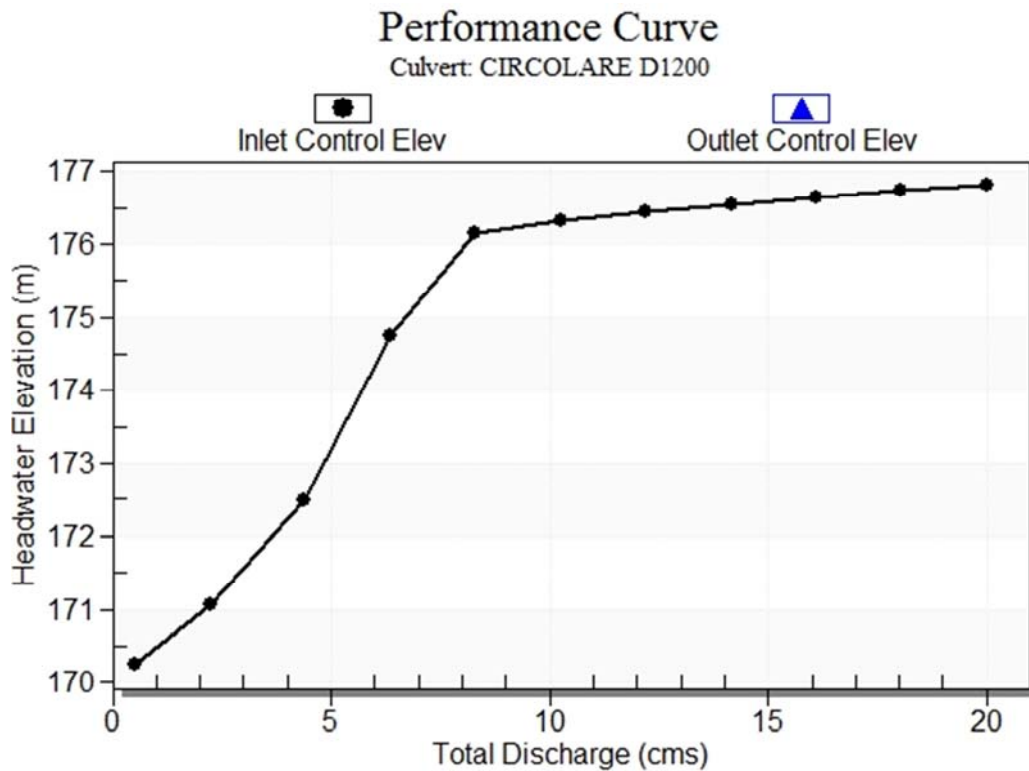

Water Surface Profile Plot for Culvert: CIRCOLARE D1200

Crossing - CO09, Design Discharge - 2.25 cms

Culvert - CIRCOLARE D1200, Culvert Discharge - 2.25 cms

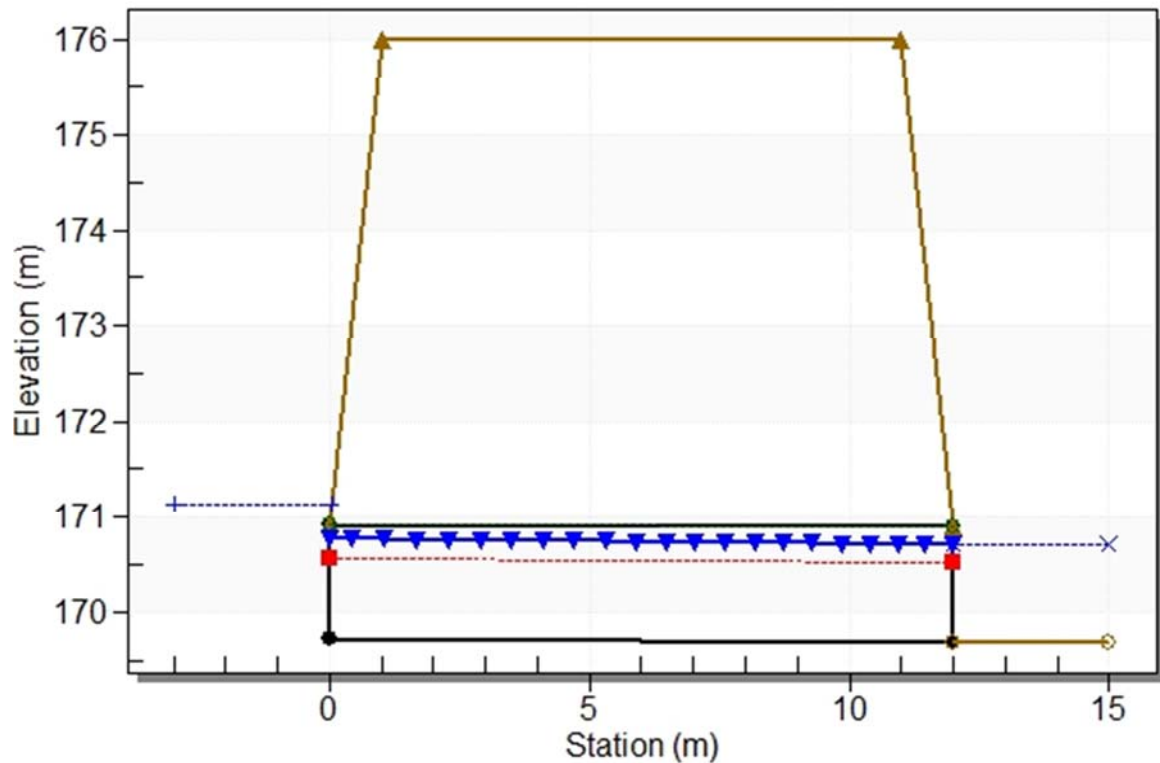

Site Data - CIRCOLARE D1200

Site Data Option: Culvert Invert Data

Inlet Station: 0.00 m

Inlet Elevation: 169.73 m

Outlet Station: 12.00 m

Outlet Elevation: 169.69 m

Number of Barrels: 1

Culvert Data Summary - CIRCOLARE D1200

Barrel Shape: Circular

Barrel Diameter: 1200.00 mm

Barrel Material: Concrete

Embedment: 0.00 mm

Barrel Manning's n: 0.0154

Culvert Type: Straight

Inlet Configuration: Square Edge with Headwall

Inlet Depression: NONE

CO10

Crossing Front View (Roadway Profile): CO10

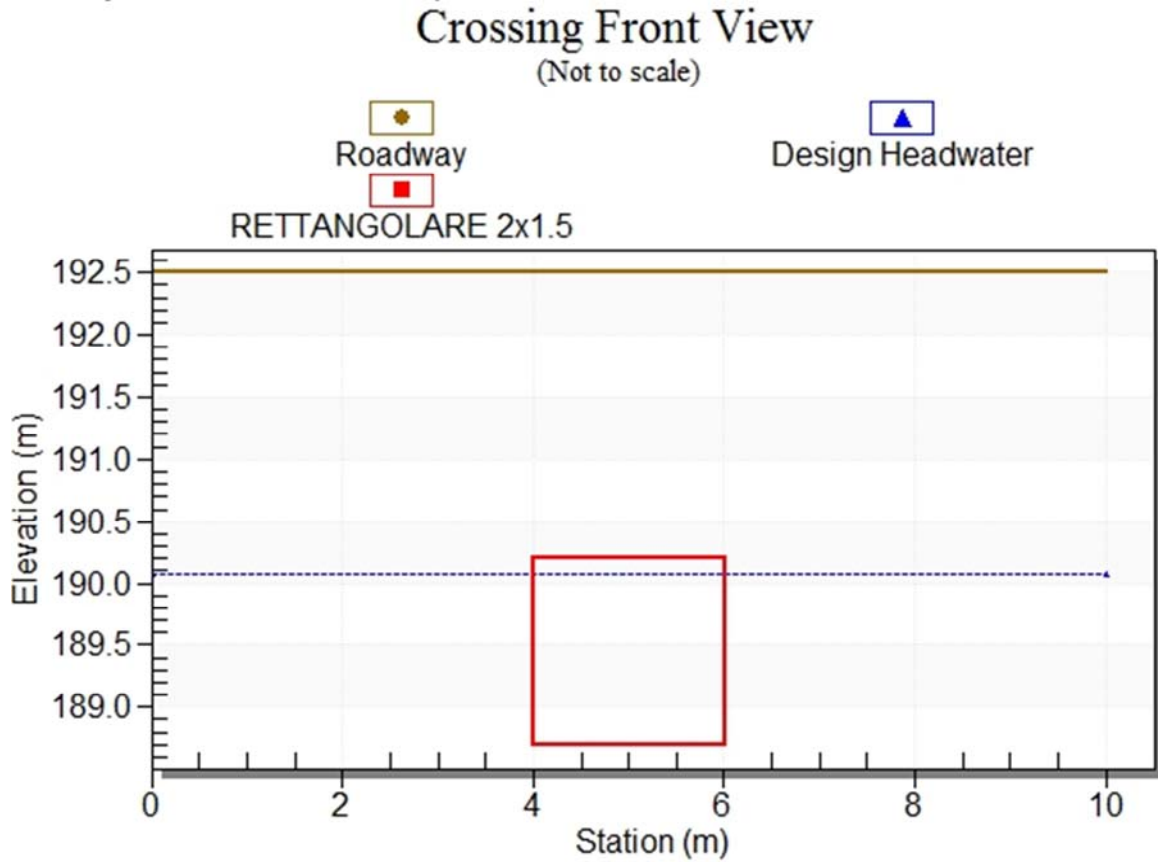

Culvert Performance Curve Plot: RETTANGOLARE 2x1.5

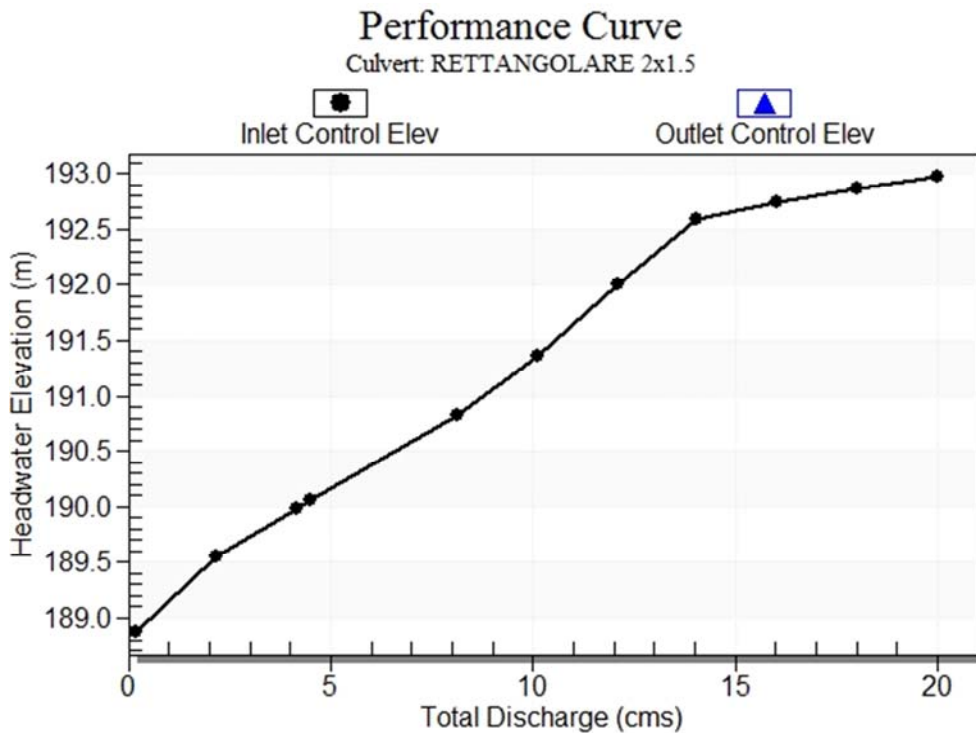

Water Surface Profile Plot for Culvert: RETTANGOLARE 2x1.5
Crossing - CO10, Design Discharge - 4.48 cms
 Culvert - RETTANGOLARE 2x1.5, Culvert Discharge - 4.48 cms

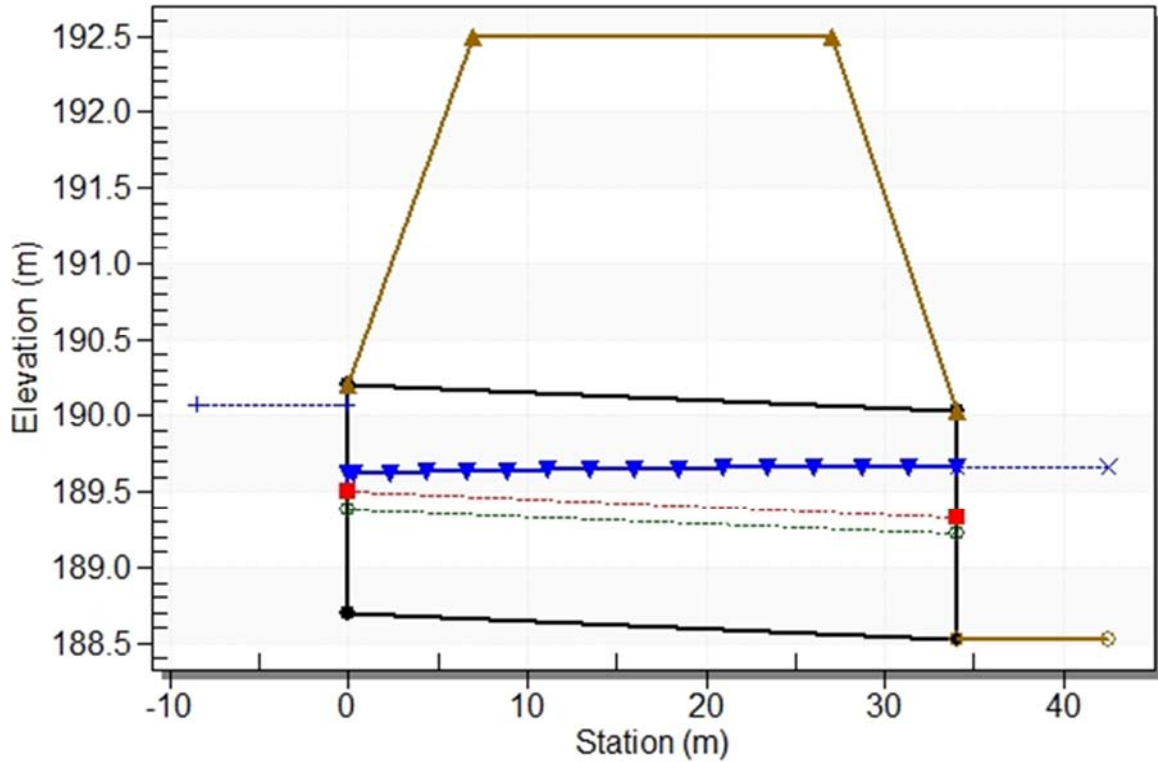

Site Data - RETTANGOLARE 2x1.5

Site Data Option: Culvert Invert Data

Inlet Station: 0.00 m

Inlet Elevation: 188.70 m

Outlet Station: 34.00 m

Outlet Elevation: 188.53 m

Number of Barrels: 1

Culvert Data Summary - RETTANGOLARE 2x1.5

Barrel Shape: Concrete Box

Barrel Span: 2000.00 mm

Barrel Rise: 1500.00 mm

Barrel Material: Concrete

Embedment: 0.00 mm

Barrel Manning's n: 0.0120

Culvert Type: Straight

Inlet Configuration: Square Edge (90°) Headwall

Inlet Depression: NONE

CO11

Crossing Front View (Roadway Profile): CO11

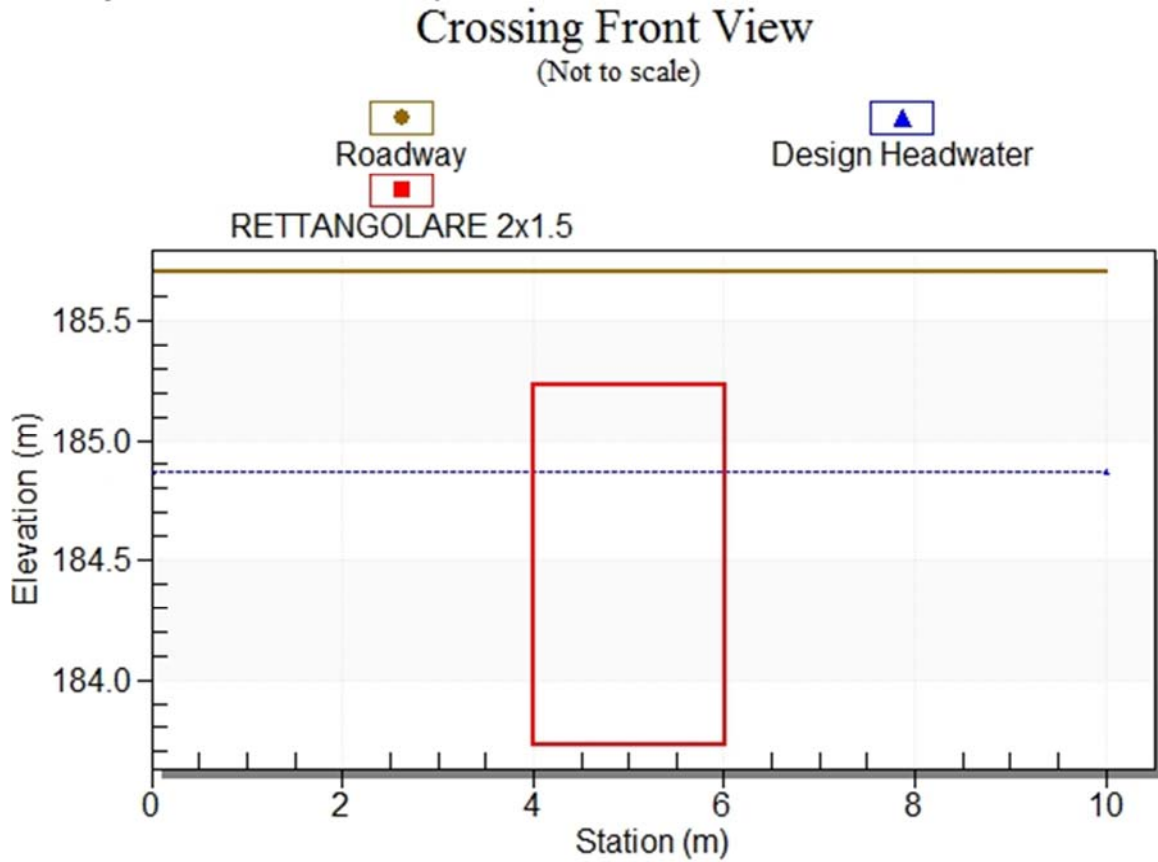

Culvert Performance Curve Plot: RETTANGOLARE 2x1.5

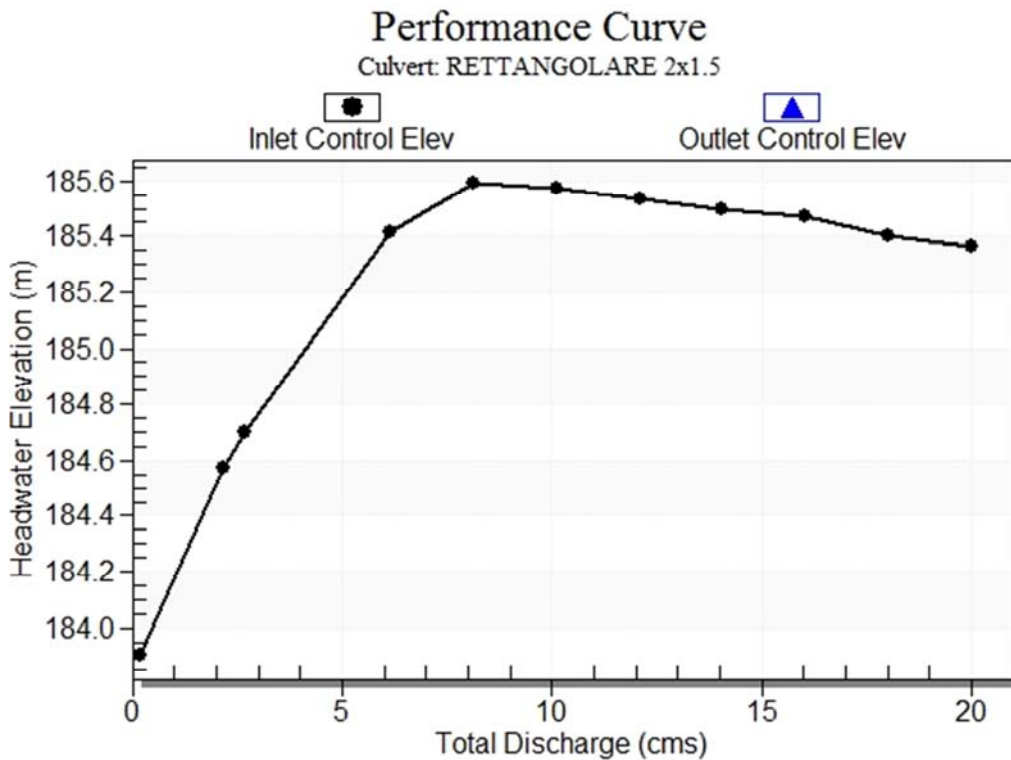

Water Surface Profile Plot for Culvert: RETTANGOLARE 2x1.5
Crossing - CO11, Design Discharge - 2.70 cms
 Culvert - RETTANGOLARE 2x1.5, Culvert Discharge - 2.70 cms

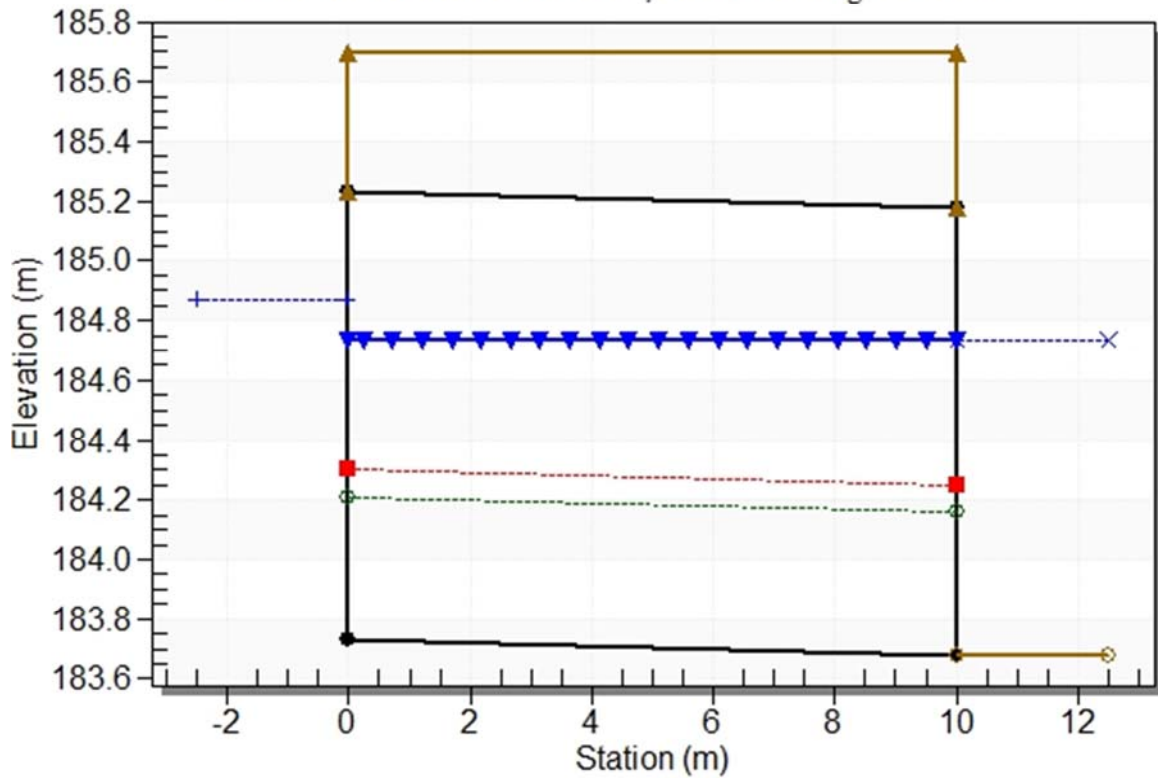

Site Data - RETTANGOLARE 2x1.5

Site Data Option: Culvert Invert Data

Inlet Station: 0.00 m

Inlet Elevation: 183.73 m

Outlet Station: 10.00 m

Outlet Elevation: 183.68 m

Number of Barrels: 1

Culvert Data Summary - RETTANGOLARE 2x1.5

Barrel Shape: Concrete Box

Barrel Span: 2000.00 mm

Barrel Rise: 1500.00 mm

Barrel Material: Concrete

Embedment: 0.00 mm

Barrel Manning's n: 0.0120

Culvert Type: Straight

Inlet Configuration: Square Edge (90°) Headwall

Inlet Depression: NONE