

CARPENTERIA SPALLA 2 scala 1:100

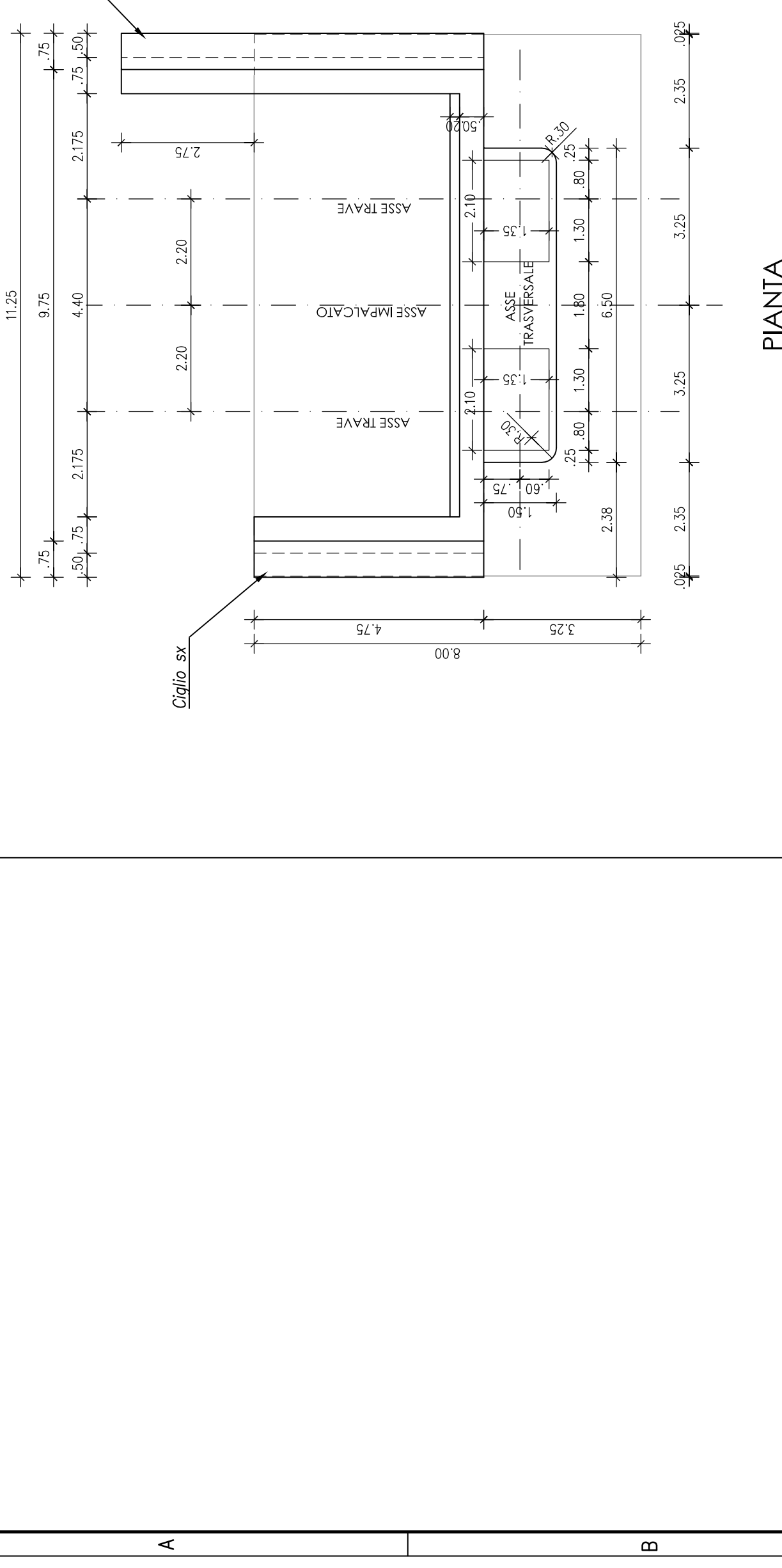

ARMATURA SPALLA 2 scala 1:50

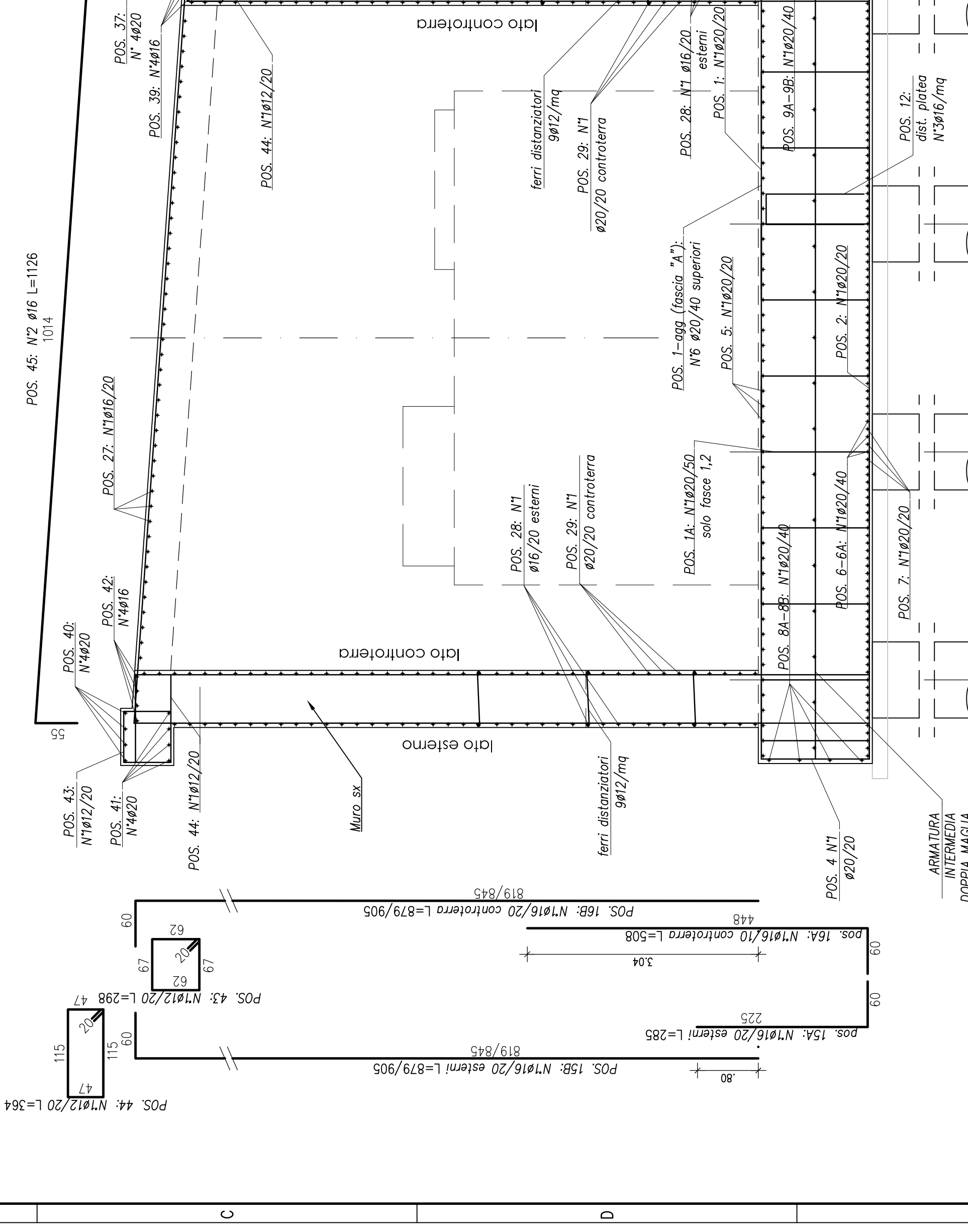

CARPENTERIA SPALLA 2 scala 1:100

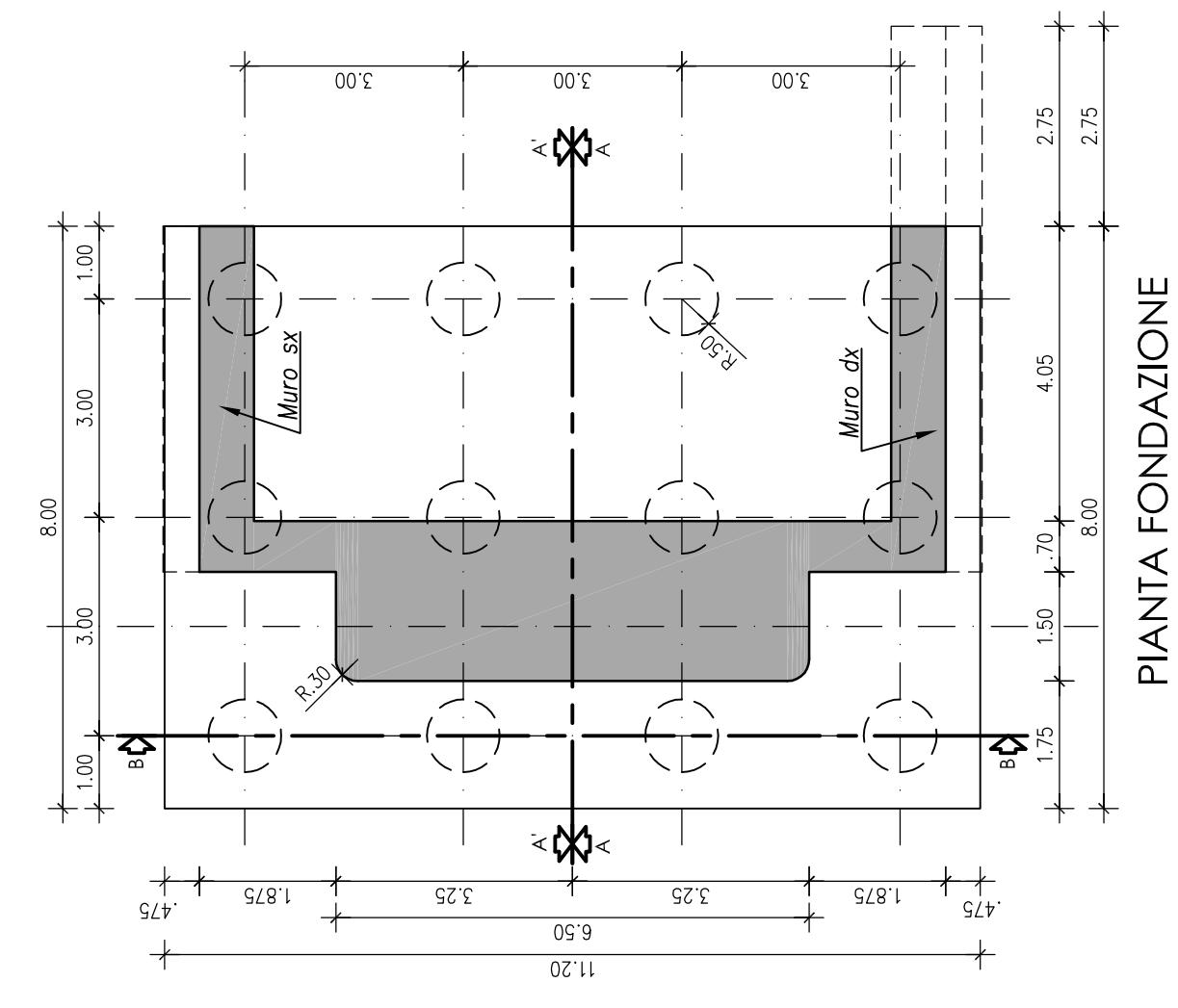

PIANTA

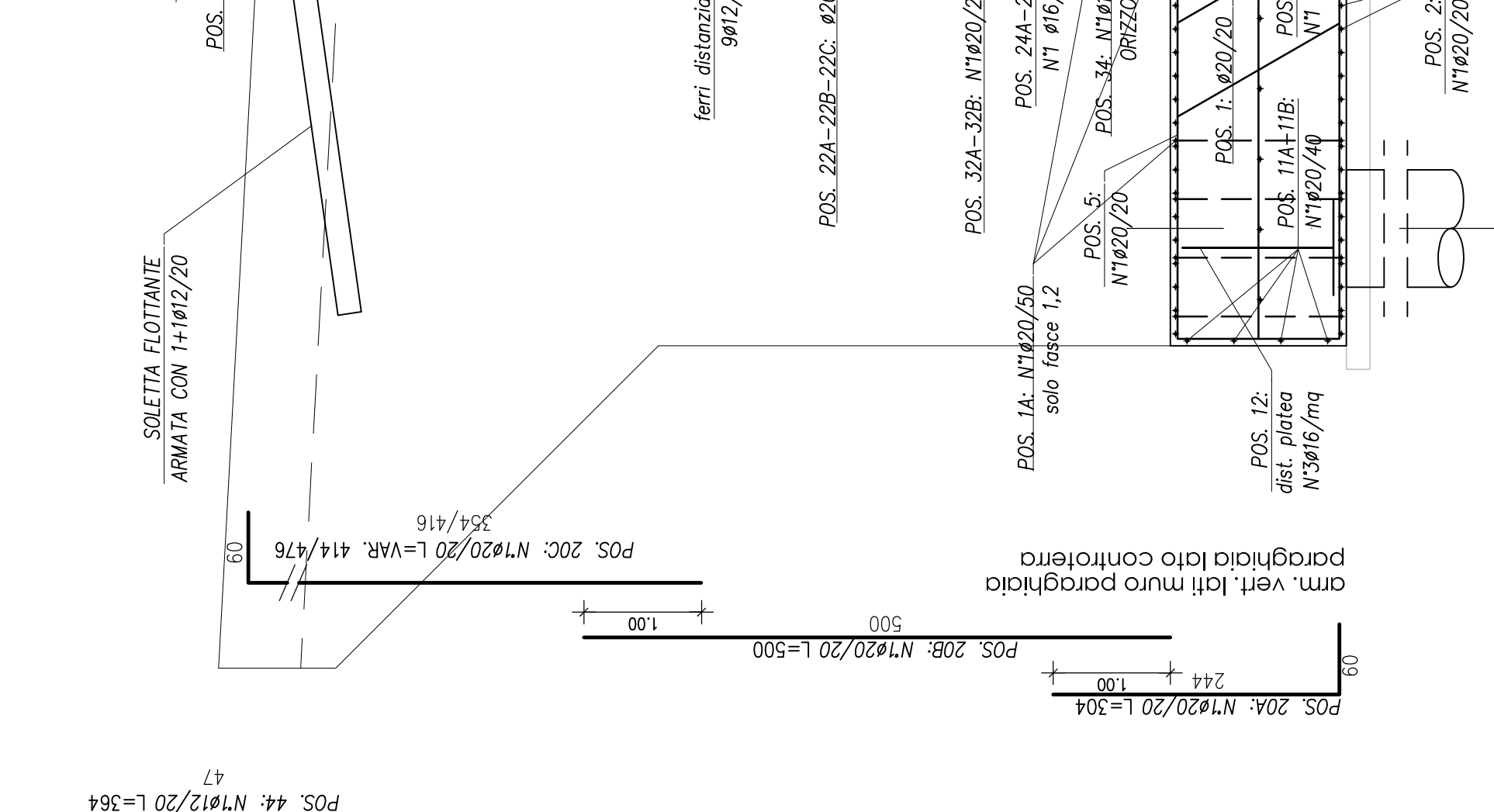

CARPENTERIA SPALLA 2 scala 1:100

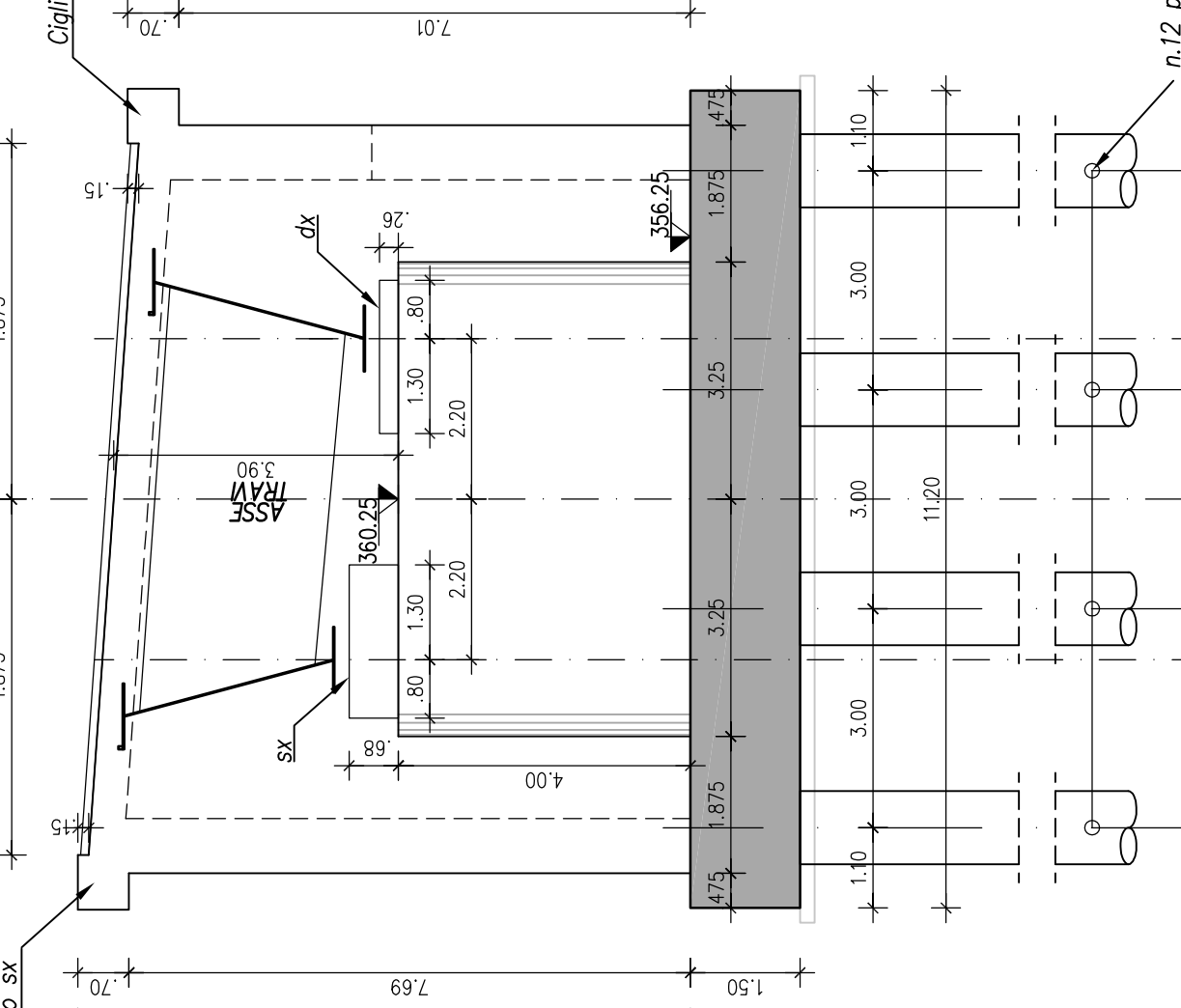

PIANTA

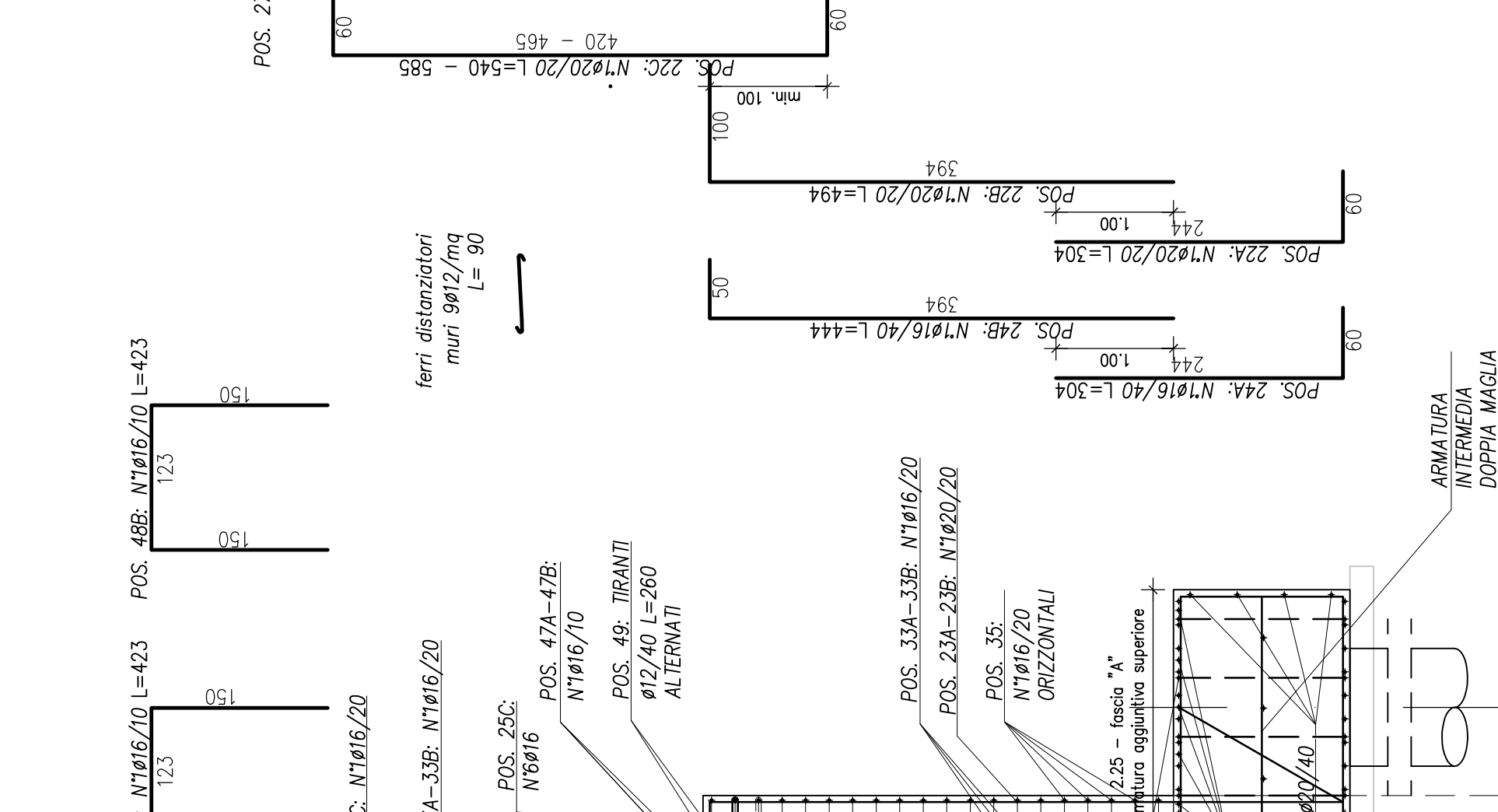

CARPENTERIA SPALLA 2 scala 1:100

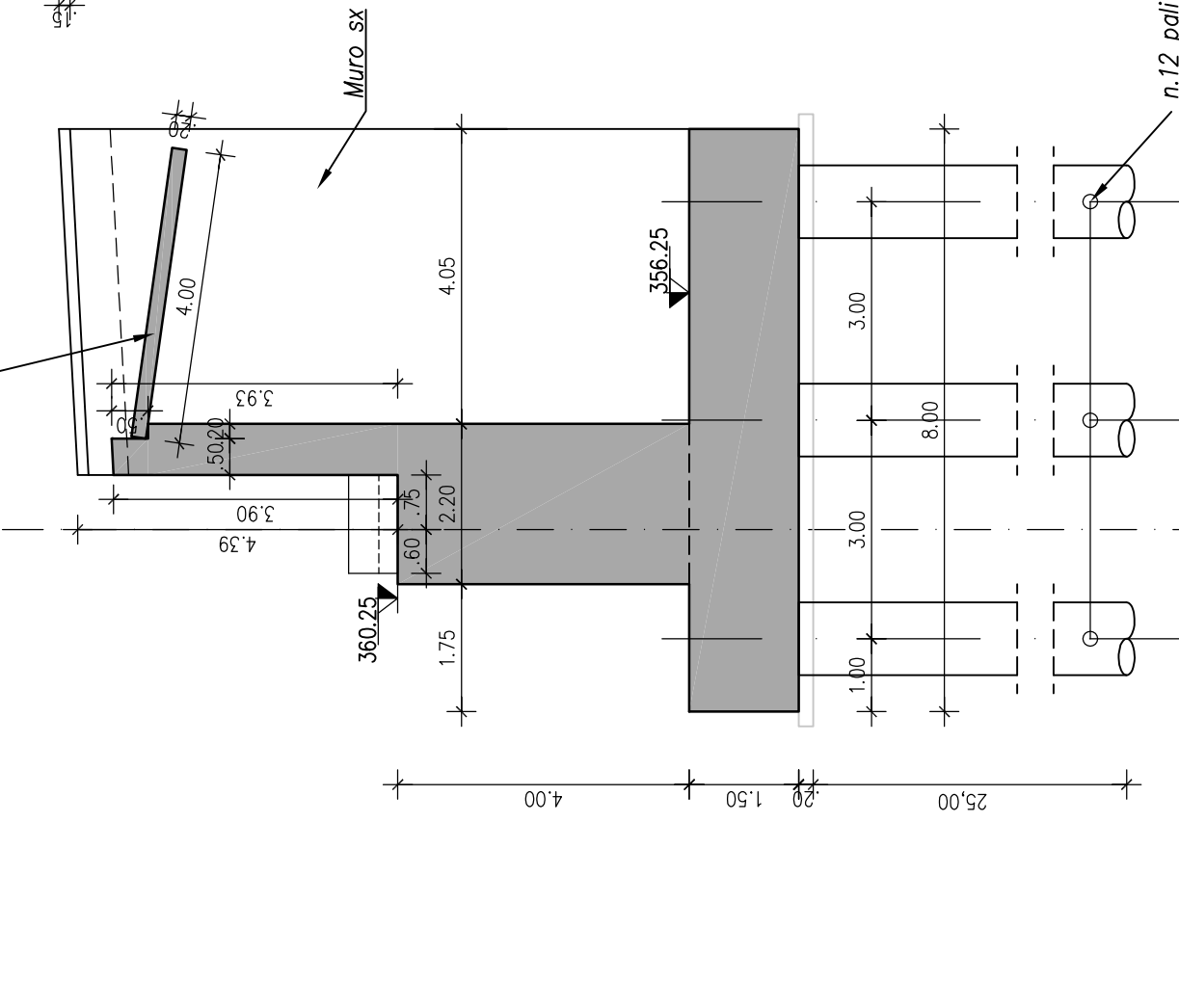

PIANTA

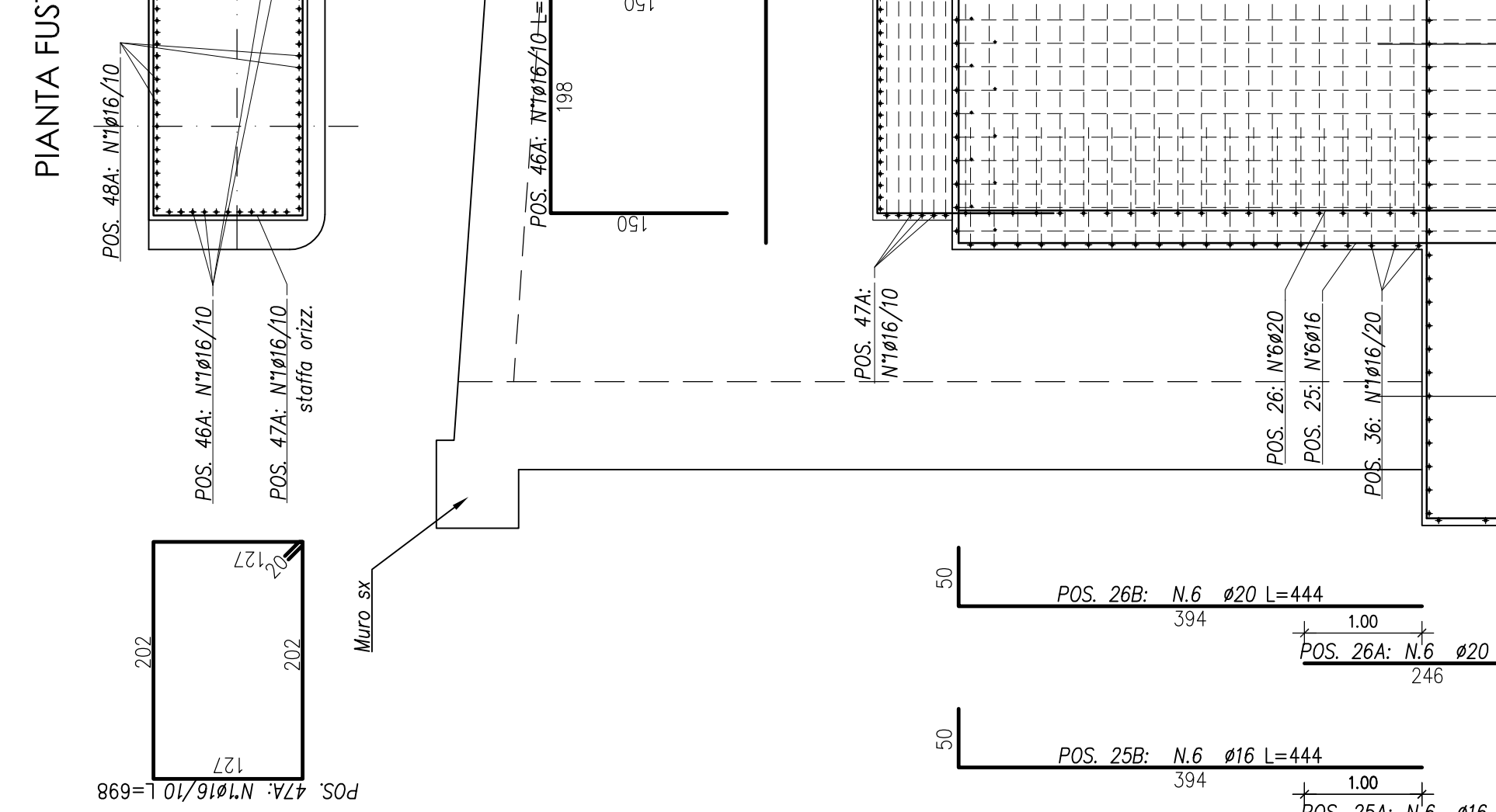

CARPENTERIA SPALLA 2 scala 1:100

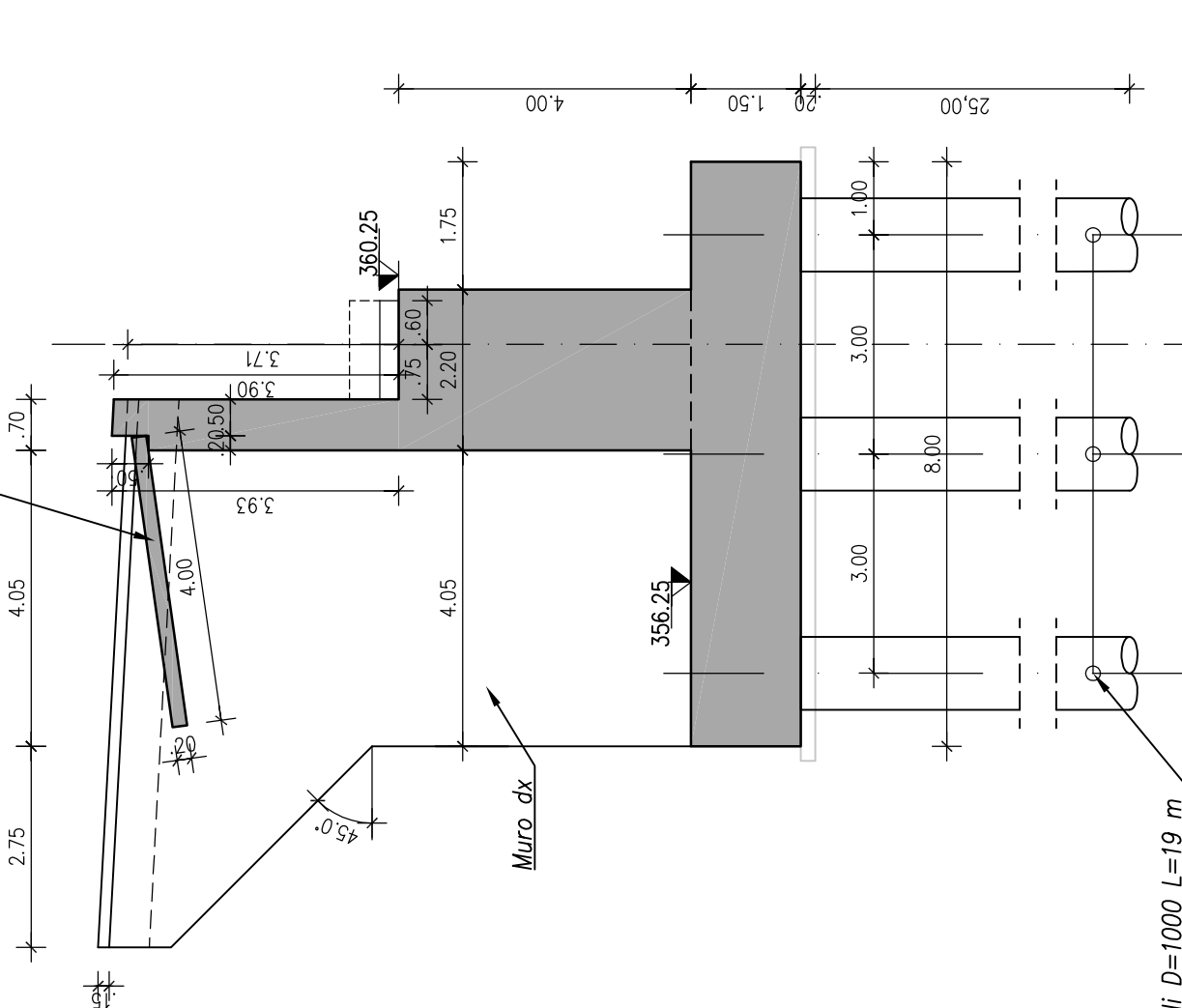

PIANTA

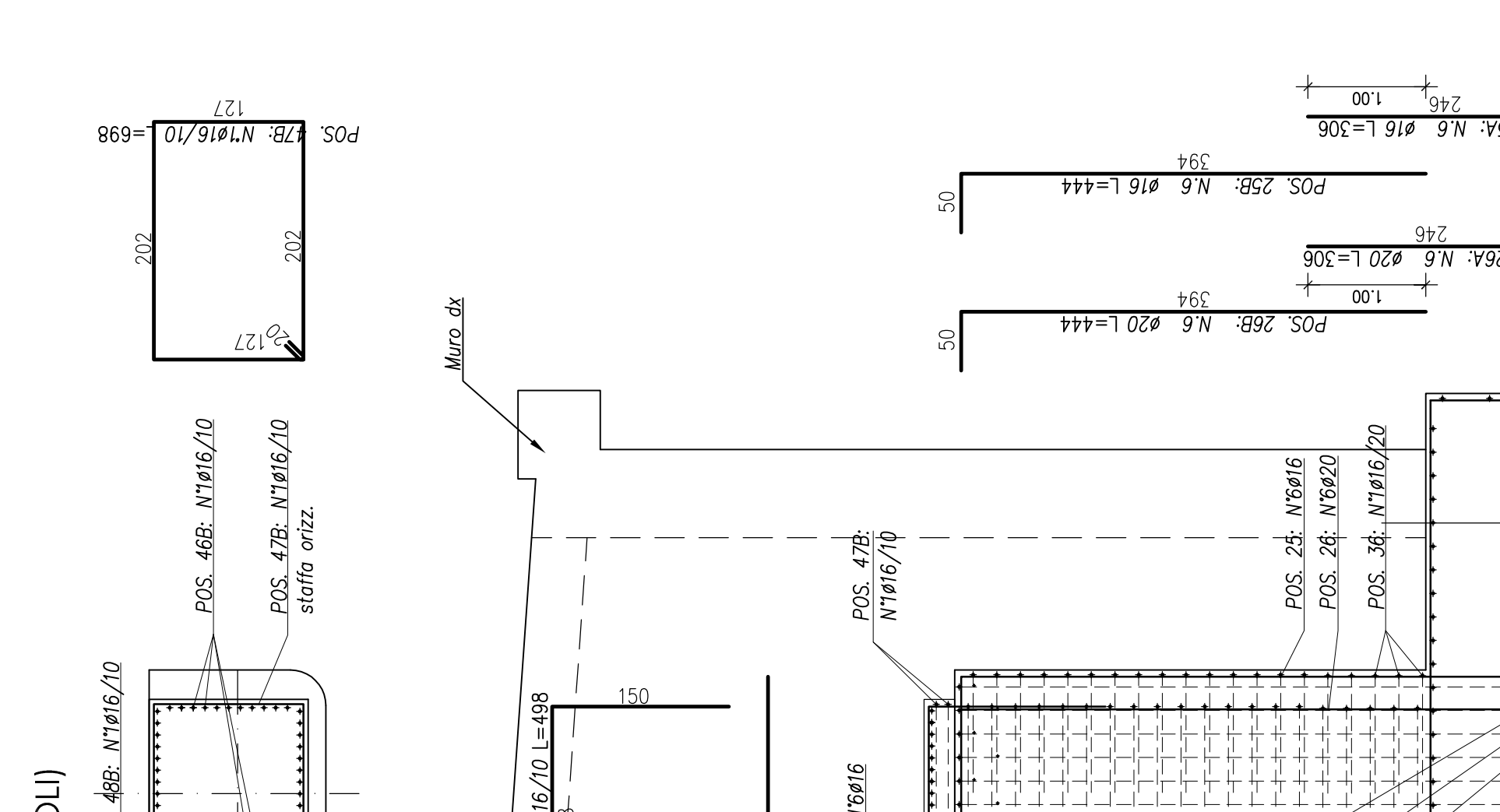
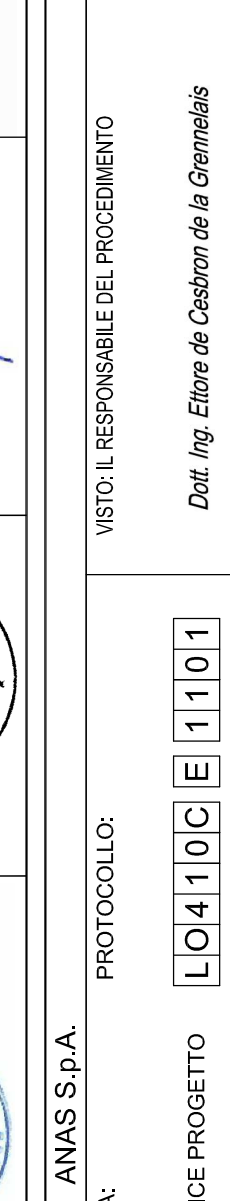
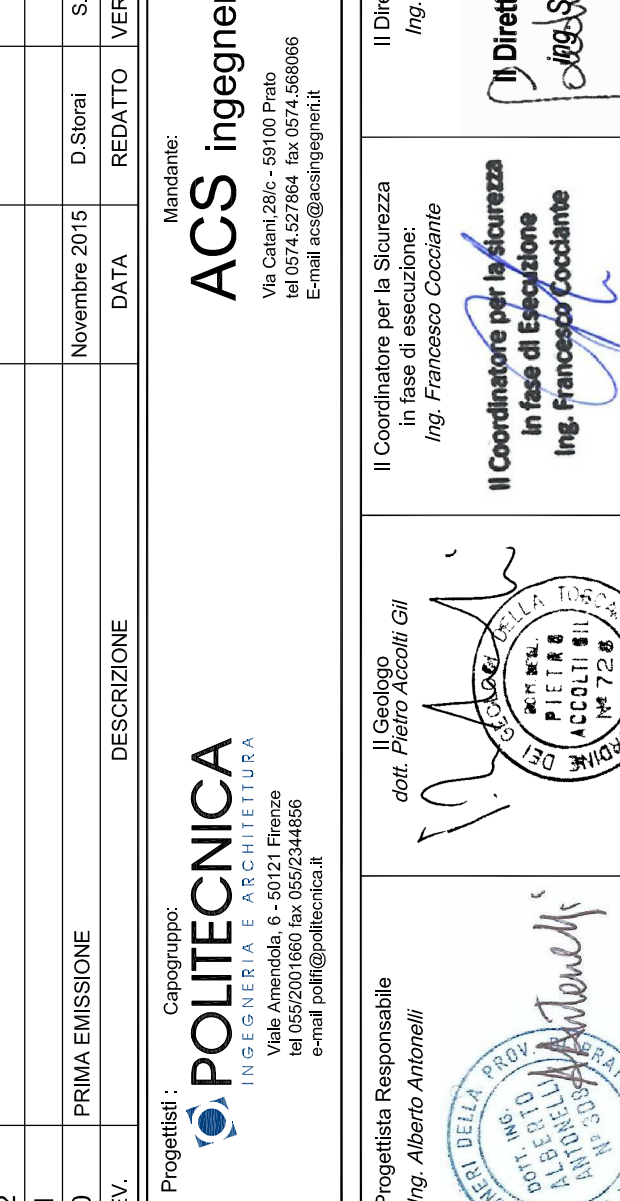
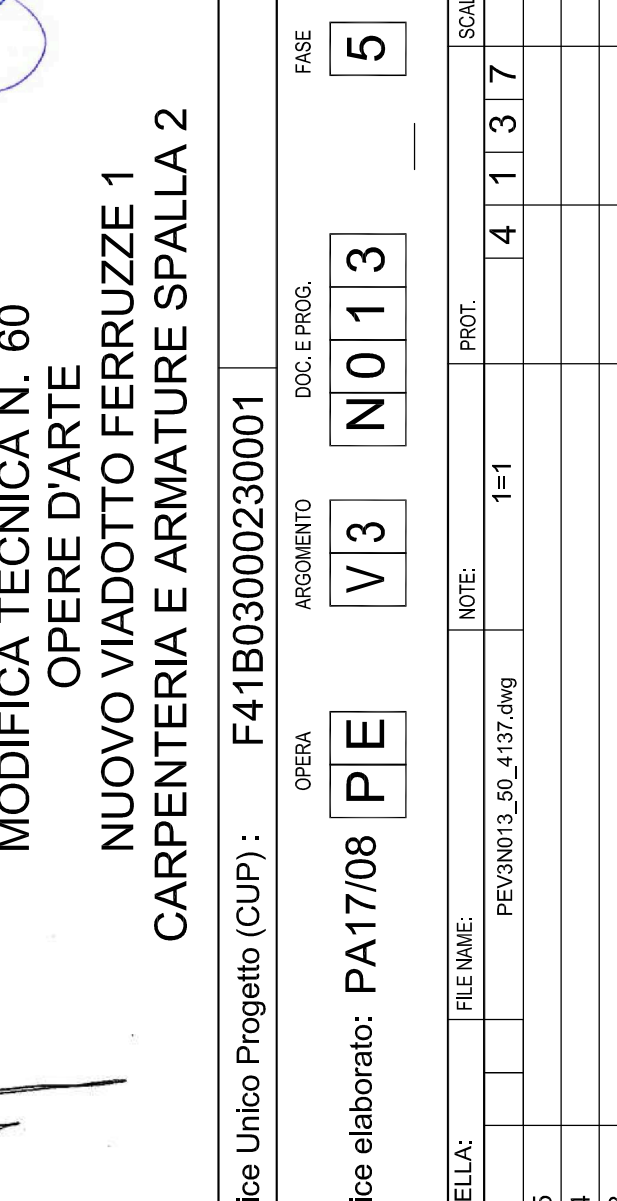
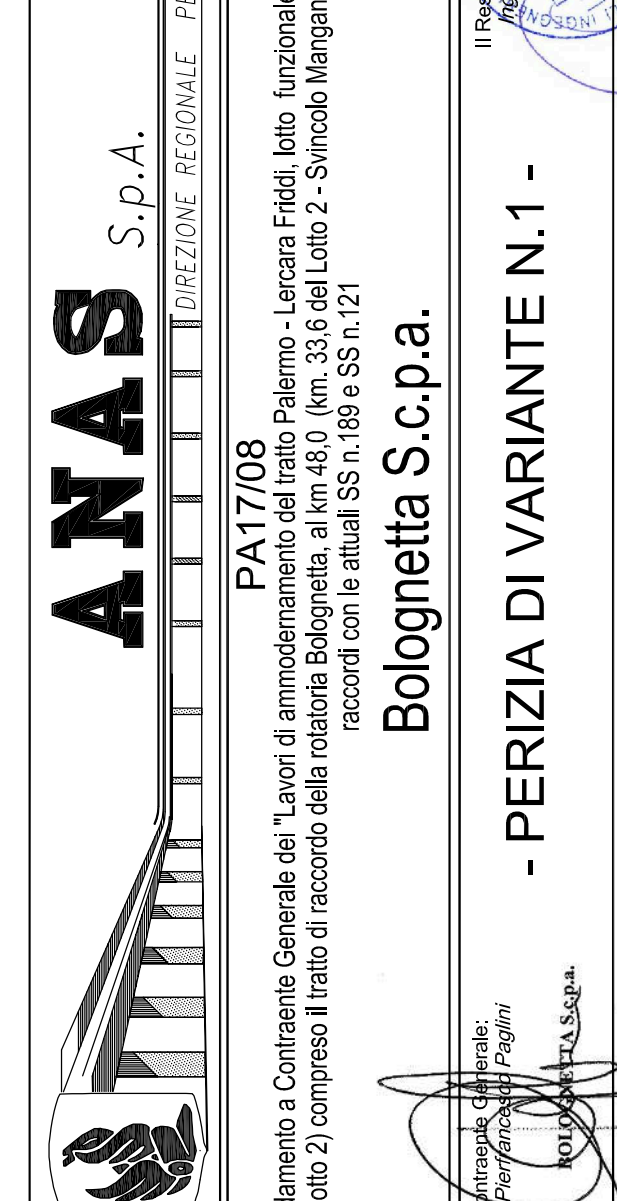
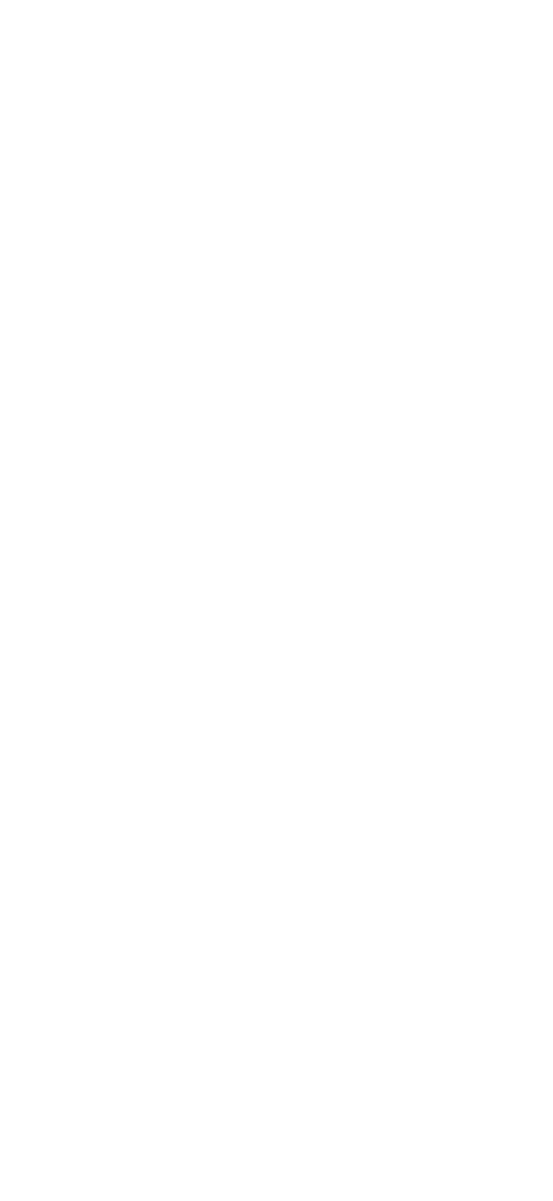
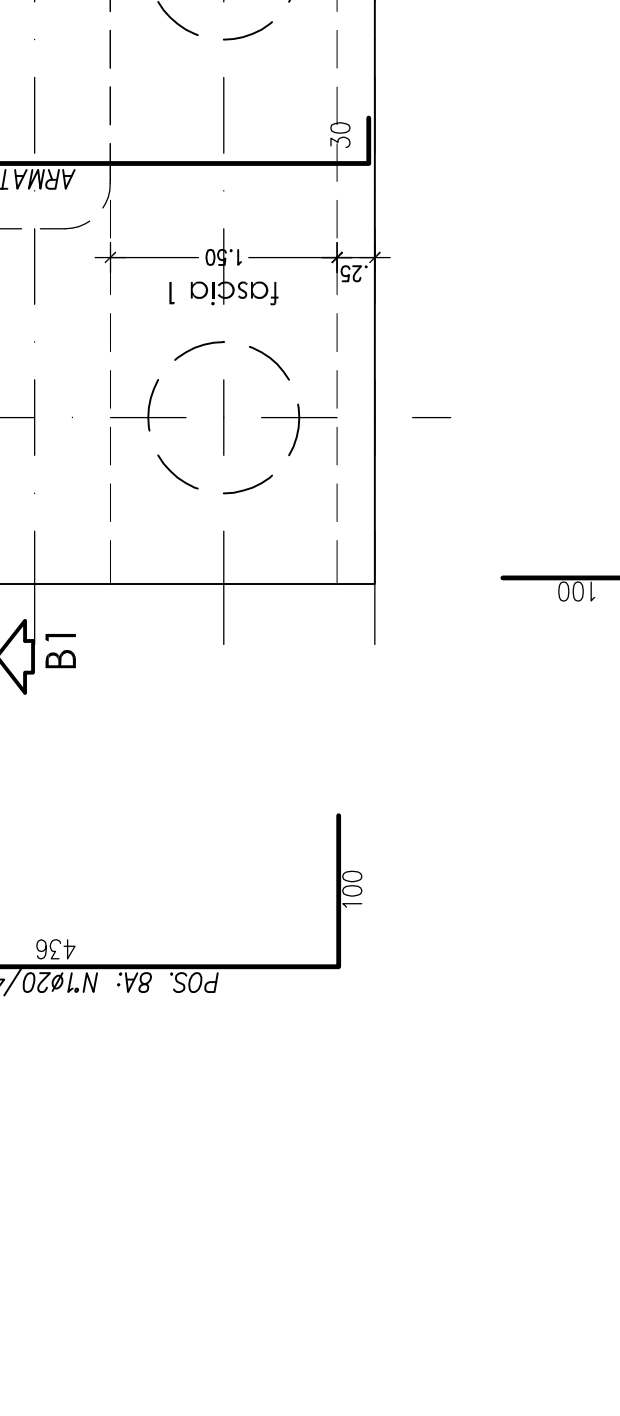
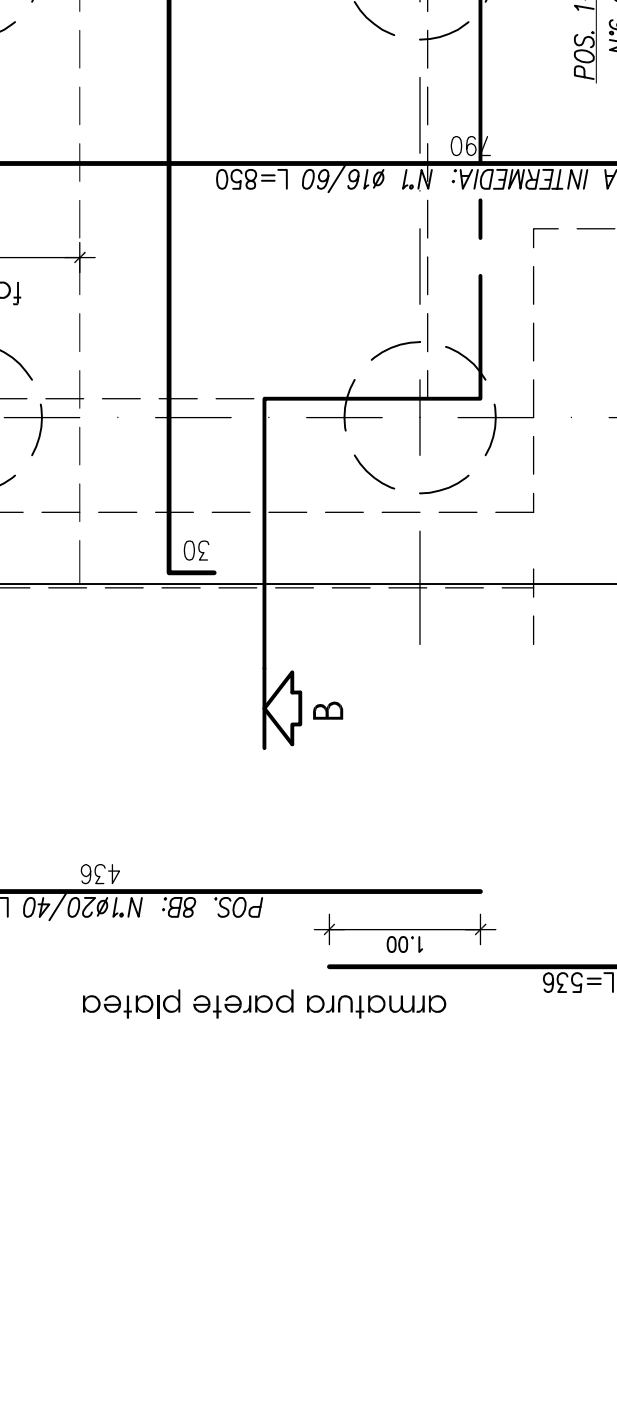
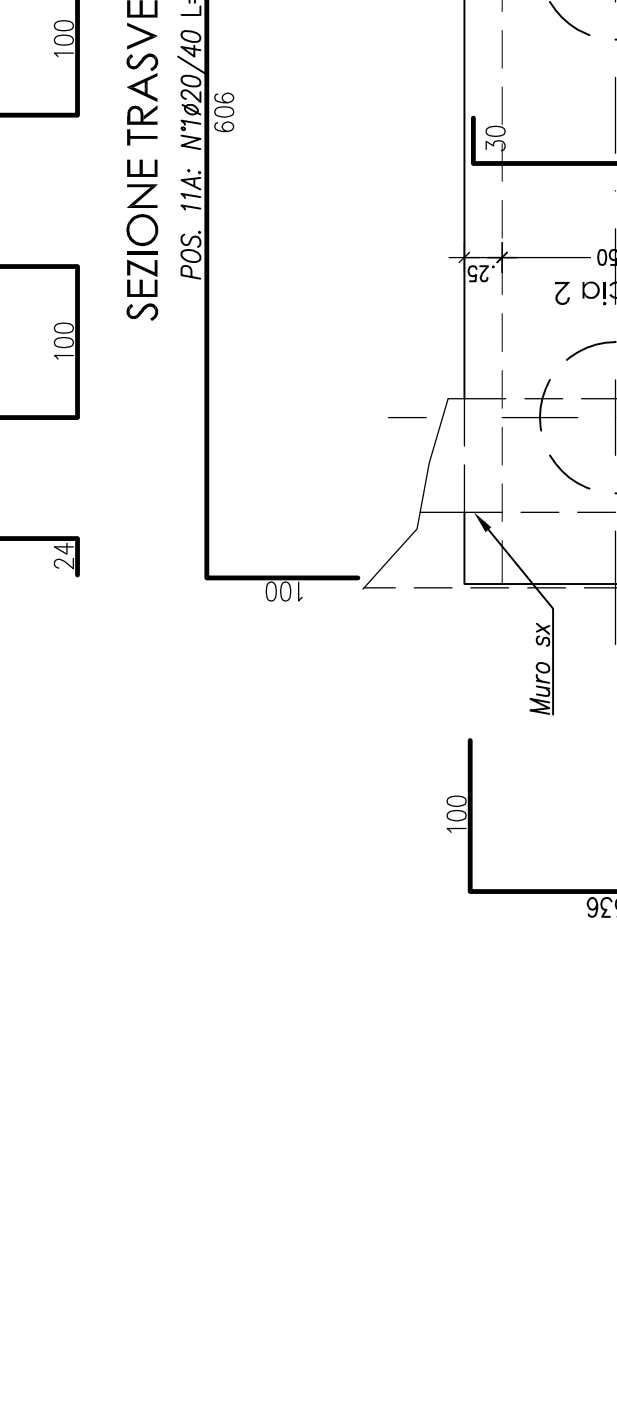
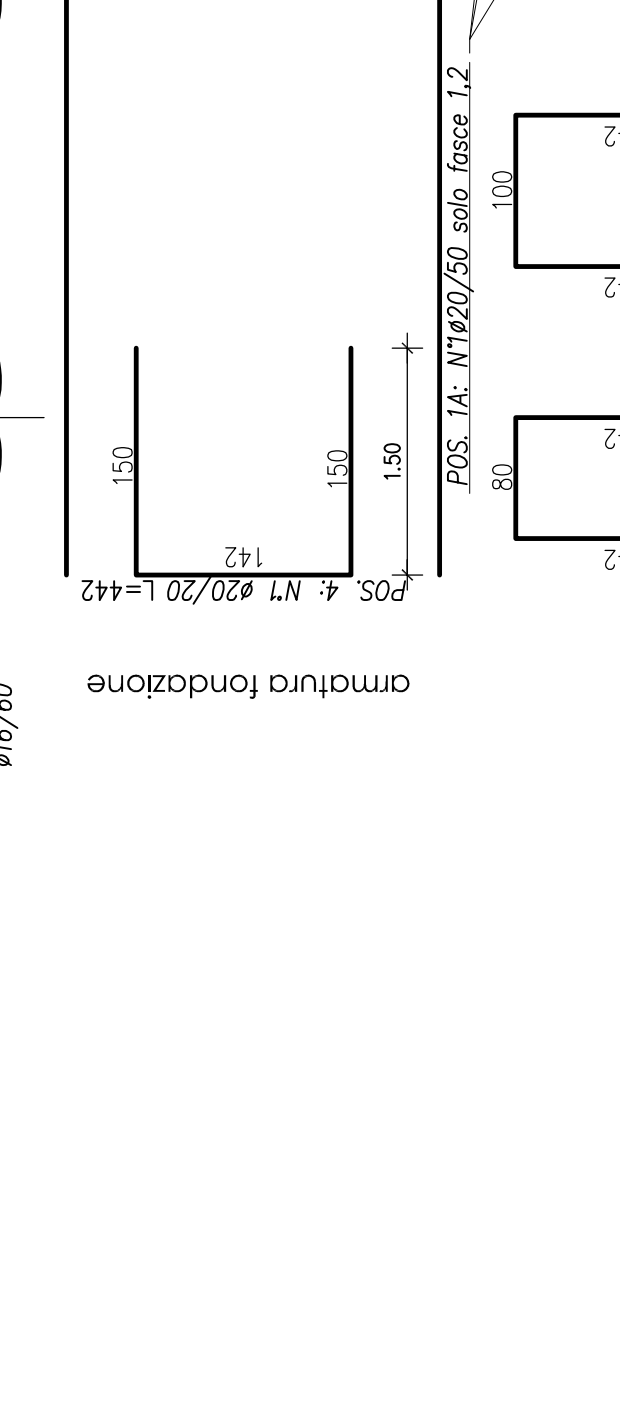
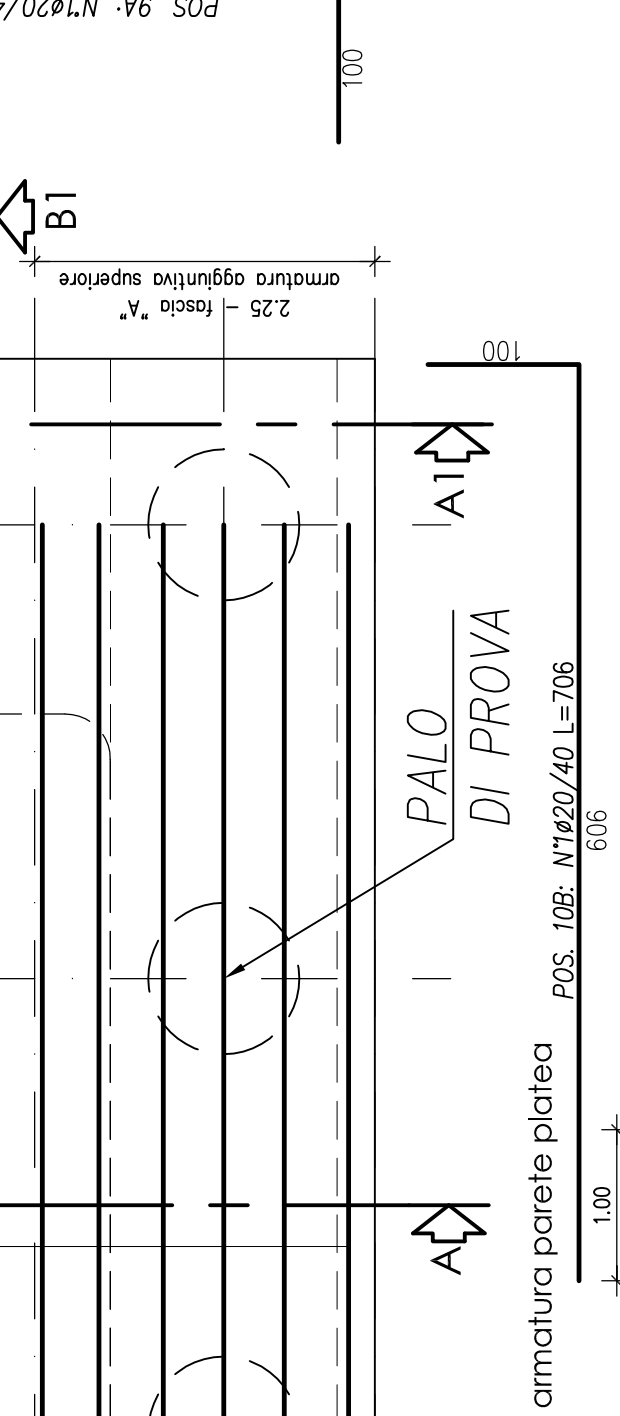
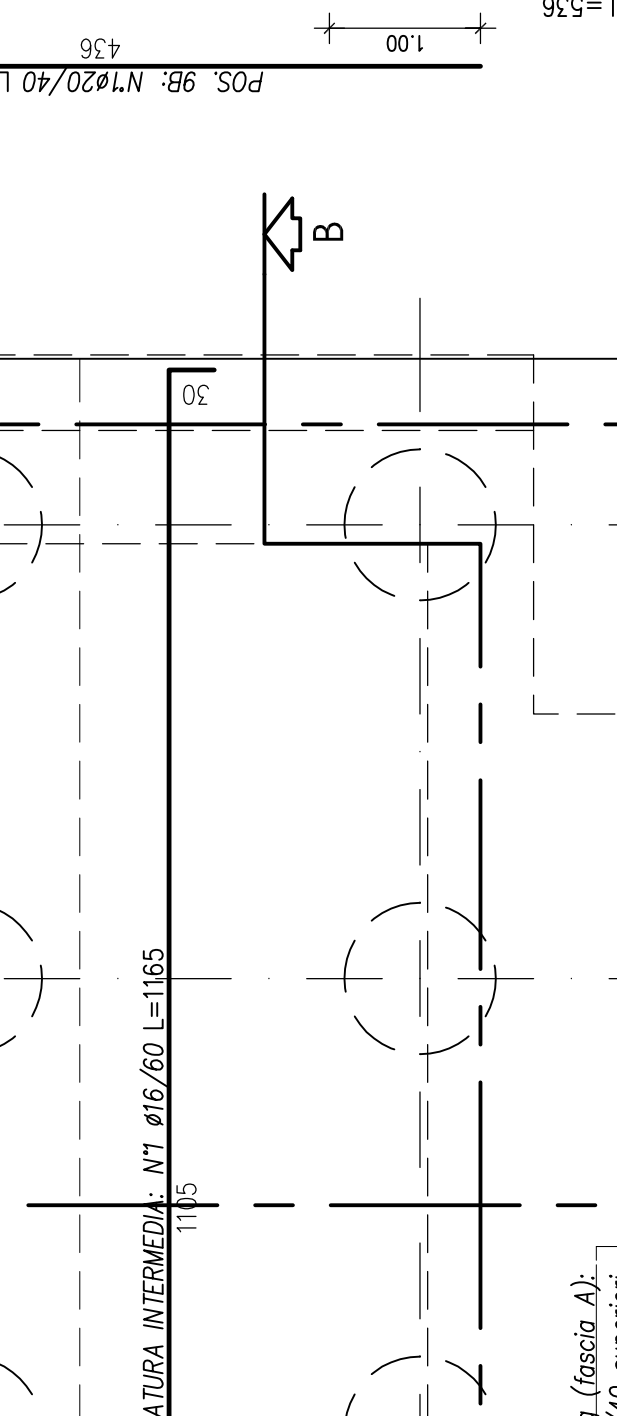
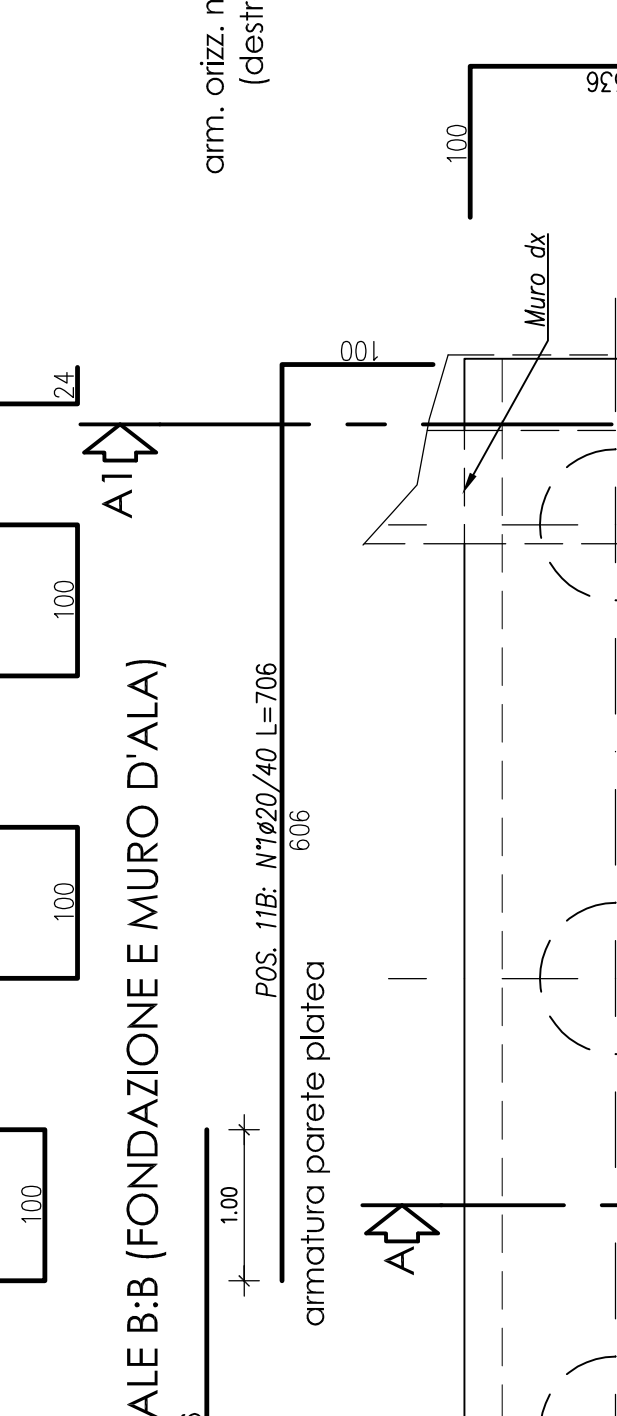
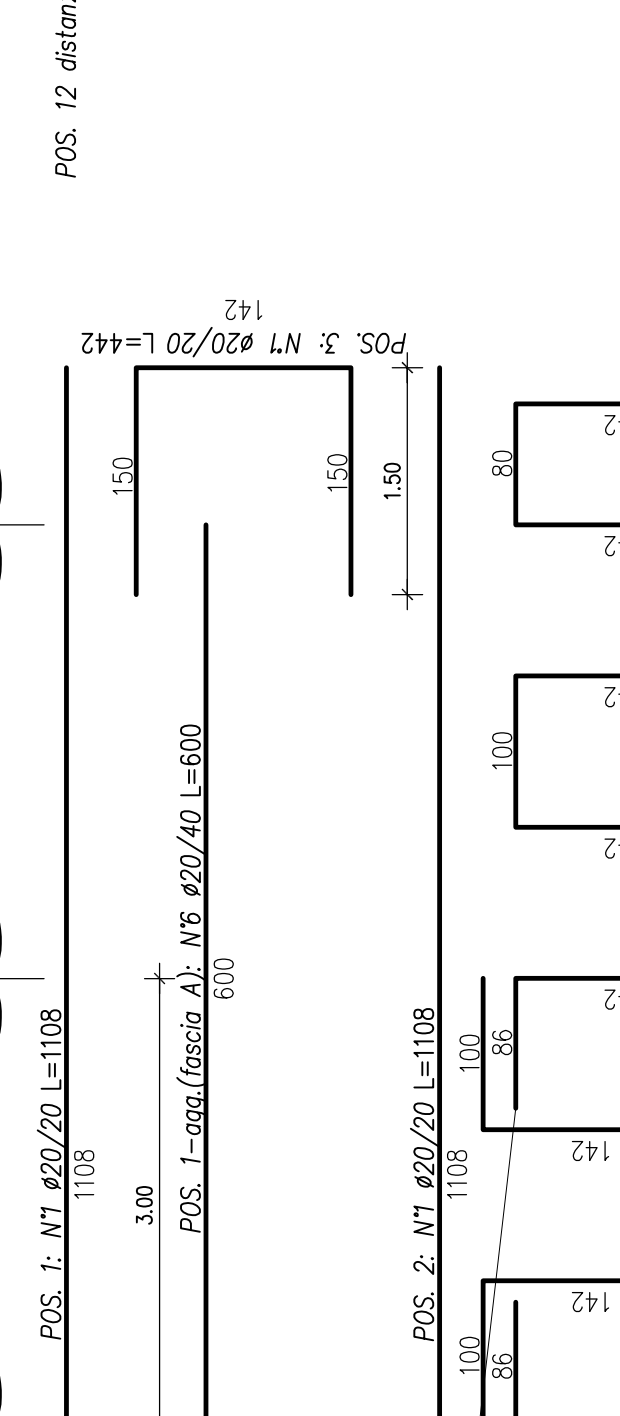
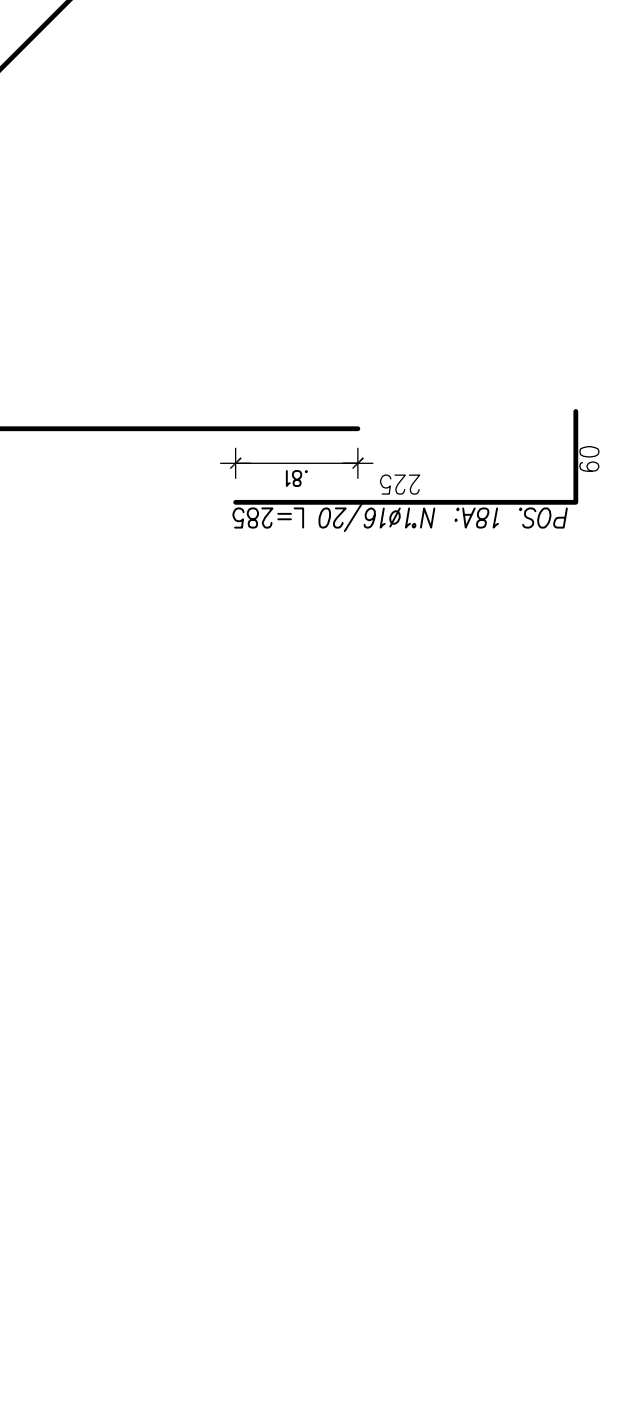
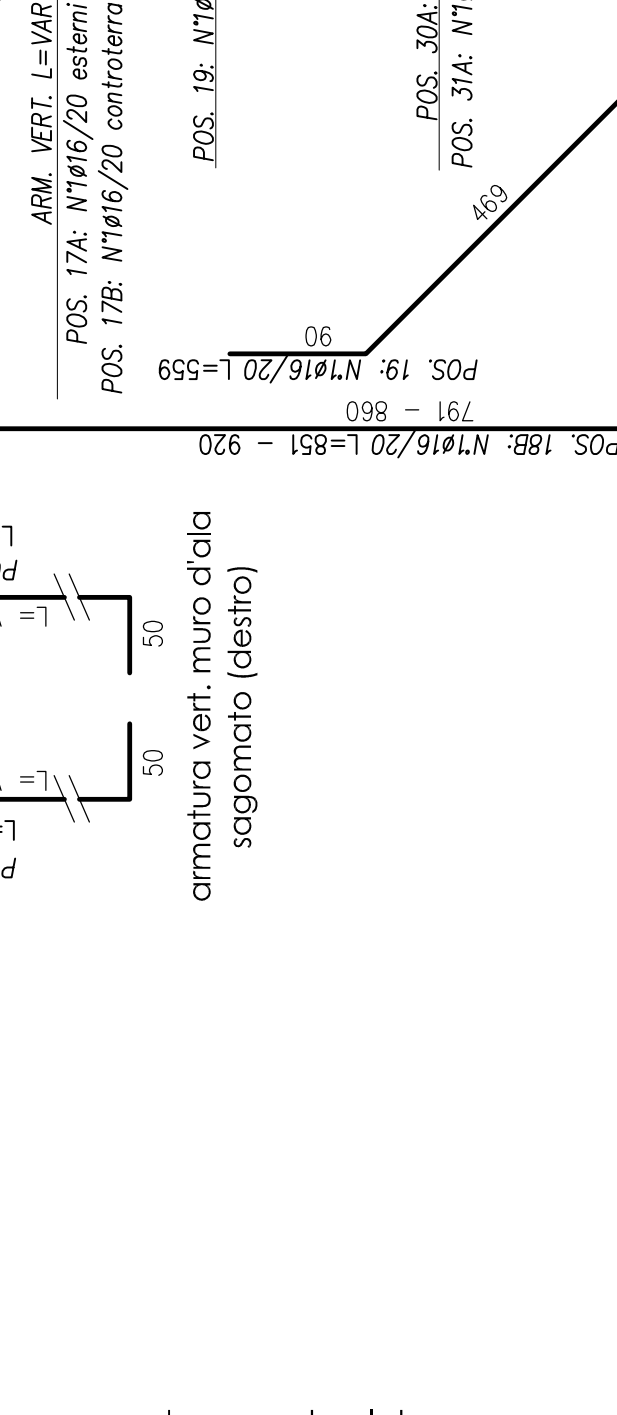
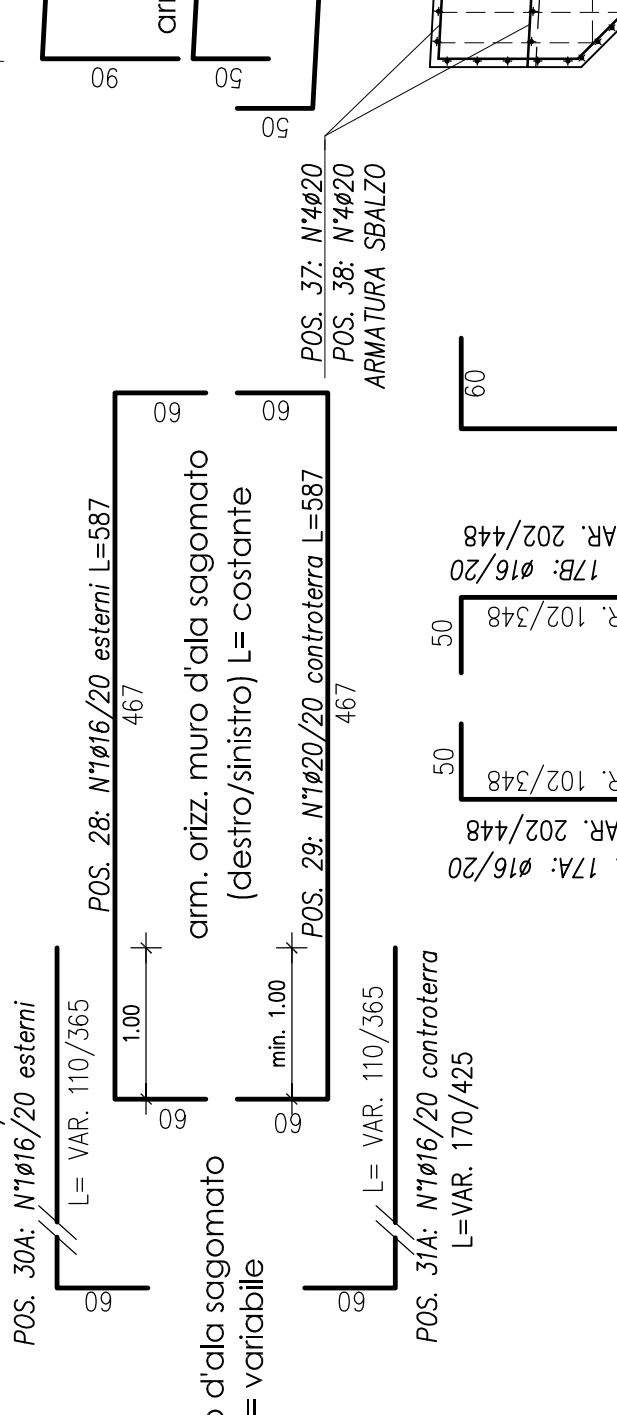
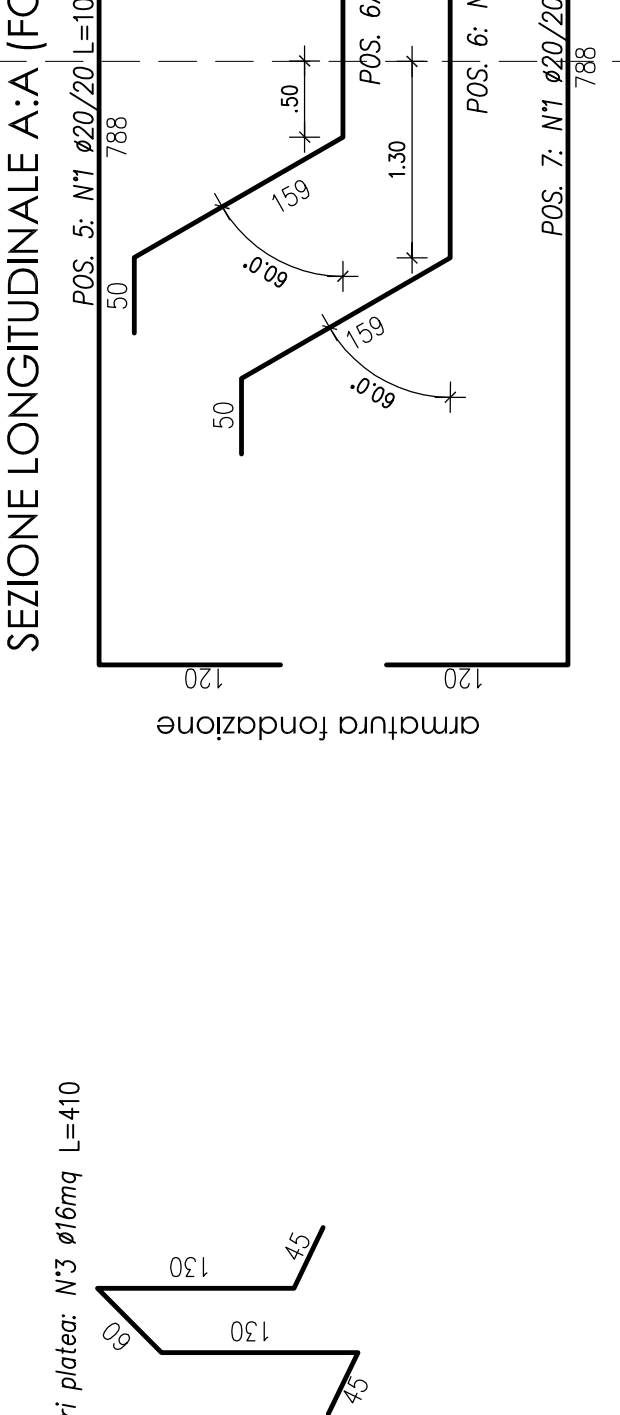
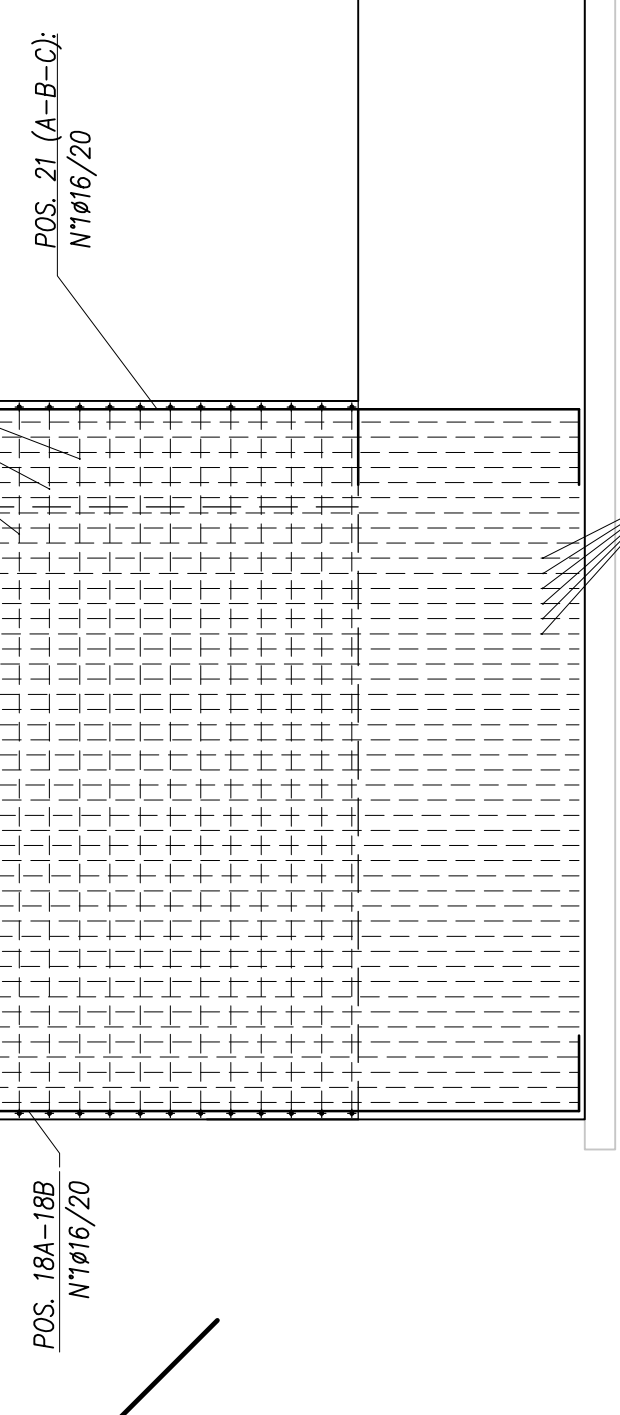
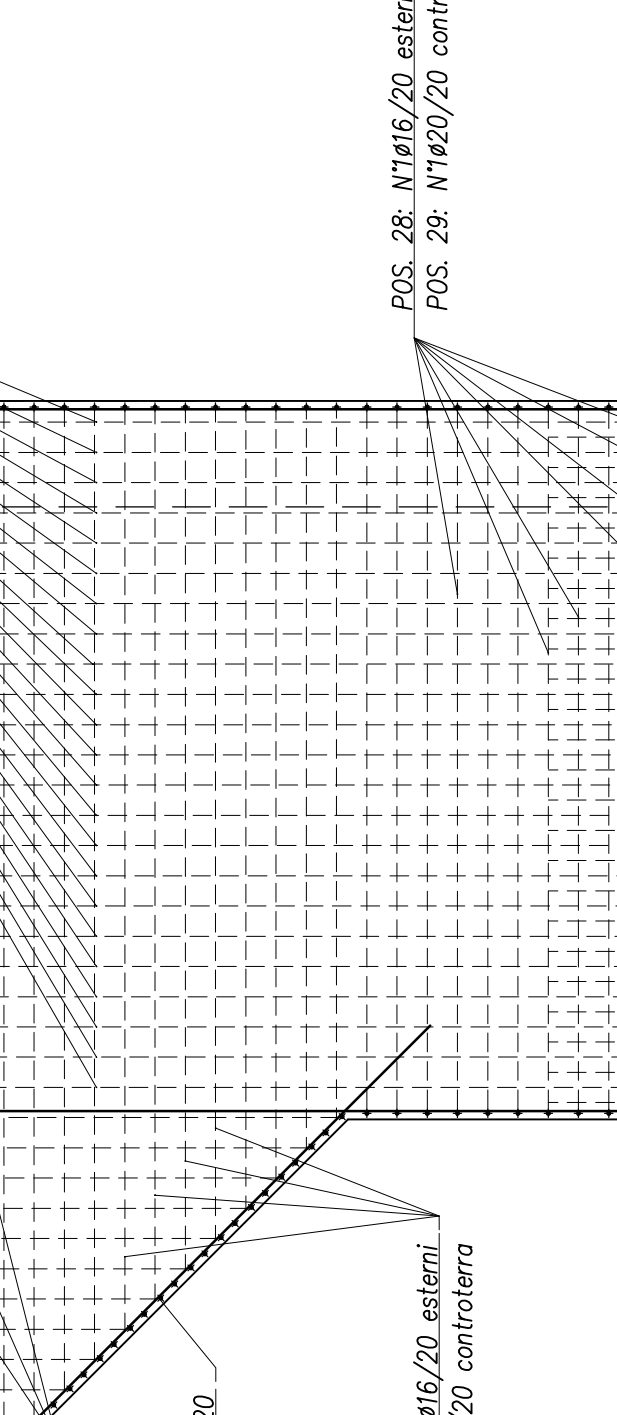
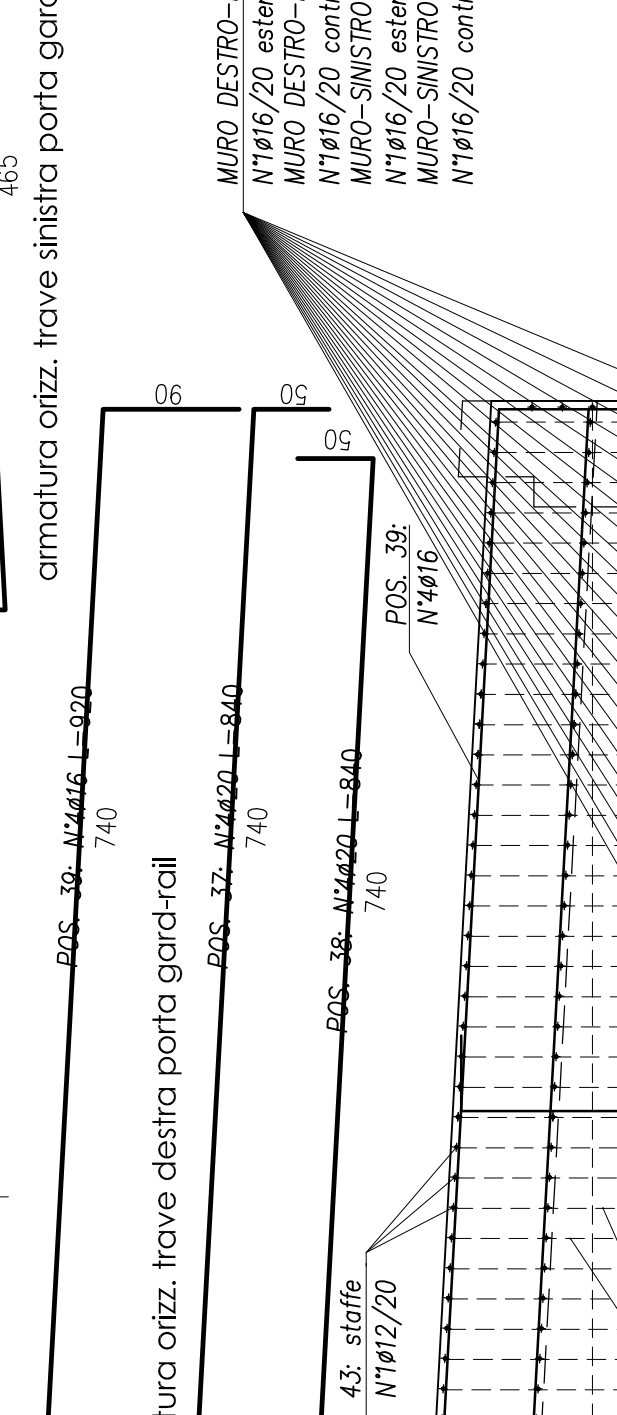
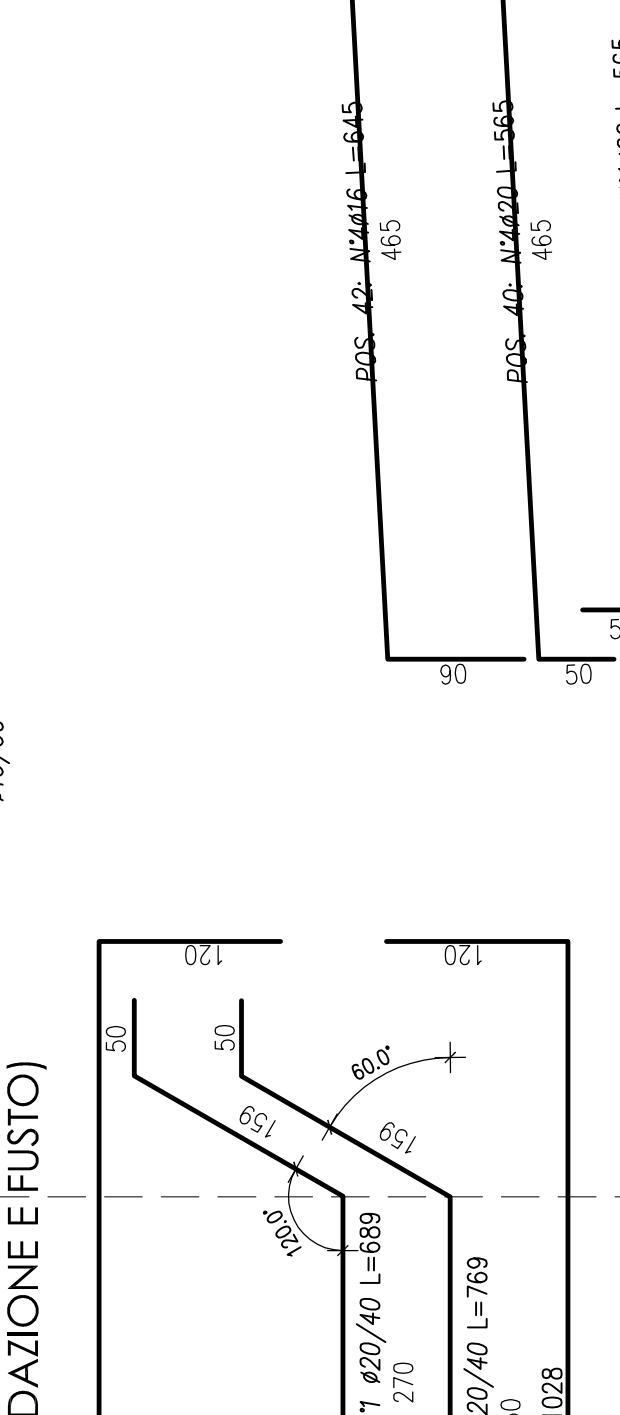
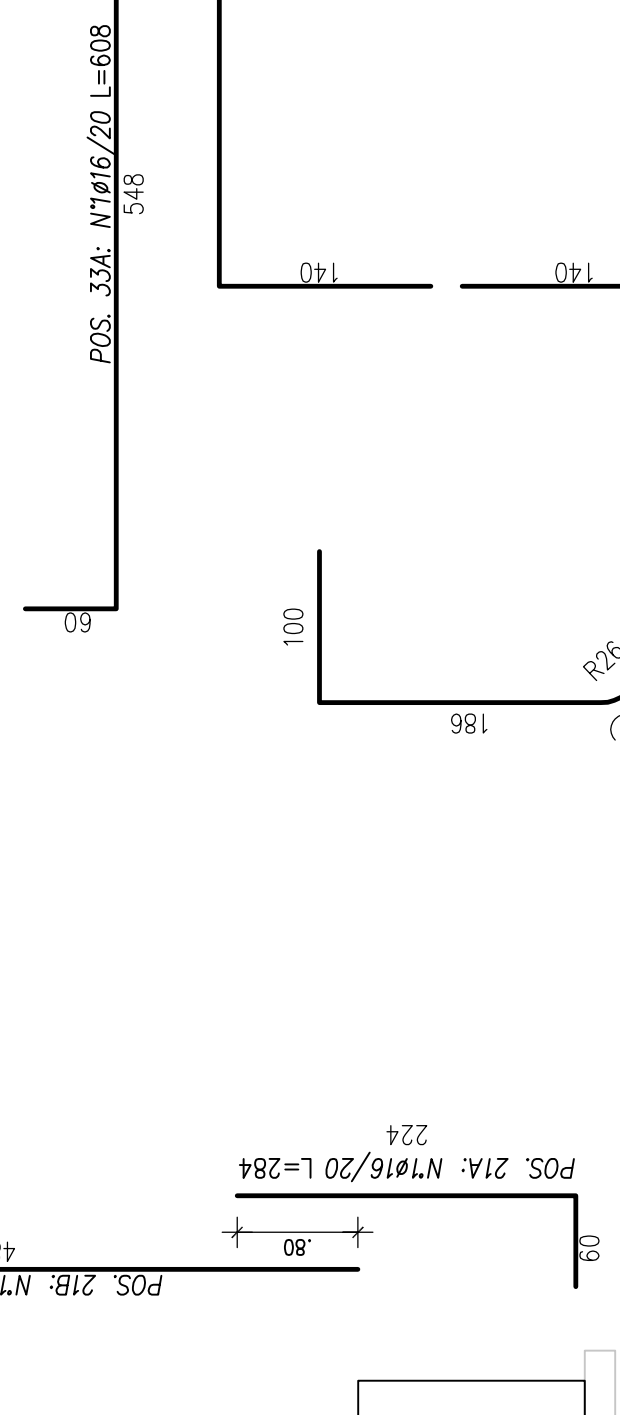
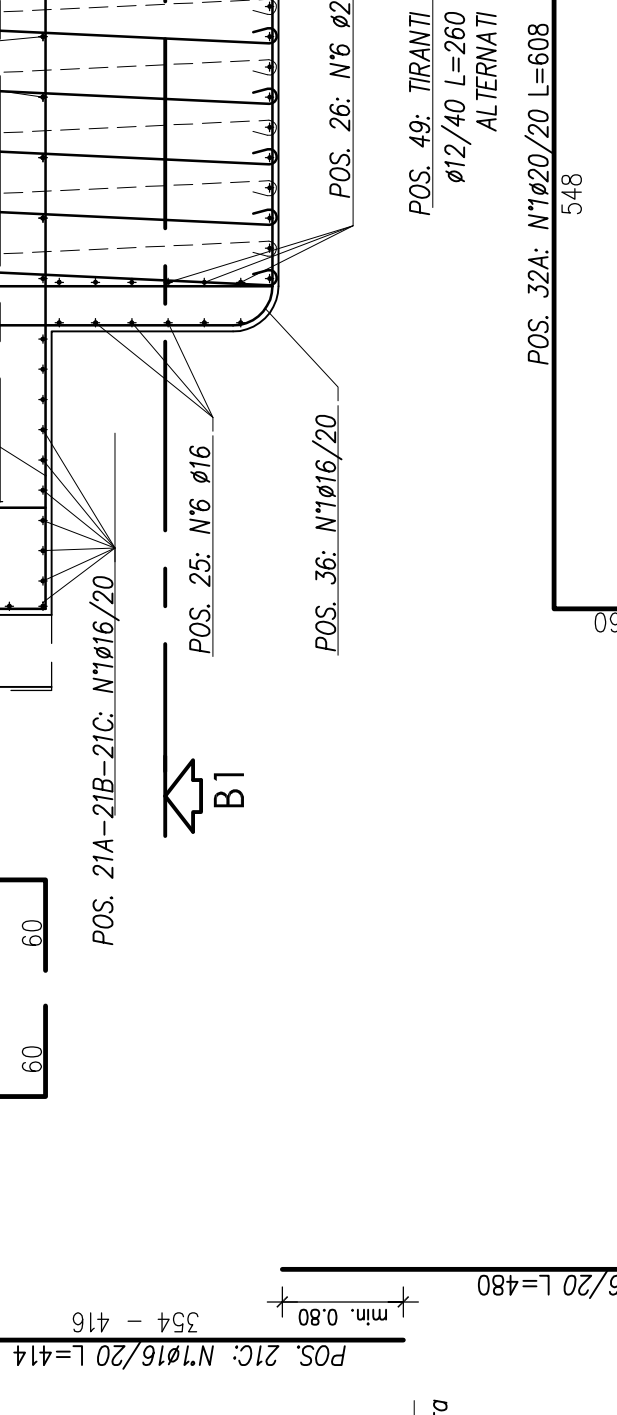
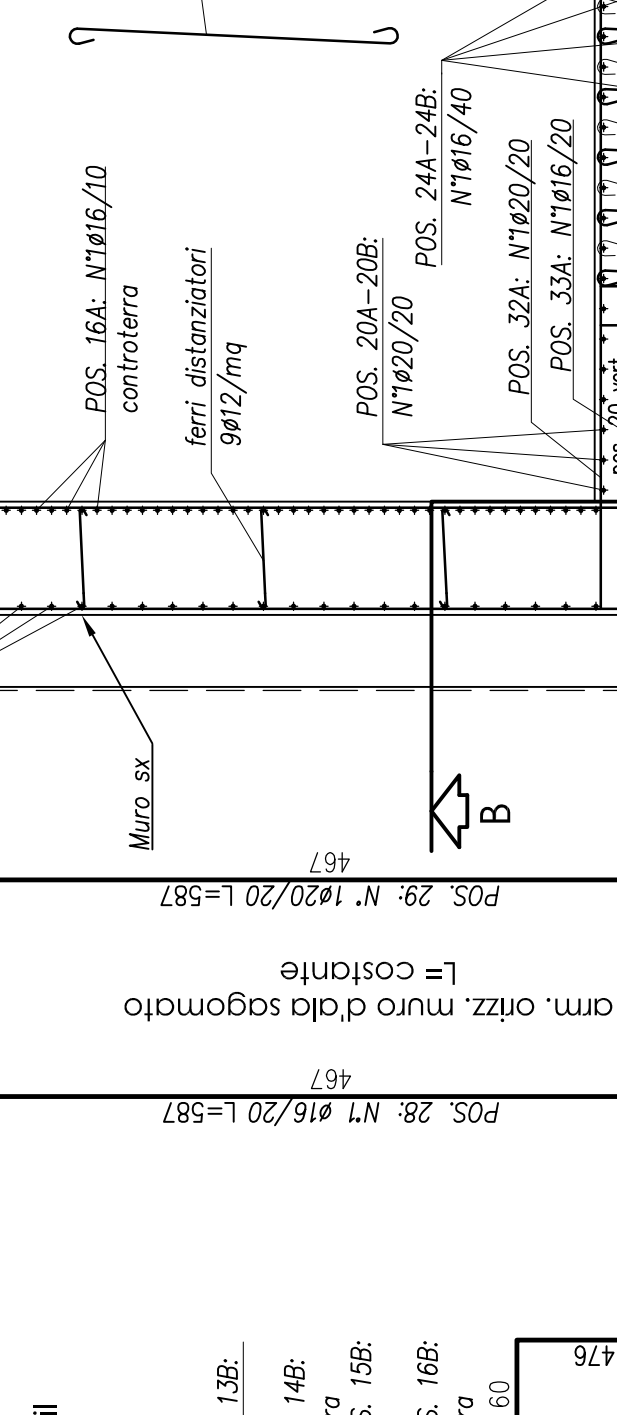
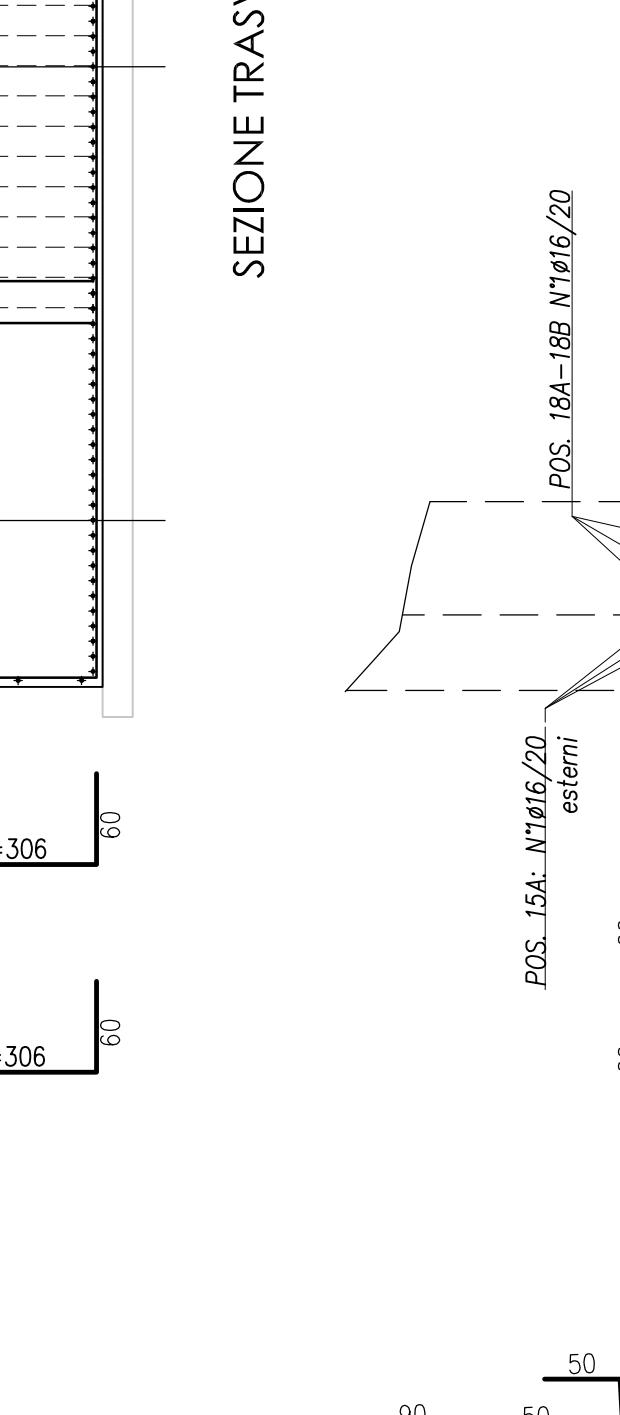
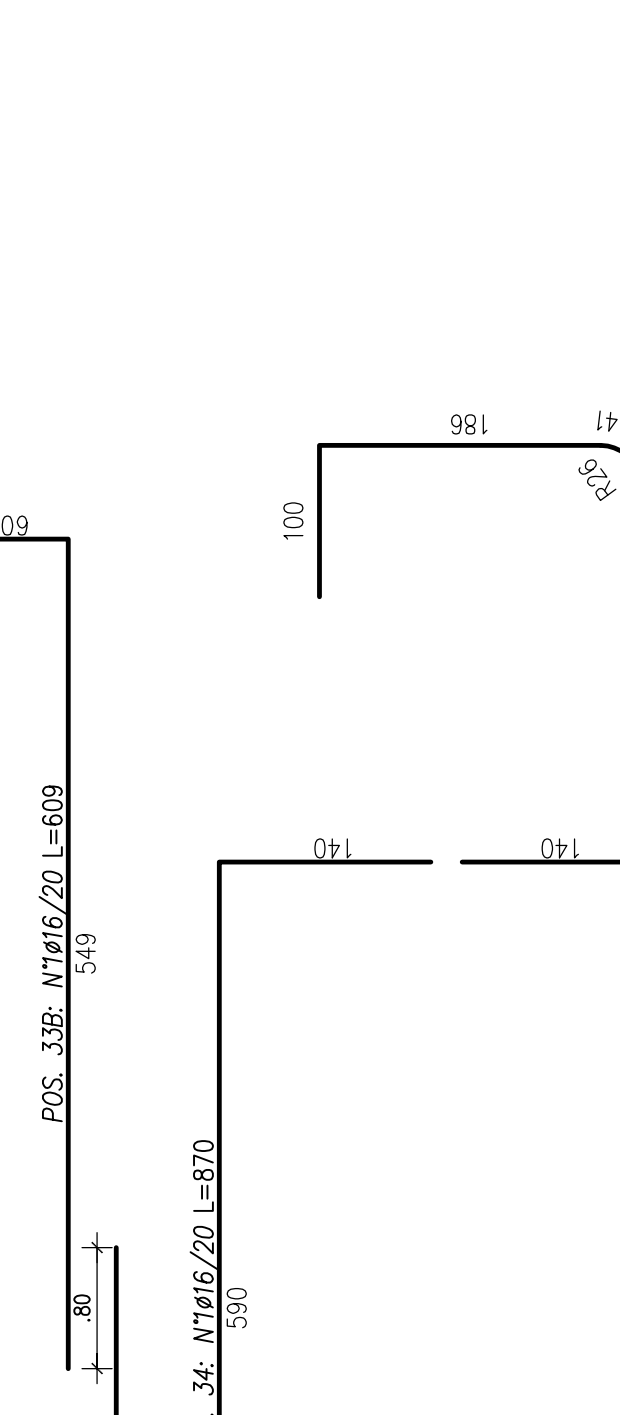
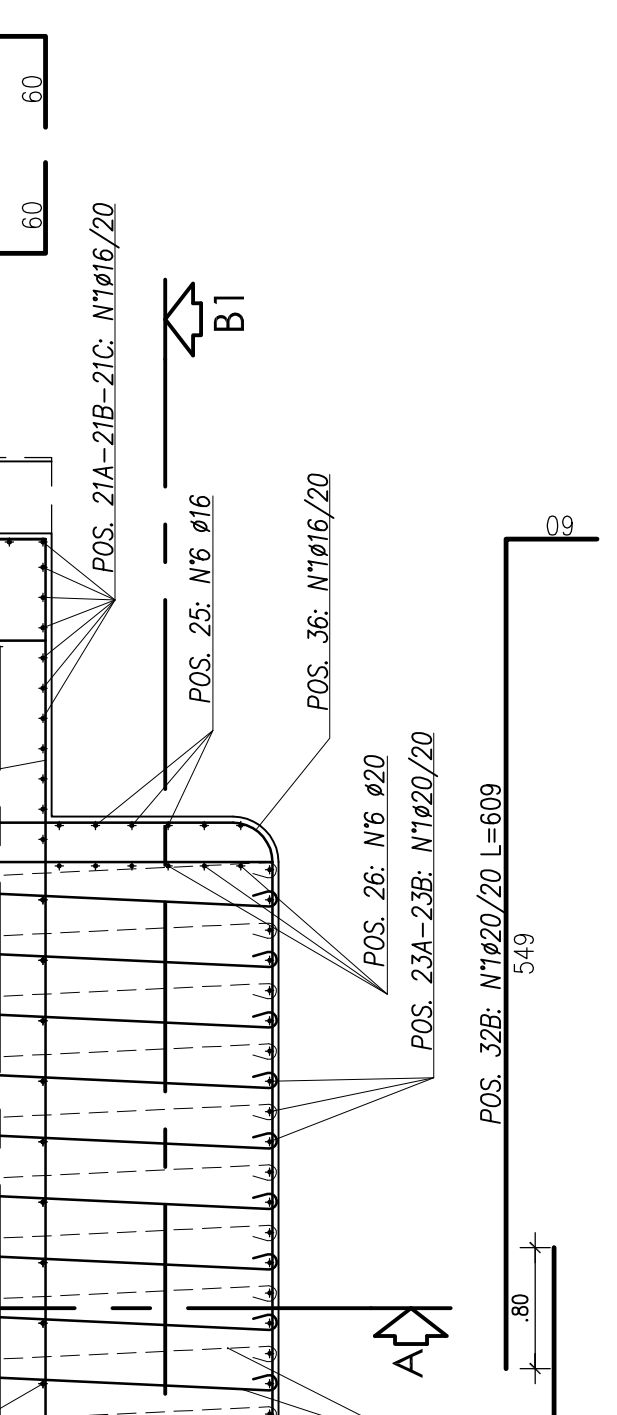
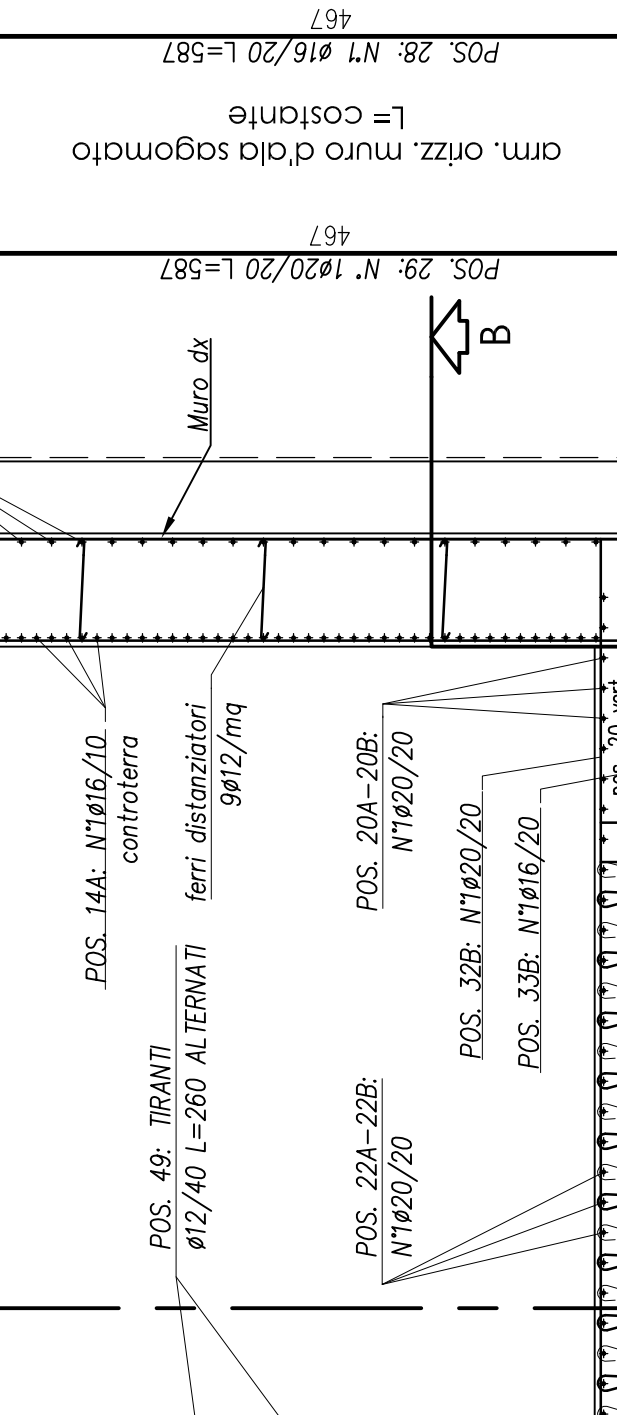
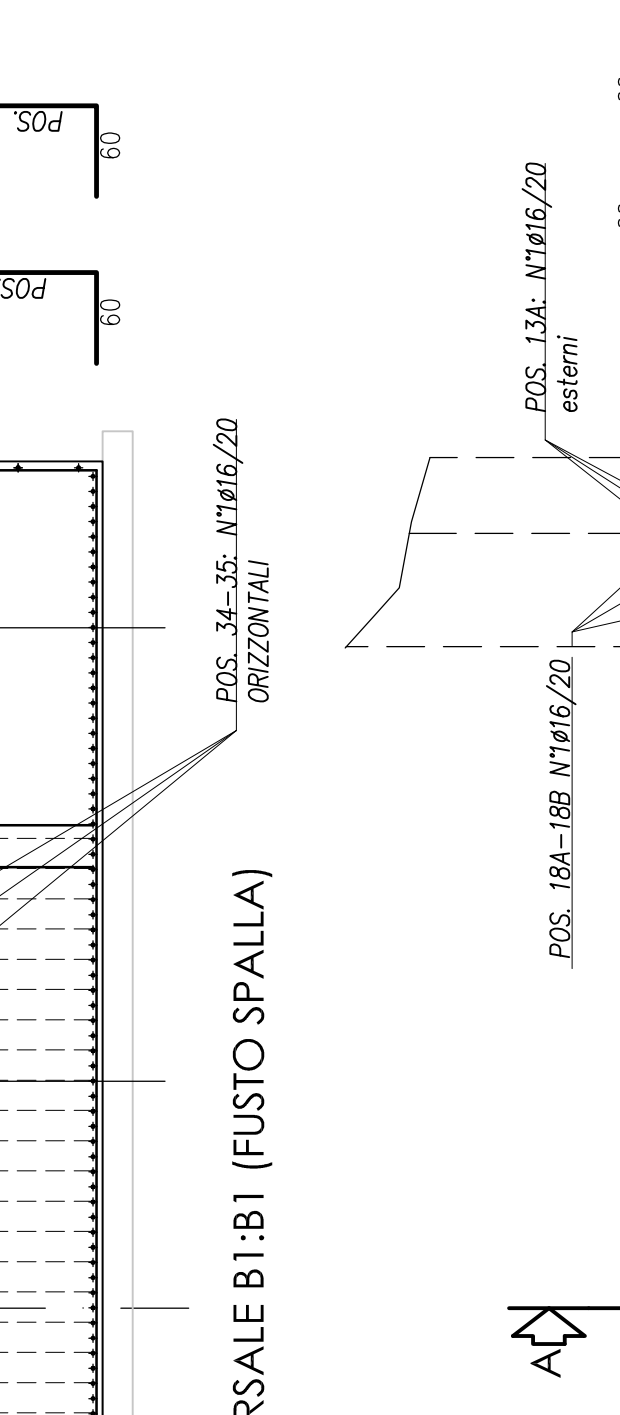

Table with 4 columns: DESCRIZIONE, QUANTITÀ, UNITÀ DI MISURA, and NOTE. It lists materials like steel bars and reinforcement mesh.



Project information block containing logos for ANAS S.p.A., Bolognetta S.p.A., and ACS Ingegneri. It includes project name, location, and contact details.



Vertical text on the right side of the page containing project details, scale information, and a list of notes regarding the reinforcement and construction requirements.