

SEZIONE A-A  
SCALA 1:30

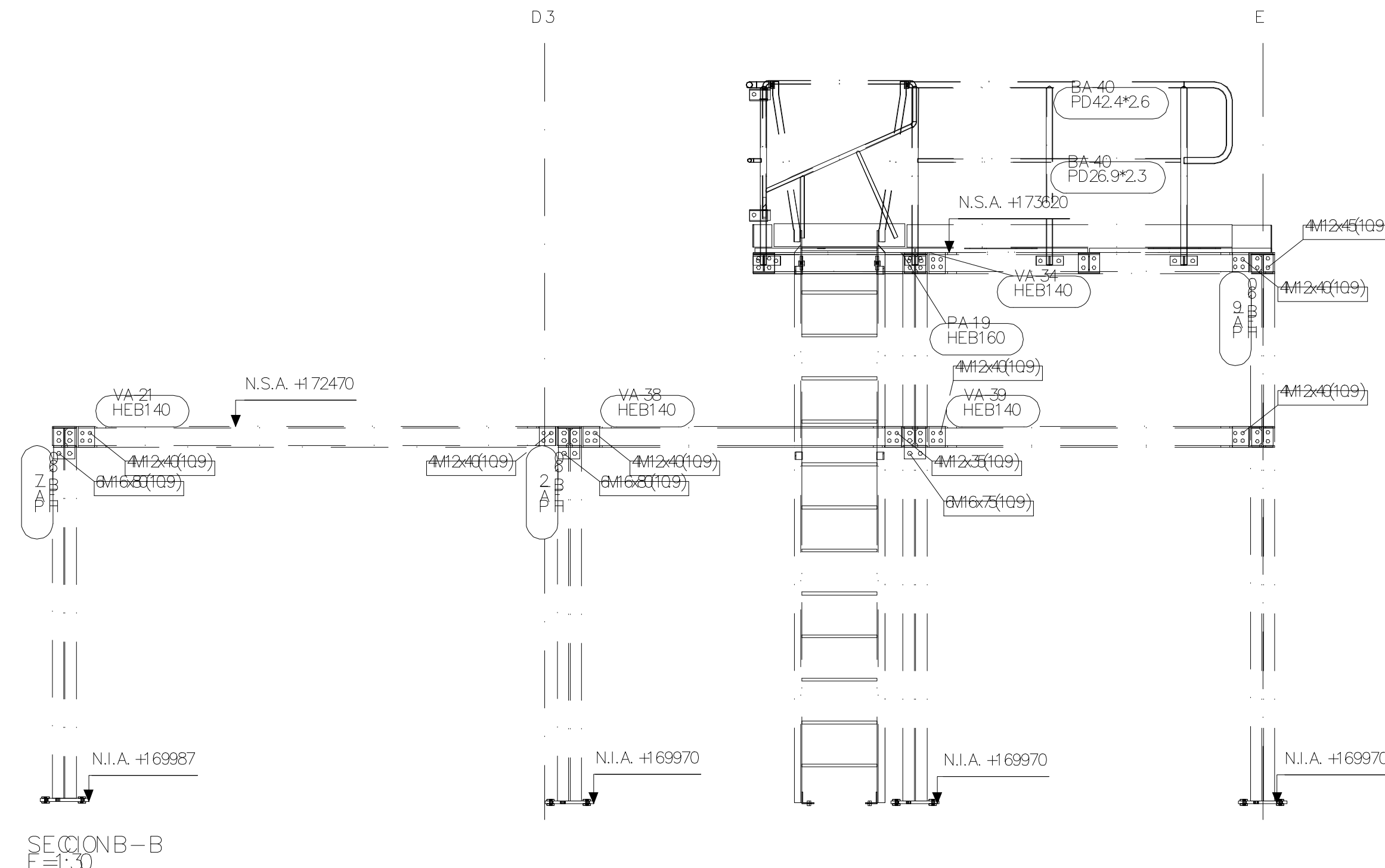

SEZIONE B-B  
SCALA 1:30

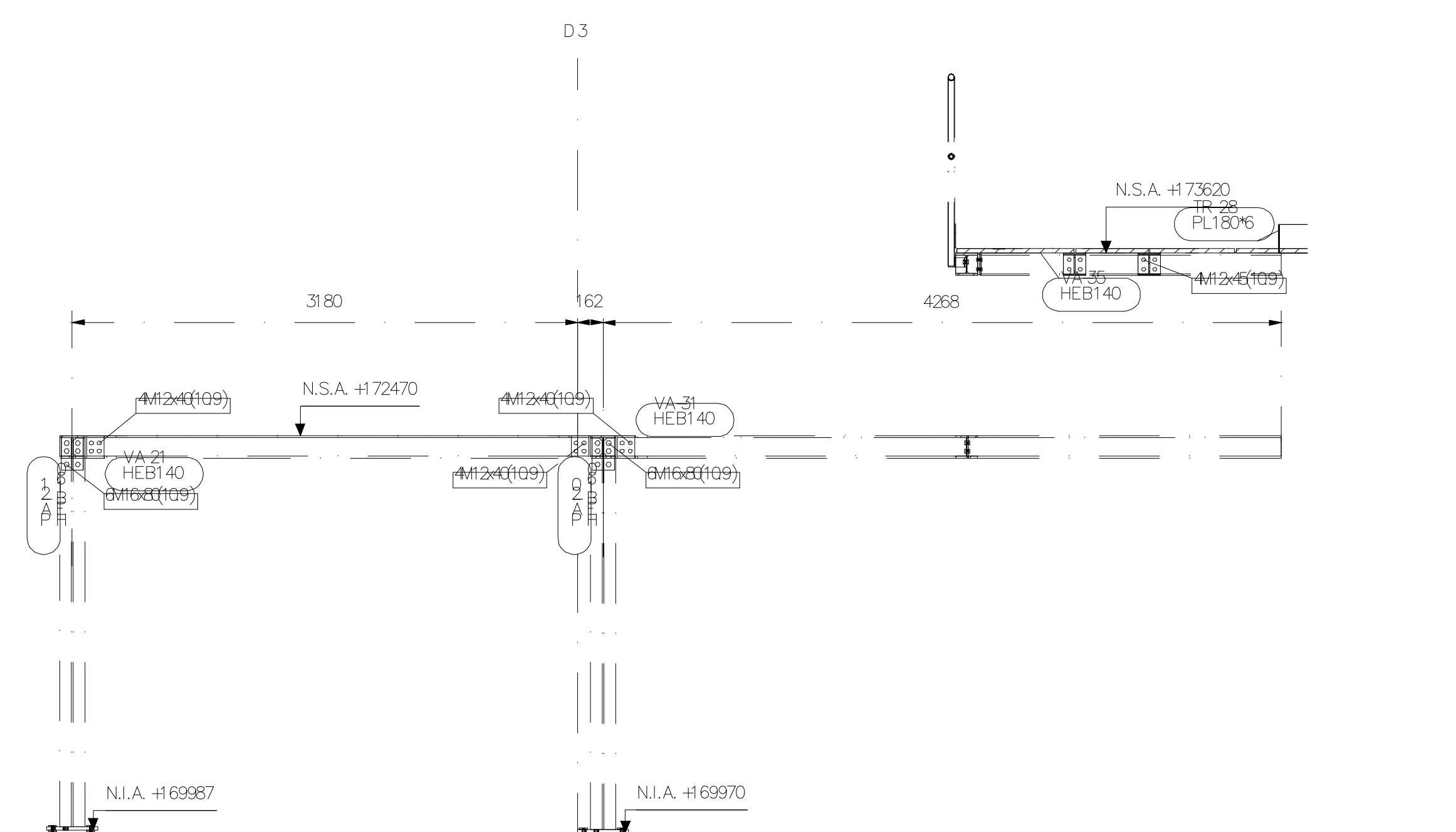

SEZIONE G-G  
SCALA 1:30

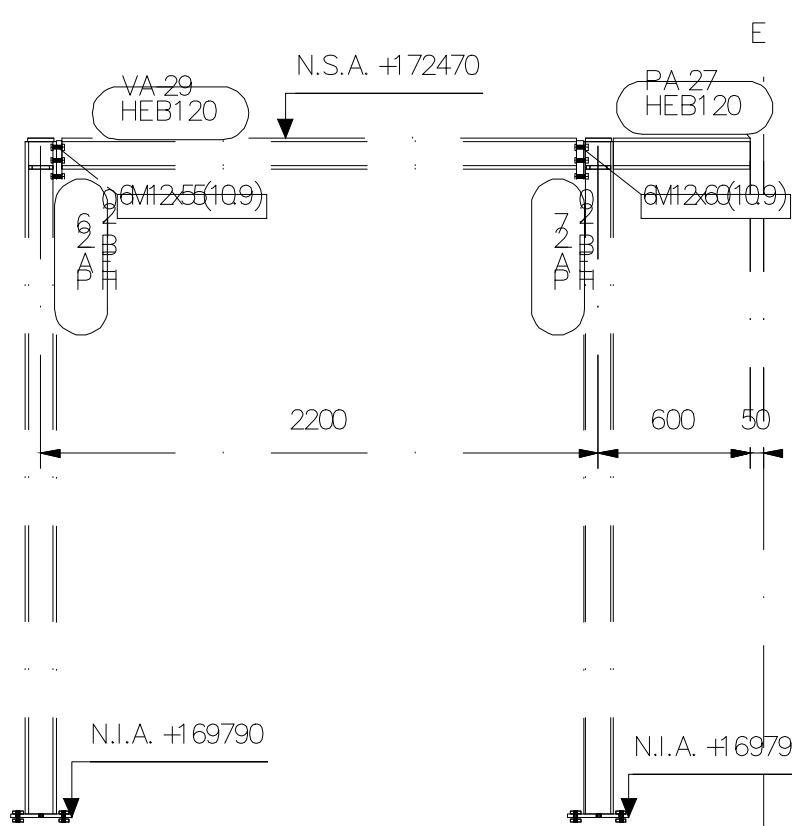

SEZIONE F-F  
SCALA 1:30

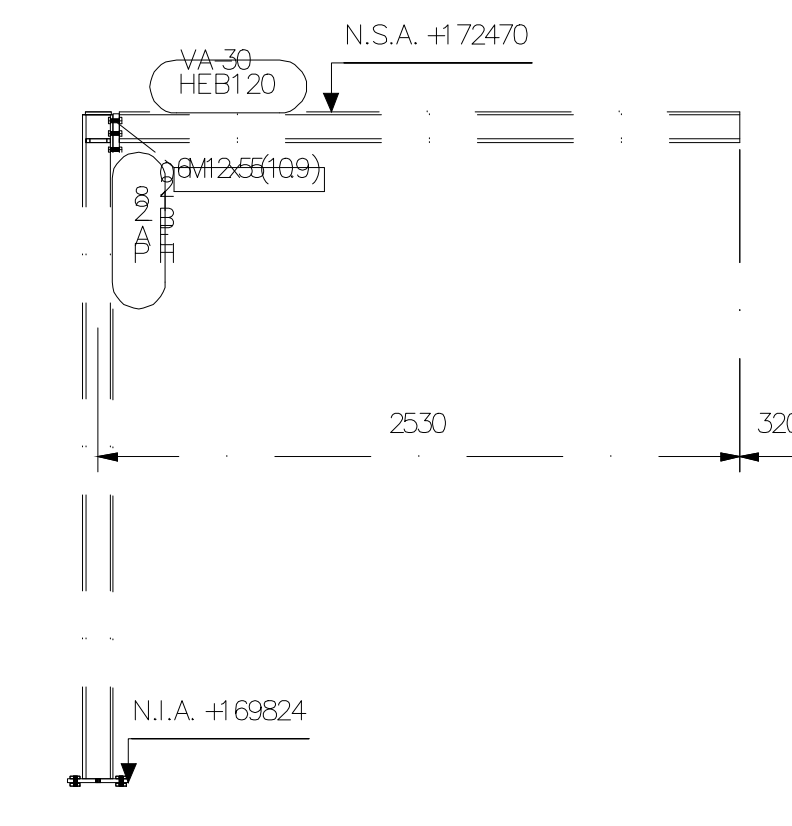

SEZIONE E-E  
SCALA 1:30

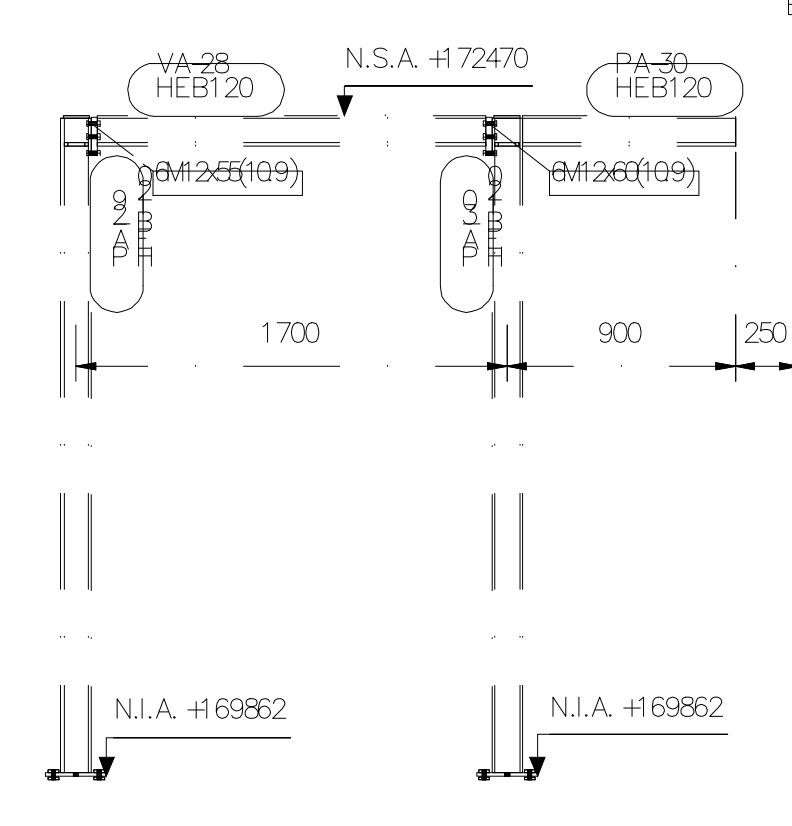

SEZIONE C-C  
SCALA 1:30

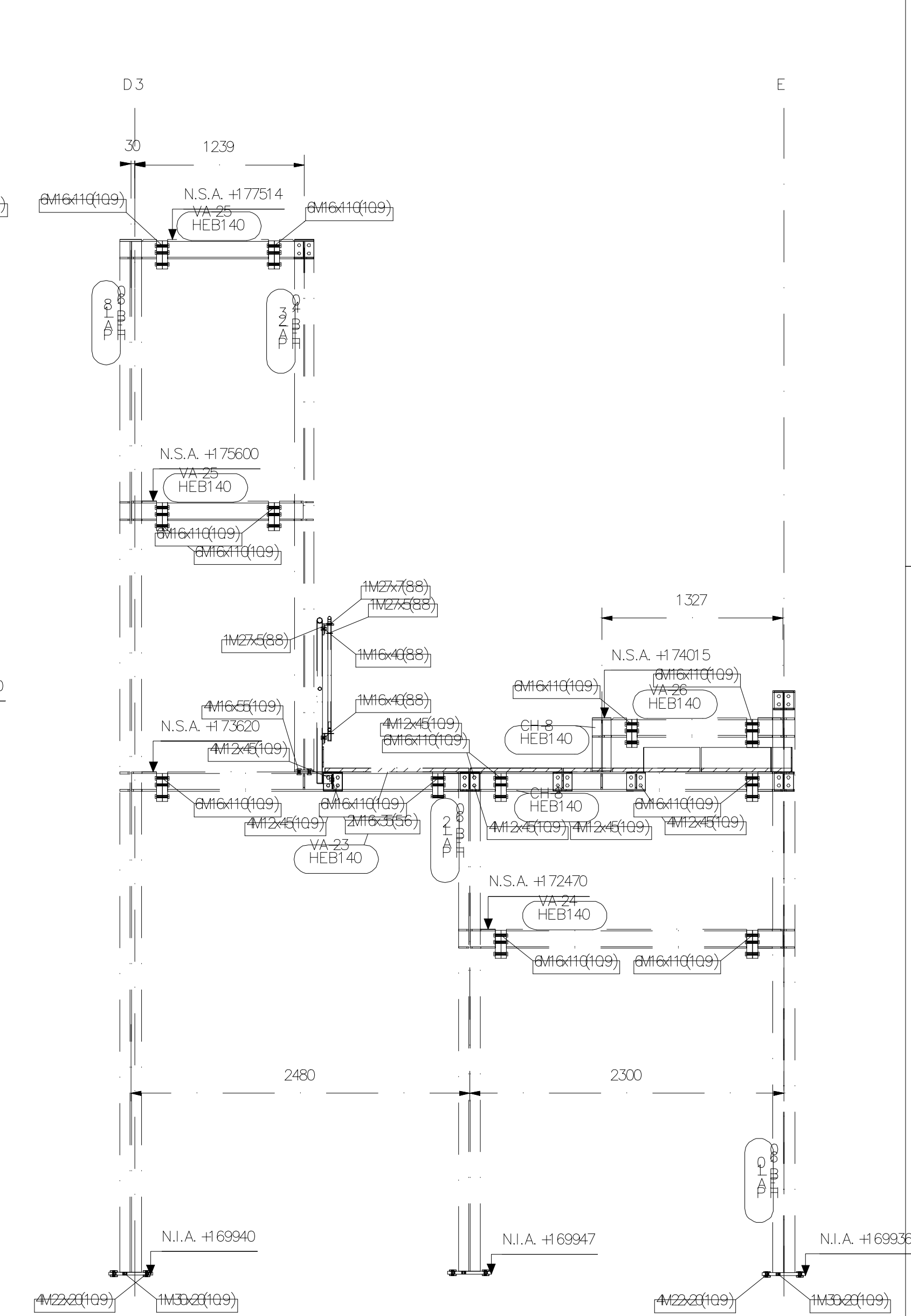

SEZIONE D-D  
SCALA 1:30

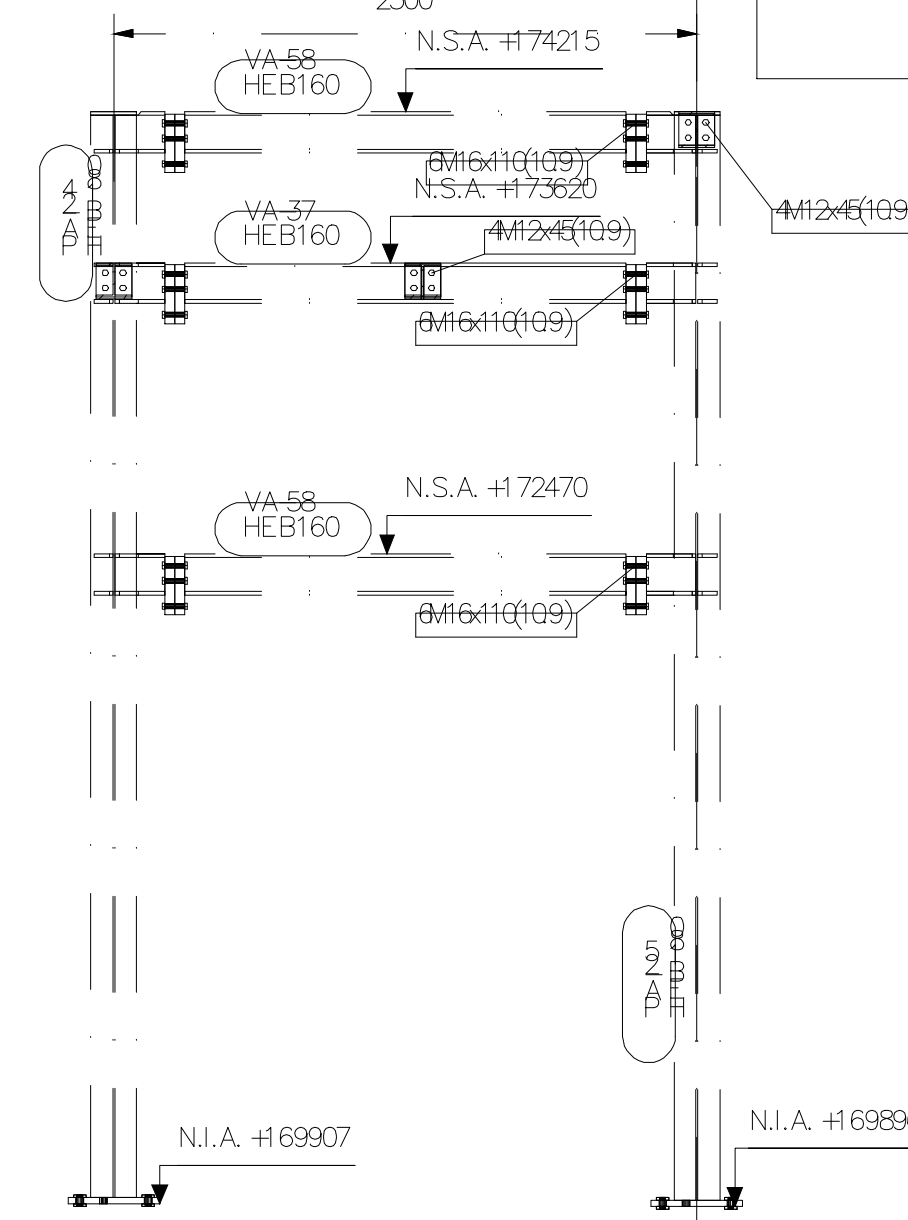

DETTAGLIO A  
SCALA 1:10

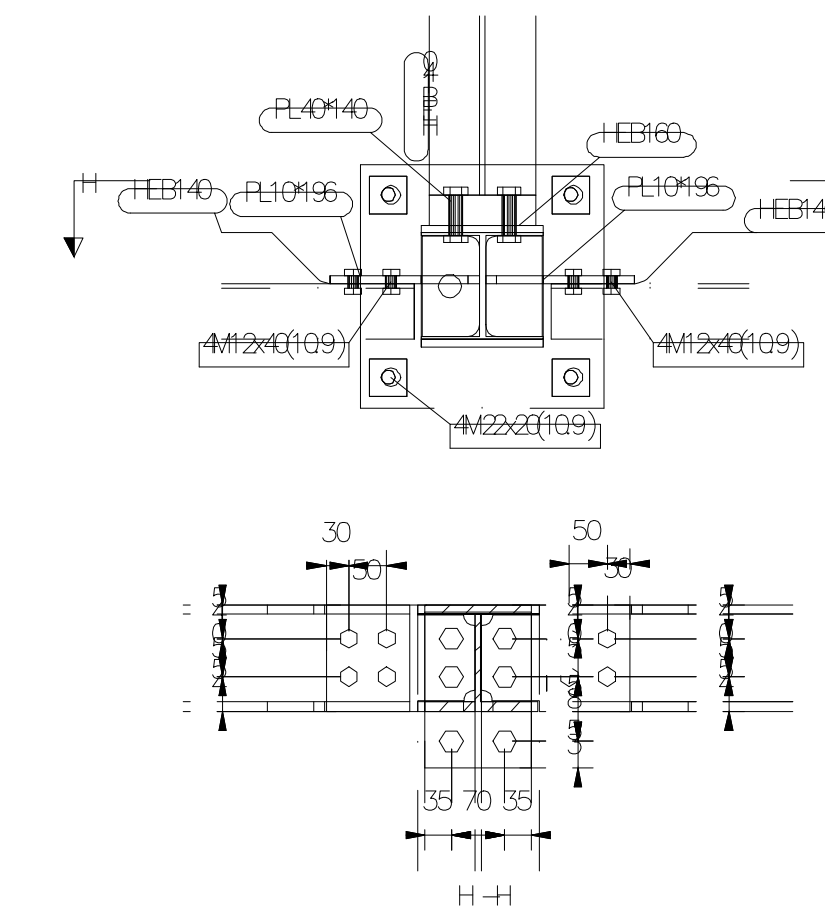

DETTAGLIO PLACCA BASE HEB180  
SCALA 1:5

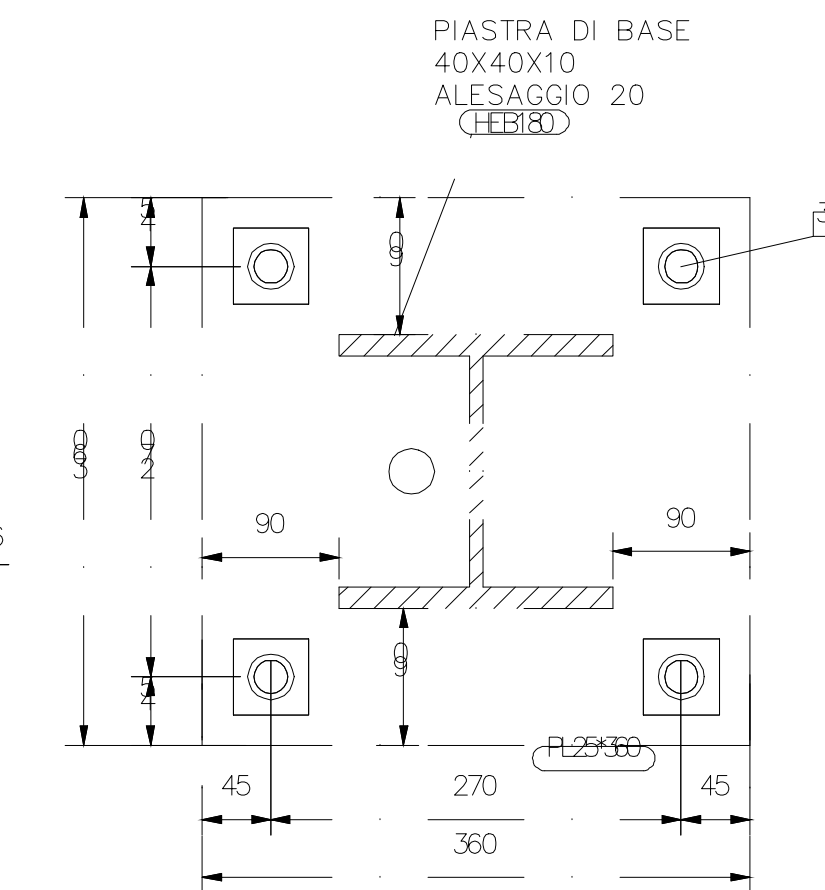
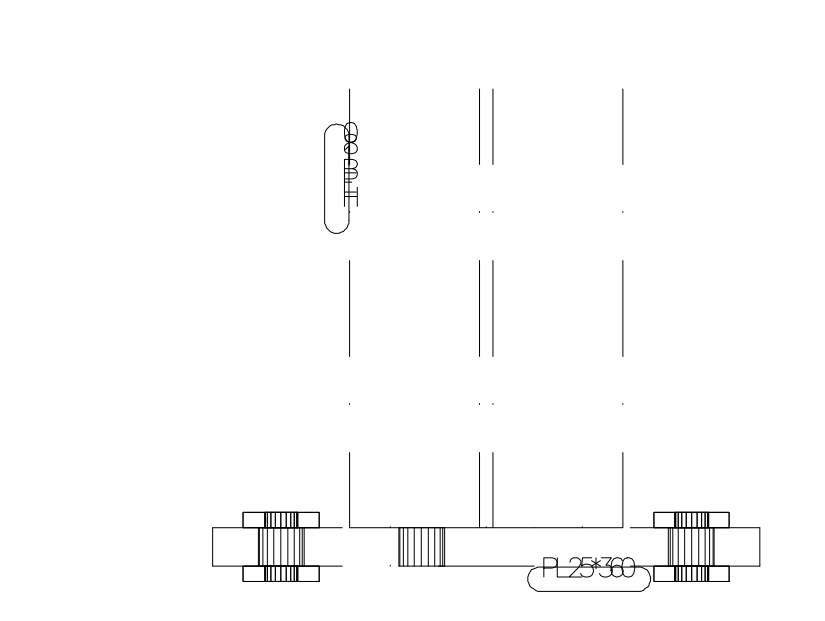

DETTAGLIO B  
SCALA 1:10

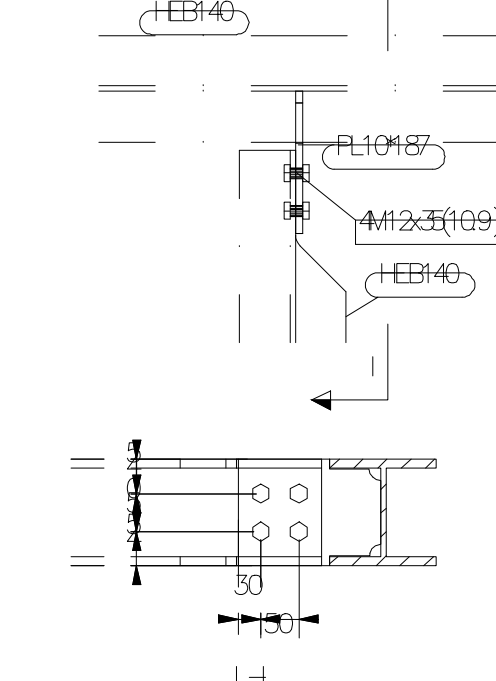

DETTAGLIO D  
SCALA 1:10

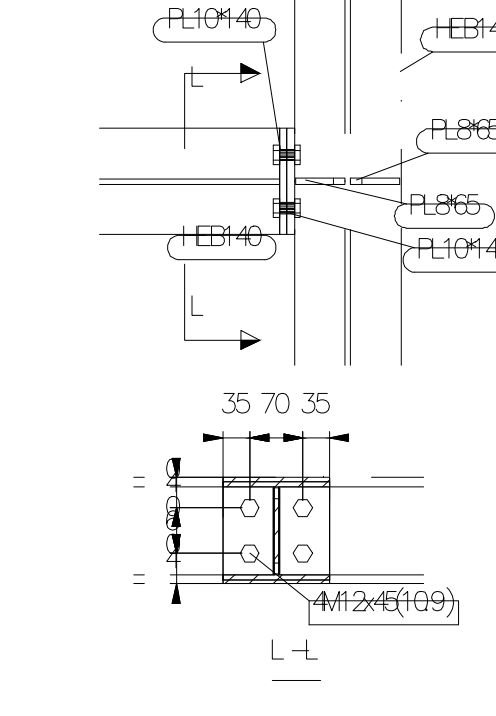

DETTAGLIO PLACCA BASE HEB160  
SCALA 1:5

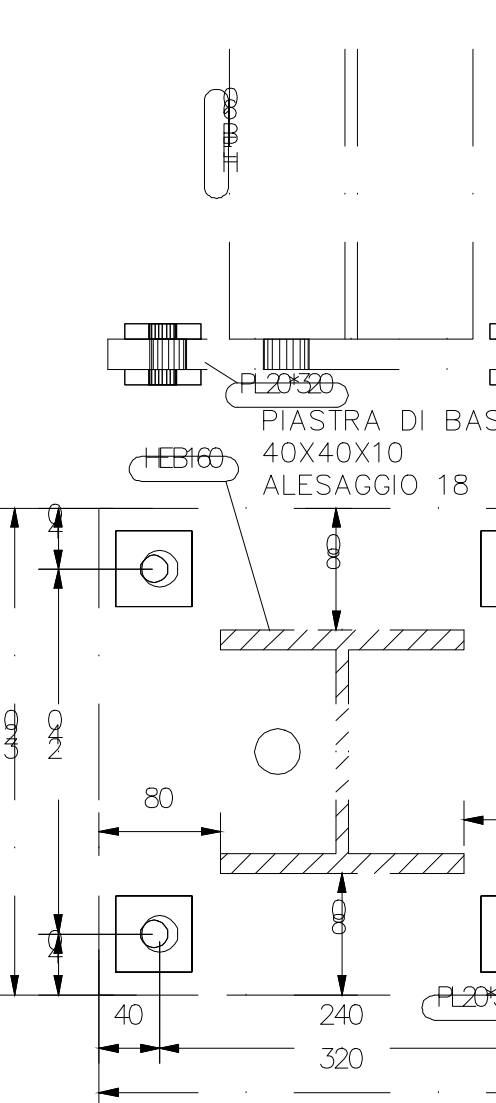

DETTAGLIO C  
SCALA 1:10

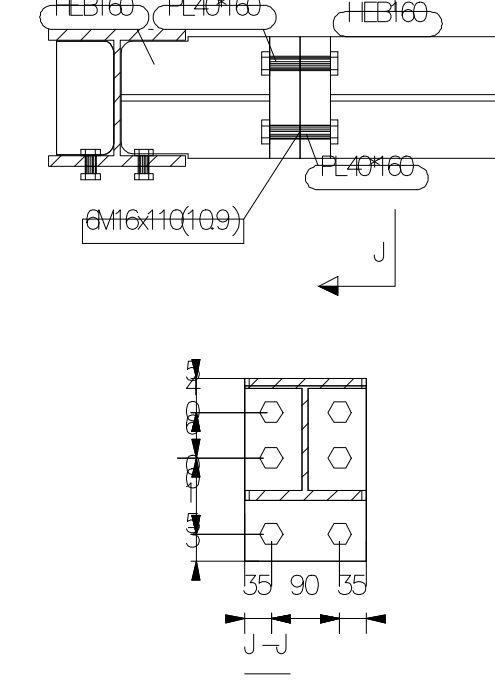

DETTAGLIO F  
SCALA 1:10

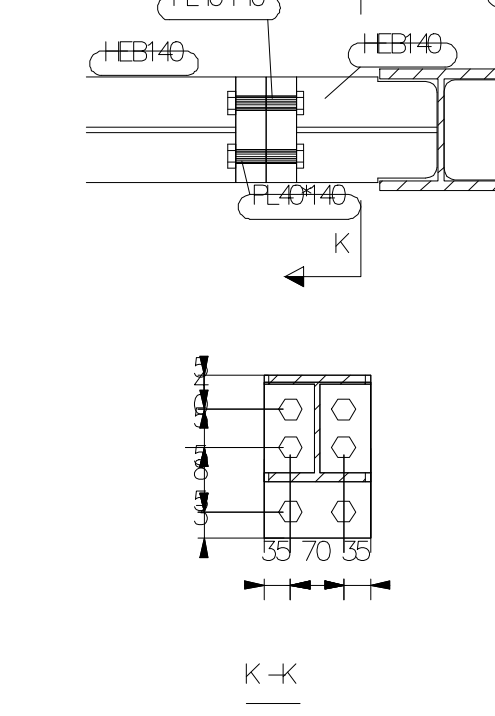

DETTAGLIO PLACCA BASE HEB120  
SCALA 1:5

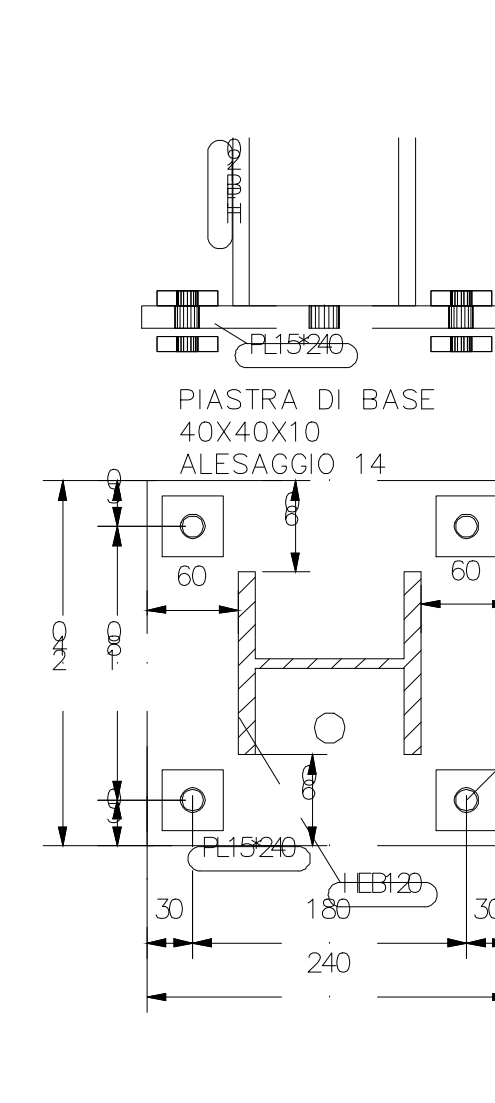

COMUNE DI UTA  
Provincia di Cagliari

ISTANZA DI VERIFICA DI ASSOGGETTABILITÀ A V.I.A.

Realizzazione di un Impianto Solare Termodinamico con  
tipologia a collettori parabolici  
Potenza 19,5 MWp

TAVOLA:  
071  
STRUTTURA AUSILIARE TURBINA  
SEZIONI SIGNIFICATIVE  
SCALA: VARIE  
data: Agosto 2017

IL COMMITTENTE:  
Sardinia Green Island  
SARDINIA GREEN ISLAND S.p.a.  
Via Roma n. 149, 09124 Cagliari  
Tel. 070.684834  
Fax 070.640144  
e-mail: info@sardiniaisland.it

I PROGETTISTI:  
Ing. Daniele Marras Ing. Lorena Vacca  
ORDINE INGEGNERI  
PROVINCIA ORISTANO  
n. 378 Dr. Ing. Daniele Marras  
ORDINE INGEGNERI  
PROVINCIA CAGLIARI  
n. 4766 Ing. Lorena Vacca

Ing. Daniele Marras, Ing. Lorena Vacca  
Ex S.S. km 10,500 Ed. Pittarello  
Int. U54, 09028 Sestu (CA)  
Cell. 393.9902069 - 342.0776977