

Eni S.p.A.

Divisione Refining & Marketing

Raffineria di Sannazzaro



ALLEGATO SCHEDA B

B.23

Planimetria dello stabilimento:

- punti di origine delle sorgenti sonore*
- zone di influenza delle sorgenti sonore*



DOCUMENTO DI VALUTAZIONE DEL RISCHIO

(art. 4 D.Leg. 19-9-94 n° 626)

Eni S.p.A. Divisione
Refining & Marketing
Raffineria di Sannazzaro

AGENTE DI RISCHIO RUMORE

REPARTO R25 SOI UTILITIES

IMPIANTO **I03** **Trattamento acqua**

CAMPAGNA I. INDUSTRIALE 2002/2005

AGENTE

Valore medio

LPicco



Rumore

89,235 dB(A)

120,4 dB

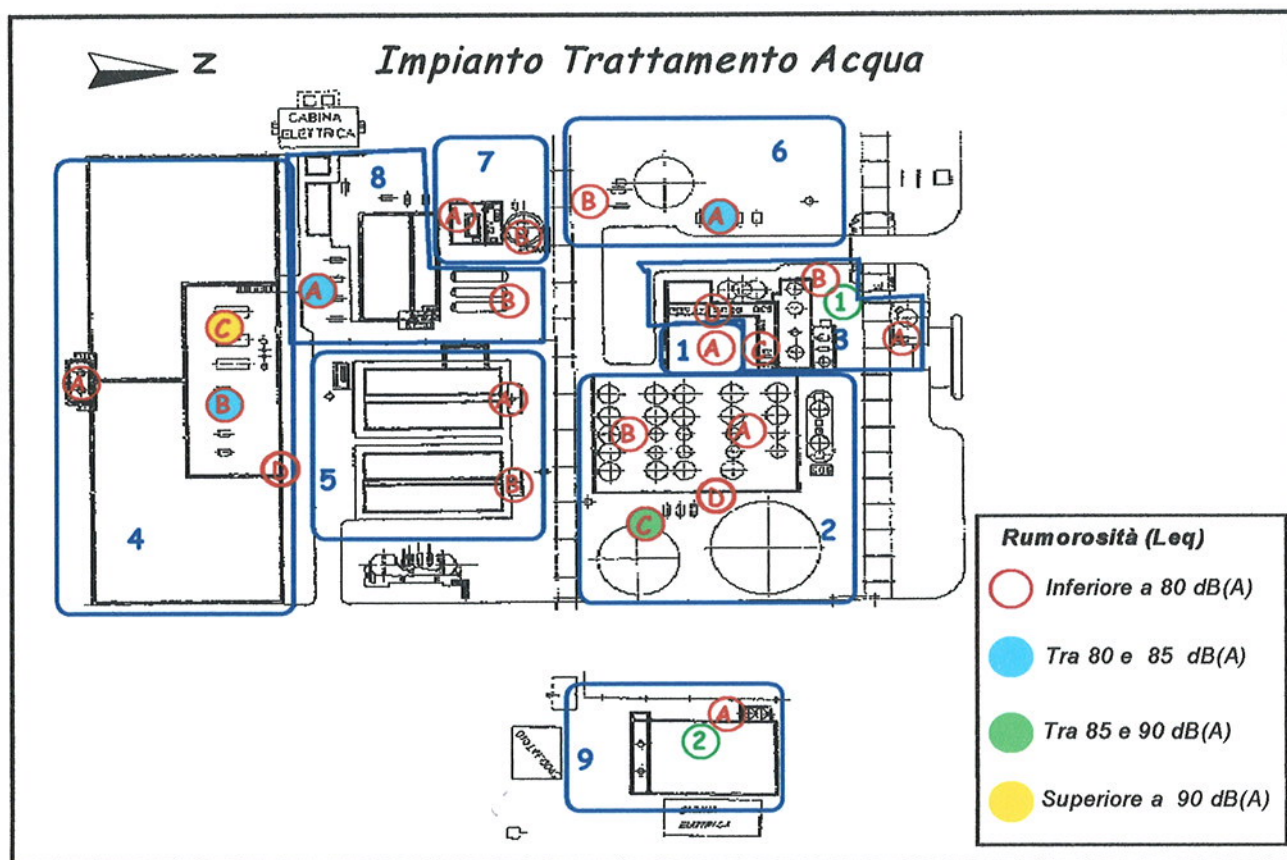



DOCUMENTO DI VALUTAZIONE DEL RISCHIO

(art. 4 D.Leg. 19-9-94 n° 626)

Eni S.p.A. Divisione
Refining & Marketing
Raffineria di Sannazzaro

AGENTE DI RISCHIO RUMORE

REPARTO R25 SOI UTILITIES

IMPIANTO **101 Centrale Termoelettrica**

CAMPAGNA I. INDUSTRIALE 2002/2005

AGENTE

Valore medio

LPicco



Rumore

94,204 dB(A)

128,6 dB

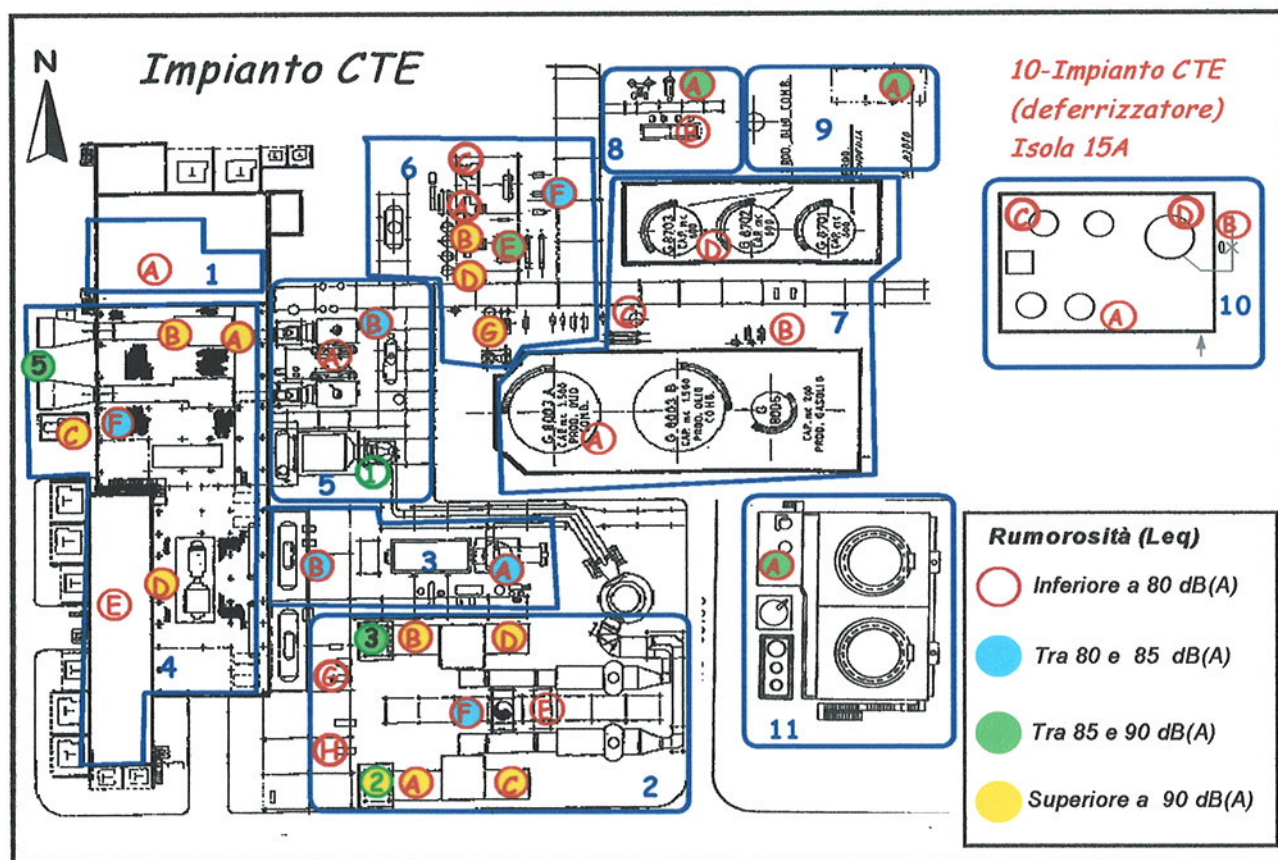



DOCUMENTO DI VALUTAZIONE DEL RISCHIO

(art. 4 D.Leg. 19-9-94 n° 626)

Eni S.p.A. Divisione
Refining & Marketing
Raffineria di Sannazzaro

AGENTE DI RISCHIO RUMORE

REPARTO R25 SOI UTILITIES

IMPIANTO **102 Biologico**

CAMPAGNA I. INDUSTRIALE 2002/2005

AGENTE

Valore medio

LPicco



Rumore

77,097 dB(A)

111,4 dB

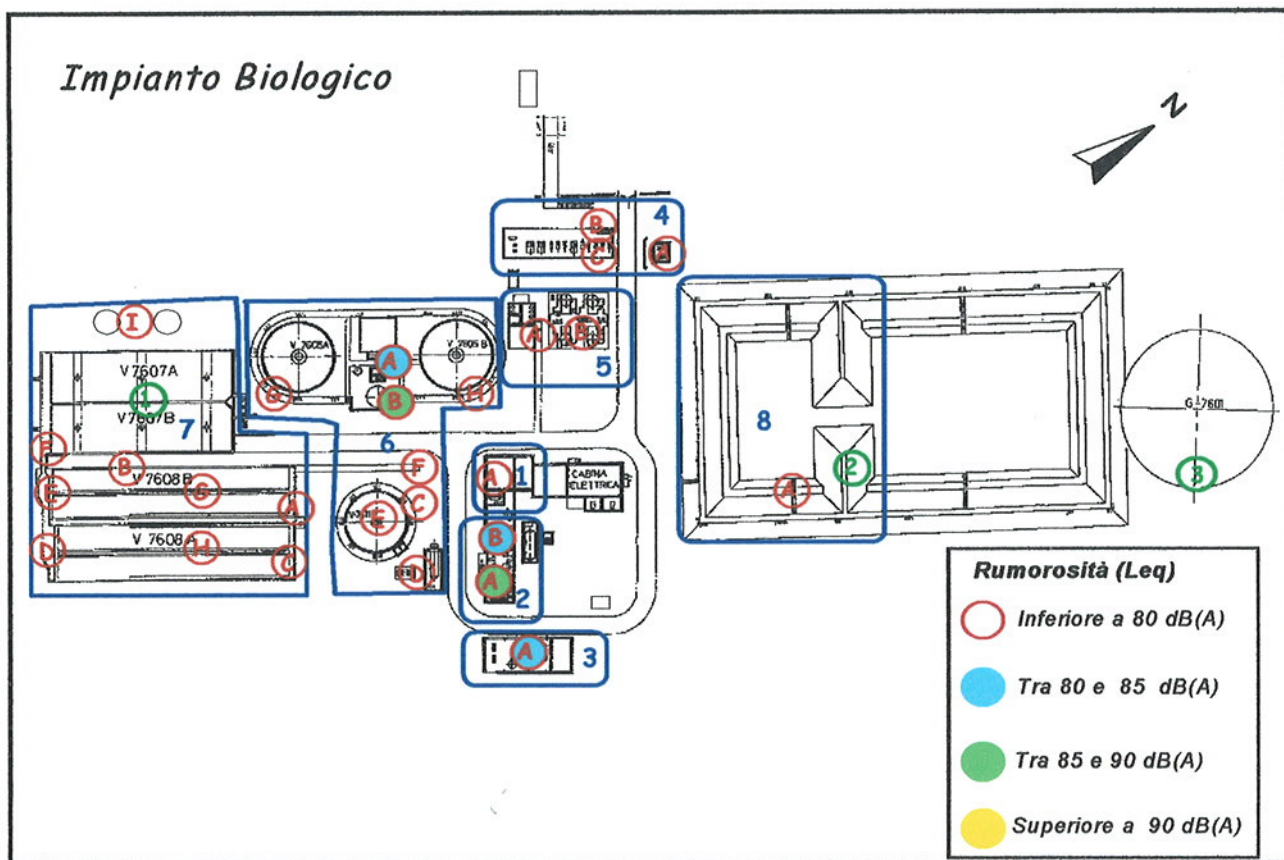



DOCUMENTO DI VALUTAZIONE DEL RISCHIO

(art. 4 D.Leg. 19-9-94 n° 626)

Eni S.p.A. Divisione
Refining & Marketing
Raffineria di Sannazzaro

AGENTE DI RISCHIO RUMORE

REPARTO R25 SOI UTILITIES

IMPIANTO **104 API separator**

CAMPAGNA I. INDUSTRIALE 2002/2005

AGENTE

Valore medio

LPicco



Rumore

70,510 dB(A)

109,8 dB

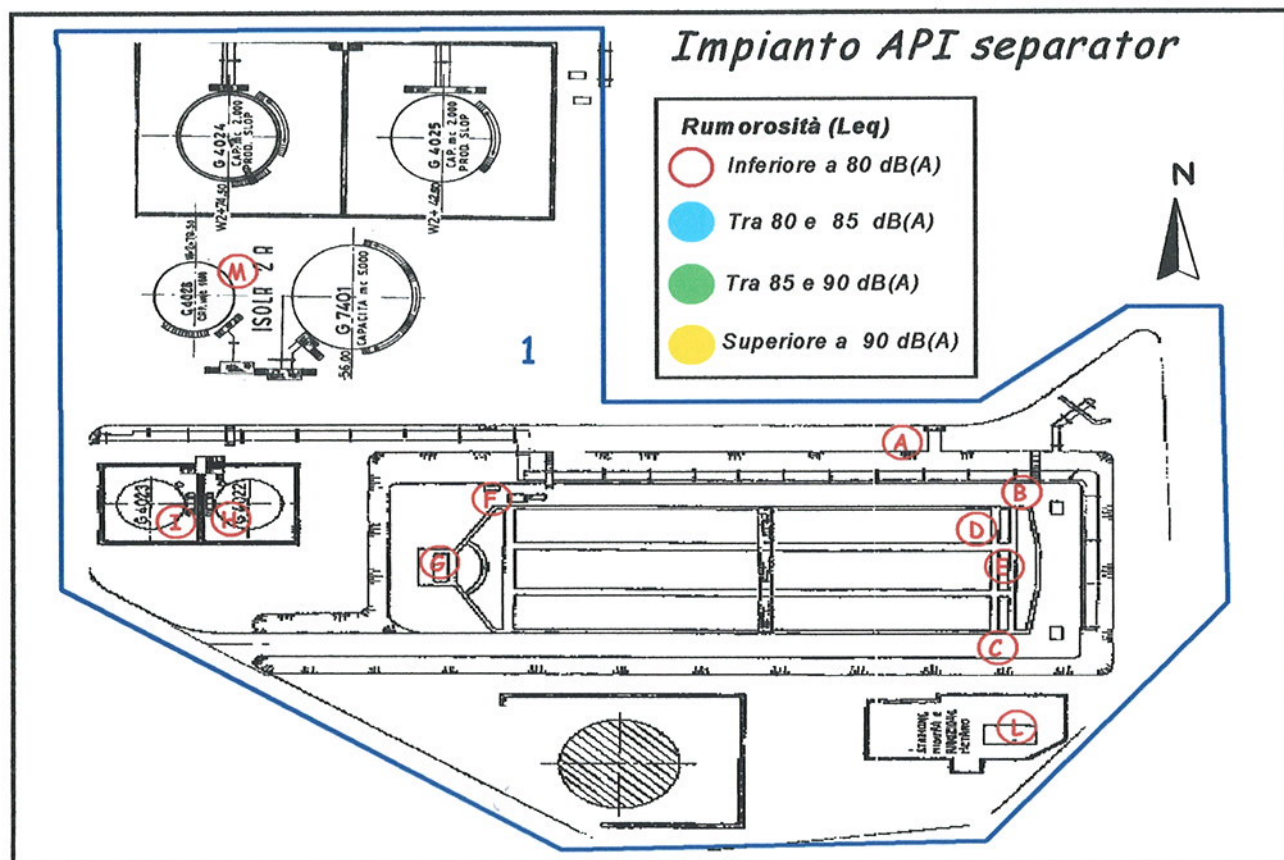



DOCUMENTO DI VALUTAZIONE DEL RISCHIO

(art. 4 D.Leg. 19-9-94 n° 626)

Eni S.p.A. Divisione
Refining & Marketing
Raffineria di Sannazzaro

AGENTE DI RISCHIO RUMORE

REPARTO R24 SOI OVEST

IMPIANTO **I01 Visbreaker**

CAMPAGNA I. INDUSTRIALE 2002/2005

AGENTE

Valore medio

LPicco



Rumore

83,629 dB(A)

110,4 dB

Impianto VISBREAKER

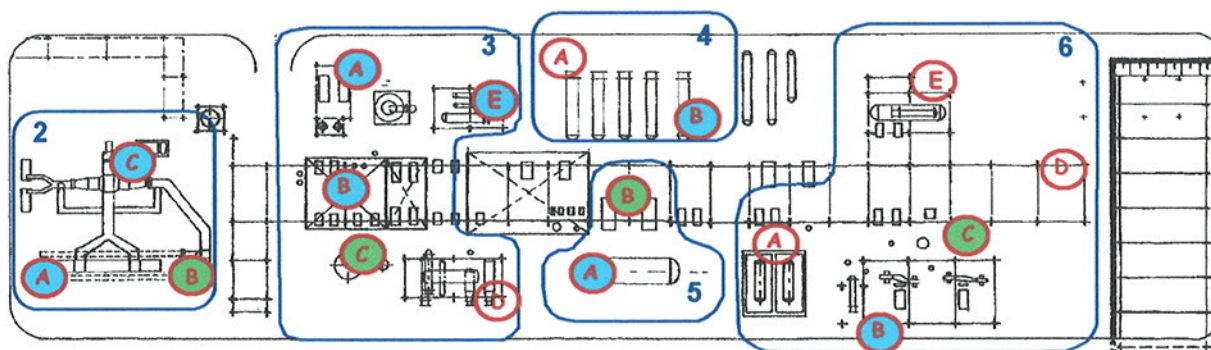

Postazioni
 Posizioni

Rumorosità

Inferiore a 80 dB(A) Tra 85 e 90 dB(A)
 Tra 80 e 85 dB(A) Superiore a 90 dB(A)



DOCUMENTO DI VALUTAZIONE DEL RISCHIO

(art. 4 D.Leg. 19-9-94 n° 626)

Eni S.p.A. Divisione
Refining & Marketing
Raffineria di Sannazzaro

AGENTE DI RISCHIO RUMORE

REPARTO R24 SOI OVEST

IMPIANTO **I02 Unicracker**

CAMPAGNA I. INDUSTRIALE 2002/2005

AGENTE

Valore medio

LPicco



Rumore

85,406 dB(A)

117 dB

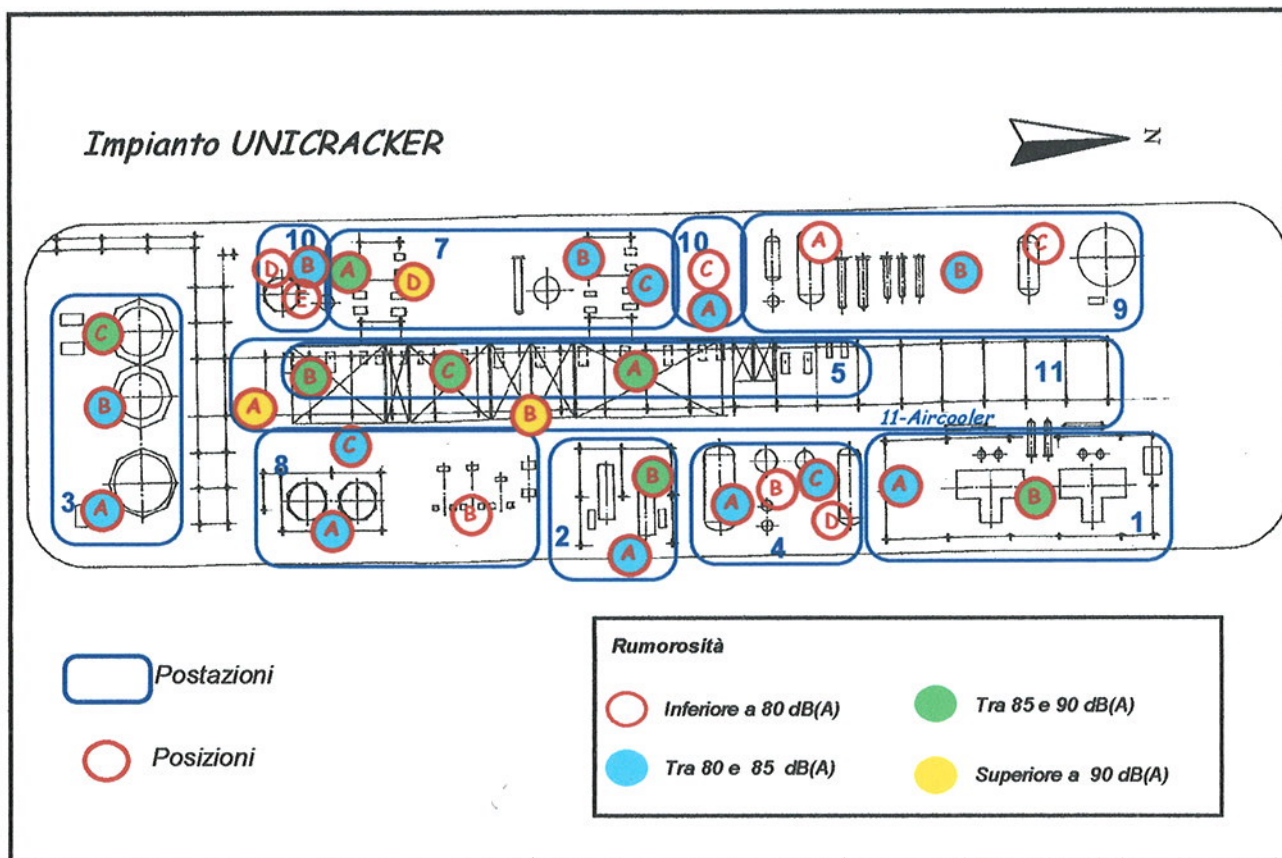



DOCUMENTO DI VALUTAZIONE DEL RISCHIO

(art. 4 D.Leg. 19-9-94 n° 626)

Eni S.p.A. Divisione
Refining & Marketing
Raffineria di Sannazzaro

AGENTE DI RISCHIO RUMORE

REPARTO R24 SOI OVEST

IMPIANTO **104 Reformer catalitico 3-Nafta Hydrobon (RC 3- NaHy)**

CAMPAGNA I. INDUSTRIALE 2002/2005

AGENTE

Valore medio

LPicco



Rumore

87,547 dB(A)

118 dB

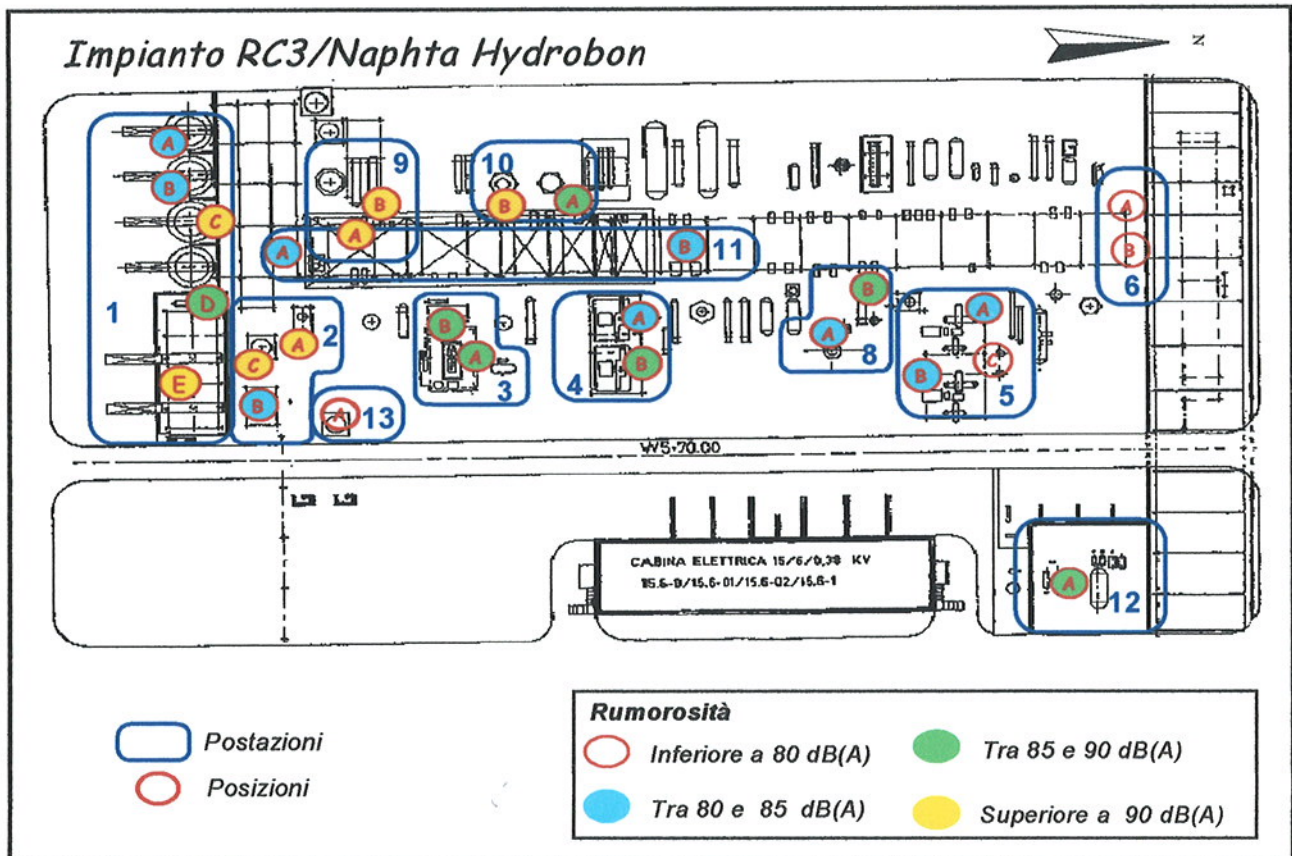



DOCUMENTO DI VALUTAZIONE DEL RISCHIO

(art. 4 D.Leg. 19-9-94 n° 626)

Eni S.p.A. Divisione
Refining & Marketing
Raffineria di Sannazzaro

AGENTE DI RISCHIO RUMORE

REPARTO R24 SOI OVEST

IMPIANTO **106 Idrogeno-Desolforazione GAS 3**

CAMPAGNA I. INDUSTRIALE 2002/2005

AGENTE

Valore medio

LPicco



Rumore

82,448 dB(A)

118,4 dB

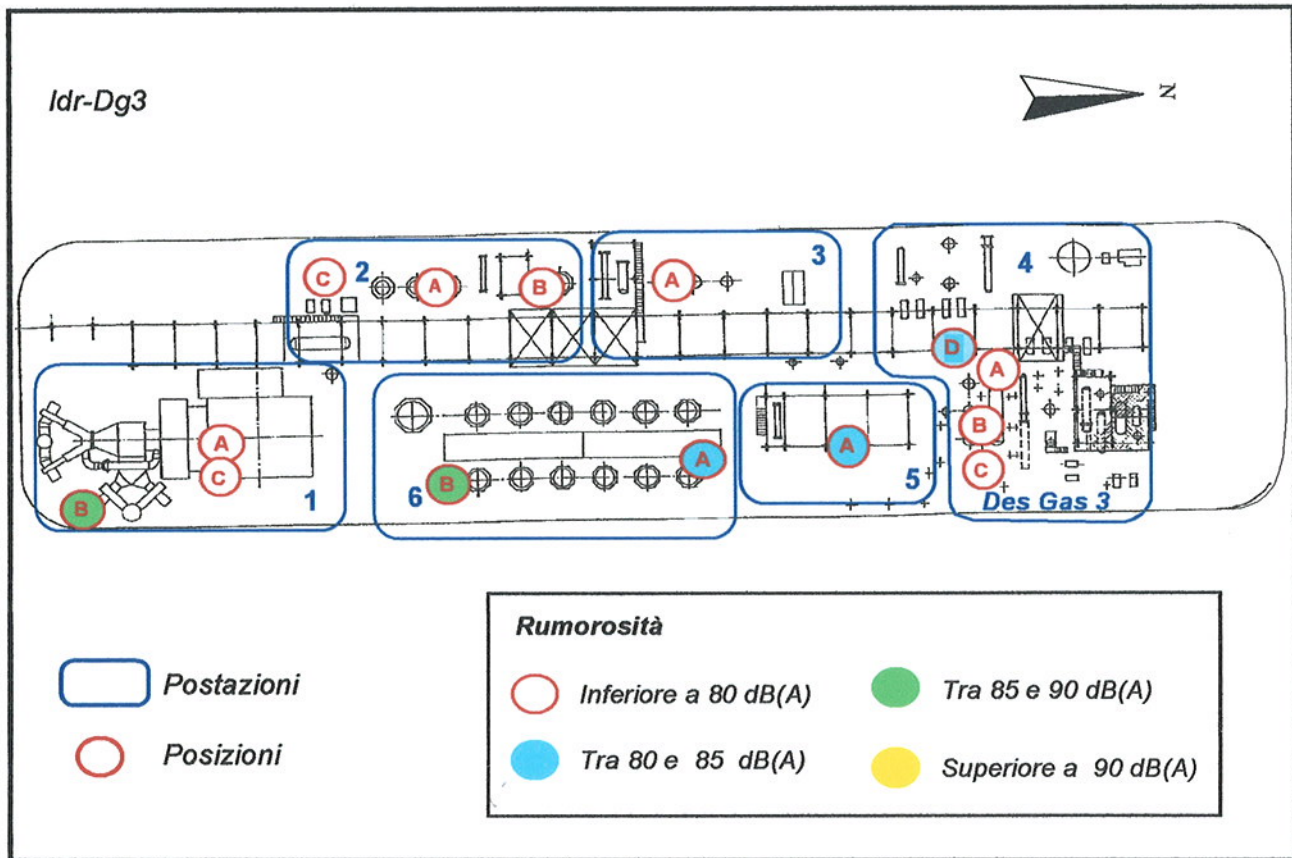



DOCUMENTO DI VALUTAZIONE DEL RISCHIO

(art. 4 D.Leg. 19-9-94 n° 626)

Eni S.p.A. Divisione
Refining & Marketing
Raffineria di Sannazzaro

AGENTE DI RISCHIO RUMORE

REPARTO R24 SOI OVEST

IMPIANTO **107 Desolforazione gasolio 2 (Hds 2- Des Gas 2- PSA 3)**

CAMPAGNA I. INDUSTRIALE 2002/2005

AGENTE

Valore medio

LPicco



Rumore

81,627 dB(A)

121,9 dB

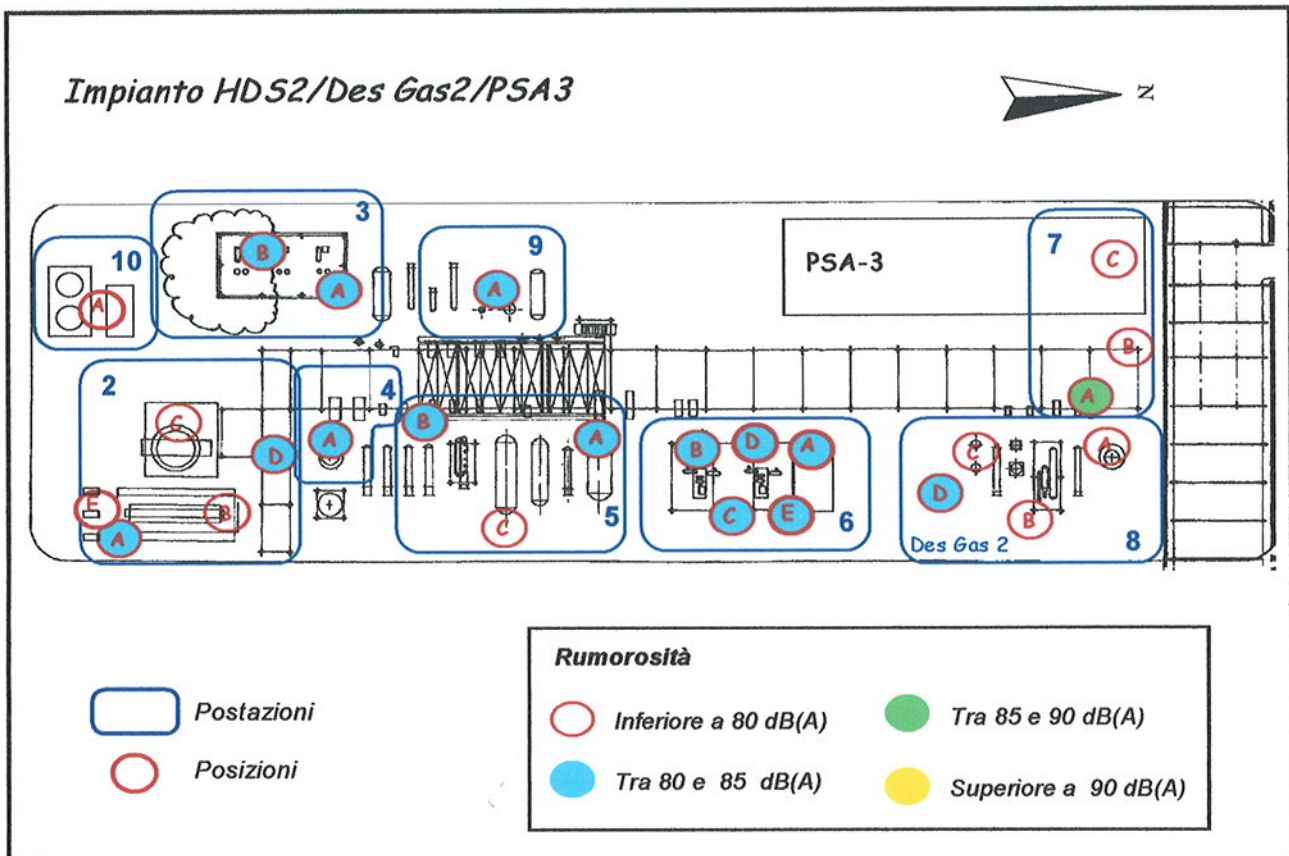



DOCUMENTO DI VALUTAZIONE DEL RISCHIO

(art. 4 D.Leg. 19-9-94 n° 626)

Eni S.p.A. Divisione
Refining & Marketing
Raffineria di Sannazzaro

AGENTE DI RISCHIO RUMORE

REPARTO R19 SOI MOVSPED

IMPIANTO **104 Uffici SPED (palazzina spedizioni)**

CAMPAGNA I. INDUSTRIALE 2002/2005

AGENTE

Valore medio

LPicco



Rumore

60,952 dB(A)

113 dB

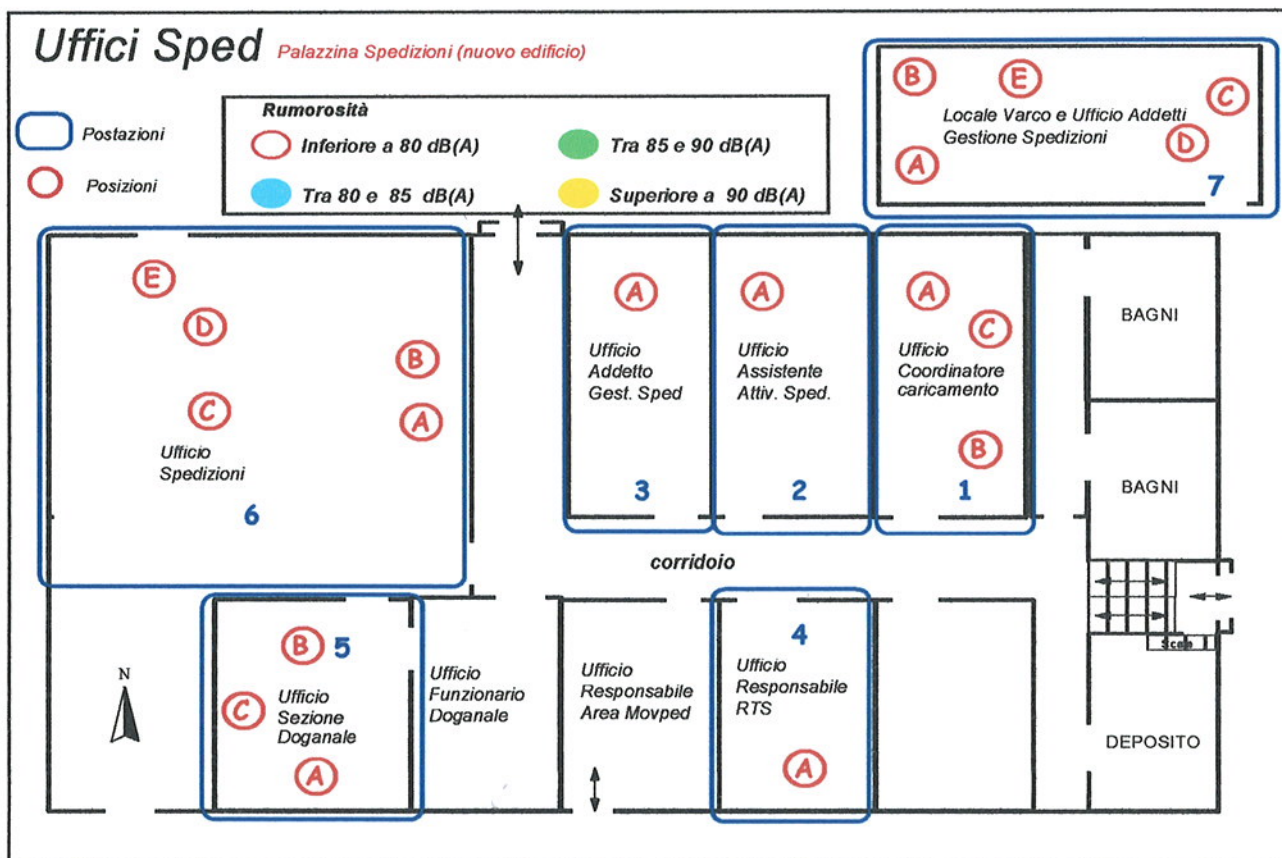



DOCUMENTO DI VALUTAZIONE DEL RISCHIO

(art. 4 D.Leg. 19-9-94 n° 626)

Eni S.p.A. Divisione
Refining & Marketing
Raffineria di Sannazzaro

AGENTE DI RISCHIO RUMORE

REPARTO R19 SOI MOVSPED

IMPIANTO **104 Uffici SPED (palazzina spedizioni)**

CAMPAGNA I. INDUSTRIALE 2002/2005

AGENTE

Valore medio

LPicco



Rumore

60,952 dB(A)

113 dB

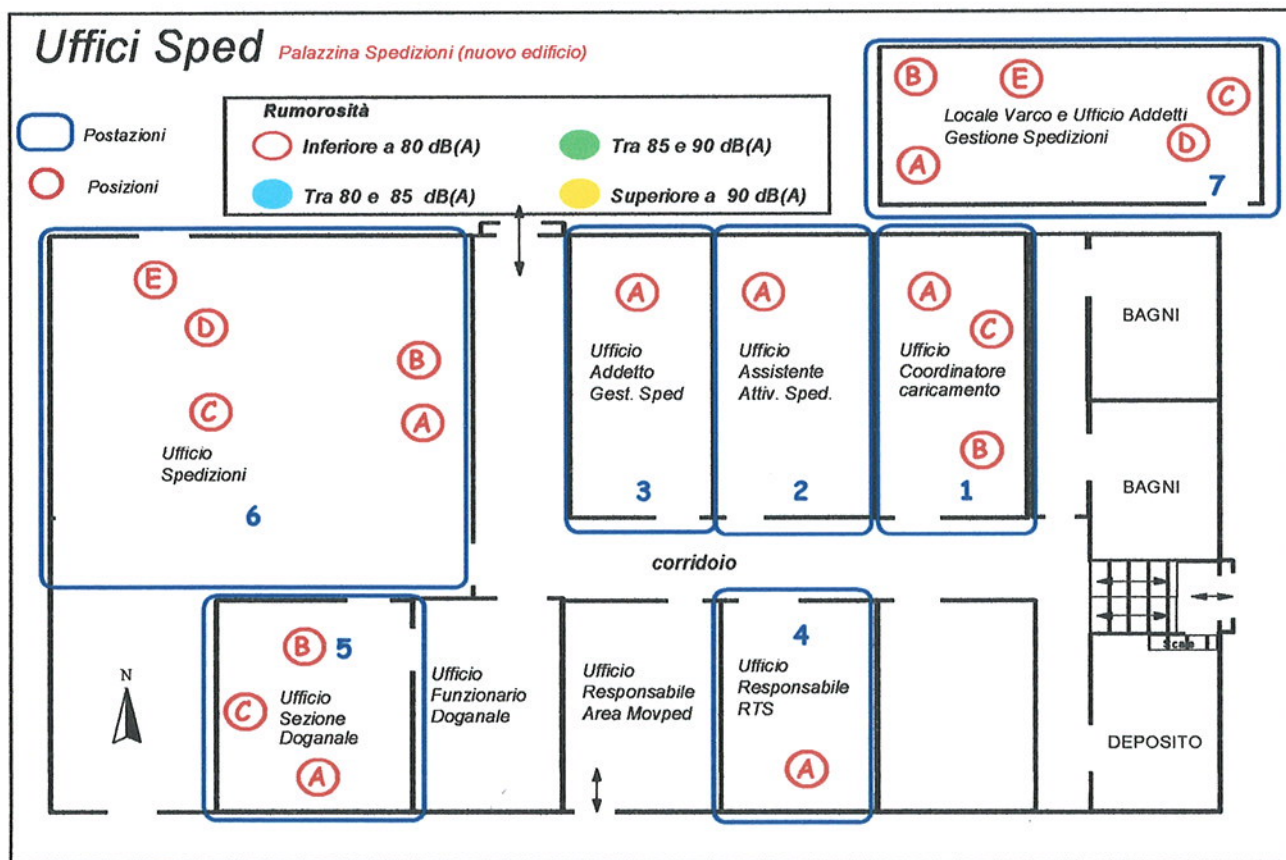



DOCUMENTO DI VALUTAZIONE DEL RISCHIO

(art. 4 D.Leg. 19-9-94 n° 626)

Eni S.p.A. Divisione
Refining & Marketing
Raffineria di Sannazzaro

AGENTE DI RISCHIO RUMORE

REPARTO R19 SOI MOVSPED

IMPIANTO **105 Sale controllo e Uffici-MOV**

CAMPAGNA I. INDUSTRIALE 2002/2005

AGENTE

Valore medio

LPicco



Rumore

59,432 dB(A)

117,9 dB

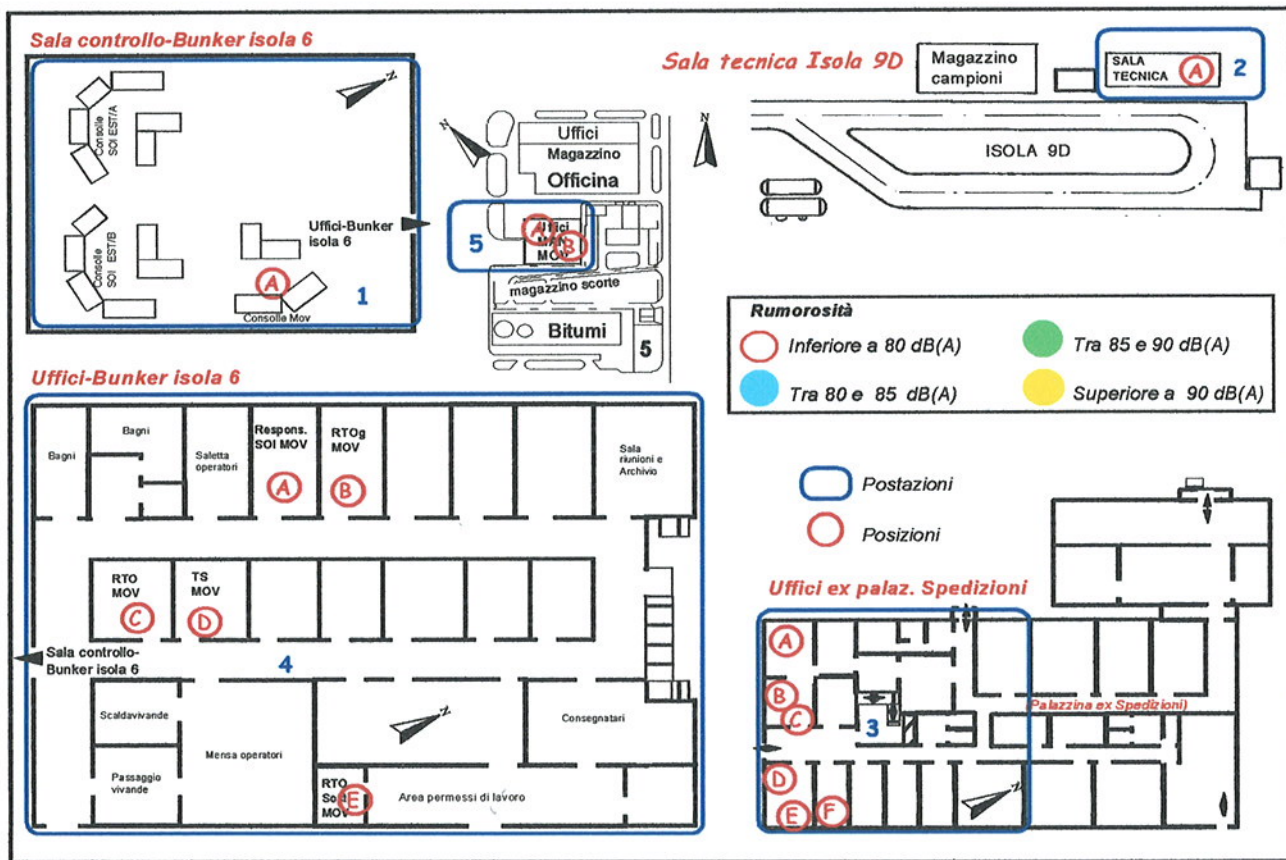



DOCUMENTO DI VALUTAZIONE DEL RISCHIO

(art. 4 D.Leg. 19-9-94 n° 626)

Eni S.p.A. Divisione
Refining & Marketing
Raffineria di Sannazzaro

AGENTE DI RISCHIO RUMORE

REPARTO R19 SOI MOVSPED

IMPIANTO **107 Spedizioni-Ricezioni ferrocisterne**

CAMPAGNA I. INDUSTRIALE 2002/2005

AGENTE

Valore medio

LPicco



Rumore

72,994 dB(A)

118,3 dB

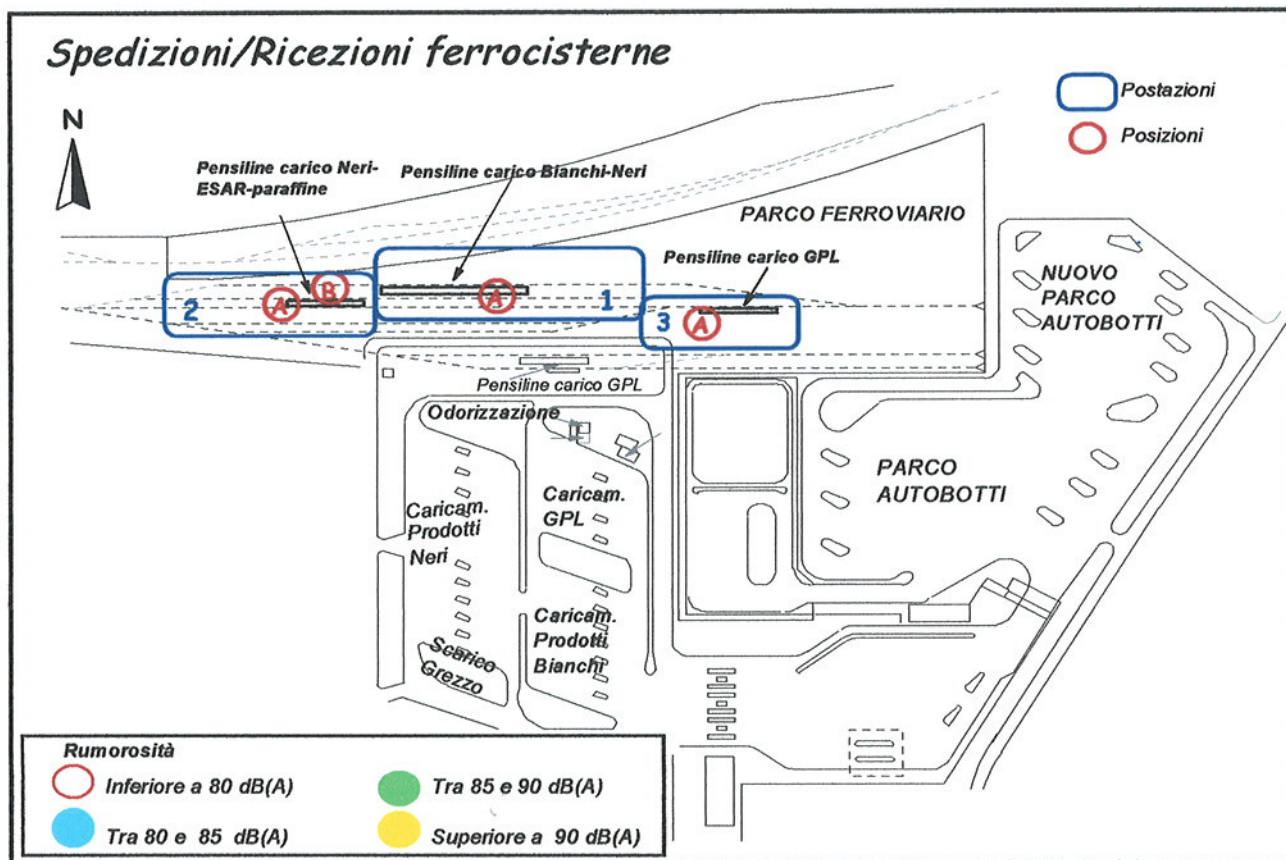



DOCUMENTO DI VALUTAZIONE DEL RISCHIO

(art. 4 D.Leg. 19-9-94 n° 626)

Eni S.p.A. Divisione
Refining & Marketing
Raffineria di Sannazzaro

AGENTE DI RISCHIO RUMORE

REPARTO R19 SOI MOVSPED

IMPIANTO **106 Spedizioni Bianchi-Neri-GPL**

CAMPAGNA I. INDUSTRIALE 2002/2005

AGENTE

Valore medio

LPicco



Rumore

68,109 dB(A)

113 dB

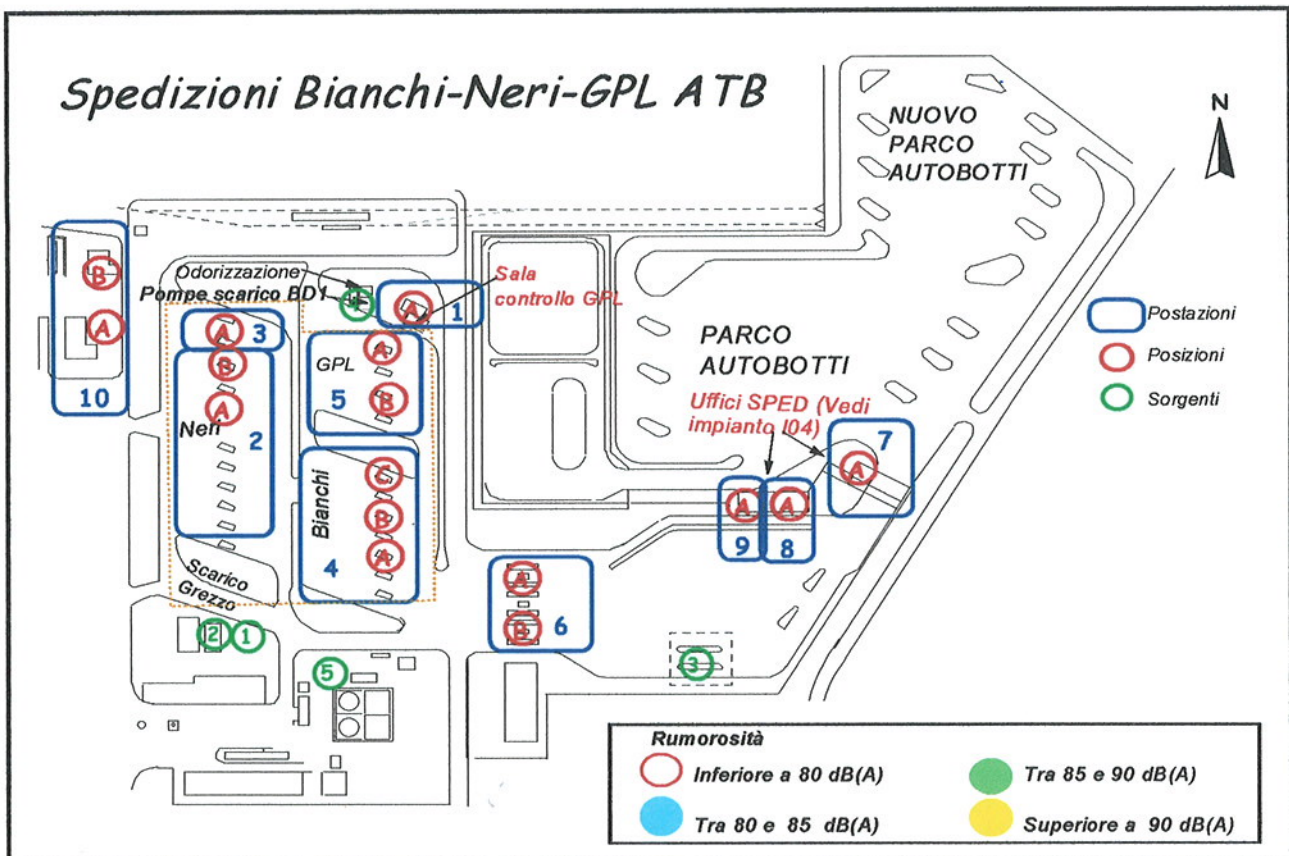



DOCUMENTO DI VALUTAZIONE DEL RISCHIO

(art. 4 D.Leg. 19-9-94 n° 626)

Eni S.p.A. Divisione
Refining & Marketing
Raffineria di Sannazzaro

AGENTE DI RISCHIO RUMORE

REPARTO R19 SOI MOVSPED

IMPIANTO **I01 Sale pompe**

CAMPAGNA I. INDUSTRIALE 2002/2005

AGENTE



Rumore

Valore medio

84,120 dB(A)

LPicco

116,6 dB

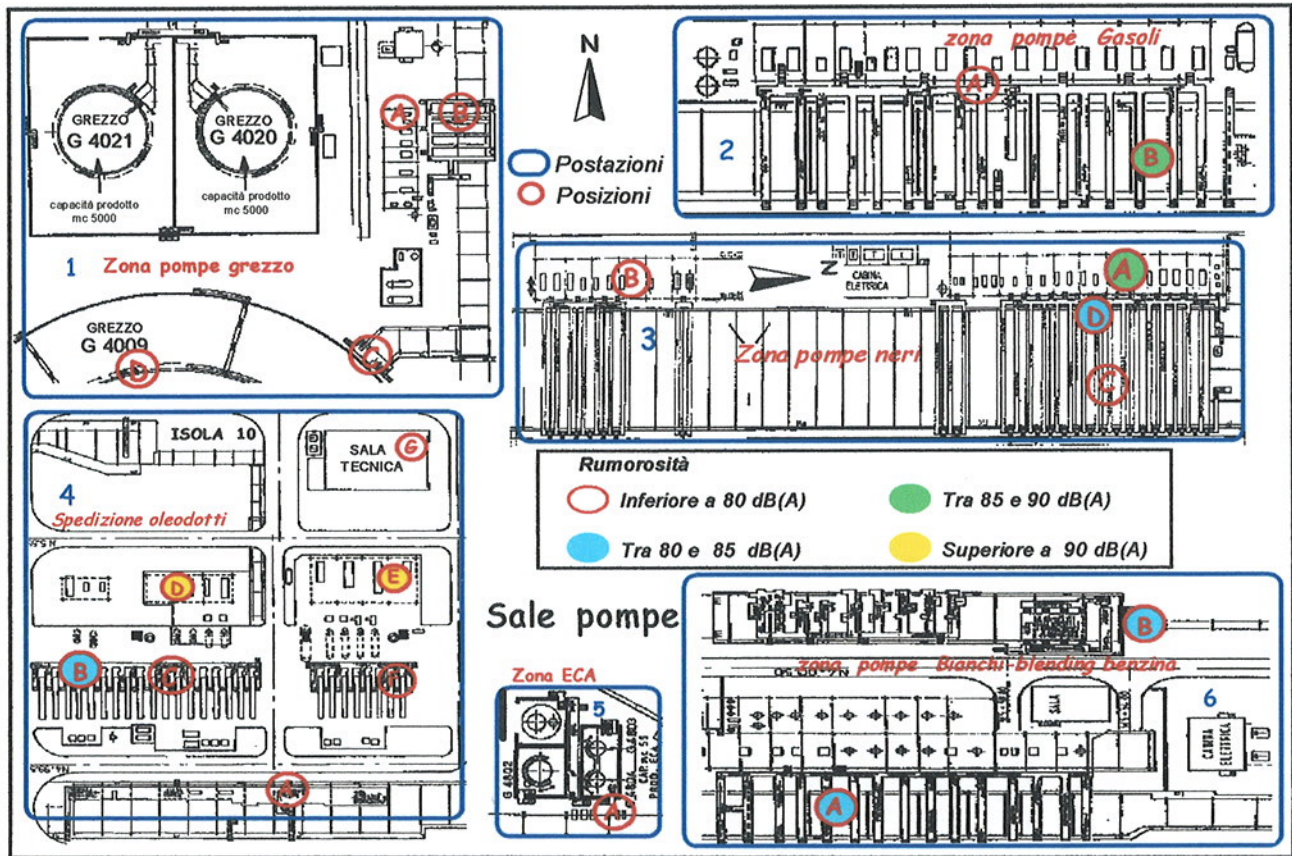



DOCUMENTO DI VALUTAZIONE DEL RISCHIO

(art. 4 D.Leg. 19-9-94 n° 626)

Eni S.p.A. Divisione
Refining & Marketing
Raffineria di Sannazzaro

AGENTE DI RISCHIO RUMORE

REPARTO R19 SOI MOVSPED

IMPIANTO **102 Parco serbatoi**

CAMPAGNA I. INDUSTRIALE 2002/2005

AGENTE

Valore medio

LPicco



Rumore

73,452 dB(A)

110,4 dB

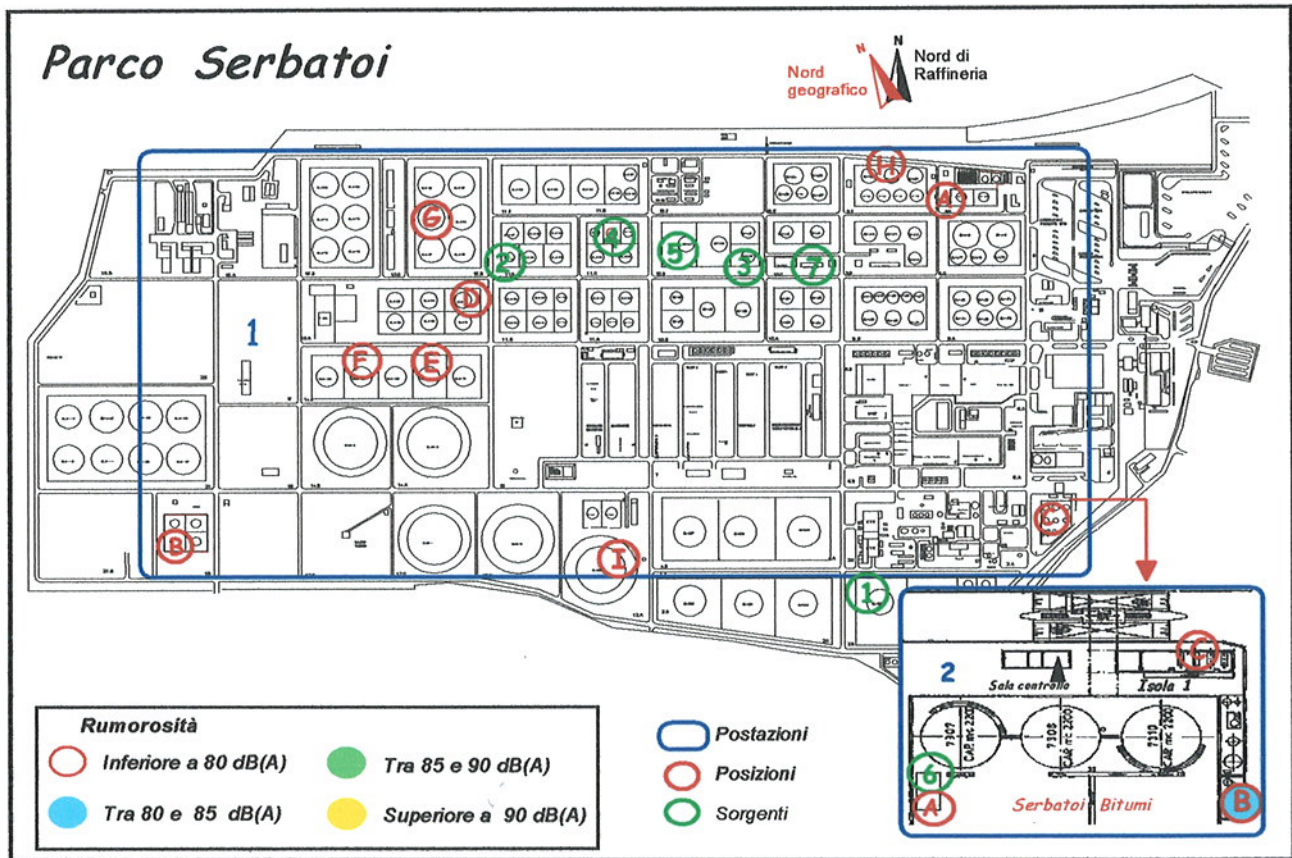



DOCUMENTO DI VALUTAZIONE DEL RISCHIO

(art. 4 D.Leg. 19-9-94 n° 626)

Eni S.p.A. Divisione
Refining & Marketing
Raffineria di Sannazzaro

AGENTE DI RISCHIO RUMORE

REPARTO R19 SOI MOVSPED

IMPIANTO **I03 Gpl 1-Gpl 2-Gpl 3**

CAMPAGNA I. INDUSTRIALE 2002/2005

AGENTE

Valore medio

LPicco



Rumore

81,113 dB(A)

100,8 dB

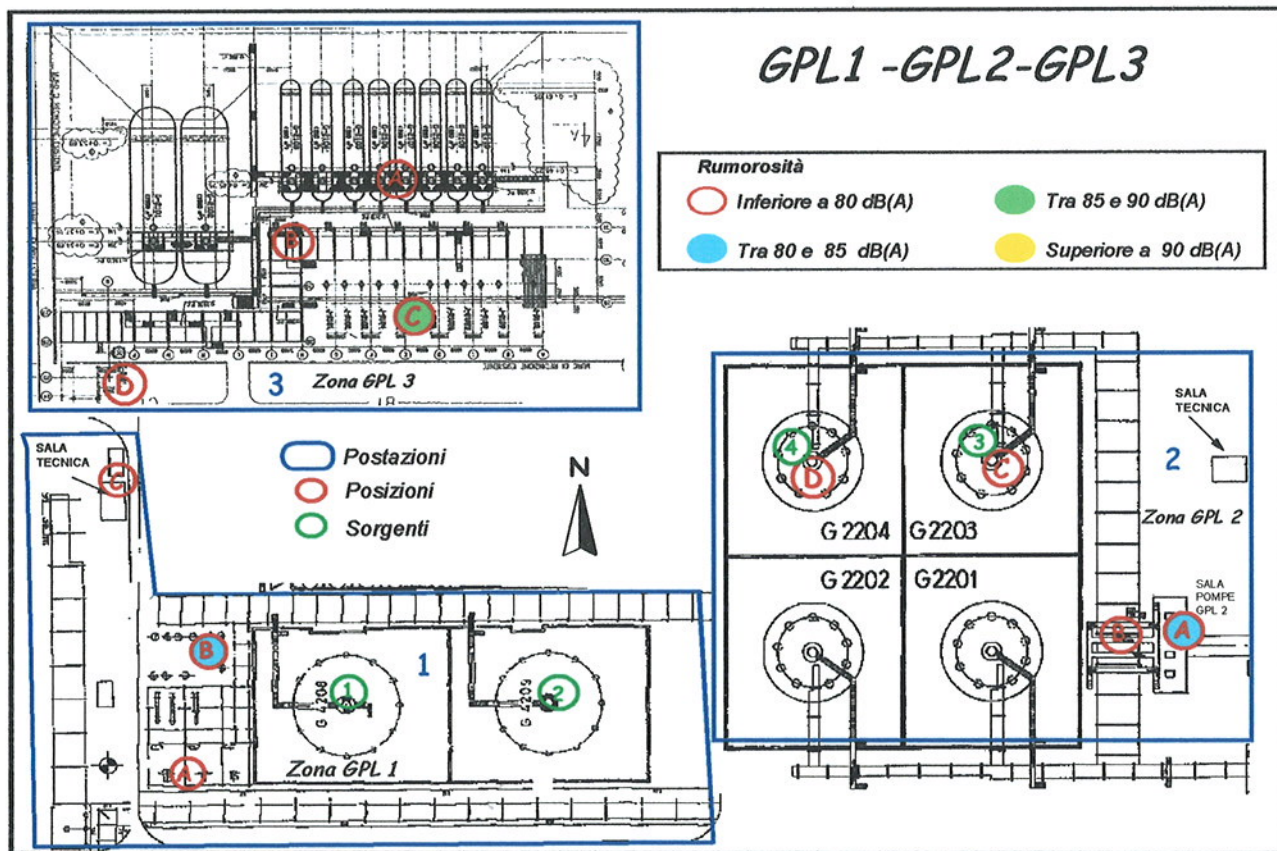



DOCUMENTO DI VALUTAZIONE DEL RISCHIO

(art. 4 D.Leg. 19-9-94 n° 626)

Eni S.p.A. Divisione
Refining & Marketing
Raffineria di Sannazzaro

AGENTE DI RISCHIO RUMORE

REPARTO R19 SOI MOVSPED

IMPIANTO **108 Caricamento Bitumi-Zolfi**

CAMPAGNA I. INDUSTRIALE 2002/2005

AGENTE

Valore medio

LPicco



Rumore

75,725 dB(A)

117,7 dB

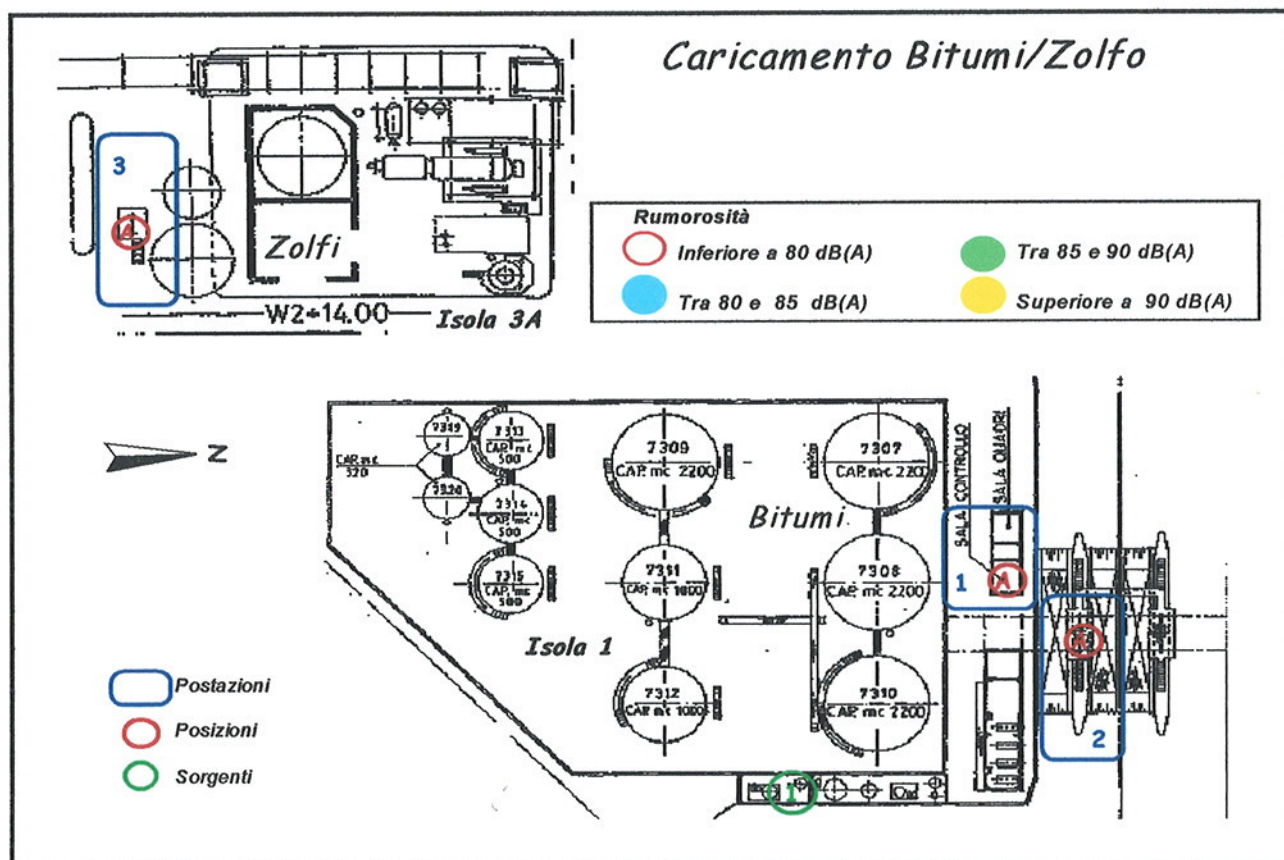



DOCUMENTO DI VALUTAZIONE DEL RISCHIO

(art. 4 D.Leg. 19-9-94 n° 626)

Eni S.p.A. Divisione
Refining & Marketing
Raffineria di Sannazzaro

AGENTE DI RISCHIO RUMORE

REPARTO R22 SOI EST

IMPIANTO **116 Desolforazione benzine da FCC (CD TECH)**

CAMPAGNA I. INDUSTRIALE 2002/2005

AGENTE

Valore medio

LPicco



Rumore

86,850 dB(A)

119,6 dB

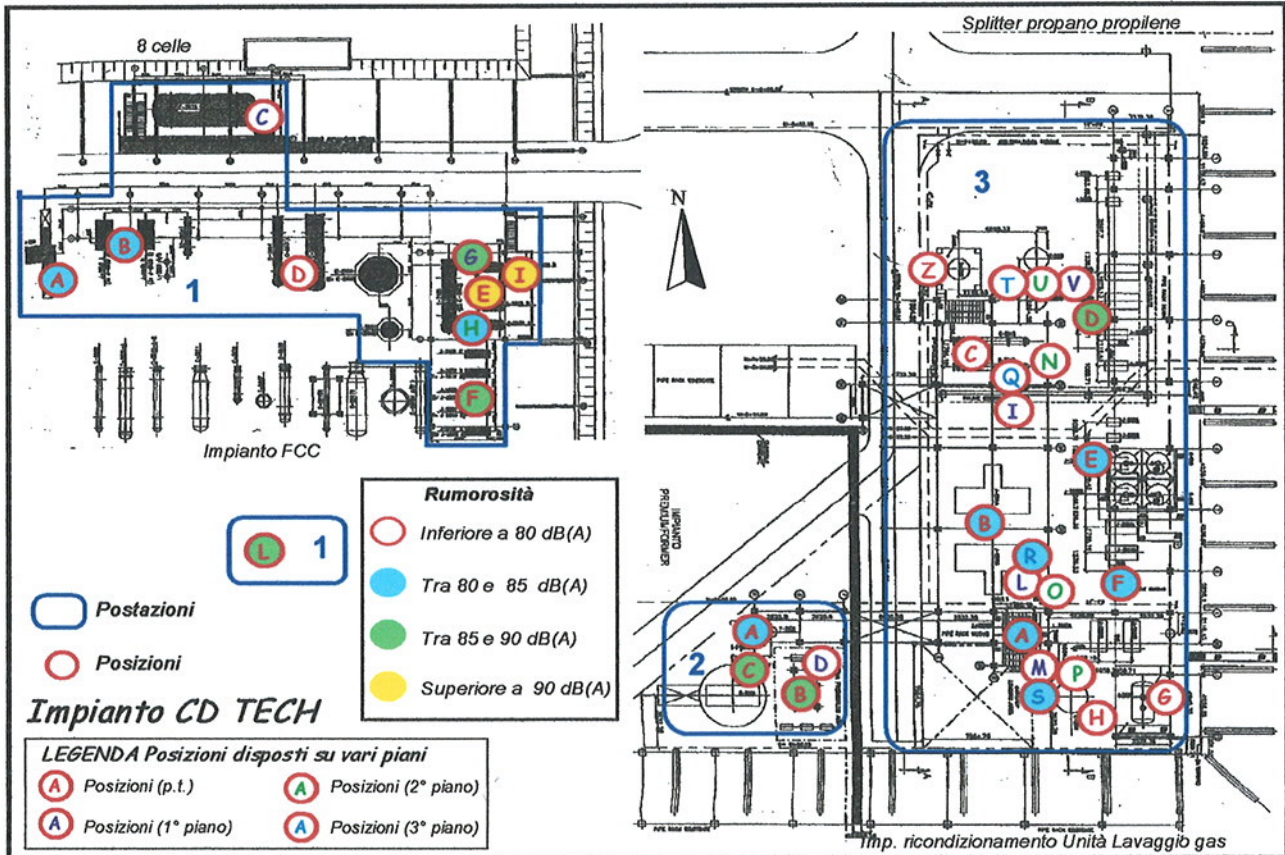



DOCUMENTO DI VALUTAZIONE DEL RISCHIO

(art. 4 D.Leg. 19-9-94 n° 626)

Eni S.p.A. Divisione
Refining & Marketing
Raffineria di Sannazzaro

AGENTE DI RISCHIO RUMORE

REPARTO R22 SOI EST

IMPIANTO **I04 Zolfi-Scot**

CAMPAGNA I. INDUSTRIALE 2002/2005

AGENTE

Valore medio

LPicco



Rumore

89,730 dB(A)

115,3 dB

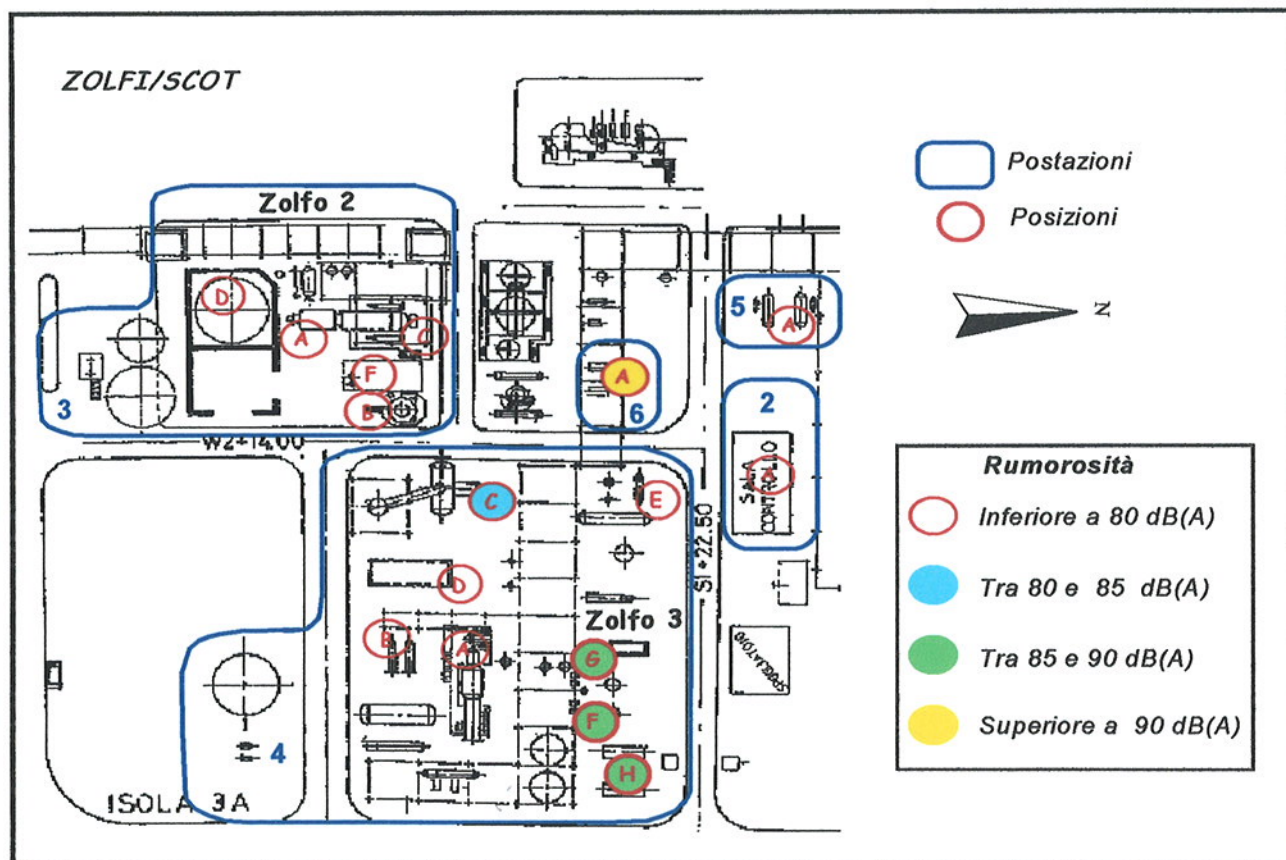



DOCUMENTO DI VALUTAZIONE DEL RISCHIO

(art. 4 D.Leg. 19-9-94 n° 626)

Eni S.p.A. Divisione
Refining & Marketing
Raffineria di Sannazzaro

AGENTE DI RISCHIO RUMORE

REPARTO R22 SOI EST

IMPIANTO **I01 Sour Water Stripper (SWS)**

CAMPAGNA I. INDUSTRIALE 2002/2005

AGENTE

Valore medio

LPicco



Rumore

82,483 dB(A)

105,5 dB

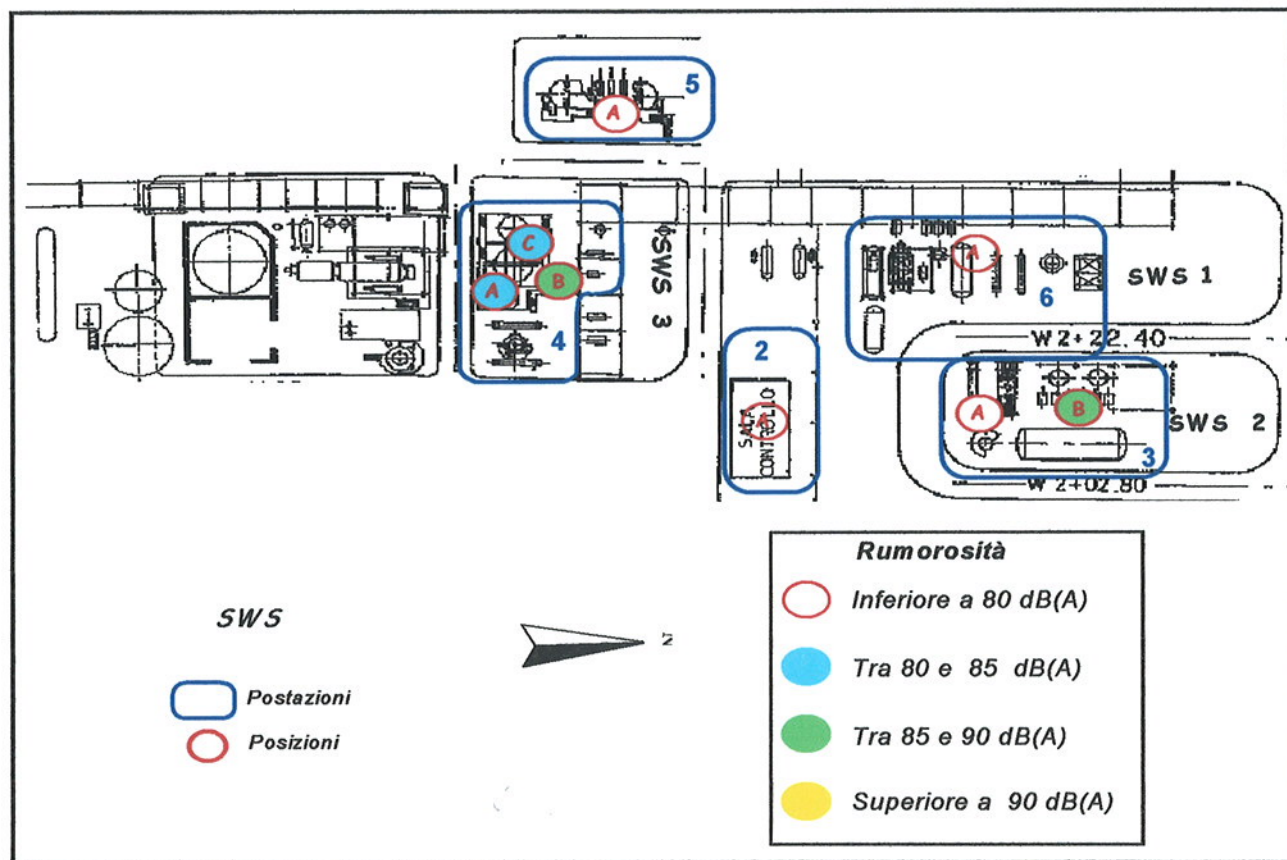



DOCUMENTO DI VALUTAZIONE DEL RISCHIO

(art. 4 D.Leg. 19-9-94 n° 626)

Eni S.p.A. Divisione
Refining & Marketing
Raffineria di Sannazzaro

AGENTE DI RISCHIO RUMORE

REPARTO R22 SOI EST

IMPIANTO **102 Reformer catalitico 2 (RC 2)**

CAMPAGNA I. INDUSTRIALE 2002/2005

AGENTE

Valore medio

LPicco



Rumore

86,462 dB(A)

111,3 dB

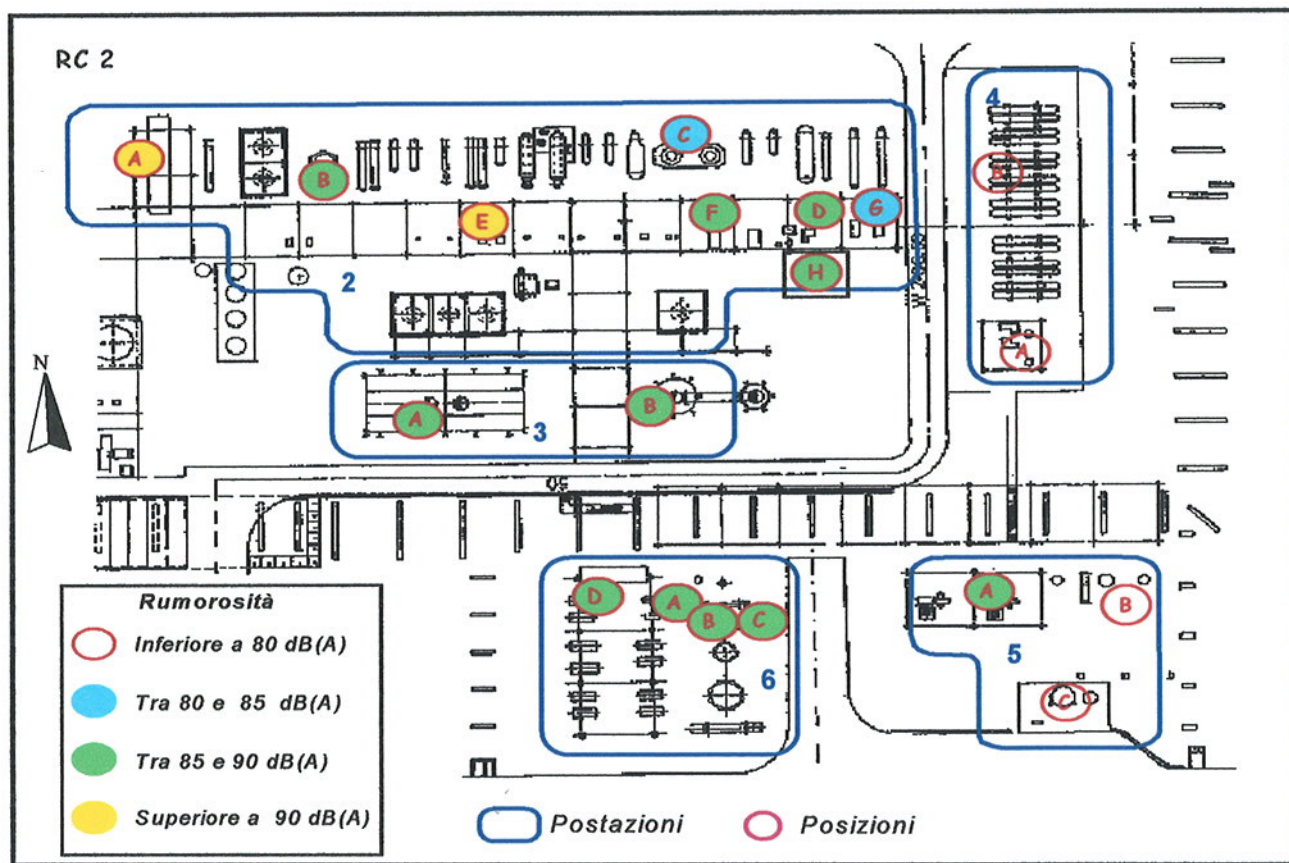



DOCUMENTO DI VALUTAZIONE DEL RISCHIO

(art. 4 D.Leg. 19-9-94 n° 626)

Eni S.p.A. Divisione
Refining & Marketing
Raffineria di Sannazzaro

AGENTE DI RISCHIO RUMORE

REPARTO R22 SOI EST

IMPIANTO **112 Mtbe**

CAMPAGNA I. INDUSTRIALE 2002/2005

AGENTE

Valore medio

LPicco



Rumore

81,838 dB(A)

110,2 dB

Impianto MTBE

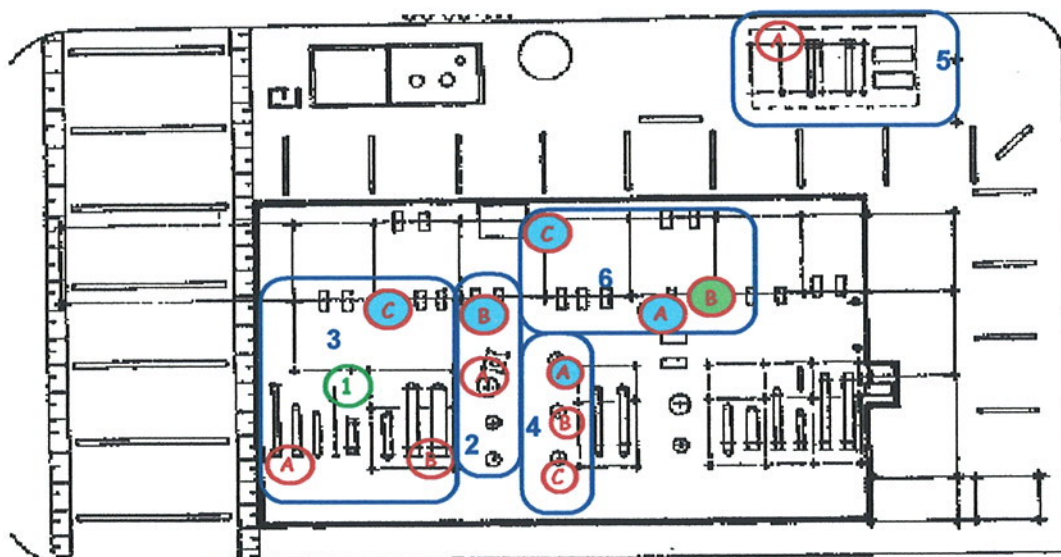

Rumorosità

Inferiore a 80 dB(A)

Tra 85 e 90 dB(A)

Tra 80 e 85 dB(A)

Superiore a 90 dB(A)

Postazioni

Posizioni

Sorgenti



DOCUMENTO DI VALUTAZIONE DEL RISCHIO

(art. 4 D.Leg. 19-9-94 n° 626)

Eni S.p.A. Divisione
Refining & Marketing

Raffineria di Sannazzaro

AGENTE DI RISCHIO RUMORE

REPARTO R22 SOI EST

IMPIANTO **I11 Merox**

CAMPAGNA I. INDUSTRIALE 2002/2005

AGENTE

Valore medio

LPicco



Rumore

83,560 dB(A)

108,3 dB

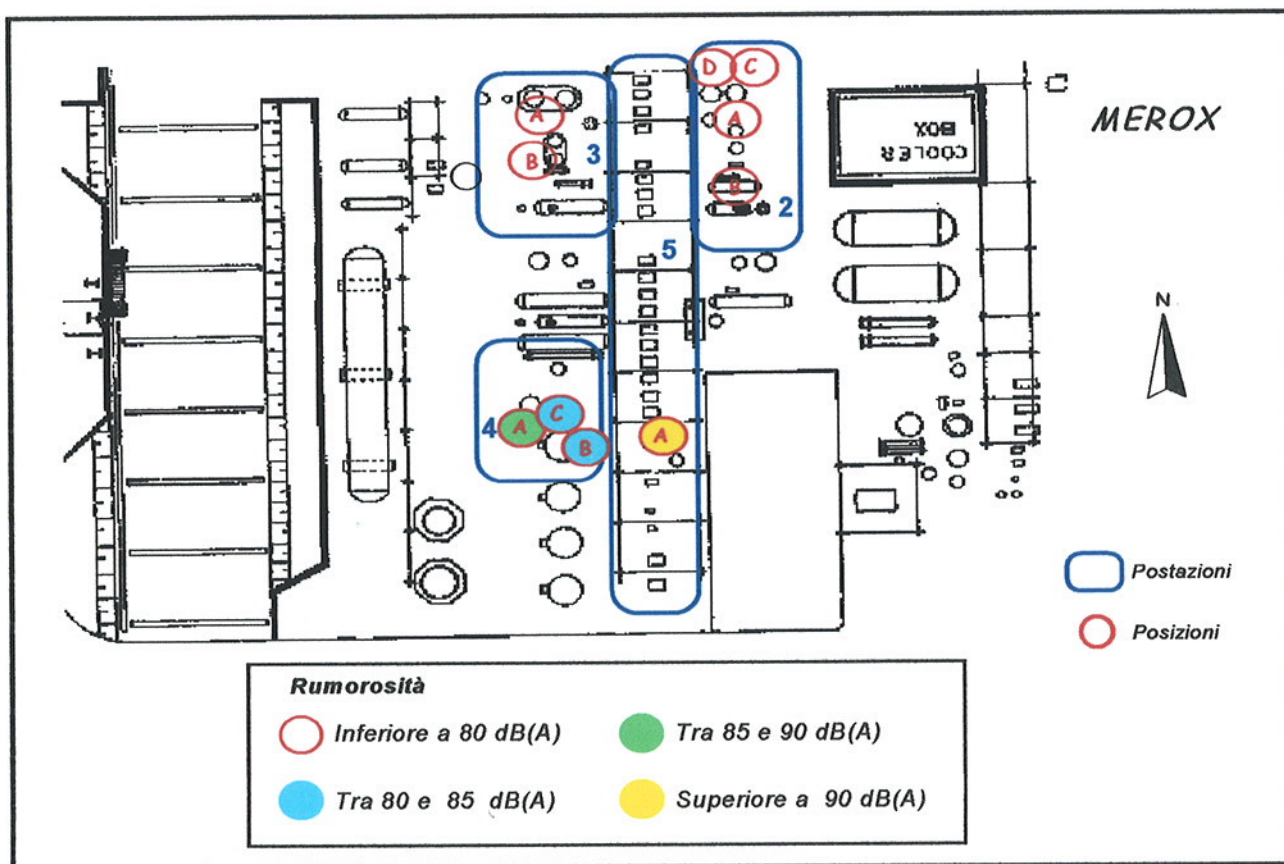



DOCUMENTO DI VALUTAZIONE DEL RISCHIO

(art. 4 D.Leg. 19-9-94 n° 626)

Eni S.p.A. Divisione
Refining & Marketing
Raffineria di Sannazzaro

AGENTE DI RISCHIO RUMORE

REPARTO R22 SOI EST

IMPIANTO **103 Isomerizzazione (TIP-ISOSIV)**

CAMPAGNA I. INDUSTRIALE 2002/2005

AGENTE

Valore medio

LPicco



Rumore

89,994 dB(A)

115,6 dB

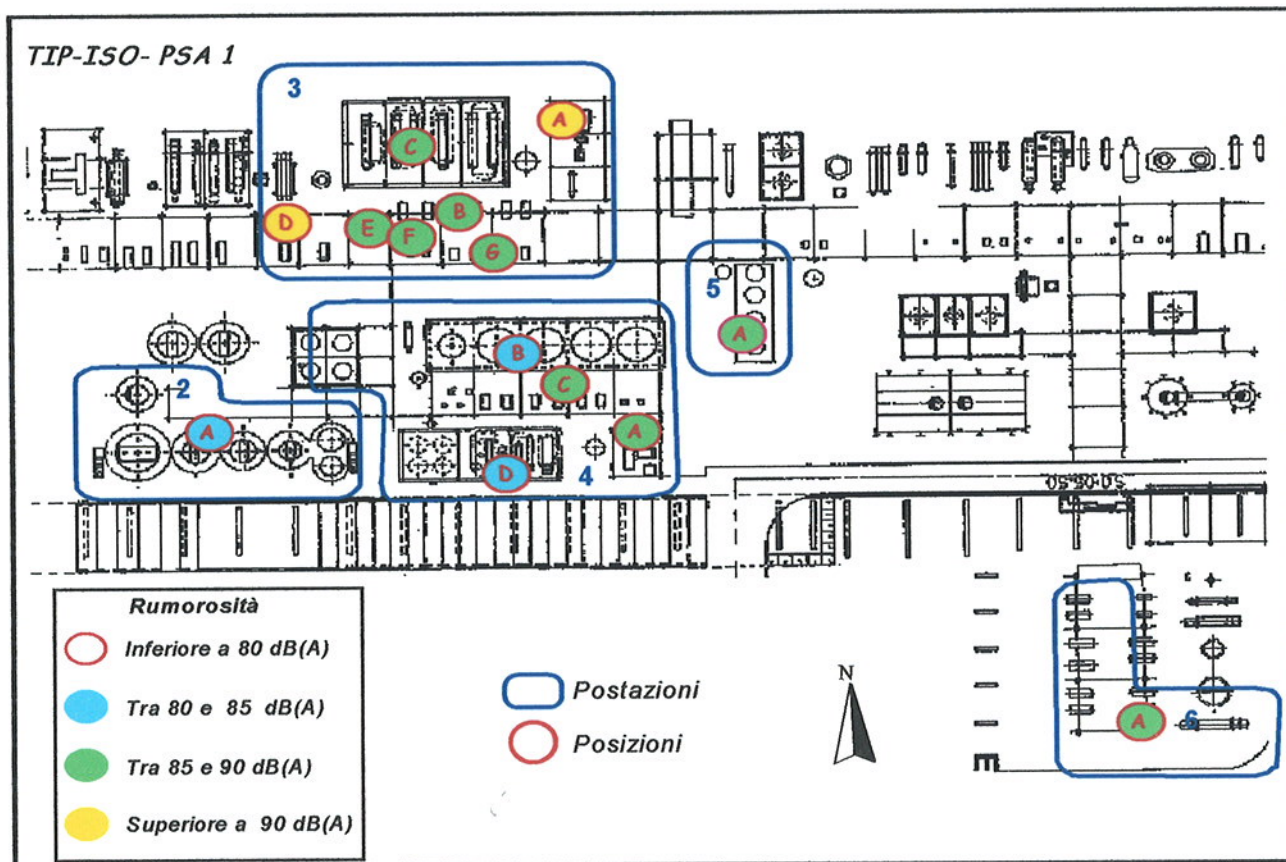



DOCUMENTO DI VALUTAZIONE DEL RISCHIO

(art. 4 D.Leg. 19-9-94 n° 626)

Eni S.p.A. Divisione
Refining & Marketing

Raffineria di Sannazzaro

AGENTE DI RISCHIO RUMORE

REPARTO R22 SOI EST

IMPIANTO **110 Fluid Catalytic Cracking -(FCC)**

CAMPAGNA I. INDUSTRIALE 2002/2005

AGENTE

Valore medio

LPicco



Rumore

89,820 dB(A)

116,7 dB

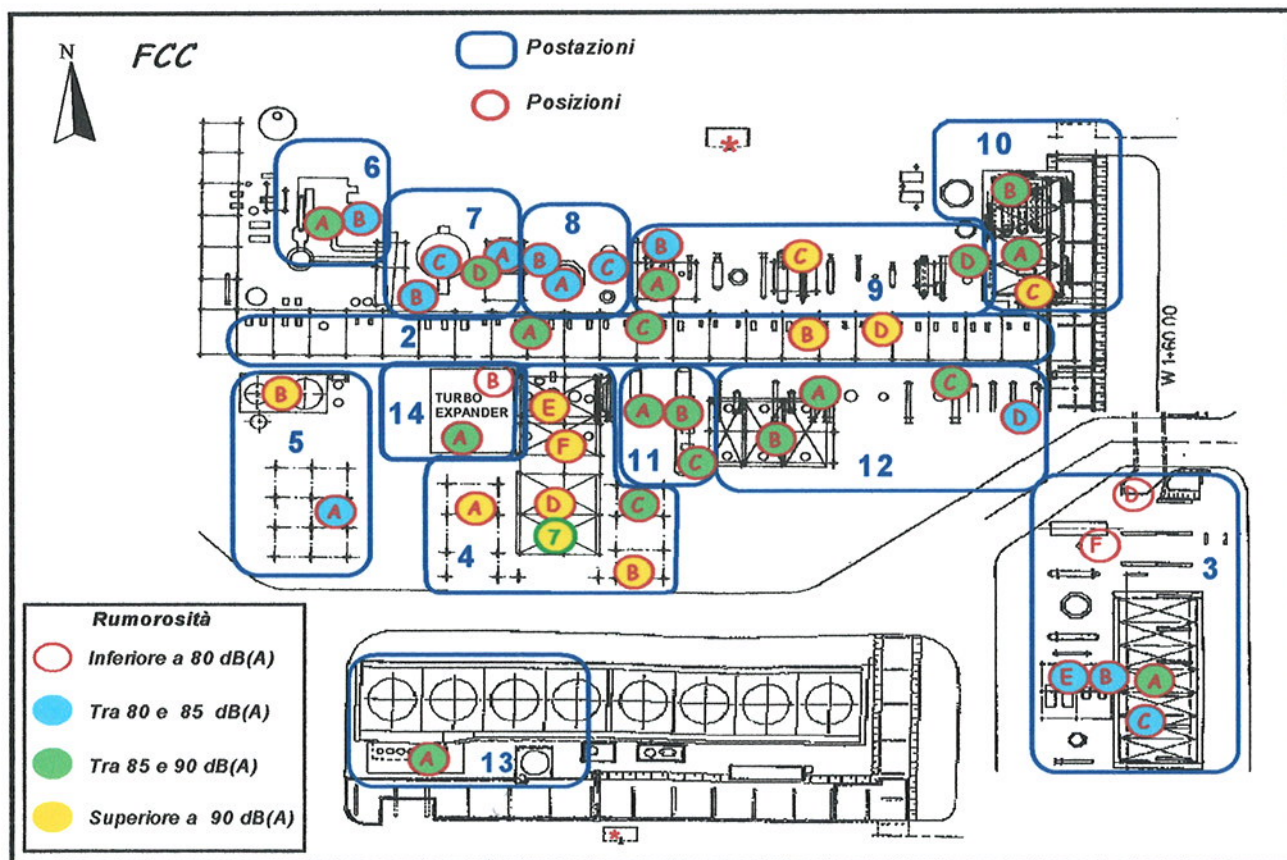



DOCUMENTO DI VALUTAZIONE DEL RISCHIO

(art. 4 D.Leg. 19-9-94 n° 626)

Eni S.p.A. Divisione
Refining & Marketing

Raffineria di Sannazzaro

AGENTE DI RISCHIO RUMORE

REPARTO R22 SOI EST

IMPIANTO **I13 Distillazione sotto vuoto -(VACUUM)**

CAMPAGNA I. INDUSTRIALE 2002/2005

AGENTE

Valore medio

LPicco



Rumore

88,425 dB(A)

111,2 dB

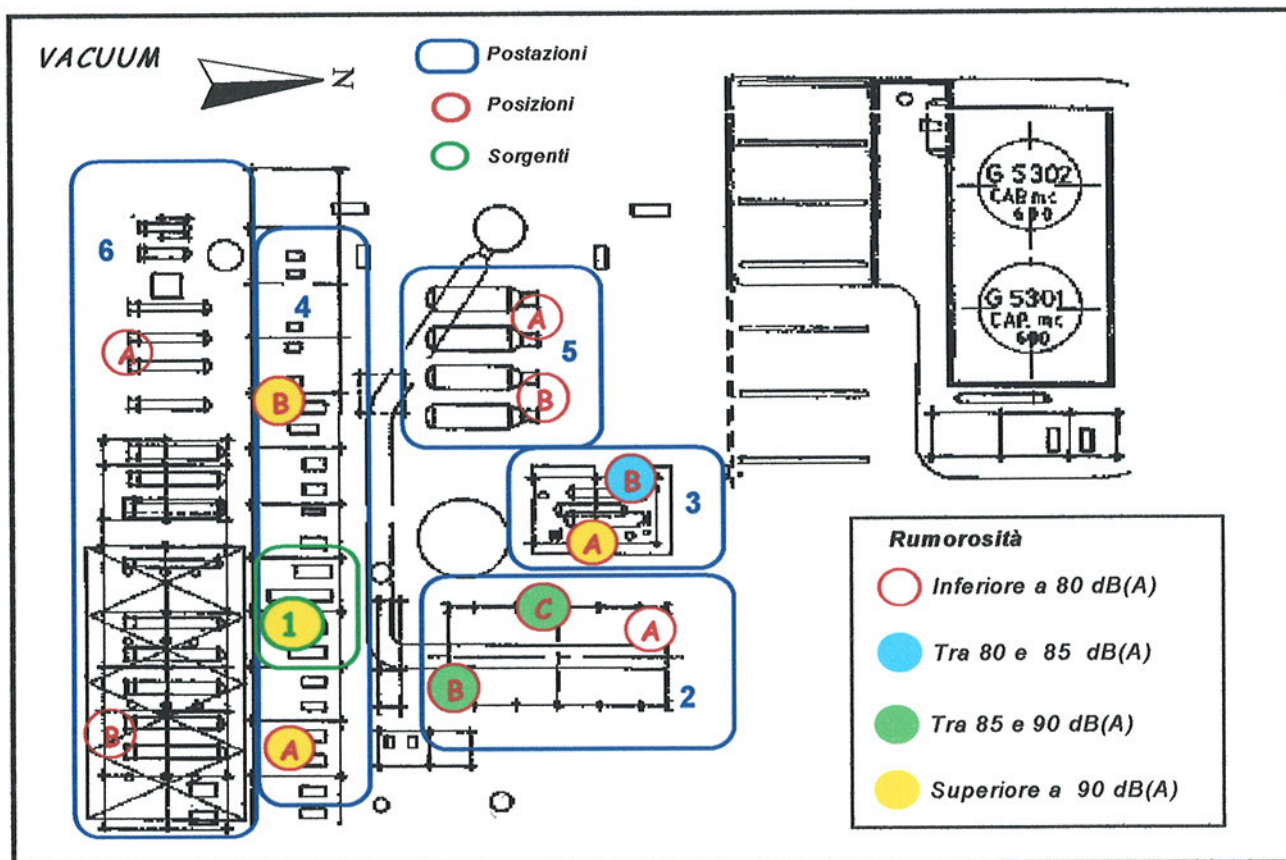



DOCUMENTO DI VALUTAZIONE DEL RISCHIO

(art. 4 D.Leg. 19-9-94 n° 626)

Eni S.p.A. Divisione
Refining & Marketing

Raffineria di Sannazzaro

AGENTE DI RISCHIO RUMORE

REPARTO R22 SOI EST

IMPIANTO **109** **Distillazione atmosferica - (DP1)**

CAMPAGNA I. INDUSTRIALE 2002/2005

AGENTE

Valore medio

LPicco



Rumore

91,559 dB(A)

113,7 dB

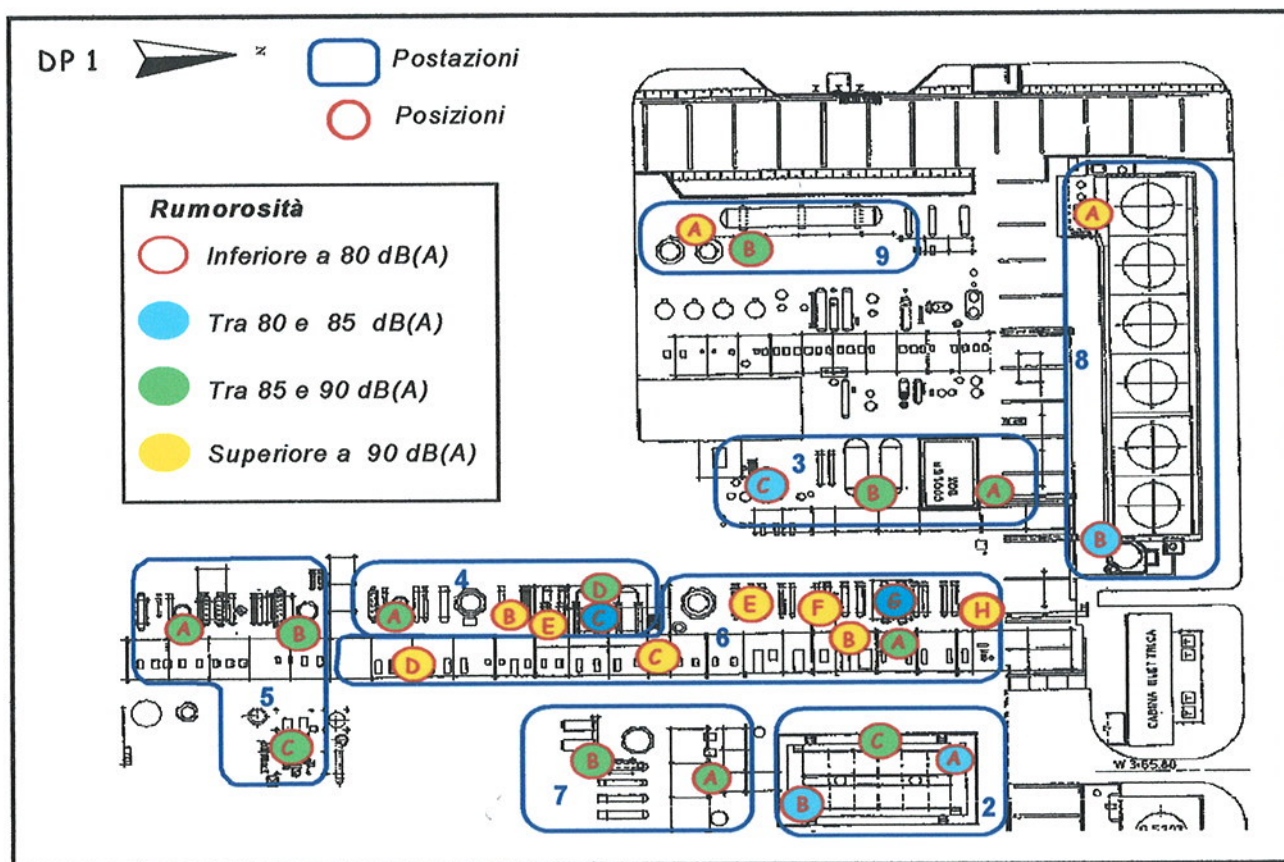



DOCUMENTO DI VALUTAZIONE DEL RISCHIO

(art. 4 D.Leg. 19-9-94 n° 626)

Eni S.p.A. Divisione
Refining & Marketing

Raffineria di Sannazzaro

AGENTE DI RISCHIO RUMORE

REPARTO R22 SOI EST

IMPIANTO **107 Desolfurazione kerosene 3 (HDS 3)**

CAMPAGNA I. INDUSTRIALE 2002/2005

AGENTE

Valore medio

LPicco



Rumore

87,558 dB(A)

111,6 dB

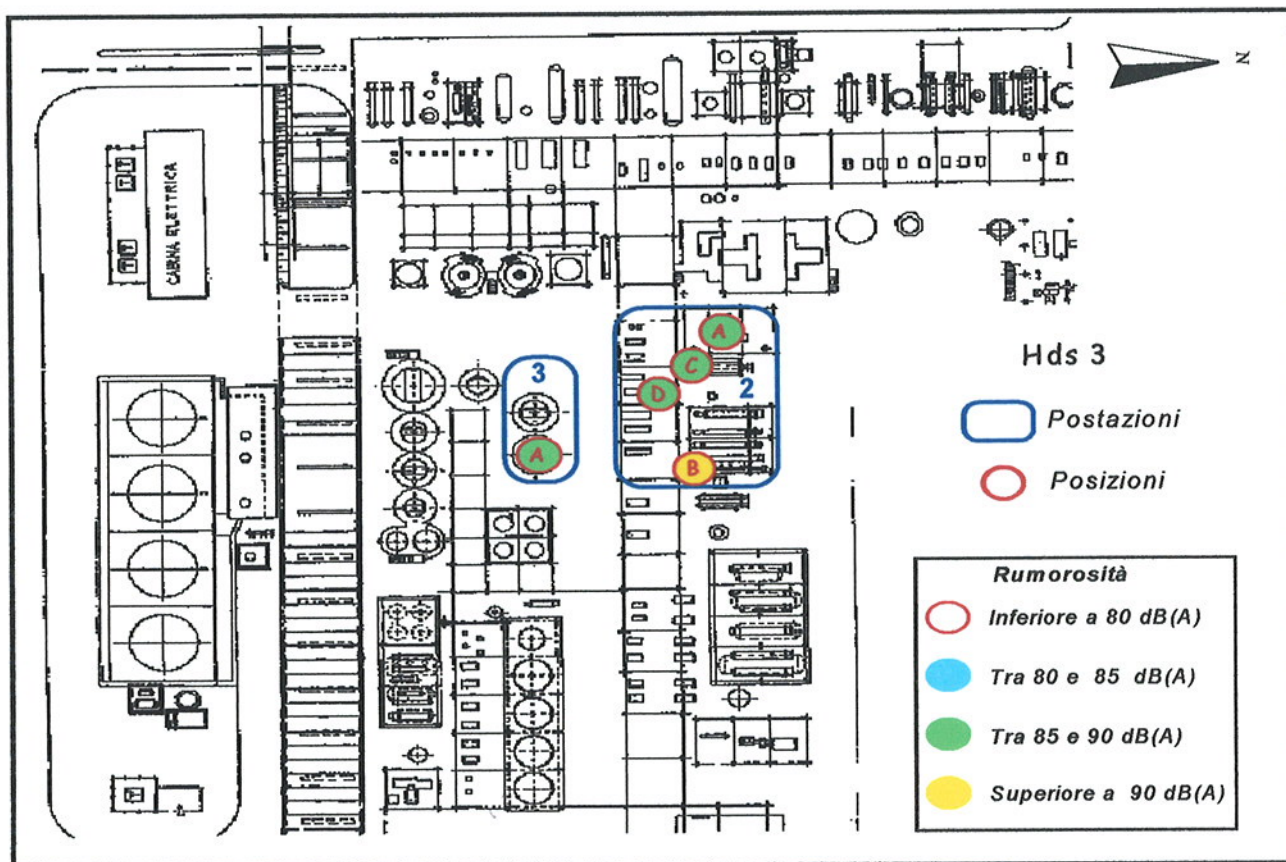



DOCUMENTO DI VALUTAZIONE DEL RISCHIO

(art. 4 D.Leg. 19-9-94 n° 626)

Eni S.p.A. Divisione
Refining & Marketing

Raffineria di Sannazzaro

AGENTE DI RISCHIO RUMORE

REPARTO R22 SOI EST

IMPIANTO **I08 Desolfurazione gas 1 (DES GAS 1)**

CAMPAGNA I. INDUSTRIALE 2002/2005

AGENTE

Valore medio

LPicco



Rumore

89,113 dB(A)

111,4 dB

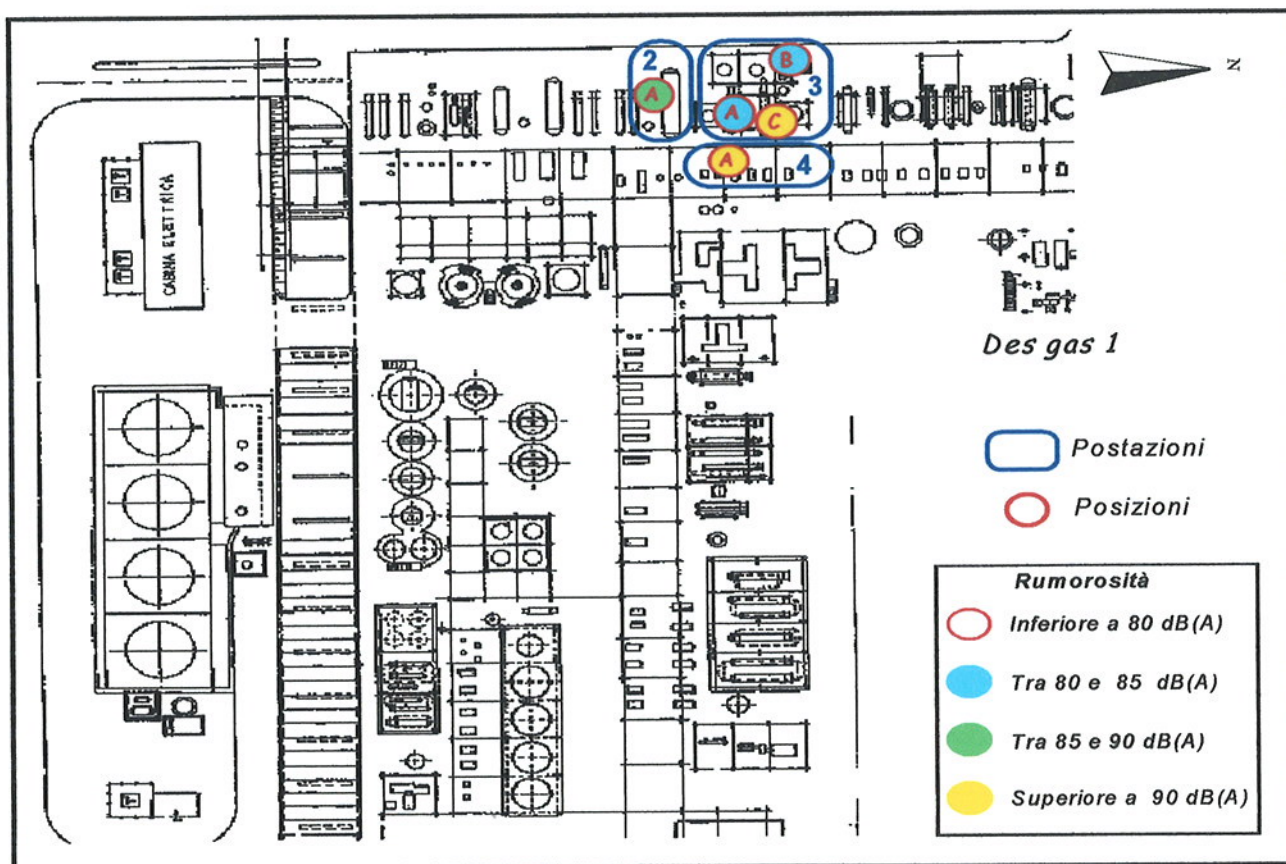



DOCUMENTO DI VALUTAZIONE DEL RISCHIO

(art. 4 D.Leg. 19-9-94 n° 626)

Eni S.p.A. Divisione
Refining & Marketing

Raffineria di Sannazzaro

AGENTE DI RISCHIO RUMORE

REPARTO R22 SOI EST

IMPIANTO **105 Alchilazione (ALK)**

CAMPAGNA I. INDUSTRIALE 2002/2005

AGENTE

Valore medio

LPicco



Rumore

83,951 dB(A)

116,7 dB

