

TRINCEA PER TUBAZIONI ESISTENTI

VASCA N° 21  
SEP. 21

MURATI PER TUBAZIONI ESISTENTI

VASCA N° 23  
SEP. 23

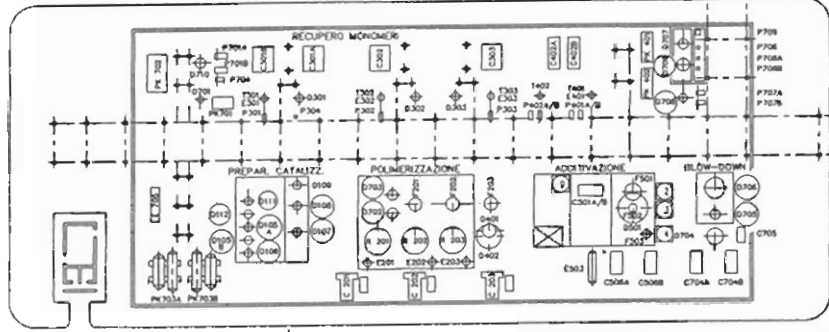

FASDA TUBAZIONI ANTIRISALE

SILERIA 200 mc.  
C805  
C804  
C804

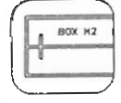
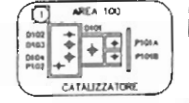
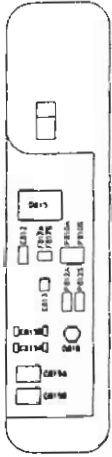
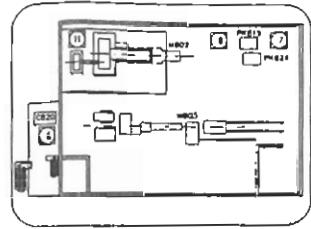
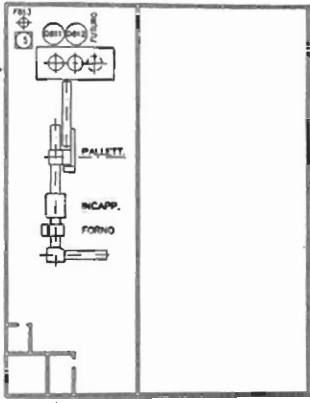

CABINA ELETTRICA N 32

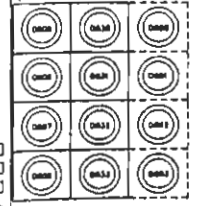

C805  
C804  
C804



IL DIRIGENTE DEL SETTORE AMBIENTE  
Ing. Paolo Maggi

DE. 14 NOV. 2000

ALLEGATO AL. ATTON. 6.02.85



LEGENDA  
 PISCIA DI CARBONE ALL'INTESSA

PROGETTO		REVISIONE	
AUTORE		VERIFICATORE	
DATA		SCALE	
TITOLO		MATERIALE	
MSE PLANT FERRARIA		MSE	
PLANTERIA		MSE	
LUBRIFICAZIONE PURTI DISSOLUZIONE		MSE	
N°		DATA	
01		1/3/00	
200042		024	