

DISPOSIZIONE APPARECCHIATURE

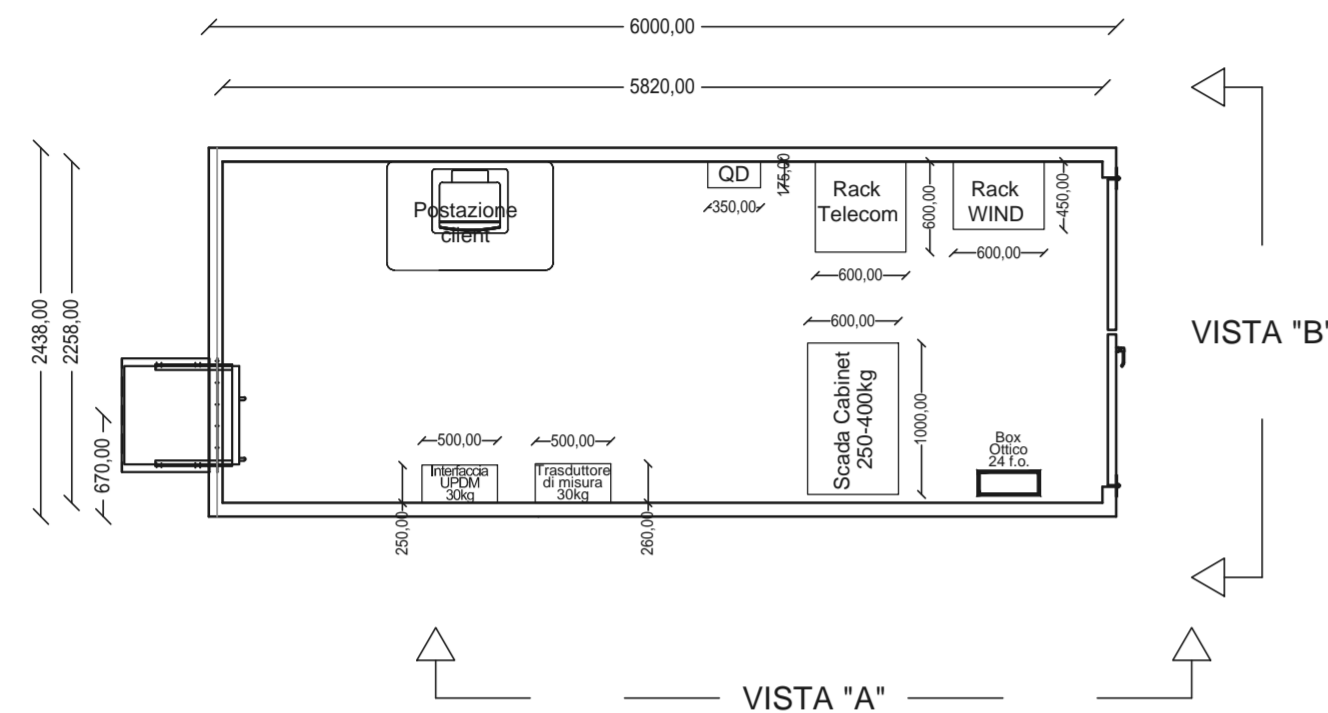

FORATURE BASE CONTAINER

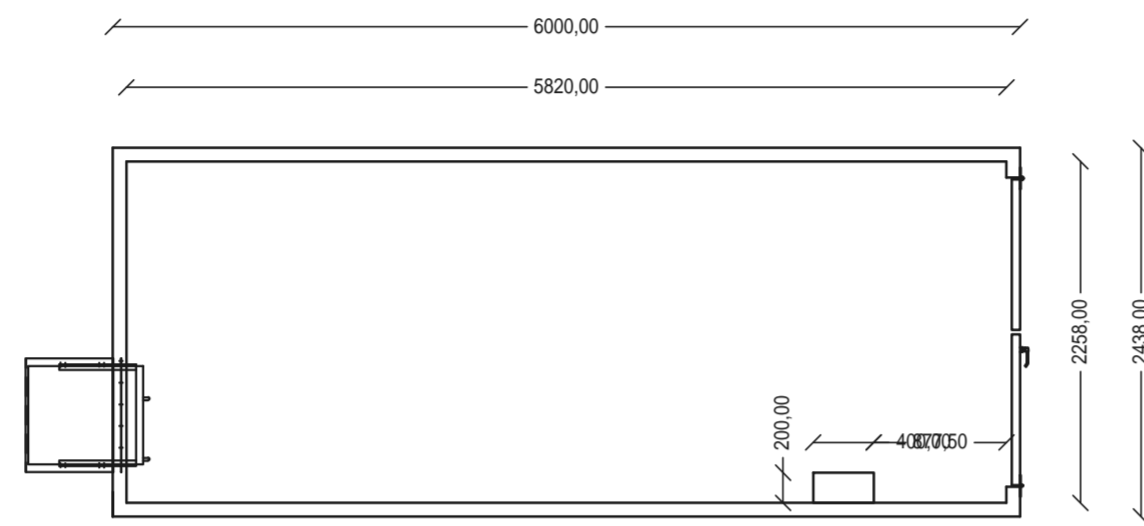

Per il particolare di montaggio del climatizzatore vedi disegno cornice allegato

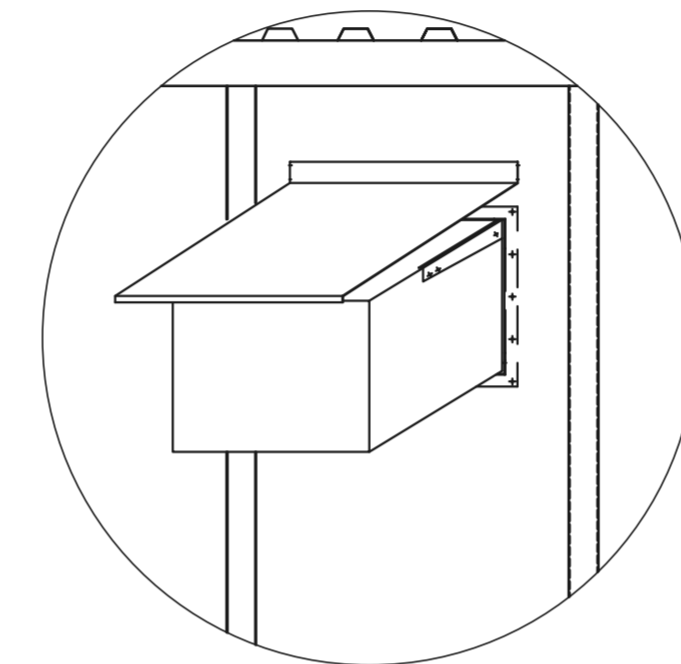

FORATURE A PAVIMENTO

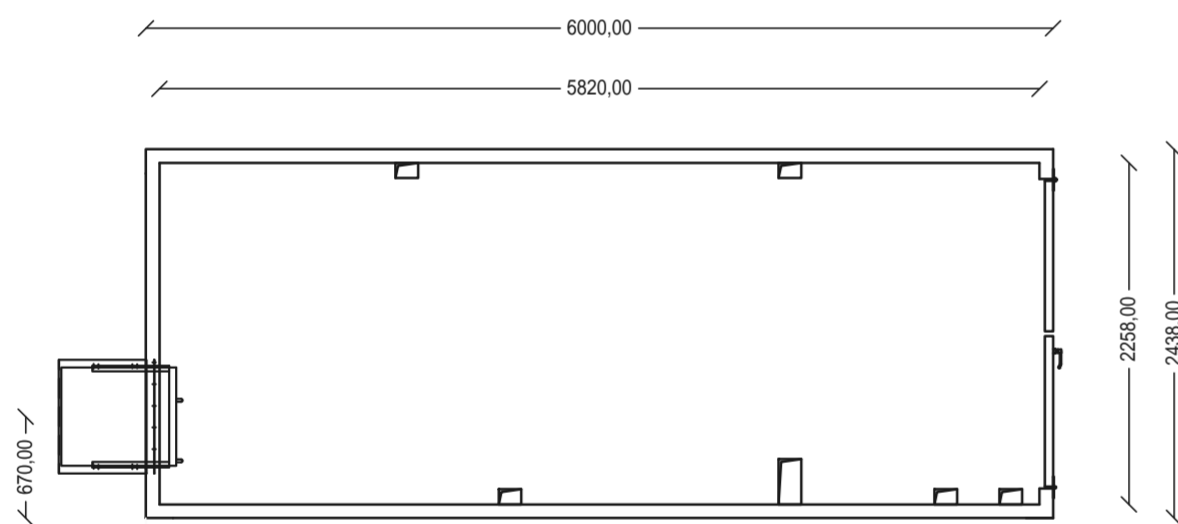

PERCORSI CANALINE

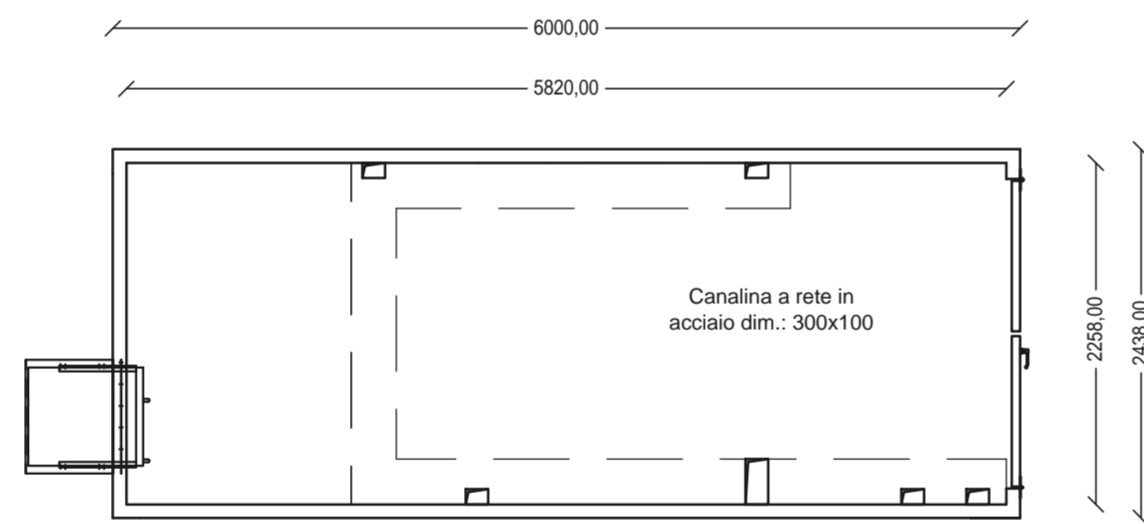

VISTA "A"

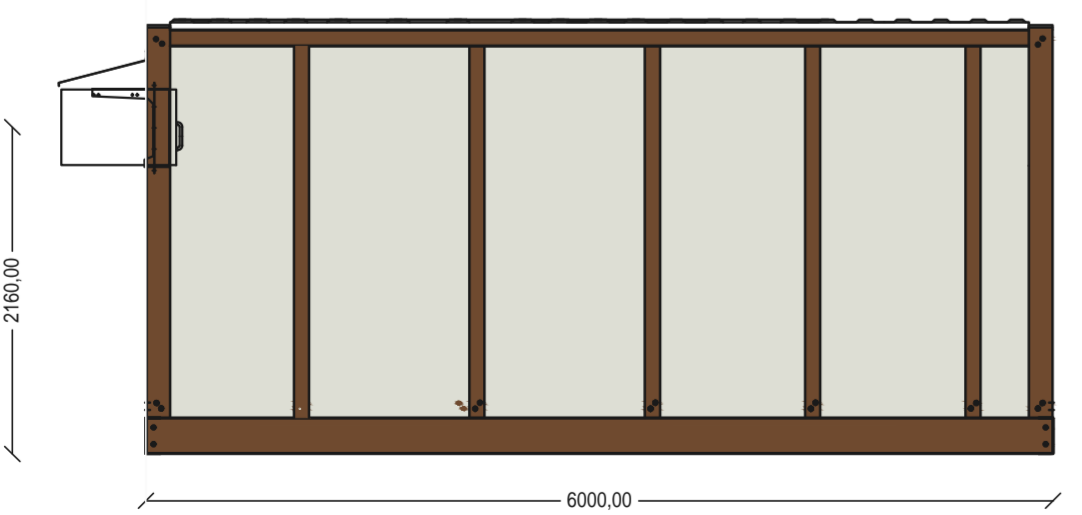

VISTA "B"

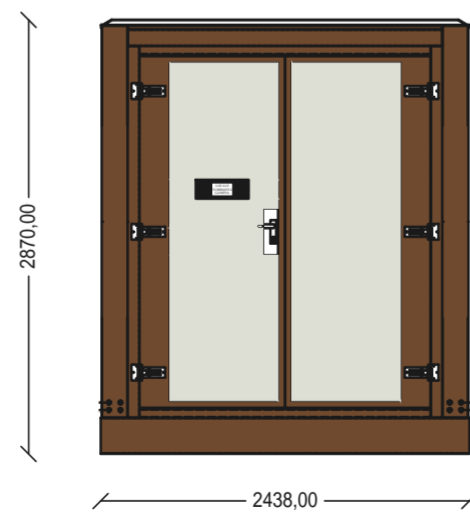

VISTA "C"

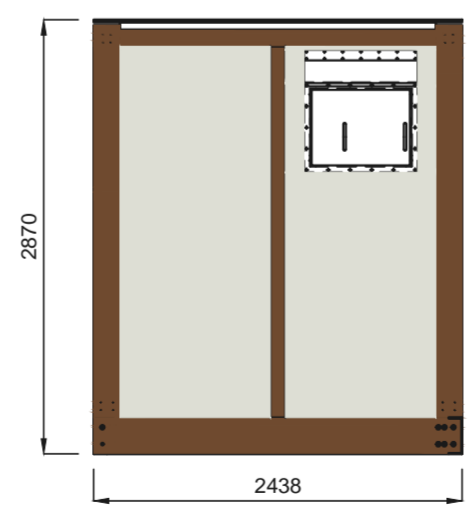

REGIONE SARDEGNA
 Provincia di SASSARI
 COMUNI DI NULVI E PLOGAGHE

PROGETTO
POTENZIAMENTO PARCO EOLICO NULVI E PLOGAGHE



PROGETTO DEFINITIVO

COMMITTENTE



PROGETTISTA

HE Hydro Engineering s.s.
 di Damiano e Mariano Galbo
 via Rossotti, 39
 91011 Alcamo (TP) Italy

Mariano Galbo



OGGETTO DELL'ELABORATO

LOCALE TURBINISTA:
 ARCHITETTONICO

| REV. | DATA | ATTIVITA' | REDATTO | VERIFICATO | APROVATO |
|------|------------|-----------------|---------|------------|----------|
| 0 | 03/08/2018 | PRIMA EMISSIONE | GL | VF | MG |

| CODICE PROGETTISTA | | | | | CODICE COMMITTENTE | | | | |
|--------------------|-------|-----------|--------|------|--------------------|-------|-----------|--------|------|
| IMP. | DISC. | TIPO DOC. | PROGR. | REV. | IMP. | DISC. | TIPO DOC. | PROGR. | REV. |
| | | | | | PLO | ENG | TAV | 0084 | 00 |

NOME FILE: PLO-ENG-TAV-0084_00.dwg

ERG Wind Sardegna S.r.l. si riserva tutti i diritti su questo documento che non può essere riprodotto neppure parzialmente senza la sua autorizzazione scritta.