

AMBITO 1A - ABACO CAMPATE
BARRIERA H4.5 - PARTE CIECA - i=3m

Scala 1:50
0 0.2 0.5 1 2 m

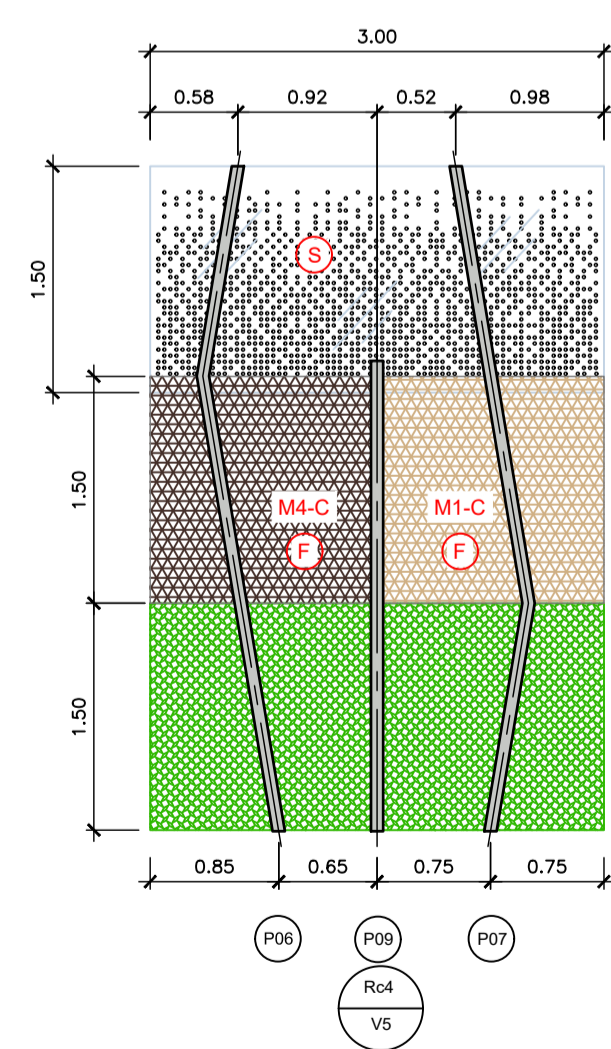
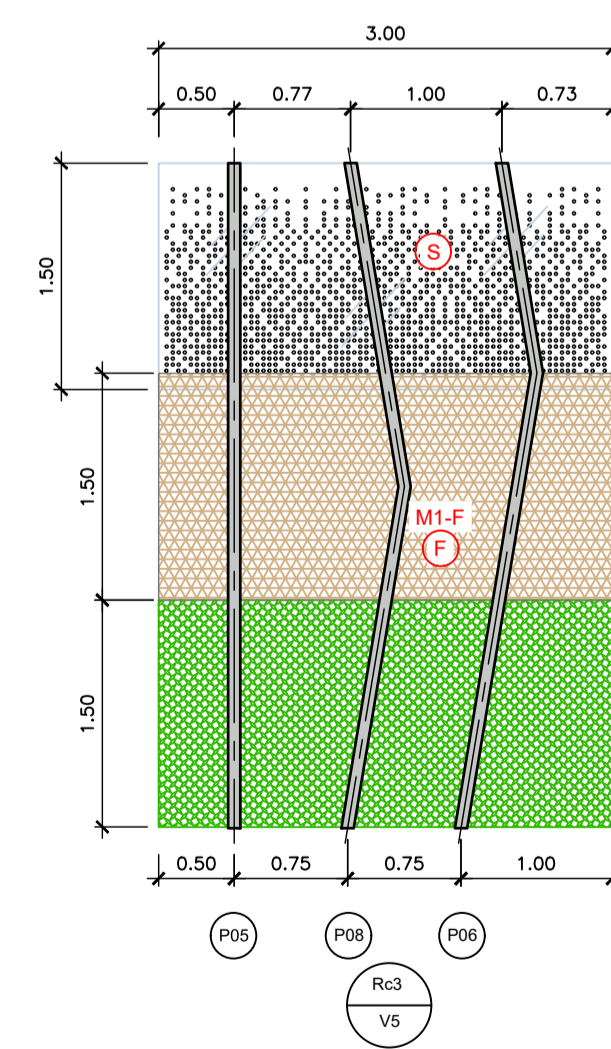
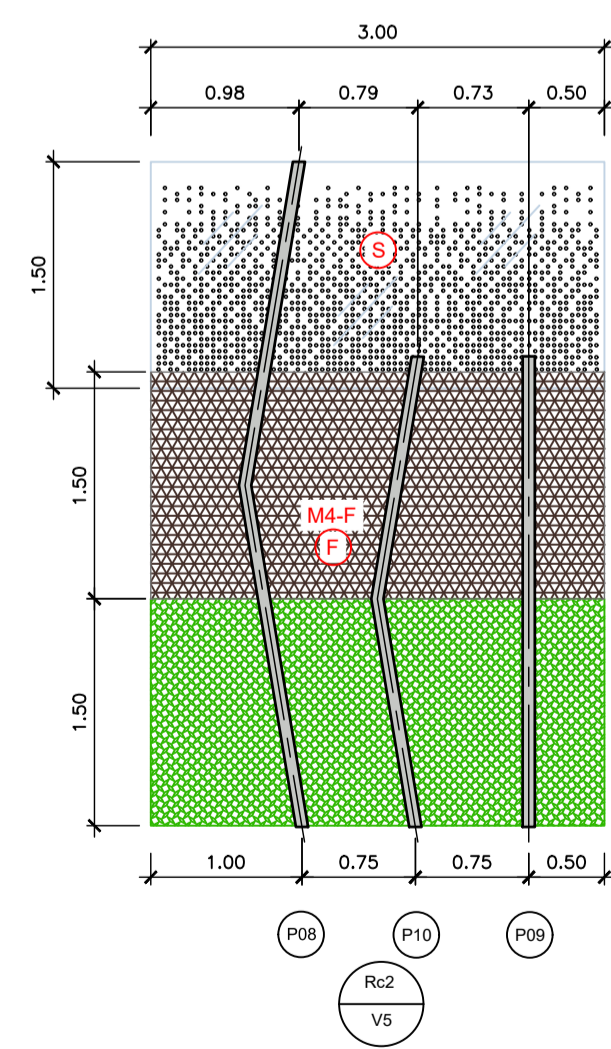
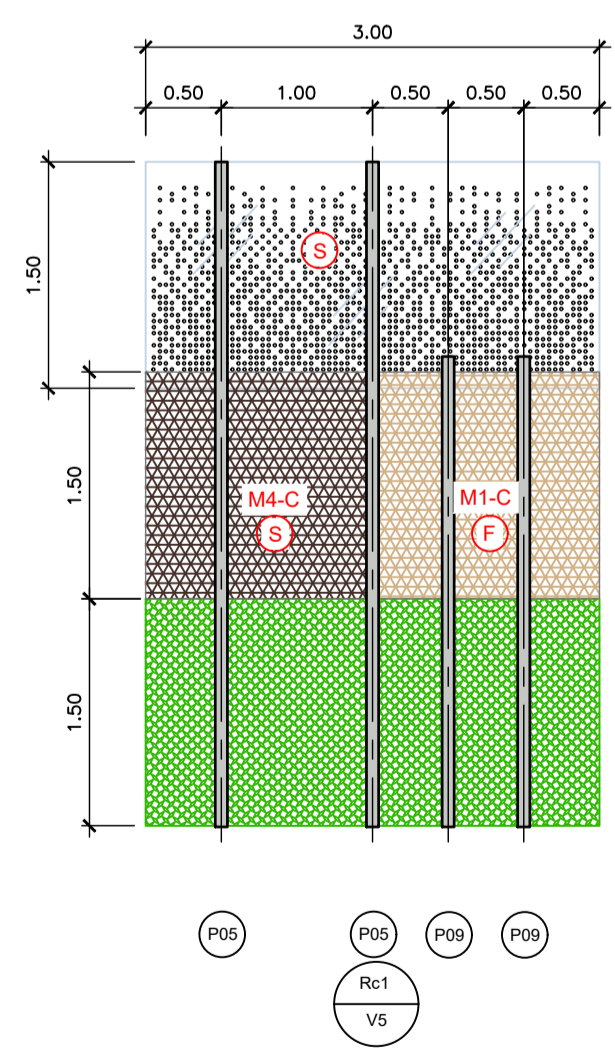
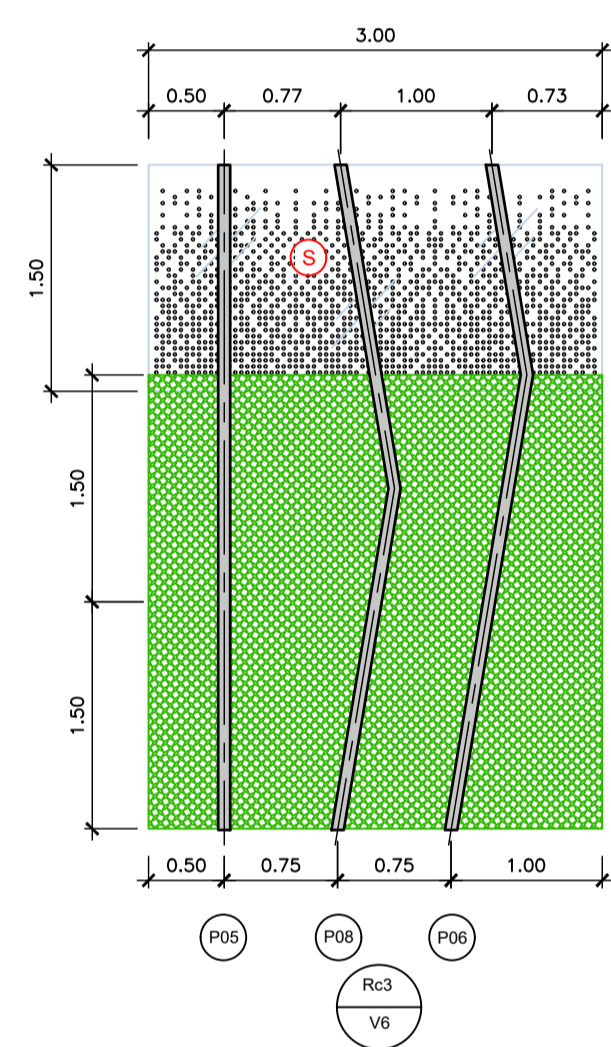
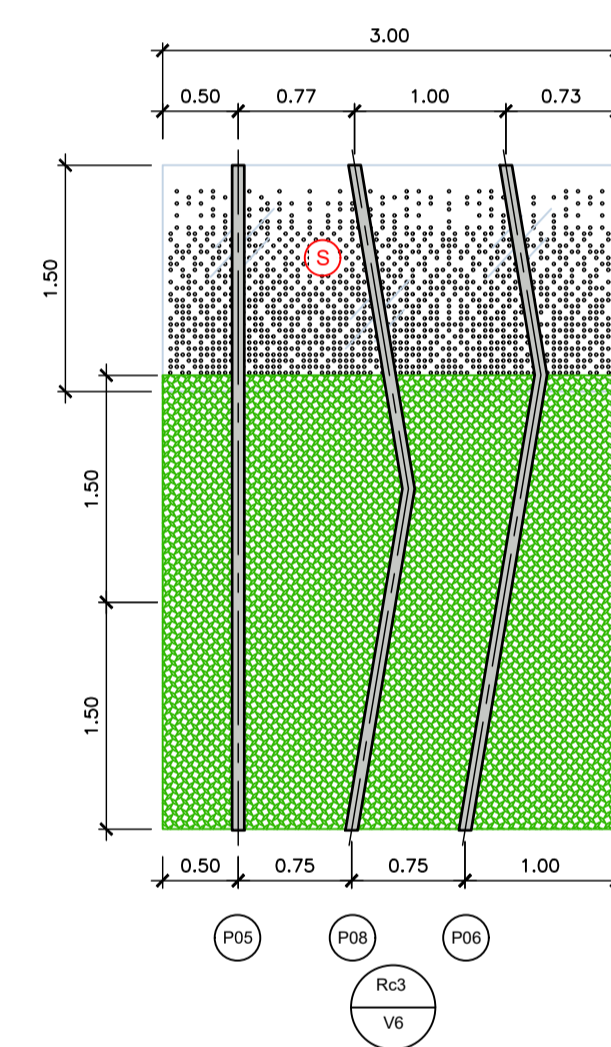
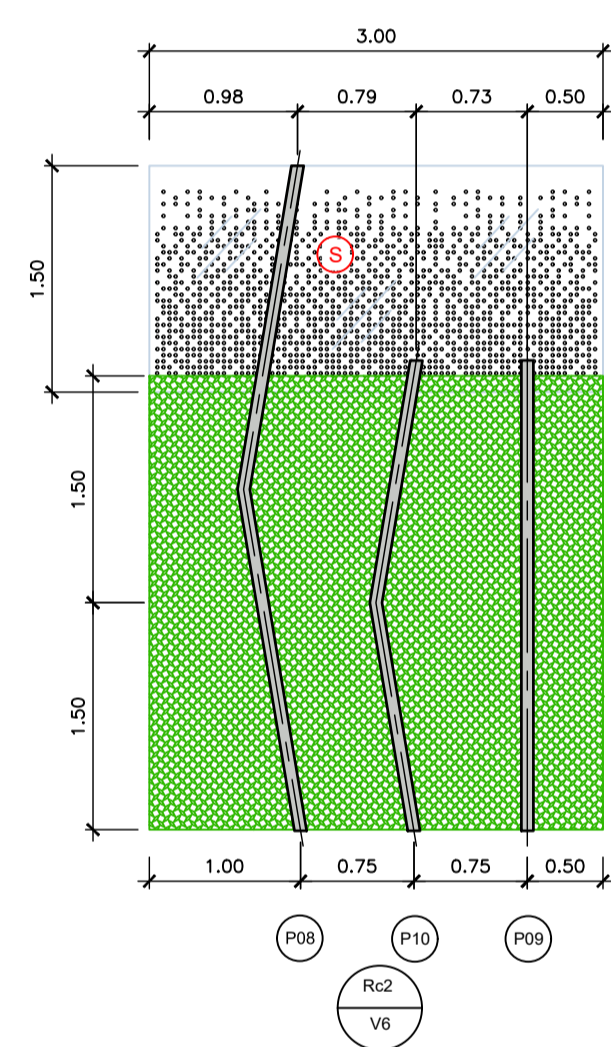
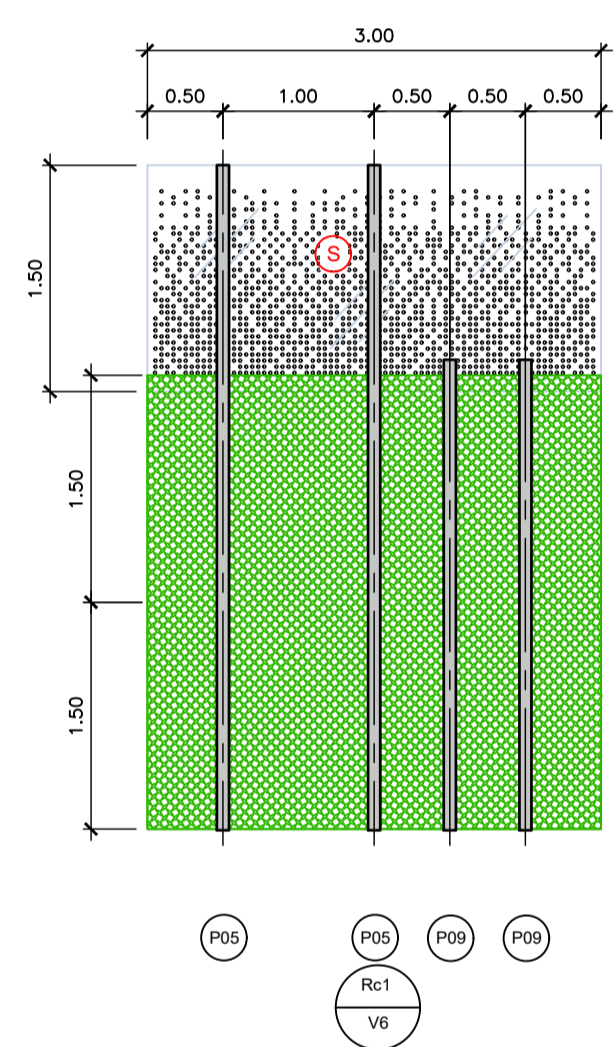
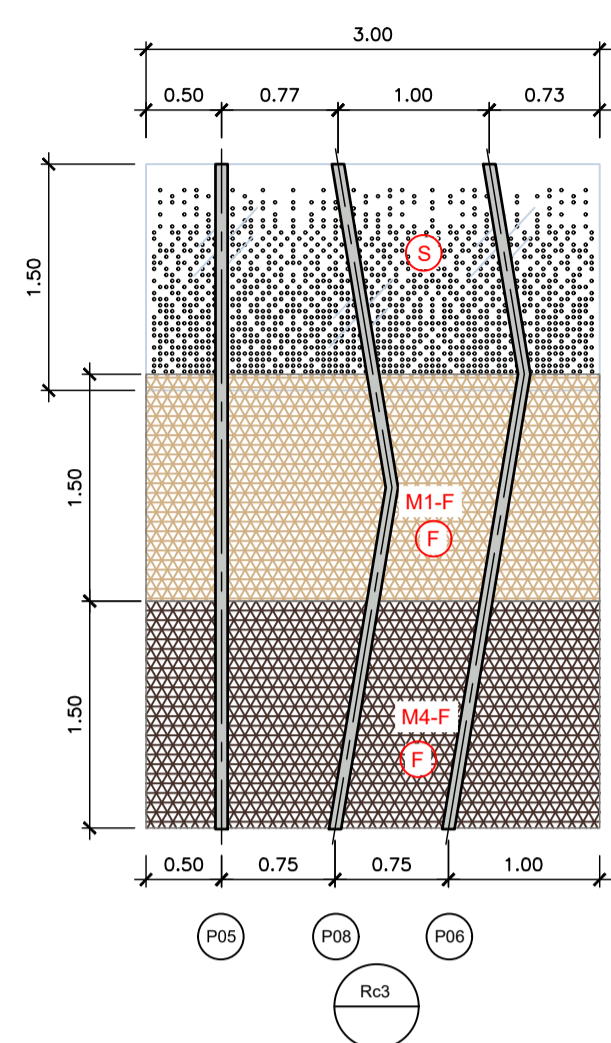
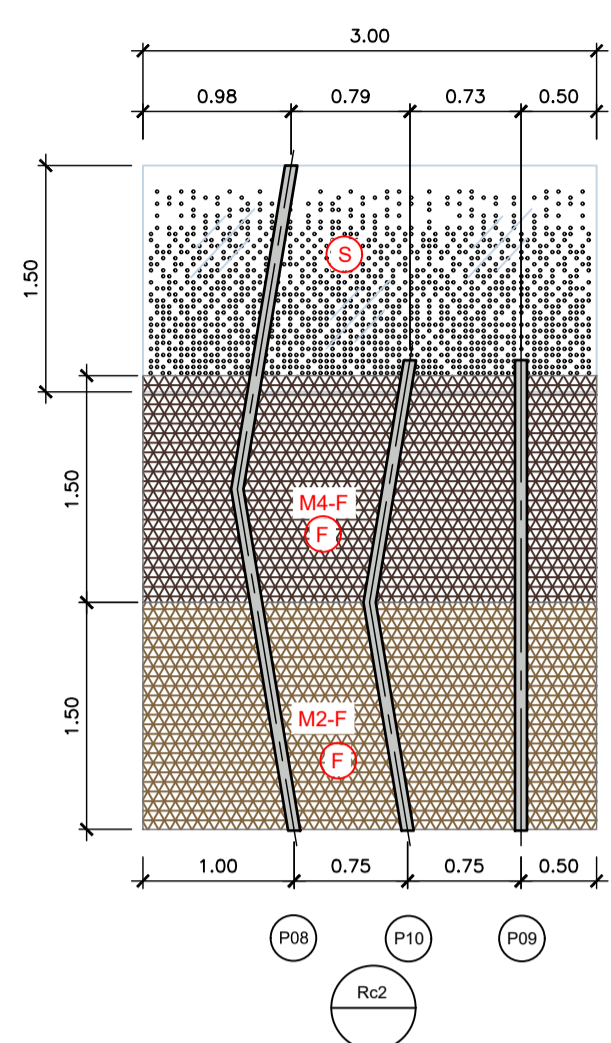
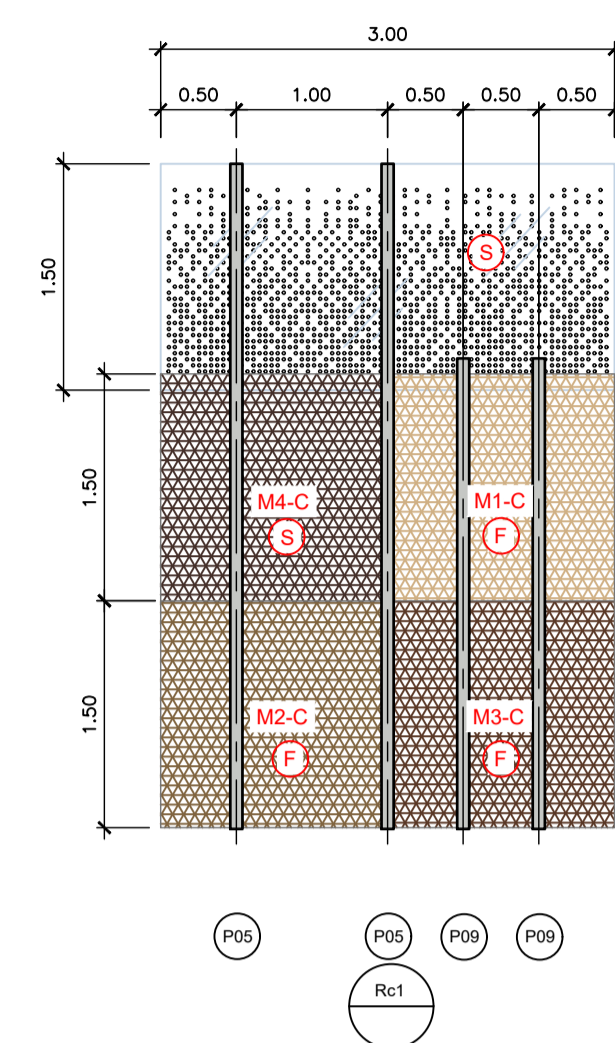

LEGENDA:

- Modulo pannello cieco
- Modulo pannello verde
- Modulo pannello misto (cieco/verde)
- Modulo pannello vetrato
- Pannello lato ferrovia
- Pannello lato strada

NOTA:

In corrispondenza dei montanti delle parti vetrate delle alberature, non vengono posizionati i profili secondari P01 (tratto 1A.2) e P05 (tratti 1A.1 e 1A.3).

LEGENDA LAMIERE

Larghezza	B (1 m)	C (1.5 m)	D (2 m)	E (2.5 m)	F (3 m)
Colori					
M1 RAL 1001					
M2 RAL 1036					
M3 RAL 8011					
M4 RAL 8017					

LEGENDA PROFILI

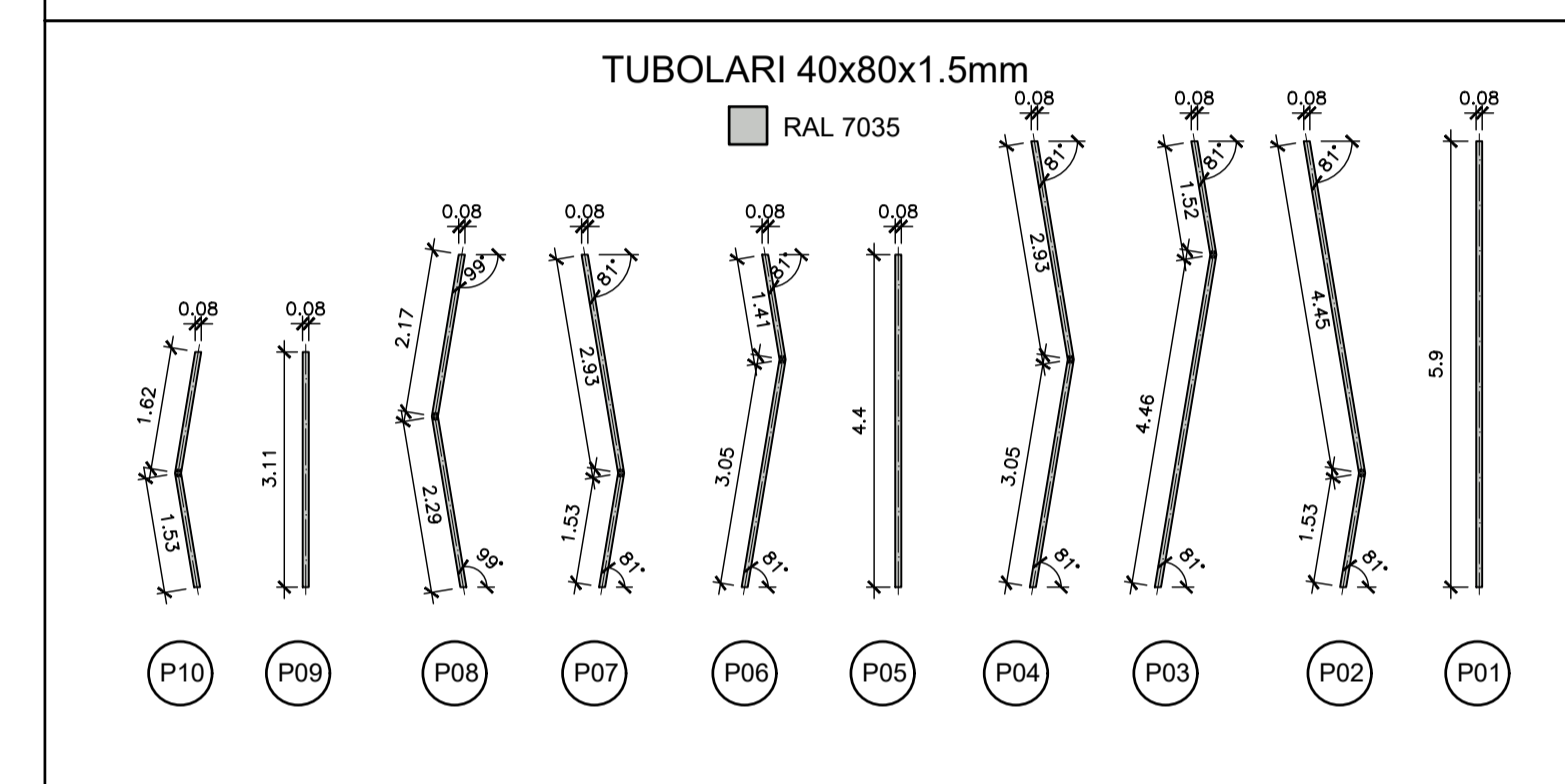

AUTORITA' PORTUALE DELLA SPEZIA
Via del Molo, 1
19126 La Spezia SP

RESPONSABILE UNICO DEL PROCEDIMENTO
ing. Franco Pomo

A.T.I. IMPRESE
CAPOGRUPPO - MANDATARIA
CIR Ambiente
40026 Imola (BO) Tel. +39 0542 6214 11
Via Molino Rosso, 3 Fax +39 0542 6214 28
www.cir-ambiente.it cirambiente@cirambiente.it

MANDANTE

19121 La Spezia Tel. +39 018 7770 030
Salita Varnicella Fax +39 018 7770 042
www.carispezia.it carispezia@carispezia.it

A.T.I. PROGETTISTI
FCM ingegneria
30035 Mirano (VE) Tel. +39 041 5785 711
Viale Belvedere, 6/10 Fax +39 041 4355 533
www.fcm-ingegneria.it fcm@ingegneria.it

G & T
31027 Spressano (TV) Tel. +39 0422 8870 31
Via Toppo, 8 Fax +39 0422 8555 89
www.gitgeo.it info@gitgeo.it

PROGETTO
RIQUALIFICAZIONE FUNZIONALE ARCHITETTONICA DELL'INTERFACCIA PORTO CITTA' DELLA SPEZIA

INTERVENTO DI PROTEZIONE ANTIFONICA E RELATIVO INSERIMENTO AMBIENTALE E PAESAGGISTICO LUNGO VIALE SAN BARTOLOMEO

EMISSIONE
PROGETTO ESECUTIVO

TITOLO
AMBITO 1A
Abaco campate - Barriera H4.5 - Parte cieca - Interasse 3m

REV.	DATA	FILE	OGGETTO	DIS.	APPR.
1	30/09/2017	1166_PE-1A-105_1.dwg	aggiornamento abaco	A. Pomo	T. Tassi
2	12/04/2018	1166_PE-1A-105_2.dwg	Recupero lettera AP post. nr. 2187 del 27/02/2018	S. Anselmi	T. Tassi
3					
4					
5					

ELABORATO N. **PE-1A-105**

DATA:	SCALA:	FILE:	J.N.
30/06/2017	1:50	1166_PE-1A-105.dwg	1166
PROGETTO	DISSEGNO	VERIFICA	APPROVAZIONE
L. Masiero	E. Balsamo	L. Masiero	T. Tassi