

COMMITTENTE:



DIREZIONE LAVORI:



APPALTATORE:



PROGETTAZIONE:	PROGETTISTA:	DIRETTORE DELLA PROGETTAZIONE
RAGGRUPPAMENTO TEMPORANEO PROGETTISTI	Ing. LUCA NANI	Ing. PIETRO MAZZOLI
		Responsabile integrazione fra le varie prestazioni specialistiche

## PROGETTO ESECUTIVO

### ITINERARIO NAPOLI-BARI

### RADDOPPIO TRATTA CANCELLO-BENEVENTO

### 1° LOTTO FUNZIONALE CANCELLO-FRASSO TELESINO E VARIANTE ALLA LINEA ROMA-NAPOLI VIA CASSINO NEL COMUNE DI MADDALONI

### IMPIANTI LUCE E FORZA MOTRICE

### GALLERIA MONTE AGLIO – PIAZZALE IMBOCCO GALLERIA LATO NORD

### VERIFICA DELLA SELETTIVITA' FRA LE PROTEZIONI ELETTRICHE

APPALTATORE		SCALA:
Consorzio CFT IL DIRETTORE TECNICO Geom. C. BIANCHI 10-07-2018		-

COMMESSA    LOTTO    FASE    ENTE    TIPO DOC.    OPERA/DISCIPLINA    PROGR.    REV.

I	F	1	N	0	1	E	Z	Z	R	O	L	F	0	2	0	0	0	1	8	A
---	---	---	---	---	---	---	---	---	---	---	---	---	---	---	---	---	---	---	---	---

Rev.	Descrizione	Redatto	Data	Verificato	Data	Approvato	Data	Autorizzato	Data
A	Emissione	F.Checucci	10-07-2018	L.Nani	10-07-2018	P. Mazzoli	10-07-2018	L.Nani	
									10-07-2018

File: IF1N.0.1.E.ZZ.RO.LF.02.0.0.018.A.doc	n. Elab.:
--	-----------

Curve tempo corrente: GALLERIA MONTE AGLIO  
 Quadro: Quadro Media tensione

Arrivo:

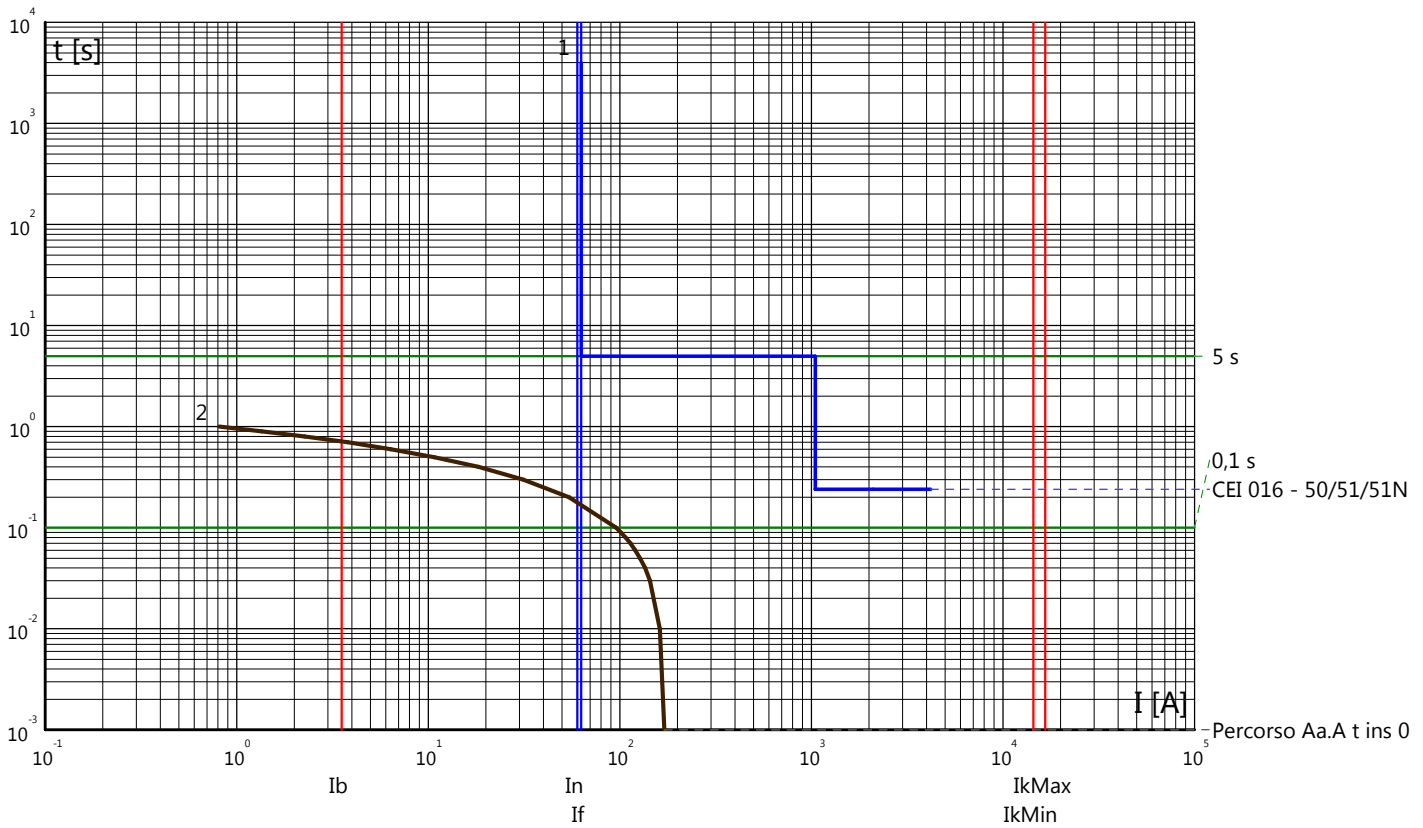

Partenza:

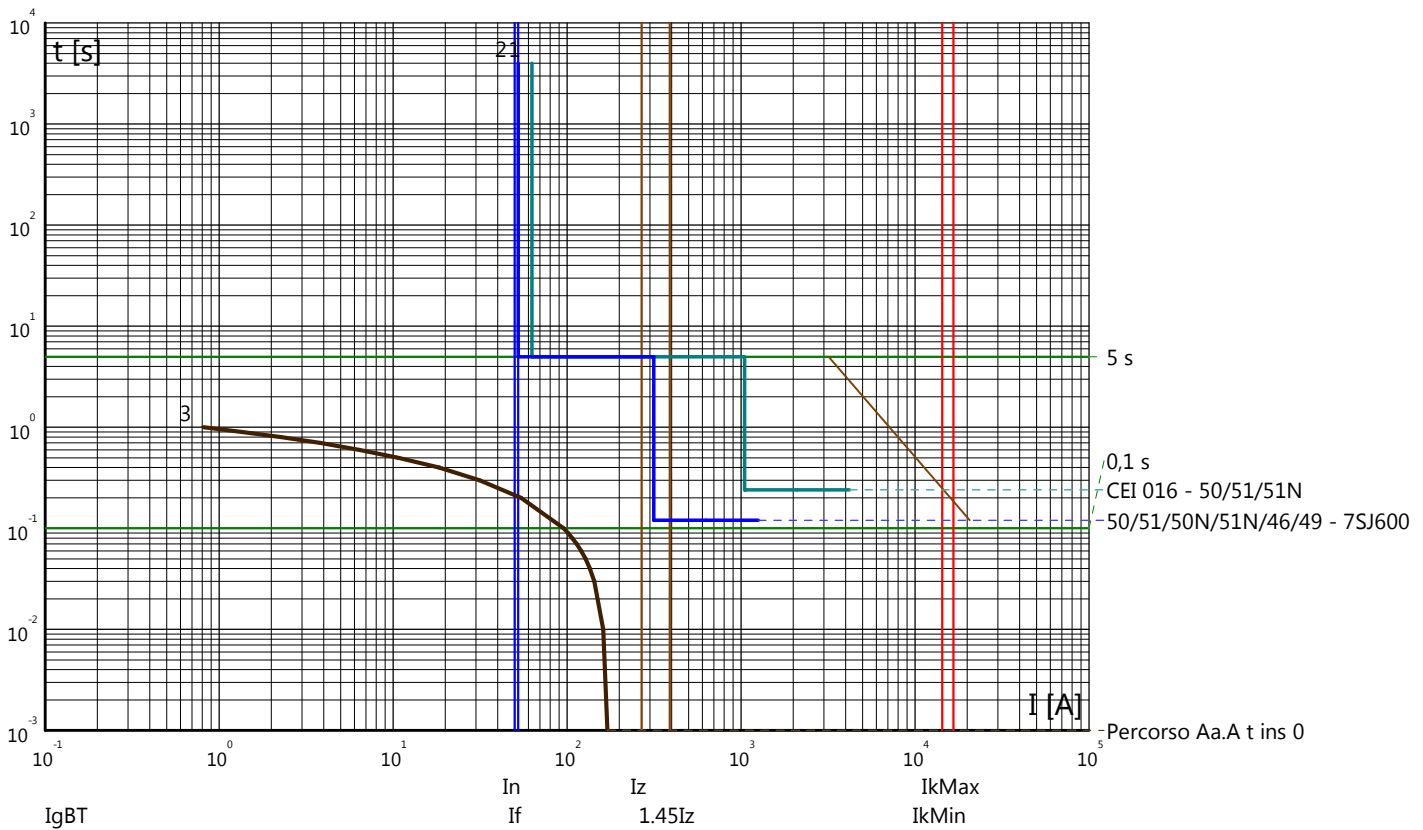

Curve tempo corrente: GALLERIA MONTE AGLIO  
 Quadro: Quadro Media tensione

Arrivo:

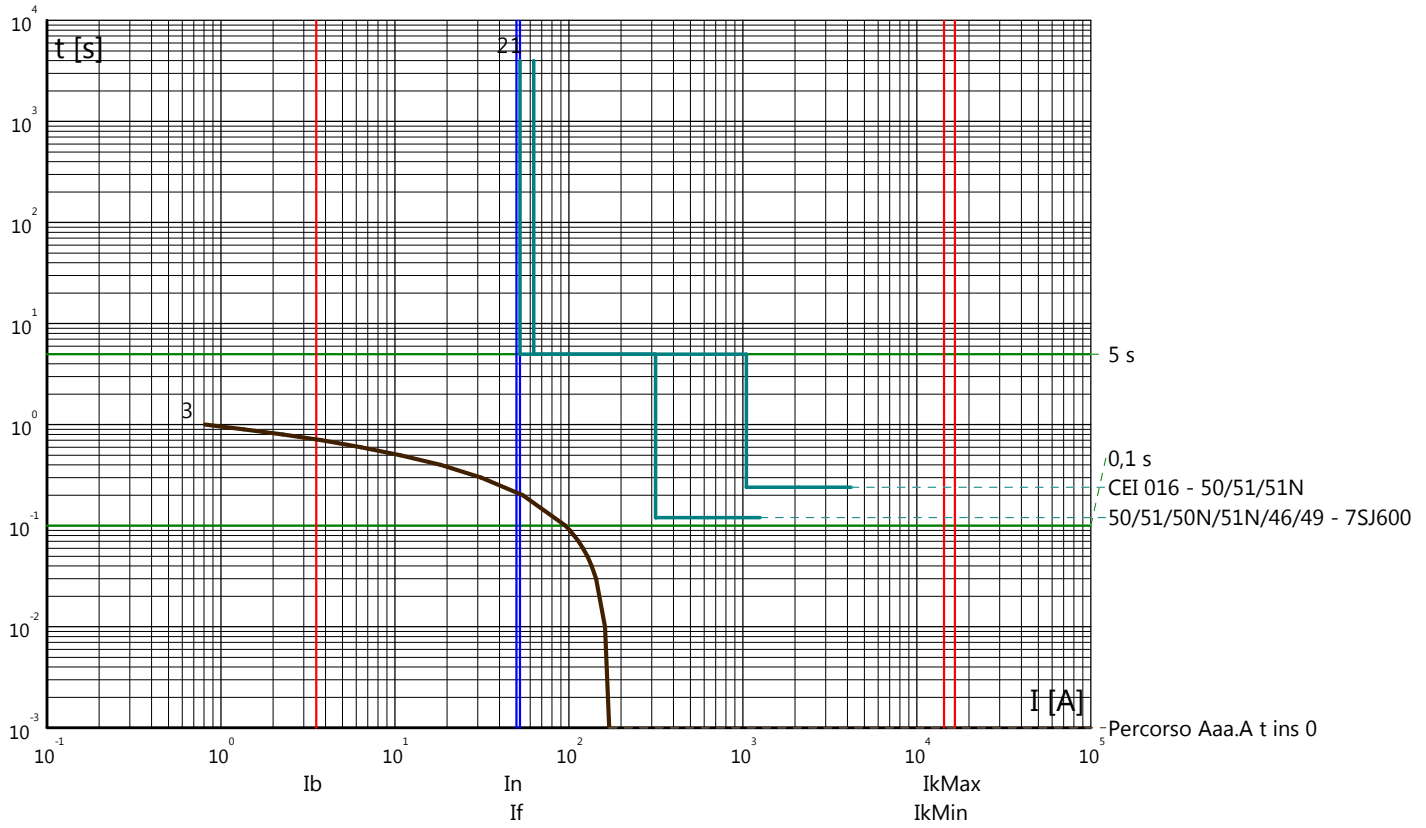

Partenza:

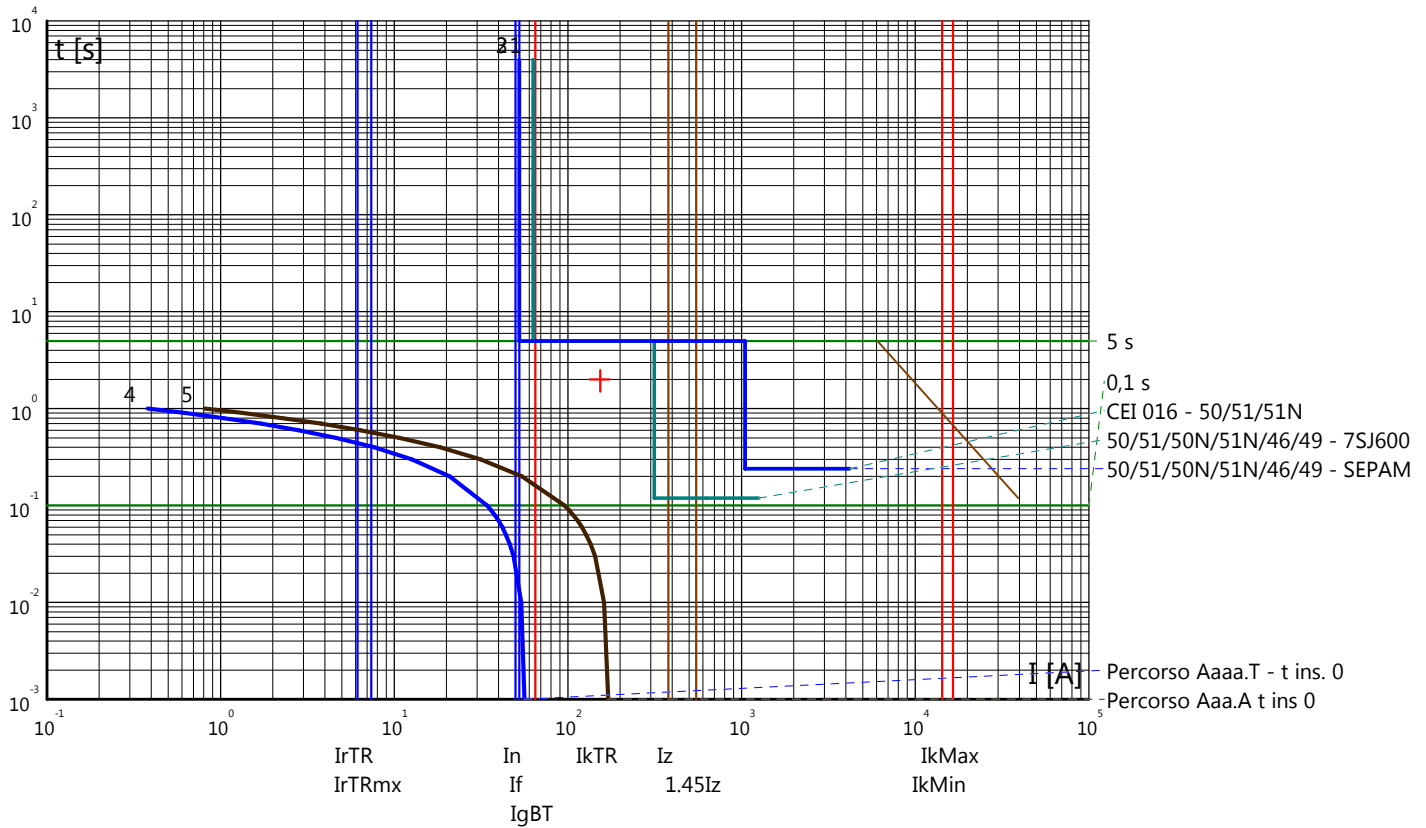

Curve tempo corrente: GALLERIA MONTE AGLIO  
 Quadro: Quadro Media tensione

Partenza:

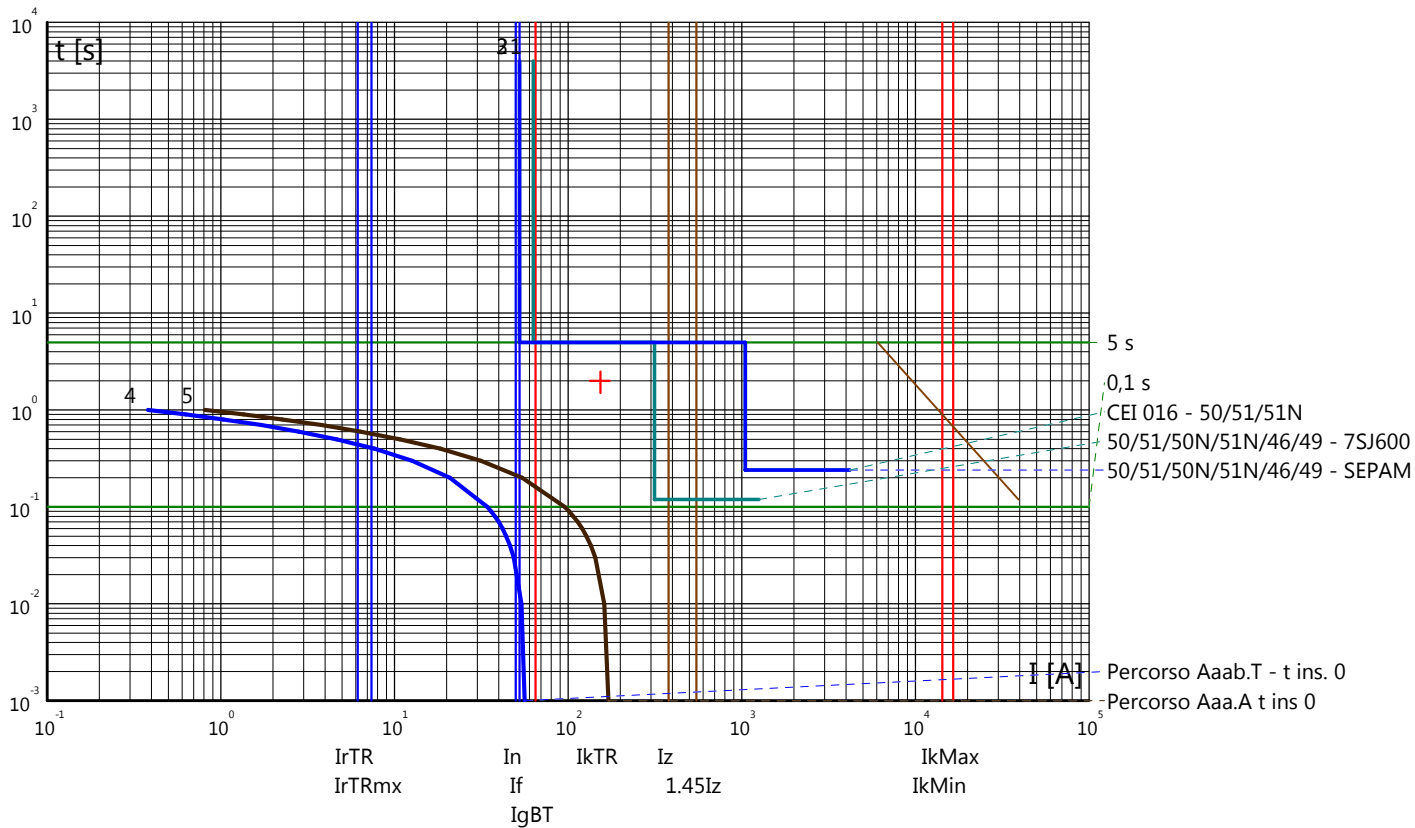

Partenza:

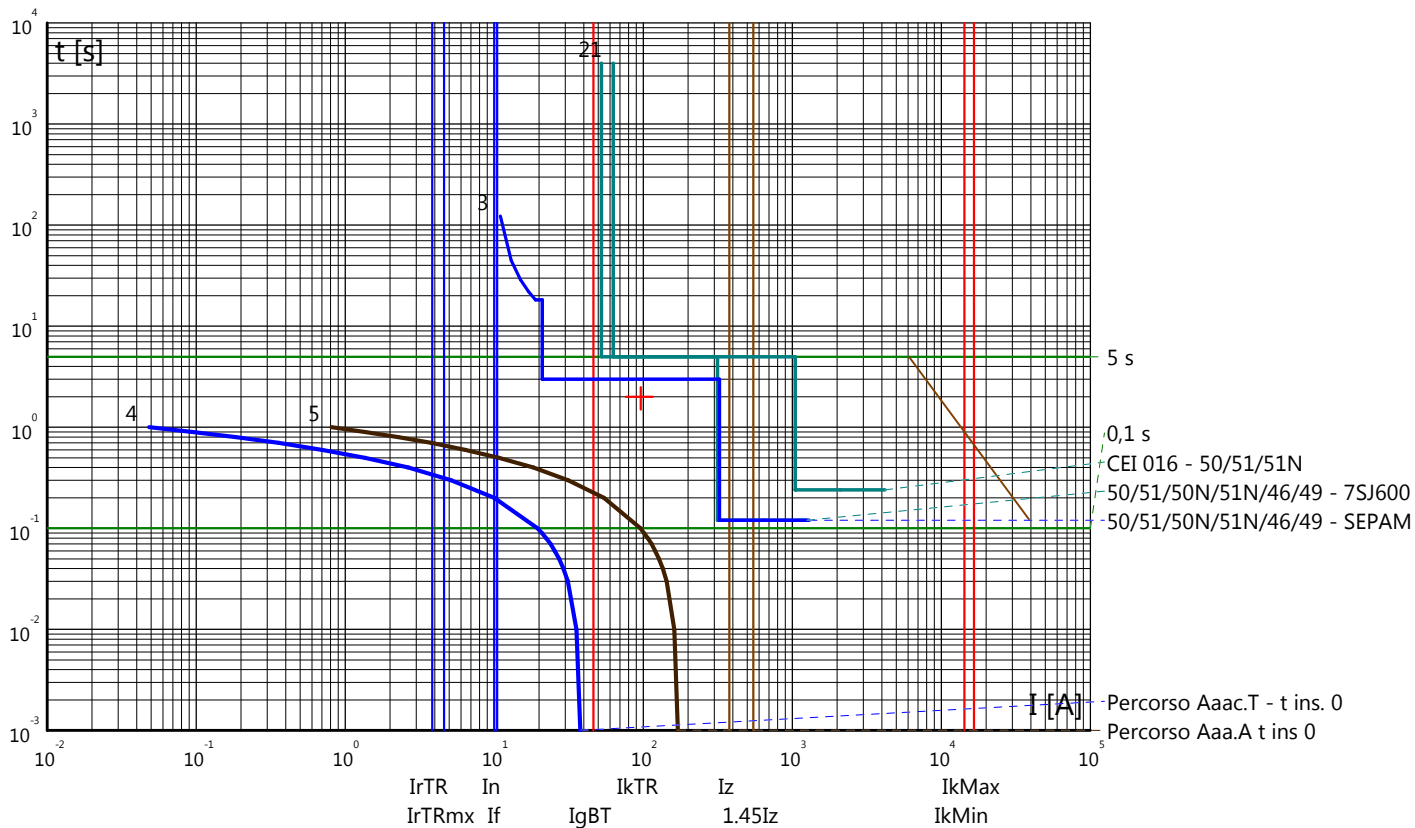

Curve tempo corrente: GALLERIA MONTE AGLIO  
 Quadro: Quadro Media tensione

Partenza:

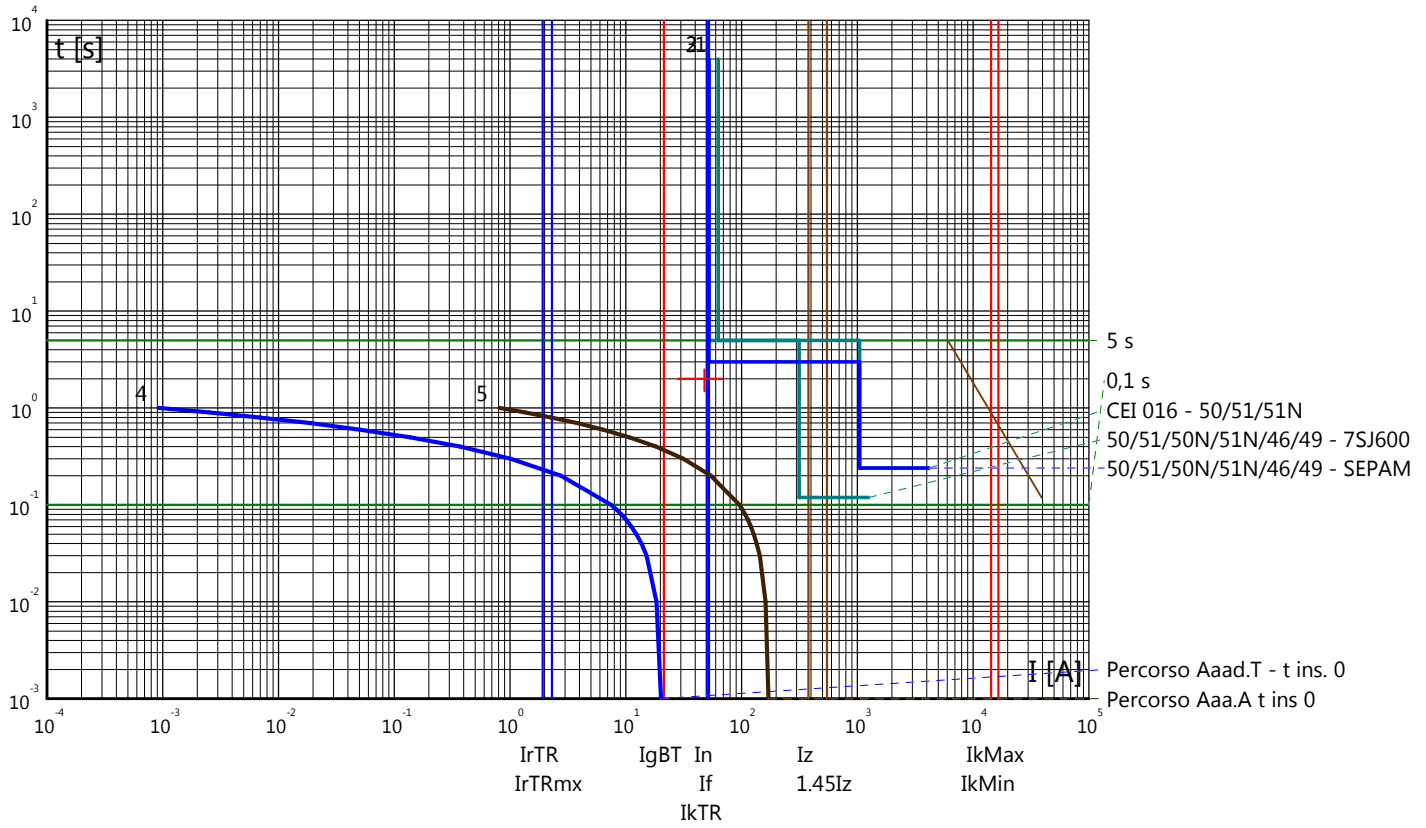

Curve tempo corrente: GALLERIA MONTE AGLIO  
 Quadro: QGBT/N

Arrivo: I/TR1

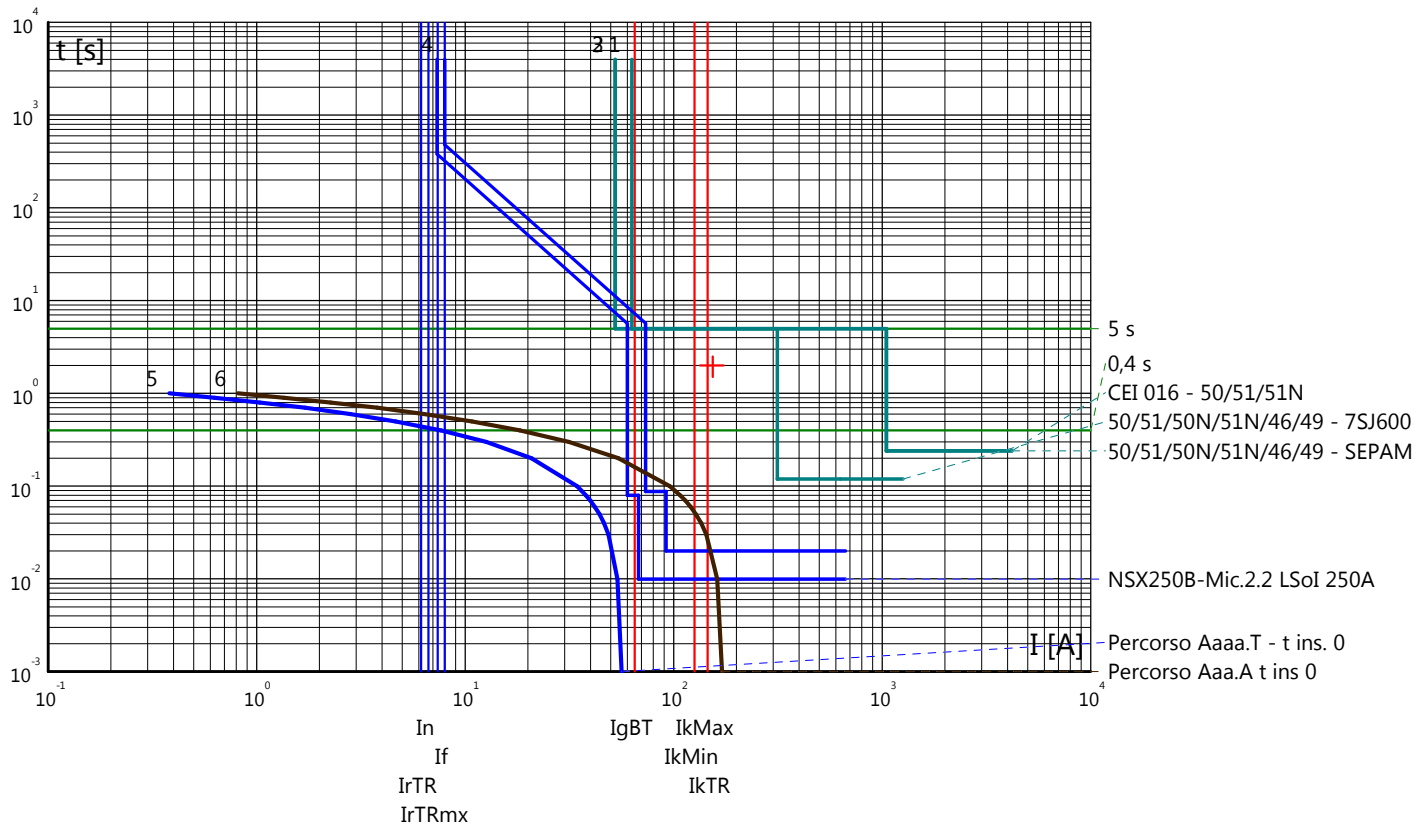

Curve tempo corrente: GALLERIA MONTE AGLIO  
 Quadro: QGBT/N

Arrivo: I/TR2

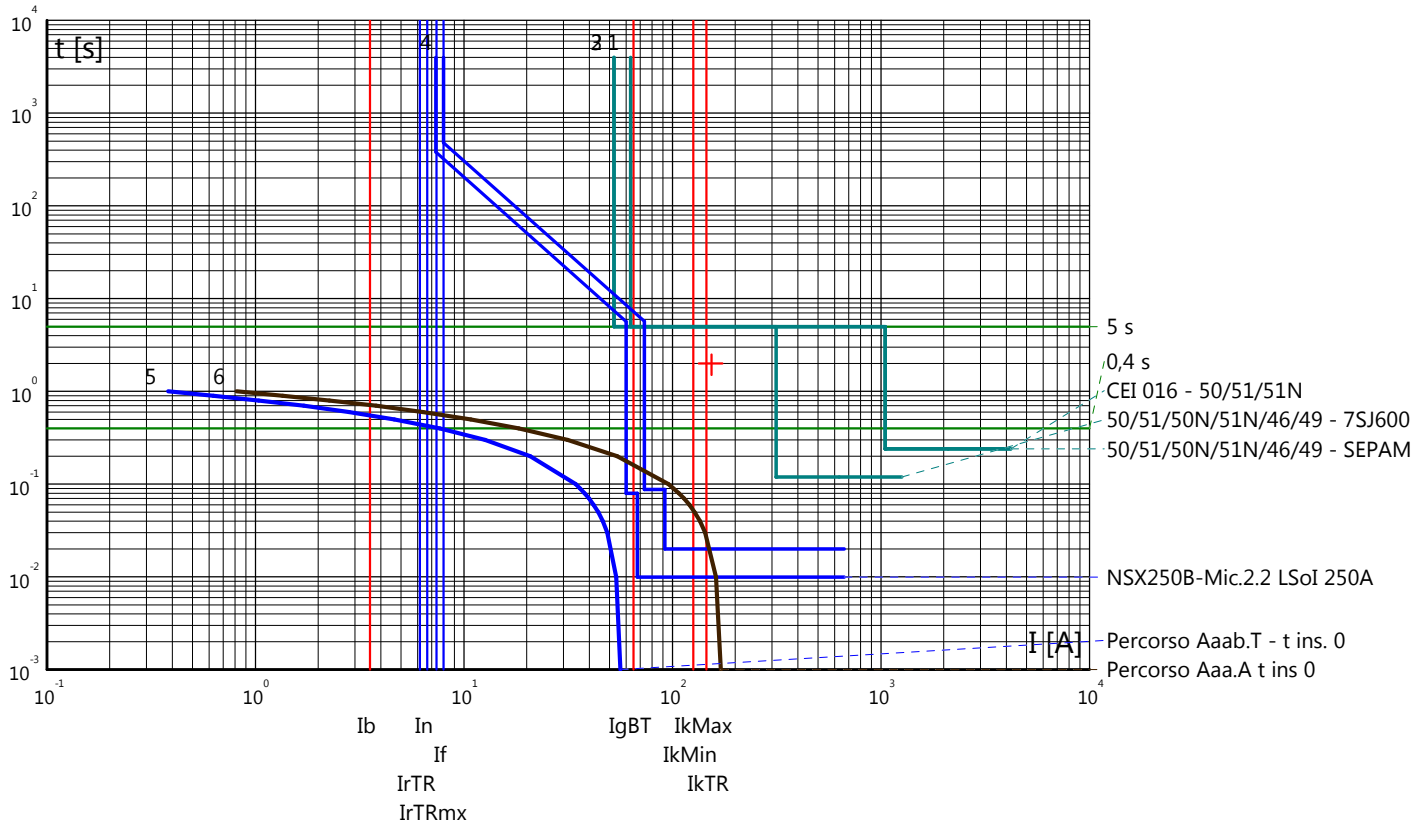

Partenza: PT/N

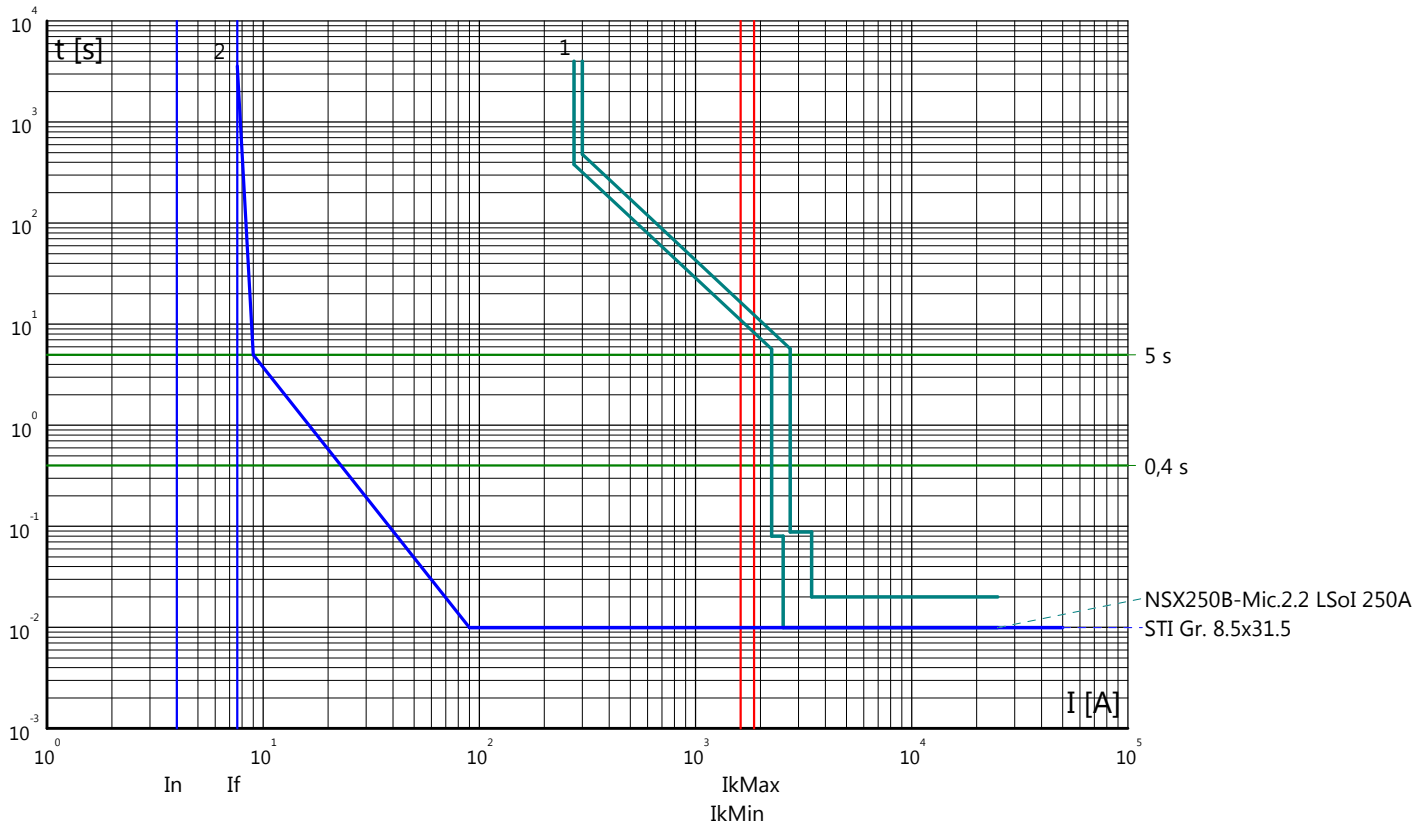

Curve tempo corrente: GALLERIA MONTE AGLIO  
 Quadro: QGBT/N

Partenza: SPD

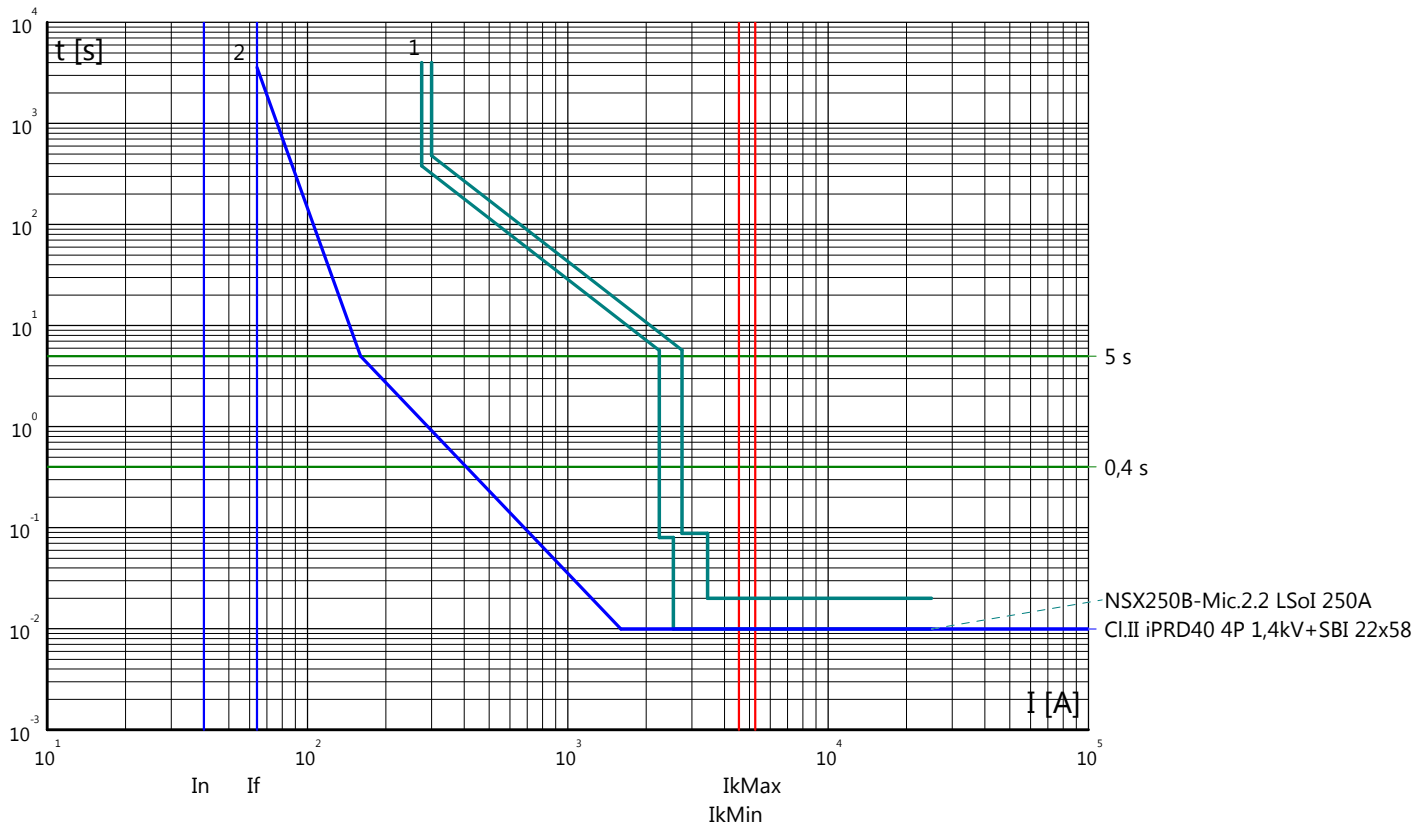

Partenza: MIS/N

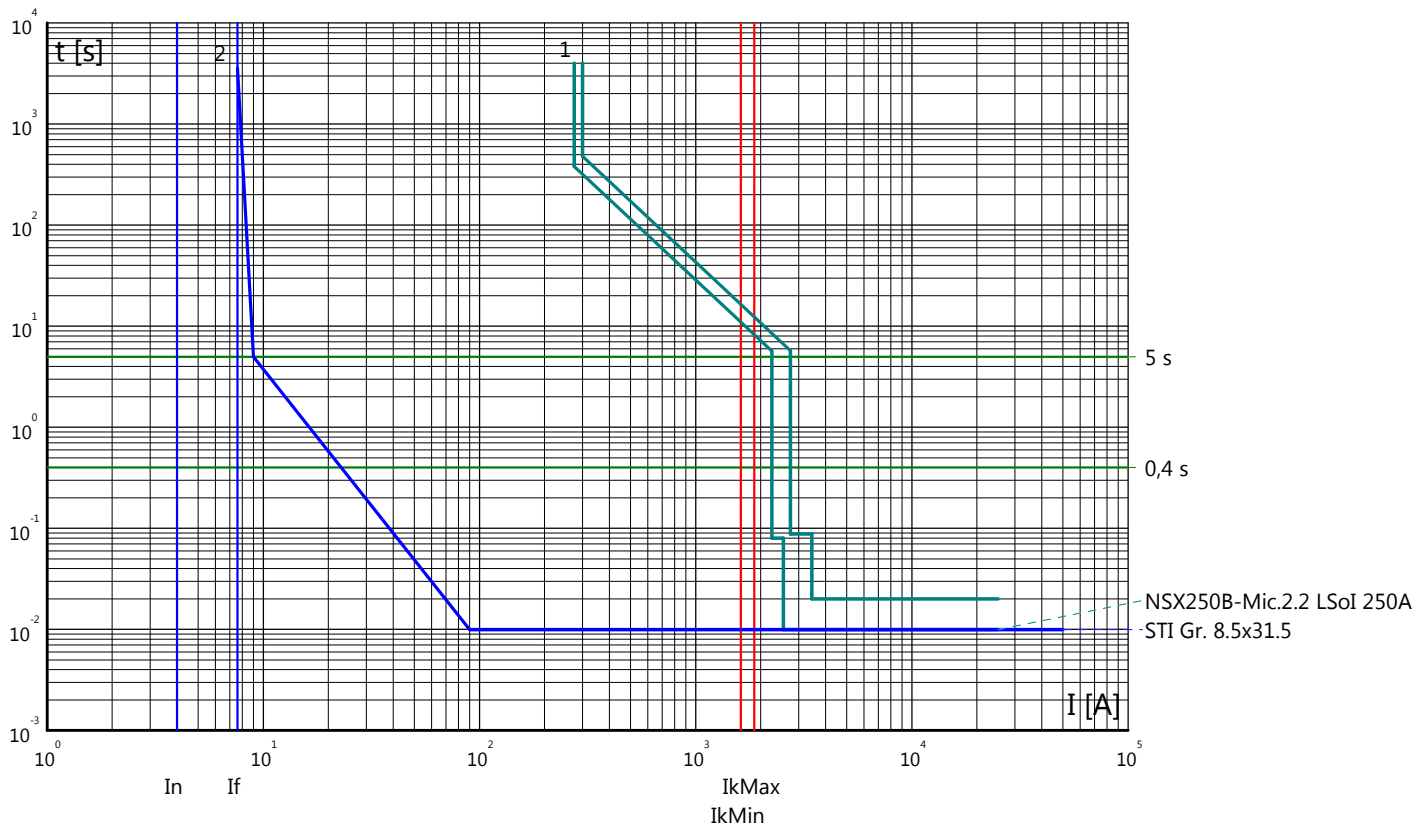



Curve tempo corrente: GALLERIA MONTE AGLIO  
 Quadro: QGBT/N

Partenza: 1.1N

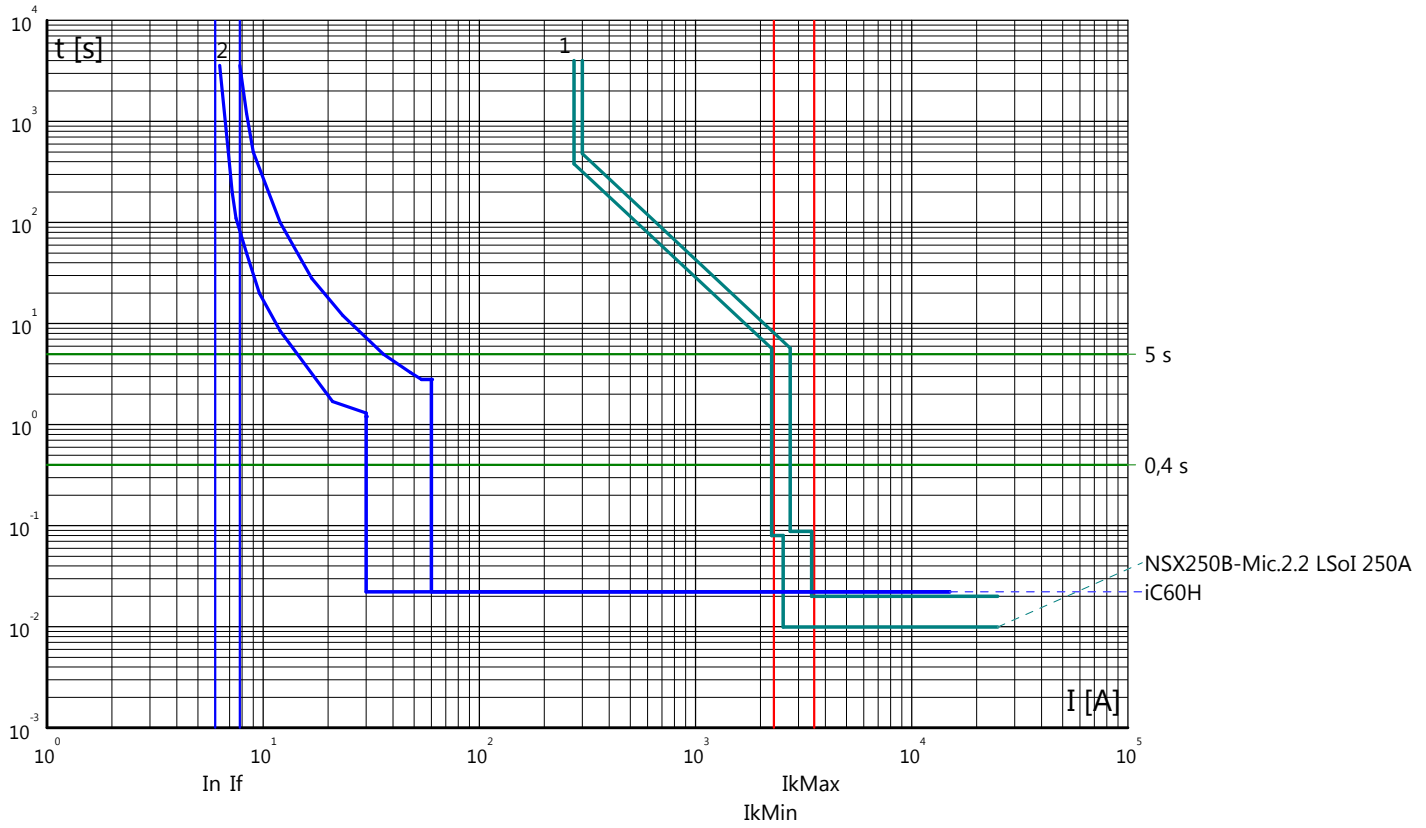

Partenza: 1.2N

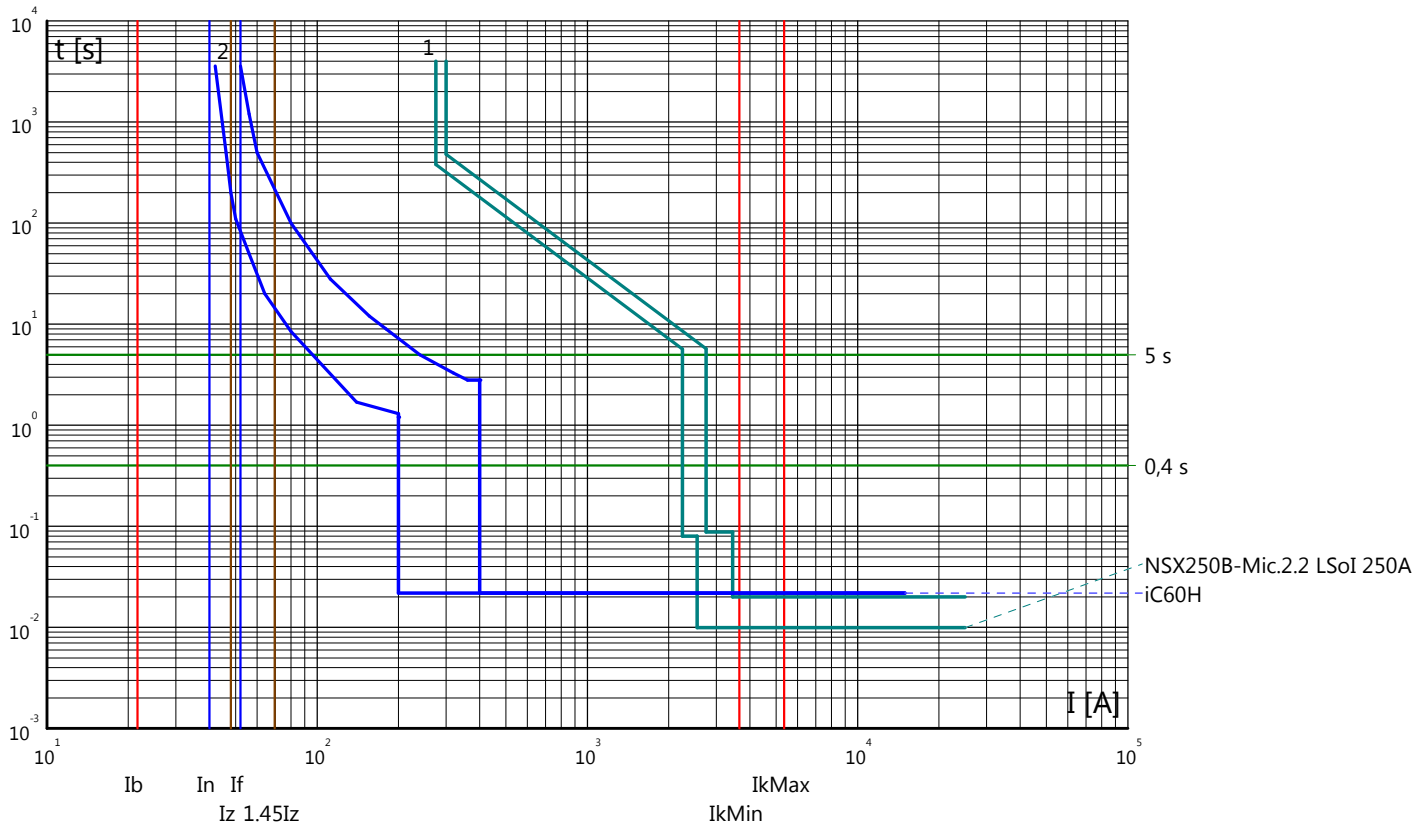

Curve tempo corrente: GALLERIA MONTE AGLIO  
 Quadro: QGBT/N

Partenza: 1.3N

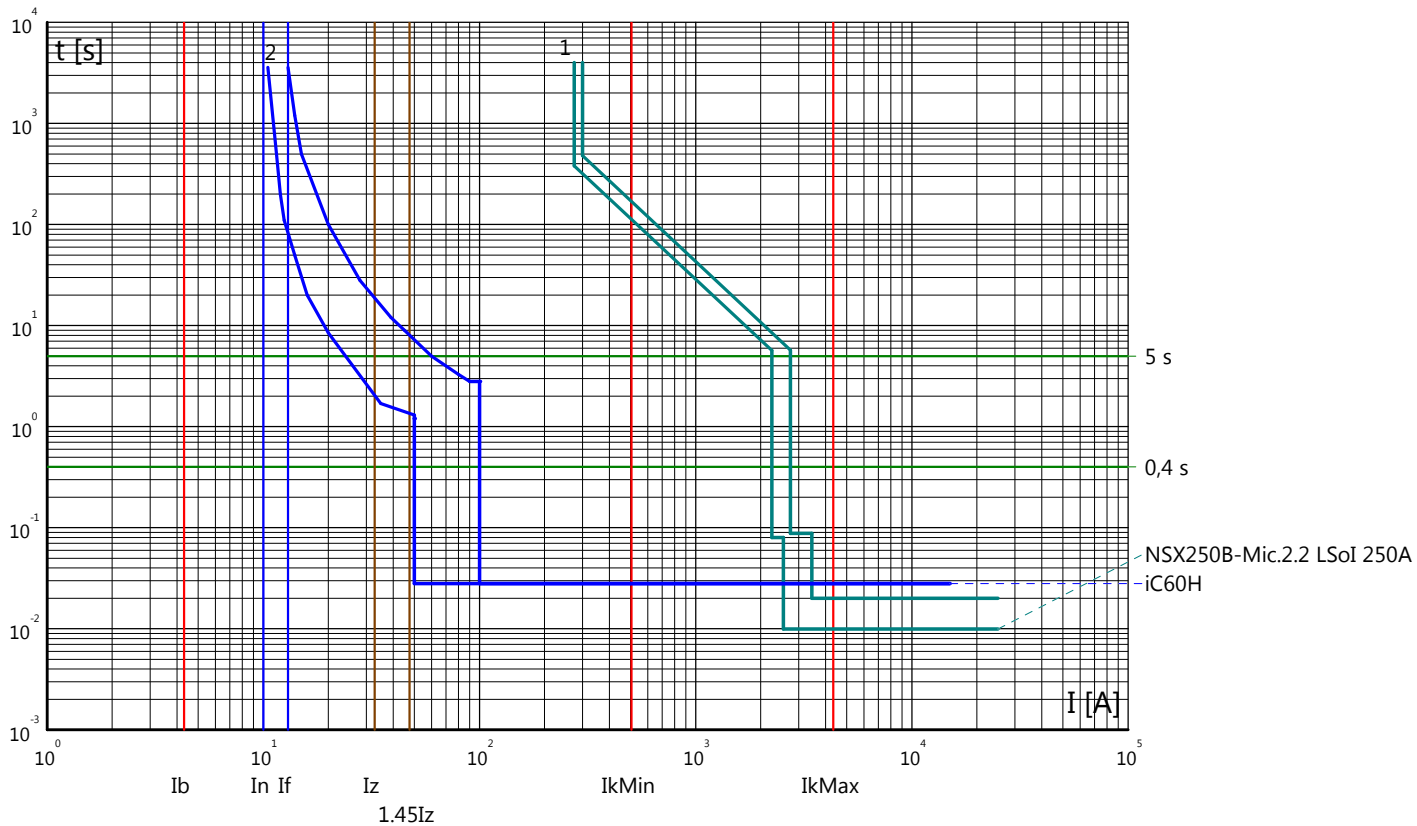

Partenza: 1.4N

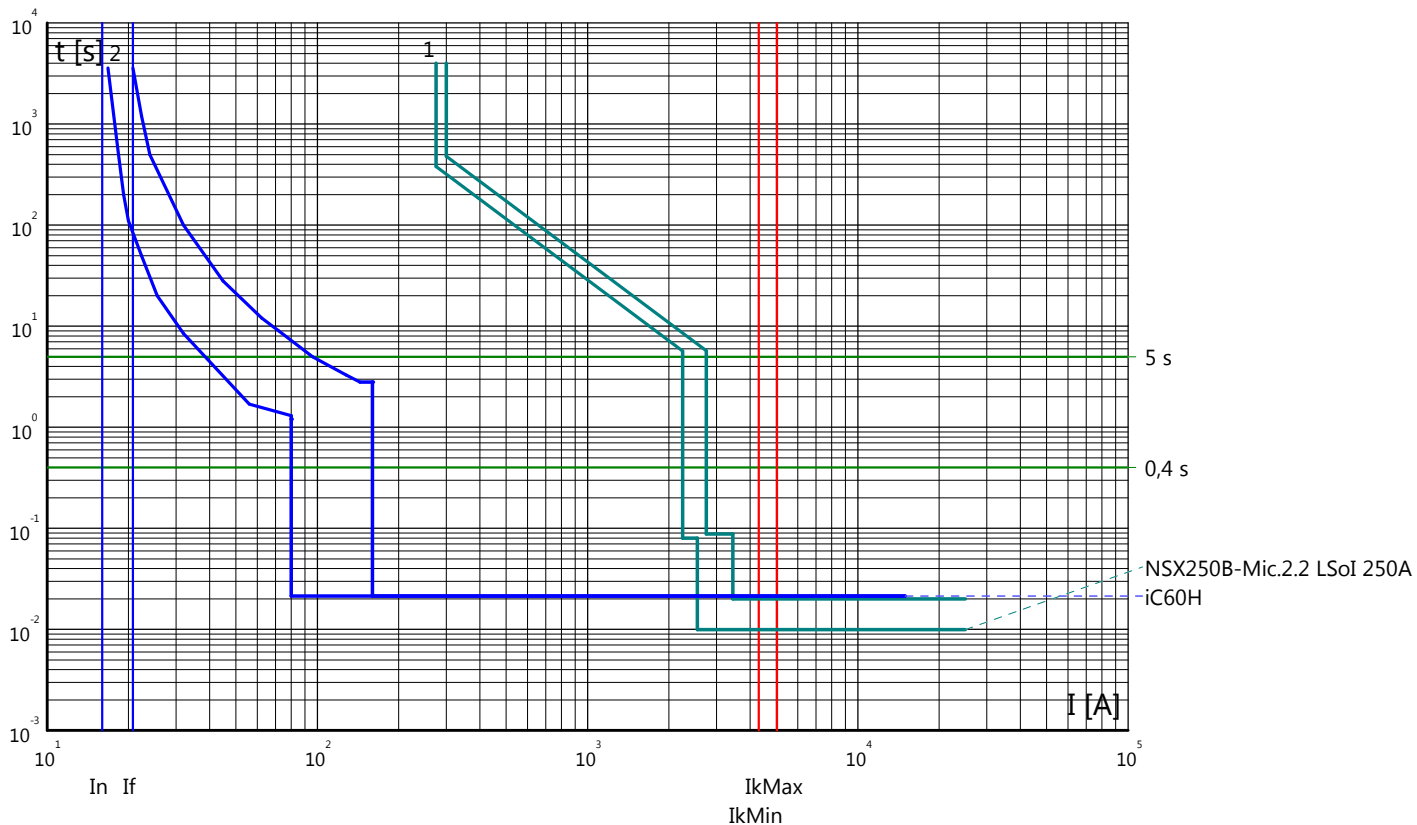

Curve tempo corrente: GALLERIA MONTE AGLIO  
 Quadro: QGBT/N

Partenza: IP1.N

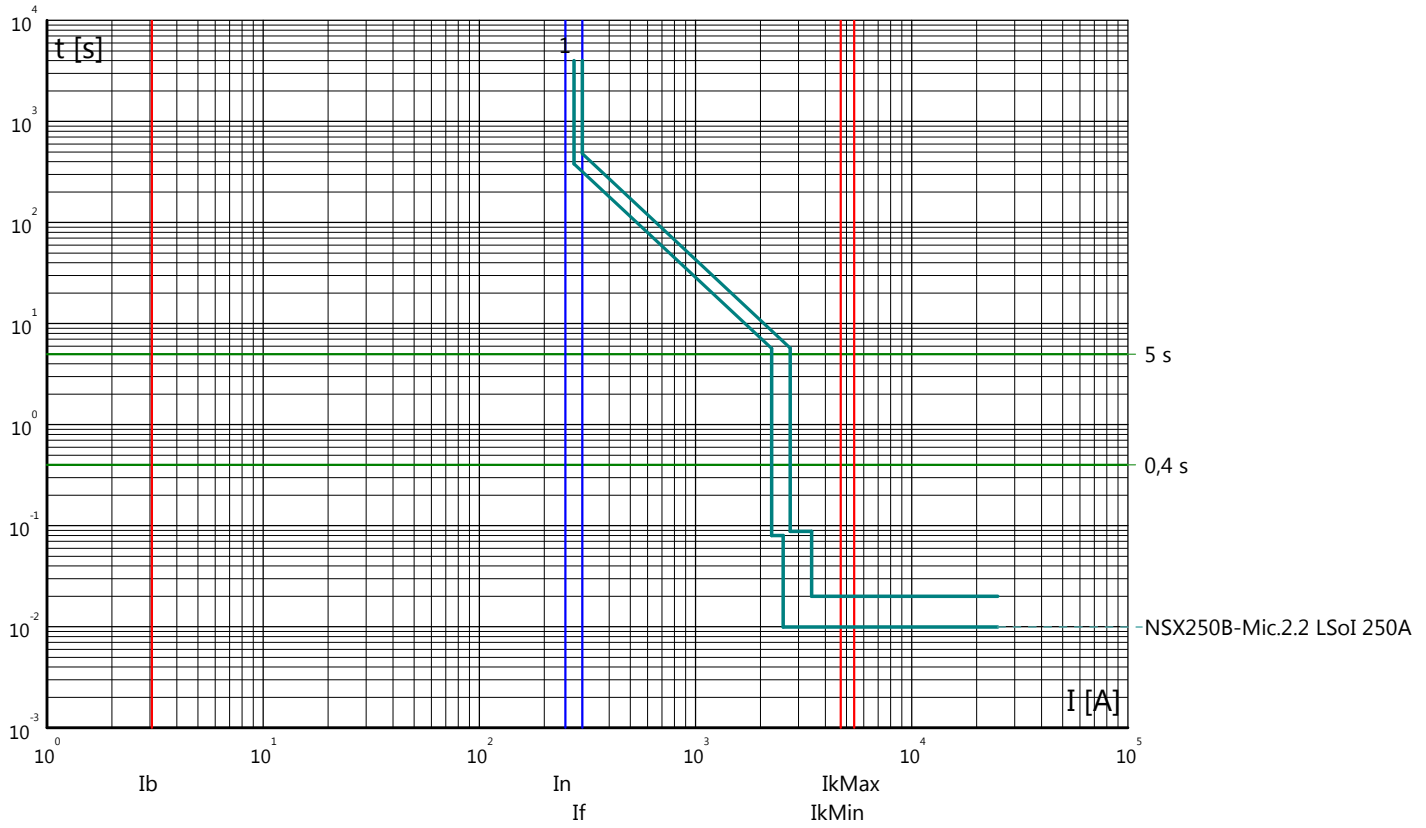

Partenza: 1.5N

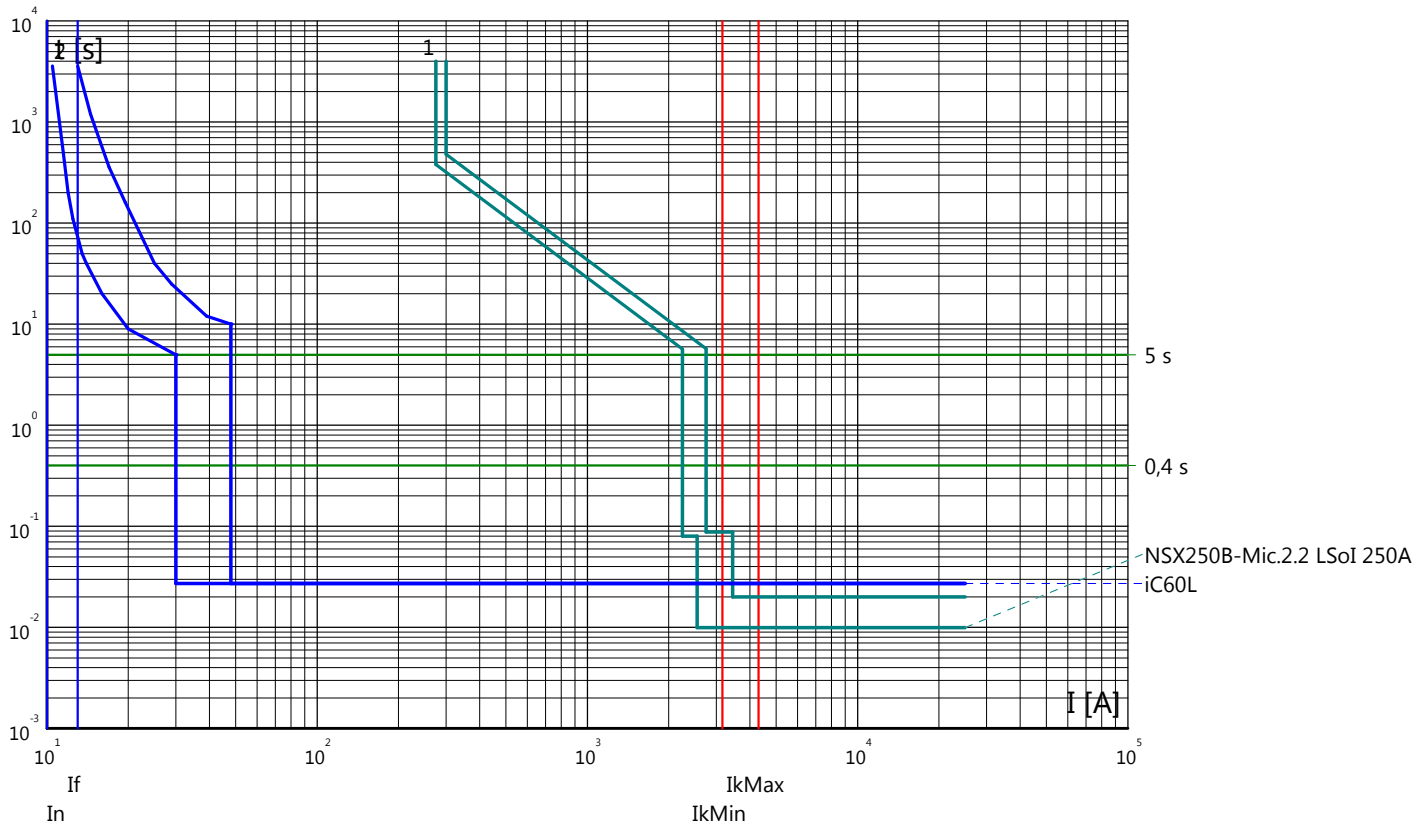

Curve tempo corrente: GALLERIA MONTE AGLIO  
 Quadro: QGBT/N

Partenza: 1.6N

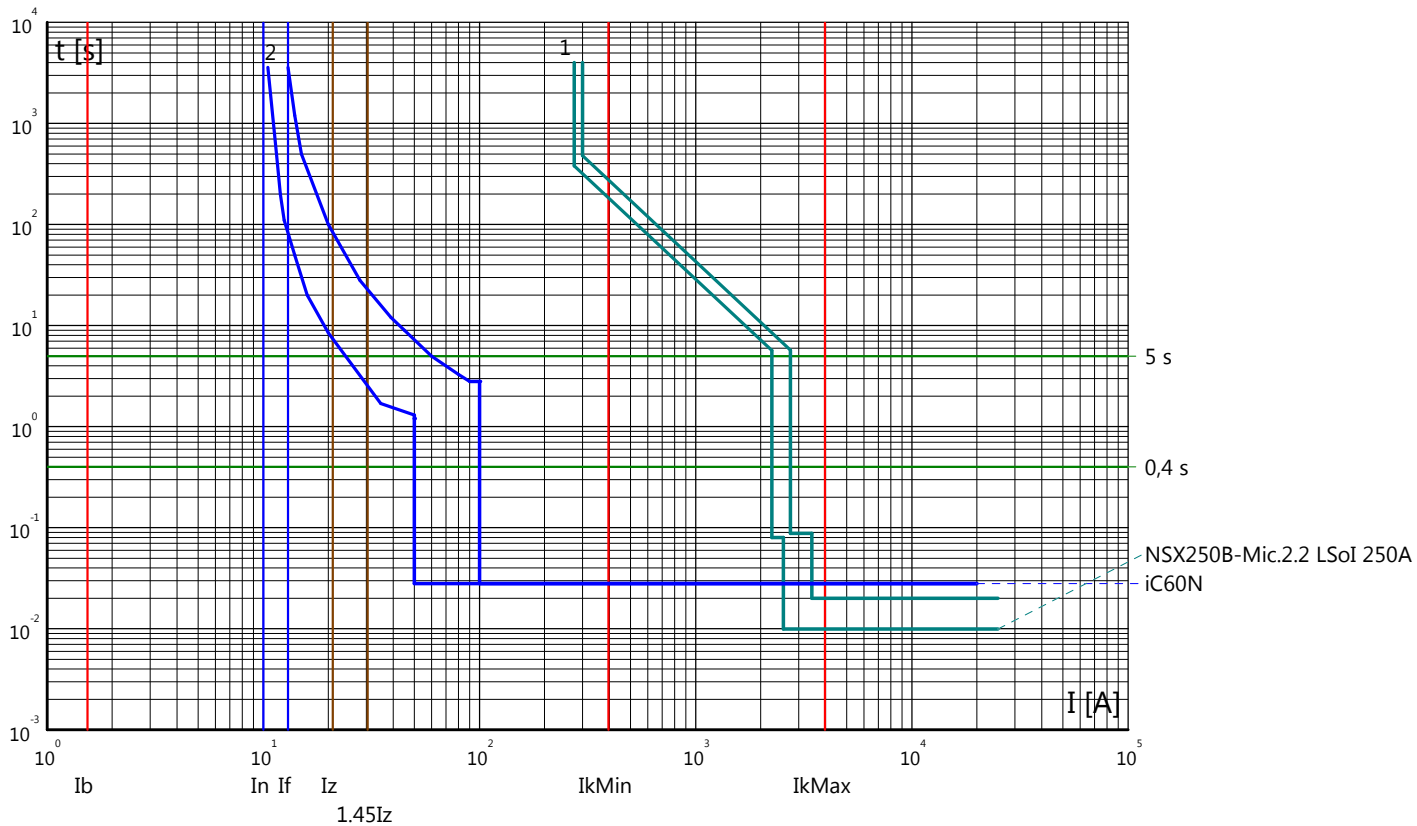

Partenza: 1.7N

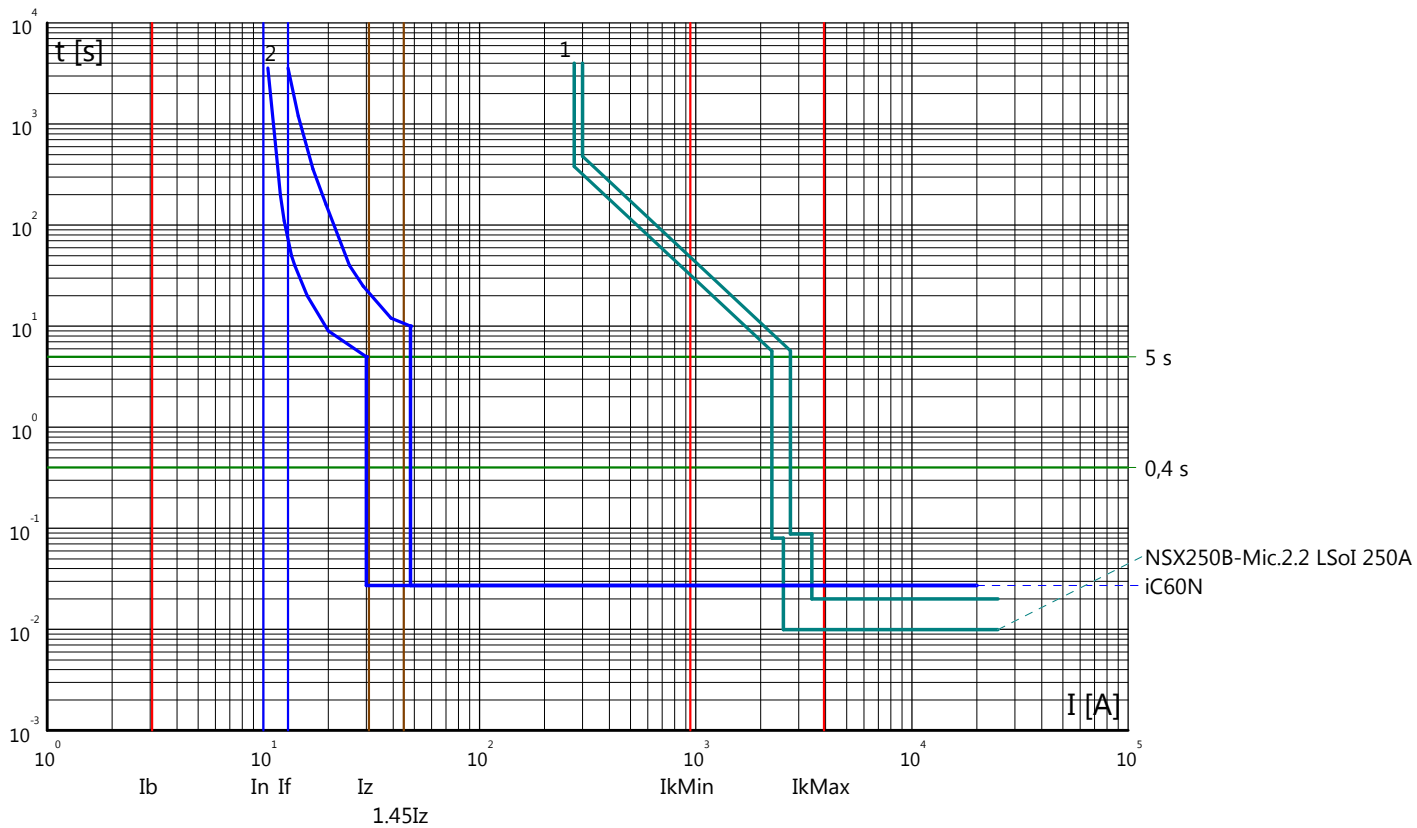

Curve tempo corrente: GALLERIA MONTE AGLIO  
 Quadro: QGBT/N

Partenza: 1.8N

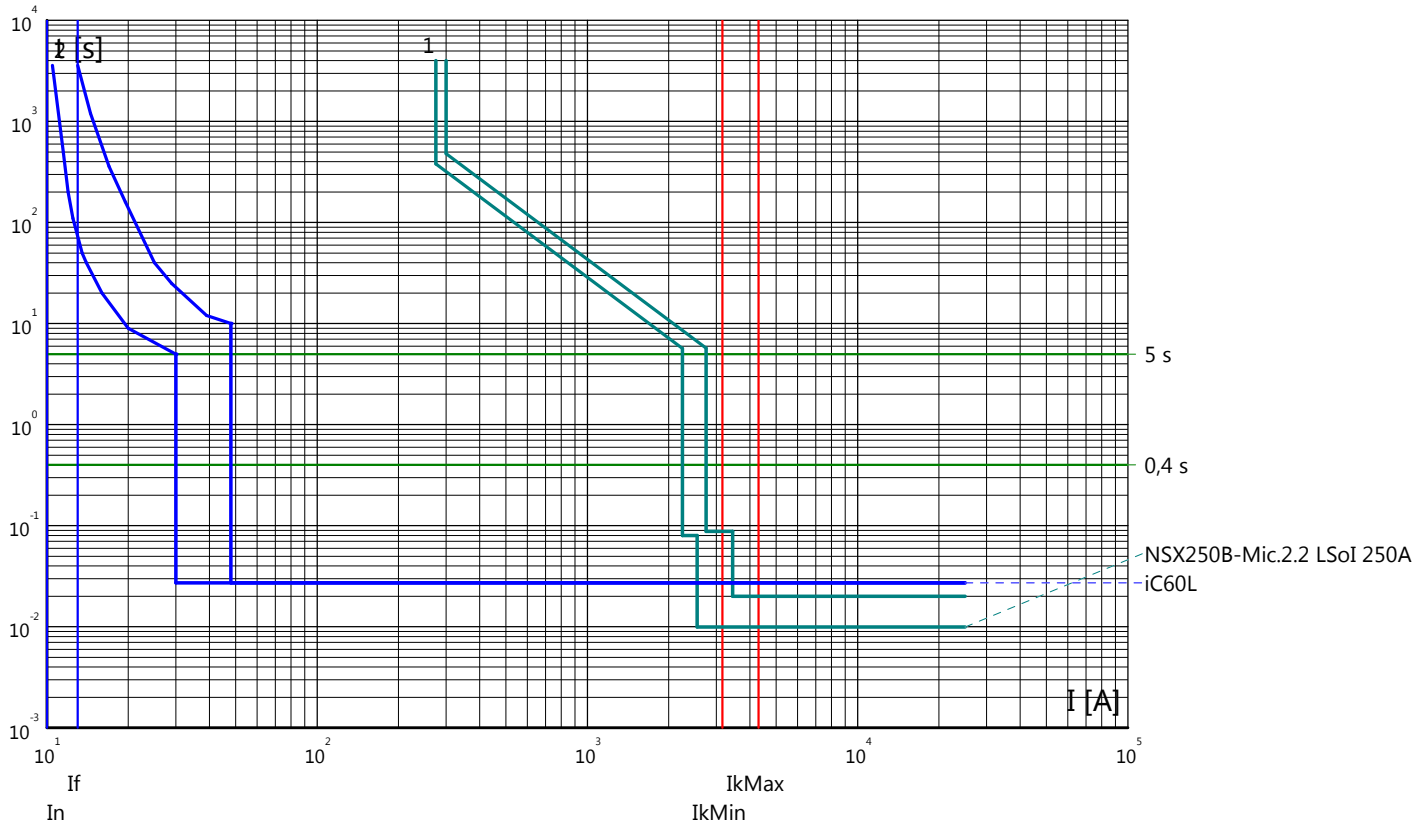

Partenza: 1.9N

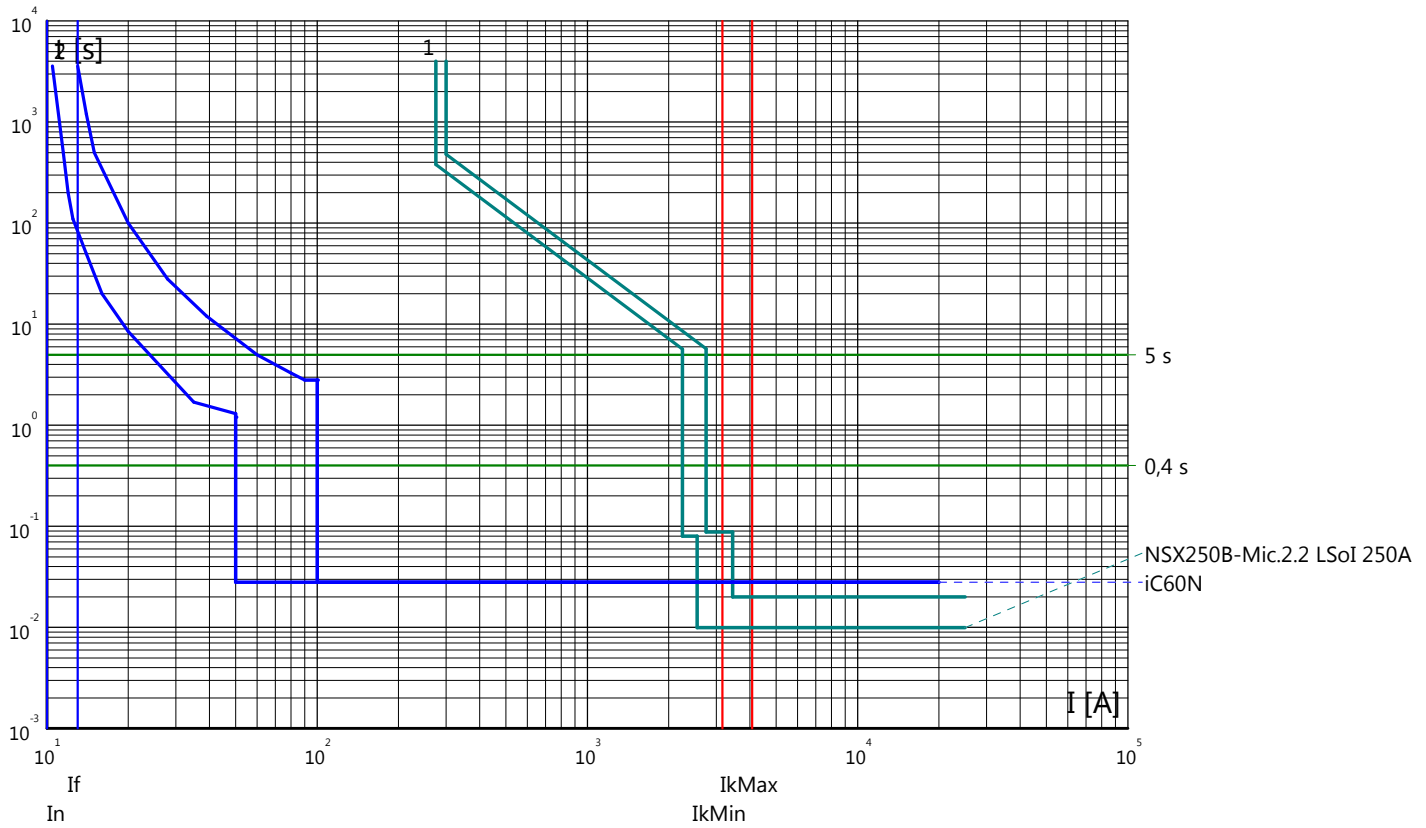

Curve tempo corrente: GALLERIA MONTE AGLIO  
 Quadro: QGBT/N

Partenza: IP2.N

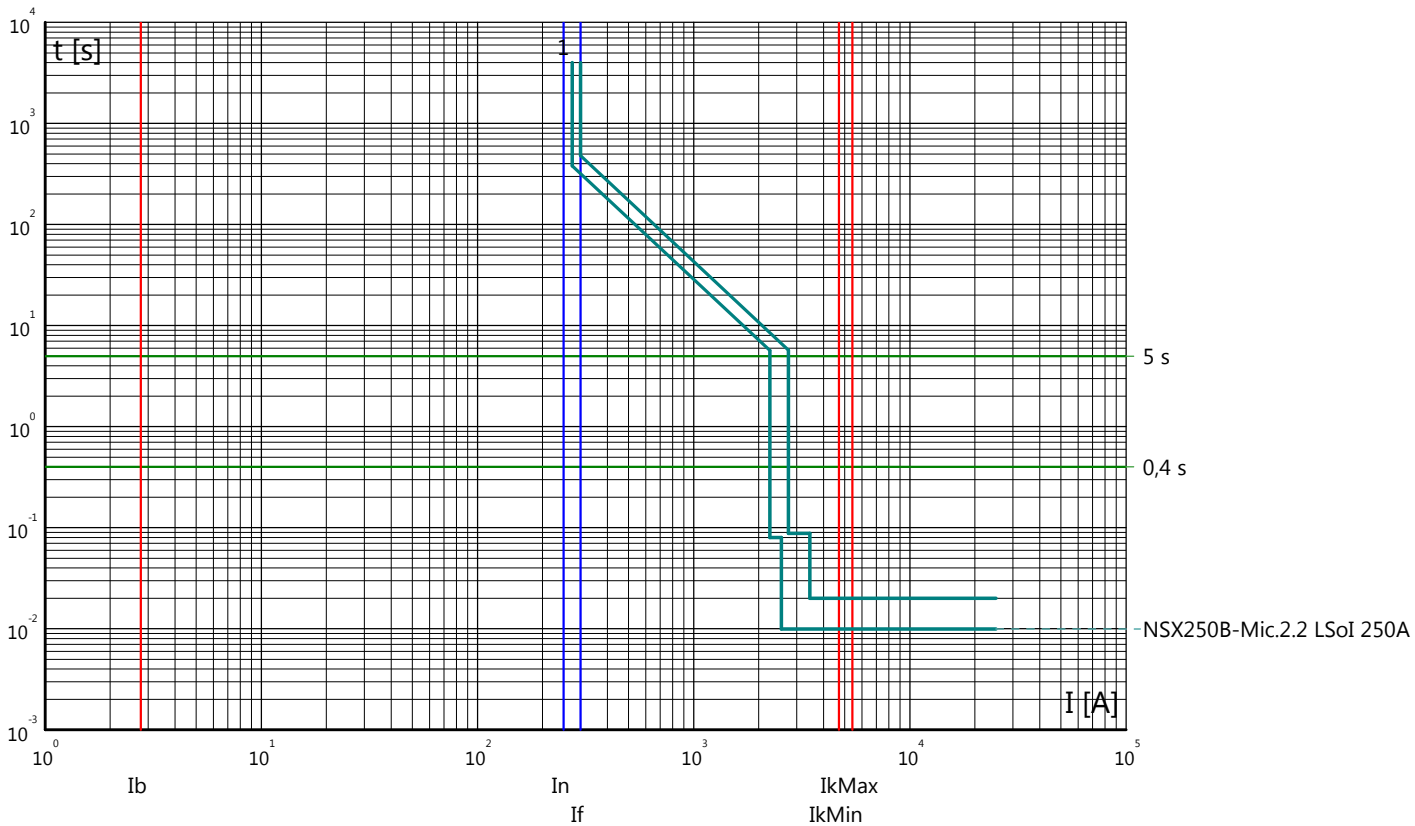

Partenza: 1.10N

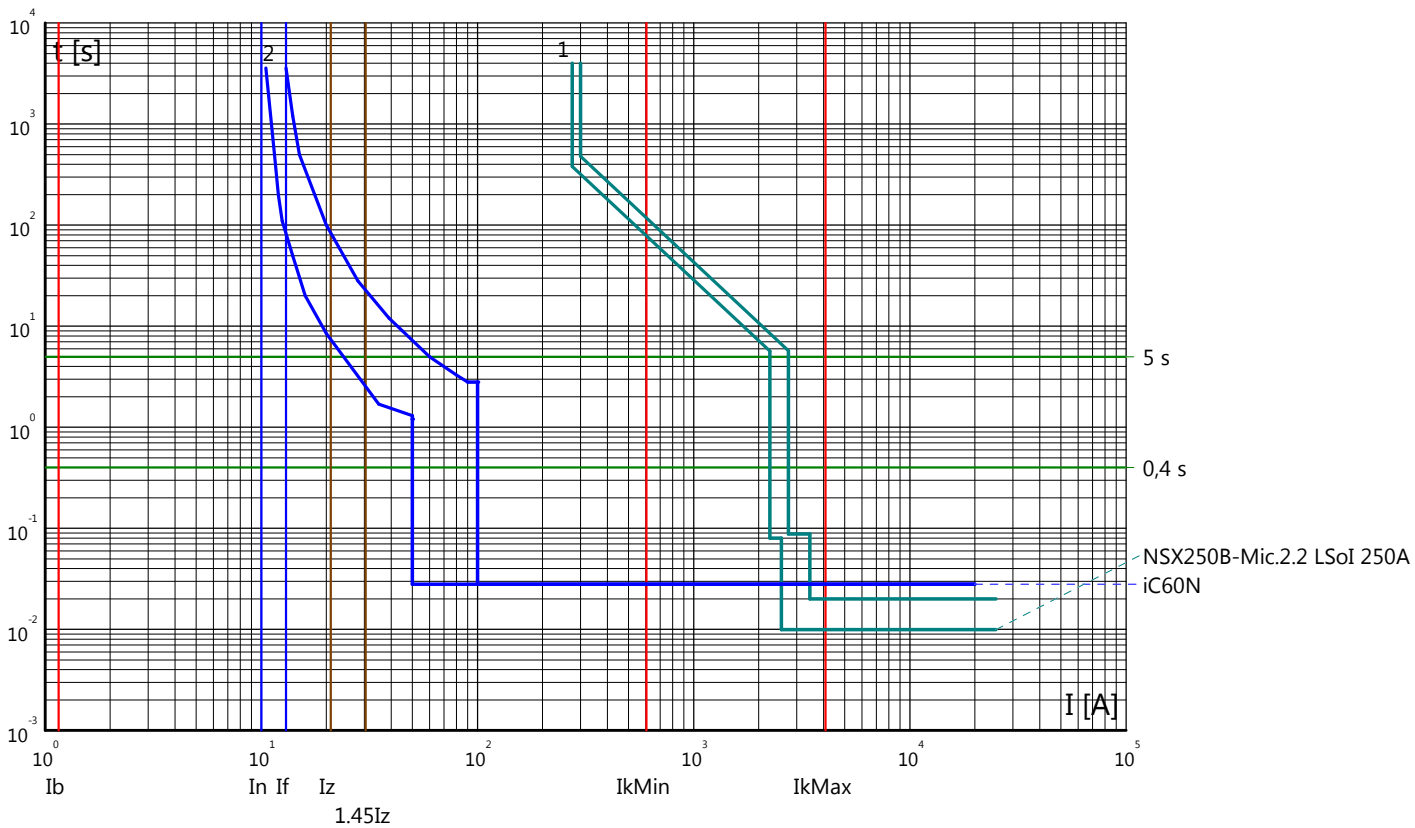

Curve tempo corrente: GALLERIA MONTE AGLIO  
 Quadro: QGBT/N

Partenza: 1.11N

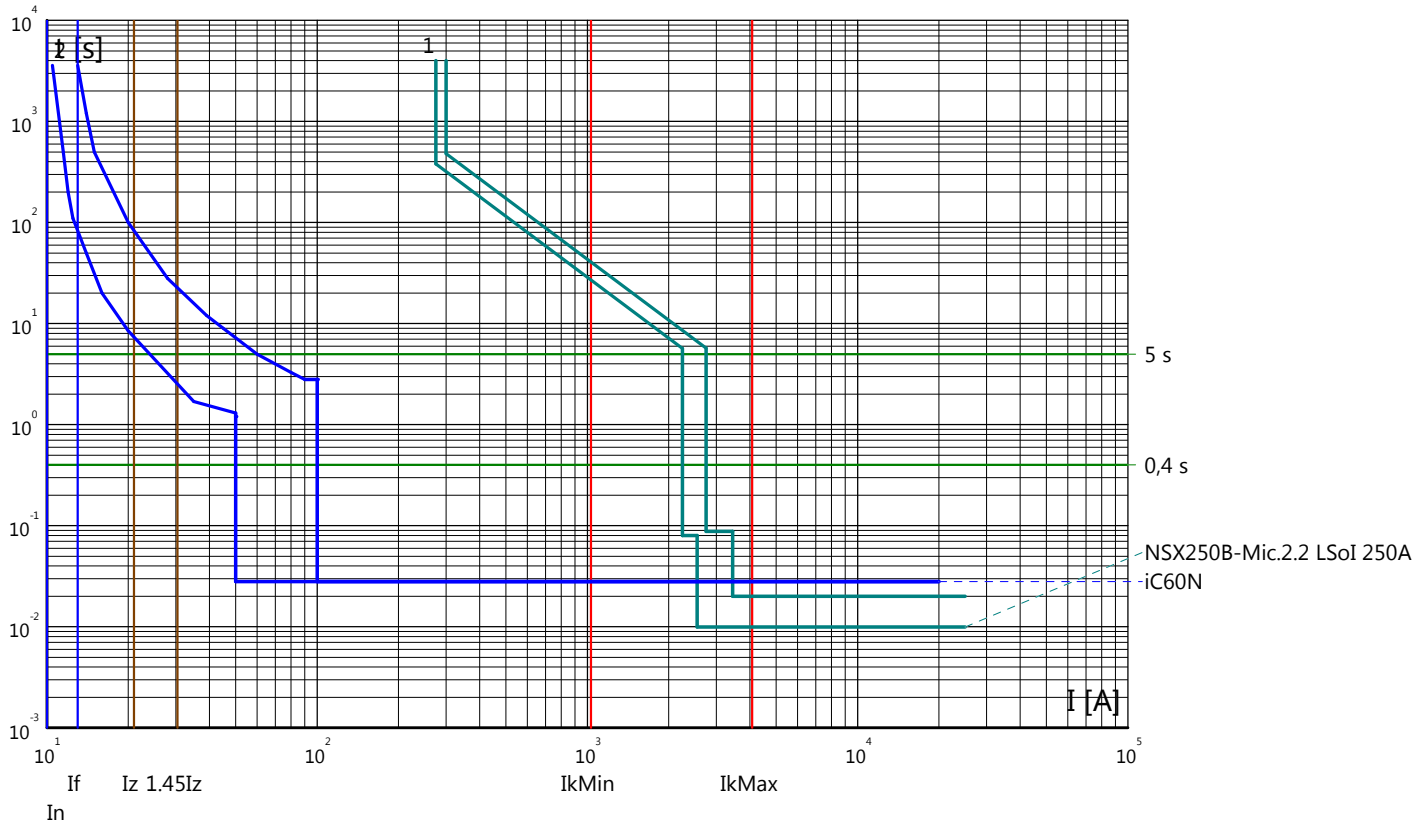

Partenza: 1.12N

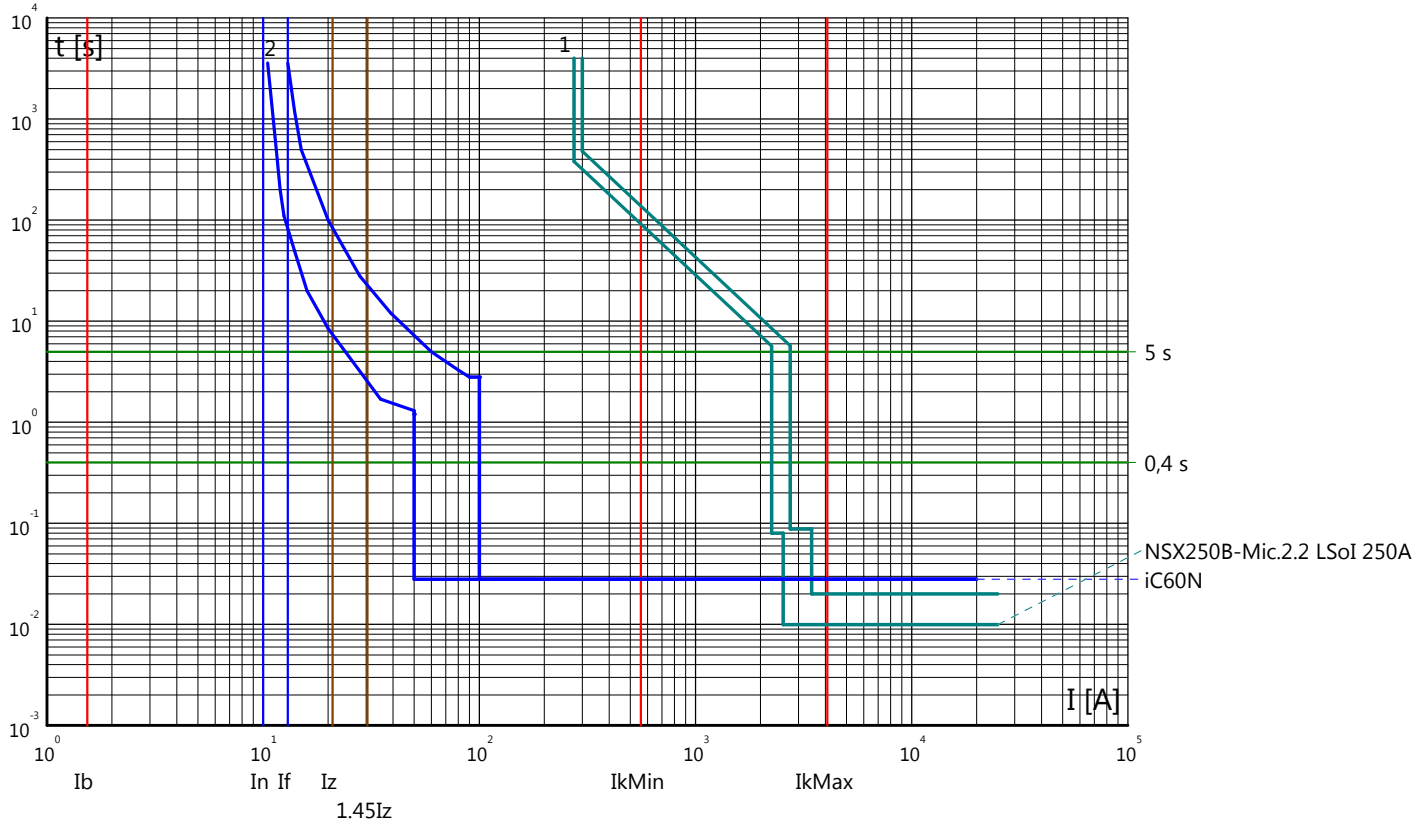

Curve tempo corrente: GALLERIA MONTE AGLIO  
 Quadro: QGBT/N

Partenza: 1.13N

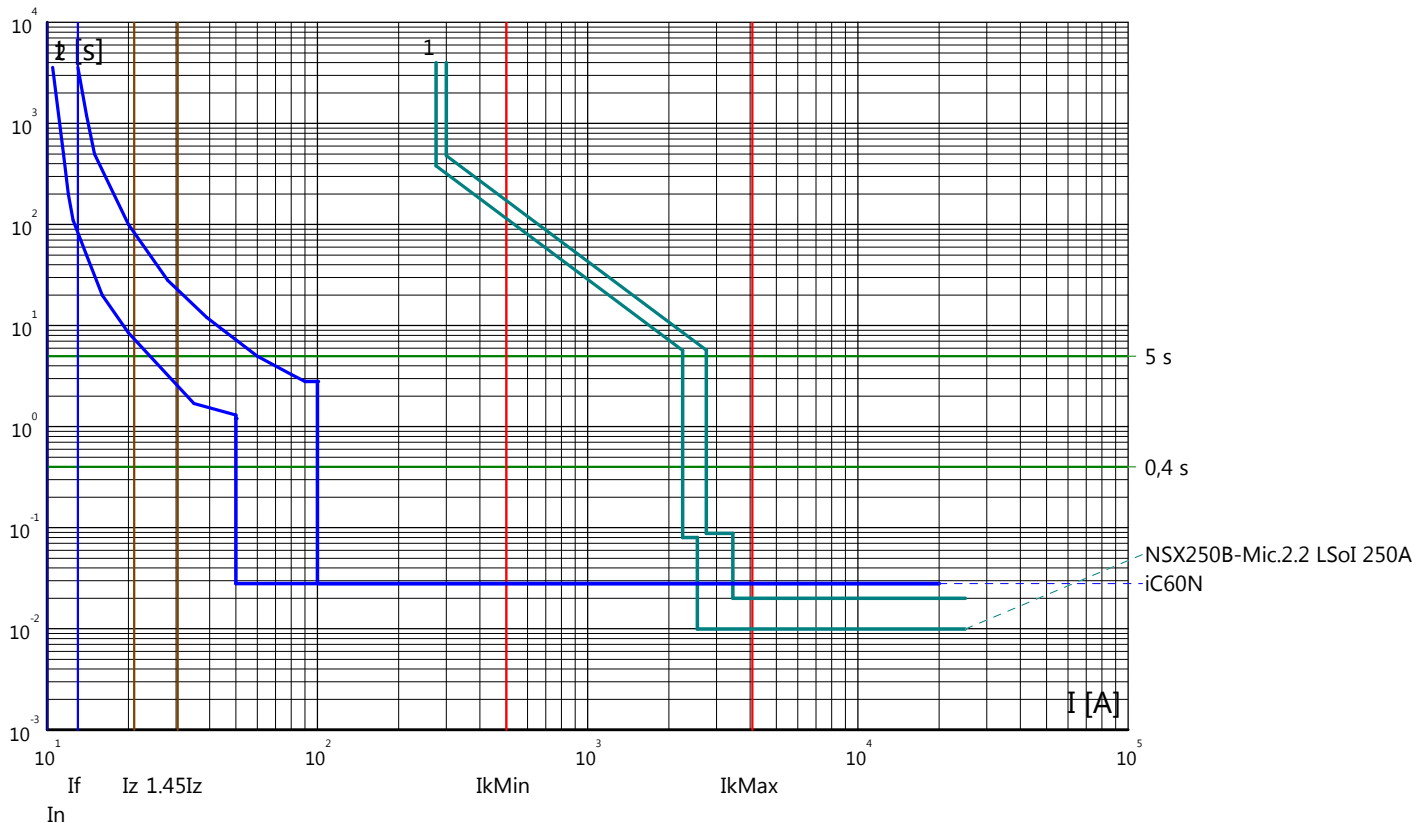

Partenza: 1.14N

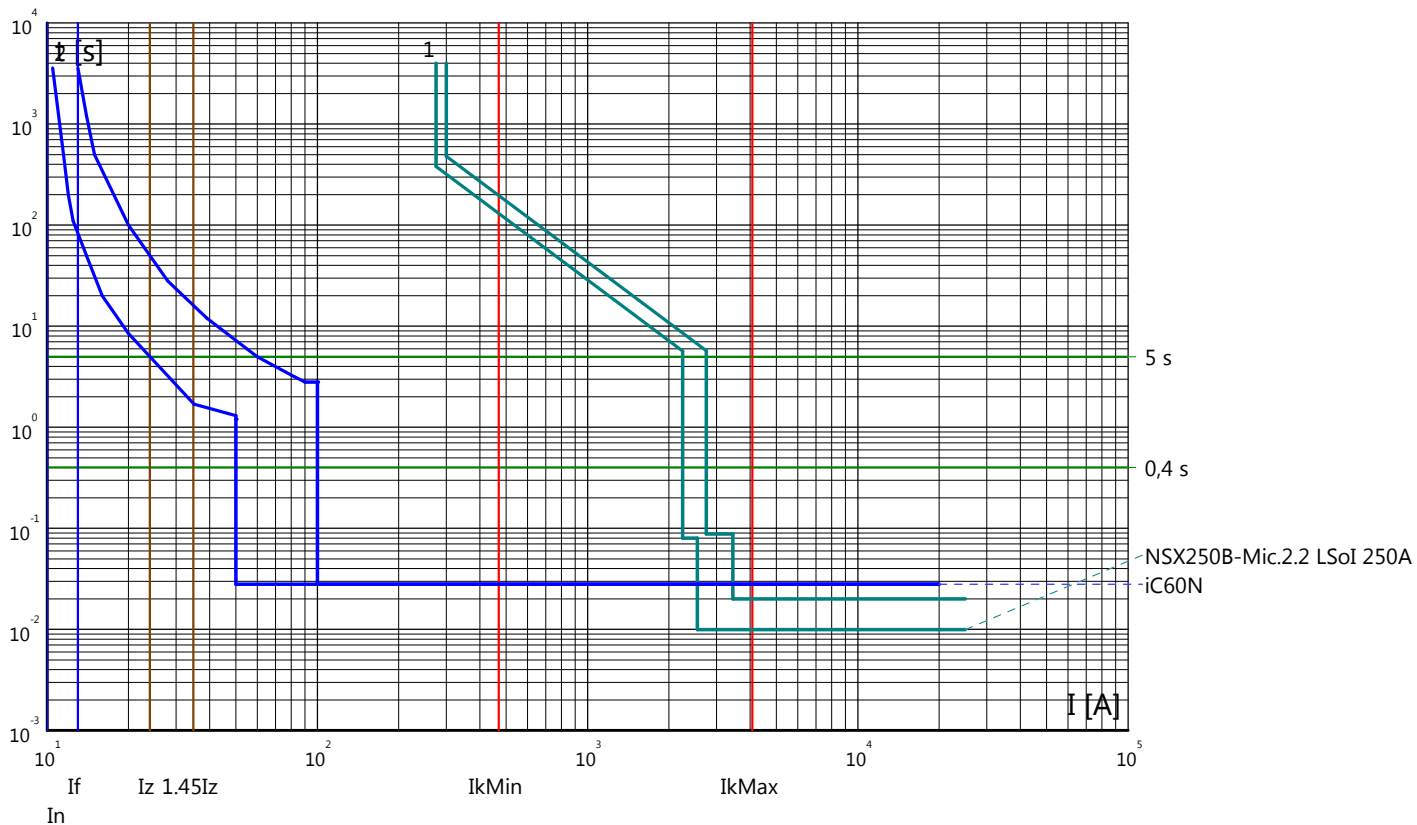



Curve tempo corrente: GALLERIA MONTE AGLIO  
 Quadro: QGBT/N

Partenza: 1.15N

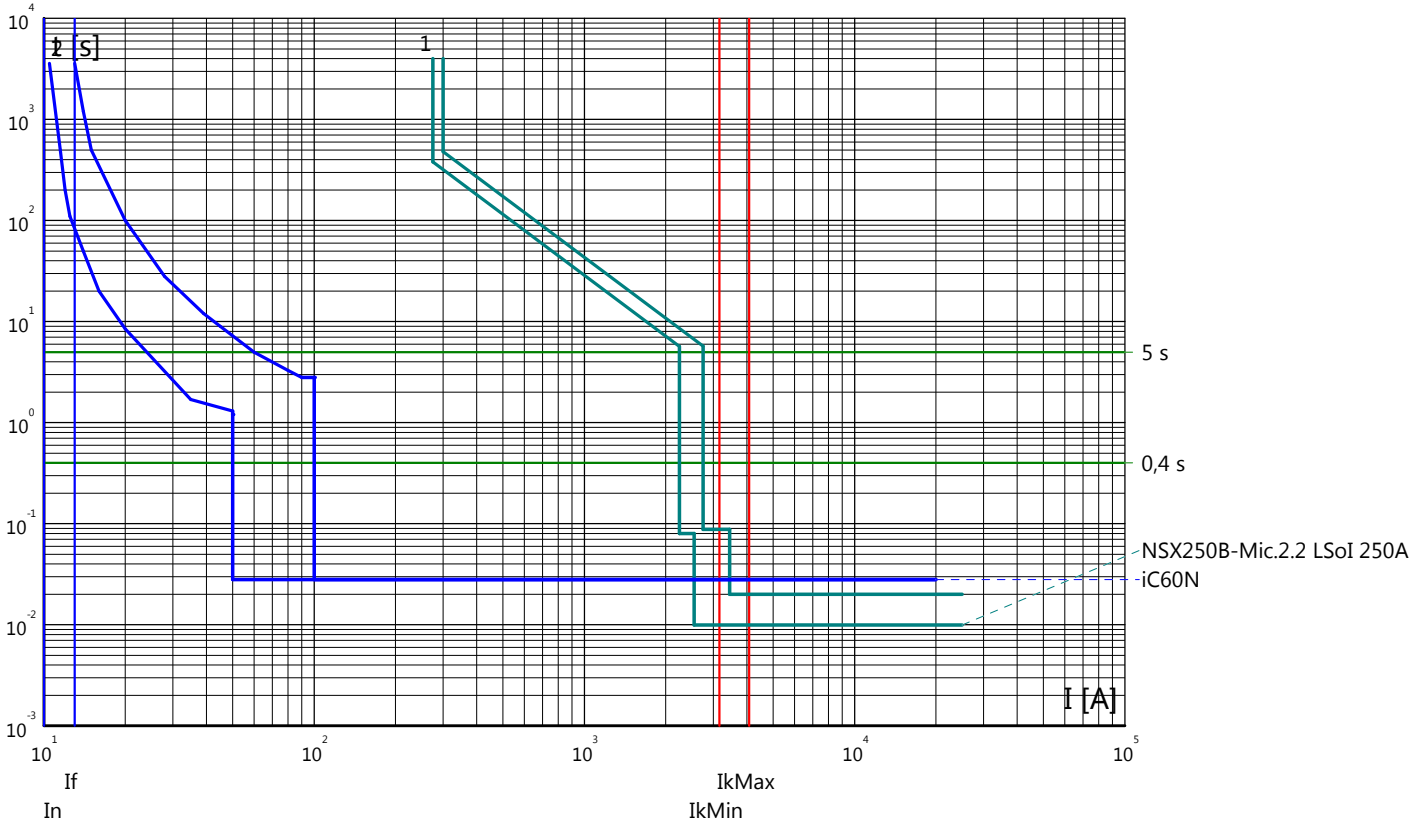

Partenza: 1.16N

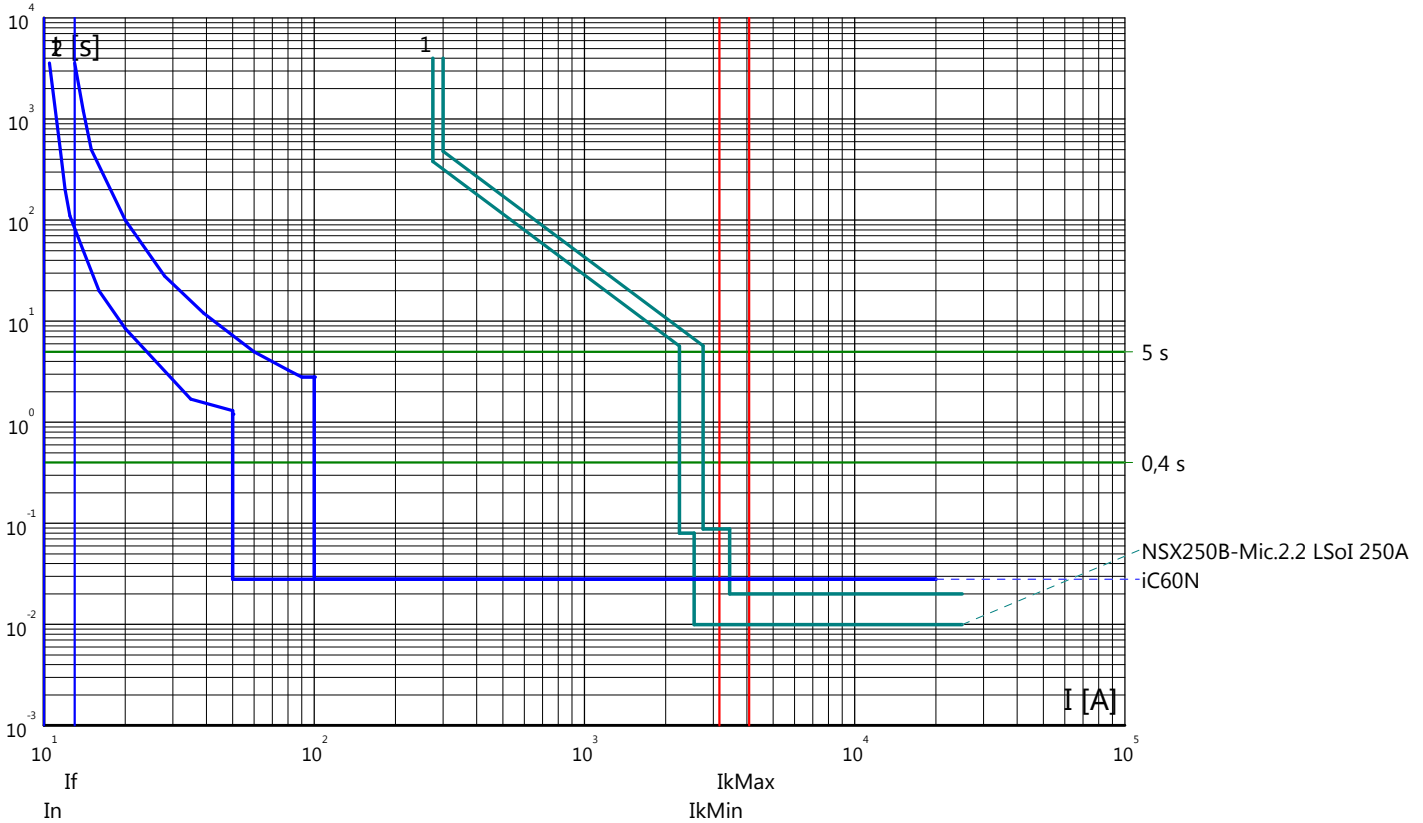

Curve tempo corrente: GALLERIA MONTE AGLIO  
 Quadro: QGBT/N

Partenza: IP3.N

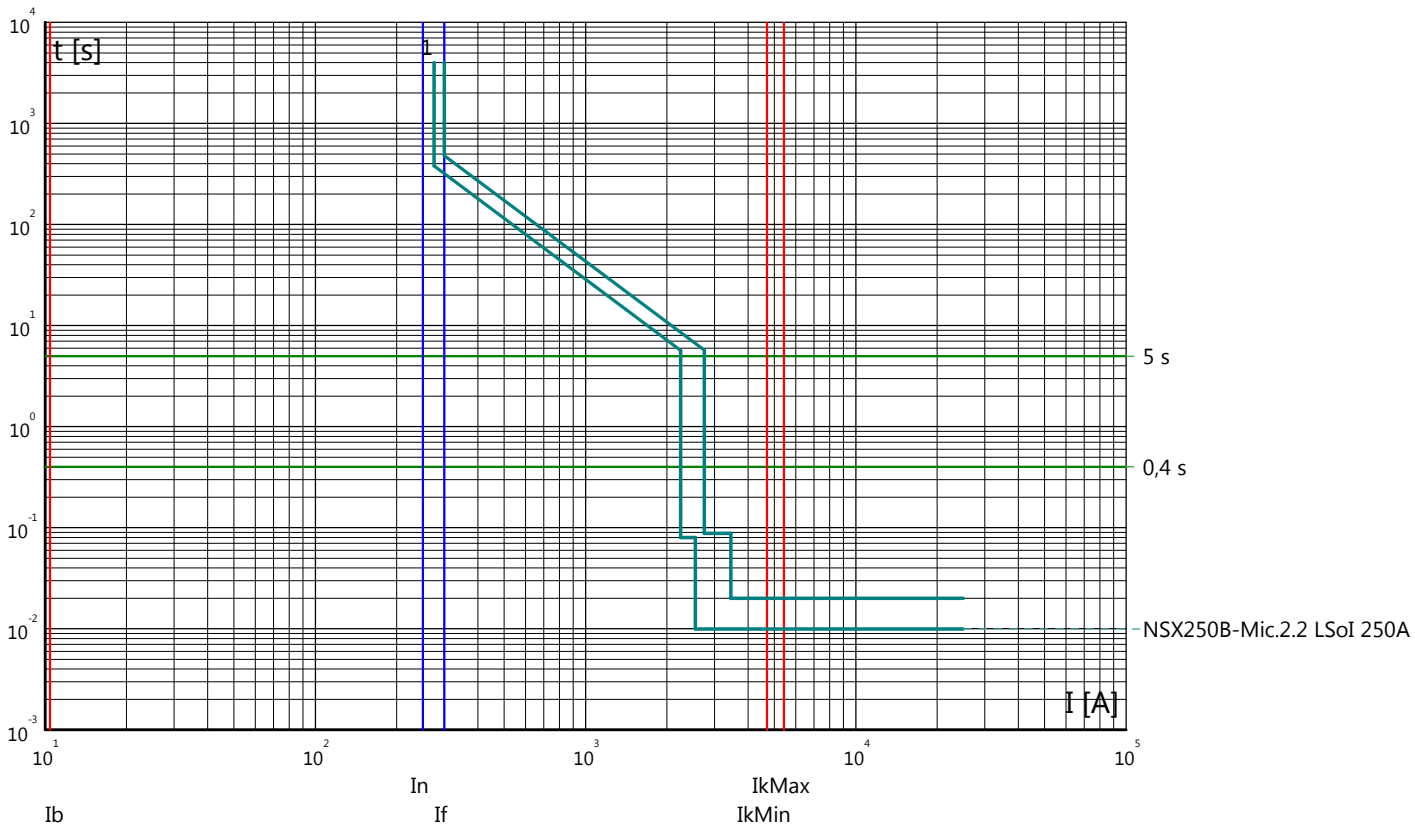

Partenza: 1.17N

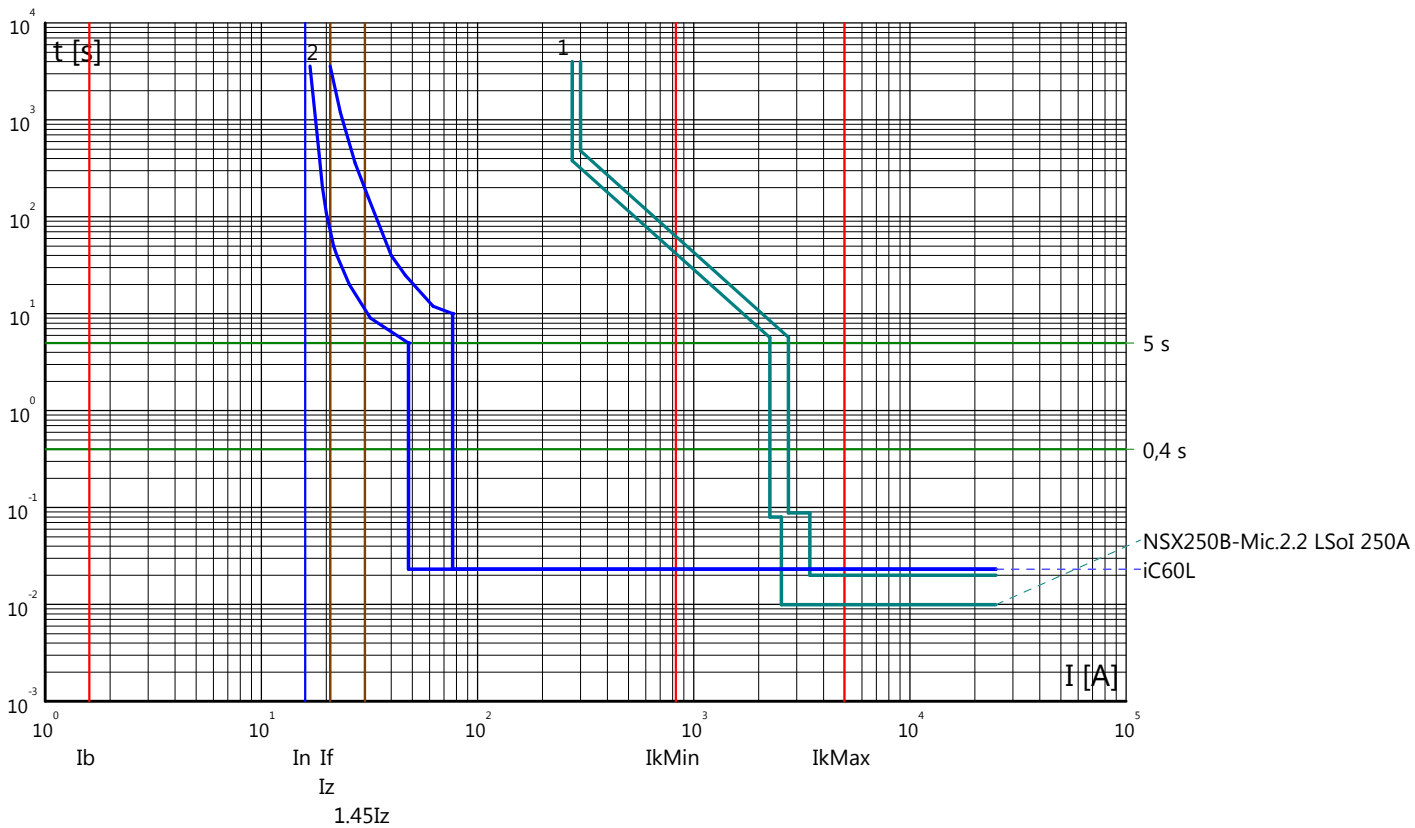

Curve tempo corrente: GALLERIA MONTE AGLIO  
 Quadro: QGBT/N

Partenza: 1.18N

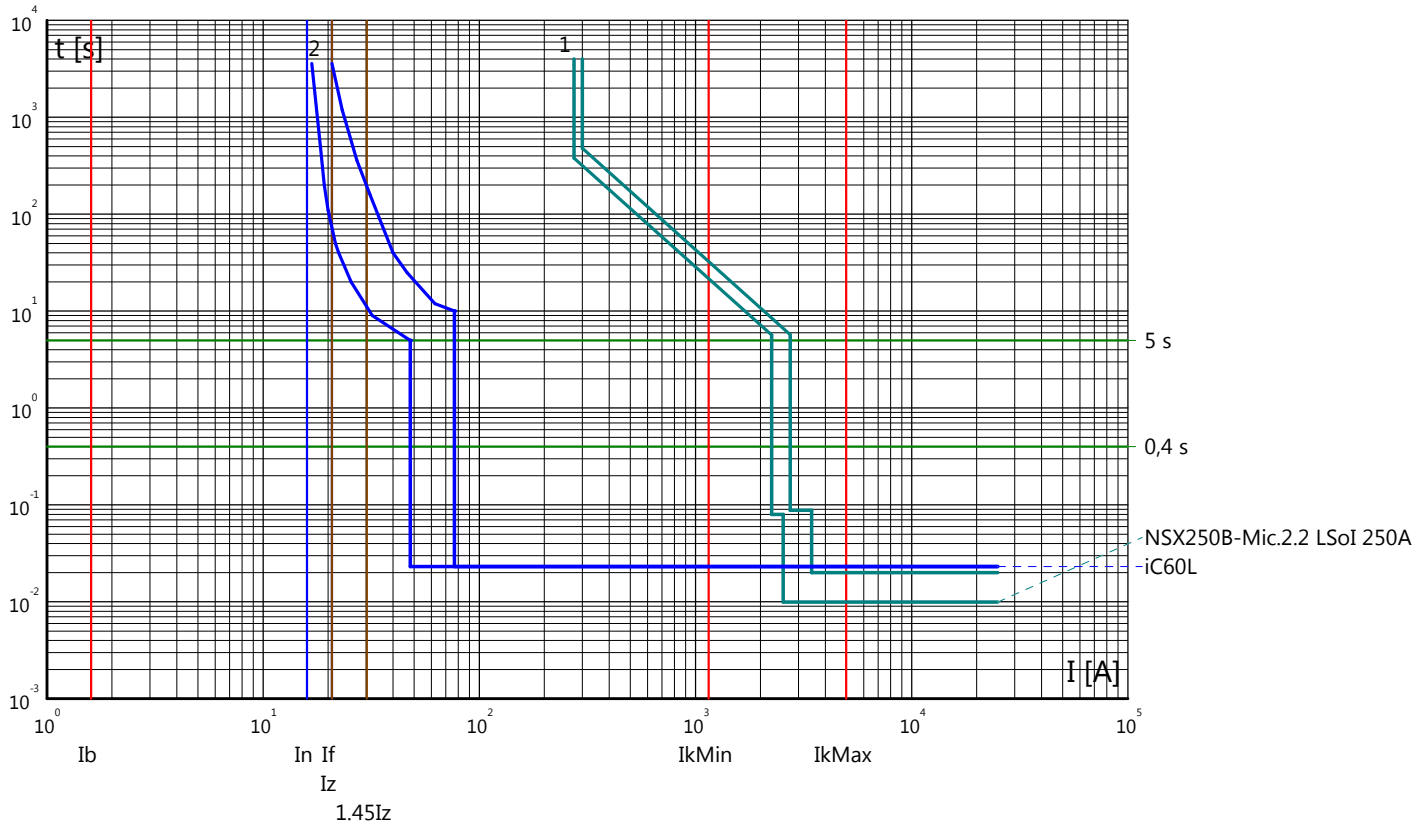

Partenza: 1.19N

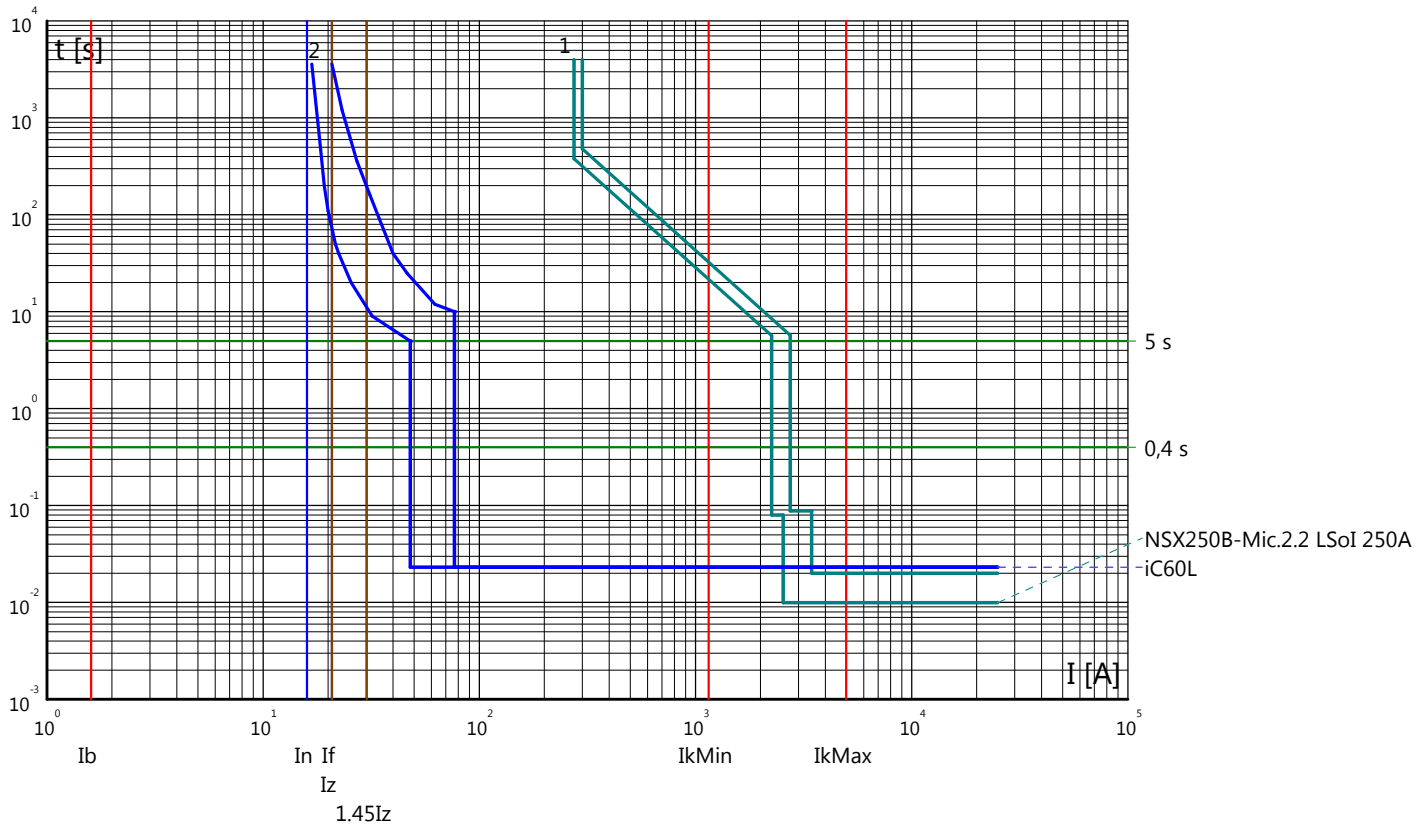

Curve tempo corrente: GALLERIA MONTE AGLIO  
 Quadro: QGBT/N

Partenza: 1.20N

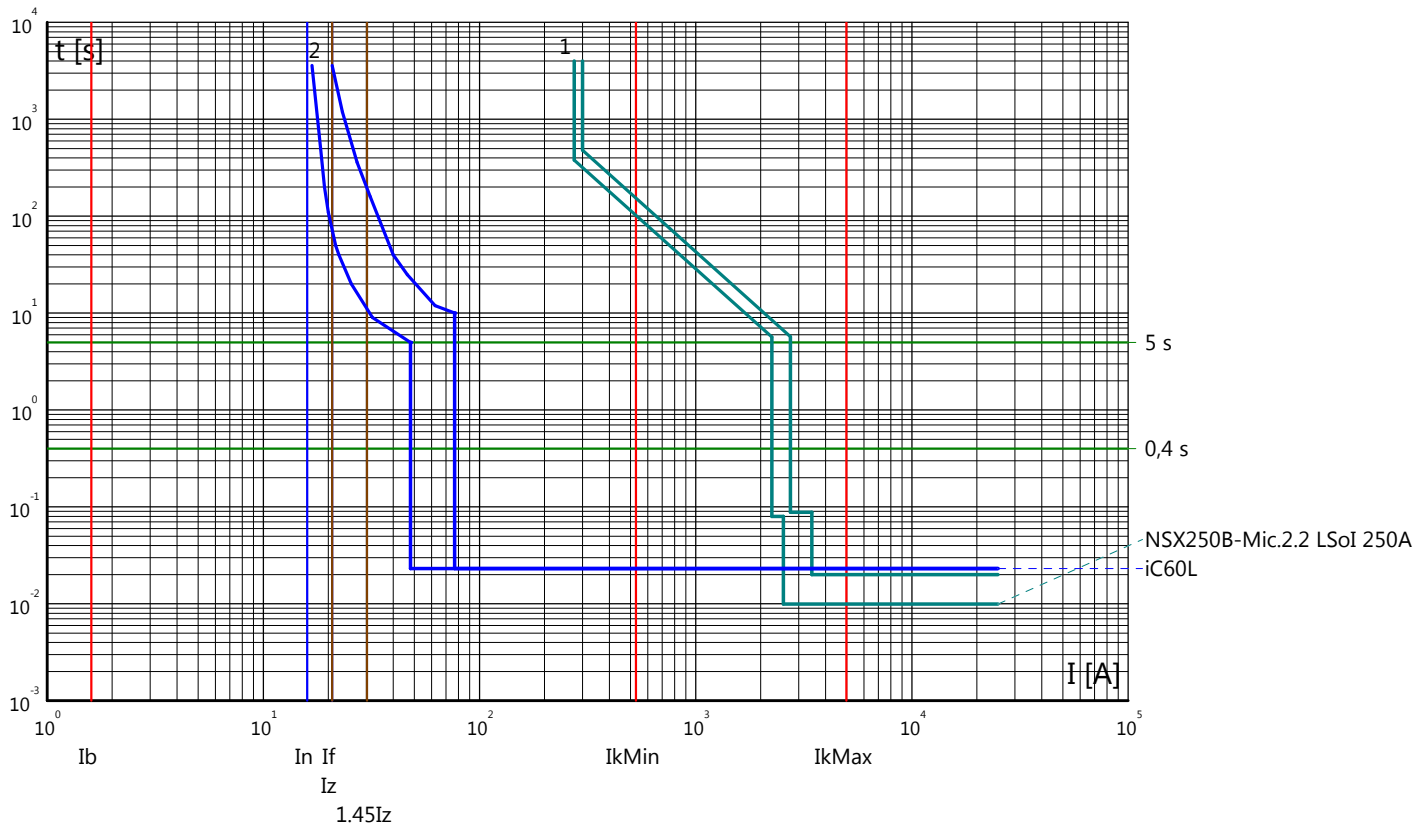

Partenza: 1.21N

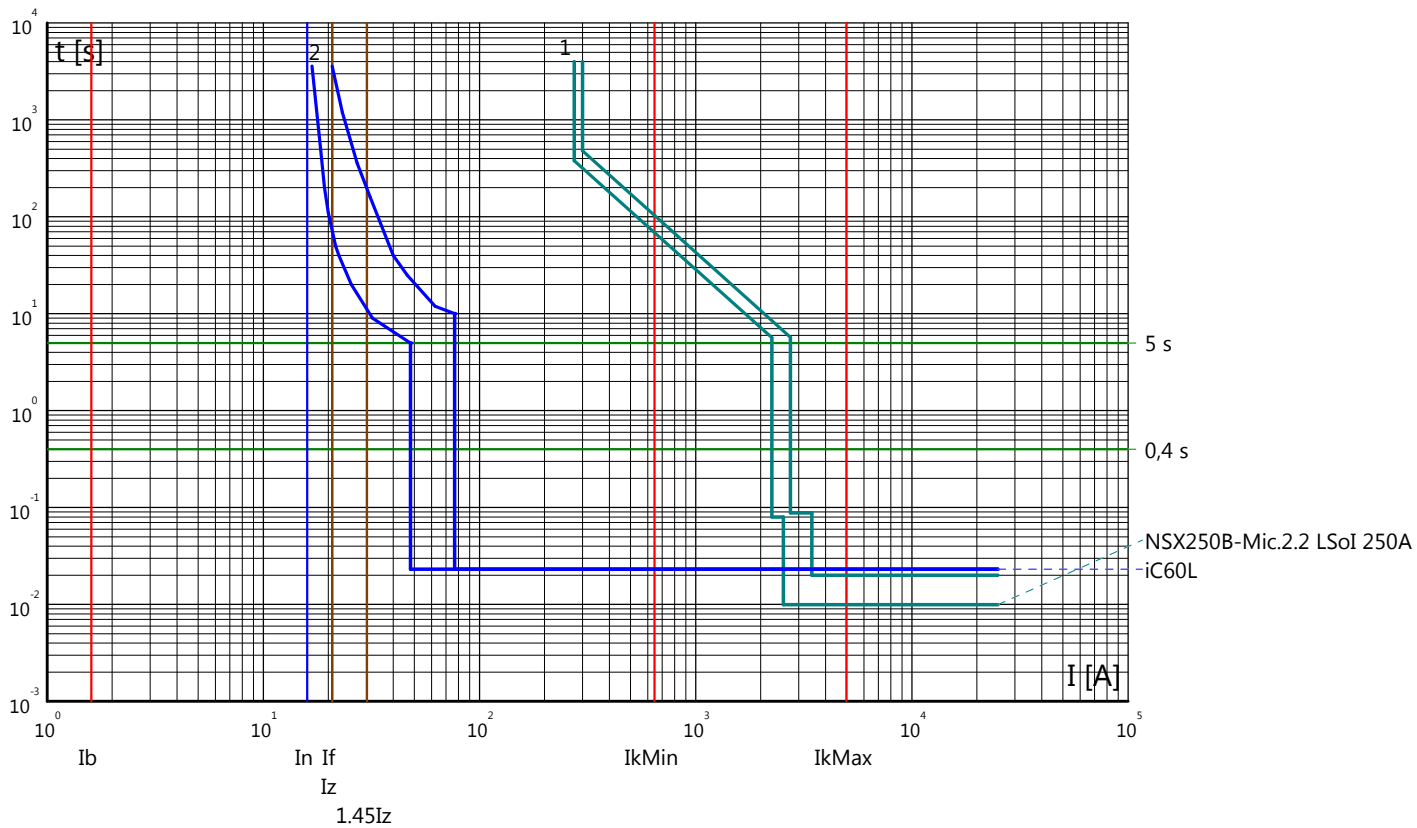

Curve tempo corrente: GALLERIA MONTE AGLIO  
 Quadro: QGBT/N

Partenza: 1.22N

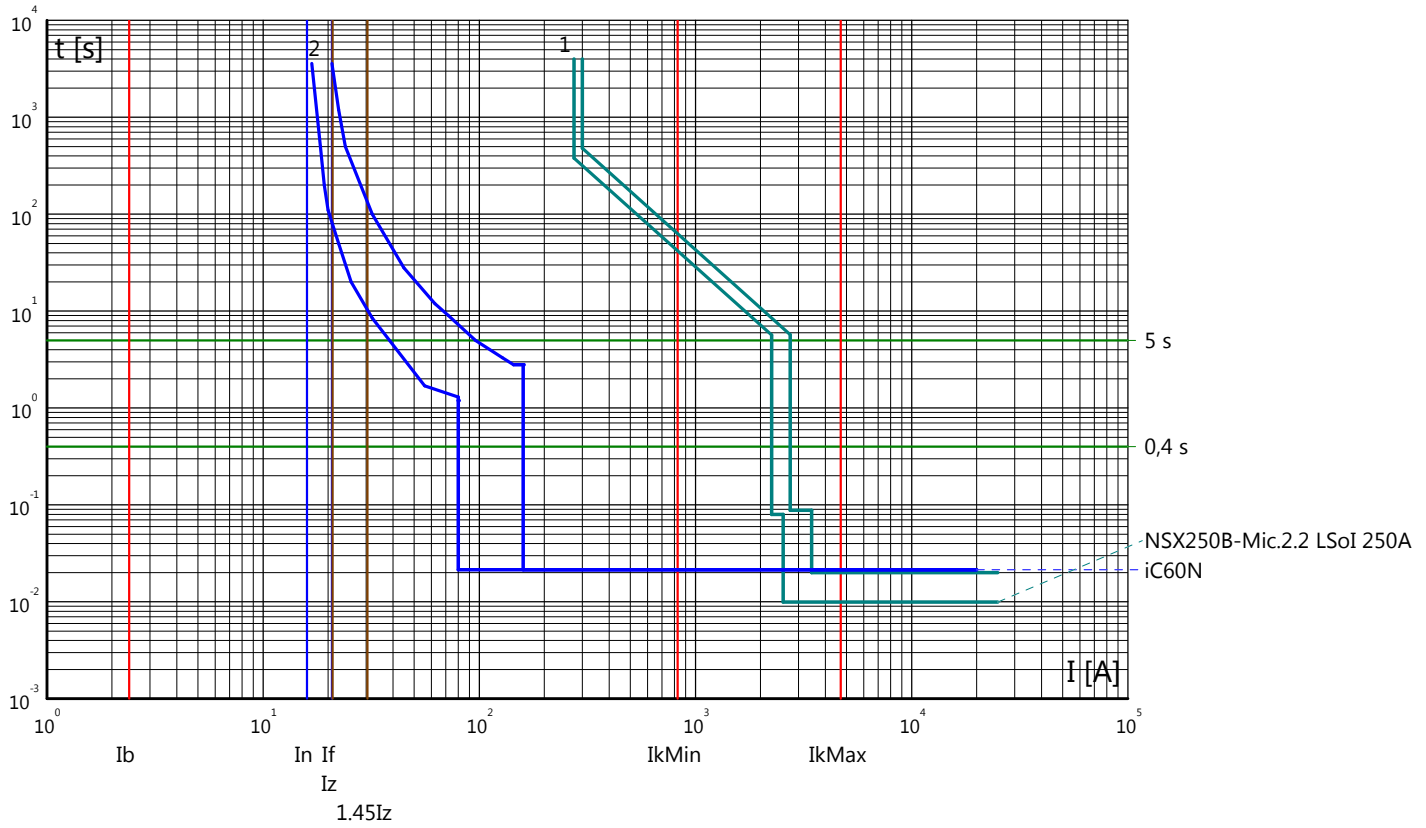

Partenza: 1.23N

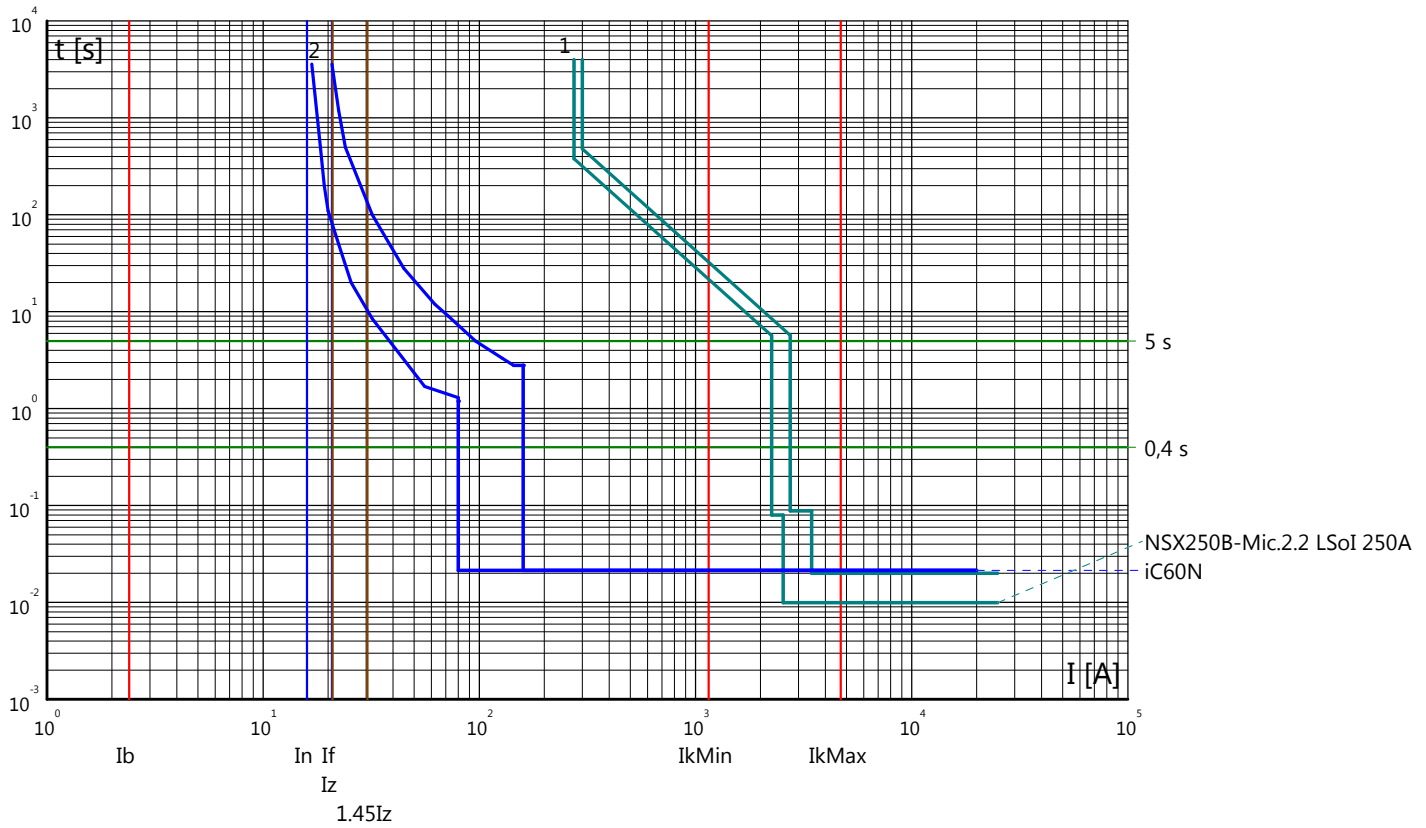

Curve tempo corrente: GALLERIA MONTE AGLIO  
 Quadro: QGBT/N

Partenza: 1.24N

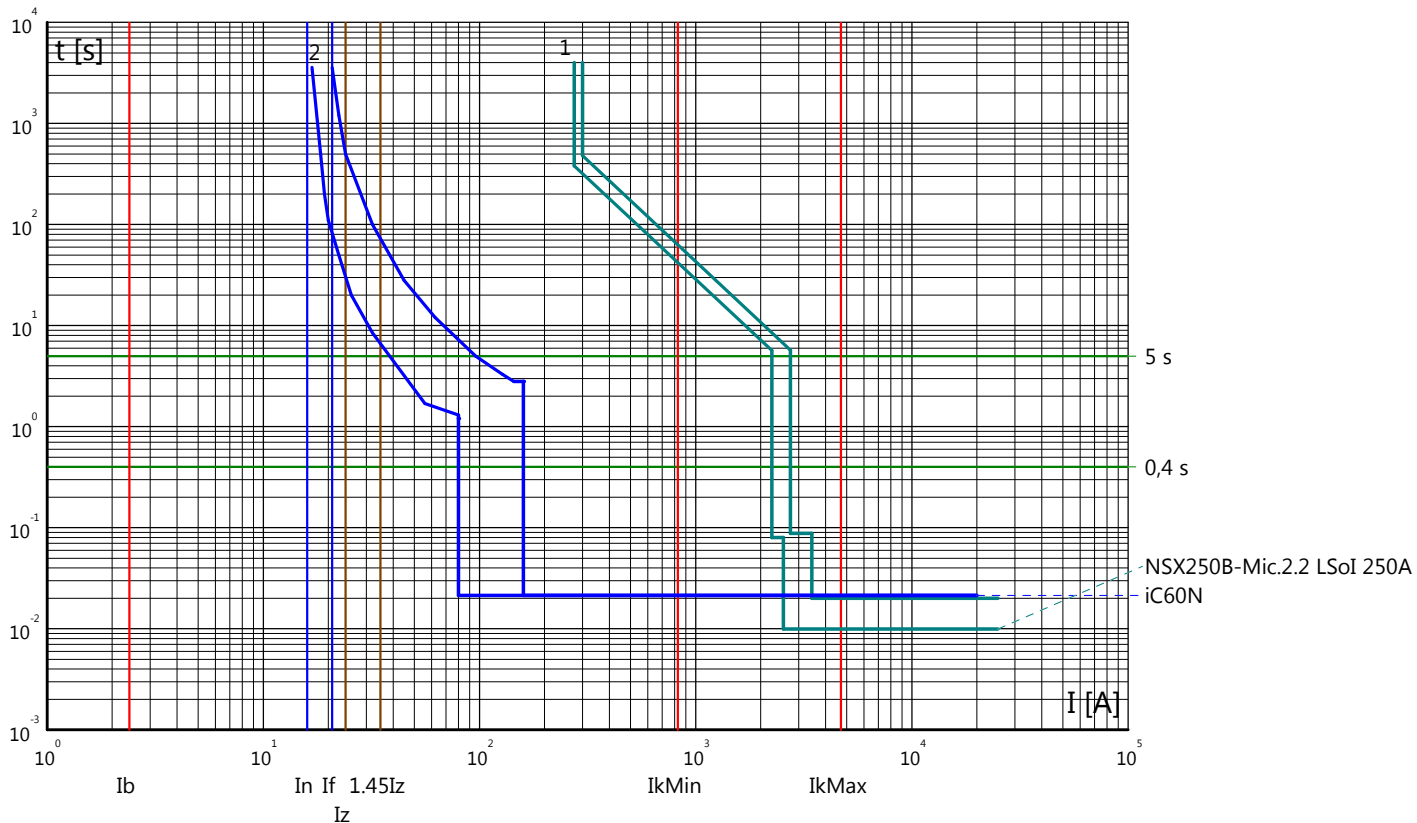

Partenza: 1.25N

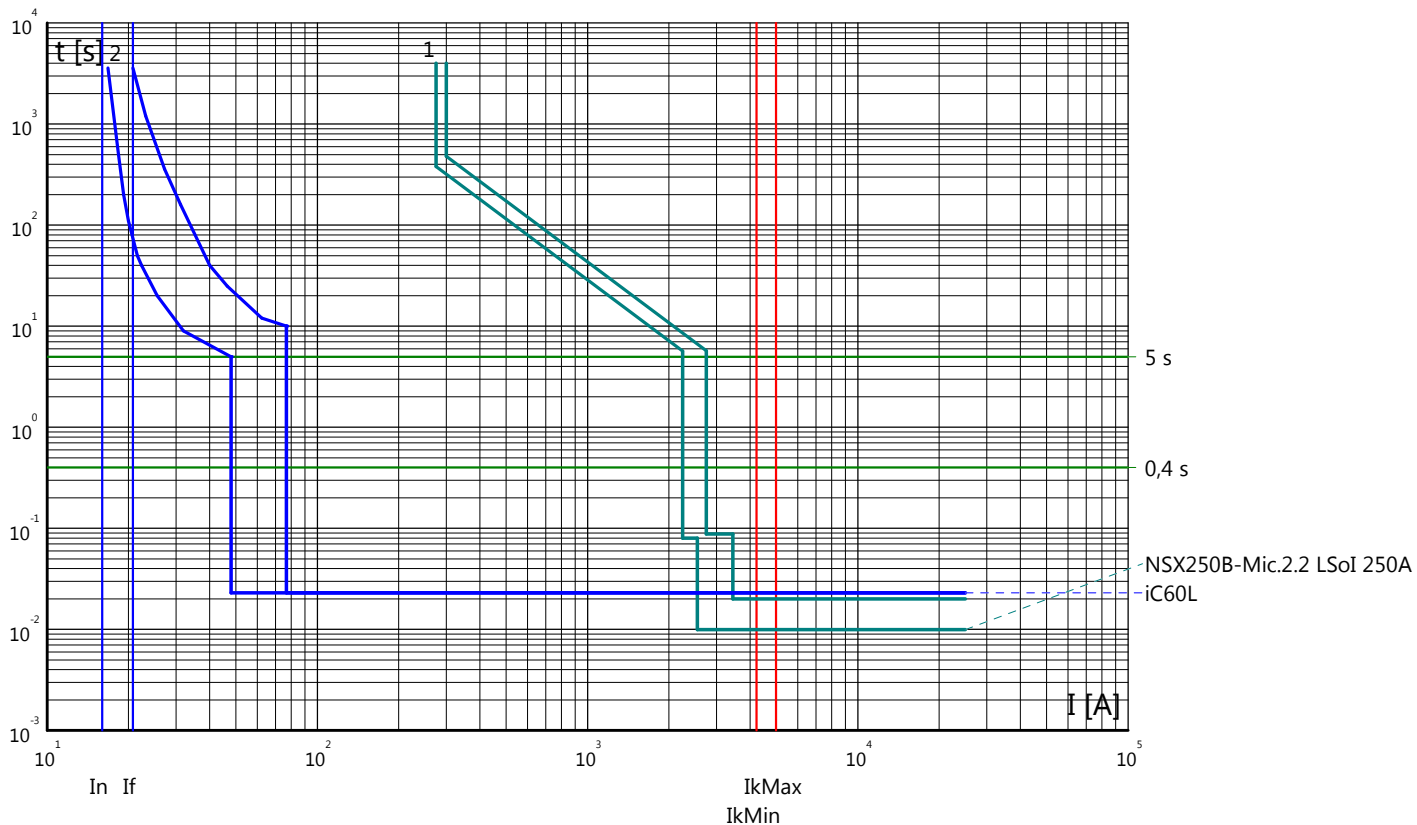

Curve tempo corrente: GALLERIA MONTE AGLIO  
Quadro: QGBT/N

Partenza: 1.26N

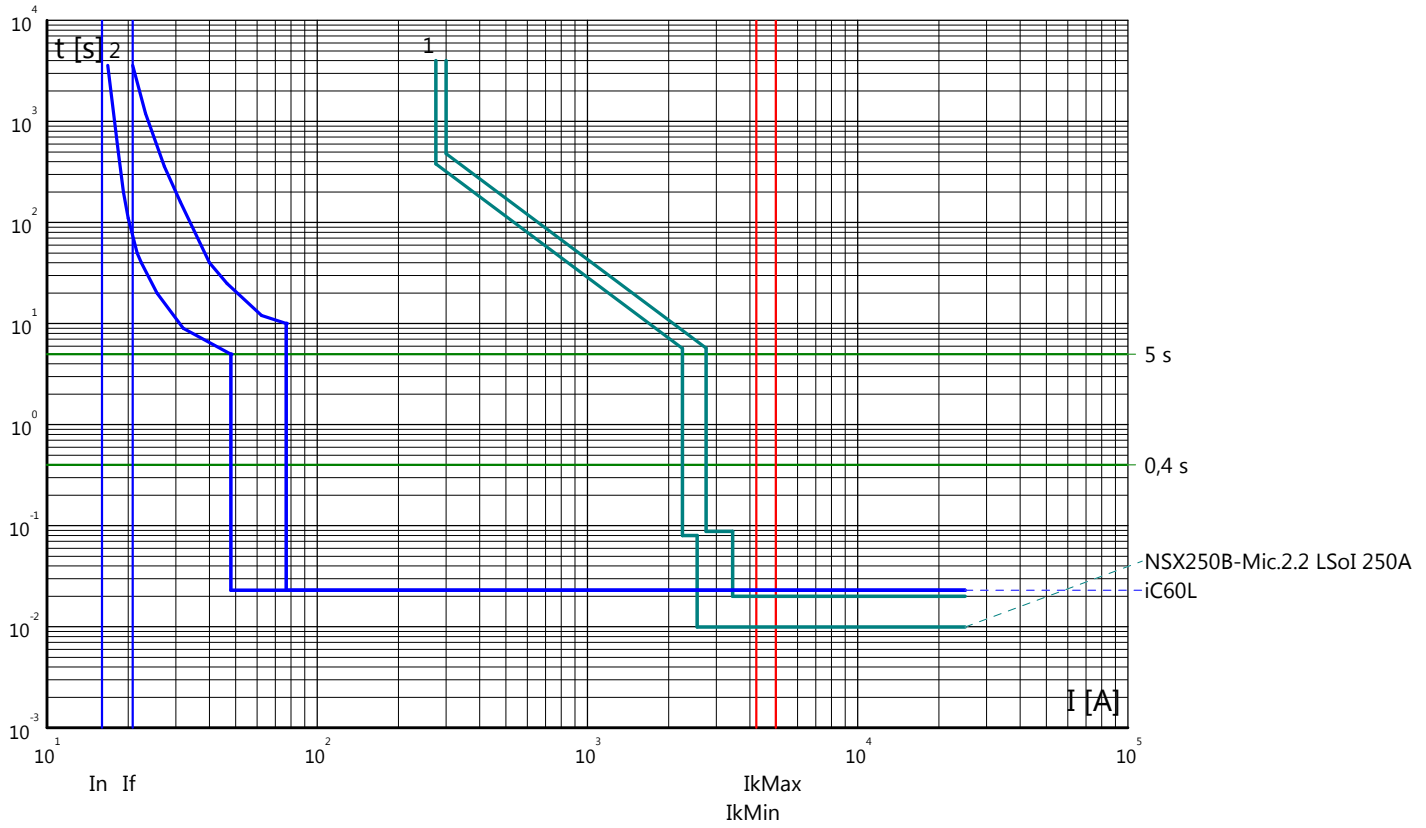

Partenza: 1.27N

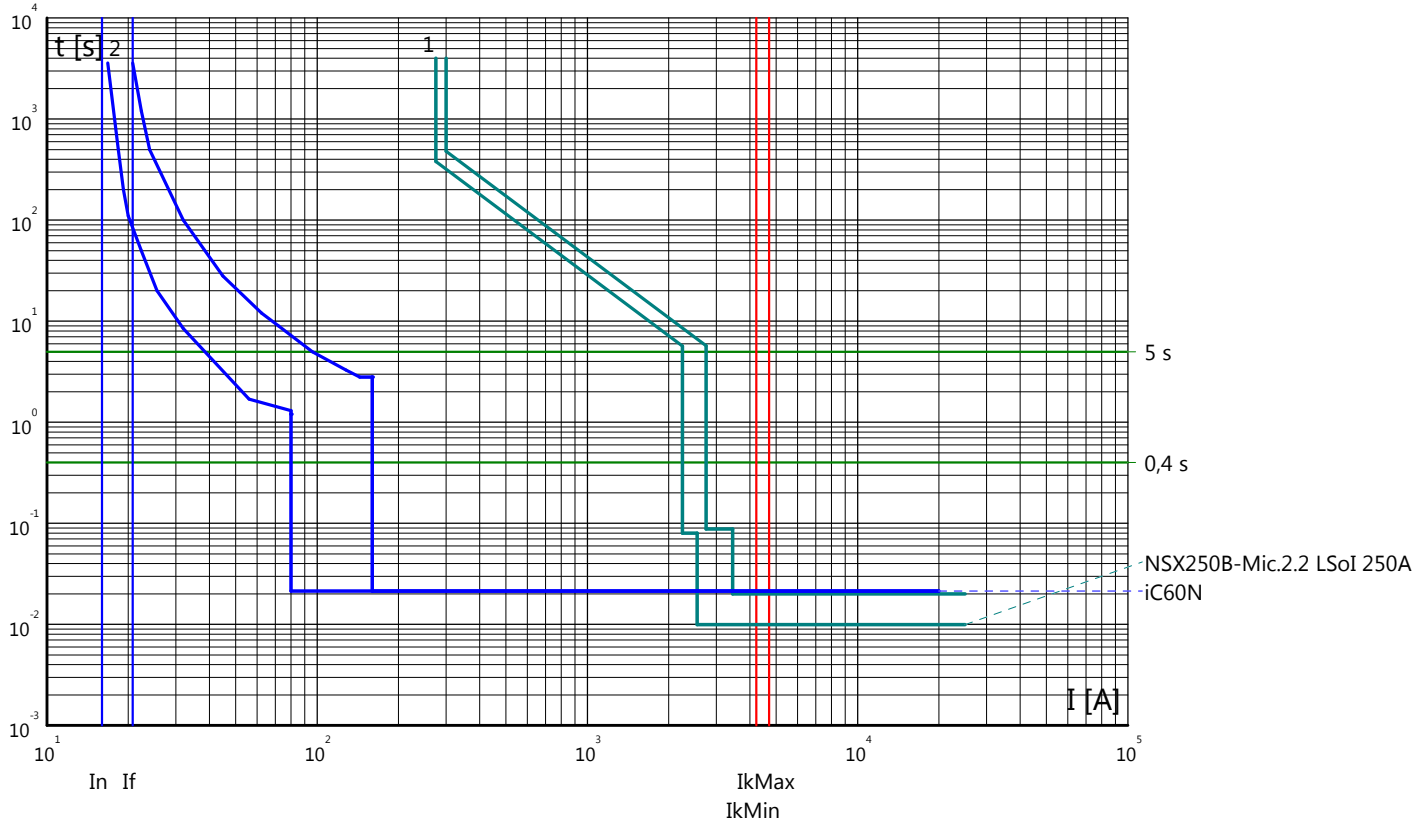

Curve tempo corrente: GALLERIA MONTE AGLIO  
Quadro: QGBT/N

Partenza: 1.28N

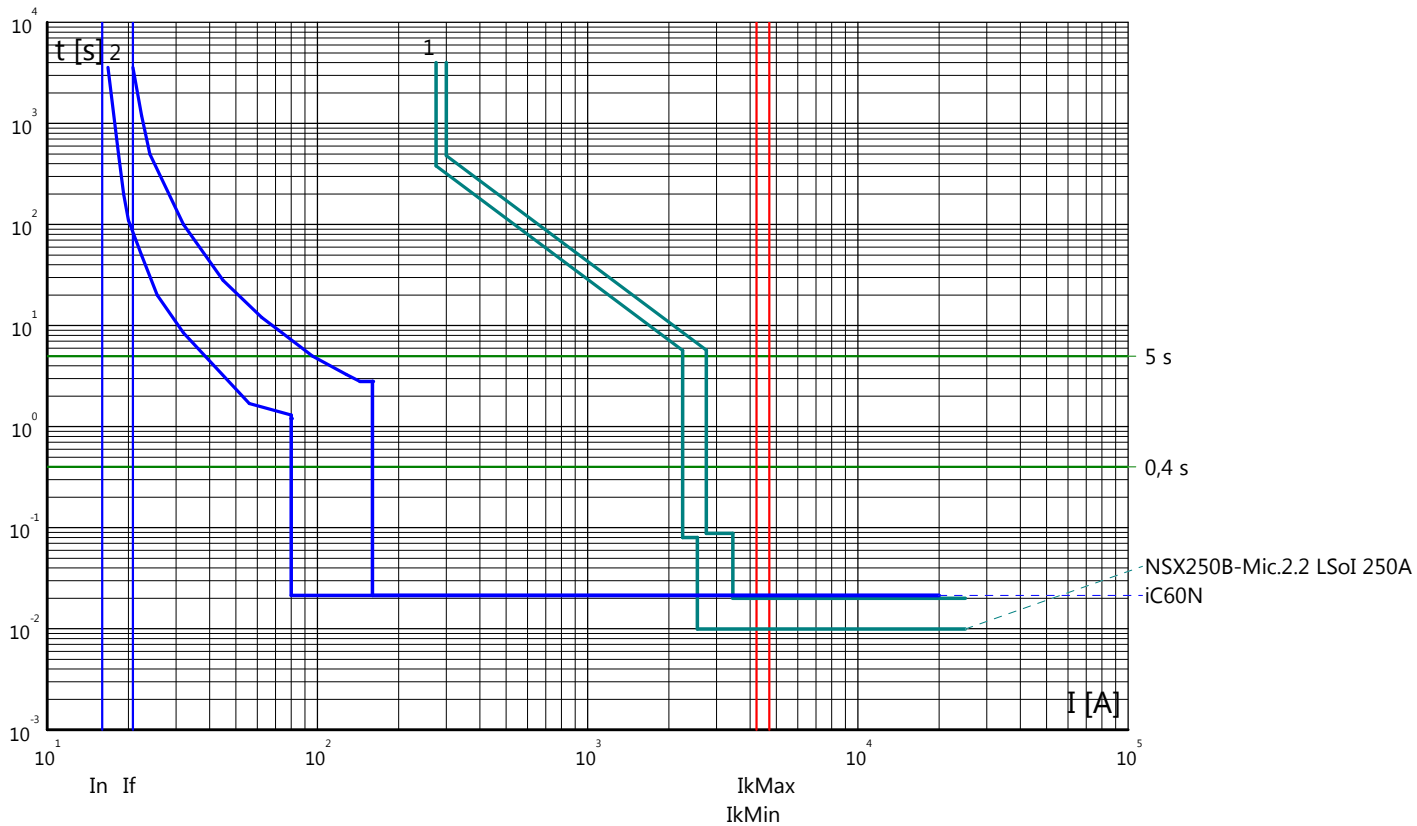

Partenza: 1.29N

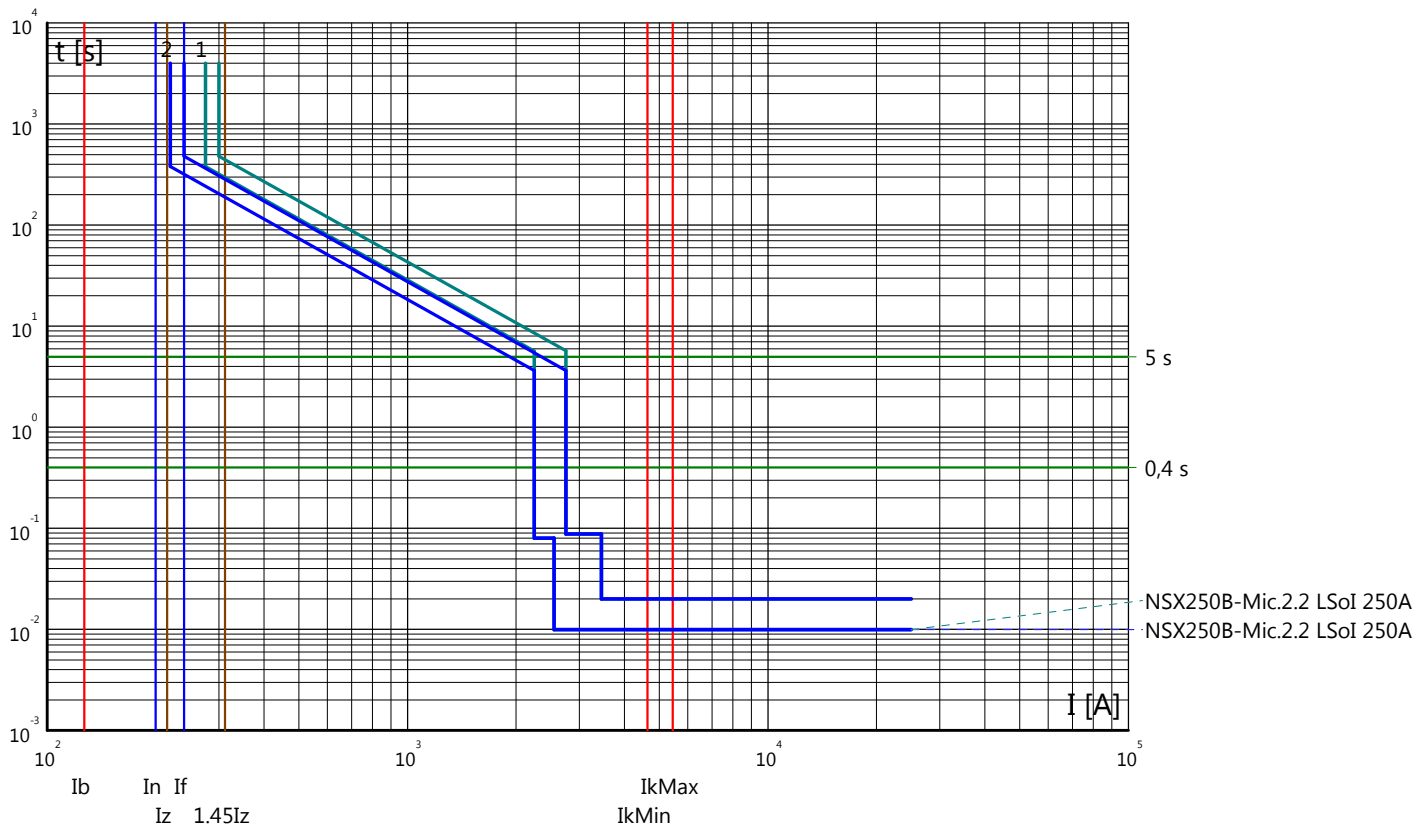



Curve tempo corrente: GALLERIA MONTE AGLIO  
 Quadro: QGBT/N

Arrivo: IG/GE

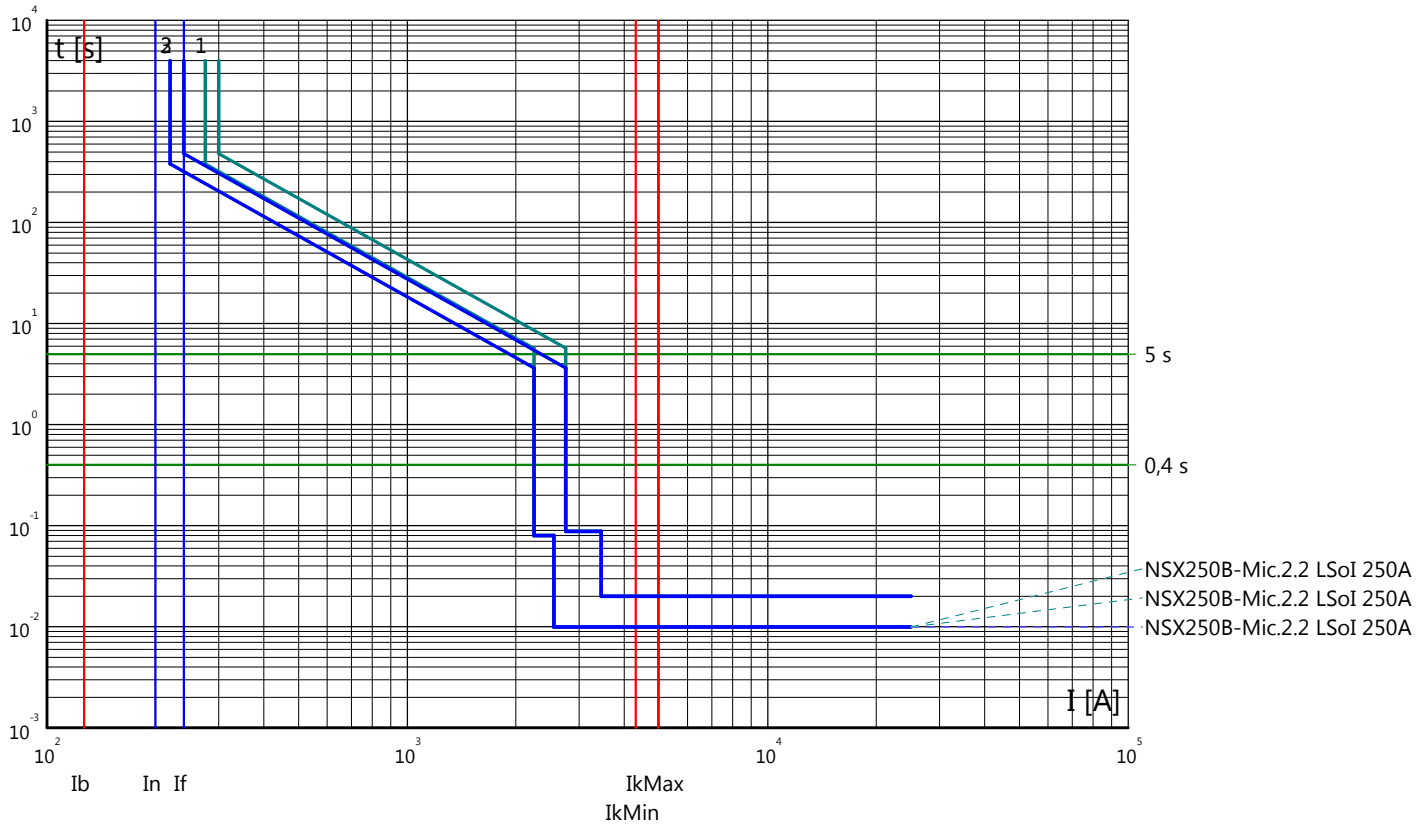

Partenza: PT/P

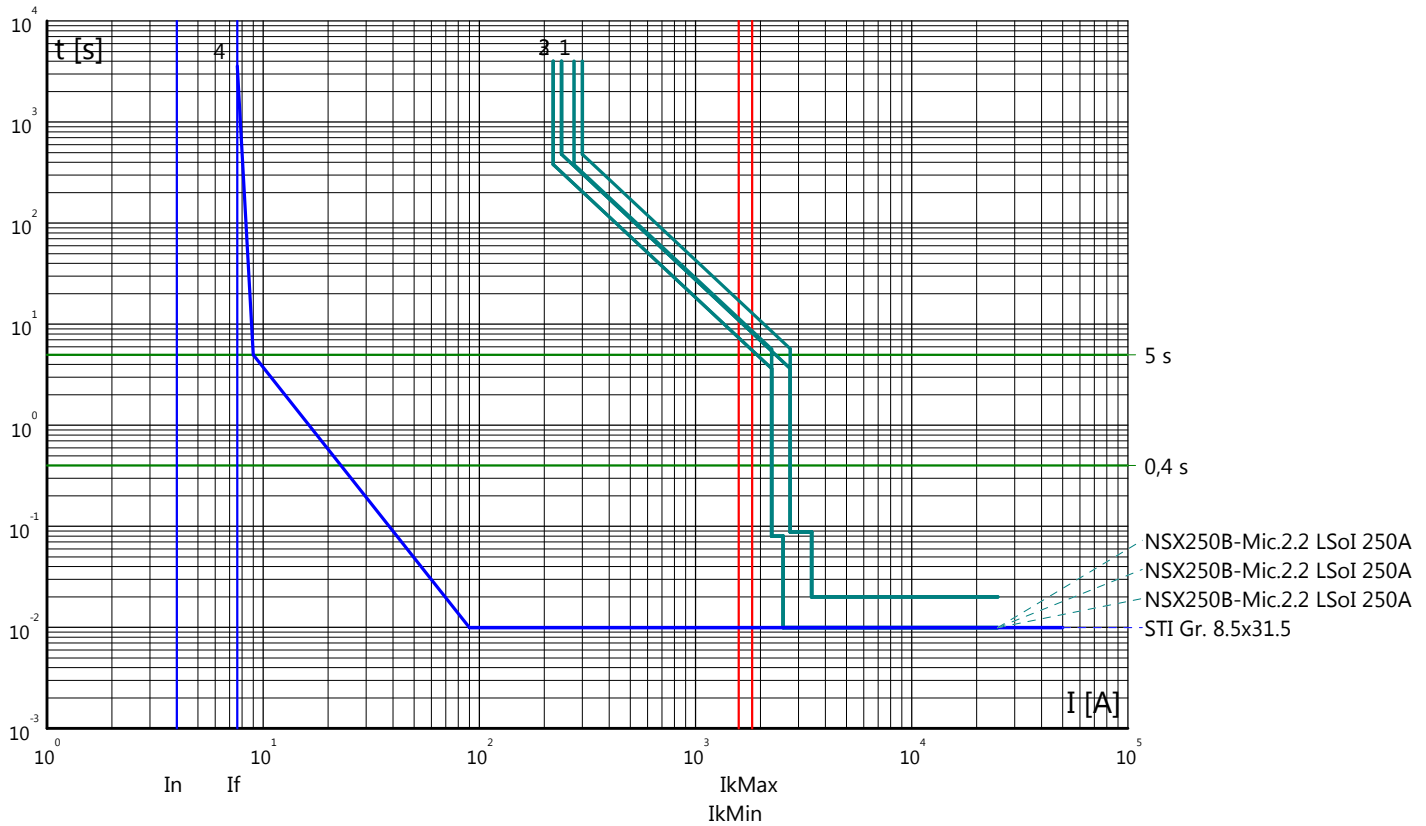

Curve tempo corrente: GALLERIA MONTE AGLIO  
 Quadro: QGBT/N

Partenza: MIS/P

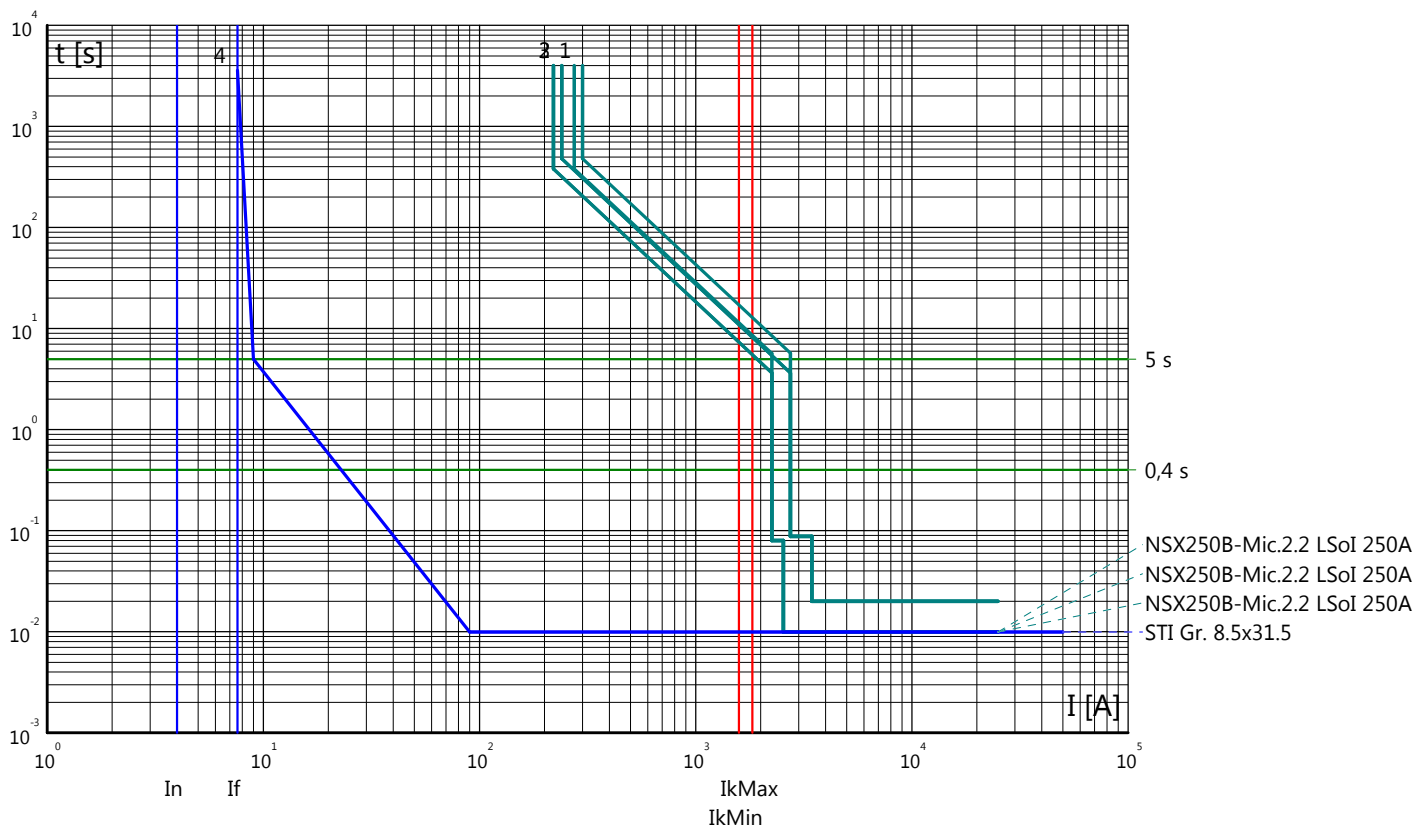

Partenza: 1.1P

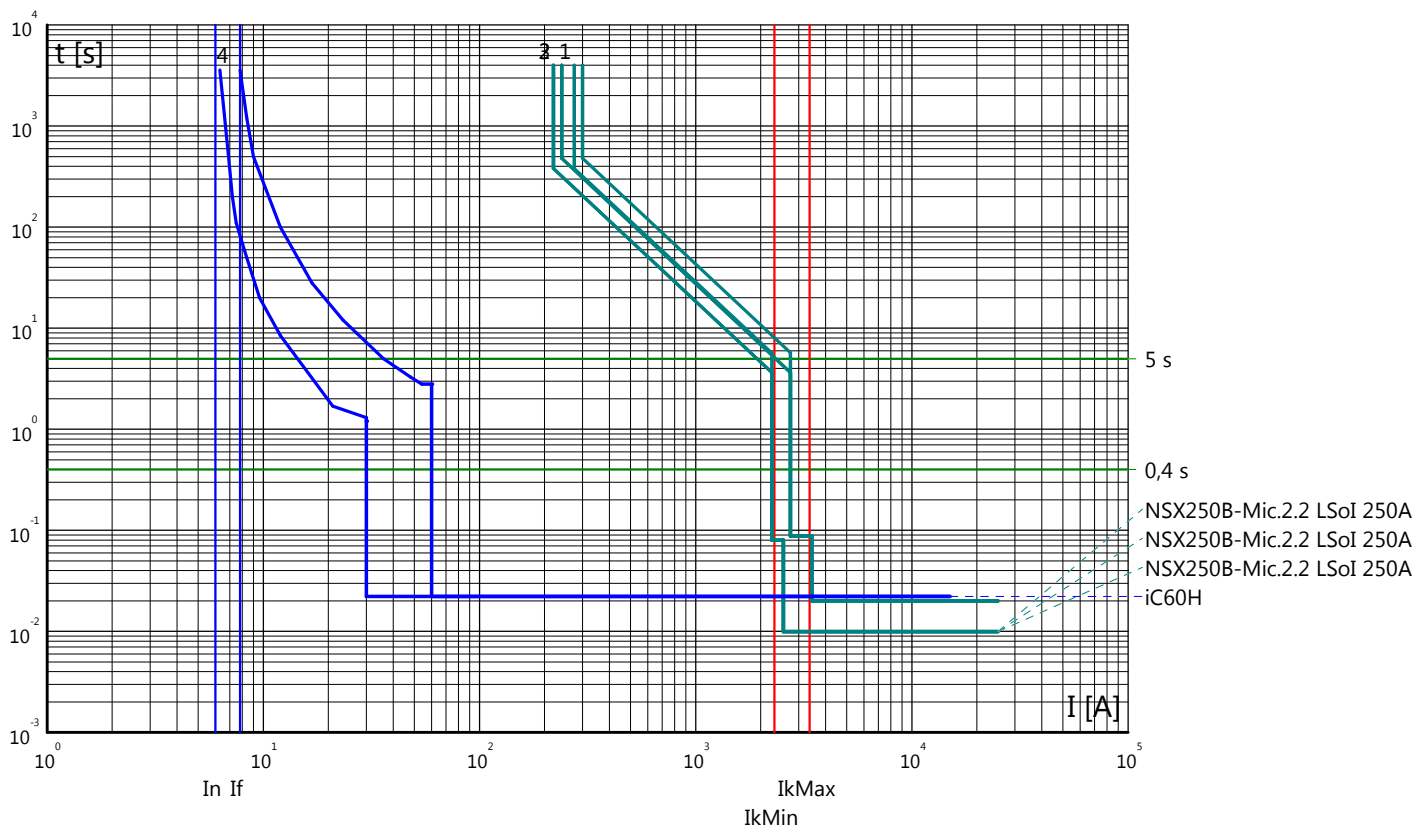

Curve tempo corrente: GALLERIA MONTE AGLIO  
 Quadro: QGBT/N

Partenza: 1.2P

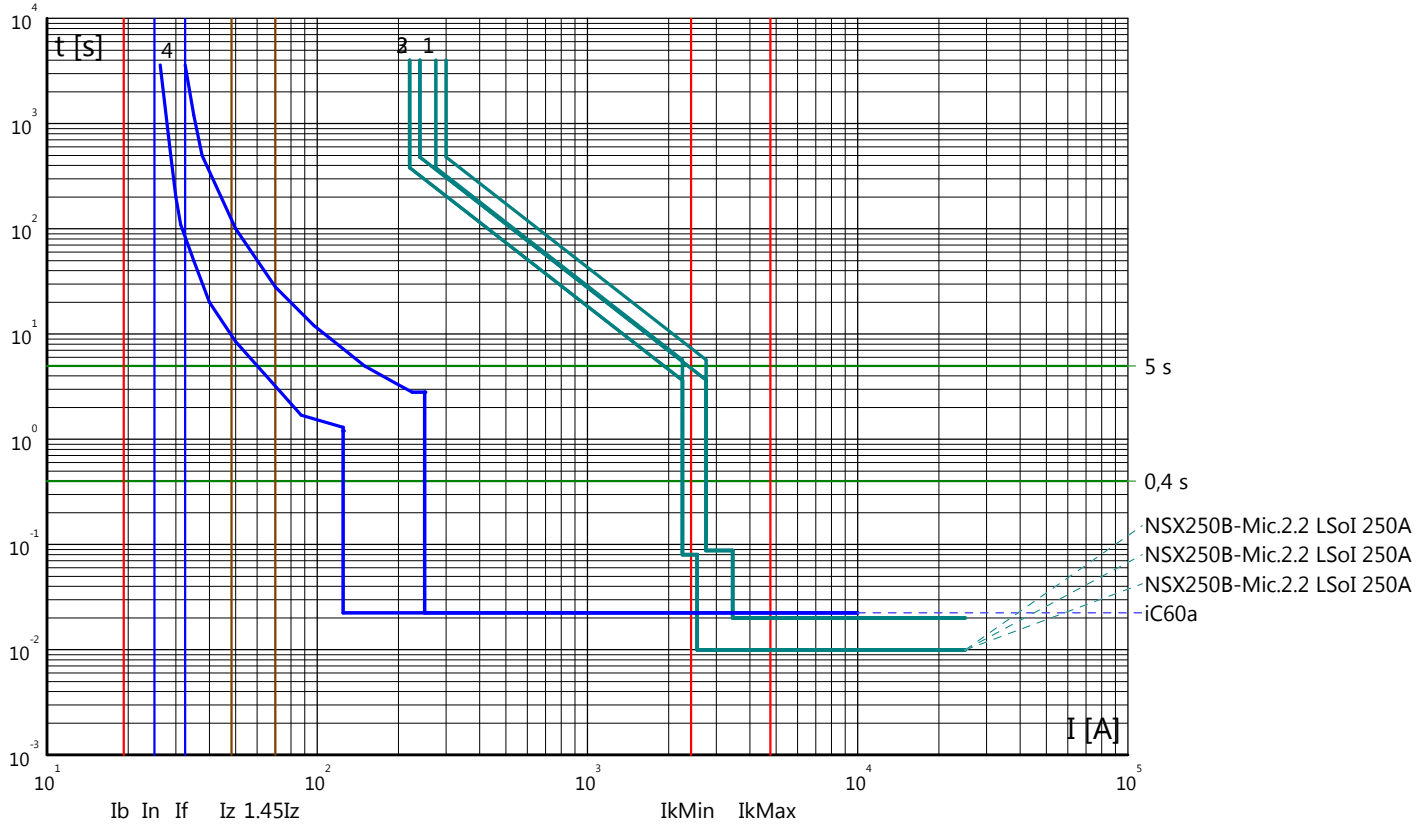

Partenza: 1.3P

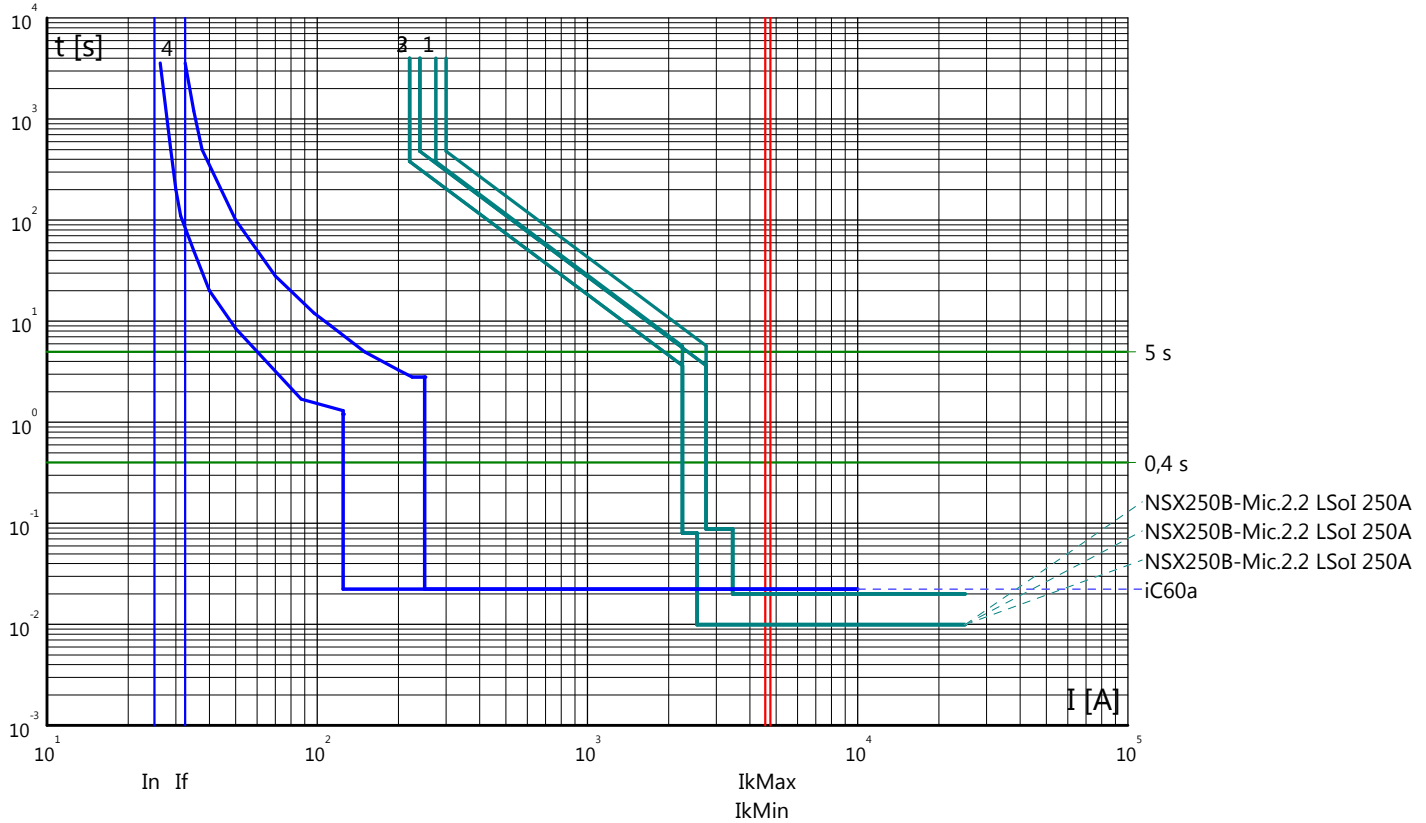

Curve tempo corrente: GALLERIA MONTE AGLIO  
Quadro: QGBT/N

Partenza: 1.4P

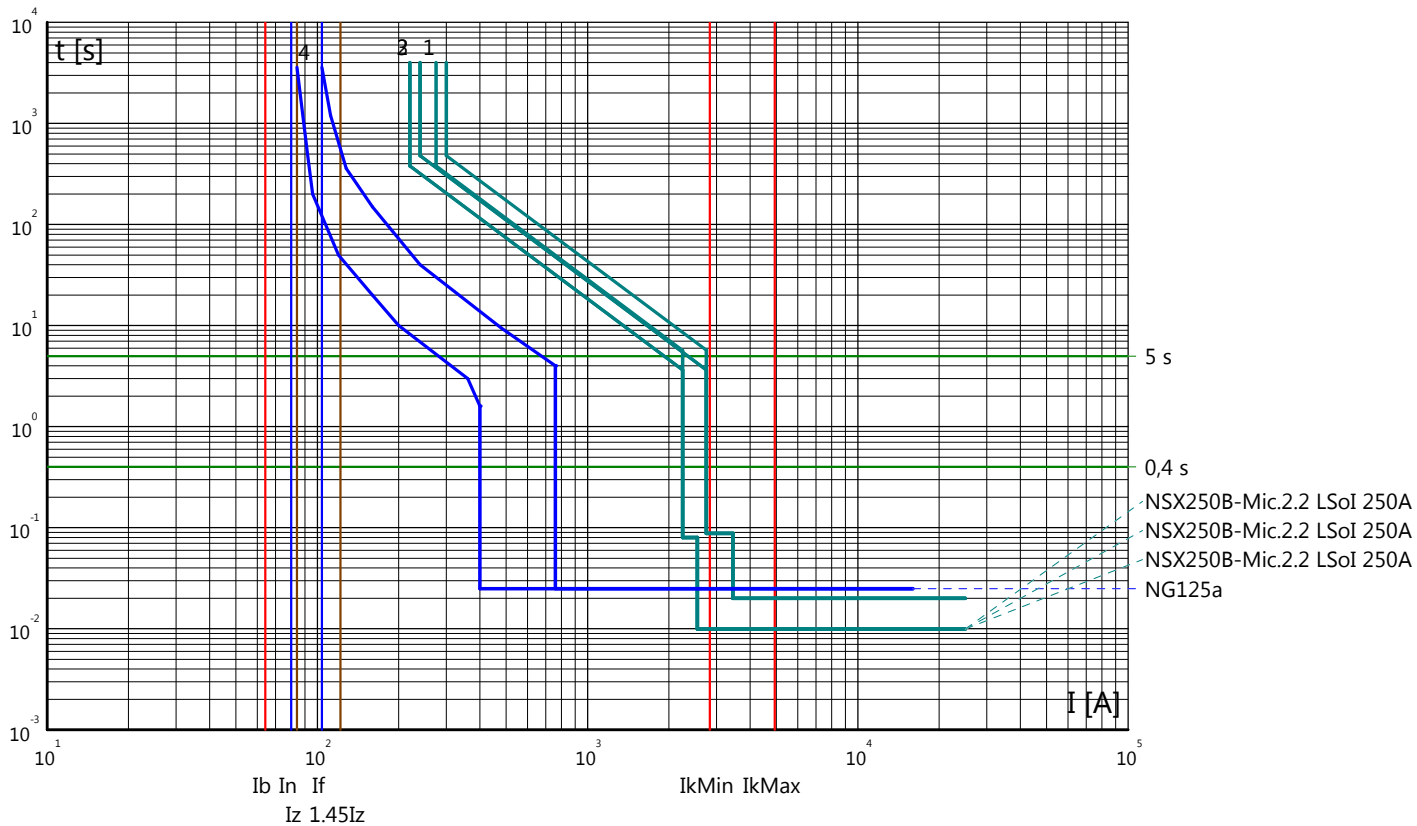

Partenza: 1.5P

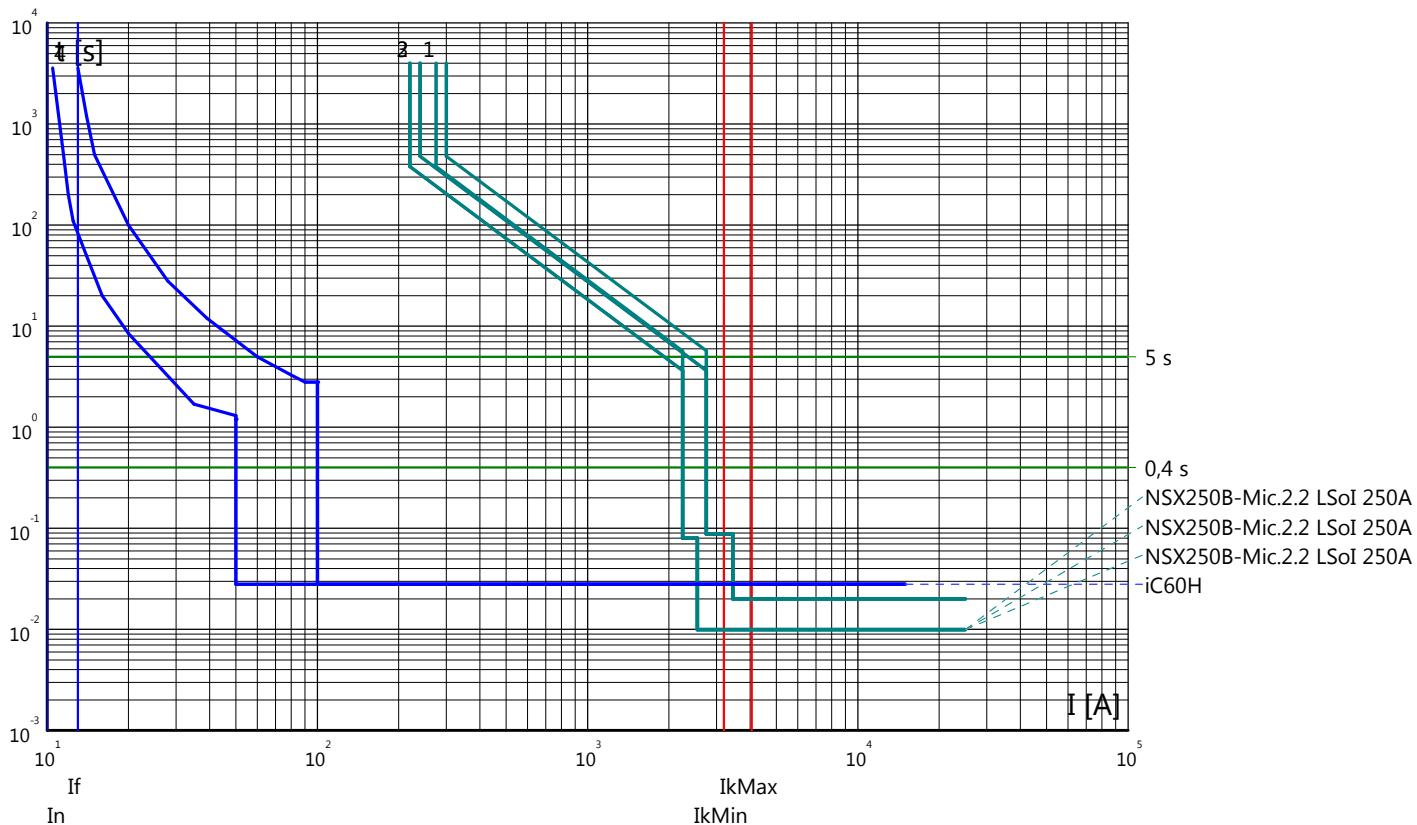

Curve tempo corrente: GALLERIA MONTE AGLIO  
 Quadro: QGBT/N

Partenza: 1.6P

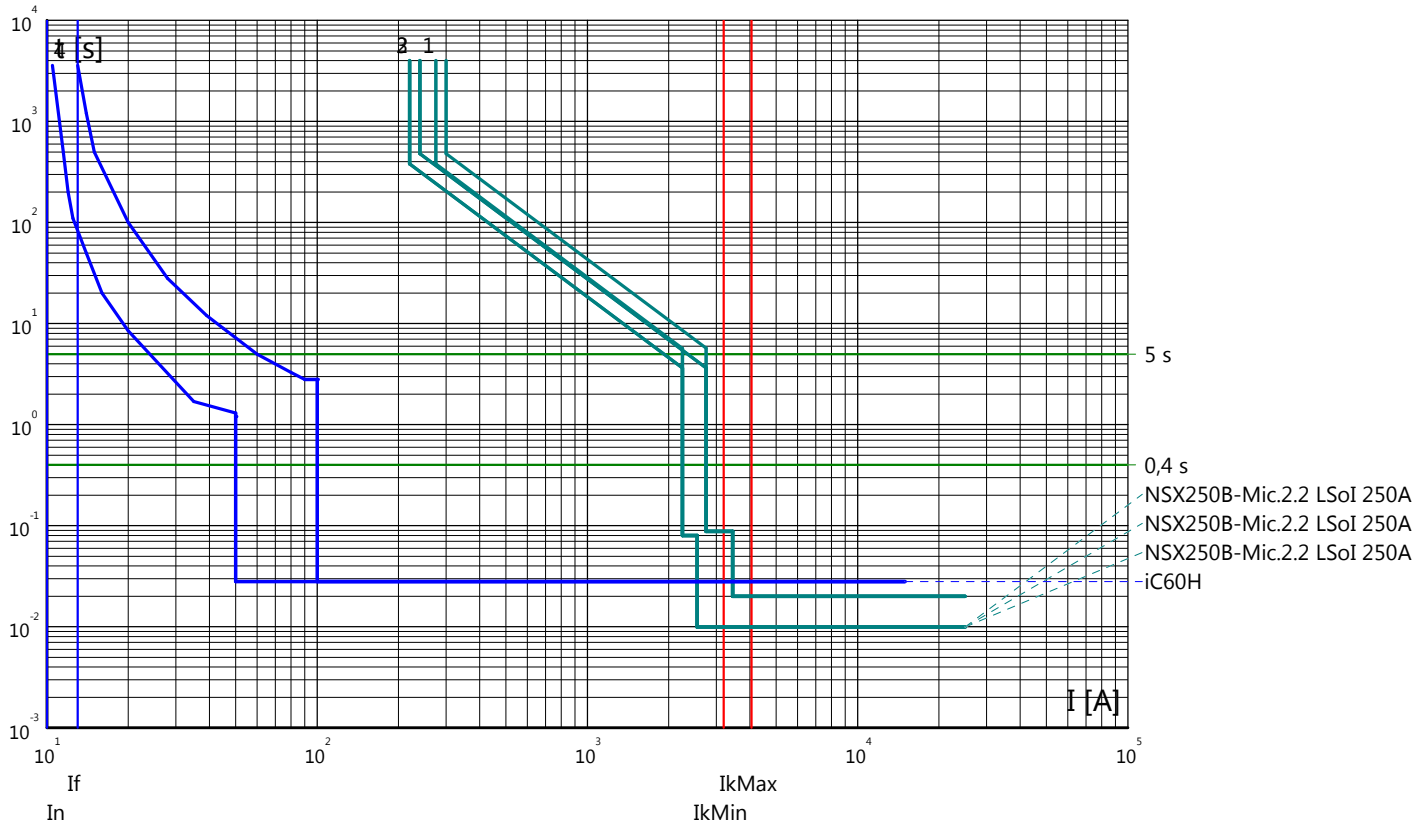

Partenza: IP1.P

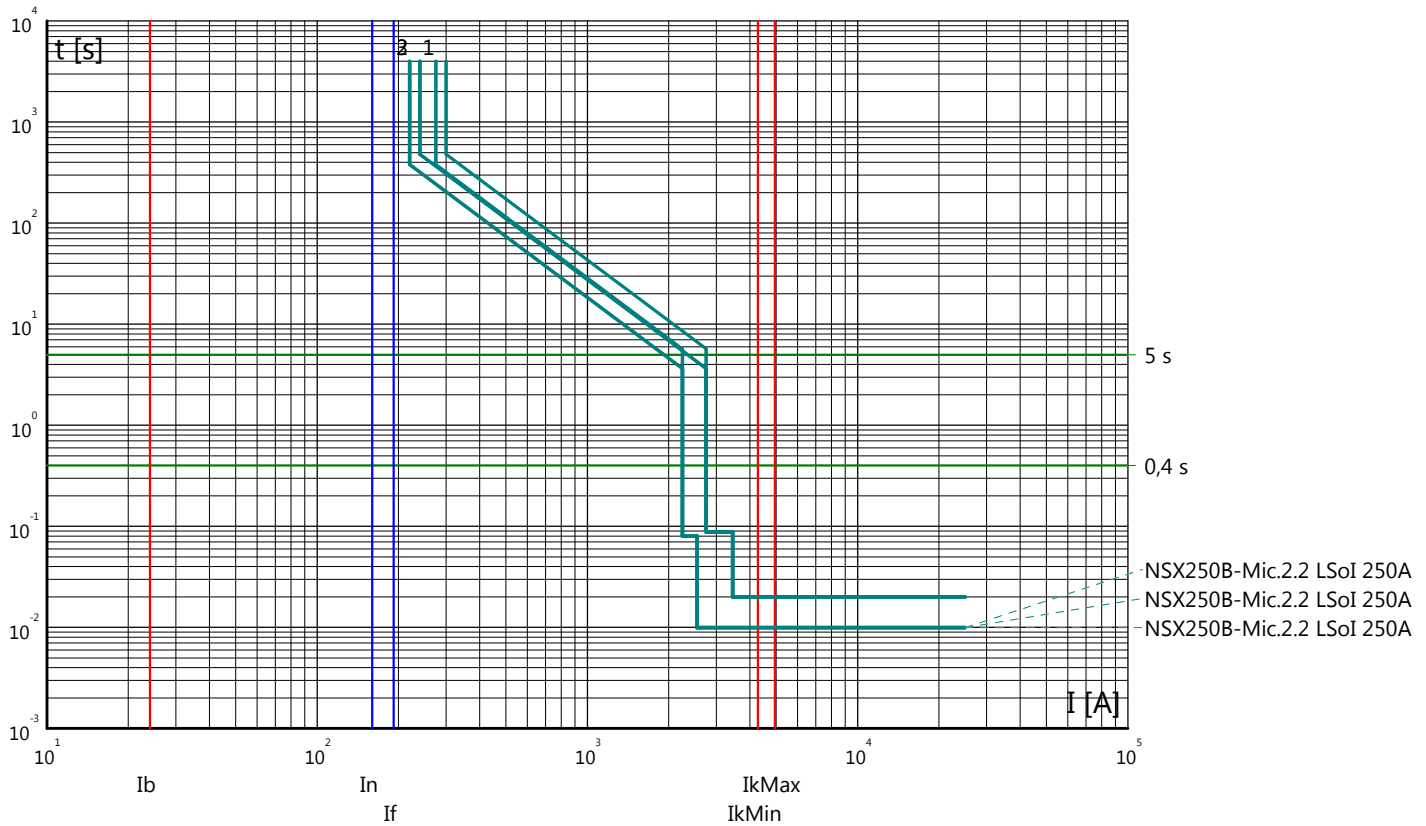

Curve tempo corrente: GALLERIA MONTE AGLIO  
 Quadro: QGBT/N

Partenza: 1.7P

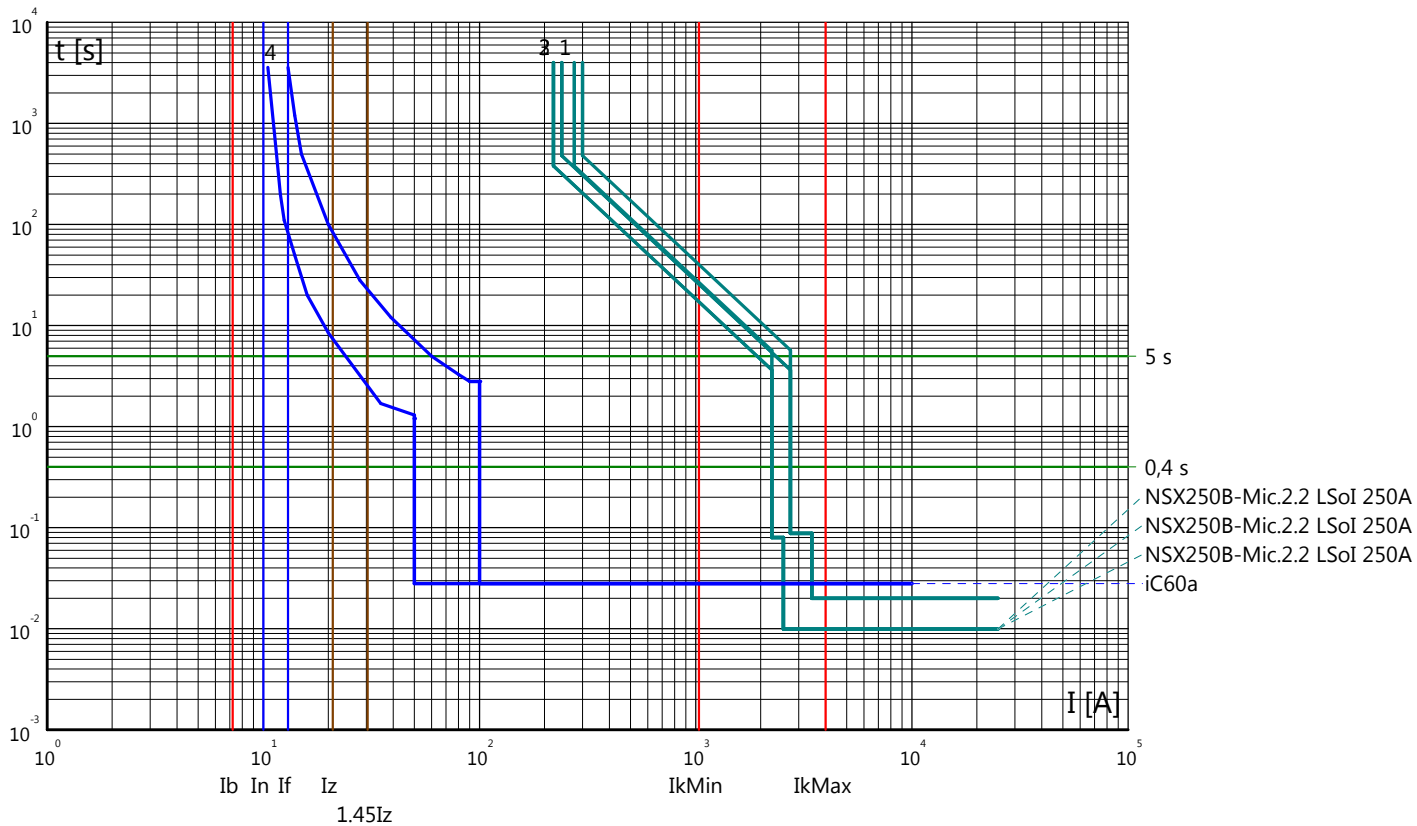

Partenza: 1.8P

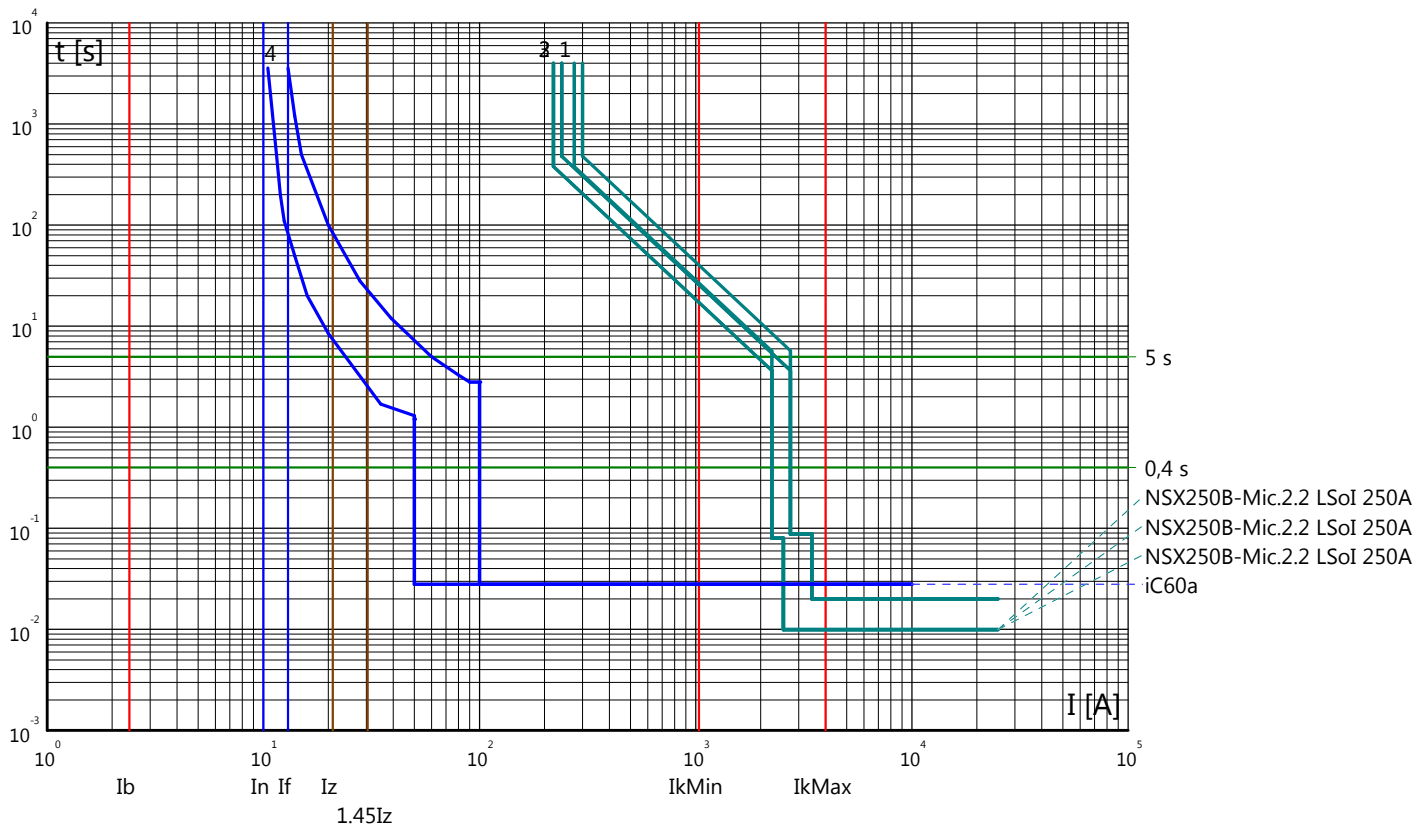

Curve tempo corrente: GALLERIA MONTE AGLIO  
 Quadro: QGBT/N

Partenza: 1.9P

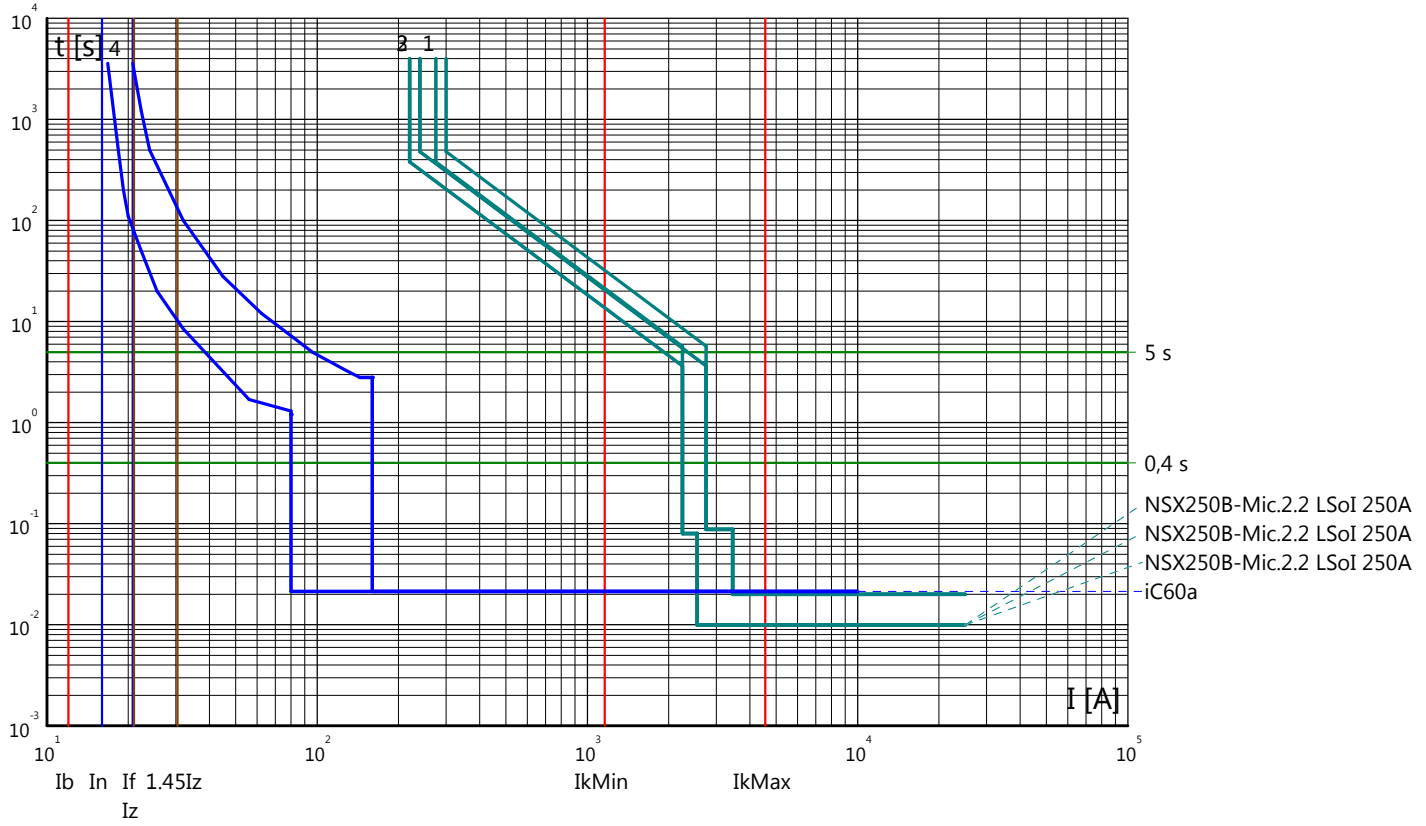

Partenza: 1.10P

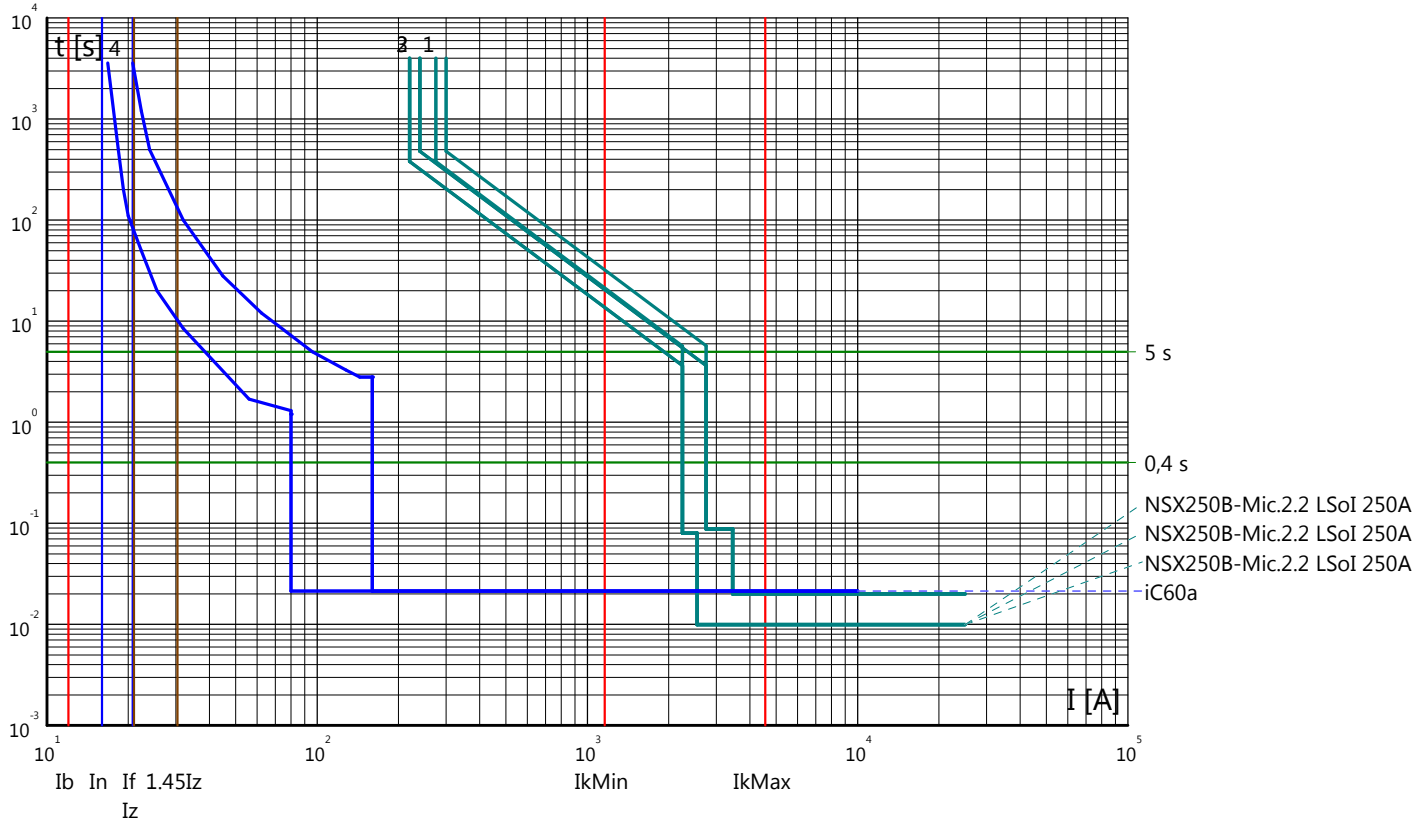

Curve tempo corrente: GALLERIA MONTE AGLIO  
 Quadro: QGBT/N

Partenza: 1.11P

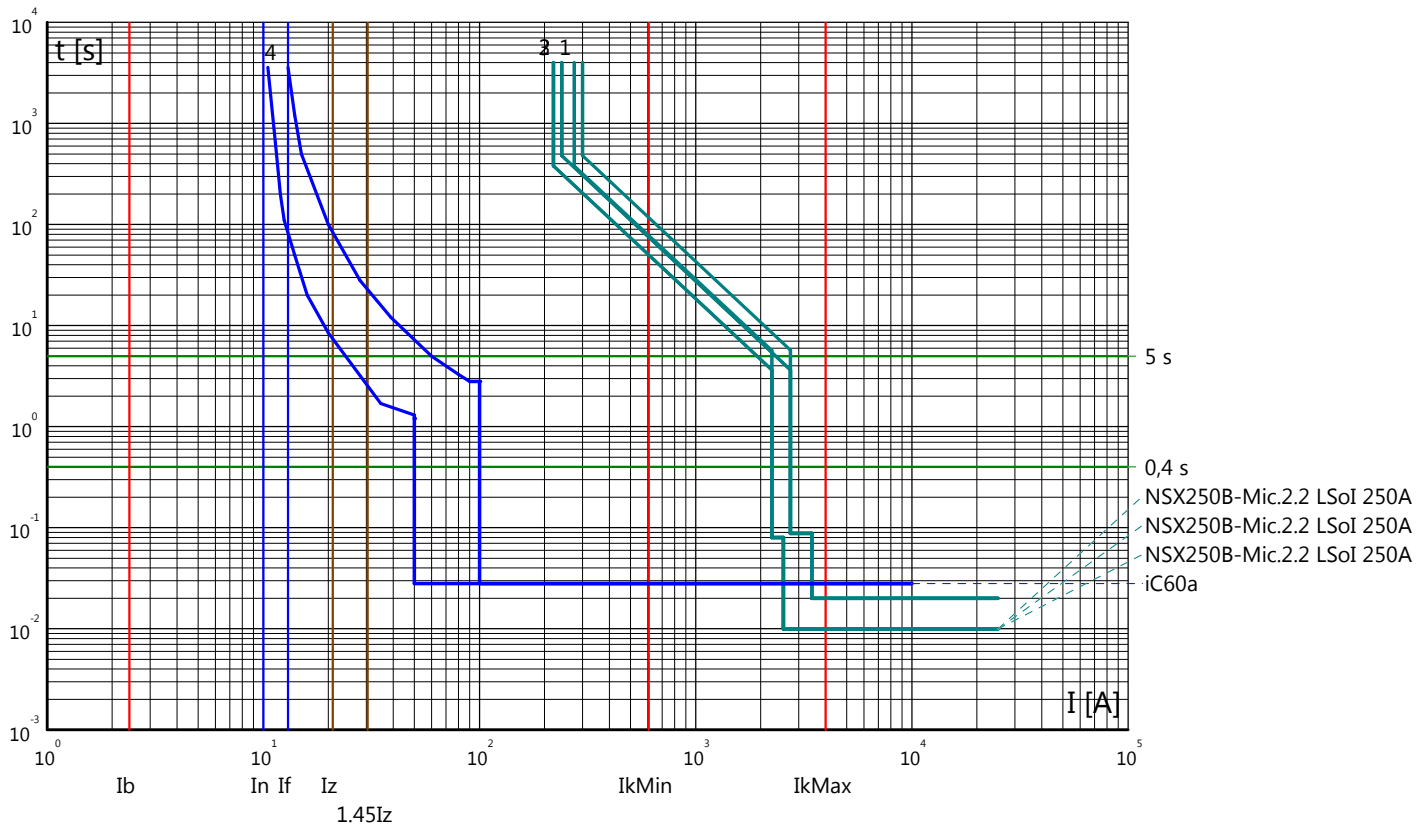

Partenza: 1.12P

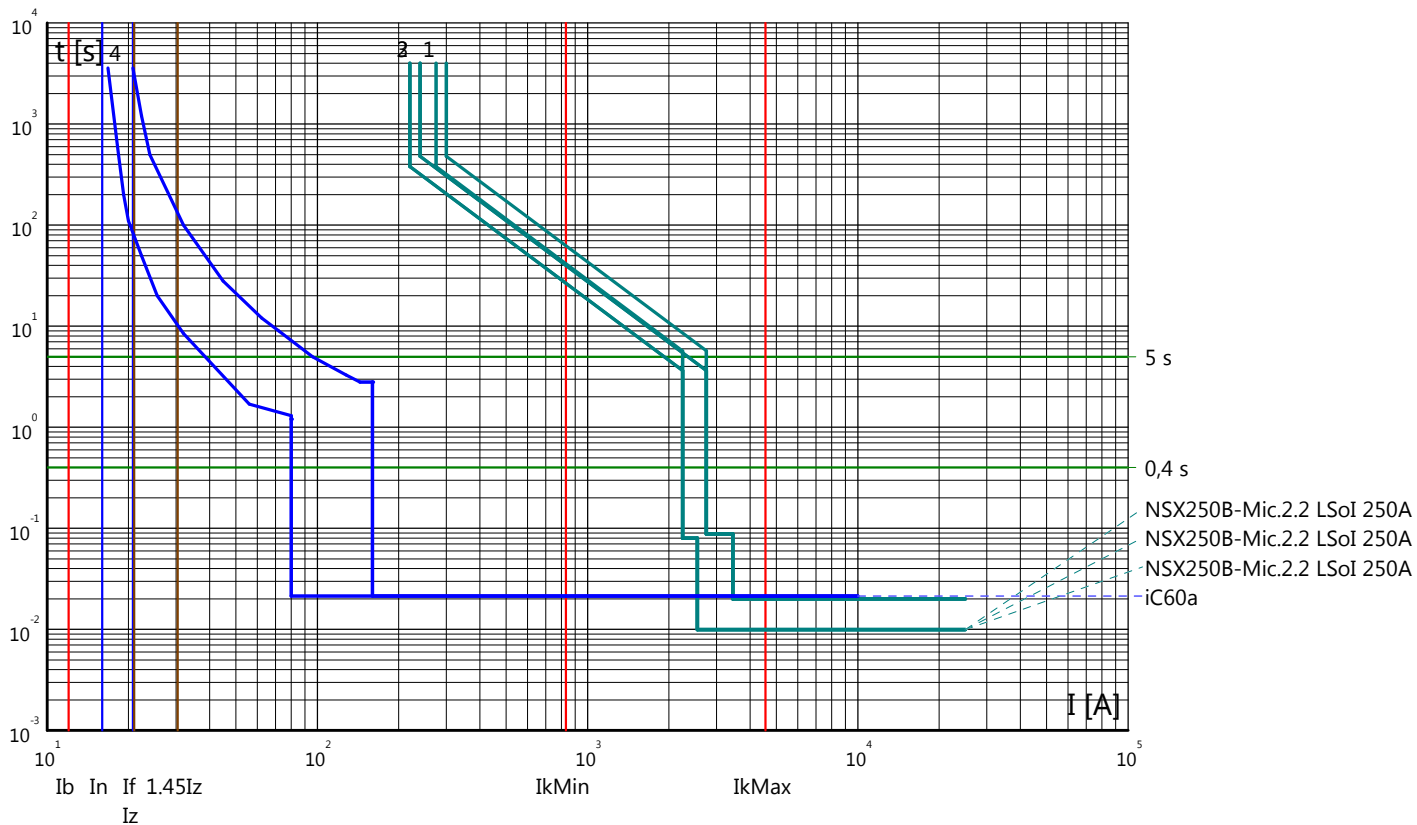



Curve tempo corrente: GALLERIA MONTE AGLIO  
 Quadro: QGBT/N

Partenza: 1.13P

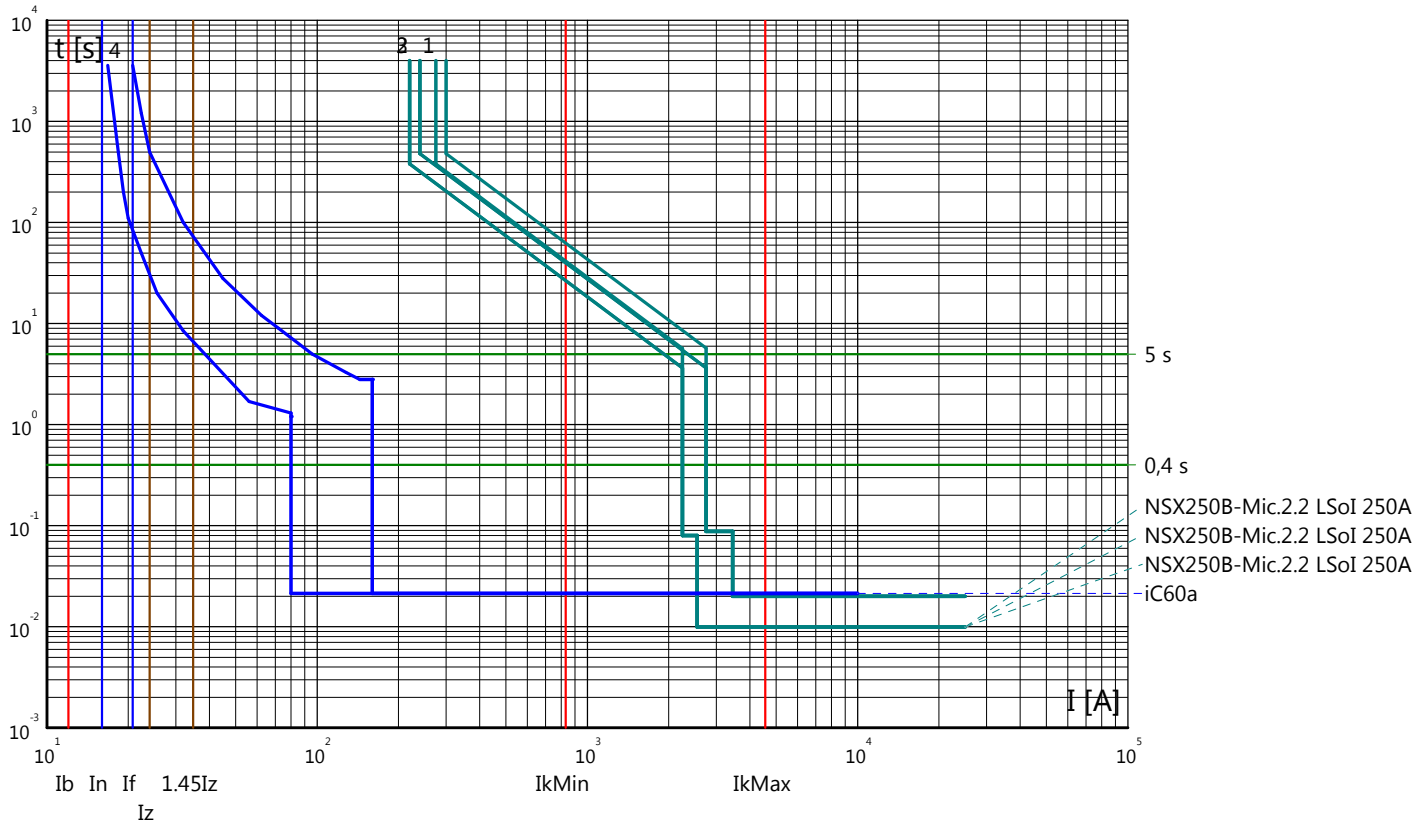

Partenza: 1.14P

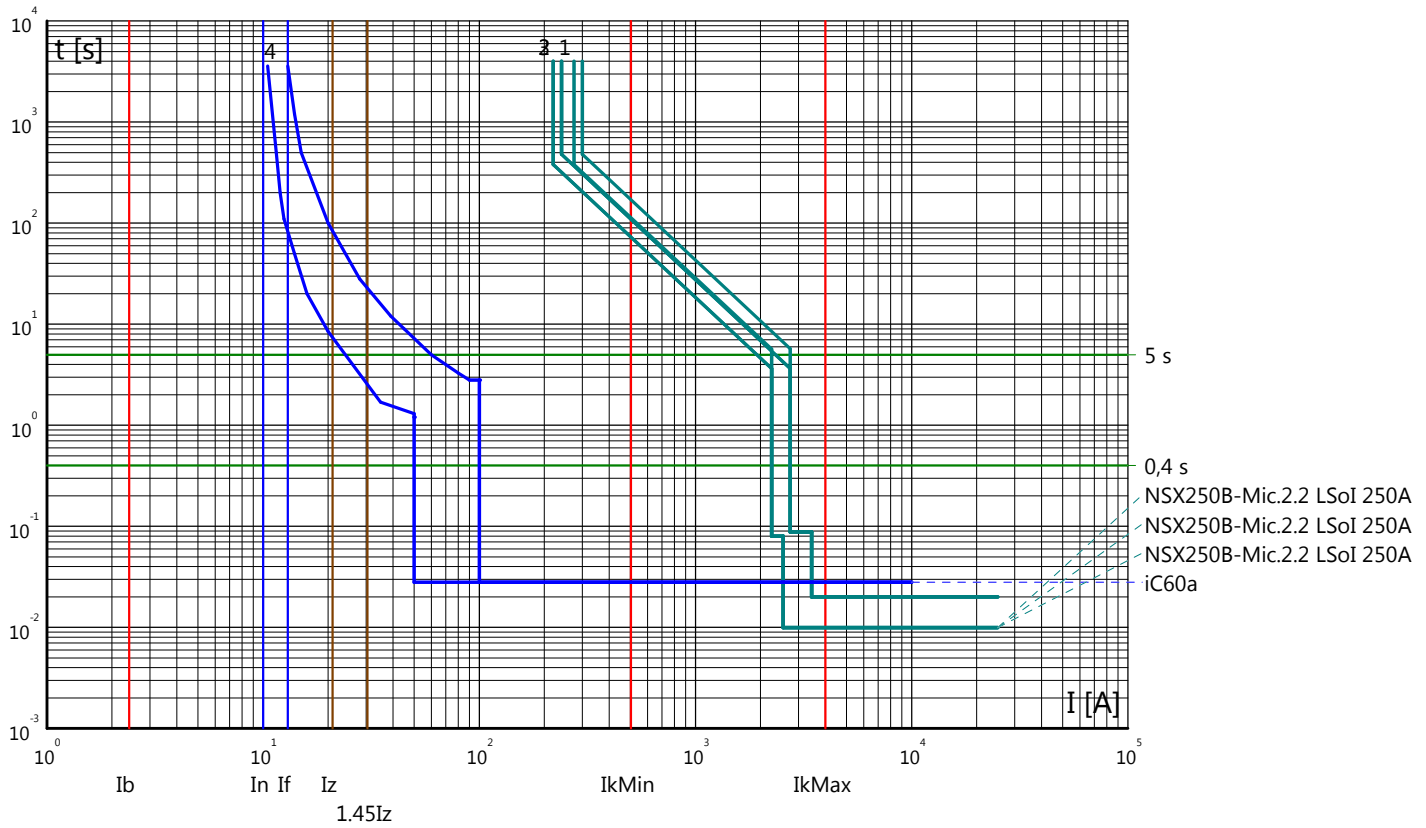

Curve tempo corrente: GALLERIA MONTE AGLIO  
 Quadro: QGBT/N

Partenza: 1.15P

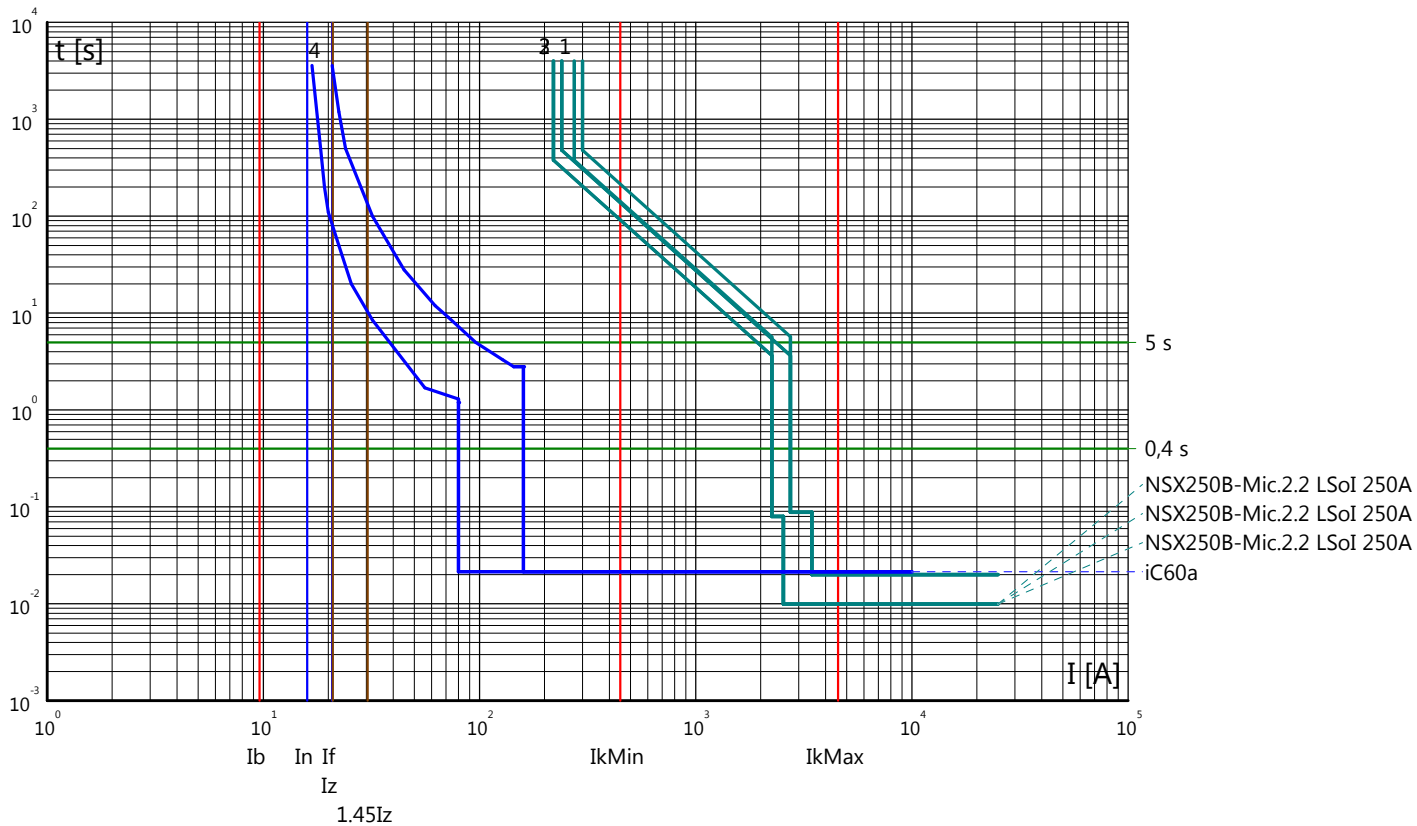

Partenza: 1.16P

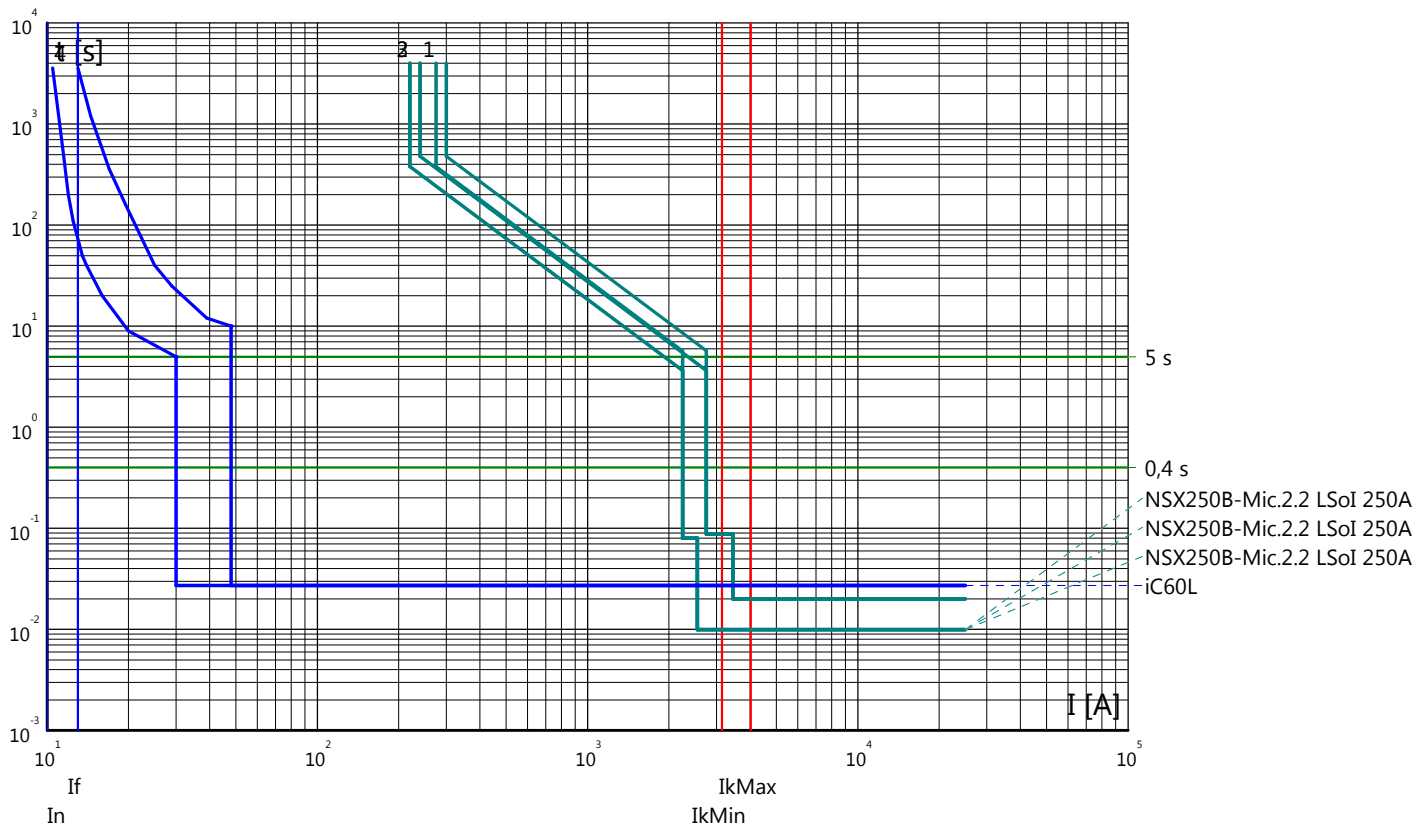

Curve tempo corrente: GALLERIA MONTE AGLIO  
 Quadro: QGBT/N

Partenza: 1.17P

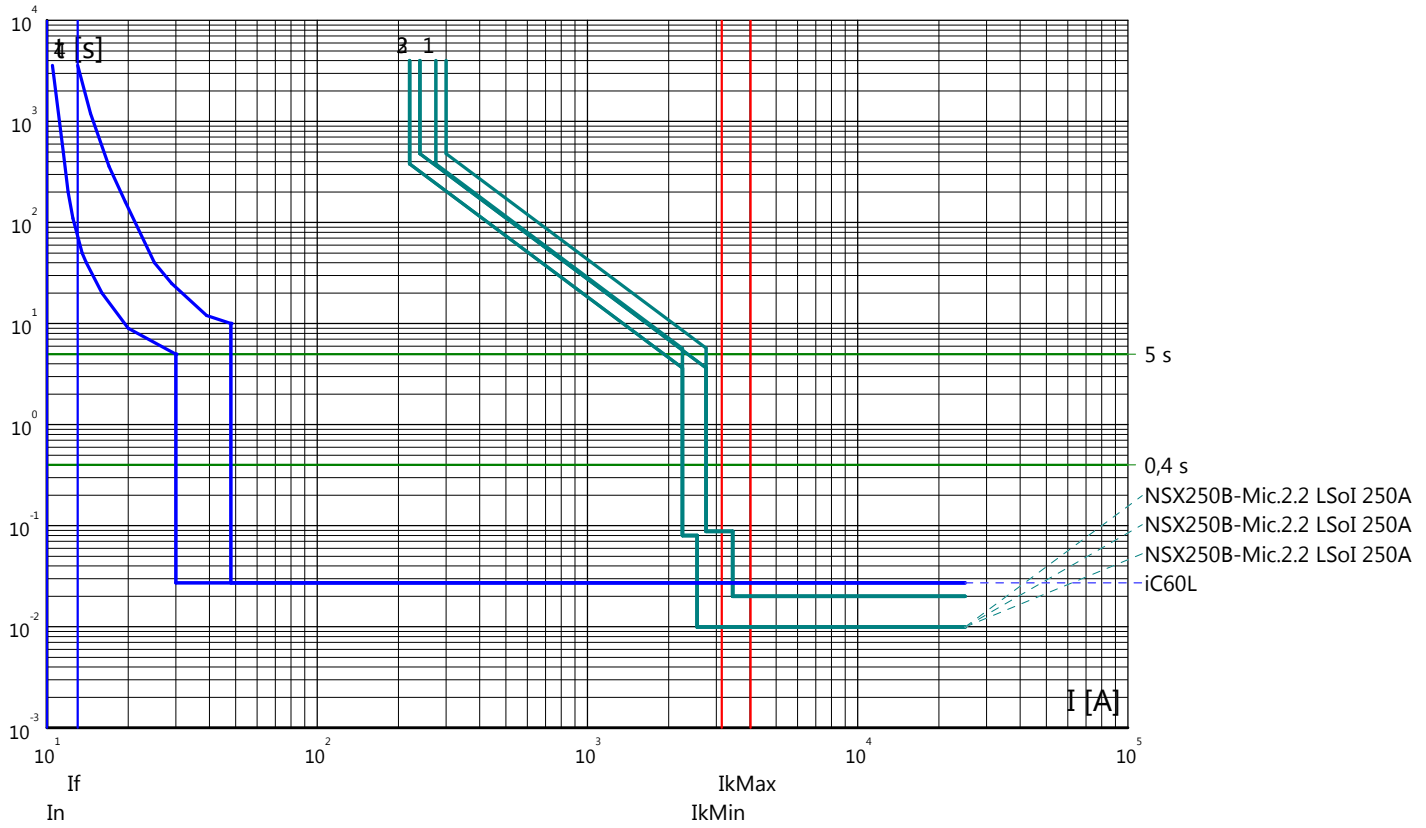

Partenza: 1.18P

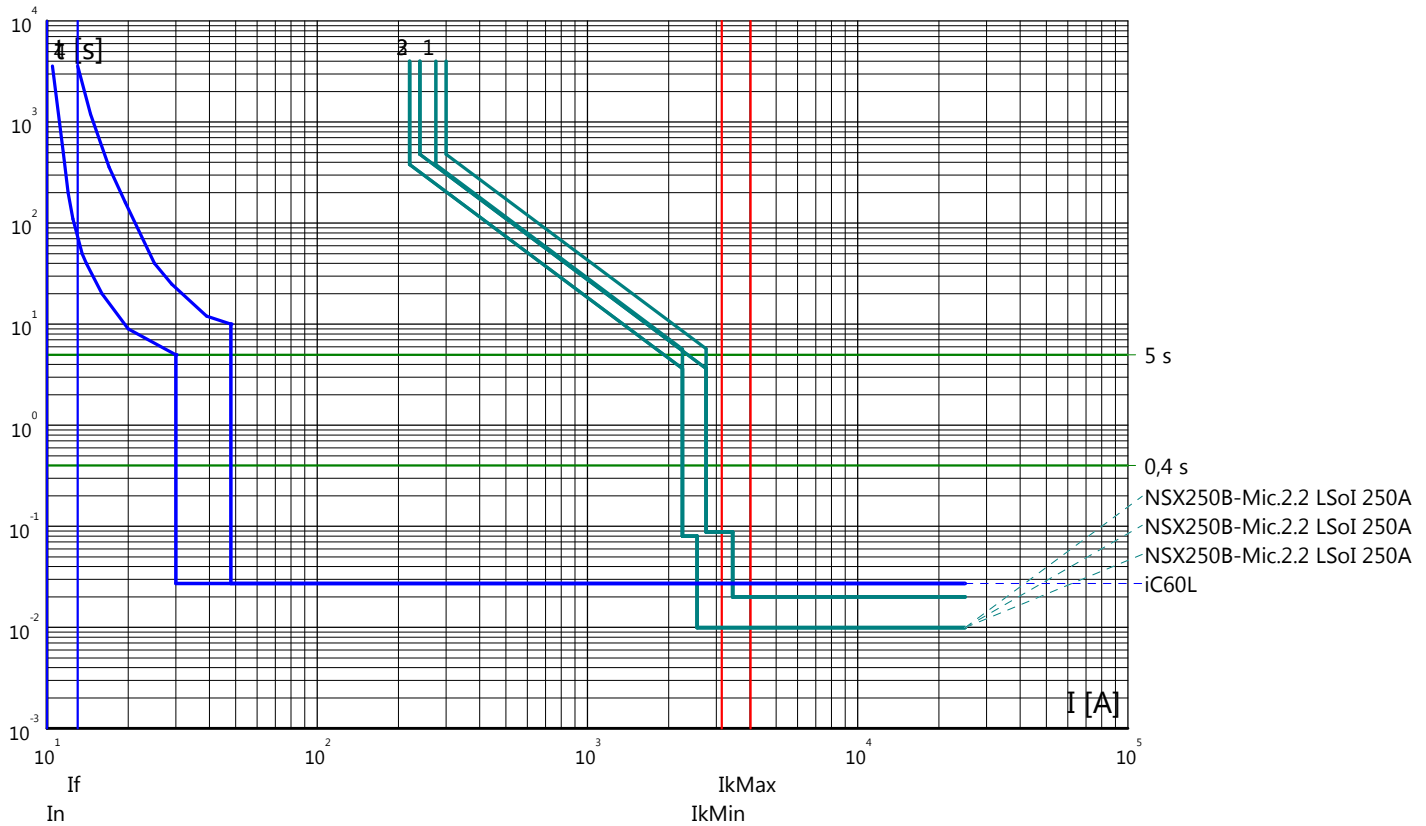

Curve tempo corrente: GALLERIA MONTE AGLIO  
 Quadro: QGBT/N

Partenza: 1.19P

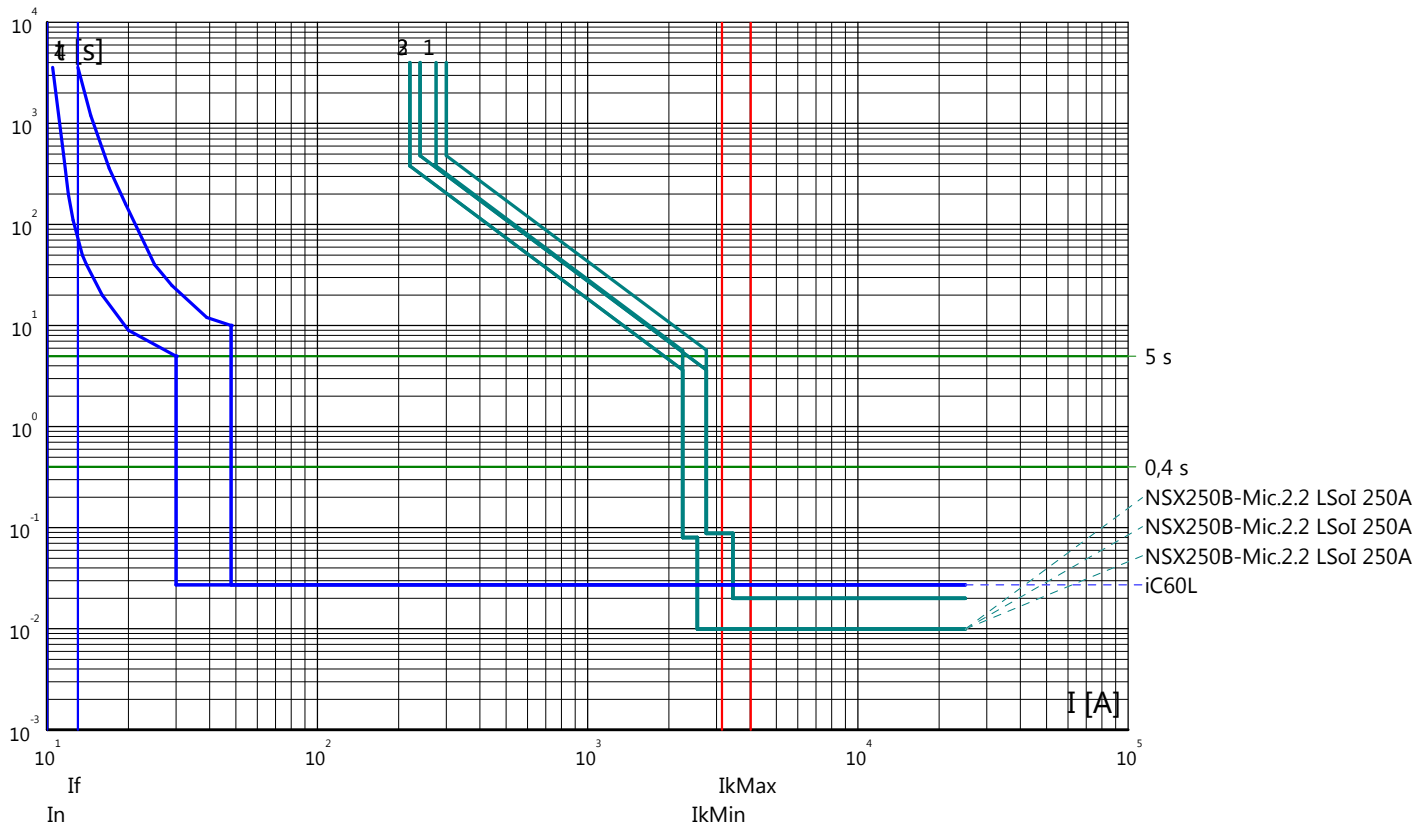

Partenza: 1.20P

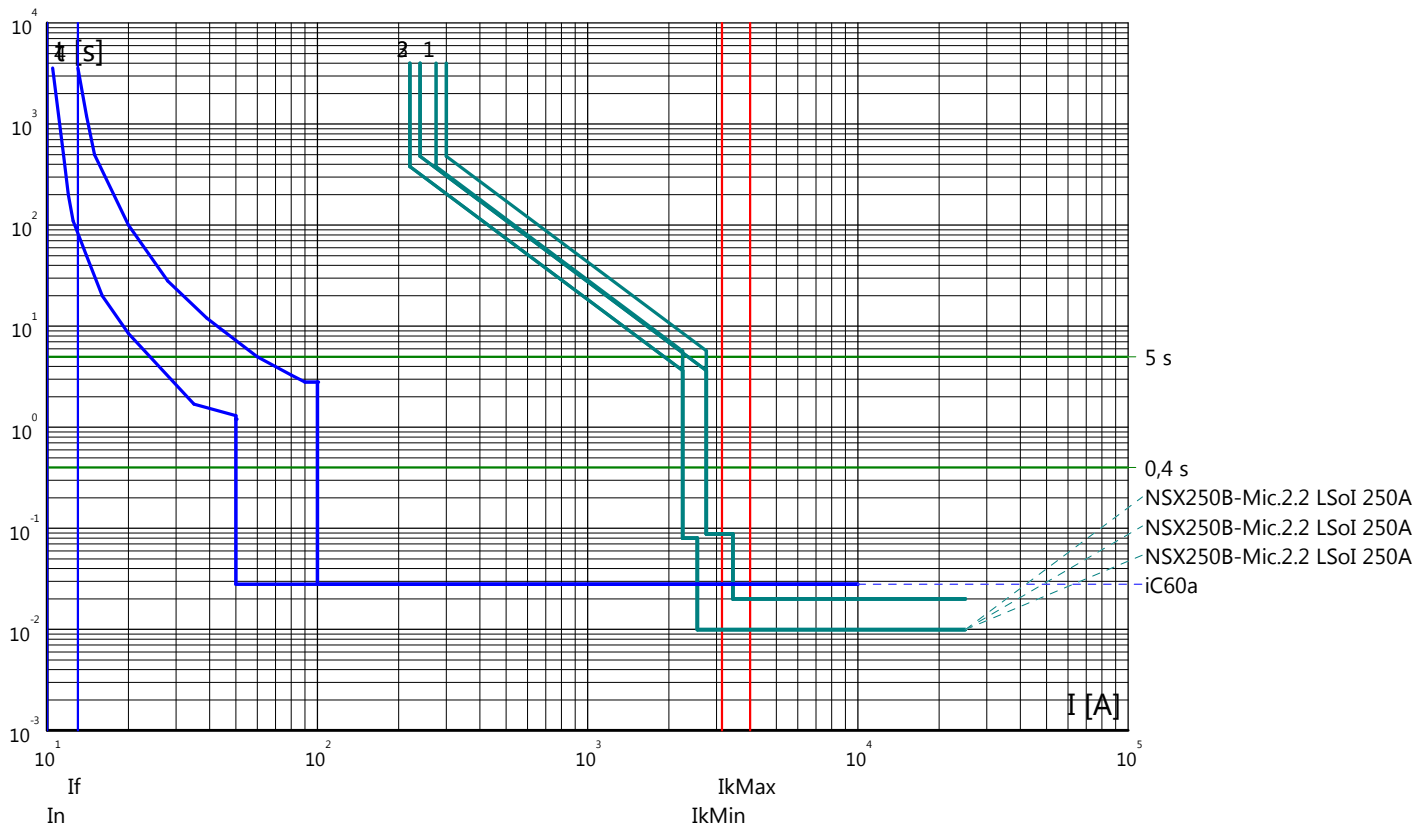

Curve tempo corrente: GALLERIA MONTE AGLIO  
 Quadro: QGBT/N

Partenza: 1.21P

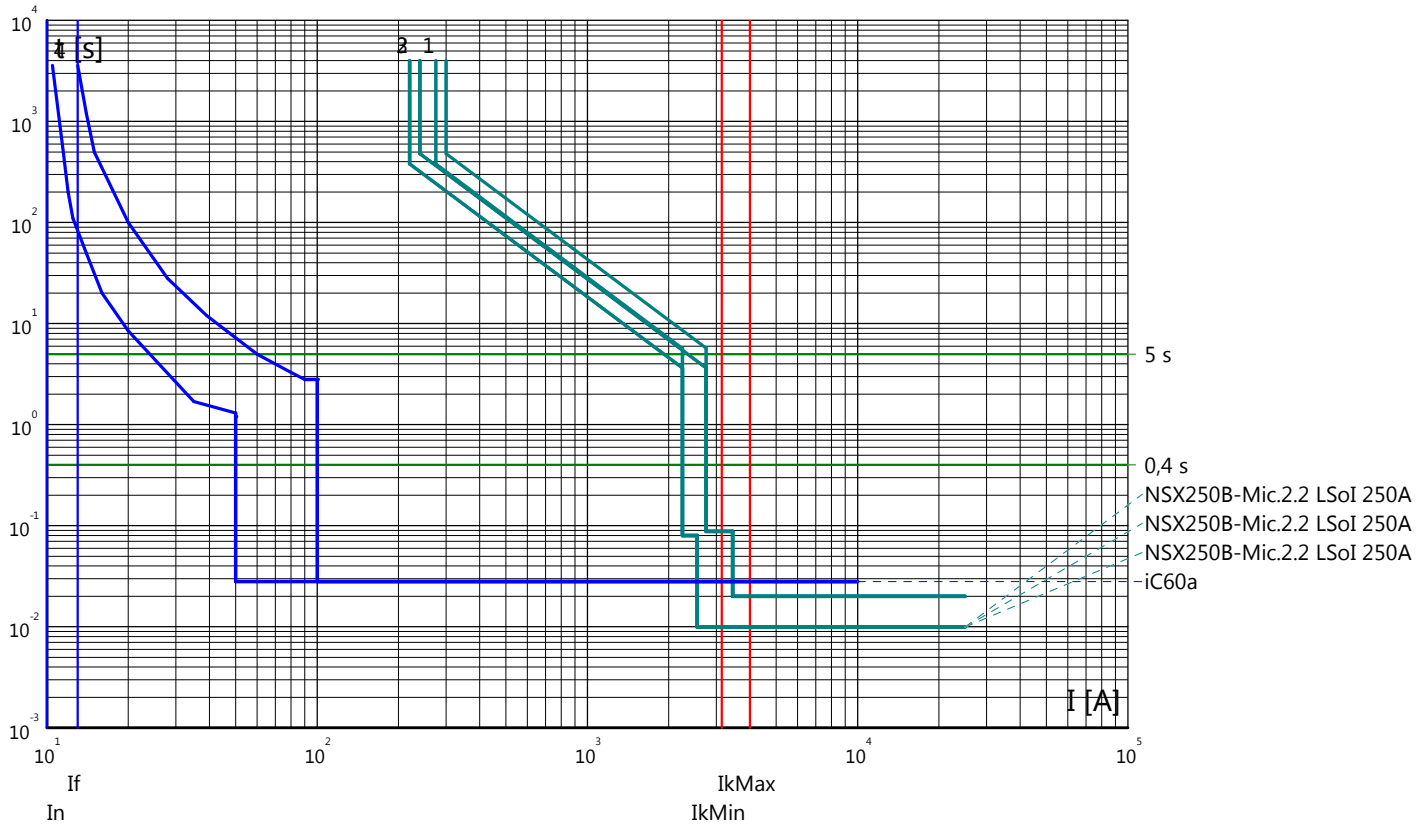

Partenza: IP2.P

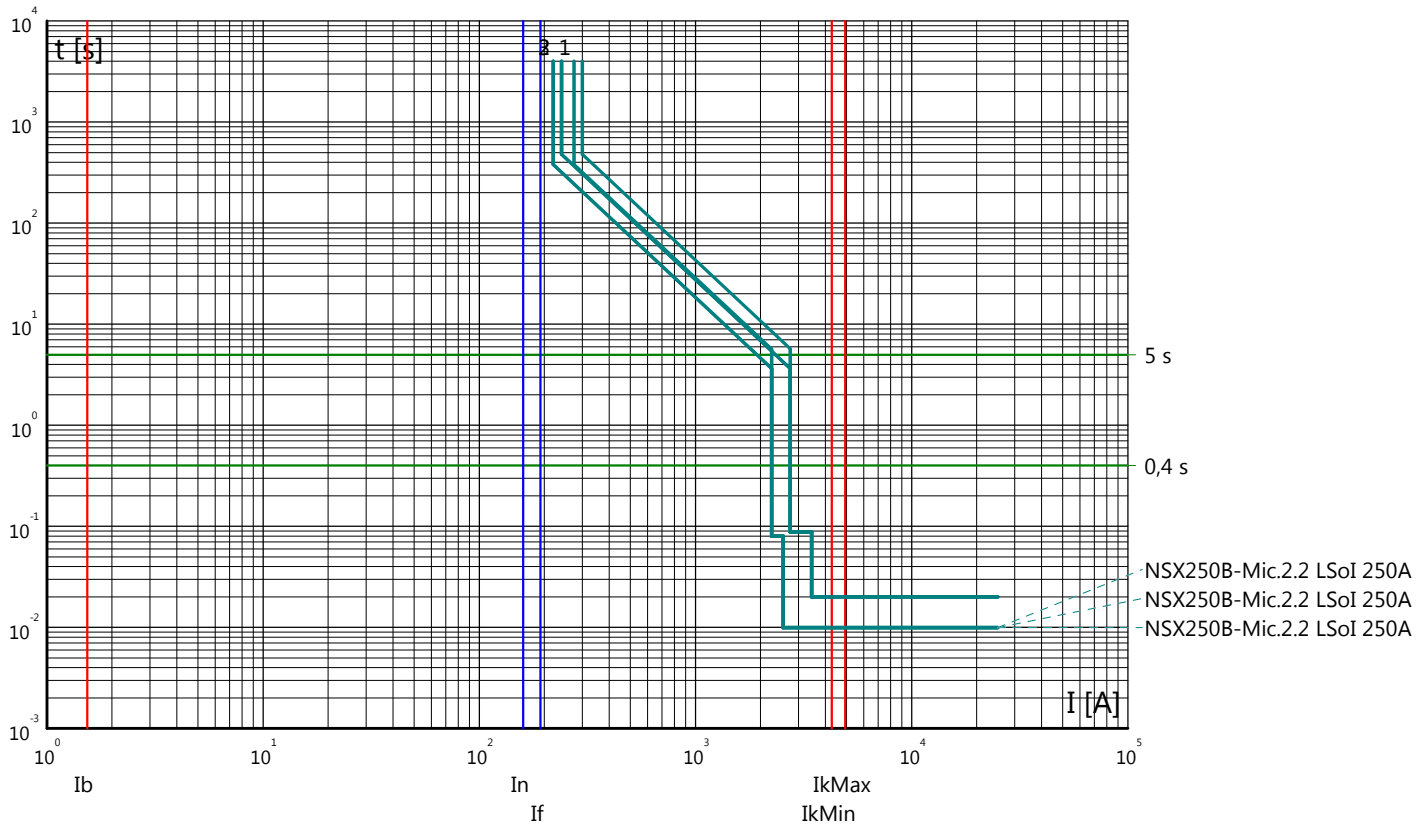

Curve tempo corrente: GALLERIA MONTE AGLIO  
 Quadro: QGBT/N

Partenza: 1.22P

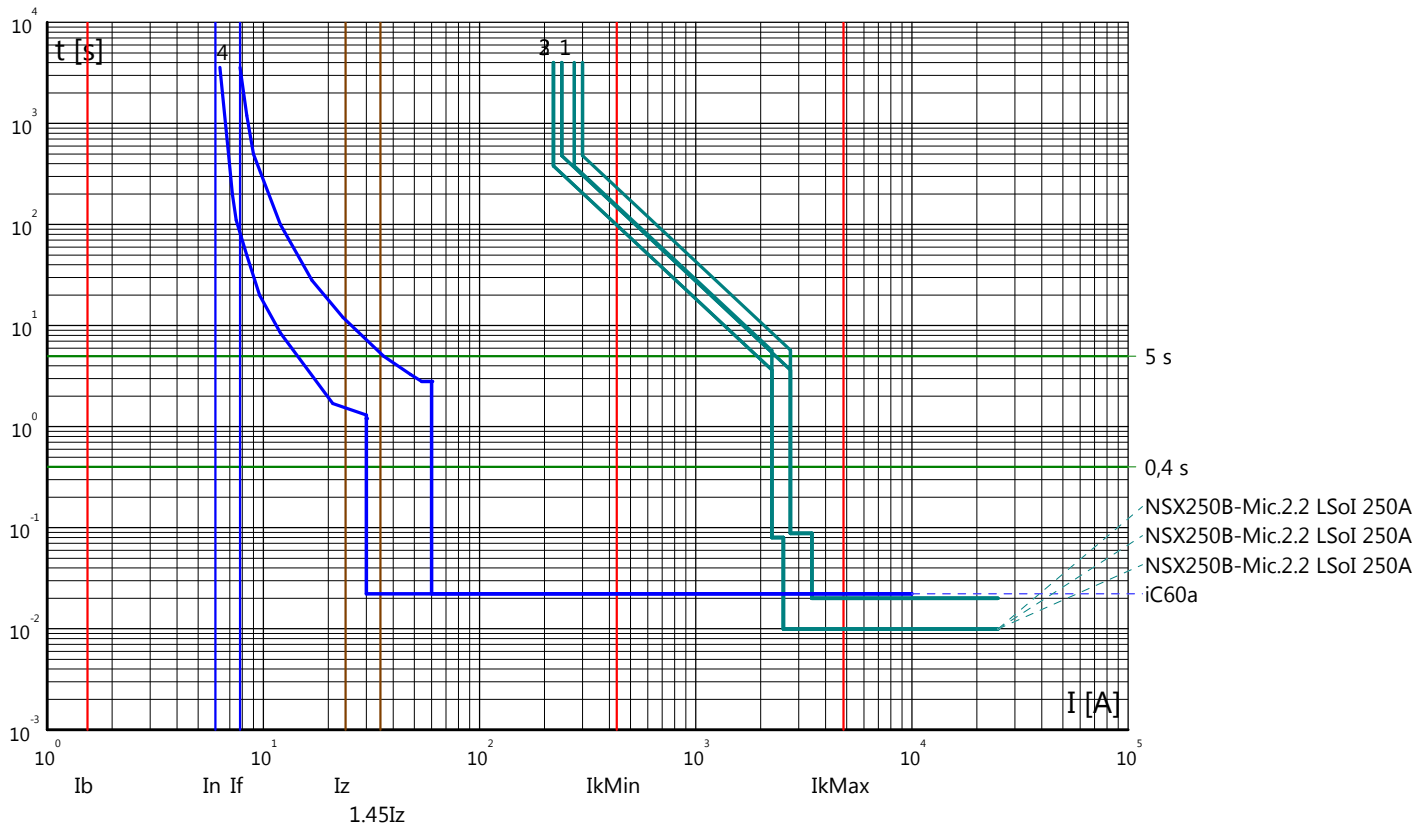

Partenza: 1.23P

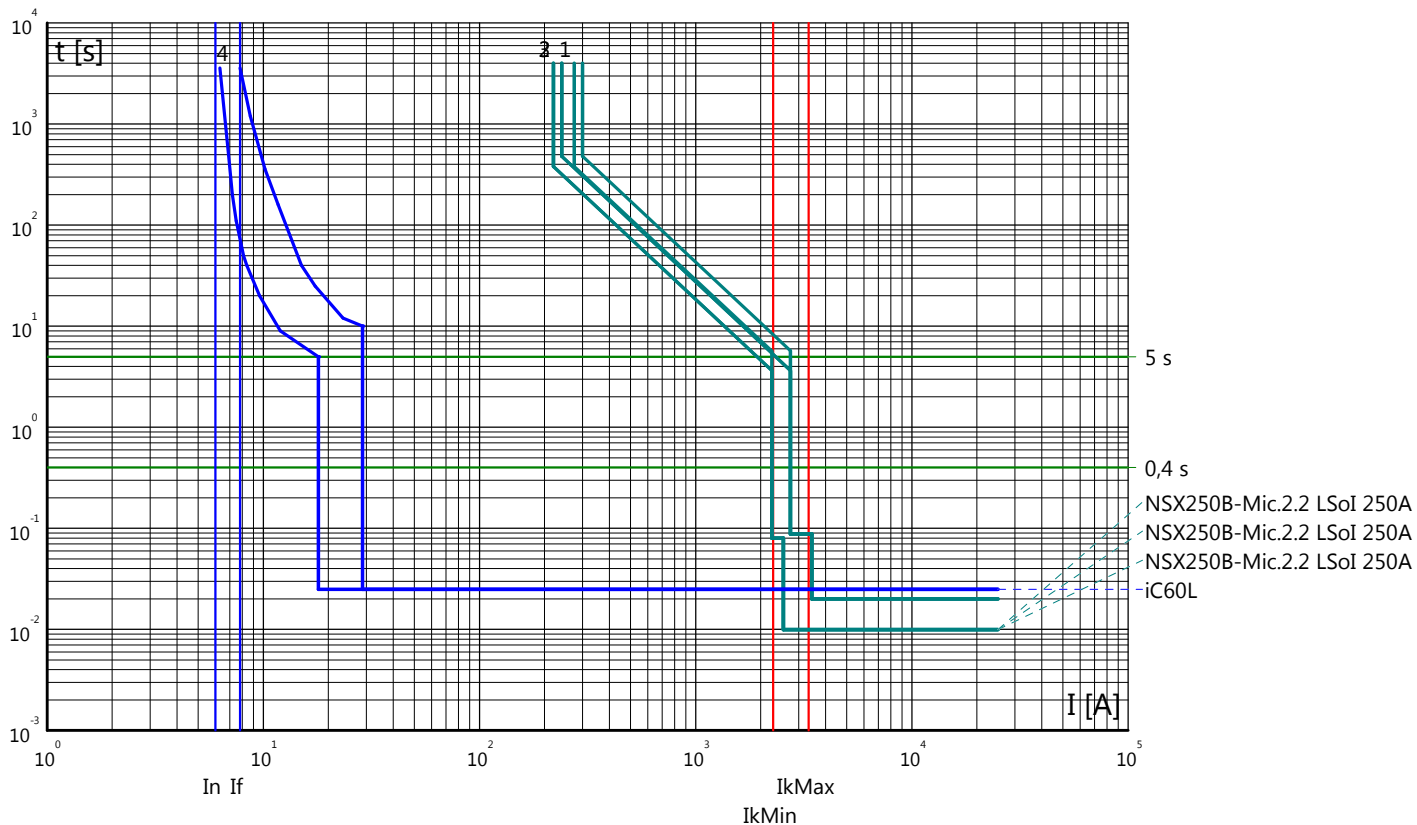

Curve tempo corrente: GALLERIA MONTE AGLIO  
 Quadro: QGBT/N

Partenza: 1.24P

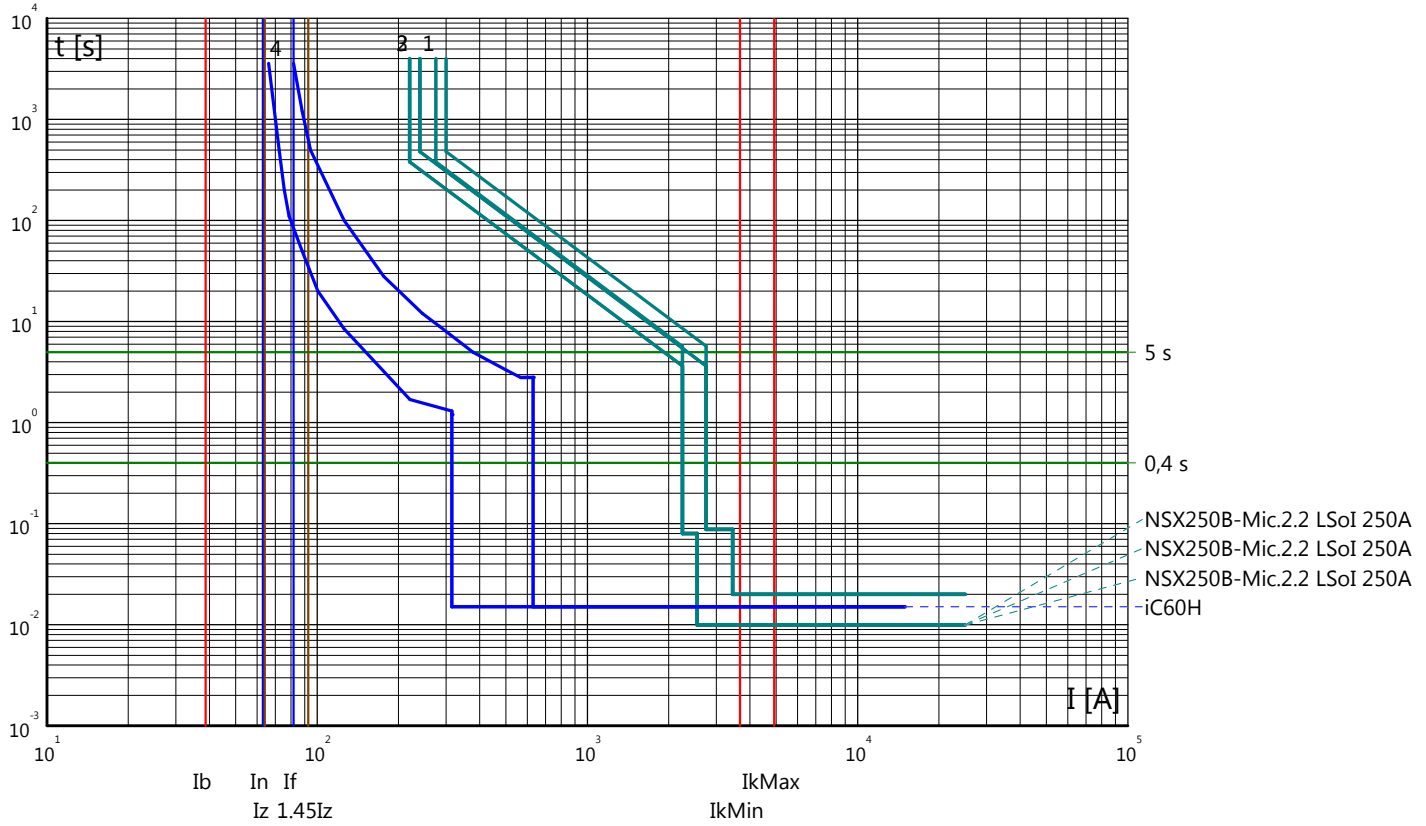

Partenza: 1.25P

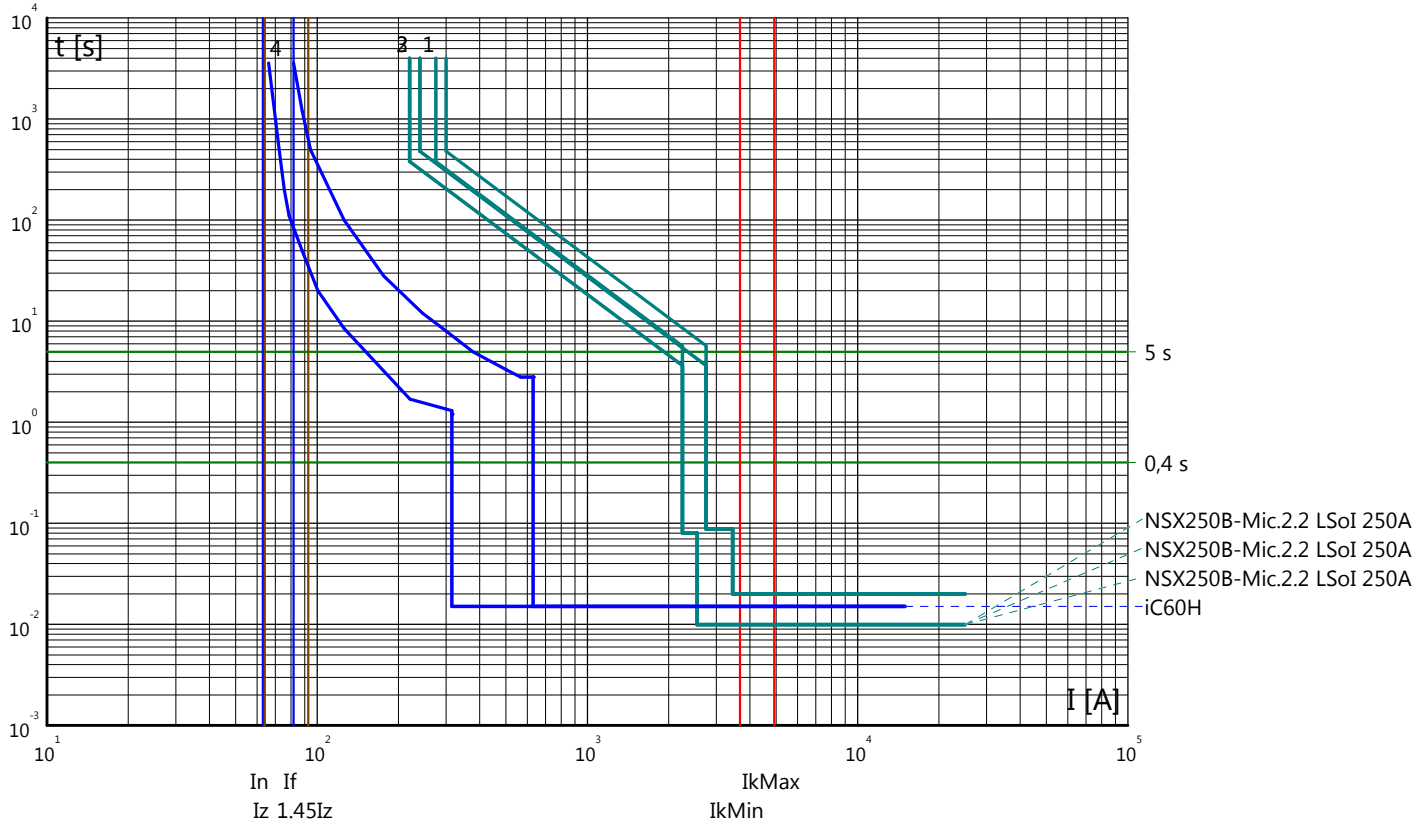

Curve tempo corrente: GALLERIA MONTE AGLIO  
 Quadro: QGBT/N

Partenza: 1.26P

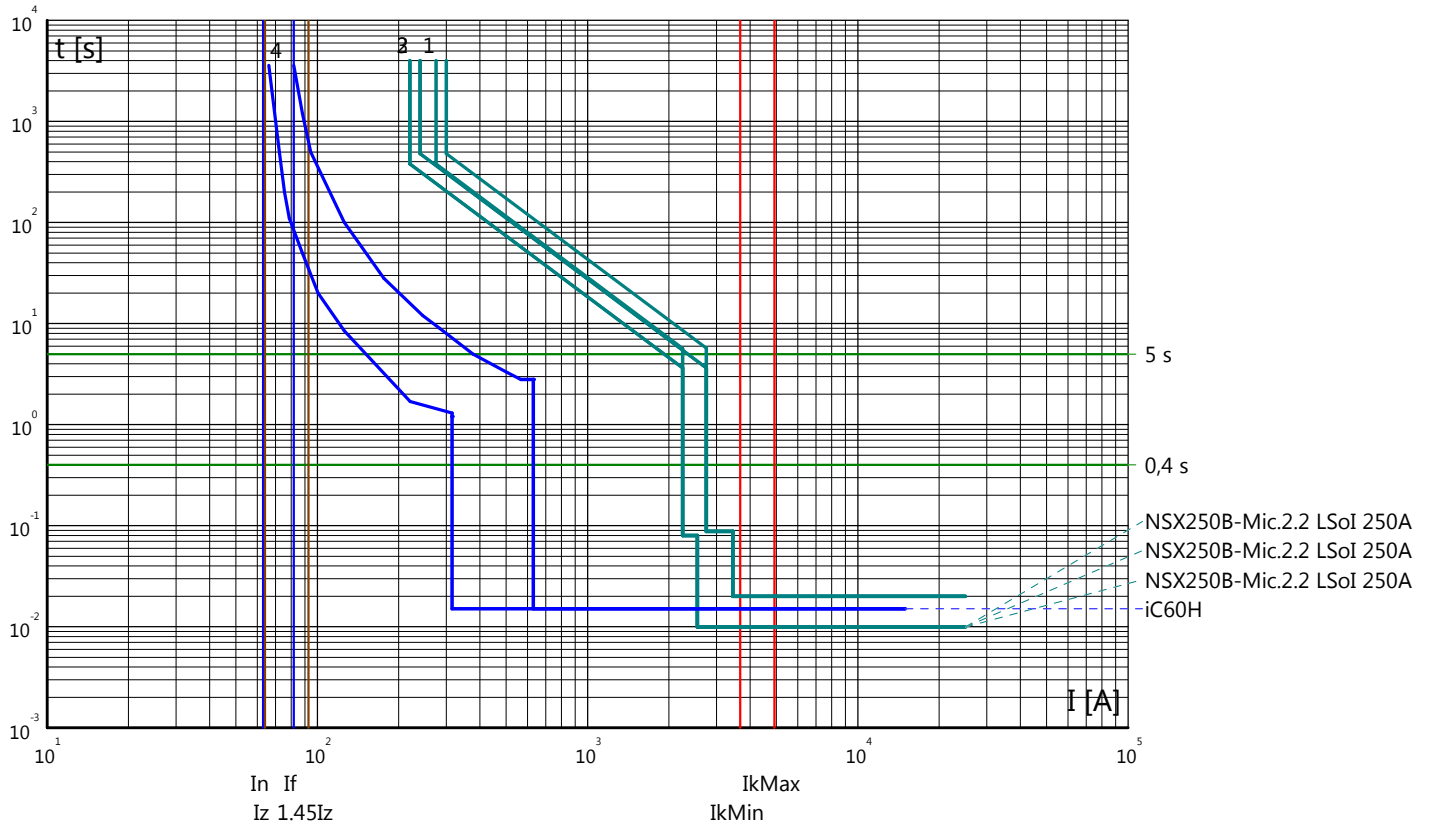



Curve tempo corrente: GALLERIA MONTE AGLIO  
 Quadro: QGBT/N

Arrivo: IG/UPS

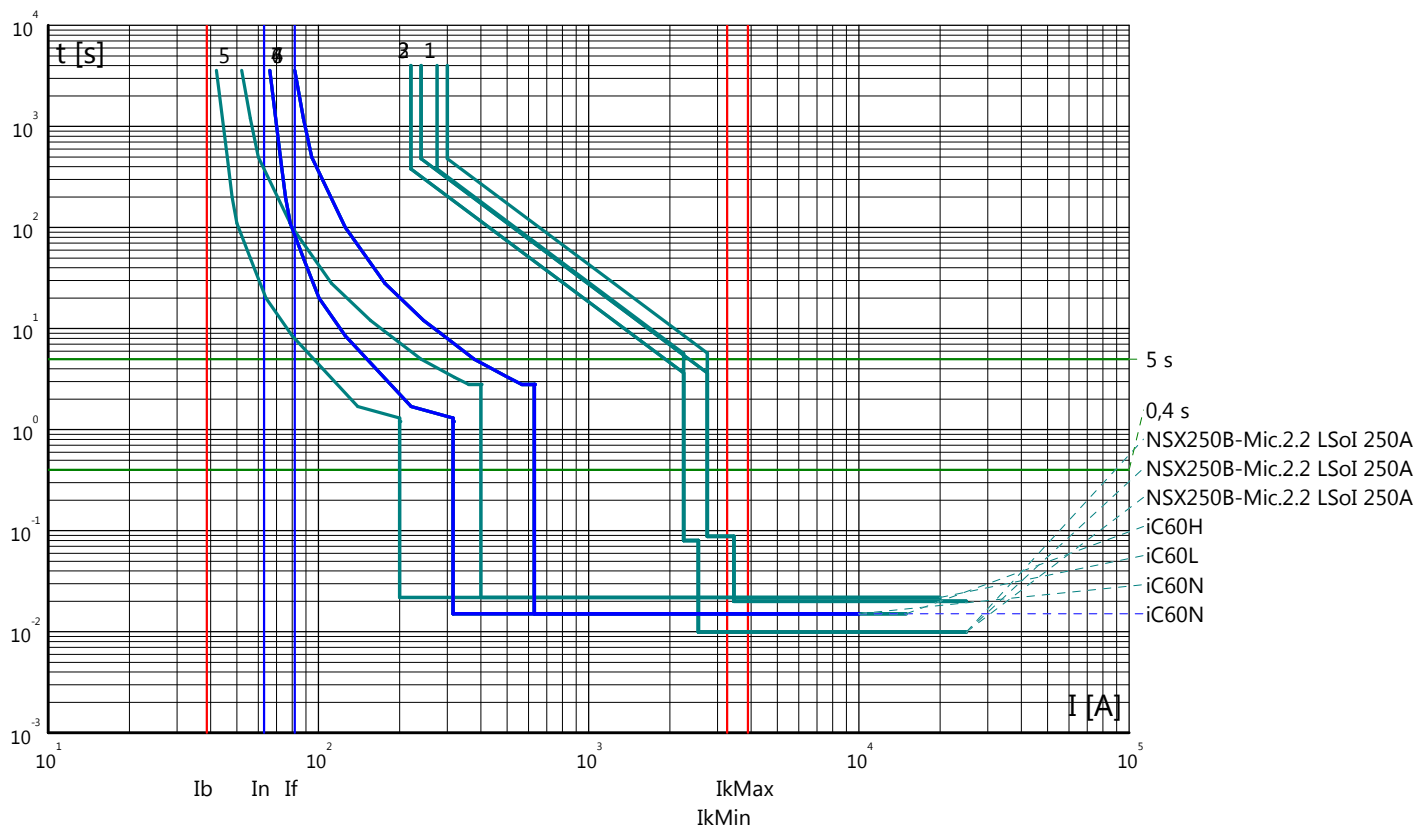

Partenza: PT/P

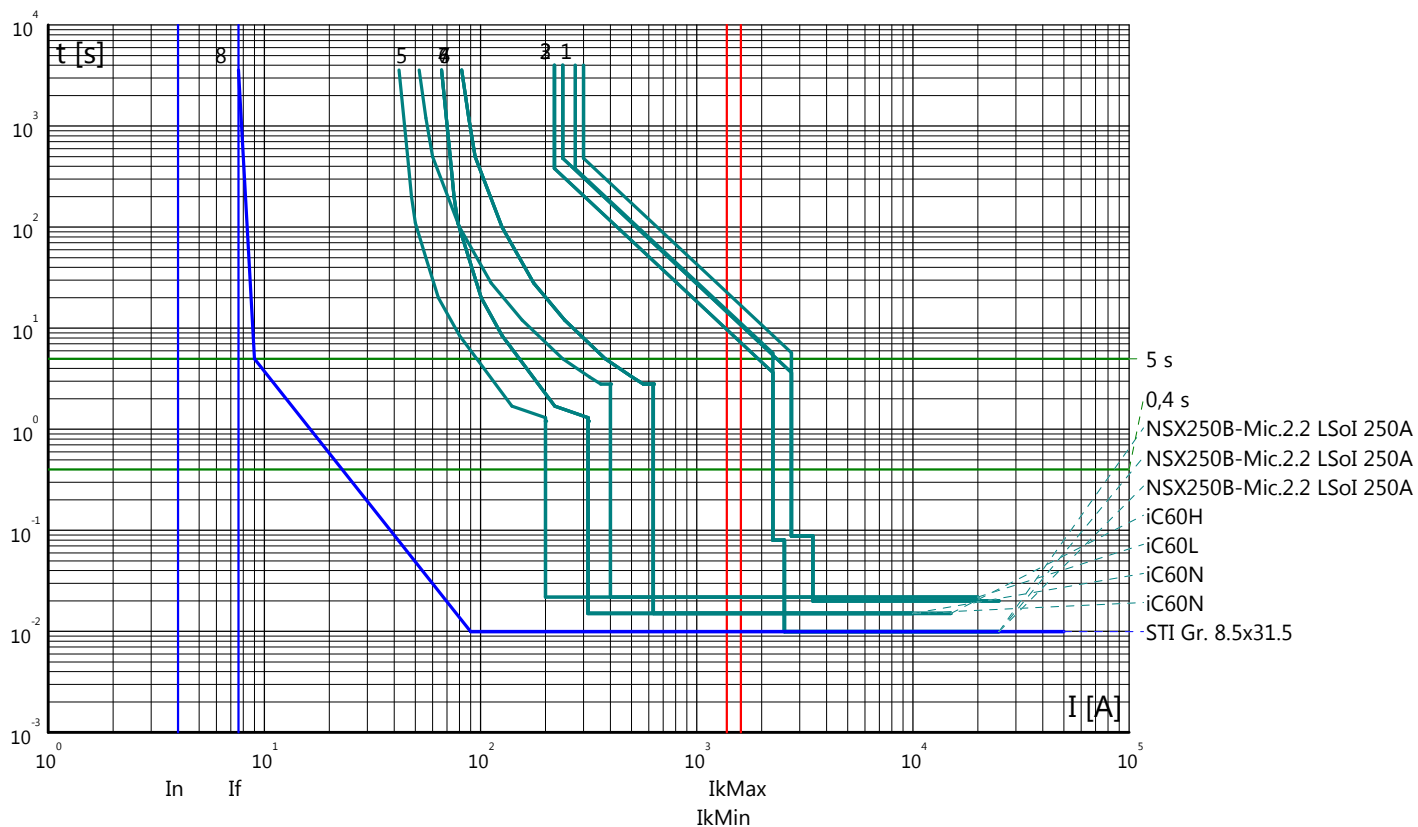

Curve tempo corrente: GALLERIA MONTE AGLIO  
 Quadro: QGBT/N

Partenza: MIS/P

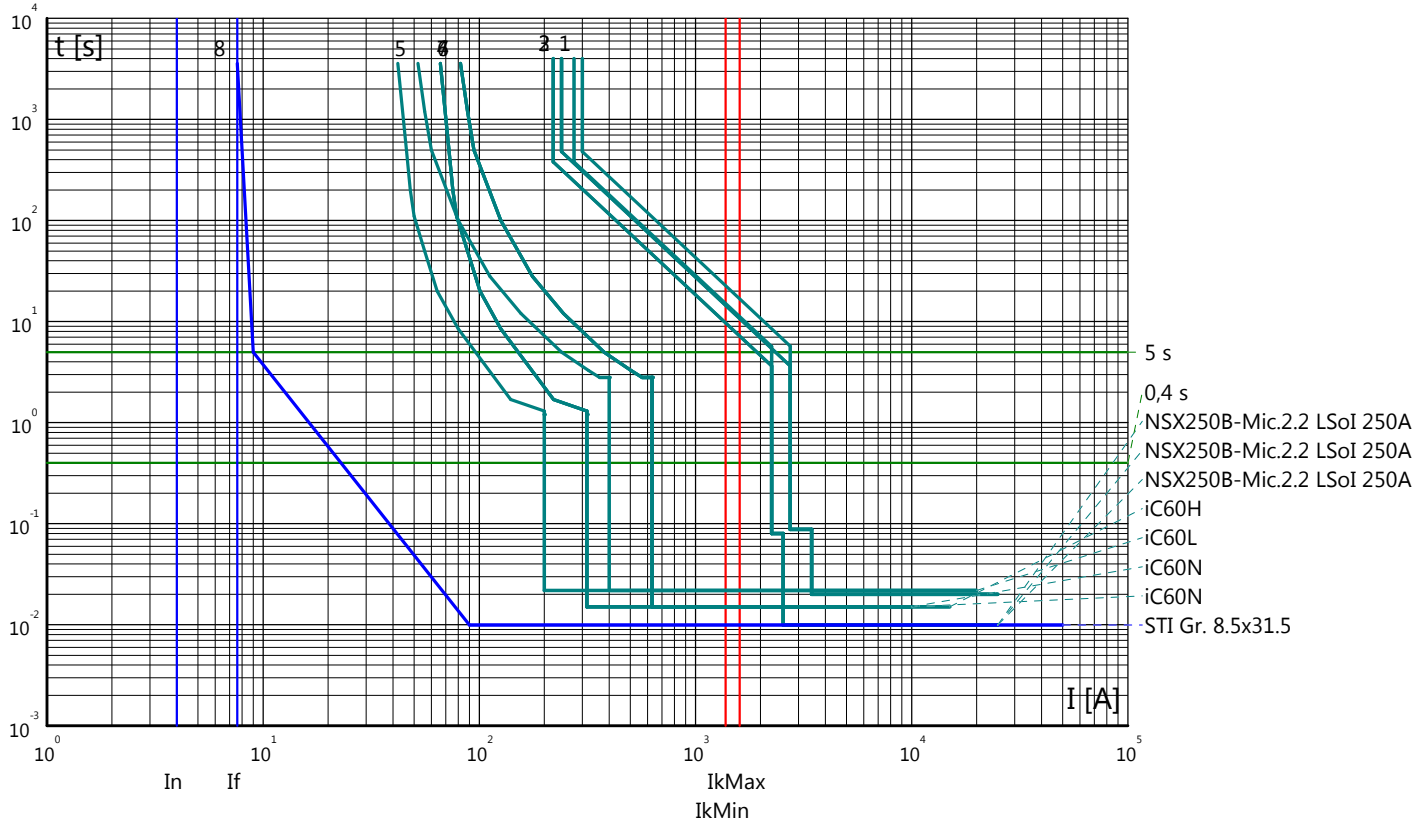

Partenza: 1.1S

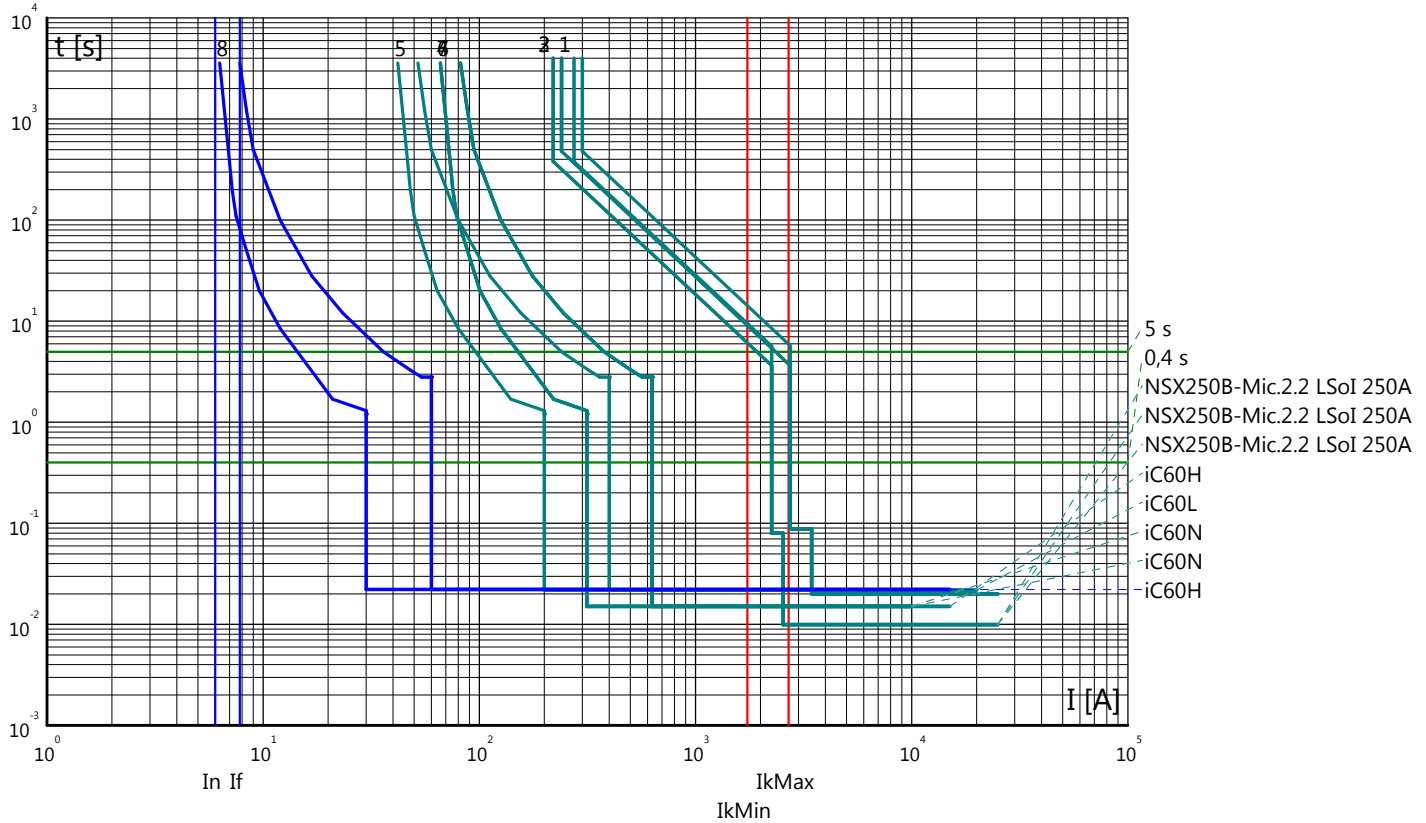

Curve tempo corrente: GALLERIA MONTE AGLIO  
 Quadro: QGBT/N

Partenza: 1.2S

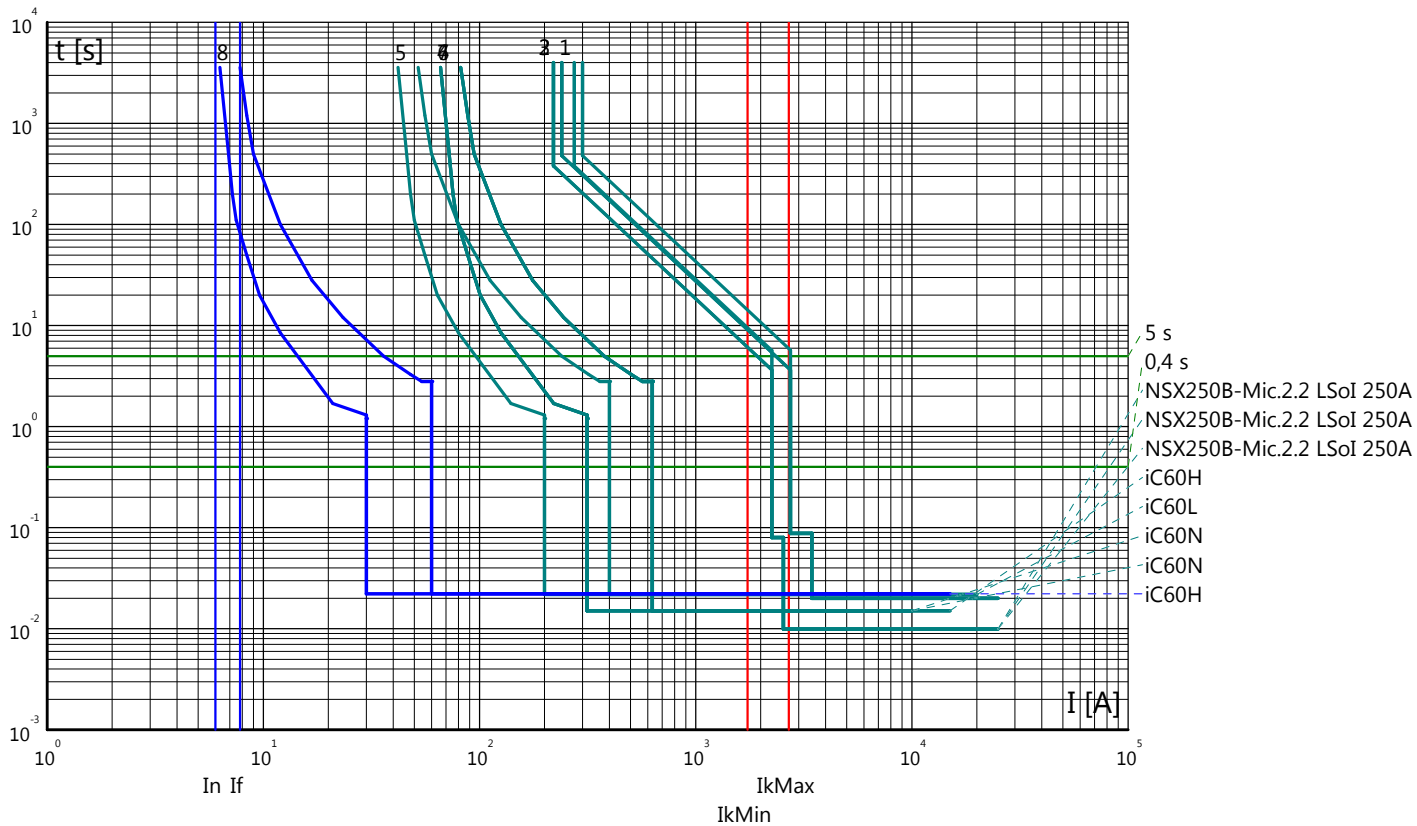

Partenza: 1.3S

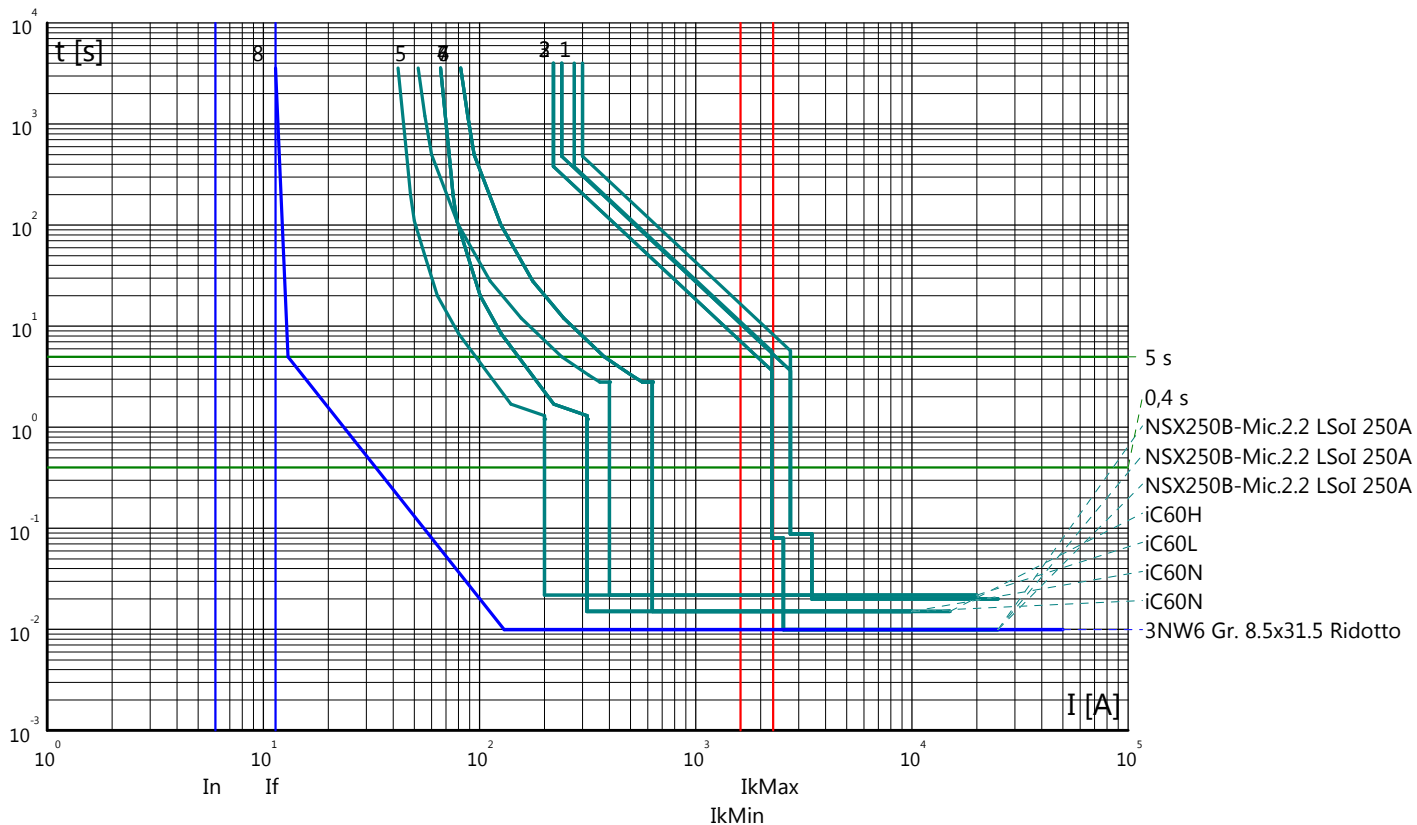

Curve tempo corrente: GALLERIA MONTE AGLIO  
 Quadro: QGBT/N

Partenza: 1.4S

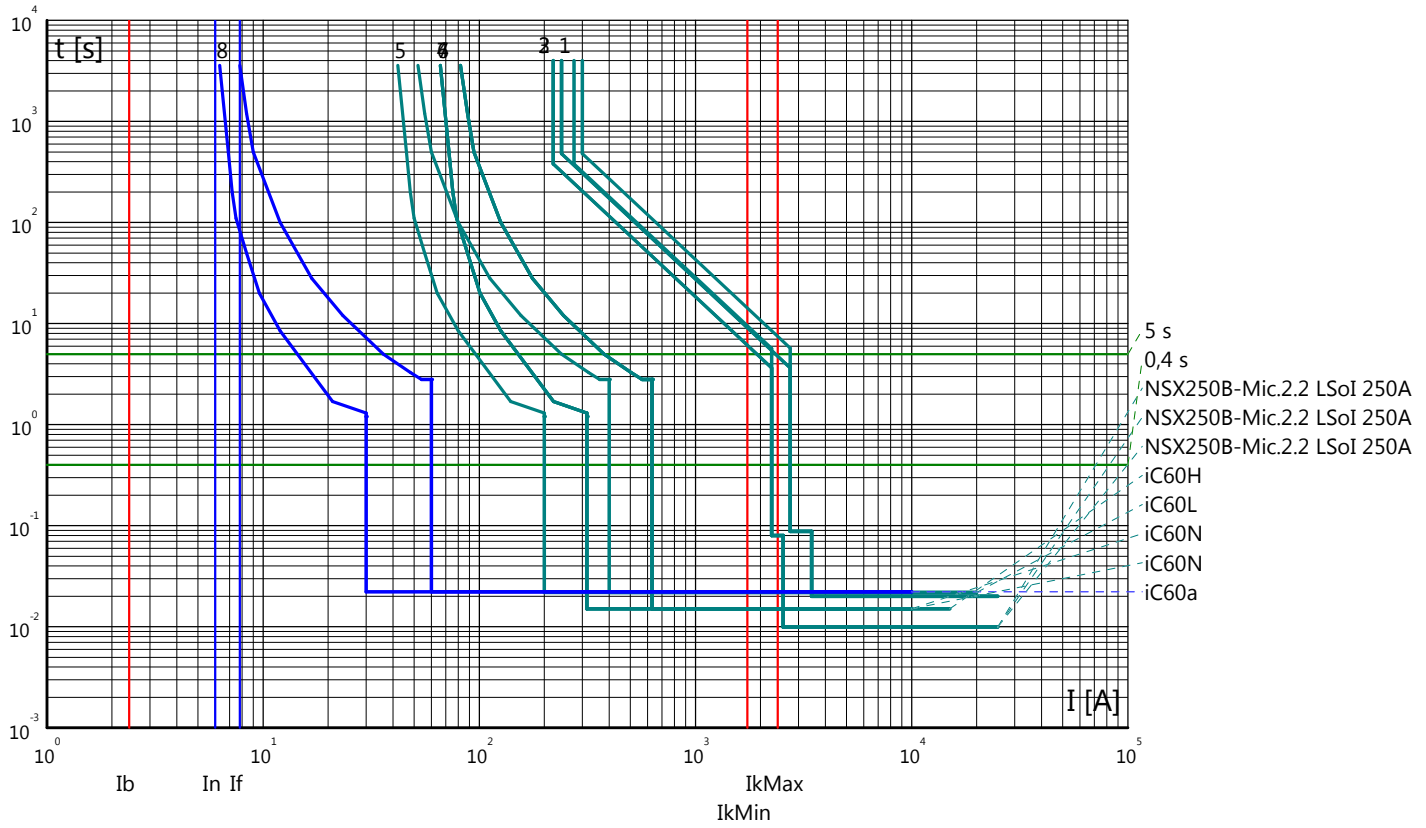

Partenza: 1.5S

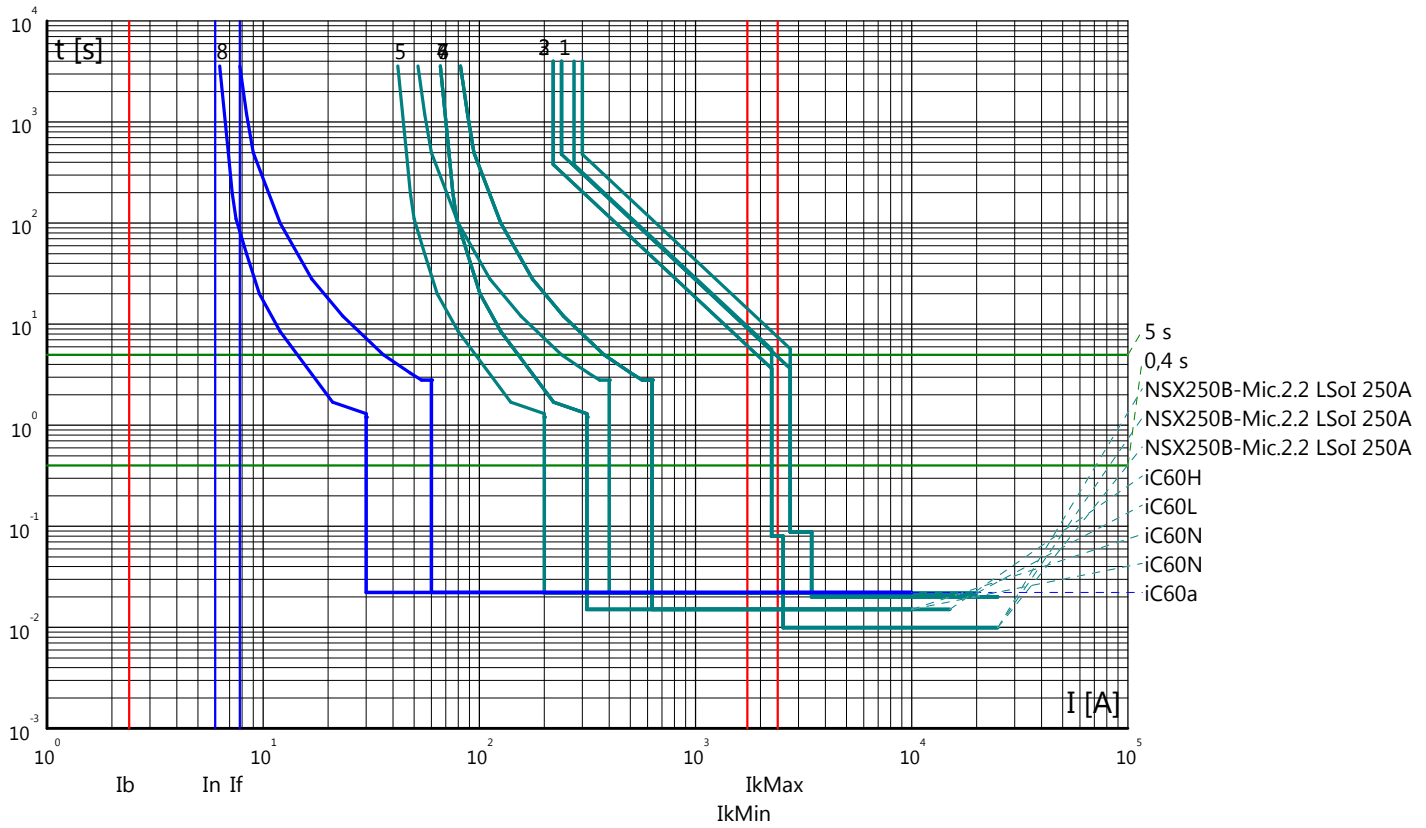

Curve tempo corrente: GALLERIA MONTE AGLIO  
 Quadro: QGBT/N

Partenza: 1.6S

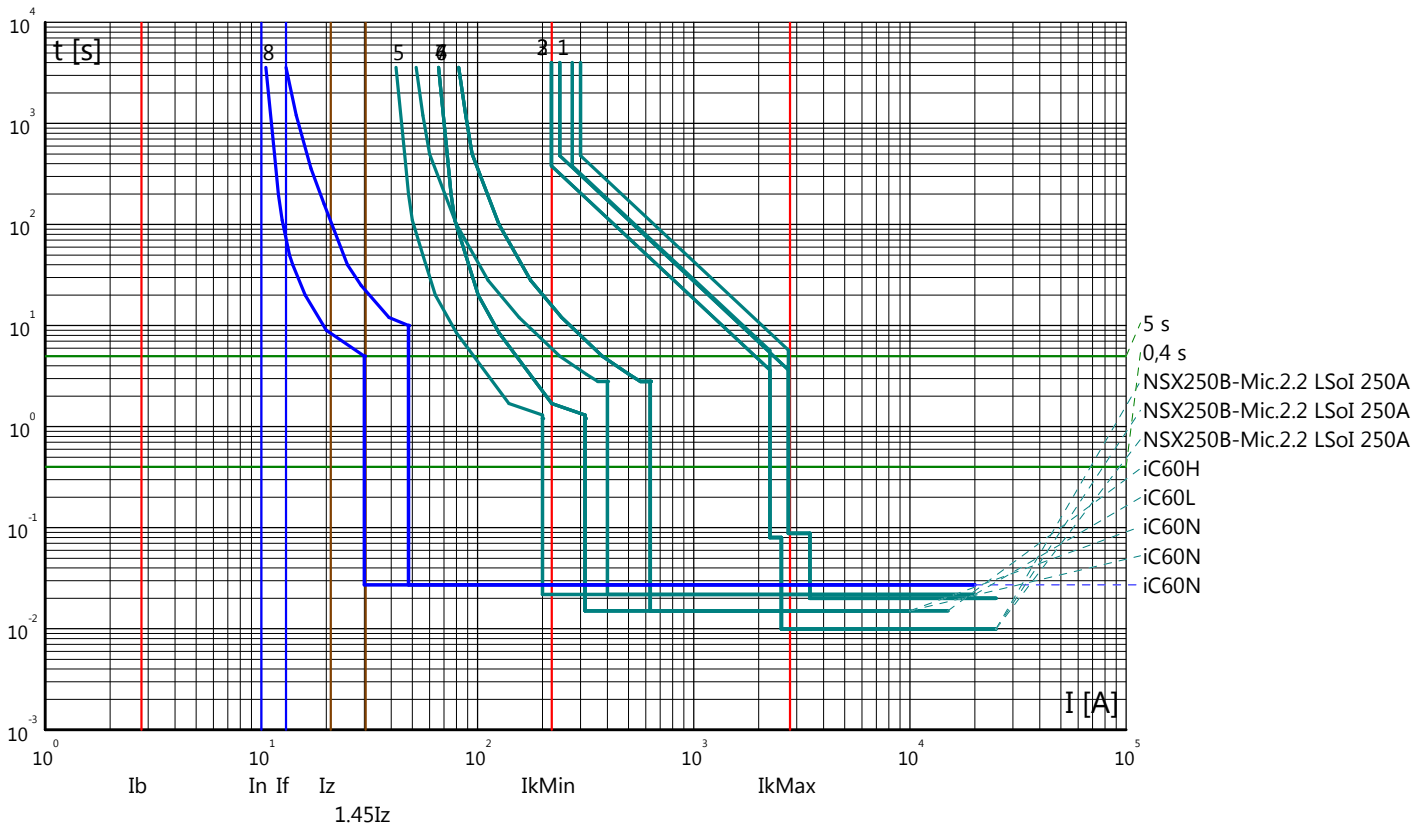

Partenza: 1.7S

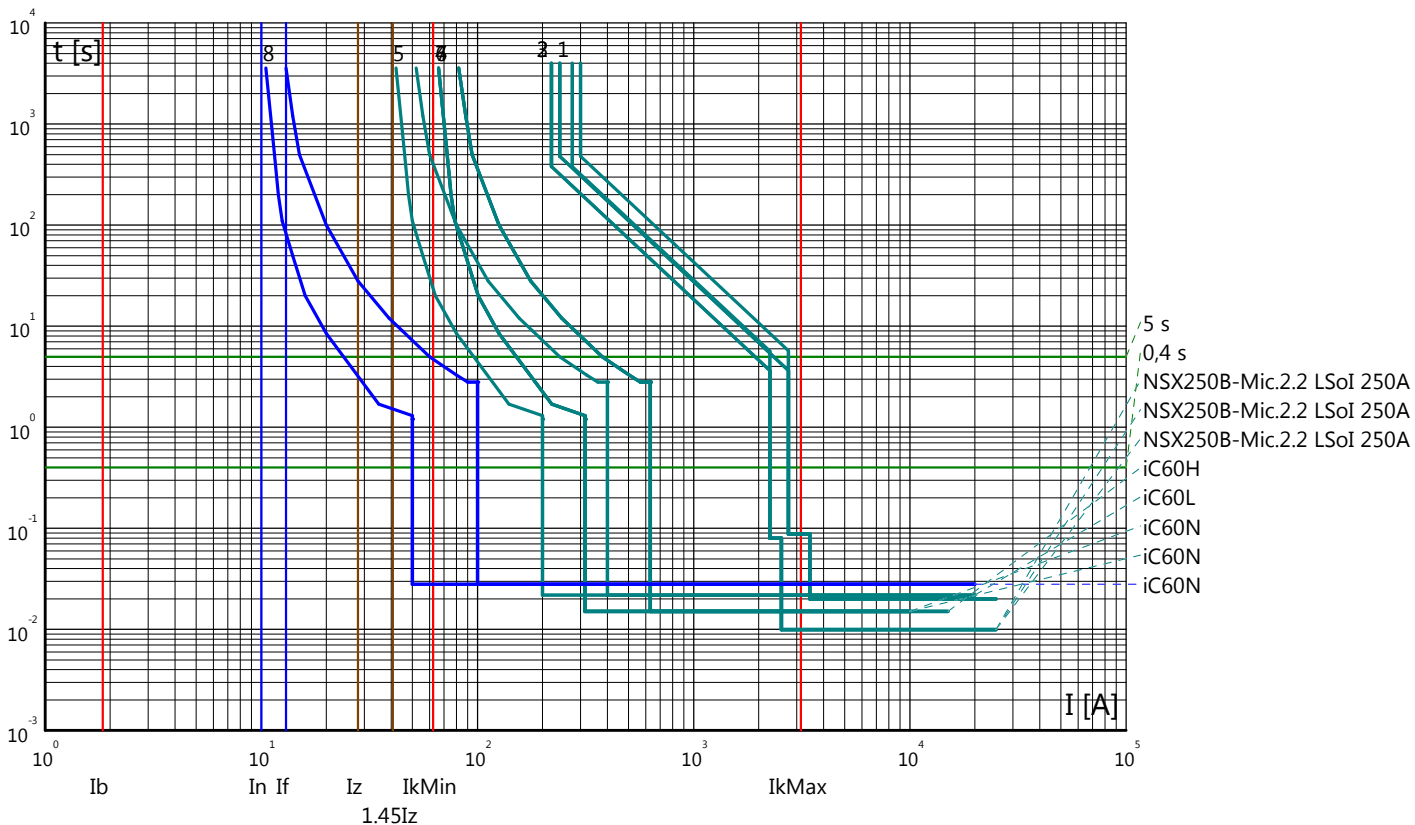

Curve tempo corrente: GALLERIA MONTE AGLIO  
 Quadro: QGBT/N

Partenza: 1.8S

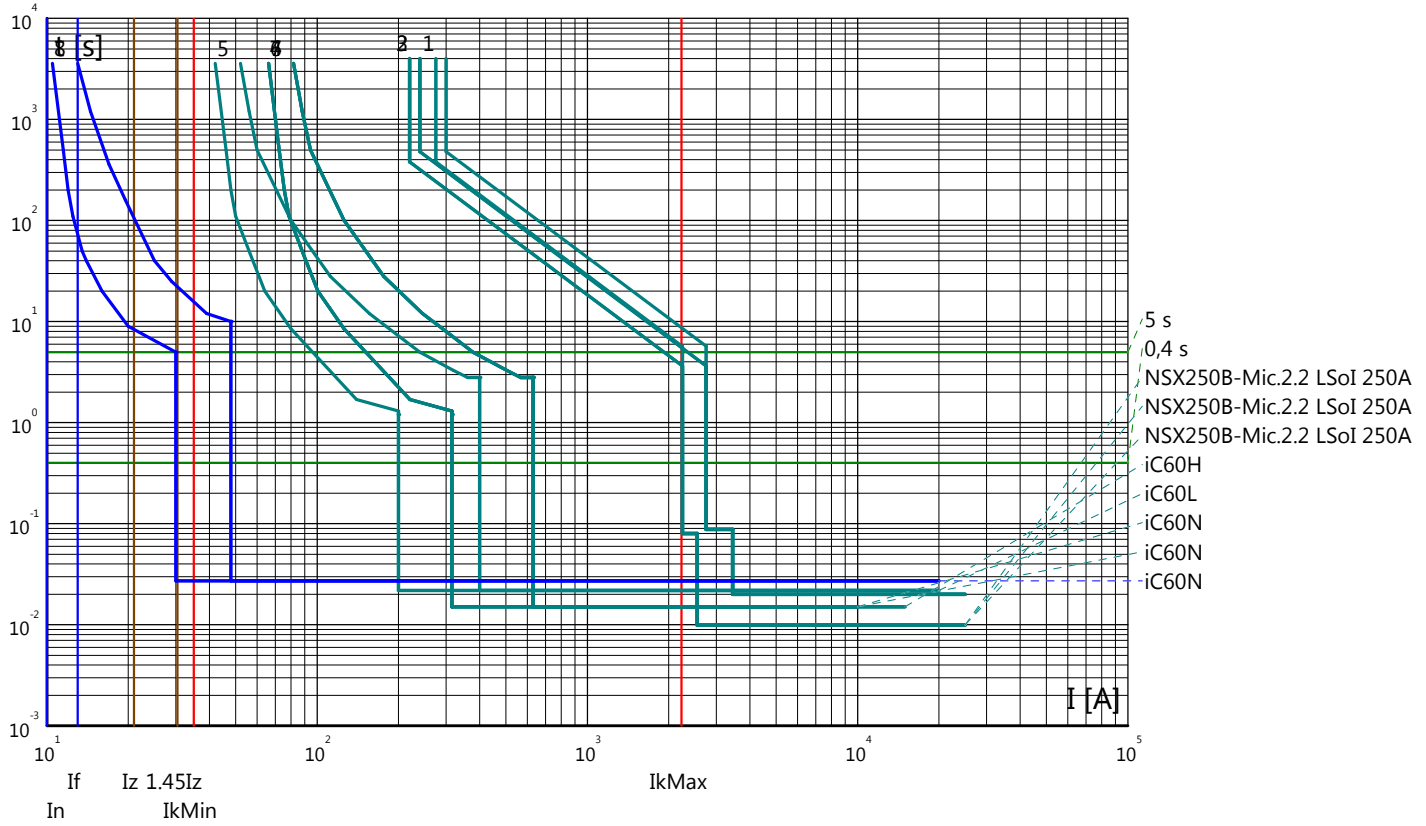

Partenza: 1.9S

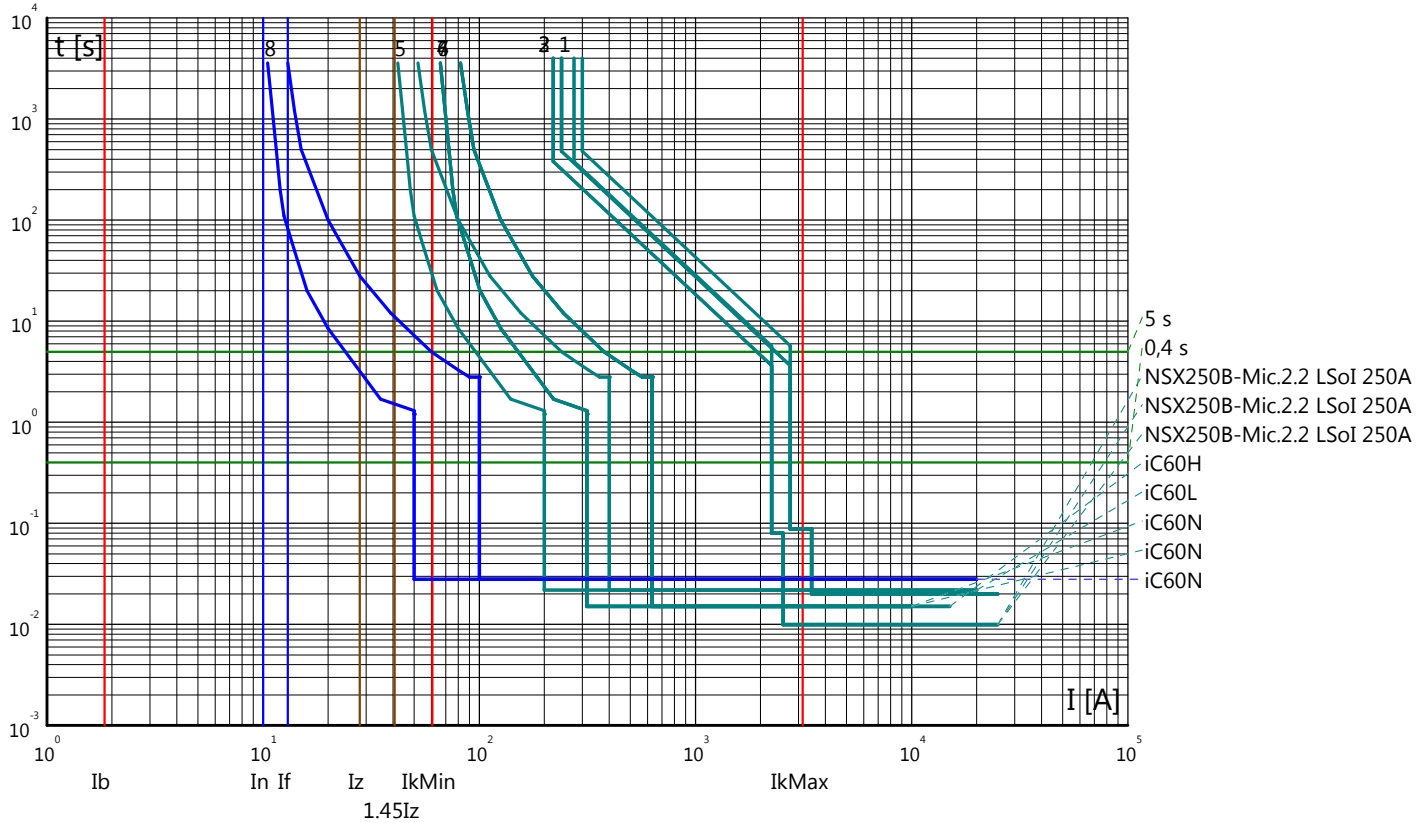

Curve tempo corrente: GALLERIA MONTE AGLIO  
 Quadro: QGBT/N

Partenza: 1.10S

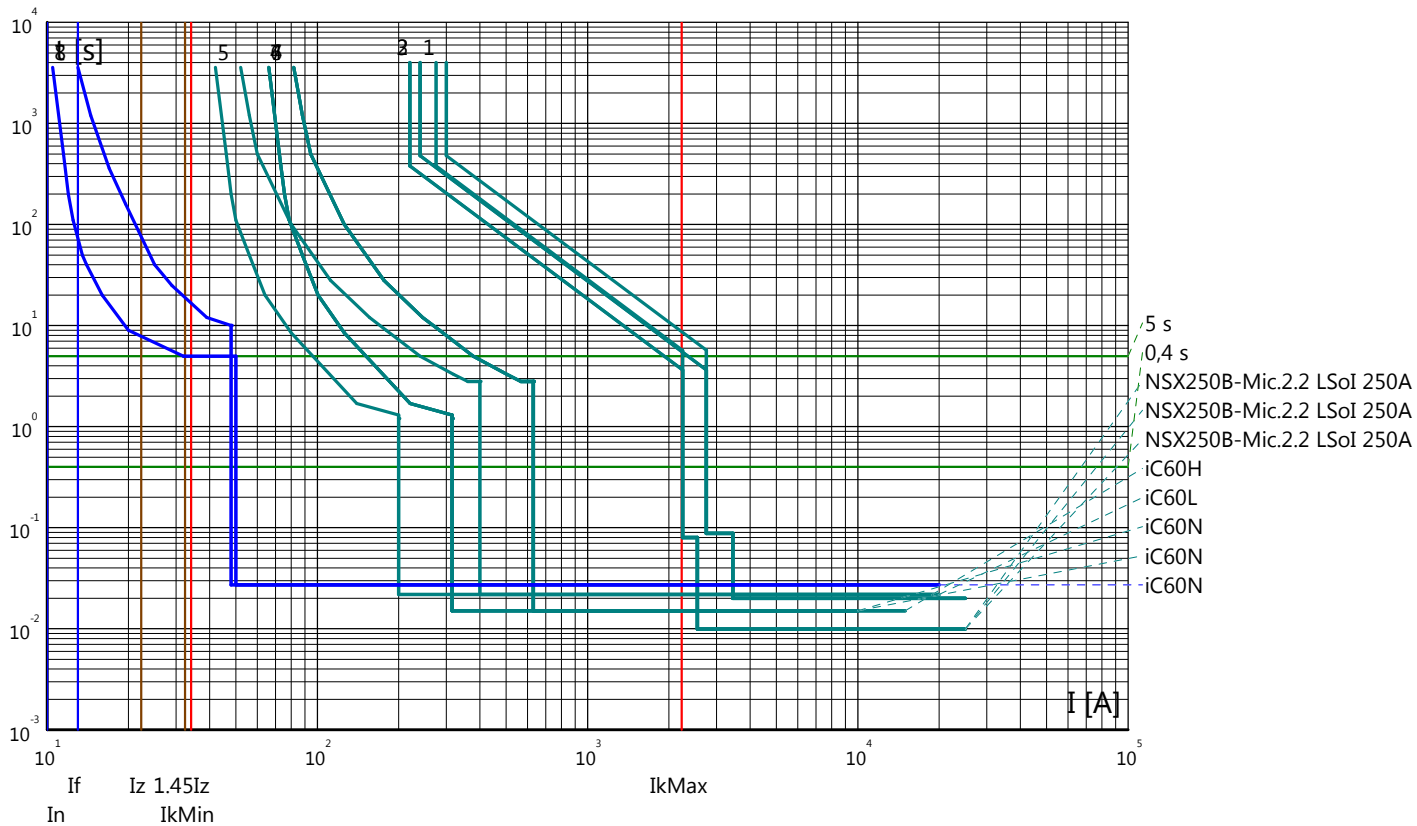

Partenza: 1.11S

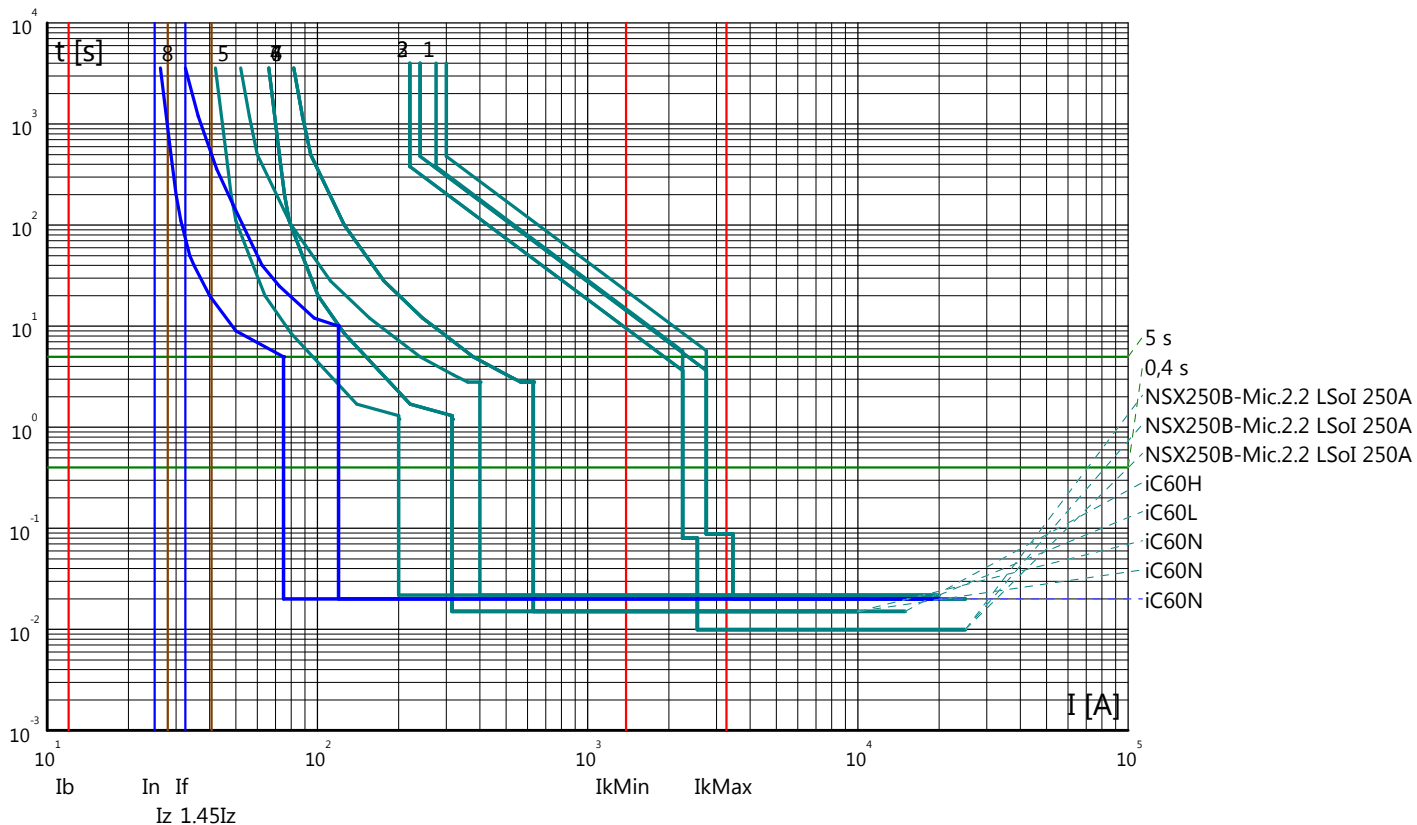

Curve tempo corrente: GALLERIA MONTE AGLIO  
 Quadro: QGBT/N

Partenza: 1.12S

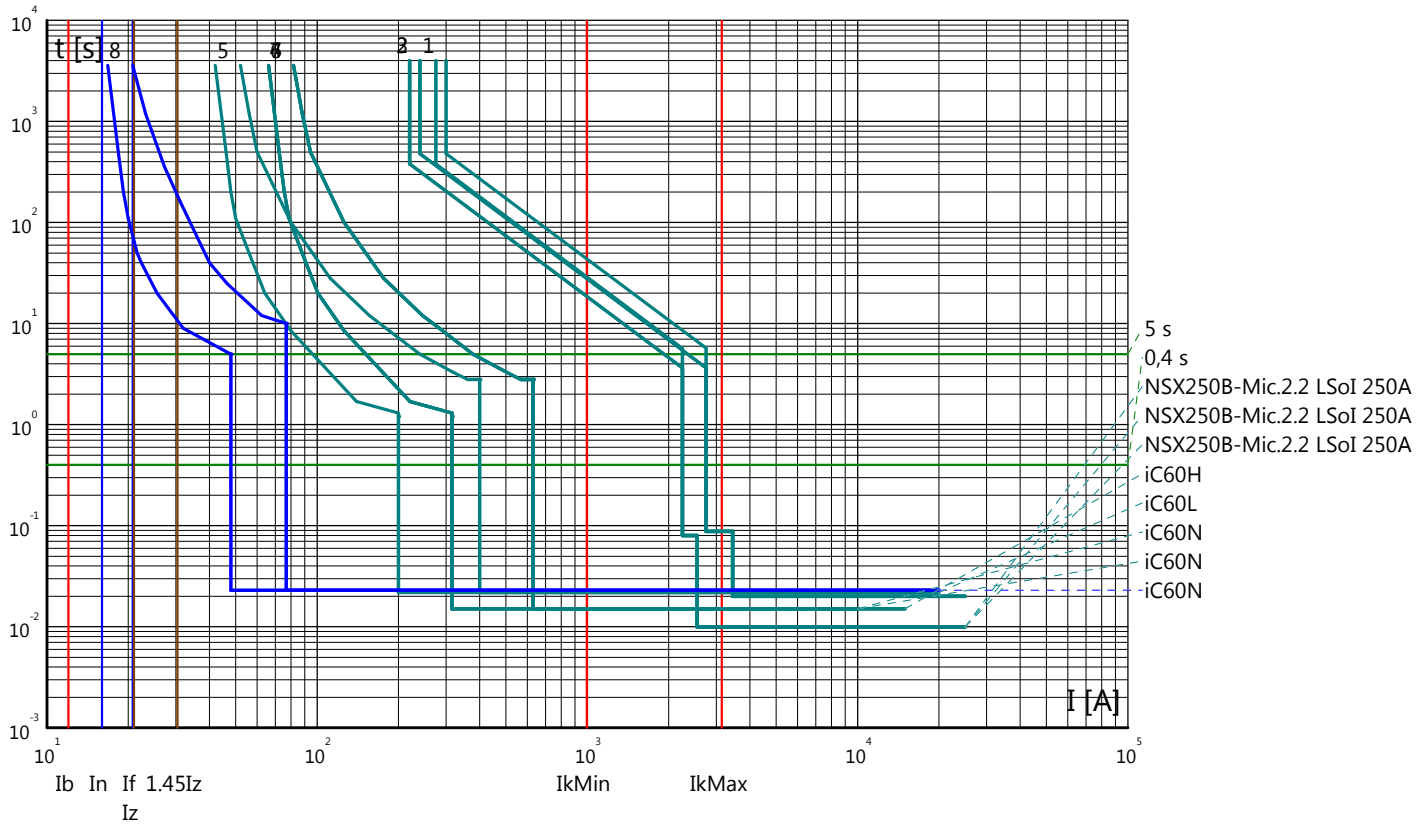

Partenza: 1.13S

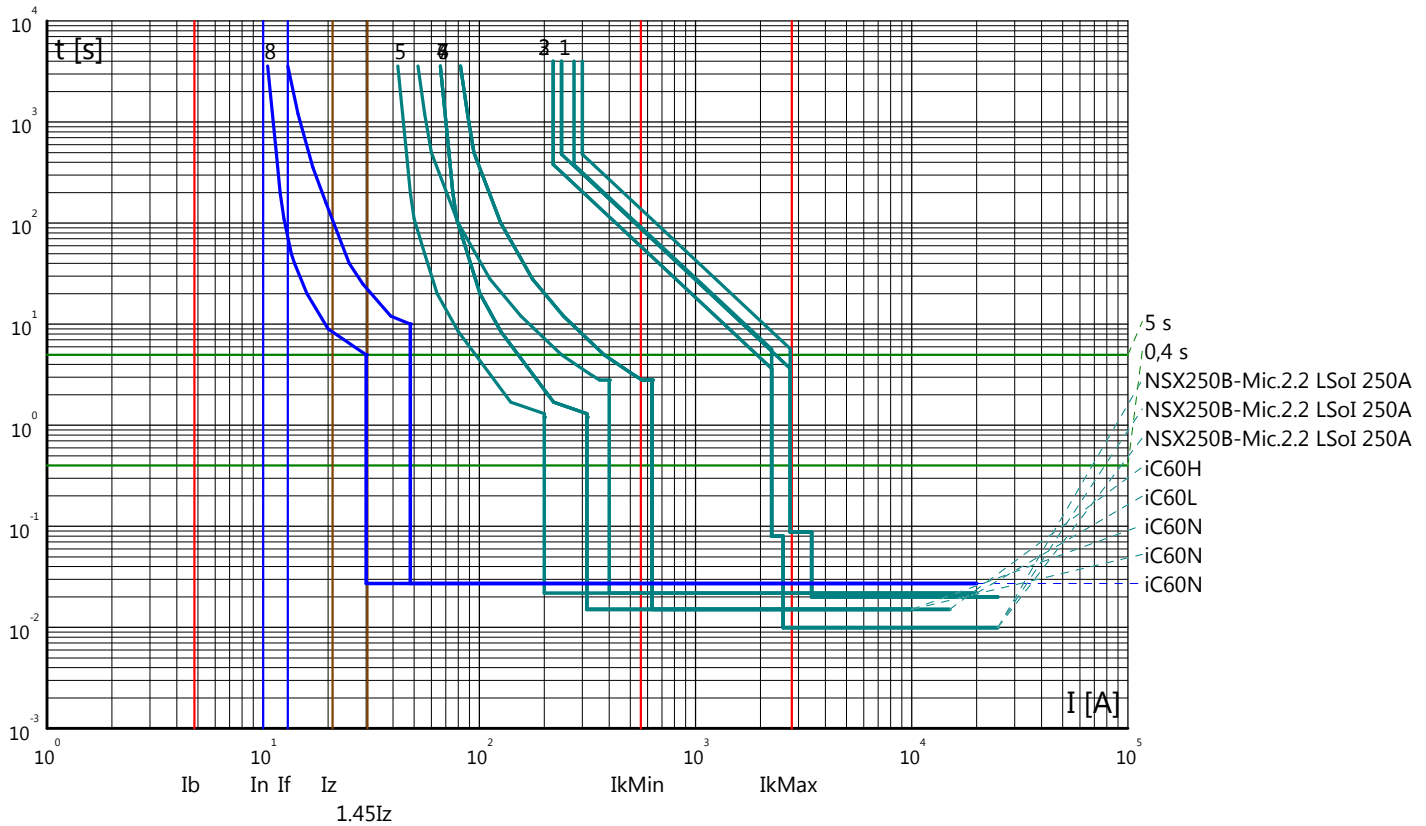



Curve tempo corrente: GALLERIA MONTE AGLIO  
 Quadro: QGBT/N

Partenza: 1.14S

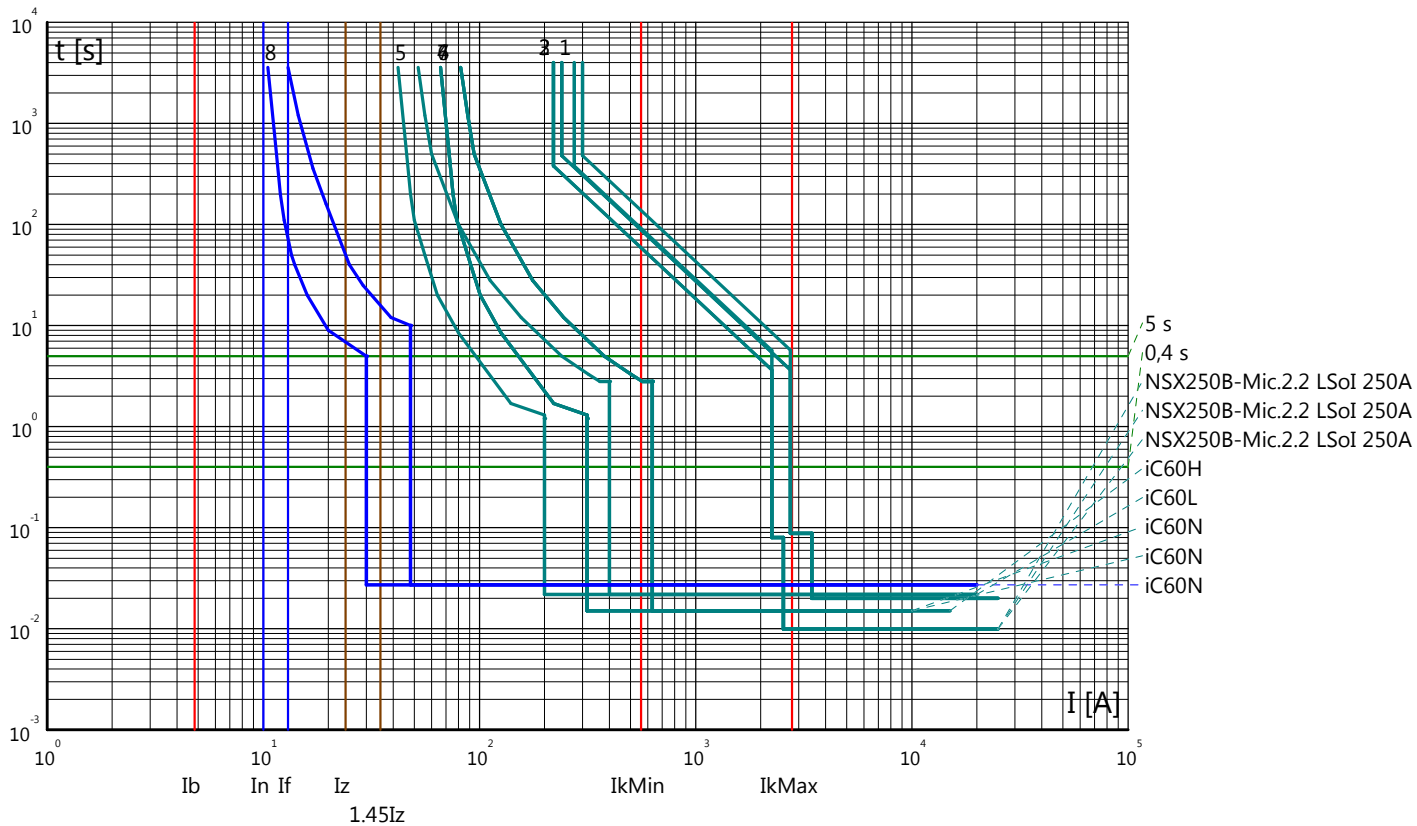

Partenza: 1.15S

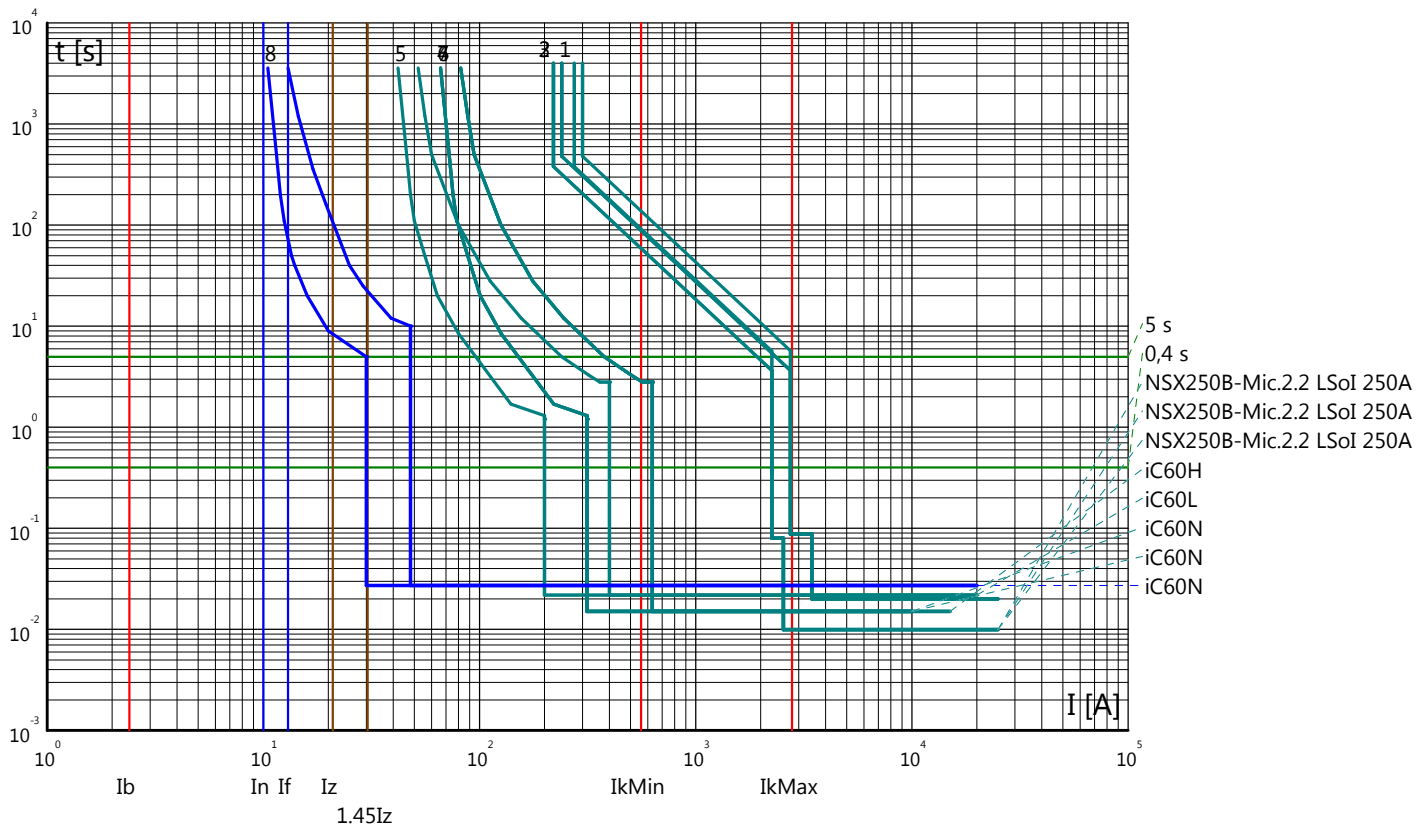

Curve tempo corrente: GALLERIA MONTE AGLIO  
 Quadro: QGBT/N

Partenza: 1.16S

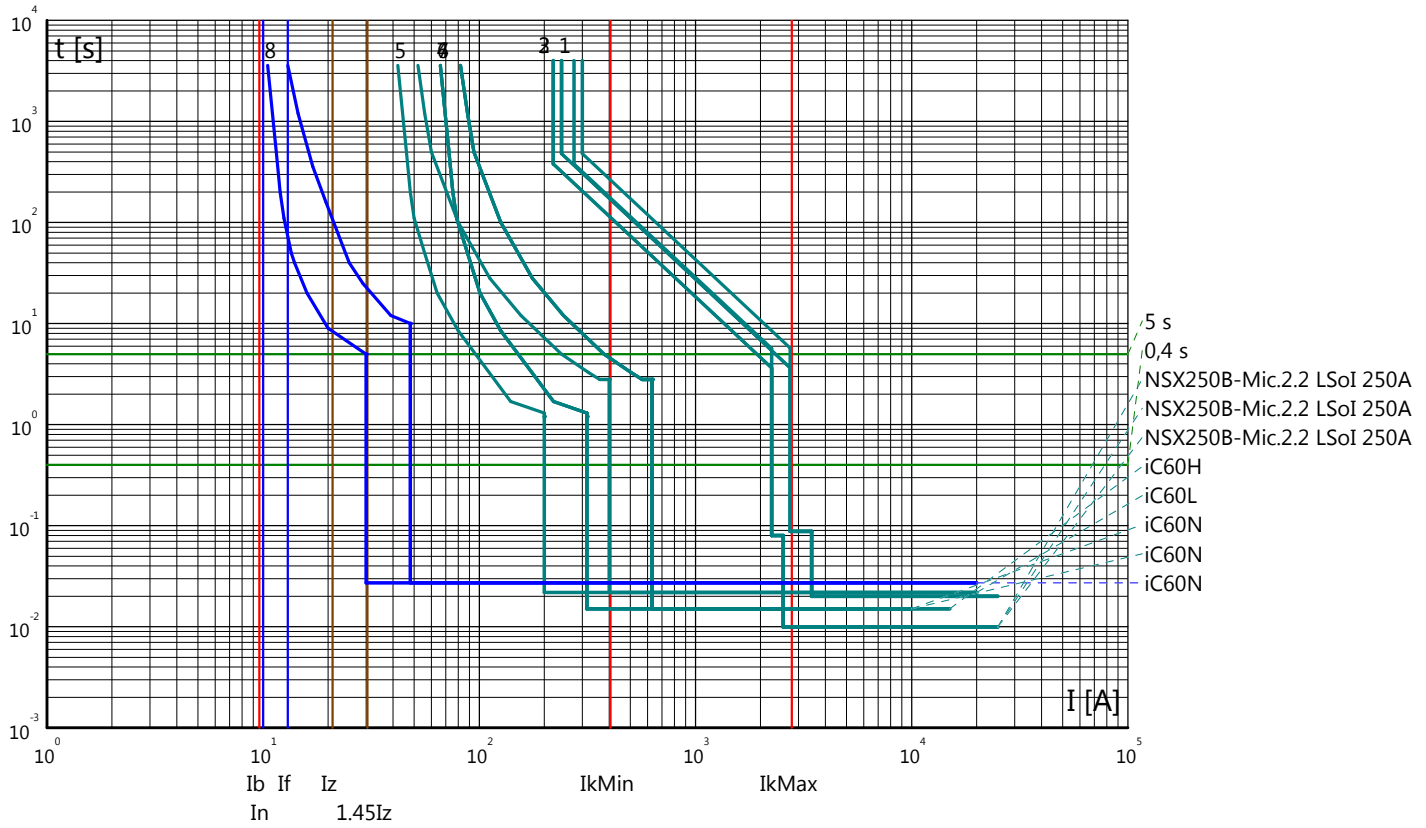

Partenza: 1.17S

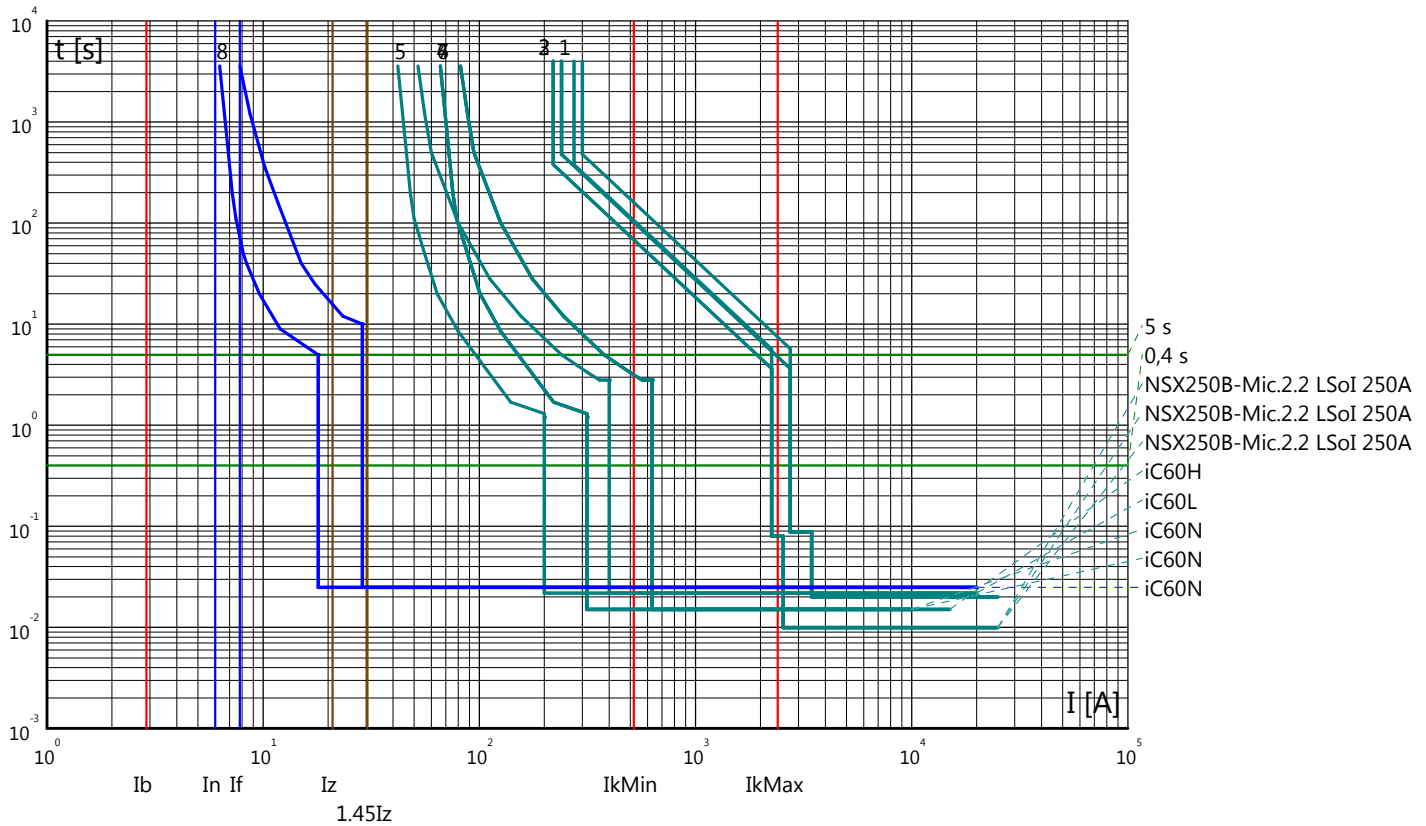

Curve tempo corrente: GALLERIA MONTE AGLIO  
 Quadro: QGBT/N

Partenza: 1.18S

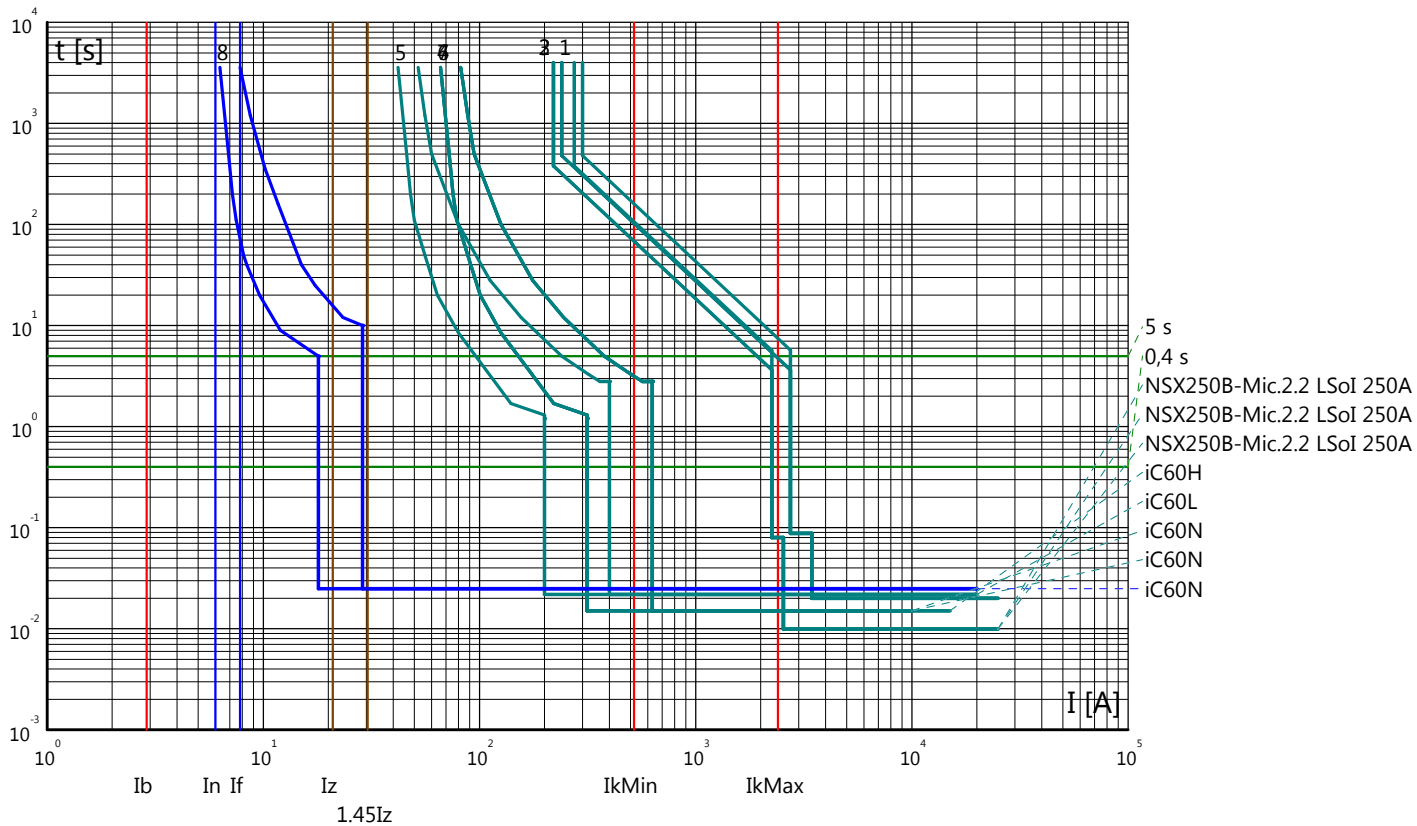

Partenza: 1.19S

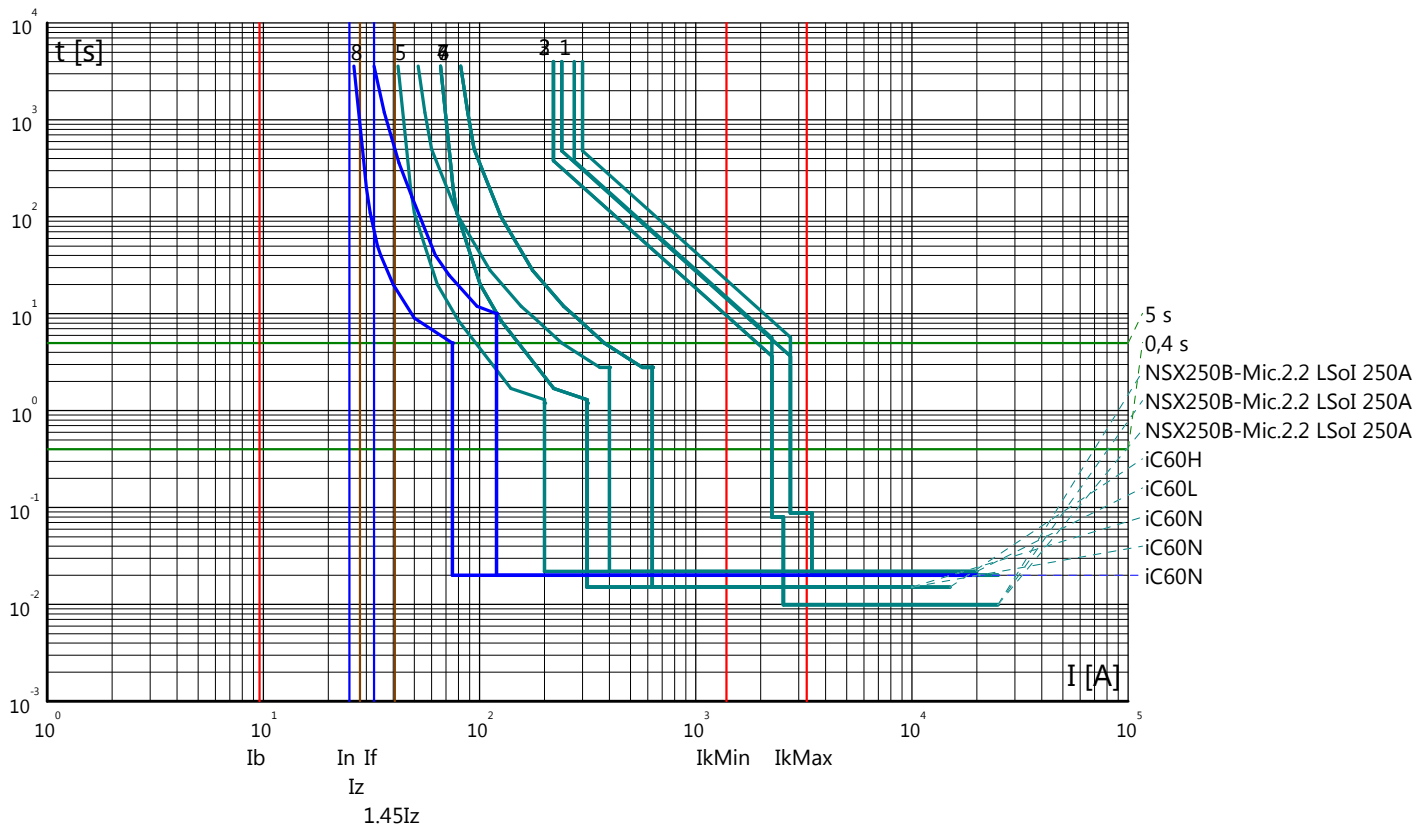

Curve tempo corrente: GALLERIA MONTE AGLIO  
 Quadro: QGBT/N

Partenza: 1.20S

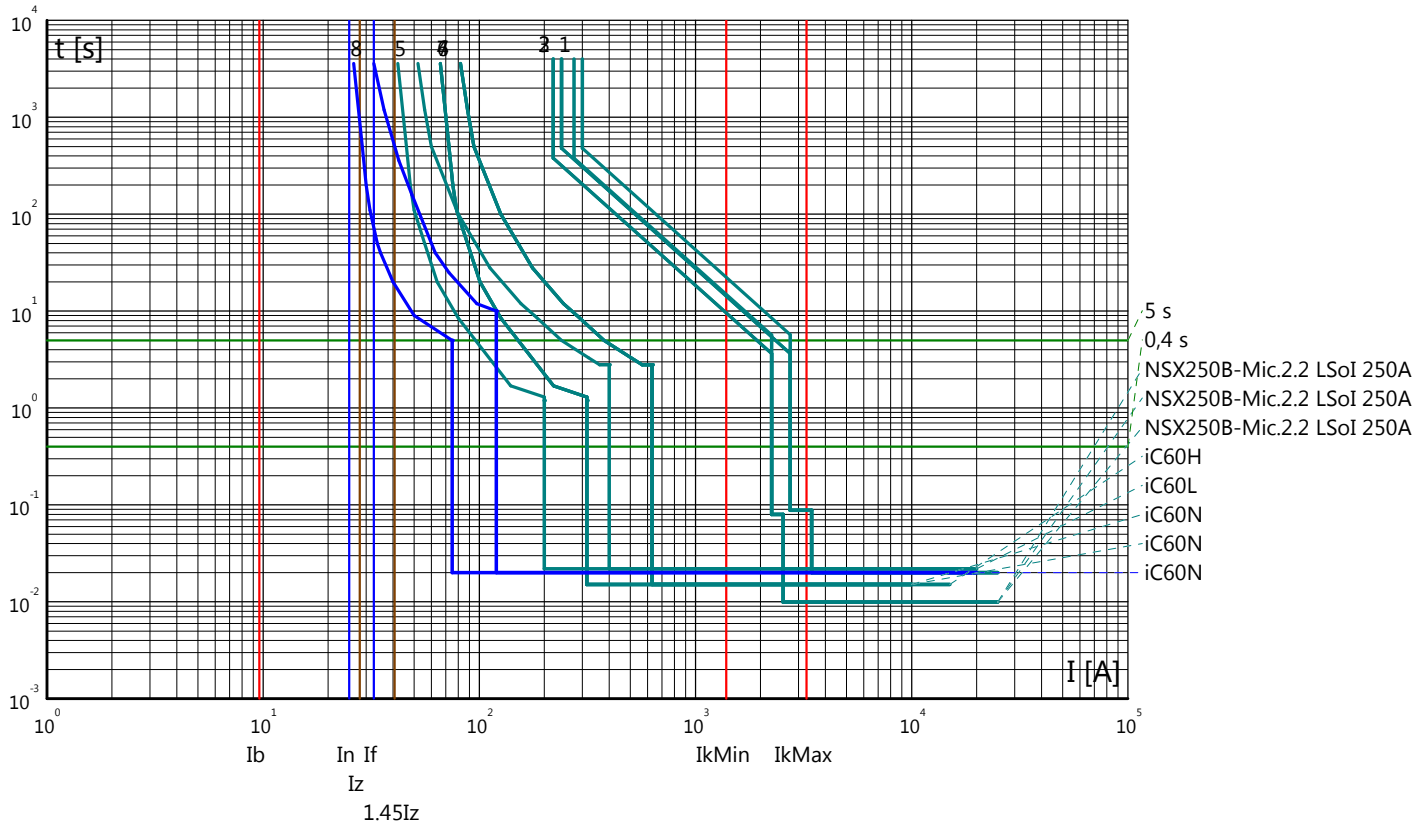

Partenza: 1.21S

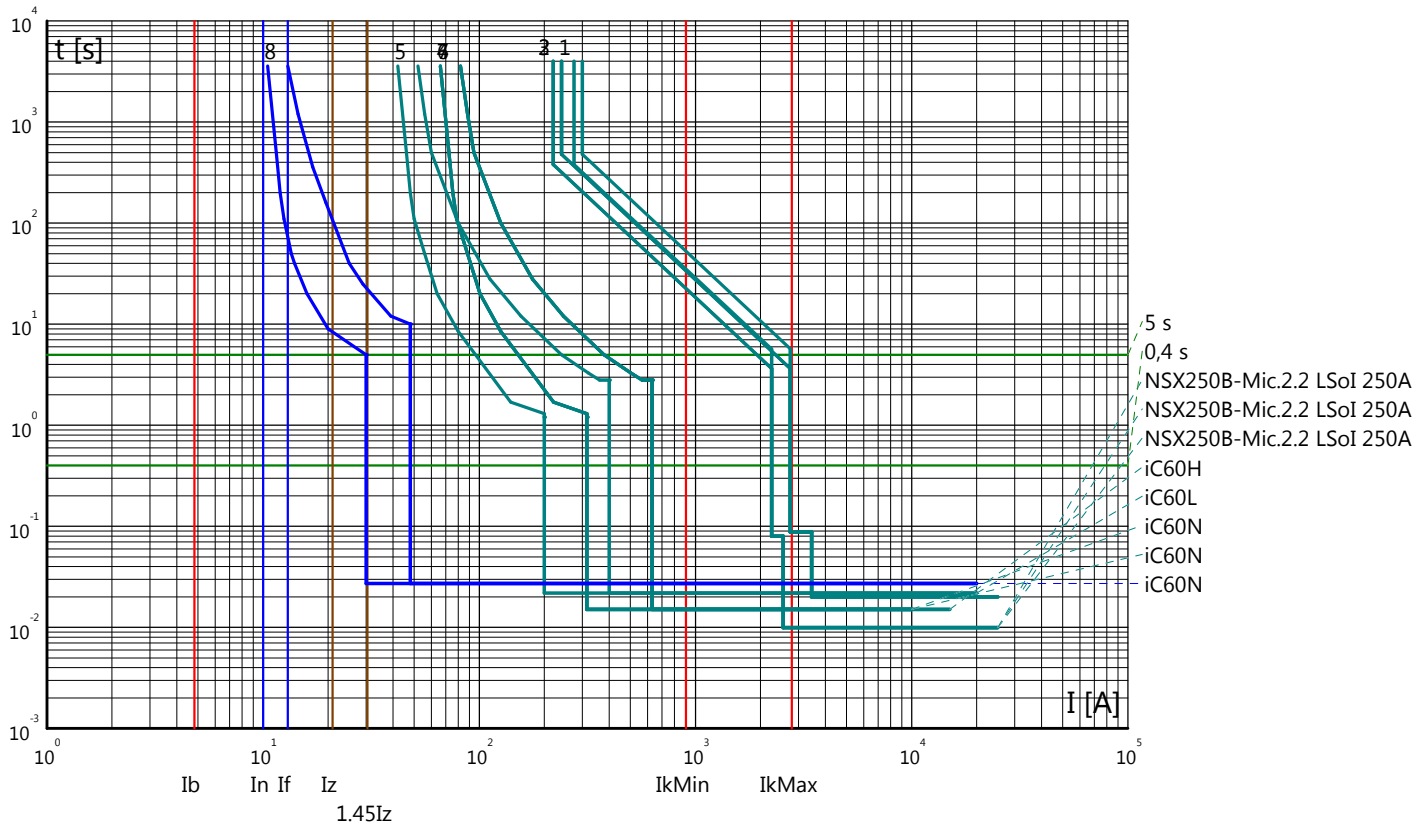

Curve tempo corrente: GALLERIA MONTE AGLIO  
 Quadro: QGBT/N

Partenza: 1.22S

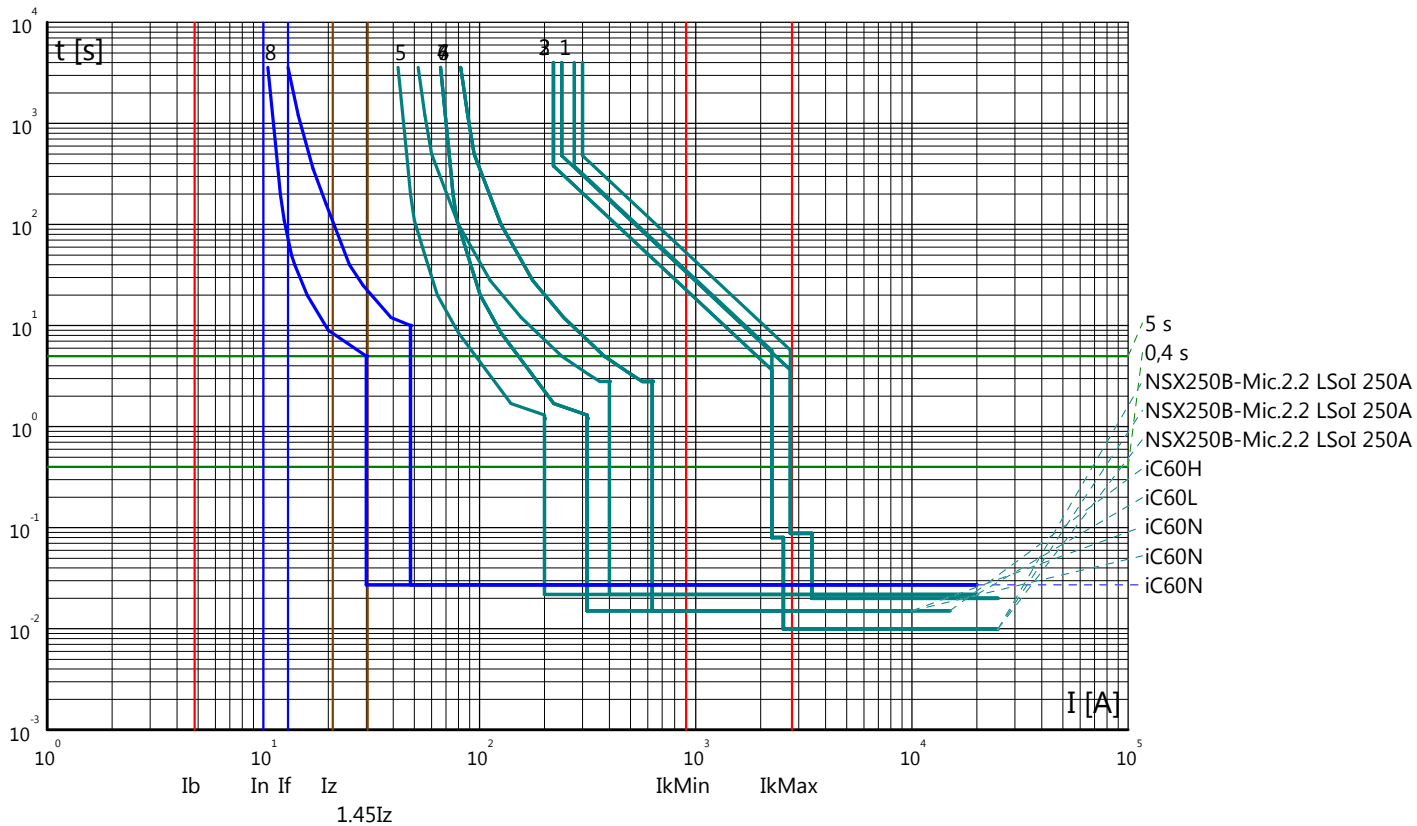

Partenza: 1.23S

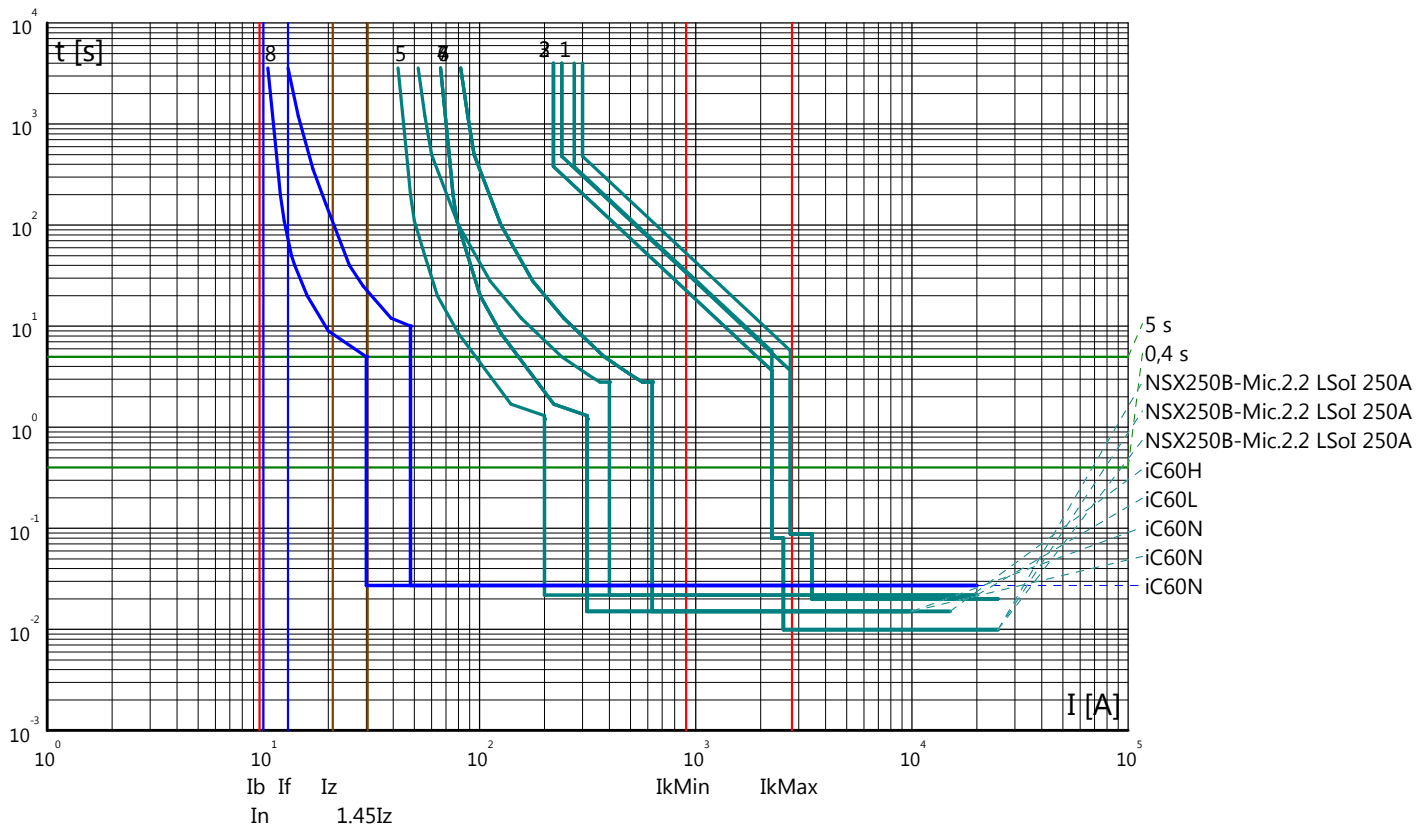

Curve tempo corrente: GALLERIA MONTE AGLIO  
 Quadro: QGBT/N

Partenza: 1.24S

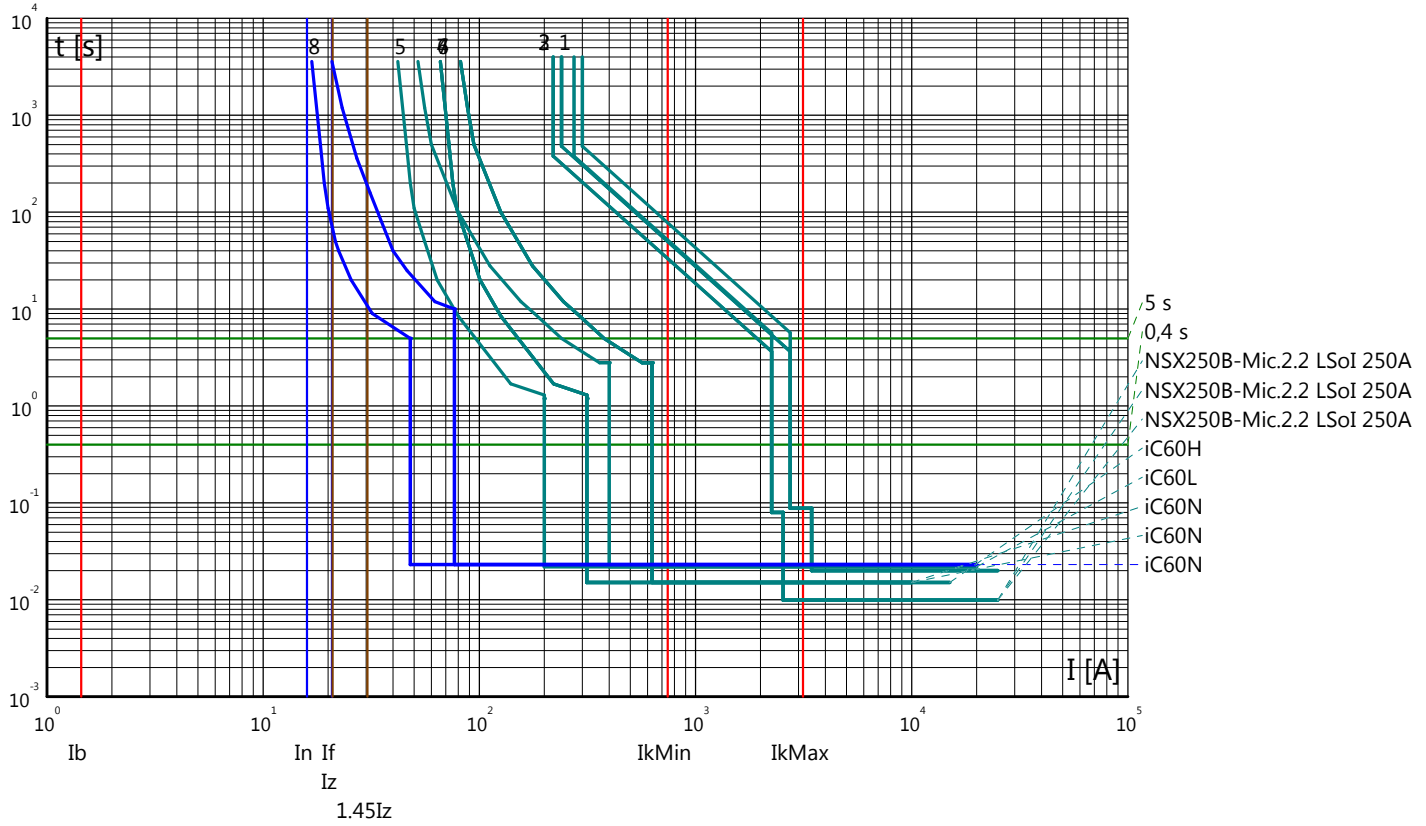

Partenza: 1.25S

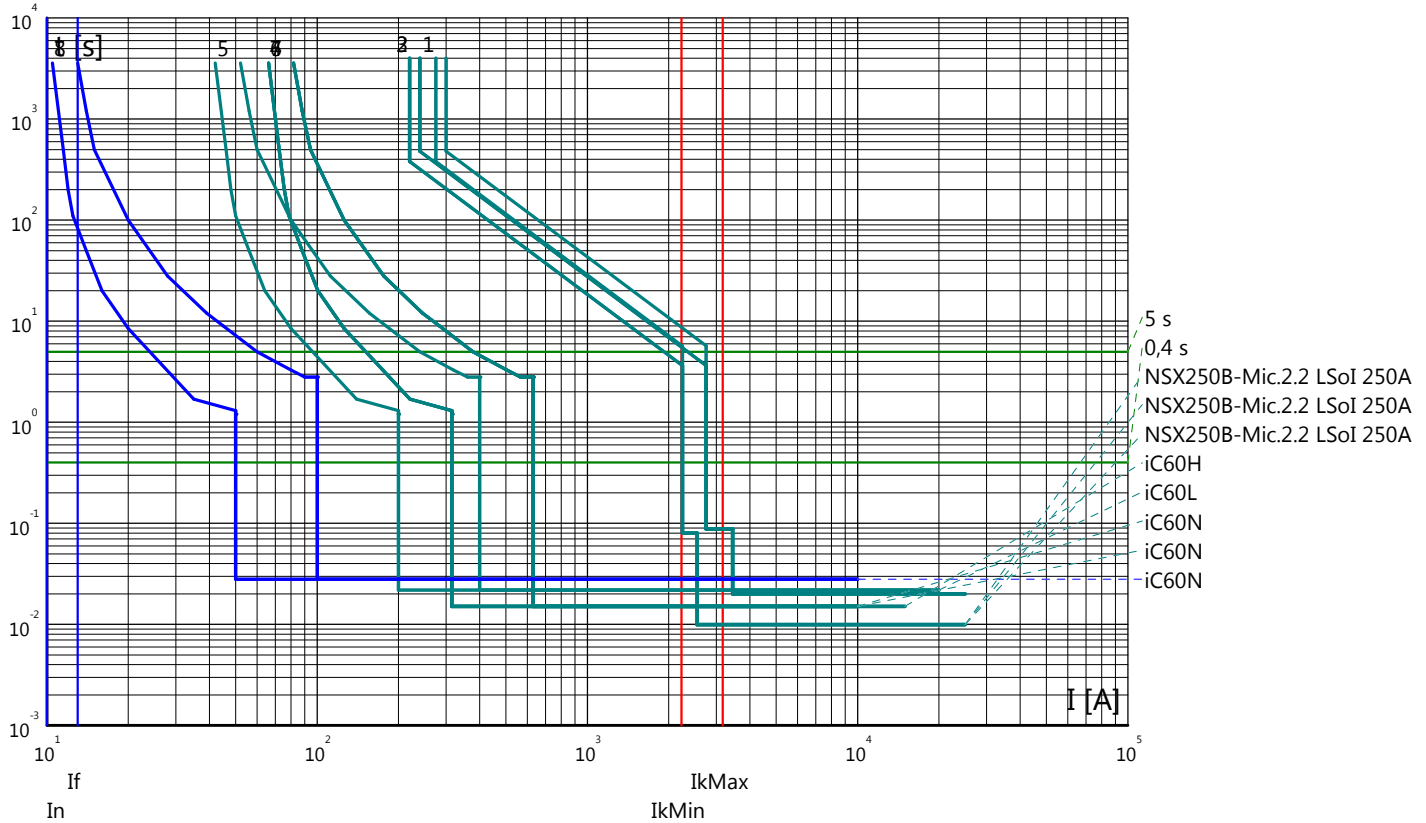

Curve tempo corrente: GALLERIA MONTE AGLIO  
 Quadro: QGBT/N

Partenza: 1.26S

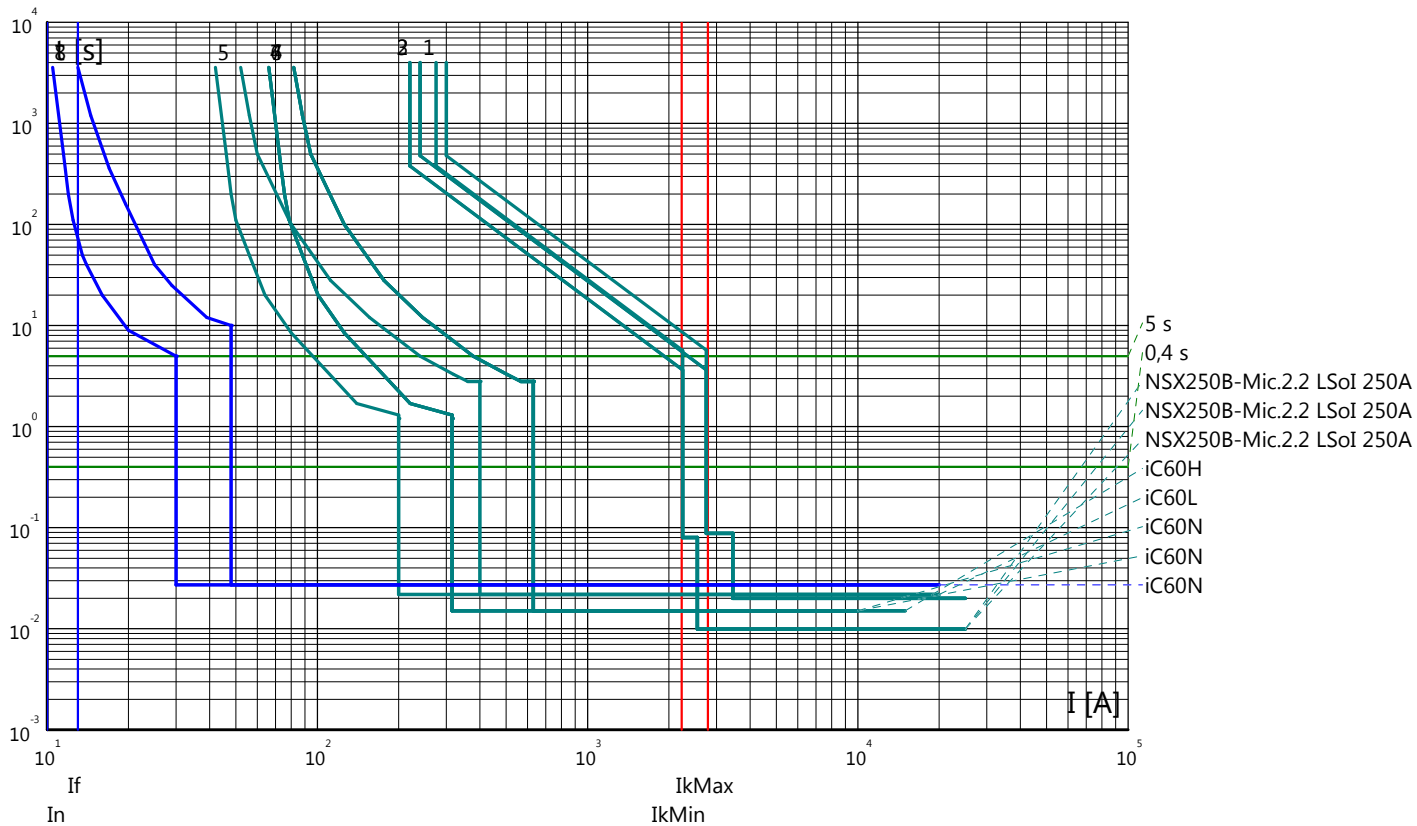

Partenza: IP1.S

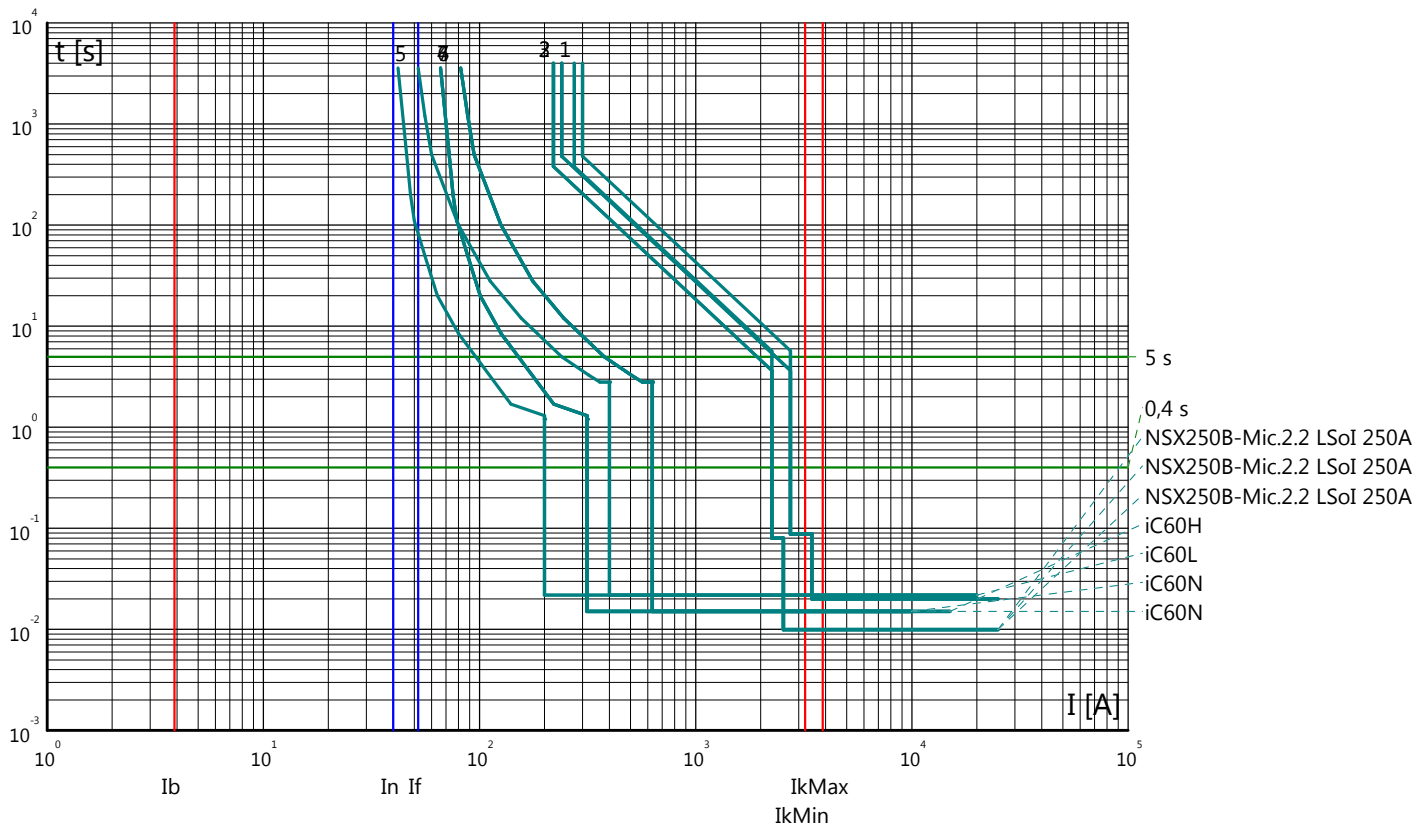

Curve tempo corrente: GALLERIA MONTE AGLIO  
 Quadro: QGBT/N

Partenza: 1.27S

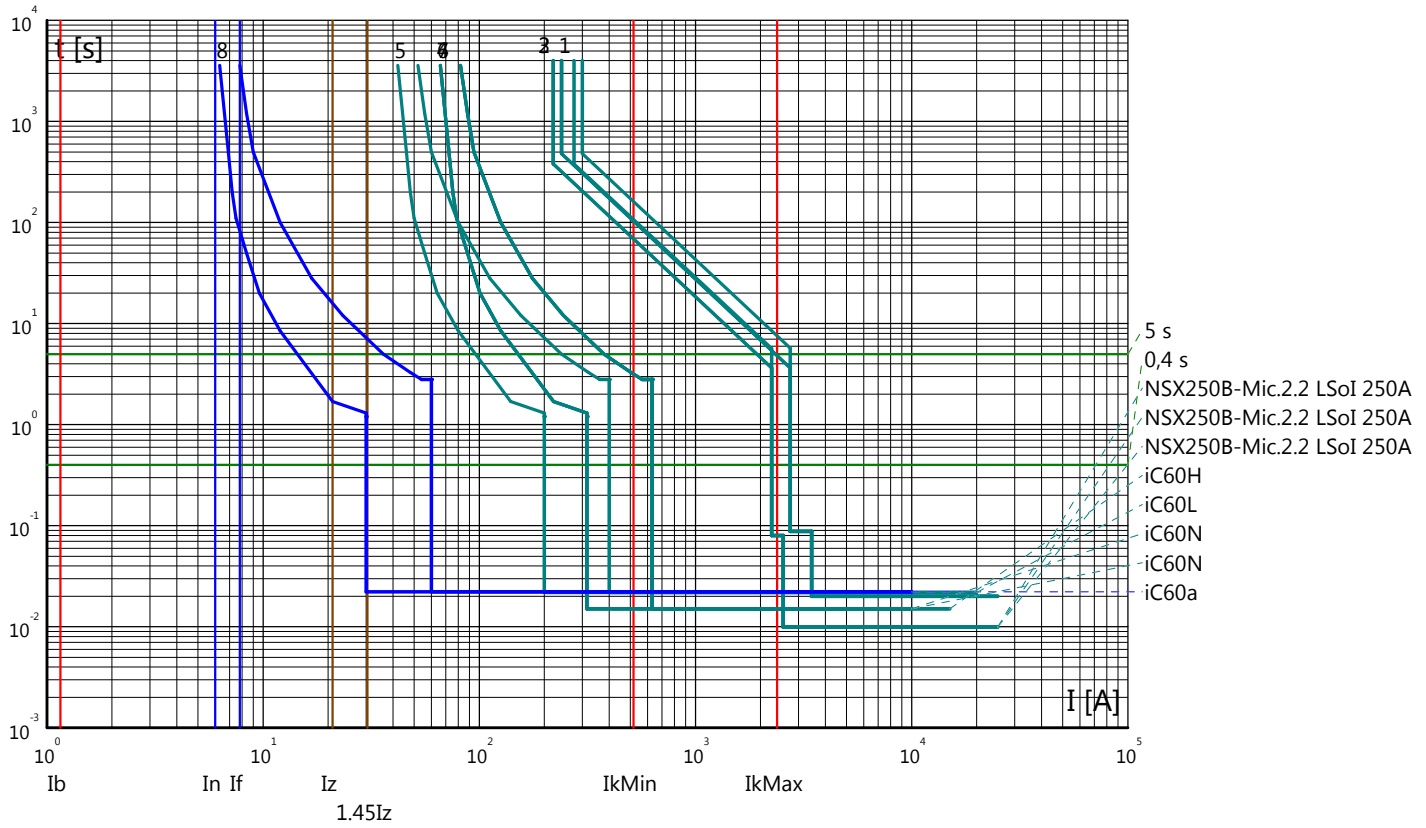

Partenza: 1.28S

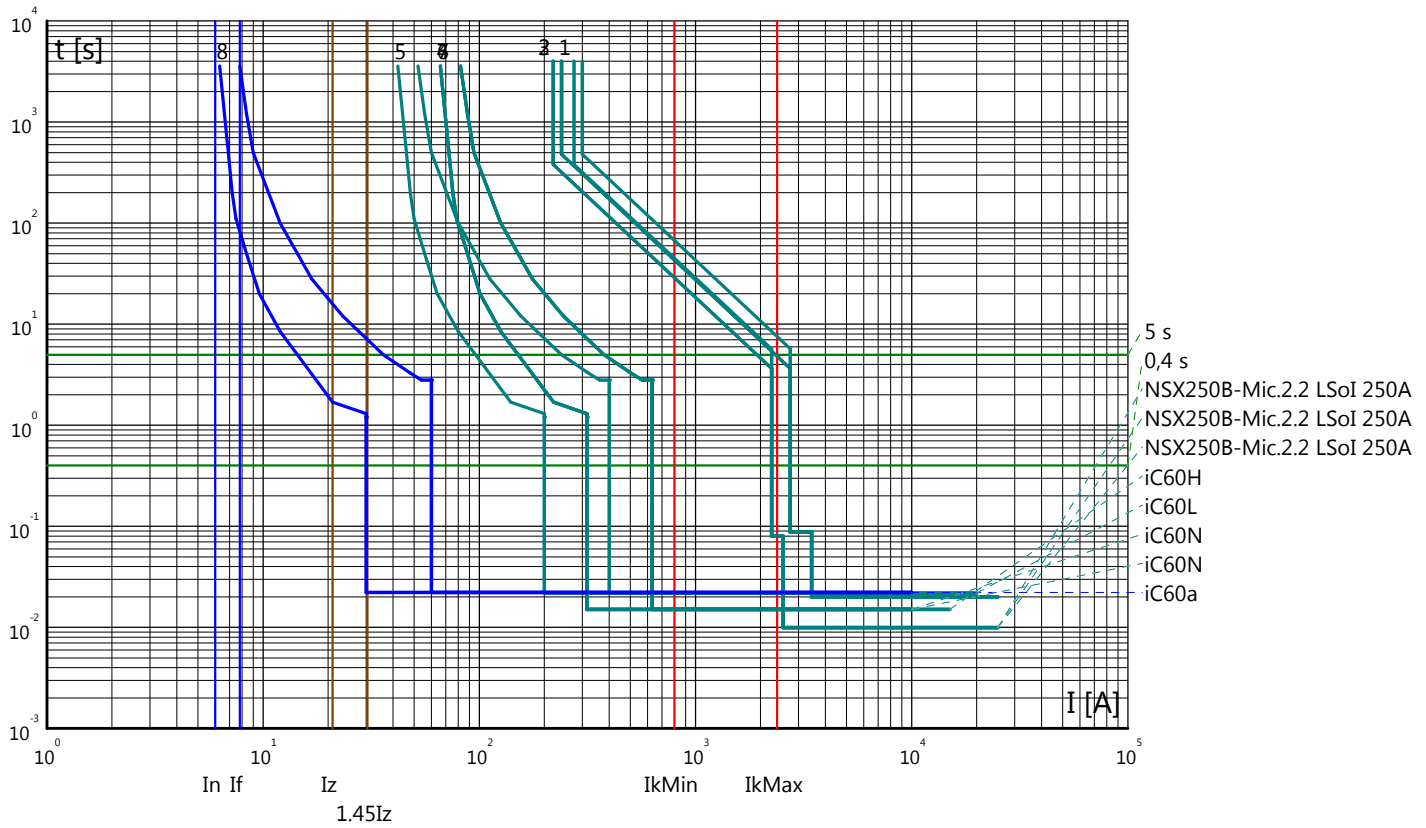



Curve tempo corrente: GALLERIA MONTE AGLIO  
 Quadro: QGBT/N

Partenza: 1.29S

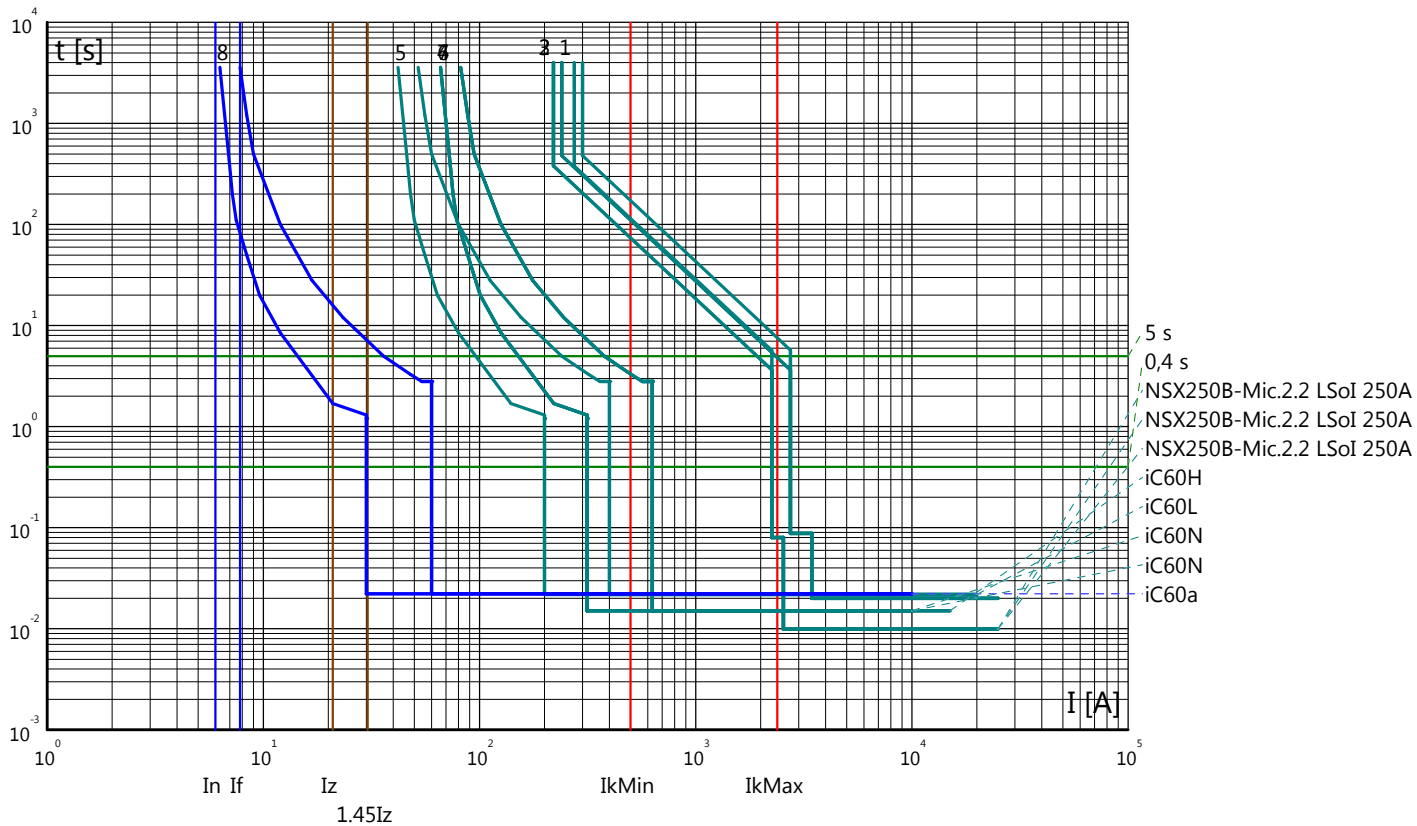

Partenza: 1.30S

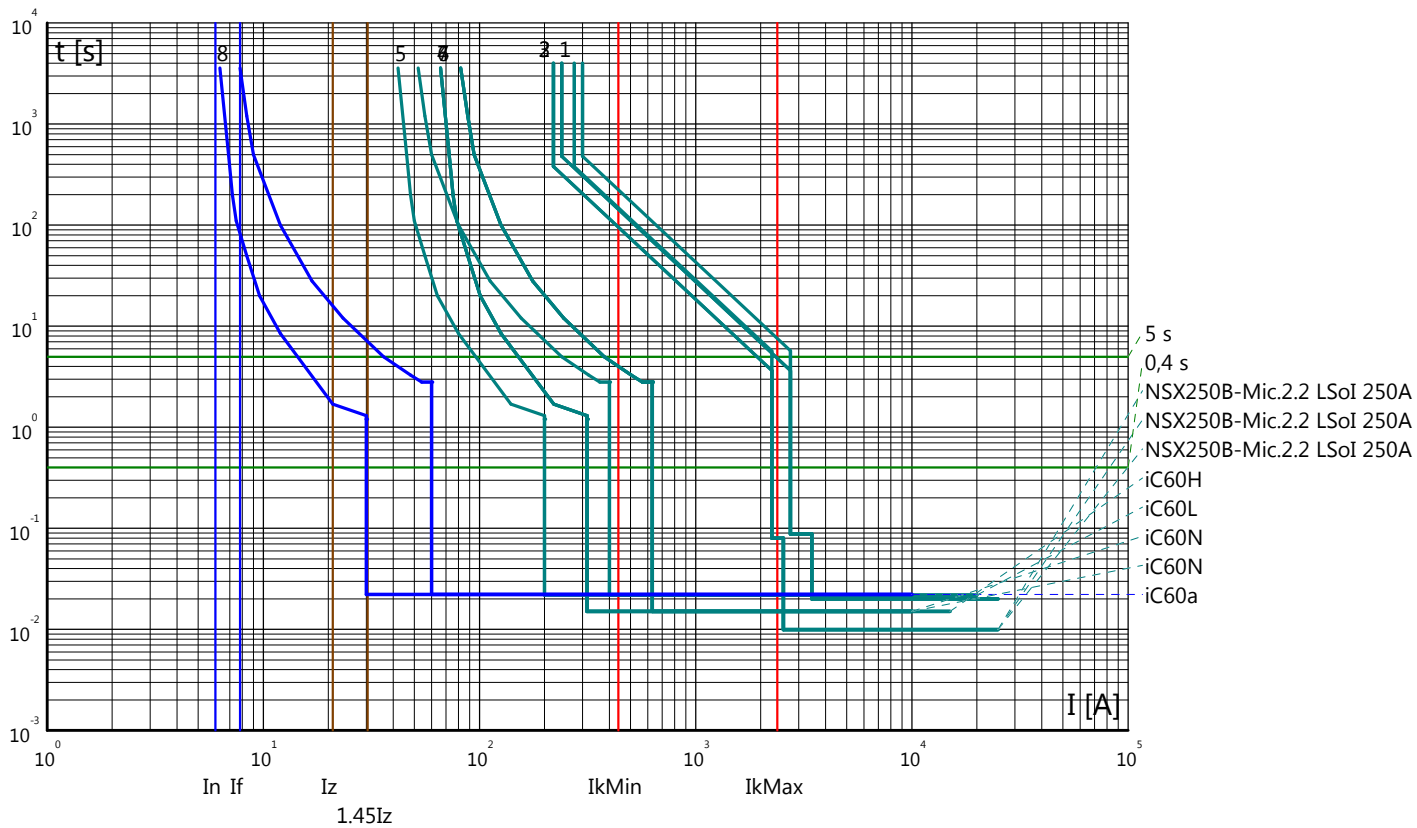

Curve tempo corrente: GALLERIA MONTE AGLIO  
 Quadro: QGBT/N

Partenza: 1.31S

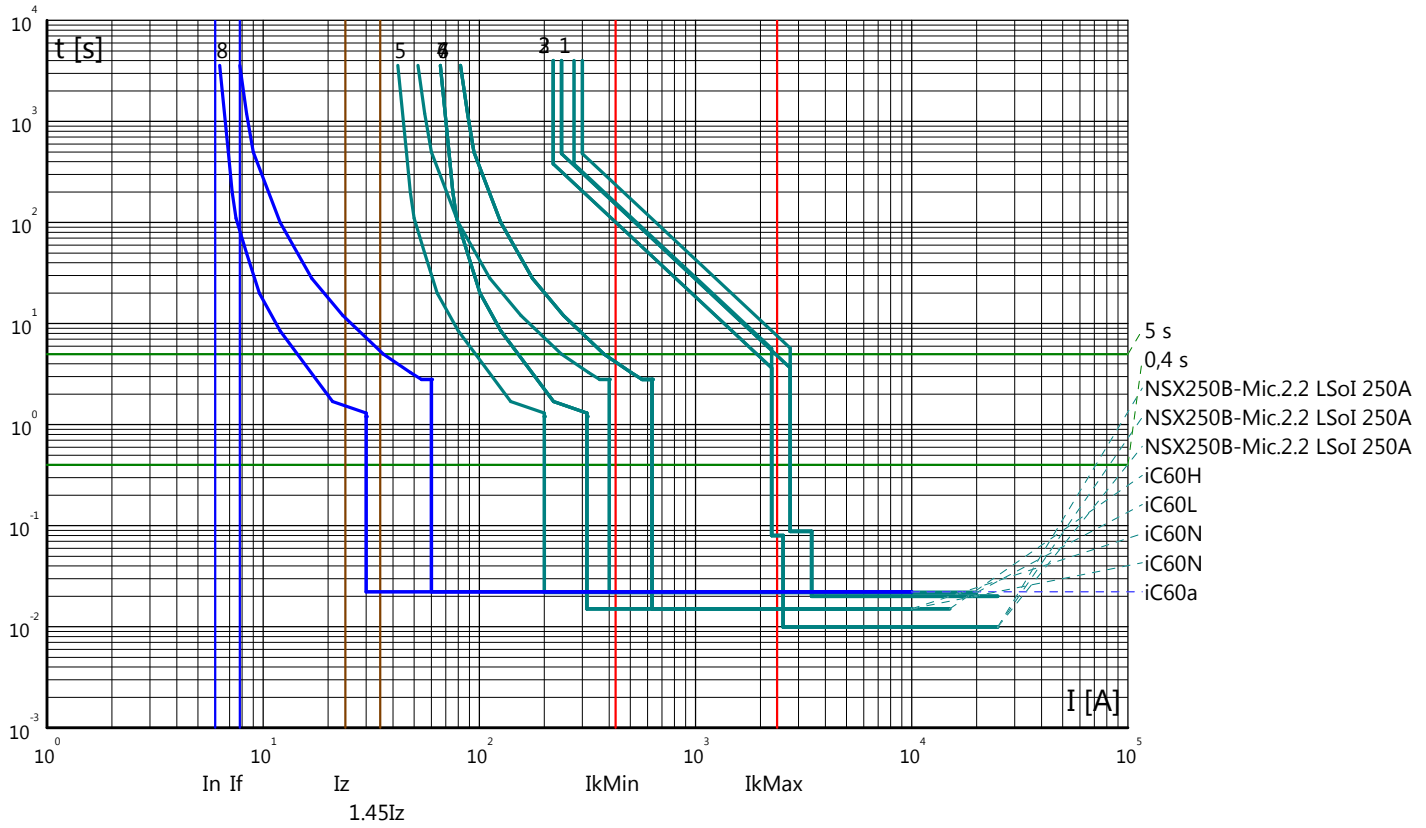

Partenza: 1.32S

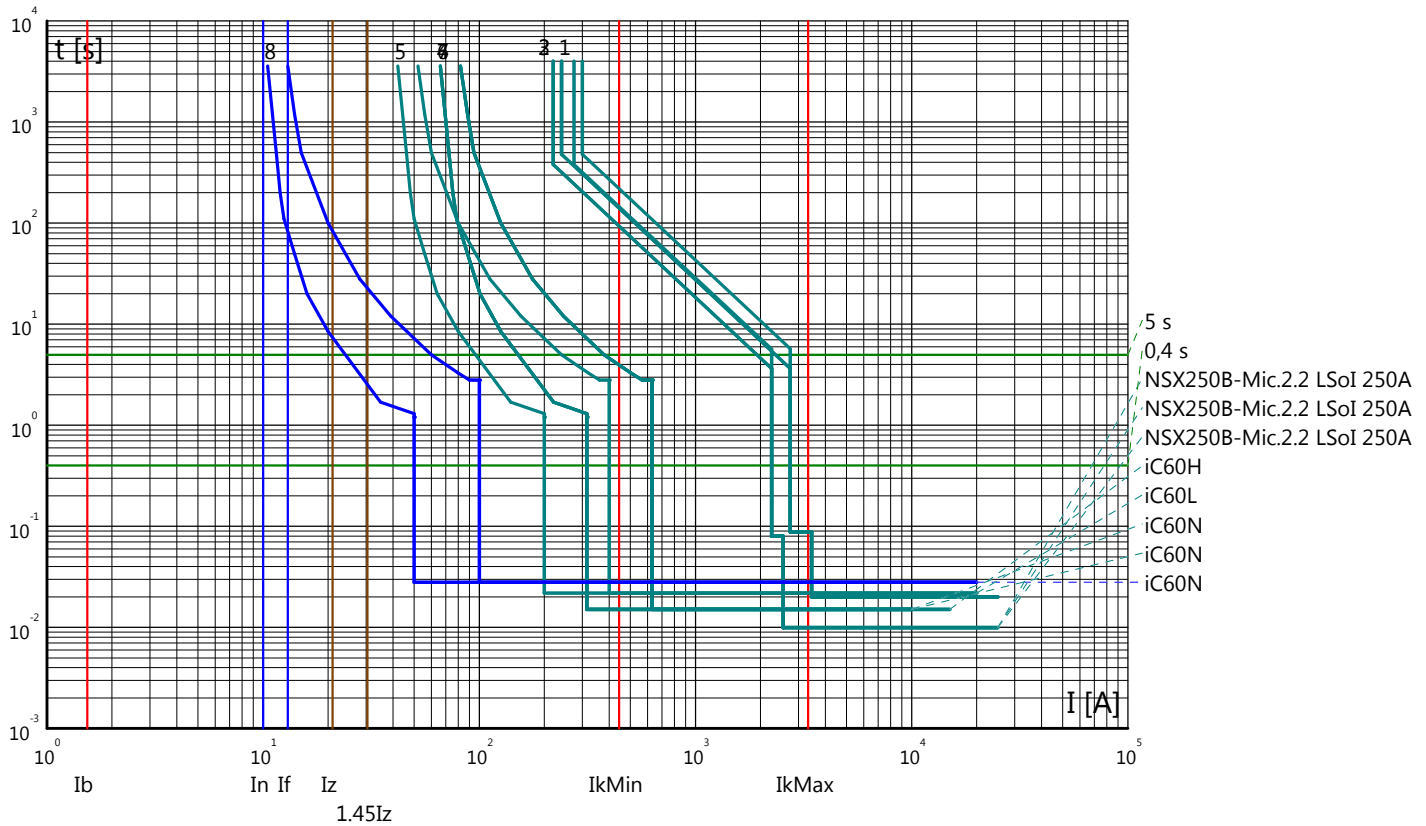

Curve tempo corrente: GALLERIA MONTE AGLIO  
 Quadro: QGBT/N

Partenza: 1.33S

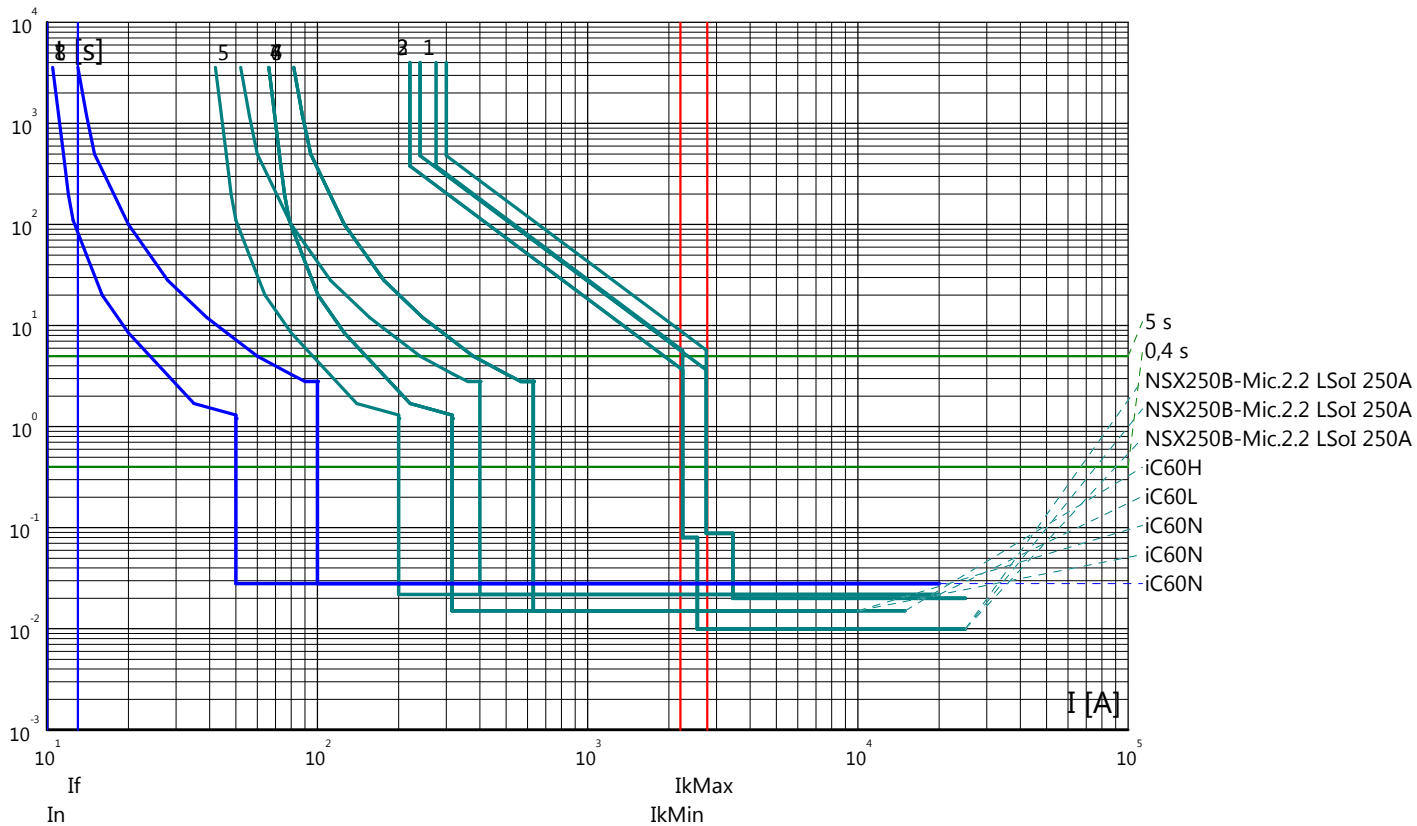

Partenza: 1.34S

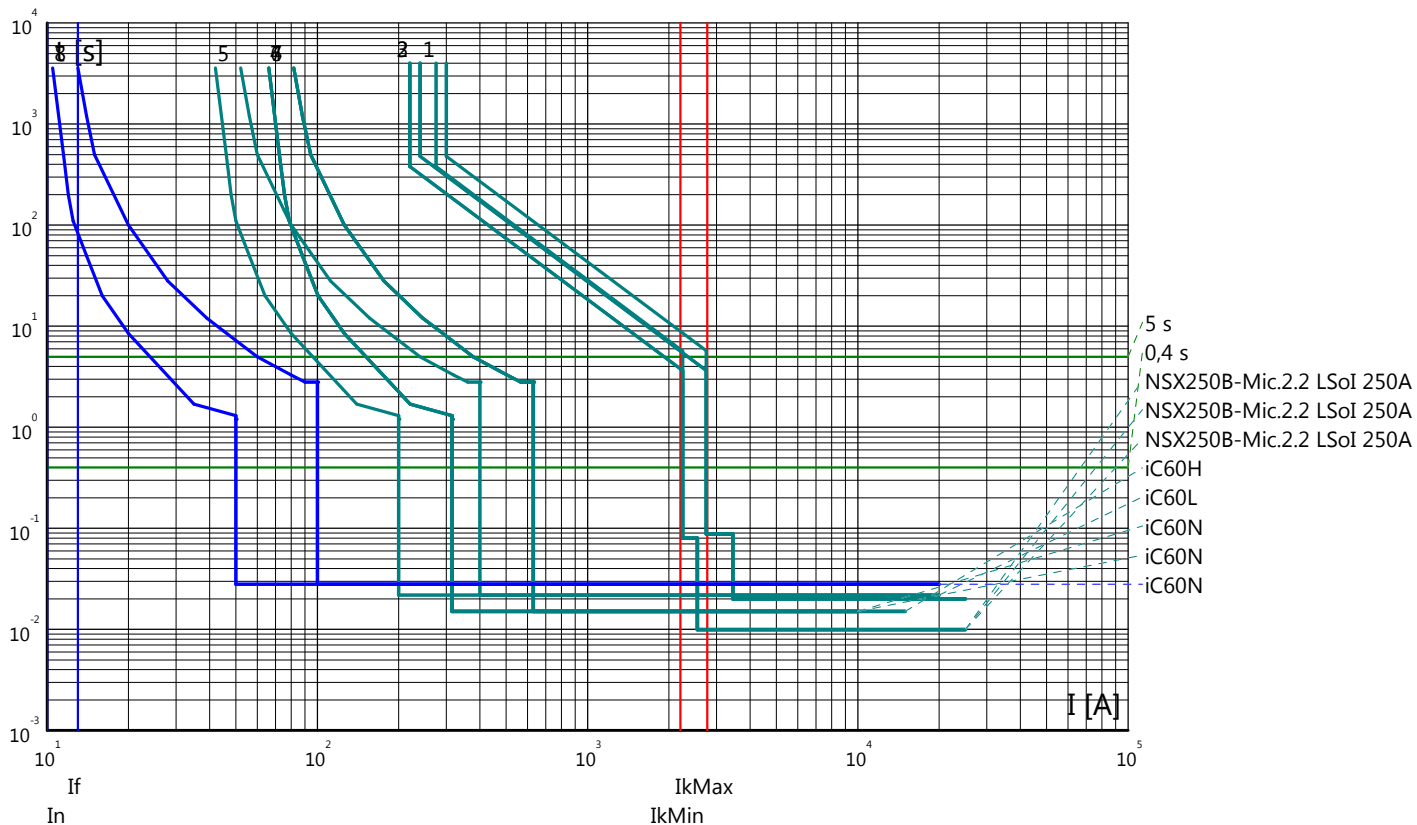

Curve tempo corrente: GALLERIA MONTE AGLIO  
 Quadro: QGBT/N

Partenza: 1.35S

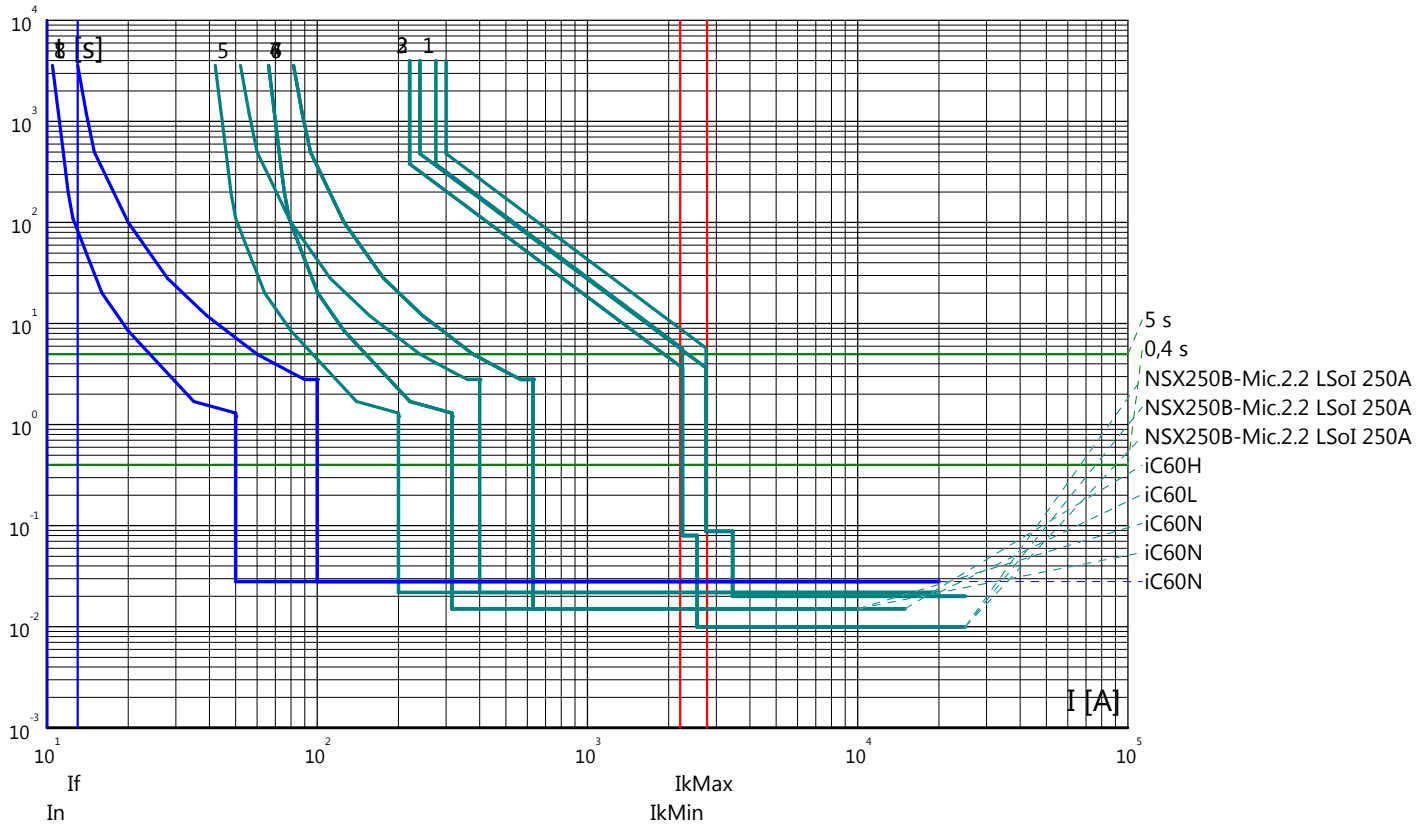

Partenza: 1.36S

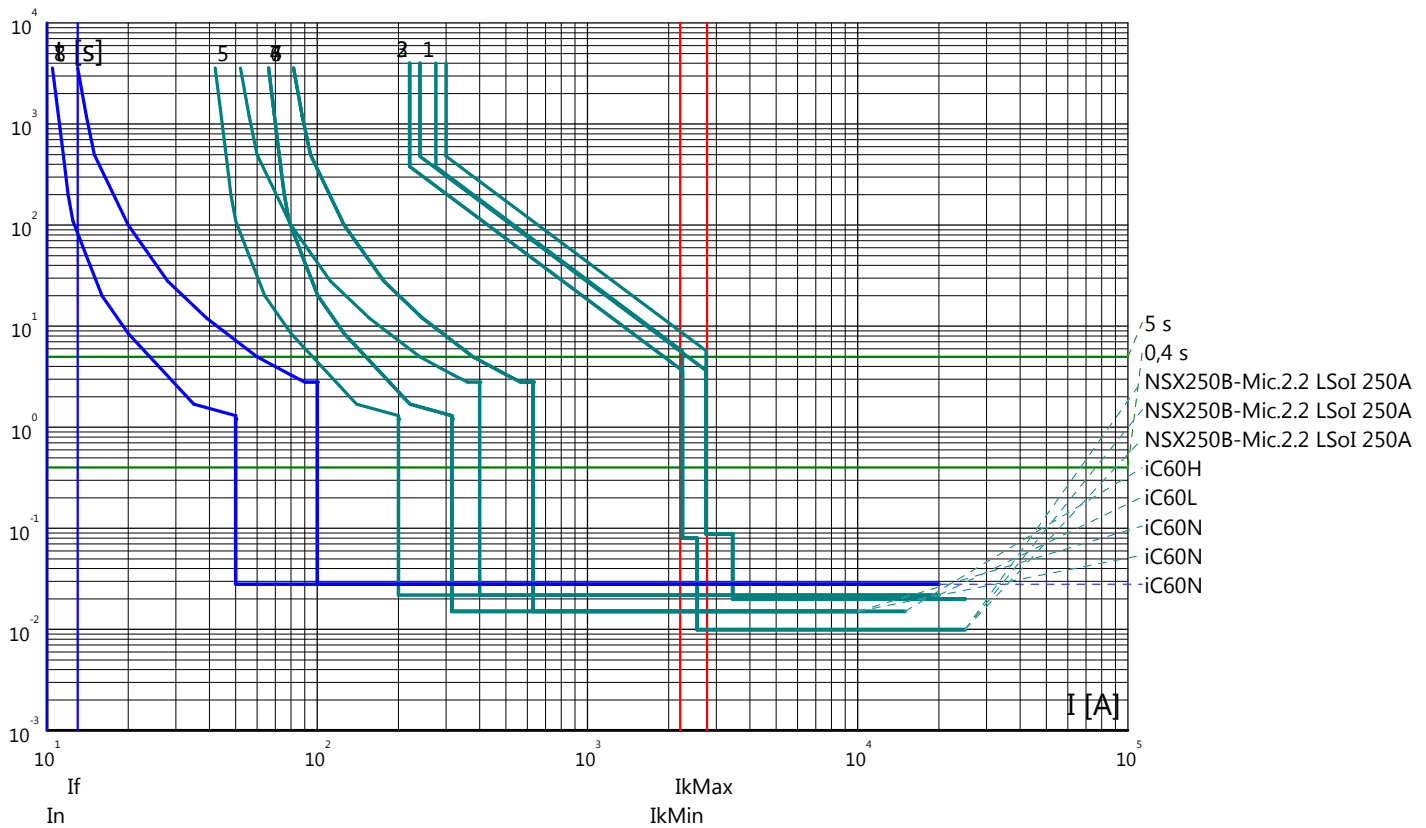

Curve tempo corrente: GALLERIA MONTE AGLIO  
 Quadro: QCE/N

Arrivo: IG

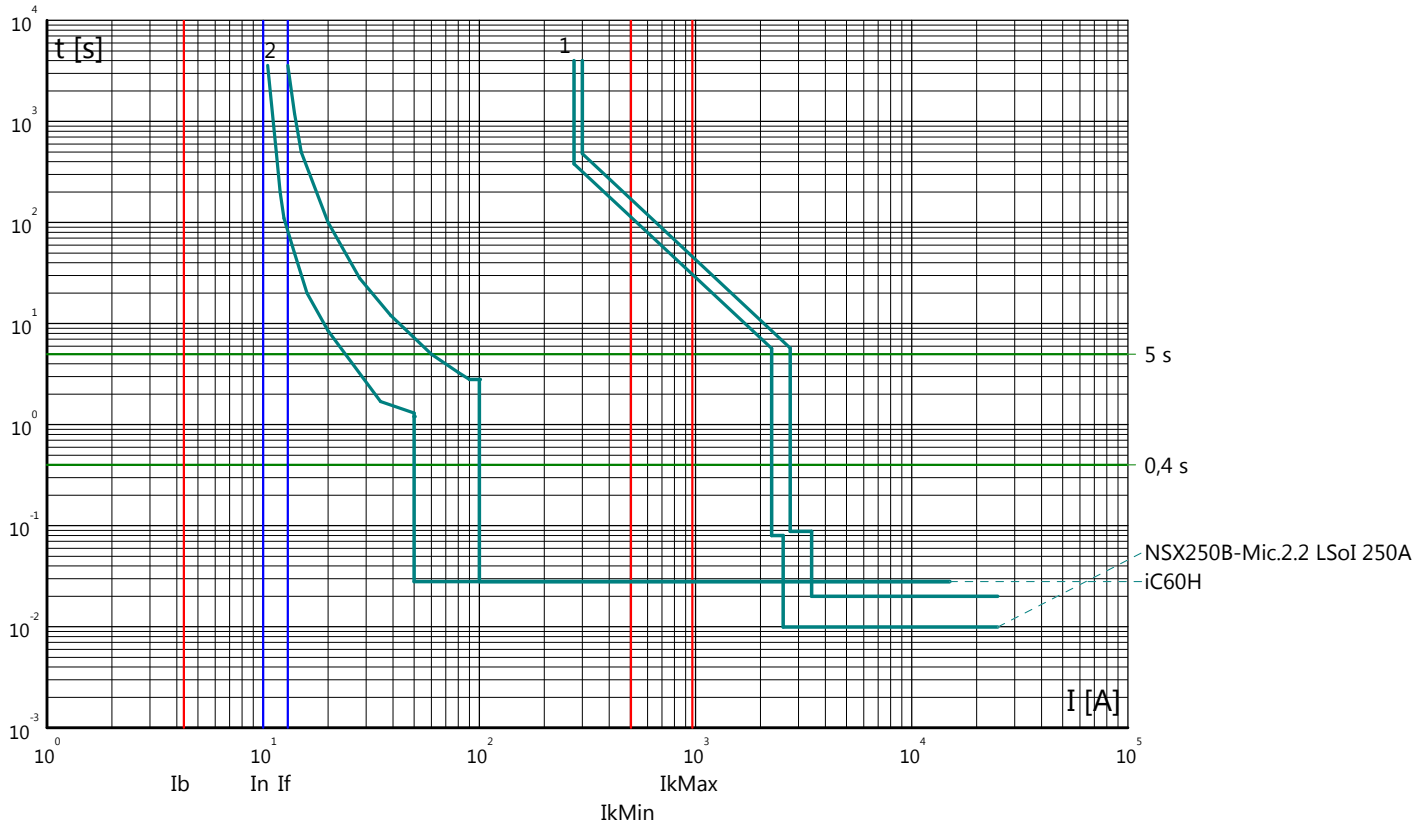

Partenza: PT/N

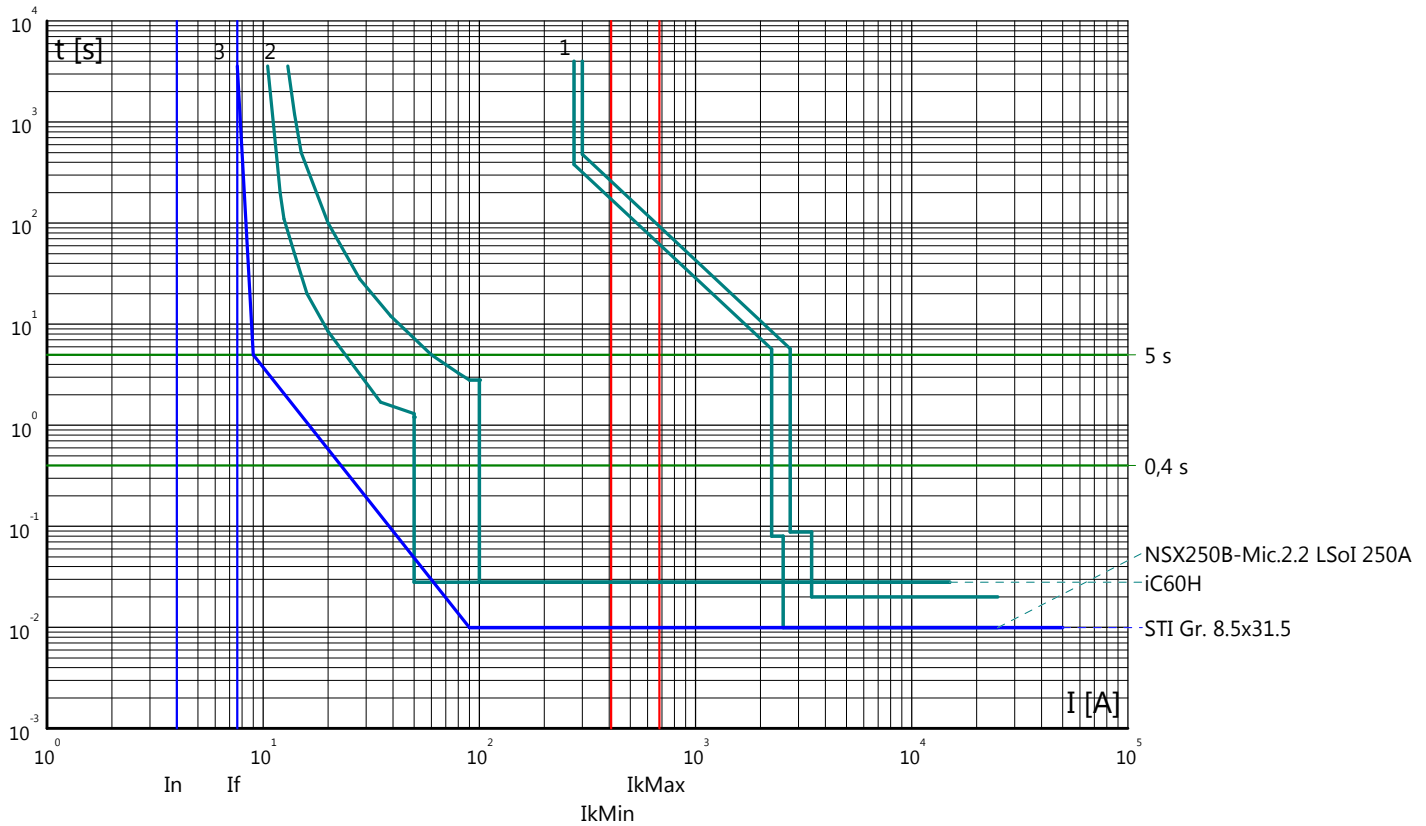

Curve tempo corrente: GALLERIA MONTE AGLIO  
 Quadro: QCE/N

Partenza: 1.3N.1

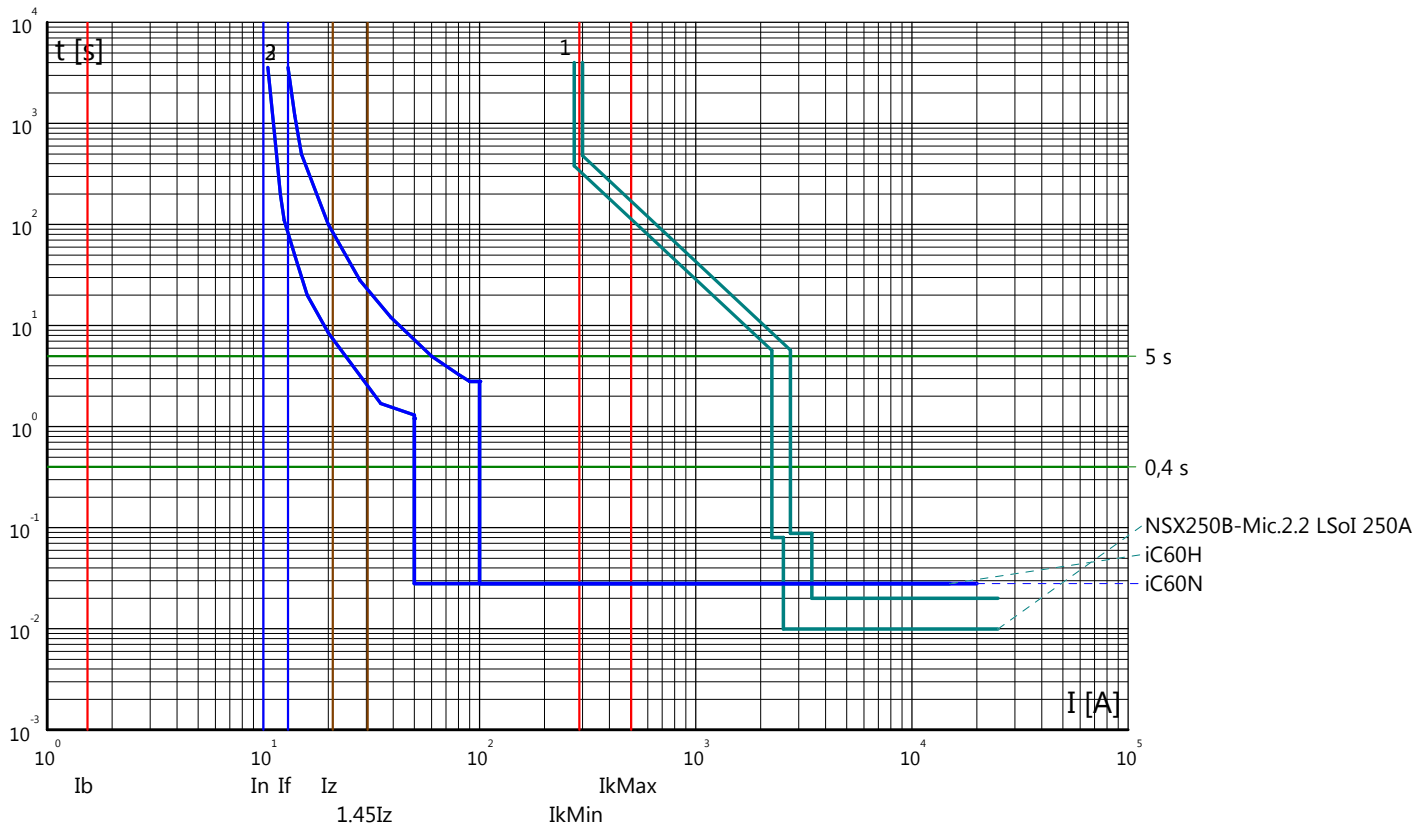

Partenza: 1.3N.2

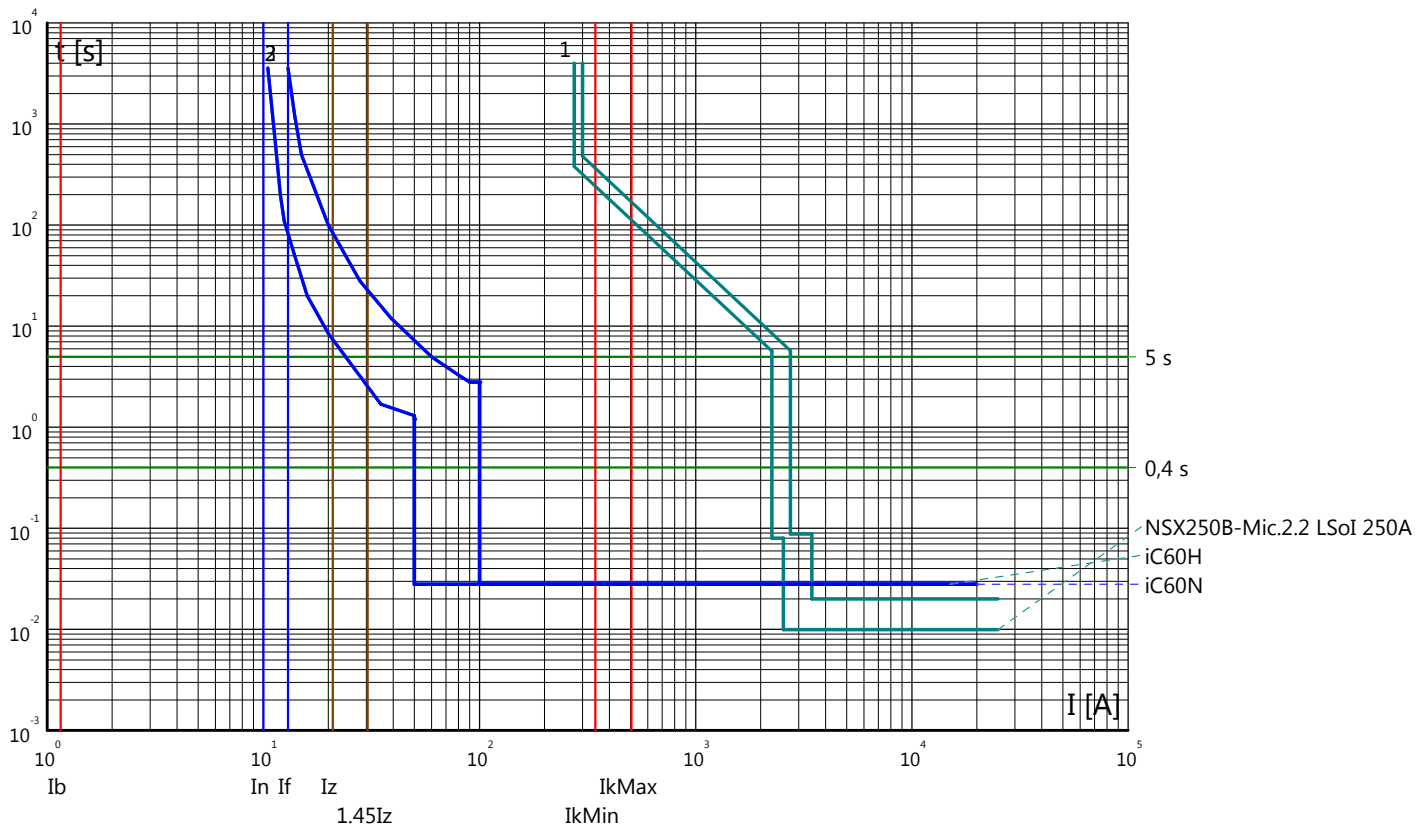

Curve tempo corrente: GALLERIA MONTE AGLIO  
 Quadro: QCE/N

Partenza: 1.3N.3

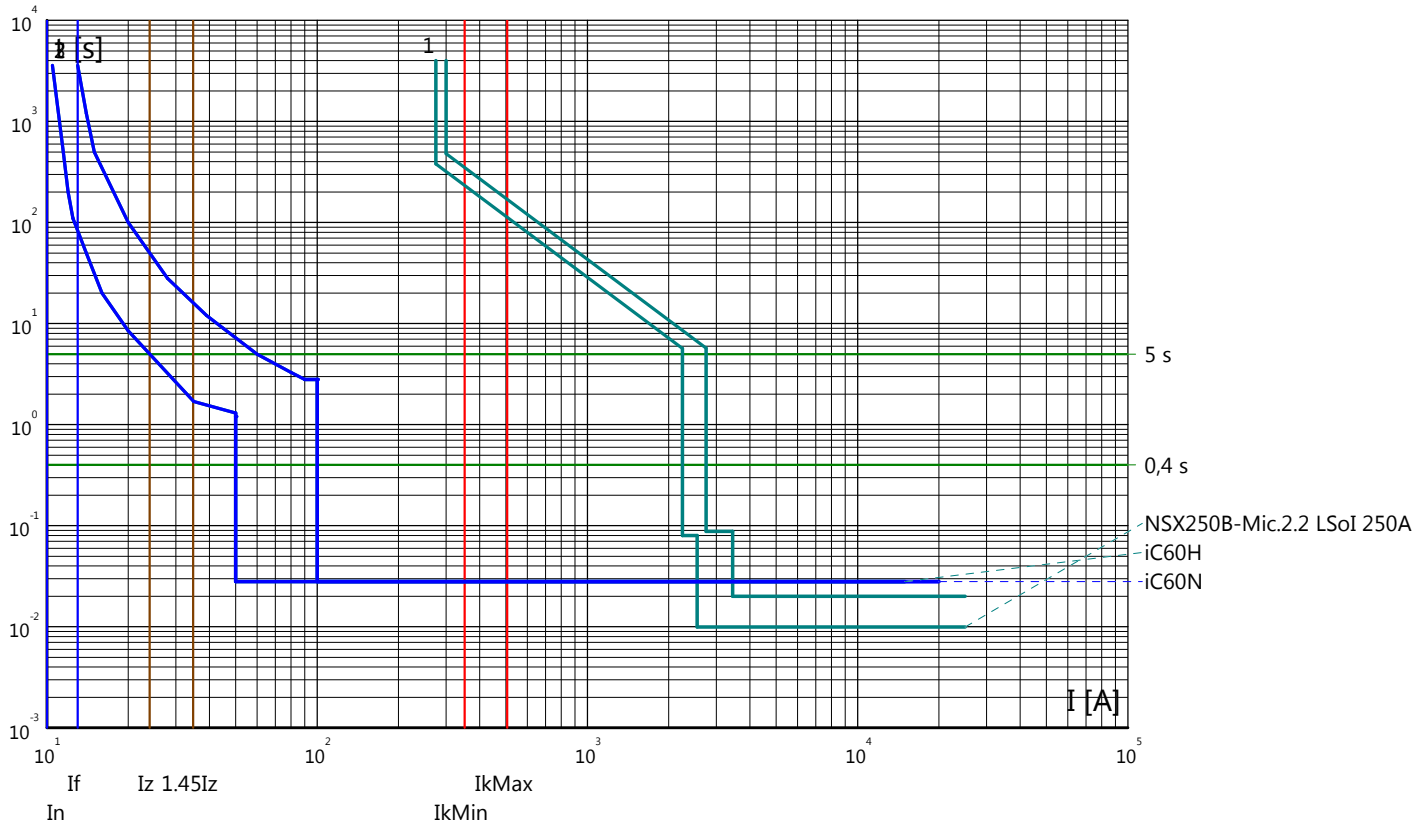

Partenza: 1.3N.4

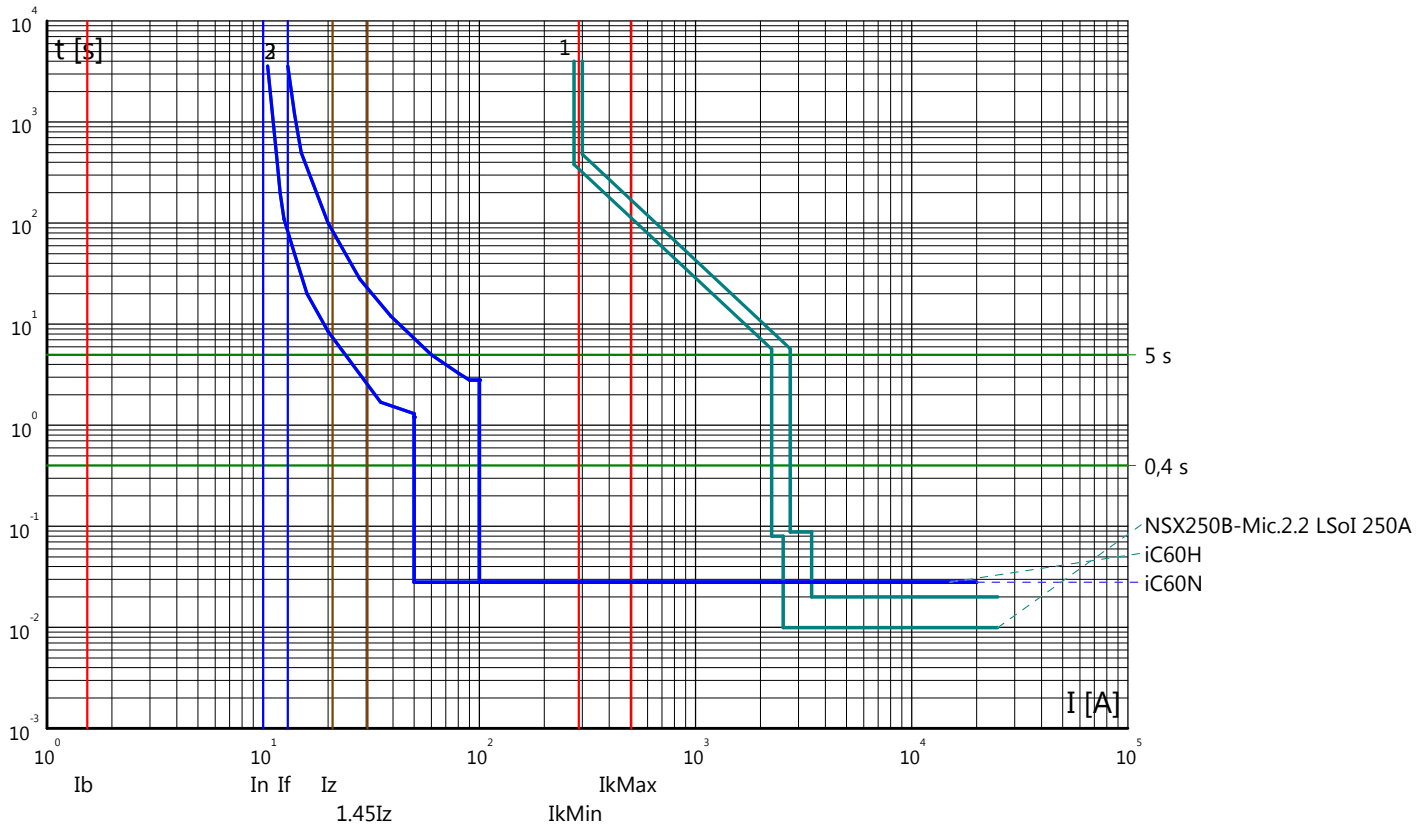

Curve tempo corrente: GALLERIA MONTE AGLIO  
 Quadro: QCE/N

Partenza: 1.3N.5

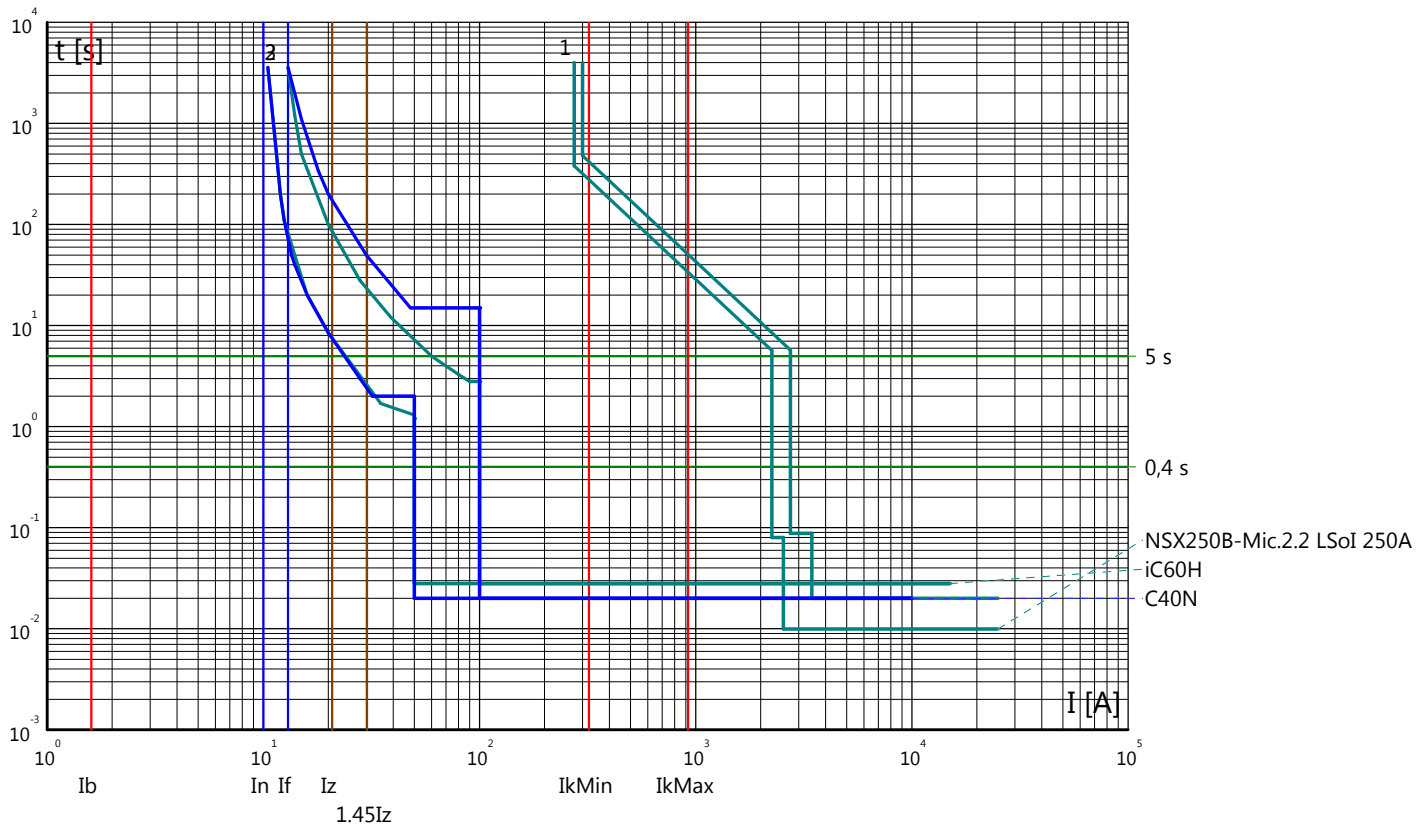

Partenza: 1.3N.6

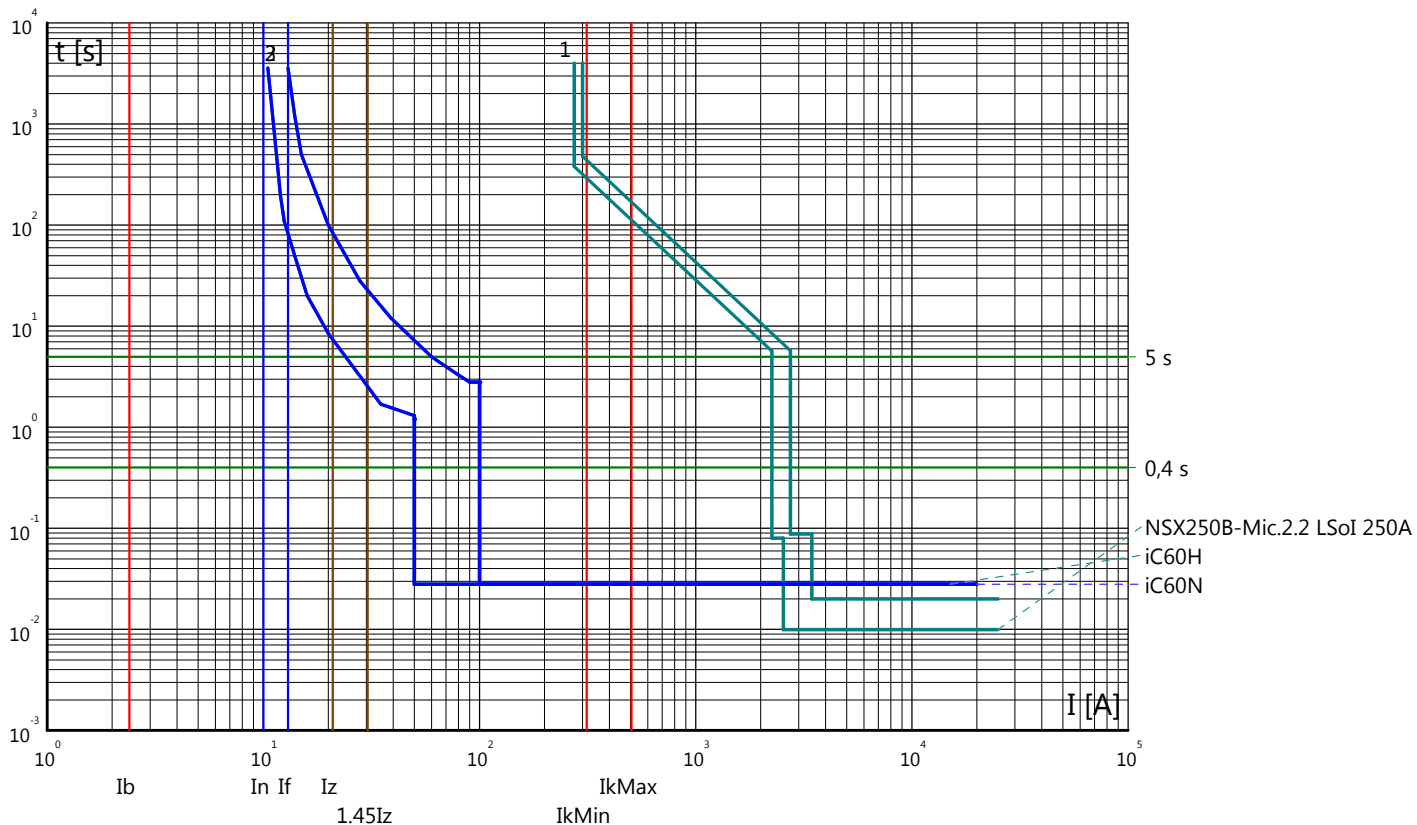



Curve tempo corrente: GALLERIA MONTE AGLIO  
 Quadro: QCE/N

Partenza: 1.3N.7

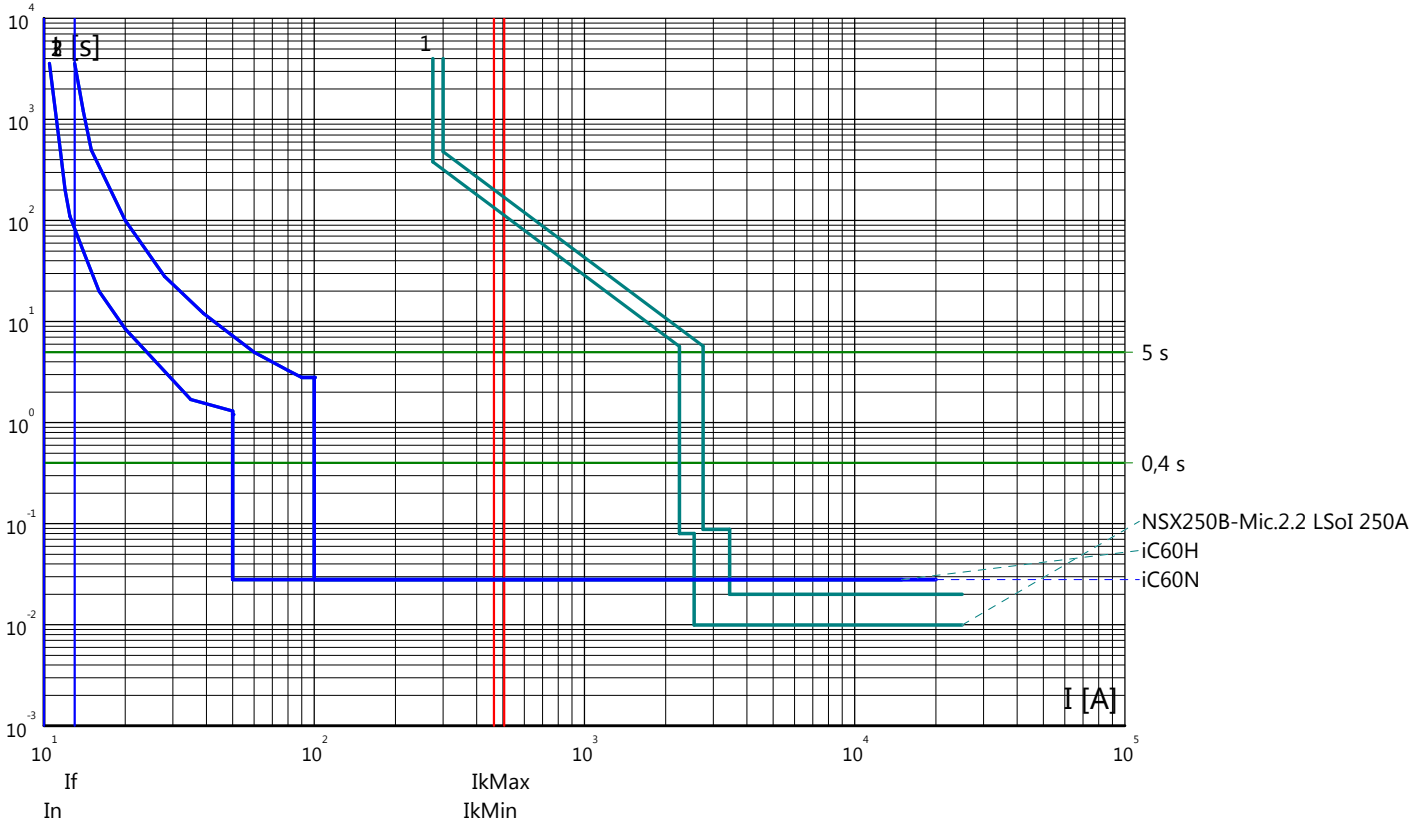

Partenza: 1.3N.8

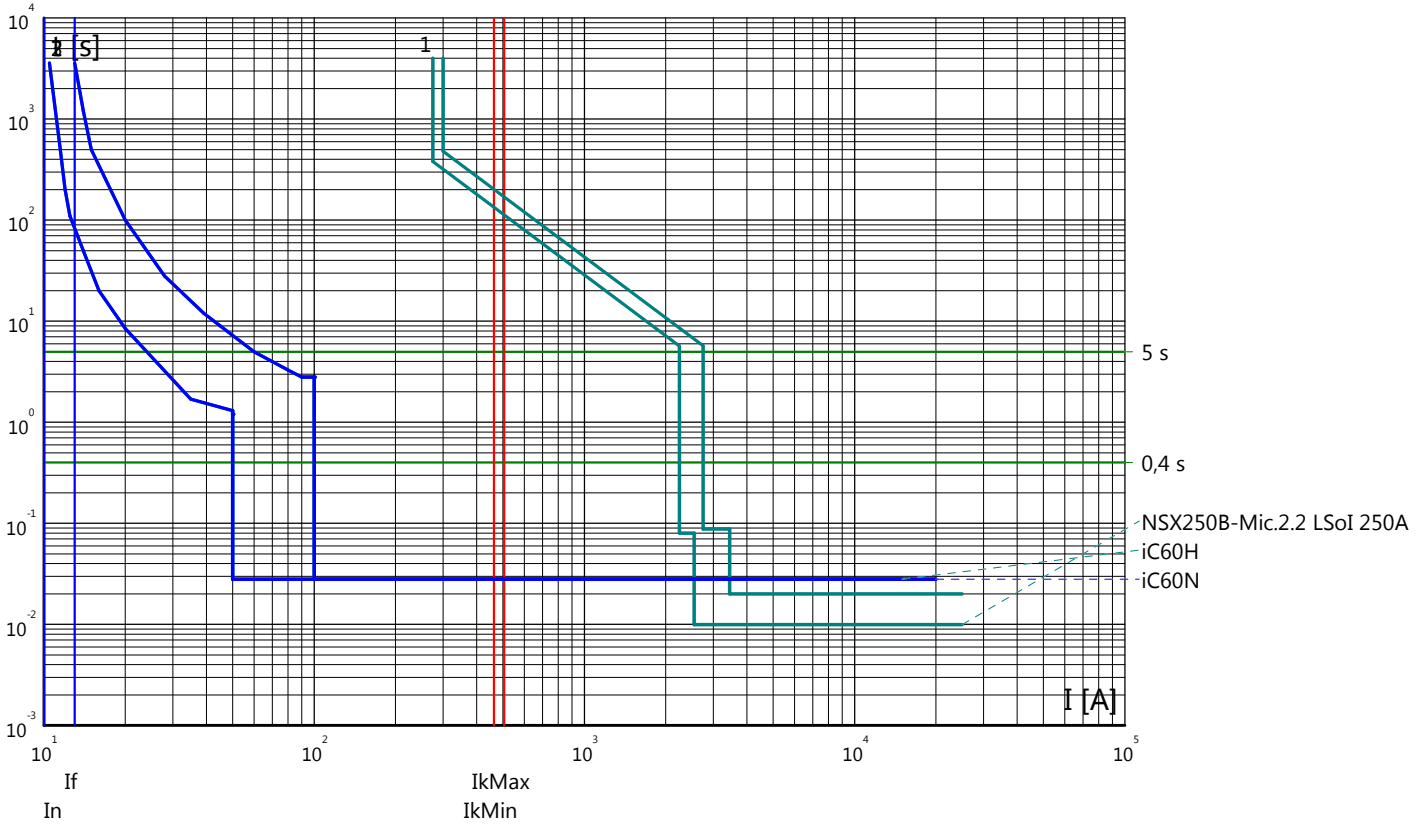

Curve tempo corrente: GALLERIA MONTE AGLIO  
 Quadro: QCE/N

Arrivo: IG/S

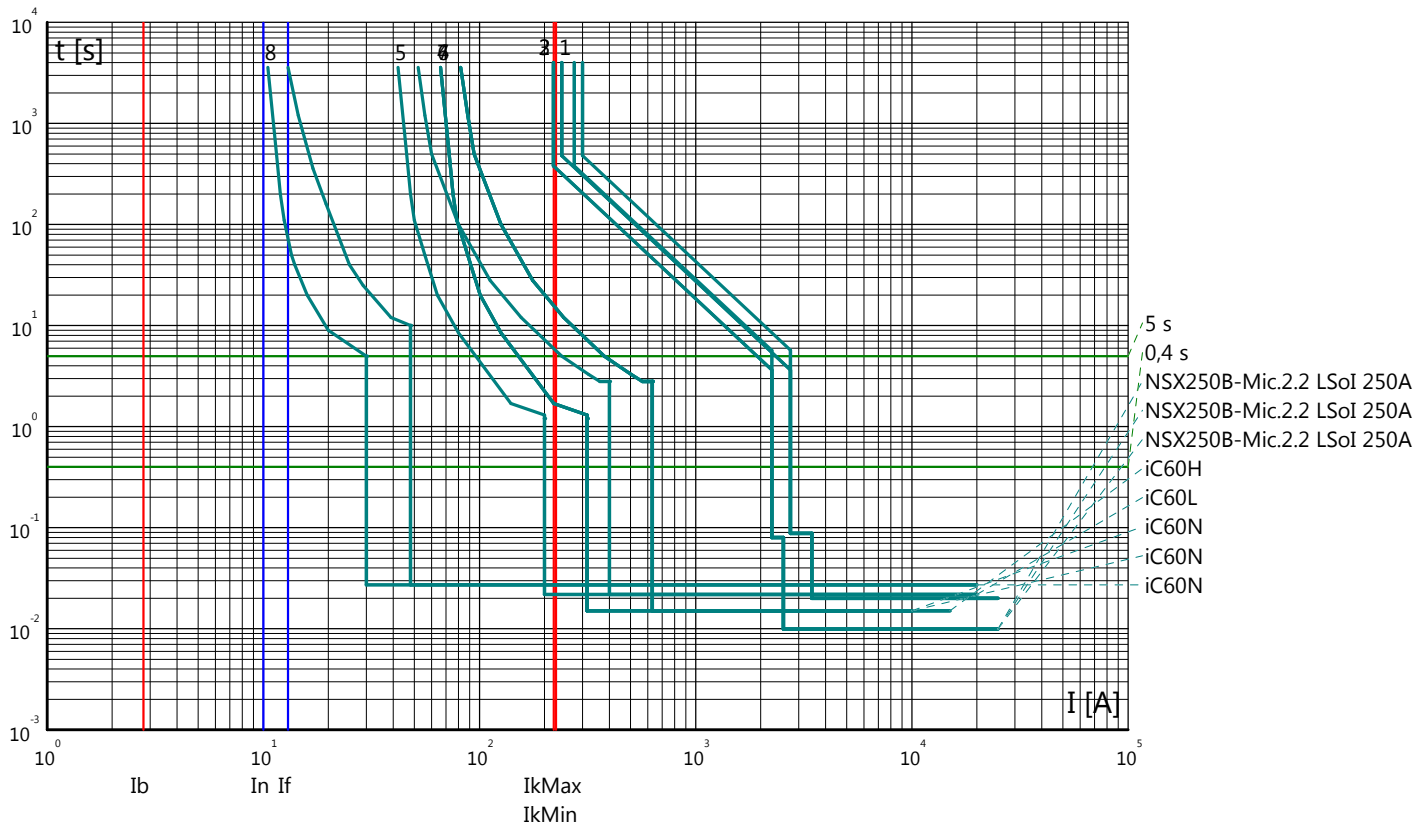

Partenza: PT/N

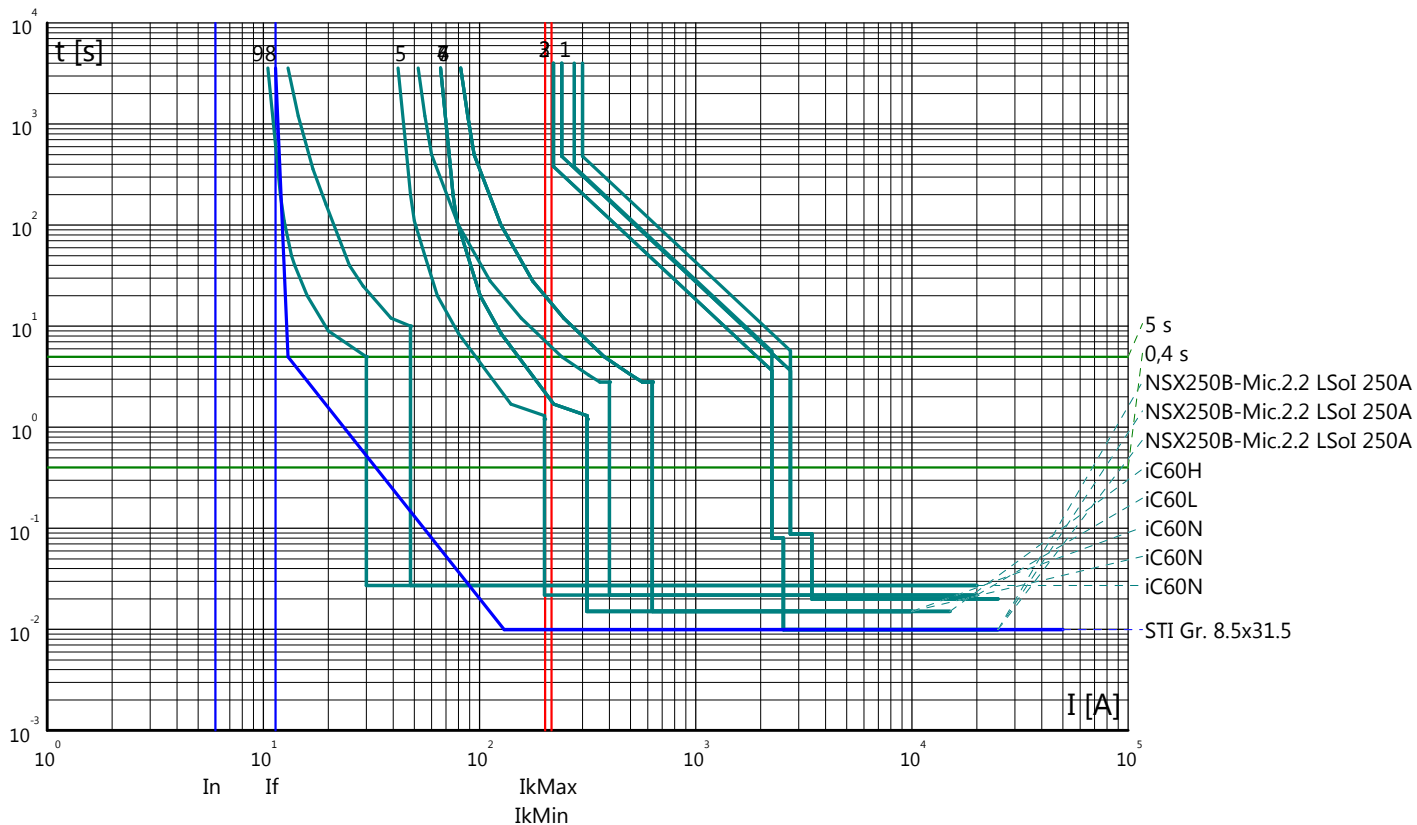

Curve tempo corrente: GALLERIA MONTE AGLIO  
 Quadro: QCE/N

Partenza: 1.6S.1

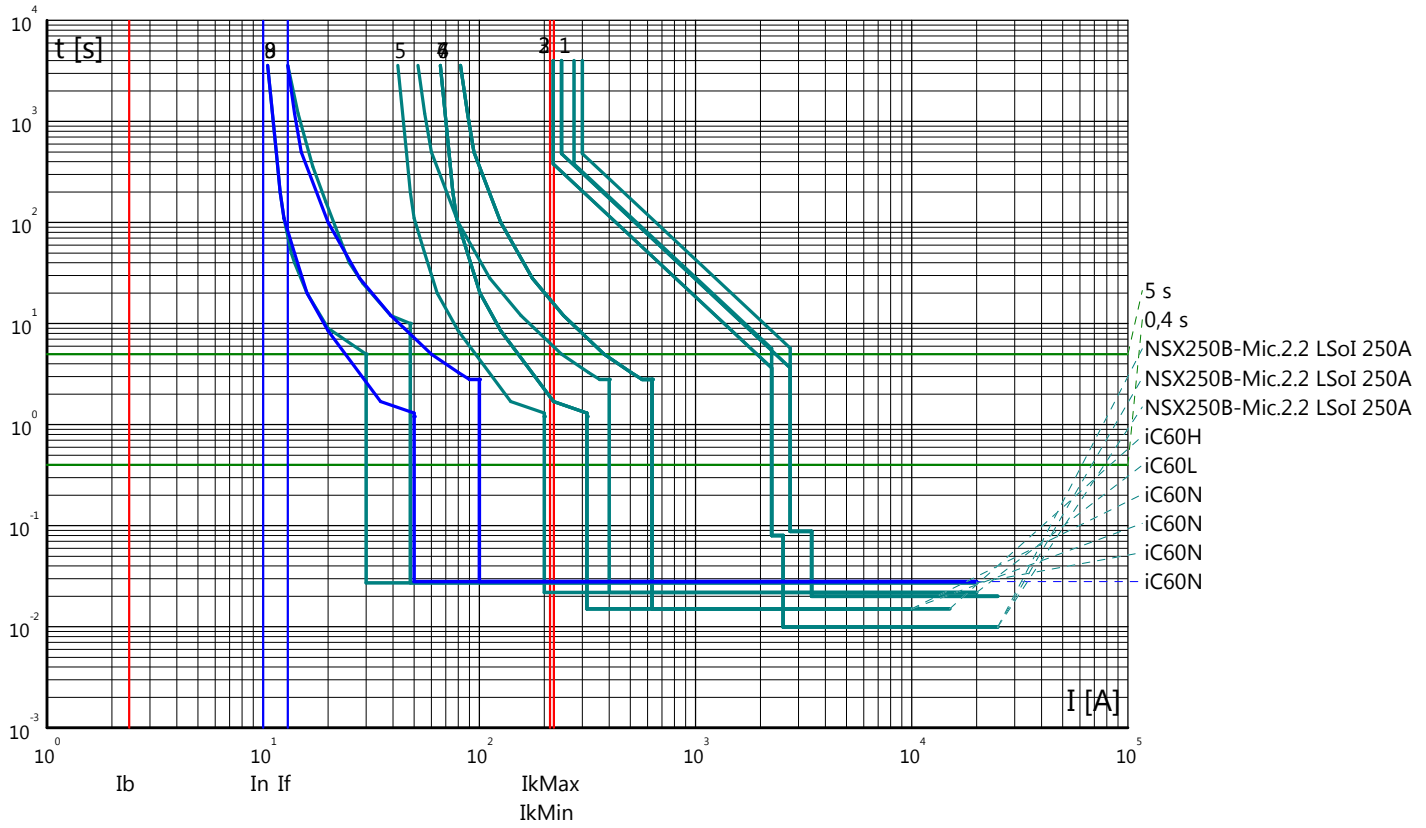

Partenza: 1.6S.2

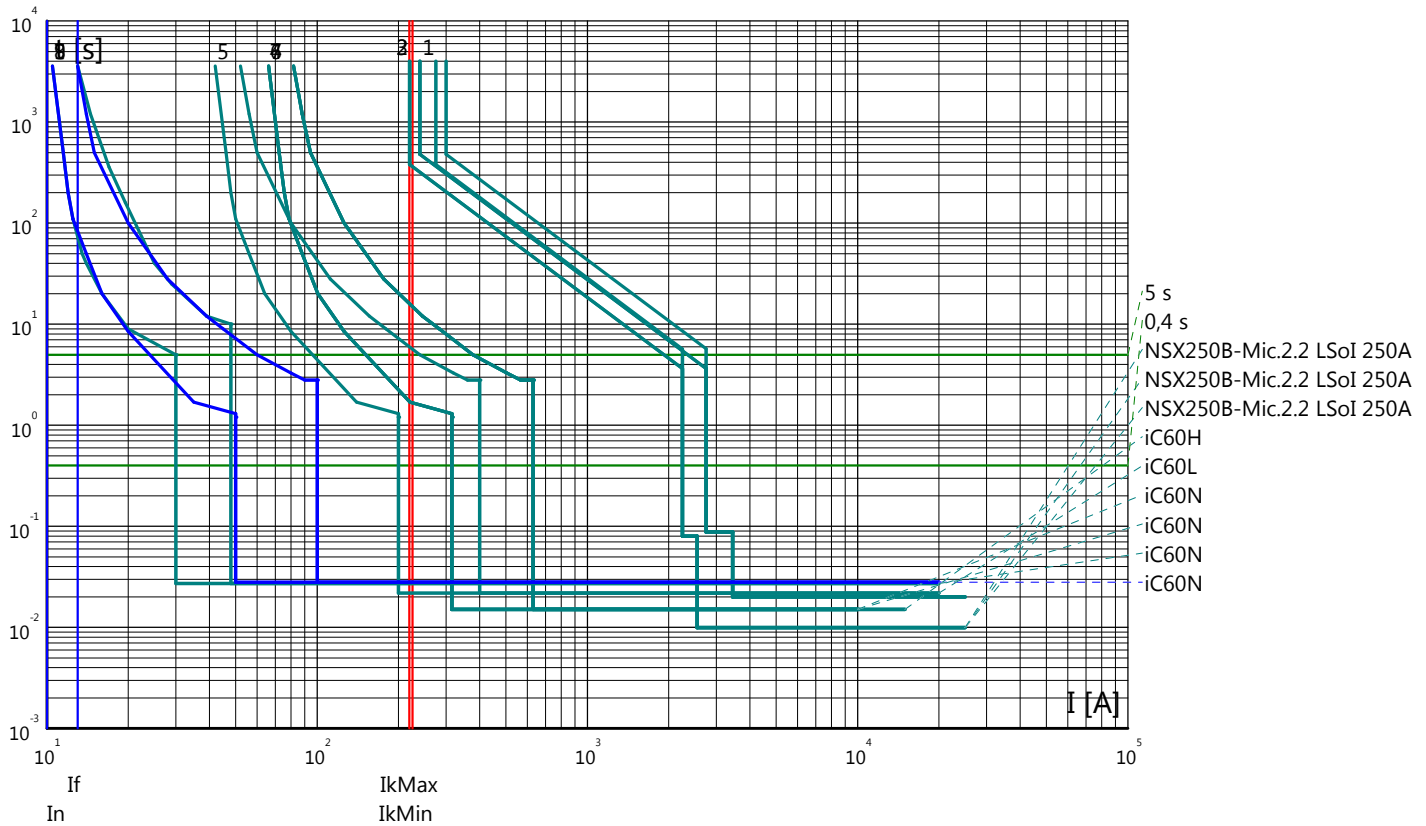

Curve tempo corrente: GALLERIA MONTE AGLIO  
 Quadro: QCE/N

Partenza: 1.6S.3

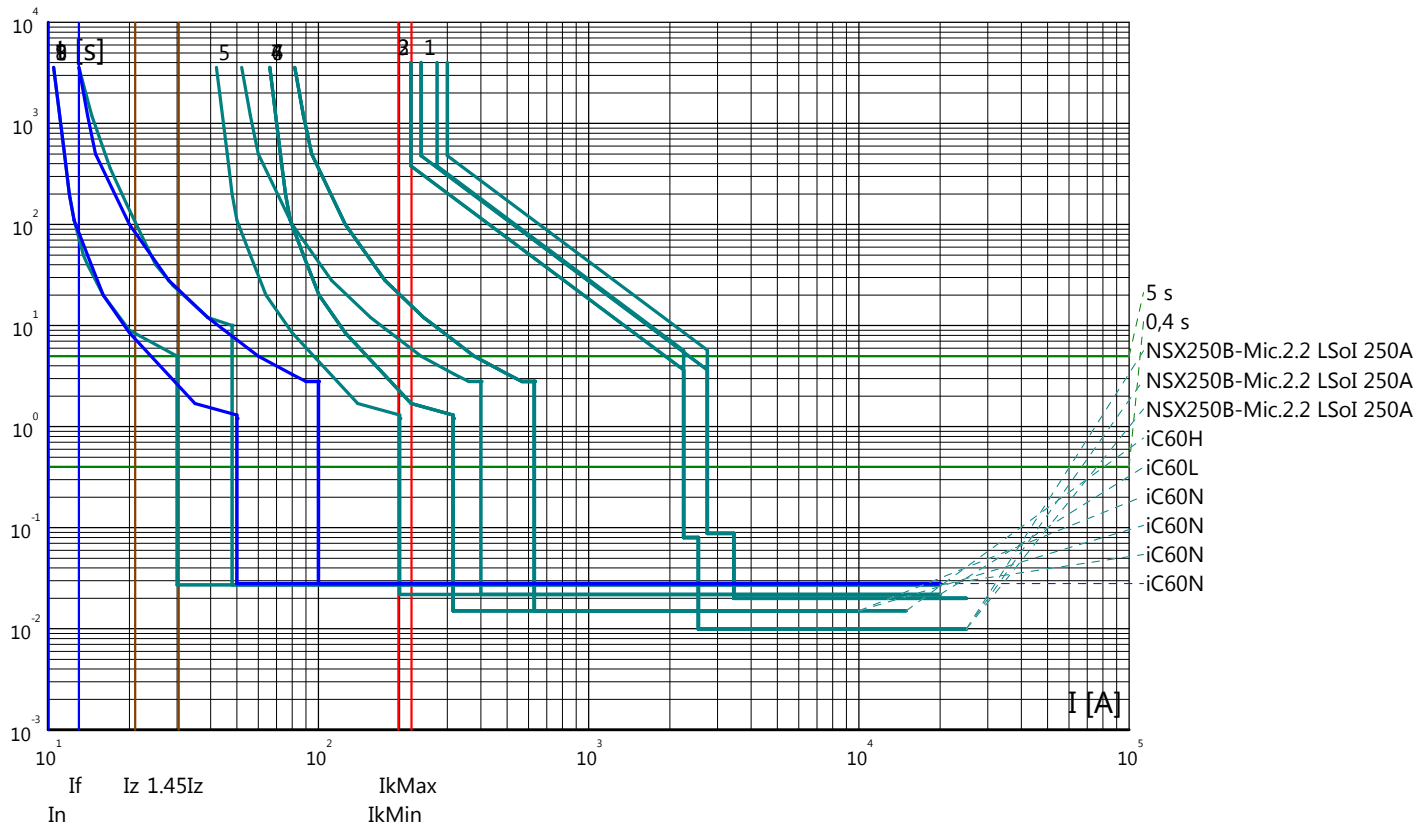

Curve tempo corrente: GALLERIA MONTE AGLIO  
 Quadro: QSTES/N

Arrivo: IG

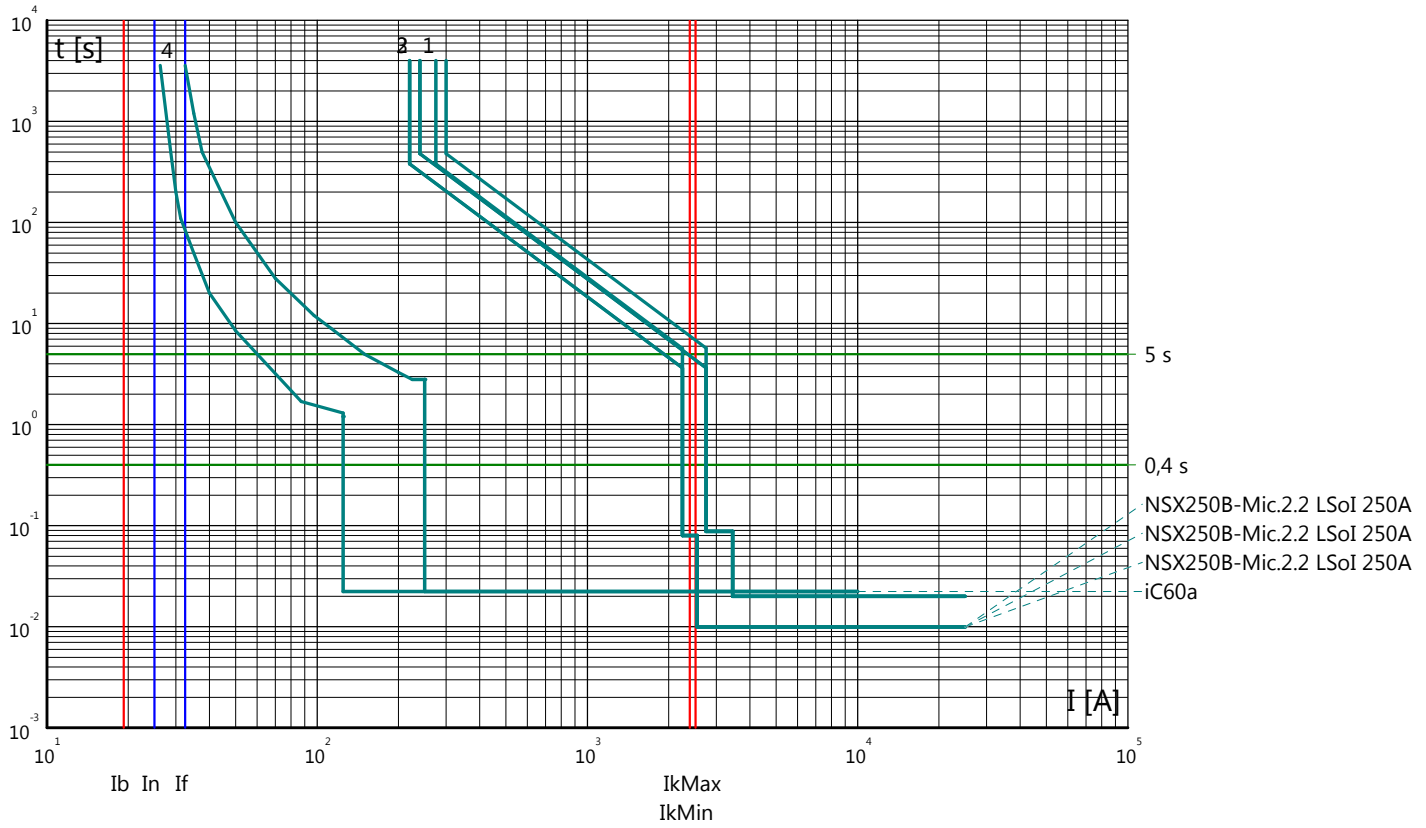

Partenza: PT/I

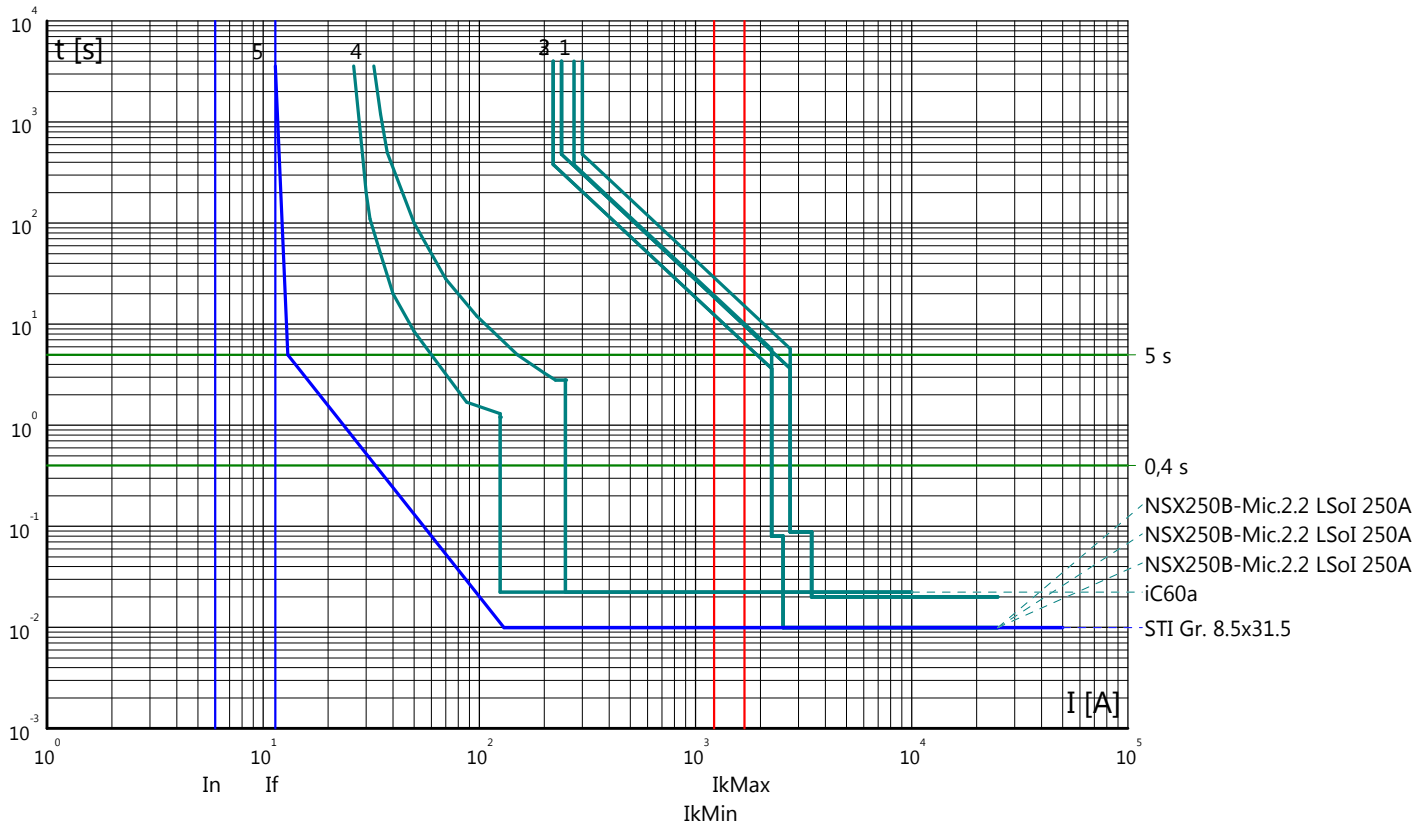

Curve tempo corrente: GALLERIA MONTE AGLIO  
 Quadro: QSTES/N

Partenza: PT/U

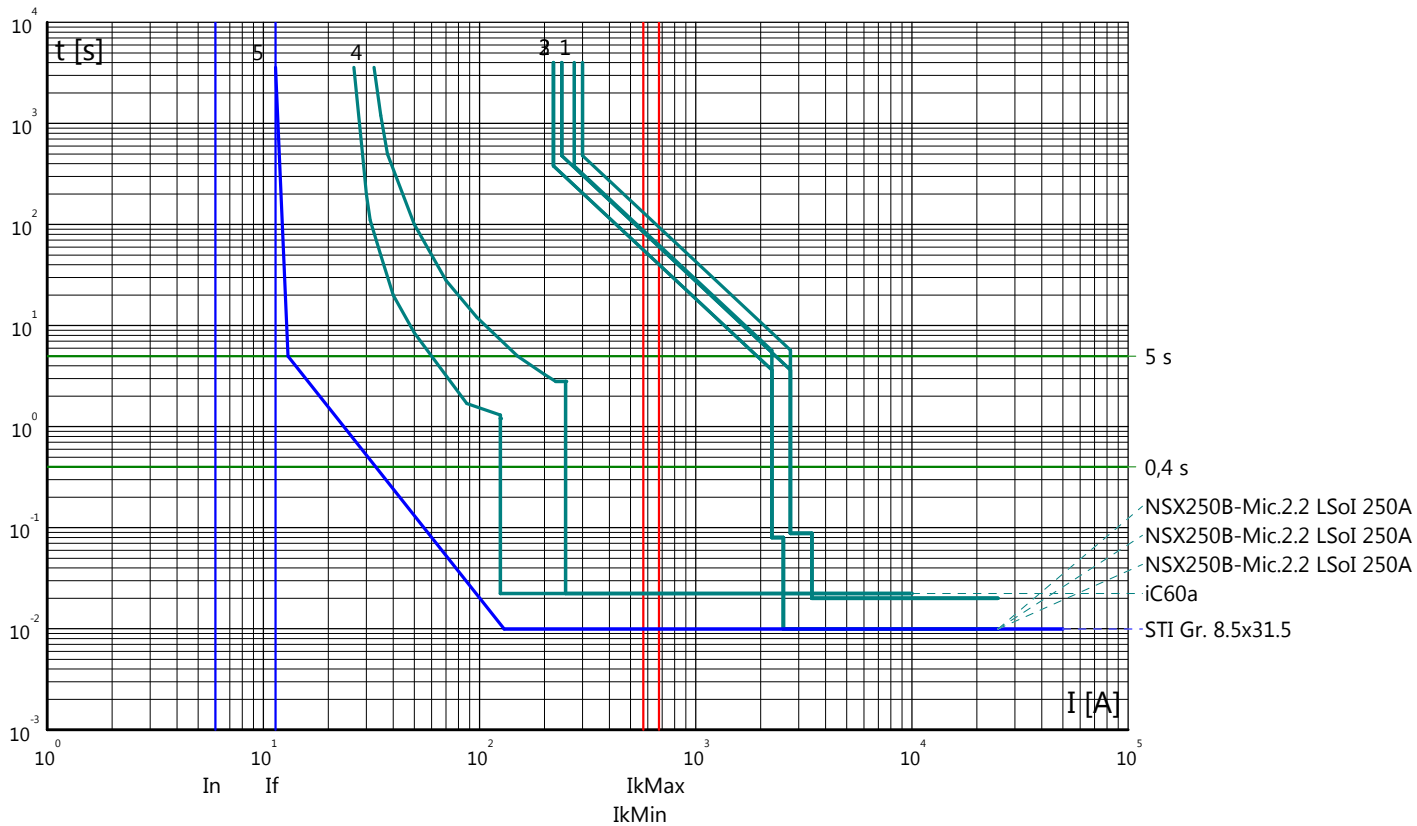

Partenza: STES

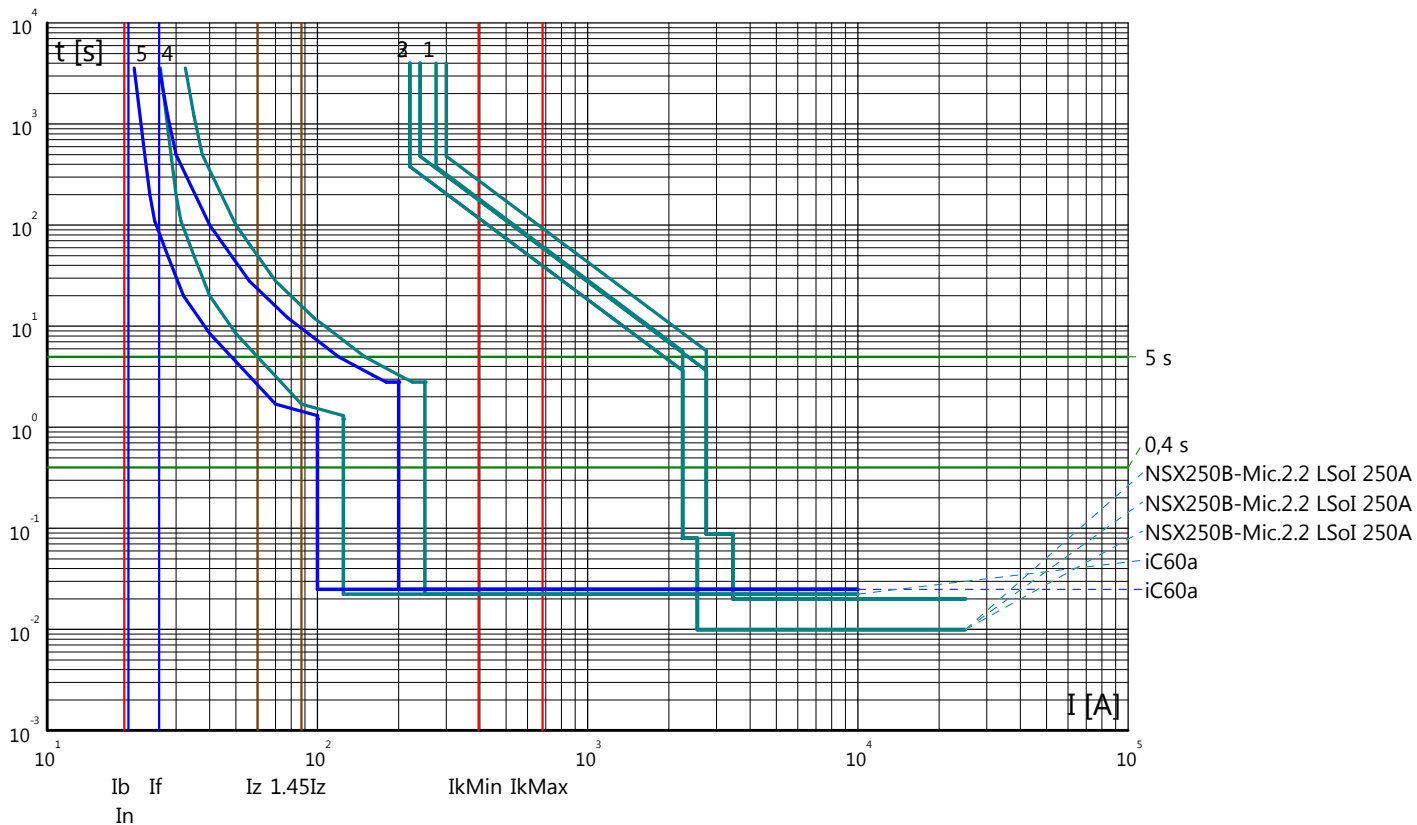

Curve tempo corrente: GALLERIA MONTE AGLIO  
 Quadro: QPLC/N

Arrivo: IG

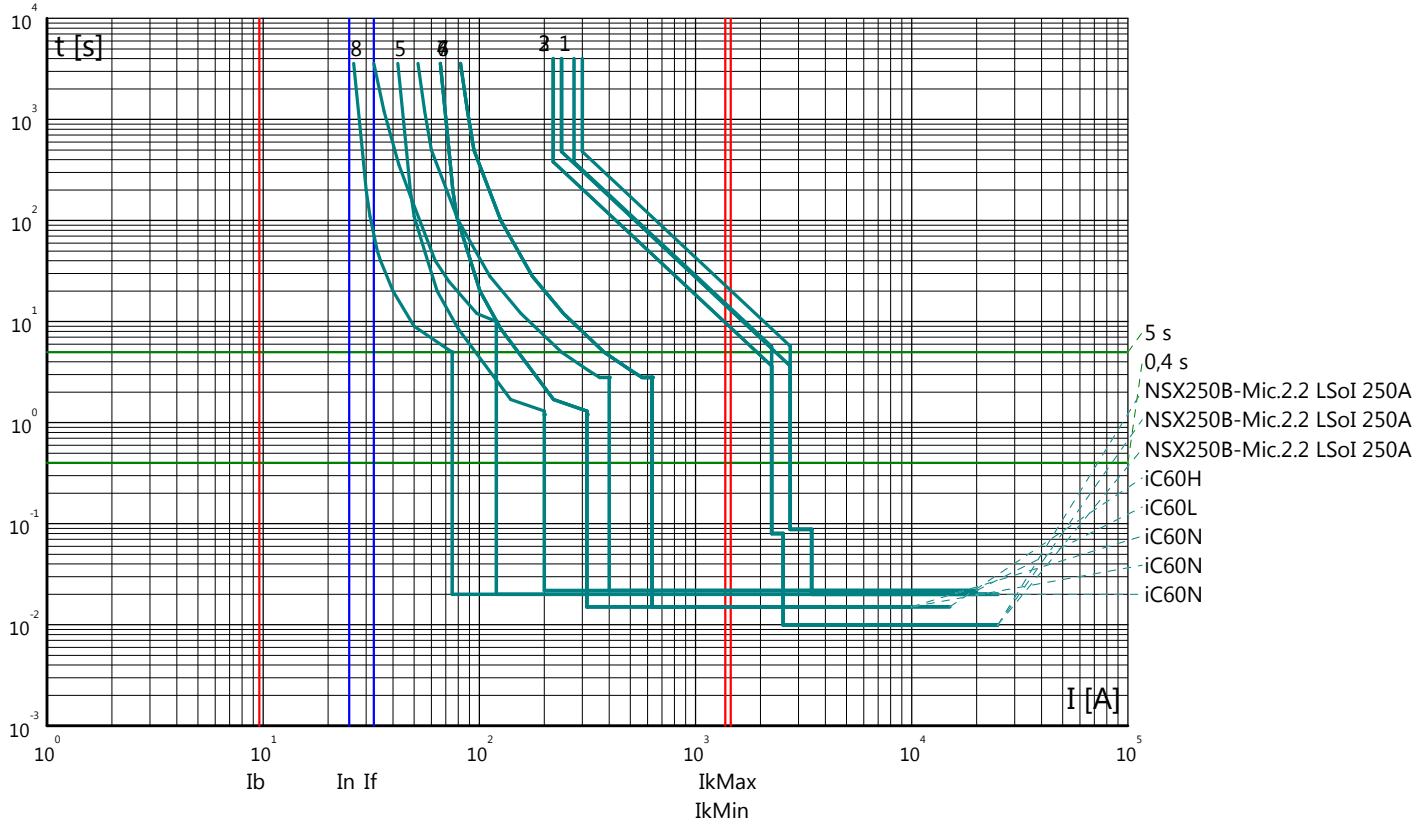

Partenza: PT/I

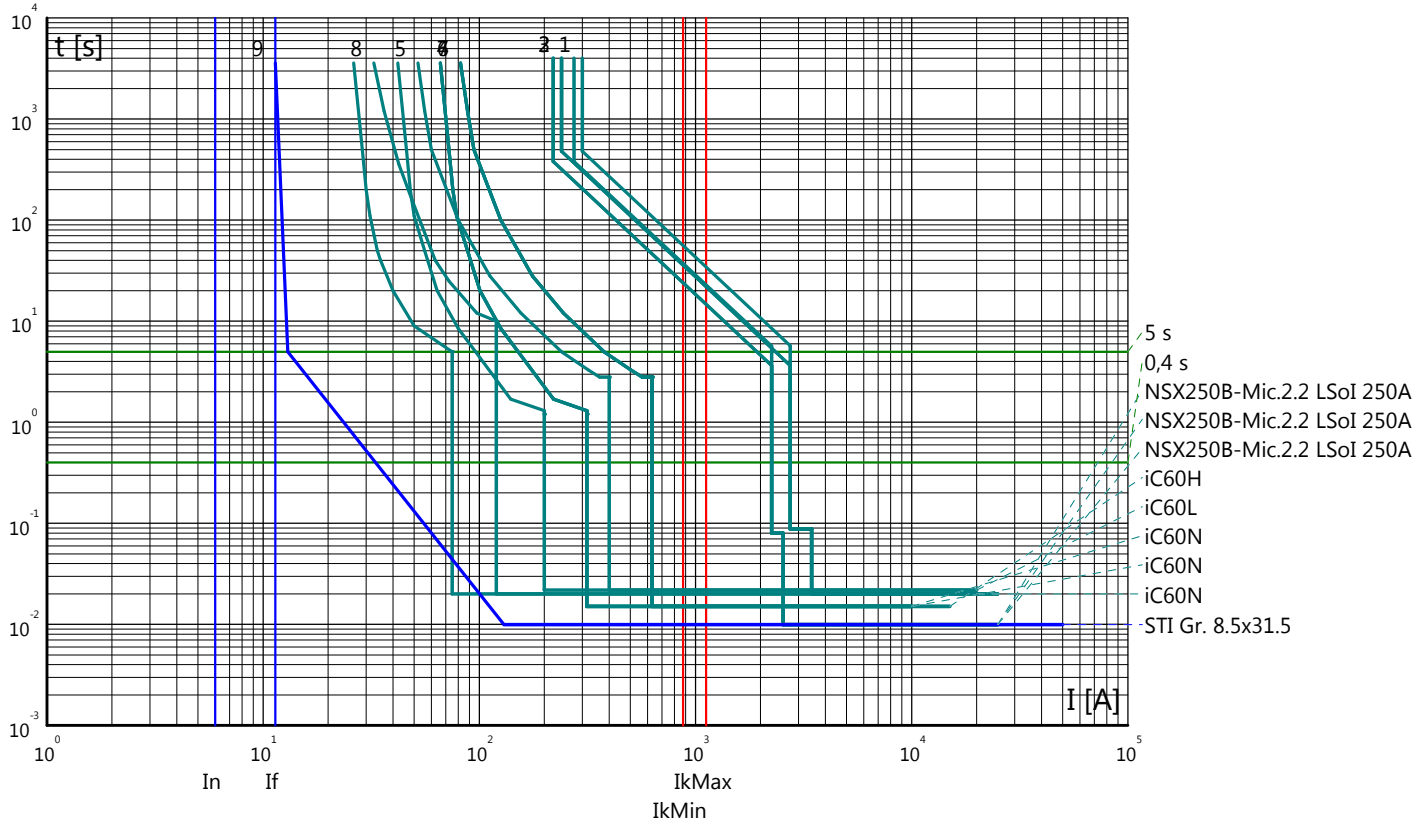

Curve tempo corrente: GALLERIA MONTE AGLIO  
 Quadro: QPLC/N

Partenza: PT/U

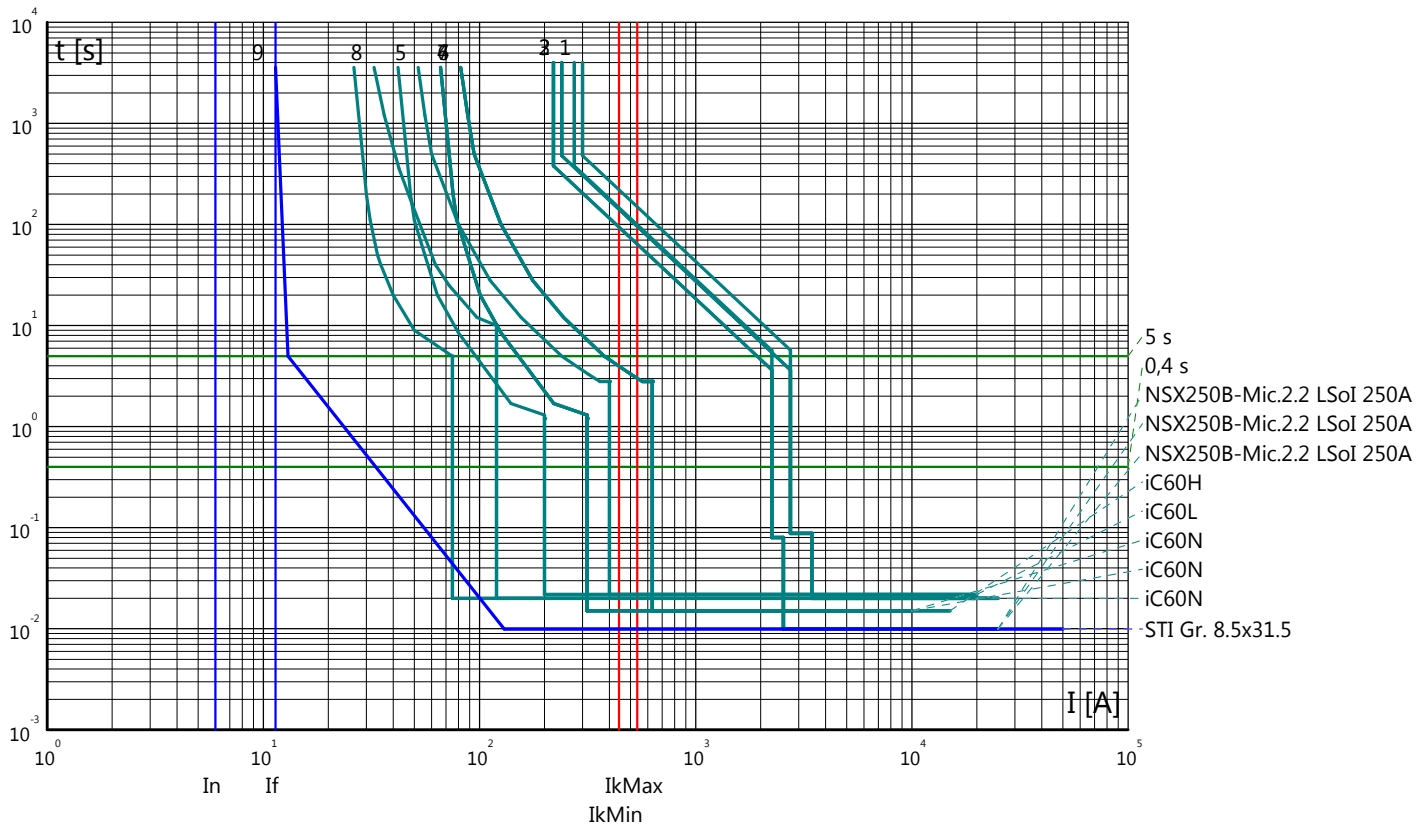

Partenza: PLC1

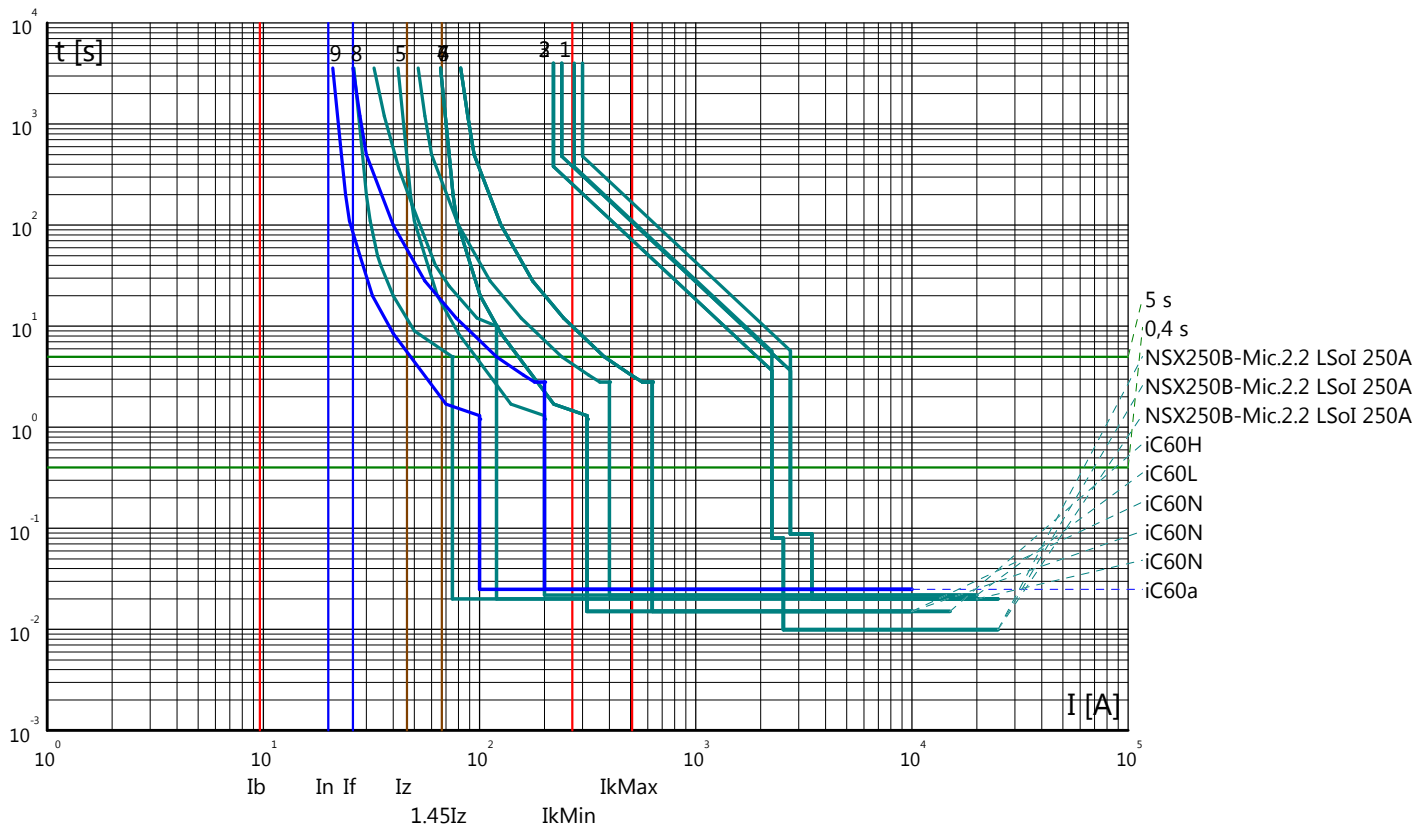



Curve tempo corrente: GALLERIA MONTE AGLIO  
 Quadro: QPLC/N

Arrivo: IG

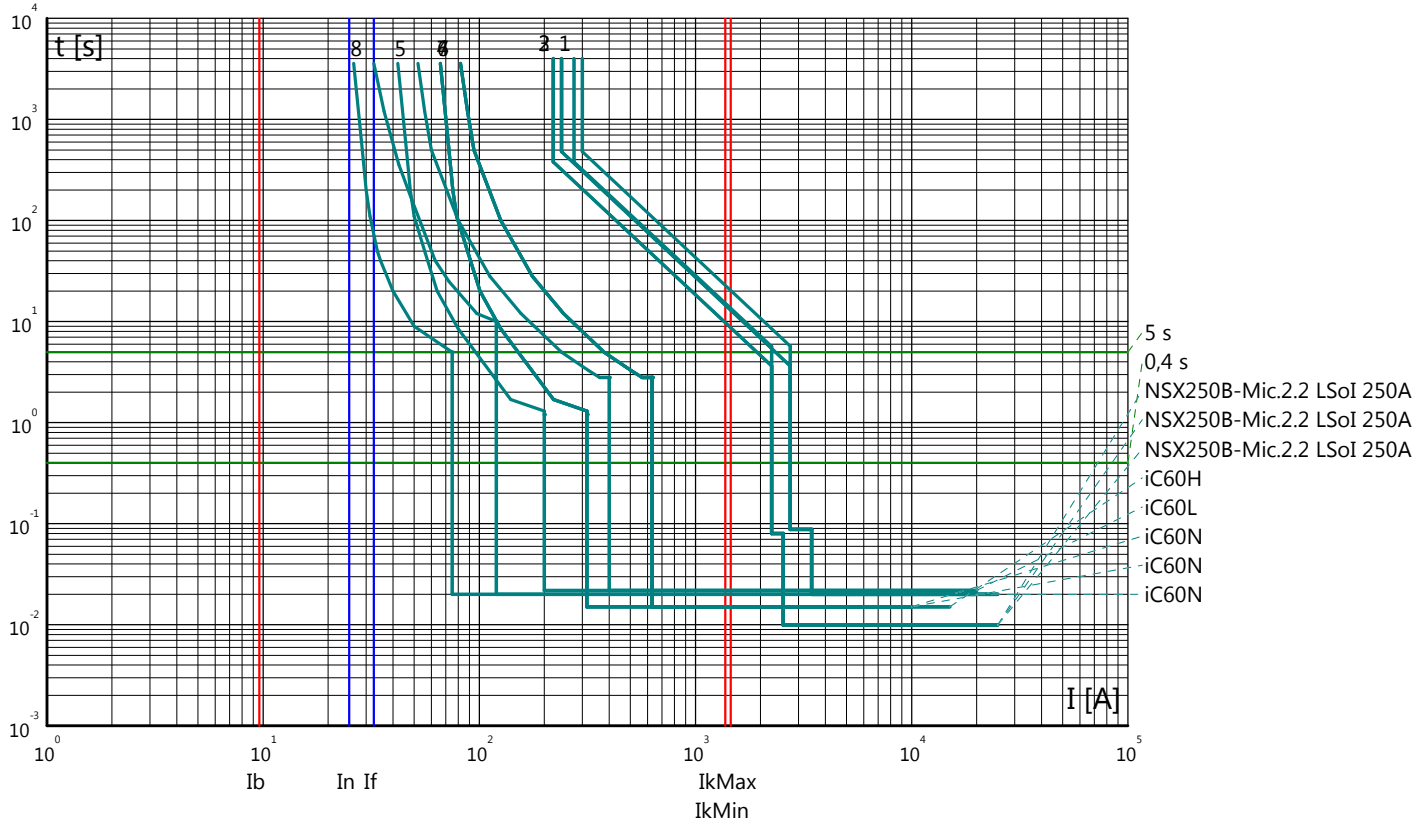

Partenza: PT/I

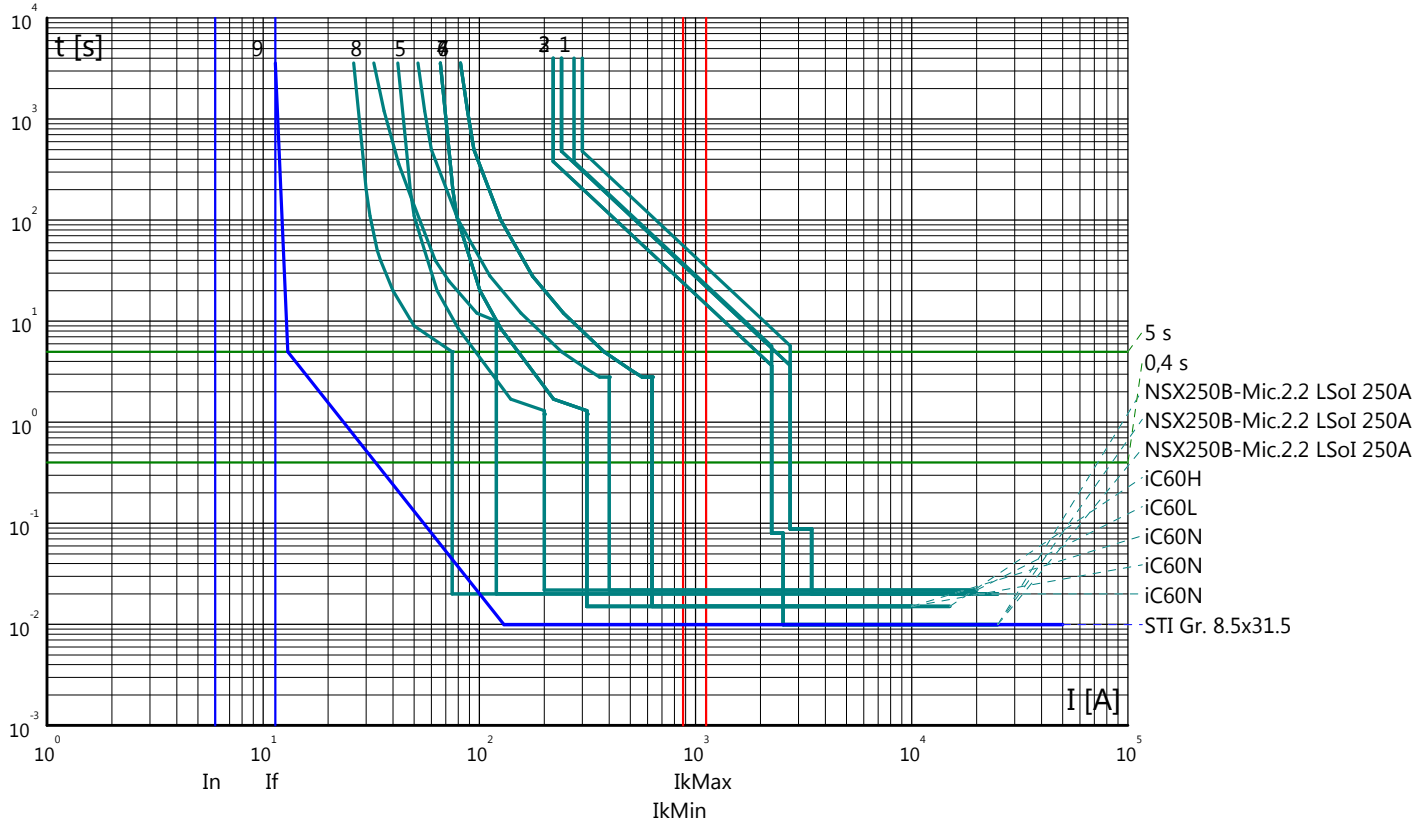

Curve tempo corrente: GALLERIA MONTE AGLIO  
 Quadro: QPLC/N

Partenza: PT/U

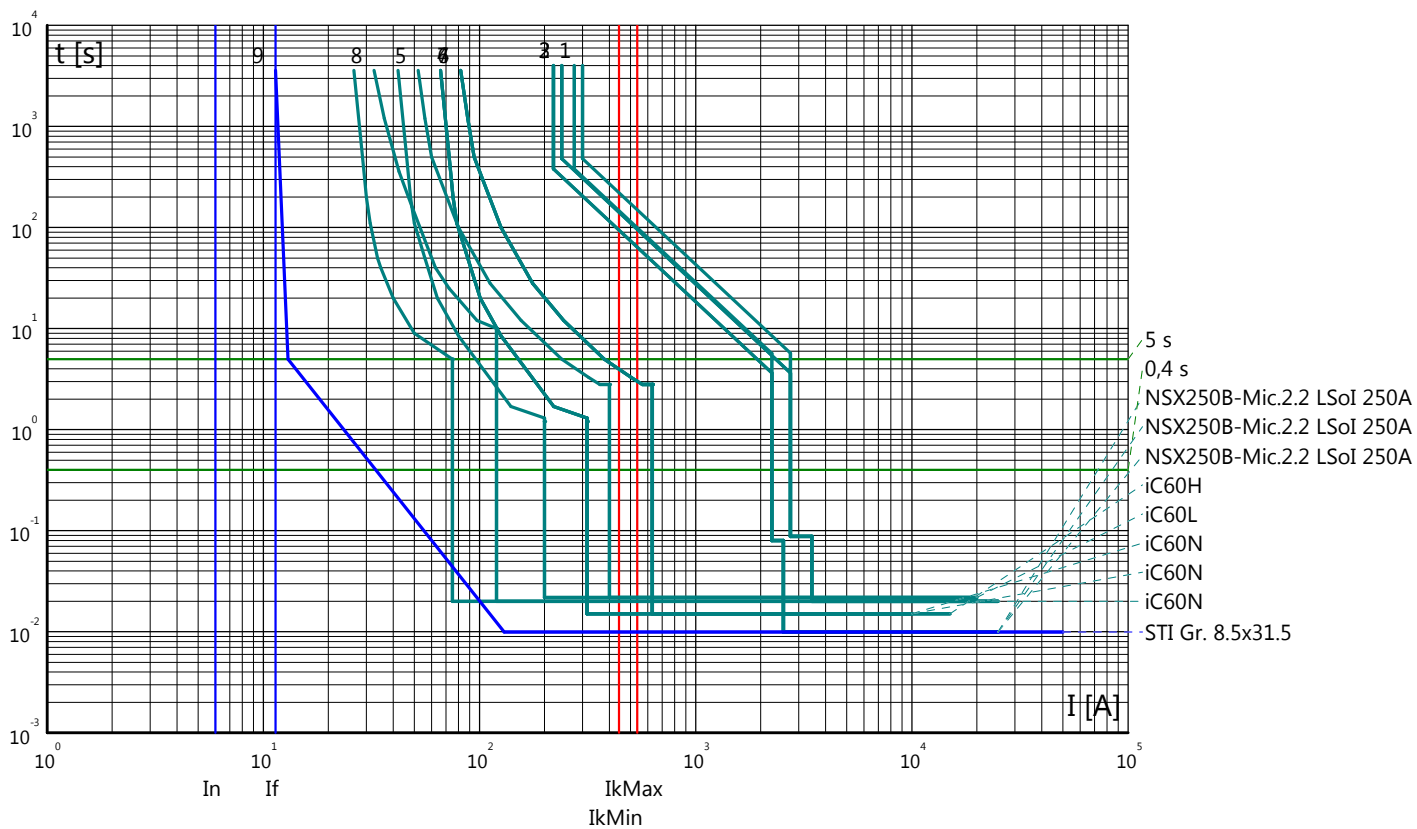

Partenza: QGPLC1

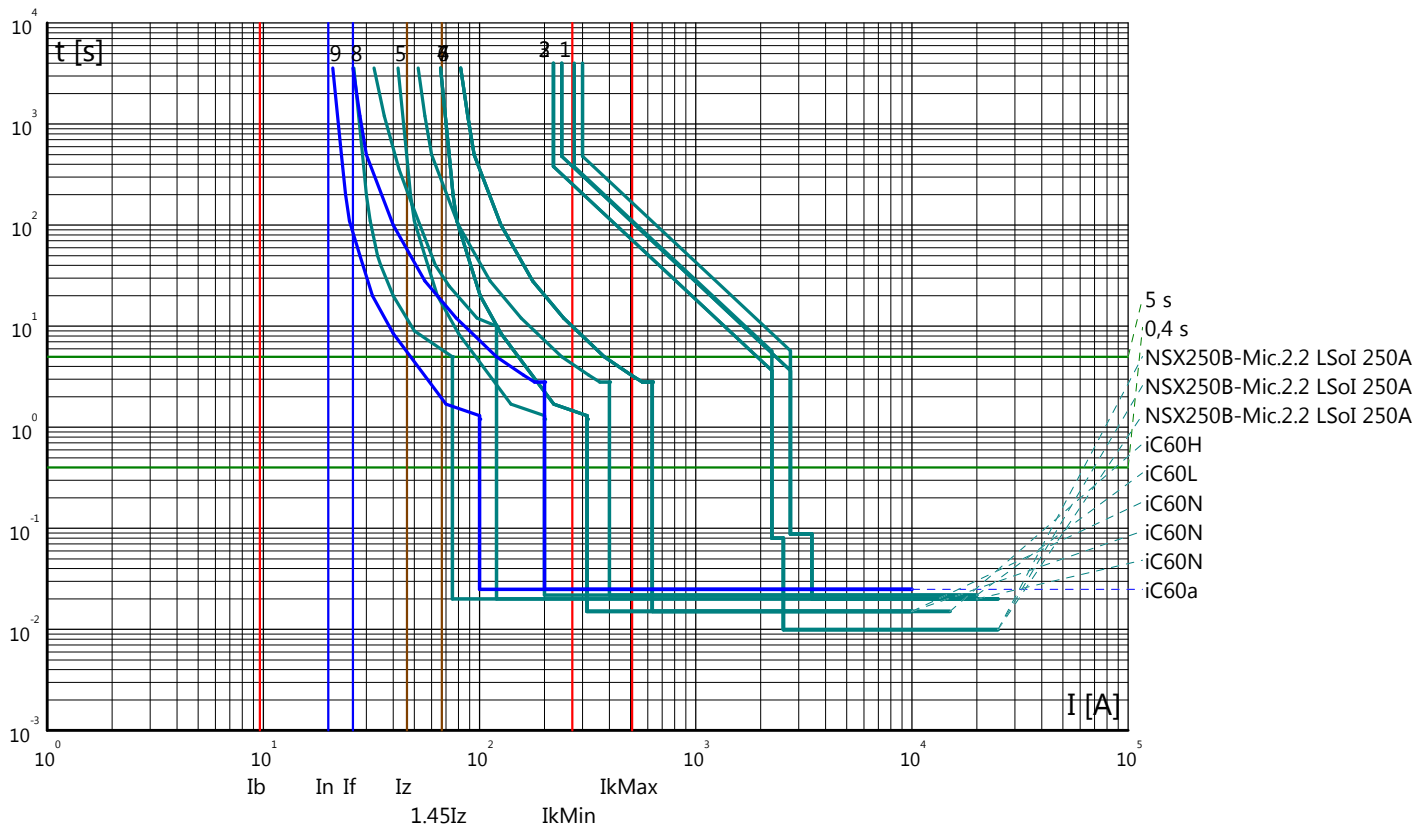

Curve tempo corrente: GALLERIA MONTE AGLIO  
 Quadro: QAPP/N

Arrivo: IG

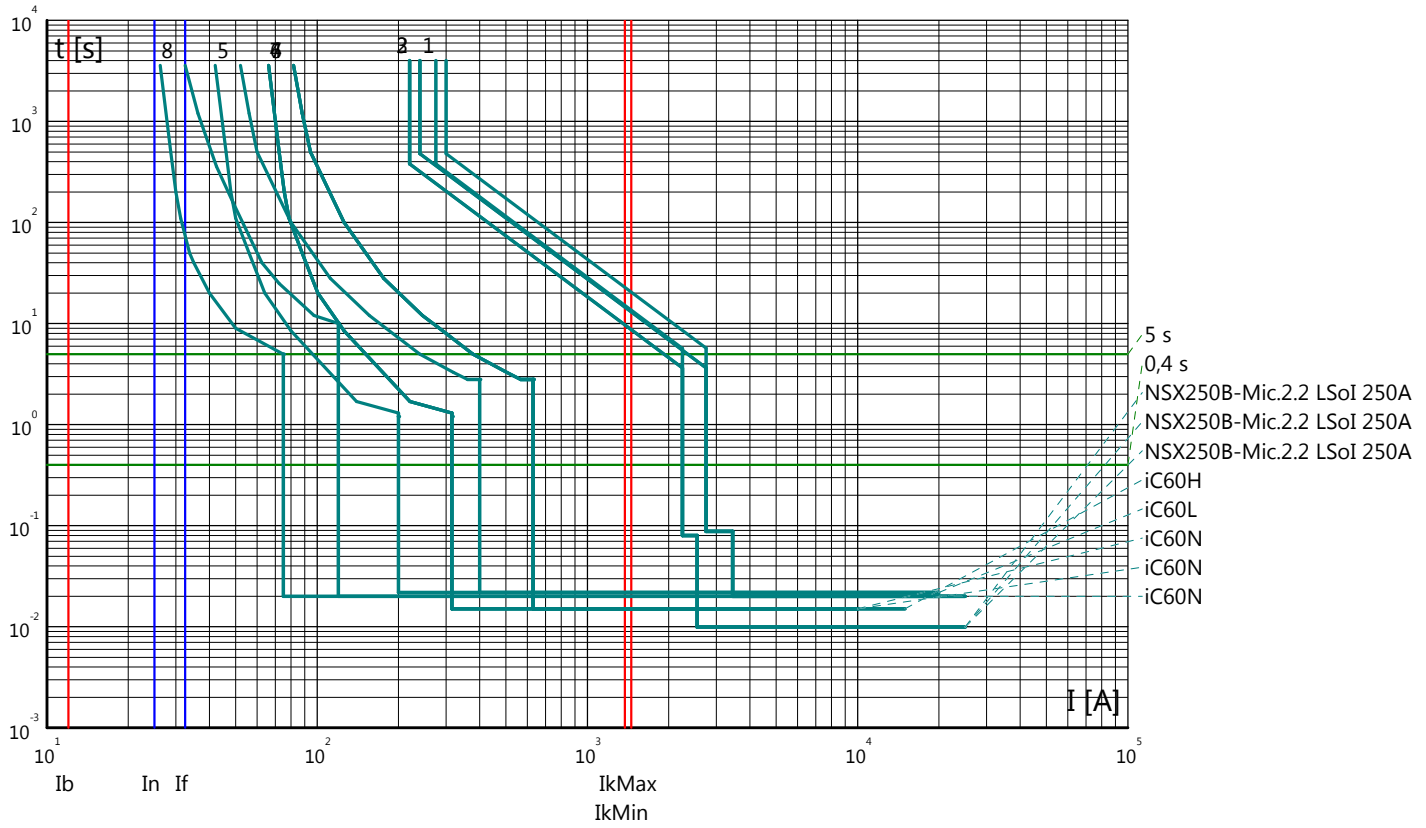

Partenza: PT/I

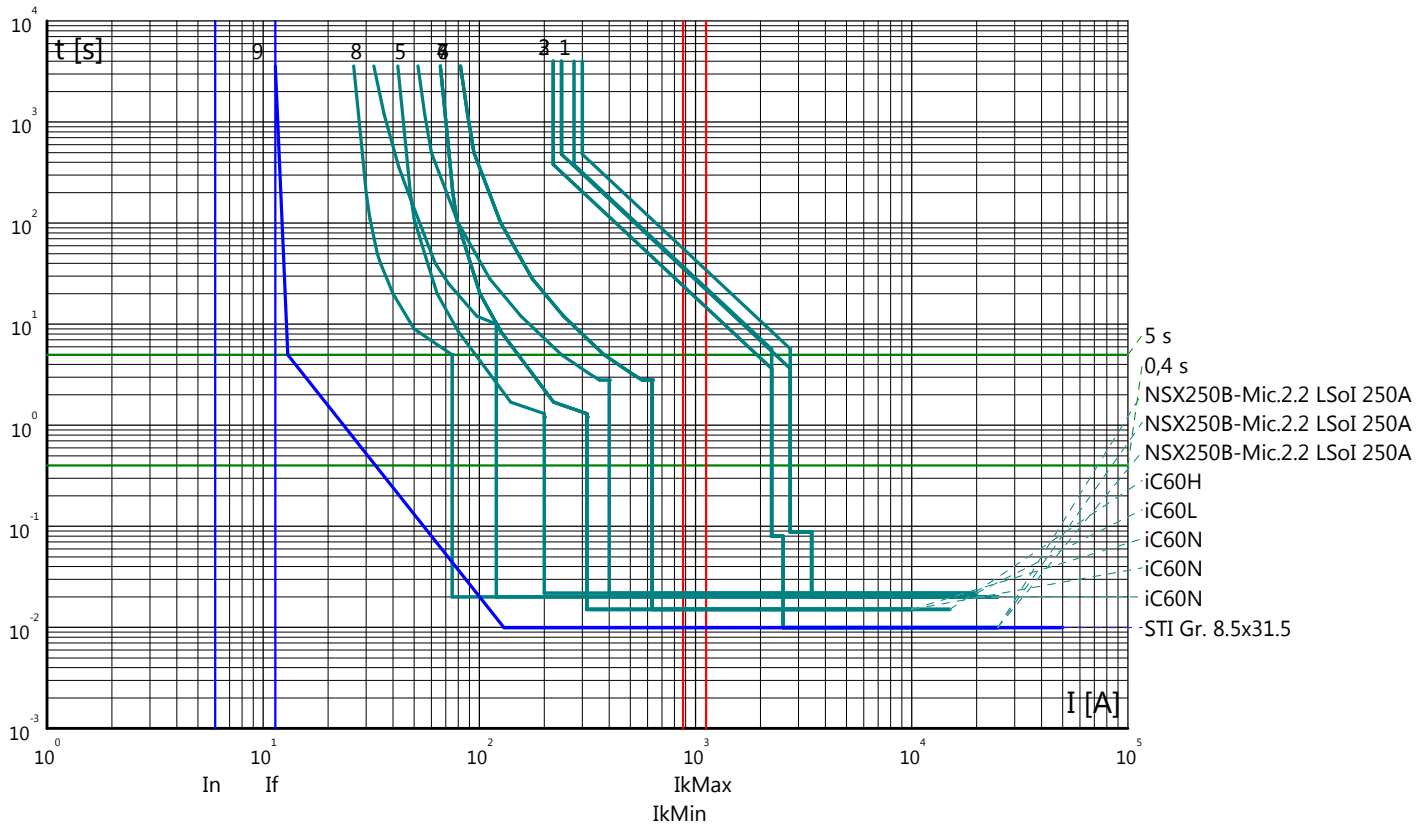

Curve tempo corrente: GALLERIA MONTE AGLIO  
 Quadro: QAPP/N

Partenza: PT/U

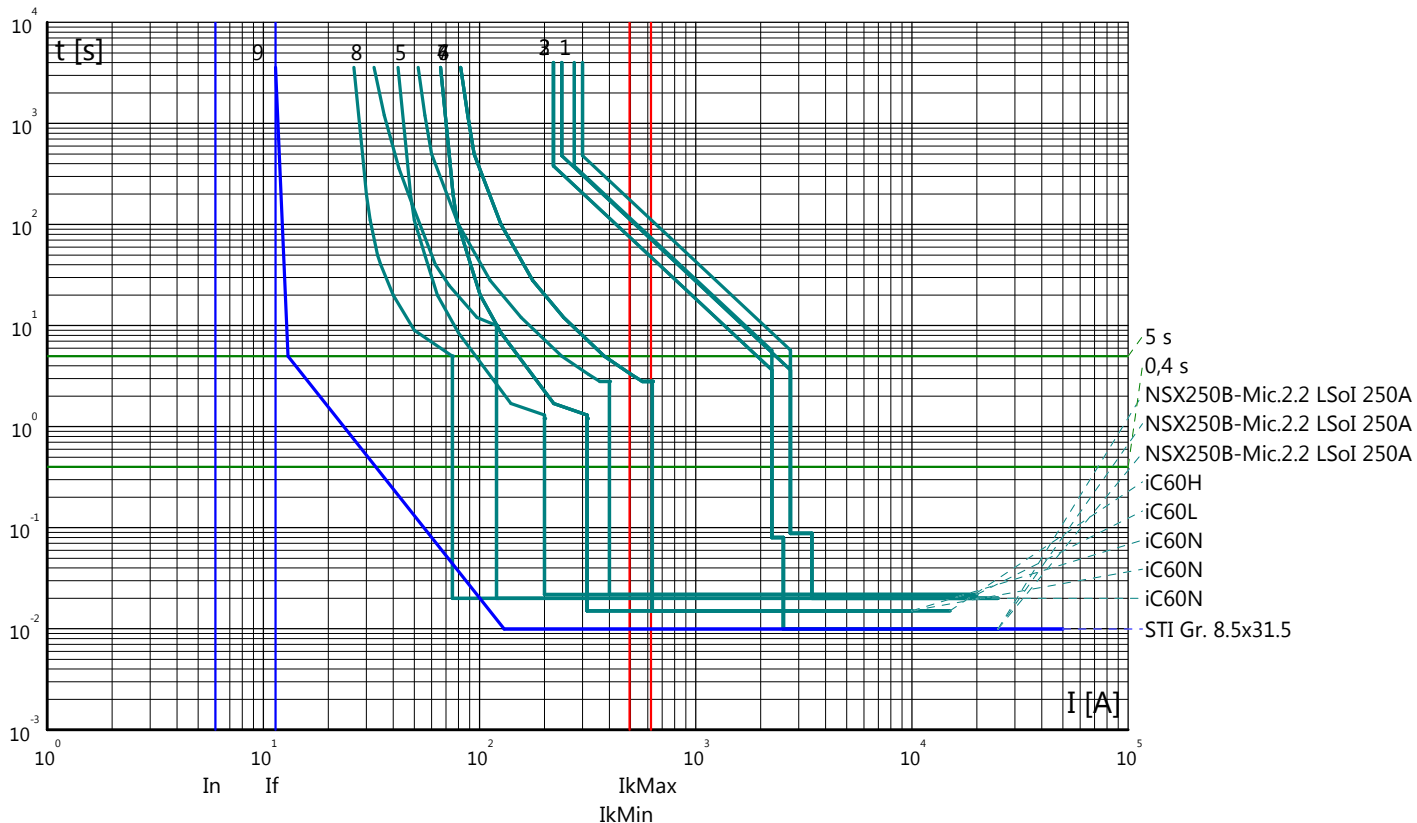

Partenza: GSM-P

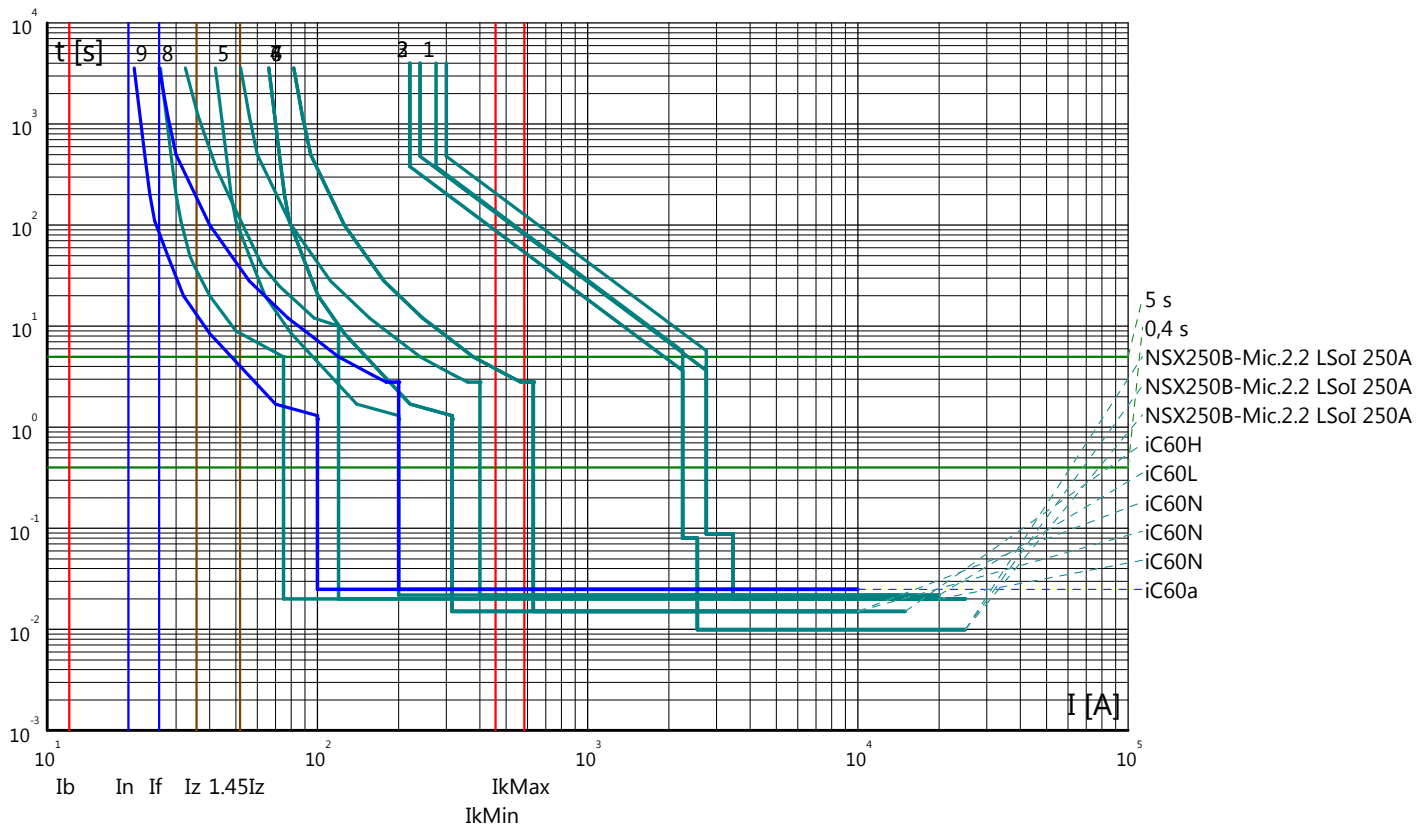

Curve tempo corrente: GALLERIA MONTE AGLIO  
 Quadro: QAPP/N

Arrivo: IG

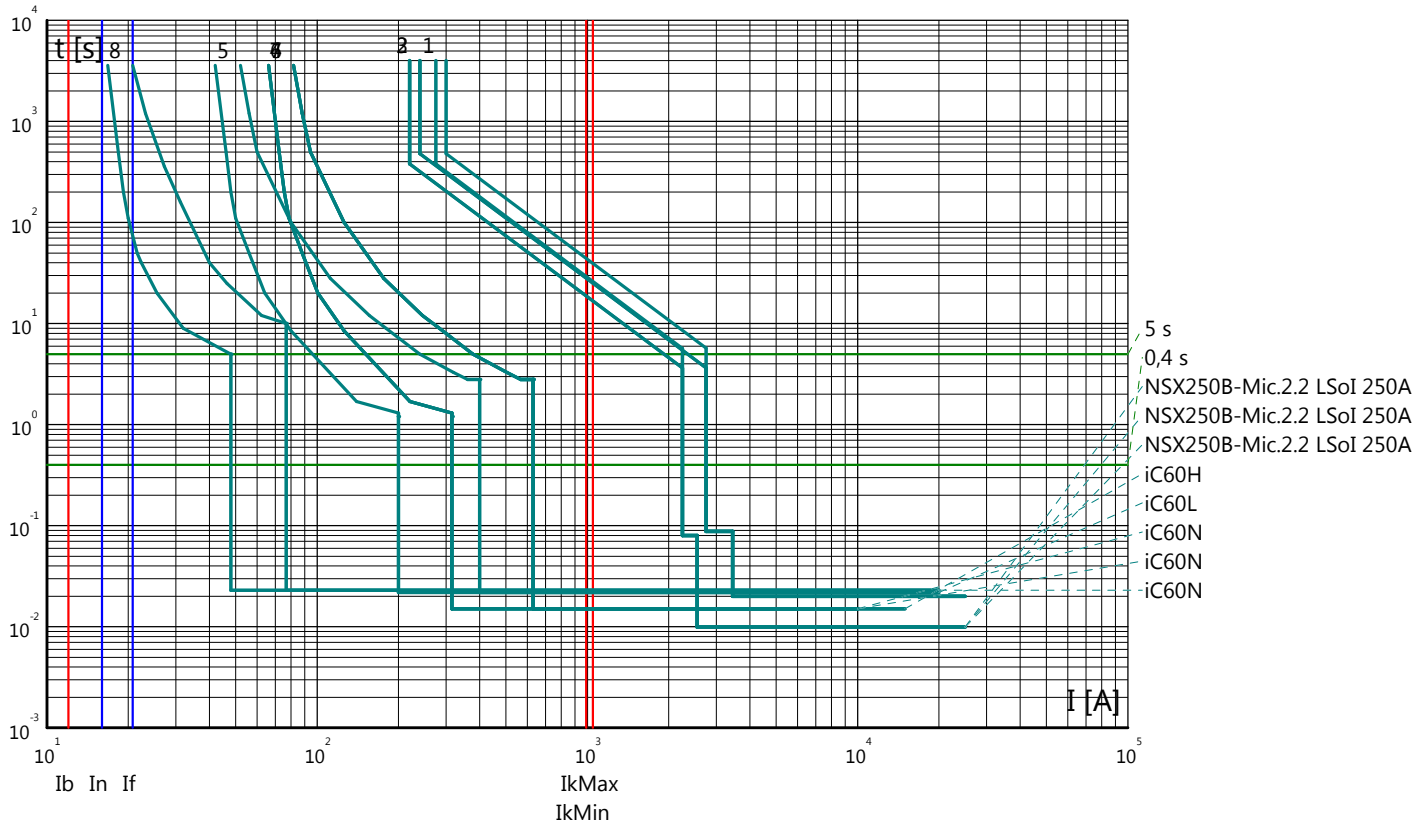

Partenza: PT/I

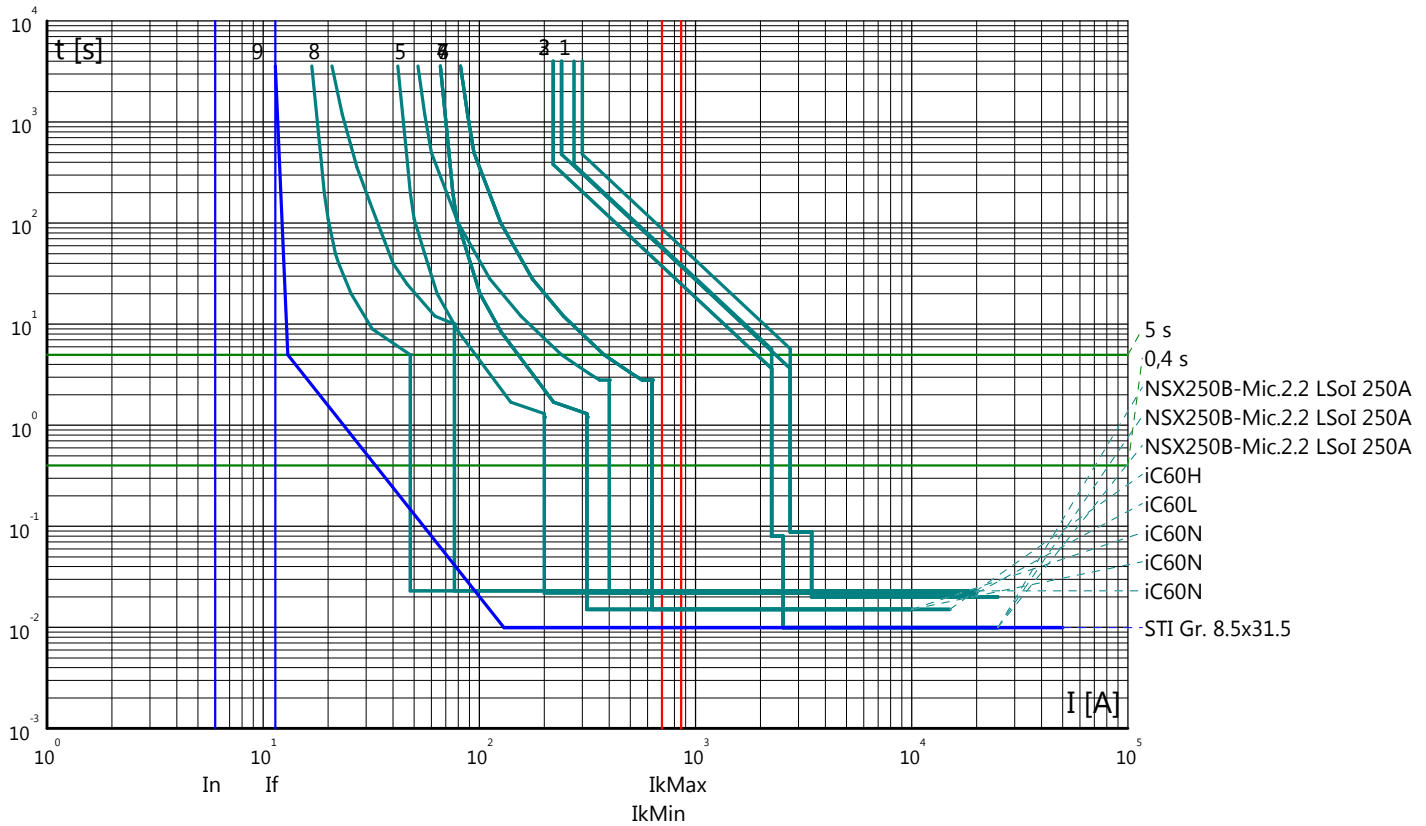

Curve tempo corrente: GALLERIA MONTE AGLIO  
 Quadro: QAPP/N

Partenza: PT/U

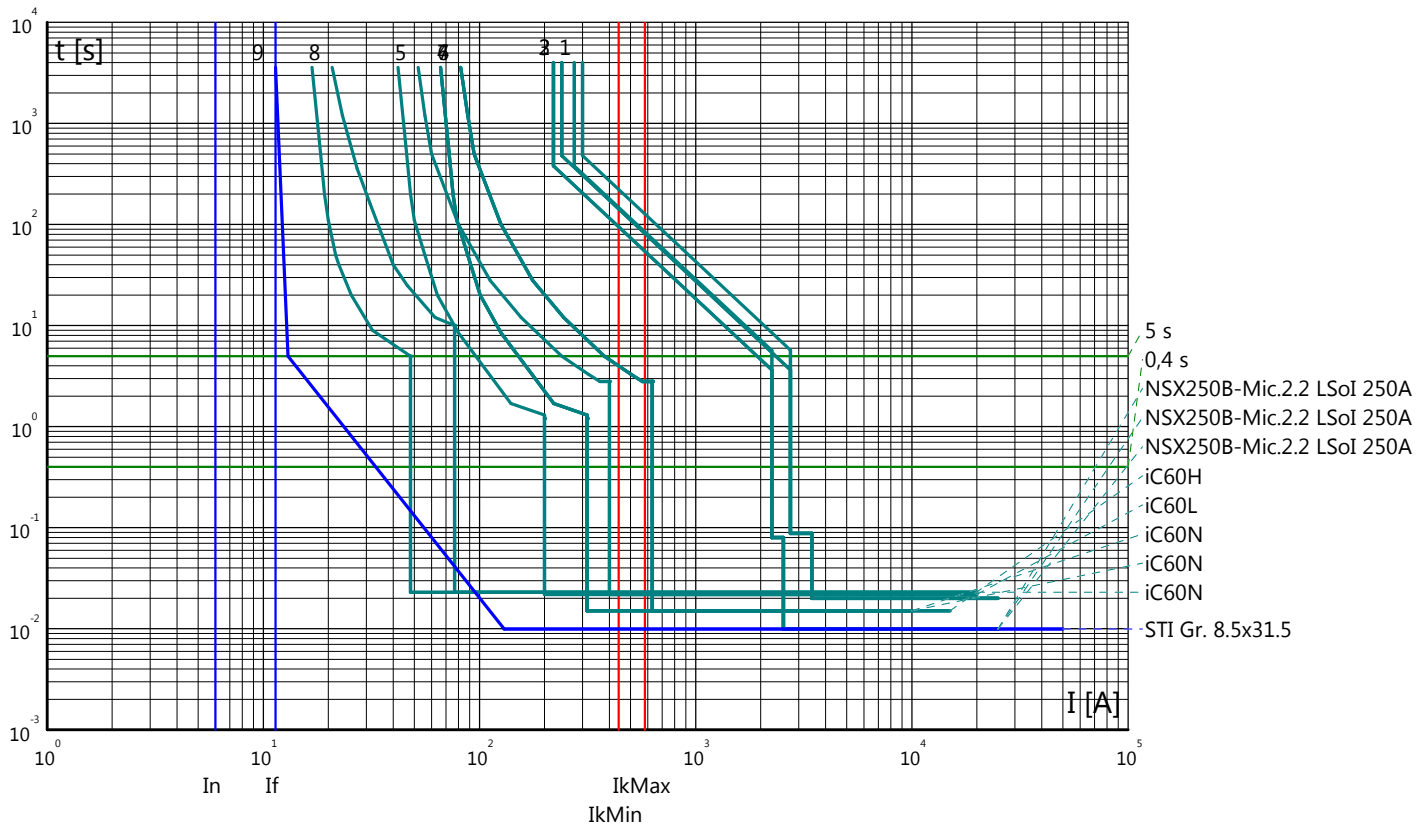

Partenza: GSM-R

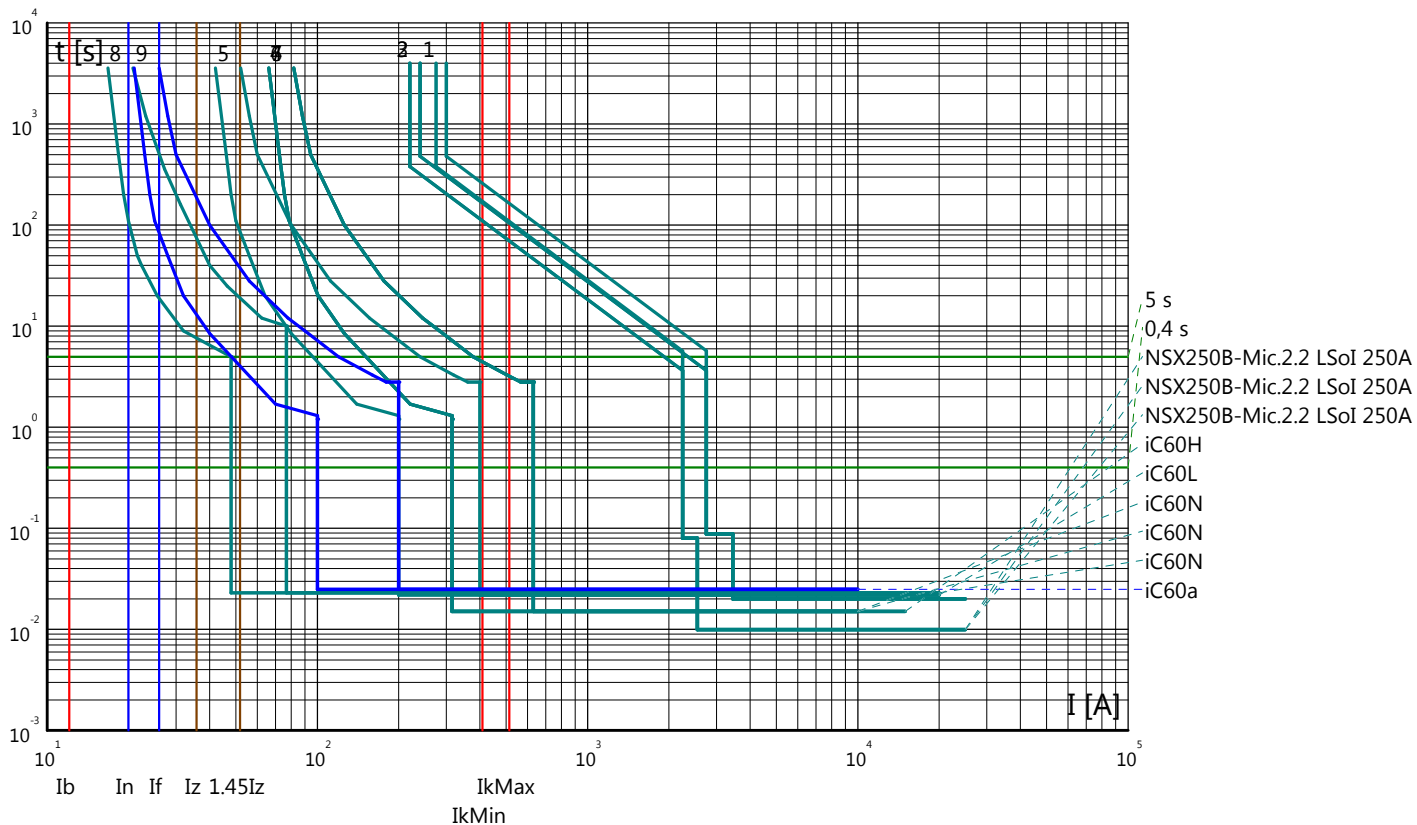

Curve tempo corrente: GALLERIA MONTE AGLIO  
 Quadro: QAPP/N

Arrivo: IG

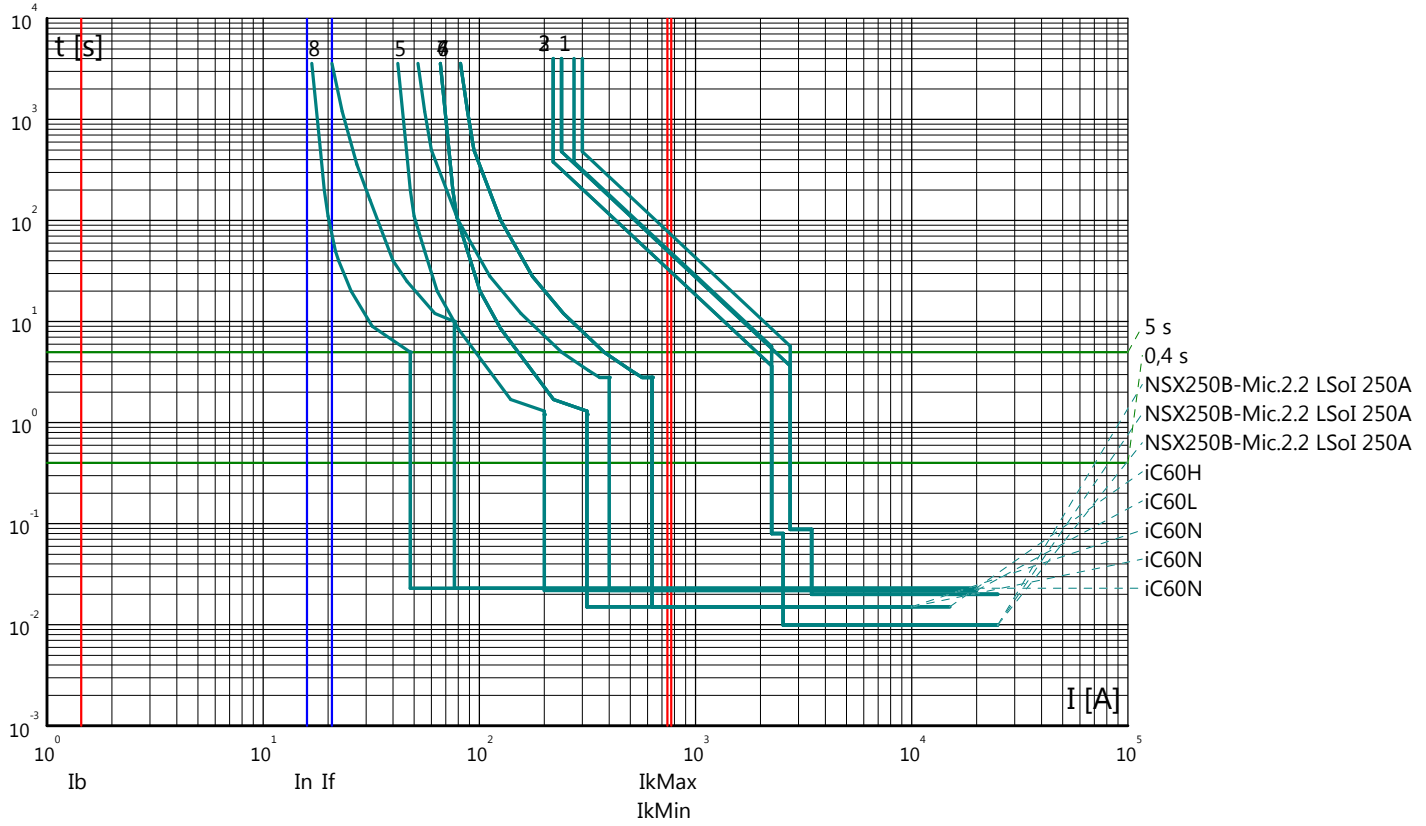

Partenza: PT/I

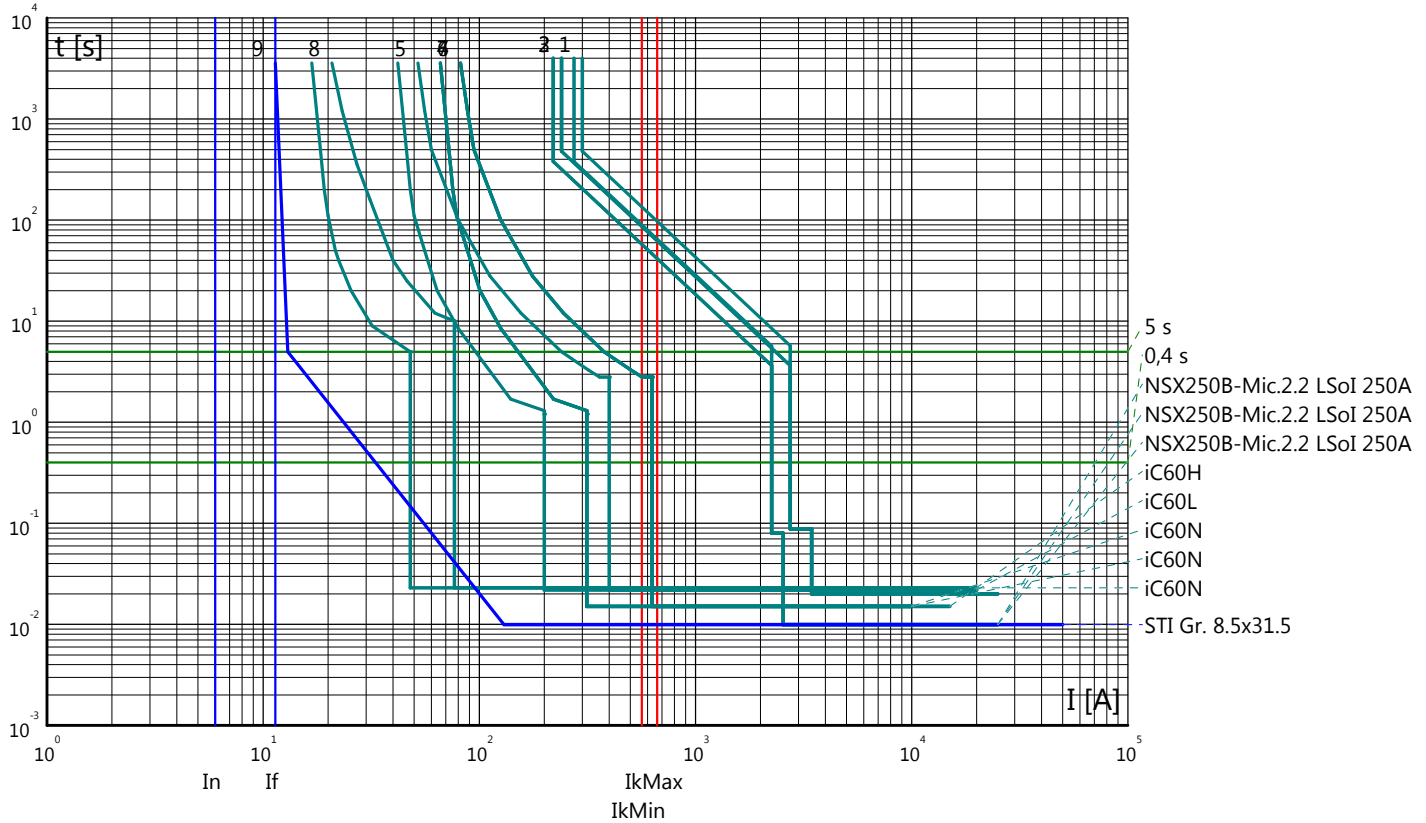

Curve tempo corrente: GALLERIA MONTE AGLIO  
 Quadro: QAPP/N

Partenza: PT/U

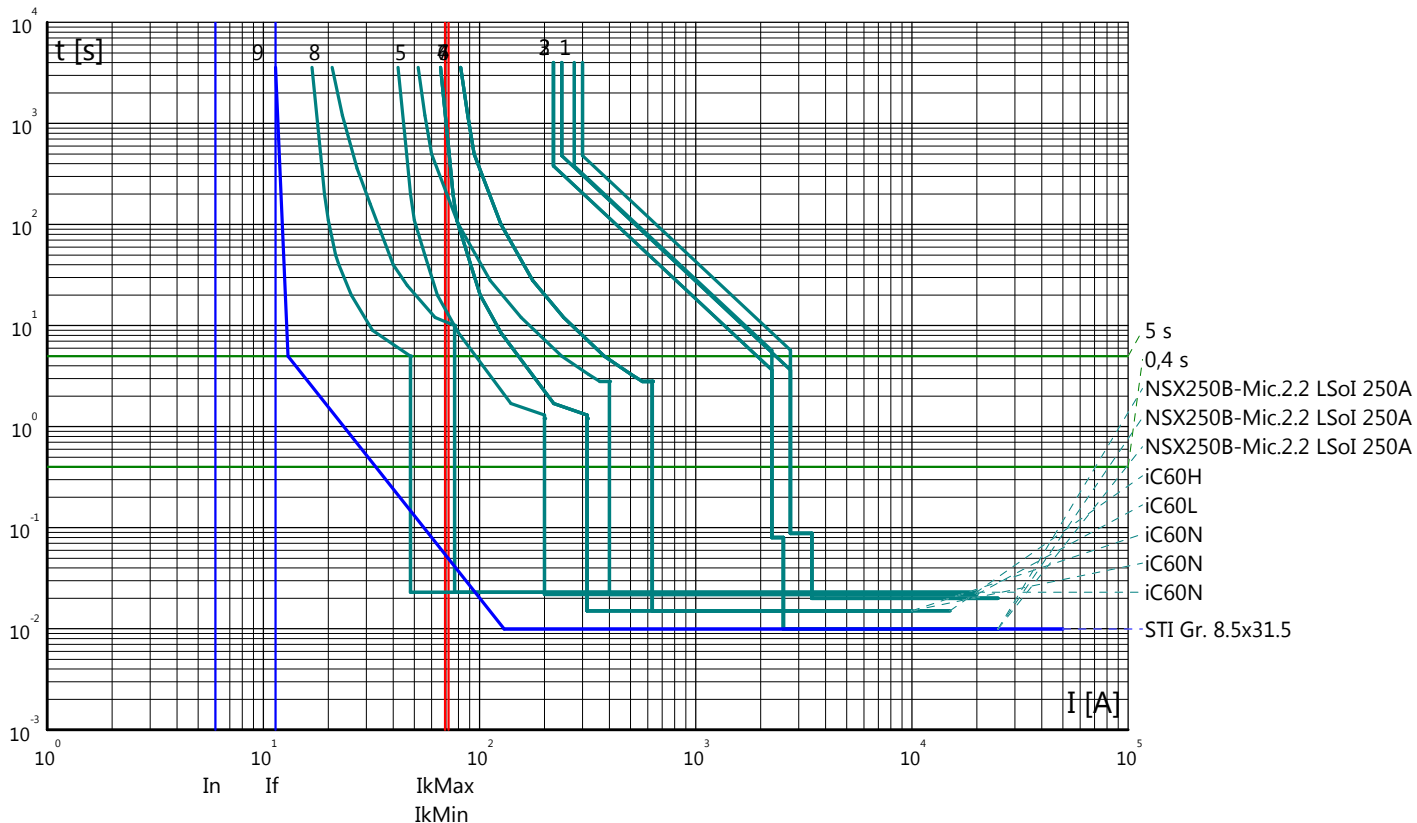

Partenza: TEM QSTES

