

COMMITTENTE:



DIREZIONE LAVORI:



APPALTATORE:



PROGETTAZIONE:	PROGETTISTA:	DIRETTORE DELLA PROGETTAZIONE
RAGGRUPPAMENTO TEMPORANEO PROGETTISTI	Ing. LUCA NANI	Ing. PIETRO MAZZOLI
		Responsabile integrazione fra le varie prestazioni specialistiche

## PROGETTO ESECUTIVO

### ITINERARIO NAPOLI-BARI

### RADDOPPIO TRATTA CANCELLO-BENEVENTO

### 1° LOTTO FUNZIONALE CANCELLO-FRASSO TELESINO E VARIANTE ALLA LINEA ROMA-NAPOLI VIA CASSINO NEL COMUNE DI MADDALONI

### IMPIANTI LUCE E FORZA MOTRICE

GALLERIA MONTE AGLIO – PIAZZALE IMBOCCO DI FINESTRA GALLERIA LATO SUD  
VERIFICA DELLA SELETTIVITA' FRA LE PROTEZIONI ELETTRICHE

APPALTATORE		SCALA:
Consorzio CFT IL DIRETTORE TECNICO Geom. C. BIANCHI 10-07-2018		-

COMMESSA	LOTTO	FASE	ENTE	TIPO DOC.	OPERA/DISCIPLINA	PROGR.	REV.
I F 1 N	0 1	E	Z Z	R O	L F 0 2 0 0	0 0 9	A

Rev.	Descrizione	Redatto	Data	Verificato	Data	Approvato	Data	Autorizzato Data
A	Emissione	F.Checucci	10-07-2018	L.Nani	10-07-2018	P. Mazzoli	10-07-2018	L.Nani
								10-07-2018

File: IF1N.0.1.E.ZZ.RO.LF.02.0.0.009.A.doc	n. Elab.:
--	-----------

Curve tempo corrente: GALLERIA MONTE AGLIO  
 Quadro: QF-NB

Arrivo: IG

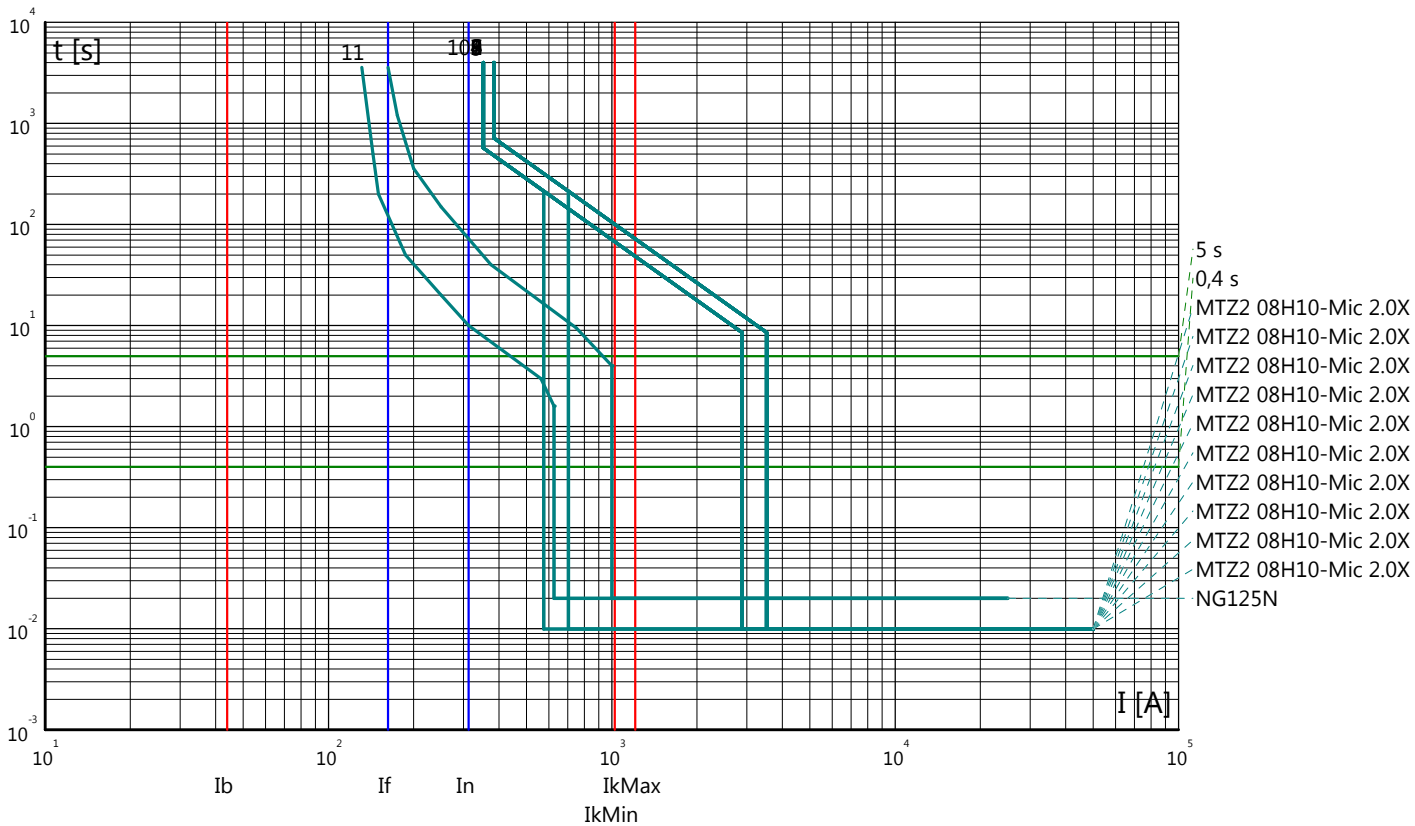

Partenza: PT

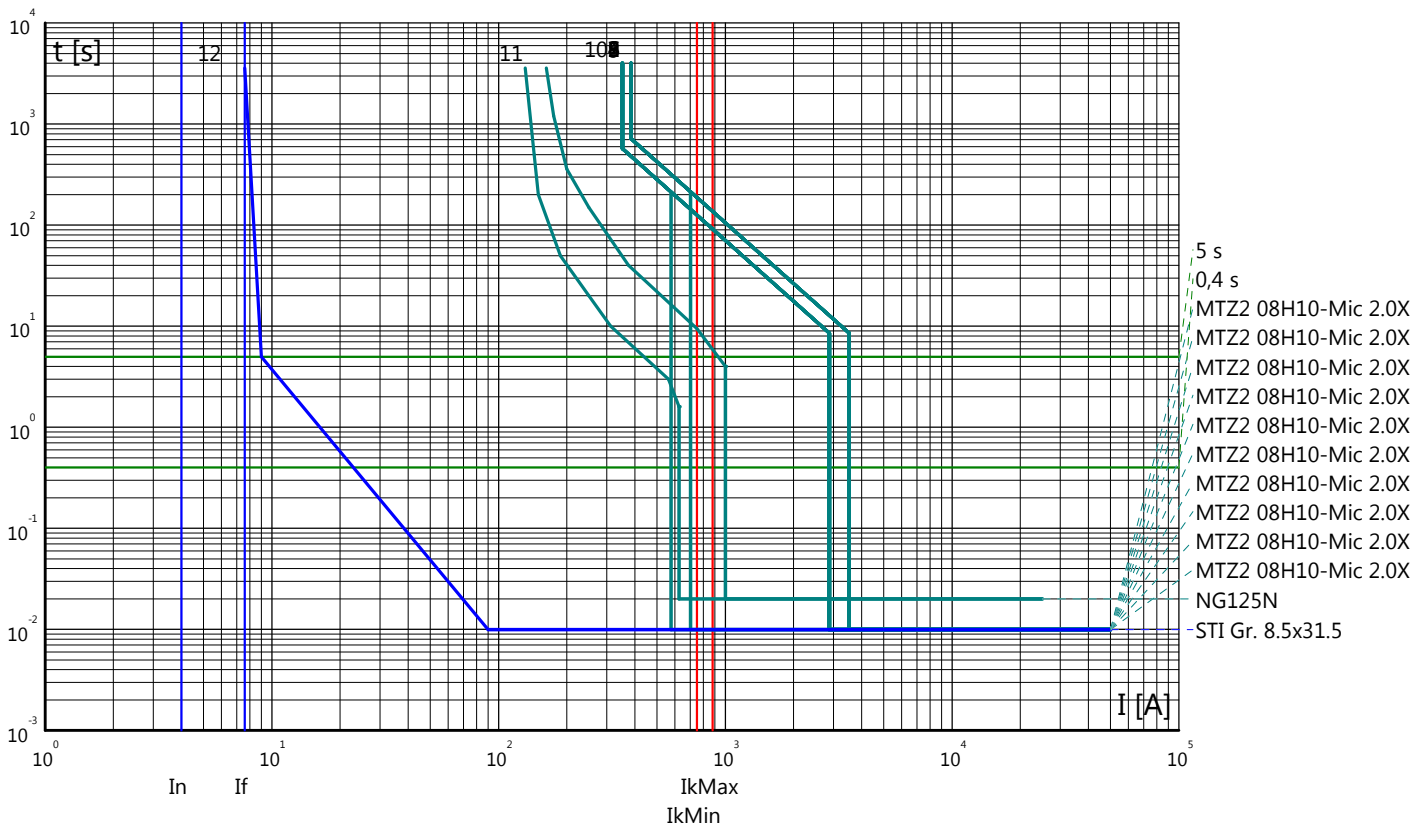

Curve tempo corrente: GALLERIA MONTE AGLIO  
 Quadro: QF-NB

Partenza: MIS

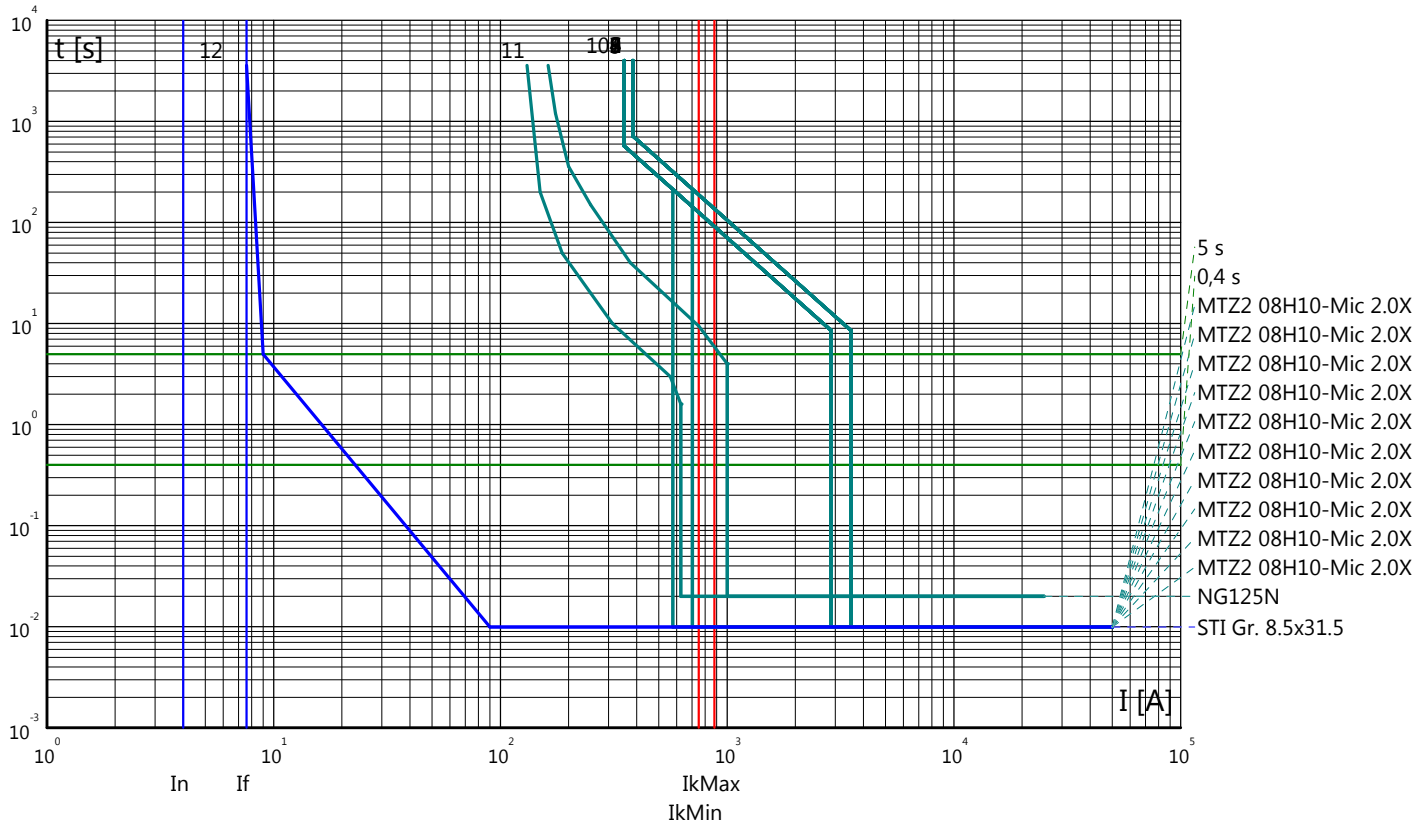

Partenza: F1.1

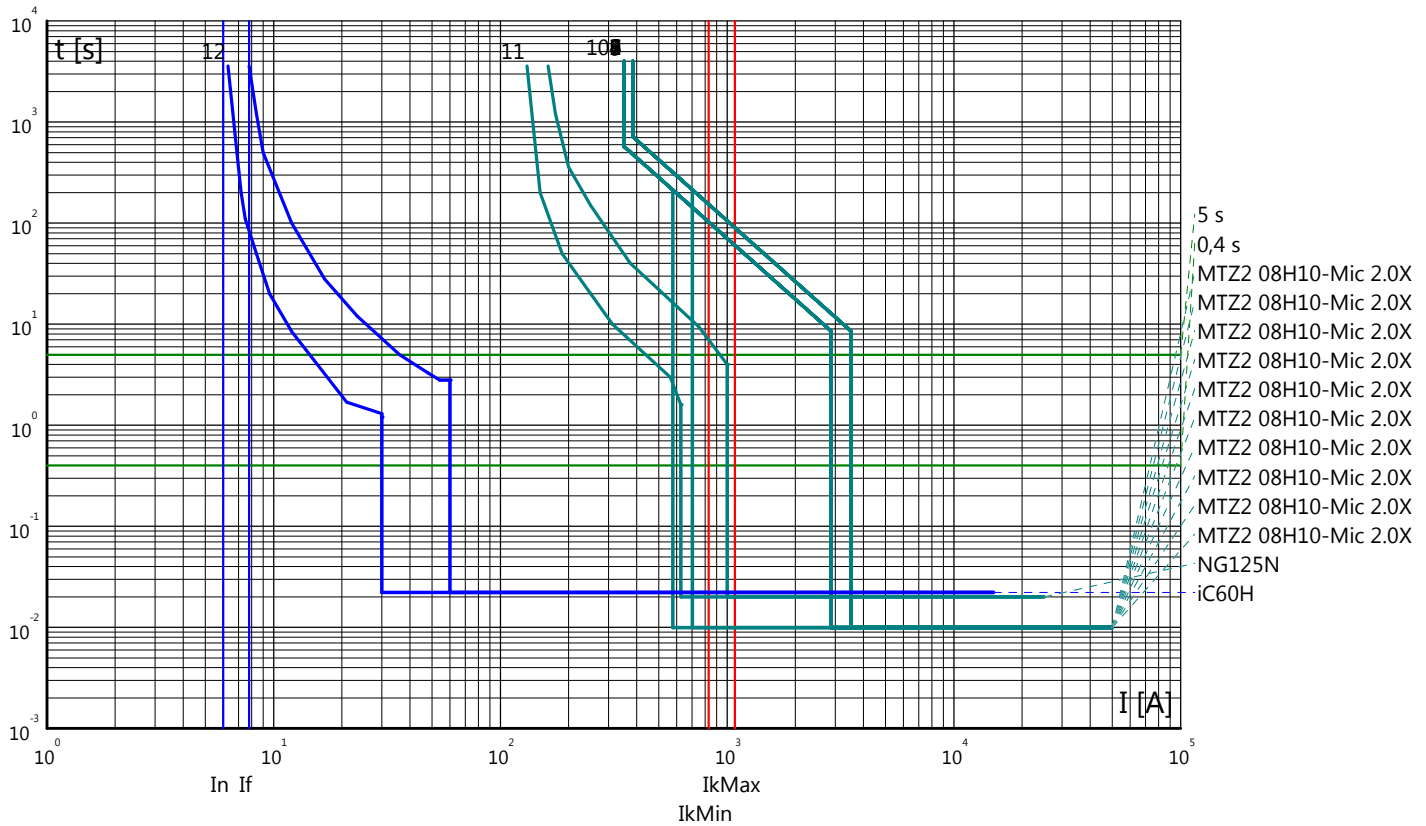

Curve tempo corrente: GALLERIA MONTE AGLIO  
 Quadro: QF-NB

Partenza: IP1

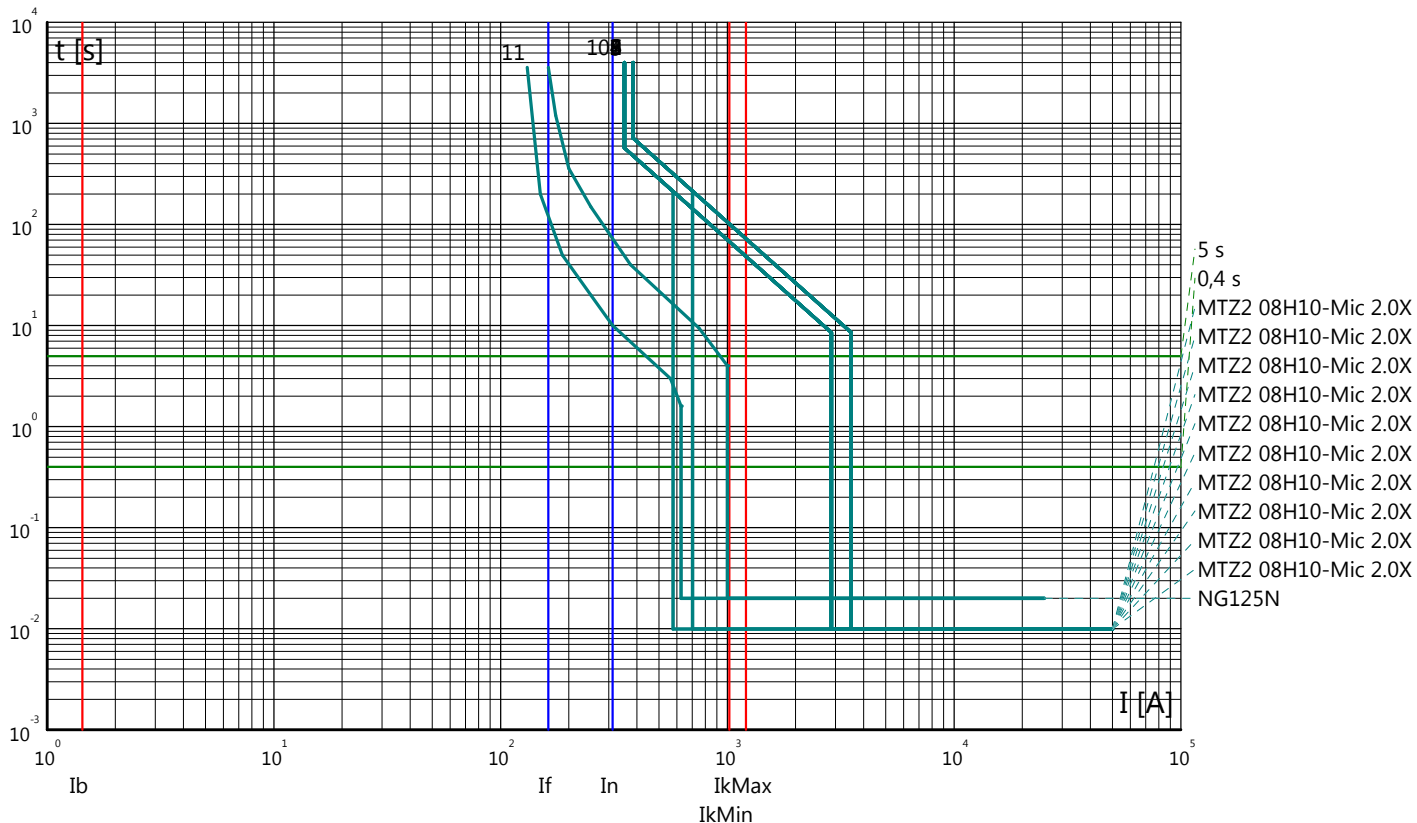

Partenza: F1.2

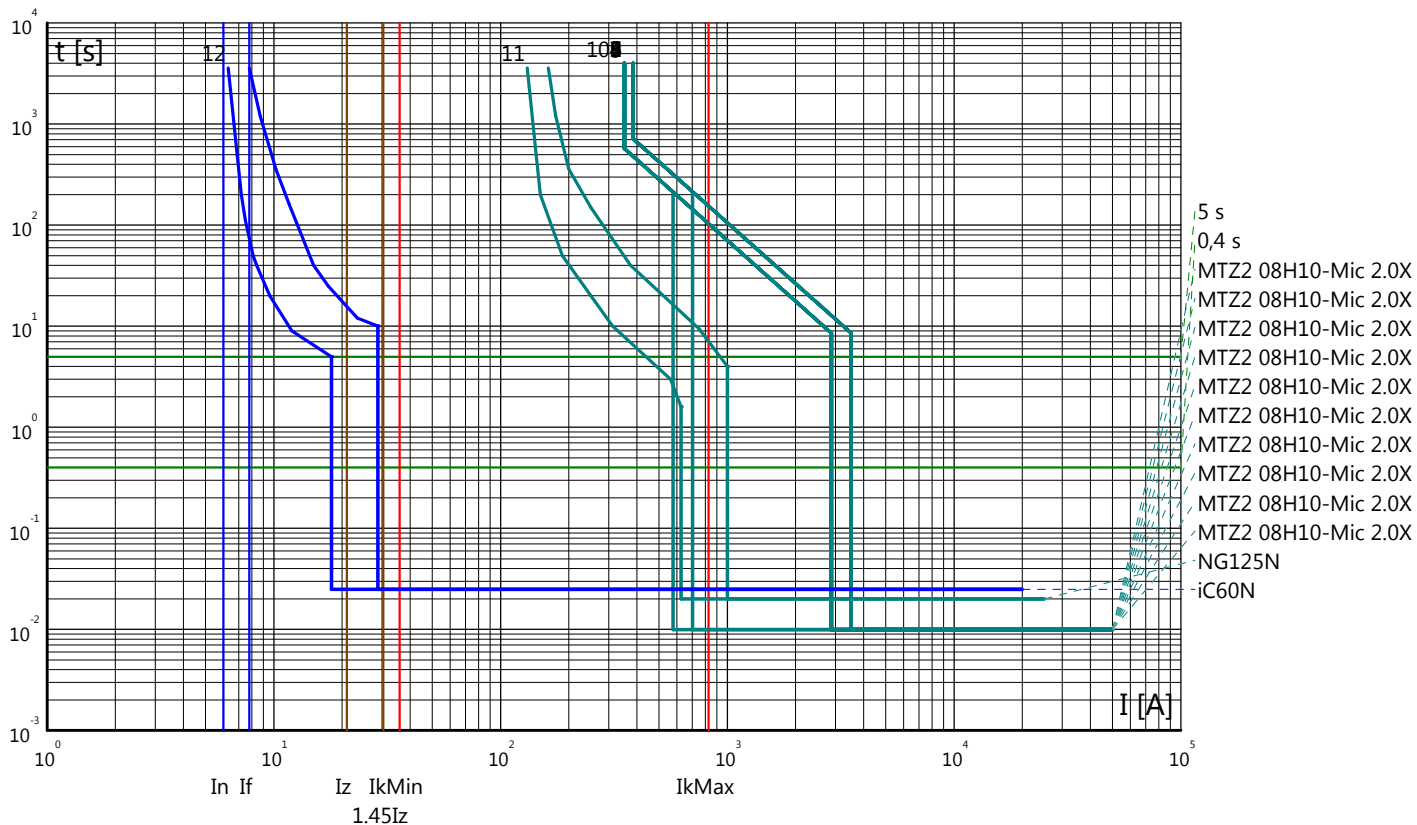

Curve tempo corrente: GALLERIA MONTE AGLIO  
 Quadro: QF-NB

Partenza: F1.3

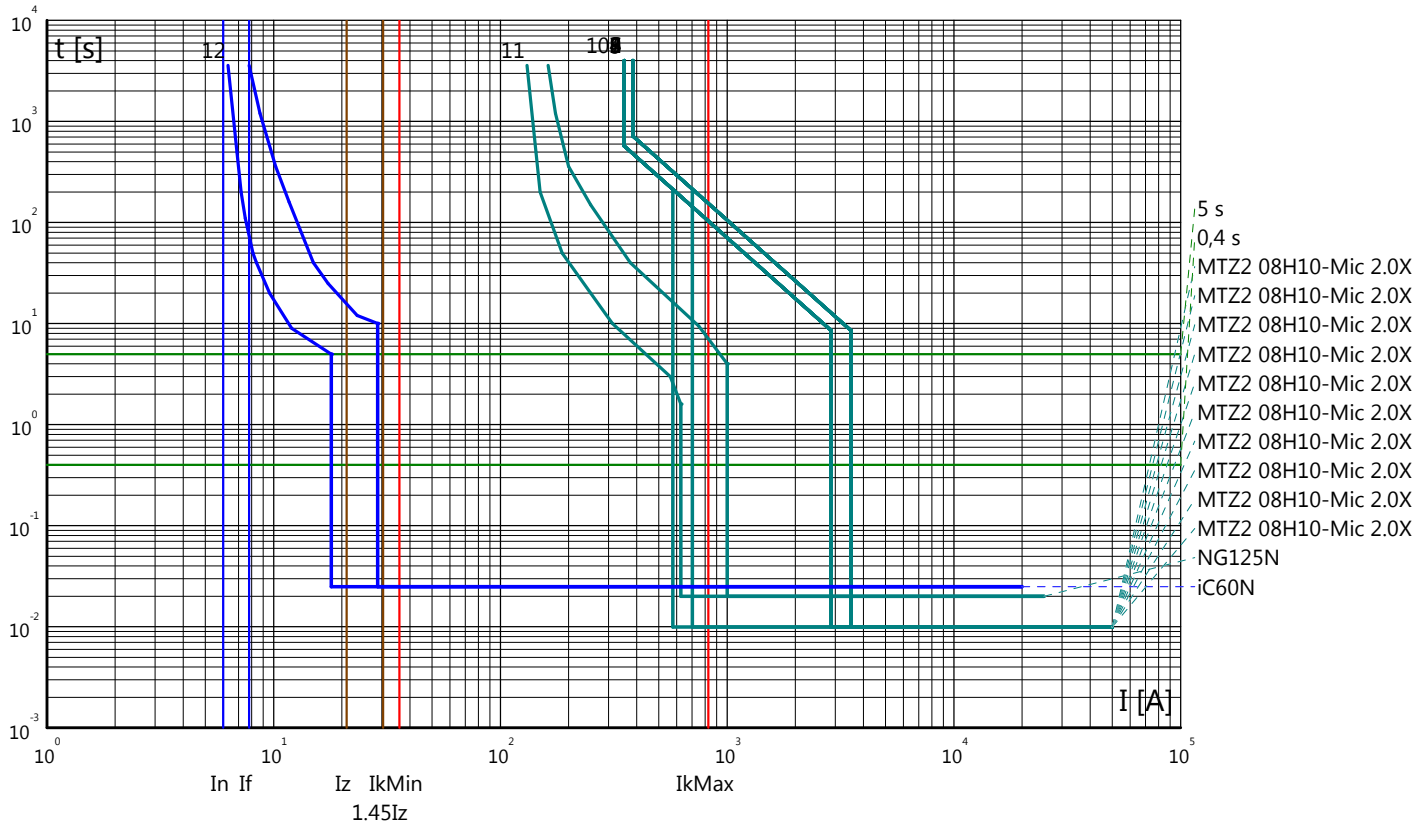

Partenza: F1.4

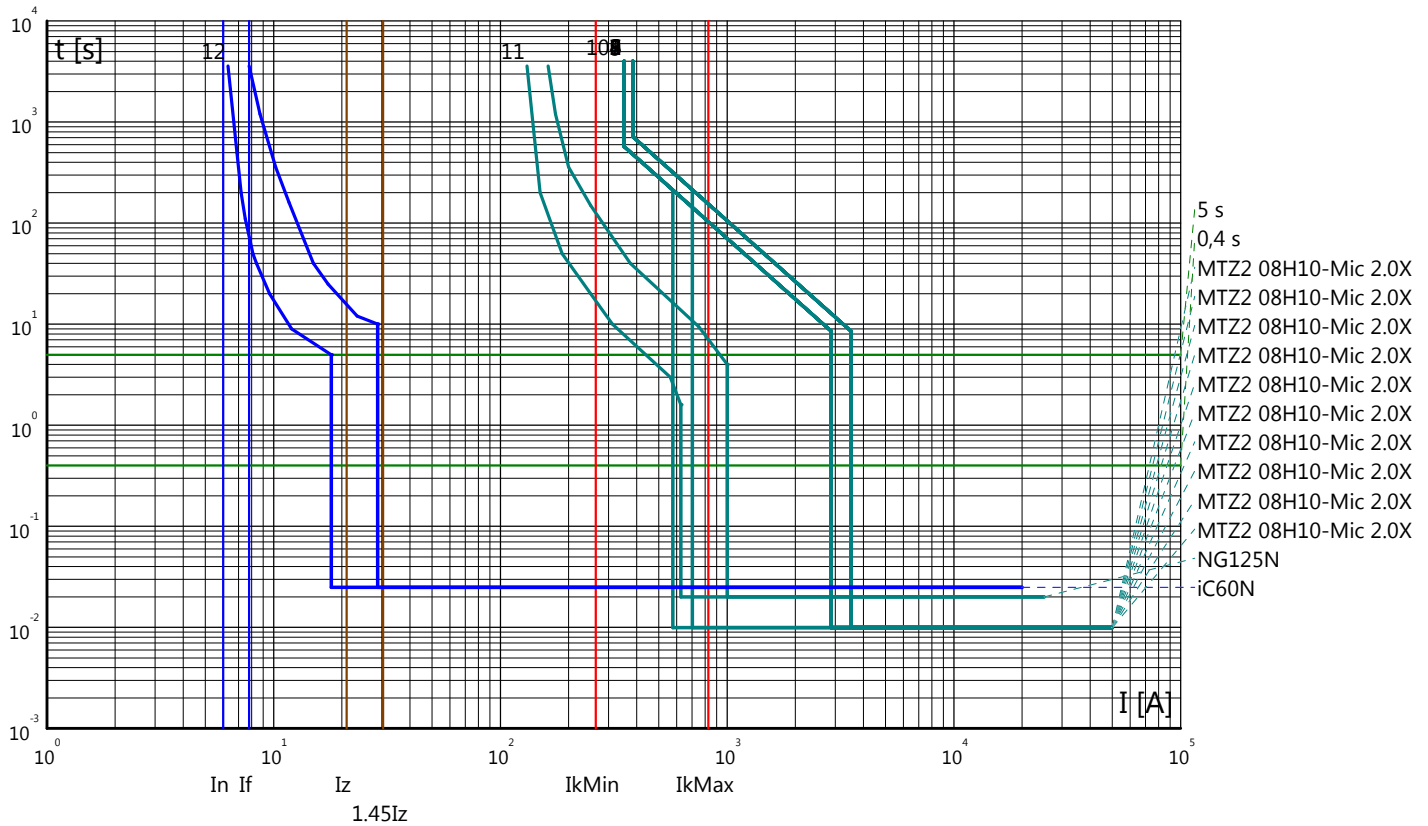

Curve tempo corrente: GALLERIA MONTE AGLIO  
 Quadro: QF-NB

Partenza: F1.5

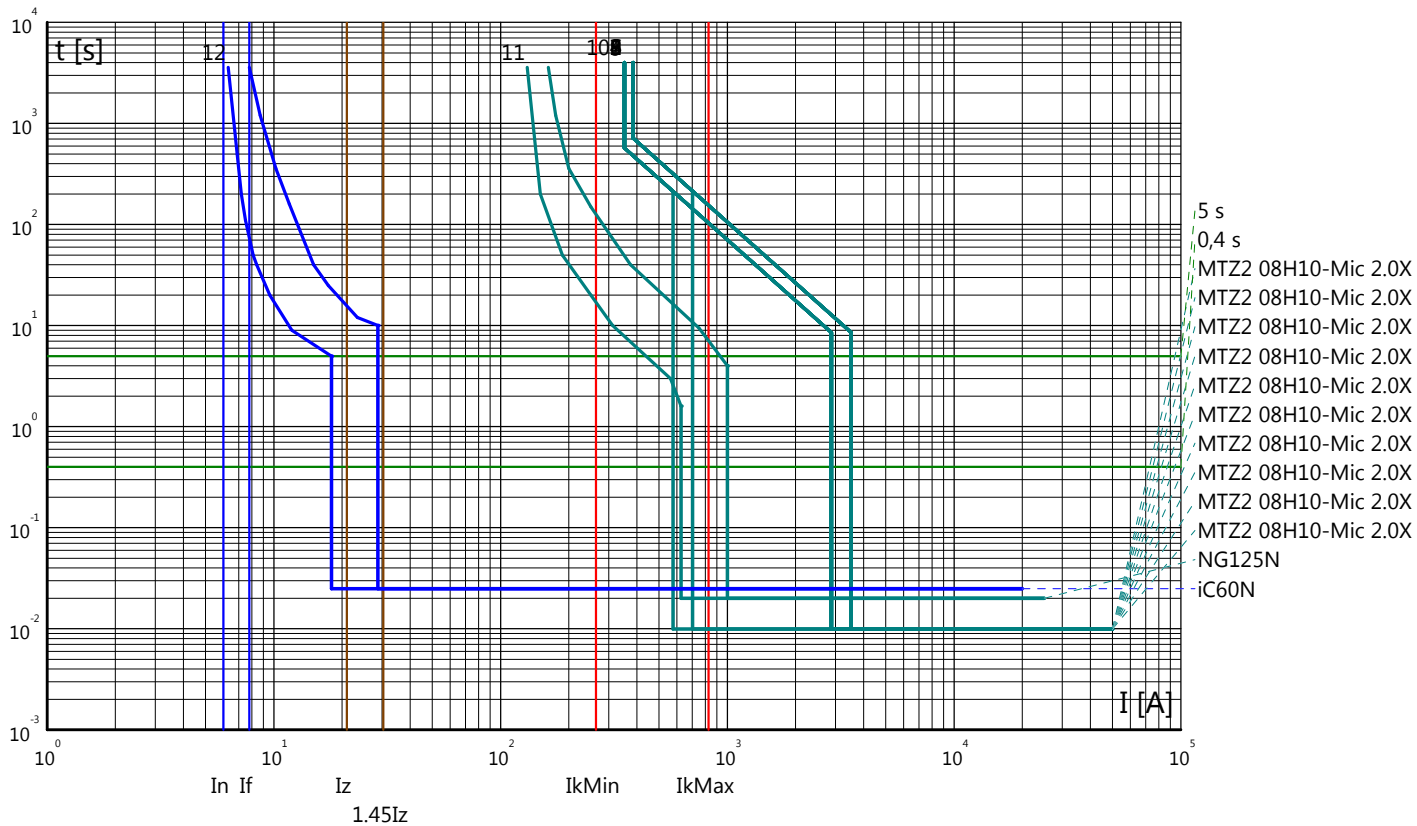

Partenza: F1.6

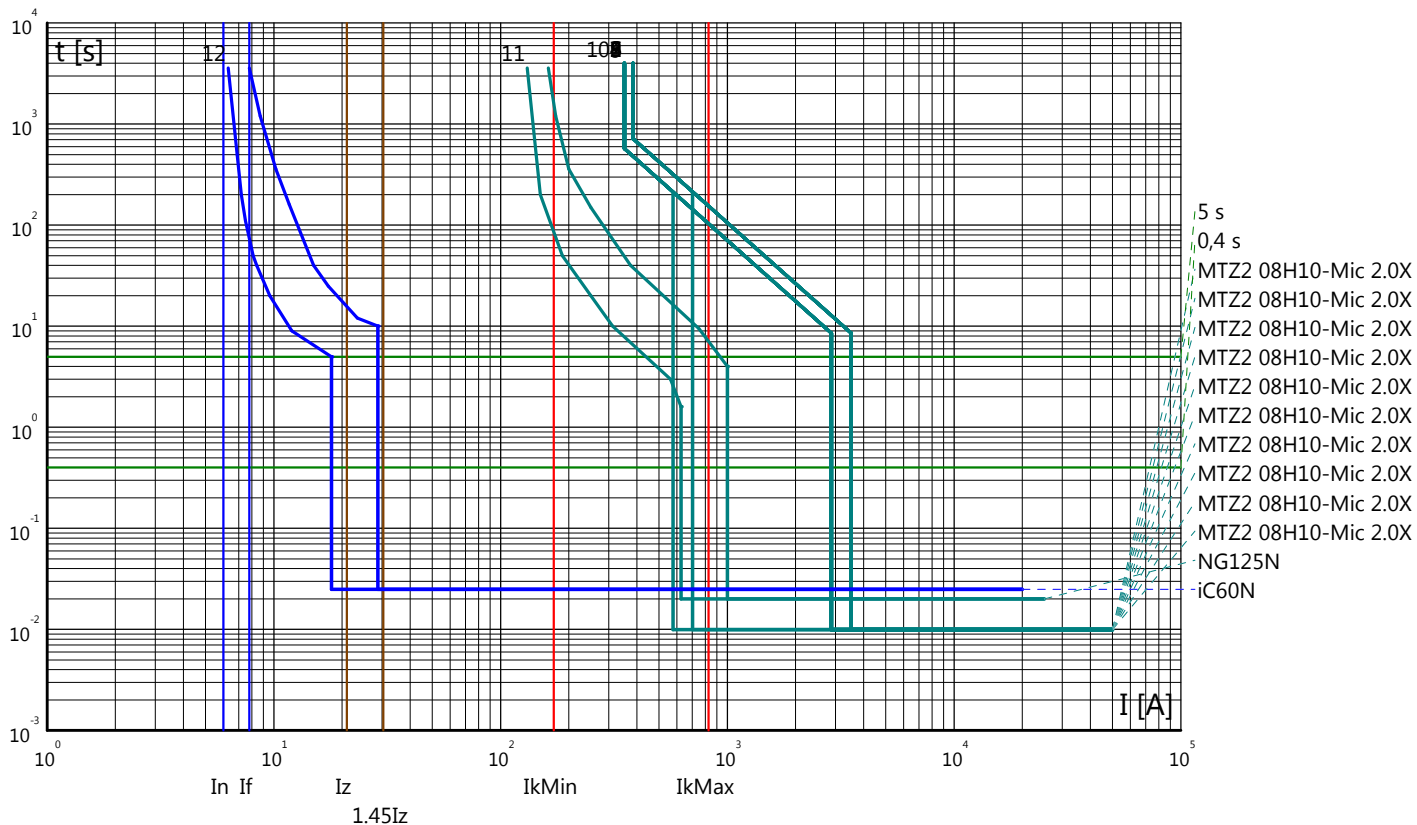

Curve tempo corrente: GALLERIA MONTE AGLIO  
 Quadro: QF-NB

Partenza: F1.7

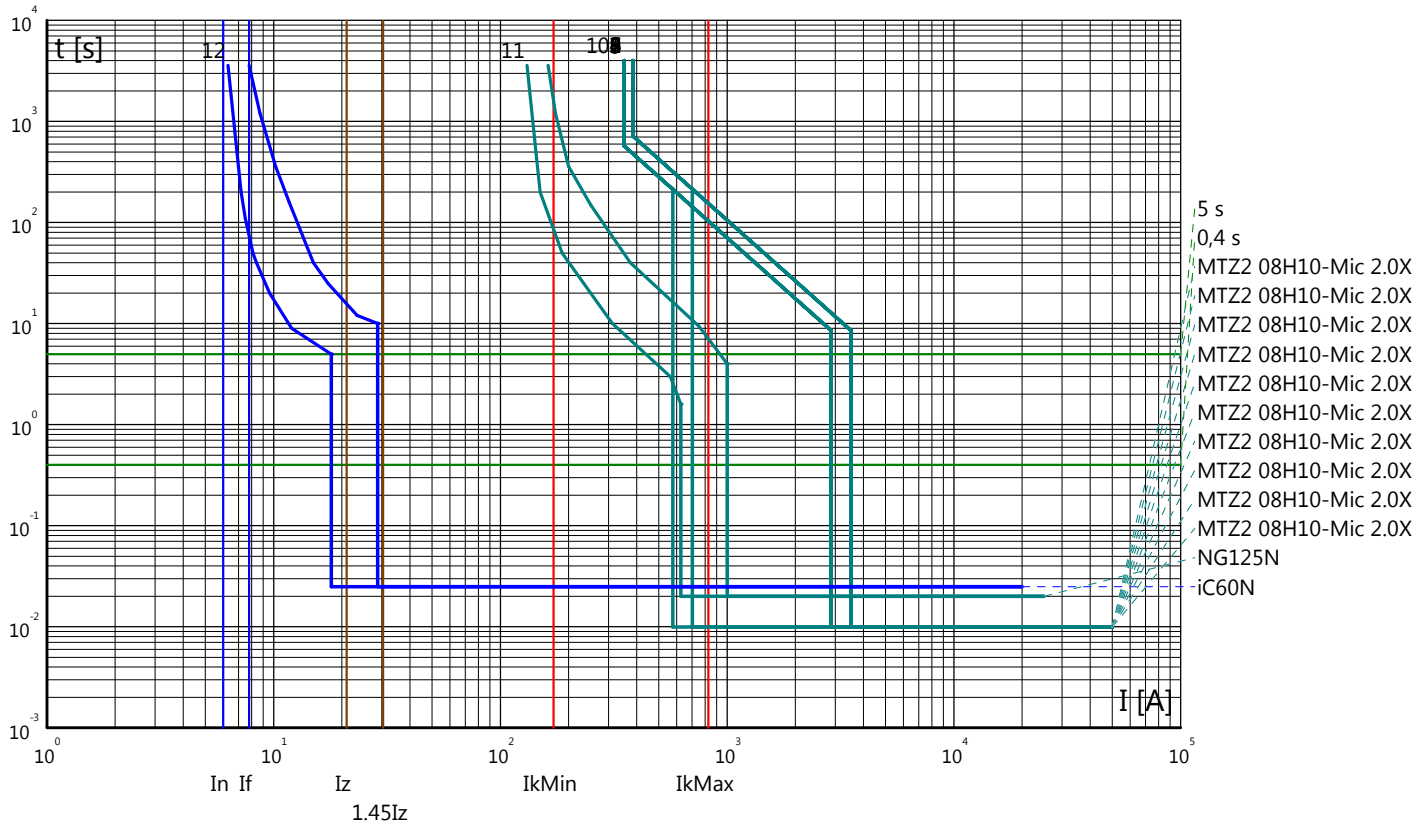

Partenza: F1.8

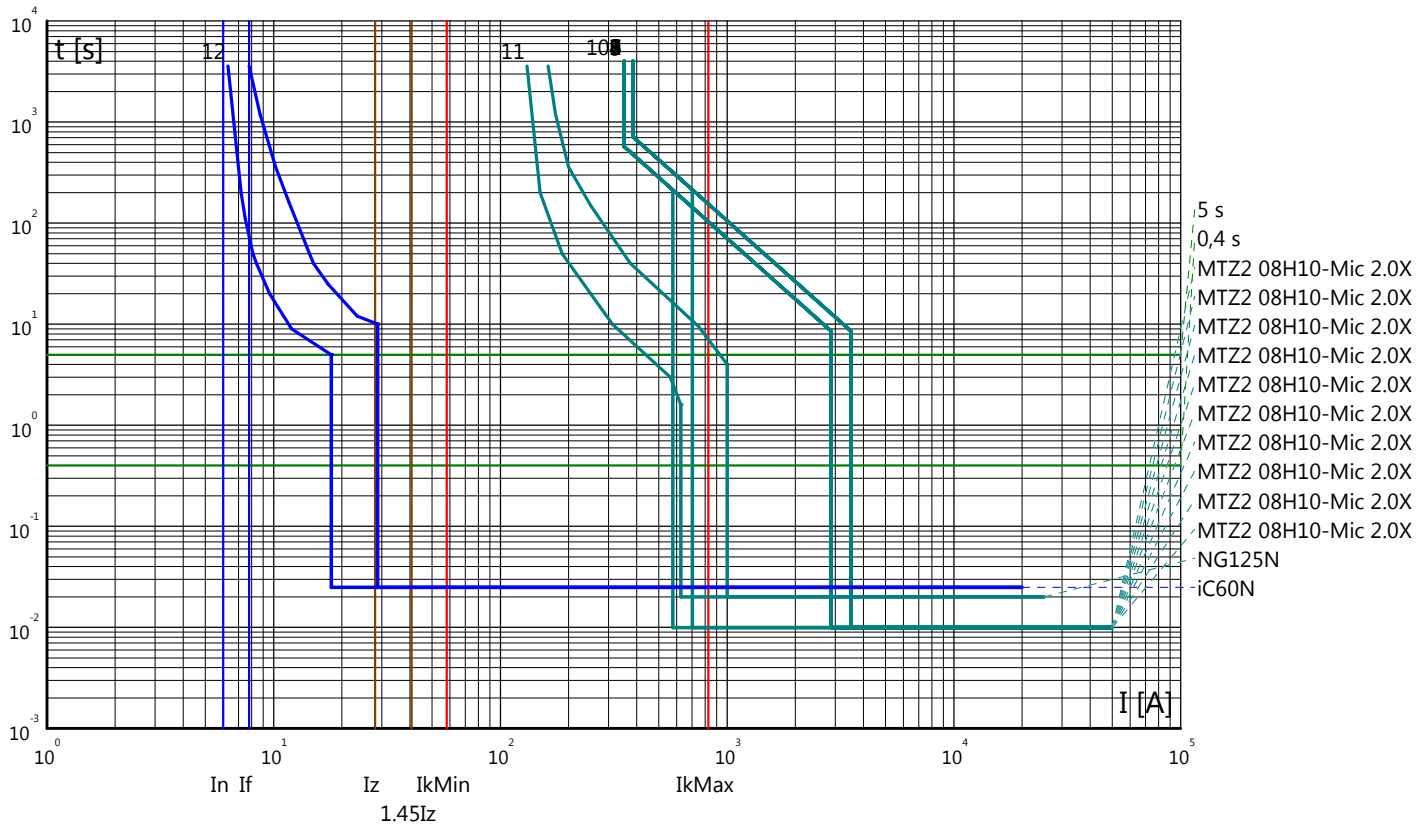





Curve tempo corrente: GALLERIA MONTE AGLIO  
 Quadro: QF-NB

Partenza: F1.11

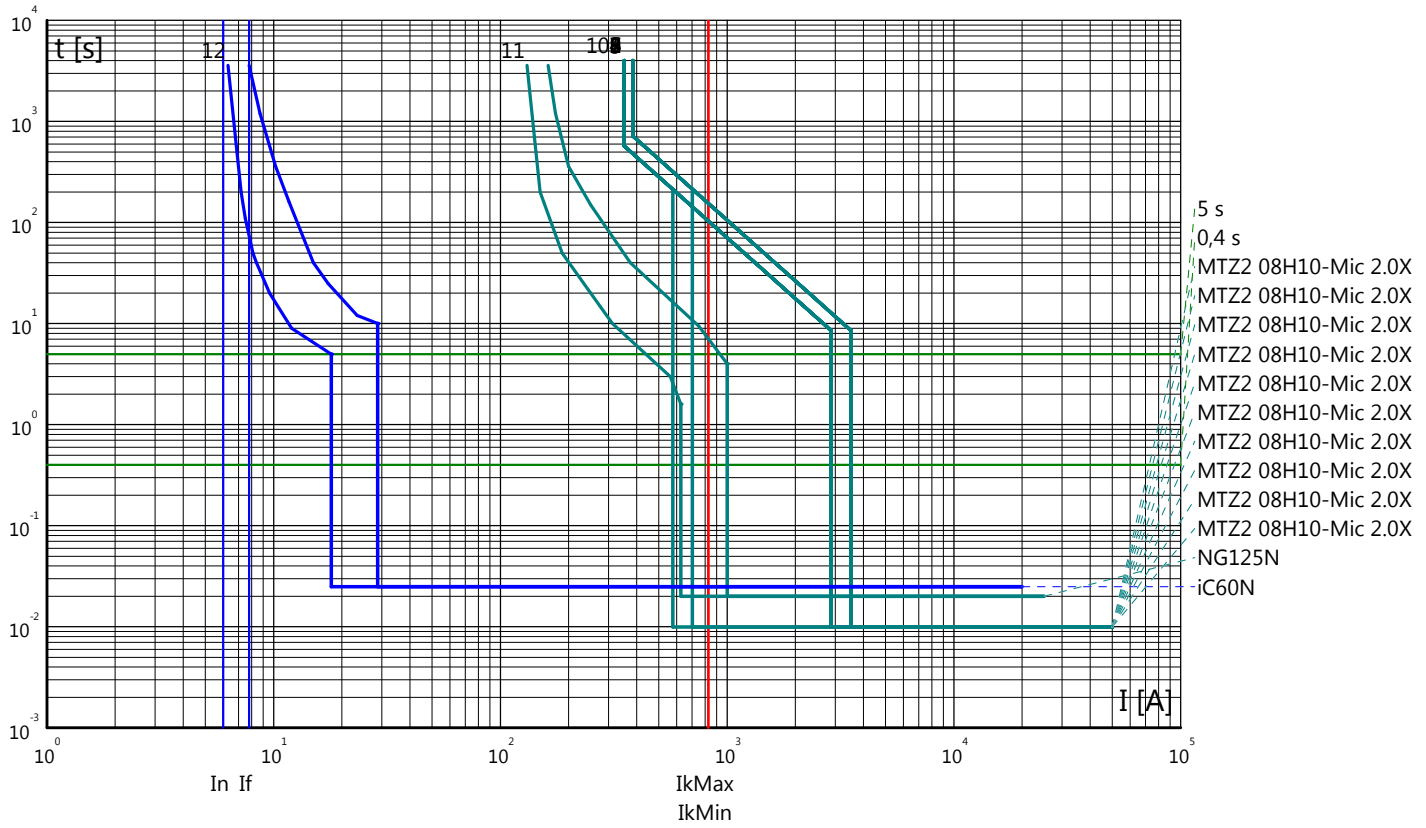

Partenza: F1.12

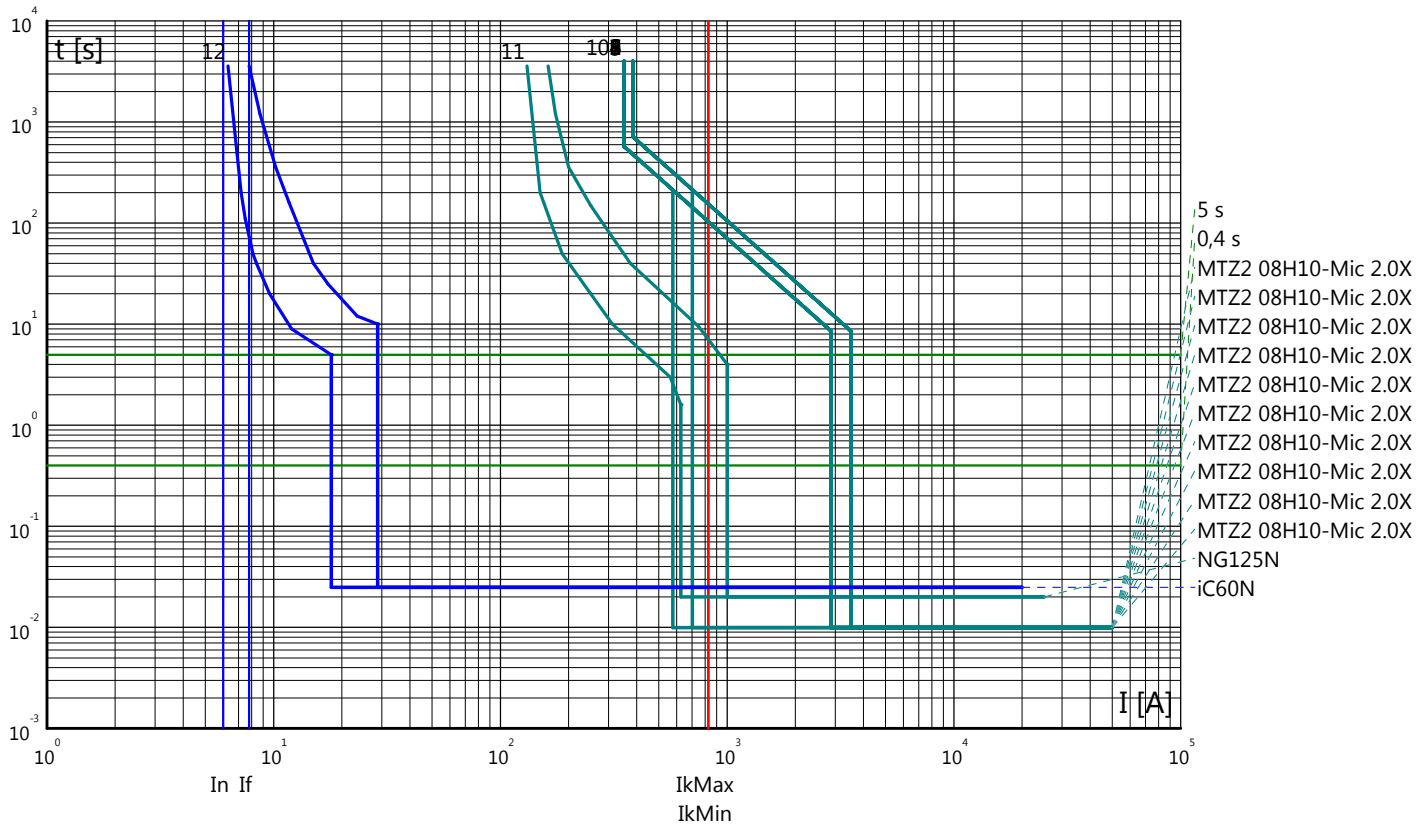

Curve tempo corrente: GALLERIA MONTE AGLIO  
 Quadro: QF-NB

Partenza: IP2

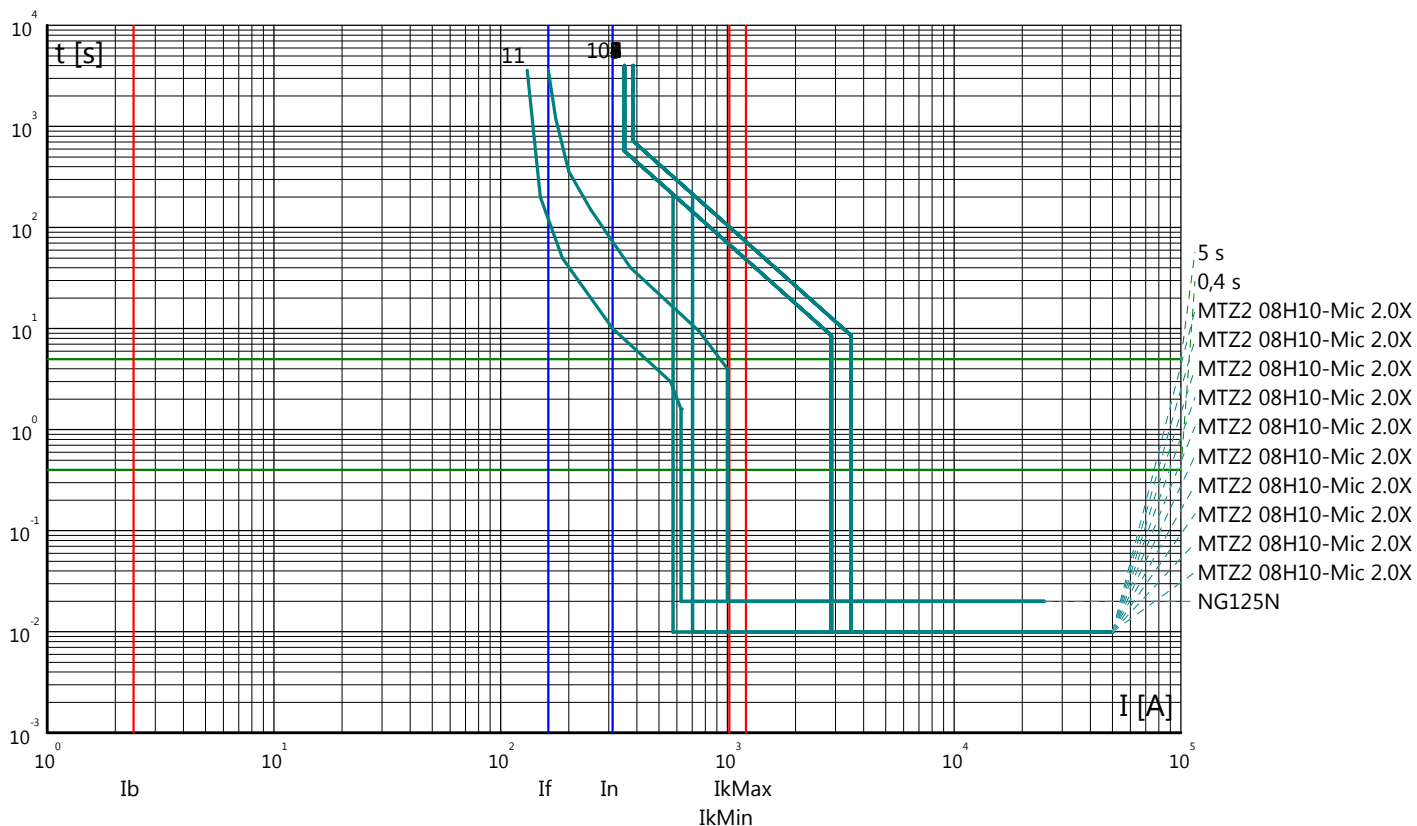

Partenza: F1.13

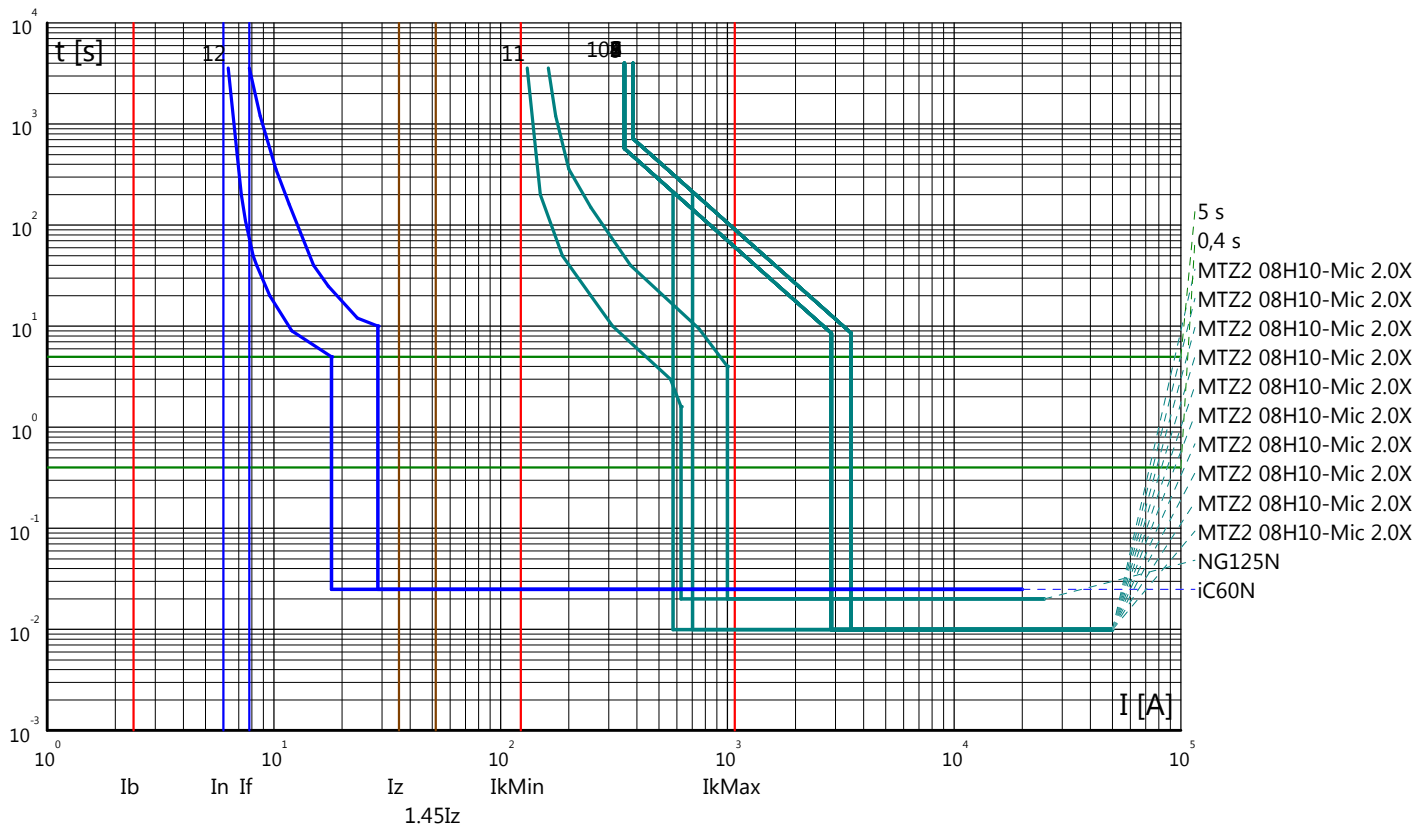

Curve tempo corrente: GALLERIA MONTE AGLIO  
 Quadro: QF-NB

Partenza: F1.14

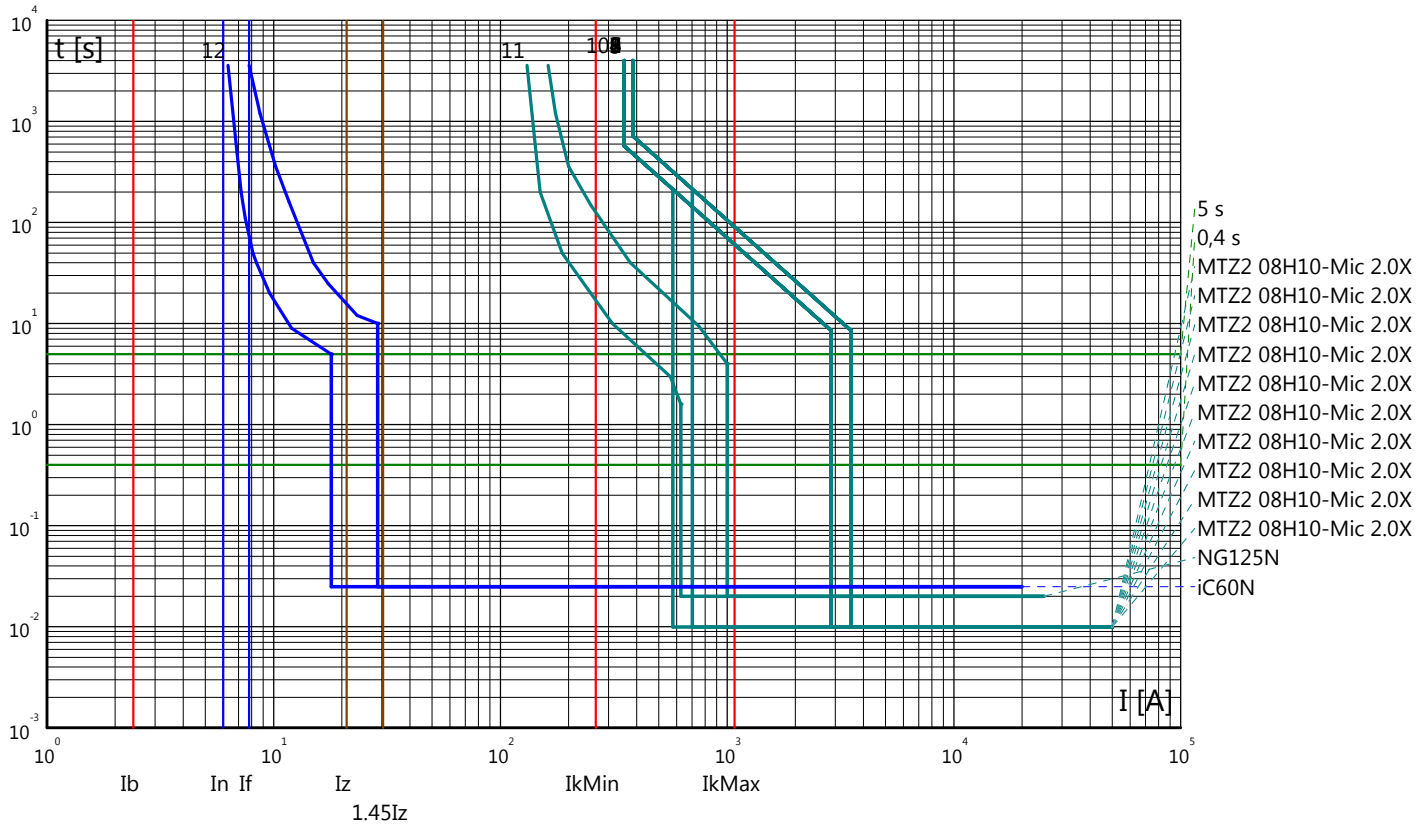

Partenza: F1.15

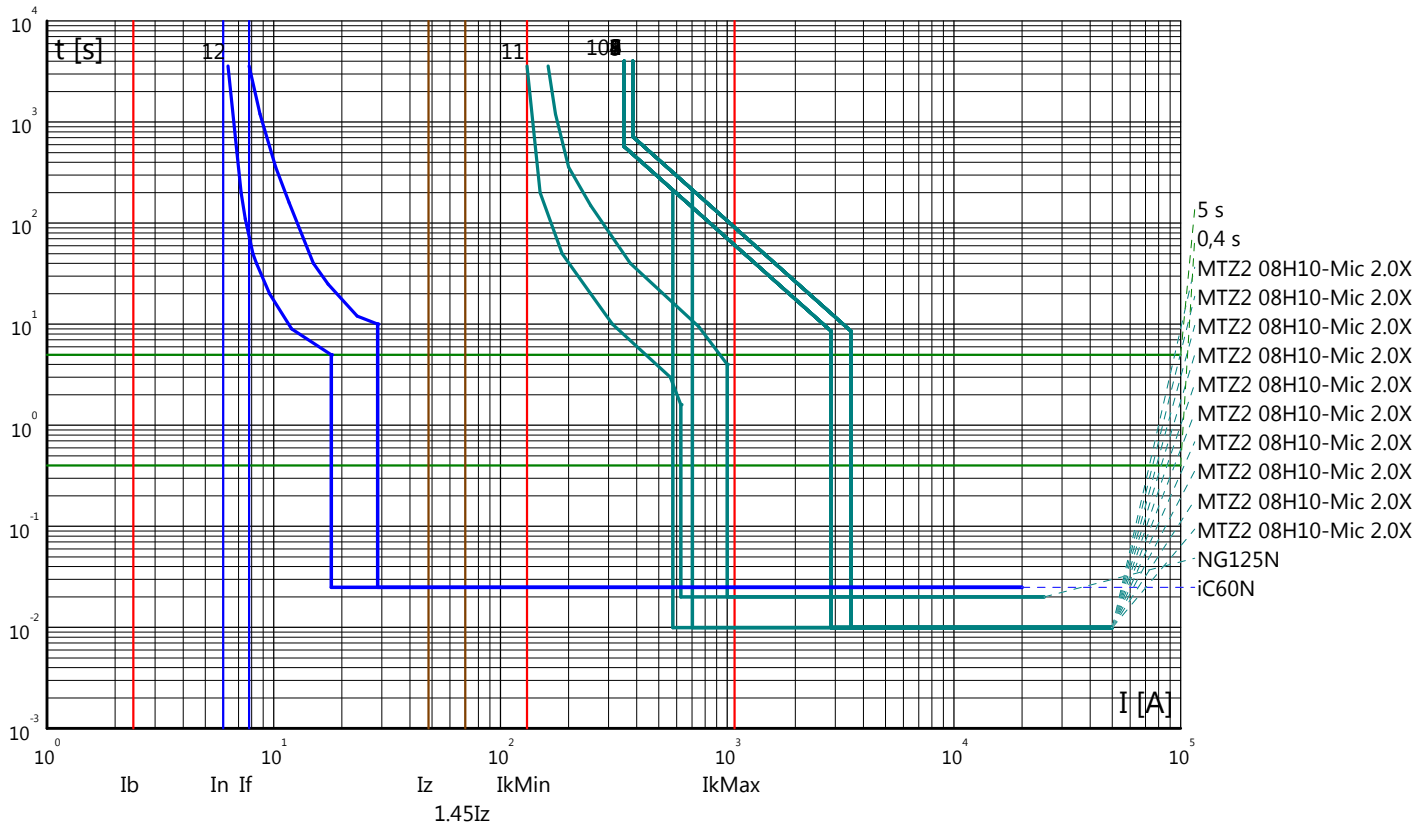

Curve tempo corrente: GALLERIA MONTE AGLIO  
 Quadro: QF-NB

Partenza: F1.16

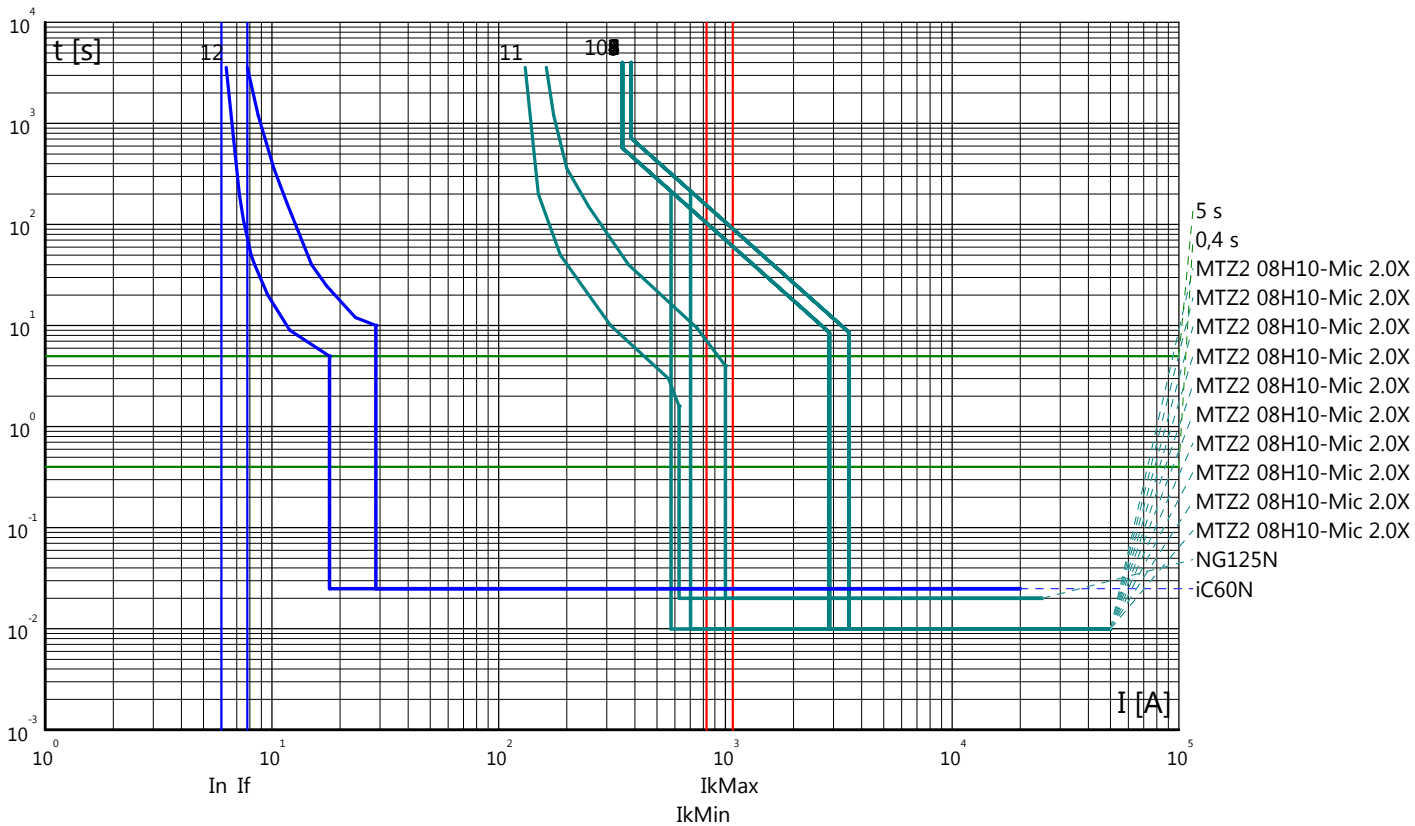

Partenza: F1.17

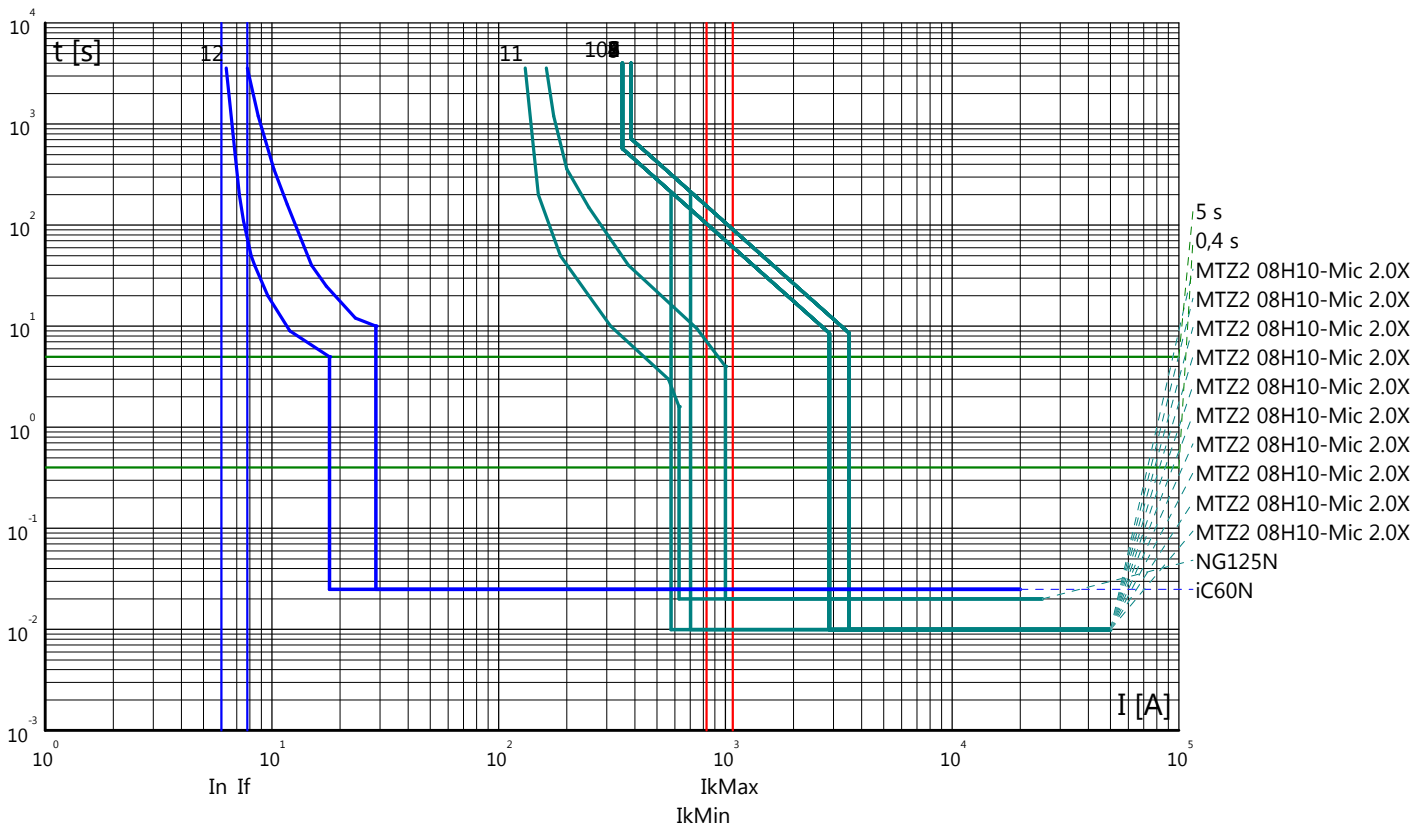



Curve tempo corrente: GALLERIA MONTE AGLIO  
 Quadro: QF-NB

Partenza: F1.20

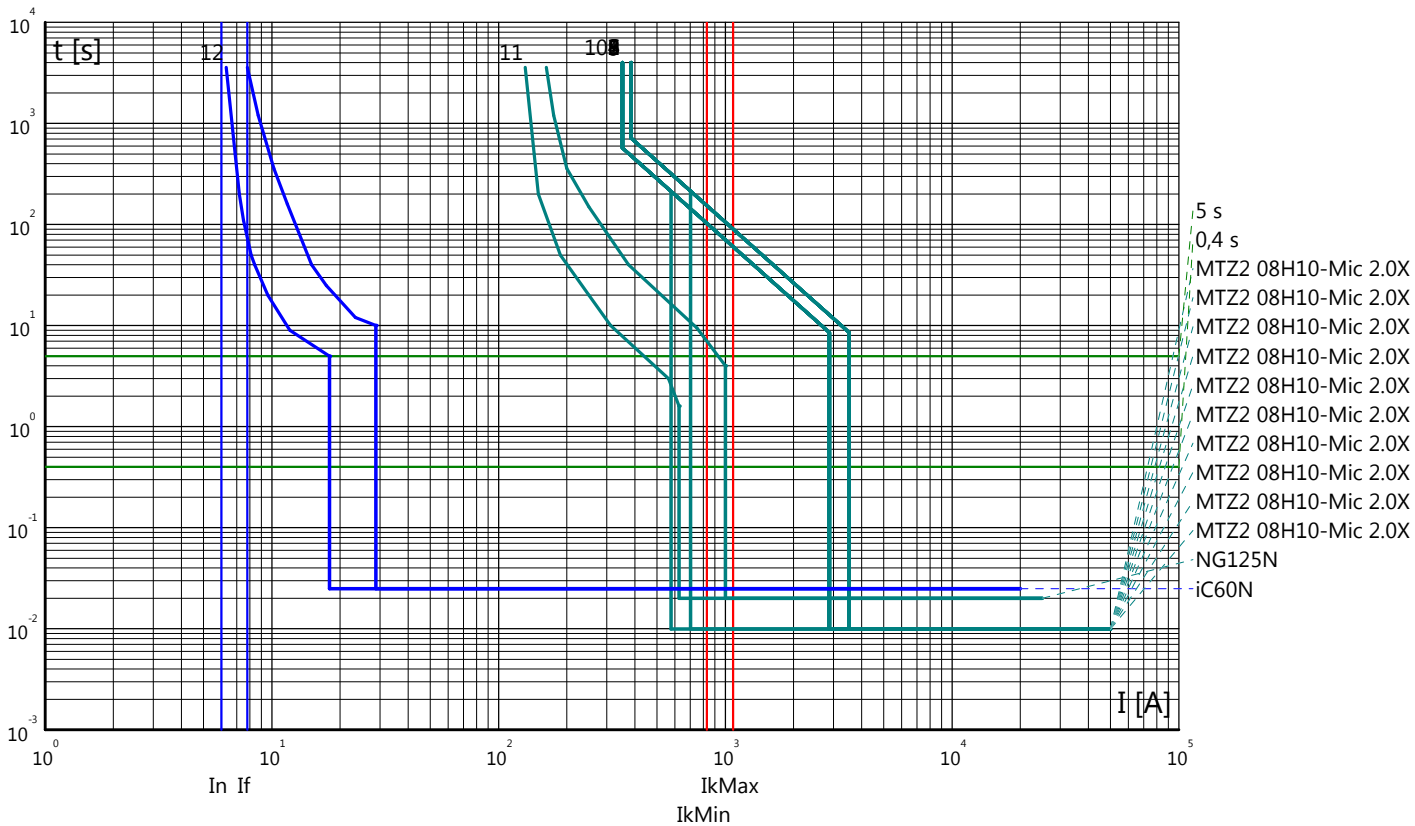

Partenza: F1.21

