

COMMITTENTE:



DIREZIONE LAVORI:



APPALTATORE:



PROGETTAZIONE:	PROGETTISTA:	DIRETTORE DELLA PROGETTAZIONE
RAGGRUPPAMENTO TEMPORANEO PROGETTISTI	Ing. LUCA NANI	Ing. PIETRO MAZZOLI
		Responsabile integrazione fra le varie prestazioni specialistiche

PROGETTO ESECUTIVO

ITINERARIO NAPOLI-BARI

RADDOPPIO TRATTA CANCELLO-BENEVENTO

1° LOTTO FUNZIONALE CANCELLO-FRASSO TELESINO E VARIANTE ALLA LINEA ROMA-NAPOLI VIA CASSINO NEL COMUNE DI MADDALONI

IMPIANTI LUCE E FORZA MOTRICE

GALLERIA MONTE AGLIO – PIAZZALE IMBOCCO GALLERIA LATO SUD

VERIFICA DELLA SELETTIVITA' FRA LE PROTEZIONI ELETTRICHE

APPALTATORE		SCALA:
Consorzio CFT IL DIRETTORE TECNICO Geom. C. BIANCHI 10-07-2018		-

COMMESSA	LOTTO	FASE	ENTE	TIPO DOC.	OPERA/DISCIPLINA	PROGR.	REV.
I F 1 N	0 1	E	Z Z	R O	L F 0 2 0 0	0 0 4	A

Rev.	Descrizione	Redatto	Data	Verificato	Data	Approvato	Data	Autorizzato Data
A	Emissione	F.Checucci	10-07-2018	L.Nani	10-07-2018	P. Mazzoli	10-07-2018	L.Nani
								10-07-2018

File: IF1N.0.1.E.ZZ.CL.LF.02.0.0.004.A.doc	n. Elab.:
--	-----------

Curve tempo corrente: GALLERIA MONTE AGLIO
 Quadro: Quadro Media tensione

Arrivo:

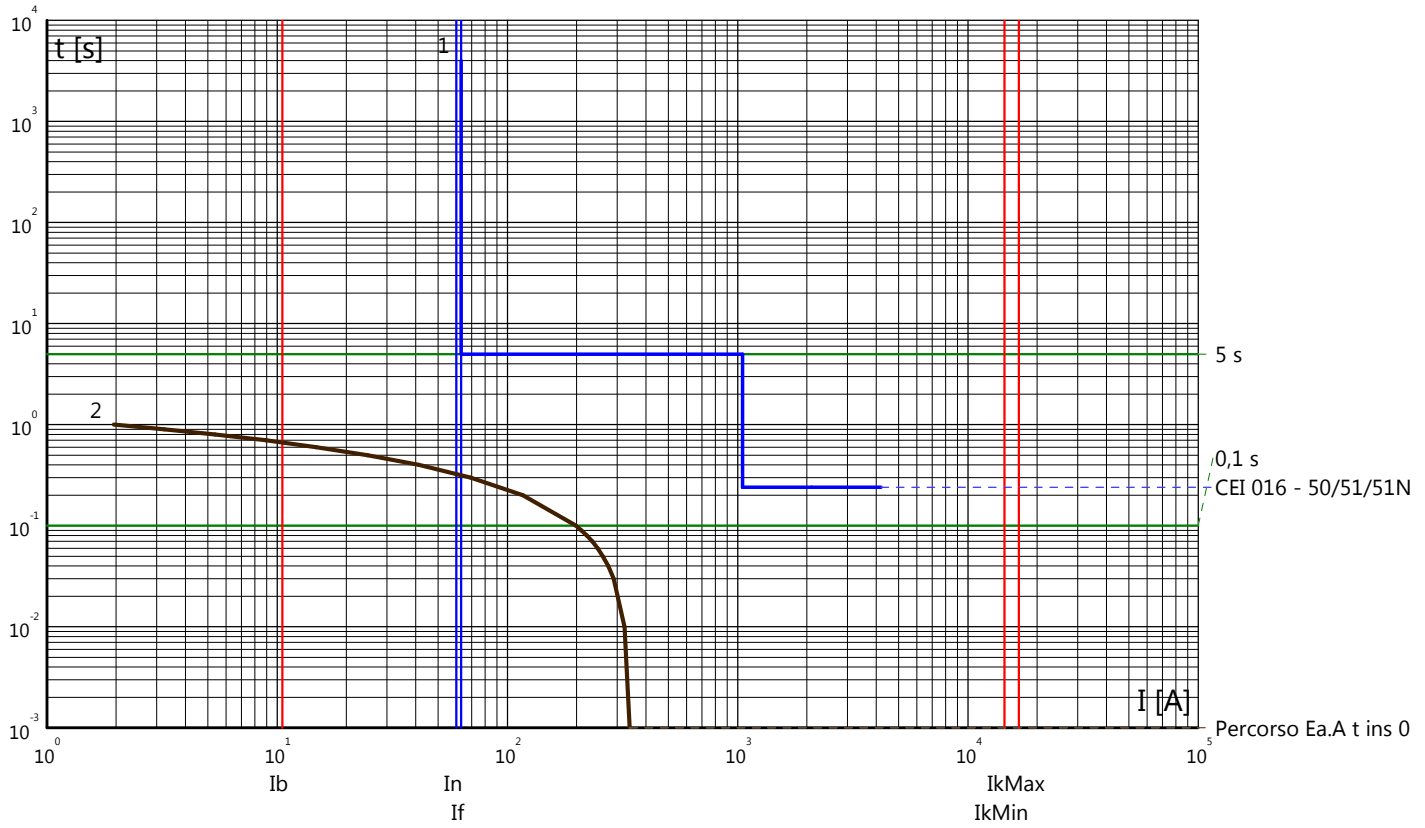

Partenza:

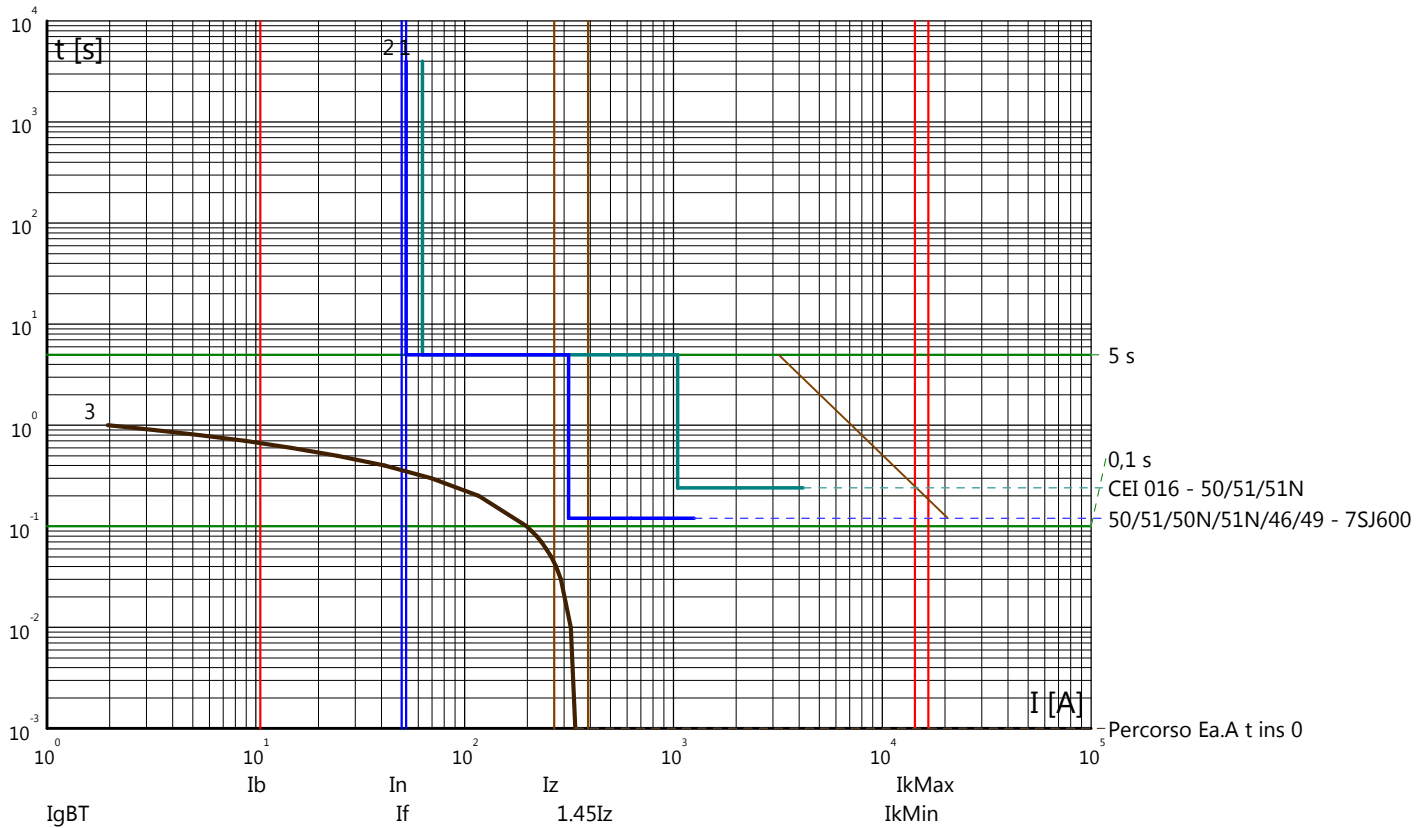

Curve tempo corrente: GALLERIA MONTE AGLIO
 Quadro: Quadro Media tensione

Arrivo:

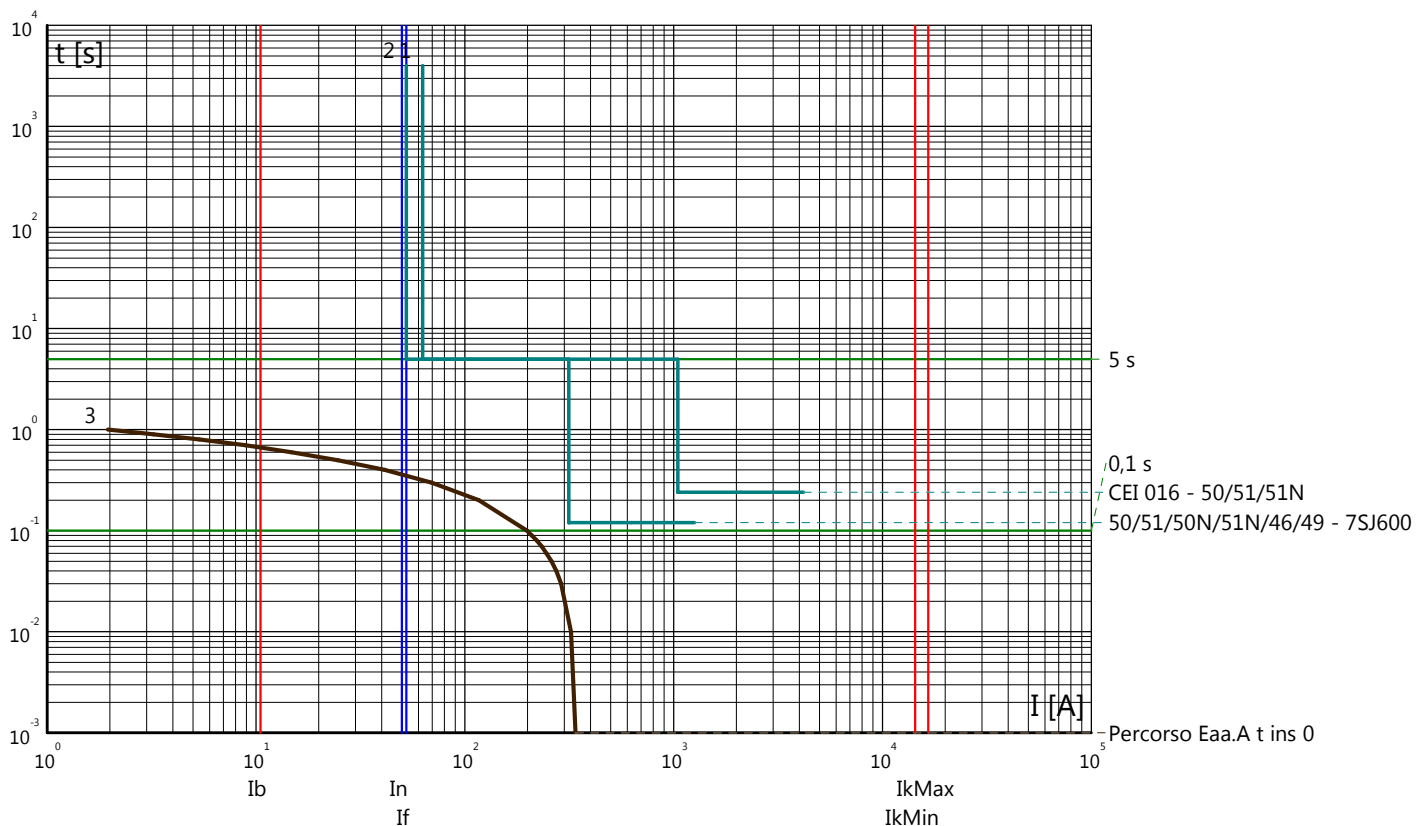

Partenza:

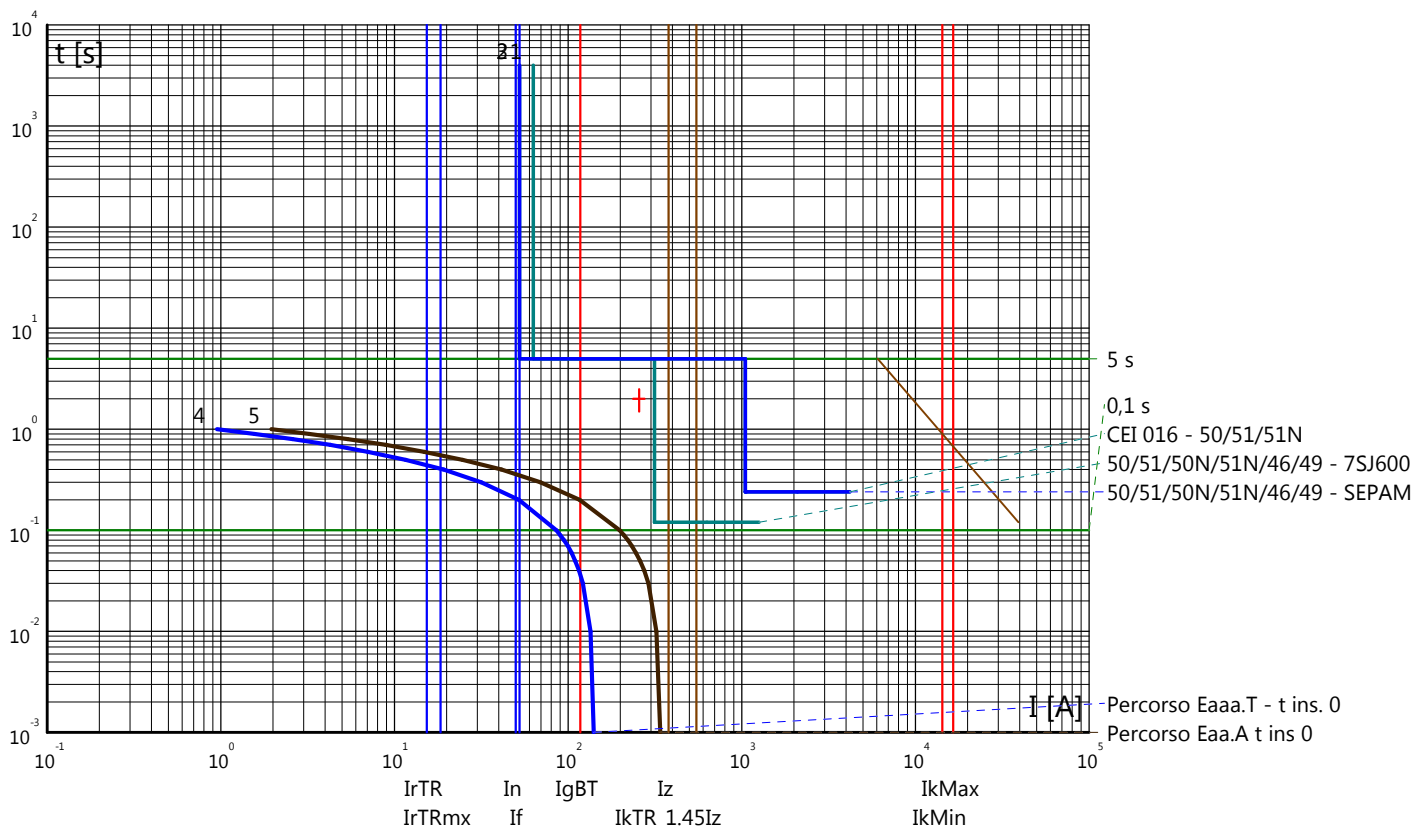

Curve tempo corrente: GALLERIA MONTE AGLIO
 Quadro: Quadro Media tensione

Partenza:

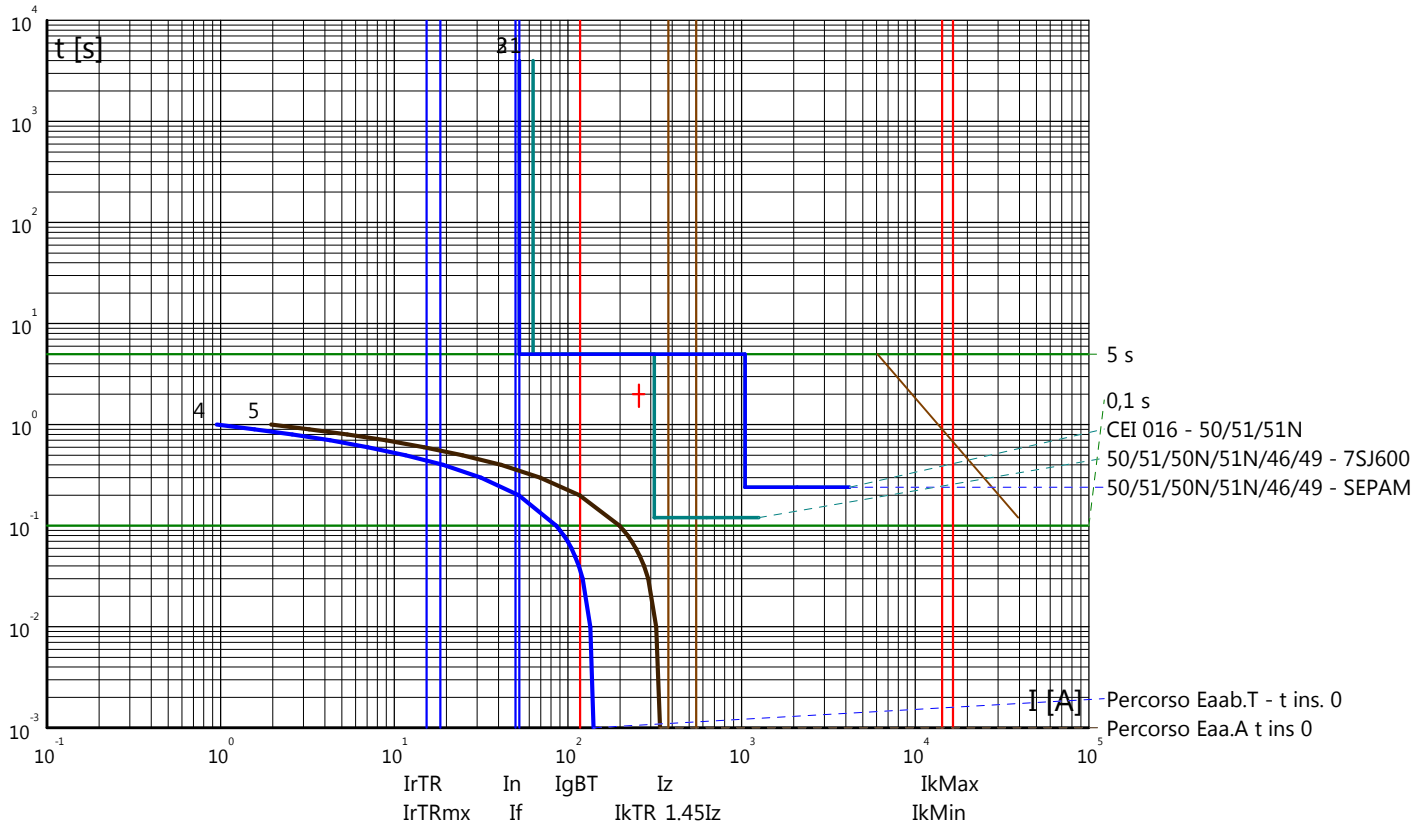

Partenza:

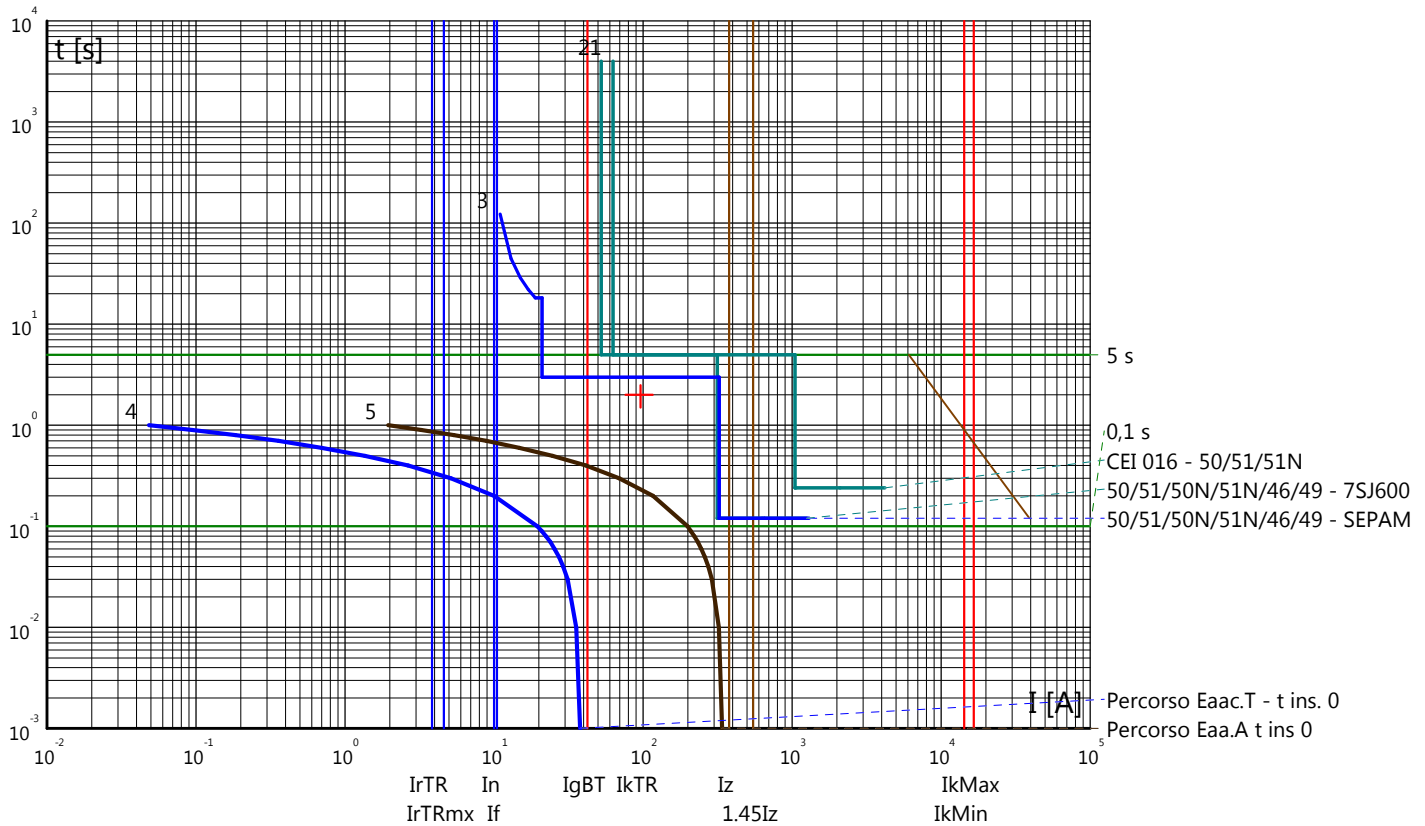

Curve tempo corrente: GALLERIA MONTE AGLIO
 Quadro: Quadro Media tensione

Partenza:

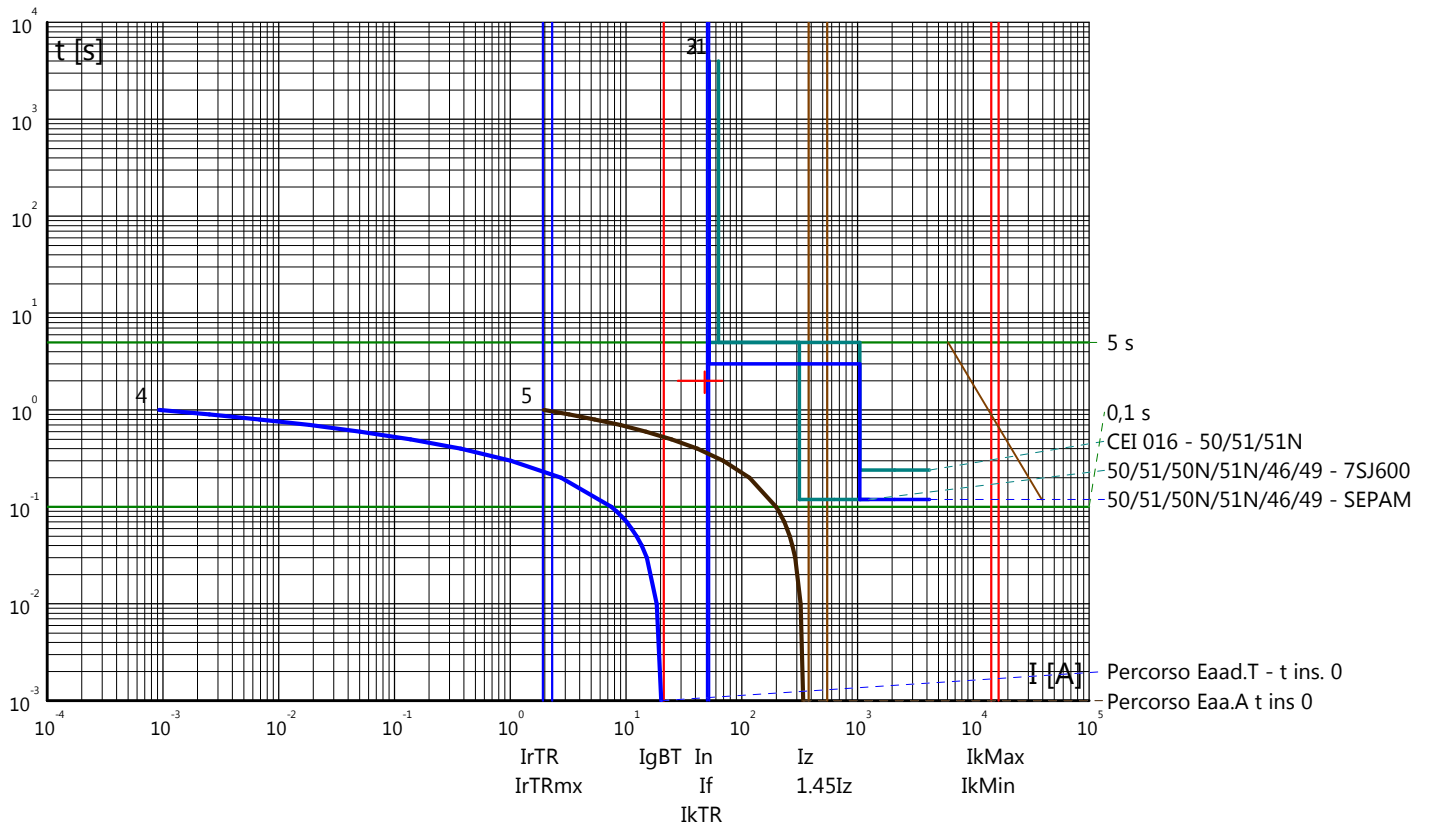

Curve tempo corrente: GALLERIA MONTE AGLIO
 Quadro: QGBT/S

Arrivo: I/TR1

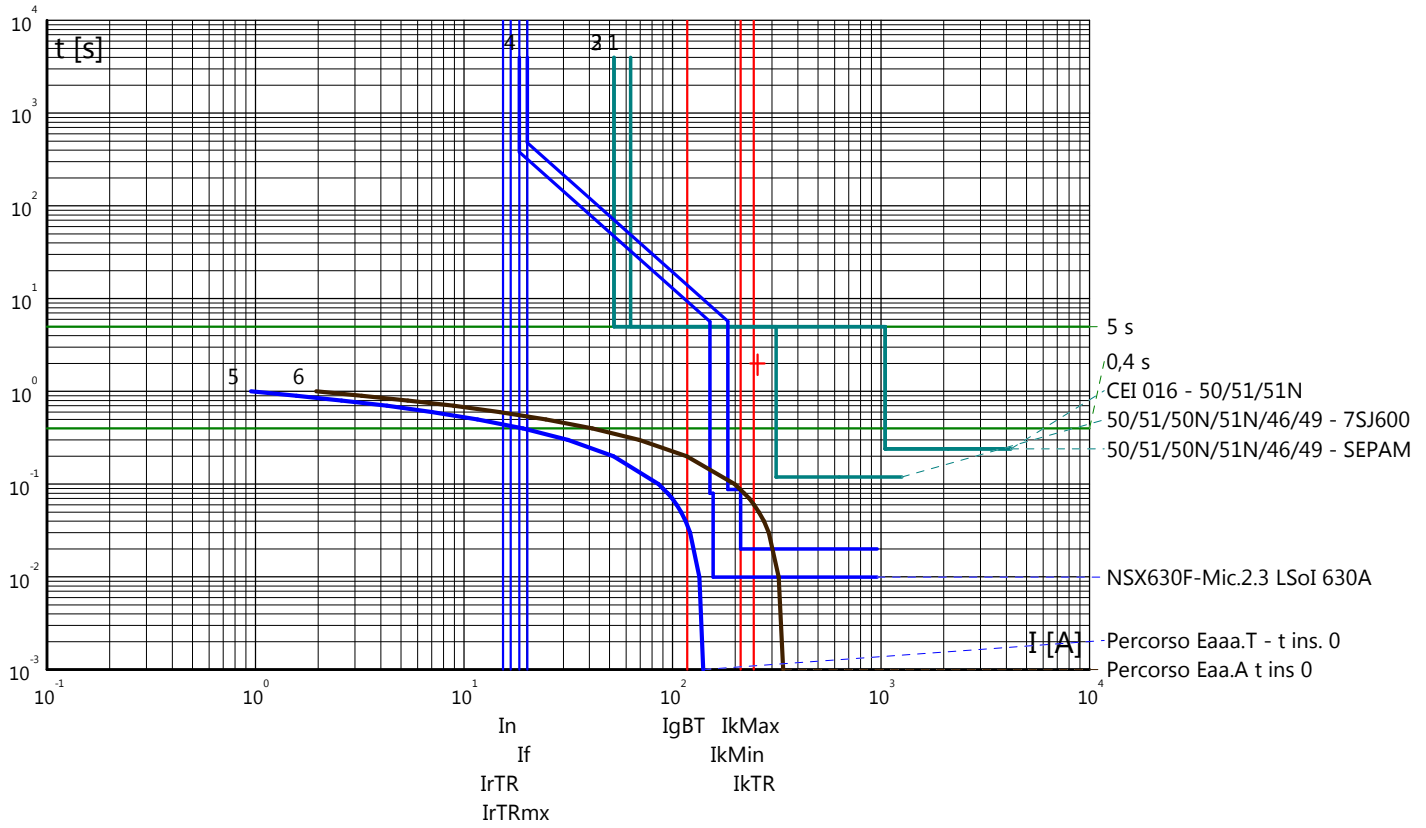

Curve tempo corrente: GALLERIA MONTE AGLIO
 Quadro: QGBT/S

Arrivo: I/TR2

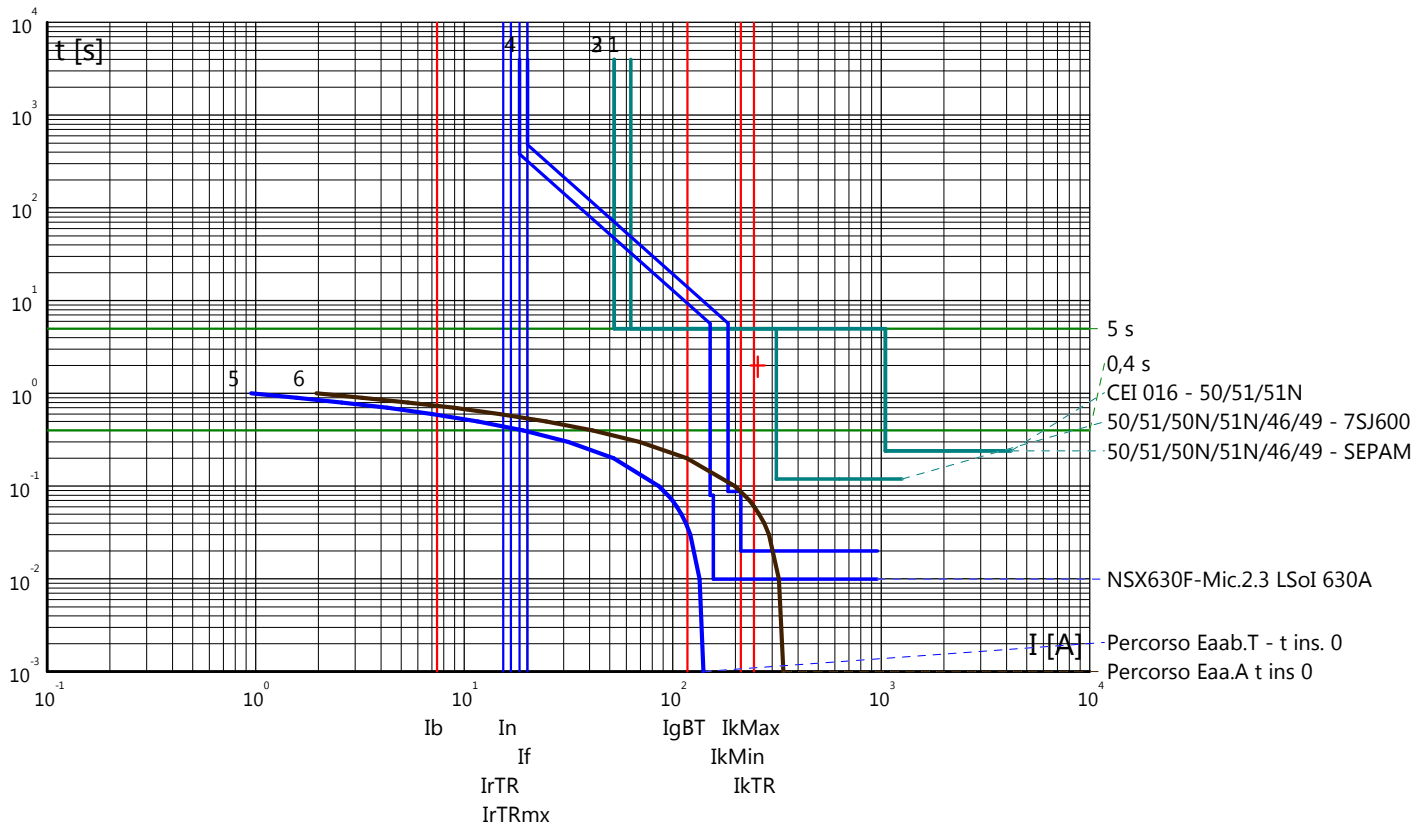

Partenza: PT/N

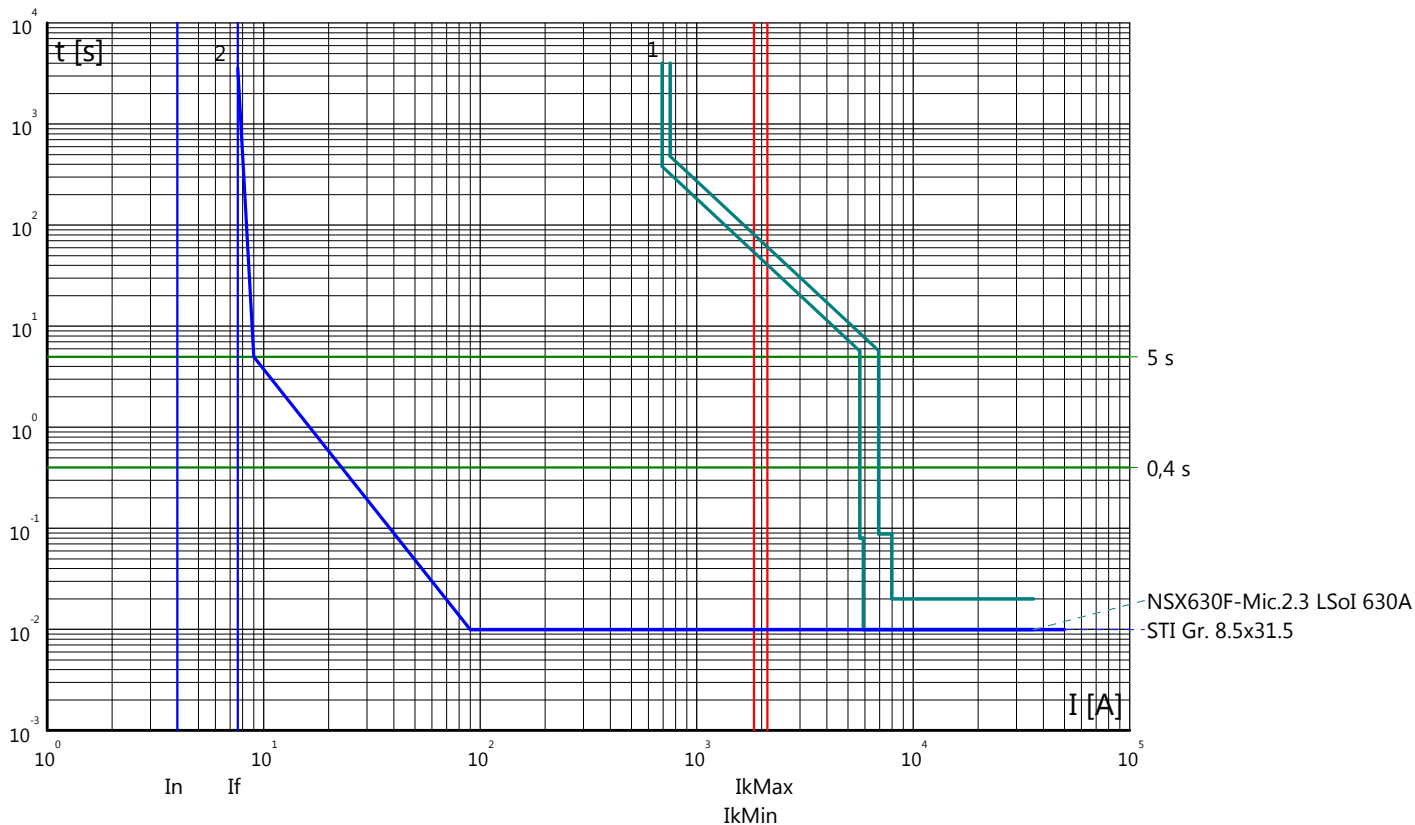

Curve tempo corrente: GALLERIA MONTE AGLIO
 Quadro: QGBT/S

Partenza: SPD

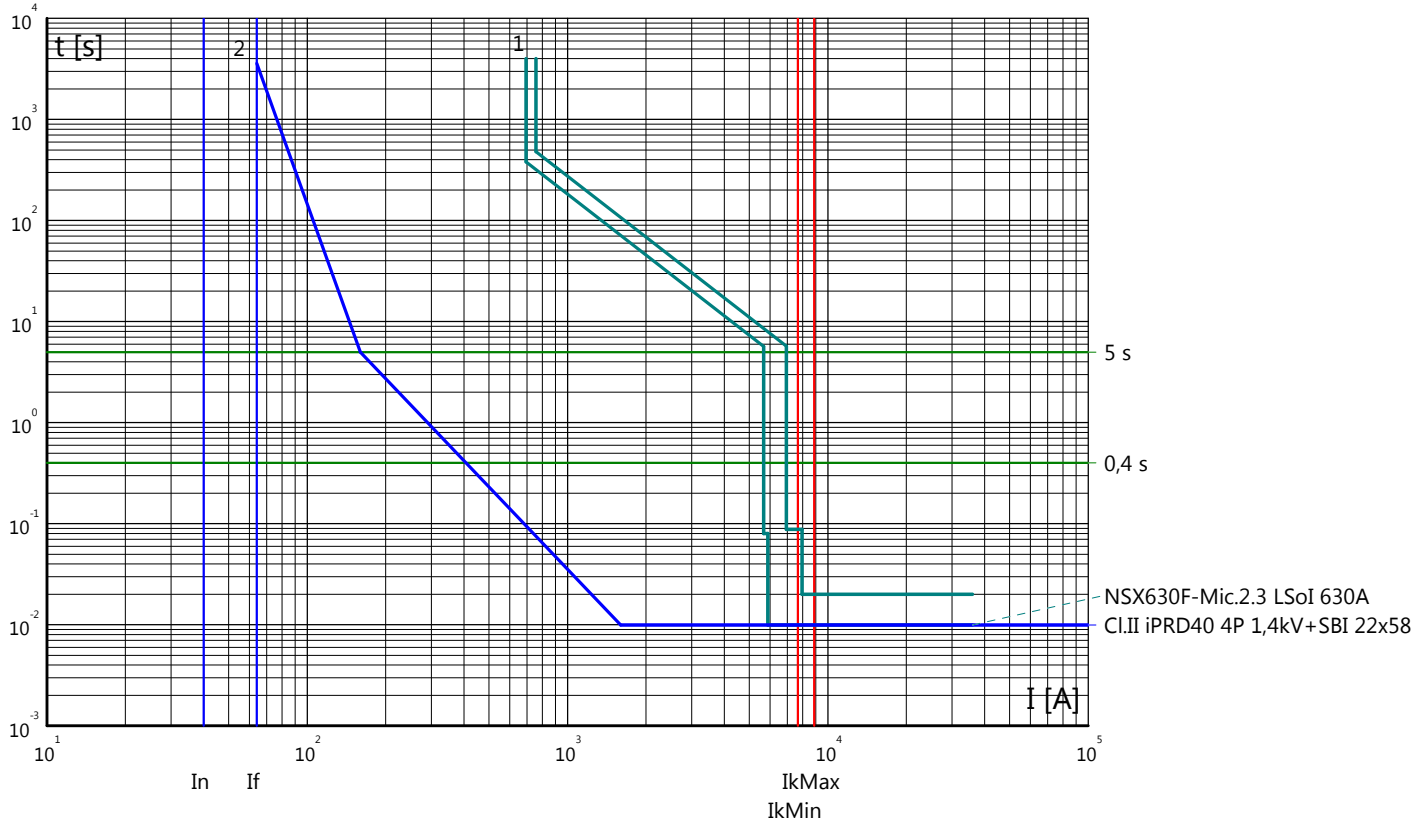

Partenza: MIS/N

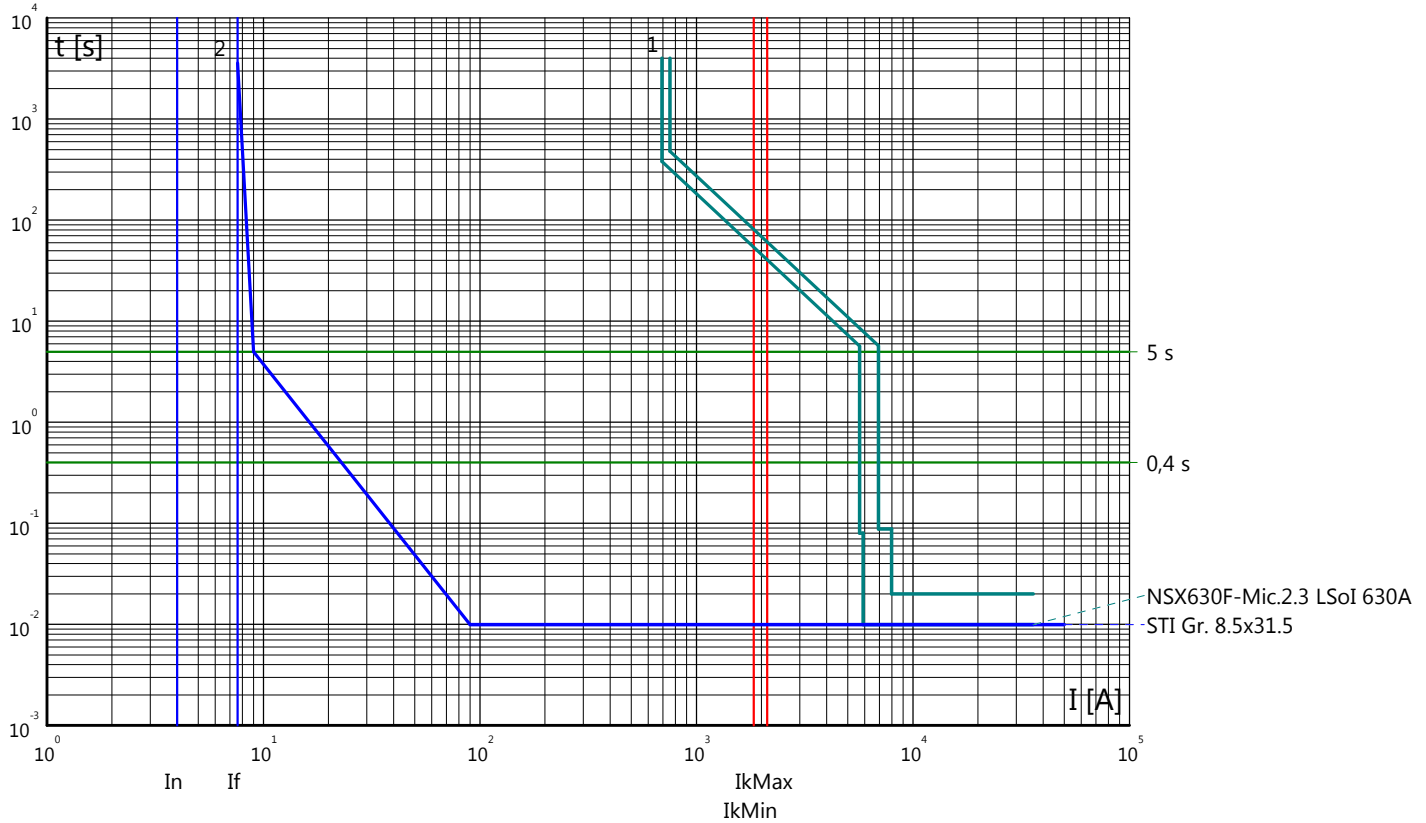

Curve tempo corrente: GALLERIA MONTE AGLIO
 Quadro: QGBT/S

Partenza: 1.1N

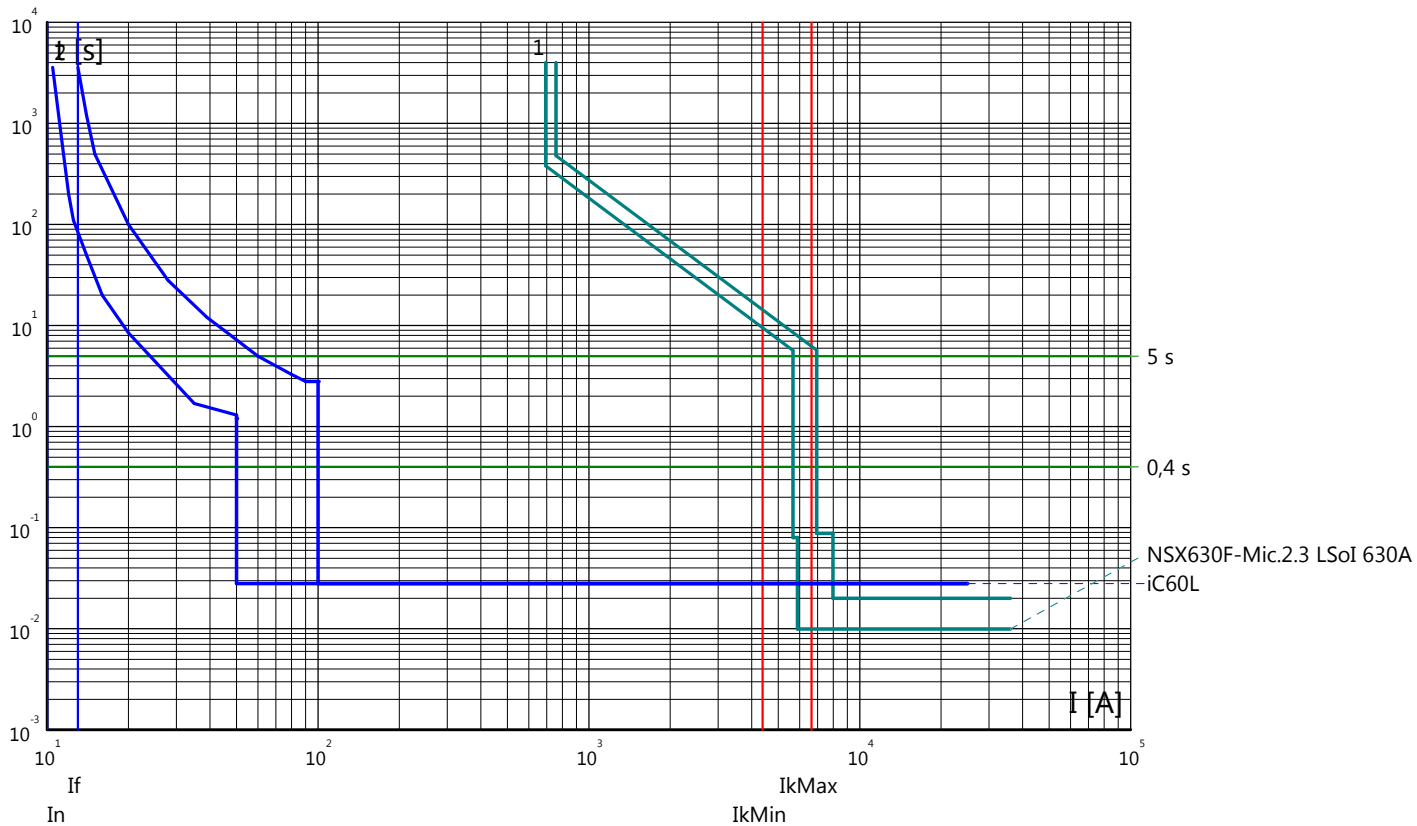

Partenza: 1.2N

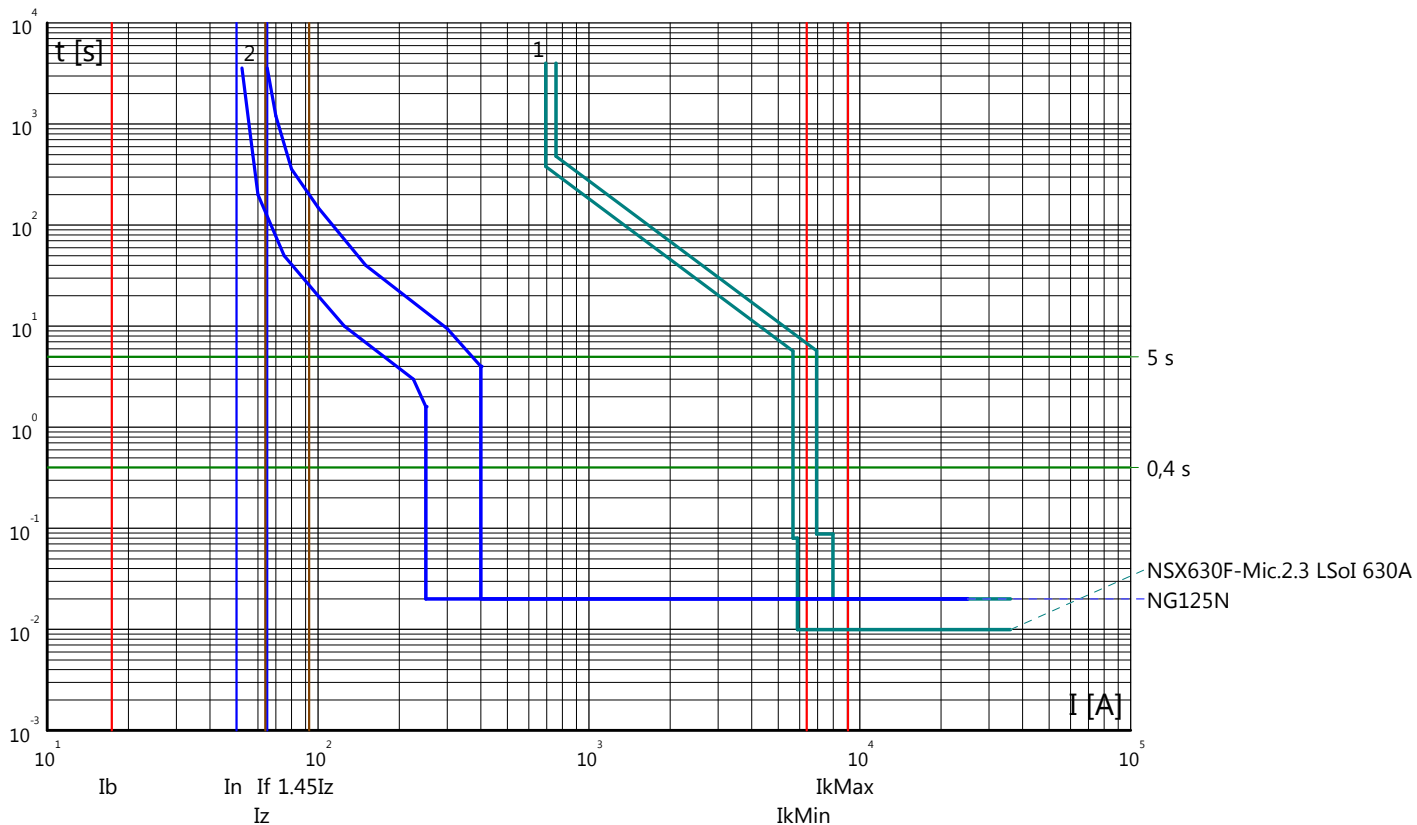

Curve tempo corrente: GALLERIA MONTE AGLIO
 Quadro: QGBT/S

Partenza: 1.3N

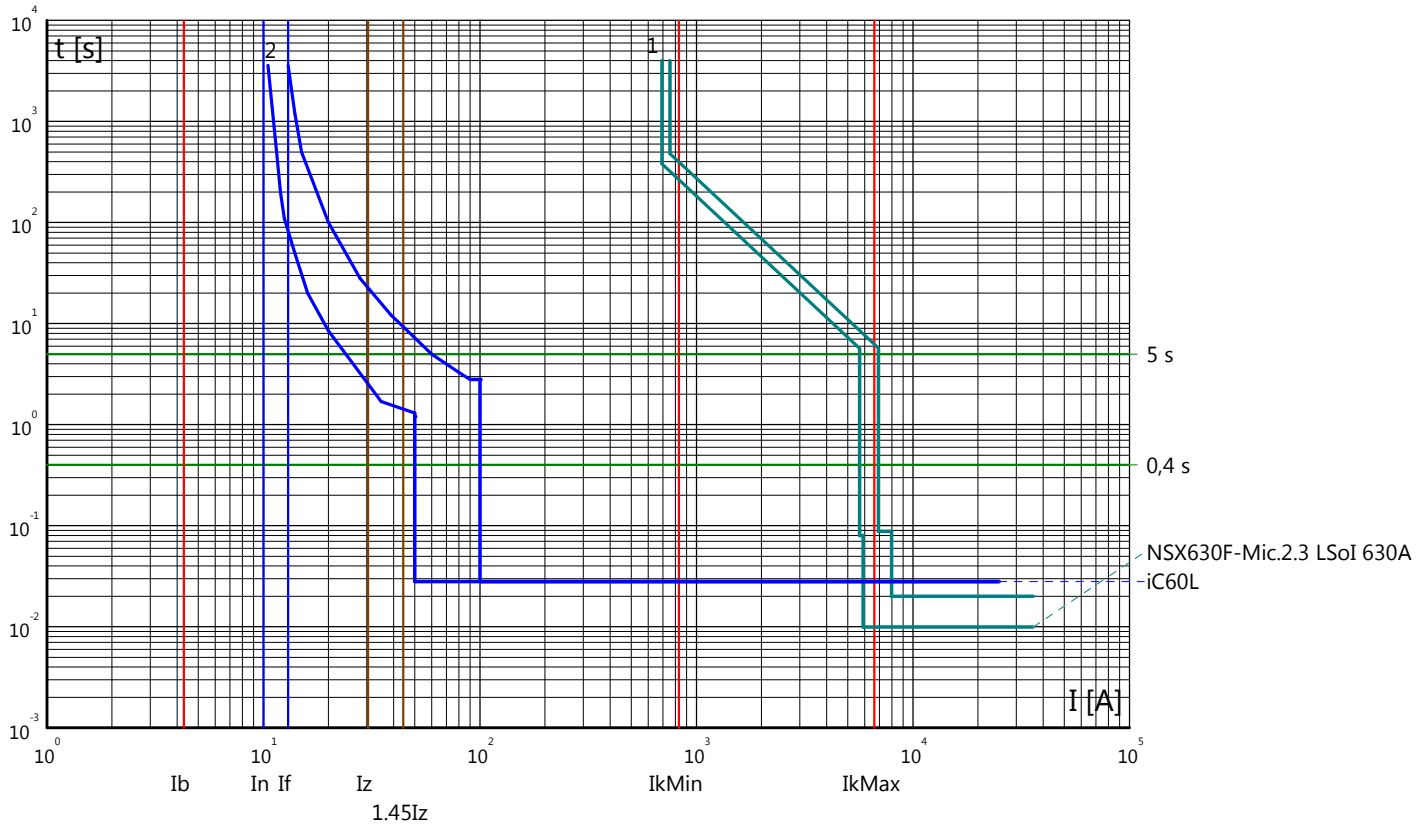

Partenza: 1.4N-G

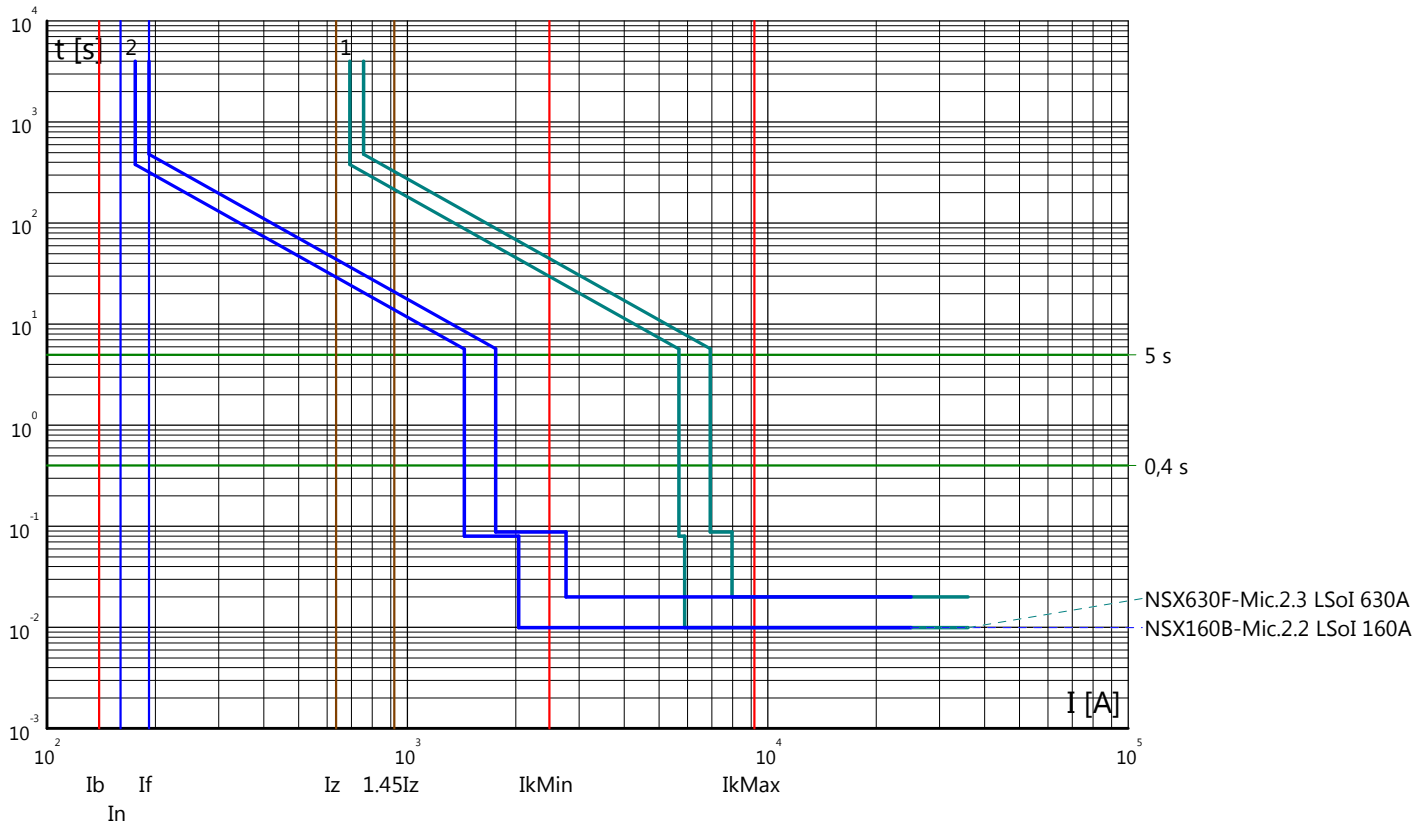

Curve tempo corrente: GALLERIA MONTE AGLIO
 Quadro: QGBT/S

Partenza: 1.5N

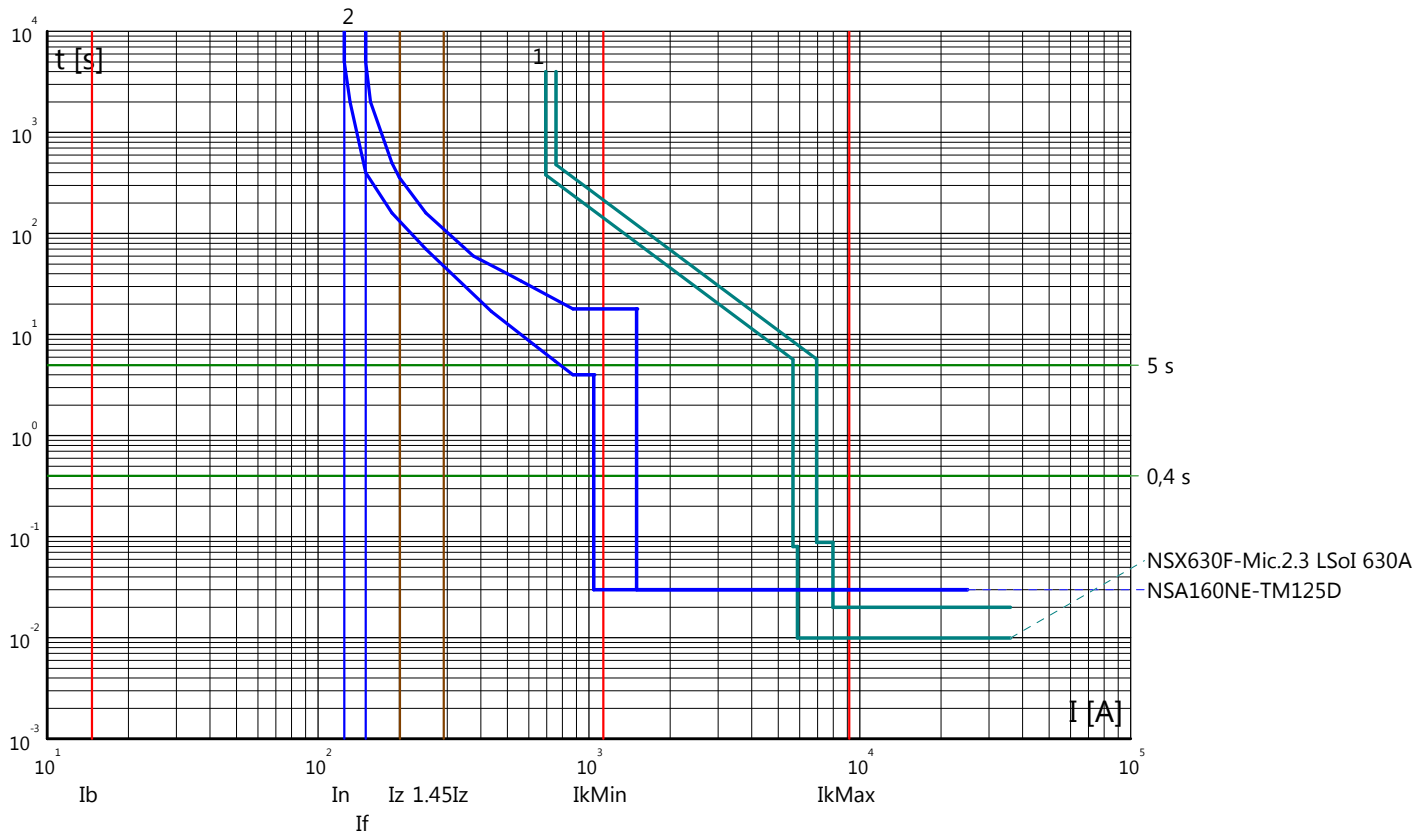

Partenza: IP1.N

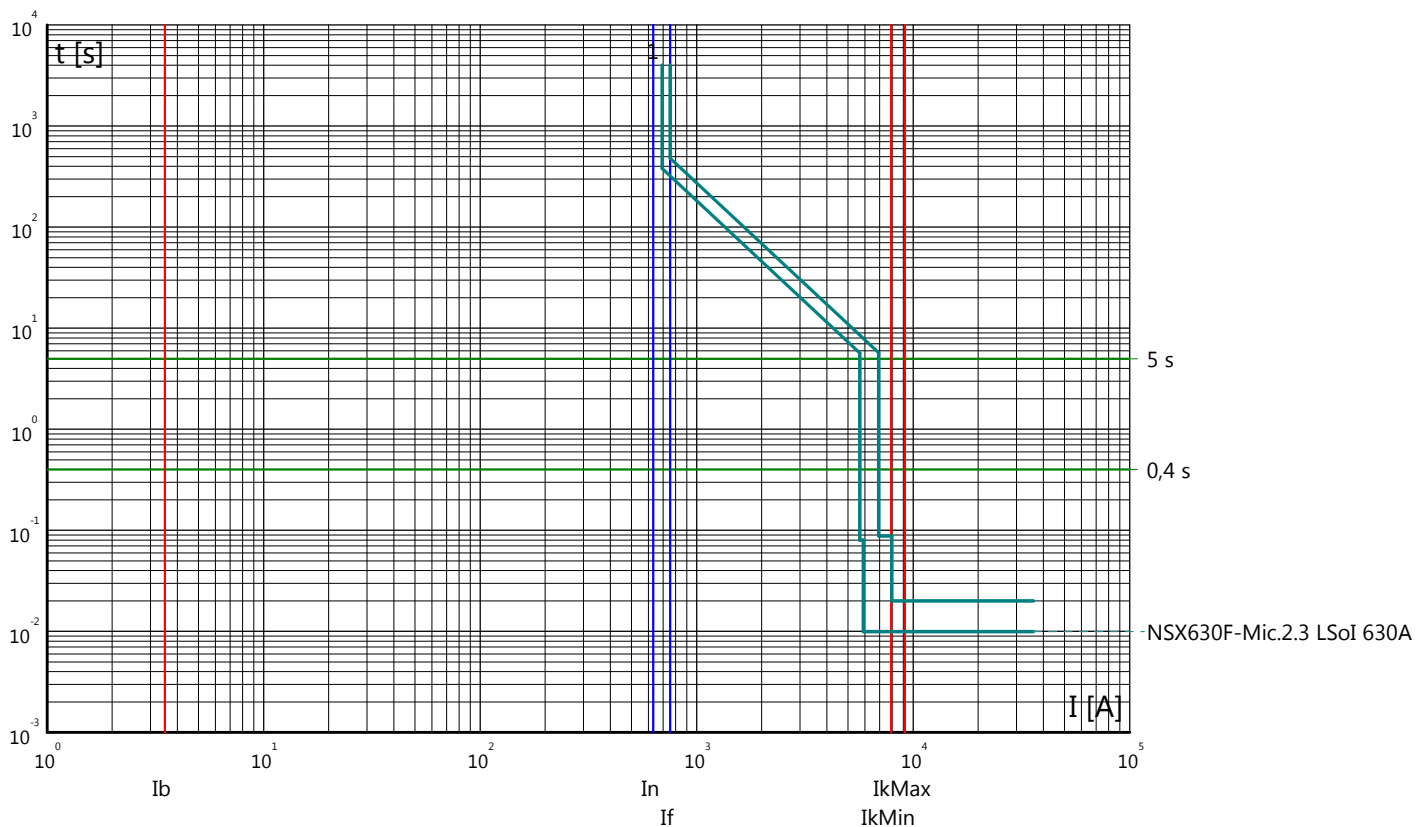

Curve tempo corrente: GALLERIA MONTE AGLIO
 Quadro: QGBT/S

Partenza: 1.6N

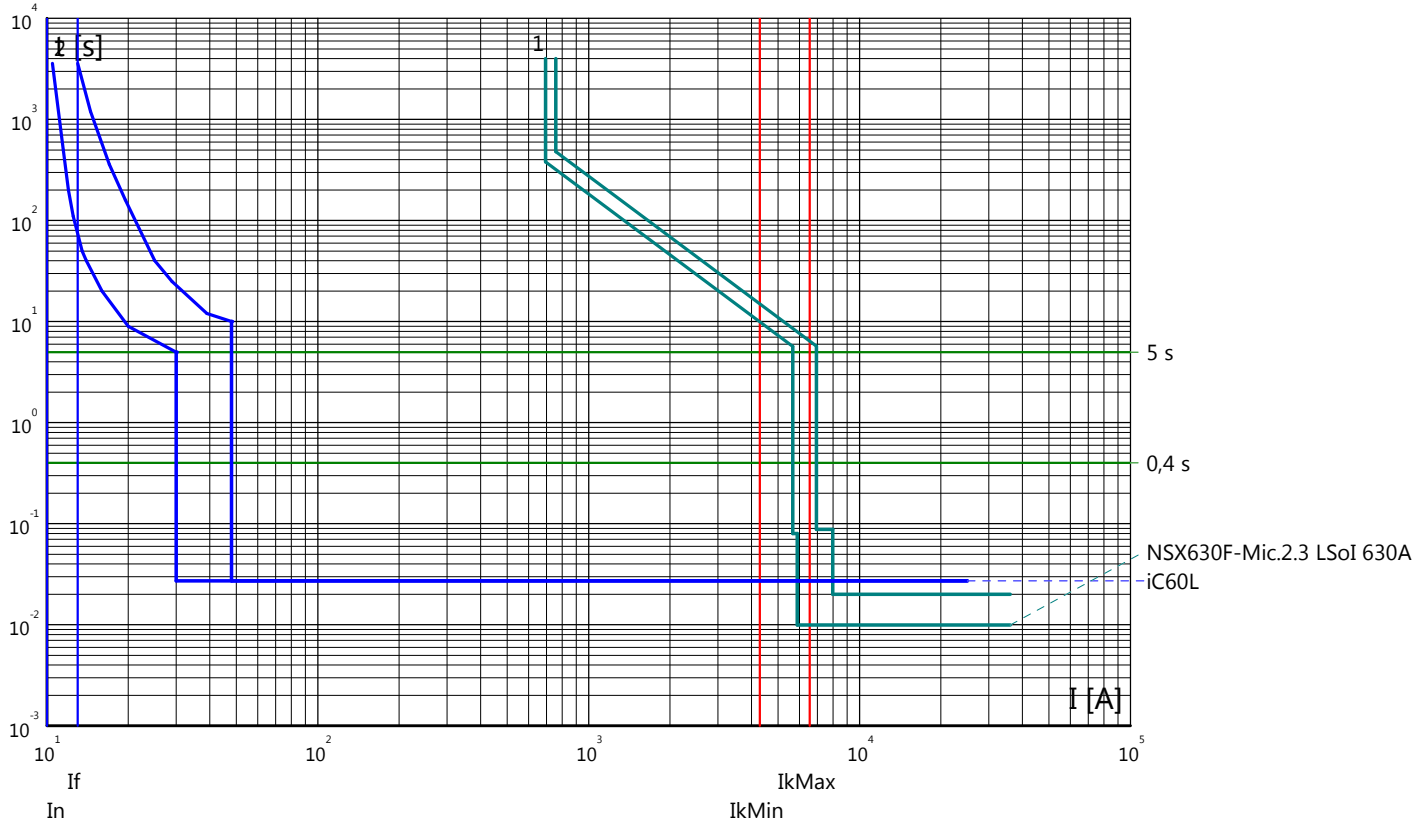

Partenza: 1.7N

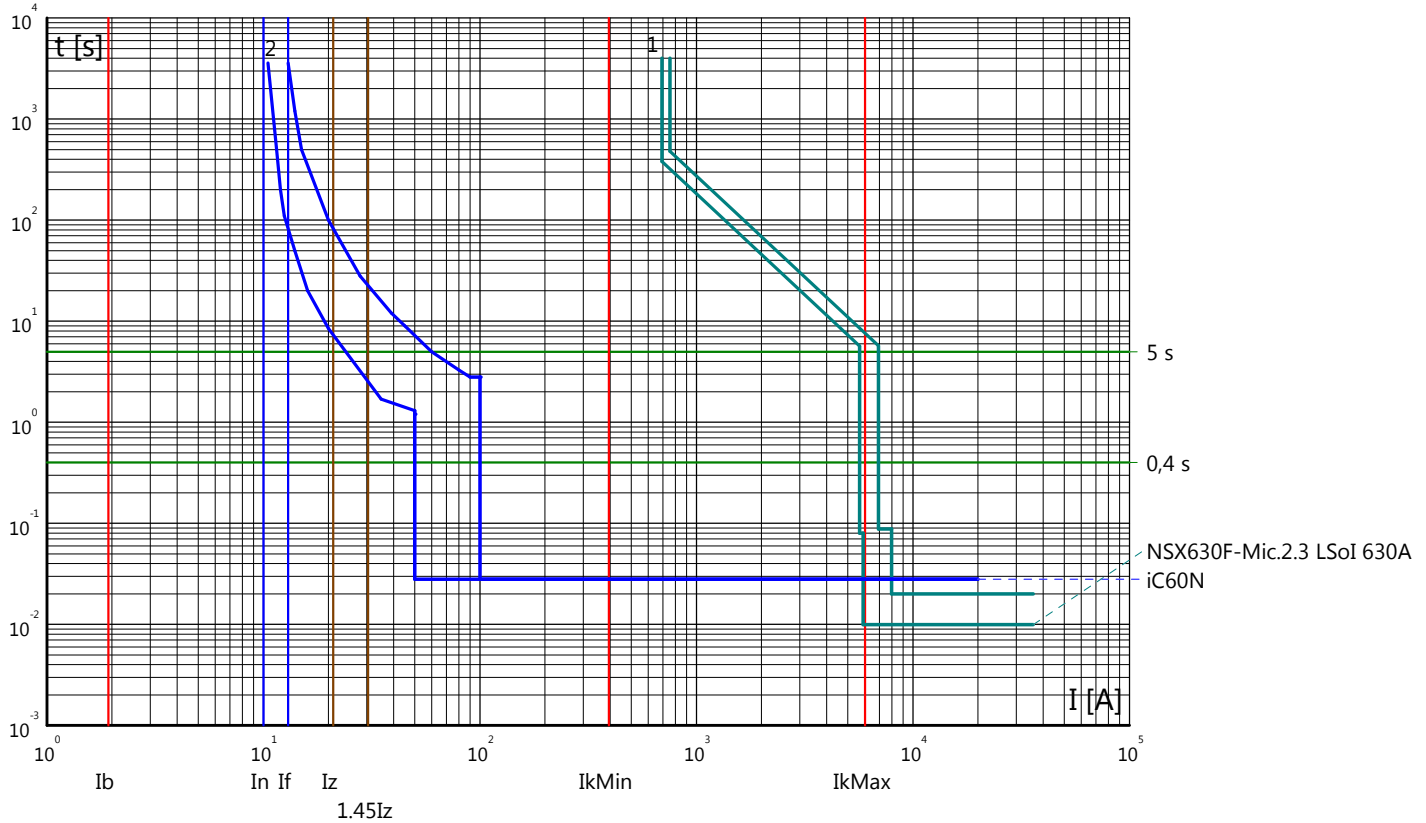

Curve tempo corrente: GALLERIA MONTE AGLIO
 Quadro: QGBT/S

Partenza: 1.8N

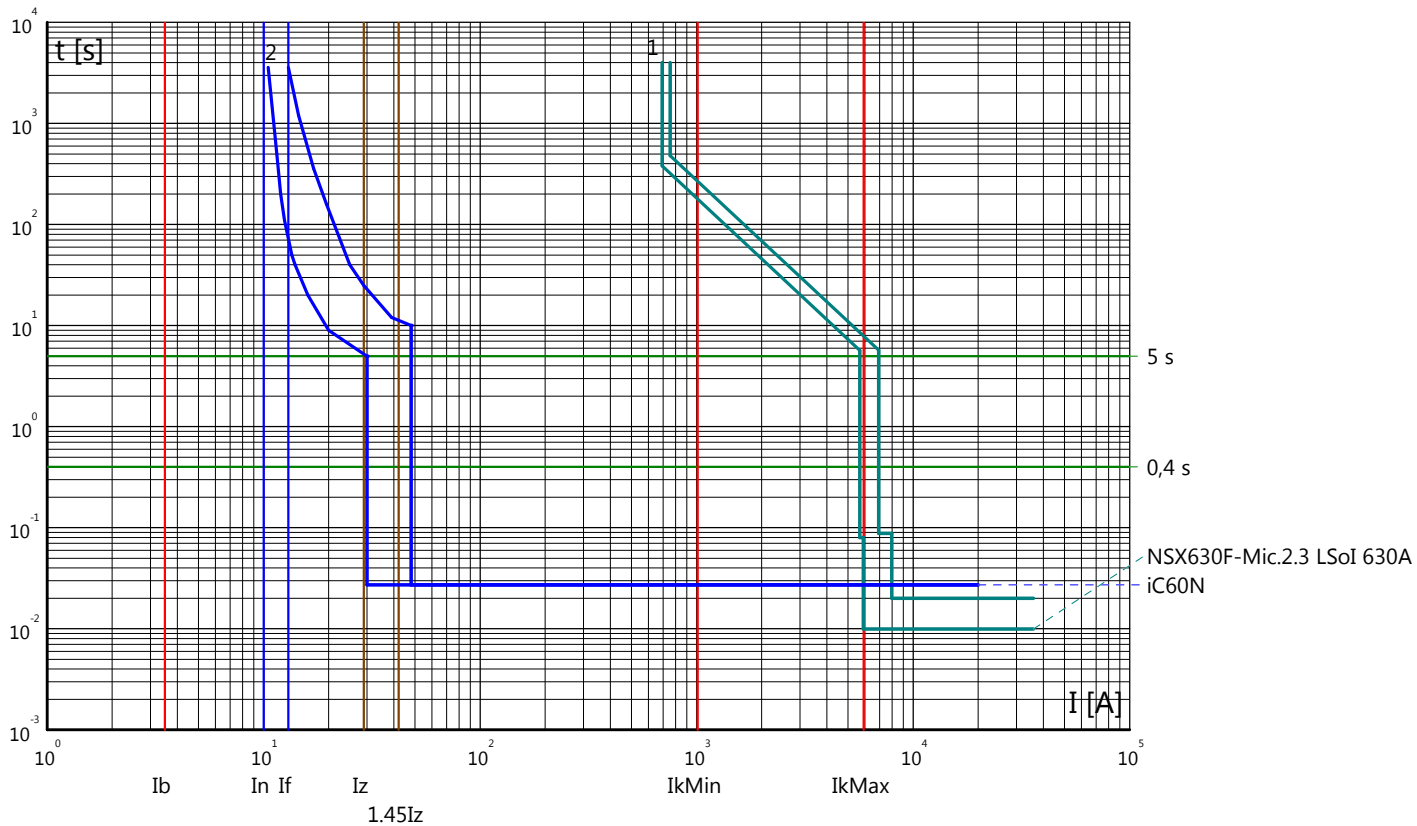

Partenza: 1.9N

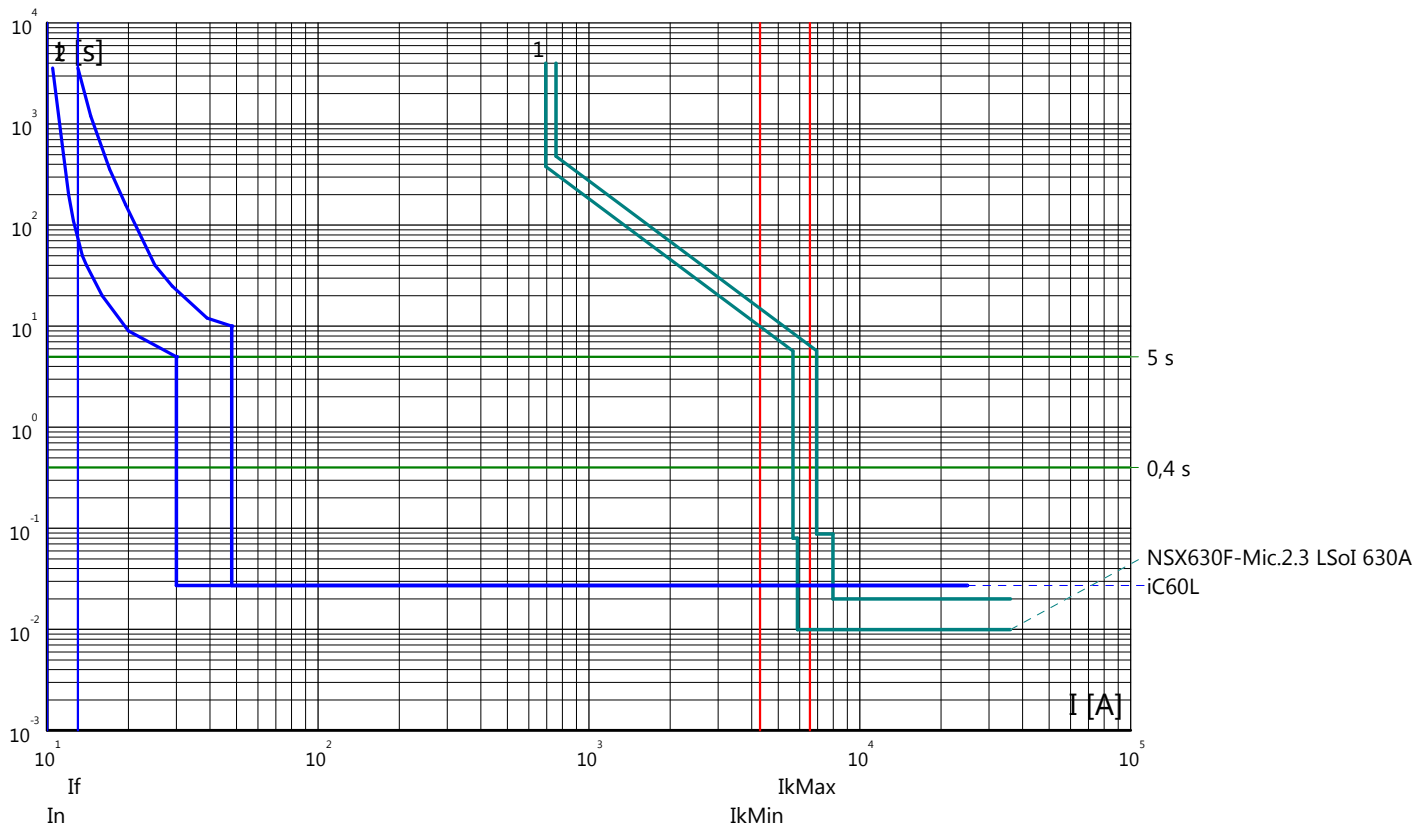

Curve tempo corrente: GALLERIA MONTE AGLIO
 Quadro: QGBT/S

Partenza: 1.10N

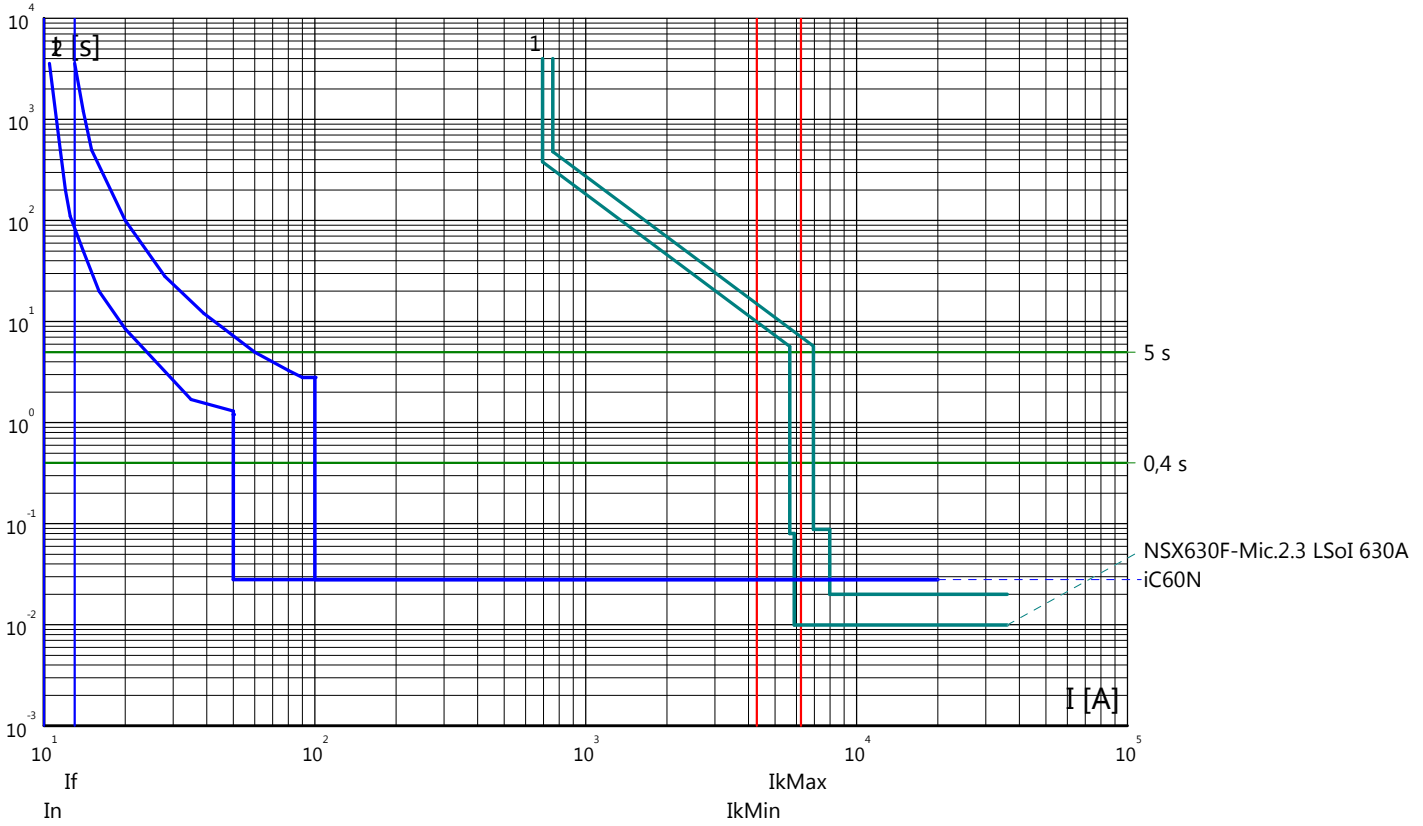

Partenza: IP2.N

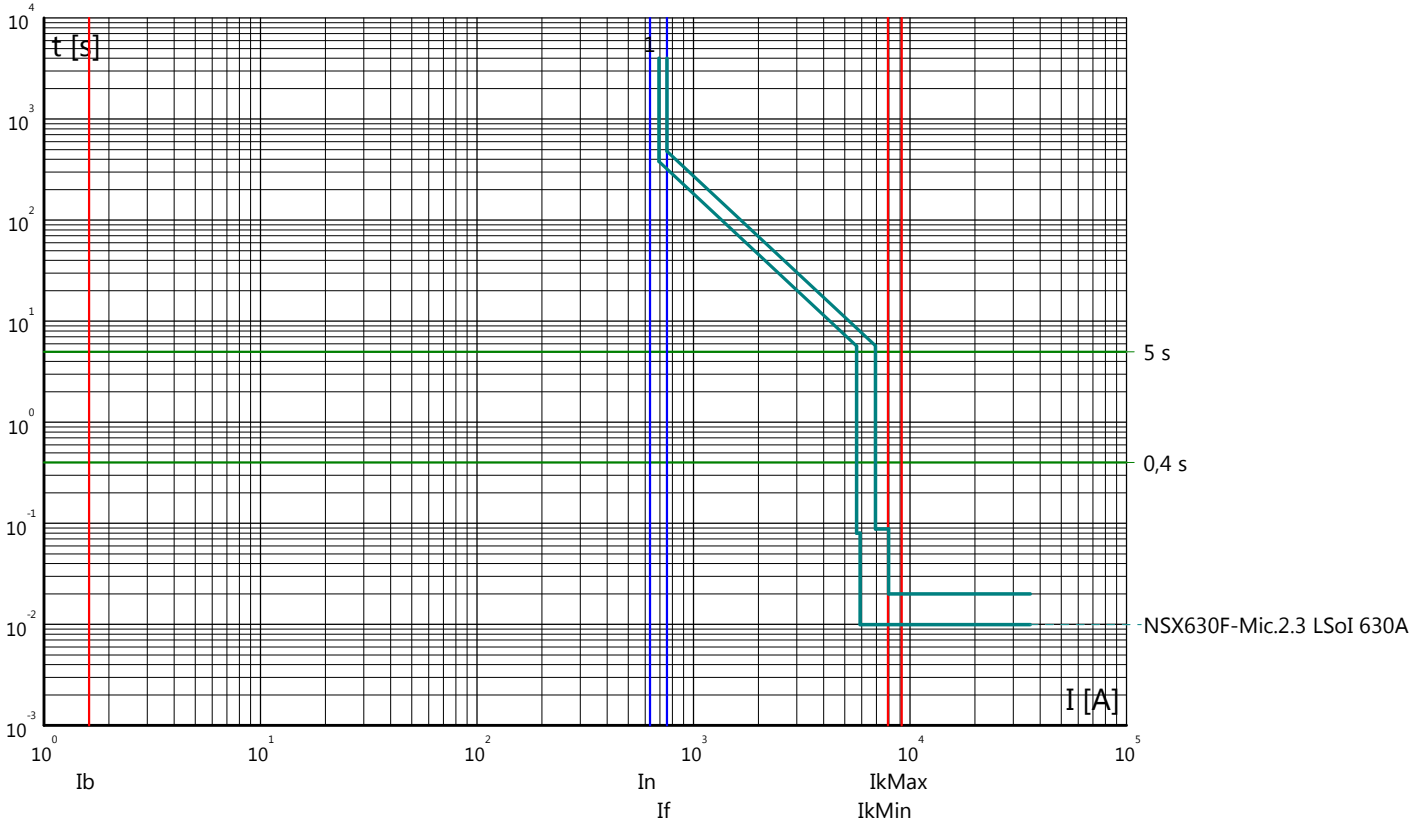

Curve tempo corrente: GALLERIA MONTE AGLIO
Quadro: QGBT/S

Partenza: 1.11N

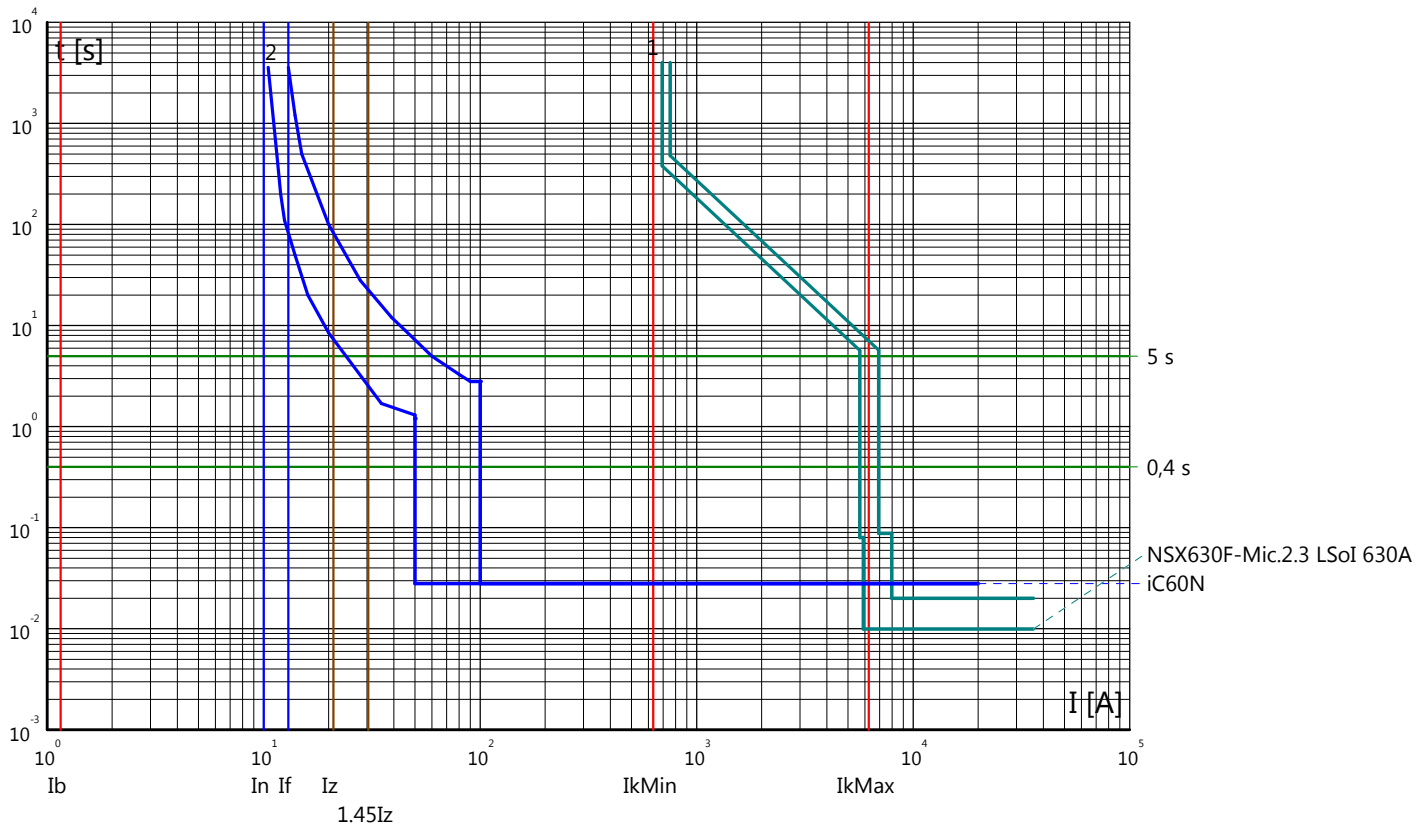

Partenza: 1.12N

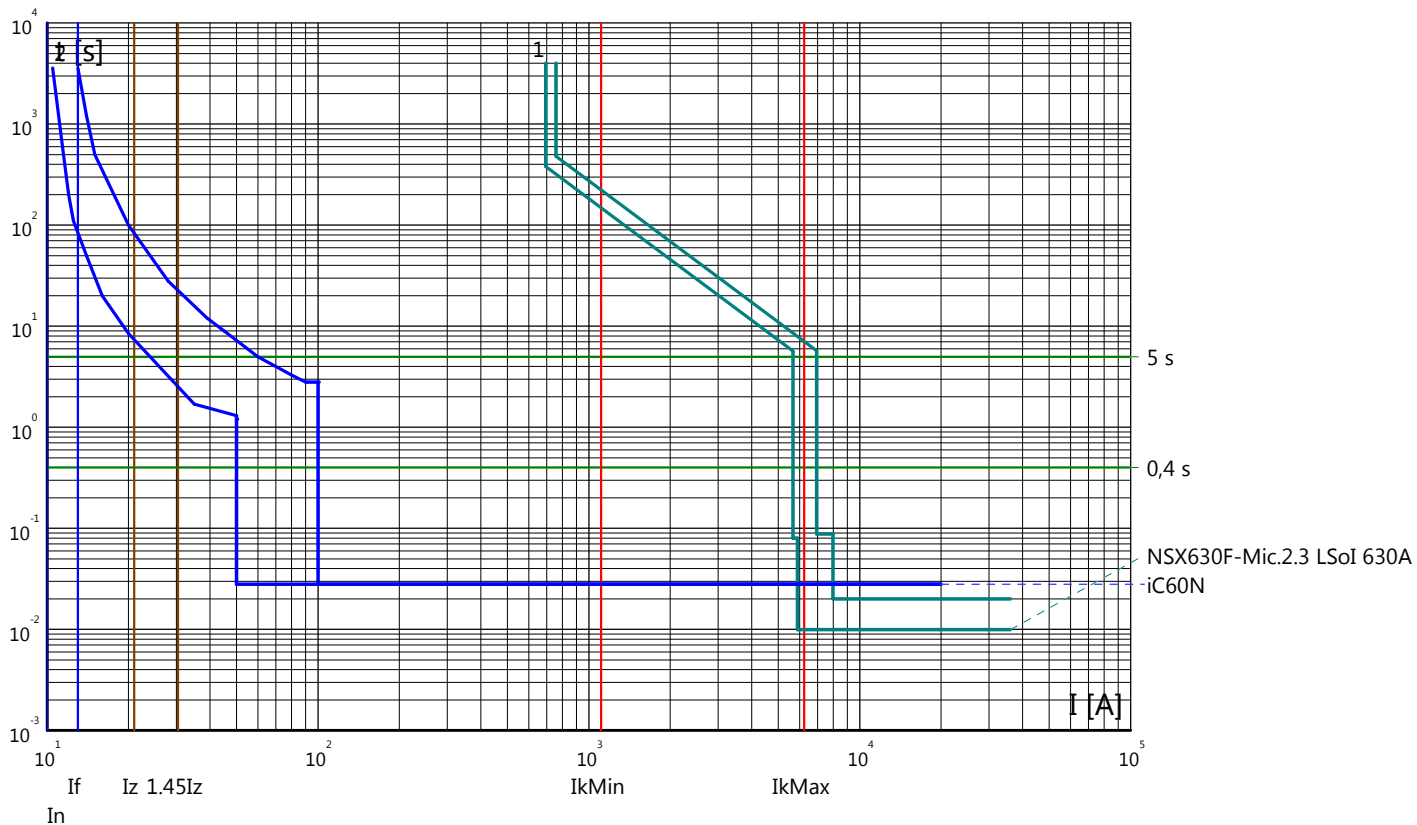

Curve tempo corrente: GALLERIA MONTE AGLIO
 Quadro: QGBT/S

Partenza: 1.13N

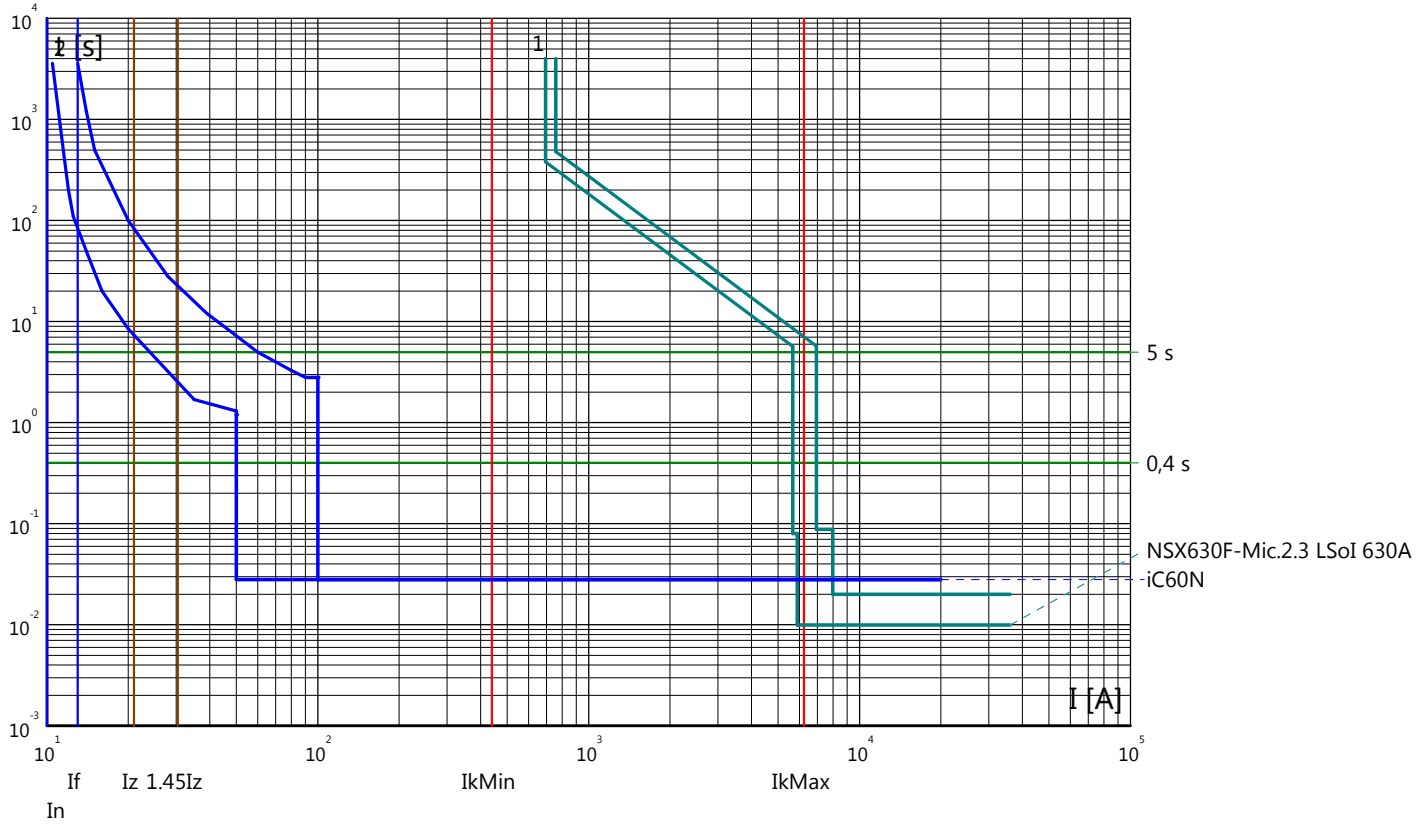

Partenza: 1.14N

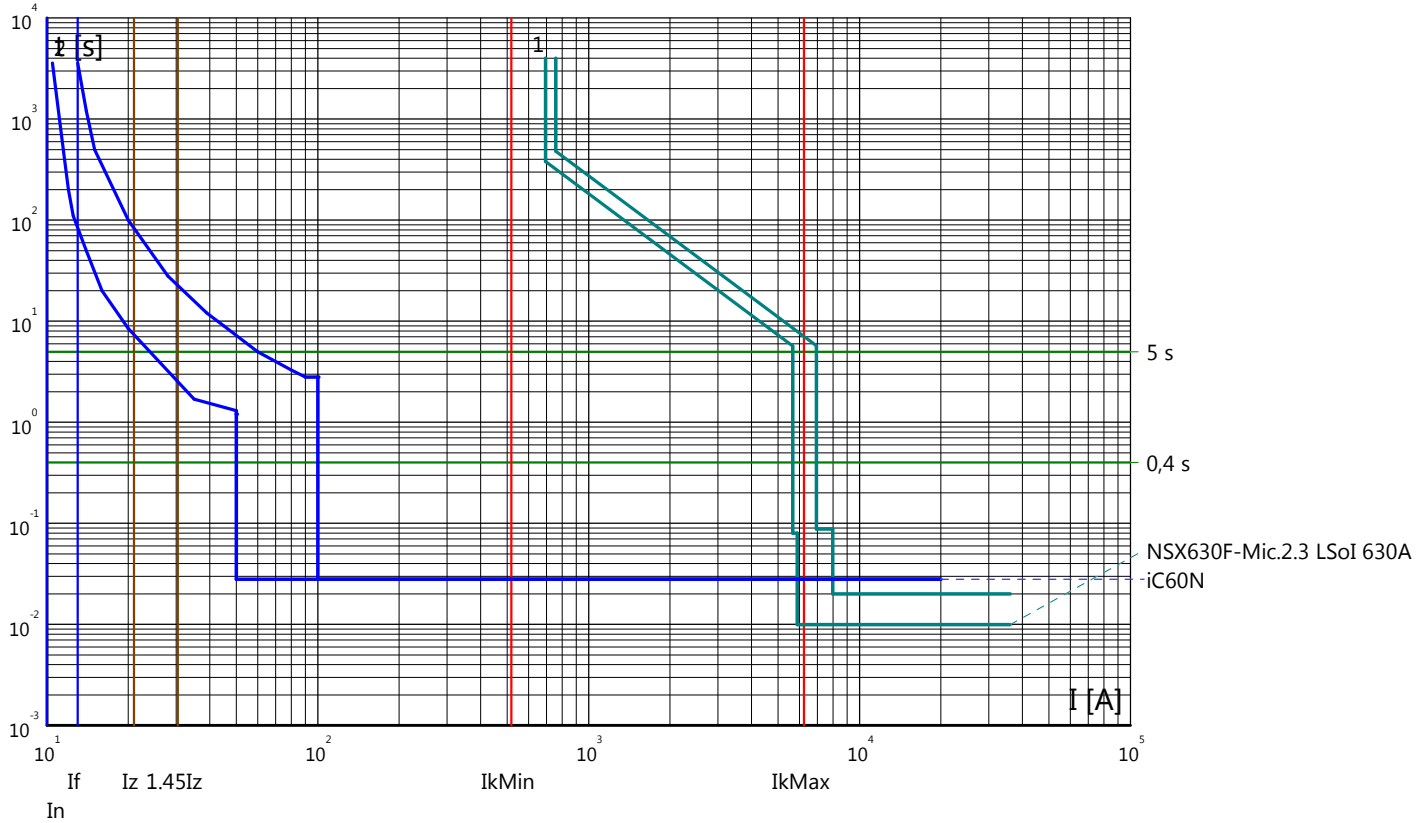

Curve tempo corrente: GALLERIA MONTE AGLIO
 Quadro: QGBT/S

Partenza: 1.15N

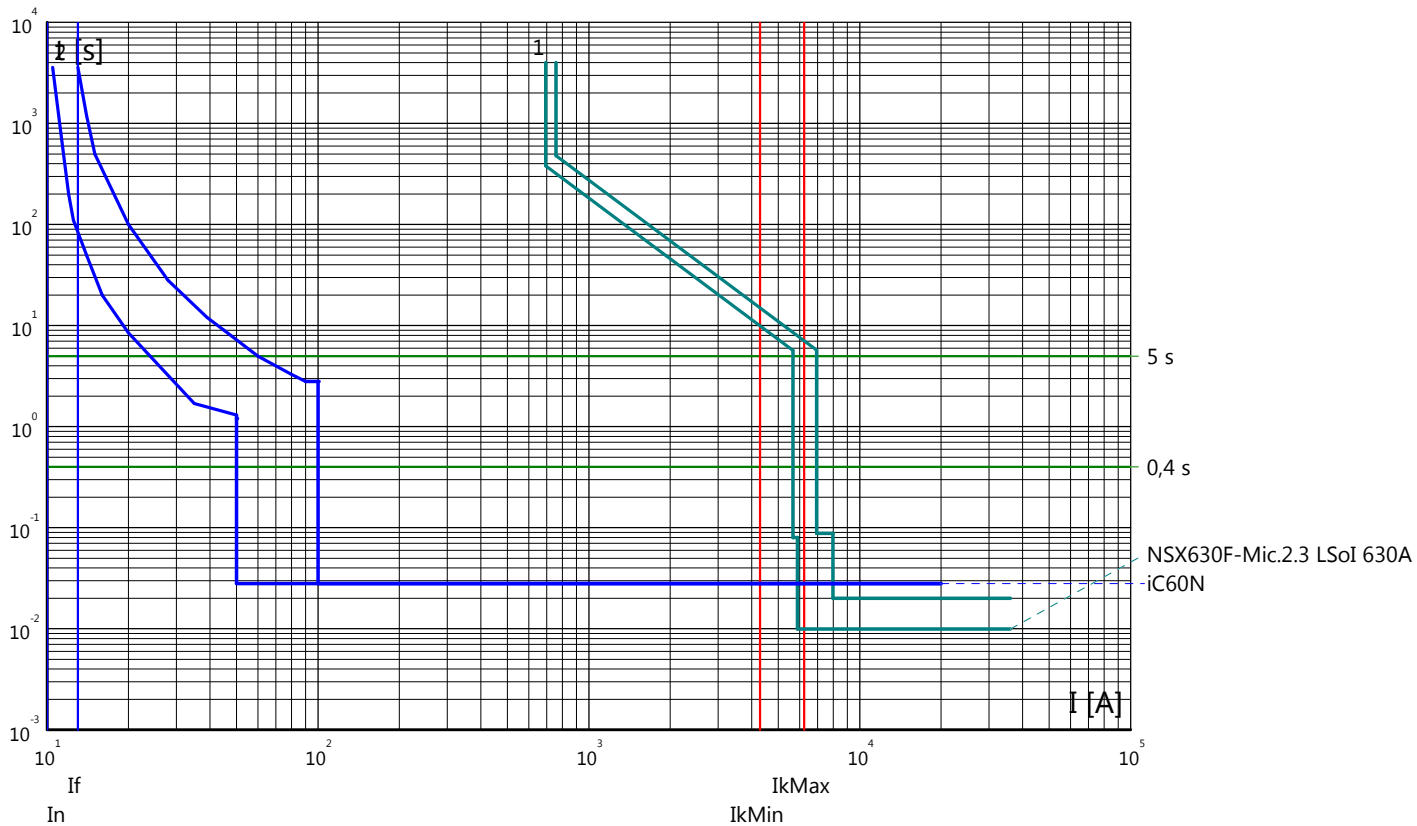

Partenza: 1.16N

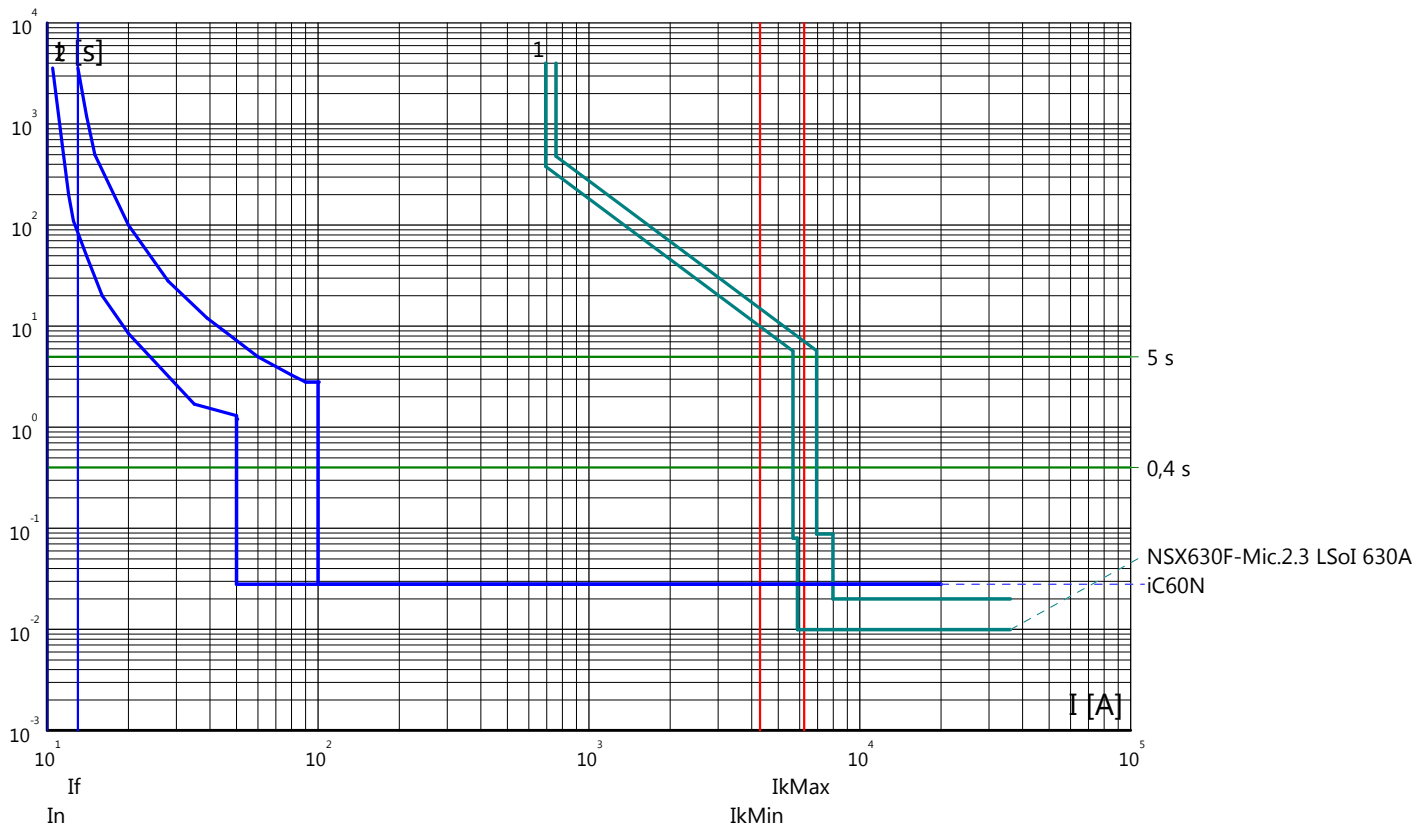

Curve tempo corrente: GALLERIA MONTE AGLIO
 Quadro: QGBT/S

Partenza: IP3.N

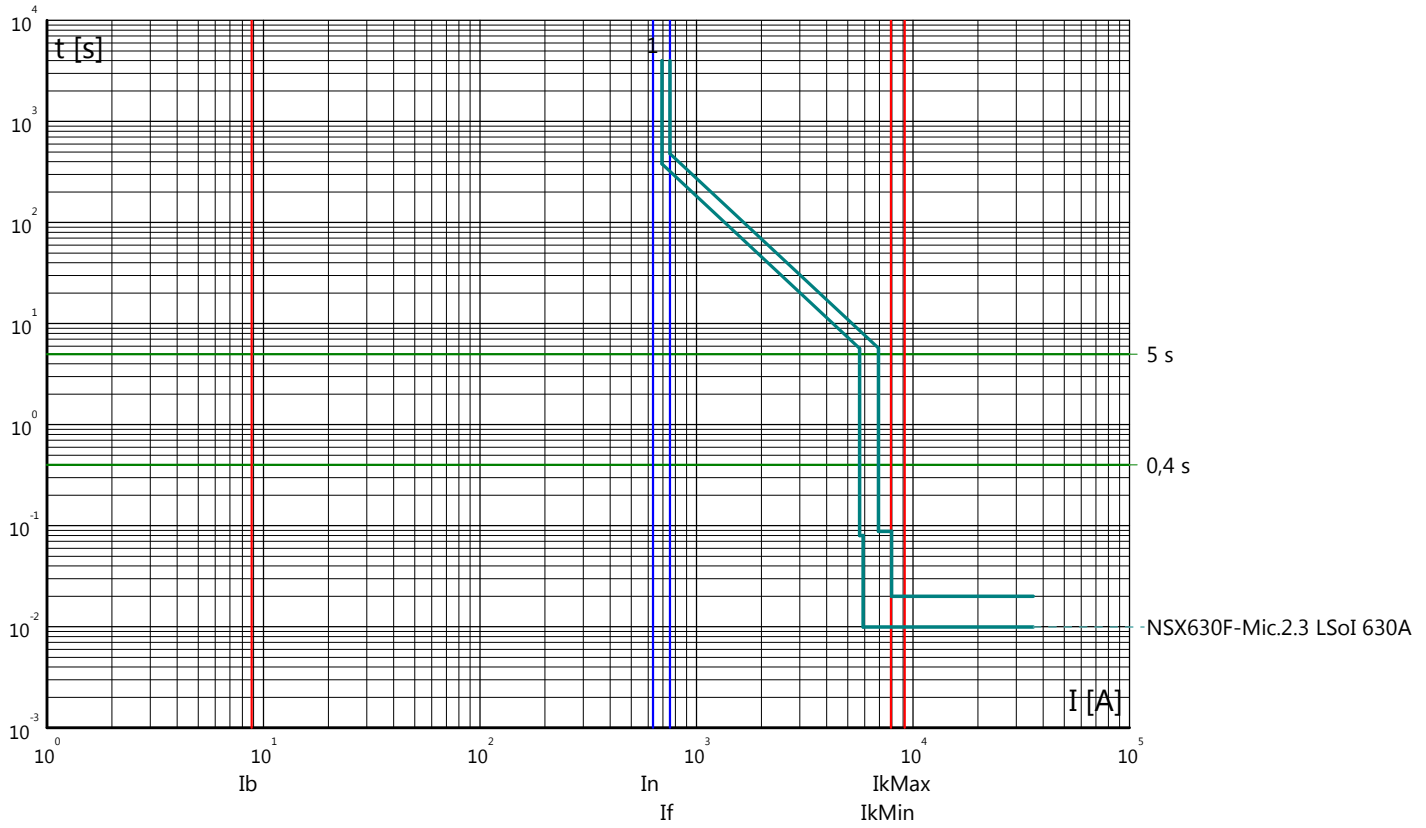

Partenza: 1.17N

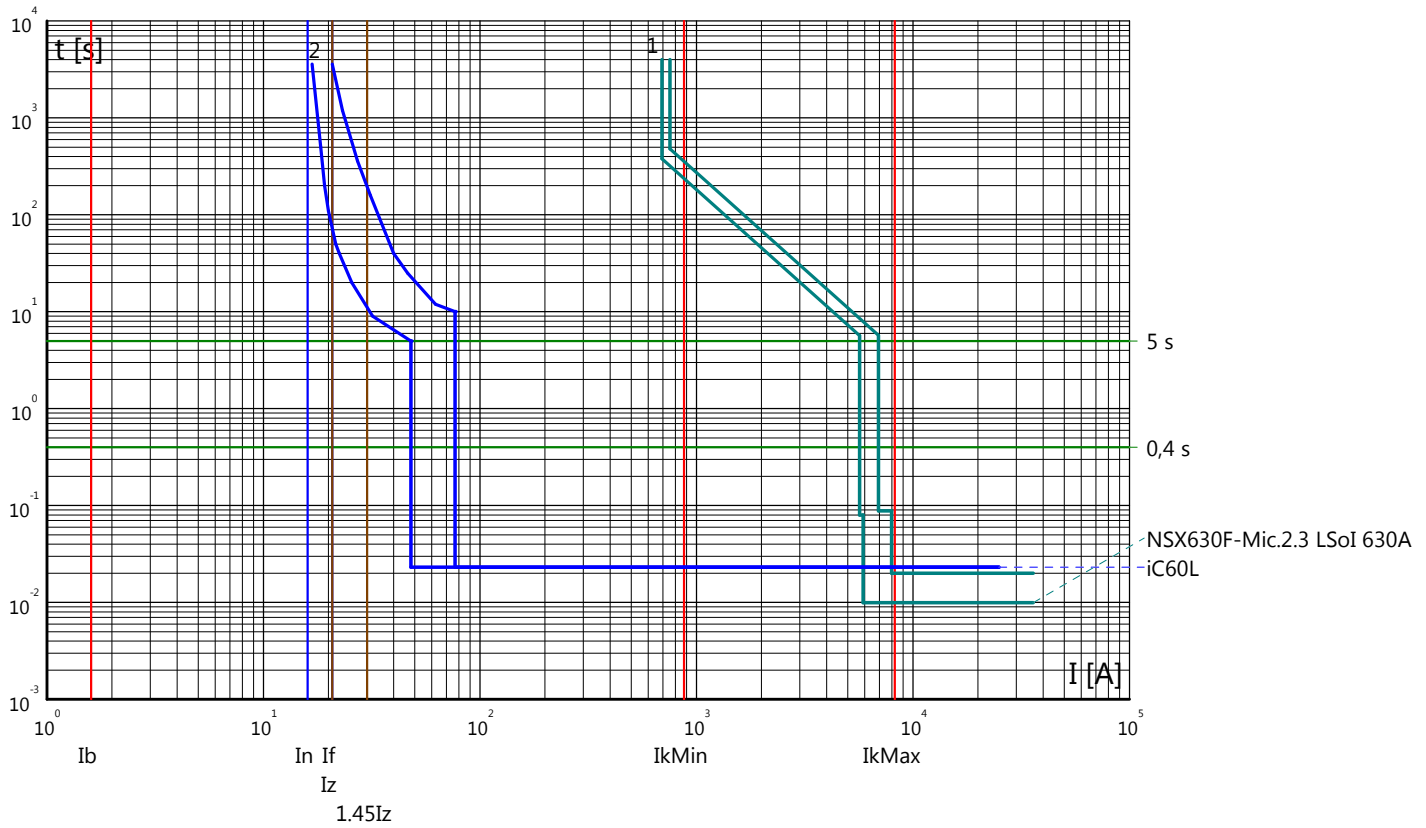

Curve tempo corrente: GALLERIA MONTE AGLIO
 Quadro: QGBT/S

Partenza: 1.18N

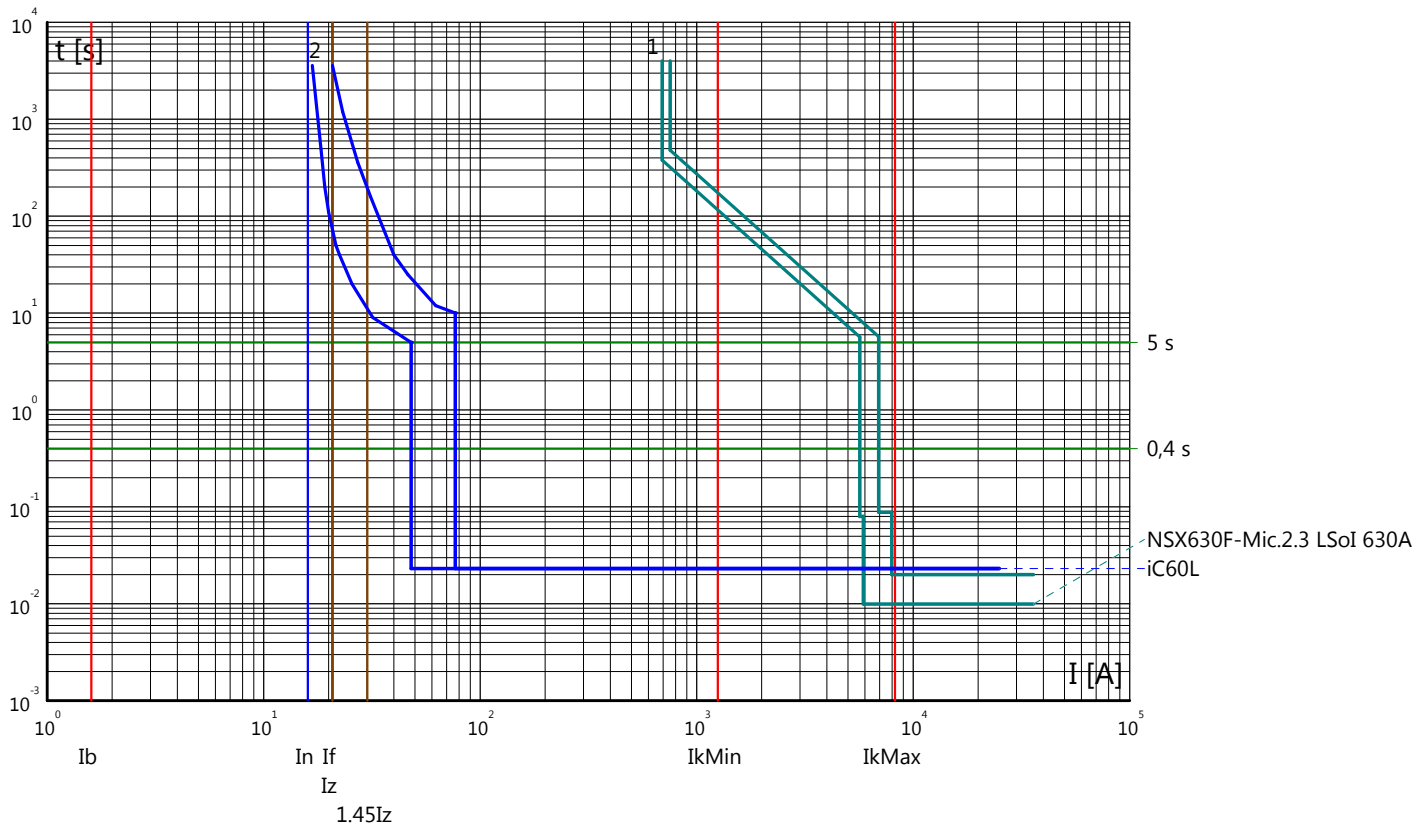

Partenza: 1.19N

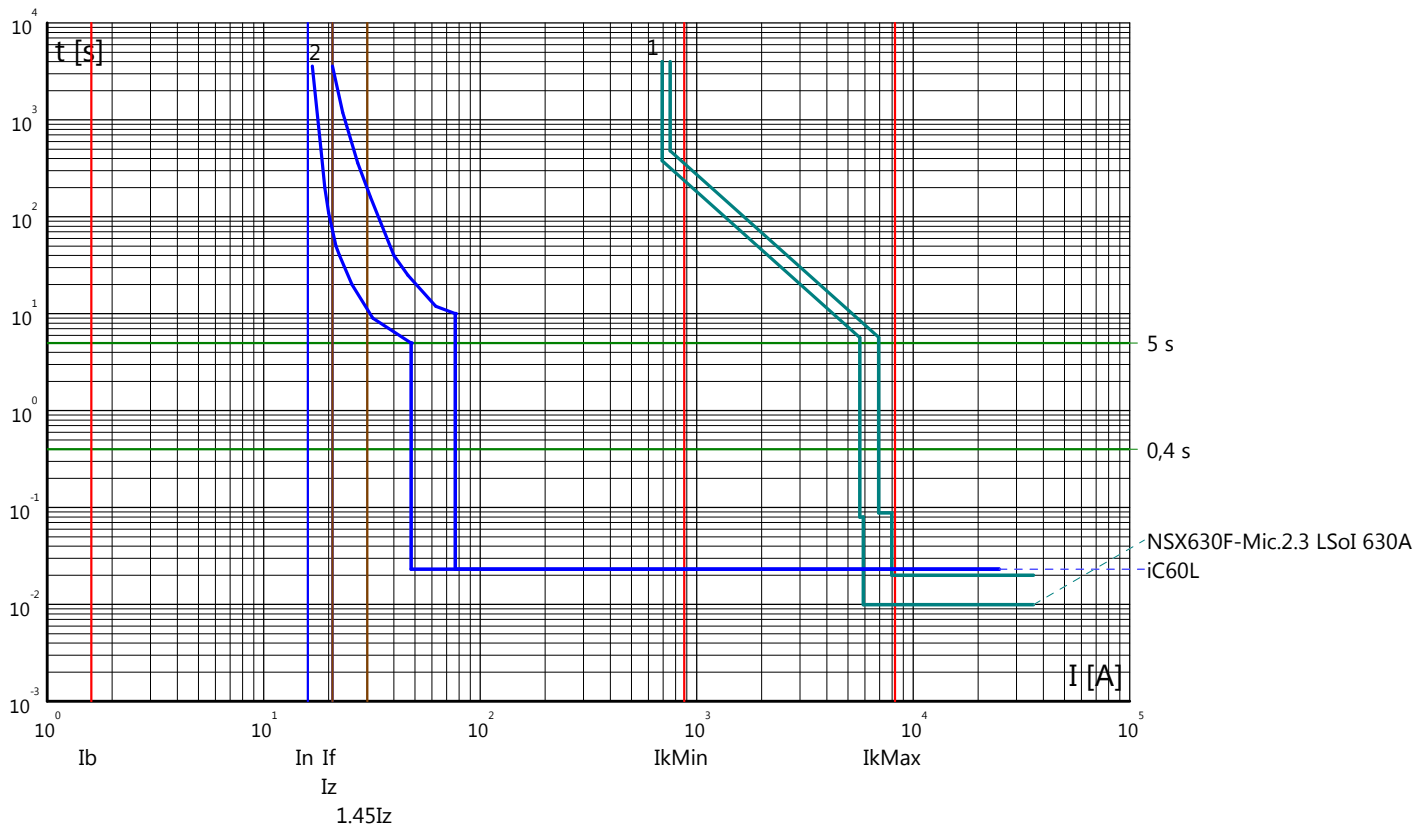

Curve tempo corrente: GALLERIA MONTE AGLIO
 Quadro: QGBT/S

Partenza: 1.20N

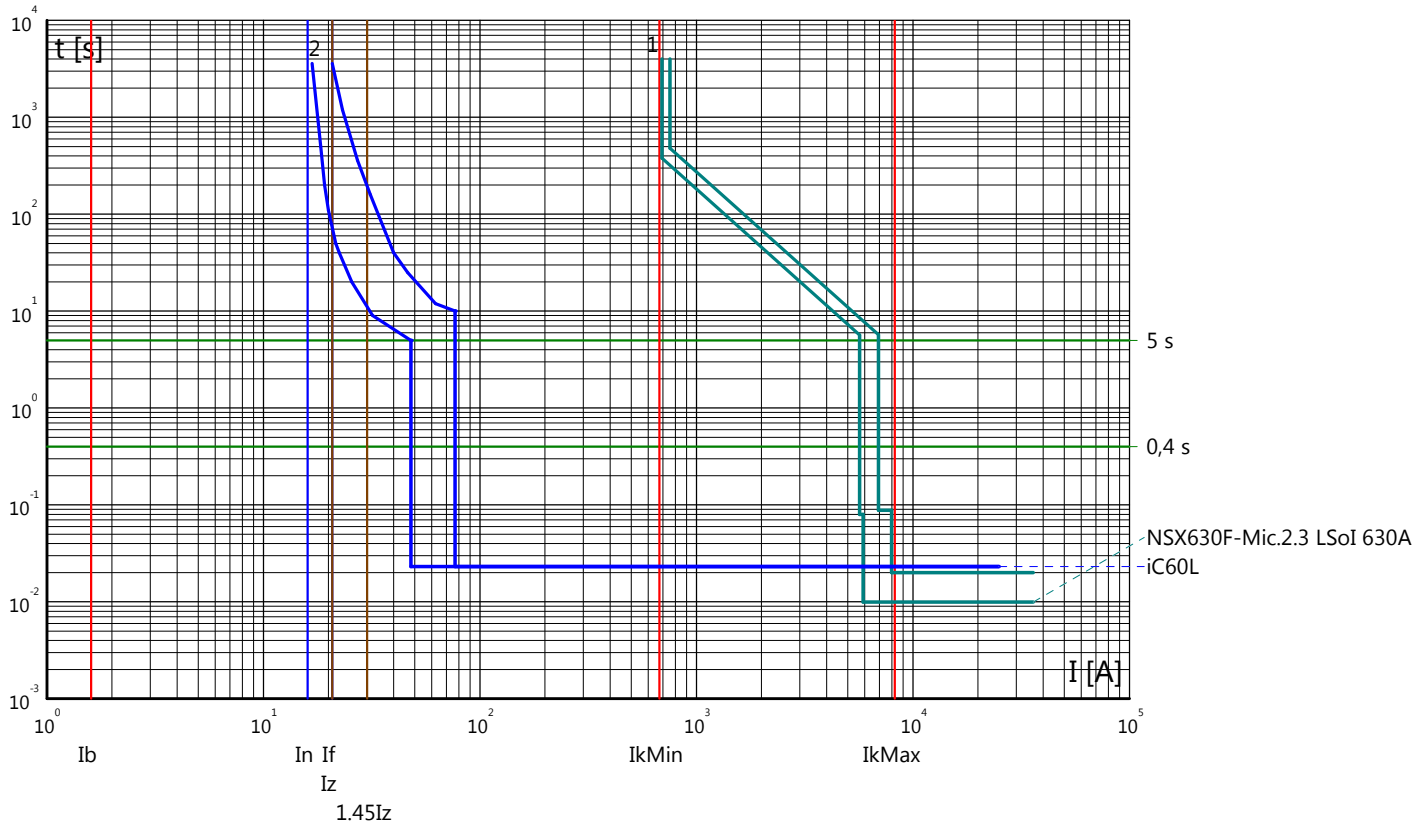

Partenza: 1.21N

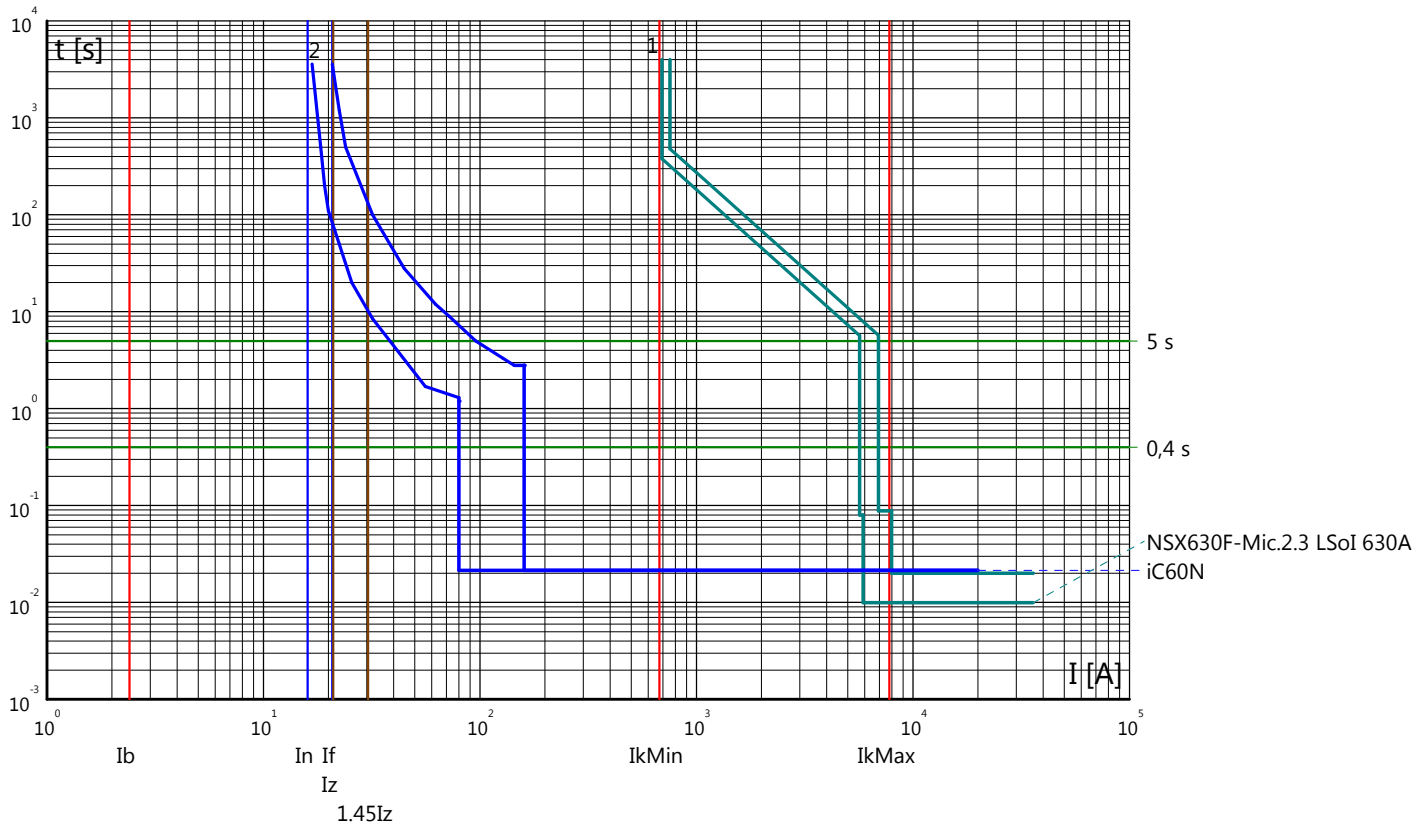

Curve tempo corrente: GALLERIA MONTE AGLIO
 Quadro: QGBT/S

Partenza: 1.22N

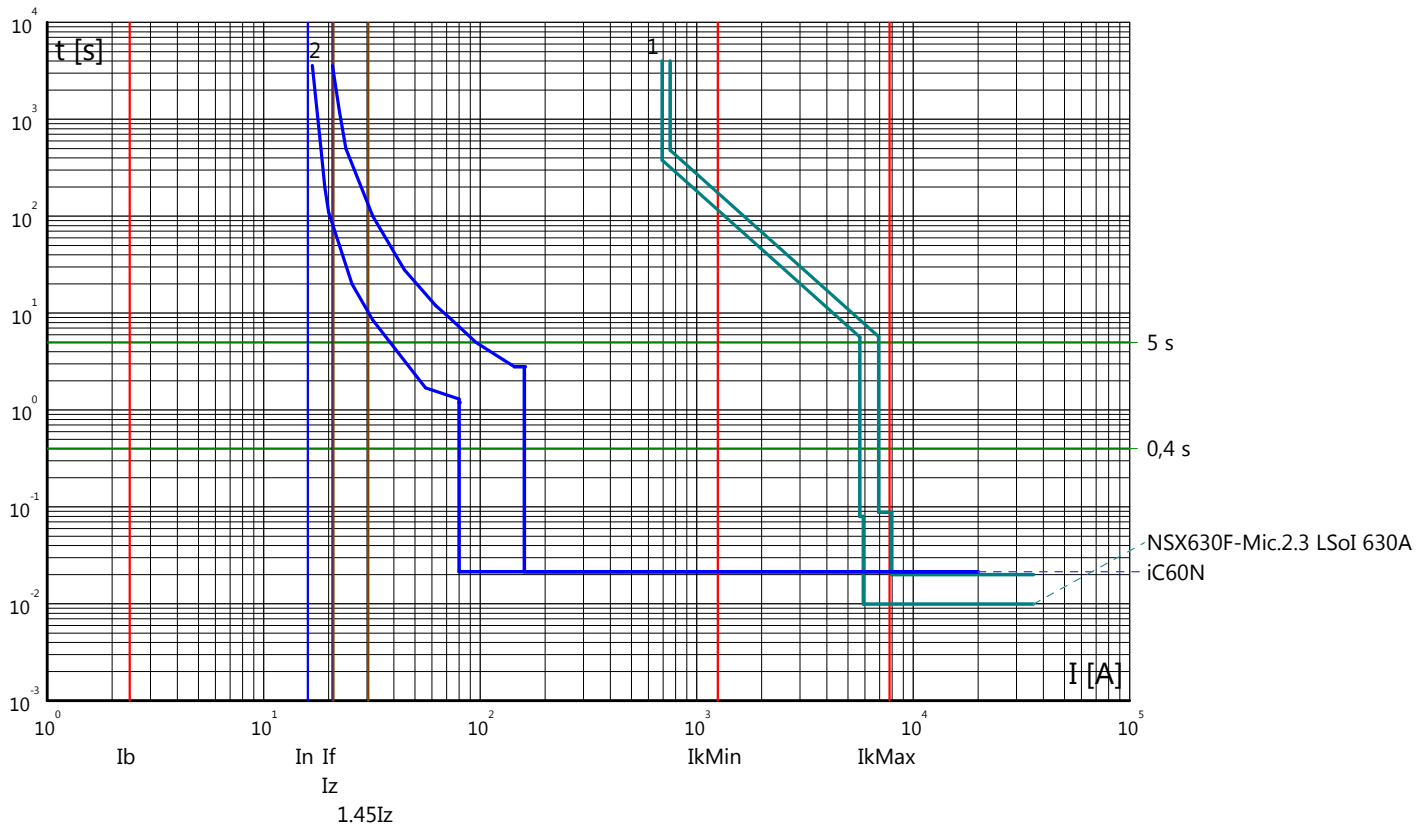

Partenza: 1.23N

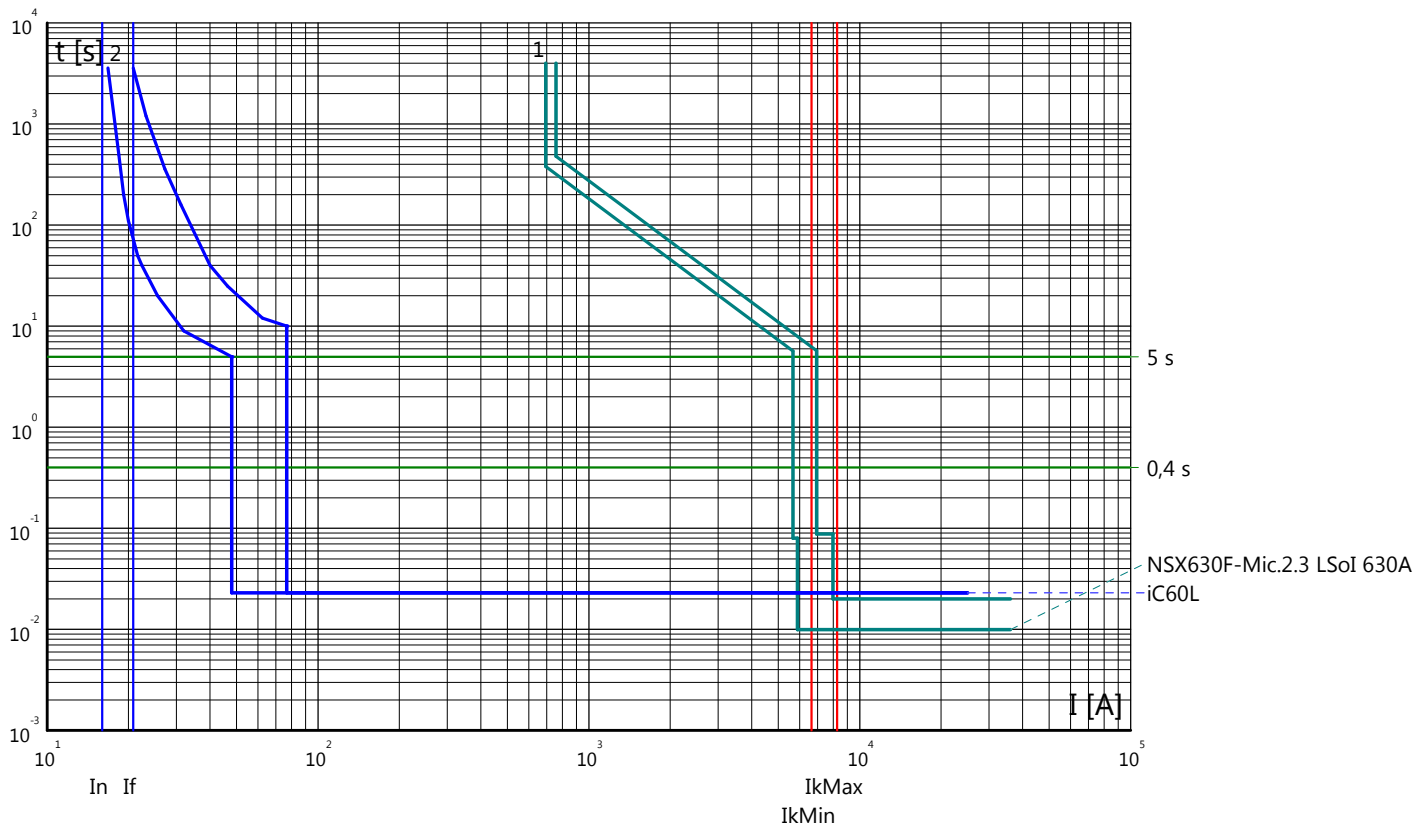

Curve tempo corrente: GALLERIA MONTE AGLIO
 Quadro: QGBT/S

Partenza: 1.24N

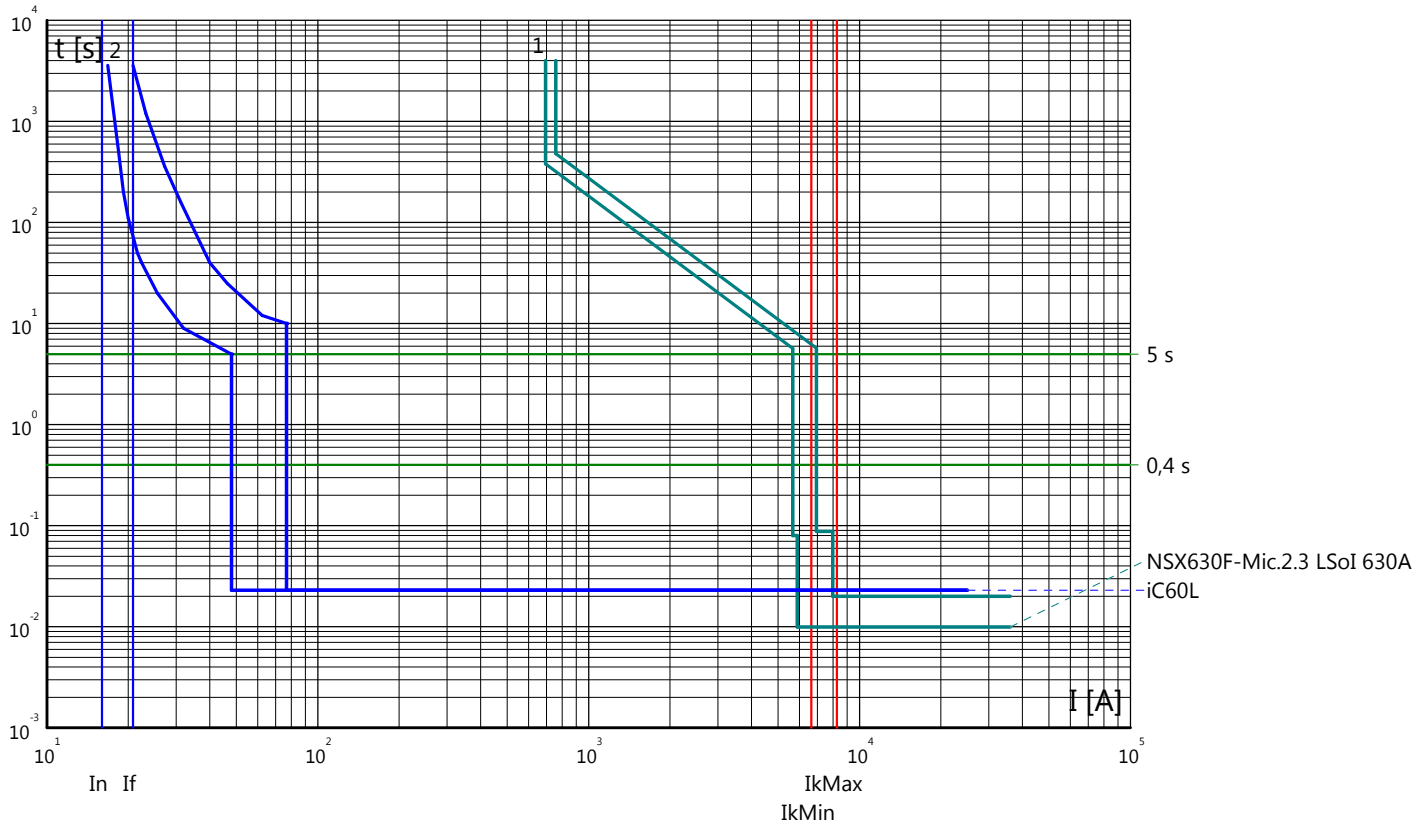

Partenza: 1.25N

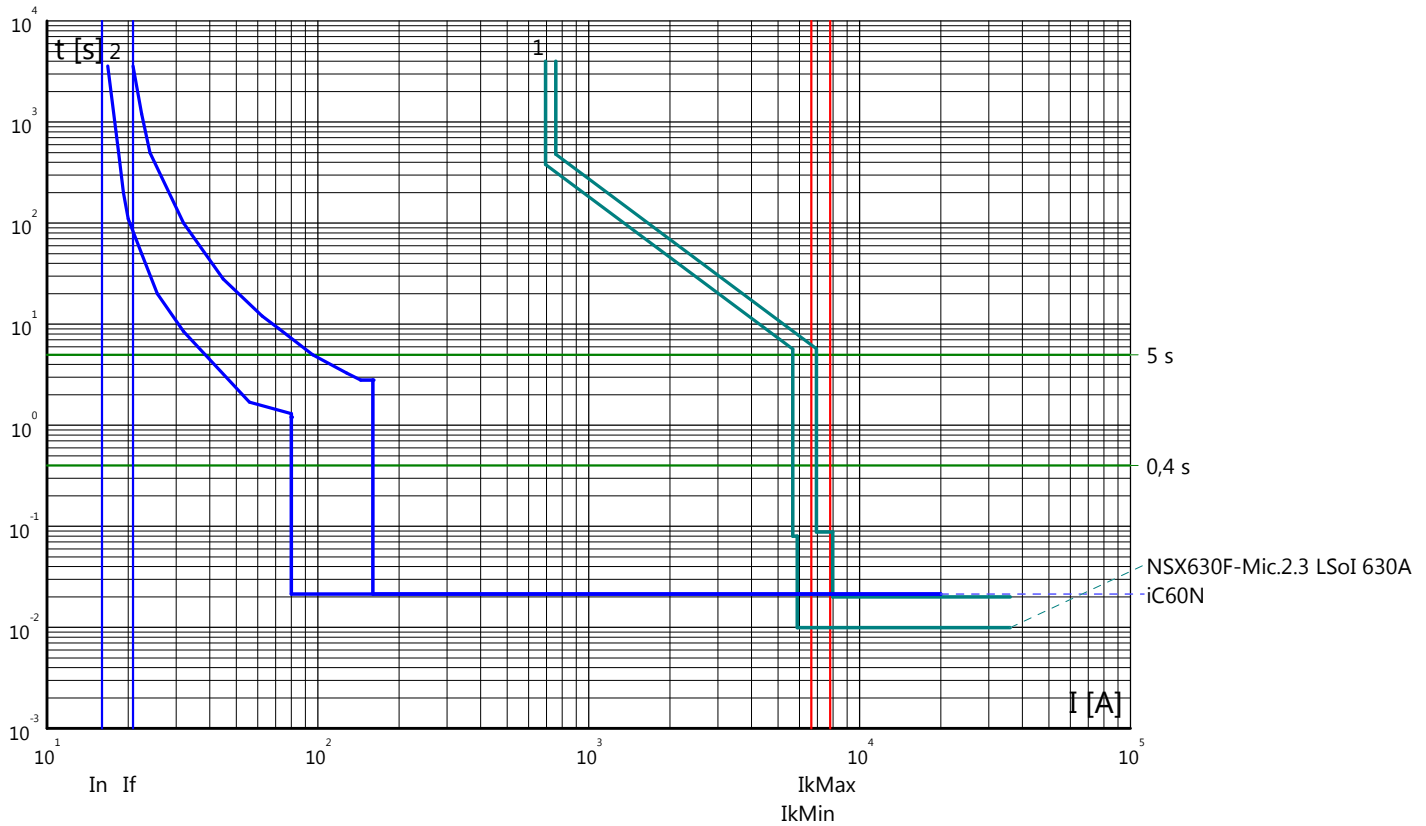

Curve tempo corrente: GALLERIA MONTE AGLIO
 Quadro: QGBT/S

Partenza: 1.26N

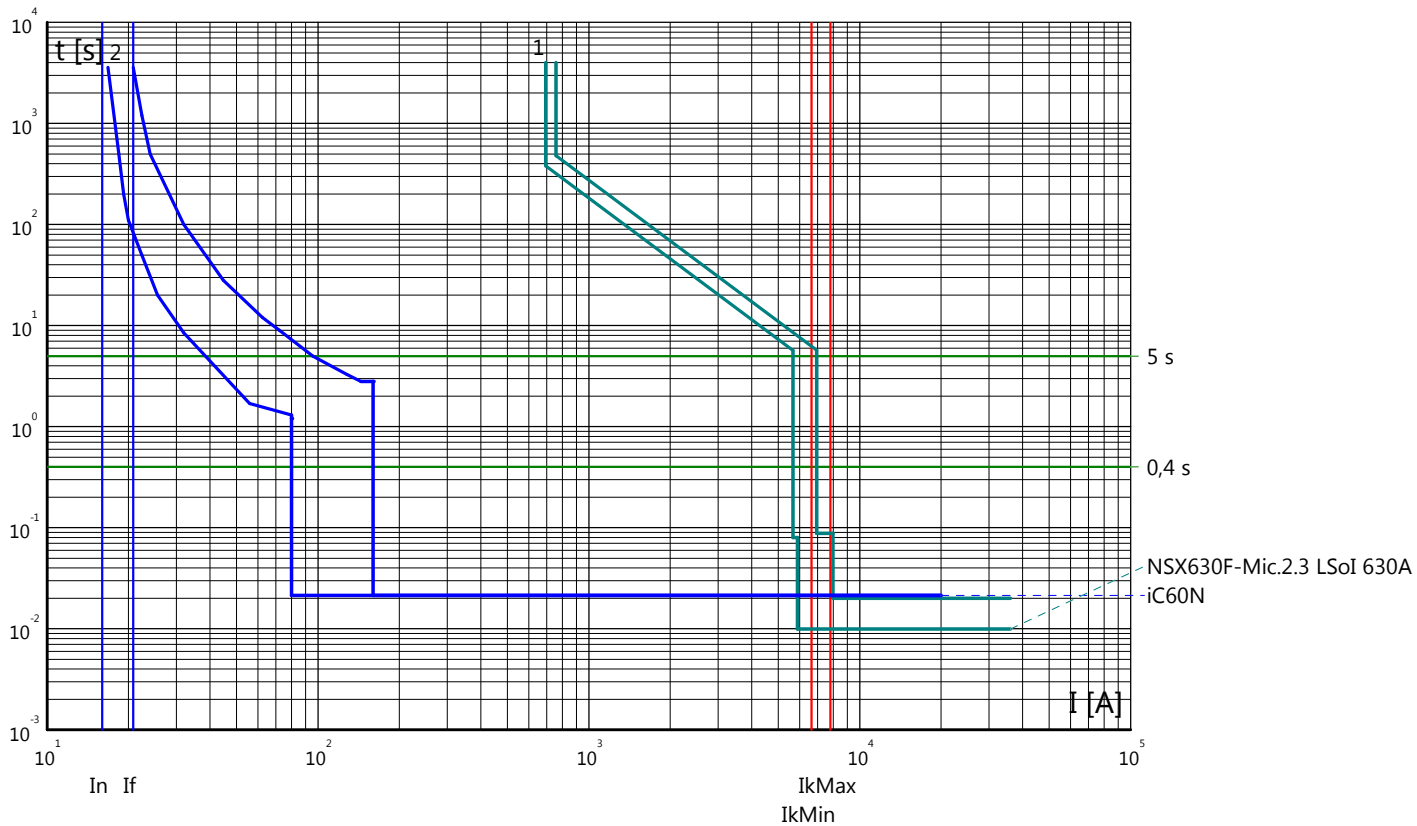

Partenza: 1.27N

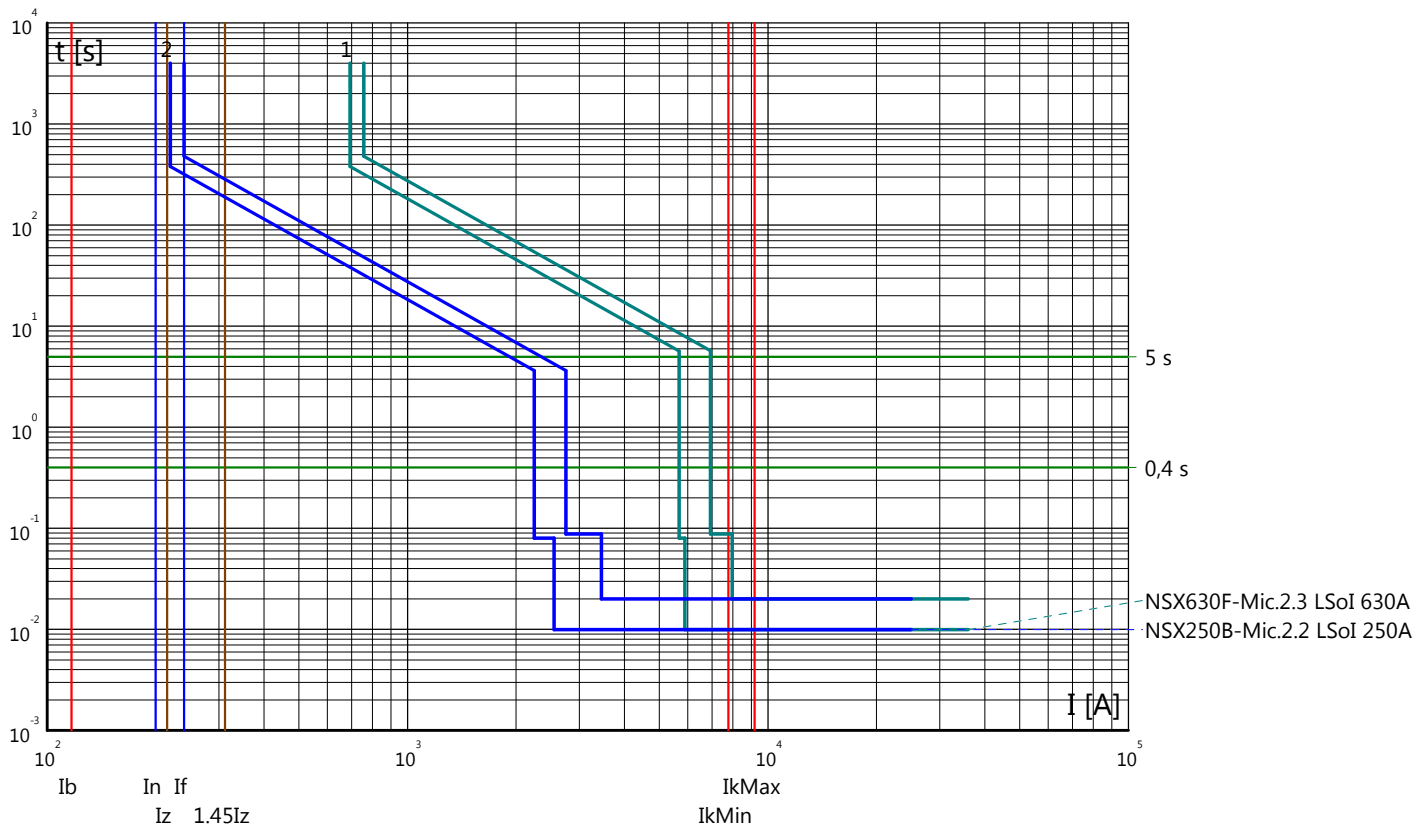

Curve tempo corrente: GALLERIA MONTE AGLIO
Quadro: QGBT/S

Arrivo: IG/GE

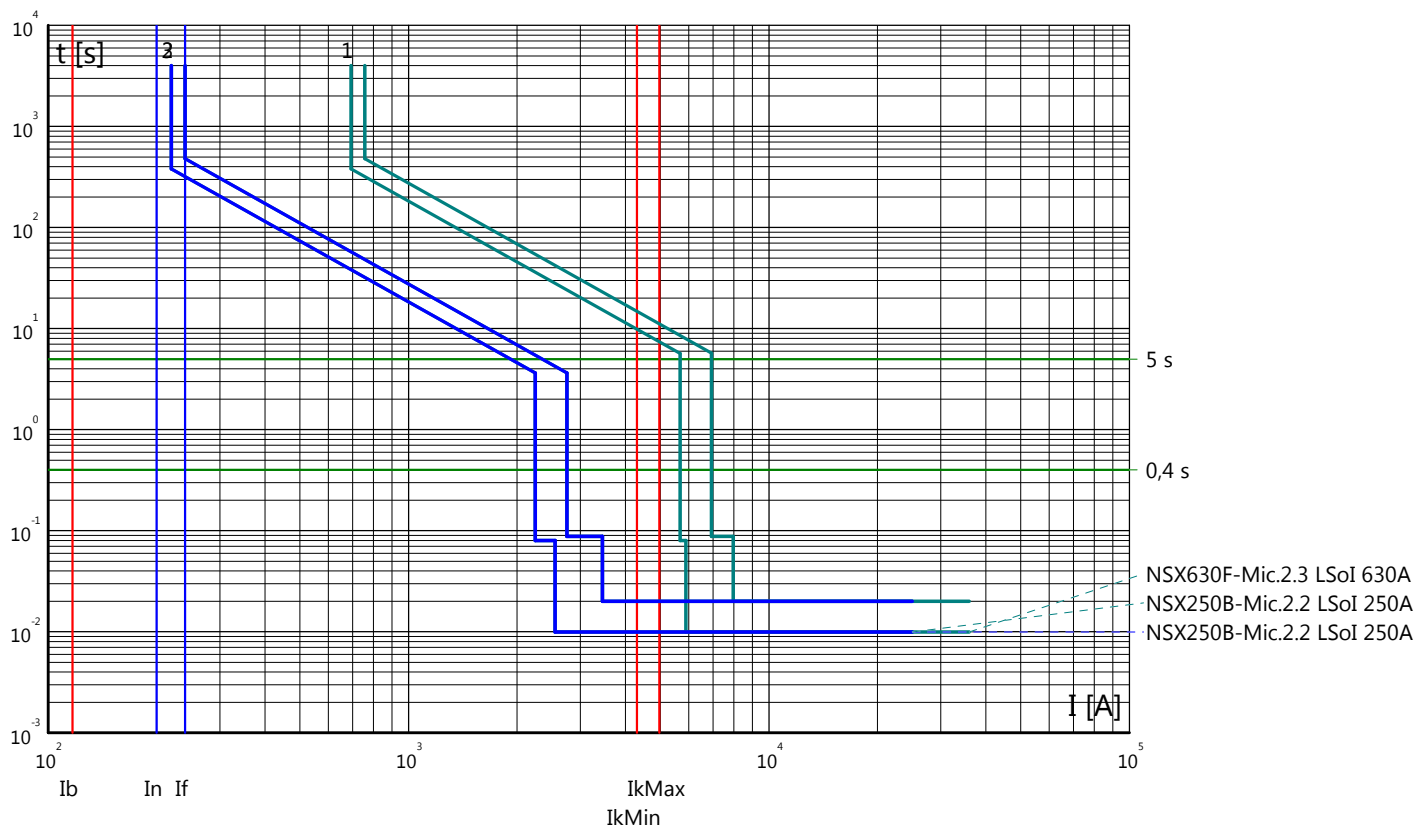

Partenza: PT/P

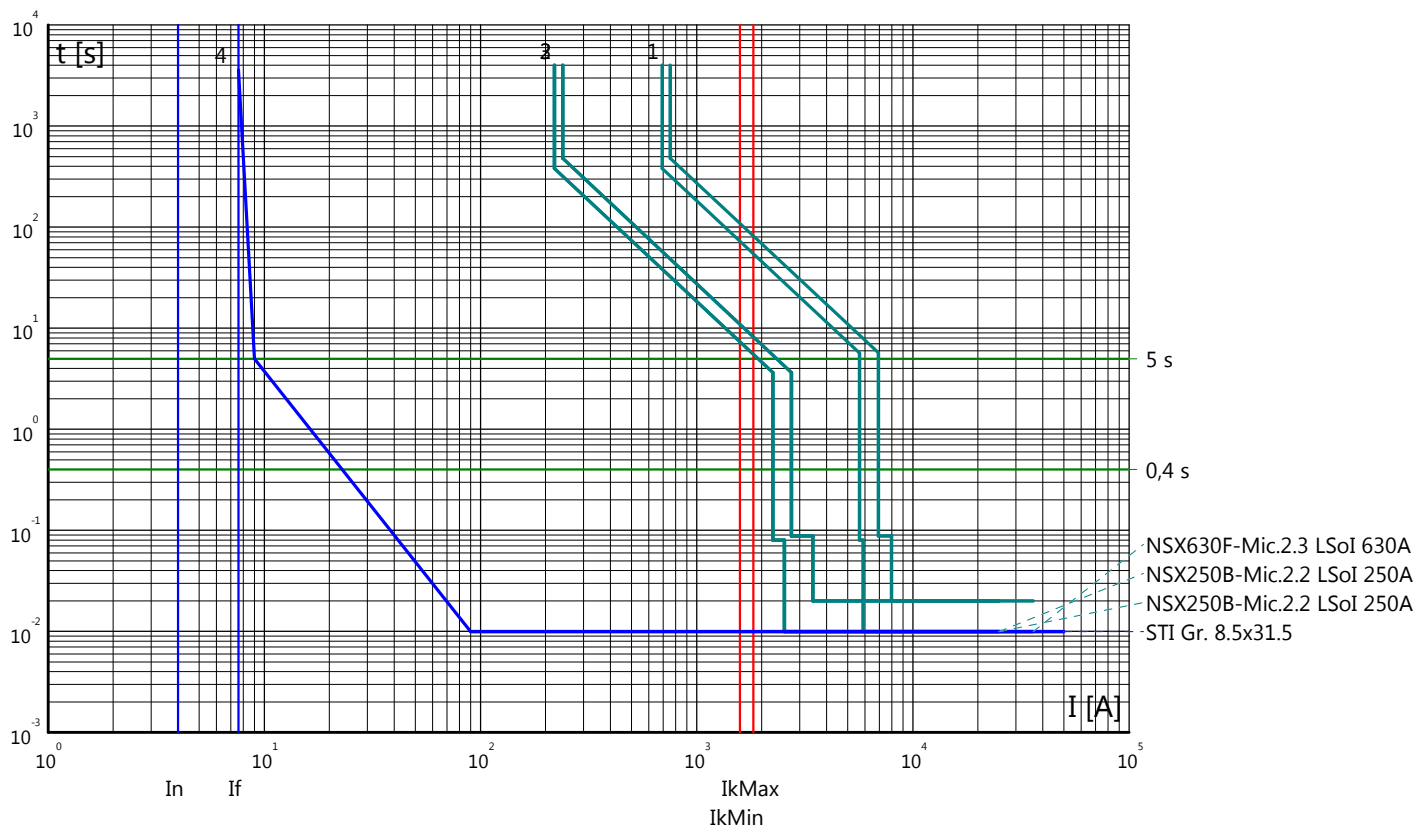

Curve tempo corrente: GALLERIA MONTE AGLIO
 Quadro: QGBT/S

Partenza: MIS/P

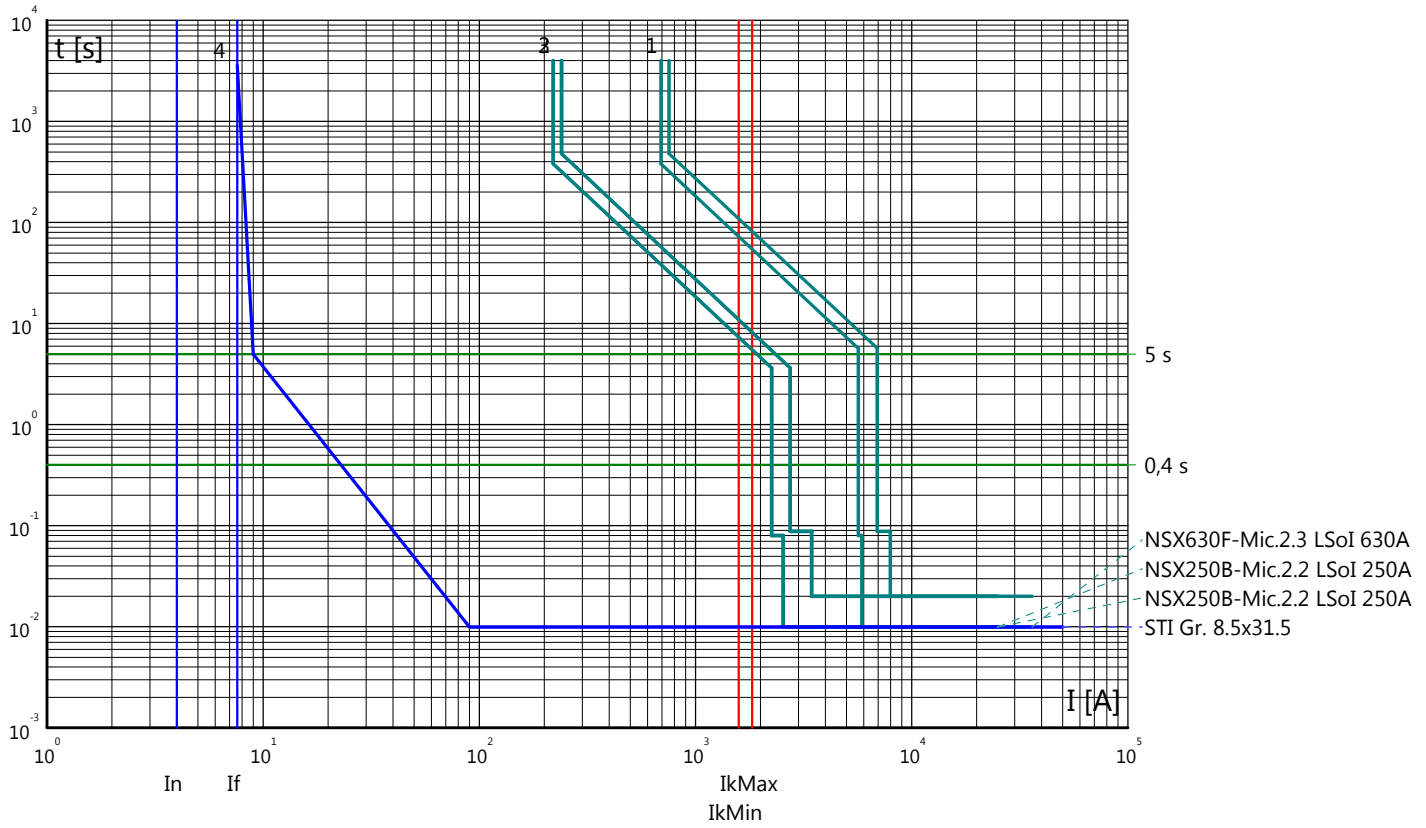

Partenza: 1.1P

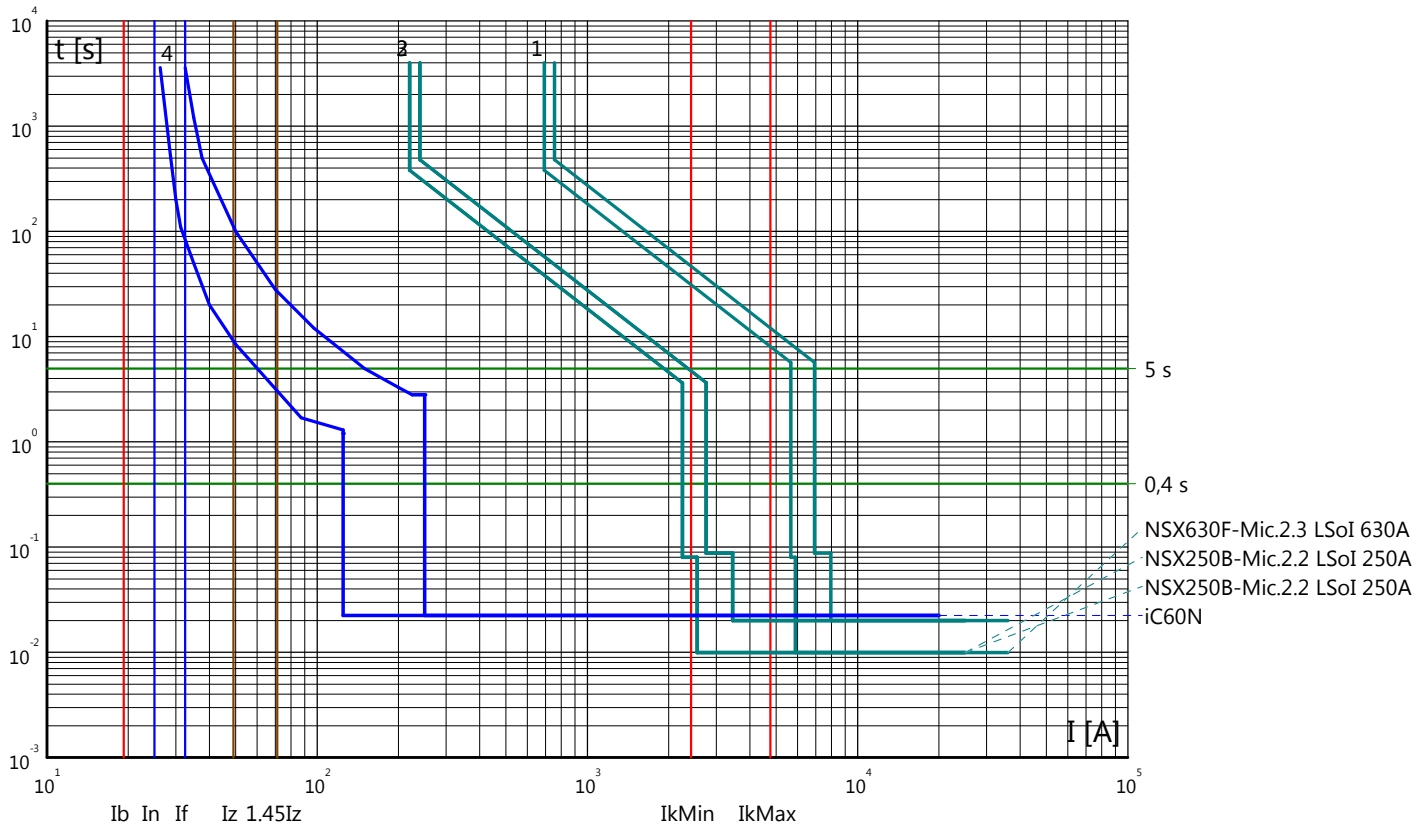

Curve tempo corrente: GALLERIA MONTE AGLIO
 Quadro: QGBT/S

Partenza: 1.2P

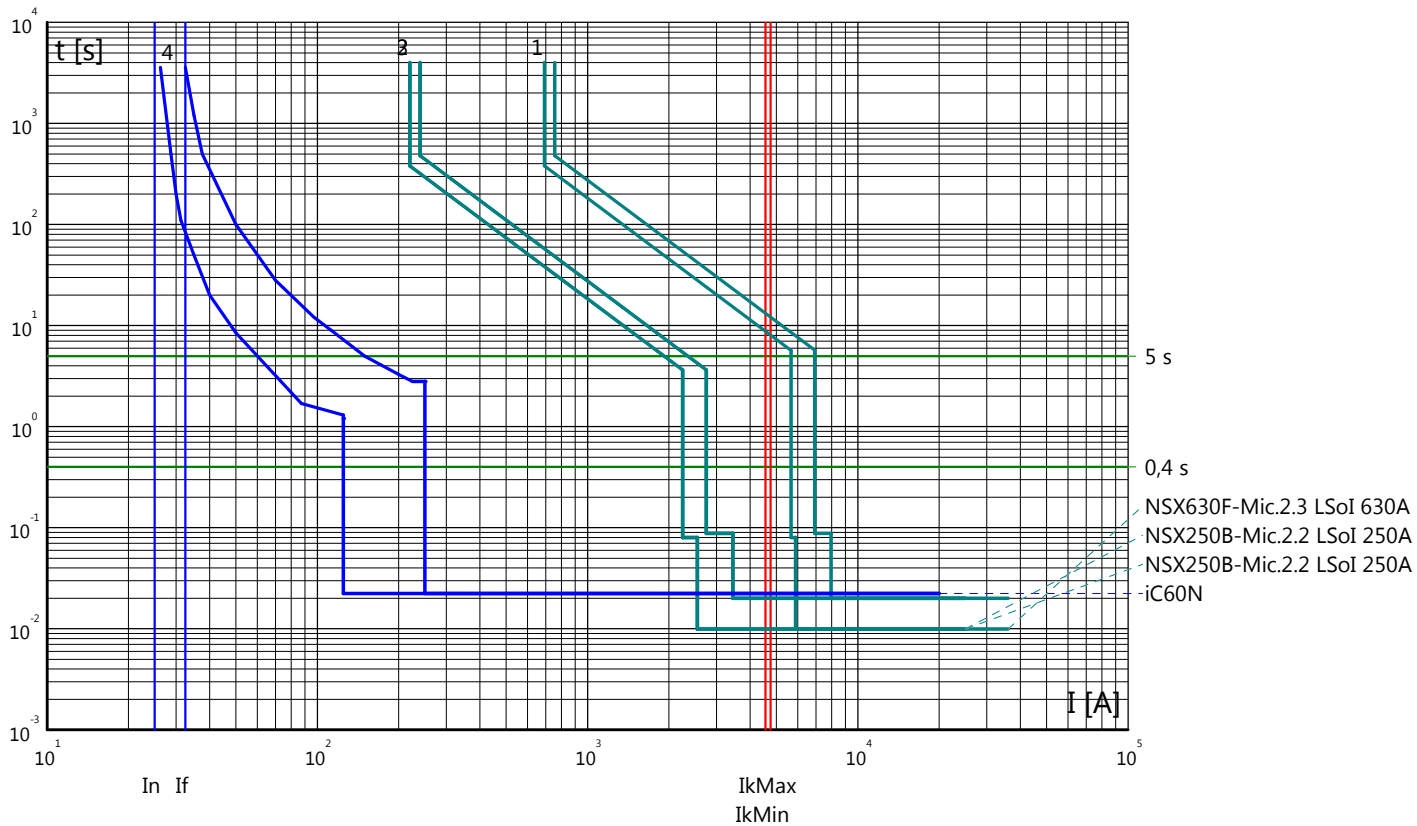

Partenza: 1.3P

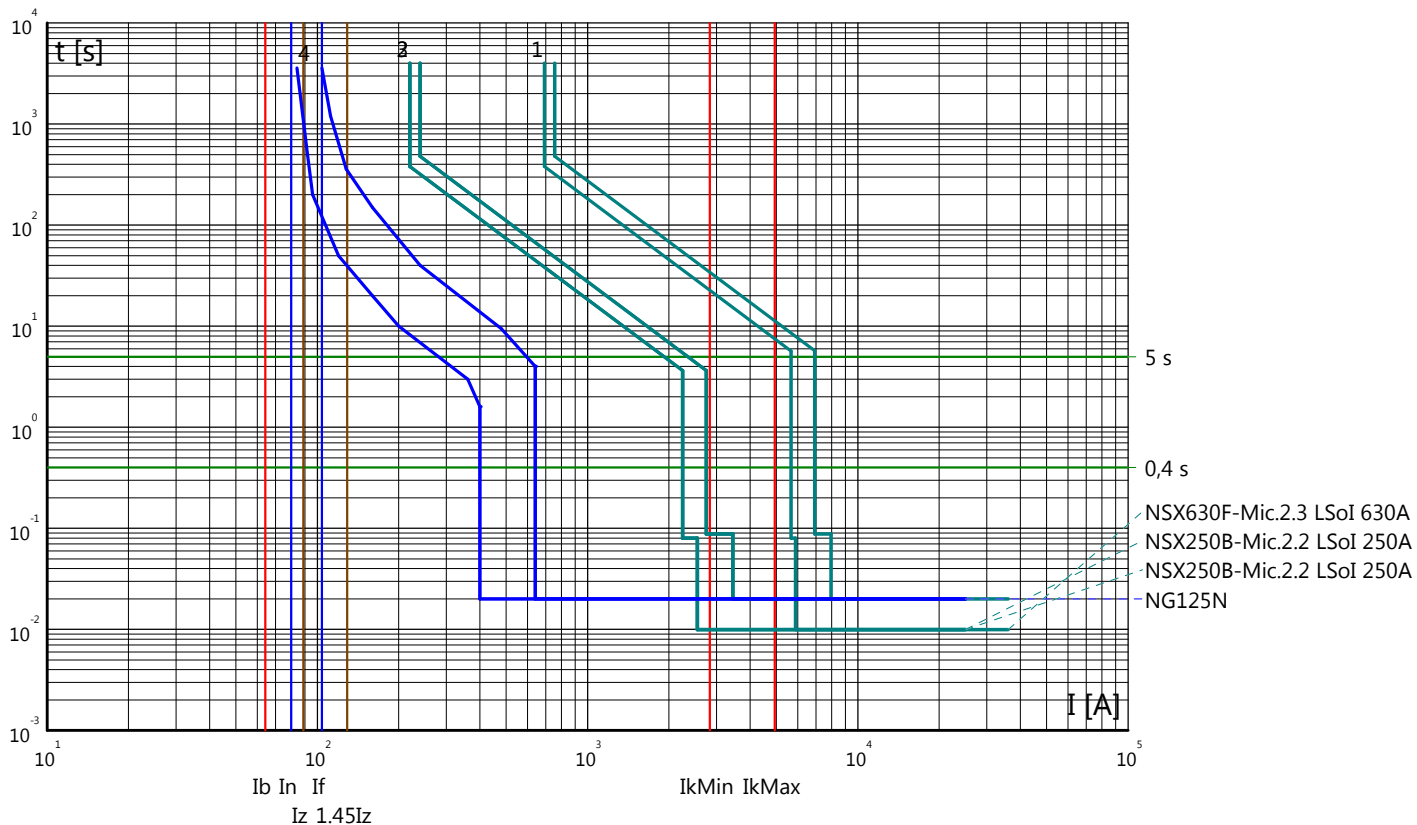

Curve tempo corrente: GALLERIA MONTE AGLIO
 Quadro: QGBT/S

Partenza: 1.4P

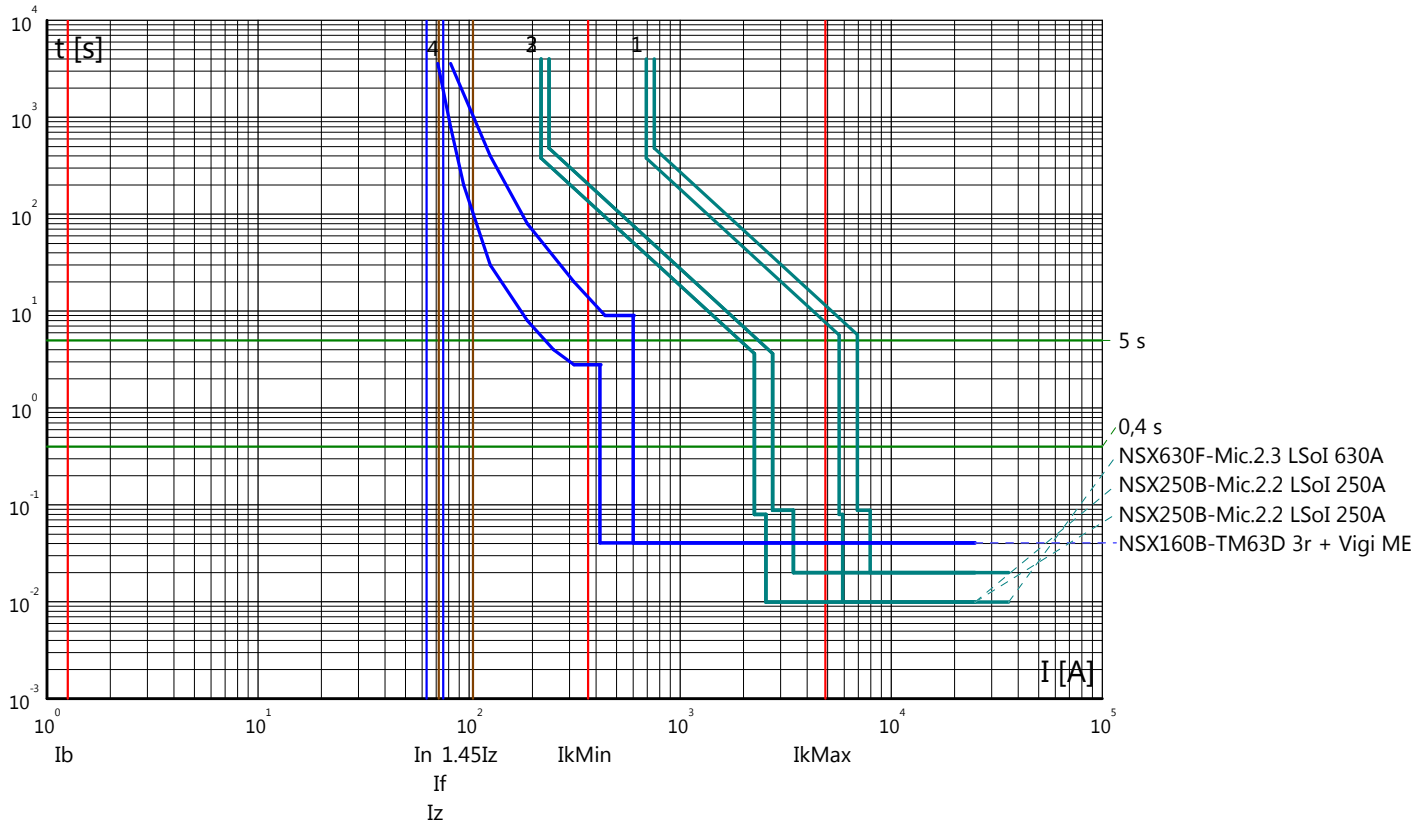

Partenza: 1.5P

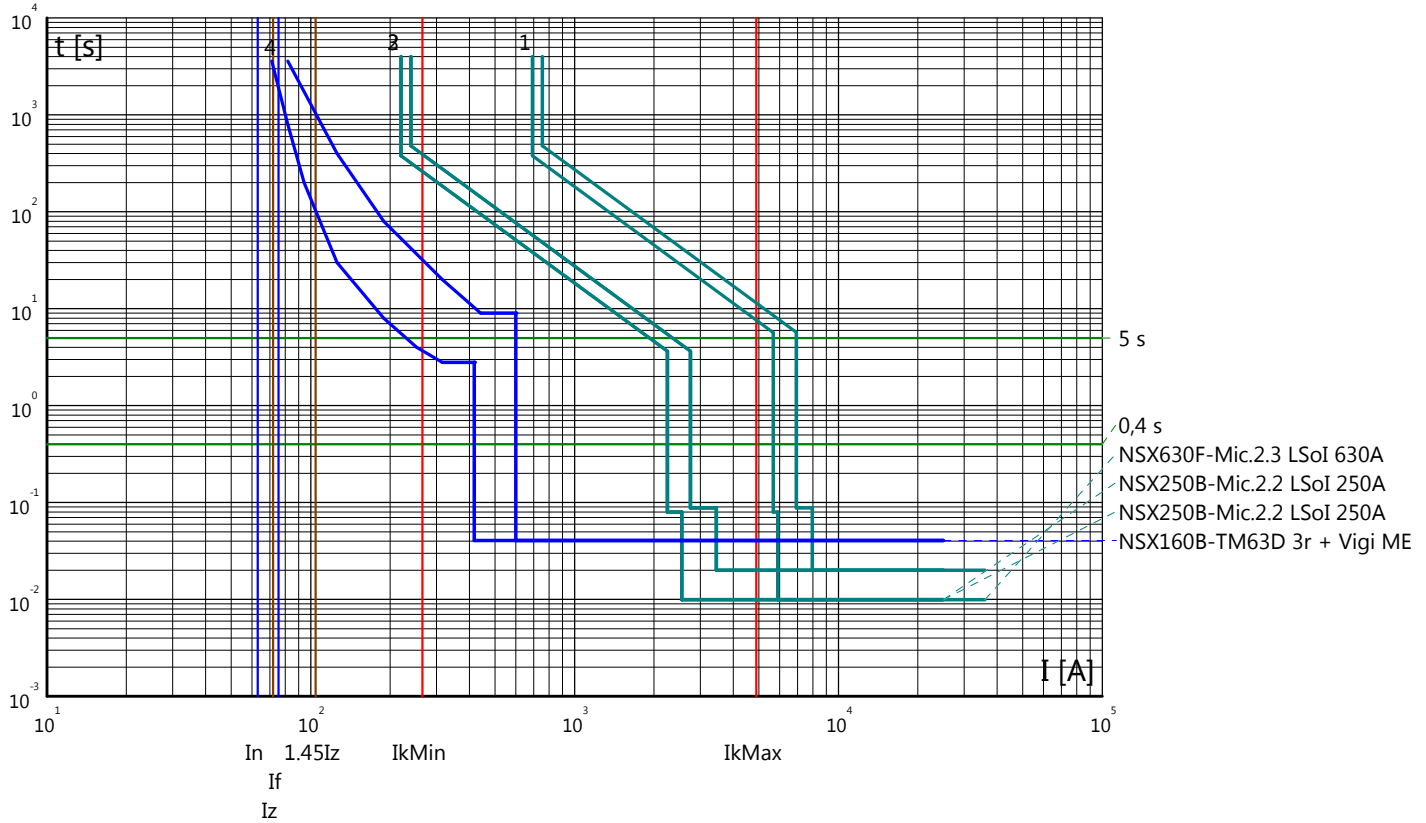

Curve tempo corrente: GALLERIA MONTE AGLIO
 Quadro: QGBT/S

Partenza: IP1.P

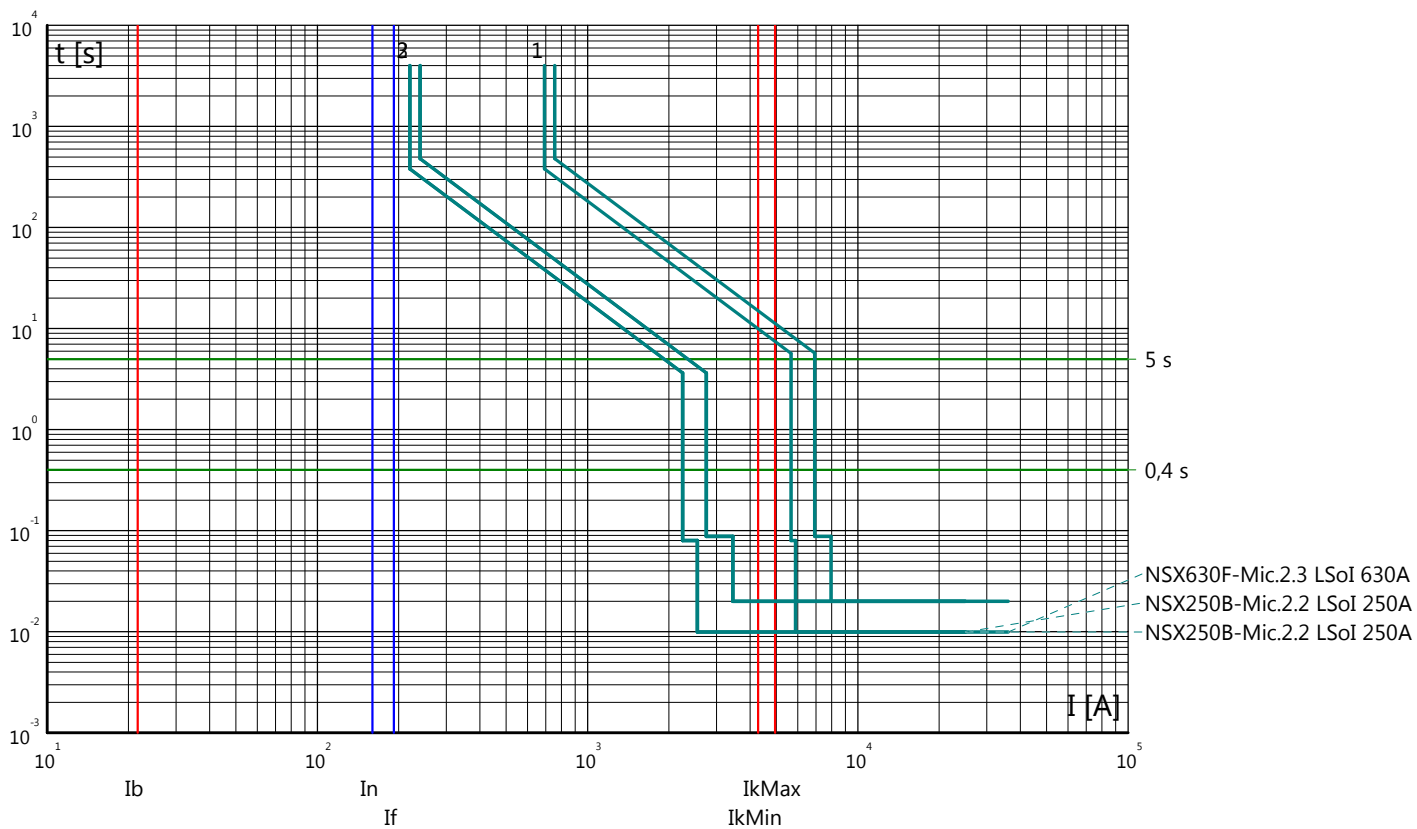

Partenza: 1.6P

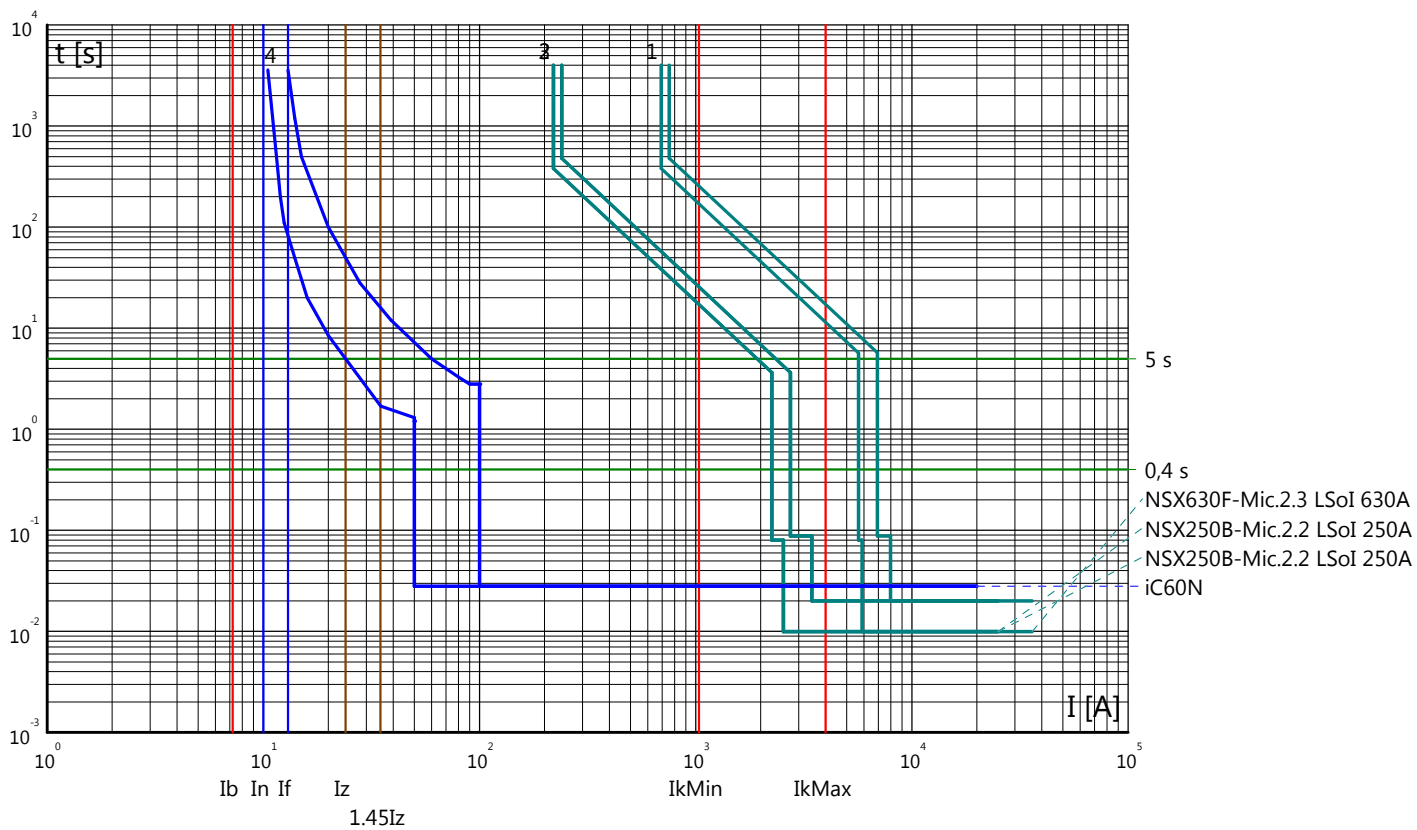

Curve tempo corrente: GALLERIA MONTE AGLIO
 Quadro: QGBT/S

Partenza: 1.7P

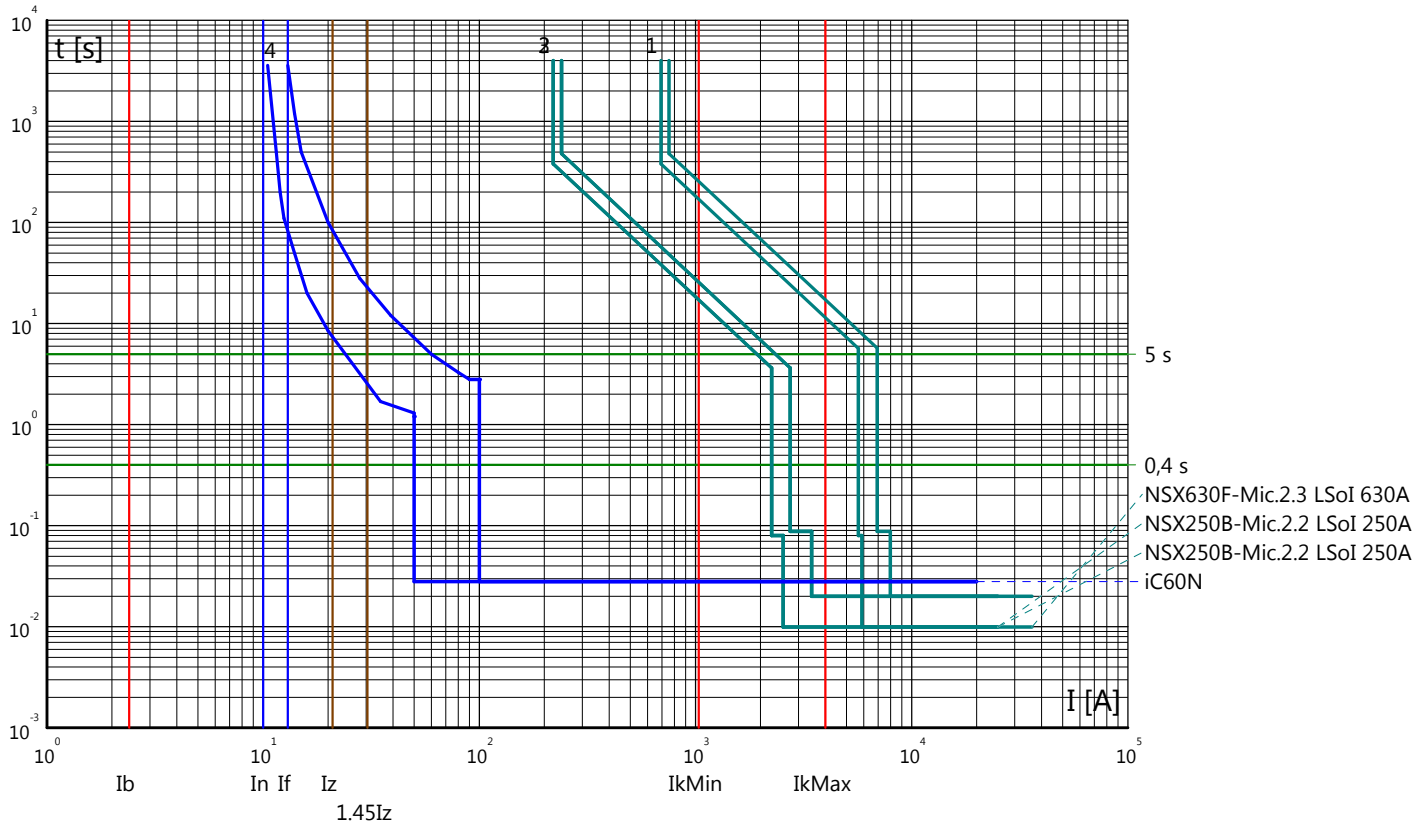

Partenza: 1.8P

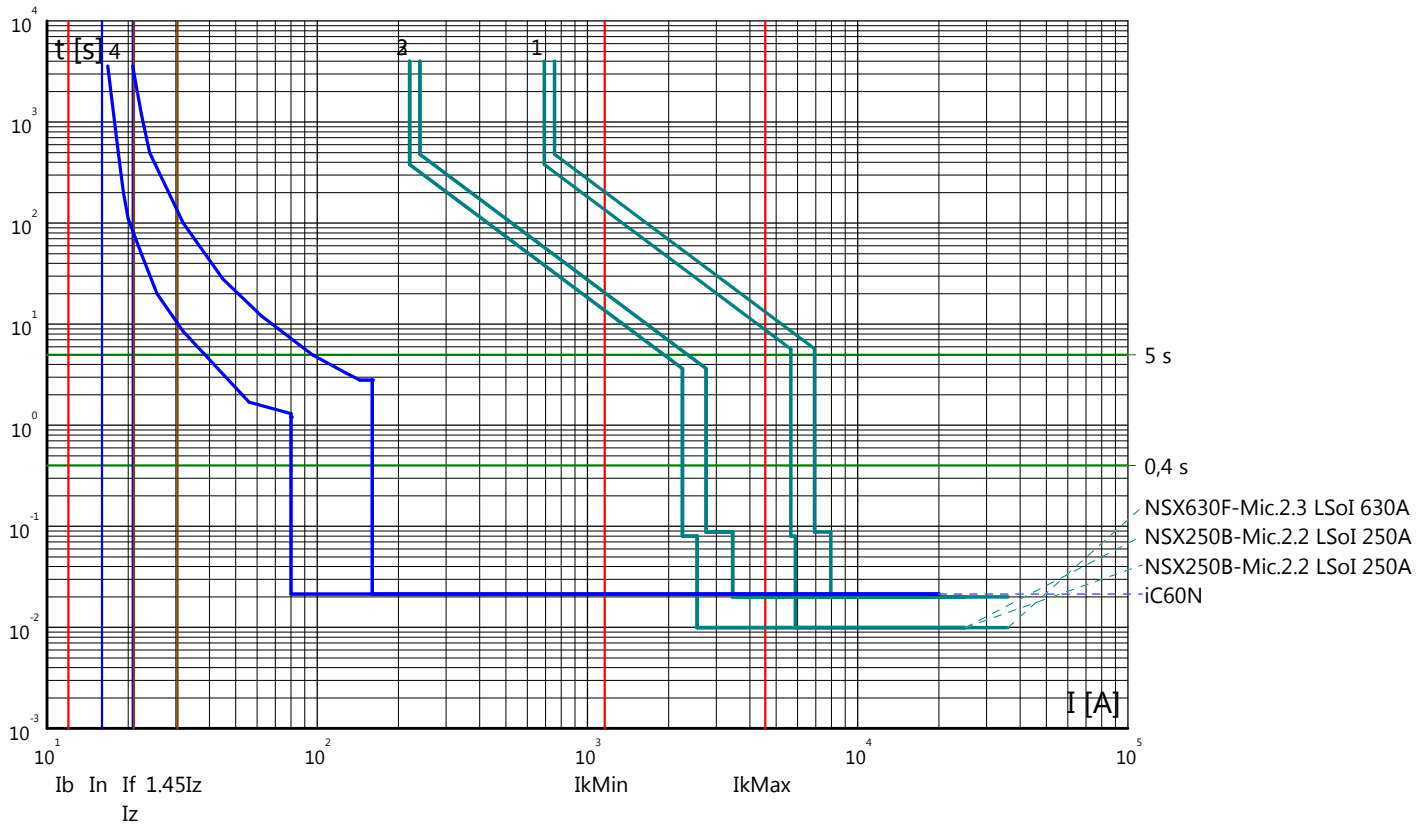

Curve tempo corrente: GALLERIA MONTE AGLIO
 Quadro: QGBT/S

Partenza: 1.9P

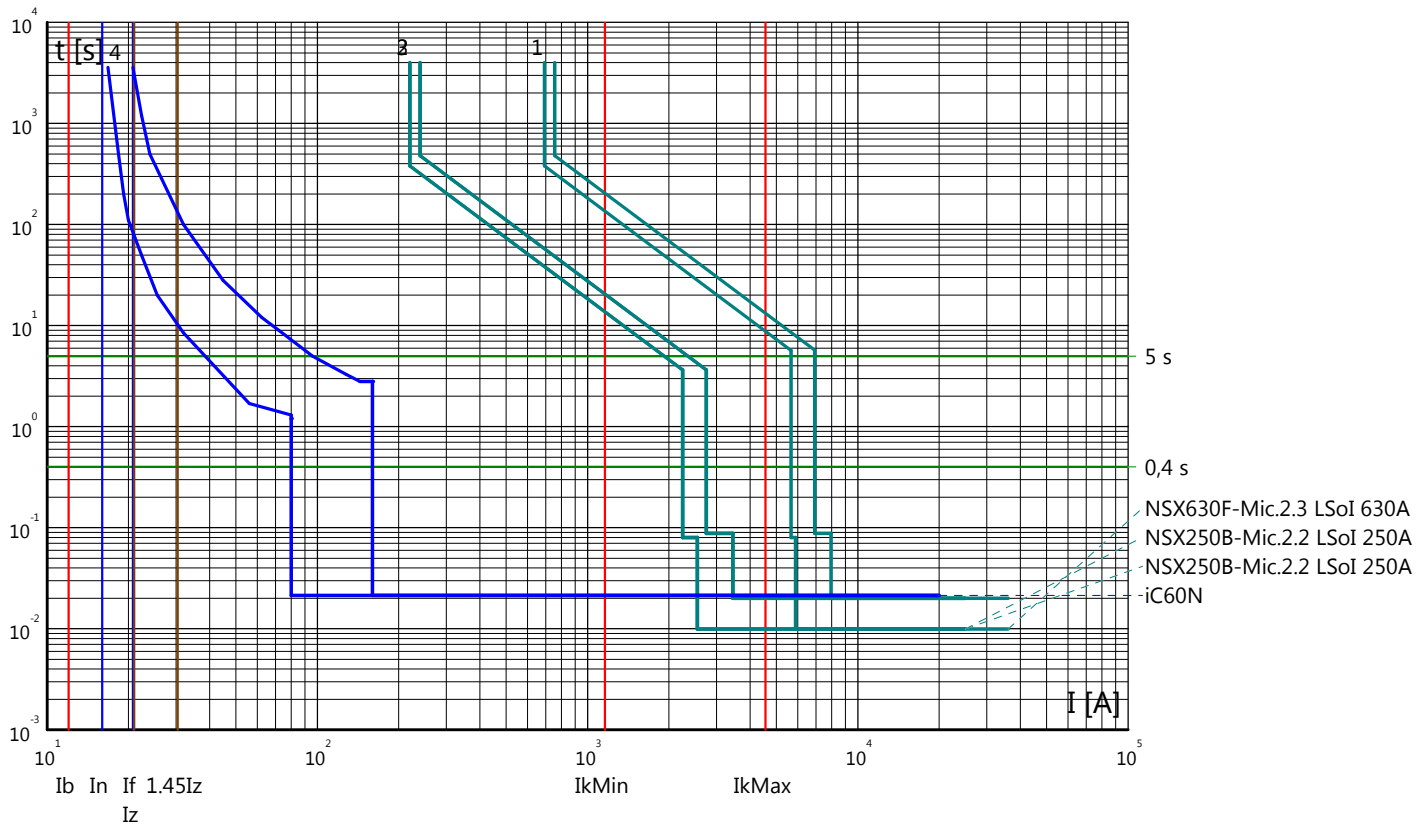

Partenza: 1.10P

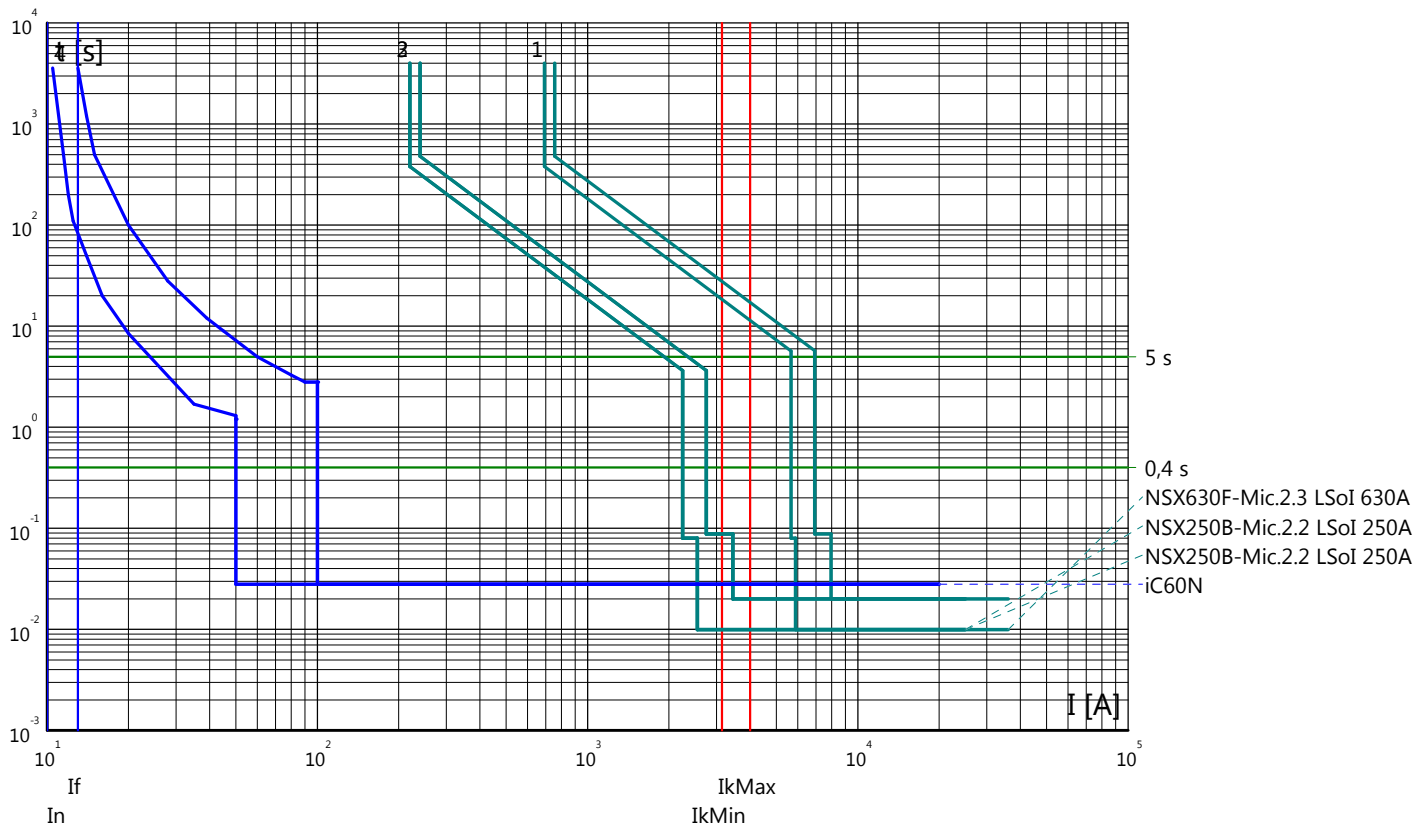

Curve tempo corrente: GALLERIA MONTE AGLIO
 Quadro: QGBT/S

Partenza: 1.11P

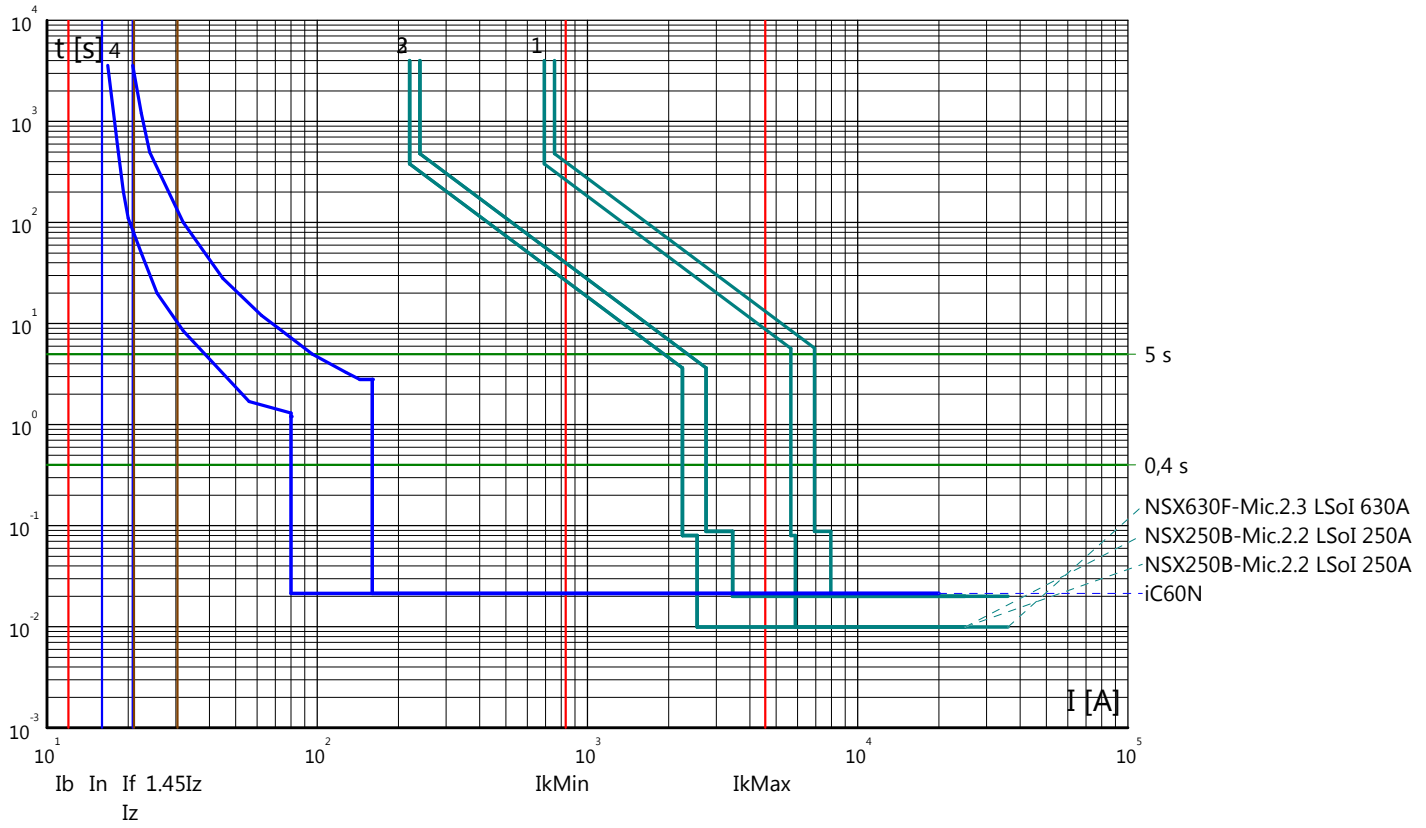

Partenza: 1.12P

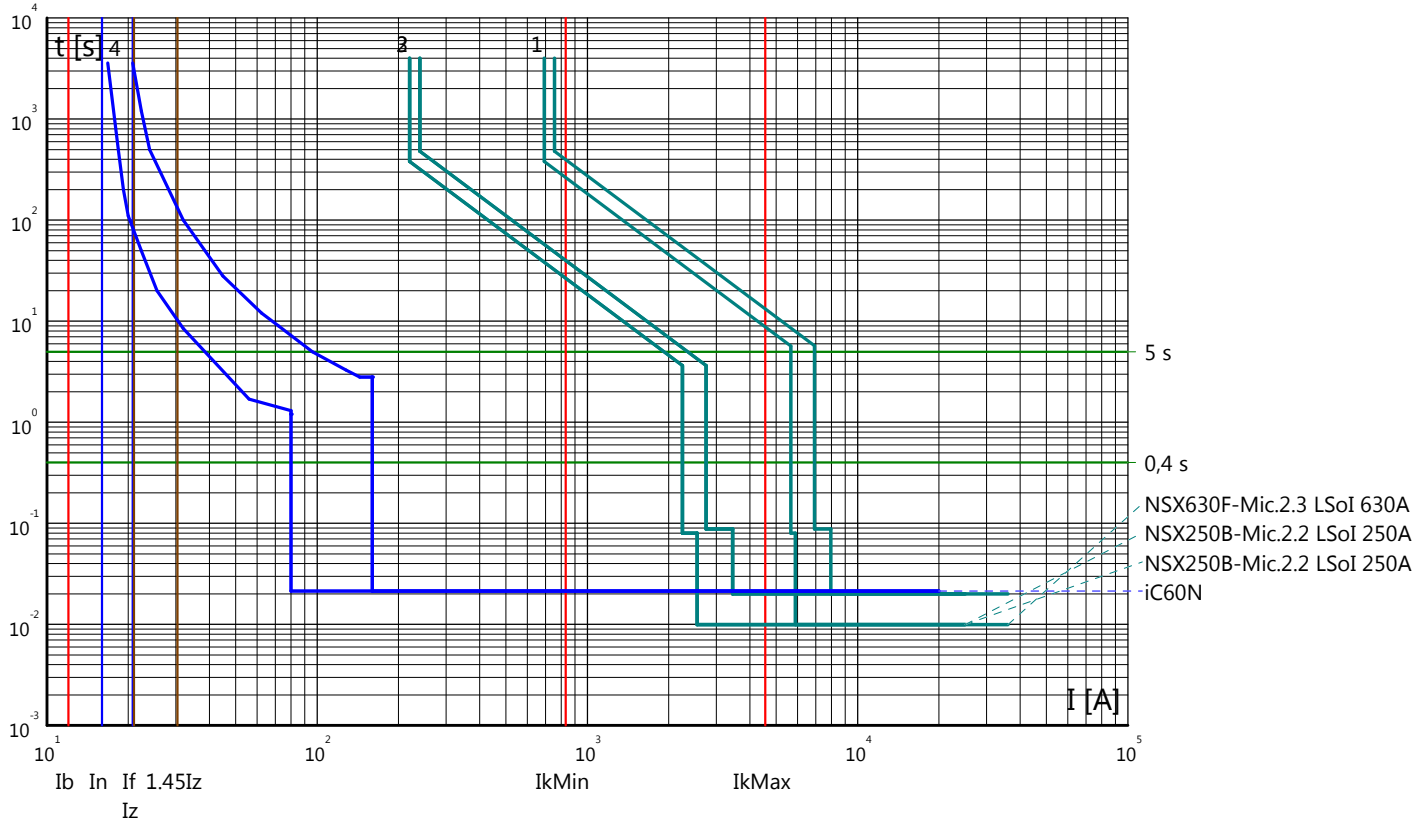

Curve tempo corrente: GALLERIA MONTE AGLIO
 Quadro: QGBT/S

Partenza: 1.13P

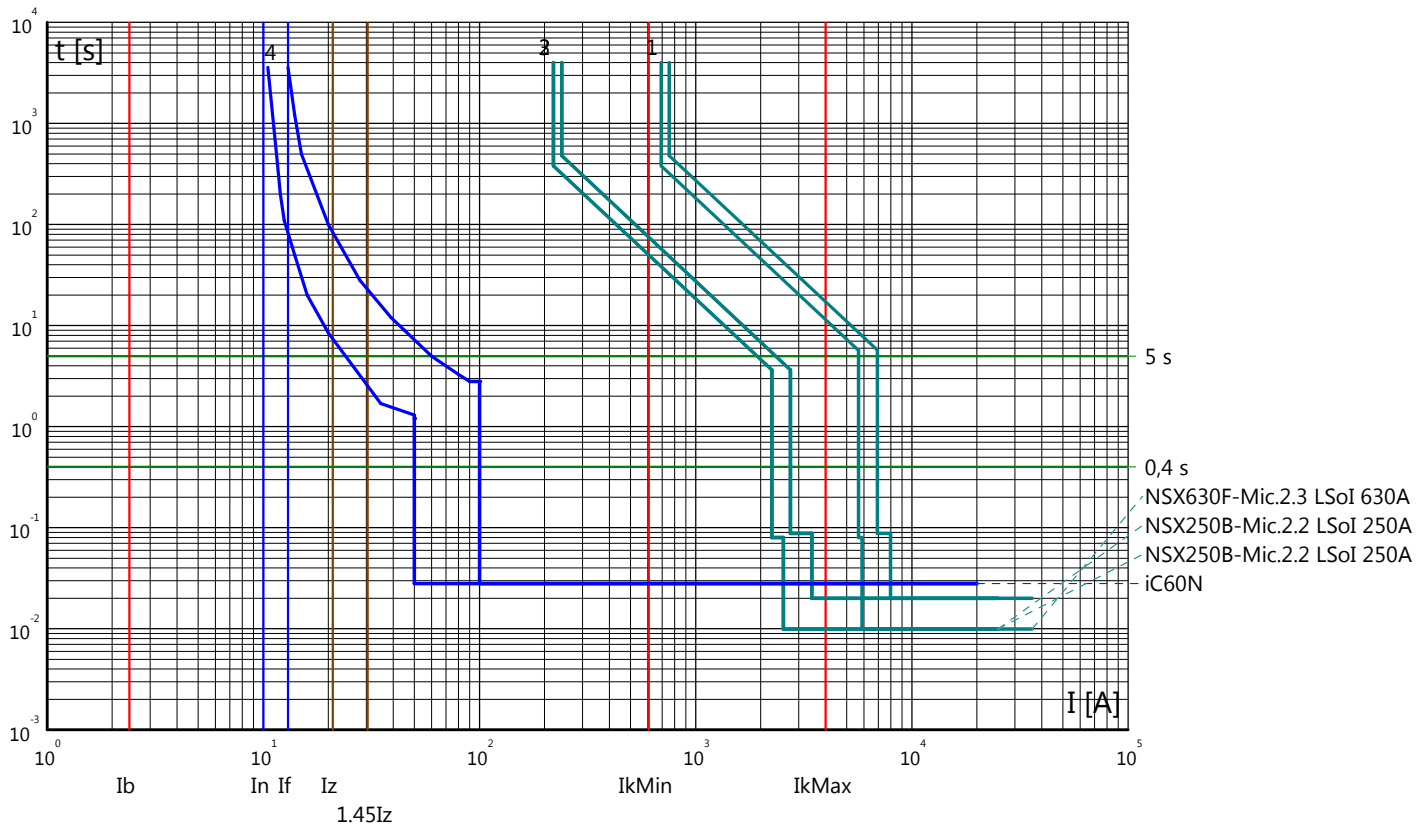

Partenza: 1.14P

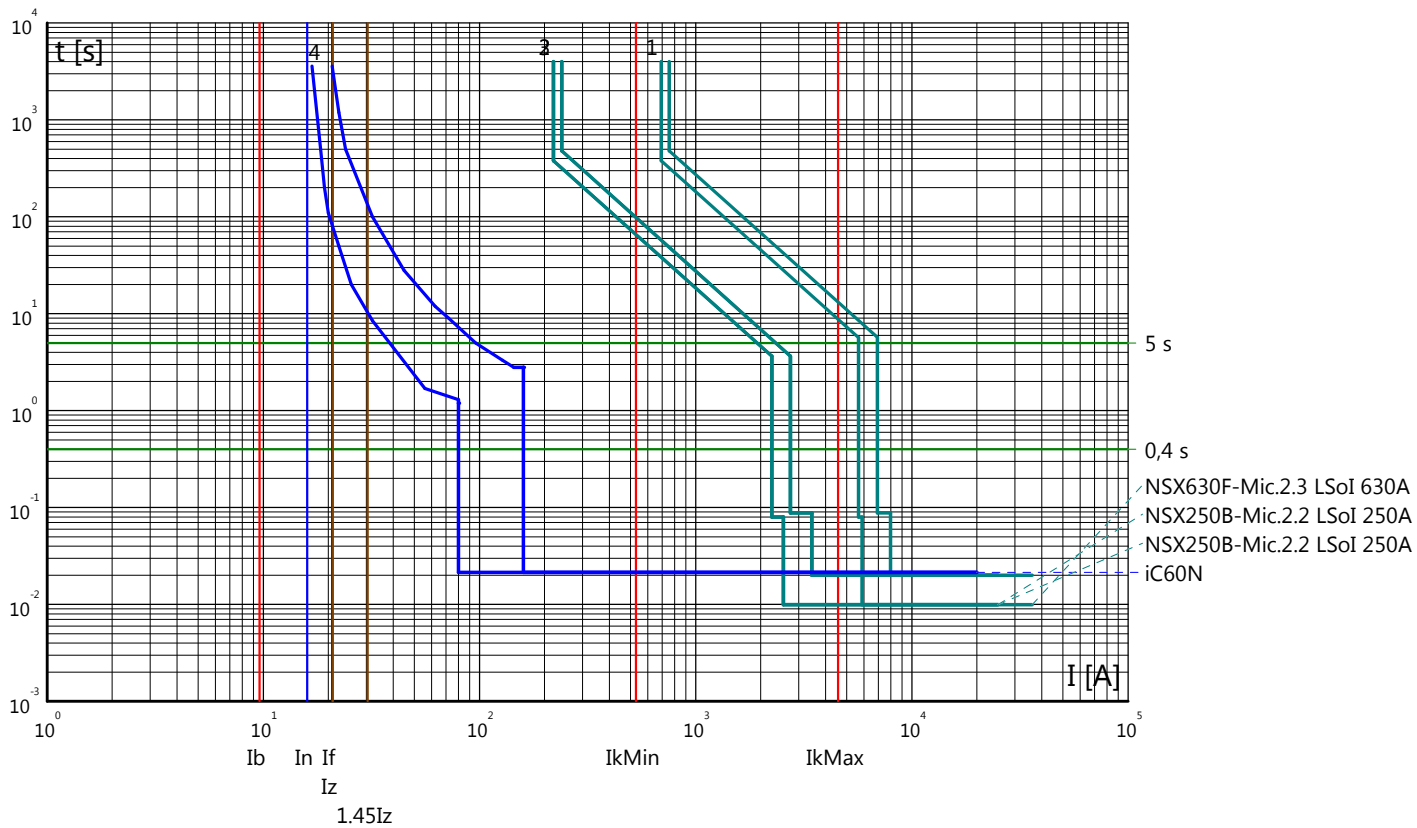

Curve tempo corrente: GALLERIA MONTE AGLIO
 Quadro: QGBT/S

Partenza: 1.15P

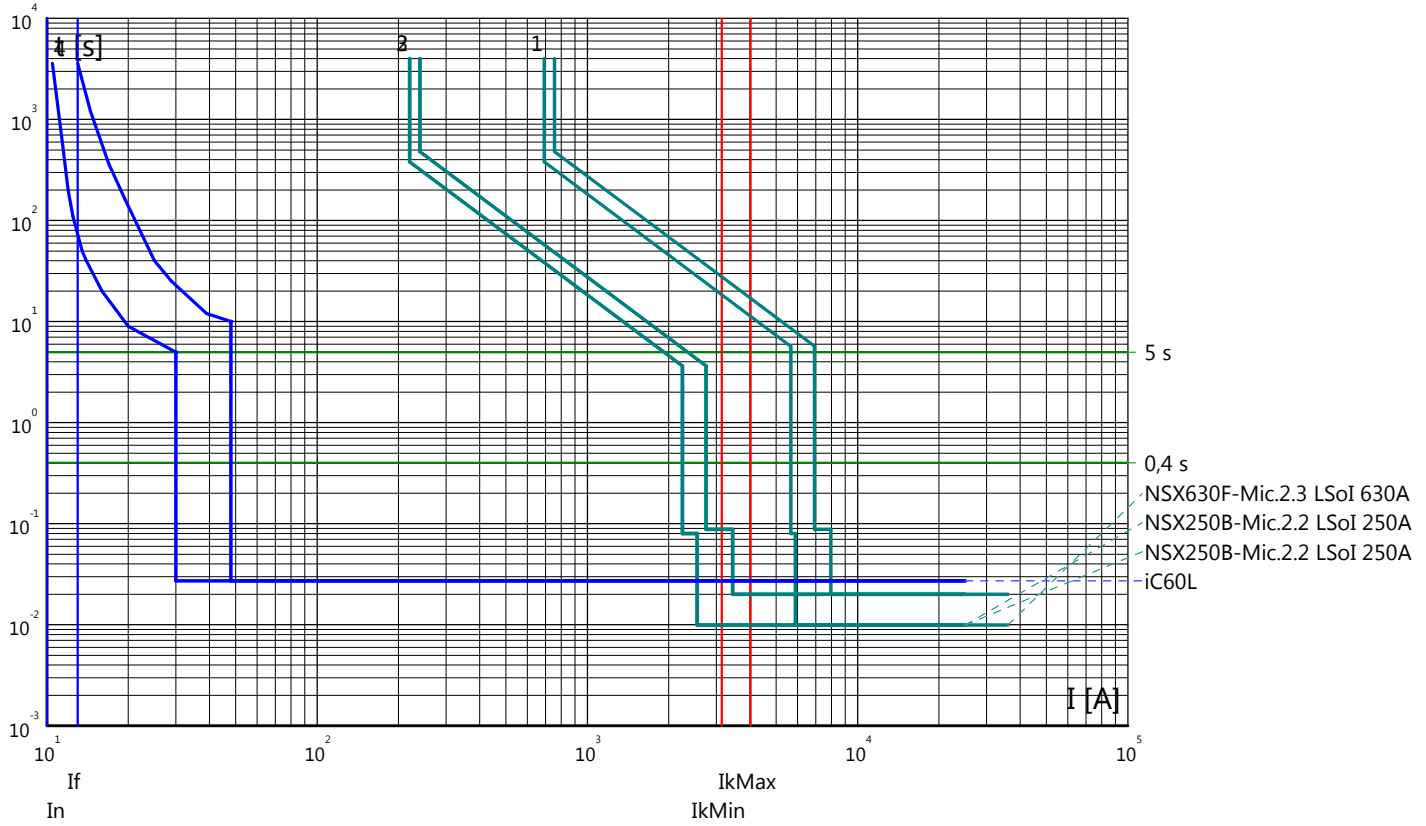

Partenza: 1.16P

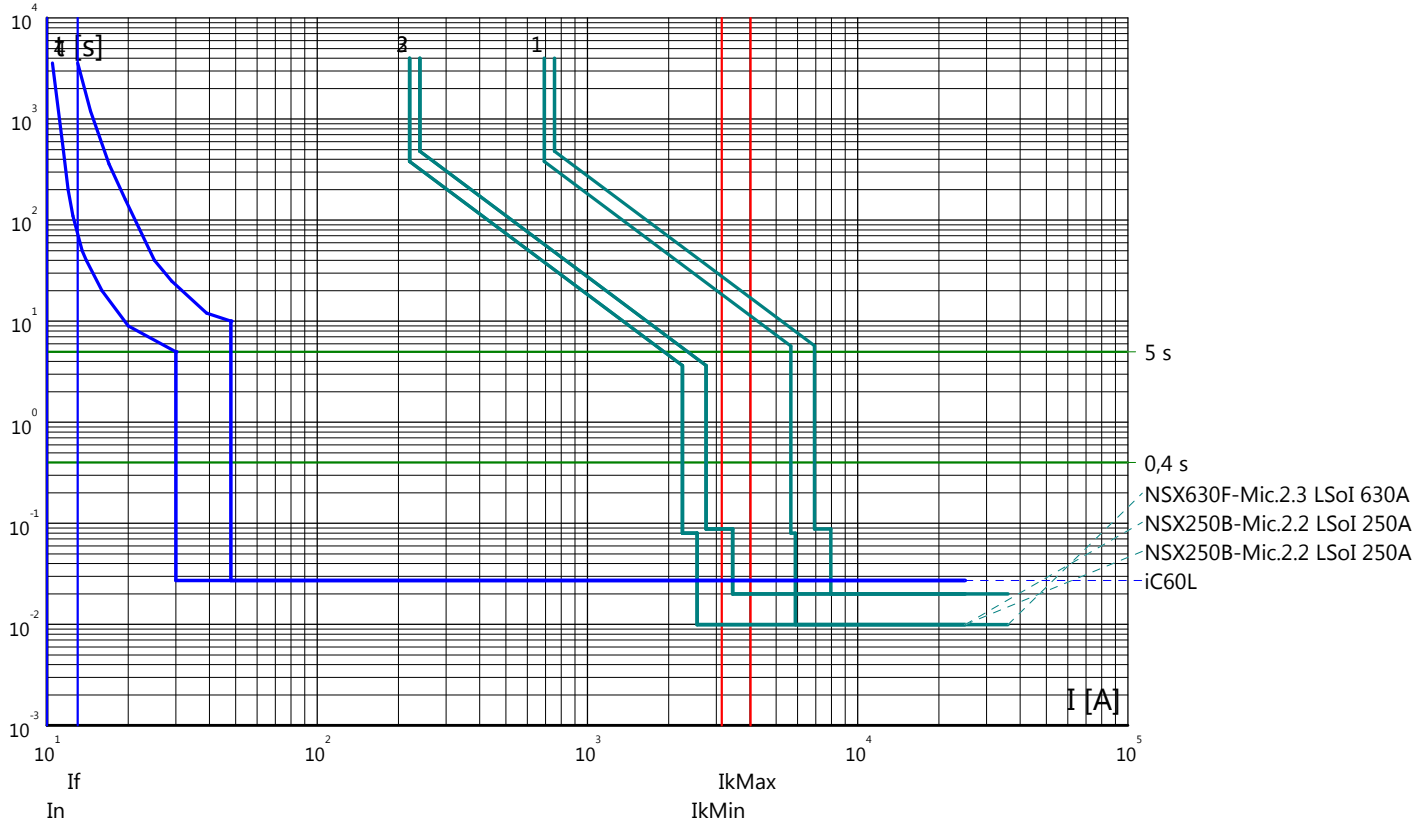

Curve tempo corrente: GALLERIA MONTE AGLIO
 Quadro: QGBT/S

Partenza: 1.17P

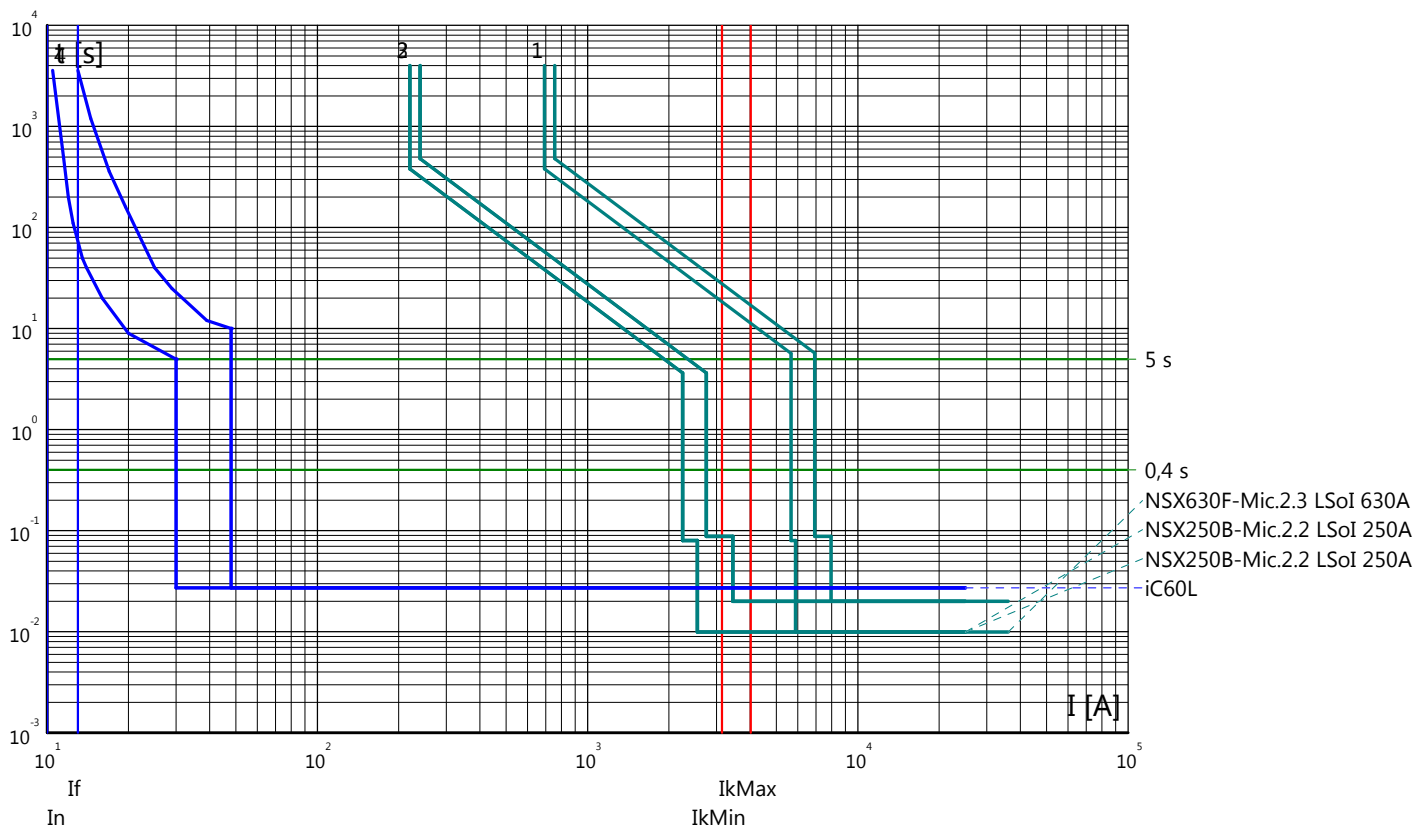

Partenza: 1.18P

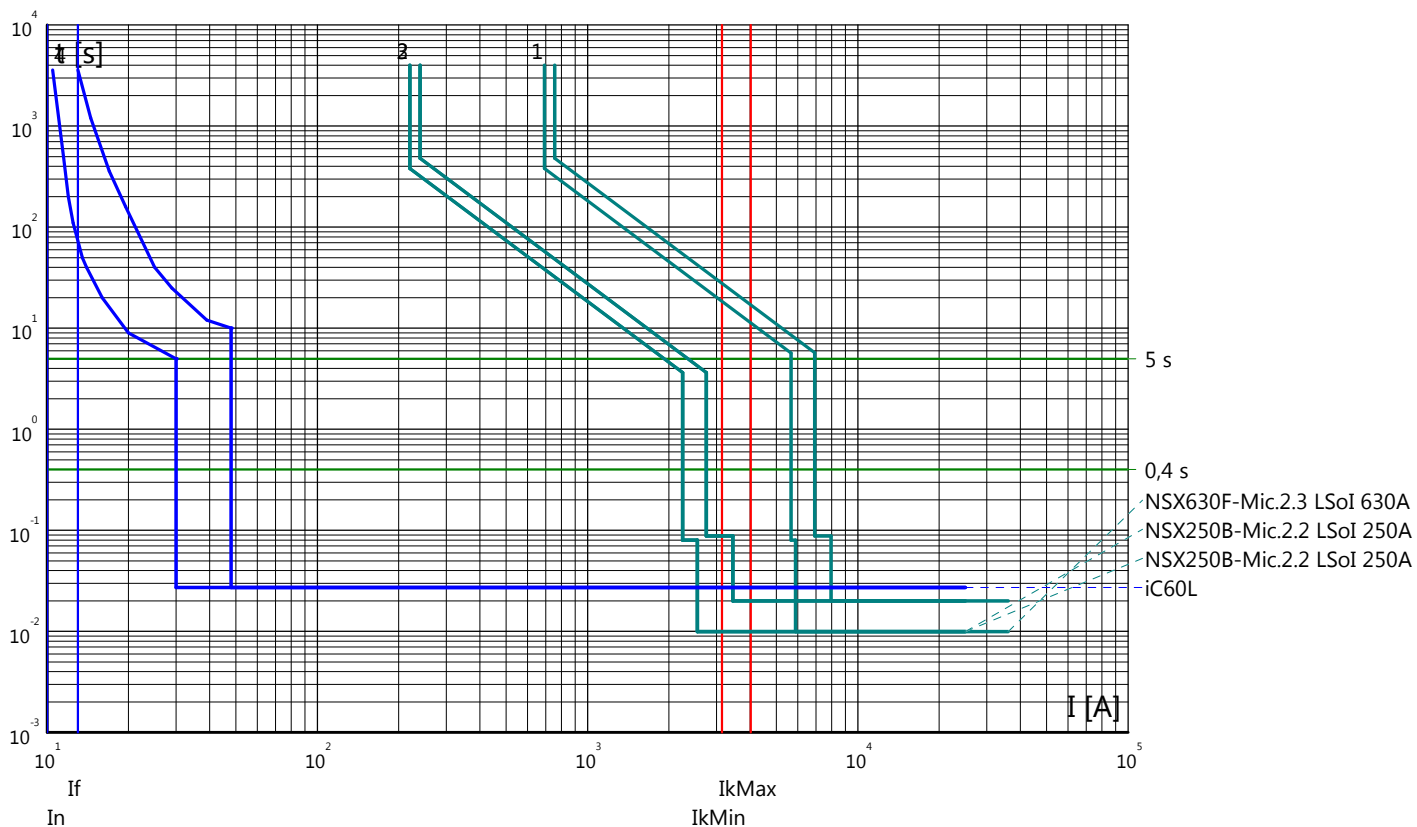

Curve tempo corrente: GALLERIA MONTE AGLIO
 Quadro: QGBT/S

Partenza: 1.19P

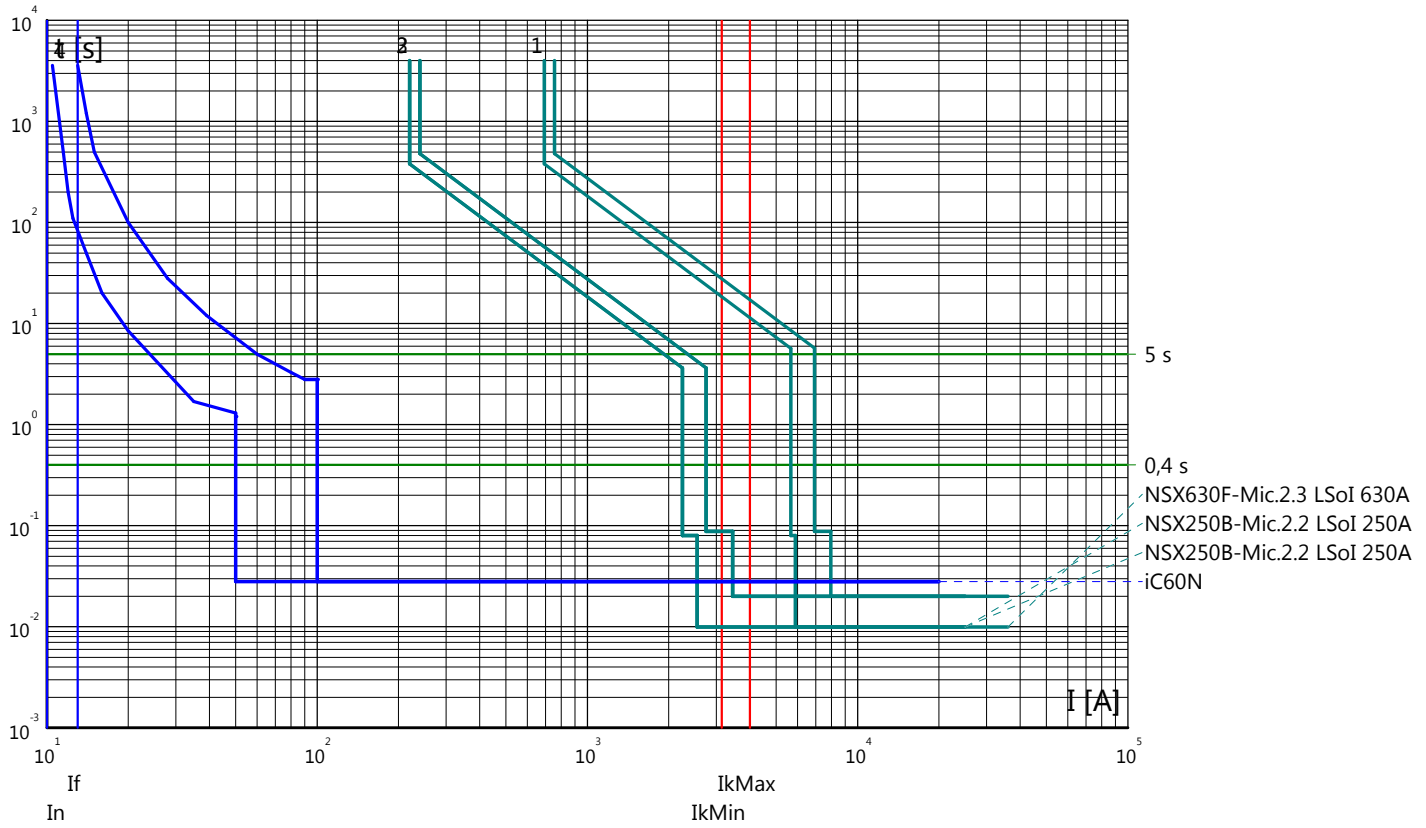

Partenza: 1.20P

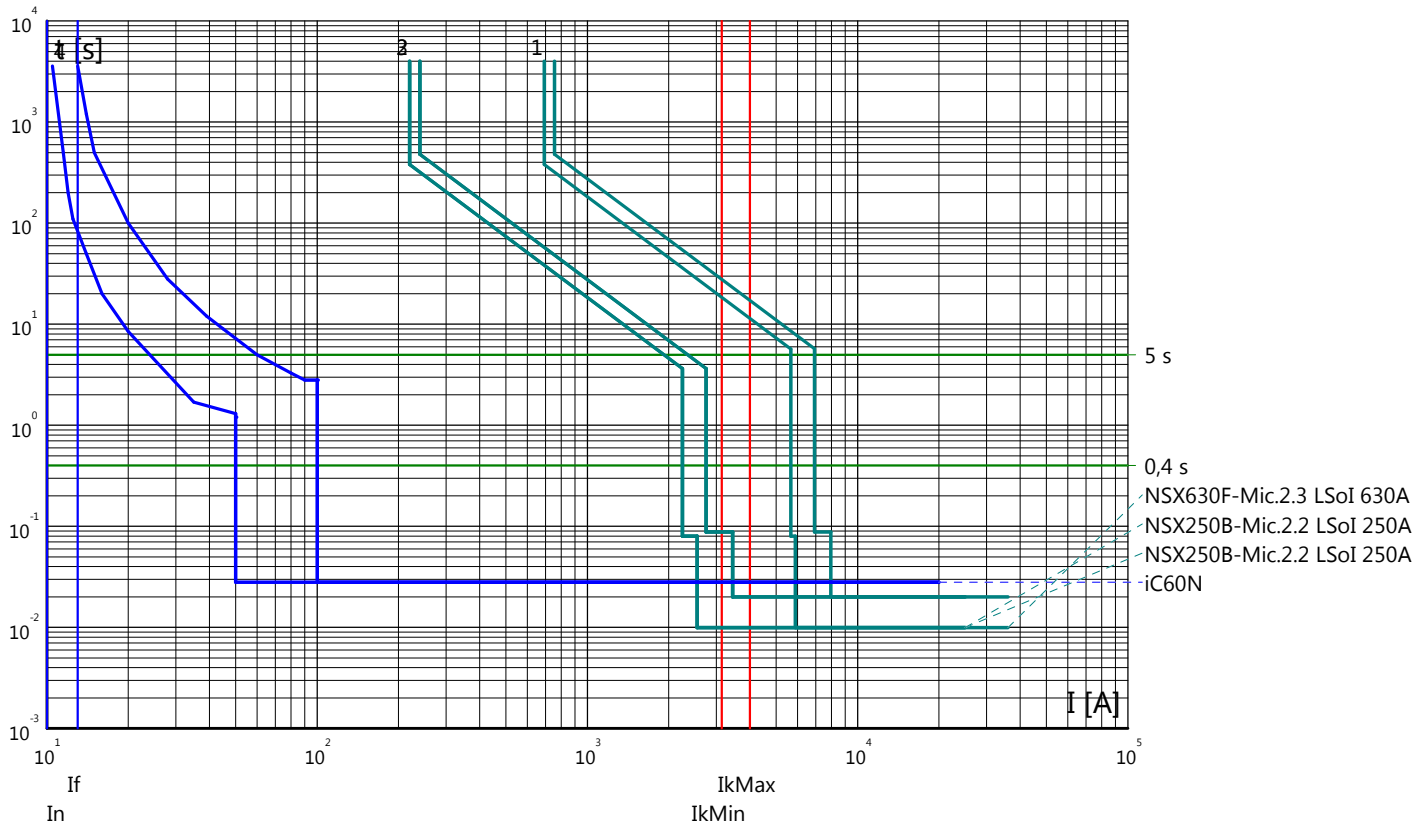

Curve tempo corrente: GALLERIA MONTE AGLIO
Quadro: QGBT/S

Partenza: IP2.P

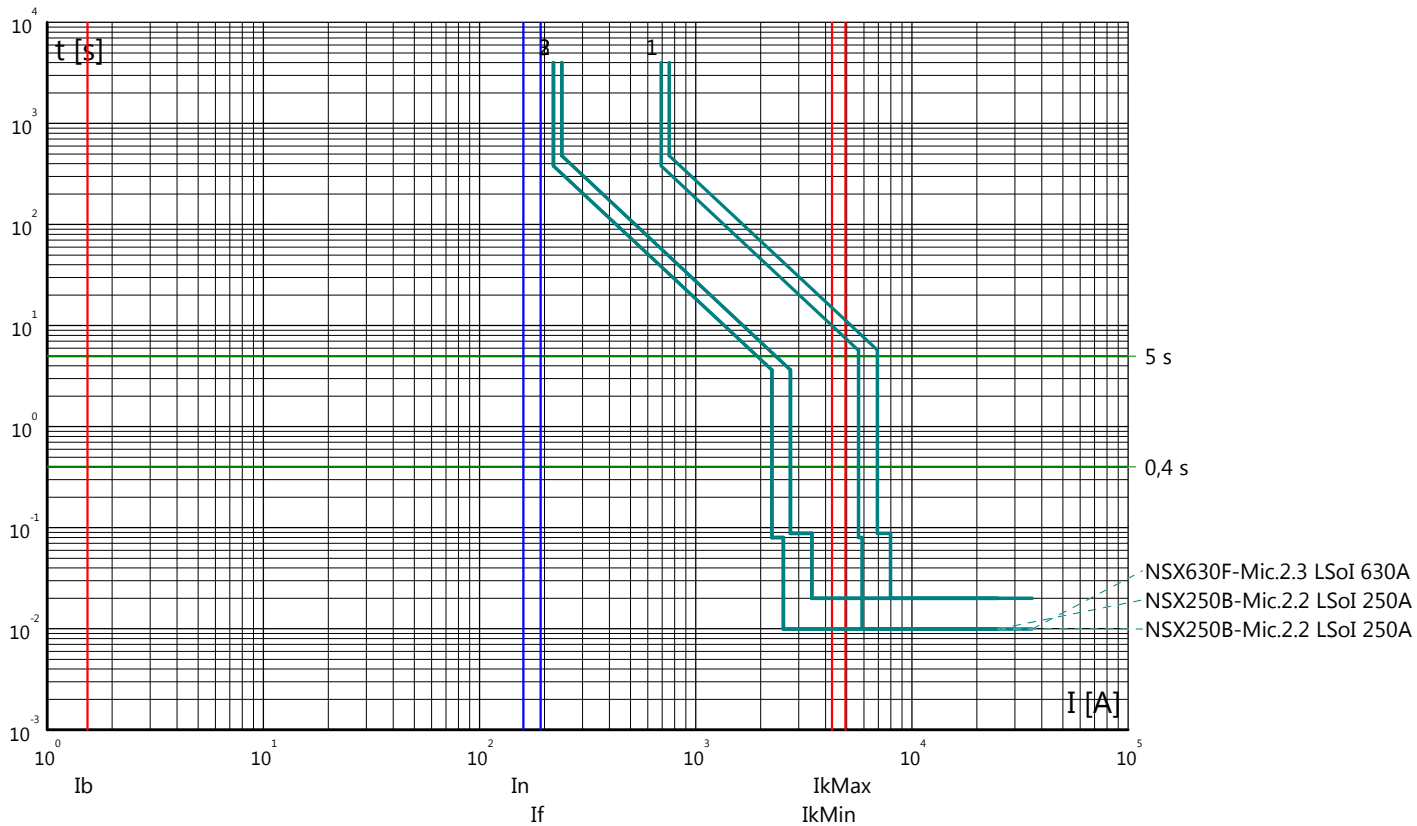

Partenza: 1.21P

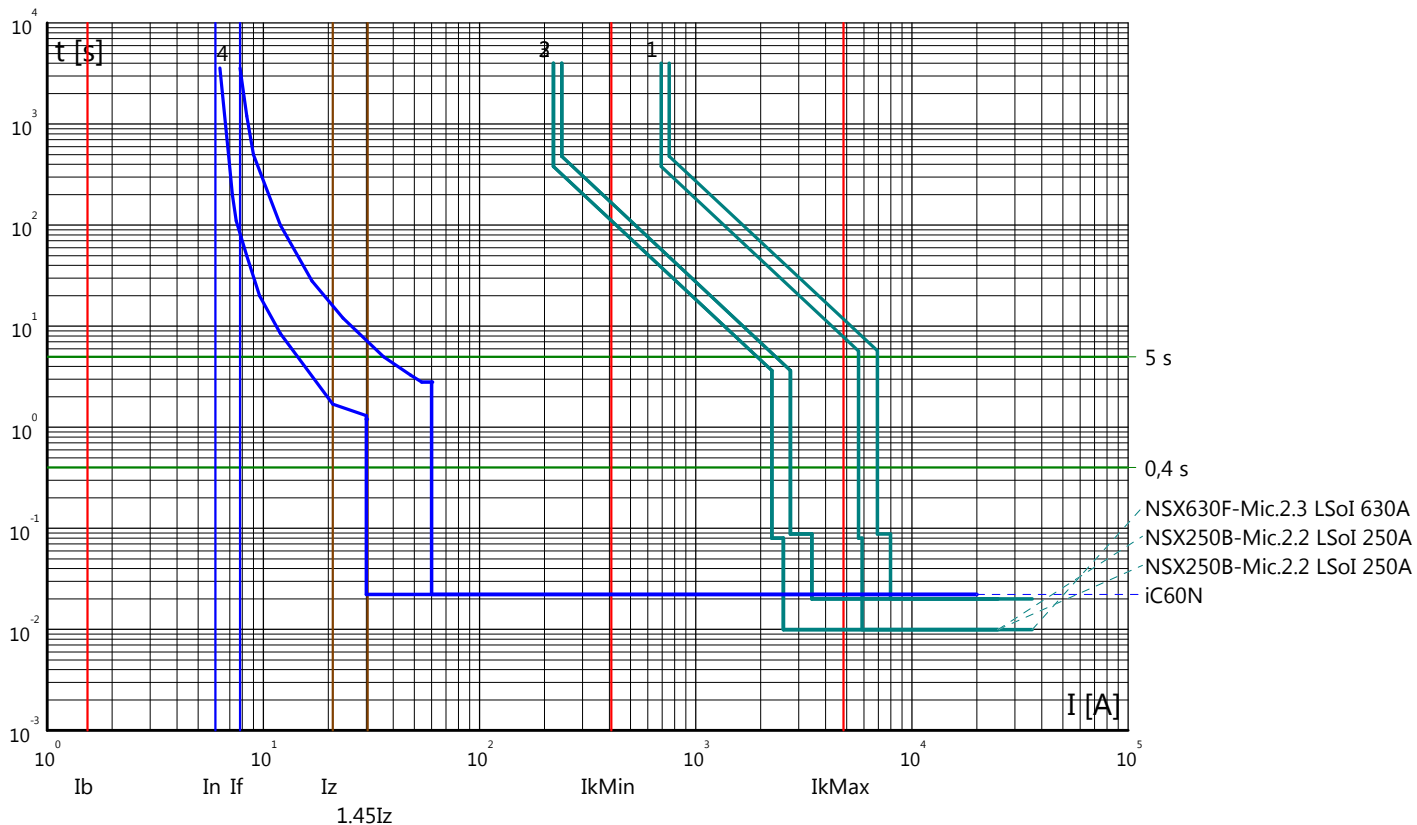

Curve tempo corrente: GALLERIA MONTE AGLIO
 Quadro: QGBT/S

Partenza: 1.22P

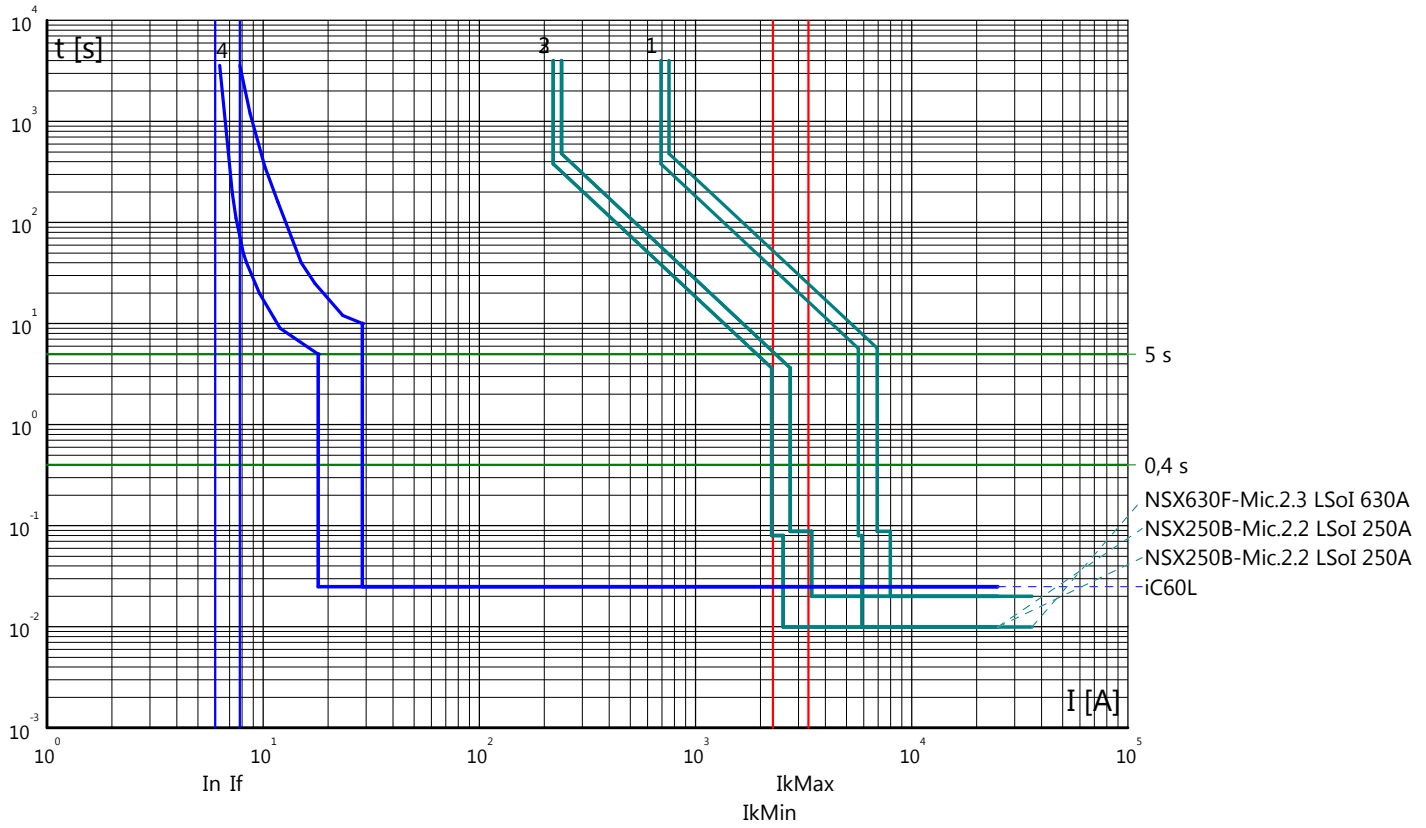

Partenza: 1.23P

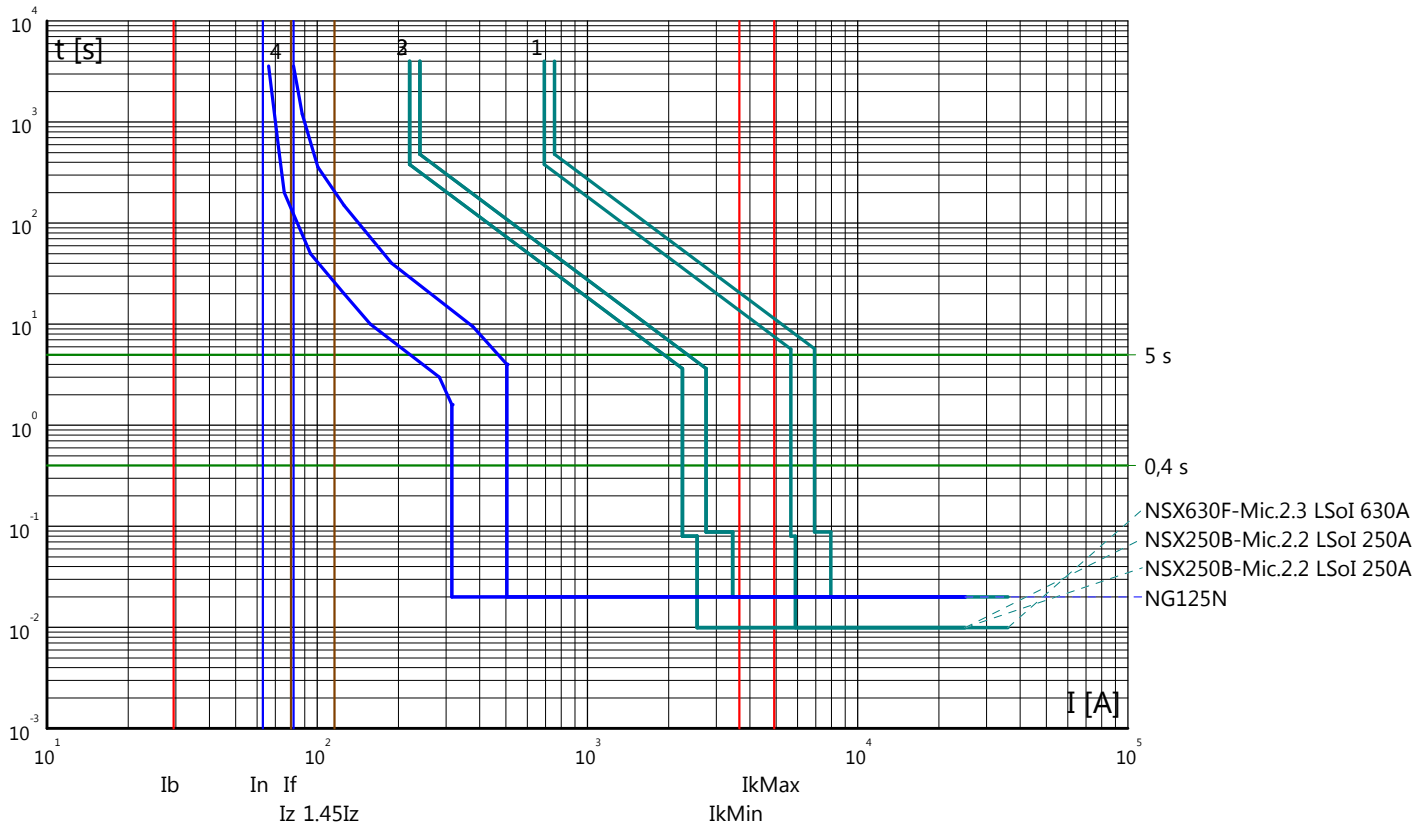

Curve tempo corrente: GALLERIA MONTE AGLIO
 Quadro: QGBT/S

Partenza: 1.24P

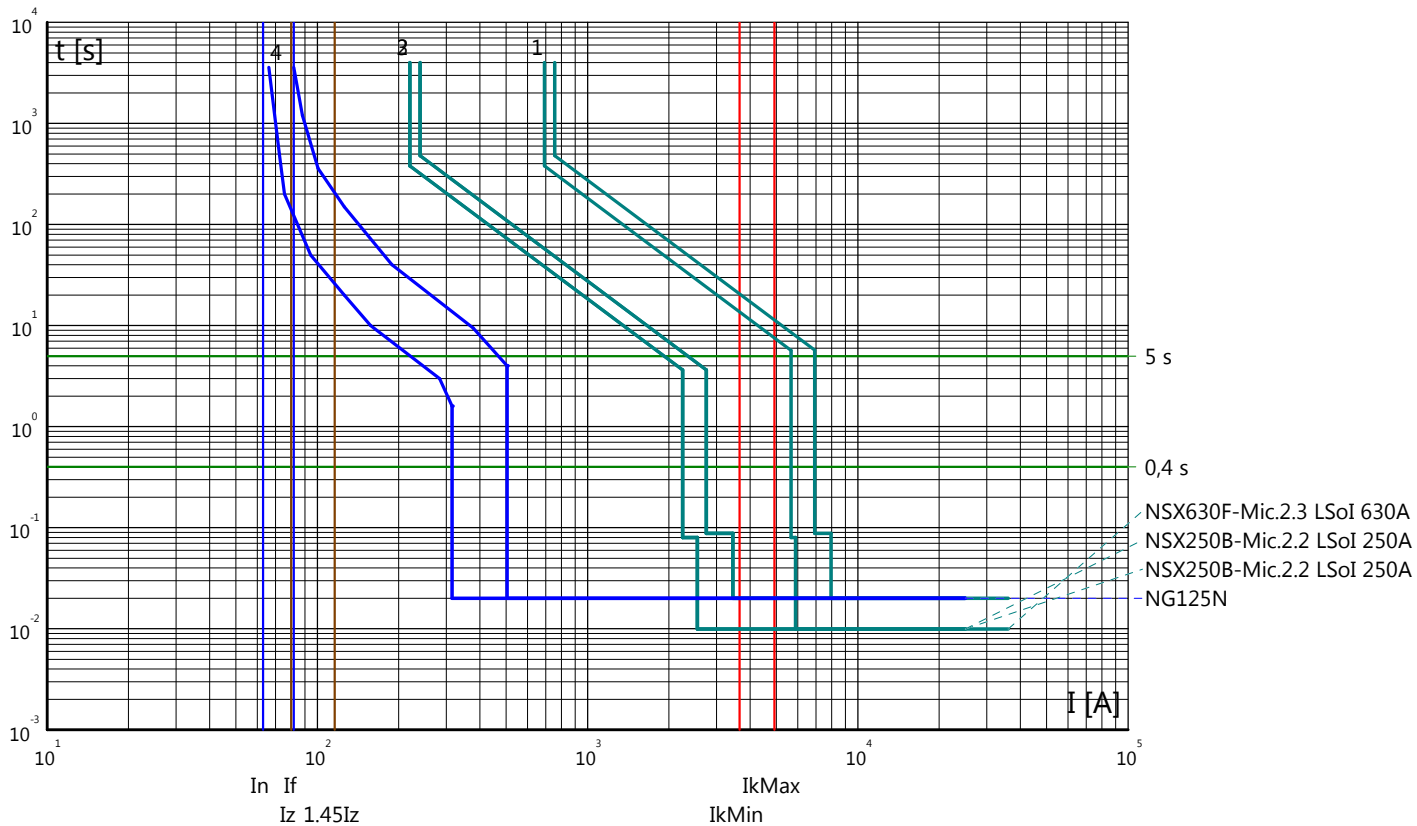

Partenza: 1.25P

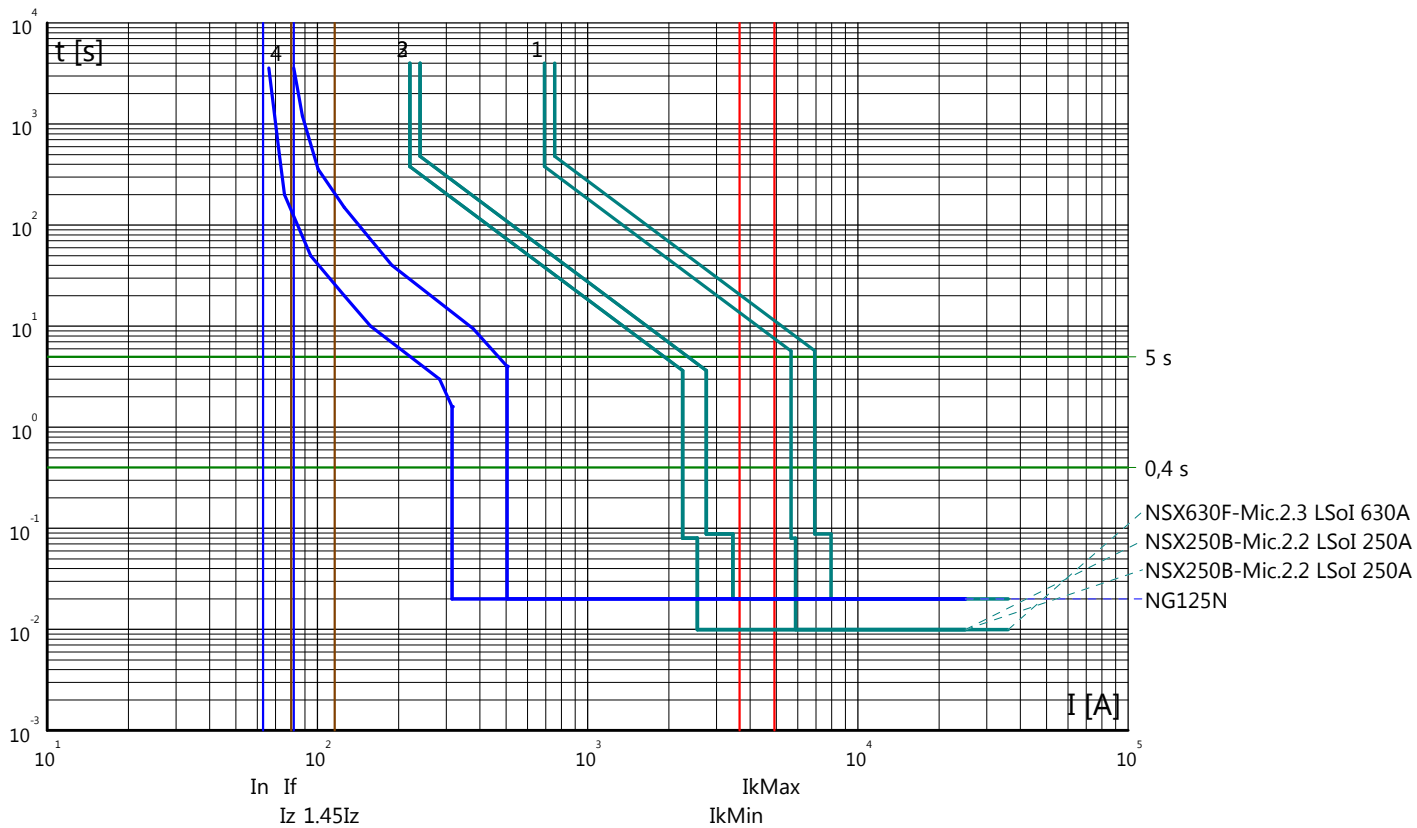

Curve tempo corrente: GALLERIA MONTE AGLIO
 Quadro: QGBT/S

Arrivo: IG/UPS

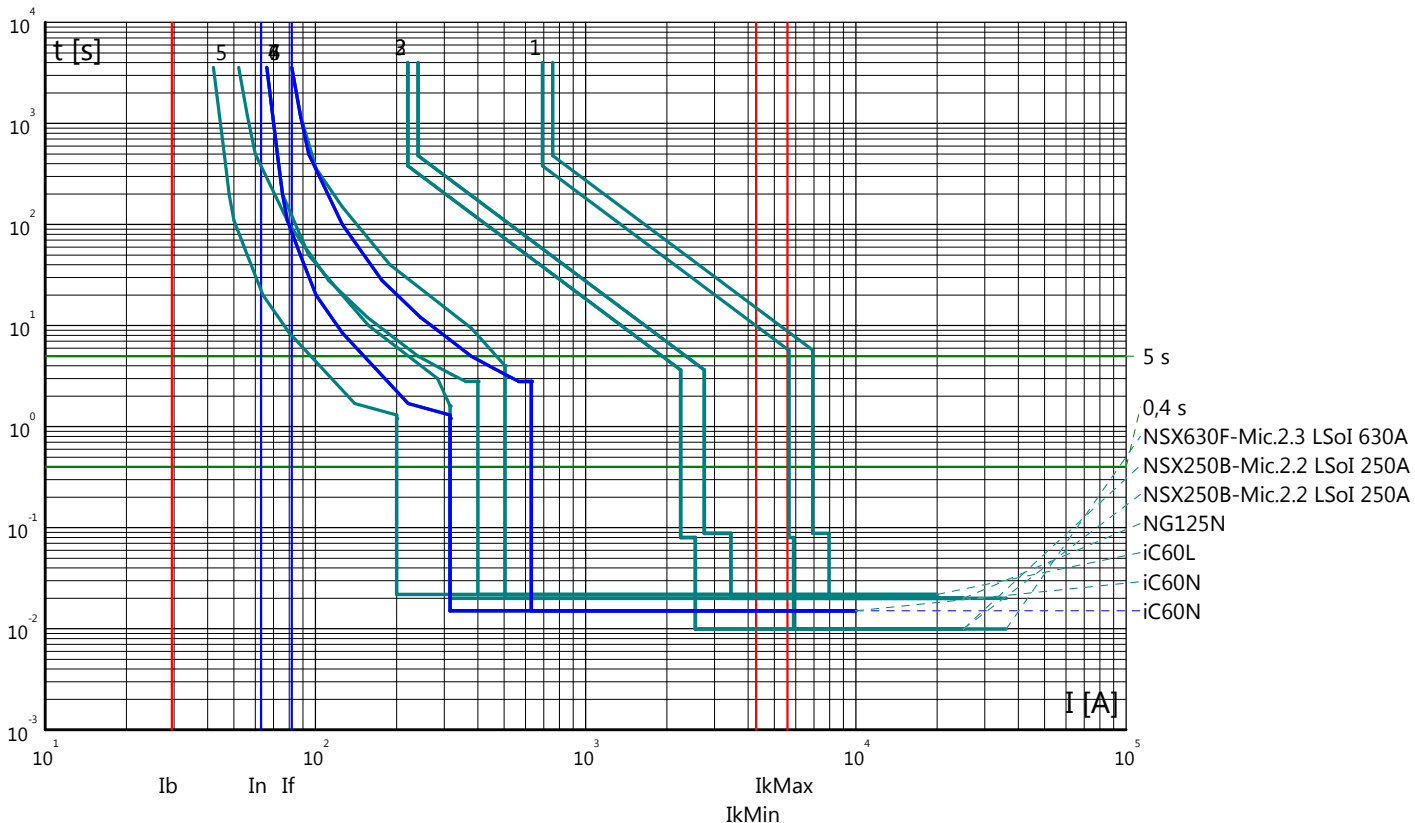

Partenza: PT/P

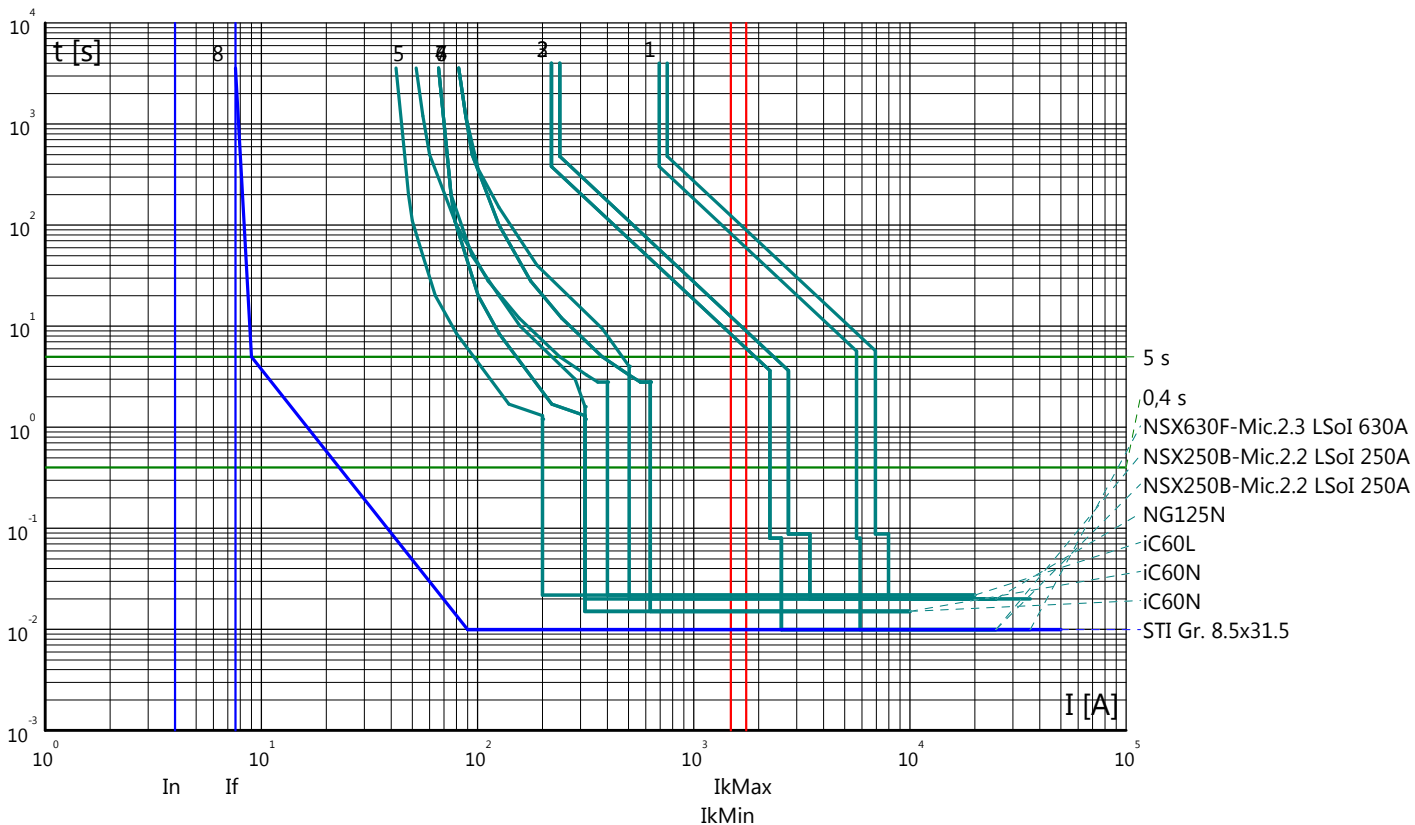

Curve tempo corrente: GALLERIA MONTE AGLIO
 Quadro: QGBT/S

Partenza: MIS/P

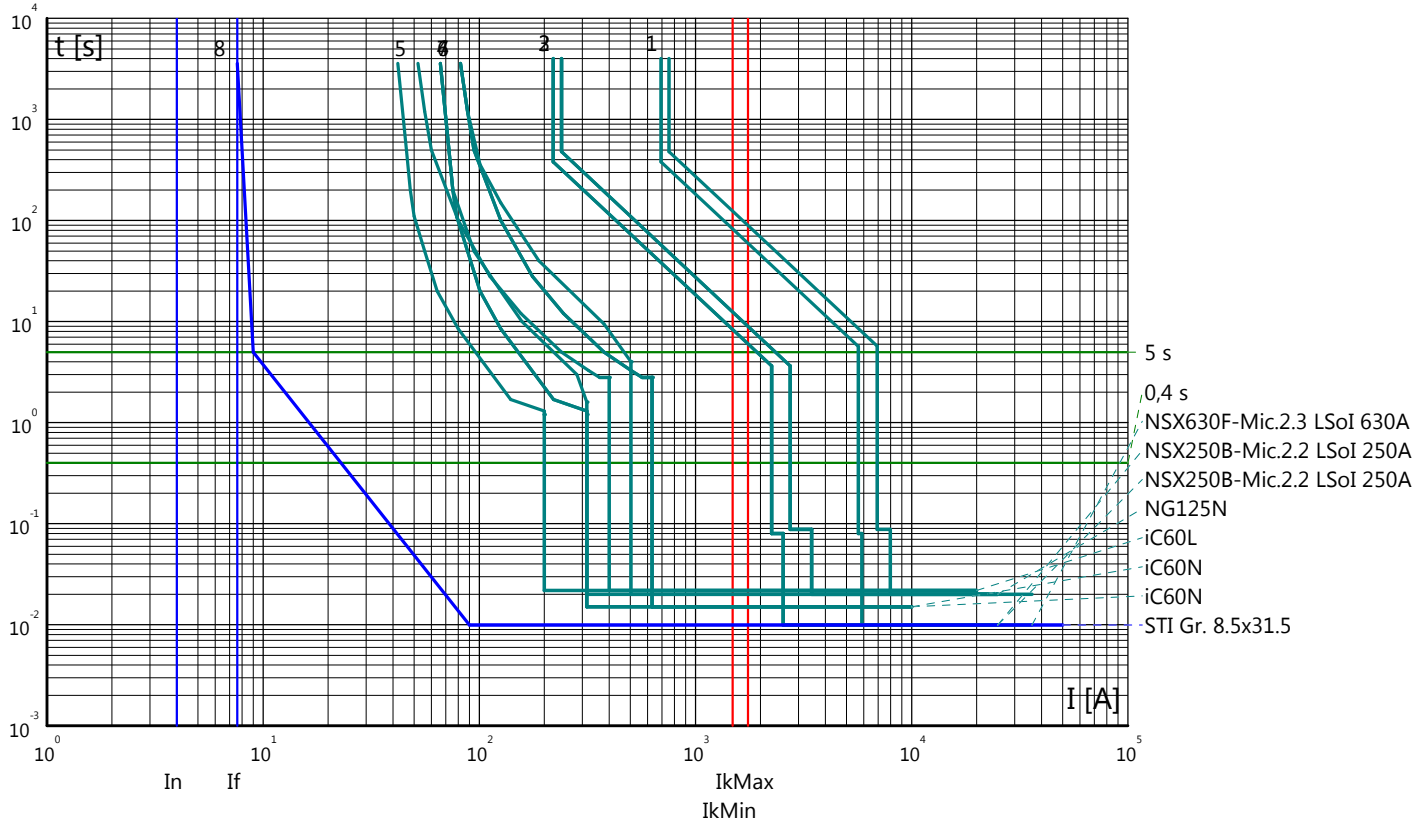

Partenza: 1.1S

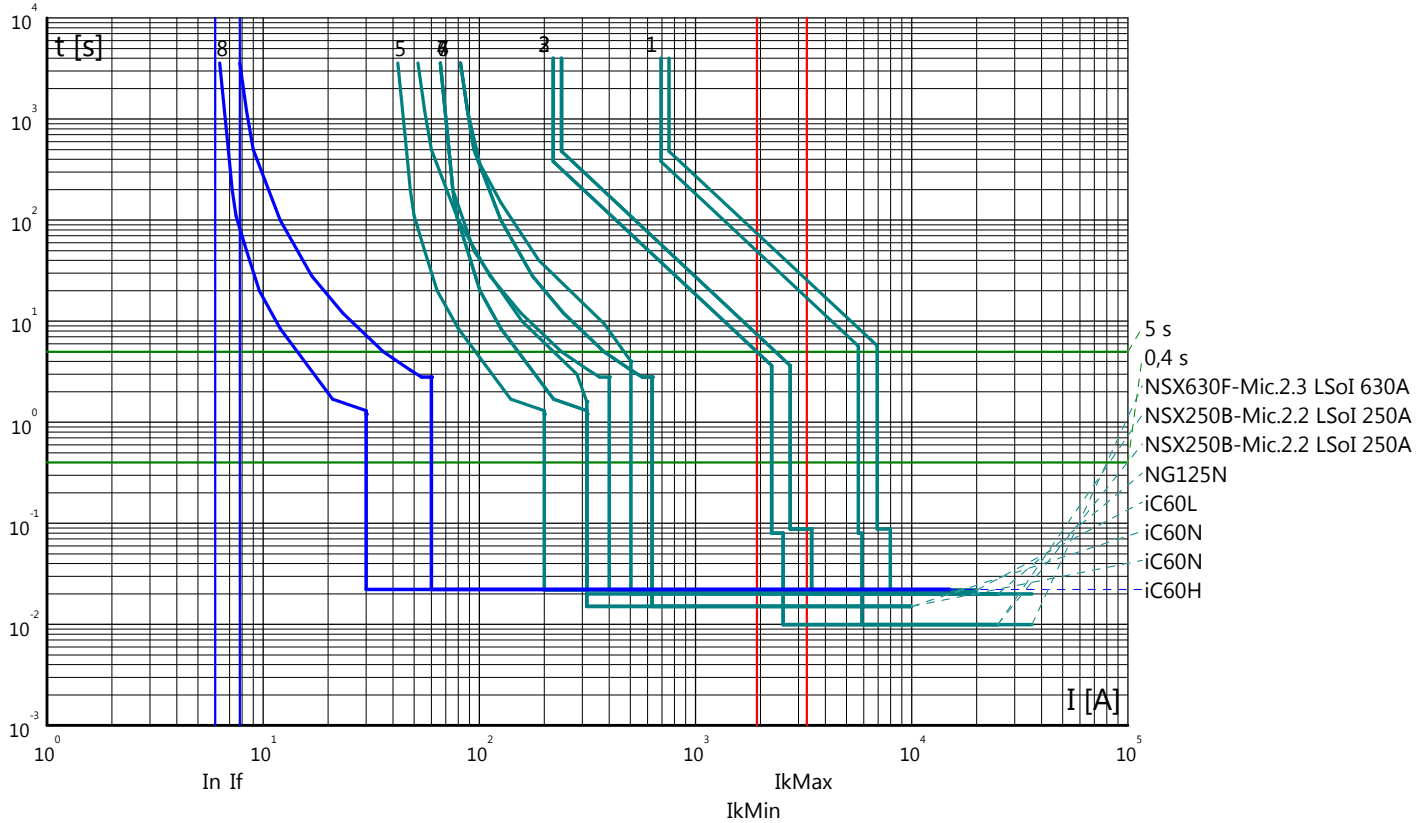

Curve tempo corrente: GALLERIA MONTE AGLIO
 Quadro: QGBT/S

Partenza: 1.2S

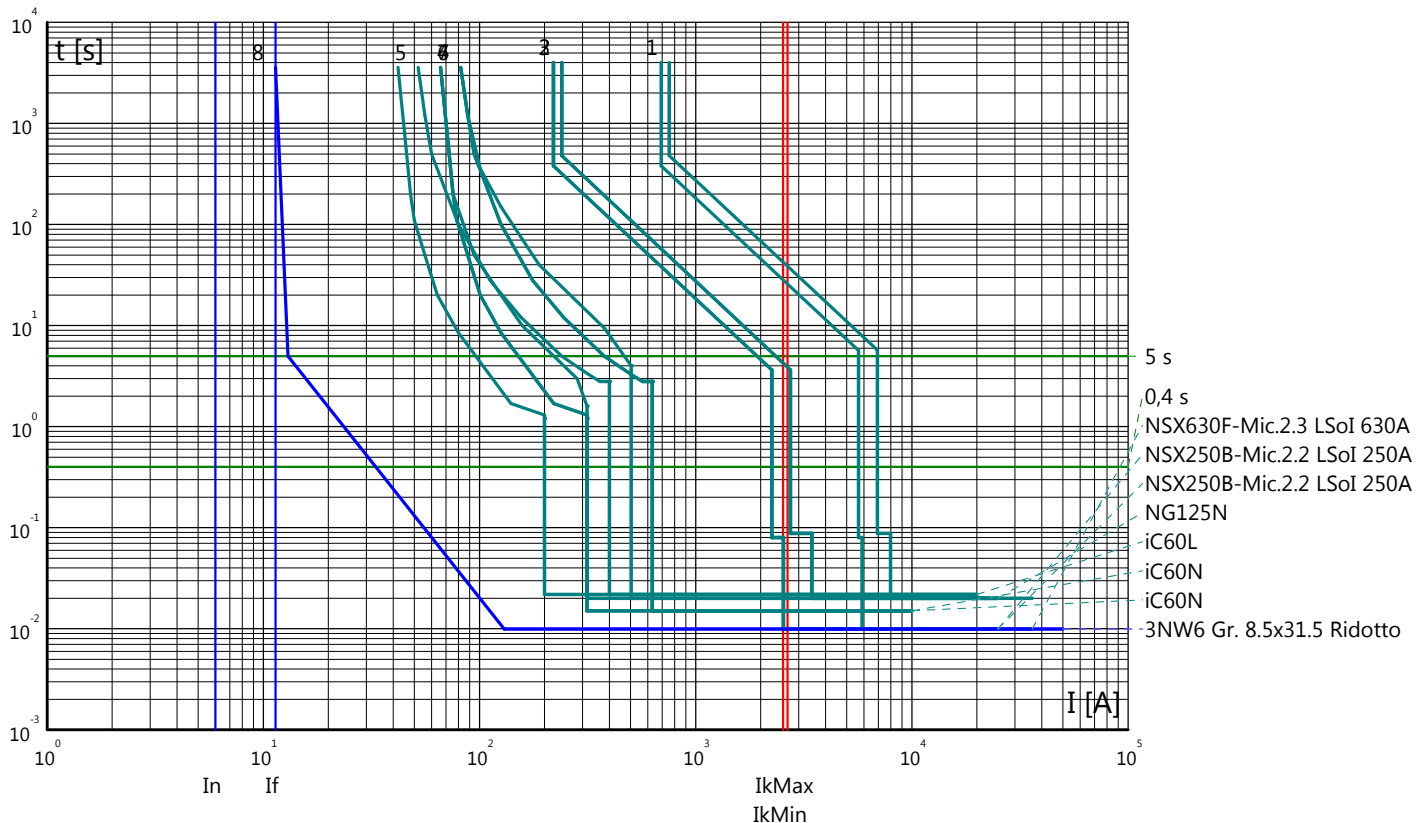

Partenza: 1.3S

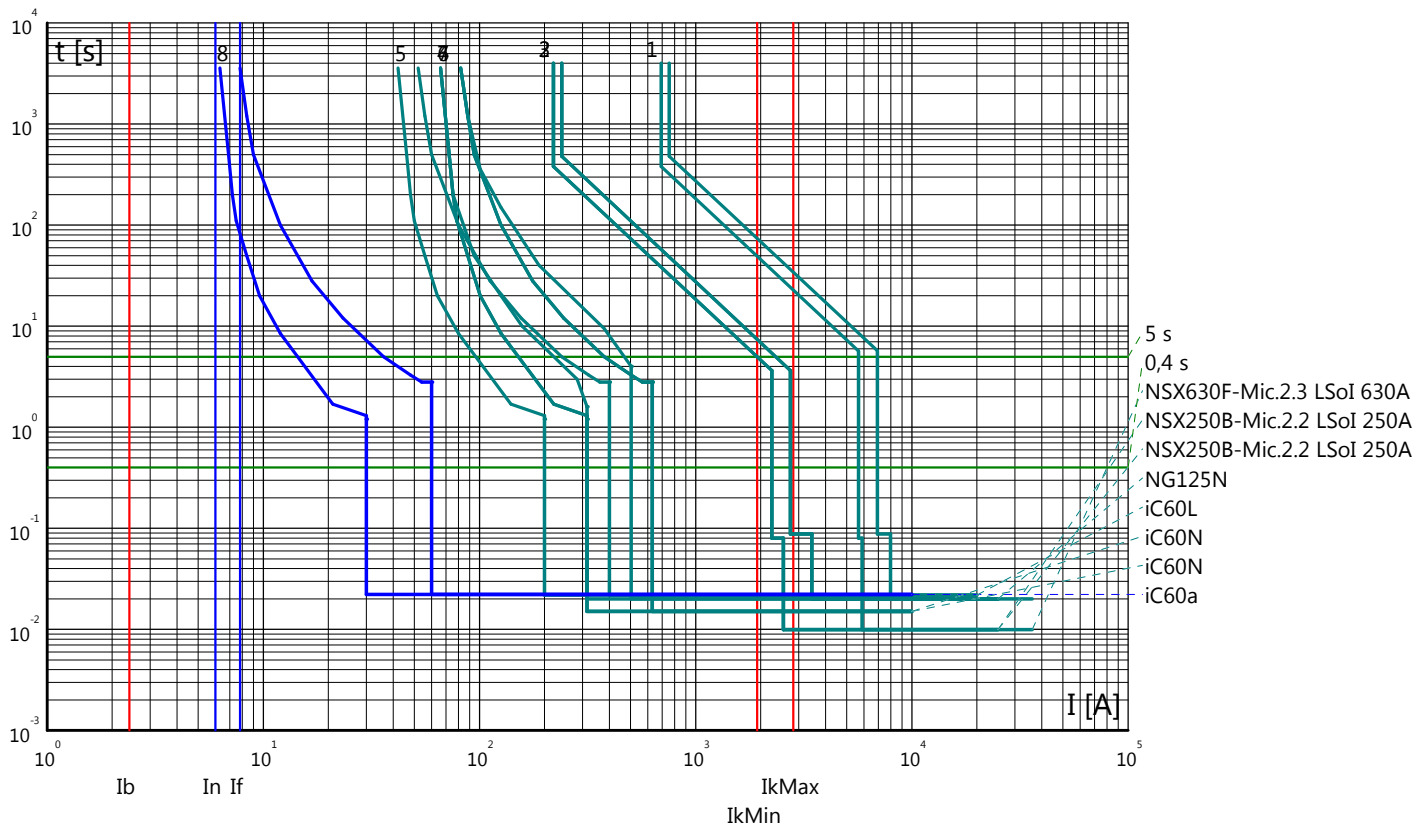

Curve tempo corrente: GALLERIA MONTE AGLIO
 Quadro: QGBT/S

Partenza: 1.4S

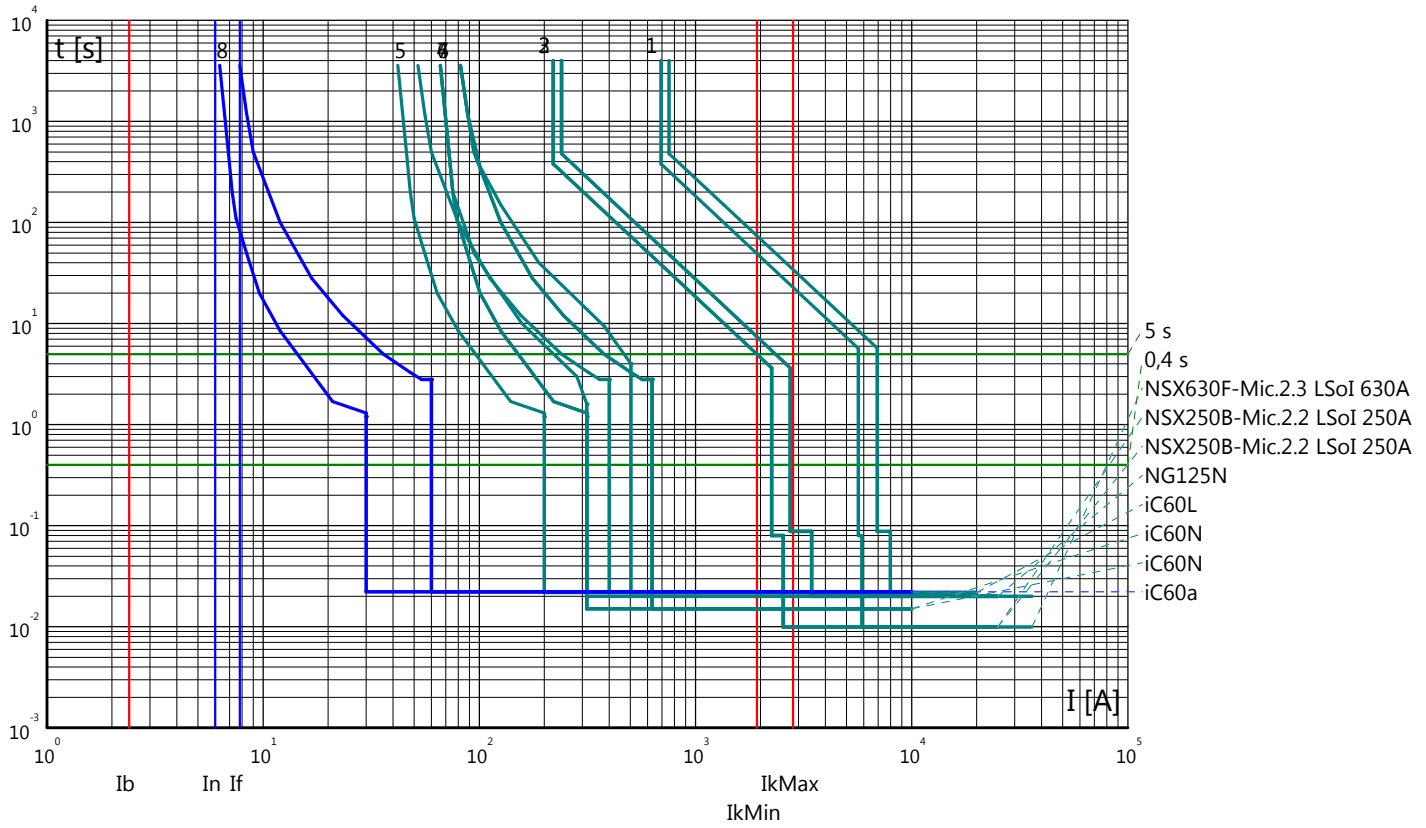

Partenza: 1.5S

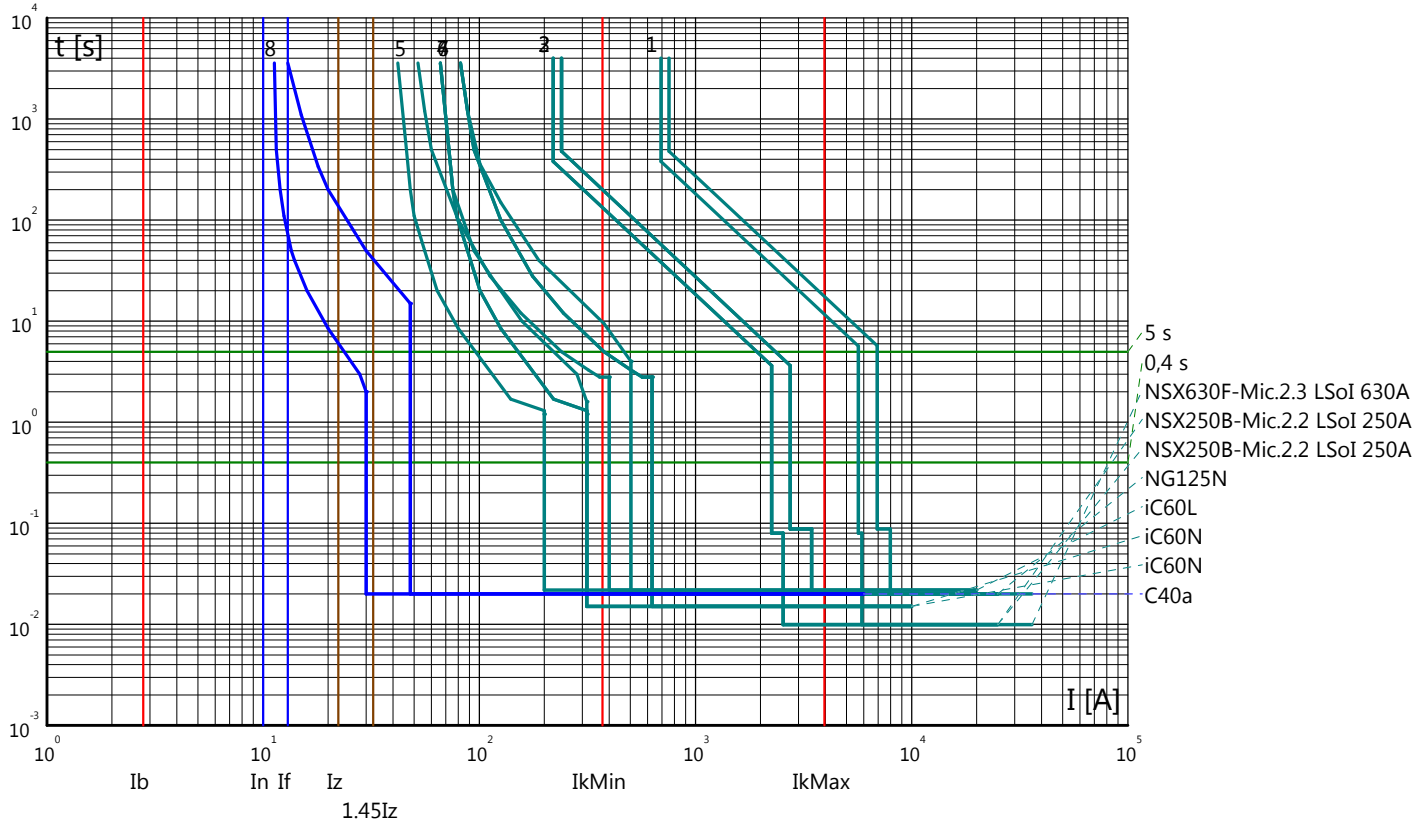

Curve tempo corrente: GALLERIA MONTE AGLIO
 Quadro: QGBT/S

Partenza: 1.6S

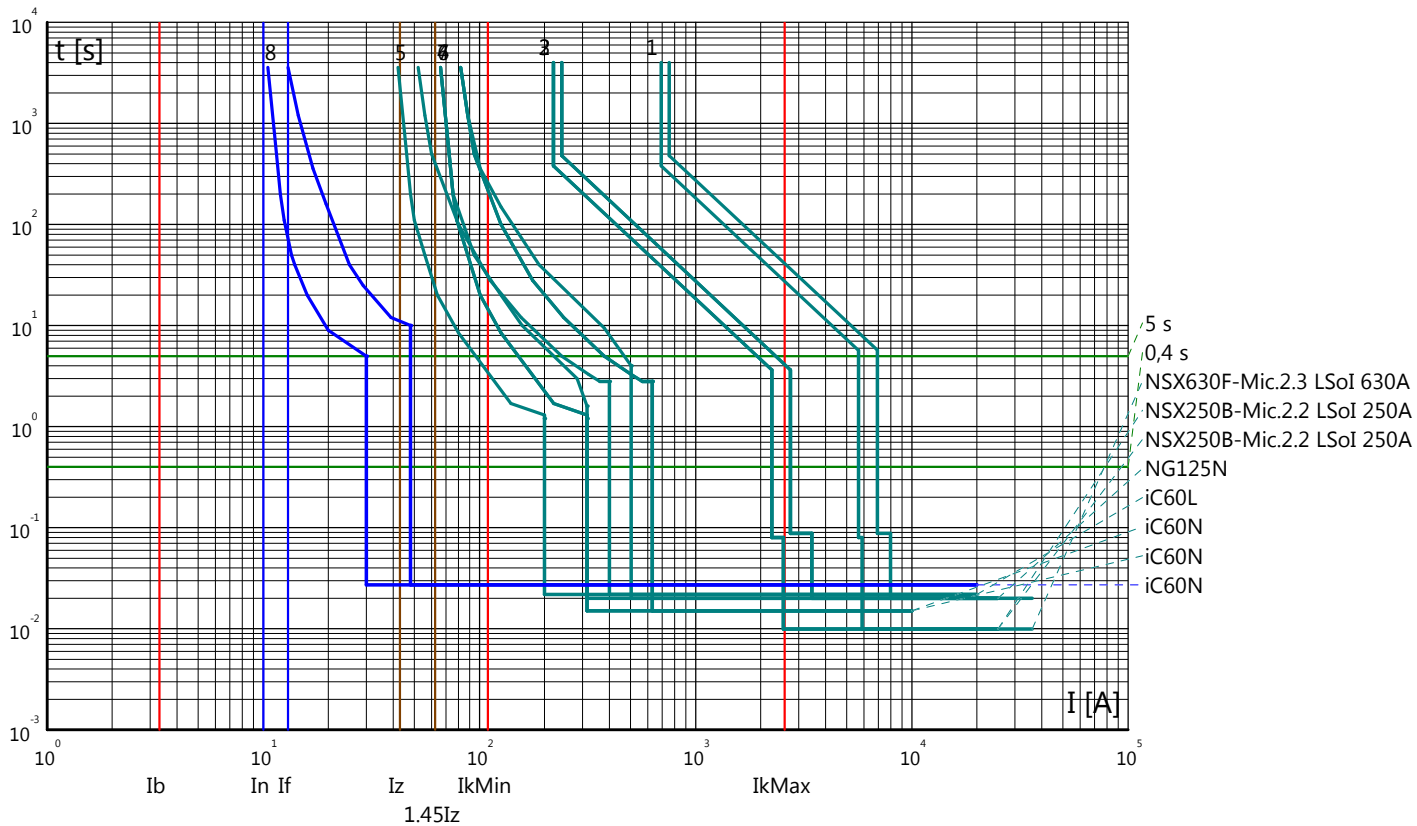

Partenza: 1.7S

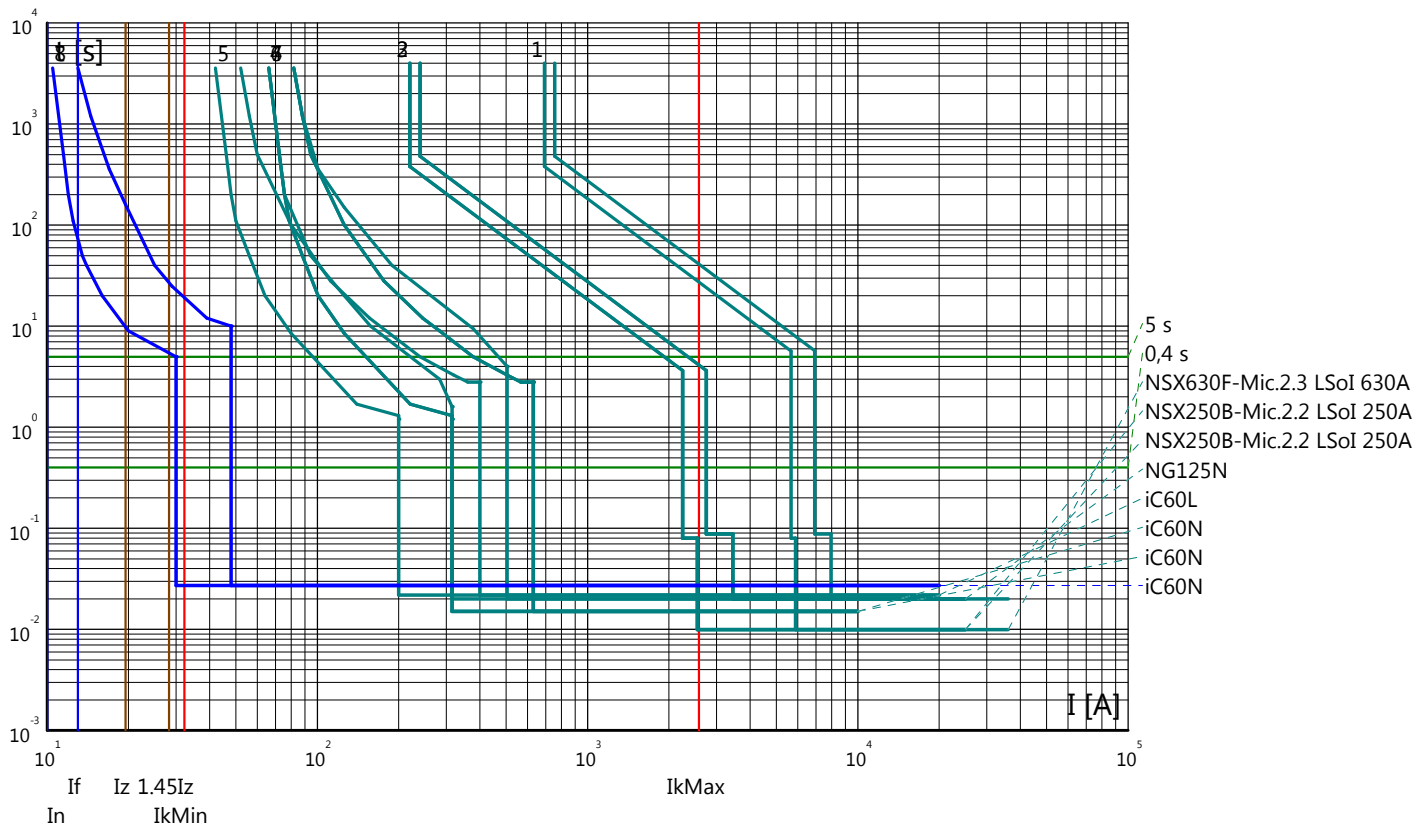

Curve tempo corrente: GALLERIA MONTE AGLIO
 Quadro: QGBT/S

Partenza: 1.8S

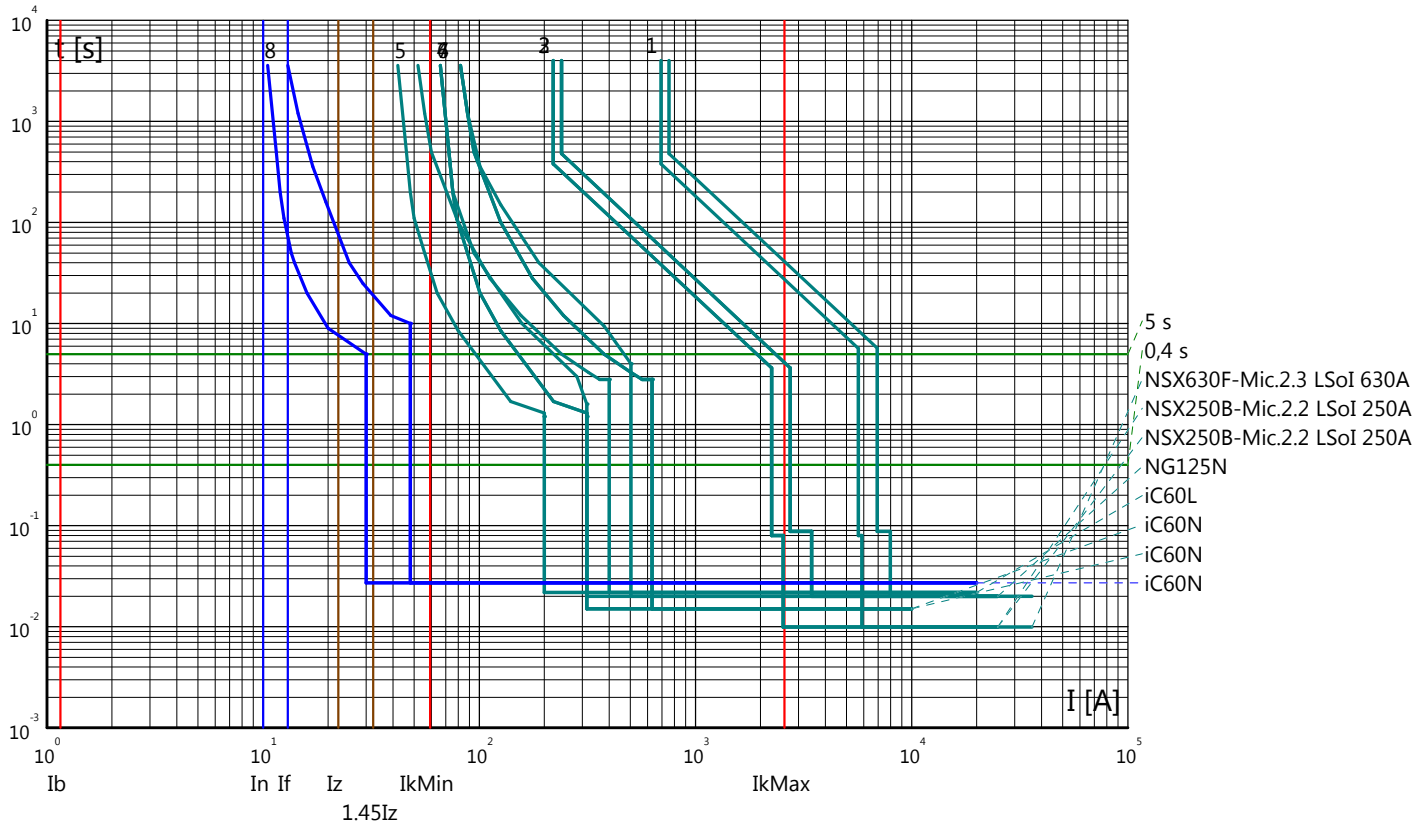

Partenza: 1.9S

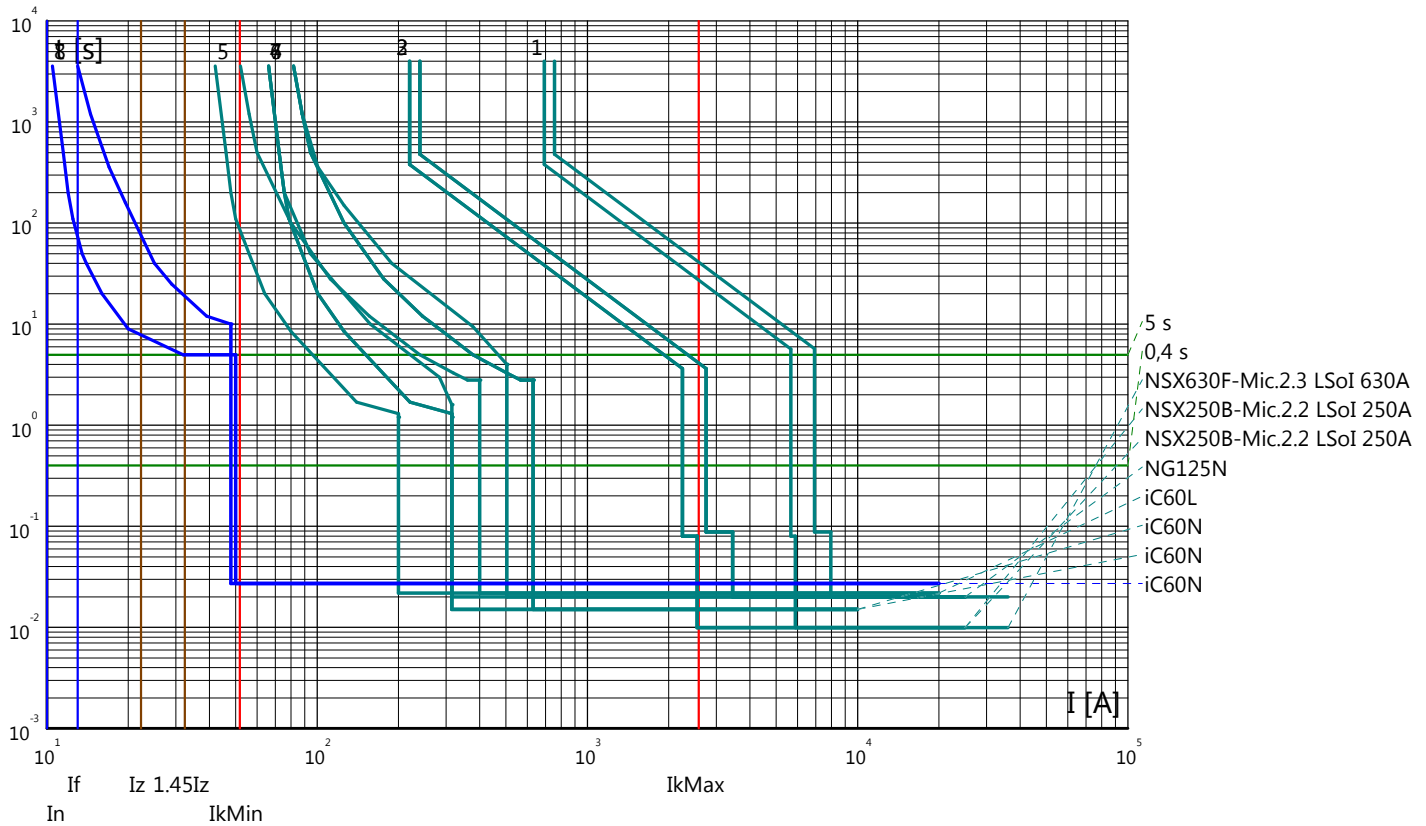

Curve tempo corrente: GALLERIA MONTE AGLIO
 Quadro: QGBT/S

Partenza: 1.10S

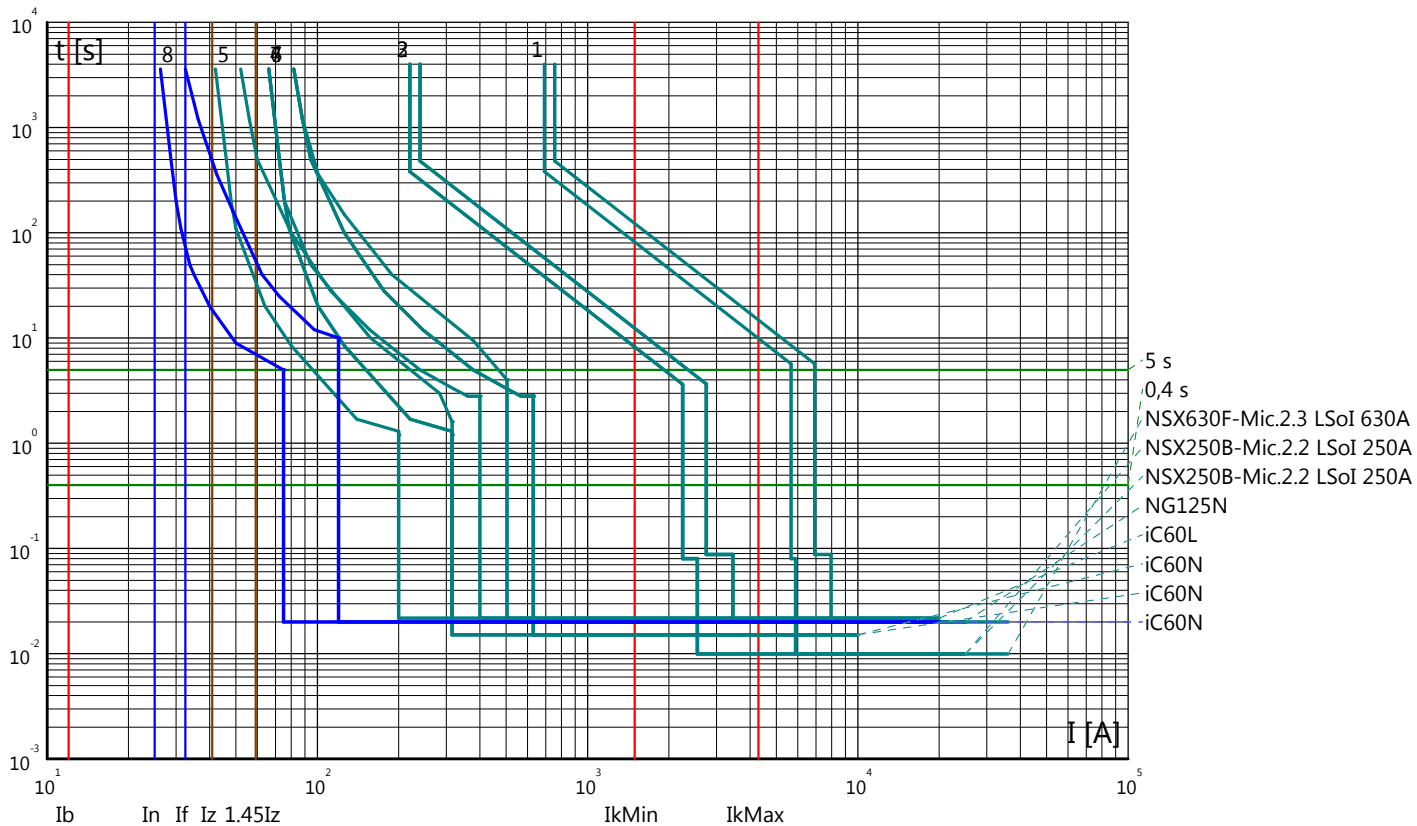

Partenza: 1.11S

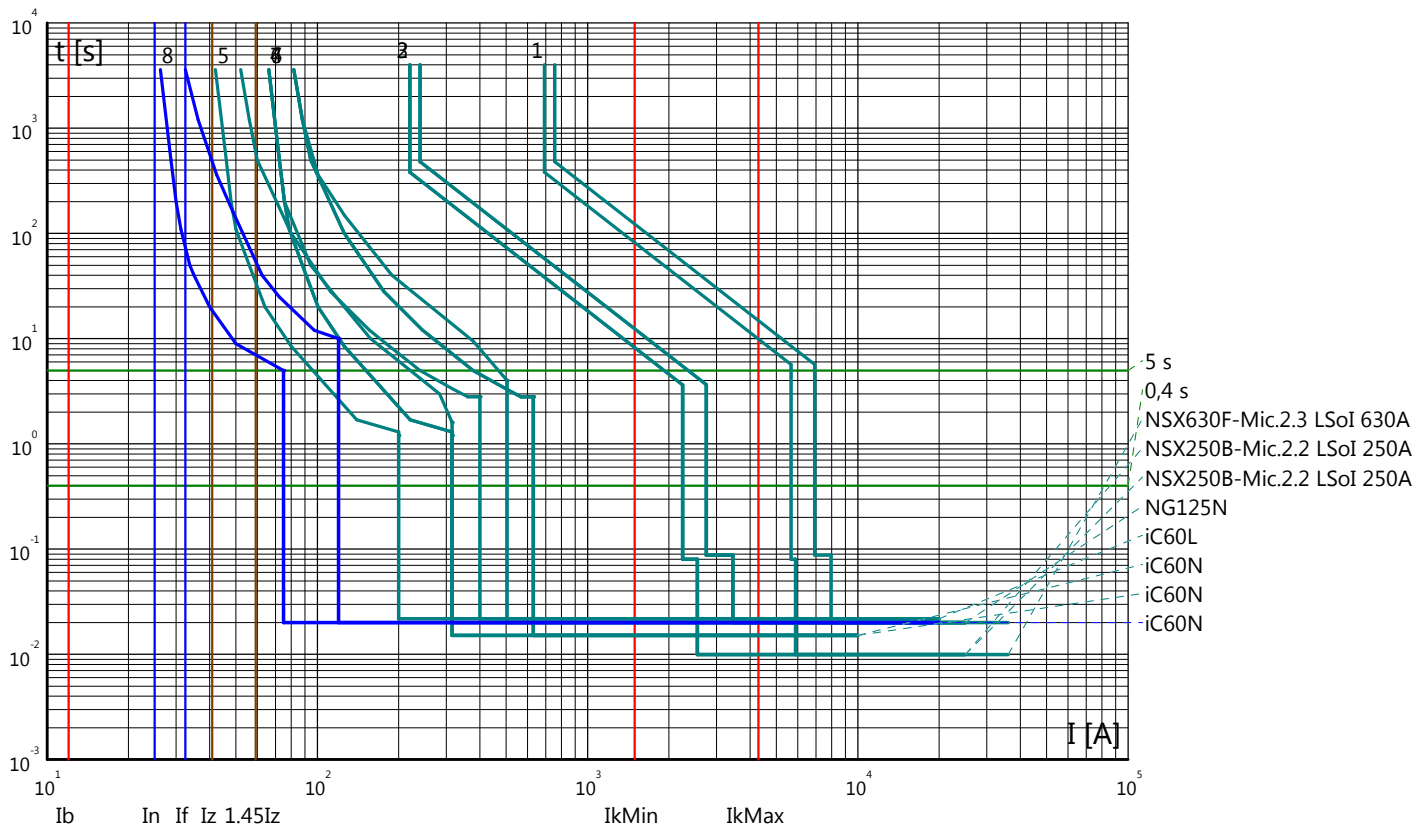

Curve tempo corrente: GALLERIA MONTE AGLIO
 Quadro: QGBT/S

Partenza: 1.12S

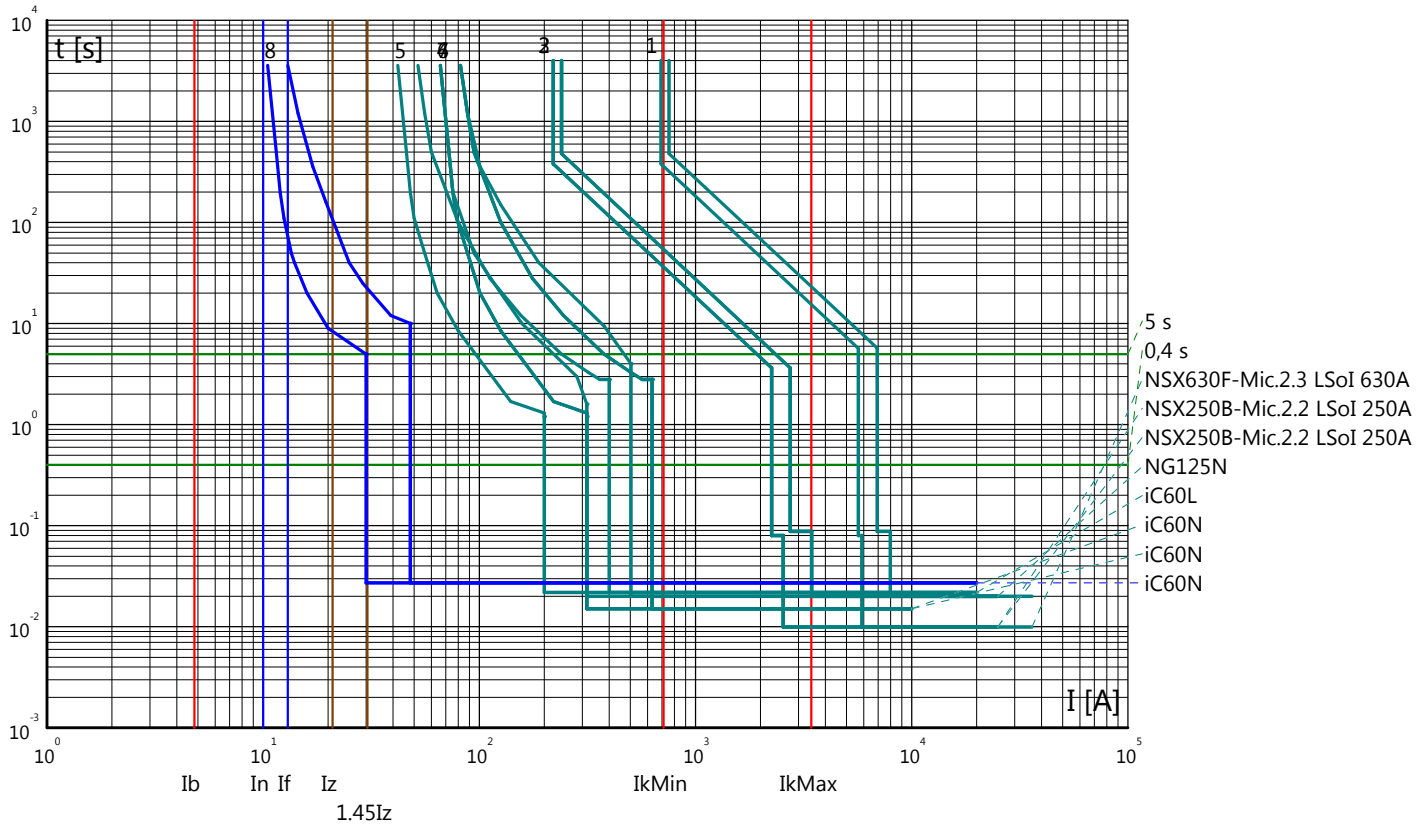

Partenza: 1.13S

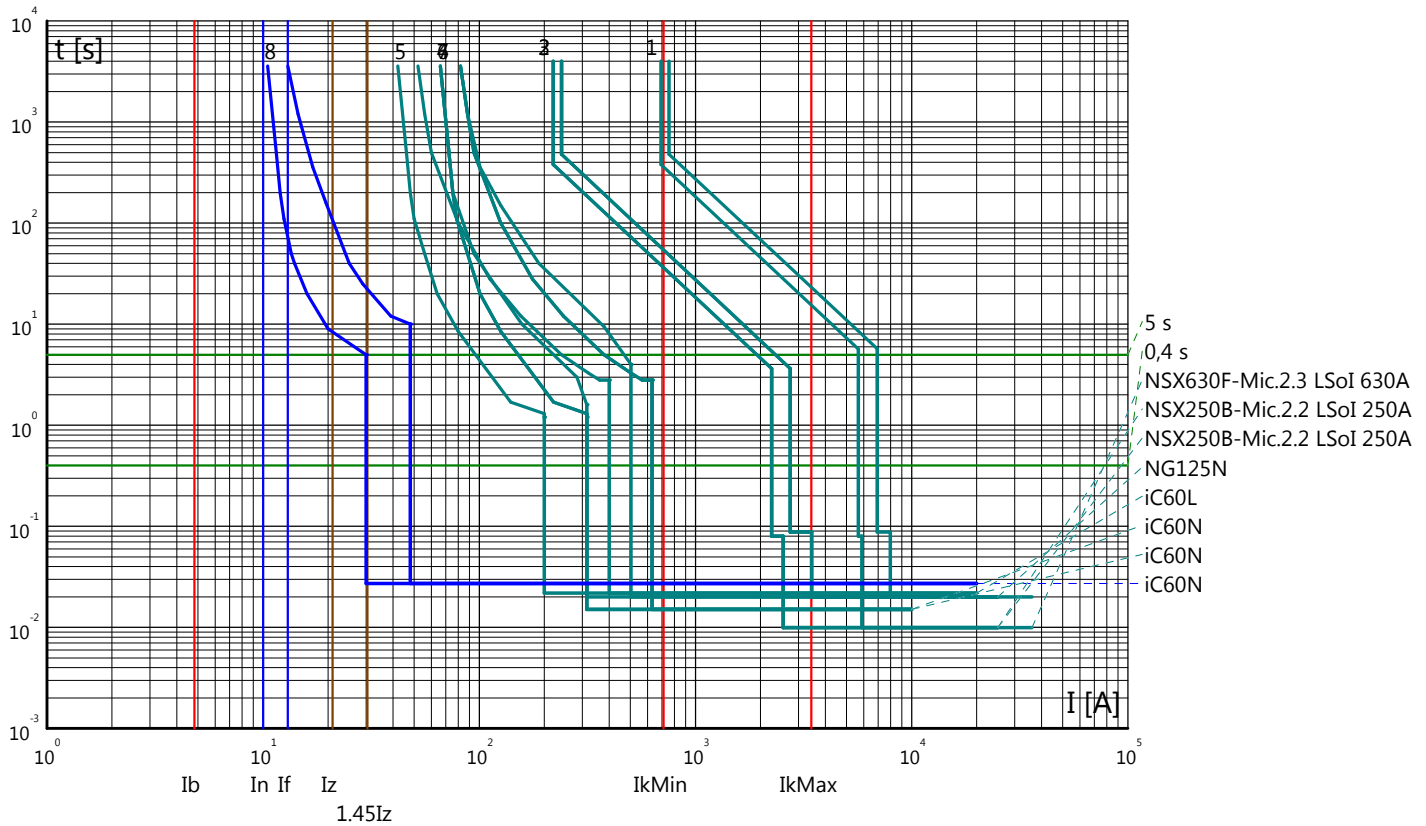

Curve tempo corrente: GALLERIA MONTE AGLIO
 Quadro: QGBT/S

Partenza: 1.14S

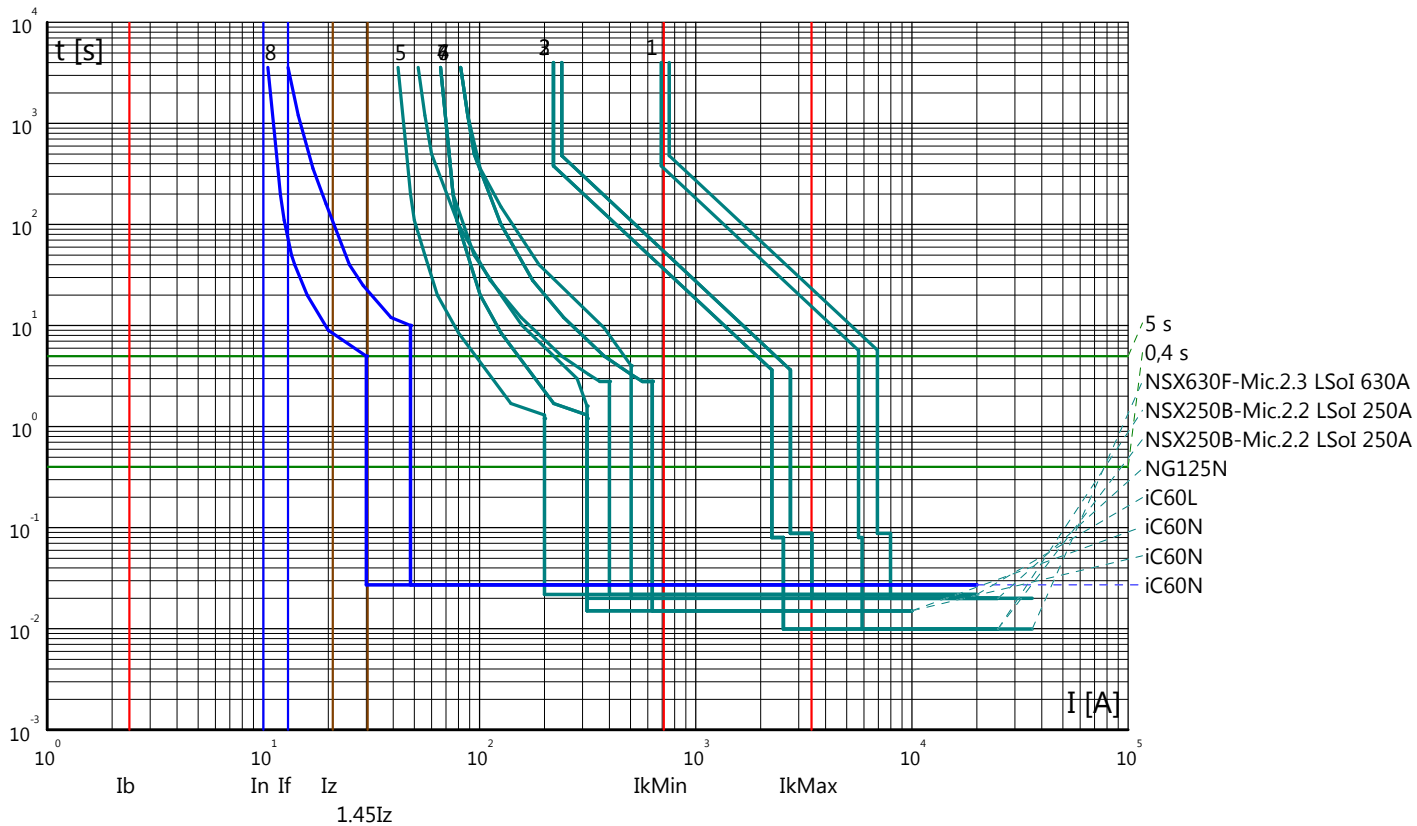

Partenza: 1.15S

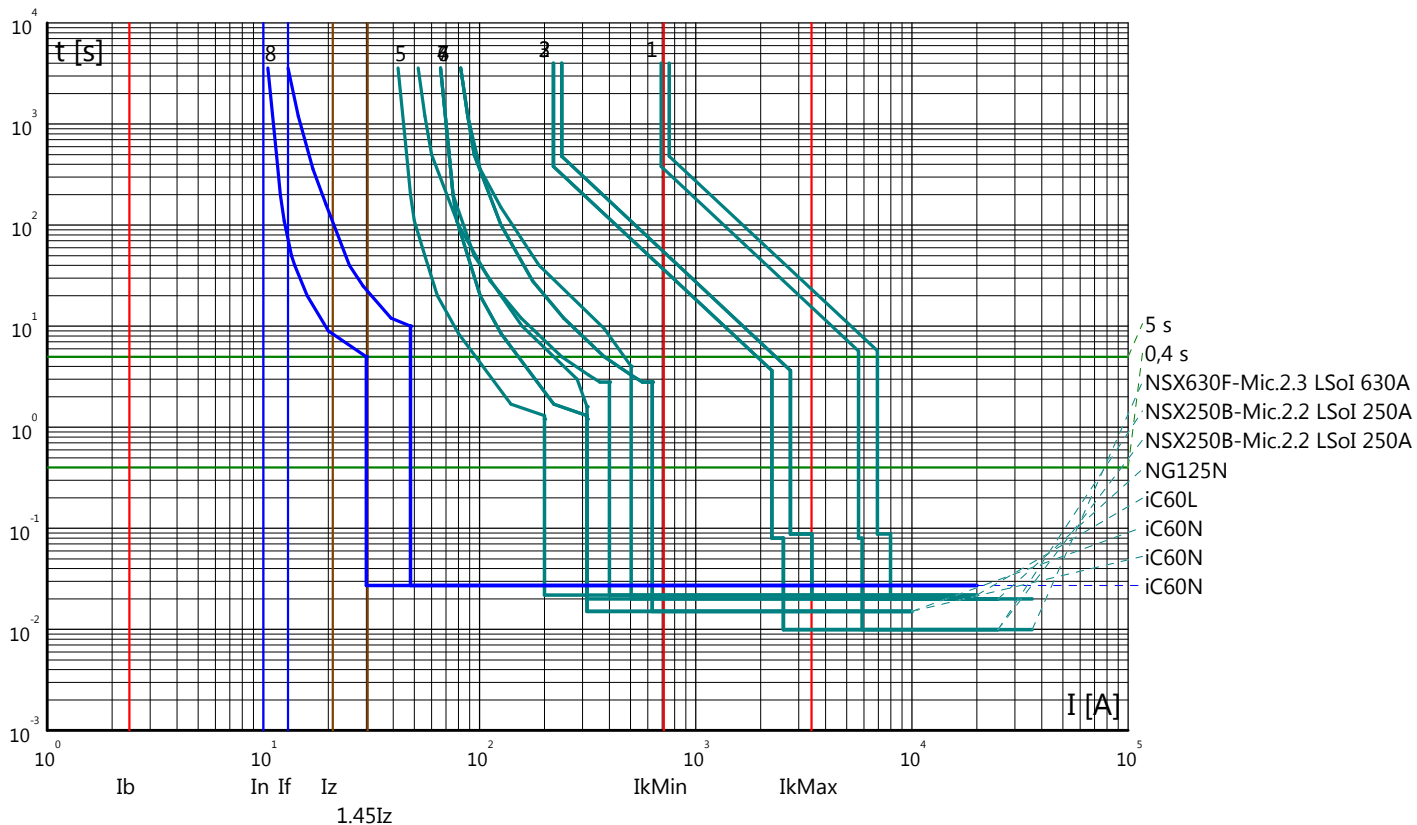

Curve tempo corrente: GALLERIA MONTE AGLIO
 Quadro: QGBT/S

Partenza: 1.16S

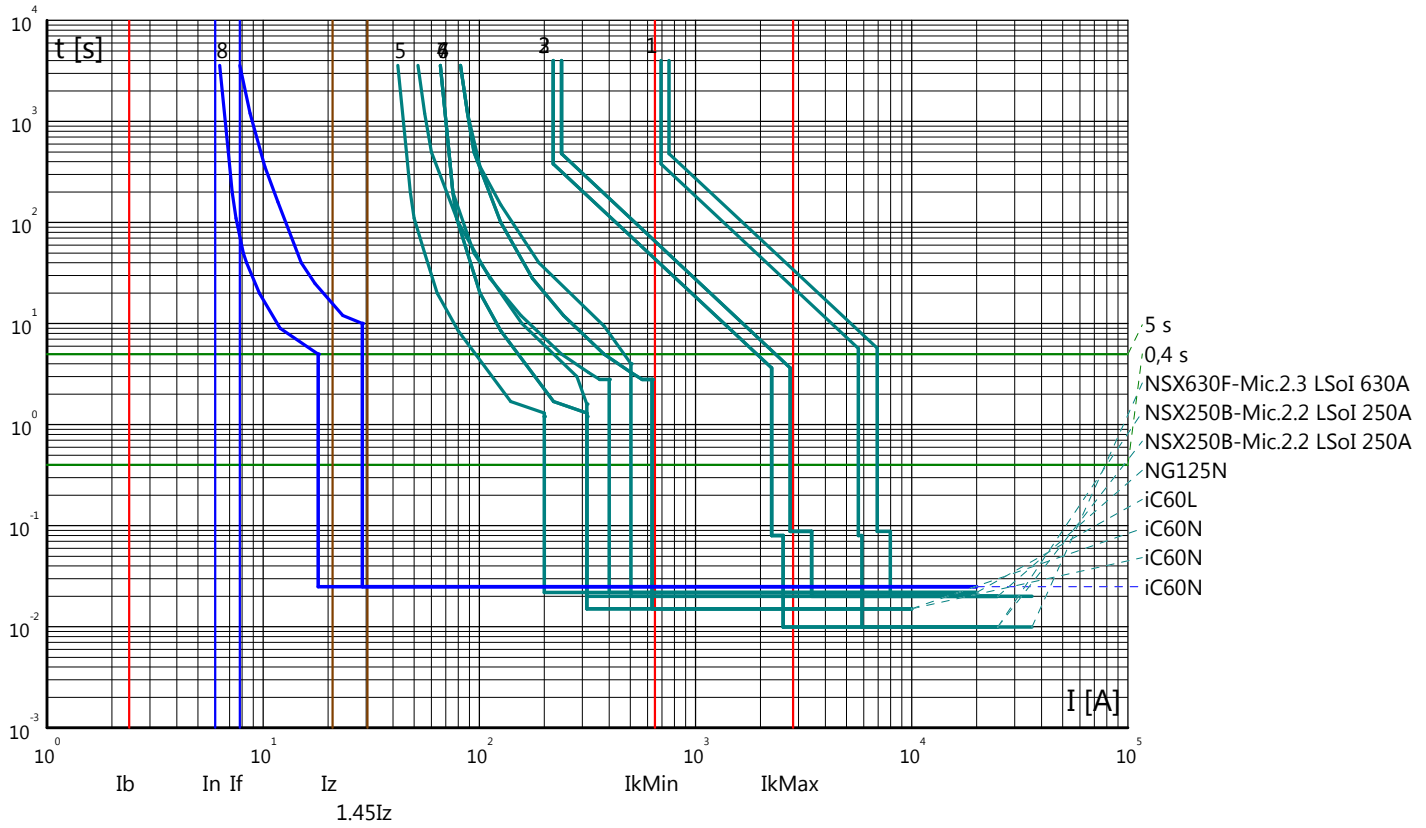

Partenza: 1.17S

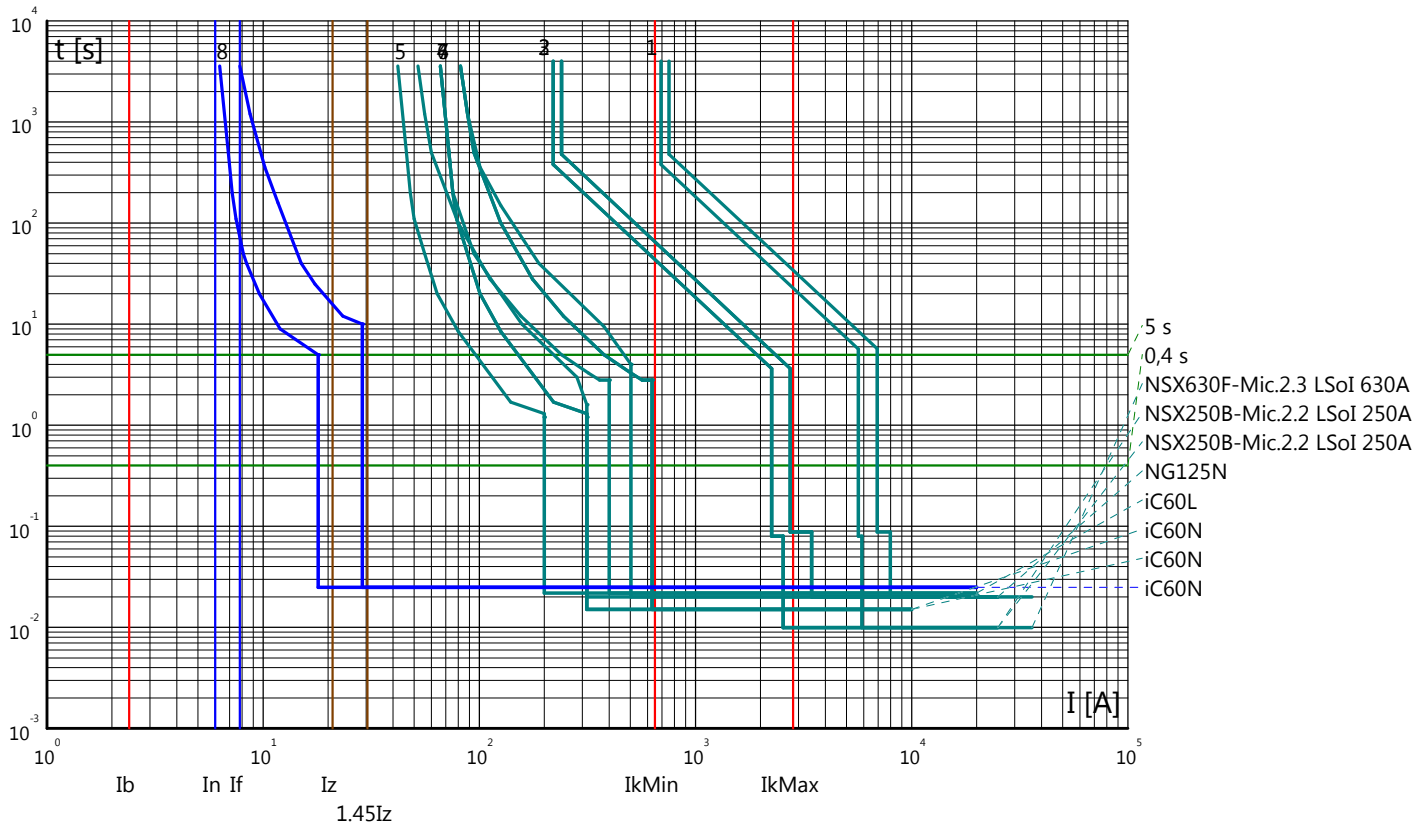

Curve tempo corrente: GALLERIA MONTE AGLIO
 Quadro: QGBT/S

Partenza: 1.18S

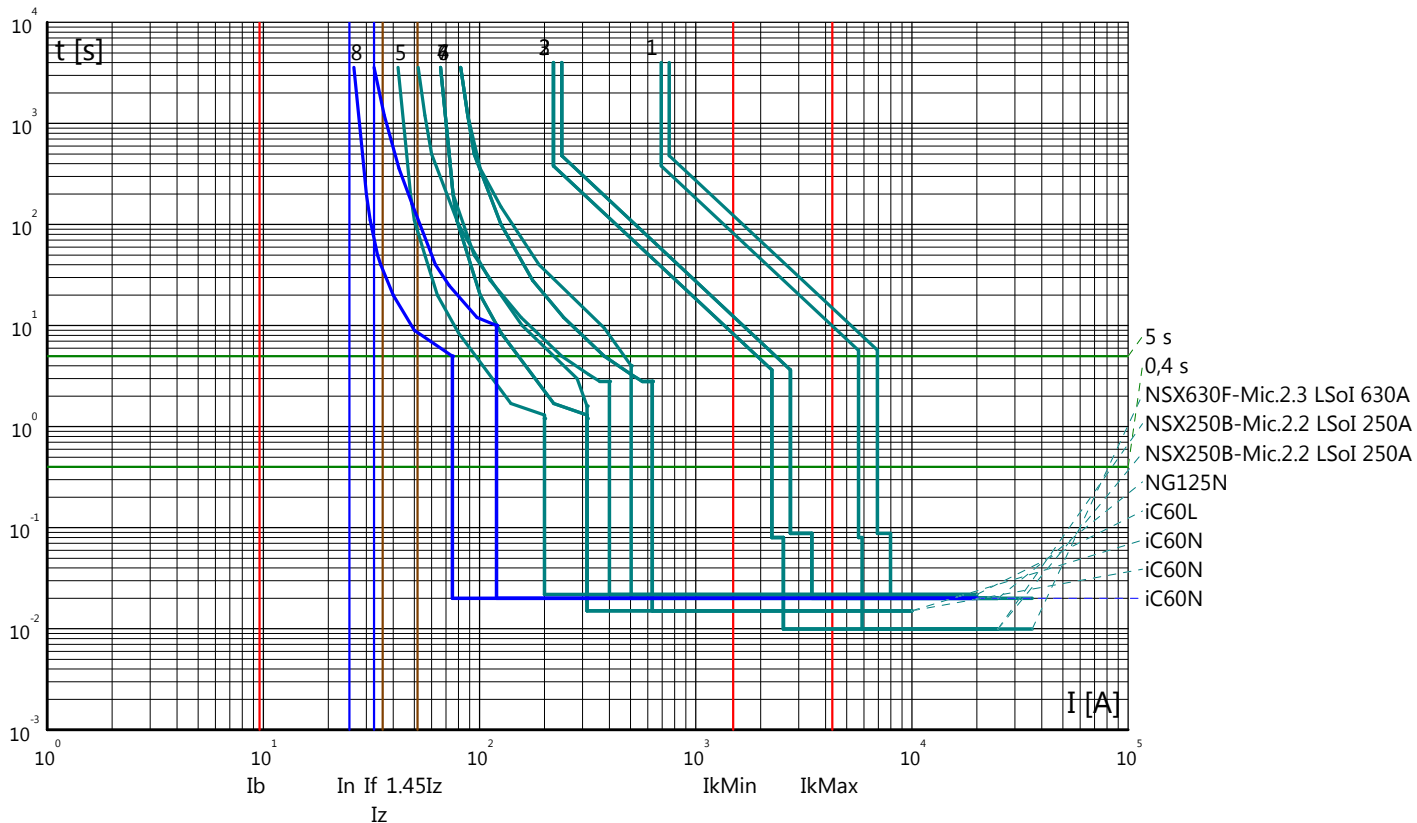

Partenza: 1.19S

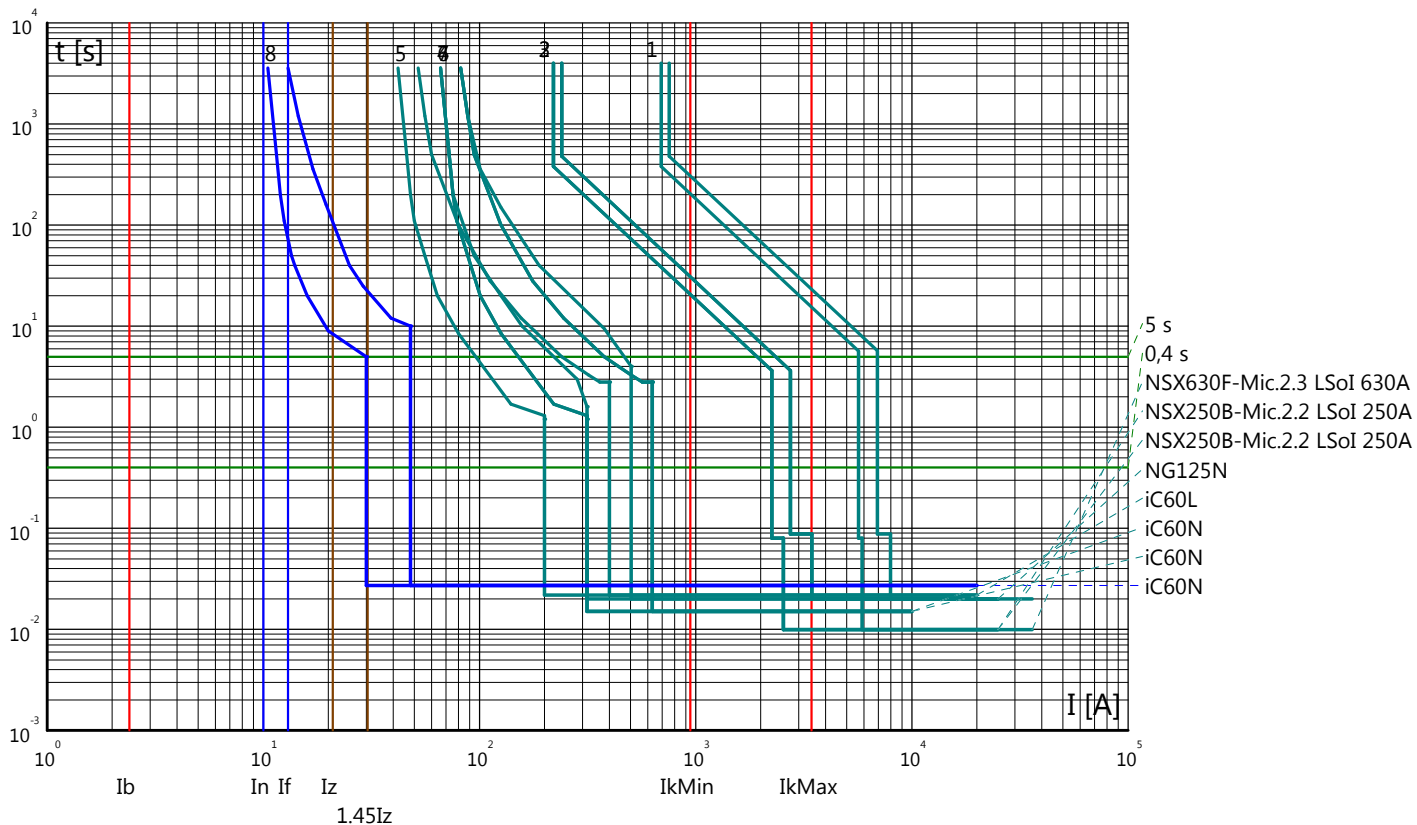

Curve tempo corrente: GALLERIA MONTE AGLIO
 Quadro: QGBT/S

Partenza: 1.20S

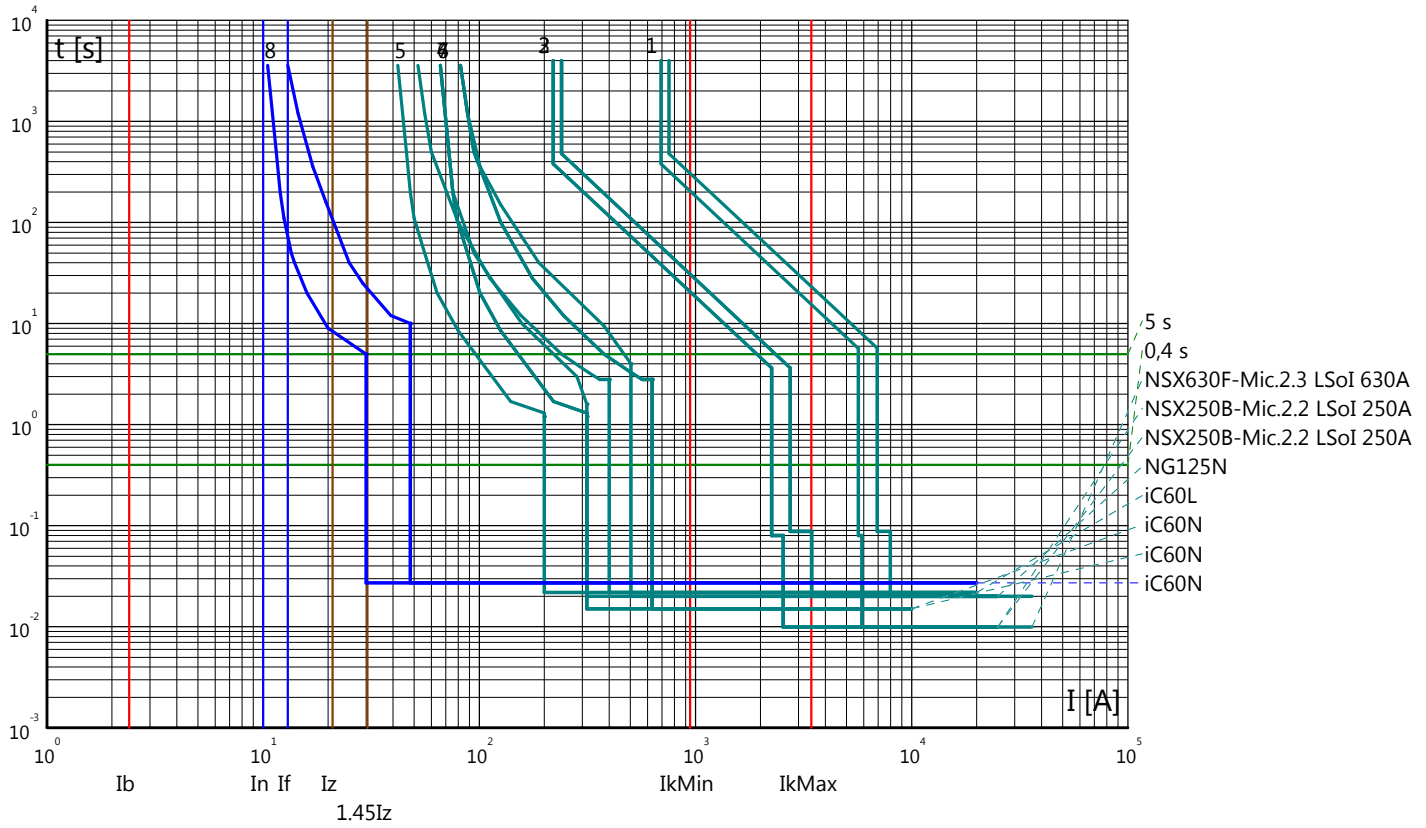

Partenza: 1.21S

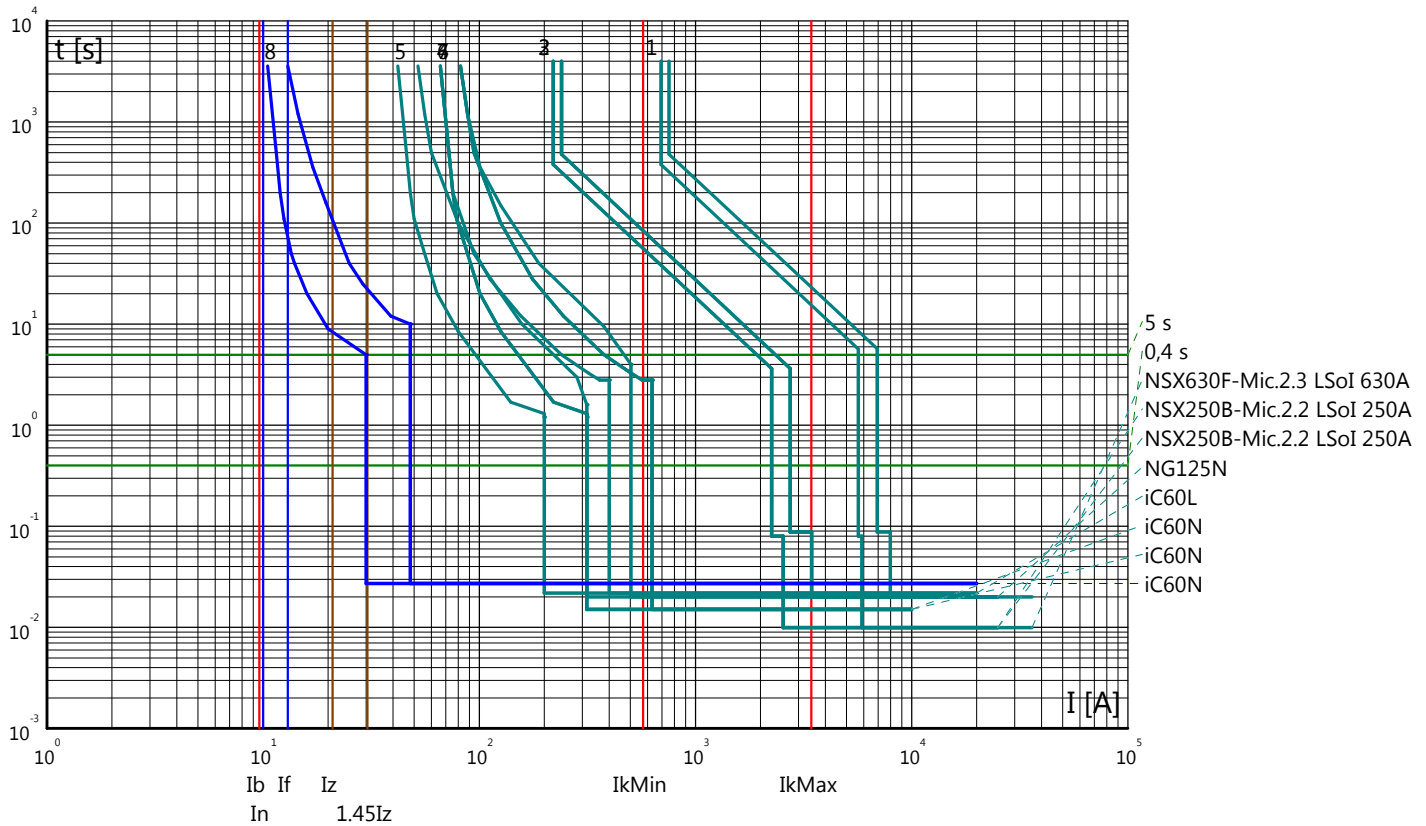

Curve tempo corrente: GALLERIA MONTE AGLIO
Quadro: QGBT/S

Partenza: 1.21S

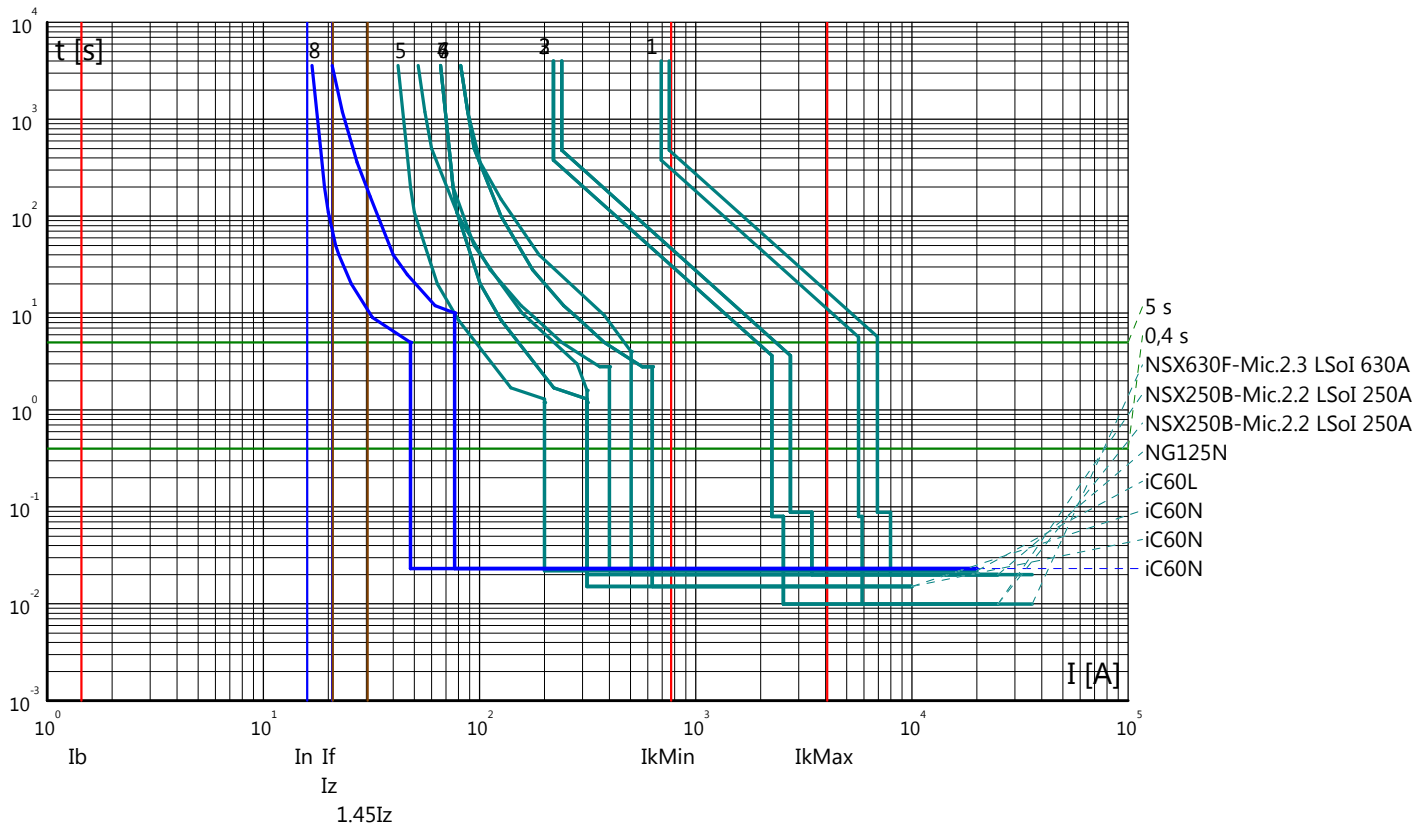

Partenza: 1.22S

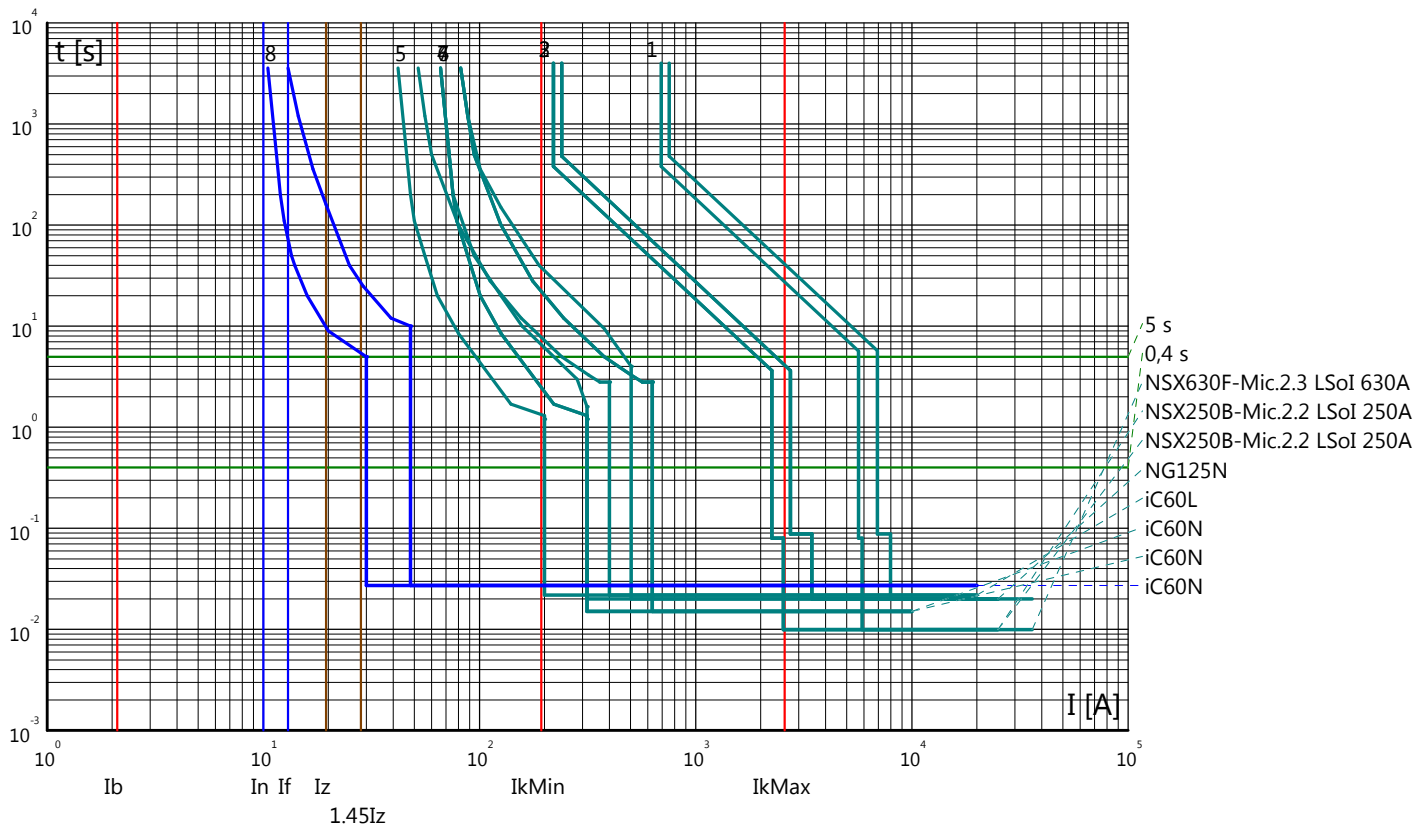

Curve tempo corrente: GALLERIA MONTE AGLIO
 Quadro: QGBT/S

Partenza: 1.23S

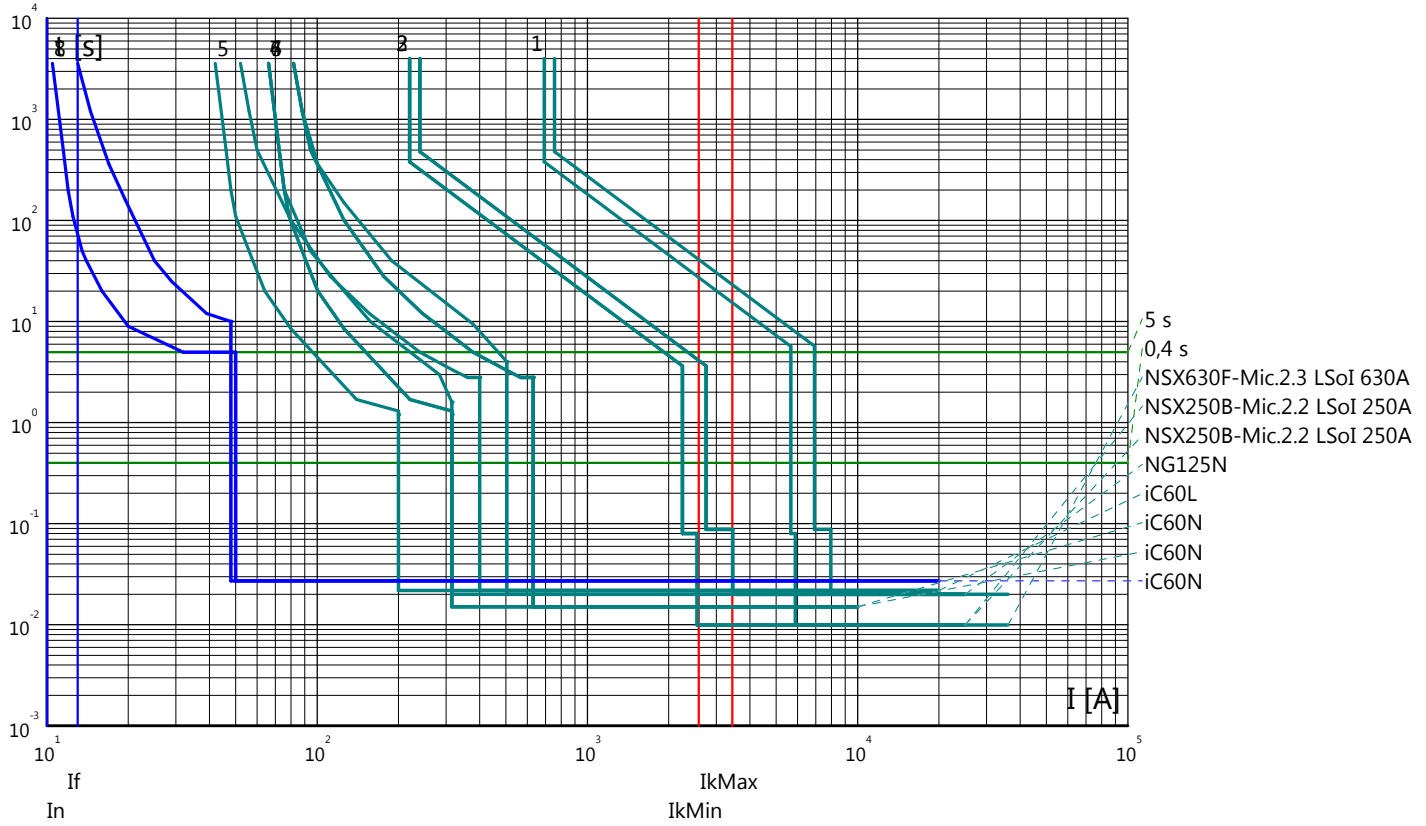

Partenza: IP1.S

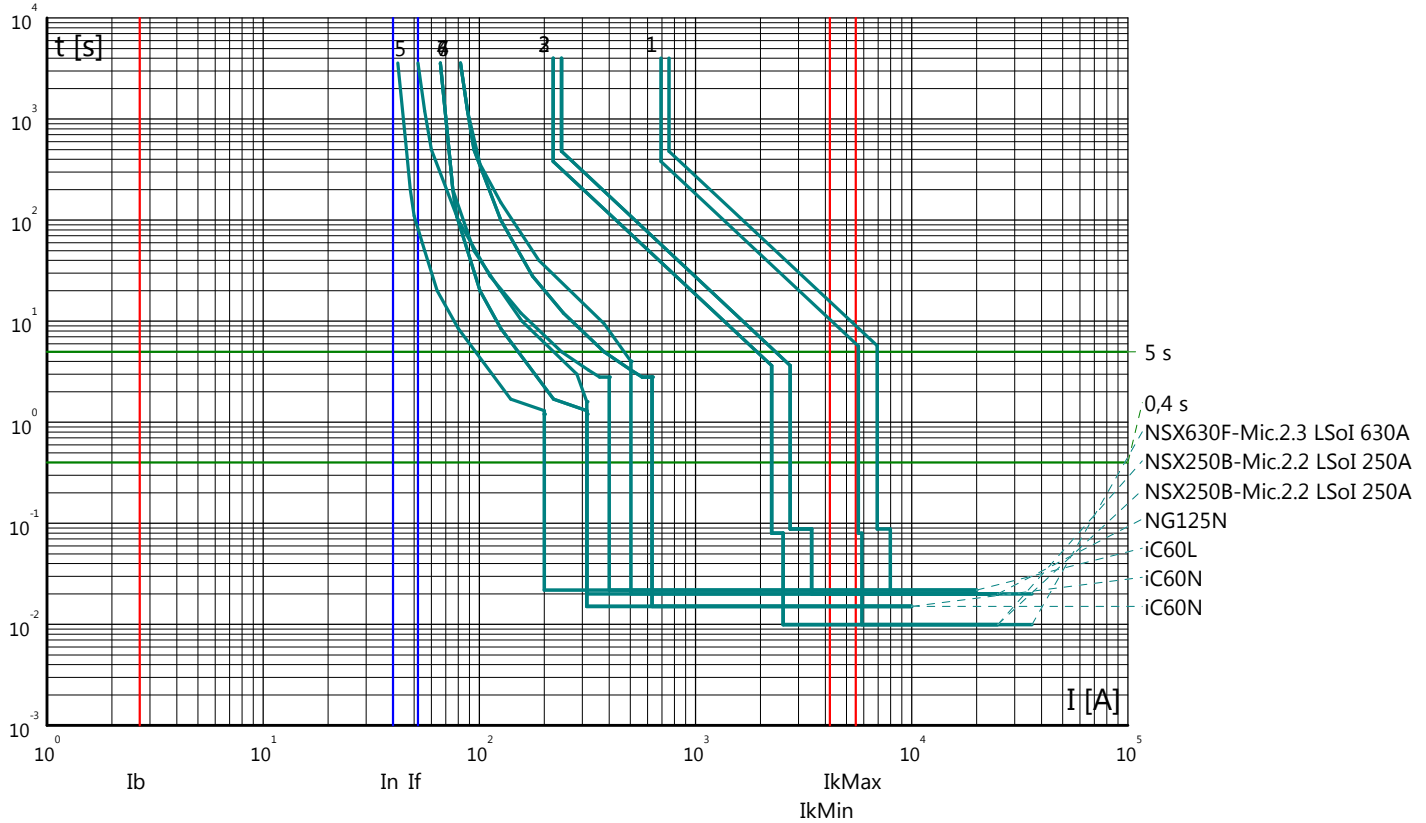

Curve tempo corrente: GALLERIA MONTE AGLIO
 Quadro: QGBT/S

Partenza: 1.24S

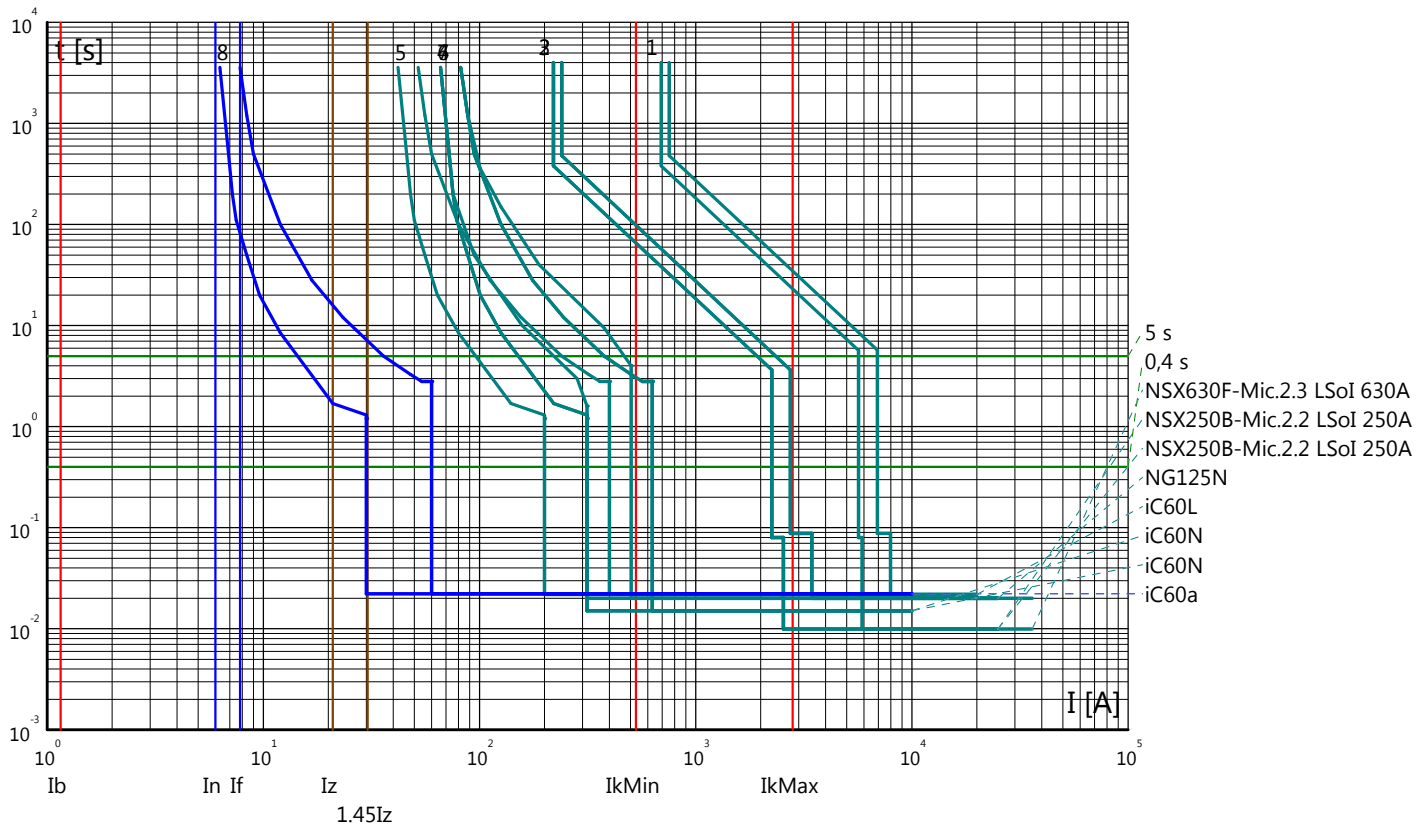

Partenza: 1.25S

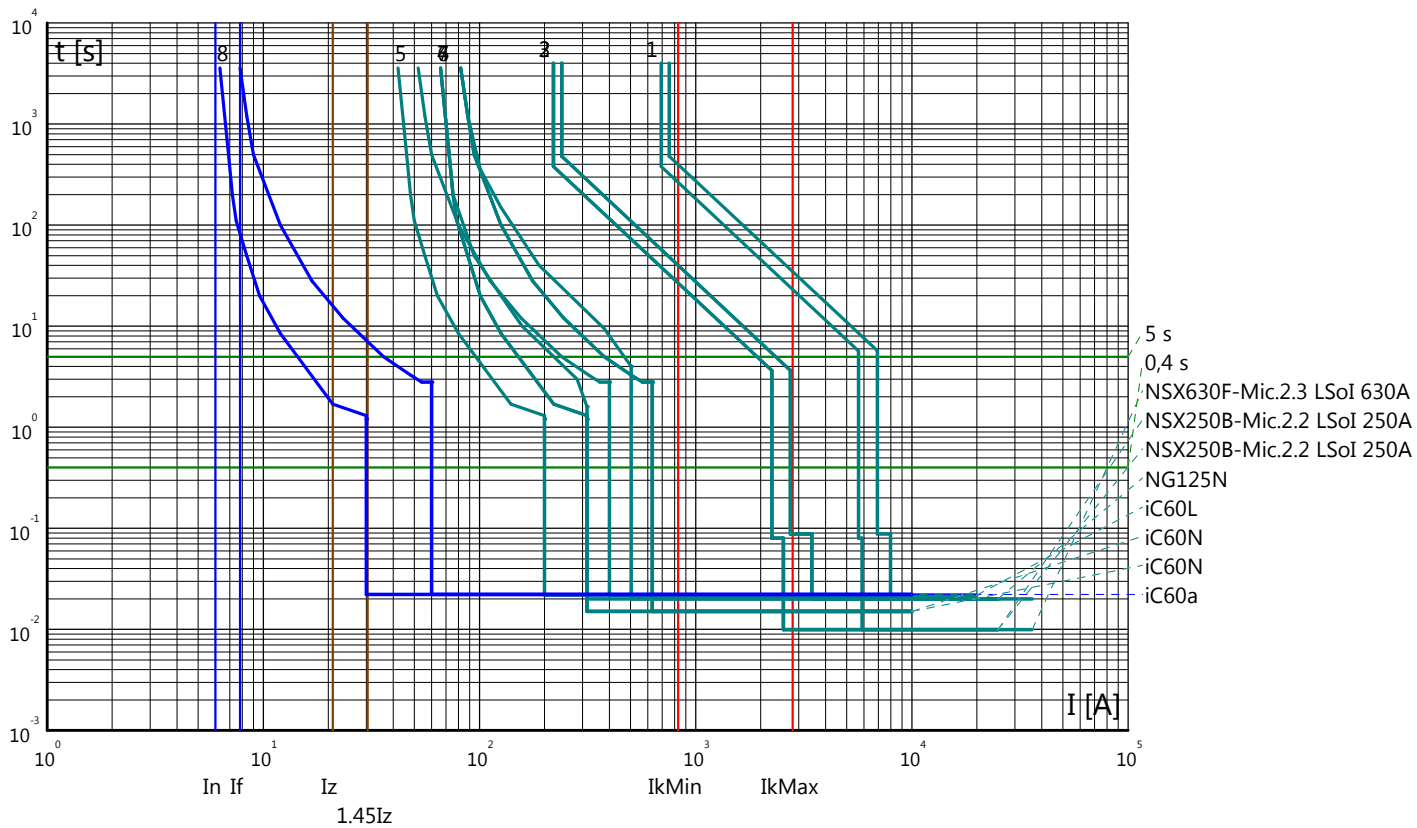

Curve tempo corrente: GALLERIA MONTE AGLIO
 Quadro: QGBT/S

Partenza: 1.26S

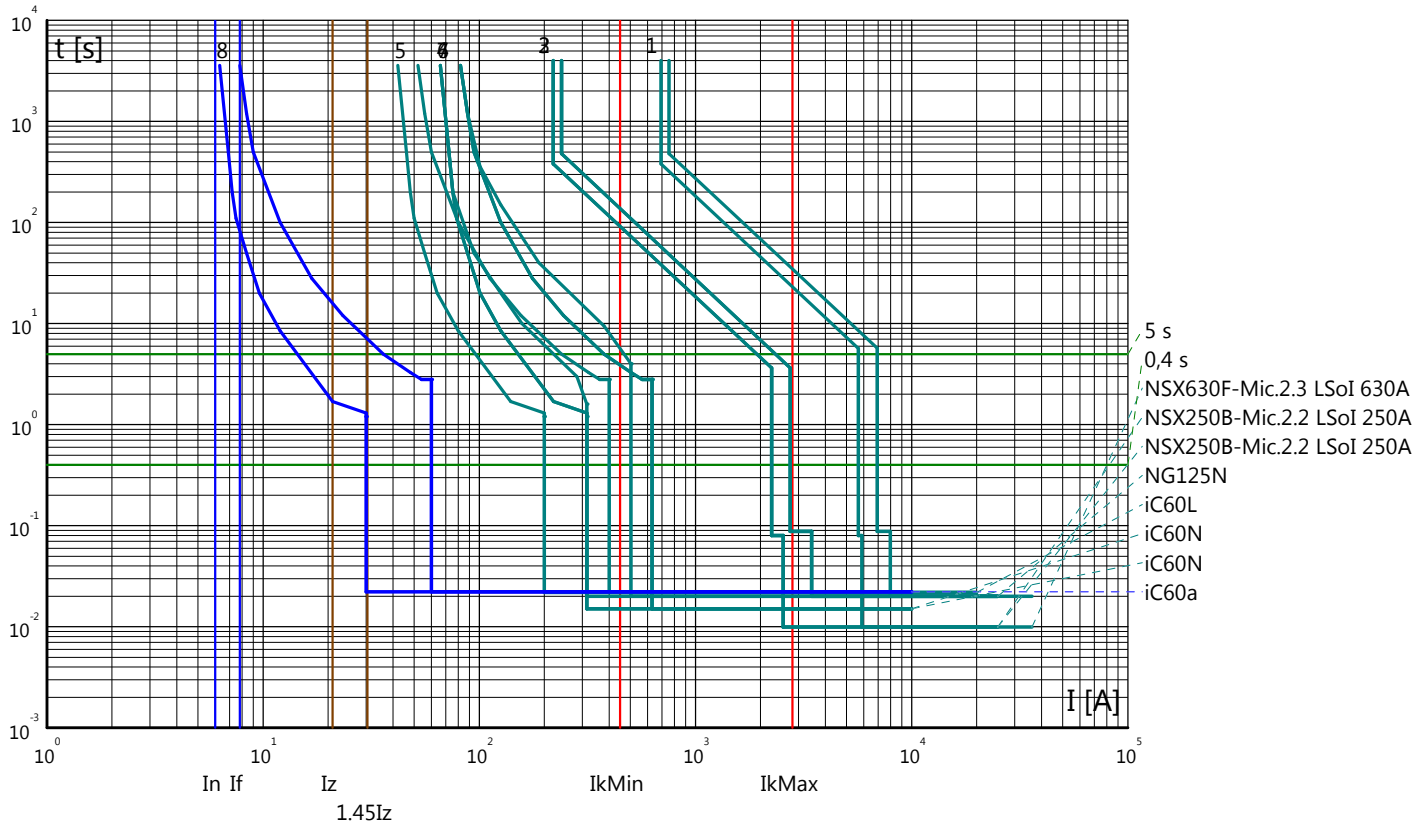

Partenza: 1.27S

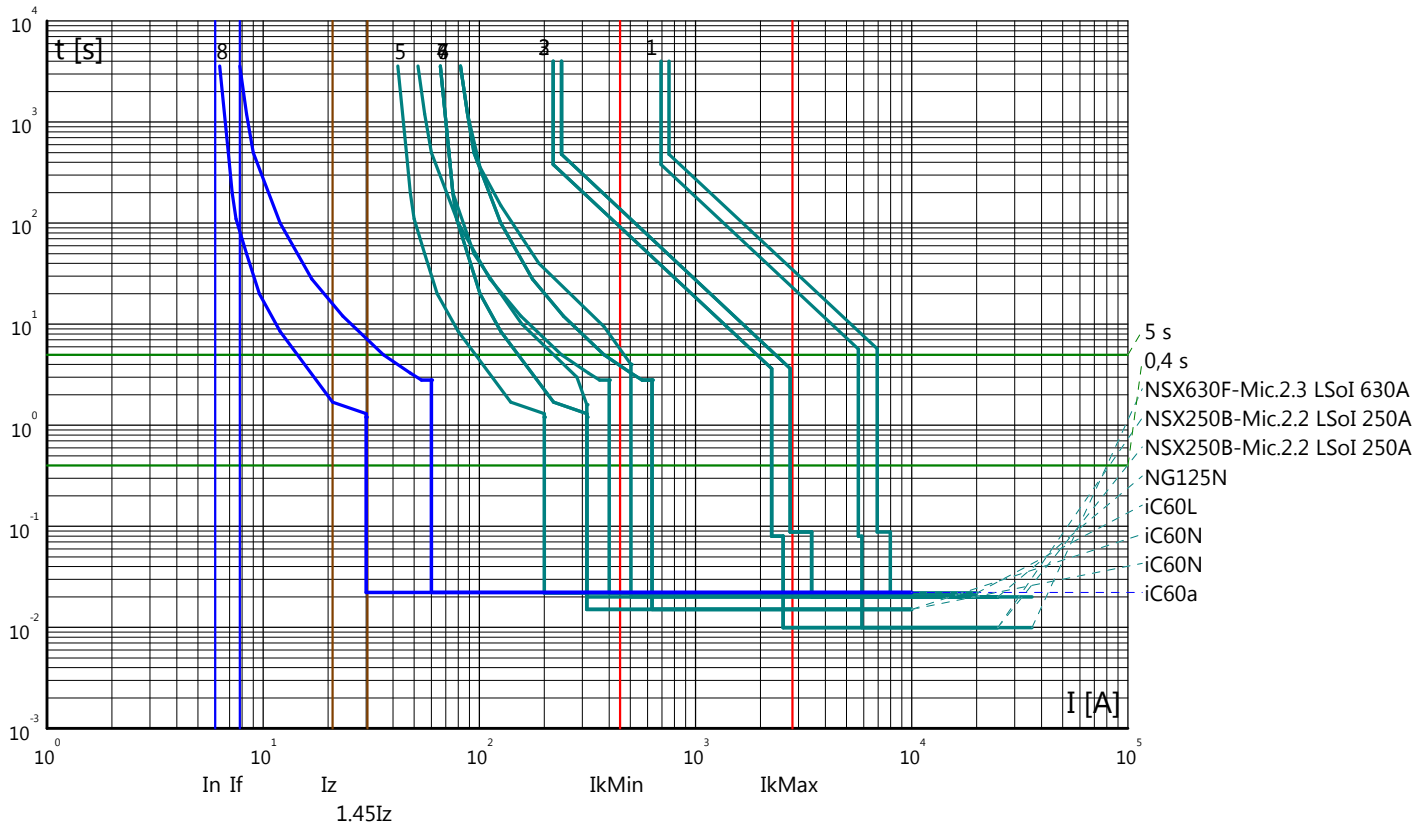

Curve tempo corrente: GALLERIA MONTE AGLIO
 Quadro: QGBT/S

Partenza: 1.28S

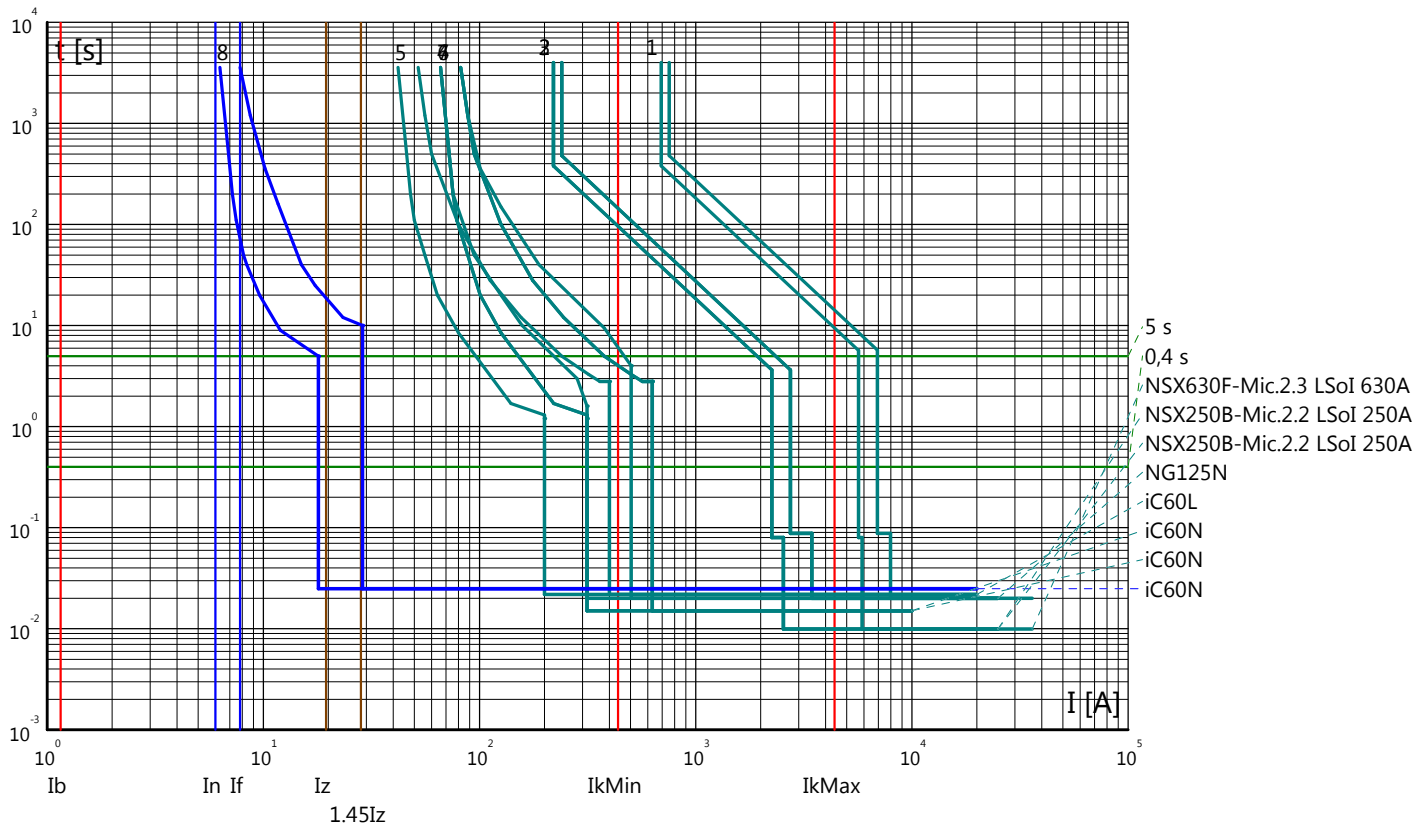

Partenza: 1.29S

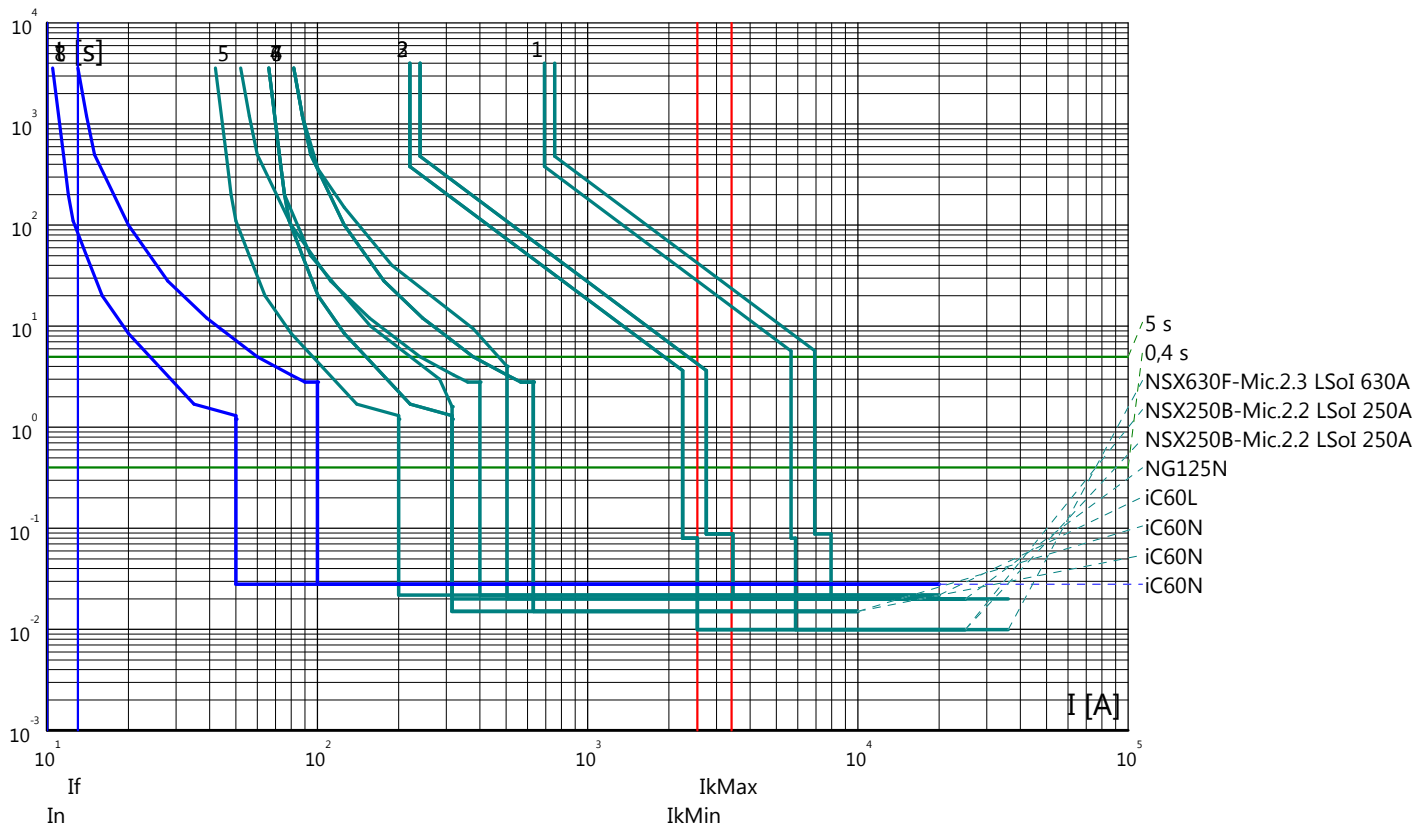

Curve tempo corrente: GALLERIA MONTE AGLIO
 Quadro: QGBT/S

Partenza: 1.30S

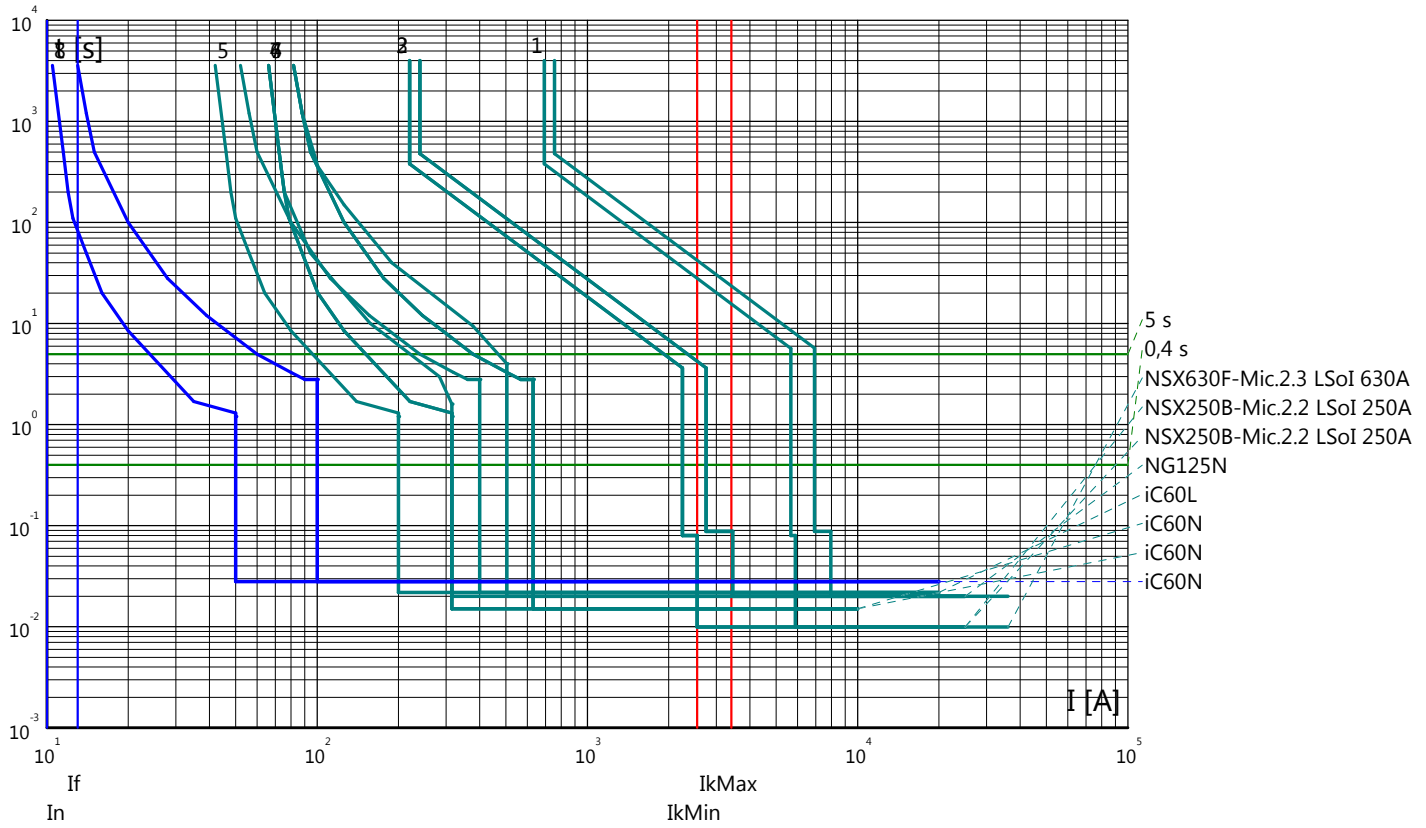

Partenza: 1.31S

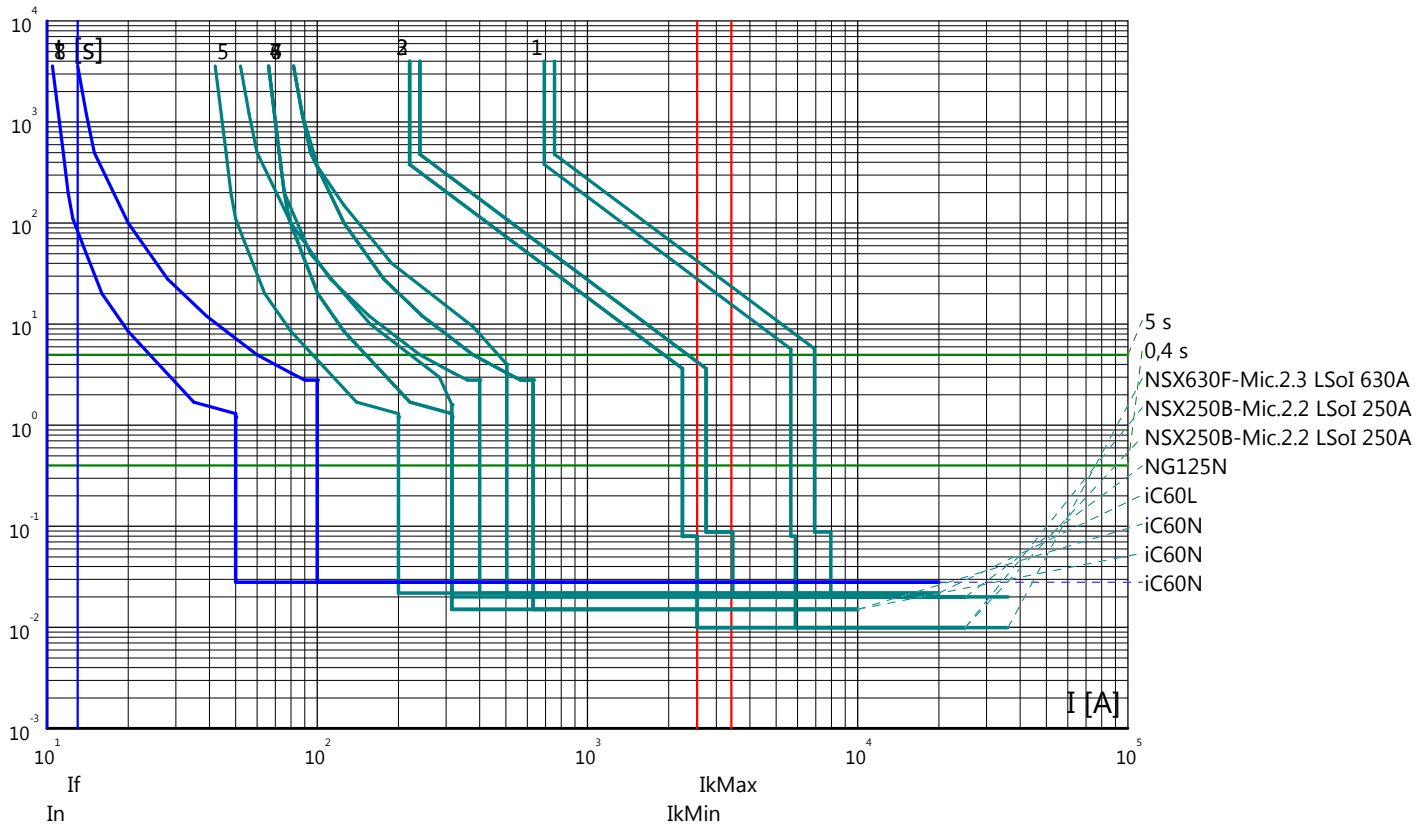

Curve tempo corrente: GALLERIA MONTE AGLIO
 Quadro: QGBT/S

Partenza: 1.32S

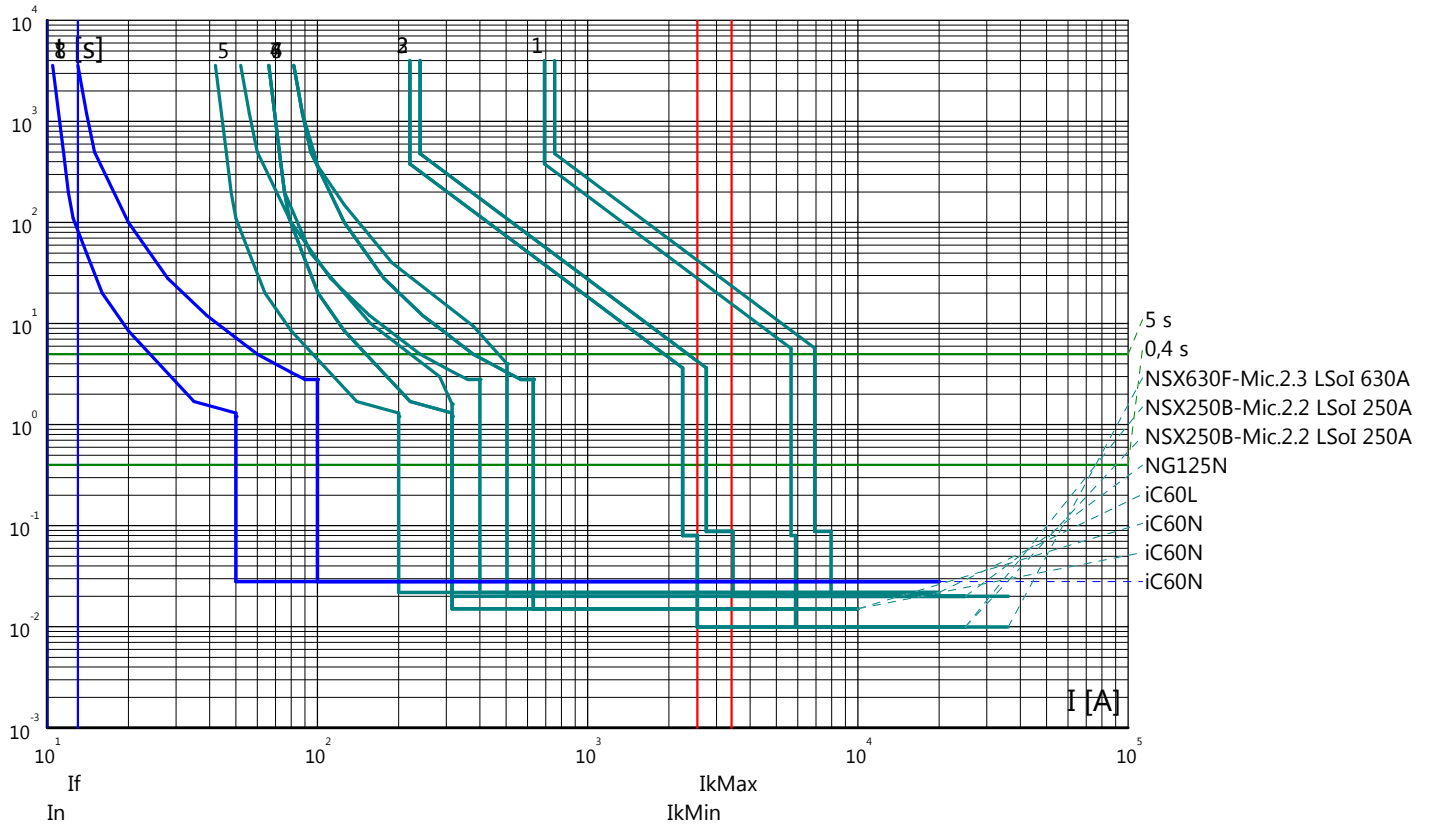

Curve tempo corrente: GALLERIA MONTE AGLIO
 Quadro: QCE/S

Arrivo: IG

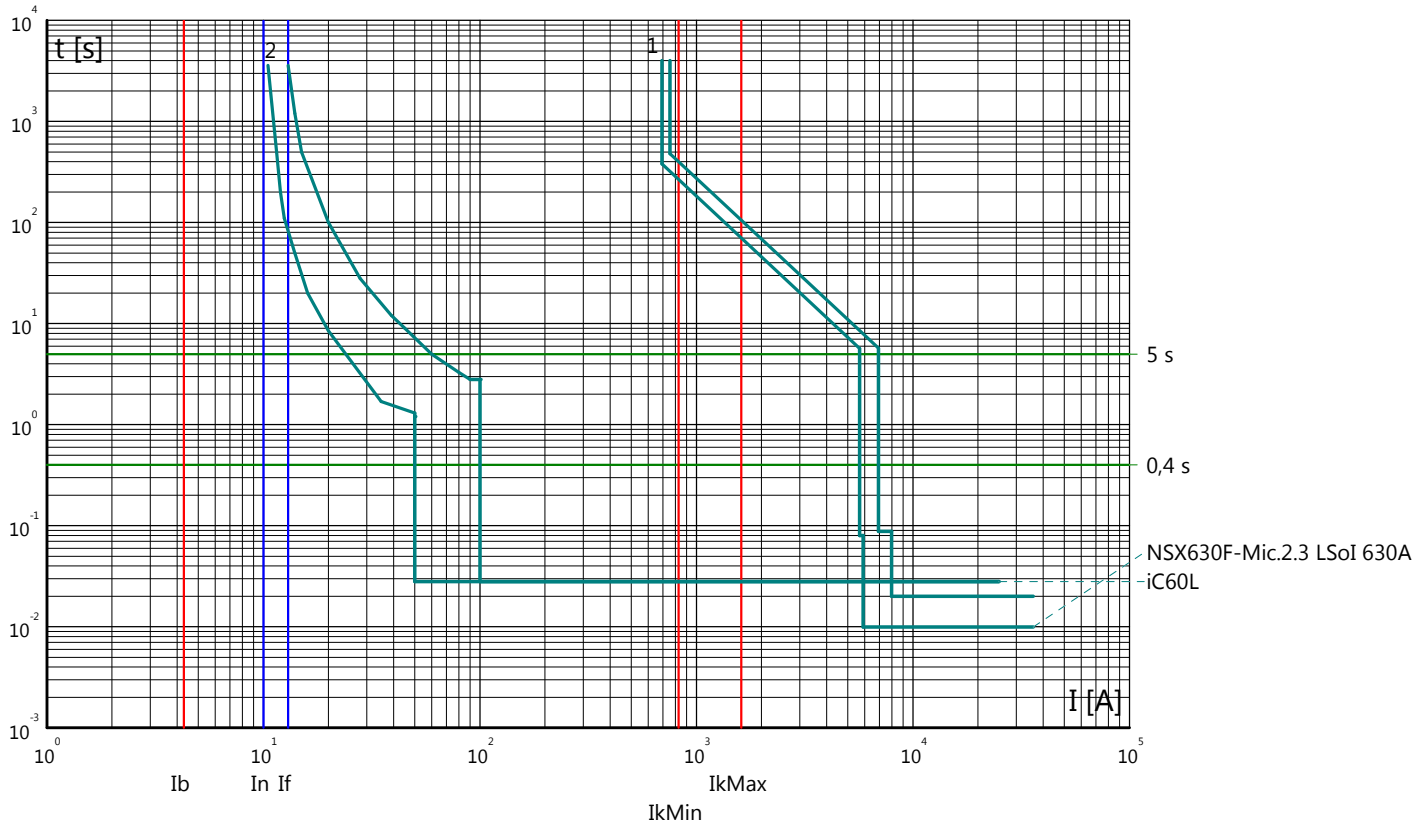

Partenza: PT/N

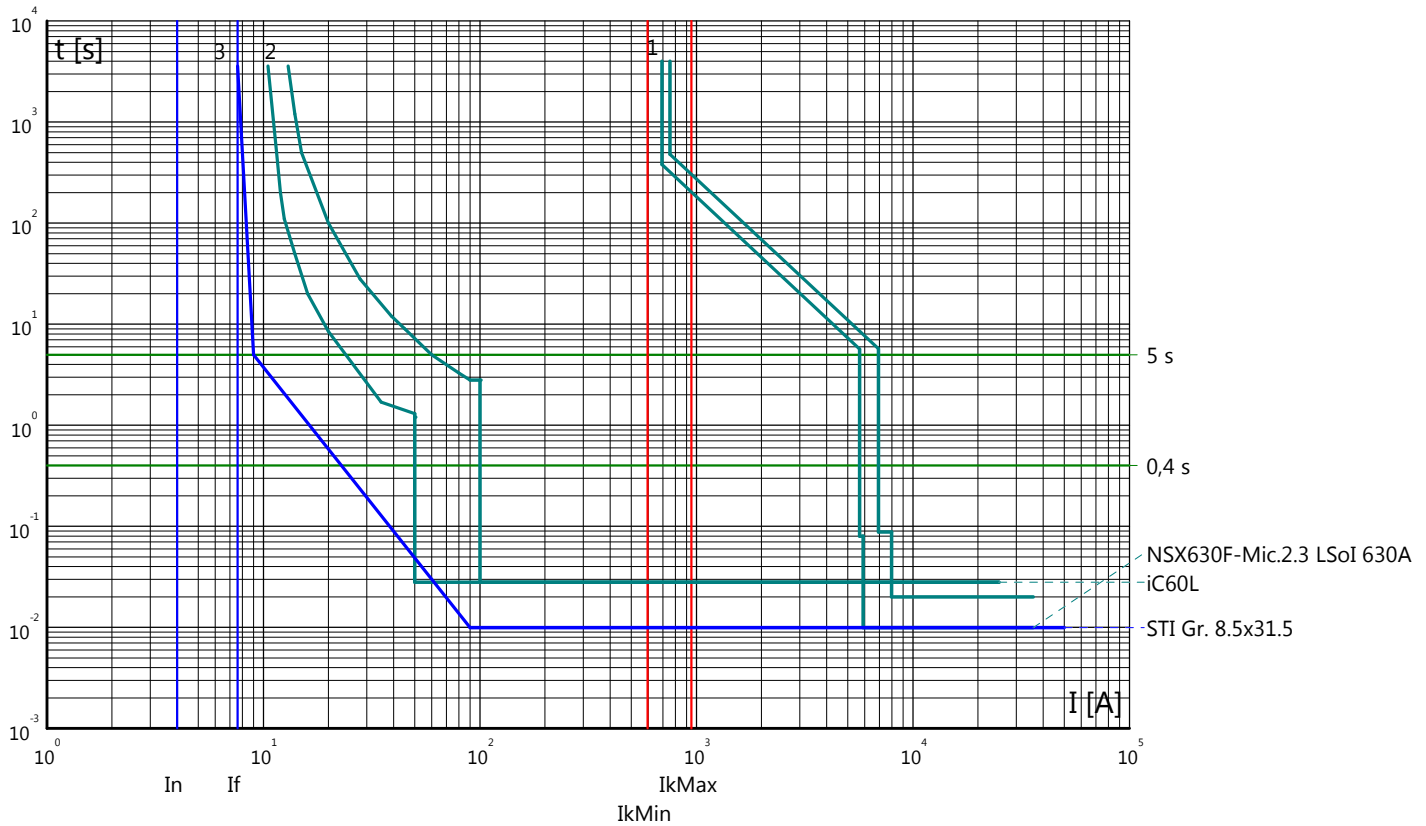

Curve tempo corrente: GALLERIA MONTE AGLIO
 Quadro: QCE/S

Partenza: 1.3N.1

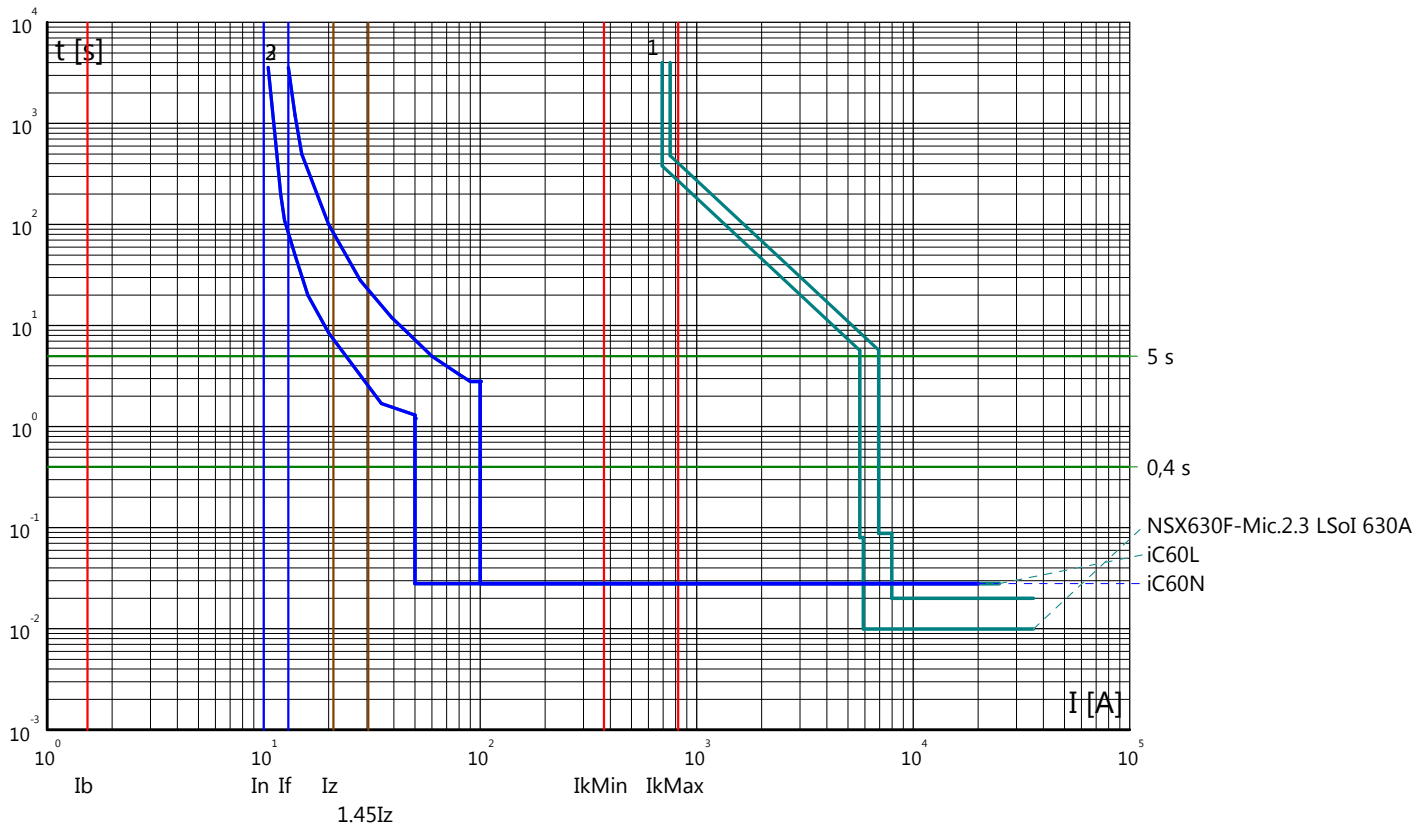

Partenza: 1.3N.2

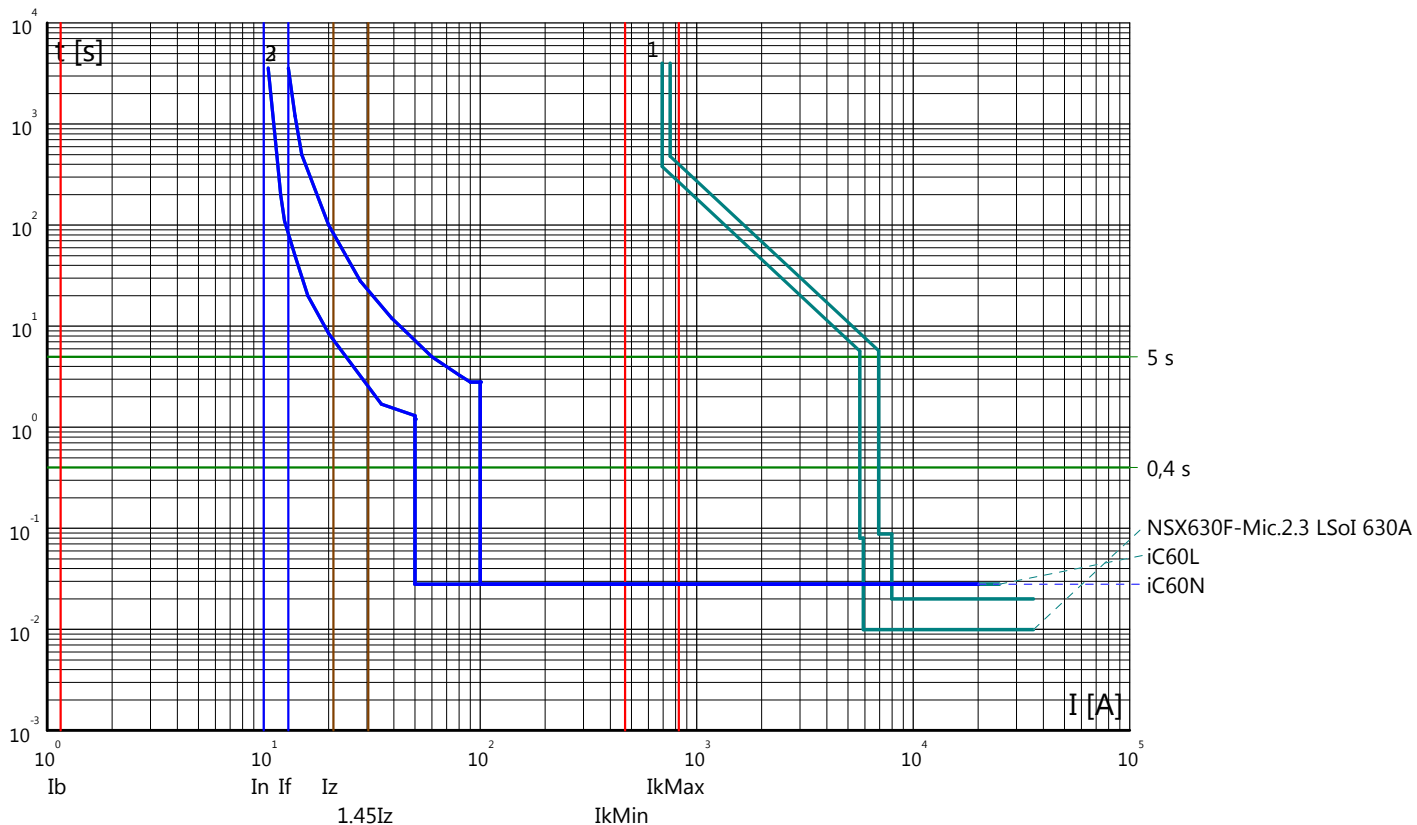

Curve tempo corrente: GALLERIA MONTE AGLIO
 Quadro: QCE/S

Partenza: 1.3N.3

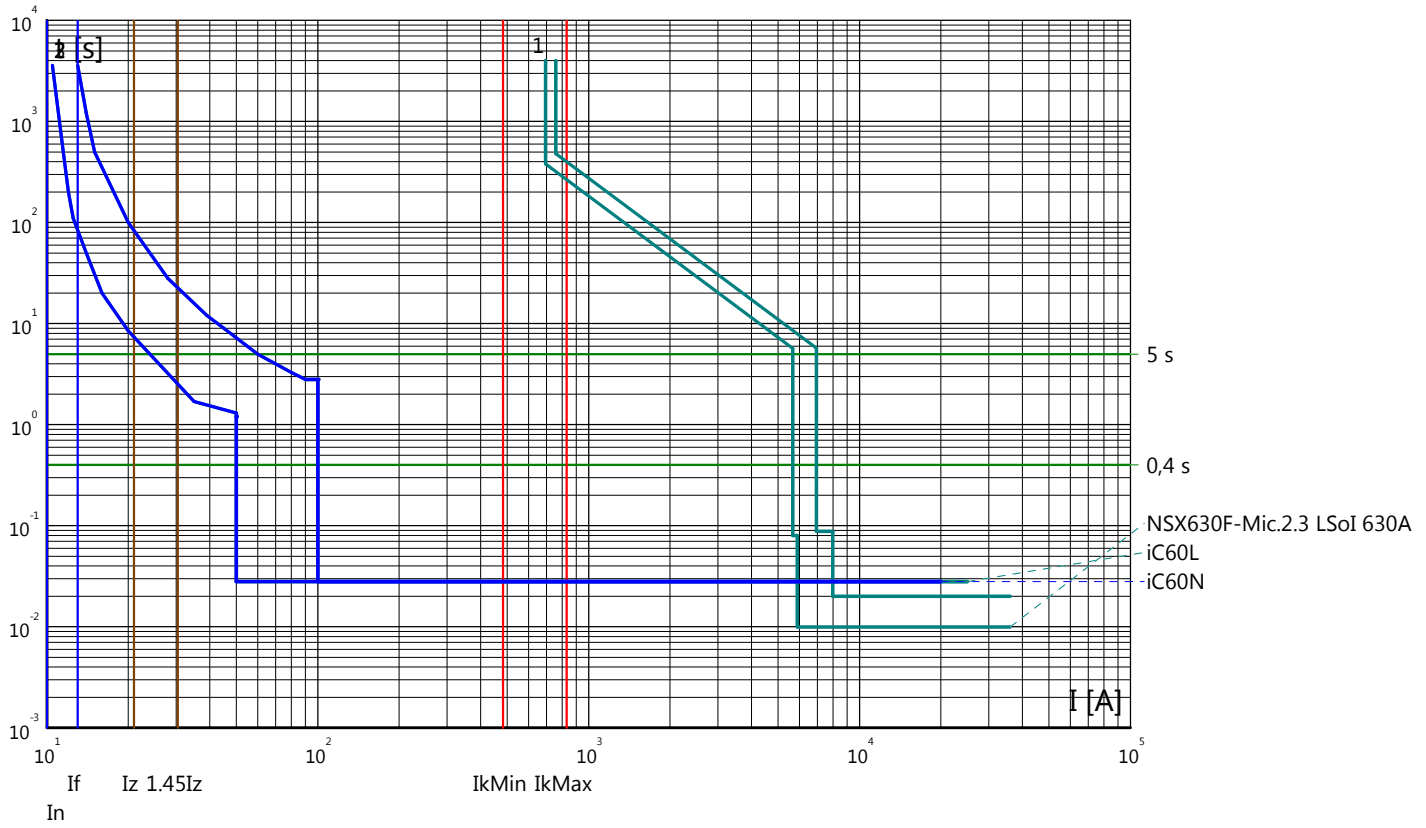

Partenza: 1.3N.4

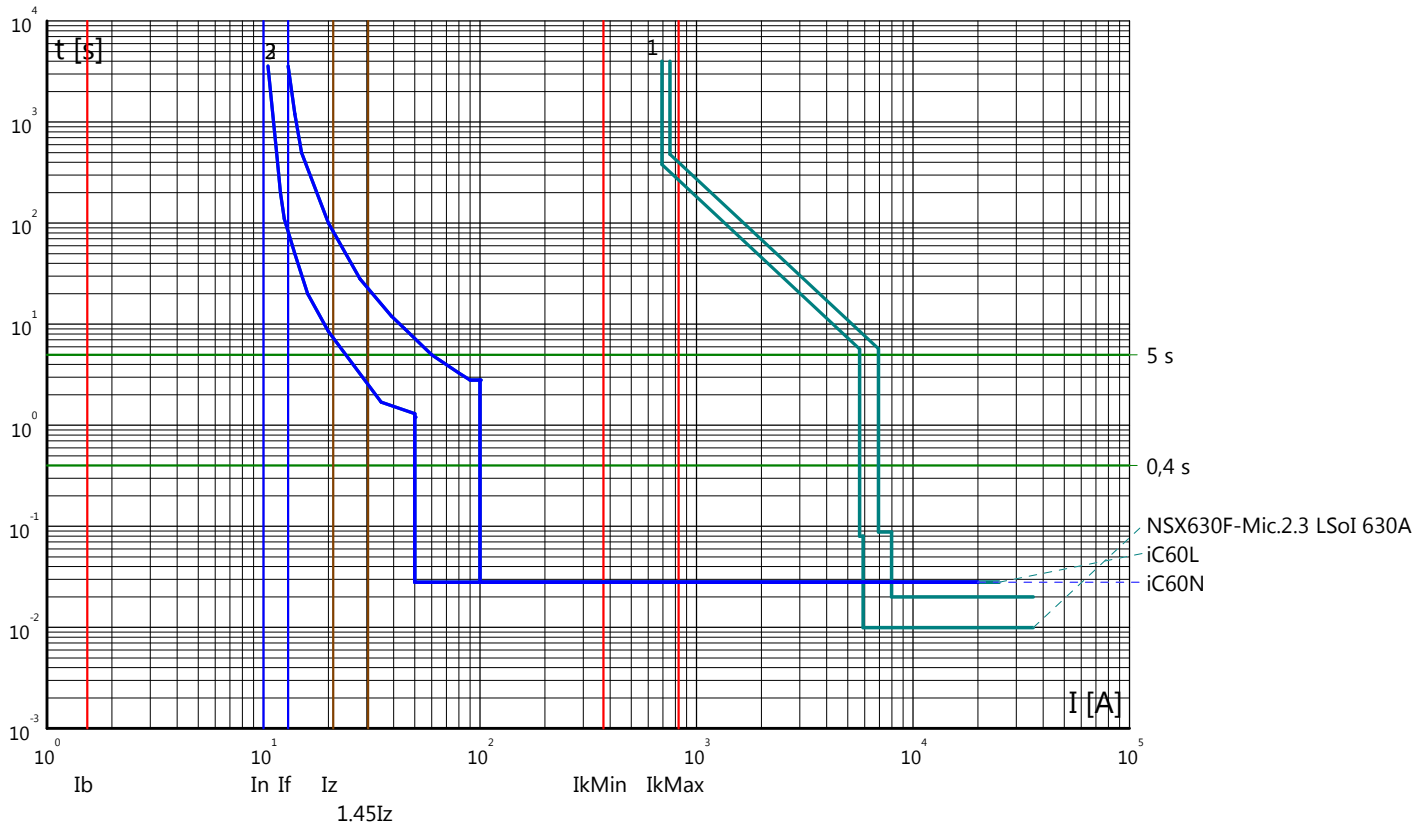

Curve tempo corrente: GALLERIA MONTE AGLIO
 Quadro: QCE/S

Partenza: 1.3N.5

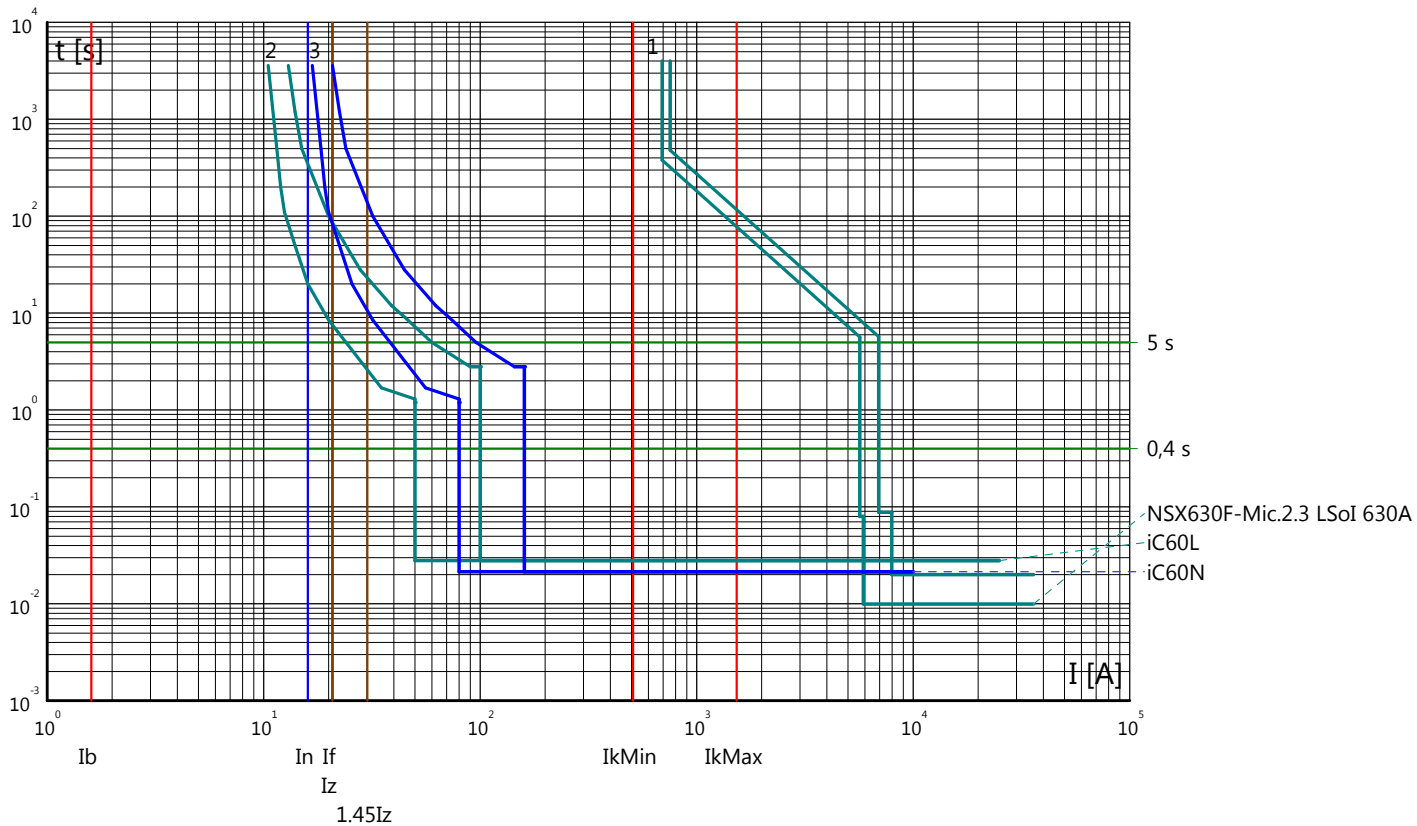

Partenza: 1.3N.6

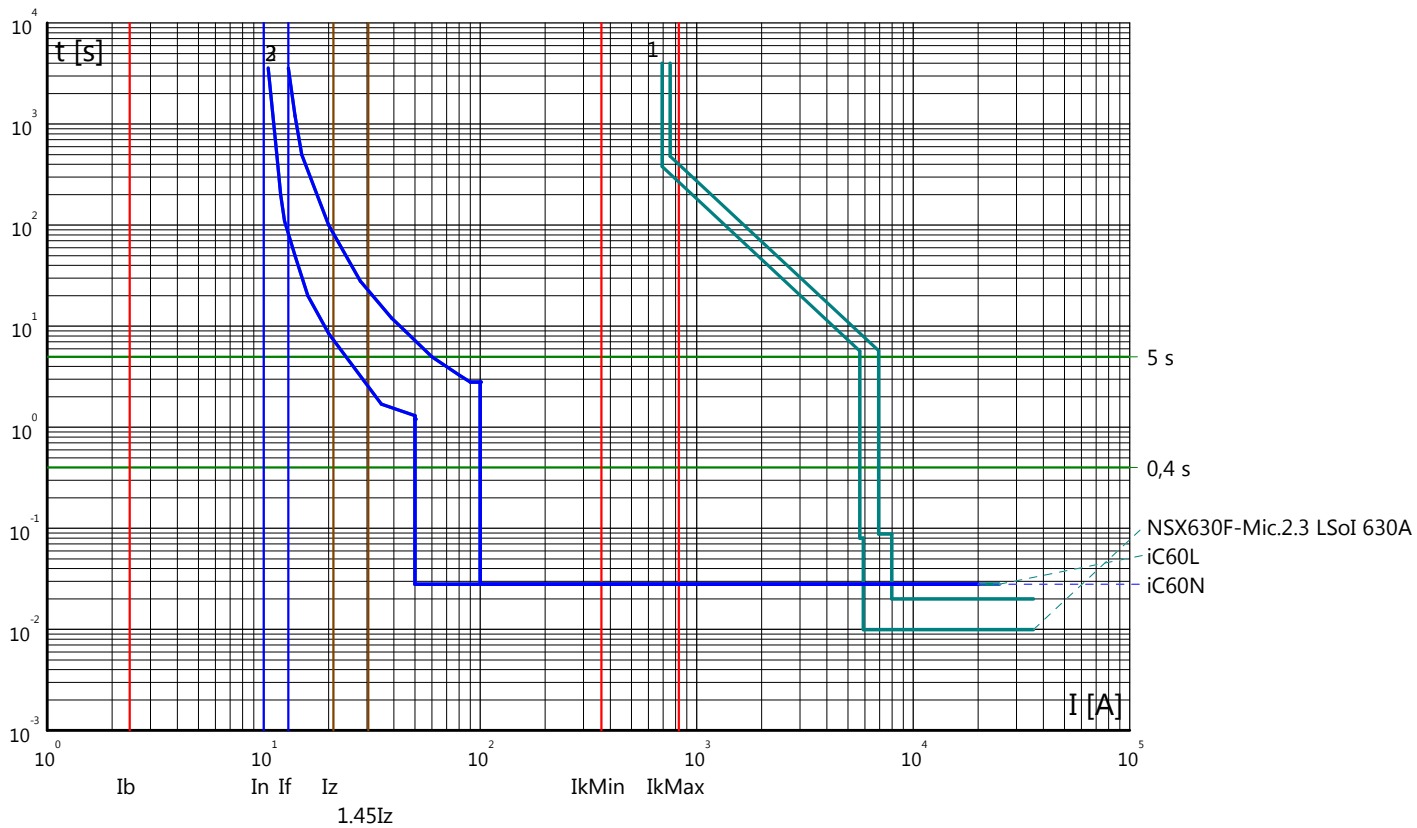

Curve tempo corrente: GALLERIA MONTE AGLIO
 Quadro: QCE/S

Partenza: 1.3N.7

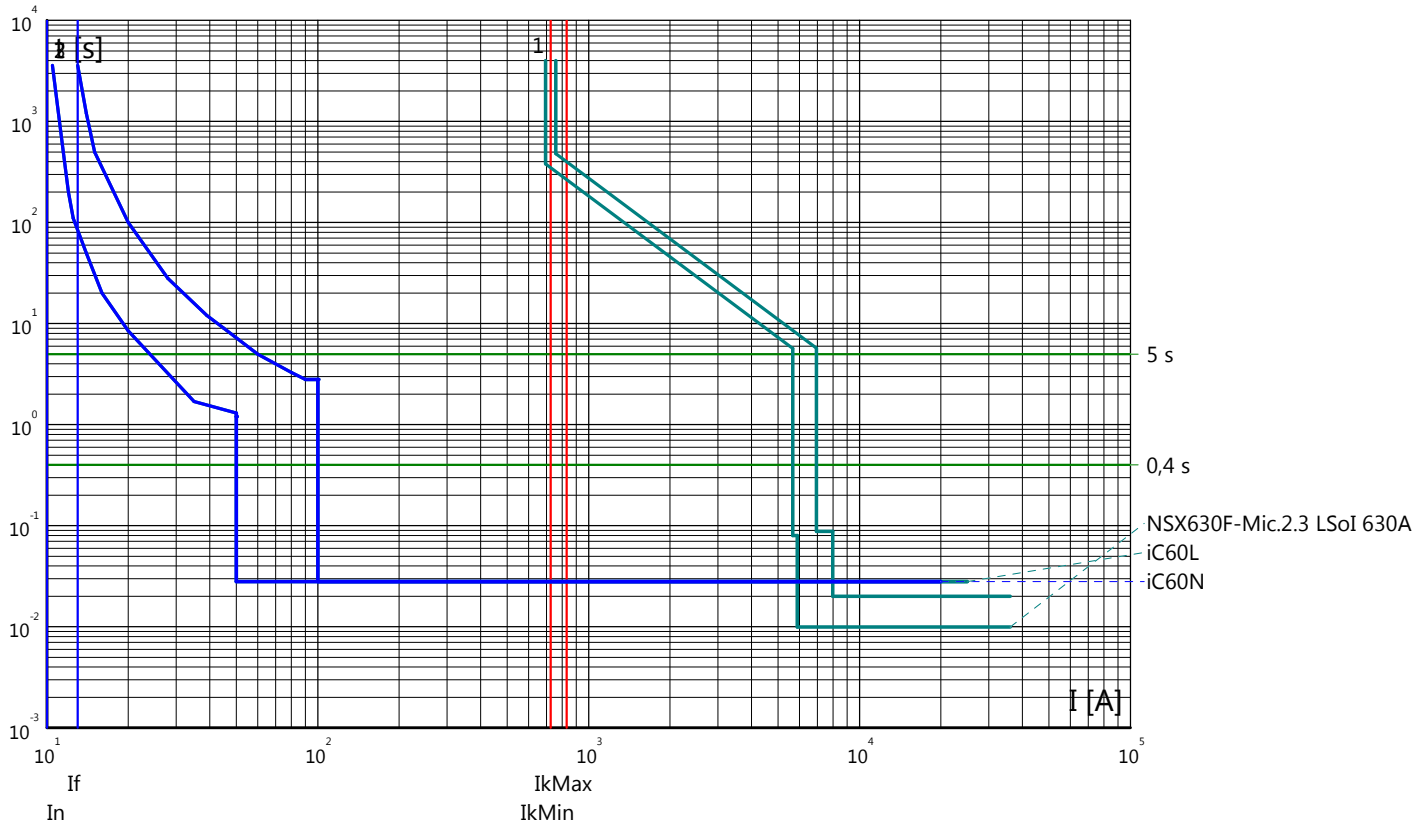

Partenza: 1.3N.8

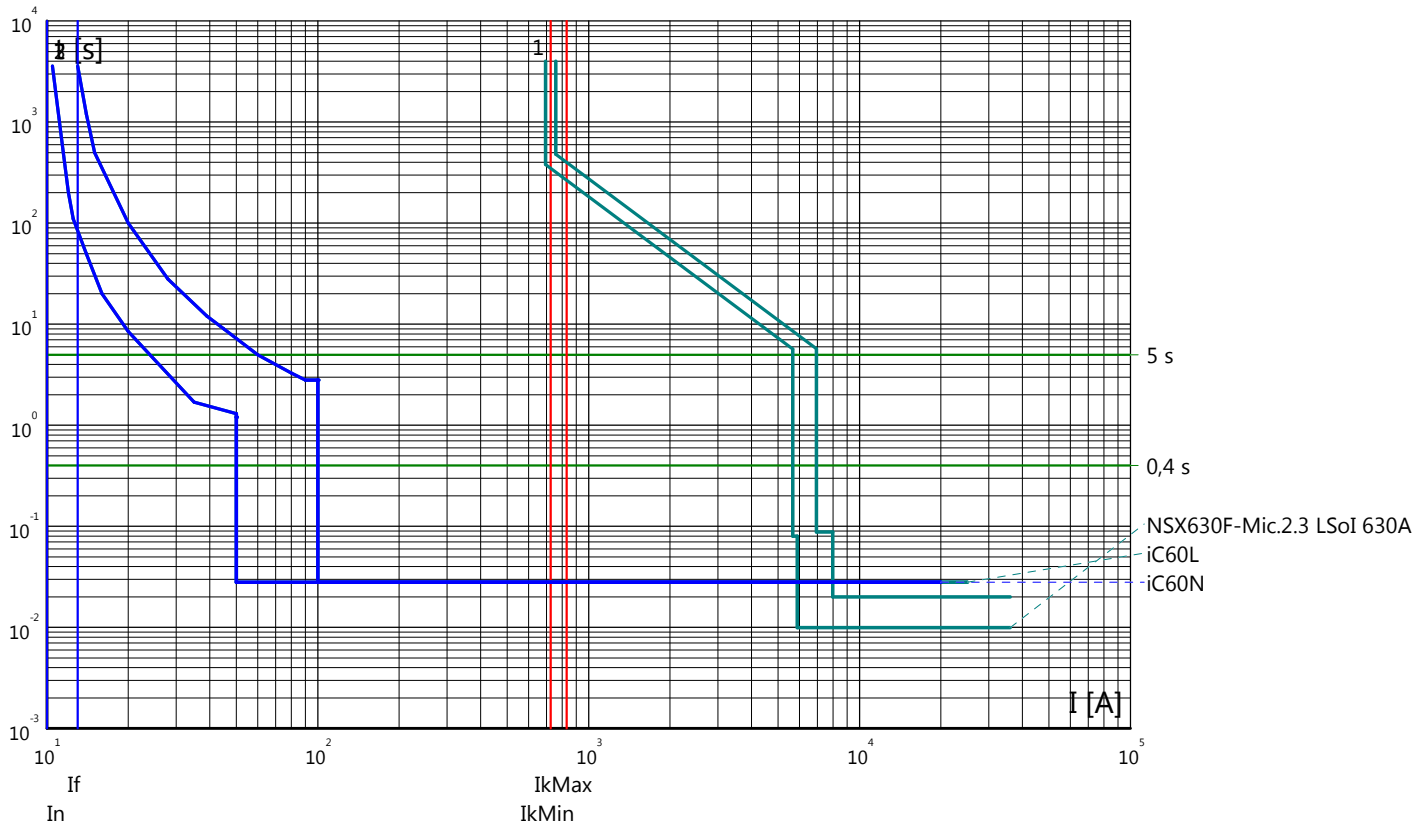

Curve tempo corrente: GALLERIA MONTE AGLIO
 Quadro: QCE/S

Arrivo: IG/S

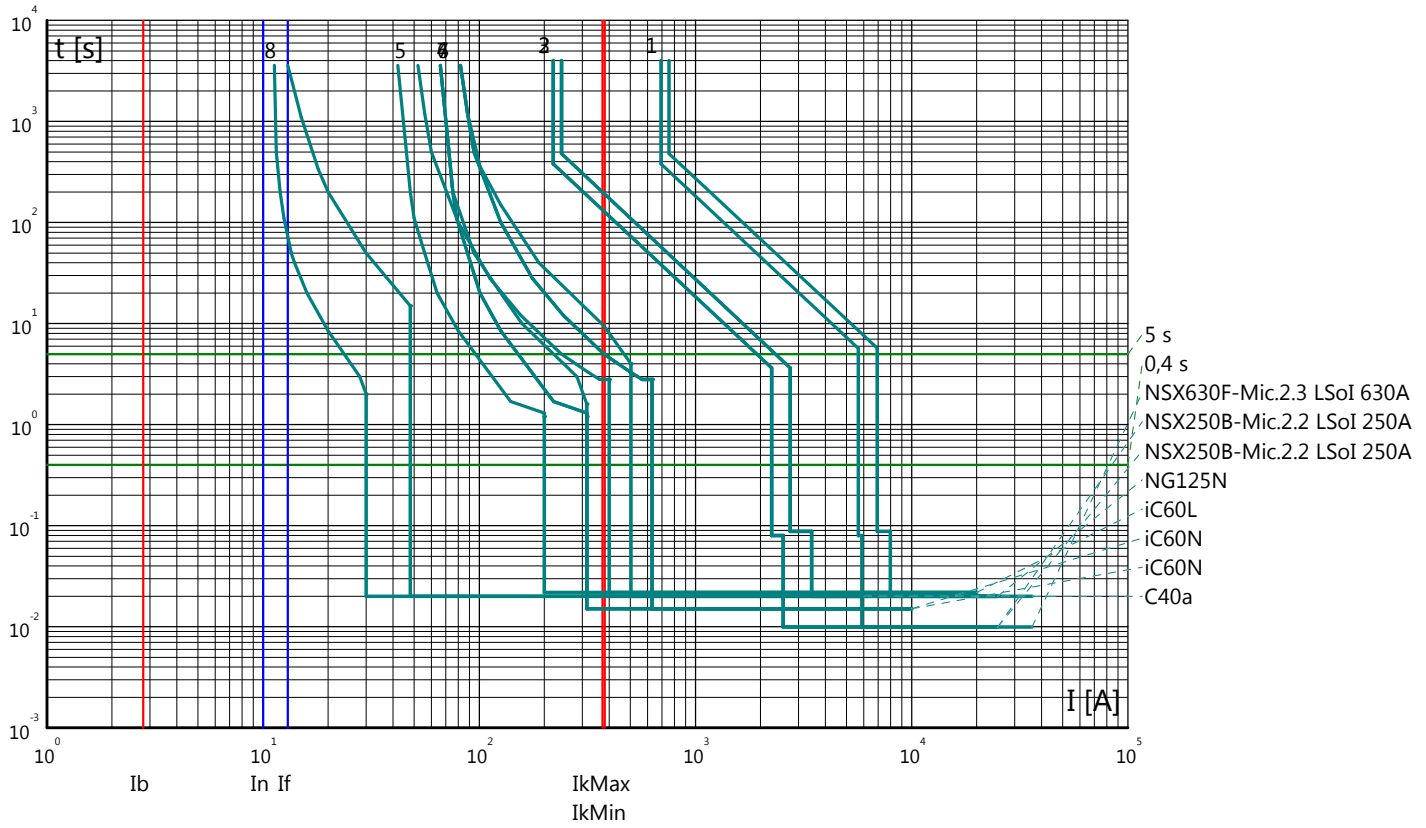

Partenza: PT/N

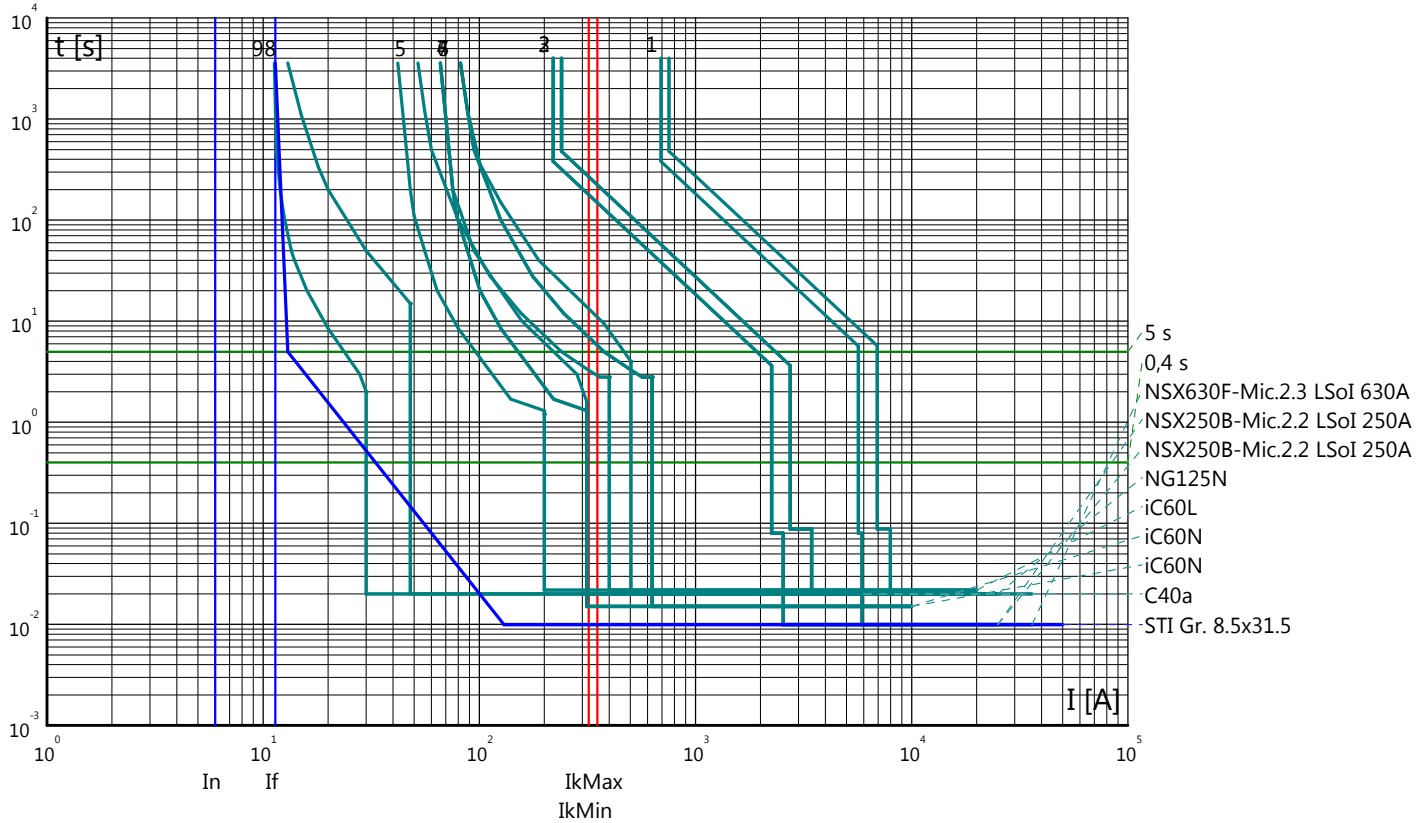

Curve tempo corrente: GALLERIA MONTE AGLIO
 Quadro: QCE/S

Partenza: 1.5S.1

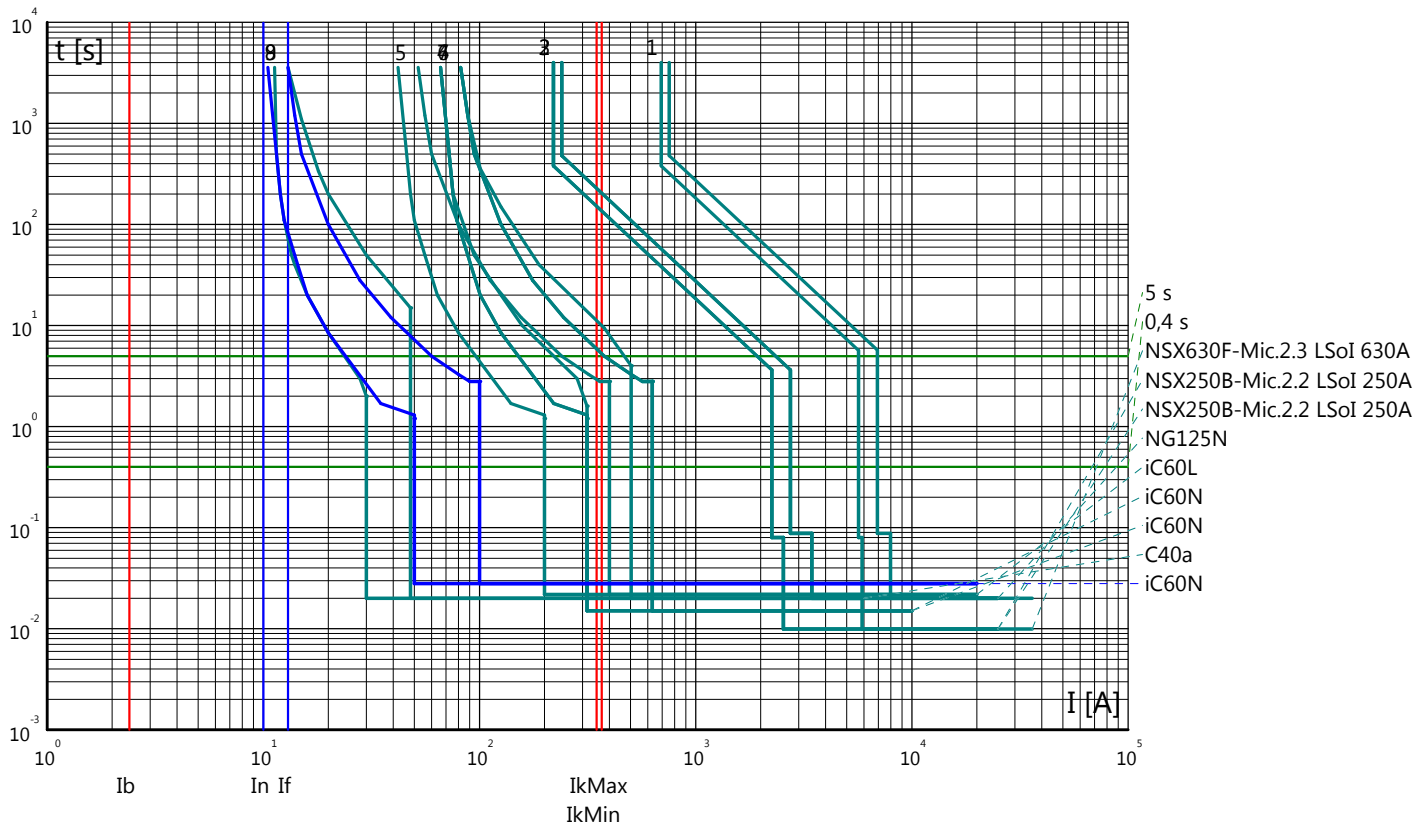

Partenza: 1.5S.2

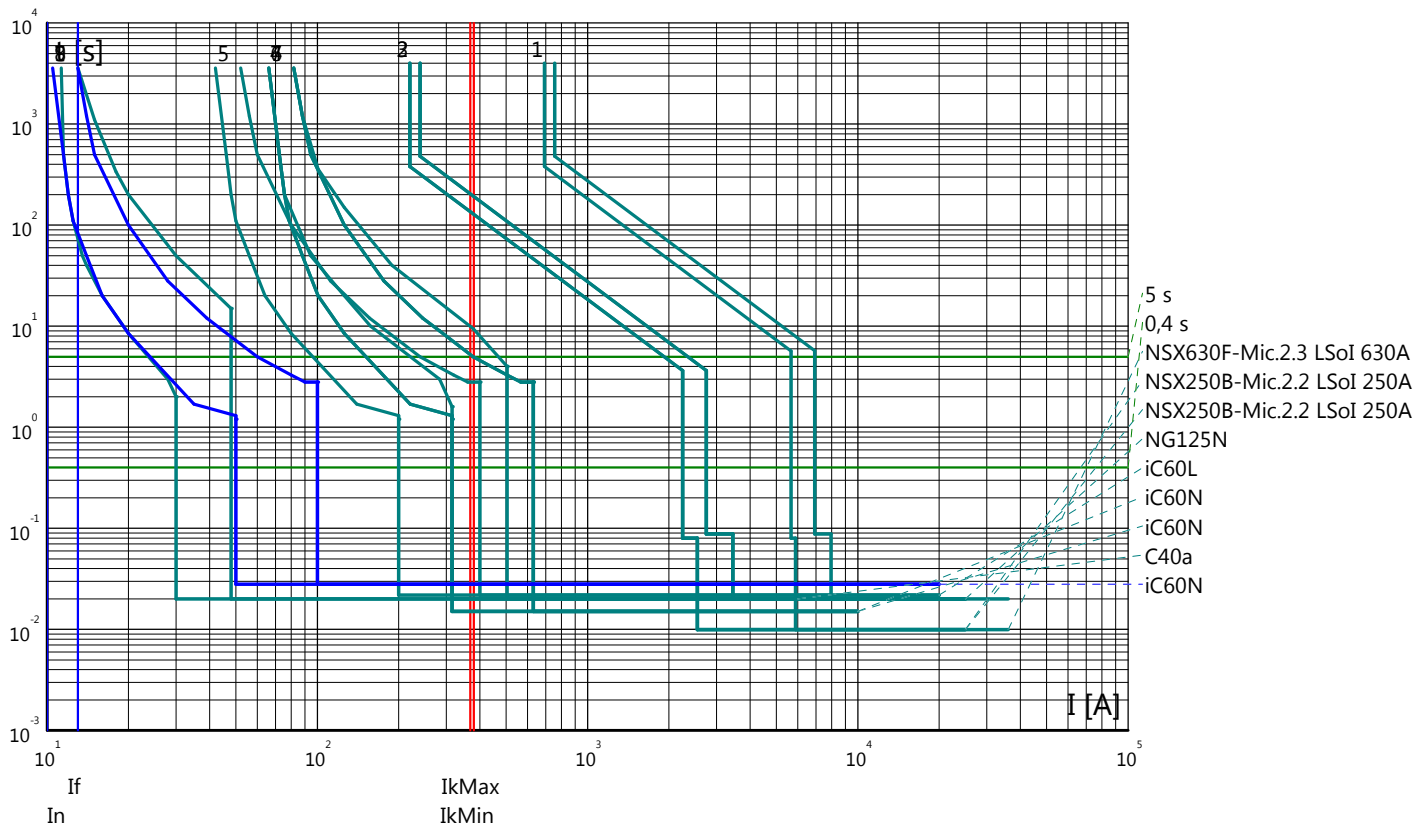

Curve tempo corrente: GALLERIA MONTE AGLIO
 Quadro: QCE/S

Partenza: 1.5S.3

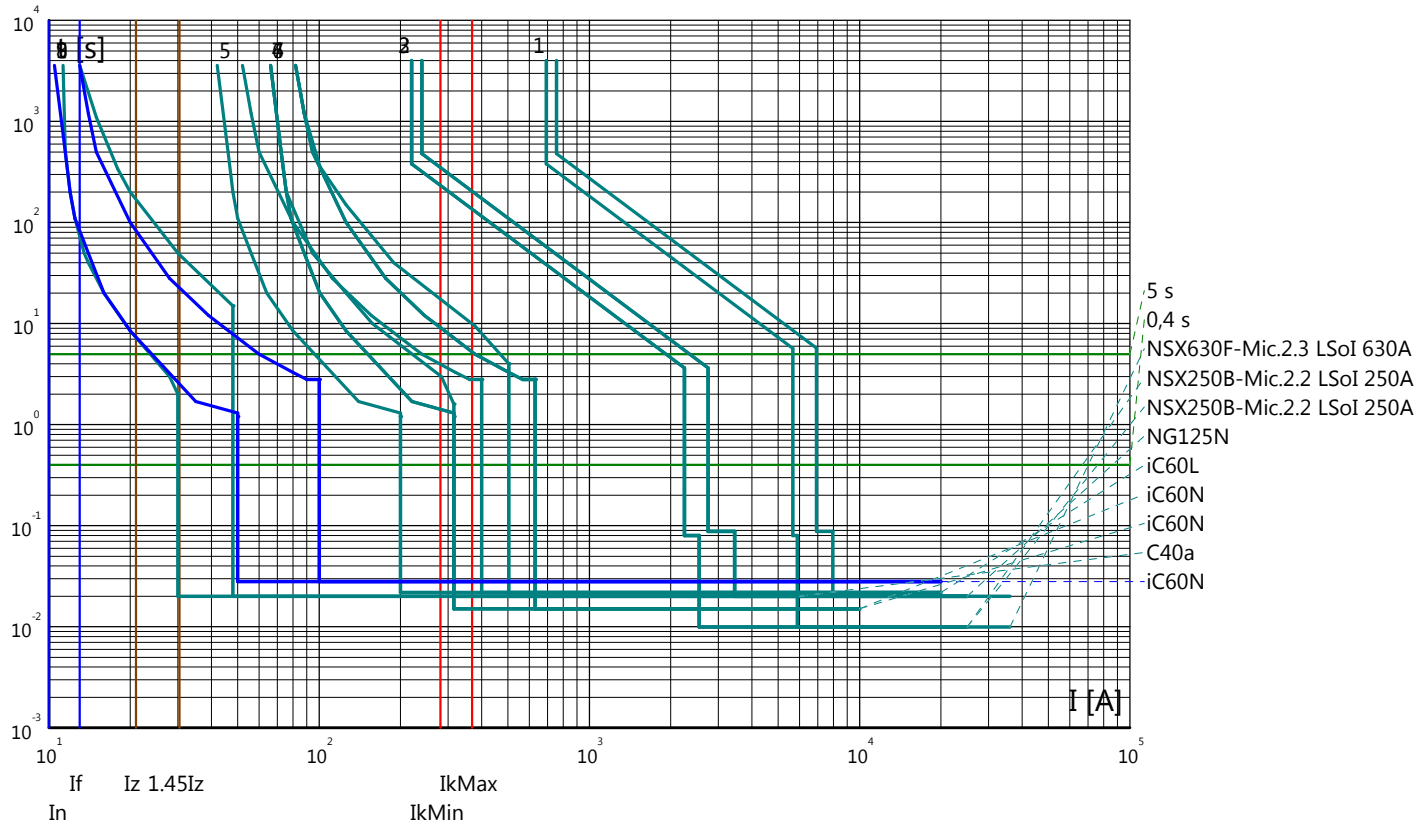

Curve tempo corrente: GALLERIA MONTE AGLIO
 Quadro: QUE1

Arrivo: IG

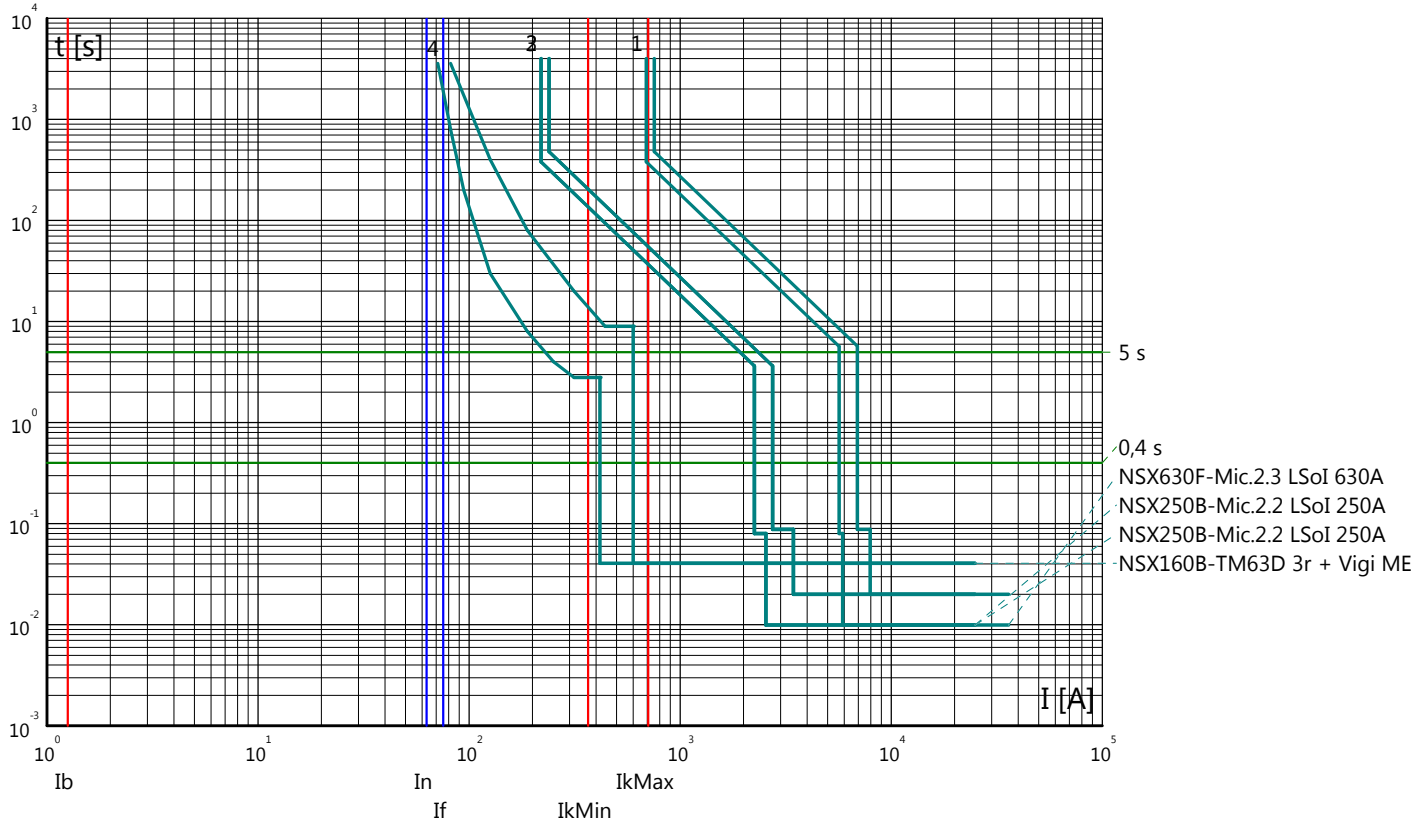

Partenza: PT/N

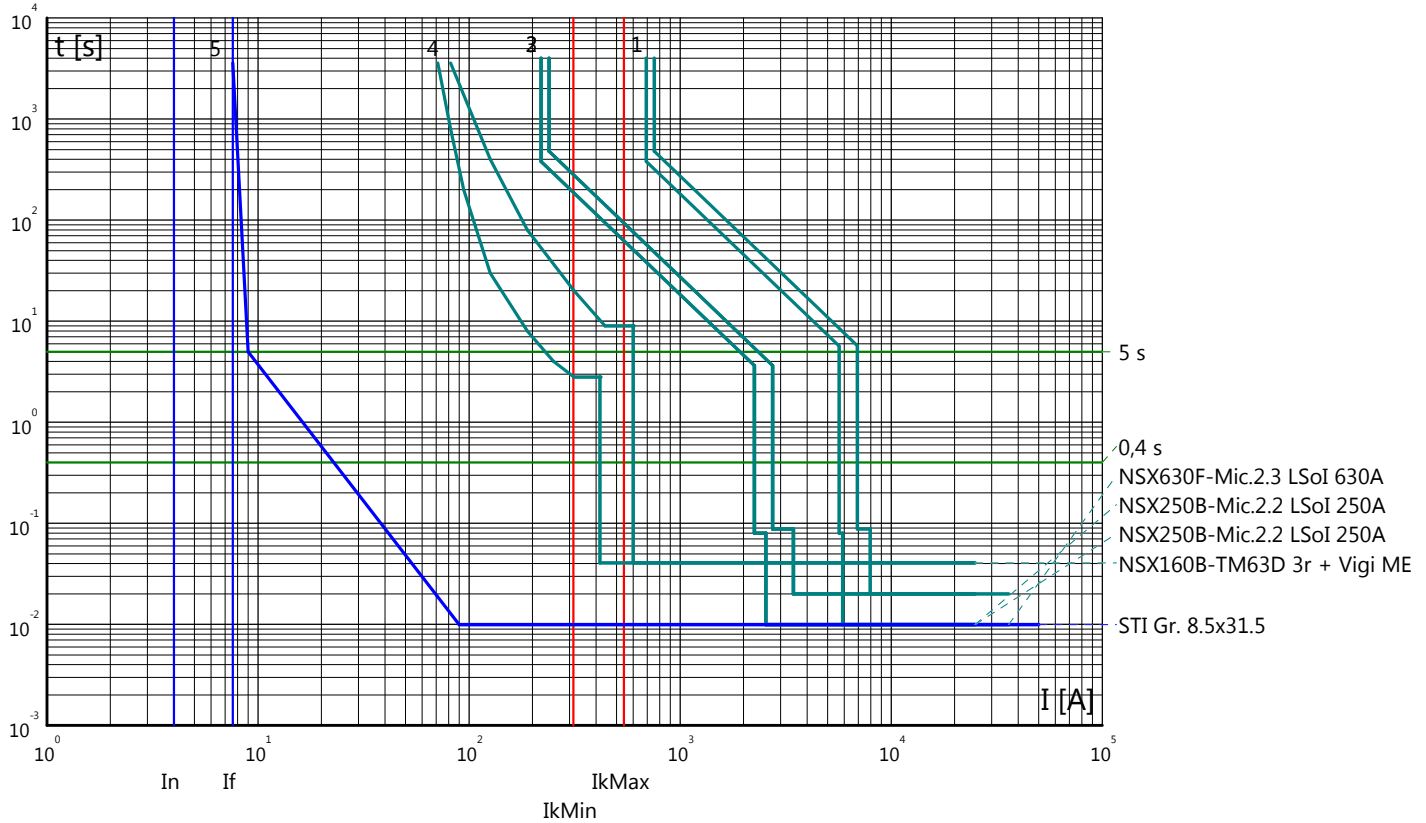

Curve tempo corrente: GALLERIA MONTE AGLIO
Quadro: QUE1

Partenza: SPD

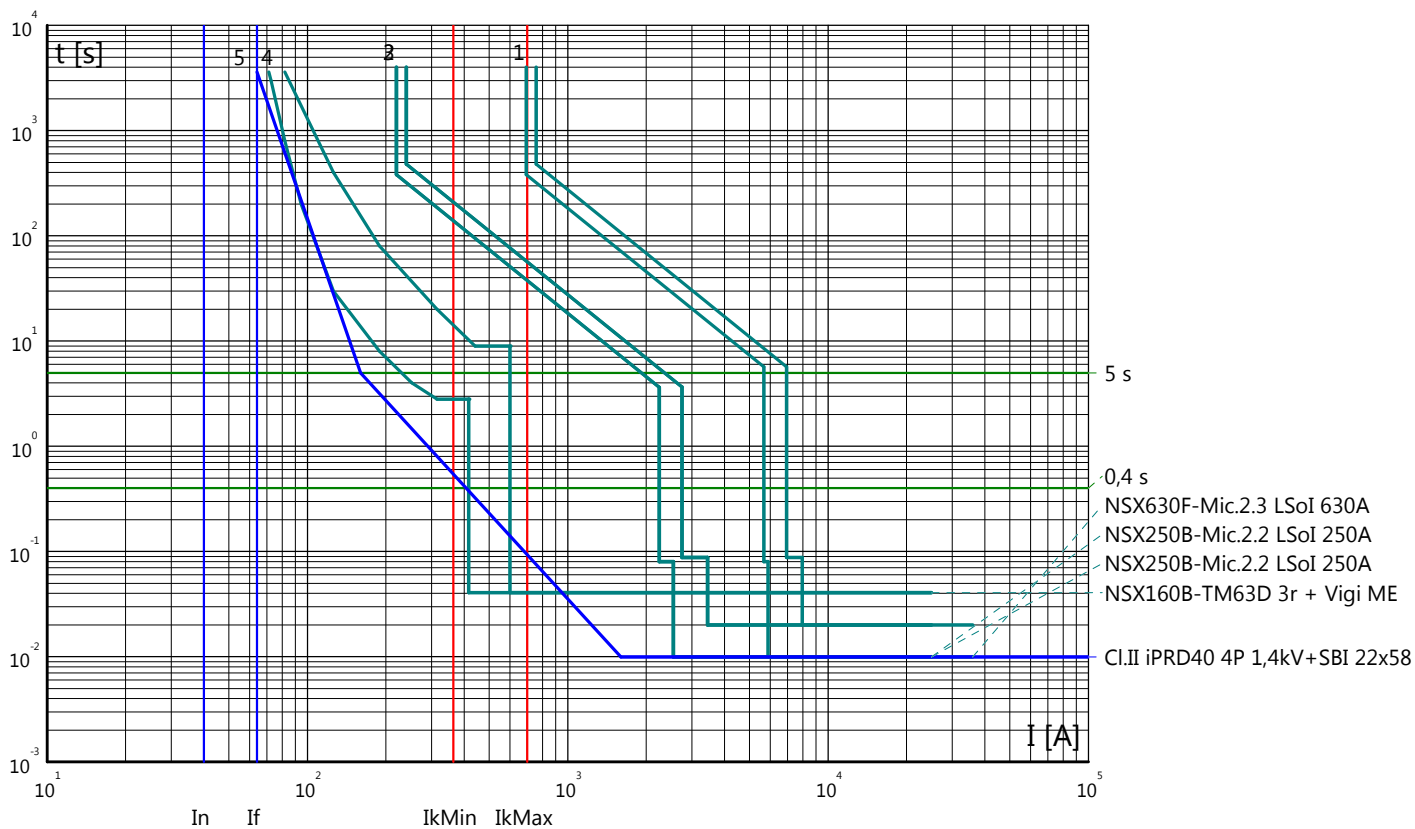

Partenza: MIS/N

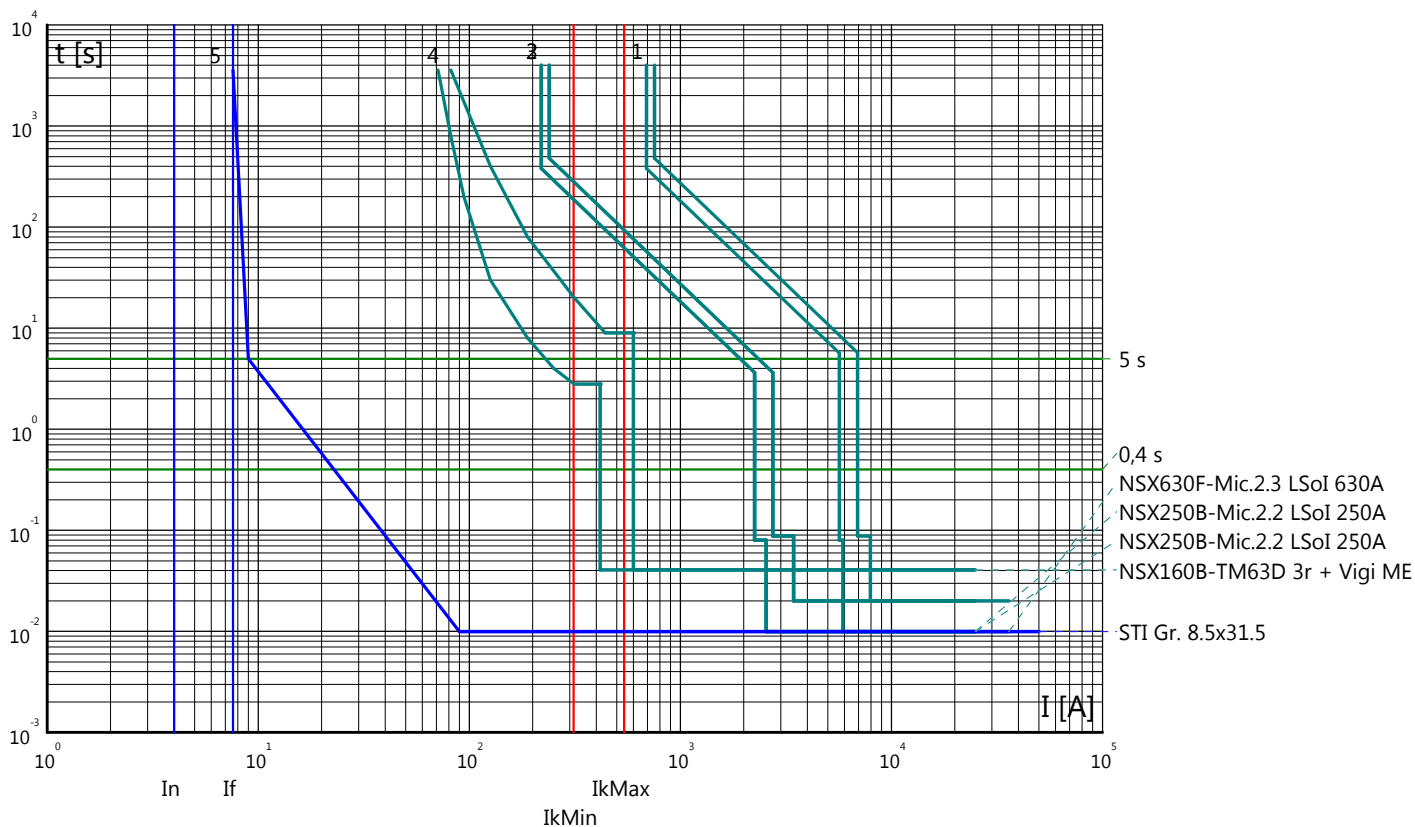

Curve tempo corrente: GALLERIA MONTE AGLIO
 Quadro: QUE1

Partenza: UE1.1

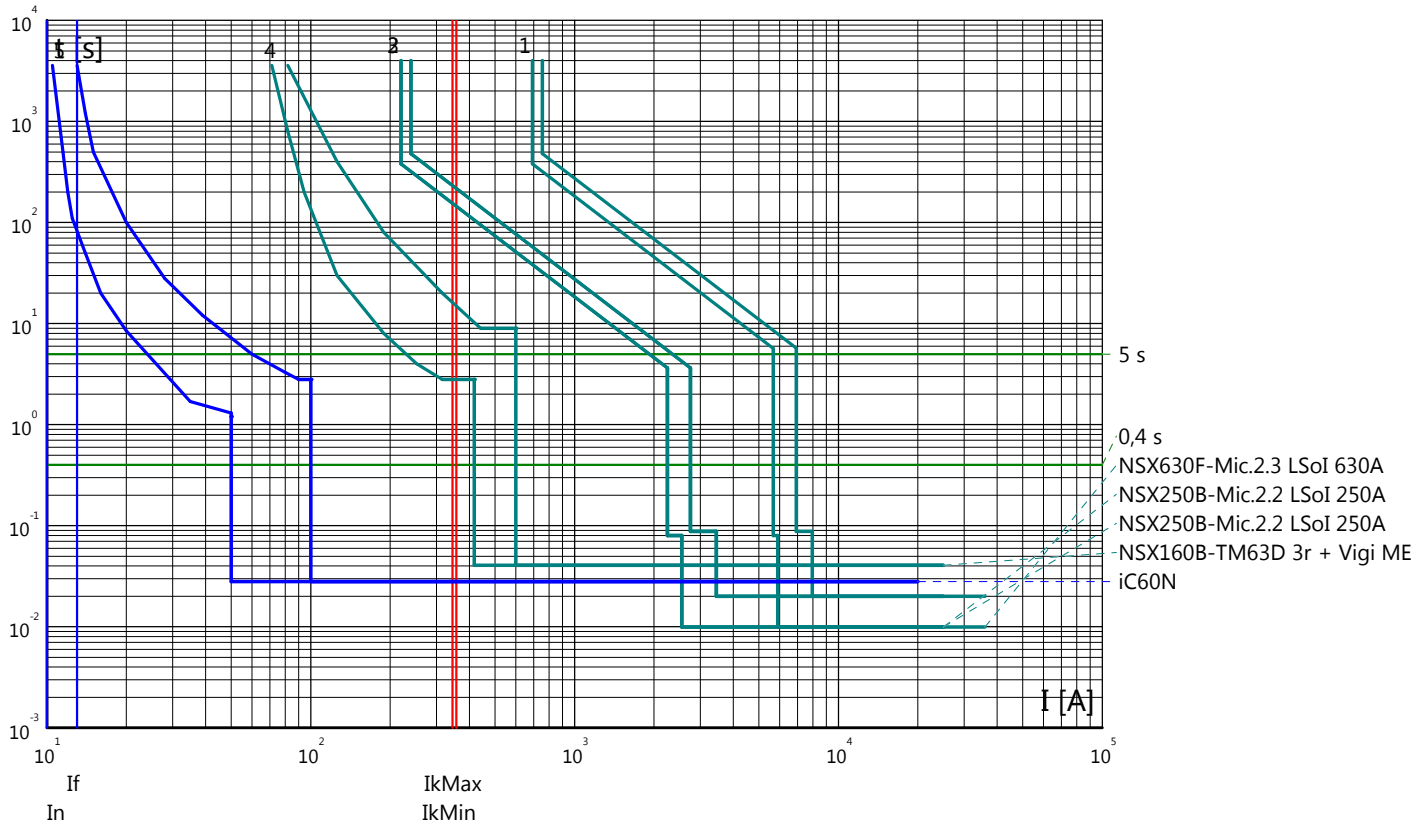

Partenza: UE1.2

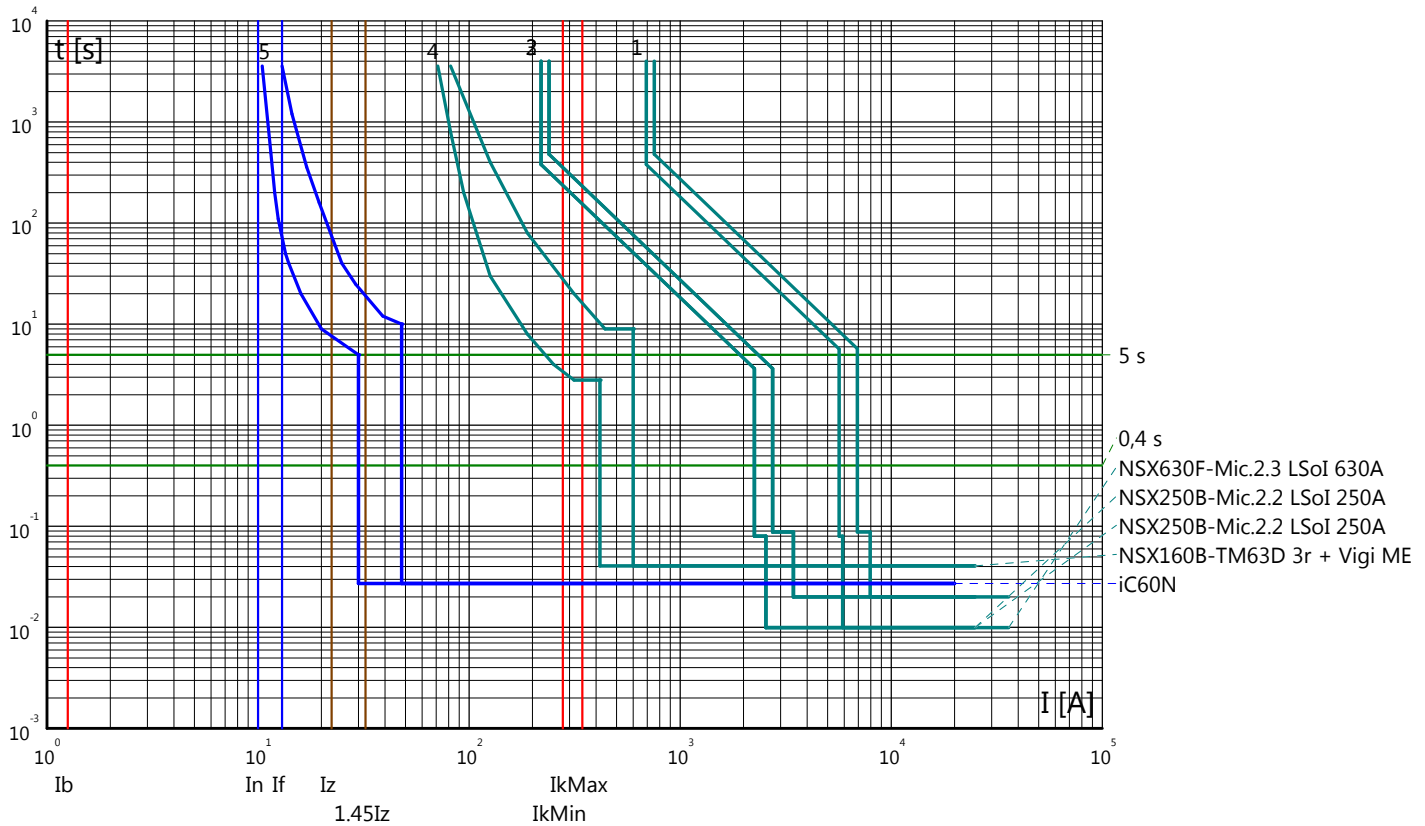

Curve tempo corrente: GALLERIA MONTE AGLIO
 Quadro: QUE1

Partenza: UE1.3

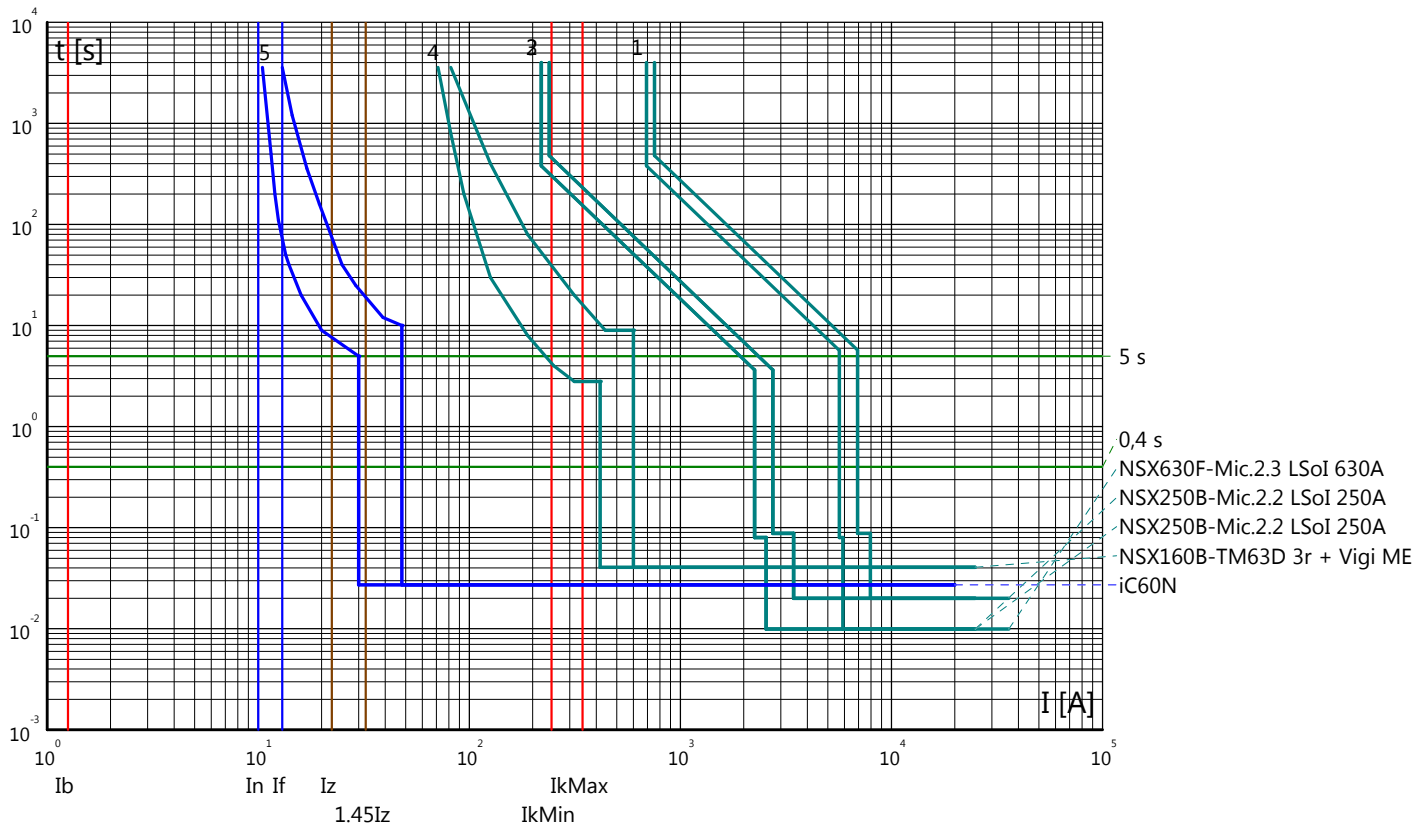

Partenza: UE1.4

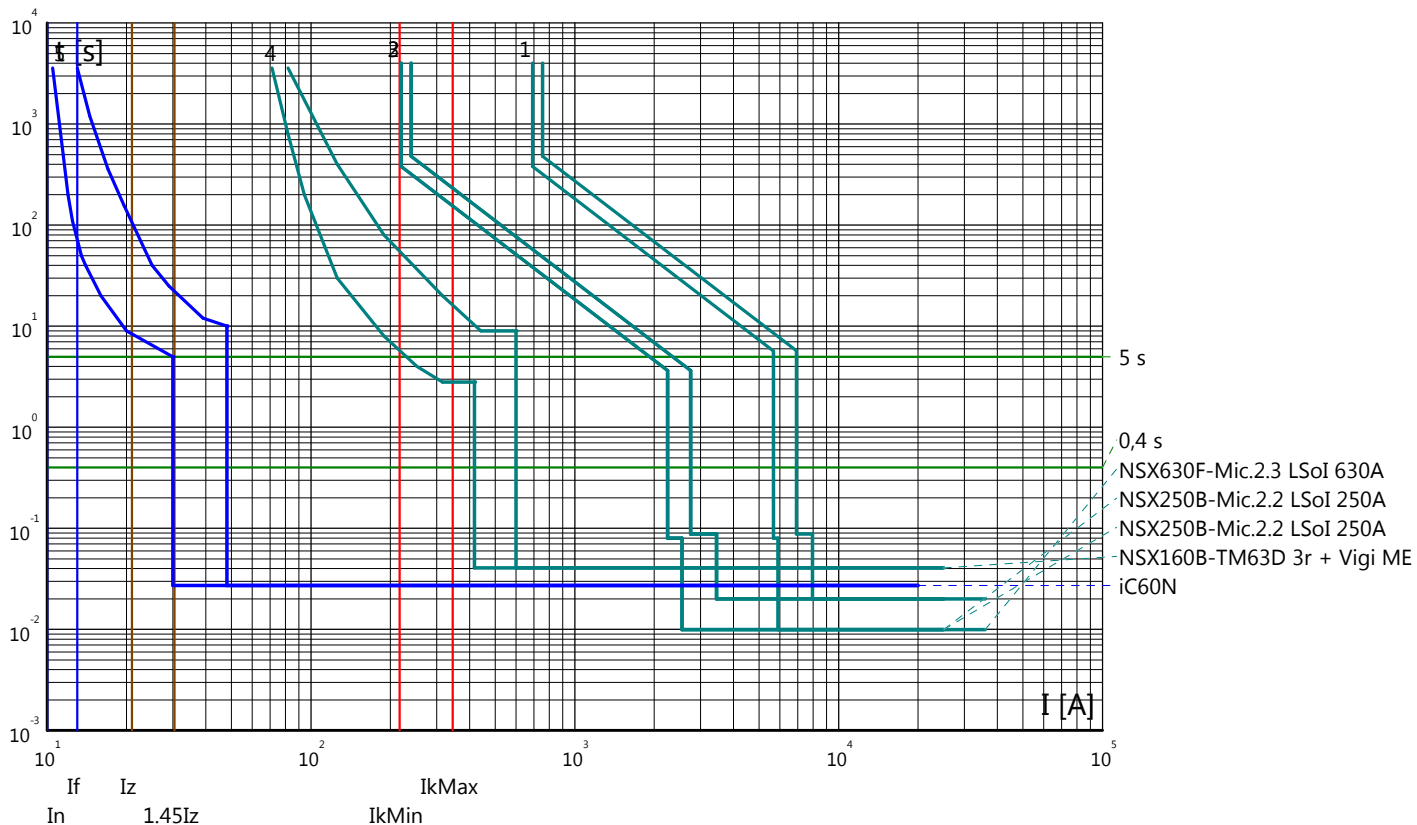

Curve tempo corrente: GALLERIA MONTE AGLIO
 Quadro: QUE1

Partenza: UE1.5

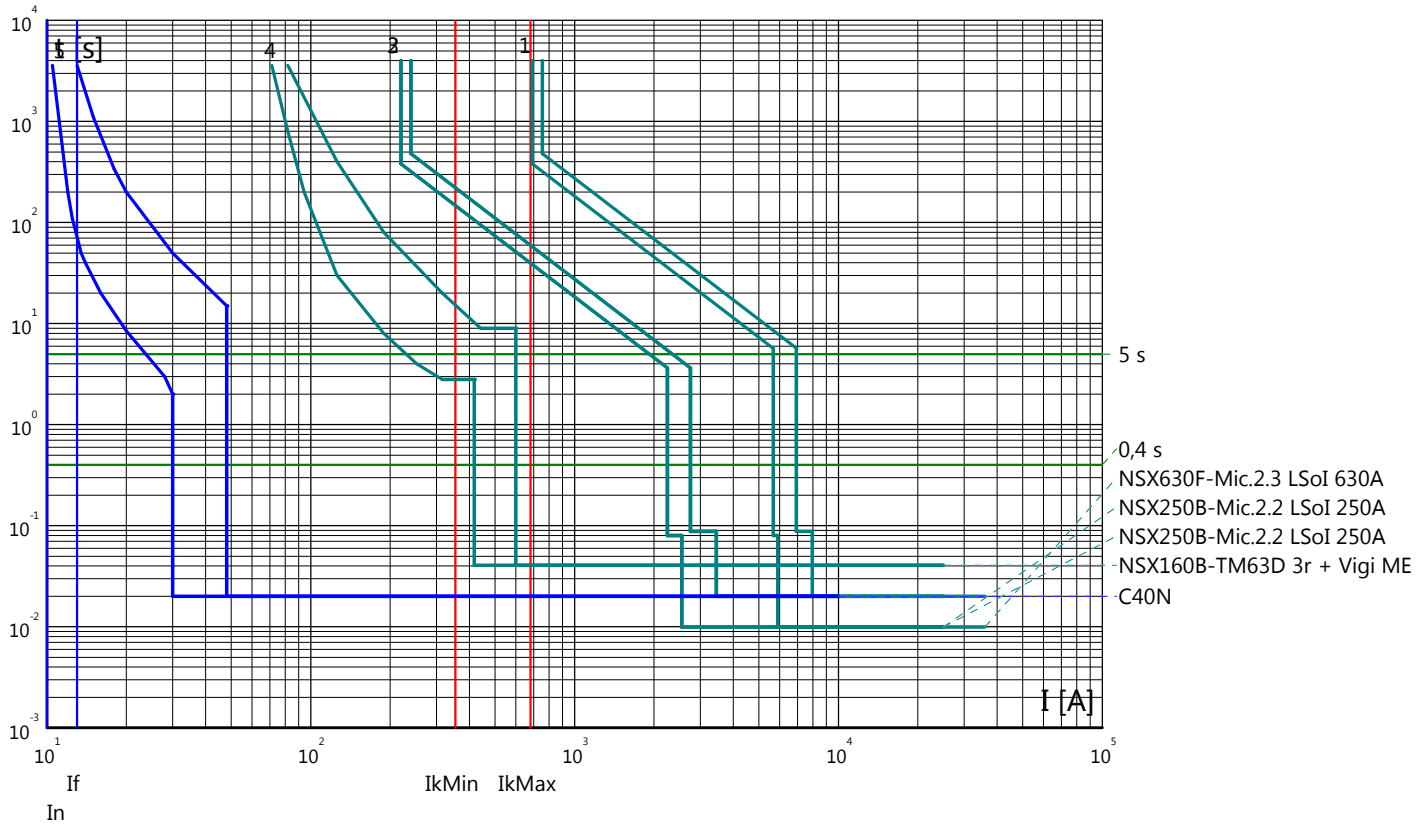

Curve tempo corrente: GALLERIA MONTE AGLIO
 Quadro: QUE2

Arrivo: IG

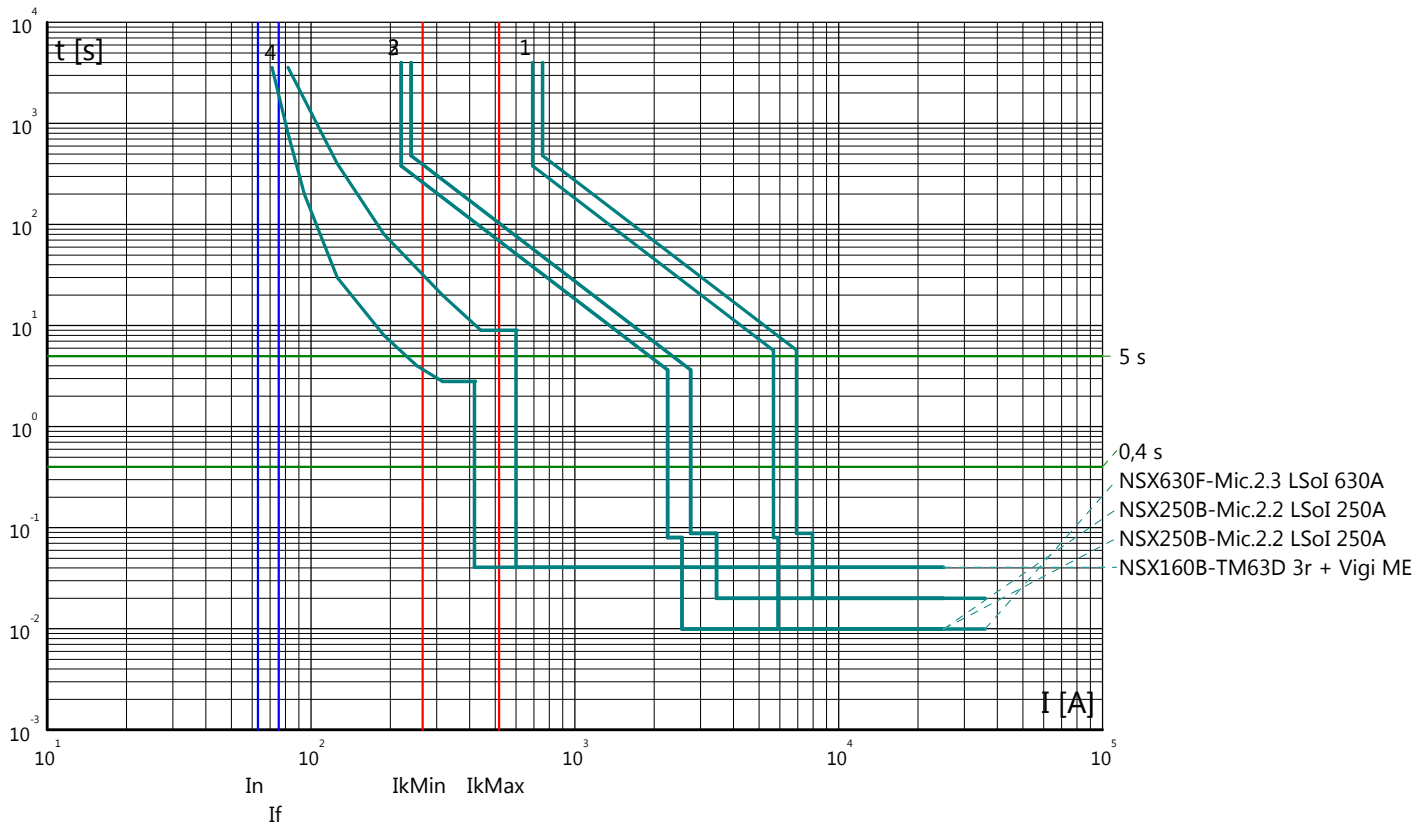

Partenza: PT/N

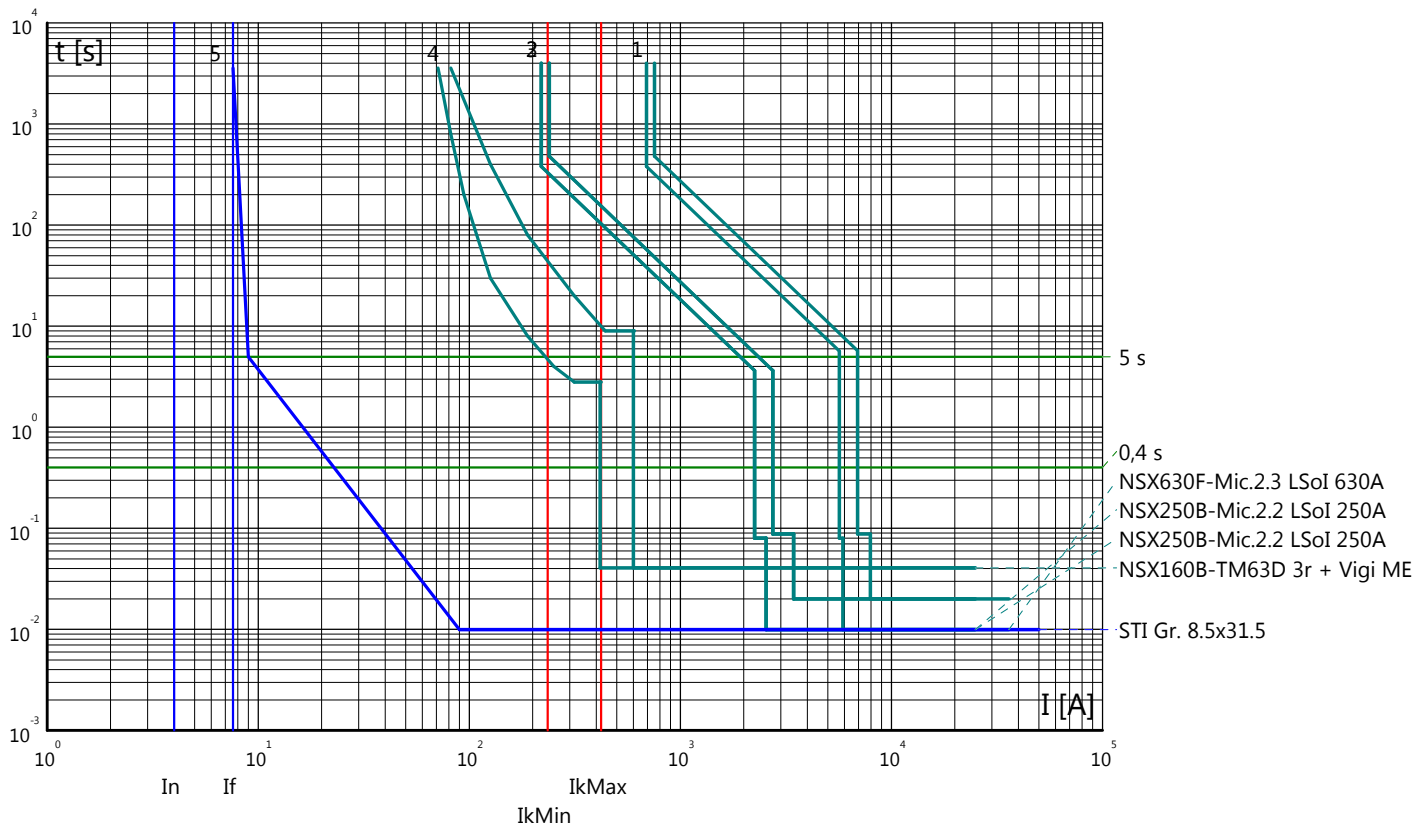

Curve tempo corrente: GALLERIA MONTE AGLIO
 Quadro: QUE2

Partenza: SPD

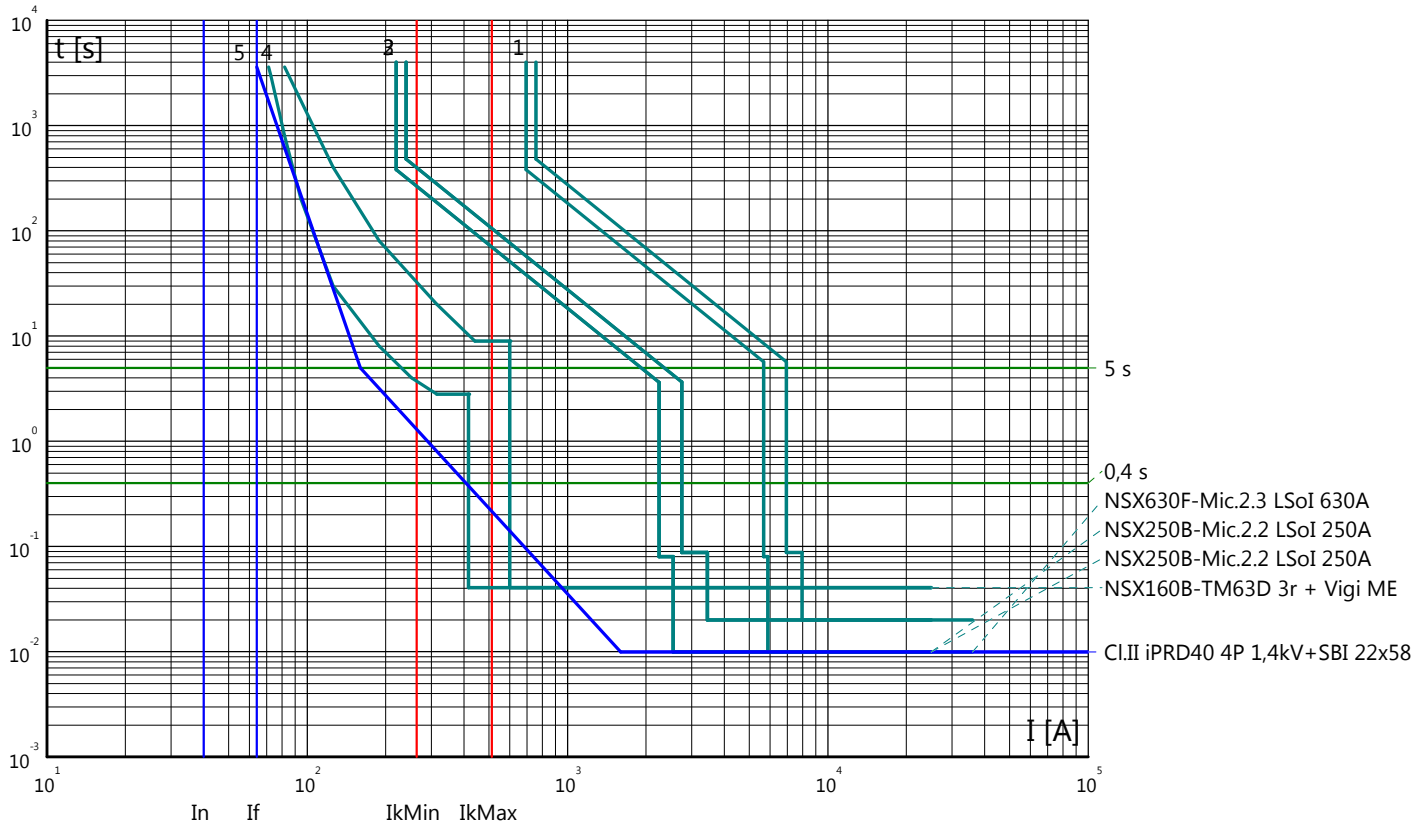

Partenza: MIS/N

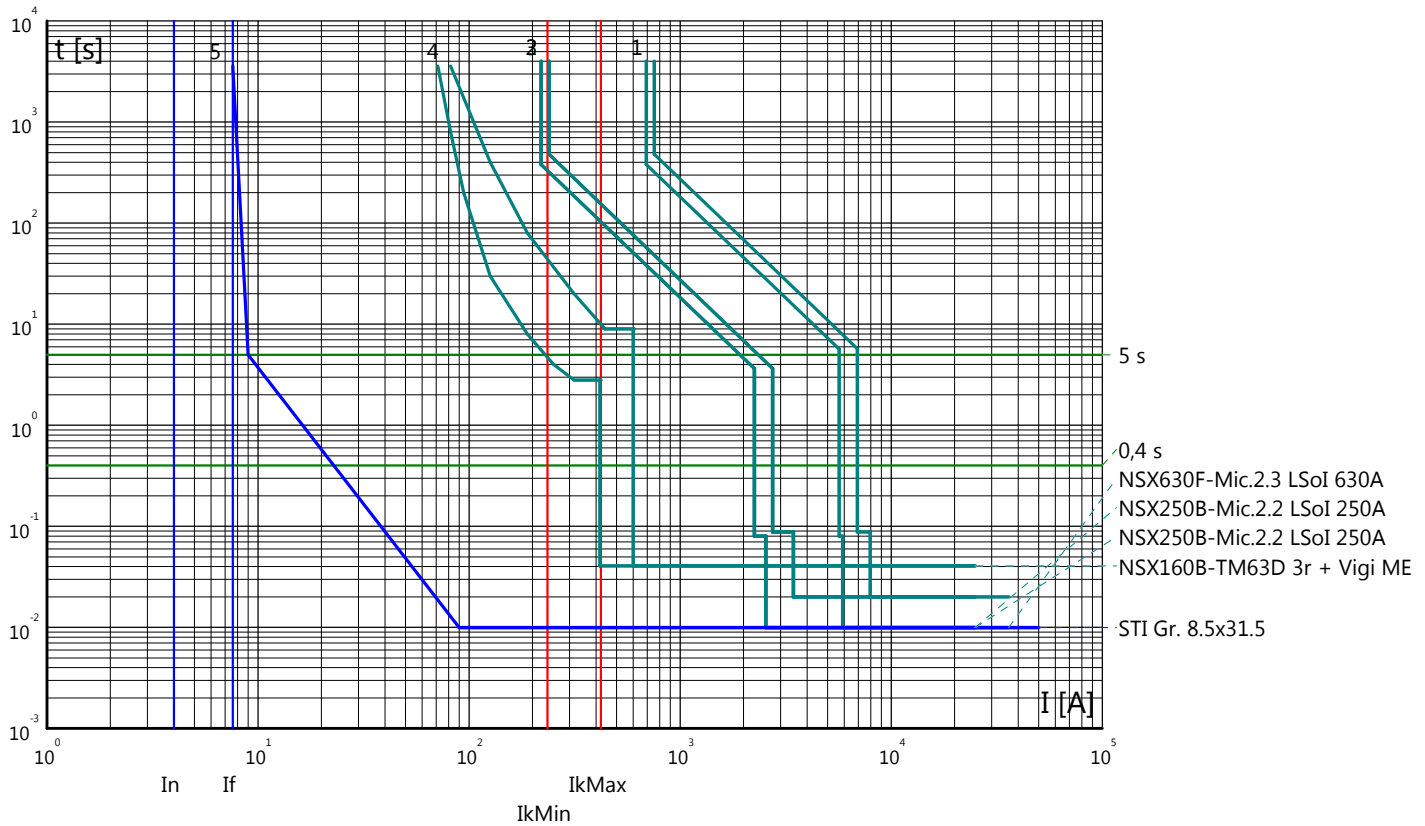

Curve tempo corrente: GALLERIA MONTE AGLIO
Quadro: QUE2

Partenza: UE2.1

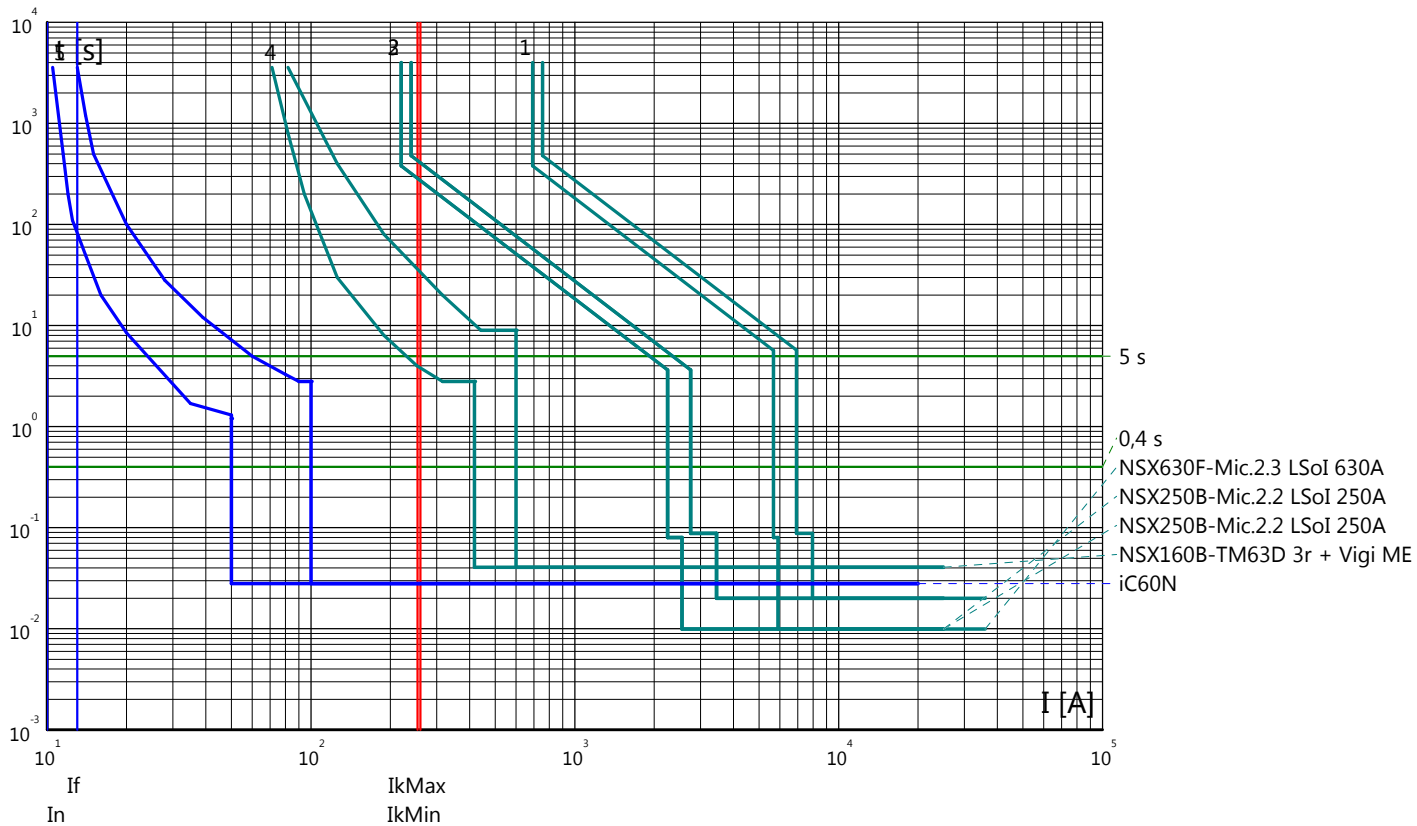

Partenza: UE2.2

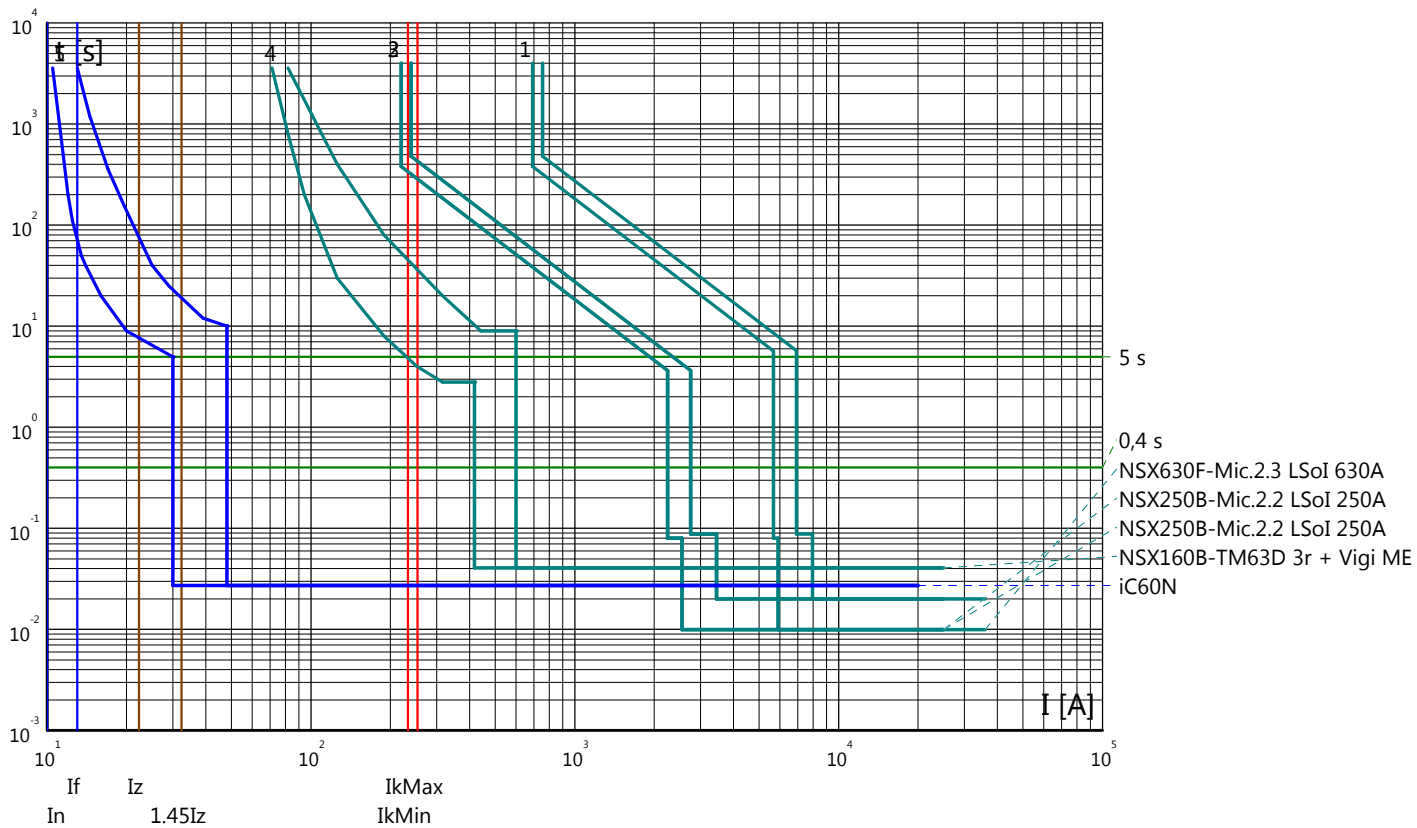

Curve tempo corrente: GALLERIA MONTE AGLIO
 Quadro: QUE2

Partenza: UE2.3

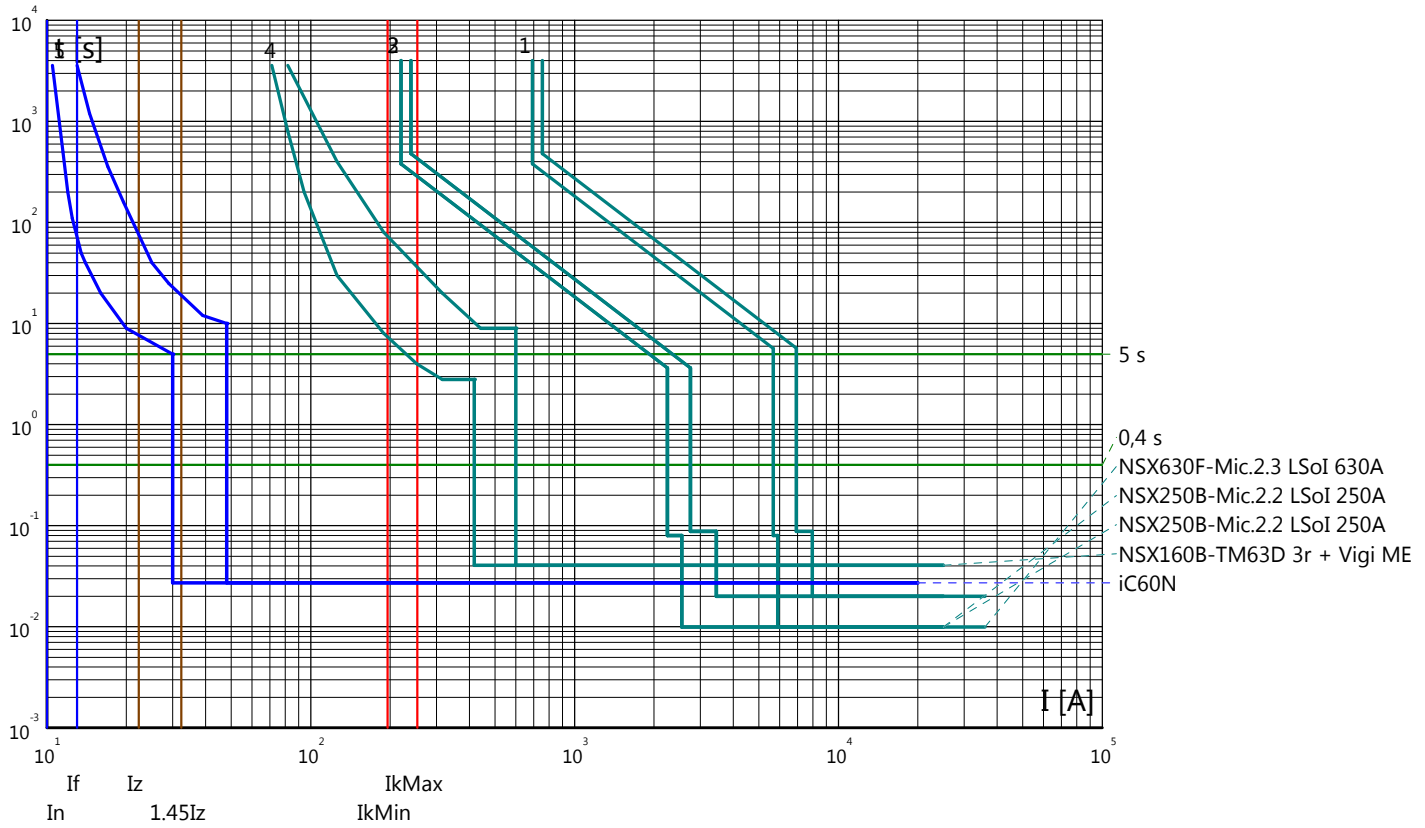

Partenza: UE2.4

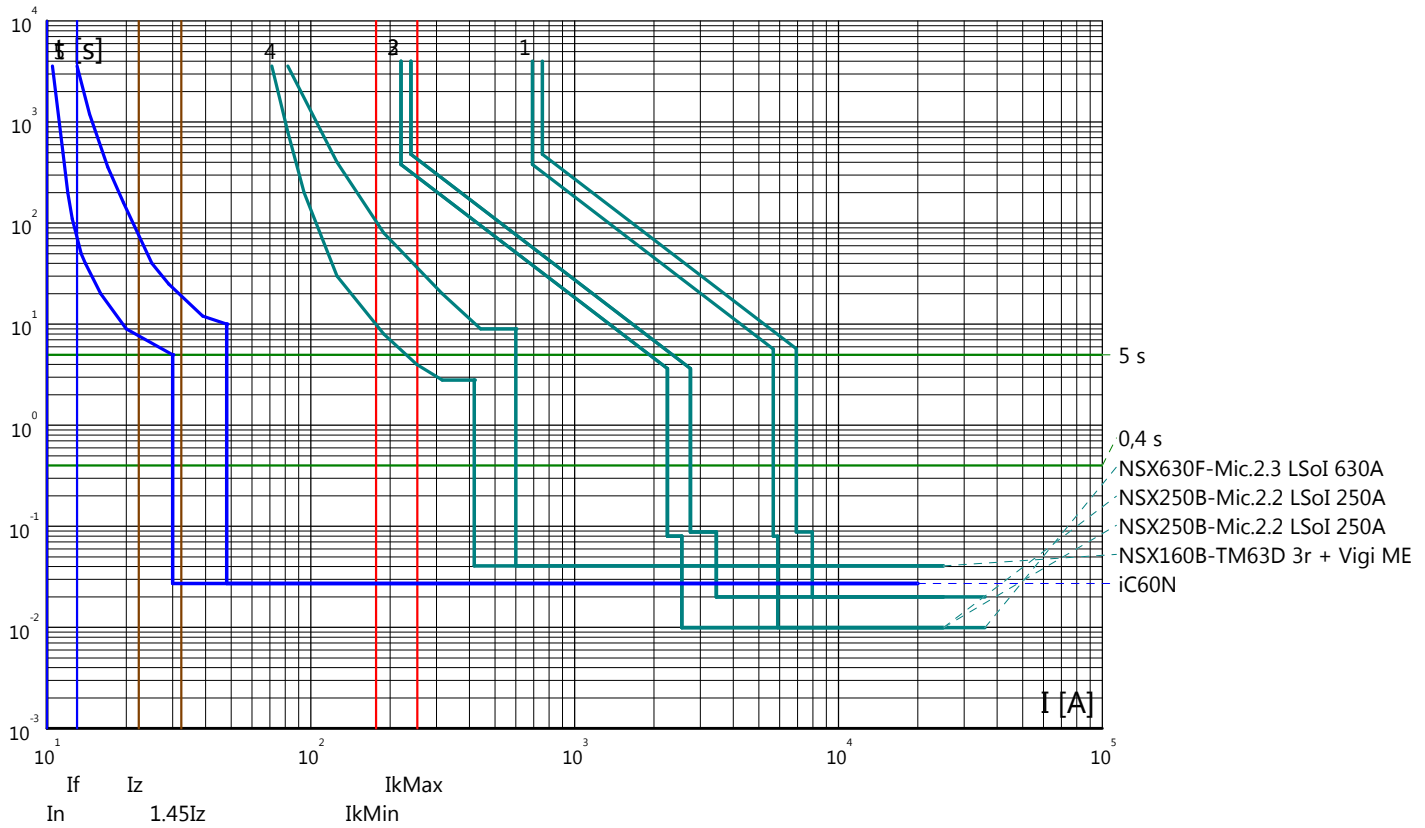

Curve tempo corrente: GALLERIA MONTE AGLIO
 Quadro: QUE2

Partenza: UE2.5

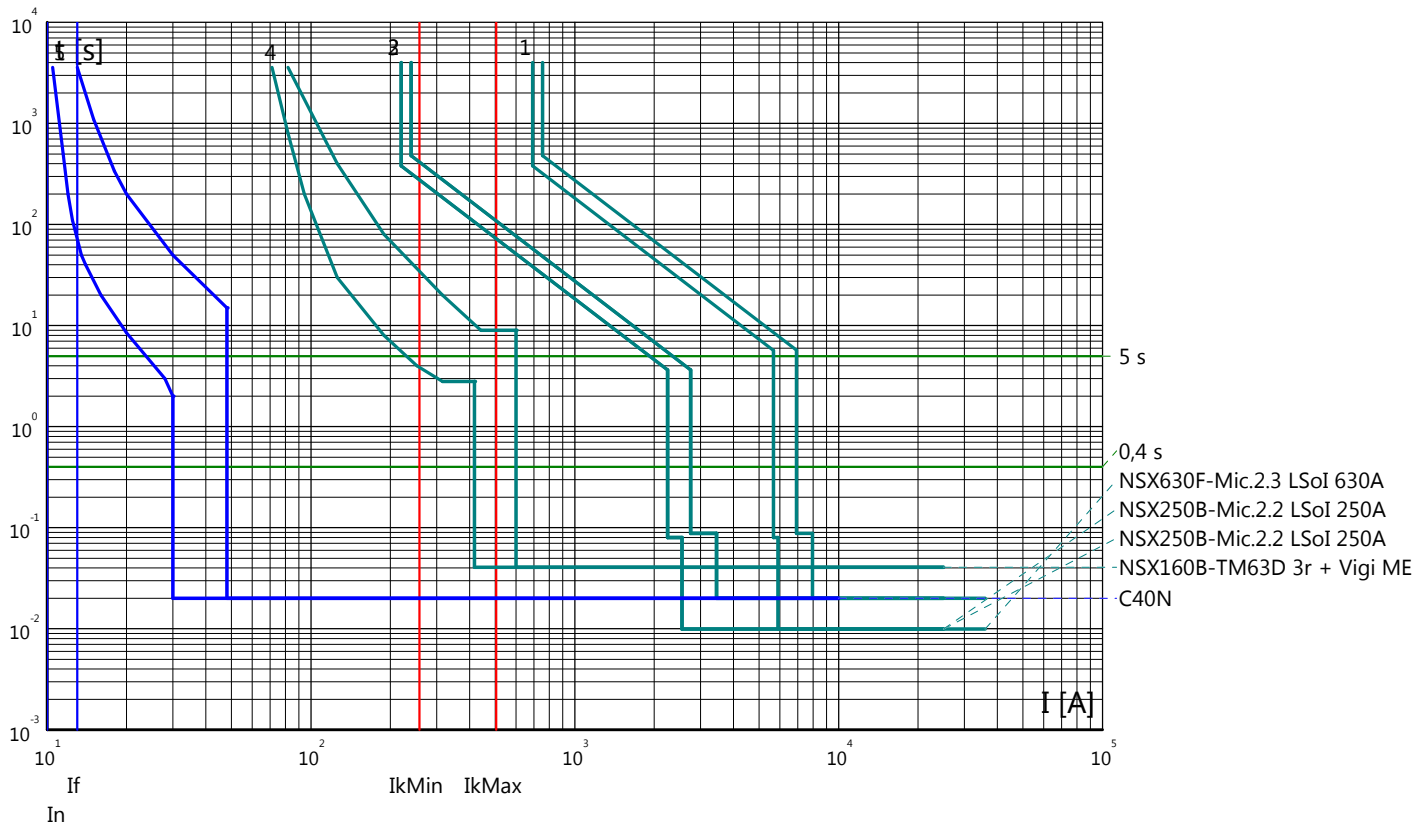

Curve tempo corrente: GALLERIA MONTE AGLIO
 Quadro: QSTES/S

Arrivo: IG

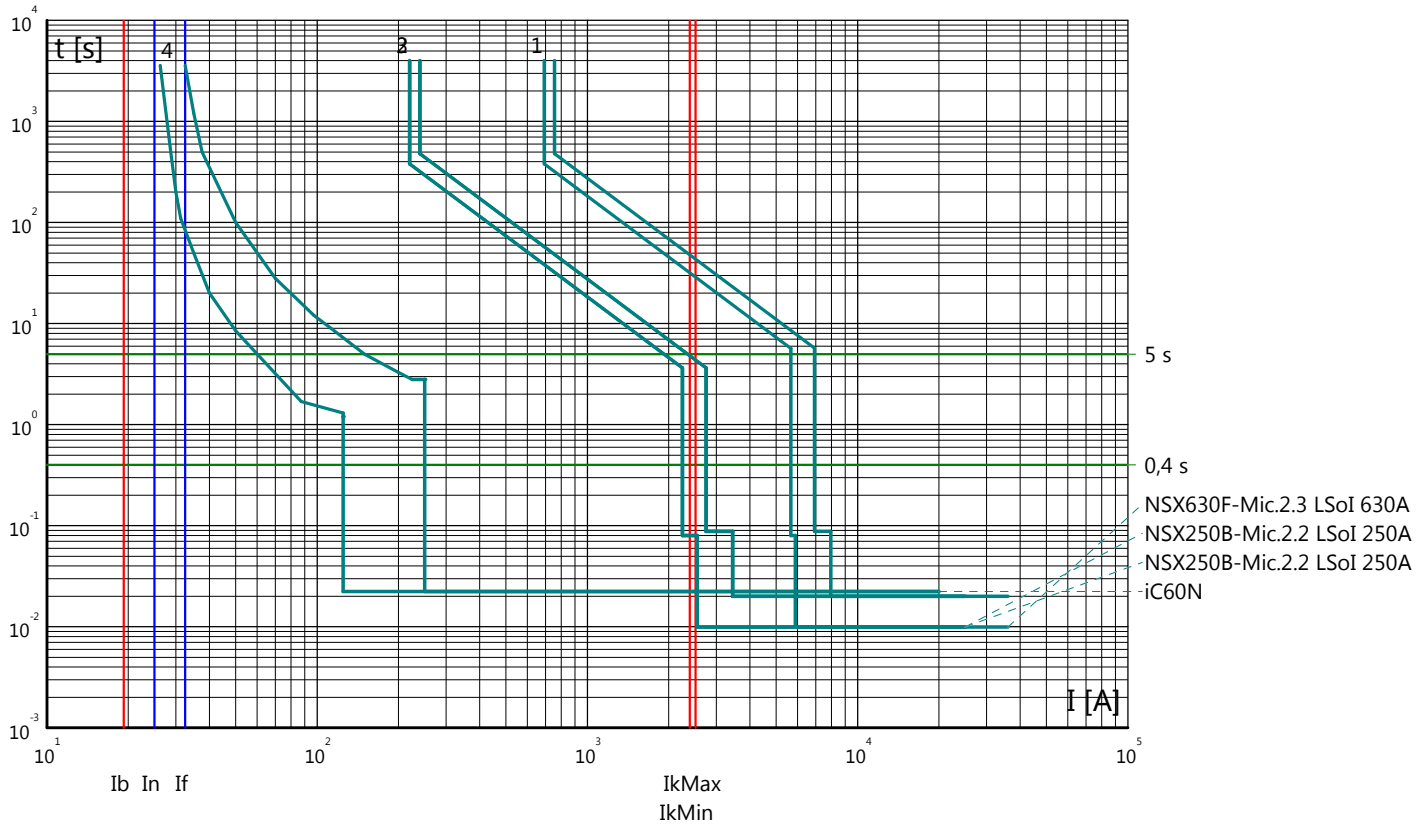

Partenza: PT/I

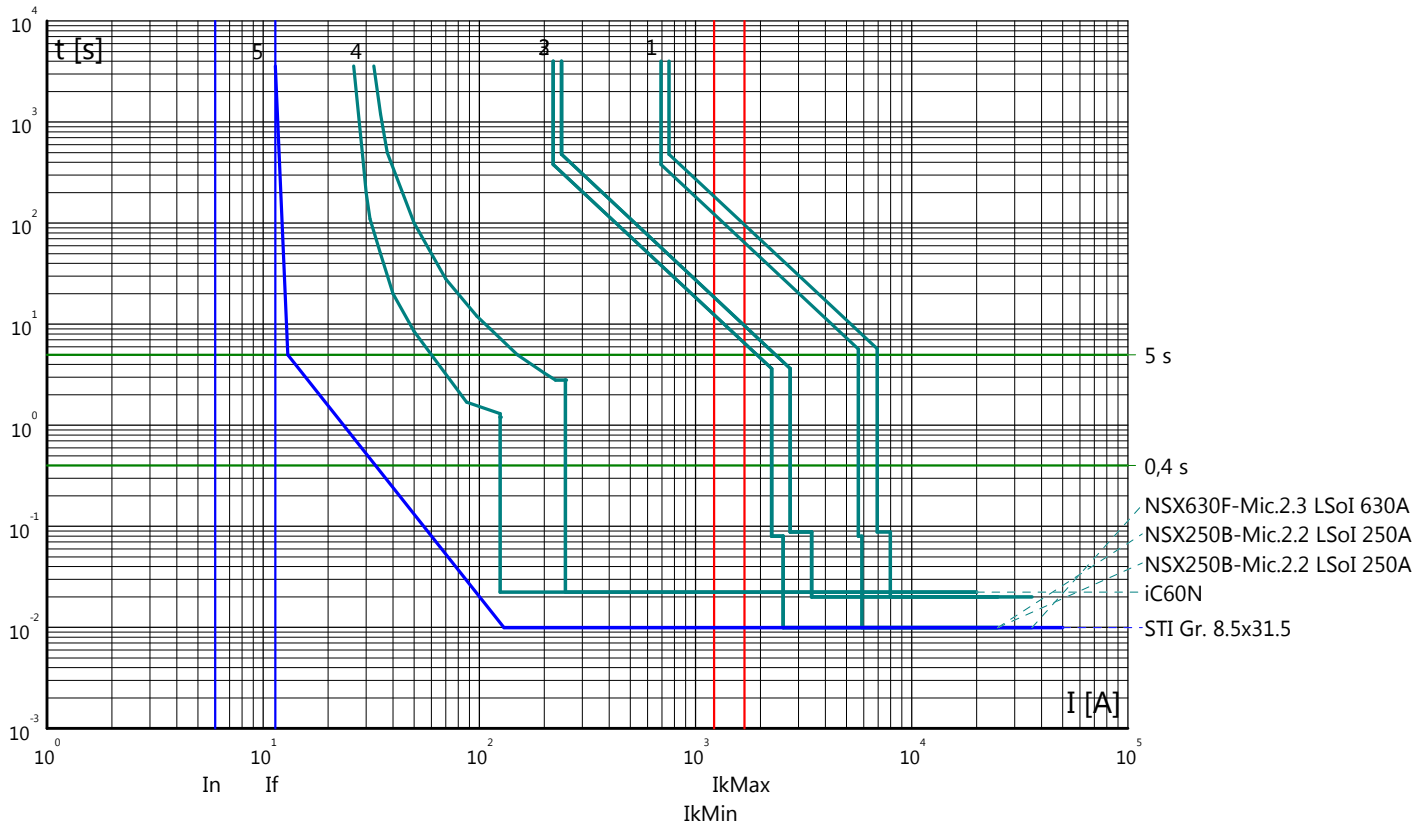

Curve tempo corrente: GALLERIA MONTE AGLIO
 Quadro: QSTES/S

Partenza: PT/U

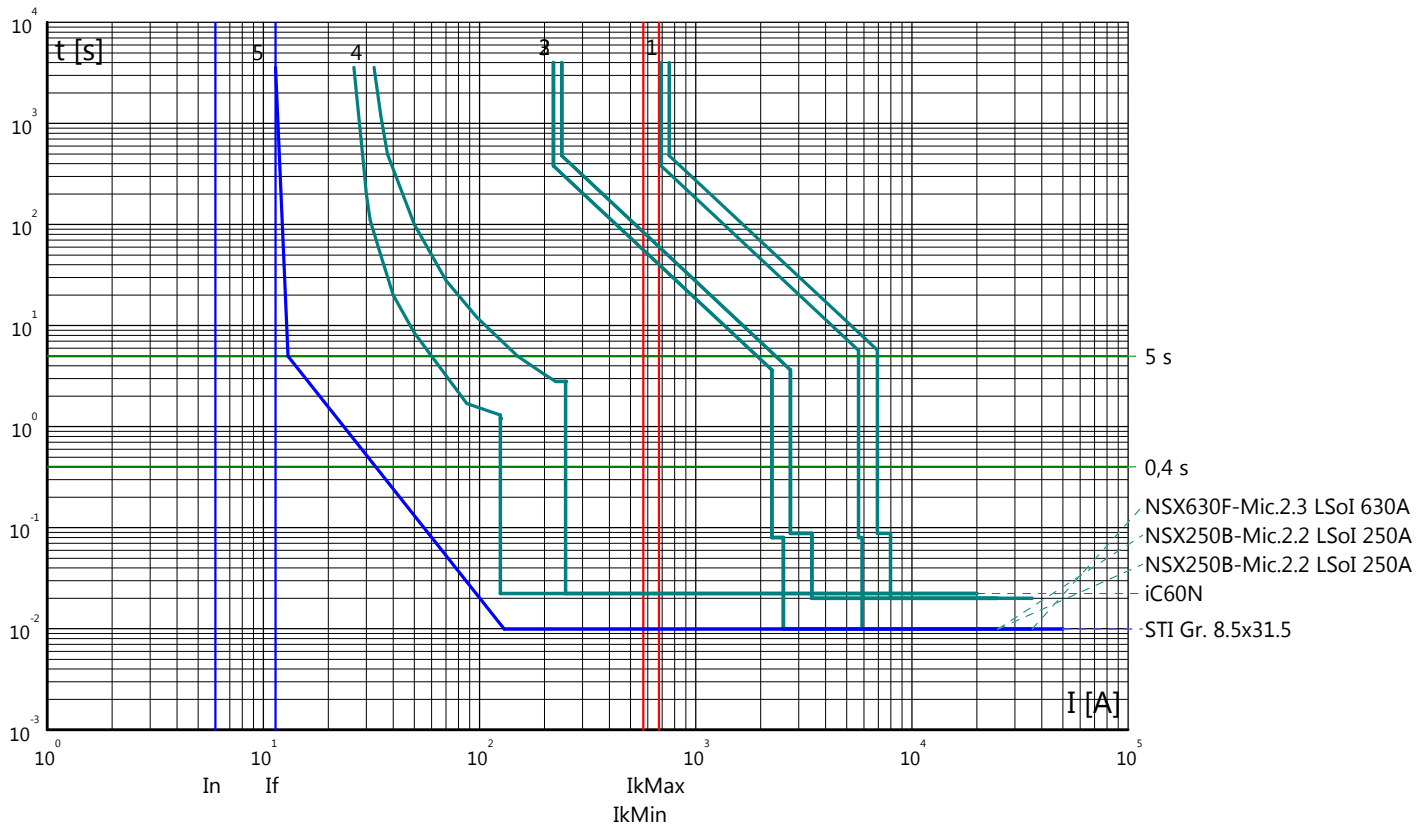

Partenza: STES1

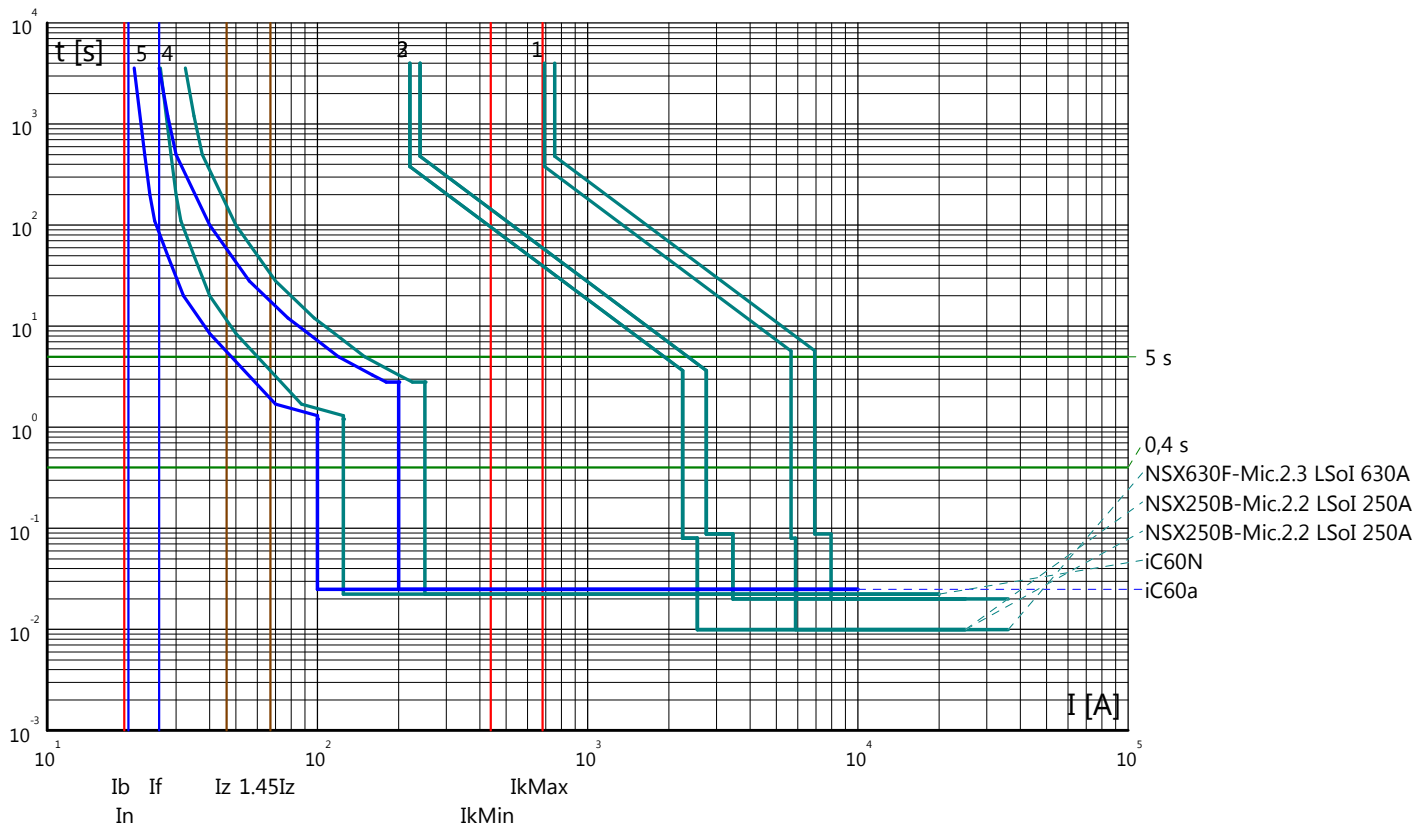

Curve tempo corrente: GALLERIA MONTE AGLIO
 Quadro: QPLC/S

Arrivo: IG

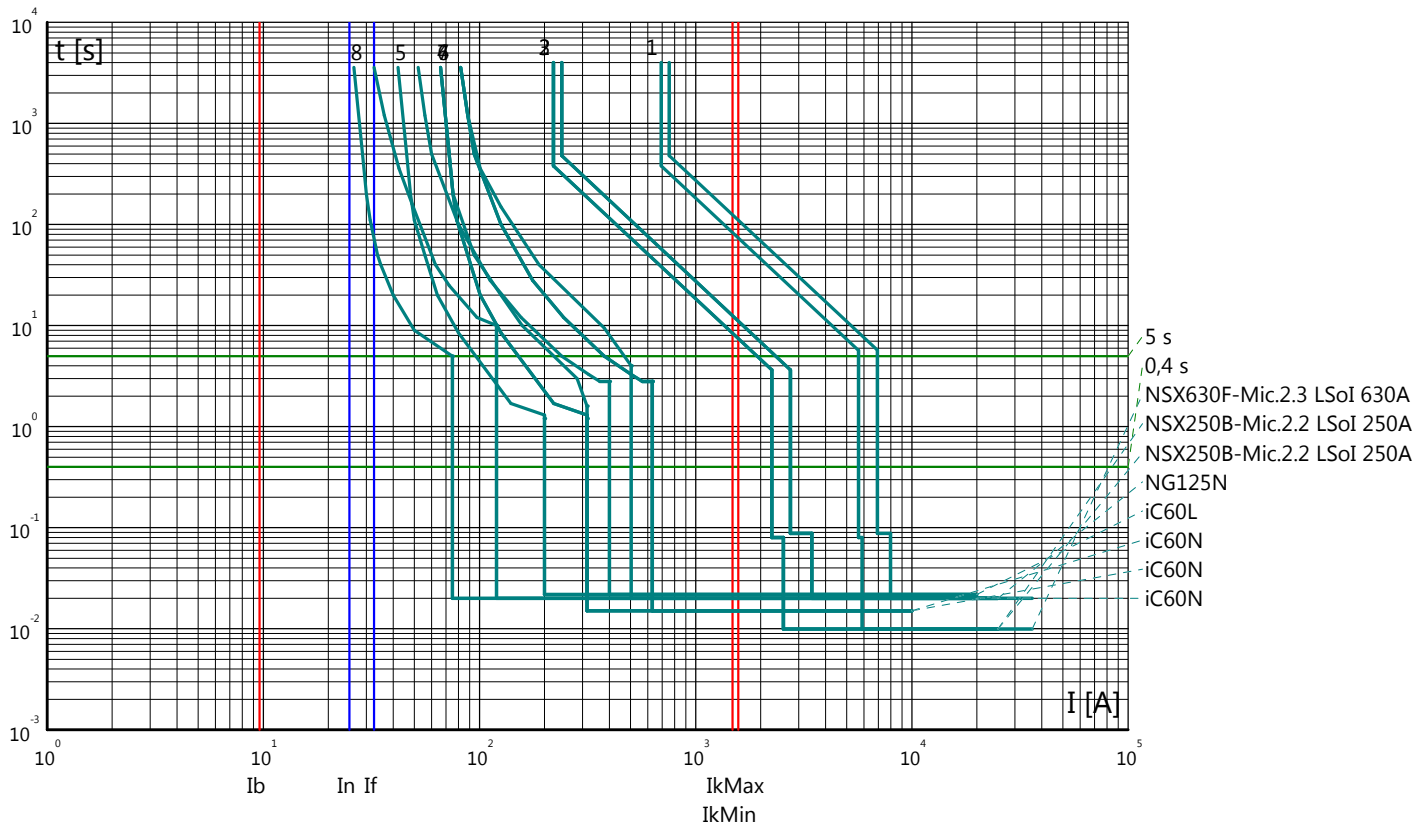

Partenza: PT/I

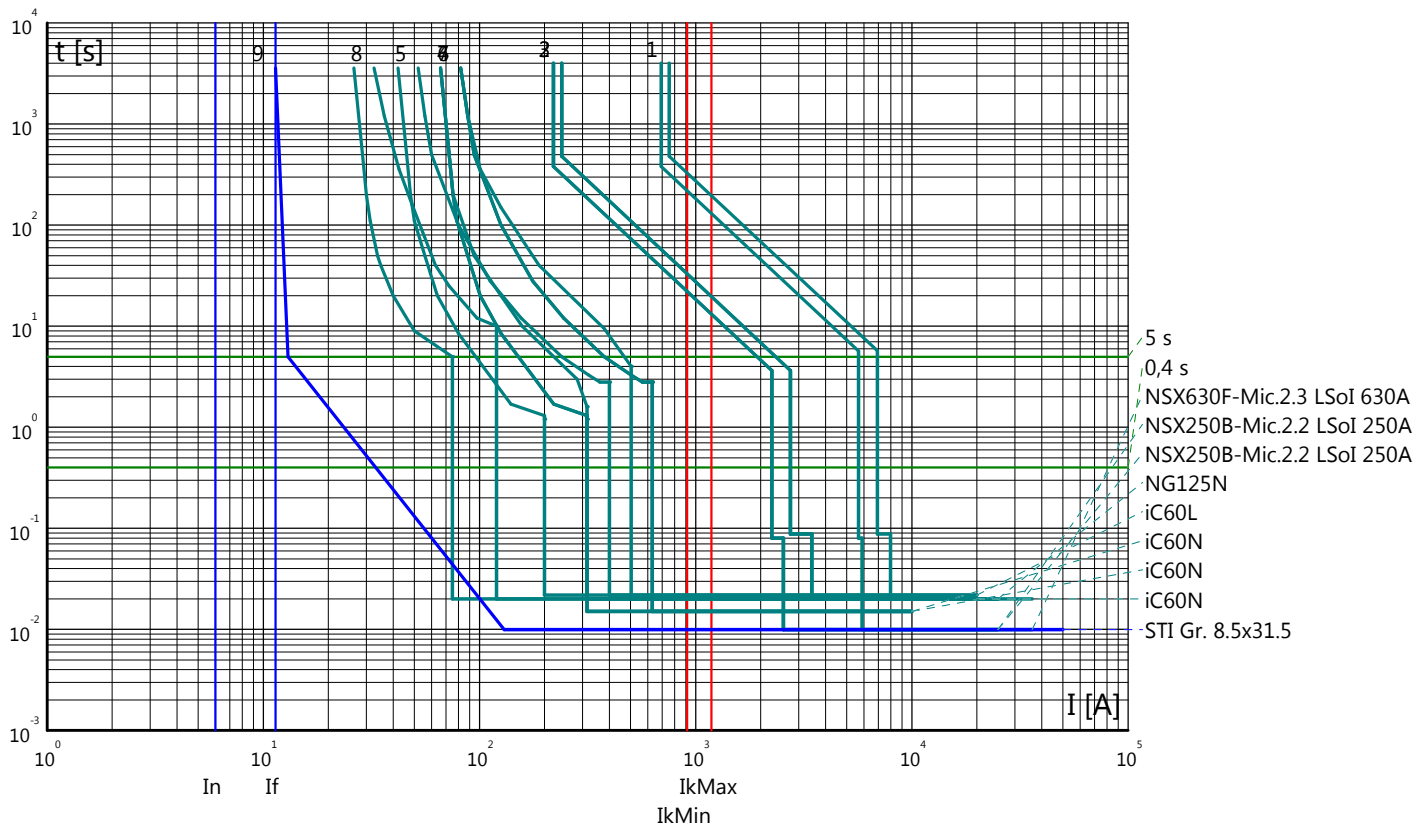

Curve tempo corrente: GALLERIA MONTE AGLIO
 Quadro: QPLC/S

Partenza: PT/U

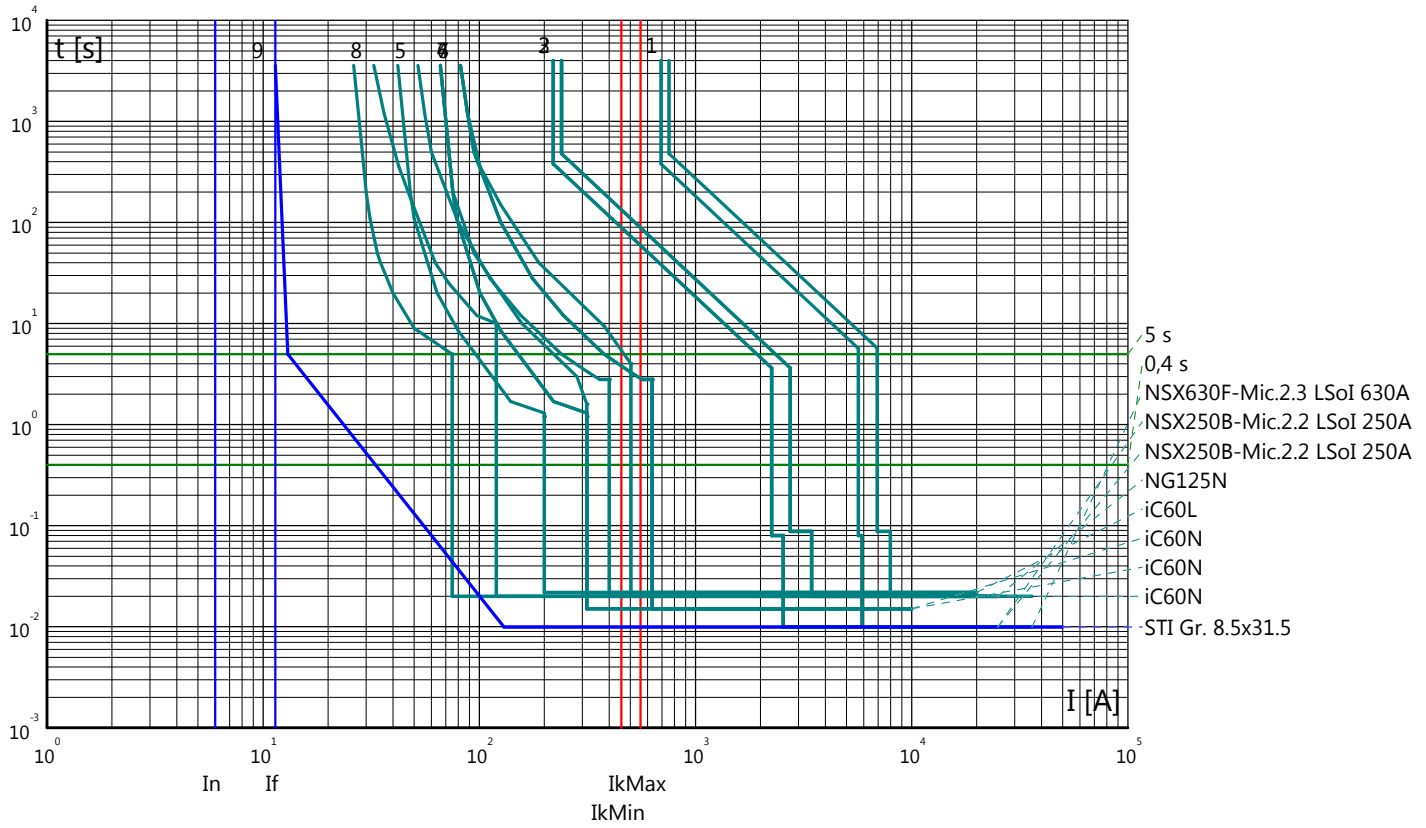

Partenza: PLC1

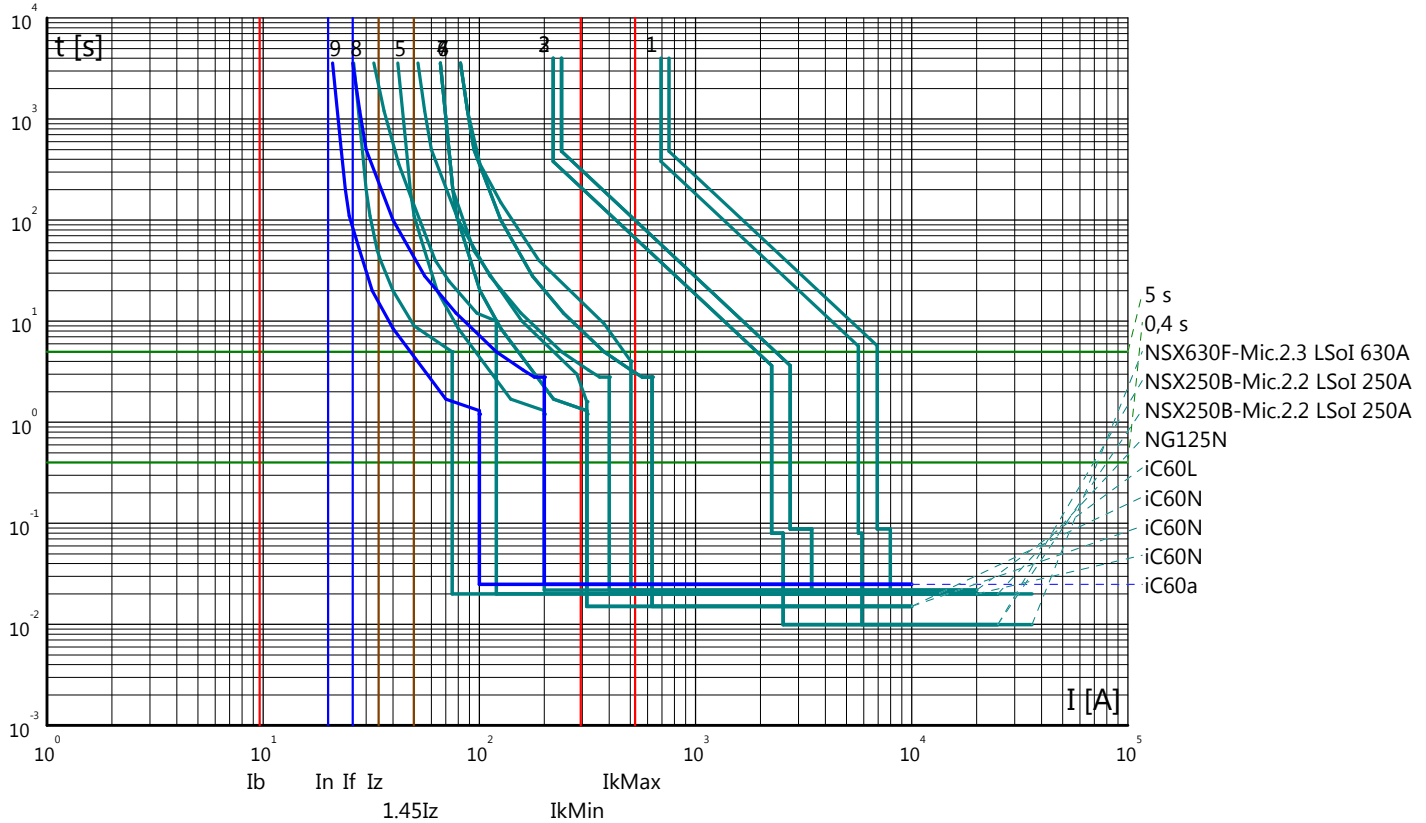

Curve tempo corrente: GALLERIA MONTE AGLIO
 Quadro: QAPP/S

Arrivo: IG

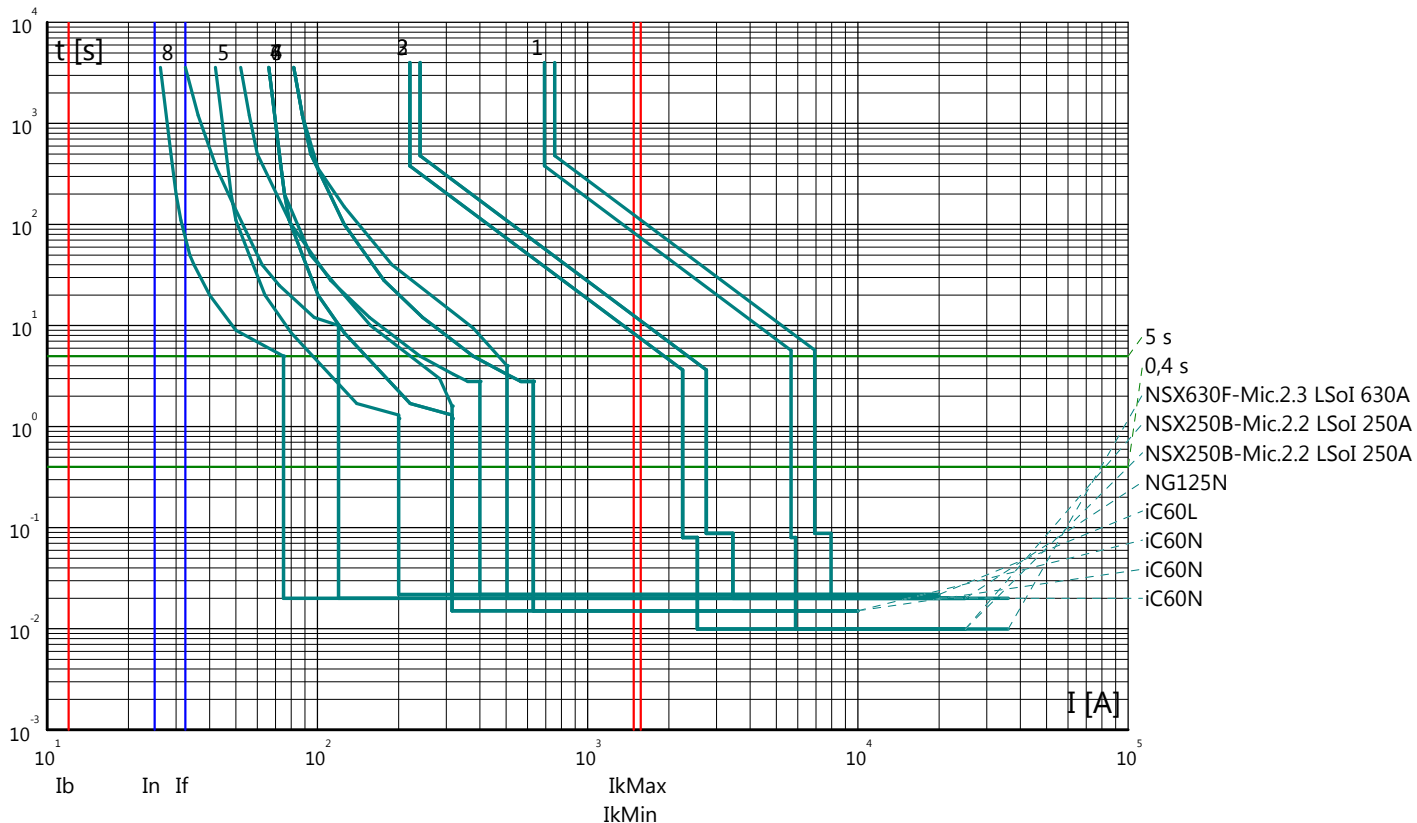

Partenza: PT/I

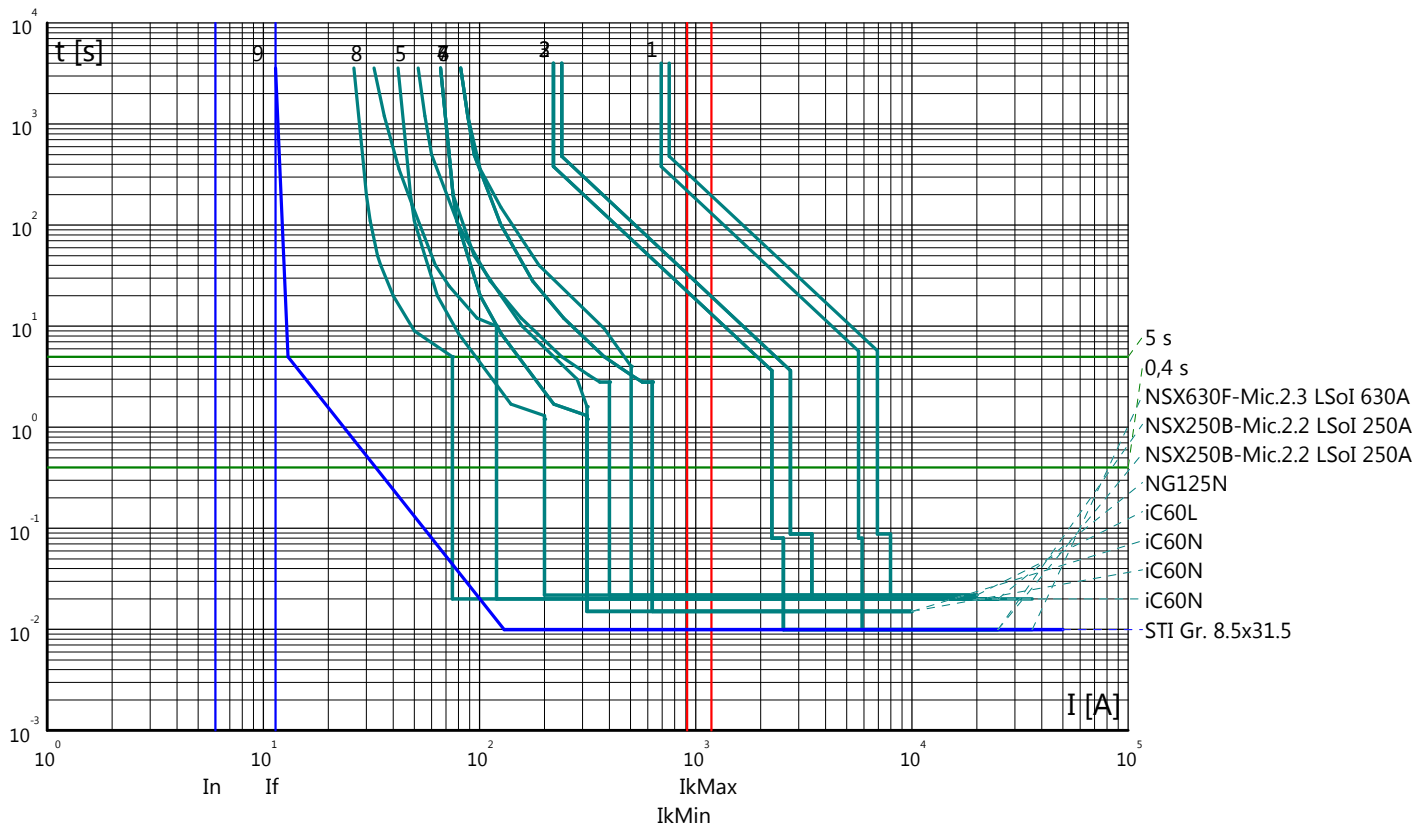

Curve tempo corrente: GALLERIA MONTE AGLIO
 Quadro: QAPP/S

Partenza: PT/U

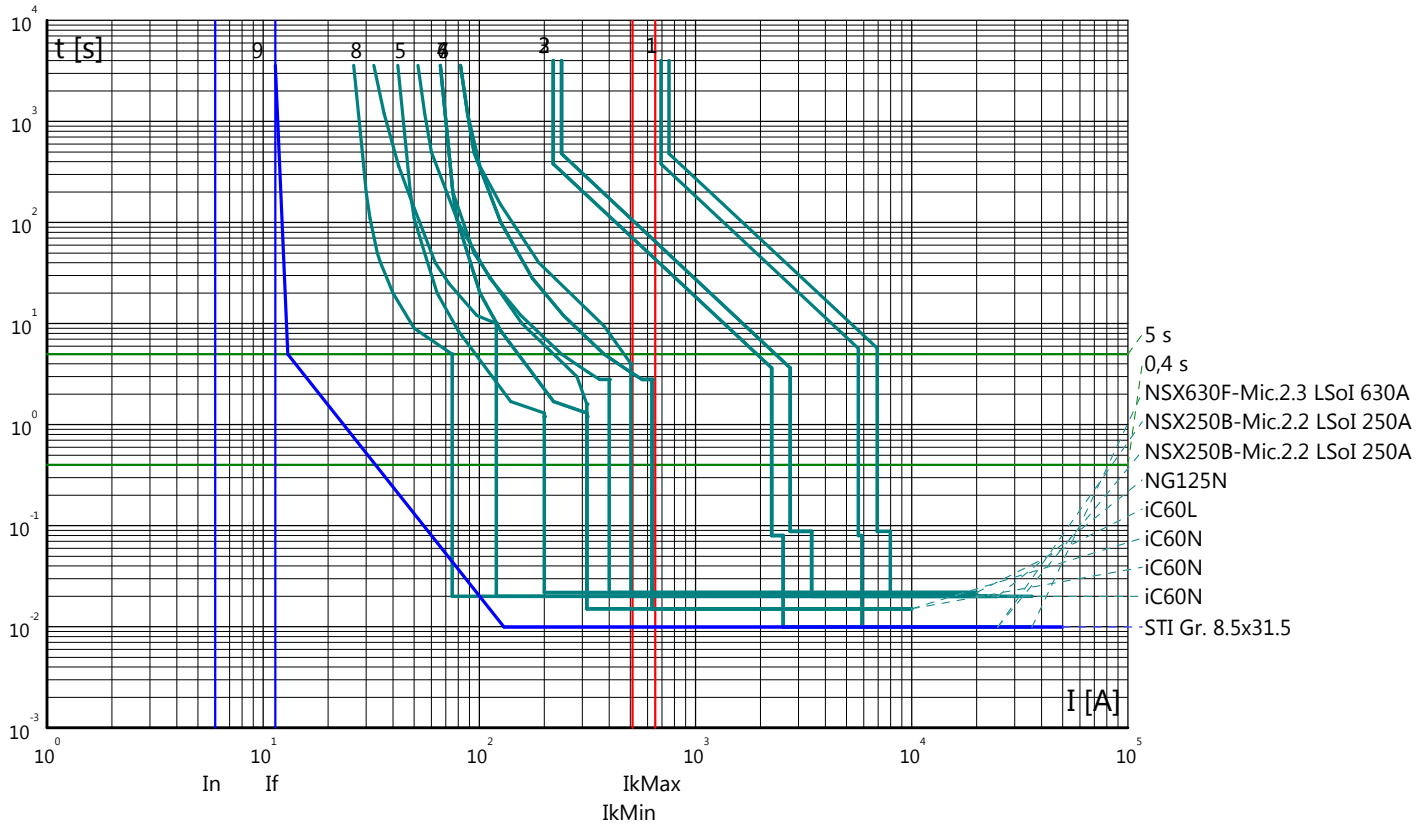

Partenza: GSM-P

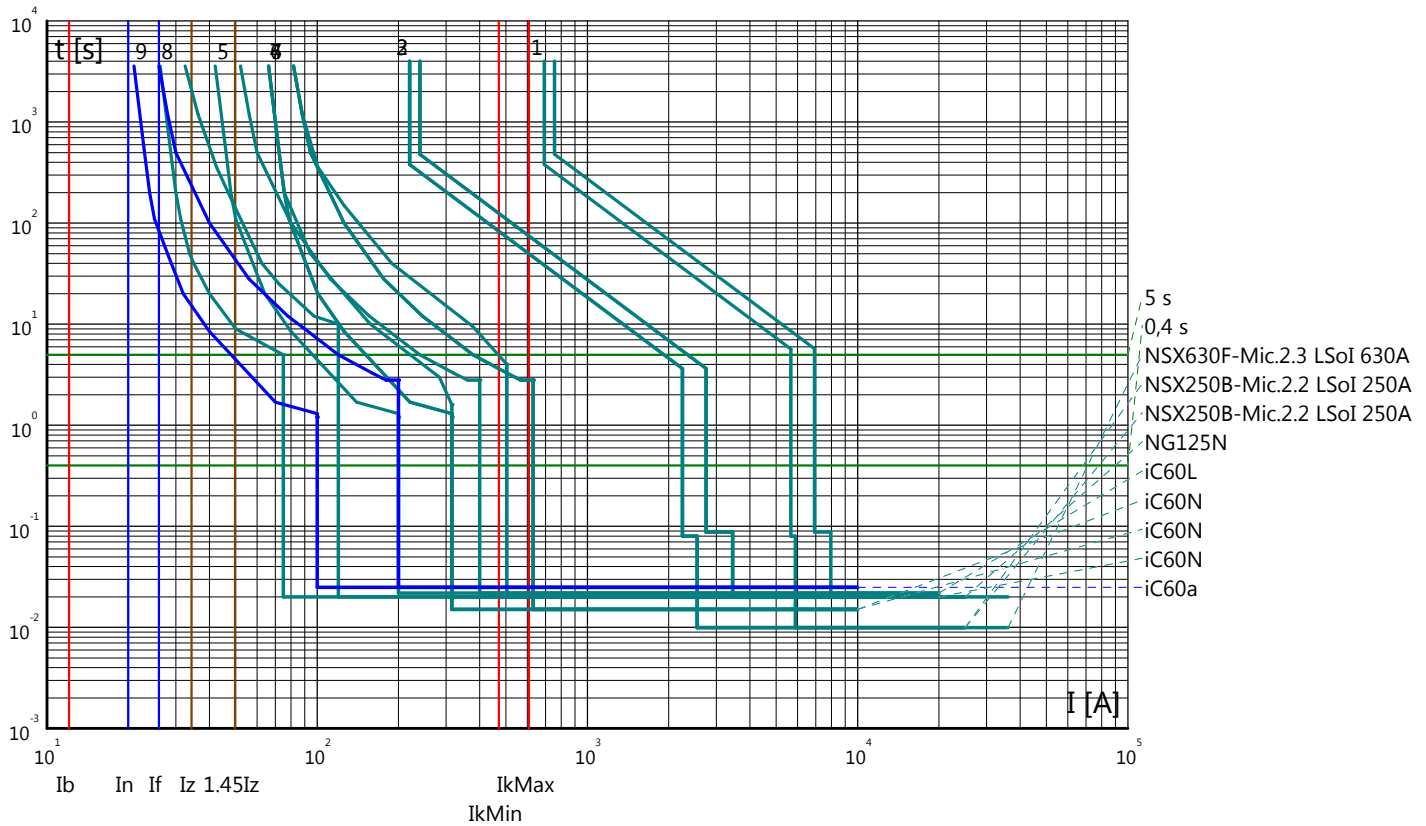

Curve tempo corrente: GALLERIA MONTE AGLIO
 Quadro: QAPP/S

Arrivo: IG

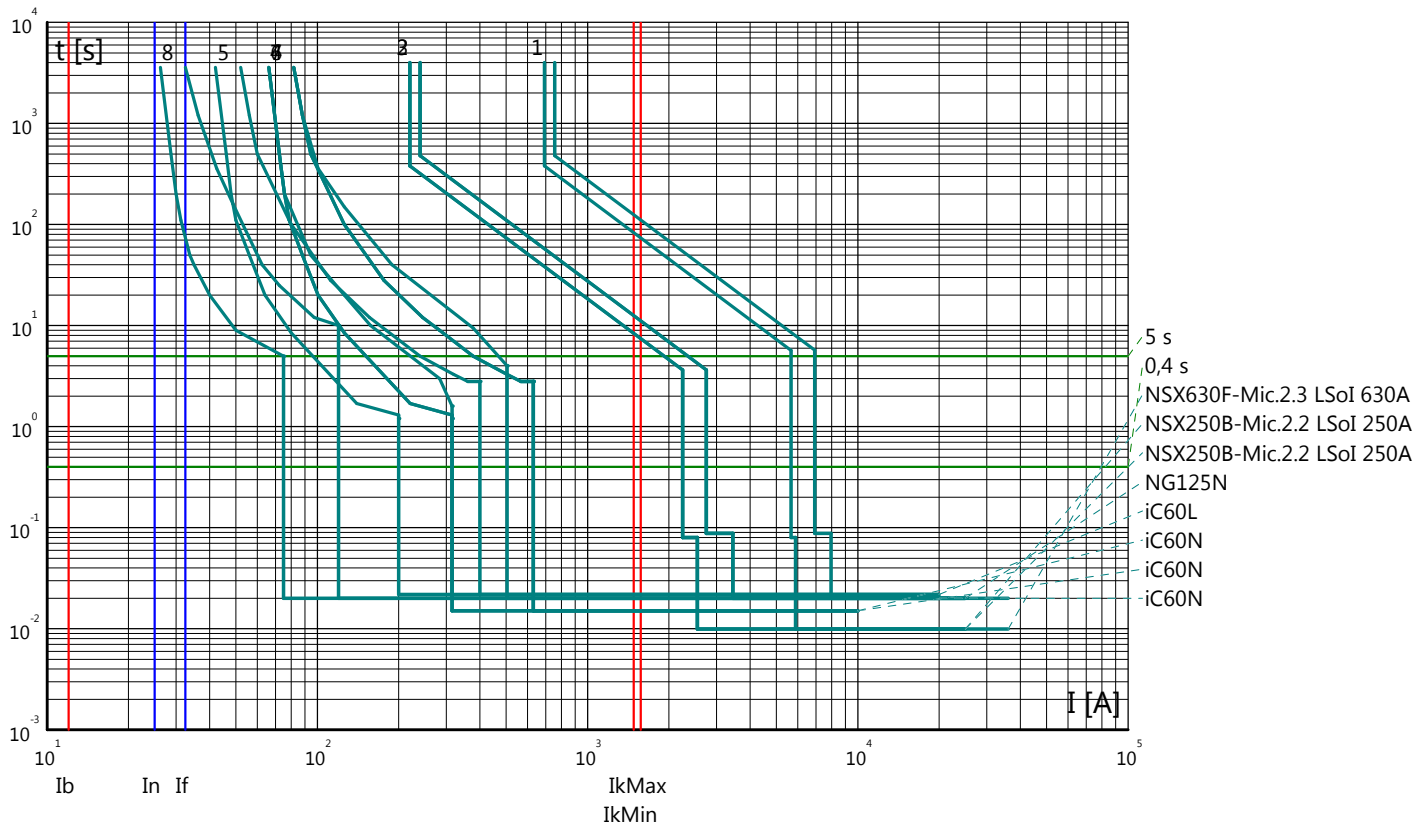

Partenza: PT/I

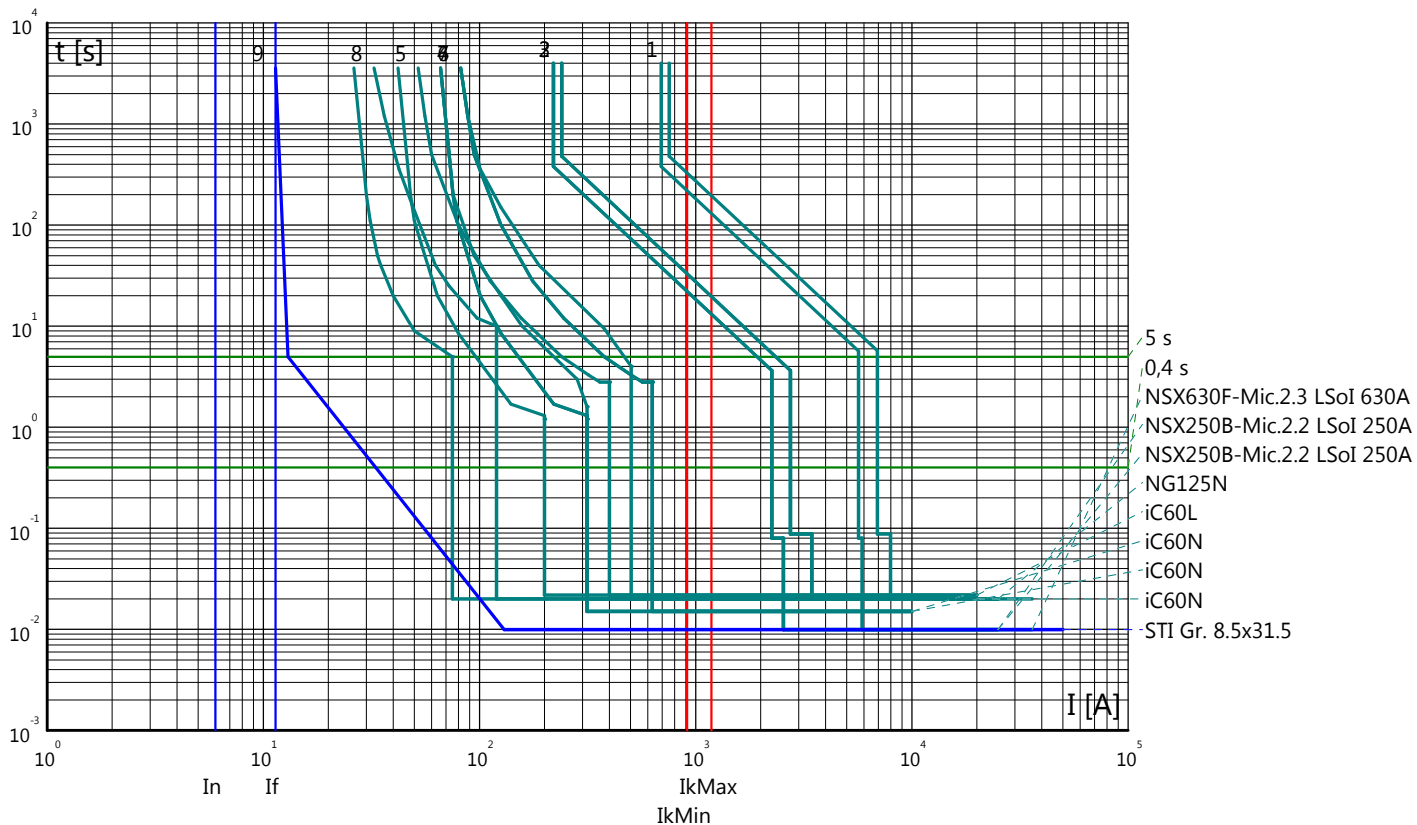

Curve tempo corrente: GALLERIA MONTE AGLIO
 Quadro: QAPP/S

Partenza: PT/U

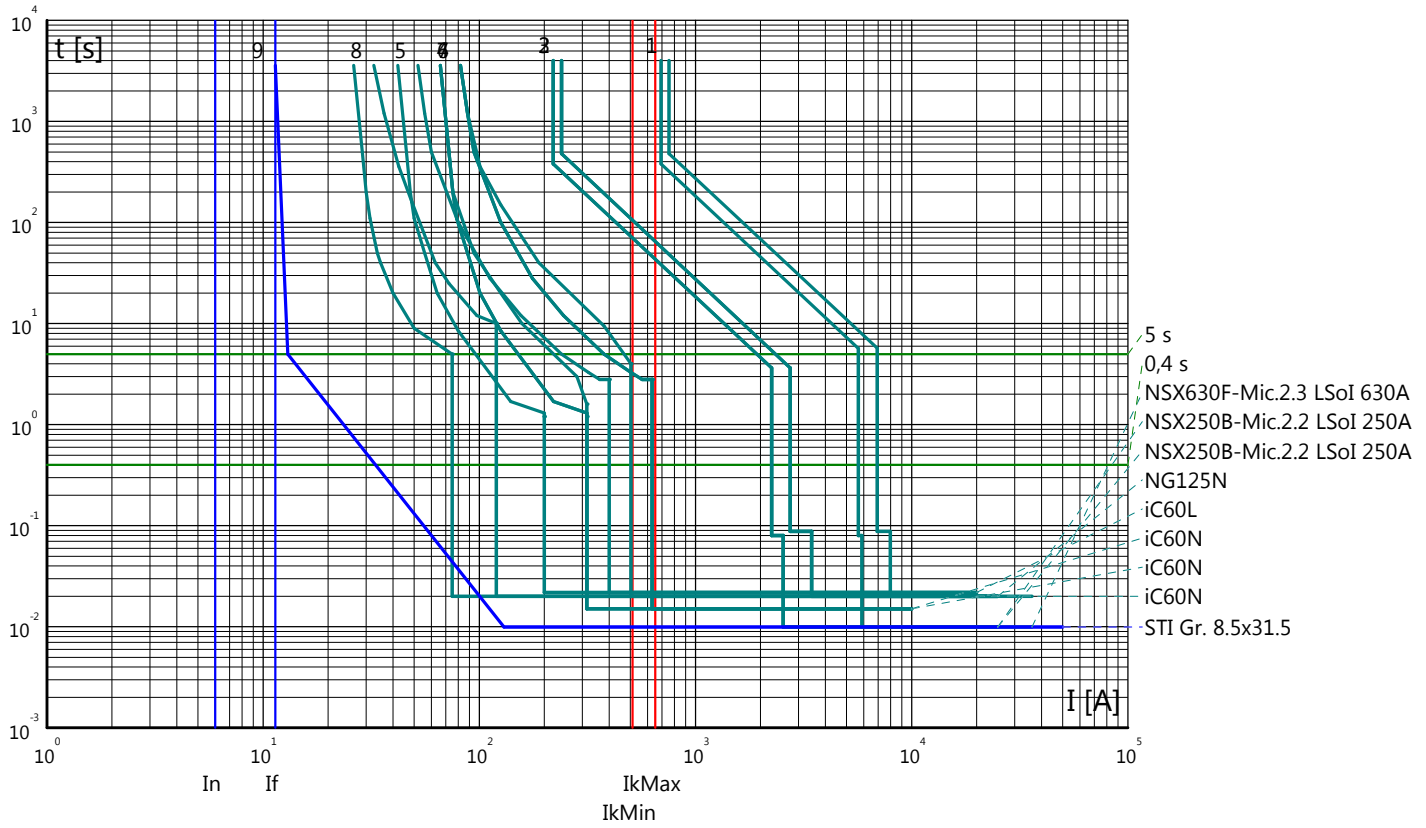

Partenza: GSM-R

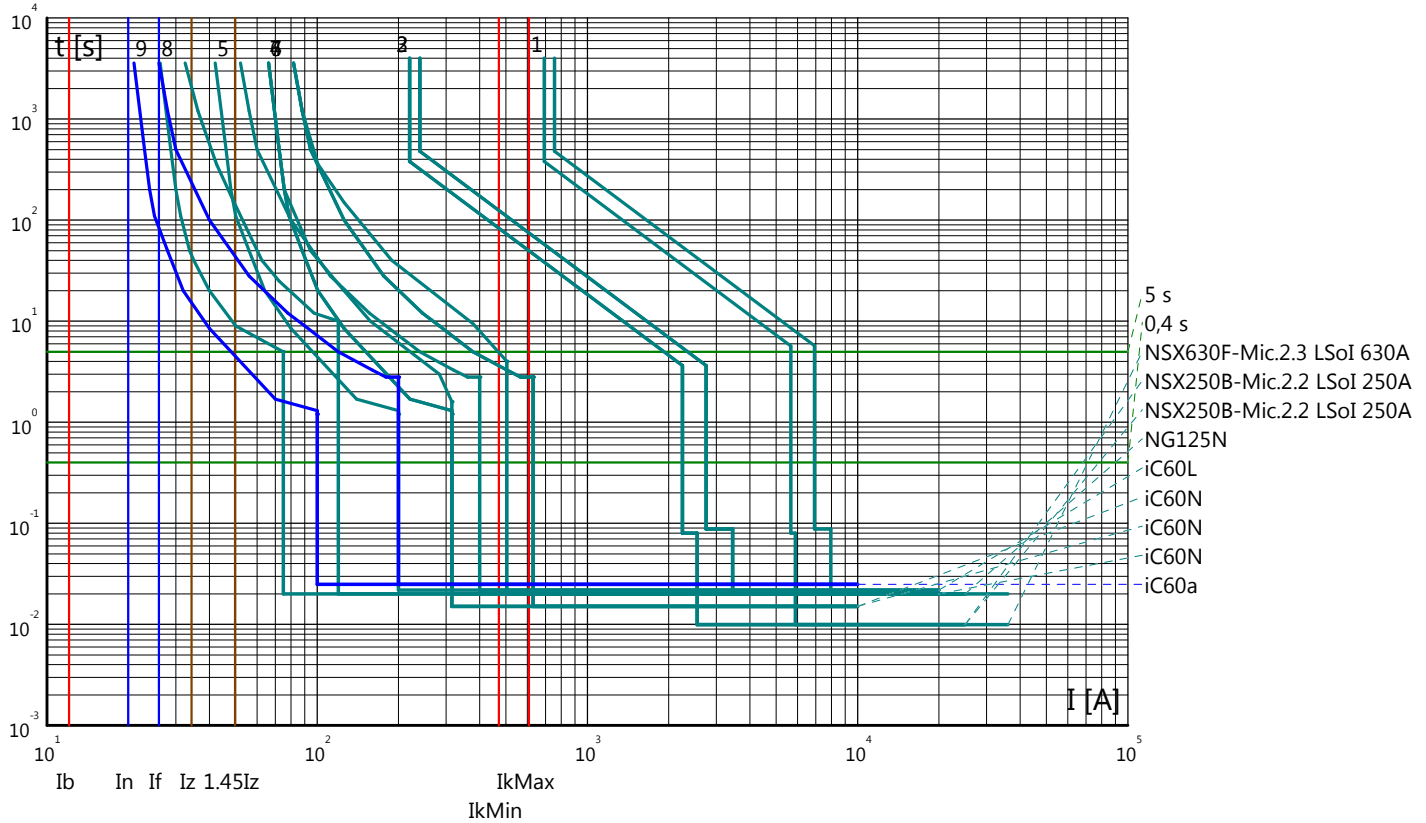

Curve tempo corrente: GALLERIA MONTE AGLIO
 Quadro: QAPP/S

Arrivo: IG

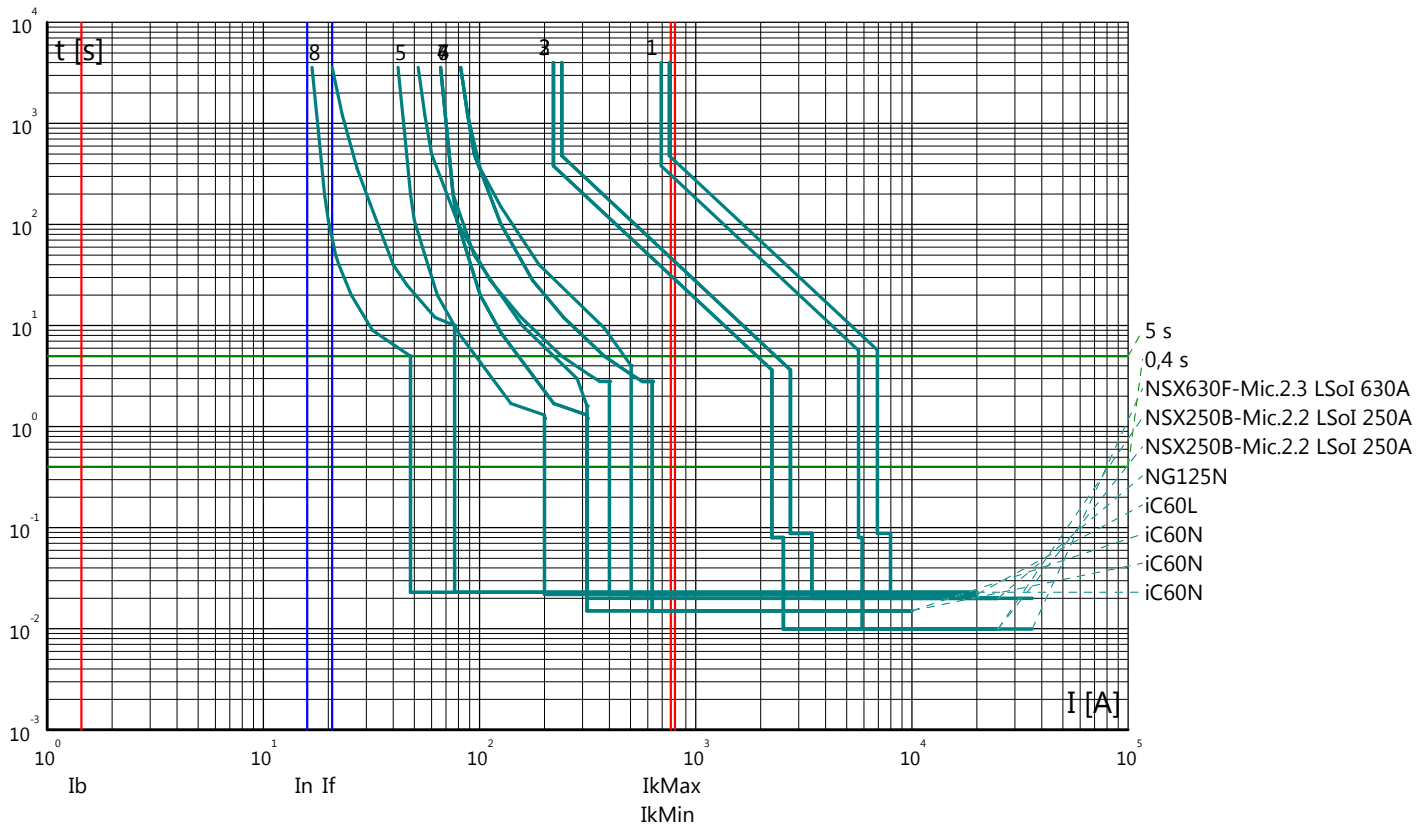

Partenza: PT/I

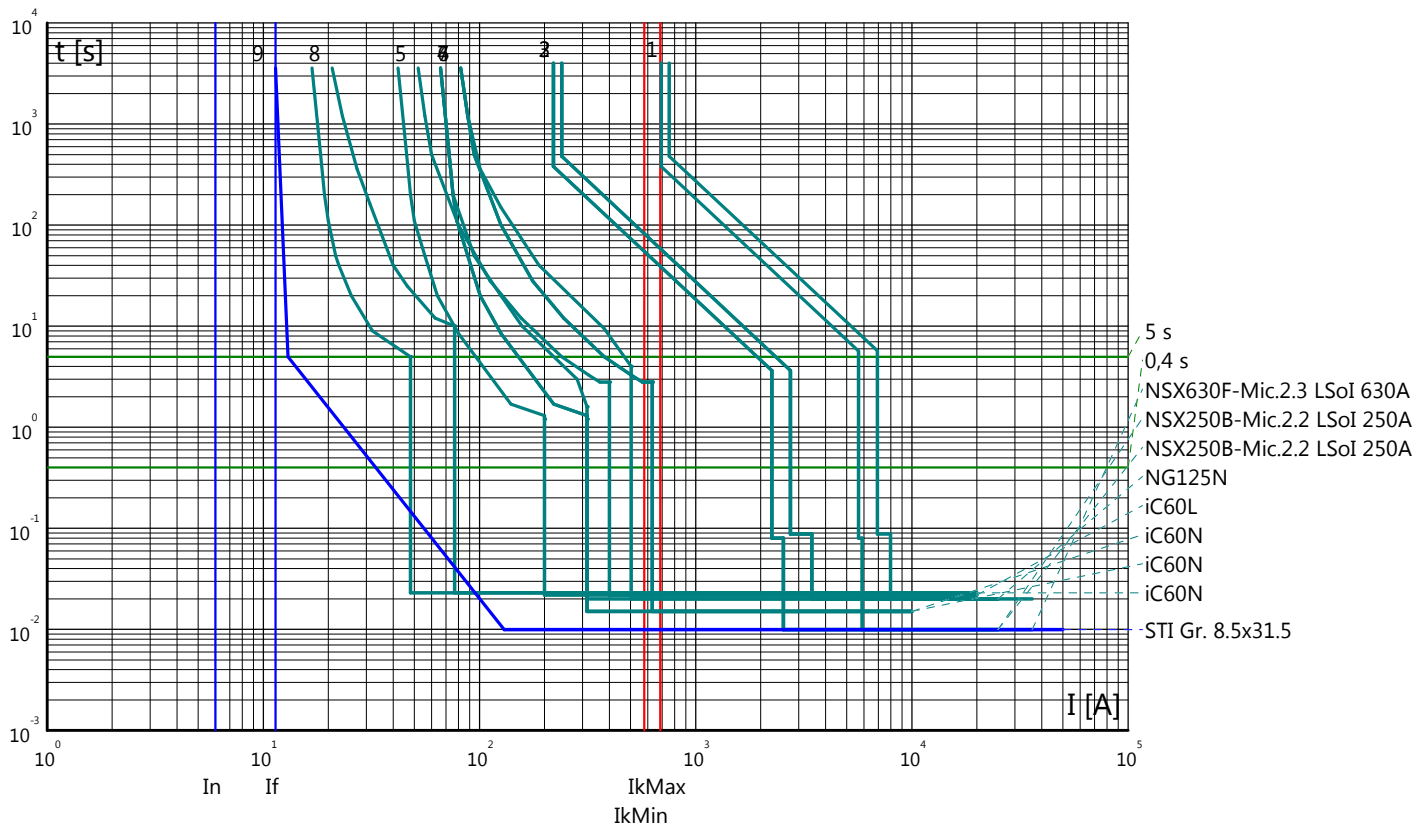

Curve tempo corrente: GALLERIA MONTE AGLIO
 Quadro: QAPP/S

Partenza: PT/U

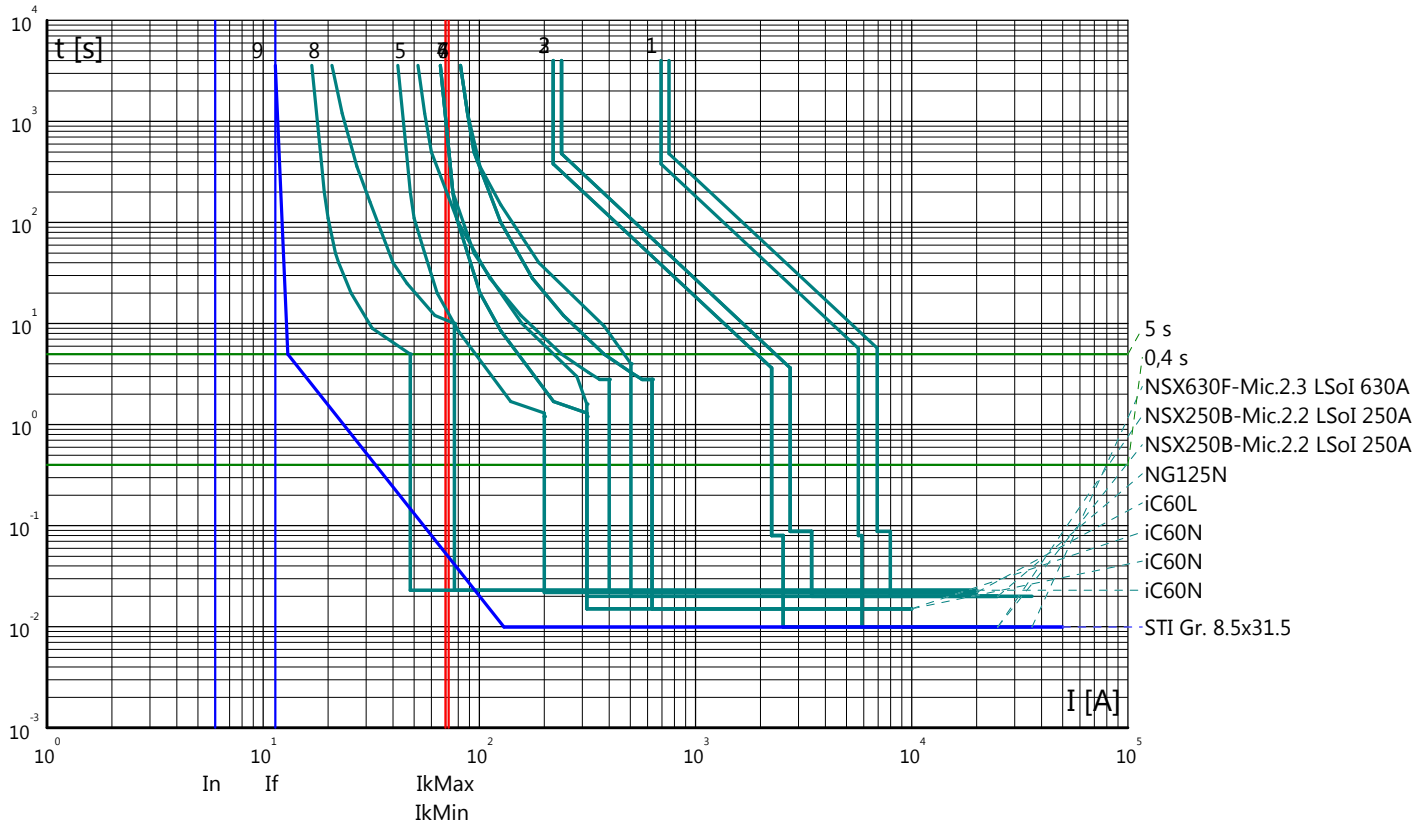

Partenza: TEM QSTES

