

101

Area di Sierro: -0,14
Area di Ripetto: 0,00

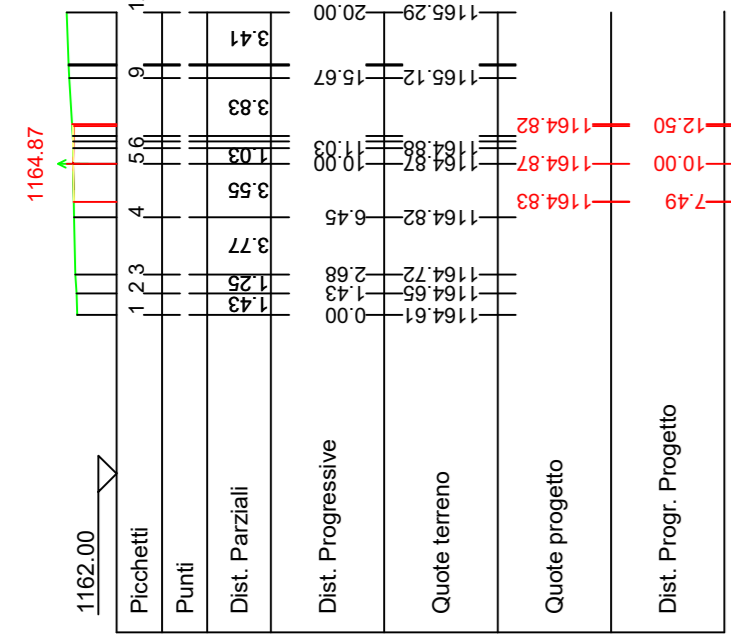

102

Area di Sierro: -0,14
Area di Ripetto: 0,00

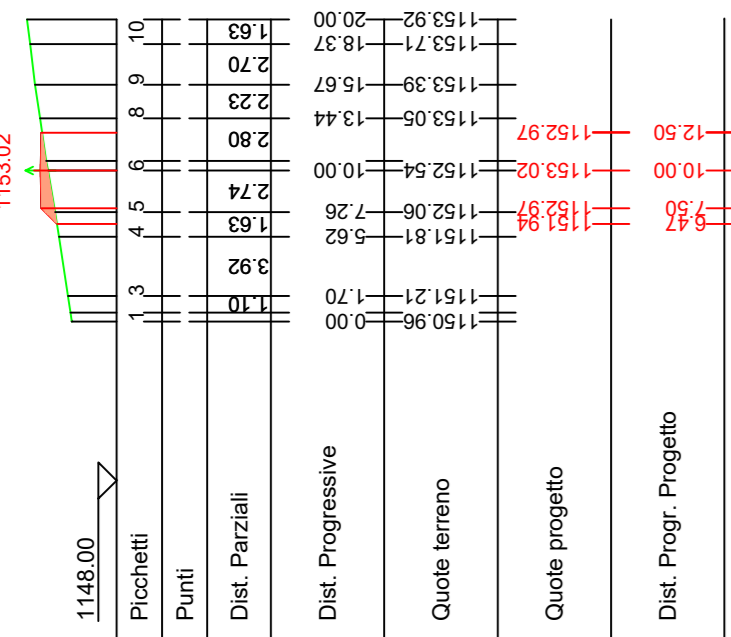

103

Area di Sierro: -0,72
Area di Ripetto: 0,00

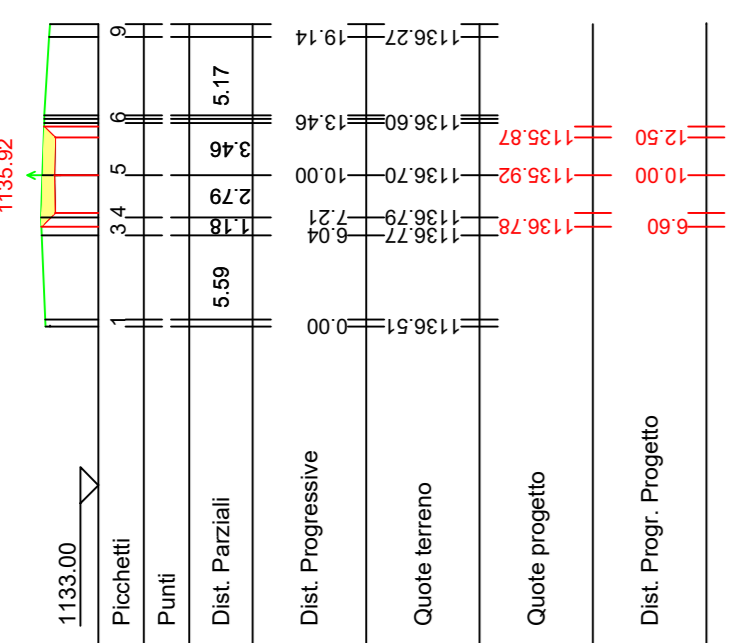

104

Area di Sierro: -0,18
Area di Ripetto: 4,73

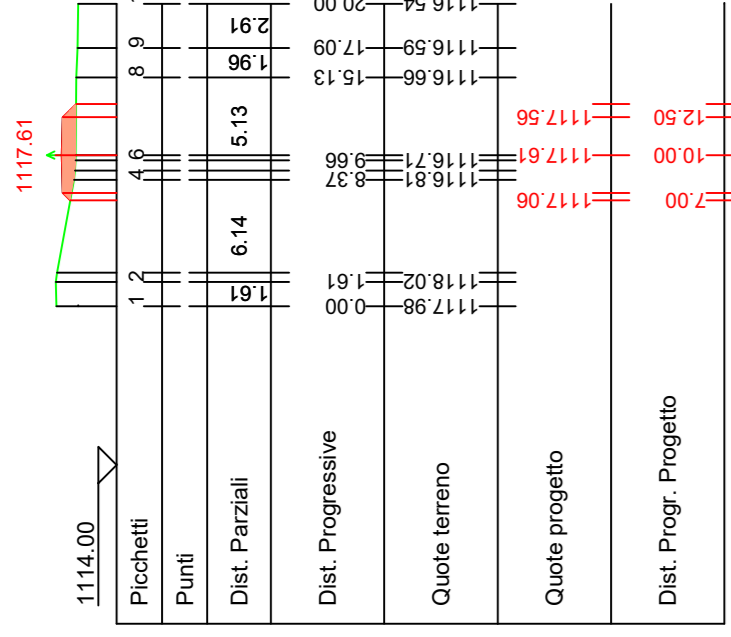

105

Area di Sierro: -0,18
Area di Ripetto: 0,16

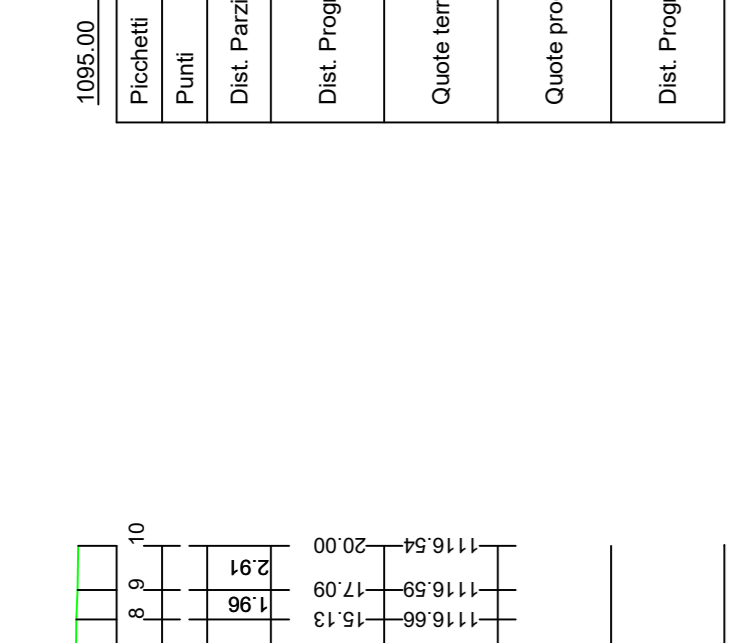

106

Area di Sierro: -0,20
Area di Ripetto: 0,16

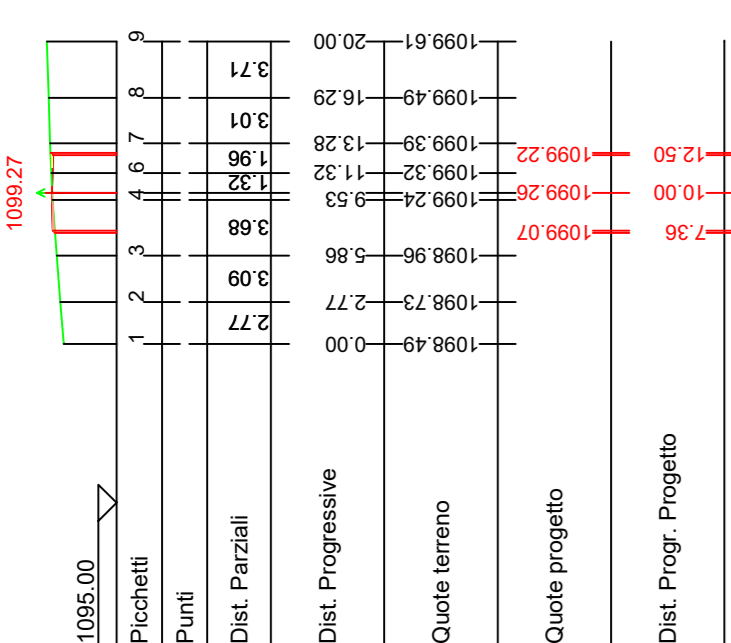

107

Area di Sierro: -8,21
Area di Ripetto: 0,00

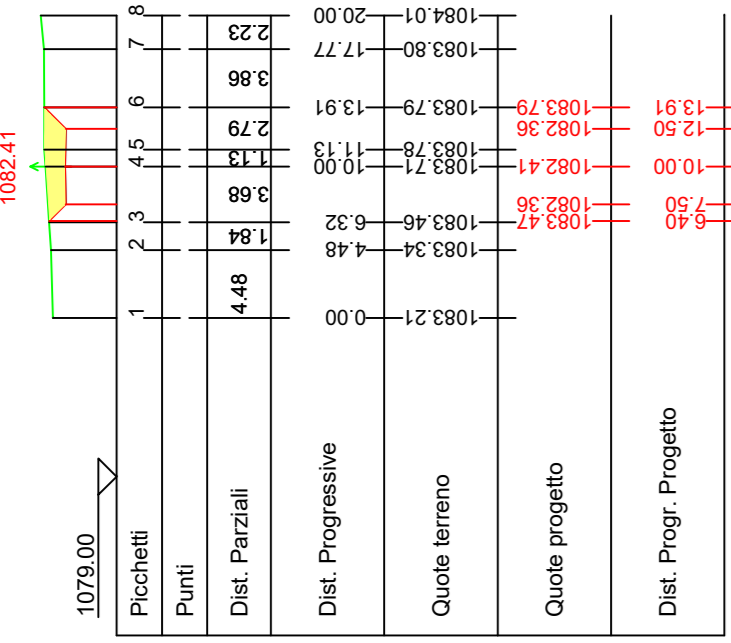

108

Area di Sierro: -13,35
Area di Ripetto: 0,00

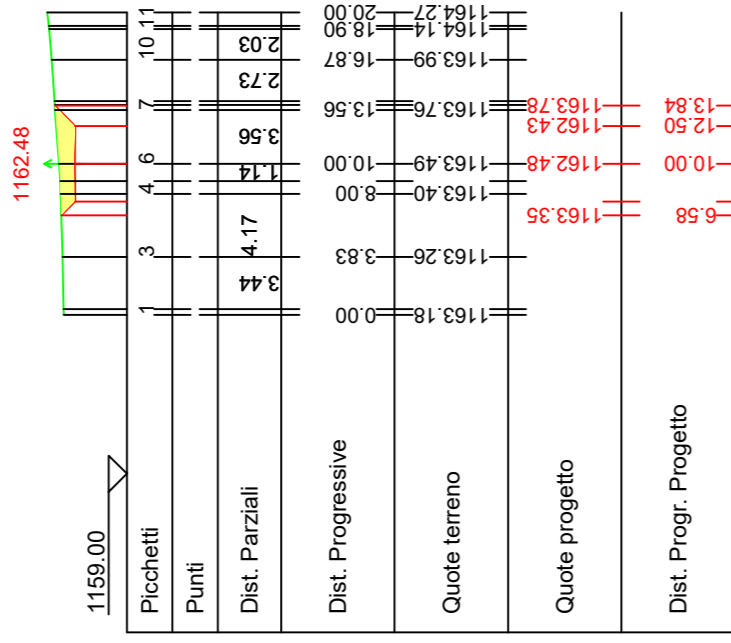

109

Area di Sierro: -20,69
Area di Ripetto: 0,00

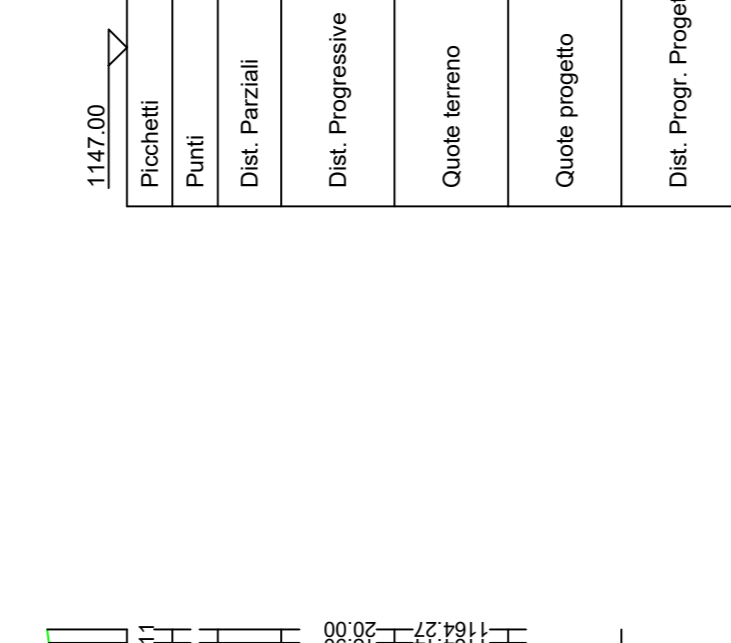

110

Area di Sierro: -2,84
Area di Ripetto: 0,00

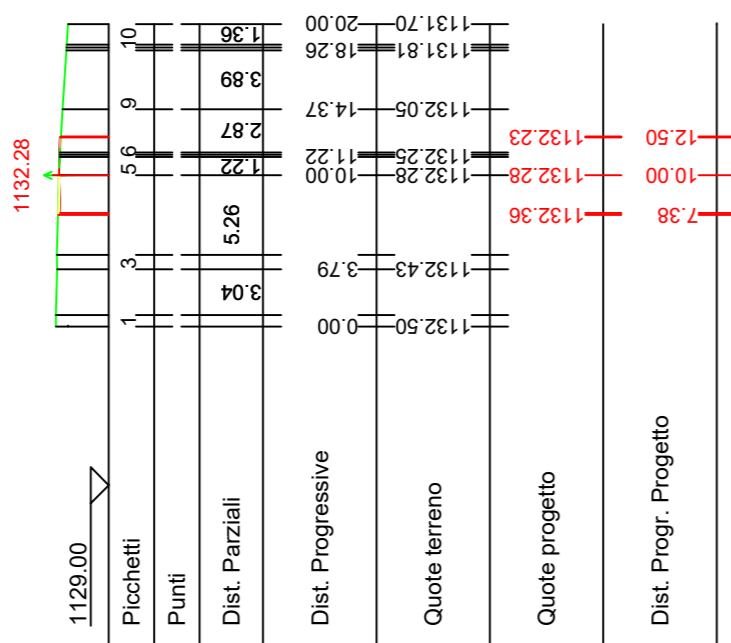

111

Area di Sierro: -4,80
Area di Ripetto: 0,00

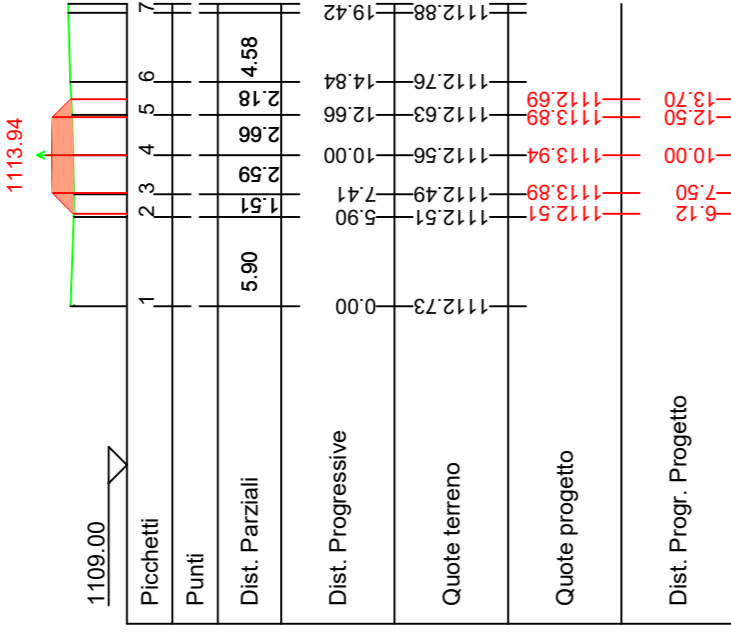

112

Area di Sierro: -4,99
Area di Ripetto: 0,00

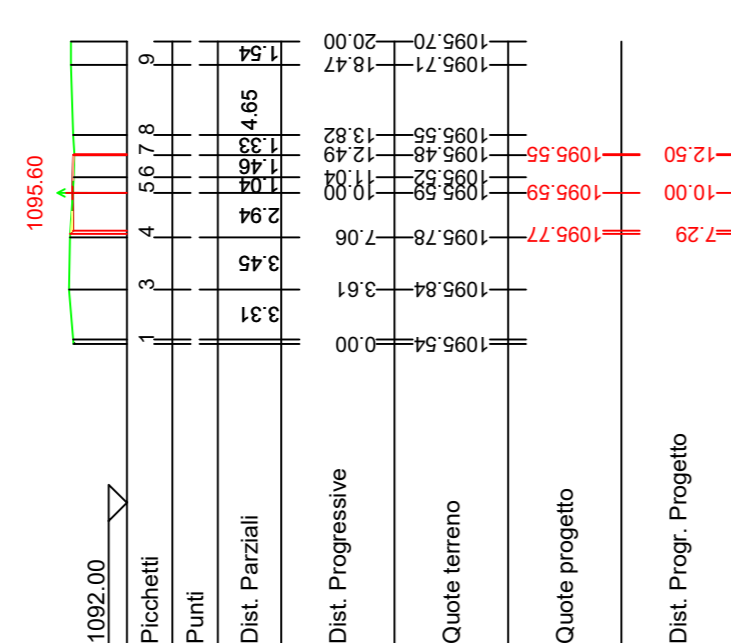

113

Area di Sierro: -0,27
Area di Ripetto: 0,12

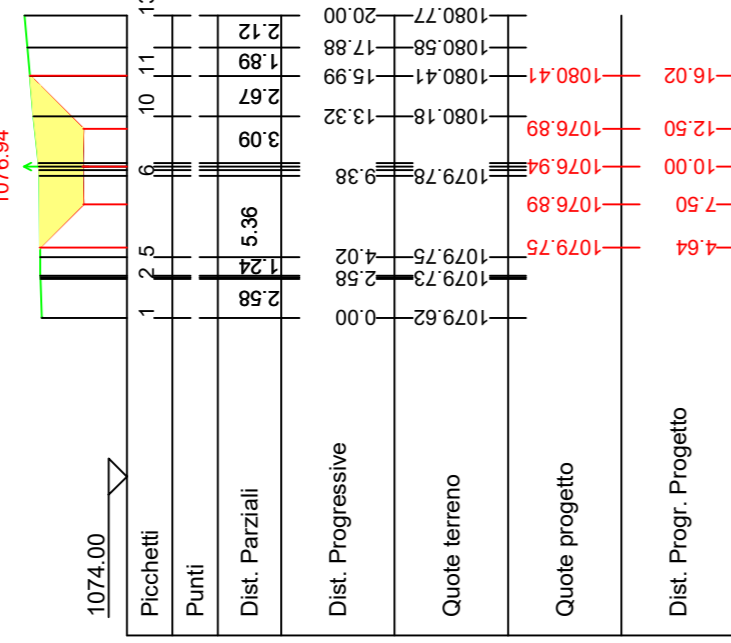

114

Area di Sierro: -0,16
Area di Ripetto: 0,05

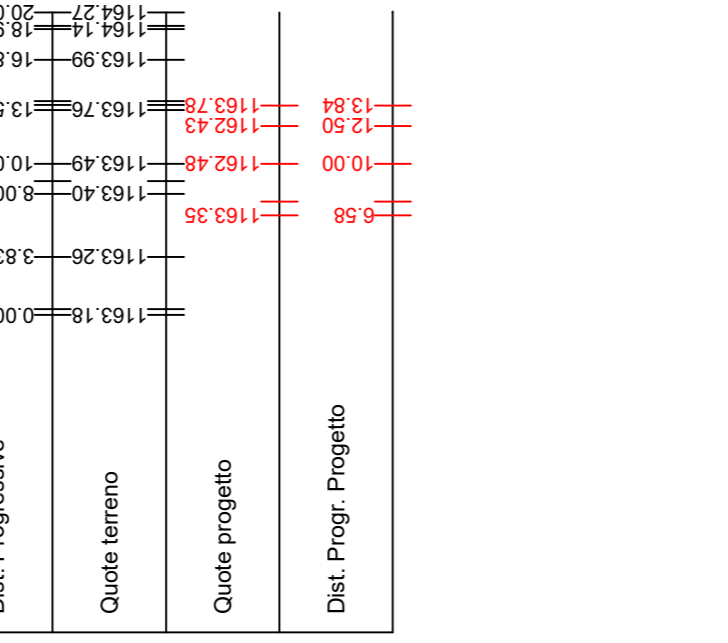

115

Area di Sierro: -4,80
Area di Ripetto: 0,00

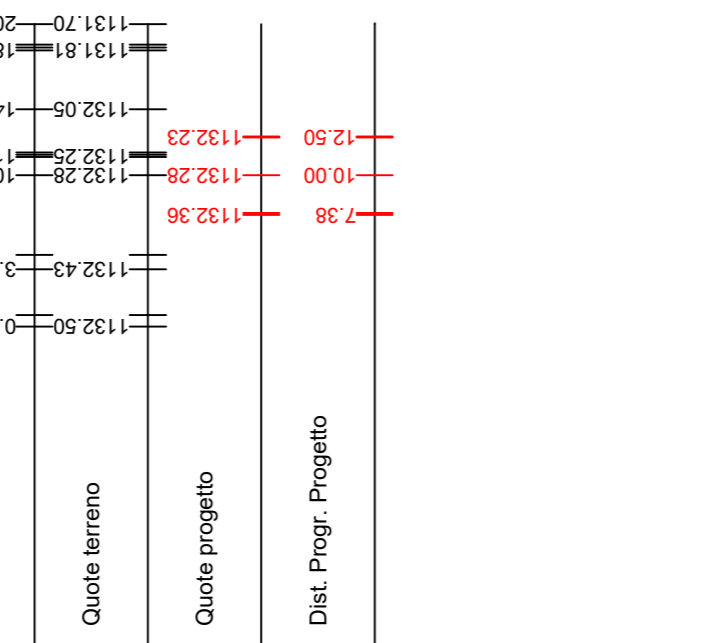

116

Area di Sierro: -0,00
Area di Ripetto: 8,52

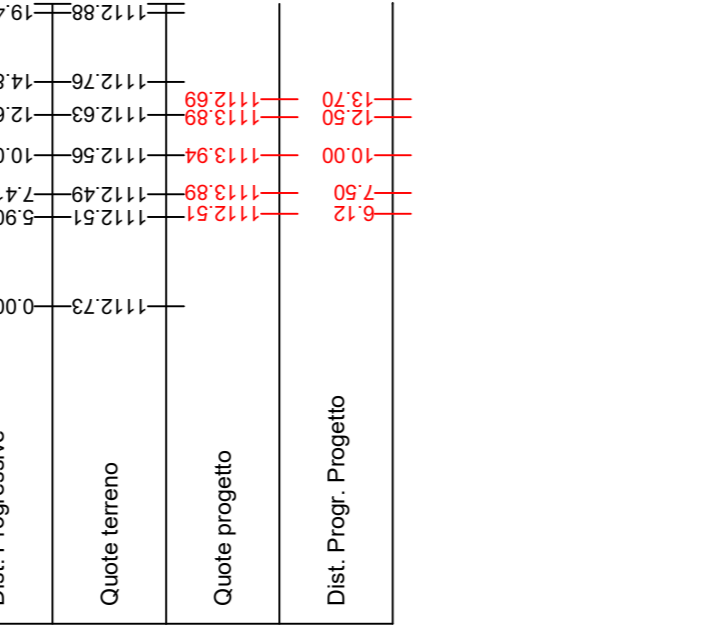

117

Area di Sierro: -0,20
Area di Ripetto: 0,12

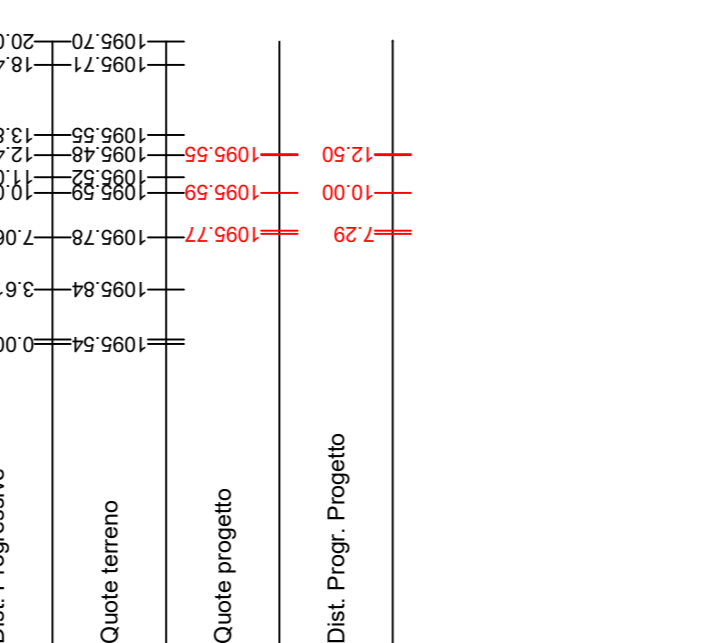

118

Area di Sierro: -0,27
Area di Ripetto: 0,12

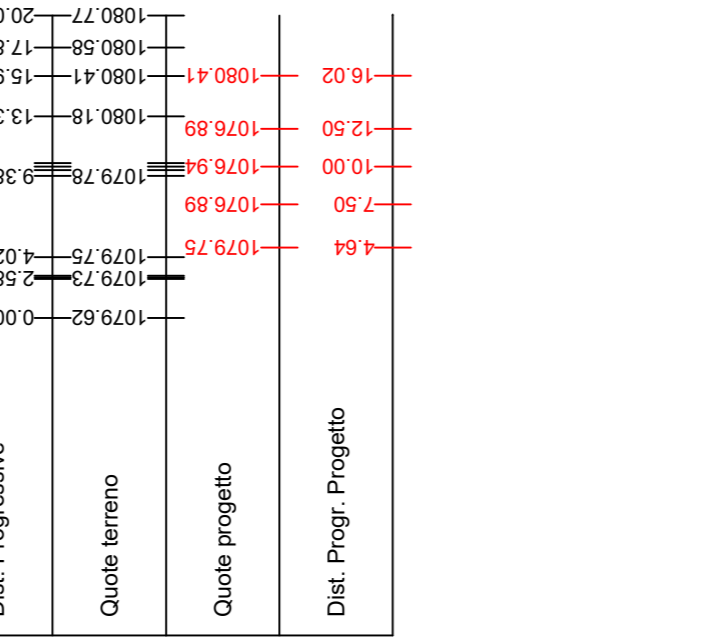

119

Area di Sierro: -2,55
Area di Ripetto: 0,00

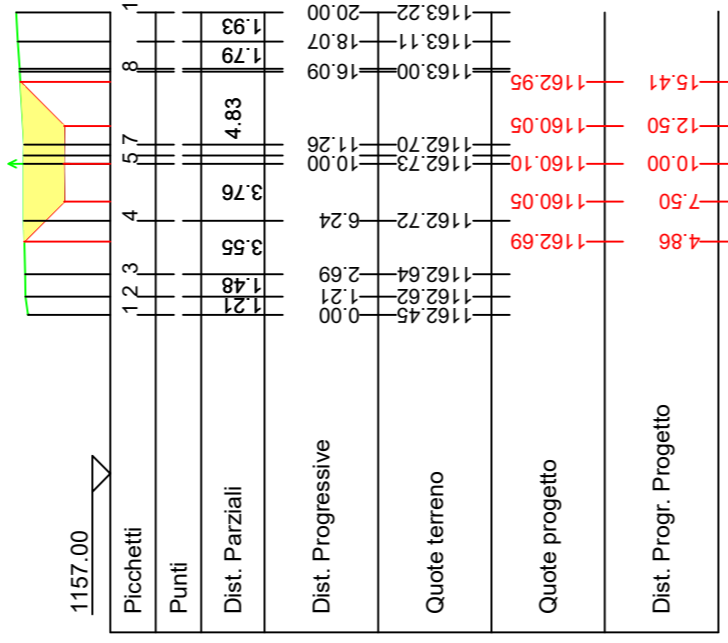

120

Area di Sierro: -0,00
Area di Ripetto: 0,00

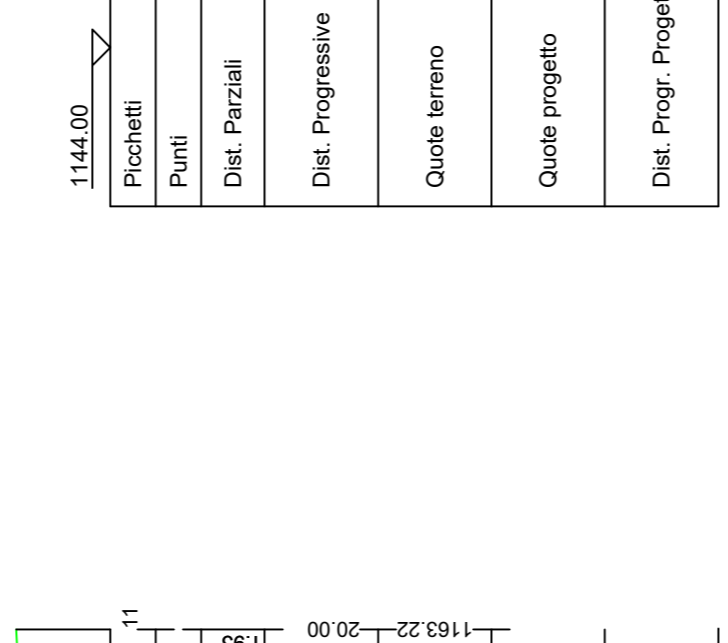

121

Area di Sierro: -0,00
Area di Ripetto: 0,00

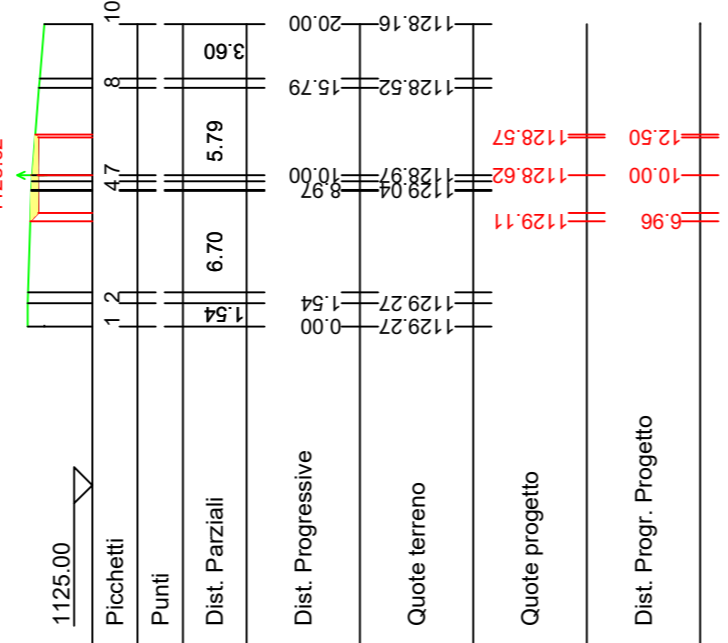

122

Area di Sierro: -2,85
Area di Ripetto: 0,07

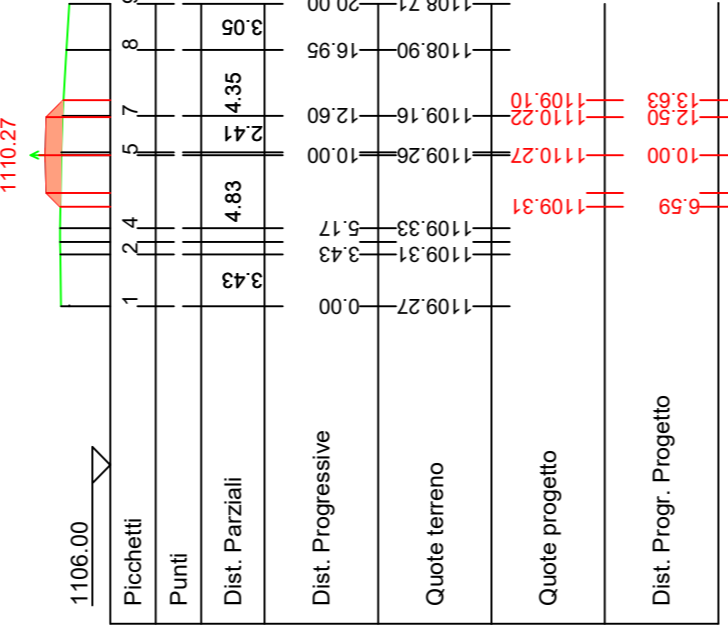

123

Area di Sierro: -4,80
Area di Ripetto: 0,00

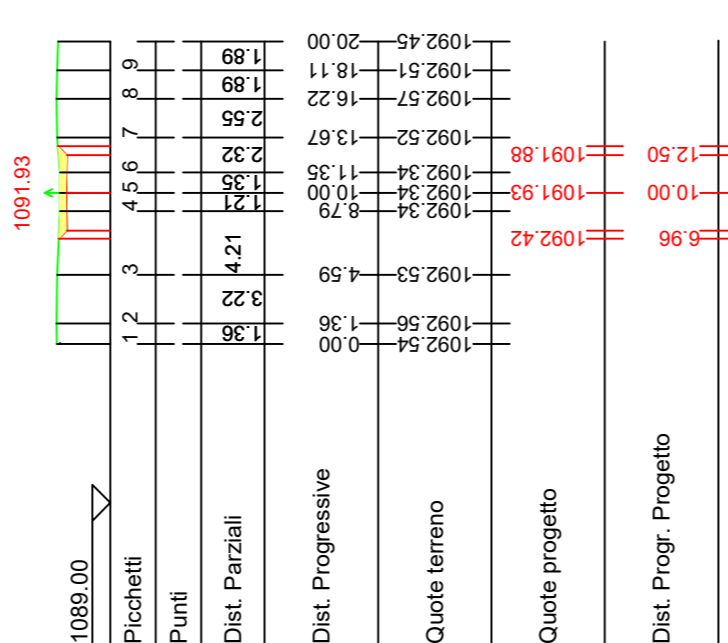

124

Area di Sierro: -4,80
Area di Ripetto: 0,00

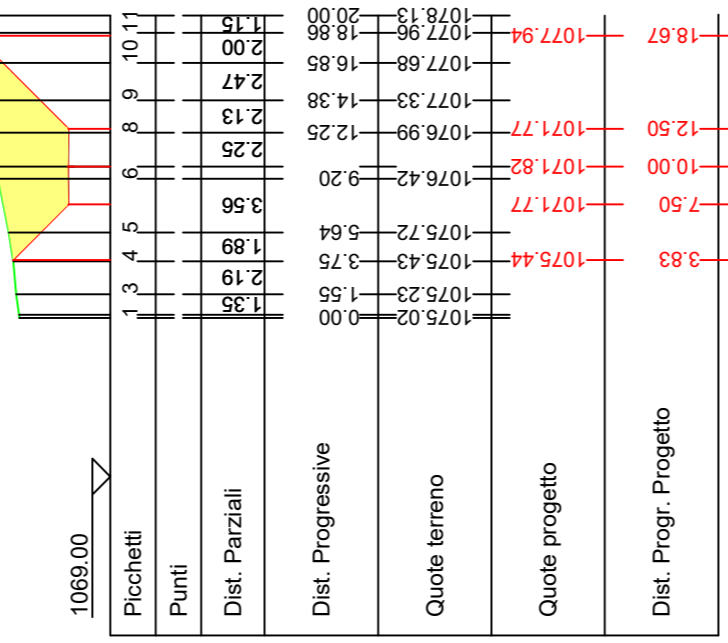

125

Area di Sierro: -7,85
Area di Ripetto: 0,00

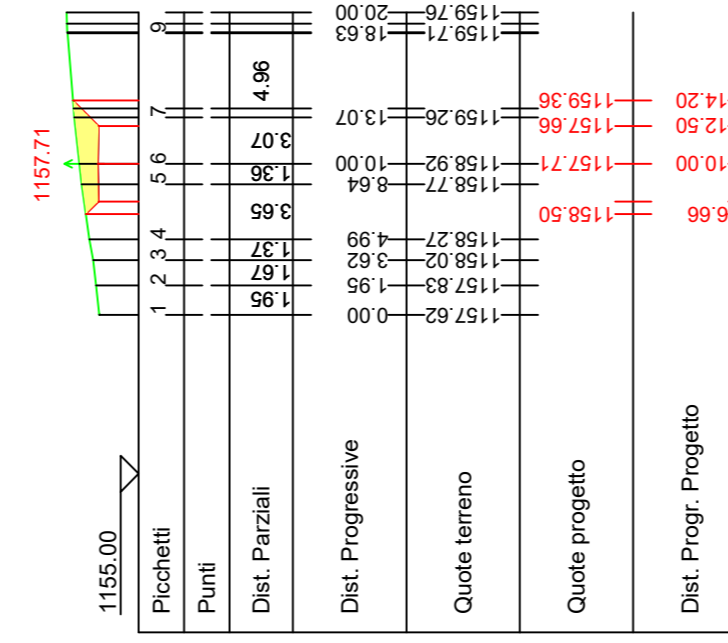

126

Area di Sierro: -15,02
Area di Ripetto: 0,00

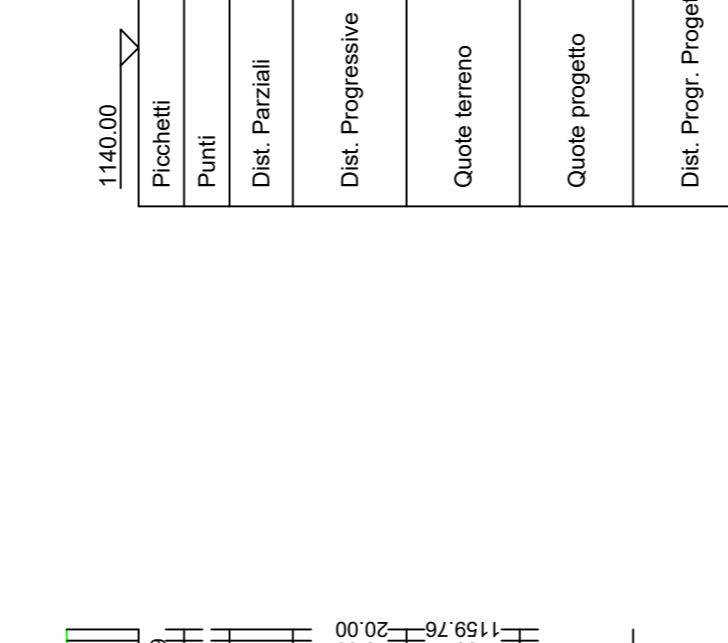

127

Area di Sierro: -0,73
Area di Ripetto: 0,00

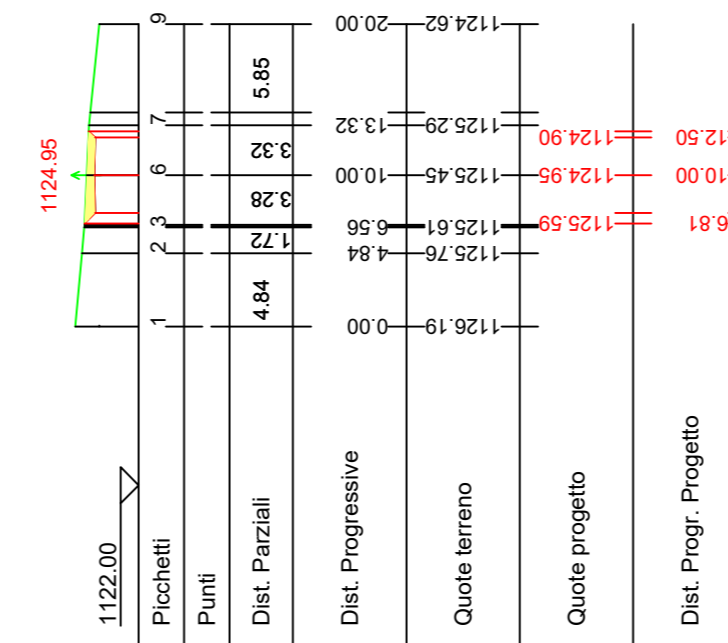

128

Area di Sierro: -0,85
Area di Ripetto: 0,07

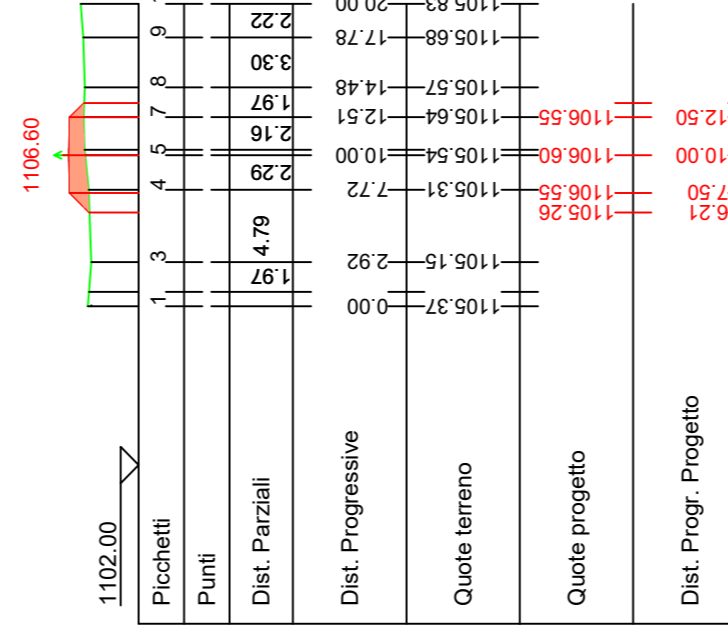

129

Area di Sierro: -9,66
Area di Ripetto: 0,00

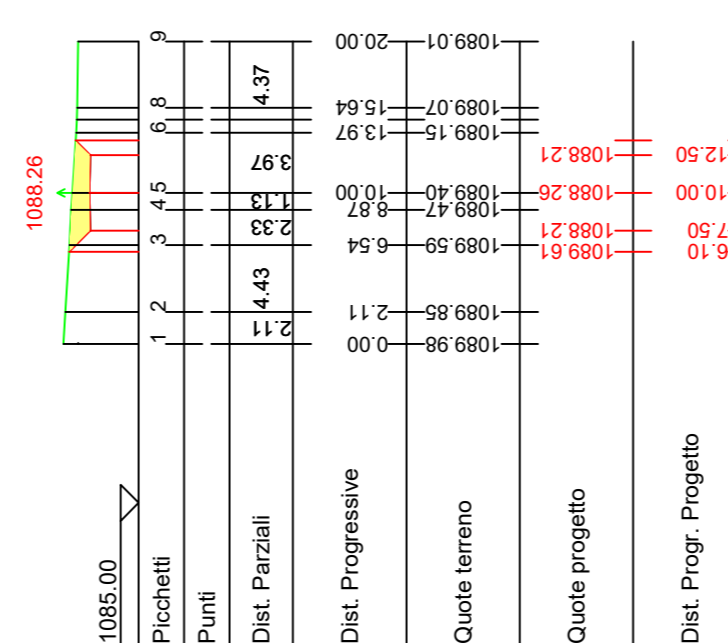

130

Area di Sierro: -0,85
Area di Ripetto: 0,07

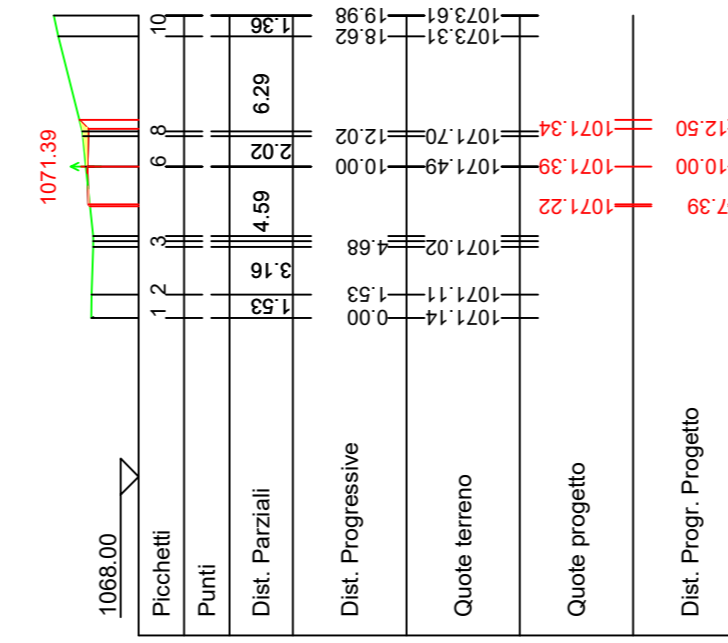

131

Area di Sierro: -0,00
Area di Ripetto: 0,00

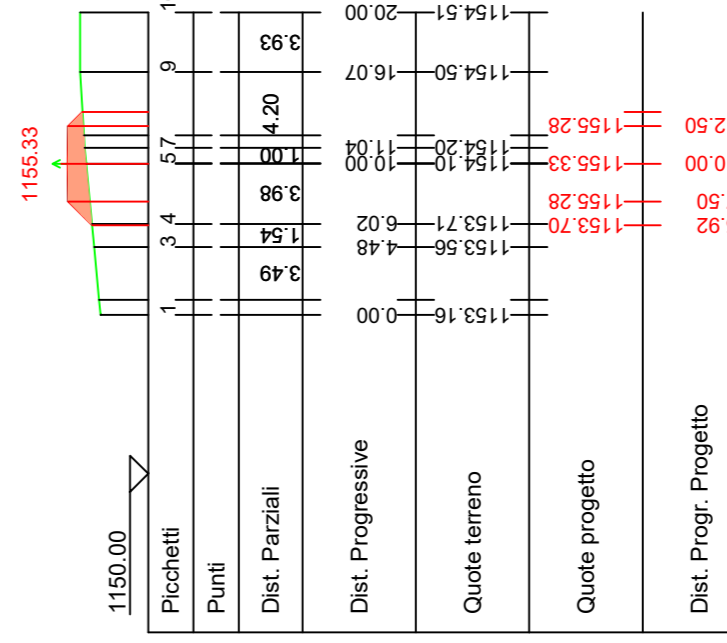

132

Area di Sierro: -11,27
Area di Ripetto: 0,00

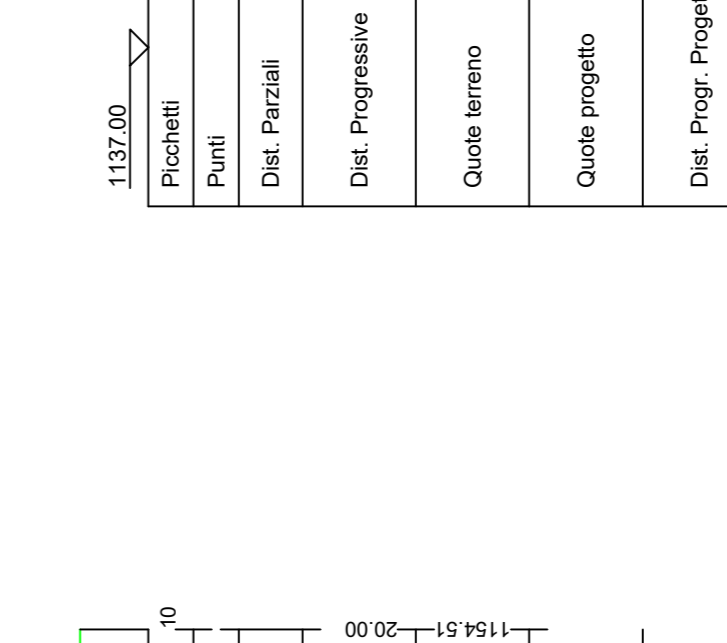

133

Area di Sierro: -0,73
Area di Ripetto: 0,00

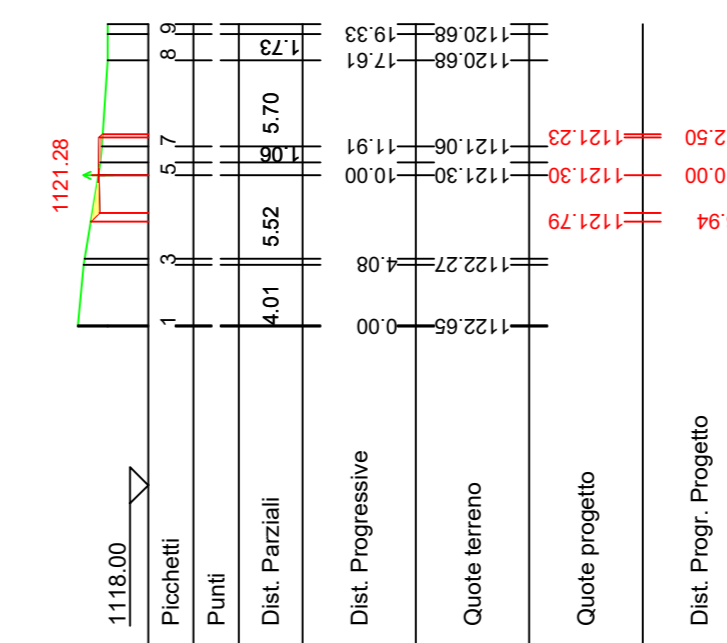

134

Area di Sierro: -0,00
Area di Ripetto: 0,00

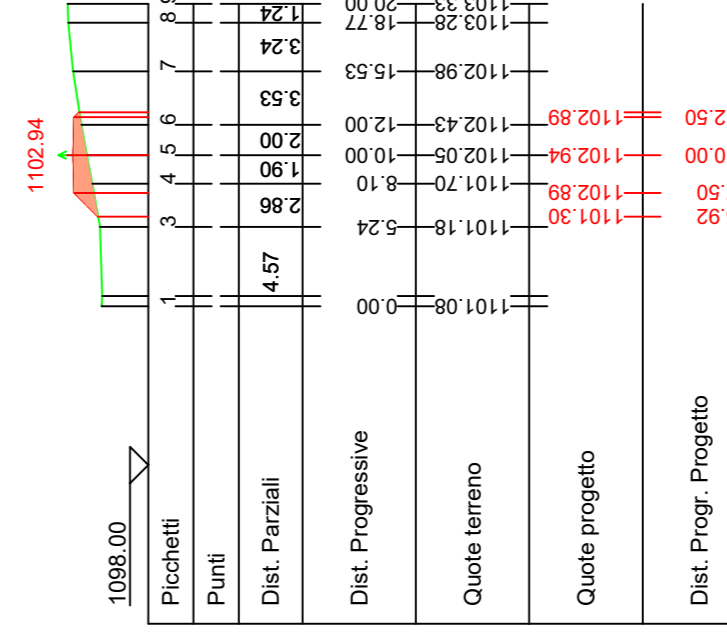

135

Area di Sierro: -0,00
Area di Ripetto: 0,00

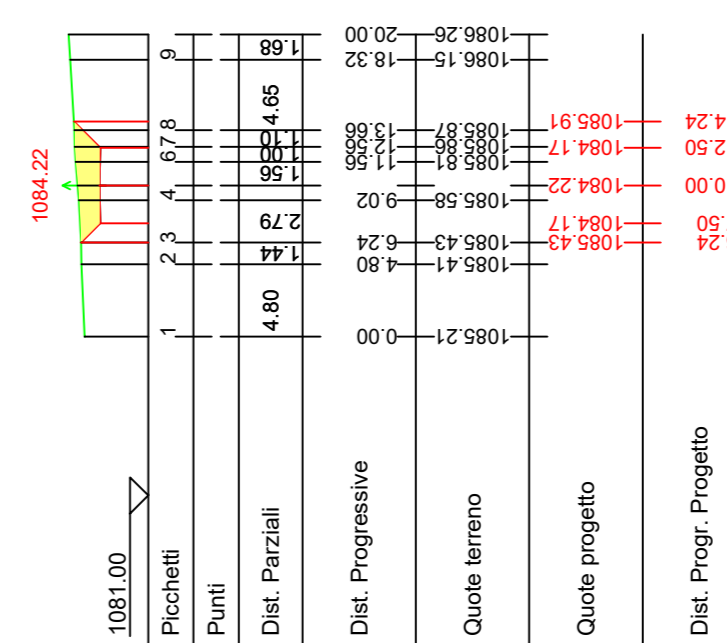

136

Area di Sierro: -0,00
Area di Ripetto: 0,00

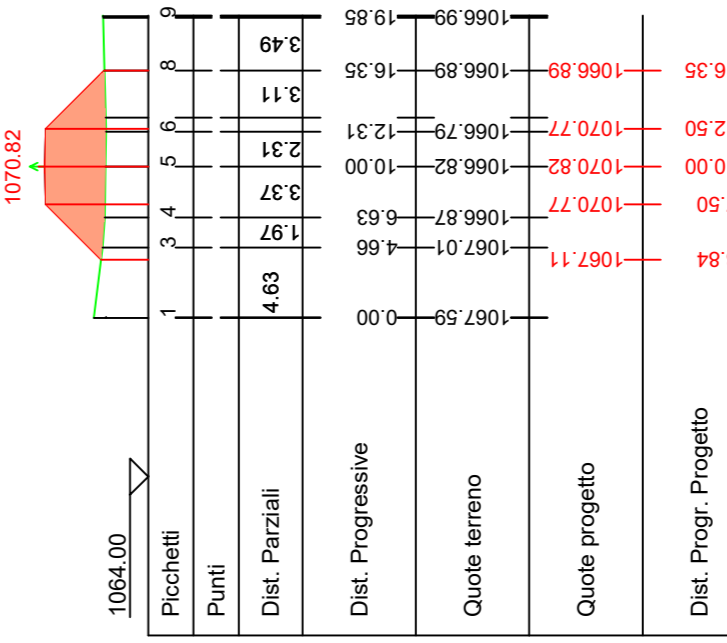

137

Area di Sierro: -0,00
Area di Ripetto: 0,00

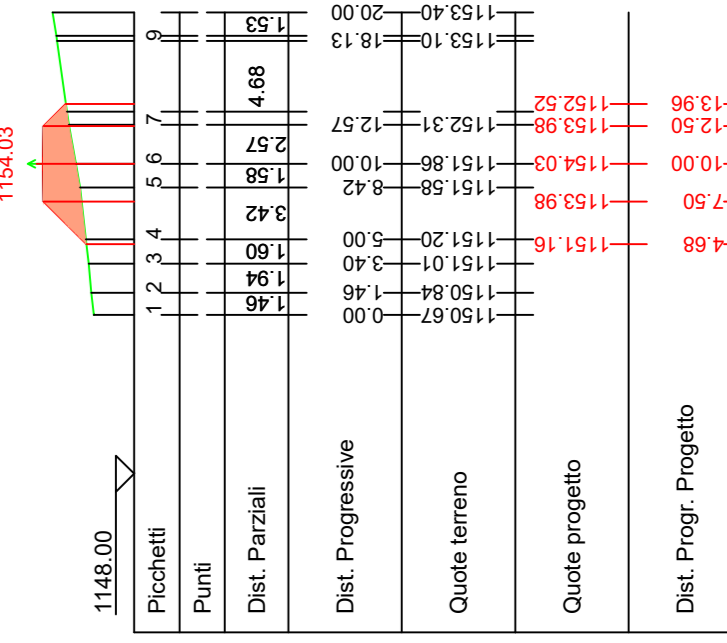

138

Area di Sierro: -0,14
Area di Ripetto: 2,80



139

Area di Sierro: -0,18
Area di Ripetto: 0,00



140

Area di Sierro: -0,27
Area di Ripetto: 0,12

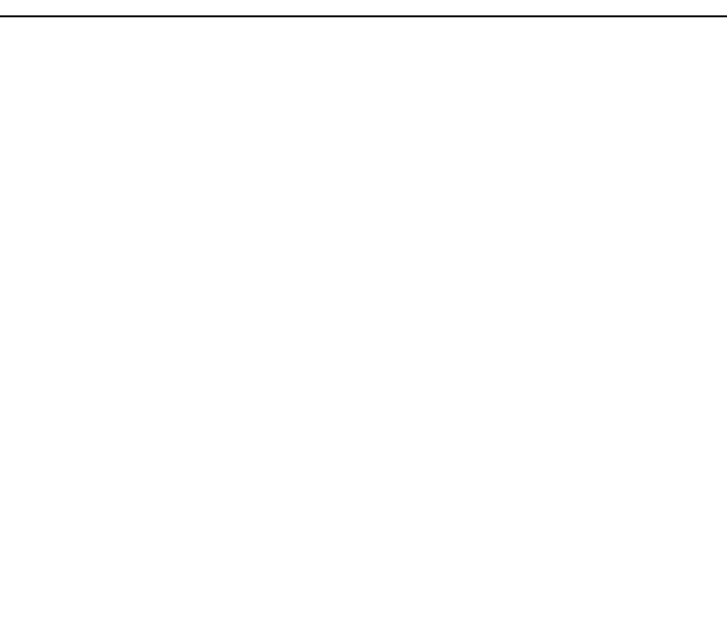

141

Area di Sierro: -0,27
Area di Ripetto: 0,12



142

Area di Sierro: -0,27
Area di Ripetto: 0,12



Regione Basilicata **Provincia di Potenza**

Comune Castelgrande Comune Muro Lucano Comune San Fele Comune Rapone

**PROGETTO PER LA REALIZZAZIONE
DI UN PARCO EOLICO PER LA PRODUZIONE DI ENERGIA ELETTRICA, DELLE OPERE
CONNESSE E DELLE INFRASTRUTTURE INDISPENSABILI**
Comune di Castelgrande, Muro Lucano, San Fele e Rapone(PZ)

PROGETTO DEFINITIVO **A. 16.a.17M**
Sezioni trasversali
ML02

Proponente

Eolica Muro Lucano Srl
Via del Galatitello 89, 1° Piano Galleria
85025 - POTENZA (PZ)

Progettista
Ing. Rossi Francesco Maria **Ing. Quirino Vassalli**

Revisione	Descrizione	Data	Preparato	Controllato	Approvato
00	Prima emissione	30/11/2017	QV	AS/QV	FR/QVAS

Formato: A0
Scala: 1:250
Scala stampa: