

PIANTA - JET GROUTING  
 SCALE 1:500

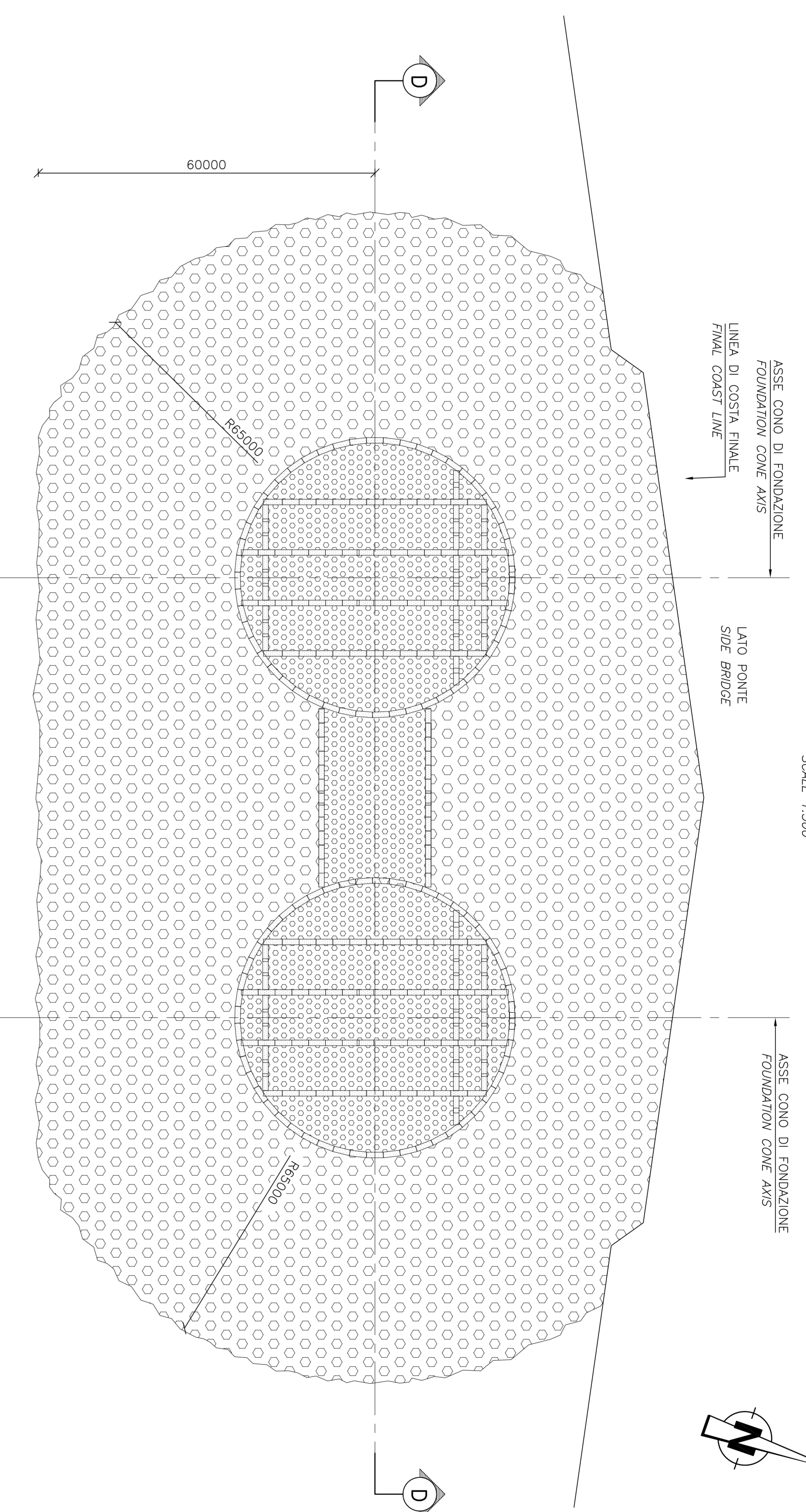

PIANTA  
 SCALE 1:500

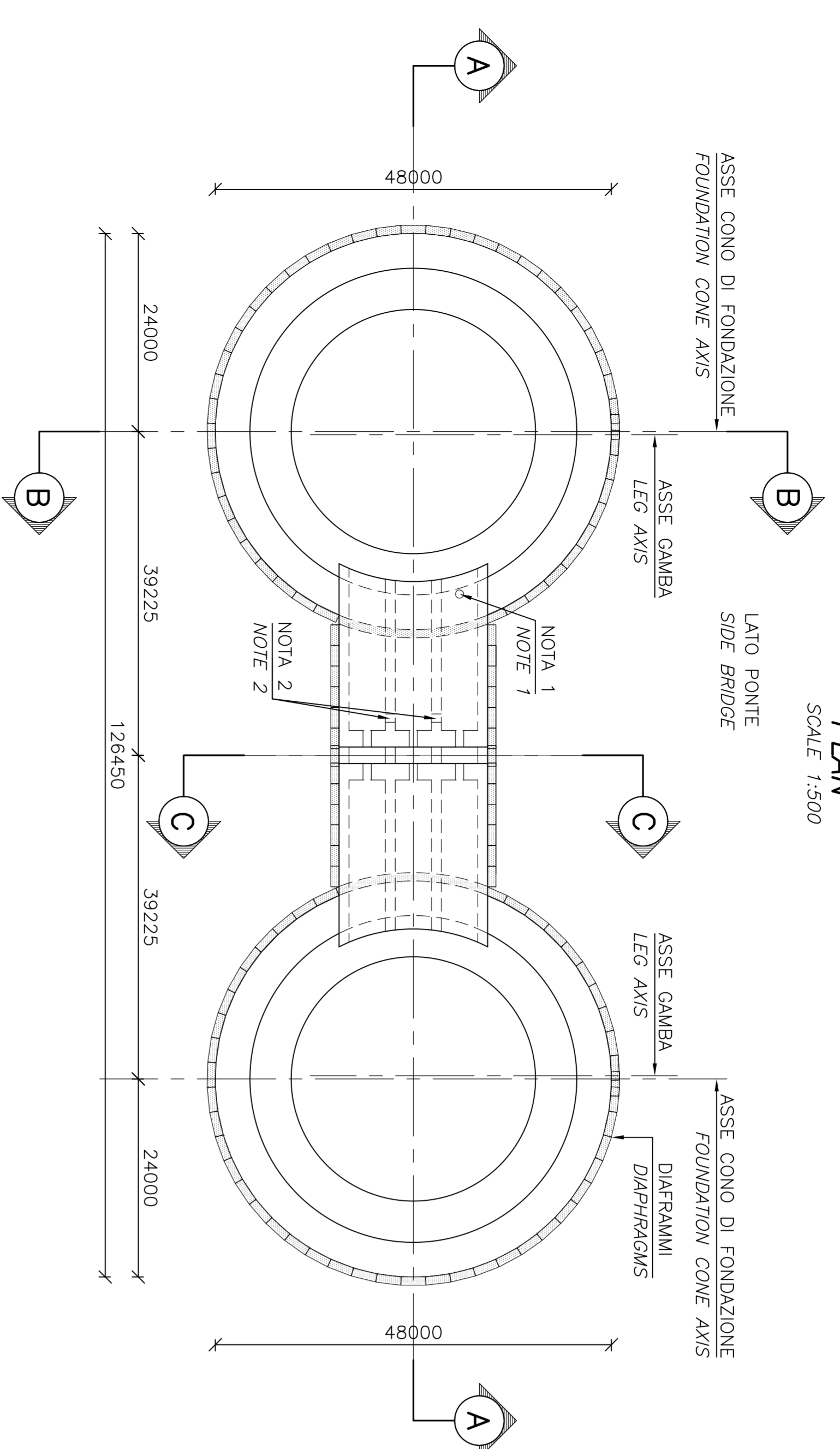

SEZIONE A-A  
 SCALE 1:500

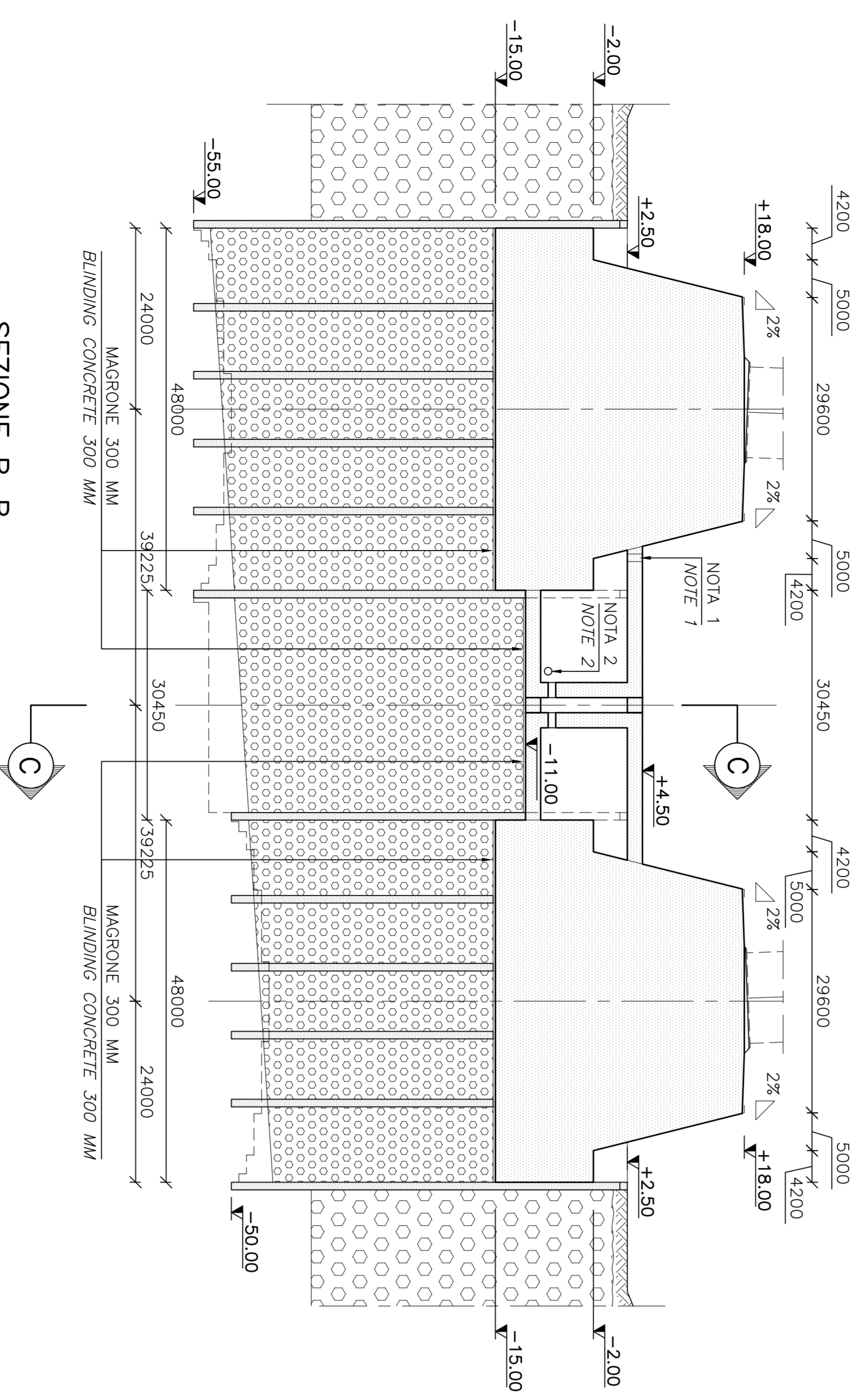

SEZIONE B-B  
 SCALE 1:500

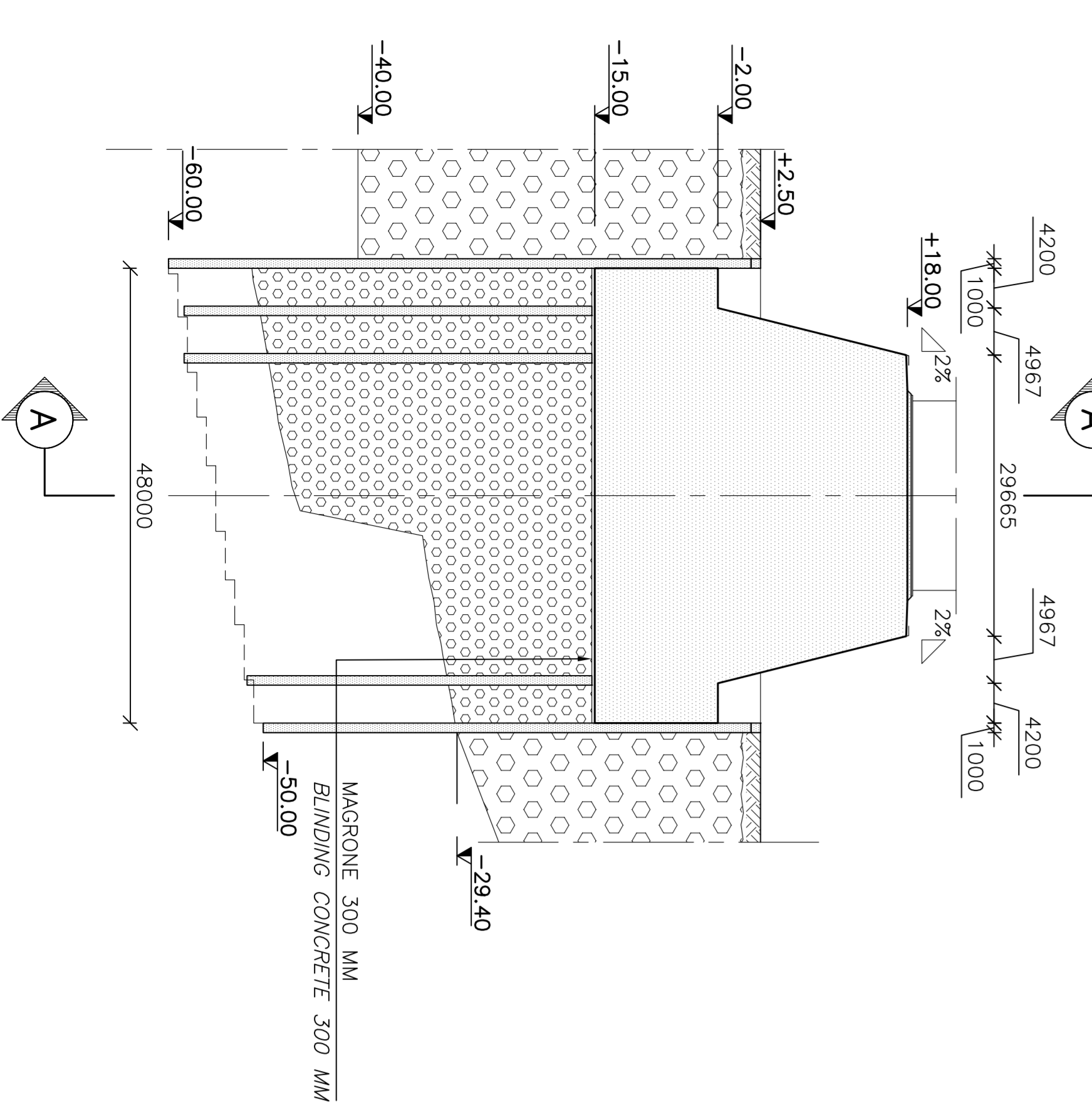

PIANTA - JET GROUTING  
 SCALE 1:500

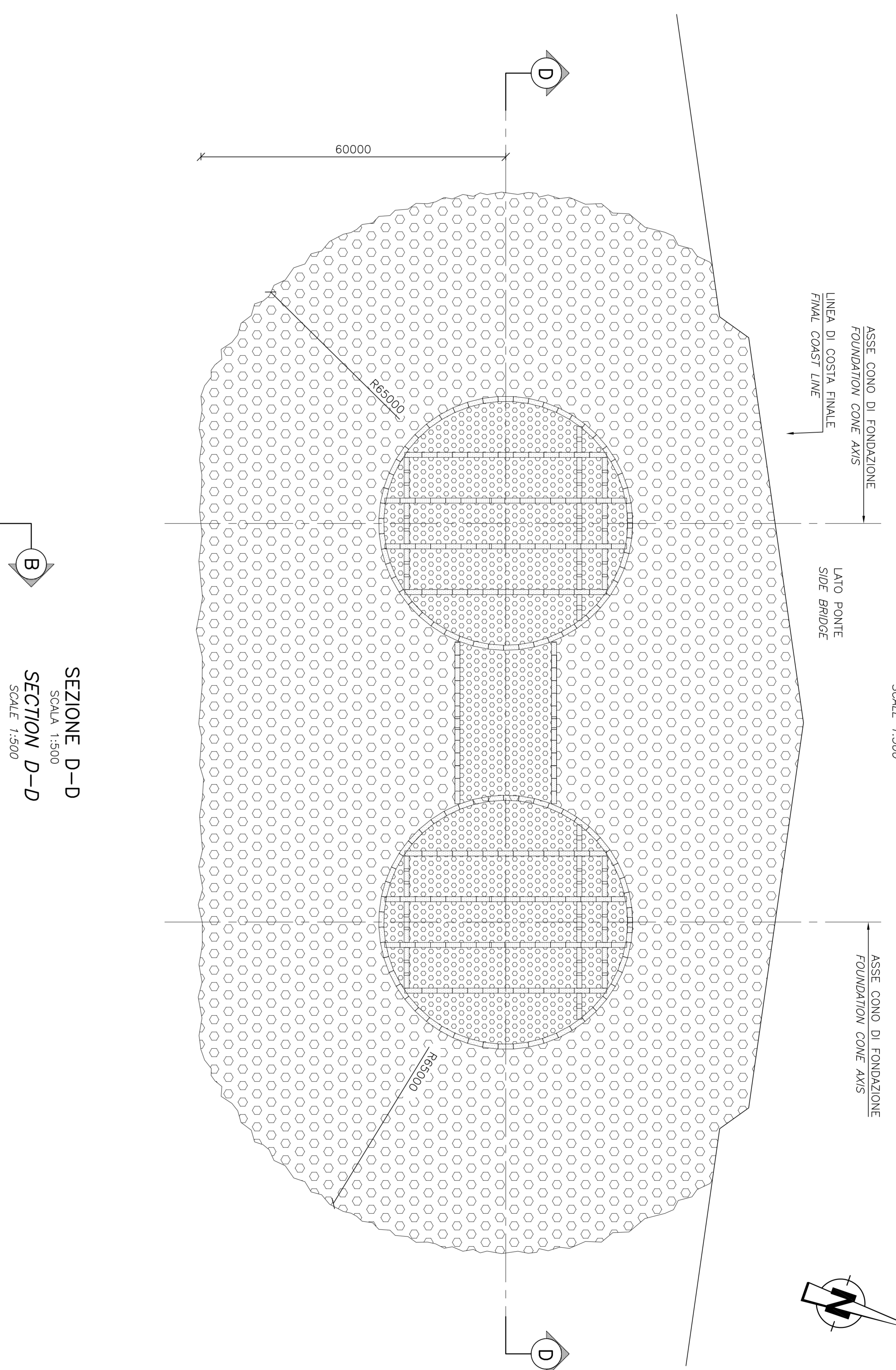

SEZIONE D-D  
 SCALE 1:500

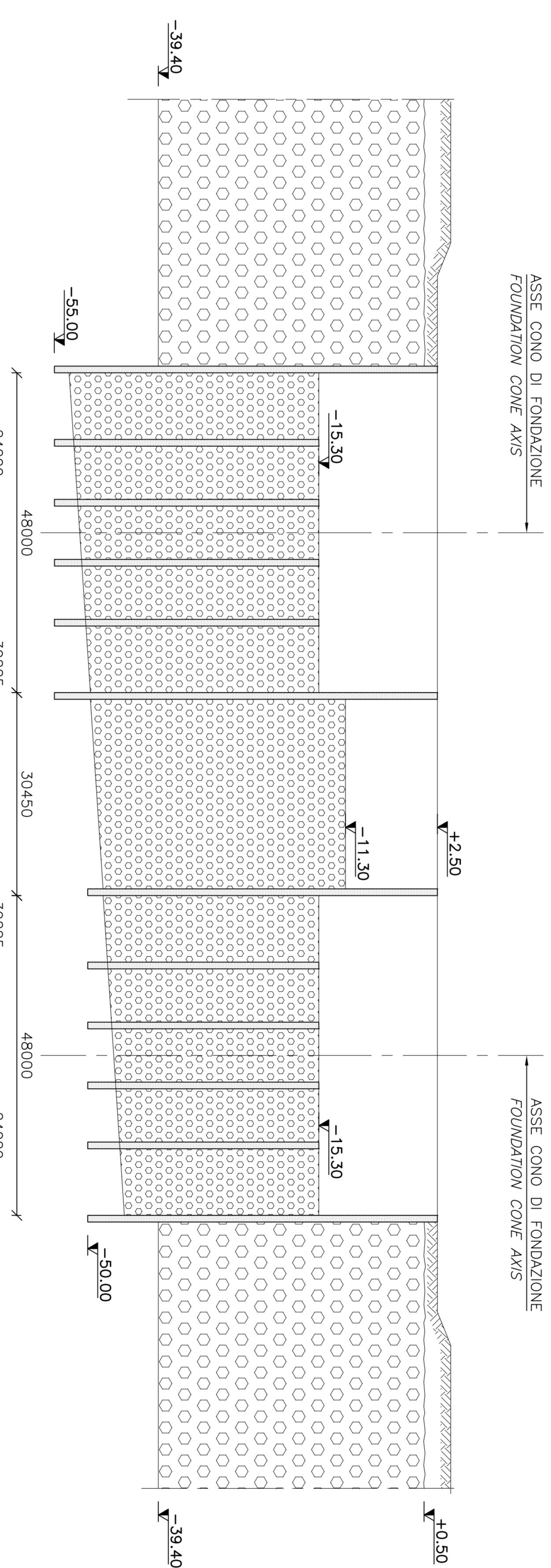

SEZIONE C-C  
 SCALE 1:200

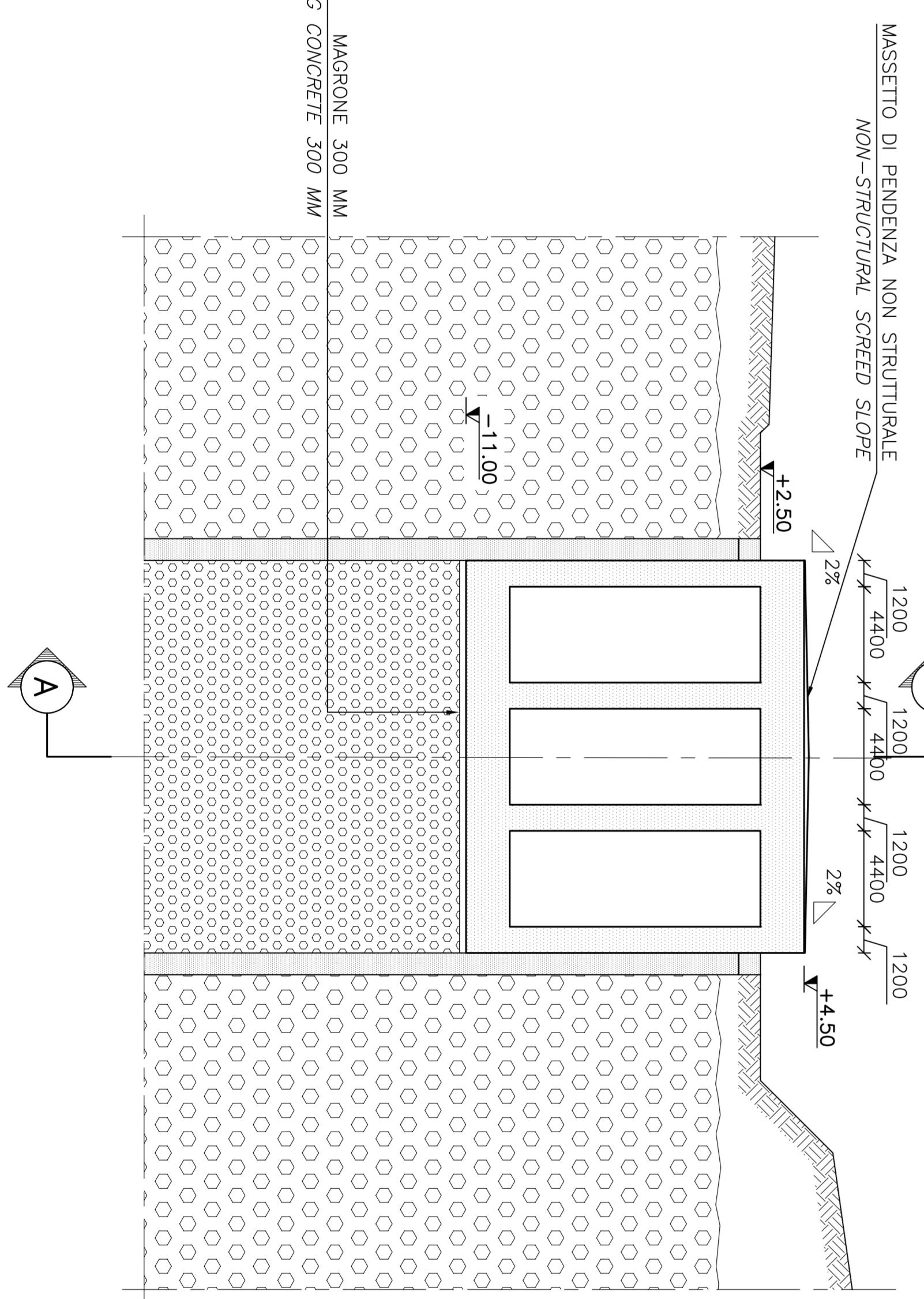

NOTE GENERALI

**NOTE:**  
 TUTTE LE DIMENSIONI SONO IN MILLIMETRI, SALVO LE DIMENSIONI IN DOLCI E LE QUOTE ALIMENTARIE SONO IN METRI. SLIM -NOTA 1: PASSO D'UOMO Ø1000 MM PER ACCESSO ALLA TRAVE DI COLLEGAMENTO -NOTA 2: PASSO D'UOMO Ø1000 MM PER IL PASSAGGIO FRA LE CELLE

**LEGENDA:**  
 CALCESTRUZZO GETTATO IN OPERA  
 DIAPHRAGMI  
 JET-GROUTING DENSITA' UNA COLONNA OGNI 4.5 M<sup>2</sup> (D>1.6 M) O IN BASSA PRESSIONE  
 JET-GROUTING DENSITA' UNA COLONNA OGNI 2.0 M<sup>2</sup> (D>1.6M)

**NOTES:**  
 ALL THE DIMENSIONS ARE IN MILLIMETERS, EXCEPT WHERE OTHERWISE INDICATED. ALL LEVELS ARE IN METERS ABOVE SEA LEVEL.  
 -NOTE 1: PORTHOLE Ø1000 MM FOR ACCESS TO THE CONNECTING BEAM  
 -NOTE 2: PORTHOLE Ø1000 MM FOR CROSSING BETWEEN THE CELLS

**LEGENDS:**  
 CONCRETE CAST IN SITU  
 DIAPHRAGMS WALLS  
 JET-GROUTING DENSITY A COLUMN EVERY 4.5 M<sup>2</sup> (D>1.6 M) OR LOW PRESSURE INJECTIONS  
 JET-GROUTING DENSITY A COLUMN EVERY 2.0 M<sup>2</sup> (D>1.6 M)

**Stretto di Messina**  
 EUROINTEK S.p.A.  
 PROGETTO DEFINITIVO

EUROINTEK S.p.A.  
 SOCIETA' ITALIANA PER CONOTTE EYACOLA S.p.A. (Messina)  
 COOPERATIVA NAZIONALE ELETTRICI S.p.A. (Messina)  
 ISHIKAWAKAWA - HARIMA HEAVY INDUSTRIES CO. LTD. (Messina)  
 A.S. S.p.A. - CONSORSIO STRADE (Messina)

**COWI**  
 L. COINQUENTE GENERALE  
 Ing. E.M. Vaga  
 SIRETTO DI MESSINA  
 SIRETTO DI MESSINA  
 SIRETTO DI MESSINA

**OPERA DI ATTRAVERSAMENTO**  
 SOTTOSTITUIRE  
 FONDAZIONI TORRI  
 TORRE CALABRIA  
 DISEGNI D'INSENE

REVISIONI	DATA	DESCRIZIONE	REVISIONI	DATA
01	20-06-2017	ESECUZIONE FINALE	02	06-07-2017
02	06-07-2017		03	06-07-2017
03	06-07-2017		04	06-07-2017
04	06-07-2017		05	06-07-2017
05	06-07-2017		06	06-07-2017
06	06-07-2017		07	06-07-2017
07	06-07-2017		08	06-07-2017
08	06-07-2017		09	06-07-2017
09	06-07-2017		10	06-07-2017
10	06-07-2017		11	06-07-2017
11	06-07-2017		12	06-07-2017
12	06-07-2017		13	06-07-2017
13	06-07-2017		14	06-07-2017
14	06-07-2017		15	06-07-2017
15	06-07-2017		16	06-07-2017
16	06-07-2017		17	06-07-2017
17	06-07-2017		18	06-07-2017
18	06-07-2017		19	06-07-2017
19	06-07-2017		20	06-07-2017
20	06-07-2017		21	06-07-2017
21	06-07-2017		22	06-07-2017
22	06-07-2017		23	06-07-2017
23	06-07-2017		24	06-07-2017
24	06-07-2017		25	06-07-2017
25	06-07-2017		26	06-07-2017
26	06-07-2017		27	06-07-2017
27	06-07-2017		28	06-07-2017
28	06-07-2017		29	06-07-2017
29	06-07-2017		30	06-07-2017
30	06-07-2017		31	06-07-2017
31	06-07-2017		32	06-07-2017
32	06-07-2017		33	06-07-2017
33	06-07-2017		34	06-07-2017
34	06-07-2017		35	06-07-2017
35	06-07-2017		36	06-07-2017
36	06-07-2017		37	06-07-2017
37	06-07-2017		38	06-07-2017
38	06-07-2017		39	06-07-2017
39	06-07-2017		40	06-07-2017
40	06-07-2017		41	06-07-2017
41	06-07-2017		42	06-07-2017
42	06-07-2017		43	06-07-2017
43	06-07-2017		44	06-07-2017
44	06-07-2017		45	06-07-2017
45	06-07-2017		46	06-07-2017
46	06-07-2017		47	06-07-2017
47	06-07-2017		48	06-07-2017
48	06-07-2017		49	06-07-2017
49	06-07-2017		50	06-07-2017
50	06-07-2017		51	06-07-2017
51	06-07-2017		52	06-07-2017
52	06-07-2017		53	06-07-2017
53	06-07-2017		54	06-07-2017
54	06-07-2017		55	06-07-2017
55	06-07-2017		56	06-07-2017
56	06-07-2017		57	06-07-2017
57	06-07-2017		58	06-07-2017
58	06-07-2017		59	06-07-2017
59	06-07-2017		60	06-07-2017
60	06-07-2017		61	06-07-2017
61	06-07-2017		62	06-07-2017
62	06-07-2017		63	06-07-2017
63	06-07-2017		64	06-07-2017
64	06-07-2017		65	06-07-2017
65	06-07-2017		66	06-07-2017
66	06-07-2017		67	06-07-2017
67	06-07-2017		68	06-07-2017
68	06-07-2017		69	06-07-2017
69	06-07-2017		70	06-07-2017
70	06-07-2017		71	06-07-2017
71	06-07-2017		72	06-07-2017
72	06-07-2017		73	06-07-2017
73	06-07-2017		74	06-07-2017
74	06-07-2017		75	06-07-2017
75	06-07-2017		76	06-07-2017
76	06-07-2017		77	06-07-2017
77	06-07-2017		78	06-07-2017
78	06-07-2017		79	06-07-2017
79	06-07-2017		80	06-07-2017
80	06-07-2017		81	06-07-2017
81	06-07-2017		82	06-07-2017
82	06-07-2017		83	06-07-2017
83	06-07-2017		84	06-07-2017
84	06-07-2017		85	06-07-2017
85	06-07-2017		86	06-07-2017
86	06-07-2017		87	06-07-2017
87	06-07-2017		88	06-07-2017
88	06-07-2017		89	06-07-2017
89	06-07-2017		90	06-07-2017
90	06-07-2017		91	06-07-2017
91	06-07-2017		92	06-07-2017
92	06-07-2017		93	06-07-2017
93	06-07-2017		94	06-07-2017
94	06-07-2017		95	06-07-2017
95	06-07-2017		96	06-07-2017
96	06-07-2017		97	06-07-2017
97	06-07-2017		98	06-07-2017
98	06-07-2017		99	06-07-2017
99	06-07-2017		100	06-07-2017