

FIGURE

CAMPO DI BORDOLANO

STORIA PRODUTTIVA

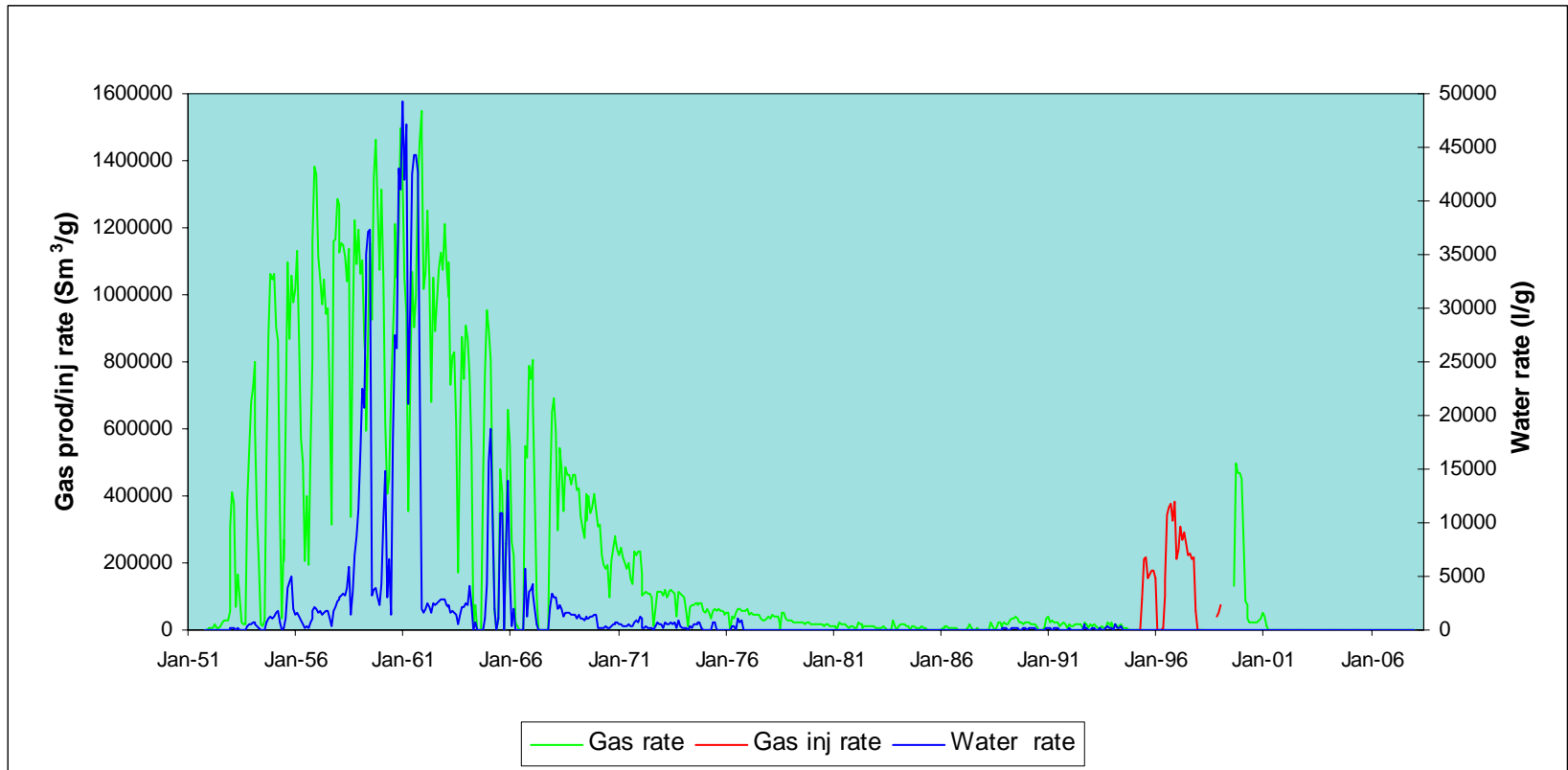

Fig. 1

CAMPO DI BORDOLANO
ANDAMENTO STATICHE
MISURATE PER LIVELLO

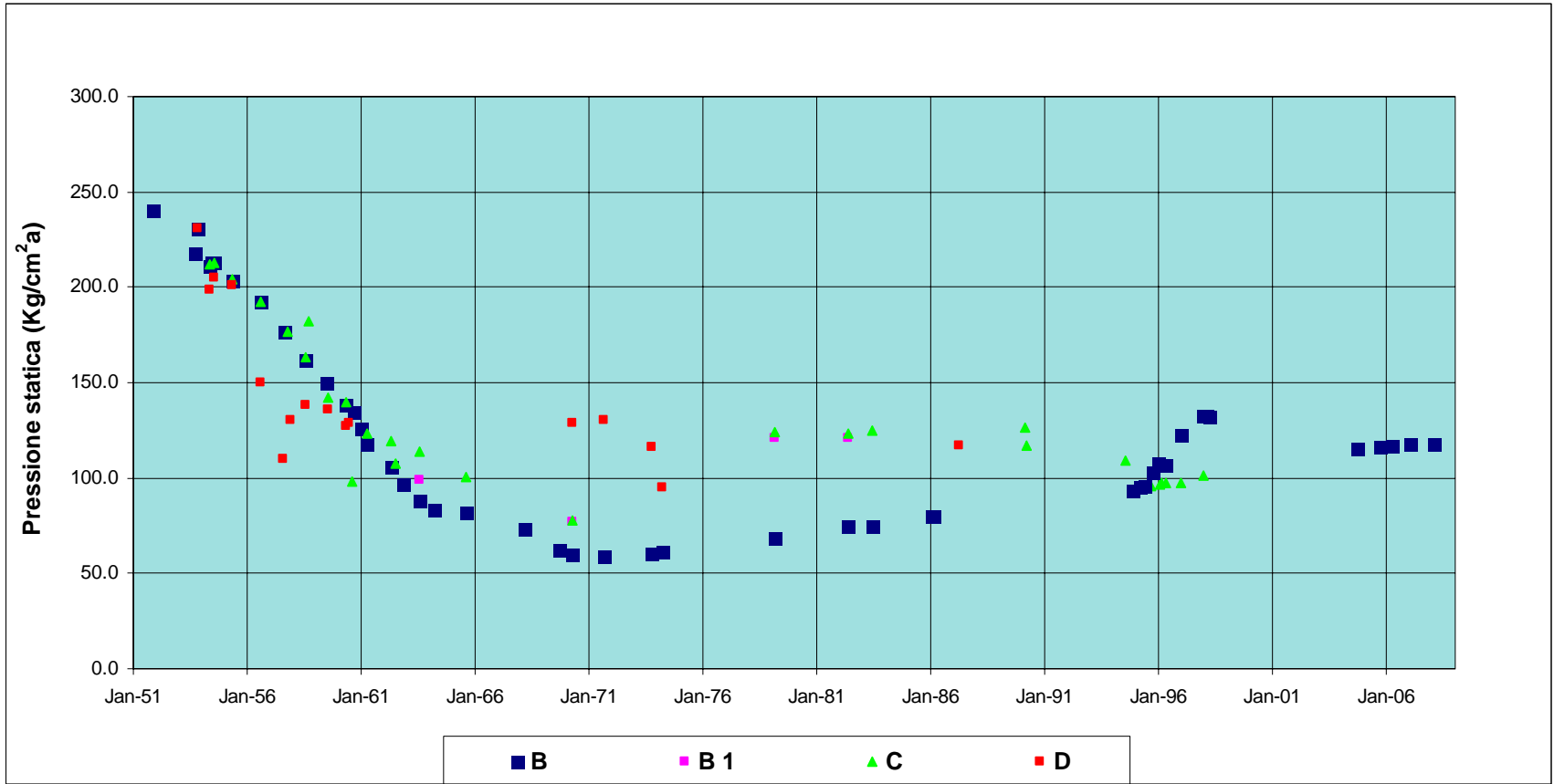

Fig. 2

CAMPO DI BORDOLANO
POOL B
STORIA PRODUTTIVA

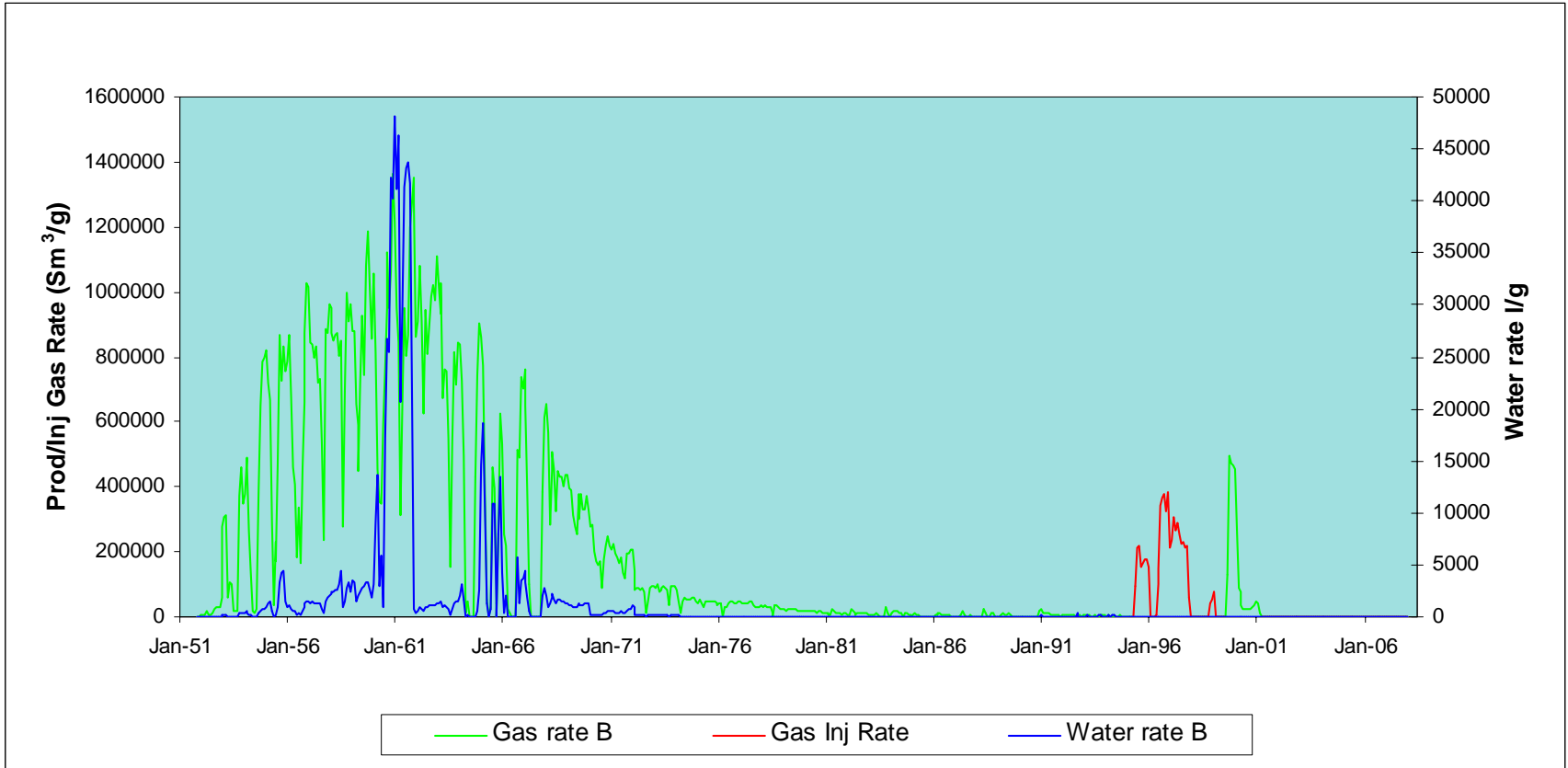

Fig. 3

CAMPO DI BORDOLANO

POOL B

ANDAMENTO STATICHE MISURATE PER LIVELLO

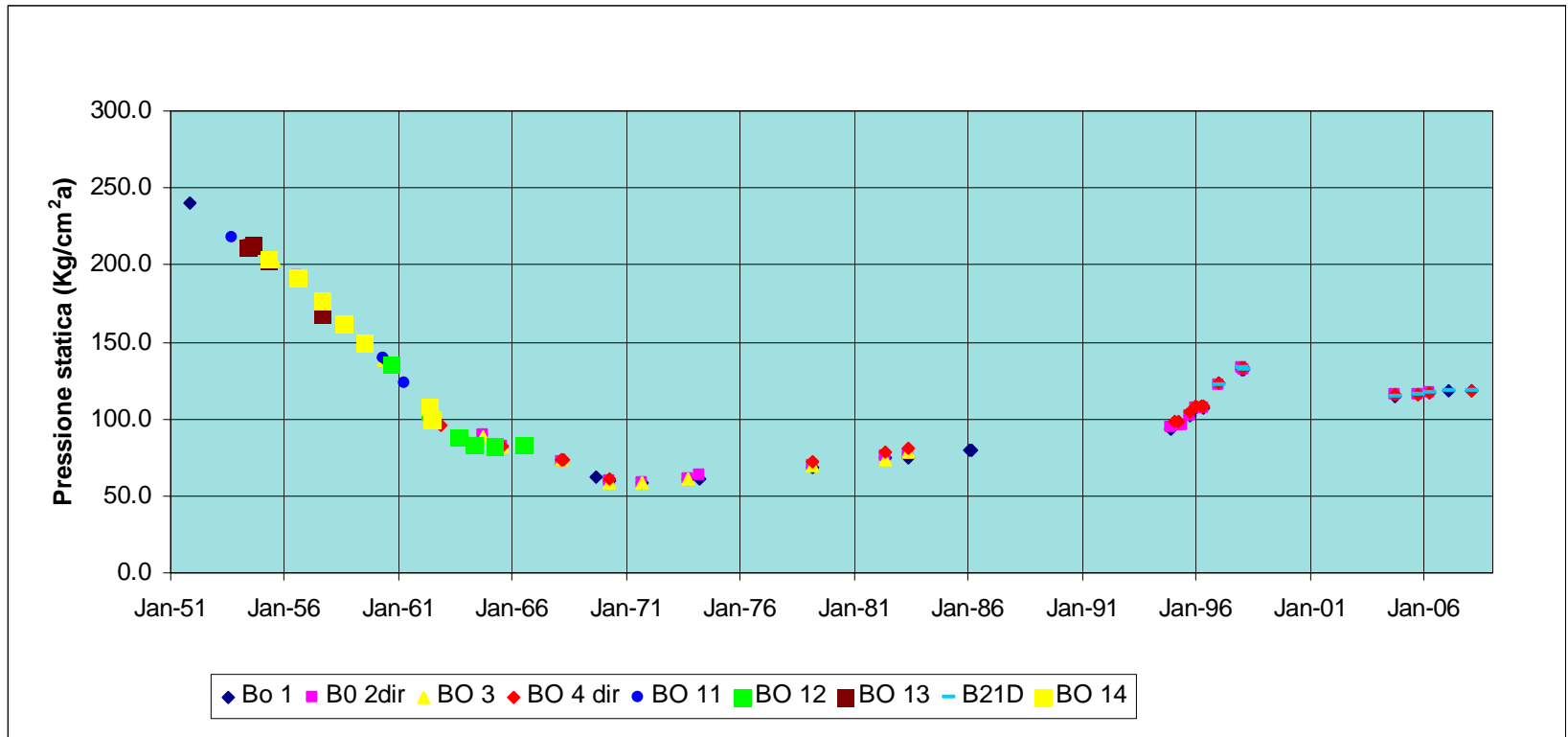

Fig. 4

CAMPO DI BORDOLANO
POOL B
SCHEMA FALL-OFF TEST POZZO 21D

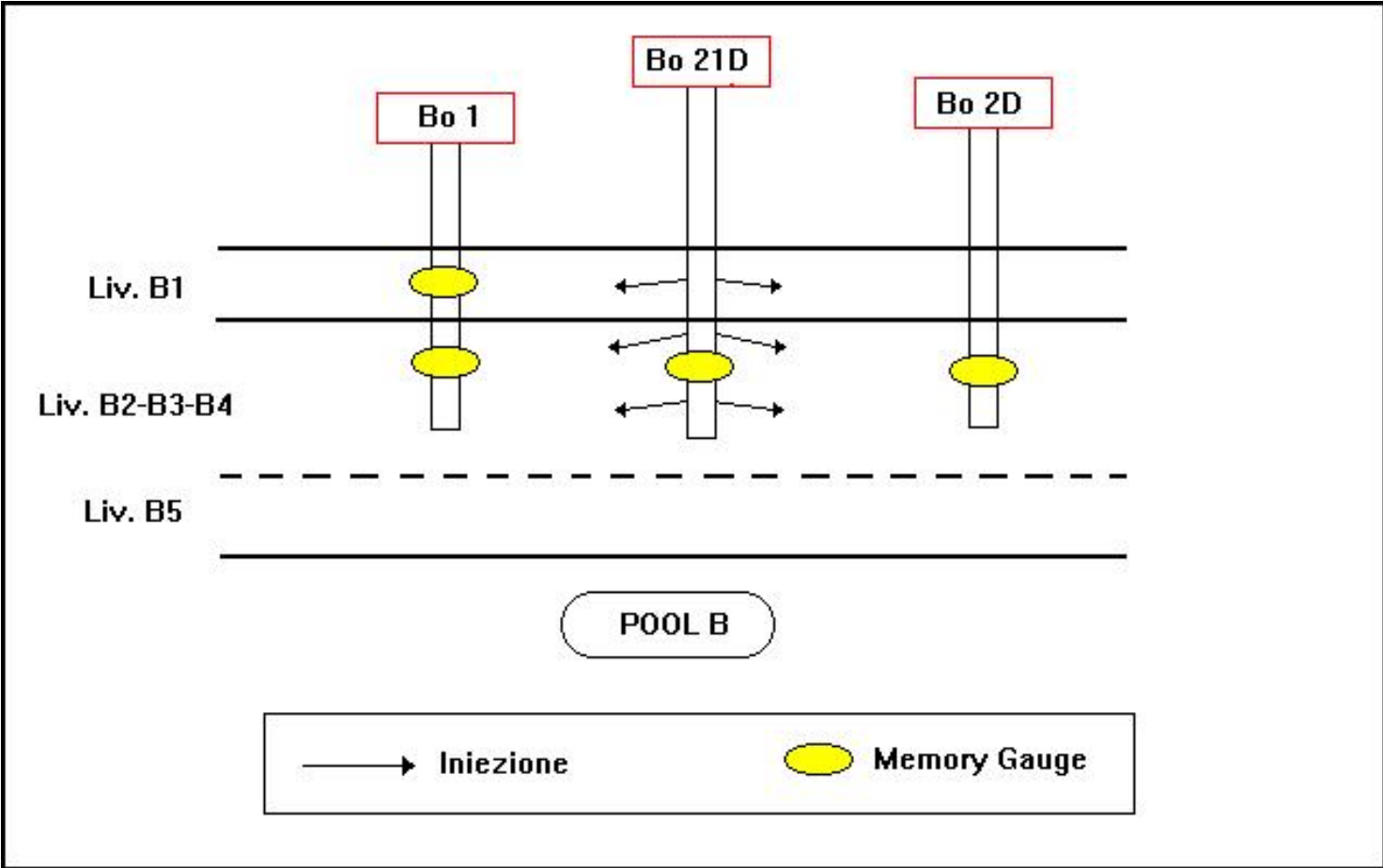

Fig.5



CAMPO DI BORDOLANO POOL B GRID DI SIMULAZIONE

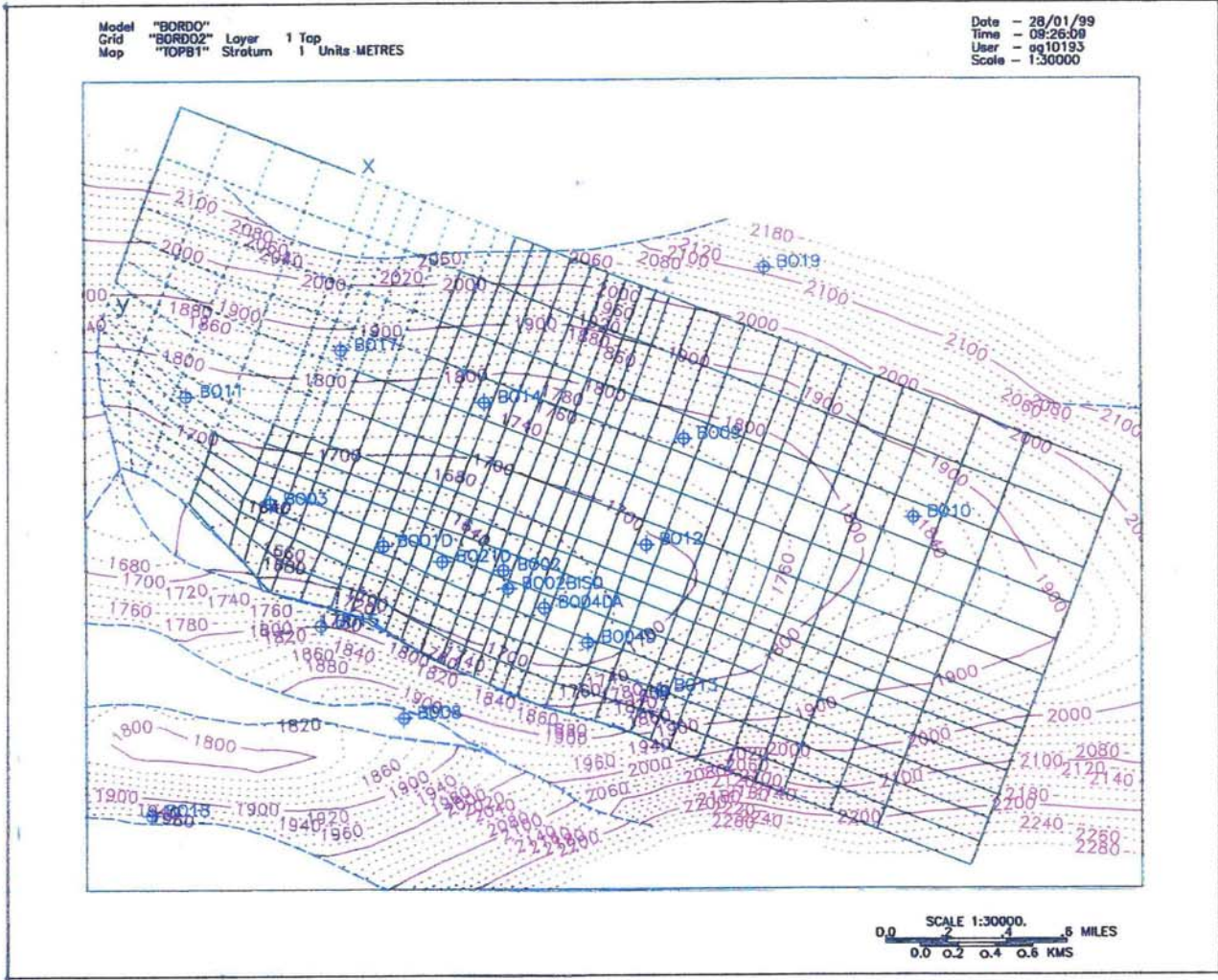

FIG 6

CAMPO DI BORDOLANO
POOL B
CURVE DI PERMEABILITA' RELATIVE

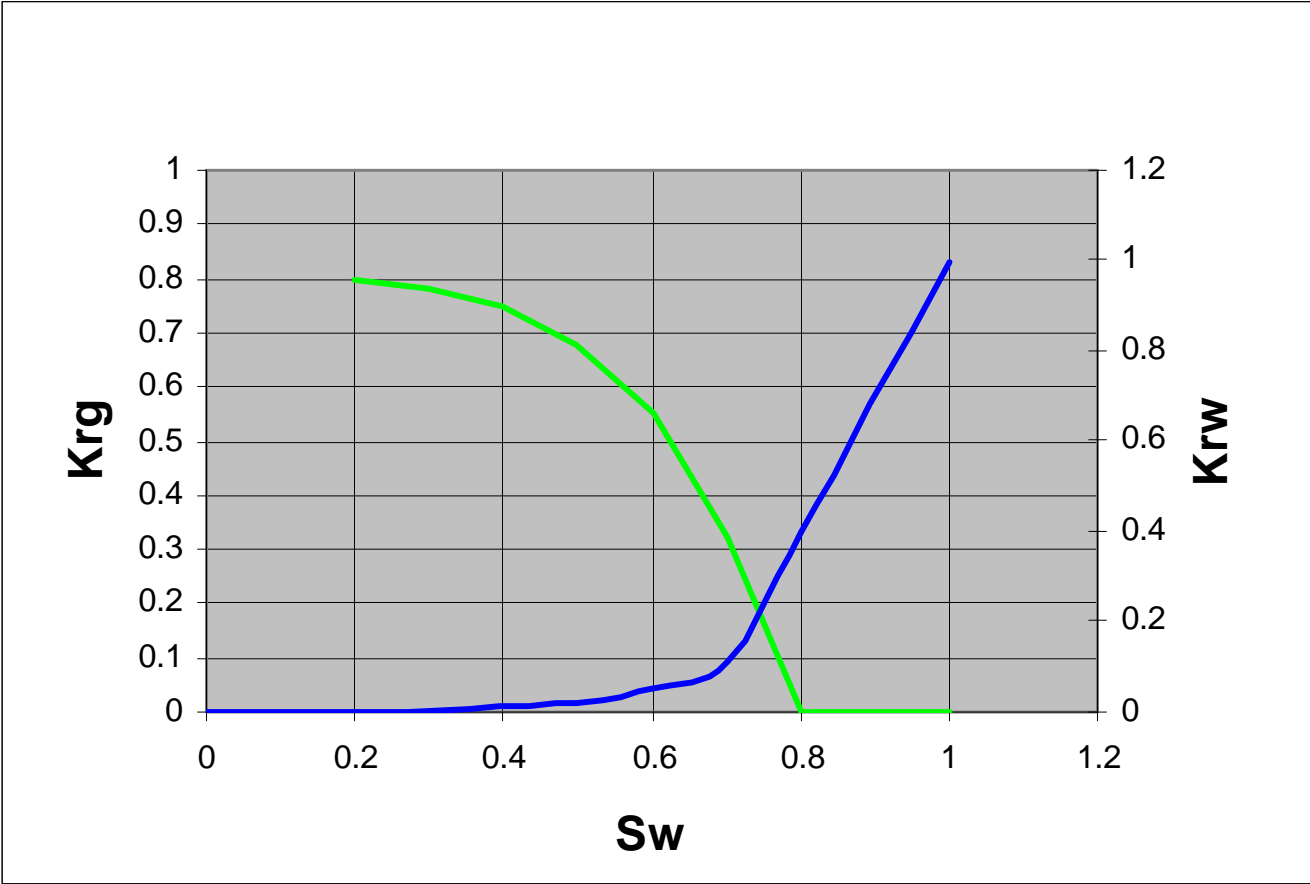

Fig.7



**CAMPO DI BORDOLANO
POOL B
HISTORY MATCH DI POZZO DELLE PRESSIONI**

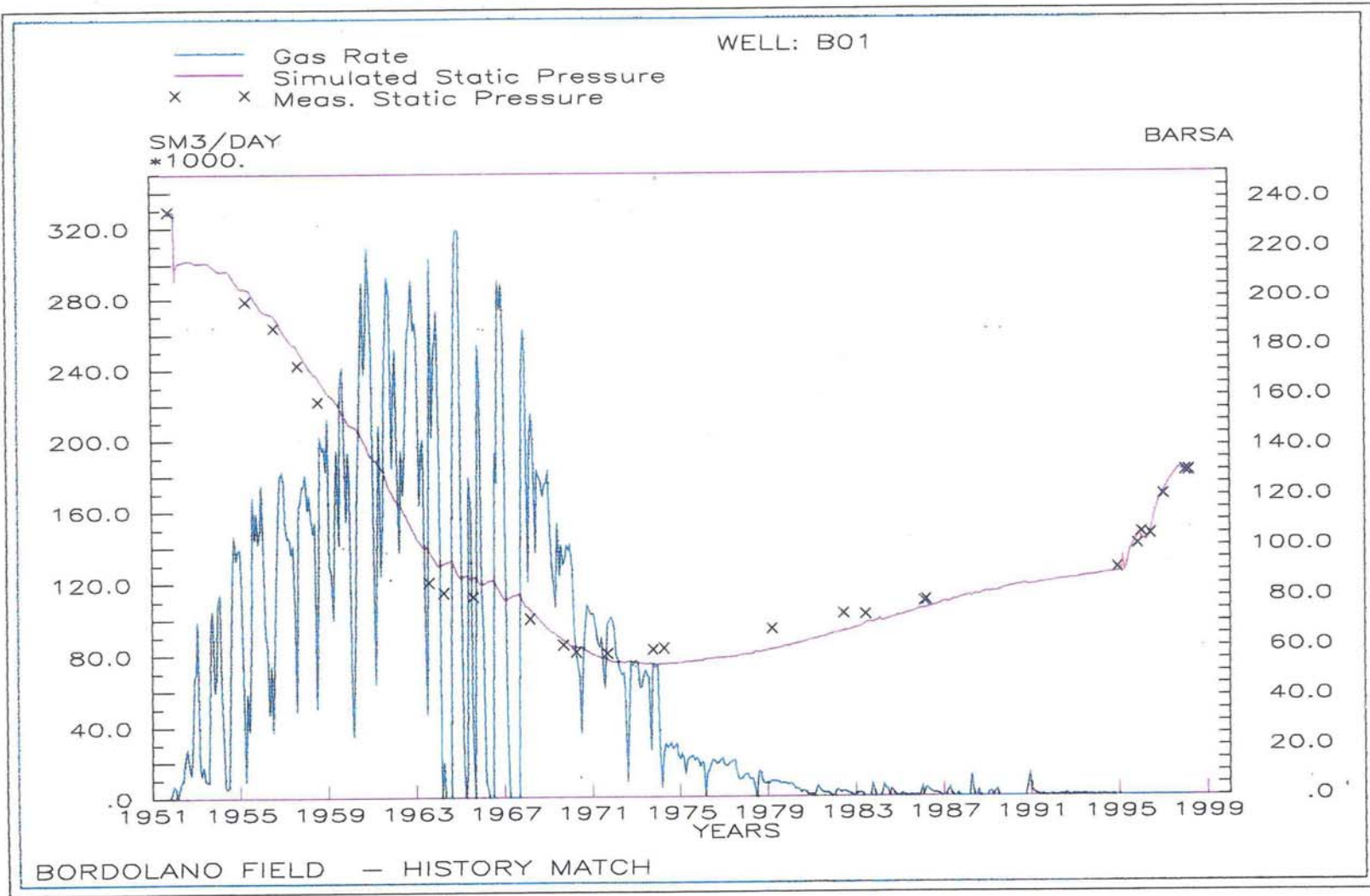

Fig 8

CAMPO DI BORDOLANO
POOL B
HISTORY MATCH DI POZZO DELLE PRESSIONI

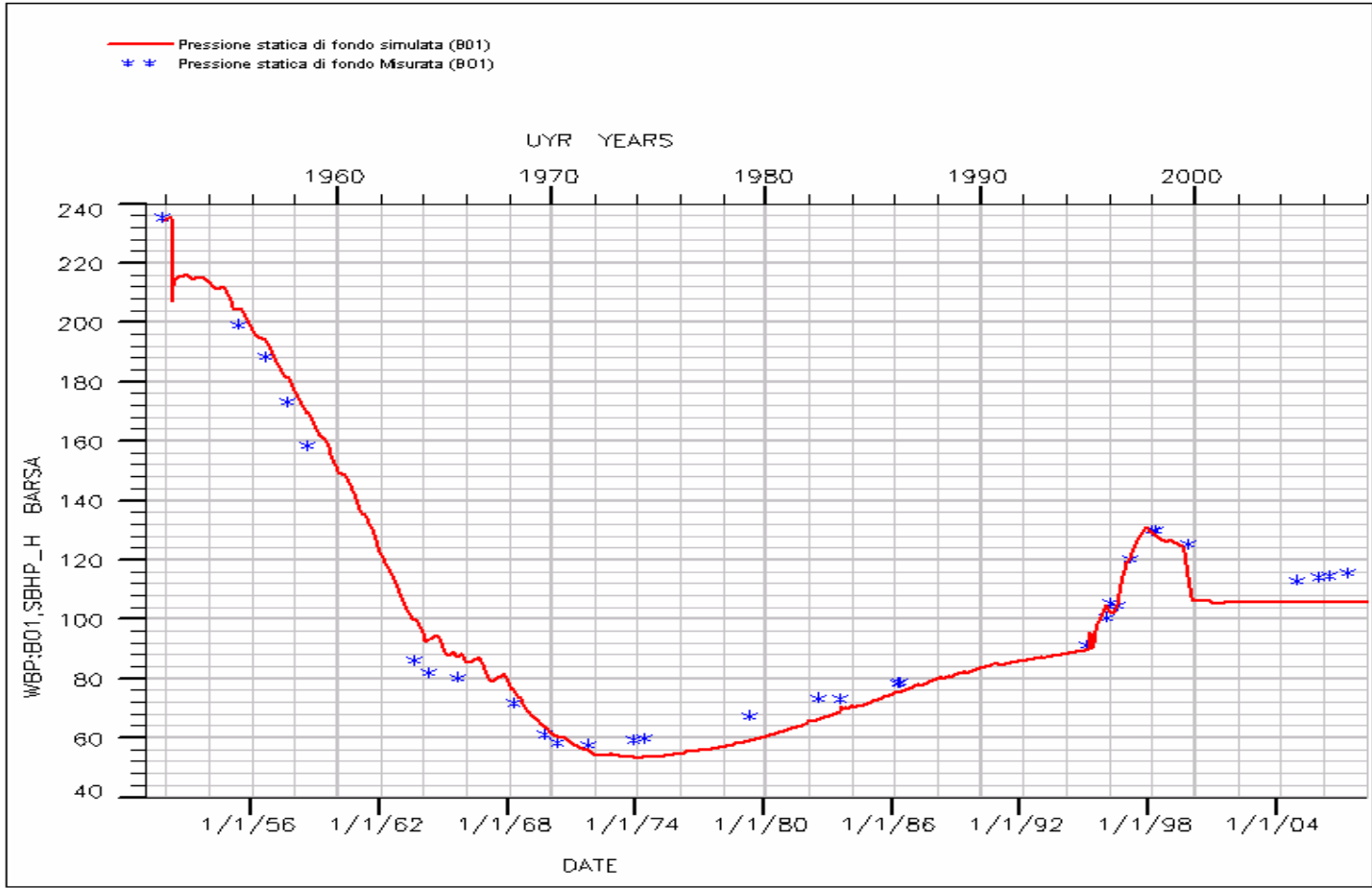

Fig.8B



**CAMPO DI BORDOLANO
POOL B
HISTORY MATCH DI POZZO DELLE PRESSIONI**

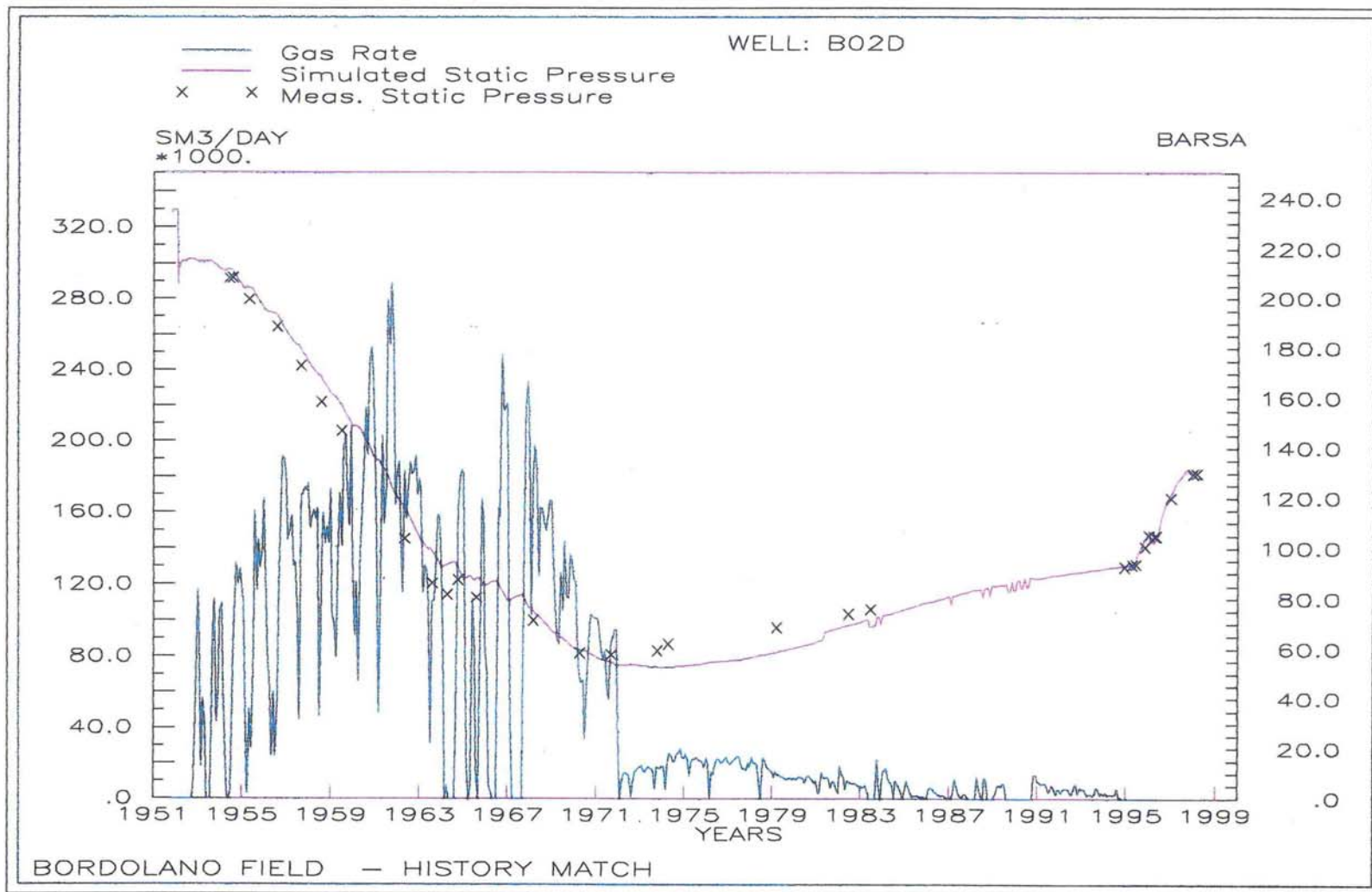

Fig 9



**CAMPO DI BORDOLANO
POOL B
HISTORY MATCH DI POZZO DELLE PRESSIONI**

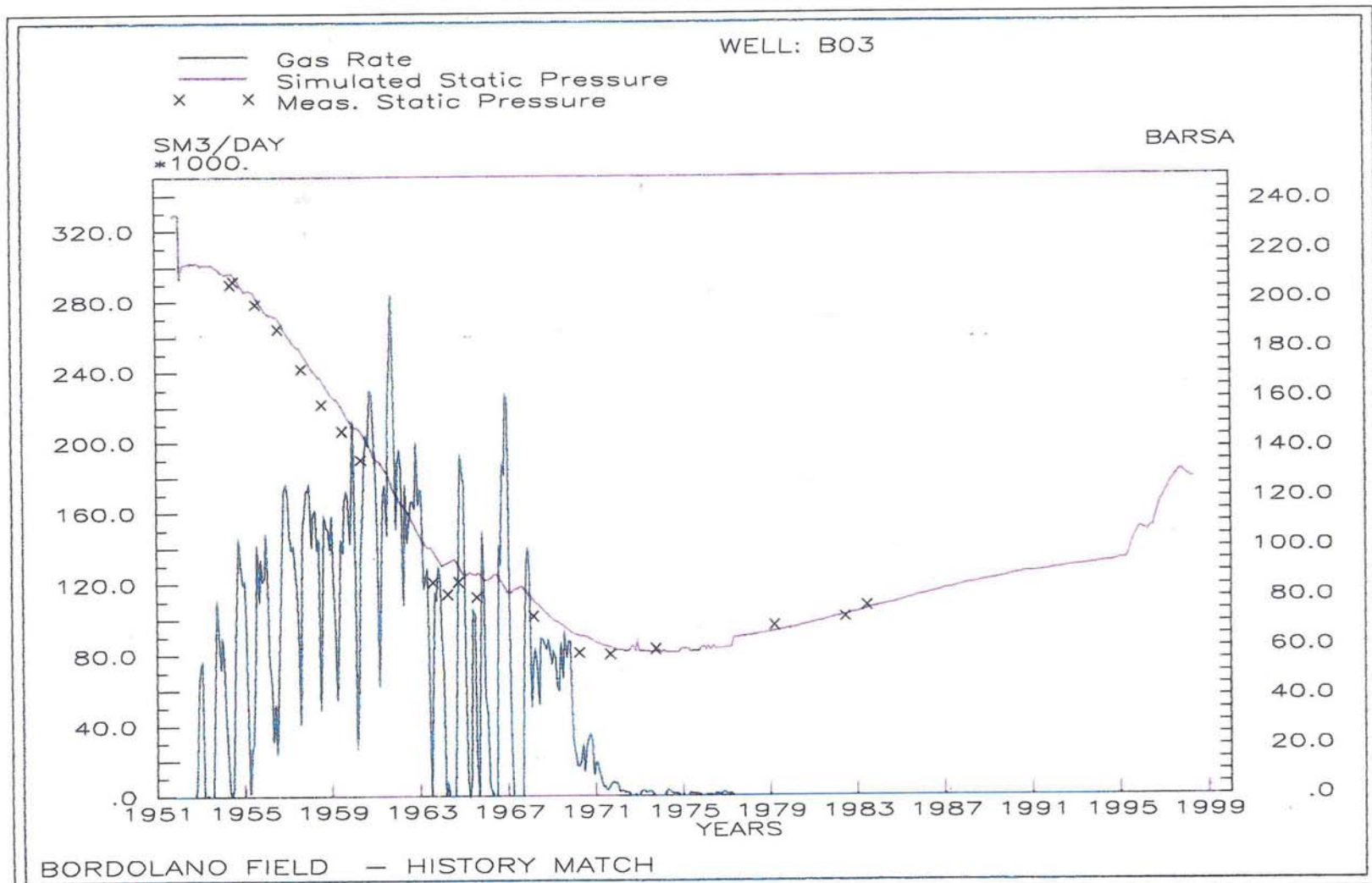

Fig 10



**CAMPO DI BORDOLANO
POOL B
HISTORY MATCH DI POZZO DELLE PRESSIONI**

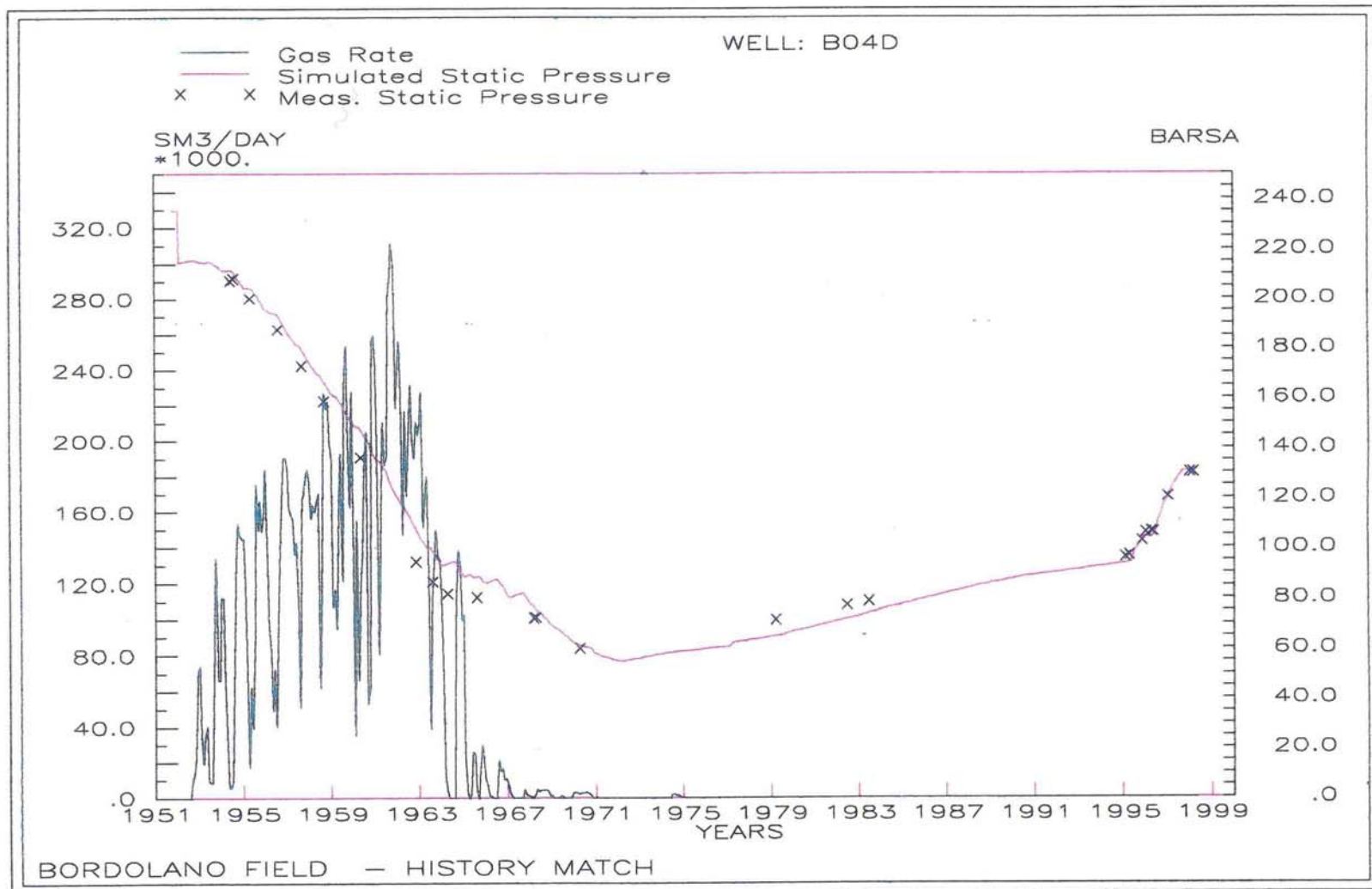

Fig 11

CAMPO DI BORDOLANO
POOL B
HISTORY MATCH DI POZZO DELLE PRESSIONI

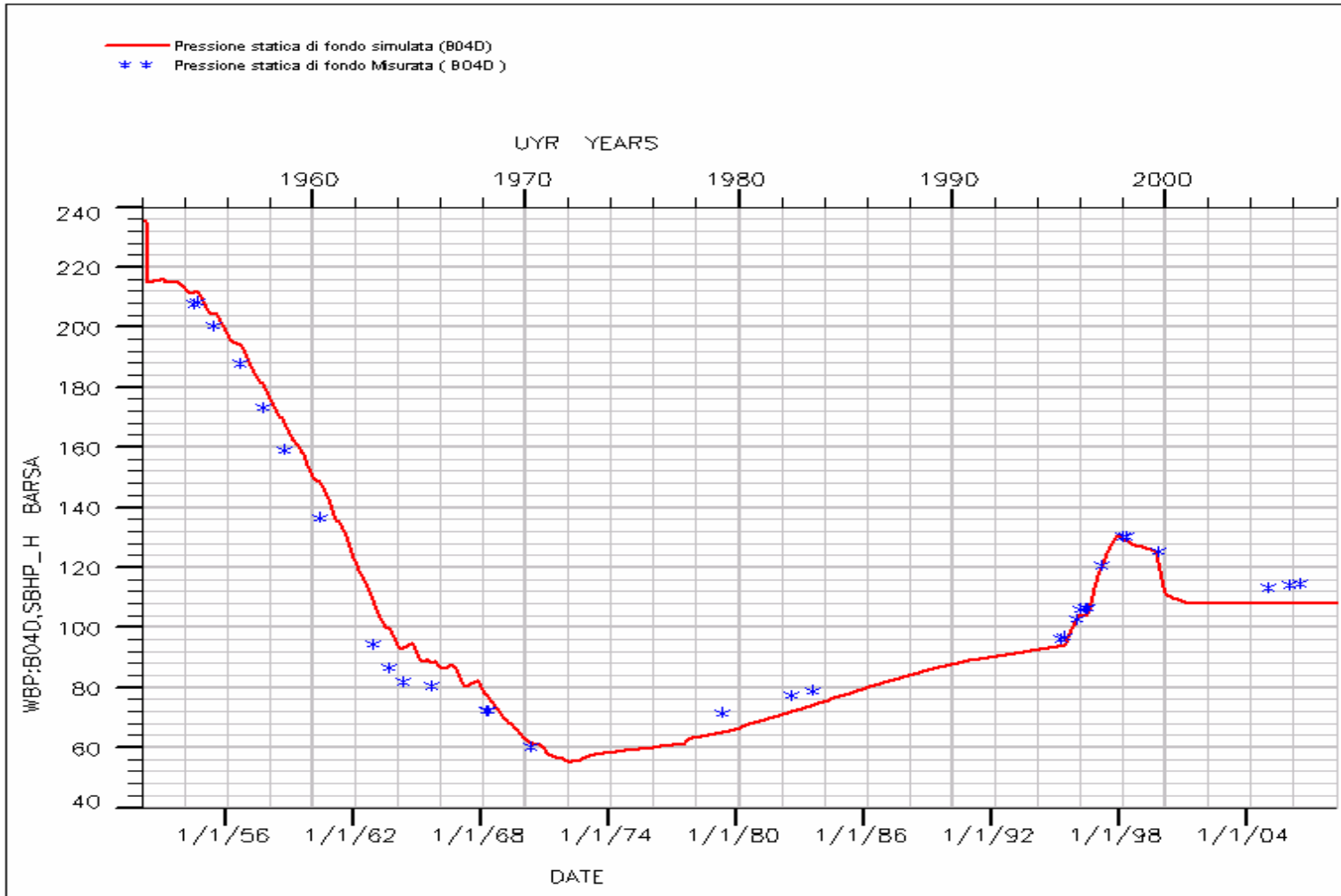

Fig.11B



**CAMPO DI BORDOLANO
POOL B
HISTORY MATCH DI POZZO DELLE PRESSIONI**

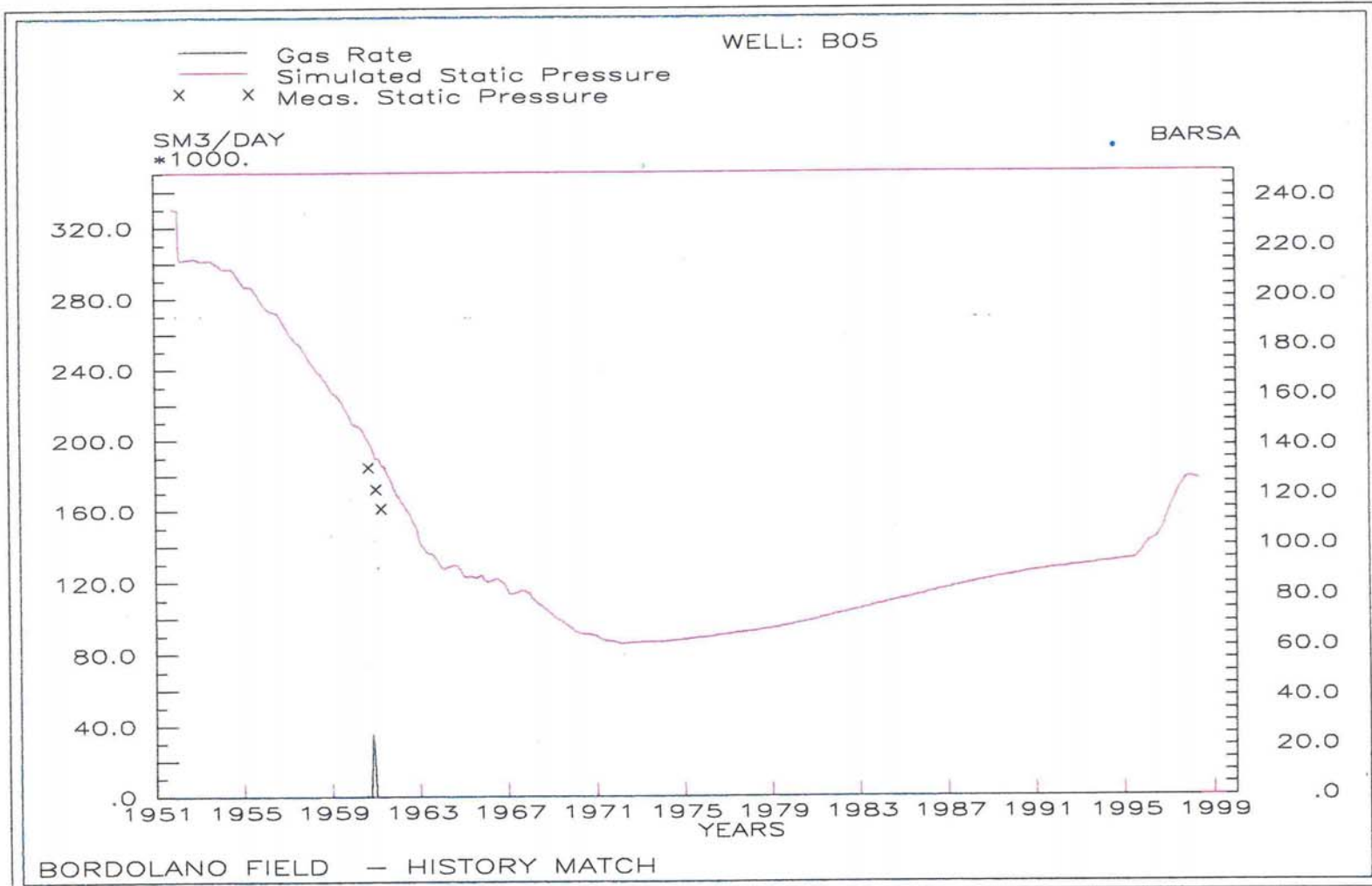

Fig 12



**CAMPO DI BORDOLANO
POOL B
HISTORY MATCH DI POZZO DELLE PRESSIONI**

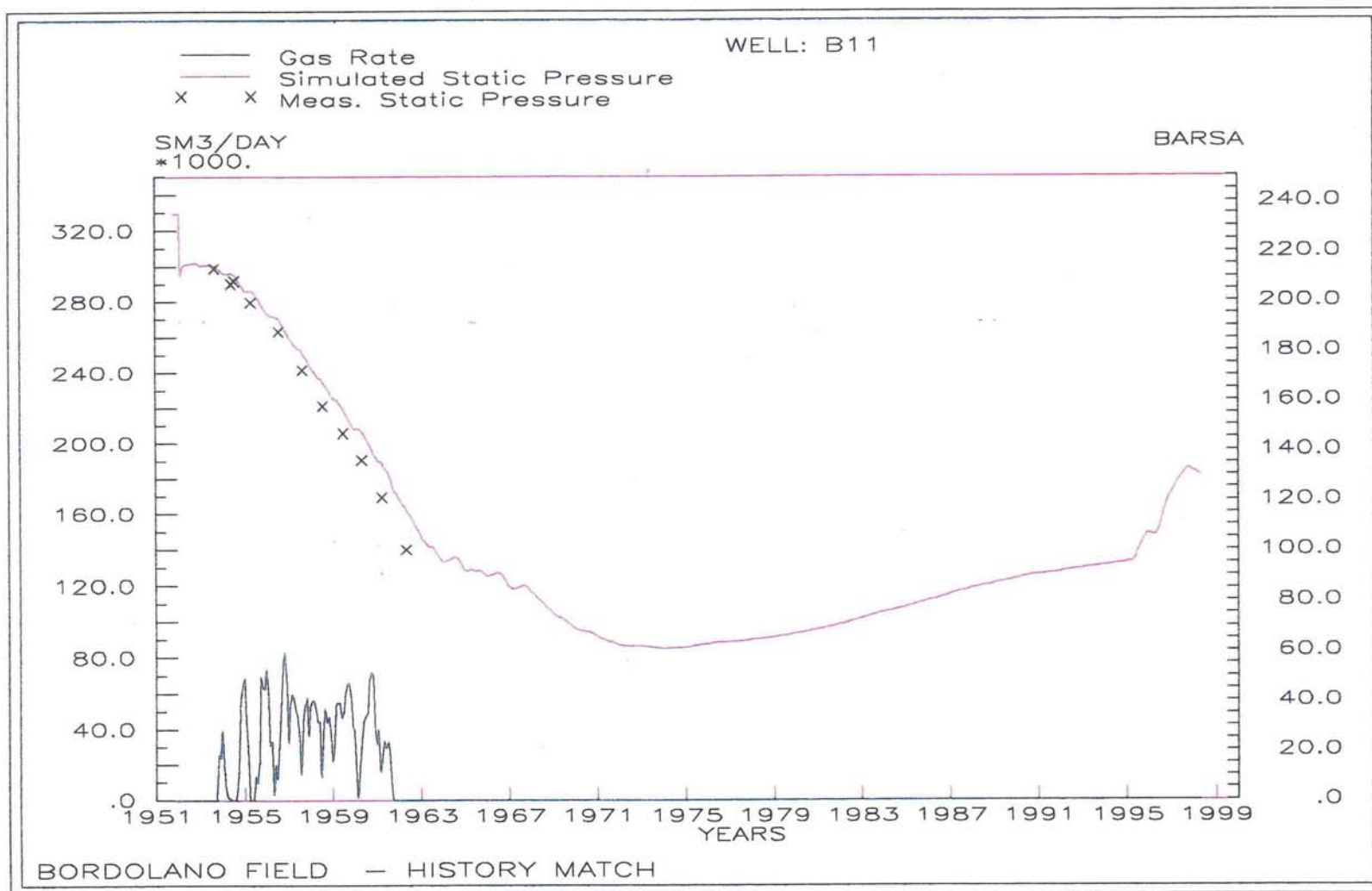

Fig 13

**CAMPO DI BORDOLANO
POOL B
HISTORY MATCH DI POZZO DELLE PRESSIONI**

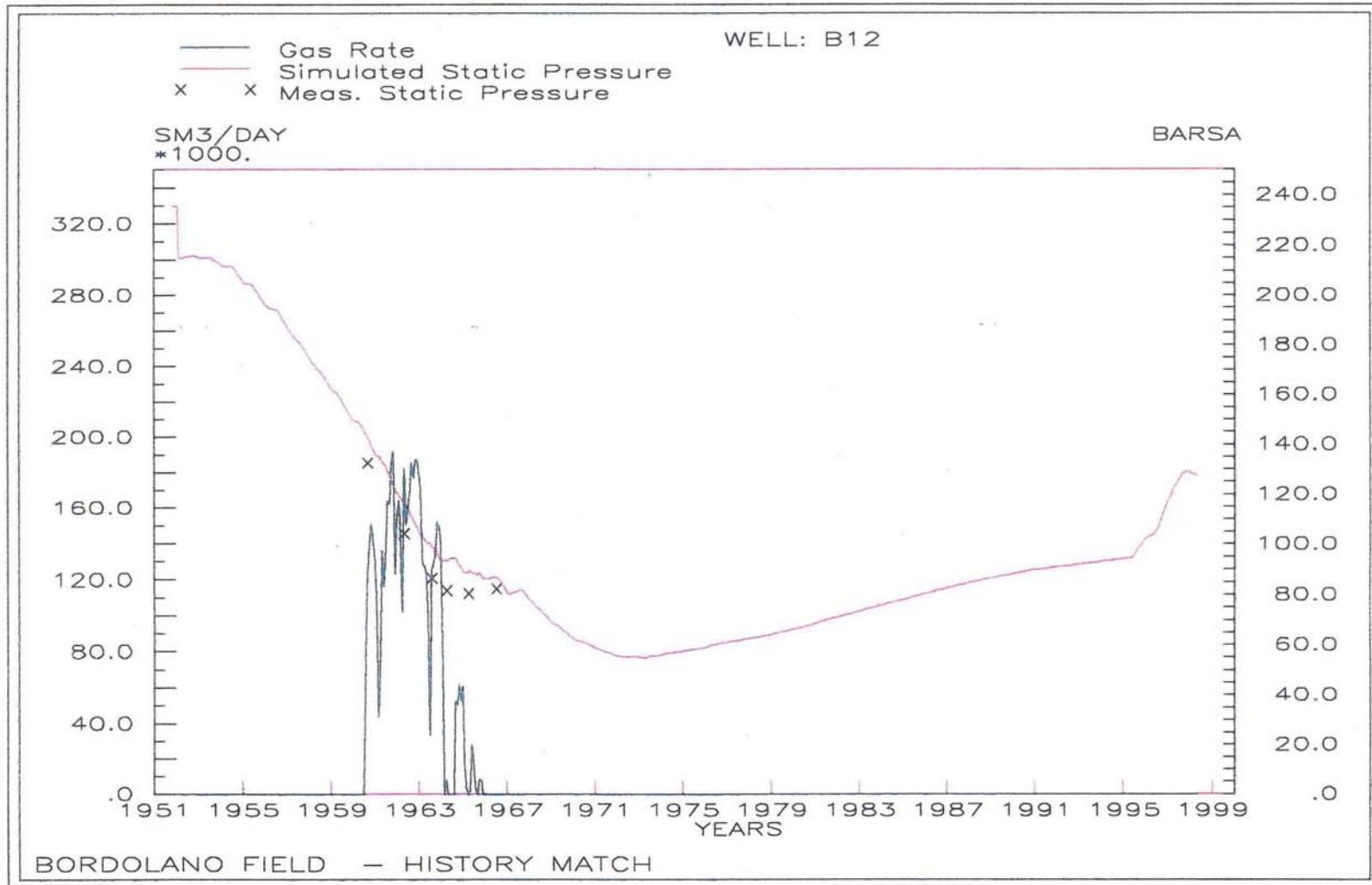

FIG 14

**CAMPO DI BORDOLANO
POOL B
HISTORY MATCH DI POZZO DELLE PRESSIONI**

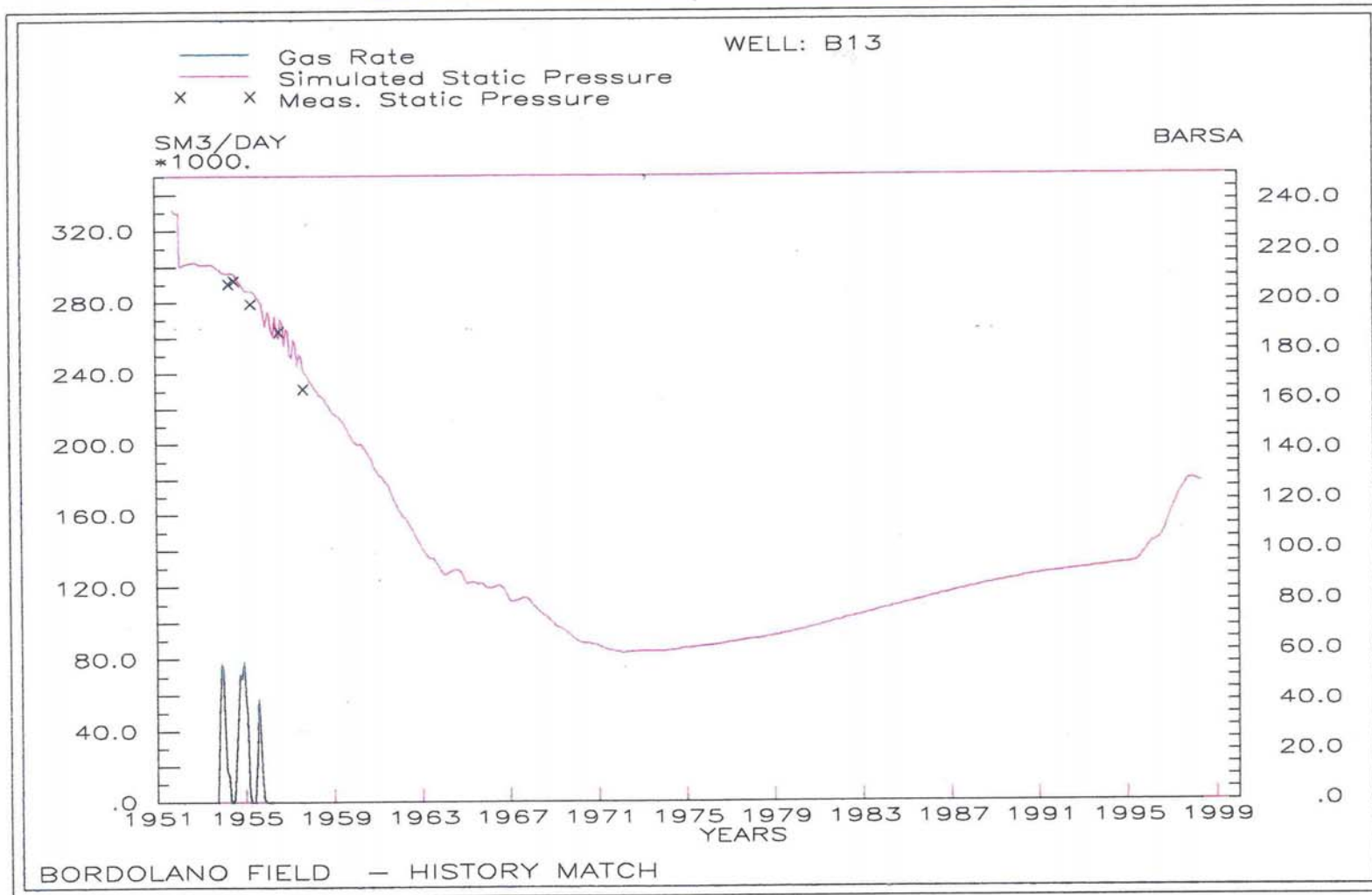

Fig 15



**CAMPO DI BORDOLANO
POOL B
HISTORY MATCH DI POZZO DELLE PRESSIONI**

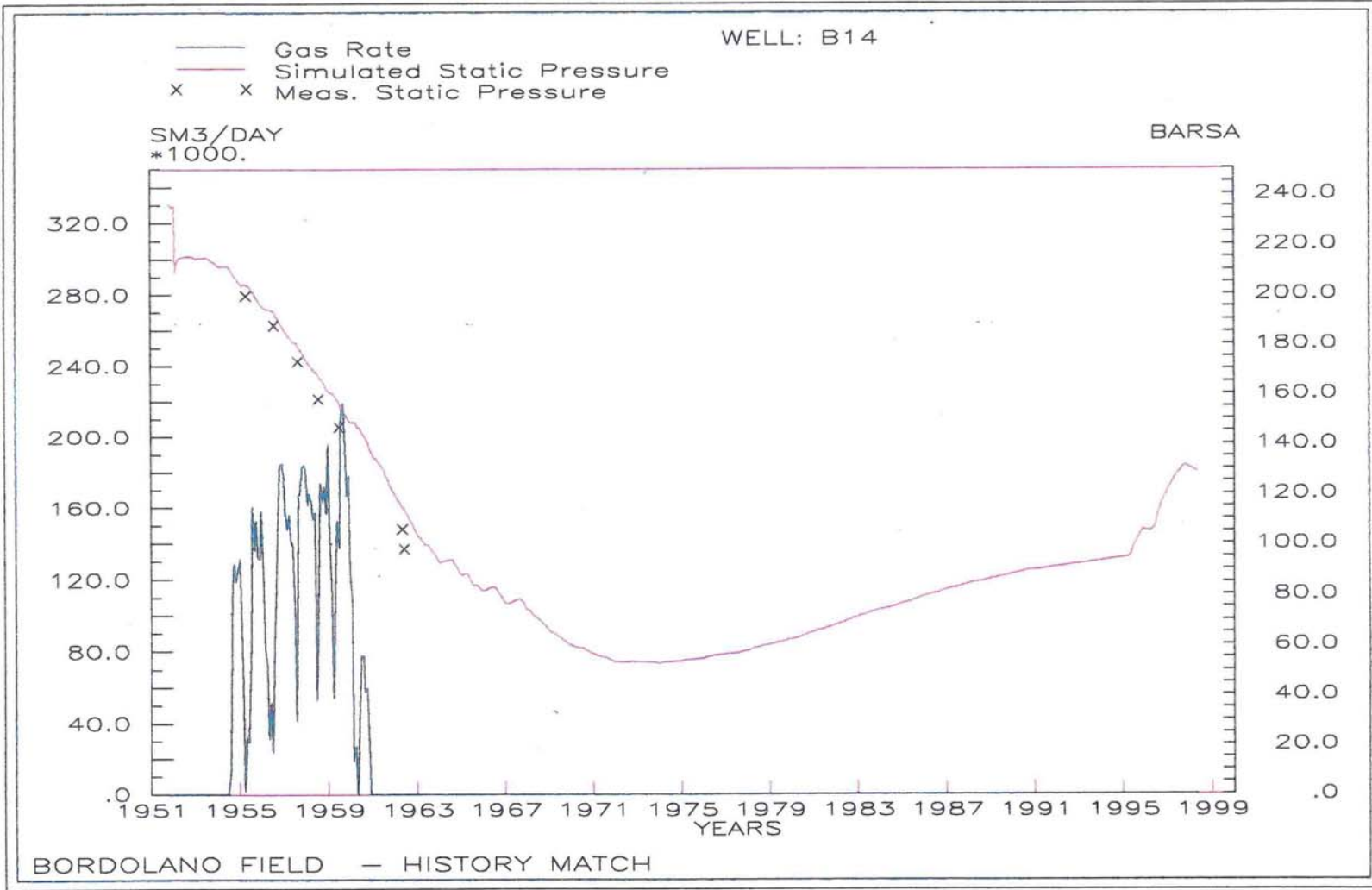

Fig 16



**CAMPO DI BORDOLANO
POOL B
HISTORY MATCH DI POZZO DELLE PRESSIONI**

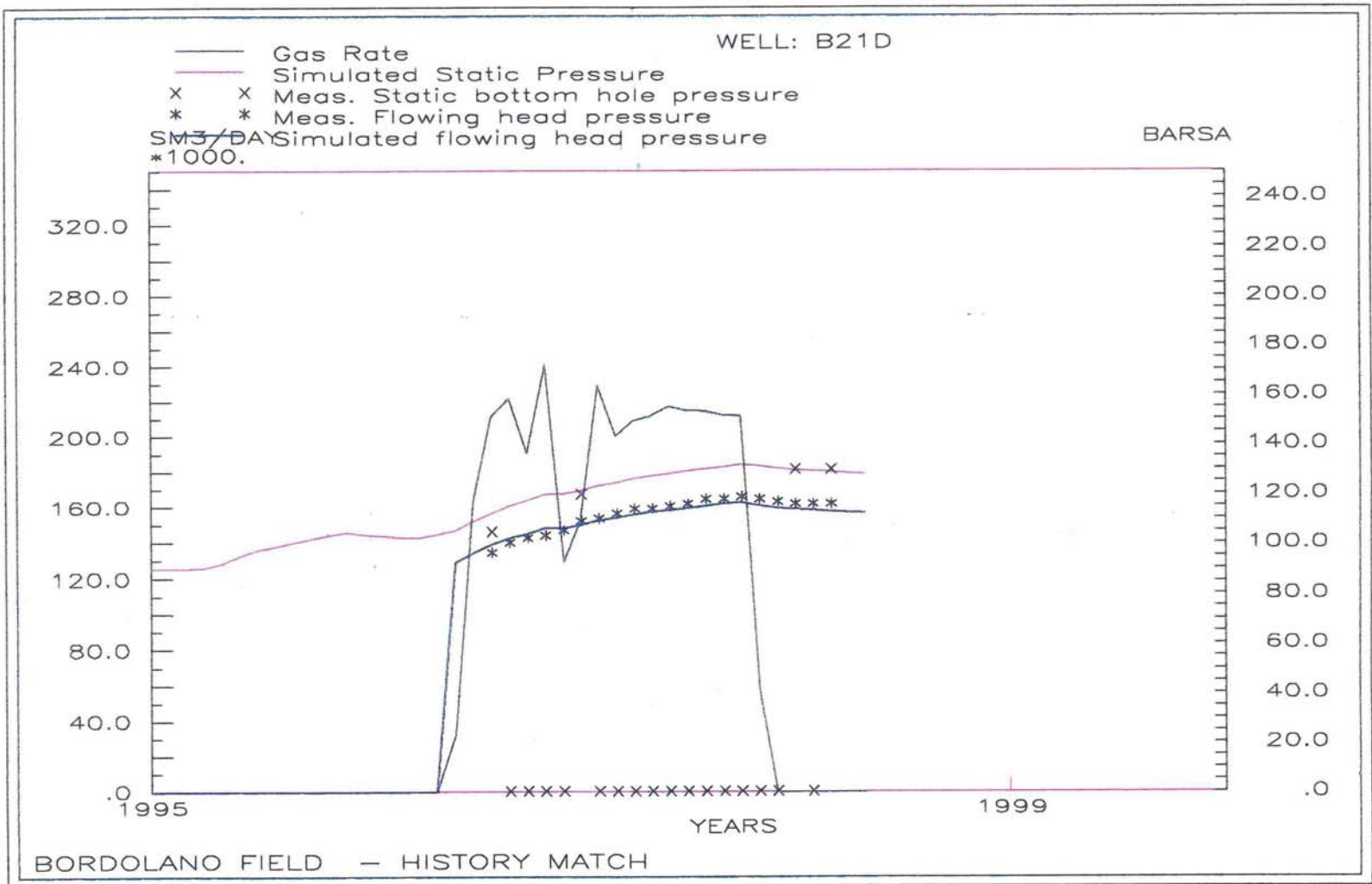

Fig 17

CAMPO DI BORDOLANO
POOL B
HISTORY MATCH DI POZZO DELLE PRESSIONI

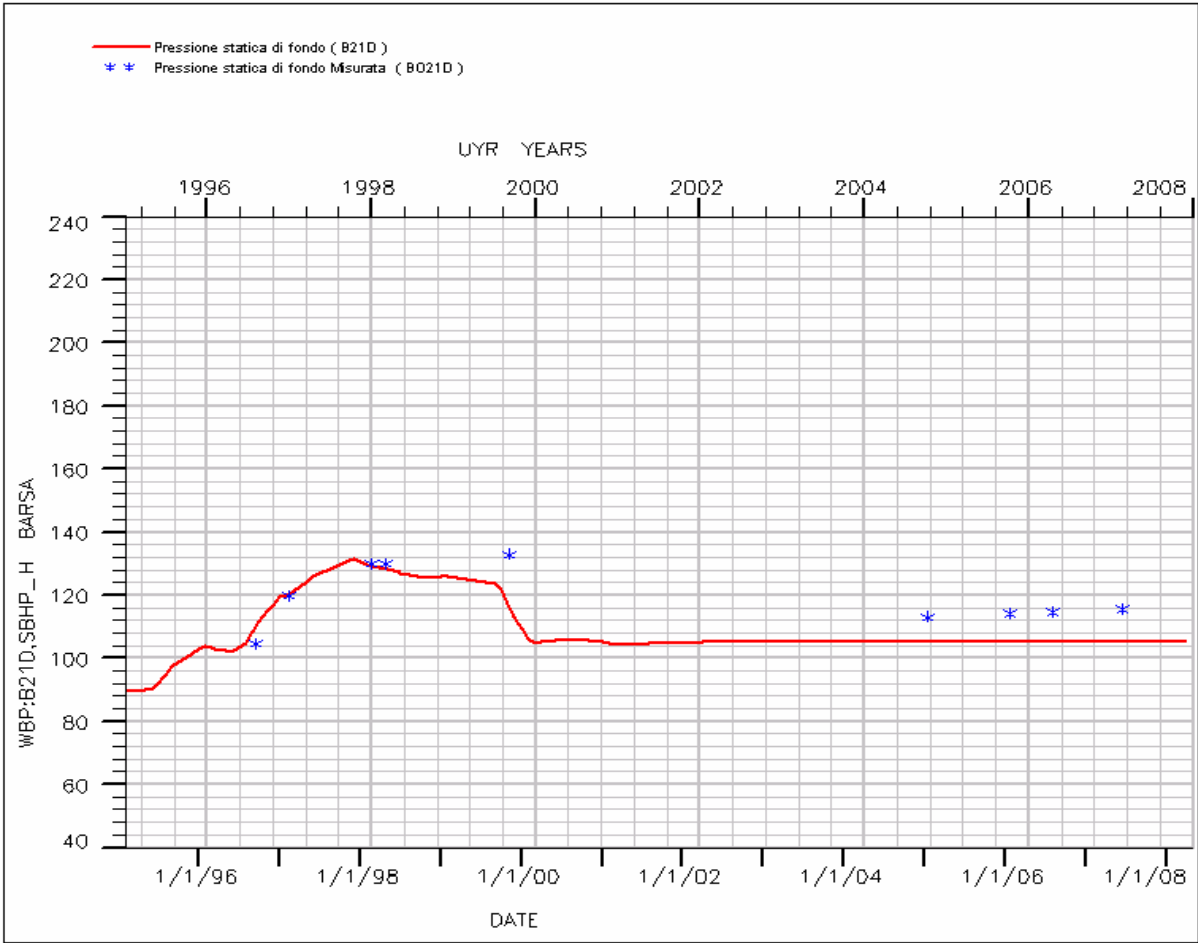

Fig.17B



**CAMPO DI BORDOLANO
POOL B
HISTORY MATCH DI POZZO DEL WATER CUT**

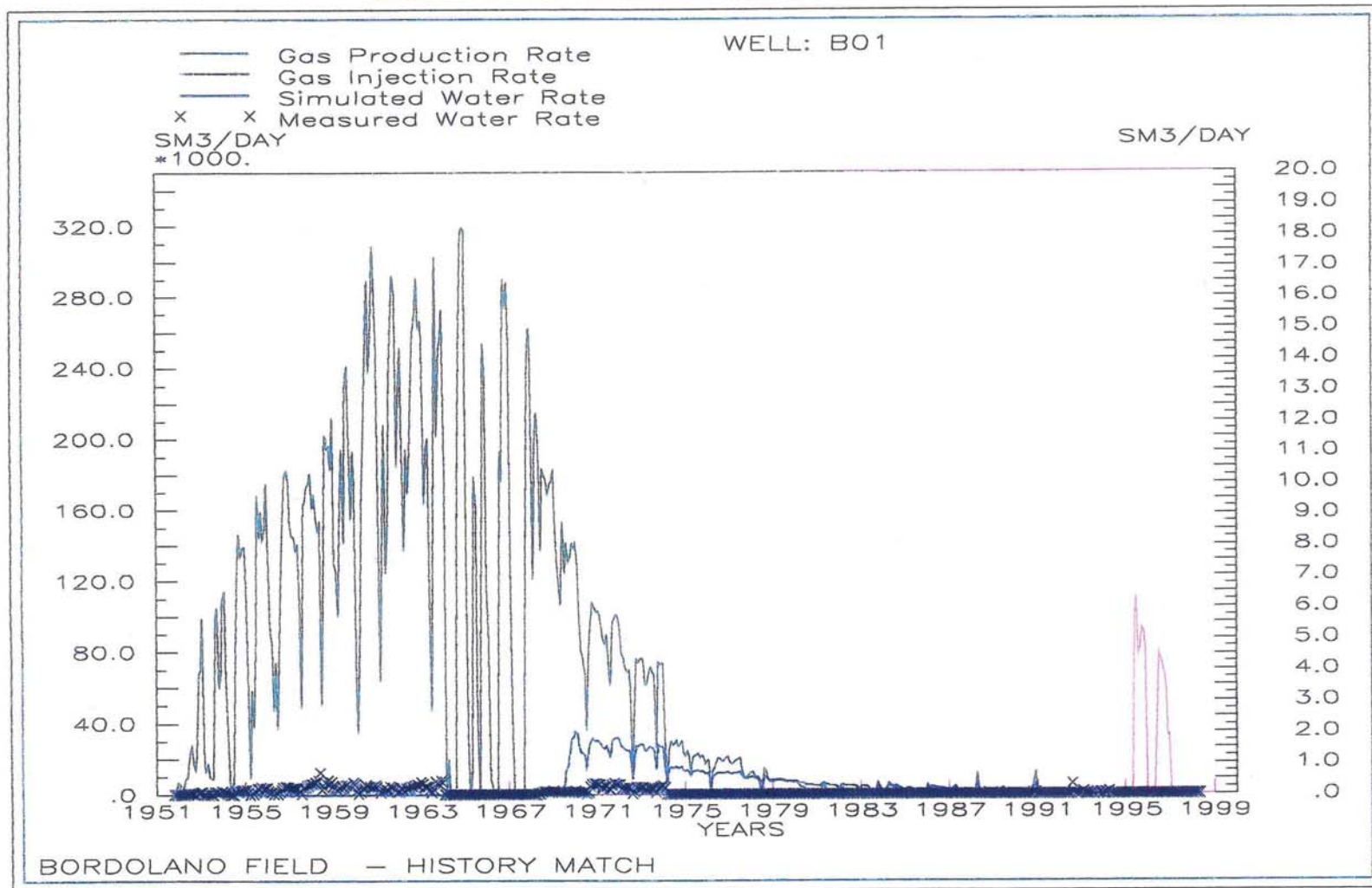

Fig 18



**CAMPO DI BORDOLANO
POOL B
HISTORY MATCH DI POZZO DEL WATER CUT**

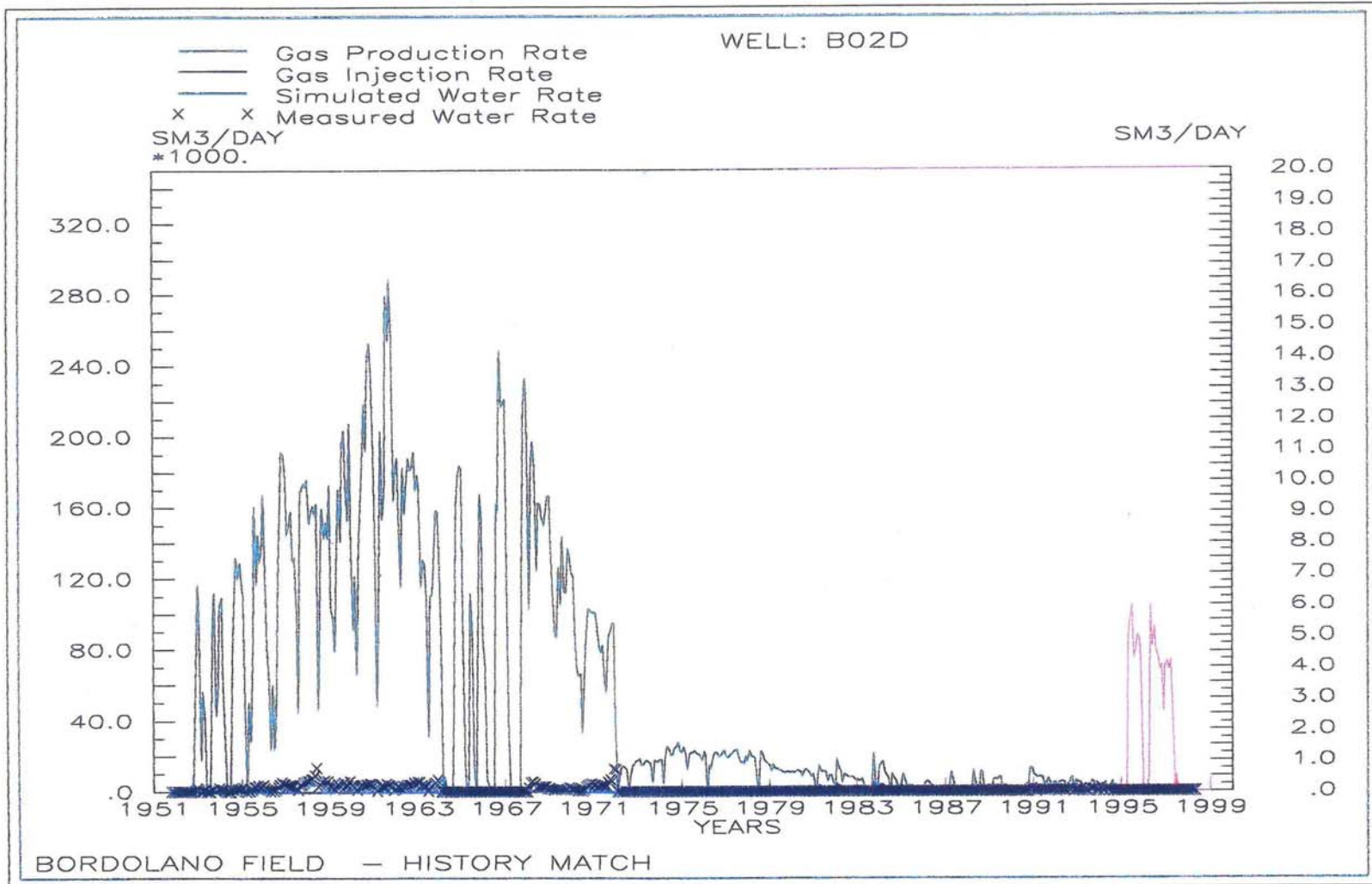

Fig 19



**CAMPO DI BORDOLANO
POOL B
HISTORY MATCH DI POZZO DEL WATER CUT**

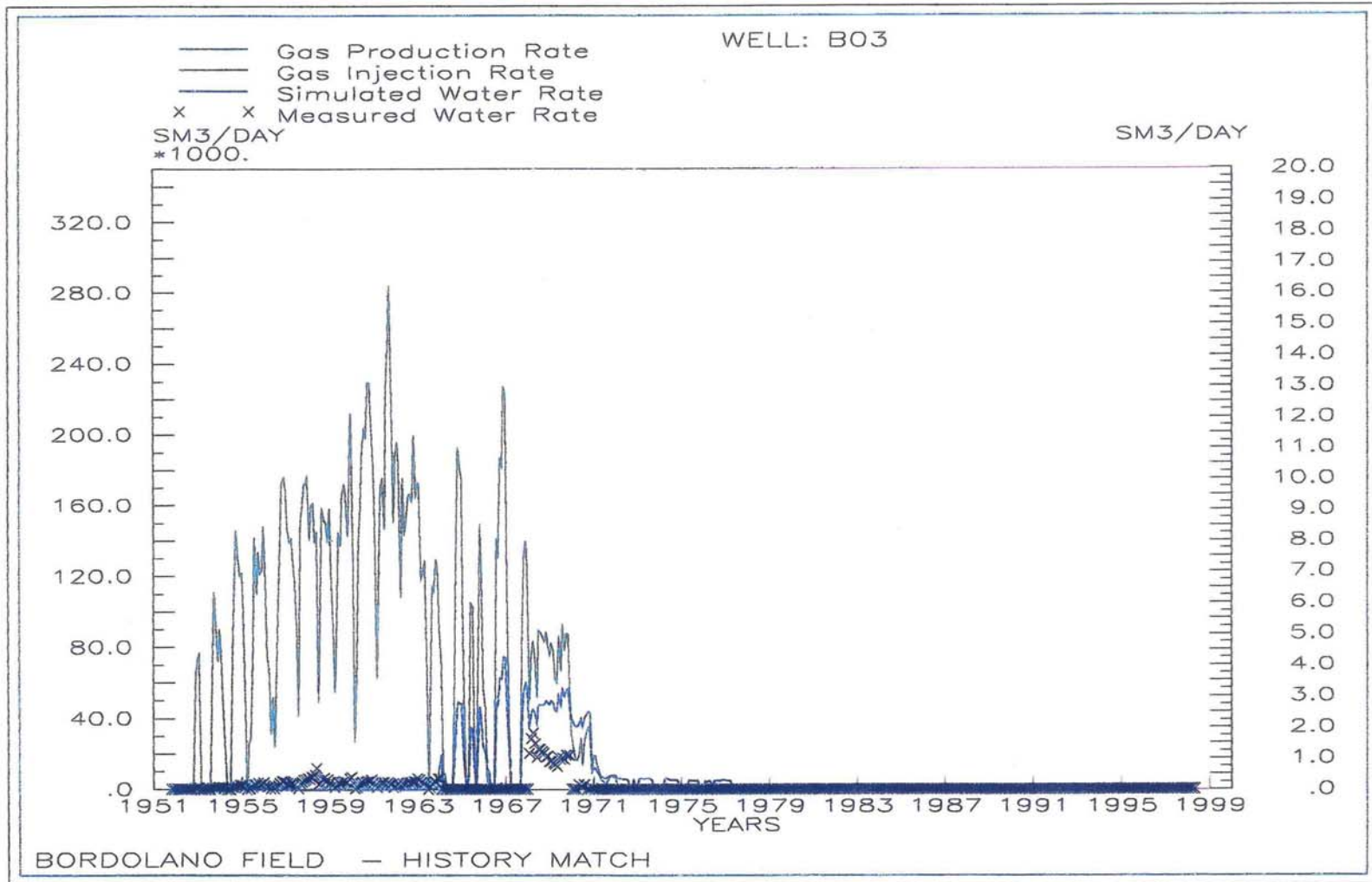

Fig 20



**CAMPO DI BORDOLANO
POOL B
HISTORY MATCH DI POZZO DEL WATER CUT**

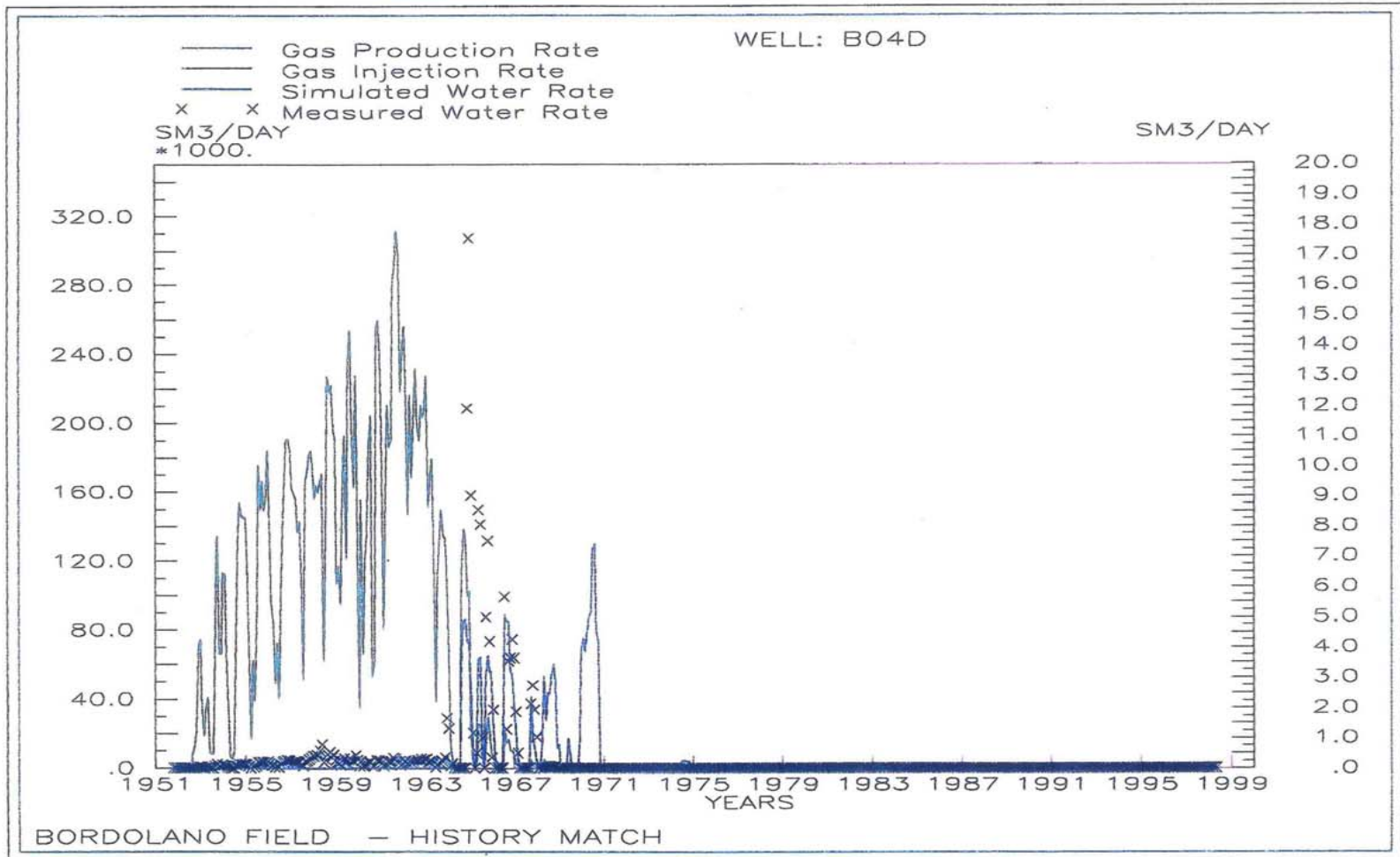

Fig 21



**CAMPO DI BORDOLANO
POOL B
HISTORY MATCH DI POZZO DEL WATER CUT**

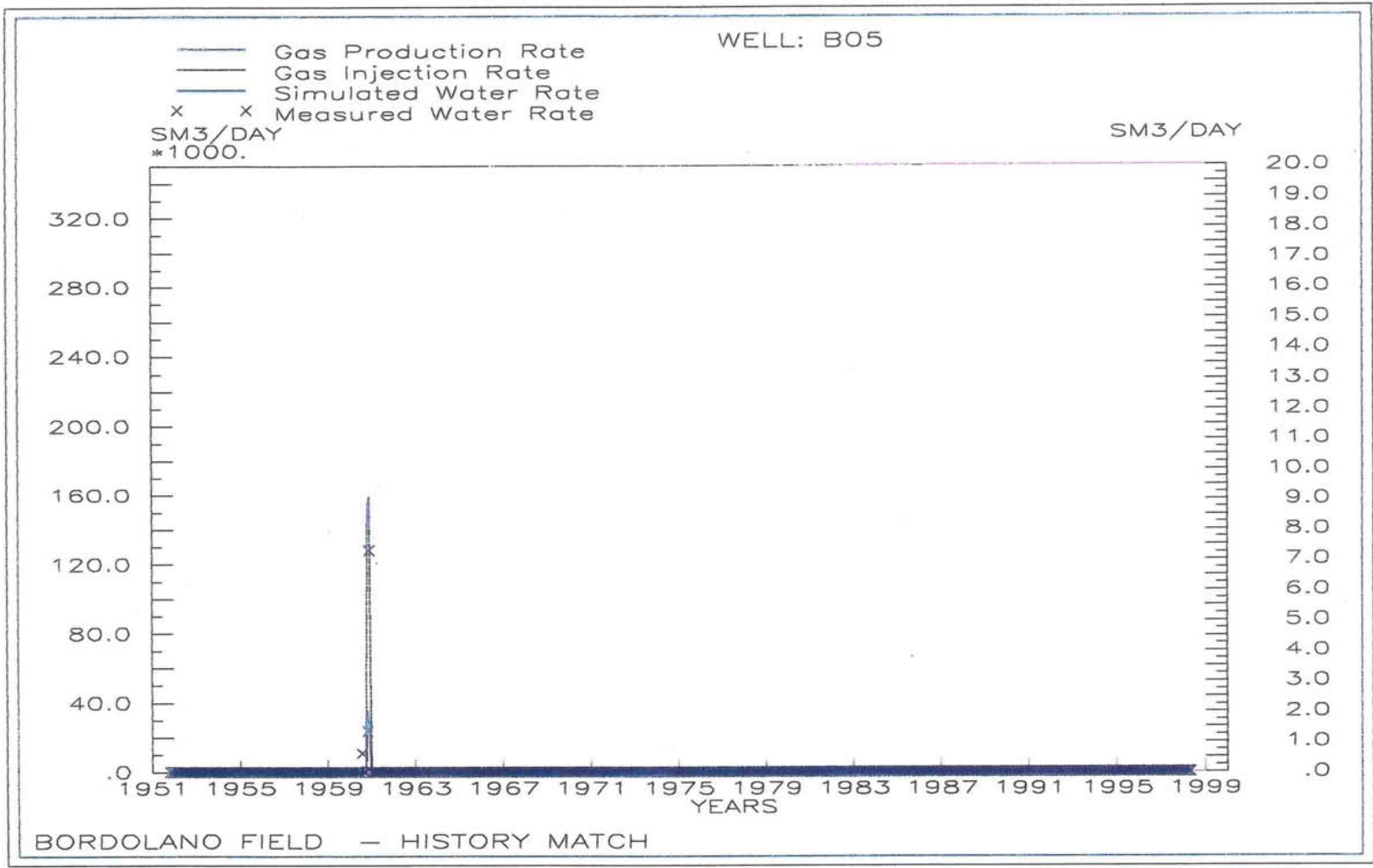

Fig 22



**CAMPO DI BORDOLANO
POOL B
HISTORY MATCH DI POZZO DEL WATER CUT**

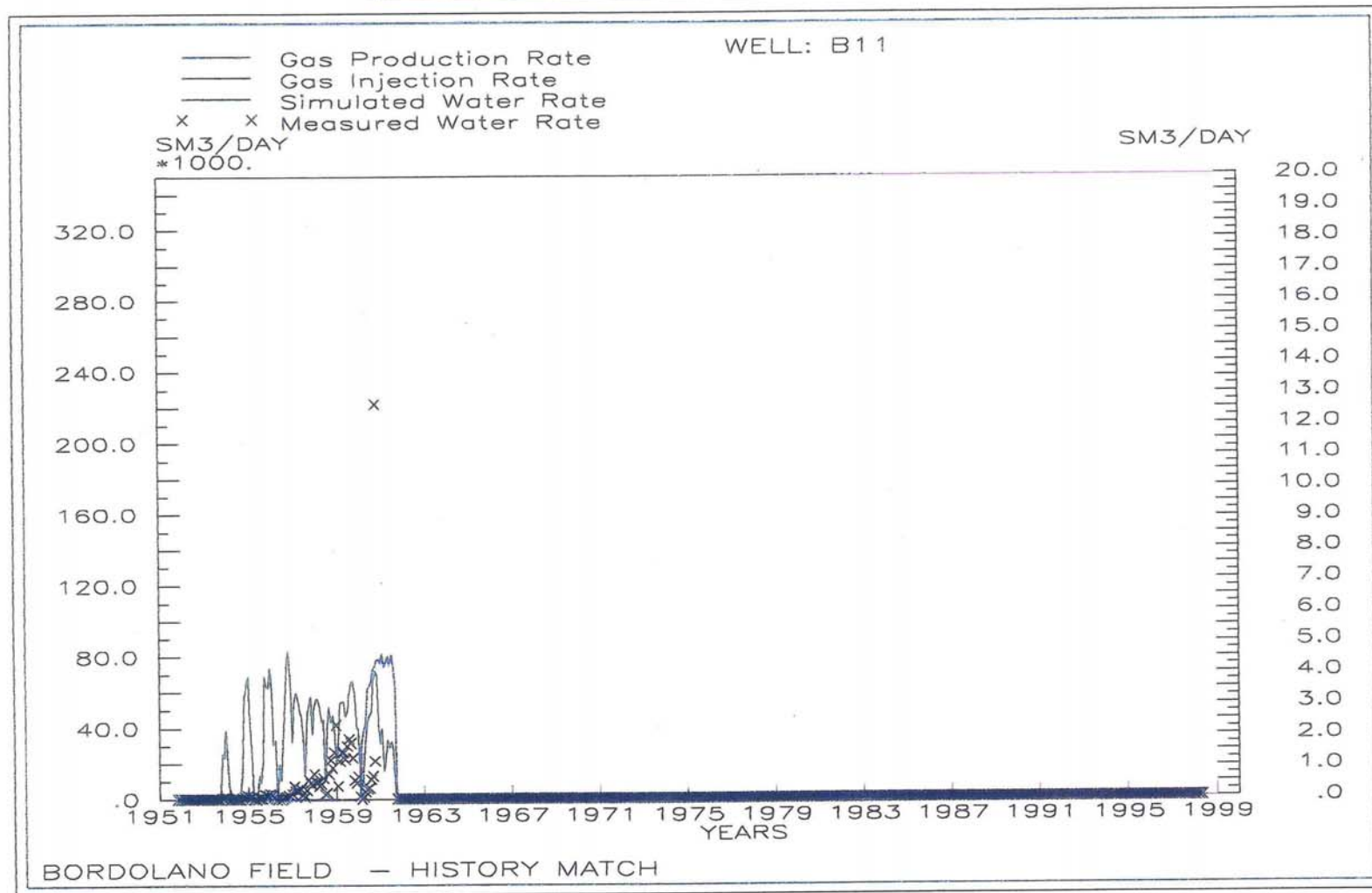

Fig 23



**CAMPO DI BORDOLANO
POOL B
HISTORY MATCH DI POZZO DEL WATER CUT**

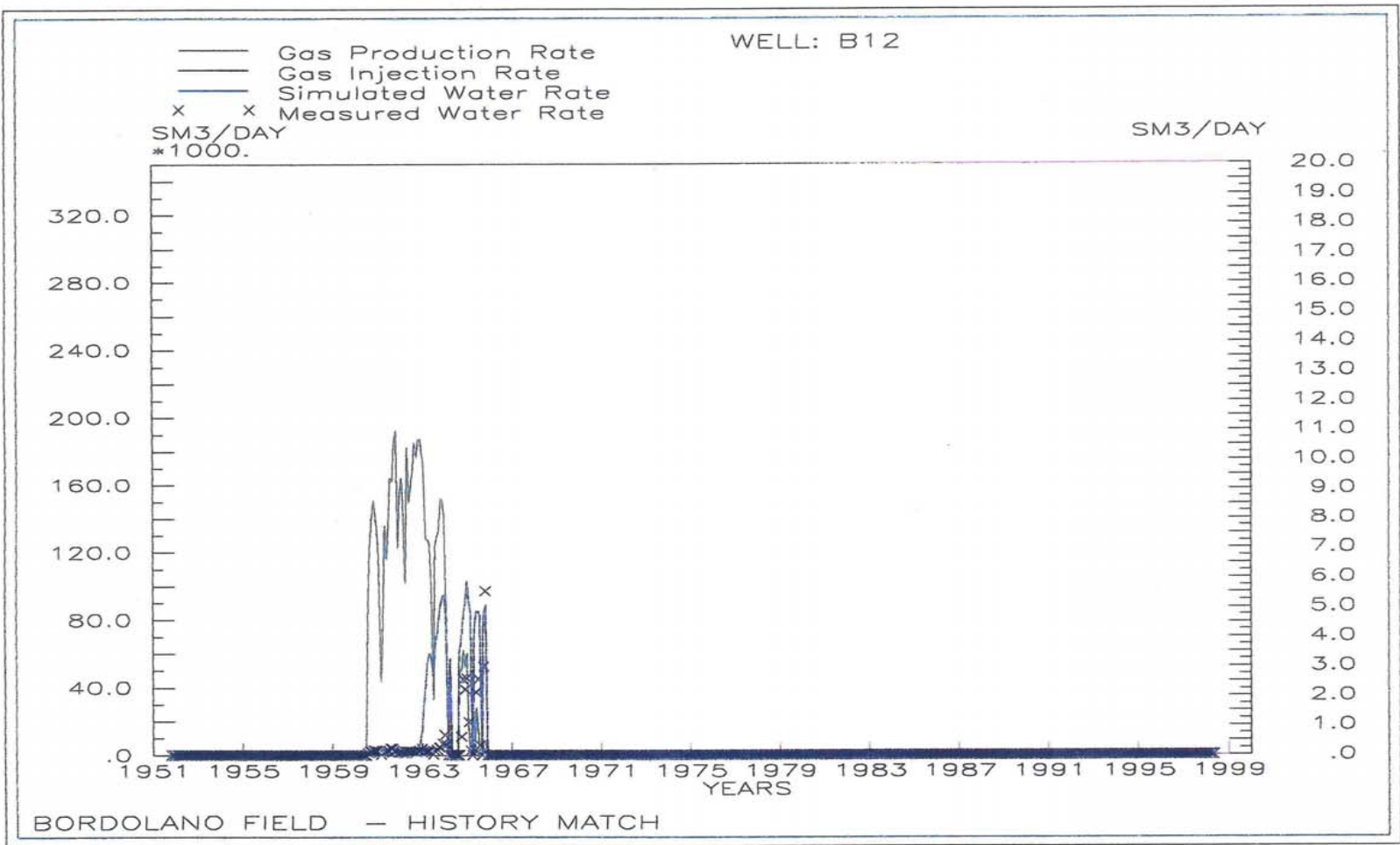

FIG 24



**CAMPO DI BORDOLANO
POOL B
HISTORY MATCH DI POZZO DEL WATER CUT**

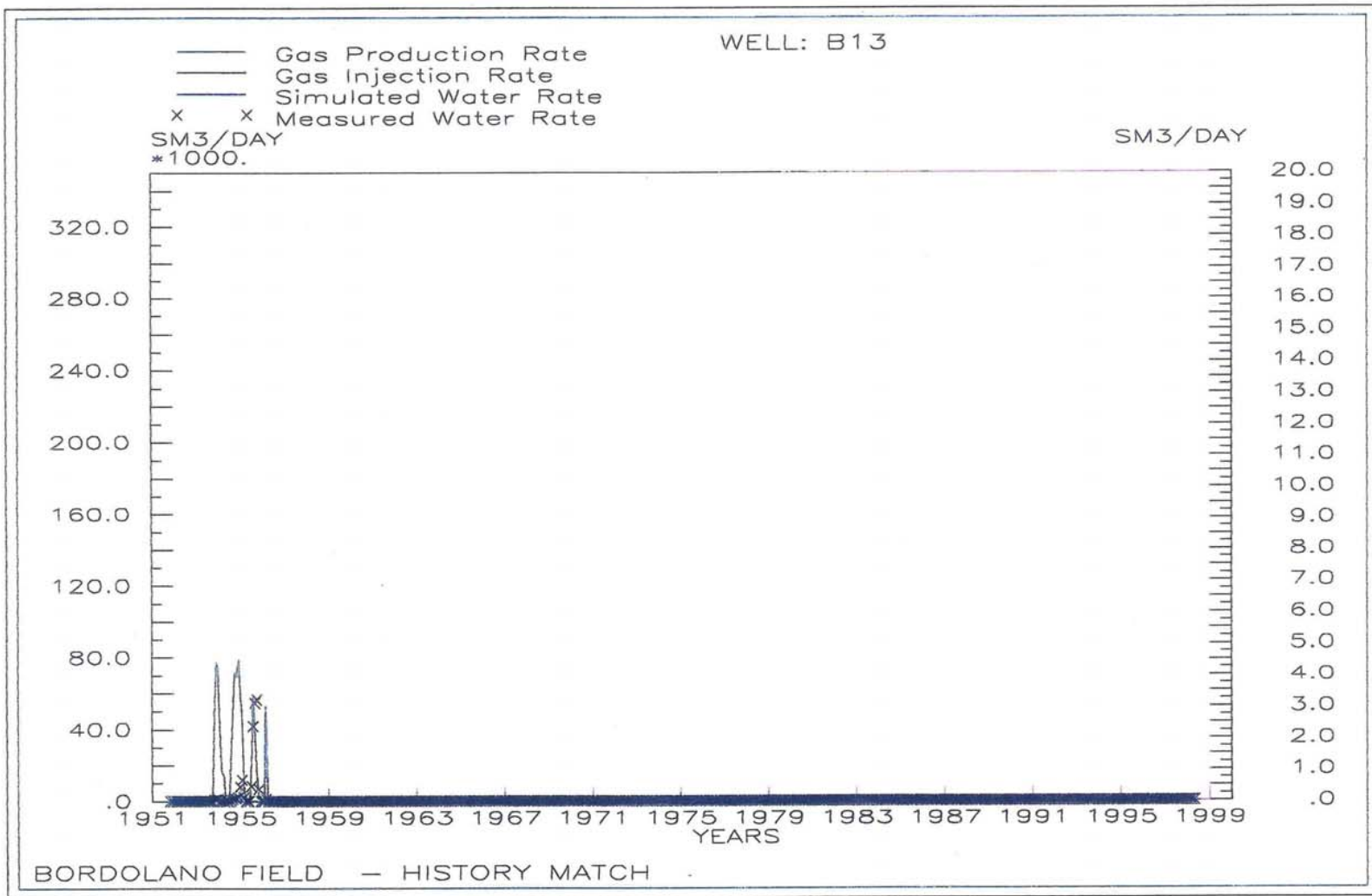

Fig 25



**CAMPO DI BORDOLANO
POOL B
HISTORY MATCH DI POZZO DEL WATER CUT**

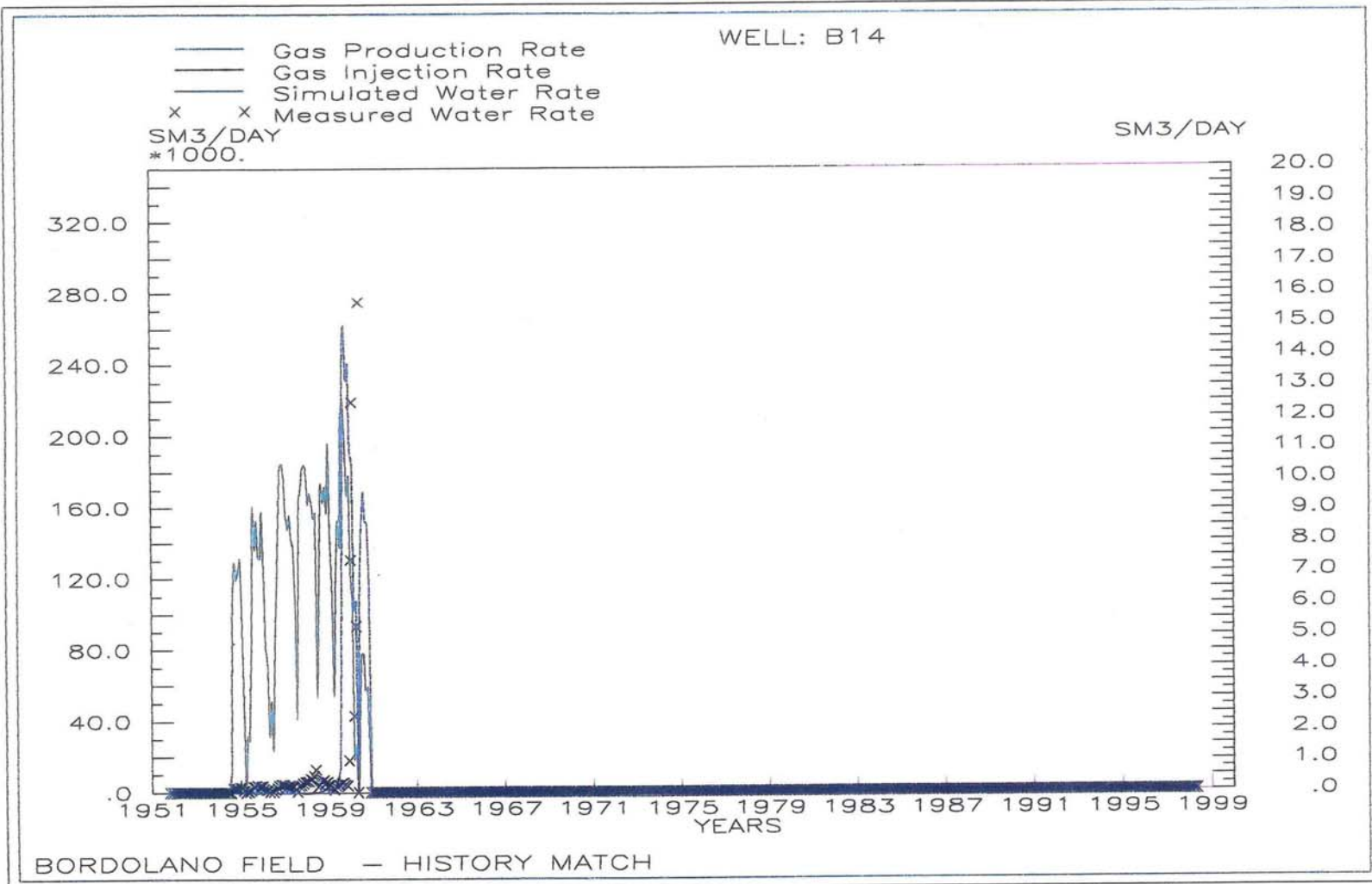

Fig 26

**CAMPO DI BORDOLANO
POOL B
DISTRIBUZIONE DI SW PER LIVELLO AD
INIZIO E A FINE STORIA PRODUTTIVA**

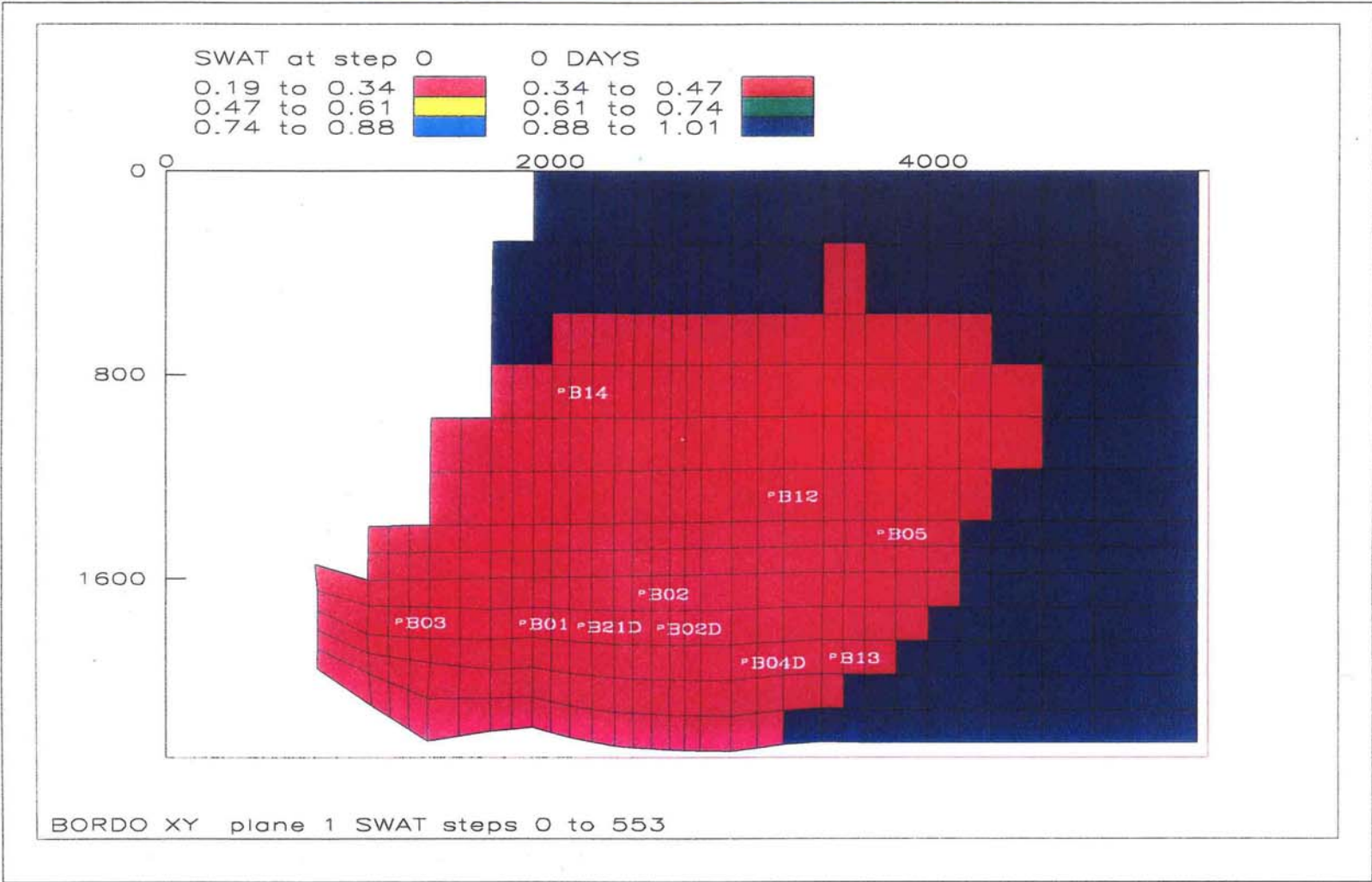
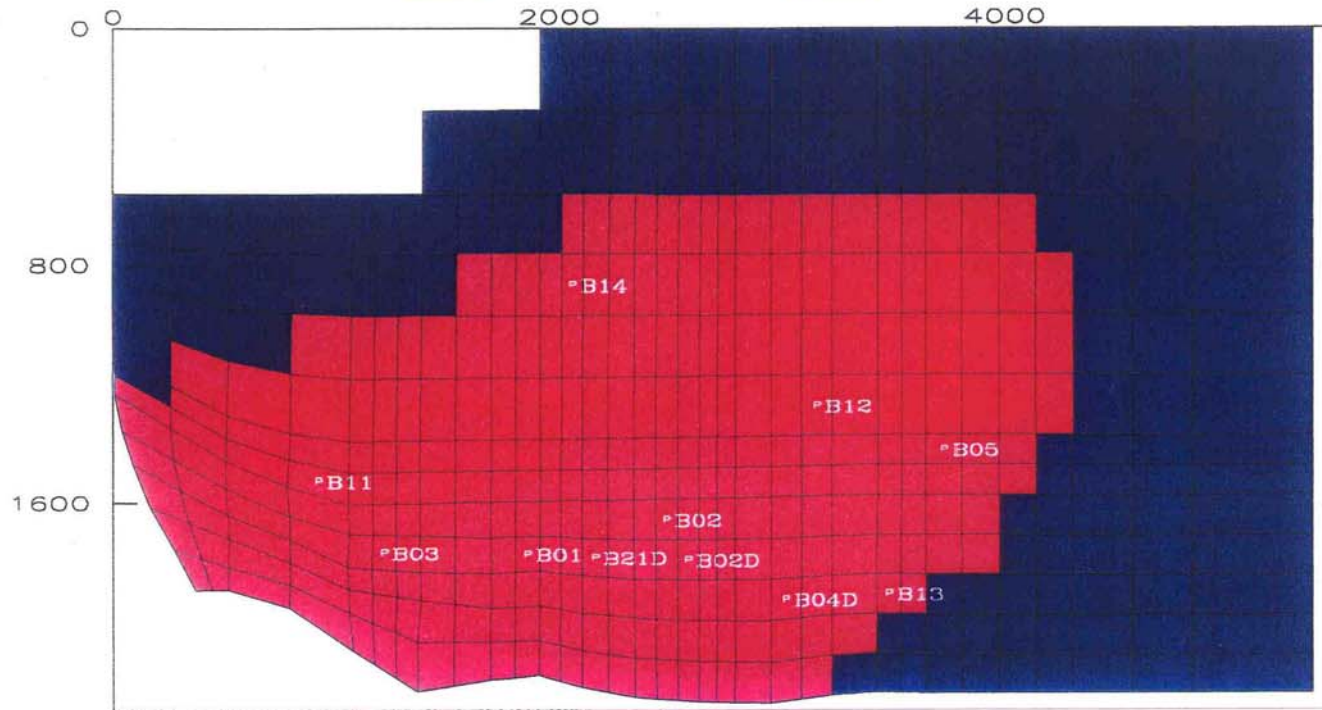

Fig 27



CAMPO DI BORDOLANO
POOL B
DISTRIBUZIONE DI SW PER LIVELLO AD
INIZIO E A FINE STORIA PRODUTTIVA

SWAT at step 0		0 DAYS	
0.19 to 0.34		0.34 to 0.47	
0.47 to 0.61		0.61 to 0.74	
0.74 to 0.88		0.88 to 1.01	



BORDO XY plane 2 SWAT steps 0 to 553

FIG 28



**CAMPO DI BORDOLANO
POOL B
DISTRIBUZIONE DI SW PER LIVELLO AD
INIZIO E A FINE STORIA PRODUTTIVA**

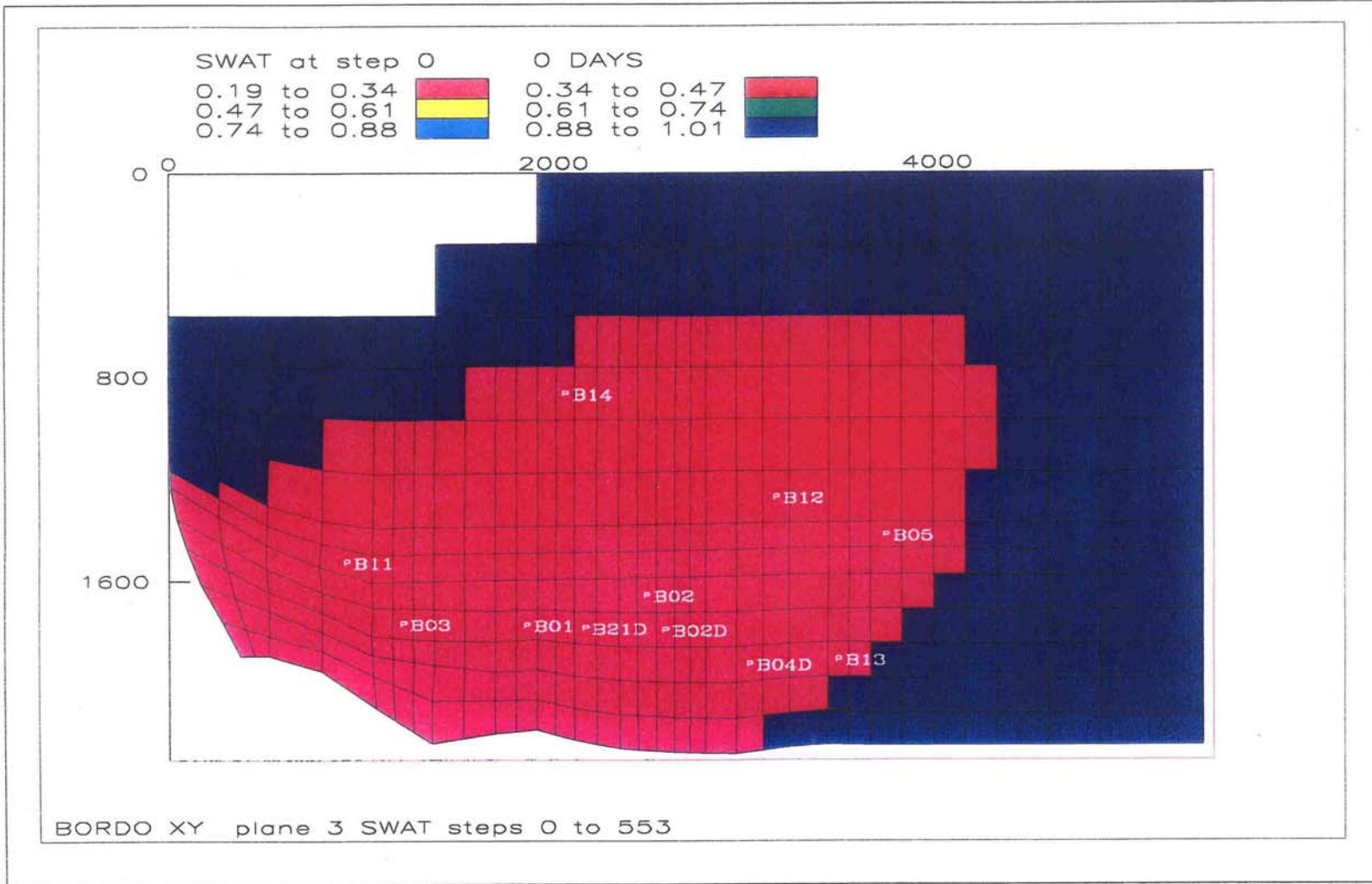
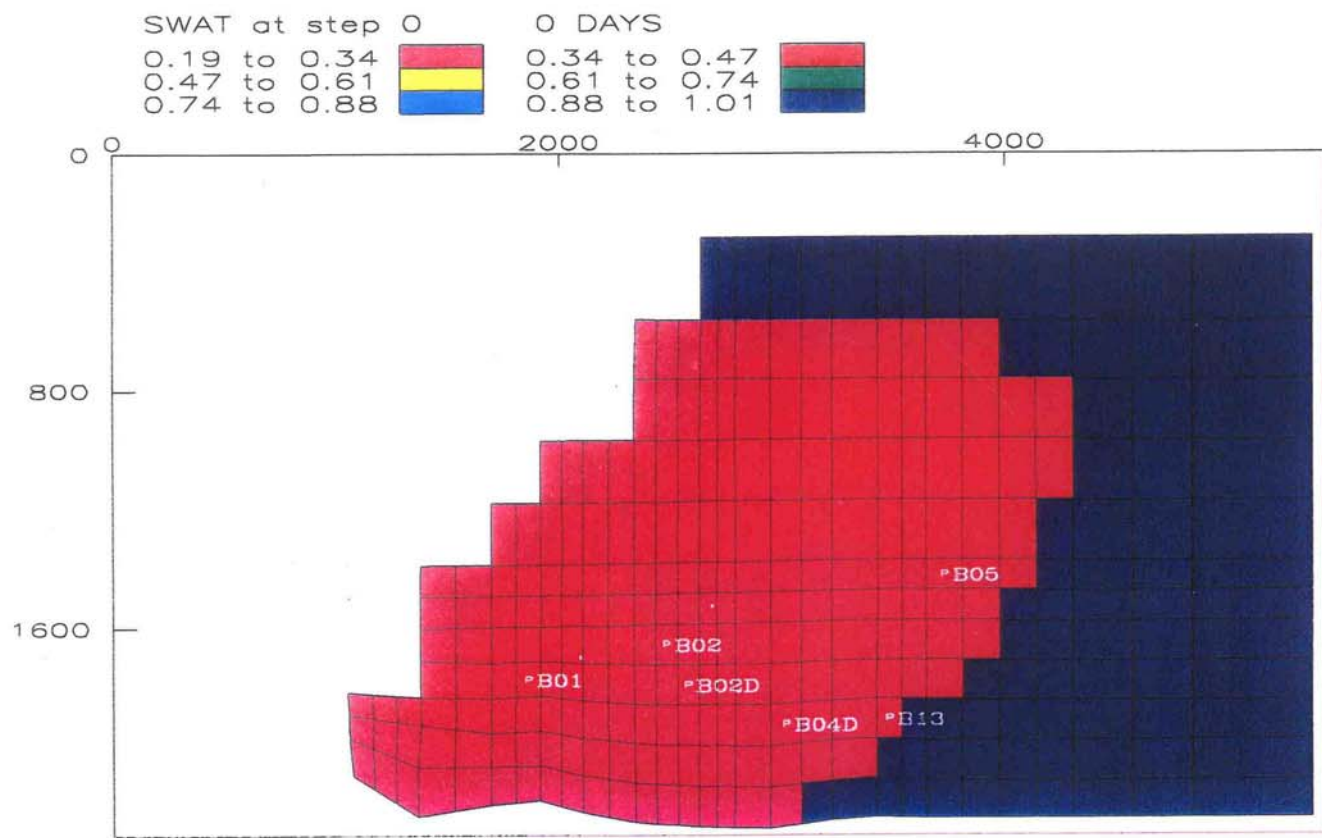

Fig 29

CAMPO DI BORDOLANO
POOL B
DISTRIBUZIONE DI SW PER LIVELLO AD
INIZIO E A FINE STORIA PRODUTTIVA



BORDO XY plane 4 SWAT steps 0 to 553

Fig 30



**CAMPO DI BORDOLANO
POOL B
DISTRIBUZIONE DI SW PER LIVELLO AD
INIZIO E A FINE STORIA PRODUTTIVA**

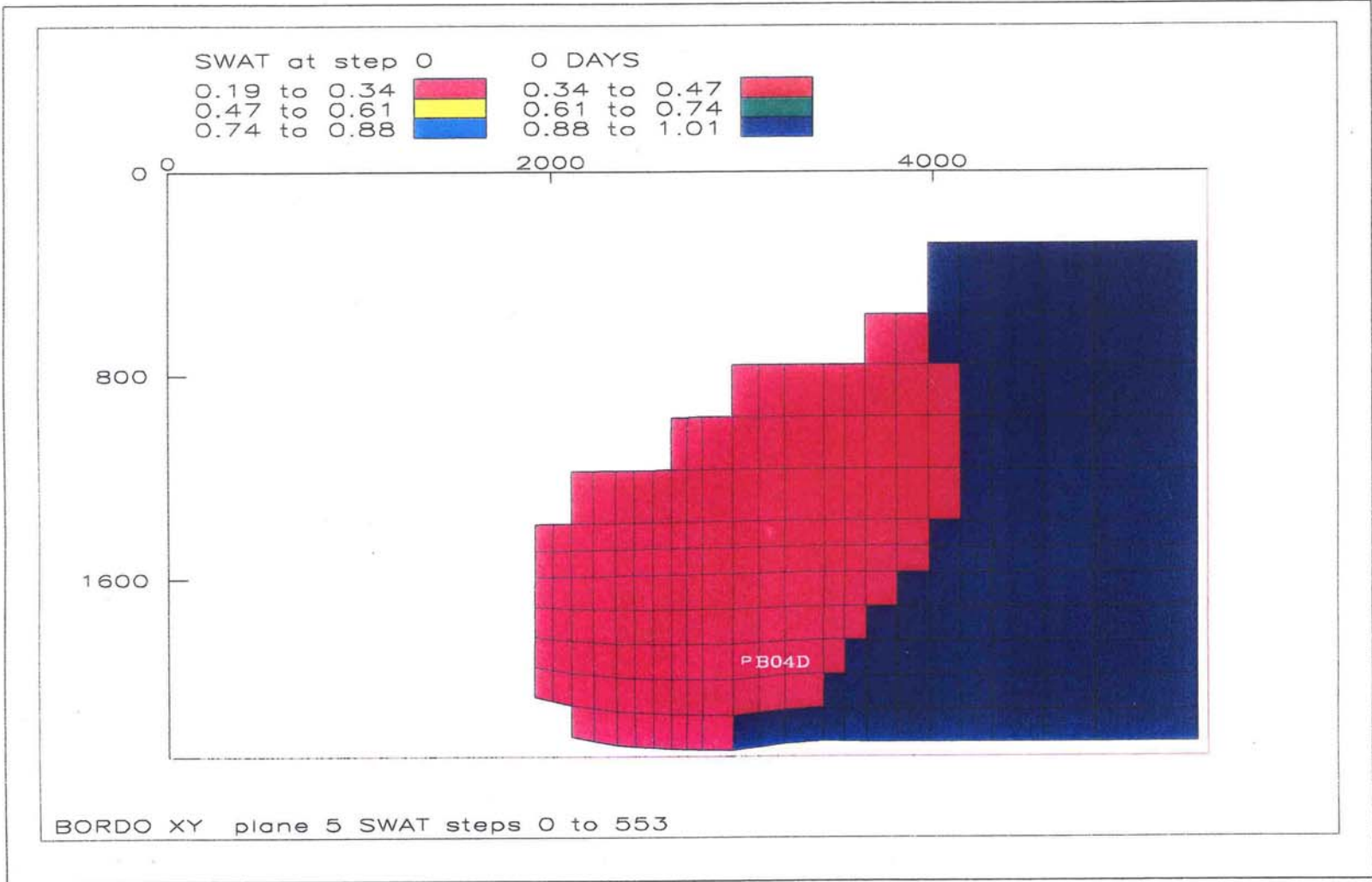

FIG 31



**CAMPO DI BORDOLANO
POOL B
DISTRIBUZIONE DI SW PER LIVELLO AD
INIZIO E A FINE STORIA PRODUTTIVA**

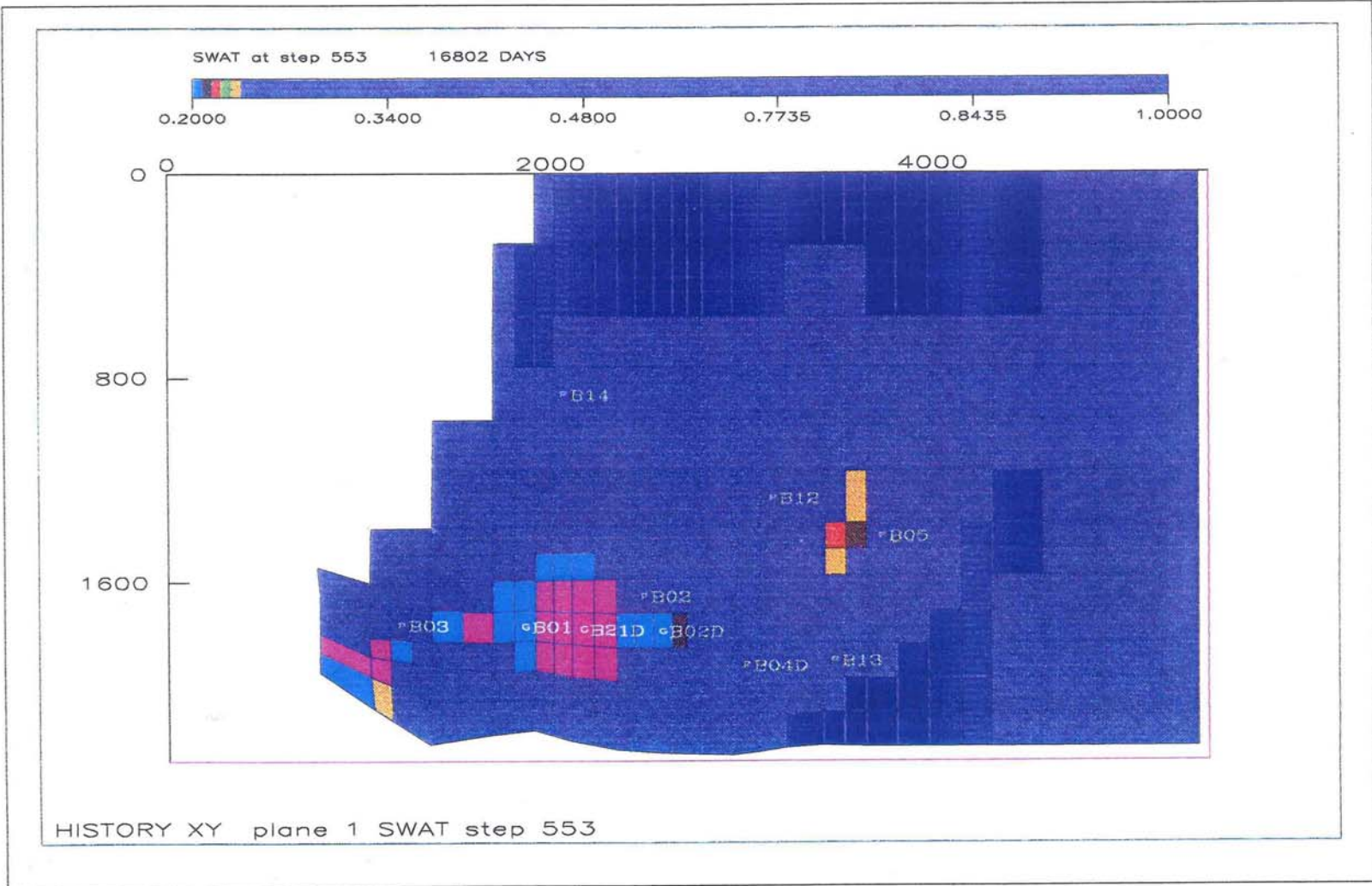

FIG 32



**CAMPO DI BORDOLANO
POOL B
DISTRIBUZIONE DI SW PER LIVELLO AD
INIZIO E A FINE STORIA PRODUTTIVA**

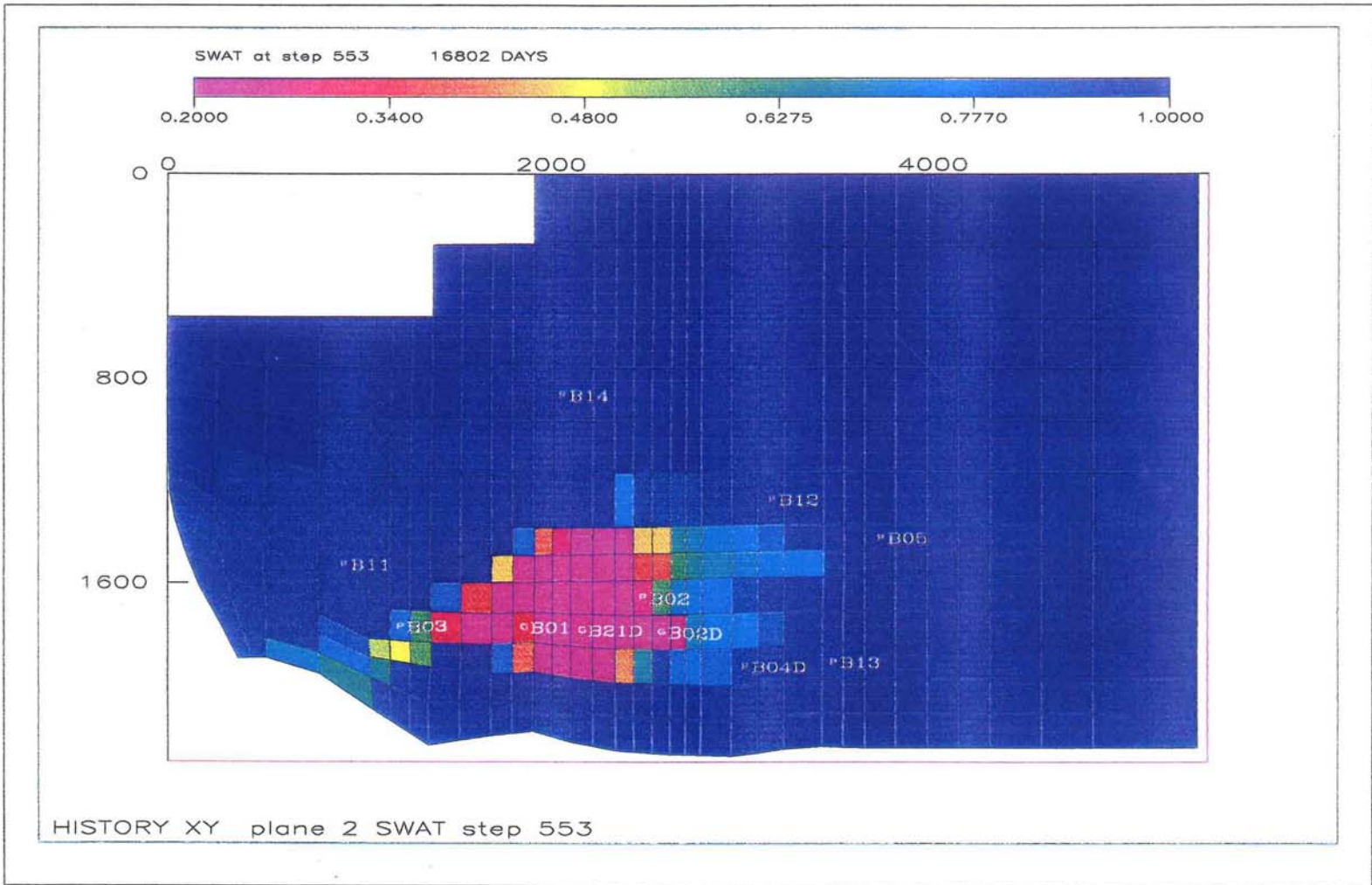

Fig 33

**CAMPO DI BORDOLANO
POOL B
DISTRIBUZIONE DI SW PER LIVELLO AD
INIZIO E A FINE STORIA PRODUTTIVA**

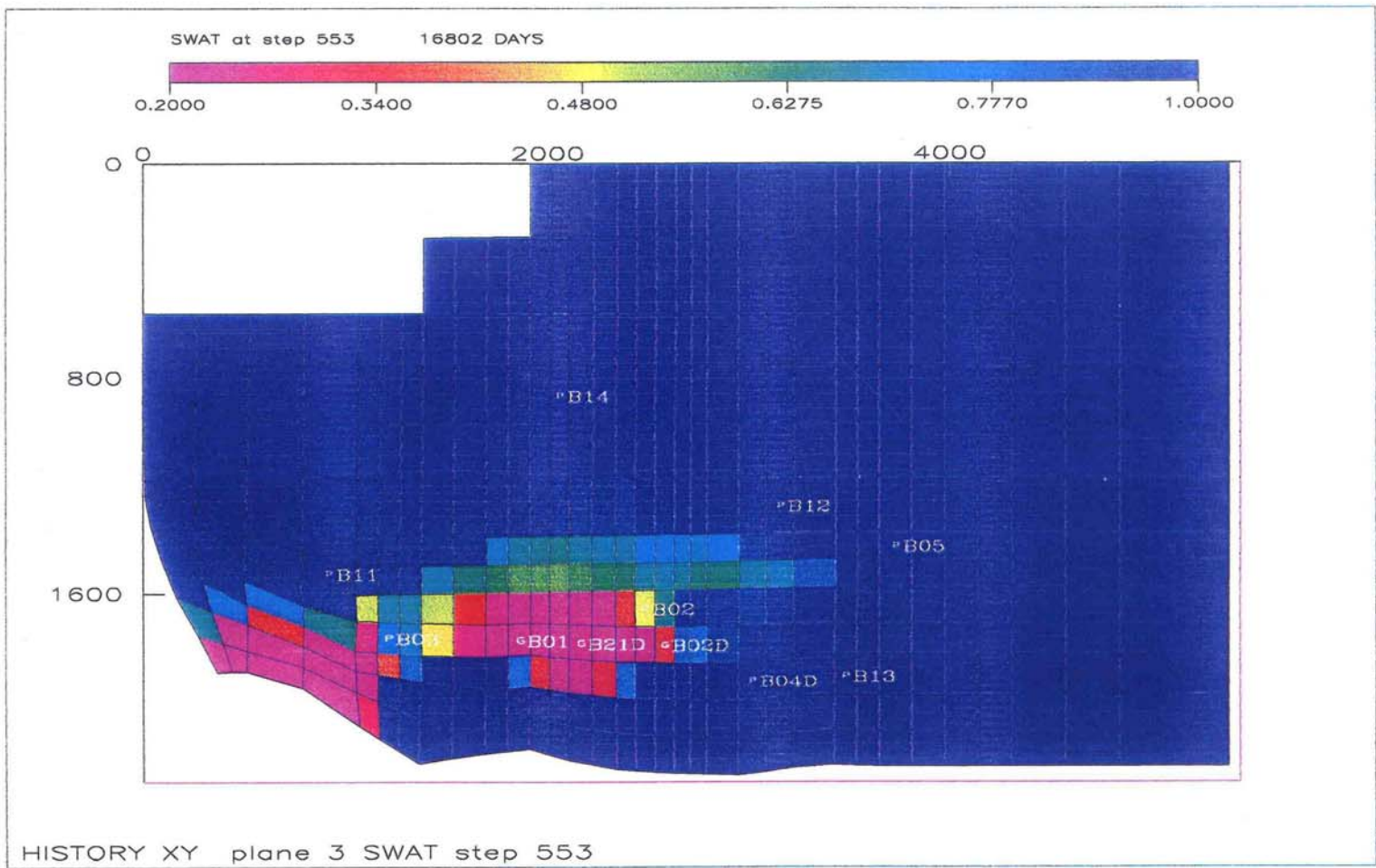

FIG 34



**CAMPO DI BORDOLANO
POOL B
DISTRIBUZIONE DI SW PER LIVELLO AD
INIZIO E A FINE STORIA PRODUTTIVA**

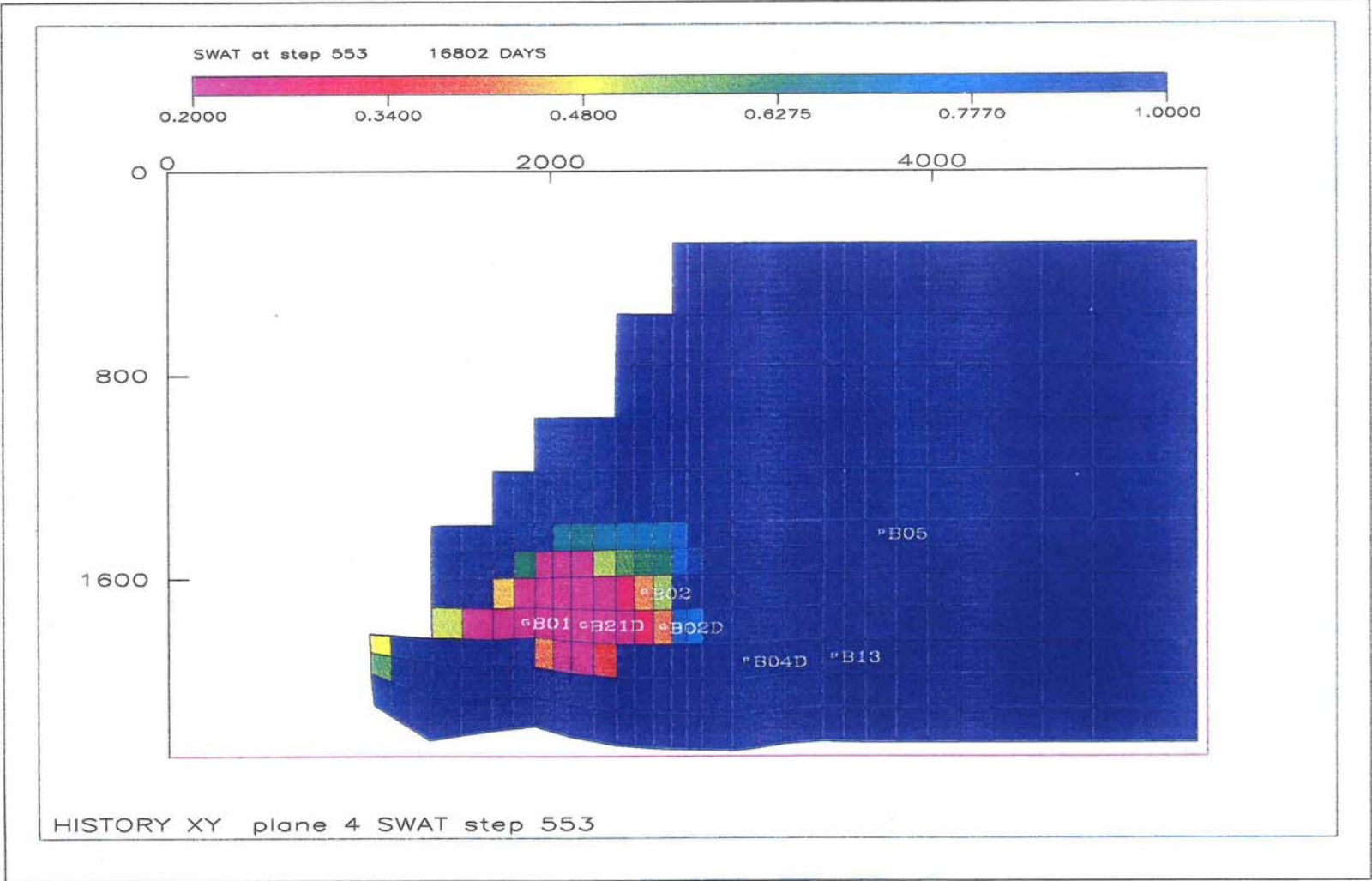

Fig 35

**CAMPO DI BORDOLANO
POOL B
DISTRIBUZIONE DI SW PER LIVELLO AD
INIZIO E A FINE STORIA PRODUTTIVA**

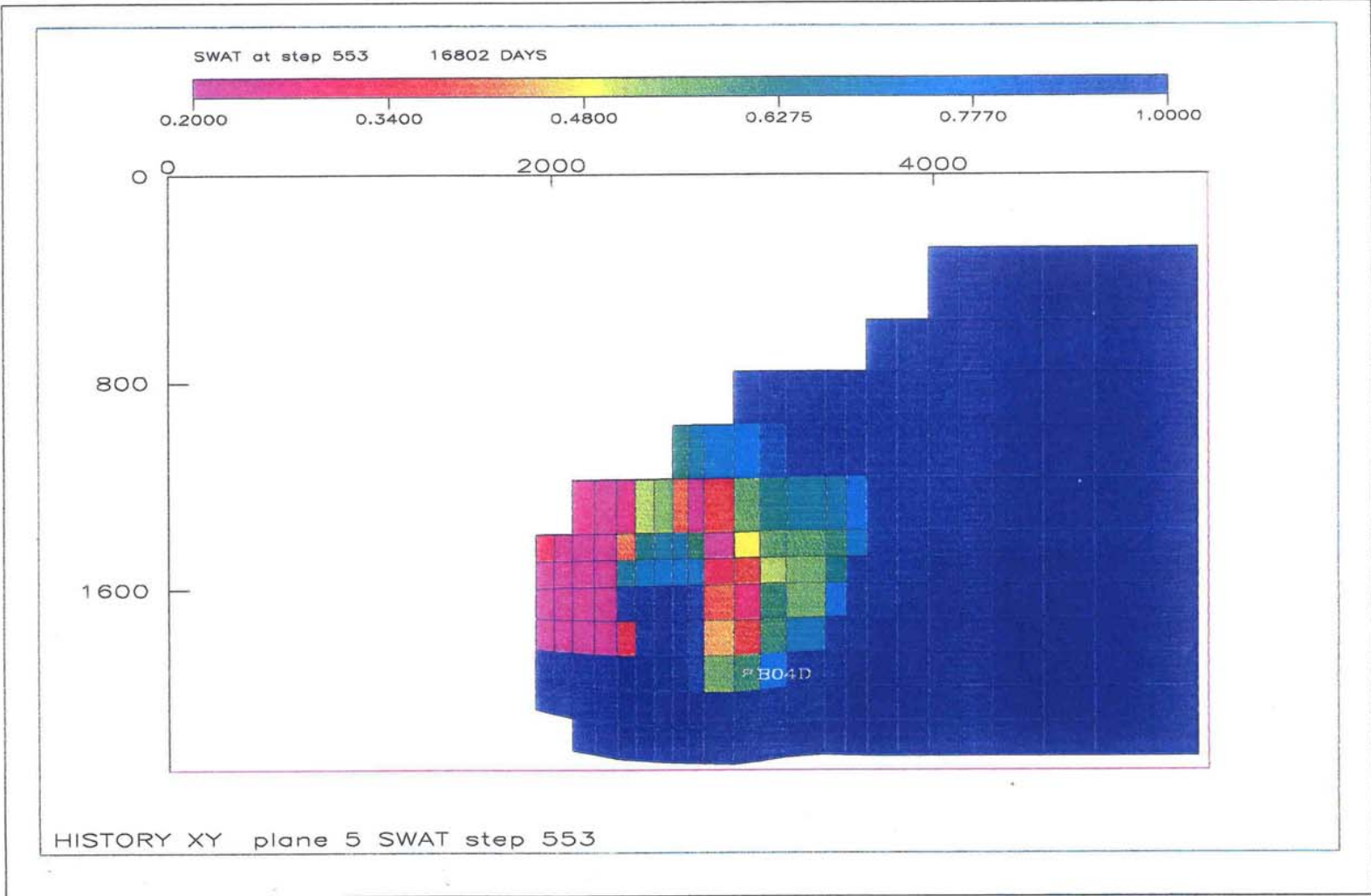

Fig 36

CAMPO DI BORDOLANO

POOL B

P/Z -vs- Gp

(INCLUSA ERUZIONE POZZO BO2)

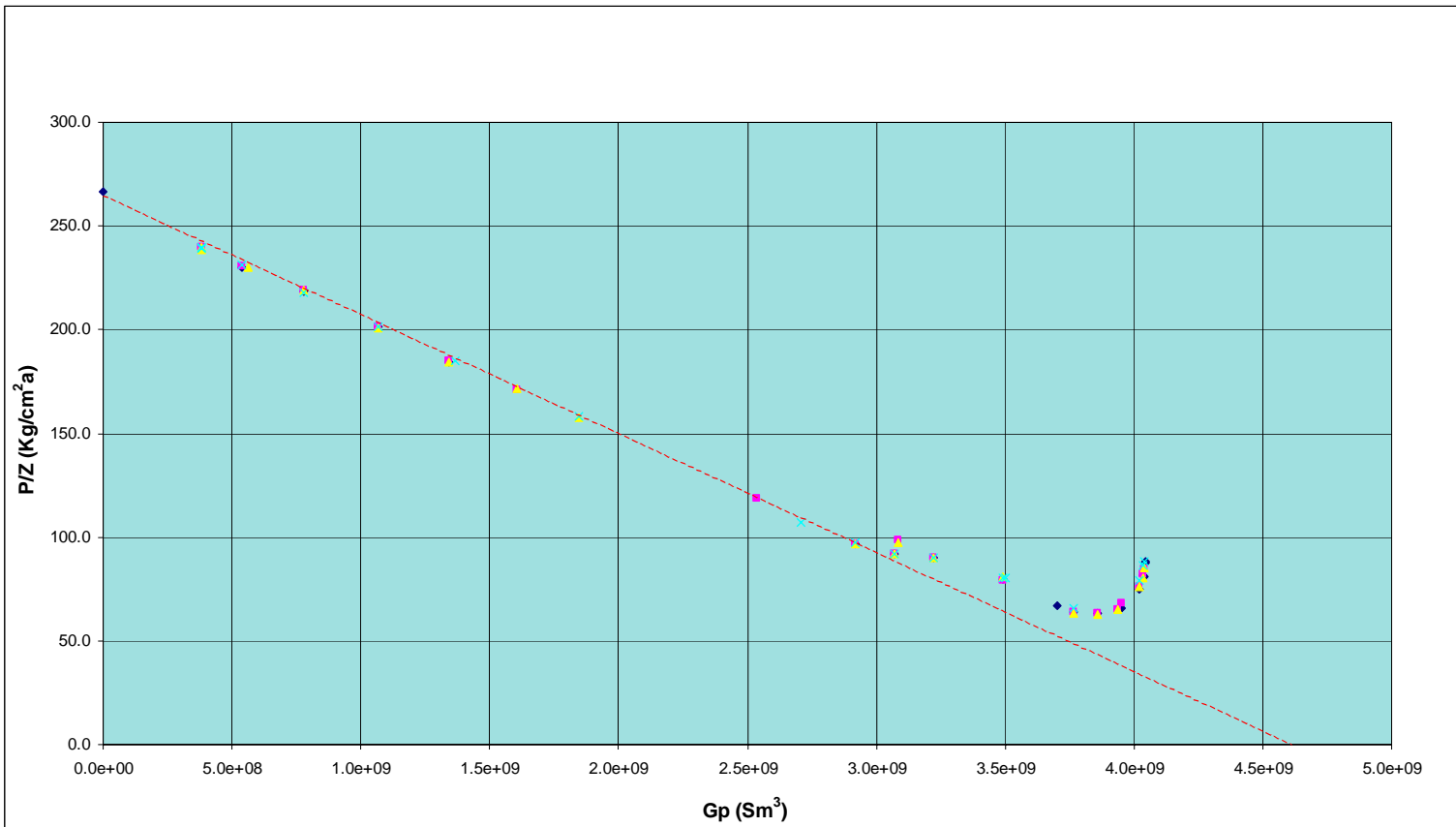

Fig. 37

CAMPO DI BORDOLANO

POOL B

P/Z e GAS RATE -vs- Gp E TEMPO

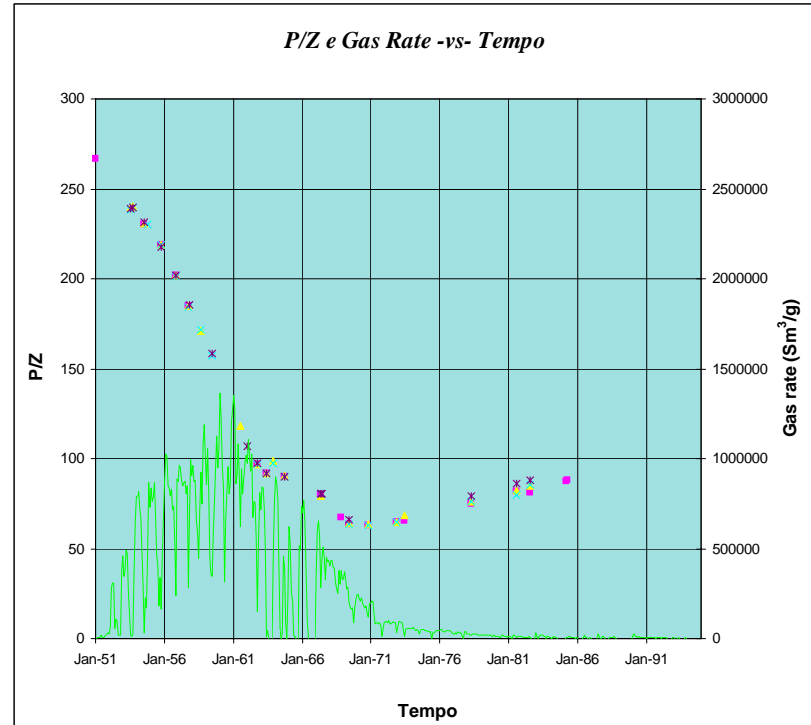
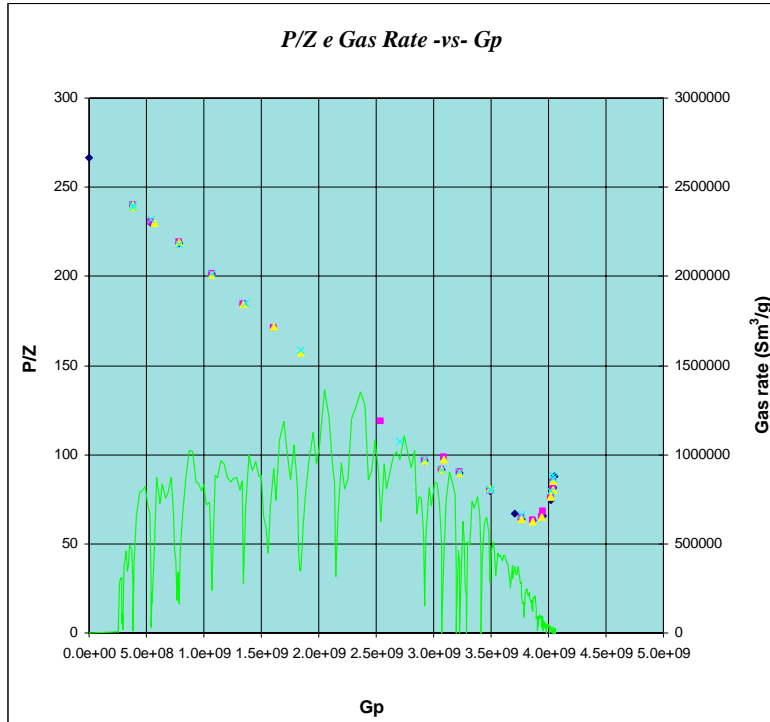

Fig. 38

CAMPO DI BORDOLANO

POOL B

HAVELENA - ODEH

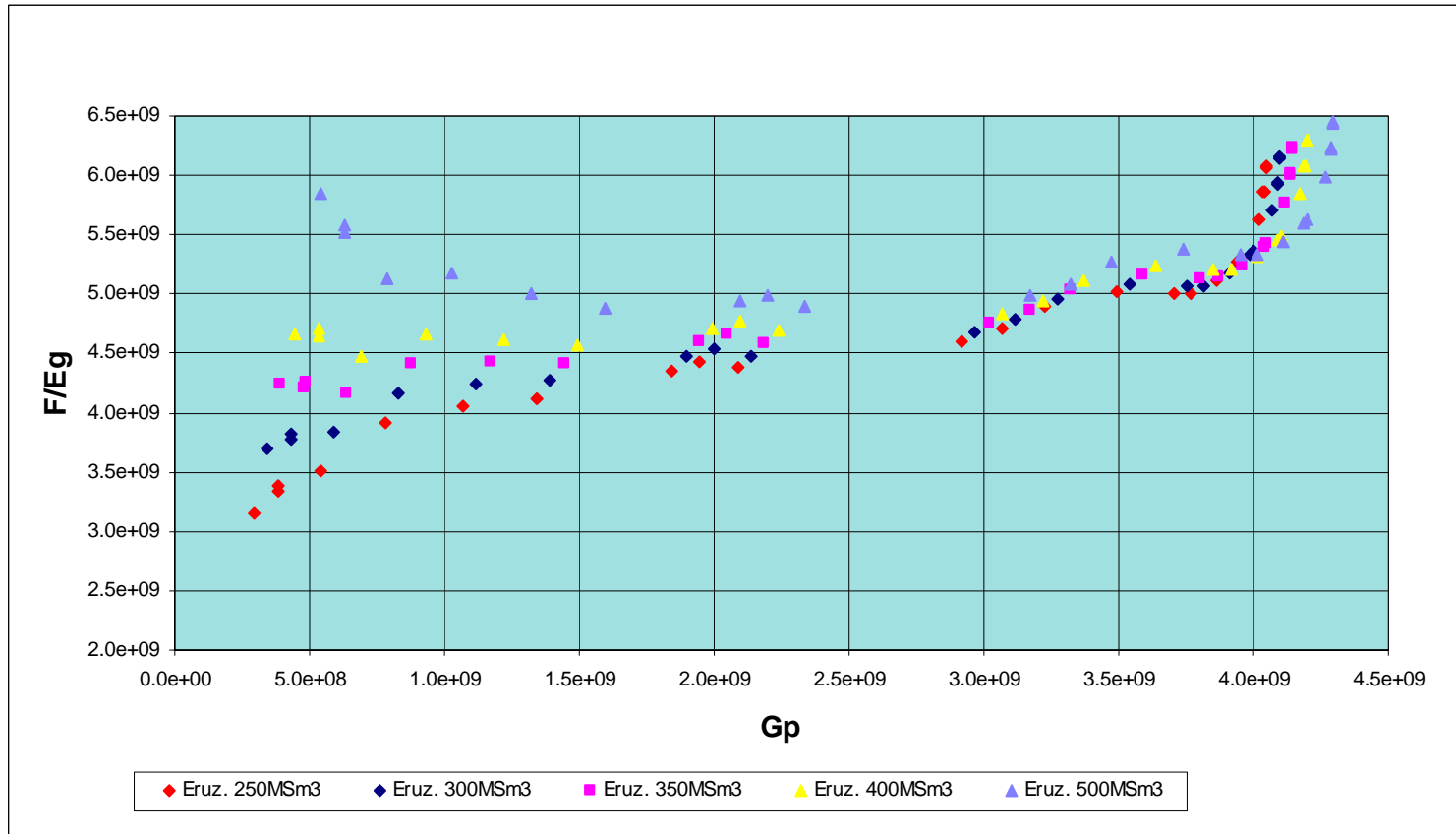

Fig. 39

CAMPO DI BORDOLANO

POOL B

FORECAST DI STOCCAGGIO – CASO 1

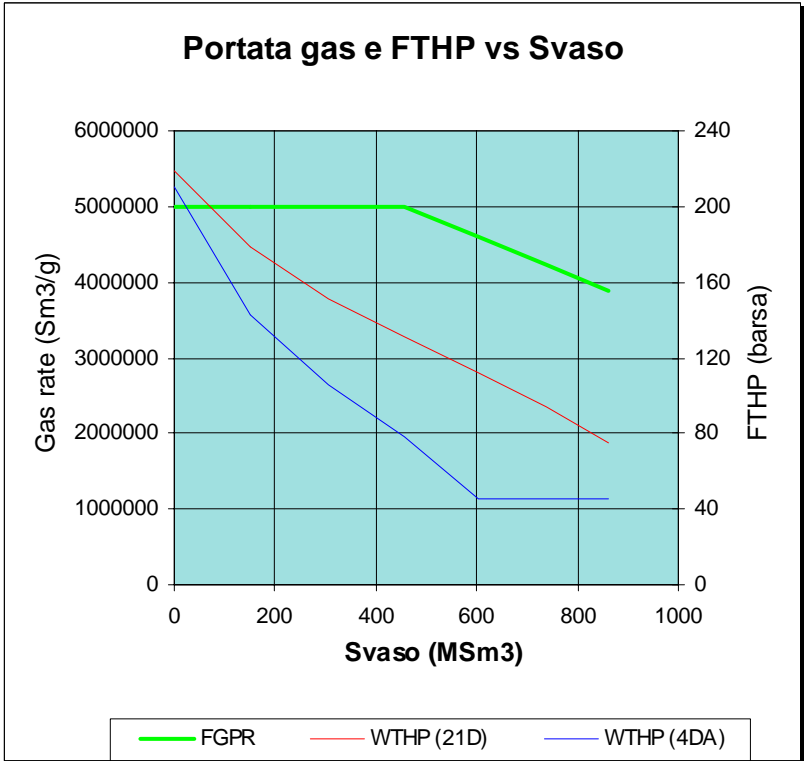
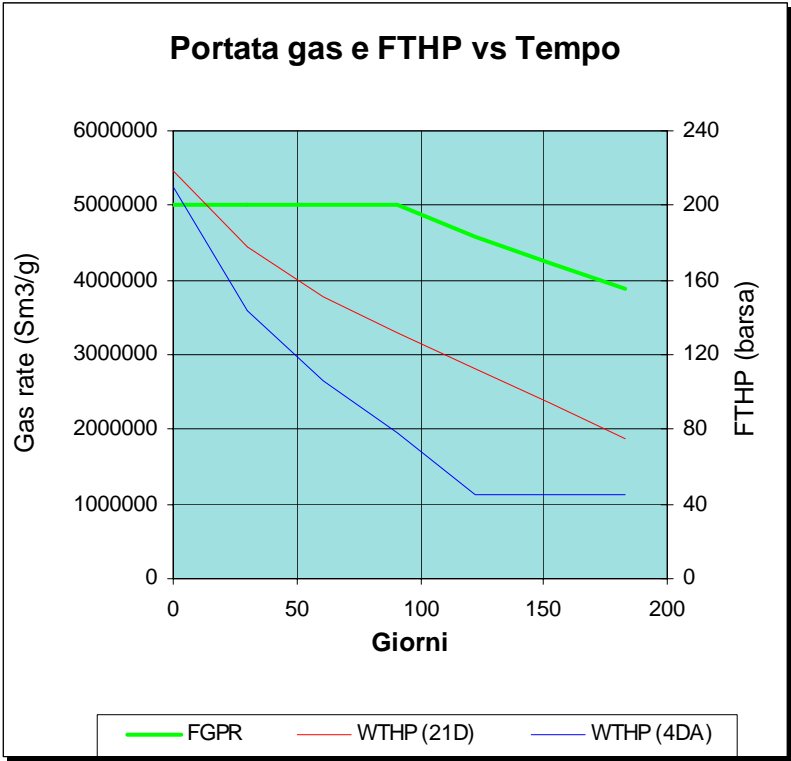

Fig. 40



**CAMPO DI BORDOLANO
POOL B
FORECAST DI STOCCAGGIO - CASO 1**

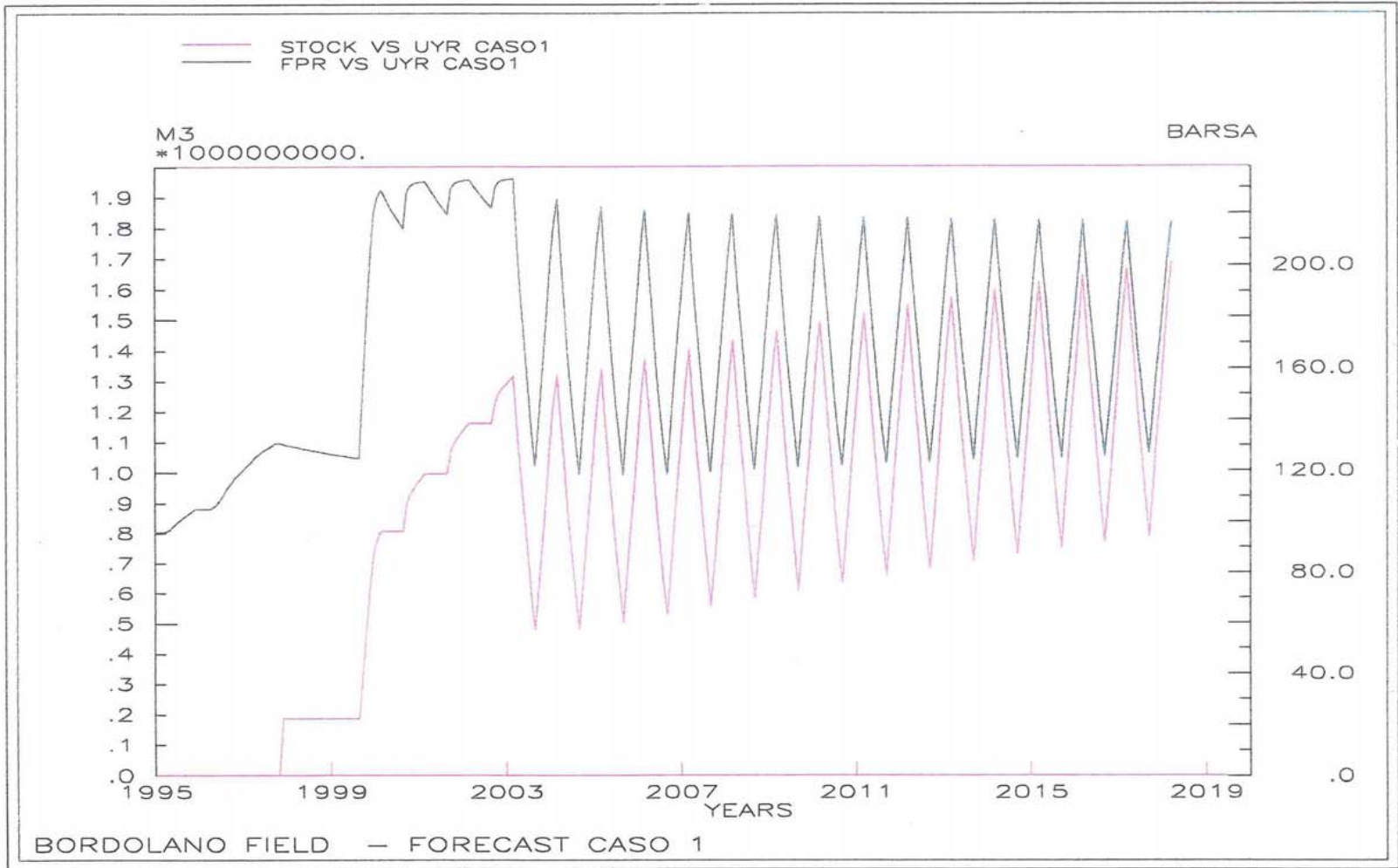

Fig 4 1



**CAMPO DI BORDOLANO
POOL B
FORECAST DI STOCCAGGIO - CASO 1**

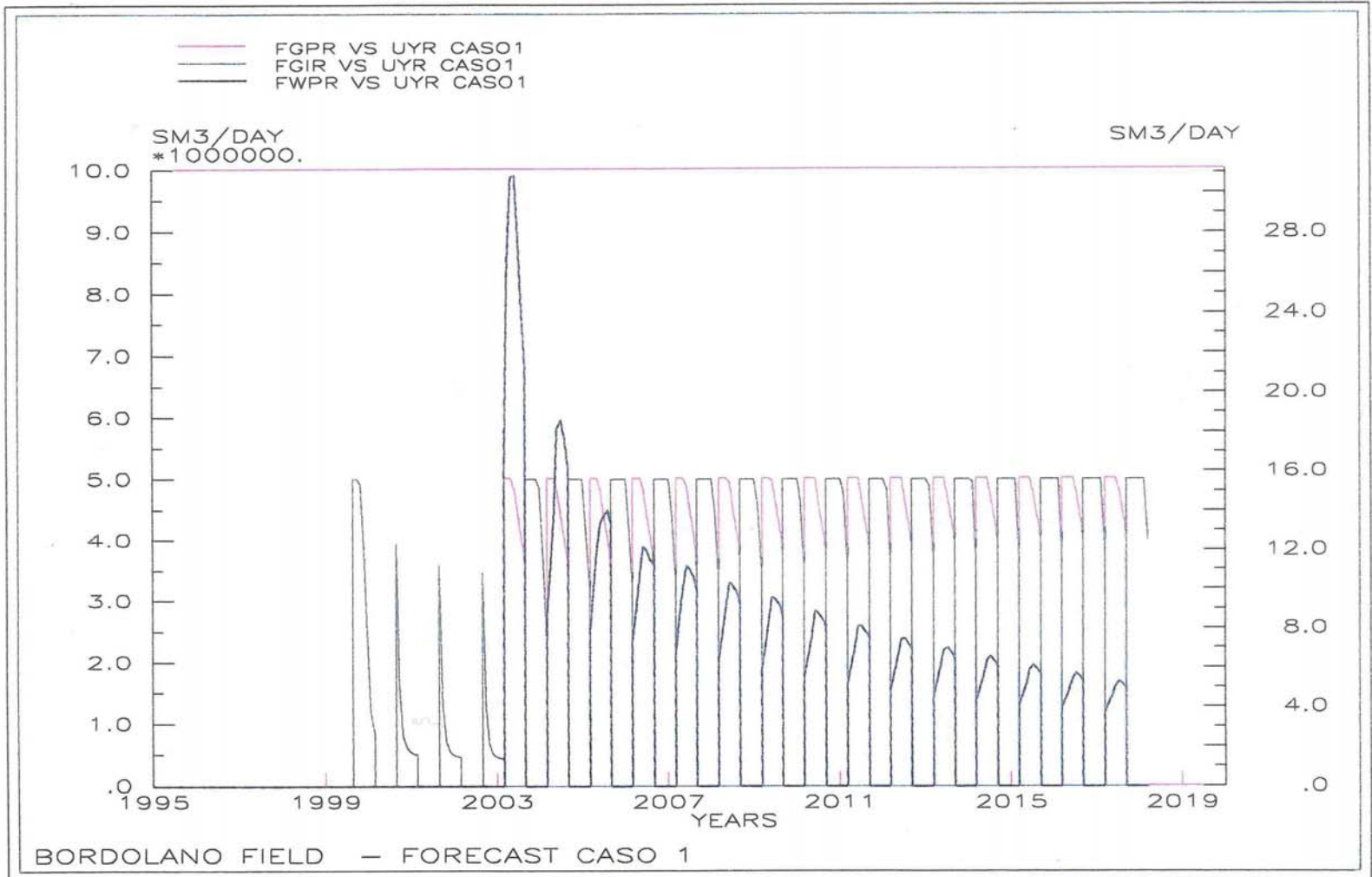

Fig 42



CAMPO DI BORDOLANO POOL B FORECAST DI STOCCAGGIO - CASO 1

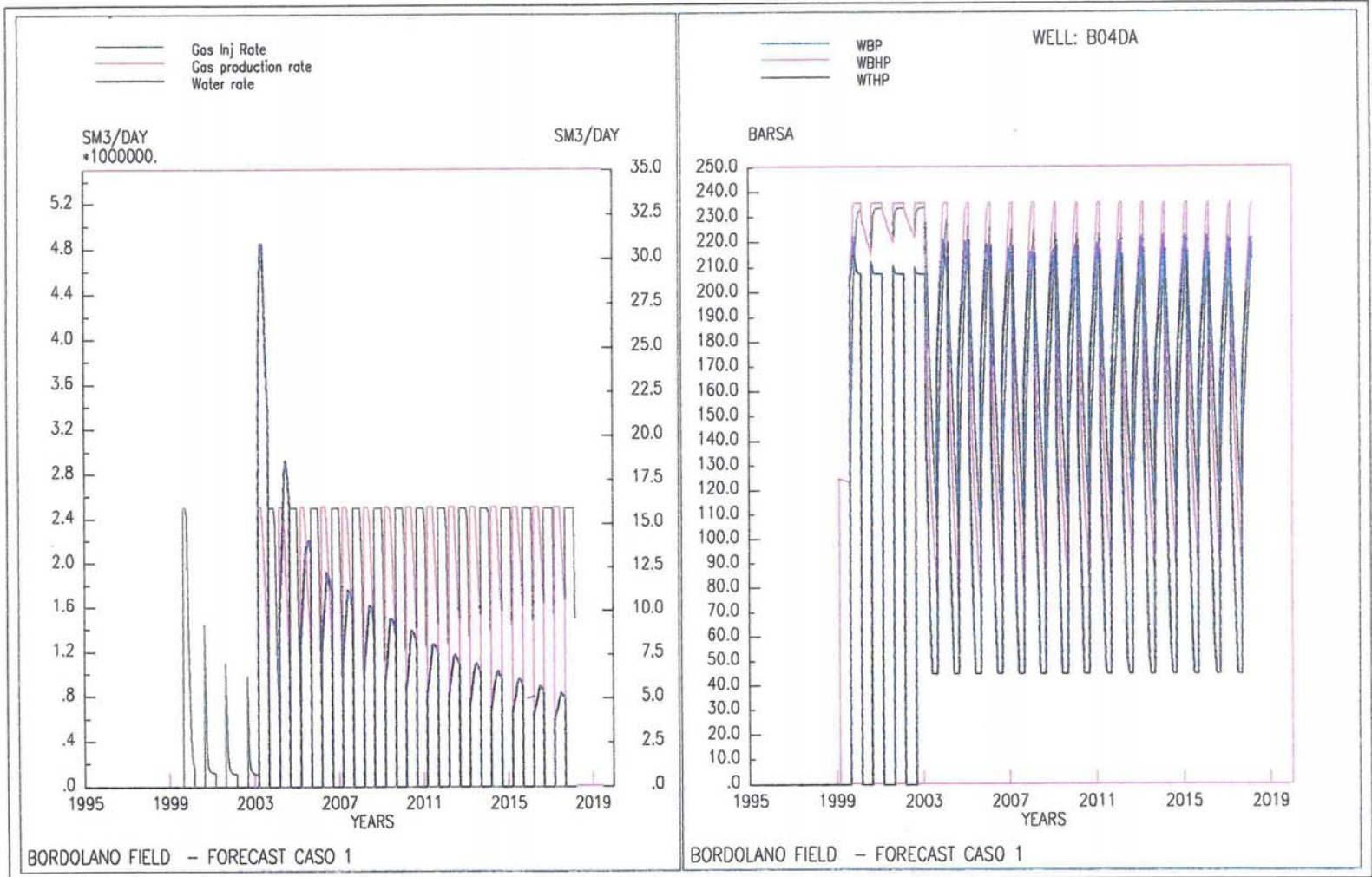

FIG 43



CAMPO DI BORDOLANO POOL B FORECAST DI STOCCAGGIO - CASO 1

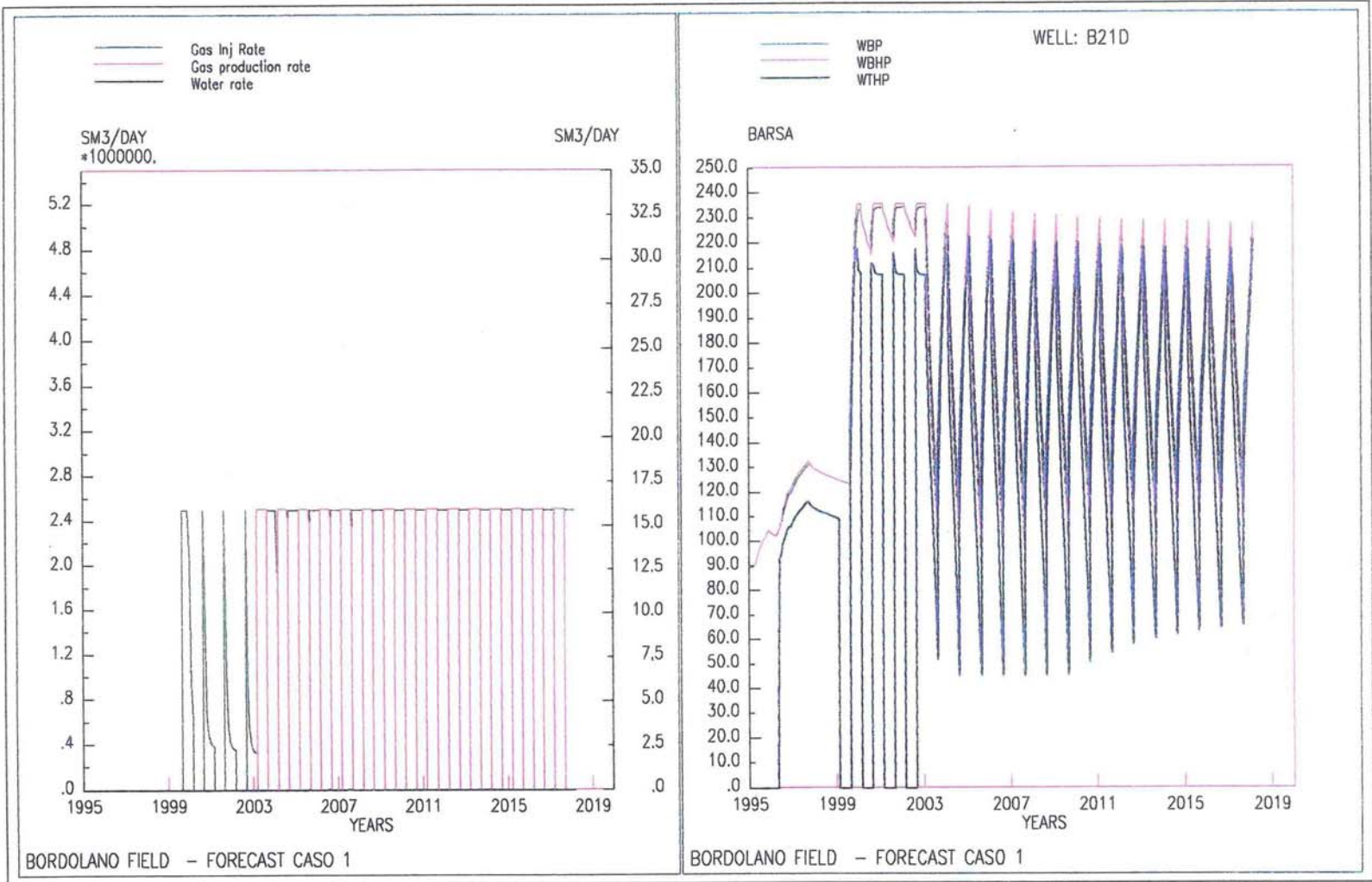

FIG 44

CAMPO DI BORDOLANO

POOL B

FORECAST DI STOCCAGGIO – CASO 1A

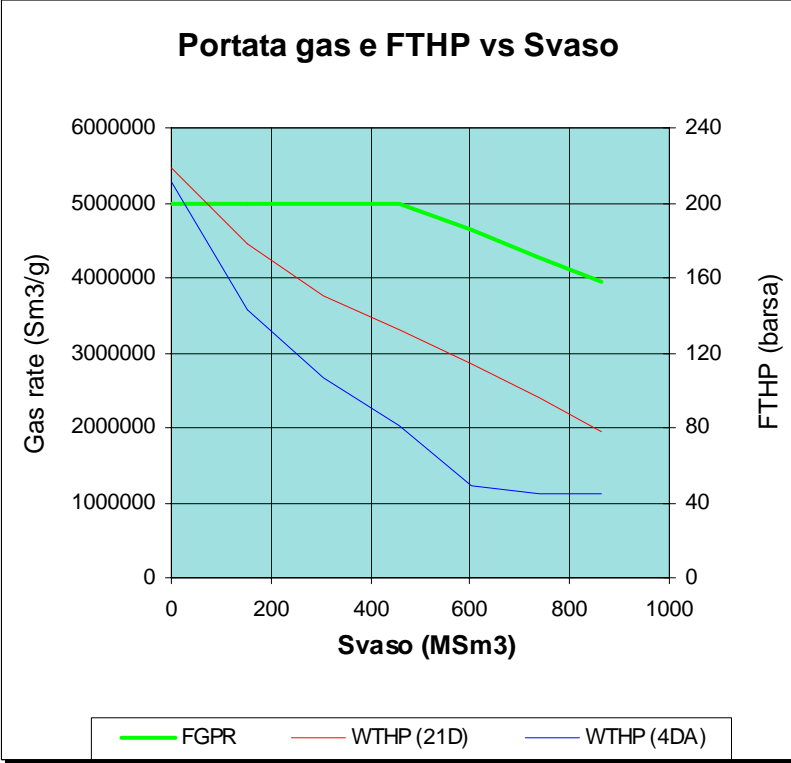
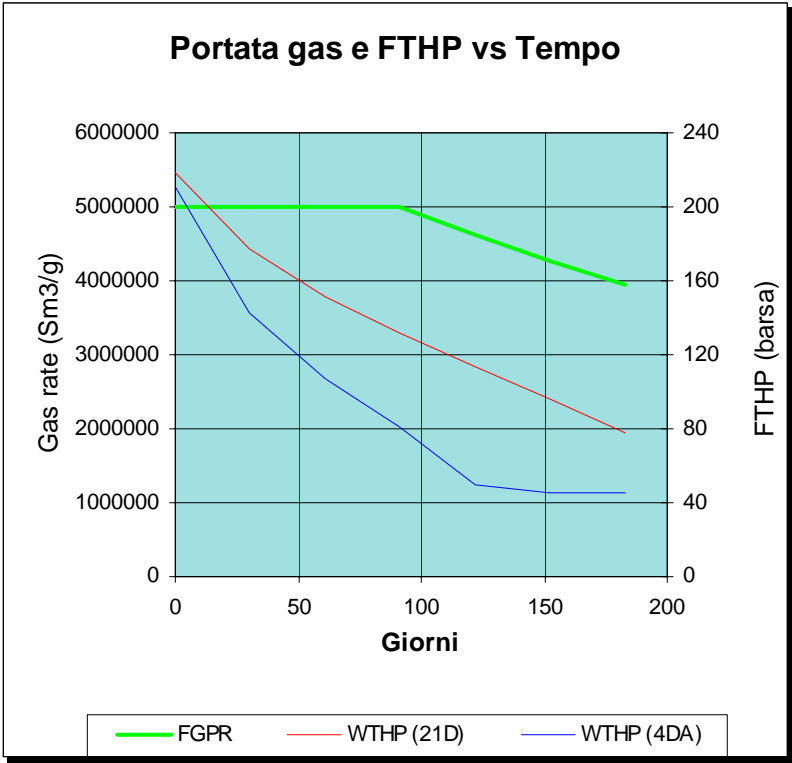

Fig. 45



**CAMPO DI BORDOLANO
POOL B
FORECAST DI STOCCAGGIO - CASO 1A**

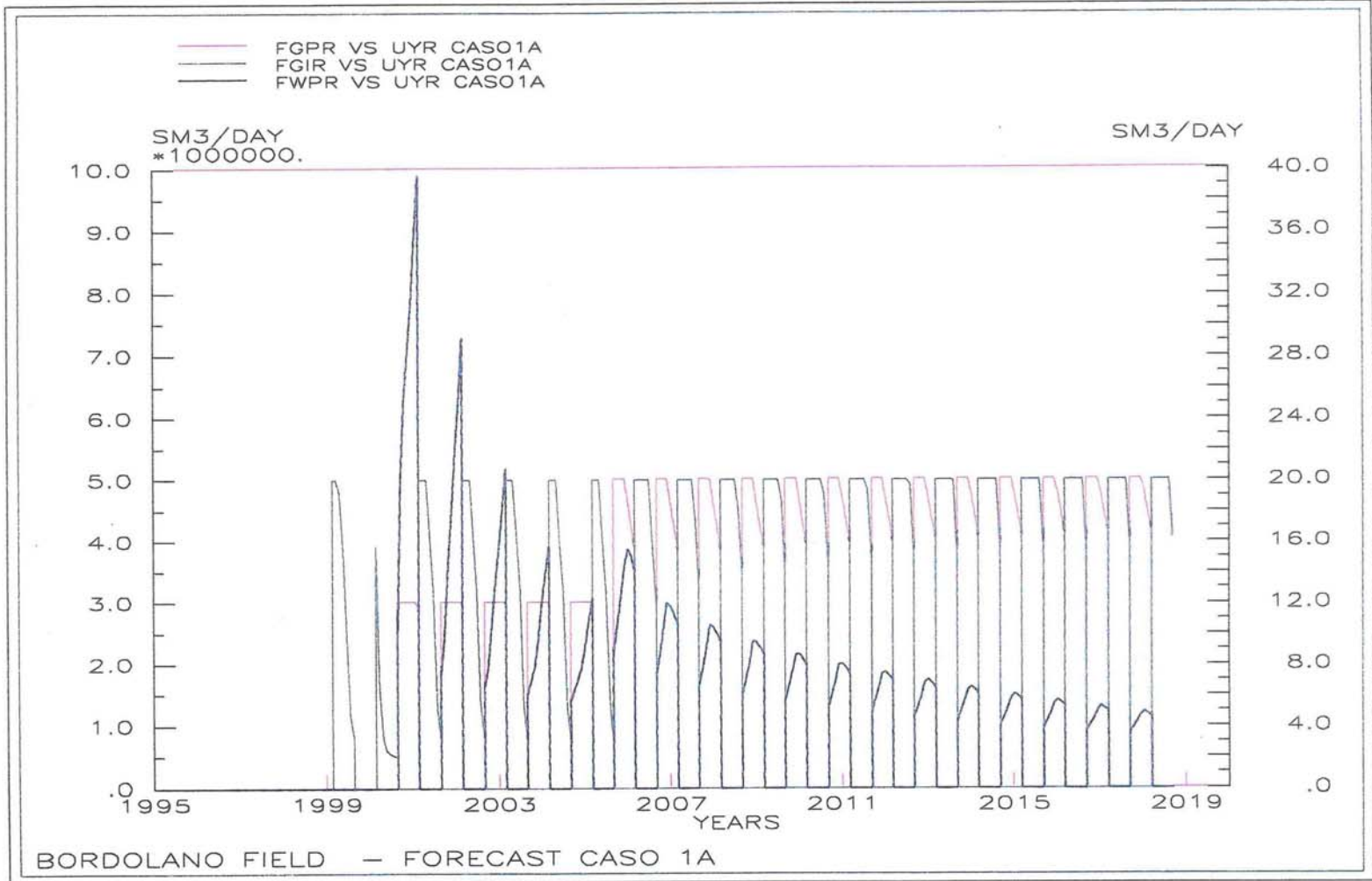

Fig 46



**CAMPO DI BORDOLANO
POOL B
FORECAST DI STOCCAGGIO - CASO 1A**

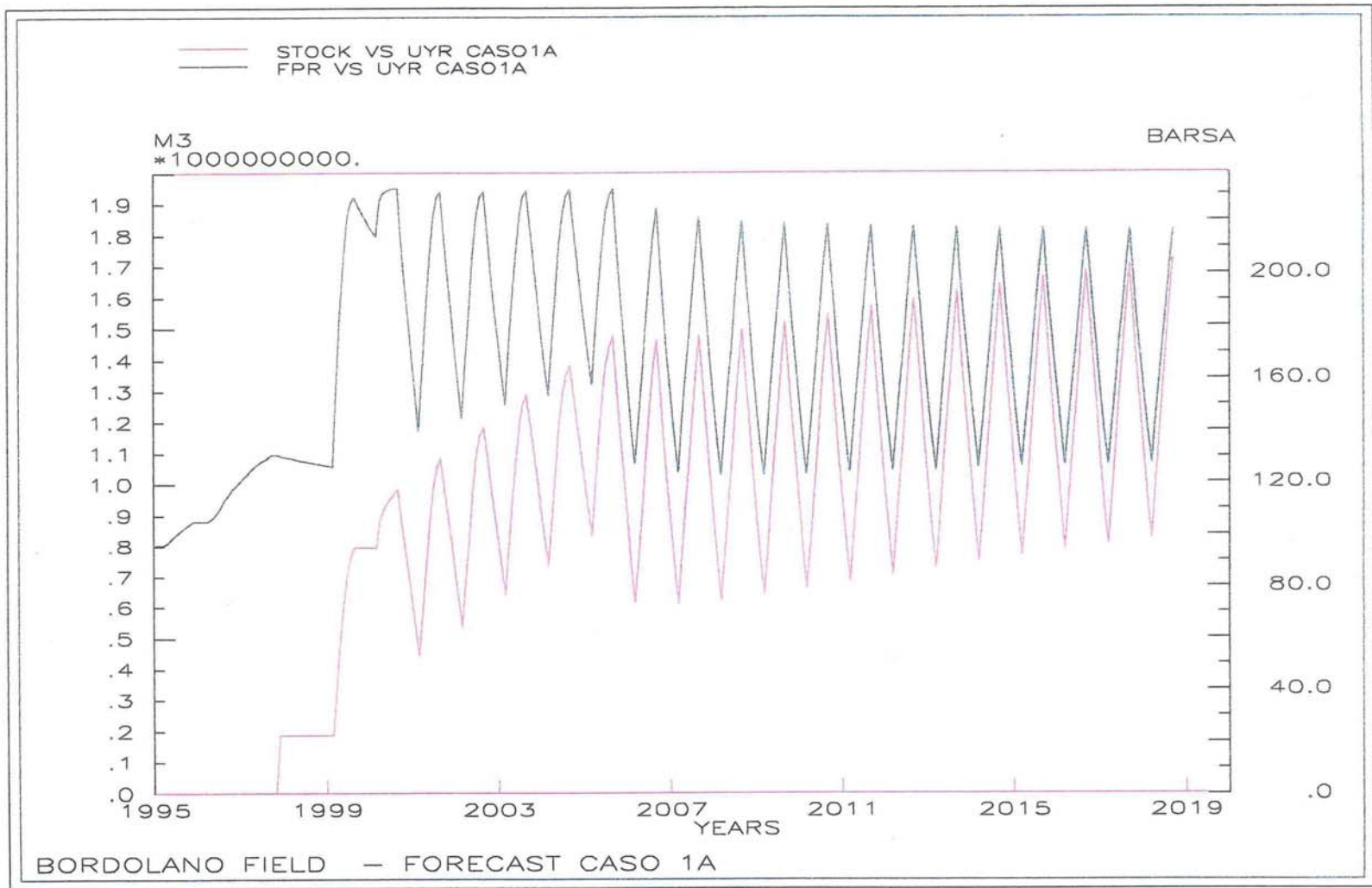

Fig 47



CAMPO DI BORDOLANO POOL B FORECAST DI STOCCAGGIO - CASO 1A

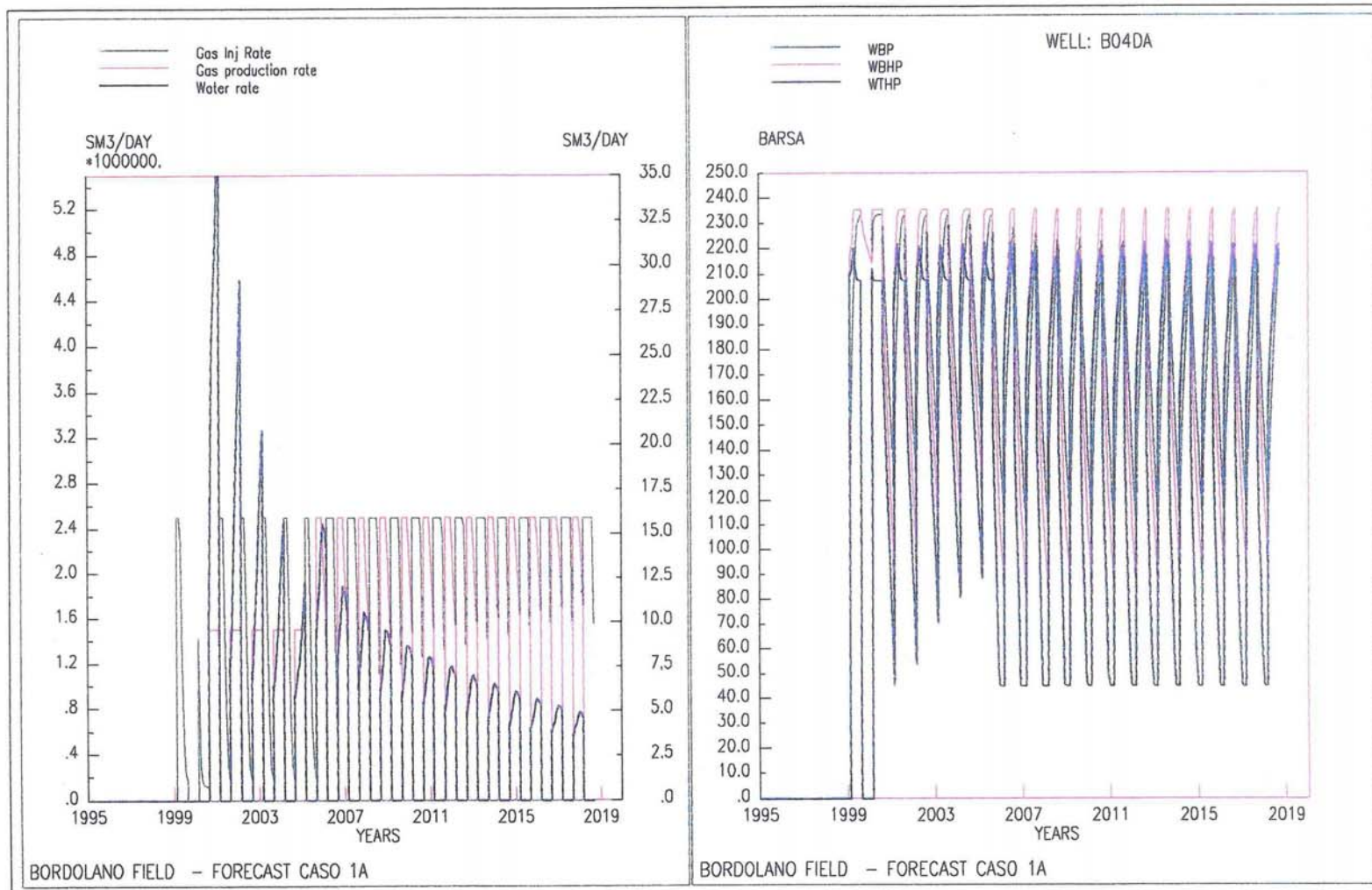

Fig 48



CAMPO DI BORDOLANO POOL B FORECAST DI STOCCAGGIO - CASO 1A

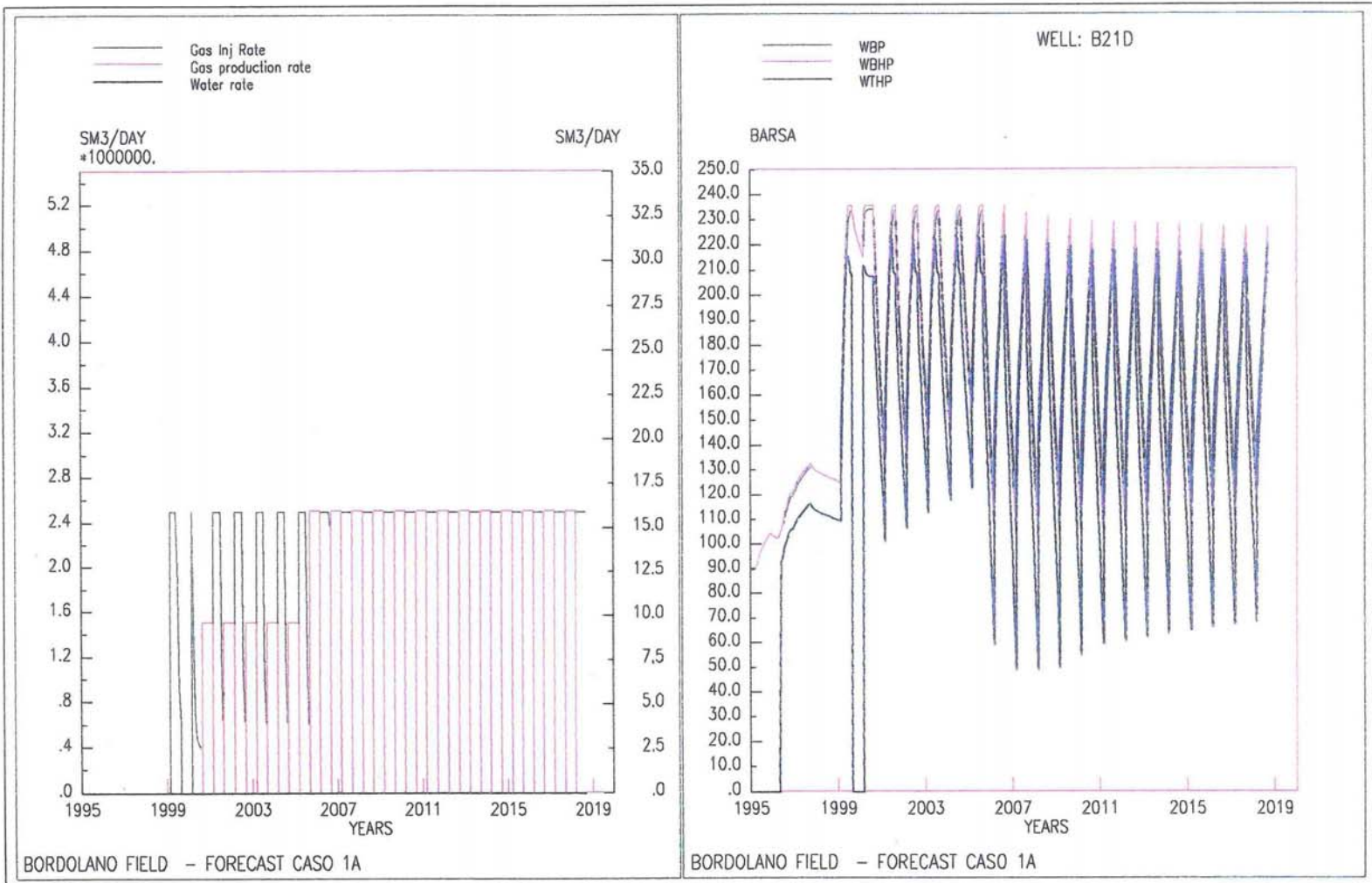

Fig 49

CAMPO DI BORDOLANO

POOL B

FORECAST DI STOCCAGGIO – CASO 1B

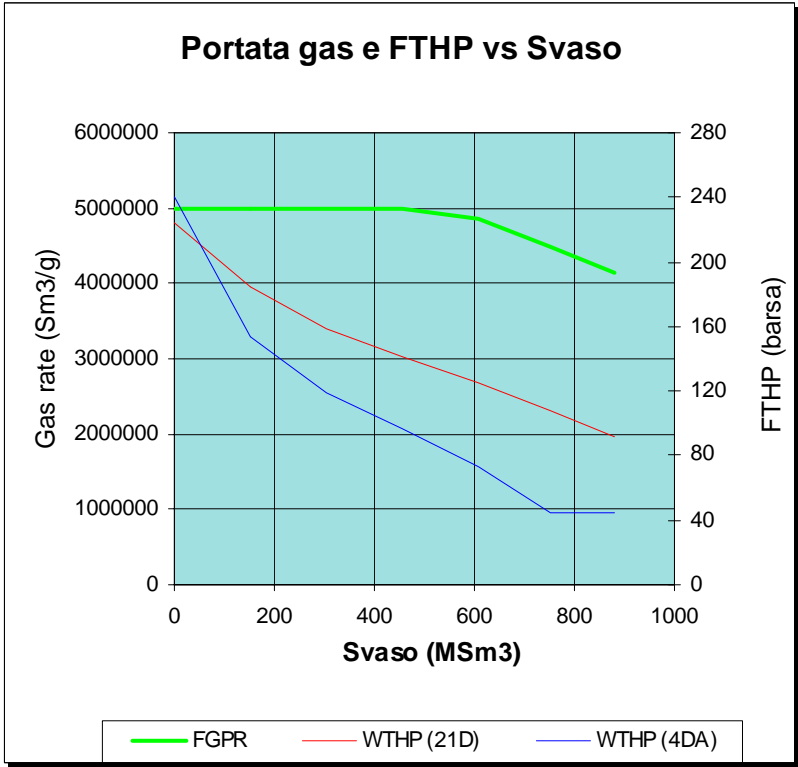
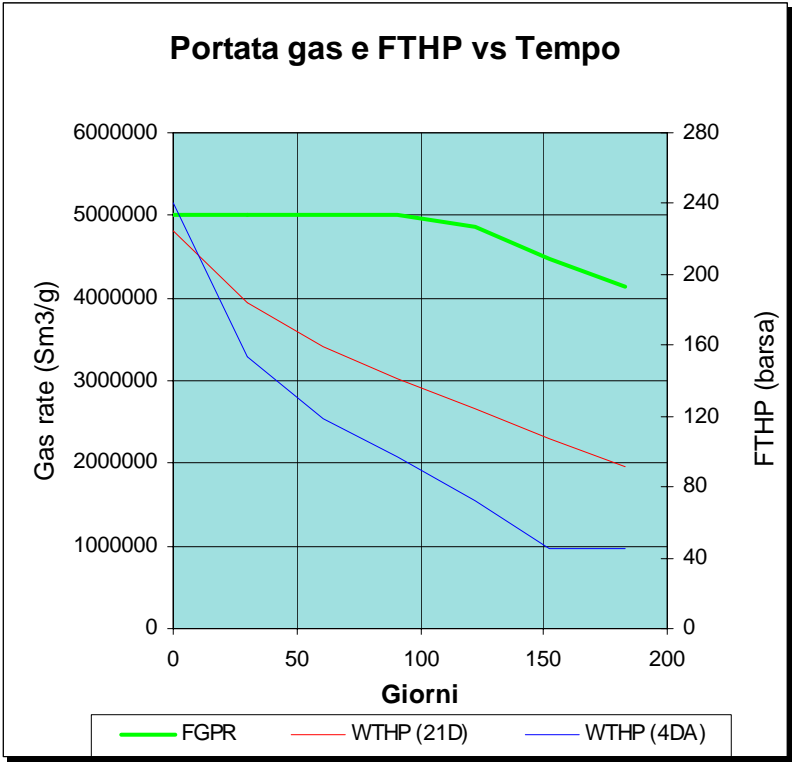

Fig. 50



**CAMPO DI BORDOLANO
POOL B
FORECAST DI STOCCAGGIO - CASO 1B**

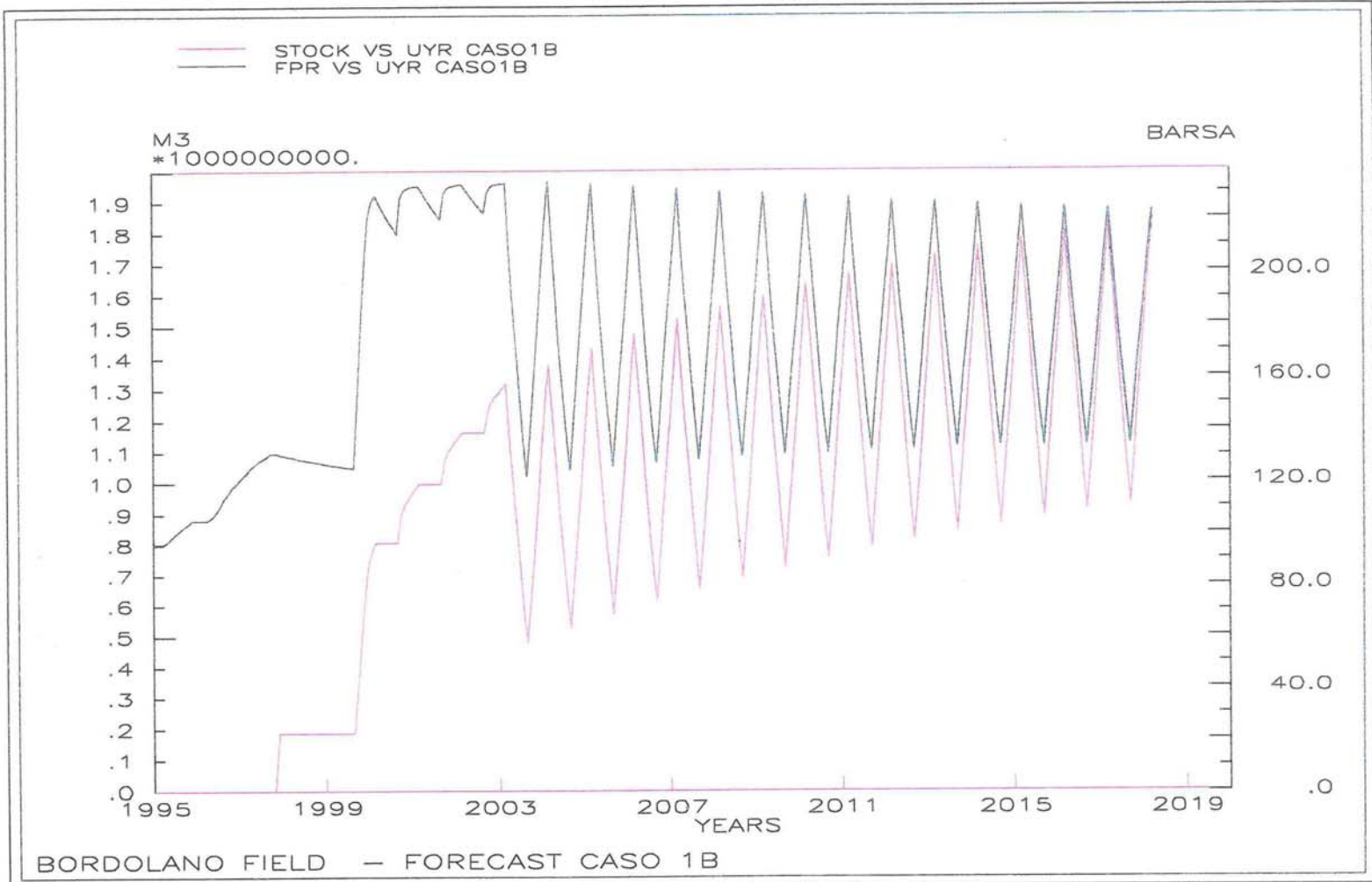

Fig 51



**CAMPO DI BORDOLANO
POOL B
FORECAST DI STOCCAGGIO - CASO 1B**

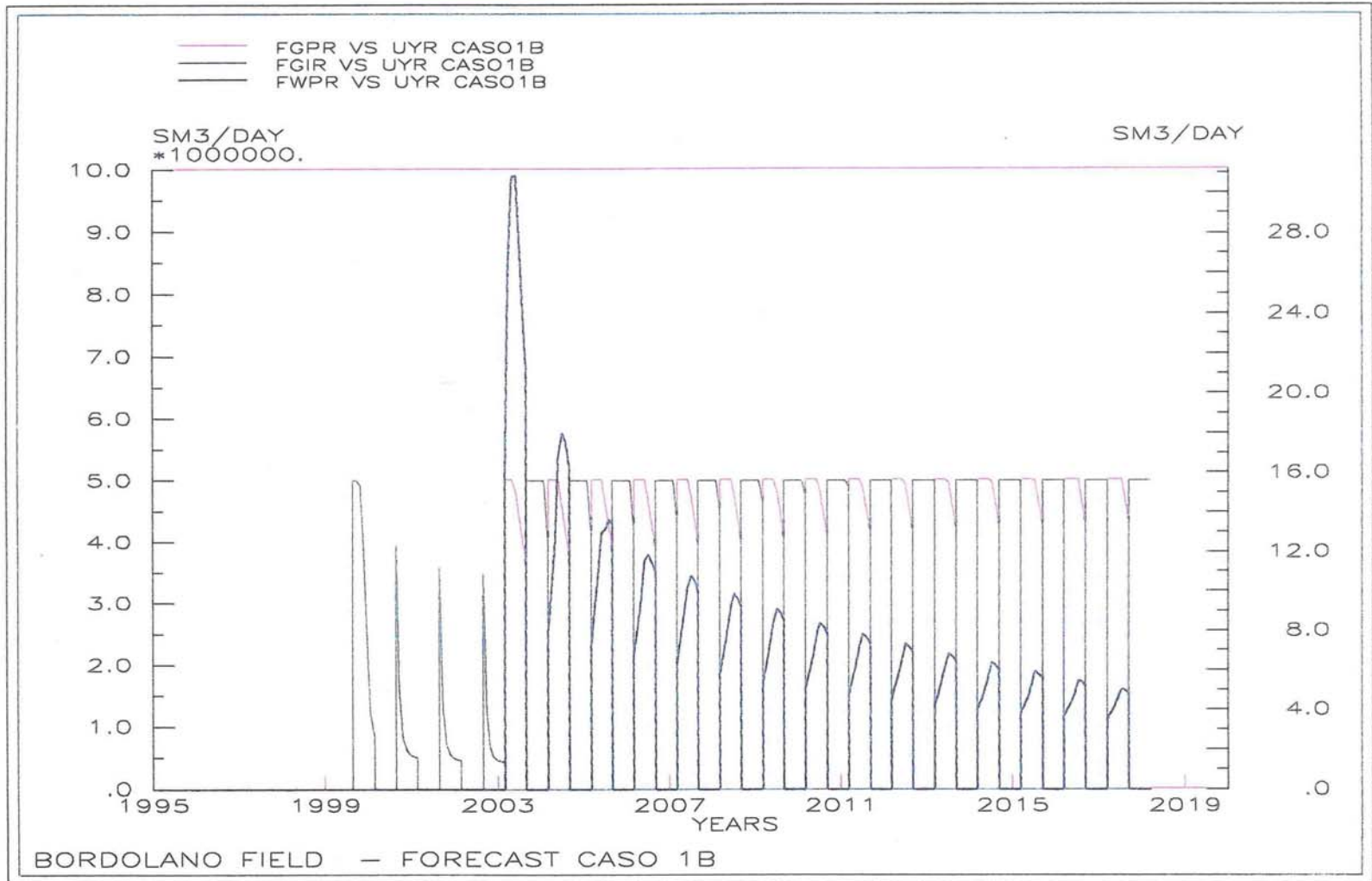

Fig 52



CAMPO DI BORDOLANO POOL B FORECAST DI STOCCAGGIO - CASO 1B

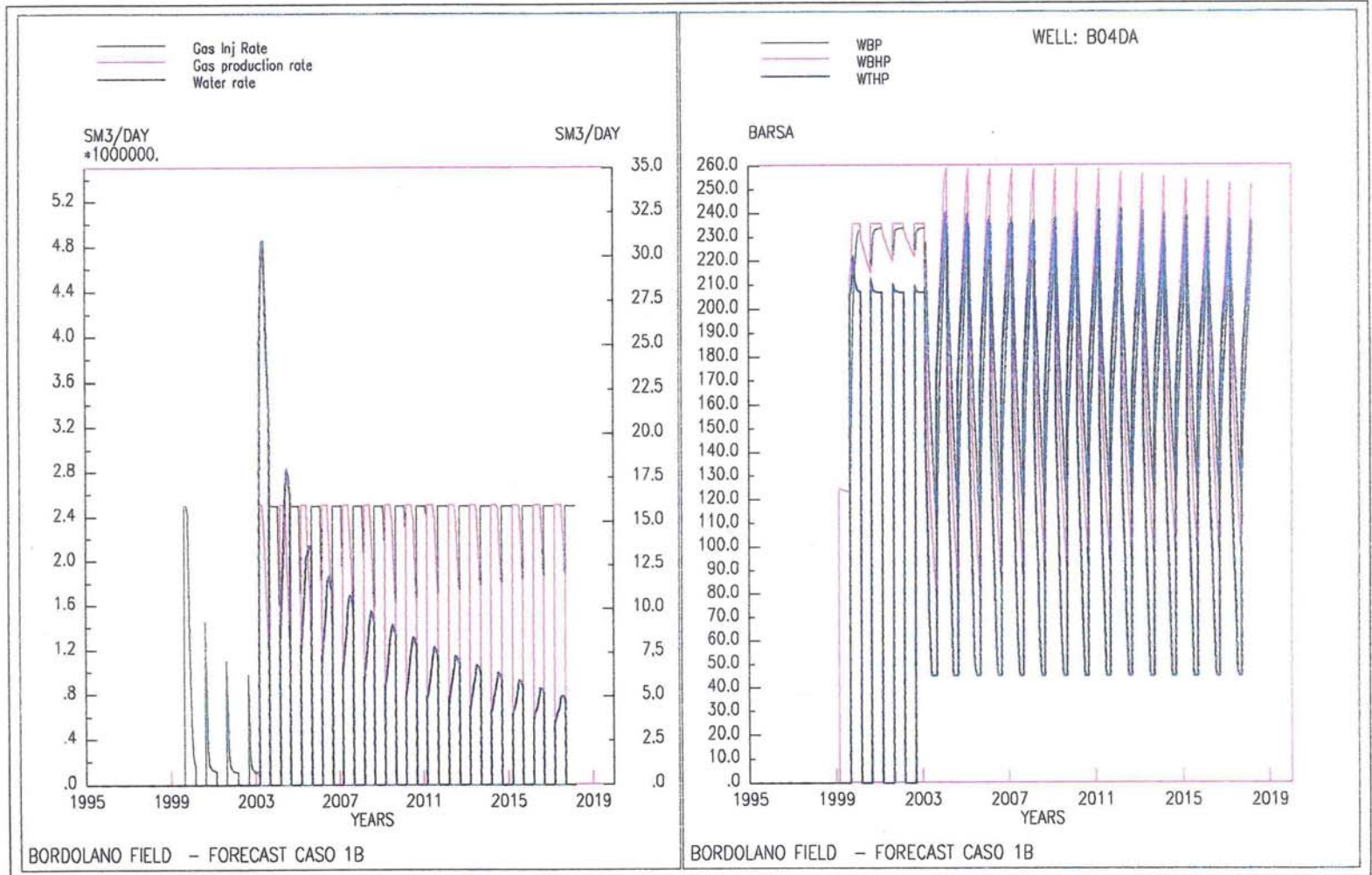

Fig 53



CAMPO DI BORDOLANO POOL B FORECAST DI STOCCAGGIO - CASO 1B

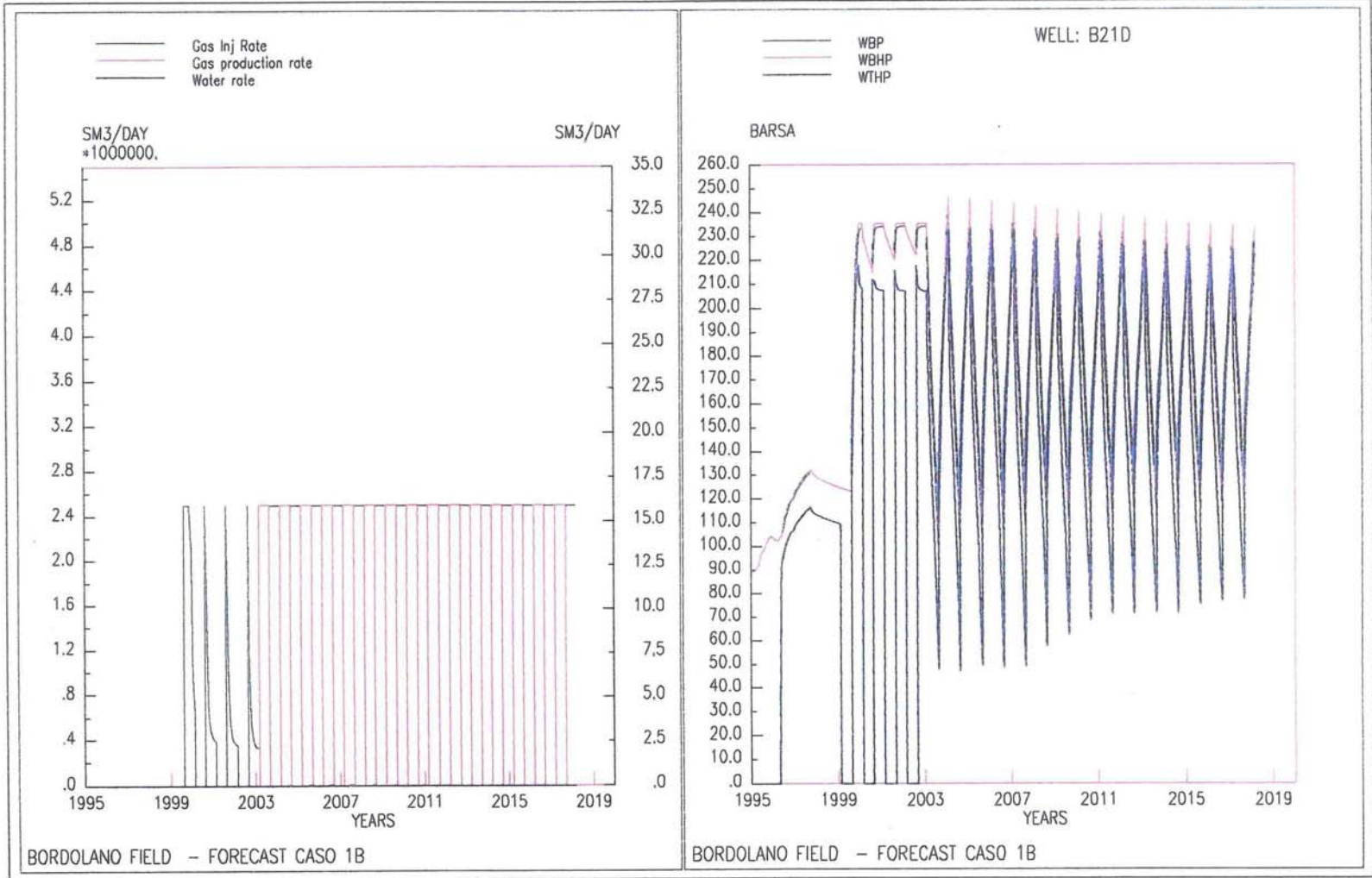

Fig 54

CAMPO DI BORDOLANO

POOL B

FORECAST DI STOCCAGGIO – CASO 2

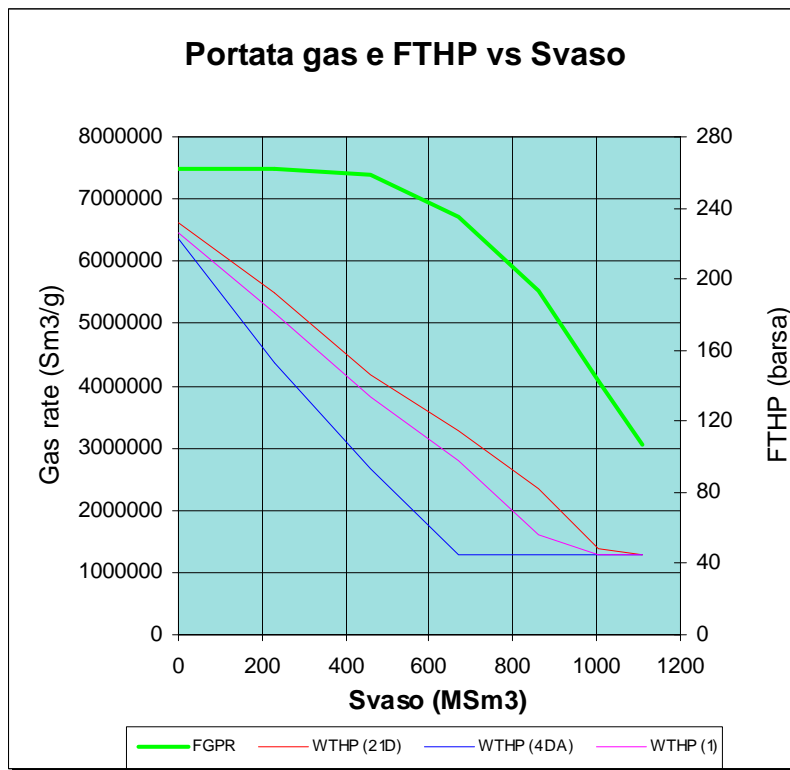
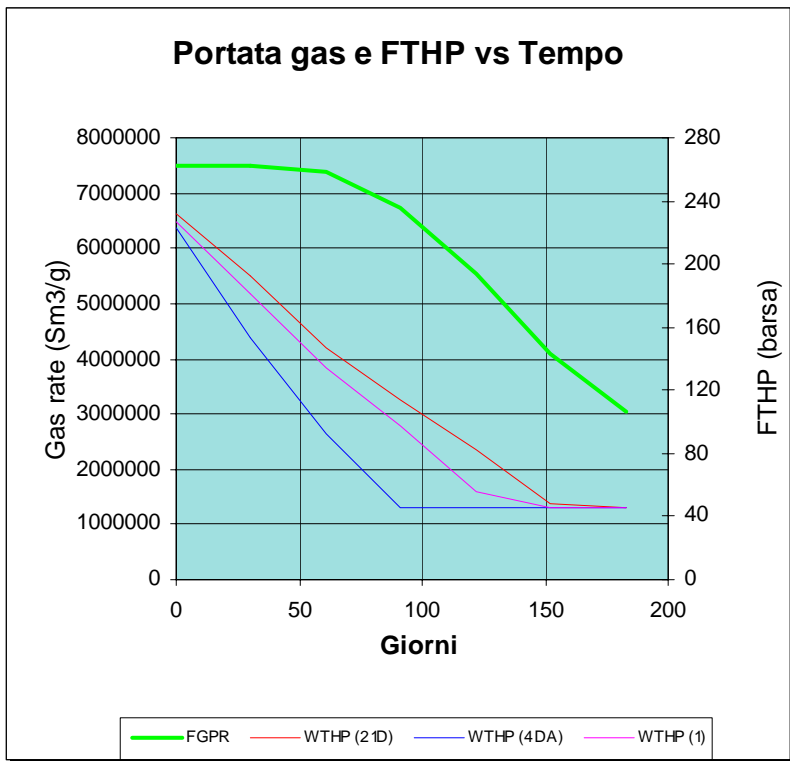
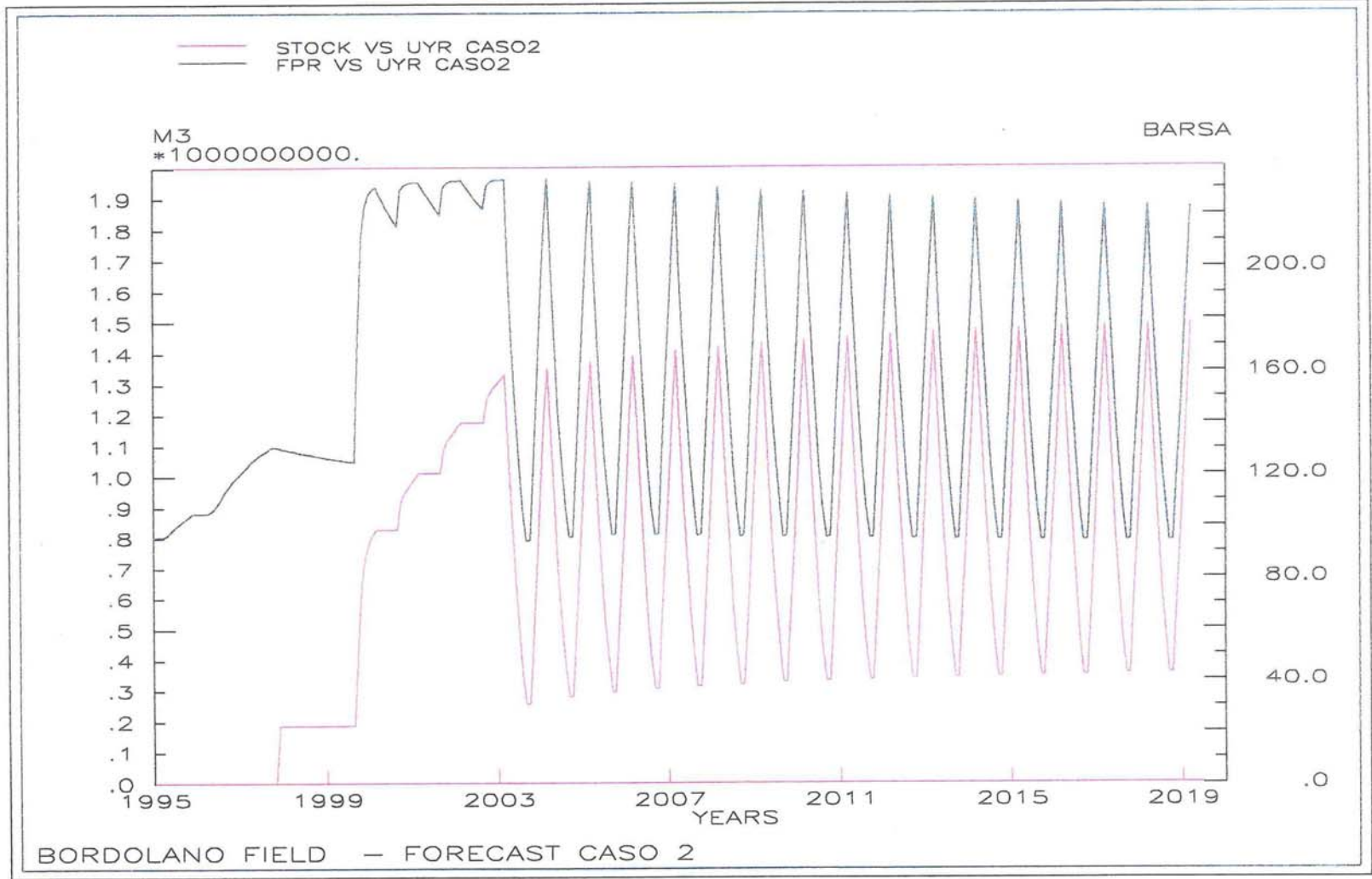

Fig. 55



**CAMPO DI BORDOLANO
POOL B
FORECAST DI STOCCAGGIO - CASO 2**



BORDOLANO FIELD - FORECAST CASO 2

Fig 56



**CAMPO DI BORDOLANO
POOL B
FORECAST DI STOCCAGGIO - CASO 2**

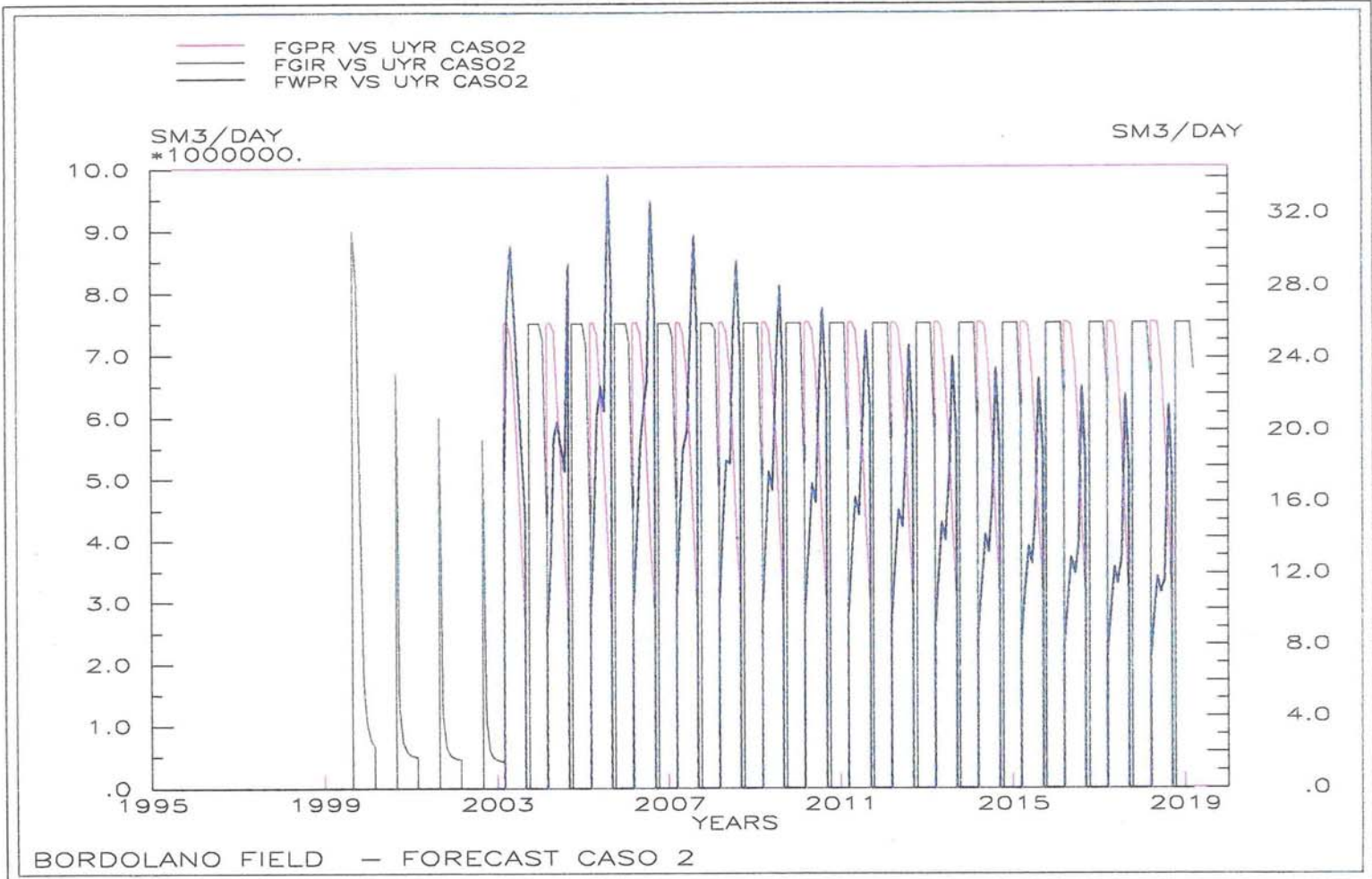

Fig 57



CAMPO DI BORDOLANO POOL B FORECAST DI STOCCAGGIO - CASO 2

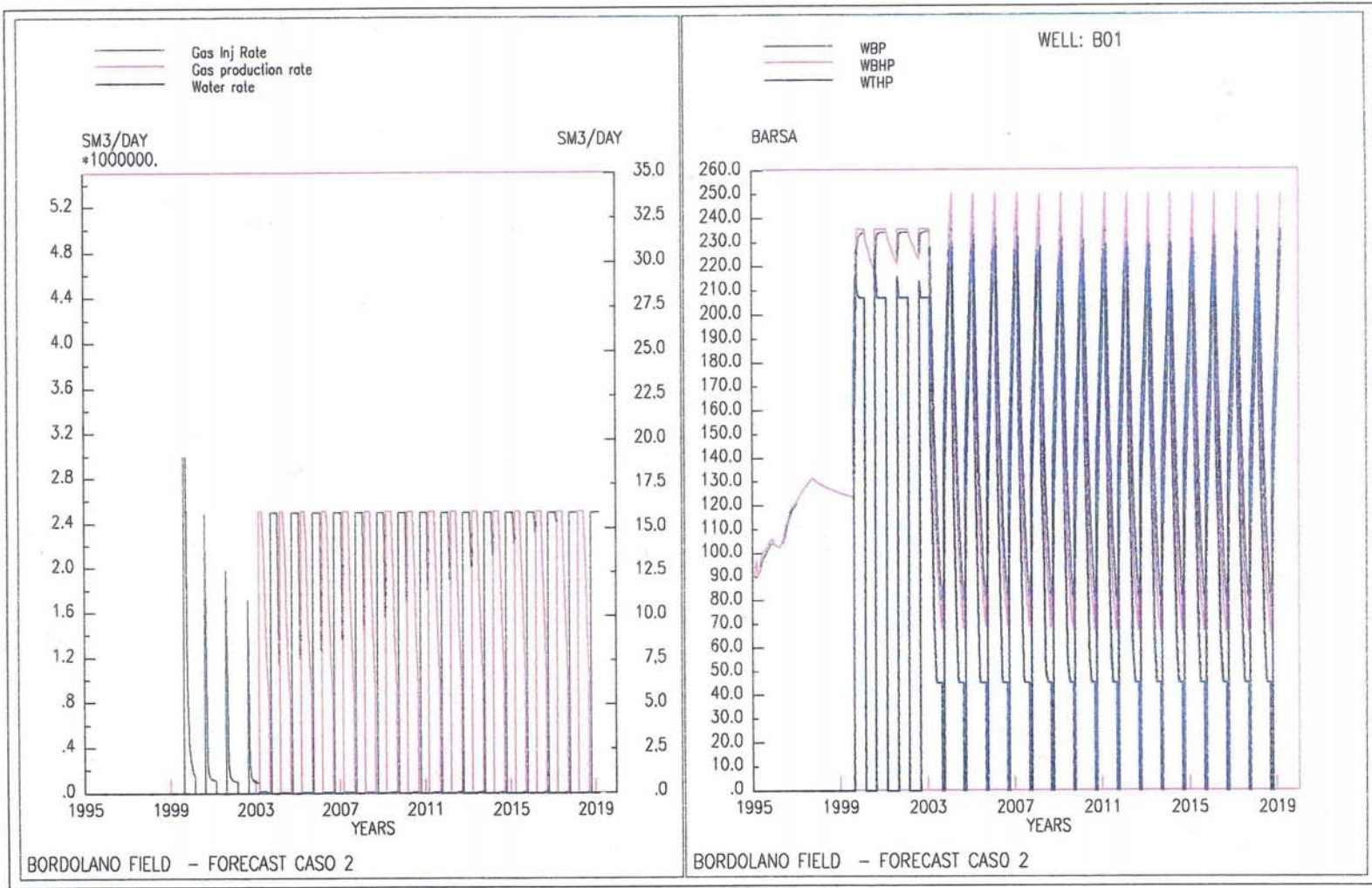

Fig 58



CAMPO DI BORDOLANO POOL B FORECAST DI STOCCAGGIO - CASO 2

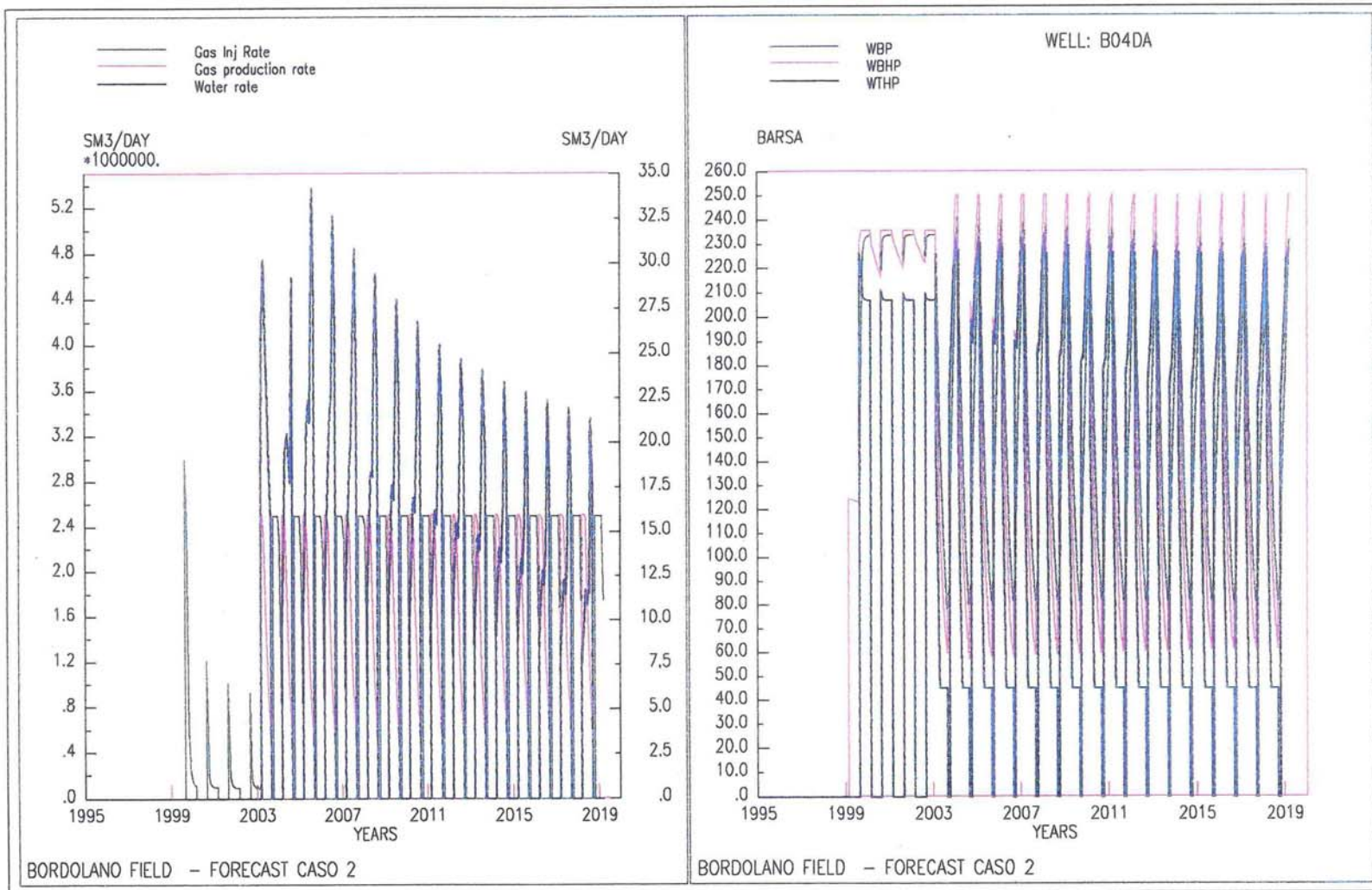

Fig 59



CAMPO DI BORDOLANO POOL B FORECAST DI STOCCAGGIO - CASO 2

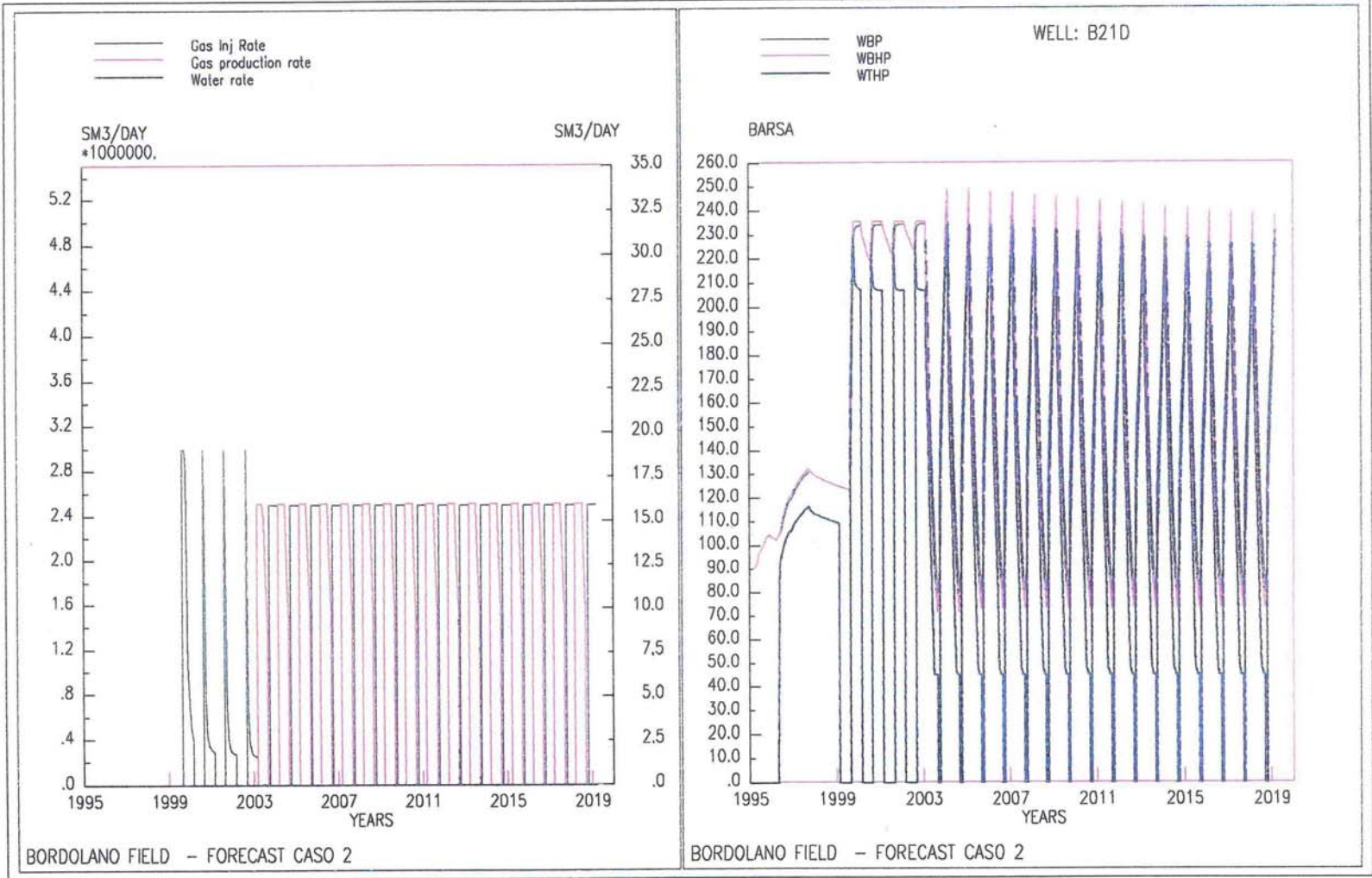

Fig 60

CAMPO DI BORDOLANO

POOL B

FORECAST DI STOCCAGGIO – CASO 3

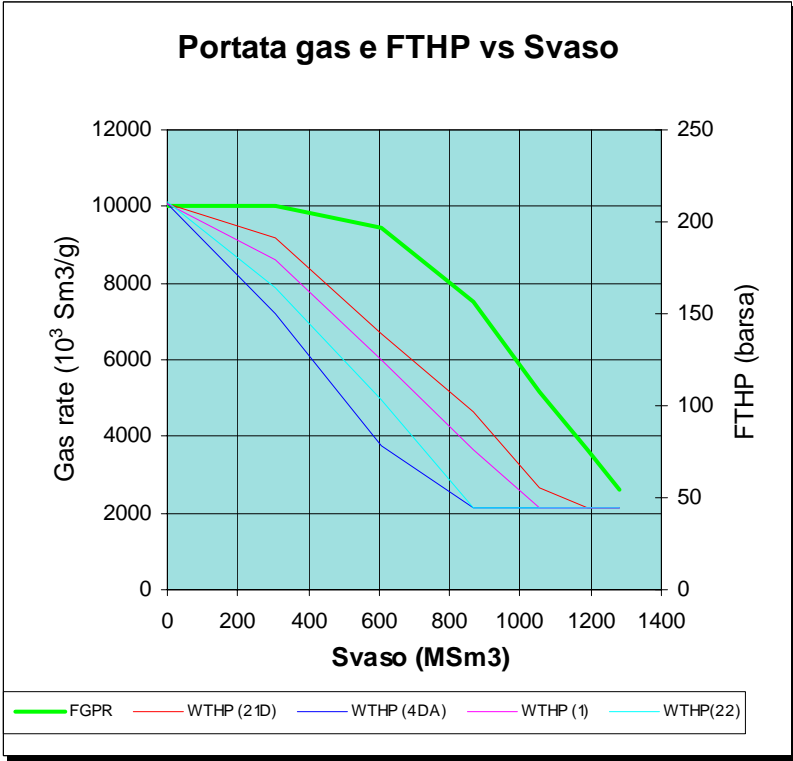
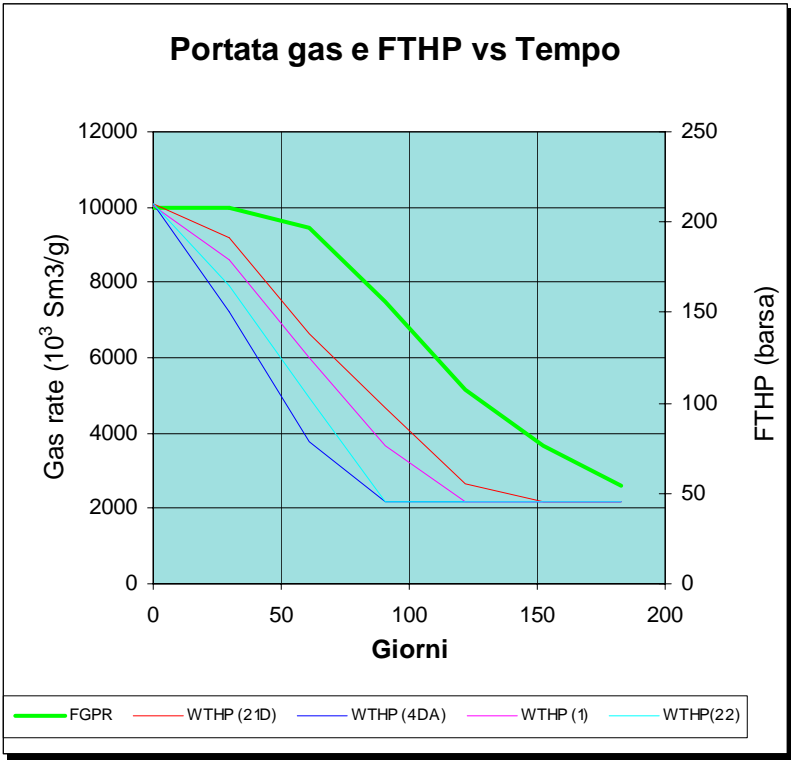
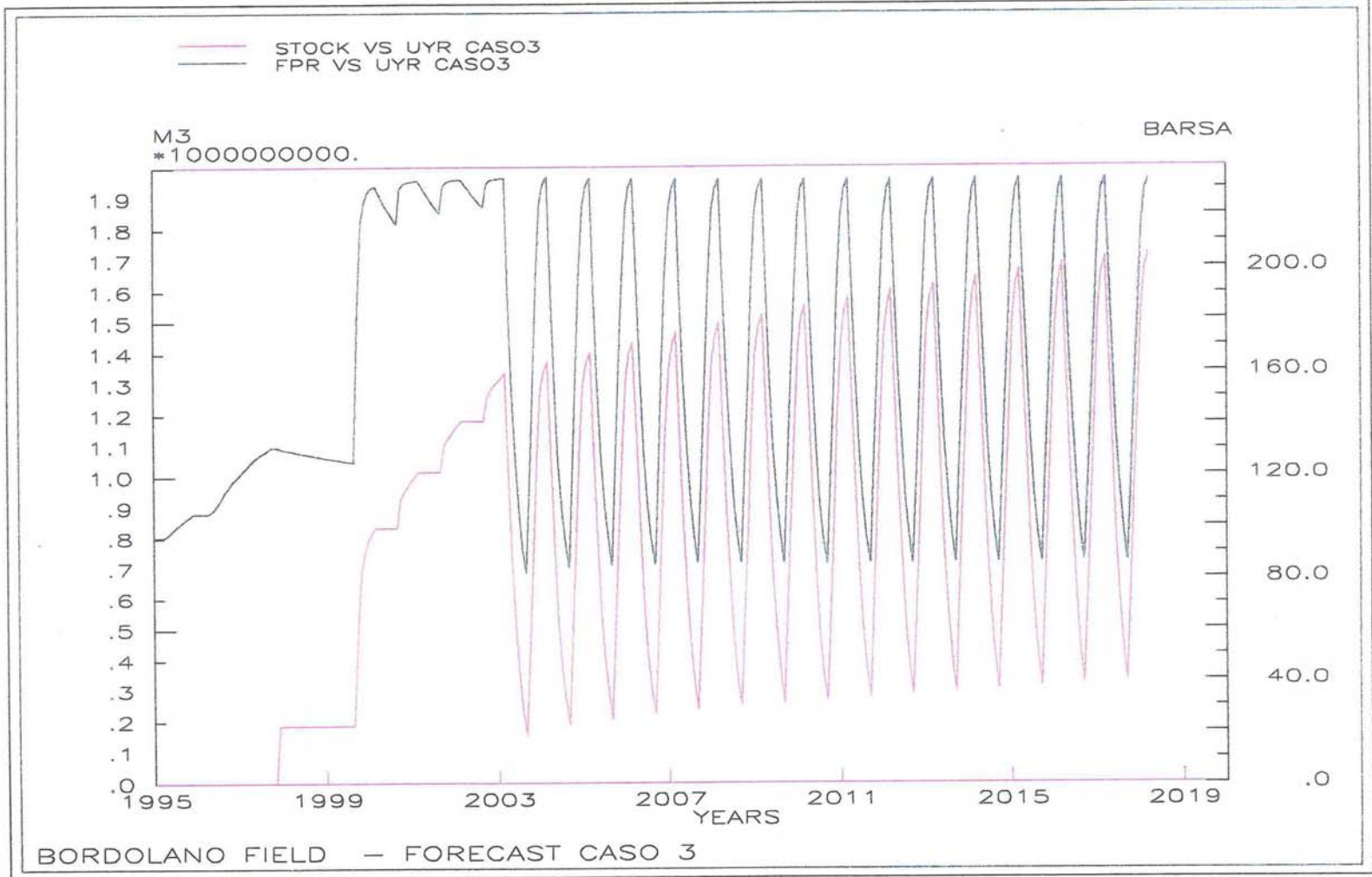

Fig. 61



**CAMPO DI BORDOLANO
POOL B
FORECAST DI STOCCAGGIO - CASO3**



BORDOLANO FIELD — FORECAST CASO 3

Fig 62



**CAMPO DI BORDOLANO
POOL B
FORECAST DI STOCCAGGIO - CASO3**

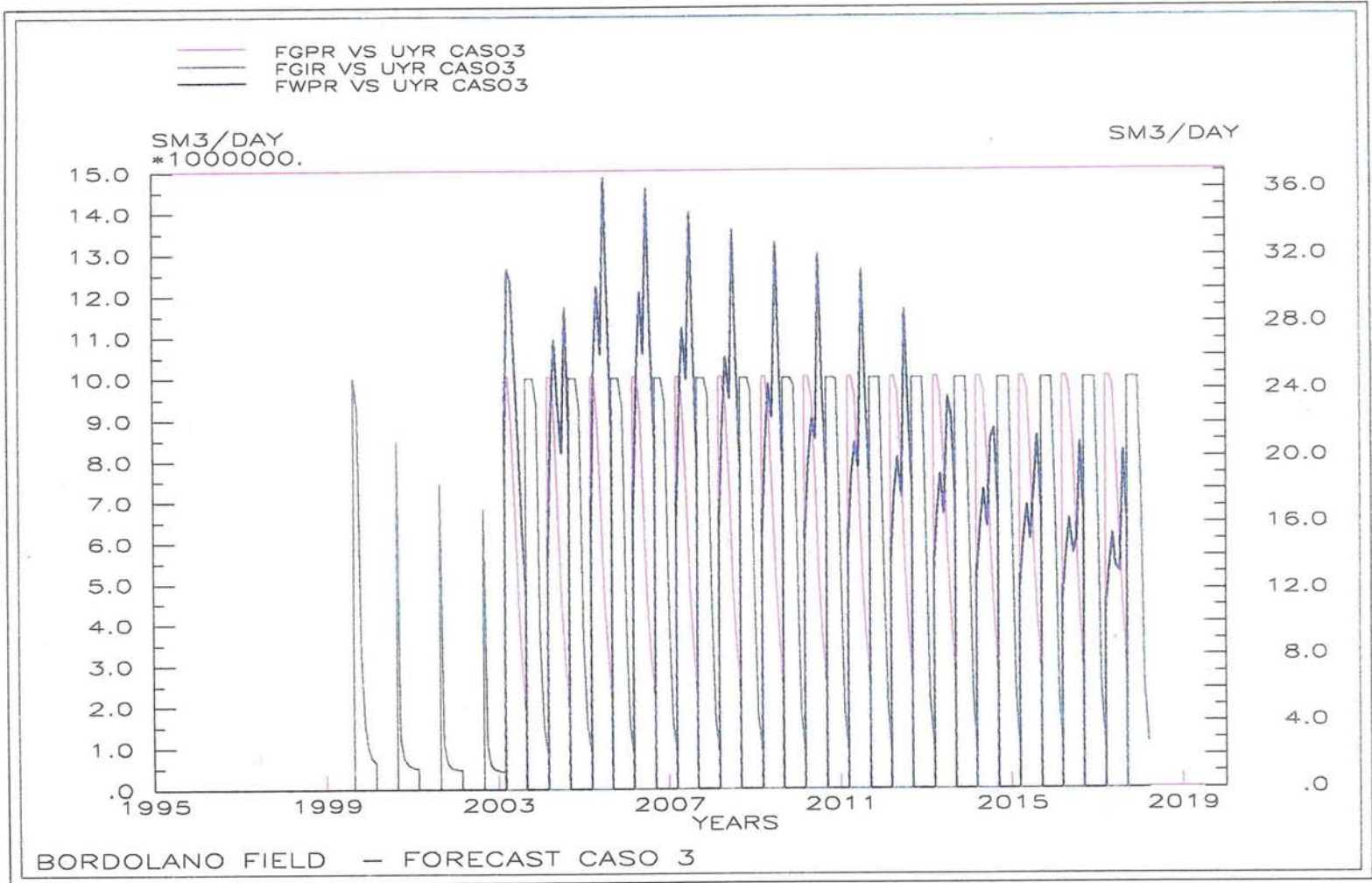

Fig 63



CAMPO DI BORDOLANO POOL B FORECAST DI STOCCAGGIO - CASO3

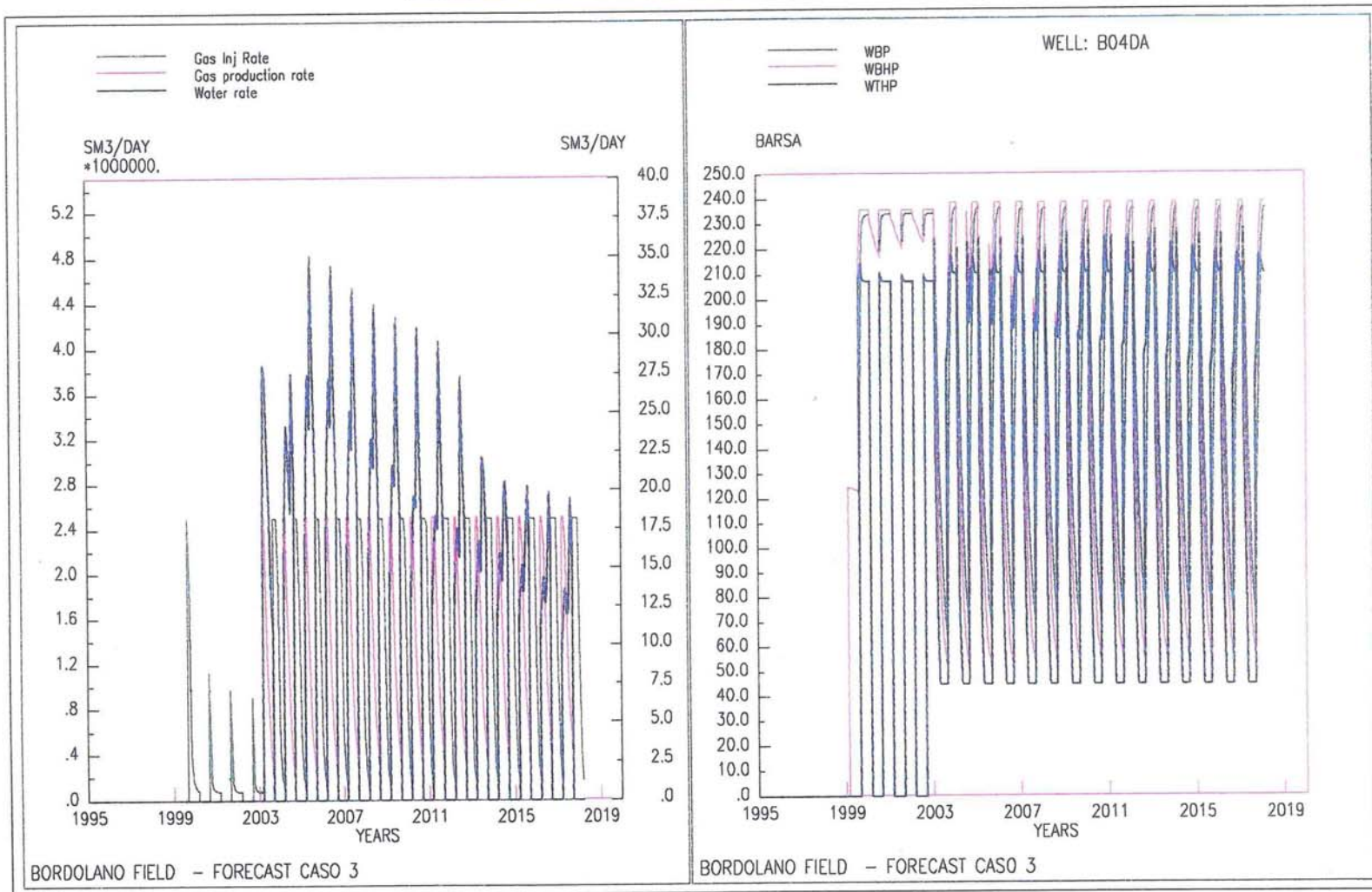

Fig 65



CAMPO DI BORDOLANO POOL B FORECAST DI STOCCAGGIO - CASO3

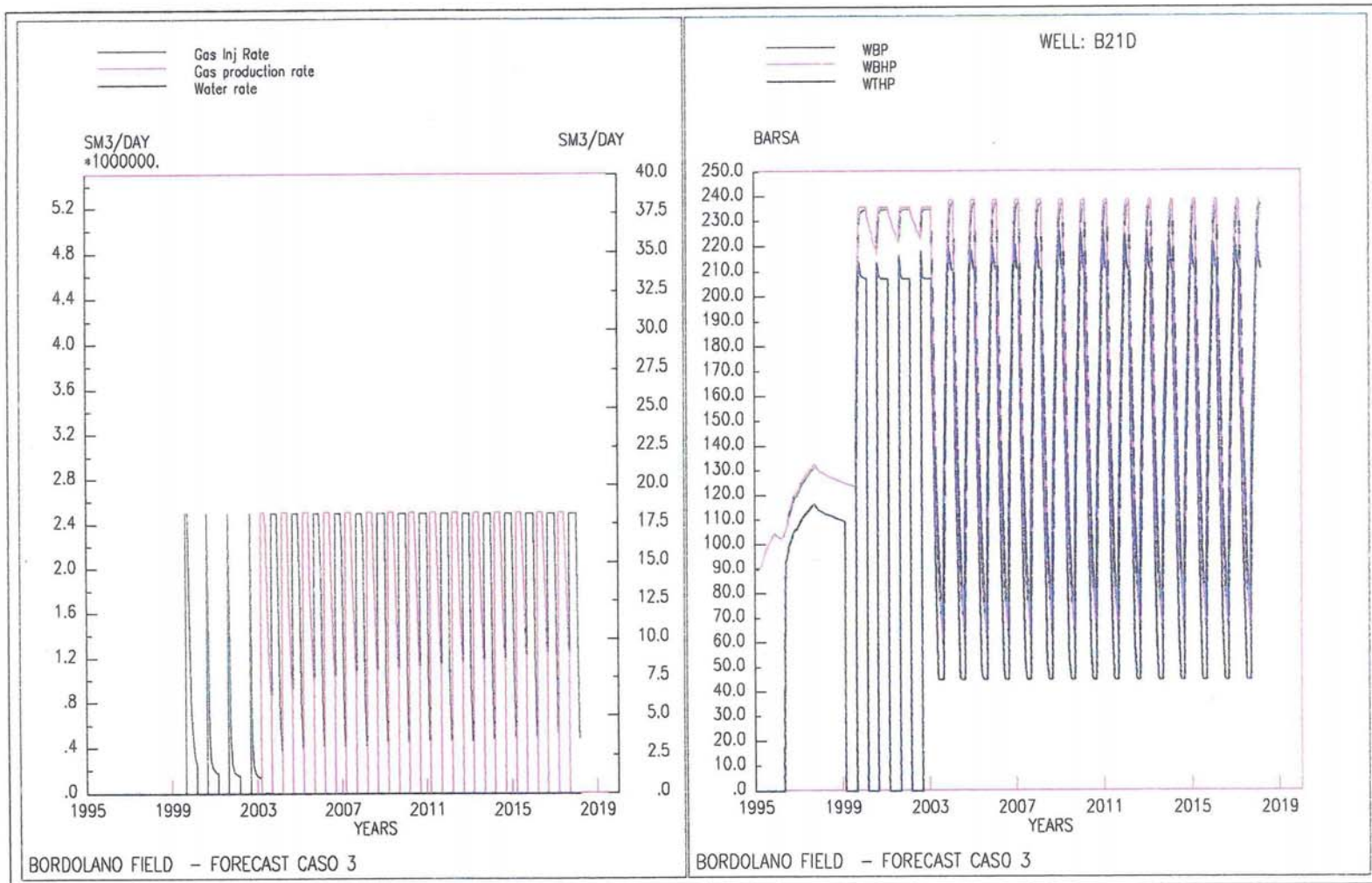

Fig 66



CAMPO DI BORDOLANO POOL B FORECAST DI STOCCAGGIO - CASO 3

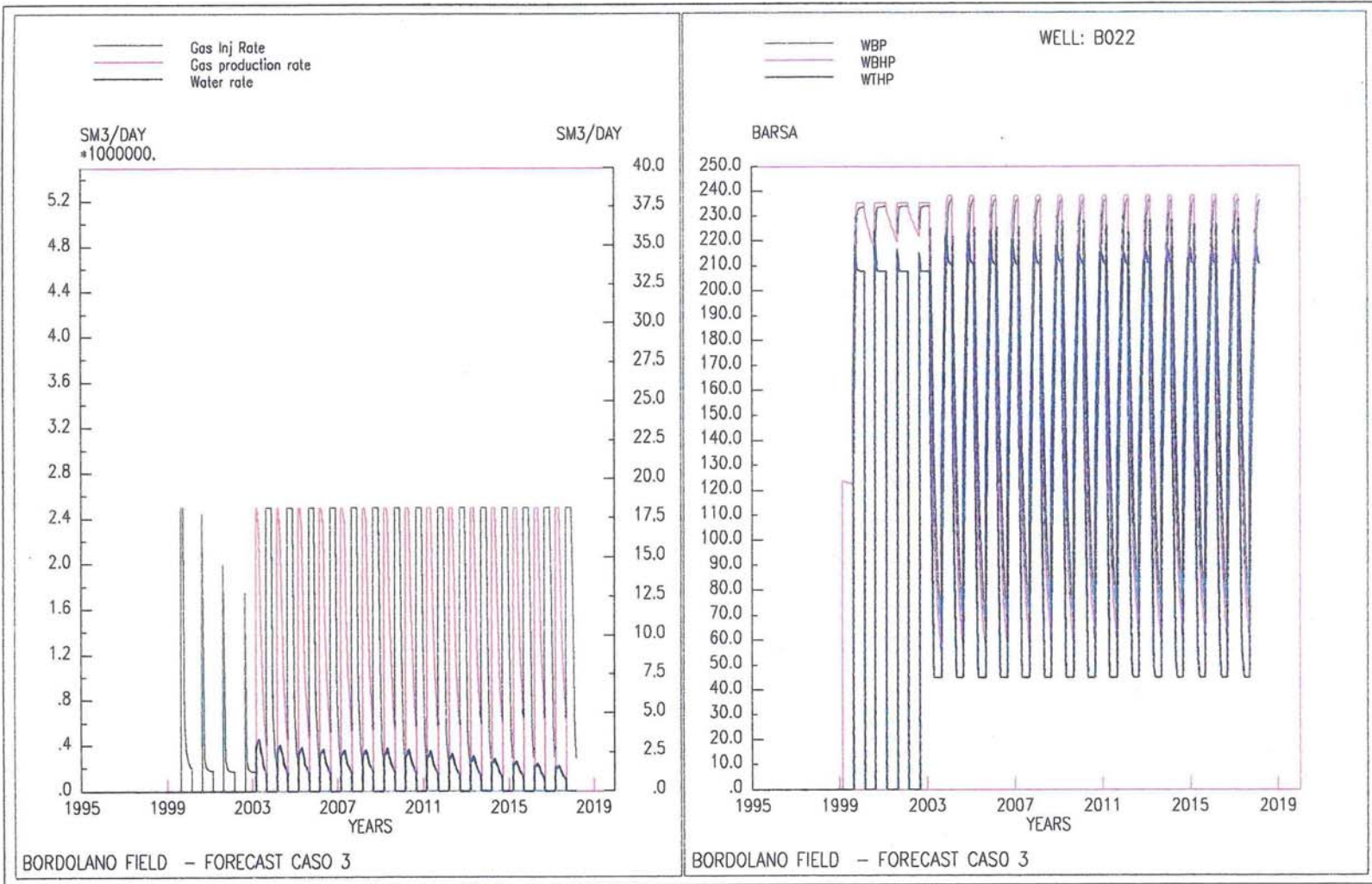

Fig 67

CAMPO DI BORDOLANO

POOL B

FORECAST DI STOCCAGGIO – CASO 4

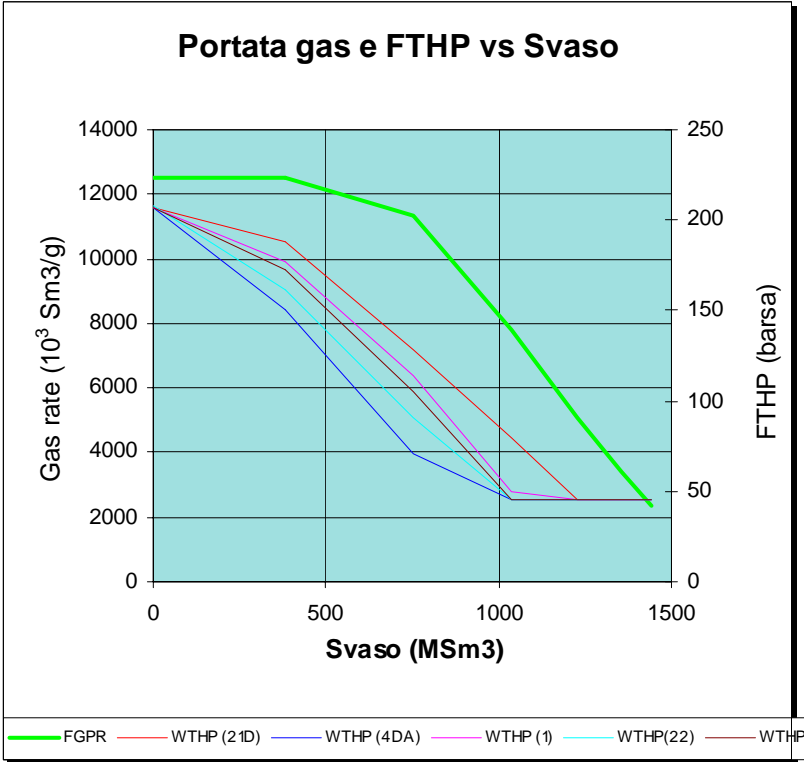
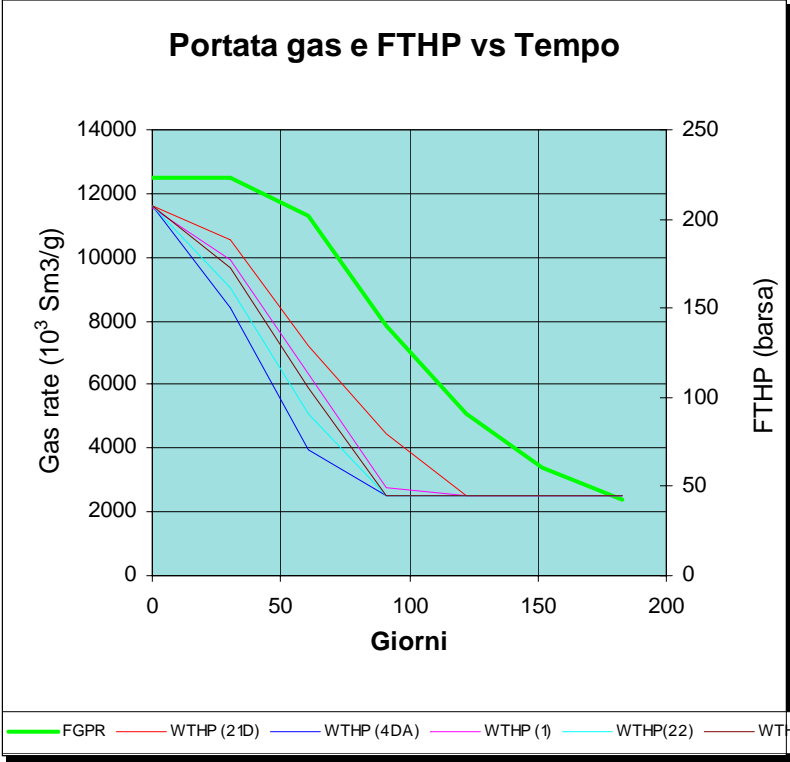

Fig. 68



**CAMPO DI BORDOLANO
POOL B
FORECAST DI STOCCAGGIO - CASO4**

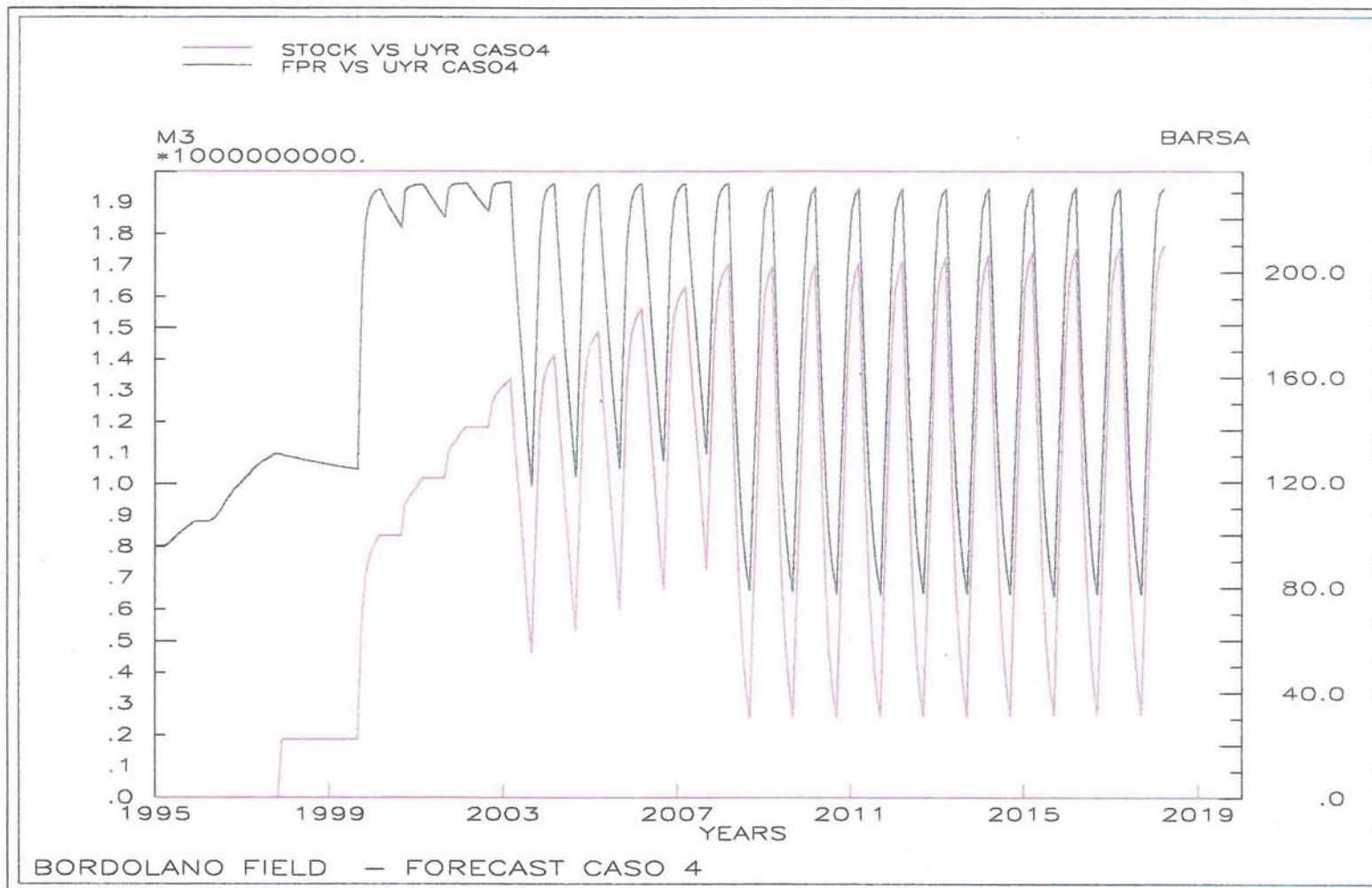

Fig 69



**CAMPO DI BORDOLANO
POOL B
FORECAST DI STOCCAGGIO - CASO4**

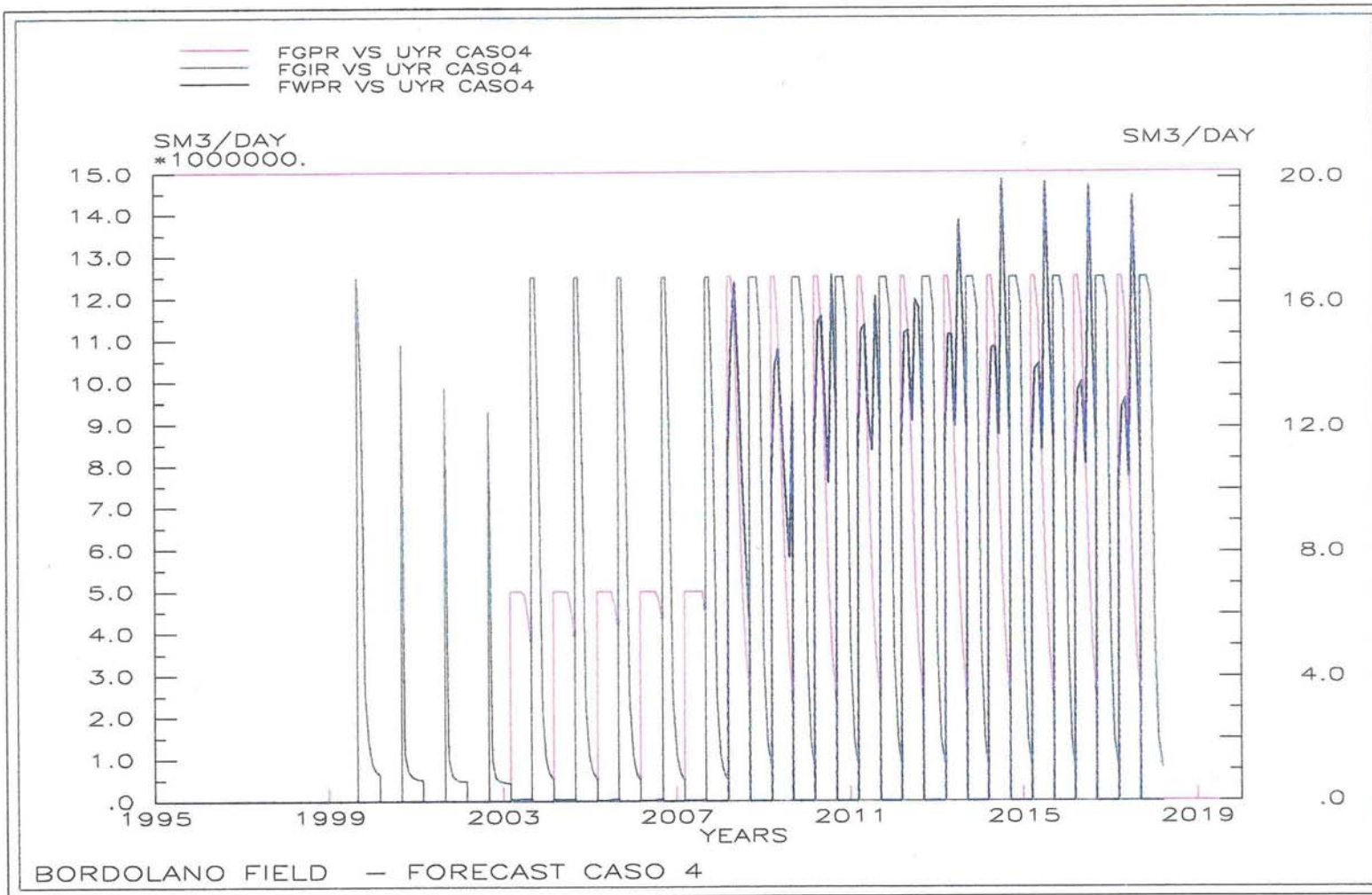

Fig 70



CAMPO DI BORDOLANO POOL B FORECAST DI STOCCAGGIO - CASO4

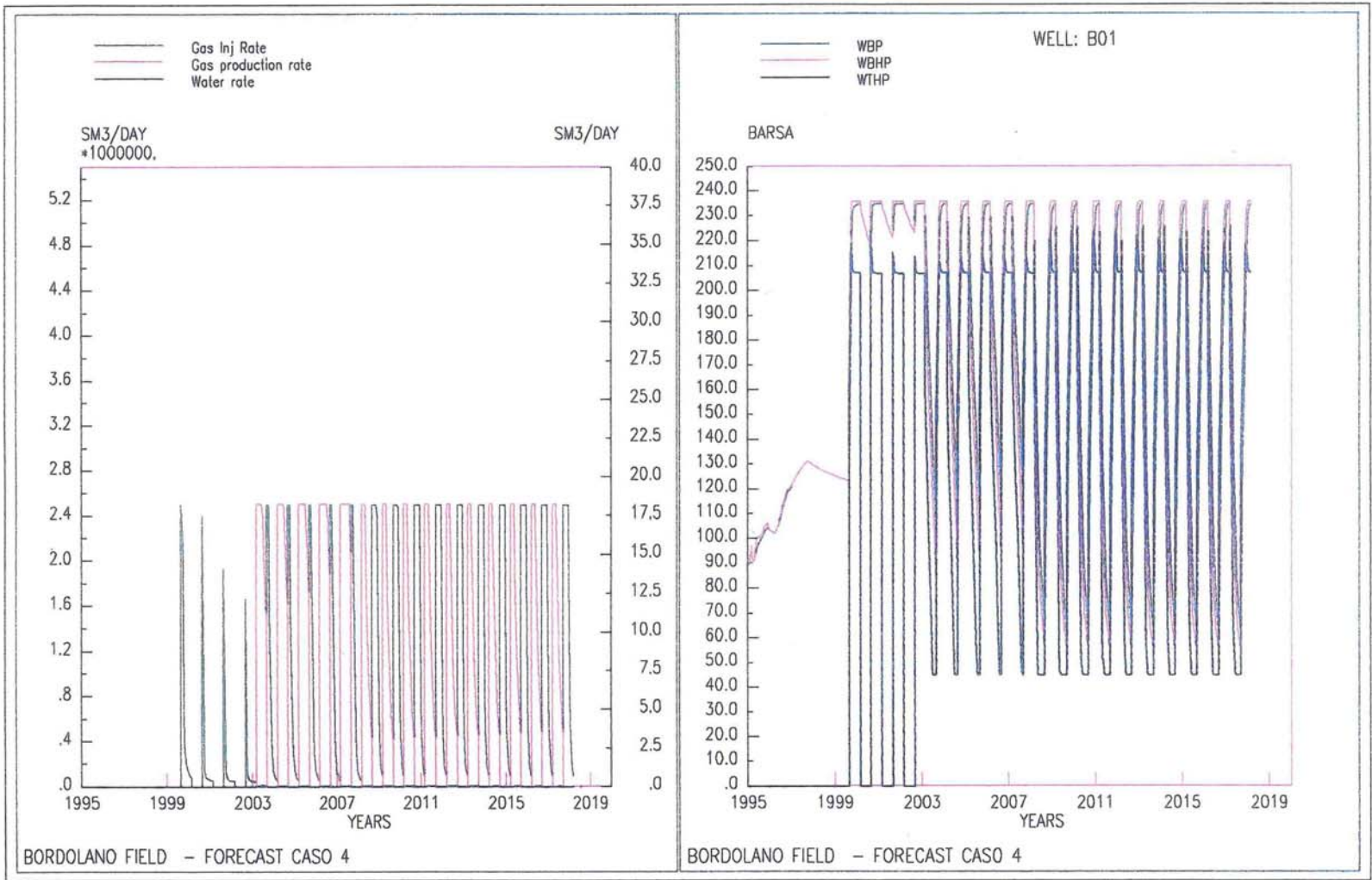

Fig 71



CAMPO DI BORDOLANO POOL B FORECAST DI STOCCAGGIO - CASO4

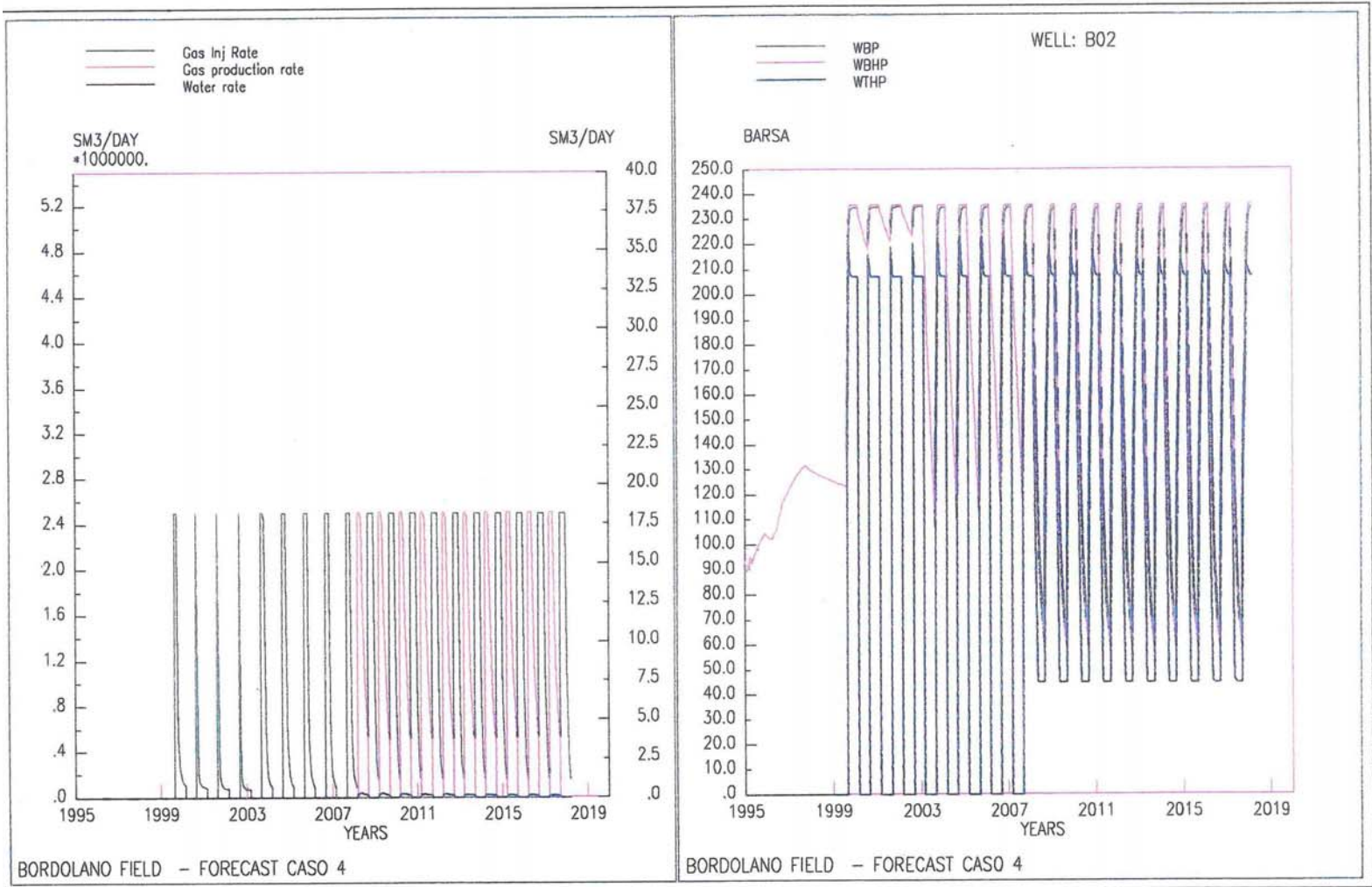

Fig 72



CAMPO DI BORDOLANO POOL B FORECAST DI STOCCAGGIO - CASO4

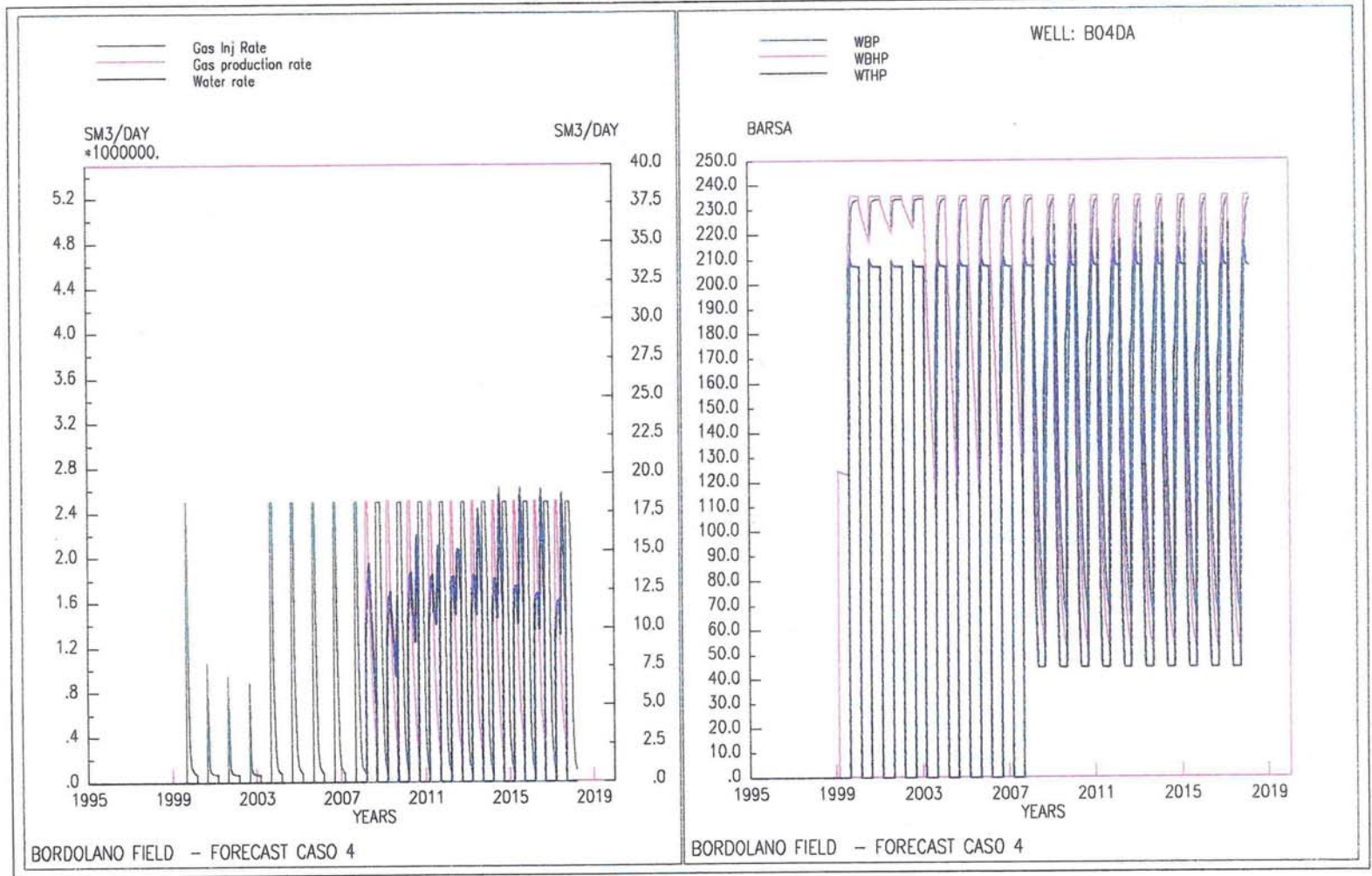

Fig 73



CAMPO DI BORDOLANO POOL B FORECAST DI STOCCAGGIO - CASO4

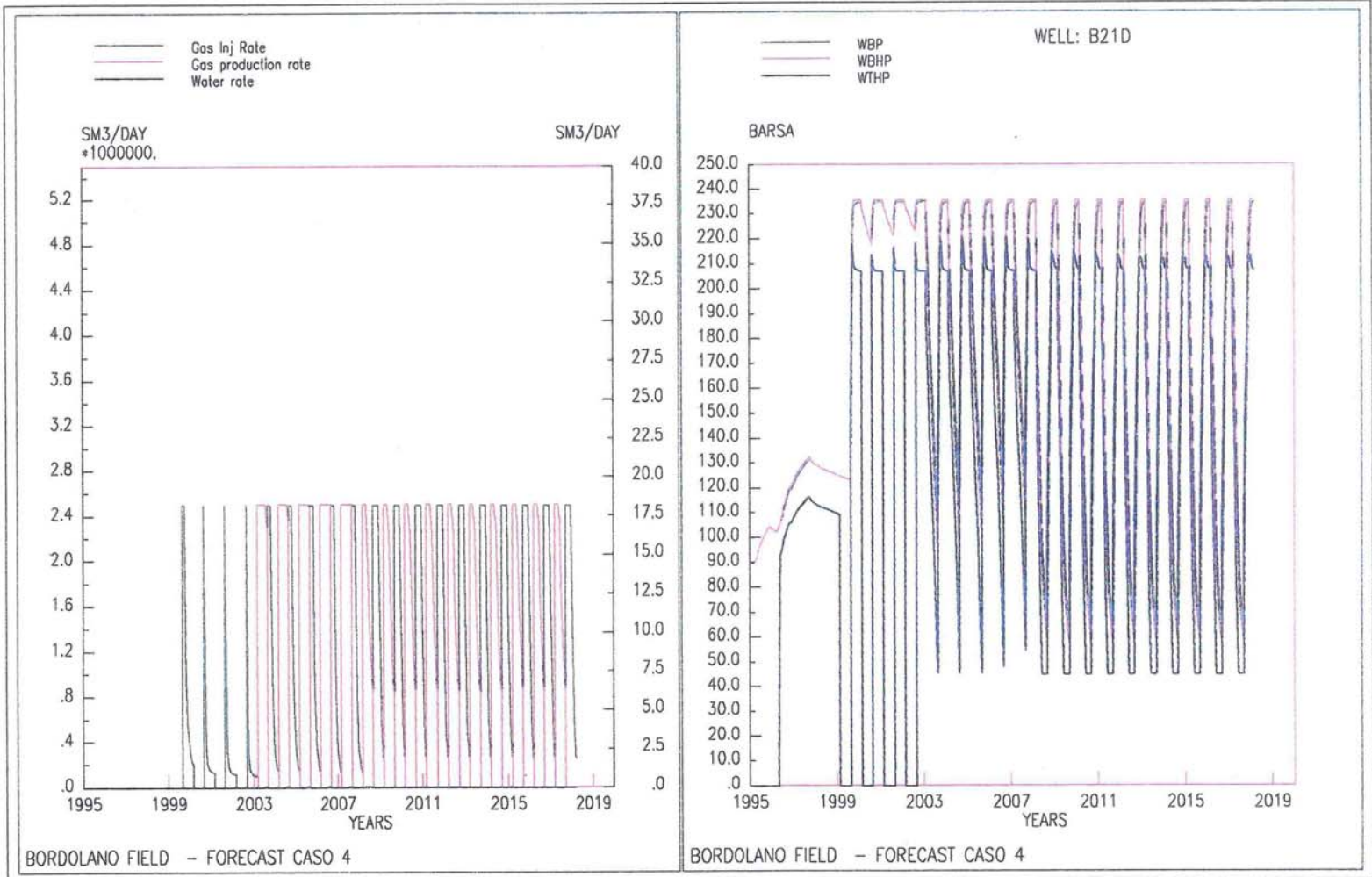

Fig 74



CAMPO DI BORDOLANO POOL B FORECAST DI STOCCAGGIO - CASO4

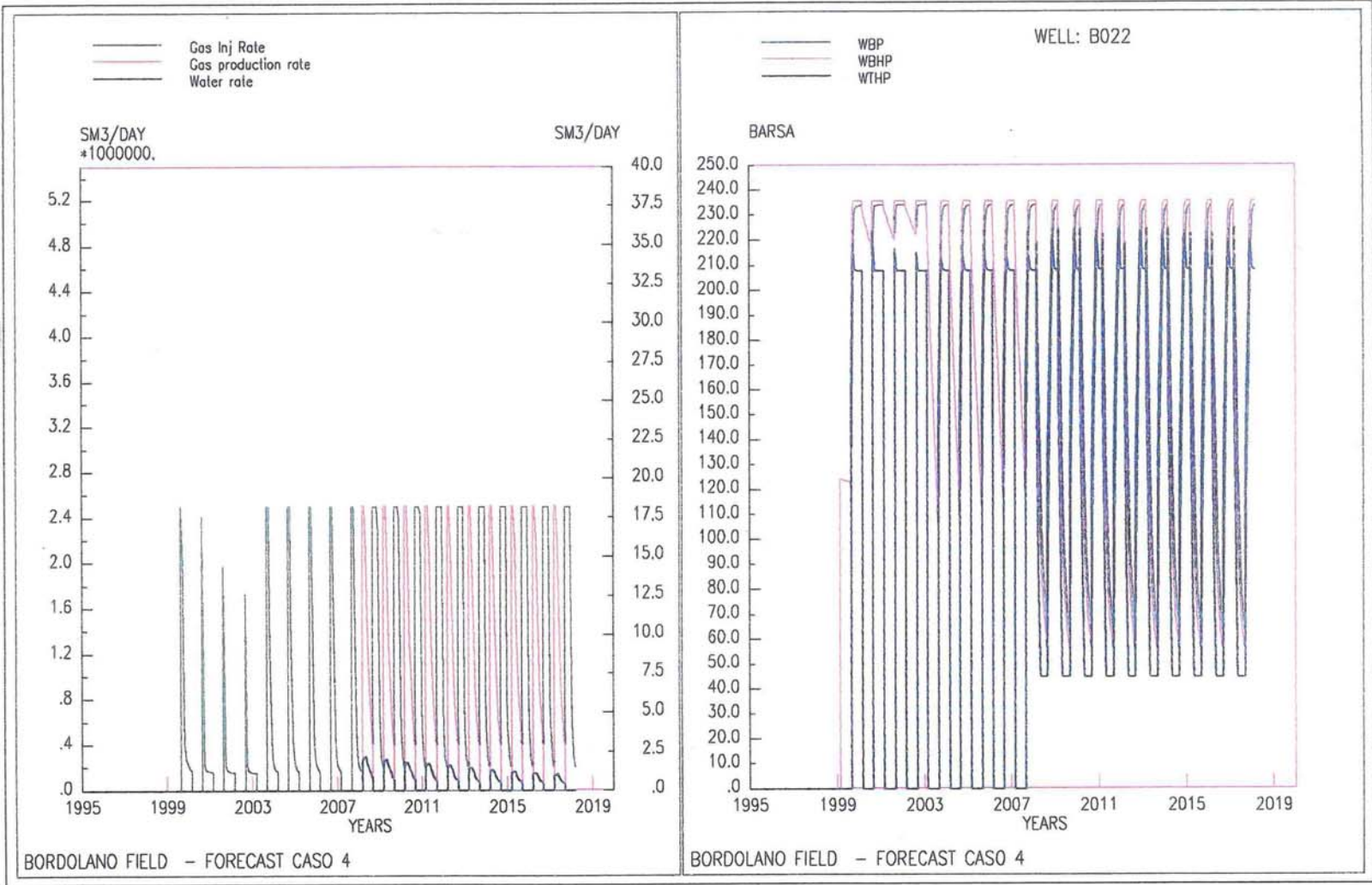

Fig 75

CAMPO DI BORDOLANO

POOL B

FORECAST DI STOCCAGGIO – CASO 4A

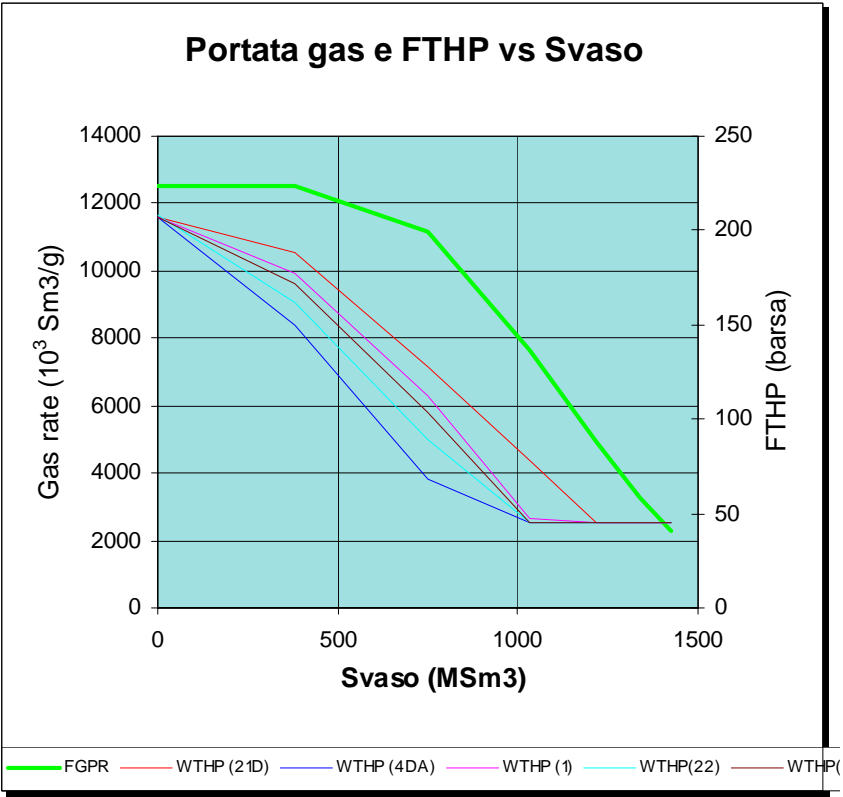
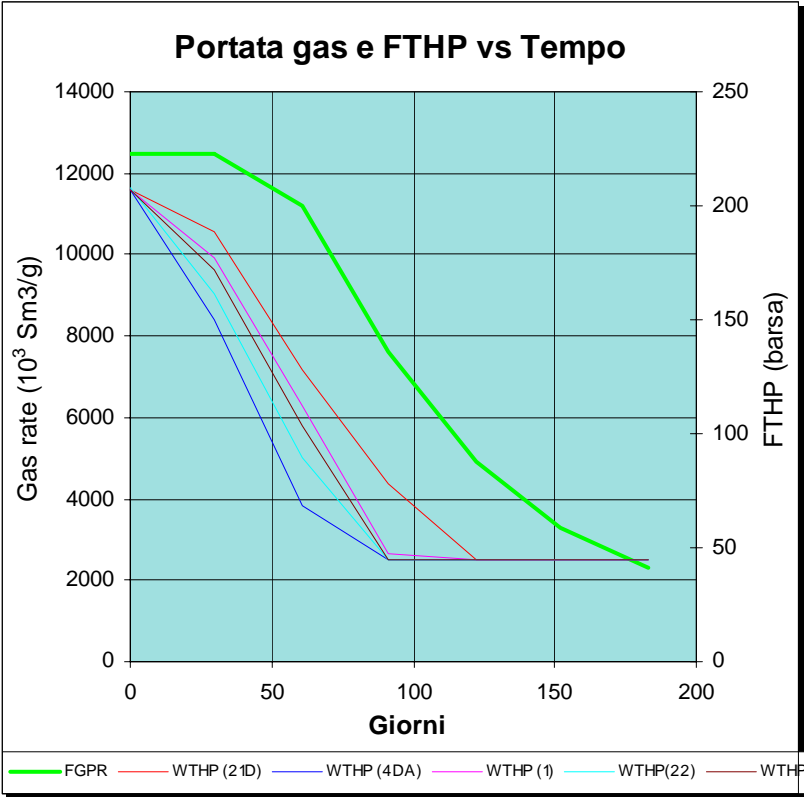

Fig. 76



**CAMPO DI BORDOLANO
POOL B
FORECAST DI STOCCAGGIO - CASO 4A**

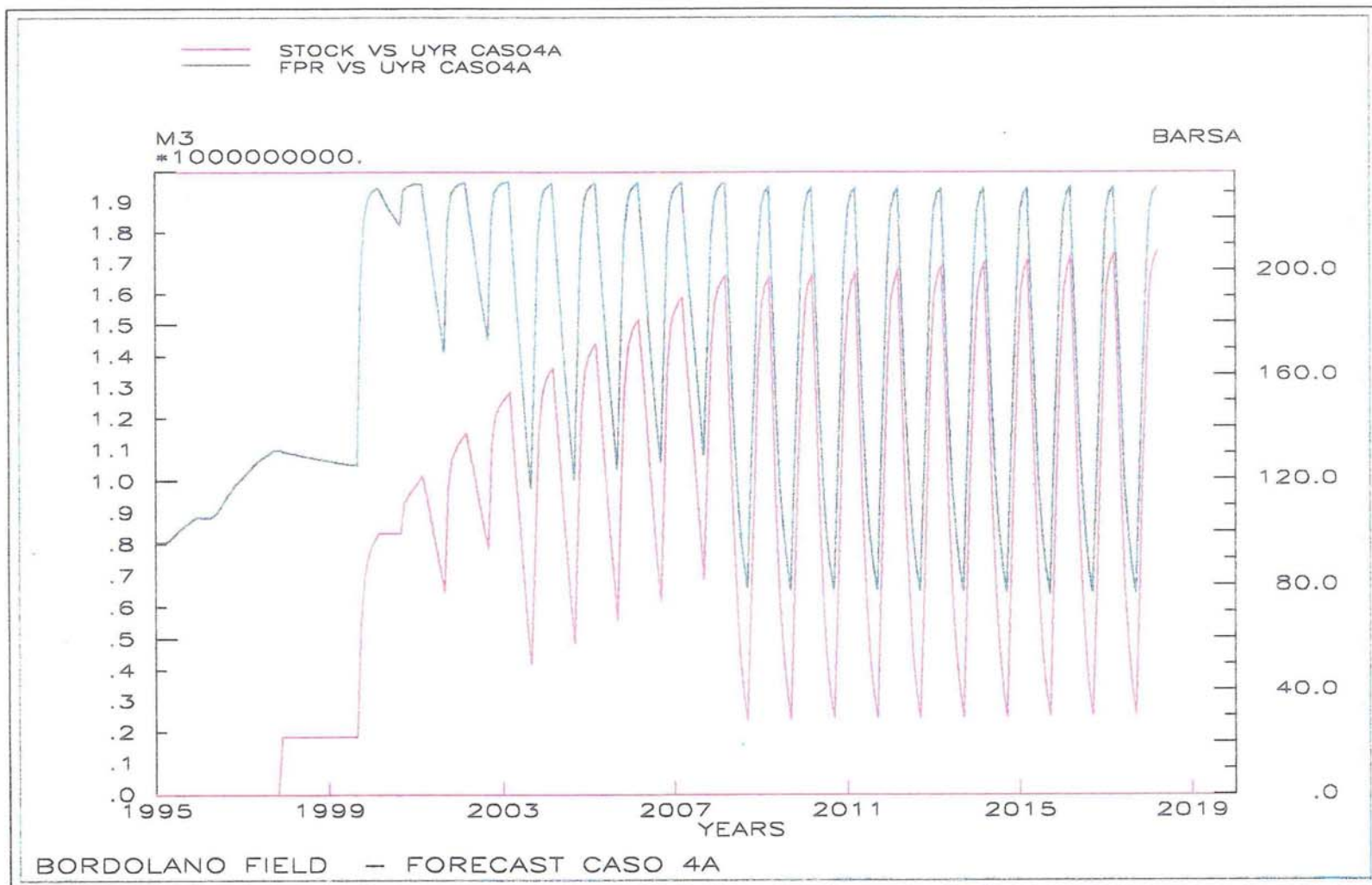

Fig 77



**CAMPO DI BORDOLANO
POOL B
FORECAST DI STOCCAGGIO - CASO 4A**

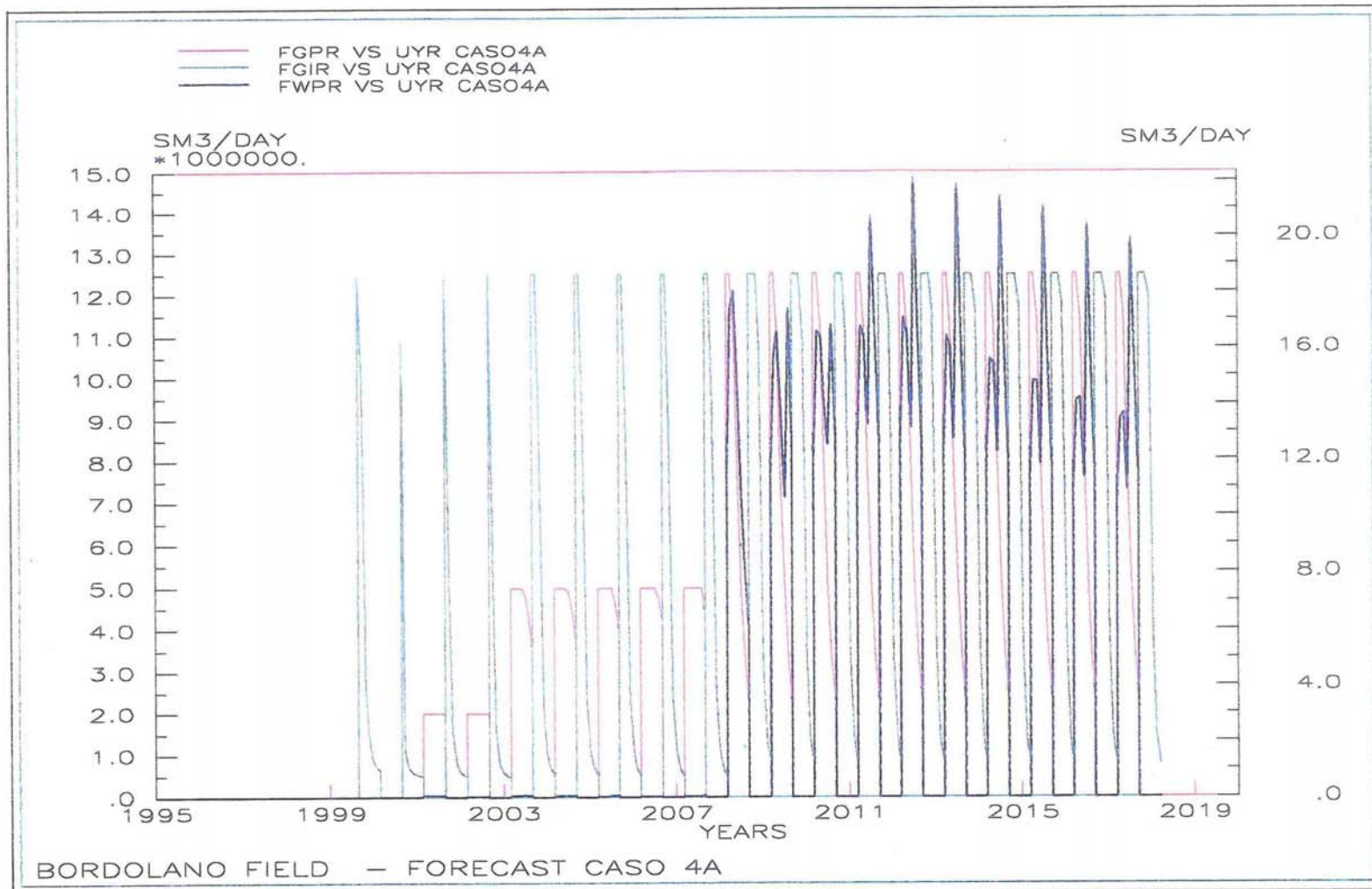

Fig 78



CAMPO DI BORDOLANO POOL B FORECAST DI STOCCAGGIO - CASO 4A

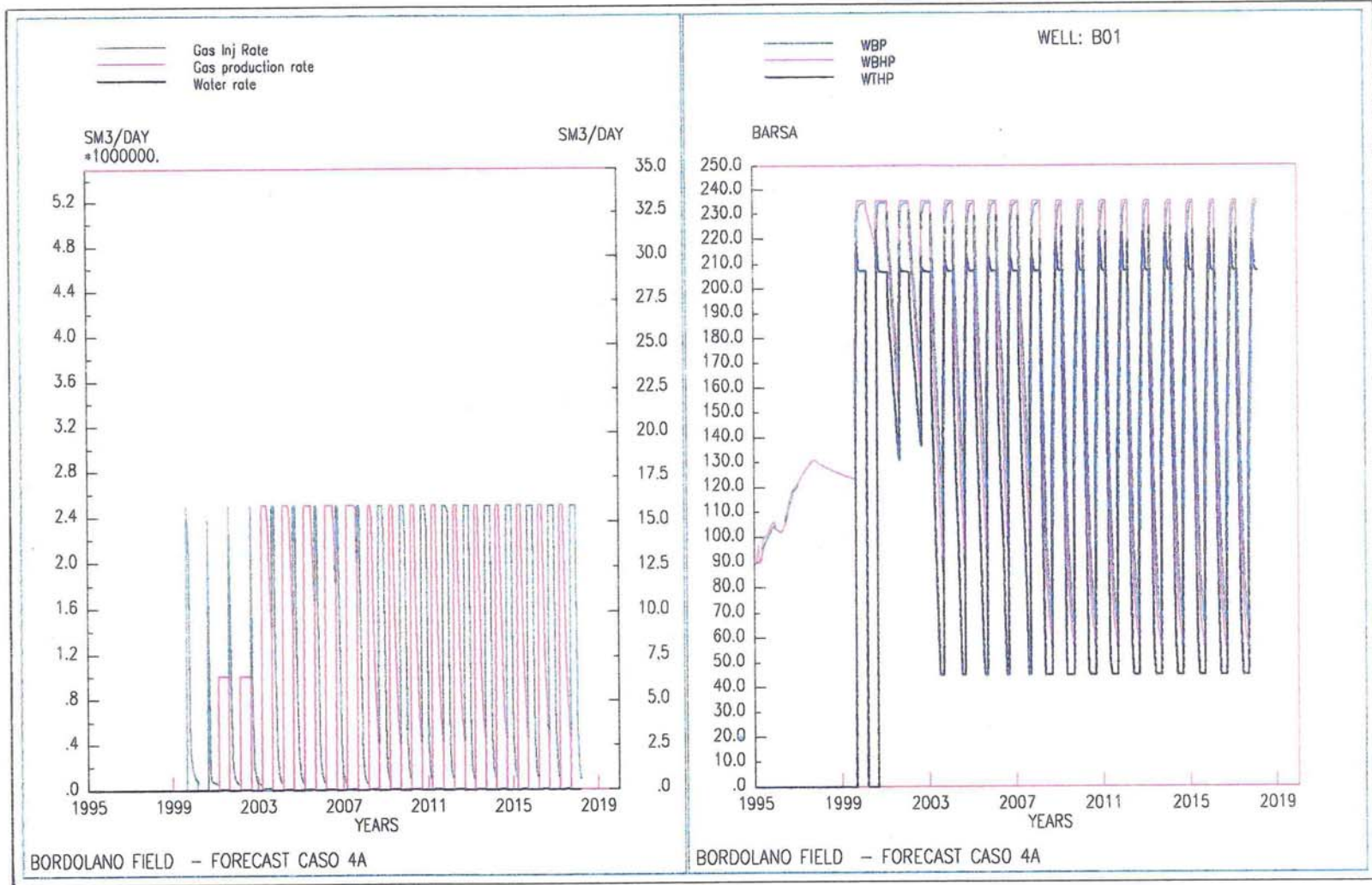

Fig 79



CAMPO DI BORDOLANO POOL B FORECAST DI STOCCAGGIO - CASO 4A

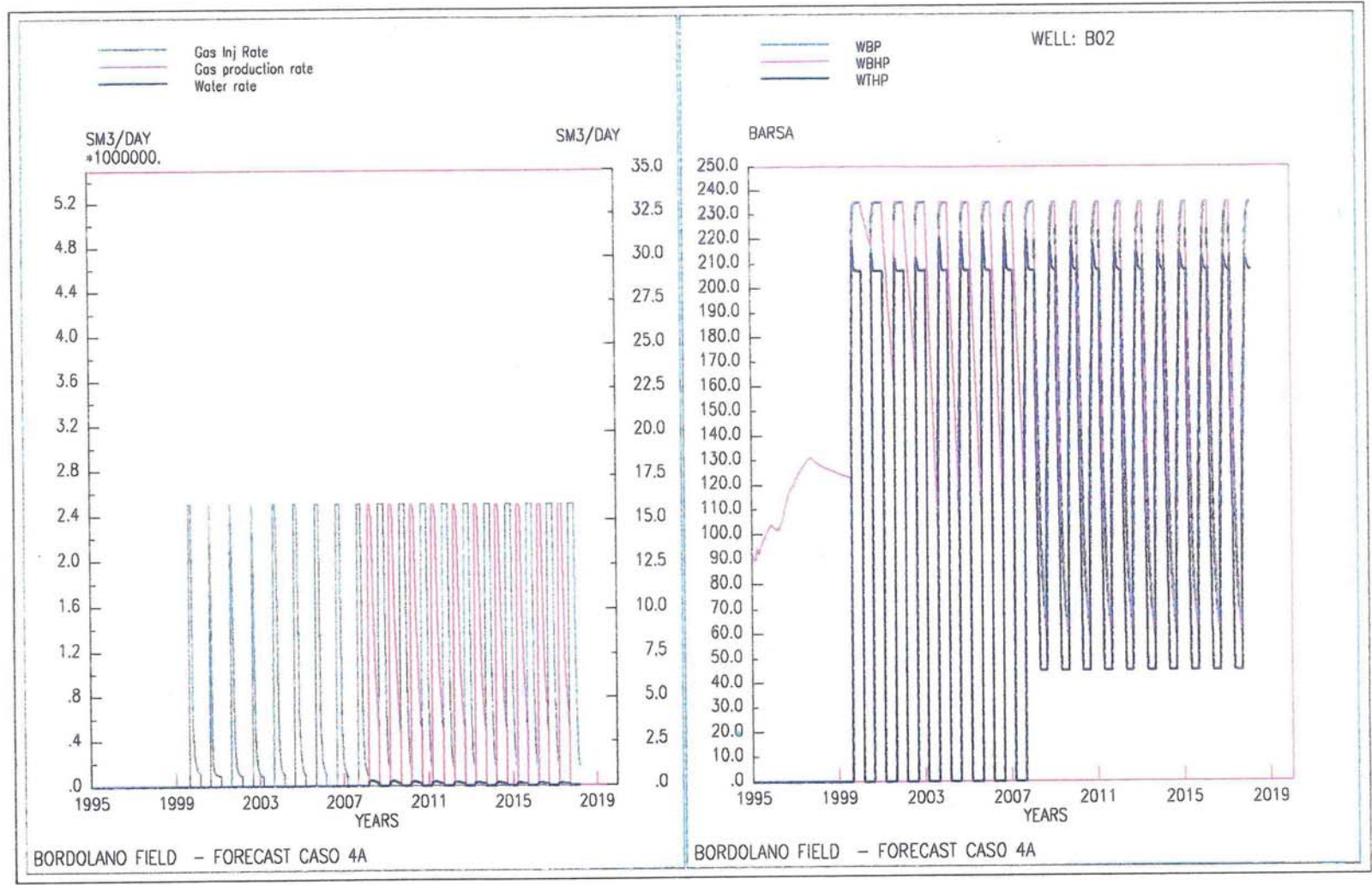

Fig 80



CAMPO DI BORDOLANO POOL B FORECAST DI STOCCAGGIO - CASO 4A

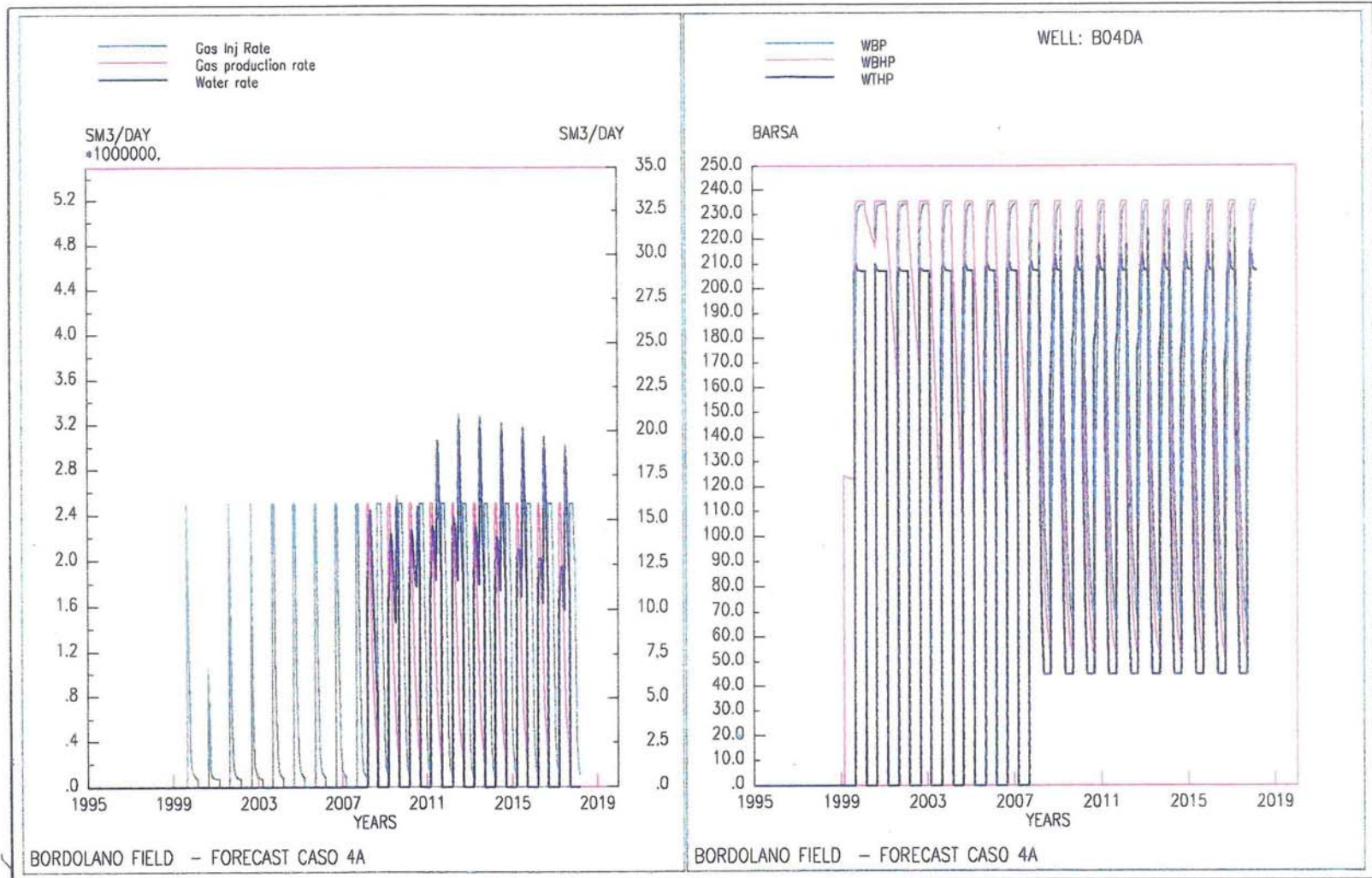

Fig 81



CAMPO DI BORDOLANO POOL B FORECAST DI STOCCAGGIO - CASO 4A

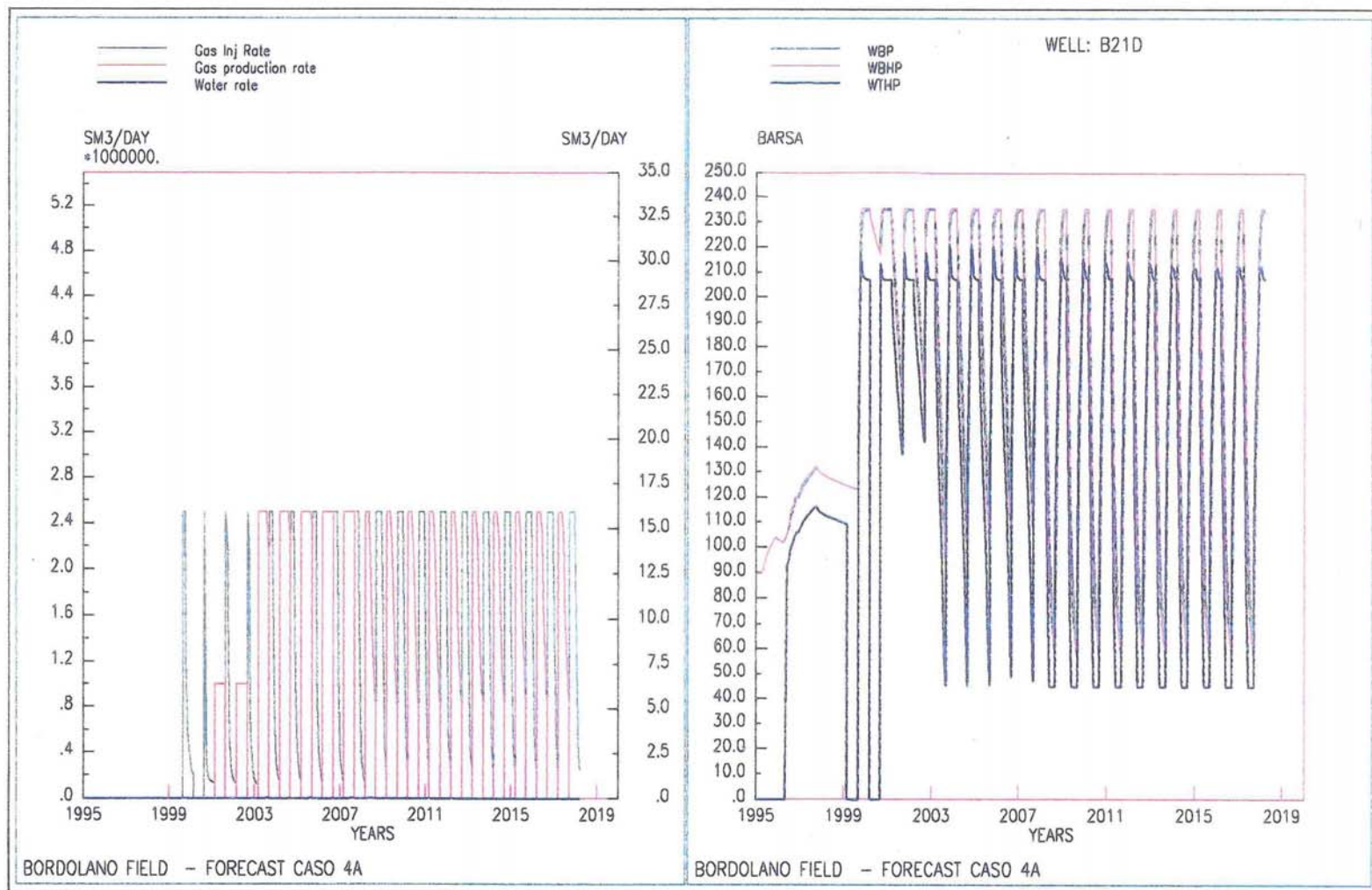

Fig 82



**CAMPO DI BORDOLANO
 POOL B
 FORECAST DI STOCCAGGIO - CASO 4A**

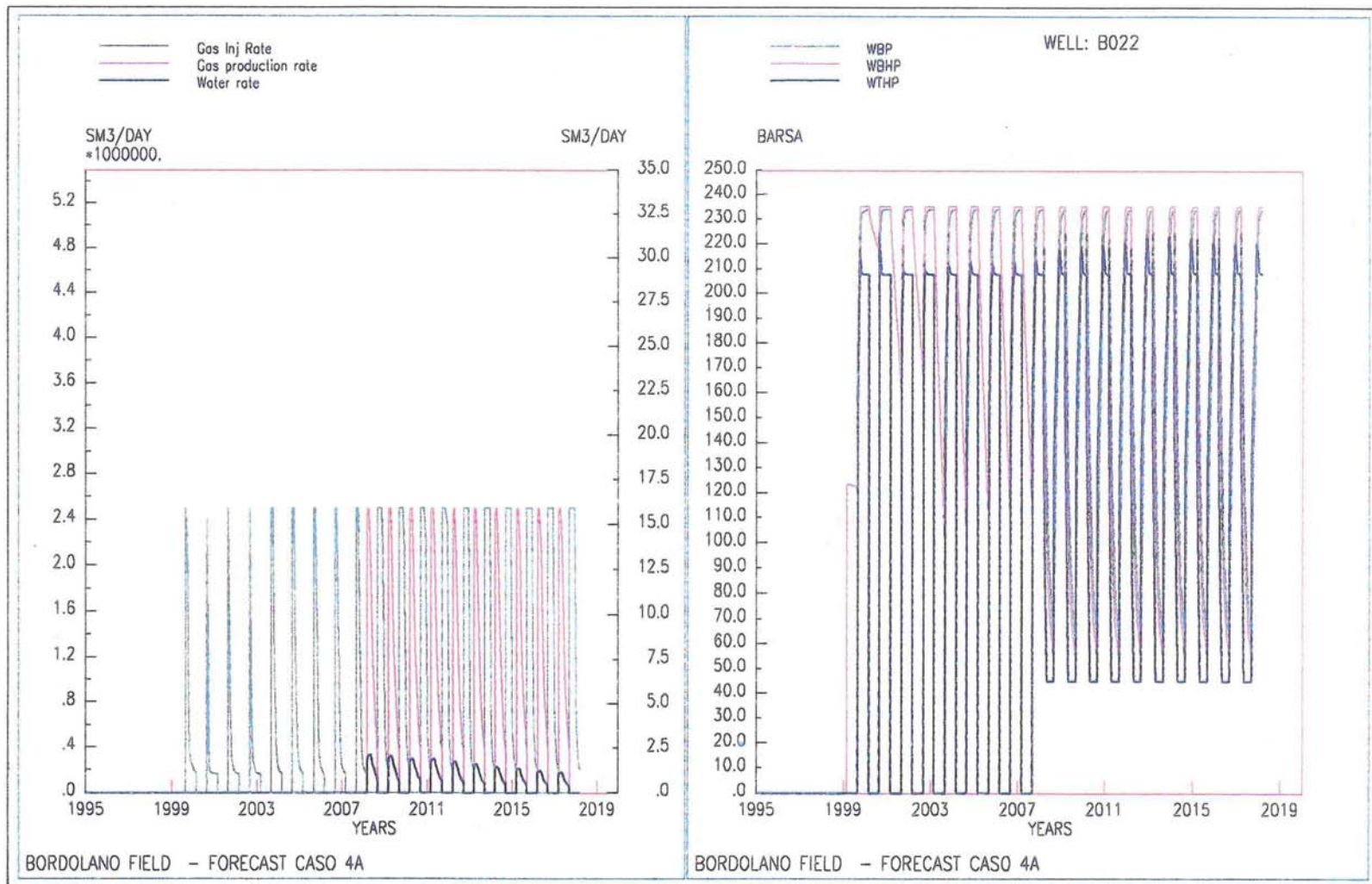

Fig 83

CAMPO DI BORDOLANO

POOL B

FORECAST DI STOCCAGGIO – CASO 5

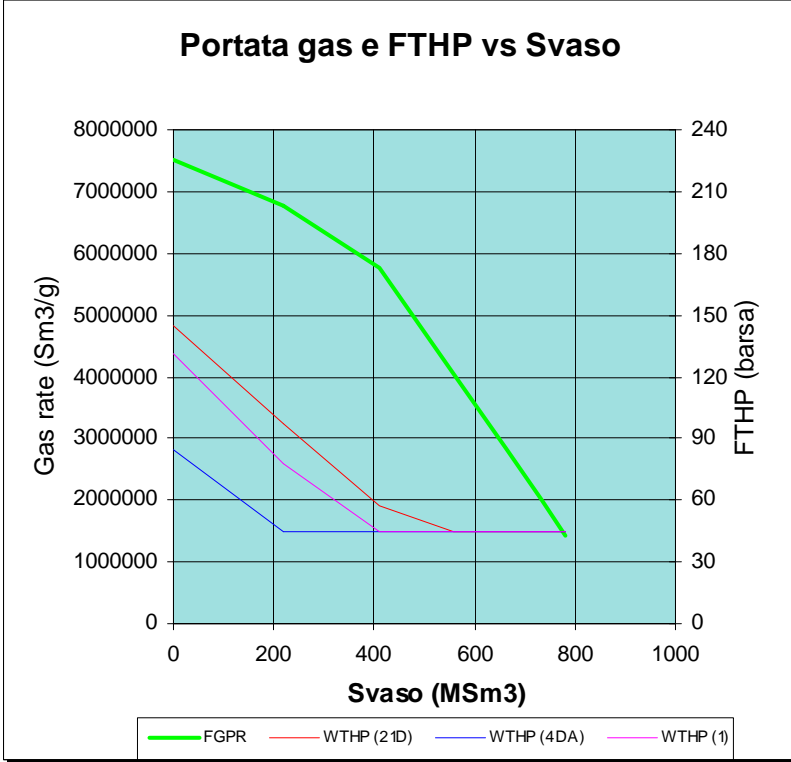
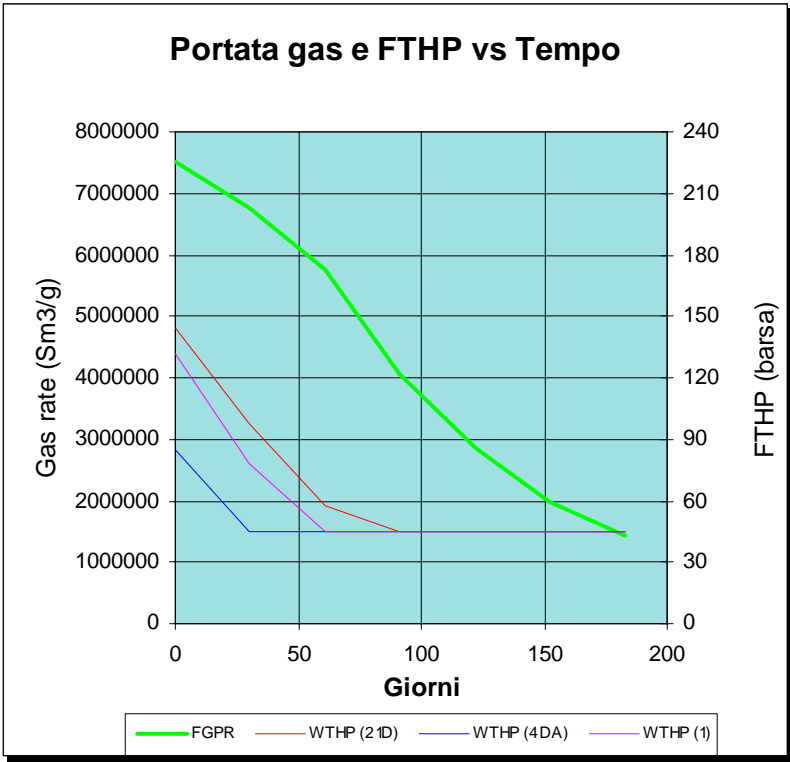

Fig. 84



**CAMPO DI BORDOLANO
POOL B
FORECAST DI STOCCAGGIO - CASO 5**

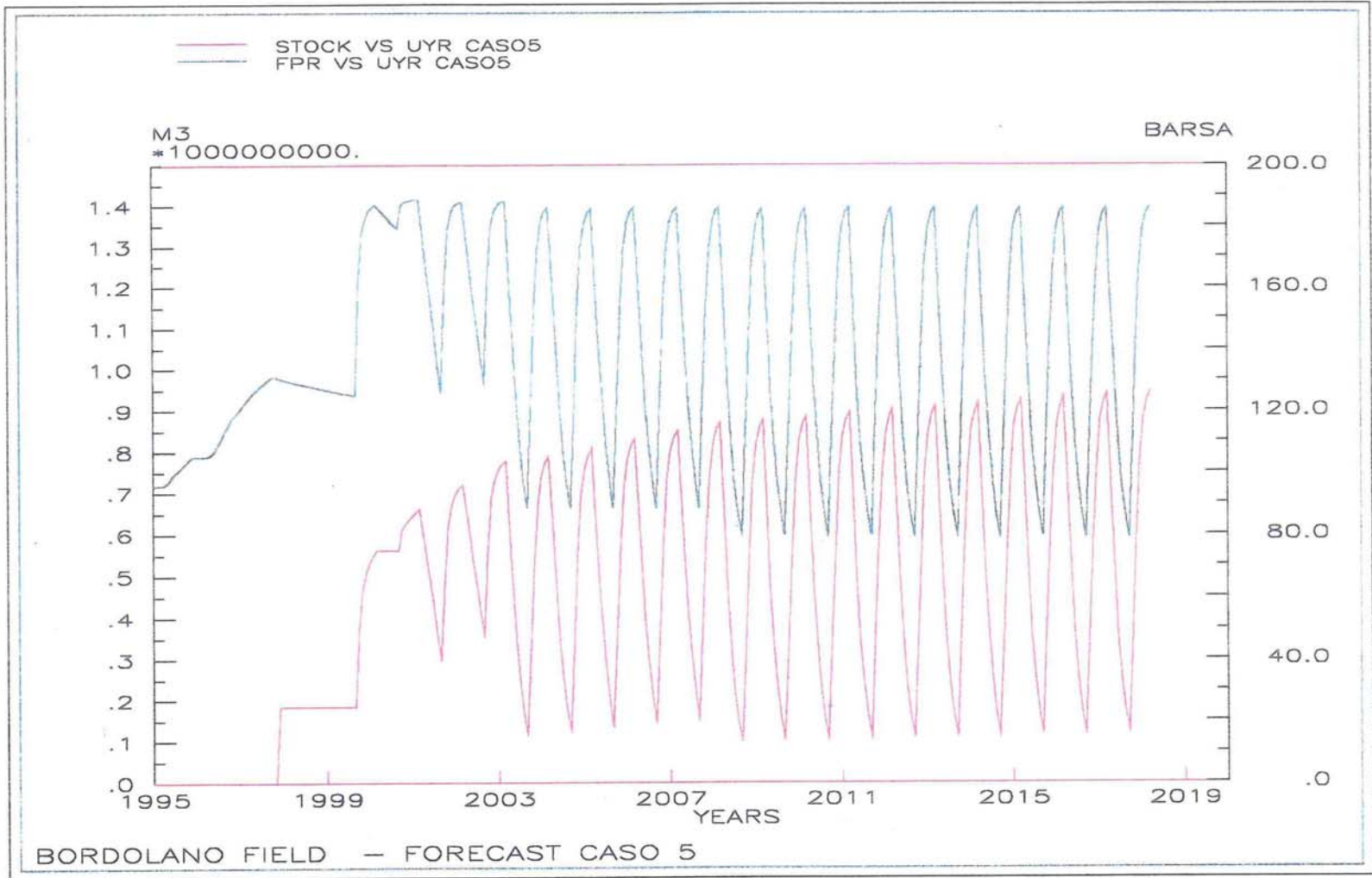

Fig 85



**CAMPO DI BORDOLANO
POOL B
FORECAST DI STOCCAGGIO - CASO 5**

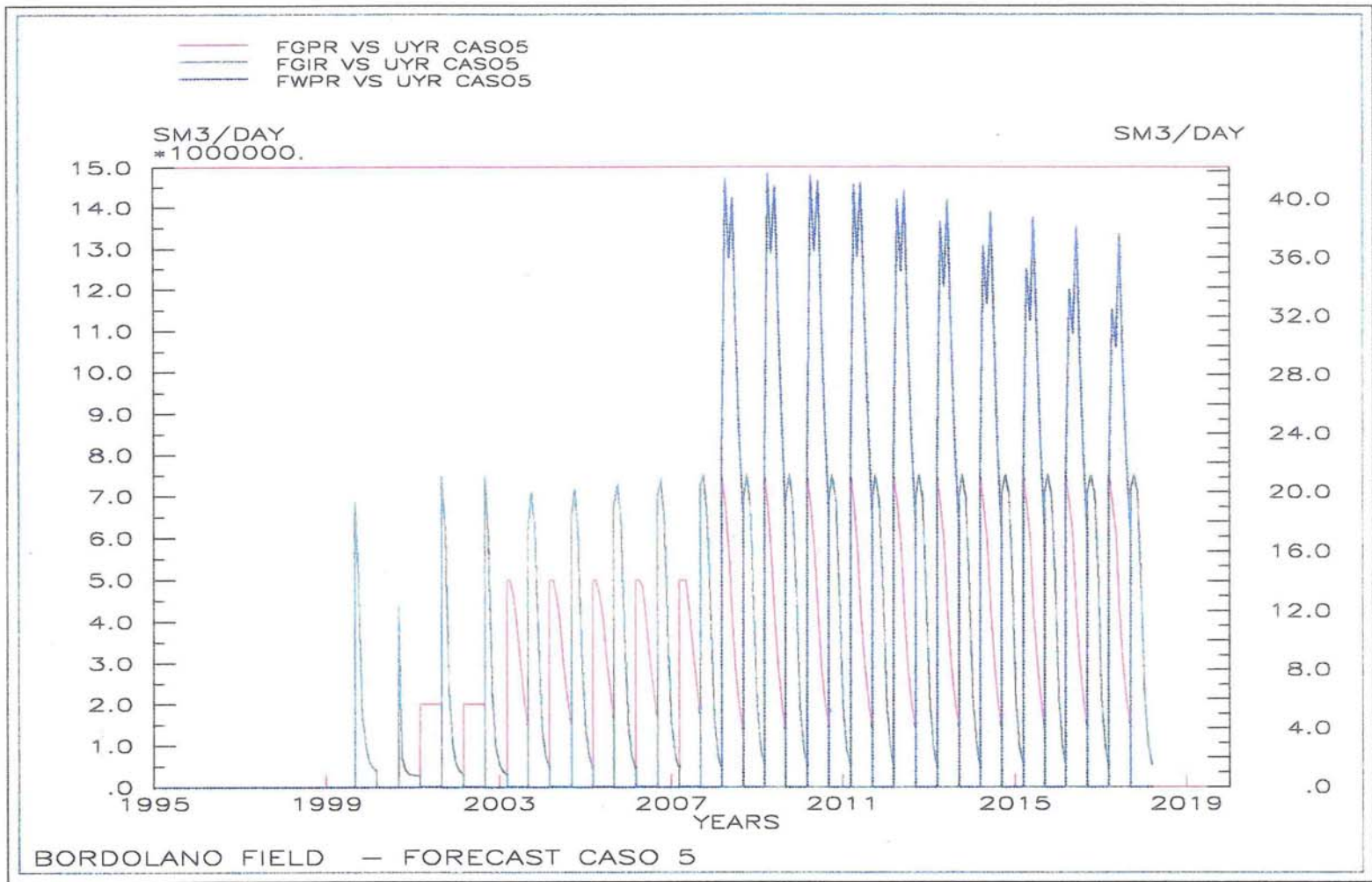

Fig 86



**CAMPO DI BORDOLANO
POOL B
FORECAST DI STOCCAGGIO - CASO 5**

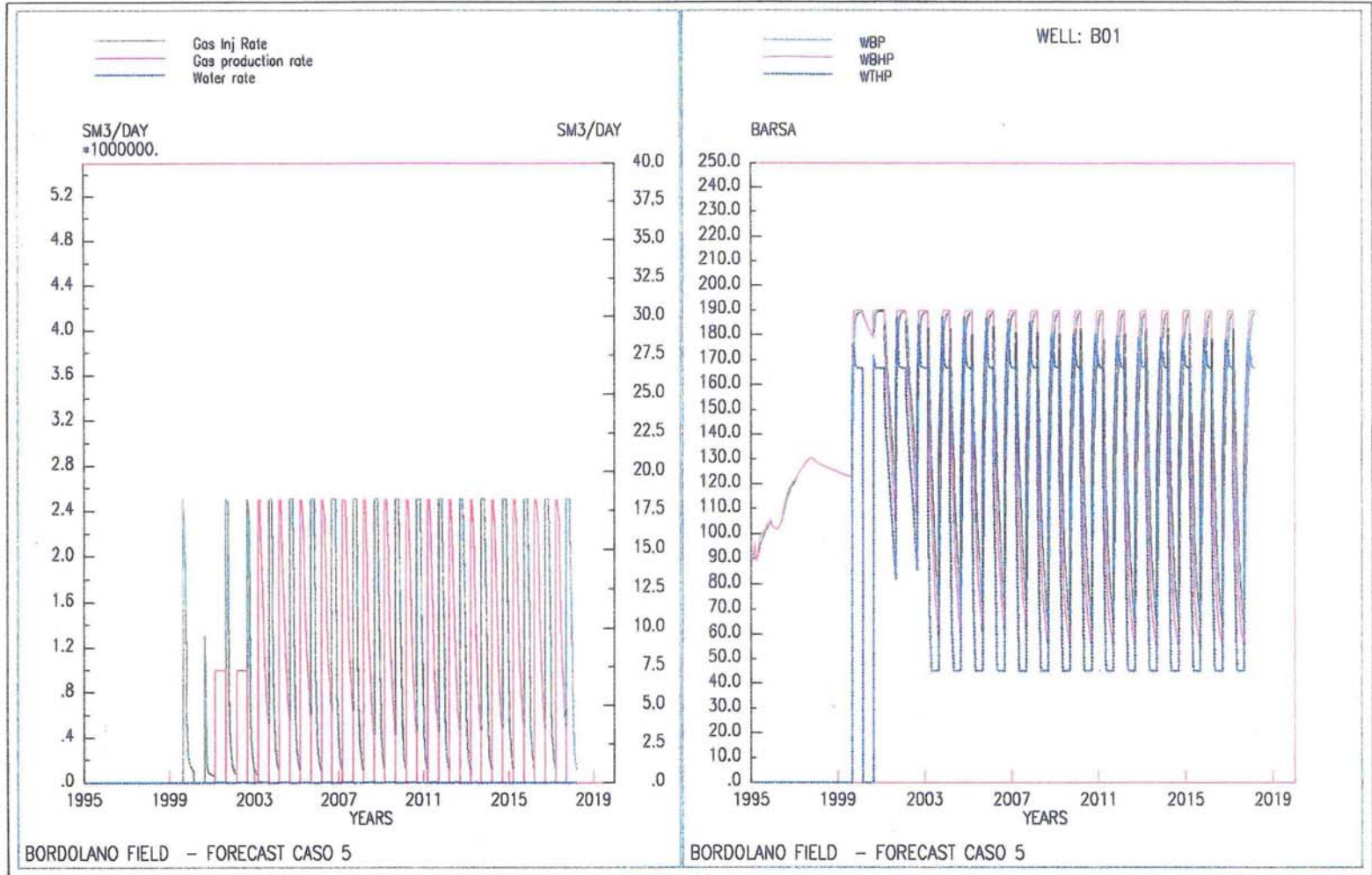

Fig 87



**CAMPO DI BORDOLANO
POOL B
FORECAST DI STOCCAGGIO - CASO 5**

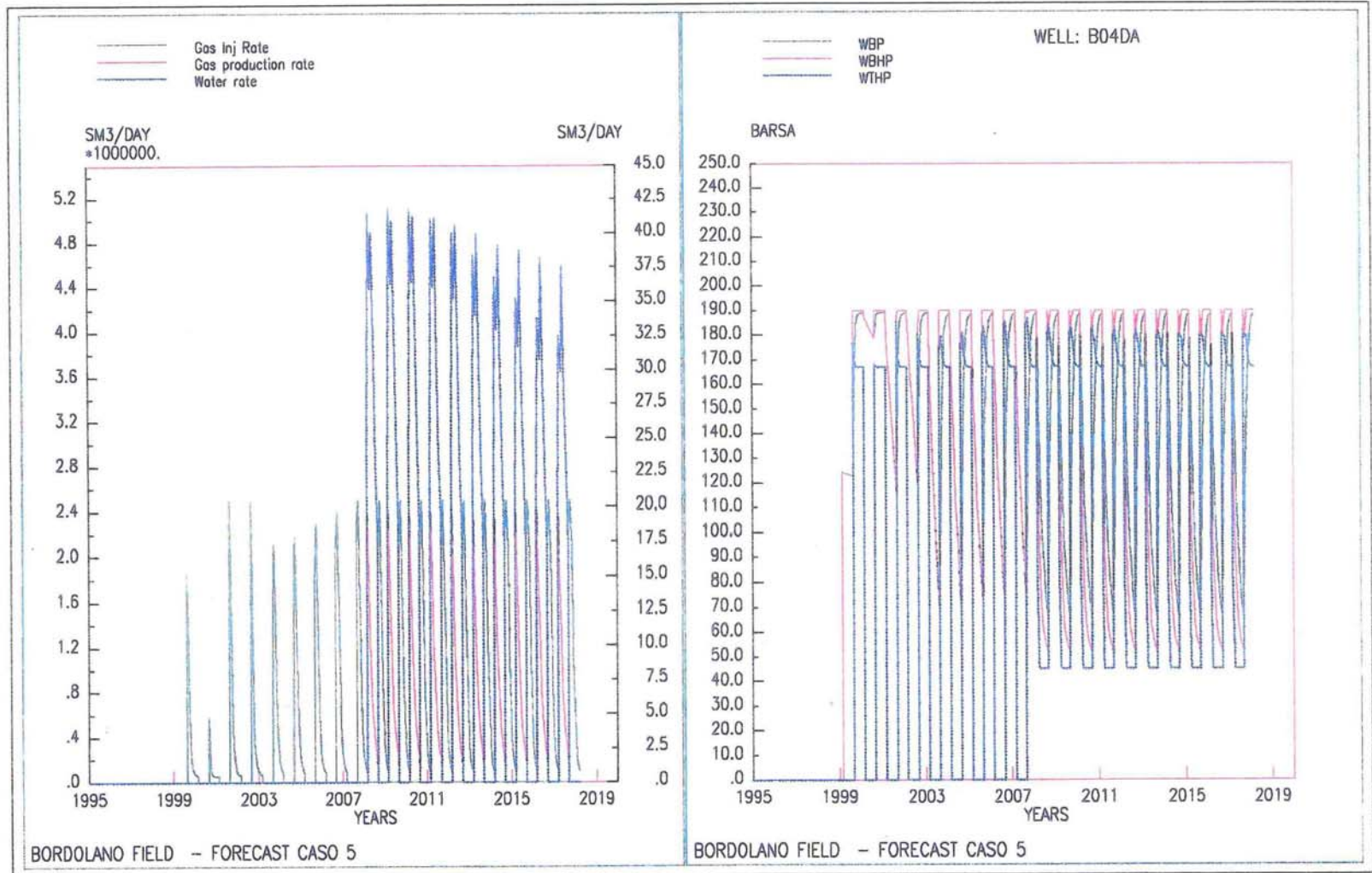

Fig 88



CAMPO DI BORDOLANO POOL B FORECAST DI STOCCAGGIO - CASO 5

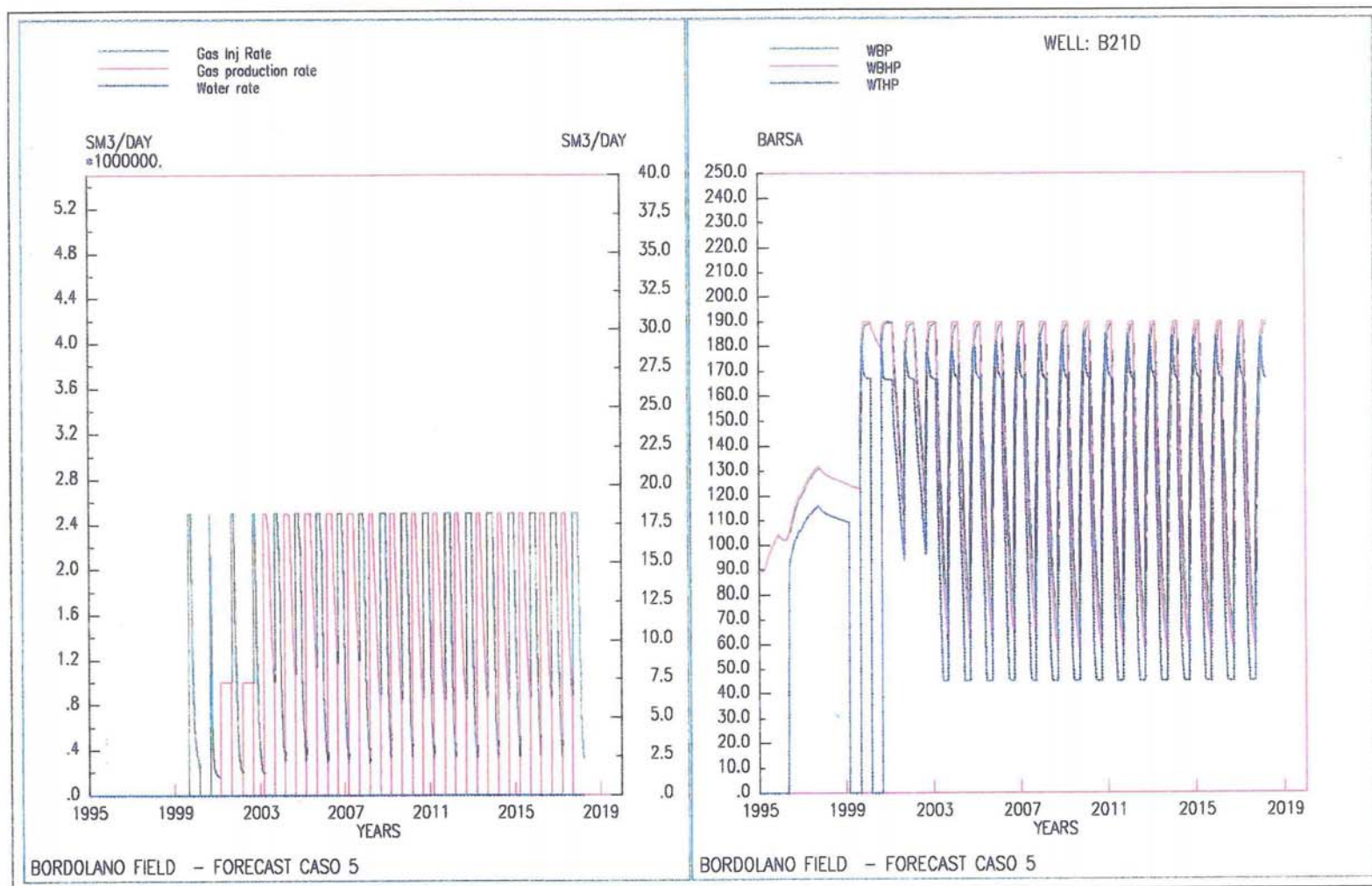

Fig 89



**CAMPO DI BORDOLANO
POOL B
RISERVE RIMANENTI CERTE SVILUPPATE AL 31/12/98**

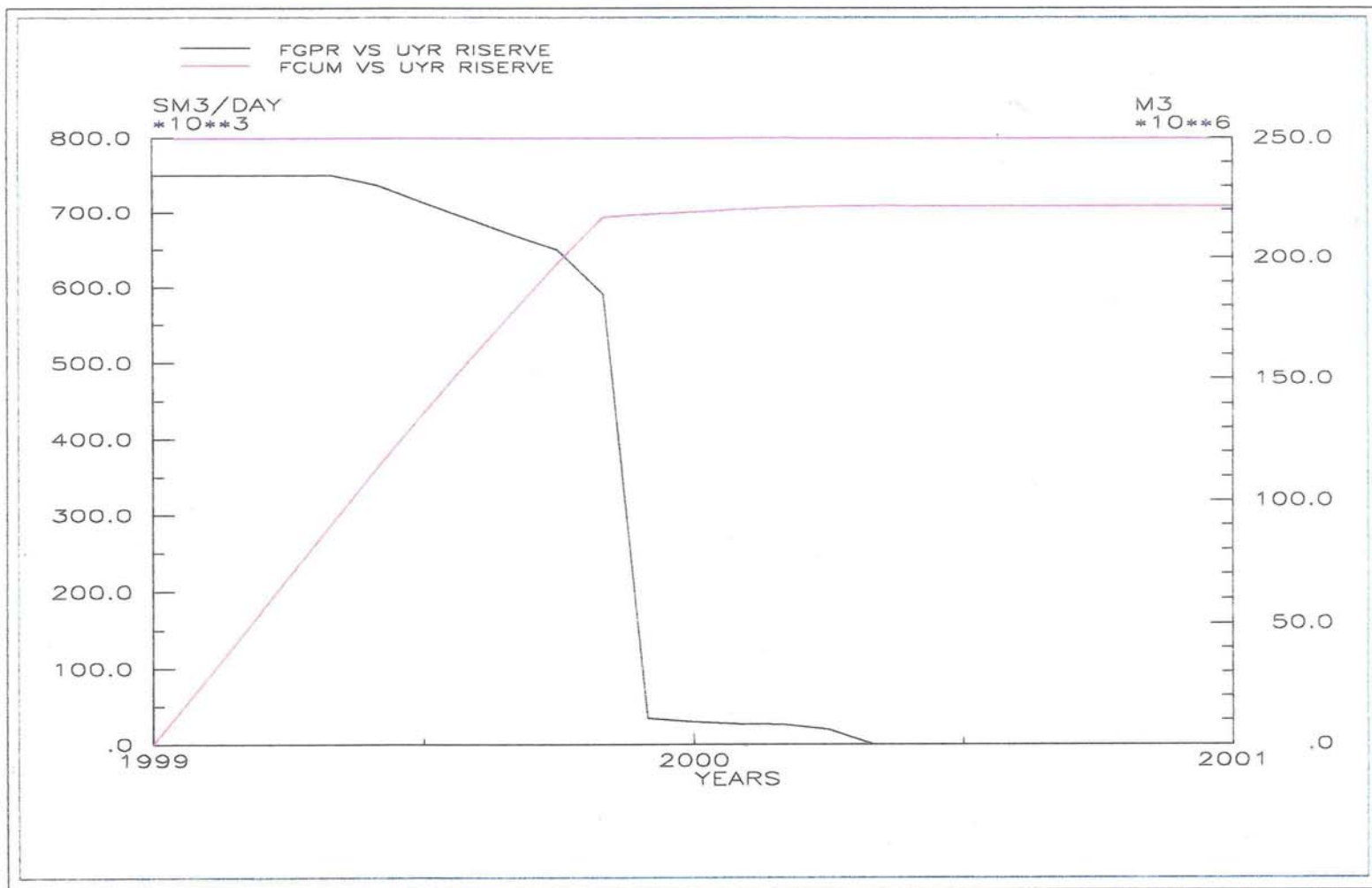

FIG 90



CAMPO DI BORDOLANO
POOL B
RISERVE RIMANENTI CERTE SVILUP. + NON SVILUP. AL 31/12/98

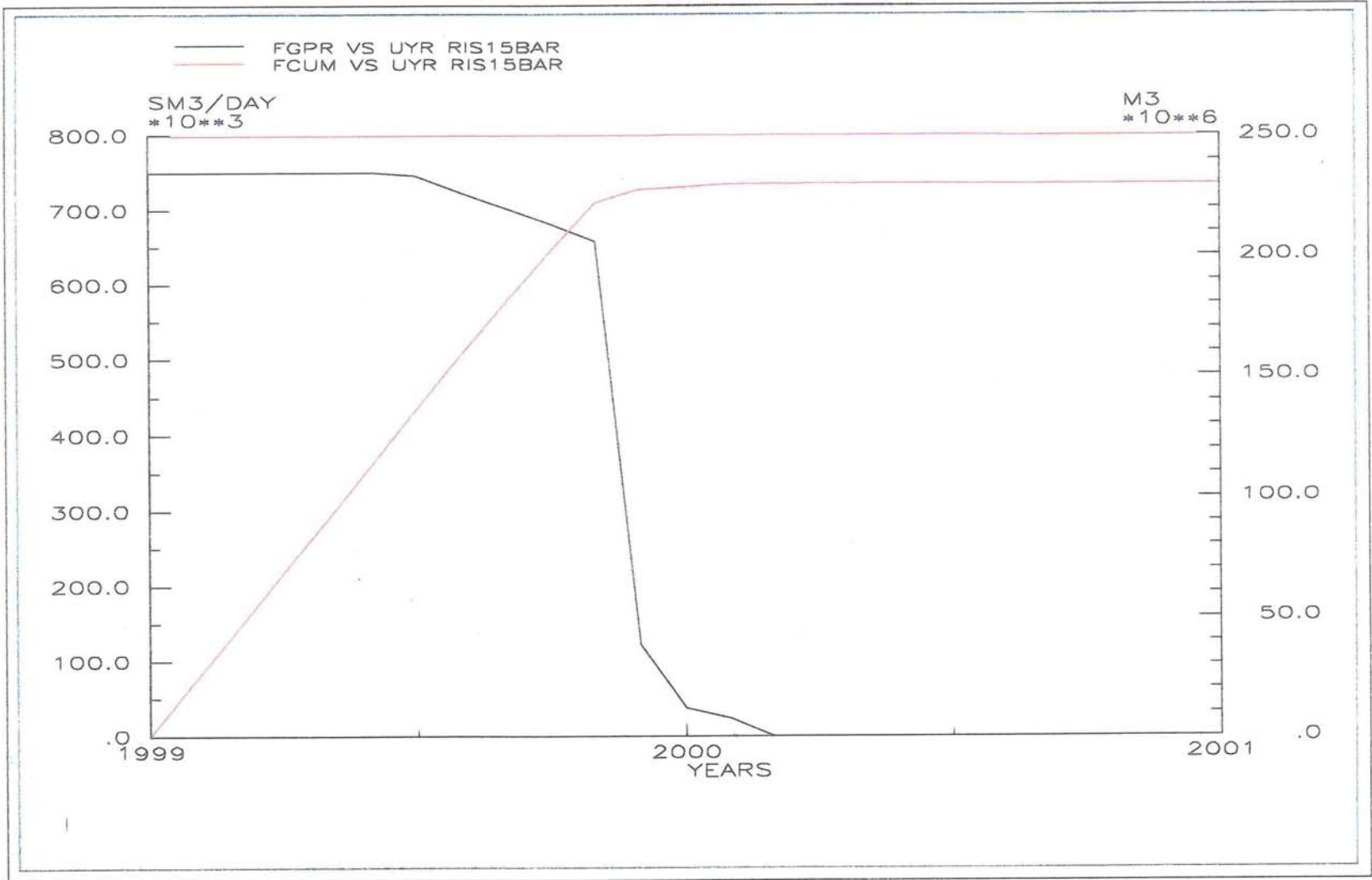
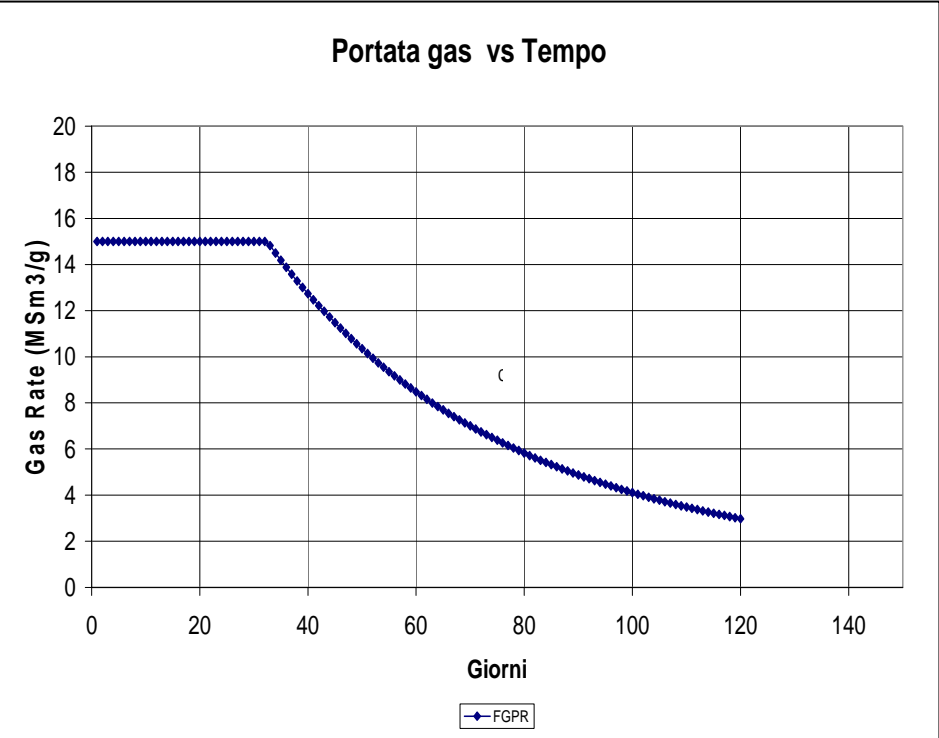

Fig 91



CAMPO DI BORDOLANO
POOL B
FORESCAST DI STOCCAGGIO – CASO 6

Portata gas vs Tempo



Portata gas vs Svaso

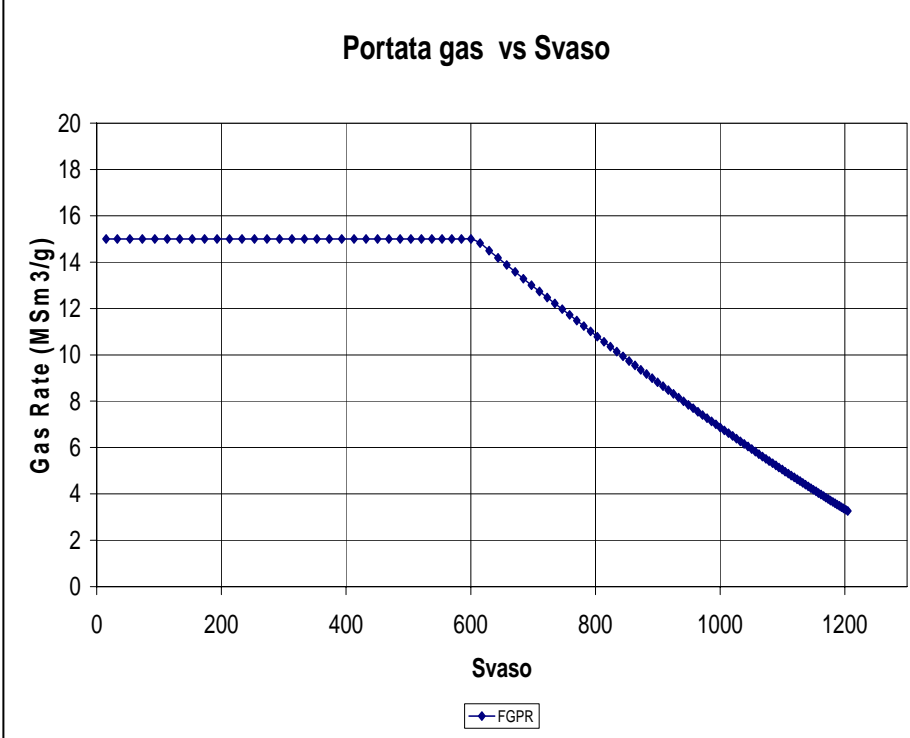

Fig. 92

CAMPO DI BORDOLANO
POOL B
FORESCAST DI STOCCAGGIO – CASO 6

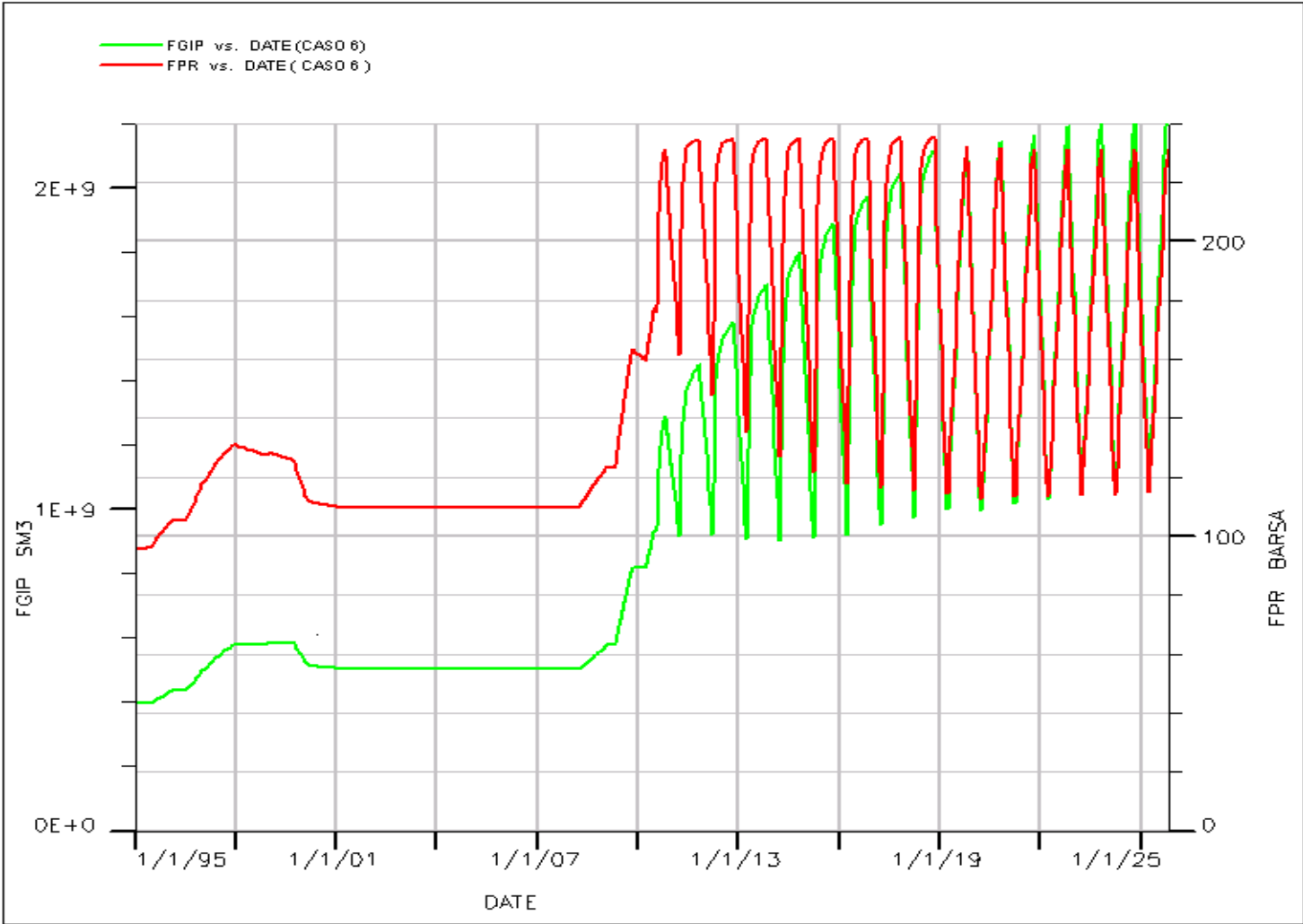

Fig. 93

CAMPO DI BORDOLANO

POOL B

FORESCAST DI STOCCAGGIO – CASO 6

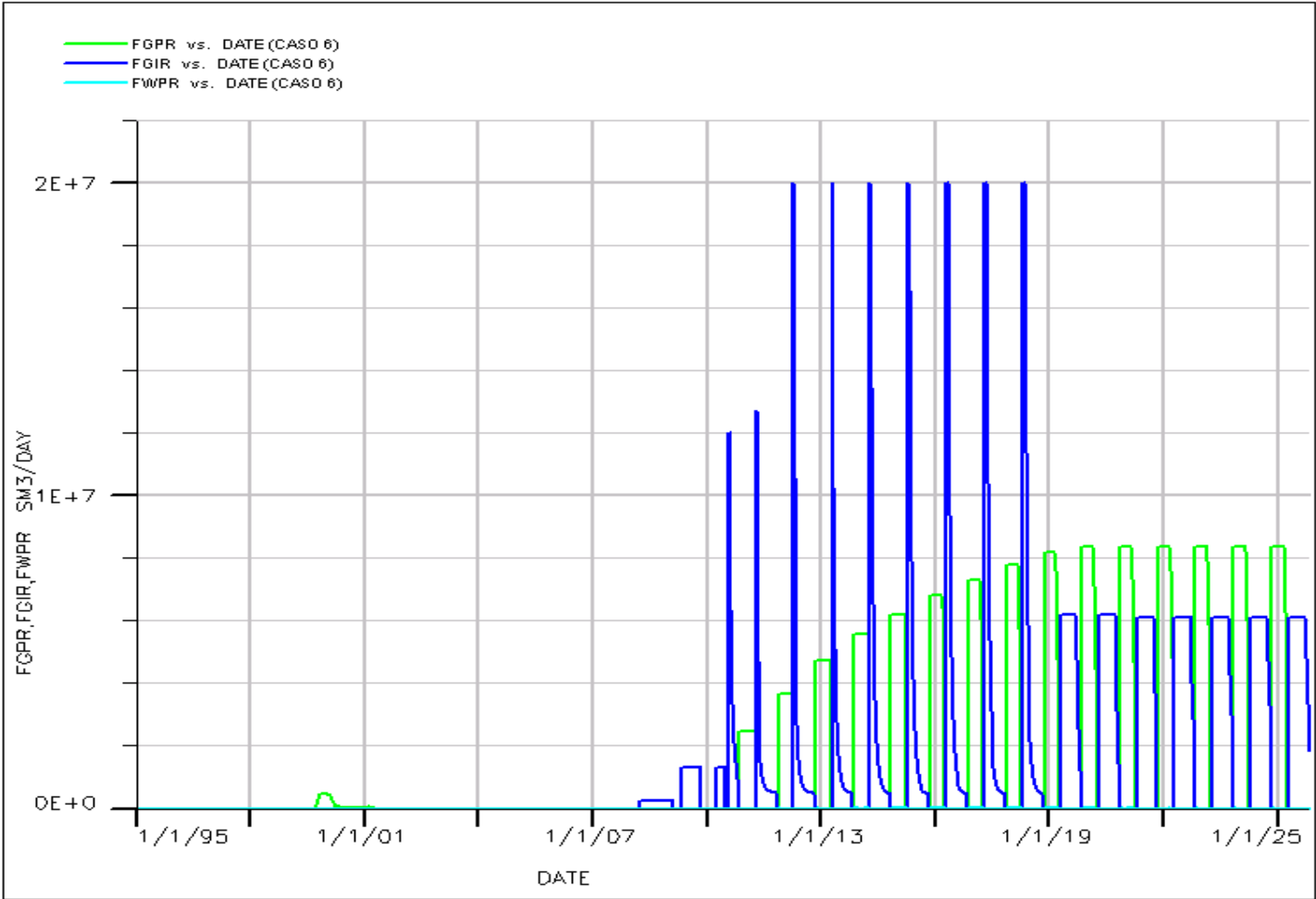

Fig. 94

CAMPO DI BORDOLANO
POOL B
FORESCAST DI STOCCAGGIO – CASO 6

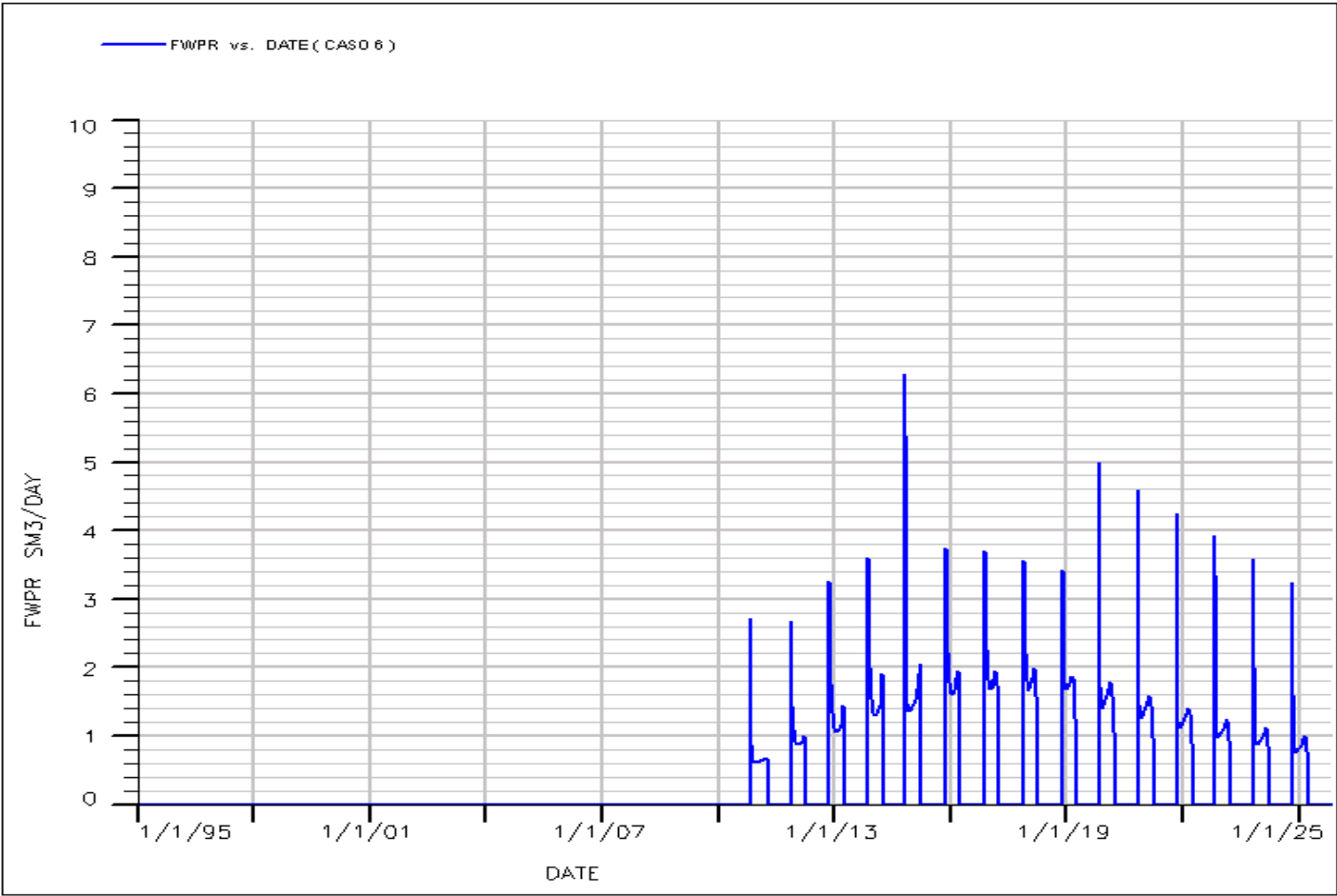
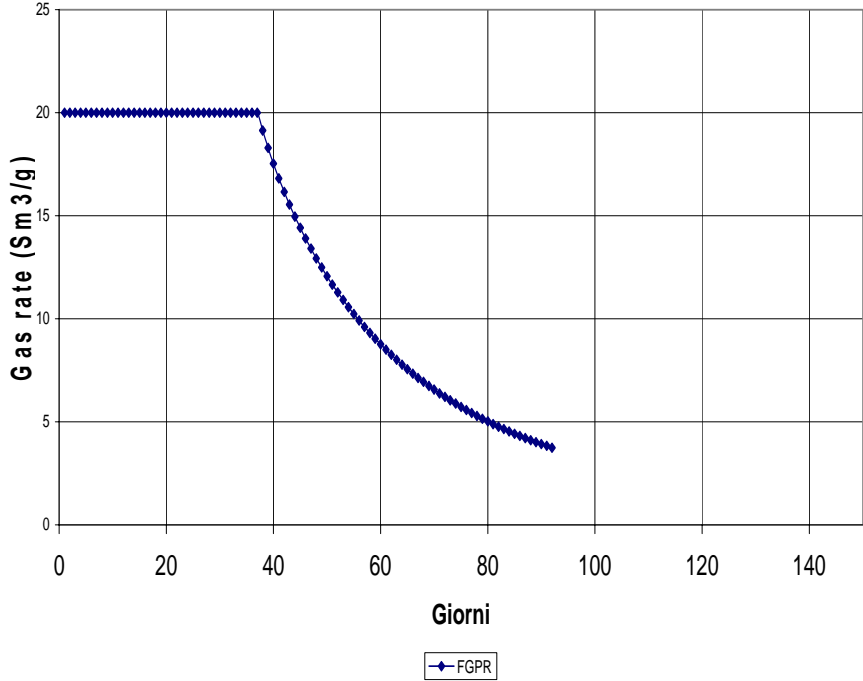

Fig. 95



CAMPO DI BORDOLANO
POOL B
FORESCAST DI STOCCAGGIO – CASO 7

Portata gas vs Tempo



Portata gas vs Svasso

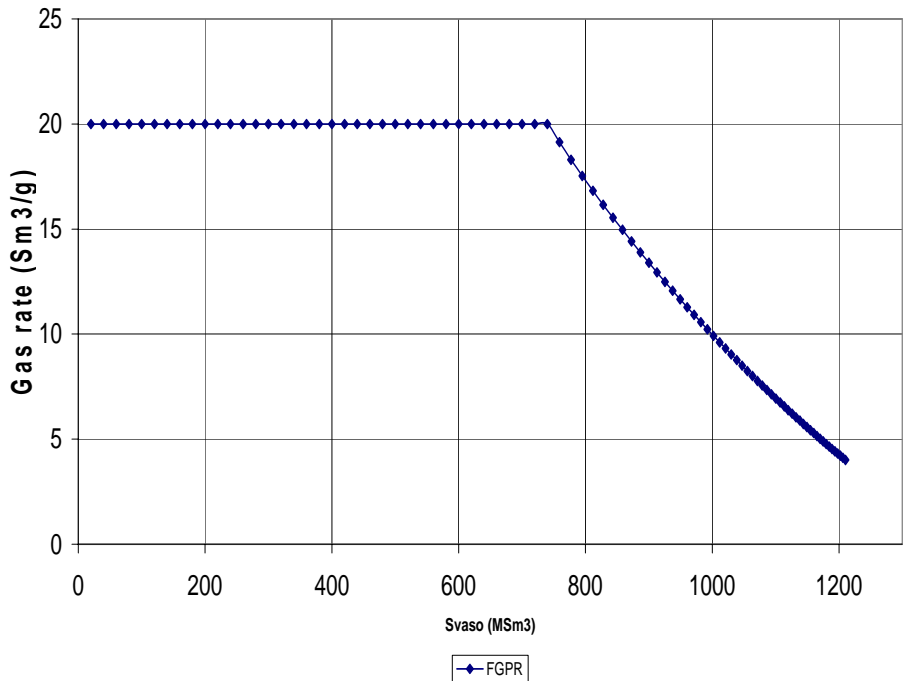

Fig. 96

CAMPO DI BORDOLANO
POOL B
FORESCAST DI STOCCAGGIO – CASO 7

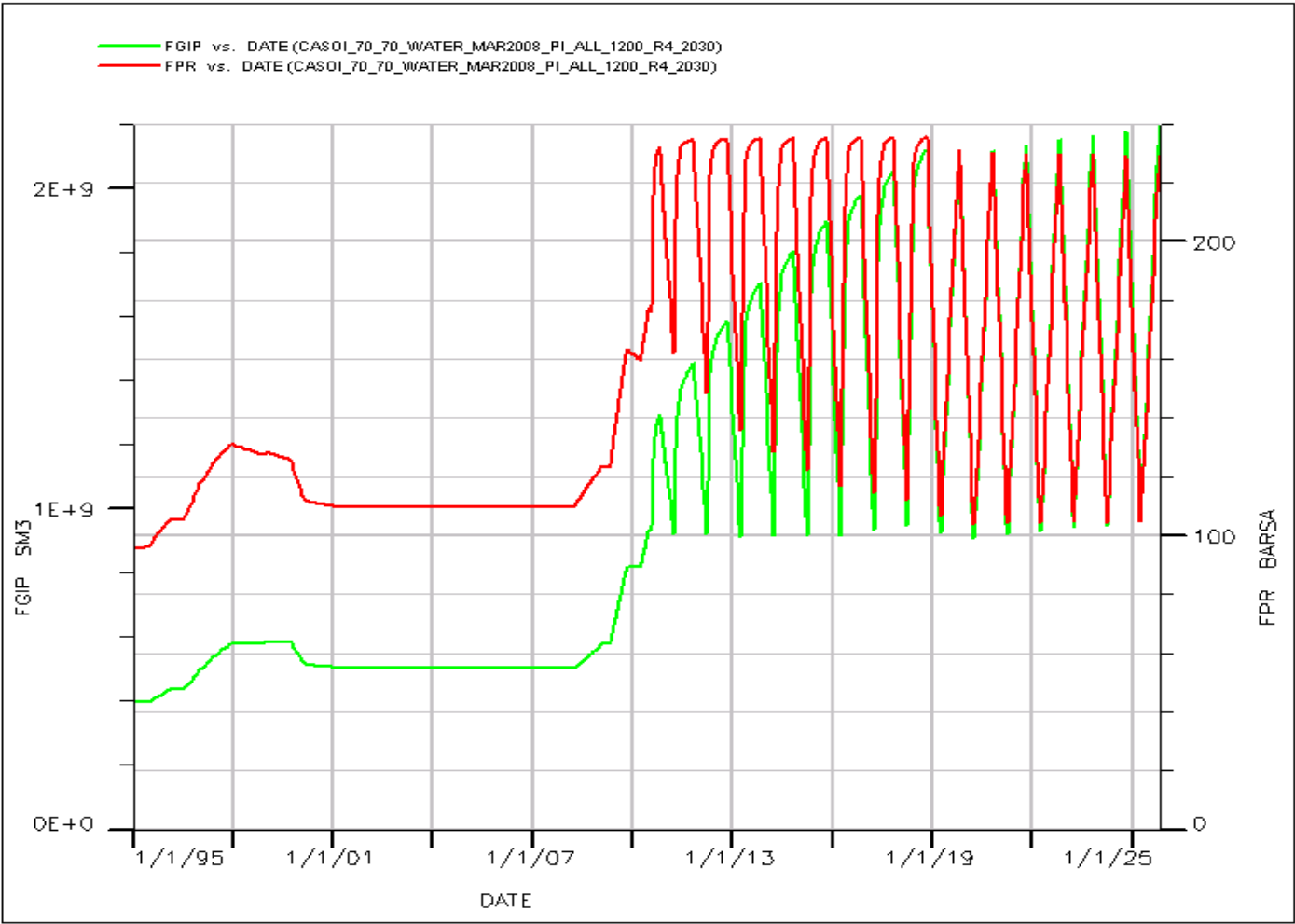

Fig. 97

CAMPO DI BORDOLANO
POOL B
FORESCAST DI STOCCAGGIO – CASO 7

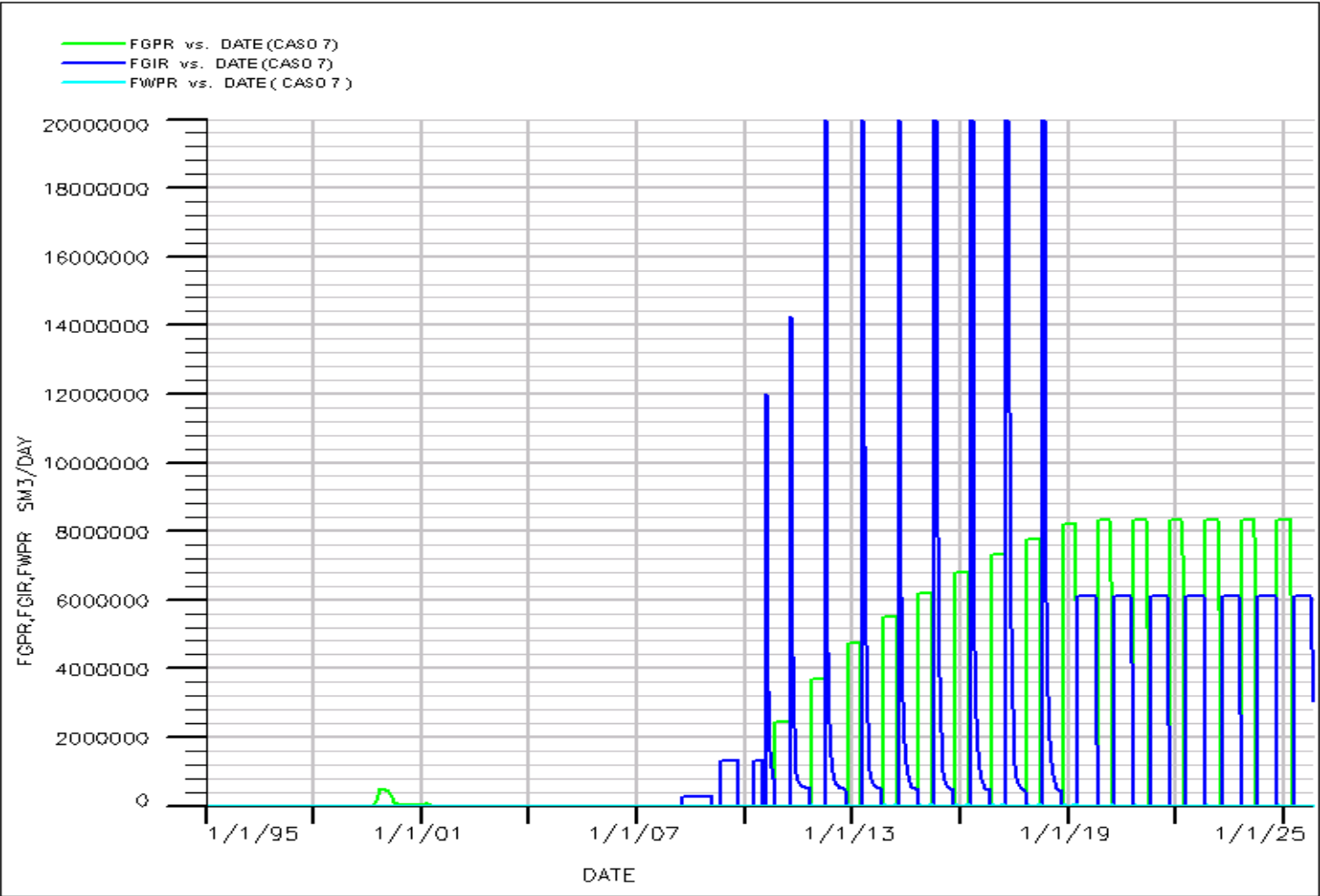

Fig. 98

CAMPO DI BORDOLANO
POOL B
FORESCAST DI STOCCAGGIO – CASO 7

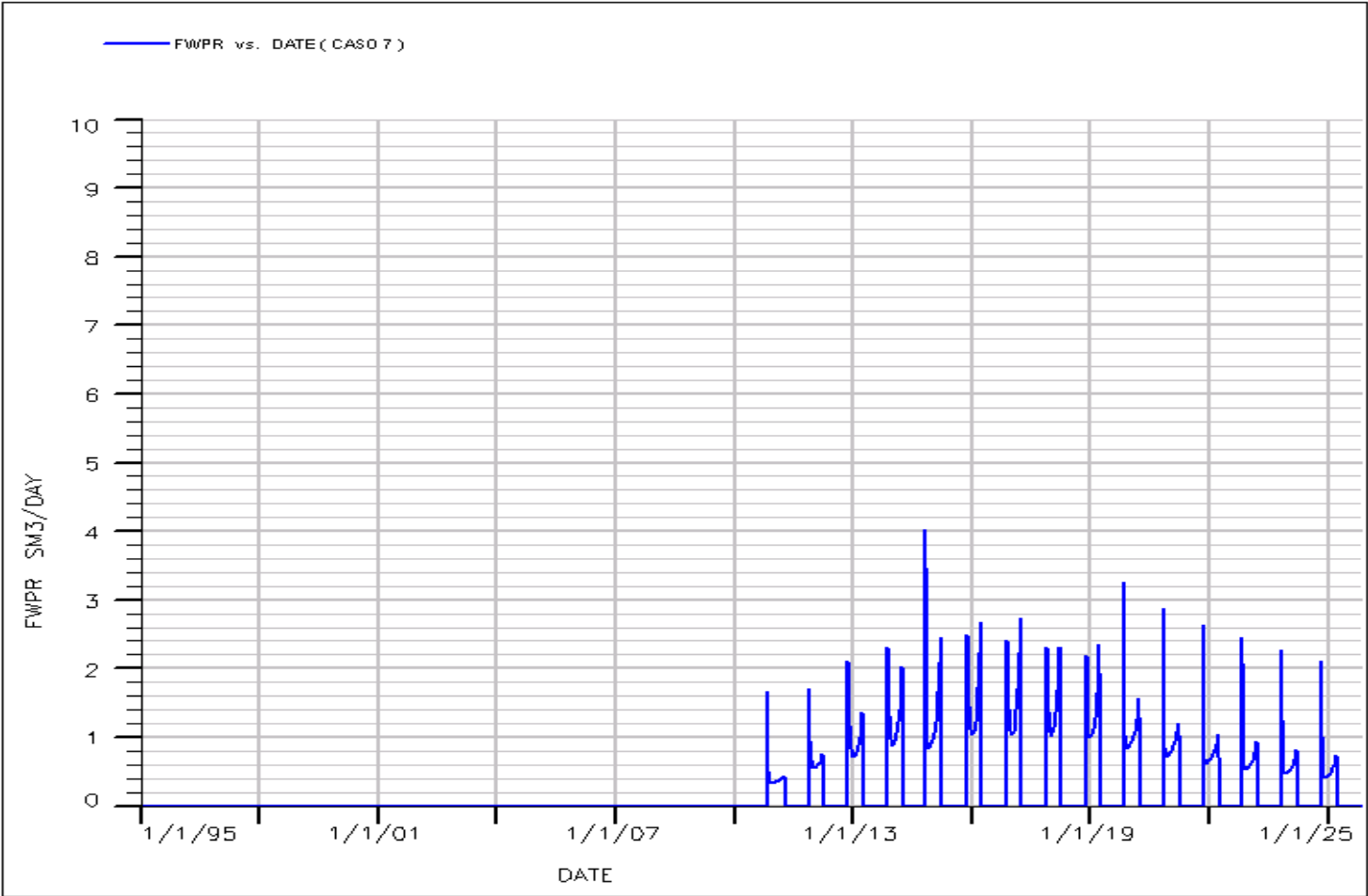

Fig. 99



CAMPO DI BORDOLANO
POOL B
FORECAST DI STOCCAGGIO – CASO 7

Andamento Volumi Coso 7 vs Caso 7 no controllo cushion

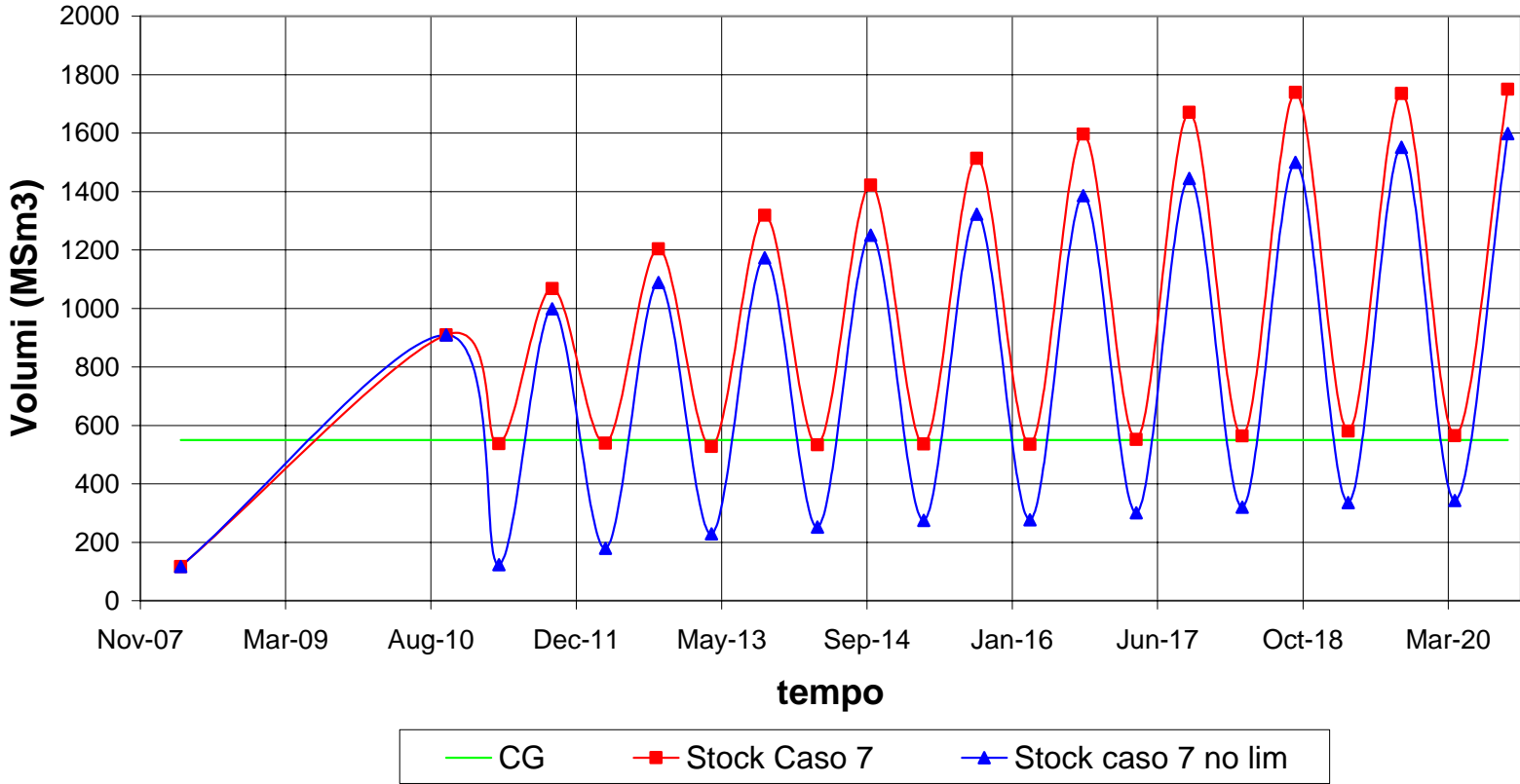

Fig. 100

CAMPO DI BORDOLANO
POOL B
FORECAST DI STOCCAGGIO – CASO 7



Andamento Produzioni di acqua
Coso 7 vs Caso 7 no controllo cushion

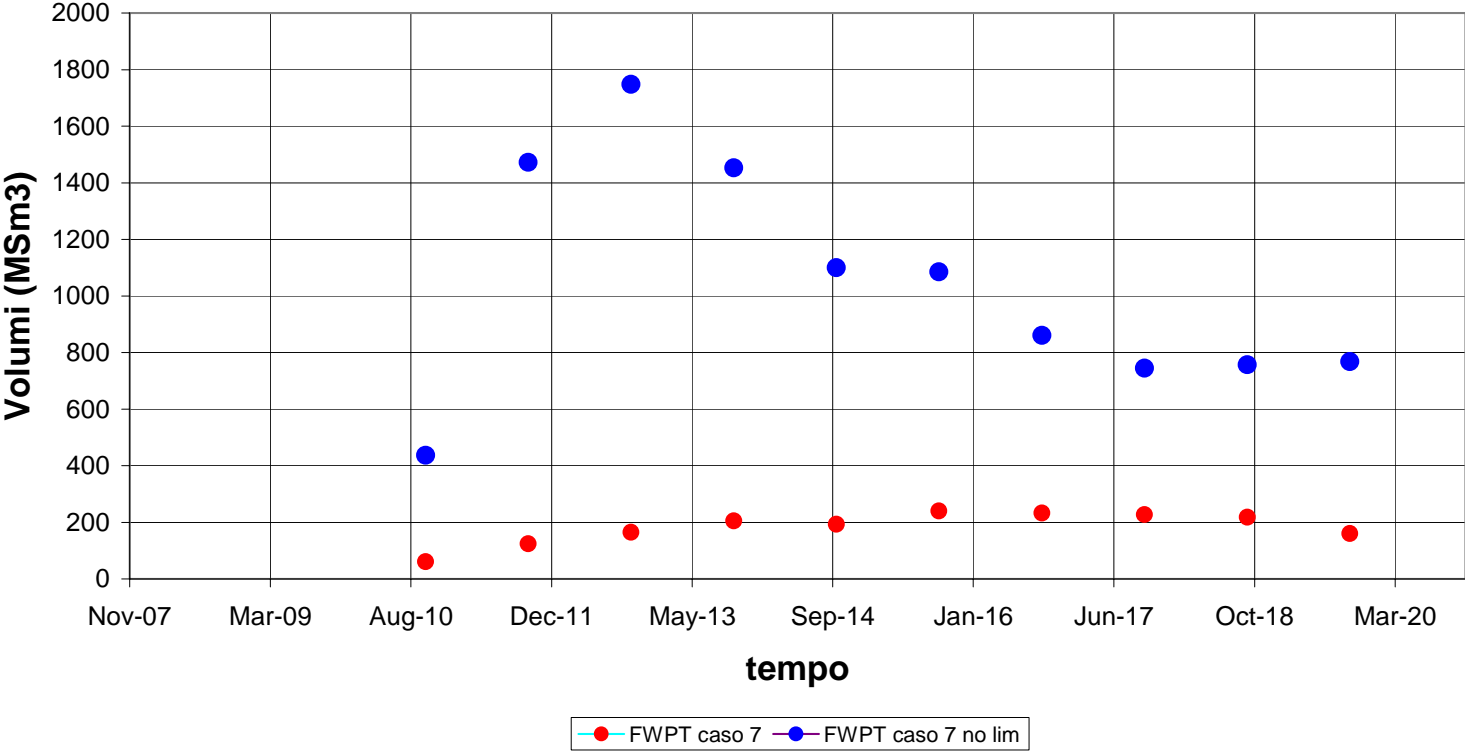

Fig. 101