

# Anas SpA

Direzione Centrale Progettazione



**Regione Lombardia**

Provincia di Milano

**Legge n. 345/97**

**Accordo di programma quadro in materia di trasporti**

Realizzazione di un sistema integrato di accessibilità ferroviaria e stradale  
all'aeroporto di Malpensa 2000

( CONVENZIONE DEL 29.10.1999 )

Collegamento tra la S.S.n.11 "Padana Superiore" a Magenta  
e la Tangenziale ovest di Milano  
Variante di Abbiategrasso sulla S.S.n.494 e adeguamento in sede  
del tratto Abbiategrasso Vigevano fino al nuovo ponte sul Ticino

**PROGETTO DEFINITIVO - 1° STRALCIO FUNZIONALE**

**C - PARTE STRADALE**

**TRATTA A : MAGENTA - ALBAIRATE**  
**SVINCOLI**  
**Svincolo n.5 (Albairate Sud)**  
**Sezioni trasversali**

Revisioni	Controllato	Approvato	Data : .....Dicembre 2008.....	Scala : .....1:200.....
			Agg.to : .....Novembre 2014.....	All.to n. ....C.6.16.2.....

Progettazione :



Società Esercizi Aeroportuali s.p.a.  
20090 Aeroporto Milano Linate tel. 02/74851

Progettazione redatta da :



**errevia** s. r. l.  
RICERCA VIABILITÀ AMBIENTE

Centro operativo: 20090 TREZZANO s/N (MI), via Cristoforo Colombo n. 23

Il Progettista :

Il Direttore Tecnico  
Dott. Ing. Alberto RINALDI

*[Handwritten signature of Alberto Rinaldi]*

Visto

La Direzione Centrale Progettazione :  
Dott. Ing. Nicola DINNELLA

.....

Visto

Il Responsabile del Procedimento :  
Dott. Ing. Domenico PETRUZZELLI

.....

*Sezioni trasversali  
Rotatoria*

PROFILO Rota\_Alba

SEZIONE 1

PROGRESSIVA 0.00

STERRI E RIPORTI

S1 2.73 mq.

S2 0.37 mq.

Totale S: 3.10 mq.

R1 0.04 mq.

R2 0.40 mq.

Totale R: 0.44 mq.

SCOTICO

E1 0.31 mq.

E2 0.37 mq.

Totale: 0.68 mq.

BONIFICA

F1 0.56 mq.

F2 0.46 mq.

Totale: 1.02 mq.

USURA

a1 9.50 ml.

PREPARAZIONE PIANO DI POSA

f1 9.50 ml.

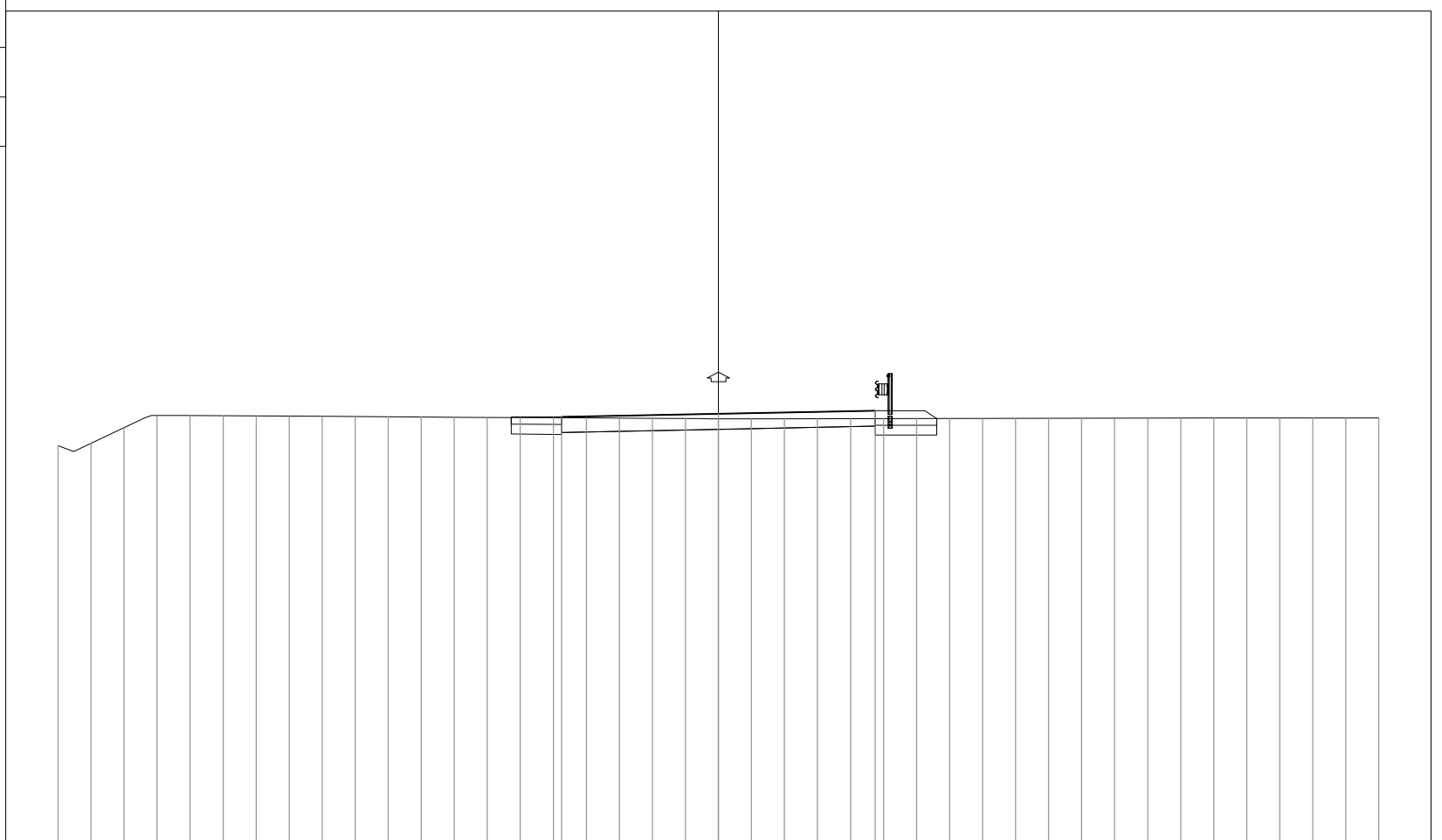

109

200

200

DISTANZE PROGRESSIVE PROGETTO

-4.75

0.00

4.75

DISTANZE PARZIALI PROGETTO

4.75

4.75

QUOTE PROGETTO

121.90

122.00

122.09

DISTANZE PROGRESSIVE TERRENO

-20.00

-19.00

-18.00

-17.00

-16.00

-15.00

-14.00

-13.00

-12.00

-11.00

-10.00

-9.00

-8.00

-7.00

-6.00

-5.00

-4.00

-3.00

-2.00

-1.00

0.00

1.00

2.00

3.00

4.00

5.00

6.00

7.00

8.00

9.00

10.00

11.00

12.00

13.00

14.00

15.00

16.00

17.00

18.00

19.00

20.00

DISTANZE PARZIALI TERRENO

1.00

1.00

1.00

1.00

1.00

1.00

1.00

1.00

1.00

1.00

1.00

1.00

1.00

1.00

1.00

1.00

1.00

1.00

1.00

1.00

1.00

1.00

1.00

1.00

1.00

1.00

1.00

1.00

1.00

1.00

1.00

1.00

1.00

1.00

1.00

1.00

1.00

1.00

QUOTE TERRENO

121.03

121.10

121.58

121.95

121.94

121.94

121.93

121.92

121.92

121.91

121.91

121.90

121.89

121.89

121.88

121.88

121.87

121.86

121.86

121.85

121.85

121.85

121.84

121.84

121.85

121.85

121.85

121.85

121.86

121.86

121.86

121.86

121.87

121.87

121.87

121.87

121.87

121.87

121.87

PROFILO Rota\_Alba  
 SEZIONE 2  
 PROGRESSIVA 20.00

STERRI E RIPIORTI  
 S1 0,32 mq.  
 S2 1,56 mq.  
 S3 2,30 mq.  
 Totale S: 4,18 mq.  
 R1 0,24 mq.  
 R2 2,32 mq.  
 Totale R: 2,56 mq.  
 SCOTICO  
 E1 0,94 mq.  
 BONIFICA  
 F1 1,44 mq.  
 USURA  
 a1 9,50 ml.  
 PREPARAZIONE PIANO DI POSA  
 f1 7,97 ml.

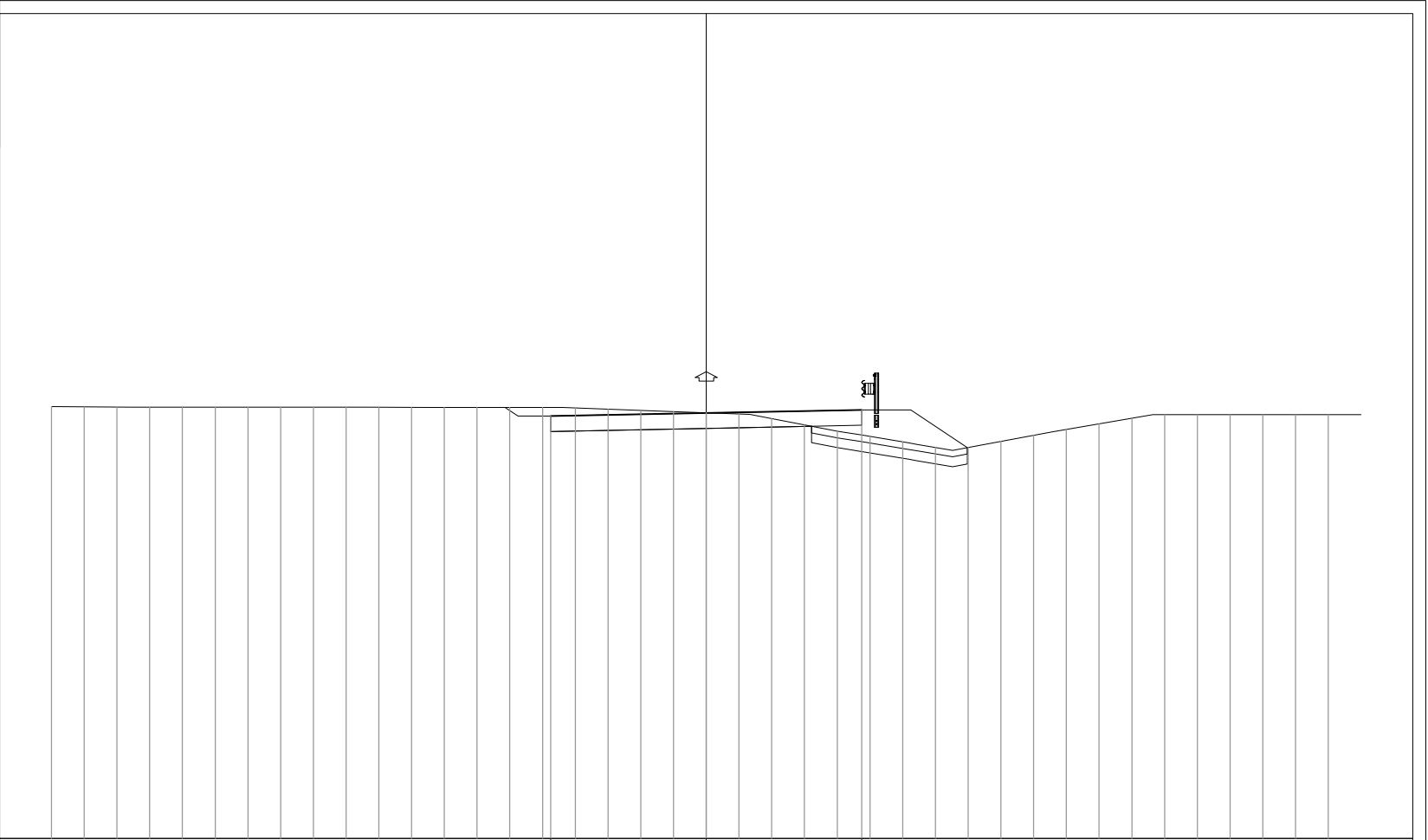

DISTANZE PROGRESSIVE PROGETTO																					-4.75	0.00	4.75																			
DISTANZE PARZIALI PROGETTO																				4.75		4.75																				
QUOTE PROGETTO																				121.90	122.00	122.09																				
DISTANZE PROGRESSIVE TERRENO	-20.00	-19.00	-18.00	-17.00	-16.00	-15.00	-14.00	-13.00	-12.00	-11.00	-10.00	-9.00	-8.00	-7.00	-6.00	-5.00	-4.00	-3.00	-2.00	-1.00	0.00	1.00	2.00	3.00	4.00	5.00	6.00	7.00	8.00	9.00	10.00	11.00	12.00	13.00	14.00	15.00	16.00	17.00	18.00	19.00		
DISTANZE PARZIALI TERRENO	1.00	1.00	1.00	1.00	1.00	1.00	1.00	1.00	1.00	1.00	1.00	1.00	1.00	1.00	1.00	1.00	1.00	1.00	1.00	1.00	1.00	1.00	1.00	1.00	1.00	1.00	1.00	1.00	1.00	1.00	1.00	1.00	1.00	1.00	1.00	1.00	1.00	1.00	1.00	1.00	1.00	1.00
QUOTE TERRENO	122.19	122.18	122.18	122.18	122.18	122.18	122.17	122.17	122.17	122.17	122.17	122.17	122.17	122.17	122.17	122.16	122.15	122.11	122.08	122.04	122.00	121.97	121.83	121.63	121.44	121.28	121.11	120.95	120.95	121.13	121.32	121.50	121.67	121.84	121.95	121.95	121.95	121.94	121.94			

PROFILO Rota\_Alba

SEZIONE 3

PROGRESSIVA 40.00

STERRI E RIPORTI

S1	0.15 mq.
R1	0.54 mq.
R2	0.85 mq.
R3	0.51 mq.
R4	1.69 mq.
Totale R:	3.59 mq.
<b>SCOTICO</b>	
E1	1.99 mq.
E2	0.38 mq.
Totale:	2.37 mq.
<b>BONIFICA</b>	
F1	2.97 mq.
F2	0.58 mq.
Totale:	3.55 mq.
<b>USURA</b>	
o1	9.50 ml.
PREPARAZIONE PIANO DI POSA	
f1	2.31 ml.

109  
▼

200  
200

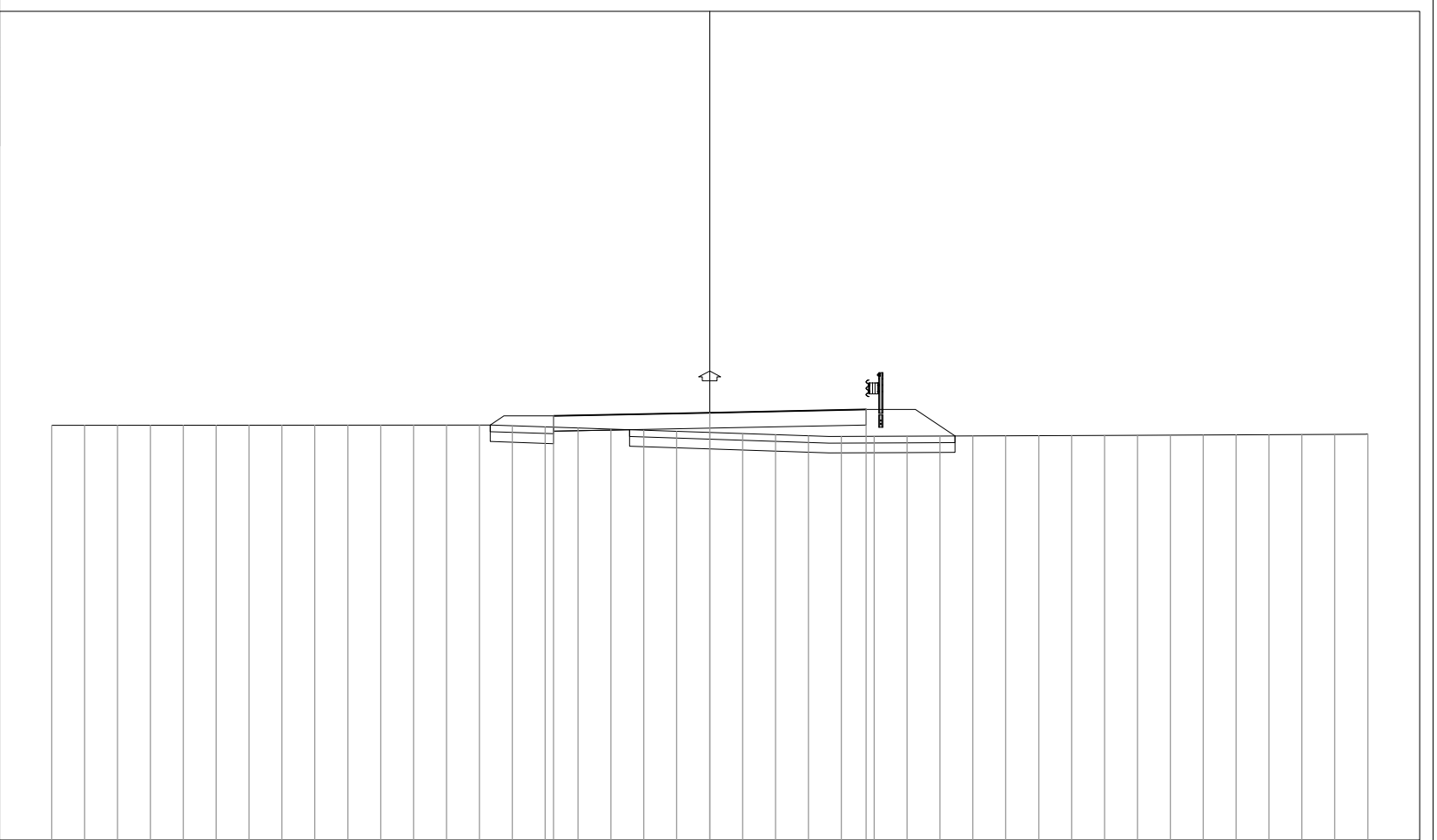

DISTANZE PROGRESSIVE  
PROGETTO

-4.75 0.00 4.75

DISTANZE PARZIALI  
PROGETTO

4.75 4.75

QUOTE  
PROGETTO

121.90 122.00 122.09

DISTANZE PROGRESSIVE  
TERRENO

-20.00 -19.00 -18.00 -17.00 -16.00 -15.00 -14.00 -13.00 -12.00 -11.00 -10.00 -9.00 -8.00 -7.00 -6.00 -5.00 -4.00 -3.00 -2.00 -1.00 0.00 1.00 2.00 3.00 4.00 5.00 6.00 7.00 8.00 9.00 10.00 11.00 12.00 13.00 14.00 15.00 16.00 17.00 18.00 19.00 20.00

DISTANZE PARZIALI  
TERRENO

1.00 1.00

QUOTE  
TERRENO

121.61 121.61 121.62 121.62 121.62 121.62 121.62 121.62 121.62 121.62 121.62 121.62 121.62 121.62 121.62 121.60 121.57 121.53 121.50 121.46 121.43 121.39 121.36 121.33 121.29 121.27 121.28 121.28 121.29 121.29 121.29 121.30 121.30 121.30 121.31 121.31 121.32 121.32 121.32 121.33 121.33 121.35

PROFILO Rota\_Alba

SEZIONE 4

PROGRESSIVA 60.00

STERRI E RIPORTI

S1	0.39 mq.
S2	0.61 mq.
Totale S:	1.00 mq.
R1	0.48 mq.
R2	0.79 mq.
Totale R:	1.27 mq.
SCOTICO	
E1	0.43 mq.
E2	0.38 mq.
Totale:	0.81 mq.
BONIFICA	
F1	0.64 mq.
F2	0.58 mq.
Totale:	1.22 mq.
USURA	
a1	9.50 ml.
PREPARAZIONE PIANO DI POSA	
f1	9.50 ml.

109

200  
200

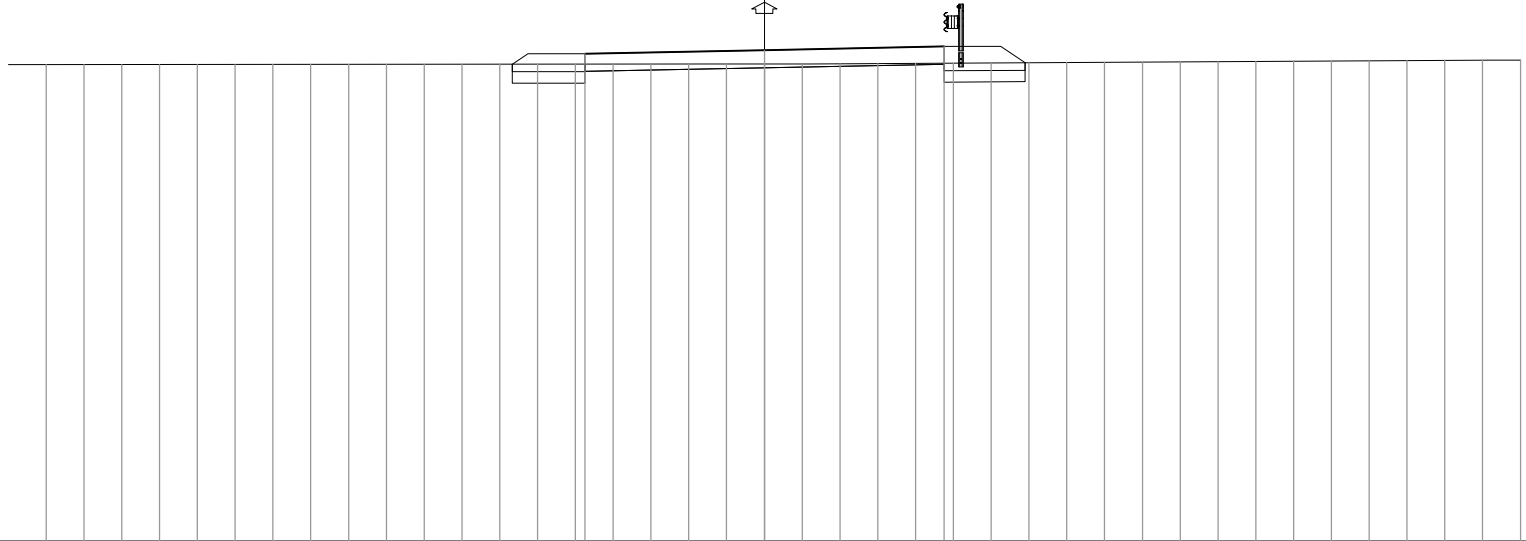

DISTANZE PROGRESSIVE  
PROGETTO

4.75 0.00 4.75

DISTANZE PARZIALI  
PROGETTO

4.75 4.75

QUOTE  
PROGETTO

121.90 122.00 122.09

DISTANZE PROGRESSIVE  
TERRENO

-19.00 -18.00 -17.00 -16.00 -15.00 -14.00 -13.00 -12.00 -11.00 -10.00 -9.00 -8.00 -7.00 -6.00 -5.00 -4.00 -3.00 -2.00 -1.00 0.00 1.00 2.00 3.00 4.00 5.00 6.00 7.00 8.00 9.00 10.00 11.00 12.00 13.00 14.00 15.00 16.00 17.00 18.00 19.00 20.00

DISTANZE PARZIALI  
TERRENO

1.00 1.00

QUOTE  
TERRENO

121.61 121.61 121.61 121.61 121.62 121.62 121.62 121.62 121.62 121.62 121.62 121.62 121.62 121.62 121.62 121.63 121.63 121.63 121.63 121.63 121.63 121.63 121.64 121.65 121.65 121.66 121.66 121.67 121.68 121.68 121.69 121.69 121.70 121.70 121.71 121.71 121.72 121.72 121.73 121.73 121.73 121.73

PROFILO Rota\_Alba

SEZIONE 5

PROGRESSIVA 80.00

STERRI E RIPORTI

S1 0.69 mq.

R1 0.58 mq.

R2 0.70 mq.

Totale R: 1.28 mq.

SCOTICO

E1 0.29 mq.

E2 0.39 mq.

Totale: 0.68 mq.

BONIFICA

F1 0.43 mq.

F2 0.60 mq.

Totale: 1.03 mq.

USURA

a1 9.50 ml.

PREPARAZIONE PIANO DI POSA

f1 9.50 ml.

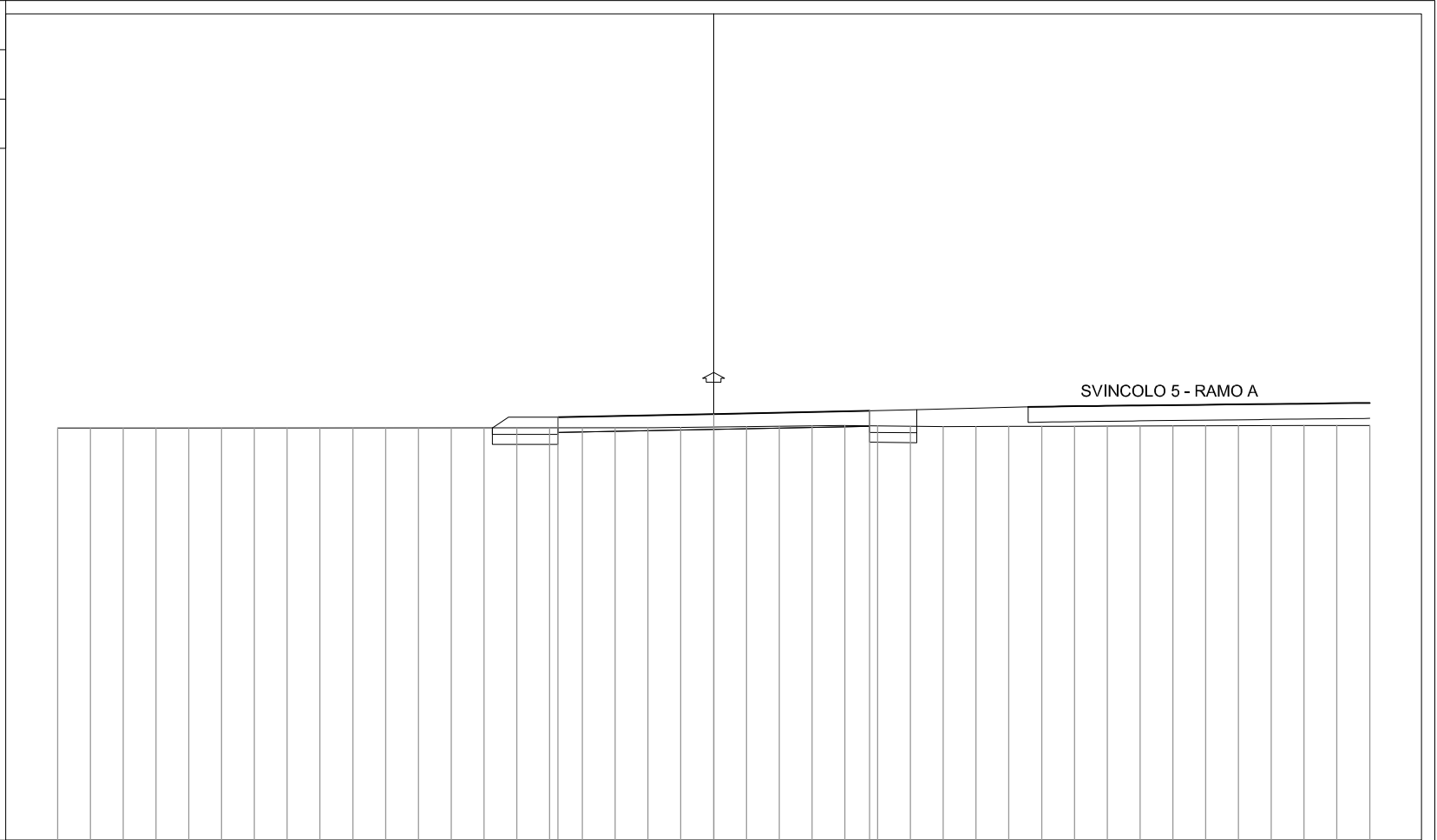

109

200  
200

DISTANZE PROGRESSIVE  
PROGETTO

-4.75

0.00

4.75

DISTANZE PARZIALI  
PROGETTO

4.75

4.75

QUOTE  
PROGETTO

121.90

122.00

122.09

DISTANZE PROGRESSIVE  
TERRENO

-20.00

-19.00

-18.00

-17.00

-16.00

-15.00

-14.00

-13.00

-12.00

-11.00

-10.00

-9.00

-8.00

-7.00

-6.00

-5.00

-4.00

-3.00

-2.00

-1.00

0.00

1.00

2.00

3.00

4.00

5.00

6.00

7.00

8.00

9.00

10.00

11.00

12.00

13.00

14.00

15.00

16.00

17.00

18.00

19.00

20.00

DISTANZE PARZIALI  
TERRENO

1.00

1.00

1.00

1.00

1.00

1.00

1.00

1.00

1.00

1.00

1.00

1.00

1.00

1.00

1.00

1.00

1.00

1.00

1.00

1.00

1.00

1.00

1.00

1.00

1.00

1.00

1.00

1.00

1.00

1.00

1.00

1.00

1.00

1.00

1.00

1.00

1.00

1.00

1.00

QUOTE  
TERRENO

121.57

121.57

121.57

121.57

121.57

121.57

121.57

121.57

121.57

121.57

121.57

121.57

121.57

121.57

121.57

121.57

121.57

121.57

121.57

121.57

121.57

121.57

121.57

121.57

121.57

121.57

121.57

121.57

121.57

121.57

121.57

121.57

121.57

121.57

121.57

121.57

121.57

121.57

121.57

121.57

PROFILO Rota\_Alba

SEZIONE 6

PROGRESSIVA 100.00

STERRI E RIPORTI

S1 3,22 mq.

R1 0,11 mq.

R2 2,31 mq.

Totale R: 2,42 mq.

SCOTICO

E1 0,53 mq.

E2 0,32 mq.

Totale: 0,85 mq.

BONIFICA

F1 0,79 mq.

F2 0,48 mq.

Totale: 1,27 mq.

USURA

a1 9,50 ml.

f1 9,50 ml.

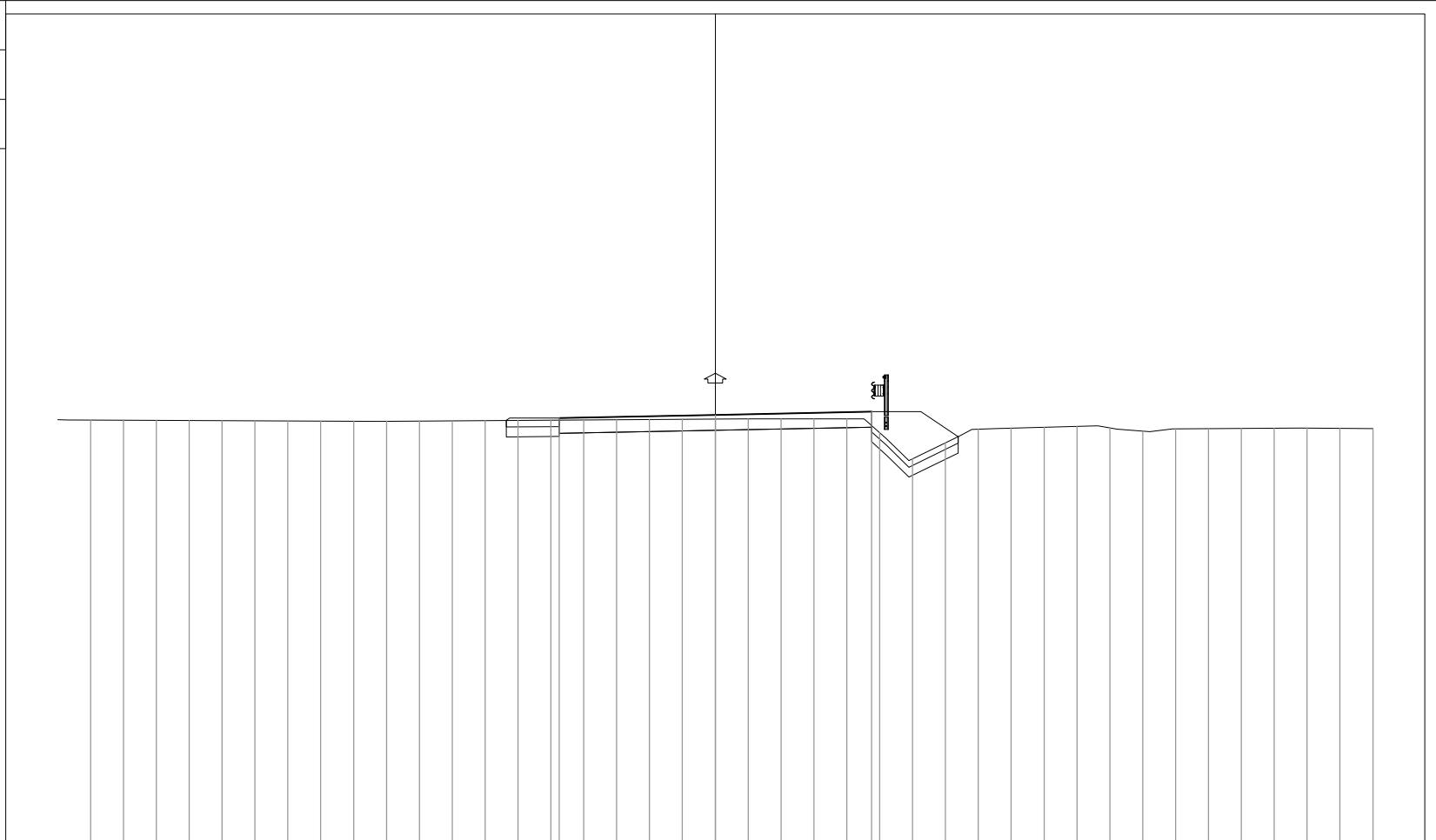

109

200  
200

DISTANZE PROGRESSIVE  
PROGETTO

-4.75

0.00

4.75

DISTANZE PARZIALI  
PROGETTO

4.75

4.75

QUOTE  
PROGETTO

121.90

122.00

122.09

DISTANZE PROGRESSIVE  
TERRENO

-19.00

-18.00

-17.00

-16.00

-15.00

-14.00

-13.00

-12.00

-11.00

-10.00

-9.00

-8.00

-7.00

-6.00

-5.00

-4.00

-3.00

-2.00

-1.00

0.00

1.00

2.00

3.00

4.00

5.00

6.00

7.00

8.00

9.00

10.00

11.00

12.00

13.00

14.00

15.00

16.00

17.00

18.00

19.00

20.00

DISTANZE PARZIALI  
TERRENO

1.00

1.00

1.00

1.00

1.00

1.00

1.00

1.00

1.00

1.00

1.00

1.00

1.00

1.00

1.00

1.00

1.00

1.00

1.00

1.00

1.00

1.00

1.00

1.00

1.00

1.00

1.00

1.00

1.00

1.00

1.00

1.00

1.00

1.00

1.00

QUOTE  
TERRENO

121.84

121.84

121.83

121.83

121.82

121.82

121.81

121.81

121.81

121.80

121.81

121.82

121.82

121.83

121.84

121.84

121.85

121.86

121.87

121.87

121.88

121.88

121.88

121.88

121.88

121.46

120.66

121.15

121.56

121.59

121.62

121.64

121.60

121.50

121.57

121.58

121.58

121.59

121.59

121.58

121.58





PROFILO Rota\_Alba

SEZIONE 8

PROGRESSIVA 140.00

STERRI E RIPORTI

S1 0.97 mq.  
R1 0.43 mq.  
R2 0.00 mq.  
R3 0.87 mq.  
Totale R: 1.30 mq.

SCOTICO

E1 0.02 mq.  
E2 0.44 mq.  
E3 0.37 mq.  
Totale: 0.83 mq.

BONIFICA

F1 0.03 mq.  
F2 0.67 mq.  
F3 0.57 mq.  
Totale: 1.27 mq.

USURA

a1 9.50 ml.

PREPARAZIONE PIANO DI POSA

f1 9.40 ml.

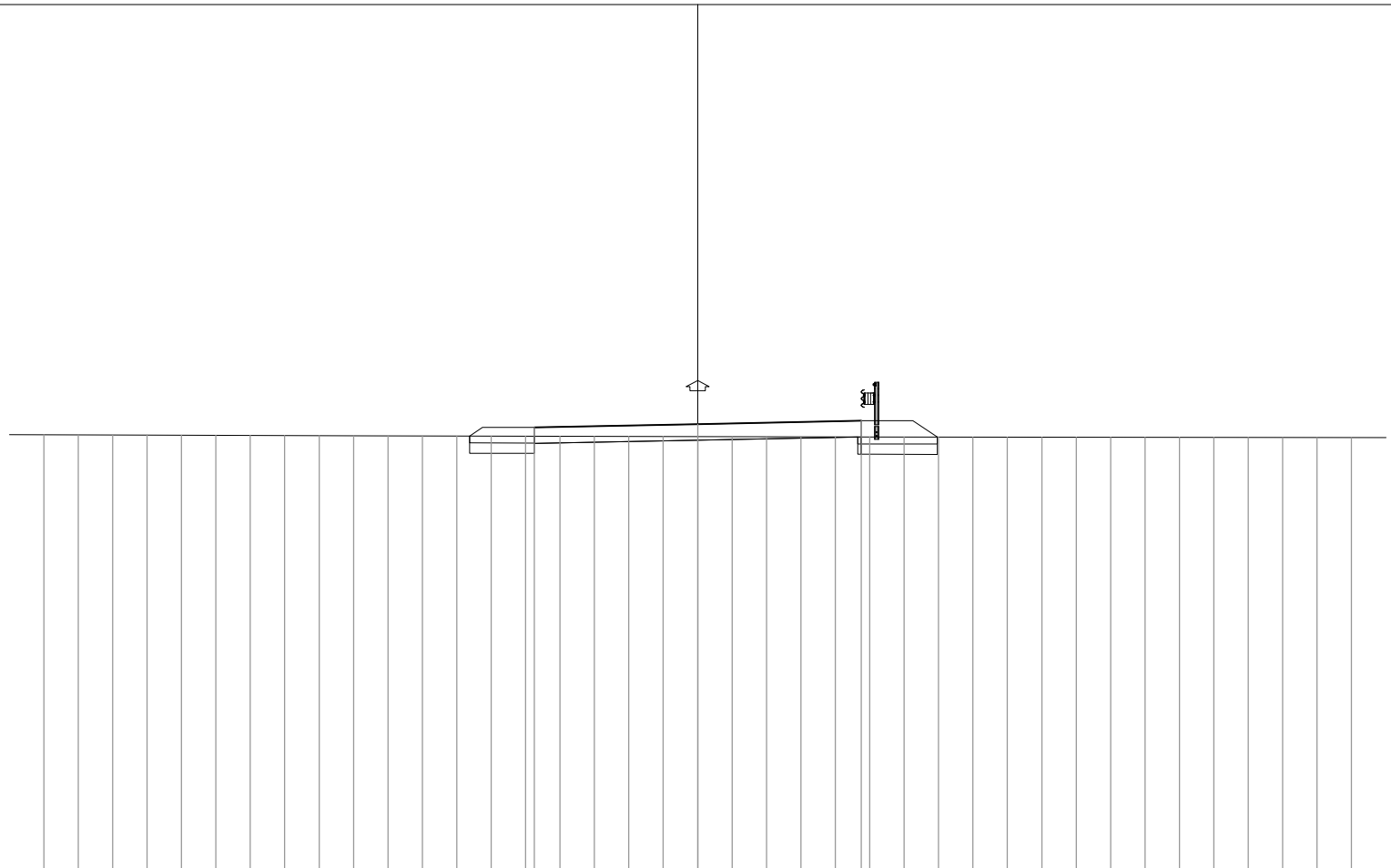

109

200

DISTANZE PROGRESSIVE  
PROGETTO

-4.75

0.00

4.75

DISTANZE PARZIALI  
PROGETTO

4.75

4.75

QUOTE  
PROGETTO

121.90

122.00

122.09

DISTANZE PROGRESSIVE  
TERRENO

-19.00

-18.00

-17.00

-16.00

-15.00

-14.00

-13.00

-12.00

-11.00

-10.00

-9.00

-8.00

-7.00

-6.00

-5.00

-4.00

-3.00

-2.00

-1.00

0.00

1.00

2.00

3.00

4.00

5.00

6.00

7.00

8.00

9.00

10.00

11.00

12.00

13.00

14.00

15.00

16.00

17.00

18.00

19.00

DISTANZE PARZIALI  
TERRENO

1.00

1.00

1.00

1.00

1.00

1.00

1.00

1.00

1.00

1.00

1.00

1.00

1.00

1.00

1.00

1.00

1.00

1.00

1.00

1.00

1.00

1.00

1.00

1.00

1.00

1.00

1.00

1.00

1.00

1.00

1.00

1.00

1.00

1.00

1.00

1.00

1.00

1.00

QUOTE  
TERRENO

121.68

121.68

121.68

121.68

121.67

121.67

121.67

121.66

121.66

121.66

121.66

121.65

121.65

121.65

121.65

121.64

121.64

121.64

121.64

121.63

121.63

121.63

121.62

121.62

121.62

121.62

121.61

121.61

121.61

121.61

121.61

121.61

121.61

121.61

121.61

121.61

121.61

121.61

121.61

PROFILO Rota\_Alba

SEZIONE 9

PROGRESSIVA 160.00

STERRI E RIPORTI

S1	1.08 mq.
S2	0.47 mq.
S3	0.01 mq.
Totale S:	1.56 mq.
R1	0.34 mq.
SCOTICO	
E1	0.36 mq.
BONIFICA	
F1	0.55 mq.
USURA	
a1	9.50 ml.
PREPARAZIONE PIANO DI POSA	
f1	12.10 ml.

109



200

200

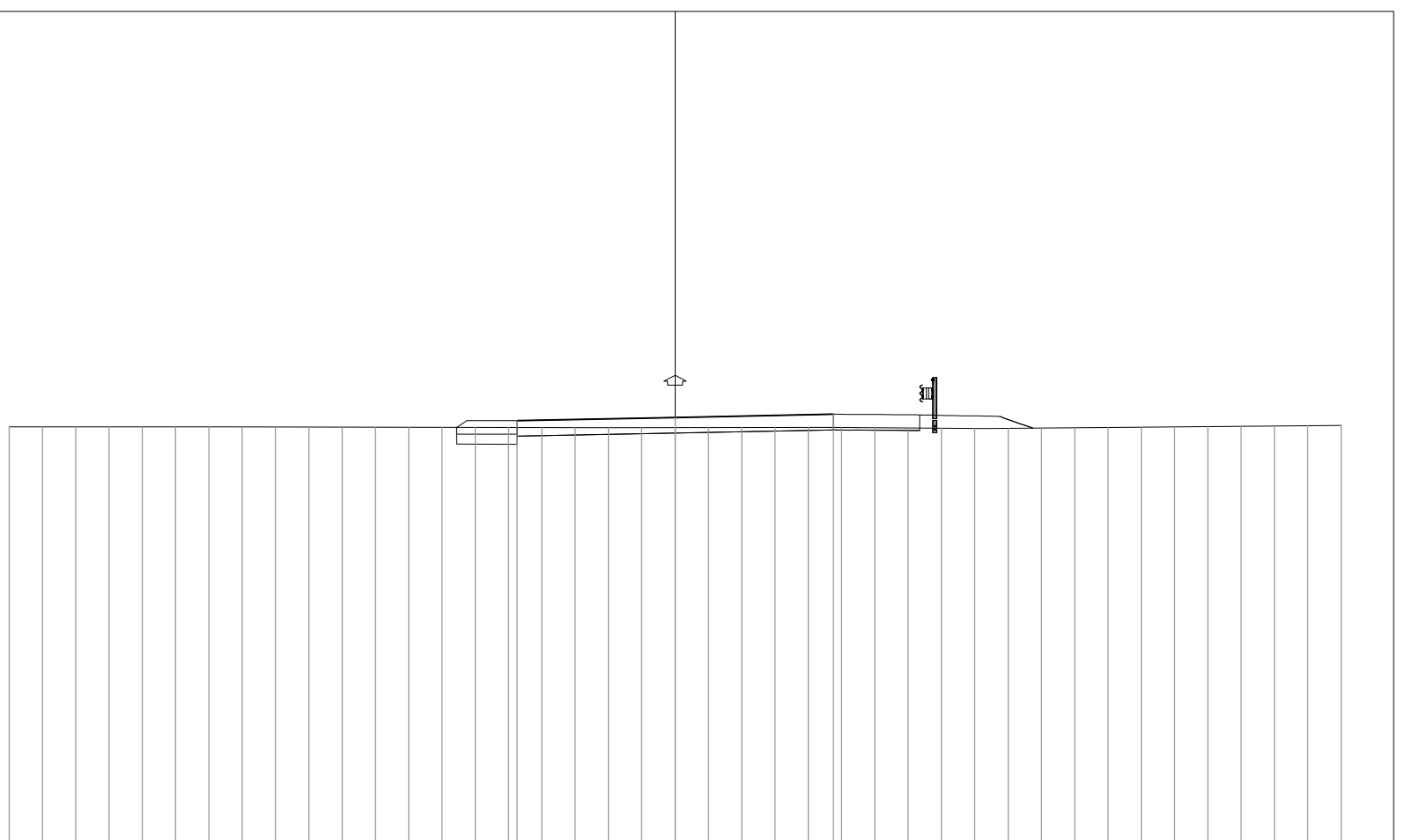

DISTANZE PROGRESSIVE  
PROGETTO

-4.75

0.00

4.75

DISTANZE PARZIALI  
PROGETTO

4.75

4.75

QUOTE  
PROGETTO

121.90

122.00

122.09

DISTANZE PROGRESSIVE  
TERRENO

-20.00

-19.00

-18.00

-17.00

-16.00

-15.00

-14.00

-13.00

-12.00

-11.00

-10.00

-9.00

-8.00

-7.00

-6.00

-5.00

-4.00

-3.00

-2.00

-1.00

0.00

1.00

2.00

3.00

4.00

5.00

6.00

7.00

8.00

9.00

10.00

11.00

12.00

13.00

14.00

15.00

16.00

17.00

18.00

19.00

20.00

DISTANZE PARZIALI  
TERRENO

1.00

1.00

1.00

1.00

1.00

1.00

1.00

1.00

1.00

1.00

1.00

1.00

1.00

1.00

1.00

1.00

1.00

1.00

1.00

1.00

1.00

1.00

1.00

1.00

1.00

1.00

1.00

1.00

1.00

1.00

1.00

1.00

1.00

1.00

1.00

1.00

1.00

1.00

QUOTE  
TERRENO

121.71

121.71

121.71

121.71

121.71

121.71

121.71

121.71

121.71

121.70

121.70

121.70

121.70

121.70

121.70

121.69

121.69

121.69

121.69

121.69

121.69

121.70

121.70

121.70

121.70

121.70

121.69

121.68

121.67

121.67

121.67

121.68

121.69

121.70

121.71

121.71

121.72

121.73

121.74

121.75

121.76





PROFILO Rota\_Alba

SEZIONE 12

PROGRESSIVA 220.00

STERRI E RIPORTI  
S1 0.02 mq.  
S2 3.48 mq.  
Totale S: 3.50 mq.  
R1 0.00 mq.  
R2 0.33 mq.  
Totale R: 0.33 mq.  
SCOTICO  
E1 0.36 mq.  
E2 0.24 mq.  
Totale: 0.60 mq.  
BONIFICA  
F1 0.54 mq.  
F2 0.38 mq.  
Totale: 0.92 mq.  
USURA  
a1 9.50 ml.  
PREPARAZIONE PIANO DI POSA  
f1 9.50 ml.

109



200

200

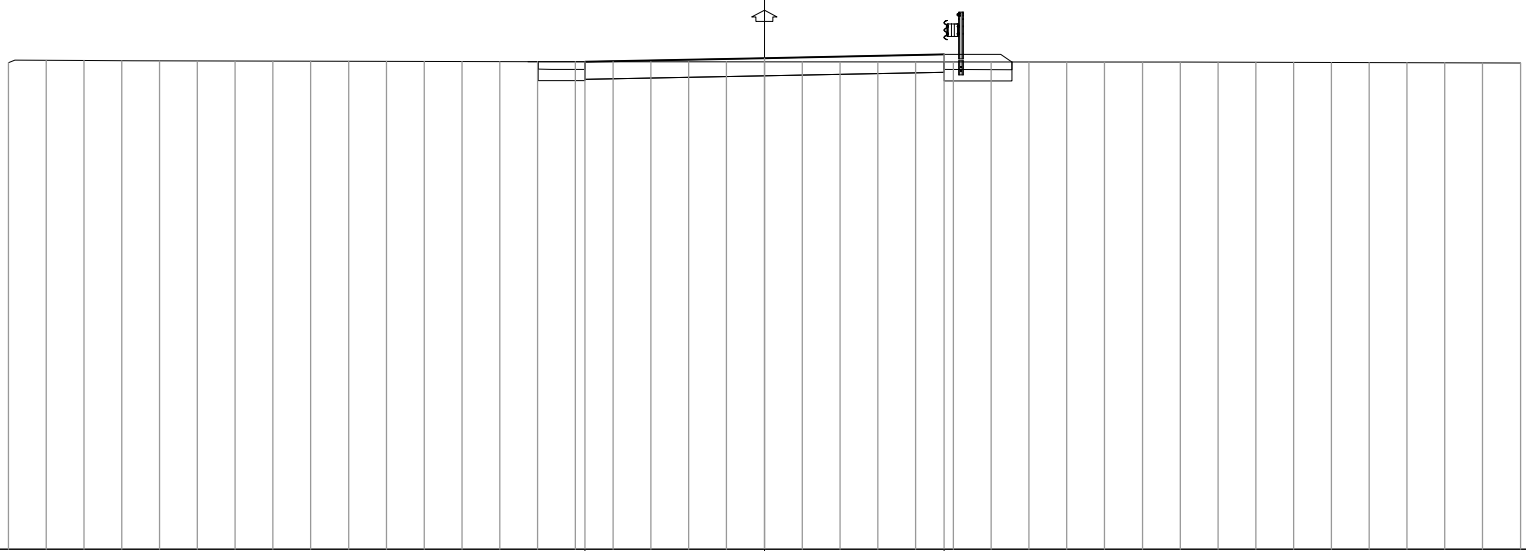

DISTANZE PROGRESSIVE  
PROGETTO

-4.75                              0.00                              4.75

DISTANZE PARZIALI  
PROGETTO

4.75                              4.75

QUOTE  
PROGETTO

121.90                              122.00                              122.09

DISTANZE PROGRESSIVE  
TERRENO

-20.00   -19.00   -18.00   -17.00   -16.00   -15.00   -14.00   -13.00   -12.00   -11.00   -10.00   -9.00   -8.00   -7.00   -6.00   -5.00   -4.00   -3.00   -2.00   -1.00   0.00   1.00   2.00   3.00   4.00   5.00   6.00   7.00   8.00   9.00   10.00   11.00   12.00   13.00   14.00   15.00   16.00   17.00   18.00   19.00   20.00

DISTANZE PARZIALI  
TERRENO

1.00   1.00

QUOTE  
TERRENO

121.88   121.94   121.93   121.92   121.92   121.92   121.92   121.92   121.91   121.91   121.91   121.91   121.91   121.90   121.90   121.90   121.90   121.90   121.89   121.89   121.89   121.89   121.89   121.89   121.89   121.89   121.89   121.88   121.88   121.88   121.87   121.87   121.87   121.87

PROFILO Rota\_Alba

SEZIONE 13

PROGRESSIVA 240.00

STERRI E RIPORTI

S1 3.35 mq.

R1 0.03 mq.

R2 1.18 mq.

Totale R: 1.21 mq.

SCOTICO

E1 0.98 mq.

E2 0.31 mq.

Totale: 1.29 mq.

BONIFICA

F1 1.47 mq.

F2 0.46 mq.

Totale: 1.93 mq.

USURA

a1 9.50 ml.

PREPARAZIONE PIANO DI POSA

f1 9.50 ml.

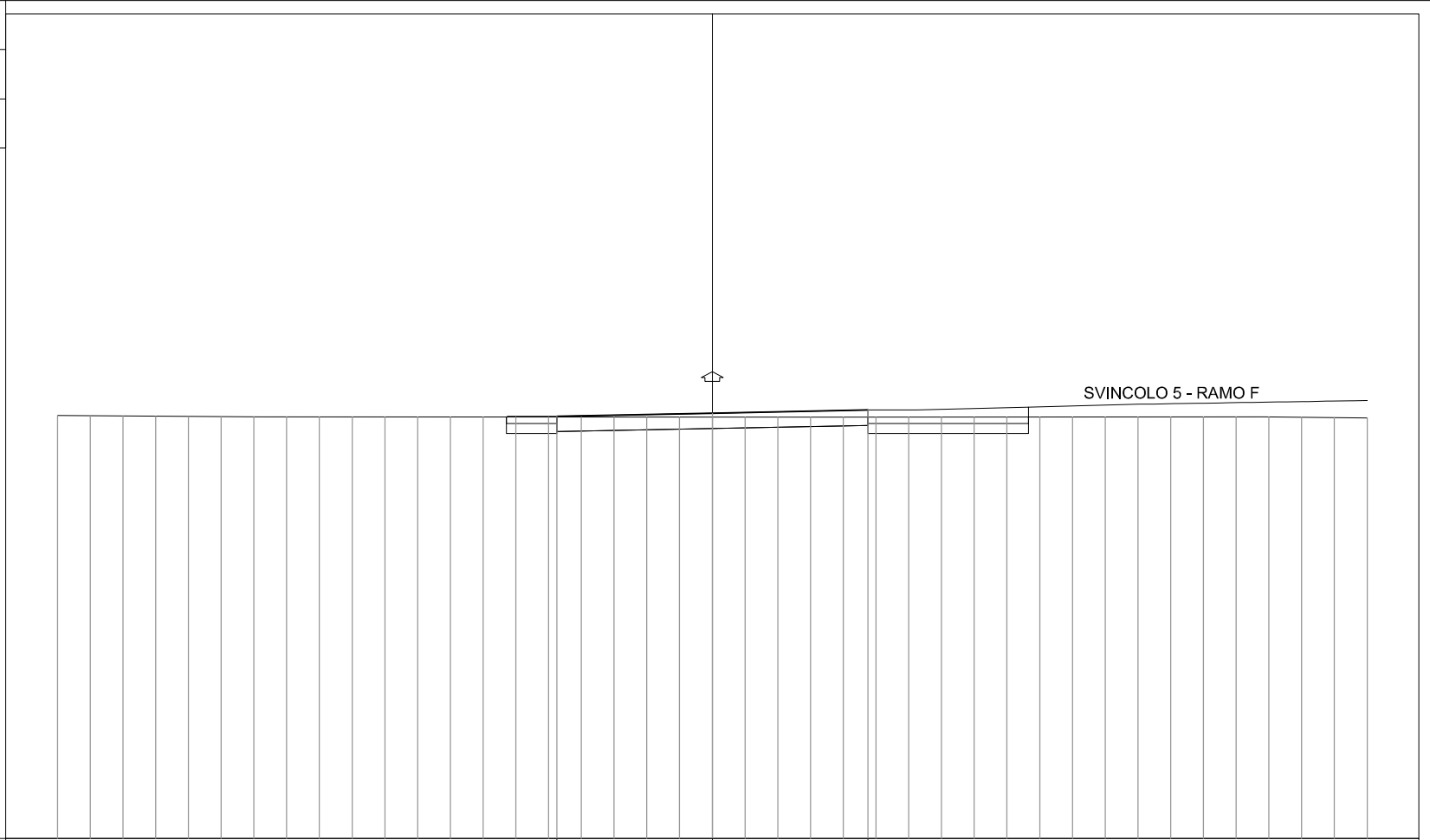

200

DISTANZE PROGRESSIVE  
PROGETTO

-4.75

0.00

4.75

DISTANZE PARZIALI  
PROGETTO

4.75

4.75

QUOTE  
PROGETTO

121.90

122.00

122.09

DISTANZE PROGRESSIVE  
TERRENO

-20.00

-19.00

-18.00

-17.00

-16.00

-15.00

-14.00

-13.00

-12.00

-11.00

-10.00

-9.00

-8.00

-7.00

-6.00

-5.00

-4.00

-3.00

-2.00

-1.00

0.00

1.00

2.00

3.00

4.00

5.00

6.00

7.00

8.00

9.00

10.00

11.00

12.00

13.00

14.00

15.00

16.00

17.00

18.00

19.00

20.00

DISTANZE PARZIALI  
TERRENO

1.00

1.00

1.00

1.00

1.00

1.00

1.00

1.00

1.00

1.00

1.00

1.00

1.00

1.00

1.00

1.00

1.00

1.00

1.00

1.00

1.00

1.00

1.00

1.00

1.00

1.00

1.00

1.00

1.00

1.00

1.00

1.00

1.00

1.00

1.00

1.00

QUOTE  
TERRENO

121.92

121.92

121.91

121.90

121.90

121.89

121.88

121.88

121.88

121.88

121.88

121.88

121.88

121.88

121.88

121.88

121.88

121.88

121.88

121.88

121.88

121.88

121.88

121.88

121.88

121.88

121.88

121.88

121.88

121.88

121.88

121.88

121.87

121.86

121.85

PROFILO Rota\_Alba

SEZIONE 14

PROGRESSIVA 260.00

STERRI E RIPORTI

S1 2.97 mq.

R1 0.09 mq.

R2 0.42 mq.

Totale R: 0.51 mq.

SCOTICO

E1 0.37 mq.

E2 0.32 mq.

Totale: 0.69 mq.

BONIFICA

F1 0.56 mq.

F2 0.48 mq.

Totale: 1.04 mq.

USURA

a1 9.50 ml.

PREPARAZIONE PIANO DI POSA

f1 9.50 ml.

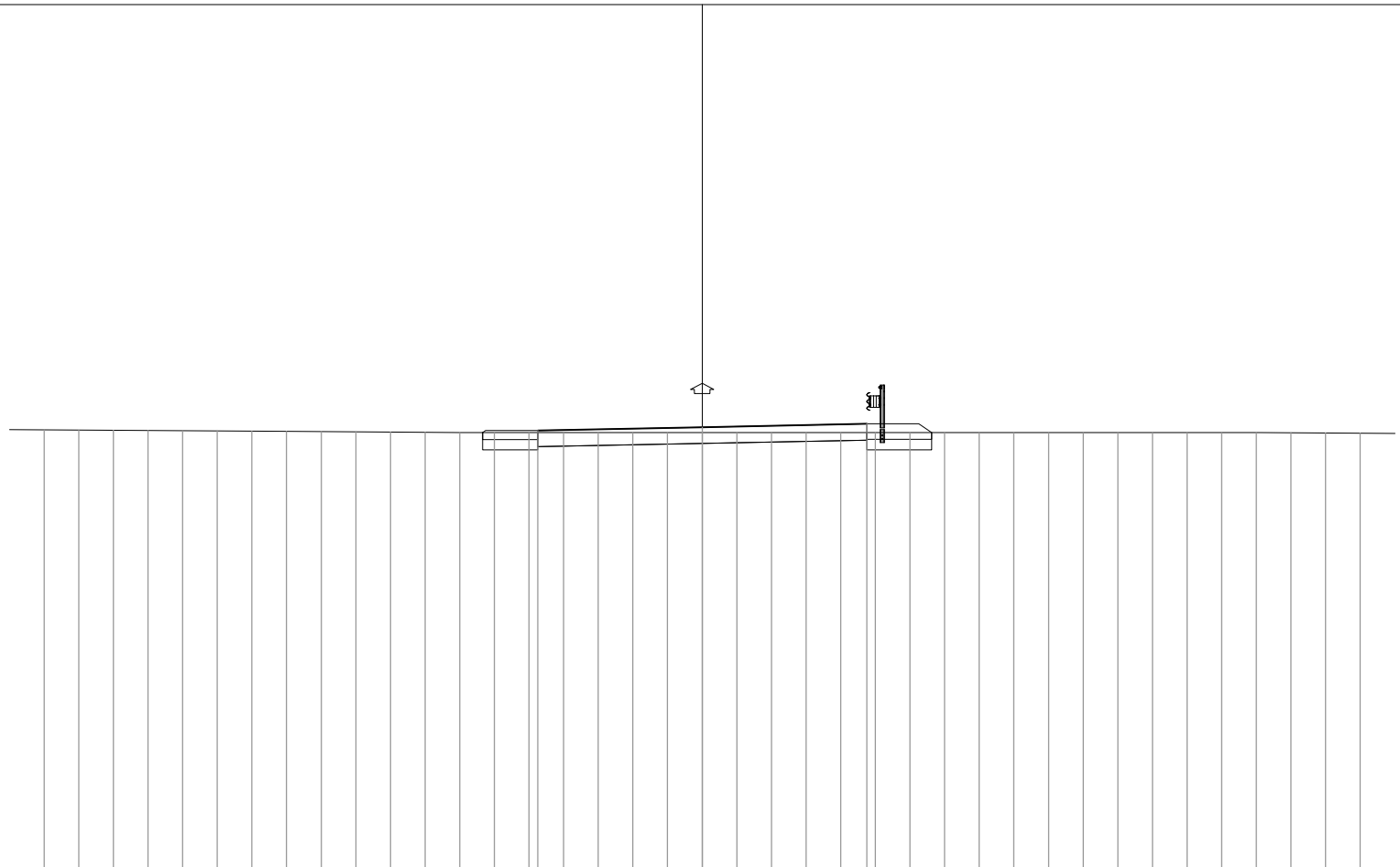

109

200

DISTANZE PROGRESSIVE  
PROGETTO

-4.75

0.00

4.75

DISTANZE PARZIALI  
PROGETTO

4.75

4.75

QUOTE  
PROGETTO

121.90

122.00

122.09

DISTANZE PROGRESSIVE  
TERRENO

-19.00

-18.00

-17.00

-16.00

-15.00

-14.00

-13.00

-12.00

-11.00

-10.00

-9.00

-8.00

-7.00

-6.00

-5.00

-4.00

-3.00

-2.00

-1.00

0.00

1.00

2.00

3.00

4.00

5.00

6.00

7.00

8.00

9.00

10.00

11.00

12.00

13.00

14.00

15.00

16.00

17.00

18.00

19.00

DISTANZE PARZIALI  
TERRENO

1.00

1.00

1.00

1.00

1.00

1.00

1.00

1.00

1.00

1.00

1.00

1.00

1.00

1.00

1.00

1.00

1.00

1.00

1.00

1.00

1.00

1.00

1.00

1.00

1.00

1.00

1.00

1.00

1.00

1.00

1.00

1.00

1.00

1.00

1.00

1.00

1.00

QUOTE  
TERRENO

121.92

121.91

121.91

121.90

121.90

121.89

121.88

121.88

121.87

121.86

121.86

121.85

121.84

121.84

121.84

121.84

121.84

121.84

121.84

121.84

121.84

121.84

121.84

121.84

121.84

121.84

121.84

121.84

121.84

121.84

121.84

121.84

121.84

121.84

121.83

121.82



PROFILO Rota\_Alba

SEZIONE 15

PROGRESSIVA 280.00

STERRI E RIPORTI

S1 2.97 mq.

R1 0.05 mq.

R2 0.42 mq.

Totale R: 0.47 mq.

SCOTICO

E1 0.38 mq.

E2 0.31 mq.

Totale: 0.69 mq.

BONIFICA

F1 0.56 mq.

F2 0.46 mq.

Totale: 1.02 mq.

USURA

a1 9.50 ml.

f1 9.50 ml.

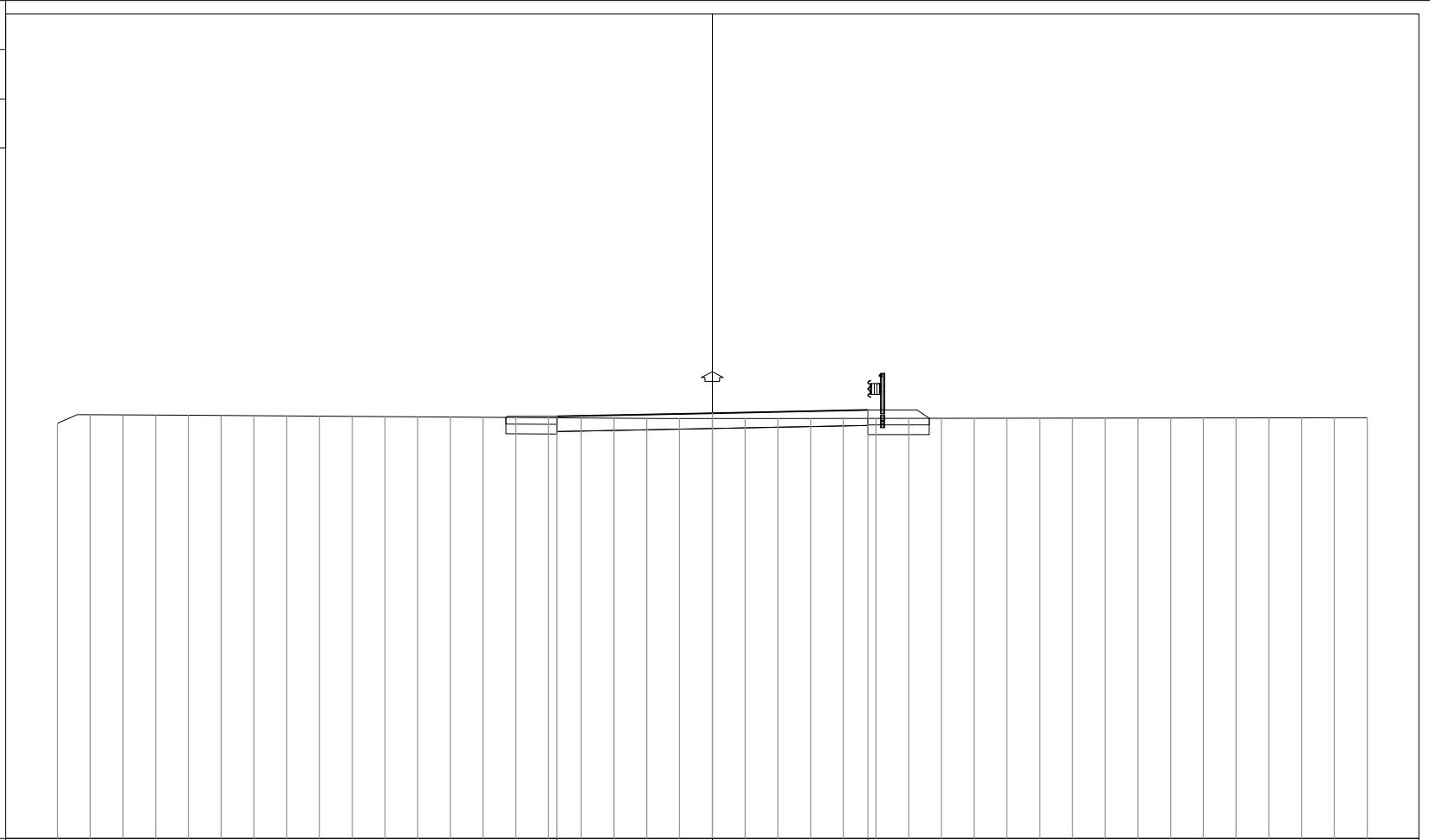

109

200

DISTANZE PROGRESSIVE  
PROGETTO

-4.75

0.00

4.75

DISTANZE PARZIALI  
PROGETTO

4.75

4.75

QUOTE  
PROGETTO

121.90

122.00

122.09

DISTANZE PROGRESSIVE  
TERRENO

-20.00

-19.00

-18.00

-17.00

-16.00

-15.00

-14.00

-13.00

-12.00

-11.00

-10.00

-9.00

-8.00

-7.00

-6.00

-5.00

-4.00

-3.00

-2.00

-1.00

0.00

1.00

2.00

3.00

4.00

5.00

6.00

7.00

8.00

9.00

10.00

11.00

12.00

13.00

14.00

15.00

16.00

17.00

18.00

19.00

20.00

DISTANZE PARZIALI  
TERRENO

1.00

1.00

1.00

1.00

1.00

1.00

1.00

1.00

1.00

1.00

1.00

1.00

1.00

1.00

1.00

1.00

1.00

1.00

1.00

1.00

1.00

1.00

1.00

1.00

1.00

1.00

1.00

1.00

1.00

1.00

1.00

1.00

1.00

1.00

1.00

1.00

1.00

1.00

1.00

1.00

QUOTE  
TERRENO

121.69

121.95

121.94

121.94

121.93

121.93

121.92

121.91

121.91

121.90

121.89

121.89

121.88

121.87

121.87

121.86

121.85

121.84

121.84

121.83

121.83

121.83

121.84

121.84

121.84

121.84

121.84

121.85

121.85

121.85

121.85

121.85

121.85

121.85

121.85

121.85

121.85

121.85

121.86



*Sezioni trasversali*  
*Ramo A*

PROFILO Ramo\_A

SEZIONE 1

PROGRESSIVA 0.00

PREPARAZIONE PIANO DI POSA  
f1 9.50 ml.

ROTATORIA SVINCOLO 5

109

200  
200

DISTANZE PROGRESSIVE  
PROGETTO

DISTANZE PARZIALI  
PROGETTO

QUOTE  
PROGETTO

DISTANZE PROGRESSIVE  
TERRENO

DISTANZE PARZIALI  
TERRENO

QUOTE  
TERRENO

121.60	-20.00
121.60	1.00
121.60	-19.00
121.60	1.00
121.60	-18.00
121.60	1.00
121.60	-17.00
121.60	1.00
121.60	-16.00
121.60	1.00
121.60	-15.00
121.60	1.00
121.60	-14.00
121.60	1.00
121.60	-13.00
121.60	1.00
121.60	-12.00
121.60	1.00
121.60	-11.00
121.60	1.00
121.60	-10.00
121.60	1.00
121.60	-9.00
121.60	1.00
121.60	-8.00
121.60	1.00
121.60	-7.00
121.60	1.00
121.61	-6.00
121.61	1.00
121.61	-5.00
121.61	1.00
121.61	-4.00
121.61	1.00
121.61	-3.00
121.61	1.00
121.61	-2.00
121.61	1.00
121.62	-1.00
121.62	1.00
121.63	0.00
121.63	1.00
121.65	1.00
121.65	1.00
121.66	2.00
121.66	1.00
121.67	3.00
121.67	1.00
121.69	4.00
121.69	1.00
121.70	5.00
121.70	1.00
121.71	6.00
121.71	1.00
121.72	7.00
121.72	1.00
121.72	8.00
121.72	1.00
121.73	9.00
121.73	1.00
121.74	10.00
121.74	1.00
121.74	11.00
121.74	1.00
121.75	12.00
121.75	1.00
121.76	13.00
121.76	1.00
121.76	14.00
121.76	1.00
121.77	15.00
121.77	1.00
121.77	16.00
121.77	1.00
121.77	17.00
121.77	1.00
121.77	18.00
121.77	1.00
121.76	19.00



PROFILO Ramo\_A

SEZIONE 3

PROGRESSIVA 21.39

STERRI E RIPORTI

S1 0.01 mq.

R1 3.54 mq.

R2 0.80 mq.

Totale R: 4.34 mq.

SCOTICO

E1 0.43 mq.

E2 1.77 mq.

Totale: 2.20 mq.

BONIFICA

F1 0.63 mq.

F2 2.65 mq.

Totale: 3.28 mq.

USURA

a1 5.00 ml.

PREPARAZIONE PIANO DI POSA

f1 0.26 ml.

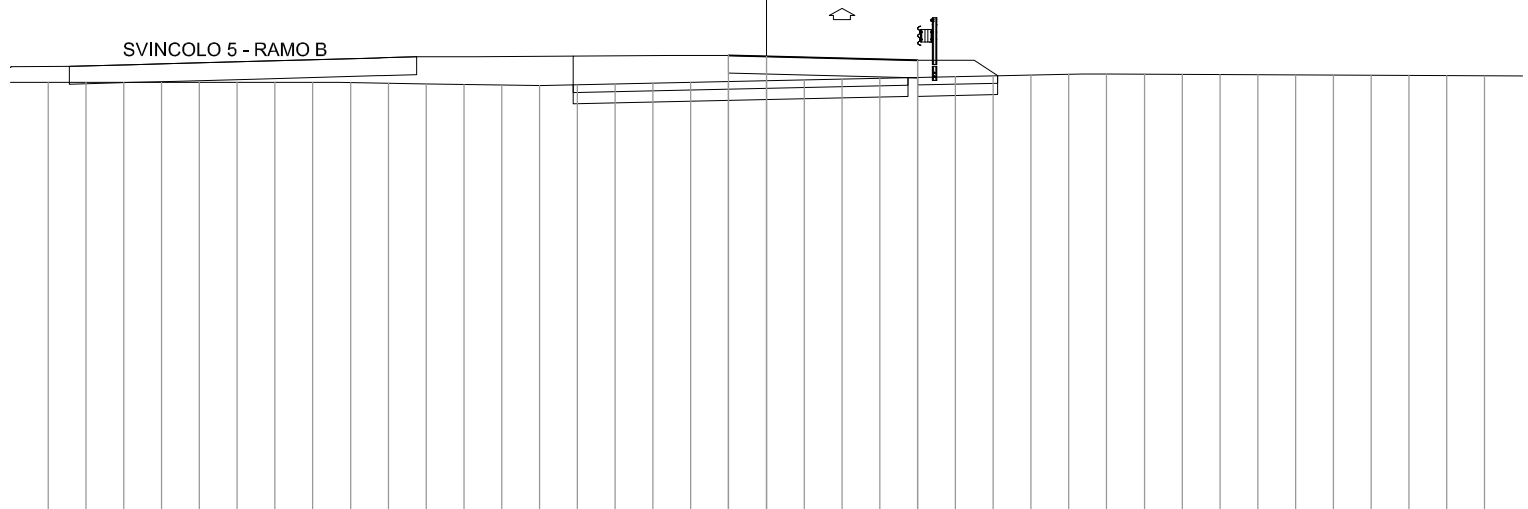

DISTANZE PROGRESSIVE PROGETTO

-1.00  
0.00

4.00

DISTANZE PARZIALI PROGETTO

1.00

4.00

QUOTE PROGETTO

122.30  
122.28

122.18

DISTANZE PROGRESSIVE TERRENO

-19.00  
-18.00  
-17.00  
-16.00  
-15.00  
-14.00  
-13.00  
-12.00  
-11.00  
-10.00  
-9.00  
-8.00  
-7.00  
-6.00  
-5.00  
-4.00  
-3.00  
-2.00  
-1.00  
0.00  
1.00  
2.00  
3.00  
4.00  
5.00  
6.00  
7.00  
8.00  
9.00  
10.00  
11.00  
12.00  
13.00  
14.00  
15.00  
16.00  
17.00  
18.00  
19.00

DISTANZE PARZIALI TERRENO

1.00  
1.00  
1.00  
1.00  
1.00  
1.00  
1.00  
1.00  
1.00  
1.00  
1.00  
1.00  
1.00  
1.00  
1.00  
1.00  
1.00  
1.00  
1.00  
1.00  
1.00  
1.00  
1.00  
1.00  
1.00  
1.00  
1.00  
1.00  
1.00  
1.00  
1.00  
1.00  
1.00  
1.00  
1.00  
1.00  
1.00  
1.00

QUOTE TERRENO

121.58  
121.58  
121.58  
121.58  
121.59  
121.59  
121.59  
121.59  
121.58  
121.56  
121.54  
121.53  
121.51  
121.50  
121.52  
121.54  
121.56  
121.59  
121.61  
121.63  
121.65  
121.67  
121.70  
121.72  
121.74  
121.76  
121.78  
121.80  
121.81  
121.80  
121.80  
121.79  
121.79  
121.78  
121.78  
121.77  
121.77  
121.76



110  
200

200









PROFILO Ramo\_A

SEZIONE 7

PROGRESSIVA 86.05

STERRI E RIPORTI  
R1 4.47 mq.  
SCOTICO  
E1 1.59 mq.  
BONIFICA  
F1 2.40 mq.  
USURA  
α1 5.18 ml.

110  
▼

200  
200

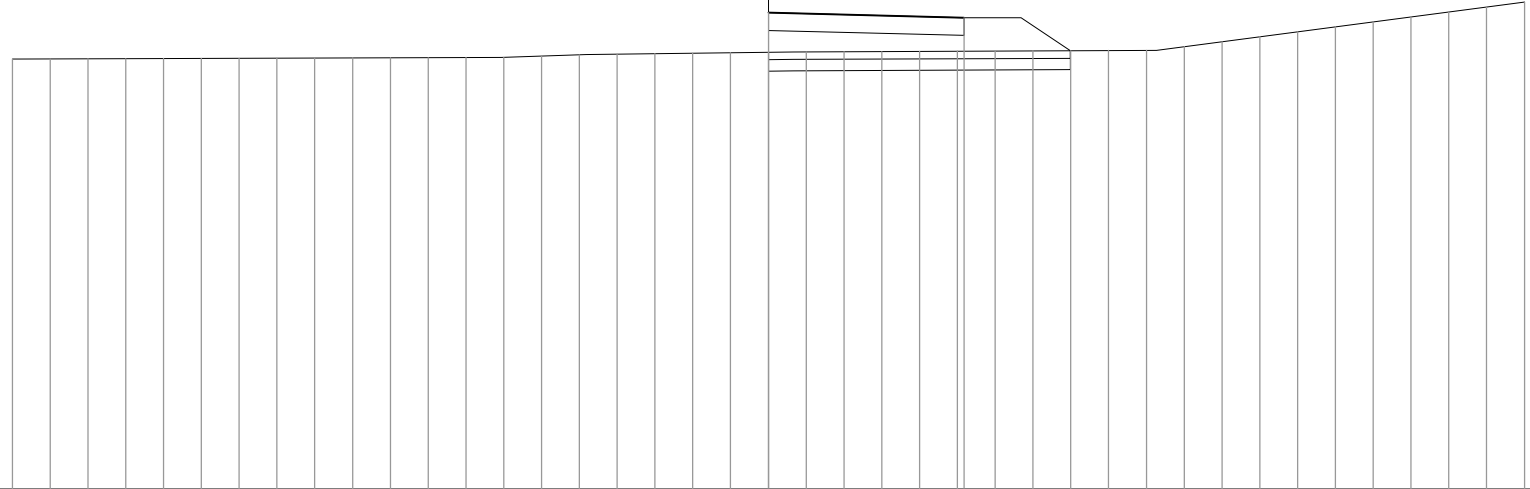

DISTANZE PROGRESSIVE  
PROGETTO

0.00

5.18

DISTANZE PARZIALI  
PROGETTO

5.18

QUOTE  
PROGETTO

122.61

122.48

DISTANZE PROGRESSIVE  
TERRENO

121.38

-20.00

121.39

-19.00

121.39

-18.00

121.39

-17.00

121.40

-16.00

121.40

-15.00

121.40

-14.00

121.41

-13.00

121.41

-12.00

121.41

-11.00

121.41

-10.00

121.42

-9.00

121.42

-8.00

121.43

-7.00

121.43

-6.00

121.46

-5.00

121.50

-4.00

121.51

-3.00

121.52

-2.00

121.54

-1.00

121.55

0.00

121.56

1.00

121.57

2.00

121.58

3.00

121.58

4.00

121.59

5.00

121.59

6.00

121.60

7.00

121.60

8.00

121.61

9.00

121.61

10.00

121.61

11.00

121.71

12.00

121.84

13.00

121.97

14.00

122.11

15.00

122.24

16.00

122.37

17.00

122.50

18.00

122.63

19.00

122.76

20.00

122.89

QUOTE  
TERRENO

121.38

1.00

121.39

1.00

121.39

1.00

121.39

1.00

121.40

1.00

121.40

1.00

121.40

1.00

121.41

1.00

121.41

1.00

121.41

1.00

121.42

1.00

121.42

1.00

121.42

1.00

121.43

1.00

121.43

1.00

121.46

1.00

121.50

1.00

121.51

1.00

121.52

1.00

121.54

1.00

121.55

1.00

121.56

1.00

121.57

1.00

121.58

1.00

121.58

1.00

121.59

1.00

121.59

1.00

121.60

1.00

121.60

1.00

121.61

1.00

121.61

1.00

121.61

1.00

121.71

1.00

121.84

1.00

121.97

1.00

122.11

1.00

122.24

1.00

122.37

1.00

122.50

1.00

122.63

1.00

122.76

1.00

122.89

PROFILO Ramo\_A

SEZIONE 8

PROGRESSIVA 91.60

STERRI E RIPORTI

R1	4.71 mq.
SCOTICO	
E1	1.62 mq.
BONIFICA	
F1	2.43 mq.
USURA	
α1	5.25 ml.

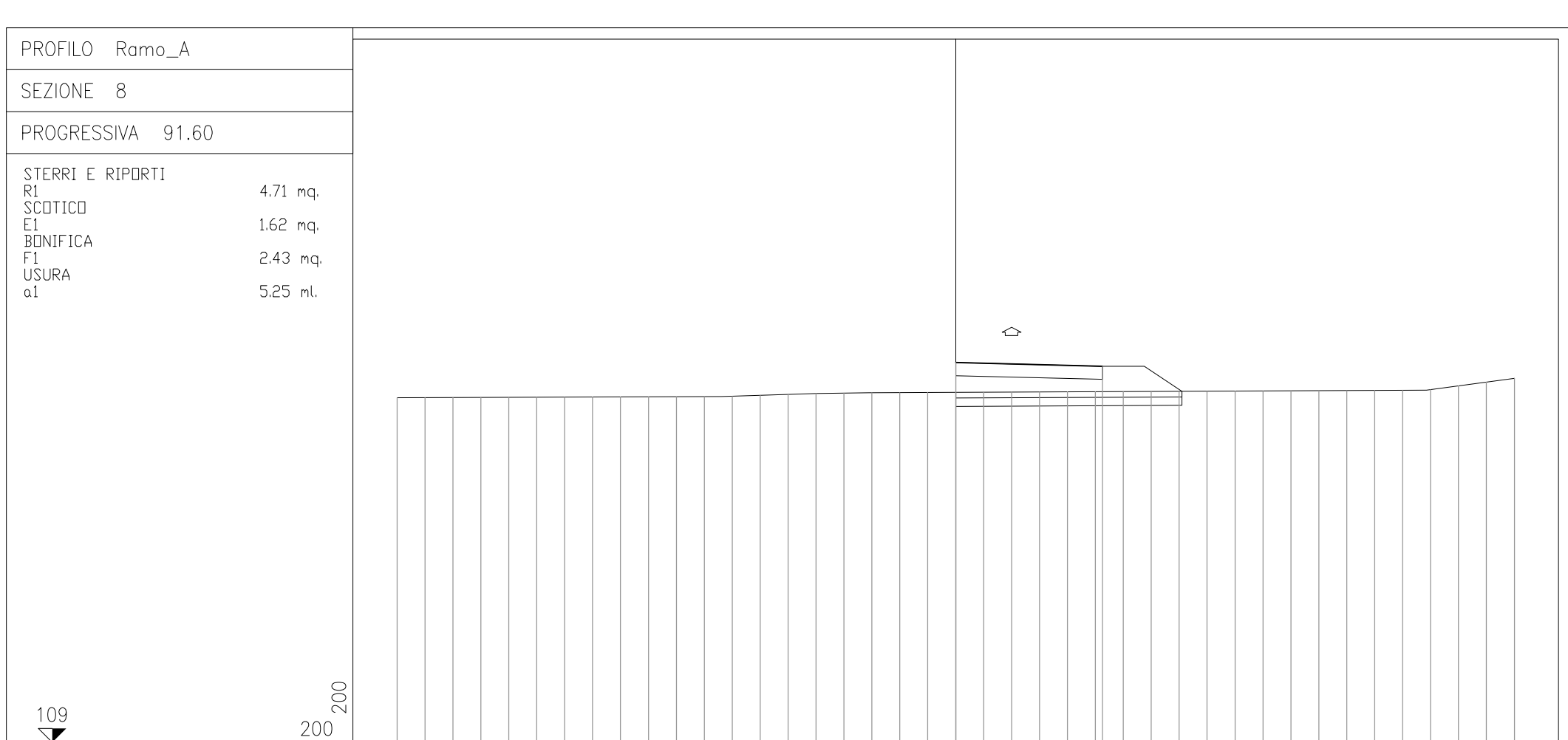

200

DISTANZE PROGRESSIVE  
PROGETTO

0.00

5.25

DISTANZE PARZIALI  
PROGETTO

5.25

QUOTE  
PROGETTO

122.61

122.48

DISTANZE PROGRESSIVE  
TERRENO

-20.00

-19.00

-18.00

-17.00

-16.00

-15.00

-14.00

-13.00

-12.00

-11.00

-10.00

-9.00

-8.00

-7.00

-6.00

-5.00

-4.00

-3.00

-2.00

-1.00

0.00

1.00

2.00

3.00

4.00

5.00

6.00

7.00

8.00

9.00

10.00

11.00

12.00

13.00

14.00

15.00

16.00

17.00

18.00

19.00

20.00

DISTANZE PARZIALI  
TERRENO

1.00

1.00

1.00

1.00

1.00

1.00

1.00

1.00

1.00

1.00

1.00

1.00

1.00

1.00

1.00

1.00

1.00

1.00

1.00

1.00

1.00

1.00

1.00

1.00

1.00

1.00

1.00

1.00

1.00

1.00

1.00

1.00

1.00

1.00

1.00

1.00

1.00

1.00

1.00

1.00

1.00

1.00

1.00

1.00

1.00

1.00

1.00

QUOTE  
TERRENO

121.35

121.35

121.36

121.36

121.36

121.37

121.37

121.37

121.38

121.38

121.39

121.39

121.40

121.44

121.47

121.50

121.51

121.53

121.53

121.54

121.54

121.54

121.55

121.55

121.56

121.56

121.57

121.57

121.58

121.58

121.59

121.59

121.60

121.60

121.60

121.61

121.61

121.64

121.77

121.91

122.04

*Sezioni trasversali*  
*Ramo B*

PROFILO Ramo\_B

SEZIONE 1

PROGRESSIVA 0.00

STERRI E RIPORTI

R1 6.38 mq.  
 SCOTICO  
 E1 1.87 mq.  
 BONIFICA  
 F1 2.81 mq.  
 USURA  
 α1 6.18 ml.

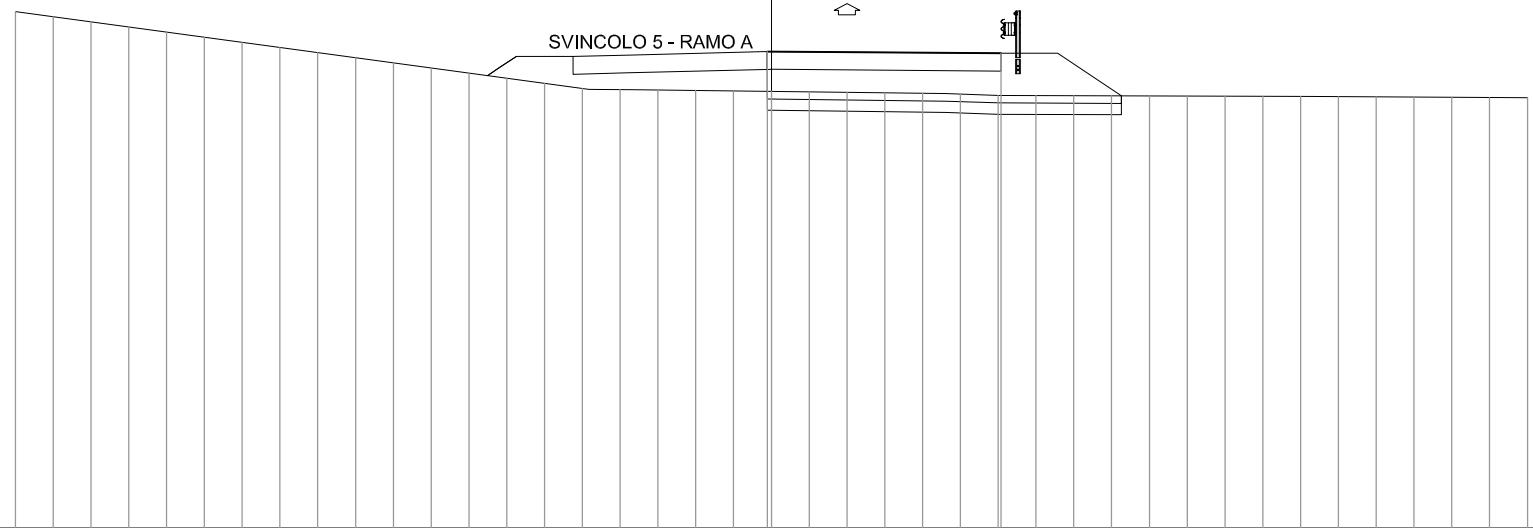

SVINCOLO 5 - RAMO A



200  
200

DISTANZE PROGRESSIVE  
PROGETTO

-0.11

6.07

DISTANZE PARZIALI  
PROGETTO

6.18

QUOTE  
PROGETTO

122.61

122.57

DISTANZE PROGRESSIVE  
TERRENO

-20.00

-19.00

-18.00

-17.00

-16.00

-15.00

-14.00

-13.00

-12.00

-11.00

-10.00

-9.00

-8.00

-7.00

-6.00

-5.00

-4.00

-3.00

-2.00

-1.00

0.00

1.00

2.00

3.00

4.00

5.00

6.00

7.00

8.00

9.00

10.00

11.00

12.00

13.00

14.00

15.00

16.00

17.00

18.00

19.00

20.00

DISTANZE PARZIALI  
TERRENO

1.00

1.00

1.00

1.00

1.00

1.00

1.00

1.00

1.00

1.00

1.00

1.00

1.00

1.00

1.00

1.00

1.00

1.00

1.00

1.00

1.00

1.00

1.00

1.00

1.00

1.00

1.00

1.00

1.00

1.00

1.00

1.00

1.00

1.00

1.00

1.00

1.00

1.00

1.00

1.00

1.00

1.00

QUOTE  
TERRENO

123.67

123.63

123.40

123.26

123.13

122.99

122.86

122.72

122.59

122.45

122.32

122.18

122.04

121.91

121.77

121.64

121.61

121.60

121.59

121.57

121.56

121.55

121.53

121.52

121.51

121.49

121.46

121.45

121.45

121.44

121.44

121.44

121.43

121.43

121.43

121.42

121.41

121.41

121.40

121.40

121.39





PROFILO Ramo\_B

SEZIONE 4

PROGRESSIVA 45.47

STERRI E RIPORTI

R1	4.86 mq.
R2	0.11 mq.
R3	1.24 mq.
Totale R:	6.21 mq.
SCOTICO	
E1	2.80 mq.
BONIFICA	
F1	4.22 mq.
USURA	
α1	9.00 ml.

SVINCOLO 5 - RAMO A



200  
200

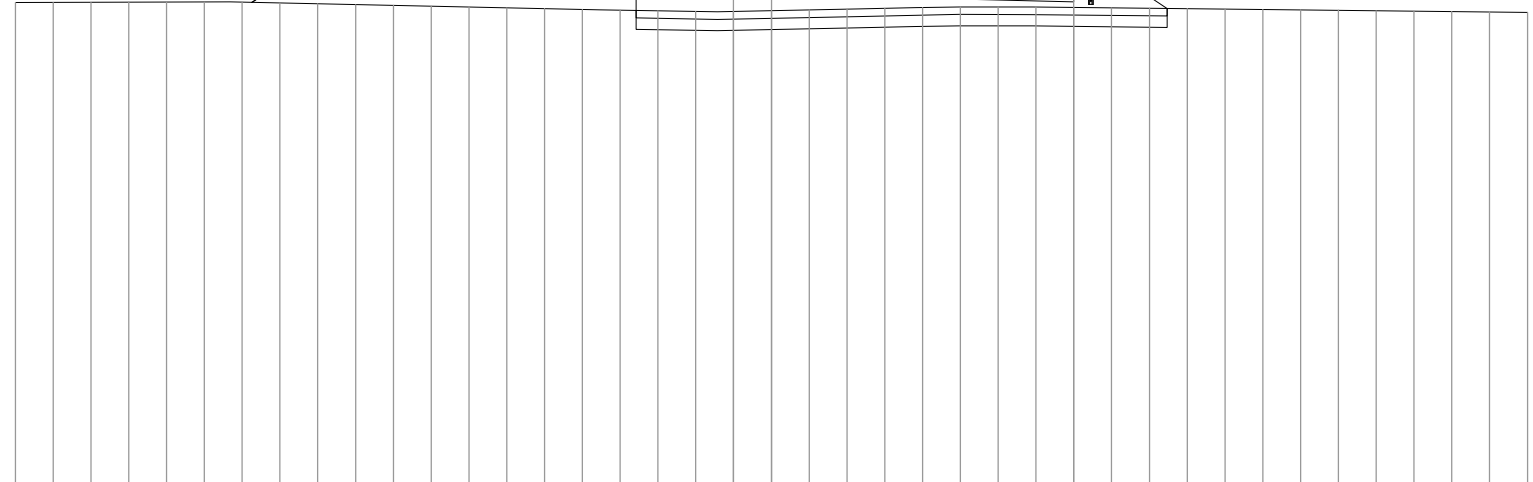

DISTANZE PROGRESSIVE  
PROGETTO

-1.00  
0.00  
8.00

DISTANZE PARZIALI  
PROGETTO

1.00  
8.00

QUOTE  
PROGETTO

122.46  
122.43  
122.23

DISTANZE PROGRESSIVE  
TERRENO

-20.00 -19.00 -18.00 -17.00 -16.00 -15.00 -14.00 -13.00 -12.00 -11.00 -10.00 -9.00 -8.00 -7.00 -6.00 -5.00 -4.00 -3.00 -2.00 -1.00 0.00 1.00 2.00 3.00 4.00 5.00 6.00 7.00 8.00 9.00 10.00 11.00 12.00 13.00 14.00 15.00 16.00 17.00 18.00 19.00 20.00

DISTANZE PARZIALI  
TERRENO

1.00 1.00

QUOTE  
TERRENO

121.75 121.75 121.75 121.75 121.76 121.76 121.75 121.73 121.71 121.69 121.67 121.65 121.63 121.61 121.59 121.56 121.55 121.53 121.51 121.51 121.53 121.55 121.57 121.59 121.61 121.63 121.63 121.62 121.61 121.60 121.58 121.57 121.56 121.55 121.54 121.53 121.52 121.51 121.50 121.49



PROFILO Ramo\_B

SEZIONE 5

PROGRESSIVA 60.00

STERRI E RIPORTI

S1 0.01 mq.  
R1 3.12 mq.  
R2 0.91 mq.  
R3 0.82 mq.  
Totale R: 4.85 mq.

SCDTICO

E1 0.43 mq.  
E2 2.47 mq.  
Totale: 2.90 mq.

BONIFICA

F1 0.65 mq.  
F2 3.67 mq.  
Totale: 4.32 mq.

USURA

a1 9.00 ml.

PREPARAZIONE PIANI DI POSA

f1 0.81 ml.

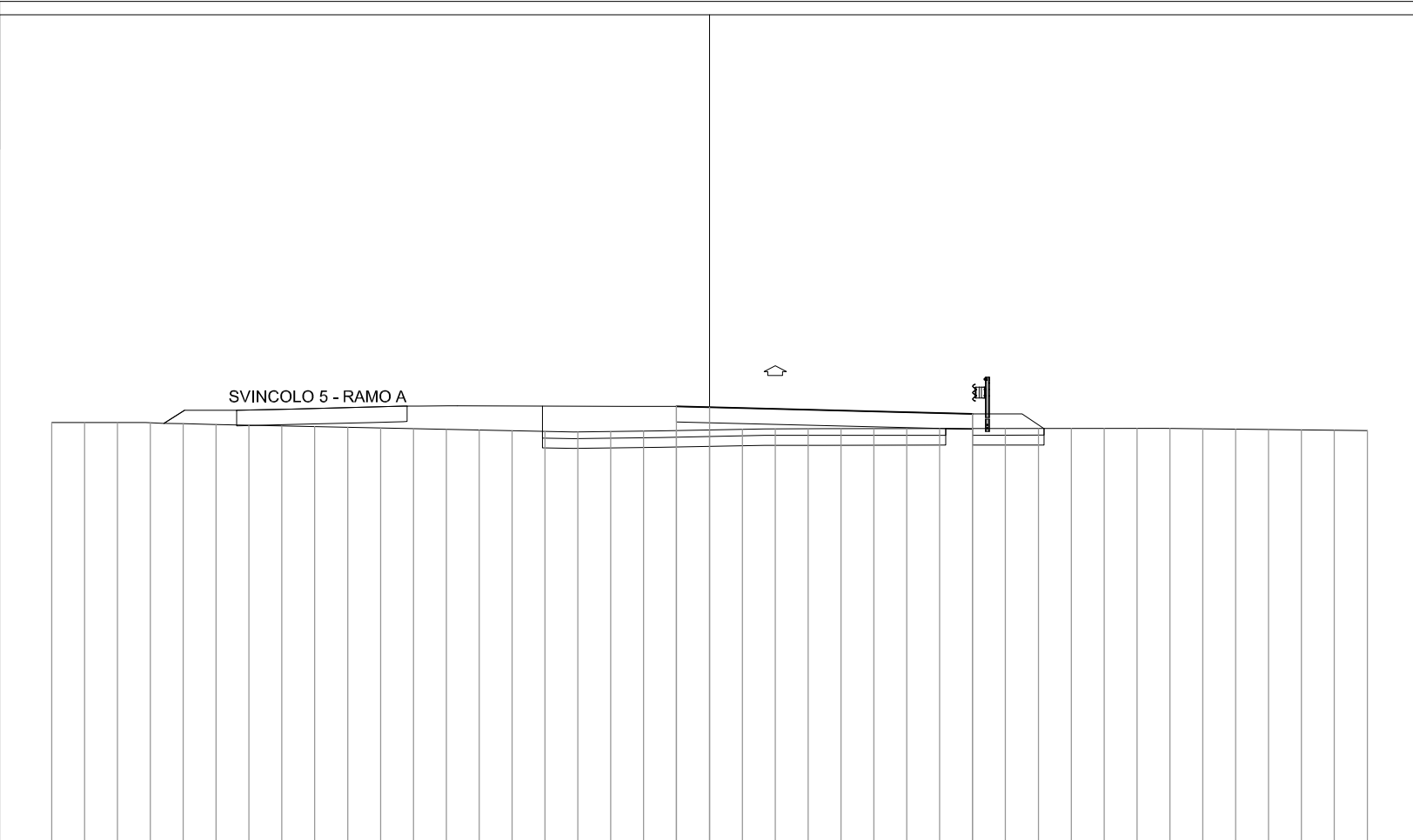

DISTANZE PROGRESSIVE PROGETTO																								-1.00	0.00																								8.00
DISTANZE PARZIALI PROGETTO																								1.00																								8.00	
QUOTE PROGETTO																								122.28	122.25																								122.05
DISTANZE PROGRESSIVE TERRENO	-20.00	-19.00	-18.00	-17.00	-16.00	-15.00	-14.00	-13.00	-12.00	-11.00	-10.00	-9.00	-8.00	-7.00	-6.00	-5.00	-4.00	-3.00	-2.00	-1.00	0.00	1.00	2.00	3.00	4.00	5.00	6.00	7.00	8.00	9.00	10.00	11.00	12.00	13.00	14.00	15.00	16.00	17.00	18.00	19.00	20.00								
DISTANZE PARZIALI TERRENO	1.00	1.00	1.00	1.00	1.00	1.00	1.00	1.00	1.00	1.00	1.00	1.00	1.00	1.00	1.00	1.00	1.00	1.00	1.00	1.00	1.00	1.00	1.00	1.00	1.00	1.00	1.00	1.00	1.00	1.00	1.00	1.00	1.00	1.00	1.00	1.00	1.00	1.00	1.00	1.00	1.00	1.00	1.00	1.00	1.00				
QUOTE TERRENO	121.79	121.79	121.79	121.78	121.75	121.73	121.71	121.69	121.67	121.65	121.63	121.60	121.58	121.56	121.54	121.52	121.50	121.51	121.53	121.55	121.57	121.59	121.60	121.60	121.60	121.60	121.60	121.60	121.60	121.60	121.61	121.61	121.61	121.61	121.61	121.61	121.60	121.59	121.58	121.57	121.56	121.55							

PROFILO Ramo\_B

SEZIONE 6

PROGRESSIVA 67.28

STERRI E RIPORTI

S1	0.36 mq.
S2	0.39 mq.
S3	0.40 mq.
S4	0.16 mq.
<b>Totale S:</b>	<b>1.31 mq.</b>
R1	0.67 mq.
R2	0.52 mq.
<b>Totale R:</b>	<b>1.19 mq.</b>
<b>SCOTICO</b>	
E1	0.41 mq.
E2	0.30 mq.
<b>Totale:</b>	<b>0.71 mq.</b>
<b>BONIFICA</b>	
F1	0.60 mq.
F2	0.45 mq.
<b>Totale:</b>	<b>1.05 mq.</b>
<b>USURA</b>	
a1	9.00 ml.
<b>PREPARAZIONE PIANO DI POSA</b>	
f1	9.00 ml.

109



200  
200

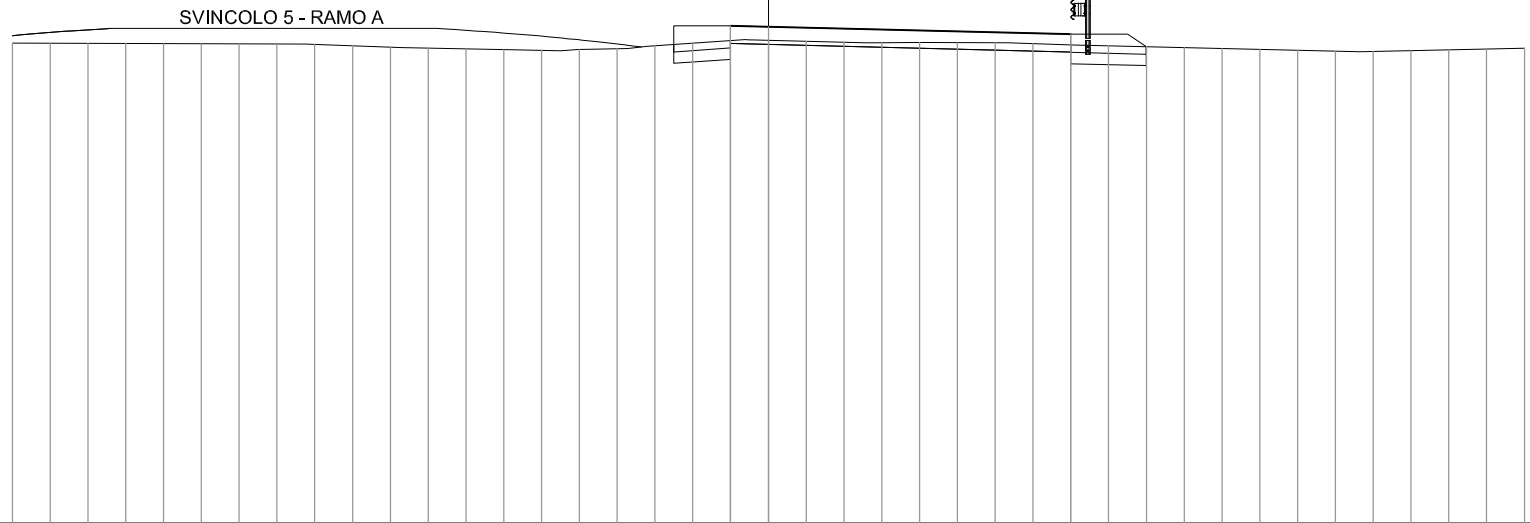

SVINCOLO 5 - RAMO A



DISTANZE PROGRESSIVE  
PROGETTO

-1.00 0.00 8.00

DISTANZE PARZIALI  
PROGETTO

1.00 8.00

QUOTE  
PROGETTO

122.17 122.14 121.94

DISTANZE PROGRESSIVE  
TERRENO

-20.00 -19.00 -18.00 -17.00 -16.00 -15.00 -14.00 -13.00 -12.00 -11.00 -10.00 -9.00 -8.00 -7.00 -6.00 -5.00 -4.00 -3.00 -2.00 -1.00 0.00 1.00 2.00 3.00 4.00 5.00 6.00 7.00 8.00 9.00 10.00 11.00 12.00 13.00 14.00 15.00 16.00 17.00 18.00 19.00 20.00

DISTANZE PARZIALI  
TERRENO

1.00 1.00

QUOTE  
TERRENO

121.70 121.70 121.70 121.69 121.69 121.69 121.68 121.68 121.67 121.63 121.60 121.57 121.55 121.53 121.51 121.53 121.56 121.63 121.70 121.78 121.78 121.75 121.73 121.71 121.72 121.72 121.71 121.69 121.66 121.63 121.61 121.59 121.56 121.54 121.52 121.49 121.48 121.51 121.53 121.55 121.57

PROFILO Ramo\_B

SEZIONE 7

PROGRESSIVA 71.85

STERRI E RIPORTI

S1 0.08 mq.  
 R1 0.26 mq.  
 R2 0.70 mq.  
 Totale R: 0.96 mq.

SCOTICO

E1 0.42 mq.  
 E2 0.55 mq.  
 Totale: 0.97 mq.

BONIFICA

F1 0.63 mq.  
 F2 0.83 mq.  
 Totale: 1.46 mq.

USURA

a1 5.64 ml.  
 PREPARAZIONE PIANO DI POSA  
 f1 2.88 ml.

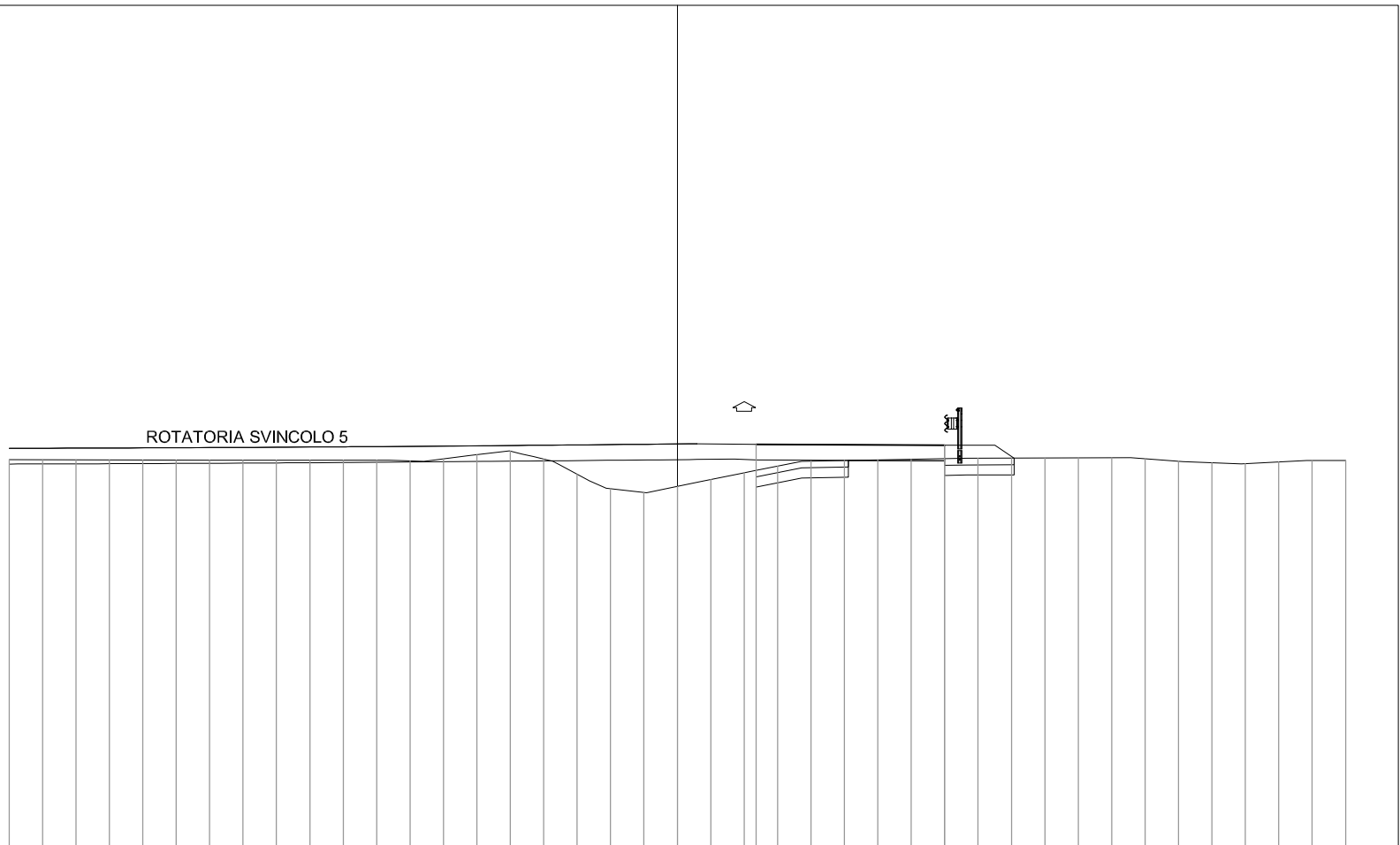

DISTANZE PROGRESSIVE PROGETTO		2.36	8.00
-------------------------------	--	------	------

DISTANZE PARZIALI PROGETTO		5.64	
----------------------------	--	------	--

QUOTE PROGETTO		122.06	122.03
----------------	--	--------	--------

DISTANZE PROGRESSIVE TERRENO	-20.00	-19.00	-18.00	-17.00	-16.00	-15.00	-14.00	-13.00	-12.00	-11.00	-10.00	-9.00	-8.00	-7.00	-6.00	-5.00	-4.00	-3.00	-2.00	-1.00	0.00	1.00	2.00	3.00	4.00	5.00	6.00	7.00	8.00	9.00	10.00	11.00	12.00	13.00	14.00	15.00	16.00	17.00	18.00	19.00	20.00
------------------------------	--------	--------	--------	--------	--------	--------	--------	--------	--------	--------	--------	-------	-------	-------	-------	-------	-------	-------	-------	-------	------	------	------	------	------	------	------	------	------	------	-------	-------	-------	-------	-------	-------	-------	-------	-------	-------	-------

DISTANZE PARZIALI TERRENO	1.00	1.00	1.00	1.00	1.00	1.00	1.00	1.00	1.00	1.00	1.00	1.00	1.00	1.00	1.00	1.00	1.00	1.00	1.00	1.00	1.00	1.00	1.00	1.00	1.00	1.00	1.00	1.00	1.00	1.00	1.00	1.00	1.00	1.00	1.00	1.00	1.00	1.00	1.00	1.00	1.00	1.00	1.00
---------------------------	------	------	------	------	------	------	------	------	------	------	------	------	------	------	------	------	------	------	------	------	------	------	------	------	------	------	------	------	------	------	------	------	------	------	------	------	------	------	------	------	------	------	------

QUOTE TERRENO	121.60	121.59	121.59	121.59	121.59	121.58	121.58	121.58	121.58	121.58	121.58	121.58	121.56	121.62	121.75	121.85	121.61	121.16	120.73	120.61	120.80	121.00	121.20	121.41	121.55	121.57	121.59	121.61	121.62	121.64	121.64	121.65	121.65	121.66	121.63	121.55	121.50	121.47	121.53	121.57	121.57
---------------	--------	--------	--------	--------	--------	--------	--------	--------	--------	--------	--------	--------	--------	--------	--------	--------	--------	--------	--------	--------	--------	--------	--------	--------	--------	--------	--------	--------	--------	--------	--------	--------	--------	--------	--------	--------	--------	--------	--------	--------	--------

PROFILO Ramo\_B

SEZIONE 8

PROGRESSIVA 76.41

ROTATORIA SVINCOLO 5

110

200  
200

DISTANZE PROGRESSIVE  
PROGETTO

DISTANZE PARZIALI  
PROGETTO

QUOTE  
PROGETTO

DISTANZE PROGRESSIVE  
TERRENO

DISTANZE PARZIALI  
TERRENO

QUOTE  
TERRENO

121.58	-20.00
121.58	1.00
121.58	-19.00
121.58	1.00
121.58	-18.00
121.58	1.00
121.57	-17.00
121.57	1.00
121.57	-16.00
121.57	1.00
121.57	-15.00
121.57	1.00
121.57	-14.00
121.57	1.00
121.56	-13.00
121.56	1.00
121.56	-12.00
121.64	-11.00
121.76	-10.00
121.85	-9.00
121.69	-8.00
121.39	-7.00
120.91	-6.00
120.86	-5.00
121.55	-4.00
121.88	-3.00
121.88	-2.00
121.88	-1.00
121.88	0.00
121.88	1.00
121.88	2.00
121.88	3.00
121.88	4.00
121.32	5.00
120.69	6.00
120.87	7.00
121.18	8.00
121.50	9.00
121.57	10.00
121.60	11.00
121.61	12.00
121.62	13.00
121.63	14.00
121.64	15.00
121.55	16.00
121.48	17.00
121.53	18.00
121.57	19.00
121.57	20.00

*Sezioni trasversali*  
*Ramo C*

PROFILO Ramo\_C

SEZIONE 1

PROGRESSIVA 0.00

200  
200



ROTATORIA SVINCOLO 5



DISTANZE PROGRESSIVE  
PROGETTO

DISTANZE PARZIALI  
PROGETTO

QUOTE  
PROGETTO

DISTANZE PROGRESSIVE  
TERRENO

DISTANZE PARZIALI  
TERRENO

QUOTE  
TERRENO

121.68	-20.00
121.68	1.00
121.68	-19.00
121.68	1.00
121.67	-18.00
121.67	1.00
121.67	-17.00
121.67	1.00
121.67	-16.00
121.67	1.00
121.66	-15.00
121.66	1.00
121.66	-14.00
121.66	1.00
121.66	-13.00
121.66	1.00
121.65	-12.00
121.65	1.00
121.65	-11.00
121.65	1.00
121.65	-10.00
121.65	1.00
121.65	-9.00
121.64	-8.00
121.64	1.00
121.64	-7.00
121.64	1.00
121.64	-6.00
121.64	1.00
121.64	-5.00
121.63	-4.00
121.63	1.00
121.63	-3.00
121.63	1.00
121.62	-2.00
121.62	1.00
121.62	-1.00
121.62	1.00
121.62	0.00
121.62	1.00
121.62	2.00
121.61	3.00
121.61	1.00
121.61	4.00
121.61	1.00
121.61	5.00
121.61	1.00
121.61	6.00
121.61	1.00
121.60	7.00
121.60	1.00
121.60	8.00
121.60	1.00
121.60	9.00
121.60	1.00
121.60	10.00
121.60	1.00
121.60	11.00
121.60	1.00
121.60	12.00
121.60	1.00
121.60	13.00
121.60	1.00
121.60	14.00
121.60	1.00
121.60	15.00
121.59	1.00
121.59	16.00
121.59	1.00
121.59	17.00
121.59	1.00
121.59	18.00
121.59	1.00
121.59	19.00
121.59	1.00
121.59	20.00



PROFILO Ramo\_C

SEZIONE 3

PROGRESSIVA 14.44

STERRI E RIPORTI

R1	2.42 mq.
SCOTICO	
E1	1.79 mq.
BONIFICA	
F1	2.69 mq.
USURA	
α1	5.00 ml.

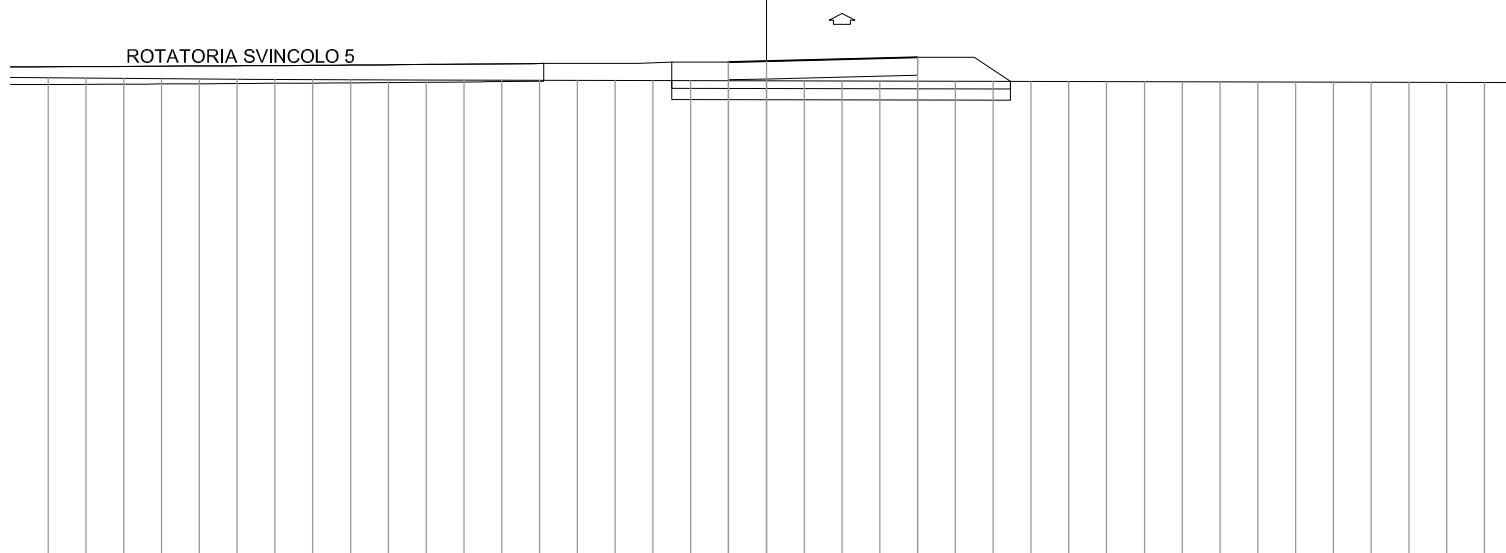

DISTANZE PROGRESSIVE  
PROGETTO

-1.00  
0.00  
4.00

DISTANZE PARZIALI  
PROGETTO

1.00  
4.00

QUOTE  
PROGETTO

122.13  
122.15  
122.25

DISTANZE PROGRESSIVE  
TERRENO

-19.00  
-18.00  
-17.00  
-16.00  
-15.00  
-14.00  
-13.00  
-12.00  
-11.00  
-10.00  
-9.00  
-8.00  
-7.00  
-6.00  
-5.00  
-4.00  
-3.00  
-2.00  
-1.00  
0.00  
1.00  
2.00  
3.00  
4.00  
5.00  
6.00  
7.00  
8.00  
9.00  
10.00  
11.00  
12.00  
13.00  
14.00  
15.00  
16.00  
17.00  
18.00  
19.00

DISTANZE PARZIALI  
TERRENO

1.00  
1.00  
1.00  
1.00  
1.00  
1.00  
1.00  
1.00  
1.00  
1.00  
1.00  
1.00  
1.00  
1.00  
1.00  
1.00  
1.00  
1.00  
1.00  
1.00  
1.00  
1.00  
1.00  
1.00  
1.00  
1.00  
1.00  
1.00  
1.00  
1.00  
1.00  
1.00  
1.00  
1.00  
1.00  
1.00  
1.00  
1.00

QUOTE  
TERRENO

121.72  
121.71  
121.70  
121.69  
121.68  
121.67  
121.67  
121.66  
121.66  
121.66  
121.65  
121.65  
121.65  
121.64  
121.64  
121.64  
121.64  
121.64  
121.64  
121.63  
121.63  
121.63  
121.63  
121.62  
121.62  
121.62  
121.62  
121.61  
121.61  
121.61  
121.61  
121.61  
121.60  
121.60  
121.60  
121.60  
121.59  
121.59



PROFILO Ramo\_C

SEZIONE 4

PROGRESSIVA 27.59

STERRI E RIPORTI

R1	0.65 mq.
R2	1.84 mq.
Totale R:	2.49 mq.
SCOTICO	
E1	1.62 mq.
BONIFICA	
F1	2.43 mq.
USURA	
a1	4.59 ml.

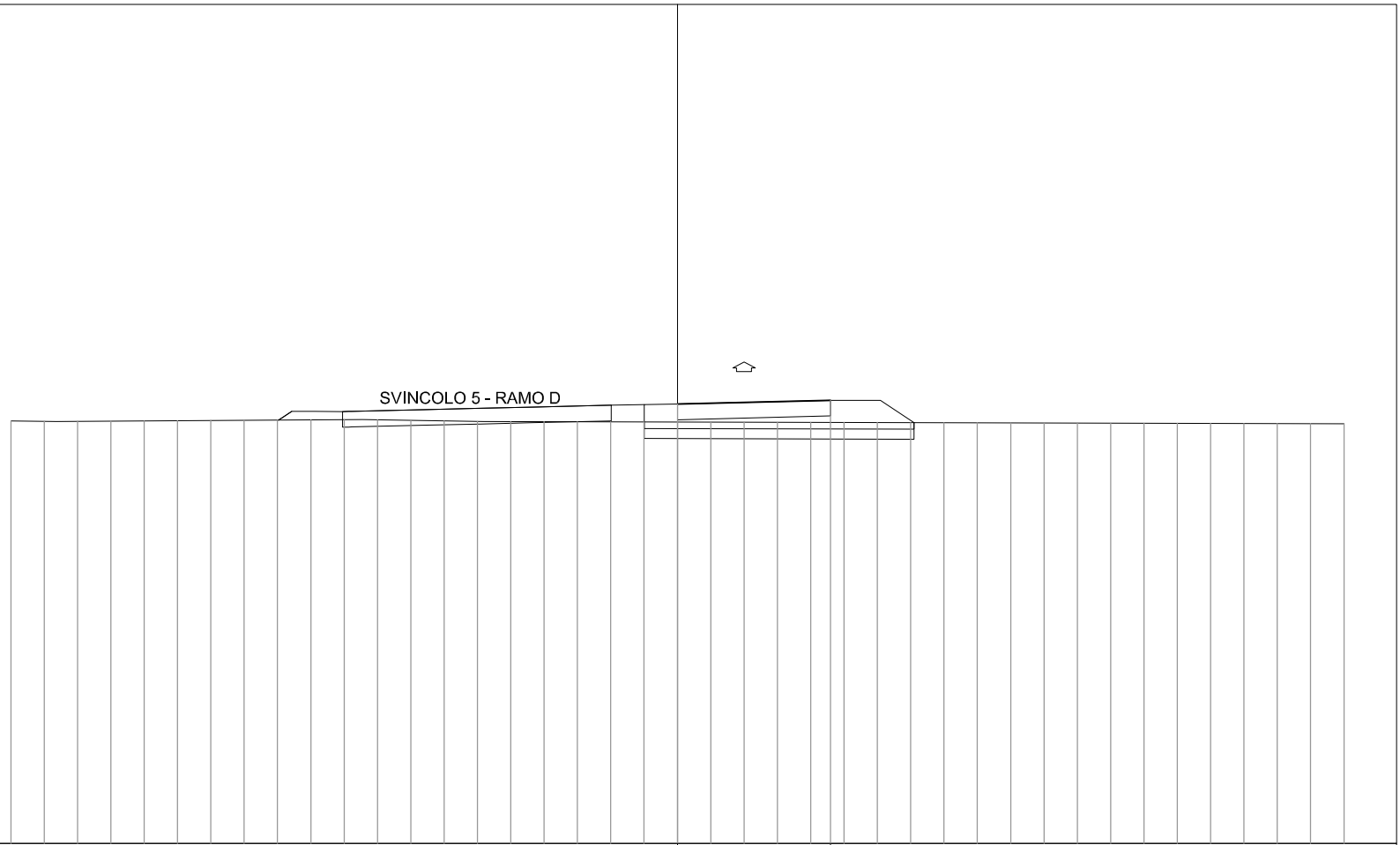

200

DISTANZE PROGRESSIVE  
PROGETTO

DISTANZE PARZIALI  
PROGETTO

QUOTE  
PROGETTO

DISTANZE PROGRESSIVE  
TERRENO

DISTANZE PARZIALI  
TERRENO

QUOTE  
TERRENO

	-20.00	-19.00	-18.00	-17.00	-16.00	-15.00	-14.00	-13.00	-12.00	-11.00	-10.00	-9.00	-8.00	-7.00	-6.00	-5.00	-4.00	-3.00	-2.00	-1.00	0.00	1.00	2.00	3.00	4.00	5.00	6.00	7.00	8.00	9.00	10.00	11.00	12.00	13.00	14.00	15.00	16.00	17.00	18.00	19.00	20.00			
	1.00	1.00	1.00	1.00	1.00	1.00	1.00	1.00	1.00	1.00	1.00	1.00	1.00	1.00	1.00	1.00	1.00	1.00	1.00	1.00	1.00	1.00	1.00	1.00	1.00	1.00	1.00	1.00	1.00	1.00	1.00	1.00	1.00	1.00	1.00	1.00	1.00	1.00	1.00	1.00	1.00	1.00	1.00	1.00
	121.69	121.68	121.68	121.68	121.69	121.70	121.70	121.71	121.72	121.72	121.73	121.73	121.71	121.69	121.68	121.67	121.67	121.67	121.66	121.66	121.66	121.66	121.66	121.65	121.65	121.65	121.65	121.64	121.64	121.64	121.64	121.63	121.63	121.63	121.63	121.62	121.62	121.62	121.61	121.61	121.61	121.61	121.61	121.61

0.00

4.59

4.59

122.20

122.31



*Sezioni trasversali*  
*Ramo D*

PROFILO Ramo\_D

SEZIONE 1

PROGRESSIVA 0.00

STERRI E RIPORTI  
 S1 2.52 mq.  
 USURA  
 a1 5.92 ml.  
 PREPARAZIONE PIANO DI POSA  
 f1 5.92 ml.

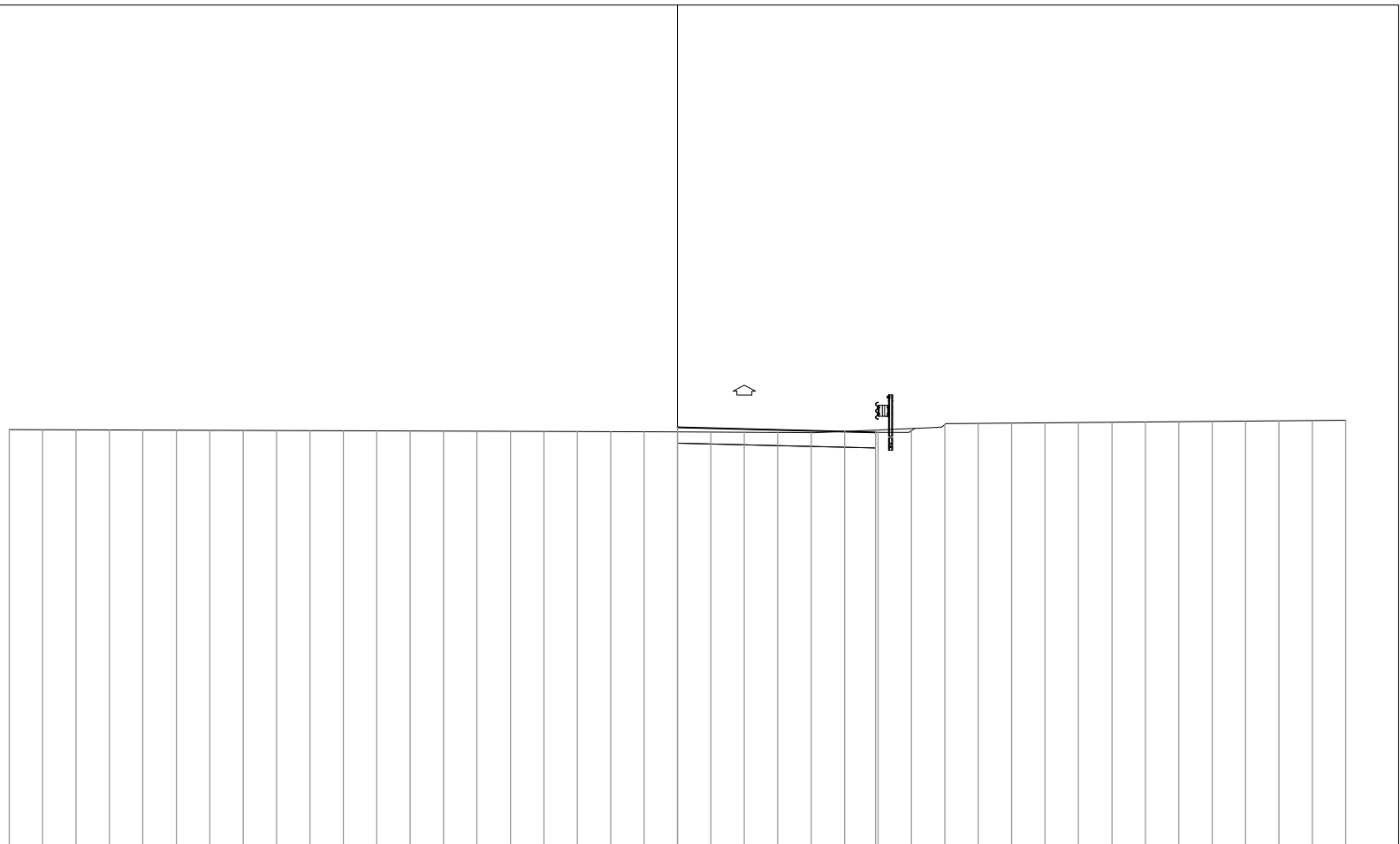

200  
 200

DISTANZE PROGRESSIVE  
PROGETTO

DISTANZE PARZIALI  
PROGETTO

QUOTE  
PROGETTO

DISTANZE PROGRESSIVE  
TERRENO

DISTANZE PARZIALI  
TERRENO

QUOTE  
TERRENO

-20.00	-19.00	-18.00	-17.00	-16.00	-15.00	-14.00	-13.00	-12.00	-11.00	-10.00	-9.00	-8.00	-7.00	-6.00	-5.00	-4.00	-3.00	-2.00	-1.00	0.00	1.00	2.00	3.00	4.00	5.00	6.00	7.00	8.00	9.00	10.00	11.00	12.00	13.00	14.00	15.00	16.00	17.00	18.00	19.00	20.00					
	1.00	1.00	1.00	1.00	1.00	1.00	1.00	1.00	1.00	1.00	1.00	1.00	1.00	1.00	1.00	1.00	1.00	1.00	1.00	1.00	1.00	1.00	1.00	1.00	1.00	1.00	1.00	1.00	1.00	1.00	1.00	1.00	1.00	1.00	1.00	1.00	1.00	1.00	1.00	1.00	1.00	1.00	1.00	1.00	1.00
121.49	121.49	121.49	121.48	121.48	121.47	121.47	121.47	121.46	121.46	121.46	121.45	121.45	121.45	121.44	121.44	121.43	121.43	121.43	121.42	121.42	121.41	121.41	121.40	121.40	121.44	121.48	121.52	121.64	121.67	121.68	121.69	121.70	121.71	121.72	121.72	121.73	121.74	121.75	121.76	121.77					

0.00

5.92

5.92

121.55

121.41

PROFILO Ramo\_D

SEZIONE 2

PROGRESSIVA 17.79

STERRI E RIPORTI	
S1	2.23 mq.
S2	0.21 mq.
Totale S:	2.44 mq.
USURA	
a1	7.68 ml.
PREPARAZIONE PIANO DI POSA	
f1	5.31 ml.

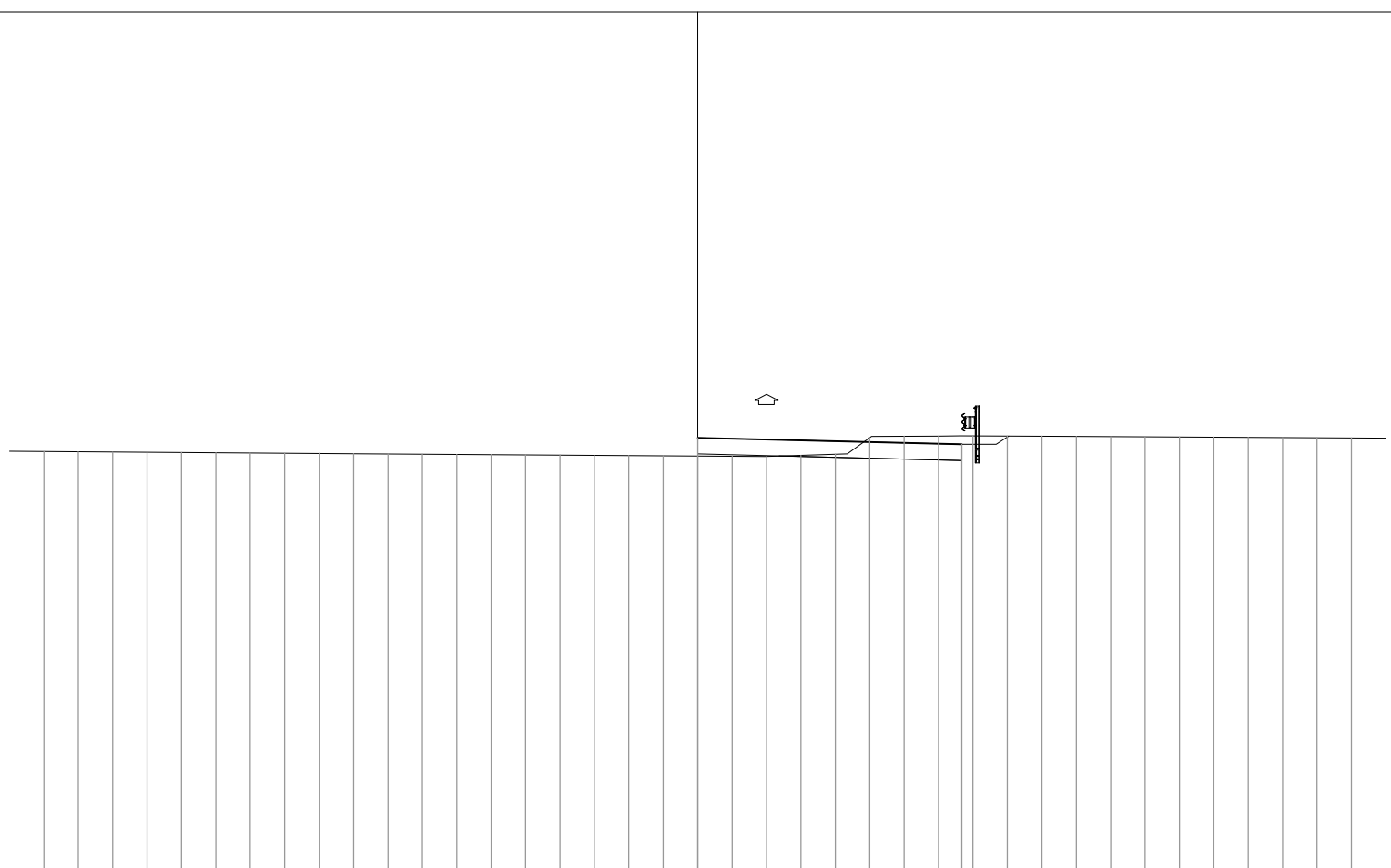

109



200

200

DISTANZE PROGRESSIVE  
PROGETTO

0.00

7.68

DISTANZE PARZIALI  
PROGETTO

7.68

QUOTE  
PROGETTO

121.81

121.62

DISTANZE PROGRESSIVE  
TERRENO

-19.00

-18.00

-17.00

-16.00

-15.00

-14.00

-13.00

-12.00

-11.00

-10.00

-9.00

-8.00

-7.00

-6.00

-5.00

-4.00

-3.00

-2.00

-1.00

0.00

1.00

2.00

3.00

4.00

5.00

6.00

7.00

8.00

9.00

10.00

11.00

12.00

13.00

14.00

15.00

16.00

17.00

18.00

19.00

DISTANZE PARZIALI  
TERRENO

1.00

1.00

1.00

1.00

1.00

1.00

1.00

1.00

1.00

1.00

1.00

1.00

1.00

1.00

1.00

1.00

1.00

1.00

1.00

1.00

1.00

1.00

1.00

1.00

1.00

1.00

1.00

1.00

1.00

1.00

1.00

1.00

1.00

1.00

1.00

1.00

1.00

1.00

QUOTE  
TERRENO

121.41

121.40

121.40

121.39

121.38

121.37

121.37

121.36

121.35

121.35

121.34

121.33

121.33

121.32

121.31

121.31

121.30

121.29

121.29

121.28

121.27

121.27

121.30

121.33

121.82

121.86

121.86

121.87

121.86

121.86

121.85

121.84

121.84

121.83

121.82

121.82

121.81

121.81

121.81

PROFILO Ramo\_D

SEZIONE 3

PROGRESSIVA 35.57

STERRI E RIPORTI

S1	0.00 mq.
S2	0.02 mq.
S3	0.73 mq.
Totale S:	0.75 mq.
R1	0.08 mq.
R2	0.00 mq.
R3	0.40 mq.
Totale R:	0.48 mq.
SCOTICO	
E1	0.47 mq.
E2	0.38 mq.
Totale:	0.85 mq.
BONIFICA	
F1	0.56 mq.
F2	0.71 mq.
Totale:	1.27 mq.
USURA	
a1	9.04 ml.
PREPARAZIONE PIANO DI POSA	
f1	6.68 ml.

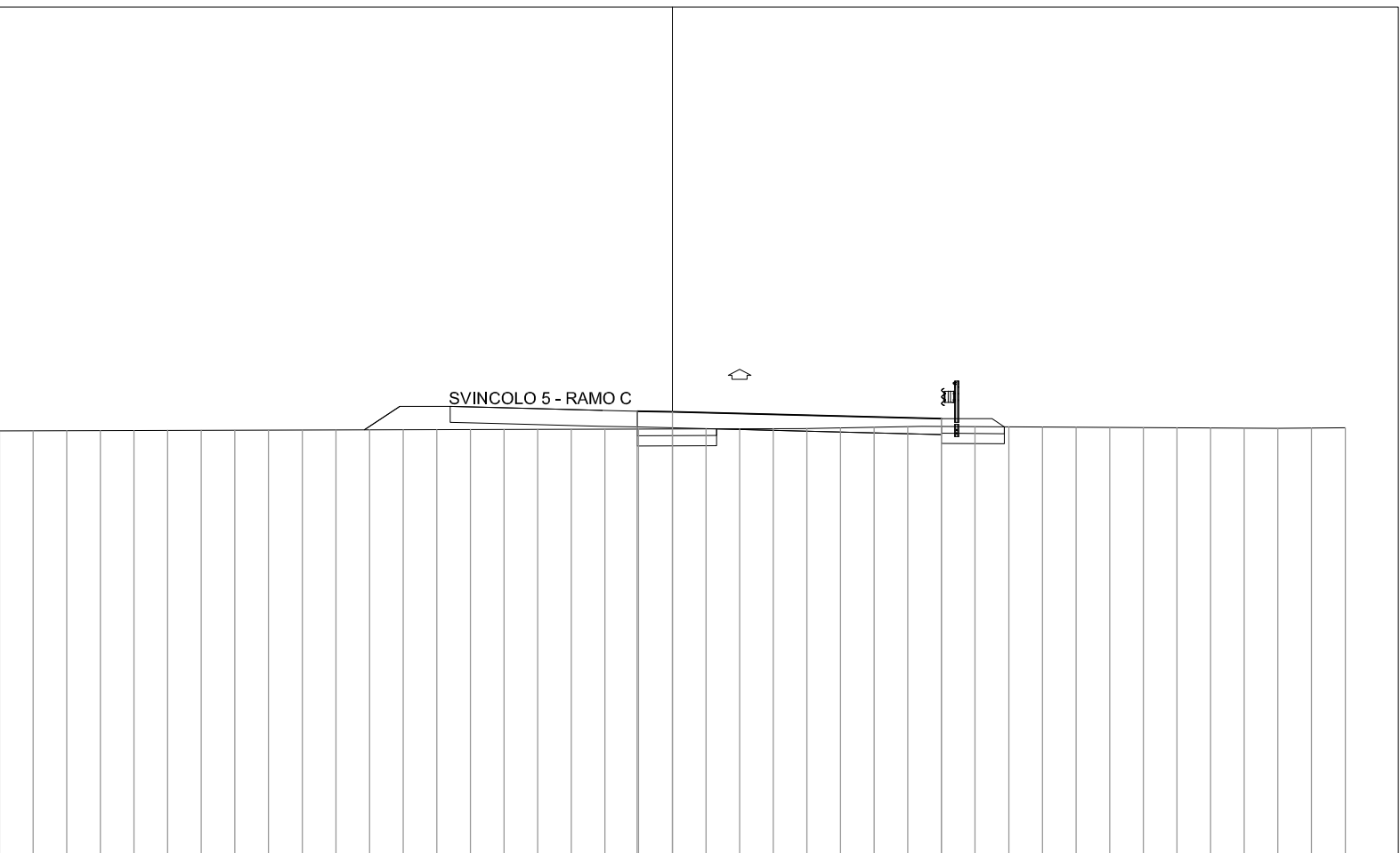

SVINCOLO 5 - RAMO C



200  
200

DISTANZE PROGRESSIVE PROGETTO																																									-1.04	0.00																																				8.00					
DISTANZE PARZIALI PROGETTO																																									1.04																																			8.00							
QUOTE PROGETTO																																									122.19	122.17																																				121.97					
DISTANZE PROGRESSIVE TERRENO	-20.00	-19.00	-18.00	-17.00	-16.00	-15.00	-14.00	-13.00	-12.00	-11.00	-10.00	-9.00	-8.00	-7.00	-6.00	-5.00	-4.00	-3.00	-2.00	-1.00	0.00	1.00	2.00	3.00	4.00	5.00	6.00	7.00	8.00	9.00	10.00	11.00	12.00	13.00	14.00	15.00	16.00	17.00	18.00	19.00	20.00																																										
DISTANZE PARZIALI TERRENO	1.00	1.00	1.00	1.00	1.00	1.00	1.00	1.00	1.00	1.00	1.00	1.00	1.00	1.00	1.00	1.00	1.00	1.00	1.00	1.00	1.00	1.00	1.00	1.00	1.00	1.00	1.00	1.00	1.00	1.00	1.00	1.00	1.00	1.00	1.00	1.00	1.00	1.00	1.00	1.00	1.00	1.00	1.00	1.00																																							
QUOTE TERRENO	121.60	121.61	121.61	121.61	121.62	121.62	121.62	121.62	121.63	121.63	121.63	121.64	121.64	121.64	121.64	121.65	121.65	121.65	121.66	121.66	121.66	121.67	121.67	121.67	121.68	121.71	121.73	121.73	121.73	121.72	121.72	121.71	121.70	121.70	121.69	121.69	121.68	121.68	121.68	121.69	121.69																																										



PROFILO Ramo\_D

SEZIONE 5

PROGRESSIVA 54.78

200  
200



ROTATORIA SVINCOLO 5



DISTANZE PROGRESSIVE  
PROGETTO

DISTANZE PARZIALI  
PROGETTO

QUOTE  
PROGETTO

DISTANZE PROGRESSIVE  
TERRENO

DISTANZE PARZIALI  
TERRENO

QUOTE  
TERRENO

121.66	-20.00
121.66	1.00
121.66	-19.00
121.66	1.00
121.66	-18.00
121.66	1.00
121.66	-17.00
121.66	1.00
121.66	-16.00
121.66	1.00
121.66	-15.00
121.67	1.00
121.67	-14.00
121.67	1.00
121.67	-13.00
121.67	1.00
121.67	-12.00
121.67	1.00
121.67	-11.00
121.67	1.00
121.67	-10.00
121.67	1.00
121.67	-9.00
121.67	1.00
121.67	-8.00
121.67	1.00
121.67	-7.00
121.67	1.00
121.67	-6.00
121.67	1.00
121.67	-5.00
121.67	1.00
121.67	-4.00
121.67	1.00
121.67	-3.00
121.67	1.00
121.67	-2.00
121.67	1.00
121.67	-1.00
121.67	1.00
121.67	0.00
121.67	1.00
121.67	2.00
121.68	3.00
121.69	4.00
121.69	5.00
121.70	6.00
121.70	7.00
121.70	8.00
121.69	9.00
121.69	10.00
121.69	11.00
121.69	12.00
121.69	13.00
121.68	14.00
121.68	15.00
121.68	16.00
121.68	17.00
121.68	18.00
121.68	19.00



*Sezioni trasversali*  
*Ramo E*

PROFILO Ramo\_E

SEZIONE 1

PROGRESSIVA 0.00

ROTATORIA SVINCOLO 5

109

200  
200

DISTANZE PROGRESSIVE  
PROGETTO

DISTANZE PARZIALI  
PROGETTO

QUOTE  
PROGETTO

DISTANZE PROGRESSIVE  
TERRENO

DISTANZE PARZIALI  
TERRENO

QUOTE  
TERRENO

121.94	-20.00
121.93	1.00
121.92	-19.00
121.92	1.00
121.92	-18.00
121.92	1.00
121.92	-17.00
121.92	1.00
121.91	-16.00
121.91	1.00
121.91	-15.00
121.91	1.00
121.91	-14.00
121.91	1.00
121.91	-13.00
121.91	1.00
121.91	-12.00
121.91	1.00
121.91	-11.00
121.91	1.00
121.90	-10.00
121.90	1.00
121.90	-9.00
121.90	1.00
121.90	-8.00
121.90	1.00
121.90	-7.00
121.90	1.00
121.90	-6.00
121.90	1.00
121.90	-5.00
121.90	1.00
121.90	-4.00
121.90	1.00
121.90	-3.00
121.90	1.00
121.90	-2.00
121.90	1.00
121.90	-1.00
121.90	1.00
121.90	0.00
121.90	1.00
121.90	1.00
121.90	2.00
121.90	1.00
121.90	3.00
121.90	1.00
121.90	4.00
121.90	1.00
121.90	5.00
121.90	1.00
121.89	6.00
121.89	1.00
121.89	7.00
121.89	1.00
121.89	8.00
121.89	1.00
121.89	9.00
121.89	1.00
121.89	10.00
121.89	1.00
121.89	11.00
121.89	1.00
121.89	12.00
121.89	1.00
121.89	13.00
121.89	1.00
121.88	14.00
121.88	1.00
121.88	15.00
121.88	1.00
121.88	16.00
121.88	1.00
121.87	17.00
121.87	1.00
121.87	18.00
121.87	1.00
121.87	19.00

PROFILO Ramo\_E

SEZIONE 2

PROGRESSIVA 10.15

STERRI E RIPORTI

S1 0.73 mq.

S2 0.09 mq.

Totale S: 0.82 mq.

R1 0.48 mq.

SCOTICO

E1 0.39 mq.

BONIFICA

F1 0.57 mq.

USURA

a1 3.47 ml.

ROTATORIA SVINCOLO 5



109



200

200

DISTANZE PROGRESSIVE  
PROGETTO

0.53

4.00

DISTANZE PARZIALI  
PROGETTO

3.47

QUOTE  
PROGETTO

122.10

122.18

DISTANZE PROGRESSIVE  
TERRENO

-20.00

-19.00

-18.00

-17.00

-16.00

-15.00

-14.00

-13.00

-12.00

-11.00

-10.00

-9.00

-8.00

-7.00

-6.00

-5.00

-4.00

-3.00

-2.00

-1.00

0.00

1.00

2.00

3.00

4.00

5.00

6.00

7.00

8.00

9.00

10.00

11.00

12.00

13.00

14.00

15.00

16.00

17.00

18.00

19.00

20.00

DISTANZE PARZIALI  
TERRENO

1.00

1.00

1.00

1.00

1.00

1.00

1.00

1.00

1.00

1.00

1.00

1.00

1.00

1.00

1.00

1.00

1.00

1.00

1.00

1.00

1.00

1.00

1.00

1.00

1.00

1.00

1.00

1.00

1.00

1.00

1.00

1.00

1.00

1.00

1.00

1.00

1.00

1.00

1.00

1.00

QUOTE  
TERRENO

121.86

121.86

121.86

121.87

121.87

121.87

121.88

121.88

121.88

121.88

121.89

121.89

121.89

121.90

121.90

121.90

121.90

121.91

121.91

121.91

121.91

121.91

121.91

121.90

121.90

121.90

121.90

121.90

121.90

121.90

121.89

121.89

121.89

121.89

121.88

121.88

121.88

121.87

121.87

121.87

121.87

PROFILO Ramo\_E  
 SEZIONE 3  
 PROGRESSIVA 20.30

STERRI E RIPORTI  
 S1 0.13 mq.  
 S2 0.11 mq.  
 Totale S: 0.24 mq.  
 R1 1.42 mq.  
 R2 0.00 mq.  
 R3 0.91 mq.  
 Totale R: 2.33 mq.  
 SCOTICO  
 E1 0.54 mq.  
 E2 0.77 mq.  
 Totale: 1.31 mq.  
 BONIFICA  
 F1 0.82 mq.  
 F2 1.14 mq.  
 Totale: 1.96 mq.  
 USURA  
 a1 5.00 ml.  
 PREPARAZIONE PIANO DI POSA  
 f1 4.51 ml.

110  
 200

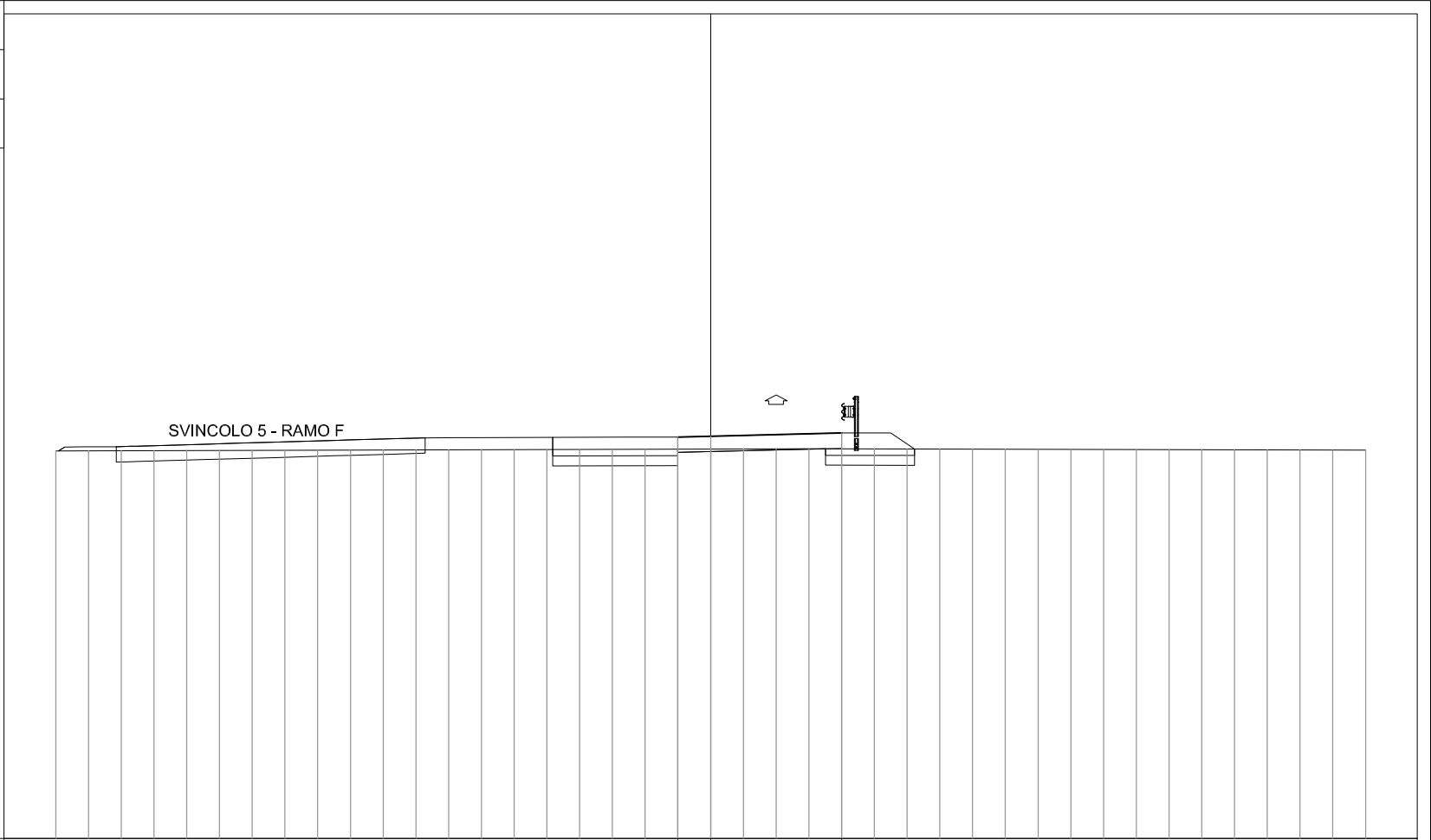

DISTANZE PROGRESSIVE PROGETTO																					-1.00	0.00																				
DISTANZE PARZIALI PROGETTO																					1.00	4.00																				
QUOTE PROGETTO																					122.27	122.29																				
DISTANZE PROGRESSIVE TERRENO	-20.00	-19.00	-18.00	-17.00	-16.00	-15.00	-14.00	-13.00	-12.00	-11.00	-10.00	-9.00	-8.00	-7.00	-6.00	-5.00	-4.00	-3.00	-2.00	-1.00	0.00	1.00	2.00	3.00	4.00	5.00	6.00	7.00	8.00	9.00	10.00	11.00	12.00	13.00	14.00	15.00	16.00	17.00	18.00	19.00	20.00	
DISTANZE PARZIALI TERRENO	1.00	1.00	1.00	1.00	1.00	1.00	1.00	1.00	1.00	1.00	1.00	1.00	1.00	1.00	1.00	1.00	1.00	1.00	1.00	1.00	1.00	1.00	1.00	1.00	1.00	1.00	1.00	1.00	1.00	1.00	1.00	1.00	1.00	1.00	1.00	1.00	1.00	1.00	1.00	1.00		
QUOTE TERRENO	121.84	121.85	121.85	121.85	121.86	121.86	121.86	121.87	121.87	121.87	121.87	121.88	121.88	121.88	121.88	121.89	121.89	121.89	121.89	121.90	121.90	121.90	121.91	121.91	121.91	121.91	121.90	121.90	121.90	121.90	121.89	121.89	121.89	121.88	121.88	121.88	121.87	121.87	121.87	121.87		





PROFILO Ramo\_E

SEZIONE 6

PROGRESSIVA 58.80

STERRI E RIPORTI  
R1 8.92 mq.  
SCOTICO  
E1 1.82 mq.  
BONIFICA  
F1 2.74 mq.  
USURA  
a1 5.32 ml.

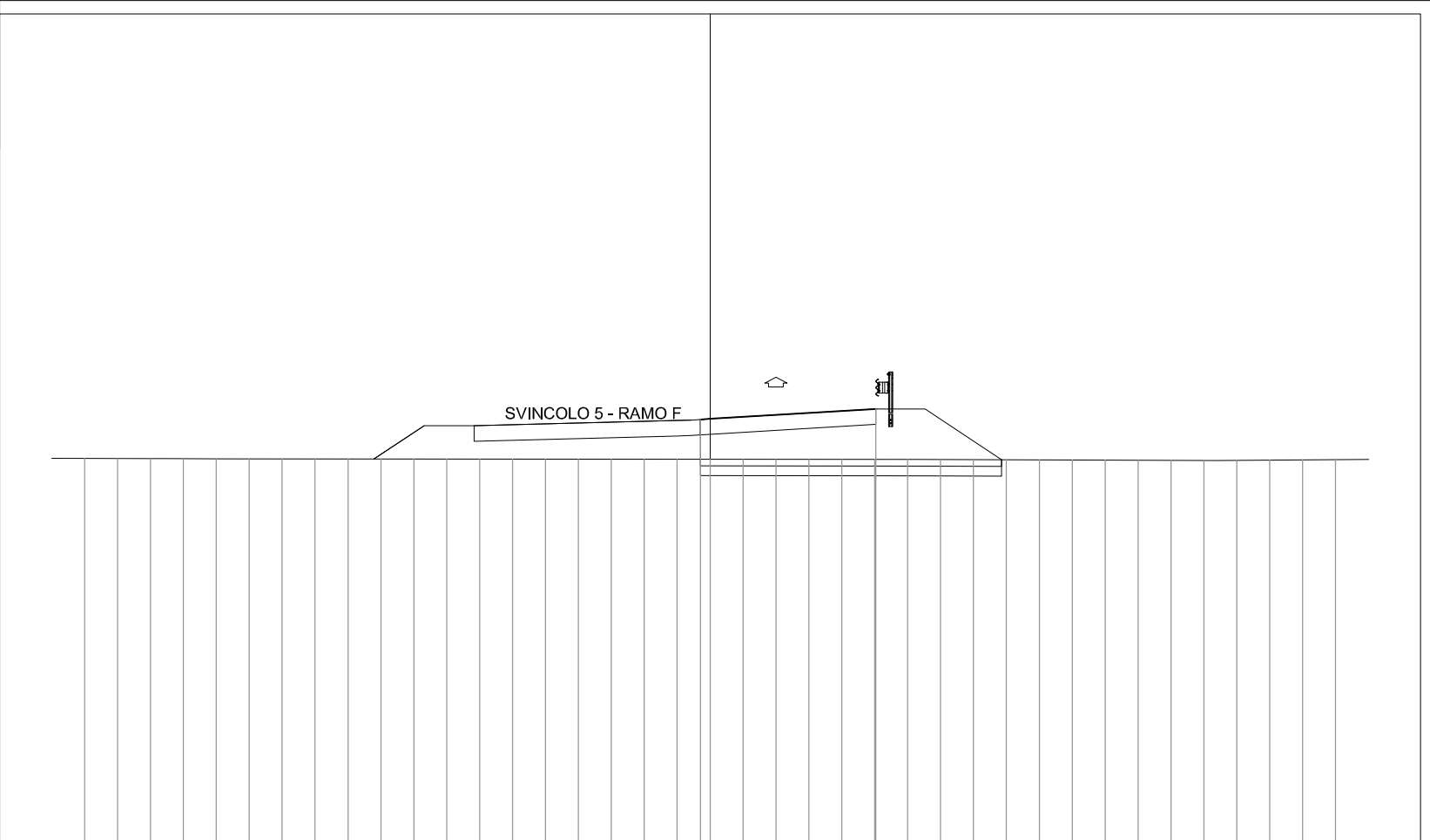

DISTANZE PROGRESSIVE PROGETTO	-0.29																												5.03																											
DISTANZE PARZIALI PROGETTO	5.32																																																							
QUOTE PROGETTO	122.87																												123.19																											
DISTANZE PROGRESSIVE TERRENO	-19.00																												0.00																											
DISTANZE PARZIALI TERRENO	1.00																												1.00																											
QUOTE TERRENO	121.69																												121.66																											

121.69	121.68	121.68	121.68	121.68	121.67	121.67	121.67	121.67	121.67	121.67	121.67	121.67	121.66	121.66	121.66	121.66	121.66	121.66	121.66	121.66	121.66	121.66	121.66	121.66	121.65	121.65	121.65	121.65	121.64	121.64	121.63	121.63	121.63	121.63	121.64	121.64	121.65
--------	--------	--------	--------	--------	--------	--------	--------	--------	--------	--------	--------	--------	--------	--------	--------	--------	--------	--------	--------	--------	--------	--------	--------	--------	--------	--------	--------	--------	--------	--------	--------	--------	--------	--------	--------	--------	--------





*Sezioni trasversali*  
*Ramo F*





PROFILO Ramo\_F

SEZIONE 3

PROGRESSIVA 46.49

STERRI E RIPORTI  
 S1 0.72 mq.  
 R1 1.45 mq.  
 R2 0.01 mq.  
 R3 0.50 mq.  
 Totale R: 1.96 mq.  
 SCOTICO  
 E1 0.39 mq.  
 E2 0.78 mq.  
 Totale: 1.17 mq.  
 BONIFICA  
 F1 0.59 mq.  
 F2 1.16 mq.  
 Totale: 1.75 mq.  
 USURA  
 a1 9.00 ml.  
 PREPARAZIONE PIANO DI POSA  
 f1 8.06 ml.

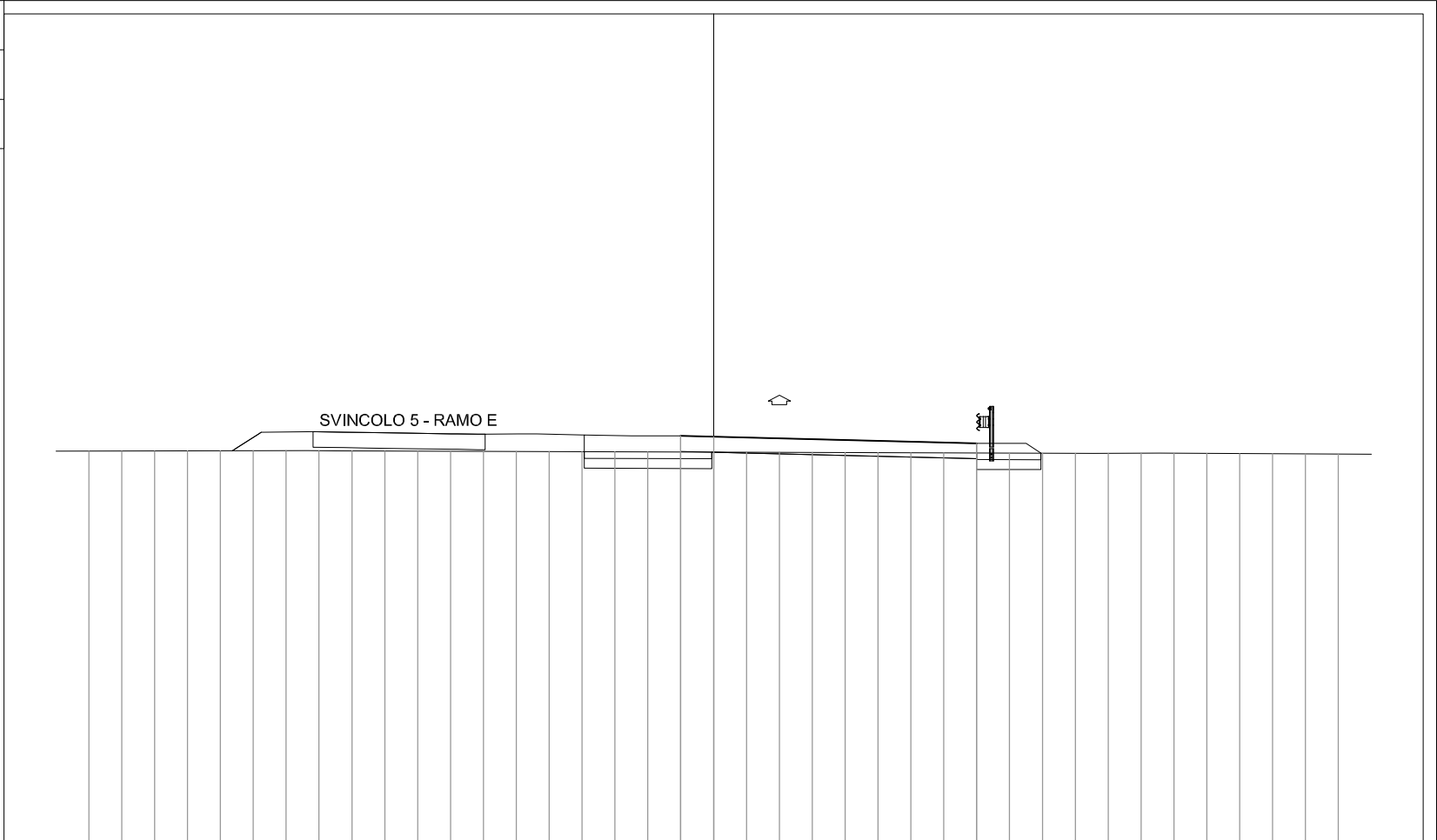

DISTANZE PROGRESSIVE PROGETTO	-1.00	0.00	8.00
-------------------------------	-------	------	------

DISTANZE PARZIALI PROGETTO	1.00	8.00
----------------------------	------	------

QUOTE PROGETTO	122.36	122.33	122.13
----------------	--------	--------	--------

DISTANZE PROGRESSIVE TERRENO	-19.00	-18.00	-17.00	-16.00	-15.00	-14.00	-13.00	-12.00	-11.00	-10.00	-9.00	-8.00	-7.00	-6.00	-5.00	-4.00	-3.00	-2.00	-1.00	0.00	1.00	2.00	3.00	4.00	5.00	6.00	7.00	8.00	9.00	10.00	11.00	12.00	13.00	14.00	15.00	16.00	17.00	18.00	19.00
------------------------------	--------	--------	--------	--------	--------	--------	--------	--------	--------	--------	-------	-------	-------	-------	-------	-------	-------	-------	-------	------	------	------	------	------	------	------	------	------	------	-------	-------	-------	-------	-------	-------	-------	-------	-------	-------

DISTANZE PARZIALI TERRENO	1.00	1.00	1.00	1.00	1.00	1.00	1.00	1.00	1.00	1.00	1.00	1.00	1.00	1.00	1.00	1.00	1.00	1.00	1.00	1.00	1.00	1.00	1.00	1.00	1.00	1.00	1.00	1.00	1.00	1.00	1.00	1.00	1.00	1.00	1.00	1.00	1.00	1.00	1.00	1.00	1.00	1.00	1.00	1.00	1.00
---------------------------	------	------	------	------	------	------	------	------	------	------	------	------	------	------	------	------	------	------	------	------	------	------	------	------	------	------	------	------	------	------	------	------	------	------	------	------	------	------	------	------	------	------	------	------	------

QUOTE TERRENO	121.89	121.89	121.90	121.90	121.90	121.90	121.90	121.90	121.90	121.89	121.89	121.89	121.89	121.88	121.88	121.88	121.87	121.87	121.87	121.86	121.86	121.86	121.85	121.85	121.85	121.84	121.84	121.84	121.83	121.83	121.83	121.83	121.83	121.82	121.82	121.81	121.81	121.81	121.80
---------------	--------	--------	--------	--------	--------	--------	--------	--------	--------	--------	--------	--------	--------	--------	--------	--------	--------	--------	--------	--------	--------	--------	--------	--------	--------	--------	--------	--------	--------	--------	--------	--------	--------	--------	--------	--------	--------	--------	--------

PROFILO Ramo\_F

SEZIONE 4

PROGRESSIVA 58.43

STERRI E RIPORTI

S1 0,19 mq.

S2 0,64 mq.

S3 1,56 mq.

Totale S: 2,39 mq.

R1 0,59 mq.

R2 0,22 mq.

Totale R: 0,81 mq.

SCOTICO

E1 0,34 mq.

E2 0,43 mq.

Totale: 0,77 mq.

BONIFICA

F1 0,50 mq.

F2 0,64 mq.

Totale: 1,14 mq.

USURA

a1 9,00 ml.

PREPARAZIONE PIANO DI POSA

f1 9,00 ml.

110

200  
200

ROTATORIA SVINCOLO 5



DISTANZE PROGRESSIVE  
PROGETTO

-1,00

0,00

8,00

DISTANZE PARZIALI  
PROGETTO

1,00

8,00

QUOTE  
PROGETTO

122,15

122,13

121,98

DISTANZE PROGRESSIVE  
TERRENO

-19,00

-18,00

-17,00

-16,00

-15,00

-14,00

-13,00

-12,00

-11,00

-10,00

-9,00

-8,00

-7,00

-6,00

-5,00

-4,00

-3,00

-2,00

-1,00

0,00

1,00

2,00

3,00

4,00

5,00

6,00

7,00

8,00

9,00

10,00

11,00

12,00

13,00

14,00

15,00

16,00

17,00

18,00

19,00

DISTANZE PARZIALI  
TERRENO

1,00

1,00

1,00

1,00

1,00

1,00

1,00

1,00

1,00

1,00

1,00

1,00

1,00

1,00

1,00

1,00

1,00

1,00

1,00

1,00

1,00

1,00

1,00

1,00

1,00

1,00

1,00

1,00

1,00

1,00

1,00

1,00

1,00

1,00

1,00

1,00

1,00

QUOTE  
TERRENO

121,90

121,90

121,91

121,91

121,91

121,91

121,91

121,91

121,90

121,90

121,89

121,89

121,89

121,88

121,88

121,88

121,87

121,87

121,87

121,86

121,86

121,86

121,86

121,85

121,85

121,85

121,85

121,84

121,84

121,84

121,84

121,84

121,84

121,84

121,84

121,84

121,84



PROFILO Ramo\_F

SEZIONE 6

PROGRESSIVA 67.02

ROTATORIA SVINCOLO 5

109

200  
200

DISTANZE PROGRESSIVE  
PROGETTO

DISTANZE PARZIALI  
PROGETTO

QUOTE  
PROGETTO

DISTANZE PROGRESSIVE  
TERRENO

DISTANZE PARZIALI  
TERRENO

QUOTE  
TERRENO

121.91	-20.00
121.91	1.00
121.91	-19.00
121.90	1.00
121.90	-18.00
121.90	1.00
121.90	-17.00
121.90	1.00
121.90	-16.00
121.90	1.00
121.90	-15.00
121.89	1.00
121.89	-14.00
121.89	1.00
121.89	-13.00
121.89	1.00
121.89	-12.00
121.88	1.00
121.88	-11.00
121.88	1.00
121.88	-10.00
121.88	1.00
121.88	-9.00
121.87	1.00
121.87	-8.00
121.87	1.00
121.87	-7.00
121.87	1.00
121.87	-6.00
121.86	1.00
121.86	-5.00
121.86	1.00
121.86	-4.00
121.86	1.00
121.86	-3.00
121.86	1.00
121.86	-2.00
121.85	1.00
121.85	-1.00
121.85	1.00
121.85	0.00
121.85	1.00
121.85	2.00
121.85	1.00
121.85	3.00
121.85	1.00
121.85	4.00
121.84	1.00
121.84	5.00
121.84	1.00
121.84	6.00
121.84	1.00
121.84	7.00
121.84	1.00
121.84	8.00
121.84	1.00
121.84	9.00
121.84	1.00
121.84	10.00
121.84	1.00
121.84	11.00
121.84	1.00
121.84	12.00
121.84	1.00
121.84	13.00
121.84	1.00
121.84	14.00
121.84	1.00
121.84	15.00
121.84	1.00
121.84	16.00
121.84	1.00
121.84	17.00
121.84	1.00
121.84	18.00
121.84	1.00
121.84	19.00
121.84	1.00
121.84	20.00