

Regione
Toscana



Provincia di
Firenze



Comune di
Montelupo Fiorentino



Interventi per il declassamento della diga di Sammontana nel
Comune di Montelupo Fiorentino (FI)

PROGETTO PRELIMINARE

CODICE:

ID.08

ELABORATO:

**Sezioni fluviali
Verifica idraulica declassamento diga**

SCALA

-

**WEST
Systems**

West Systems s.r.l. divisione PHYSIS
- Ingegneria per l'ambiente

Viale Donato Giannotti, 24 - 50126 - FI
Tel. 055 461429 / 055 4684253

Fax. 055 0460426

Email. info@westsystems.com

Pec. amministrazione@pec.westsystems.it

PROGETTISTA:

Ing. David Settesoldi

COLLABORATORI TECNICI:

Ing. Michele Catella
Geom. Daniele Natali

COMMITTENTE:

Dott. Matteo Dzieduszycki
Via di Sammontana, 8
50056 Montelupo F.no (FI)

02					
01					
00	PRIMA EMISSIONE	16/07/2018	Ing. Michele Catella	Ing. Michele Catella	Ing. David Settesoldi
REV.	DESCRIZIONE	DATA	REDATTO	VERIFICATO	APPROVATO
REVISIONE			DATA		
00			16/07/2018		

INDICE

RIO BUDELLA – tratto Budella.....	2
FOSSO CITERNA – tratto Citerna	8
FOSSO CORTENUOVA – tratto Cortenuova.....	36
FOSSO FIBBIANA – tratto Fibbiana.....	72
FOSSO MONTECUCCOLI – tratto Montecuccoli	90
RIO GRANDE – tratto Monte.....	102
RIO GRANDE – tratto Valle	113
RIO SAMMONTANA – tratto Monte.....	145
RIO SAMMONTANA – tratto Centro.....	183
RIO SAMMONTANA – tratto Valle	201

SEZIONI FLUVIALI
RIO BUDELLA – tratto Budella

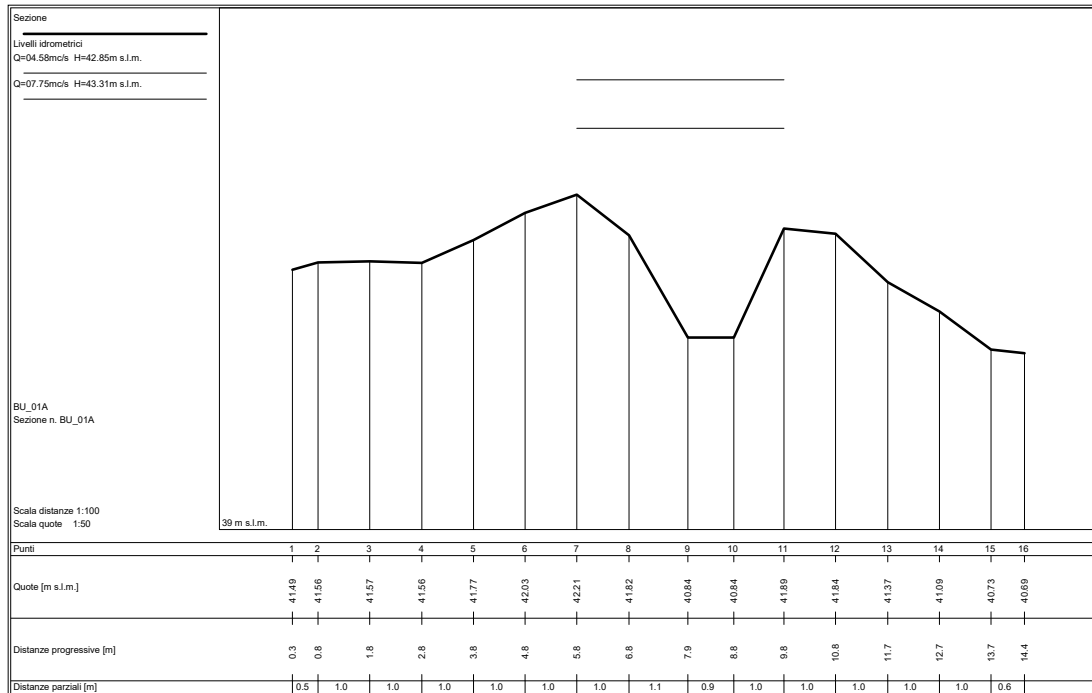
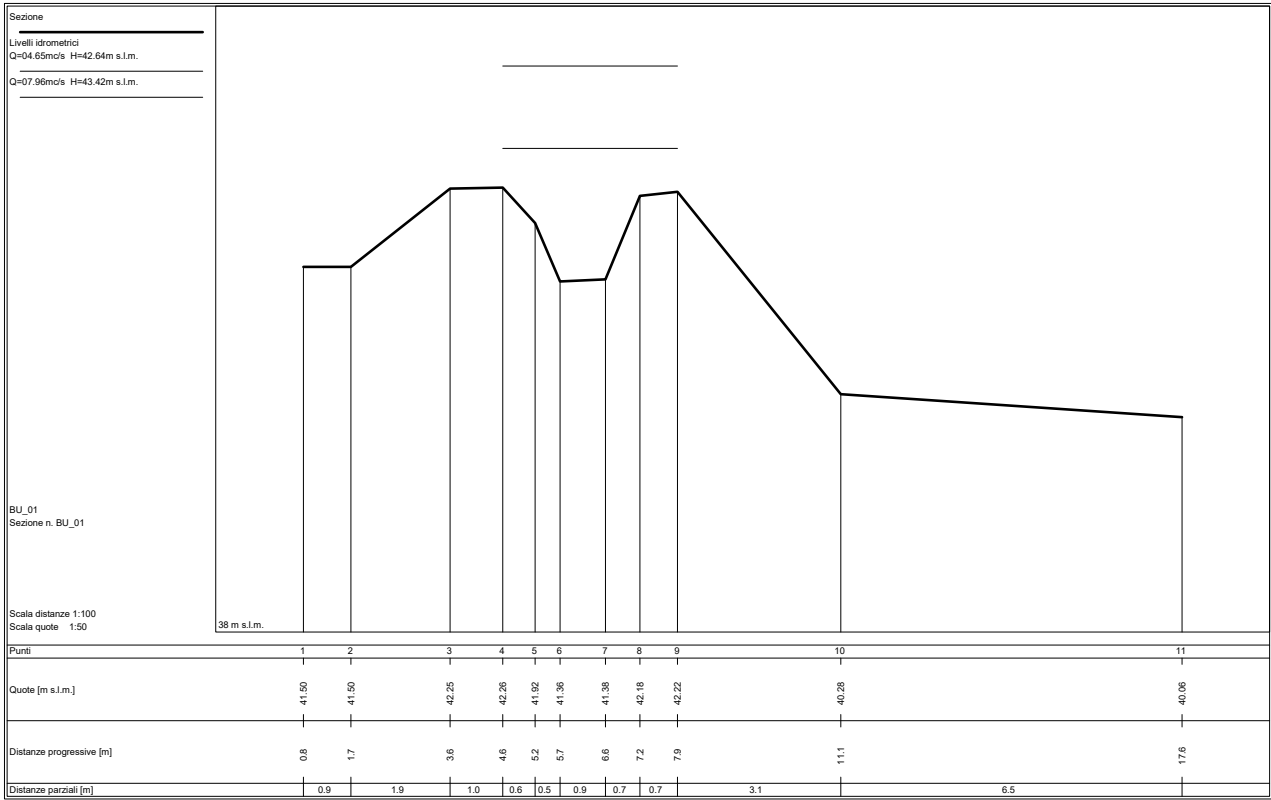

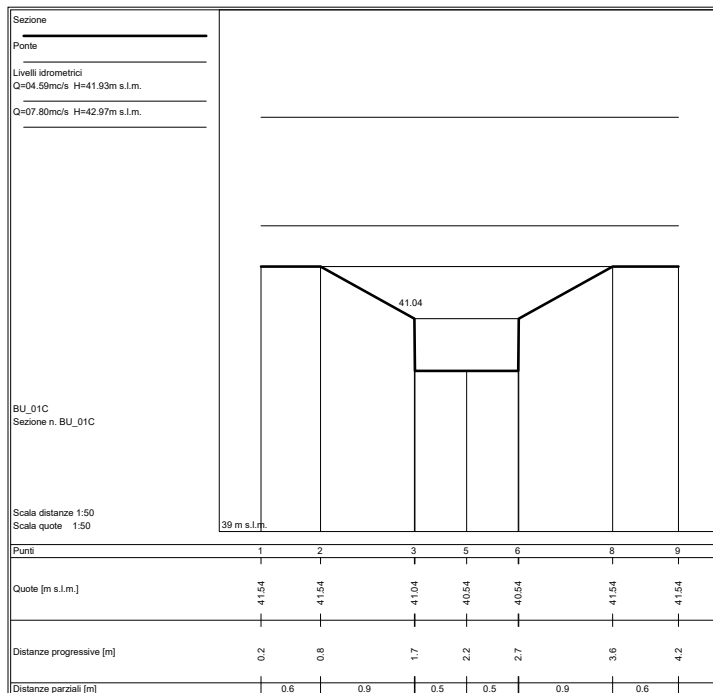
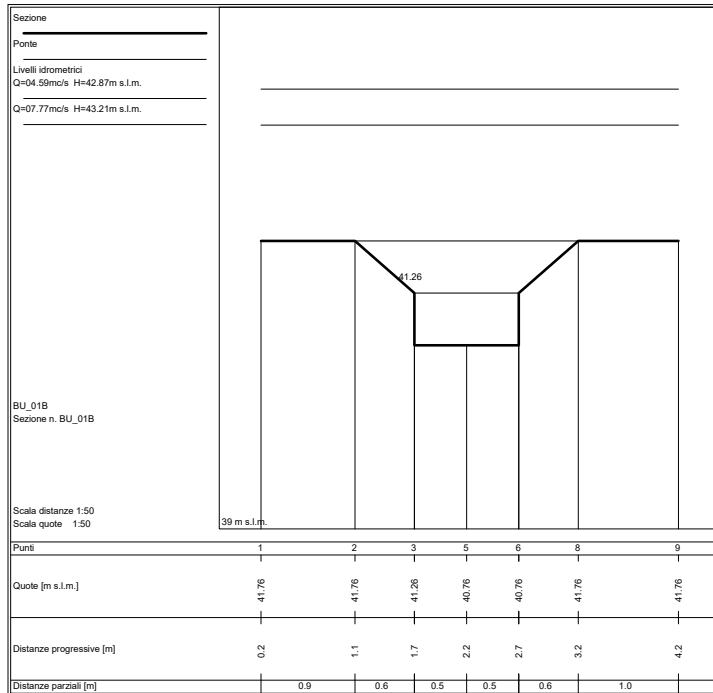

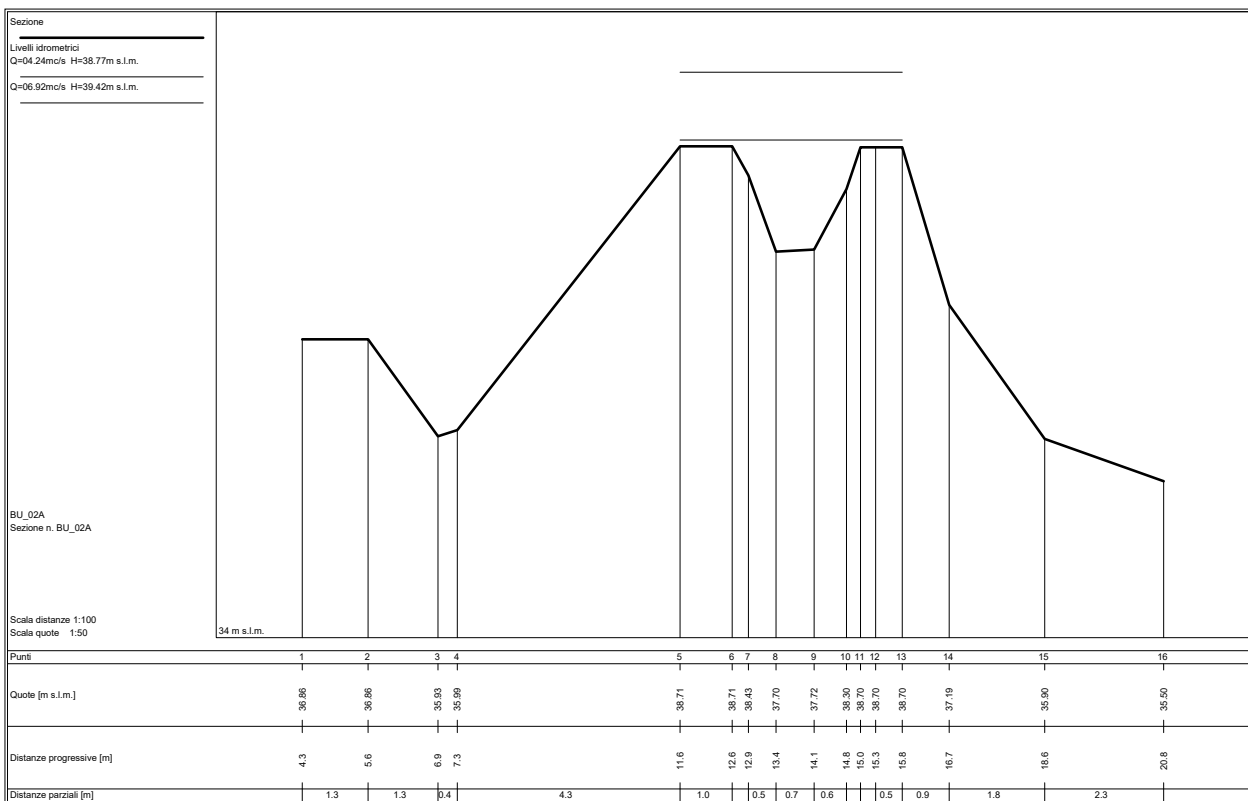
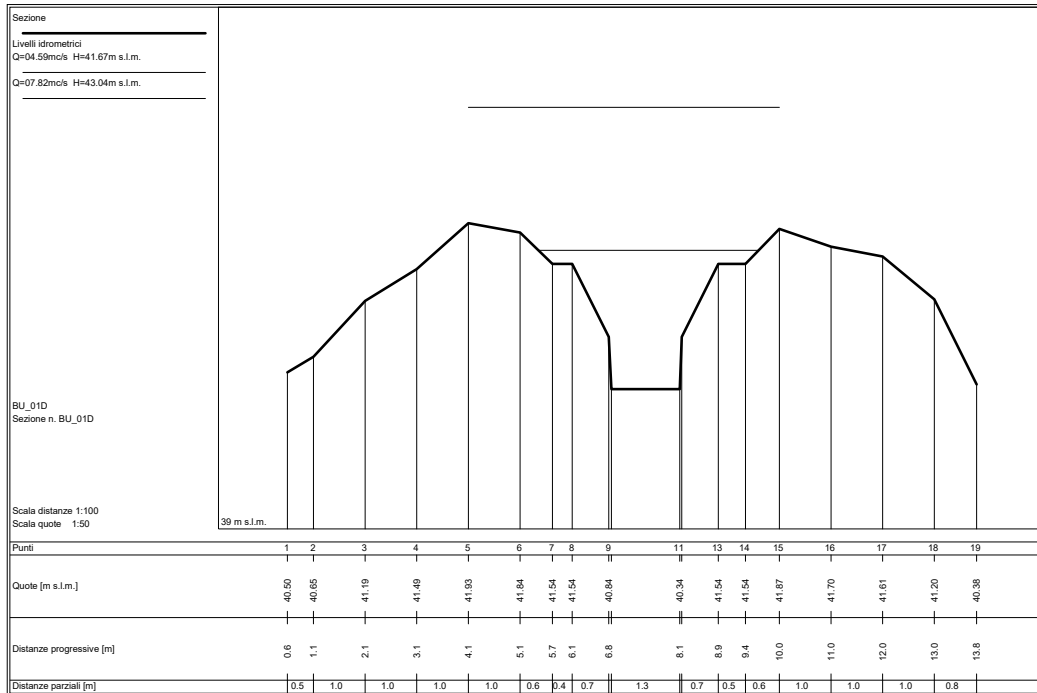

Sezione

Livelli idrometrici
 Q=03.99mc/s H=35.32m s.l.m.
 Q=04.56mc/s H=35.64m s.l.m.

RG2041
 Sezione n. RG2041
 sezione 860 modello F
 abio -

Scala distanze 1:200
 Scala quote 1:50

29 m s.l.m.

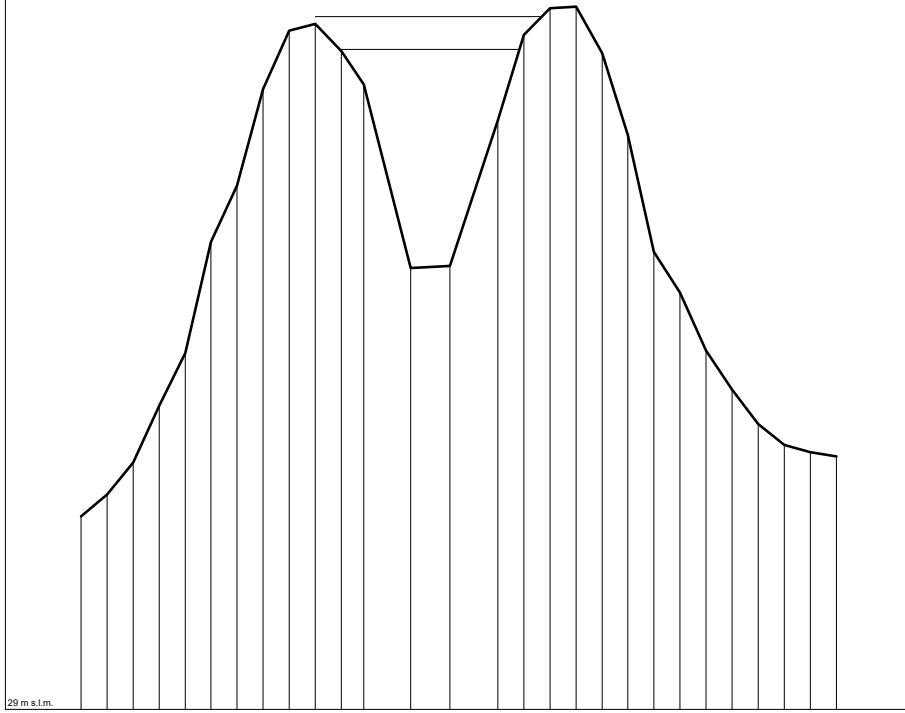

Punti	1	2	3	4	5	6	7	8	9	10	11	12	13	14	15	16	17	18	19	20	21	22	23	24	25	26	27	28
Quote [m s.l.m.]	30.85	31.06	31.36	31.91	32.42	33.48	34.02	34.94	35.51	35.57	35.31	34.99	33.23	33.25	34.64	35.46	35.72	35.73	35.29	34.50	33.39	32.99	32.44	32.06	31.73	31.54	31.46	31.43
Distanze progressive [m]	0.2	1.2	2.2	3.2	4.2	6.2	8.2	7.2	6.2	9.2	10.1	11.0	12.8	14.3	16.1	17.1	18.1	19.1	20.1	21.1	22.1	23.1	24.1	25.1	26.1	27.1	28.1	29.1
Distanze parziali [m]	1.0	1.0	1.0	1.0	1.0	1.0	1.0	1.0	1.0	1.0	0.9	1.8	1.5	1.8	1.0	1.0	1.0	1.0	1.0	1.0	1.0	1.0	1.0	1.0	1.0	1.0	1.0	1.0

SEZIONI FLUVIALI
FOSSO CITERNA – tratto Citerna

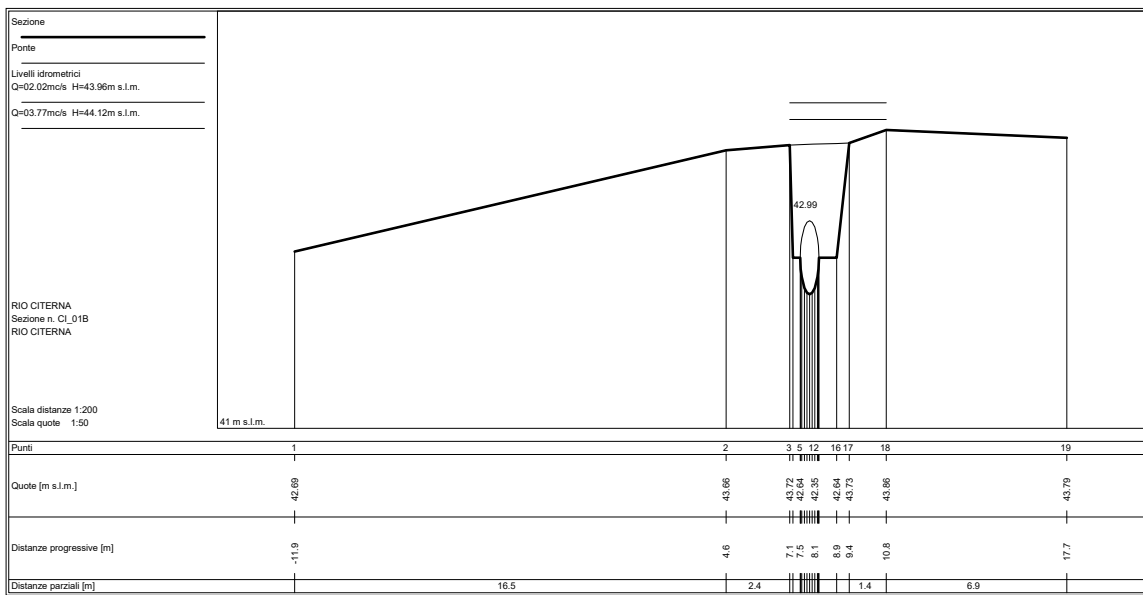
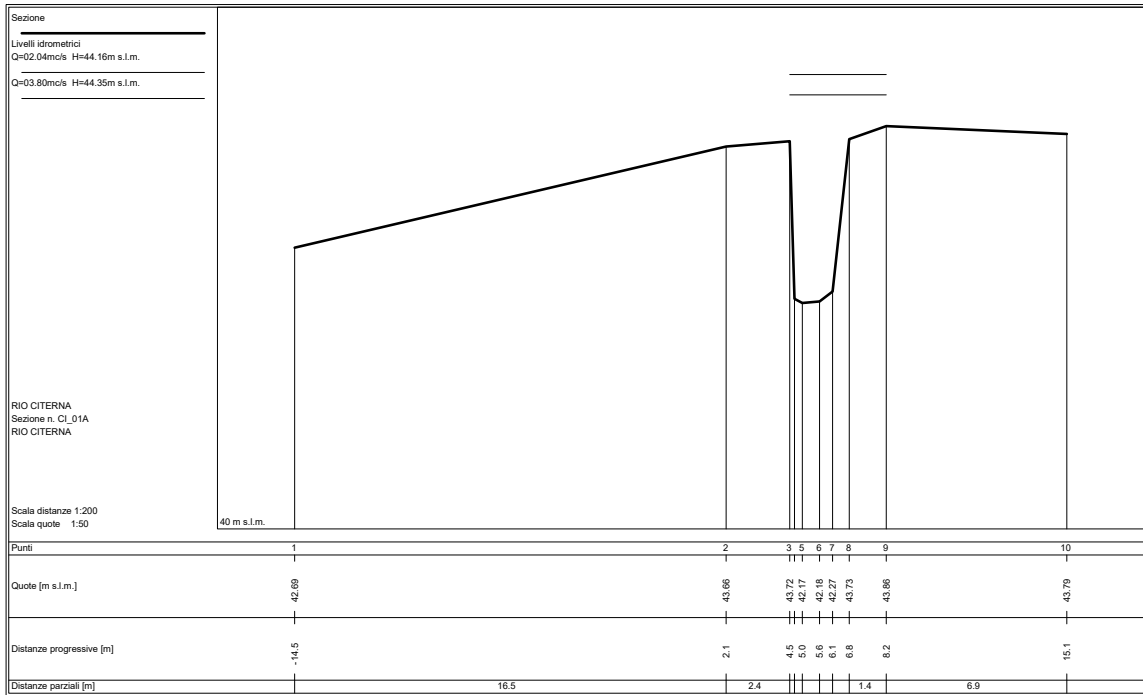

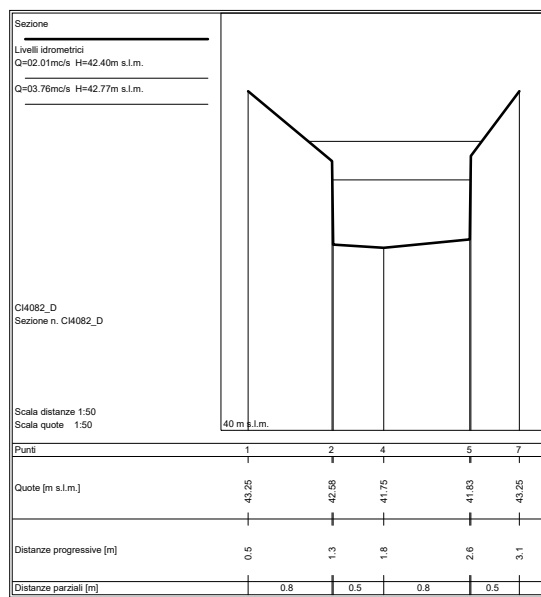
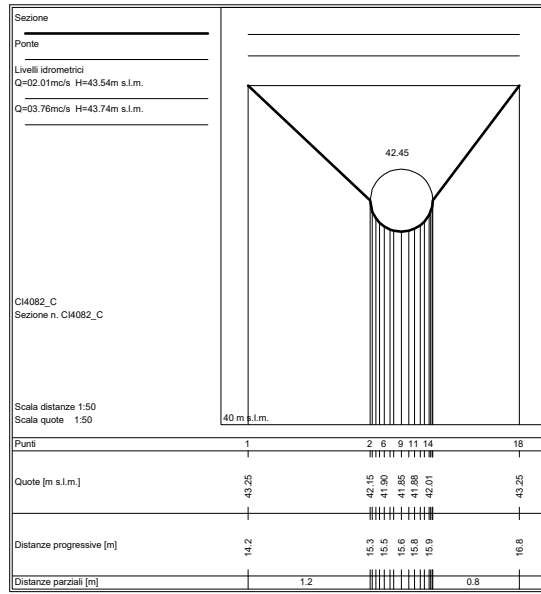

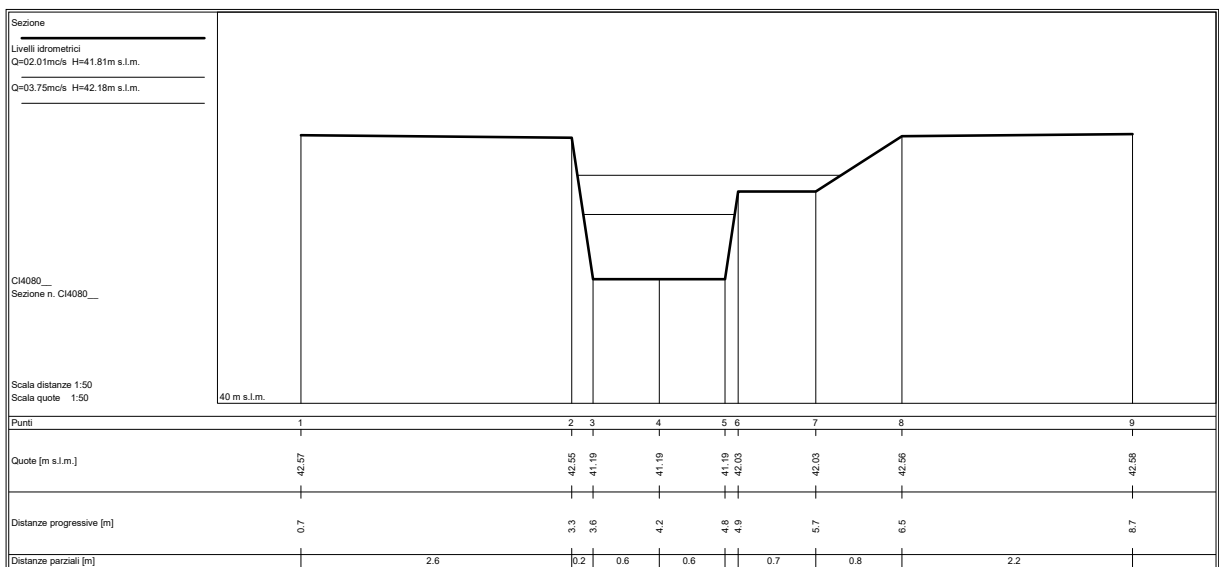
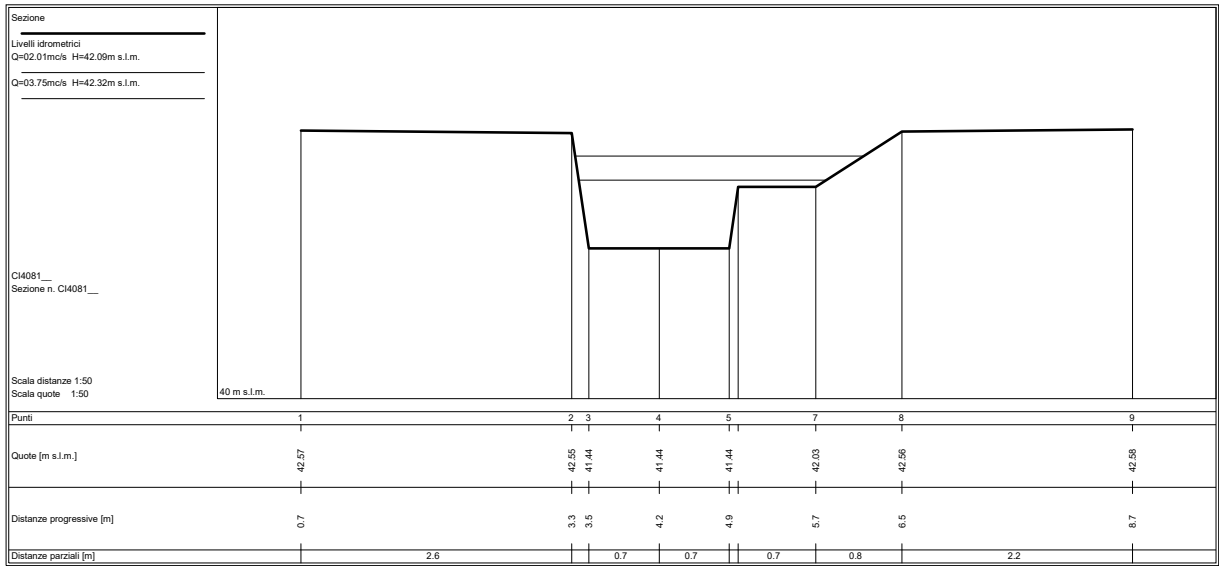

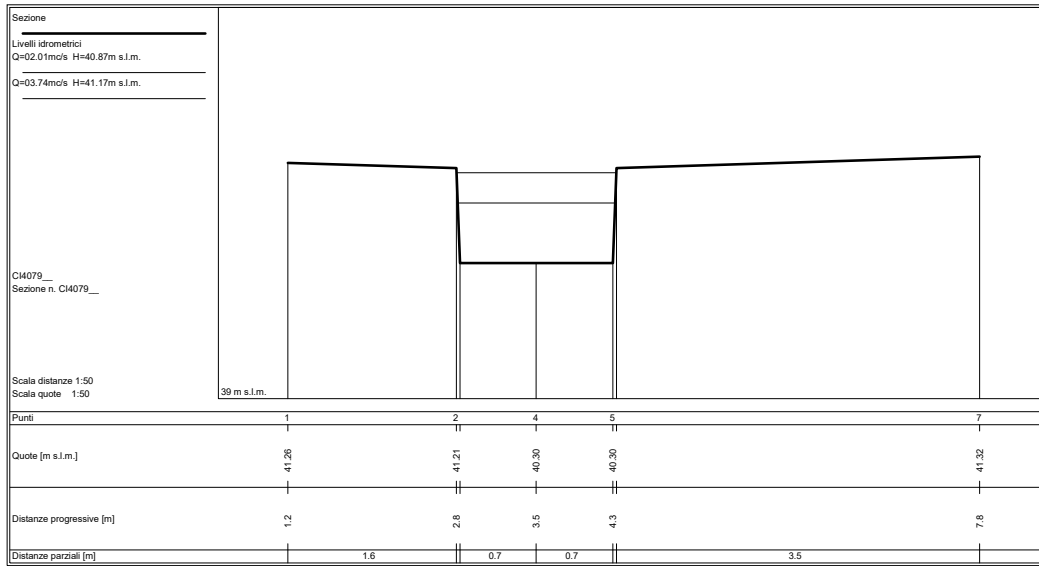

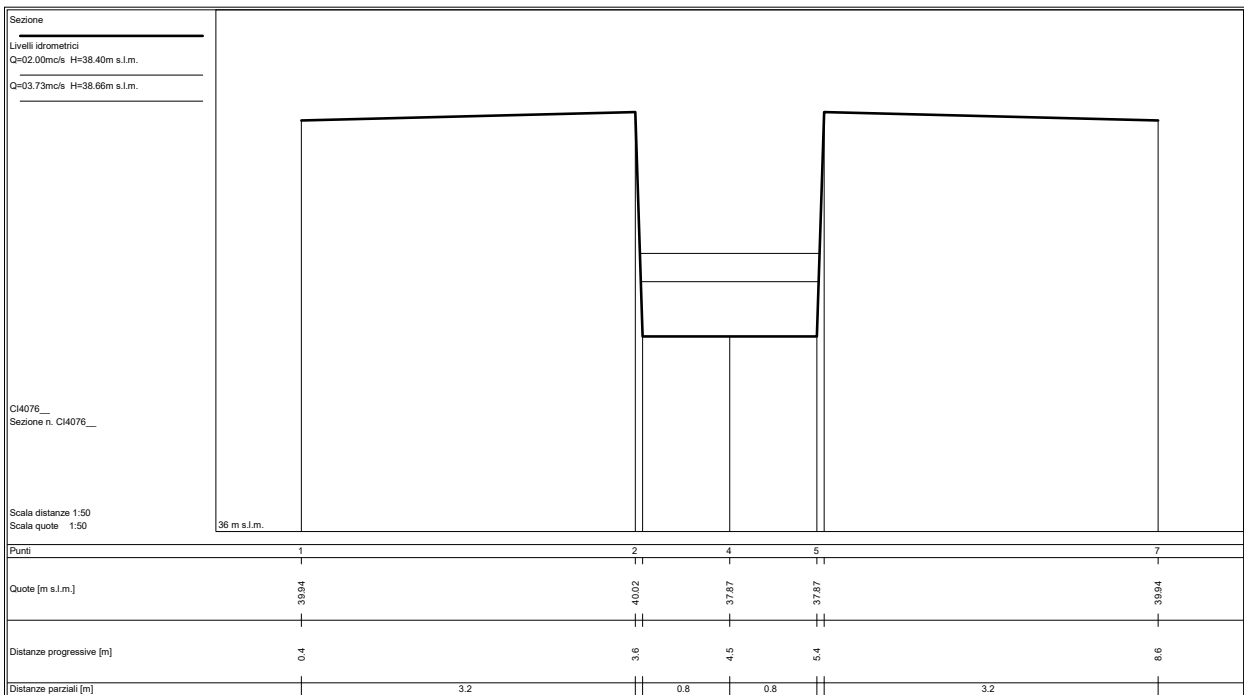
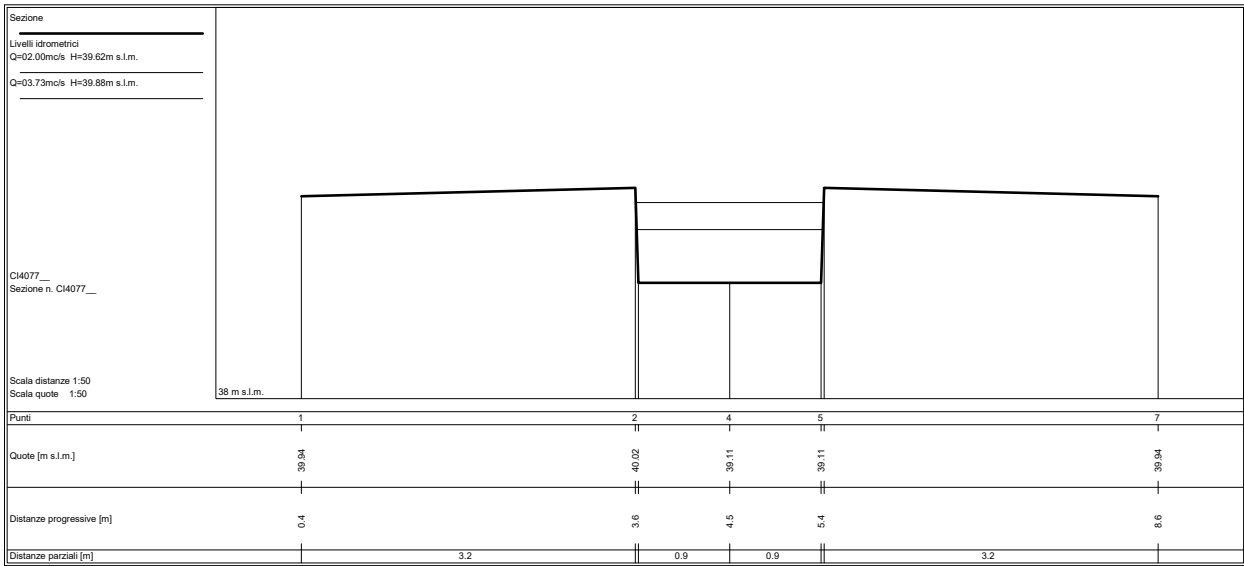

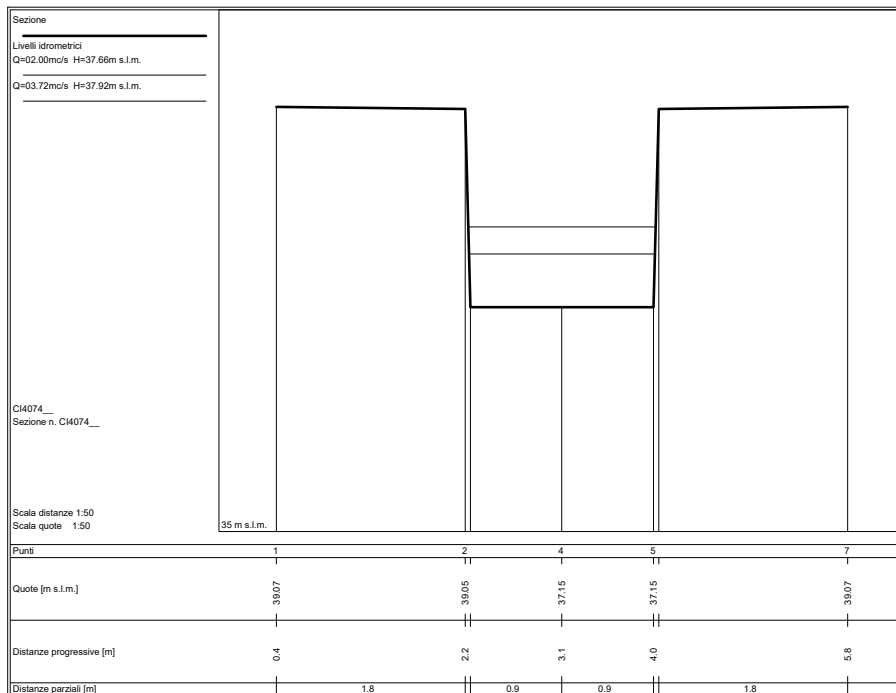
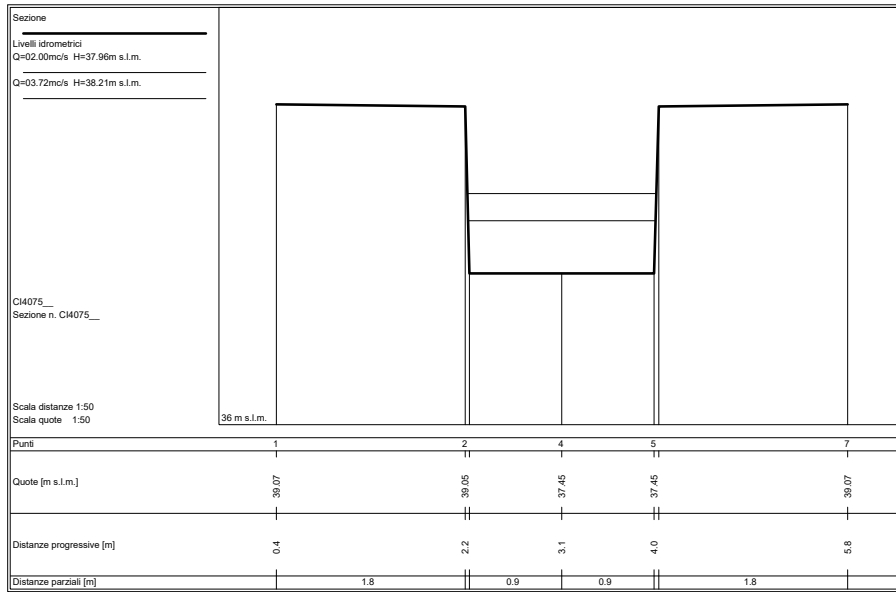

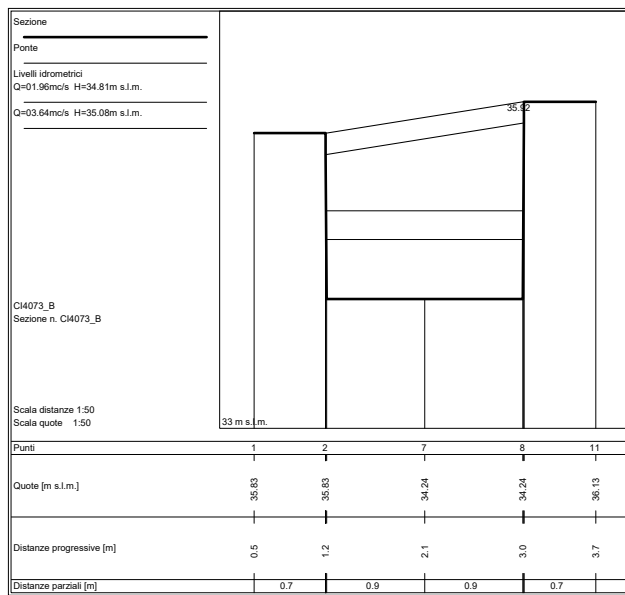
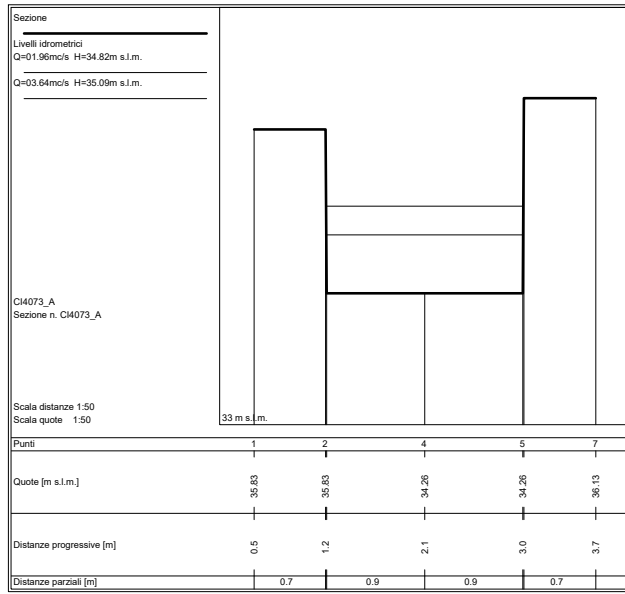

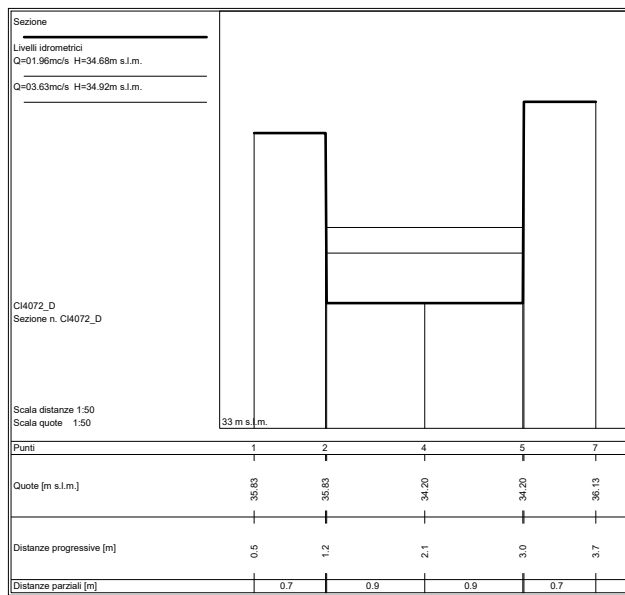
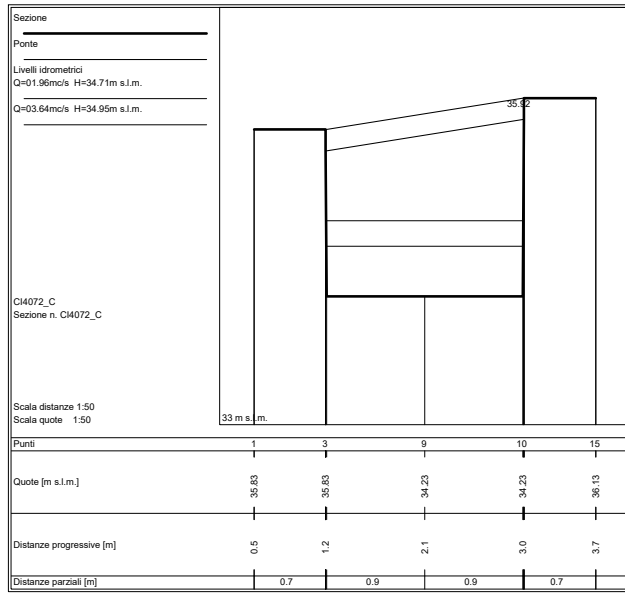

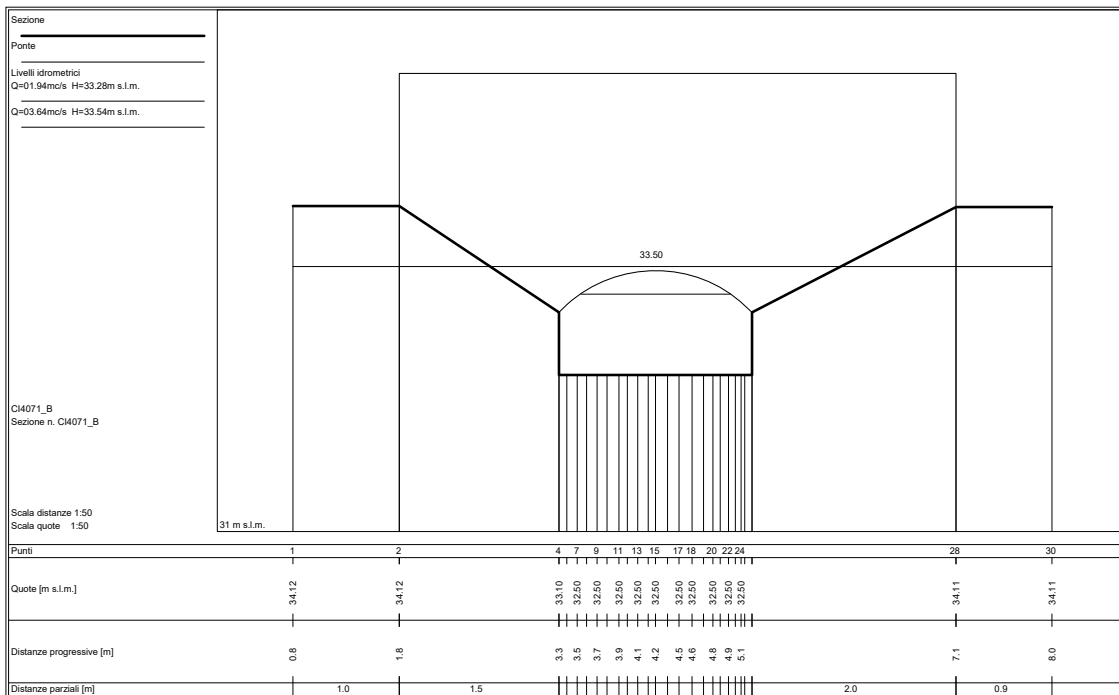
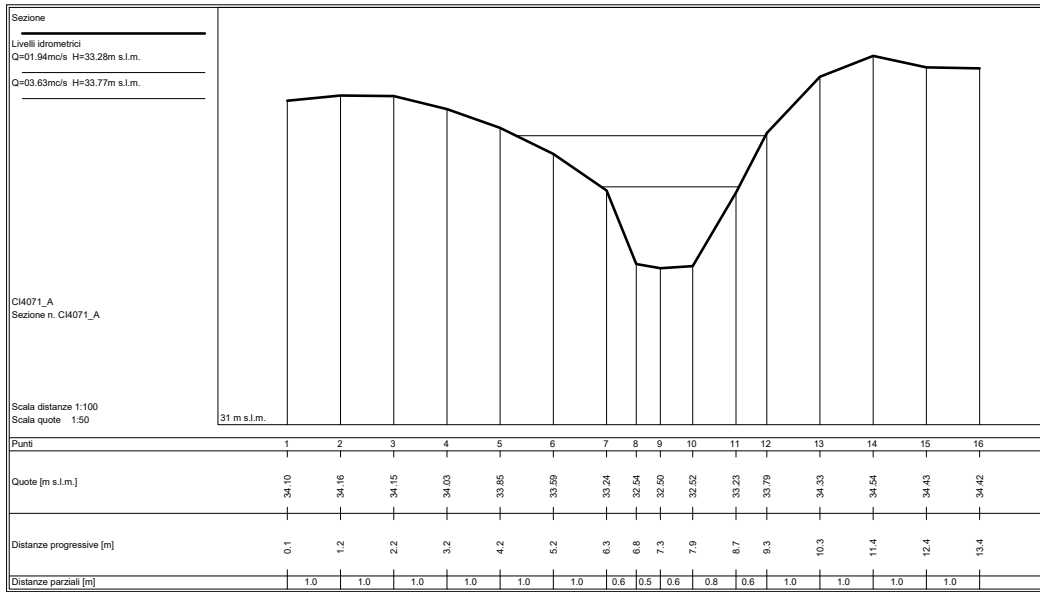

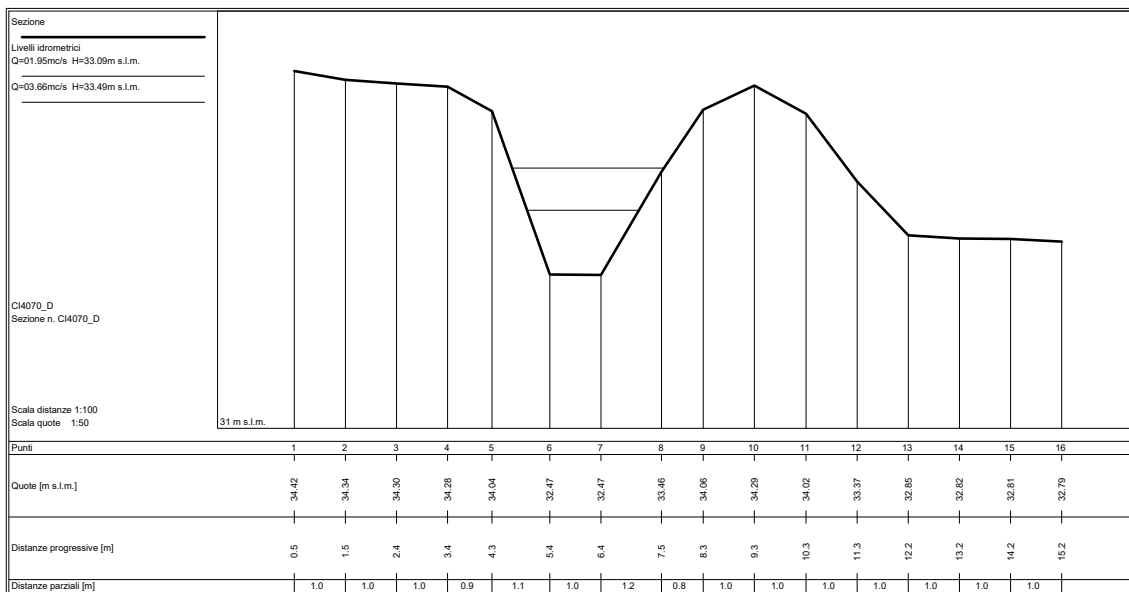
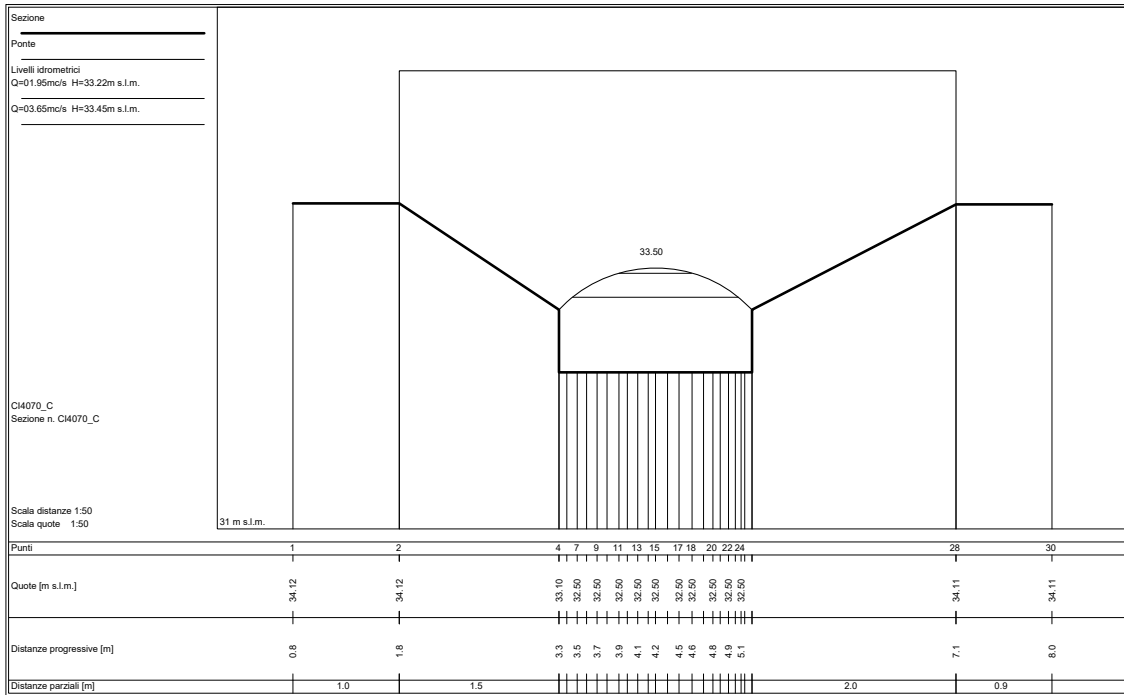

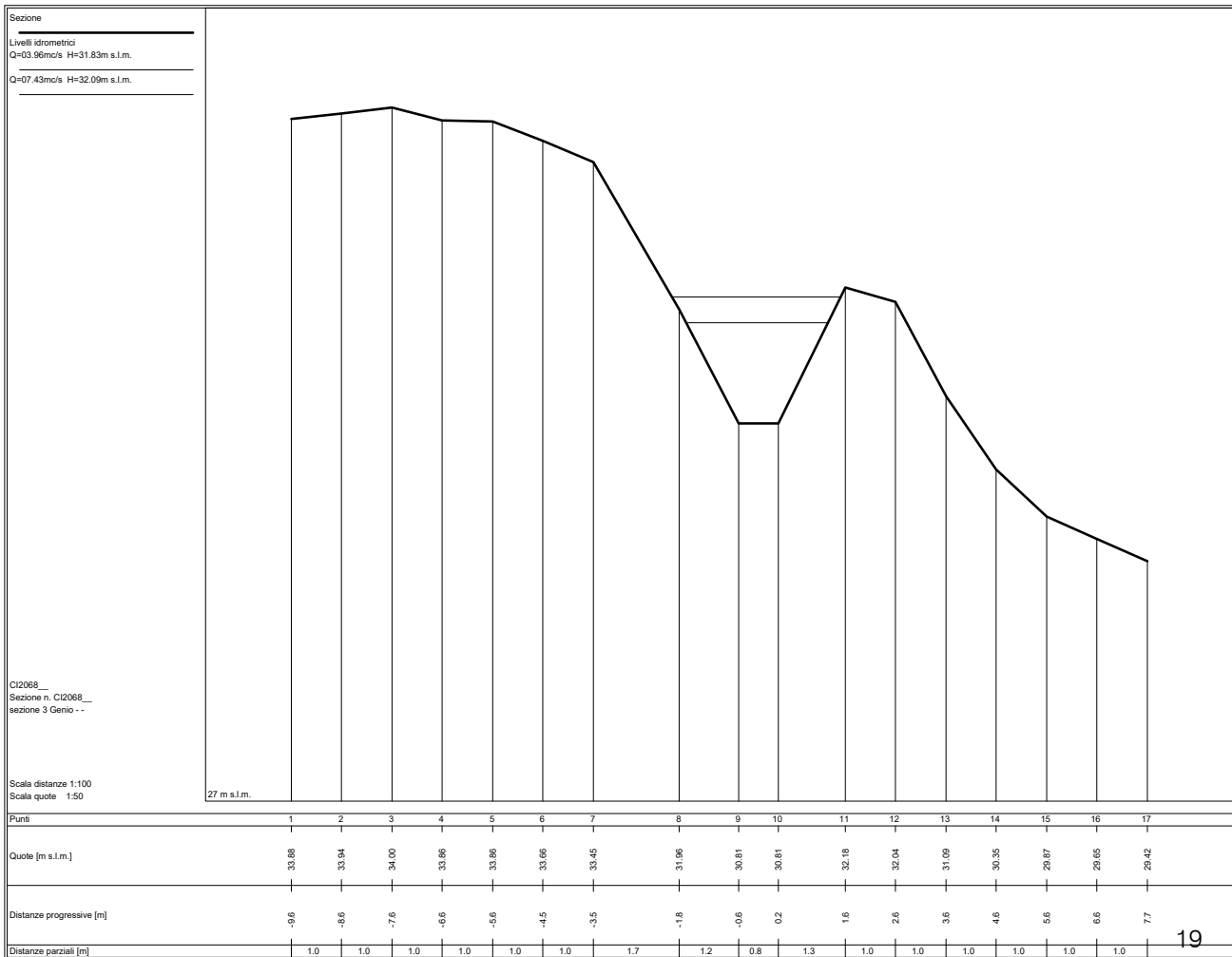
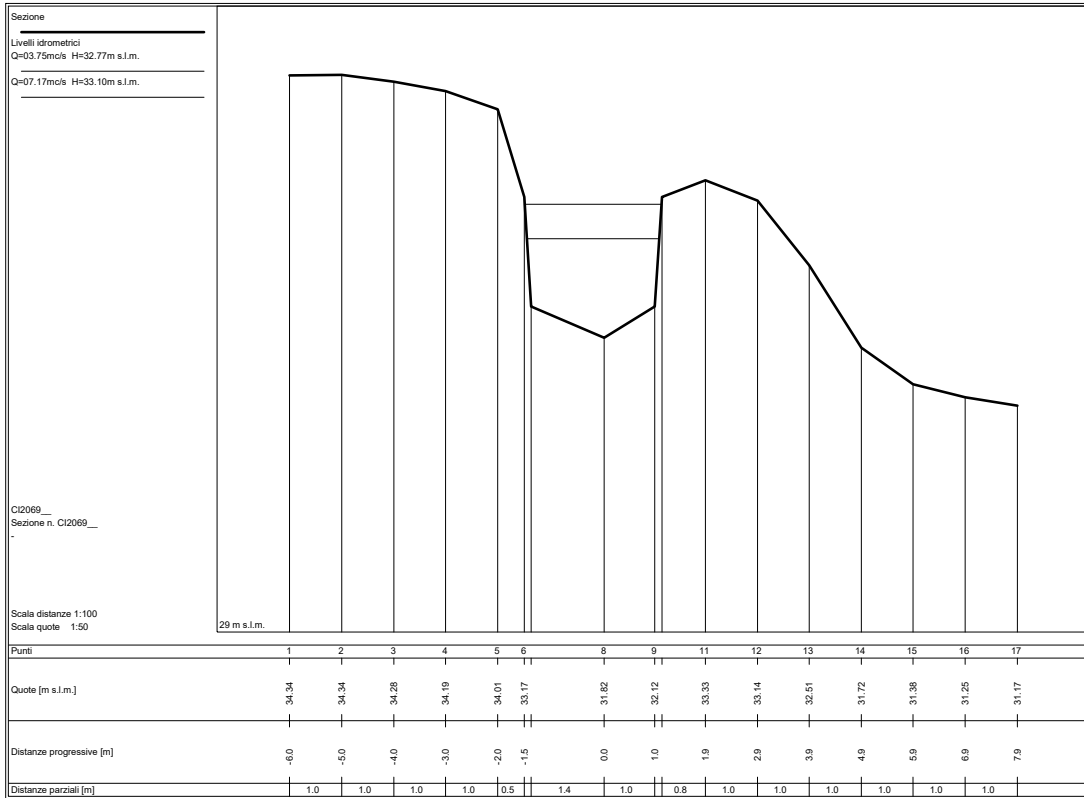

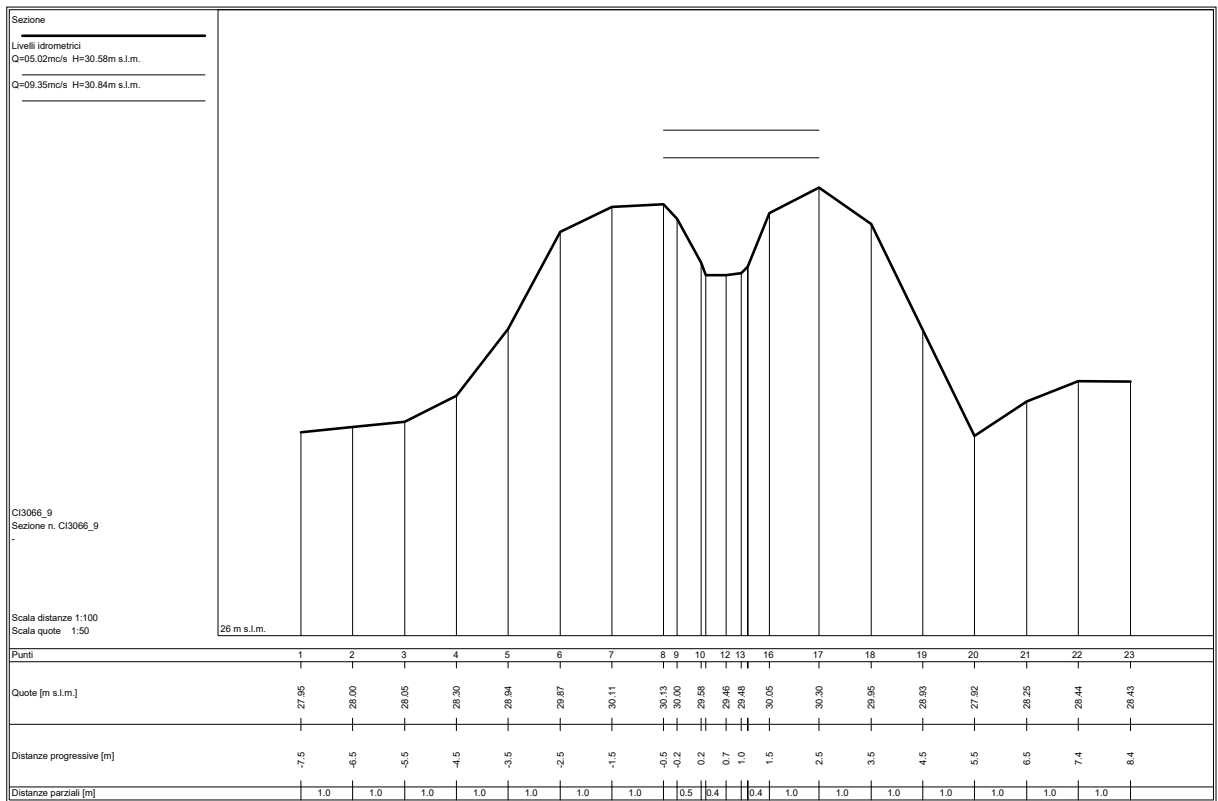
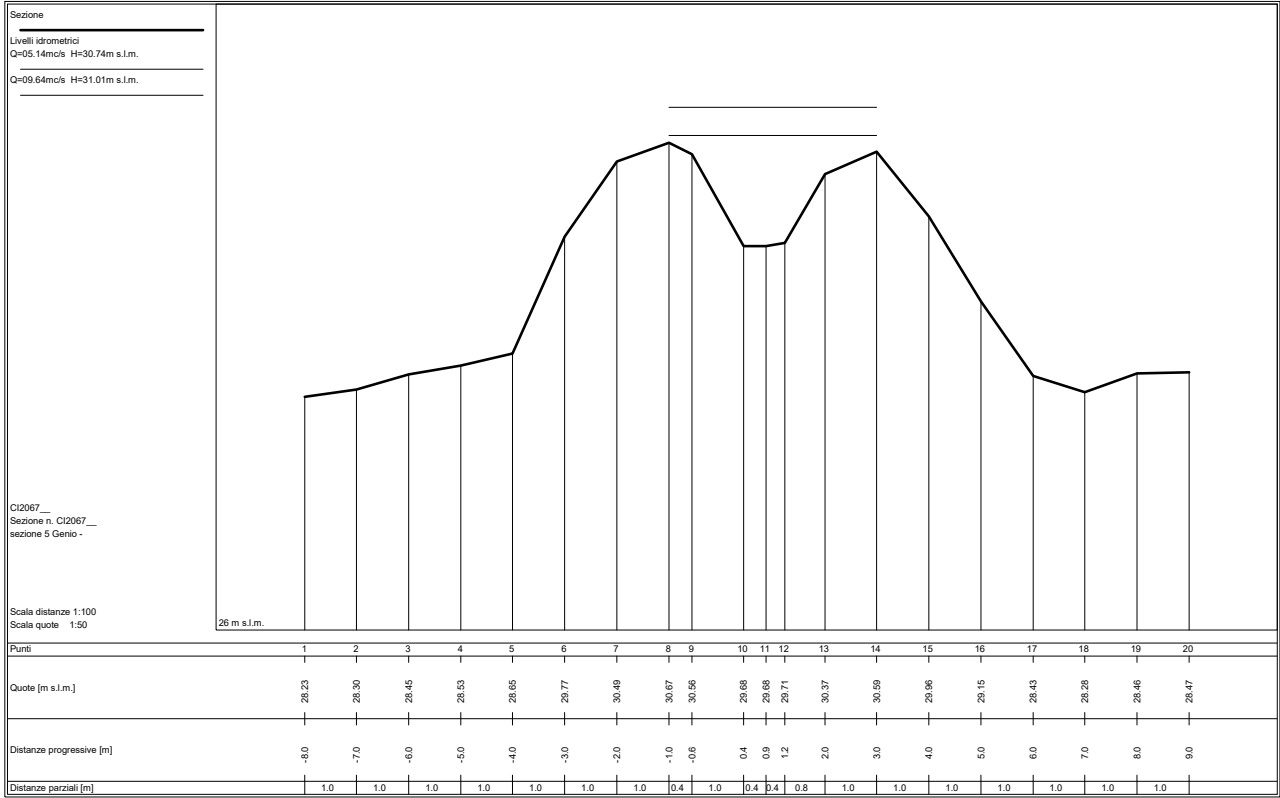

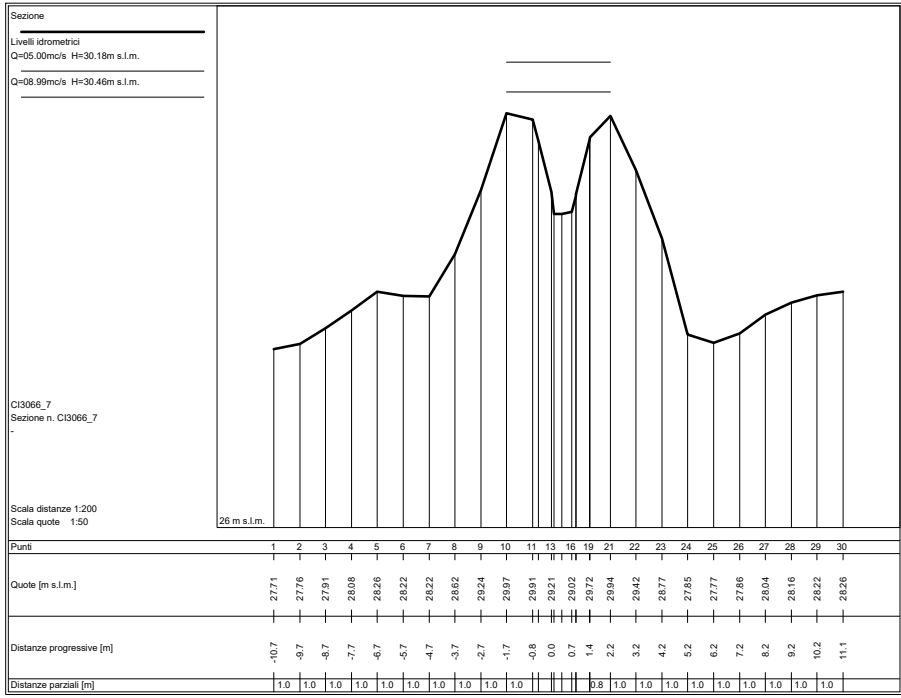
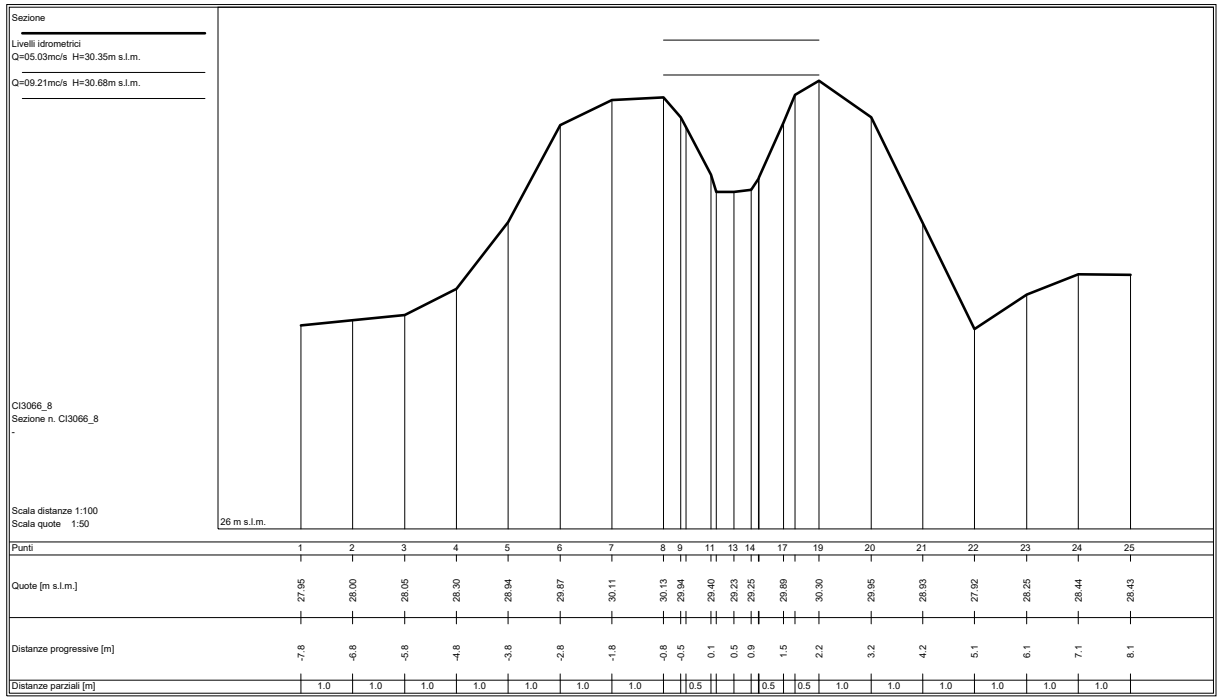

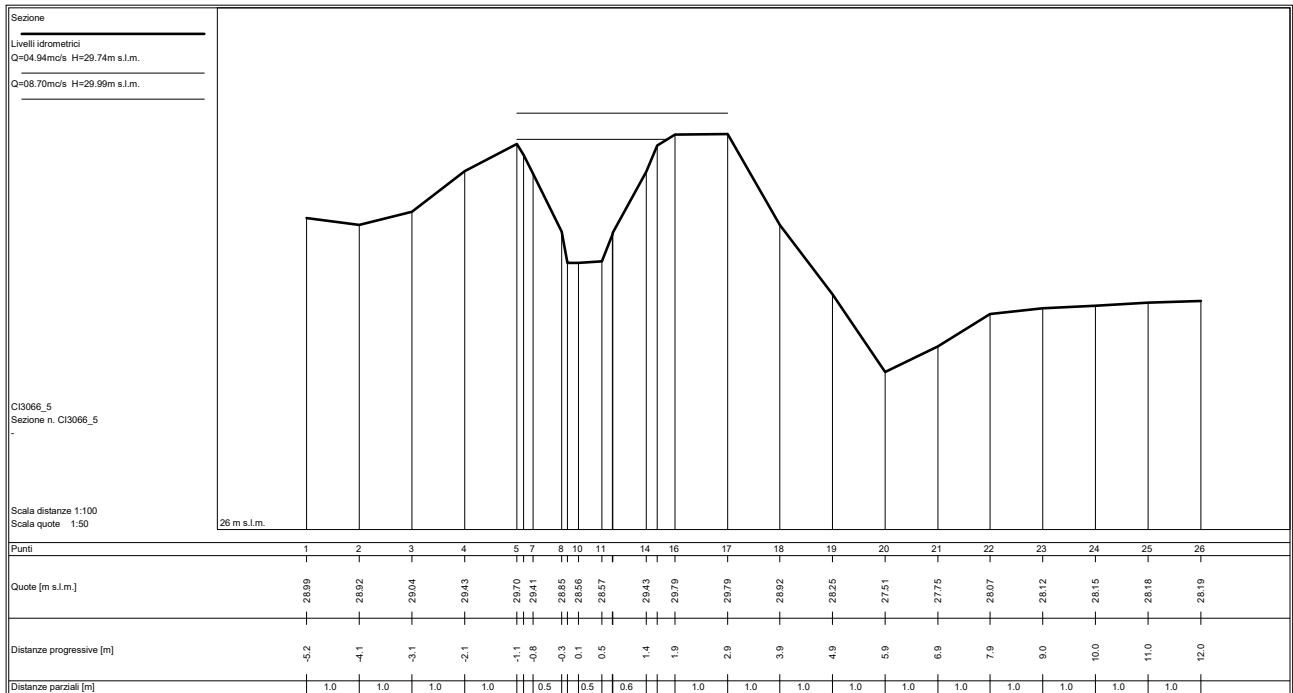
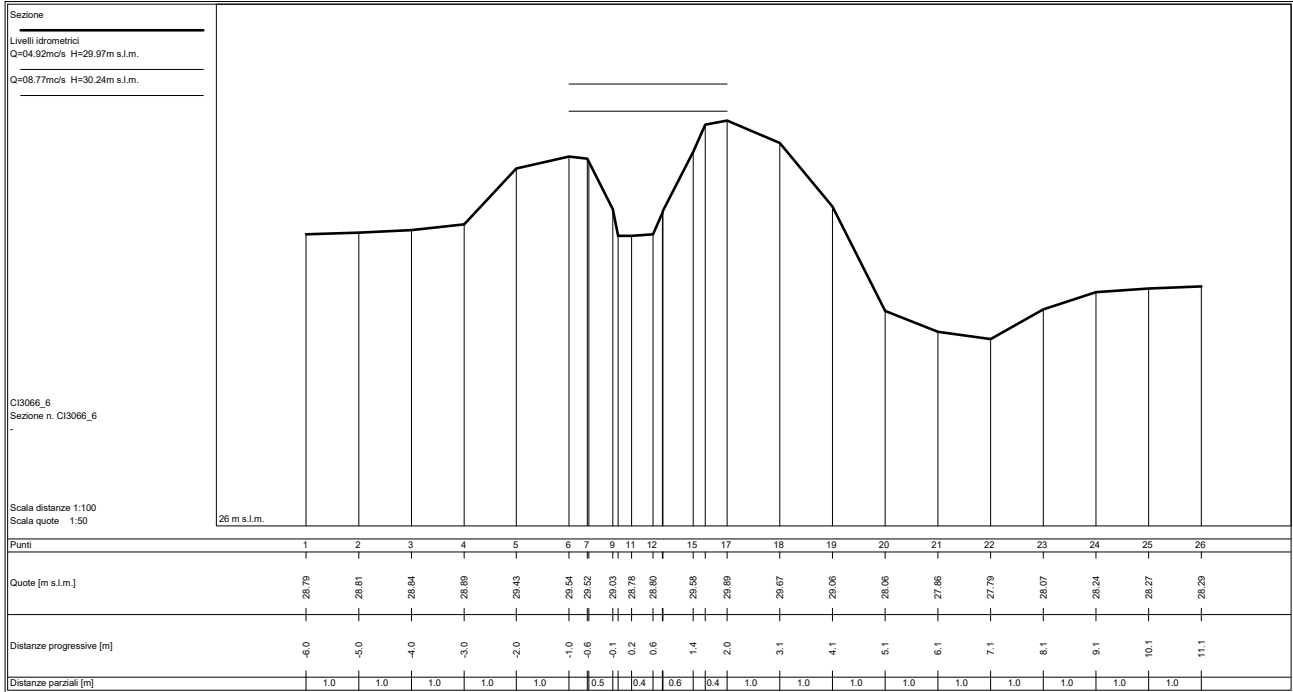

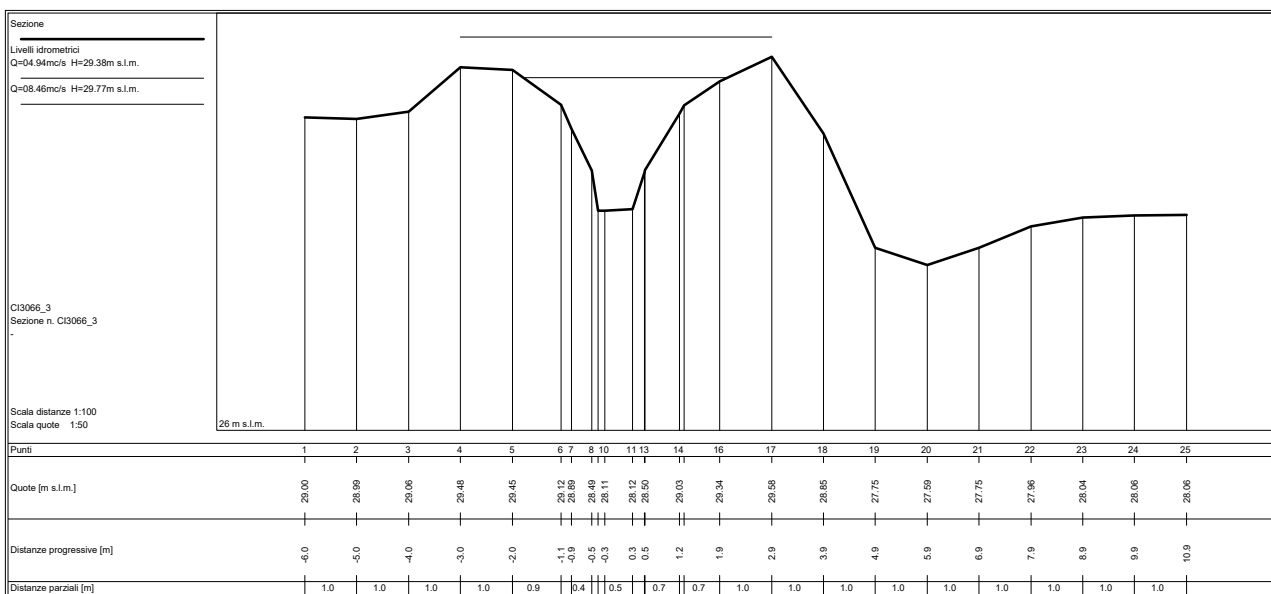
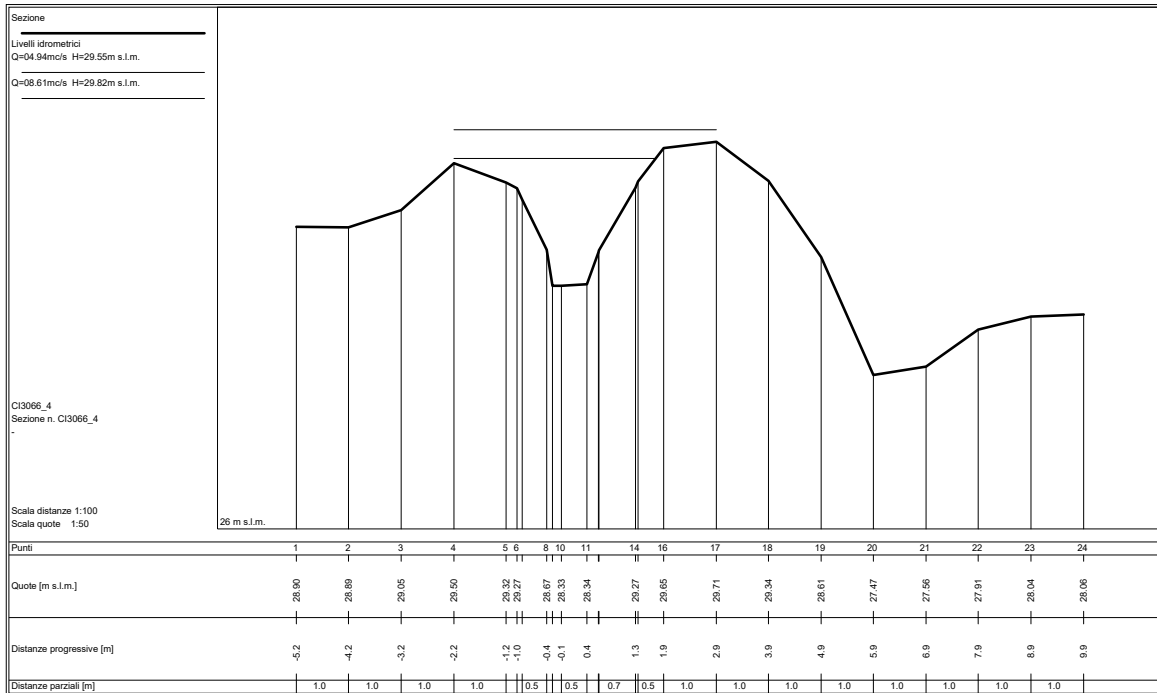

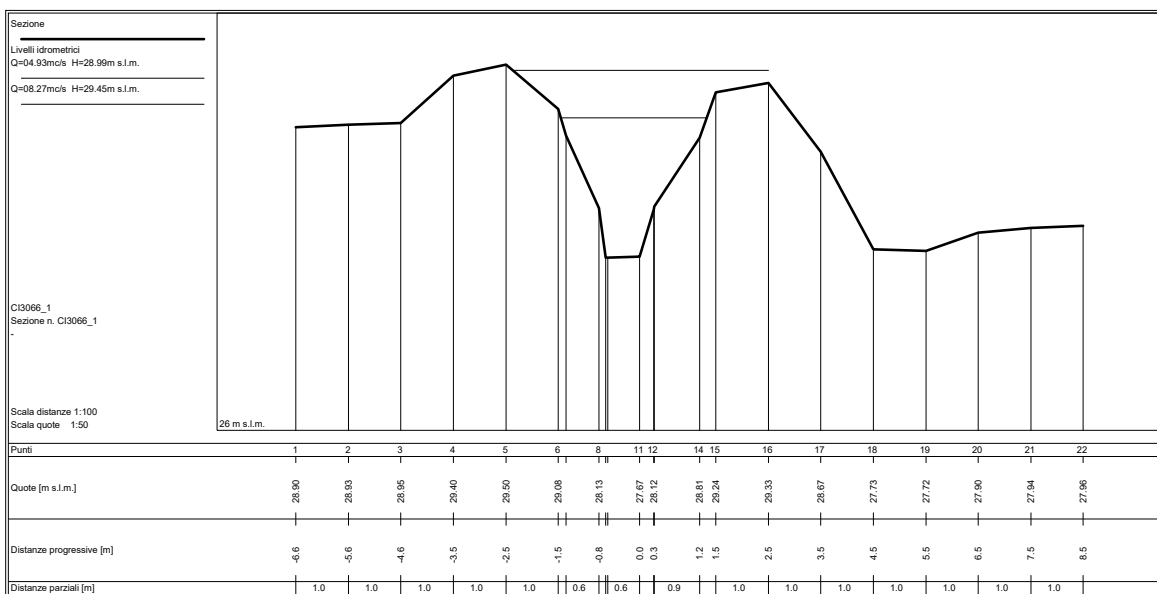
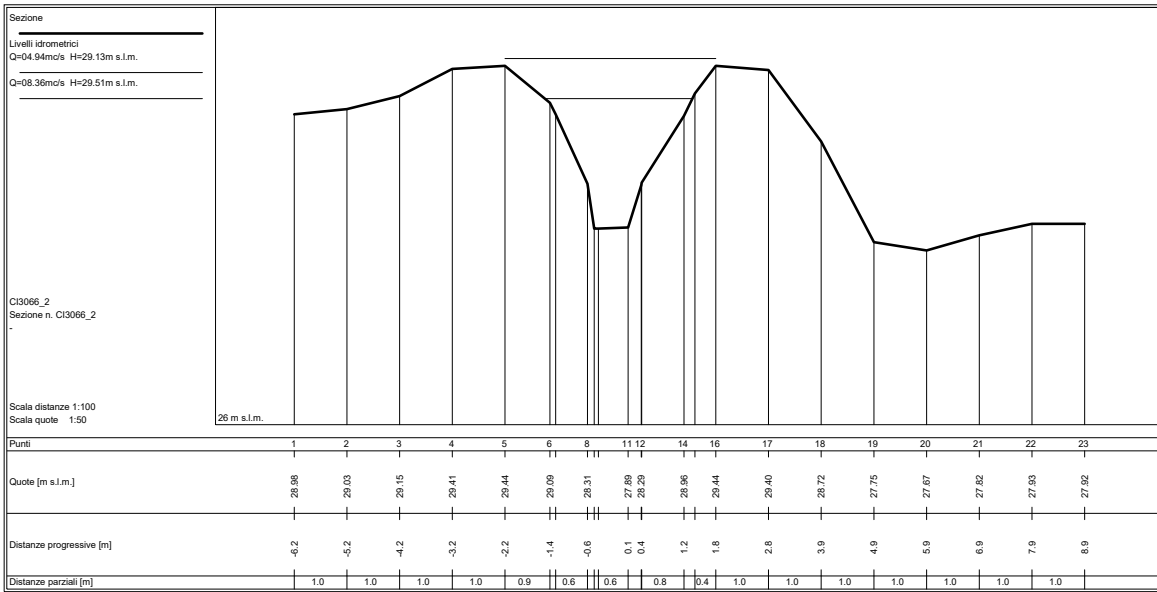

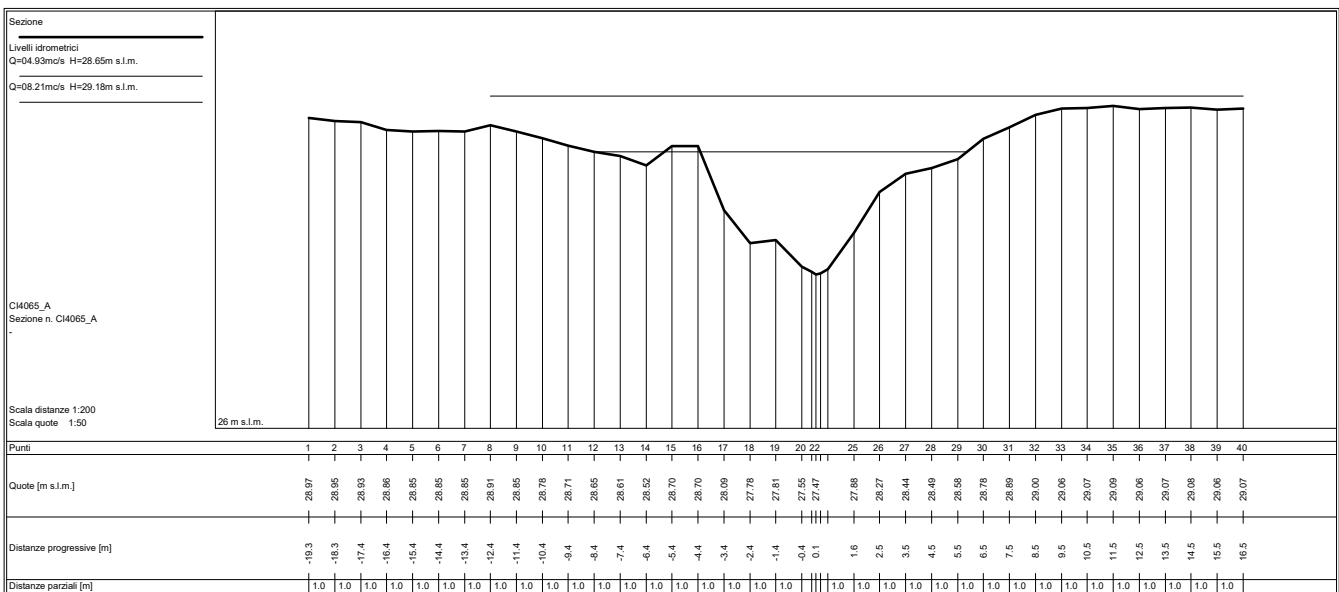
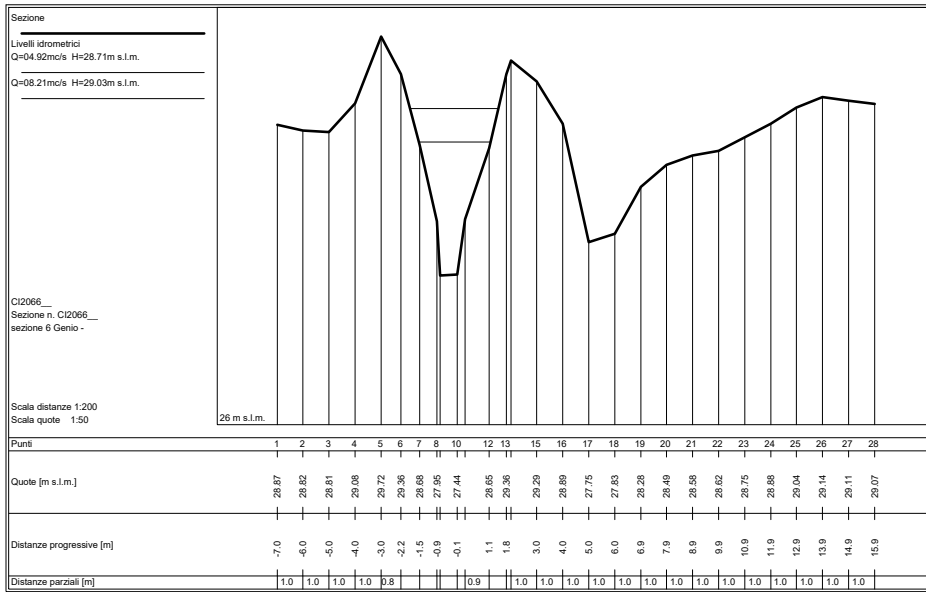

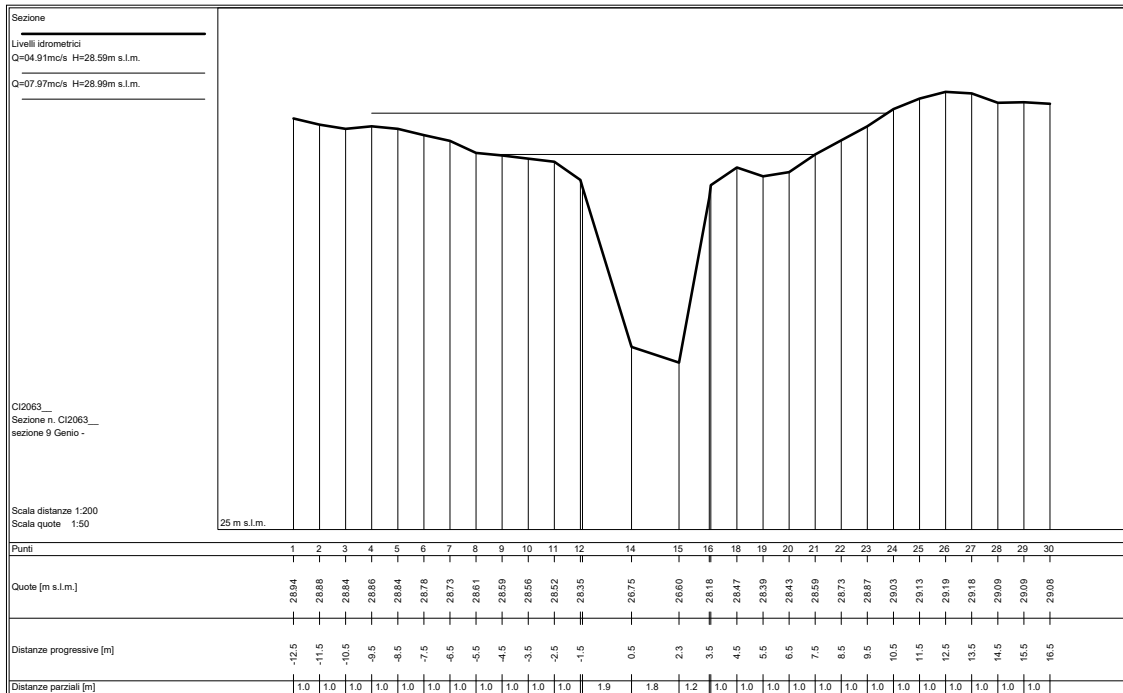
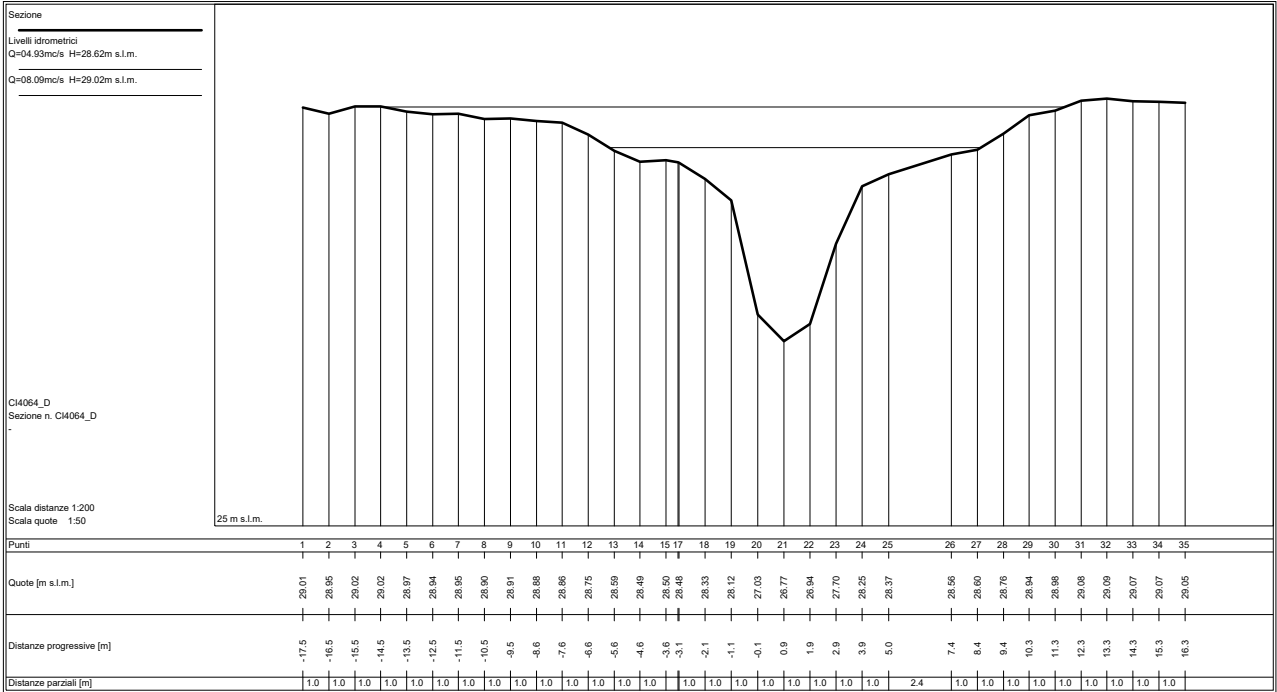

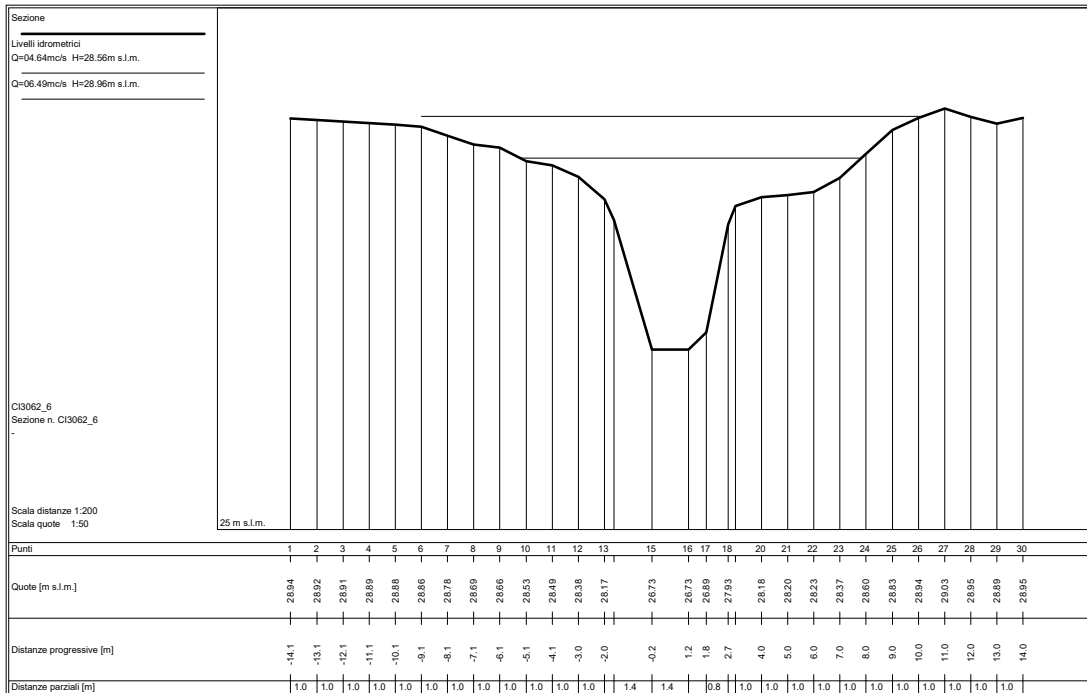
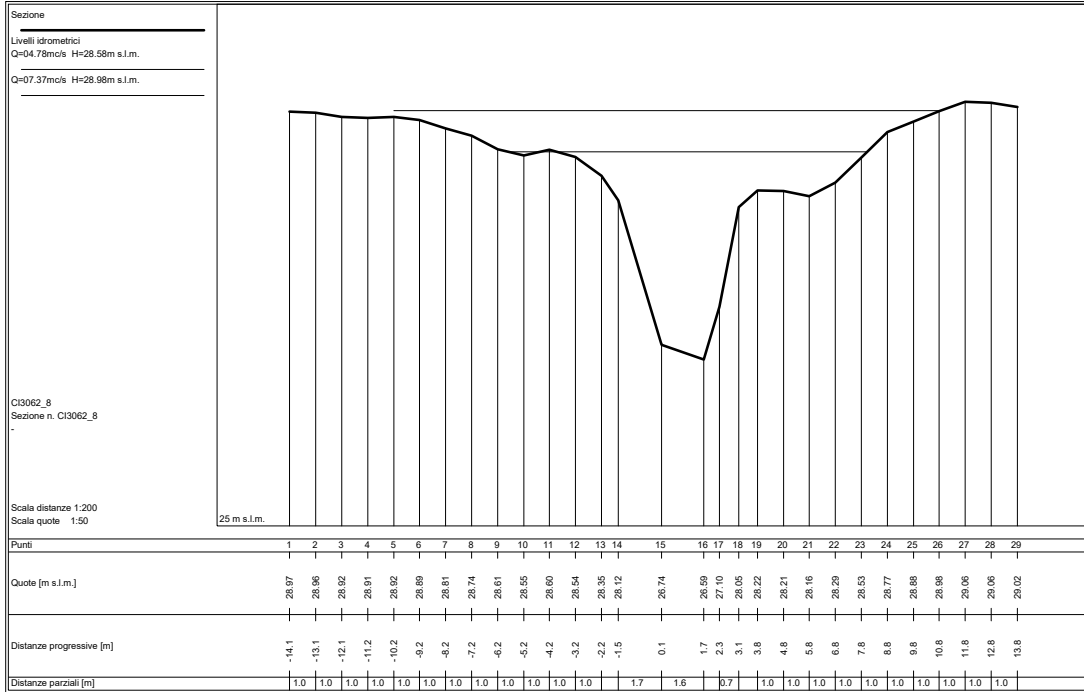

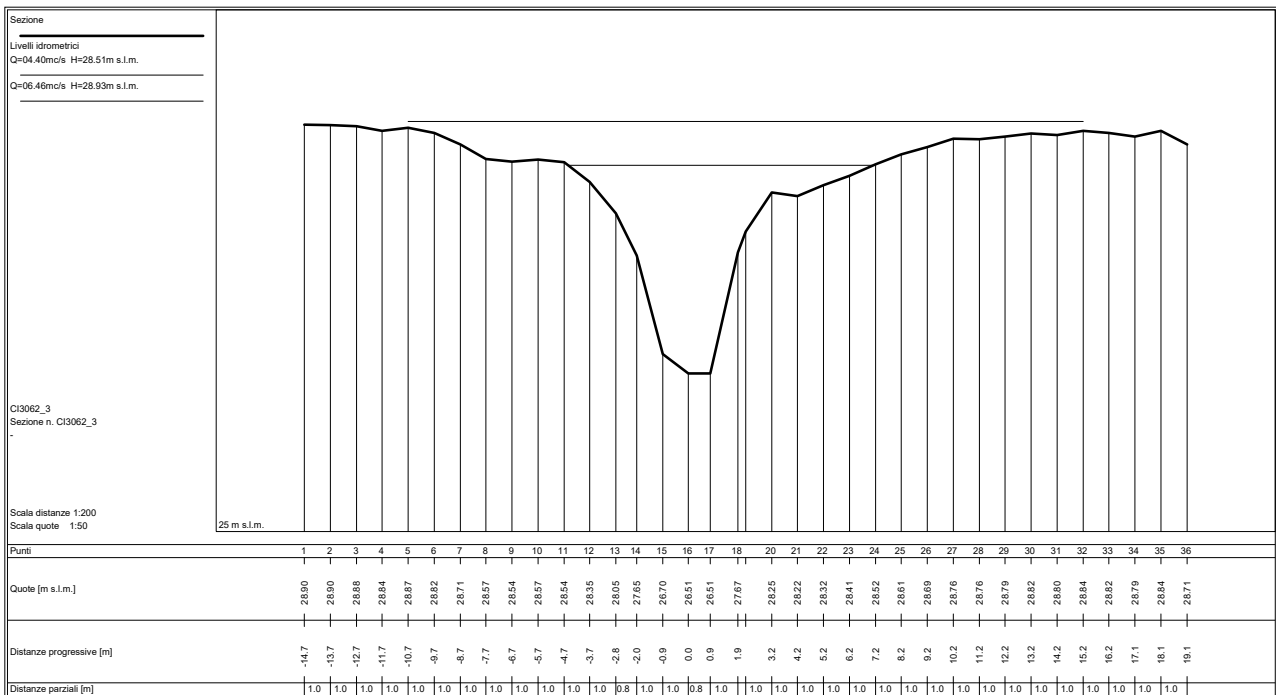
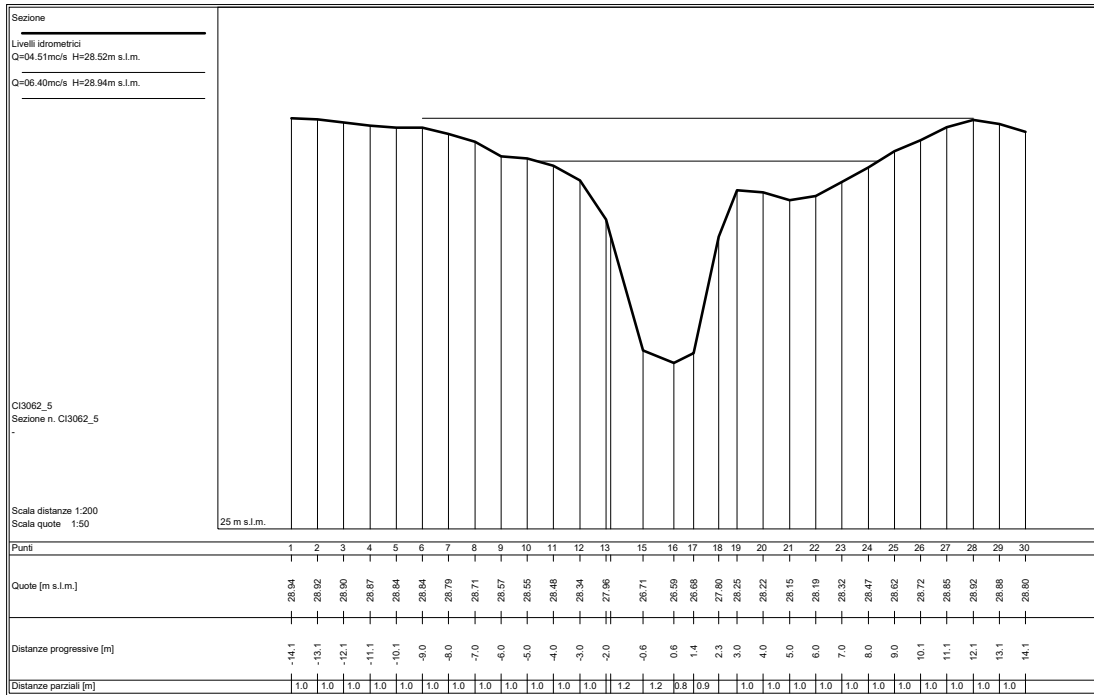

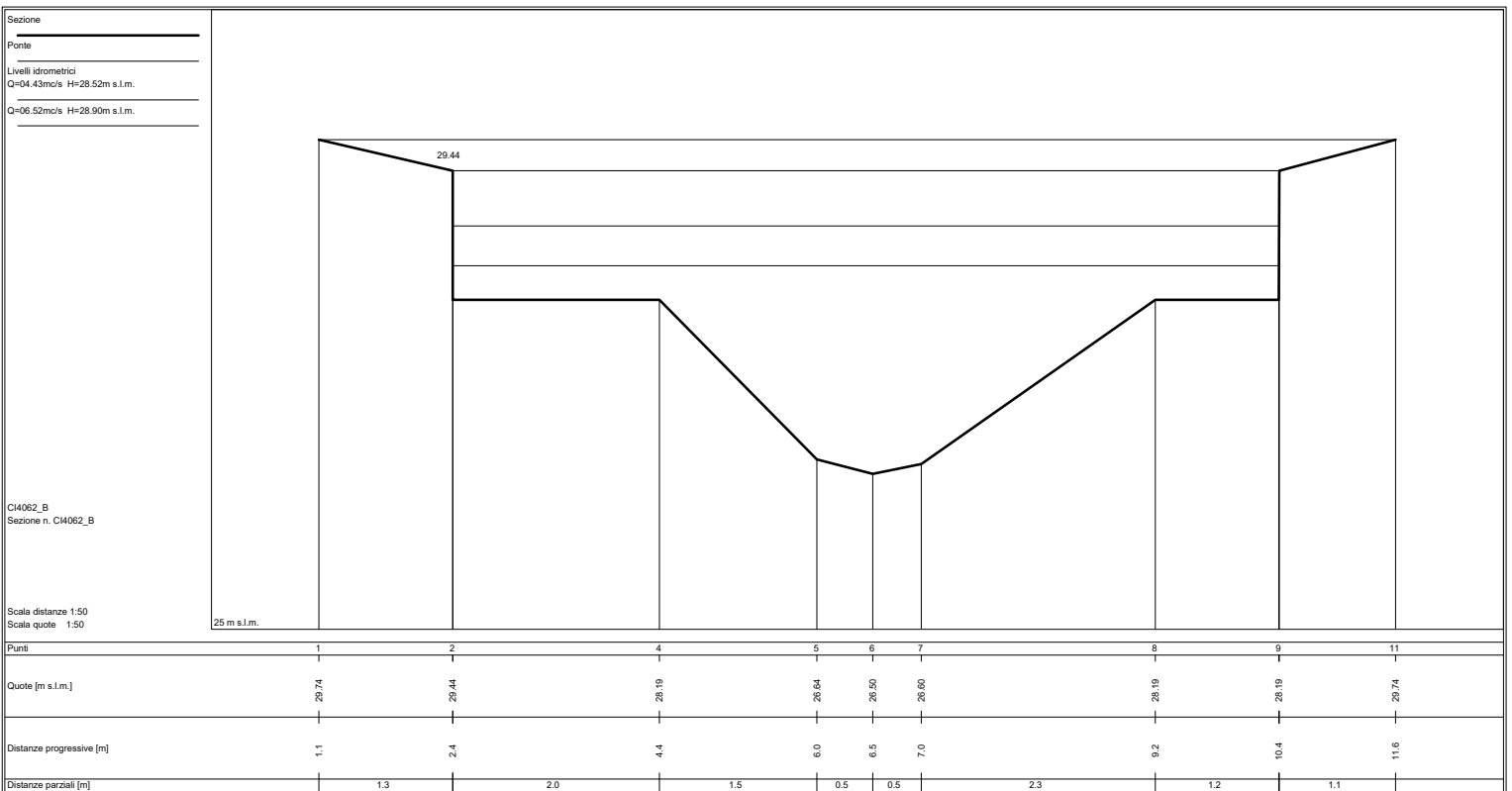
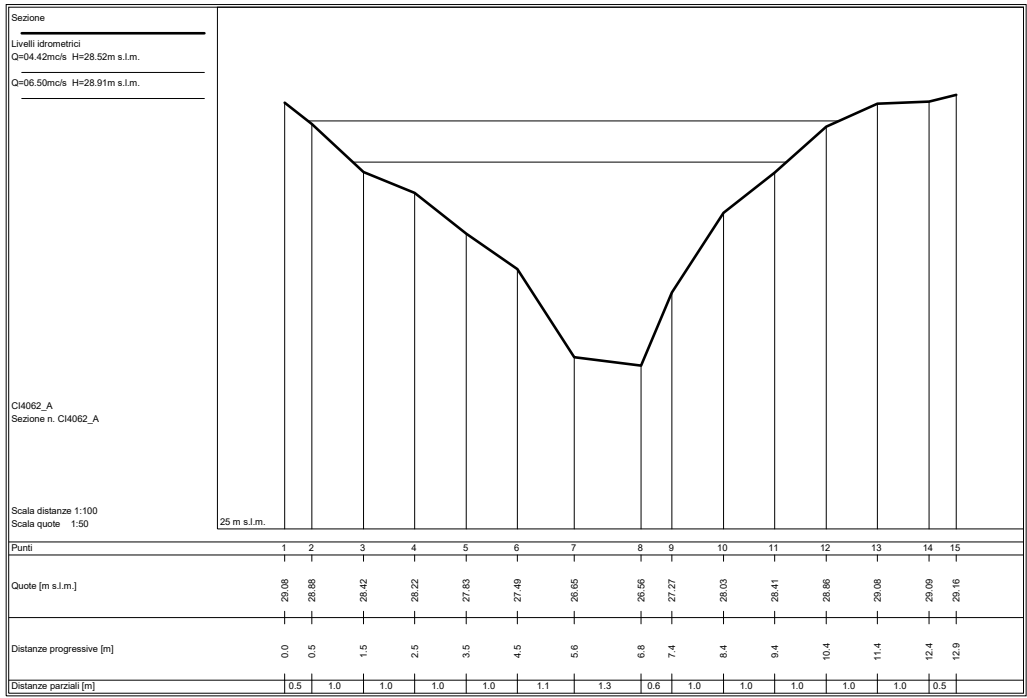

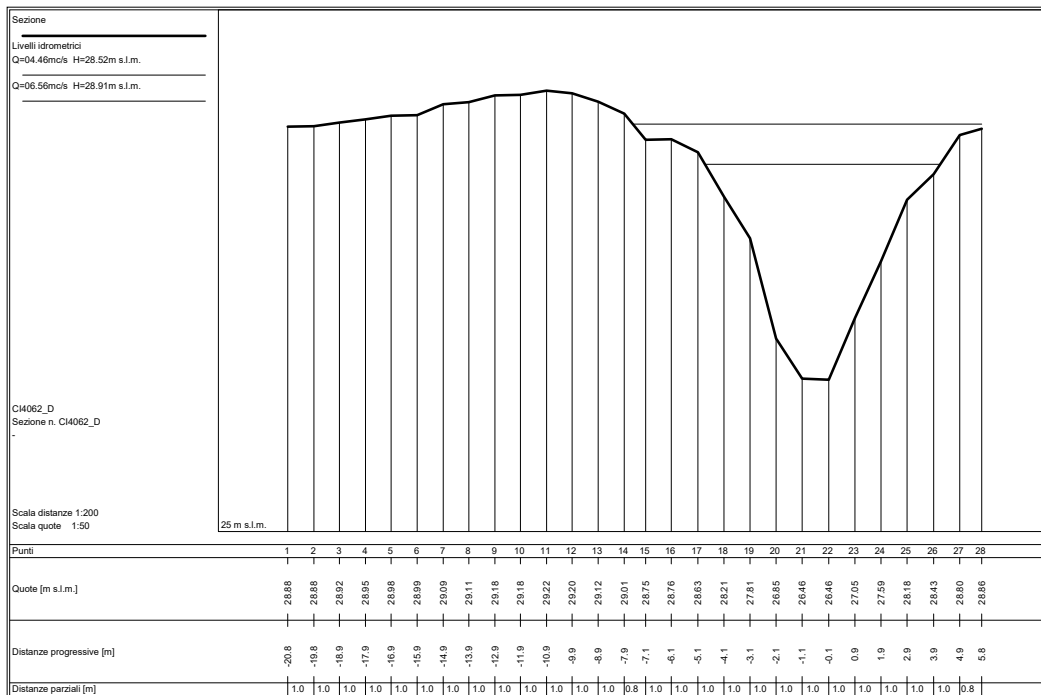
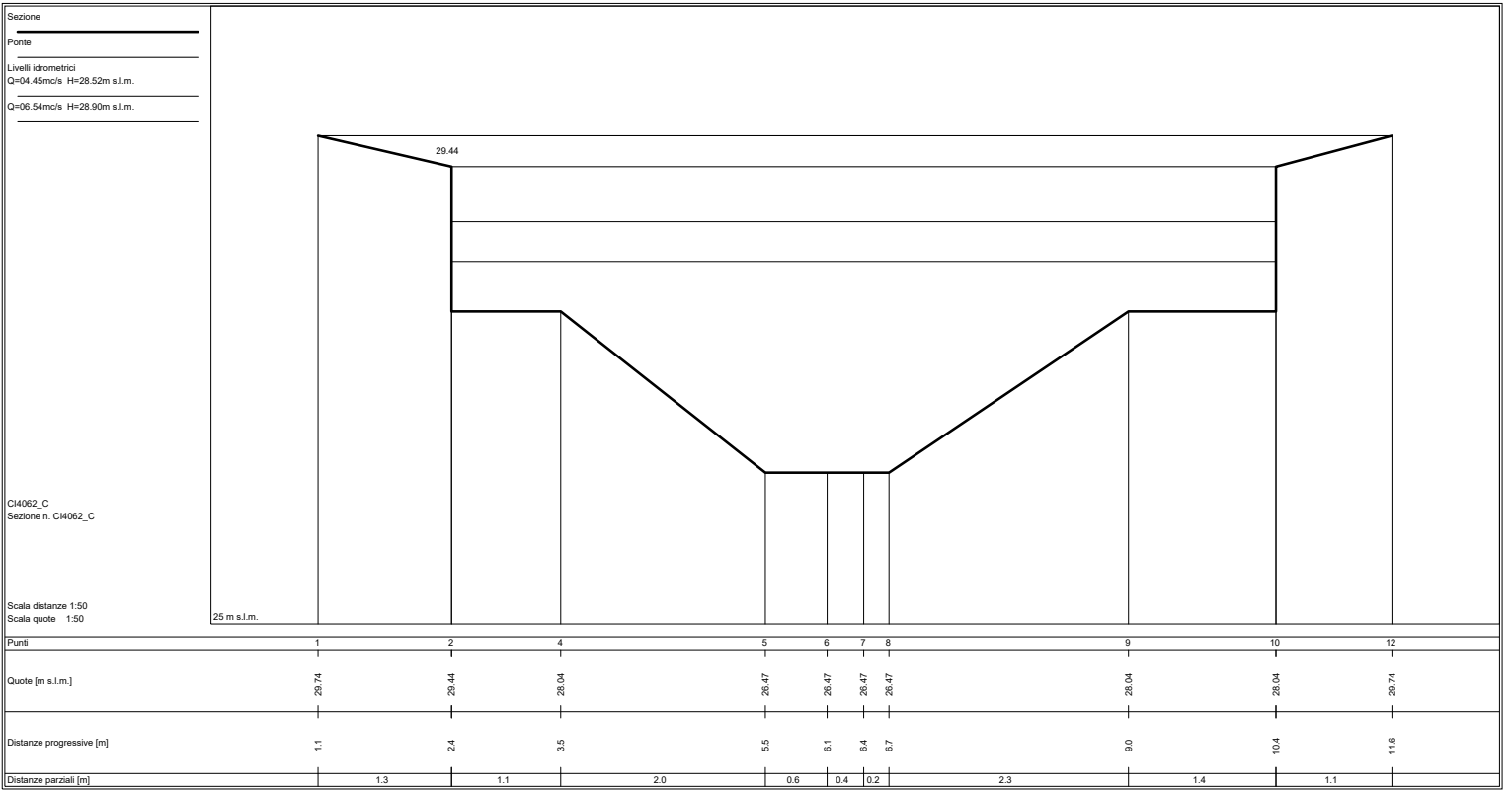

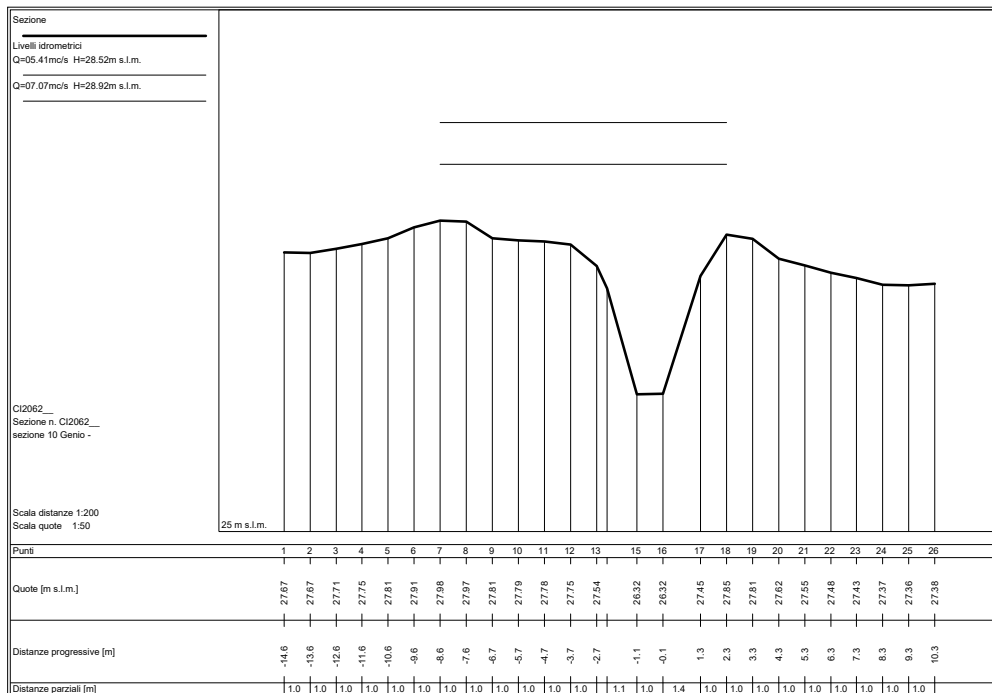
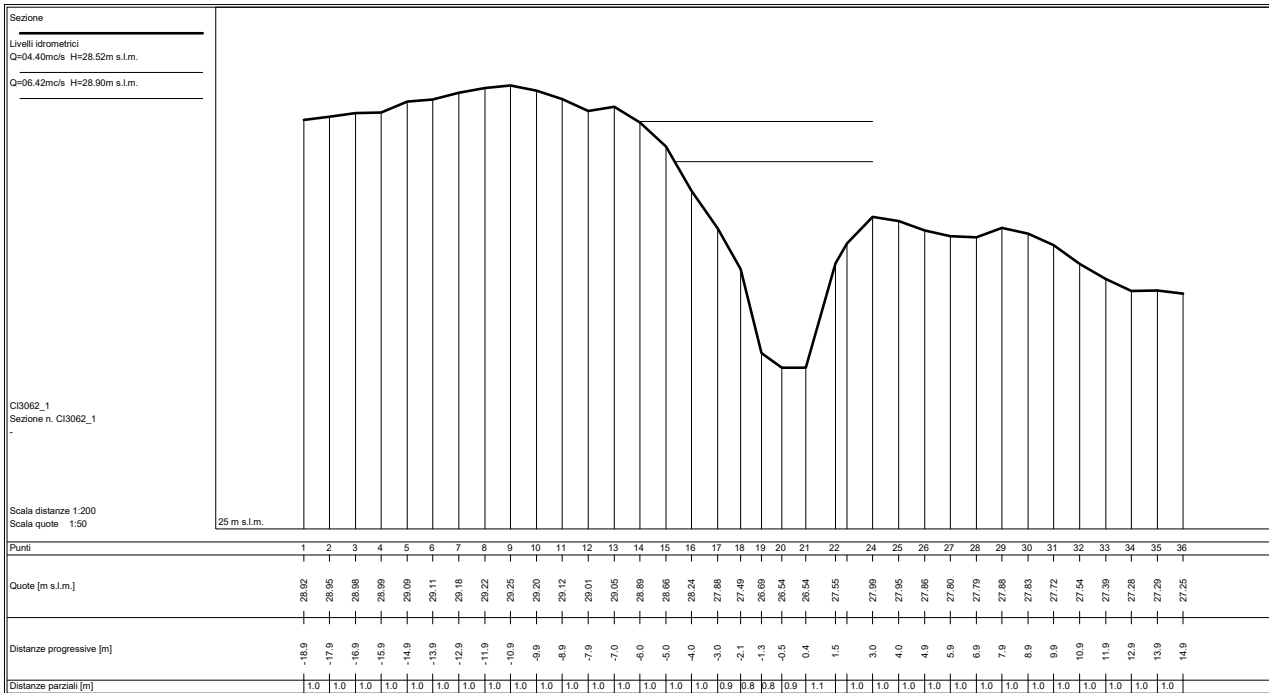

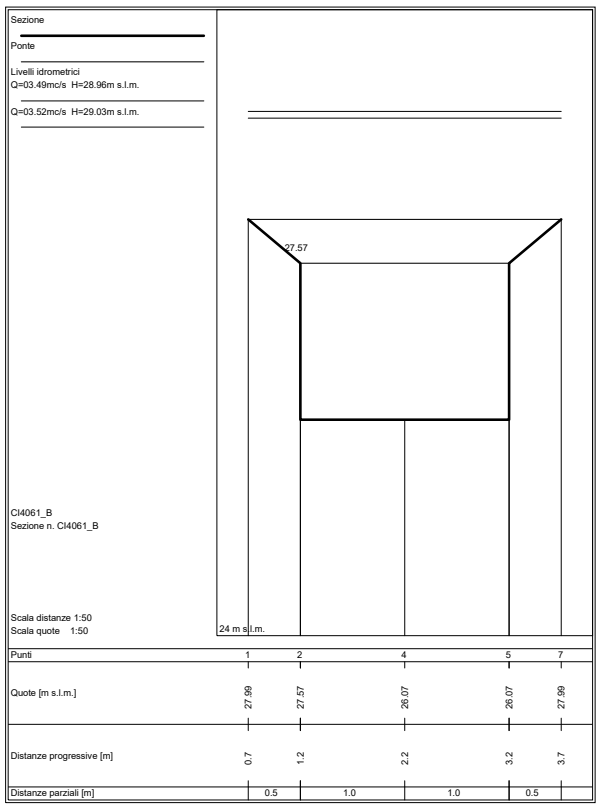
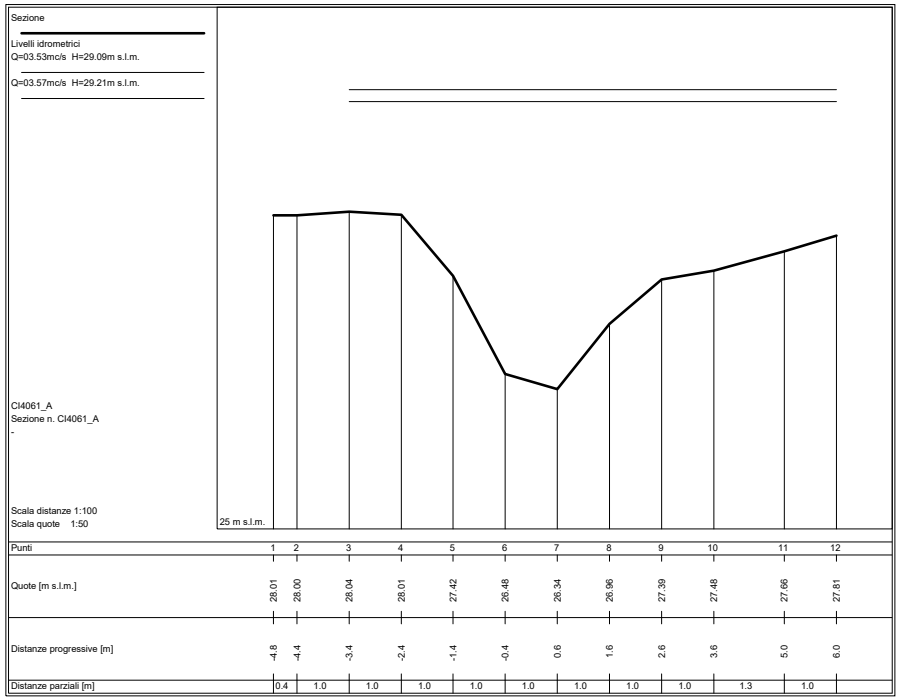

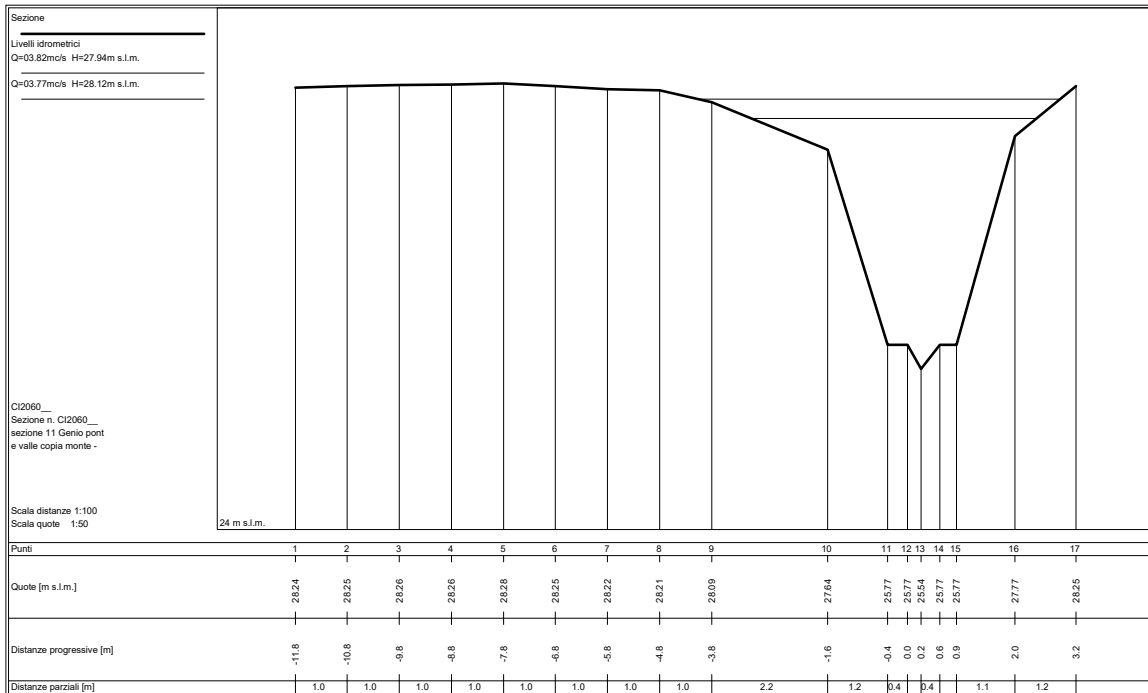
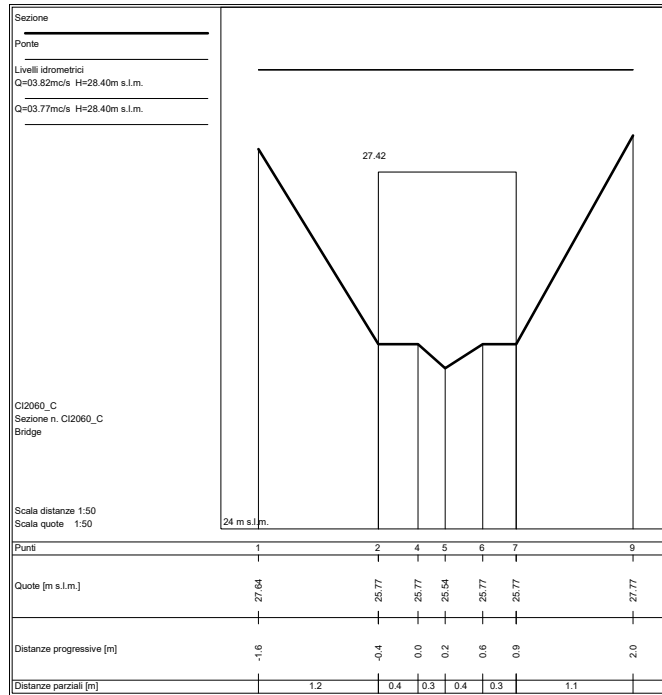

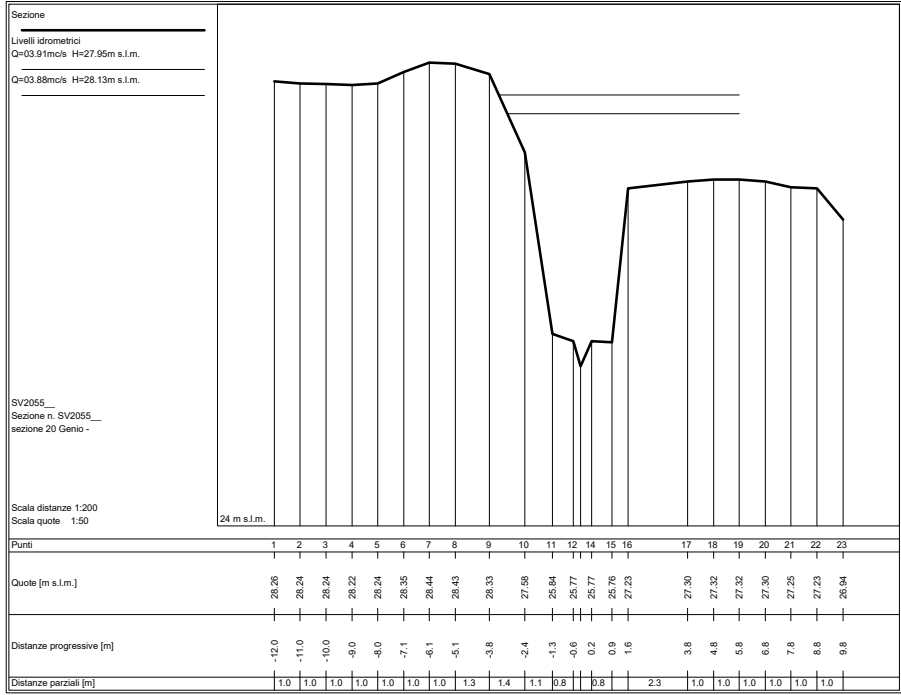

SEZIONI FLUVIALI
FOSSO CORTENUOVA – tratto Cortenuova

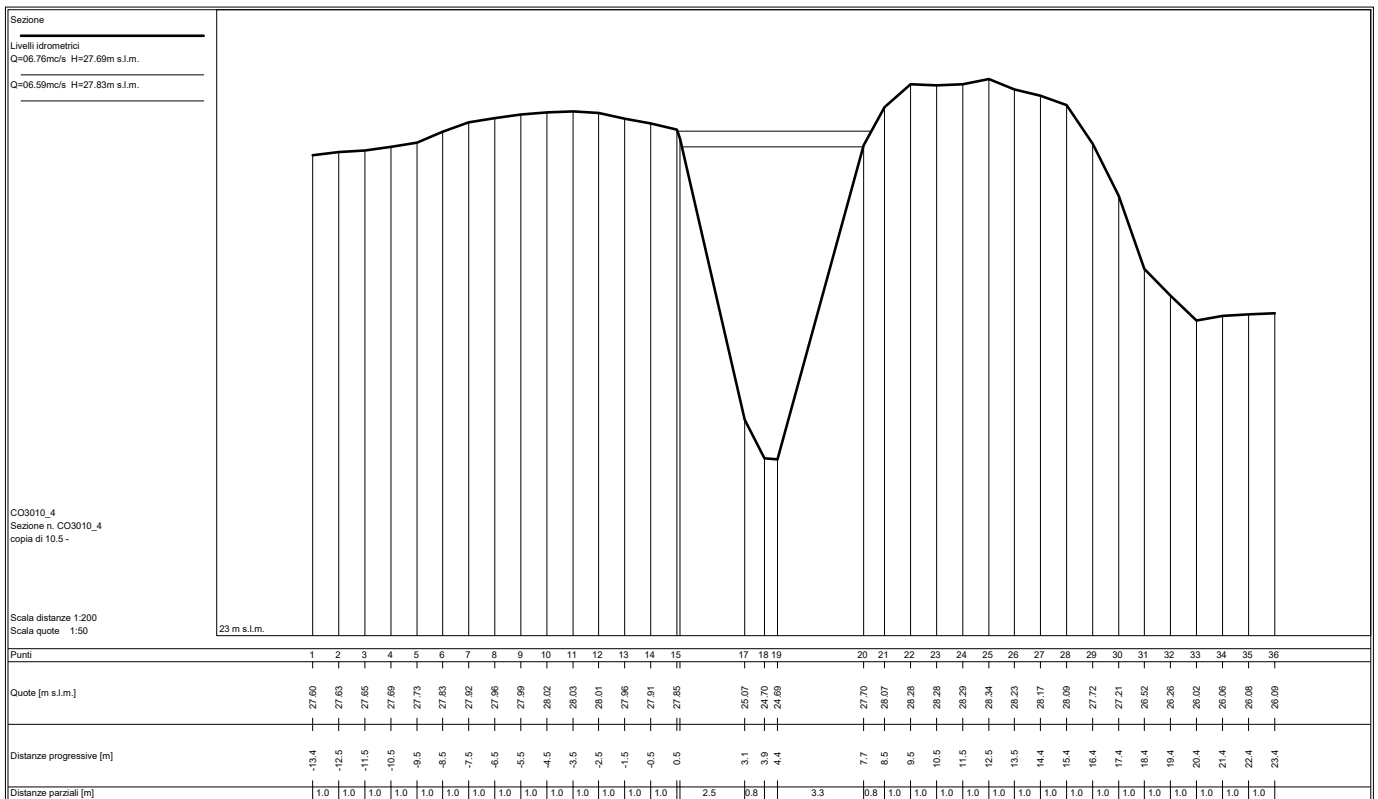
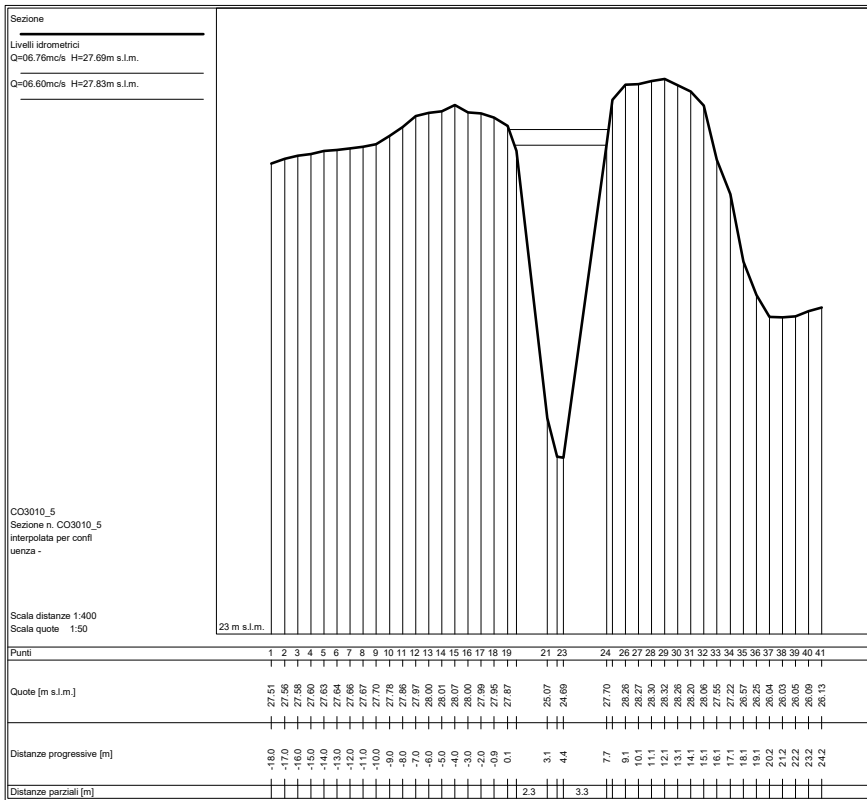

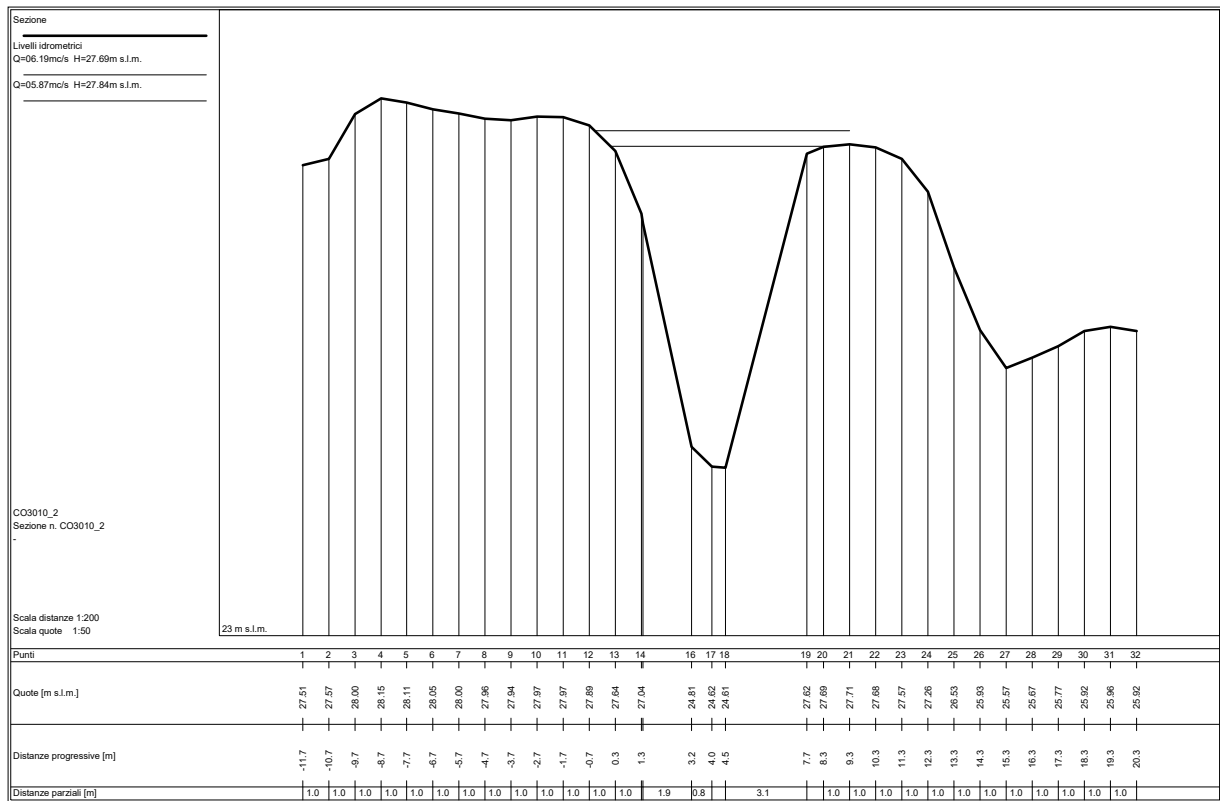
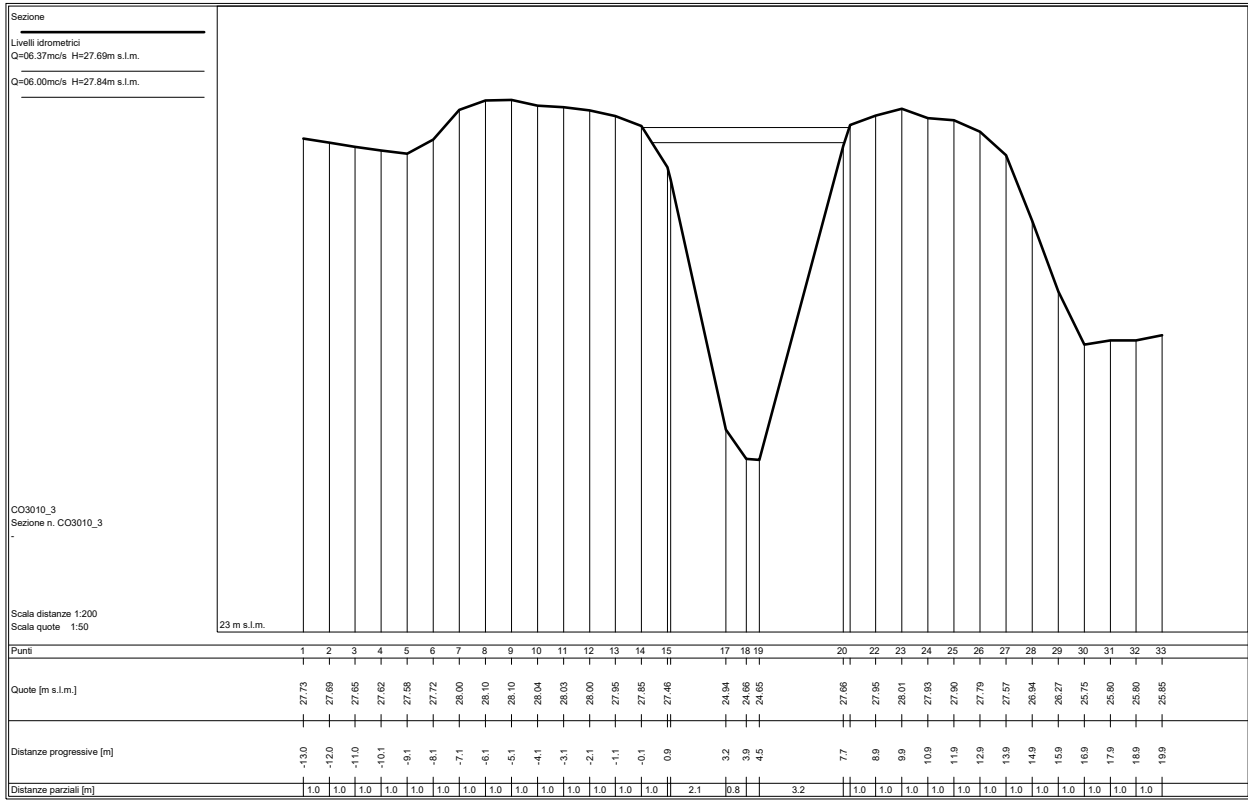

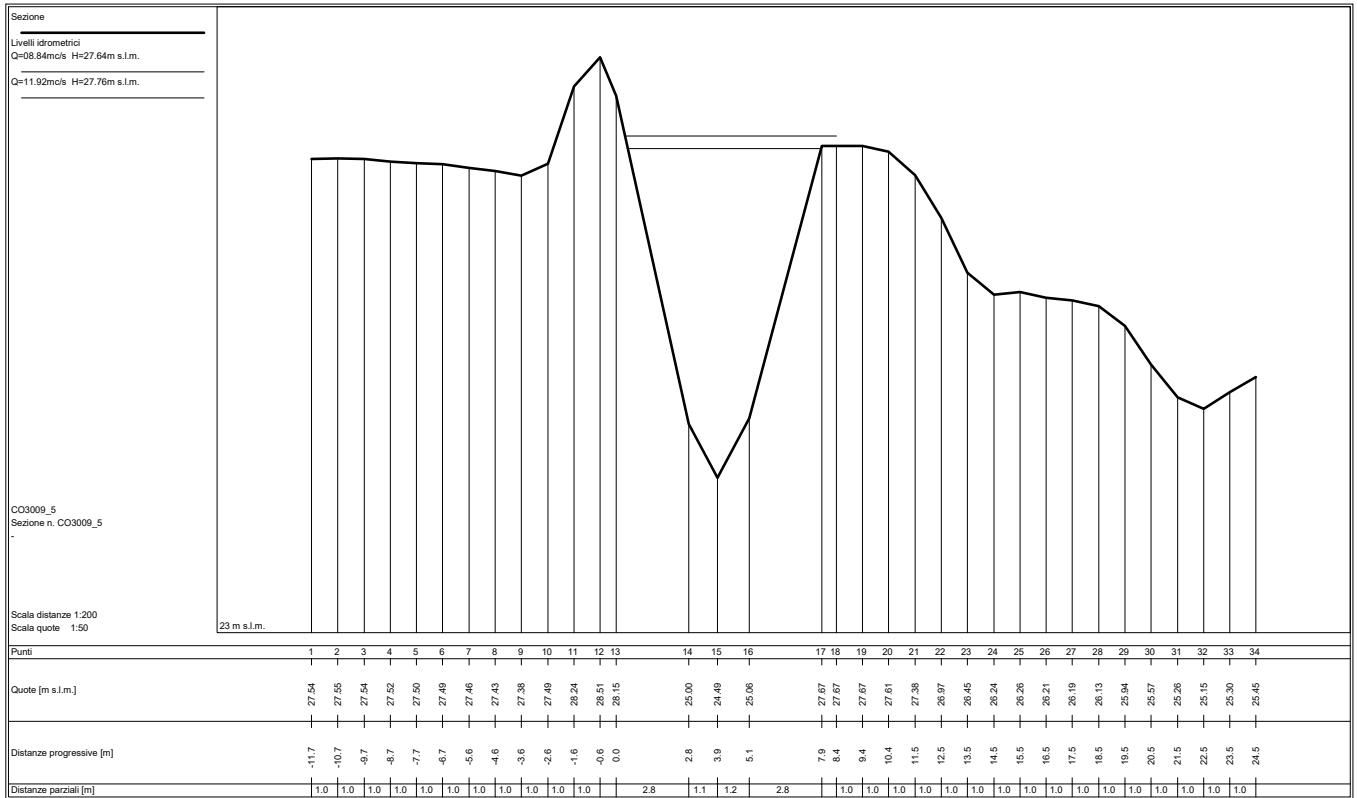
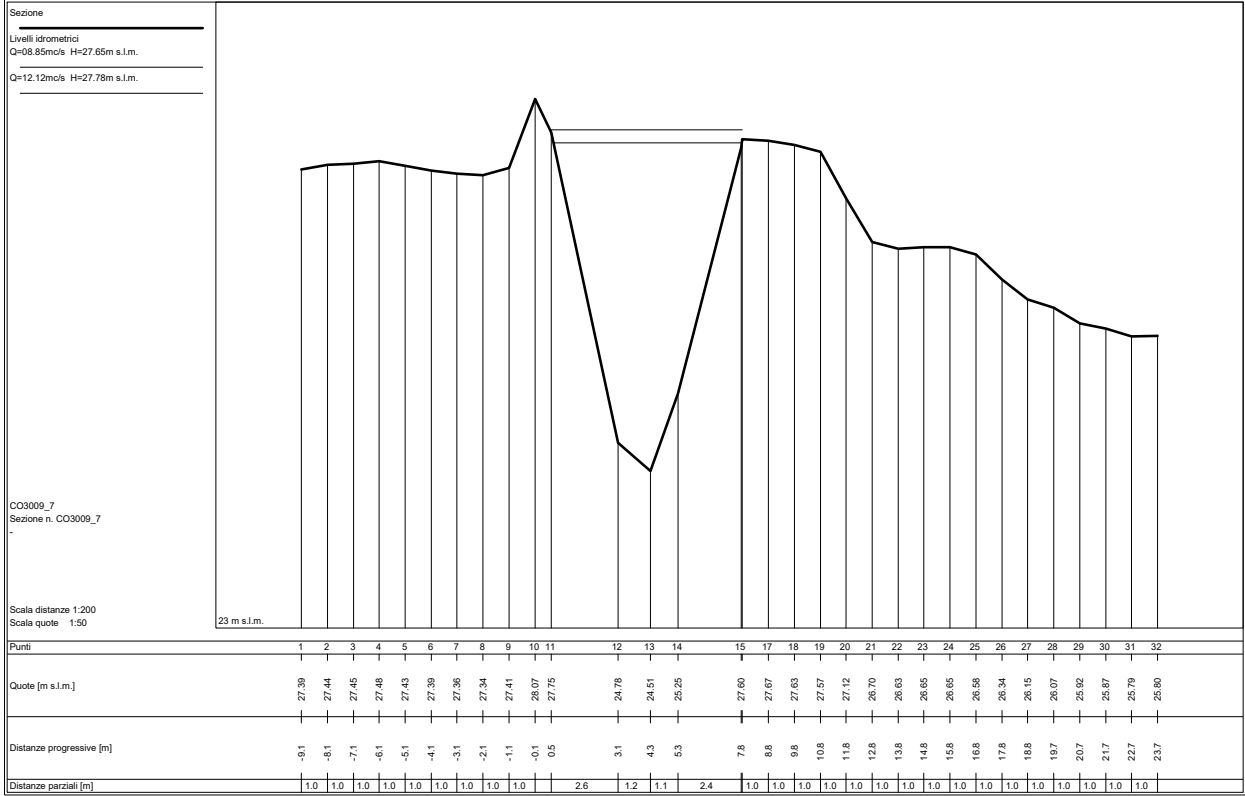

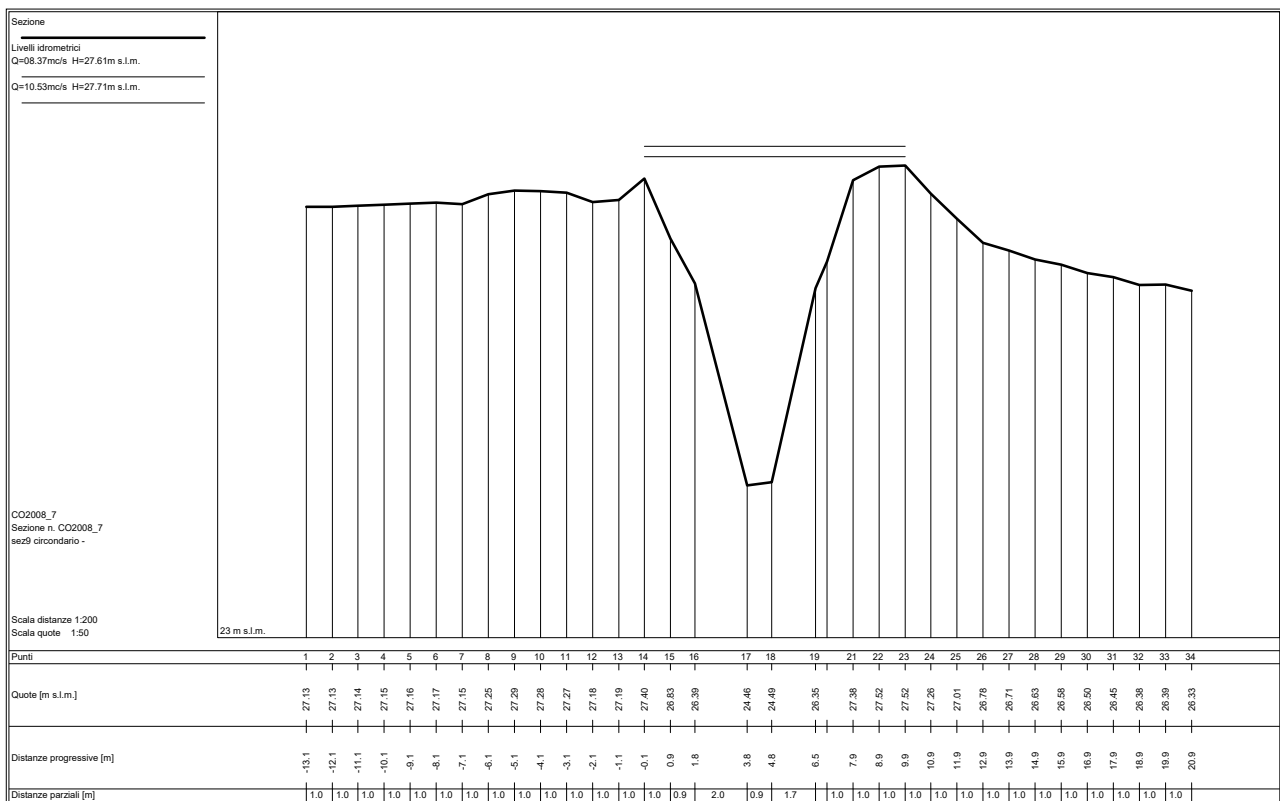
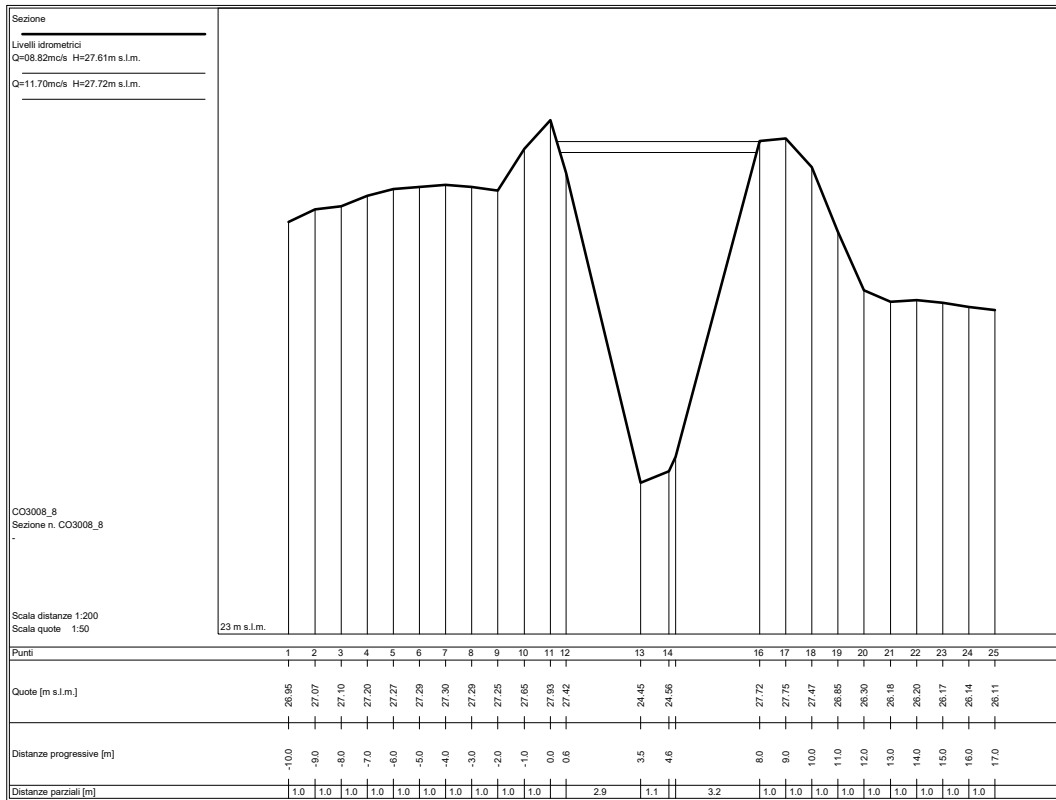

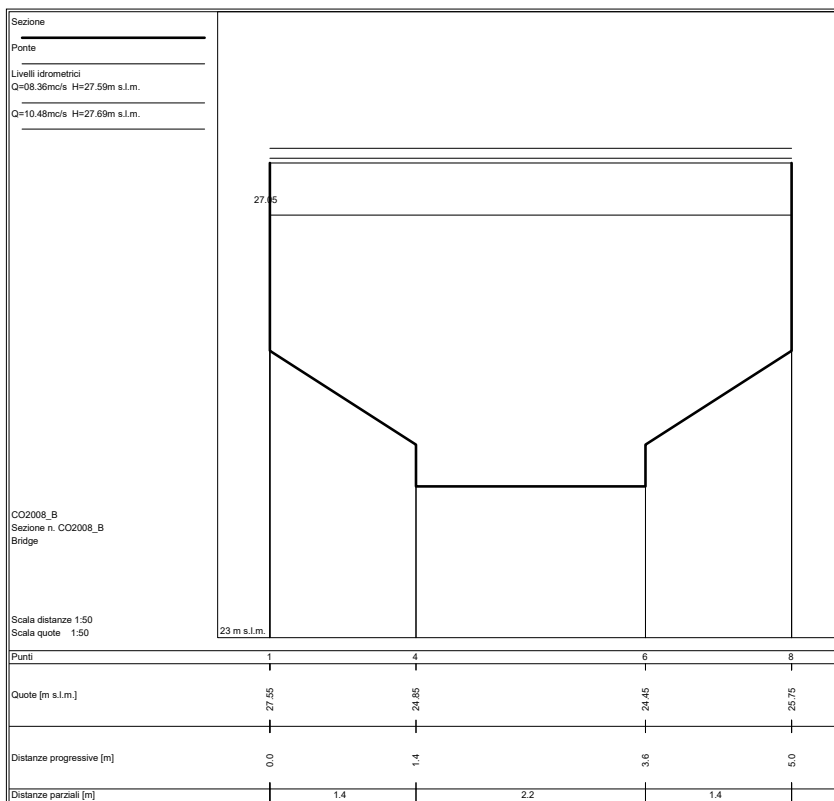
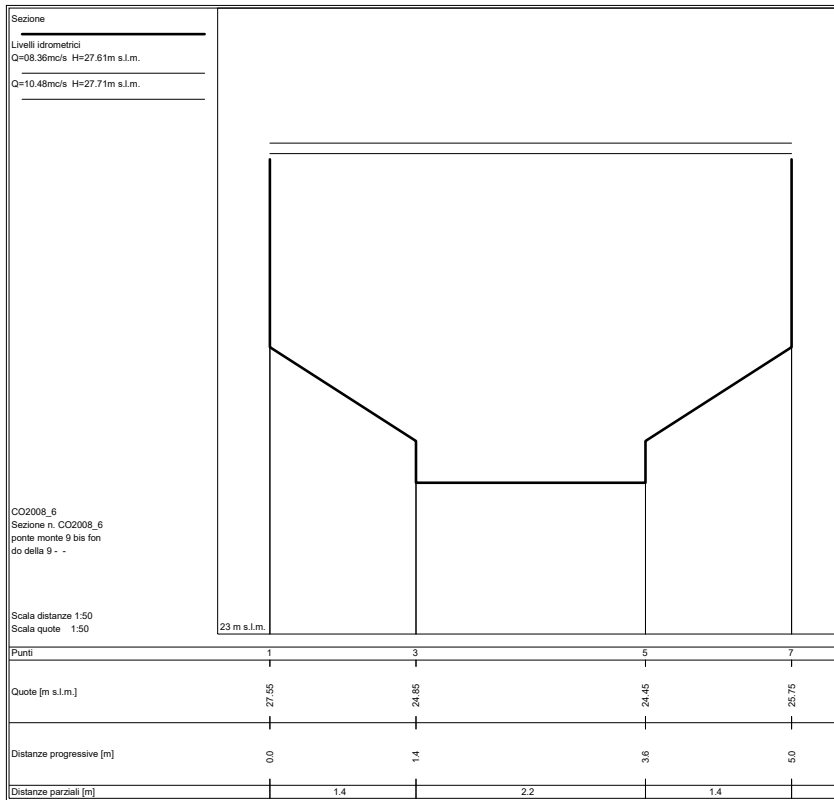

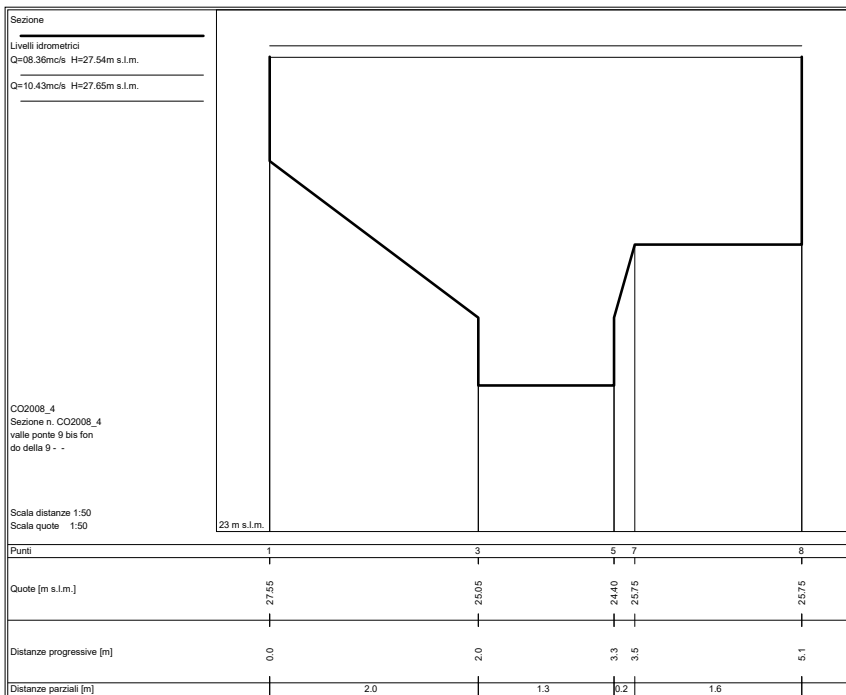
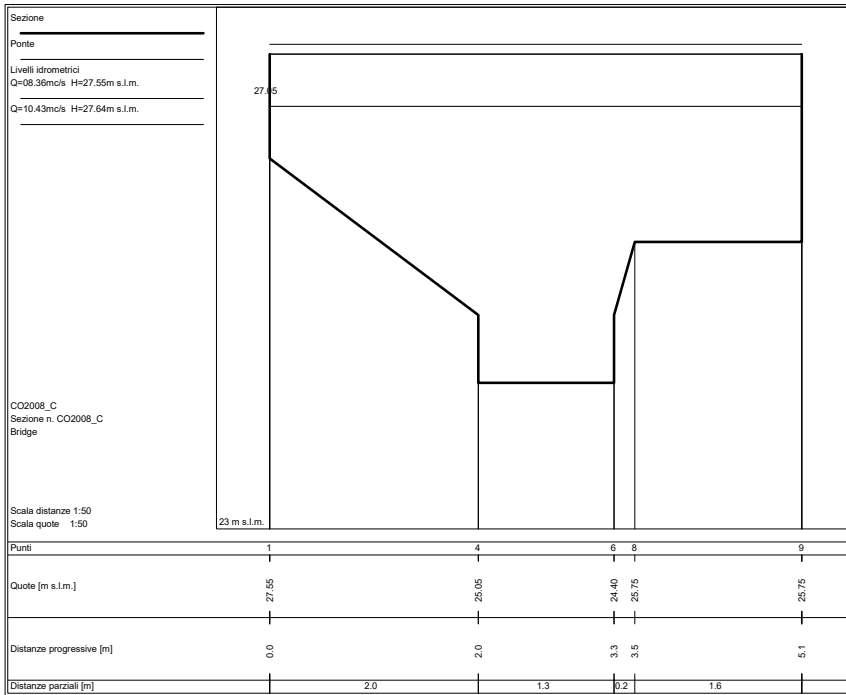

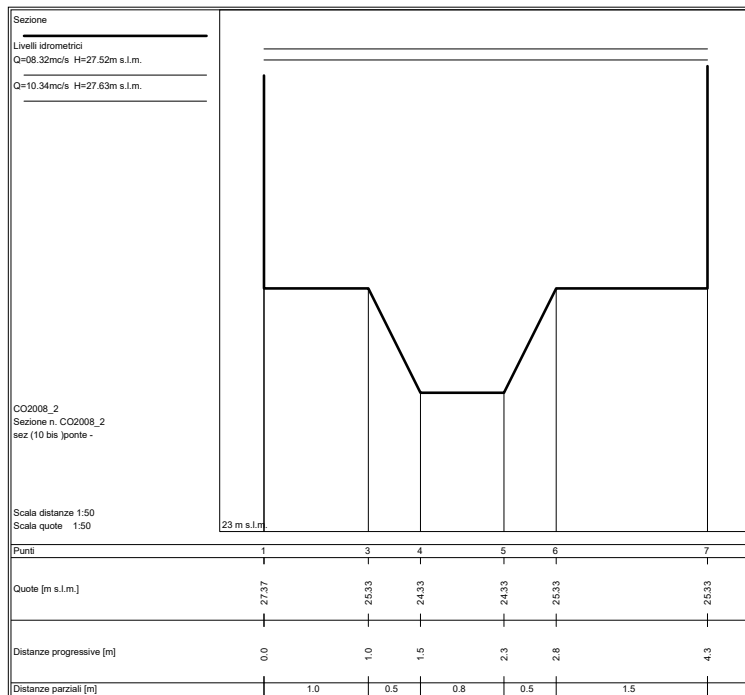
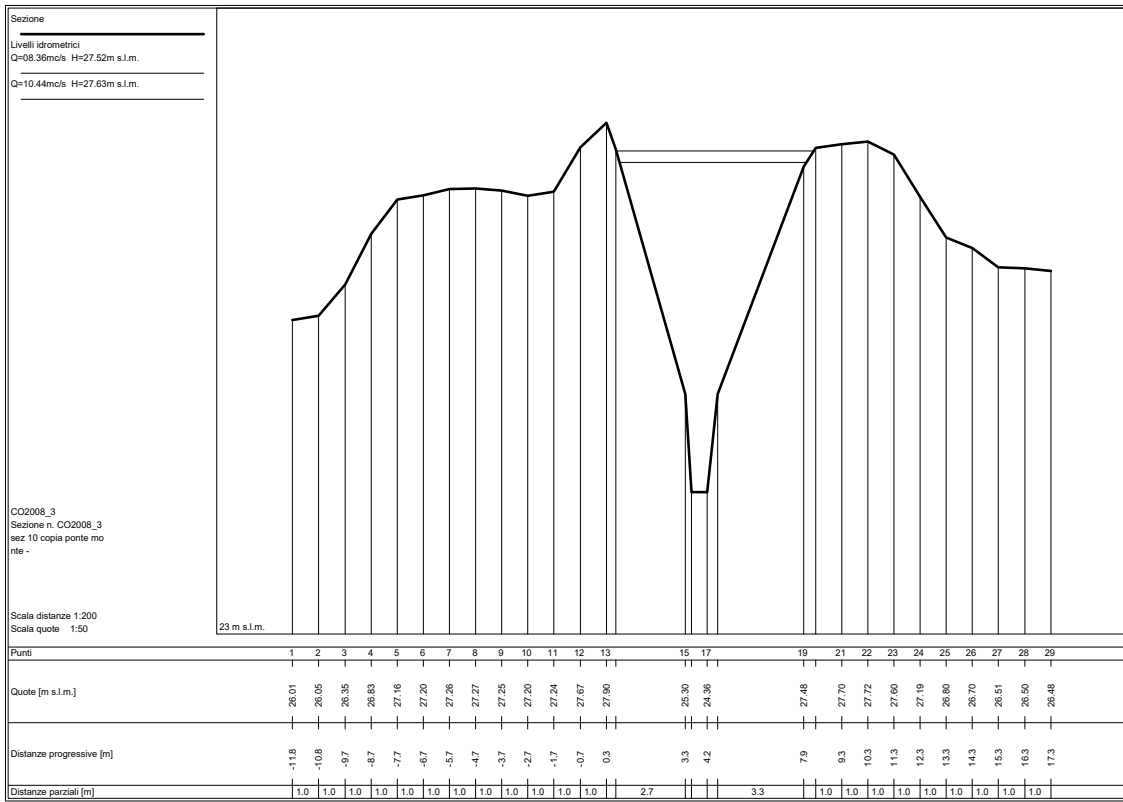

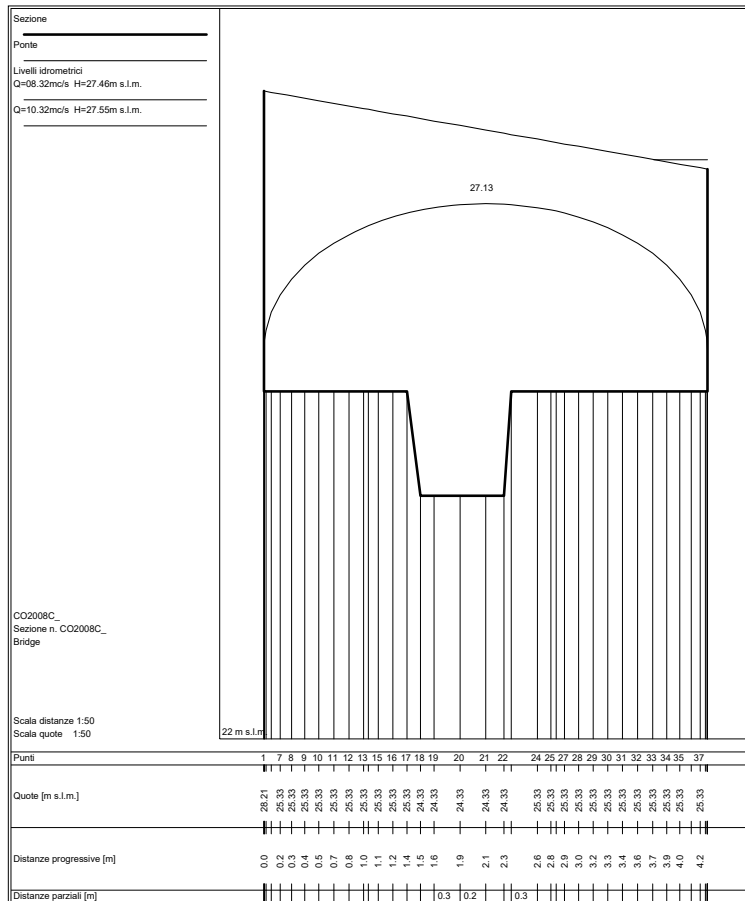
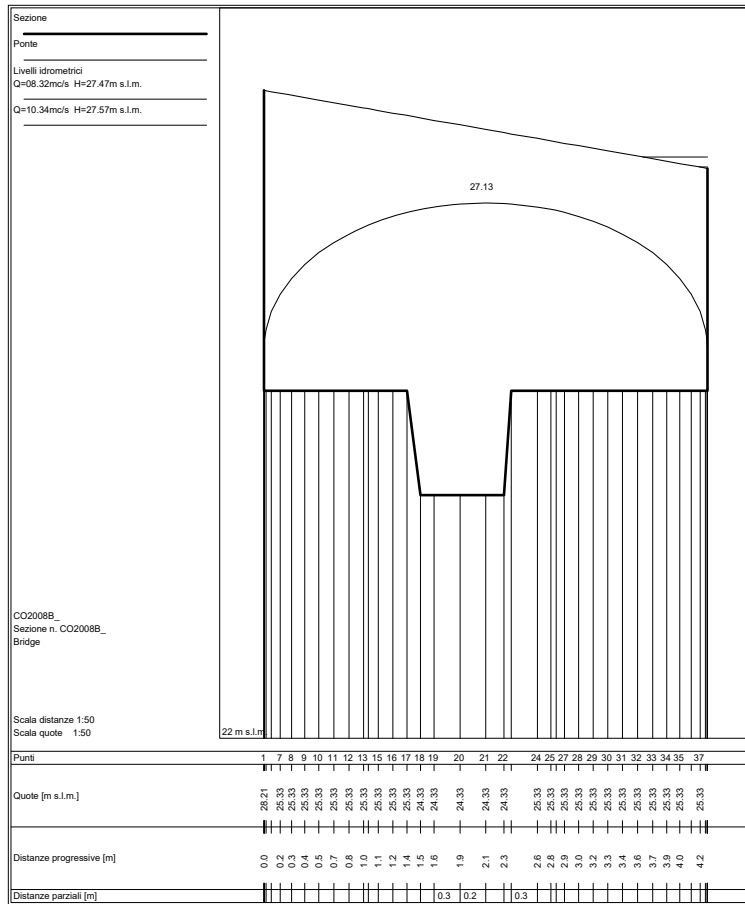

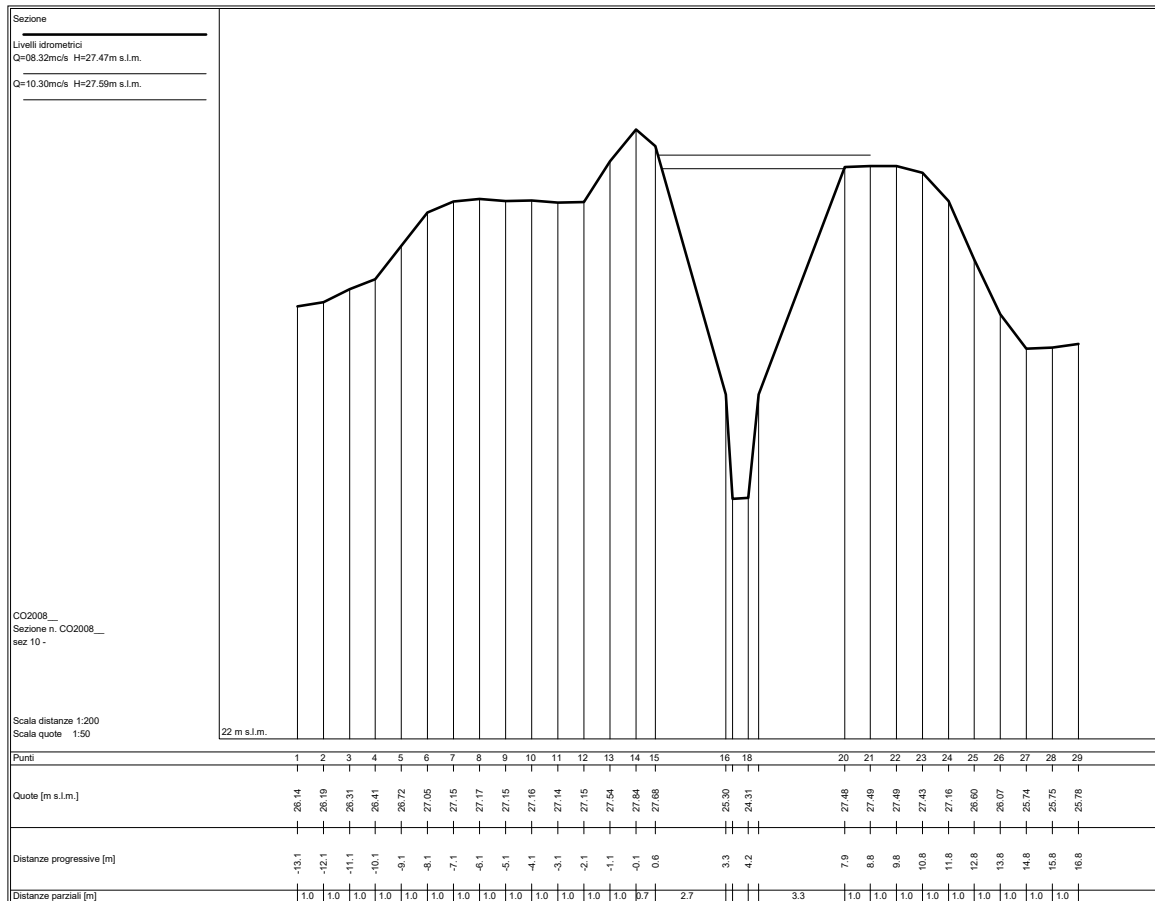
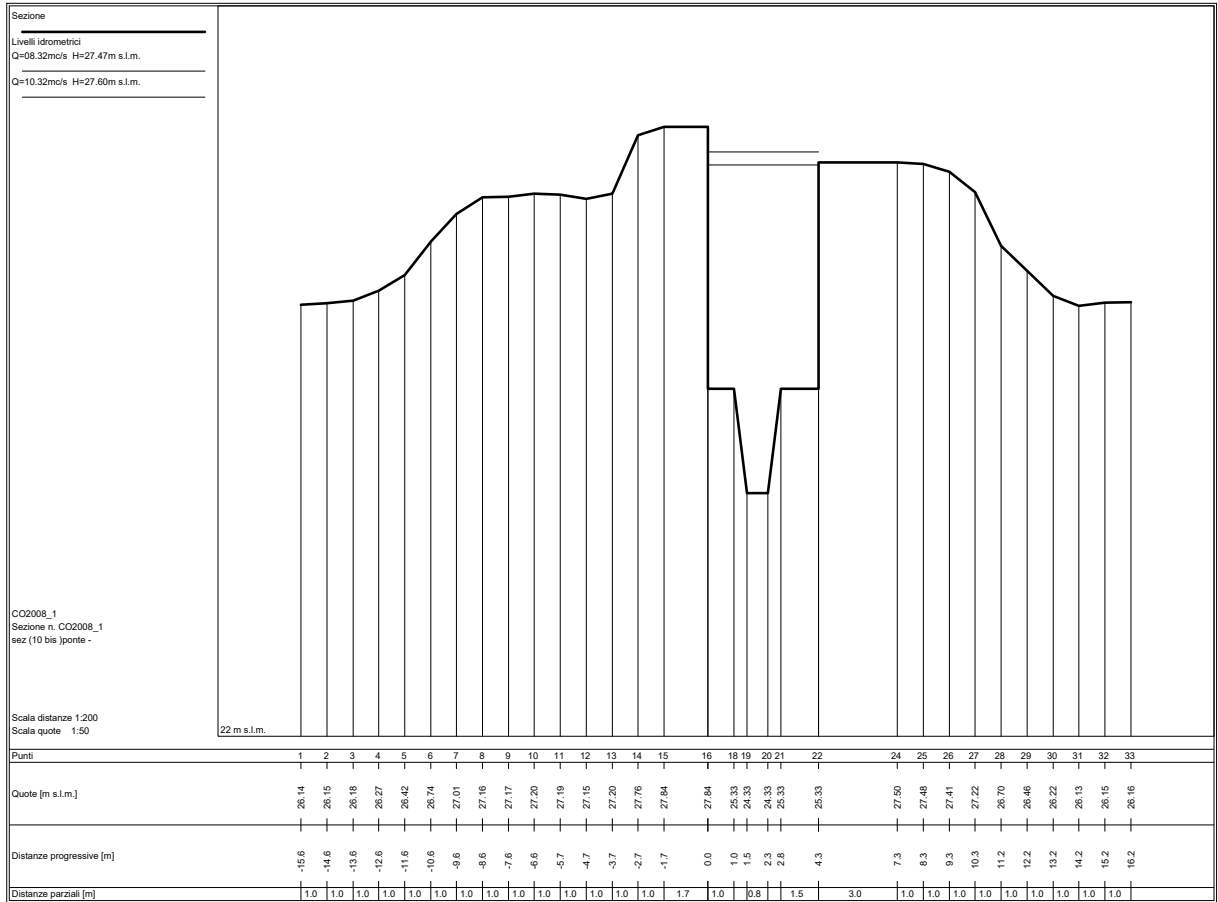

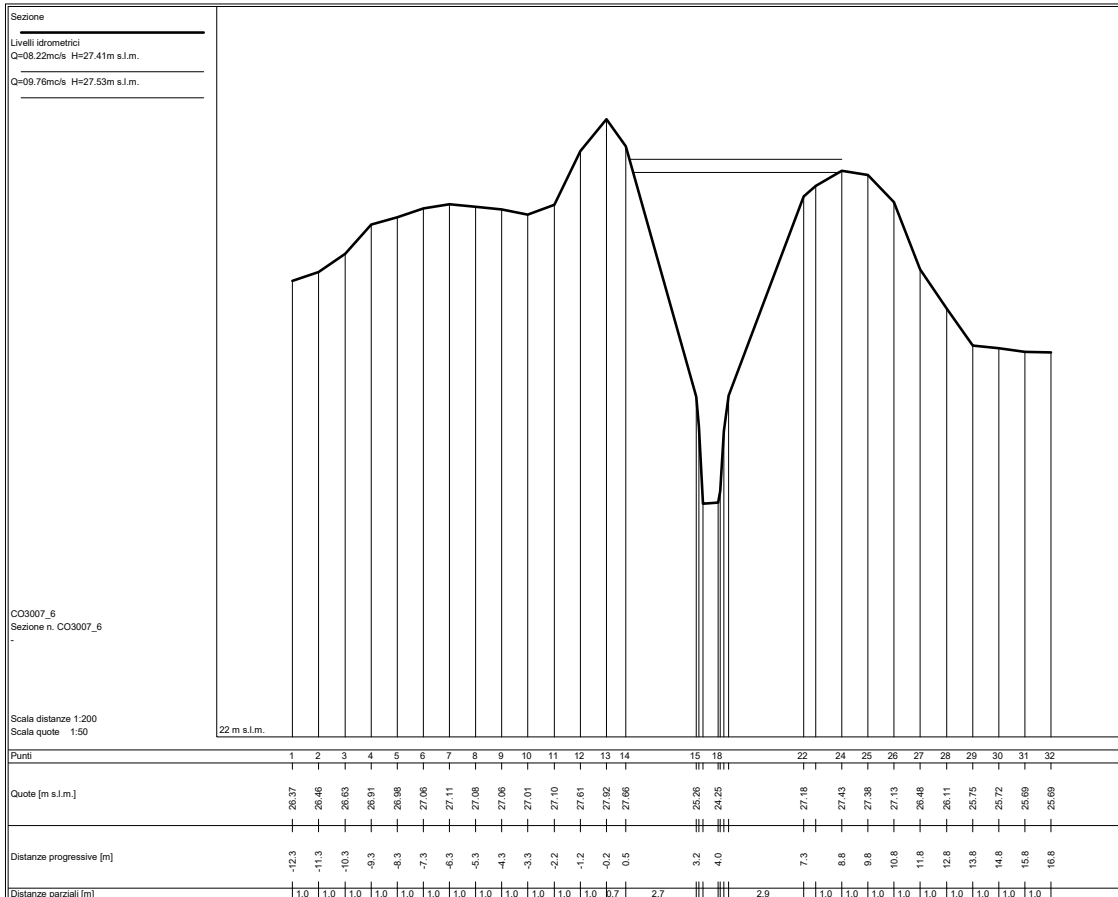
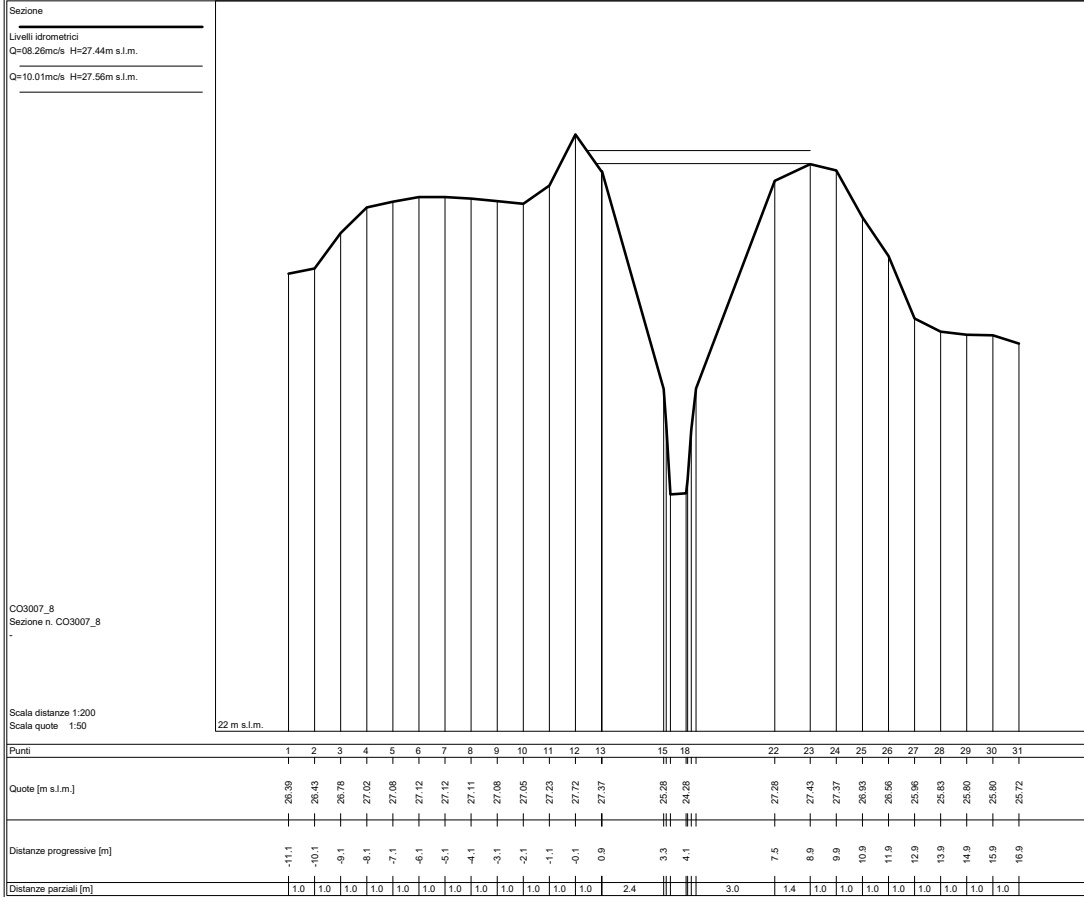

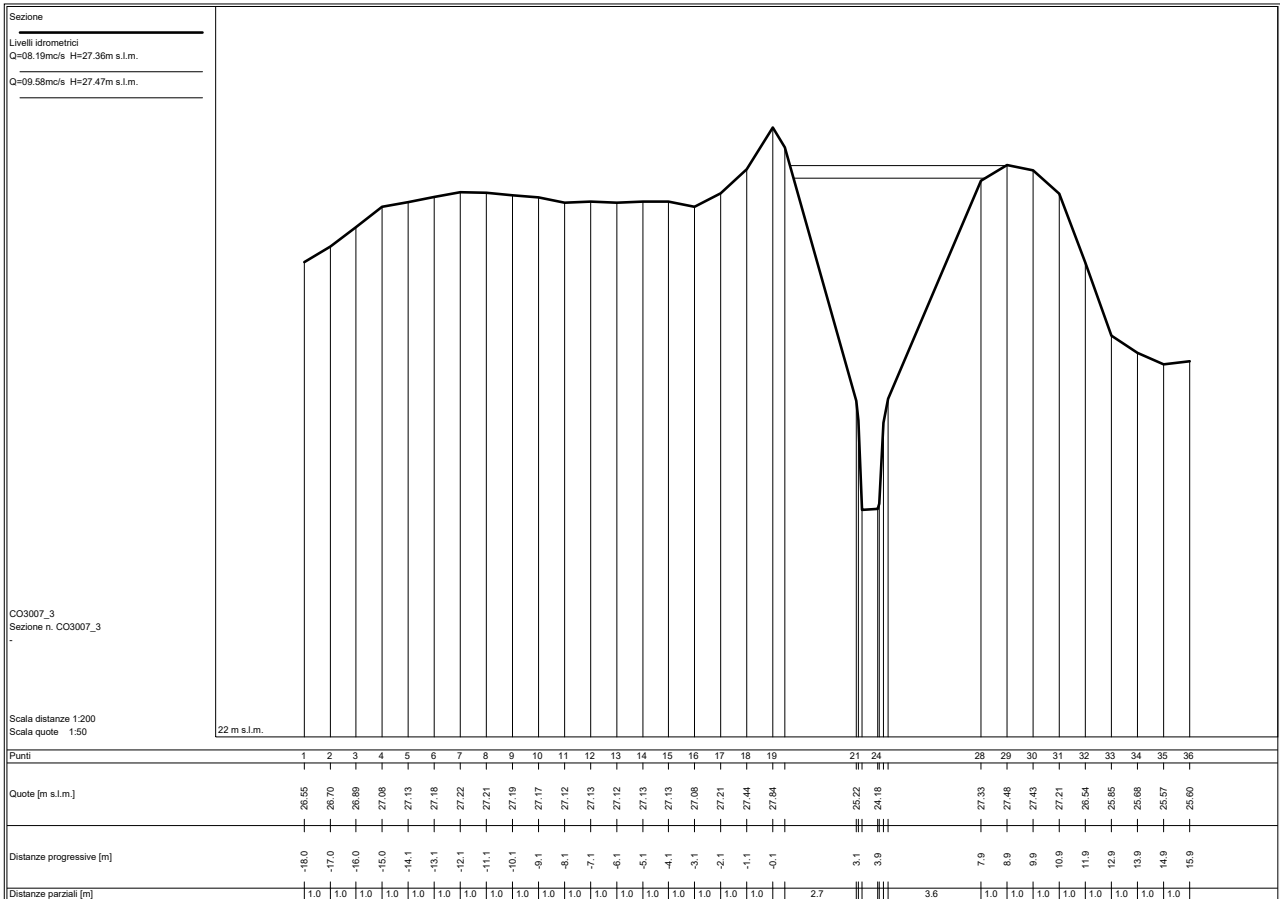
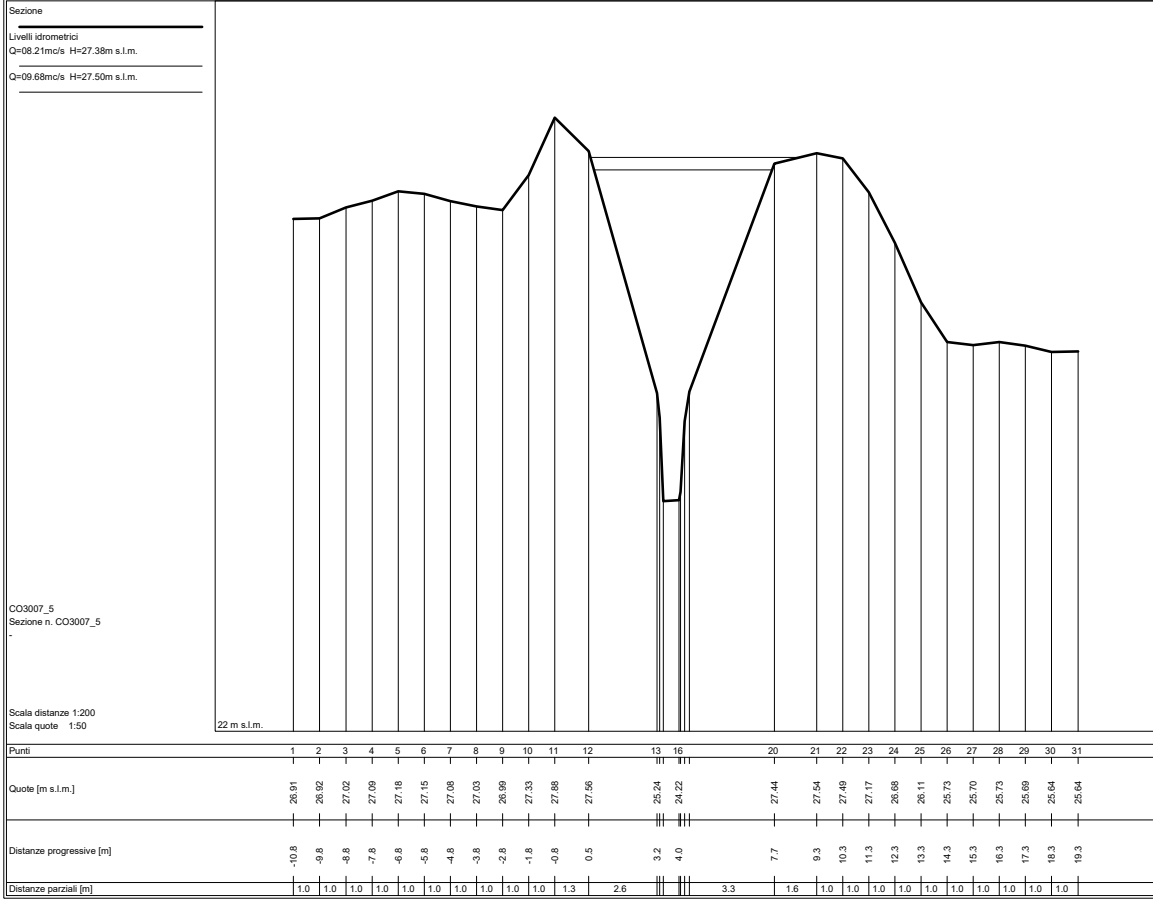

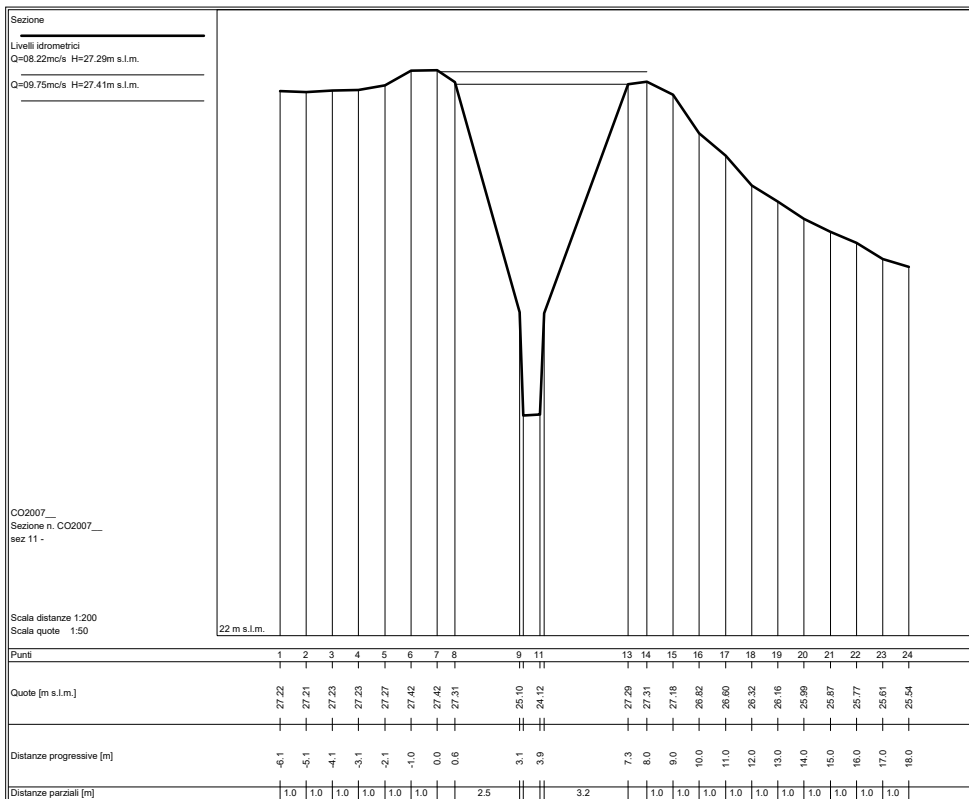
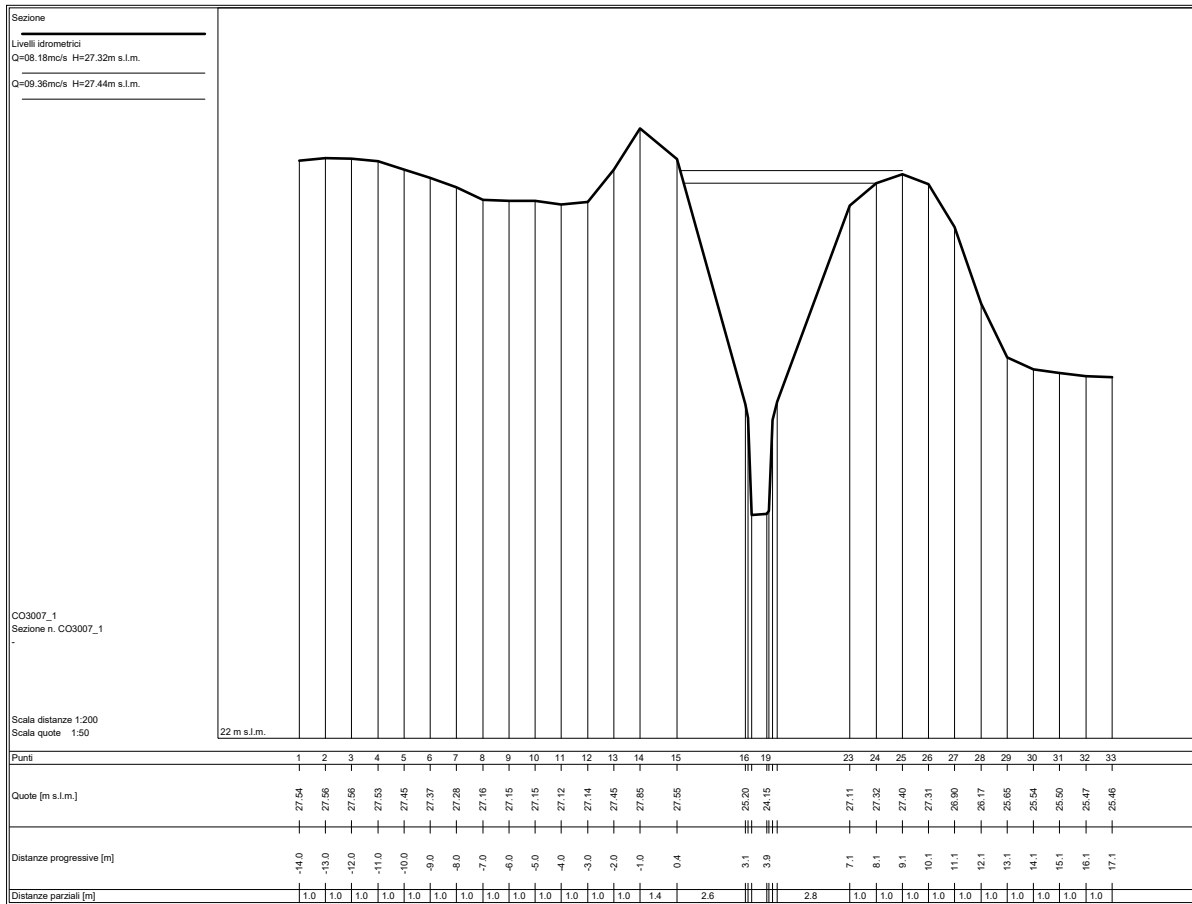

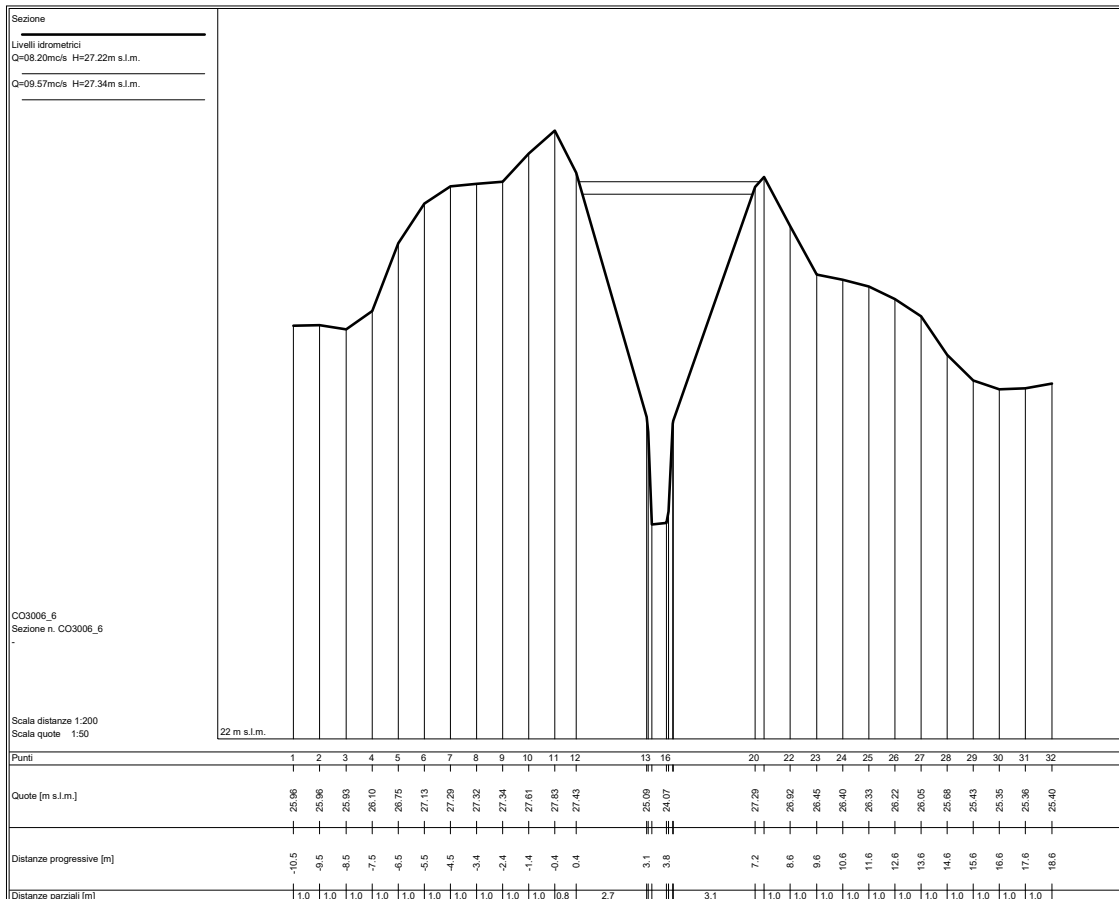
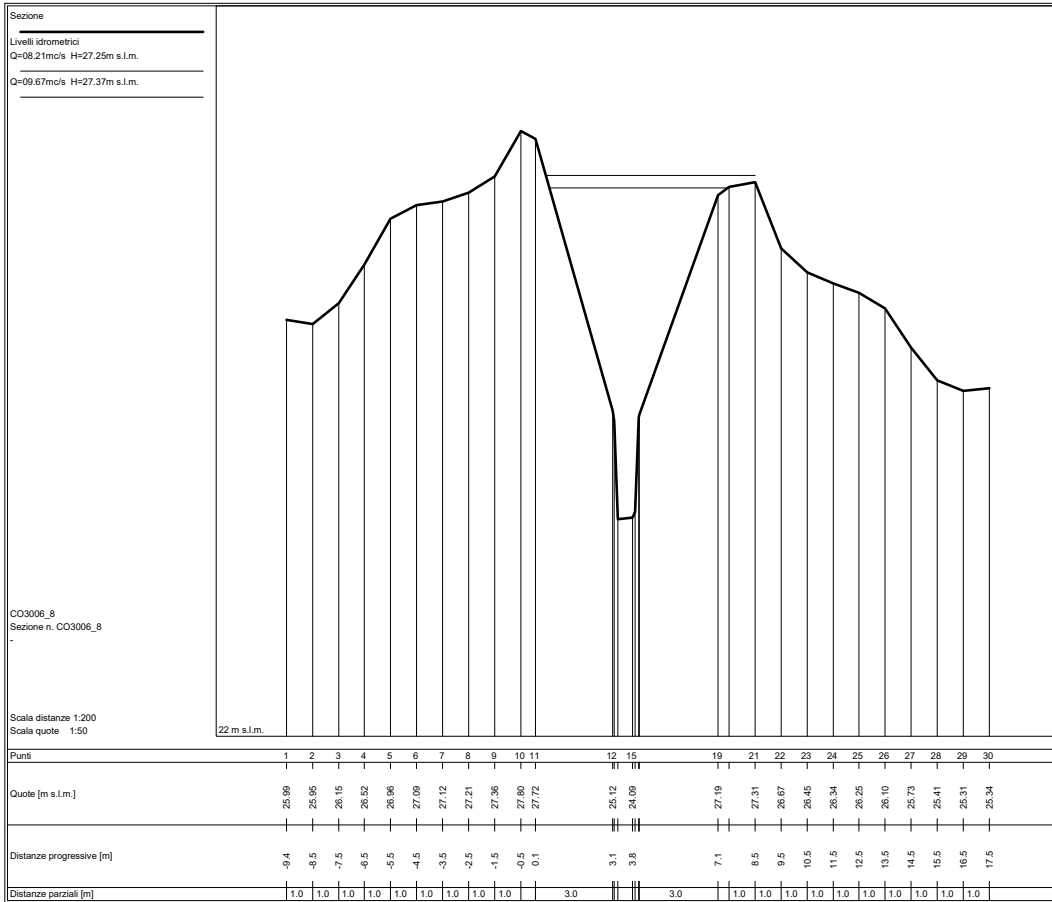

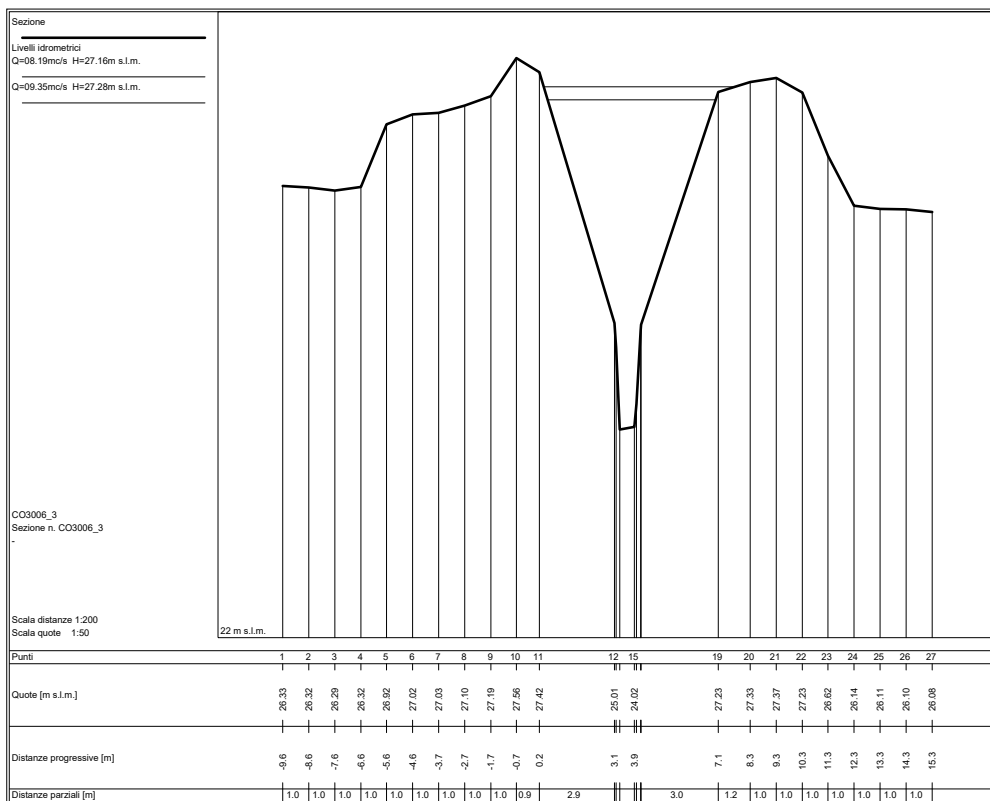
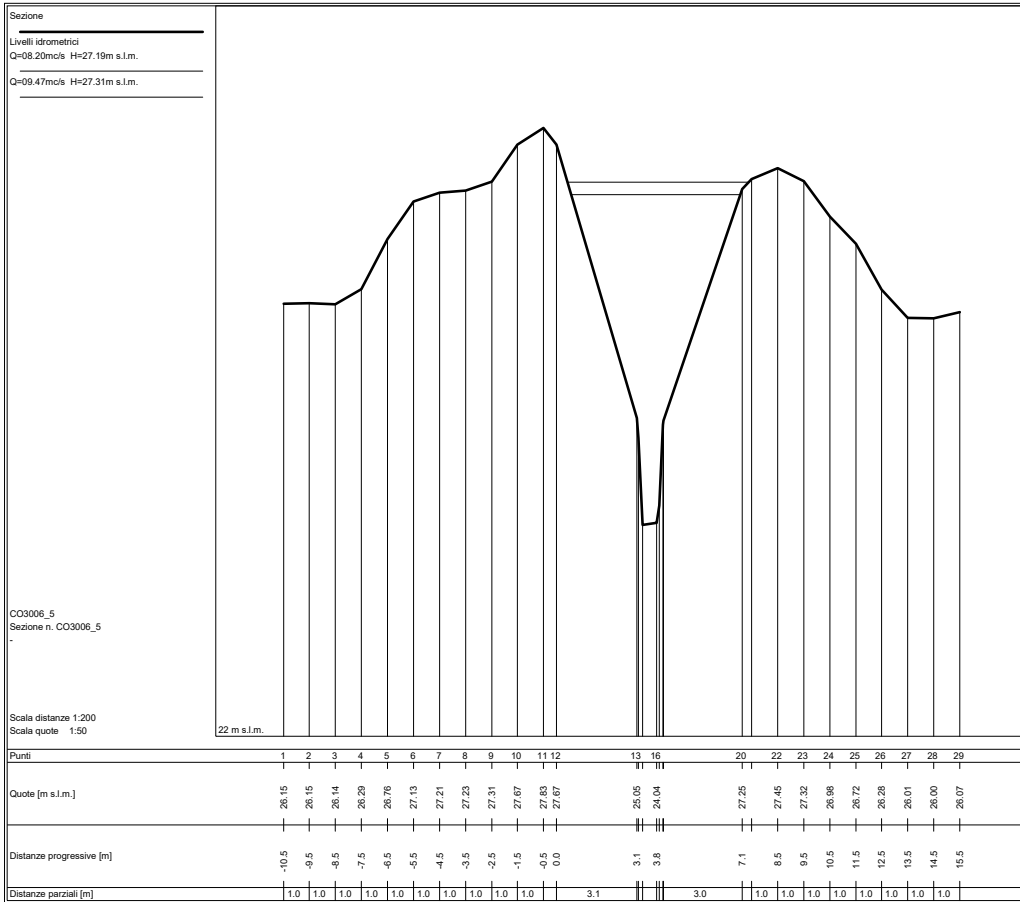

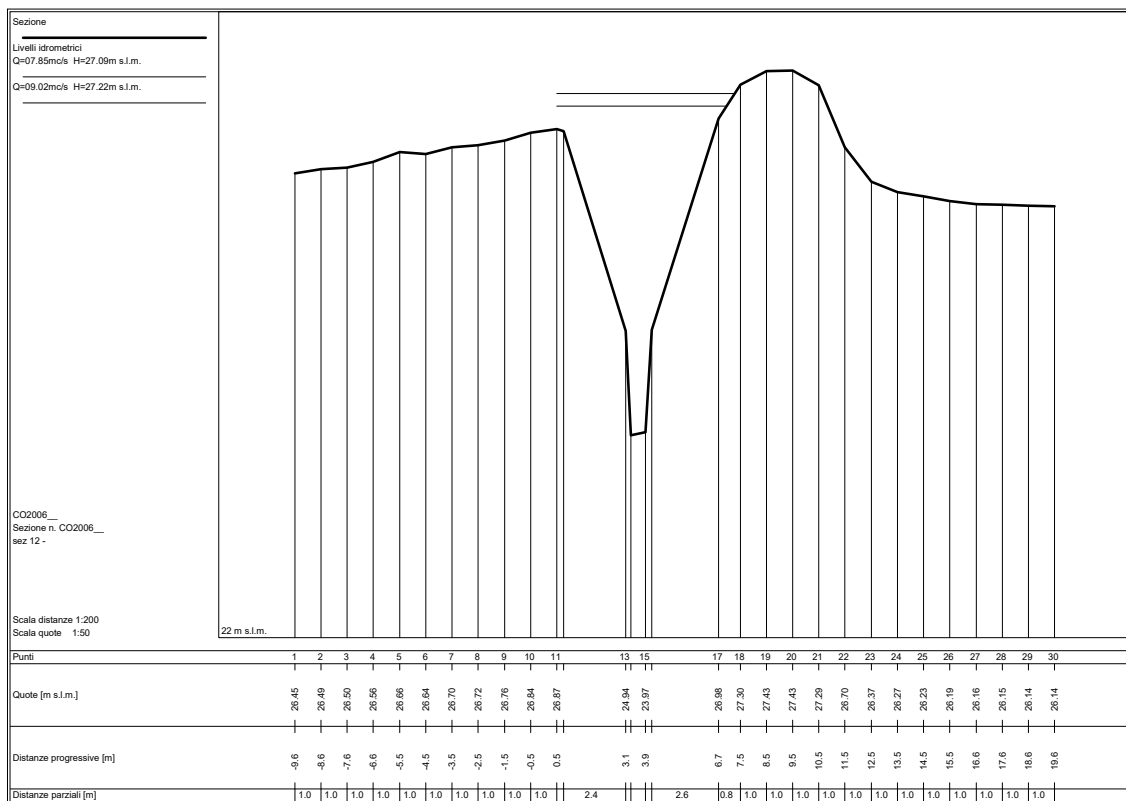
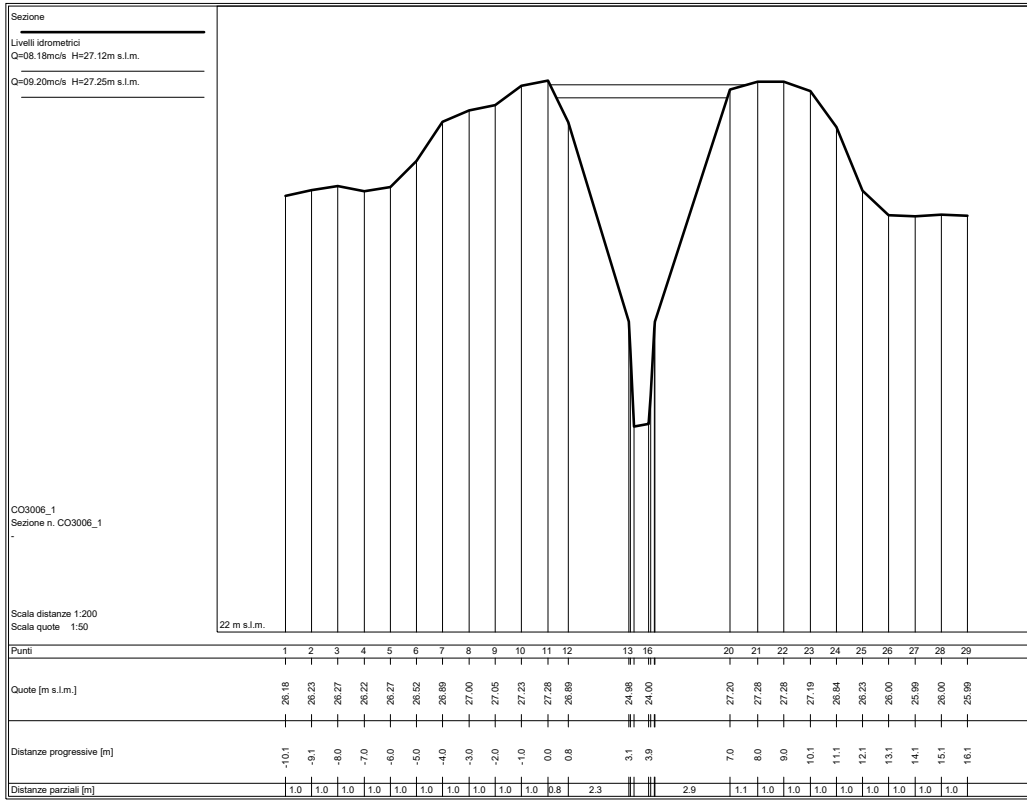

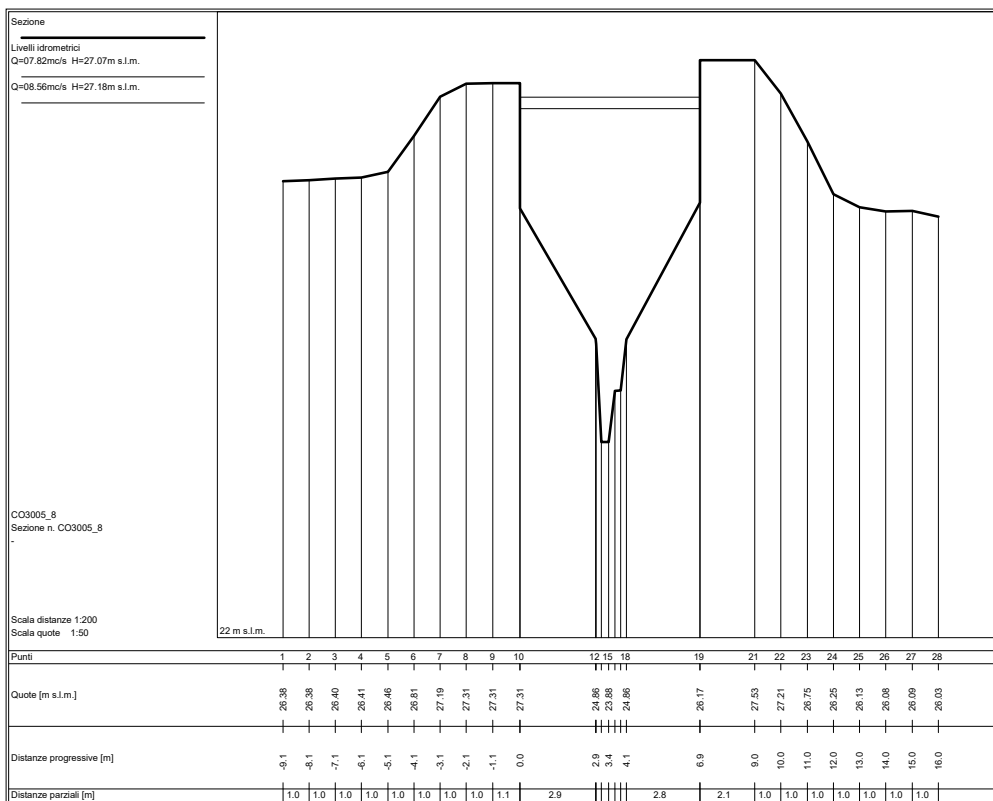
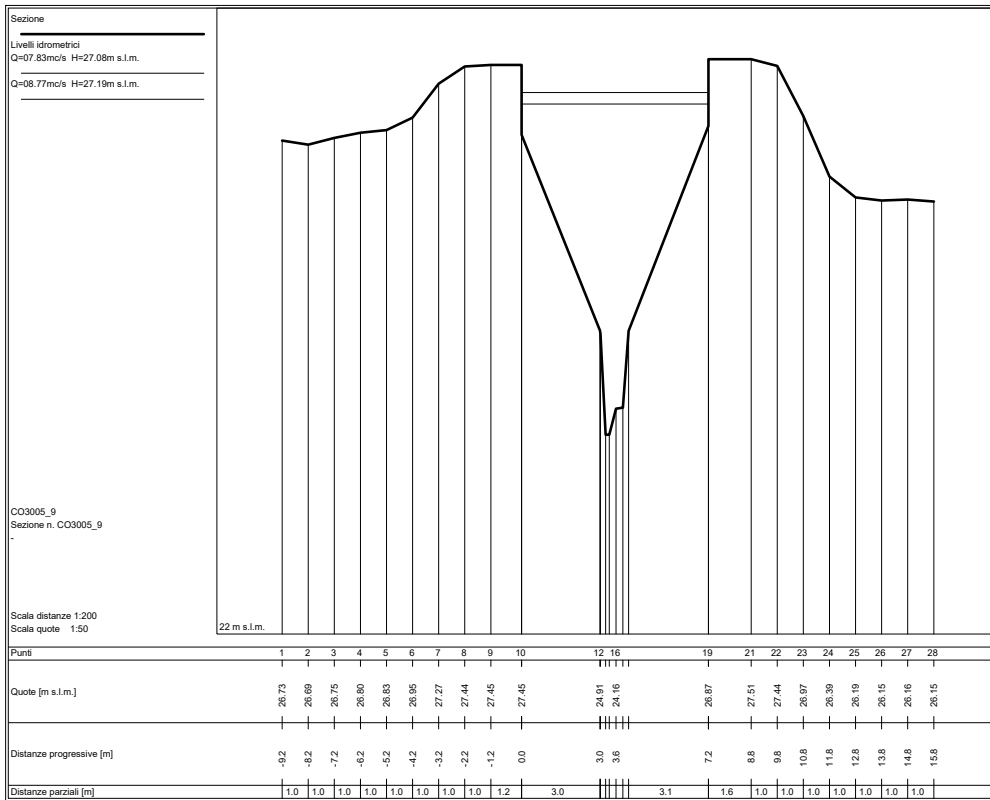

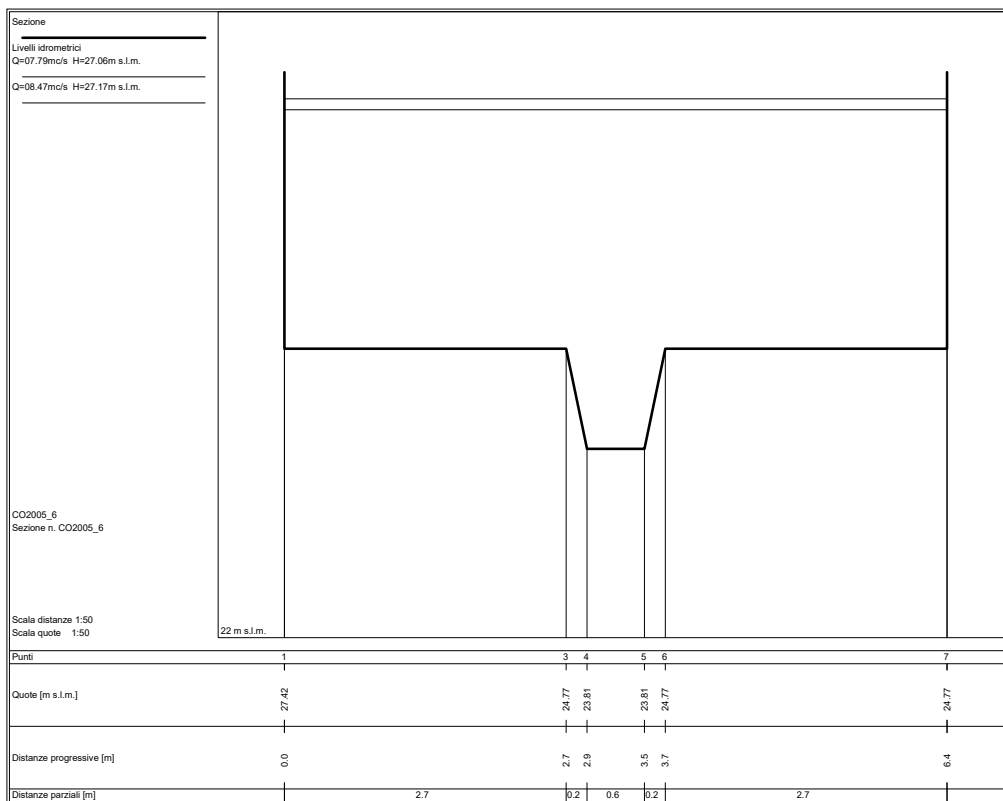
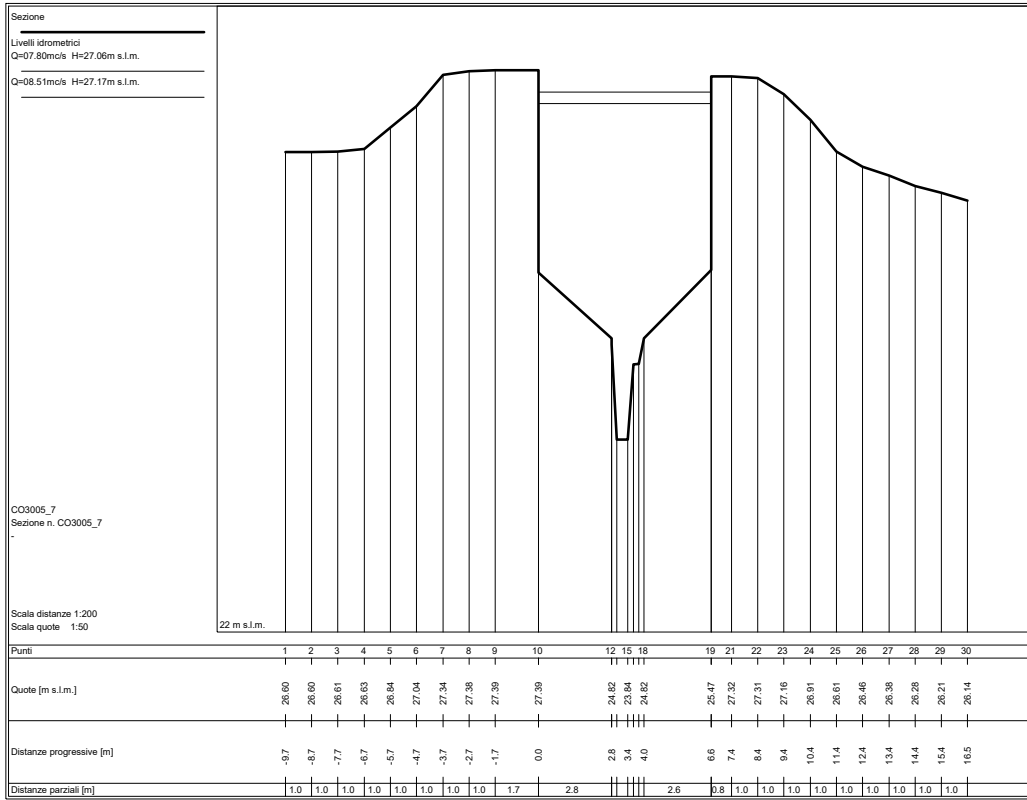

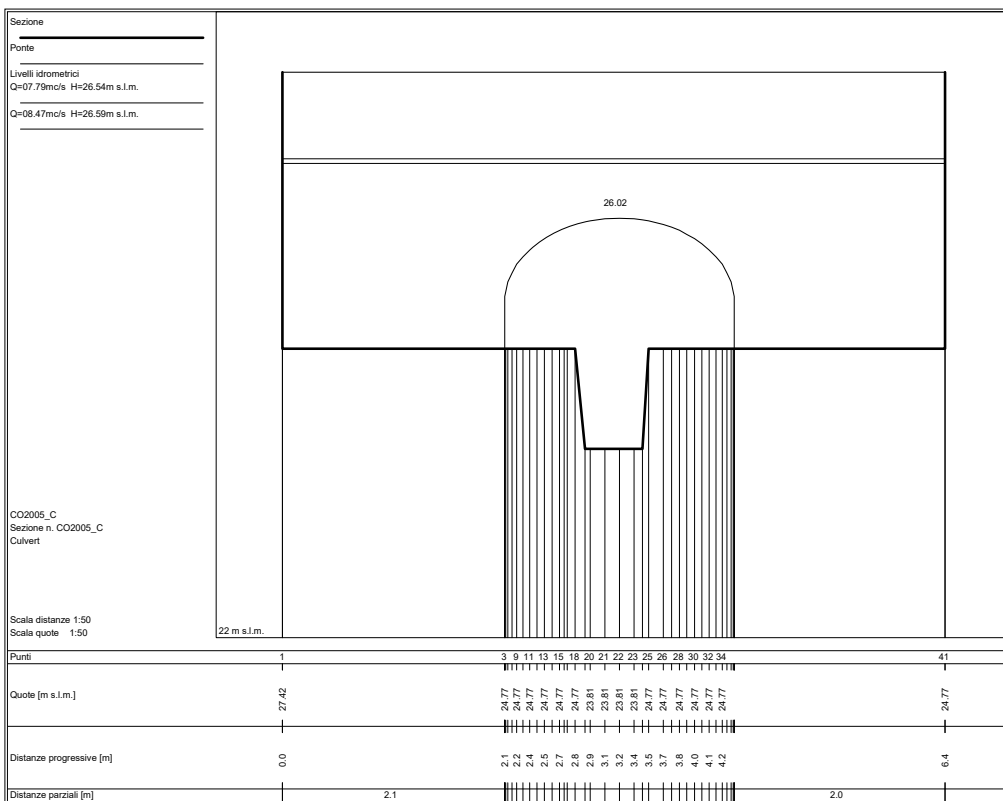
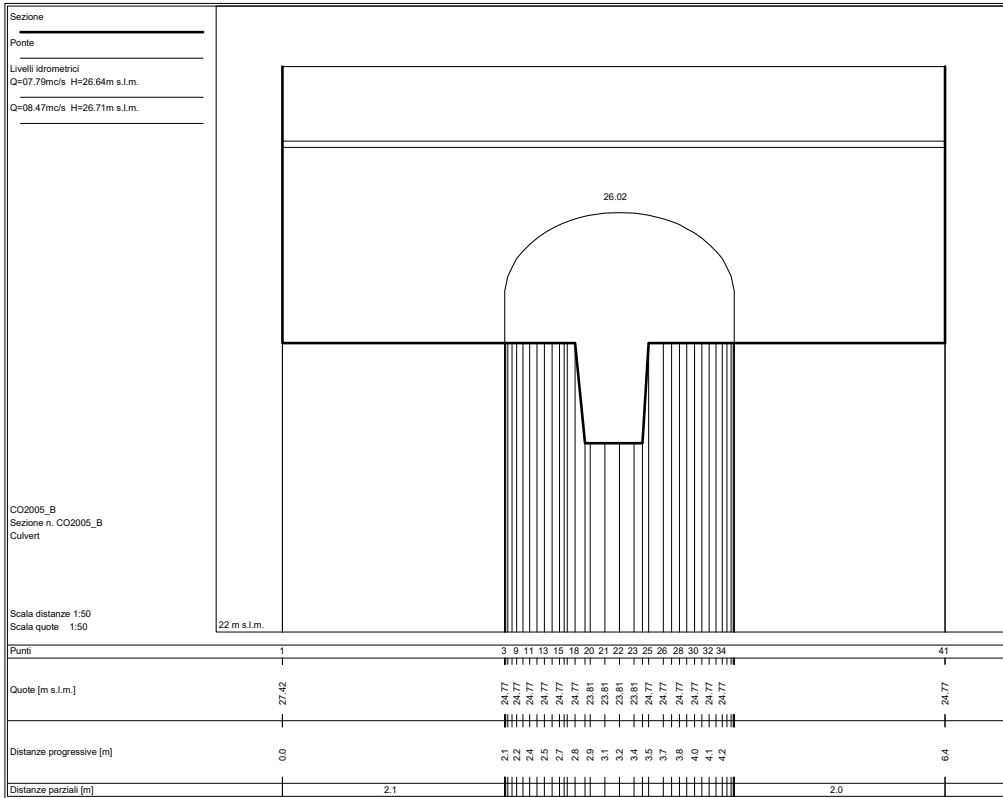

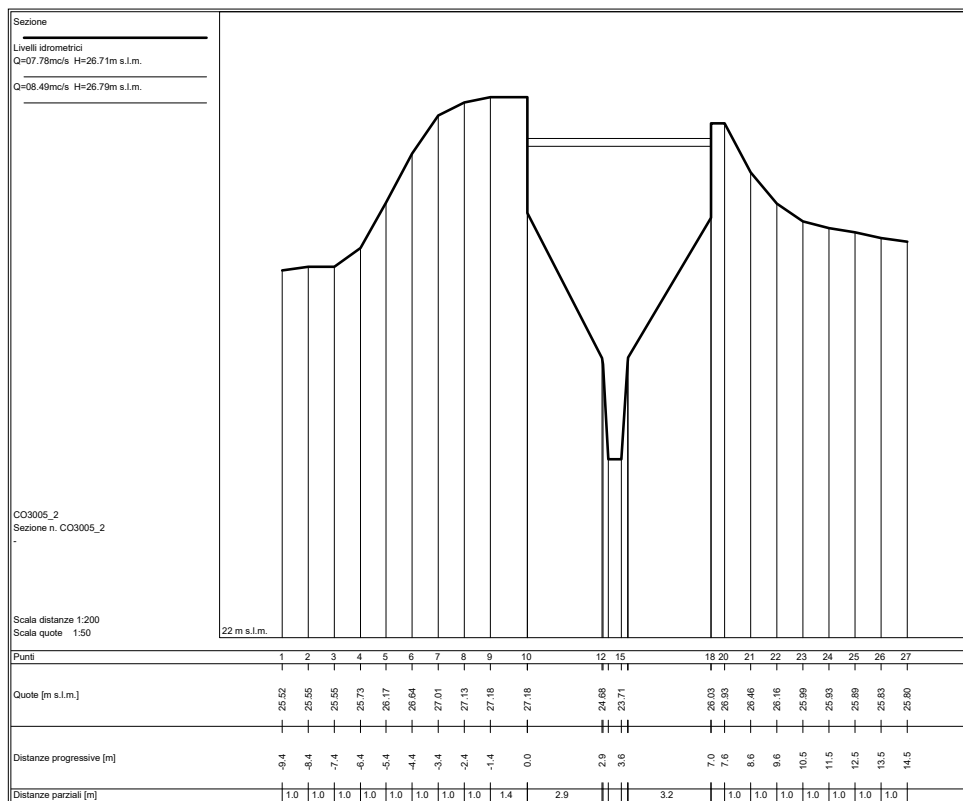
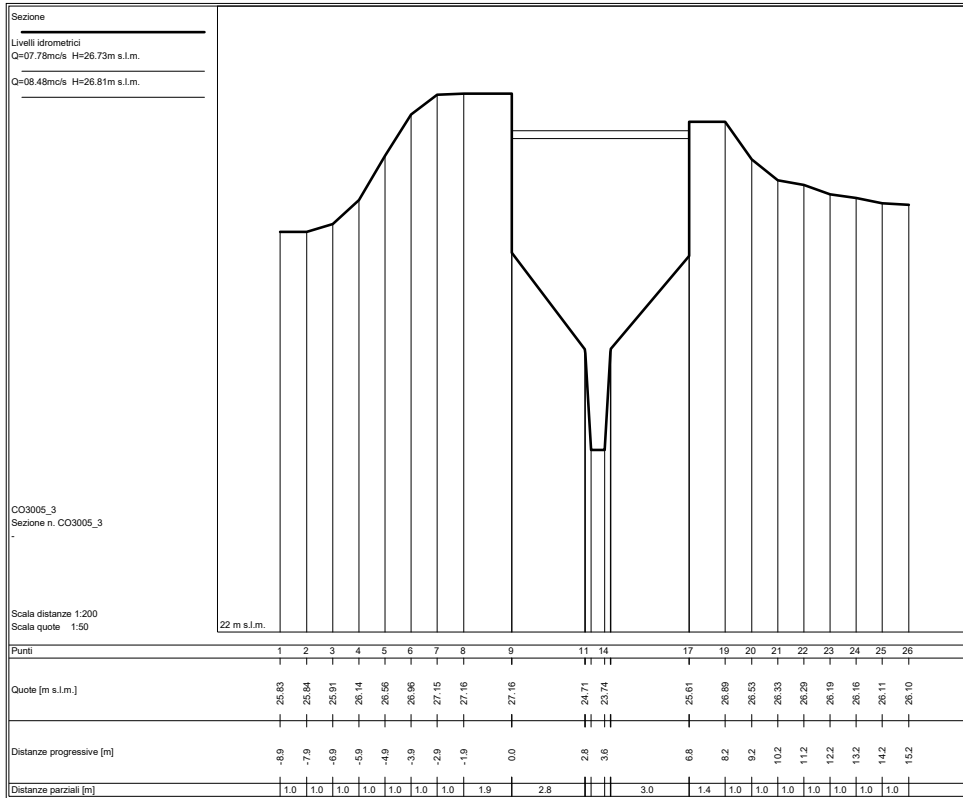

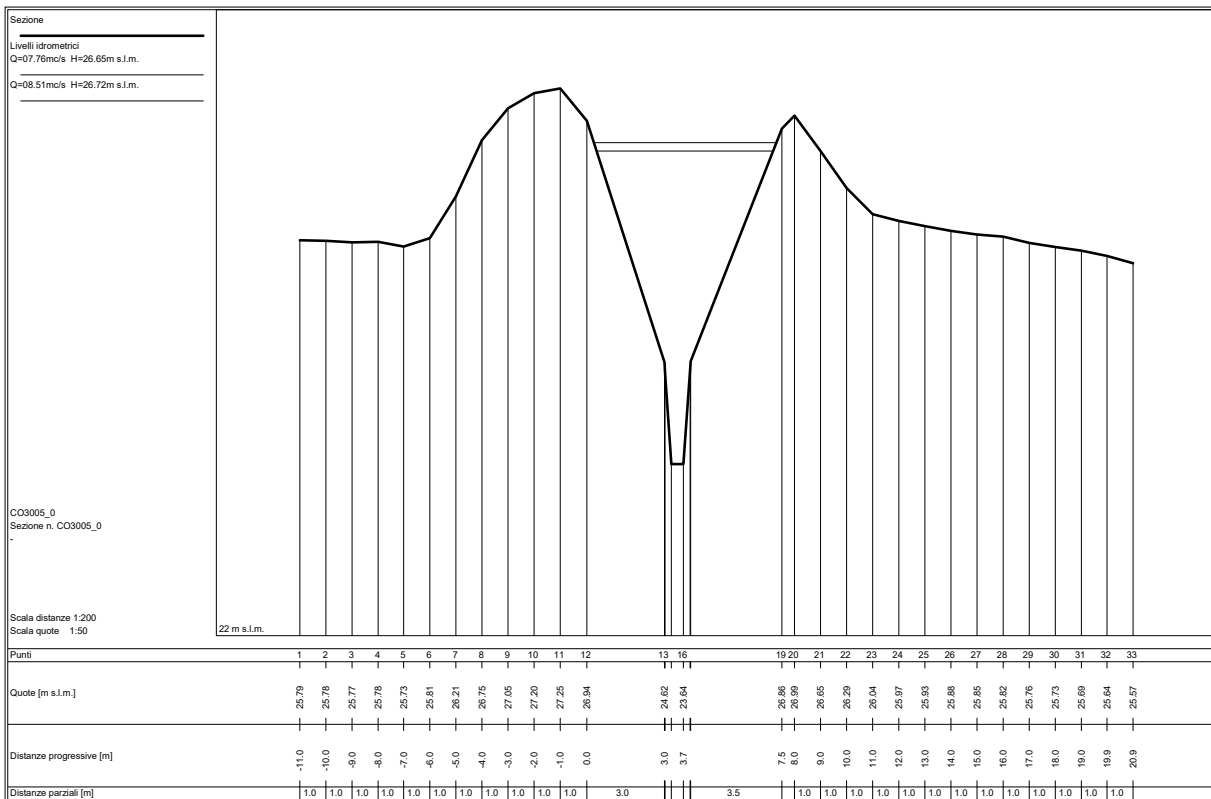
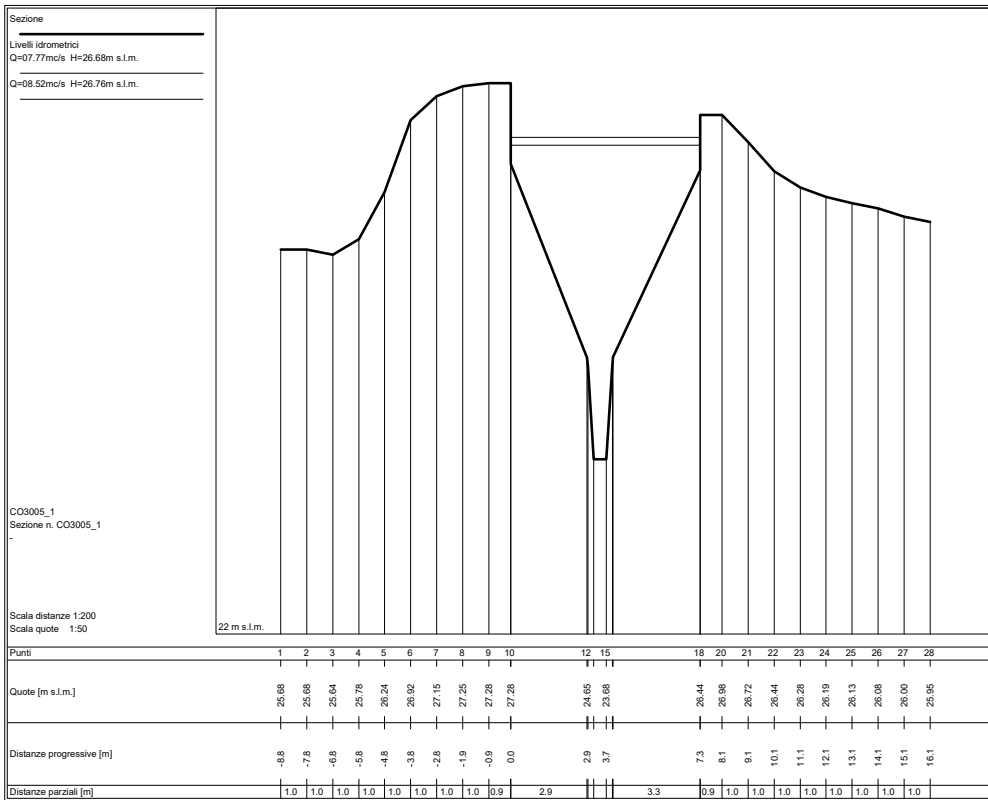

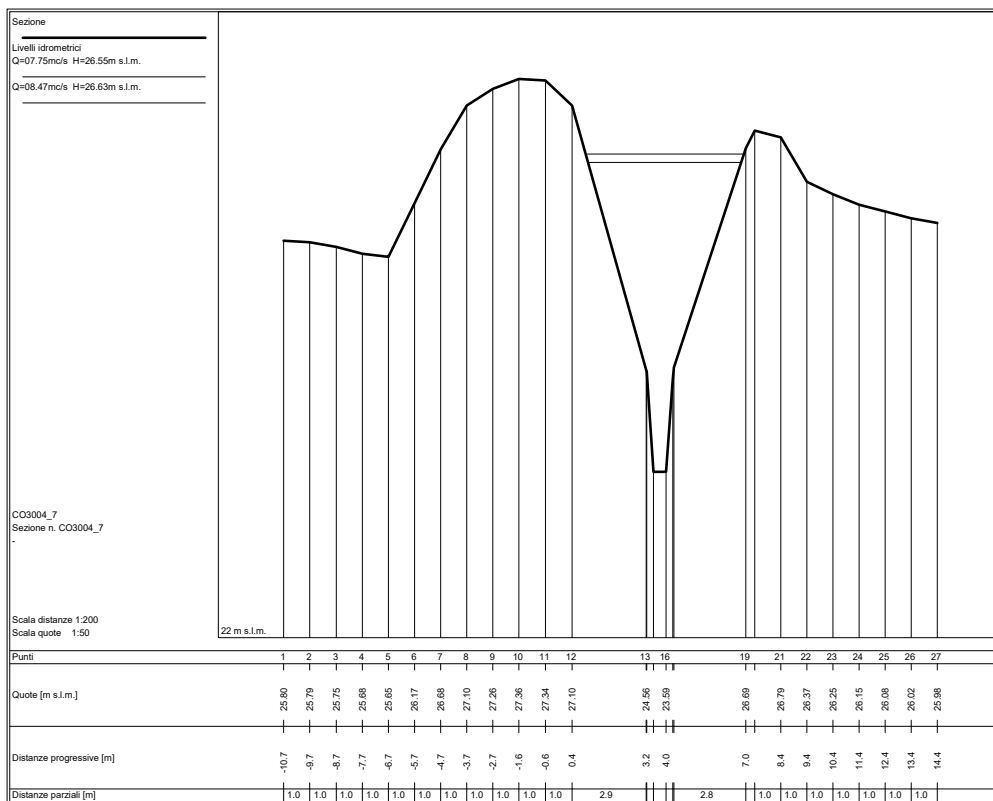
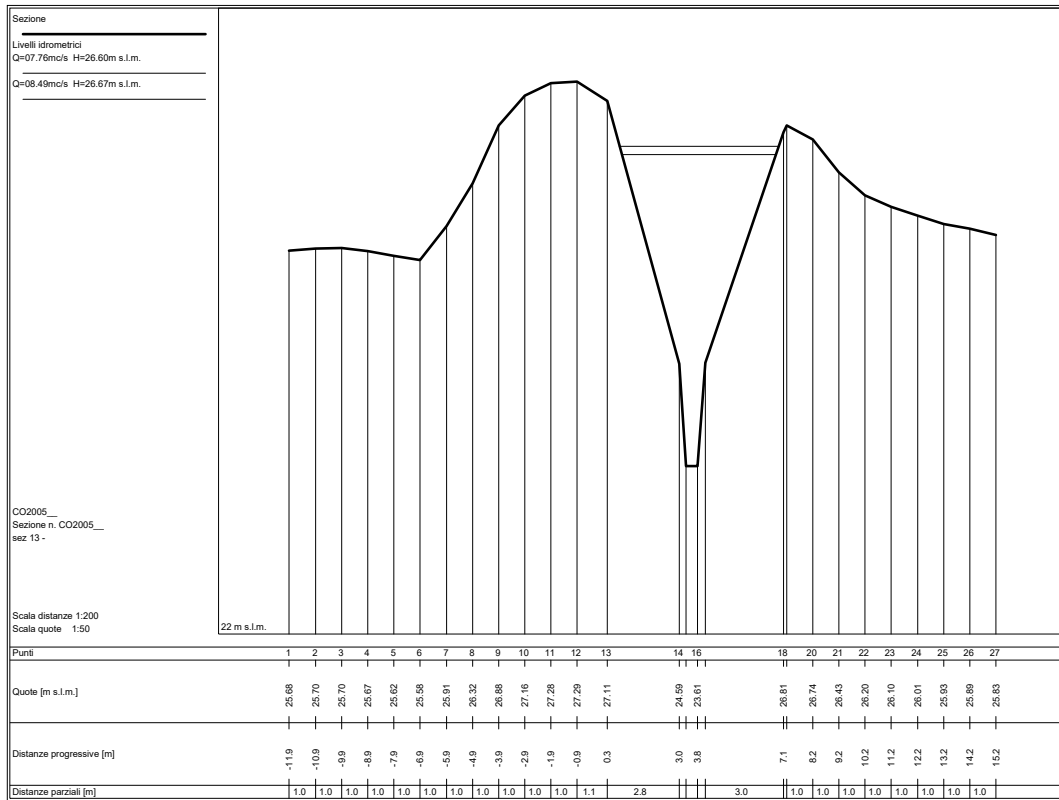

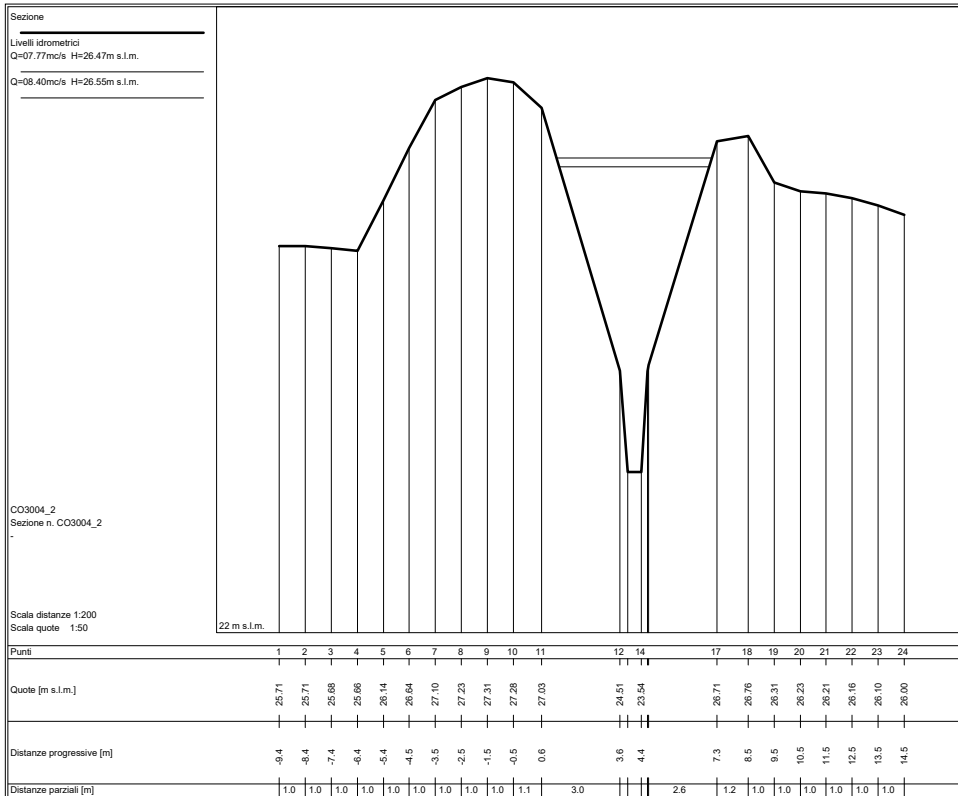
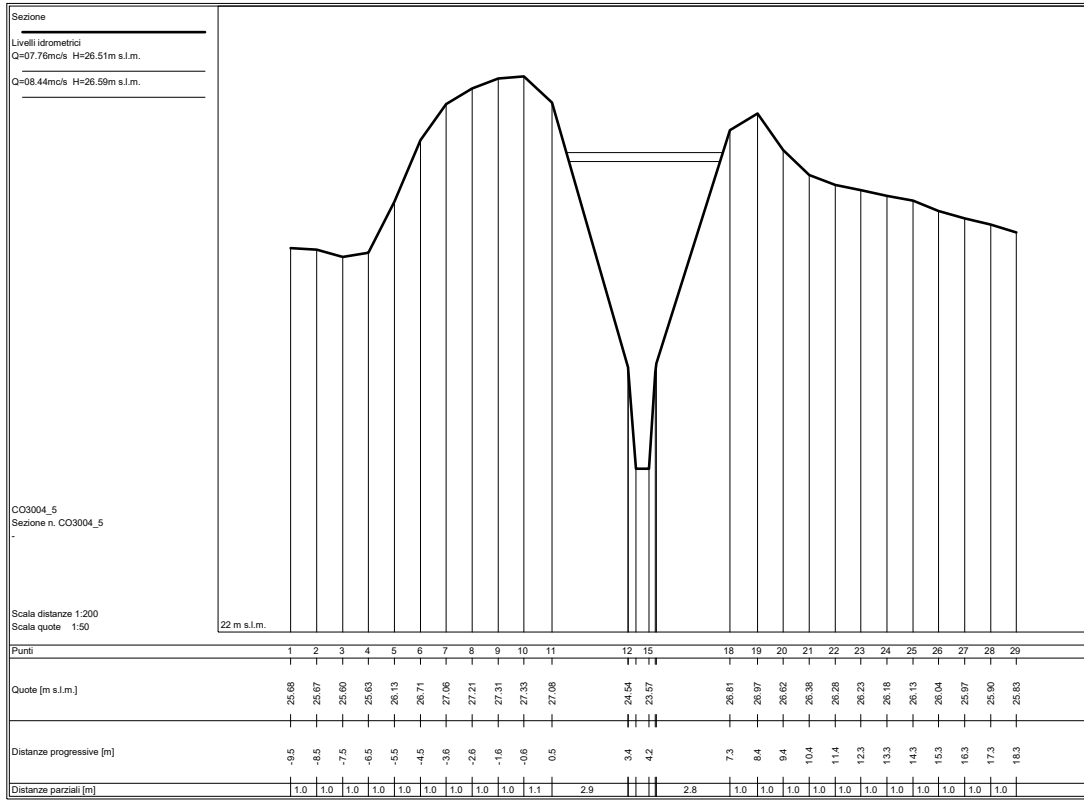

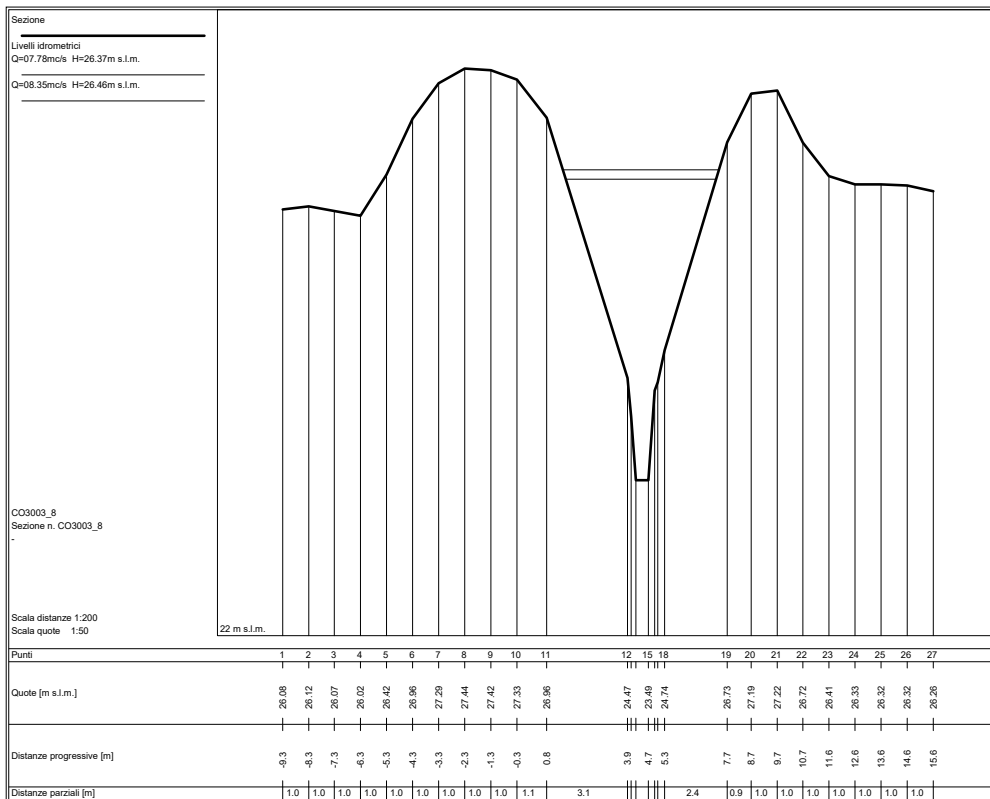
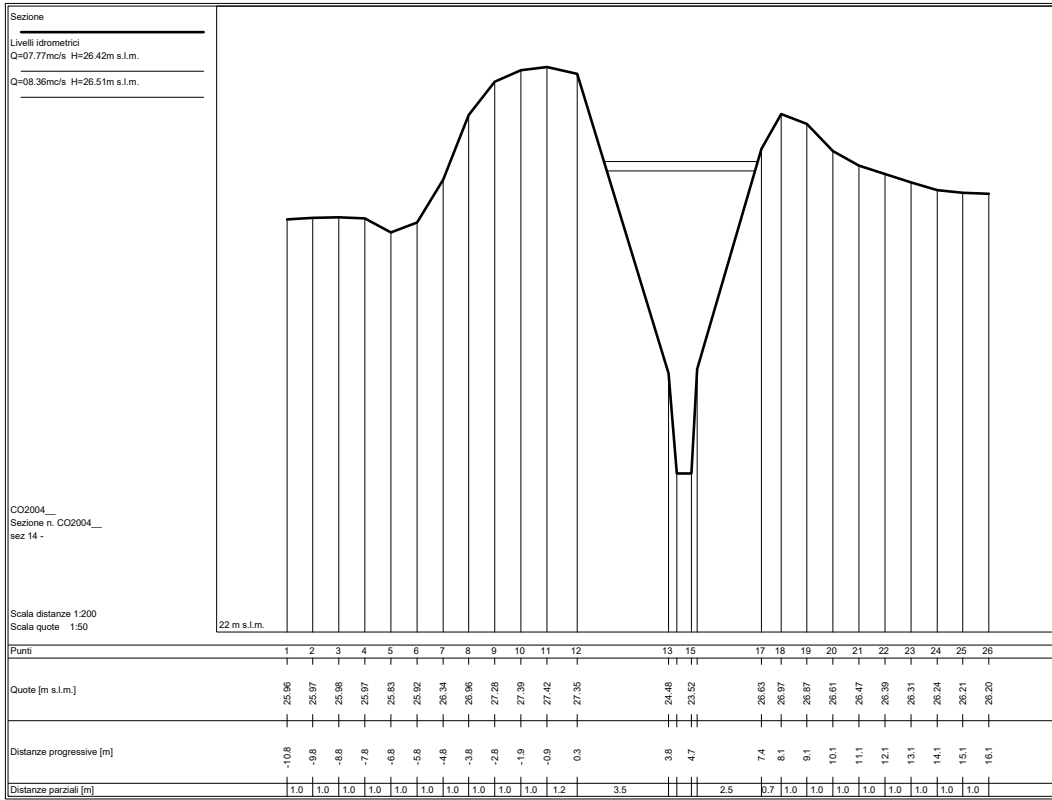

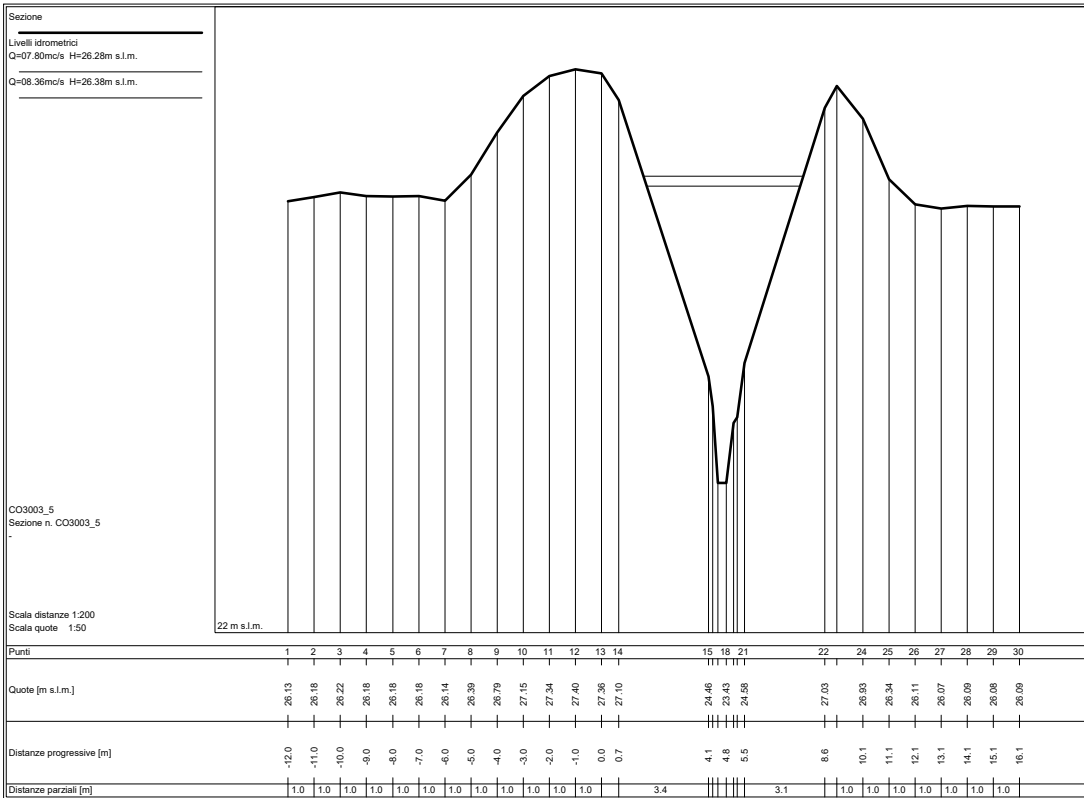
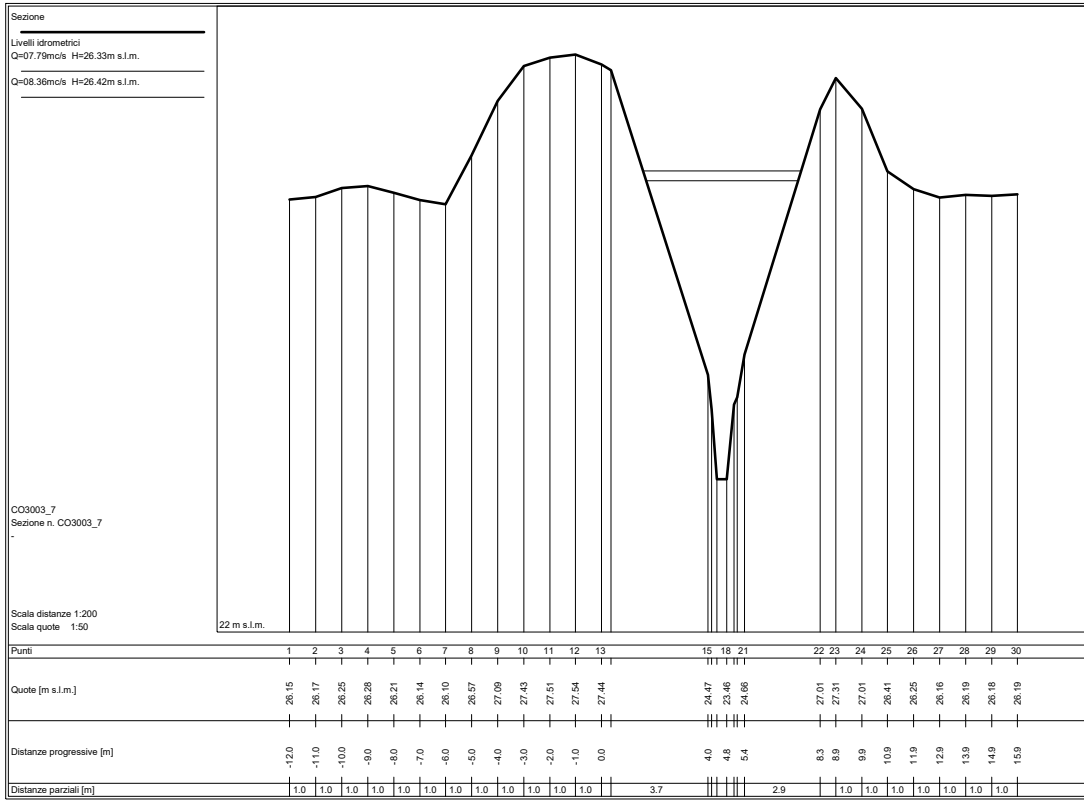

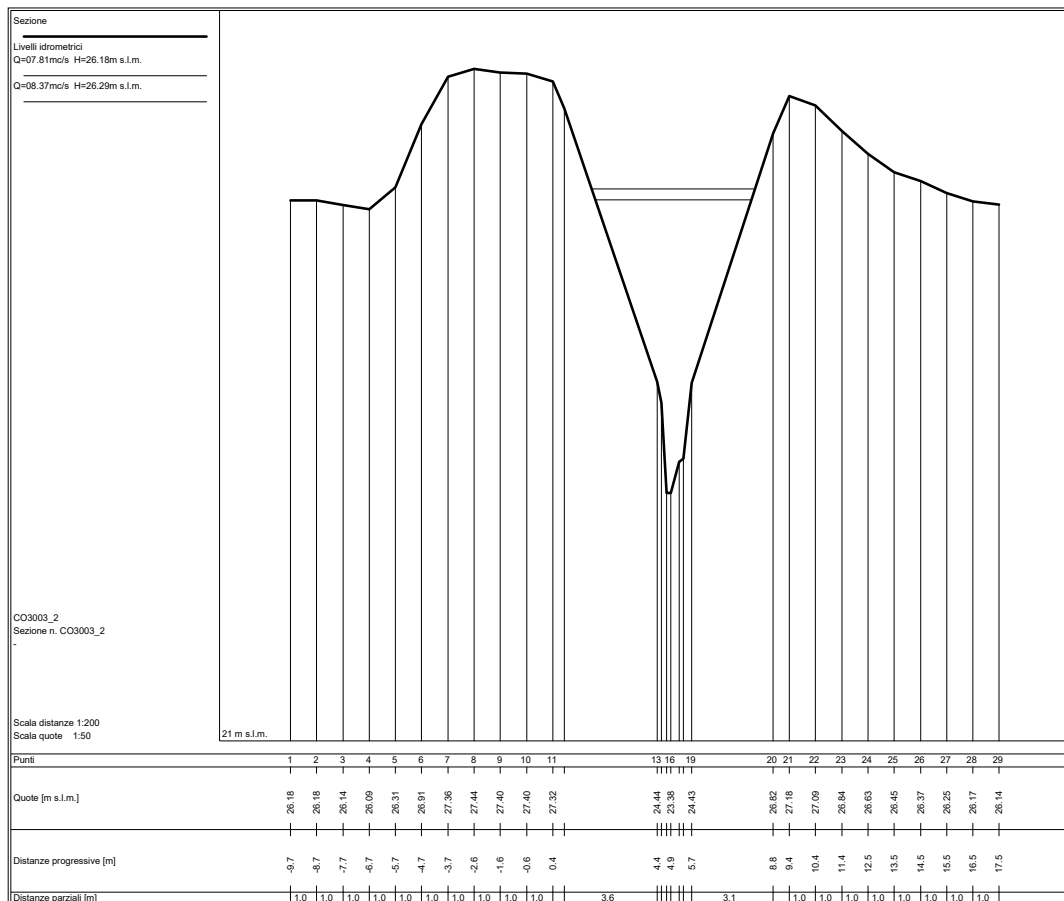
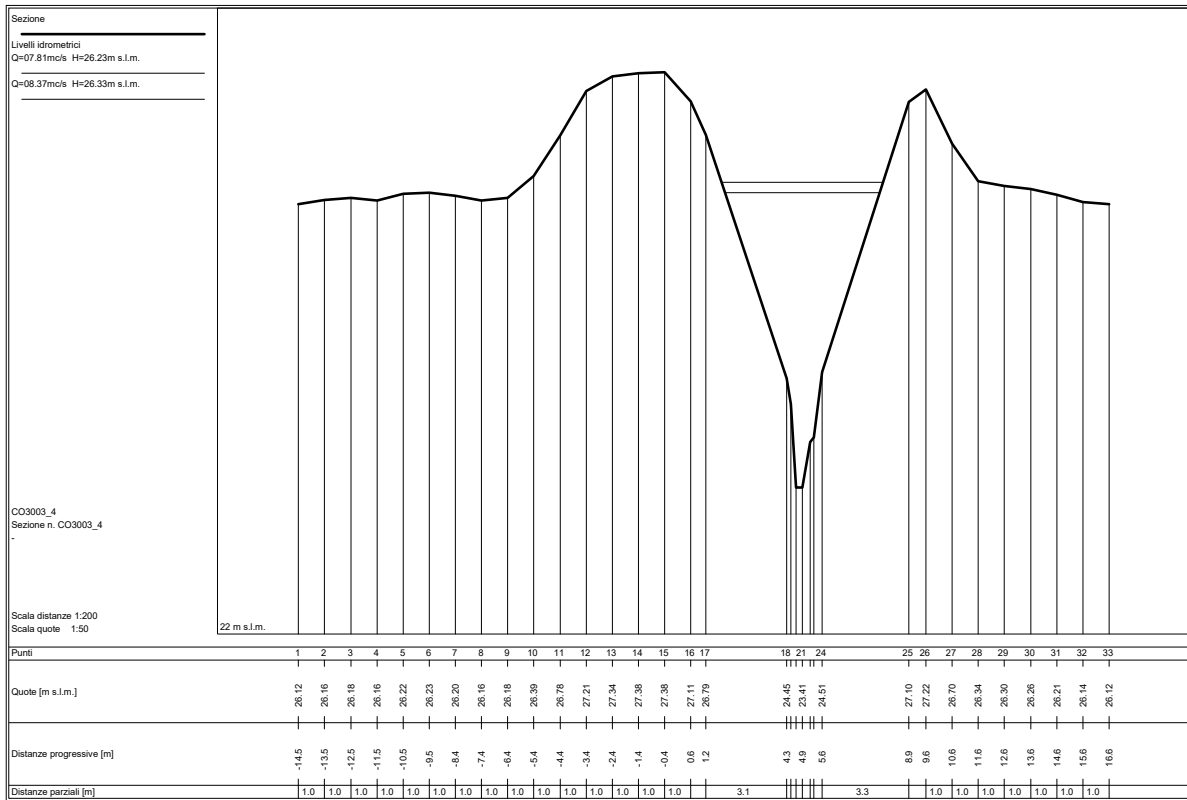

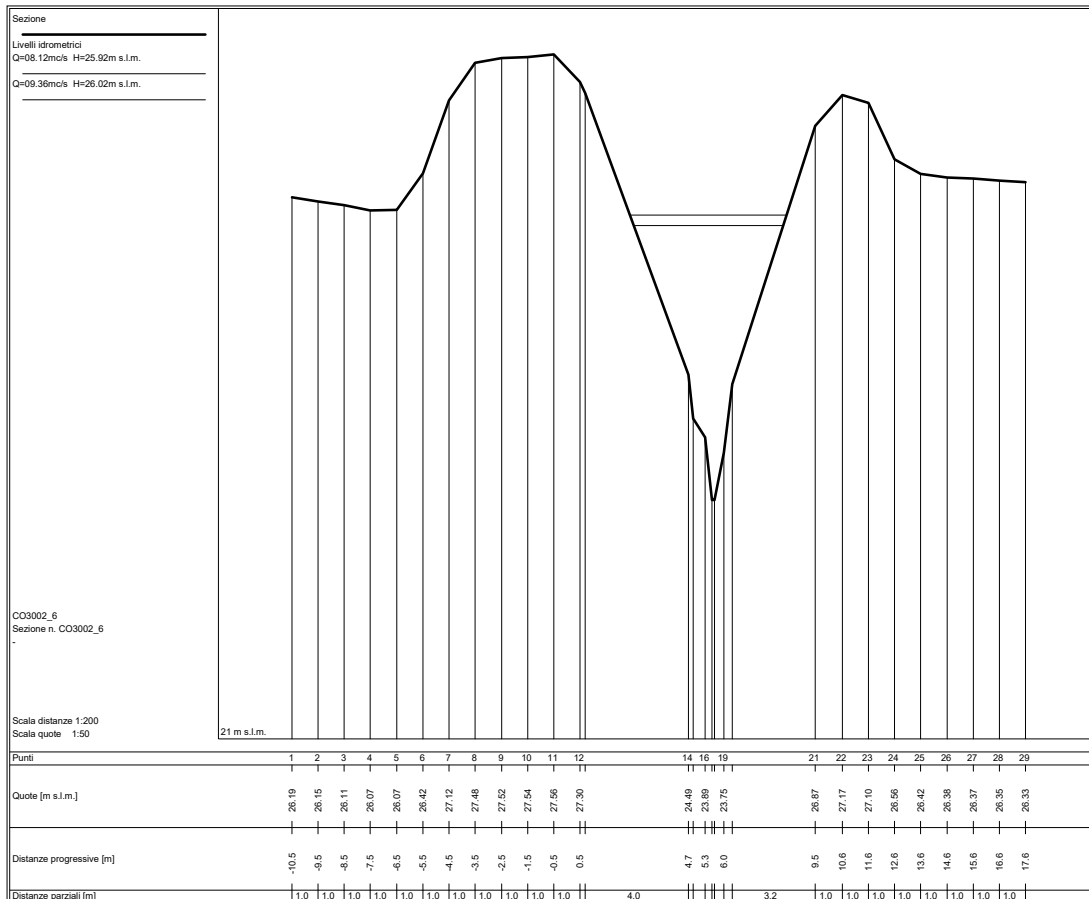
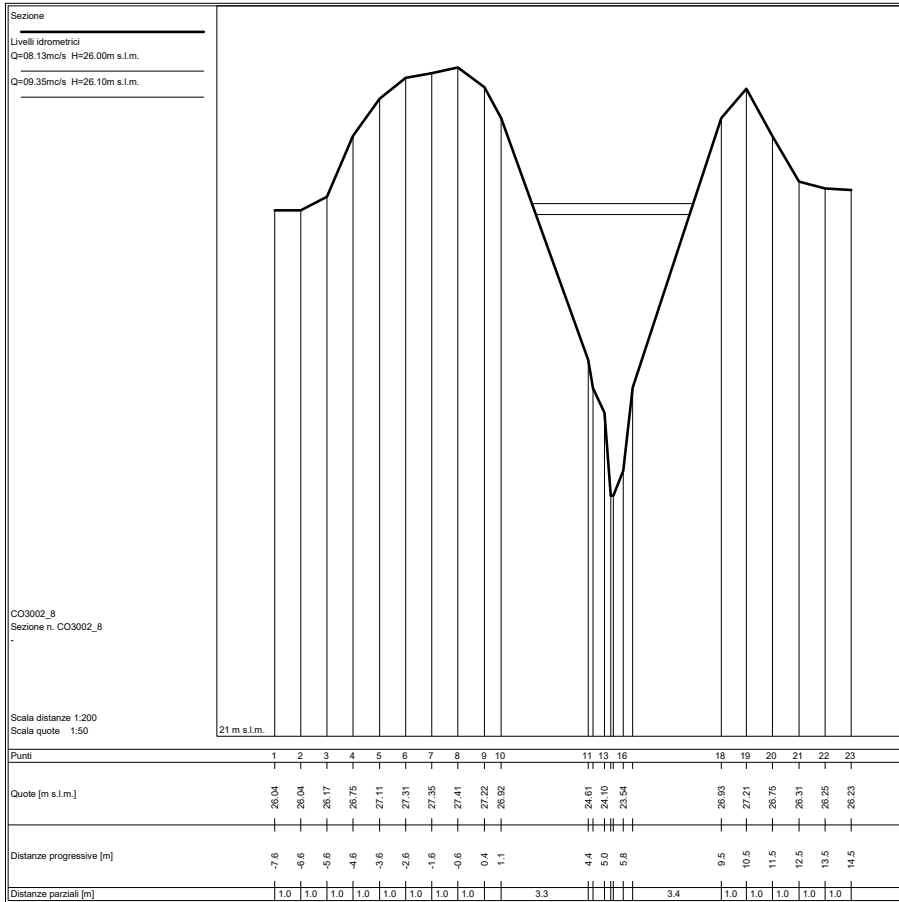

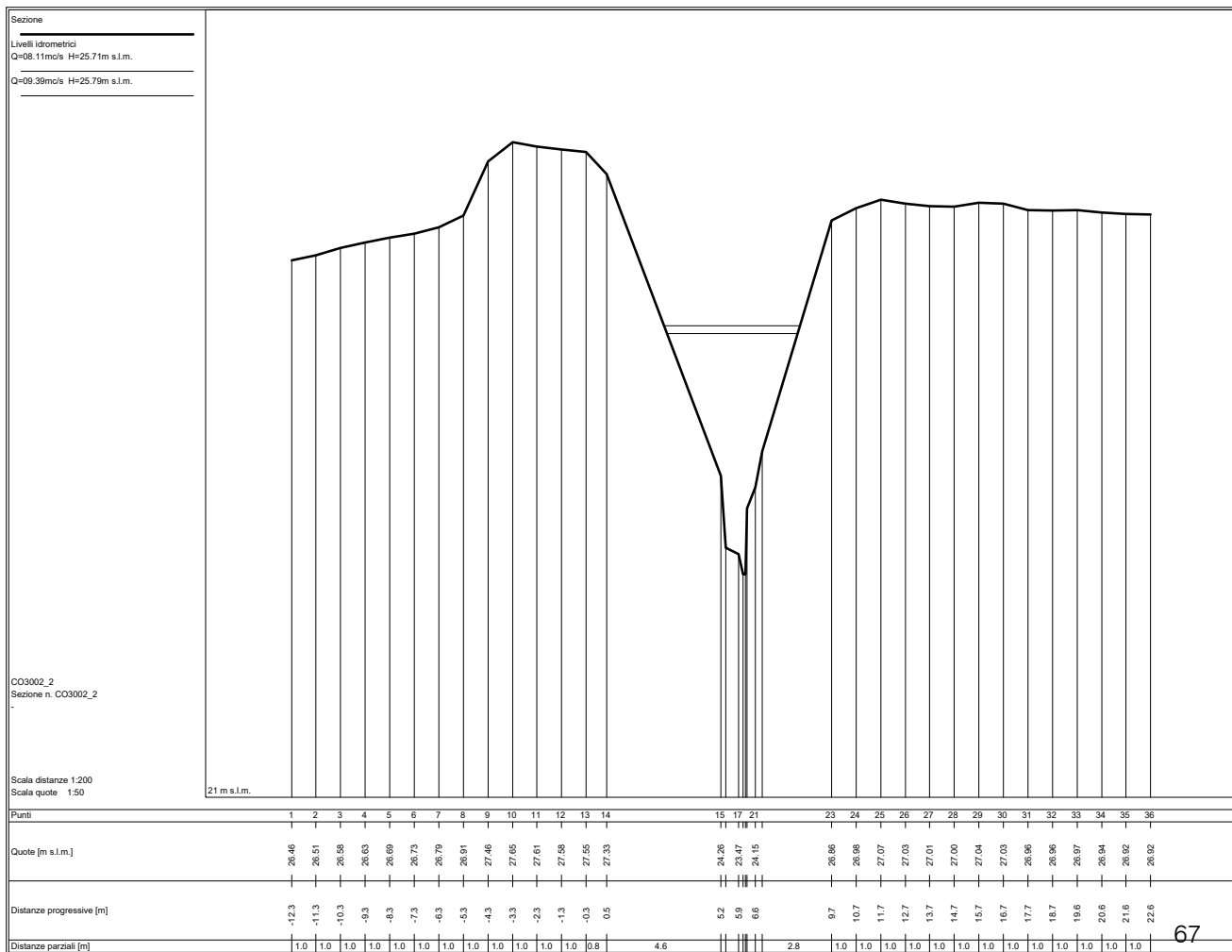
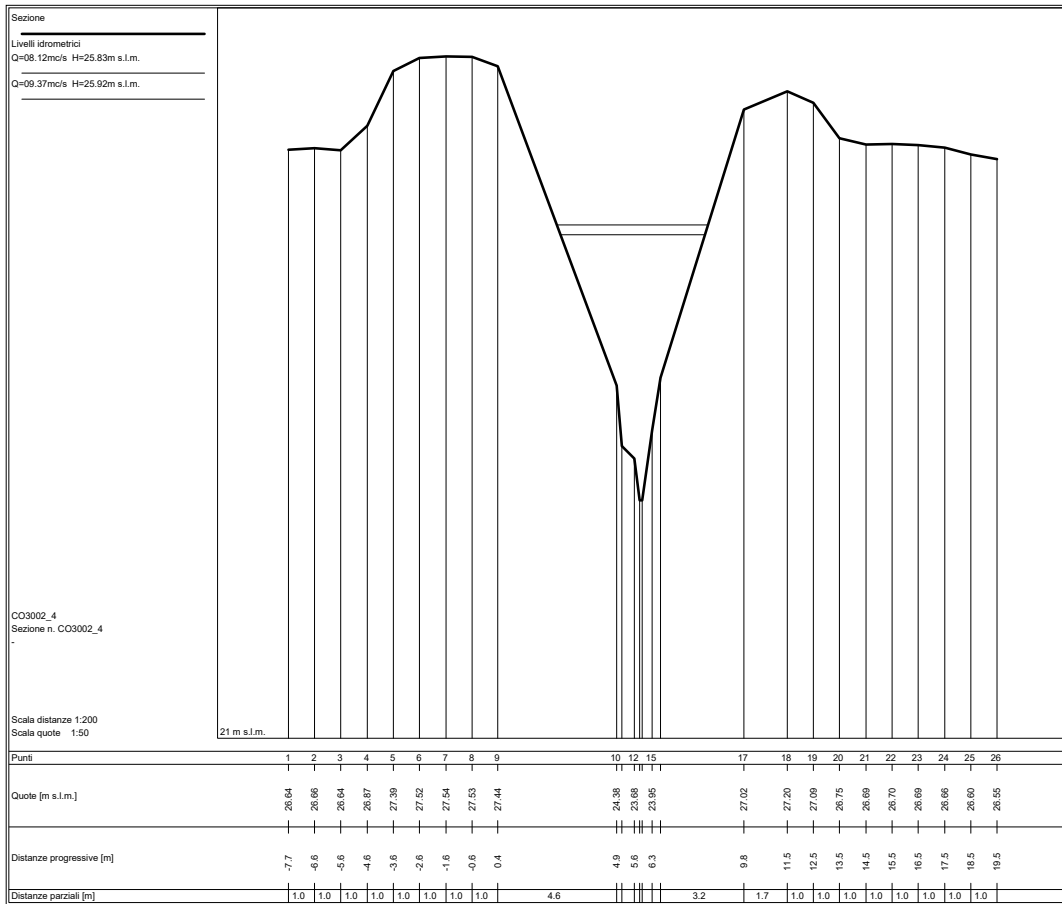

Sezione
 Livelli idrometrici
 Q=08.10mc/s H=25.01m s.l.m.
 Q=09.38mc/s H=25.11m s.l.m.

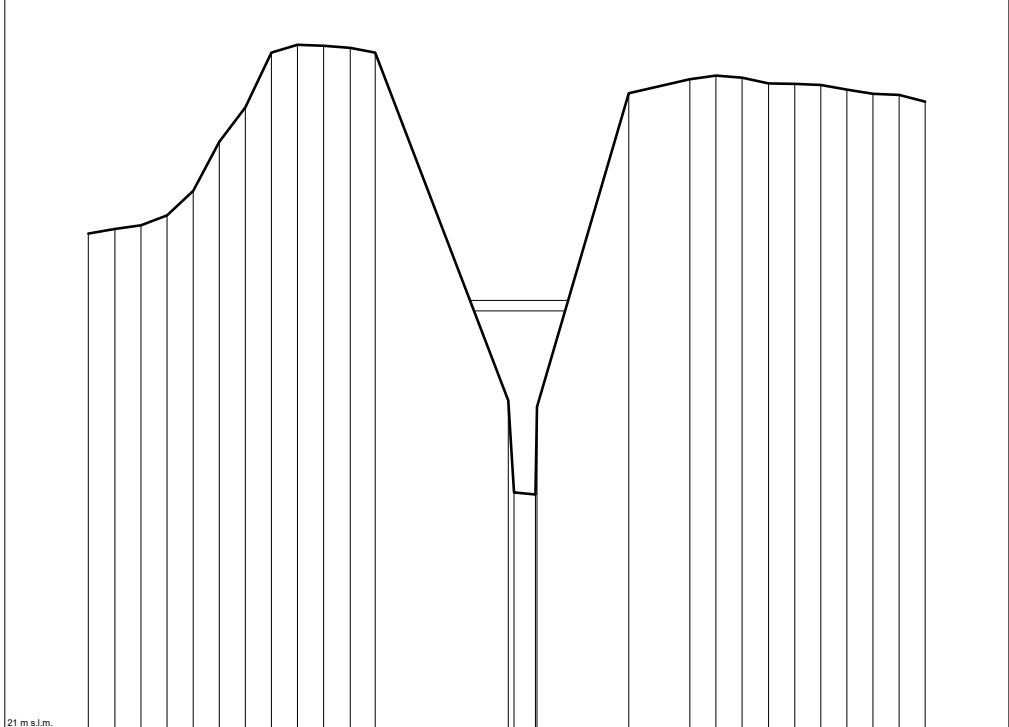

CO2002_
 Sezione n. CO2002_
 sez. 16 -

Scala distanze 1:200
 Scala quote 1:50

Punti	1	2	3	4	5	6	7	8	9	10	11	12	13	15	17	18	19	20	21	22	23	24	25	26	27		
Quote [m s.l.m.]		25.75	25.80	25.83	25.83	26.16	26.63	26.96	27.46	27.56	27.55	27.53	27.49	24.15	23.25	27.09		27.23	27.26	27.25	27.19	27.16	27.17	27.13	27.09	27.08	27.02
Distanze progressive [m]		-10.7	-9.7	-8.7	-7.7	-6.7	-5.7	-4.7	-3.7	-2.7	-1.7	-0.6	0.3	5.4	6.5	10.0		12.4	13.4	14.4	15.4	16.4	17.4	18.4	19.4	20.4	21.4
Distanze parziali [m]	1.0	1.0	1.0	1.0	1.0	1.0	1.0	1.0	1.0	1.0	1.0	1.0	5.1	0.8	3.5	2.3	1.0	1.0	1.0	1.0	1.0	1.0	1.0	1.0	1.0	1.0	1.0

Sezione
 Livelli idrometrici
 Q=08.10mc/s H=25.05m s.l.m.
 Q=09.38mc/s H=25.23m s.l.m.

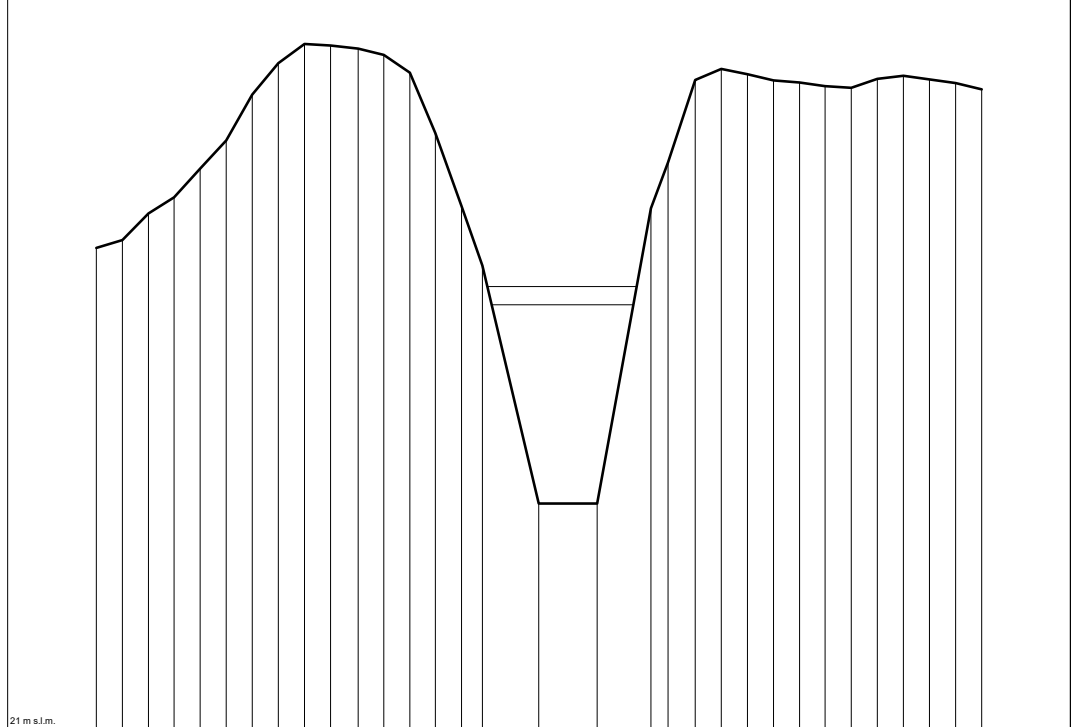

CO2001_1
 Sezione n. CO2001_1

Scala distanze 1:200
 Scala quote 1:50

Punti	1	2	3	4	5	6	7	8	9	10	11	12	13	14	15	16	17	18	19	20	21	22	23	24	25	26	27	28	29	30	31	32	
Quote [m s.l.m.]		25.60	25.67	25.93	26.08	26.36	26.63	27.07	27.37	27.55	27.54	27.51	27.45	27.28	26.70	26.00	25.43	23.15	23.15	25.98	26.42	27.21	27.31	27.26	27.20	27.19	27.15	27.13	27.22	27.25	27.21	27.18	27.12
Distanze progressive [m]		-1.1	-0.1	0.9	1.9	2.9	3.9	4.8	5.8	6.8	7.8	8.9	9.9	10.9	11.9	12.9	13.7	15.8	18.1	20.1	20.6	21.8	22.8	23.8	24.8	25.8	26.8	27.8	28.8	29.8	30.8	31.8	32.8
Distanze parziali [m]	1.0	1.0	1.0	1.0	1.0	1.0	1.0	1.0	1.0	1.0	1.1	1.0	1.0	1.0	1.0	0.8	2.2	2.2	2.1	1.0	1.0	1.0	1.0	1.0	1.0	1.0	1.0	1.0	1.0	1.0	1.0	1.0	1.0

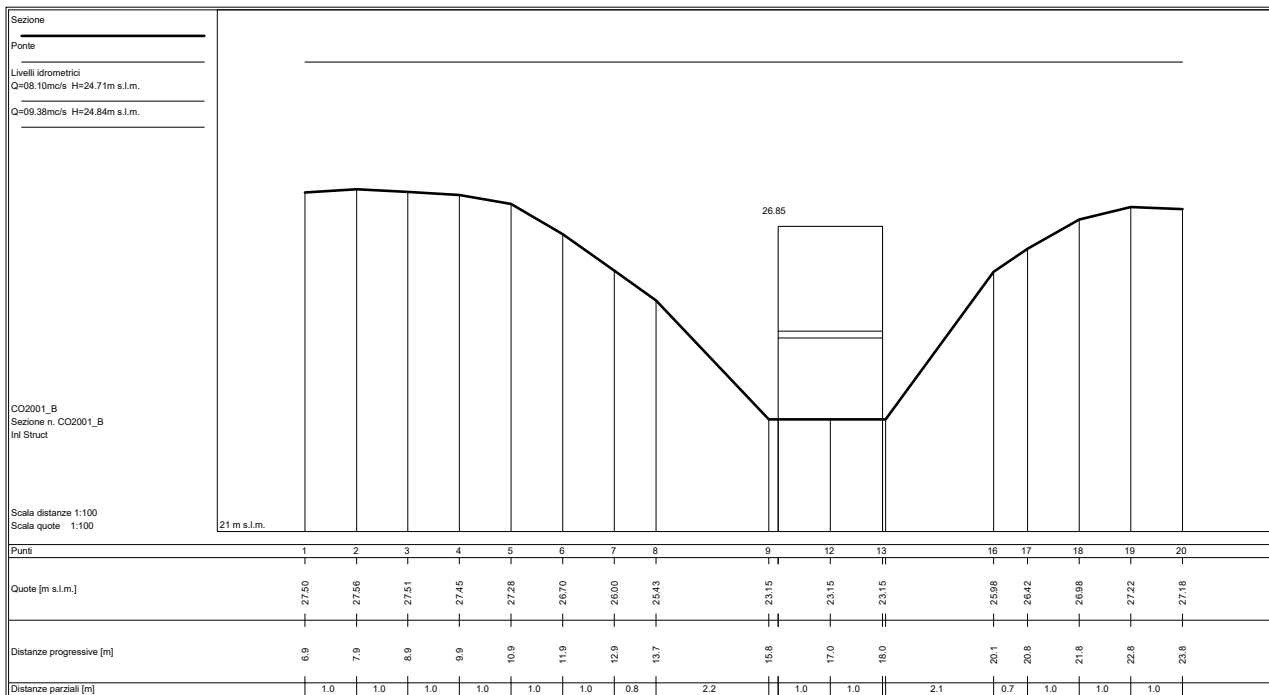
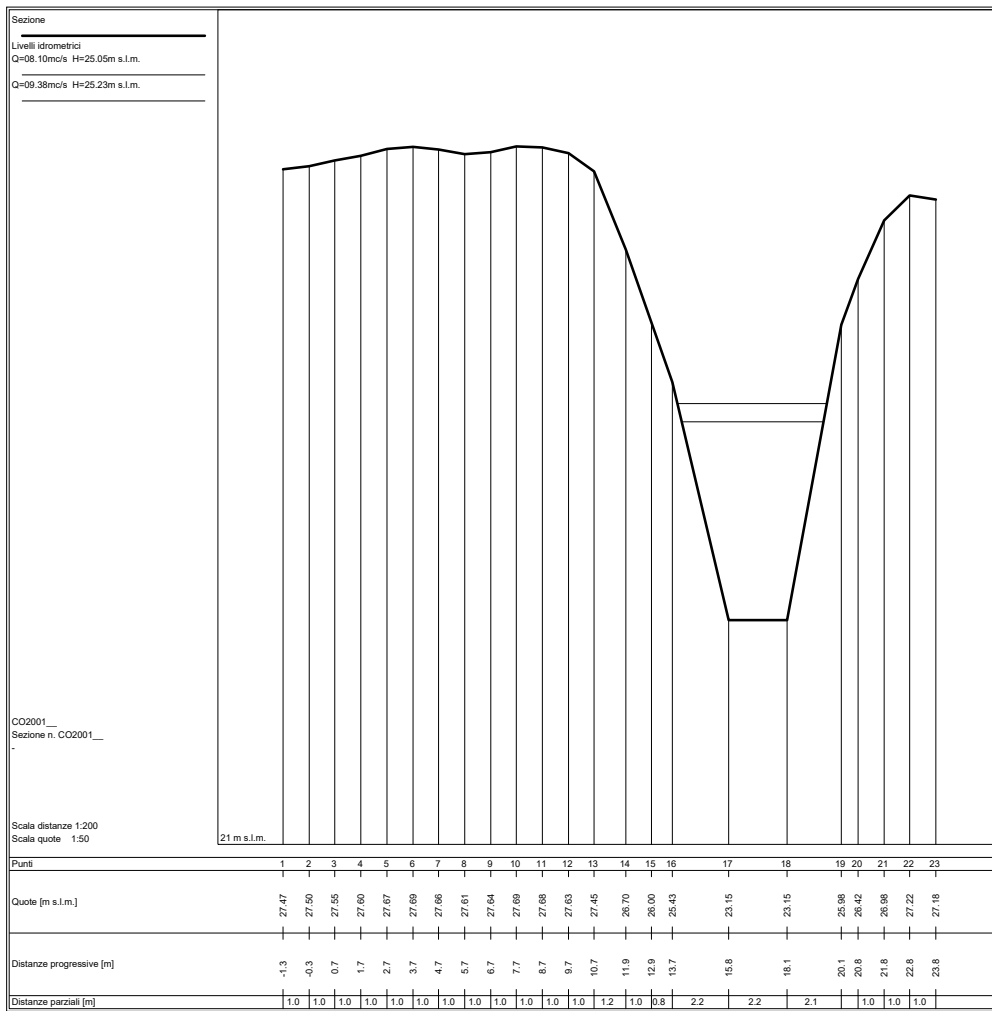

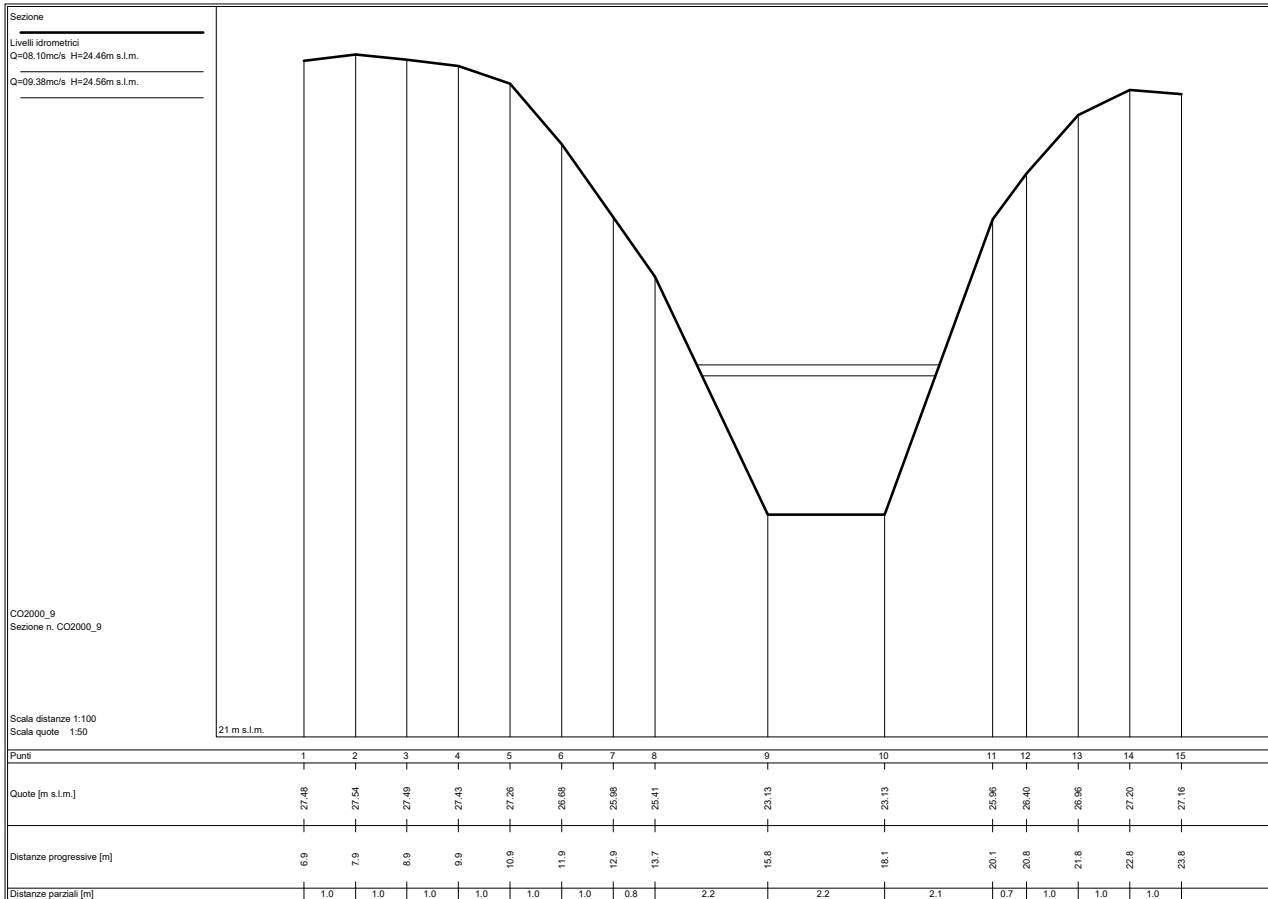
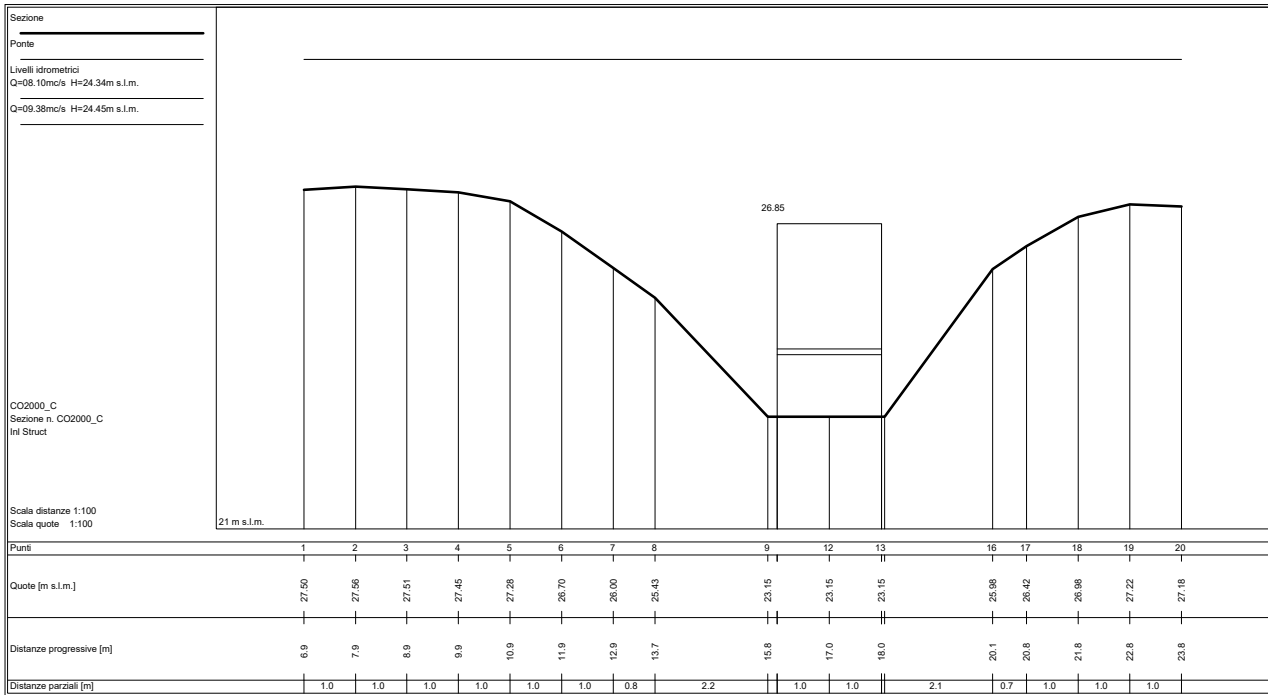

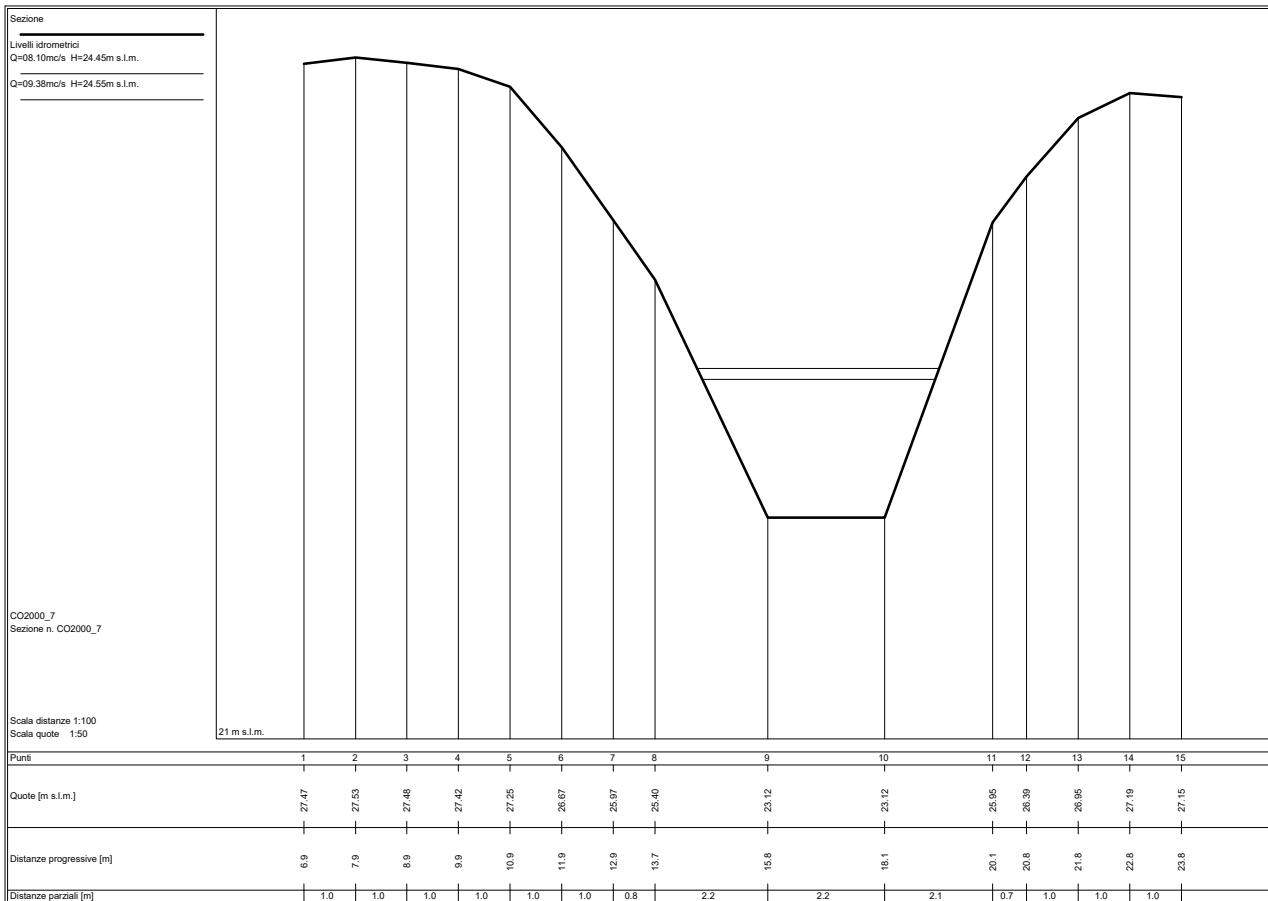
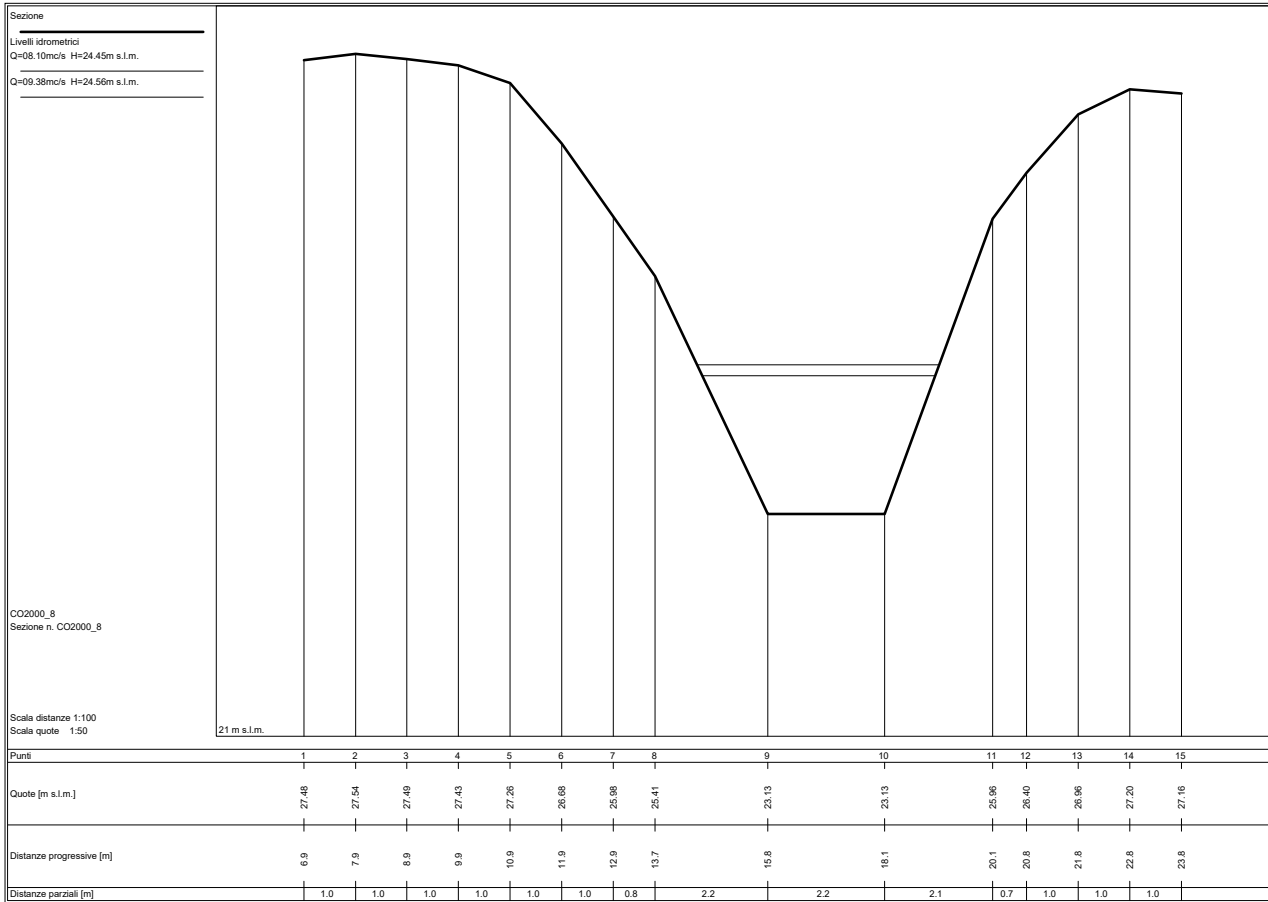

SEZIONI FLUVIALI
FOSSO FIBBIANA – tratto Fibbiana

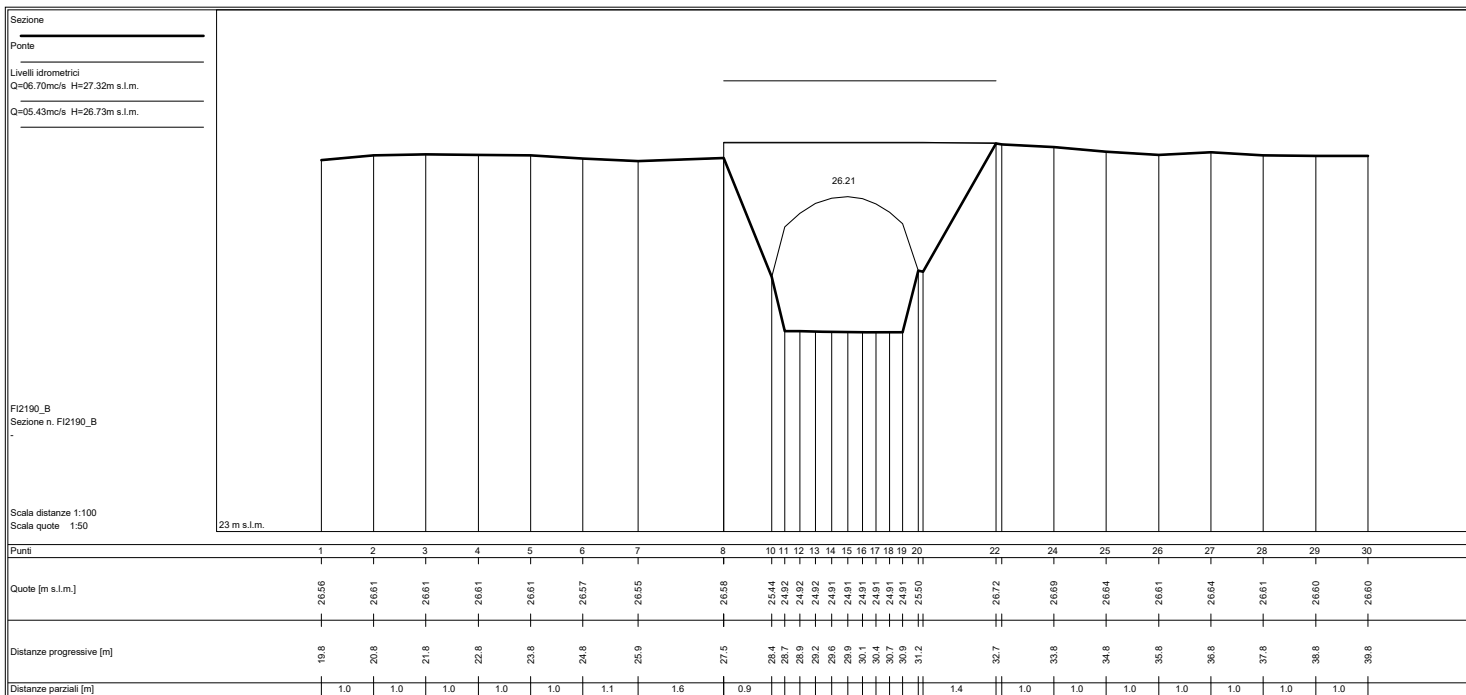
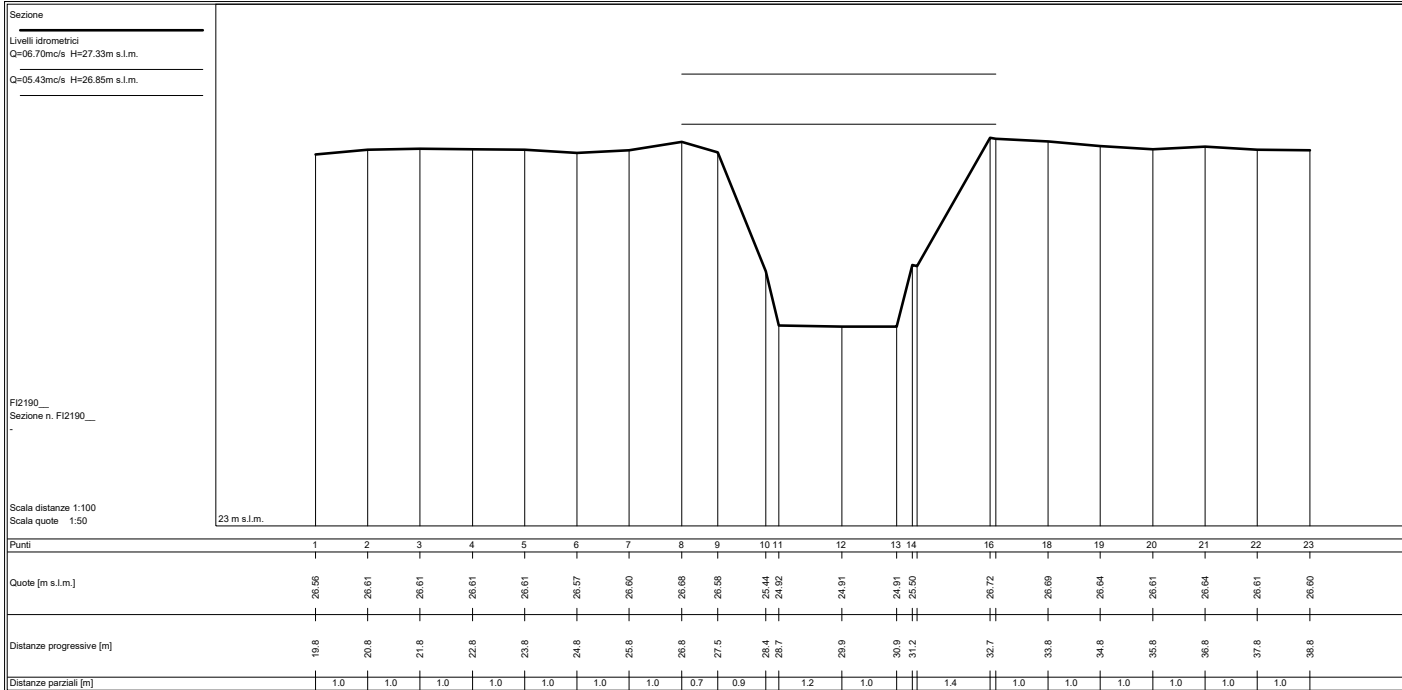

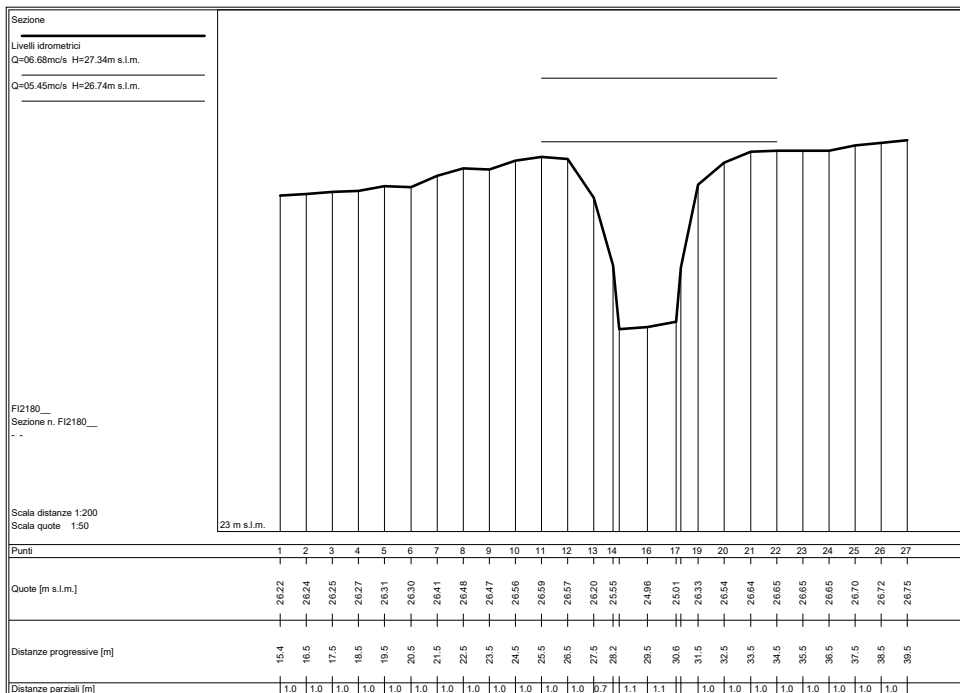
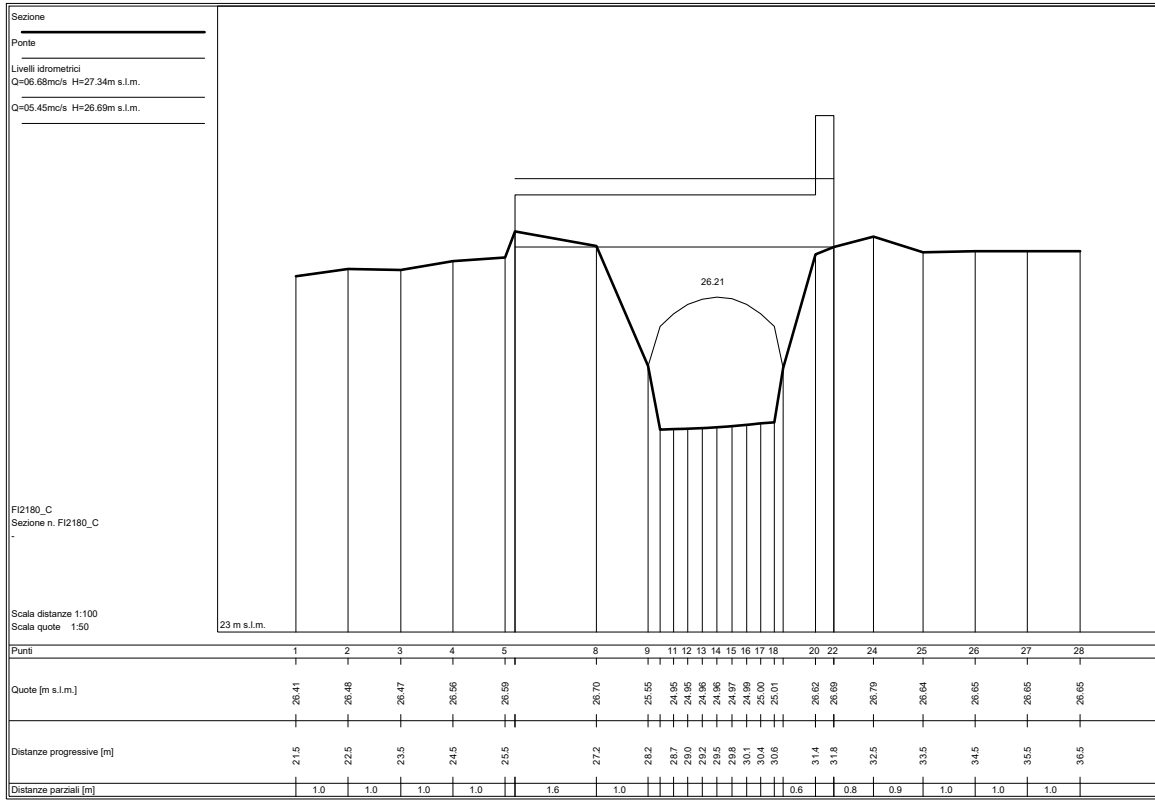

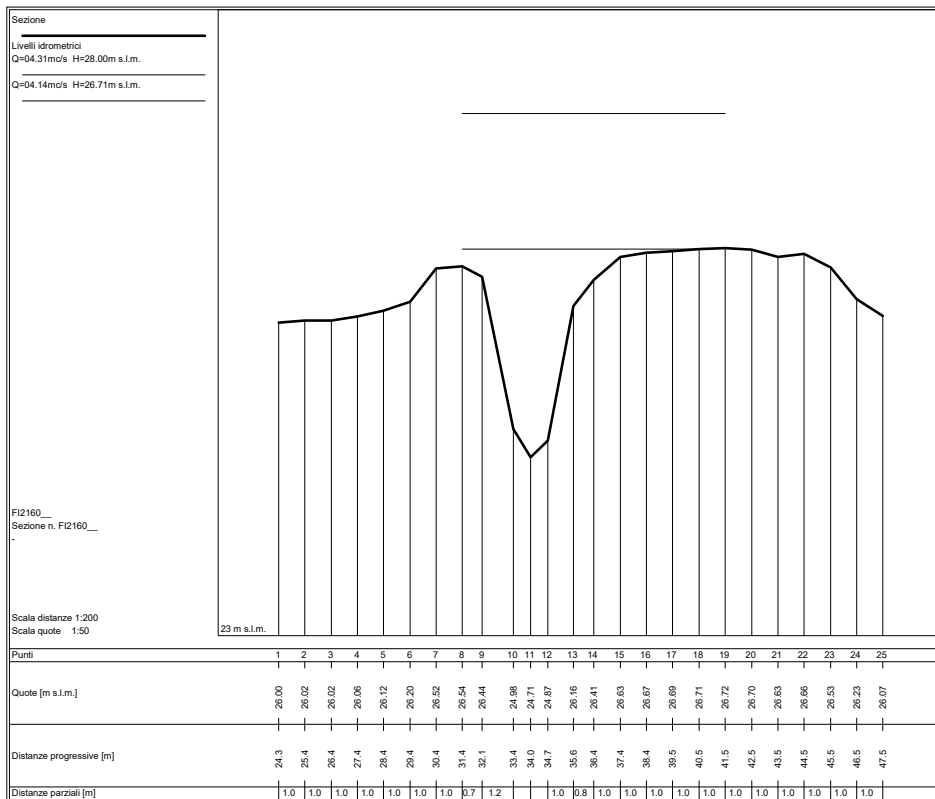
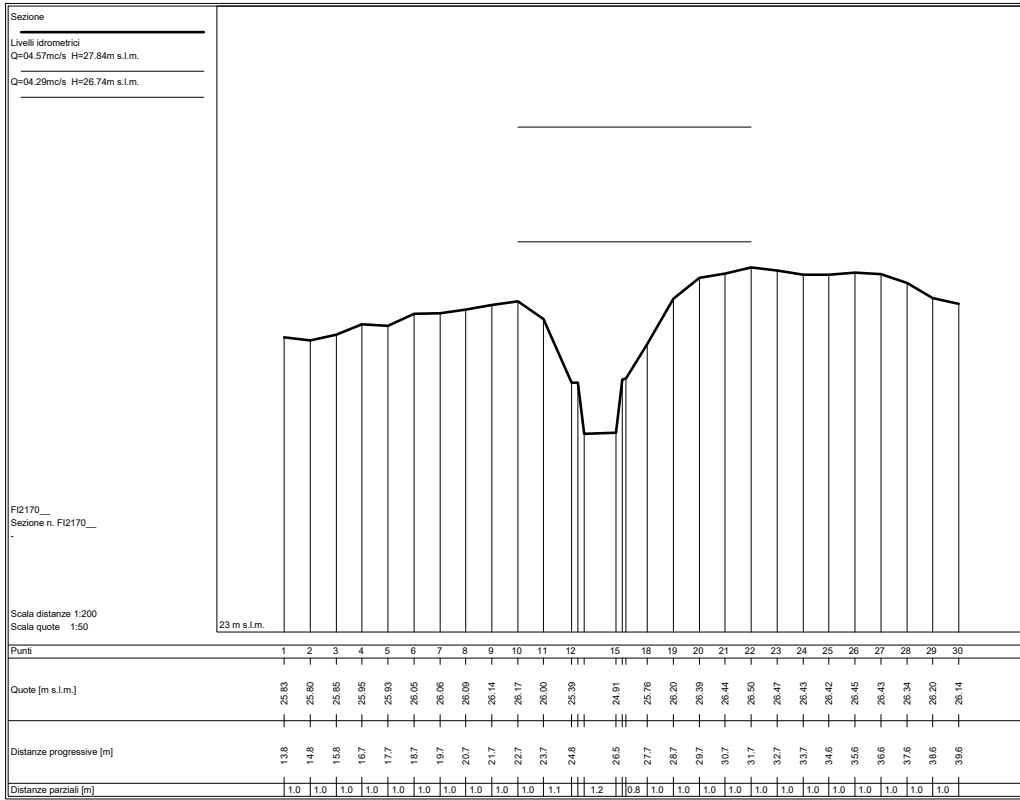

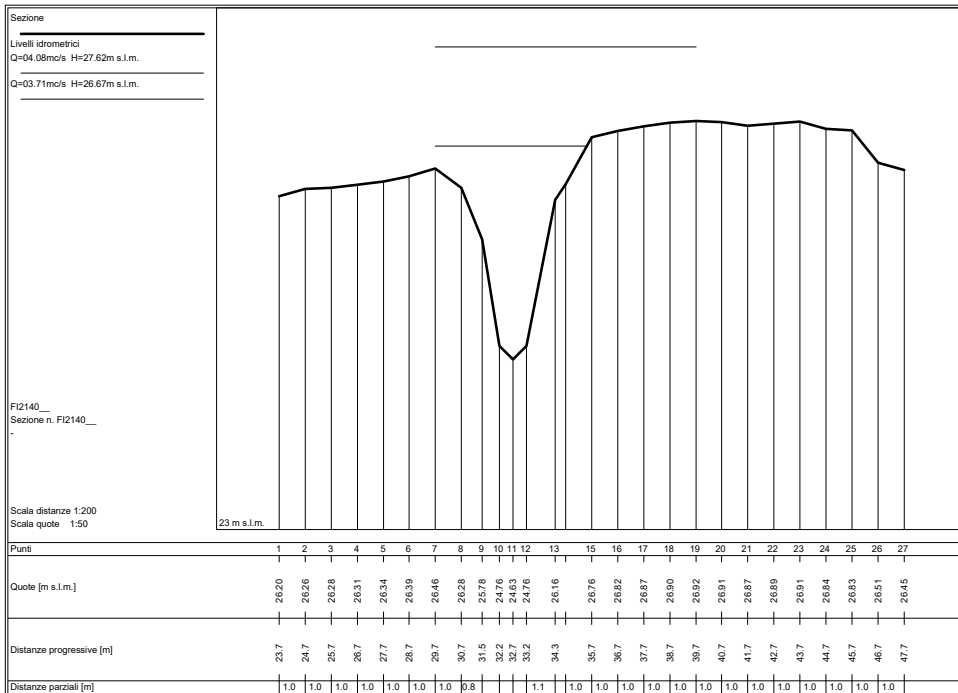
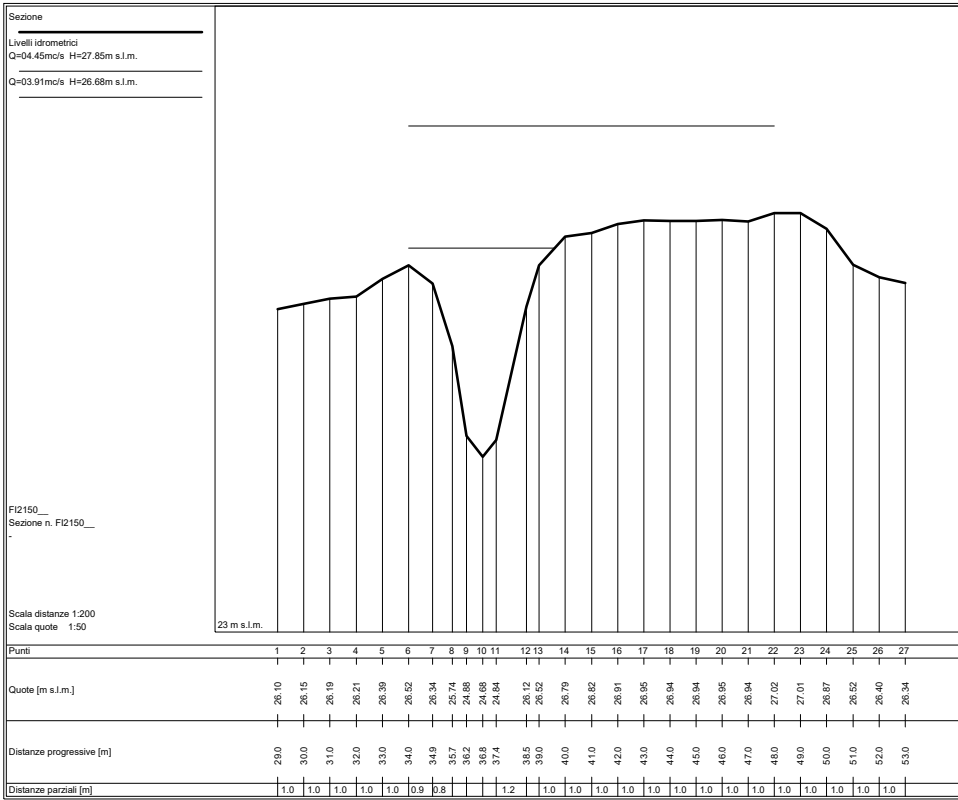

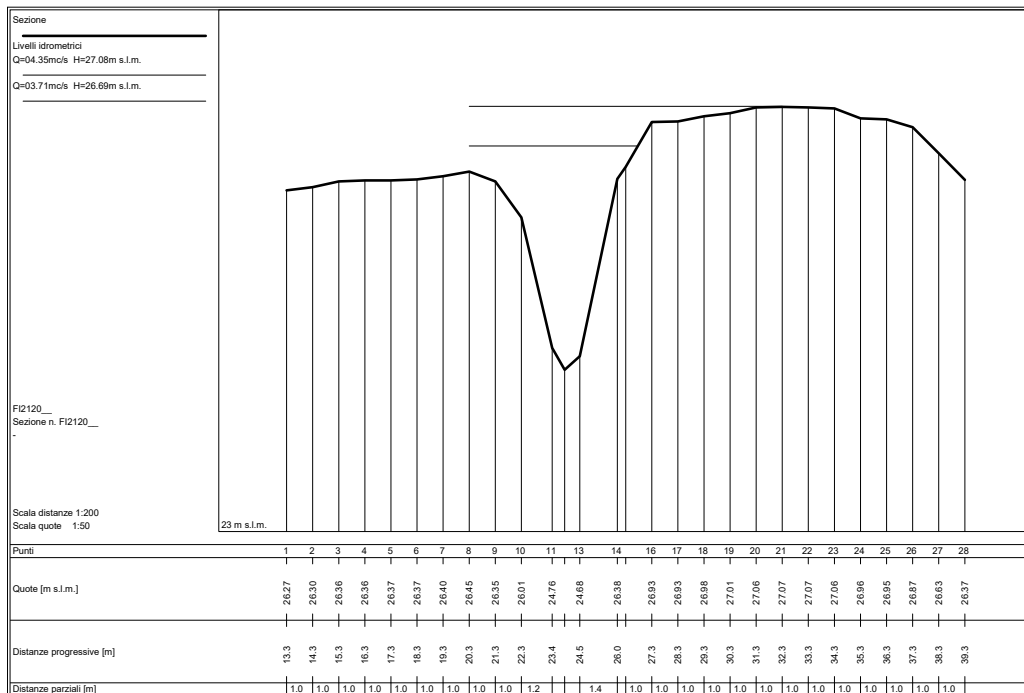
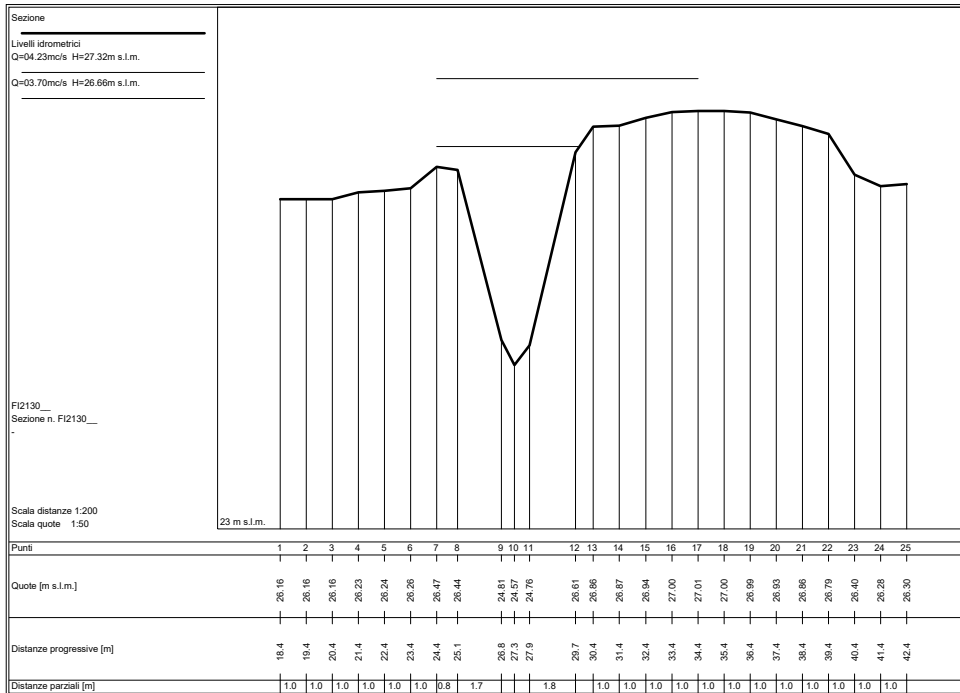

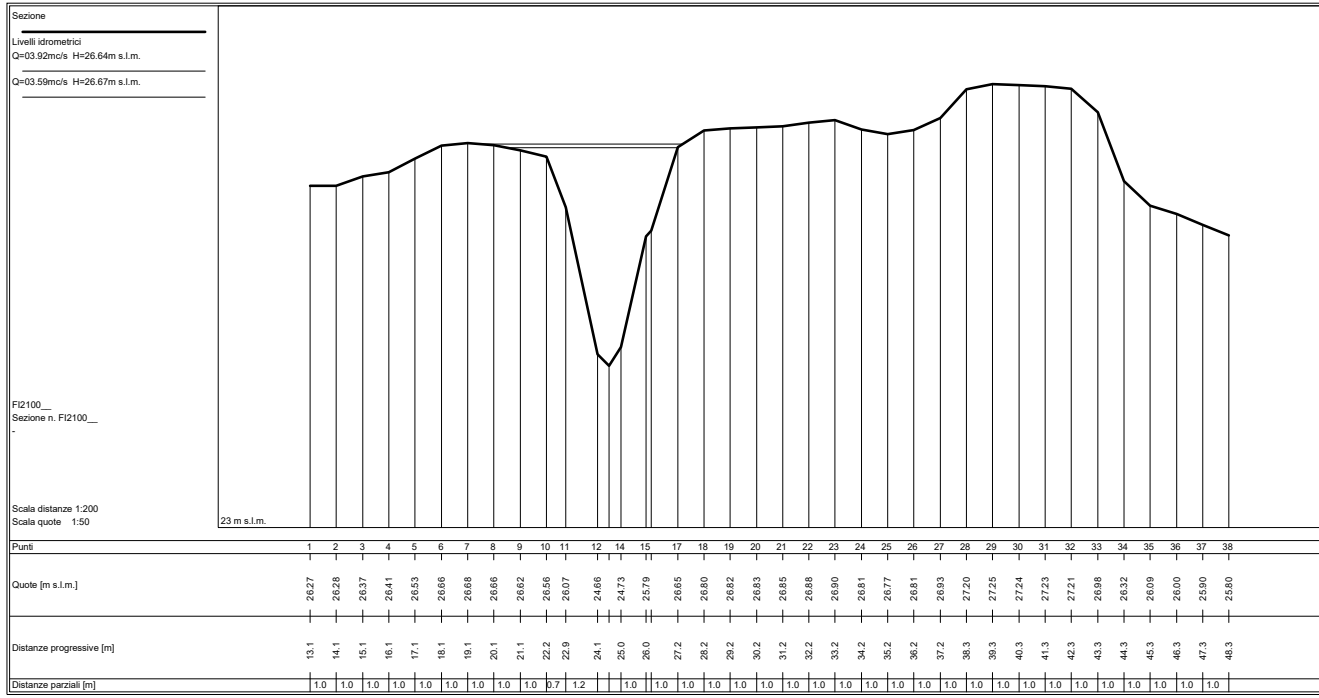
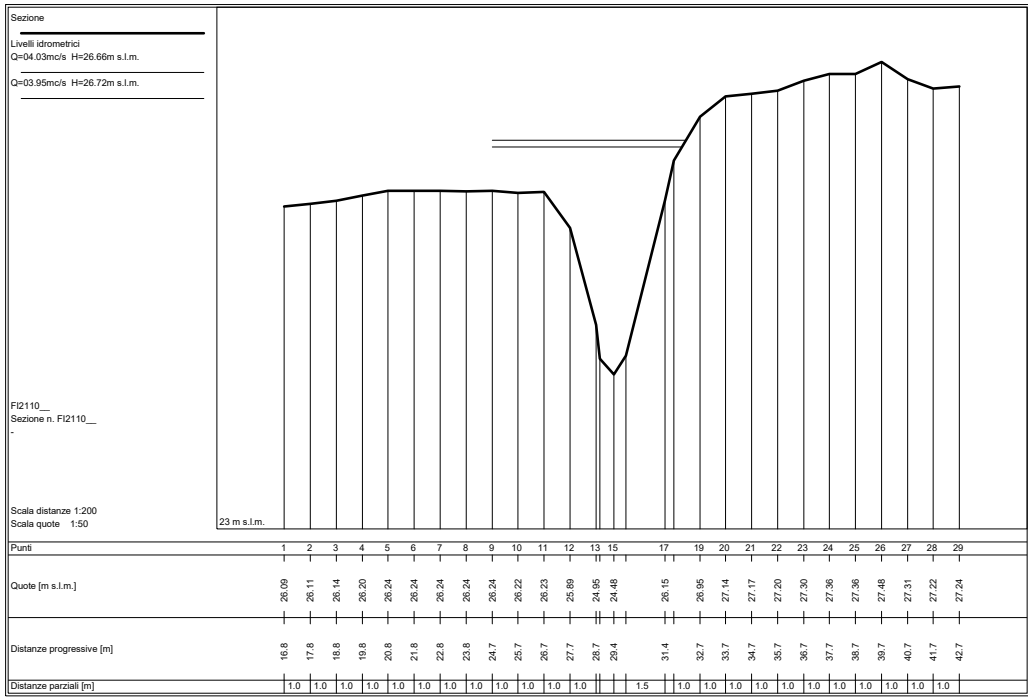

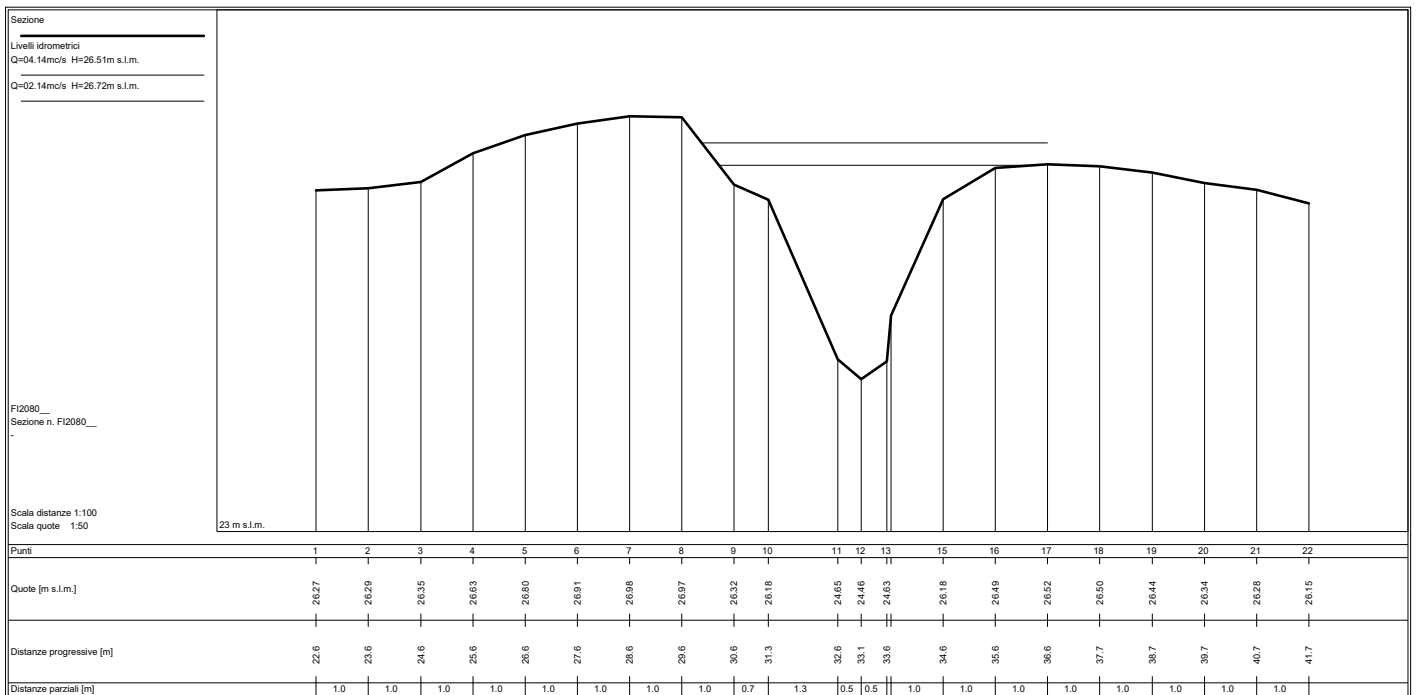
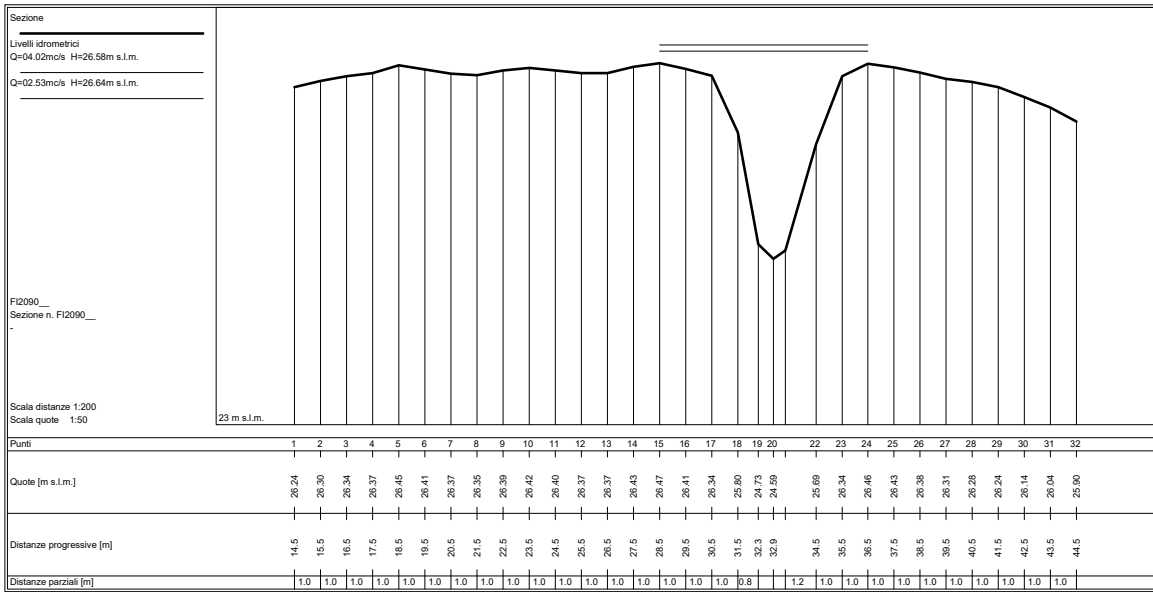

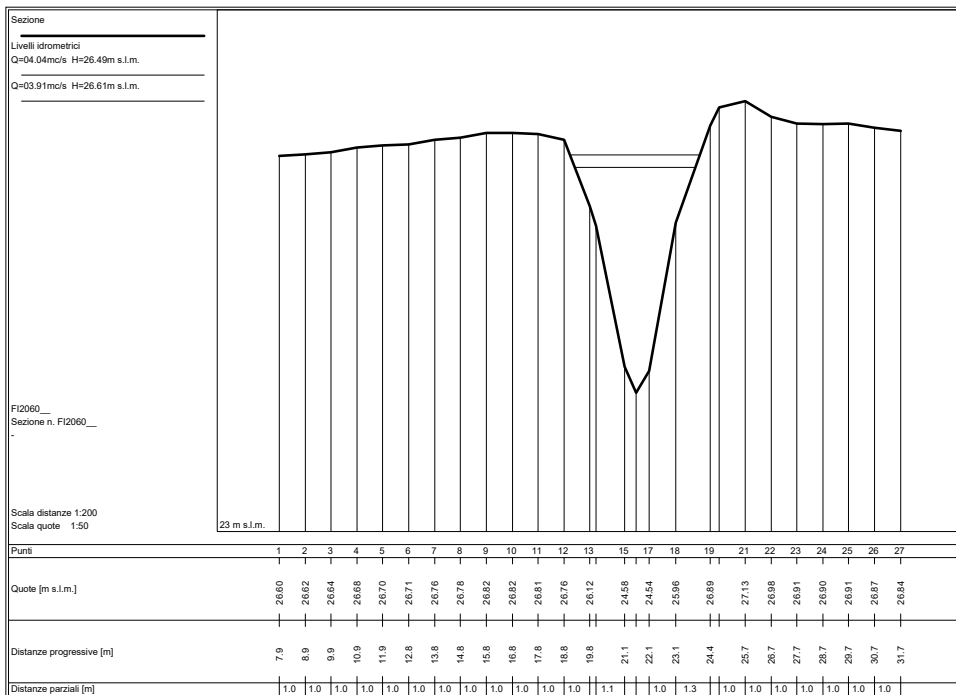
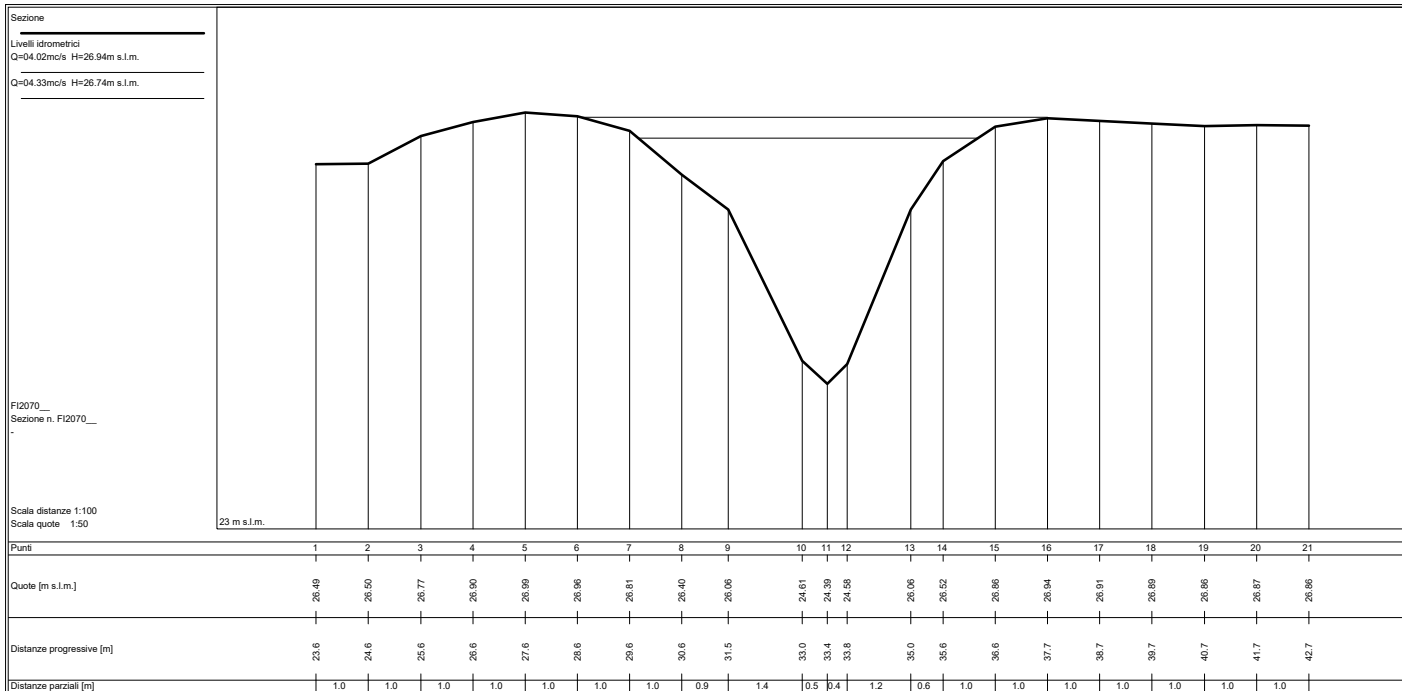

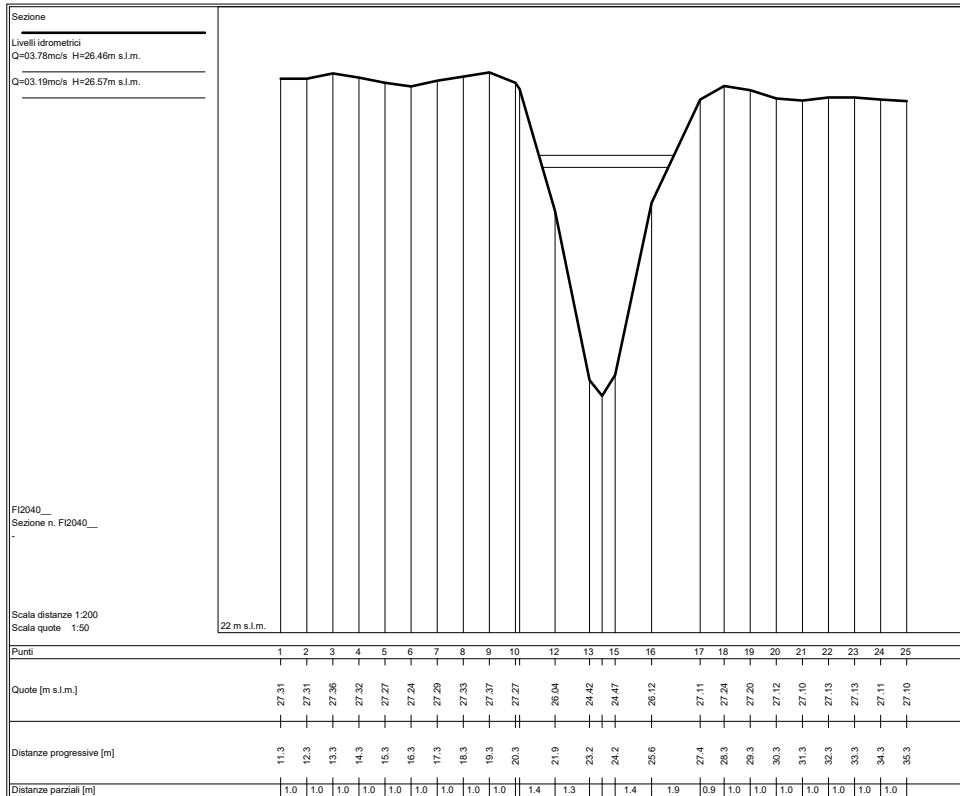
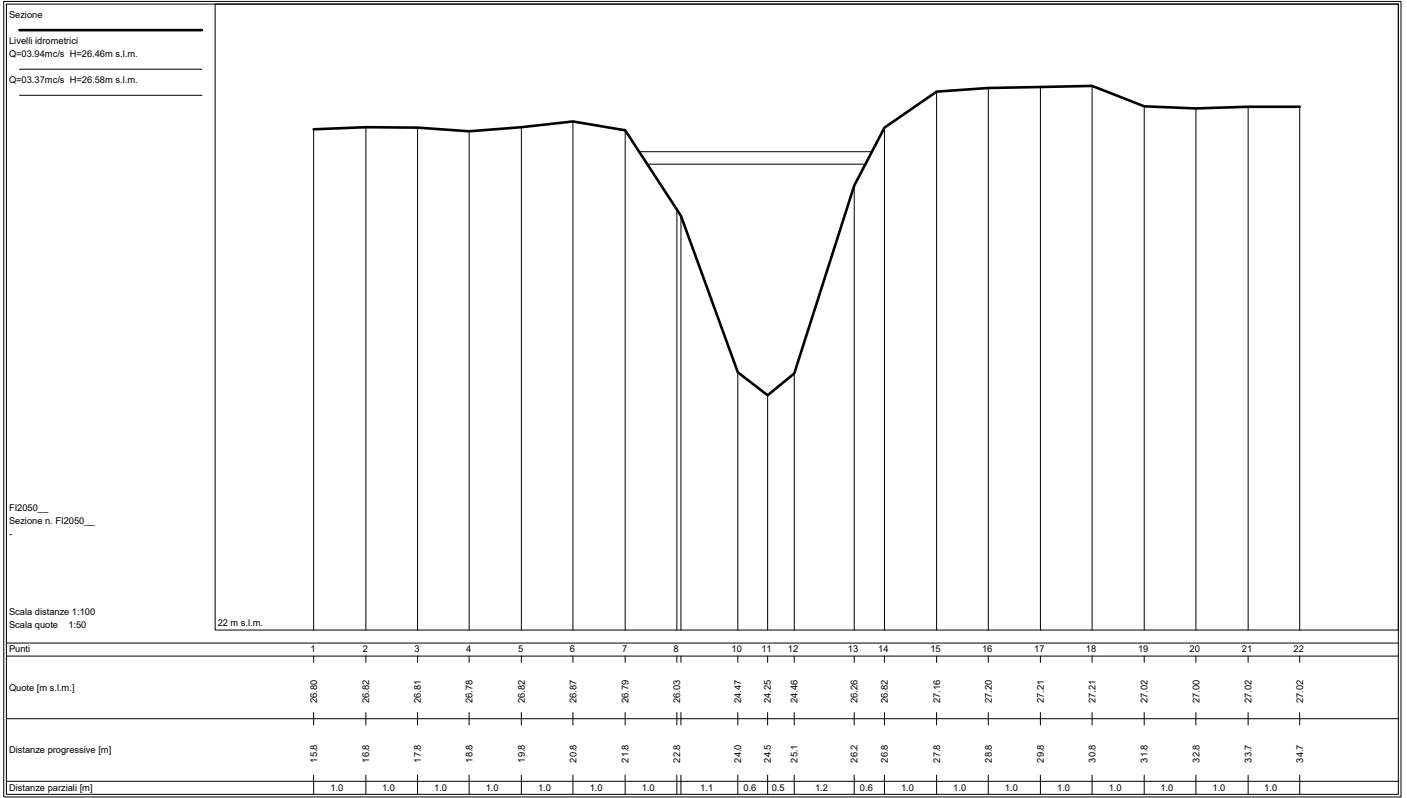

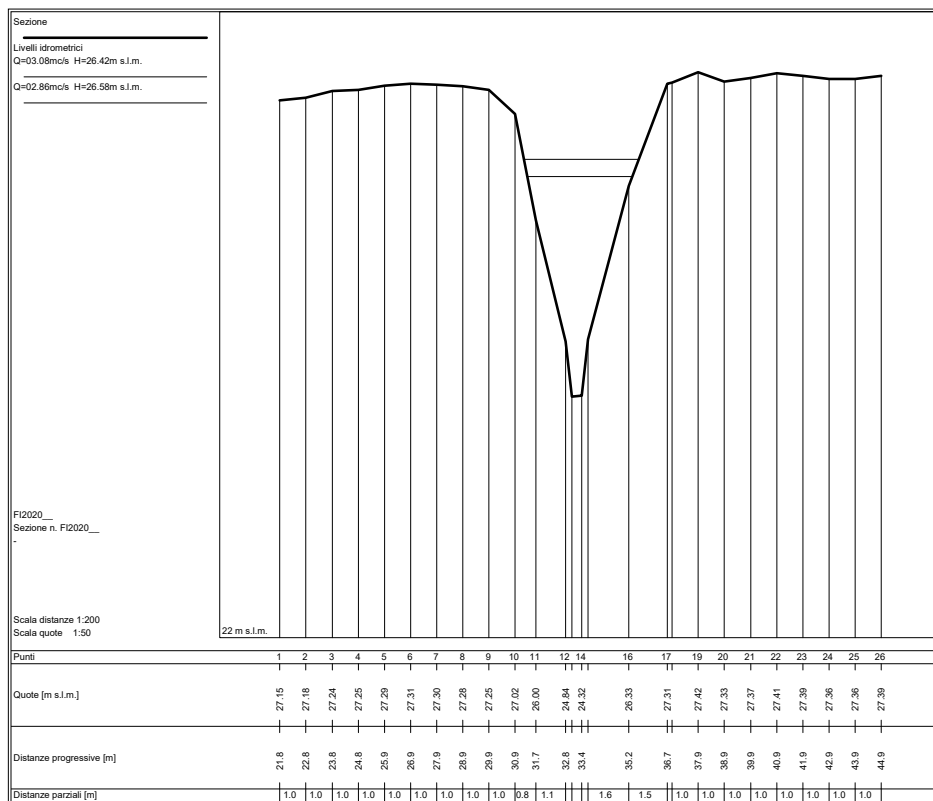
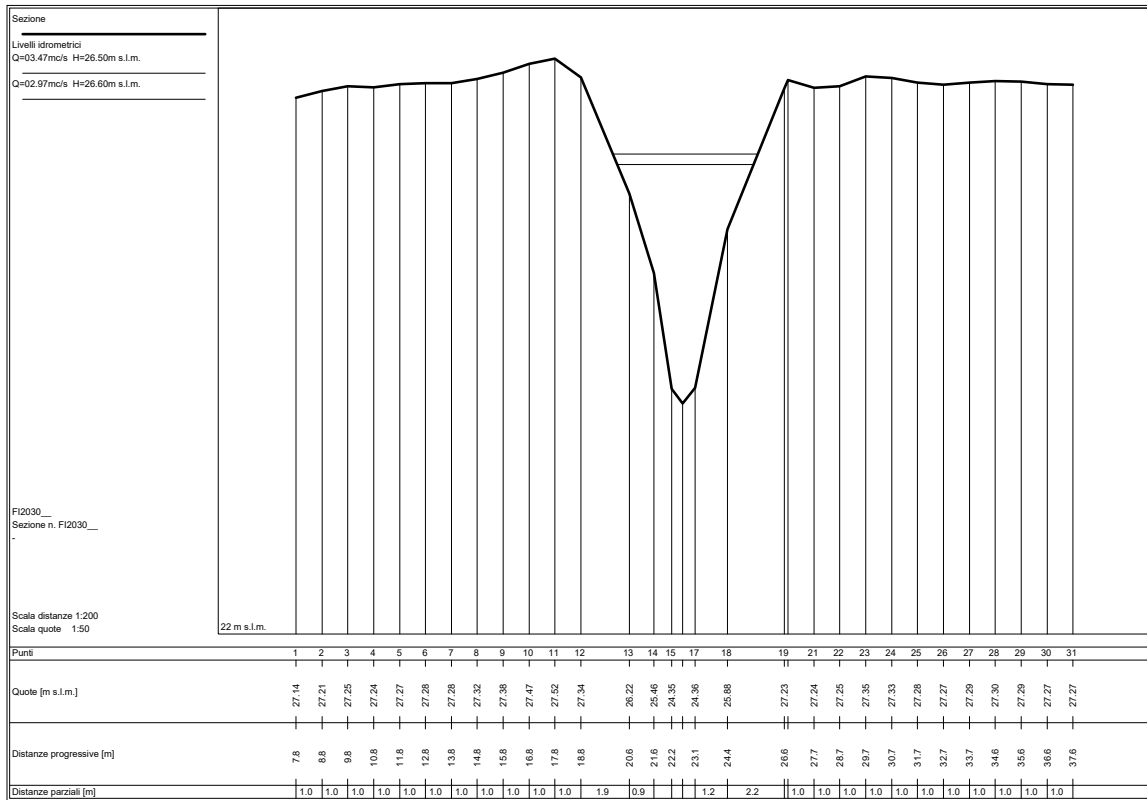

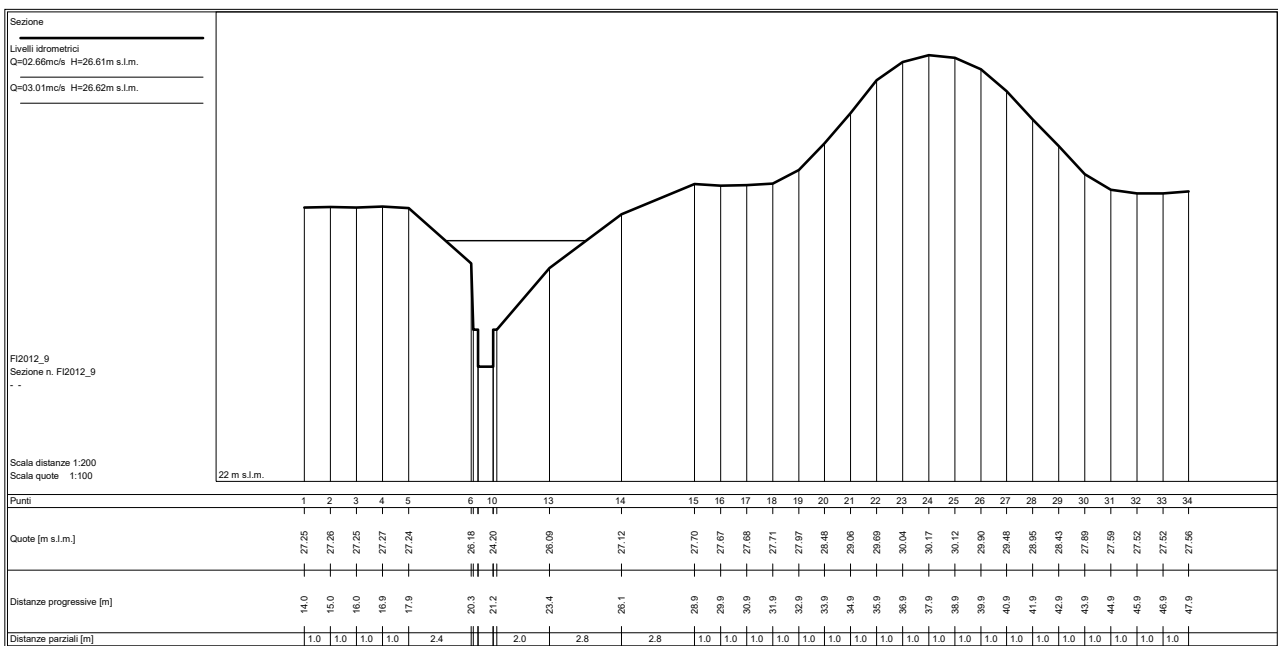
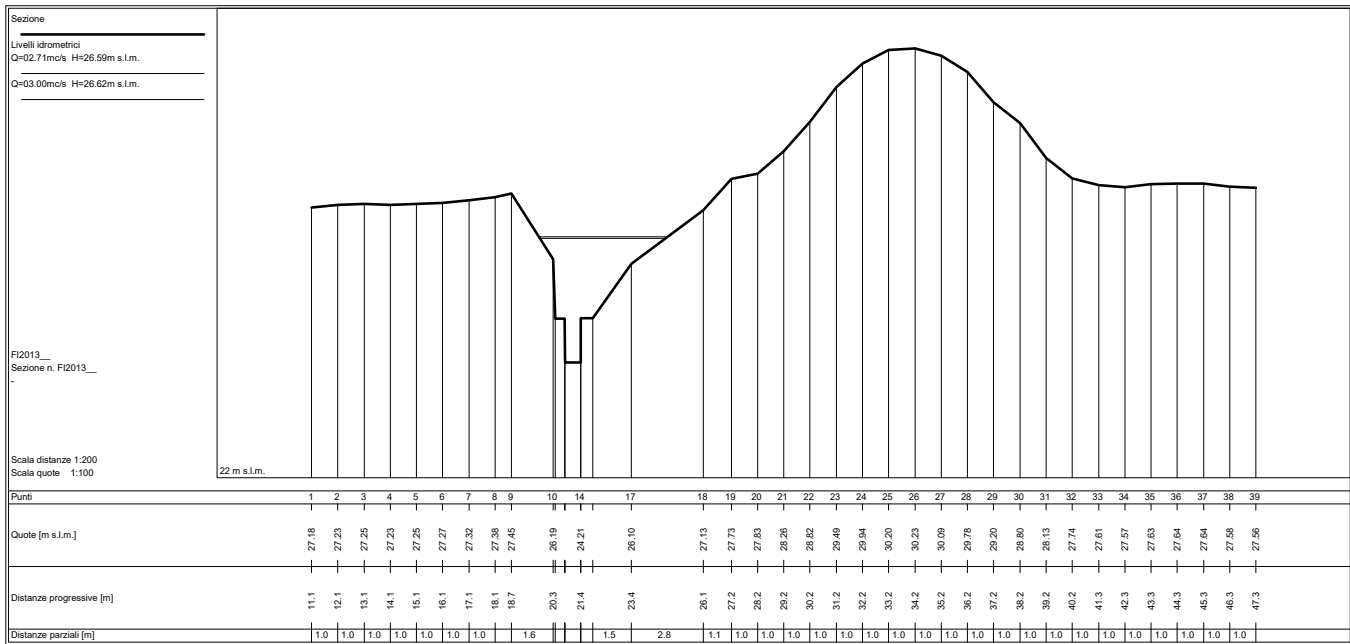

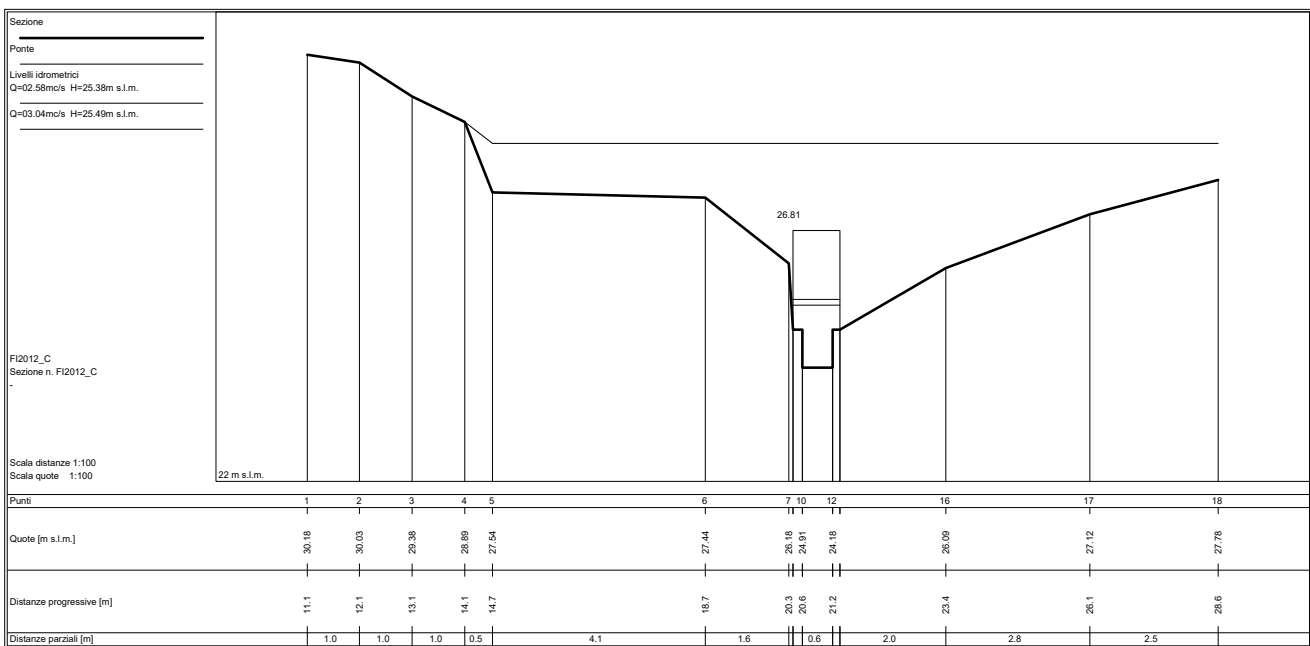
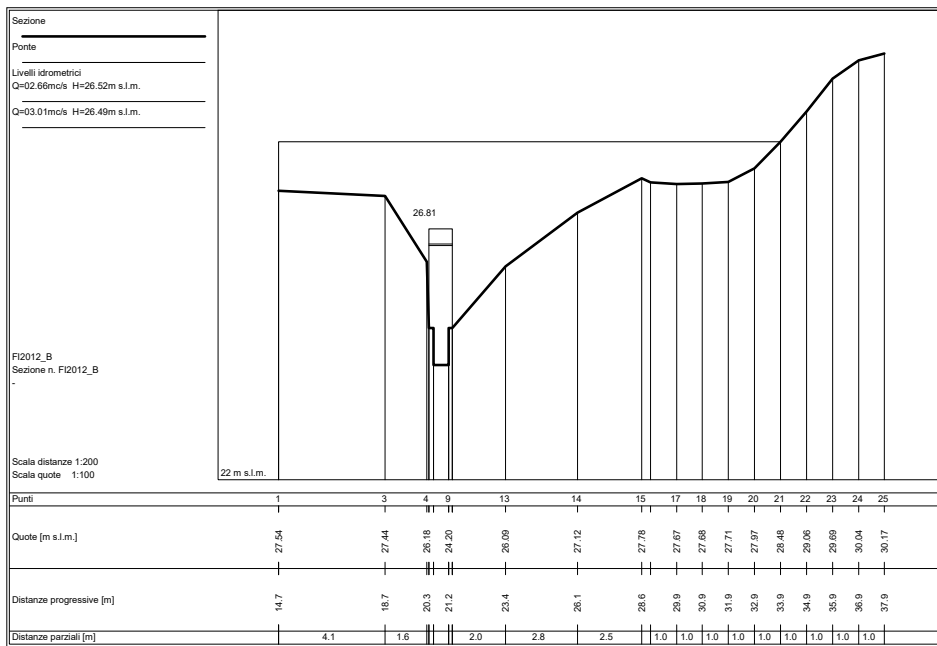

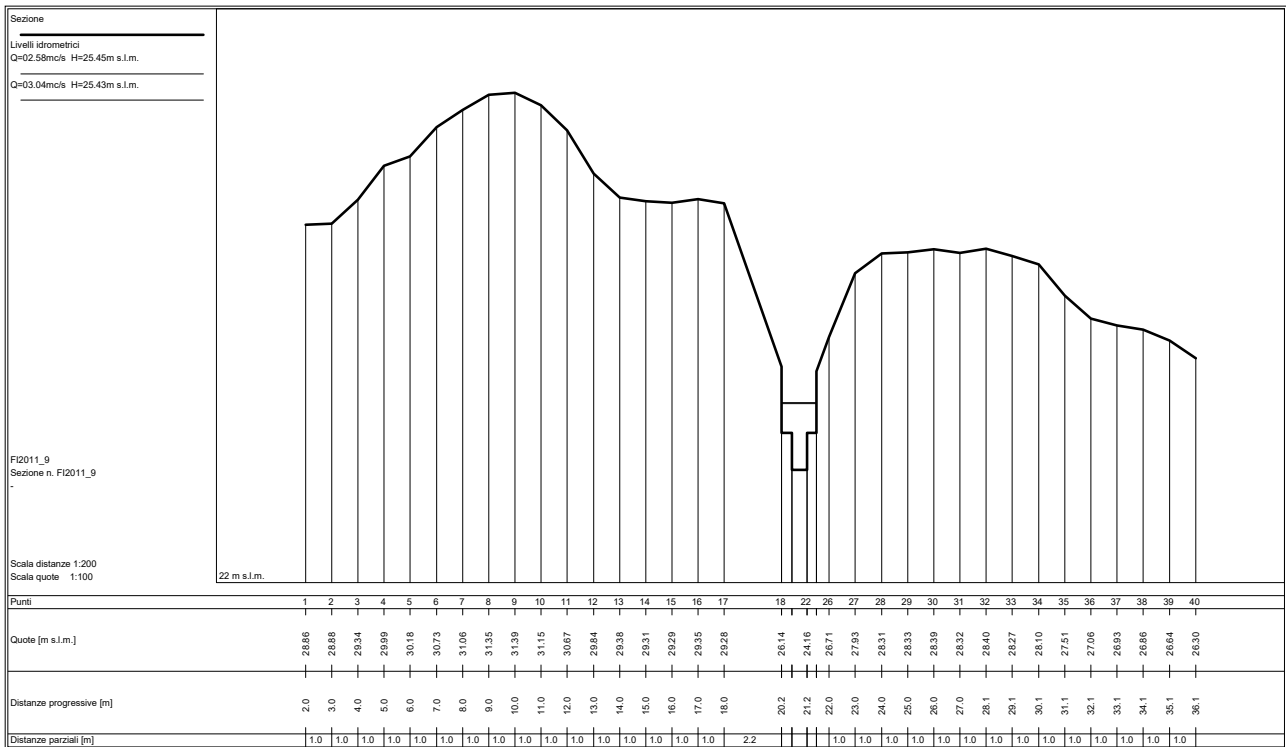
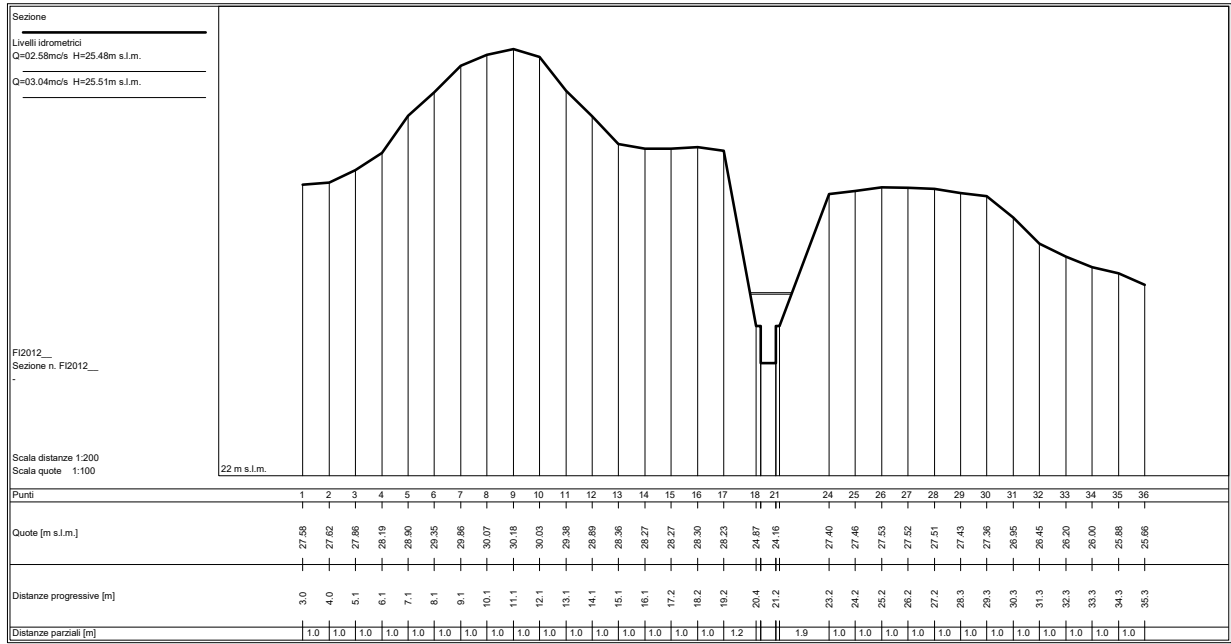

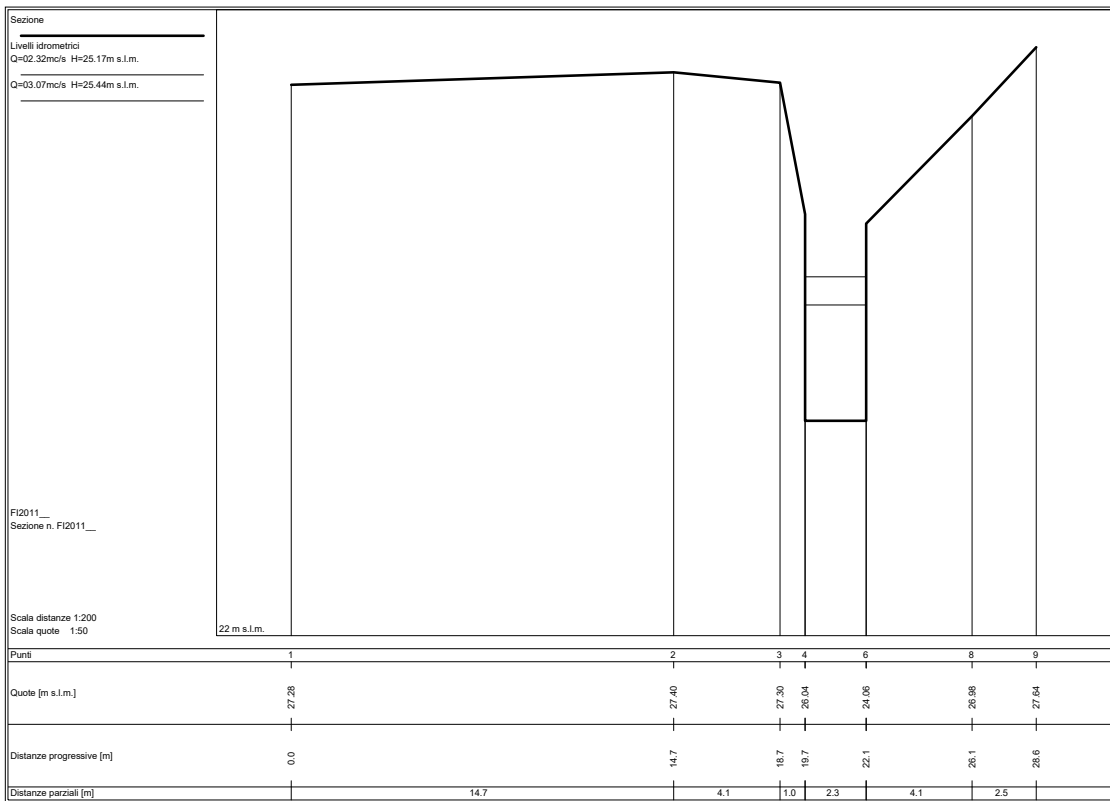
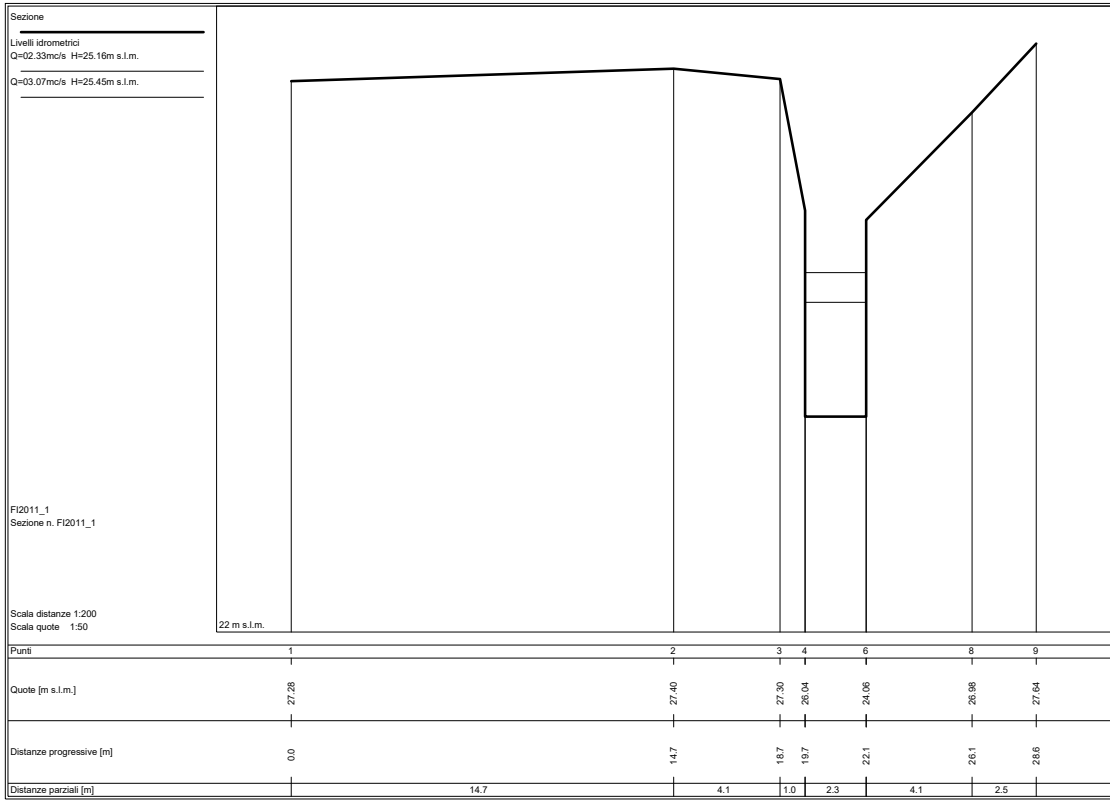

SEZIONI FLUVIALI
FOSSO MONTECUCCOLI – tratto Montecuccoli

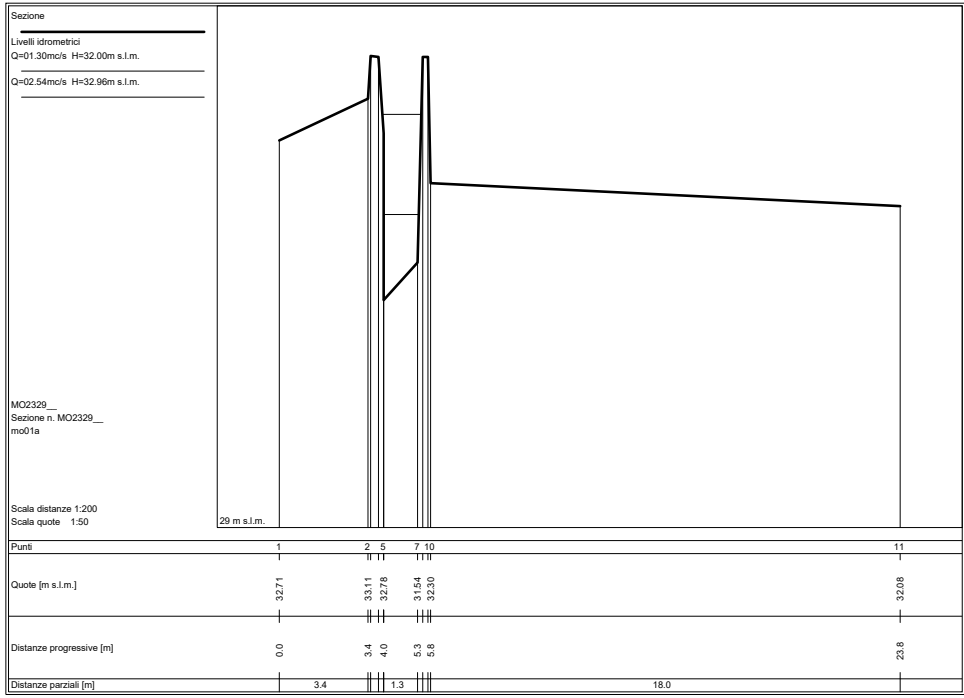
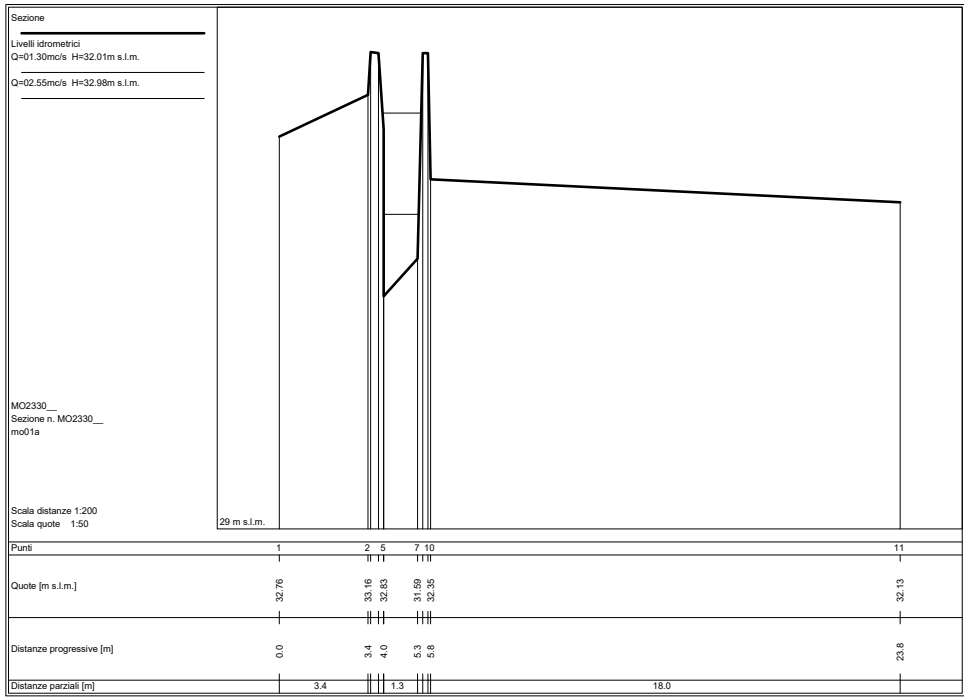

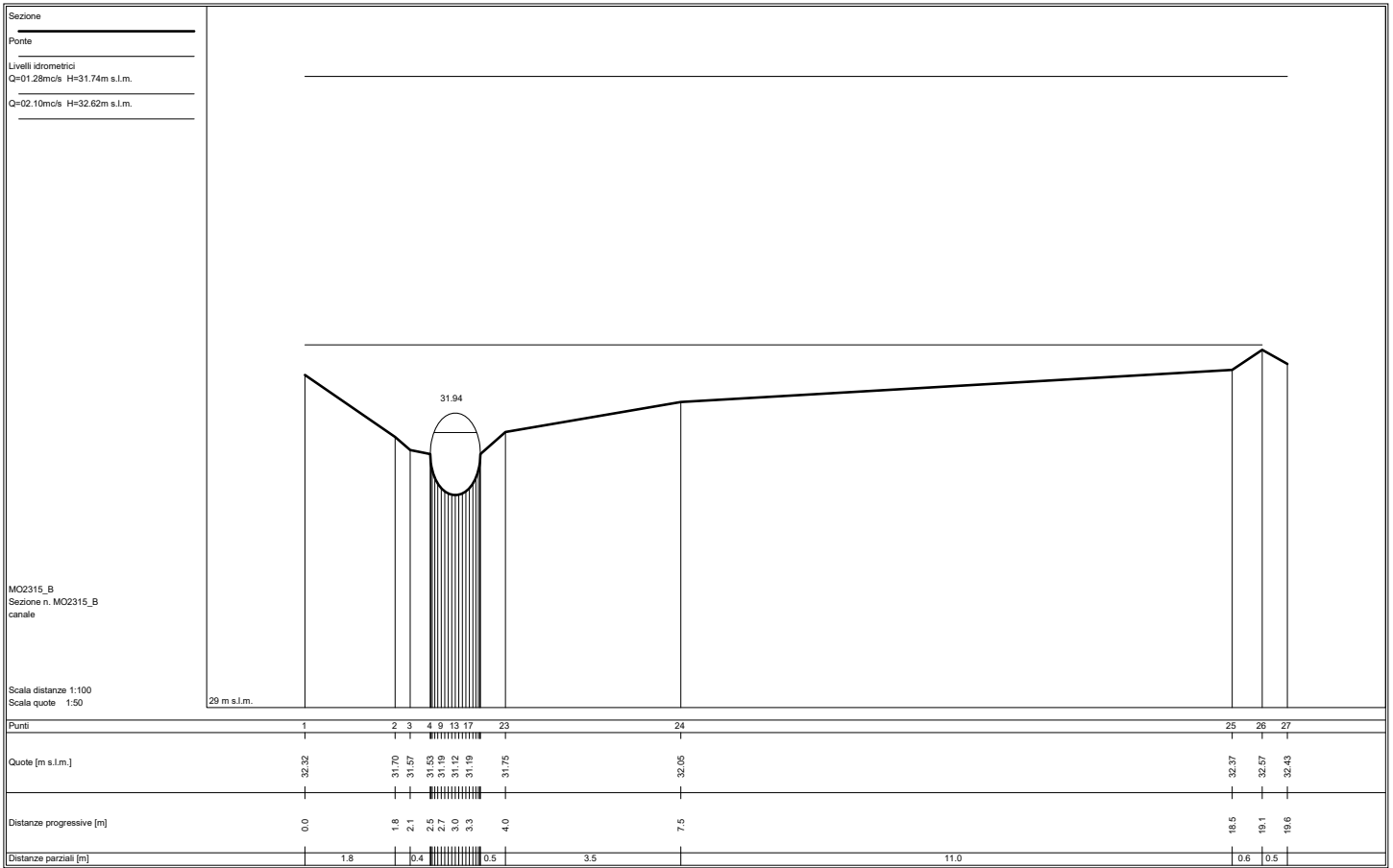
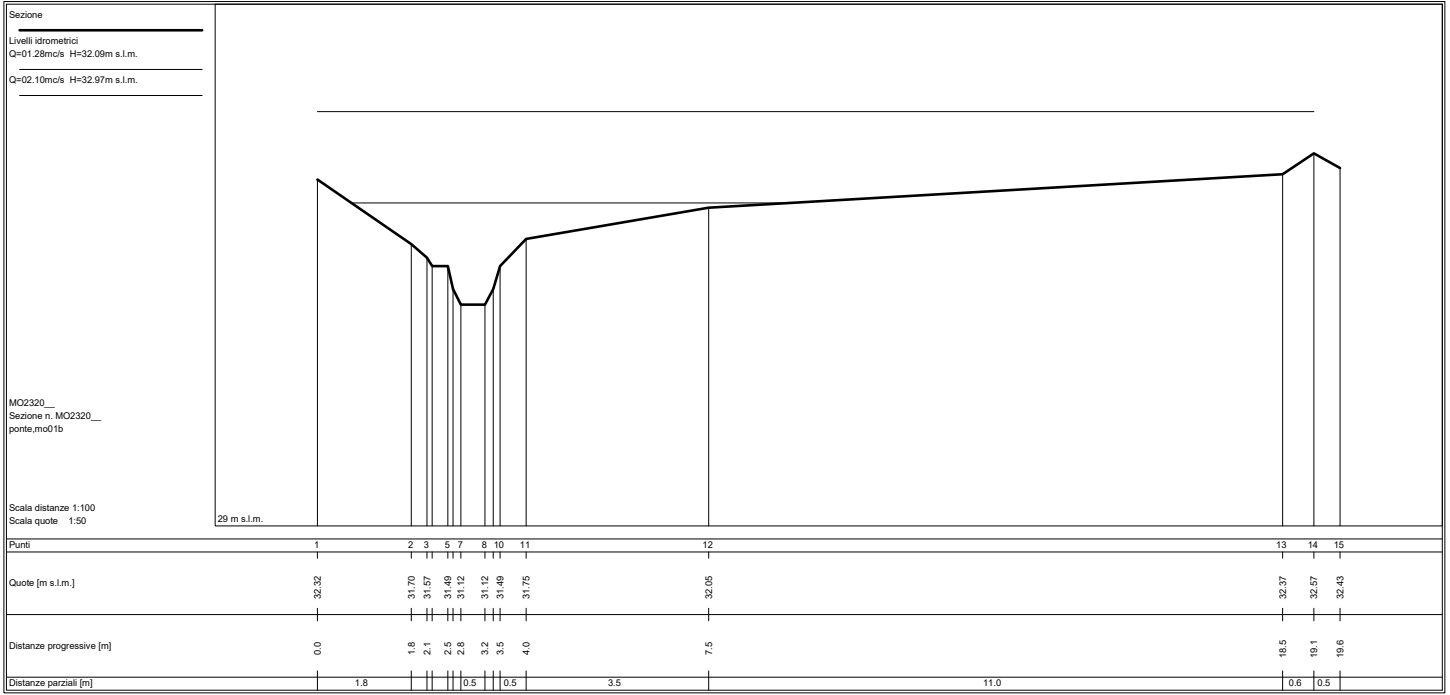

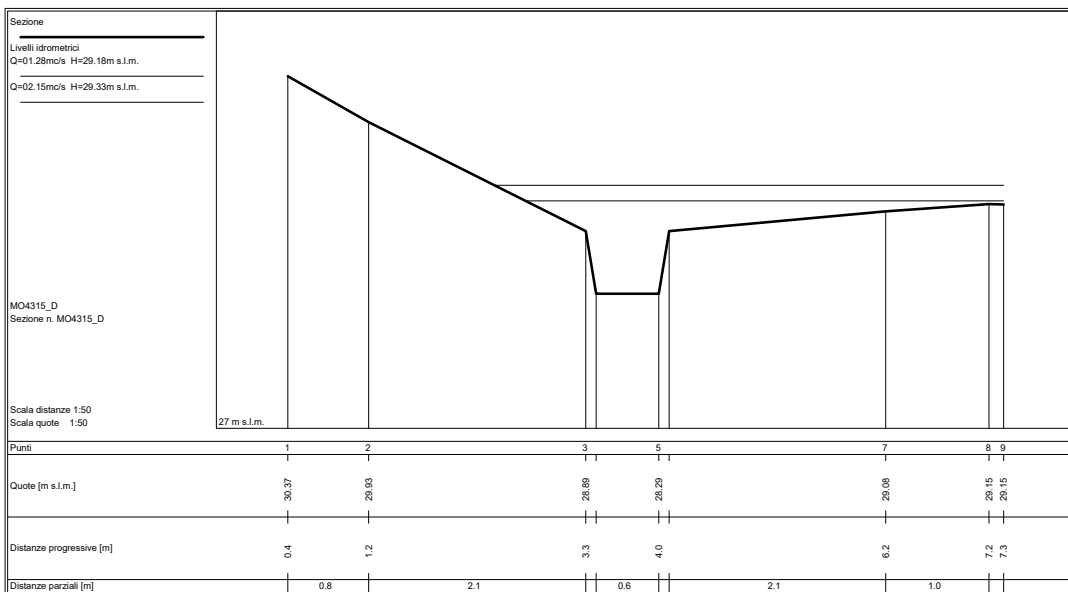
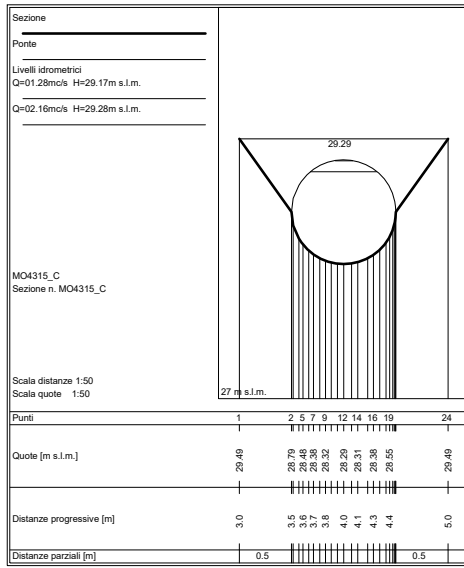

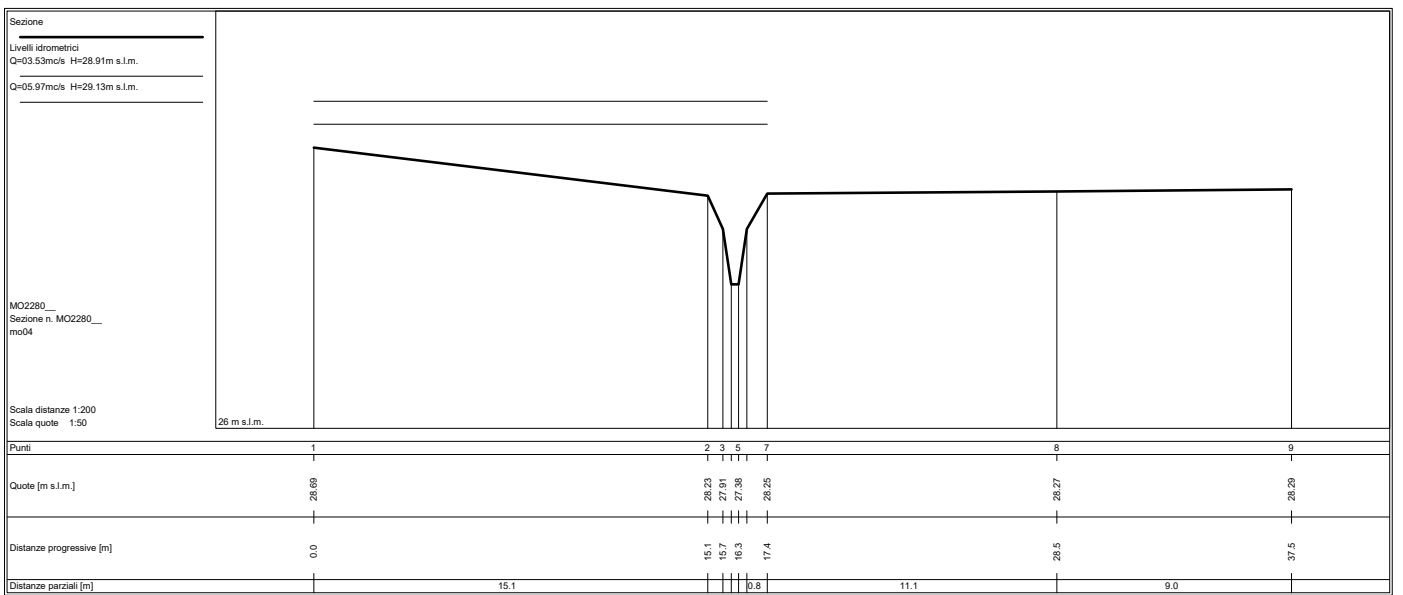
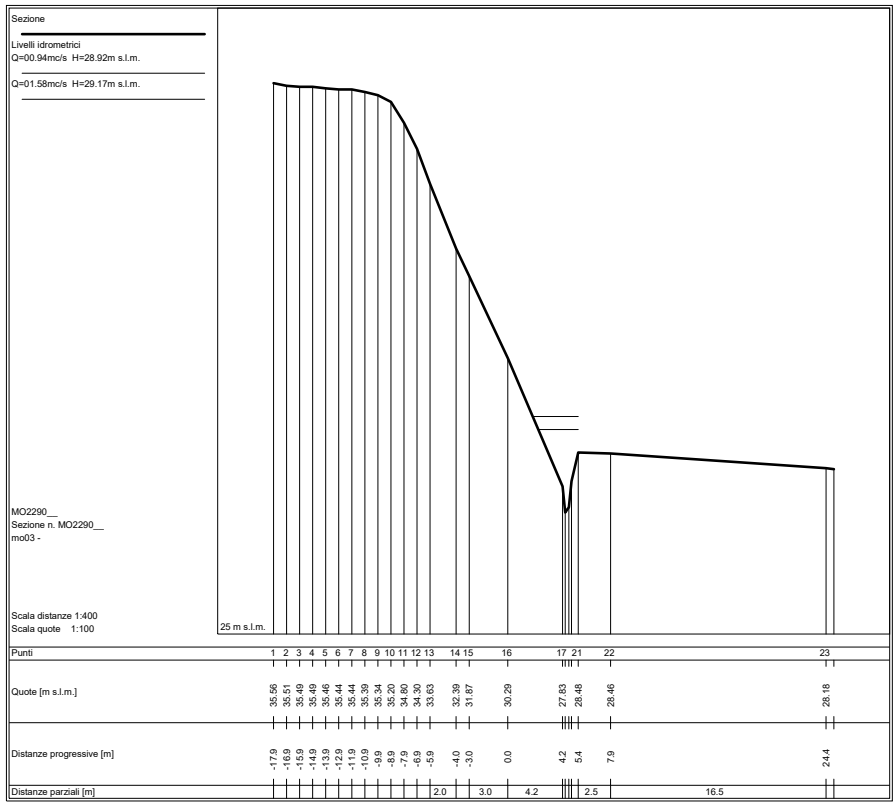

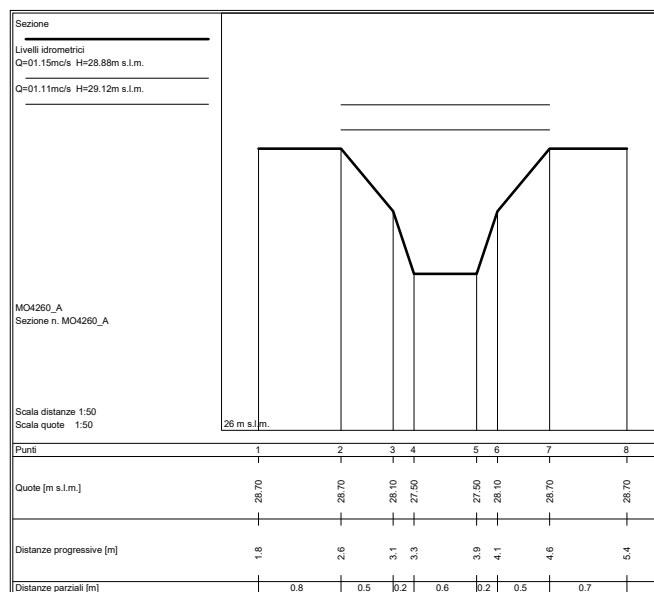
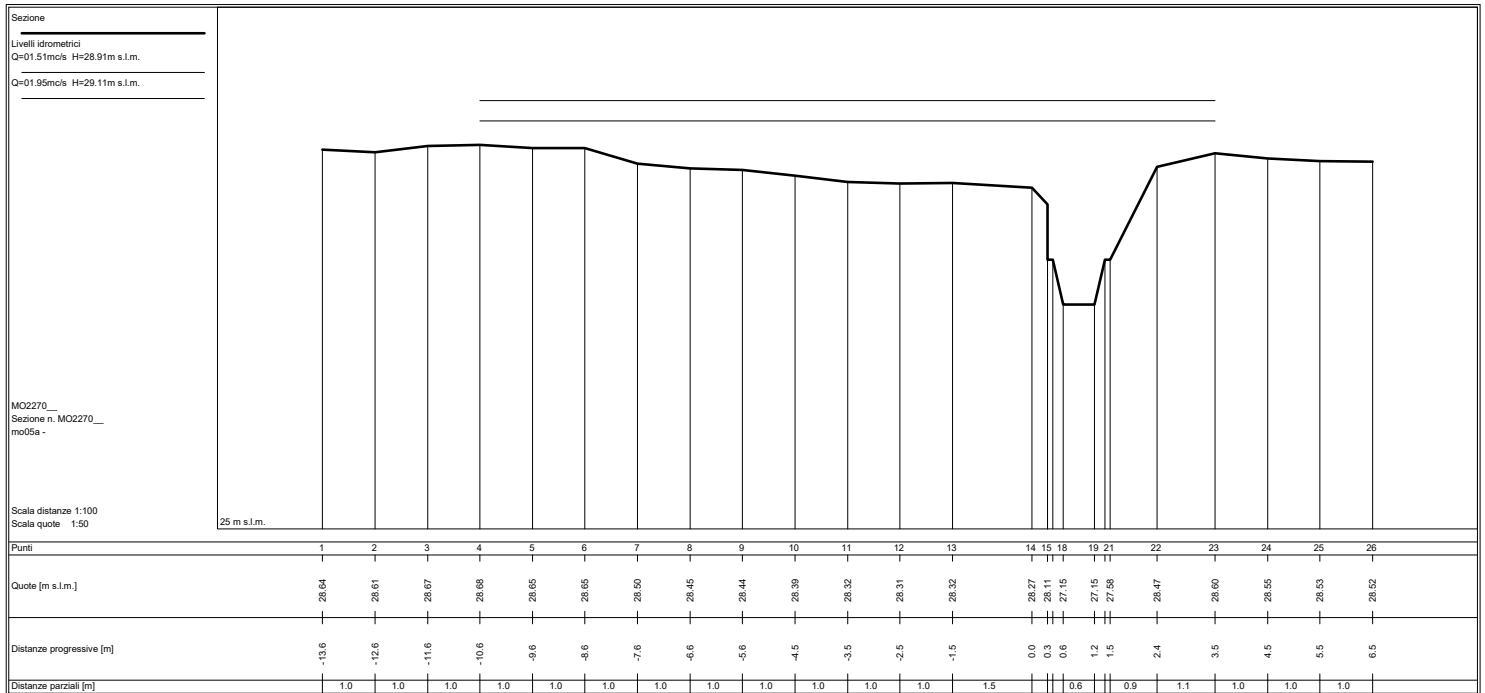

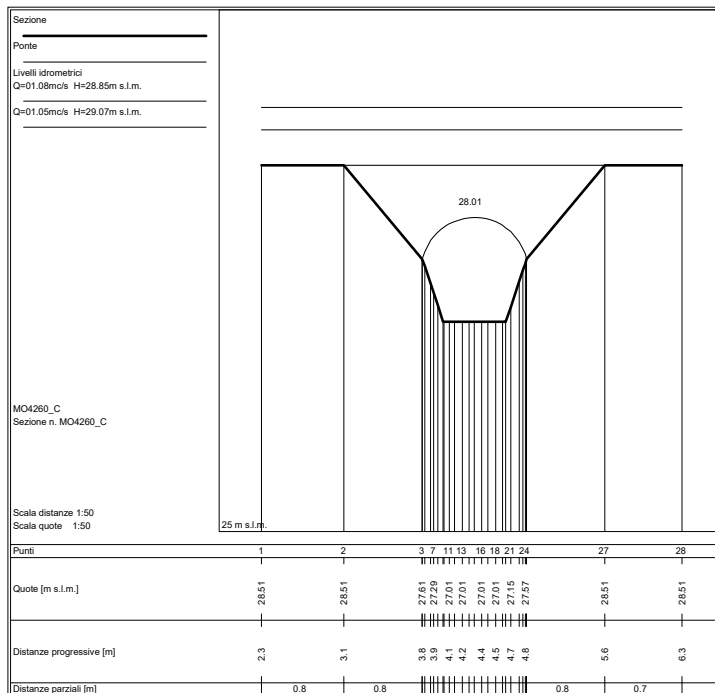
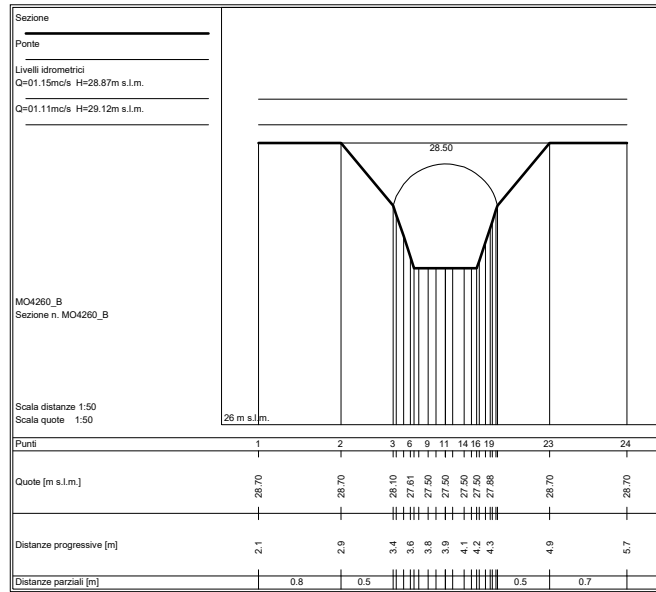

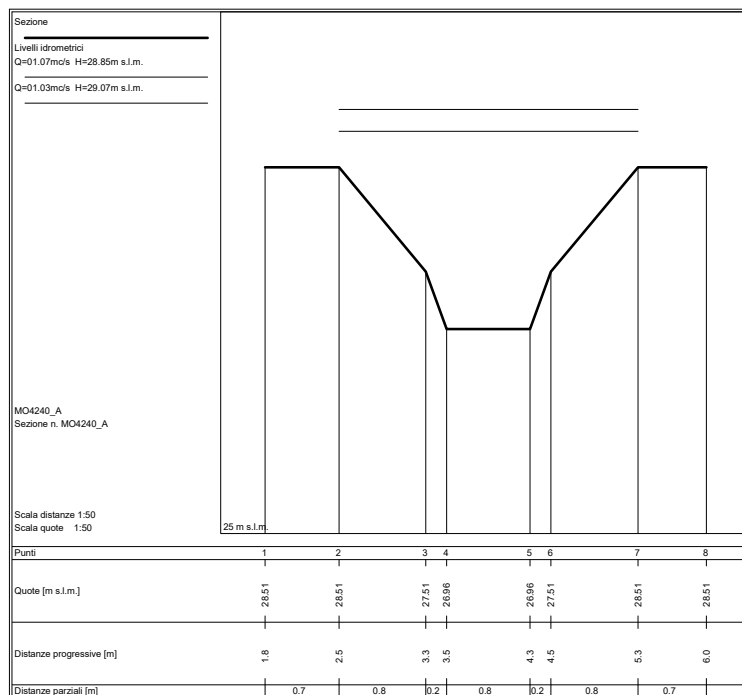
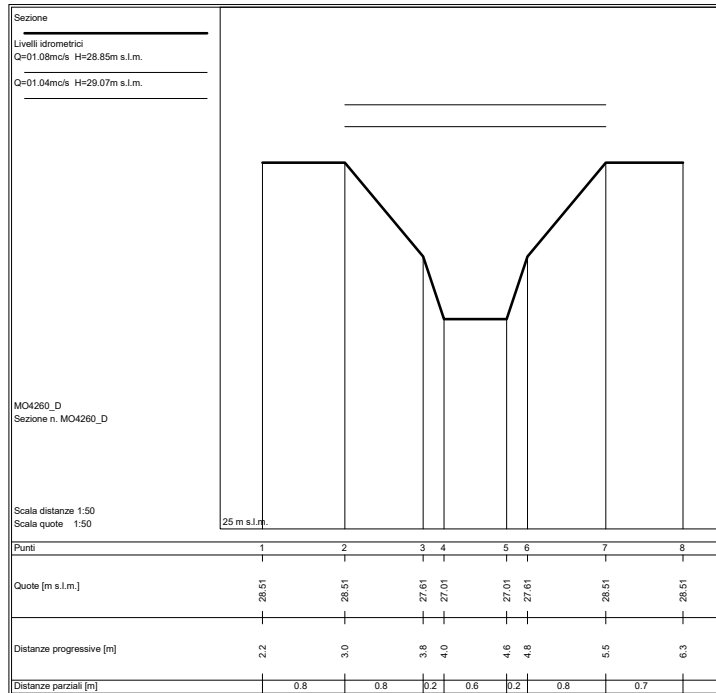

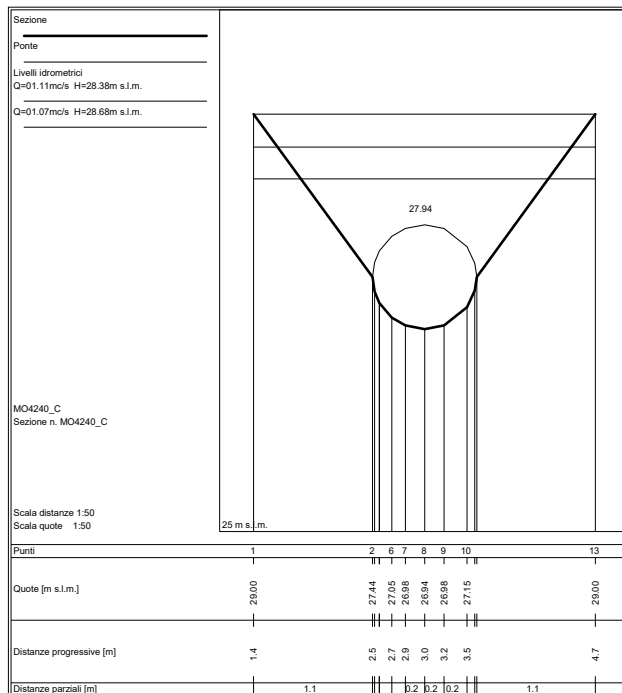
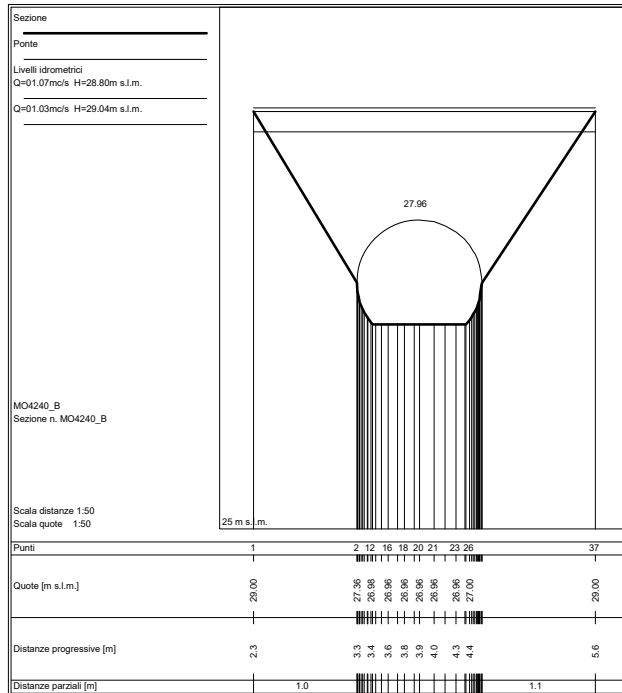

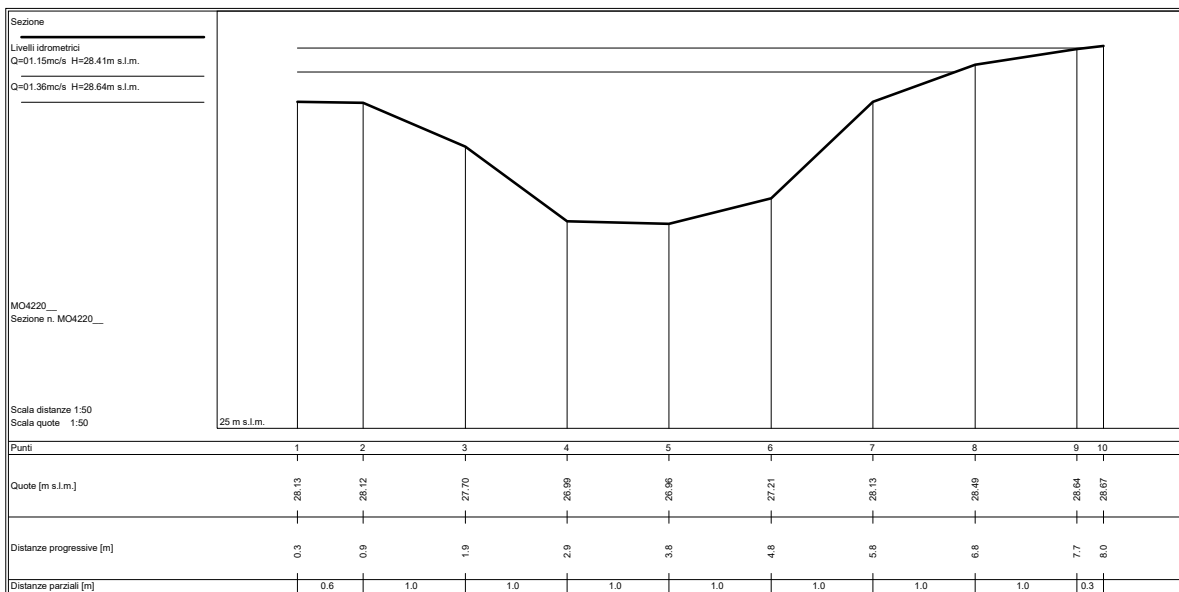
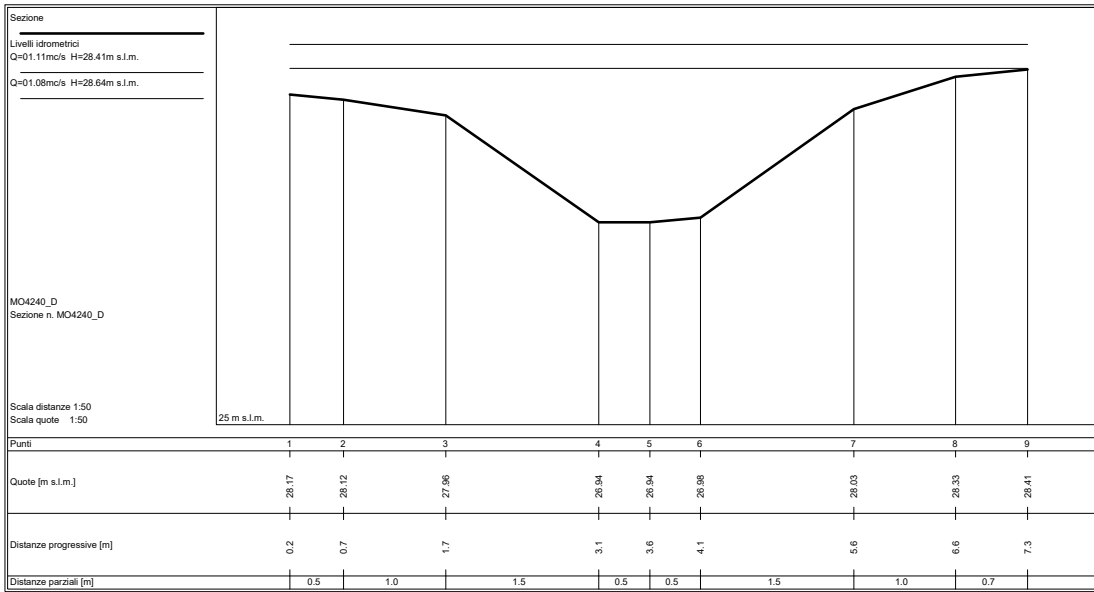

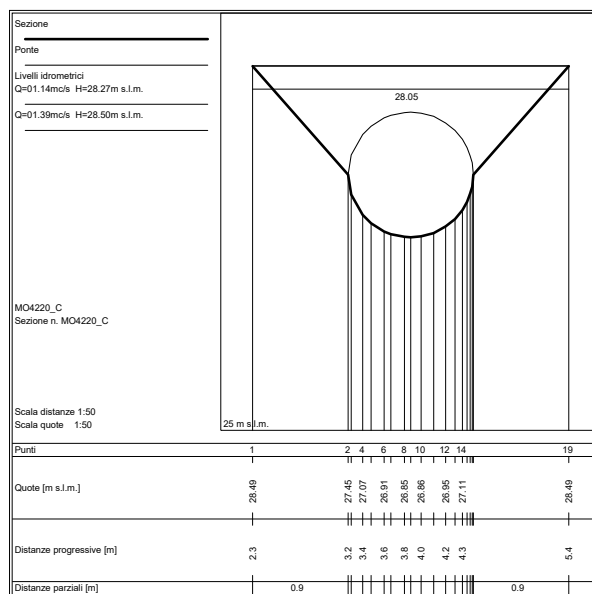
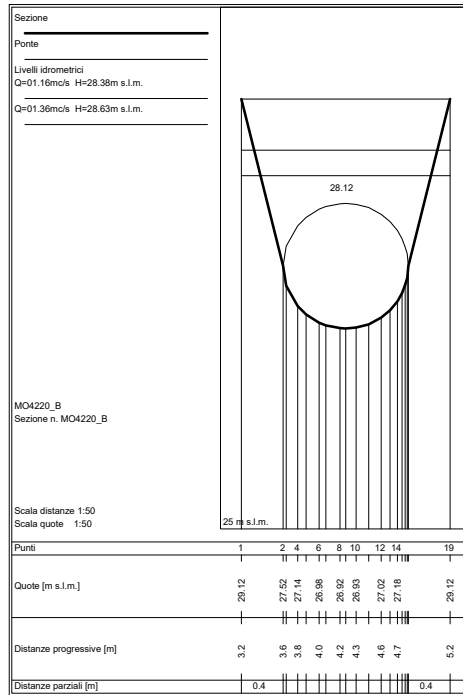

SEZIONI FLUVIALI
RIO GRANDE – tratto Monte

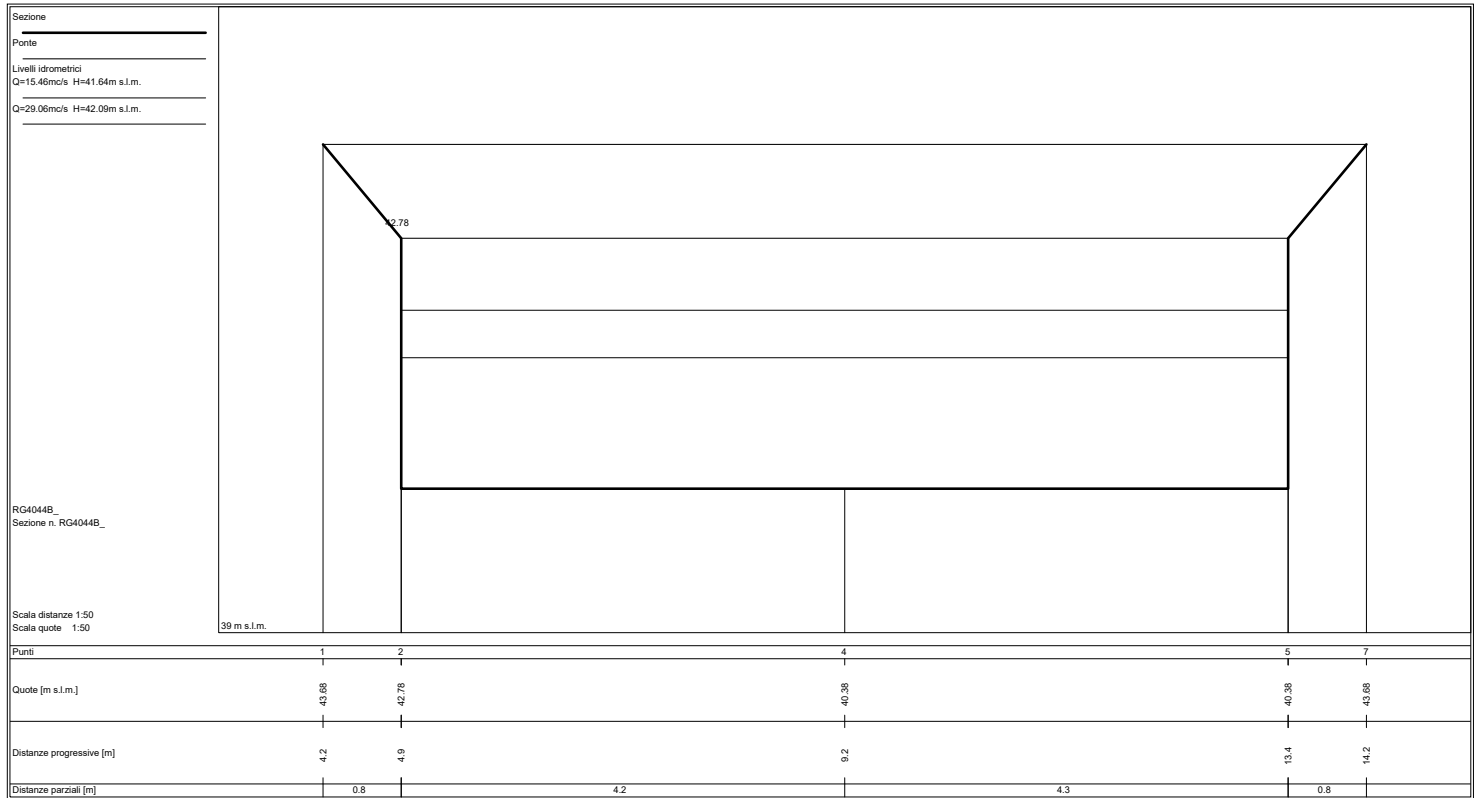
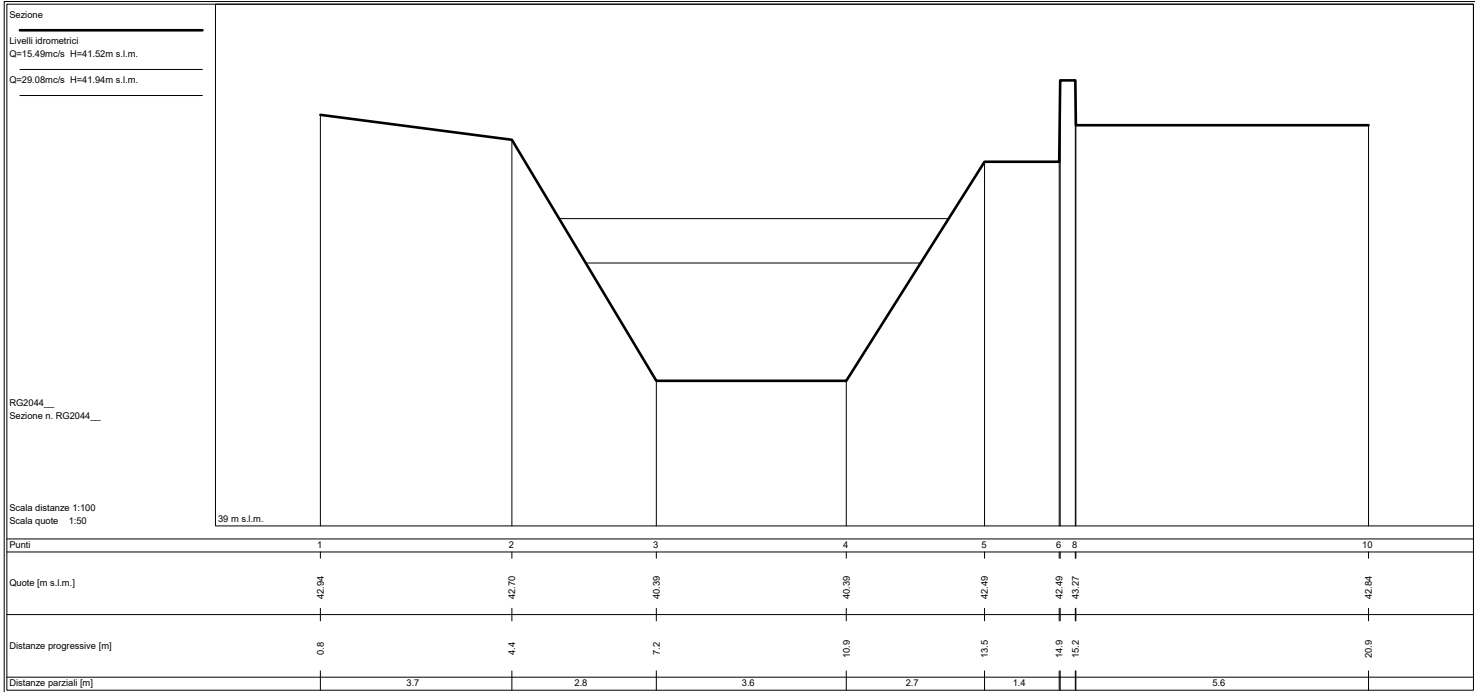

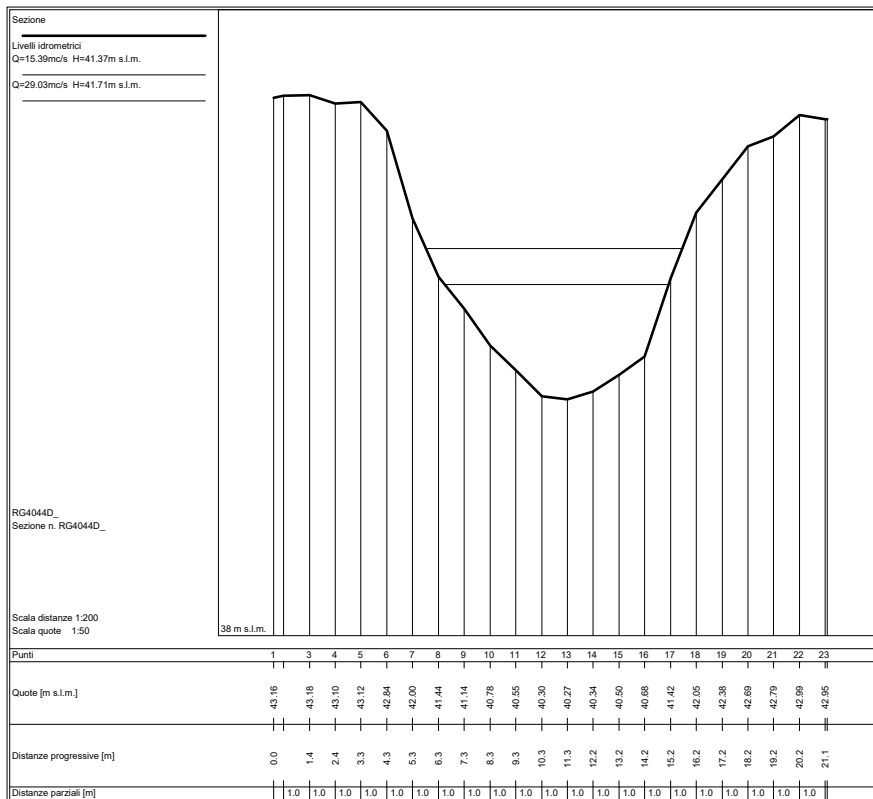
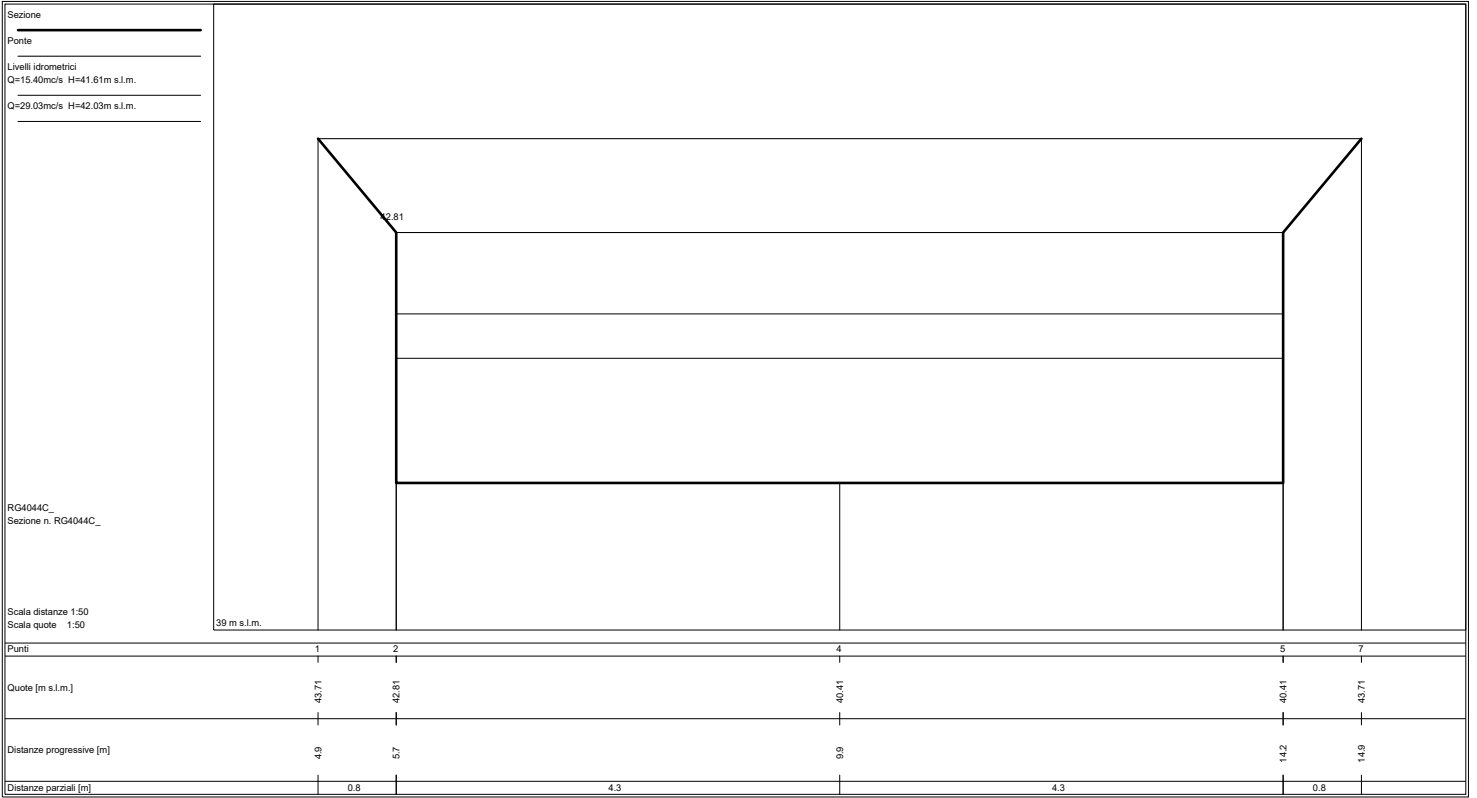

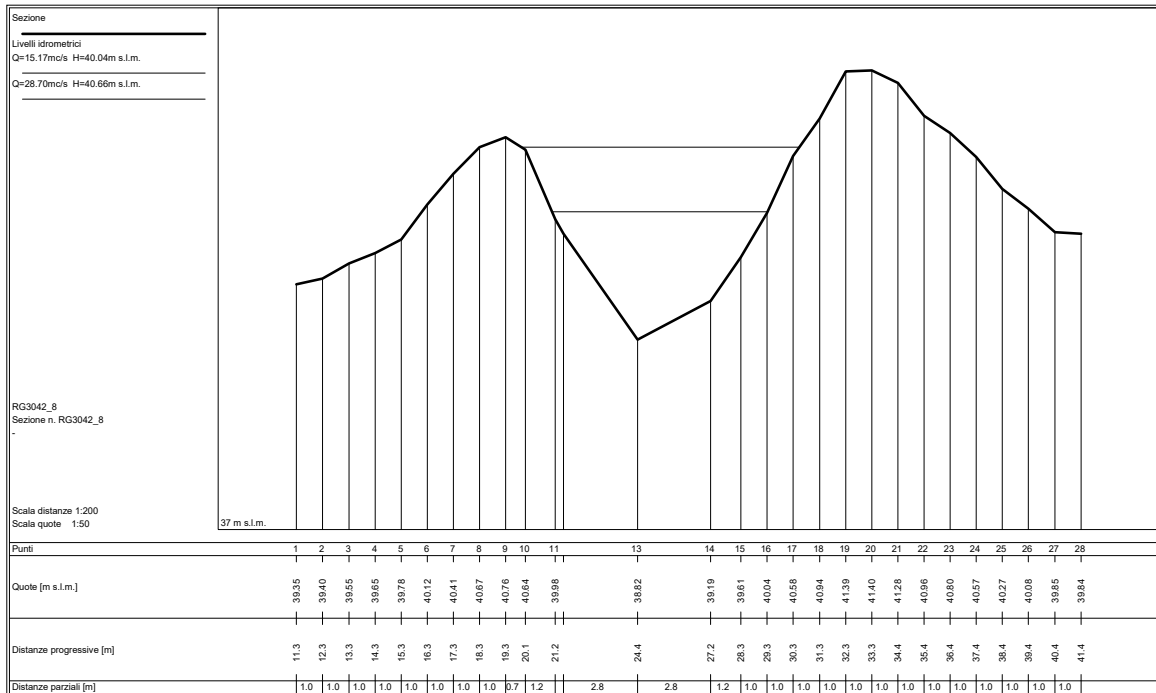
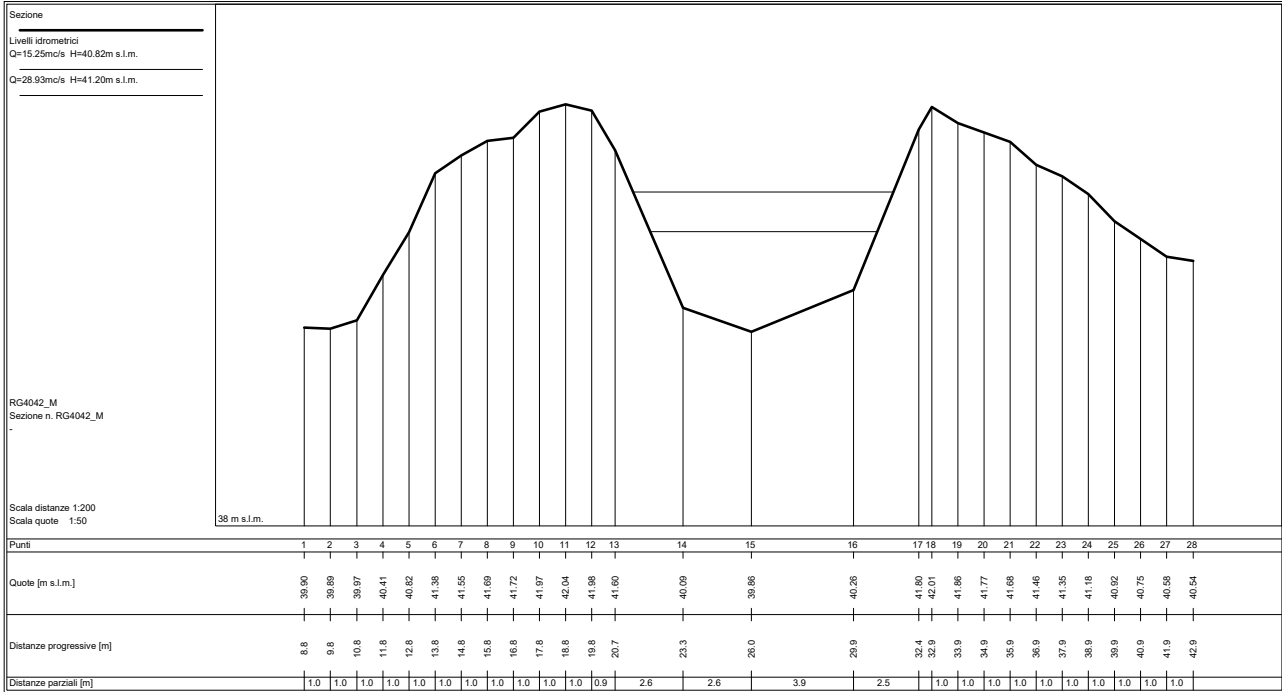

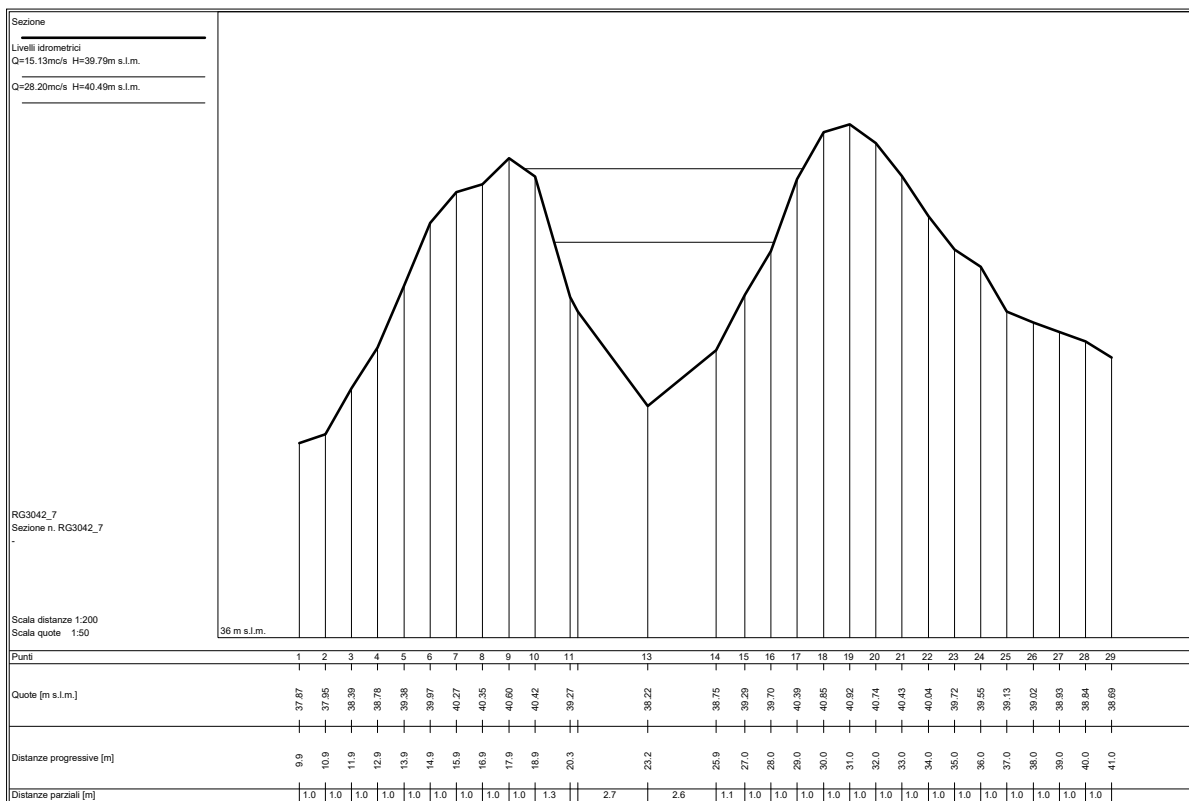
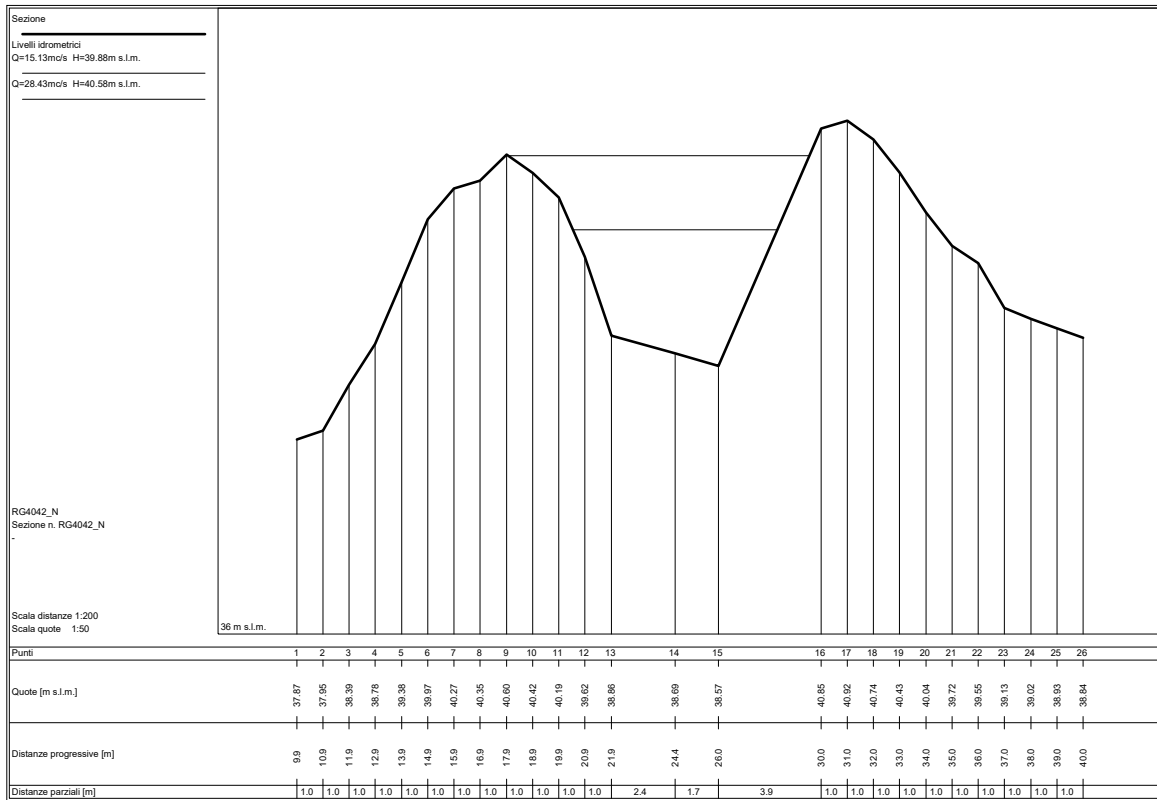

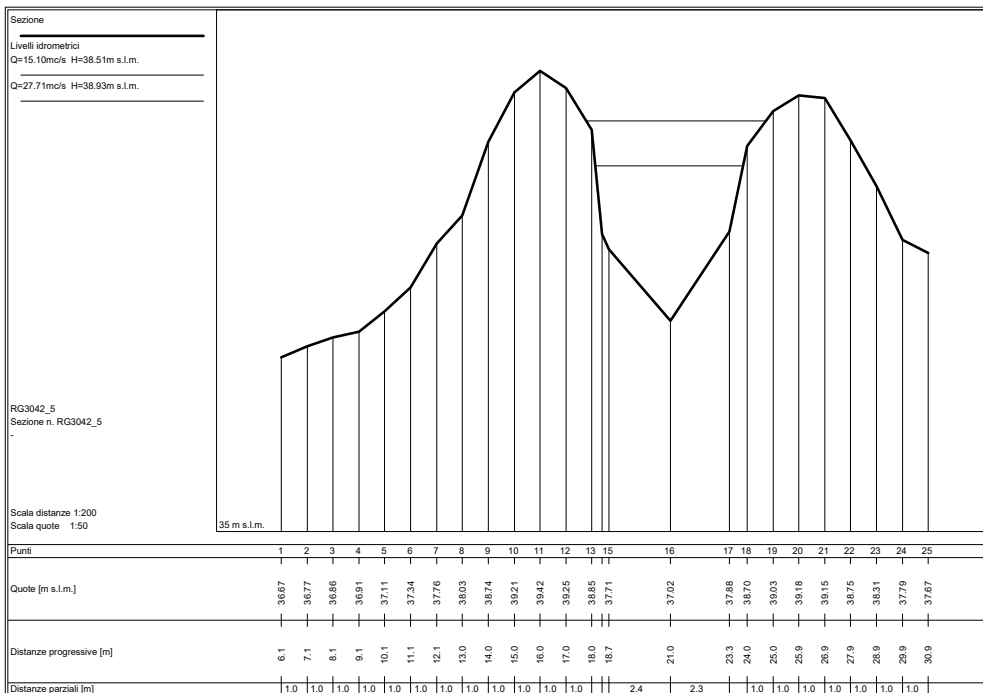
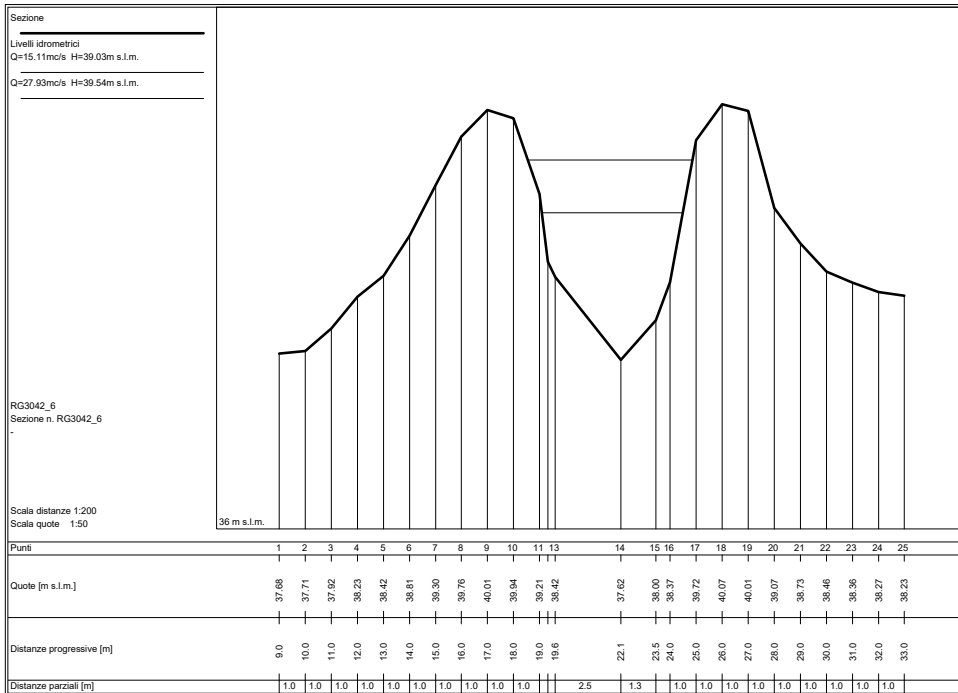

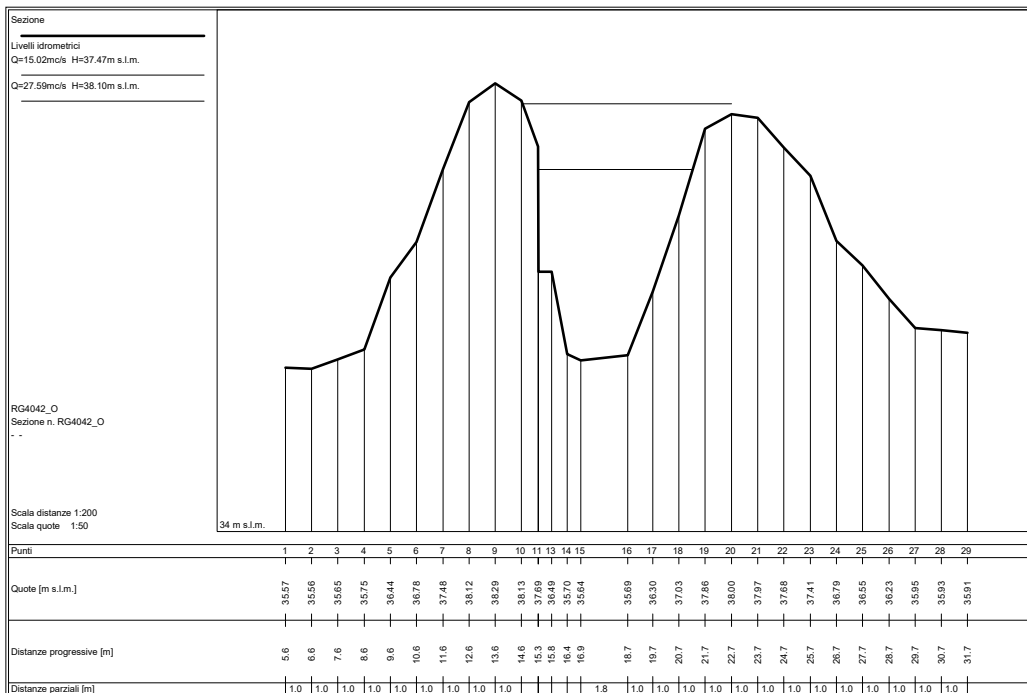
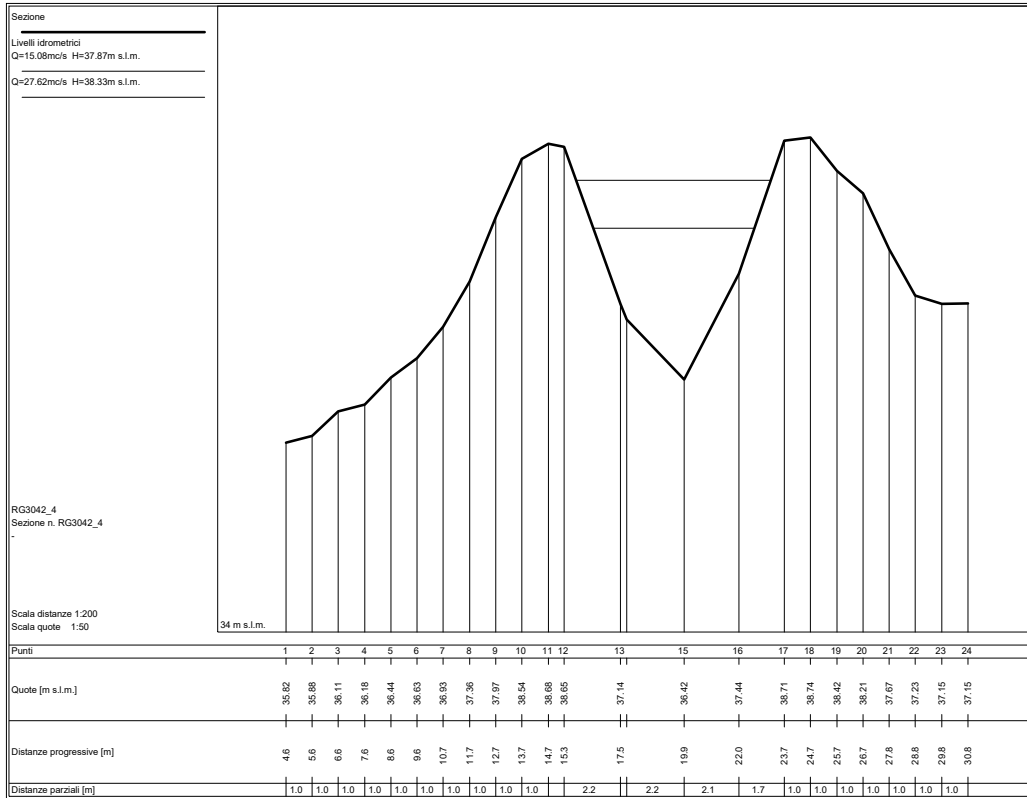

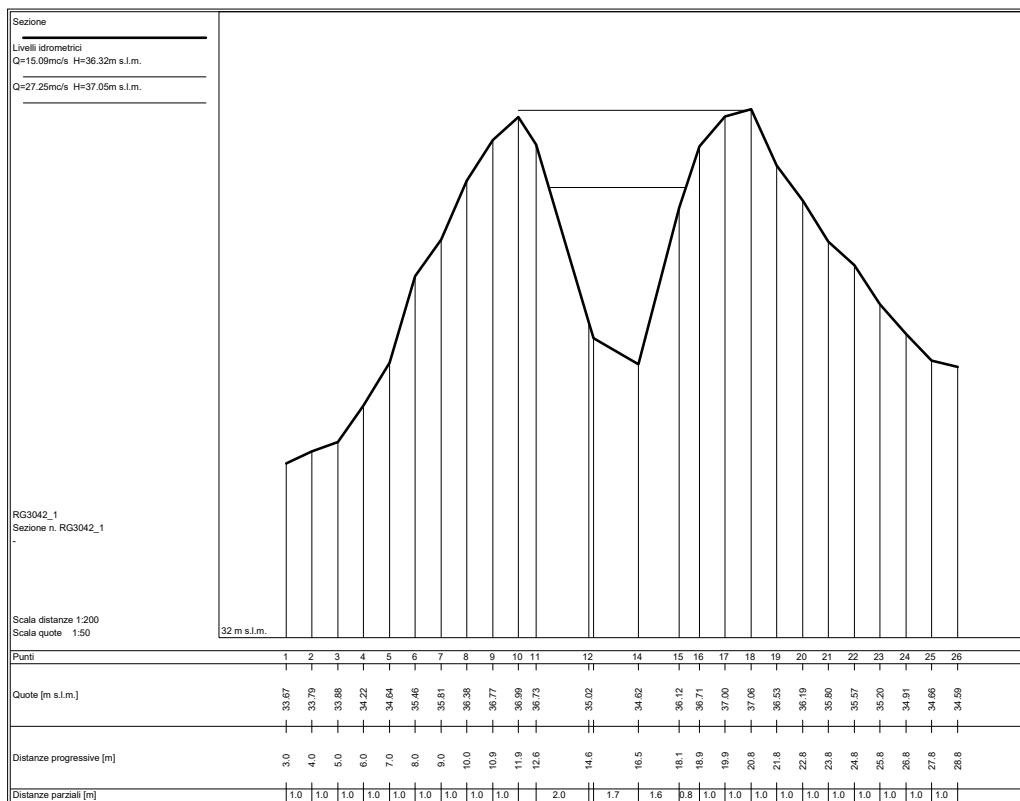
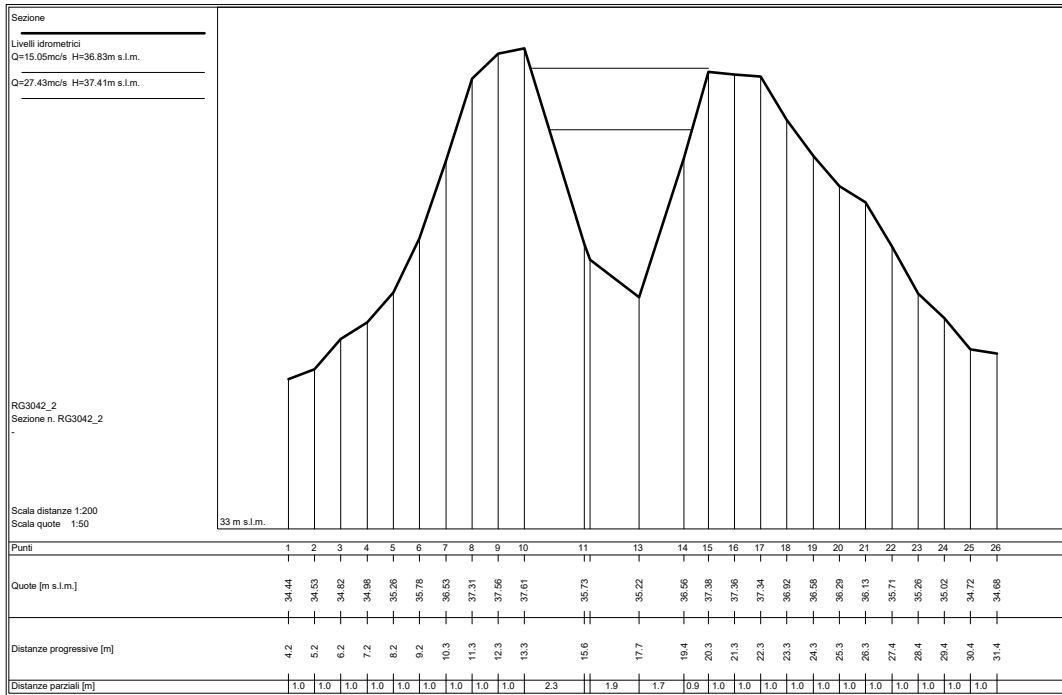

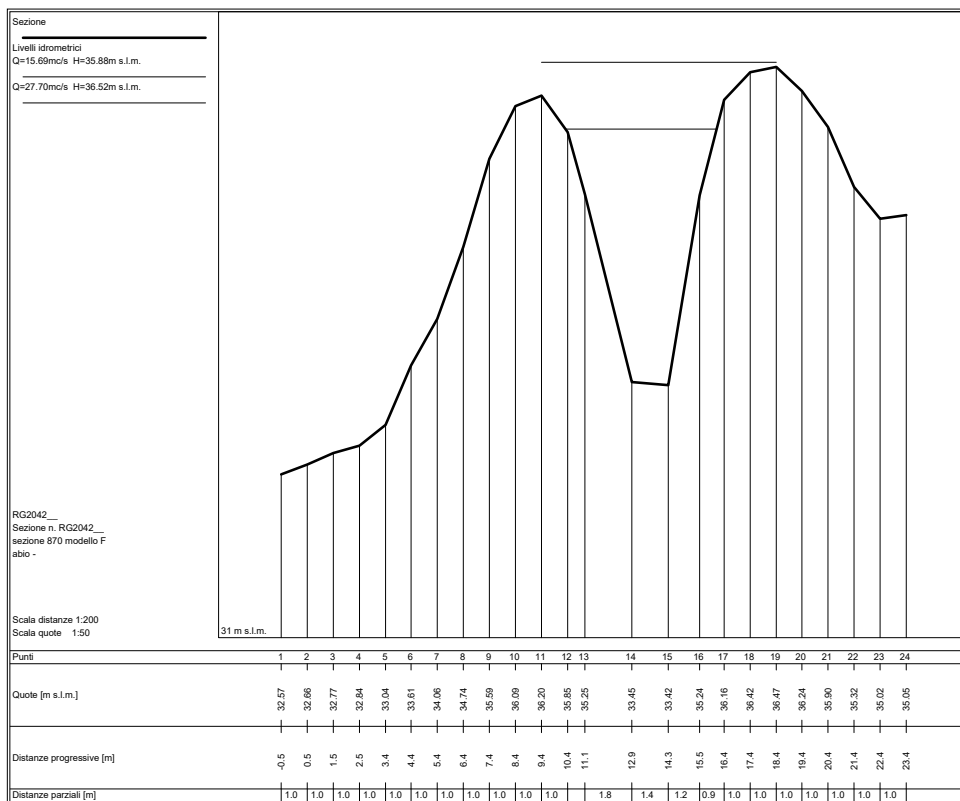
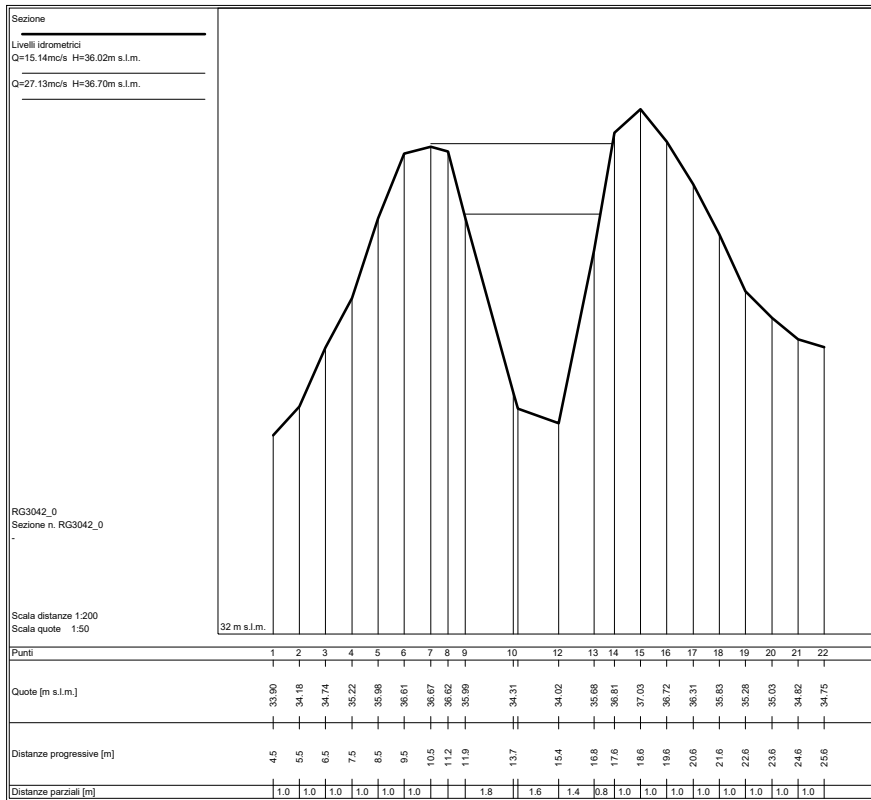

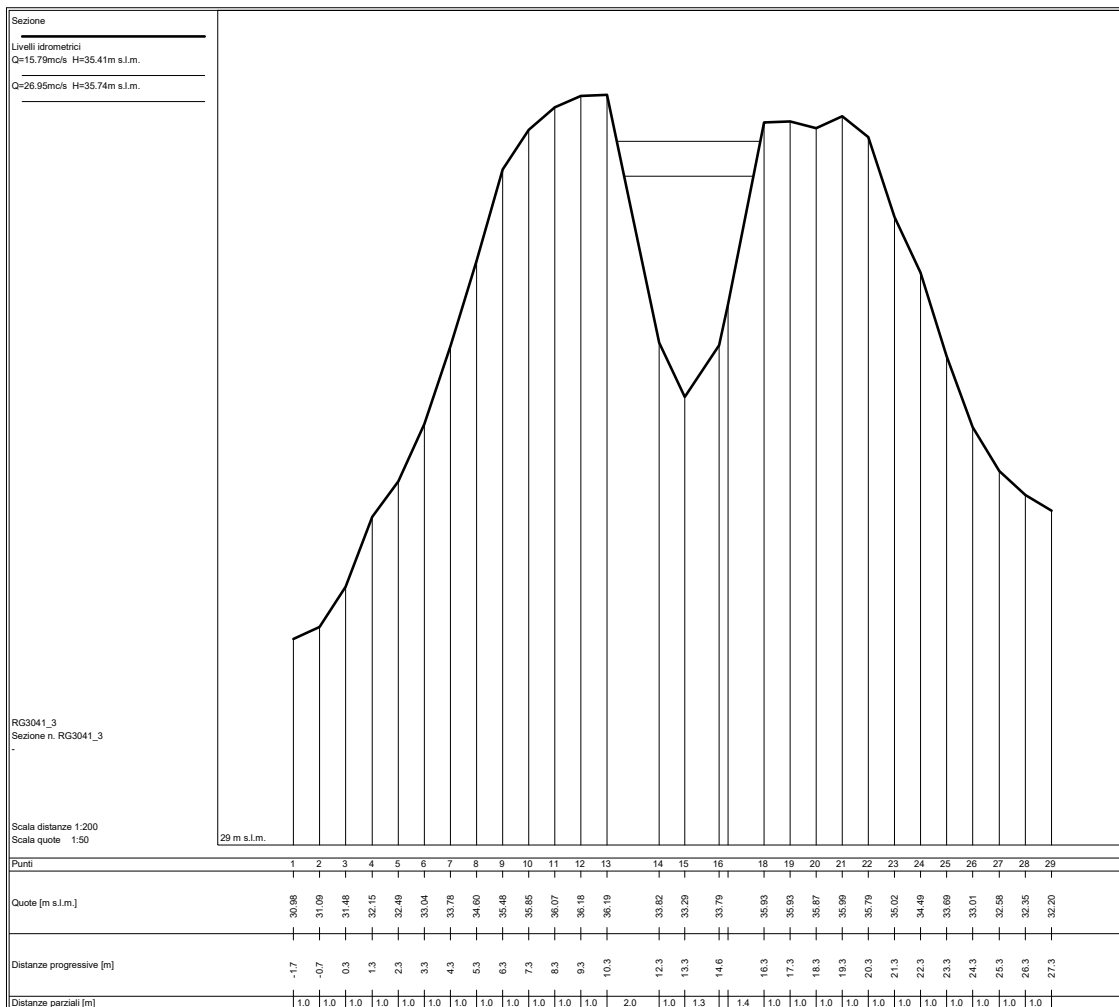
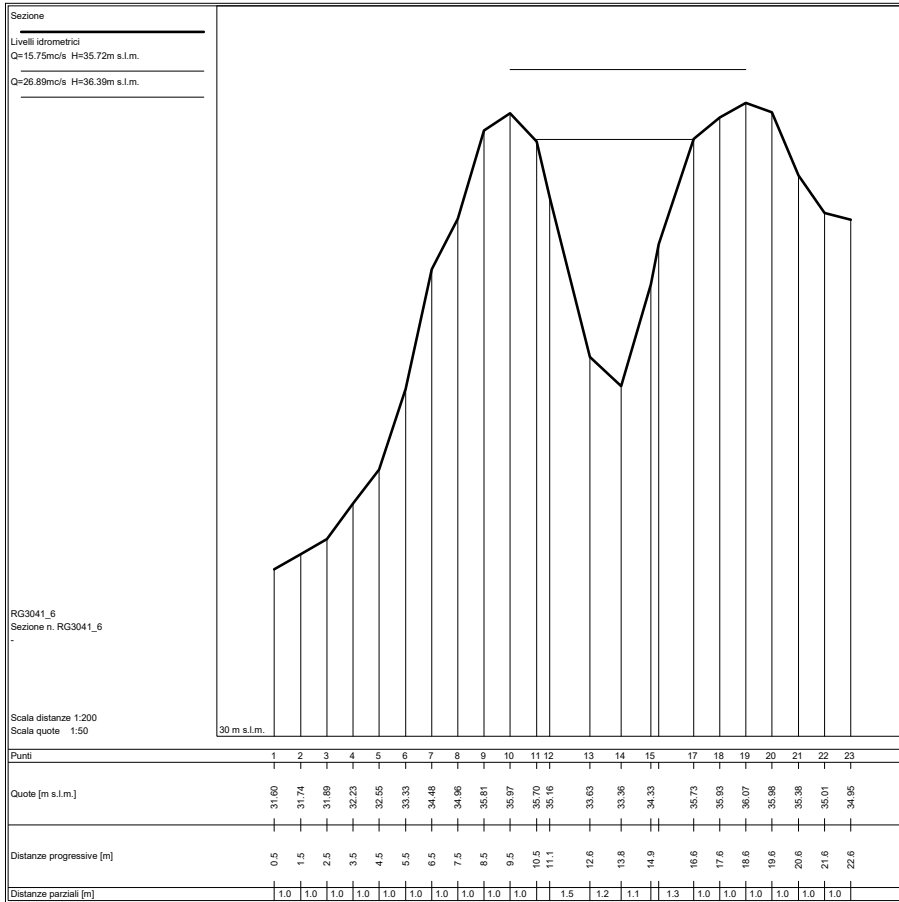

Sezione
 Livelli idrometrici
 Q=15.84mc/s H=35.32m s.l.m.
 Q=27.06mc/s H=35.64m s.l.m.

RG2041
 Sezione n. RG2041
 sezione 860 modello F
 abio -

Scala distanze 1:200
 Scala quote 1:50

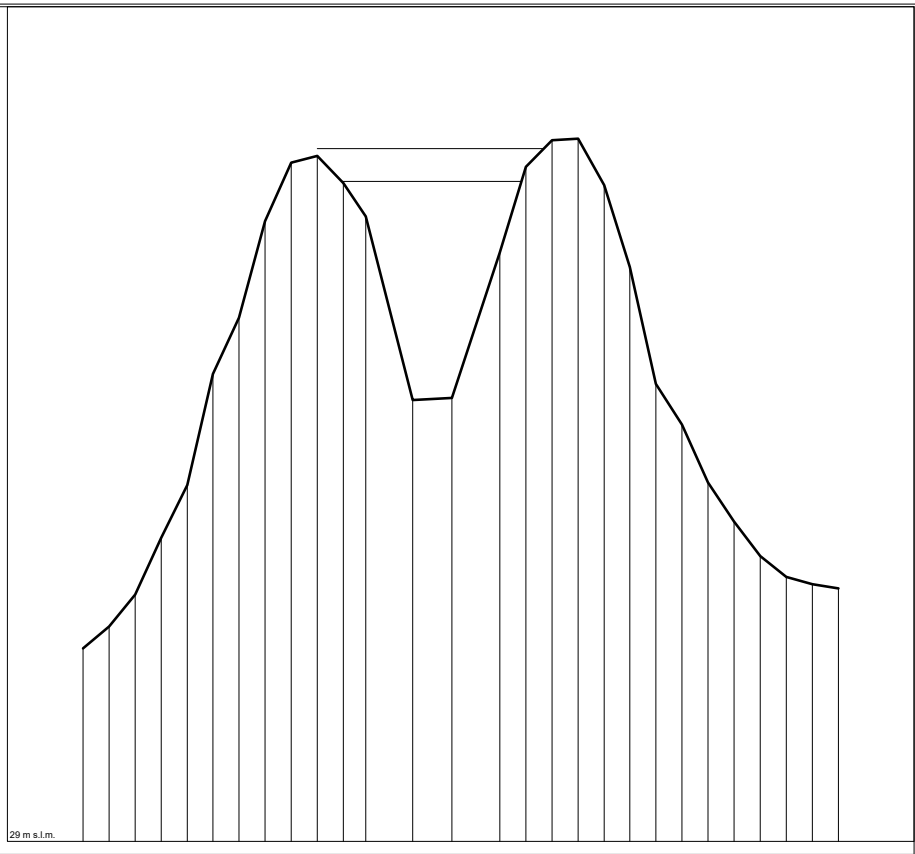

Punti	1	2	3	4	5	6	7	8	9	10	11	12	13	14	15	16	17	18	19	20	21	22	23	24	25	26	27	28
Quote [m s.l.m.]	30.85	31.06	31.36	31.91	32.42	33.48	34.02	34.94	35.51	35.57	35.31	34.99	33.23	33.25	34.64	35.46	35.72	35.73	35.29	34.50	33.39	32.99	32.44	32.06	31.73	31.54	31.46	31.43
Distanze progressive [m]	0.2	1.2	2.2	3.2	4.2	6.2	8.2	7.2	6.2	9.2	10.1	11.0	12.8	14.3	16.1	17.1	18.1	19.1	20.1	21.1	22.1	23.1	24.1	25.1	26.1	27.1	28.1	29.1
Distanze parziali [m]	1.0	1.0	1.0	1.0	1.0	1.0	1.0	1.0	1.0	1.0	0.9	1.8	1.5	1.8	1.0	1.0	1.0	1.0	1.0	1.0	1.0	1.0	1.0	1.0	1.0	1.0	1.0	1.0

SEZIONI FLUVIALI
RIO GRANDE – tratto Valle

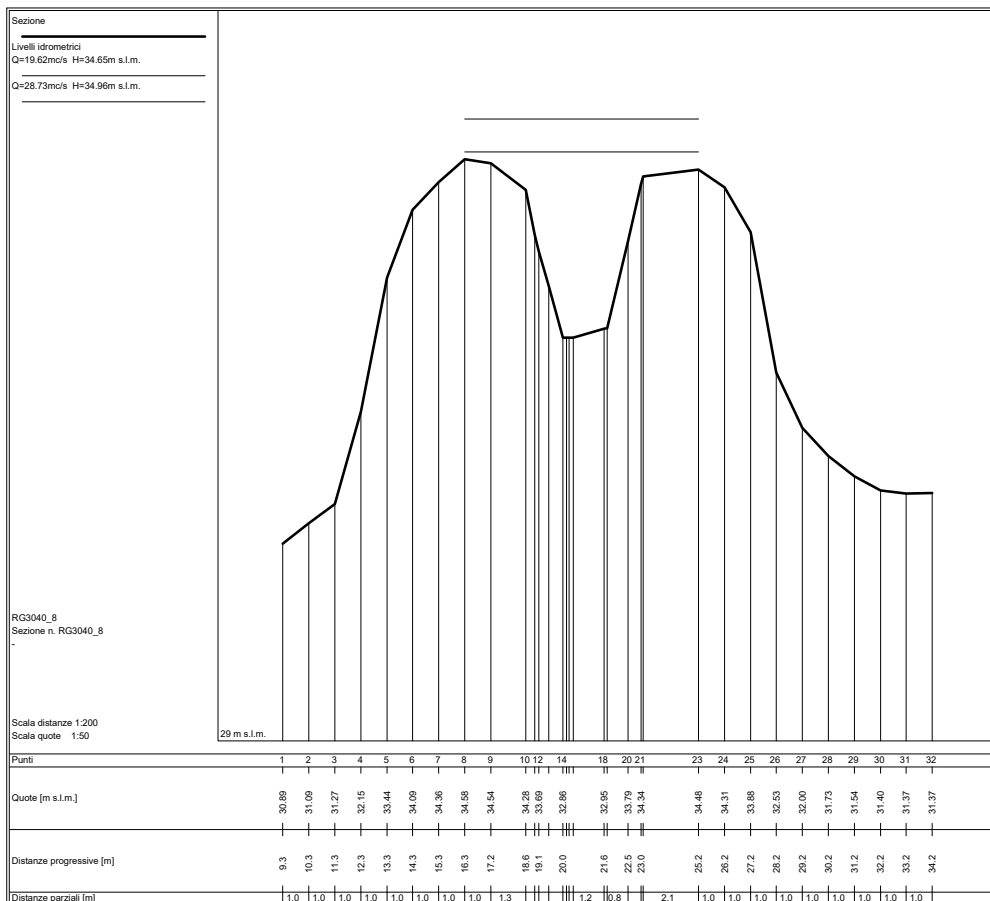
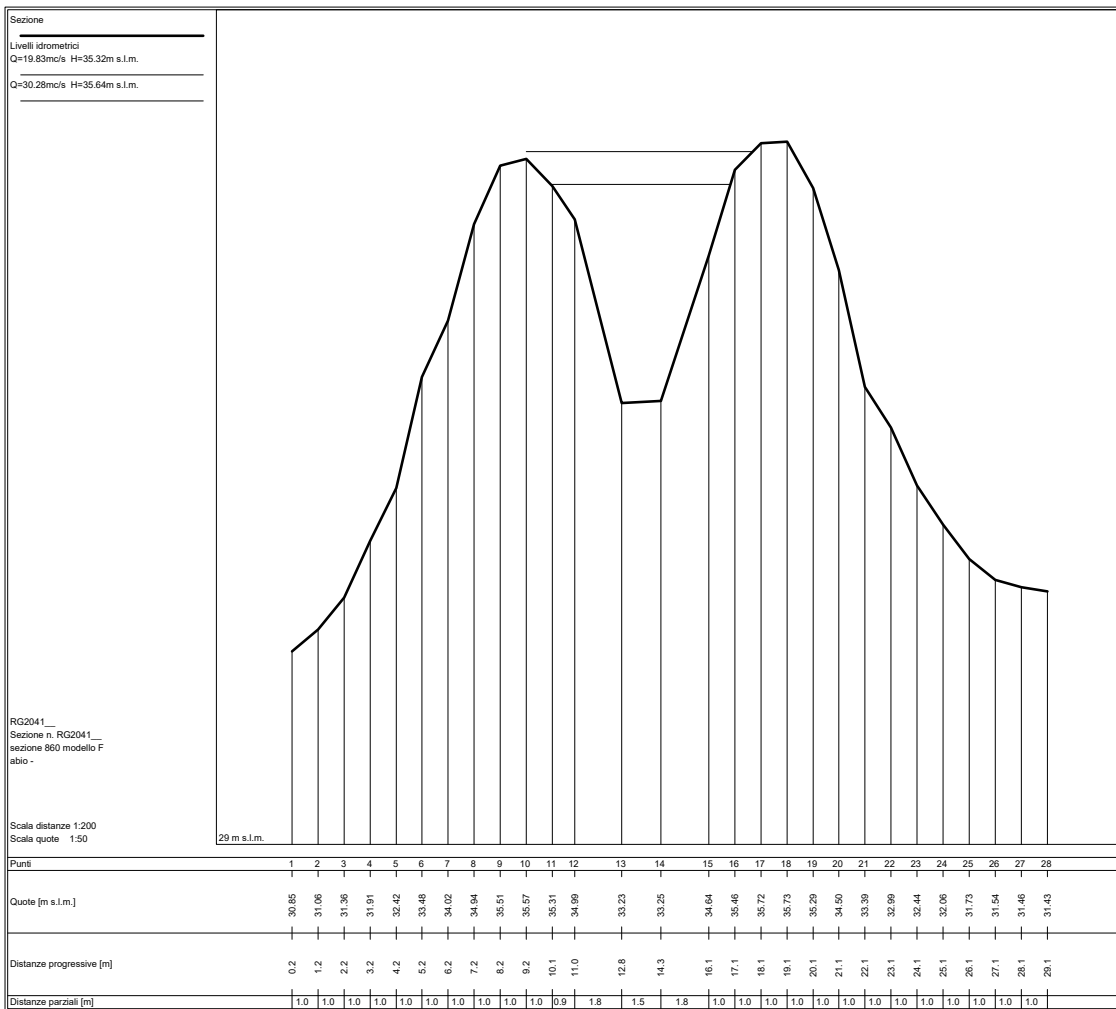

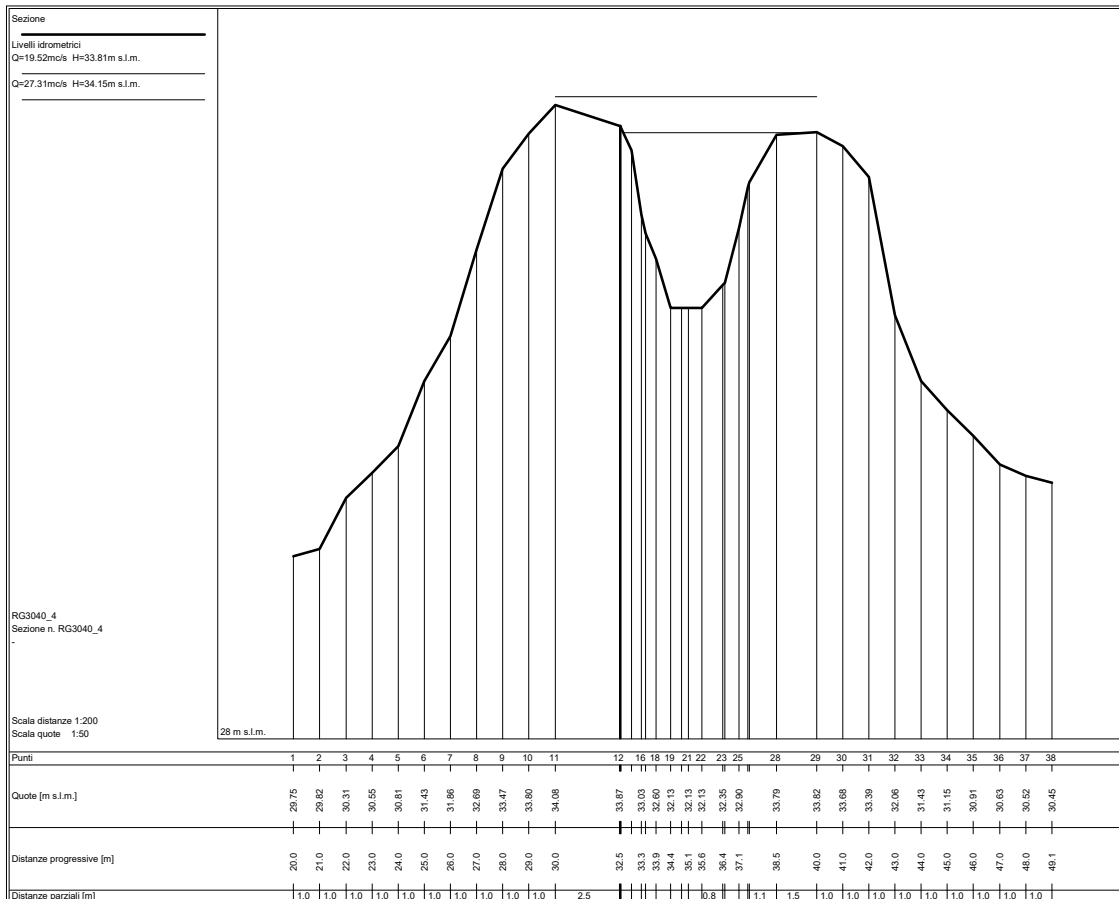
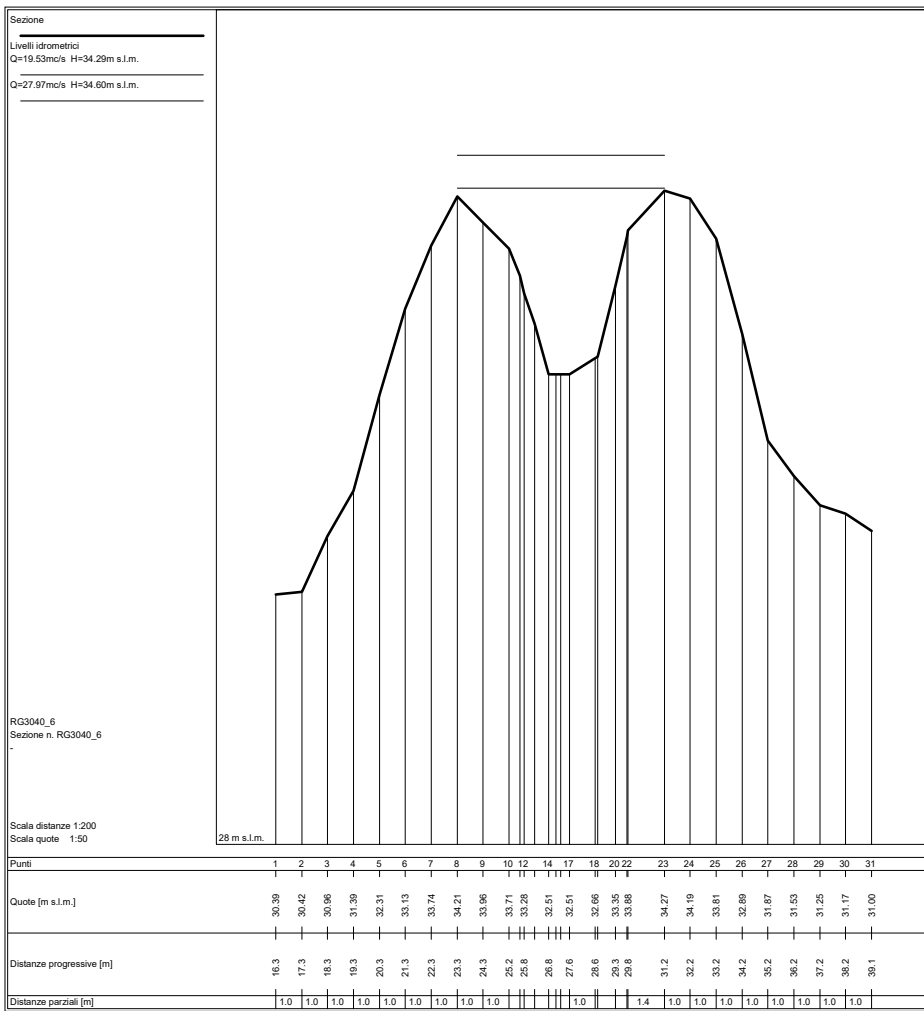

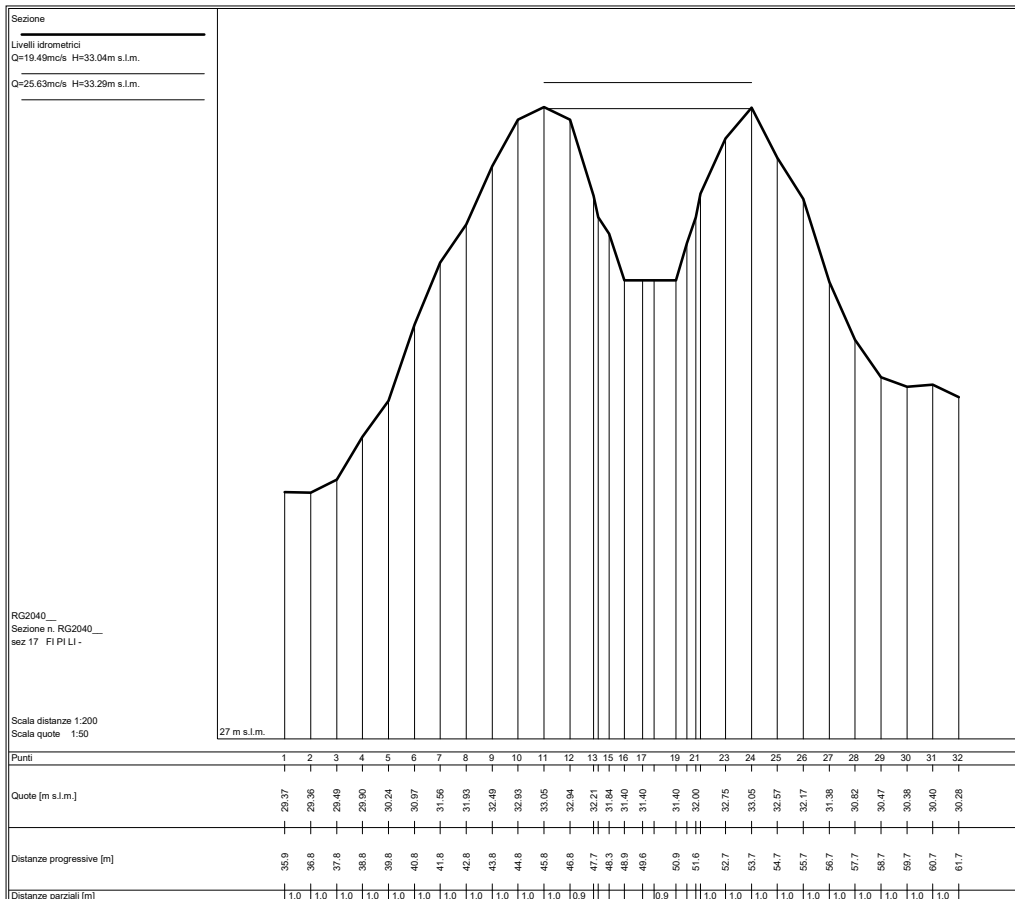
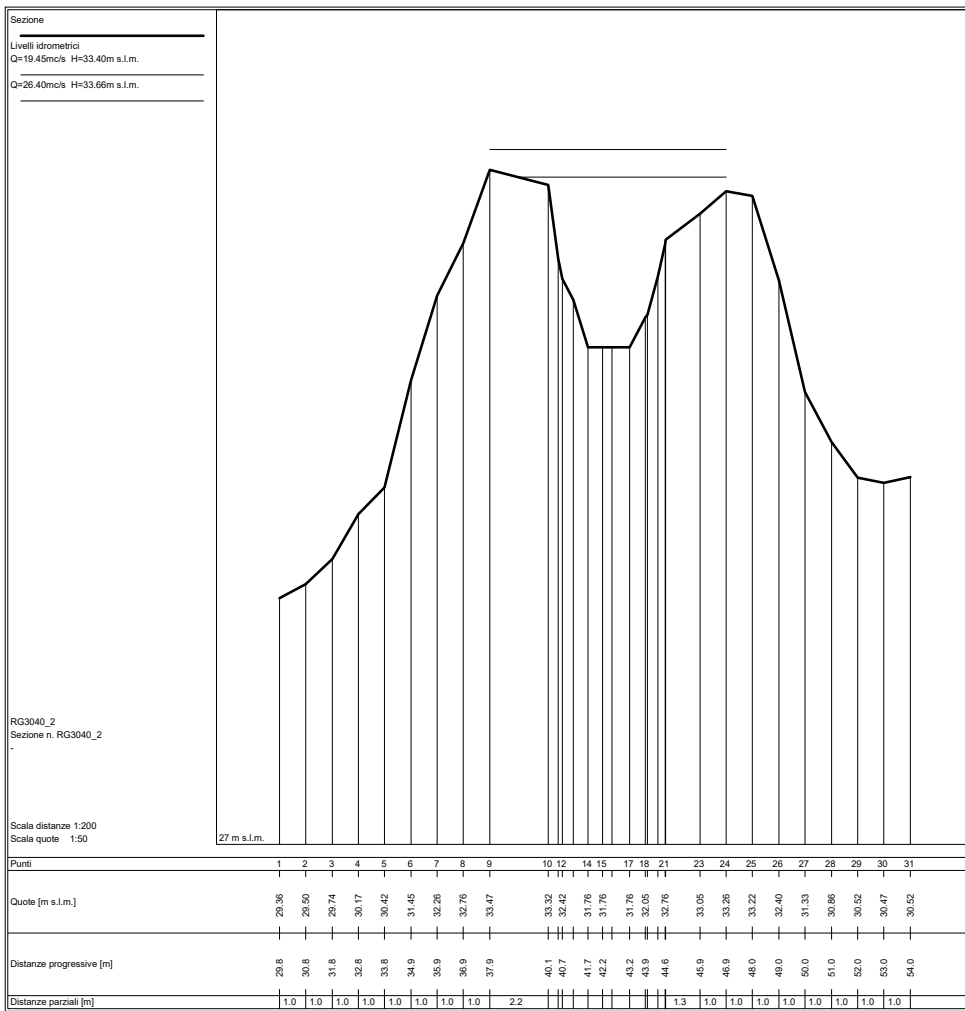

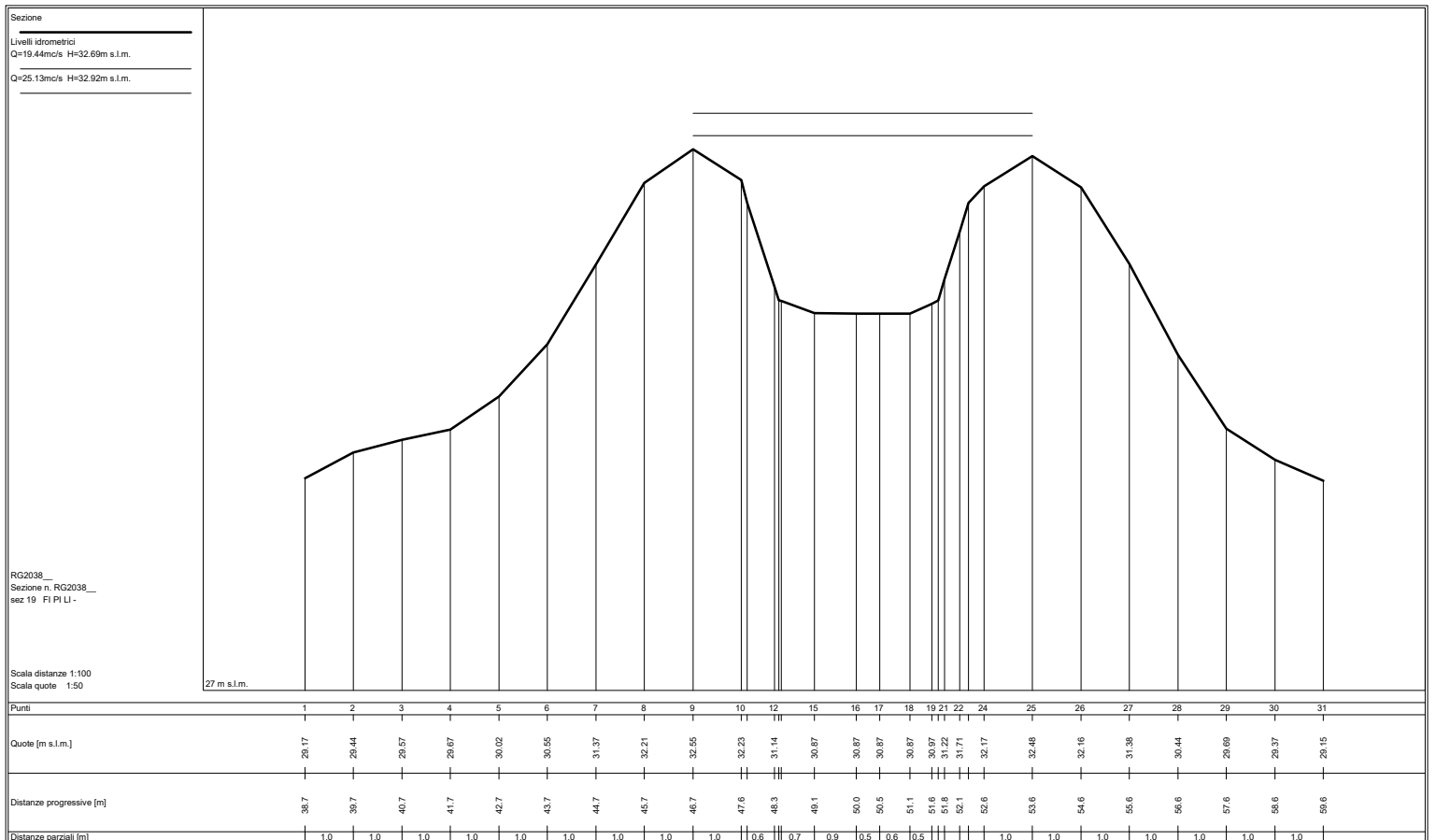
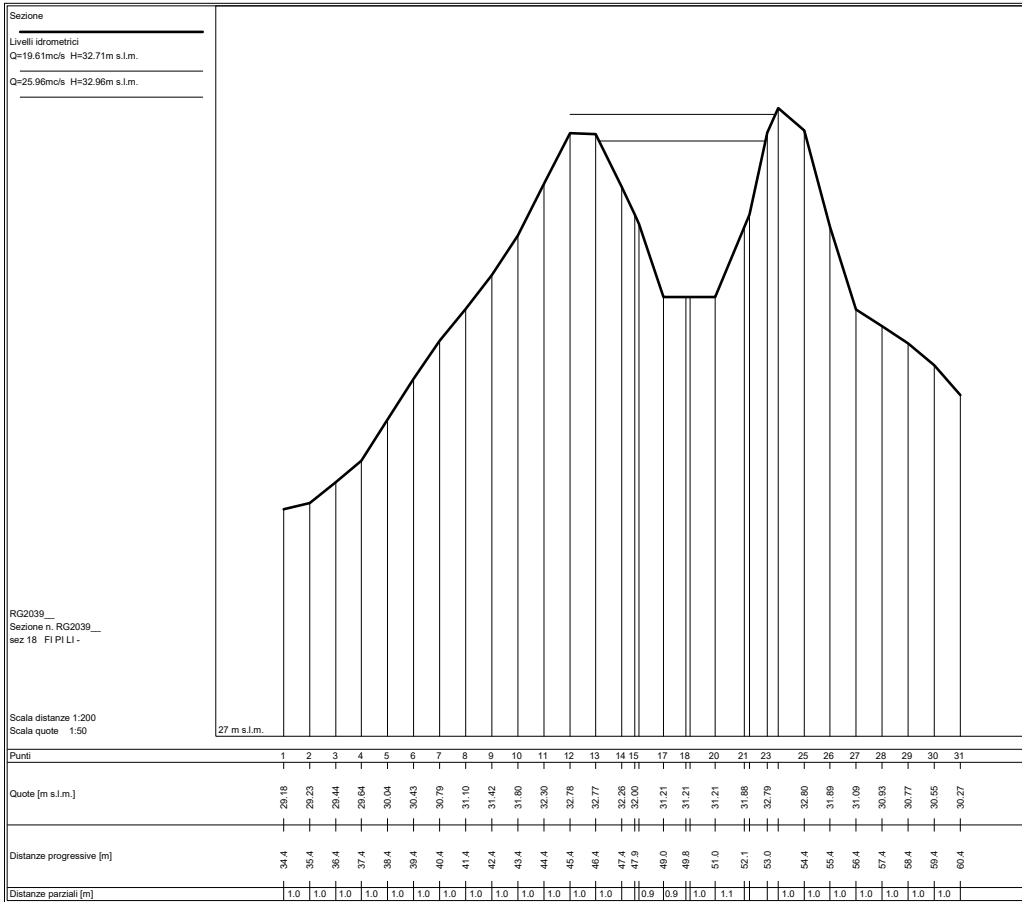

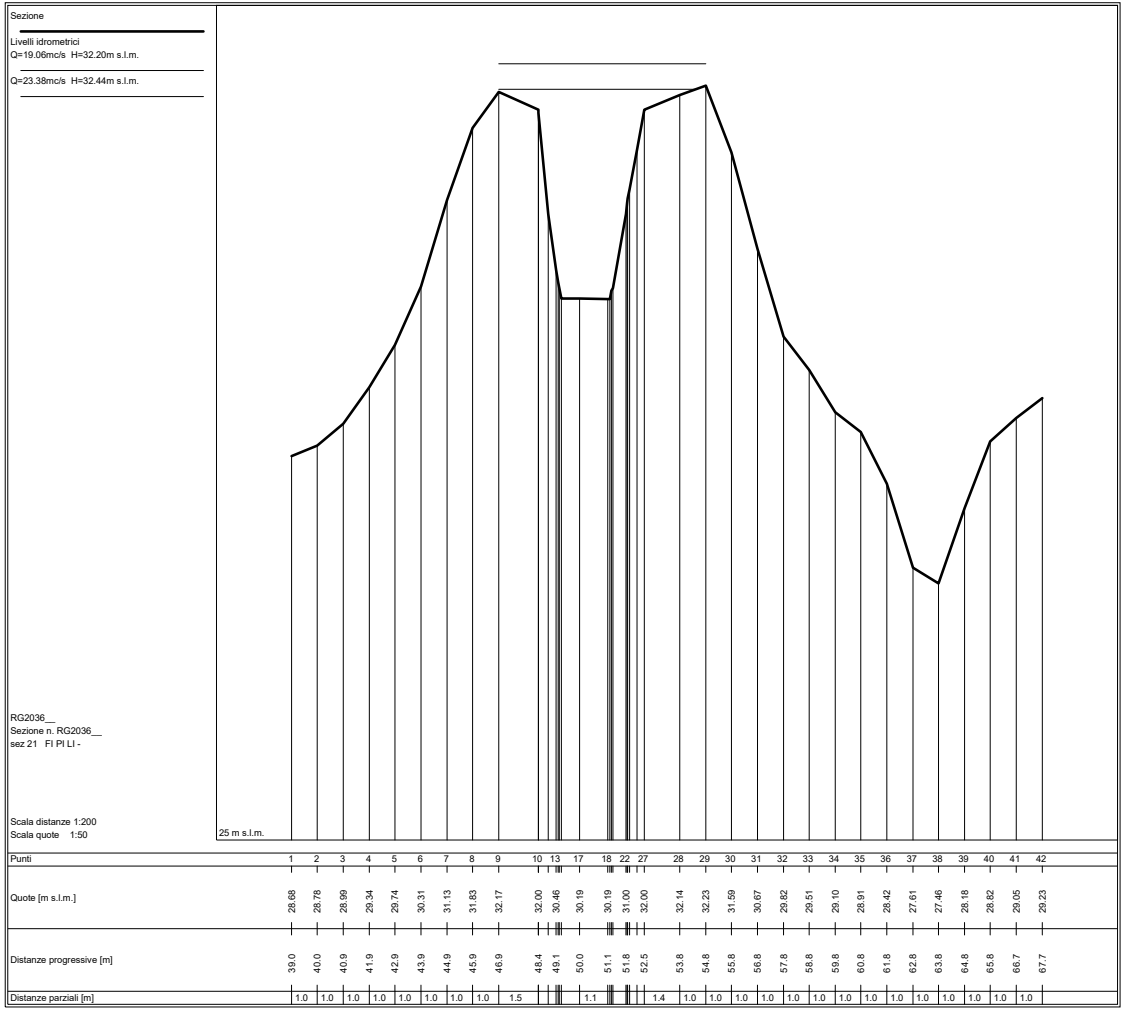
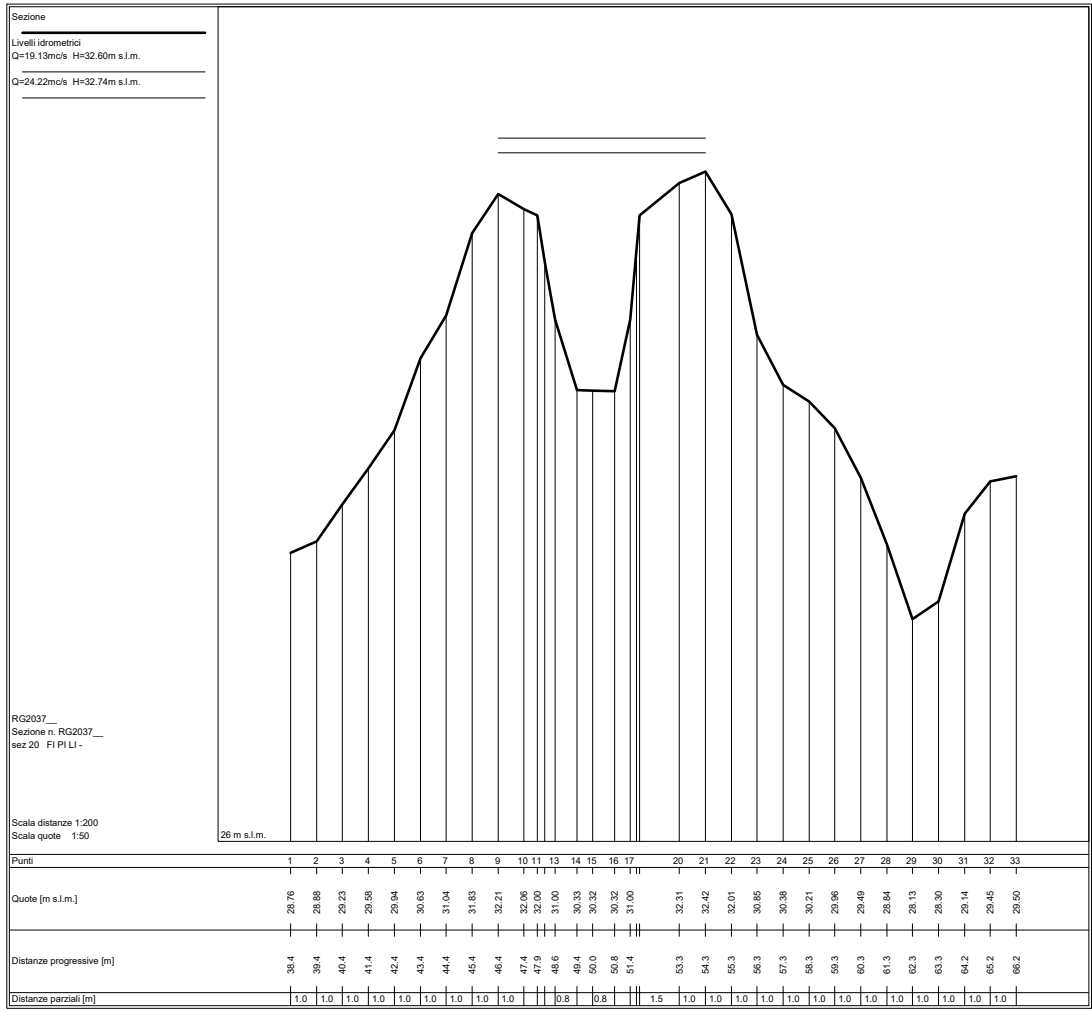

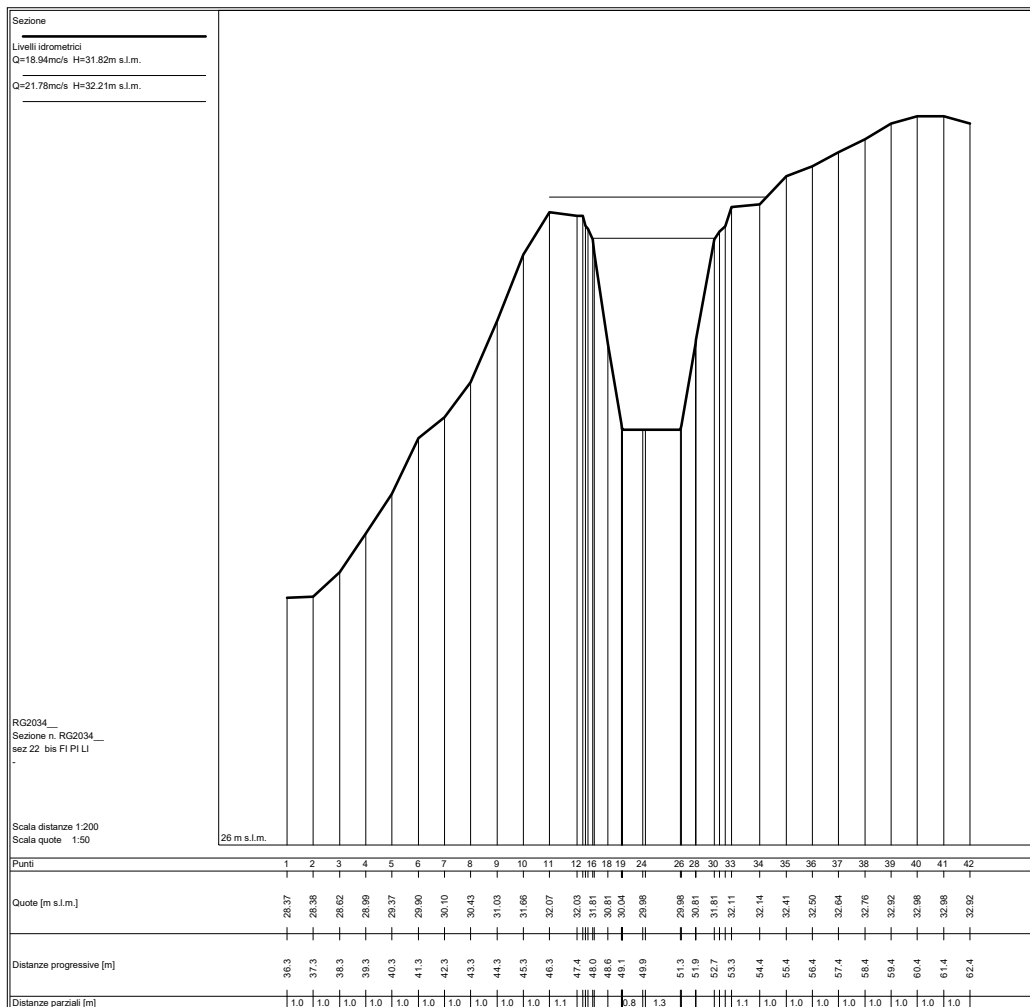
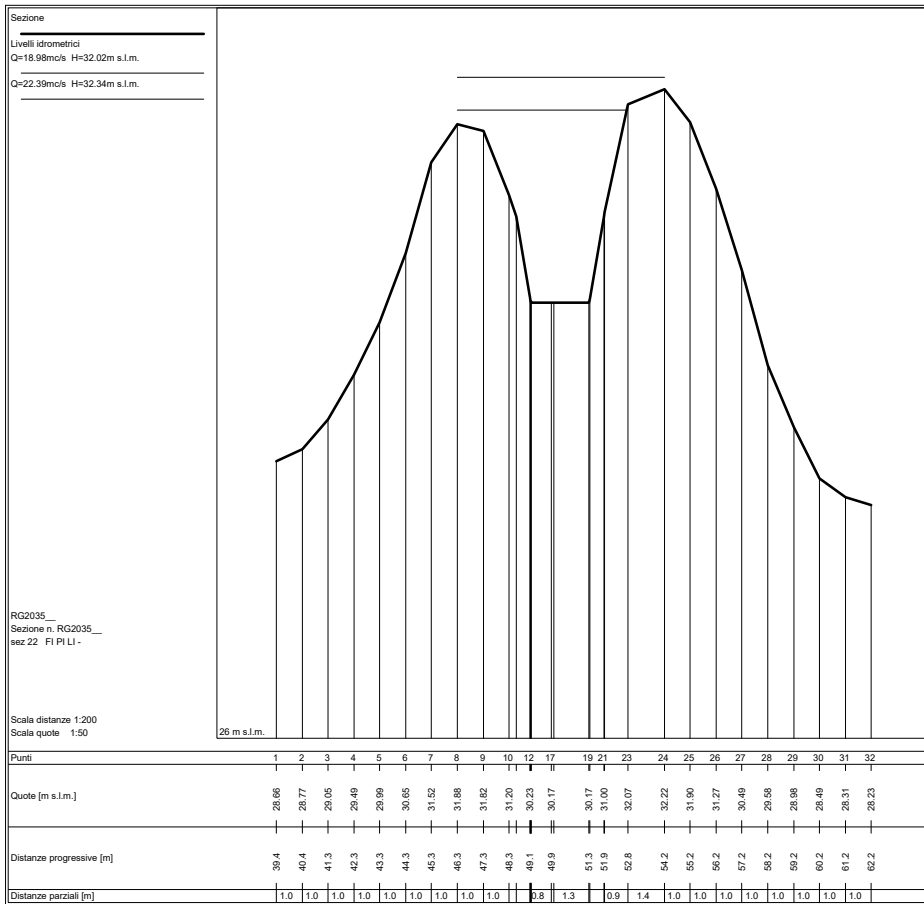

Sezione
 Ponte
 Livelli idrometrici
 Q=18.94mc/s H=31.61m s.l.m.
 Q=21.78mc/s H=31.66m s.l.m.

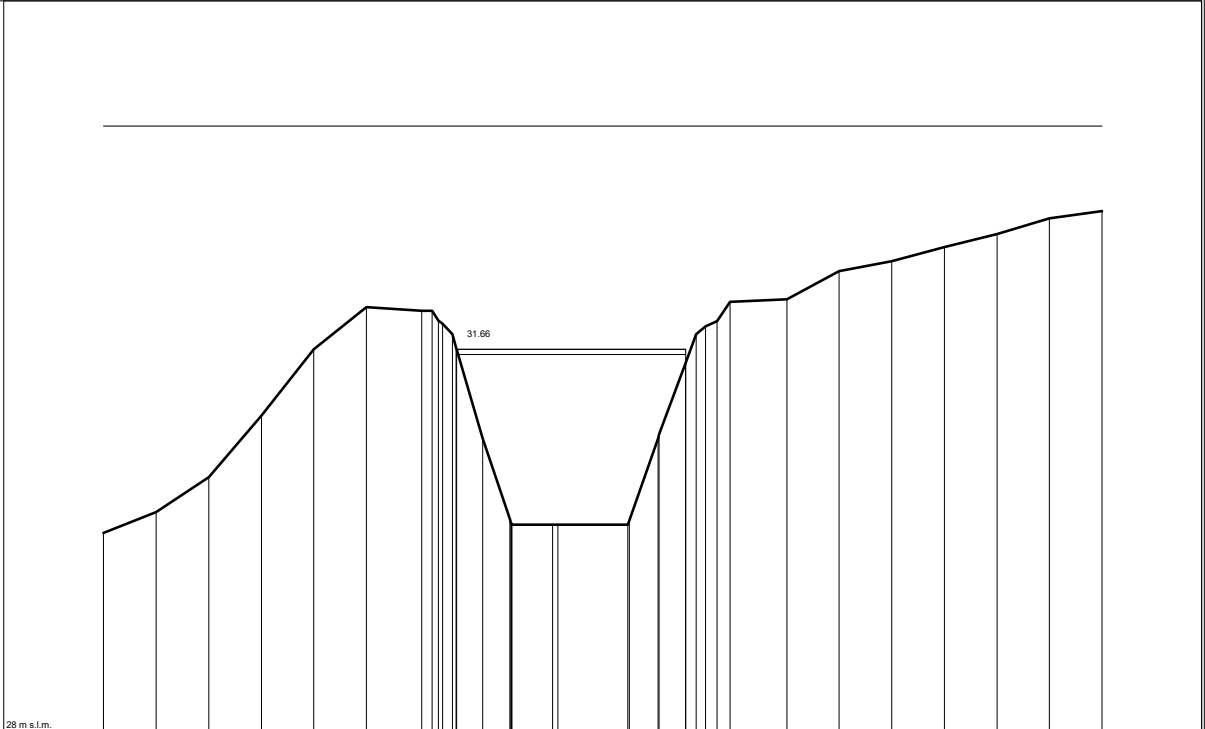

RG2034_B
 Sezione n. RG2034_B

Scala distanze 1:100
 Scala quote 1:50

Punti	1	2	3	4	5	6	7	8	11	14	15	20	22	24	26	29	31	32	33	34	35	36	37	38
Quote [m s.l.m.]	29.90	30.10	30.43	31.03	31.66	32.07	32.03	32.03	31.81	30.81	30.04	29.88	29.88	30.81	31.53	31.88	32.11	32.14	32.41	32.50	32.84	32.76	32.82	32.98
Distanze progressive [m]	41.3	42.3	43.3	44.3	45.3	46.3	47.4	47.6	48.0	48.6	49.1	49.9	51.3	51.9	52.5	52.8	53.3	54.4	55.4	56.4	57.4	58.4	59.4	60.4
Distanze parziali [m]	1.0	1.0	1.0	1.0	1.0	1.1	0.5	0.5	0.5	0.8	0.8	1.3	0.5	0.5	0.5	0.5	1.1	1.0	1.0	1.0	1.0	1.0	1.0	1.0

Sezione
 Ponte
 Livelli idrometrici
 Q=18.91mc/s H=30.97m s.l.m.
 Q=21.58mc/s H=31.37m s.l.m.

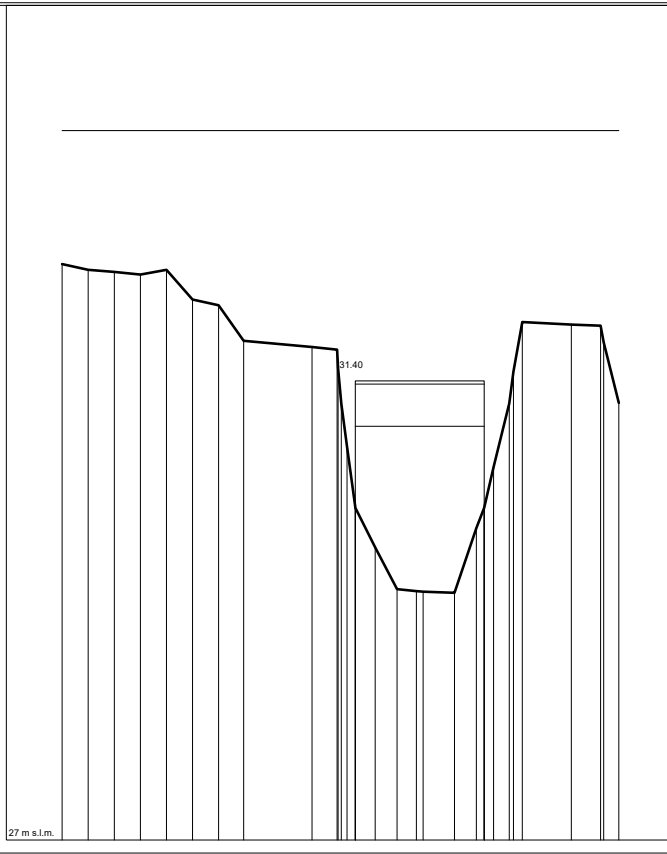

RG2033_C
 Sezione n. RG2033_C

Scala distanze 1:200
 Scala quote 1:50

Punti	1	2	3	4	5	6	7	8	9	10	14	17	18	19	21	22	26	27	29	30	31	33	
Quote [m s.l.m.]		32.52	32.46	32.45	32.42	32.47	32.18	32.12	31.76	31.72	31.70	30.19	29.61	29.41	29.38	29.37	29.99	30.57	31.18	31.97	31.94	31.93	31.19
Distanze progressive [m]	36.2	37.2	38.2	39.2	40.2	41.2	42.2	43.1	45.7	46.7	47.4	48.2	49.0	49.7	51.2	52.1	52.7	53.3	53.8	55.7	56.6	57.5	
Distanze parziali [m]	1.0	1.0	1.0	1.0	1.0	1.0	1.0	1.0	2.6	1.0	0.8	0.8	0.7	1.2	0.8	0.8	0.8	0.8	0.8	1.9	1.1	1.0	1.0

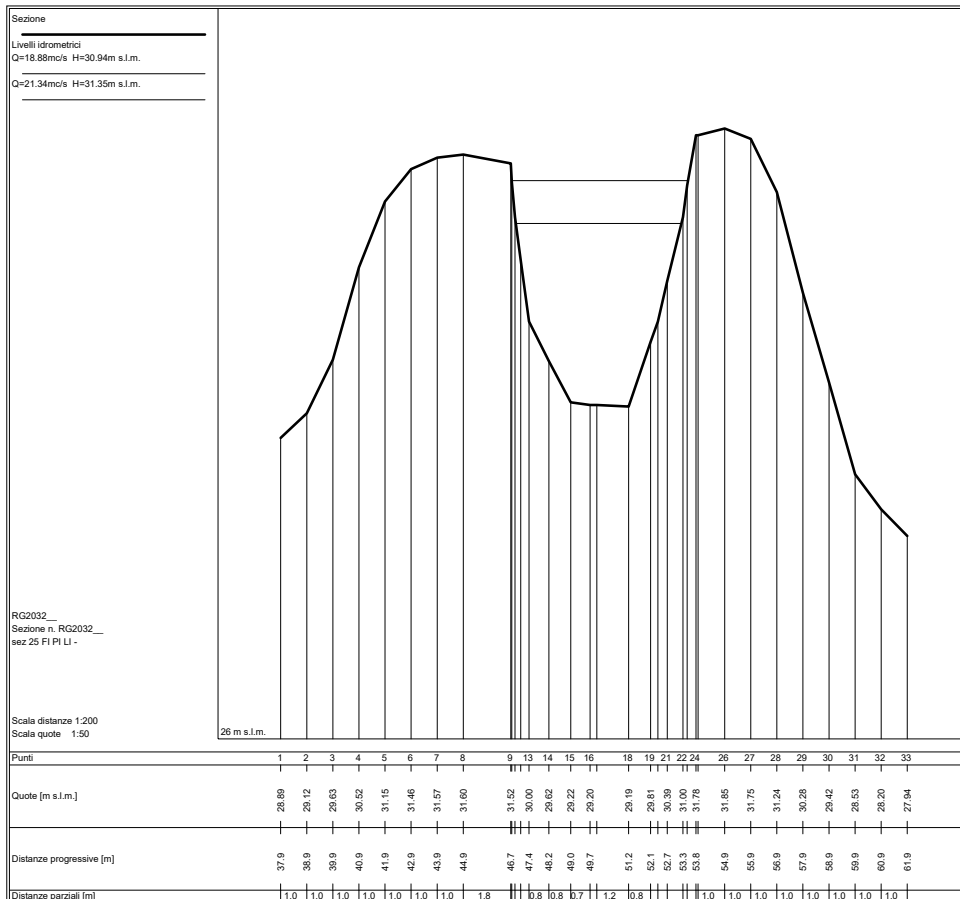
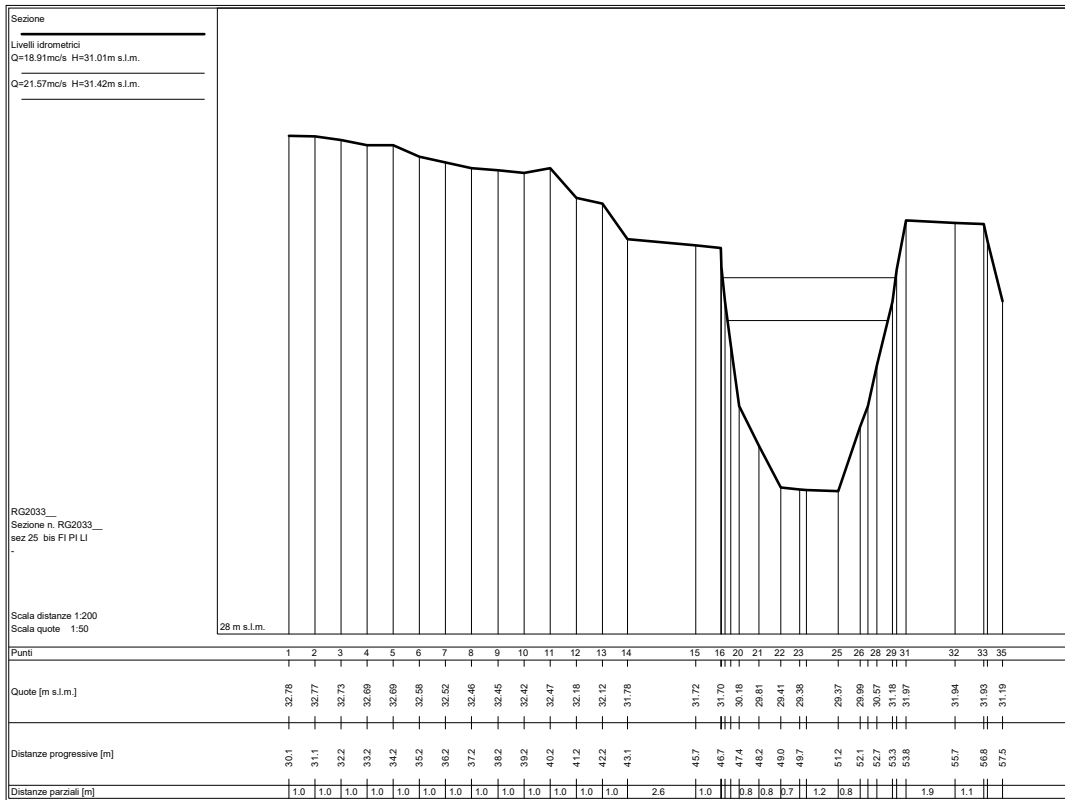

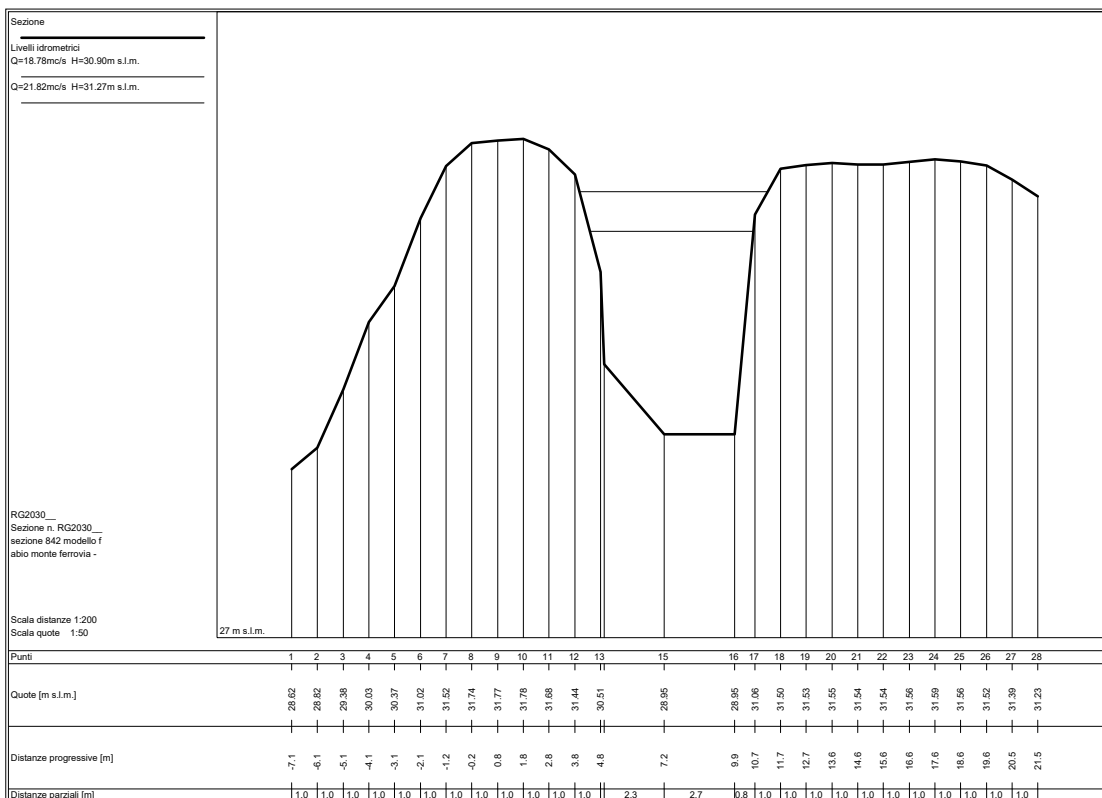
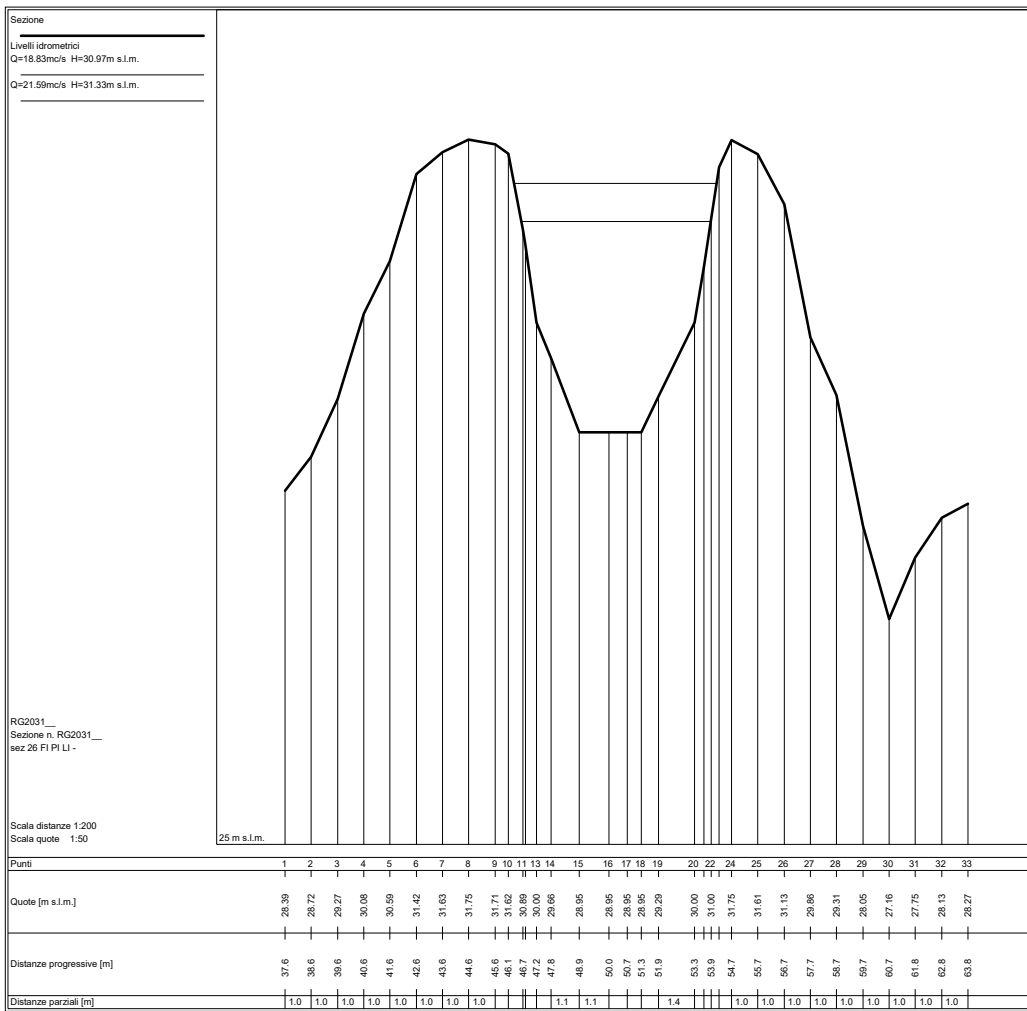

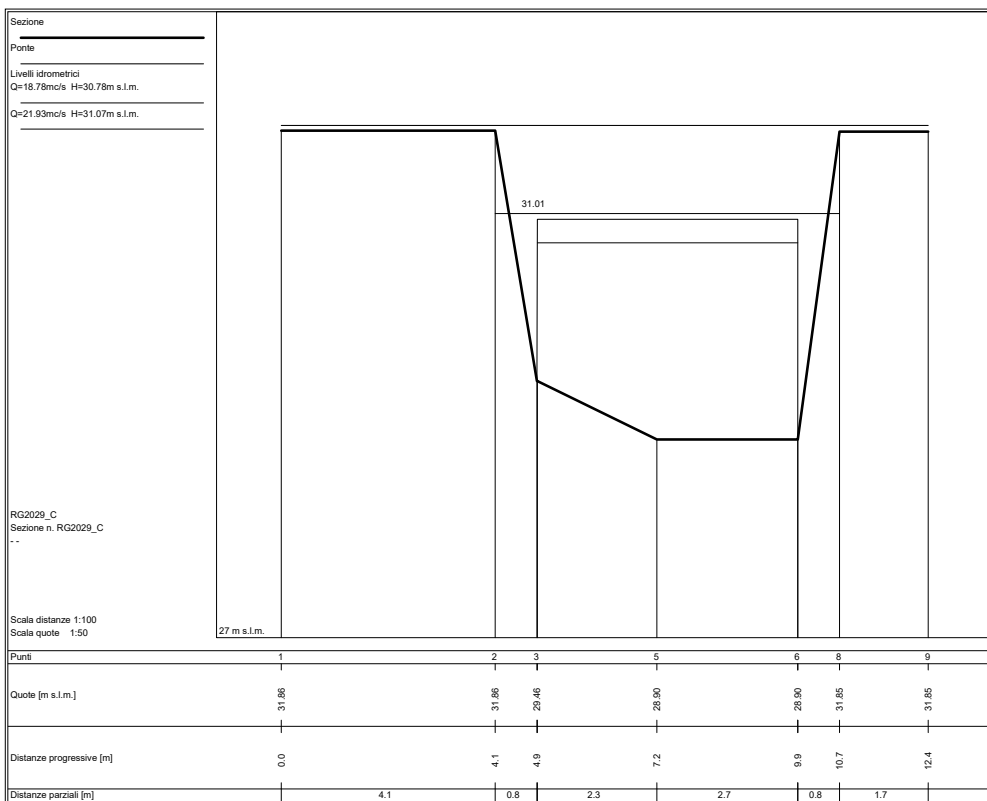
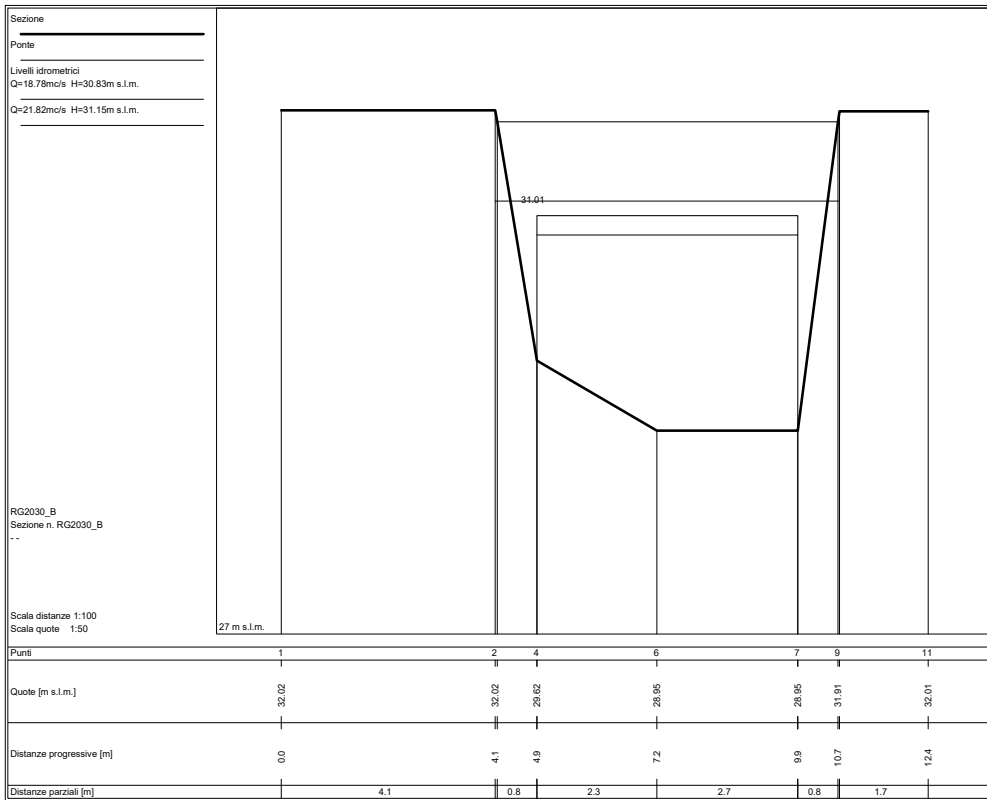

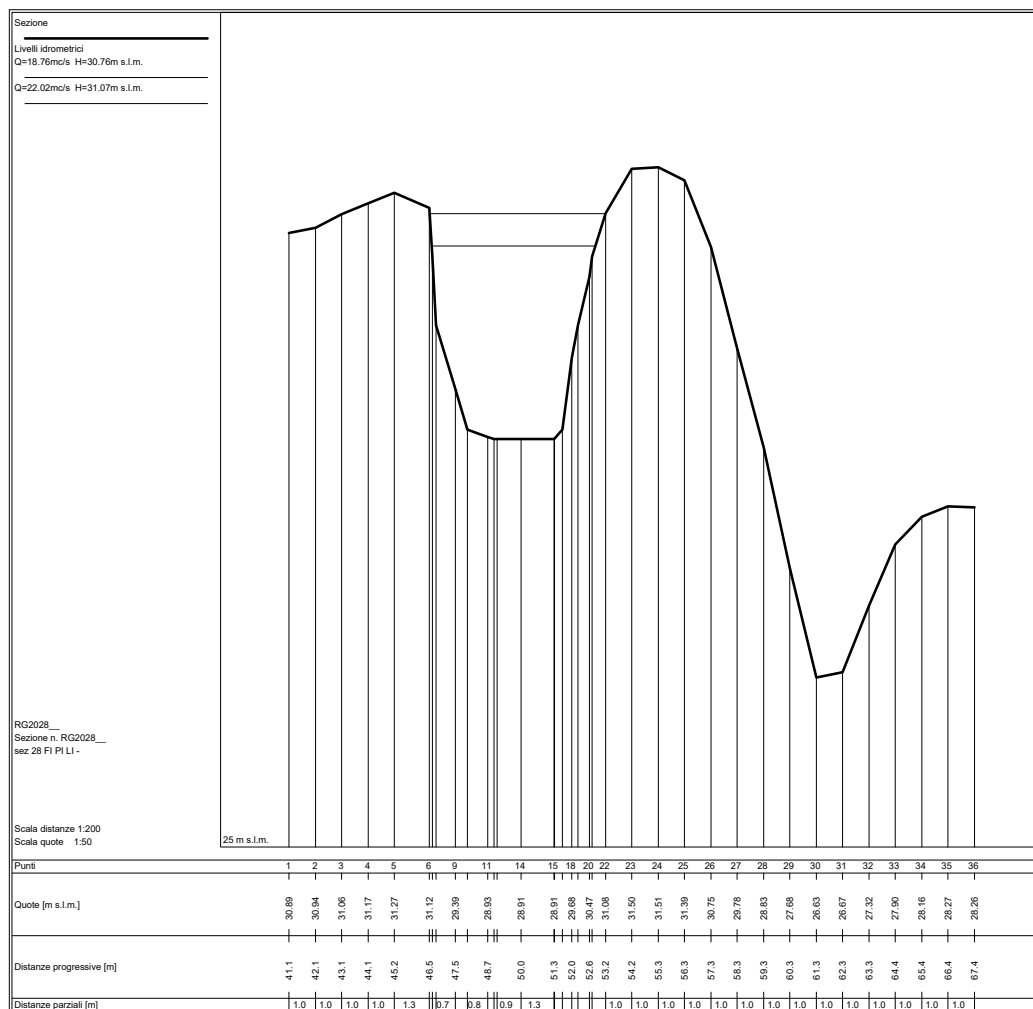
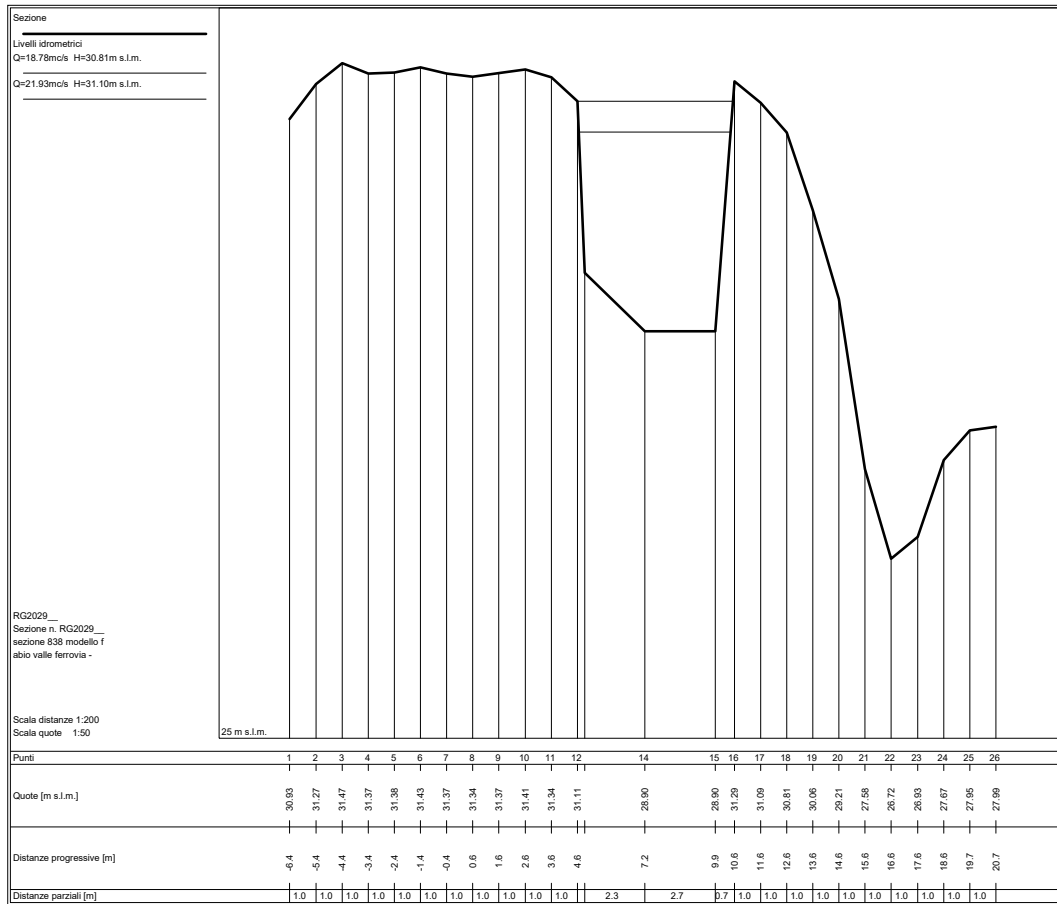

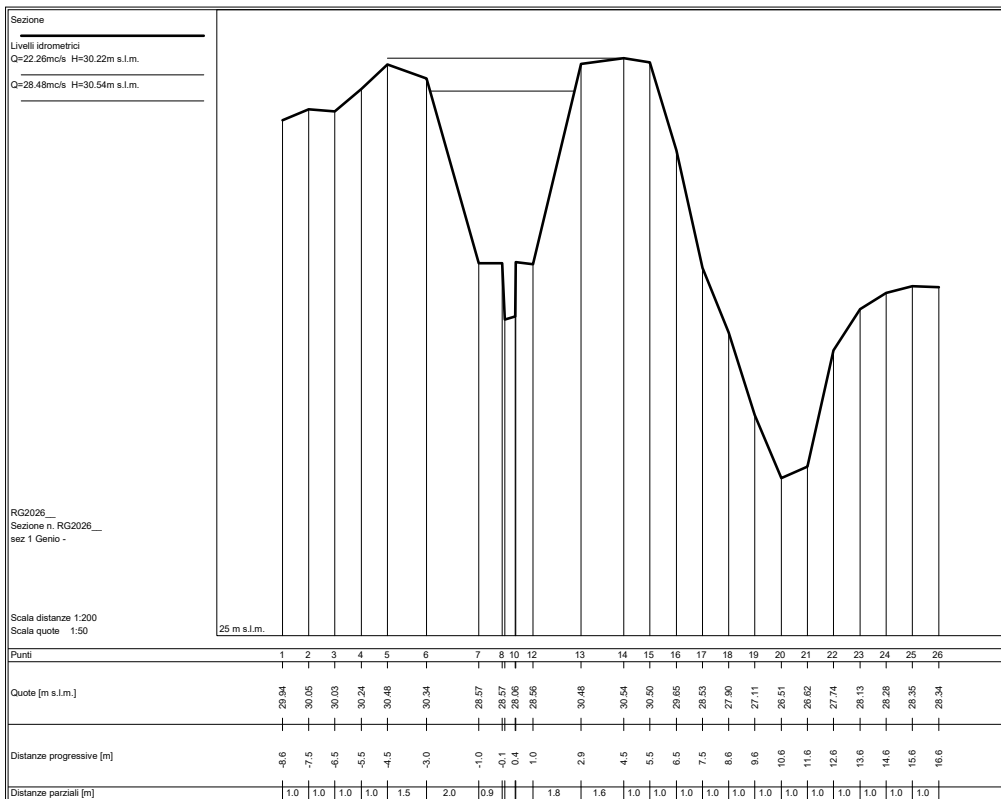
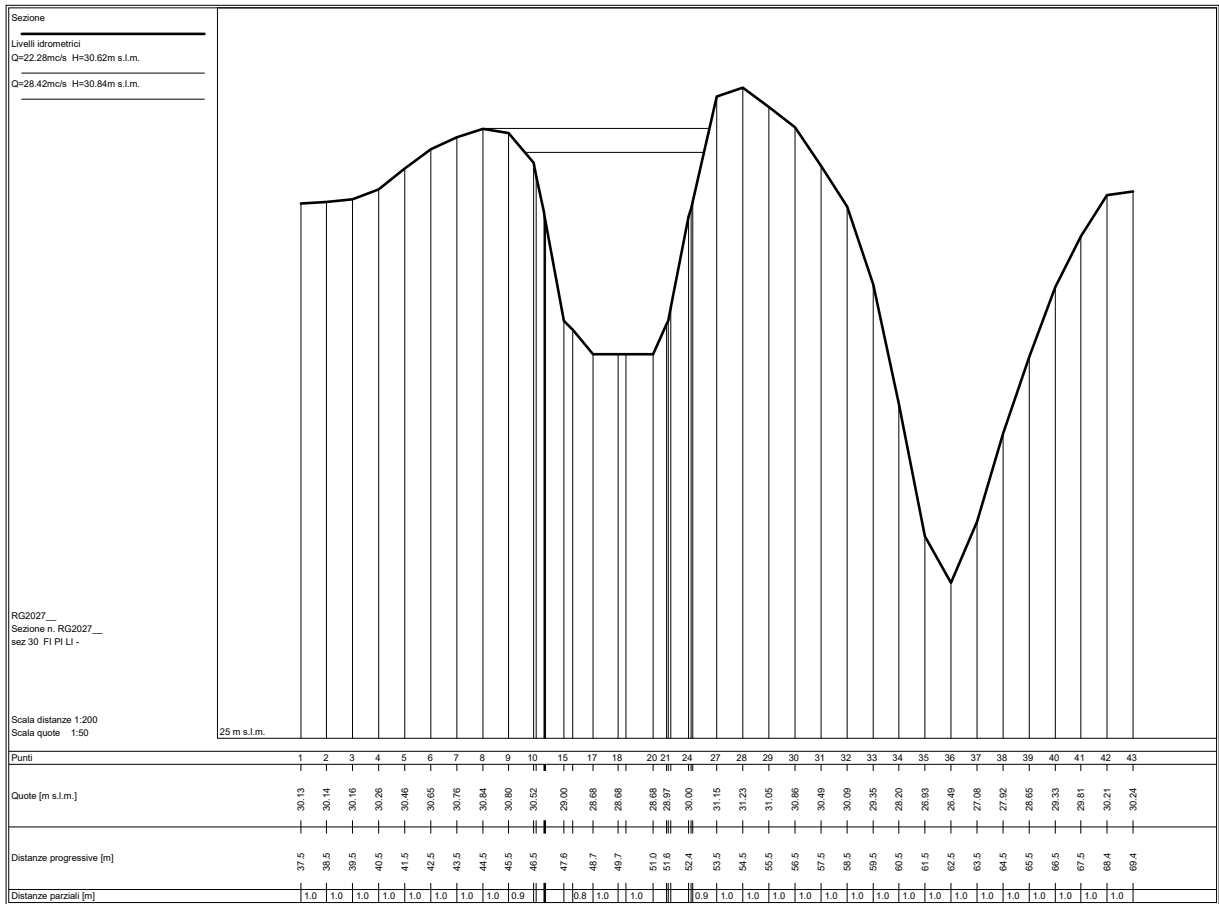

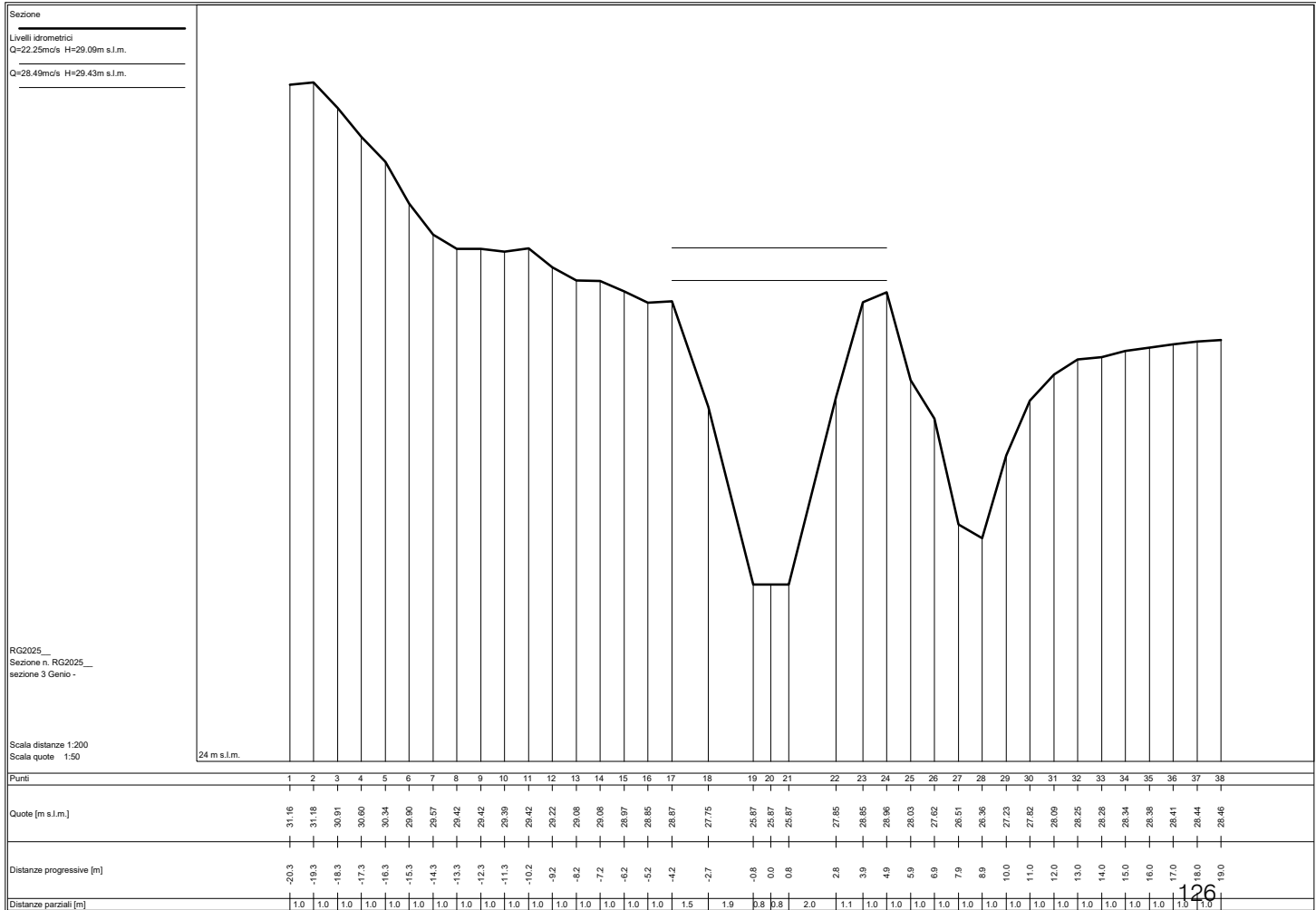
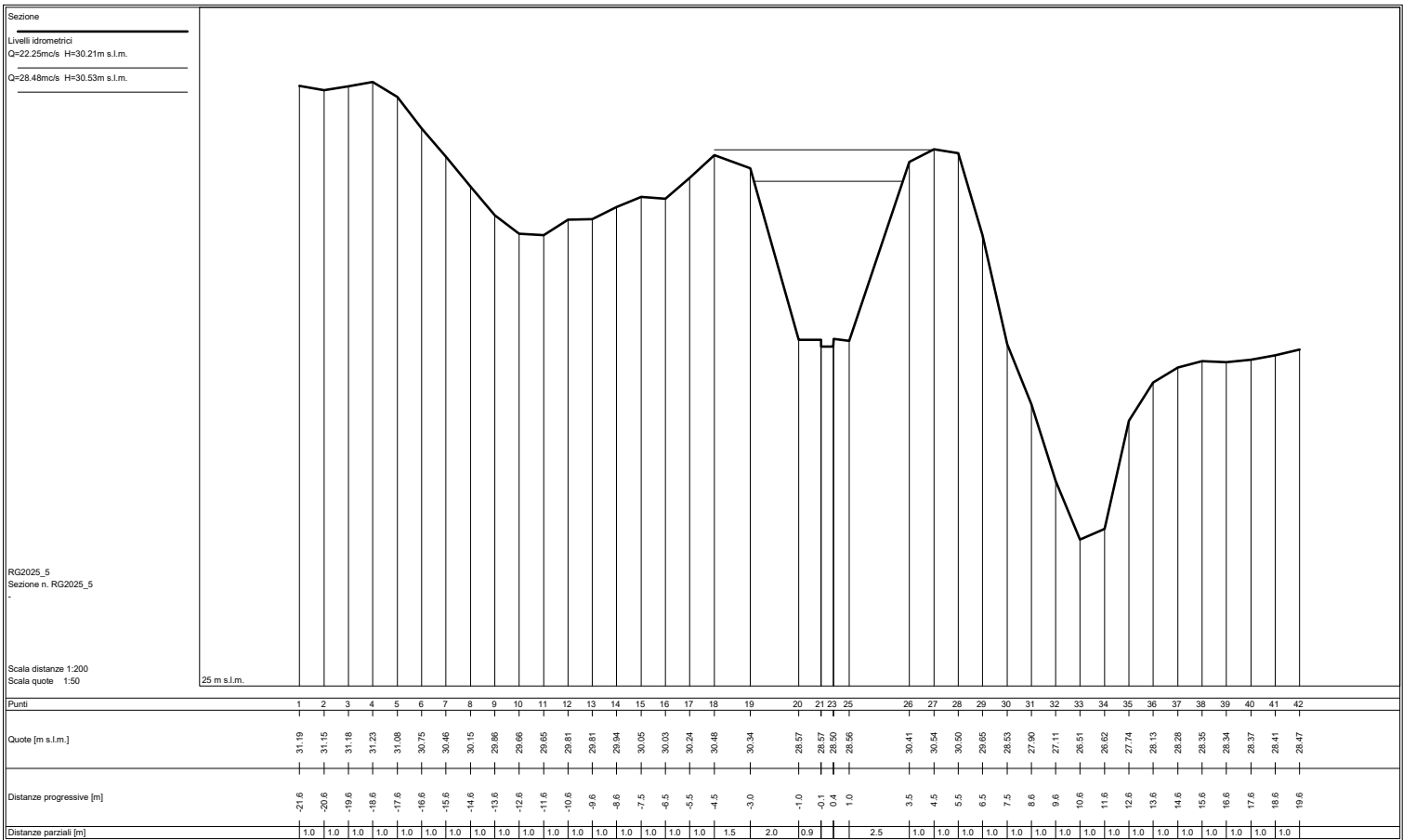

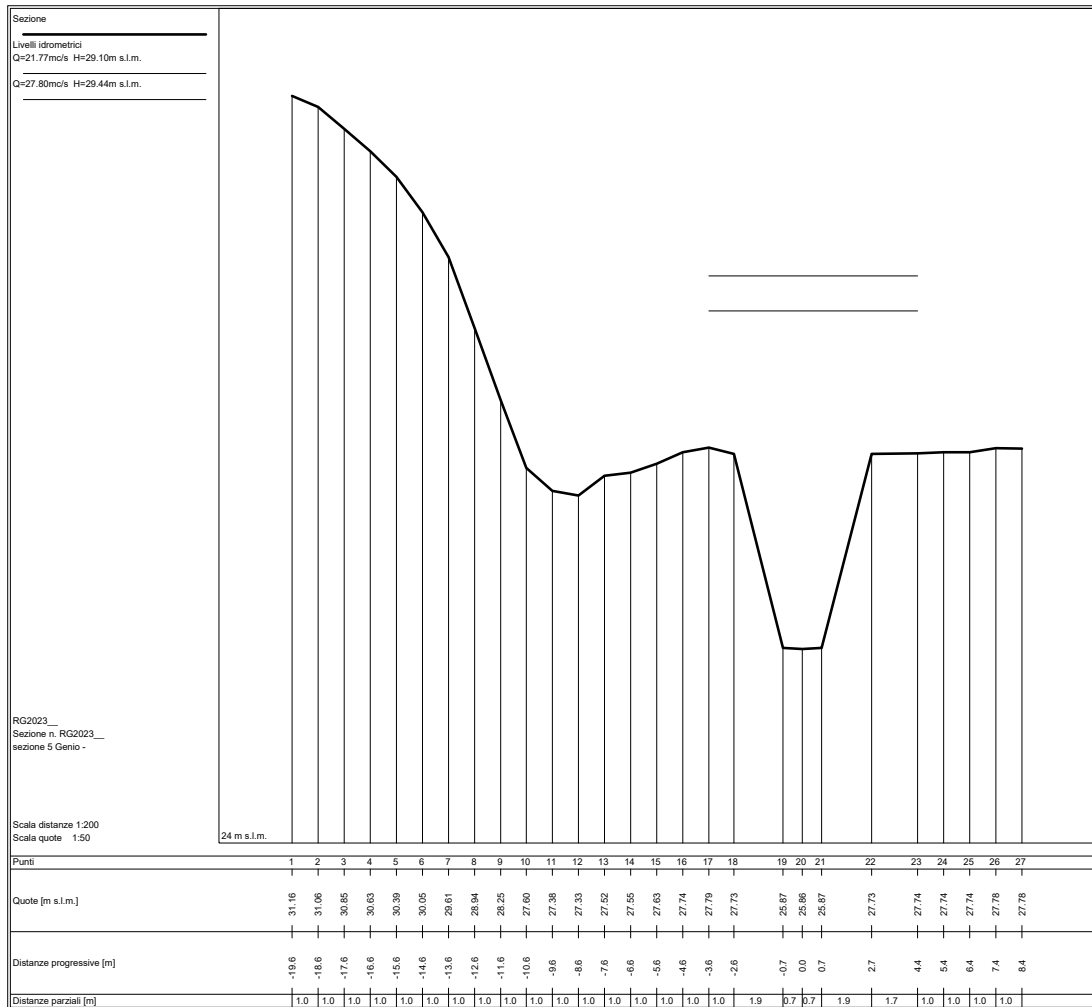
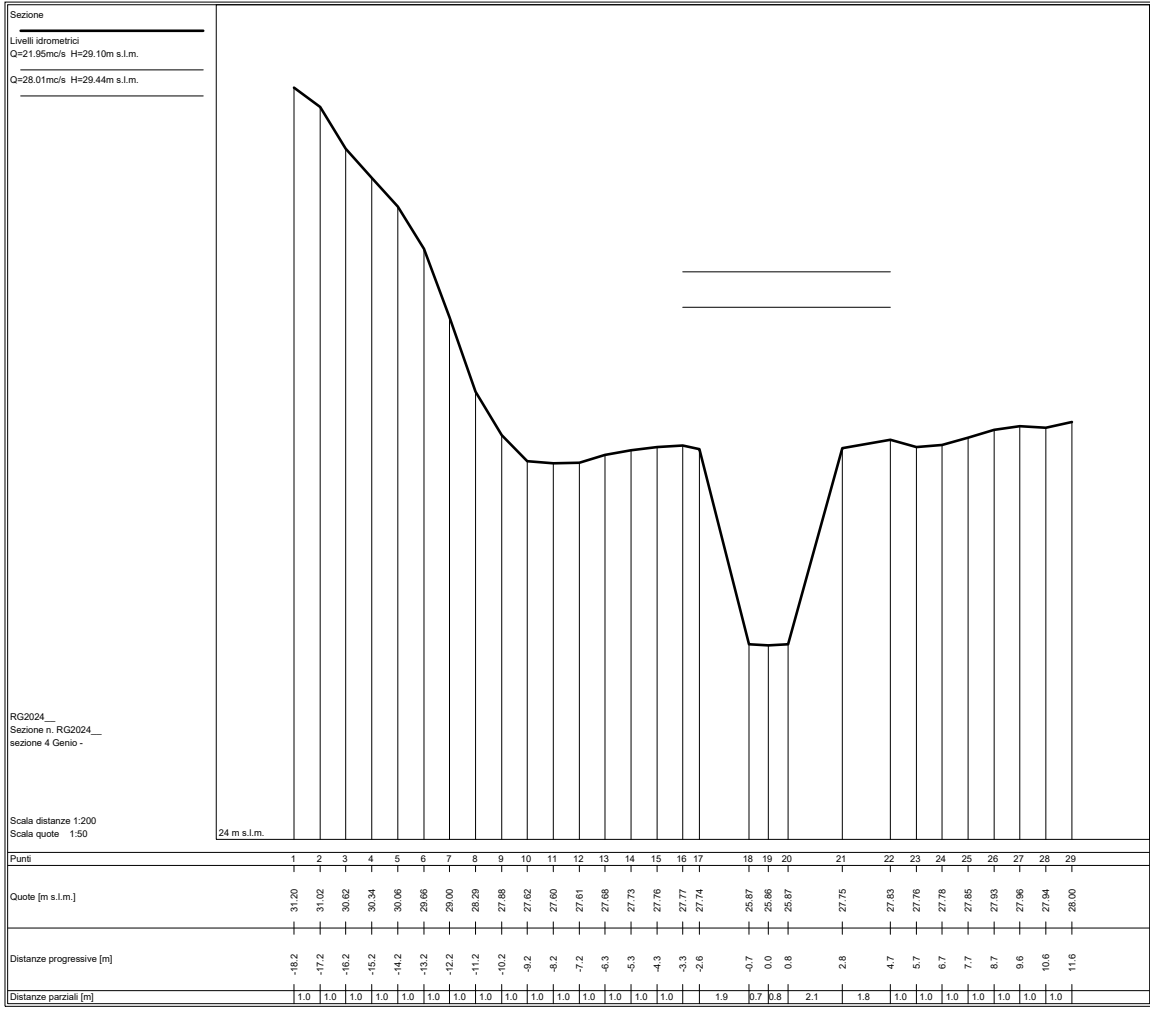

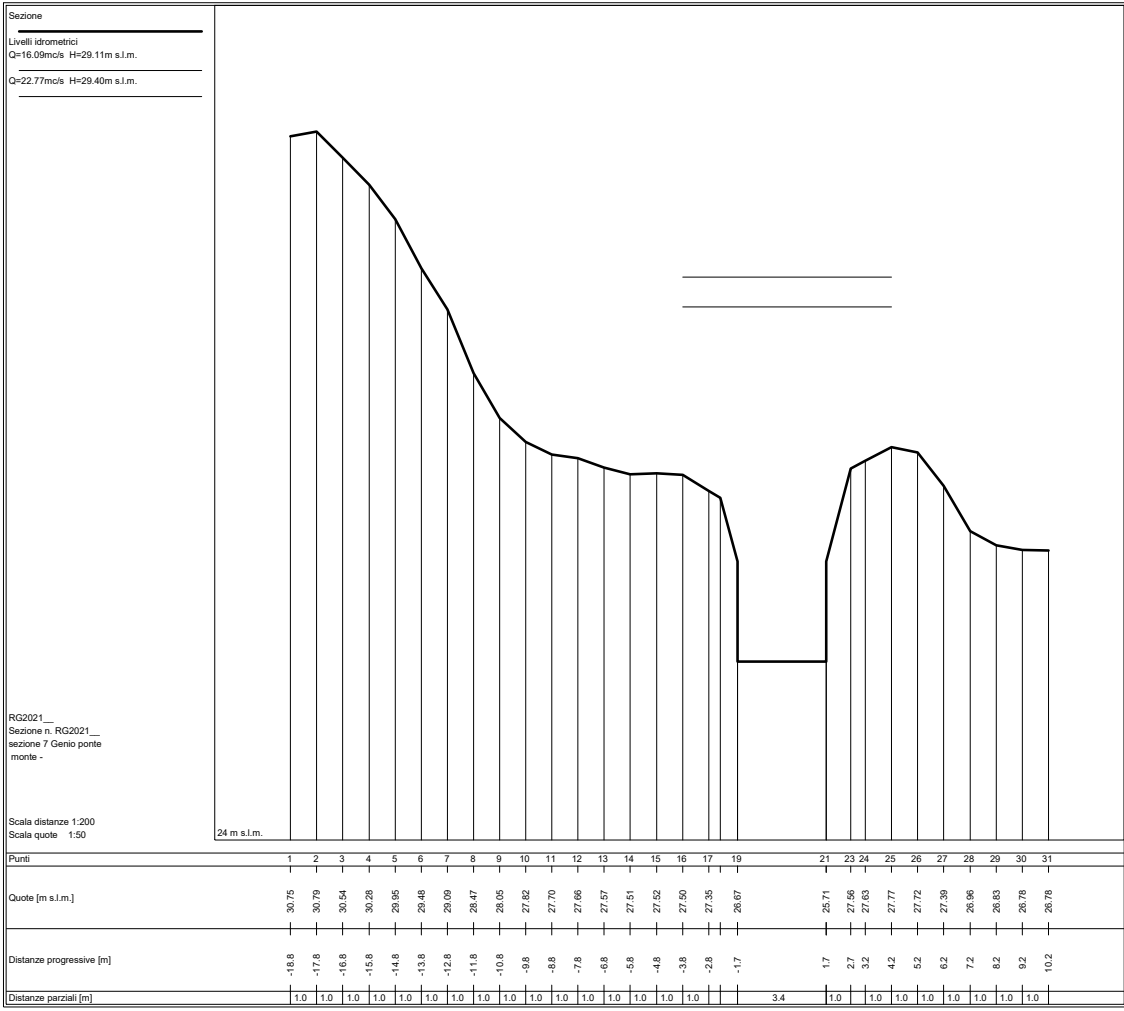
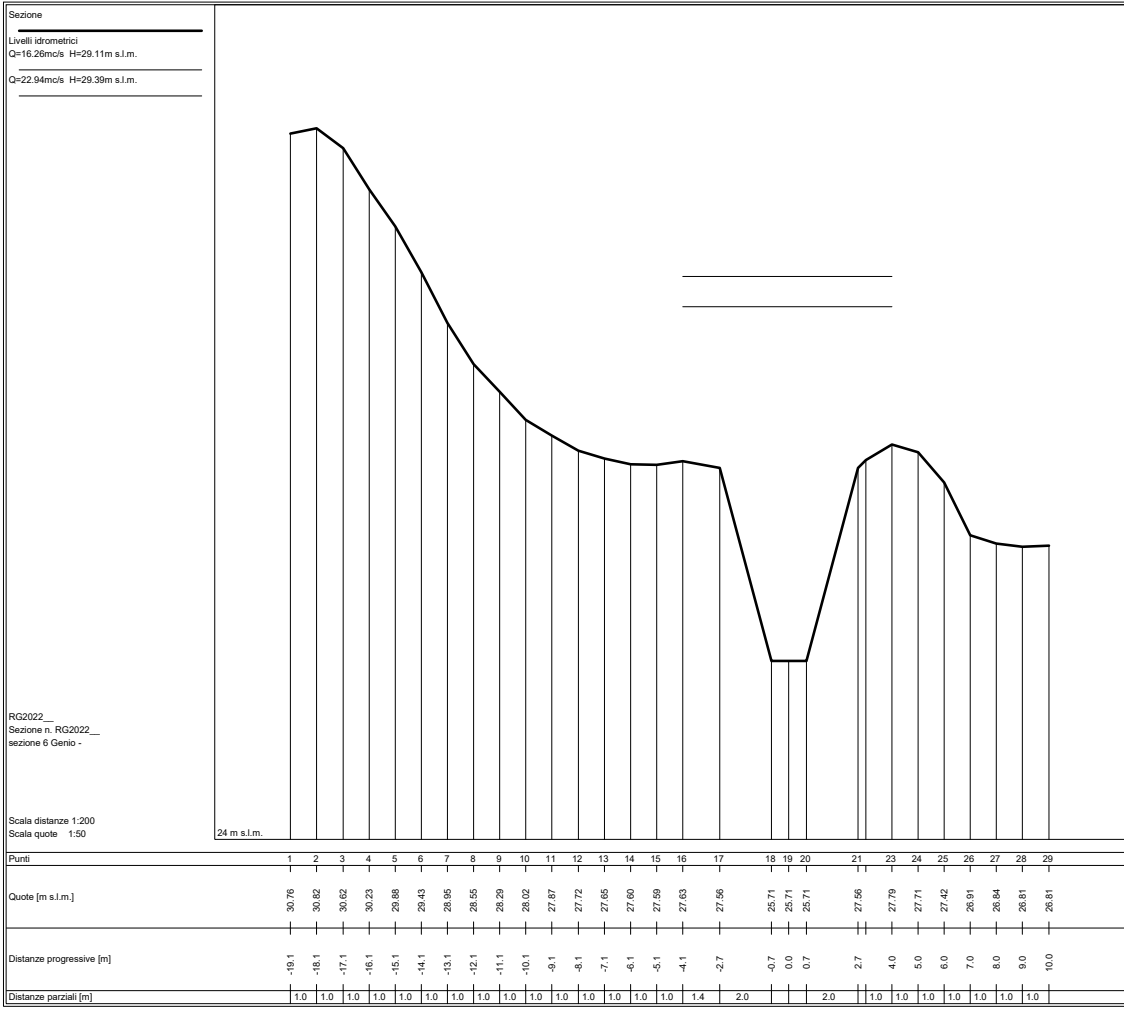

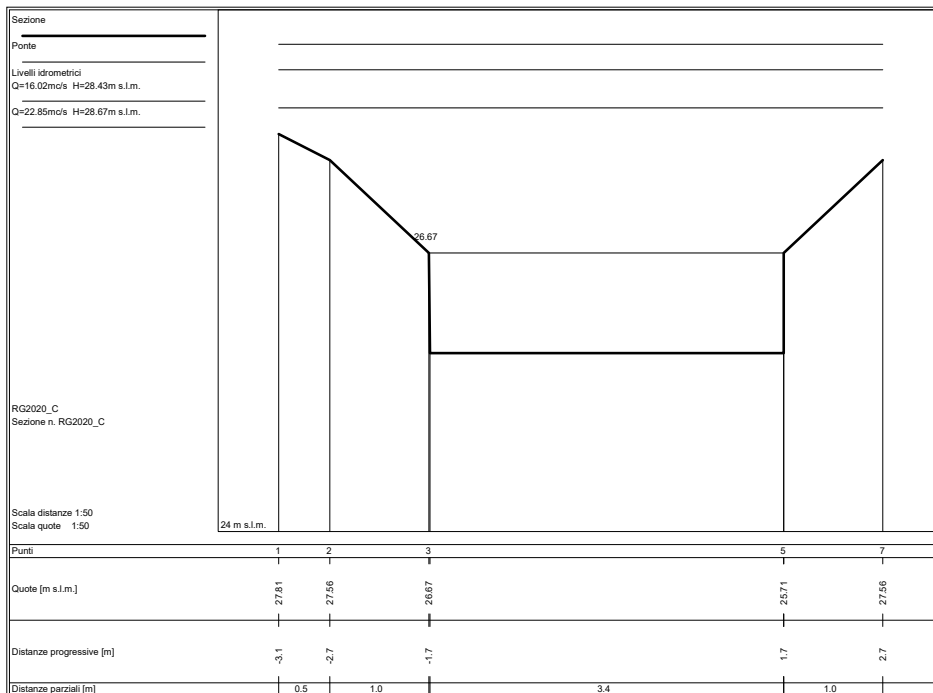
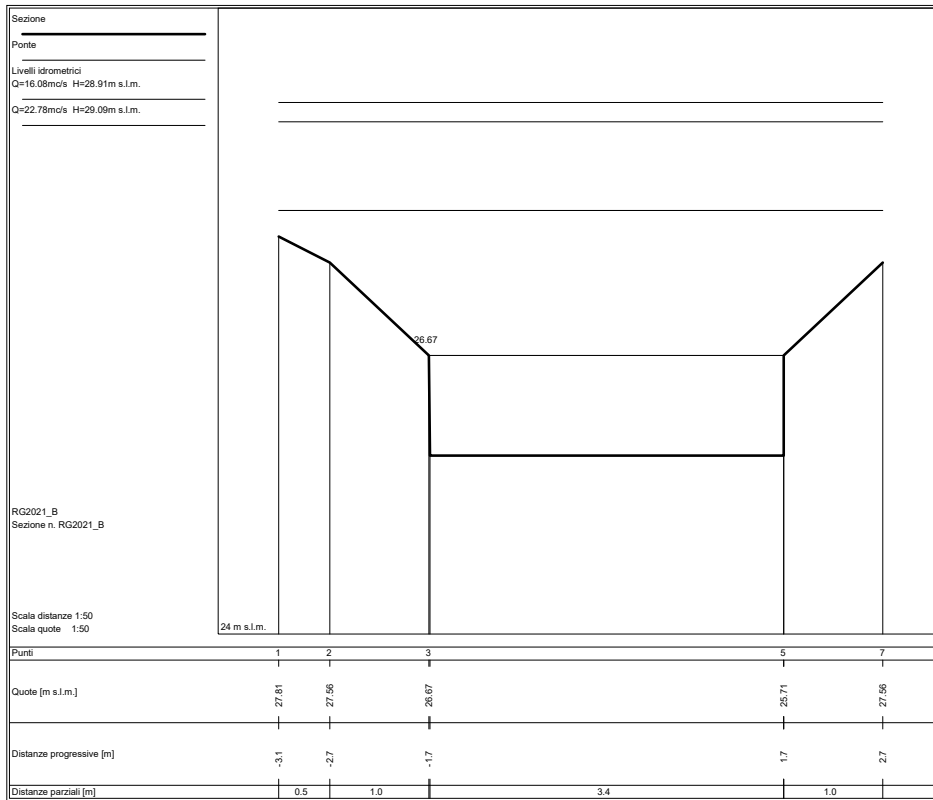

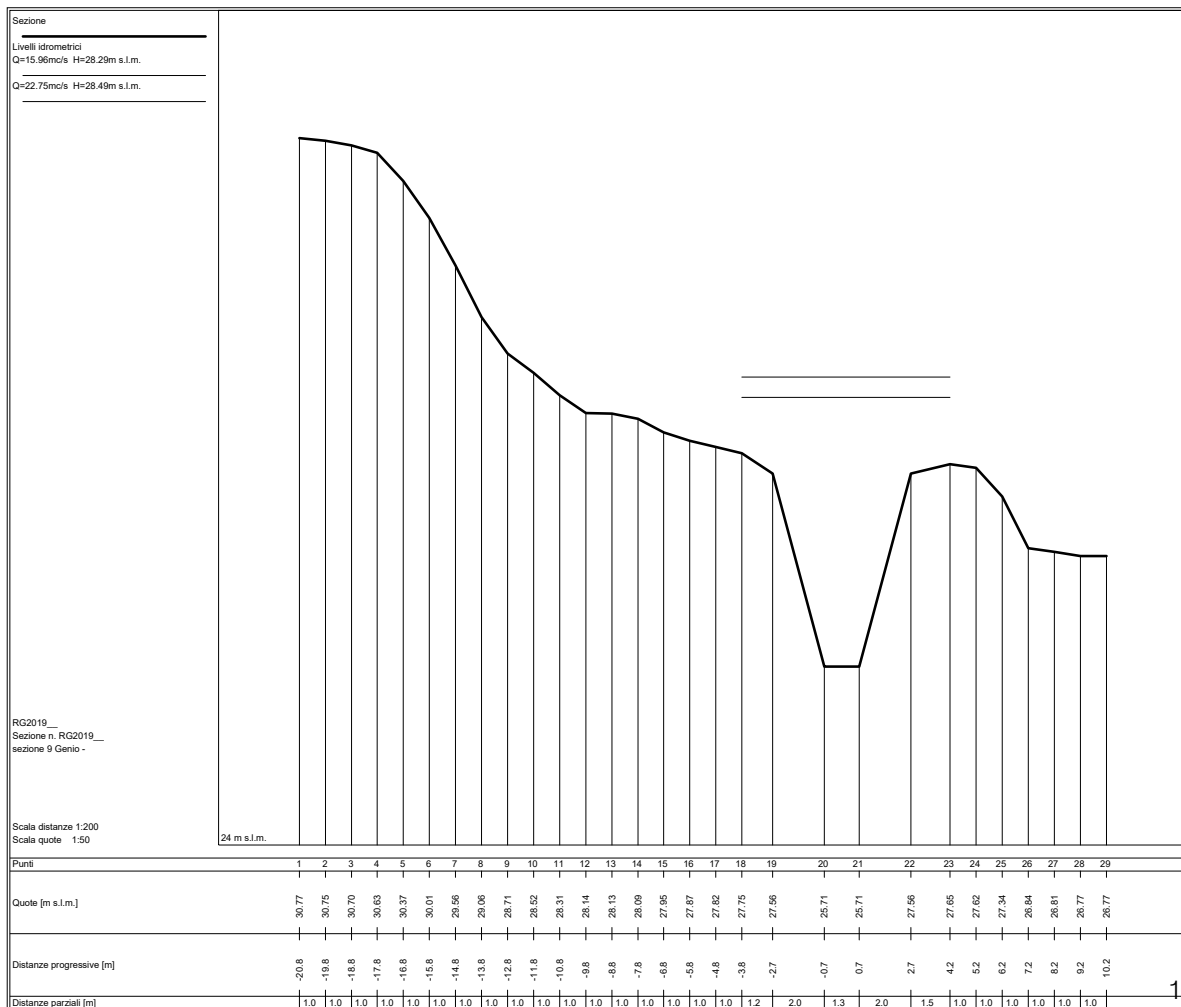
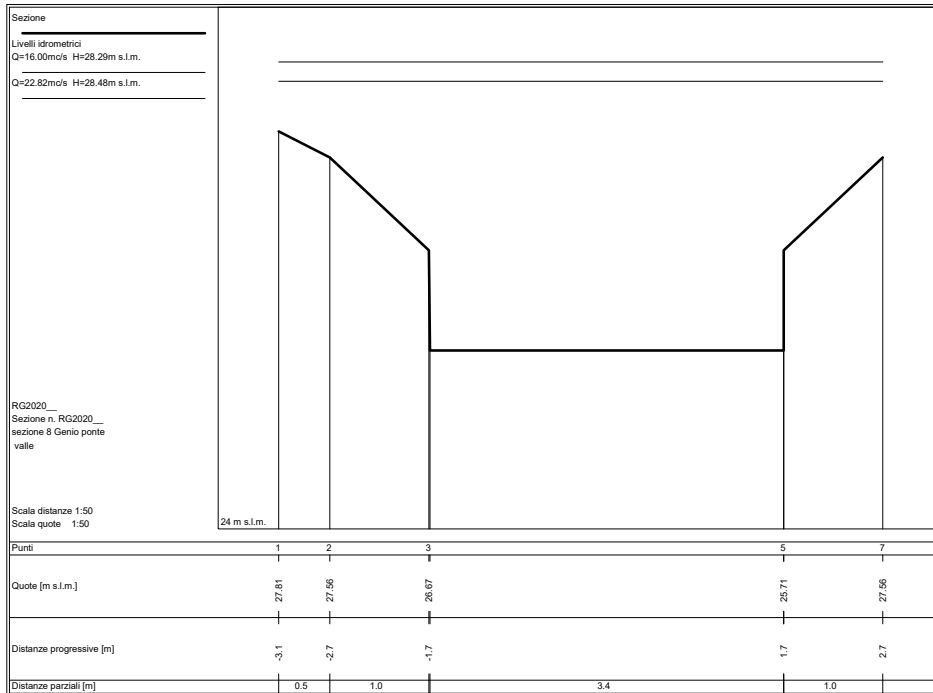

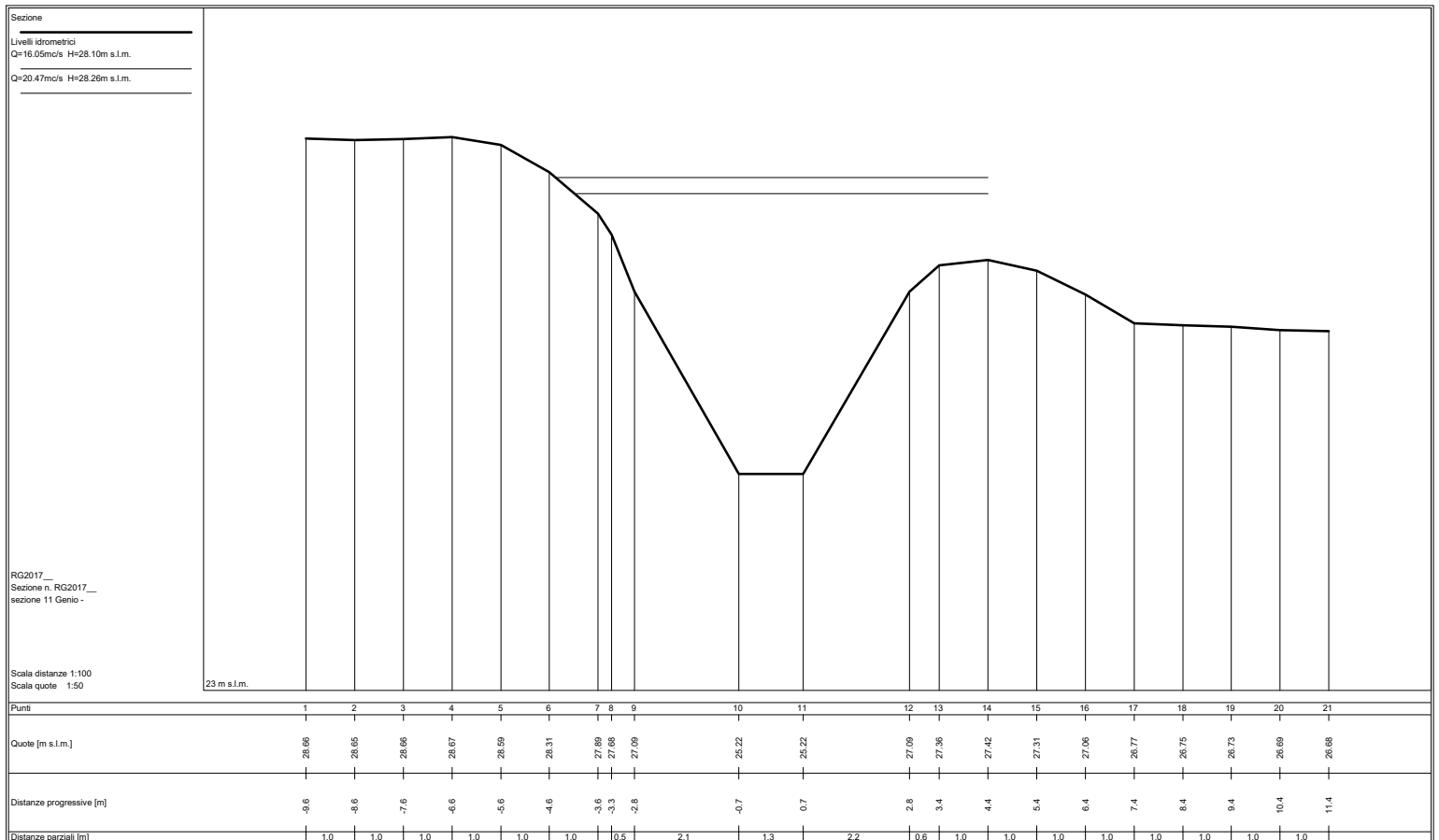
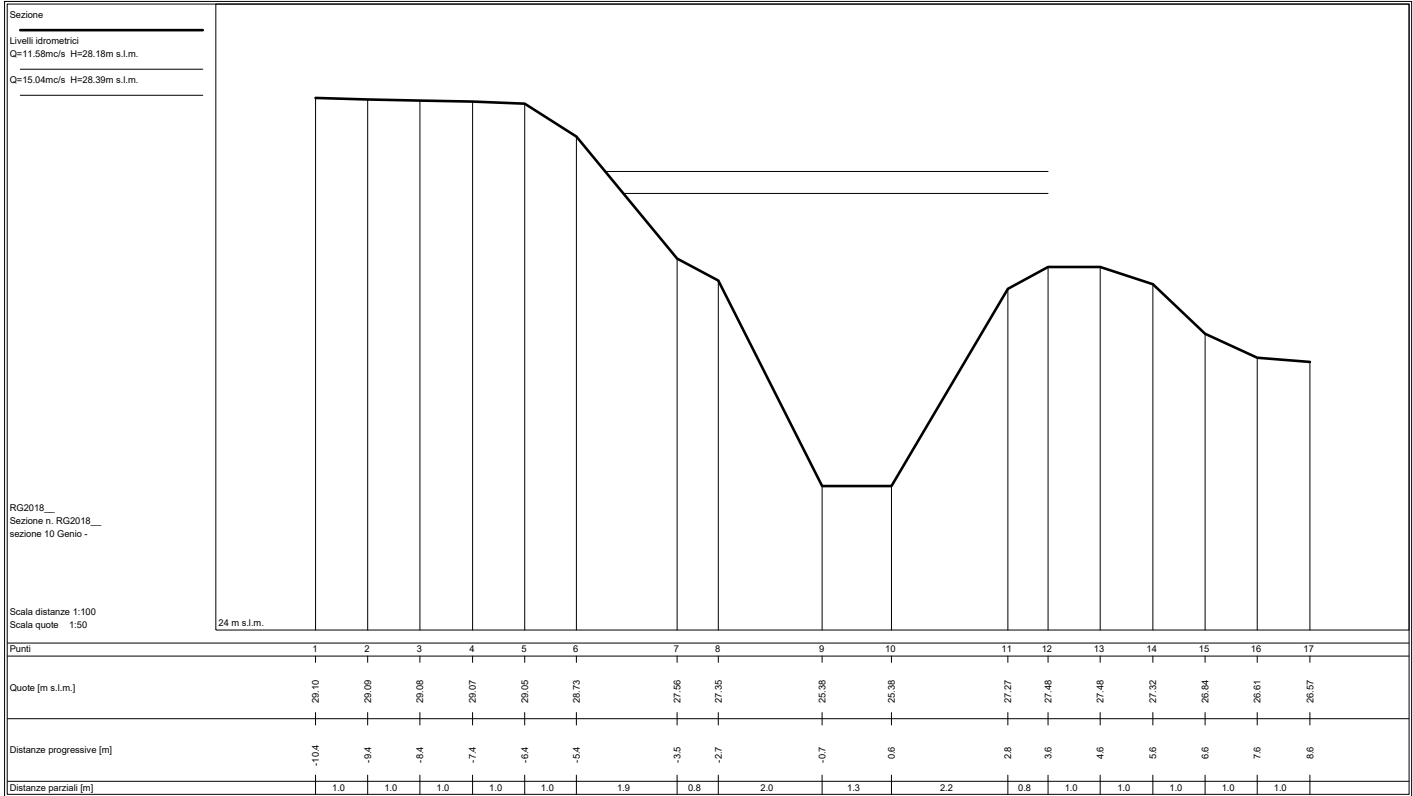

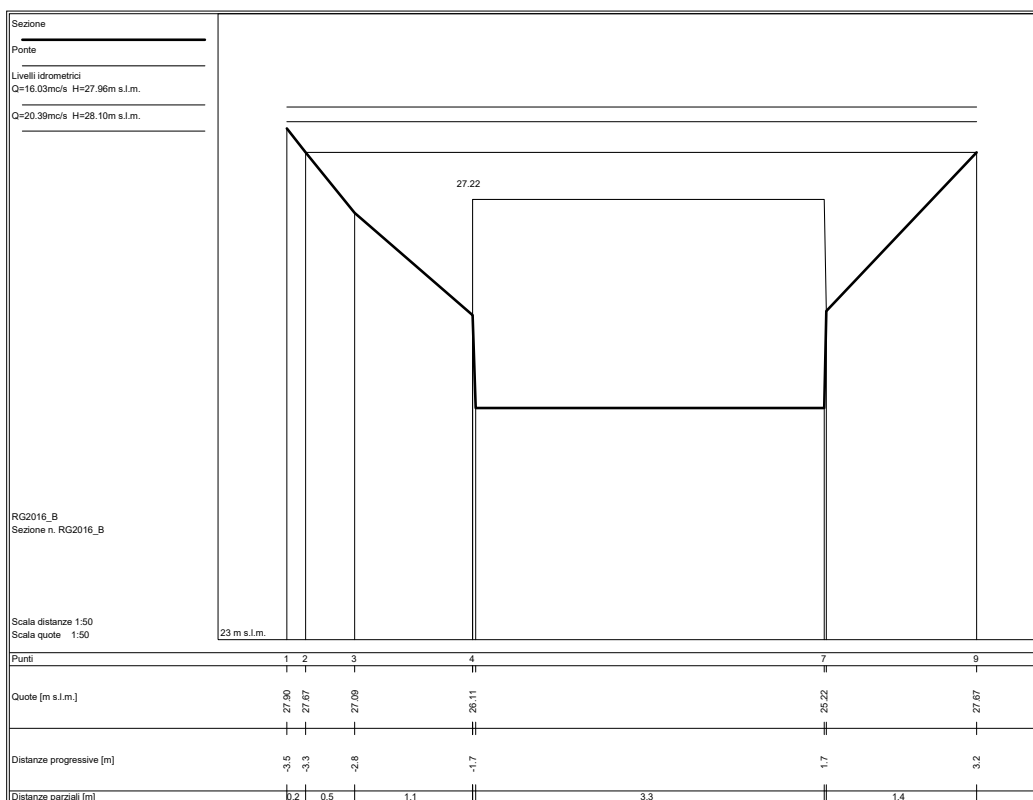
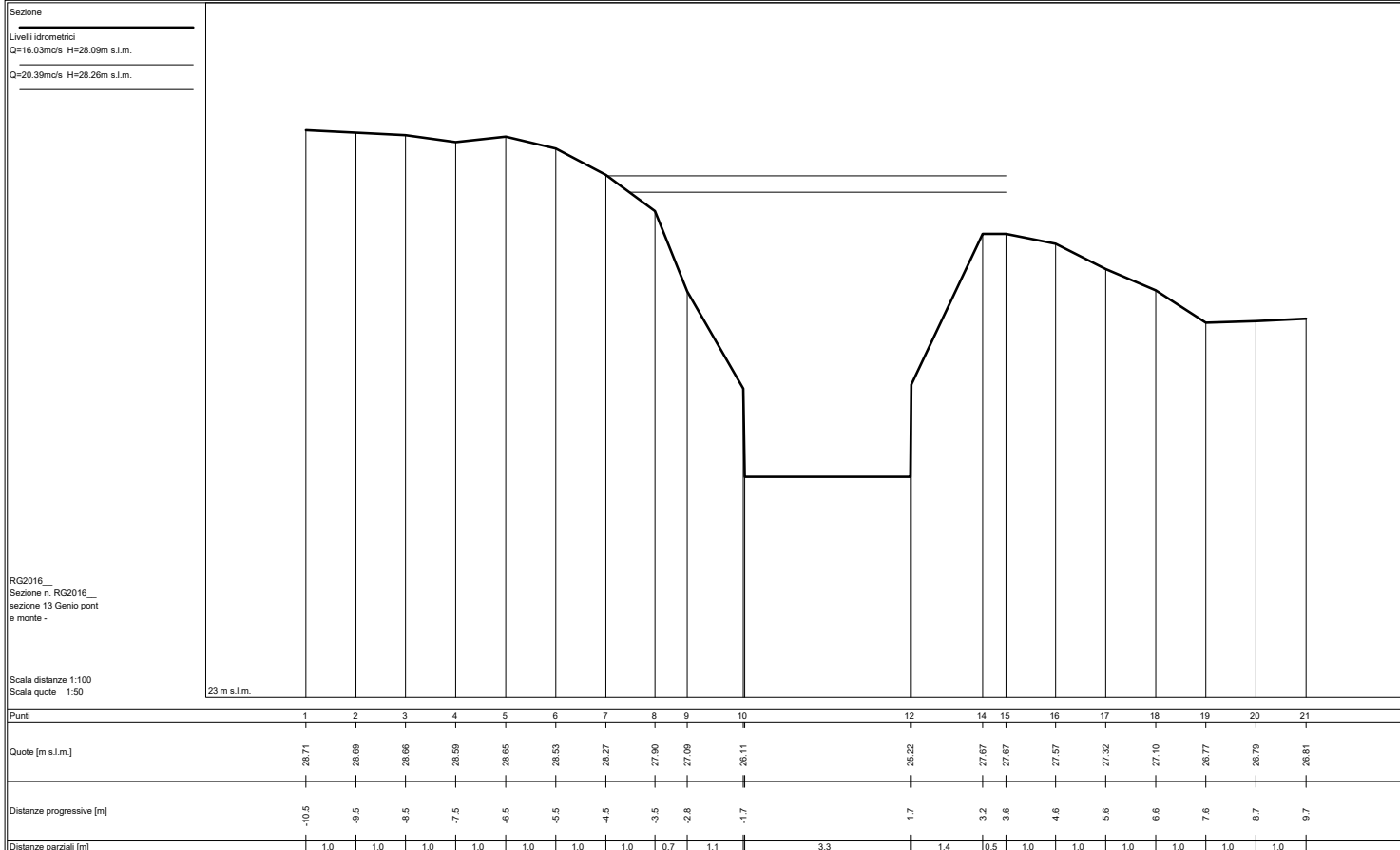

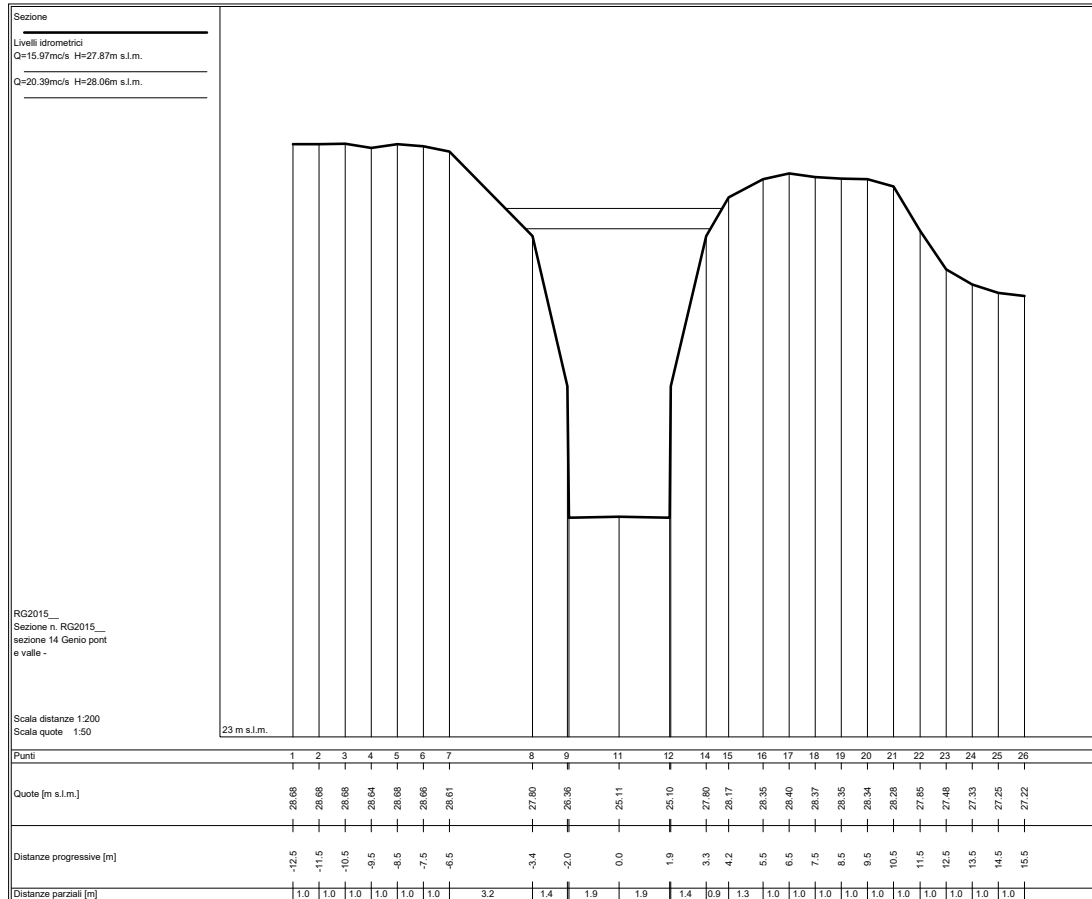
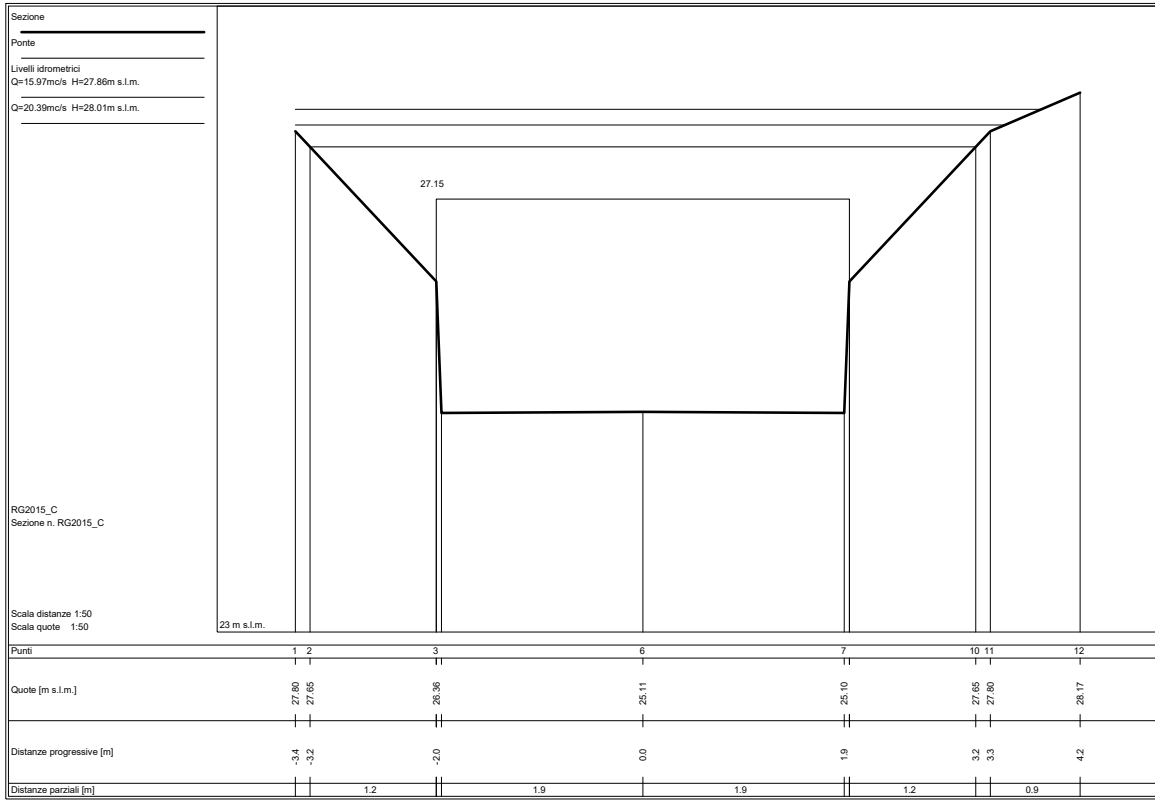

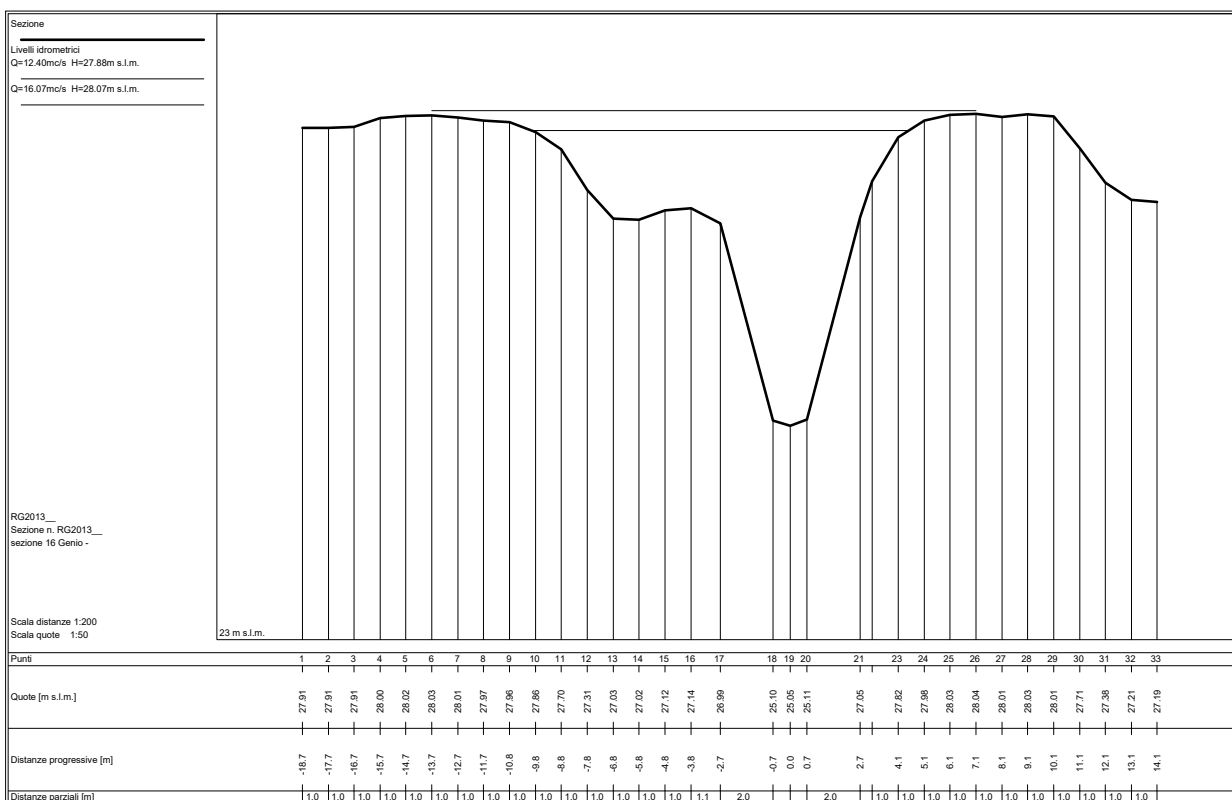
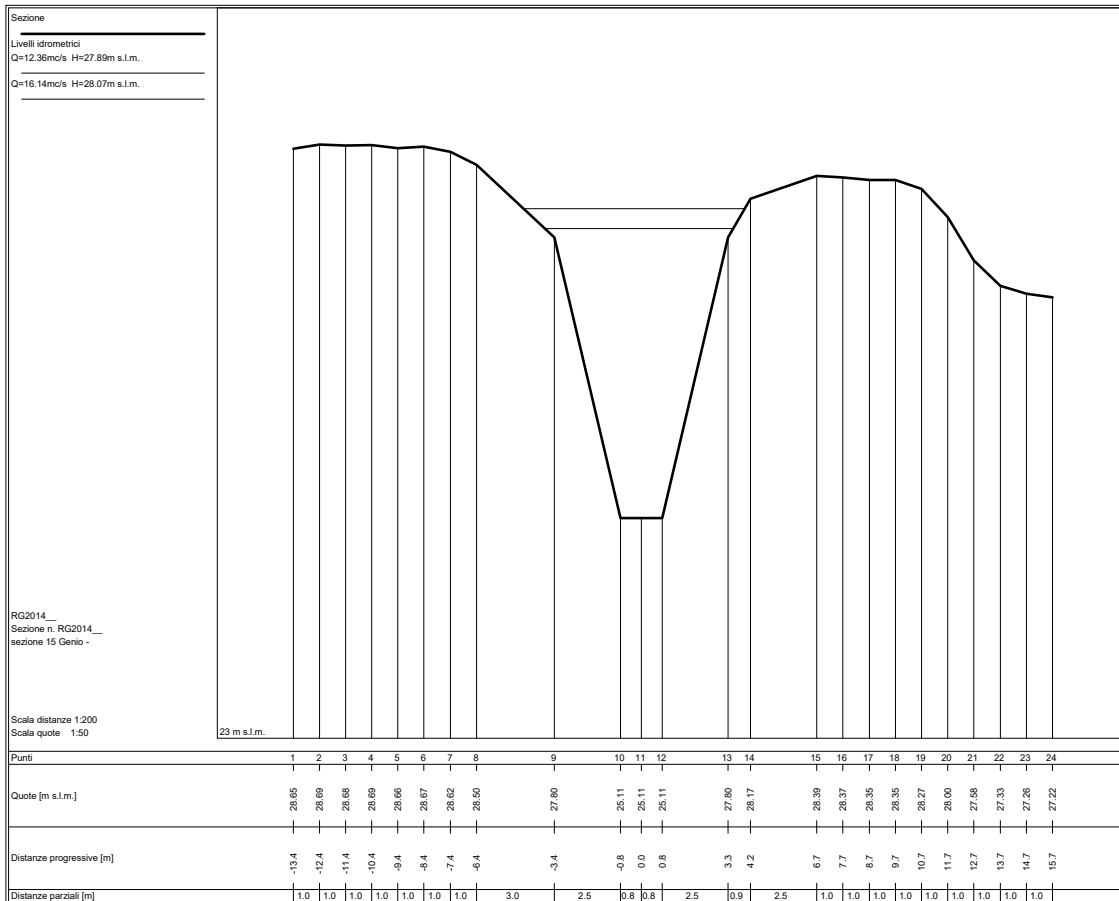

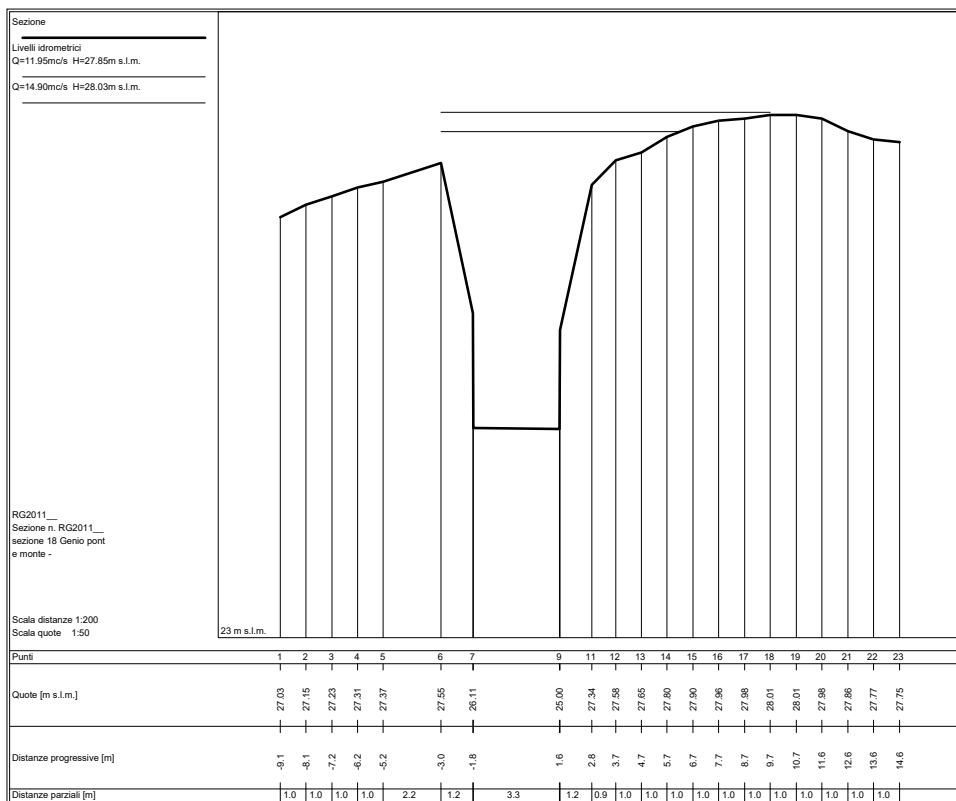
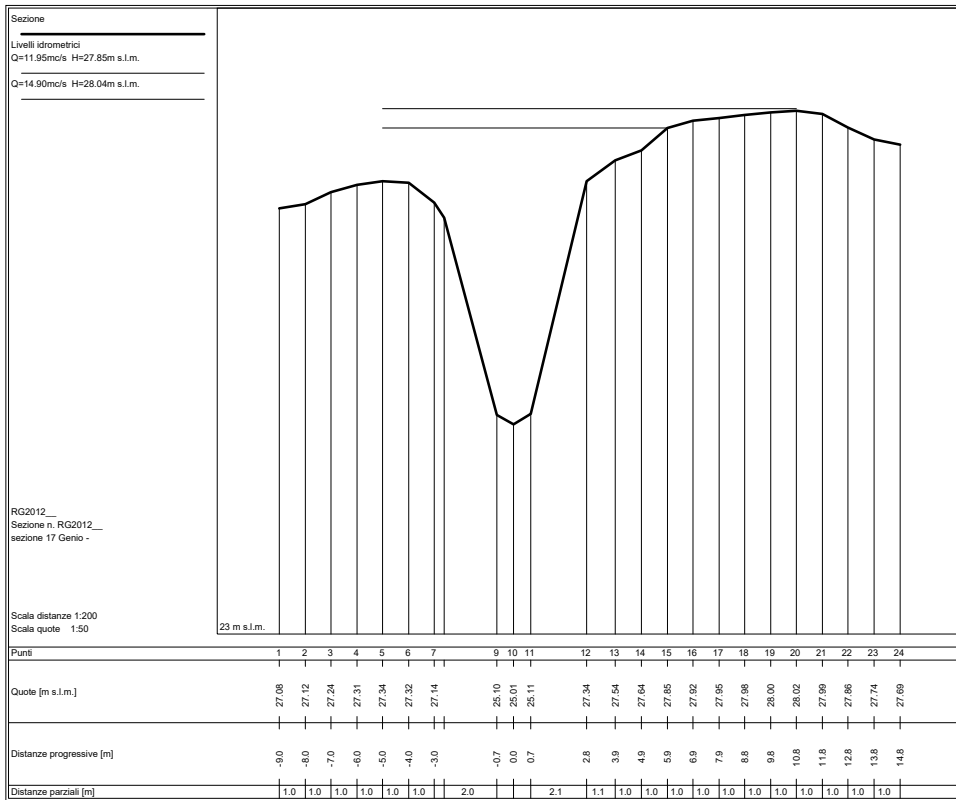

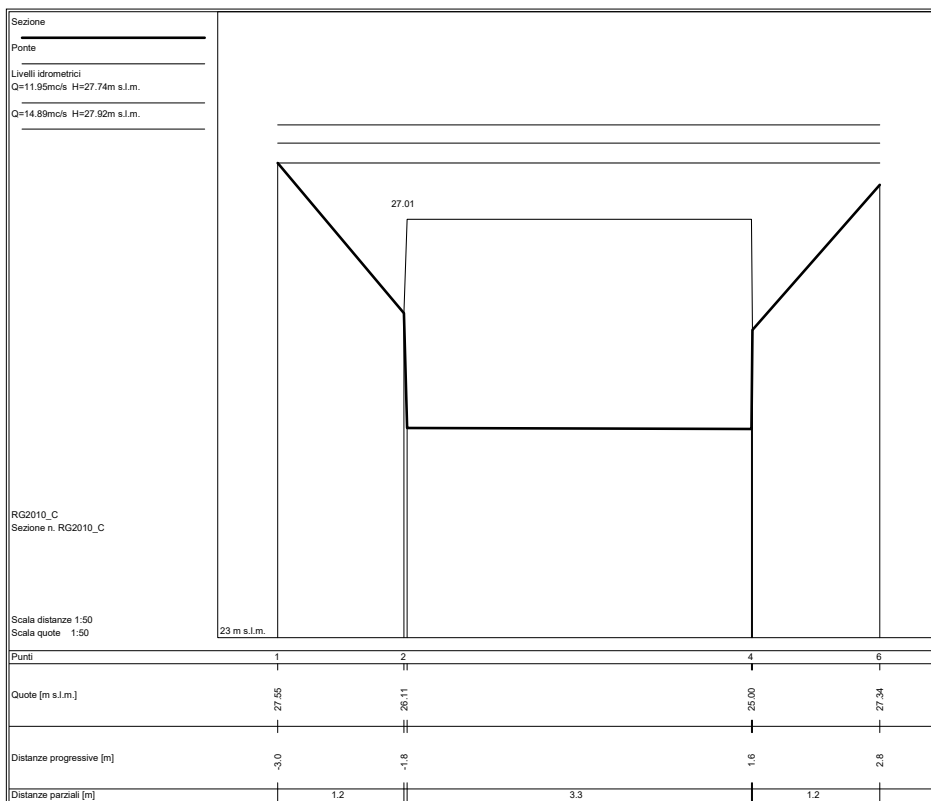
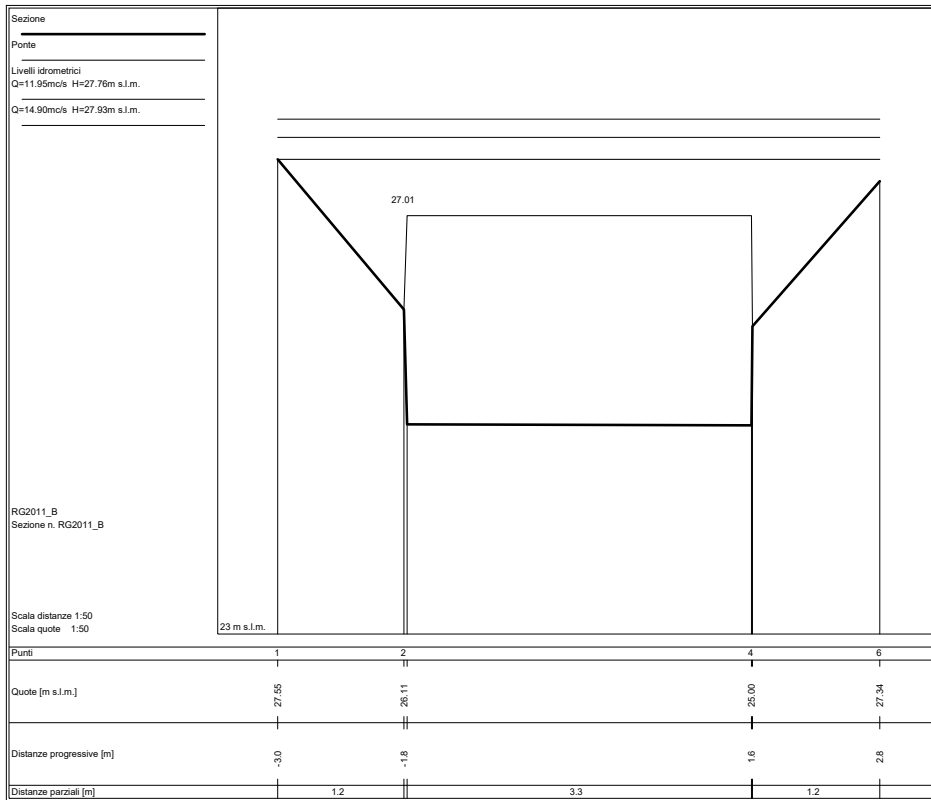

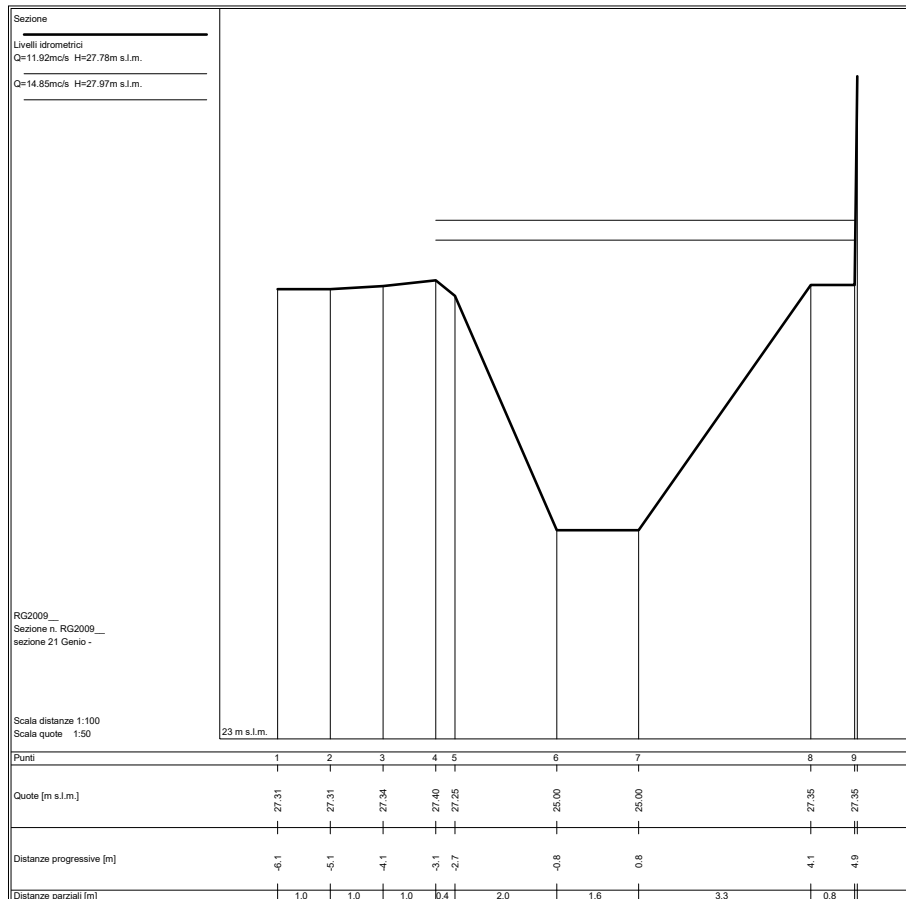
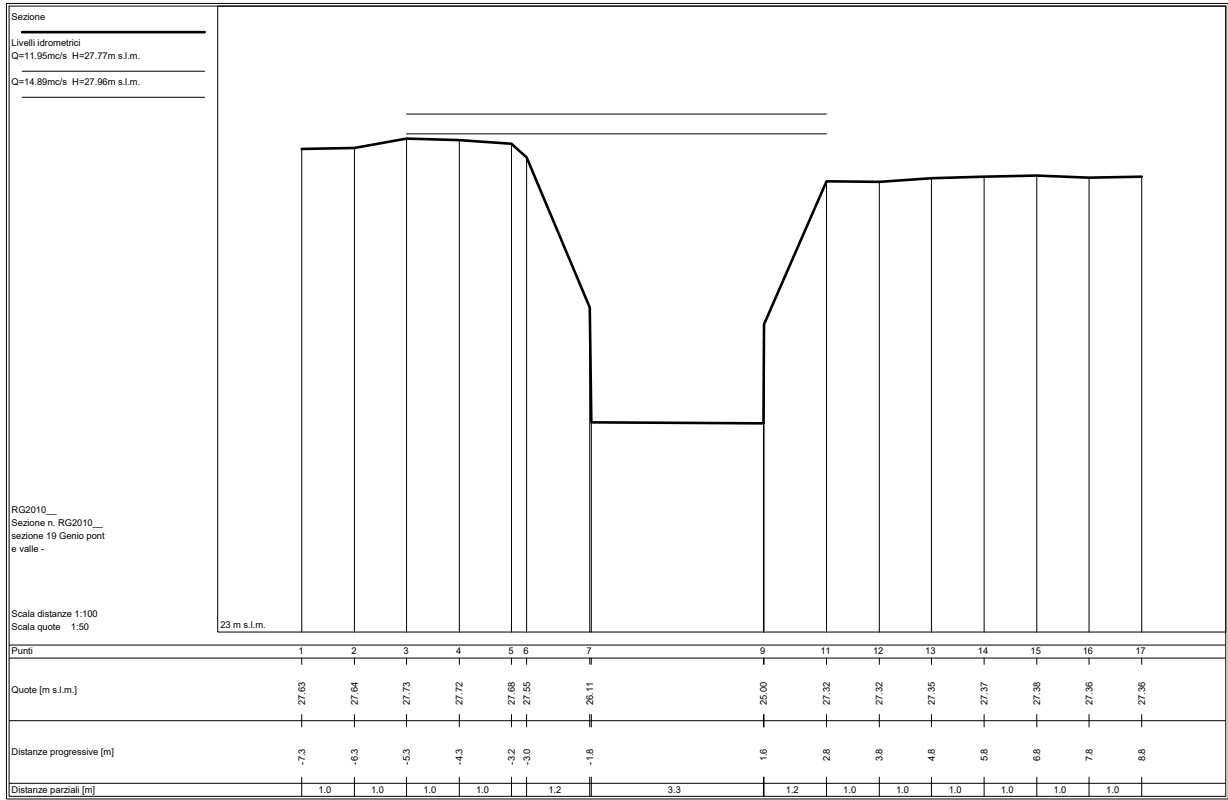

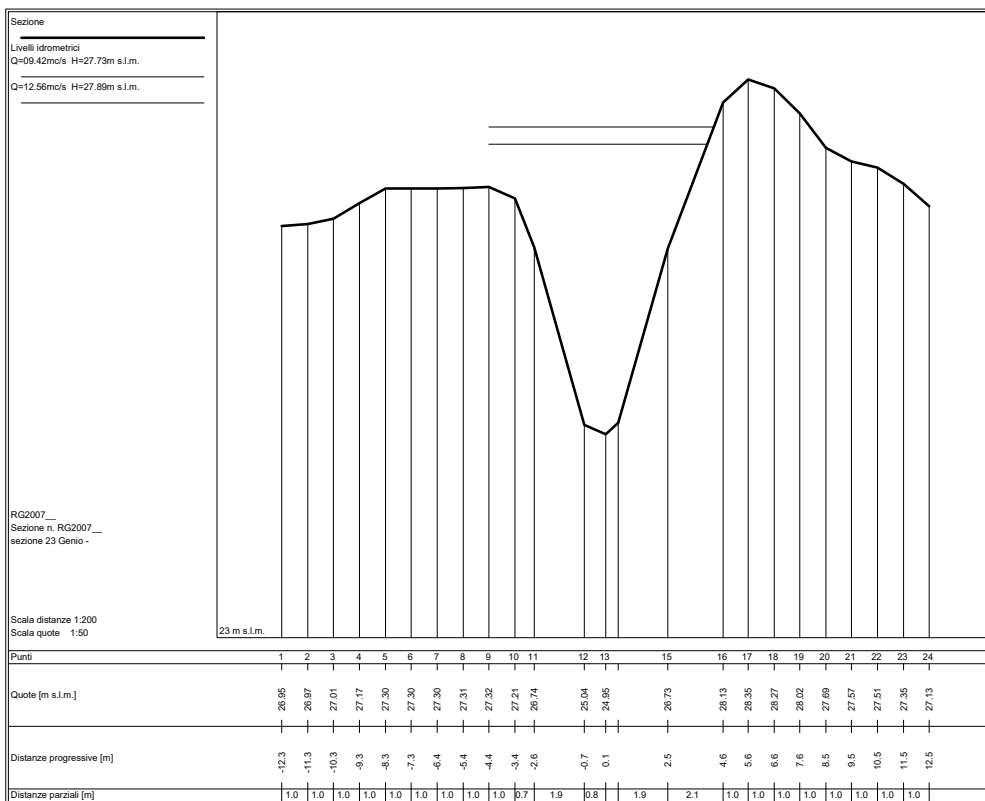
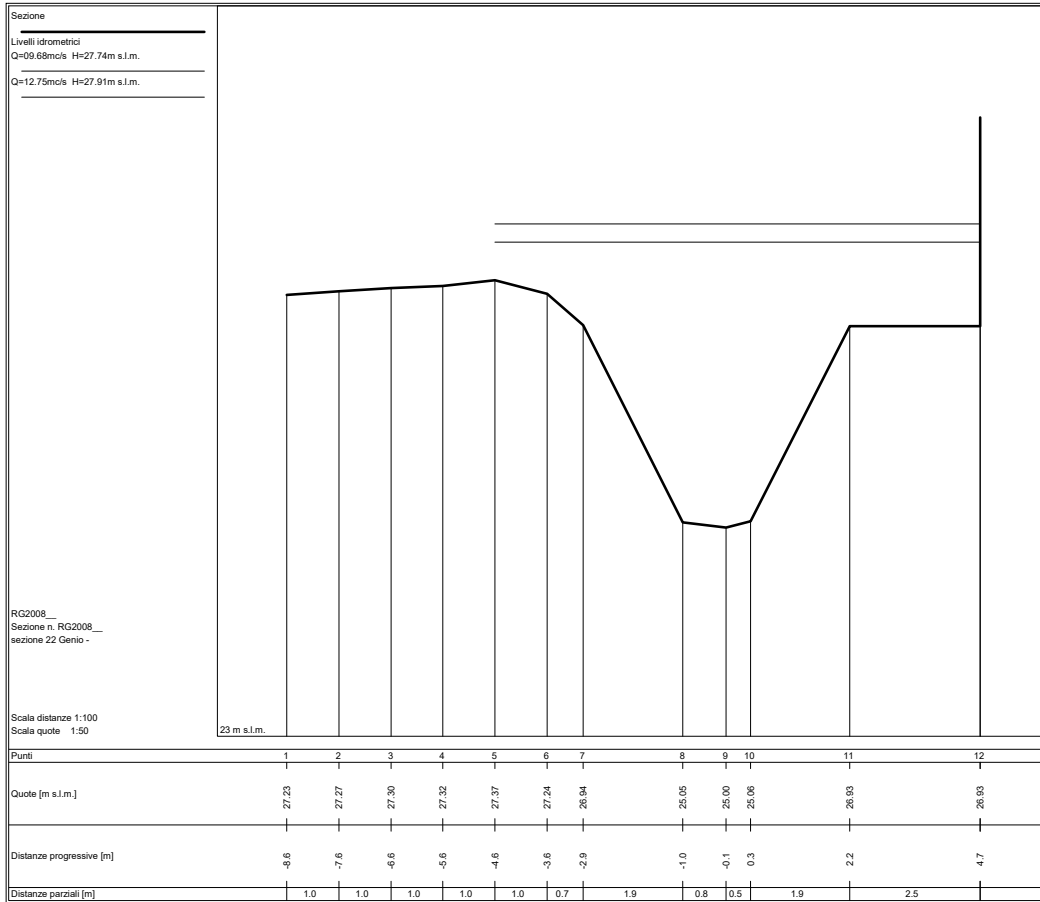

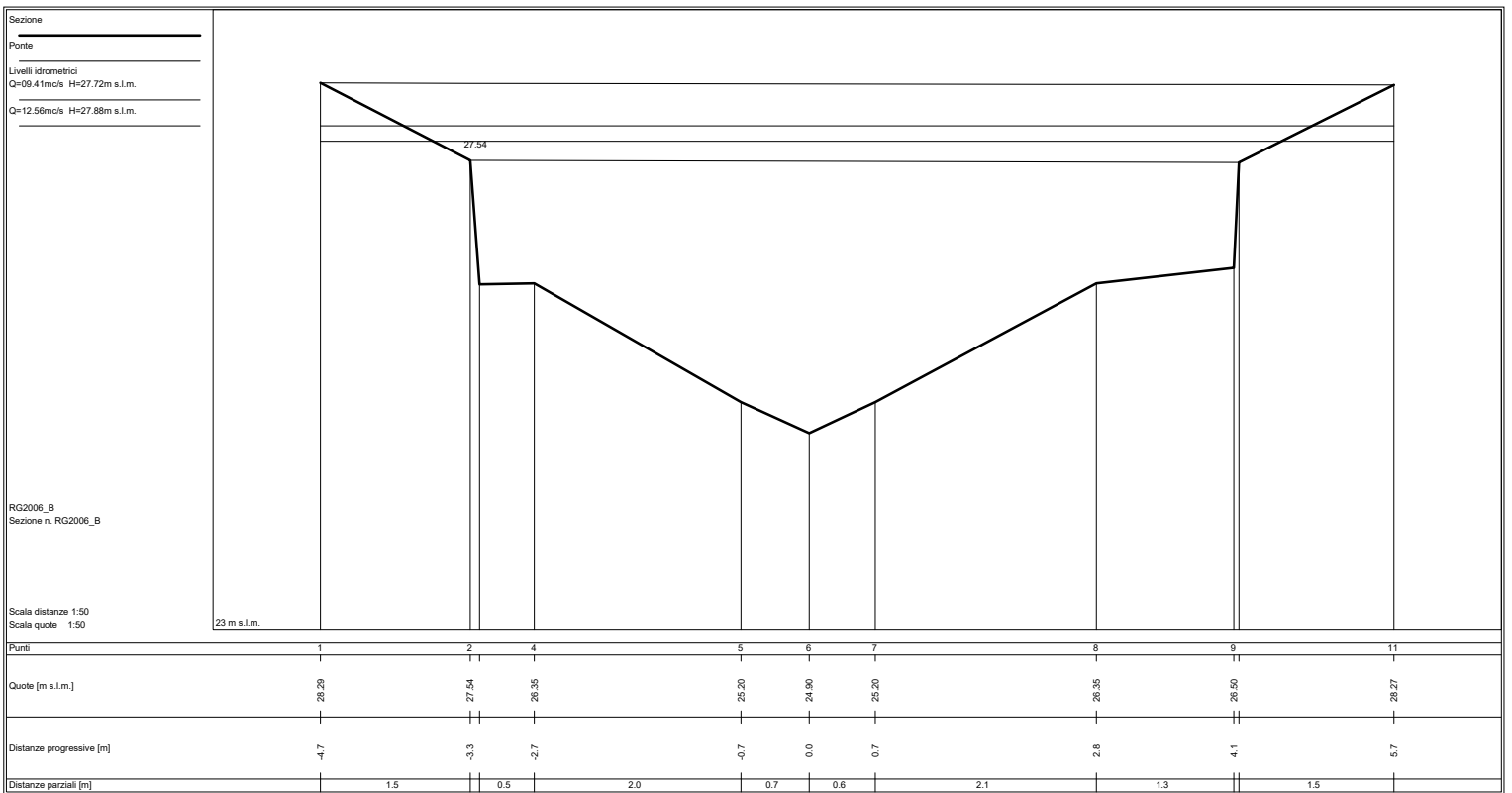
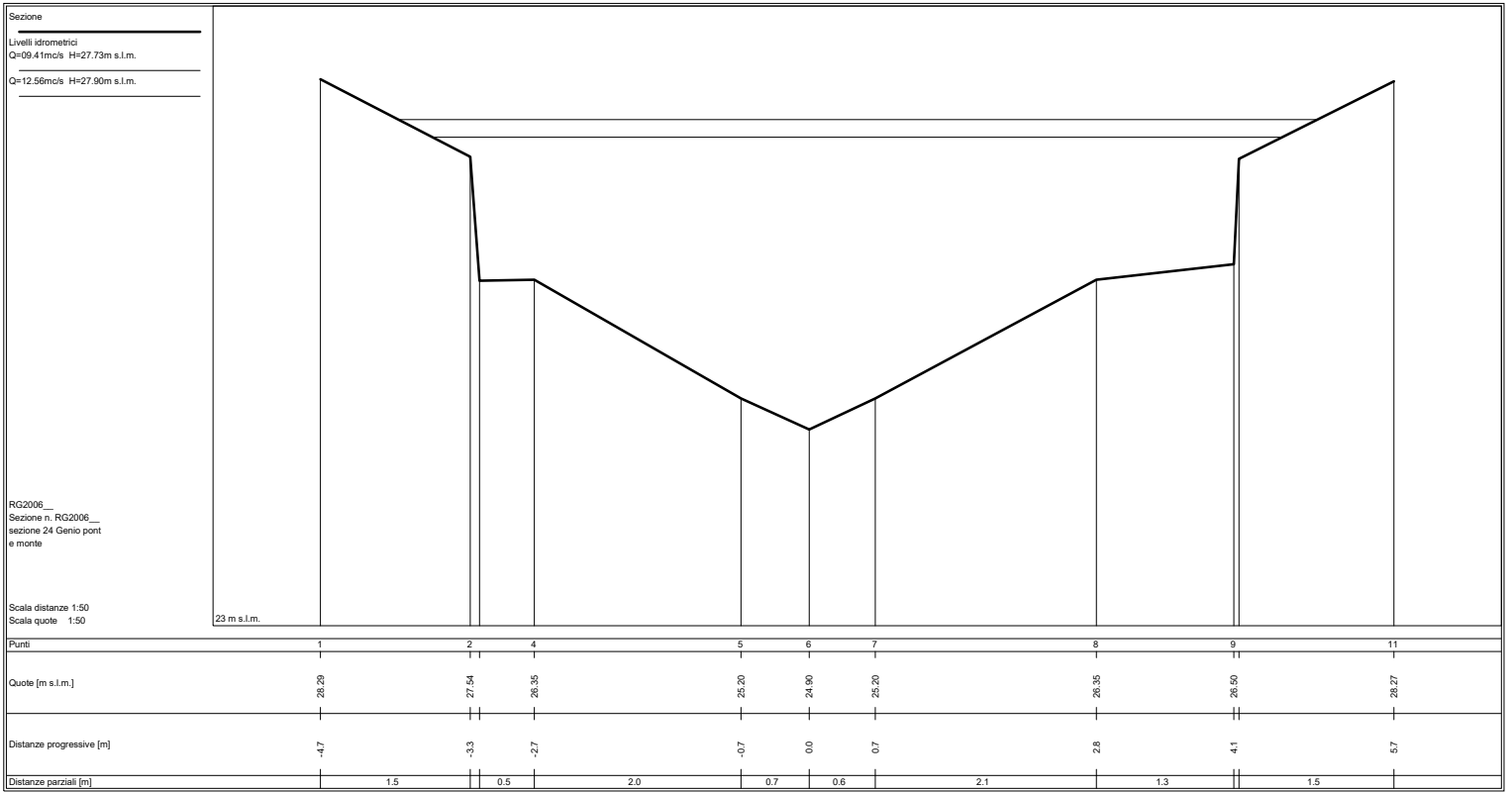

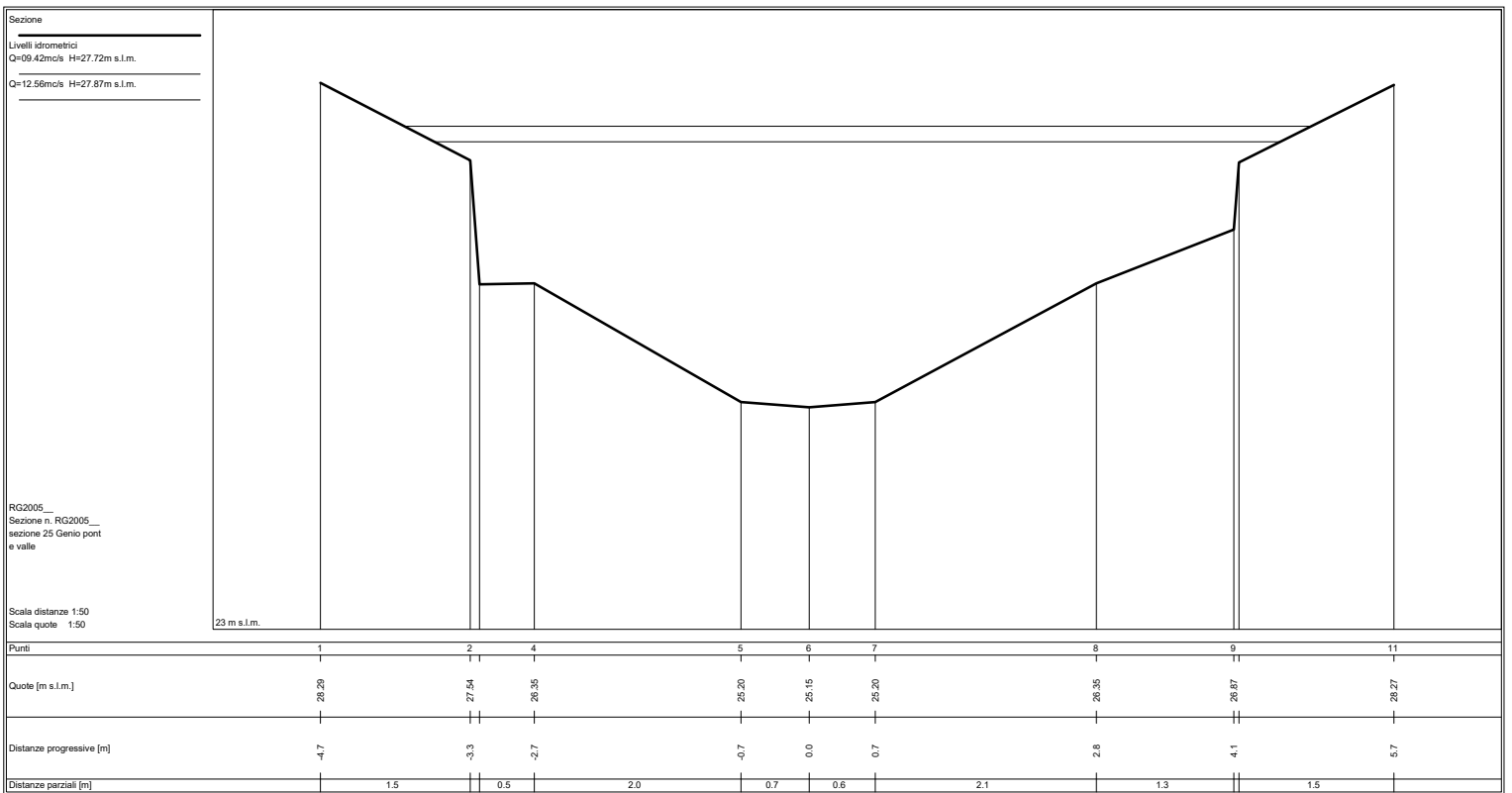
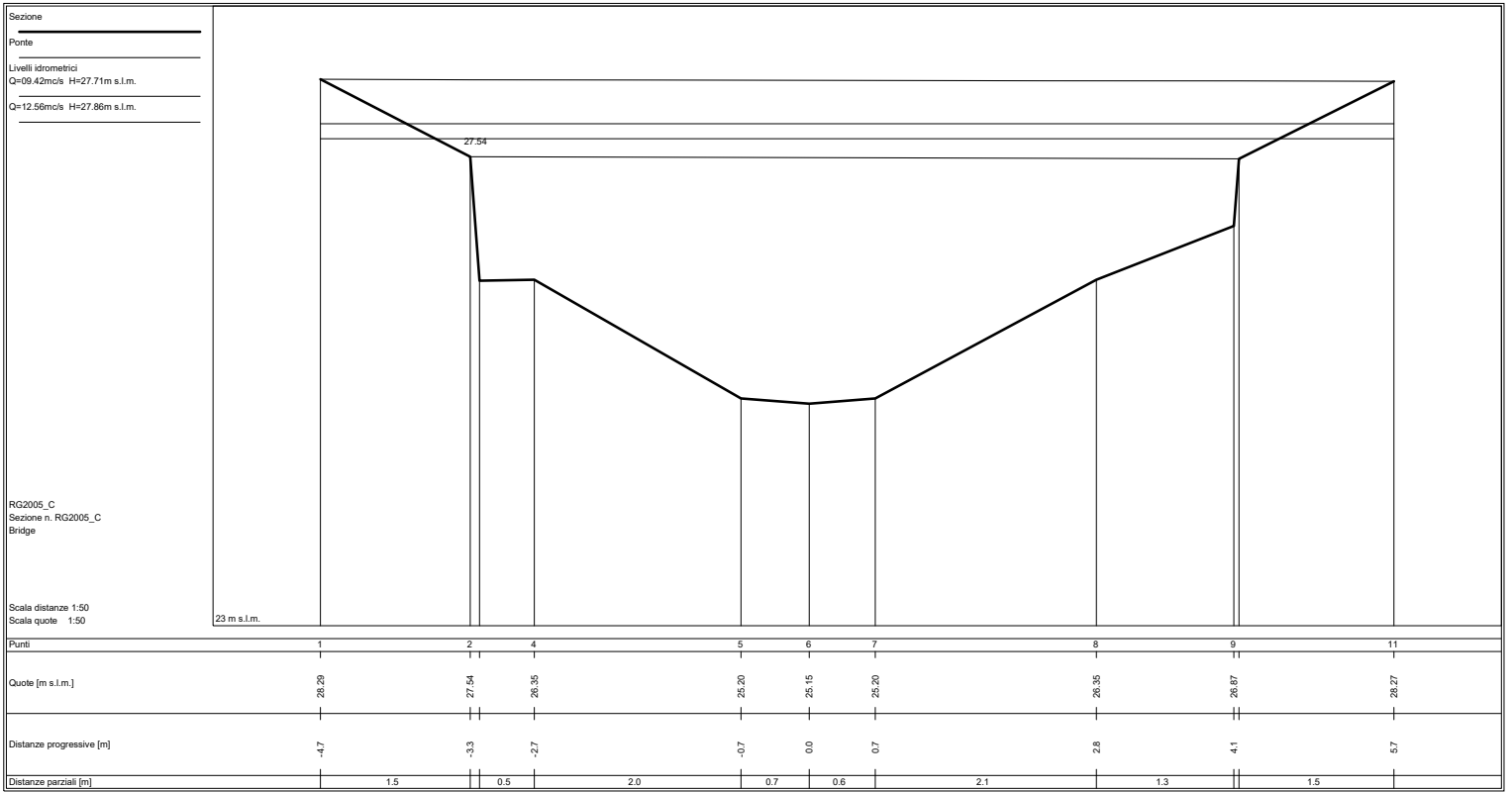

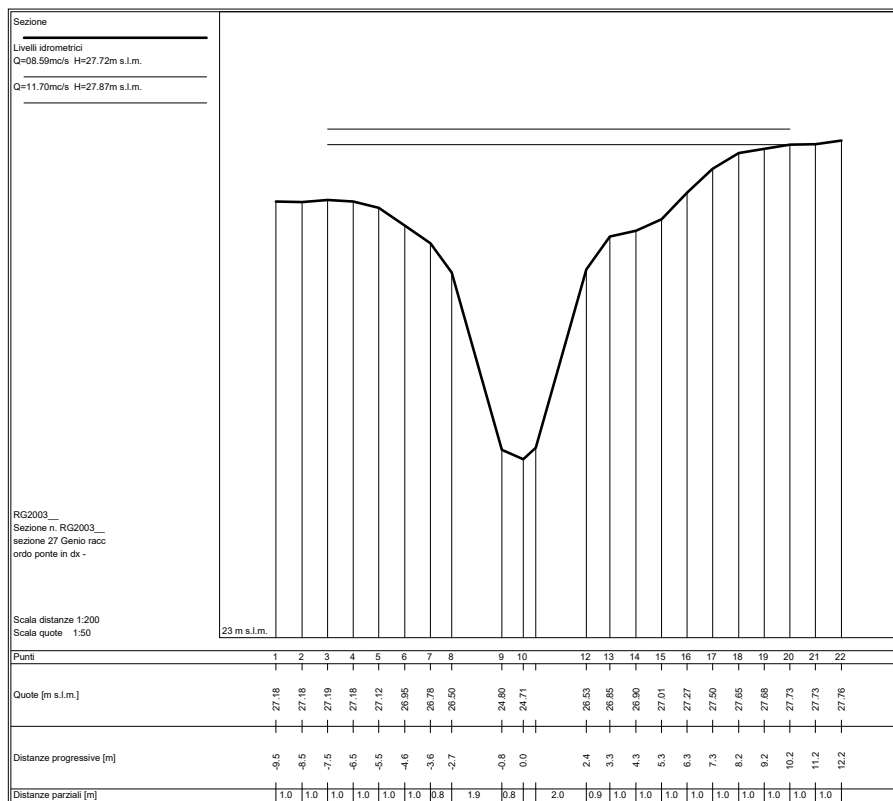
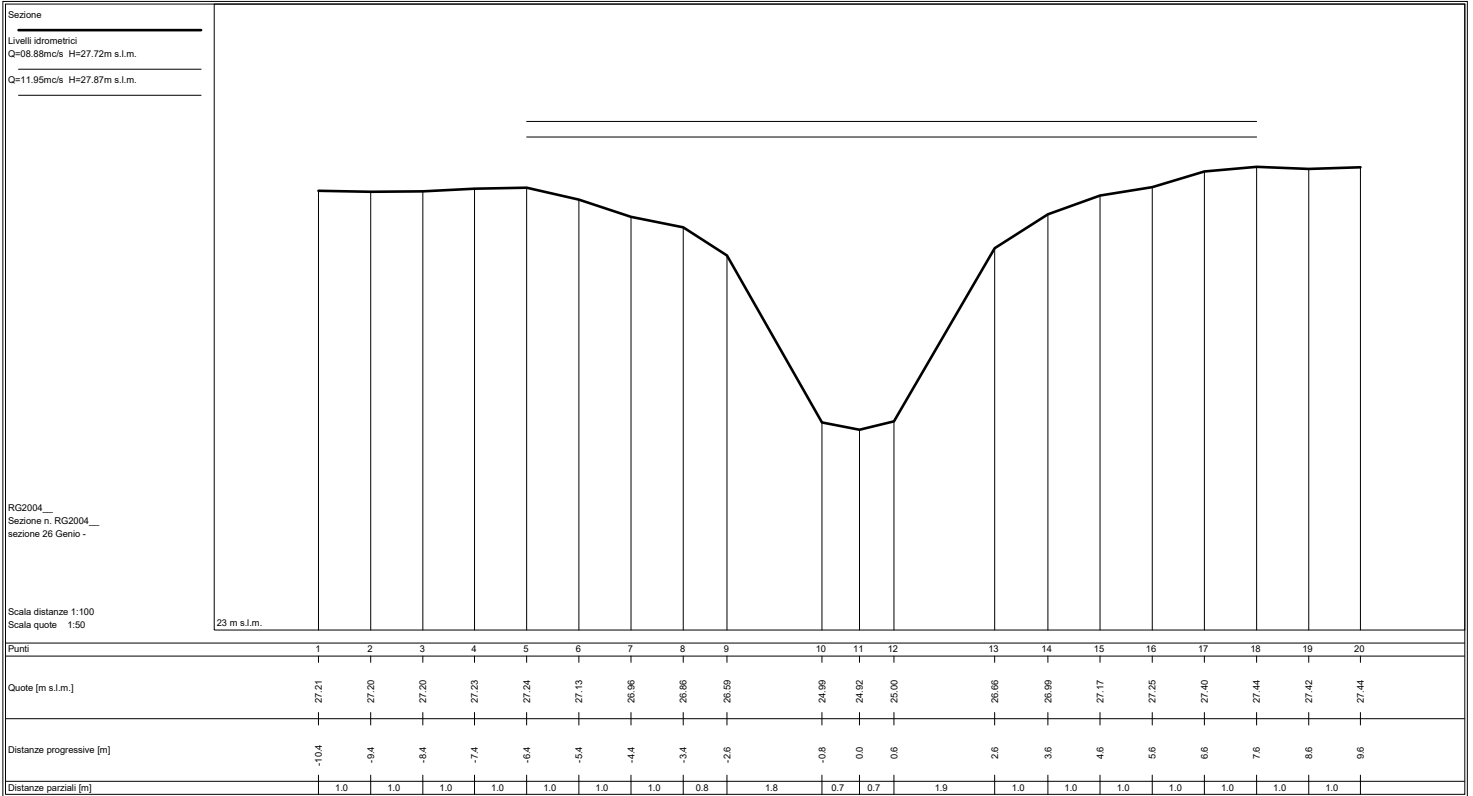

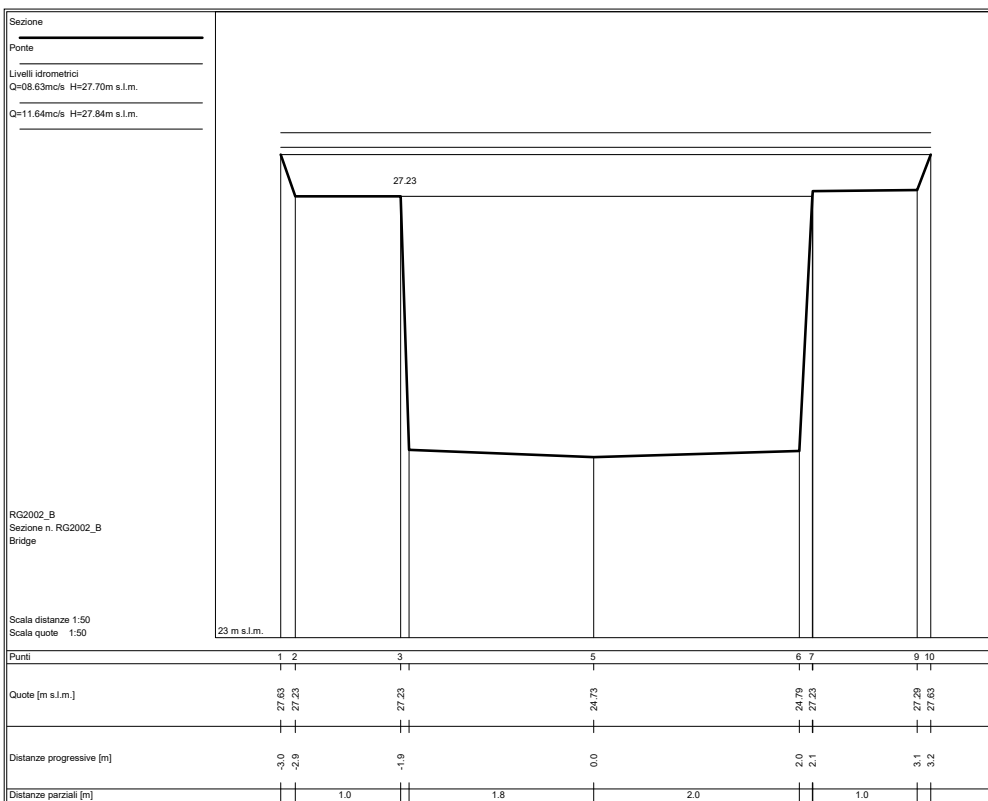
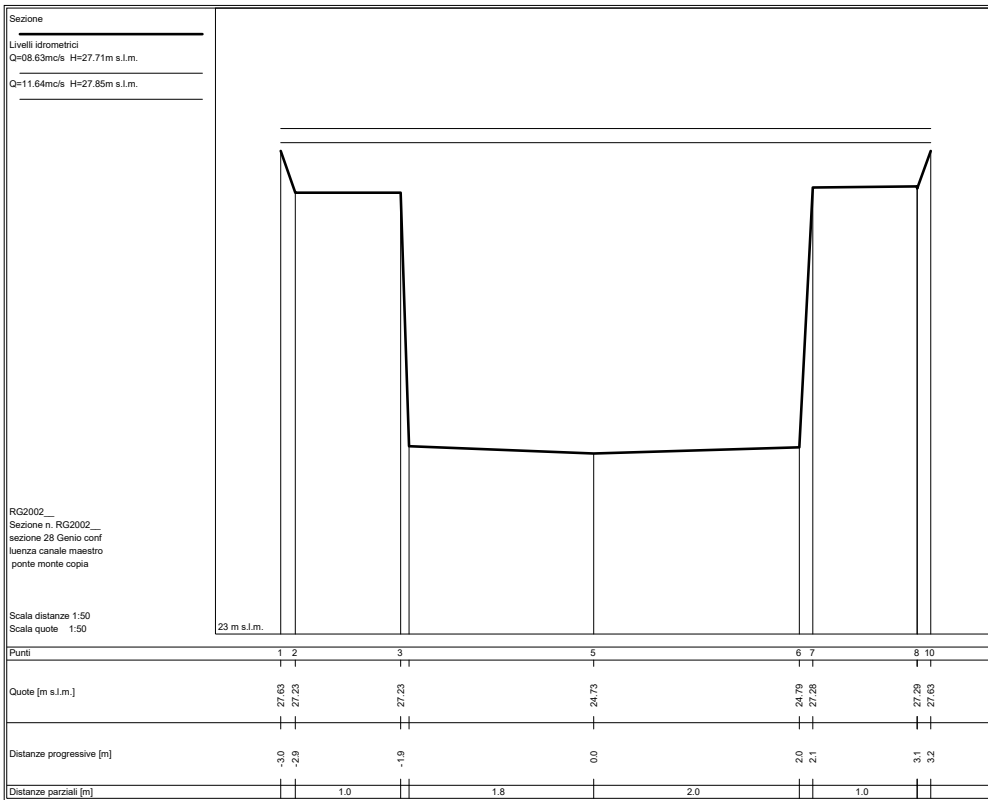

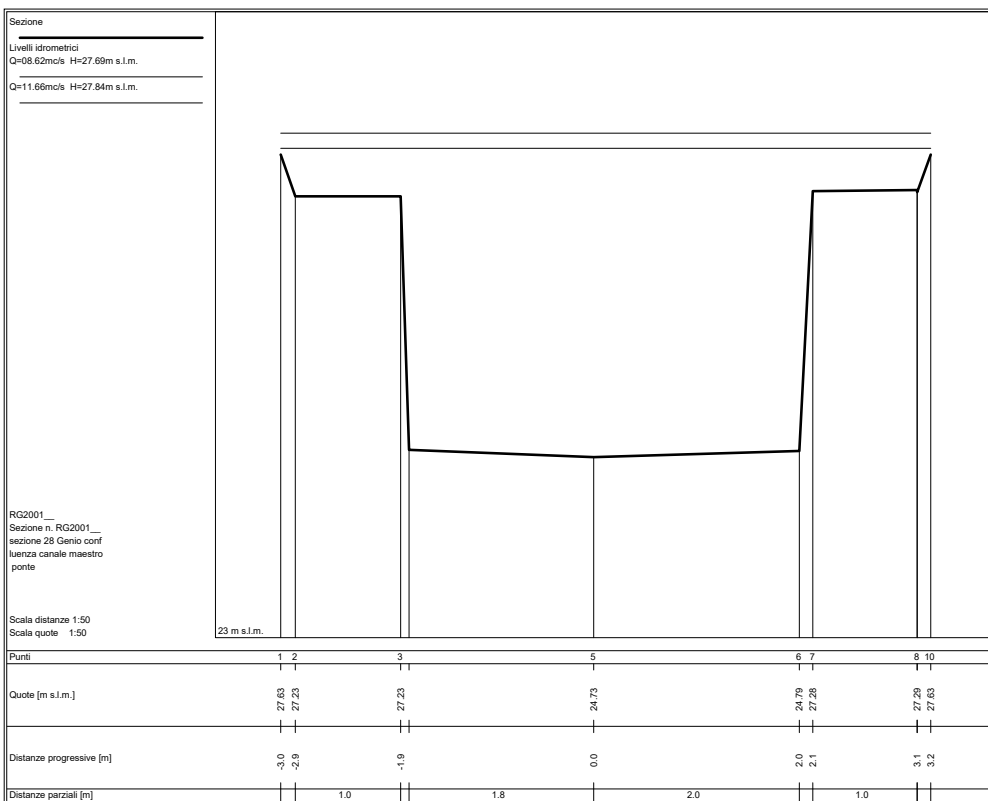
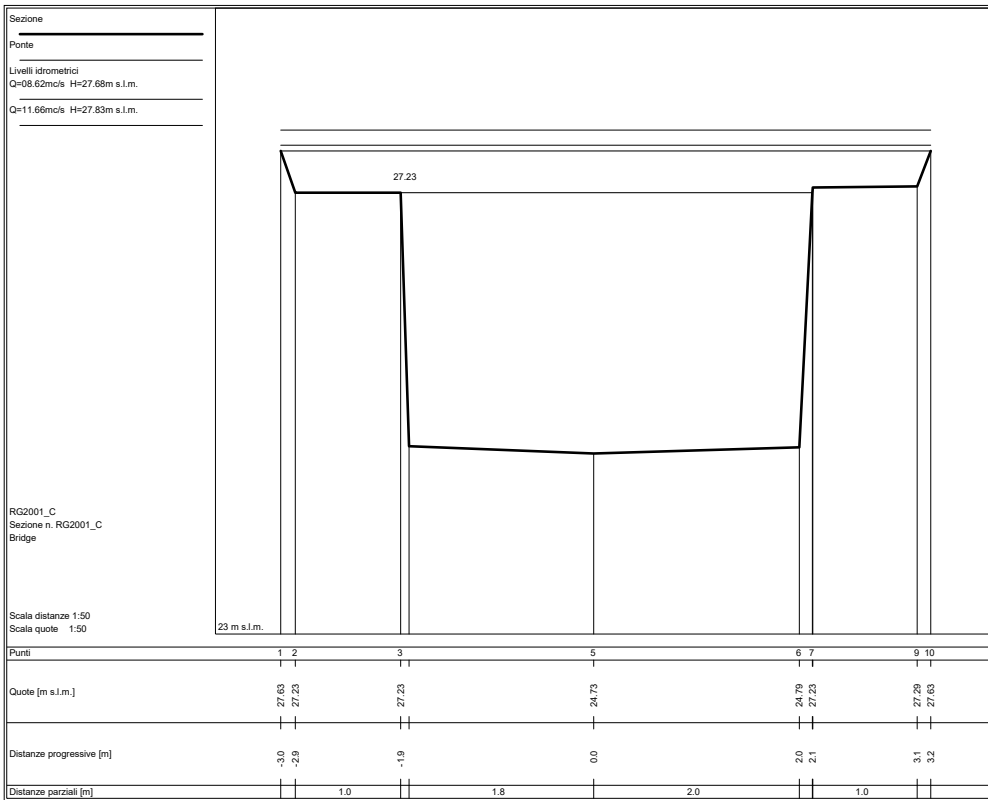

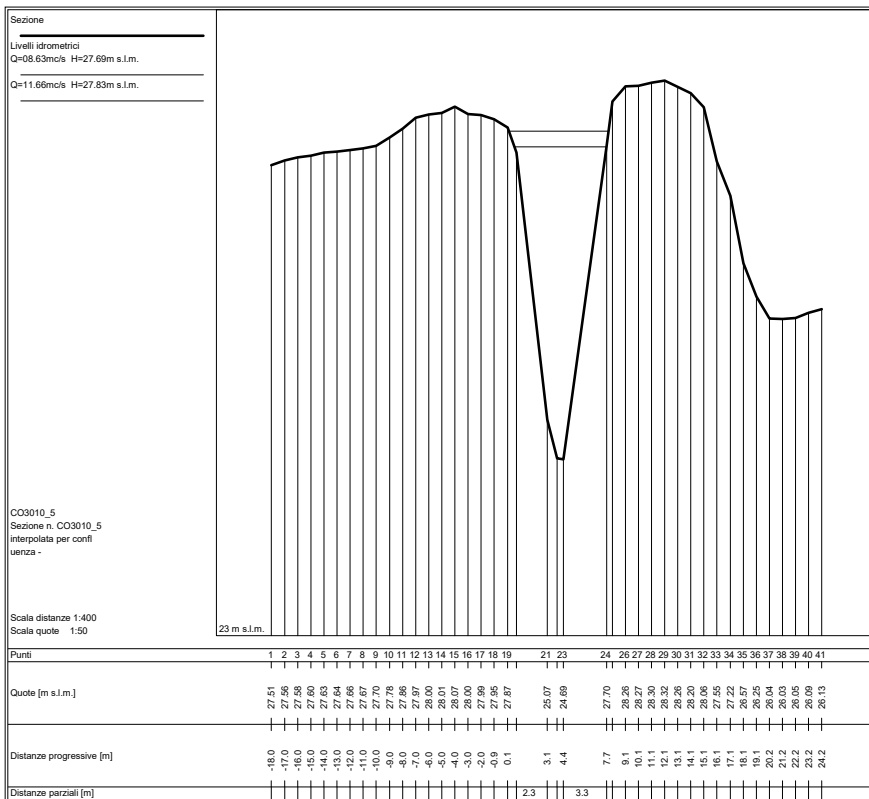
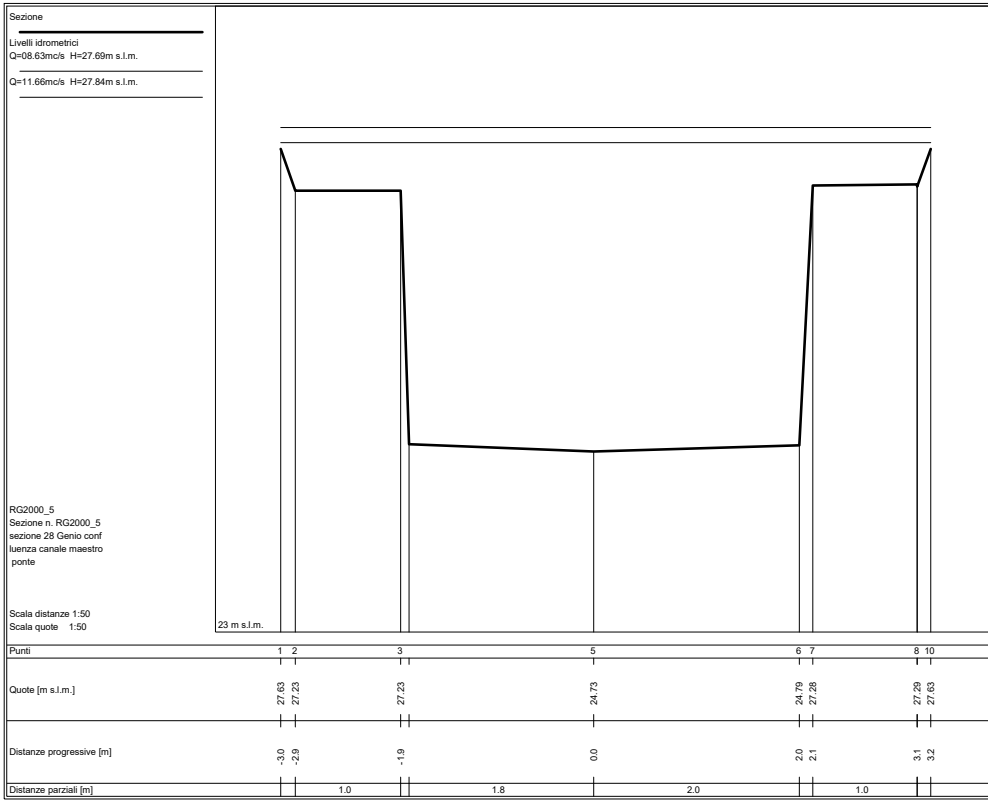

SEZIONI FLUVIALI
RIO SAMMONTANA – tratto Monte

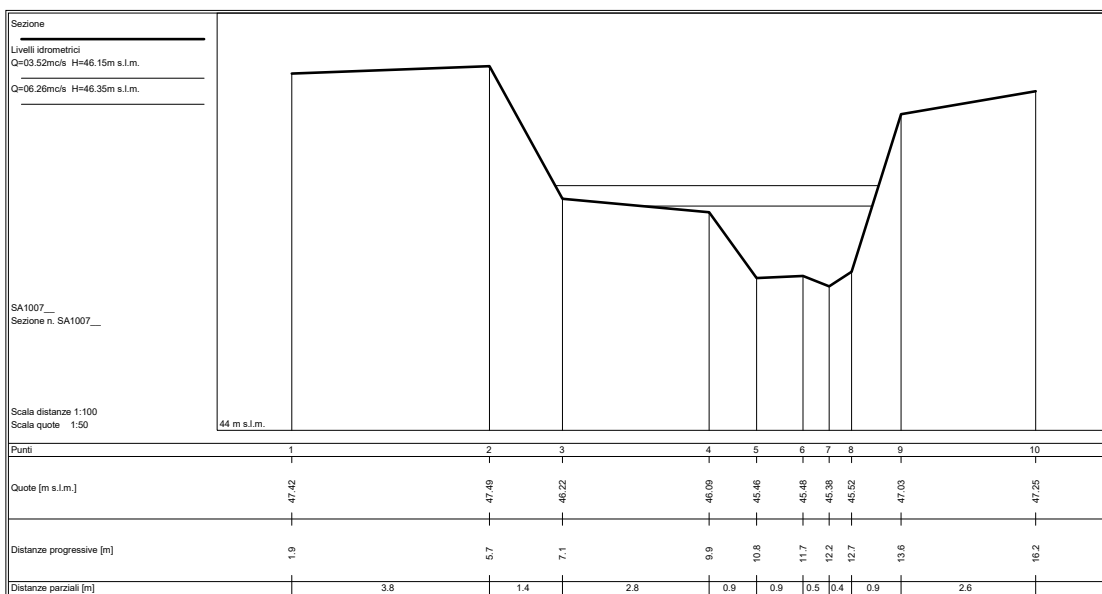
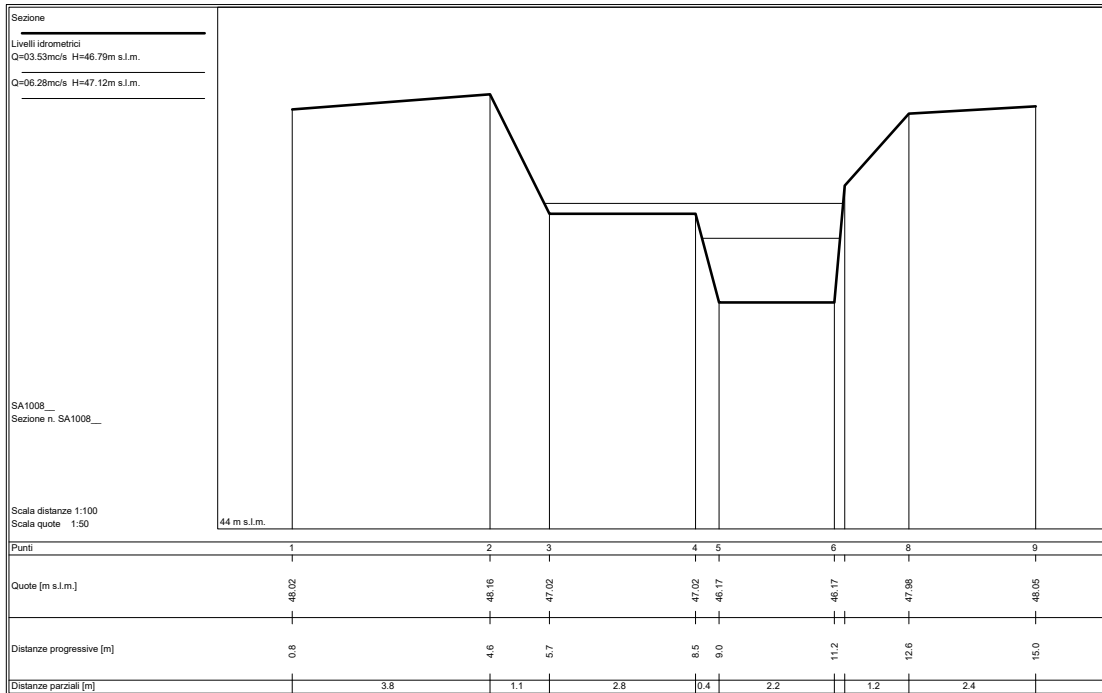

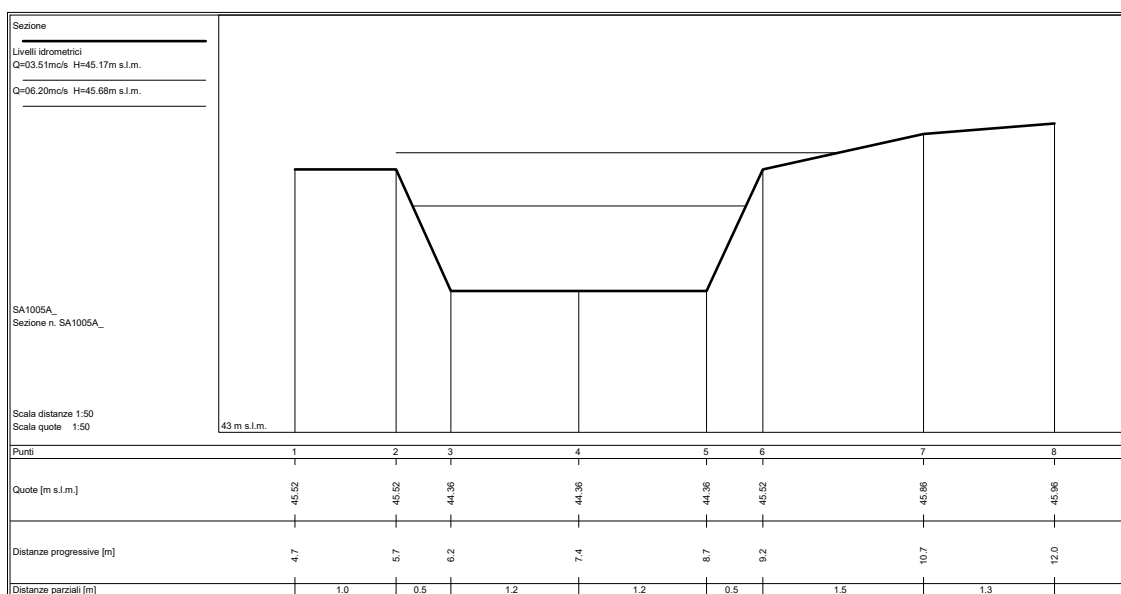
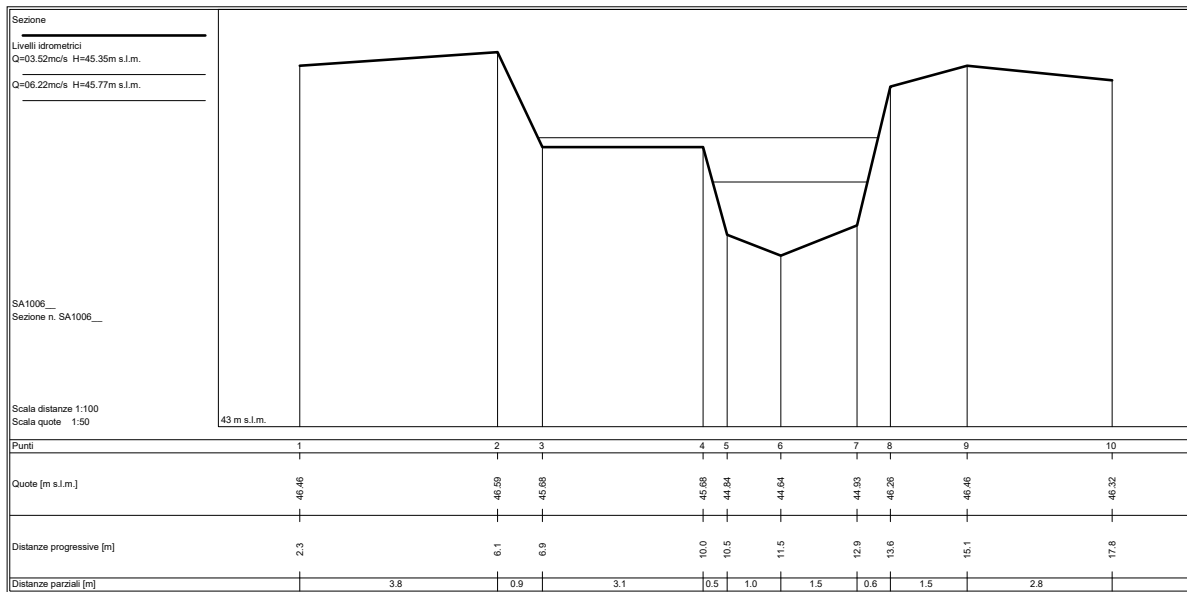

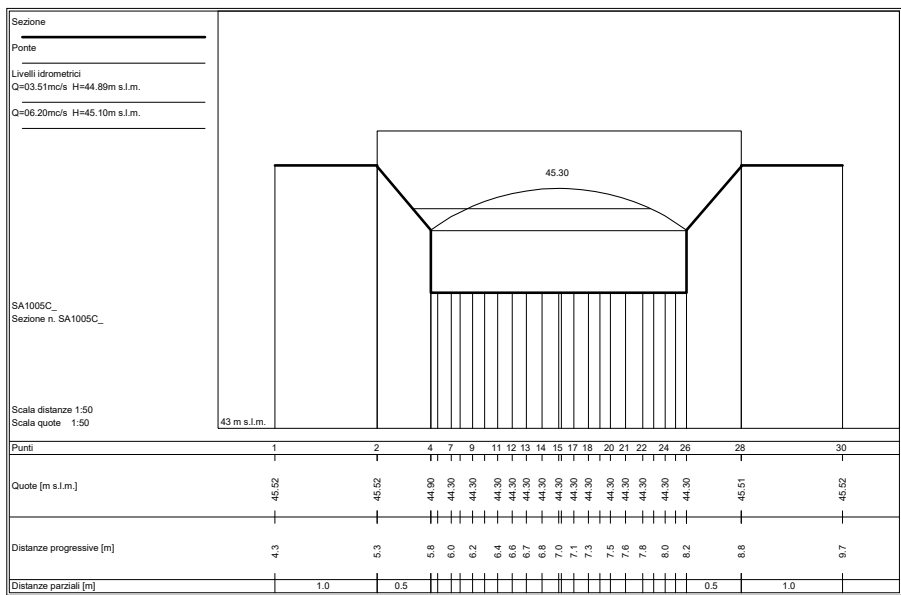
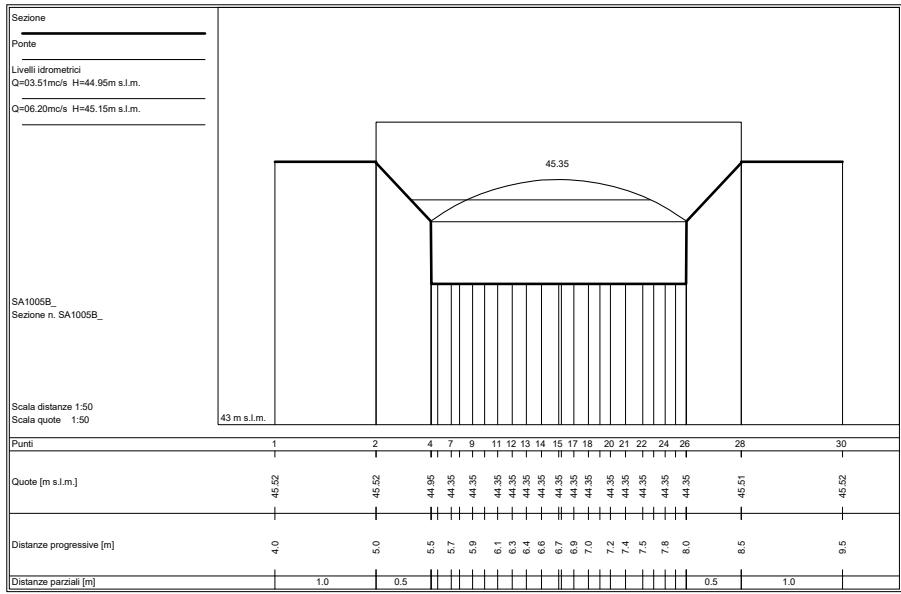

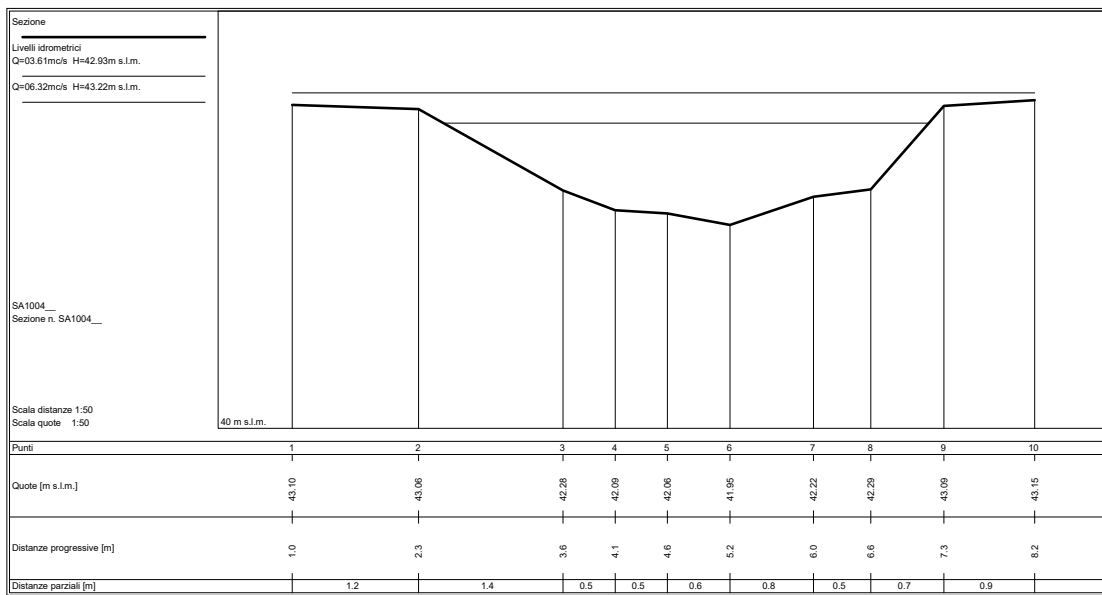
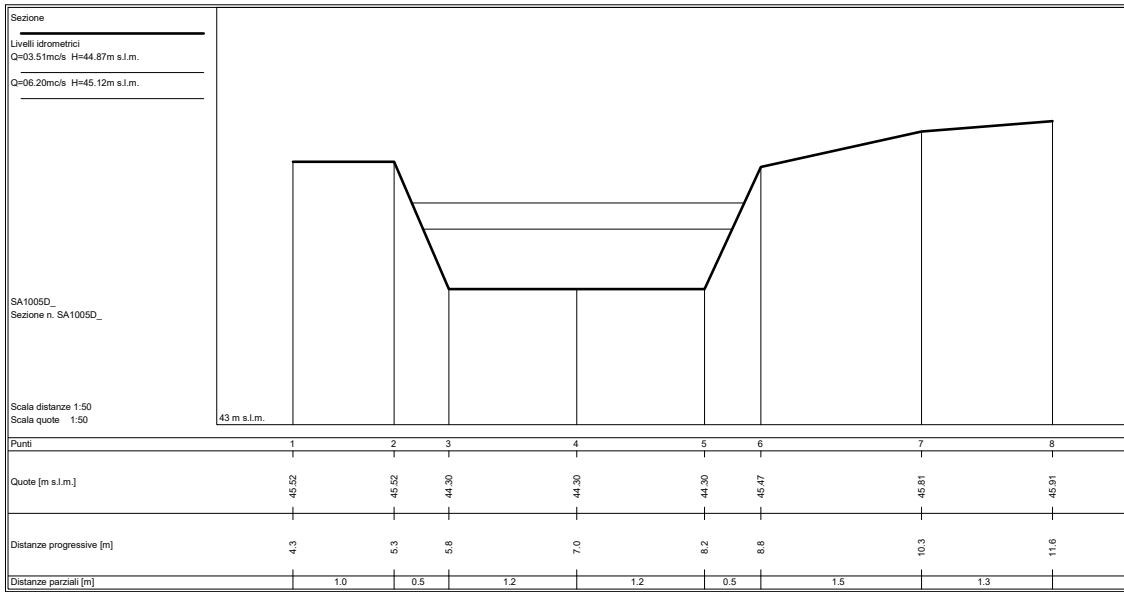

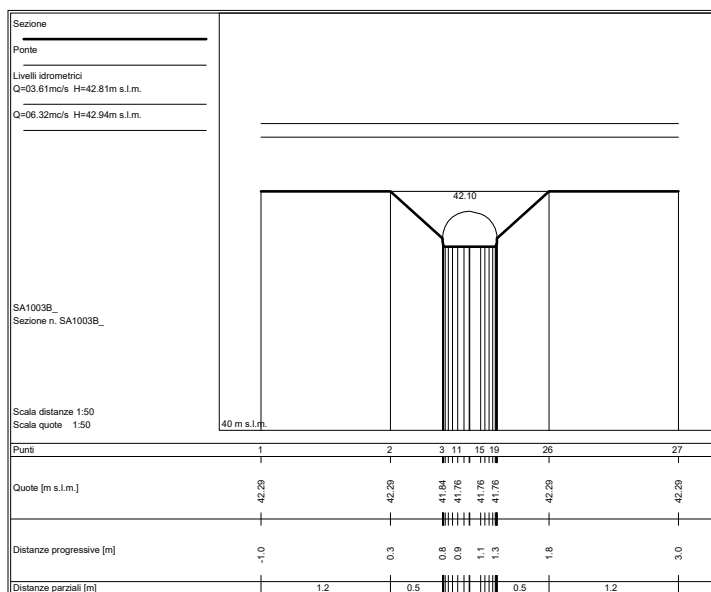
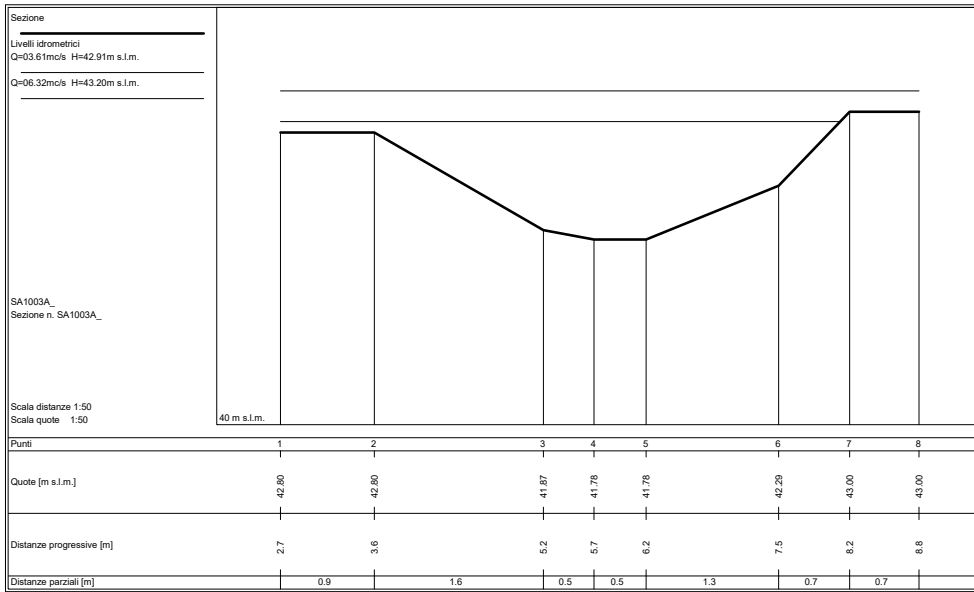

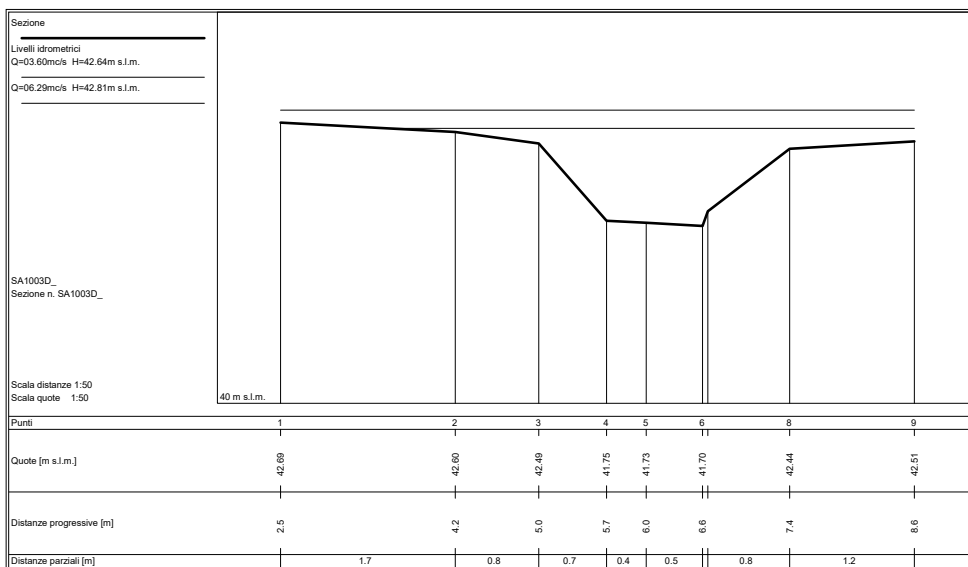
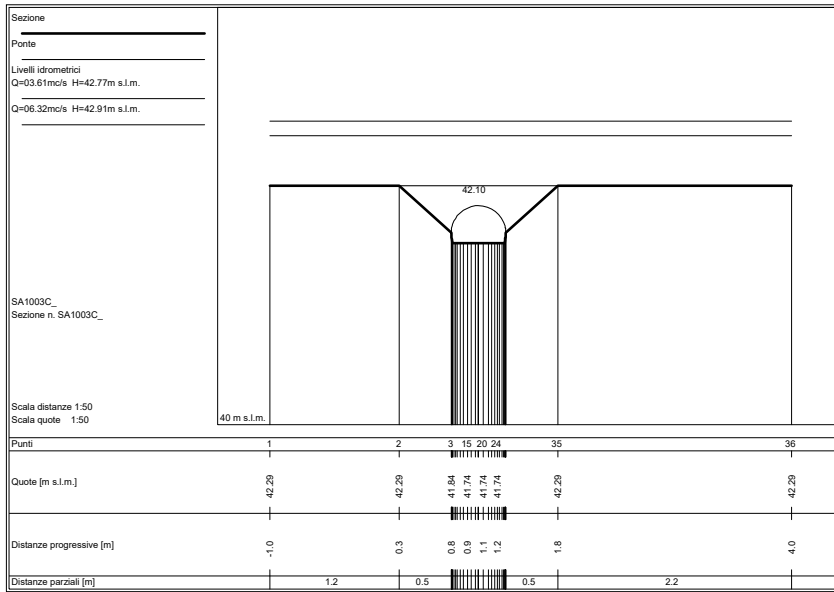

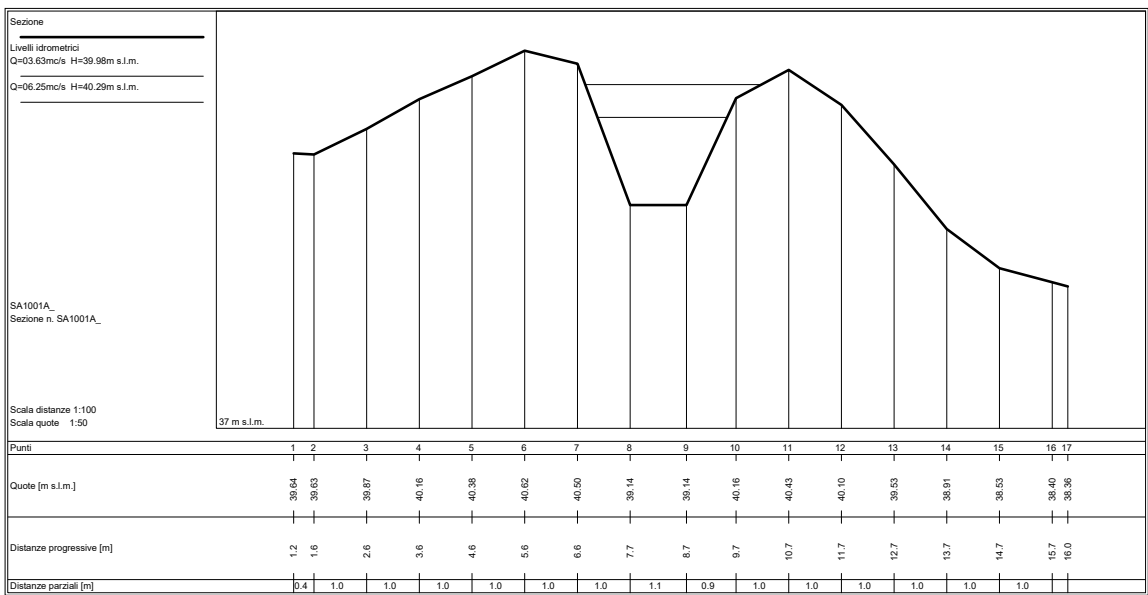
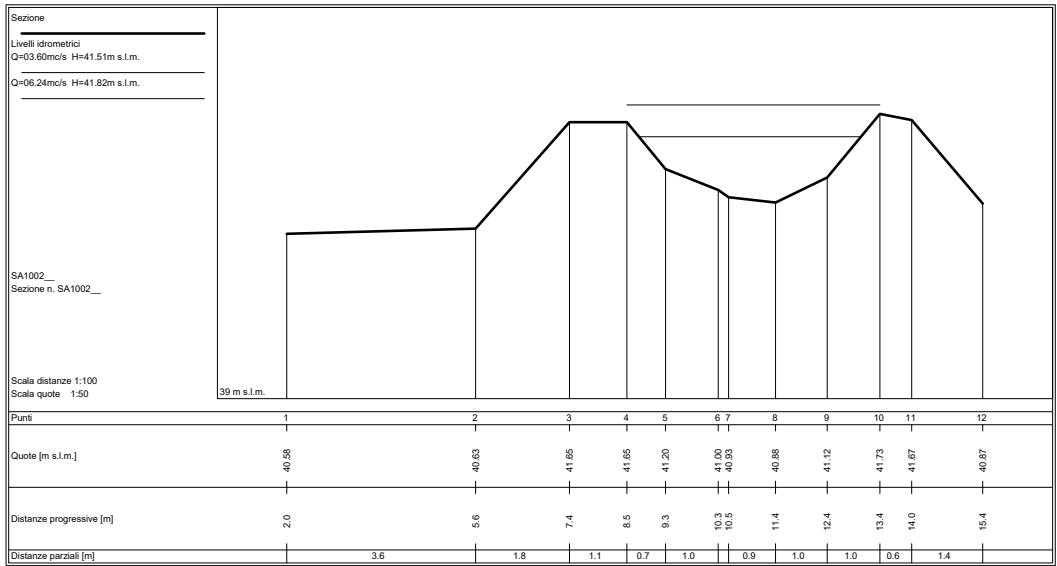

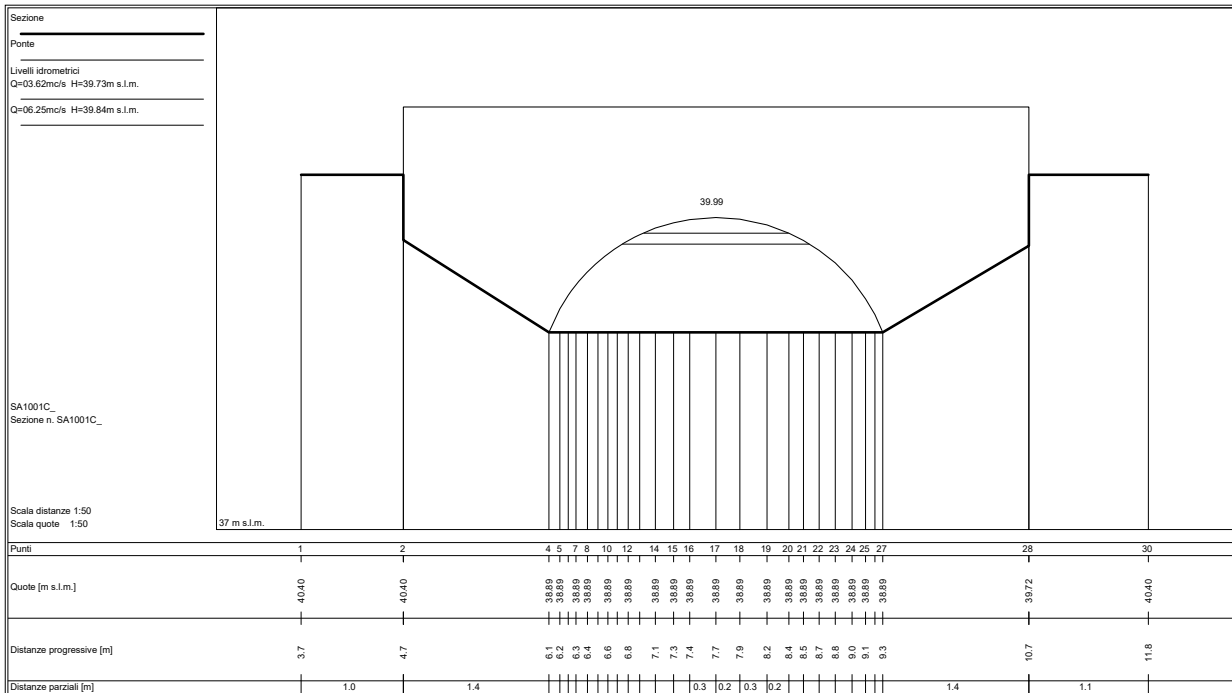
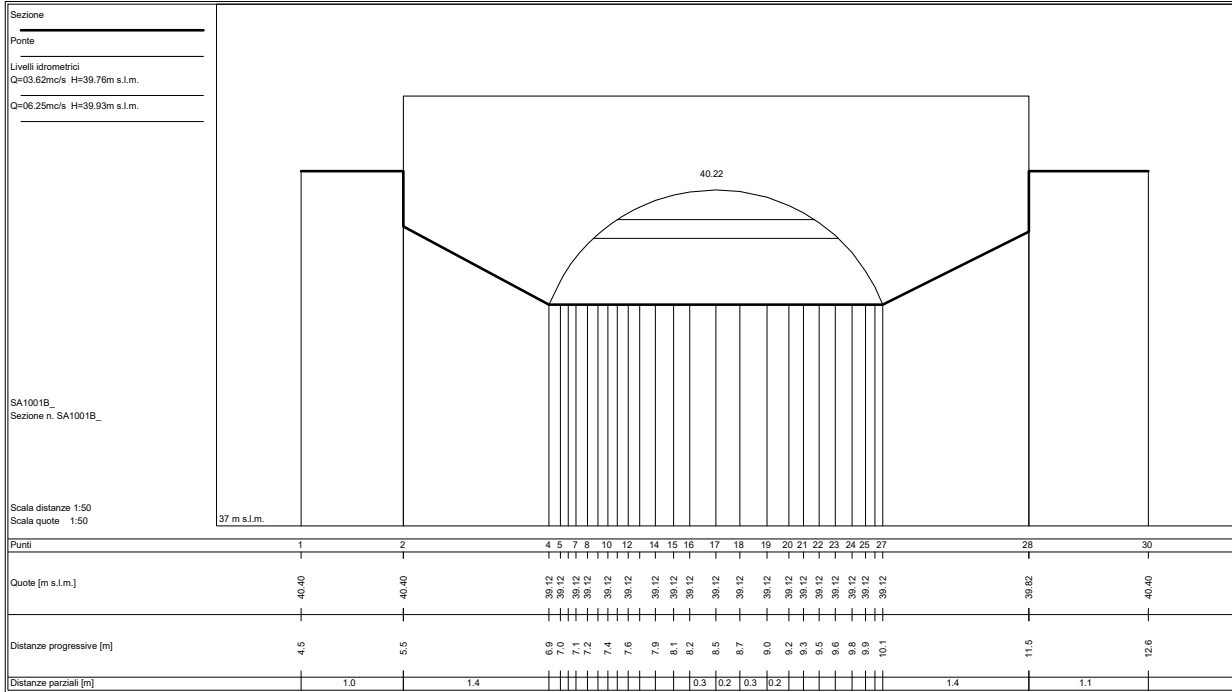

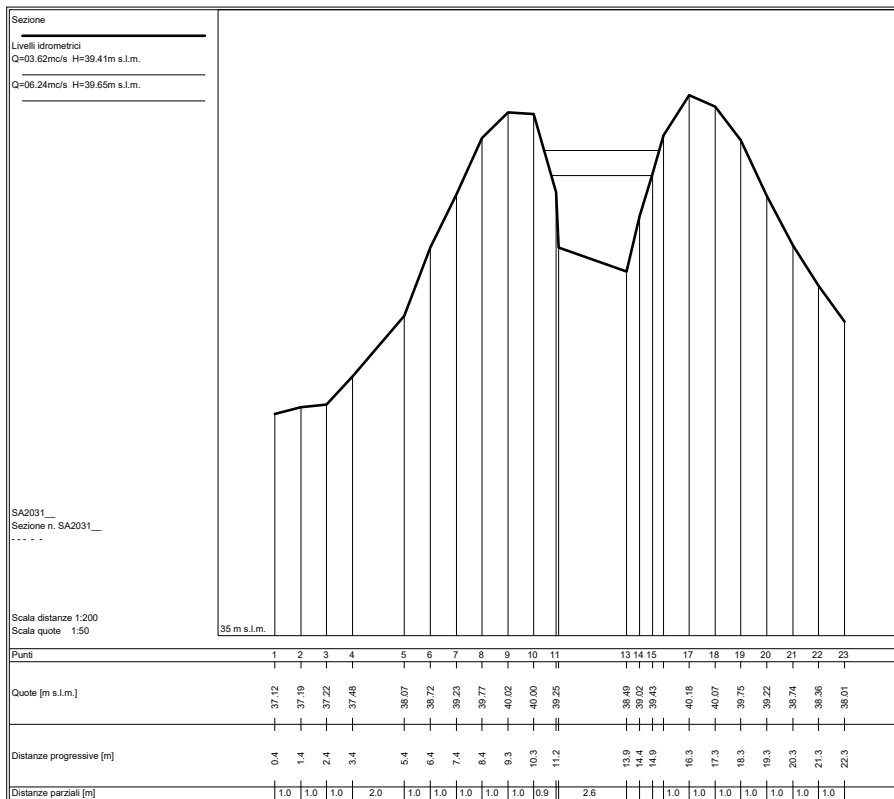
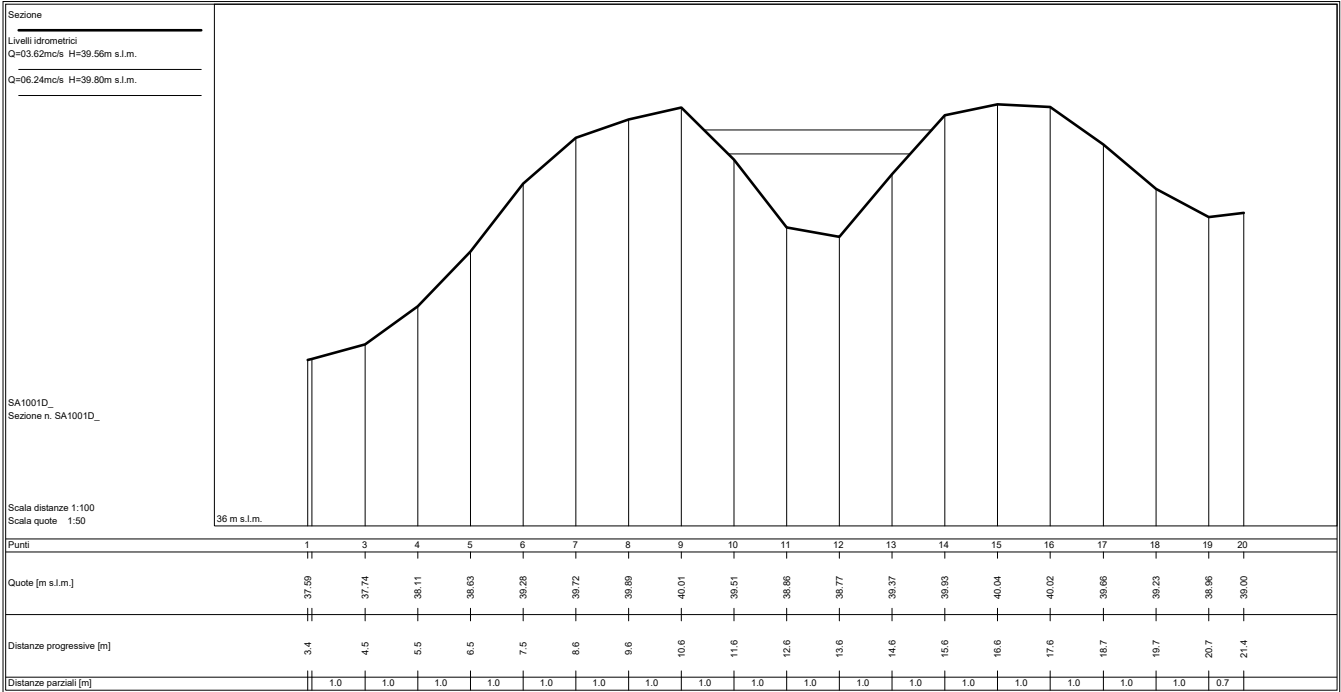

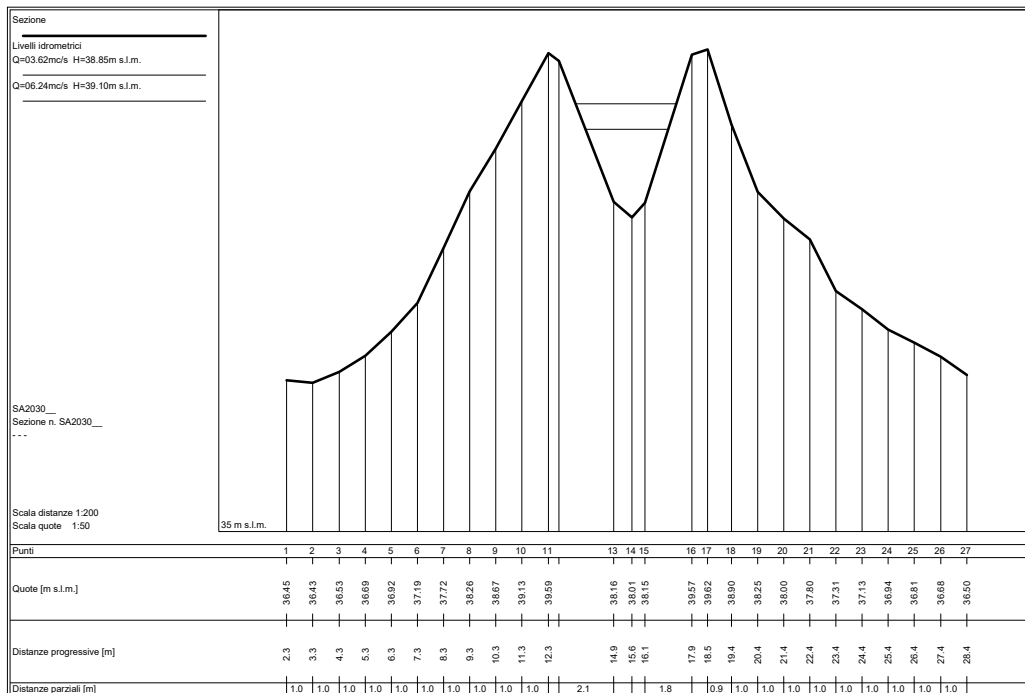
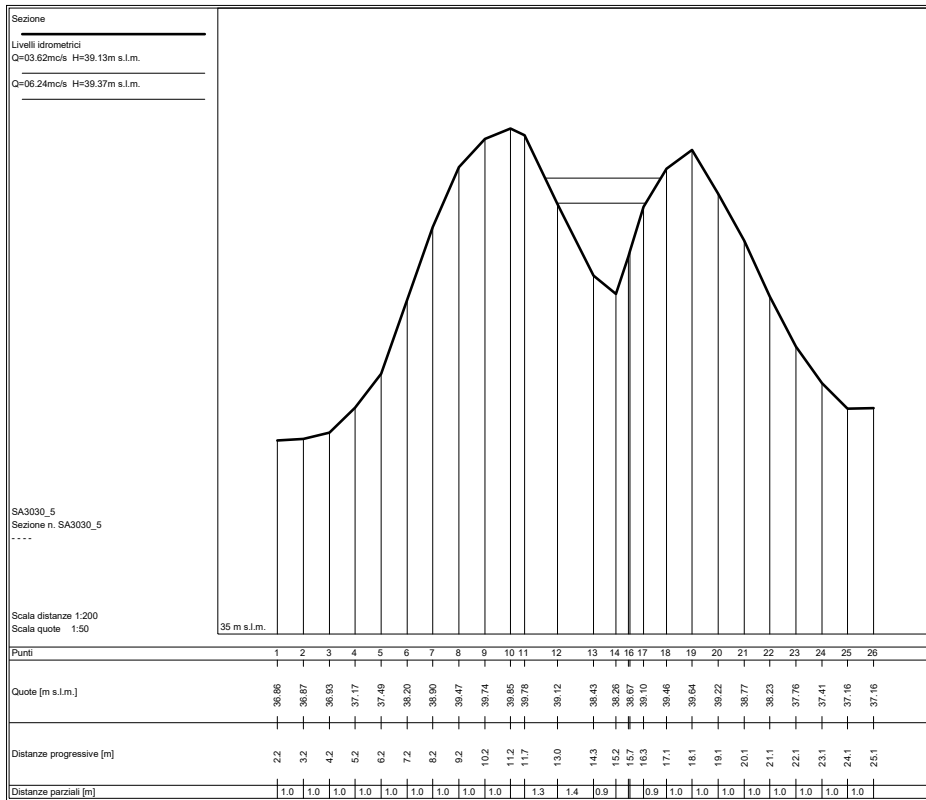

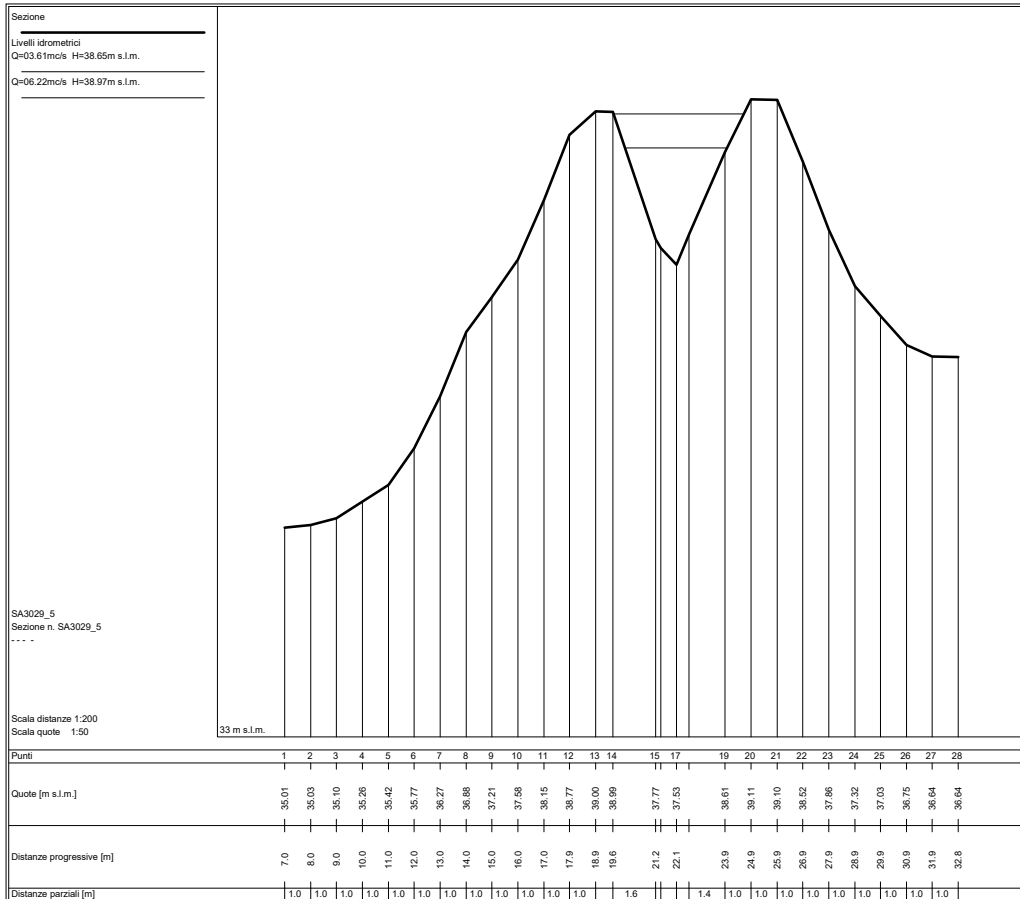
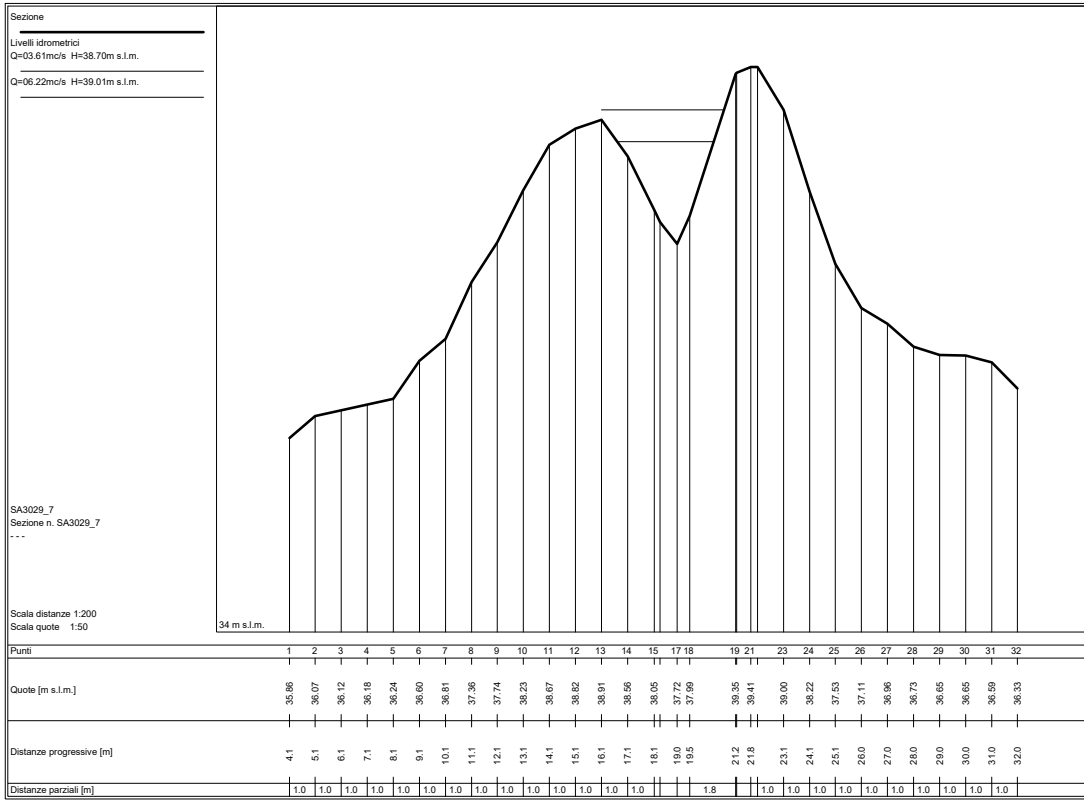

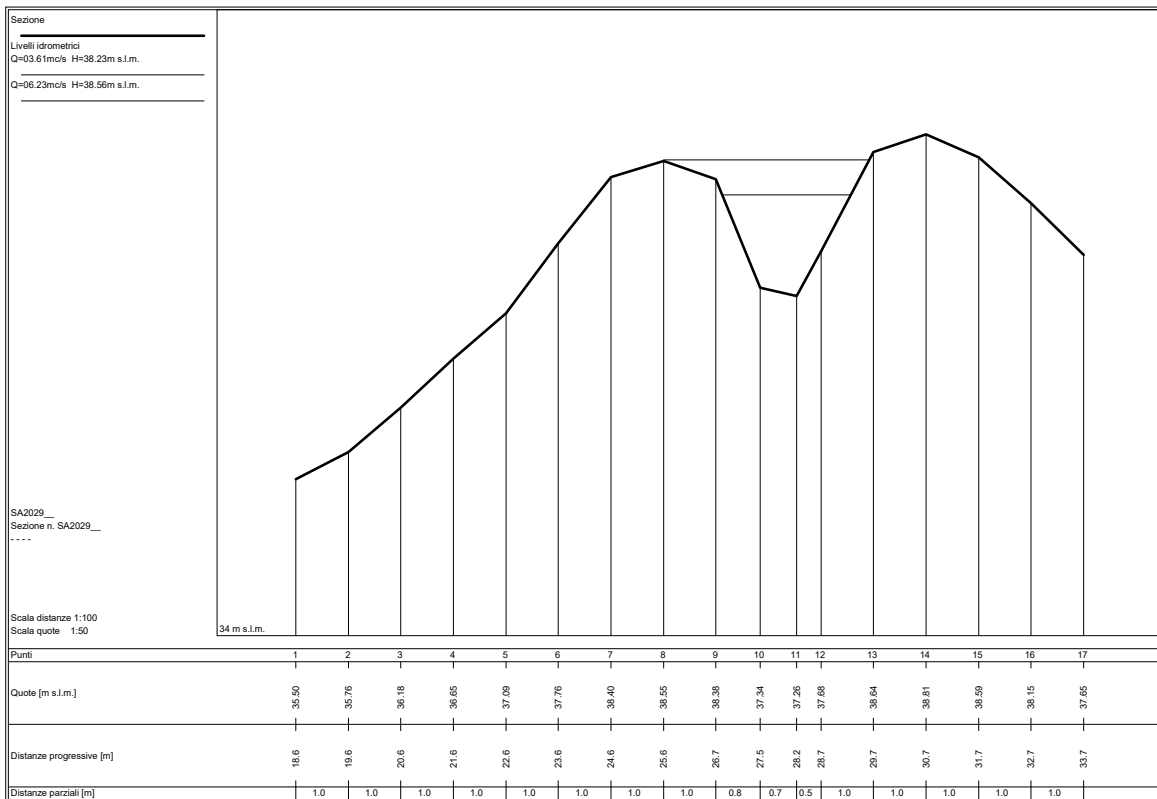
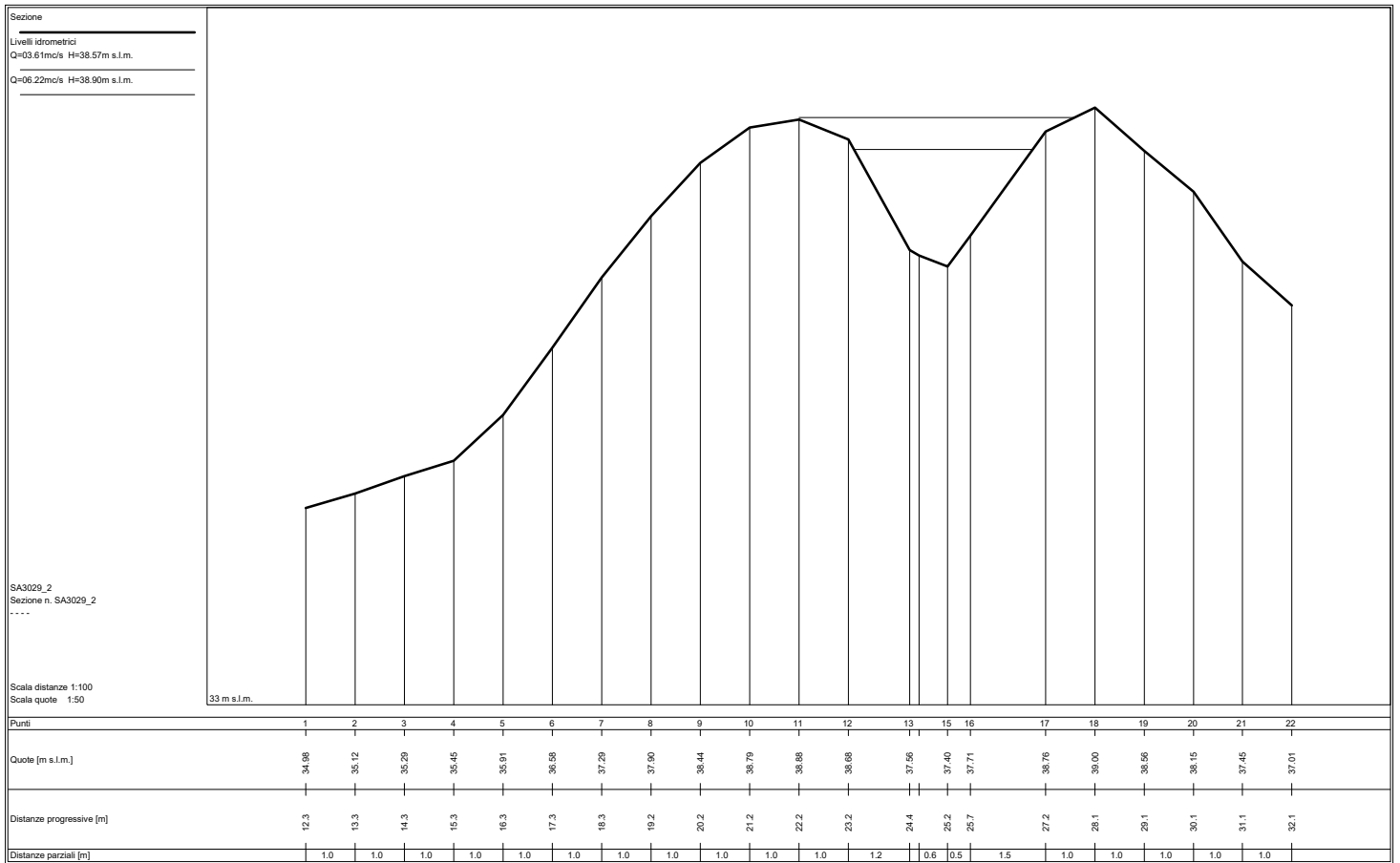

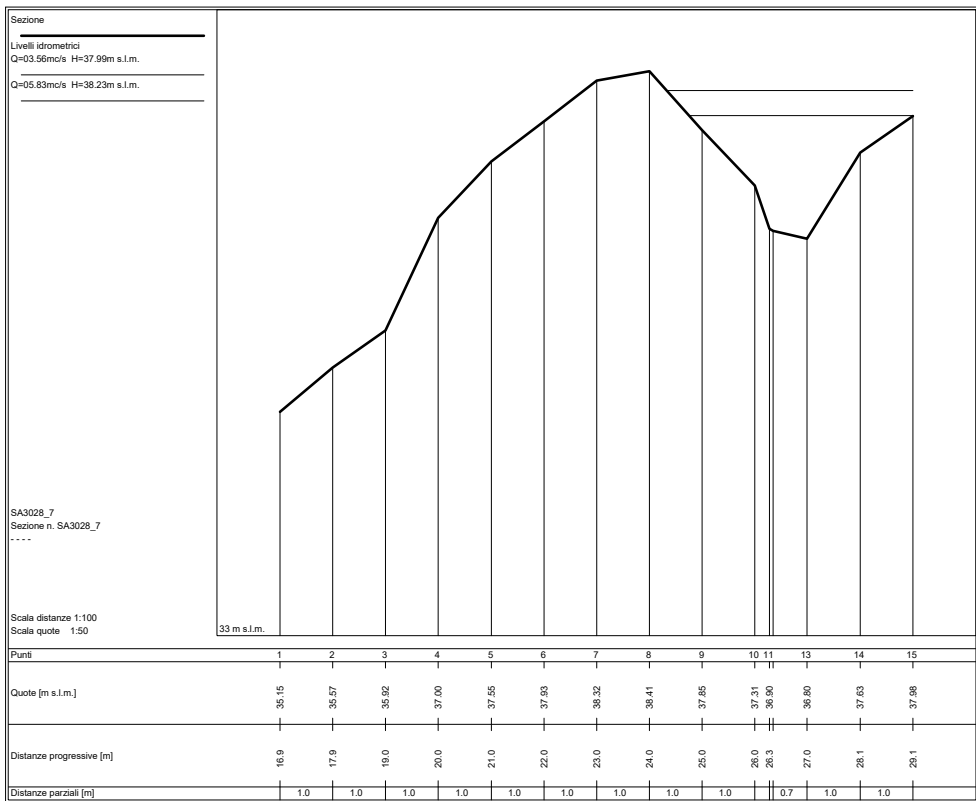
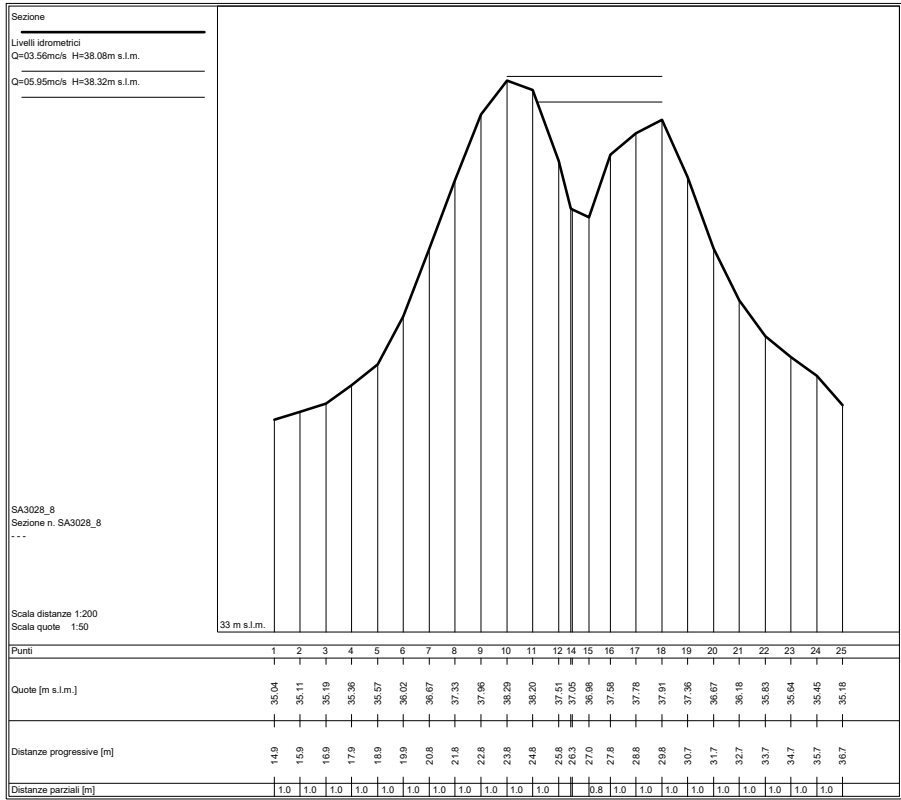

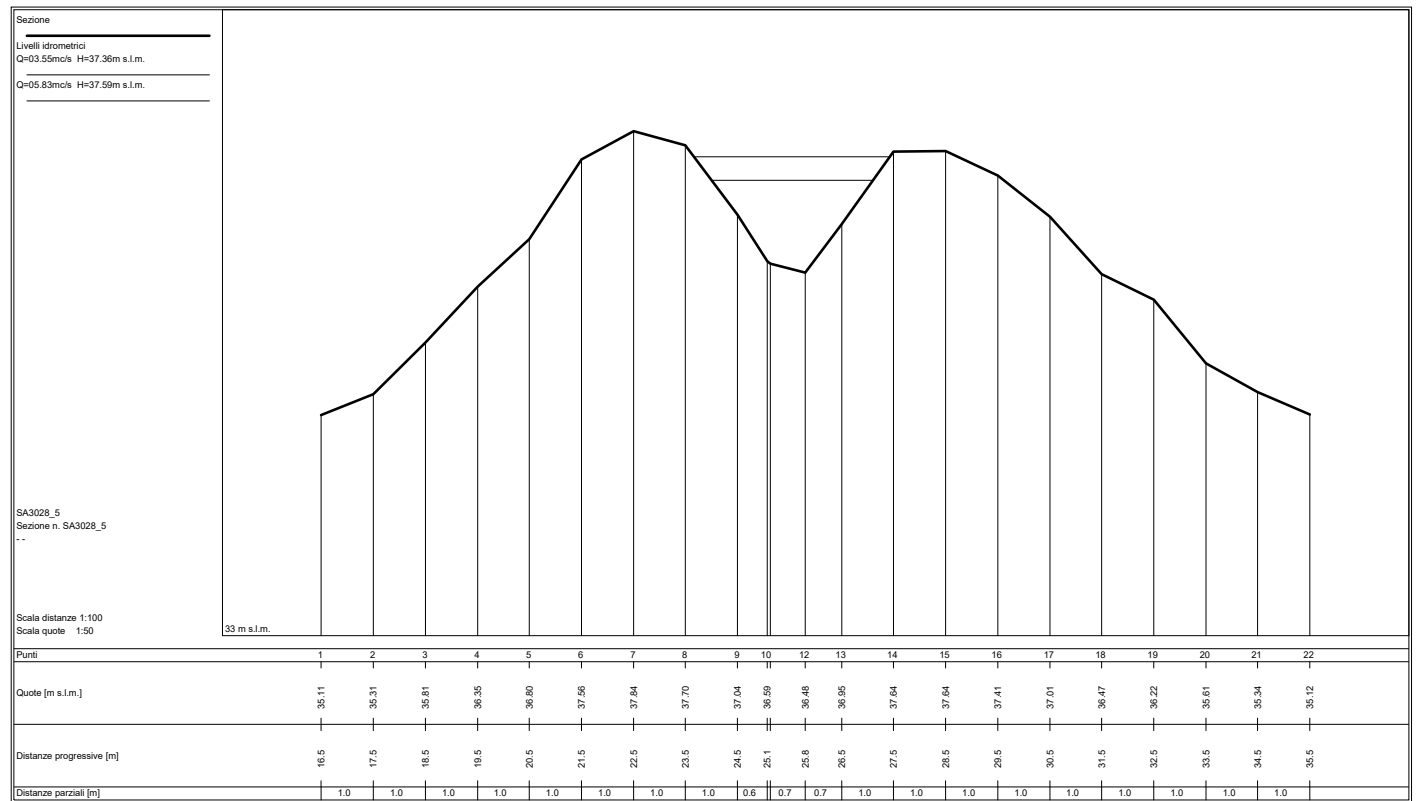
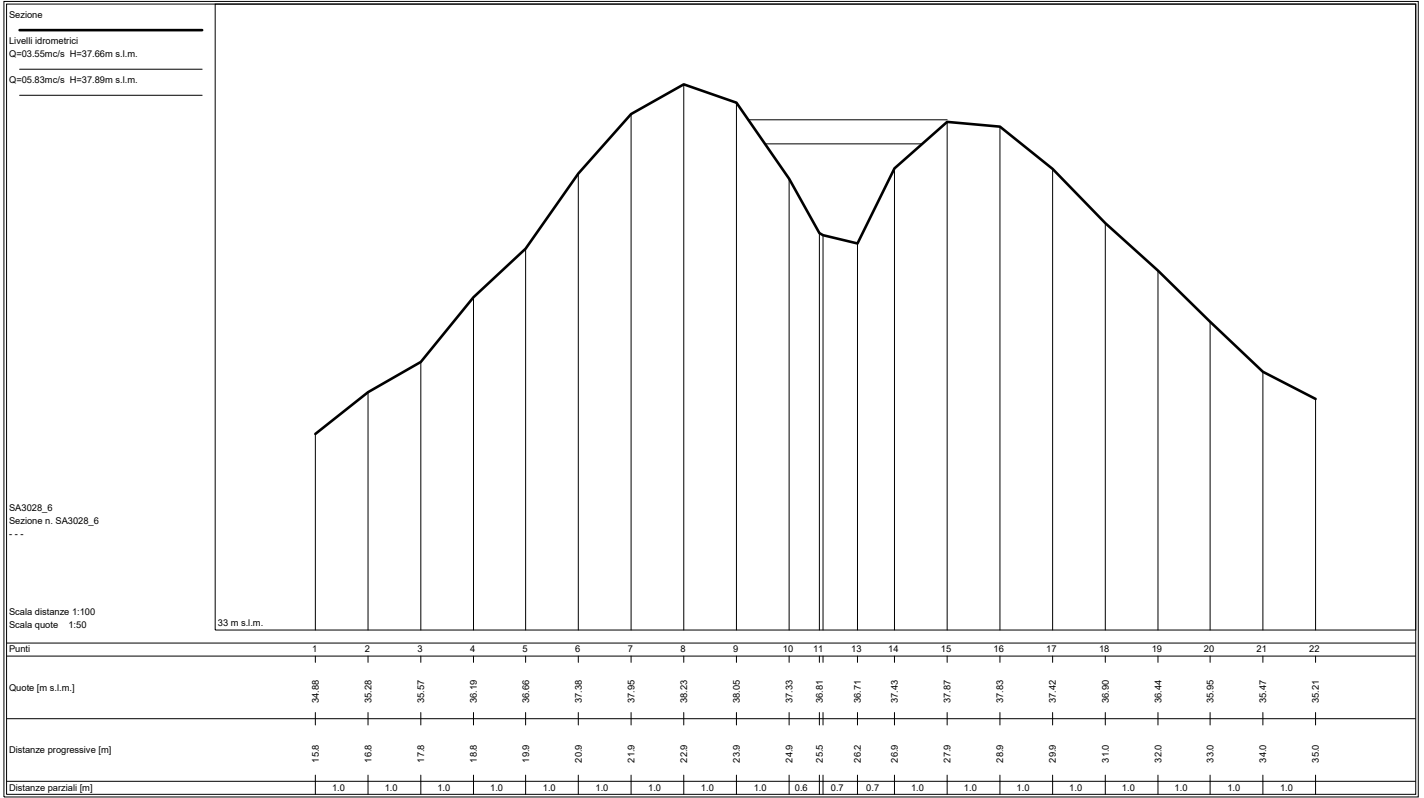

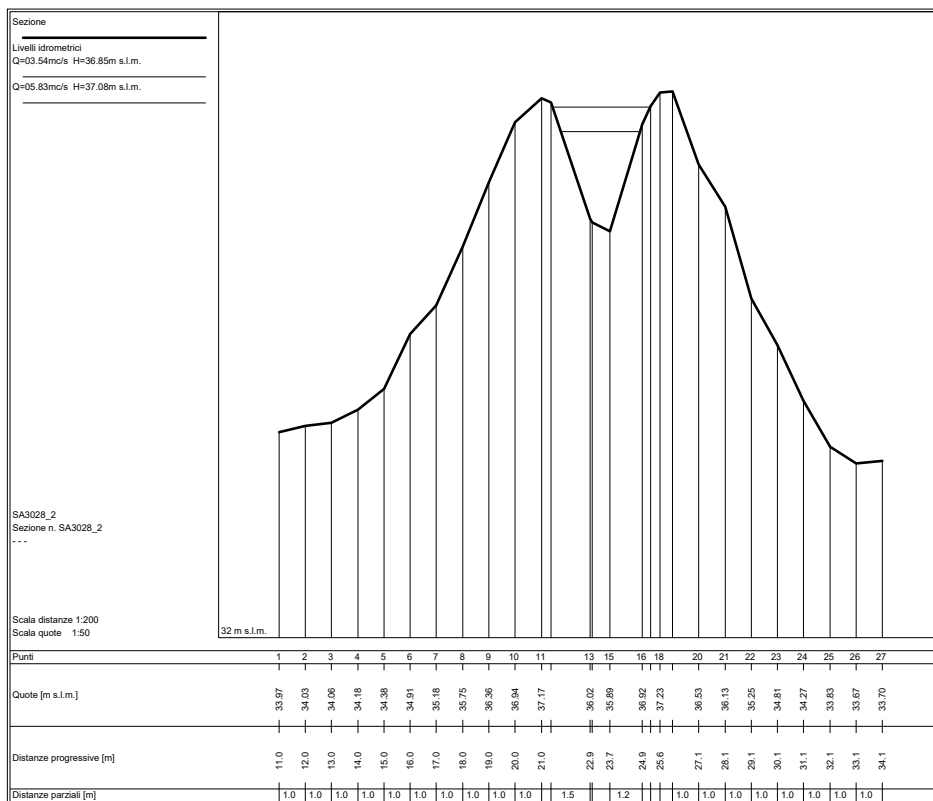
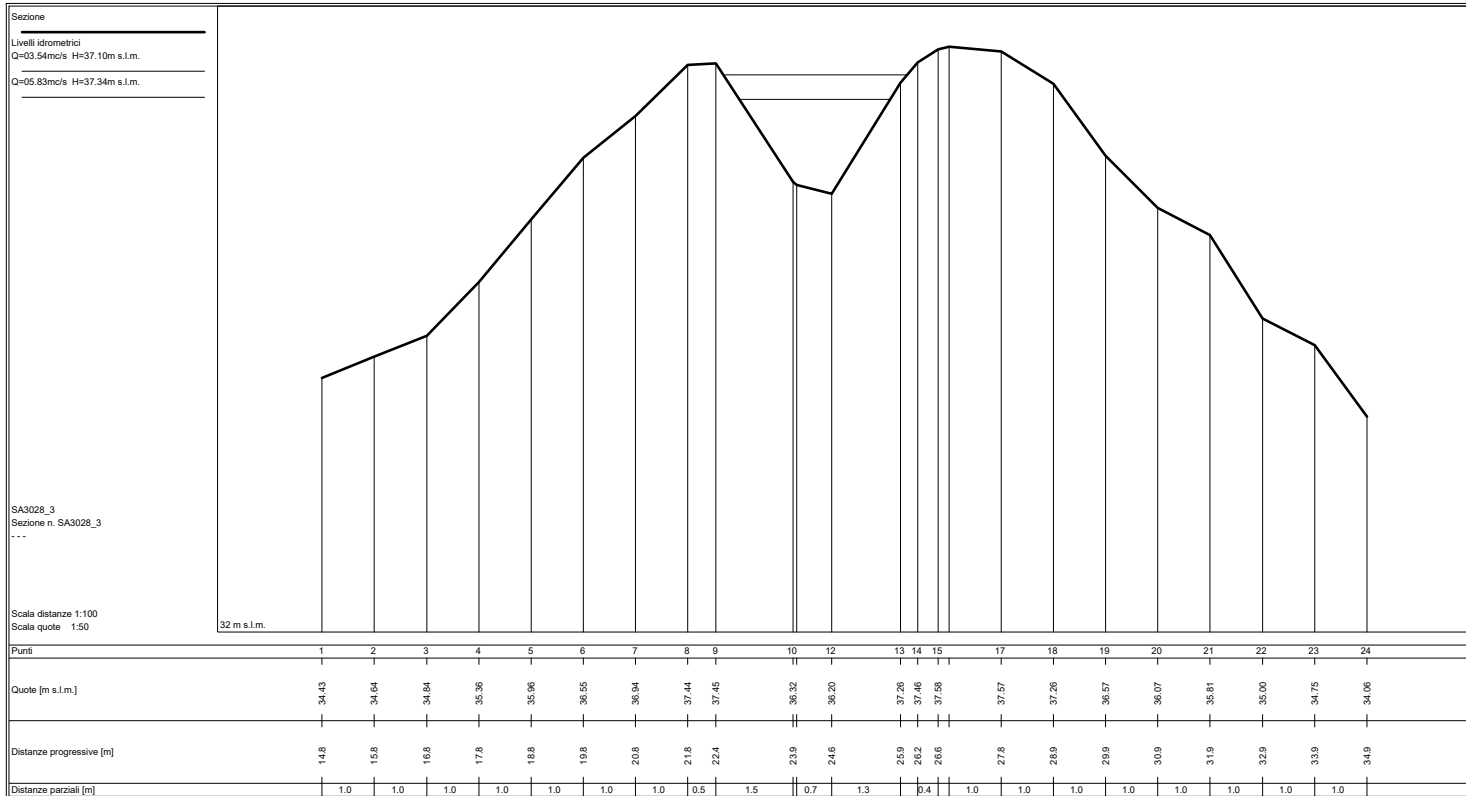

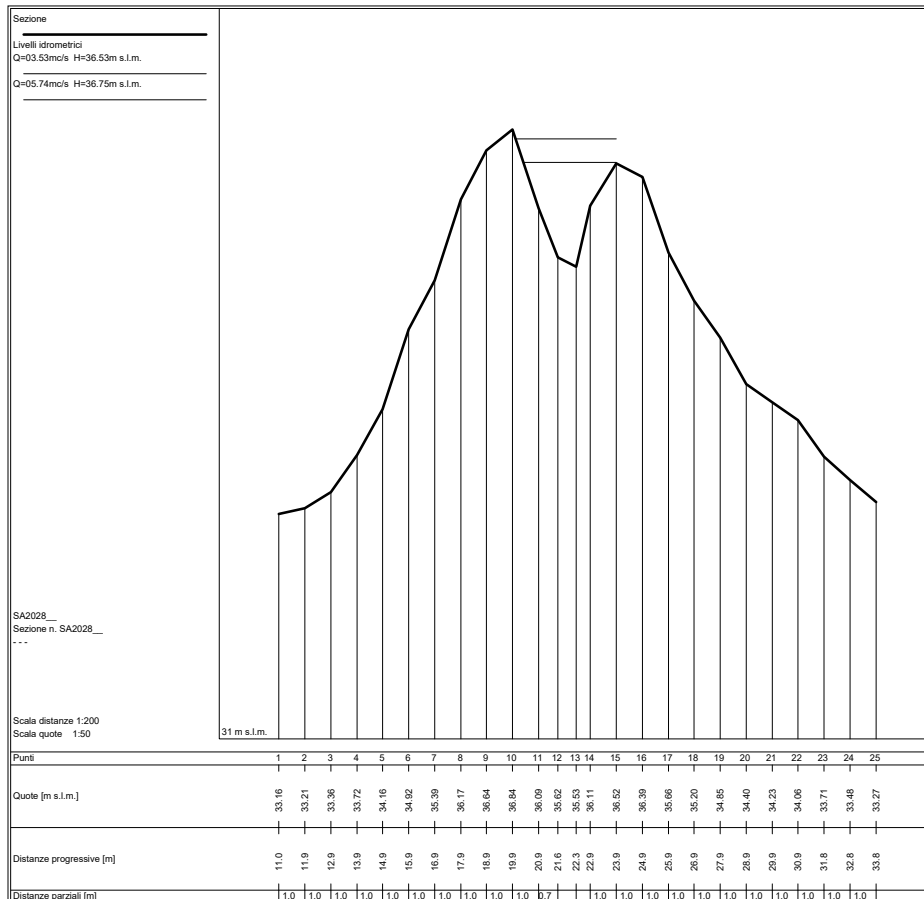
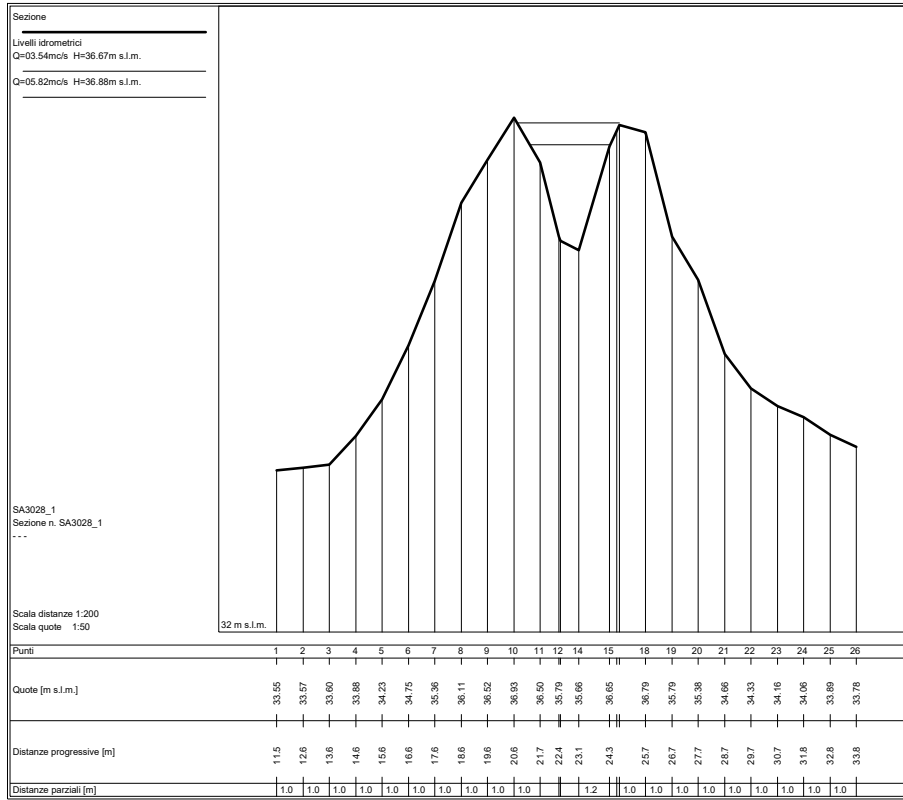

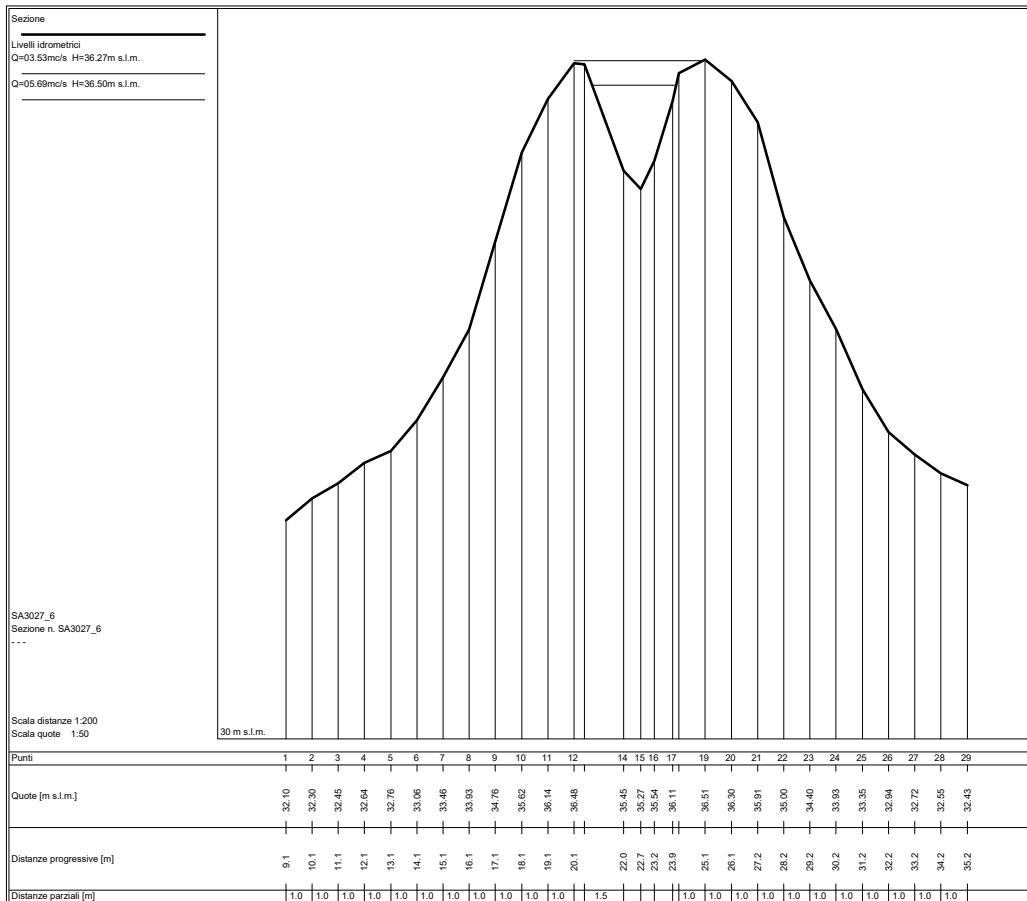
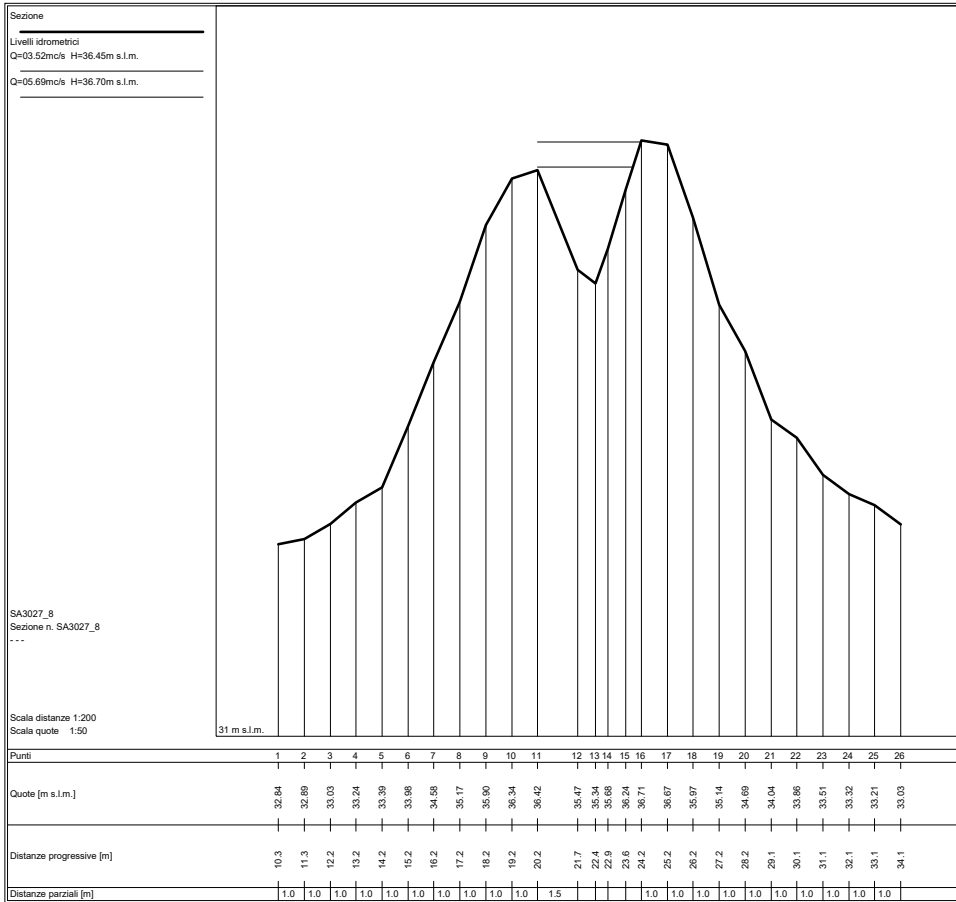

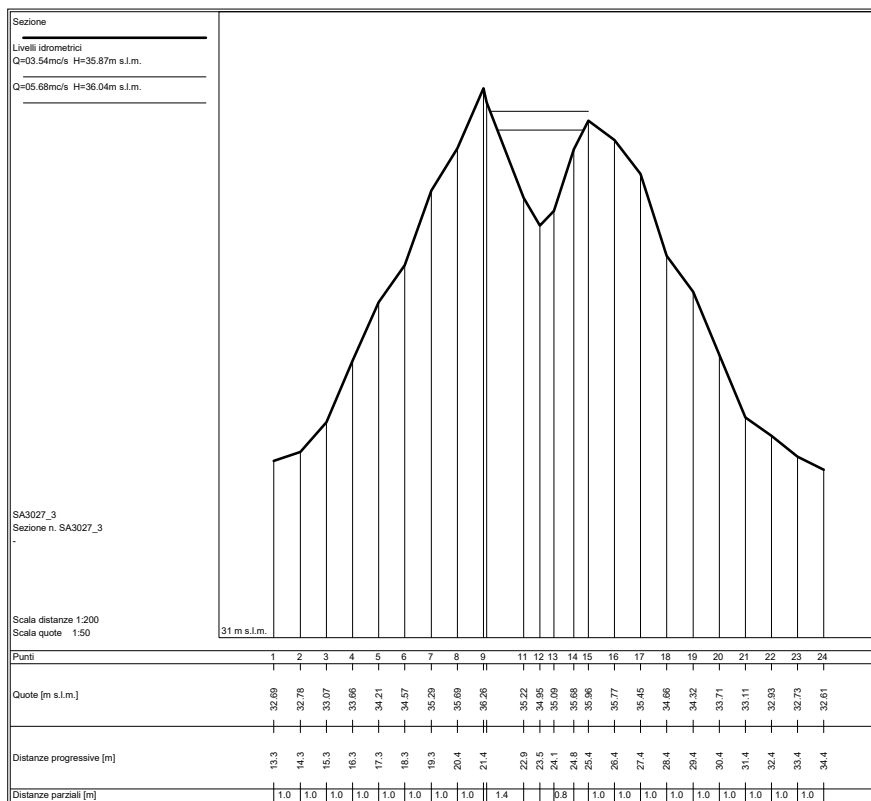
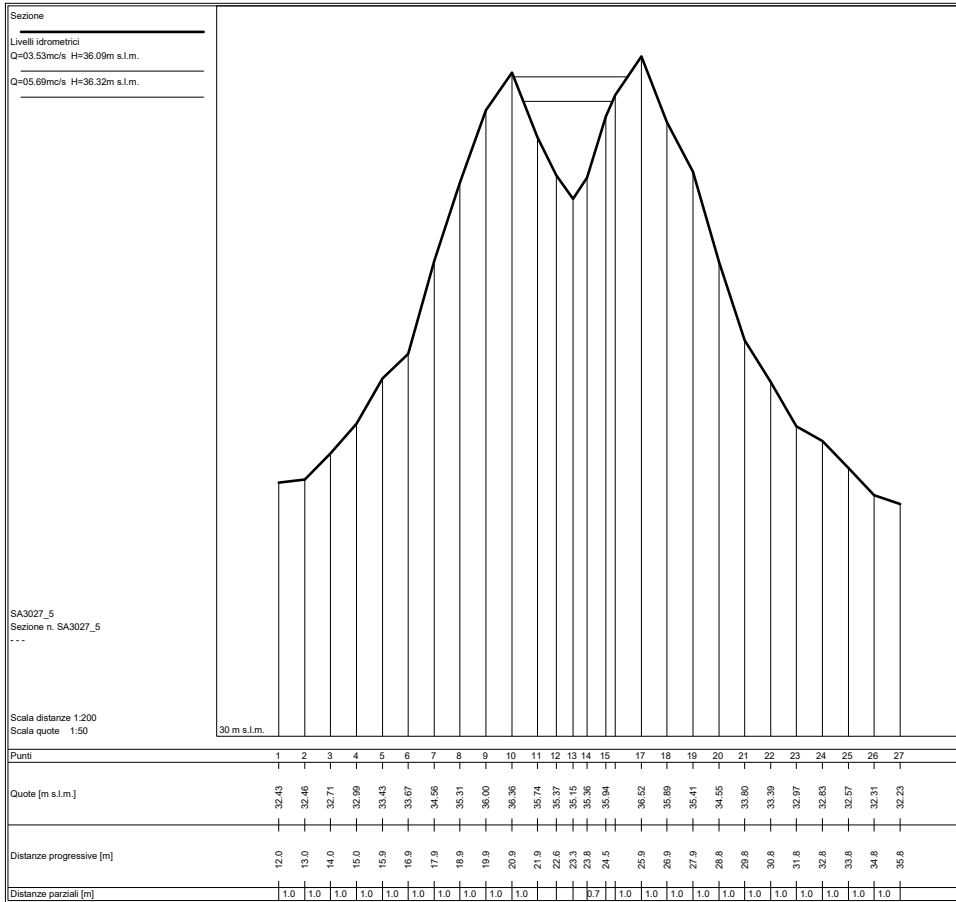

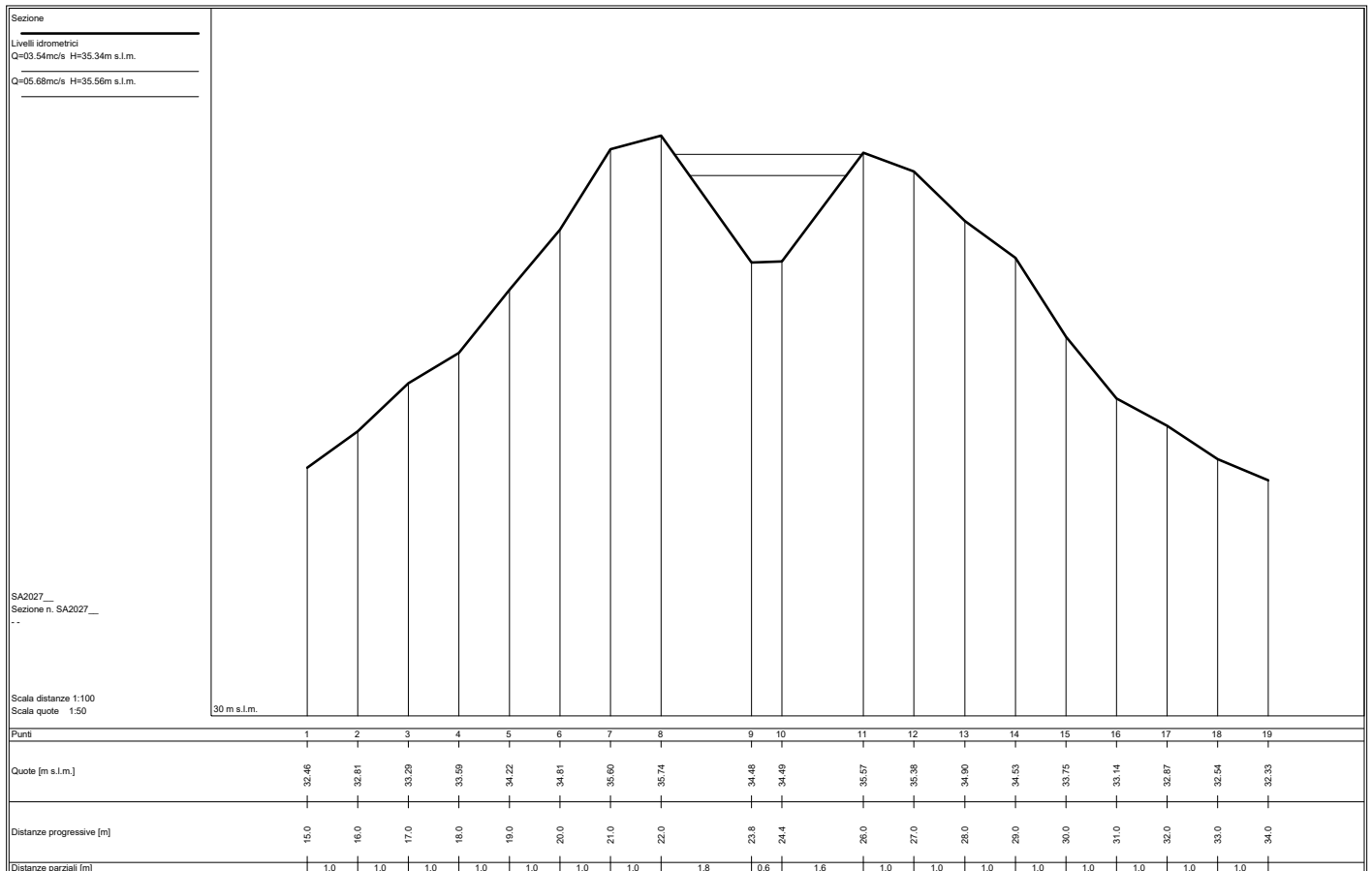
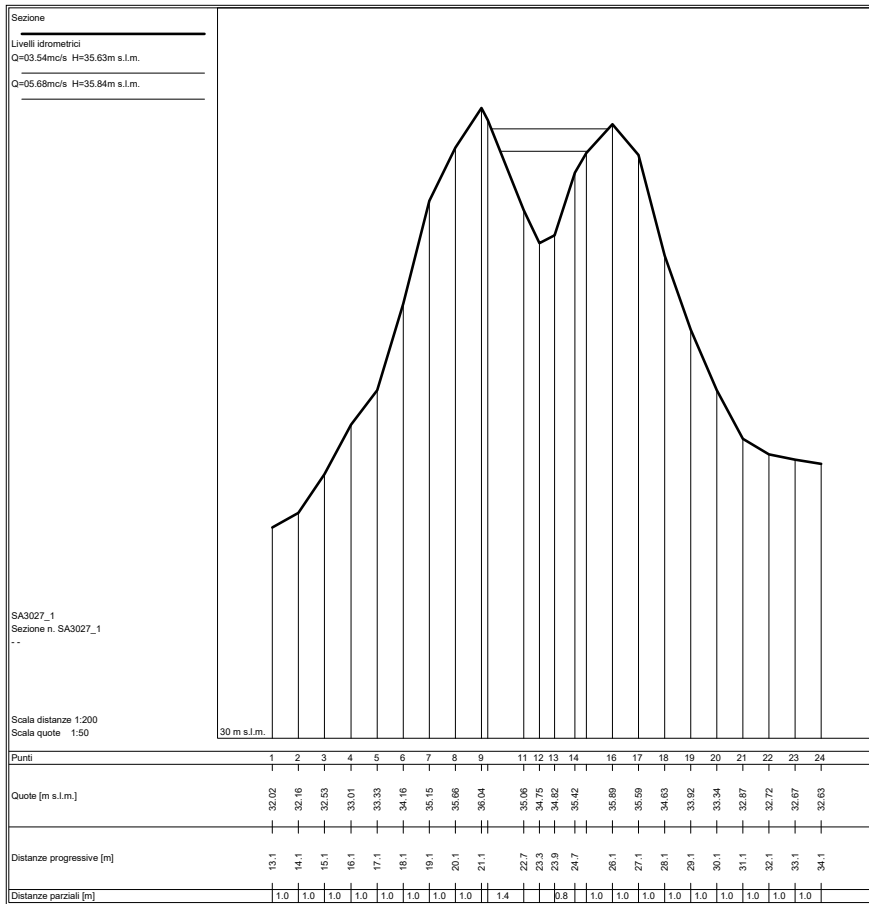

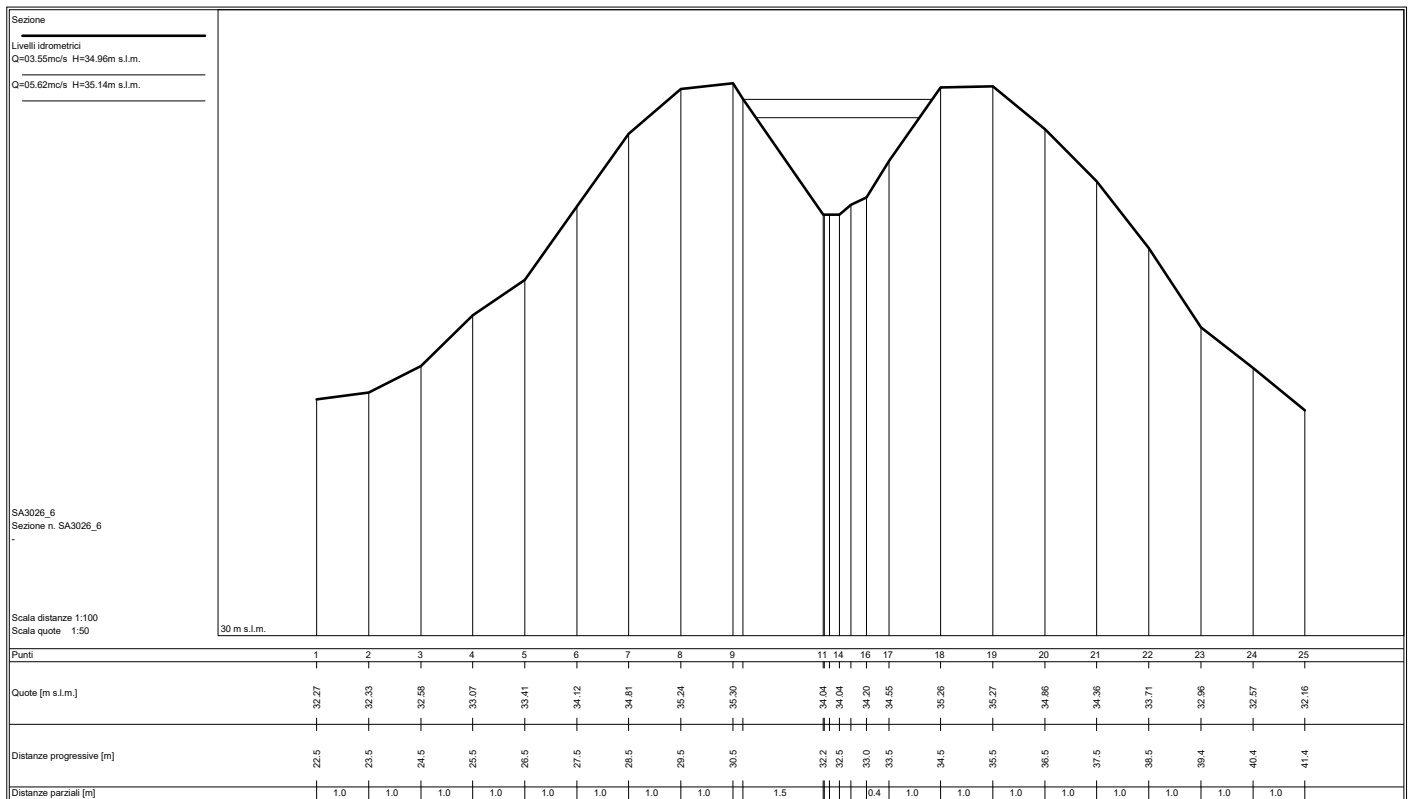
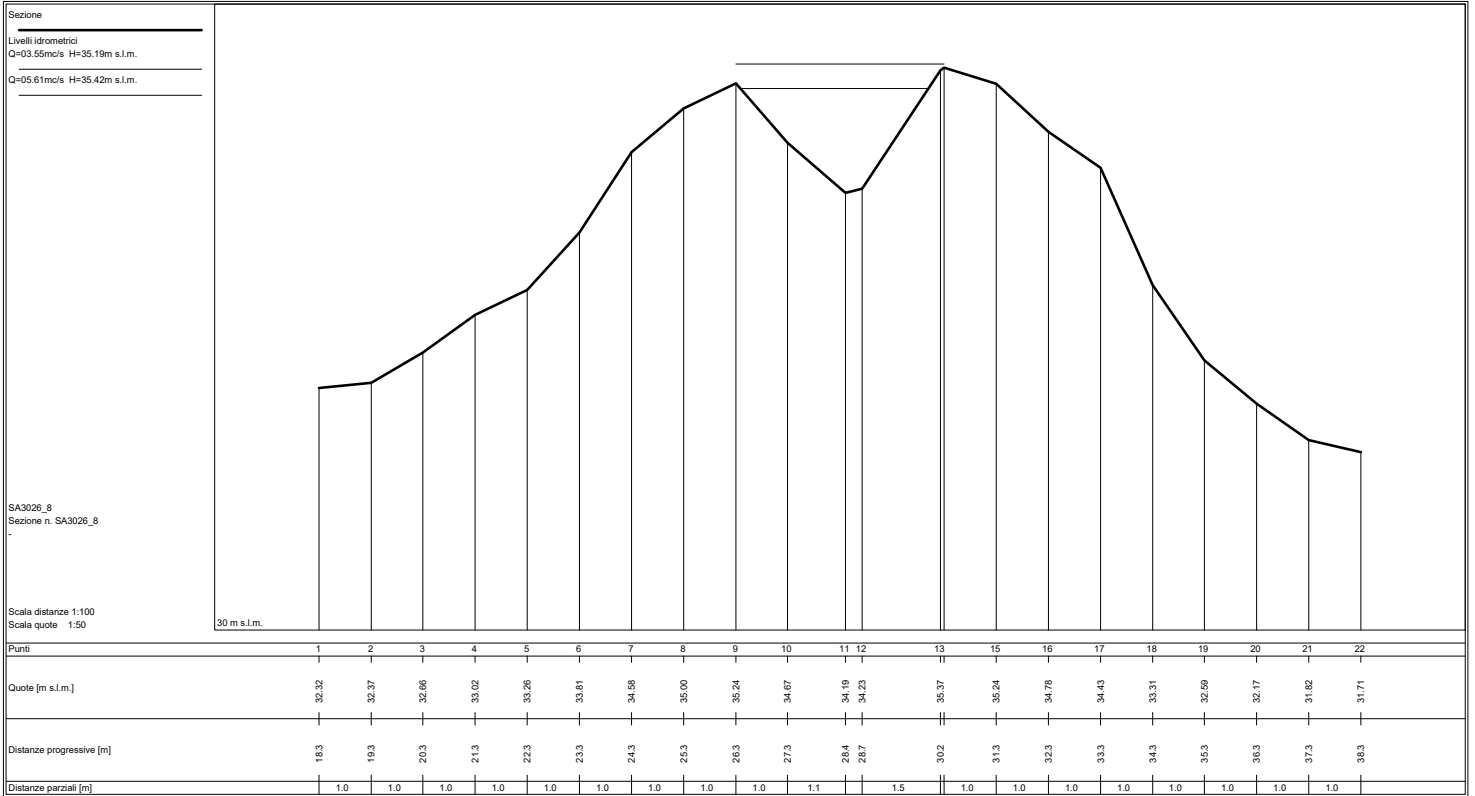

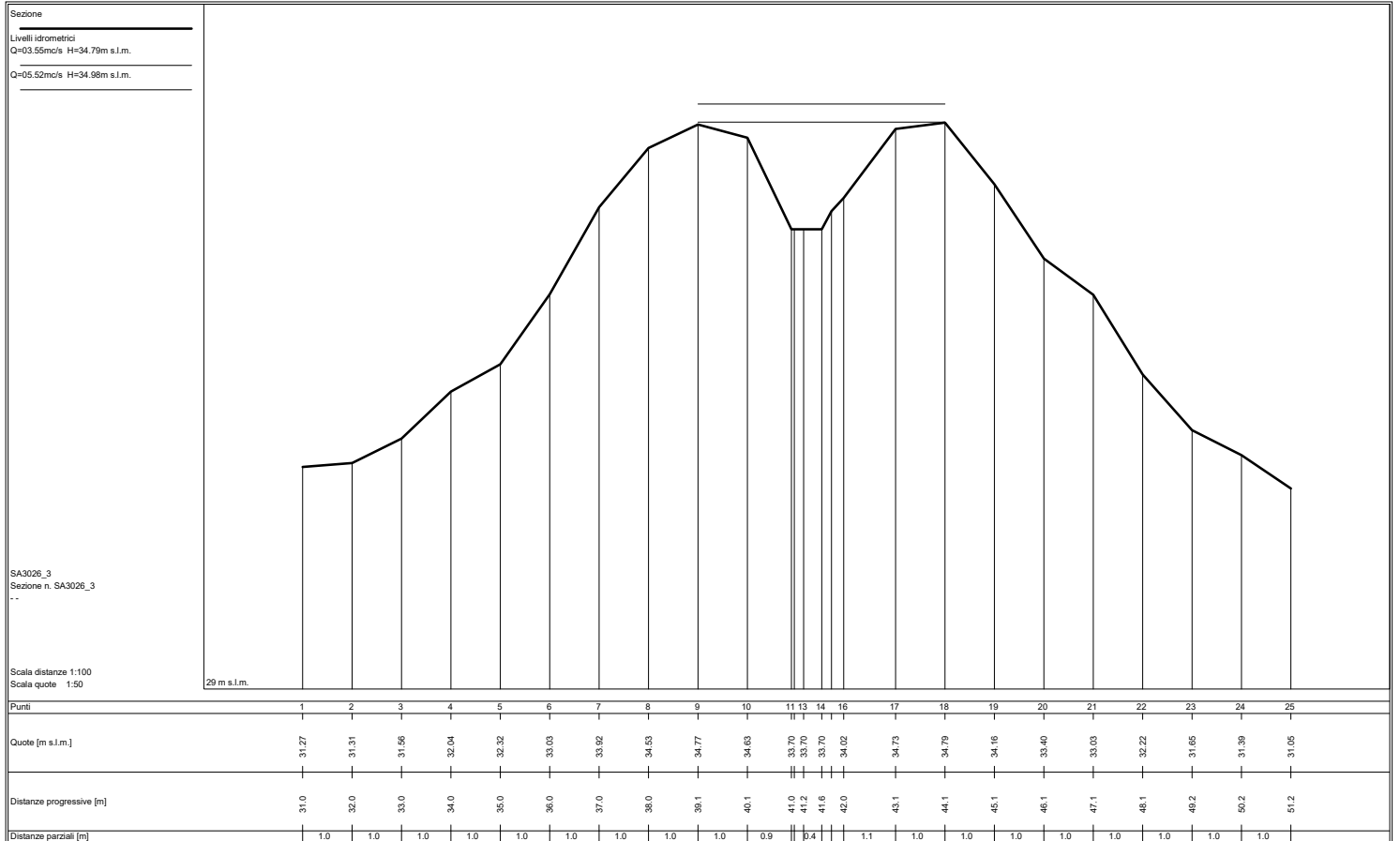
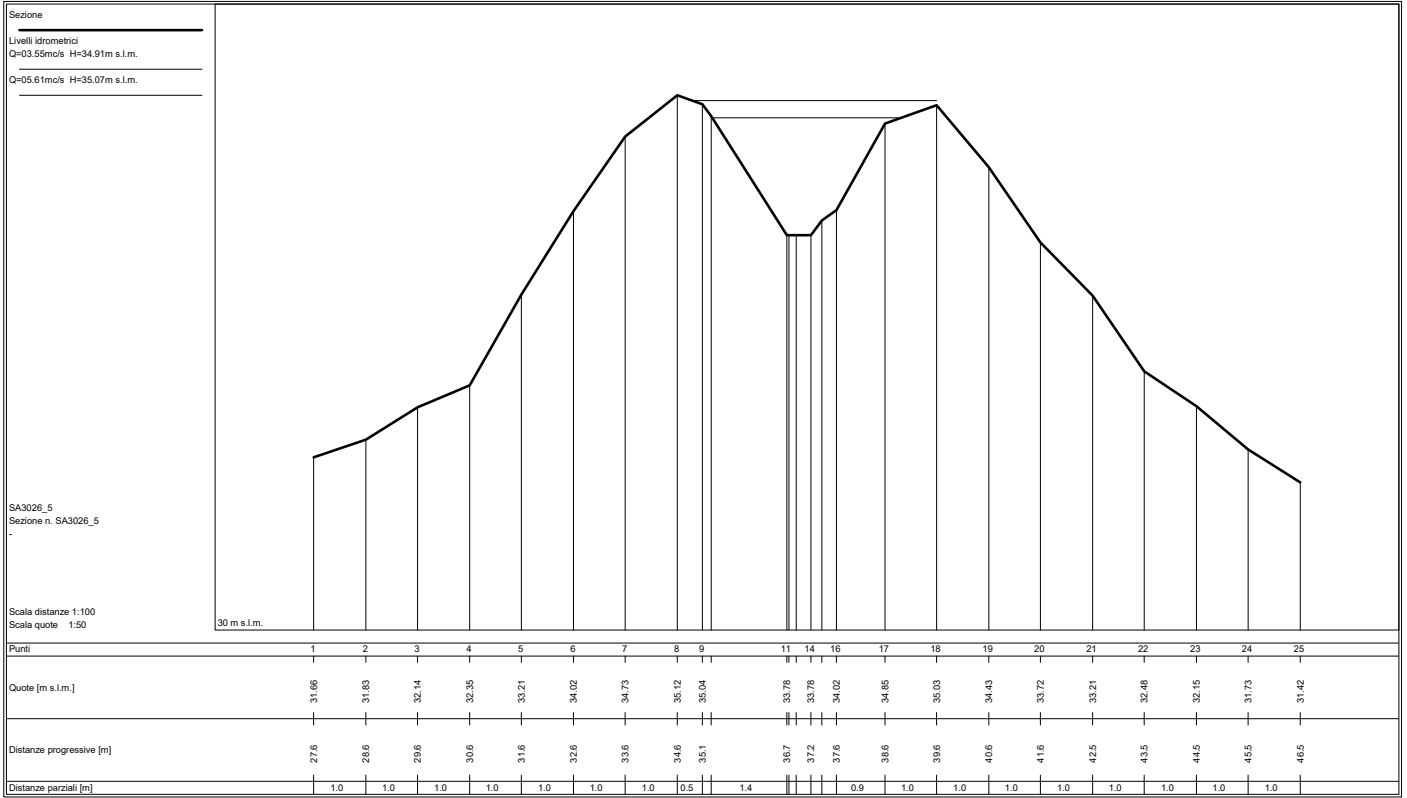

Sezione
 Livelli idrometrici
 Q=03.55mc/s H=34.70m s.l.m.
 Q=05.43mc/s H=34.88m s.l.m.

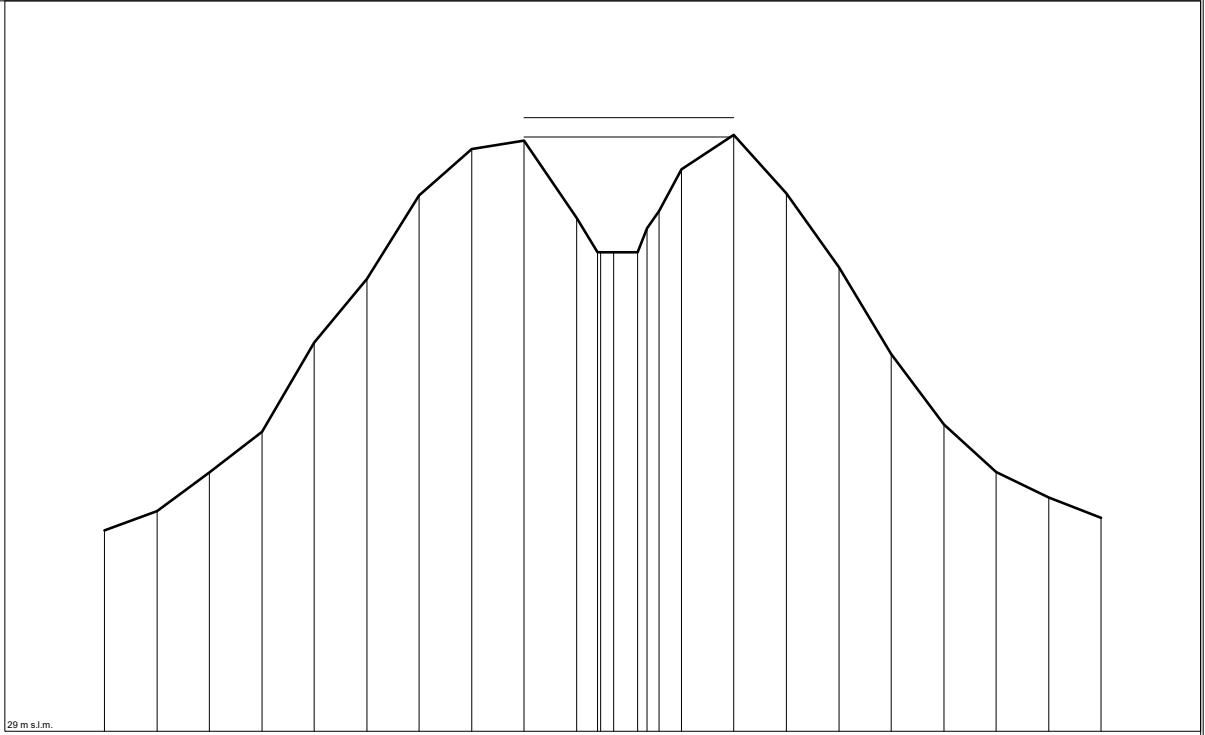

SA3026_1
 Sezione n. SA3026_1

Scala distanze 1:100
 Scala quote 1:50

29 m s.l.m.

Punti	1	2	3	4	5	6	7	8	9	10	11	13	14	16	17	18	19	20	21	22	23	24	25	
Quote [m s.l.m.]	30.92	31.11	31.48	31.87	32.72	33.34	34.13	34.58	34.66	33.92	33.59	33.59	33.59	33.59	33.99	34.39	34.71	34.15	33.45	32.61	31.94	31.48	31.24	31.05
Distanze progressive [m]	35.9	36.9	37.9	38.9	39.9	40.9	41.9	42.9	43.9	44.9	45.3	45.6	46.1	46.5	46.9	47.9	48.9	50.0	51.0	52.0	53.0	54.0	55.0	
Distanze parziali [m]	1.0	1.0	1.0	1.0	1.0	1.0	1.0	1.0	1.0	0.4	0.5	0.4	0.4	1.0	1.0	1.0	1.0	1.0	1.0	1.0	1.0	1.0	1.0	1.0

Sezione
 Livelli idrometrici
 Q=03.55mc/s H=34.37m s.l.m.
 Q=05.43mc/s H=34.58m s.l.m.

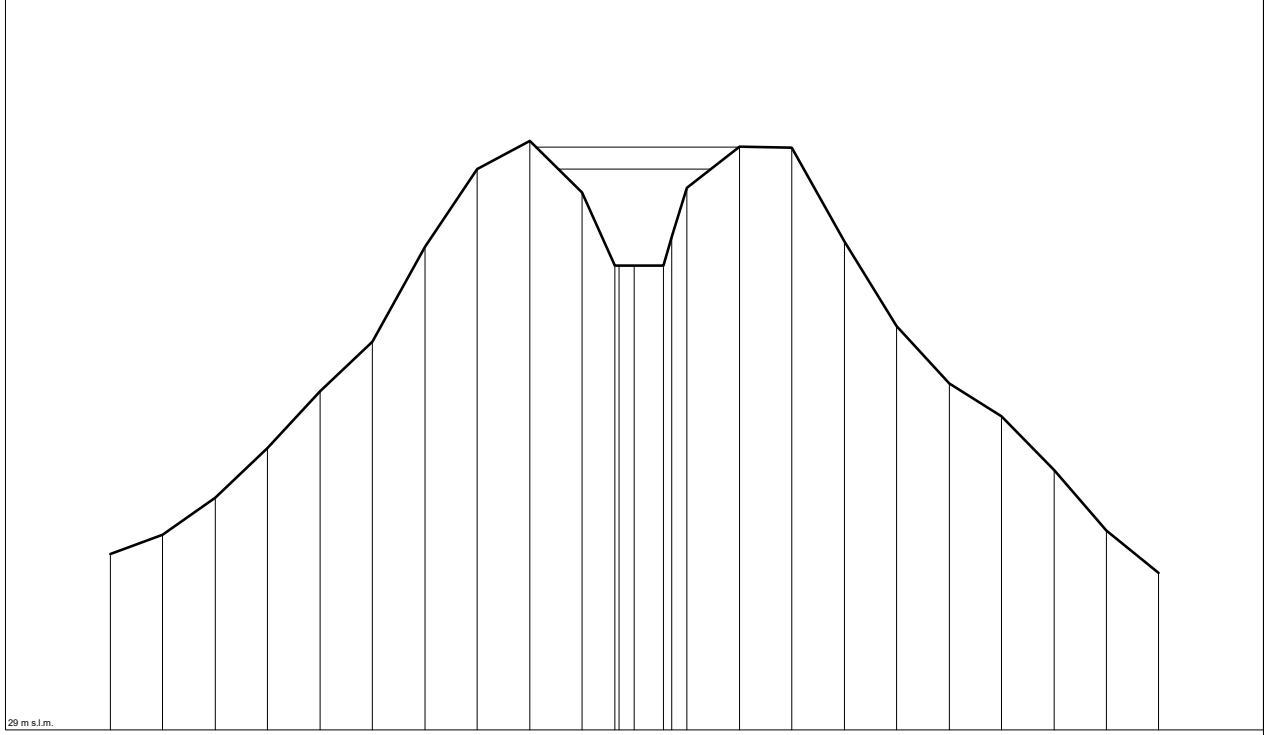

SA2026_1
 Sezione n. SA2026_1

Scala distanze 1:100
 Scala quote 1:50

29 m s.l.m.

Punti	1	2	3	4	5	6	7	8	9	10	11	13	14	16	17	18	19	20	21	22	23	24	25	
Quote [m s.l.m.]	30.68	30.87	31.23	31.70	32.24	32.72	33.63	34.38	34.65	34.15	33.45	33.45	33.45	34.19	34.59	34.58	33.68	32.87	32.32	32.00	31.49	30.91	30.51	
Distanze progressive [m]	40.0	41.0	42.0	43.0	44.1	45.1	46.1	47.1	48.1	49.1	49.7	50.1	50.6	51.1	52.1	53.1	54.1	55.1	56.1	57.1	58.1	59.1	60.1	
Distanze parziali [m]	1.0	1.0	1.0	1.0	1.0	1.0	1.0	1.0	1.0	1.0	0.6	0.6	0.6	1.0	1.0	1.0	1.0	1.0	1.0	1.0	1.0	1.0	1.0	1.0

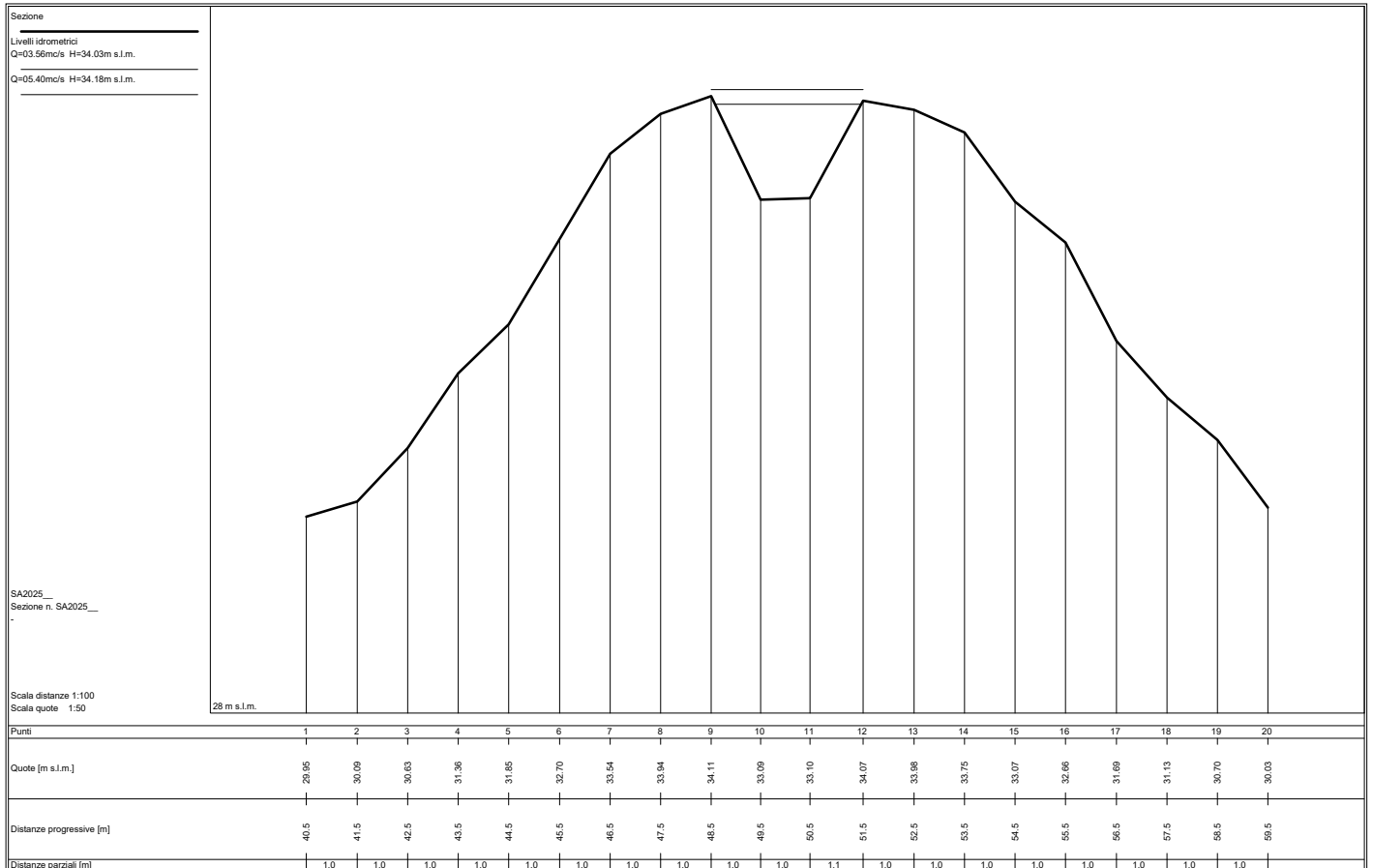
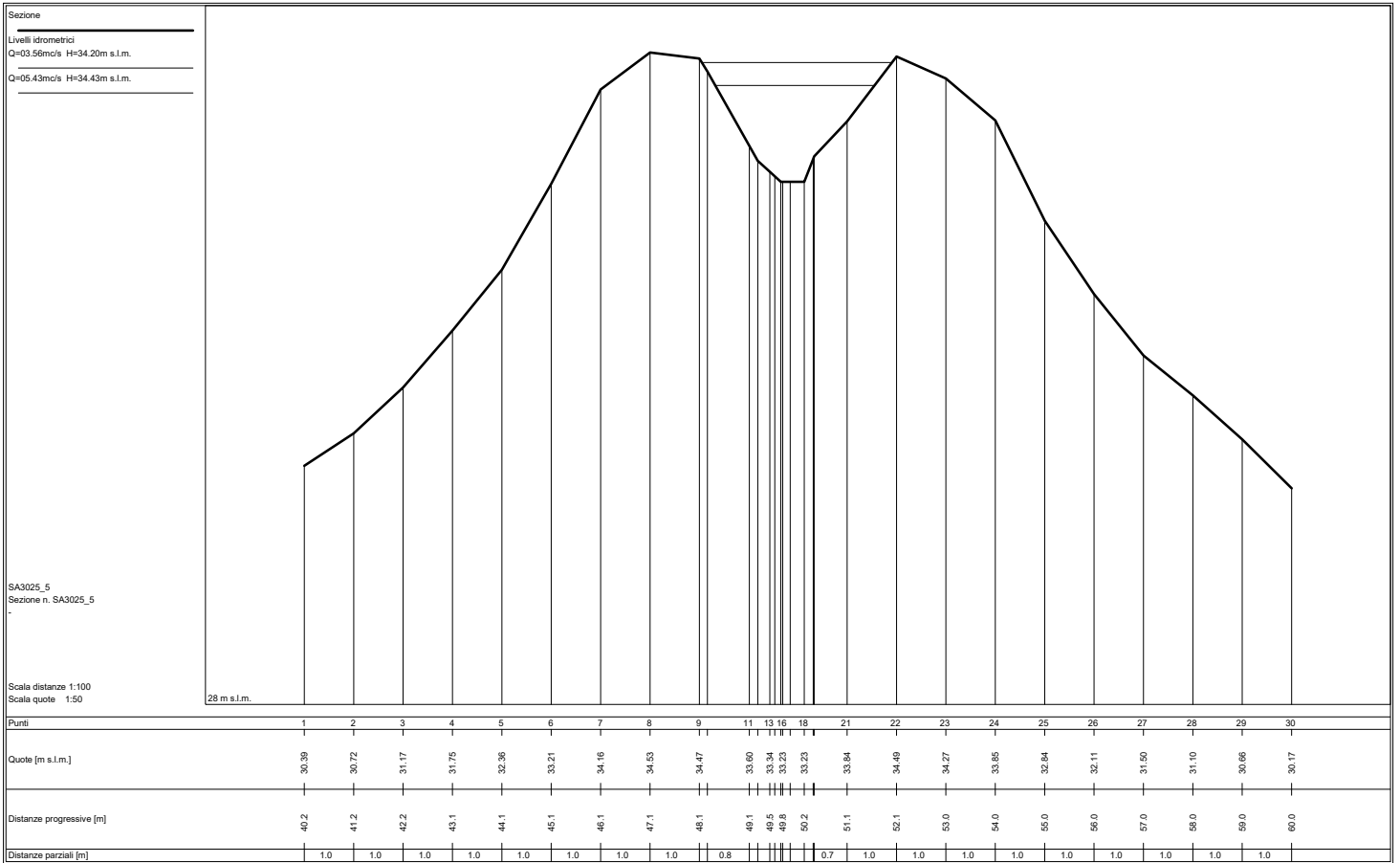

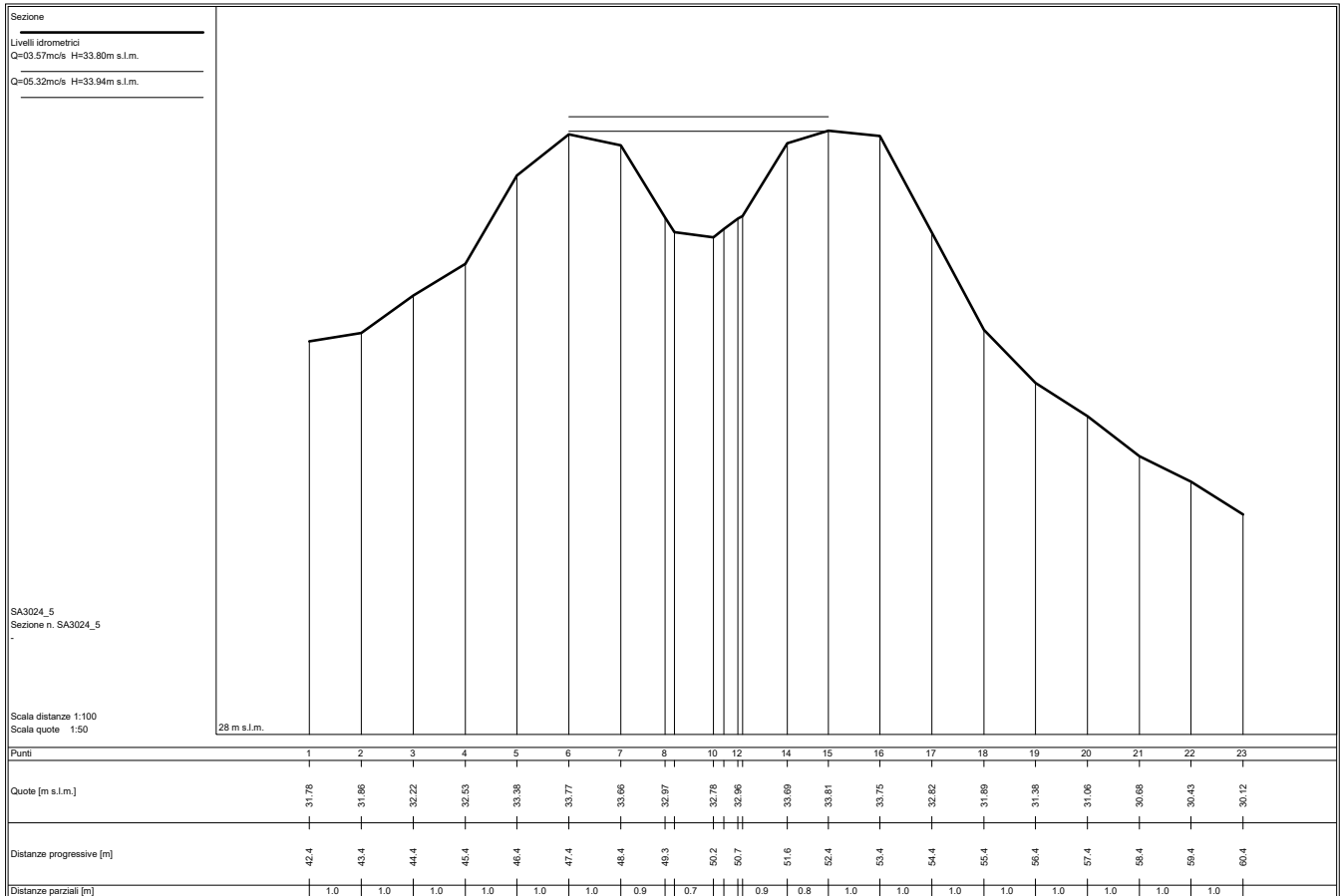
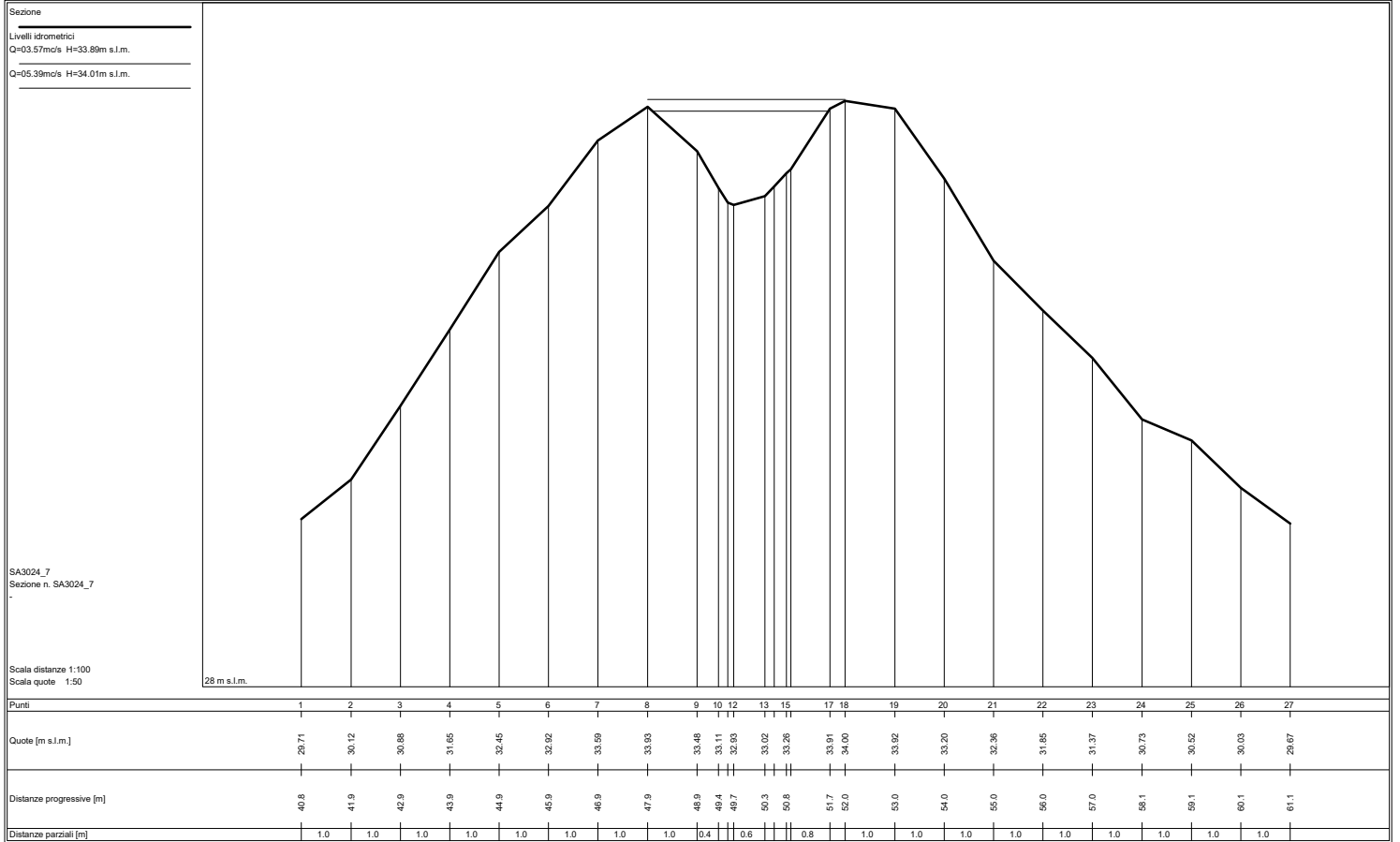

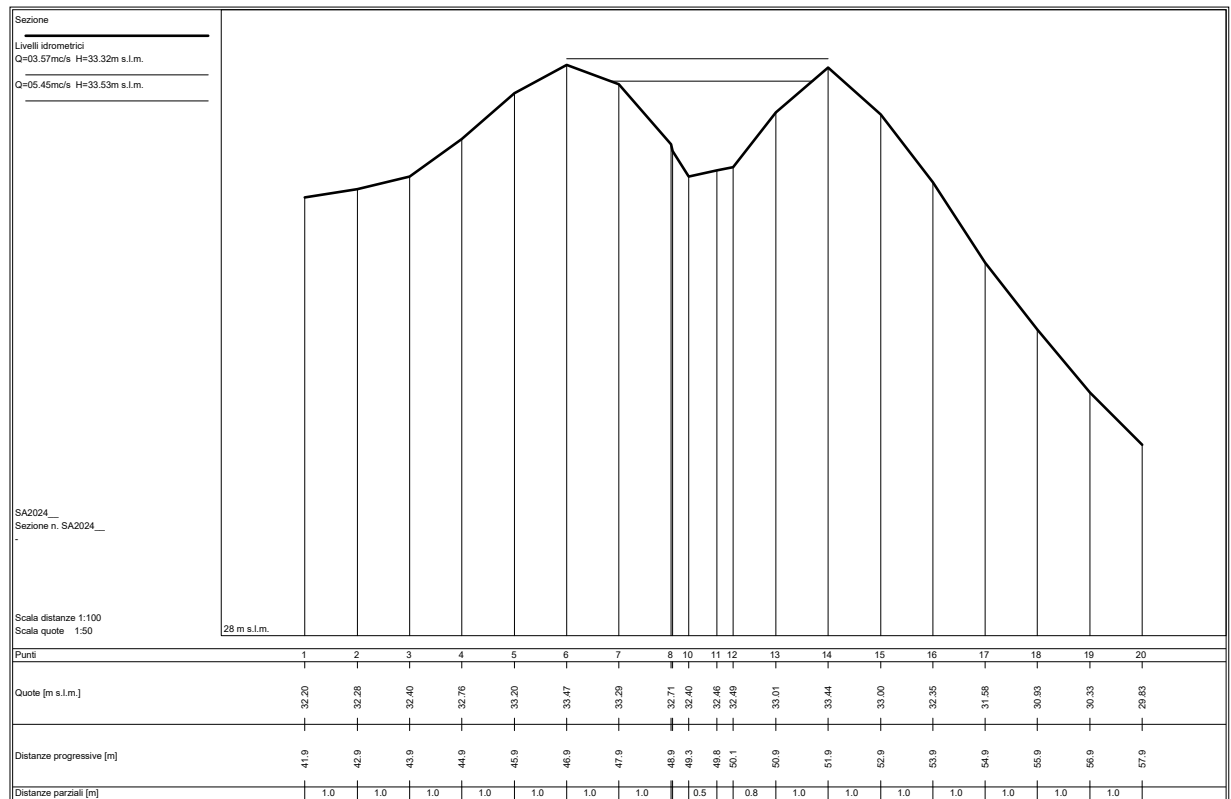
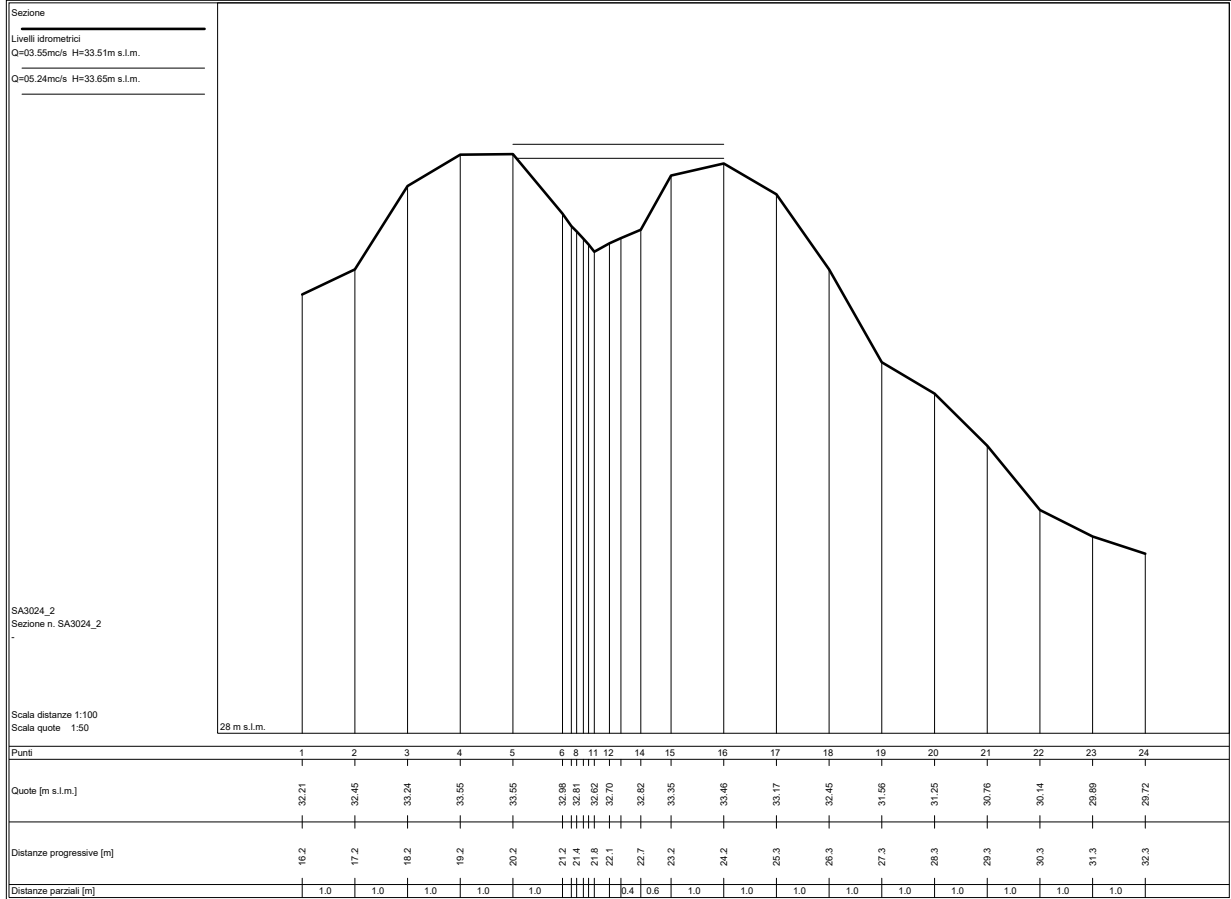

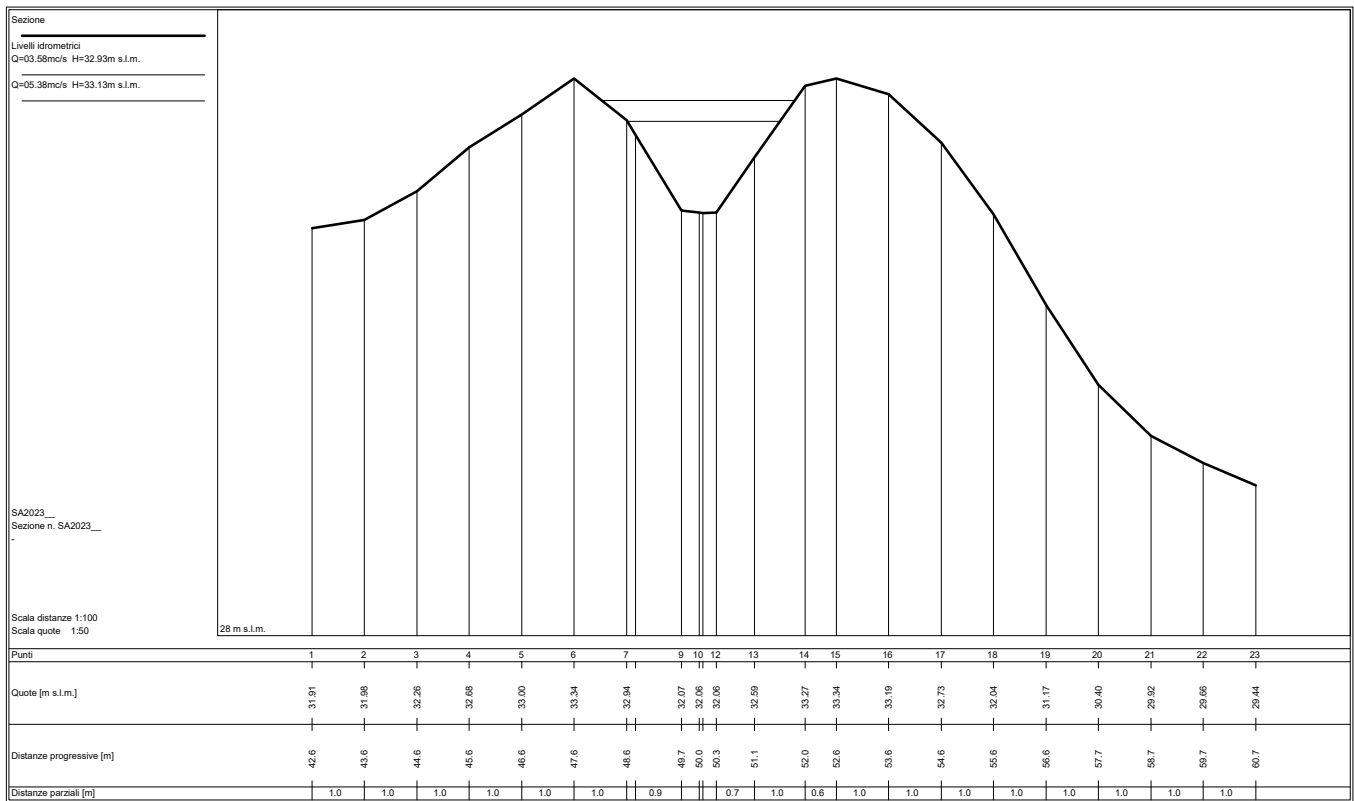
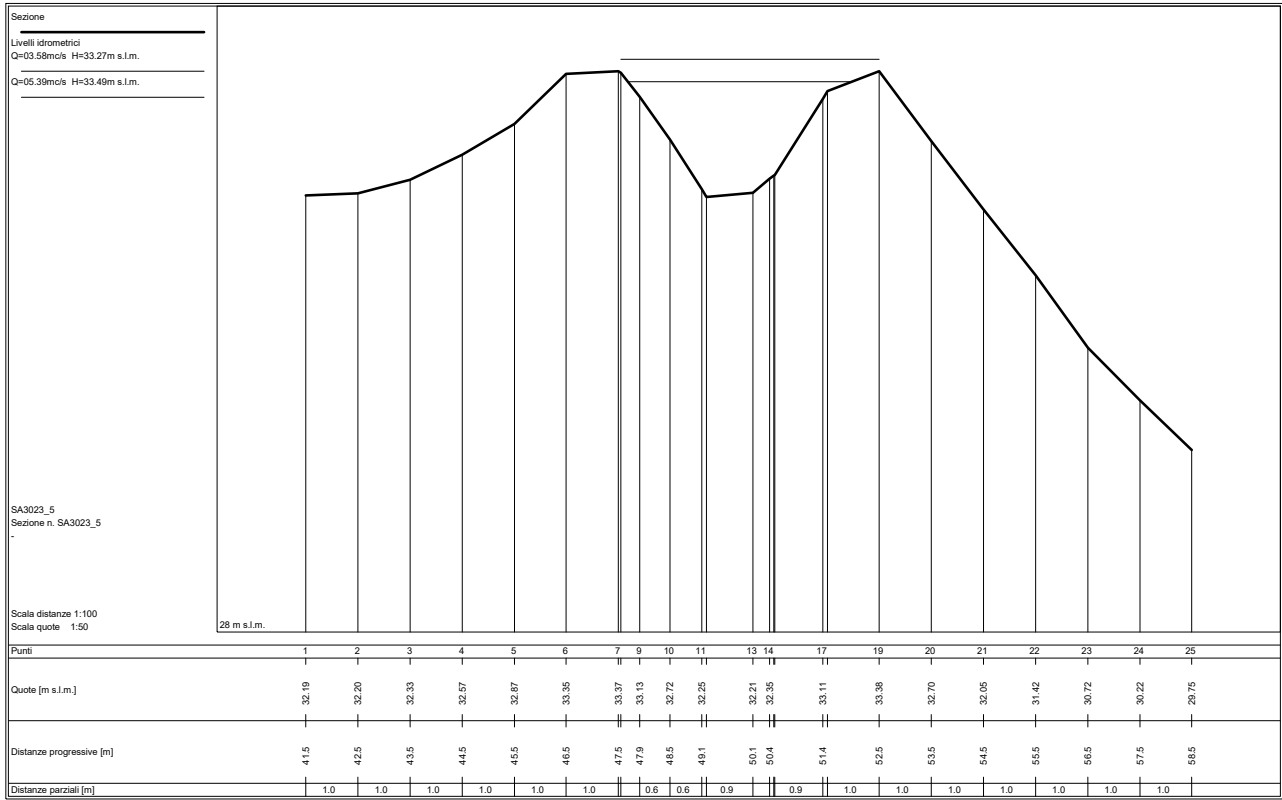

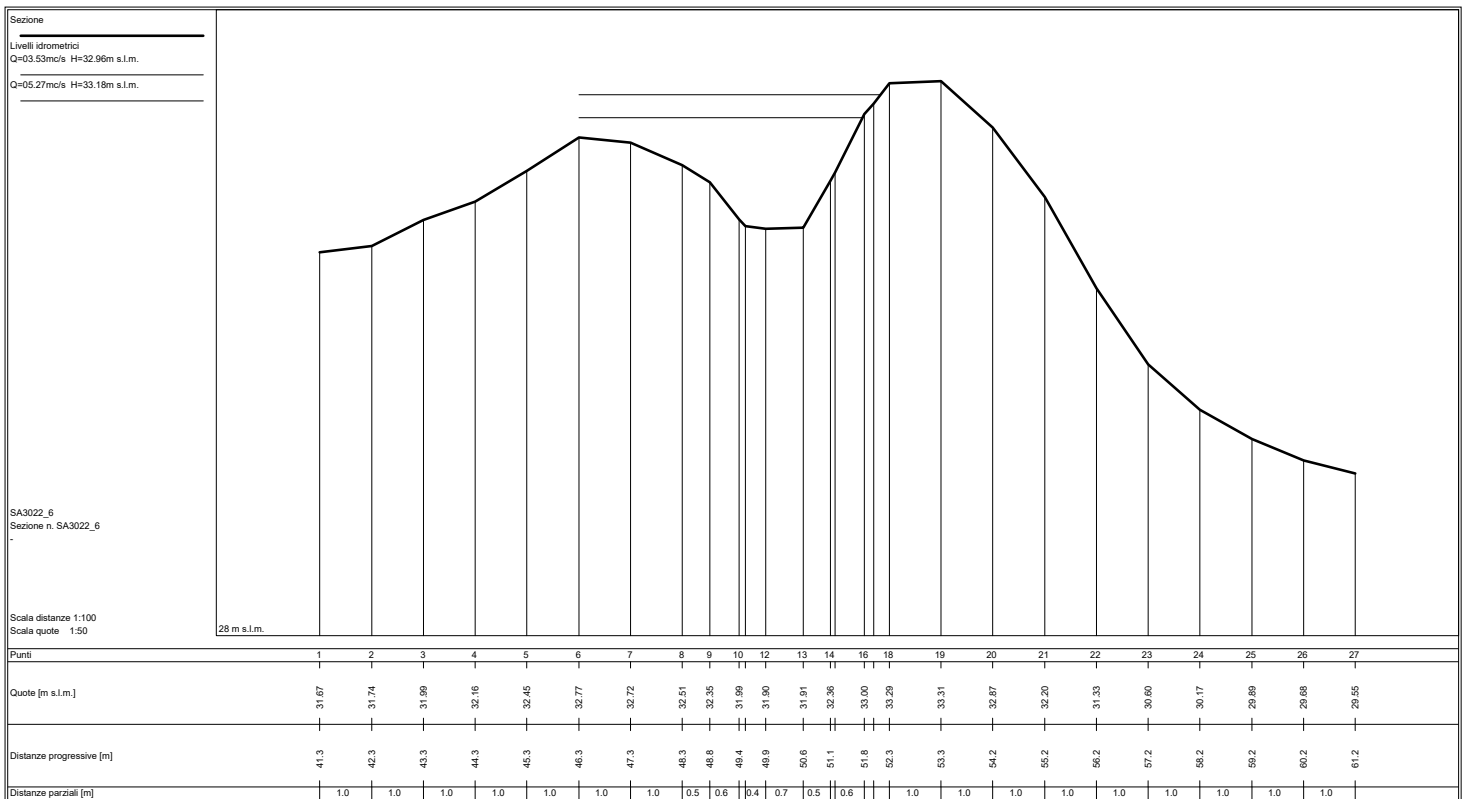
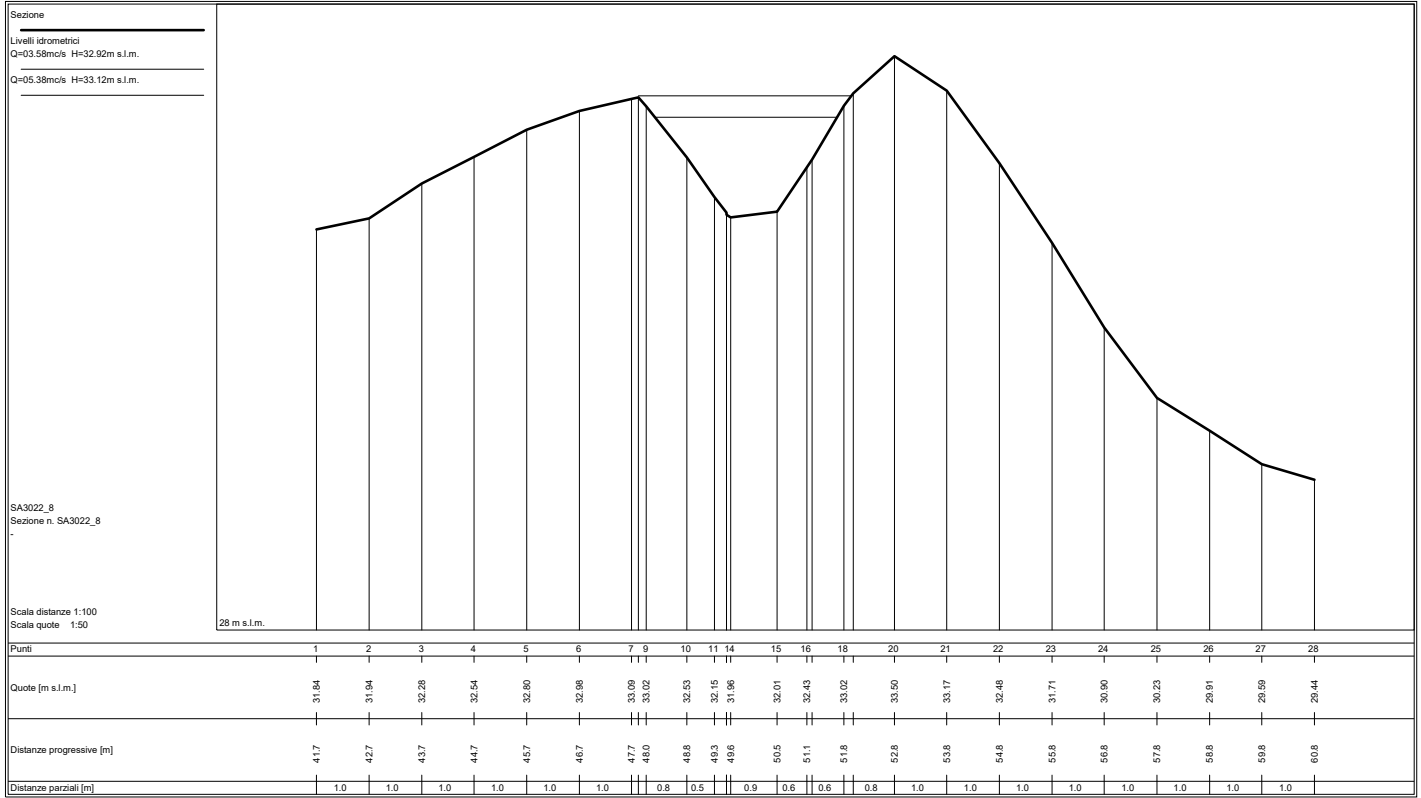

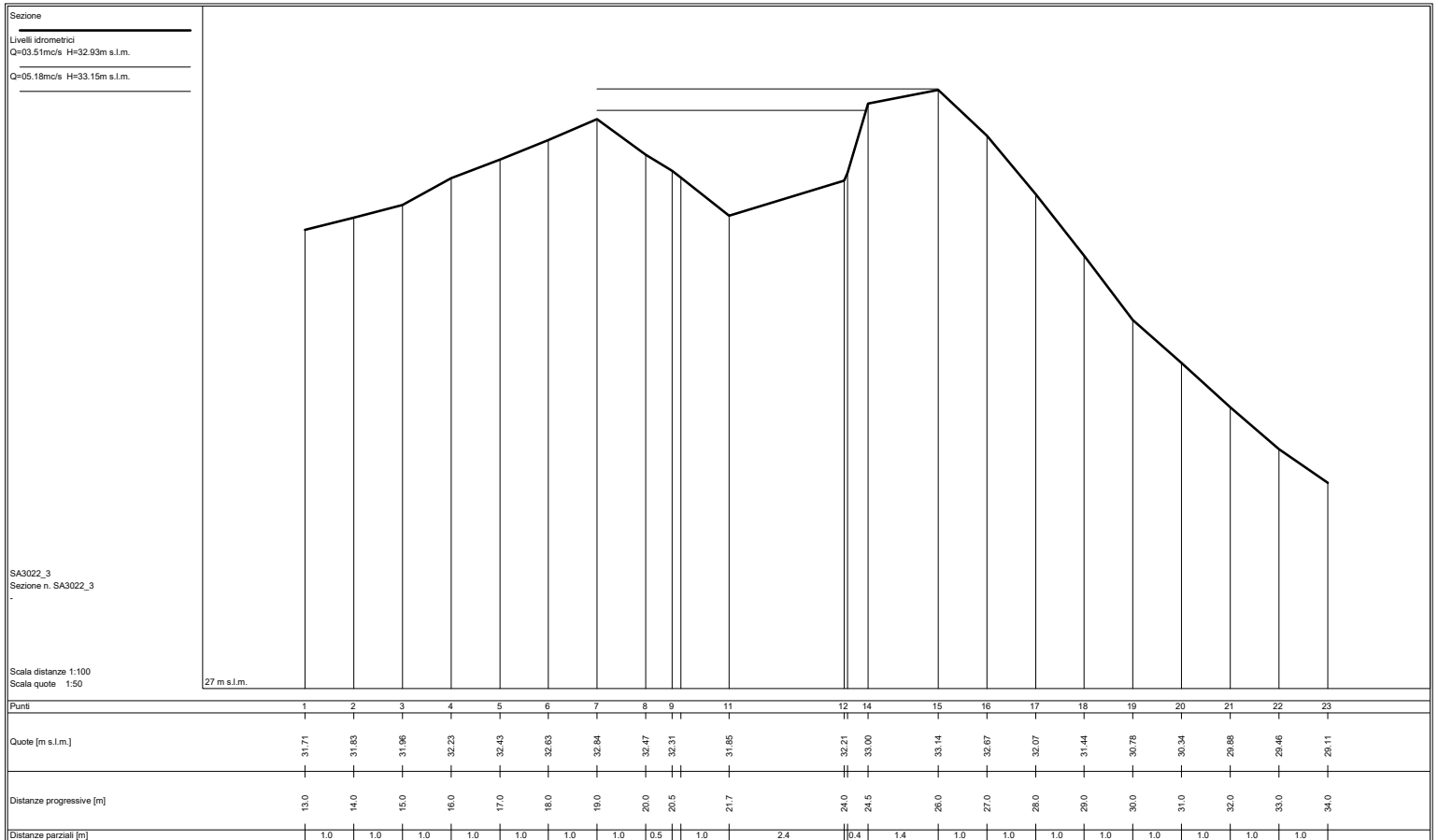
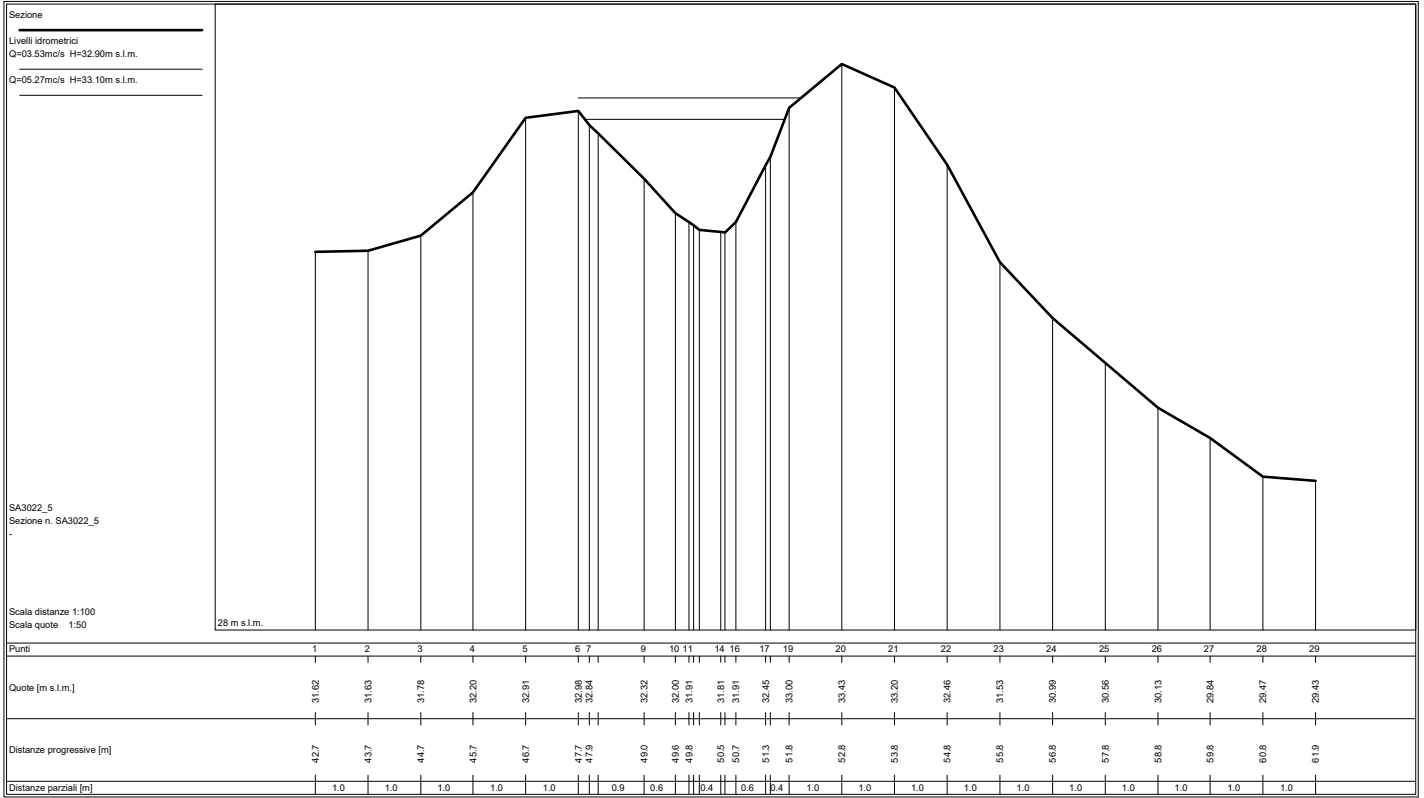

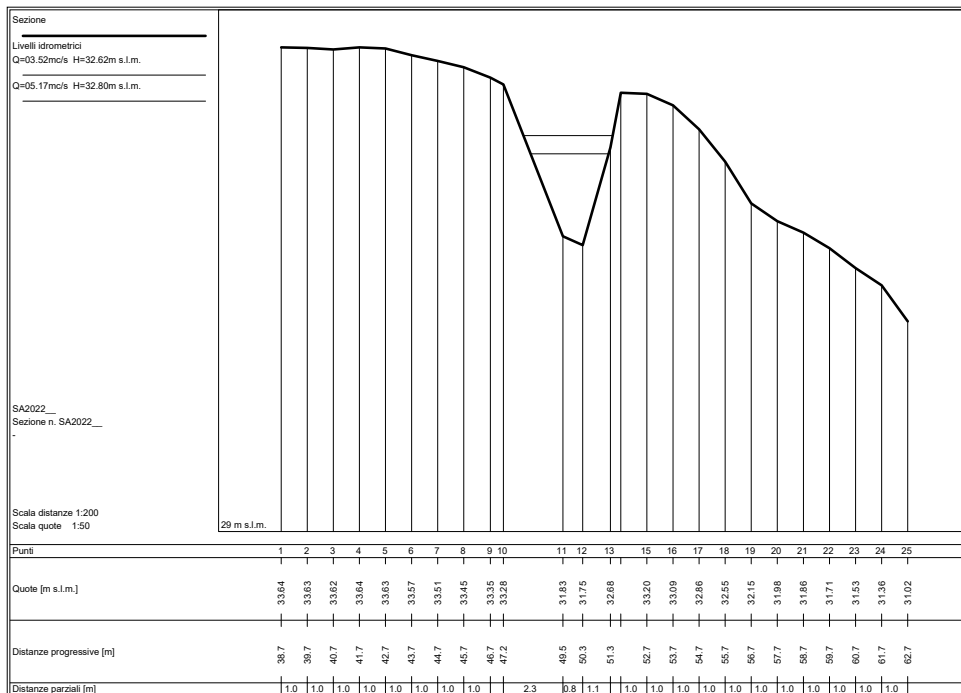
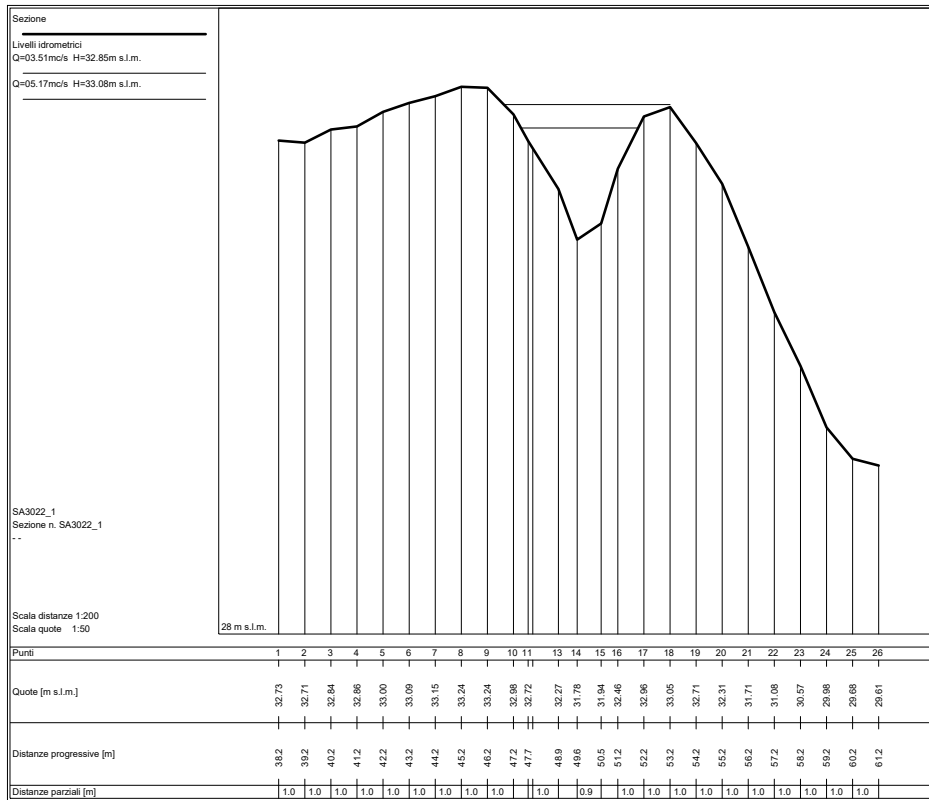

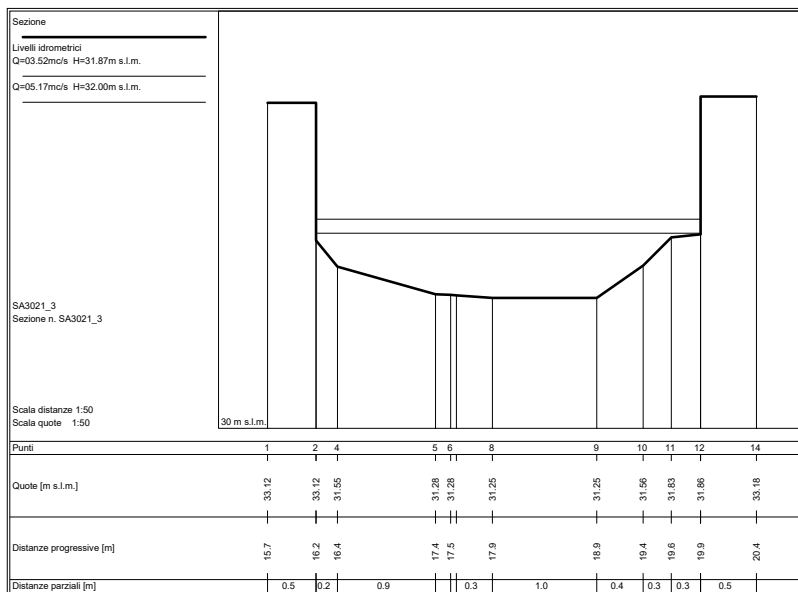
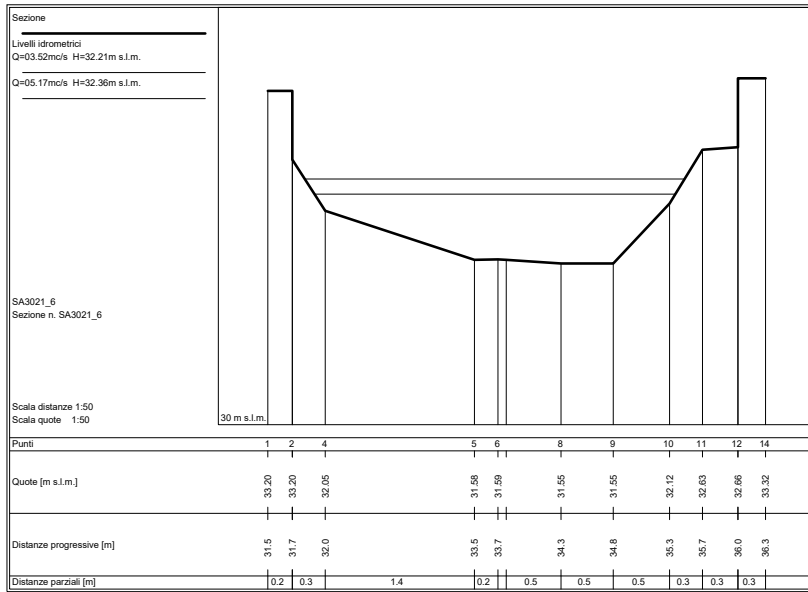

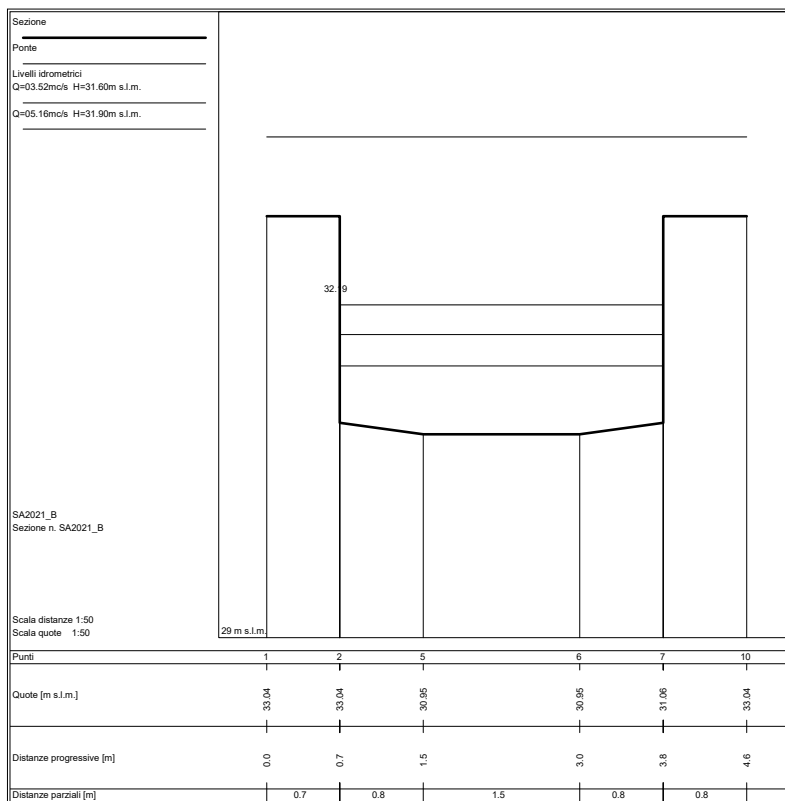
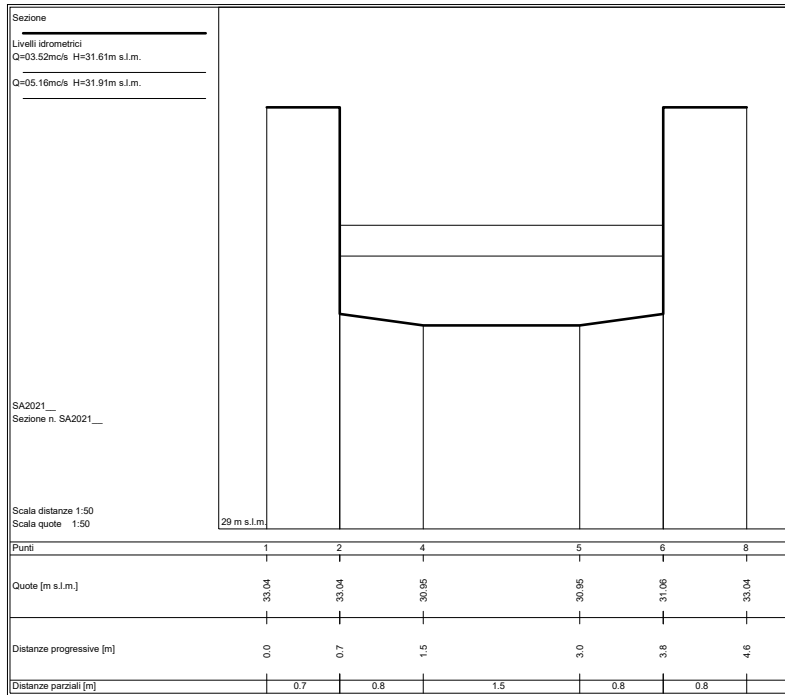

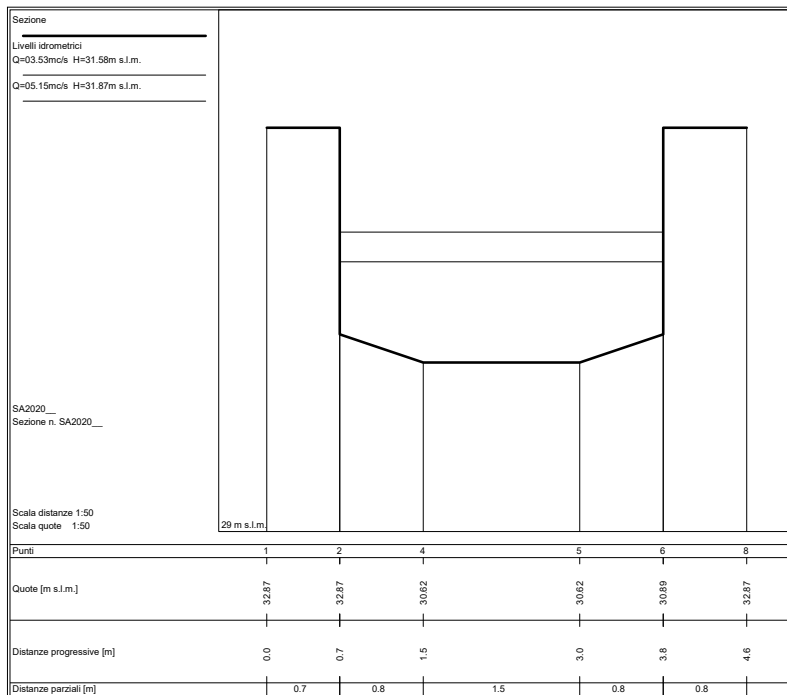
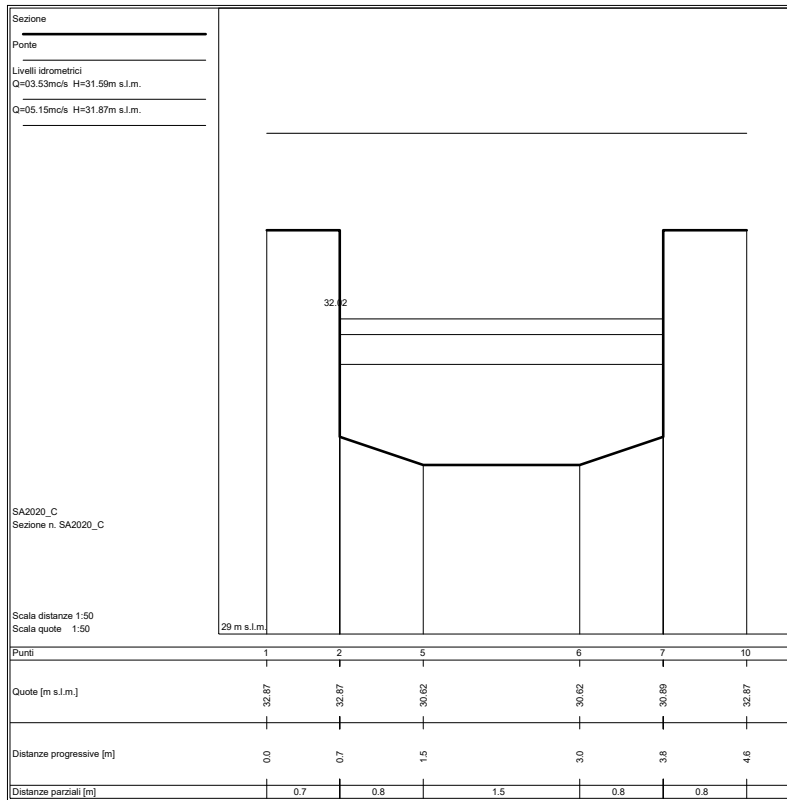

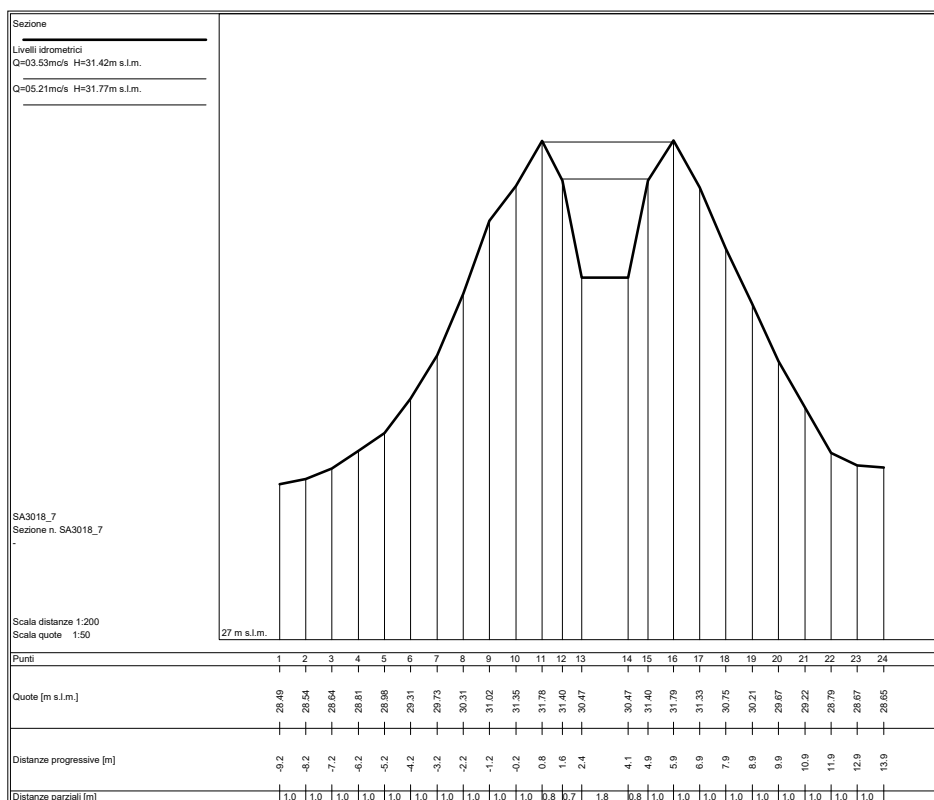
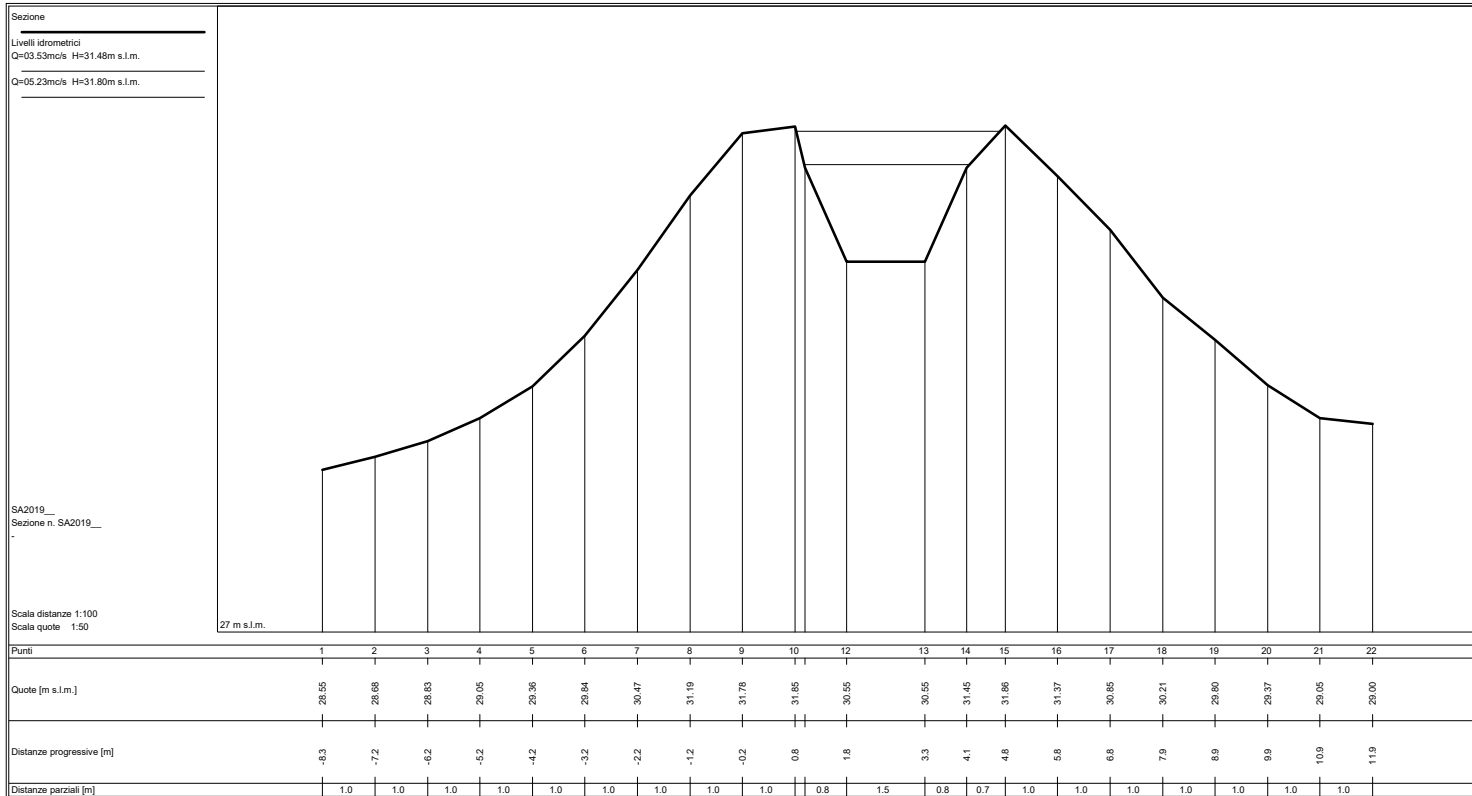

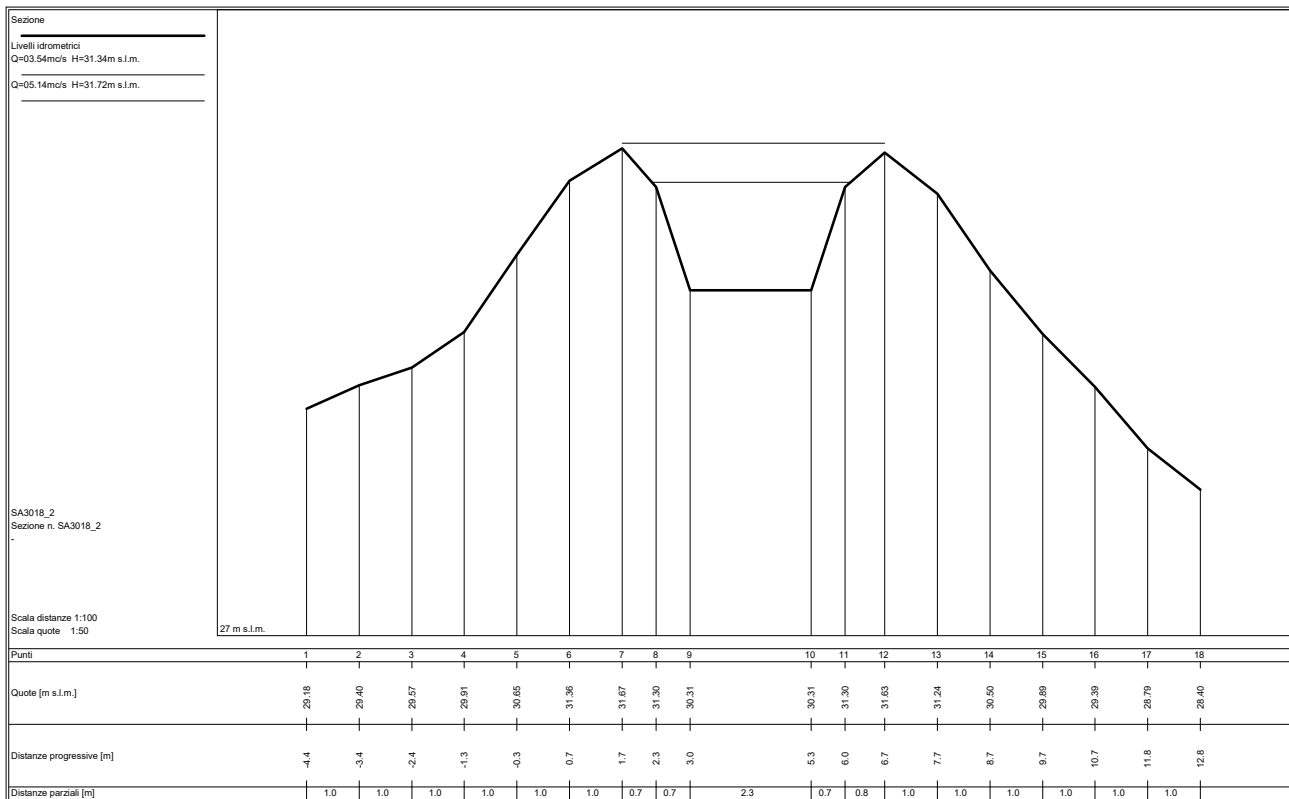
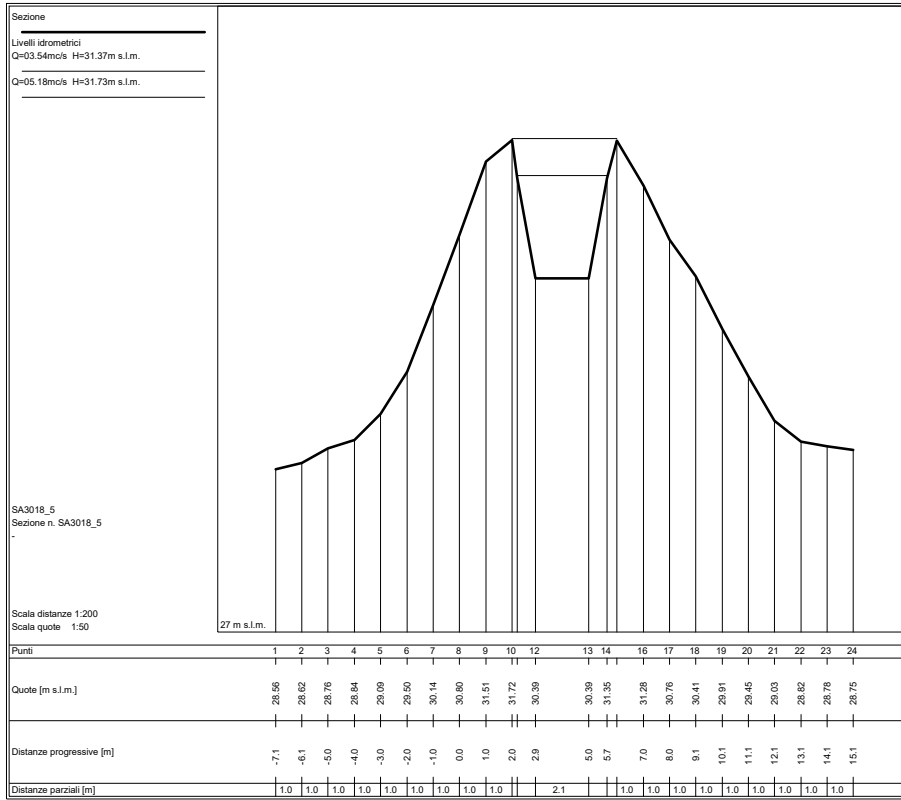

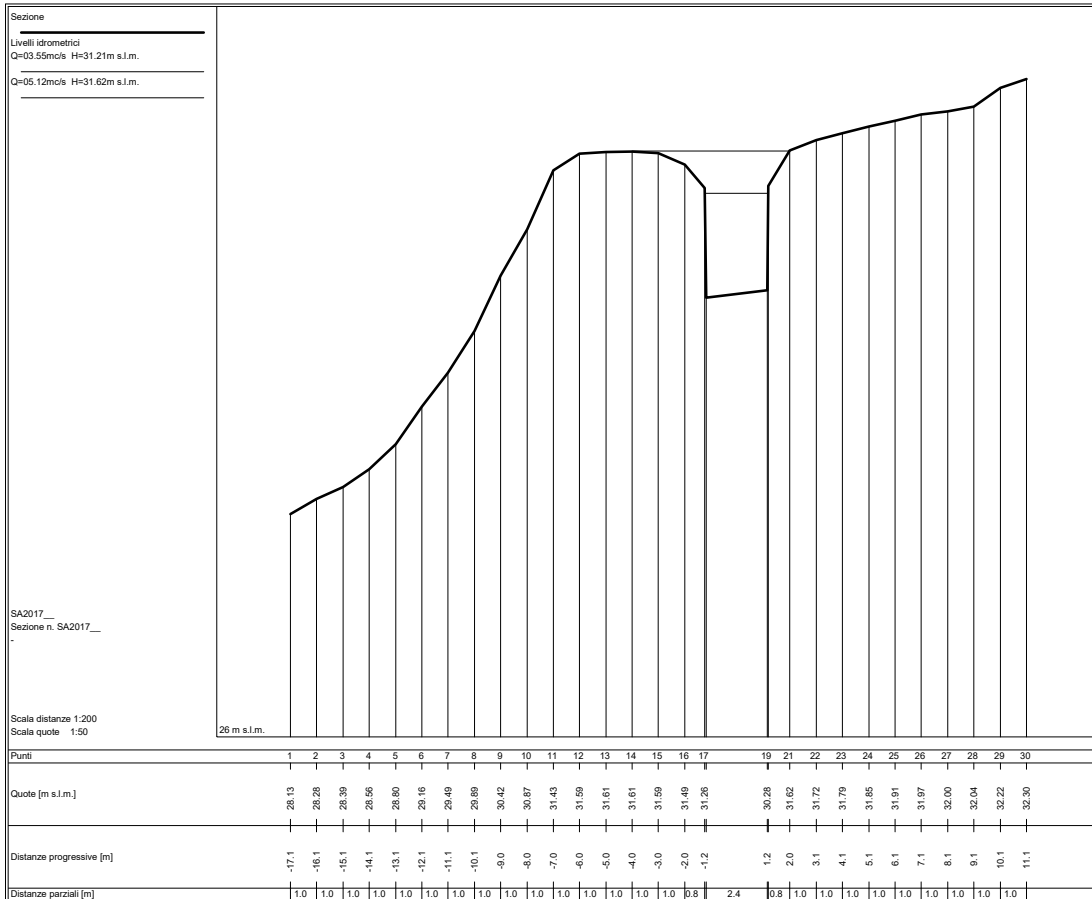
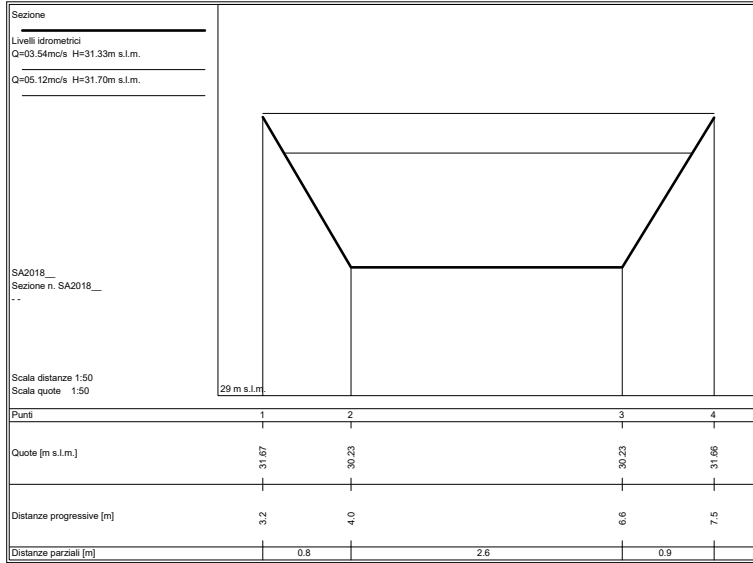

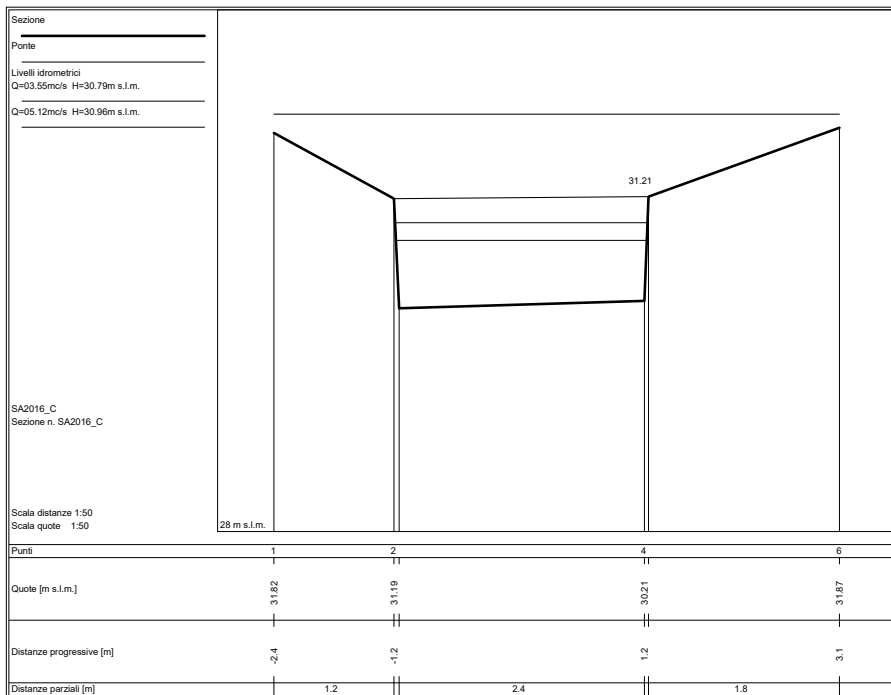
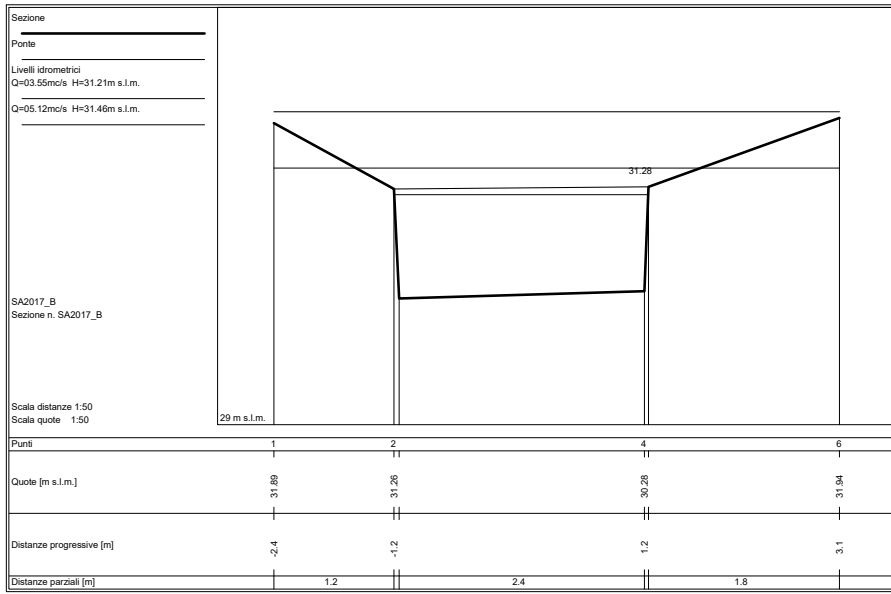

SEZIONI FLUVIALI
RIO SAMMONTANA – tratto Centro

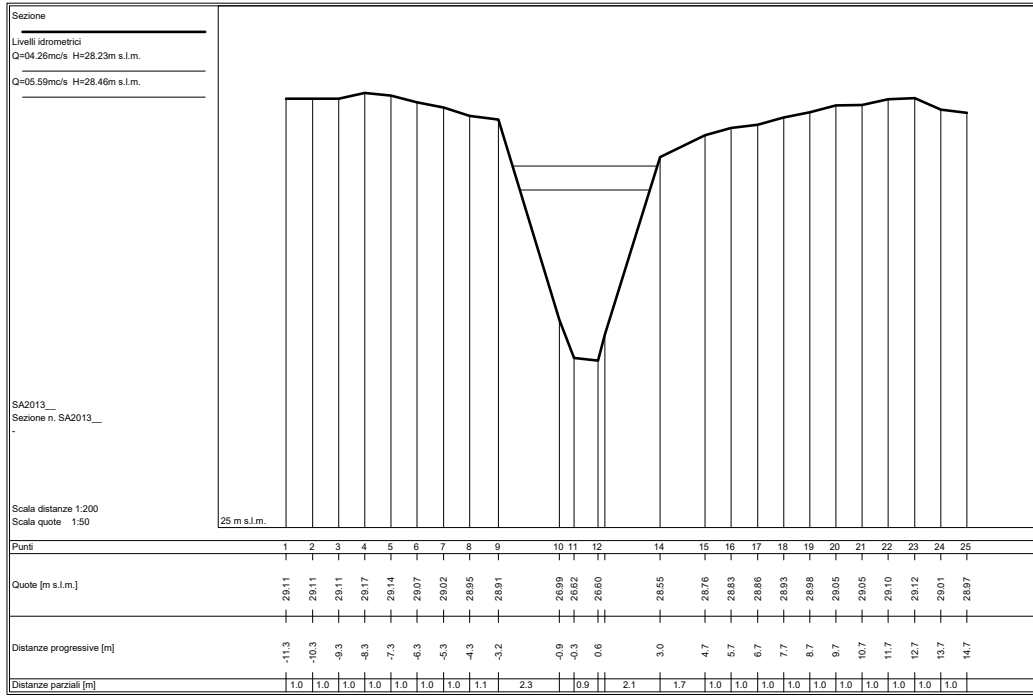
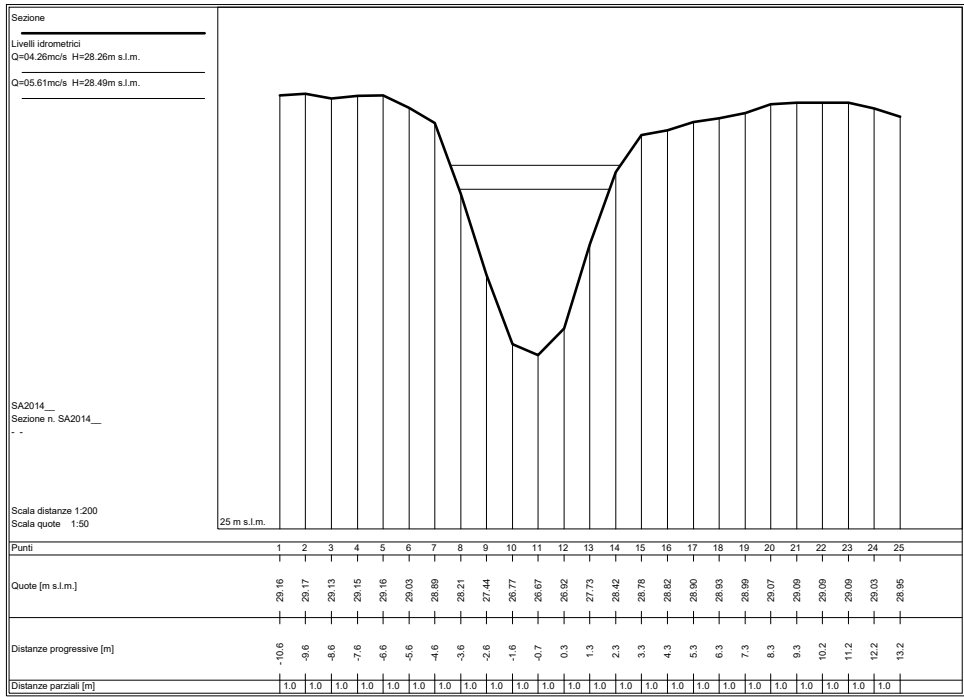

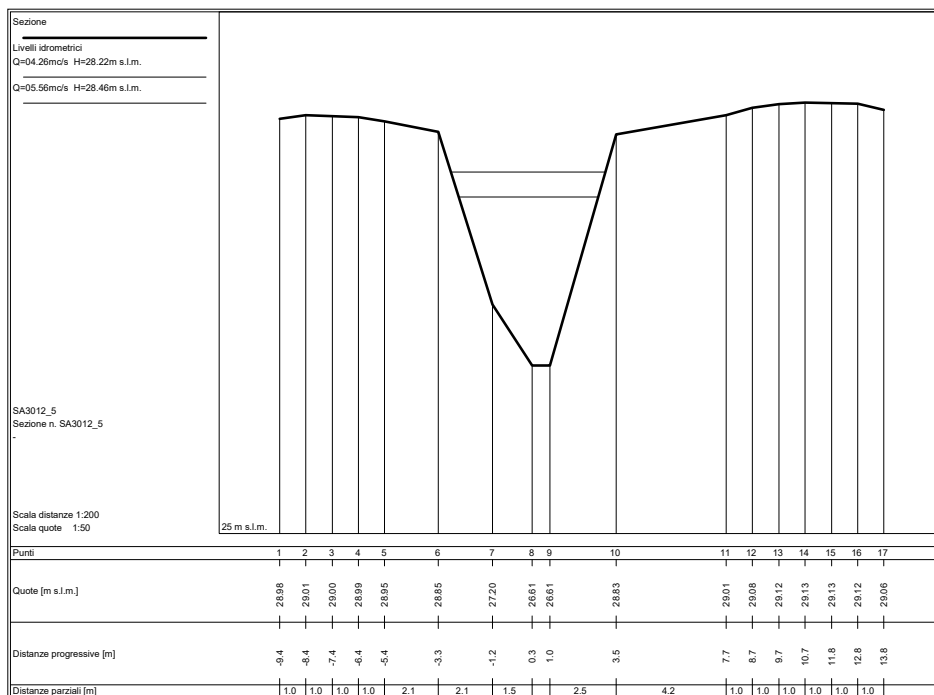
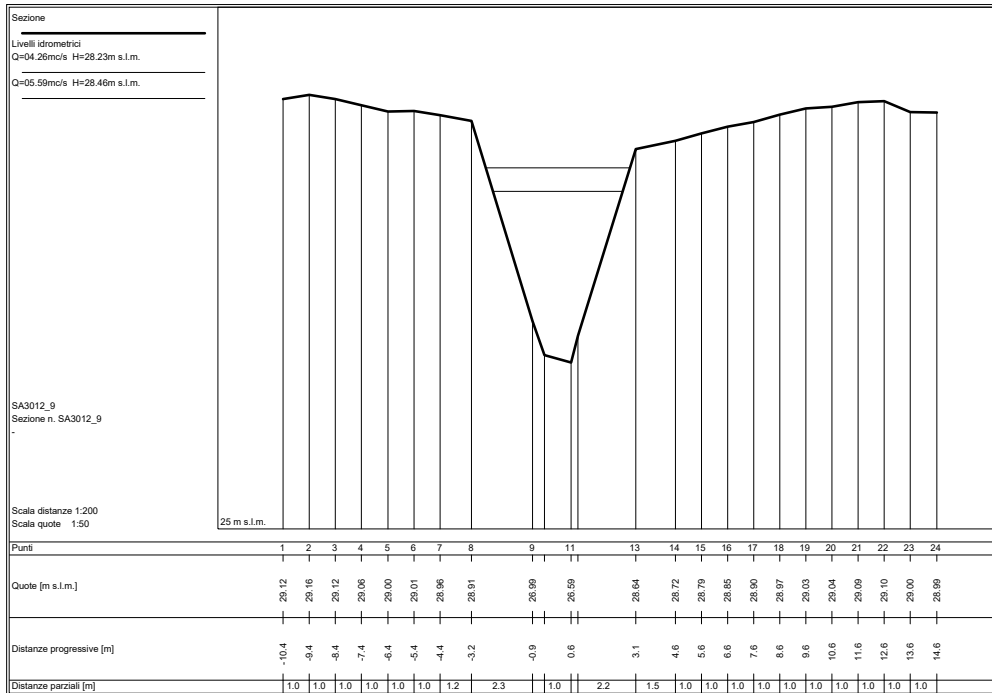

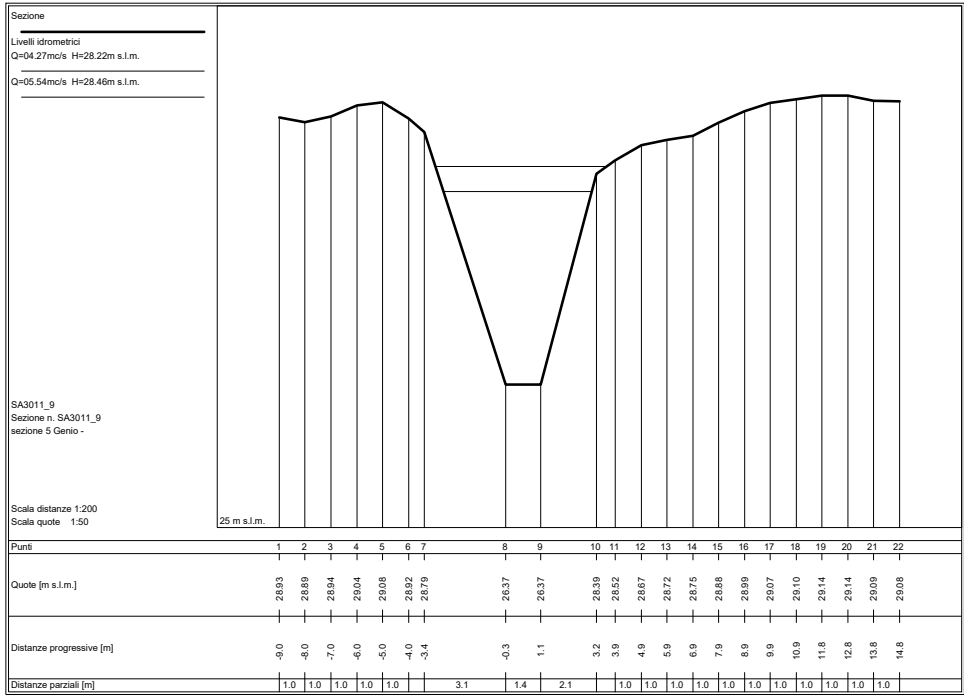
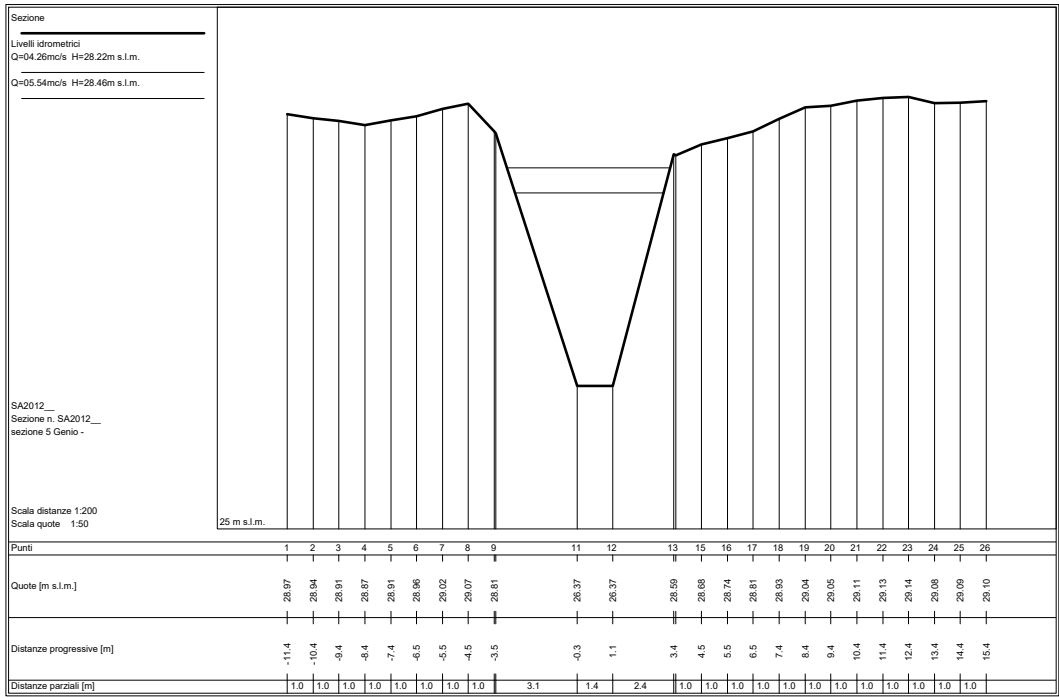

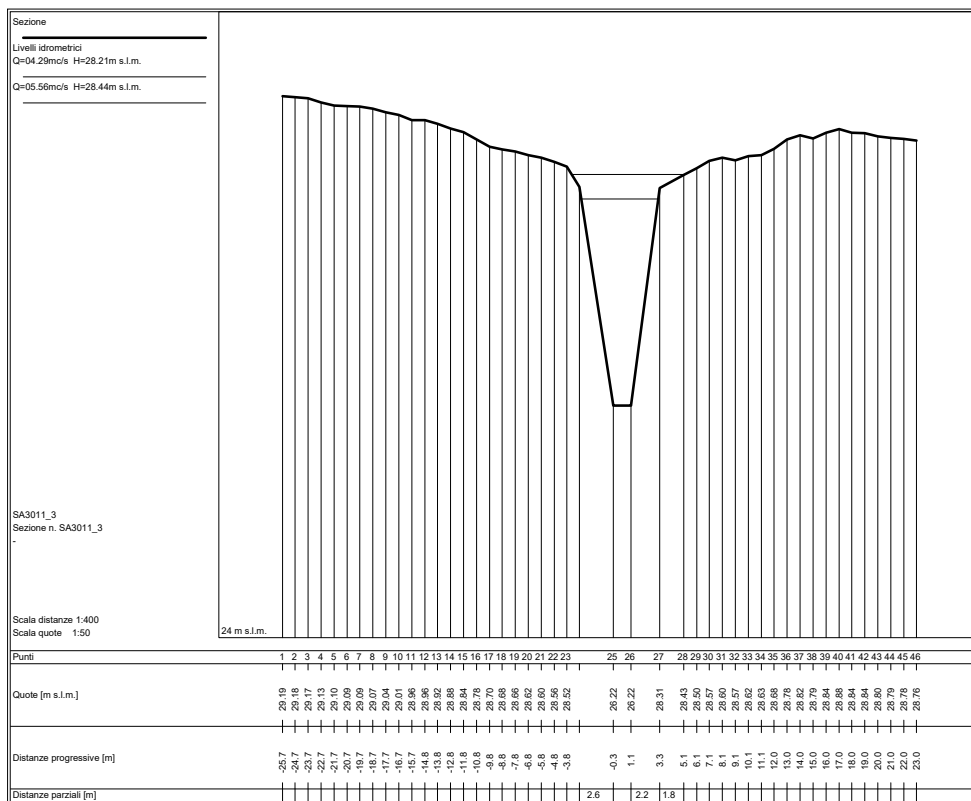
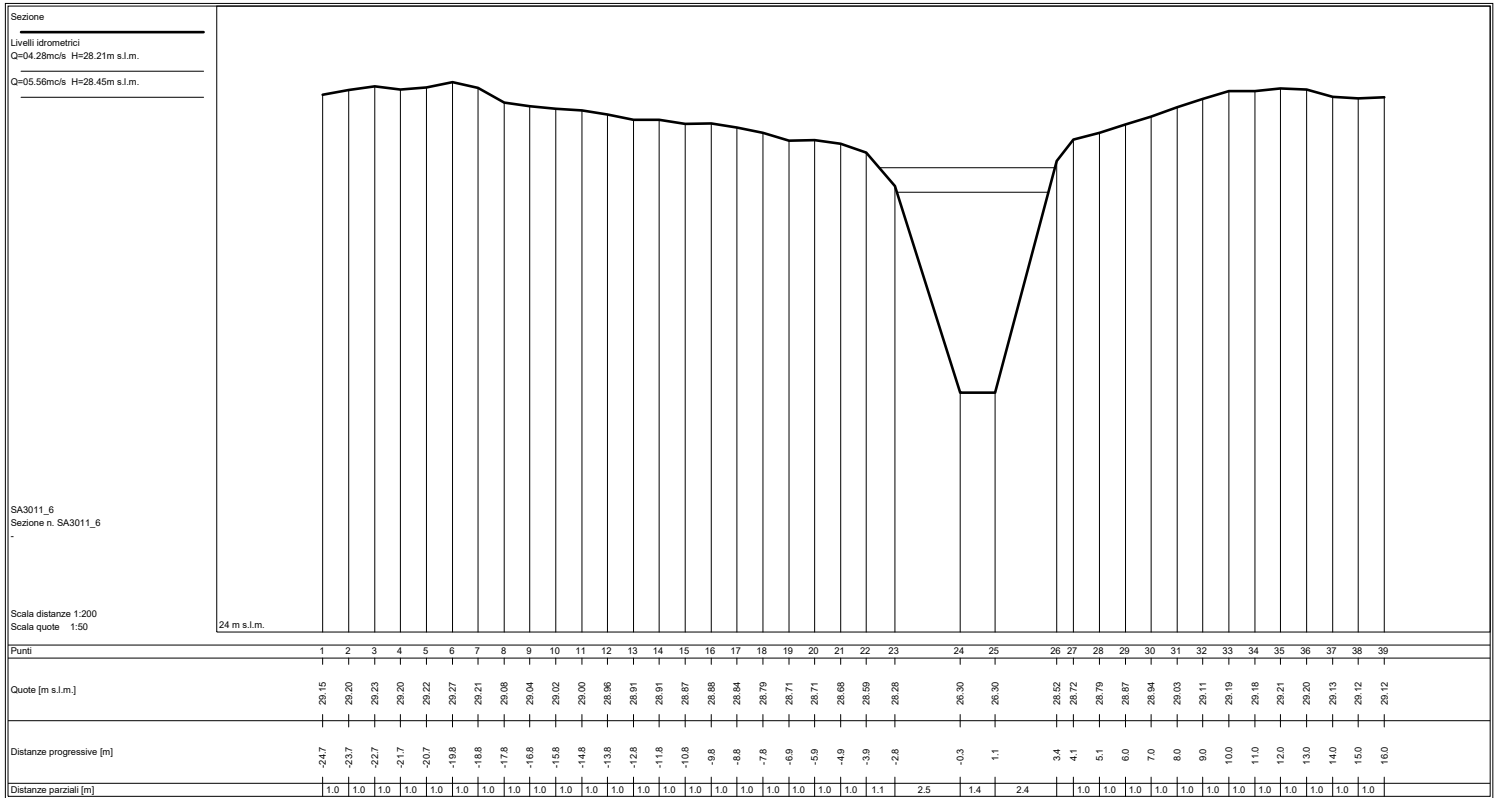

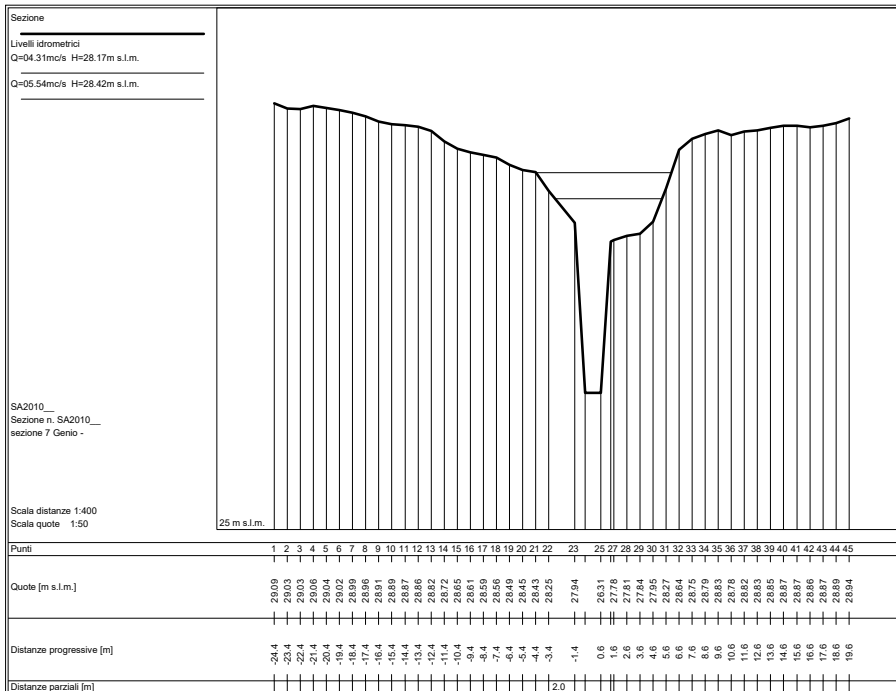
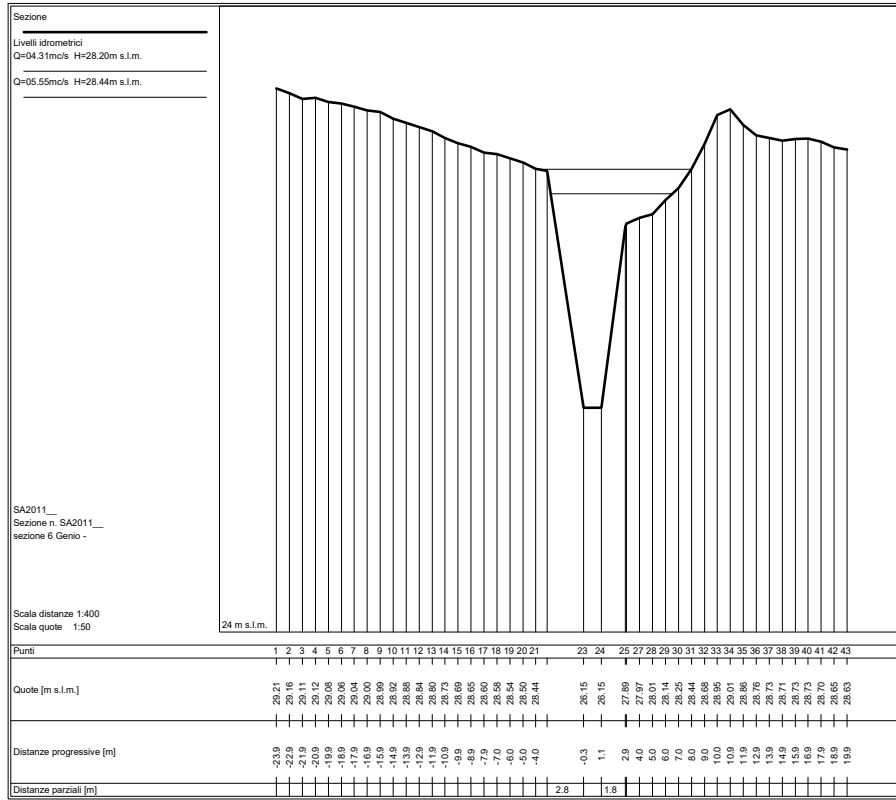

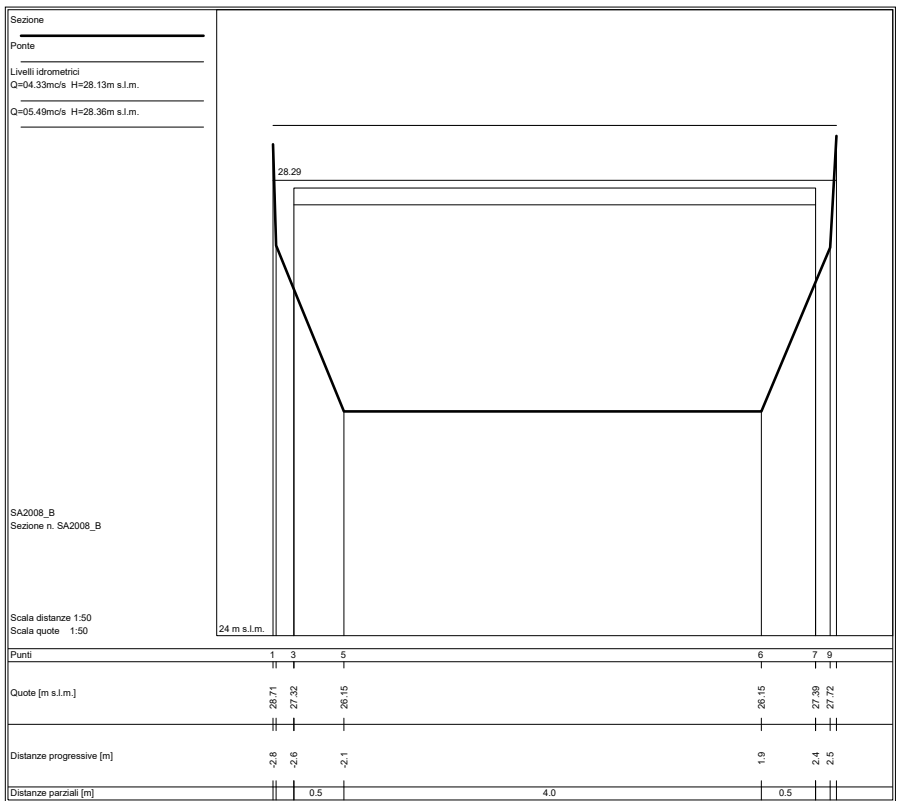
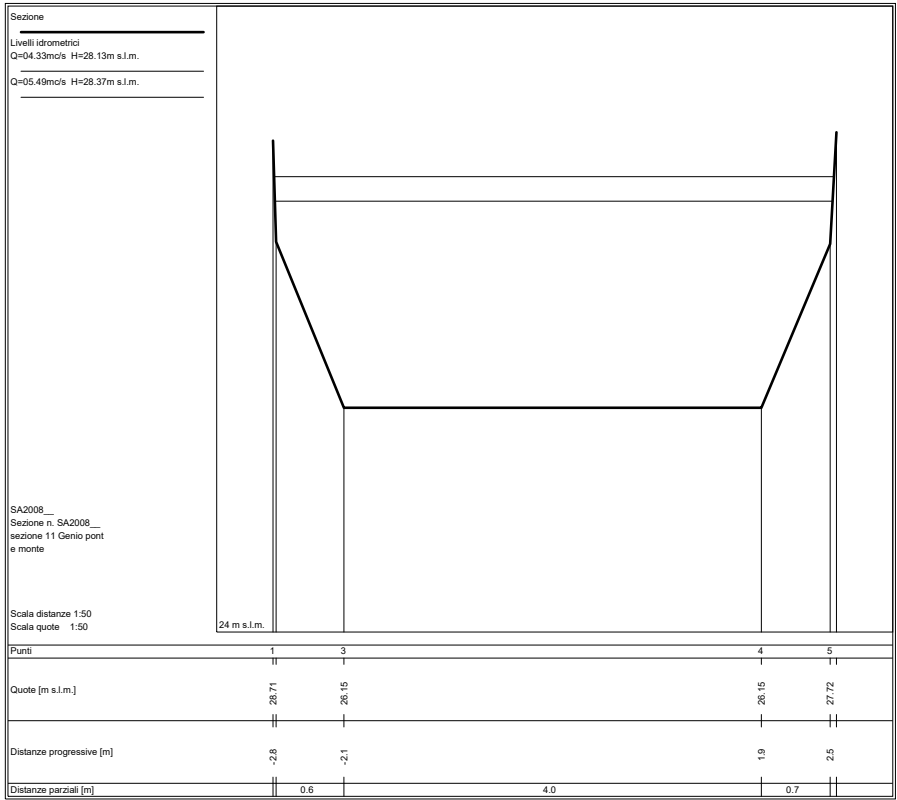

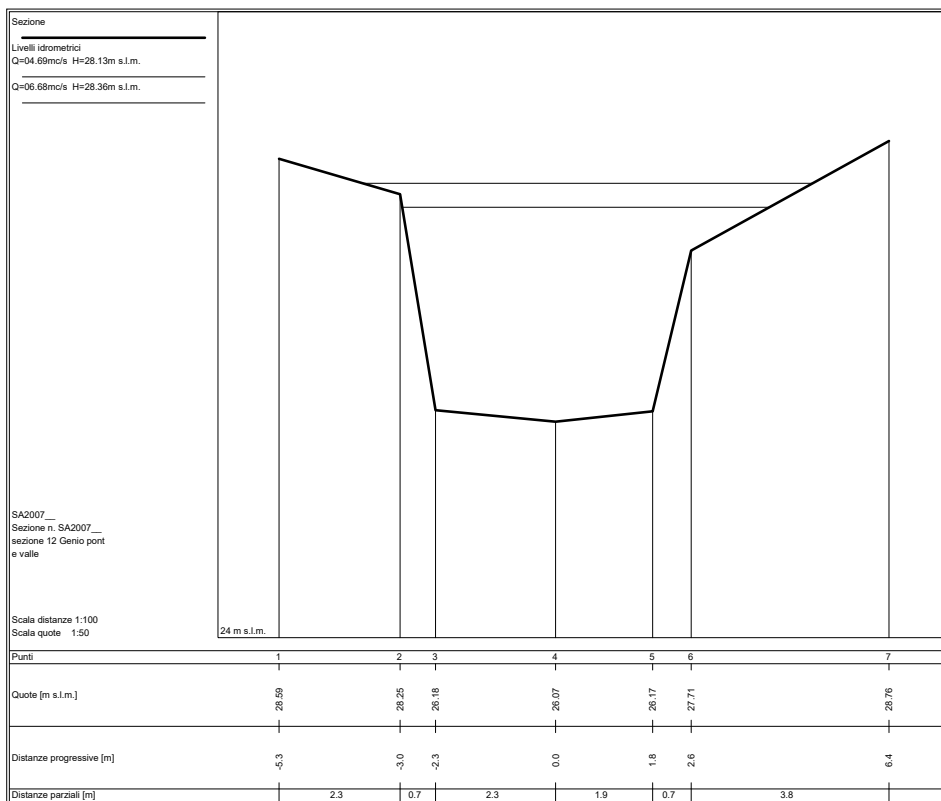
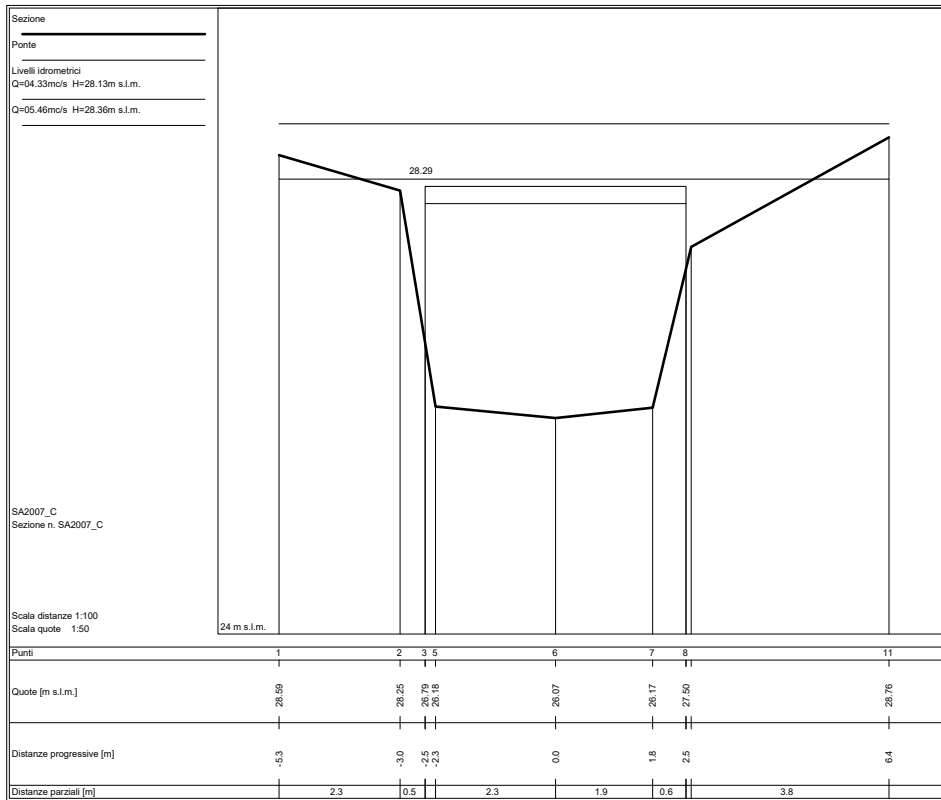

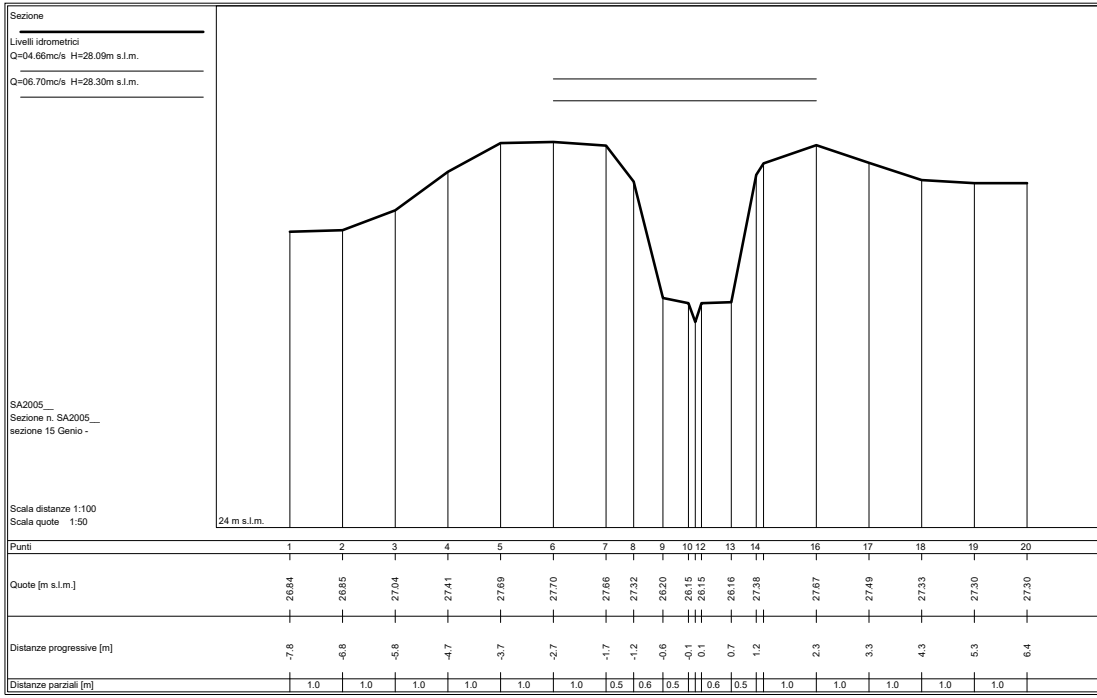
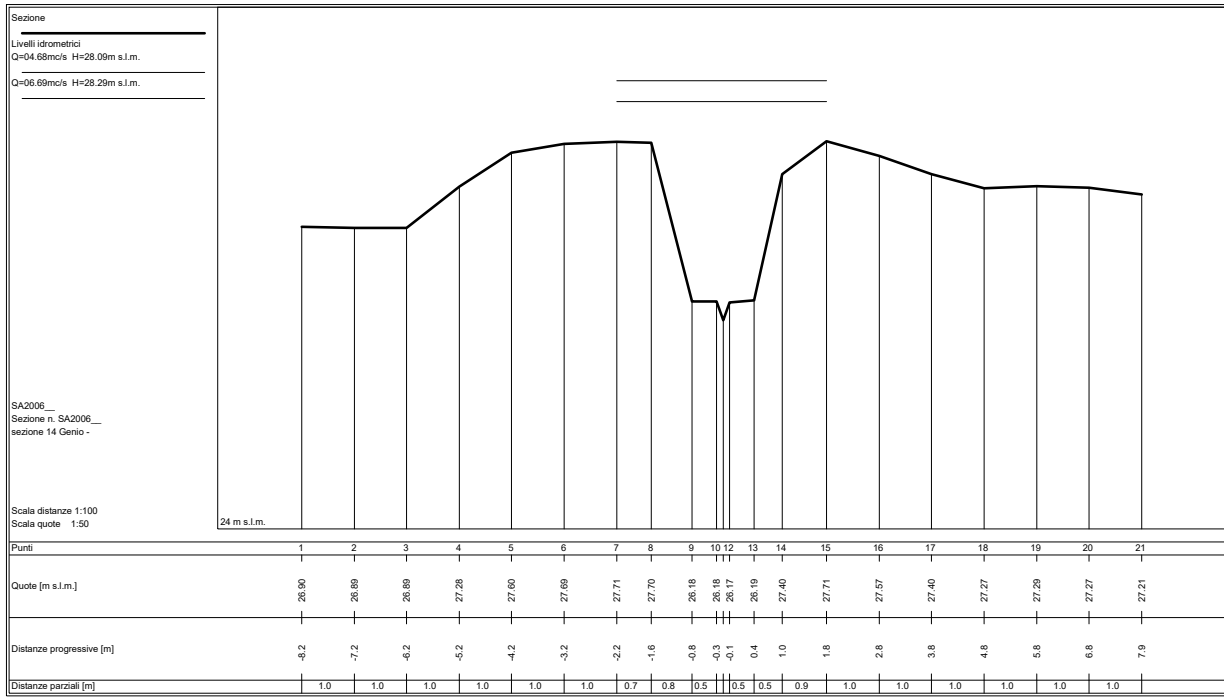

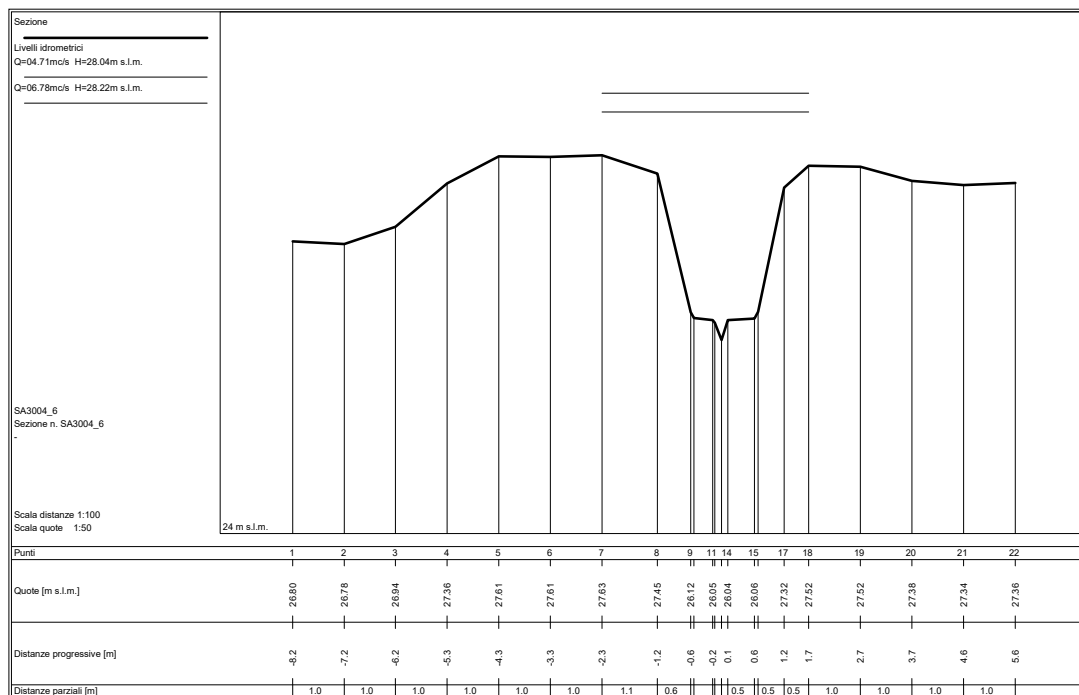
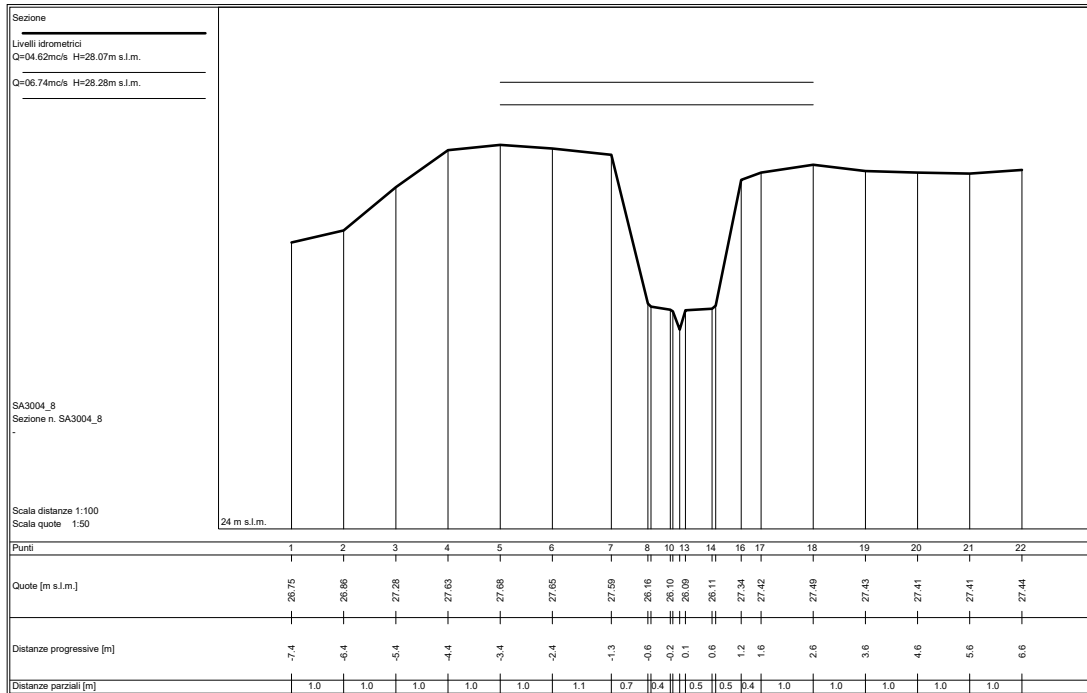

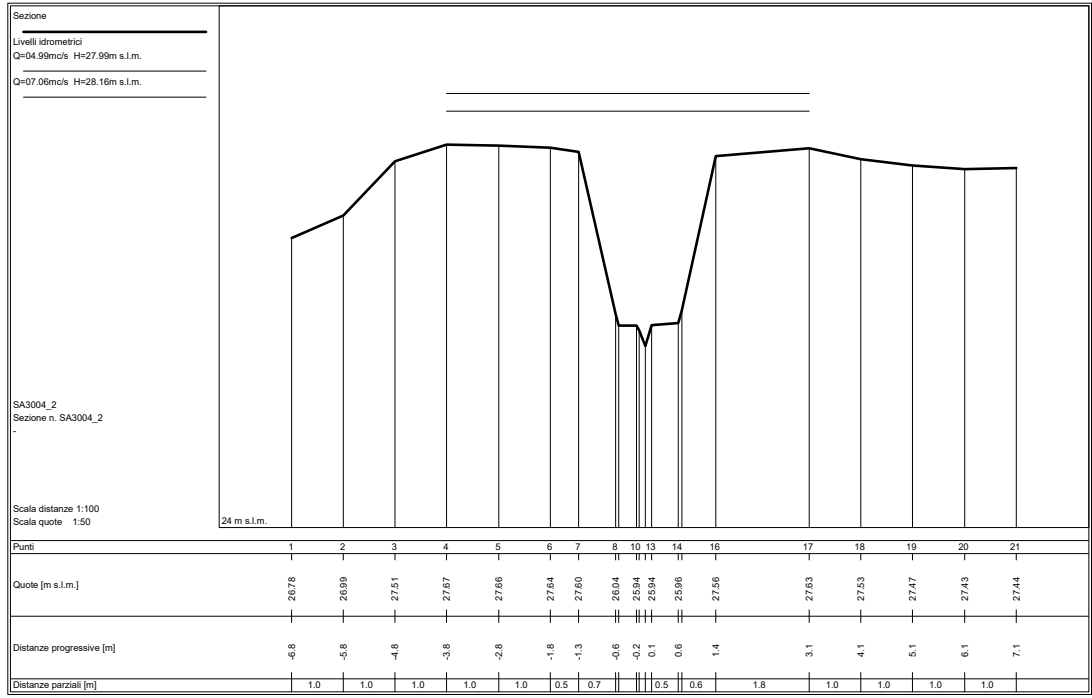
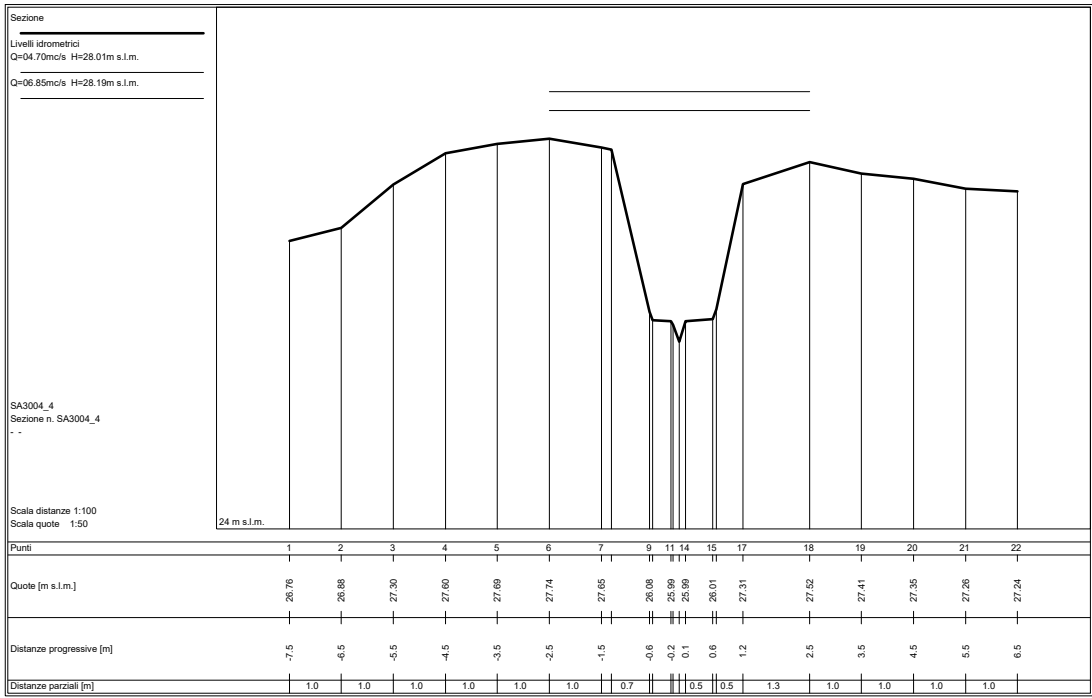

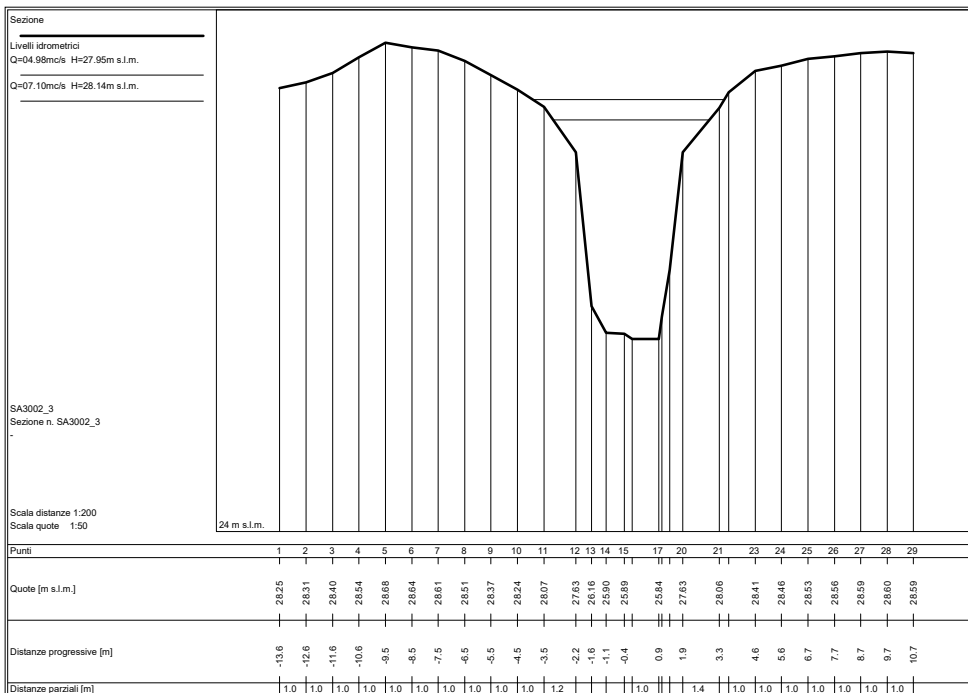
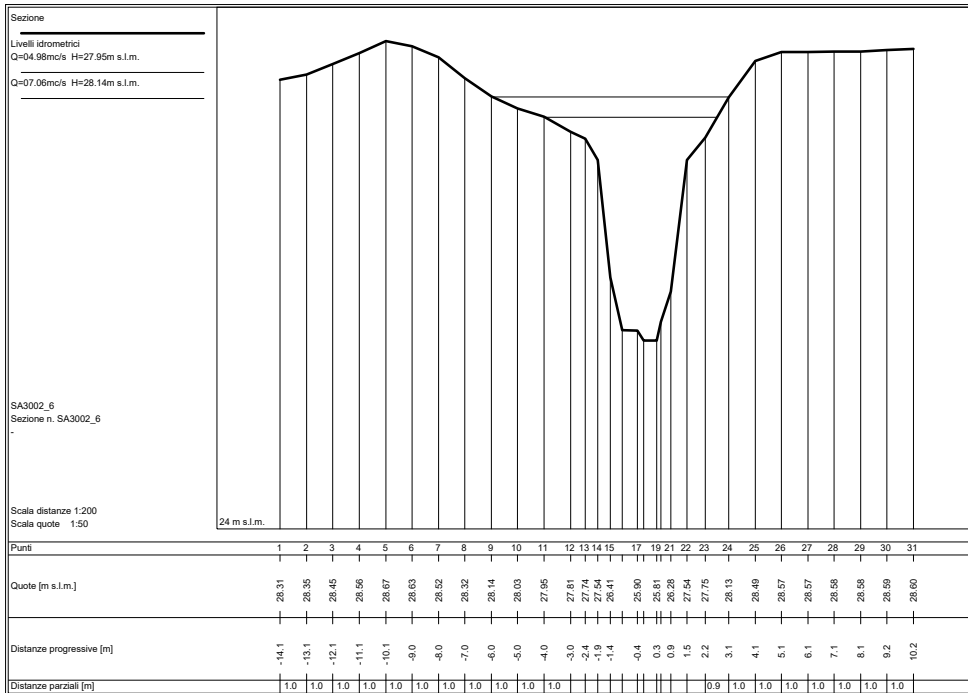

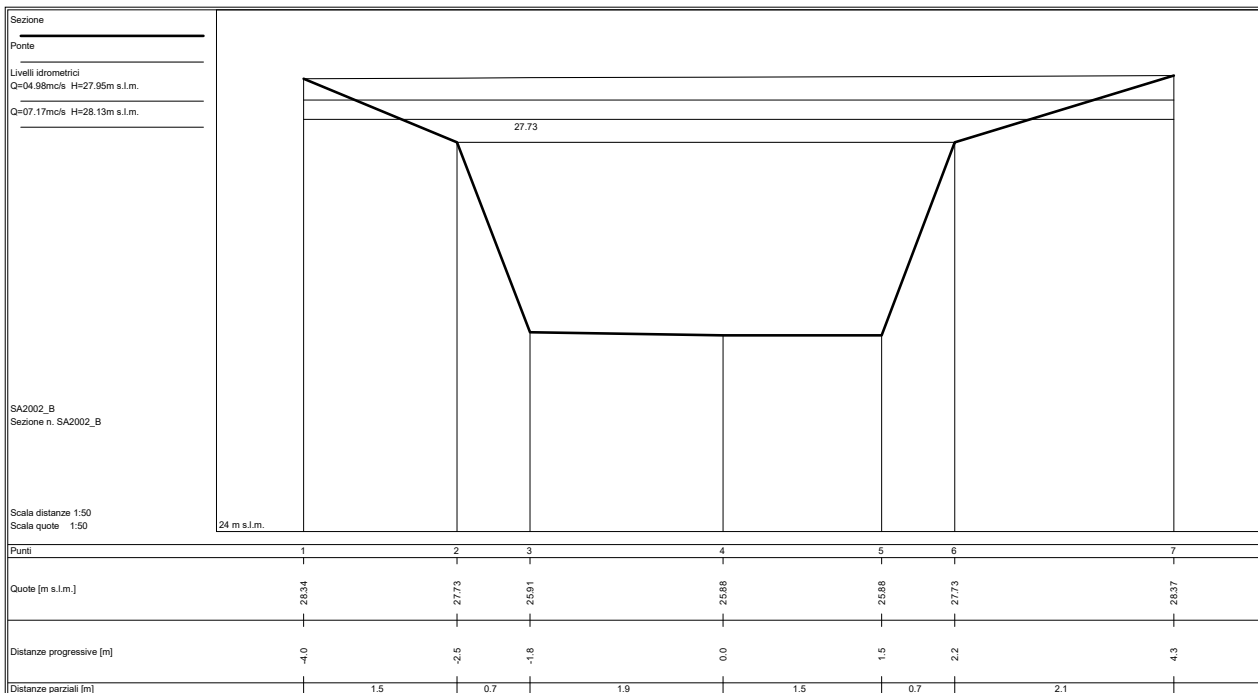
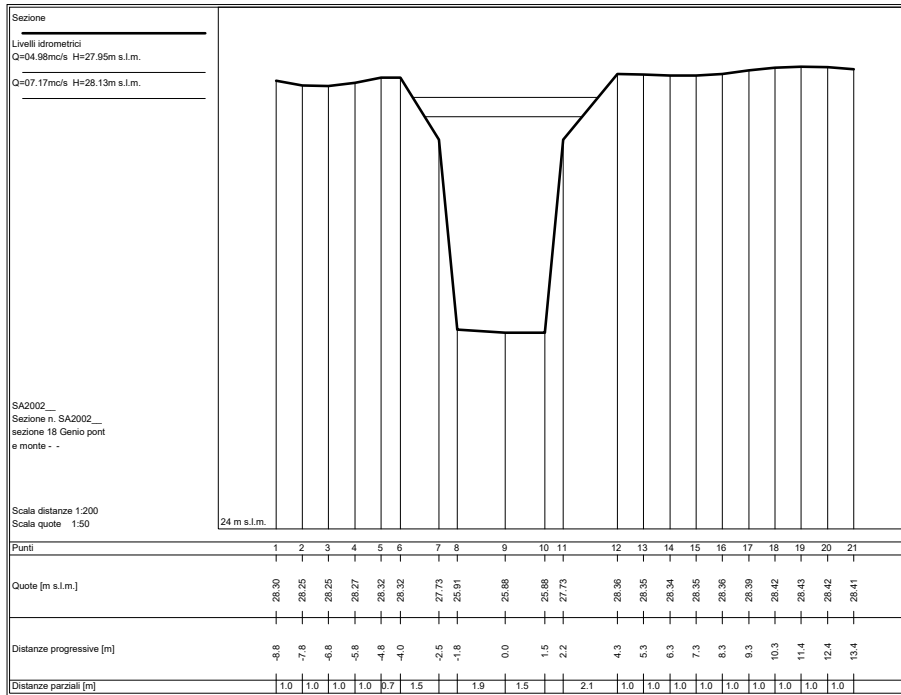

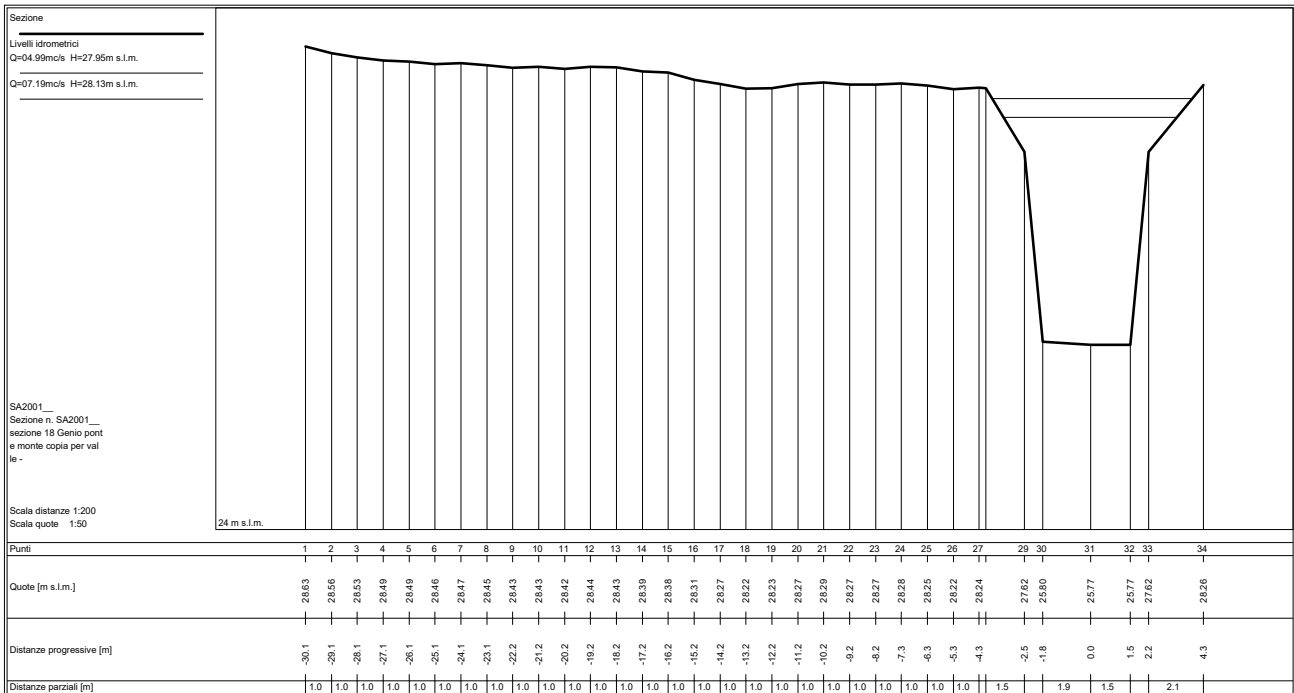
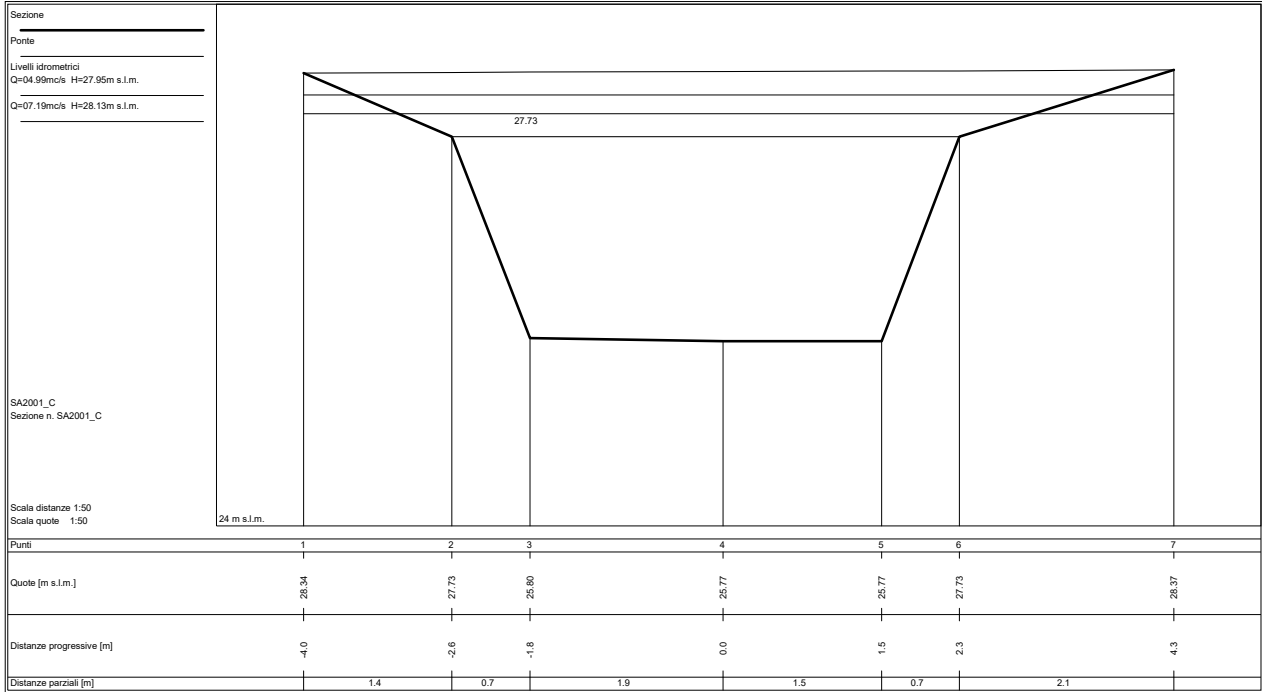

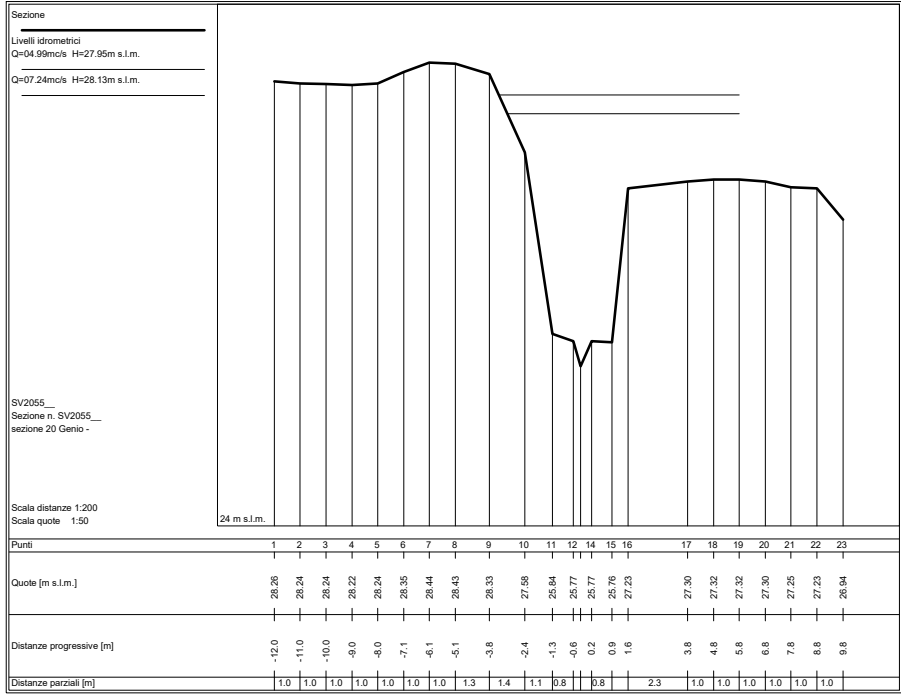

SEZIONI FLUVIALI
RIO SAMMONTANA – tratto Valle

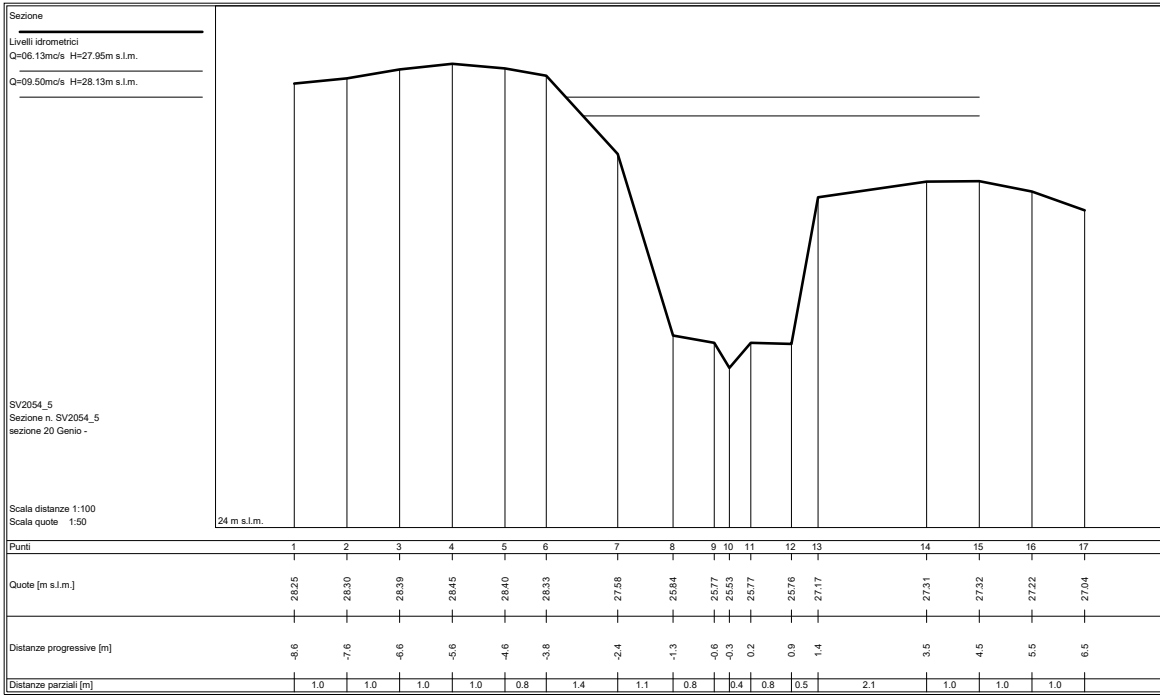
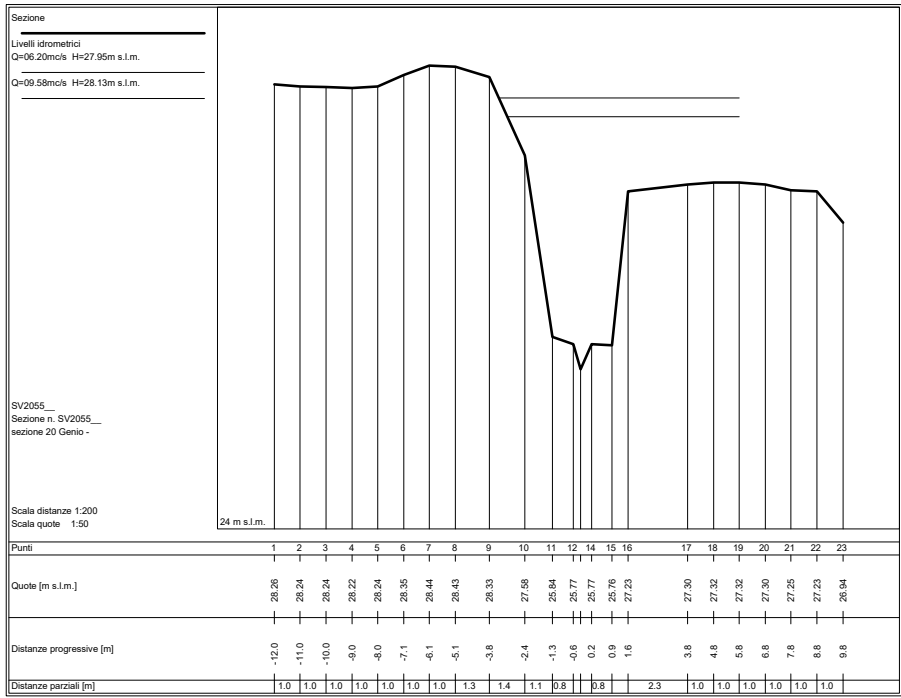

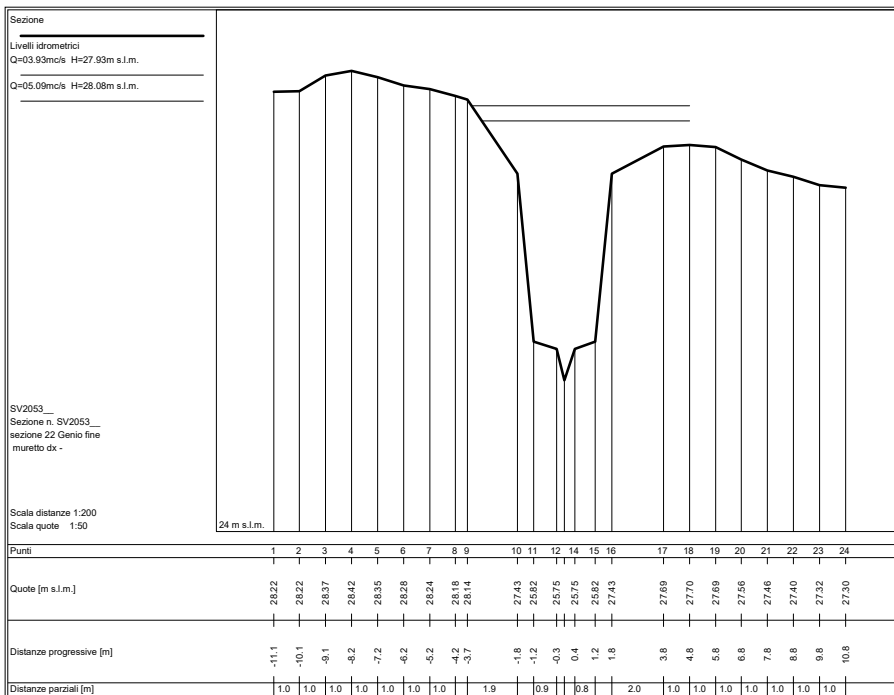
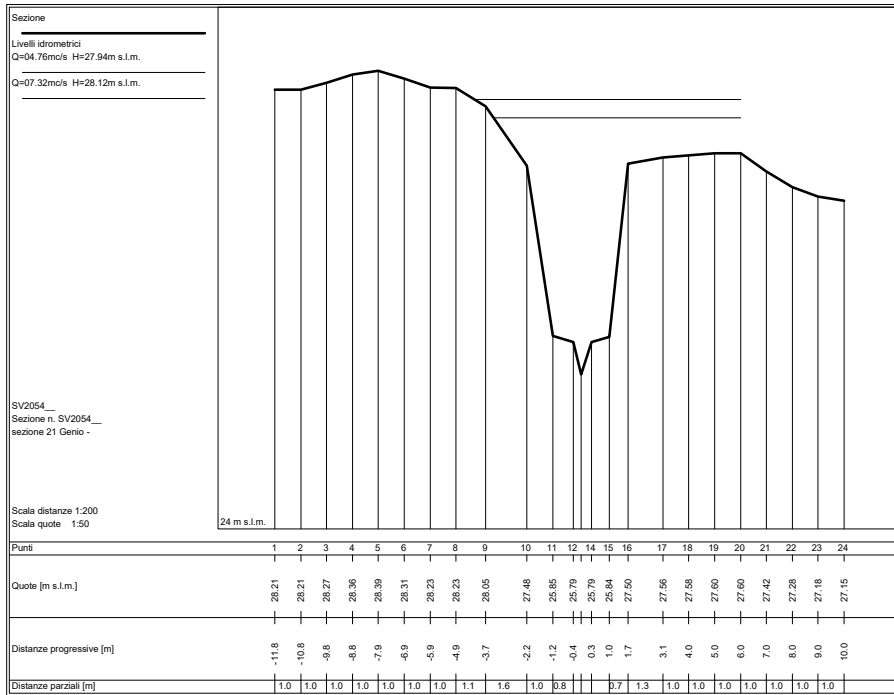

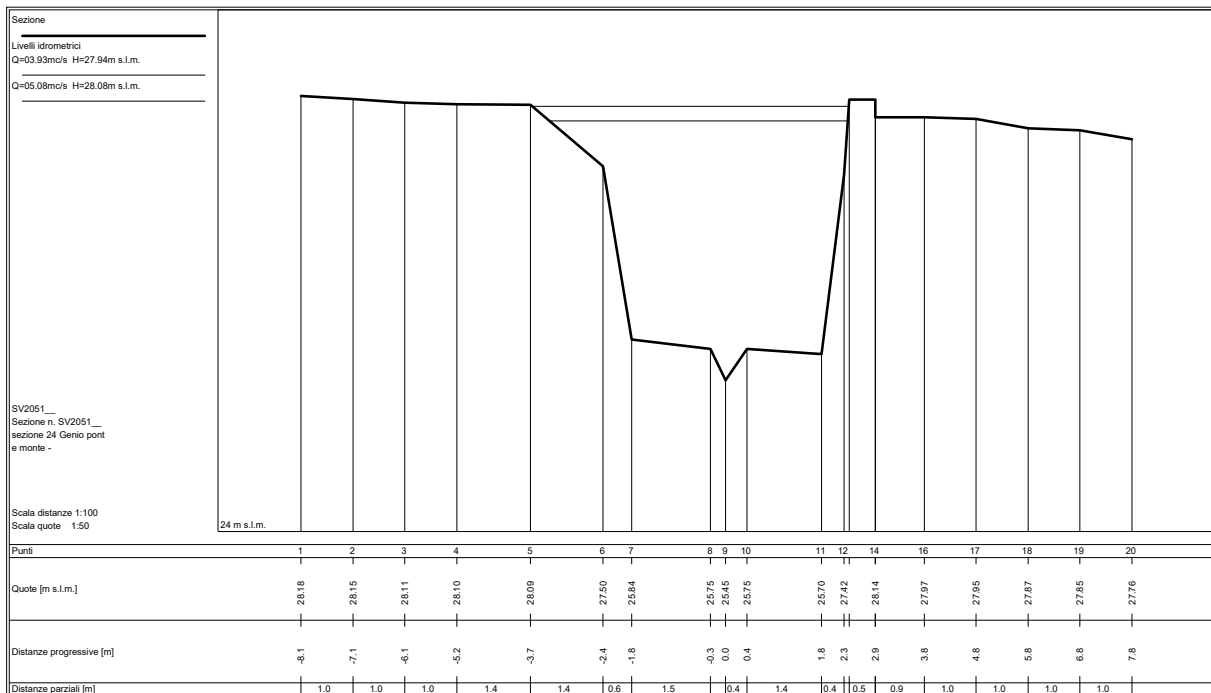
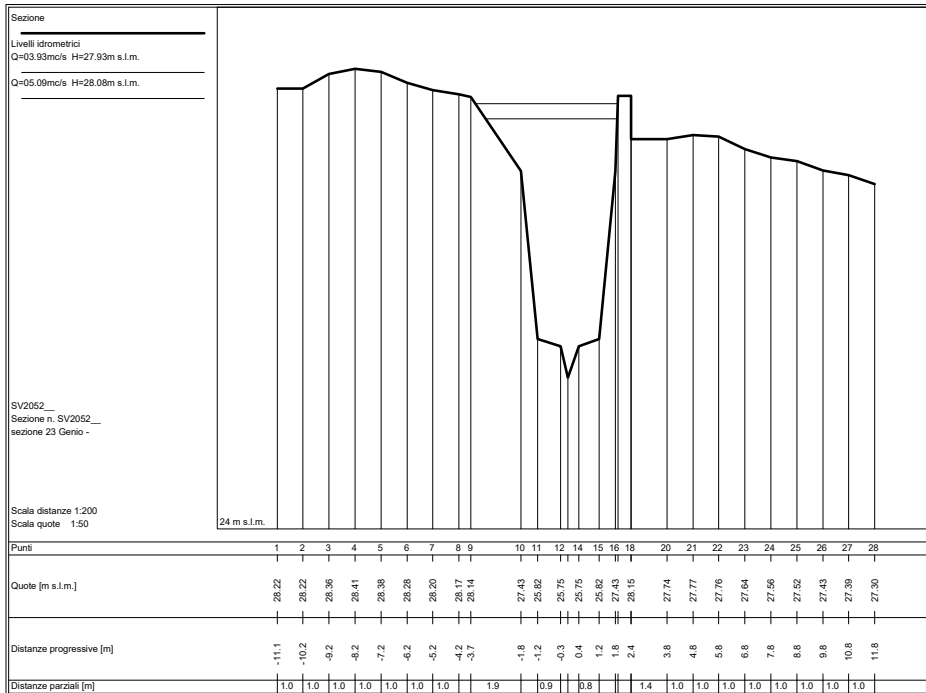

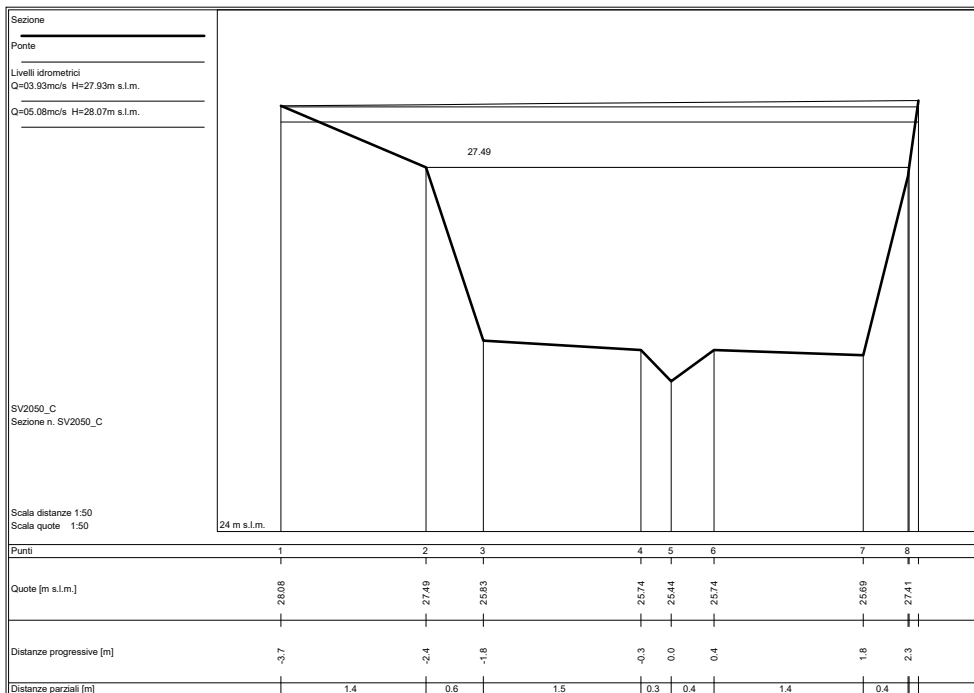
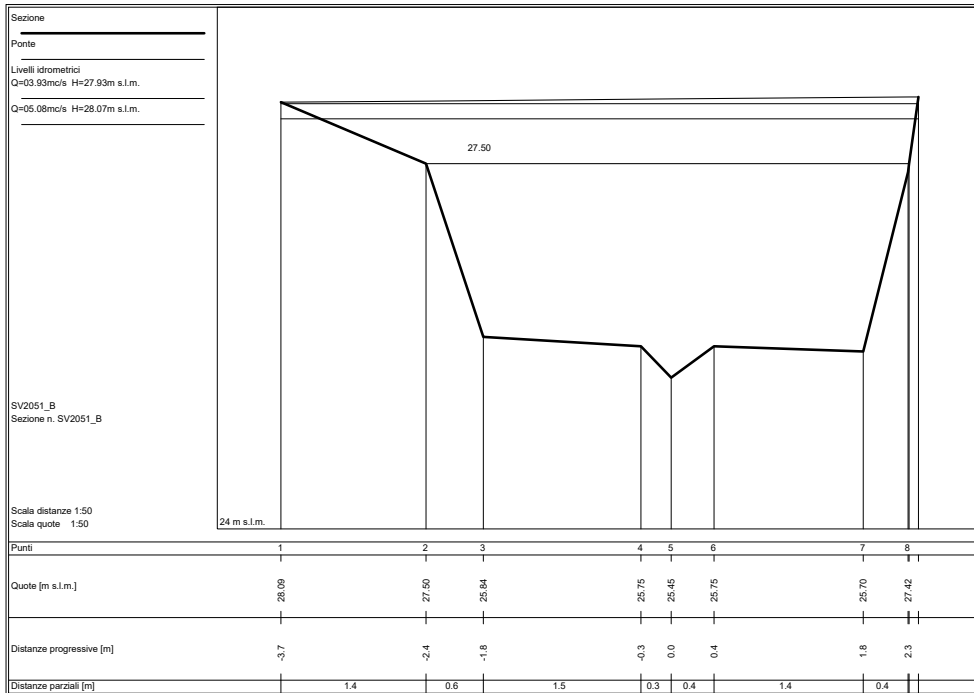

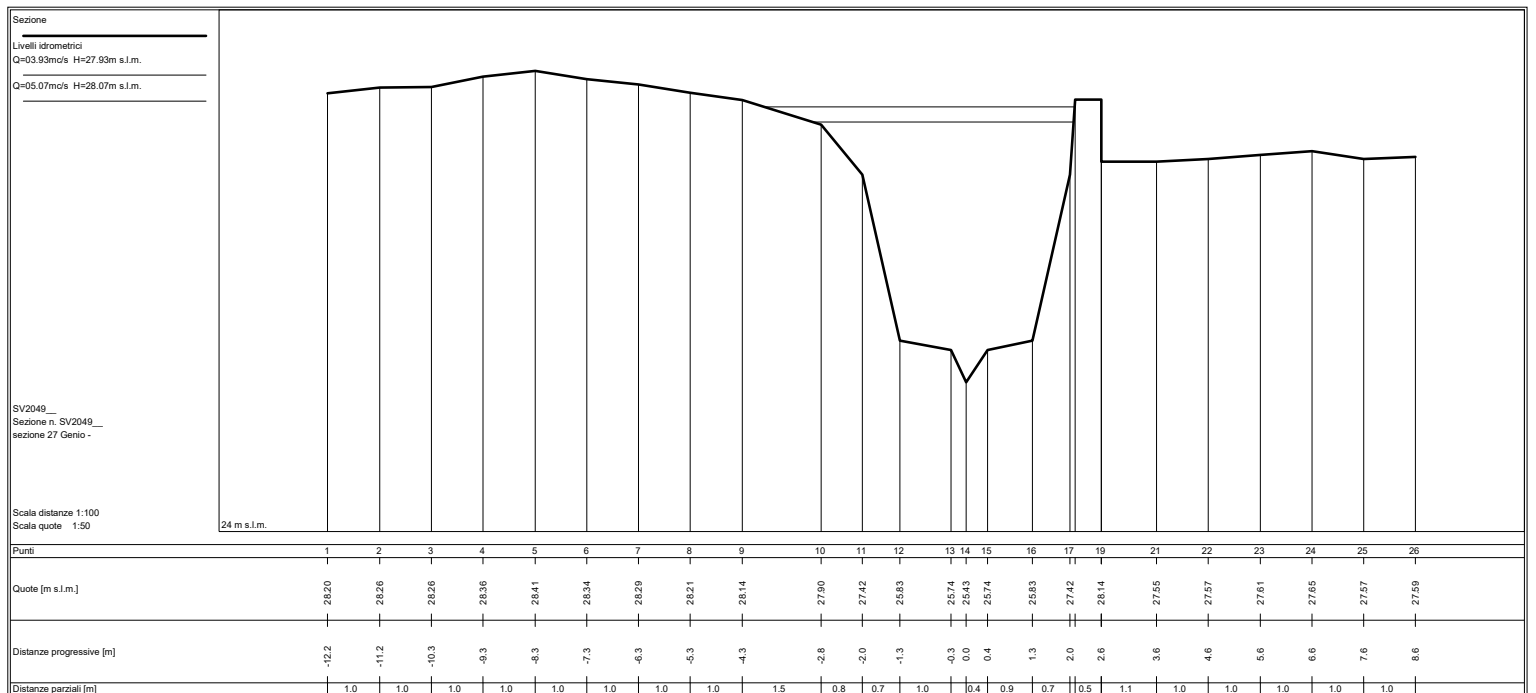
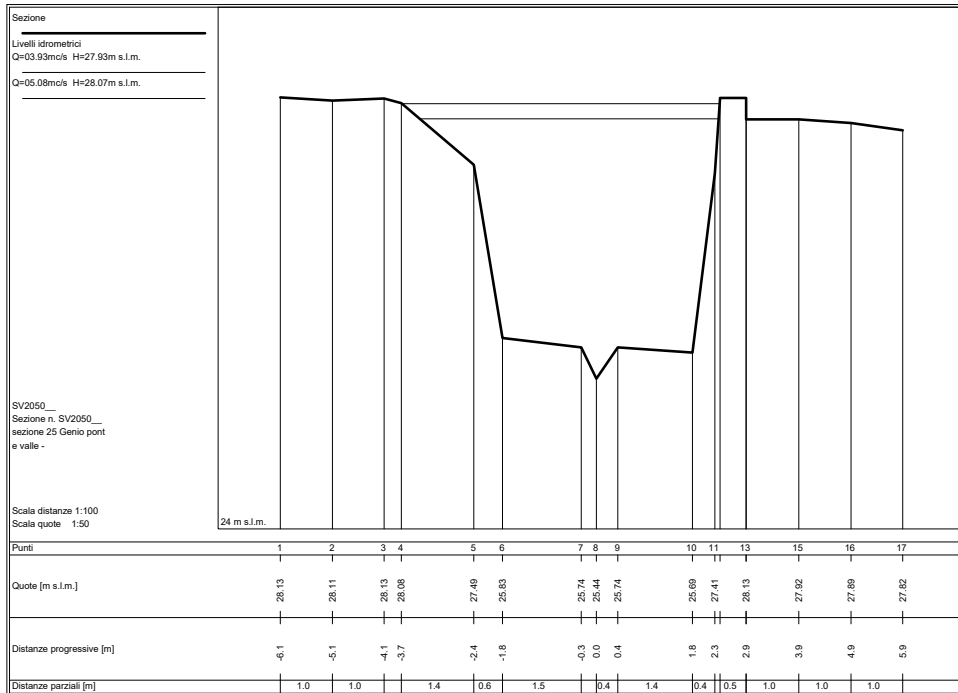

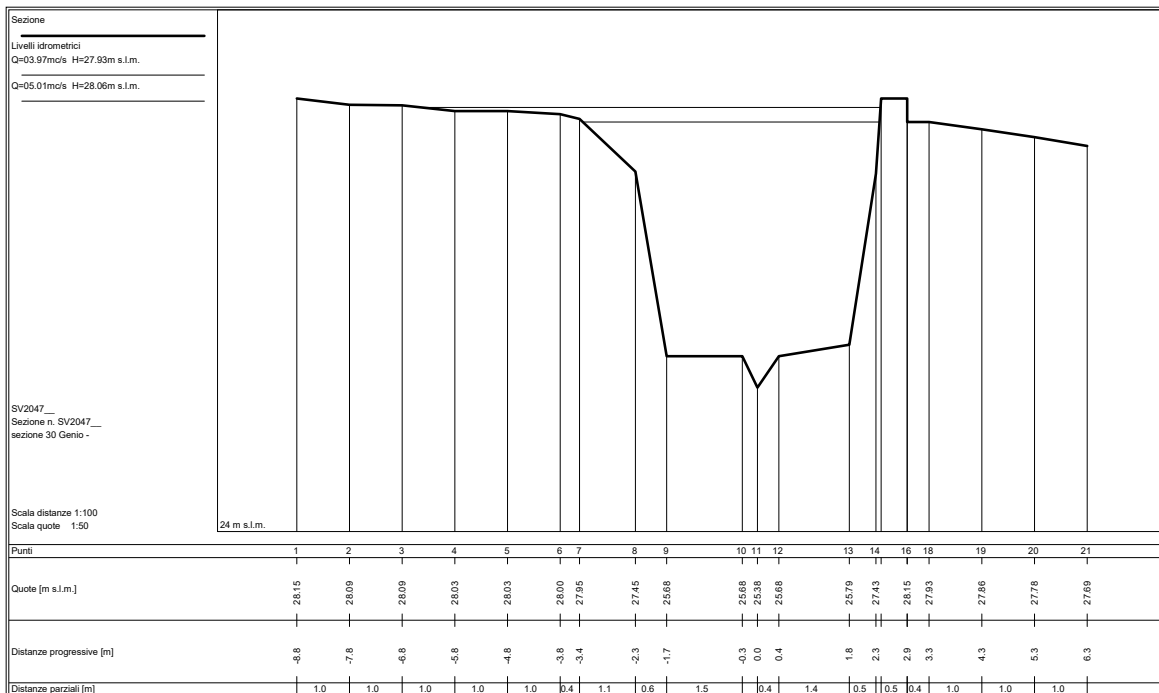
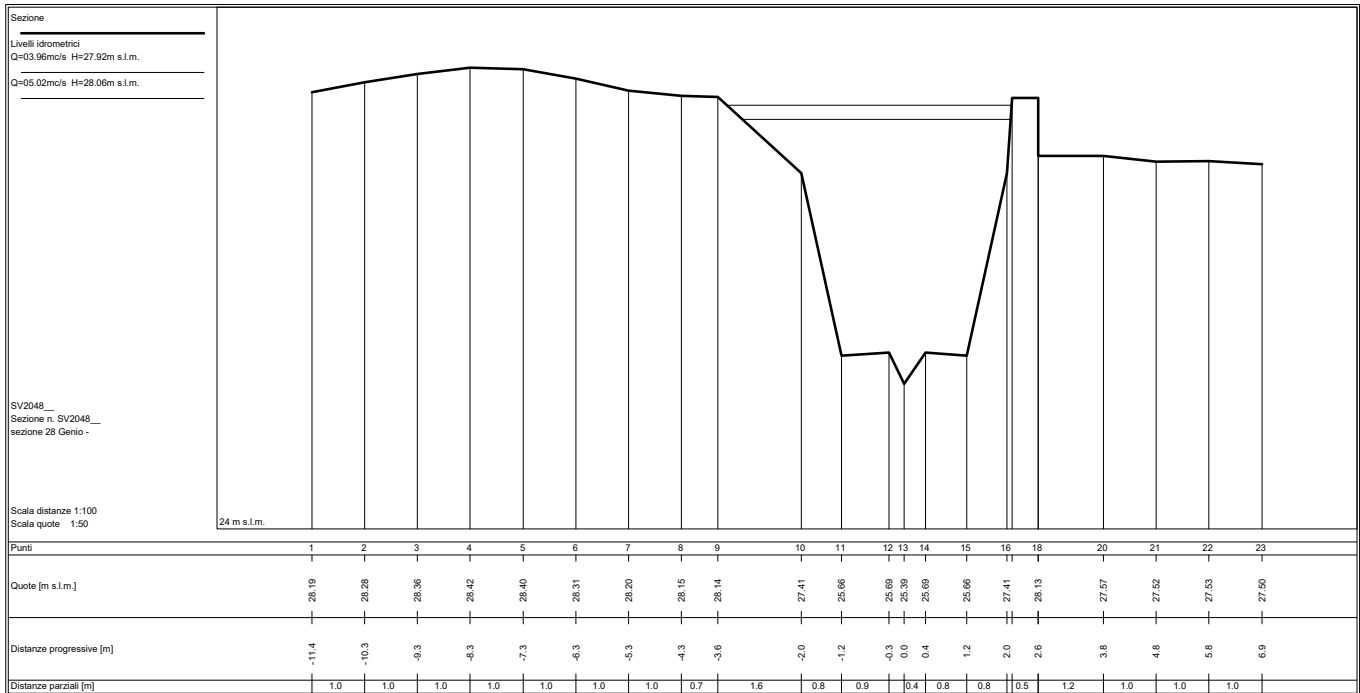

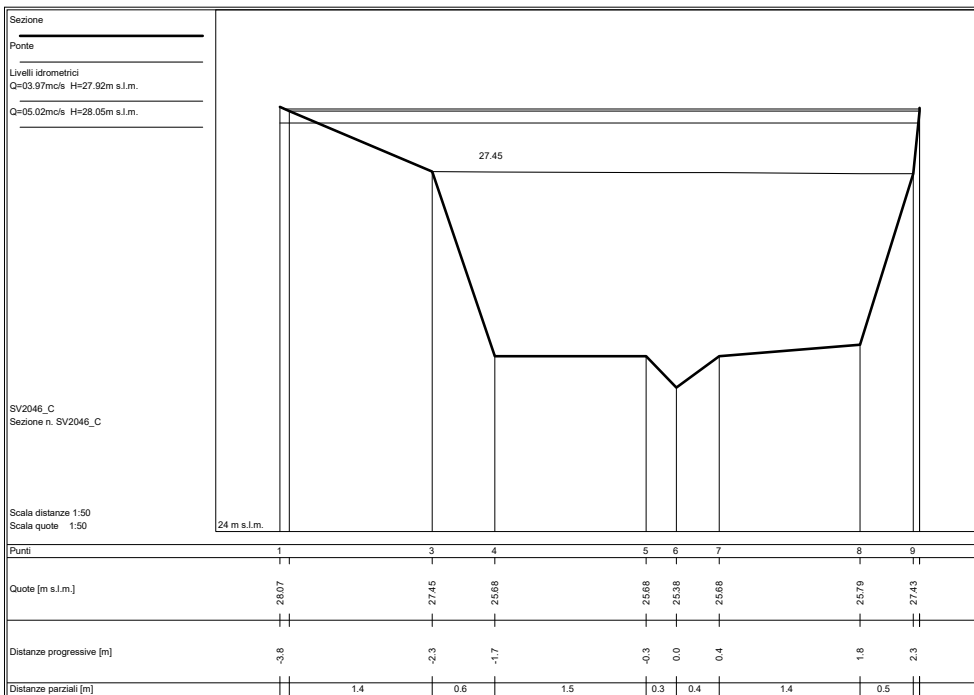
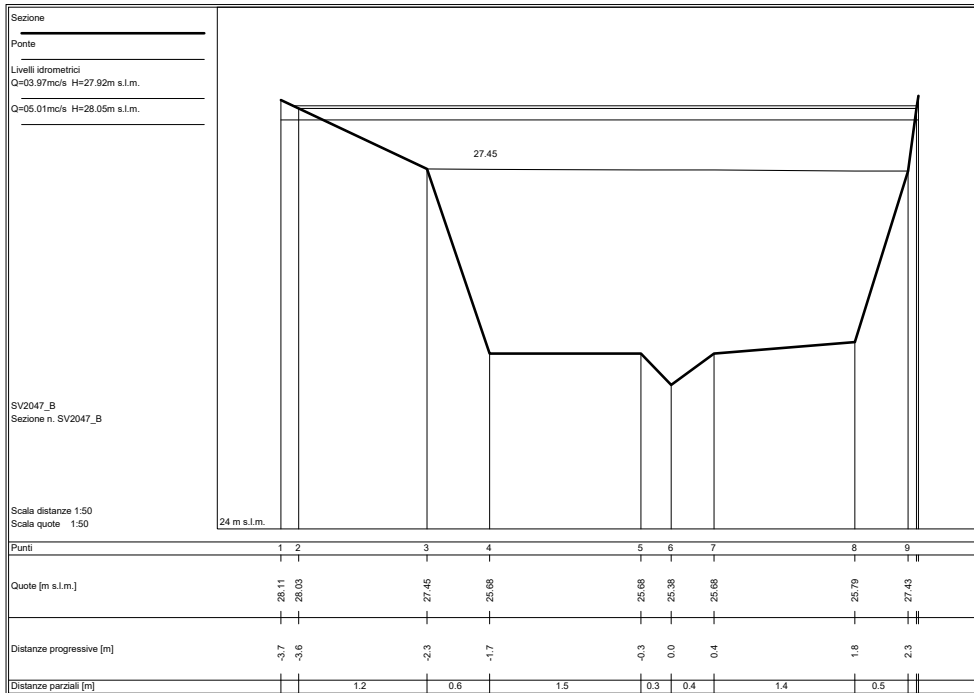

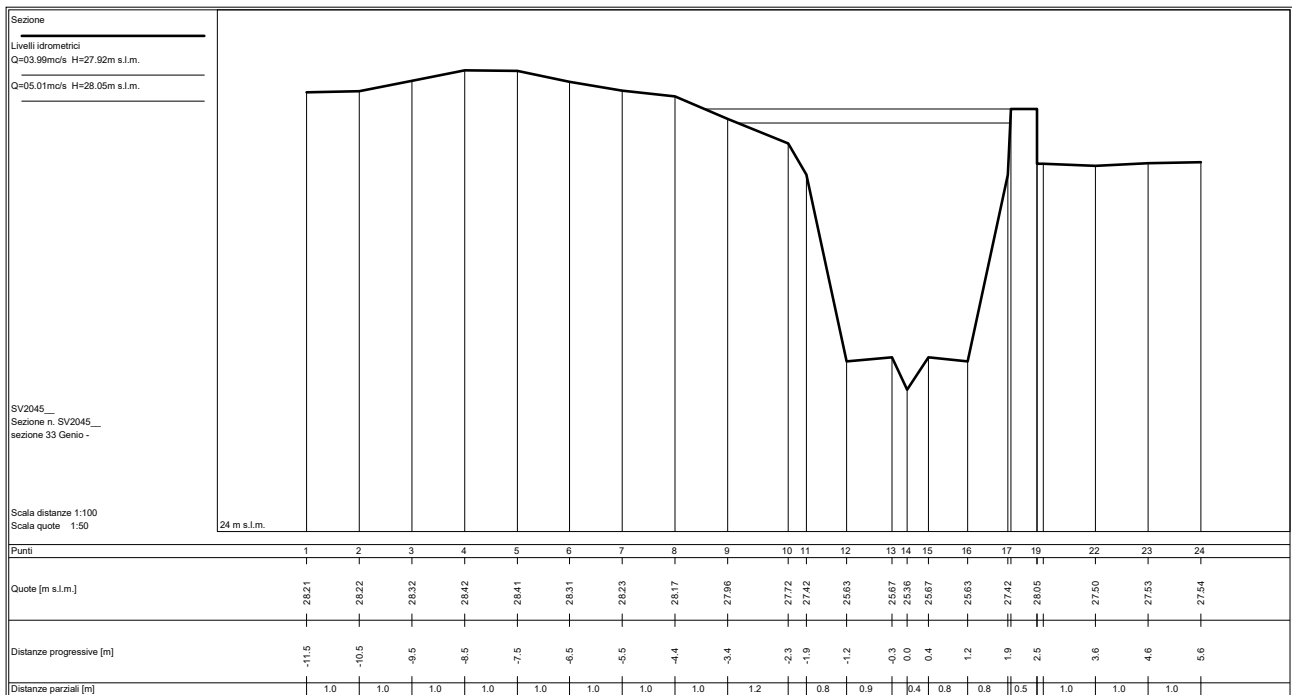
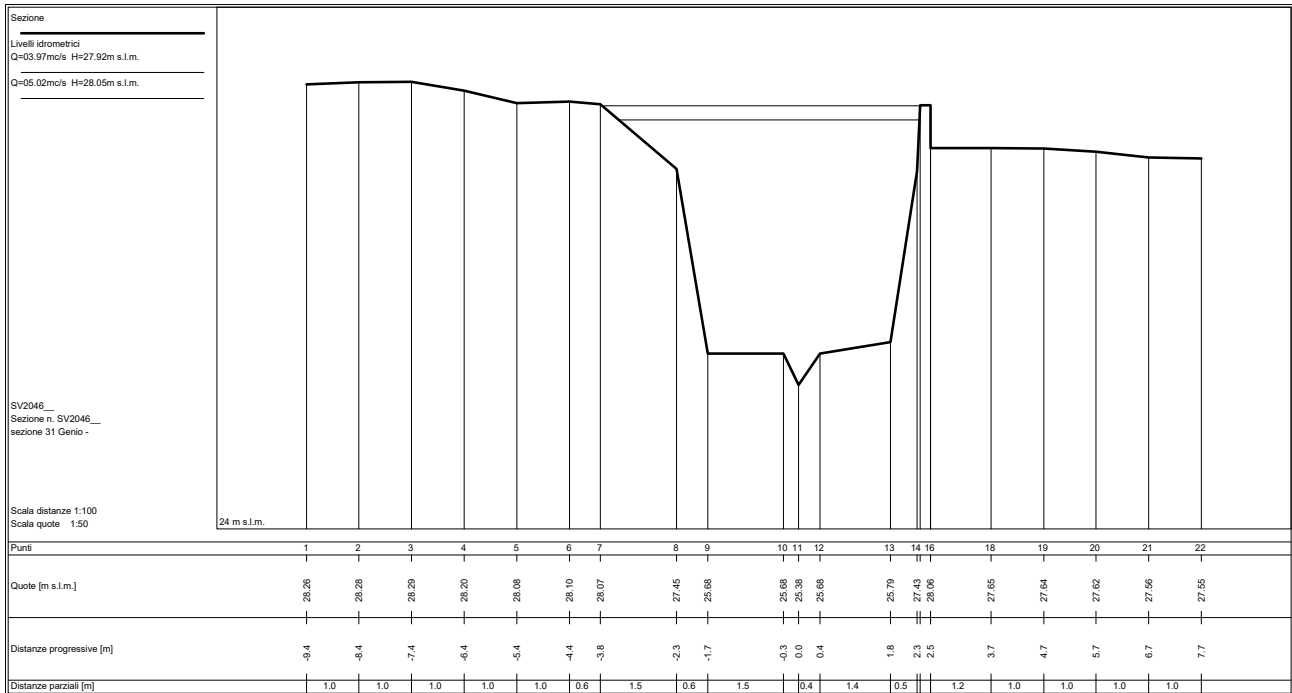

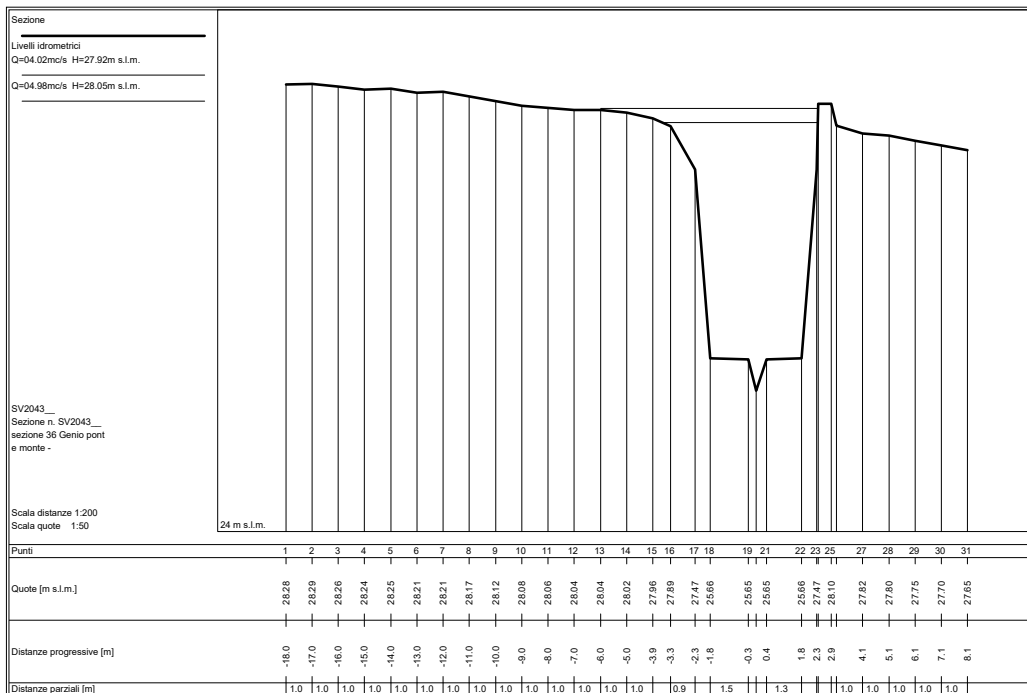
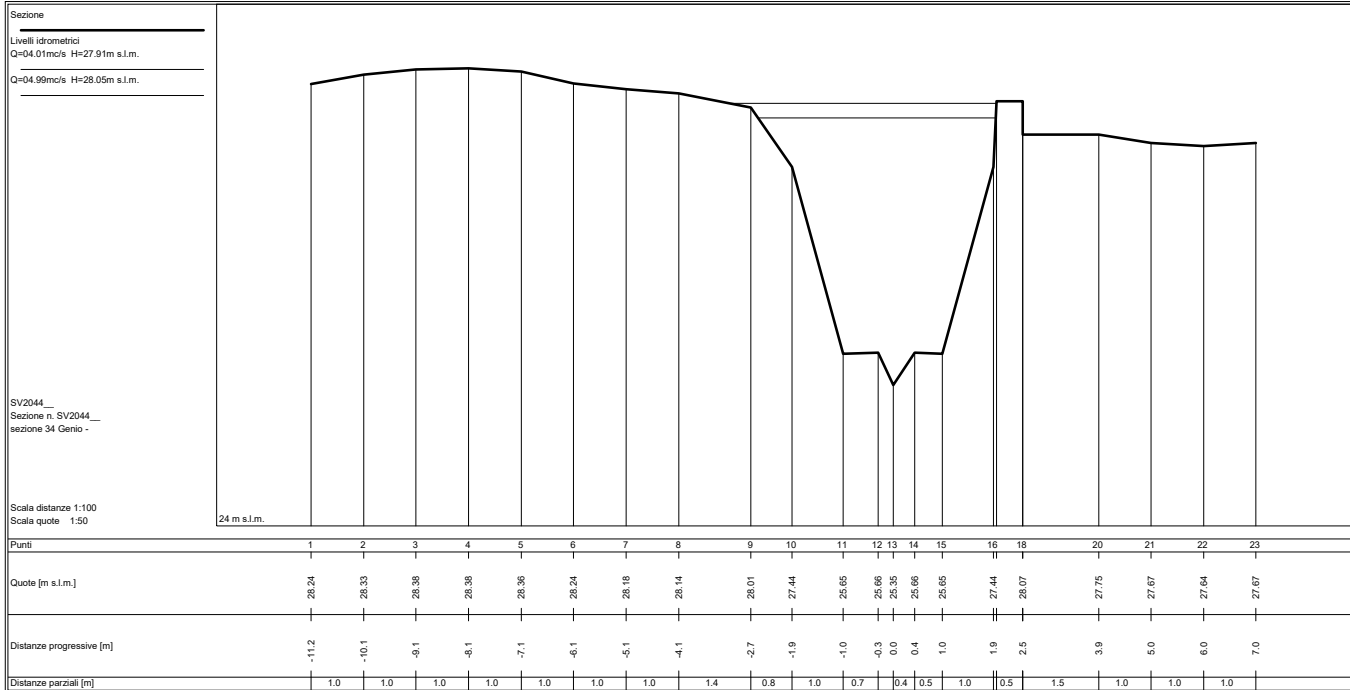

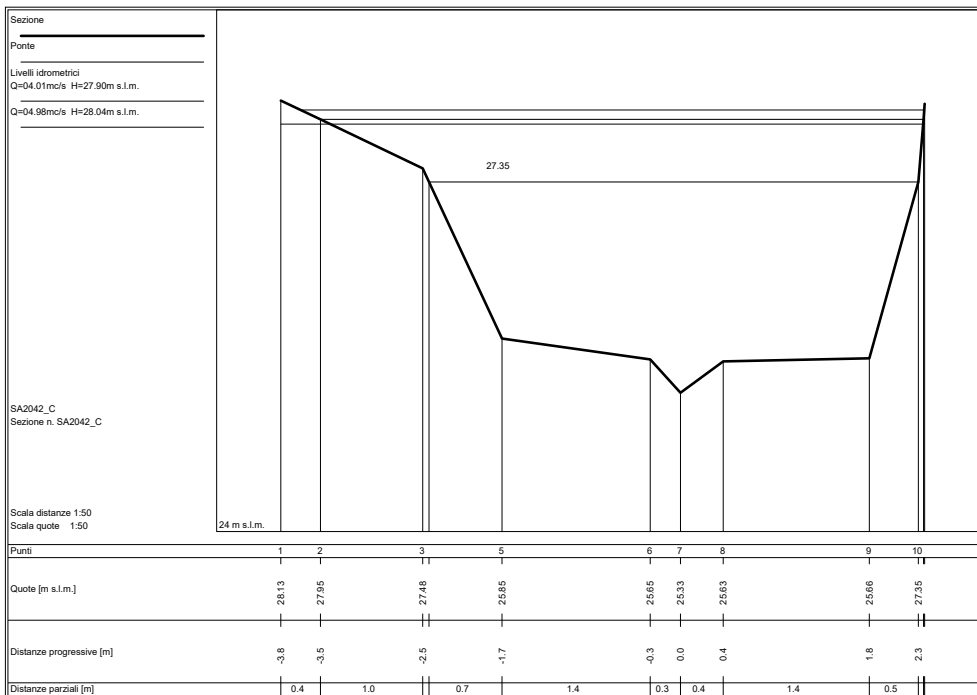
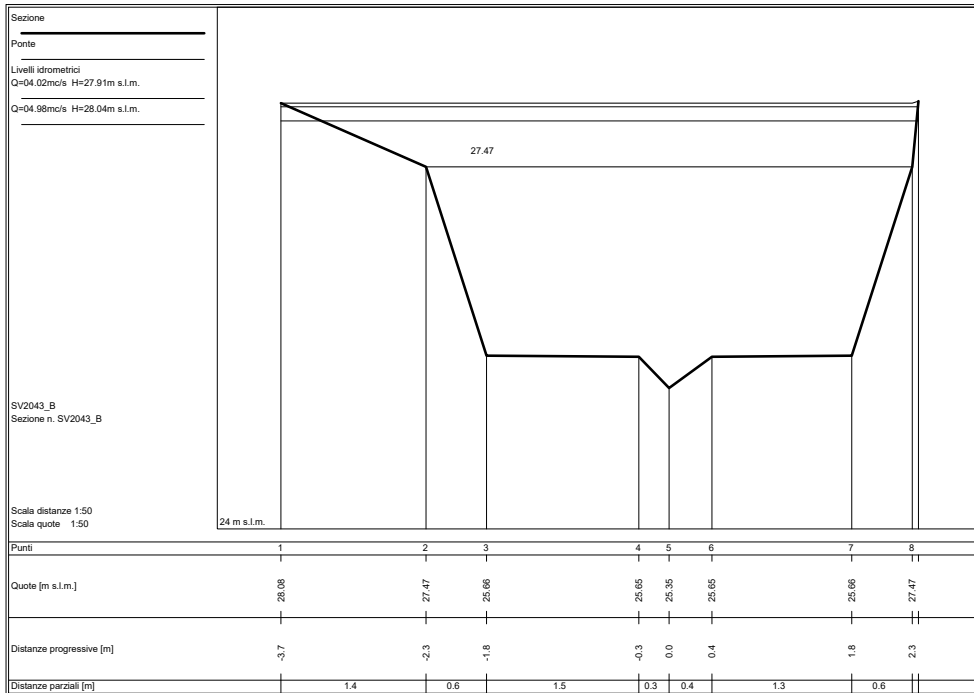

Sezione
 Livelli idrometrici
 Q=04.01mc/s H=27.91m s.l.m.
 Q=04.98mc/s H=28.04m s.l.m.

SV2042
 Sezione n. SV2042
 sezione 37 Genio pont
 e valle -
 Scala distanze 1:100
 Scala quote 1:50

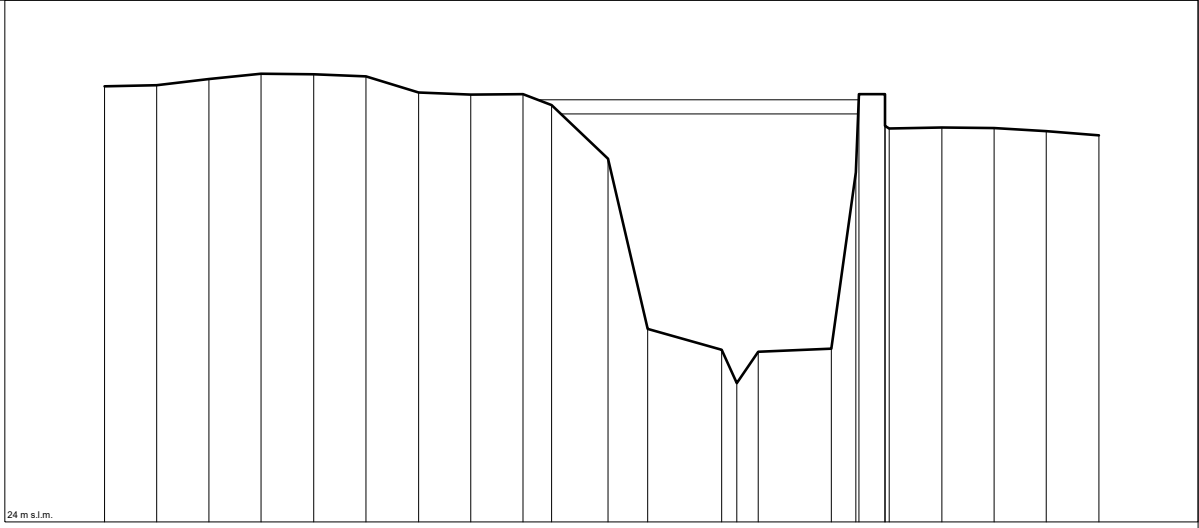

Punti	1	2	3	4	5	6	7	8	9	10	11	12	13	14	15	16	17	19	22	23	24	25	
Quote [m s.l.m.]	28.18	28.19	28.25	28.29	28.29	28.27	28.12	28.10	28.10	28.00	27.48	25.85	25.85	25.33	25.63	25.66	27.35	28.10	27.78	27.77	27.74	27.71	
Distanze progressive [m]	-12.1	-11.1	-10.1	-9.1	-8.1	-7.1	-6.1	-5.1	-4.1	-3.6	-2.5	-1.7	-0.3	0.0	0.4	1.4	1.8	2.3	2.8	3.9	4.9	5.9	6.9
Distanze parziali [m]	1.0	1.0	1.0	1.0	1.0	1.0	1.0	1.0	1.0	0.6	1.1	0.8	1.4	0.4	0.4	1.4	0.5	0.5	1.0	1.0	1.0	1.0	1.0

Sezione
 Livelli idrometrici
 Q=04.02mc/s H=27.91m s.l.m.
 Q=04.97mc/s H=28.04m s.l.m.

SV2041
 Sezione n. SV2041
 sezione 38 Genio -
 Scala distanze 1:100
 Scala quote 1:50

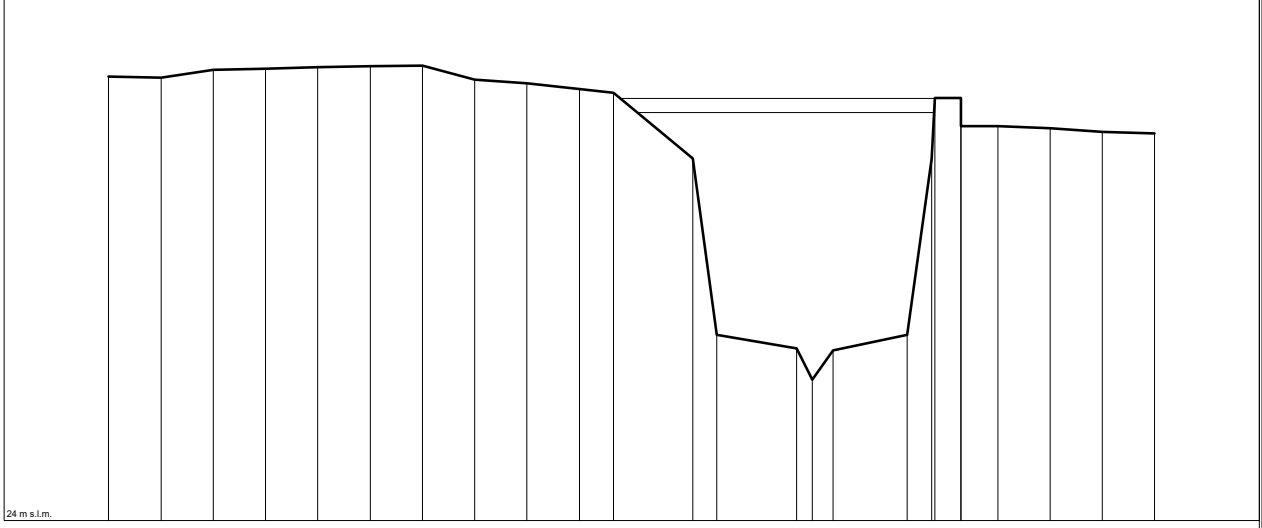

Punti	1	2	3	4	5	6	7	8	9	10	11	12	13	14	15	16	17	18	20	22	23	24	25	
Quote [m s.l.m.]	28.25	28.25	28.32	28.33	28.35	28.35	28.38	28.23	28.19	28.14	28.10	27.47	25.78	25.65	25.35	25.63	25.78	27.47	28.05	27.78	27.76	27.72	27.71	
Distanze progressive [m]	-13.5	-12.5	-11.5	-10.5	-9.5	-8.5	-7.4	-6.4	-5.4	-4.4	-3.8	-2.3	-1.8	-0.3	0.0	0.4	1.4	1.8	2.3	2.9	3.6	4.6	5.6	6.6
Distanze parziali [m]	1.0	1.0	1.0	1.0	1.0	1.0	1.0	1.0	1.0	1.0	0.7	1.5	0.5	1.5	0.4	0.4	1.4	0.5	0.5	0.7	1.0	1.0	1.0	1.0

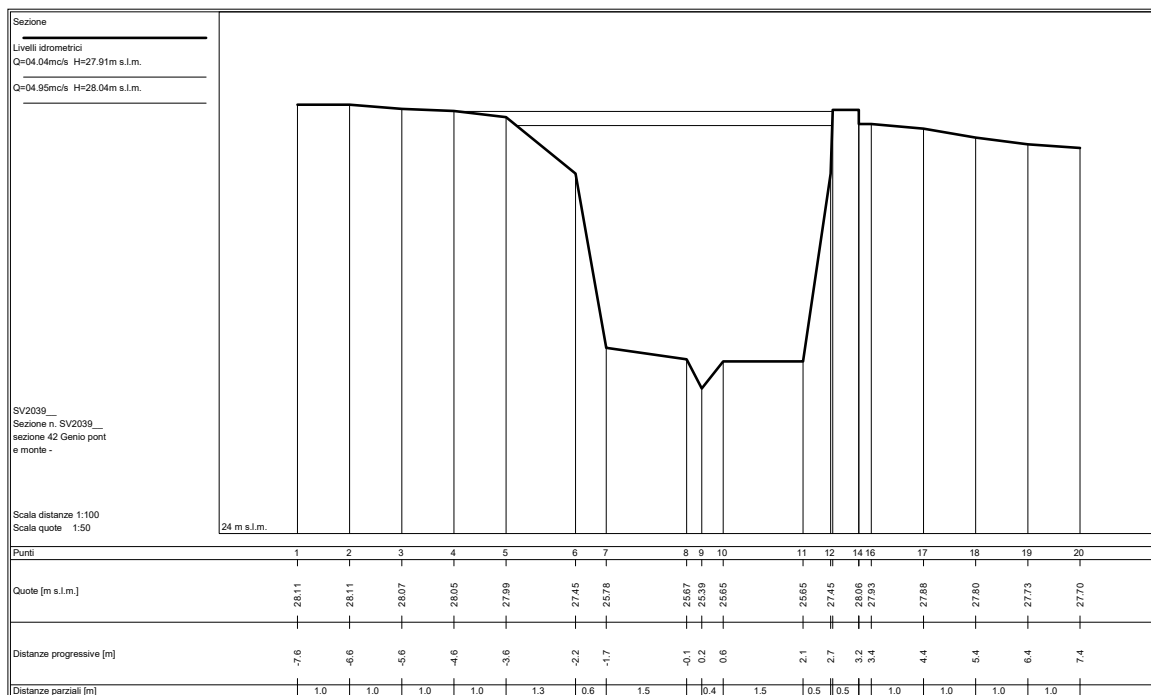
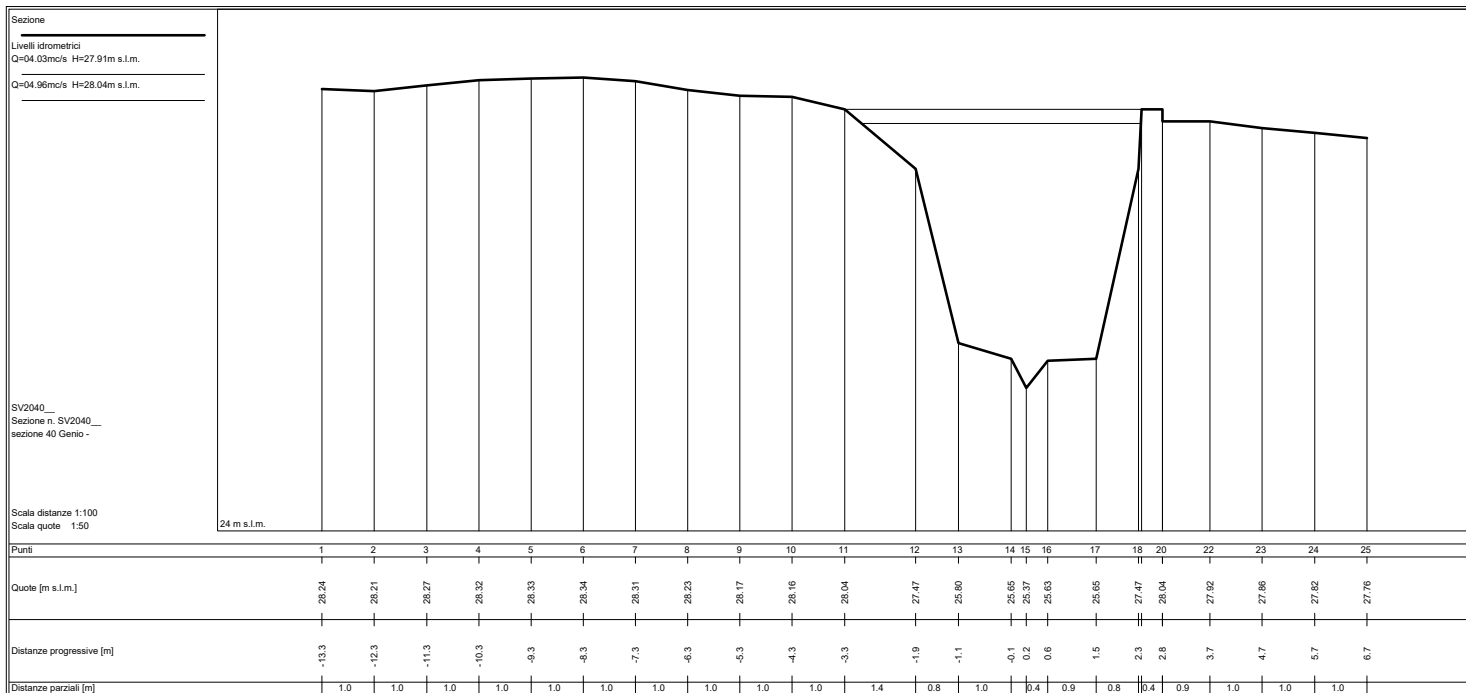

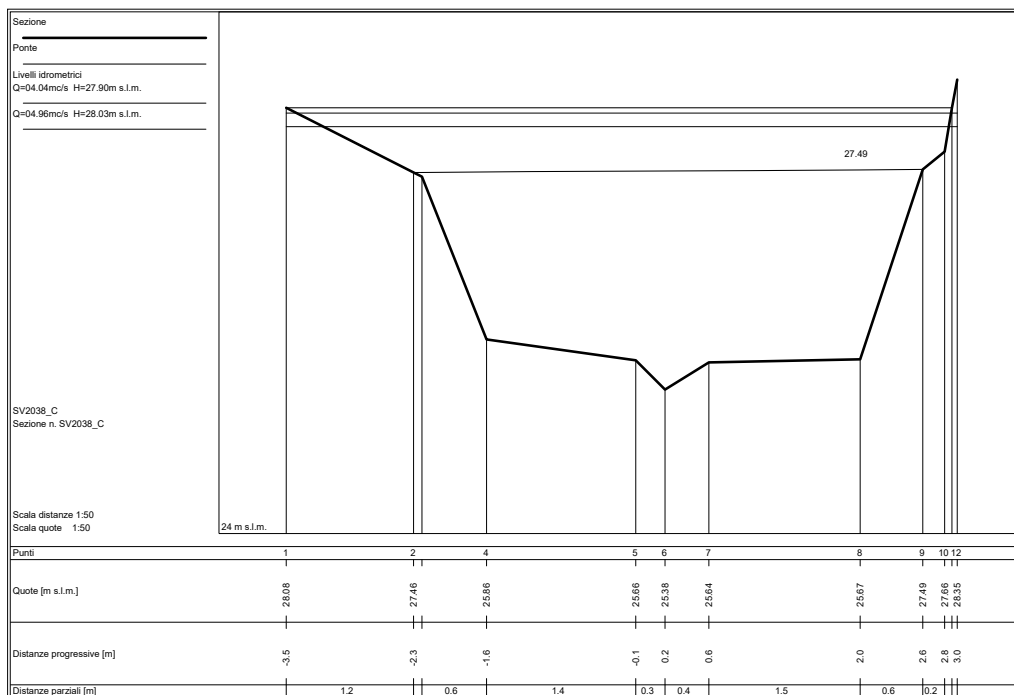
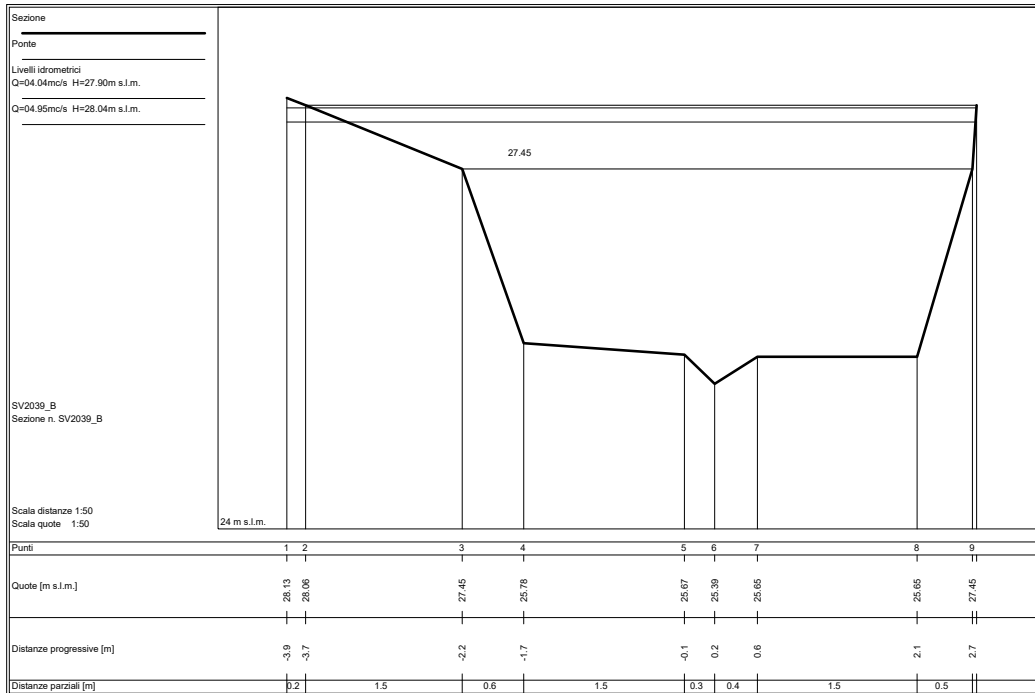

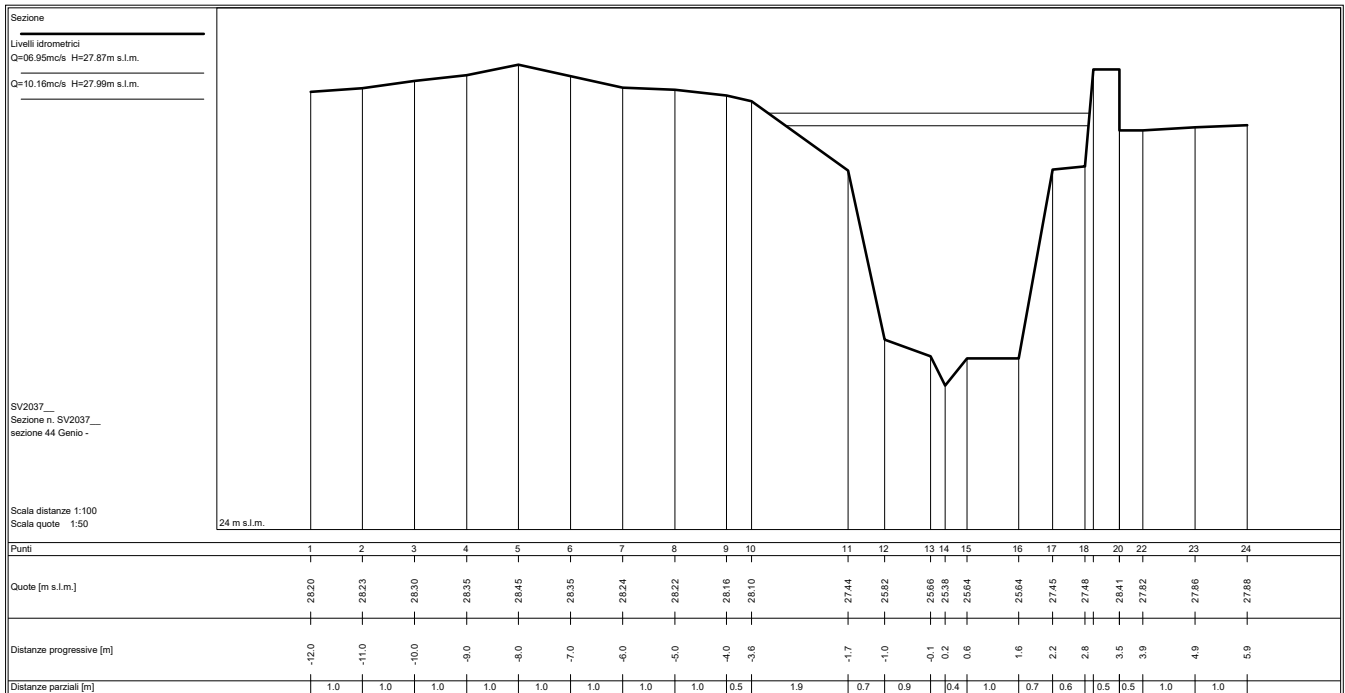
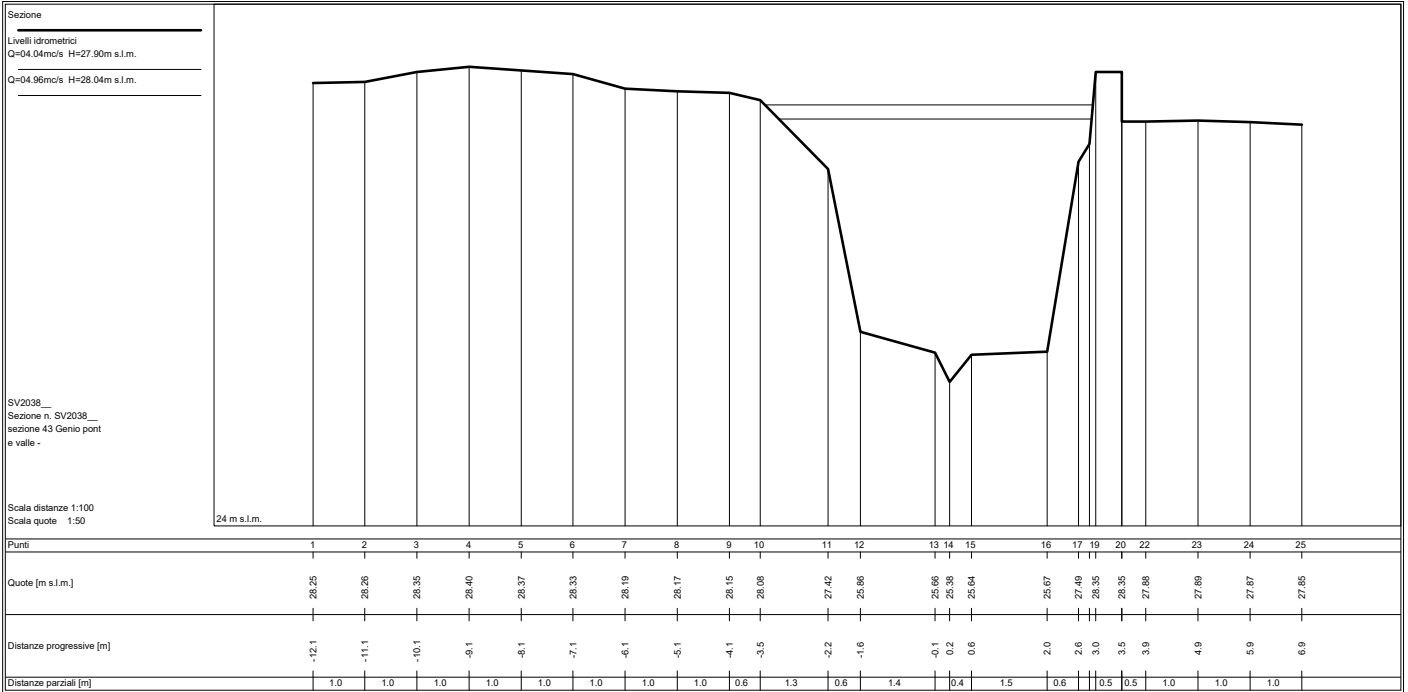

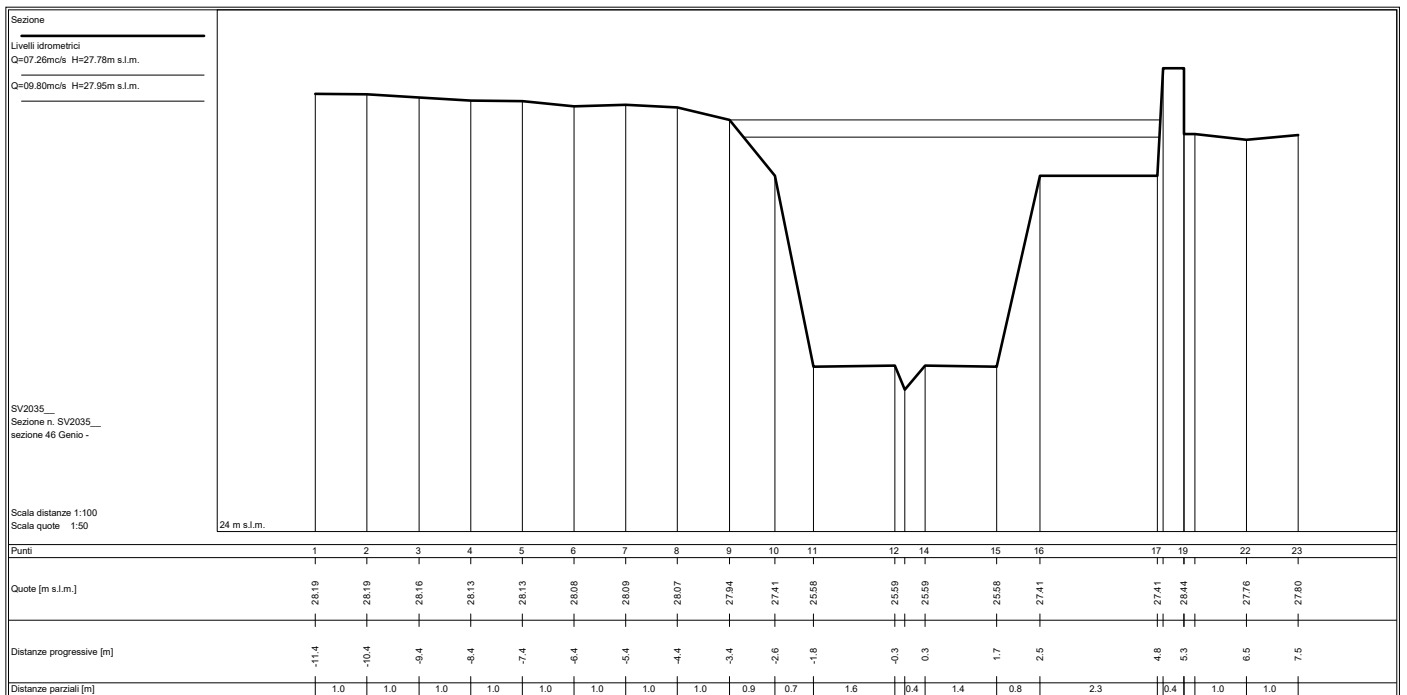
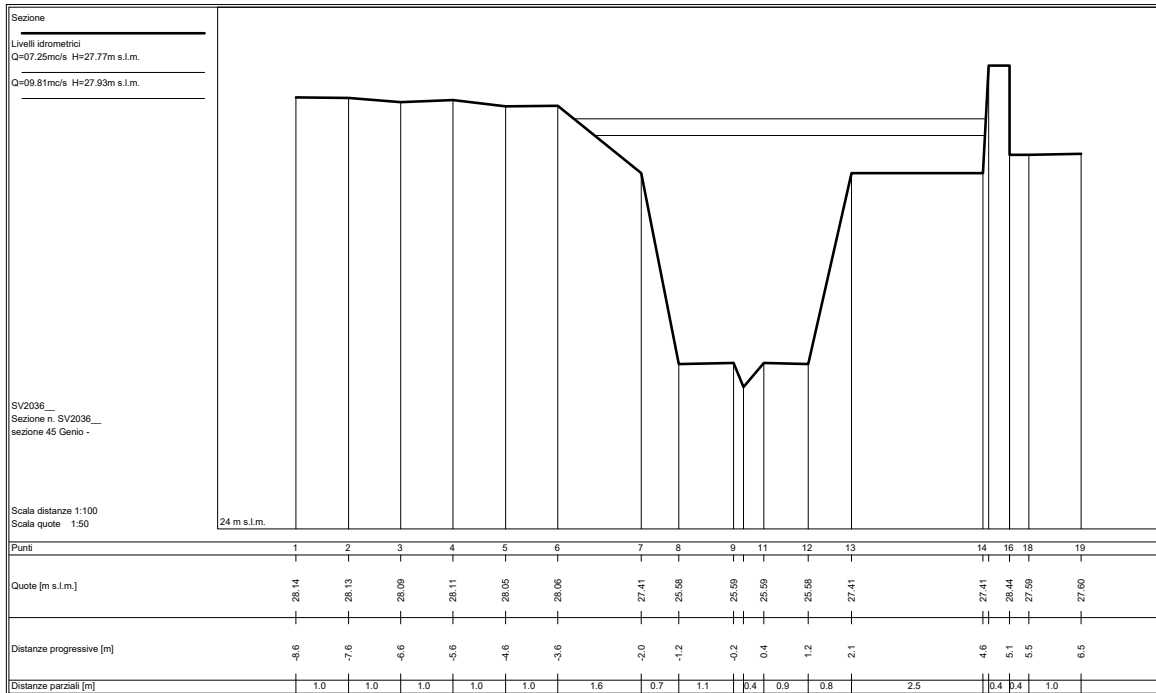

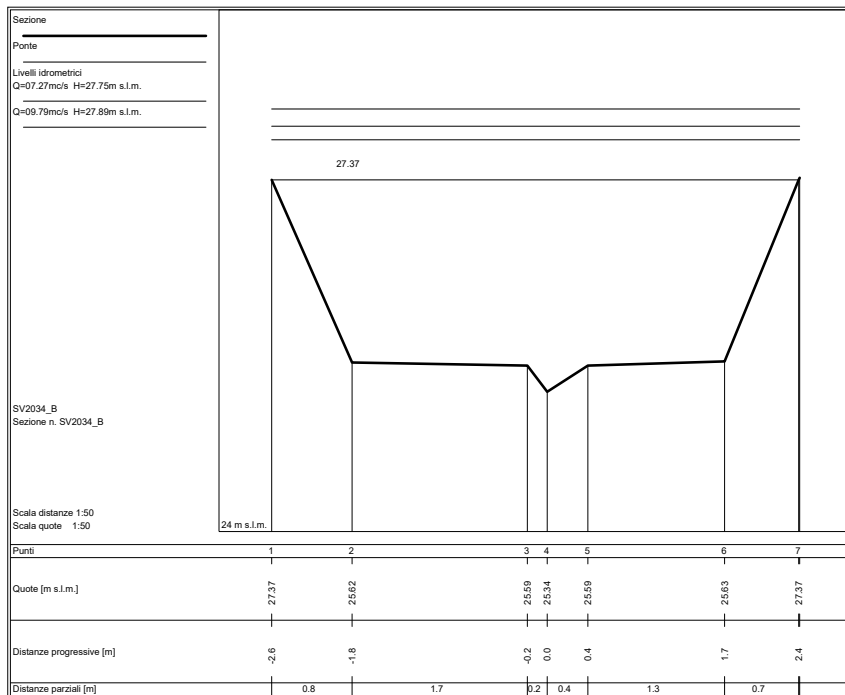
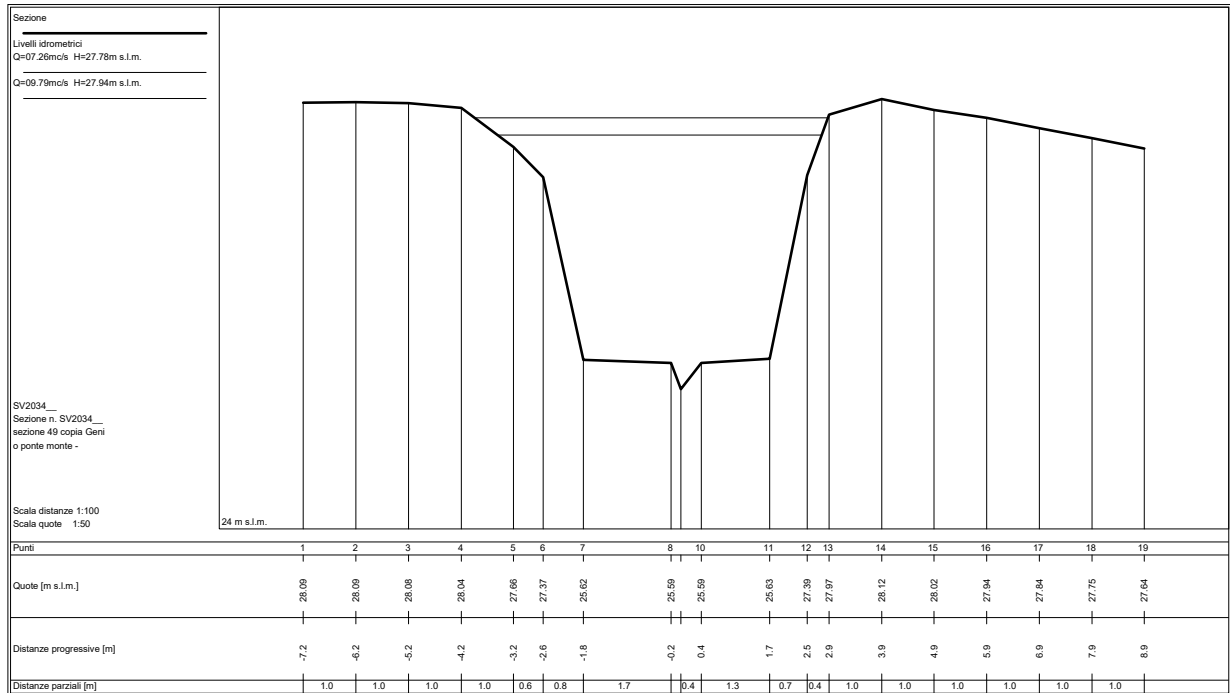

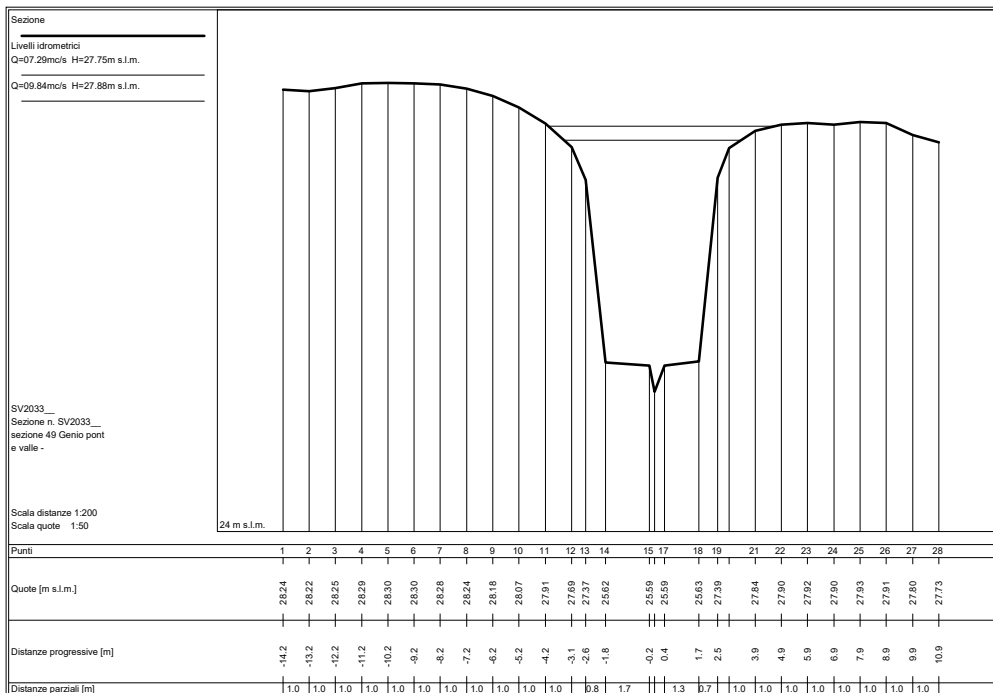
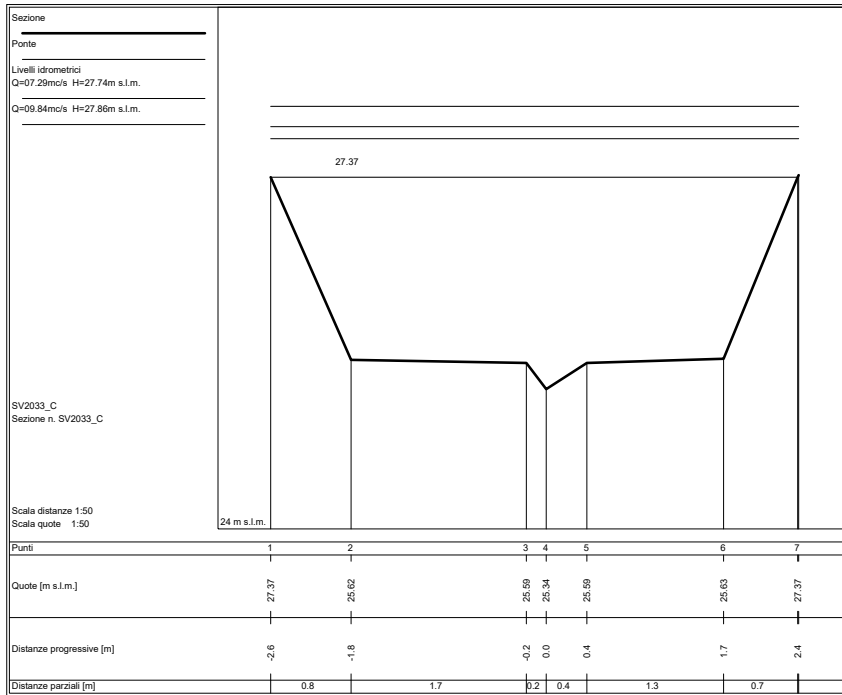

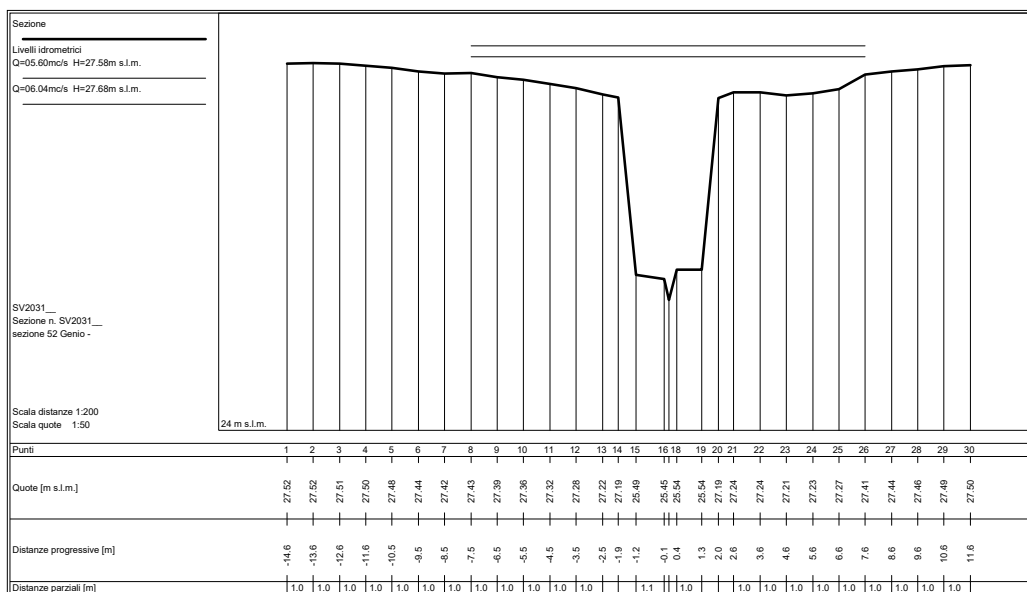
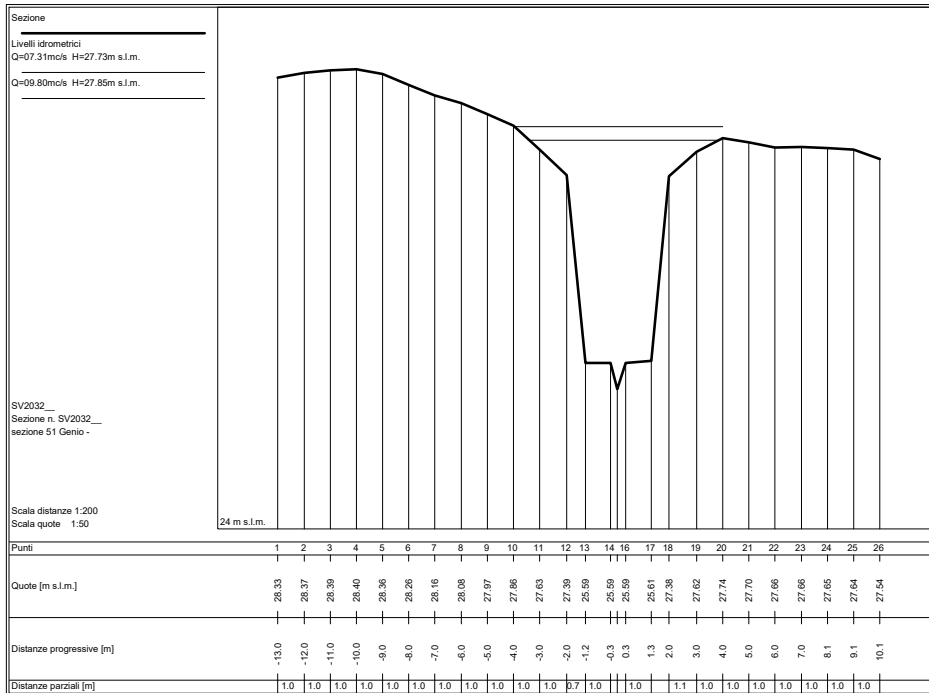

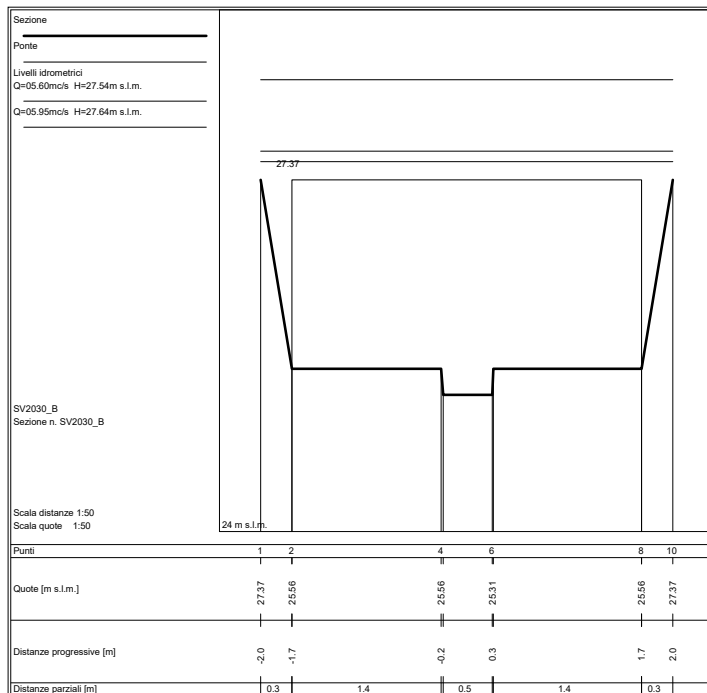
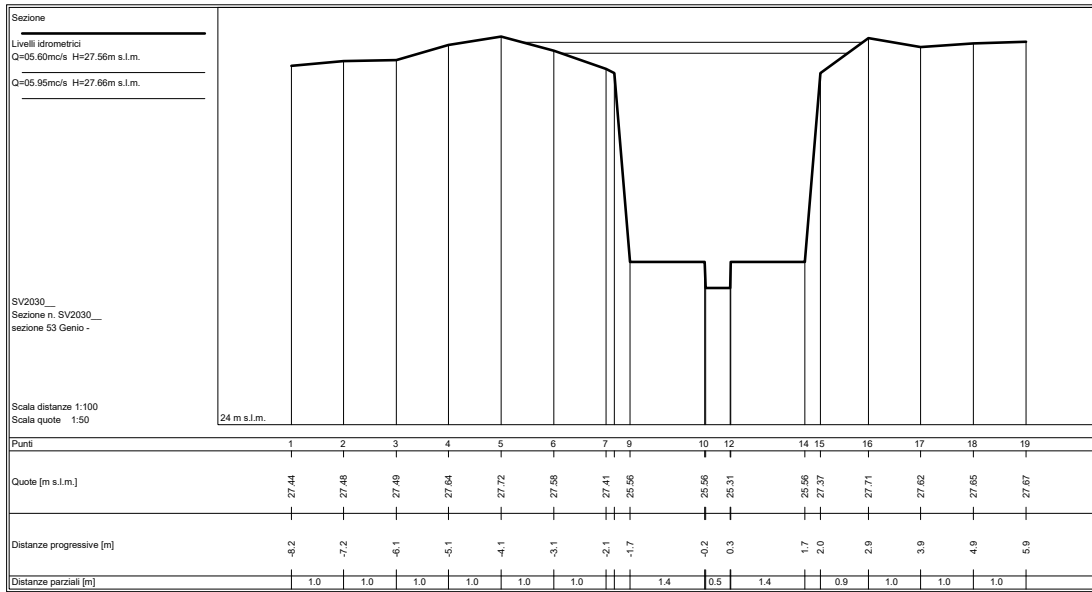

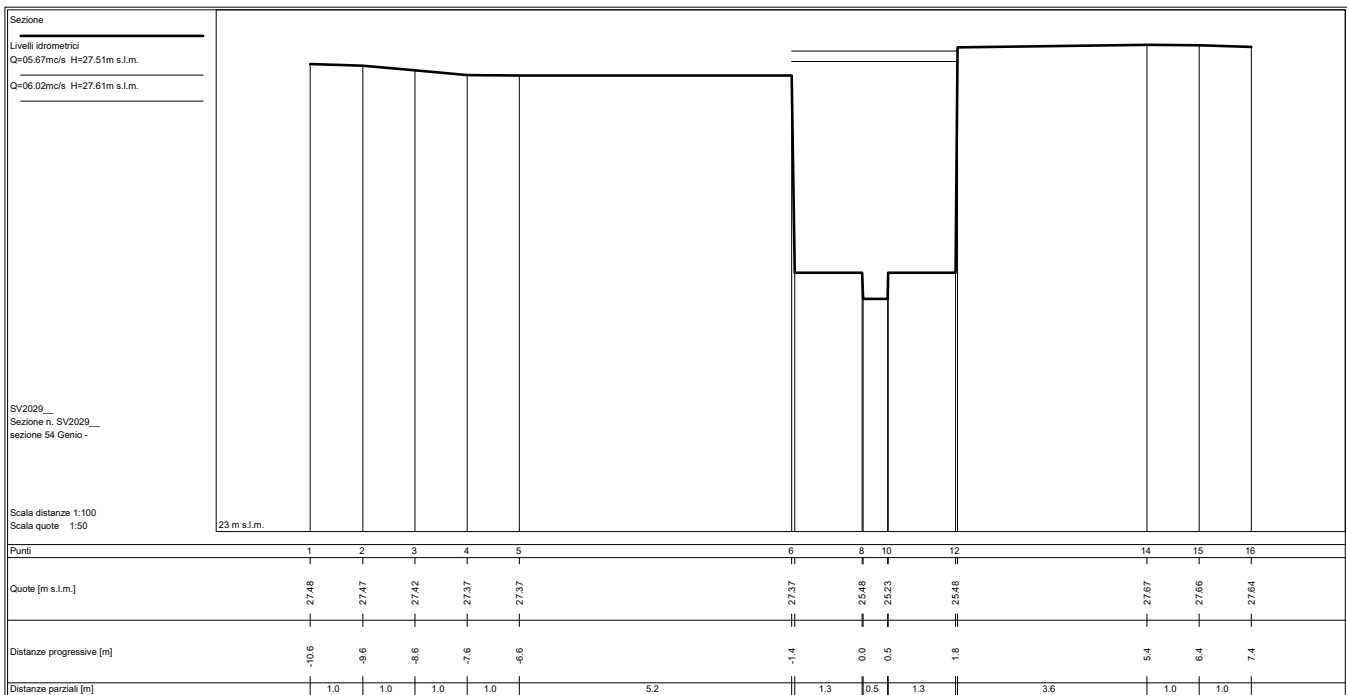
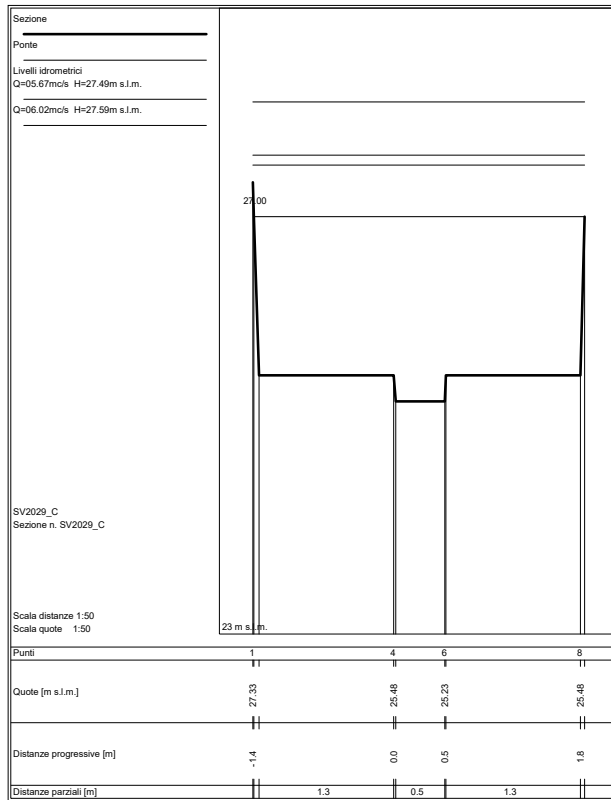

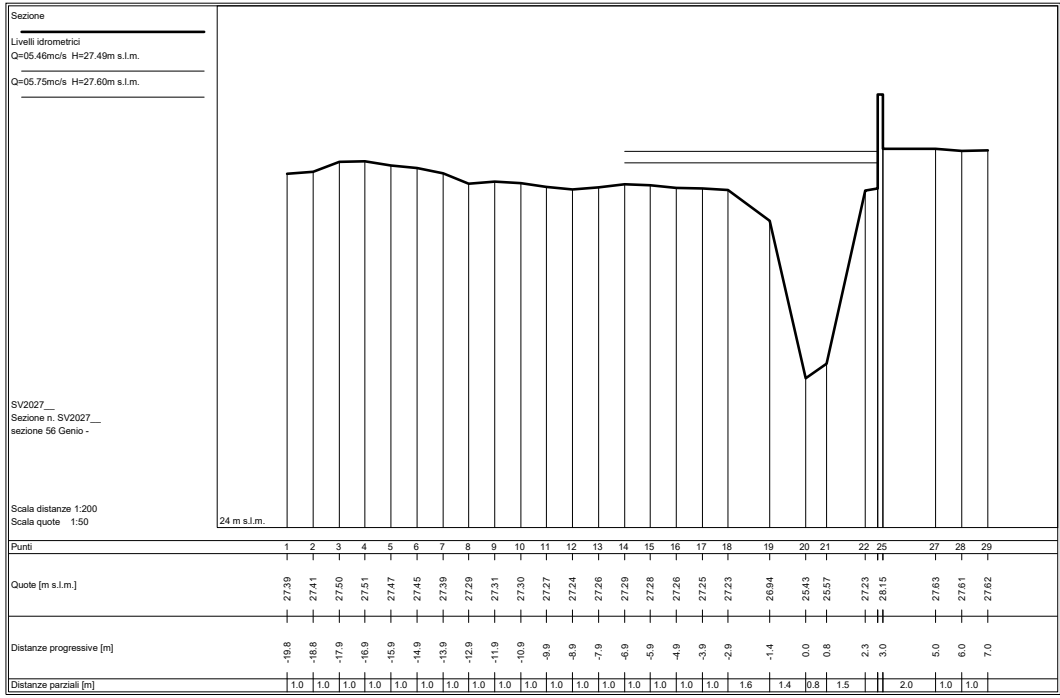
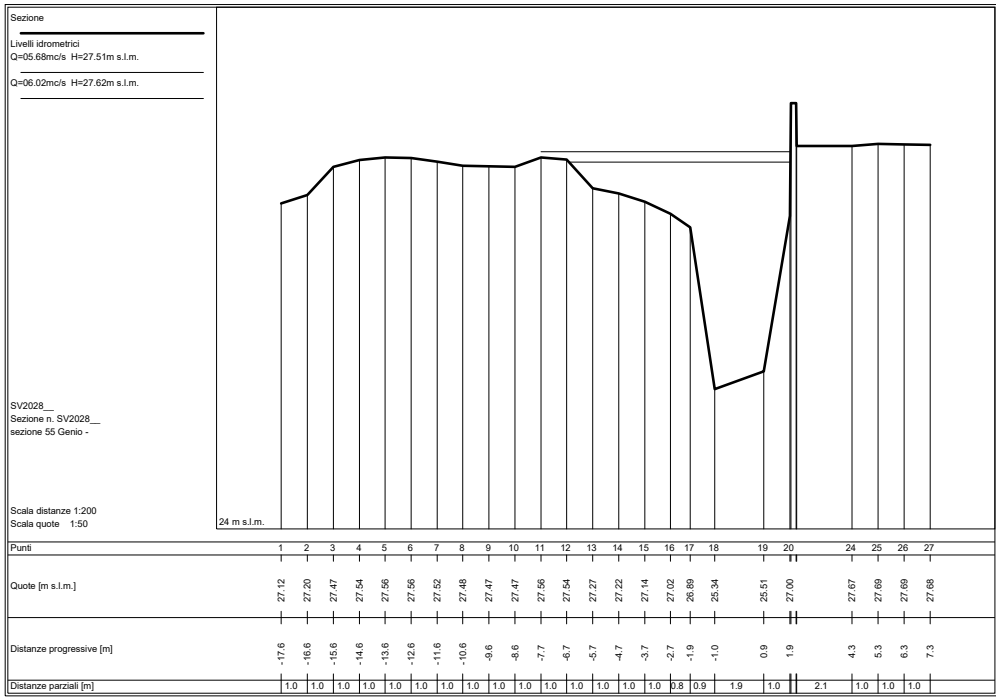

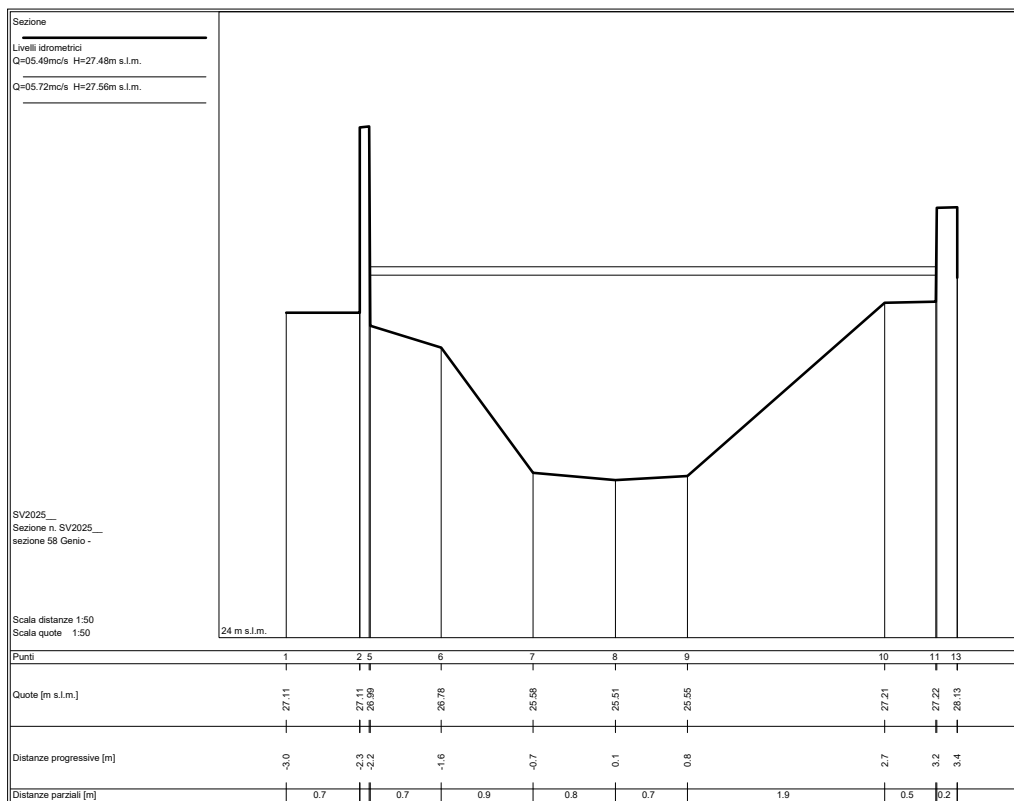
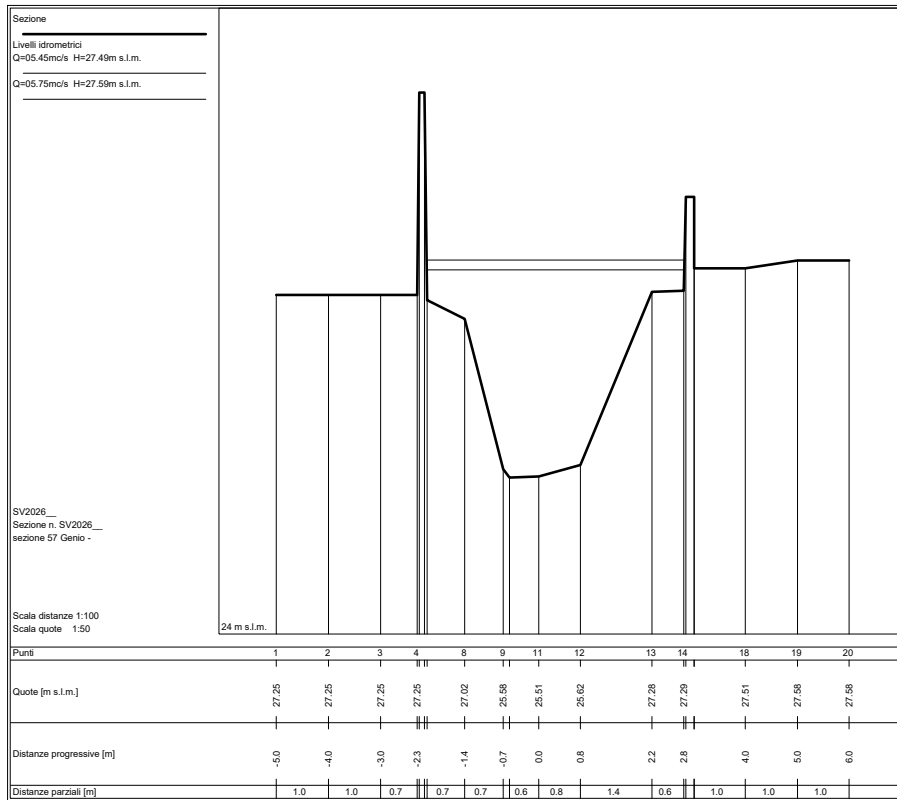

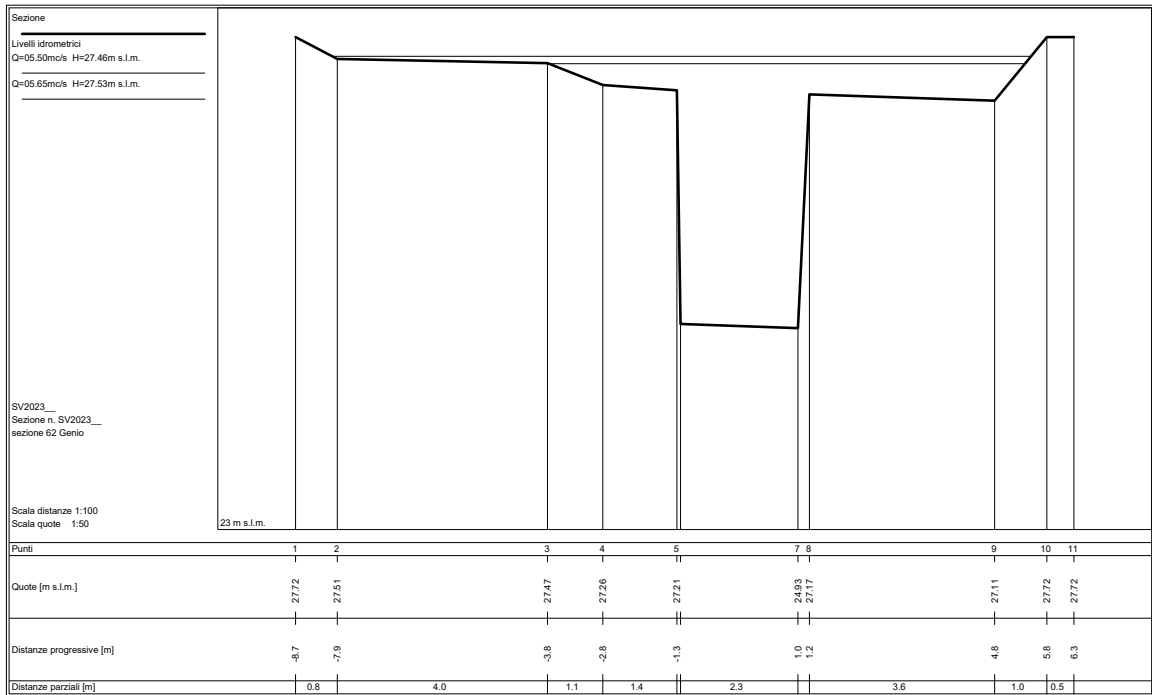
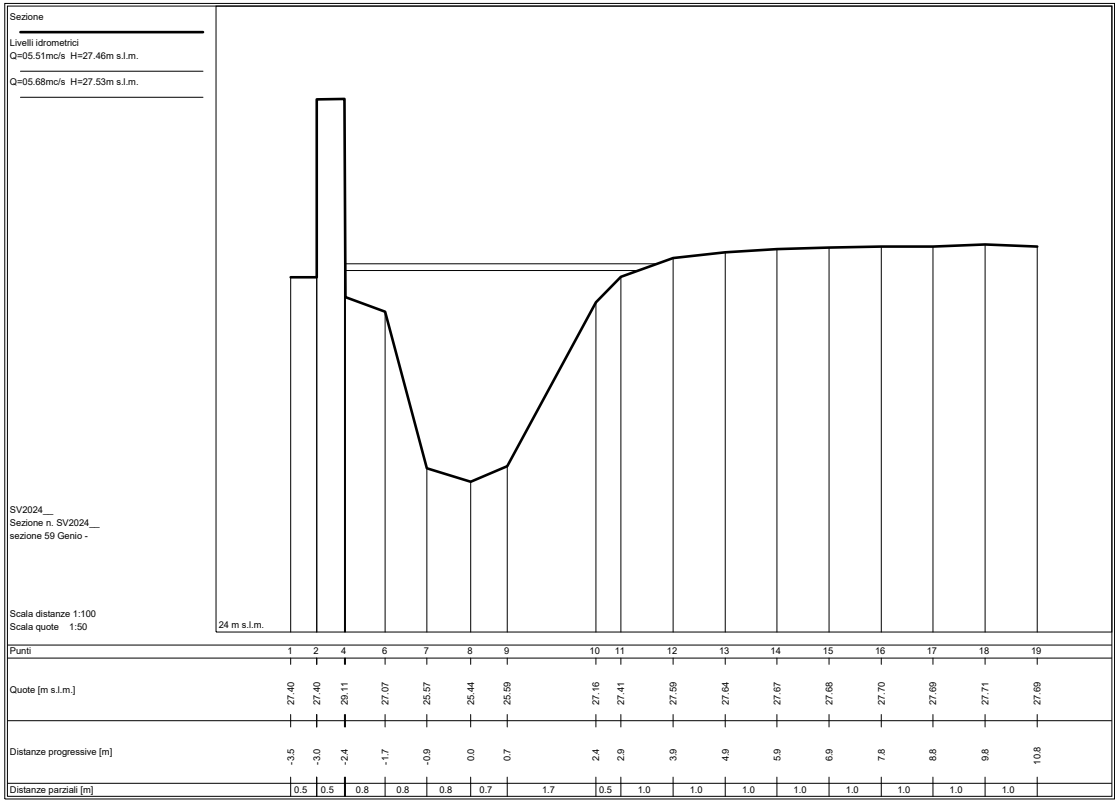

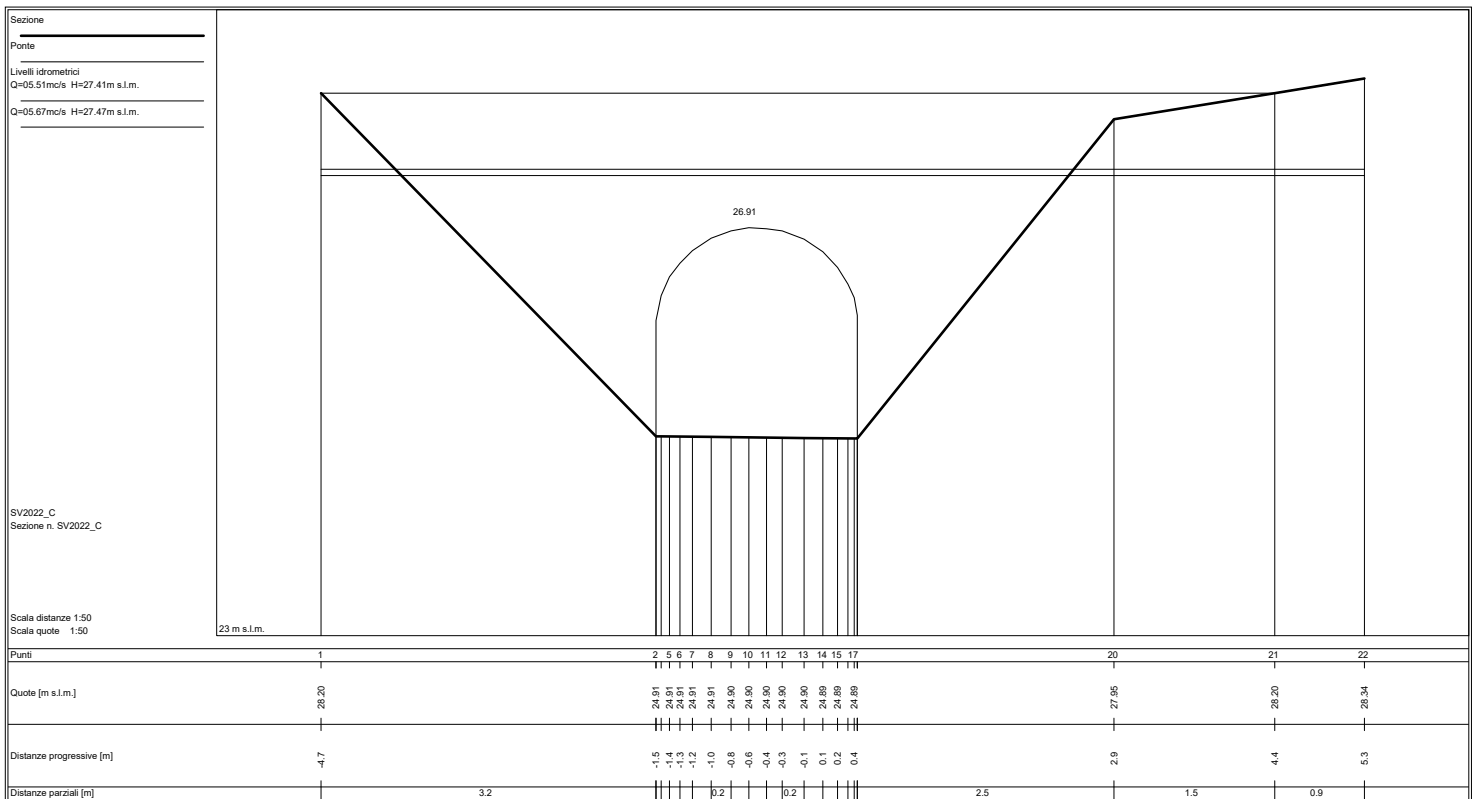
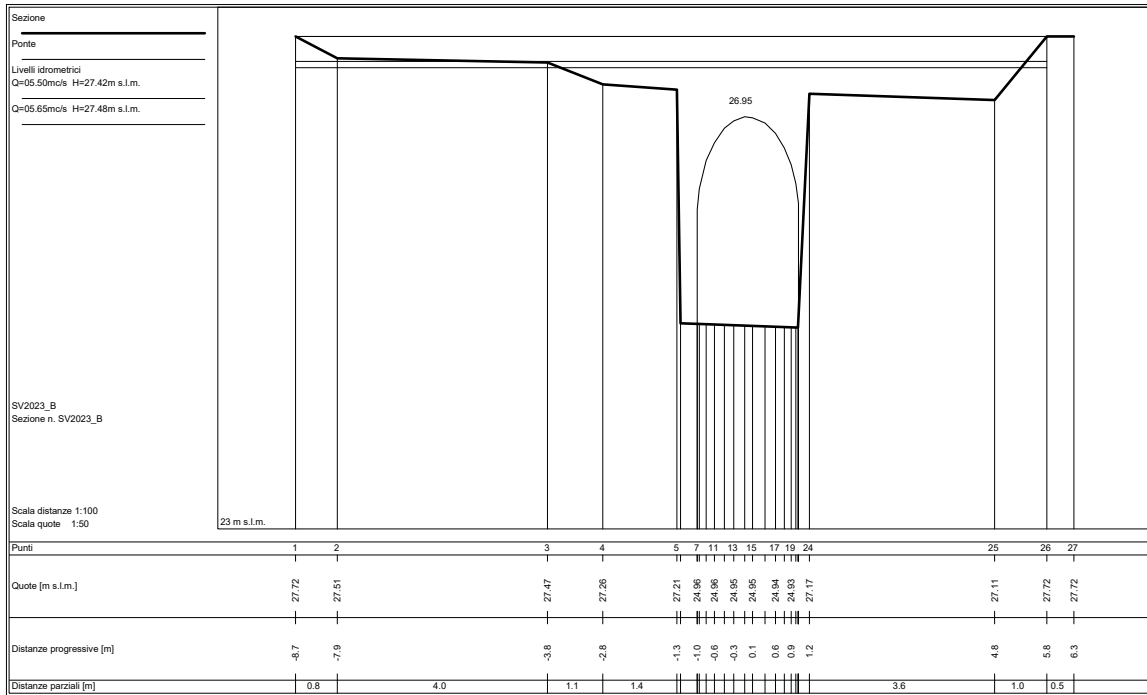

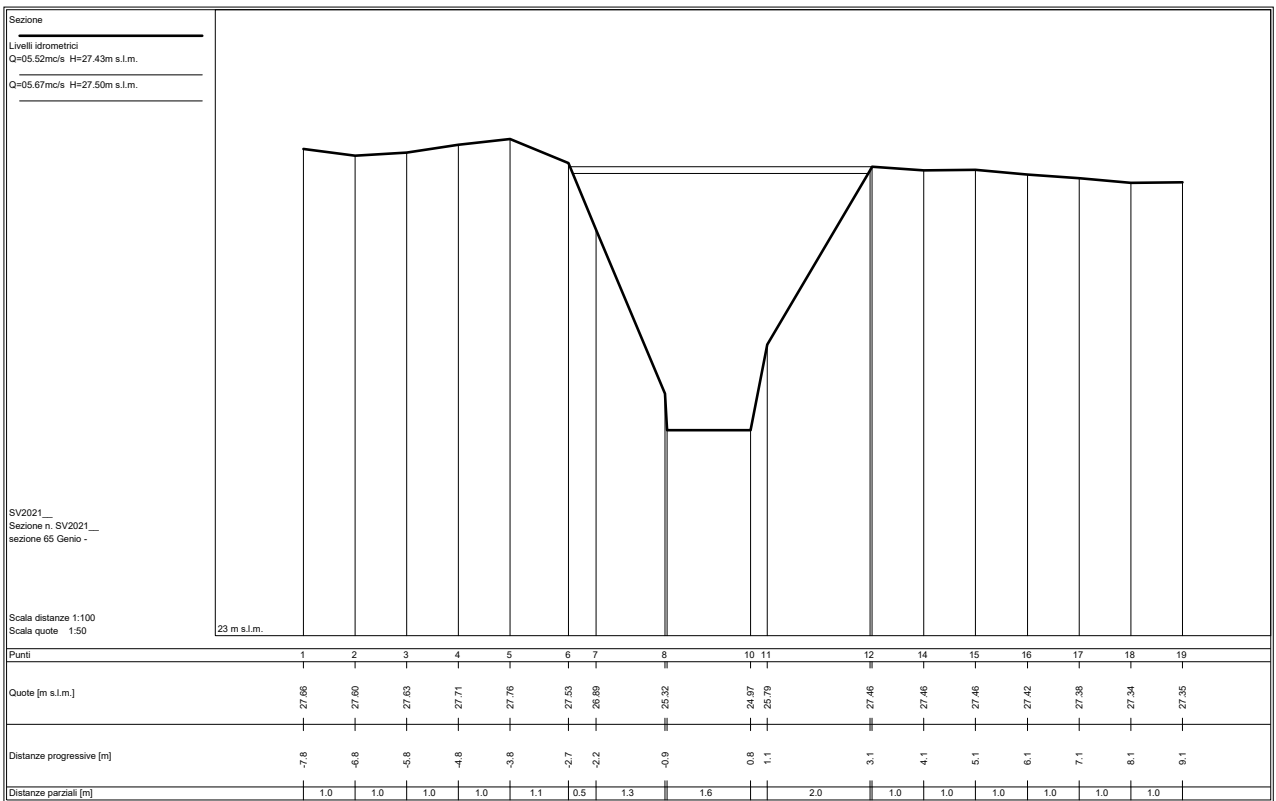
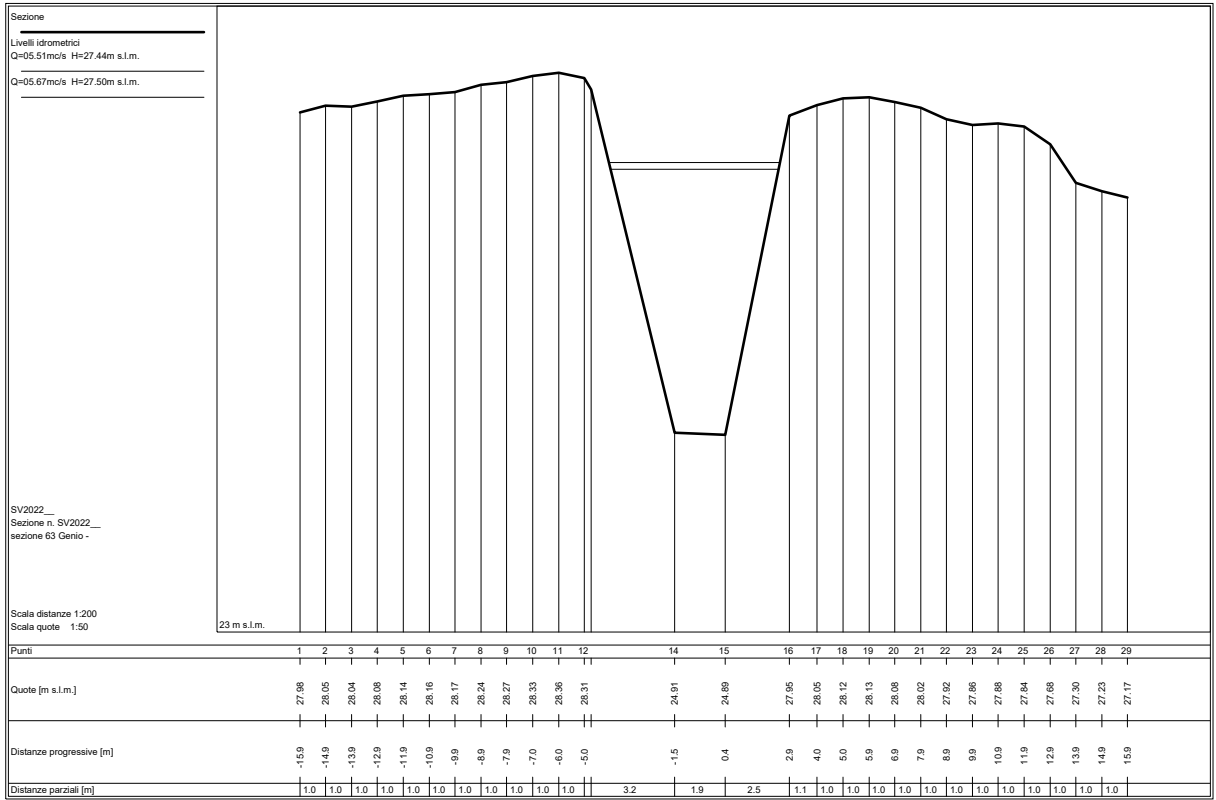

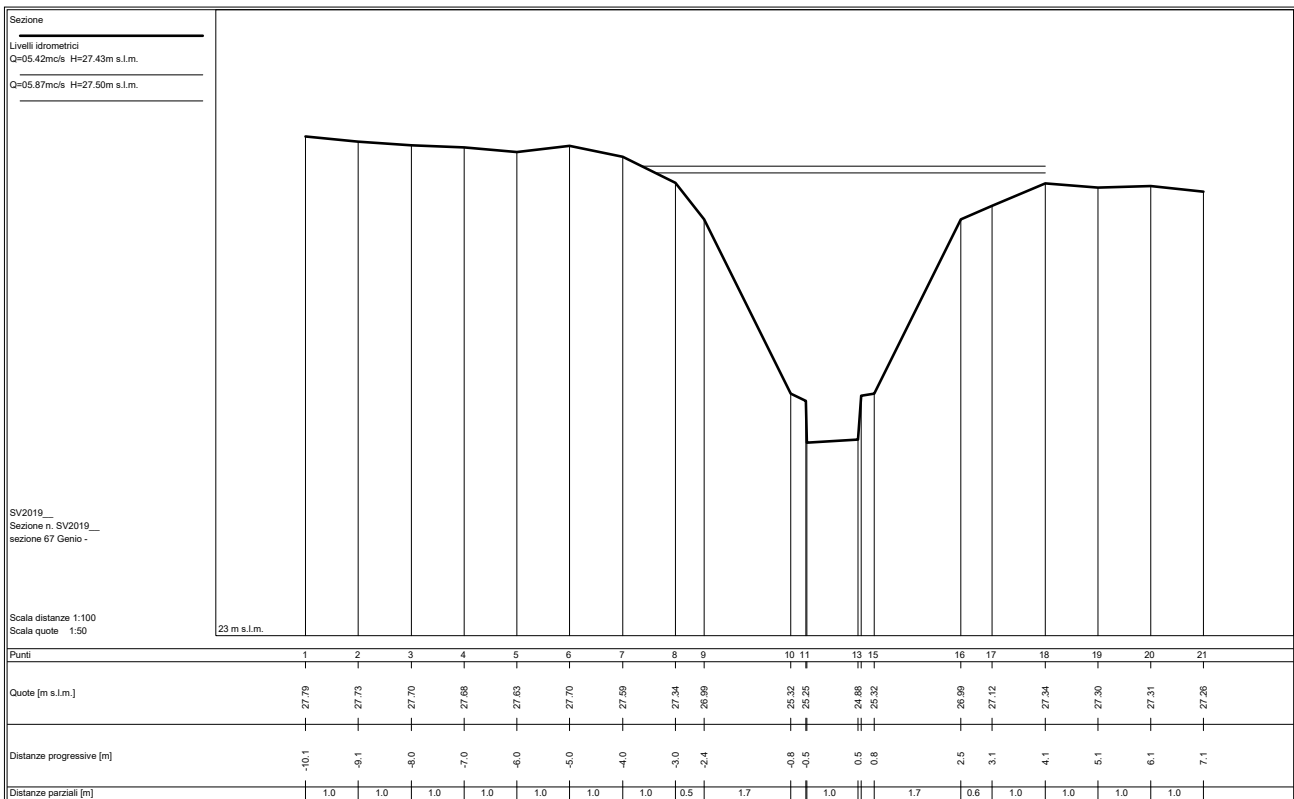
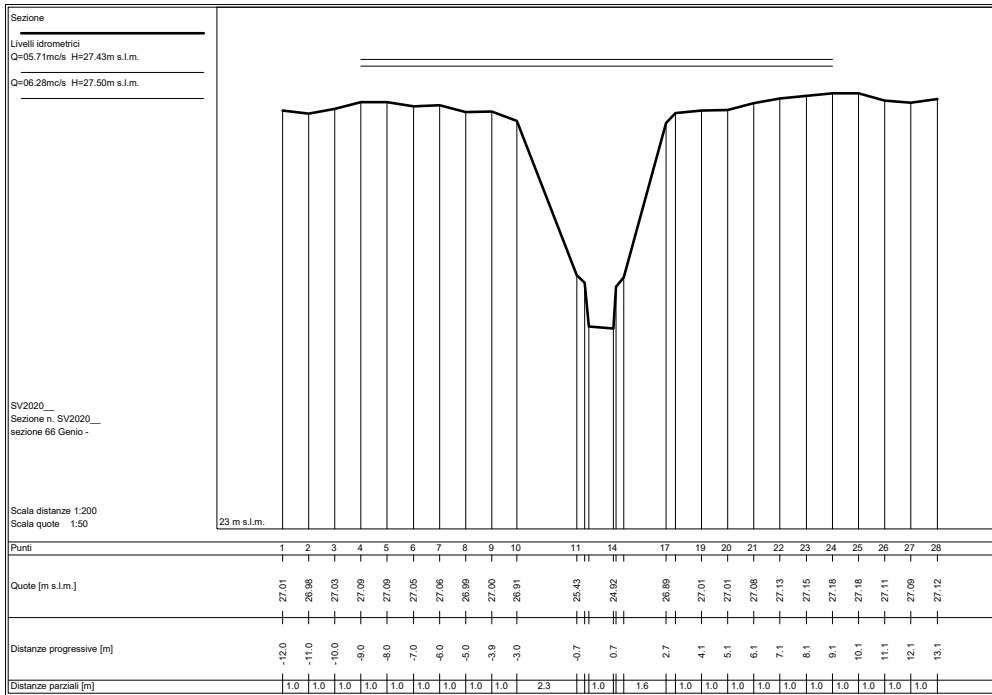

Sezione
 Livelli idrometrici
 Q=05.41mc/s H=27.43m s.l.m.
 Q=05.86mc/s H=27.50m s.l.m.

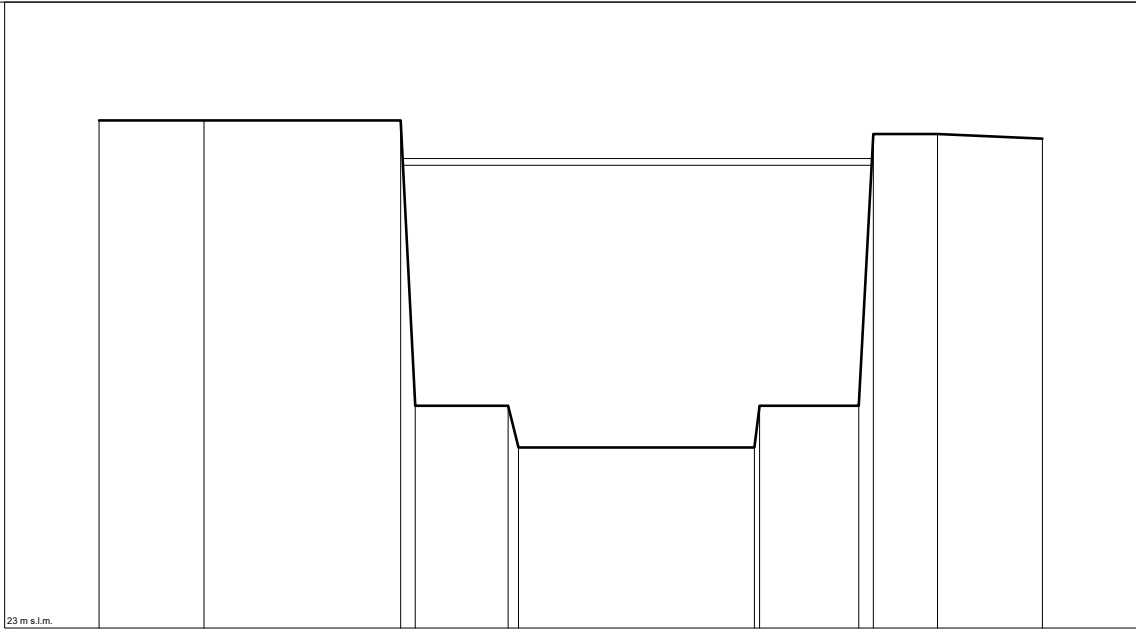

SV2018
 Sezione n. SV2018
 sez 69 Genio monte po
 rte -
 Scala distanze 1:50
 Scala quote 1:50

Punti	1	2	3	4	5	6	7	9	10	11	12	
Quote [m s.l.m.]	27.86	27.87	27.87	25.13	25.13	24.73	24.73	24.73	25.13	27.74	27.74	27.69
Distanze progressive [m]	-5.4	-4.4	-2.5	-2.4	-1.5	-1.4	0.9	1.9	2.0	2.6	3.7	
Distanze parziali [m]		1.0	1.9	0.9		2.3		1.0	0.6	1.0		

Sezione
 Ponte
 Livelli idrometrici
 Q=05.41mc/s H=27.43m s.l.m.
 Q=05.86mc/s H=27.50m s.l.m.

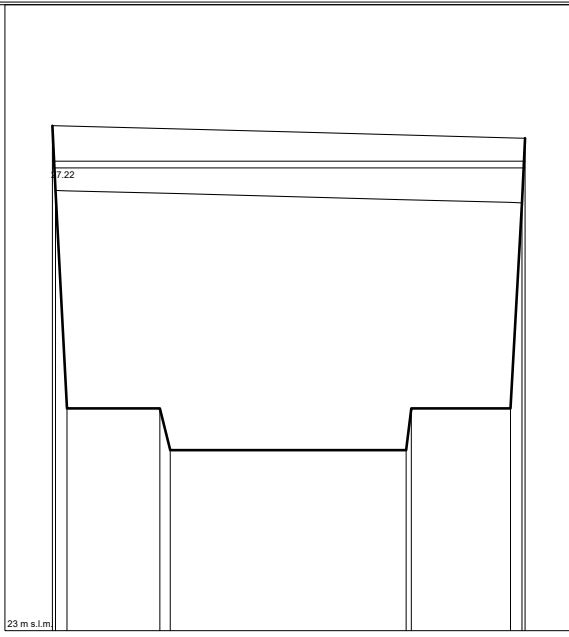

SV2018_B
 Sezione n. SV2018_B
 Scala distanze 1:50
 Scala quote 1:50

Punti	1	3	4	5	6	8	9
Quote [m s.l.m.]	27.84	25.13	25.13	24.73	24.73	25.13	27.10
Distanze progressive [m]	-2.5	-2.4	-1.5	-1.4	0.9	1.9	2.0
Distanze parziali [m]		0.9		2.3		1.0	

