



REGIONE PUGLIA



PROVINCIA di FOGGIA



COMUNE di FOGGIA

<p>Proponente</p>	<p>WIND ENERGY LA ROCCA S.R.L.</p> <p>Sede Operativa Via Caravaggio, 125 - 65125 Pescara (PE) P.IVA 02276610686</p>				
<p>Progettazione e Coordinamento</p>	 <p>VEGA sas LANDSCAPE ECOLOGY & URBAN PLANNING Via delli Carri, 48 - 71121 Foggia - Tel. 0881.756251 - Fax 1784412324 mail: info@studiovega.org - website: www.studiovega.org</p>				
<p>Paesaggio e beni culturali</p>	<p>Arch. Antonio Demaio Tel. 0881.756251 Fax 1784412324 E-Mail: info@studiovega.org</p>	<p>Progettazione elettrica</p>	<p>Dott. Ing. Francesco Gramazio Tel. 338.9722166 E-Mail: francesco.gramazio@carlomaresca.it</p>		
<p>Studio Geologico</p>	<p>Studio di Geologia Tecnica & Ambientale Dott.sa Geol. Giovanna Amedei Via Pietro Nenni, 4 - 71012 Rodi Garganico (Fg) Tel./Fax 0884.965793 Cell. 347.6262259 E-Mail: giovannaamedei@tiscali.it</p>	<p>Studio Acustico</p>	<p>Arch. Marianna Denora Via Savona, 3 - 70022 Altamura (BA) Tel. Fax 080 3147468 E-Mail: info@studioprogettazioneacustica.it</p>		
<p>Studio Idraulico e elettrico</p>	<p>Ing. Antonella Laura Giordano & Ing. Michea Napoli Viale degli Aviatori, 73/F14 - 71122 - Foggia e-mail: micheanapoli@gmail.com</p>	<p>Studio Naturalistico</p>	<p>Dott. Forestale Luigi Lupo Corso Roma, 110 71121 Foggia E-Mail: luigilupo@libero.it</p>		
<p>Studio Archeologico</p>		<p>Elaborazione e rilievi di campo</p>	<p>Geom. Nicola Laonigro E-Mail: nicola.laonigro@gmail.com</p>		
<p>Opera</p>	<p>Progetto di un impianto eolico composto da n. 10 Aerogeneratori nel Comune di Foggia (FG) alla località "La Stella - Duanera"</p>				
<p>Oggetto</p>	<p>Folder: PROGETTO - Parte A</p> <p>Nome Elaborato: U5U1VR6_ARCH_TAV_B07</p> <p>Descrizione Elaborato: Planimetria particellare di esproprio</p>				
<p>00</p>	<p>Gennaio 2020</p>	<p>Progetto definitivo</p>	<p>Vega</p>	<p>Arch. A. Demaio</p>	<p>Wind Energy La Rocca</p>
<p>Rev.</p>	<p>Data</p>	<p>Oggetto della revisione</p>	<p>Elaborazione</p>	<p>Verifica</p>	<p>Approvazione</p>
<p>Scala: Vaire</p>	<p>Codice Pratica U5U1VR6</p>				
<p>Formato:</p>					

AEROGENERATORI 1-2

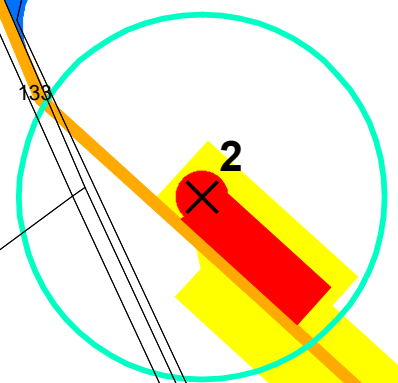
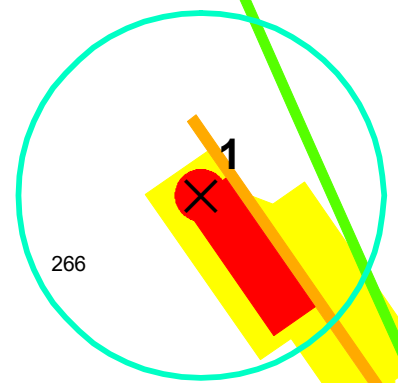

21

Legenda

OPERE PREVISTE DAL PROGETTO

Aerogeneratori

✕ AEROGENERATORI

TIPOLOGIA DI OCCUPAZIONE SUPERFICIE DA ESPROPRIARE

- SERVITU' AEREA
- ESPROPRIO
- ASSERVIMENTO STRADA E CAVIDOTTO
- ASSERVIMENTO CAVIDOTTO
- ASSERVIMENTO CAVIDOTTO AEREO
- ASSERVIMENTO STRADE
- OCCUPAZIONE TEMPORANEA
- ESPROPRIO STALLO UTENTE

STRADA DI ACCESSO

Legenda

OPERE PREVISTE DAL PROGETTO

Aerogeneratori

✕ AEROGENERATORI

TIPOLOGIA DI OCCUPAZIONE SUPERFICIE DA ESPROPRIARE

-  SERVITU' AEREA
-  ESPROPRIO
-  ASSERVIMENTO STRADA E CAVIDOTTO
-  ASSERVIMENTO CAVIDOTTO
-  ASSERVIMENTO CAVIDOTTO AEREO
-  ASSERVIMENTO STRADE
-  OCCUPAZIONE TEMPORANEA
-  ESPROPRIO STALLO UTENTE

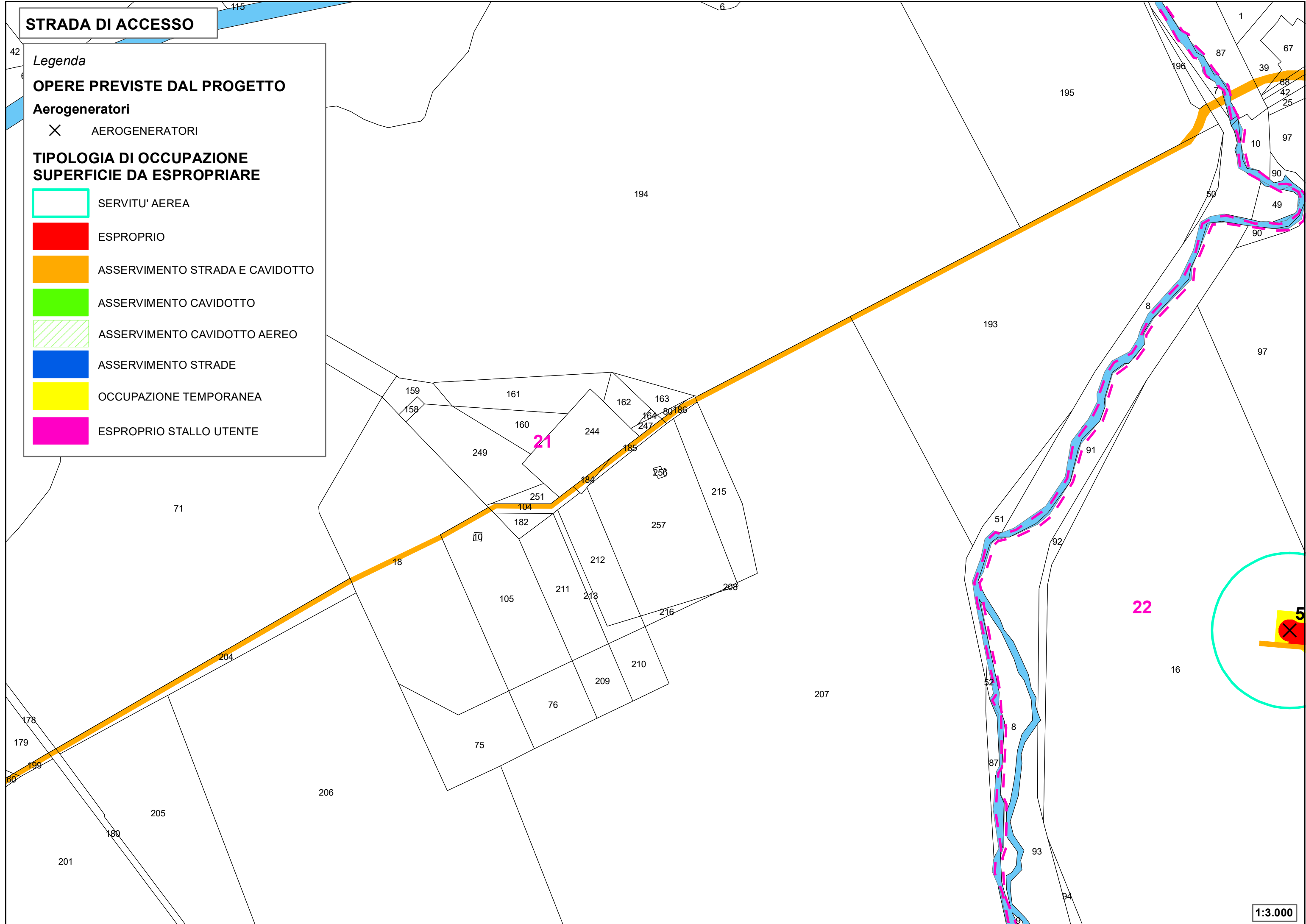

STRADA DI ACCESSO

Legenda

OPERE PREVISTE DAL PROGETTO

Aerogeneratori

✕ AEROGENERATORI

TIPOLOGIA DI OCCUPAZIONE SUPERFICIE DA ESPROPRIARE

-  SERVITU' AEREA
-  ESPROPRIO
-  ASSERVIMENTO STRADA E CAVIDOTTO
-  ASSERVIMENTO CAVIDOTTO
-  ASSERVIMENTO CAVIDOTTO AEREO
-  ASSERVIMENTO STRADE
-  OCCUPAZIONE TEMPORANEA
-  ESPROPRIO STALLO UTENTE

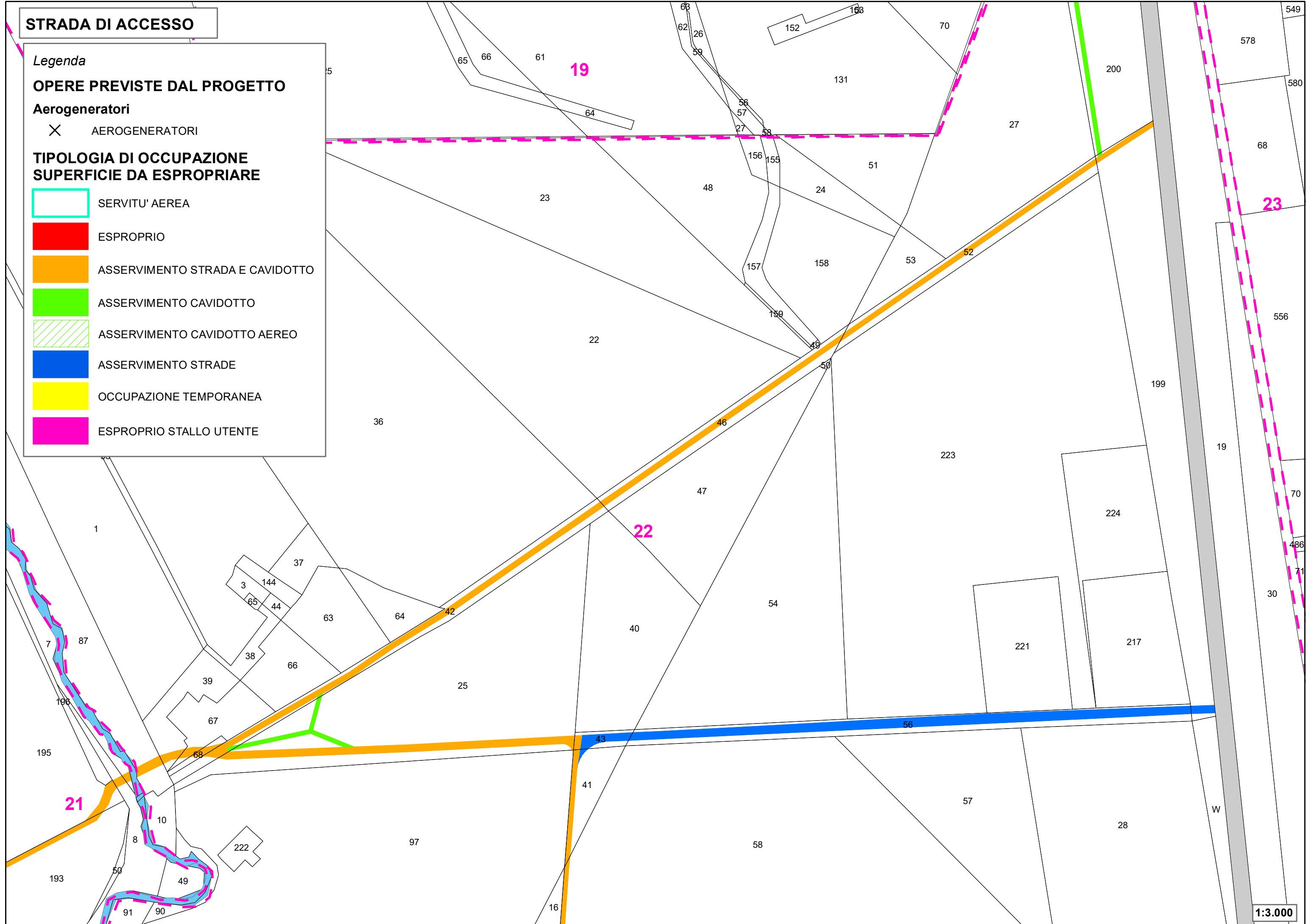

19

23

22

21

1:3.000

AEROGENERATORE 5

Legenda

OPERE PREVISTE DAL PROGETTO

Aerogeneratori

✕ AEROGENERATORI

TIPOLOGIA DI OCCUPAZIONE SUPERFICIE DA ESPROPRIARE

- SERVITU' AEREA
- ESPROPRIO
- ASSERVIMENTO STRADA E CAVIDOTTO
- ASSERVIMENTO CAVIDOTTO
- ASSERVIMENTO CAVIDOTTO AEREO
- ASSERVIMENTO STRADE
- OCCUPAZIONE TEMPORANEA
- ESPROPRIO STALLO UTENTE

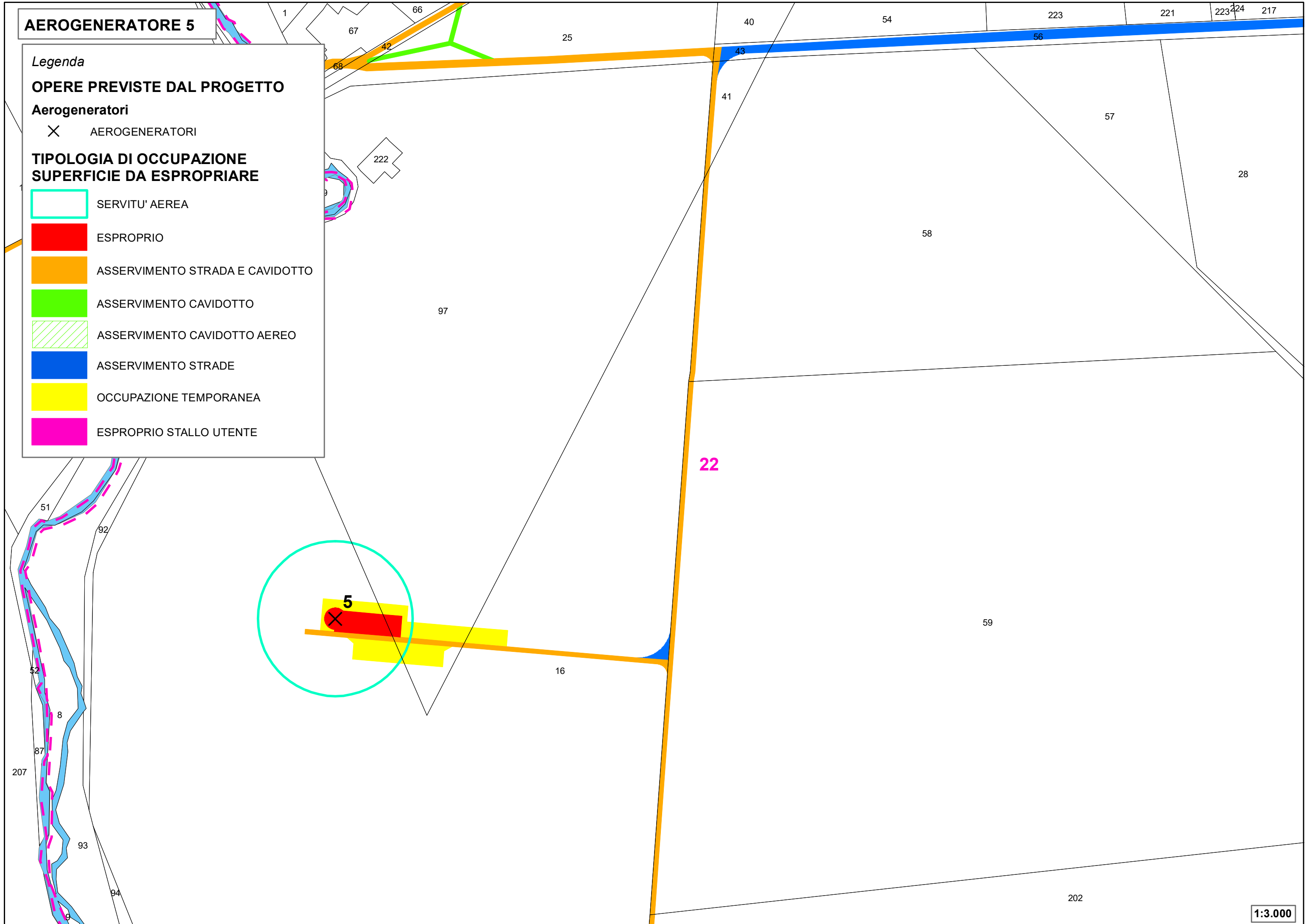

AEROGENERATORE 4

Legenda

OPERE PREVISTE DAL PROGETTO

Aerogeneratori

✕ AEROGENERATORI

TIPOLOGIA DI OCCUPAZIONE SUPERFICIE DA ESPROPRIARE

- SERVITU' AEREA
- ESPROPRIO
- ASSERVIMENTO STRADA E CAVIDOTTO
- ASSERVIMENTO CAVIDOTTO
- ASSERVIMENTO CAVIDOTTO AEREO
- ASSERVIMENTO STRADE
- OCCUPAZIONE TEMPORANEA
- ESPROPRIO STALLO UTENTE

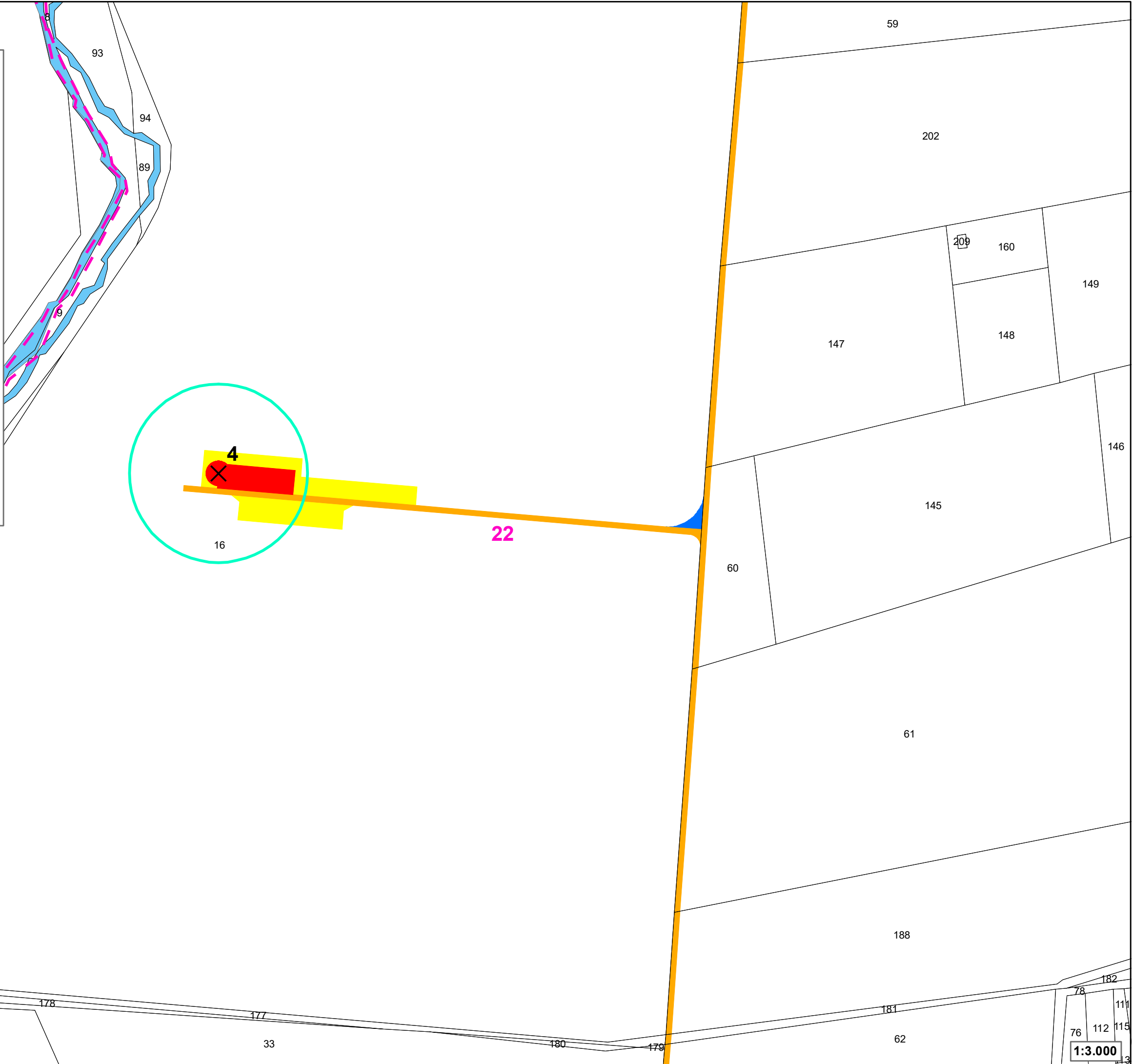

AEROGENERATORE 3

Legenda

OPERE PREVISTE DAL PROGETTO

Aerogeneratori

✕ AEROGENERATORI

TIPOLOGIA DI OCCUPAZIONE SUPERFICIE DA ESPROPRIARE

-  SERVITU' AEREA
-  ESPROPRIO
-  ASSERVIMENTO STRADA E CAVIDOTTO
-  ASSERVIMENTO CAVIDOTTO
-  ASSERVIMENTO CAVIDOTTO AEREO
-  ASSERVIMENTO STRADE
-  OCCUPAZIONE TEMPORANEA
-  ESPROPRIO STALLO UTENTE

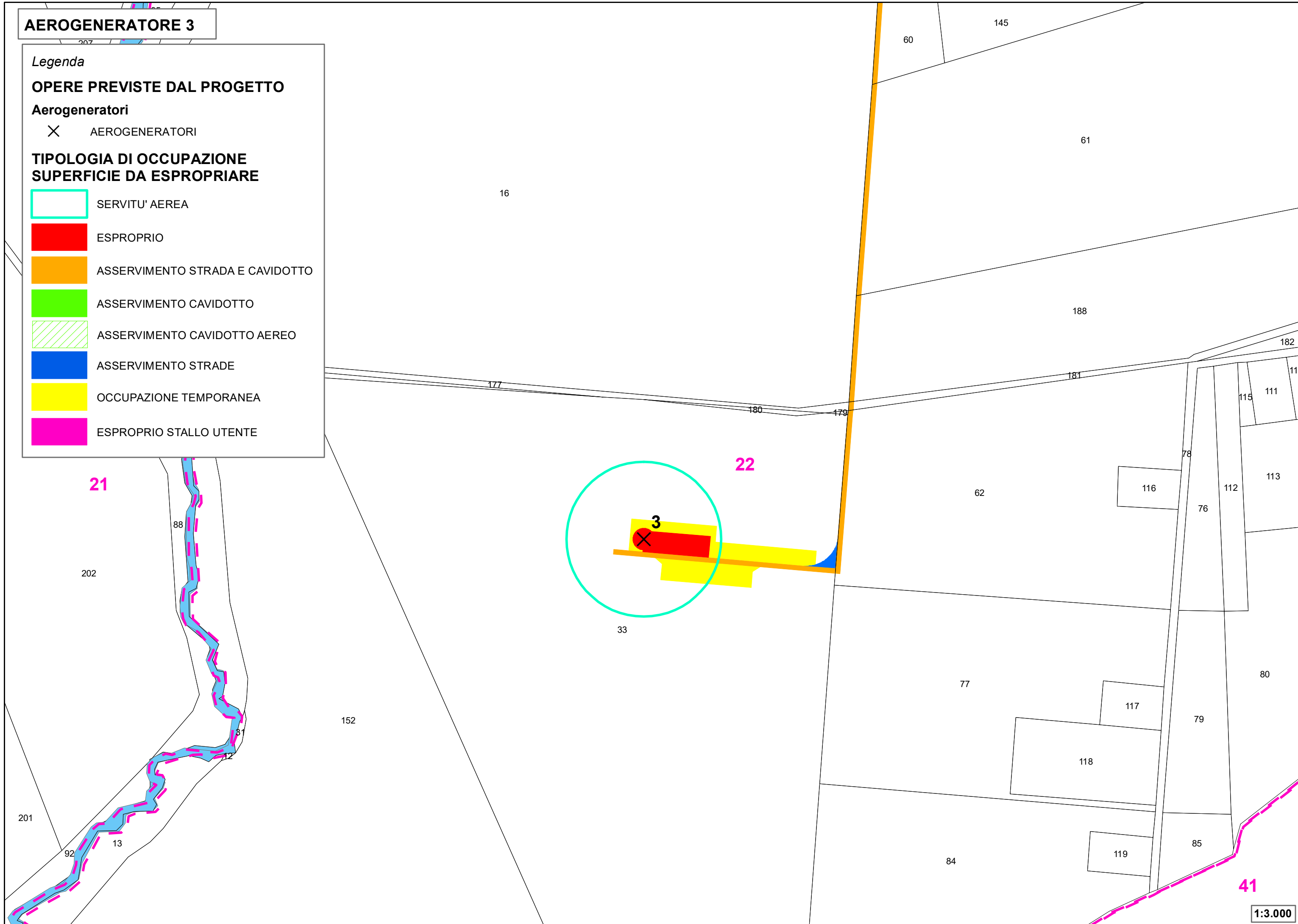

CAVIDOTTO DI CONNESSIONE TRA LE MACCHINE





Legenda

OPERE PREVISTE DAL PROGETTO

Aerogeneratori

✕ AEROGENERATORI

TIPOLOGIA DI OCCUPAZIONE SUPERFICIE DA ESPROPRIARE

-  SERVITU' AEREA
-  ESPROPRIO
-  ASSERVIMENTO STRADA E CAVIDOTTO
-  ASSERVIMENTO CAVIDOTTO
-  ASSERVIMENTO CAVIDOTTO AEREO
-  ASSERVIMENTO STRADE
-  OCCUPAZIONE TEMPORANEA
-  ESPROPRIO STALLO UTENTE

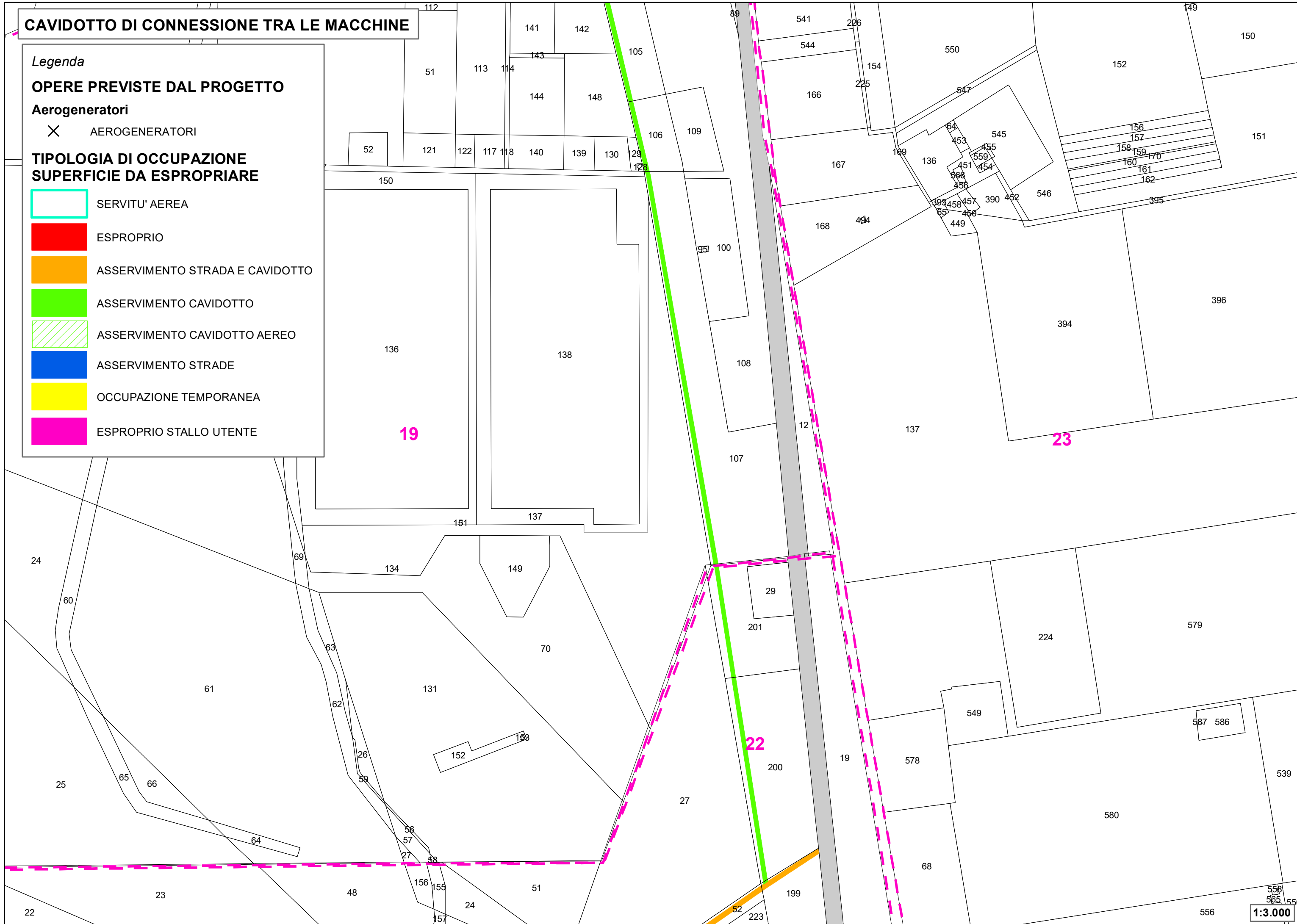

CAVIDOTTO DI CONNESSIONE TRA LE MACCHINE

Legenda

OPERE PREVISTE DAL PROGETTO

Aerogeneratori

✕ AEROGENERATORI

TIPOLOGIA DI OCCUPAZIONE SUPERFICIE DA ESPROPRIARE

-  SERVITU' AEREA
-  ESPROPRIO
-  ASSERVIMENTO STRADA E CAVIDOTTO
-  ASSERVIMENTO CAVIDOTTO
-  ASSERVIMENTO CAVIDOTTO AEREO
-  ASSERVIMENTO STRADE
-  OCCUPAZIONE TEMPORANEA
-  ESPROPRIO STALLO UTENTE

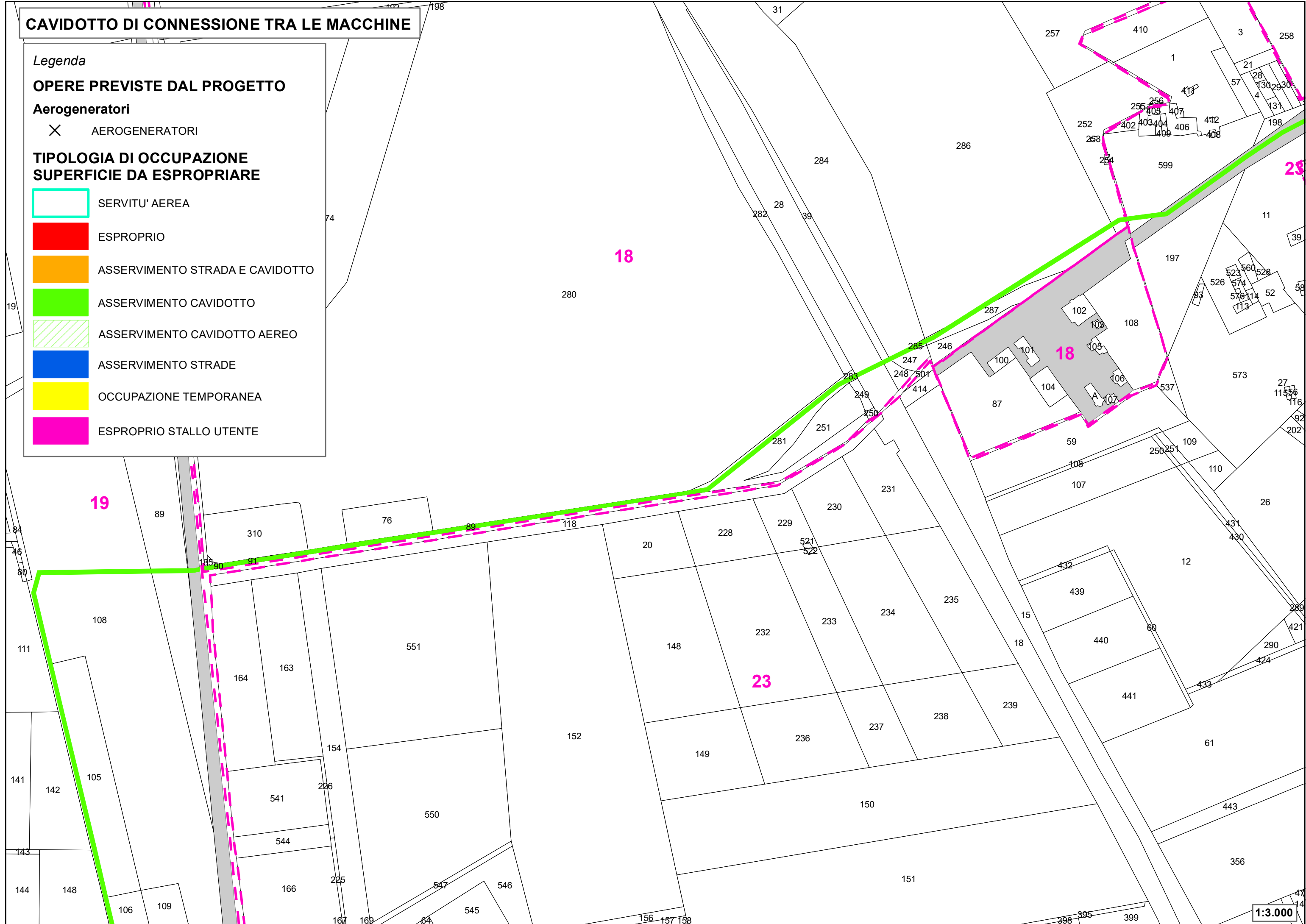

CAVIDOTTO DI CONNESSIONE TRA LE MACCHINE

Legenda

OPERE PREVISTE DAL PROGETTO

Aerogeneratori

✕ AEROGENERATORI

TIPOLOGIA DI OCCUPAZIONE SUPERFICIE DA ESPROPRIARE

-  SERVITU' AEREA
-  ESPROPRIO
-  ASSERVIMENTO STRADA E CAVIDOTTO
-  ASSERVIMENTO CAVIDOTTO
-  ASSERVIMENTO CAVIDOTTO AEREO
-  ASSERVIMENTO STRADE
-  OCCUPAZIONE TEMPORANEA
-  ESPROPRIO STALLO UTENTE

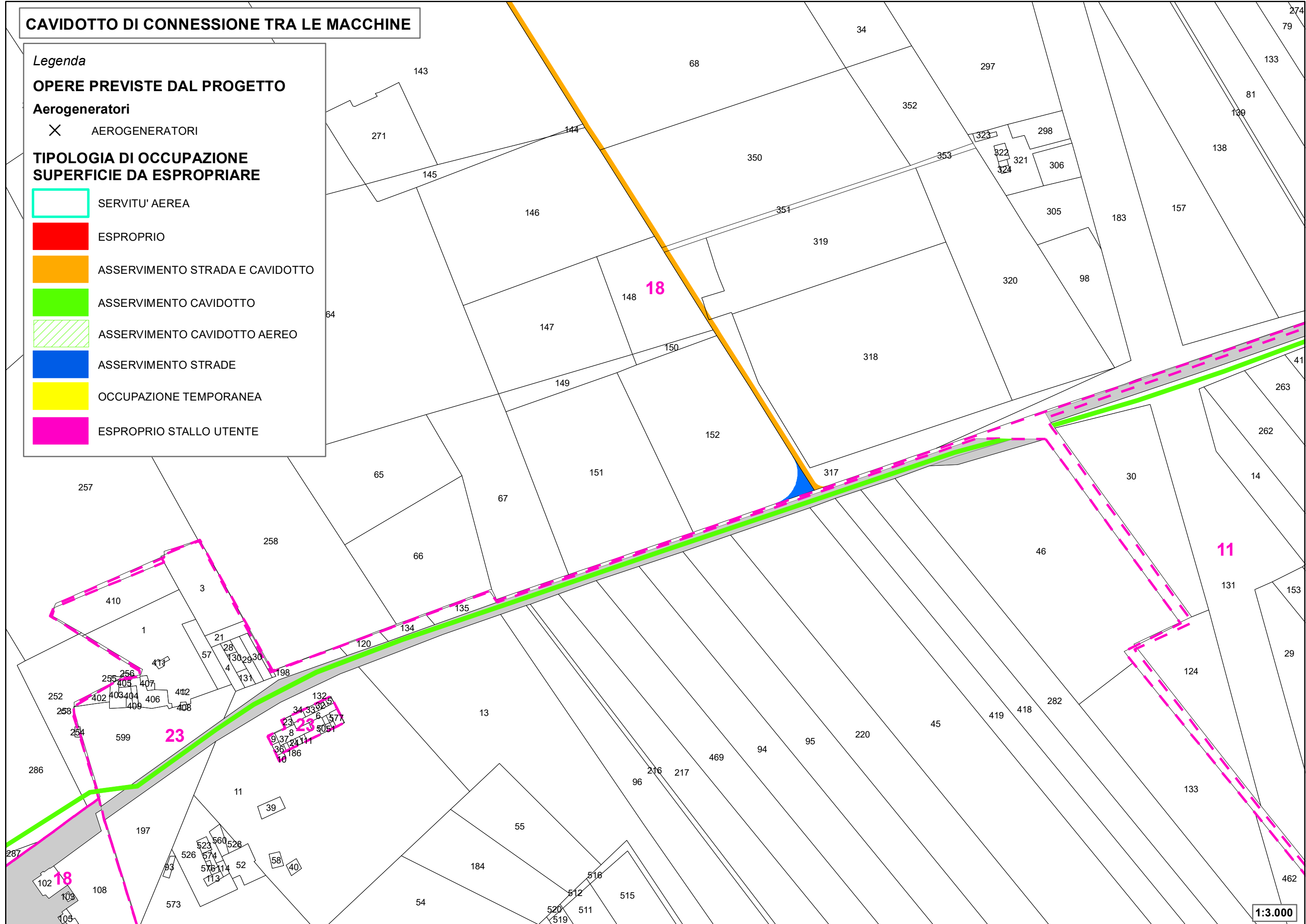

AEROGENERATORE 6

Legenda

OPERE PREVISTE DAL PROGETTO

Aerogeneratori

✕ AEROGENERATORI

TIPOLOGIA DI OCCUPAZIONE SUPERFICIE DA ESPROPRIARE

-  SERVITU' AEREA
-  ESPROPRIO
-  ASSERVIMENTO STRADA E CAVIDOTTO
-  ASSERVIMENTO CAVIDOTTO
-  ASSERVIMENTO CAVIDOTTO AEREO
-  ASSERVIMENTO STRADE
-  OCCUPAZIONE TEMPORANEA
-  ESPROPRIO STALLO UTENTE

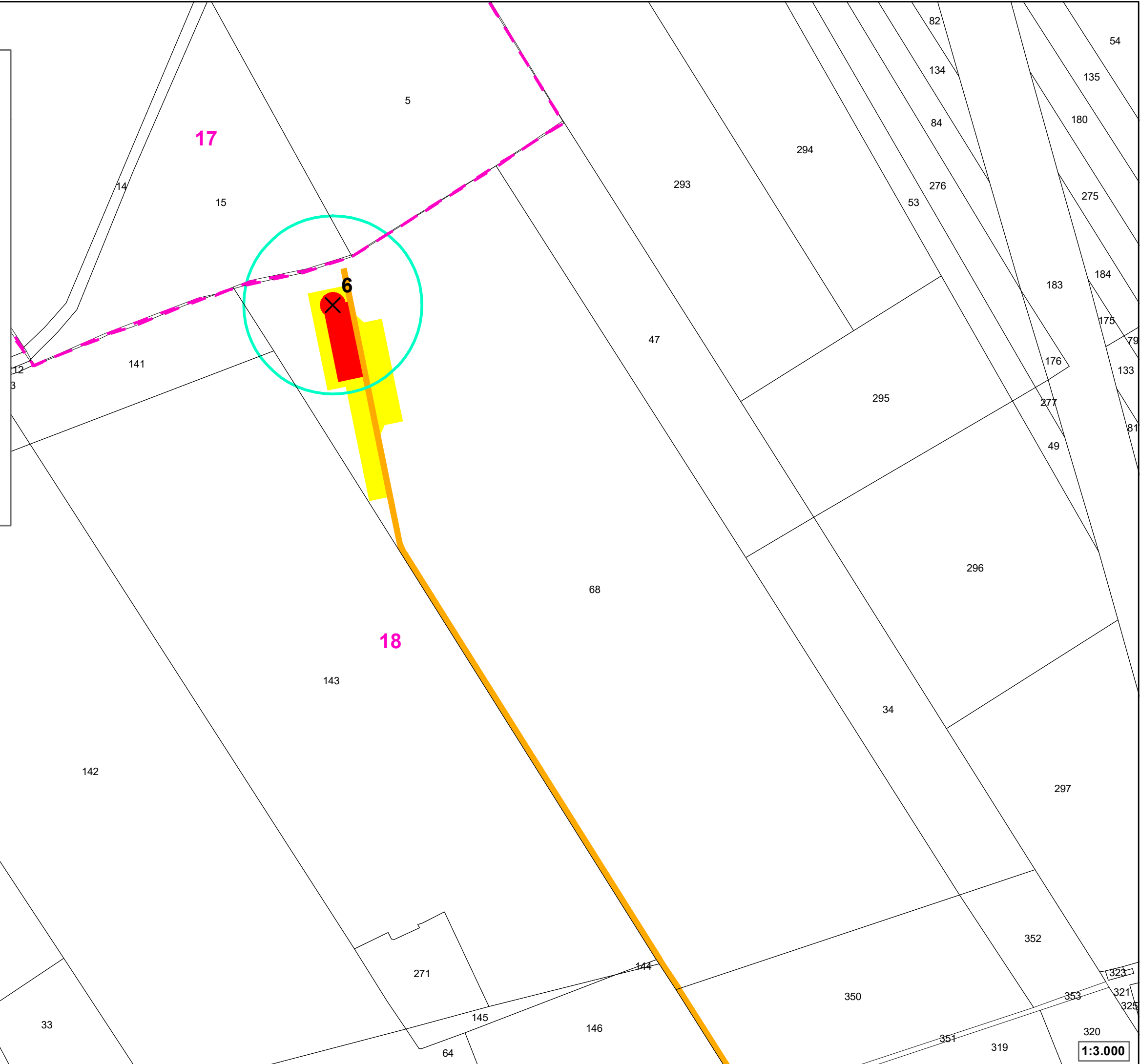

AEROGENERATORE 7

Legenda

OPERE PREVISTE DAL PROGETTO

Aerogeneratori

✕ AEROGENERATORI

TIPOLOGIA DI OCCUPAZIONE SUPERFICIE DA ESPROPRIARE

-  SERVITU' AEREA
-  ESPROPRIO
-  ASSERVIMENTO STRADA E CAVIDOTTO
-  ASSERVIMENTO CAVIDOTTO
-  ASSERVIMENTO CAVIDOTTO AEREO
-  ASSERVIMENTO STRADE
-  OCCUPAZIONE TEMPORANEA
-  ESPROPRIO STALLO UTENTE

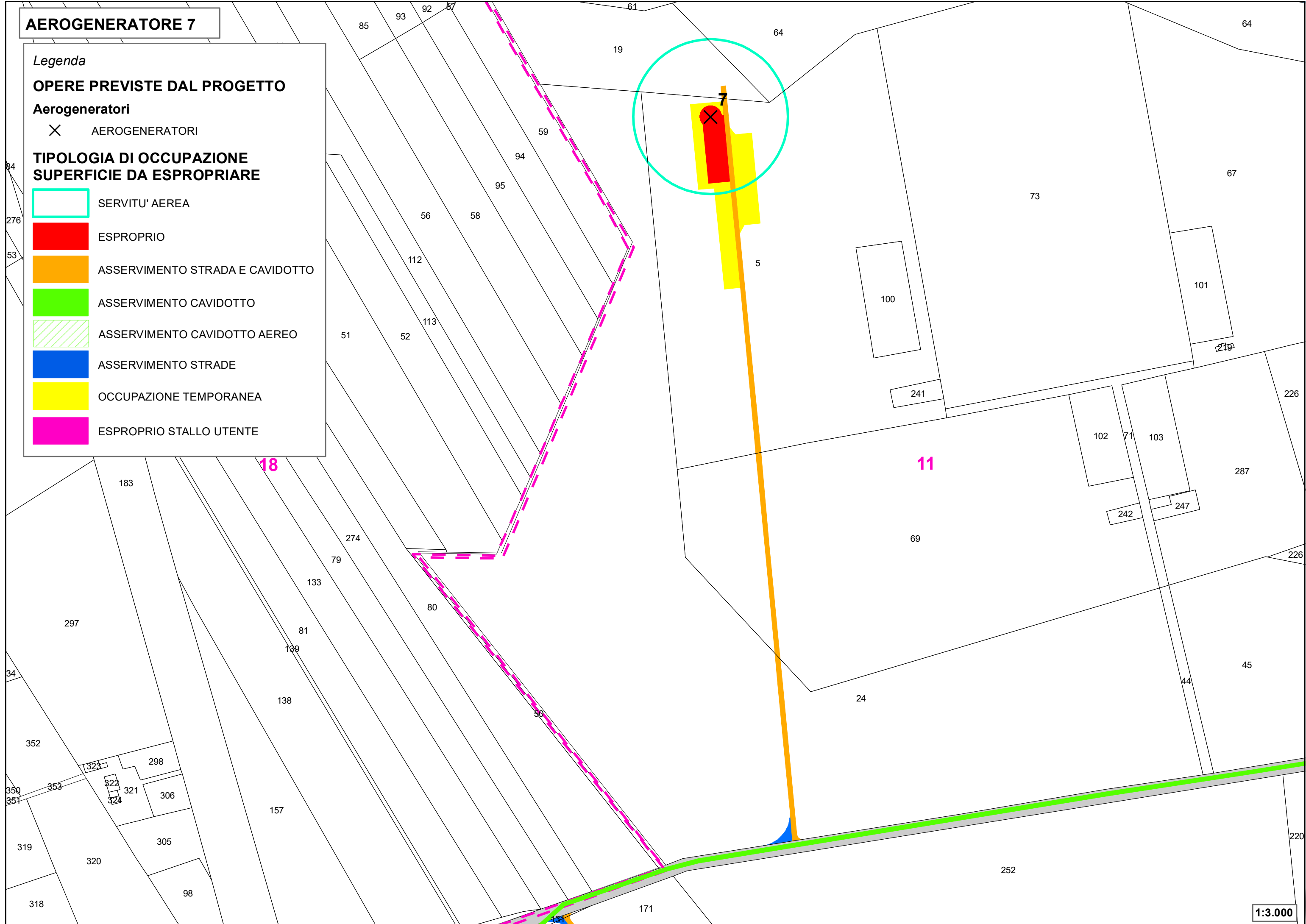

AEROGENERATORE 8

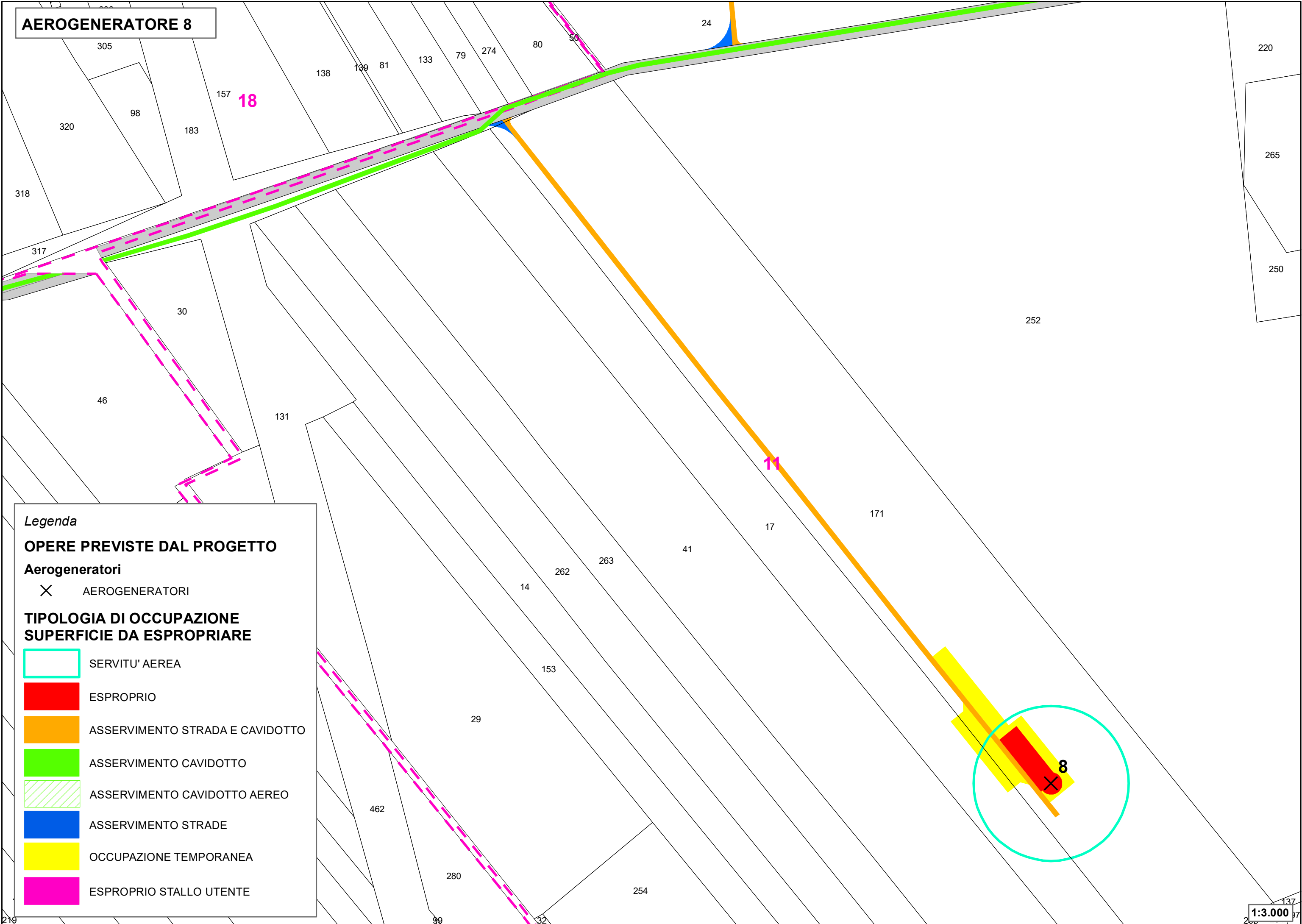

Legenda

OPERE PREVISTE DAL PROGETTO

Aerogeneratori

✕ AEROGENERATORI

TIPOLOGIA DI OCCUPAZIONE SUPERFICIE DA ESPROPRIARE

- SERVITU' AEREA
- ESPROPRIO
- ASSERVIMENTO STRADA E CAVIDOTTO
- ASSERVIMENTO CAVIDOTTO
- ASSERVIMENTO CAVIDOTTO AEREO
- ASSERVIMENTO STRADE
- OCCUPAZIONE TEMPORANEA
- ESPROPRIO STALLO UTENTE

AEROGENERATORE 9

Legenda

OPERE PREVISTE DAL PROGETTO

Aerogeneratori

✕ AEROGENERATORI

TIPOLOGIA DI OCCUPAZIONE SUPERFICIE DA ESPROPRIARE

-  SERVITU' AEREA
-  ESPROPRIO
-  ASSERVIMENTO STRADA E CAVIDOTTO
-  ASSERVIMENTO CAVIDOTTO
-  ASSERVIMENTO CAVIDOTTO AEREO
-  ASSERVIMENTO STRADE
-  OCCUPAZIONE TEMPORANEA
-  ESPROPRIO STALLO UTENTE

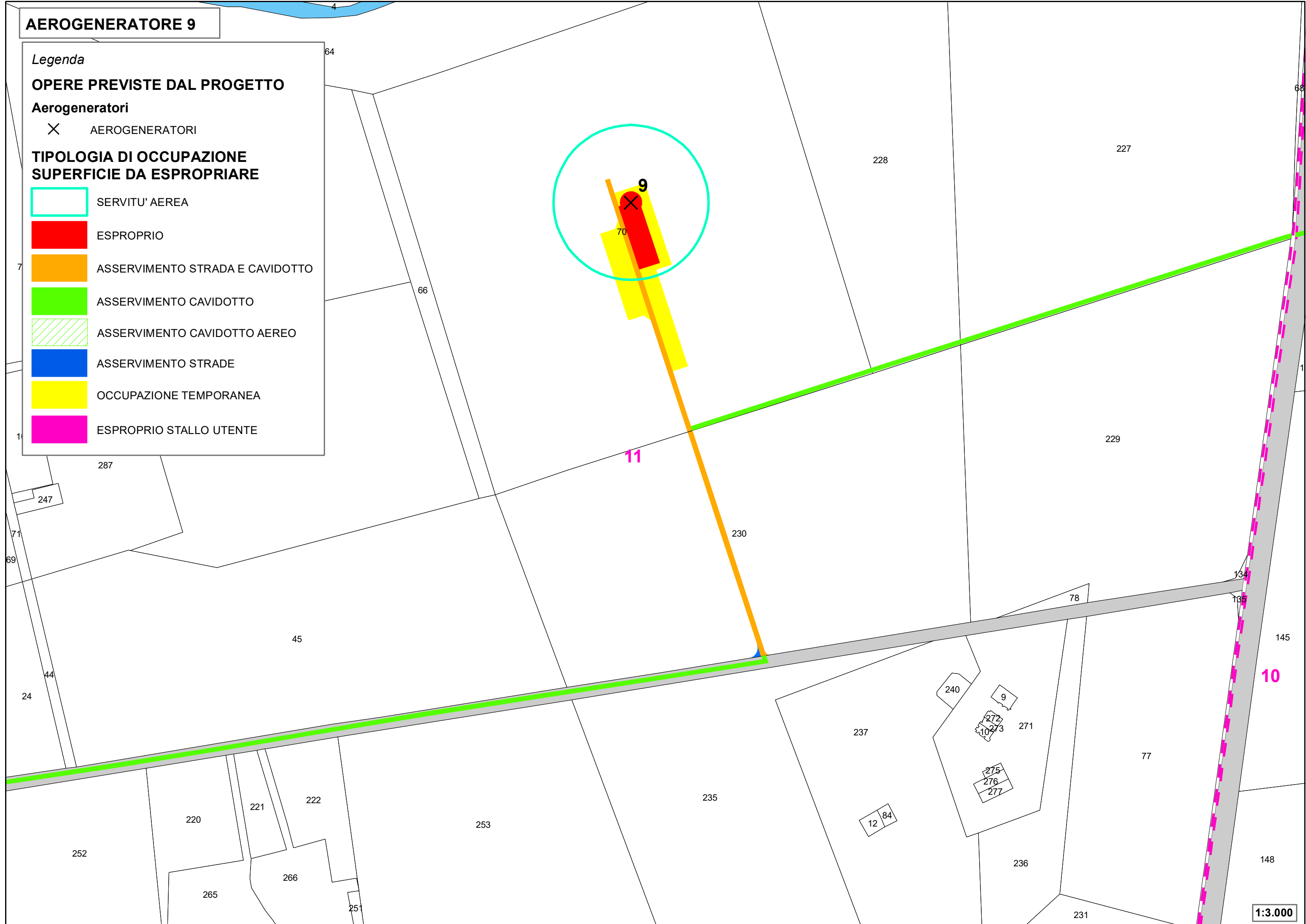

AEROGENERATORE 10

Legenda

OPERE PREVISTE DAL PROGETTO

Aerogeneratori

✕ AEROGENERATORI

TIPOLOGIA DI OCCUPAZIONE SUPERFICIE DA ESPROPRIARE

-  SERVITU' AEREA
-  ESPROPRIO
-  ASSERVIMENTO STRADA E CAVIDOTTO
-  ASSERVIMENTO CAVIDOTTO
-  ASSERVIMENTO CAVIDOTTO AEREO
-  ASSERVIMENTO STRADE
-  OCCUPAZIONE TEMPORANEA
-  ESPROPRIO STALLO UTENTE

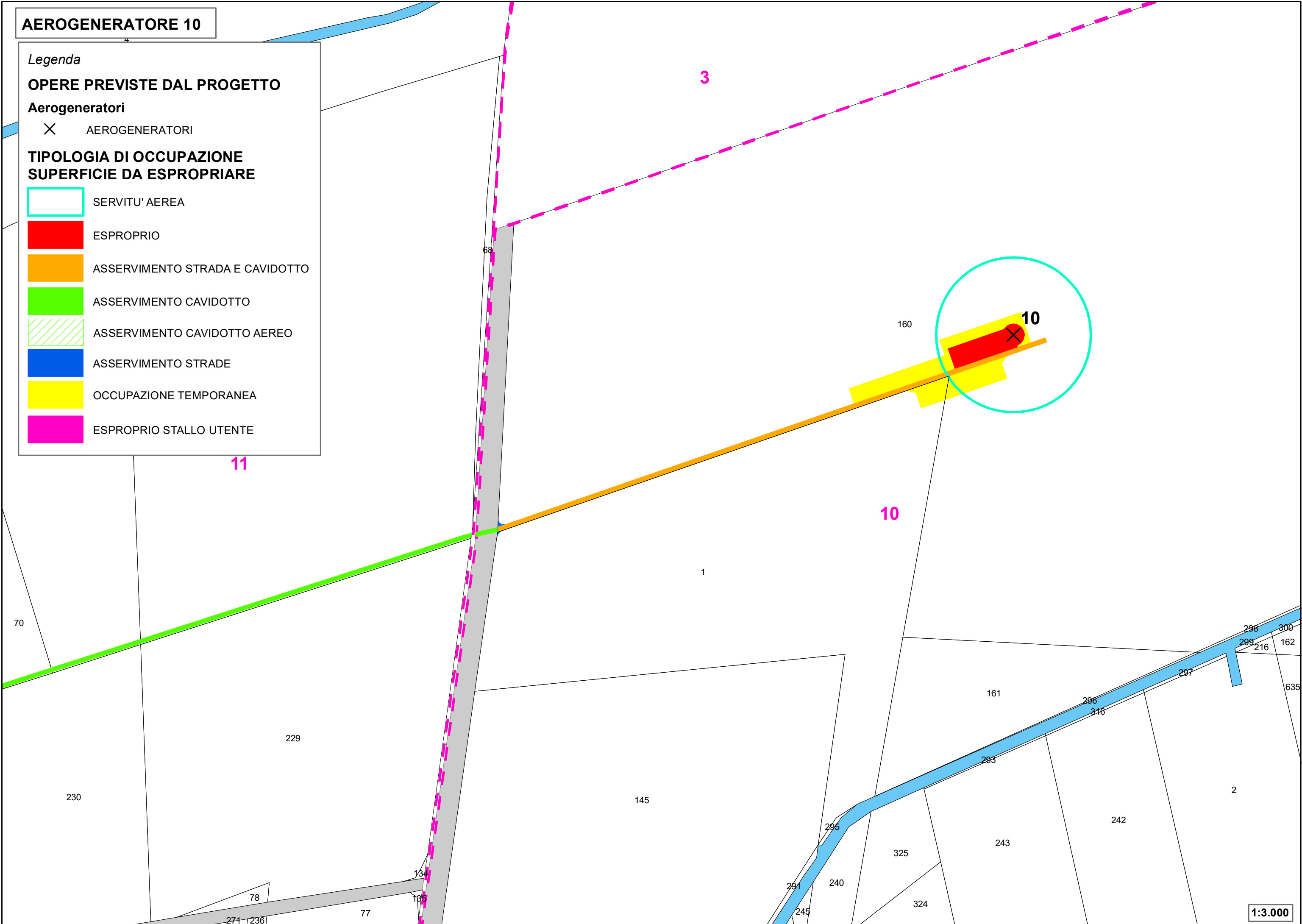

CAVIDOTTO DI CONNESSIONE ALLA SE

Legenda

OPERE PREVISTE DAL PROGETTO

Aerogeneratori

✕ AEROGENERATORI

TIPOLOGIA DI OCCUPAZIONE SUPERFICIE DA ESPROPRIARE

-  SERVITU' AEREA
-  ESPROPRIO
-  ASSERVIMENTO STRADA E CAVIDOTTO
-  ASSERVIMENTO CAVIDOTTO
-  ASSERVIMENTO CAVIDOTTO AEREO
-  ASSERVIMENTO STRADE
-  OCCUPAZIONE TEMPORANEA
-  ESPROPRIO STALLO UTENTE

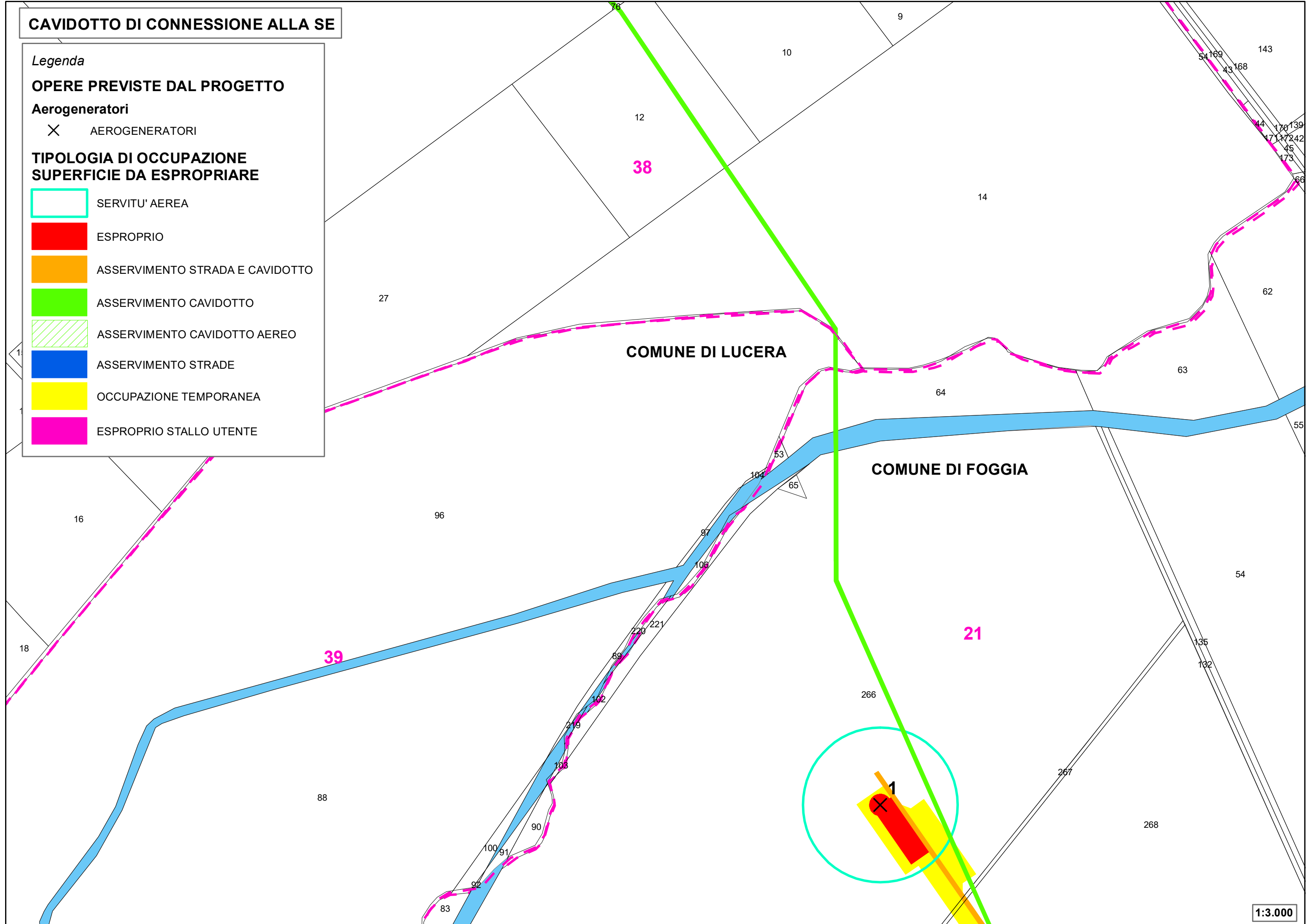

CAVIDOTTO DI CONNESSIONE ALLA SE

Legenda

OPERE PREVISTE DAL PROGETTO

Aerogeneratori

✕ AEROGENERATORI

TIPOLOGIA DI OCCUPAZIONE SUPERFICIE DA ESPROPRIARE

-  SERVITU' AEREA
-  ESPROPRIO
-  ASSERVIMENTO STRADA E CAVIDOTTO
-  ASSERVIMENTO CAVIDOTTO
-  ASSERVIMENTO CAVIDOTTO AEREO
-  ASSERVIMENTO STRADE
-  OCCUPAZIONE TEMPORANEA
-  ESPROPRIO STALLO UTENTE

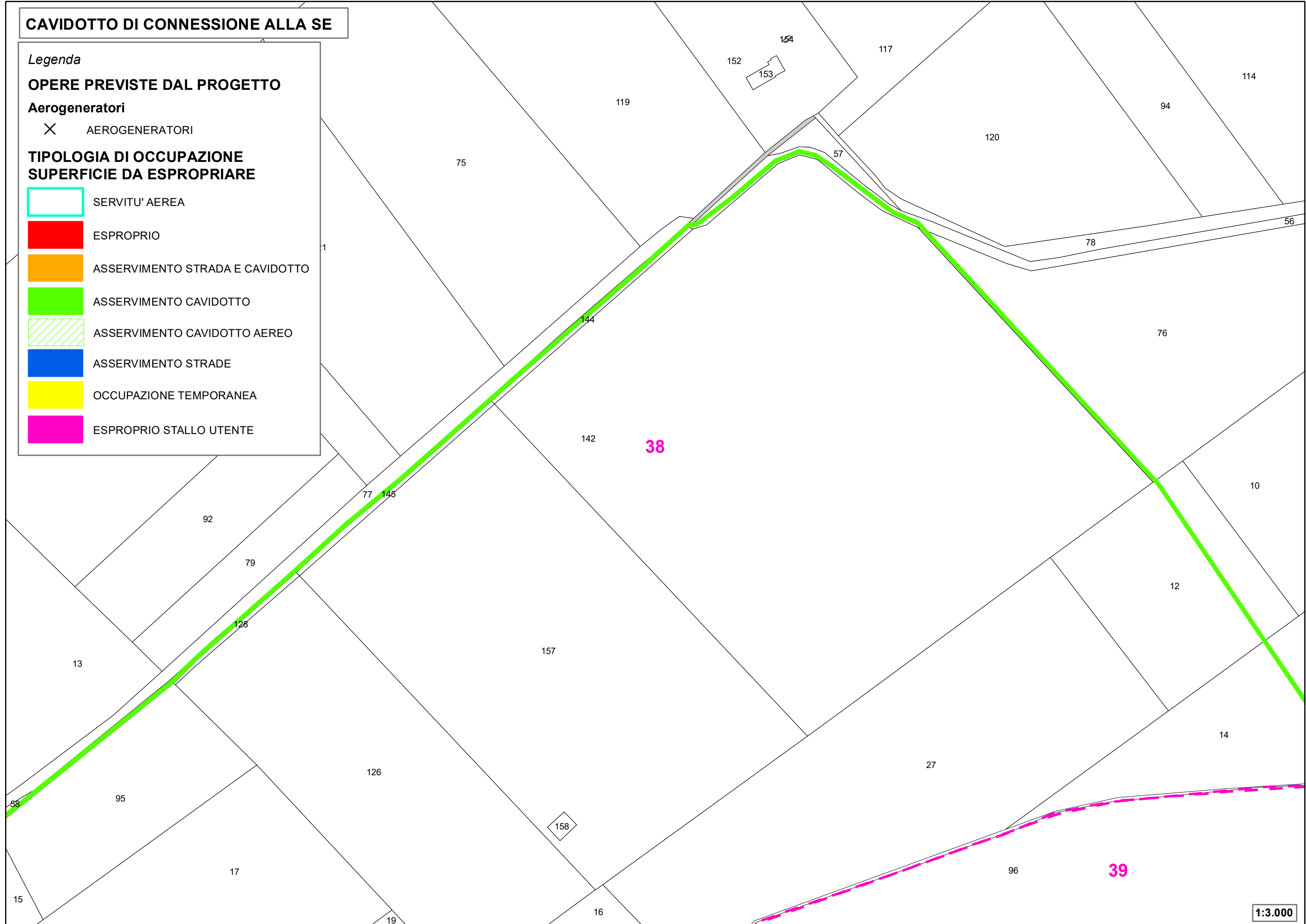

CAVIDOTTO DI CONNESSIONE ALLA SE

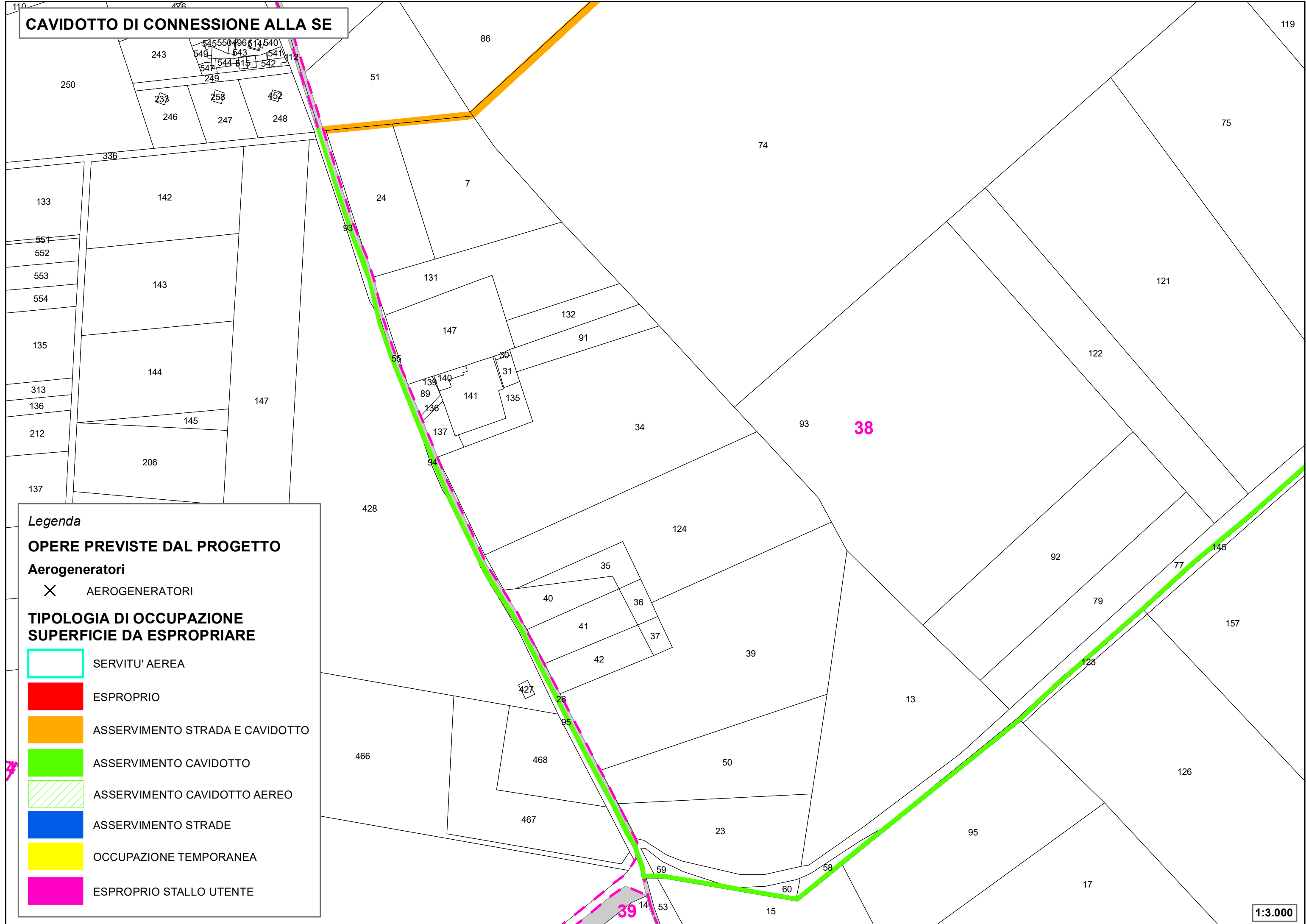

Legenda

OPERE PREVISTE DAL PROGETTO

Aerogeneratori

✕ AEROGENERATORI

TIPOLOGIA DI OCCUPAZIONE SUPERFICIE DA ESPROPRIARE

- SERVITU' AEREA
- ESPROPRIO
- ASSERVIMENTO STRADA E CAVIDOTTO
- ASSERVIMENTO CAVIDOTTO
- ASSERVIMENTO CAVIDOTTO AEREO
- ASSERVIMENTO STRADE
- OCCUPAZIONE TEMPORANEA
- ESPROPRIO STALLO UTENTE

IMPIANTO DI RETE - SE "Palmori"

Legenda

OPERE PREVISTE DAL PROGETTO

Aerogeneratori

✕ AEROGENERATORI

TIPOLOGIA DI OCCUPAZIONE SUPERFICIE DA ESPROPRIARE

-  SERVITU' AEREA
-  ESPROPRIO
-  ASSERVIMENTO STRADA E CAVIDOTTO
-  ASSERVIMENTO CAVIDOTTO
-  ASSERVIMENTO CAVIDOTTO AEREO
-  ASSERVIMENTO STRADE
-  OCCUPAZIONE TEMPORANEA
-  ESPROPRIO STALLO UTENTE

